

Engine Bearings

Gleitlager

Cuscinetti

Coussinets

Cojinetes

Łożyska silnikowe

Подшипники скольжения

محامل المحركات

CATGY1601



2017-2019

ENGINE EXPERTISE BY FEDERAL-MOGUL MOTORPARTS



GLYCO

GOETZE

Nirral

Payen

NOTES

NOTES

Note Nr.								
1	"SPUTTER" upper half bearing	"SPUTTER" obere Lagerhälfte	Semicuscinetto superiore "SPUTTER"	Demi-coussinet supérieur "SPUTTER"	Medio cojinete superior "SPUTTER"	Górna półpanewka typu "SPUTTER"	Верхняя составная часть "СПАТТЕРНОГО" вкладыша	محمل النصف العلوي للرشاش "SPUTTER"
2	"SPUTTER" lower half bearing	"SPUTTER" untere Lagerhälfte	Semicuscinetto inferiore "SPUTTER"	Demi-coussinet inférieur "SPUTTER"	Medio cojinete inferior "SPUTTER"	Dolna półpanewka typu "SPUTTER"	Нижняя составная часть "СПАТТЕРНОГО" вкладыша	محمل النصف السفلي للرشاش "SPUTTER"
3	All gas and marine engines must be equipped with the "SPUTTER" connecting rod bearings	Alle Gas- und Marinemotoren müssen mit dem "SPUTTER" Pleuellager ausgerüstet werden	Tutti motori a gas e marini devono essere equipaggiati con cuscinetti di biella "SPUTTER"	Tous les moteurs à gaz et marins doivent être équipés de coussinets de bielle "SPUTTER"	Todos los motores de gas y marinos deben ser equipados con cojinetes de biela "SPUTTER"	Wszystkie silniki zasilane gazem i silniki do zastosowań marynistycznych muszą być wyposażone w panewki korbowodowe typu "SPUTTER"	Все газовые и судовые двигатели должны быть оборудованы "СПАТТЕРНЫМИ" шатунными вкладышами	يجب تجهيز جميع المحركات البحرية ومحركات الغاز بمحامل قضبان التوصيل الخاصة بالرشاش "SPUTTER"
4	G-188	G-188	G-188	G-188	G-188	G-188	G-188	G-188
5	G-488	G-488	G-488	G-488	G-488	G-488	G-488	G-488
6	G-149	G-149	G-149	G-149	G-149	G-149	G-149	G-149
7	G-411 Irox	G-411 Irox	G-411 Irox	G-411 Irox	G-411 Irox	G-411 Irox	G-411 Irox	G-411 Irox
8	Trapezoidal	Trapezförmig	Trapezoidale	Trapézoïdal	Trapezoidal	Trapezowy	Трапецеидальный	شبه منحرف
9	With eccentric bore	Mit exzentrischer Bohrung	Con diametro eccentrico	Avec alésage excentrique	Con agujero excéntrico	Z ekscentrycznych otworem	С эксцентричным отверстием	ذات تجويف لا مركزي
10	Compressor	Kompressor	Compressore	Compresseur	Compresor	Sprężarka	Компрессор	ضاغط
11	For cracked connecting rod	Für gebrochene Pleuelstangen	Per bielle fratturate	Pour bielle sécable	Para biela agrietada	Dla łamanych korbowodów	Для шатунов с крышкой колотого типа	خاص بقضيب التوصيل المشقوق
12	For reworked cylinder heads only	Nur für aufbereitete Zylinderköpfe	Soltanto per testate rilavorate	Uniquement pour culasses réusinées	Solamente para culatas reconducionadas	Tylko dla ponownie obrobionych głowic cylindrów	Только для восстановленных головок блока цилиндров	خاص برووس الأسطوانة التي تم تغييرها فقط
13	The O.E. procedure requires that the intermediate shaft bushings are machined once fitted to optimize clearance, centring, and alignment. We therefore recommend our 'semi' bushings and to follow the same procedure.	Bei der Erstausrüstung werden die Zwischenwellenbuchsen nach dem Einpressen fertigbearbeitet, um Spiel, Verzug und Flucht zu optimieren. Deshalb empfehlen wir die Verwendung unserer 'Semi' Buchsen und die gleiche Vorgehensweise.	L'OE suggerisce per l'installazione che le boccole dell'albero intermedio di distribuzione siano lavorate e finite con tolleranza, centratura e l'allineamento corretti. Vi consigliamo le nostre boccole 'semifinite' e di seguire la stessa procedura.	En première monte, les bagues d'arbre intermédiaire sont usinées après montage pour optimiser jeu, centrage, et alignement. De ce fait, nous recommandons d'utiliser nos bagues 'semi' et de suivre la même procédure.	En equipo original, los casquillos del árbol intermedio son terminados en posición para optimizar el juego, el centrado y la alineación. Recomendamos nuestros casquillos 'semi' y el mismo procedimiento.	Procedury OE wymagają, aby tuleje wałka pośredniego były obrabiane po zamontowaniu w celu optymalizacji luzów, centrowania i współosiowości. Z tego powodu my również, dla naszych tulei typu "semi", zalecamy stosowanie tej samej procedury.	Процедура установки в соответствии с требованиями автопроизводителя требует, чтобы промежуточные втулки вала, после их установки были подвергнуты механической обработке для оптимизации зазора, центрирования и выравнивания. Поэтому, мы советуем вам использовать наши "полуготовые" втулки и следовать аналогичным рекомендациям по установке от автопроизводителей.	يستلزم إجراء المعاداة الأصلية تصنيع جلب عمود الوسط بمجرد ملاءمتها لضبط مسافة الخلوص والمركز والمحاذاة، لذا ننصح باستخدام الجلب الشبيهة الخاصة بنا واتباع نفس الإجراء.
14	The following procedures must be carried out according to the manufacturer's manual: 1) Drill two holes in the bearing for the valve rocker's oil supply corresponding to the position of the oil channels in the housing. 2) Drill one dowel hole.	Folgende Vorbereitungen sind gemäß Werkvorschriftenhandbuch durchzuführen: 1) Zwei Löcher zur Ölversorgung der Kipphebel sind nachträglich ins Lager zu bohren; gemäss Lage der Ölkanäle im Gehäuse. 2) Ein Stiftloch bohren.	La seguente procedura va eseguita secondo raccomandazione del costruttore: 1) Effettuare 2 fori per l'alimentazione dell'olio dei bilancieri in corrispondenza dei canali di lubrificazione sull'alloggiamento. 2) Eseguire un foro sul perno di riferimento.	Les opérations suivantes doivent être effectuées selon le manuel du constructeur: 1) Percer deux orifices dans le coussinet pour l'alimentation en huile des culbuteurs en face des passages de lubrification dans le carter. 2) Percer un alésage pour goujon.	Se deben seguir las recomendaciones del fabricante: 1) Realizar dos taladros en el cojinete para la lubricación de los balancines teniendo en cuenta la localización del canal de lubricación en el cárter 2) Realizar un taladro para un perno	Zgodnie z zaleceniami producenta należy przeprowadzić następujące czynności: 1) Wywiercić dwa otwory w łożysku przeznaczonym dla rozrządu zaworów w miejscu odpowiadającym kanalom olejowym umieszczonym w obudowie, w celu umożliwienia smarowania. 2) Wywiercić jeden otwór czopowy.	В соответствии с руководством изготовителя необходимо осуществить следующие процедуры: 1) Просверлите два отверстия в подшипнике для подвода масла от коромысла клапана в соответствии с положением масляных каналов в корпусе. 2) Просверлите одно отверстие под установочный штифт.	"يجب تنفيذ الإجراءات التالية وفقاً لدليل الجهة المصنعة: 1) انقب فتحتين في المحمل لإمداد زيت الذراع المترجح للصمام المقابل لوضع قنوات توزيع الزيت في التجويف. 2) انقب فتحة دسار واحدة."
15	After installation drill a 4 mm hole	Nach dem Einbau muss ein 4 mm Loch gebohrt werden	Dopo l'installazione praticare un foro di 4 mm	Après montage percer un trou de 4 mm	Después de la instalación perfora un agujero de 4 mm	Po zamontowaniu wywiercić otwór o średnicy 4 mm	После установки просверлите отверстие диаметром 4 мм	بعد التركيب، انقب فتحة قطر 4 مم
16	Undersize bearings width 0.75/1.00 mm is 34.6/1.3622" wide (semi) and resizeable to Std.	Die Unterstufen 0.75/1.00 mm haben eine Lagerbreite (semi) von 34.6/1.3622" und sind abdrehtbar bis Std.	I cuscinetti, nelle minorazioni 0.75/1.00 mm, hanno una larghezza (semi) di 34.6 mm (1.3622 inch), barenabili fino a misura Std.	Les coussinets en cote réparation 0.75/1.00 mm ont une largeur de 34.6/1.3622" et sont rectifiables jusqu'à la cote Std.	Las submedidas 0.75/1.00 mm tienen una anchura (semi) de 34.6/1.3622" y son torneables hasta Std.	Szerokości łożysk podwymiarowych 0,75/1,00 mm wynoszą 34,6/1,3622" (typ - semi) i są zmienialne do wymiaru standardowego.	Ширина (полу) подшипников заниженного размера 0.75/1.00 мм составляет 34,6/1,3622" и может быть изменена на стандартную.	يكون البديل لعرض المحامل ذات الحجم غير المألوف الذي يبلغ 34.6/1.3622 مم هو 0.75/1.00 بوصة ويكون قابلاً لتغيير الحجم حتى يكون قياسياً.

MORE THAN 5X LONGER LIFE

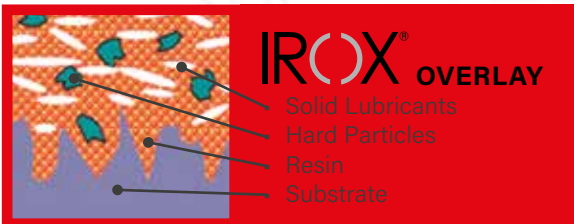

INNOVATIVE, OE-PROVEN TECHNOLOGY FOR THE AFTERMARKET

The Glyco IROX[®] bearing overlay increases the life of the bearing shells and crankshaft by more than 5 times in the most demanding applications and drive cycles such as start-stop and hybrid.

- Increased impact absorption and wear resistance
- Reduces CO₂ and improves fuel economy
- Cuts friction up to 50% compared to metallic sliding layers



CONTENTS



Contents	II
Federal-Mogul anti-counterfeit program	IV
Manufacturers list	V
How to use this catalogue	VI-VII
Bearings terminology	XXII-XXIII
Bearings positioning	XXIV
Engine part numbering system	XXV
Federal-Mogul latest engine & sealing catalogues	XXVI
Campus	XXVII
Terms of business	XXVIII-XXIX
New parts list	XXX-XXXIII
Applications by manufacturer	1-1414
Numerical parts list	1415-1450



Contenuti	II
Programma di anti-contraffazione di Federal-Mogul	IV
Elenco costruttori	V
Come si utilizza il catalogo	X-XI
Definizioni cuscinetto	XXII-XXIII
Posizionamento cuscinetti	XXIV
Sistema di numerazione dei ricambi	XXV
Ultimi cataloghi guarnizioni e motori Federal-Mogul	XXVI
Campus	XXVII
Condizioni generali	XXVIII-XXIX
Elenco codici nuovi	XXX-XXXIII
Applicazioni del costruttore	1-1414
Elenco riferimenti	1415-1450



Inhaltsverzeichnis	II
Federal-Mogul Anti-Fälschungsprogramm	IV
Herstellerliste	V
So benutzen Sie diesen Katalog	VIII-IX
Gleitlager Bezeichnungen	XXII-XXIII
Gleitlager Positionen	XXIV
Motorteile-Nummerierungssystem	XXV
Neueste Motoren- und Dichtungskataloge von Federal Mogul	XXVI
Campus	XXVII
Geschäftsbedingungen	XXVIII-XXIX
Neuaufnahmen	XXX-XXXIII
Anwendungen nach Hersteller	1-1414
Numerische Teilleiste	1415-1450



Contenu	II
Le programme anti-contrefaçon de Federal-Mogul	IV
Liste des constructeurs	V
Comment utiliser ce catalogue	XII-XIII
Terminologie du coussinet	XXII-XXIII
Emplacement du coussinet	XXIV
Système de numérotation des pièces moteur	XXV
Catalogues de Federal-Mogul de pièces moteur et étanchéité les plus récents	XXVI
Campus	XXVII
Conditions générales de vente	XXVIII-XXIX
Liste des nouvelles références	XXX-XXXIII
Applications par constructeur	1-1414
Liste numérique des références	1415-1450



Contenido	III
Programa antifalsificación de Federal-Mogul	IV
Lista de fabricantes	V
Cómo utilizar este catálogo	XIV-XV
Terminología de los cojinetes	XXII-XXIII
Posicionamiento de los cojinetes	XXIV
Sistema de codificación de piezas del motor	XXV
Últimos catálogos de componentes de sellado y motores de Federal-Mogul	XXVI
Campus	XXVII
Condiciones de venta	XXVIII-XXIX
Lista de nuevas referencias	XXX-XXXIII
Aplicaciones por fabricante	1-1414
Lista de referencias numéricas	1415-1450



Содержание	III
Программа защиты от подделок Federal-Mogul	IV
Список производителей	V
Как пользоваться каталогом	XVIII-XIX
Подшипники скольжения: терминология	XXII-XXIII
Подшипники скольжения: расположение	XXIV
Система нумерации деталей двигателя	XXV
Новейшие каталоги уплотнений и деталей для двигателей Federal-Mogul	XXVI
Campus	XXVII
Условия делового сотрудничества	XXVIII-XXIX
Список новой продукции	XXX-XXXIII
Модели автомобилей, сортировка по производителю	1-1414
Список номеров деталей	1415-1450



Zawartość	III
Program przeciwdziałania podrabianiu części Federal-Mogul	IV
Lista producentów	V
Jak używać tego katalogu	XVI-XVII
Terminologia w łożyskach ślizgowych	XXII-XXIII
Umieszczenie łożysk ślizgowych	XXIV
System numerowania części silnikowych	XXV
Najnowsze katalogi części silnikowych i uszczelnień Federal-Mogul	XXVI
Campus	XXVII
Warunki prowadzenia biznesu	XXVIII-XXIX
Lista nowych części	XXX-XXXIII
Lista zastosowań wg producentów	1-1414
Numeryczna lista części	1415-1450



المحتويات	III
برنامج Federal-Mogul لمكافحة إنتاج قطع الغيار المقلدة	IV
قائمة جهات التصنيع	V
كيفية استخدام هذا الكatalog	XX-XXI
مصطلحات المحامل	XXII-XXIII
تحديد موضع المحامل	XXIV
نظام ترقيم قطع غيار المحرك	XXV
أحدث كتالوجات Federal-Mogul للمحركات ومنتجات منع التسرب	XXVI
Campus	XXVII
شروط العمل التجاري	XXVIII-XXIX
قائمة قطع الغيار الجديدة	XXX-XXXIII
التطبيقات حسب جهة التصنيع	1-1414
قائمة الأجزاء الرقمية	1415-1450



**KEEP IT REAL
KEEP OUT COUNTERFEIT**

The authenticity of all our engine and sealing products is protected by the MAPP Code (Manufacturers Against Product Piracy) and the PrioSpot® Authentication device, featured on a special Anti-Counterfeit label on the packaging. In this way you can be sure of our trusted Federal-Mogul quality!

HOW TO CHECK THE AUTHENTICITY OF YOUR PRODUCTS

1 Check if the packaging is closed and the label is intact

2 Verify the unique alphanumeric code and data matrix code

- Type in the alphanumeric code at www.fmecat.eu
- or
- Read the Data Matrix Code with a 2-D scanner
- or
- Read the Data Matrix Code on your smartphone with a barcode reader app

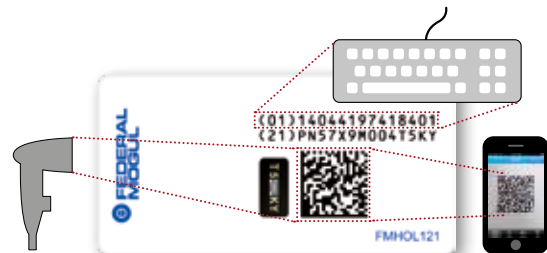

3 Verify the unique security code on the PrioSpot® Label

- Different code on each packaging



- Code contains the last 4 digits of the alphanumeric code
- The code and the Federal-Mogul logo shimmer in rainbow colours only in direct light
- Only in direct light a digit, repeating the last digit of the security code, is visible. This digit will move up and down when you change the angle of the PrioSpot®



ENGINE EXPERTISE
BY **FEDERAL-MOGUL**
MOTORPARTS



MANUFACTURERS LIST

ABARTH _____	[see FIAT]	LOTUS _____	[see ISUZU/ROVER/TOYOTA]
AGRIFULL _____	[see NEW HOLLAND]	MAGIRUS _____	[see DEUTZ/FIAT]
AIFO _____	[see FIAT]	MAN _____	617
ALFA ROMEO _____	1	MASSEY FERGUSSON _____	[see PERKINS]
ARO _____	[see CITROEN/PEUGEOT/RENAULT/VM]	MAZDA _____	667
ASTRA _____	[see IVECO]	MERCEDES-BENZ _____	679
AUDI _____	29	MINI _____	824
AUSTIN _____	102	MITSUBISHI _____	827
AUTOBIANCHI _____	[see FIAT]	MORGAN _____	[see BMW/FIAT/FORD/ROVER]
BEDFORD _____	111	MORRIS _____	[see AUSTIN]
BERLIET _____	[see RENAULT]	MWM _____	845
BMW _____	118	NEW HOLLAND _____	848
BMW MOTORCYCLES _____	149	NISSAN _____	864
CHEVROLET _____	152	NUFFIELD TRACTORS _____	[see LEYLAND]
CHRYSLER _____	163	OM _____	[see FIAT/IVECO]
CITROEN _____	169	OPEL _____	894
CUMMINS _____	[see NEW HOLLAND]	PEGASO _____	[see IVECO]
DACIA _____	208	PERKINS _____	936
DAEWOO_ [see CHEVROLET/MERCEDES-BENZ/OPEL/SUZUKI]		PEUGEOT _____	944
DAF _____	214	POLSKI FIAT _____	[see FIAT]
DAIHATSU _____	233	PORSCHE _____	991
DAVID BROWN _____	239	RELIANT _____	[see FORD/NISSAN/ROVER]
DEUTZ _____	241	RENAULT _____	1004
FIAT _____	260	RILEY _____	[see AUSTIN]
FIAT AGRI _____	[see NEW HOLLAND]	ROVER _____	1103
FIAT ALLIS _____	[see IVECO]	RVI _____	[see RENAULT]
FIAT INDUSTRIALE _____	[see IVECO]	SAAB _____	1115
FORD _____	359	SAME _____	1121
HANOMAG-HENSCHEL _____	[see MERCEDES]	SAVIEM _____	[see RENAULT]
HINO _____	437	SCANIA _____	1125
HONDA _____	441	SEAT _____	1138
HYUNDAI _____	453	SKODA _____	1184
IHC _____	462	SMART _____	1204
INBUS _____	[see IVECO]	SSANGYONG _____	[see MERCEDES/PEUGEOT]
INNOCENTI _____	[see AUSTIN/DAIHATSU/FIAT]	SUBARU _____	1207
ISUZU _____	468	SUZUKI _____	1210
IVECO _____	478	TALBOT _____	[see PEUGEOT]
JAGUAR _____	546	TOYOTA _____	1220
JEEP _____	550	TRIUMPH _____	1243
JOHN DEERE _____	555	UAZ _____	[see CITROEN/IVECO]
KAMAZ _____	559	UNIC-SIMCA _____	[see FIAT/IVECO]
KHD _____	[see DEUTZ]	VAUXHALL _____	[see OPEL/BEDFORD]
KIA _____	561	VM _____	1247
LADA _____	566	VOLVO _____	1251
LAMBORGHINI _____	[see SAME]	VOLKSWAGEN _____	1365
LANCIA _____	573	WABCO _____	1414
LAND ROVER _____	598	WOLSELEY _____	[see AUSTIN]
LAVERDA _____	[see NEW HOLLAND]	YUGO _____	[see FIAT]
LEYLAND _____	607	ZASTAVA _____	[see FIAT]
LISTER _____	614		

🇬🇧 HOW TO USE

Manufacturers are sorted in alphabetical order, as shown in the index. The panels have a progressive numbering per manufacturer. The bore is the first sorting criteria, starting from the smallest diameter, followed by the stroke, number of cylinders, petrol/diesel/gas and engine name. Engines fitting the same parts are panelled together and sorted in alphabetical order. Additional pictures, part specific information as distances between crank webs and thrust bearing location are given after each bearing type. Parts in red font are new range introductions.

ALFA ROMEO									
16 80.50 x 86.00									
199 B6.000 Euro 6		2 Cyl.		875cc	74-77kW (101-105PS)		Petrol Turbo Intercooler		TD27856
312 A2.000 Euro 5		2 Cyl.		875cc	63kW (86PS)		Petrol Turbo Intercooler		TD26187
BE/PL	2	41,982/42,000	45,125/45,135	18,000	1,550	0,025/0,061	AL-LF	01-4967	01-4967/2 STD
MB/HL 1-3	3	47,982/48,000	51,705/51,718	16,150	1,846	0,022/0,069	AL-LF	02-4968	H1337/3 STD
TW/A	2	53.100/53.300	68.766/69.020		2.335	0.105/0.275	AL-LF	04-4969	A321/2 STD
SE/PB	1		23,939/23,972	22,070			BS-LF	55-4970	55-4970 SEMI

- 1 Bearing type and position
- 2 Set composition
- 3 Journal diameter (standard): Measures quoted are the smallest and largest journal diameter
- 4 Housing bore: Measures quoted are the smallest and largest housing bore diameter
- 5 Bearing width: Measure quoted is the maximum bearing width
- 6 Standard wall thickness: Maximum value
- 7 Oil clearance
- 8 Material
- 9 Component reference
- 10 **Glyco** set reference and available undersizes

ALFA ROMEO



16

80.50 x 86.00

199 B6.000 Euro 6		2 Cyl.		875cc	74-77kW (101-105PS)		Petrol Turbo Intercooler			TD27856
312 A2.000 Euro 5		2 Cyl.		875cc	63kW (86PS)		Petrol Turbo Intercooler			TD26187
BE/PL	2	41,982/42,000	45,125/45,135	18,000	1,550	0,025/0,061	AL-LF	01-4967	01-4967/2 STD	<input type="checkbox"/>
MB/HL 1-3	3	47,982/48,000	51,705/51,718	16,150	1,846	0,022/0,069	AL-LF	02-4968	H1337/3 STD	<input type="checkbox"/>
TW/A	2	53.100/53.300	68.766/69.020		2.335	0.105/0.275	AL-LF	04-4969	A321/2 STD	<input type="checkbox"/>
SE/PB	1		23,939/23,972	22,070			BS-LF	55-4970	55-4970 SEMI	<input type="checkbox"/>

12

13

14

11

Engine specifications

Bore x stroke
Engine name
Number of cylinders
CC Capacity
Engine characteristics
Petrol/diesel/gas
Tecdoc/FM number

13

Bearing material codes

AL Steel back aluminium.....Bi-/Trimetallic
B Brass
BB Steel back babbit.....Bimetallic
BC Steel back cast bronze - no overlay.....Bimetallic
BS Steel back sintered bronze - no overlay.....Bi-/Trimetallic
EC Steel back bronze - electrocoated.....Trimetallic
SP Steel back bronze - Sputter.....Trimetallic
IX Steel Back aluminium - Polymer
-LF Lead-free

12

Bearing type and position

BE/PL: Connecting rod (big end) bearing
MB/HL: Main bearing
TW/A: Thrust washer
SE/PB: Piston pin (small end) bushing
CB/NWB: Camshaft bushing
CS/NWL: Camshaft bearing
BU: Other bushings

14

Glyco set reference

H: Main bearing
N: Camshaft bushing/bearing
A: Thrust washer
.../4: Number of pairs (bearings) or pieces (washers/bushings) per set
...H: Thrust (flange) bearing

15

Additional information

See footnote cover flap

BENUTZERHINWEISE

Die Hersteller sind, wie auch in der Liste, alphabetisch verzeichnet. Auf der Herstellerseite sind die Felder aufsteigend nummeriert. Die Bohrung ist das erste Sortiermerkmal, von klein nach groß, danach der Hub, die Anzahl Zylinder, nach Verbrennungsprinzip Benzin-/Diesel-/Gasmotor und dann folgt die Motorenbezeichnung. Motoren die gleiche Teile verwenden, sind in einem Feld zusammengefasst und innerhalb dessen alphabetisch sortiert. Auf die Angabe der Lagerart folgen weitere Abbildungen und teilespezifische Informationen, wie Wangenabstandsmasse der Passlagerstelle/Kurbelwelle und der Einbauort von Axiallagern. Teile in roter Schrift sind Neuaufnahmen in das Sortiment.

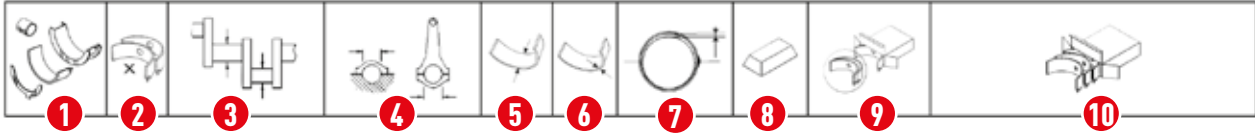
ALFA ROMEO										
										
16		80.50 x 86.00								
199 B6.000 Euro 6		2 Cyl.		875cc	74-77kW (101-105PS)		Petrol Turbo Intercooler		TD27856	
312 A2.000 Euro 5		2 Cyl.		875cc	63kW (86PS)		Petrol Turbo Intercooler		TD26187	
BE/PL	2	41,982/42,000	45,125/45,135	18,000	1,550	0,025/0,061	AL-LF	01-4967	01-4967/2 STD	
MB/HL 1-3	3	47,982/48,000	51,705/51,718	16,150	1,846	0,022/0,069	AL-LF	02-4968	H1337/3 STD	
TW/A	2	53.100/53.300	68.766/69.020		2.335	0.105/0.275	AL-LF	04-4969	A321/2 STD	
SE/PB	1		23,939/23,972	22,070			BS-LF	55-4970	55-4970 SEMI	

- ① Lagertyp und Positionen
- ② Satzbestandteile
- ③ Zapfendurchmesser (Standard): Es ist der kleinste und der größte Durchmesser angegeben
- ④ Gehäusebohrung: Es ist der kleinste und der größte Durchmesser angegeben
- ⑤ Lagerbreite: Es ist die maximale Gleitlagerbreite angegeben
- ⑥ Wanddicke Standard: Maximalwert
- ⑦ Lagerspiel
- ⑧ Material
- ⑨ Einzelkomponentennummer
- ⑩ **Glyco**-Satz-Nr. und Reparaturstufen

ALFA ROMEO



16

80.50 x 86.00

199 B6.000 Euro 6		2 Cyl.		875cc	74-77kW (101-105PS)		Petrol Turbo Intercooler		TD27856	
312 A2.000 Euro 5		2 Cyl.		875cc	63kW (86PS)		Petrol Turbo Intercooler		TD26187	
BE/PL	2	41,982/42,000	45,125/45,135	18,000	1,550	0,025/0,061	AL-LF	01-4967	01-4967/2 STD	<input type="checkbox"/>
MB/HL 1-3	3	47,982/48,000	51,705/51,718	16,150	1,846	0,022/0,069	AL-LF	02-4968	H1337/3 STD	15
TW/A	2	53.100/53.300	68.766/69.020		2.335	0.105/0.275	AL-LF	04-4969	A321/2 STD	
SE/PB	1		23,939/23,972	22,070			BS-LF	55-4970	55-4970 SEMI	

12

13

14

11

Motorendaten

Bohrung x Hub
Motorbezeichnung
Anzahl Zylinder
Hubraum
Motorendaten
Benzin / Diesel / Gas
Tecdoc-/F-M-Nummer

13

Werkstoffe für Gleitlager

AL ...Stahlrücken Aluminium..... Bi-/Trimetall
B ...Messing
BB ...Weissmetall..... Bimetall
BC ...Stahlrücken Gussbronze - ohne Gleitschicht..... Bimetall
BS ...Stahlrücken Sinterbronze - ohne Gleitschicht..... Bi-/Trimetall
EC ...Stahlrücken Bronze - Galvanische Gleitschicht..... Trimetall
SP ...Stahlrücken Bronze - Sputter Gleitschicht..... Trimetall
IX ...Stahlrücken Aluminium - Polymer
LF ...Bleifrei

12

Gleitlagerart und Position

BE/PL: Pleuellager
MB/HL: Hauptlager
TW/A: Anlaufscheibe
SE/PB: Pleuelbuchse
CB/NWB: Nockenwellenbuchse
CS/NWL: Nockenwellenlager
BU: Andere Buchsen

14

Glyco-Satzbezeichnung

H: Hauptlager
N: Nockenwellenbuchse/lager
A: Anlaufscheibe
.../4: Anzahl Paare (Lager) oder Stück (Scheiben/Buchsen) pro Satz
...H: Bundlager

15

Zusätzliche Angaben

Siehe Fußnote Umschlagklappe

🇮🇹 COME SI UTILIZZA IL CATALOGO

I costruttori sono elencati in ordine alfabetico, come indicato nell'indice. I pannelli hanno una numerazione progressiva per ogni costruttore. L'alesaggio e il primo criterio di selezione, iniziando dal diametro più piccolo, seguito dalla corsa, dal numero di cilindri, dall'alimentazione (benzina/gasolio/gas) e codice motore. I motori che montano gli stessi componenti si trovano nello stesso pannello, in ordine alfabetico. Foto supplementari, informazioni specifiche dei pezzi come le distanze sullo spazio necessario per il posizionamento dei cuscinetti flangiati sull'albero motore sono indicate alla fine di ogni pannello. I riferimenti in rosso sono i nuovi componenti introdotti in gamma.

ALFA ROMEO									
16 80.50 x 86.00									
199 B6.000 Euro 6		2 Cyl.		875cc	74-77kW (101-105PS)		Petrol Turbo Intercooler		TD27856
312 A2.000 Euro 5		2 Cyl.		875cc	63kW (86PS)		Petrol Turbo Intercooler		TD26187
BE/PL	2	41,982/42,000	45,125/45,135	18,000	1,550	0,025/0,061	AL-LF	01-4967	01-4967/2 STD
MB/HL 1-3	3	47,982/48,000	51,705/51,718	16,150	1,846	0,022/0,069	AL-LF	02-4968	H1337/3 STD
TW/A	2	53.100/53.300	68.766/69.020		2.335	0.105/0.275	AL-LF	04-4969	A321/2 STD
SE/PB	1		23,939/23,972	22,070			BS-LF	55-4970	55-4970 SEMI

- ❶ Tipo e posizione cuscinetto
- ❷ Composizione set
- ❸ Diametro perno di banco (standard): Le misure quotate sono la minima e la massima del diametro perno
- ❹ Diametro interno sede: Le misure quotate sono la minima e la massima dell'alesaggio
- ❺ Lunghezza cuscinetto: La misura quotate è la lunghezza massima del cuscinetto
- ❻ Spessore standard: Valore massimo
- ❼ Tolleranza olio
- ❽ Materiale
- ❾ Codice componente
- ❿ Codice set **Glyco** e misure minorazioni disponibili

ALFA ROMEO



16

80.50 x 86.00

199 B6.000 Euro 6		2 Cyl.		875cc	74-77kW (101-105PS)		Petrol Turbo Intercooler		TD27856
312 A2.000 Euro 5		2 Cyl.		875cc	63kW (86PS)		Petrol Turbo Intercooler		TD26187
BE/PL	2	41,982/42,000	45,125/45,135	18,000	1,550	0,025/0,061	AL-LF	01-4967	01-4967/2 STD
MB/HL 1-3	3	47,982/48,000	51,705/51,718	16,150	1,846	0,022/0,069	AL-LF	02-4968	H1337/3 STD
TW/A	2	53.100/53.300	68.766/69.020		2.335	0.105/0.275	AL-LF	04-4969	A321/2 STD
SE/PB	1		23,939/23,972	22,070			BS-LF	55-4970	55-4970 SEMI

12

13

14

15

11

Dati motore

Alesaggio x corsa
Nome motore
Numero cilindri
Cilindrata cc
Caratteristiche motore
Benzina/gasolio/gas
Codice Tecdoc/F-M

13

Codici materiale cuscinetti

AL Alluminio su supporto in acciaio Bi-/Trimetallico
B Ottone
BB Lega antifrizione su supporto in acciaio Bimetallico
BC Bronzo su supporto in acciaio - no rivestimento Bimetallico
BS Bronzo sinterizzato su supporto in acciaio - no rivestimento Bi-/Trimetallico
EC Bronzo su supporto in acciaio - rivestimento elettrolitico Trimetallico
SP Bronzo su supporto in acciaio - rivestimento Sputter Trimetallico
IX Alluminio fondo acciaio - Polimerico
LF Senza piombo

12

Tipo e posizione cuscinetto

BE/PL: Cuscinetto di biella
MB/HL: Cuscinetto di banco
TW/A: Spallamenti
SE/PB: Boccole piede di biella
CB/NWB: Boccola albero a camme
CS/NWL: Cuscinetto albero a camme
BU: Altre boccole

14

Riferimento Glyco

H: Cuscinetti di banco
N: Boccola/cuscinetto/albero a camme
A: Spallamenti
.../4: Numero di paia (di cuscinetti) o pezzi (spallamenti/boccole) per ciascun set
...H: Cuscinetti flangiati (con spallamento annesso)

15

Informazioni aggiuntive

Vedere le note indicate nella pagina di controcopertina

INSTRUCTIONS POUR L'UTILISATION DU CATALOGUE

Les constructeurs sont classés par ordre alphabétique, comme illustré dans l'index. Les différentes sections suivent un ordre séquentiel par constructeur. L'alésage est le premier critère de tri, partant du plus petit diamètre et suivi par la course, le nombre de cylindres, le type de carburant (essence/diesel/gaz) et le nom du moteur. Les moteurs utilisant les mêmes pièces sont rassemblés dans une même section et classés par ordre alphabétique. Les photos supplémentaires, informations spécifiques sur les pièces et l'espacement pour l'emplacement des flasques de butée sur le vilebrequin sont données après chaque type de coussinet. Les références indiquées en rouge sont des nouveautés récentes.

ALFA ROMEO									
16	80.50 x 86.00								
199 B6.000 Euro 6			2 Cyl.	875cc	74-77kW (101-105PS)		Petrol Turbo Intercooler		TD27856
312 A2.000 Euro 5			2 Cyl.	875cc	63kW (86PS)		Petrol Turbo Intercooler		TD26187
BE/PL	2	41,982/42,000	45,125/45,135	18,000	1,550	0,025/0,061	AL-LF	01-4967	01-4967/2 STD
MB/HL 1-3	3	47,982/48,000	51,705/51,718	16,150	1,846	0,022/0,069	AL-LF	02-4968	H1337/3 STD
TW/A	2	53.100/53.300	68.766/69.020		2.335	0.105/0.275	AL-LF	04-4969	A321/2 STD
SE/PB	1		23,939/23,972	22,070			BS-LF	55-4970	55-4970 SEMI

- 1 Type et emplacement du coussinet
- 2 Composition du jeu de coussinet
- 3 Diamètre de maneton (standard) : dimensions minimum et maximum du diamètre du maneton standard
- 4 Alésage du logement : dimensions minimum et maximum du diamètre de l'alésage du logement
- 5 Largeur de coussinet : valeur maximum
- 6 Épaisseur standard : valeur maximum
- 7 Jeu de fonctionnement
- 8 Matériel
- 9 Référence de composant
- 10 Référence de jeu **Glyco** et cotes réparation

INSTRUCTIONS POUR L'UTILISATION DU CATALOGUE

ALFA ROMEO



16

80.50 x 86.00

199 B6.000 Euro 6		2 Cyl.		875cc	74-77kW (101-105PS)		Petrol Turbo Intercooler		TD27856	
312 A2.000 Euro 5		2 Cyl.		875cc	63kW (86PS)		Petrol Turbo Intercooler		TD26187	
BE/PL	2	41,982/42,000	45,125/45,135	18,000	1,550	0,025/0,061	AL-LF	01-4967	01-4967/2 STD	<input type="checkbox"/>
MB/HL 1-3	3	47,982/48,000	51,705/51,718	16,150	1,846	0,022/0,069	AL-LF	02-4968	H1337/3 STD	<input type="checkbox"/>
TW/A	2	53.100/53.300	68.766/69.020		2.335	0.105/0.275	AL-LF	04-4969	A321/2 STD	<input type="checkbox"/>
SE/PB	1		23,939/23,972	22,070			BS-LF	55-4970	55-4970 SEMI	<input type="checkbox"/>

12

13

14

11

Données du moteur

Logement x course
Nom du moteur
Nombre de cylindres
Cylindrée
Caractéristiques du moteur
Essence/diesel/gaz
Numéro Tecdoc/F-M

13

Codification des matériaux de coussinets

AL Aluminium sur support acier..... bi/trimétallique
B Laiton
BB Étain-plomb sur support acier..... bimétallique
BC Bronze coulé sur support acier - sans revêtement... bimétallique
BS Bronze fritté sur support acier - sans revêtement... bi/trimétallique
EC Bronze sur support acier - électrolytique..... trimétallique
SP Bronze sur support acier - Sputter..... trimétallique
IX Aluminium sur support acier - polymère
LF Sans plomb

12

Type et emplacement du coussinet

BE/PL : Coussinet de bielle
MB/HL : Coussinet de palier
TW/A : Flasque de butée
SE/PB : Bague de bielle
CB/NWB : Bague d'arbre à came
CS/NWL : Coussinet d'arbre à came
BU : Bagues diverses

14

Référence de jeu Glyco

H : Coussinet de palier
N : Bague/coussinet d'arbre à came
A : Flasque de butée
.../4 : Paires (coussinets) ou pièces (flasques de butée/bagues) par jeu
...H : Coussinet à joues

15

Informations supplémentaires

Voir rabat page de couverture

 **GLYCO**[®]

CÓMO UTILIZAR ESTE CATÁLOGO

Los fabricantes se ordenan alfabéticamente, tal como se muestra en el índice. Los paneles cuentan con una numeración progresiva por fabricante. El alojamiento es el primer criterio de ordenación, empezando por el más pequeño, seguido de la carrera, el número de cilindros, el combustible (gasolina, diésel o gas) y el nombre de motor. Los motores que montan las mismas piezas comparten el mismo panel y se ordenan alfabéticamente. Después de cada tipo de cojinete, se muestran imágenes adicionales e información específica de la pieza, como las distancias entre la gualdera del cigüeñal en el lugar de ubicación de los cojinetes con pestaña. Las partes de color rojo son los nuevos productos de la gama.

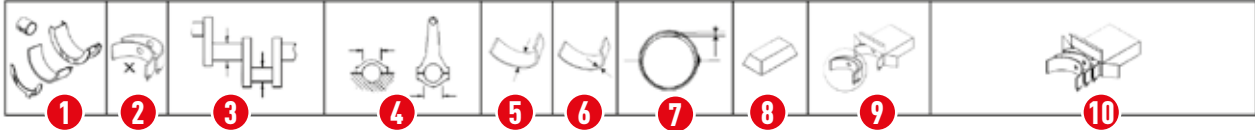
ALFA ROMEO									
									
16	80.50 x 86.00								
199 B6.000 Euro 6	2 Cyl.		875cc	74-77kW (101-105PS)		Petrol Turbo Intercooler		TD27856	
312 A2.000 Euro 5	2 Cyl.		875cc	63kW (86PS)		Petrol Turbo Intercooler		TD26187	
BE/PL	2	41,982/42,000	45,125/45,135	18,000	1,550	0,025/0,061	AL-LF	01-4967	01-4967/2 STD
MB/HL 1-3	3	47,982/48,000	51,705/51,718	16,150	1,846	0,022/0,069	AL-LF	02-4968	H1337/3 STD
TW/A	2	53,100/53,300	68,766/69,020		2,335	0,105/0,275	AL-LF	04-4969	A321/2 STD
SE/PB	1		23,939/23,972	22,070			BS-LF	55-4970	55-4970 SEMI

- 1 Tipo de cojinete y disposición
- 2 Composición del juego
- 3 Diámetro de la muñequilla (estándar): Las medidas indicadas son las del diámetro más grande y más pequeño de la muñequilla
- 4 Diámetro del alojamiento: Las medidas indicadas son las del diámetro más grande y más pequeño del alojamiento
- 5 Anchura del cojinete: La medida indicada es la anchura máxima del cojinete
- 6 Espesor estándar de la pared: Valor máximo
- 7 Tolerancia del aceite
- 8 Material
- 9 Referencia del componente
- 10 Referencia del juego de los cojinetes **Glyco** y bajomedidas disponibles para reparación

CÓMO UTILIZAR ESTE CATÁLOGO

ALFA ROMEO



16

80.50 x 86.00

199 B6.000 Euro 6				2 Cyl.	875cc	74-77kW (101-105PS)		Petrol Turbo Intercooler	TD27856	
312 A2.000 Euro 5				2 Cyl.	875cc	63kW (86PS)		Petrol Turbo Intercooler	TD26187	
BE/PL	2	41,982/42,000	45,125/45,135	18,000	1,550	0,025/0,061	AL-LF	01-4967	01-4967/2 STD	<input type="checkbox"/>
MB/HL 1-3	3	47,982/48,000	51,705/51,718	16,150	1,846	0,022/0,069	AL-LF	02-4968	H1337/3 STD	15
TW/A	2	53.100/53.300	68.766/69.020		2.335	0.105/0.275	AL-LF	04-4969	A321/2 STD	
SE/PB	1		23,939/23,972	22,070			BS-LF	55-4970	55-4970 SEMI	

12

13

14

11

Especificaciones del motor

Alojamiento x carrera
Nombre de motor
Número de cilindros
Cilindrada
Características del motor
Gasolina/diésel/gas
Número Tecdoc/F-M

13

Código del material de los cojinetes

AL Aluminio con soporte acero.....Bi/trimetálico
B Latón
BB Antifricción con soporte acero.....Bimetálico
BC Bronce fundido con soporte acero – sin revestimiento.....Bimetálico
BS Bronce aglomerado con soporte acero –
sin revestimiento.....Bi/trimetálico
EC Bronce con acero – revestimiento electrogalvánico.....Trimetálico
SP Bronce con acero – Sputter.....Trimetálico
IX Aluminio con acero - Polímero
LF Sin plomo

12

Tipo de cojinete y posición

BE/PL: Cojinete de biela
MB/HL: Cojinete bancada
TW/A: Arandela de empuje axial
SE/PB: Casquillo de pie de biela
CB/NWB: Casquillo de árbol de levas
CS/NWL: Cojinete de árbol de levas
BU: Otros casquillos

14

Referencia de conjunto de Glyco

H: Cojinete de bancada
N: Cojinete/casquillo de árbol de levas
A: Arandela de empuje axial
.../4: Número de pares (cojinetes) o piezas (arandelas/casquillos)
por juego
...H: Cojinete con pestaña

15

Información adicional

Consulte el pie de página de la tapa de la portada

— JAK UŻYWAĆ TEGO KATALOGU

Producenci są uszeregowani wg kolejności alfabetycznej, jak pokazano na spisie. Panele mają rosnące numery według kolejności producentów. Pierwszym parametrem, wg którego następuje sortowanie jest średnica cylindra, zaczynając od najmniejszej średnicy. Następnie podawane są skok tłoka, liczba cylindrów, rozróżnienie rodzaju paliwa - benzyna/diesel/gaz i nazwa silnika. Silniki, w których zastosowano te same części są wymienione razem i uszeregowane wg kolejności alfabetycznej. Po każdym typie łożyska podawane są dodatkowe rysunki i charakterystyczne informacje takie jak odległość pomiędzy wykorbieniami czy umiejscowienie łożyska oporowego. Numery części podane w kolorze czerwonym oznaczają nowe produkty w programie.

ALFA ROMEO									
16		80.50 x 86.00							
199 B6.000 Euro 6		2 Cyl.		875cc	74-77kW (101-105PS)		Petrol Turbo Intercooler		TD27856
312 A2.000 Euro 5		2 Cyl.		875cc	63kW (86PS)		Petrol Turbo Intercooler		TD26187
BE/PL	2	41,982/42,000	45,125/45,135	18,000	1,550	0,025/0,061	AL-LF	01-4967	01-4967/2 STD
MB/HL 1-3	3	47,982/48,000	51,705/51,718	16,150	1,846	0,022/0,069	AL-LF	02-4968	H1337/3 STD
TW/A	2	53.100/53.300	68.766/69.020		2.335	0.105/0.275	AL-LF	04-4969	A321/2 STD
SE/PB	1		23,939/23,972	22,070			BS-LF	55-4970	55-4970 SEMI

- 1 Typ łożyska i umiejscowienie
- 2 Skład zestawu
- 3 Średnica czopa (standard): Podawane są najmniejsza i największa średnicę czopa
- 4 Średnica gniazda łożyska: Podawane są największa i najmniejsza średnica otworu
- 5 Szerokość łożyska: Podawana jest maksymalna długość łożyska
- 6 Standardowa grubość ścianki: Wartość maksymalna
- 7 Luz olejowy
- 8 Materiał
- 9 Numer referencyjny części
- 10 Numer referencyjny części **Glyco** i dostępne podwymiary

ALFA ROMEO



16

80.50 x 86.00

199 B6.000 Euro 6	2 Cyl.	875cc	74-77kW (101-105PS)	Petrol Turbo Intercooler	TD27856					
312 A2.000 Euro 5	2 Cyl.	875cc	63kW (86PS)	Petrol Turbo Intercooler	TD26187					
BE/PL	2	41,982/42,000	45,125/45,135	18,000	1,550	0,025/0,061	AL-LF	01-4967	01-4967/2 STD	<input type="checkbox"/>
MB/HL 1-3	3	47,982/48,000	51,705/51,718	16,150	1,846	0,022/0,069	AL-LF	02-4968	H1337/3 STD	15
TW/A	2	53,100/53,300	68,766/69,020		2,335	0,105/0,275	AL-LF	04-4969	A321/2 STD	
SE/PB	1		23,939/23,972	22,070			BS-LF	55-4970	55-4970 SEMI	

12

13

14

11

Dane techniczne silnika

Średnica cylindra x skok
Oznaczenie silnika
Liczba cylindrów
Pojemność skokowa
Charakterystyka silnika
Benzyna/diesel/gaz
Tecdoc/FM numer

13

Kod materiału łożyska

AL Stalowa warstwa nośna bi-/trzymetaliczna
B Mosiądz
BB Stalowa warstwa nośna babbitt bimetaliczna
BC Stalowa warstwa nośna brąz odlewany - bez pokryć bimetalicznych
BS Stalowa warstwa nośna brąz spiekany - bez pokryć bi/trzymetalicznych
EC Stalowa warstwa nośna brąz - pokrywana elektrycznie trzymetaliczna
SP Stalowa warstwa nośna brąz - Sputter trzymetaliczna
IX Stalowa warstwa nośna aluminium - polimer
LF Bez ołowiu

12

Typ łożyska i umiejscowienie

BE/PL: Łożysko stopy korbowodu
MB/HL: Łożysko główne
TW/A: Łożysko oporowe
SE/PB: Tuleja sworznia tłokowego (główek korbowodu)
CB/NWB: Tuleja wałka rozrządu
CS/NWL: Łożysko wałka rozrządu
BU: Inne tuleje

14

Numer referencyjny Glyco

H: Łożysko główne
N: Tuleja/łożysko wałka rozrządu
A: Łożysko oporowe
.../4: Liczba par (łożyska) lub sztuk (łożyska oporowe/tuleje) w zestawie
...H: Łożysko oporowe (kołnierzowe)

15

Informacje uzupełniające

Zobacz przypis na okładce

КАК ПОЛЬЗОВАТЬСЯ КАТАЛОГОМ

Производители представлены в алфавитном порядке в соответствии с алфавитным указателем. Секции нумеруются по возрастающей по производителям. Диаметр отверстия - это первый критерий сортировки. Сортировка начинается с наименьшего диаметра отверстия, затем учитывается ход поршня, количество цилиндров, бензин/дизельное топливо/газ и наименование двигателя. Двигатели, на которые подходят одни и те же детали, объединяются в одну секцию и сортируются в алфавитном порядке. Дополнительные изображения, информация о детали (напр., расстояние между щекой коленчатого вала и упорным подшипником) приводятся после указания каждого вида подшипника. Детали, отмеченные красным цветом шрифта, являются новинкой в ассортименте.

ALFA ROMEO									
16		80.50 x 86.00							
199 B6.000 Euro 6		2 Cyl.		875cc	74-77kW (101-105PS)		Petrol Turbo Intercooler		TD27856
312 A2.000 Euro 5		2 Cyl.		875cc	63kW (86PS)		Petrol Turbo Intercooler		TD26187
BE/PL	2	41,982/42,000	45,125/45,135	18,000	1,550	0,025/0,061	AL-LF	01-4967	01-4967/2 STD
MB/HL 1-3	3	47,982/48,000	51,705/51,718	16,150	1,846	0,022/0,069	AL-LF	02-4968	H1337/3 STD
TW/A	2	53.100/53.300	68.766/69.020		2.335	0.105/0.275	AL-LF	04-4969	A321/2 STD
SE/PB	1		23,939/23,972	22,070			BS-LF	55-4970	55-4970 SEMI

- 1 Тип подшипника скольжения и его положение
- 2 Состав комплекта
- 3 Диаметр шейки вала (стандартный): Приведены размеры минимального и максимального диаметра шейки вала
- 4 Диаметр постели подшипника: Приведены размеры минимального и максимального диаметра шейки вала
- 5 Ширина подшипника: Приведены размеры максимальной ширины подшипника
- 6 Стандартная толщина стенки: Максимальное значение
- 7 Масляный зазор
- 8 Материал
- 9 Номер детали
- 10 Номер комплекта **Glyco** и доступные ремонтные размеры

ALFA ROMEO



16

80.50 x 86.00

199 B6.000 Euro 6		2 Cyl.		875cc	74-77kW (101-105PS)		Petrol Turbo Intercooler		TD27856	
312 A2.000 Euro 5		2 Cyl.		875cc	63kW (86PS)		Petrol Turbo Intercooler		TD26187	
BE/PL	2	41,982/42,000	45,125/45,135	18,000	1,550	0,025/0,061	AL-LF	01-4967	01-4967/2 STD	<input type="checkbox"/>
MB/HL 1-3	3	47,982/48,000	51,705/51,718	16,150	1,846	0,022/0,069	AL-LF	02-4968	H1337/3 STD	<input type="checkbox"/>
TW/A	2	53.100/53.300	68.766/69.020		2.335	0.105/0.275	AL-LF	04-4969	A321/2 STD	<input type="checkbox"/>
SE/PB	1		23,939/23,972	22,070			BS-LF	55-4970	55-4970 SEMI	<input type="checkbox"/>

12

13

14

15

11

Спецификация двигателя

Внутр. диаметр x ход
Наименование двигателя
Количество цилиндров
Объем, см³
Характеристики двигателя
Бензин/дизельное топливо/газ
TecDoc/номер FM

12

Тип подшипника и его положение

BE/PL: Вкладыш большой головки шатуна
MB/HL: Коренной вкладыш
TW/A: Упорная шайба
SE/PB: Втулка поршневого пальца
(малая головка шатуна)
CB/NWB: Втулка распределительного вала
CS/NWL: Подшипник
распределительного вала
BU: Другие втулки

13

Коды материала подшипников скольжения

AL Алюминий с би-/триметаллическим покрытием, стальная подложка
B Латунь
BB Баббит биметаллический, стальная подложка
BC Литая бронза без биметаллического покрытия, стальная подложка
BS Спеченная бронза без би-/триметаллического покрытия, стальная подложка
EC Бронза с триметаллическим покрытием методом электроосаждения, стальная подложка
SP Бронза с триметаллическим спаттерным напылением, стальная подложка
IX Алюминий с полимерным покрытием, стальная подложка
LF Не содержит свинец

14

Ссылка на комплект Glyco

H: Коренной вкладыш
N: Втулка / подшипник распределительного вала
A: Упорная шайба
.../4: Количество пар (подшипников) или штук (шайб/втулок) в комплекте
...H: Упорный (фланцевый) подшипник скольжения

15

Дополнительная информация

См. сноску на обложке

ALFA ROMEO



16

80.50 x 86.00

199 B6.000 Euro 6		2 Cyl.		875cc	74-77kW (101-105PS)		Petrol Turbo Intercooler		TD27856	
312 A2.000 Euro 5		2 Cyl.		875cc	63kW (86PS)		Petrol Turbo Intercooler		TD26187	
BE/PL	2	41,982/42,000	45,125/45,135	18,000	1,550	0,025/0,061	AL-LF	01-4967	01-4967/2 STD	<input type="checkbox"/>
MB/HL 1-3	3	47,982/48,000	51,705/51,718	16,150	1,846	0,022/0,069	AL-LF	02-4968	H1337/3 STD	15
TW/A	2	53.100/53.300	68.766/69.020		2.335	0.105/0.275	AL-LF	04-4969	A321/2 STD	
SE/PB	1		23,939/23,972	22,070			BS-LF	55-4970	55-4970 SEMI	

12

13

14

13

رموز مواد المحمل

Bi-/Trimetallic	AL	ألومنيوم مظهر بالصلب ثنائي النحاس
Bimetallic	BB	بابيت ثنائي المعدن مظهر بالصلب
Bimetallic	BC	برونز مصبوب مظهر بالصلب - غير مطلو بثنائي المعدن
Bi-/Trimetallic	BS	برونز مصبوب مظهر بالصلب - غير مطلو بثنائي/ثلاثي المعدن
Trimetallic	EC	برونز مظهر بالصلب - ثلاثي المعدن مطلي بالكهرباء
Trimetallic	SP	برونز مظهر بالصلب - Sputter ثلاثي المعدن
	IX	ألومنيوم مظهر بالصلب - بوليمر
	-LF	خالي من الرصاص

11

مواصفات المحرك

القطر x الشوط
اسم المحرك
عدد الأسطوانات
السعة اللترية
مزايا المحرك
البنزين/الديزل/الغاز
مستند المواصفات/رقم FM

14

مرجع مجموعة Glyco

H:	محمل رئيسي
N:	محمل/جلب عمود الحدبات
A:	حلقة دفع
4/...:	رقم الأزواج (المحامل) أو القطع (الحلقات/الجلب) حسب كل مجموعة
H...:	محمل (شفة) الدفع

12

نوع المحمل وموضعه

BE/PL:	محمل (ذو طرف كبير) قضيب التوصيل
MB/HL:	محمل رئيسي
TW/A:	حلقة دفع
SE/PB:	جلبية (ذات طرف صغير) مسامير الكباس
CB/NWB:	جلبية عمود الحدبات
CS/NWL:	محمل عمود الحدبات
BU:	الجلب الأخرى

15

المزيد من المعلومات

يُرجى الرجوع إلى هامش الغطاء القلاب السفلي

يتم ترتيب جهات التصنيع ترتيبًا أبجديًا كما هو موضح بالفهرس، حيث أن لكل لوحة رقم تقديمي حسب جهة التصنيع. على أن يكون التجويف في أولى معايير التصنيف، يبدأ من القطر الأصغر ثم يتبعه بالشوط وعدد الأسطوانات/البنزين/الديزل/الغاز واسم المحرك. تجمع تجهيزات المحركات التي لها نفس قطع الغيار معًا وترتب ترتيبًا أبجديًا. وتأتي المزيد من الصور ومعلومات قطع الغيار المحددة كالمسافات بين أنسجة المرفق و موقع محمل الدفع بعد كافة أنواع المحمل، وتكون قطع الغيار بالخط الأحمر بمثابة عروض لمجموعة جديدة.

ALFA ROMEO										
1	2	3	4	5	6	7	8	9	10	
16		80.50 x 86.00								
199 B6.000 Euro 6		2 Cyl.		875cc	74-77kW (101-105PS)		Petrol Turbo Intercooler		TD27856	
312 A2.000 Euro 5		2 Cyl.		875cc	63kW (86PS)		Petrol Turbo Intercooler		TD26187	
BE/PL	2	41,982/42,000	45,125/45,135	18,000	1,550	0,025/0,061	AL-LF	01-4967	01-4967/2 STD	
MB/HL 1-3	3	47,982/48,000	51,705/51,718	16,150	1,846	0,022/0,069	AL-LF	02-4968	H1337/3 STD	
TW/A	2	53.100/53.300	68.766/69.020		2.335	0.105/0.275	AL-LF	04-4969	A321/2 STD	
SE/PB	1		23,939/23,972	22,070			BS-LF	55-4970	55-4970 SEMI	

1 نوع المحمل وموضعه

2 مجموعة التركيب

3 قطر المرتكز (قياسي): تمثل المقاييس المذكورة أصغر وأكبر قطر مرتكز

4 تجويف الحوض: تمثل المقاييس المذكورة أصغر وأكبر قطر مرتكز

5 عرض المحمل: تمثل المقاييس المذكورة أقصى عرض للمحمل

6 سمك الجدار القياسي: الحد الأقصى للقيمة

7 خلوص الزيت

8 المواد

9 مرجع المركب

10 مرجع مجموعة Glyco والأحجام الأقل المتوفرة

GLYCO BEARINGS TERMINOLOGY



BEARINGS TERMINOLOGY

A BEARING SHELL

- 1 Free spread
- 2 Bearing length
- 3 Bearing wall thickness
- 4 Bearing surface
- 5 Lubrication hole
- 6 Length of locating lug
- 7 Width of locating lug
- 8 Height of locating lug
- 9 Locating lug relief
- 10 Bearing back

B THRUST WASHER

- 11 Wall thickness
- 12 Sliding surface
- 13 Oil groove
- 14 Locking lug

C FLANGE BEARING

- 15 Flange bearing length
- 16 Distance between flanges
- 17 Flange thickness
- 18 Flange relief grooves
- 19 Flange diameter
- 20 Relief at joint face
- 21 Locating lug
- 22 Relief at joint face
- 23 Lubrication hole
- 24 Oil groove
- 25 Relief at surface

D ASSEMBLED FLANGE BEARING

- 26 Flange and bearing assembly

E BUSHING

- 1 Outside diameter
- 2 Inside diameter
- 3 Oil groove
- 4 Bushing length
- 5 Lubrication hole
- 6 Joint
- 7 Clinch

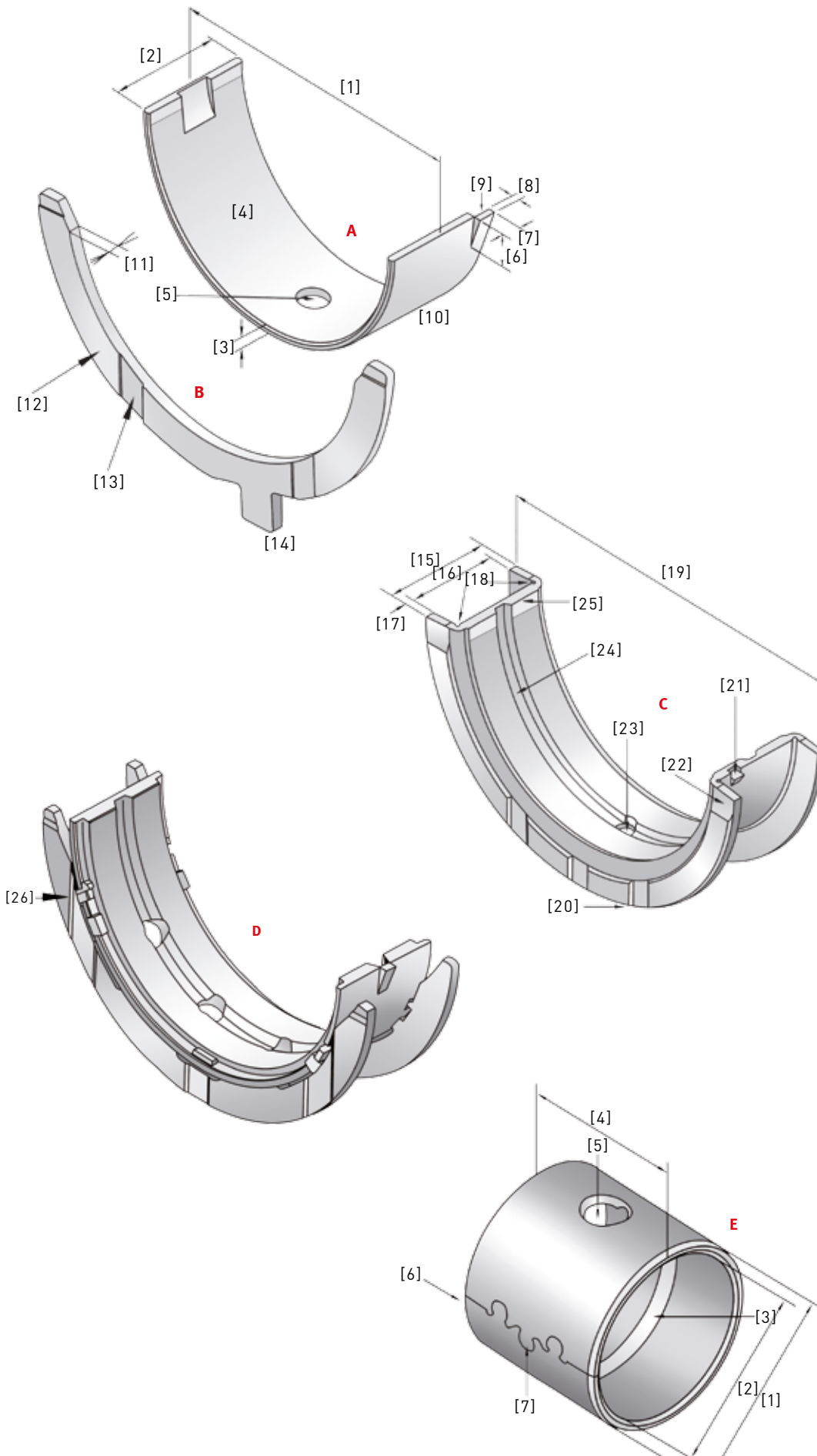

LAGER BEZEICHNUNGEN

A LAGERSCHALE

- 1 Spreizung
- 2 Lagerbreite
- 3 Lagerwanddicke
- 4 Gleitfläche
- 5 Schmierloch
- 6 Nockenlänge
- 7 Nockenbreite
- 8 Nockenhöhe
- 9 Nockenfreilegung
- 10 Lagerrücken

B ANLAUFSCHLEIFE

- 11 Wanddicke
- 12 Gleitfläche
- 13 Schmiernut
- 14 Haltenase

C BUNDLAGER

- 15 Bundlagerbreite

- 16 Bundabstand
- 17 Bunddicke
- 18 Entlastungsrollen
- 19 Bunddurchmesser
- 20 Freilegung der Bundgleitfläche
- 21 Stauchnocken
- 22 Freilegung der Bundgleitfläche
- 23 Schmierloch
- 24 Schmiernut
- 25 Freilegung der Gleitfläche

D GEBAUTES BUNDLAGER

- 26 Verklüngung

E BUCHSE

- 1 Aussendurchmesser
- 2 Innendurchmesser
- 3 Schmiernut
- 4 Buchsenbreite
- 5 Schmierloch
- 6 Stoffuge
- 7 Verklüngung



DEFINIZIONI CUSCINETTO

A CUSCINETTO

- 1 Espansione libera
- 2 Larghezza cuscinetto
- 3 Spessore cuscinetto
- 4 Superficie cuscinetto
- 5 Foro passaggio olio
- 6 Lunghezza dente d'arresto
- 7 Larghezza dente d'arresto
- 8 Altezza dente d'arresto
- 9 Sporgenza dente d'arresto
- 10 Supporto d'acciaio

B ANELLO DI SPALLAMENTO

- 11 Spessore semianello
- 12 Superficie di strisciamento
- 13 Scanalatura per lubrificazione
- 14 Dente di posizionamento

C CUSCINETTO FLANGIATO

- 15 Larghezza esterna del cuscinetto
- 16 Rasamento interno flangia
- 17 Spessore flangia
- 18 Scanalatura di scarico
- 19 Diametro esterno flangia
- 20 Smusso al piano di giunzione
- 21 Dente d'arresto
- 22 Scarico ai piani di giunzione
- 23 Foro per lubrificazione
- 24 Canale di lubrificazione
- 25 Rastrematura

D CUSCINETTO CON

FLANGE MOBILI

- 26 Graffatura

E BOCCOLA

- 1 Diametro esterno
- 2 Diametro interno
- 3 Canale di lubrificazione
- 4 Lunghezza boccola
- 5 Foro passaggio olio
- 6 Giunzione
- 7 Graffatura



TERMINOLOGIE DU COUSSINET

A COUSSINET

- 1 État libre
- 2 Largeur du coussinet
- 3 Épaisseur paroi de coussinet
- 4 Surface de glissement
- 5 Trou d'huile
- 6 Longueur de l'ergot
- 7 Largeur de l'ergot
- 8 Hauteur de l'ergot
- 9 Dégagement de l'ergot
- 10 Dos du coussinet

B FLASQUE DE BUTÉE

- 11 Épaisseur de paroi
- 12 Surface de glissement
- 13 Rainure de lubrification
- 14 Ergot d'arrêt

C COUSSINET À JOUES

- 15 Largeur totale sur joues
- 16 Distance entre joues
- 17 Épaisseur de la joue
- 18 Dégagements
- 19 Diamètre de la joue
- 20 Dégagement du plan de joint de la joue
- 21 Ergot piqué
- 22 Dépinçage de la surface de la joue
- 23 Trou d'huile
- 24 Rainure de lubrification
- 25 Dépinçage de la surface de glissement

D COUSSINET À JOUES ASSEMBLÉES

- 26 Agrafage

E BAGUE

- 1 Diamètre extérieur
- 2 Diamètre intérieur
- 3 Rainure de lubrification
- 4 Largeur de la bague
- 5 Trou d'huile
- 6 Fente
- 7 Agrafage



REPRESENTACIÓN DE LOS COJINETES

A COJINETE

- 1 Extensión libre
- 2 Anchura total
- 3 Espesor de pared
- 4 Superficie de deslizamiento
- 5 Taladro de engrase

- 6 Longitud de muesca
- 7 Anchura de muesca
- 8 Altura de muesca
- 9 Ranura de muesca
- 10 Espalda o soporte

B ARANDELA DE EMPUJE AXIAL

- 11 Espesor de pared
- 12 Superficie de deslizamiento
- 13 Ranura de engrase
- 14 Pestaña de ajuste

C COJINETE CON PESTAÑA

- 15 Anchura total
- 16 Anchura entre valonas
- 17 Espesor de valona
- 18 Garganta de salida
- 19 Diámetro de valona
- 20 Rebaje del extremo
- 21 Muesca de posicionamiento
- 22 Rebaje del extremo
- 23 Taladro de engrase
- 24 Ranura de engrase
- 25 Desmochado

D COJINETE DE PESTAÑA MONTADO

- 26 Montaje de cojinete y pestaña

E CASQUILLO

- 1 Diámetro exterior
- 2 Diámetro interior
- 3 Ranura de engrase
- 4 Anchura total
- 5 Taladro de engrase
- 6 Unión
- 7 Engatillado



TERMINOLOGIA W ŁOŻYSKACH ŚLIZGOWYCH

A PÓŁ-PANEWKA

- 1 Rozmiar w stanie wolnym
- 2 Długość panewki
- 3 Grubość panewki
- 4 Powierzchnia ślizgowa
- 5 Otwór smarowniczy
- 6 Długość zamka
- 7 Szerokość zamka
- 8 Wysokość zamka
- 9 Wysunięcie zamka
- 10 Tylna strona panewki

B ŁOŻYSKO OPOROWE

- 11 Grubość
- 12 Powierzchnia ślizgowa
- 13 Rowek smarowniczy
- 14 Zamek ustalający

C PANEWKA KOŁNIERZOWA

- 15 Długość panewki kołnierzowej
- 16 Wymiar pomiędzy kołnierzami
- 17 Grubość kołnierza

- 18 Rowki kołnierzowe
- 19 Średnica kołnierza
- 20 Podcięcie na powierzchni styku
- 21 Zamek ustalający
- 22 Podcięcie na powierzchni styku
- 23 Otwór smarowniczy
- 24 Rowek olejowy
- 25 Podcięcie na powierzchni

D KOMPLET PANEWKI KOŁNIERZOWEJ

- 26 Komplet panewki i kołnierza

E TULEJA ŚLIZGOWA

- 1 Średnica zewnętrzna
- 2 Średnica wewnętrzna
- 3 Rowek olejowy
- 4 Długość tulei ślizgowej
- 5 Otwór smarowniczy
- 6 Połączenie
- 7 Wpust



ТЕРМИНОЛОГИЯ ПО ВКЛАДЫШАМ

A ВКЛАДЫШ

- 1 Диаметр в свободном состоянии
- 2 Длина вкладыша
- 3 Толщина стенки
- 4 Поверхность скольжения
- 5 Отверстие для смазки
- 6 Длина замка
- 7 Ширина замка
- 8 Высота замка
- 9 Глубина замка
- 10 Посадочная поверхность

B УПОРНЫЕ КОЛЬЦА

- 11 Толщина стенки
- 12 Поверхность скольжения
- 13 Смазочная канавка
- 14 Выступ установочный

C УПОРНЫЙ ВКЛАДЫШ

- 15 Длина вкладыша
- 16 Расстояние между фланцами
- 17 Толщина фланца
- 18 Проточки для снятия напряжений на фланце
- 19 Фланцевый диаметр вкладыша
- 20 Проточки для снятия напряжений на упорной поверхности
- 21 Выступ установочный
- 22 Проточки для снятия напряжений на упорной поверхности
- 23 Отверстие для смазки
- 24 Смазочная канавка

- 25 Проточки для снятия напряжений на поверхности разъема

D СБОРНЫЙ ФЛАНЦЕВЫЙ ВКЛАДЫШ

- 26 Фланцевый вкладыш в сборе

E ВТУЛКА

- 1 Наружный диаметр
- 2 Внутренний диаметр
- 3 Смазочная канавка
- 4 Длина втулки
- 5 Отверстие для смазки
- 6 Соединение
- 7 Замок



مصطلحات المحمل

- 1- ميكمل المحمل
- 2- الأنتشار الحر
- 3- طول المحمل
- 4- سمك جدار المحمل
- 5- سطح المحمل
- 6- فتحة التشحيم
- 7- طول مسقط التثبيت
- 8- عرض مسقط التثبيت
- 9- ارتفاع مسقط التثبيت
- 10- مخفف مسقط التثبيت
- 11- ظهر المحمل

- ب- حلقة الدفع
- 11- سمك الجدار
- 12- السطح المنزلق
- 13- مجرى الزيت
- 14- مسقط القفل

ج- محمل ذو شفة

- 15- طول المحمل ذي الشفة
- 16- المسافة بين الشفاه
- 17- سمك الشفة
- 18- مجاري المخفف ذات شفة
- 19- قطر الشفة
- 20- مخفف في وجه الوصلة
- 21- مسقط التثبيت
- 22- مخفف في وجه الوصلة
- 23- فتحة التشحيم
- 24- مجرى الزيت
- 25- مخفف في الوجه

د- محمل ذي شفة مجمع

- 26- مجموعة الشفة والمحمل

هـ- الجلبة

- 1- القطر الخارجي
- 2- القطر الداخلي
- 3- مجرى الزيت
- 4- طول الجلبة
- 5- فتحة التشحيم
- 6- الوصلة
- 7- التثبيت المحكم



GLYCO BEARINGS POSITIONING

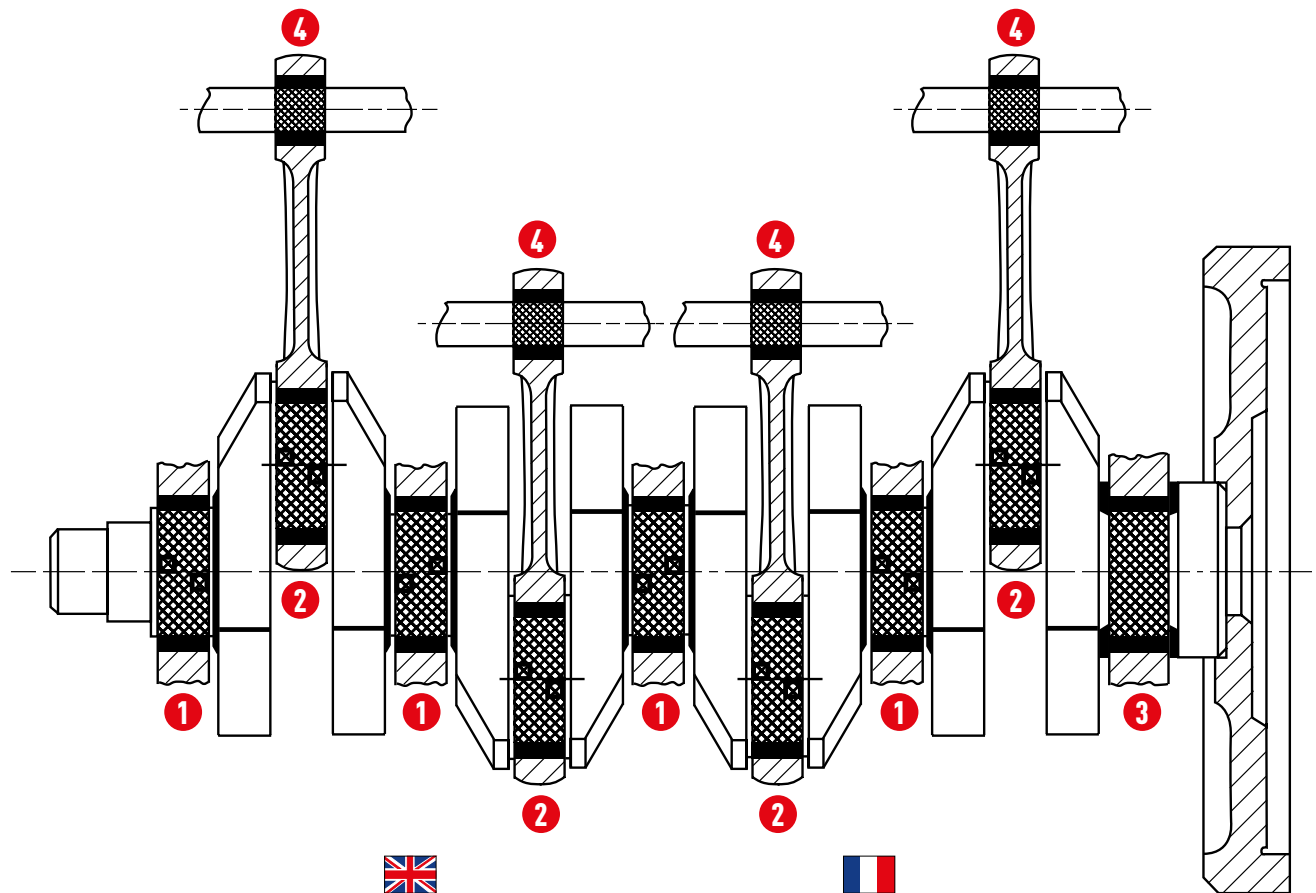

- 1 Main bearing
- 2 Connecting rod bearing
- 3 Thrust bearing or main bearing and thrust washer
- 4 Piston pin bushing
- 5 Camshaft bush or camshaft bearing



- 1 Coussinet de palier
- 2 Coussinet de bielle
- 3 Coussinet à joues ou coussinet de palier et flasque de butée
- 4 Bague de pied de bielle
- 5 Bague d'arbre à came ou coussinet d'arbre à came



- 1 Hauptlager
- 2 Pleuellager
- 3 Bundlager oder Hauptlager und Anlaufscheibe
- 4 Pleuelbuchse
- 5 Nockenwellenbuchse oder Nockenwellenlager



- 1 Cojinete de bancada
- 2 Cojinete de biela
- 3 Cojinete de bancada con pestaña, o cojinete de bancada más arandela de empuje axial
- 4 Casquillo de pie de biela
- 5 Casquillo de árbol de levas o cojinete de árbol de levas



- 1 Коренной вкладыш
- 2 Шатунный вкладыш
- 3 Упорный подшипник или коренной вкладыш и упорный подшипник
- 4 Втулка малой головки шатуна
- 5 Вкладыш или втулка распределительного вала



- 1 Cuscinetto di banco
- 2 Cuscinetto di biella
- 3 Cuscinetto flangiato o cuscinetto con spallamenti
- 4 Boccia piede di biella
- 5 Boccia albero a camme o cuscinetto albero a camme



- 1 Łożysko główne
- 2 Łożysko stopy korbowaodu
- 3 Zintegrowane łożysko oporowe lub łożysko główne i łożysko oporowe
- 4 Tuleja ślizgowa sworznia tłokowego
- 5 Tuleje ślizgowe lub panewki wałka rozrządu



- 1 المحمل الرئيسي
 - 2 محمل قضيب التوصيل
 - 3 محمل الدفع أو المحمل الرئيسي
 - 4 حلقة دفع
 - 5 جلبية مسمار الكباس
- جلبية عمود الحديبات أو محمل عمود الحديبات

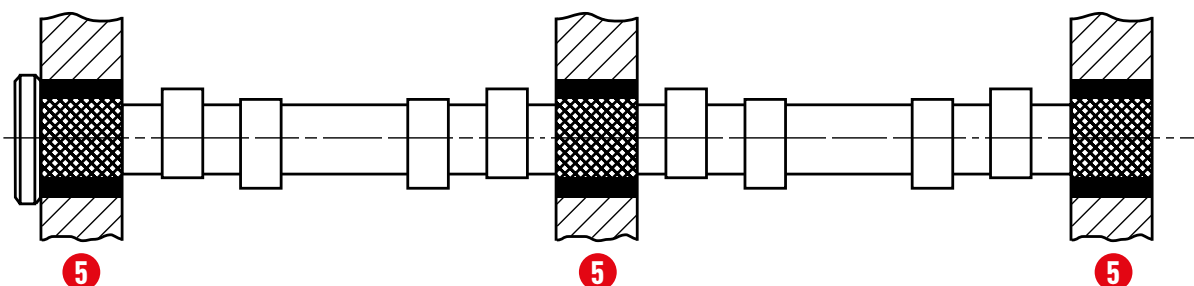



ENGINE PART NUMBERING SYSTEM



TOP ENGINE

	PREFIX	NUMBER	SUFFIX/SIZE	FULL PART NUMBER EXAMPLE
Engine Valve	V	94168	None	V94168
Valve Guide	VAG	96215	None or B ⁽¹⁾	VAG96215
Valve Seat Insert	VS	6344	None	VS6344
Camshaft	CAM	376	None	CAM376
Camshaft Kit	CKS	2373	None	CKS2373
Cam Follower	FOL	101	None	FOL101

⁽¹⁾ "B" indicates BRONZE valve guide.



BEARINGS

SETS	COMPONENTS	*TYPE
01-3040/4 STD Quantity (pairs: bearings; pieces: washers, bushings)	01-3040 Material	1 Conrod bearing
01-3040/4 STD Size	01-3040 Type*	2 Main bearing
H821/5 STD Main bearing	01-3040 Reference	3 Camshaft bush/bearing
A123/4 STD Thrust washer	02-3823H Flanged	4 Thrust washer
N110/5 SEMI Camshaft bush/bearing		5 Small end bushing
		7 Auxiliary bushing



RINGS & LINERS

PISTON RINGS	CYLINDER LINERS
08 - 114900 - 00 Catalogue reference	14 - 451160 - 00 Catalogue reference
08 - 114900 - 00 Ring set assembly	14 - 451160 - 00 Cylinder liner without seals
08 - 114900 - 00 Reference	15 - 451160 - 00 Cylinder liner with seals
08 - 114900 - 00 Size* (See Nüral pistons table) *If imperial in the past, it continues to be imperial	14 - 451160 - 00 Liner type ⁽¹⁾
08 - 114900 - 00 Version	14 - 451160 - 00 Serial number
	14 - 451160 - 00 Size ⁽²⁾
	14 - 451160 - 00 Version

⁽¹⁾ 01 - 19 = Dry liner
⁽²⁾ 0 = STD
 1 = 1st oversize
 2 = 2nd oversize



PISTONS

Size	Metric	Imperial	Size	Metric	Imperial	Size	Metric	Imperial
87 - 114900 - 25 Catalogue reference	00	STD	08	0.60 mm		16	2.00 mm	
87 - 114900 - 25 Piston assembly	03	0.125 mm	09	0.75 mm	.030	17	2.286 mm	.090
88 - 114900 - 25 Kit-set without seals	04	0.20 mm	10	0.80 mm		20	0.70 mm	
89 - 114900 - 25 Kit-set with seals	05	0.25 mm	11	1.00 mm	.040	21	0.65 mm	
87 - 114900 - 25 Reference *If imperial in the past, it continues to be imperial	06	0.40 mm	13	1.25 mm		22	0.30 mm	
87 - 114900 - 25 Size*	07	0.50 mm	14	1.50 mm	.060			
87 - 114900 - 25 Version								



GASKETS

2 LETTERS PREFIX FOR GASKETS AND SEALS - 3 LETTERS PREFIX FOR HEADBOLTS

AA - BZ Cylinder head gaskets	HM Valve cover sets	KG - KJ Washers
CA - DZ Head sets	HR Valve stem seals sets	KK - LZ Miscellaneous joints
EA - EZ Conversion sets	JA - JD Manifold gaskets	LA - LJ O-rings
FA - GZ Full sets	JE - JF Exhaust pipe joints	LK - LN Integrated seal and housing
HA Manifold sets	JH - JJ Sump gaskets	NA - NZ Dynamic oil seals
HBS Headbolt sets	JM - JP Valve cover gaskets	PA - PB Valve stem seals multipacks
HC Oil sump sets	JR - JS Timing case gaskets	
HL Miscellaneous sets	KA Water pump gaskets	

ENGINE EXPERTISE
BY FEDERAL-MOGUL
MOTORPARTS





CHECK OUT OUR CATALOGUES



CATAE902 - Belts and Timing Belt kits

CATAE130I - Valves and Components

CATAE150I - Camshaft, Kits and Components

CATPA110I - Gaskets, Oil Seals and Cylinder Headbolts

CATPA120I - Cylinder Headbolts

CATPA140I - Gaskets, Oil Seals and Cylinder Headbolts



CATGY160I
Engine Bearings



CATGT140I - Piston Rings
CATGT150I - Liners



CATNU160I
Pistons, Liners and Assemblies



Combined E&S catalogues per vehicle makes:

CATMX130I - Audi / Seat / Skoda / Volkswagen

CATMX1402 - PSA Renault

CATMX1403 - BMW / Mini / Mercedes-Benz / Smart / Porsche

CATMX150I - Alfa / Fiat / Lancia / Iveco

CATMX160I - Ford - Jaguar - Land Rover - Opel - Saab

Visit www.fmmotorparts.eu
Online catalogue website. Available 24/7

You can obtain these catalogues through your Federal-Mogul sales representative
or through your local distributor

CAMPUS

Federal-Mogul Motorparts' Technical Portal



ENHANCE YOUR KNOWLEDGE AND SKILLS

- ▶ Comprehensive interactive training modules
- ▶ 9 languages
- ▶ Accessible online using your PC or tablet and offline via an iPad app
- ▶ Free registration
- ▶ Technical Resource Center: diagnostic & troubleshooting documents
- ▶ Free Registration & Available 24/7
- ▶ Latest Automotive News
- ▶ Personal Training Scoreboard
- ▶ Follow Federal Mogul Events!
- ▶ F-M Campus Newsletter. Sign up & Keep up with the latest trainings & automotive news

For additional information:

 www.fmcampus.eu

 info@fmcampus.eu

 @FMCampus_EMEA

 F-M Campus



Used in more than
120 countries!

CONTENT FOR MY CAMPUS

- ▶ Generic Training
- ▶ Brake Training
- ▶ Chassis Training
- ▶ Engine parts Training
- ▶ Wheel-end Bearing Training
- ▶ Filter Training
- ▶ Installation Guides
- ▶ Technical Tips
- ▶ Diagnostic Aids
- ▶ Sales Arguments
- ▶ Technical Posters

TERMS OF BUSINESS

IMPORTANT

Reproduction of this catalogue or parts thereof is only allowed with our explicit permission in writing. Pictorial representations and design are copyrighted. Claims for damages, of any form whatsoever, resulting from details made in this catalogue or from incorrect use, application, storage or handling, are explicitly excluded. Contractual rights and any resulting or related claims based thereon, irrespective of form, initially come into being on the basis of a separate written agreement, in particular on the basis of our general terms of sale and delivery.

All former statements lose their validity with the publication of this catalogue.

The catalogue is not an operating manual for the use and installation of the bearings. It does not contain any advice in a legal sense. The catalogue neither replaces the constantly applicable technical regulations – particularly for tolerances – nor the installation and maintenance stipulations of the individual engine manufacturer.

Also, it is not possible to forego the expertise of those carrying out the installation and application. The individual references made in this catalogue for the installation and the application of the bearings are instructions solely for the technically qualified specialist and are to be checked and verified by them for their suitability in each case. Federal-Mogul accepts no responsibility for application decisions.

The contents of the catalogue are not intended to create or substitute any contractual agreement which has to be reserved exclusively to a separate agreement between 2 identified parties, whereby seller can be only one of our Federal-Mogul entities as mentioned on the back cover page.

The right is retained to correct errors and alterations, particularly with regard to amendments in the engine manufacturers details and stipulations.

ZUR BEACHTUNG

Nachdruck, auch auszugsweise, ist nur mit unserer ausdrücklichen schriftlichen Zustimmung gestattet. Die bildlichen Darstellungen und Ausstattungen sind geschützt. Ersatzansprüche, gleich welcher Art, aufgrund der Angaben in diesem Katalog oder auf Grund unsachgemäßem Umgang, unsachgemäßer Verwendung, Lagerung oder Handhabung der angebotenen Produkte, sind ausdrücklich ausgeschlossen. Vertragliche Ansprüche und daraus abgeleitete oder darauf beruhende Ansprüche, gleich welcher Art, kommen erst auf Grund einer besonderen schriftlichen Vereinbarung, insbesondere auf der Grundlage unserer allgemeinen Verkaufs- und Lieferbedingungen, zustande.

Der Katalog ist keine Einbauanleitung für Gleitlager.

Er enthält keine Beratung im Rechtssinne. Der Katalog ersetzt weder die immer vorrangigen technischen Vorschriften, insbesondere für Toleranzen, sowie die Einbau- und Wartungsvorschriften des jeweiligen Motorenherstellers, noch kann auf das notwendige Fachwissen des die Montage und die Verwendung Durchführenden verzichtet werden. Die in diesem Katalog jeweils gegebenen Hinweise für Einbau und Verwendung der Gleitlager sind Hinweise ausschließlich für den technisch ausgebildeten und versierten Fachmann, die von ihm im jeweiligen Anwendungsfall auf ihre Eignung geprüft und entschieden werden müssen. Eine Haftung von Federal-Mogul für Anwendungsentscheidungen nicht übernommen.

Die Inhalte dieses Katalogs sind nicht dazu bestimmt eine vertragliche Verpflichtung zu begründen oder zu ersetzen, was ausschliesslich einer gesonderten Vereinbarung zwischen 2 konkret bezeichneten Parteien vorbehalten bleibt, wobei der Verkäufer eine unserer Federal-Mogul Gesellschaften sein wird, wie auf der Rückseite des Kataloges.

Die Korrektur von Irrtümern und Änderungen, in besondere auf Grund von geänderten Angaben und Vorschriften der Motorenhersteller, bleibt vorbehalten.

IMPORTANTE

La riproduzione di questo catalogo, anche parziale, è permessa soltanto in seguito ad una autorizzazione scritta. I grafici ed i disegni sono a marchio depositato. Reclami per difetti, di qualsiasi natura essi siano, relativi al contenuto di questo catalogo, o all'uso improprio di esso, verranno respinti. Le pretese avanzate od i reclami dovranno essere in conformità con le nostre condizioni generali di vendita.

Il presente catalogo annulla e sostituisce tutte le edizioni precedenti.

Il catalogo non è un manuale per l'utilizzo ed il montaggio degli cuscinetti. Non contiene indicazioni in questo senso. Esso non sostituisce le descrizioni tecniche, sempre prioritarie, in particolare per le tolleranze, né le istruzioni relative al montaggio ed alla manutenzione, date dai costruttori dei rispettivi motori. Non può in nessun caso essere paragonato alla conoscenza professionale necessaria per il montaggio e l'utilizzo. Le considerazioni sul montaggio degli cuscinetti, fatte su questo catalogo, sono destinate esclusivamente a professionisti con formazione tecnica i quali verificheranno l'esattezza della informazioni, in ogni caso.

Le responsabilità derivanti dall'utilizzo improprio dello stesso non potranno essere addebitate alla Federal-Mogul.

I contenuti del catalogo non sostituiscono in alcun modo gli accordi contrattuali che sono riservati esclusivamente a due contraenti definiti; come venditore si intende una delle società Federal-Mogul menzionate sul retro del catalogo.

Ci riserviamo di apportare correzioni e/o modifiche, relative, in particolare, a dati o istruzioni ricevute dal costruttore del motore.

IMPORTANT

La reproduction de ce catalogue, même partielle, n'est autorisée qu'avec notre accord préalable et par écrit. Les illustrations graphiques et la présentation font l'objet d'un copyright. Nous excluons toutes réclamations ayant pour objet ce catalogue ou pouvant résulter de son incompréhension, portant sur de mauvaises utilisations, manipulations, manutentions ou mauvais stockage. Des droits contractuels et des droits dérivés, de quelque nature qu'ils soient, ne peuvent résulter que d'un accord écrit, particulièrement sur la base de nos conditions générales de vente et de livraison.

Ce catalogue annule et remplace toute édition antérieure.

Le catalogue n'est pas une notice d'utilisation et de montage des coussinets. Il ne contient pas de directives en tant que telles. Le catalogue ne remplace ni les prescriptions techniques, toujours prioritaires, particulièrement pour les tolérances, ni les prescriptions de montage et d'entretien des constructeurs des moteurs figurant dans ce catalogue. Il ne peut en aucun cas remplacer les connaissances professionnelles nécessaires pour le montage et l'utilisation. Les remarques données pour le montage et l'utilisation des coussinets sont exclusivement destinées au professionnel averti et de formation technique, à qui il appartiendra de vérifier la conformité des indications pour chaque cas. La responsabilité des décisions d'utilisation ne peut être prise en charge par Federal-Mogul.

Le contenu de ce catalogue ne peut constituer ou remplacer un contrat qui doit faire l'objet d'un document séparé établi entre 2 parties, dont l'une doit être une entité légale de Federal-Mogul dont la liste figure sur la couverture arrière.

Nous nous réservons le droit d'apporter toutes corrections d'erreurs et modifications, suite notamment à de nouvelles données fournies par les constructeurs.

TERMS OF BUSINESS

IMPORTANTE

Queda totalmente prohibida la reproducción, total o parcial, del contenido de este catálogo, salvo previa autorización nuestra, realizada por escrito. Están, asimismo, reservados todos los derechos sobre el diseño y presentación del catálogo. No se aceptará ningún tipo de reclamación que esté basada en la interpretación de los datos contenidos en este catálogo, así como en el incorrecto uso, manipulación o almacenaje de nuestras piezas. Únicamente se aceptarán reclamaciones que estén basadas en derechos contractuales o en los motivos arriba indicados, siempre que exista un acuerdo especial y por escrito basado en nuestras condiciones generales de venta y suministro.

Con la edición de este catálogo queda anulada toda la información contenida en catálogos anteriores.

El catálogo no es un manual para el uso e instalación de los cojinetes, y no representa una asesoría técnica, en el sentido legal. Los datos del catálogo no sustituyen, en ningún caso, a las especificaciones técnicas, tanto en lo que se refiere a tolerancias como a las instrucciones de instalación y mantenimiento, indicadas por los fabricantes de los motores, especificaciones que serán siempre prioritarias. Se entiende que el uso y montaje de estas piezas está encomendado a personal debidamente cualificado. Las indicaciones sobre uso y montaje de los cojinetes contenidas en este catálogo, están exclusivamente dirigidas a profesionales con la debida capacitación y formación técnica, que deben decidir en cada caso sobre la exactitud de las mismas. La responsabilidad de estas decisiones no puede ser, en ningún caso, achacada a Federal-Mogul.

La información facilitada en el catálogo no representa o sustituye ningún tipo de acuerdo, quedando a tal efecto, el acuerdo por separado entre dos partes donde sólo entidades de Federal-Mogul, pueden ser identificadas como la parte vendedora como se menciona en la contraportada.

Los datos e instrucciones contenidos en este catálogo podrán ser corregidos o modificados sin previo aviso.

WAŻNE

Reprodukcja tego katalogu lub jego części jest możliwa tylko za wyraźną zgodą na piśmie. Ilustracje i grafika są chronione prawem autorskim. Roszczenia dotyczące szkód, niezależnie od formy, wynikających z przedstawionych w tym katalogu treści lub z nieprawidłowego użycia, zastosowania, przechowywania lub obsługi są w sposób wyraźny wyłączone. Prawa umowne i inne wynikające lub związane z roszczeniami na nimi opartymi, niezależnie od formy, są tworzone na podstawie oddzielnej umowy pisemnej, w szczególności na podstawie naszych ogólnych warunków sprzedaży i dostawy.

Wszystkie wcześniejsze oświadczenia tracą ważność wraz z opublikowaniem tego katalogu.

Katalog nie jest instrukcją obsługi i instalacji łożysk silnikowych. Nie zawiera porad w sensie prawnym. Katalog nie zastępuje obowiązujących uregulowań technicznych – zwłaszcza w zakresie tolerancji – ani opisów montażu i konserwacji poszczególnych producentów silników.

Nie jest również możliwe pominięcie doświadczenia osób dokonujących doboru i przeprowadzających montaż części. Poszczególne odniesienia zawarte w tym katalogu, a dotyczące doboru, montażu i stosowania łożysk silnikowych, są instrukcjami wyłącznie dla wykwalifikowanego technicznie specjalisty, który w każdym przypadku musi je sprawdzić i zweryfikować ich przydatność. Federal-Mogul nie przyjmuje odpowiedzialności za decyzje dotyczące zastosowania.

Zawartość tego katalogu nie stanowi ani nie zastępuje umowy, która może być zawarta jedynie jako oddzielny dokument podpisany przez dwie strony, przy czym sprzedawcą może być tylko jedna z jednostek koncernu Federal-Mogul, zgodnie z opisem na wewnętrznej stronie tylnej okładki.

Zachowane zostaje prawo korygowania błędów i wprowadzania zmian, zwłaszcza odnośnie zmian dotyczących parametrów i warunków pracy określonych przez producentów silników.

ВАЖНО

Копирование данного каталога или его частей допускается исключительно при получении нашего разрешения в письменной форме.

Иллюстрации и дизайн защищены авторским правом. Требования о возмещении ущерба любой формы, исходя из содержания каталога или из-за неправильного использования, хранения или обращения, абсолютно исключены. Договорные права и любые результирующие или связанные с этим требования, независимо от их формы, должны являться частью отдельного письменного соглашения и основываться на наших общих условиях продаж и поставок.

Все прежние утверждения теряют свою юридическую силу с момента публикации данного каталога.

Каталог не является руководством пользователя и инструкцией по установке. Оно не содержит советов в юридическом понимании этого слова. Каталог не является заменой для издаваемых производителями двигателей технических инструкций по ремонту, в особенности для допусков технических величин, а также инструкций по монтажу и регламентному обслуживанию. Отдельные ссылки для установки и замены комплектующих, приведенные в этом каталоге, являются инструкциями исключительно для технически компетентного специалиста и в каждом случае должны быть проверены им на предмет их пригодности. Federal-Mogul не несет ответственность за ремонтные работы.

Содержимое каталога не предназначено для создания или замены любого контрактного соглашения, которое может быть оформлено только в виде отдельного соглашения между двумя установленными сторонами, где продавцом может являться только одно из юридических лиц Federal-Mogul, как упомянуто на внутренней стороне обложки каталога.

Federal-Mogul оставляет за собой право вносить исправления и изменения в частности в отношении поправок по деталям изготовителей двигателей и их условиям.

هام

لا يُسمح بنسخ هذا الدليل أو أي جزء منه إلا بتصريح كتابي صريح. جميع التمثيلات التصويرية والتصميمات محفوظة بموجب حقوق الطبع والنشر، ولا تتحمل الشركة صراحة أي مطالبات بخسائر، أيًا كانت صورتها، تنشأ عن التفاصيل الواردة في هذا الدليل أو نتيجة لسوء الاستخدام أو التطبيق أو التخزين أو النقل. أي حقوق تعاقدية أو أي مطالبات لها علاقة بتلك الحقوق أو تنشأ تأسيسًا عليها، بغض النظر عن صورتها، تنشأ تأسيسًا على اتفاق كتابي منفصل، وبخاصة تأسيسًا على شروط البيع والتسليم الخاصة بنا. تفقد كل البيانات السابقة صلاحيتها بمجرد نشر هذا الدليل.

هذا الدليل ليس دليلًا للتشغيل لتوضيح استخدام وتركيب المكابس أو البطانة أو التجميع. كما لا يحتوي على أي نصيحة بالمعنى القانوني، ولا يحل هذا الدليل محل القواعد الفنية المطبقة باستمرار خاصة فيما يتعلق بالتحميل، كما لا يحل محل شروط التركيب والصيانة الخاصة بمصنعي المحركات الفردية. كذلك لا يمكن الاستغناء عن خبرة الفنيين الذين يقومون بالتركيب أو التطبيق. وجميع الإشارات الواردة في هذا الدليل والتي تتعلق بتركيب وتطبيق المكابس والبطانة وعمليات التجميع هي إرشادات للمتخصصين الفنيين المؤهلين فحسب ويتم مراجعتها والتأكد من ملاءمتها في كل حالة على حدة. ولا تتحمل شركة Federal-Mogul أي مسؤولية تتعلق بقرارات التطبيق.

ليس المقصود بمحتوى هذا الدليل أن يخلق أو يستبدل أي اتفاقات تعاقدية يتم الاحتفاظ بها حصريًا في اتفاقية منفصلة بين طرفين محددتين، والتي يمكن أن يكون بموجبها أحد الكيانات التابعة لشركة Federal-Mogul هو الطرف البائع كما هو موضح في الوجه الداخلي للغلاف الخارجي. وتحفظ الشركة بحقها في تصحيح أي أخطاء وإجراء أي تعديلات وبخاصة فيما يتعلق بتعديل تفاصيل مصنع المحرك والأحكام المنصوص عليها.

© Federal-Mogul Corporation 2015

The contents of this publication are the copyright of Federal-Mogul Corporation. Unauthorised reproduction in whole or in part is expressly forbidden.

 GLYCO® is a trademark of Federal-Mogul Corporation



NEW PARTS LIST

Neuaufnahmen • Elenco codici nuovi • Liste des nouvelles références
 Lista de nuevas referencias • Lista nowych części
 Список новой продукции • قائمة الأجزاء الجديدة









ALFA ROMEO	199 B6.000	01-4967/2	16	16	HONDA	L13A6	01-5040/4	4	448	HONDA	R18ZF	H1339/5	14	450
ALFA ROMEO	199 B6.000	55-4970	16	16	HONDA	L13A6	A332/2	4	448	HYUNDAI	D4HA	71-5006/4	17	459
ALFA ROMEO	199 B6.000	A321/2	16	16	HONDA	L13A6	H1355/5	4	448	HYUNDAI	D4HA	H1348/5	17	459
ALFA ROMEO	199 B6.000	H1337/3	16	16	HONDA	L13A7	01-5040/4	4	448	HYUNDAI	D4HA	A328/2	17	460
ALFA ROMEO	312 A2.000	01-4967/2	16	16	HONDA	L13A7	A332/2	4	448	HYUNDAI	D4HB	71-5007/4	19	460
ALFA ROMEO	312 A2.000	55-4970	16	16	HONDA	L13A7	H1355/5	4	448	HYUNDAI	D4HB	A328/2	19	460
ALFA ROMEO	312 A2.000	A321/2	16	16	HONDA	L13A8	01-5040/4	4	448	HYUNDAI	D4HB	H1348/5	19	460
ALFA ROMEO	312 A2.000	H1337/3	16	16	HONDA	L13A8	A332/2	4	448	HYUNDAI	G4FA	01-4999/4	8	458
CHEVROLET	7A-FE	01-5041/4	16	158	HONDA	L13A8	H1355/5	4	448	HYUNDAI	G4FA	A326/2	8	458
CHRYSLER	312 A2.000	01-4967/2	7	166	HONDA	L13Z1	01-5040/4	4	448	HYUNDAI	G4FA	H1346/5	8	458
CHRYSLER	312 A2.000	55-4970	7	166	HONDA	L13Z1	A332/2	4	448	HYUNDAI	G4FG	01-4999/4	9	458
CHRYSLER	312 A2.000	A321/2	7	166	HONDA	L13Z1	H1355/5	4	448	HYUNDAI	G4FG	A326/2	9	458
CHRYSLER	312 A2.000	H1337/3	7	166	HONDA	L13Z4	01-5040/4	4	448	HYUNDAI	G4FG	H1346/5	9	458
CITROËN	1KR-FE	01-4980/3	4	184	HONDA	L13Z4	A332/2	4	448	HYUNDAI	G4NA	71-5002/4	11	458
CITROËN	1KR-FE	A322/2	4	184	HONDA	L13Z4	H1355/5	4	448	HYUNDAI	G4NA	A327/2	11	458
CITROËN	1KR-FE	H1338/4	4	184	HONDA	L15A	01-5040/4	5	448	HYUNDAI	G4NA	H1347/5	11	458
CITROËN	CFA (384F)	01-4980/3	4	184	HONDA	L15A	H1355/5	5	448	HYUNDAI	G4NB	71-5002/4	11	458
CITROËN	CFA (384F)	A322/2	4	184	HONDA	L15A	A332/2	5	449	HYUNDAI	G4NB	A327/2	11	458
CITROËN	CFA (384F)	H1338/4	4	184	HONDA	L15A1	01-5040/4	5	448	HYUNDAI	G4NB	H1347/5	11	458
CITROËN	HNZ (EB2DT)	01-4990/3	21	191	HONDA	L15A1	H1355/5	5	448	HYUNDAI	G4NB-B	71-5002/4	11	458
CITROËN	HNZ (EB2DT)	H1345/4	21	191	HONDA	L15A1	A332/2	5	449	HYUNDAI	G4NB-B	A327/2	11	458
DAIHATSU	1KR-FE	01-4980/3	2	235	HONDA	L15A2	01-5040/4	5	448	HYUNDAI	G4NB-B	H1347/5	11	458
DAIHATSU	1KR-FE	A322/2	2	235	HONDA	L15A2	H1355/5	5	448	HYUNDAI	G4NC	71-5002/4	12	459
DAIHATSU	1KR-FE	H1338/4	2	235	HONDA	L15A2	A332/2	5	449	HYUNDAI	G4NC	A327/2	12	459
FIAT	199 B6.000	01-4967/2	48	301	HONDA	L15A3	01-5040/4	5	448	HYUNDAI	G4NC	H1347/5	12	459
FIAT	199 B6.000	55-4970	48	301	HONDA	L15A3	H1355/5	5	448	ISUZU	ZD30DDTi	01-4977/4	22	475
FIAT	199 B6.000	A321/2	48	301	HONDA	L15A3	A332/2	5	449	ISUZU	ZD30DDTi	A323/2	22	475
FIAT	199 B6.000	H1337/3	48	301	HONDA	L15A4	01-5040/4	5	448	ISUZU	ZD30DDTi	H1342/5	22	475
FIAT	312 A2.000	01-4967/2	48	301	HONDA	L15A4	H1355/5	5	448	IVECO	F2CE0681A	N207/7	64	537
FIAT	312 A2.000	55-4970	48	301	HONDA	L15A4	A332/2	5	449	IVECO	F2CE0682A	N207/7	64	537
FIAT	312 A2.000	A321/2	48	301	HONDA	L15A7	01-5040/4	5	448	IVECO	F2CE0683A	N207/7	64	537
FIAT	312 A2.000	H1337/3	48	301	HONDA	L15A7	H1355/5	5	448	IVECO	F2CE0684A	N207/7	64	537
FORD	FS	01-5044/4	76	413	HONDA	L15A7	A332/2	5	449	KIA	D4HA	71-5006/4	10	564
FORD	FS	A336/2	76	413	HONDA	L15AV	01-5040/4	5	448	KIA	D4HA	A328/2	10	564
FORD	FS	H1358/5	76	413	HONDA	L15AV	H1355/5	5	448	KIA	D4HA	H1348/5	10	564
FORD	HXJA	H1350/5	35	399	HONDA	L15AV	A332/2	5	449	KIA	D4HB	71-5007/4	12	564
FORD	HXJB	H1350/5	35	399	HONDA	LDA1	01-5040/4	4	448	KIA	D4HB	A328/2	12	564
FORD	IQDA	H1350/5	35	399	HONDA	LDA1	A332/2	4	448	KIA	D4HB	H1348/5	12	564
FORD	IQDB	H1350/5	35	399	HONDA	LDA1	H1355/5	4	448	KIA	G4FA	01-4999/4	5	563
FORD	IQJA	H1350/5	35	399	HONDA	LDA2	01-5040/4	4	448	KIA	G4FA	A326/2	5	563
FORD	MUDA	H1350/5	35	399	HONDA	LDA2	A332/2	4	448	KIA	G4FA	H1346/5	5	563
FORD	PNBA	H1350/5	35	399	HONDA	LDA2	H1355/5	4	448	KIA	G4FA-L	01-4999/4	5	563
FORD	PNDA	H1350/5	35	399	HONDA	LDA3	01-5040/4	4	448	KIA	G4FA-L	A326/2	5	563
FORD	RHBA	H1350/5	35	399	HONDA	LDA3	A332/2	4	448	KIA	G4FA-L	H1346/5	5	563
FORD	SIDA	H1350/5	35	399	HONDA	LDA3	H1355/5	4	448	KIA	G4FC	01-4999/4	6	563
FORD	SNJA	H1350/5	6	390	HONDA	LEA1	01-5040/4	5	448	KIA	G4FC	A326/2	6	563
FORD	SPJA	H1350/5	24	395	HONDA	LEA1	H1355/5	5	448	KIA	G4FC	H1346/5	6	563
FORD	SPJC	H1350/5	24	395	HONDA	LEA1	A332/2	5	449	KIA	G4NC	71-5002/4	9	564
FORD	STJA	H1350/5	6	390	HONDA	LEA3	01-5040/4	5	448	KIA	G4NC	A327/2	9	564
FORD	STJB	H1350/5	6	390	HONDA	LEA3	H1355/5	5	448	KIA	G4NC	H1347/5	9	564
FORD	XTDA	H1350/5	35	399	HONDA	LEA3	A332/2	5	449	LANCIA	312 A2.000	01-4967/2	20	584
HONDA	L13A1	01-5040/4	4	448	HONDA	R18A1	01-4976/4	14	450	LANCIA	312 A2.000	A321/2	20	584
HONDA	L13A1	A332/2	4	448	HONDA	R18A1	H1339/5	14	450	LANCIA	312 A2.000	H1337/3	20	584
HONDA	L13A1	H1355/5	4	448	HONDA	R18A2	01-4976/4	14	450	LANCIA	312 A2.000	55-4970	20	585
HONDA	L13A3	01-5040/4	4	448	HONDA	R18A2	H1339/5	14	450	LANCIA	312 A5.000	01-4967/2	20	584
HONDA	L13A3	A332/2	4	448	HONDA	R18A9	01-4976/4	14	450	LANCIA	312 A5.000	A321/2	20	584
HONDA	L13A3	H1355/5	4	448	HONDA	R18A9	H1339/5	14	450	LANCIA	312 A5.000	H1337/3	20	584
HONDA	L13A5	01-5040/4	4	448	HONDA	R18Z9	01-4976/4	14	450	LANCIA	312 A5.000	55-4970	20	585
HONDA	L13A5	A332/2	4	448	HONDA	R18Z9	H1339/5	14	450	MAN	D 2066 LE 621	07-4997	13	640
HONDA	L13A5	H1355/5	4	448	HONDA	R18ZF	01-4976/4	14	450	MAN	D 2066 LF 01	07-4997	14	641

NEW PARTS LIST

MAN		GLYCO		MAN		GLYCO		MAN		GLYCO		MAN		
MAN	D 2066 LF 02	07-4997	14	641	MAN	D 2066 LF 69	07-4997	14	641	MAN	D 2676 LF 17	07-4997	28	650
MAN	D 2066 LF 03	07-4997	14	641	MAN	D 2066 LF 70	07-4997	14	641	MAN	D 2676 LF 18	07-4997	28	650
MAN	D 2066 LF 04	07-4997	14	641	MAN	D 2066 LF 71	07-4997	14	641	MAN	D 2676 LF 19	07-4997	28	650
MAN	D 2066 LF 06	07-4997	14	641	MAN	D 2066 LF 72	07-4997	14	641	MAN	D 2676 LF 20	07-4997	28	650
MAN	D 2066 LF 07	07-4997	14	641	MAN	D 2066 LOH 01	07-4997	13	640	MAN	D 2676 LF 21	07-4997	28	650
MAN	D 2066 LF 11	07-4997	14	641	MAN	D 2066 LOH 02	07-4997	15	642	MAN	D 2676 LF 22	07-4997	28	650
MAN	D 2066 LF 12	07-4997	14	641	MAN	D 2066 LOH 03	07-4997	15	642	MAN	D 2676 LF 23	07-4997	28	650
MAN	D 2066 LF 13	07-4997	14	641	MAN	D 2066 LOH 04	07-4997	15	642	MAN	D 2676 LF 24	07-4997	28	650
MAN	D 2066 LF 14	07-4997	14	641	MAN	D 2066 LOH 05	07-4997	13	640	MAN	D 2676 LF 25	07-4997	28	650
MAN	D 2066 LF 17	07-4997	13	640	MAN	D 2066 LOH 06	07-4997	15	642	MAN	D 2676 LF 26	07-4997	28	650
MAN	D 2066 LF 18	07-4997	13	640	MAN	D 2066 LOH 07	07-4997	13	640	MAN	D 2676 LF 28	07-4997	28	650
MAN	D 2066 LF 19	07-4997	13	640	MAN	D 2066 LOH 08	07-4997	15	642	MAN	D 2676 LF 32	07-4997	28	650
MAN	D 2066 LF 20	07-4997	13	640	MAN	D 2066 LOH 10	07-4997	15	642	MAN	D 2676 LF 33	07-4997	28	650
MAN	D 2066 LF 21	07-4997	13	640	MAN	D 2066 LOH 11	07-4997	13	640	MAN	D 2676 LOH 01	07-4997	28	650
MAN	D 2066 LF 22	07-4997	13	640	MAN	D 2066 LOH 12	07-4997	13	640	MAN	D 2676 LOH 02	07-4997	28	650
MAN	D 2066 LF 23	07-4997	14	641	MAN	D 2066 LOH 13	07-4997	13	640	MAN	D 2676 LOH 03	07-4997	28	650
MAN	D 2066 LF 24	07-4997	14	641	MAN	D 2066 LOH 26	07-4997	13	640	MAN	D 2676 LOH 04	07-4997	28	650
MAN	D 2066 LF 25	07-4997	13	640	MAN	D 2066 LOH 27	07-4997	15	642	MAN	D 2676 LOH 10	07-4997	28	650
MAN	D 2066 LF 26	07-4997	13	640	MAN	D 2066 LOH 28	07-4997	13	640	MAN	D 2676 LOH 18	07-4997	28	650
MAN	D 2066 LF 27	07-4997	13	640	MAN	D 2066 LOH 35	07-4997	14	641	MAN	D 2676 LOH 26	07-4997	28	650
MAN	D 2066 LF 28	07-4997	13	640	MAN	D 2066 LUH 07	07-4997	13	640	MAN	D 2676 LOH 27	07-4997	28	650
MAN	D 2066 LF 29	07-4997	14	641	MAN	D 2066 LUH 08	07-4997	13	640	MAN	D 2676 LOH 28	07-4997	28	650
MAN	D 2066 LF 30	07-4997	14	641	MAN	D 2066 LUH 09	07-4997	13	640	MAN	D 2676 LOH 30	07-4997	28	650
MAN	D 2066 LF 31	07-4997	14	641	MAN	D 2066 LUH 11	07-4997	15	642	MAN	D 2676 LOH 31	07-4997	28	650
MAN	D 2066 LF 32	07-4997	14	641	MAN	D 2066 LUH 12	07-4997	15	642	MAN	D 2676 LOH 32	07-4997	28	650
MAN	D 2066 LF 33	07-4997	14	641	MAN	D 2066 LUH 13	07-4997	15	642	MAN	D 2676 LOH 33	07-4997	28	650
MAN	D 2066 LF 34	07-4997	14	641	MAN	D 2066 LUH 14	07-4997	13	640	MAN	D 2676 LOH 34	07-4997	28	650
MAN	D 2066 LF 35	07-4997	14	641	MAN	D 2066 LUH 15	07-4997	13	640	MAZDA	B5	A335/2	15	674
MAN	D 2066 LF 36	07-4997	13	640	MAN	D 2066 LUH 21	07-4997	13	640	MAZDA	B518	A335/2	15	674
MAN	D 2066 LF 37	07-4997	13	640	MAN	D 2066 LUH 22	07-4997	13	640	MAZDA	B53	A335/2	15	674
MAN	D 2066 LF 38	07-4997	13	640	MAN	D 2066 LUH 23	07-4997	15	642	MAZDA	B572	A335/2	15	674
MAN	D 2066 LF 39	07-4997	13	640	MAN	D 2066 LUH 24	07-4997	13	640	MAZDA	B573	A335/2	15	674
MAN	D 2066 LF 40	07-4997	15	642	MAN	D 2066 LUH 32	07-4997	13	640	MAZDA	B5C4	A335/2	15	674
MAN	D 2066 LF 41	07-4997	15	642	MAN	D 2066 LUH 33	07-4997	13	640	MAZDA	B5C5	A335/2	15	674
MAN	D 2066 LF 42	07-4997	15	642	MAN	D 2066 LUH 34	07-4997	13	640	MAZDA	B6	A335/2	17	675
MAN	D 2066 LF 43	07-4997	15	642	MAN	D 2066 LUH 41	07-4997	13	640	MAZDA	B6 (DOHC)	A335/2	17	675
MAN	D 2066 LF 44	07-4997	14	641	MAN	D 2066 LUH 42	07-4997	14	641	MAZDA	B6 (SOHC)	A335/2	17	675
MAN	D 2066 LF 45	07-4997	14	641	MAN	D 2066 LUH 43	07-4997	13	640	MAZDA	B61V	A335/2	17	675
MAN	D 2066 LF 46	07-4997	14	641	MAN	D 2066 LUH 46	07-4997	13	640	MAZDA	B67J	A335/2	17	675
MAN	D 2066 LF 47	07-4997	14	641	MAN	D 2066 LUH 47	07-4997	13	640	MAZDA	B67K	A335/2	17	675
MAN	D 2066 LF 48	07-4997	15	642	MAN	D 2066 LUH 48	07-4997	15	642	MAZDA	B67L	A335/2	17	675
MAN	D 2066 LF 49	07-4997	15	642	MAN	D 2676 440	07-4997	28	650	MAZDA	B6E	A335/2	17	675
MAN	D 2066 LF 50	07-4997	15	642	MAN	D 2676 LE 621	07-4997	28	650	MAZDA	B6EW	A335/2	17	675
MAN	D 2066 LF 51	07-4997	15	642	MAN	D 2676 LE 622	07-4997	28	650	MAZDA	B6T	A335/2	18	675
MAN	D 2066 LF 52	07-4997	15	642	MAN	D 2676 LF 01	07-4997	28	650	MAZDA	FP	01-5044/4	24	676
MAN	D 2066 LF 53	07-4997	15	642	MAN	D 2676 LF 02	07-4997	28	650	MAZDA	FP	A336/2	24	676
MAN	D 2066 LF 54	07-4997	14	641	MAN	D 2676 LF 03	07-4997	28	650	MAZDA	FP	H1358/5	24	676
MAN	D 2066 LF 55	07-4997	14	641	MAN	D 2676 LF 04	07-4997	28	650	MAZDA	FP55	01-5044/4	24	676
MAN	D 2066 LF 56	07-4997	14	641	MAN	D 2676 LF 05	07-4997	28	650	MAZDA	FP55	A336/2	24	676
MAN	D 2066 LF 57	07-4997	15	642	MAN	D 2676 LF 06	07-4997	28	650	MAZDA	FP55	H1358/5	24	676
MAN	D 2066 LF 58	07-4997	14	641	MAN	D 2676 LF 07	07-4997	28	650	MAZDA	FP9A	01-5044/4	24	676
MAN	D 2066 LF 59	07-4997	13	640	MAN	D 2676 LF 08	07-4997	28	650	MAZDA	FP9A	A336/2	24	676
MAN	D 2066 LF 60	07-4997	13	640	MAN	D 2676 LF 09	07-4997	28	650	MAZDA	FP9A	H1358/5	24	676
MAN	D 2066 LF 61	07-4997	15	642	MAN	D 2676 LF 10	07-4997	28	650	MAZDA	FPY3	01-5044/4	24	676
MAN	D 2066 LF 62	07-4997	15	642	MAN	D 2676 LF 11	07-4997	28	650	MAZDA	FPY3	A336/2	24	676
MAN	D 2066 LF 63	07-4997	15	642	MAN	D 2676 LF 12	07-4997	28	650	MAZDA	FPY3	H1358/5	24	676
MAN	D 2066 LF 64	07-4997	15	642	MAN	D 2676 LF 13	07-4997	28	650	MAZDA	FS	01-5044/4	25	676
MAN	D 2066 LF 65	07-4997	14	641	MAN	D 2676 LF 14	07-4997	28	650	MAZDA	FS	A336/2	25	676
MAN	D 2066 LF 67	07-4997	15	642	MAN	D 2676 LF 15	07-4997	28	650	MAZDA	FS	H1358/5	25	676
MAN	D 2066 LF 68	07-4997	15	642	MAN	D 2676 LF 16	07-4997	28	650	MAZDA	FS2C	01-5044/4	25	676

NEW PARTS LIST

Neuaufnahmen • Elenco codici nuovi • Liste des nouvelles références
Lista de nuevas referencias • Lista nowych części
Список новой продукции • قائمة الأجزاء الجديدة

        											
MAZDA	FS2C	A336/2	25 676	NISSAN	ZD30DDTi	H1342/5	64 893	SUZUKI	MR20	H1340/5	26 1218
MAZDA	FS2C	H1358/5	25 676	NISSAN	ZD30H HD-5	01-4977/4	64 893	SUZUKI	MR20DE	01-4978/4	26 1218
MAZDA	FS7E	01-5044/4	25 676	NISSAN	ZD30H HD-5	A323/2	64 893	SUZUKI	MR20DE	A324/2	26 1218
MAZDA	FS7E	A336/2	25 676	NISSAN	ZD30H HD-5	H1342/5	64 893	SUZUKI	MR20DE	H1340/5	26 1218
MAZDA	FS7E	H1358/5	25 676	NISSAN	ZD30Ti	01-4977/4	64 893	SUZUKI	QR25	01-4979/4	30 1219
MAZDA	FS7G	01-5044/4	25 676	NISSAN	ZD30Ti	A323/2	64 893	SUZUKI	QR25	H1341/5	30 1219
MAZDA	FS7G	A336/2	25 676	NISSAN	ZD30Ti	H1342/5	64 893	SUZUKI	QR25DE	01-4979/4	30 1219
MAZDA	FS7G	H1358/5	25 676	PEUGEOT	1KR (384 F)	01-4980/3	7 963	SUZUKI	QR25DE	H1341/5	30 1219
MAZDA	MR18DE	01-4978/4	26 676	PEUGEOT	1KR (384 F)	A322/2	7 963	TOYOTA	1KR-FE	01-4980/3	3 1231
MAZDA	MR18DE	A324/2	26 677	PEUGEOT	1KR (384 F)	H1338/4	7 963	TOYOTA	1KR-FE	A322/2	3 1231
MAZDA	MR18DE	H1340/5	26 677	PEUGEOT	HNY (EB2DTS)	01-4990/3	28 970	TOYOTA	1KR-FE	H1338/4	3 1231
MAZDA	MR18DE	01-4978/4	26 677	PEUGEOT	HNY (EB2DTS)	H1345/4	28 971	TOYOTA	7A-FE	01-5041/4	29 1237
MITSUBISHI	4G91	A334/2	11 836	PEUGEOT	HNY (EB2DT)	01-4990/3	28 970	TOYOTA	7K	01-5041/4	24 1235
MITSUBISHI	4G91	H1357/5	11 836	PEUGEOT	HNZ (EB2DT)	H1345/4	28 971	TOYOTA	7K-E	01-5041/4	24 1235
MITSUBISHI	4G91	01-5043/4	11 836	RENAULT	DXi 12	57-4994	107 1100	VOLKSWAGEN	AWY	H1343/4	36 1297
MITSUBISHI	4G92	01-5043/4	19 839	RENAULT	DXi 13 440	57-4994	108 1101	VOLKSWAGEN	AZQ	H1343/4	36 1297
MITSUBISHI	4G92	A334/2	19 839	RENAULT	DXi 13 440	71-4949/6	108 1101	VOLKSWAGEN	BBM	H1343/4	36 1297
MITSUBISHI	4G92	H1357/5	19 839	RENAULT	DXi 13 440	57-4994	108 1101	VOLKSWAGEN	BMD	H1343/4	36 1297
MITSUBISHI	4G93	01-5043/4	20 839	RENAULT	DXi 13 460	71-4949/6	108 1101	VOLKSWAGEN	BME	H1343/4	36 1297
MITSUBISHI	4G93	A334/2	20 839	RENAULT	DXi 13 460	57-4994	108 1101	VOLKSWAGEN	BZG	H1343/4	36 1297
MITSUBISHI	4G93	H1357/5	20 839	RENAULT	DXi 13 480	71-4949/6	108 1101	VOLKSWAGEN	CGPA	H1343/4	36 1297
MITSUBISHI	MR18DE	01-4978/4	25 840	RENAULT	DXi 13 500	57-4994	108 1101	VOLKSWAGEN	CGPB	H1343/4	36 1297
MITSUBISHI	MR18DE	A324/2	25 840	RENAULT	DXi 13 500	71-4949/6	108 1101	VOLKSWAGEN	CHFA	H1343/4	36 1297
MITSUBISHI	MR18DE	H1340/5	25 840	RENAULT	DXi 13 520	57-4994	108 1101	VOLKSWAGEN	CHFB	H1343/4	36 1297
MITSUBISHI	MR18DE	01-4978/4	25 840	RENAULT	DXi 13 520	71-4949/6	108 1101	VOLVO	D12A340	57-4994	69 1412
NEW HOLLAND	6 C 8.3	H1344/7	23 863	RENAULT	DXi 13	57-4994	108 1101	VOLVO	D12A380	57-4994	69 1412
NEW HOLLAND	6 C NA	H1344/7	23 863	SEAT	AZQ	H1343/4	22 1156	VOLVO	D12A420	57-4994	69 1412
NEW HOLLAND	6 CT	H1344/7	23 863	SEAT	BBM	H1343/4	22 1156	VOLVO	D12C340	57-4994	69 1412
NEW HOLLAND	6 CT 8.3	H1344/7	23 863	SEAT	BME	H1343/4	22 1156	VOLVO	D12C380	57-4994	69 1412
NEW HOLLAND	6 CTA 8.3	H1344/7	23 863	SEAT	BZG	H1343/4	22 1156	VOLVO	D12C390	57-4994	69 1412
NEW HOLLAND	6 CTA A	H1344/7	23 863	SEAT	CGPA	H1343/4	22 1156	VOLVO	D12C420	57-4994	69 1412
NEW HOLLAND	6 CTA A 8.3	H1344/7	23 863	SEAT	CGPB	H1343/4	22 1156	VOLVO	D12C460	57-4994	69 1412
NISSAN	HR15DE	01-5049/4	17 882	SEAT	CHFA	H1343/4	22 1156	VOLVO	D12D340	57-4994	69 1412
NISSAN	HR15DE	A338/2	17 882	SKODA	AWY	H1343/4	8 1192	VOLVO	D12D380	57-4994	69 1412
NISSAN	HR15DE	H1359/5	17 882	SKODA	AZQ	H1343/4	8 1192	VOLVO	D12D390	57-4994	69 1412
NISSAN	HR16DE	01-5049/4	19 883	SKODA	BBM	H1343/4	8 1192	VOLVO	D12D420	57-4994	69 1412
NISSAN	HR16DE	A338/2	19 883	SKODA	BMD	H1343/4	8 1192	VOLVO	D12D460	57-4994	69 1412
NISSAN	HR16DE	H1359/5	19 883	SKODA	BME	H1343/4	8 1192	VOLVO	D12D500	57-4994	69 1412
NISSAN	MR18DE	01-4978/4	35 887	SKODA	BZG	H1343/4	8 1192	VOLVO	D13A360	57-4994	70 1412
NISSAN	MR18DE	A324/2	35 887	SKODA	CGPA	H1343/4	8 1192	VOLVO	D13A360	71-4949/6	70 1412
NISSAN	MR18DE	H1340/5	35 887	SKODA	CGPB	H1343/4	8 1192	VOLVO	D13A400	57-4994	70 1412
NISSAN	MR20DE	01-4978/4	37 888	SKODA	CHFA	H1343/4	8 1192	VOLVO	D13A400	71-4949/6	70 1412
NISSAN	MR20DE	A324/2	37 888	SUBARU	1KR-FE	01-4980/3	1 1209	VOLVO	D13A440	57-4994	70 1412
NISSAN	MR20DE	H1340/5	37 888	SUBARU	1KR-FE	A322/2	1 1209	VOLVO	D13A440	71-4949/6	70 1412
NISSAN	MR20DE	01-4979/4	50 890	SUBARU	1KR-FE	H1338/4	1 1209	VOLVO	D13A480	57-4994	70 1412
NISSAN	QR20DD	01-4979/4	50 890	SUZUKI	G15A	01-5042/4	11 1215	VOLVO	D13A480	71-4949/6	70 1412
NISSAN	QR20DD	H1341/5	50 890	SUZUKI	G15A	A333/2	11 1215	VOLVO	D13A520	57-4994	70 1412
NISSAN	QR20DE	01-4979/4	50 890	SUZUKI	G15A	H1356/5	11 1215	VOLVO	D13A520	71-4949/6	70 1412
NISSAN	QR20DE	H1341/5	50 890	SUZUKI	G16A (16V)	01-5042/4	13 1216	VOLVO	D13B360	57-4994	70 1412
NISSAN	QR25DD	01-4979/4	55 891	SUZUKI	G16A (16V)	A333/2	13 1216	VOLVO	D13B360	71-4949/6	70 1412
NISSAN	QR25DD	H1341/5	55 891	SUZUKI	G16A (16V)	H1356/5	13 1216	VOLVO	D13B400	57-4994	70 1412
NISSAN	QR25DE	01-4979/4	55 891	SUZUKI	G16A (16V)	01-5042/4	13 1216	VOLVO	D13B400	71-4949/6	70 1412
NISSAN	QR25DE	H1341/5	55 891	SUZUKI	G16A (8V)	01-5042/4	13 1216	VOLVO	D13B440	57-4994	70 1412
NISSAN	QR25DER	01-4979/4	55 891	SUZUKI	G16A (8V)	A333/2	13 1216	VOLVO	D13B440	71-4949/6	70 1412
NISSAN	QR25DER	H1341/5	55 891	SUZUKI	G16A (8V)	H1356/5	13 1216	VOLVO	D13B500	57-4994	70 1412
NISSAN	ZD30	01-4977/4	64 893	SUZUKI	G16A (8V)	01-5042/4	13 1216	VOLVO	D13B500	71-4949/6	70 1412
NISSAN	ZD30	A323/2	64 893	SUZUKI	G16B	01-5042/4	13 1216	VOLVO	D13C380	57-4994	70 1412
NISSAN	ZD30	H1342/5	64 893	SUZUKI	G16B	A333/2	13 1216	VOLVO	D13C380	71-4949/6	70 1412
NISSAN	ZD30	01-4977/4	64 893	SUZUKI	G16B	H1356/5	13 1216	VOLVO	D13C380	71-4949/6	70 1412
NISSAN	ZD30DDT	01-4977/4	64 893	SUZUKI	G16B	01-5042/4	13 1216	VOLVO	D13C420	57-4994	70 1412
NISSAN	ZD30DDT	A323/2	64 893	SUZUKI	MR20	01-4978/4	26 1218	VOLVO	D13C420	71-4949/6	70 1412
NISSAN	ZD30DDT	H1342/5	64 893	SUZUKI	MR20	A324/2	26 1218	VOLVO	D13C420	71-4949/6	70 1412
NISSAN	ZD30DDTi	01-4977/4	64 893	SUZUKI	MR20	01-4978/4	26 1218	VOLVO	D13C420	71-4949/6	70 1412
NISSAN	ZD30DDTi	A323/2	64 893	SUZUKI	MR20	A324/2	26 1218	VOLVO	D13C420	71-4949/6	70 1412

Neuaufnahmen • Elenco codici nuovi • Liste des nouvelles références
Lista de nuevas referencias • Lista nowych części
Список новой продукции • قائمة الأجزاء الجديدة

NEW PARTS LIST

				
VOLVO	D13C460	57-4994	70	1412
VOLVO	D13C460	71-4949/6	70	1412
VOLVO	D13C500	57-4994	70	1412
VOLVO	D13C500	71-4949/6	70	1412
VOLVO	D13C540	57-4994	70	1412
VOLVO	D13C540	71-4949/6	70	1412
VOLVO	DH12D340	57-4994	69	1412
VOLVO	DH12D380	57-4994	69	1412
VOLVO	DH12D420	57-4994	69	1412
VOLVO	DH12E340	57-4994	69	1412
VOLVO	DH12E380	57-4994	69	1412
VOLVO	DH12E420	57-4994	69	1412
VOLVO	DH12E460	57-4994	69	1412

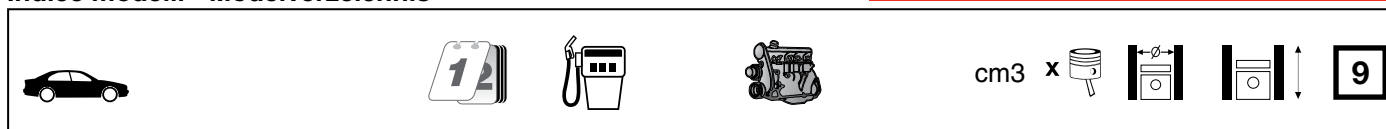

6 2.0	07/81→12/86	Petrol	AR 01932	1997	V6	80.00	66.20	12
6 2.5 i.e.	04/79→12/86	Petrol	AR 01928	2492	V6	88.00	68.30	44
6 2.5 TD	07/81→05/86	Diesel	VM-HR 588 HT	2493	5	88.00	82.00	46
33 1.2	06/83→12/89	Petrol	AR 30585	1186	4	80.00	59.00	10
33 1.3	10/84→12/89	Petrol	AR 30168	1351	4	80.00	67.20	13
33 1.3	05/83→12/89	Petrol	AR 30502	1351	4	80.00	67.20	13
33 1.3	06/83→12/89	Petrol	AR 30586	1351	4	80.00	67.20	13
33 1.3	10/84→12/89	Petrol	AR 30587	1351	4	80.00	67.20	13
33 1.4	01/84→12/88	Petrol	AR 30587	1351	4	80.00	67.20	13
33 1.4 i.e.	06/91→09/94	Petrol	AR 30753	1351	4	80.00	67.20	13
33 1.4 i.e.	06/91→09/94	Petrol	AR 30755	1351	4	80.00	67.20	13
33 1.4 i.e. 4x4	07/90→09/94	Petrol	AR 30755	1351	4	80.00	67.20	13
33 1.5	06/83→12/85	Petrol	AR 30143	1490	4	84.00	67.20	34
33 1.5	12/86→12/89	Petrol	AR 30146	1490	4	84.00	67.20	34
33 1.5	05/83→12/93	Petrol	AR 30182	1490	4	84.00	67.20	34
33 1.5	06/83→12/85	Petrol	AR 30504	1490	4	84.00	67.20	34
33 1.5	12/86→12/89	Petrol	AR 30508	1490	4	73.02	67.20	5
33 1.5	09/84→12/87	Petrol	AR 30514	1490	4	84.00	67.20	34
33 1.5	06/83→12/86	Petrol	AR 30520	1490	4	84.00	67.20	34
33 1.5	07/86→12/89	Petrol	AR 30588	1490	4	84.00	67.20	34
33 1.5	01/90→04/93	Petrol	AR 30734	1490	4	84.00	67.20	34
33 1.5 4x4	09/86→12/89	Petrol	AR 30146	1490	4	84.00	67.20	34
33 1.5 4x4	09/84→12/87	Petrol	AR 30182	1490	4	84.00	67.20	34
33 1.5 4x4	11/83→12/84	Petrol	AR 30504	1490	4	84.00	67.20	34
33 1.5 4x4	12/86→03/89	Petrol	AR 30508	1490	4	73.02	67.20	5
33 1.5 4x4	01/84→12/89	Petrol	AR 30514	1490	4	84.00	67.20	34
33 1.5 4x4	09/84→12/86	Petrol	AR 30520	1490	4	84.00	67.20	34
33 1.5 4x4	07/86→12/89	Petrol	AR 30588	1490	4	84.00	67.20	34
33 1.5 i.e	01/90→09/94	Petrol	AR 30751	1490	4	84.00	67.20	34
33 1.5 i.e.	07/90→08/91	Petrol	AR 30750	1490	4	84.00	67.20	34
33 1.5 QV	06/84→12/89	Petrol	AR 30146	1490	4	84.00	67.20	34
33 1.5 QV	06/84→12/89	Petrol	AR 30508	1490	4	73.02	67.20	5
33 1.5 QV	06/84→12/89	Petrol	AR 30588	1490	4	84.00	67.20	34
33 1.7	01/86→12/89	Petrol	AR 30550	1712	4	87.00	72.20	42
33 1.7 16V	01/90→03/92	Petrol	AR 30746	1712	4	87.00	72.20	43
33 1.7 16V	01/90→09/94	Petrol	AR 30747	1712	4	87.00	72.20	43
33 1.7 16V 4x4	01/90→09/94	Petrol	AR 30746	1712	4	87.00	72.20	43
33 1.7 16V 4x4	01/90→09/94	Petrol	AR 30747	1712	4	87.00	72.20	43
33 1.7 i.e.	09/88→12/89	Petrol	AR 30558	1712	4	87.00	72.20	42
33 1.7 i.e.	01/90→09/94	Petrol	AR 30736	1712	4	87.00	72.20	42
33 1.7 i.e.	01/90→09/94	Petrol	AR 30737	1712	4	87.00	72.20	42
33 1.7 i.e.	04/92→09/94	Petrol	AR 30737 A	1712	4	87.00	72.20	42
33 1.7 i.e. 4x4	09/88→12/89	Petrol	AR 30558	1712	4	87.00	72.20	42
33 1.7 i.e. 4x4	01/90→03/92	Petrol	AR 30736	1712	4	87.00	72.20	42
33 1.7 i.e. 4x4	09/88→03/92	Petrol	AR 30737	1712	4	87.00	72.20	42
33 1.7 QV	03/88→12/89	Petrol	AR 30550	1712	4	87.00	72.20	42
33 1.8 TD	01/86→06/90	Diesel	VM 82 A	1779	3	92.00	89.20	48
33 1.8 TD	01/86→09/94	Diesel	VM 96 A	1779	3	92.00	89.20	48
75 1.6	05/85→09/89	Petrol	AR 06100	1567	4	78.00	82.00	7
75 1.6	05/85→02/92	Petrol	AR 61101	1567	4	78.00	82.00	7
75 1.8	08/89→02/92	Petrol	AR 67101	1773	4	84.00	80.00	37
75 1.8	09/88→02/92	Petrol	AR 06168	1779	4	80.00	88.50	15
75 1.8	09/85→06/89	Petrol	AR 06202	1779	4	80.00	88.50	15
75 1.8	09/88→02/92	Petrol	AR 61102	1779	4	80.00	88.50	15
75 1.8	08/89→02/92	Petrol	AR 61201	1779	4	80.00	88.50	15
75 1.8	05/89→12/92	Petrol	AR 61202	1779	4	80.00	88.50	15
75 1.8 Turbo	09/86→02/92	Petrol	AR 06134	1779	4	80.00	88.50	15
75 1.8 Turbo i.e.	02/86→01/90	Petrol	AR 06134	1779	4	80.00	88.50	15
75 1.8 Turbo i.e.	02/86→01/90	Petrol	AR 06158	1779	4	80.00	88.50	15
75 2.0	05/85→10/88	Petrol	AR 06212	1962	4	84.00	88.50	38
75 2.0 T.S	05/85→02/92	Petrol	AR 06224	1962	4	84.00	88.50	38
75 2.0 T.S.	01/87→02/92	Petrol	AR 06166	1962	4	84.00	88.50	38
75 2.0 T.S.	01/87→02/92	Petrol	AR 06224	1962	4	84.00	88.50	38
75 2.0 TD	05/85→09/92	Diesel	VM 80 A	1995	4	88.00	82.00	45
75 2.4 TD	01/89→02/92	Diesel	VM 81 A	2393	4	92.00	90.00	49
75 2.5 V6	05/85→08/86	Petrol	AR 01646	2492	V6	88.00	68.30	44
75 2.5 V6	05/85→08/86	Petrol	AR 01648	2492	V6	88.00	68.30	44
75 2.5 V6	05/85→08/86	Petrol	AR 01911	2492	V6	88.00	68.30	44
75 2.5 V6 CAT	09/86→05/90	Petrol	AR 01648	2492	V6	88.00	68.30	44



cm3 x



75 3.0 V6	01/87→02/92	Petrol	AR 06124	2959	V6	93.00	72.60	51
75 3.0 V6	02/90→02/92	Petrol	AR 61503	2959	V6	93.00	72.60	51
90 1.8	10/84→07/87	Petrol	AR 06202	1779	4	80.00	88.50	15
90 2.0 i.e.	10/84→07/87	Petrol	AR 01713	1962	4	84.00	88.50	38
90 2.0 i.e.	10/84→07/87	Petrol	AR 06212	1962	4	84.00	88.50	38
90 2.0 i.e.	10/84→07/87	Petrol	AR 06210	1997	V6	80.00	66.20	12
90 2.4 TD	10/84→07/87	Diesel	VM 81 A	2393	4	92.00	90.00	49
90 2.5 i.e. V6	10/84→07/87	Petrol	AR 01646	2492	V6	88.00	68.30	44
90 2.5 i.e. V6	10/84→07/87	Petrol	AR 01911	2492	V6	88.00	68.30	44
145 1.4 i.e.	07/94→12/96	Petrol	AR 33501	1351	4	80.00	67.20	13
145 1.4 i.e. 16V T.S.	12/96→01/01	Petrol	AR 33503	1370	4	82.00	64.90	17
145 1.4 i.e. 16V T.S.	12/96→01/01	Petrol	AR 38501	1370	4	82.00	64.90	17
145 1.6 16V T.S.	09/97→12/00	Petrol	AR 32102	1598	4	82.00	75.70	18
145 1.6 i.e.	10/94→12/96	Petrol	AR 33201	1596	4	84.00	72.00	35
145 1.6 i.e. 16V T.S.	12/96→01/01	Petrol	AR 38201	1598	4	82.00	75.70	18
145 1.6 i.e. 16V T.S.	12/96→01/01	Petrol	AR 67601	1598	4	82.00	75.70	18
145 1.7 i.e. 16V	10/94→12/96	Petrol	AR 33401	1712	4	87.00	72.20	43
145 1.8 i.e. 16V	03/98→01/01	Petrol	AR 32201	1747	4	82.00	82.70	19
145 1.8 i.e. 16V T.S.	12/96→12/98	Petrol	AR 38401	1747	4	82.00	82.70	19
145 1.8 i.e. 16V T.S.	12/96→12/98	Petrol	AR 67106	1747	4	82.00	82.70	19
145 1.8 i.e. 16V T.S.	12/96→12/98	Petrol	AR 67199	1747	4	82.00	82.70	19
145 1.9 D	07/94→02/99	Diesel	AR 67501	1929	4	82.60	90.00	27
145 1.9 JTD	02/99→01/01	Diesel	AR 32302	1910	4	82.00	90.40	20
145 1.9 TD	10/94→02/99	Diesel	AR 33601	1929	4	82.60	90.00	27
145 1.9 TD	10/94→02/99	Diesel	AR 67501	1929	4	82.60	90.00	27
145 2.0 16V Quadrifoglio	03/98→01/01	Petrol	AR 32301	1970	4	83.00	91.00	32
145 2.0 16V T.S.	10/95→01/01	Petrol	AR 67204	1970	4	83.00	91.00	32
146 1.4 i.e.	12/94→12/96	Petrol	AR 33501	1351	4	80.00	67.20	13
146 1.4 i.e. 16V T.S.	11/96→01/01	Petrol	AR 33503	1370	4	82.00	64.90	17
146 1.4 i.e. 16V T.S.	11/96→01/01	Petrol	AR 38501	1370	4	82.00	64.90	17
146 1.6 16V T.S.	09/97→12/00	Petrol	AR 32102	1598	4	82.00	75.70	18
146 1.6 i.e.	12/94→12/96	Petrol	AR 33201	1596	4	84.00	72.00	35
146 1.6 i.e. 16V T.S.	11/96→01/01	Petrol	AR 38201	1598	4	82.00	75.70	18
146 1.6 i.e. 16V T.S.	11/96→01/01	Petrol	AR 67601	1598	4	82.00	75.70	18
146 1.7 i.e. 16V	12/94→12/96	Petrol	AR 33401	1712	4	87.00	72.20	43
146 1.8 i.e. 16V T.S.	03/98→01/01	Petrol	AR 32201	1747	4	82.00	82.70	19
146 1.8 i.e. 16V T.S.	11/96→01/01	Petrol	AR 38401	1747	4	82.00	82.70	19
146 1.8 i.e. 16V T.S.	11/96→01/01	Petrol	AR 67106	1747	4	82.00	82.70	19
146 1.9 D	05/95→09/96	Diesel	AR 67501	1929	4	82.60	90.00	27
146 1.9 JTD	02/99→01/01	Diesel	AR 32302	1910	4	82.00	90.40	20
146 1.9 TD	12/94→02/99	Diesel	AR 33601	1929	4	82.60	90.00	27
146 1.9 TD	12/94→02/99	Diesel	AR 67501	1929	4	82.60	90.00	27
146 2.0 16V Quadrifoglio	03/98→01/01	Petrol	AR 32301	1970	4	83.00	91.00	32
146 2.0 16V T.S.	10/95→01/01	Petrol	AR 67204	1970	4	83.00	91.00	32
147 1.6 16V T.Spark	01/01→03/10	Petrol	AR 32104	1598	4	82.00	75.70	18
147 1.6 16V T.Spark Eco	01/01→03/10	Petrol	AR 37203	1598	4	82.00	75.70	18
147 1.9 JTD	06/03→03/10	Diesel	182 B9.000	1910	4	82.00	90.40	20
147 1.9 JTD	04/01→03/10	Diesel	937 A2.000	1910	4	82.00	90.40	20
147 1.9 JTD 16V	11/02→03/10	Diesel	192 A5.000	1910	4	82.00	90.40	21
147 1.9 JTD 16V	10/04→03/10	Diesel	192 B1.000	1910	4	82.00	90.40	21
147 1.9 JTD 16V	09/03→09/04	Diesel	937 A4.000	1910	4	82.00	90.40	21
147 1.9 JTDM	10/04→03/10	Diesel	939 A7.000	1910	4	82.00	90.40	20
147 1.9 JTDM 8V	07/05→03/10	Diesel	937 A3.000	1910	4	82.00	90.40	21
147 1.9 JTDM 16V	09/04→03/10	Diesel	937 A5.000	1910	4	82.00	90.40	21
147 1.9 JTDM 16V	06/08→03/10	Diesel	937 A6.000	1910	4	82.00	90.40	21
147 2.0	07/02→05/05	Petrol	937 A1.000	1970	4	83.00	91.00	31
147 2.0 16V T.Spark	01/01→03/10	Petrol	AR 32310	1970	4	83.00	91.00	32
155 1.6 16V T.S.	05/96→12/97	Petrol	AR 67601	1598	4	82.00	75.70	18
155 1.7 T.S.	04/93→04/96	Petrol	AR 67103	1748	4	83.40	80.00	33
155 1.7 T.S.	04/93→04/96	Petrol	AR 67105	1748	4	83.40	80.00	33
155 1.7 T.S. 16V	05/96→12/97	Petrol	AR 67106	1747	4	82.00	82.70	19
155 1.8 T.S.	02/92→12/97	Petrol	AR 67402	1756	4	84.00	79.20	36
155 1.8 T.S.	02/92→06/93	Petrol	AR 67101	1773	4	84.00	80.00	37
155 1.8 T.S.	01/92→12/96	Petrol	AR 67101	1773	4	84.00	80.00	37
155 1.8 T.S.	01/92→12/96	Petrol	AR 67102	1773	4	84.00	80.00	37
155 1.9 TD	04/93→12/97	Diesel	AR 67501	1929	4	82.60	90.00	27
155 2.0 16V Turbo Q4	01/92→12/97	Petrol	AR 67203	1995	4	84.00	90.00	41
155 2.0 T.S.	02/92→04/93	Petrol	AR 67201	1995	4	84.00	90.00	39
155 2.0 T.S.	02/92→02/95	Petrol	AR 67202	1995	4	84.00	90.00	39

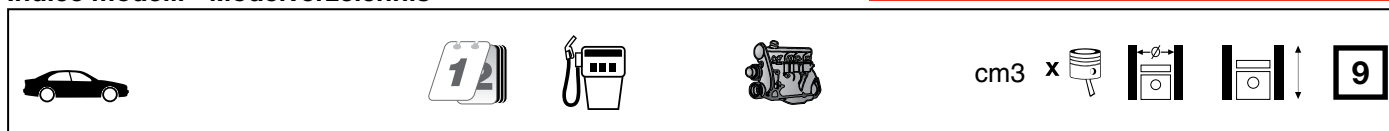









155 2.0 T.S. 16V	03/95→12/97	Petrol	AR 67204	1970	4	83.00	91.00	32
155 2.0 T.S. 16V	03/95→12/97	Petrol	AR 67299	1970	4	83.00	91.00	32
155 2.5 V6	02/92→09/96	Petrol	AR 67301	2492	V6	88.00	68.30	44
155 2.5 V6	10/92→12/97	Petrol	AR 67302	2492	V6	91.35	63.40	47
155 2.5 V6	10/92→12/97	Petrol	AR 67303	2492	V6	88.00	68.30	44
155 2.5 TD	04/93→12/97	Diesel	VM 07 B	2499	4	92.00	94.00	50
155 2.5 TD	04/93→12/97	Diesel	VM 31 B	2499	4	92.00	94.00	50
156 1.6 16V T.Spark	09/97→09/05	Petrol	AR 32102	1598	4	82.00	75.70	18
156 1.6 16V T.Spark	09/97→09/05	Petrol	AR 32103	1598	4	82.00	75.70	18
156 1.6 16V T.Spark	09/97→09/05	Petrol	AR 32104	1598	4	82.00	75.70	18
156 1.6 16V T.Spark	09/97→09/05	Petrol	AR 67601	1598	4	82.00	75.70	18
156 1.6 16V T.Spark	05/00→05/06	Petrol	AR 32102	1598	4	82.00	75.70	18
156 1.6 16V T.Spark	05/00→05/06	Petrol	AR 32103	1598	4	82.00	75.70	18
156 1.6 16V T.Spark	05/00→05/06	Petrol	AR 32104	1598	4	82.00	75.70	18
156 1.6 16V T.Spark	05/00→05/06	Petrol	AR 67601	1598	4	82.00	75.70	18
156 1.8 16V T.Spark	09/97→10/00	Petrol	AR 32201	1747	4	82.00	82.70	19
156 1.8 16V T.Spark	10/00→05/06	Petrol	AR 32205	1747	4	82.00	82.70	19
156 1.9 JTD	11/02→11/04	Diesel	192 B1.000	1910	4	82.00	90.40	21
156 1.9 JTD	05/01→05/06	Diesel	937 A2.000	1910	4	82.00	90.40	20
156 1.9 JTD	11/03→05/06	Diesel	937 A4.000	1910	4	82.00	90.40	21
156 1.9 JTD	07/04→05/06	Diesel	937 A5.000	1910	4	82.00	90.40	21
156 1.9 JTD	09/97→10/00	Diesel	AR 32302	1910	4	82.00	90.40	20
156 1.9 JTD	10/00→05/01	Diesel	AR 37101	1910	4	82.00	90.40	20
156 1.9 JTD 16V	11/02→05/06	Diesel	192 A5.000	1910	4	82.00	90.40	21
156 1.9 JTD 16V Q4	07/04→05/06	Diesel	937 A5.000	1910	4	82.00	90.40	21
156 2.0 16V T.Spark	09/97→06/02	Petrol	AR 32301	1970	4	83.00	91.00	32
156 2.0 16V T.Spark	10/00→03/02	Petrol	AR 32310	1970	4	83.00	91.00	32
156 2.0 JTS	11/97→05/06	Petrol	932 A2.000	1970	4	83.00	91.00	31
156 2.0 JTS	03/02→05/06	Petrol	937 A1.000	1970	4	83.00	91.00	31
156 2.4 JTD	10/00→05/06	Diesel	839 A6.000	2387	5	82.00	90.40	23
156 2.4 JTD	03/02→05/06	Diesel	841 C000	2387	5	82.00	90.40	23
156 2.4 JTD	10/03→05/06	Diesel	841 G.000	2387	5	82.00	90.40	24
156 2.4 JTD	06/03→05/06	Diesel	841 M.000	2387	5	82.00	90.40	24
156 2.4 JTD	06/03→05/06	Diesel	841 N.000	2387	5	82.00	90.40	25
156 2.4 JTD	09/97→09/03	Diesel	AR 32501	2387	5	82.00	90.40	23
156 2.5 V6 24V	09/97→08/03	Petrol	AR 32401	2492	V6	88.00	68.30	44
156 2.5 V6 24V	09/97→12/01	Petrol	AR 32402	2492	V6	88.00	68.30	44
156 2.5 V6 24V	10/00→05/06	Petrol	AR 32405	2492	V6	88.00	68.30	44
159 1.8 TBi	05/09→11/11	Petrol	939 B1.000	1742	4	83.00	80.50	28
159 1.9 JTDM 8V	09/05→11/11	Diesel	937 A7.000	1910	4	82.00	90.40	21
159 1.9 JTDM 8V	09/05→11/11	Diesel	939 A1.000	1910	4	82.00	90.40	20
159 1.9 JTDM 8V	09/05→11/11	Diesel	939 A7.000	1910	4	82.00	90.40	20
159 1.9 JTDM 16V	09/05→11/11	Diesel	937 A8.000	1910	4	82.00	90.40	21
159 1.9 JTDM 16V	09/05→11/11	Diesel	939 A2.000	1910	4	82.00	90.40	21
159 1.9 JTDM 16V	09/05→11/11	Diesel	939 A8.000	1910	4	82.00	90.40	21
159 2.0 JTDM	05/09→11/11	Diesel	844 A2.000	1956	4	83.00	90.40	30
159 2.4 JTDM	09/05→11/11	Diesel	939 A3.000	2387	5	82.00	90.40	25
164 2.0	06/87→09/98	Petrol	AR 06416	1962	4	84.00	88.50	38
164 2.0	11/87→10/92	Petrol	AR 64103	1995	4	84.00	90.00	39
164 2.0 V6 Turbo	03/91→09/92	Petrol	AR 64101	1996	V6	80.00	66.20	12
164 2.0 V6 Turbo	09/92→09/98	Petrol	AR 64102	1996	V6	80.00	66.20	12
164 2.0 T.S.	06/87→09/92	Petrol	AR 06416	1962	4	84.00	88.50	38
164 2.0 T.S.	06/87→12/90	Petrol	AR 06420	1995	4	84.00	90.00	39
164 2.0 T.S.	09/92→09/98	Petrol	AR 64103	1995	4	84.00	90.00	39
164 2.0 Turbo	10/87→09/98	Petrol	AR 06476	1995	4	84.00	90.00	40
164 2.0 Turbo	07/90→10/92	Petrol	AR 64102	1996	V6	80.00	66.20	12
164 2.0 Twin Spark	07/90→10/92	Petrol	AR 06416	1962	4	84.00	88.50	38
164 2.0 Twin Spark	06/87→06/90	Petrol	AR 06420	1995	4	84.00	90.00	39
164 2.5 V6	09/92→09/98	Petrol	AR 66201	2492	V6	88.00	68.30	44
164 2.5 TD	09/92→09/98	Diesel	VM 08 B	2499	4	92.00	94.00	50
164 2.5 TD	09/92→09/98	Diesel	VM 32 B	2499	4	92.00	94.00	50
164 2.5 TD	06/87→09/92	Diesel	VM 84 A	2499	4	92.00	94.00	50
164 3.0	11/87→12/93	Petrol	AR 06410	2959	V6	93.00	72.60	51
164 3.0	04/93→08/97	Petrol	AR 64304	2959	V6	93.00	72.60	51
164 3.0	10/94→08/97	Petrol	AR 64399	2959	V6	93.00	72.60	51
164 3.0	03/95→10/97	Petrol	AR 66306	2959	V6	93.00	72.60	51
164 3.0 24V	09/92→09/98	Petrol	AR 64306	2959	V6	93.00	72.60	51
164 3.0 24V	11/92→10/97	Petrol	AR 64308	2959	V6	93.00	72.60	51
164 3.0 24V	09/92→09/98	Petrol	AR 66301	2959	V6	93.00	72.60	51



cm3 x







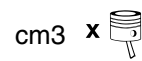







164 3.0 24V	09/92→09/98	Petrol	AR 66302	2959	V6	93.00	72.60	51
164 3.0 24V Q4	02/94→09/98	Petrol	AR 64307	2959	V6	93.00	72.60	51
164 3.0 24V Q4	02/94→09/98	Petrol	AR 64308	2959	V6	93.00	72.60	51
164 3.0 24V QV	09/92→09/98	Petrol	AR 64304	2959	V6	93.00	72.60	51
164 3.0 24V QV All-wheel Drive	11/92→10/97	Petrol	AR 64304	2959	V6	93.00	72.60	51
164 3.0 24V QV All-wheel Drive	11/92→10/97	Petrol	AR 64307	2959	V6	93.00	72.60	51
164 3.0 i.e. QV	09/90→09/92	Petrol	AR 06430	2959	V6	93.00	72.60	51
164 3.0 i.e. QV	09/90→09/92	Petrol	AR 64301	2959	V6	93.00	72.60	51
164 3.0 V6	06/87→09/92	Petrol	AR 06410	2959	V6	93.00	72.60	51
164 3.0 V6	06/87→09/92	Petrol	AR 06412	2959	V6	93.00	72.60	51
164 3.0 V6	09/92→09/98	Petrol	AR 64303	2959	V6	93.00	72.60	51
164 3.0 V6	09/92→09/98	Petrol	AR 64305	2959	V6	93.00	72.60	51
164 3.0 V6	09/92→09/98	Petrol	AR 64399	2959	V6	93.00	72.60	51
164 3.0 V6	09/92→09/98	Petrol	AR 66303	2959	V6	93.00	72.60	51
166 2.0 V6	09/98→10/00	Petrol	AR 34102	1996	V6	80.00	66.20	12
166 2.0 T.Spark	09/98→10/00	Petrol	AR 34103	1970	4	83.00	91.00	32
166 2.0 T.Spark	10/00→06/07	Petrol	AR 36301	1970	4	83.00	91.00	32
166 2.4 JTD	10/00→06/07	Diesel	839 A6.000	2387	5	82.00	90.40	23
166 2.4 JTD	04/02→06/07	Diesel	841 C000	2387	5	82.00	90.40	23
166 2.4 JTD	10/03→06/07	Diesel	841 G.000	2387	5	82.00	90.40	24
166 2.4 JTD	10/03→06/07	Diesel	841 H.000	2387	5	82.00	90.40	24
166 2.4 JTD	10/03→06/07	Diesel	841 M.000	2387	5	82.00	90.40	24
166 2.4 JTD	10/03→06/07	Diesel	841 N.000	2387	5	82.00	90.40	25
166 2.4 JTD	07/05→06/07	Diesel	936 B.000	2387	5	82.00	90.40	25
166 2.4 JTD	09/98→10/00	Diesel	AR 34202	2387	5	82.00	90.40	23
166 2.5 V6 24V	09/98→10/00	Petrol	AR 34201	2492	V6	88.00	68.30	44
166 2.5 V6 24V	10/00→06/07	Petrol	AR 36201	2492	V6	88.00	68.30	44
166 3.0 V6 24V	09/98→10/00	Petrol	AR 34301	2959	V6	93.00	72.60	51
166 3.0 V6 24V	09/98→10/00	Petrol	AR 34302	2959	V6	93.00	72.60	51
166 3.0 V6 24V	10/00→06/07	Petrol	AR 36101	2959	V6	93.00	72.60	51
1750-2000 1750	03/68→10/72	Petrol	AR 00548	1779	4	80.00	88.50	15
1750-2000 2000	10/71→07/75	Petrol	AR 10520	1962	4	84.00	88.50	38
A11 / A12 1.3	01/67→12/71	Petrol	AR 00500	1290	4	74.00	75.00	6
A11 / A12 1.3	01/67→12/83	Petrol	AR 00504	1290	4	74.00	75.00	6
Alfasud 1.2	06/72→09/84	Petrol	AR 30102	1186	4	80.00	59.00	10
Alfasud 1.2	03/80→09/84	Petrol	AR 30102 S	1186	4	80.00	59.00	10
Alfasud 1.2 ti	11/73→09/84	Petrol	AR 30104	1186	4	80.00	59.00	10
Alfasud 1.3	01/78→02/80	Petrol	AR 30180	1286	4	80.00	64.00	11
Alfasud 1.3	09/76→12/81	Petrol	AR 30184	1286	4	80.00	64.00	11
Alfasud 1.3	03/80→12/81	Petrol	AR 30160	1351	4	80.00	67.20	13
Alfasud 1.3 SC/ti Super	09/77→09/84	Petrol	AR 30164	1351	4	80.00	67.20	13
Alfasud 1.3 Super	01/79→09/84	Petrol	AR 30160	1351	4	80.00	67.20	13
Alfasud 1.3 ti	09/77→09/84	Petrol	AR 30184	1286	4	80.00	64.00	11
Alfasud 1.3 ti	03/80→12/84	Petrol	AR 30168	1351	4	80.00	67.20	13
Alfasud 1.4	05/78→02/80	Petrol	AR 30164	1351	4	80.00	67.20	13
Alfasud 1.4	07/79→12/89	Petrol	AR 30168	1351	4	80.00	67.20	13
Alfasud 1.5	05/78→12/81	Petrol	AR 30124	1490	4	84.00	67.20	34
Alfasud 1.5	07/79→01/87	Petrol	AR 30128	1490	4	84.00	67.20	34
Alfasud 1.5	01/83→12/87	Petrol	AR 30146	1490	4	84.00	67.20	34
Alfasud 1.5 ti	01/79→09/84	Petrol	AR 30124	1490	4	84.00	67.20	34
Alfasud 1.5 ti	03/80→12/84	Petrol	AR 30128	1490	4	84.00	67.20	34
Alfasud 1.5 ti Sprint	01/83→12/84	Petrol	AR 30146	1490	4	84.00	67.20	34
Alfasud 1.5 Veloce	01/80→12/87	Petrol	AR 30146	1490	4	84.00	67.20	34
Alfasud 1.7	03/87→12/89	Petrol	AR 30550	1712	4	87.00	72.20	42
Alfasud 1.7 i.e.	10/87→12/89	Petrol	AR 30558	1712	4	87.00	72.20	42
Alfetta 1.6	01/75→12/84	Petrol	AR 01600	1570	4	78.00	82.00	7
Alfetta 1.8	10/79→12/84	Petrol	AR 01608	1779	4	80.00	88.50	15
Alfetta 1.8	07/74→12/77	Petrol	AR 01608 X	1779	4	80.00	88.50	15
Alfetta 1.8	10/79→12/84	Petrol	AR 01678	1779	4	80.00	88.50	15
Alfetta 2.0	09/74→02/80	Petrol	AR 01623	1962	4	84.00	88.50	38
Alfetta 2.0	07/78→12/84	Petrol	AR 01655	1962	4	84.00	88.50	38
Alfetta 2.0	07/78→12/84	Petrol	AR 01713	1962	4	84.00	88.50	38
Alfetta 2.0	07/78→12/84	Petrol	AR 10520	1962	4	84.00	88.50	38
Alfetta 2.0 TD	10/79→03/83	Diesel	VM4HT/2	1995	4	88.00	82.00	45
Alfetta 2.4 TD	04/83→12/84	Diesel	VM4HT 2.4	2393	4	92.00	90.00	49
Alfetta GT 1.6	01/76→09/82	Petrol	AR 01600	1570	4	78.00	82.00	7
Alfetta GT 1.8	01/74→12/76	Petrol	AR 01608	1779	4	80.00	88.50	15
Alfetta GT 1.8	01/74→12/76	Petrol	AR 01608 X	1779	4	80.00	88.50	15
Alfetta GT 2.0	07/78→01/86	Petrol	AR 01623	1962	4	84.00	88.50	38







				cm3	x 			
Alfetta GT 2.0	06/77→12/84	Petrol	AR 01655	1962	4	84.00	88.50	38
Alfetta GT 2.0	09/74→12/77	Petrol	AR 11634	1962	4	84.00	88.50	38
AR 6 1.9 D	04/85→12/89	Diesel	160 D100	1929	4	82.60	90.00	26
AR 6 2.4 D	04/85→02/86	Diesel	8144.61.200	2445	4	93.00	90.00	52
AR 6 2.4 TD	09/86→12/89	Diesel	8144.21.220	2445	4	93.00	90.00	52
AR 6 2.5 D	03/86→12/89	Diesel	8144.67.220	2499	4	93.00	92.00	53
AR 8 2.4 D	04/78→08/86	Diesel	8140.61.200	2445	4	93.00	90.00	52
AR 8 2.4 TD	04/85→12/89	Diesel	8140.21.200 D.I.	2445	4	93.00	90.00	52
AR 8 2.5 D	09/86→12/89	Diesel	8144.67.220	2499	4	93.00	92.00	53
Arna 1.2	03/83→12/86	Petrol	AR 30102	1186	4	80.00	59.00	10
Arna 1.2	01/85→12/86	Petrol	AR 30500	1186	4	80.00	59.00	10
Arna 1.2	01/85→12/86	Petrol	AR 31000	1186	4	80.00	59.00	10
Arna 1.3	01/85→12/86	Petrol	AR 30100	1351	4	80.00	67.20	13
Arna 1.3 TI	03/83→12/86	Petrol	AR 30168	1351	4	80.00	67.20	13
Arna 1.3 TI	03/83→12/86	Petrol	AR 31010	1351	4	80.00	67.20	13
Arna 1.5	01/85→12/86	Petrol	AR 30182	1490	4	84.00	67.20	34
Berlina 1.8	09/68→12/72	Petrol	AR 00548	1779	4	80.00	88.50	15
Berlina 1.8	09/68→12/72	Petrol	AR 01608	1779	4	80.00	88.50	15
Brera 1.8 TBi	05/09→06/10	Petrol	939 B1.000	1742	4	83.00	80.50	28
Brera 2.0 JTDM	03/08→06/10	Diesel	844 A2.000	1956	4	83.00	90.40	30
Brera 2.4 JTDM 20V	01/06→06/10	Diesel	939 A3.000	2387	5	82.00	90.40	25
F11 / F12 1.3	01/67→12/71	Petrol	AR 00500	1290	4	74.00	75.00	6
F11 / F12 1.3	01/67→12/83	Petrol	AR 00504	1290	4	74.00	75.00	6
Giulia 1.6	03/62→12/66	Petrol	AR 00112	1570	4	78.00	82.00	7
Giulia 1.6	03/62→12/66	Petrol	AR 00121	1570	4	78.00	82.00	7
Giulia 1.6 T.I	01/62→12/78	Petrol	AR 00112	1570	4	78.00	82.00	7
Giulia 1.6 T.I. Super	01/63→12/78	Petrol	AR 00516	1570	4	78.00	82.00	7
Giulia 1.8 D	06/76→12/78	Diesel	4.108	1760	4	79.38	88.60	8
Giulia 1300	01/64→08/69	Petrol	AR 00506	1290	4	74.00	75.00	6
Giulia 1300 Super	01/74→12/78	Petrol	AR 00530	1290	4	74.00	75.00	6
Giulia 1600 Super	06/64→12/78	Petrol	AR 00526	1570	4	78.00	82.00	7
Giulia GT 1300 Super	01/74→12/78	Petrol	AR 00530	1290	4	74.00	75.00	6
Giulia GT 1600 Sprint	01/62→12/64	Petrol	AR 00112	1570	4	78.00	82.00	7
Giulia GT 1600 Sprint	01/63→12/65	Petrol	AR 00121	1570	4	78.00	82.00	7
Giulia GT 1600 Super	01/74→12/78	Petrol	AR 00526	1570	4	78.00	82.00	7
Giulietta 1.3	01/55→12/62	Petrol	AR 00500	1290	4	74.00	75.00	6
Giulietta 1.3	01/54→12/62	Petrol	AR 00501	1290	4	74.00	75.00	6
Giulietta 1.3	01/61→12/62	Petrol	AR 00502	1290	4	74.00	75.00	6
Giulietta 1.3	01/58→12/62	Petrol	AR 00504	1290	4	74.00	75.00	6
Giulietta 1.3	01/61→12/62	Petrol	AR 00508	1290	4	74.00	75.00	6
Giulietta 1.3	01/56→12/62	Petrol	AR 00510	1290	4	74.00	75.00	6
Giulietta 1.3	01/58→12/61	Petrol	AR 00514	1290	4	74.00	75.00	6
Giulietta 1.3	10/77→06/83	Petrol	AR 01644	1357	4	80.00	67.50	14
Giulietta 1.3 ti	01/57→12/62	Petrol	AR 00502	1290	4	74.00	75.00	6
Giulietta 1.4 BiFuel	12/11→	Petrol	198 A4.000	1368	4	72.00	84.00	2
Giulietta 1.4 TB	04/10→	Petrol	198 A4.000	1368	4	72.00	84.00	2
Giulietta 1.4 TB	04/10→	Petrol	940 A6.000	1368	4	72.00	84.00	3
Giulietta 1.4 TB	04/11→	Petrol	940 B1.000	1368	4	72.00	84.00	2
Giulietta 1.4 TB	04/10→	Petrol	940 B7.000	1368	4	72.00	84.00	2
Giulietta 1.4 TB	04/11→	Petrol	940 B8.000	1368	4	72.00	84.00	2
Giulietta 1.4 TB	04/10→	Petrol	955 A8.000	1368	4	72.00	84.00	3
Giulietta 1.6	10/77→04/85	Petrol	AR 01600	1570	4	78.00	82.00	7
Giulietta 1.6 JTDM	04/10→	Diesel	940 A3.000	1598	4	79.50	80.50	9
Giulietta 1.8	04/79→07/85	Petrol	AR 01678	1779	4	80.00	88.50	15
Giulietta 1.8 Turbo	01/84→12/85	Petrol	AR 01354	1779	4	80.00	88.50	15
Giulietta 2.0	06/80→04/85	Petrol	AR 01655	1962	4	84.00	88.50	38
Giulietta 2.0	06/80→04/85	Petrol	AR 11671	1962	4	84.00	88.50	38
Giulietta 2.0 JTDM	04/10→	Diesel	940 A4.000	1956	4	83.00	90.40	29
Giulietta 2.0 TD	01/83→12/85	Diesel	VM 4 HT	1995	4	88.00	82.00	45
GT 1.8 TS	11/03→09/10	Petrol	AR 32205	1747	4	82.00	82.70	19
GT 1.9 JTD	11/03→09/10	Diesel	937 A5.000	1910	4	82.00	90.40	21
GT 1.9 JTD	05/08→09/10	Diesel	937 A6.000	1910	4	82.00	90.40	21
GT 2.0 JTS	11/03→09/10	Petrol	932 A2.000	1970	4	83.00	91.00	31
GT 2.0 JTS	11/03→09/10	Petrol	937 A1.000	1970	4	83.00	91.00	31
GT 1300 Junior	01/66→12/77	Petrol	AR 00530	1290	4	74.00	75.00	6
GT 1600	03/63→12/77	Petrol	AR 00526 S	1570	4	78.00	82.00	7
GT 1600	01/66→12/77	Petrol	AR 00536	1570	4	78.00	82.00	7
GT A 1600	01/65→12/70	Petrol	AR 10538	1570	4	78.00	82.00	7
GT V 1750	01/67→12/72	Petrol	AR 00548	1779	4	80.00	88.50	15









GT V 2000	01/71→12/77	Petrol	AR 10527	1962	4	84.00	88.50	38
GTA 1.3 Junior	05/68→12/76	Petrol	AR 10531	1290	4	74.00	75.00	6
GTA 1.3 Junior	05/68→12/76	Petrol	AR 10534	1290	4	74.00	75.00	6
GTV 1.8 16V	05/98→10/05	Petrol	AR 32201	1747	4	82.00	82.70	19
GTV 2.0	07/78→01/86	Petrol	AR 01655	1962	4	84.00	88.50	38
GTV 2.0	07/78→01/86	Petrol	AR 06212	1962	4	84.00	88.50	38
GTV 2.0 V6 Turbo	06/95→09/98	Petrol	AR 16202	1996	V6	80.00	66.20	12
GTV 2.0 JTS	04/03→10/05	Petrol	937 A1.000	1970	4	83.00	91.00	31
GTV 2.0 T.Spark 16V	06/95→10/05	Petrol	AR 16201	1970	4	83.00	91.00	32
GTV 2.0 T.Spark 16V	05/98→08/00	Petrol	AR 32301	1970	4	83.00	91.00	32
GTV 2.0 T.Spark 16V	06/95→10/05	Petrol	AR 32310	1970	4	83.00	91.00	32
GTV 3.0 V6 24V	10/96→10/00	Petrol	AR 16102	2959	V6	93.00	72.60	51
GTV 3.0 V6 24V	10/00→10/05	Petrol	AR 16105	2959	V6	93.00	72.60	51
GTV 6 2.5	11/80→02/87	Petrol	AR 01646	2492	V6	88.00	68.30	44
Mito 0.9	12/13→	Petrol	199 B6.000	875	2	80.50	86.00	16
Mito 0.9 TwinAir	04/13→	Petrol	199 B6.000	875	2	80.50	86.00	16
Mito 0.9 TwinAir	07/11→	Petrol	312 A2.000	875	2	80.50	86.00	16
Mito 1.3 MultiJet	09/08→	Diesel	199 A3.000	1248	4	69.60	82.00	1
Mito 1.3 MultiJet	10/09→	Diesel	199 B1.000	1248	4	69.60	82.00	1
Mito 1.3 MultiJet	01/11→	Diesel	199 B4.000	1248	4	69.60	82.00	1
Mito 1.3 MultiJet	12/13→	Diesel	199 B8.000	1248	4	69.60	82.00	1
Mito 1.4	09/08→	Petrol	199 A6.000	1368	4	72.00	84.00	3
Mito 1.4	03/11→	Petrol	350 A1.000	1368	4	72.00	84.00	3
Mito 1.4	09/08→	Petrol	955 A1.000	1368	4	72.00	84.00	3
Mito 1.4	05/11→	Petrol	955 A9.000	1368	4	72.00	84.00	4
Mito 1.4 Bifuel	07/11→	Petrol	198 A4.000	1368	4	72.00	84.00	2
Mito 1.4 MultiAir	08/10→	Petrol	955 A6.000	1368	4	72.00	84.00	3
Mito 1.4 TB	12/13→	Petrol	955 B1.000	1368	4	72.00	84.00	3
Mito 1.4 TJet	09/08→	Petrol	198 A1.000	1368	4	72.00	84.00	2
Mito 1.4 TJet	09/08→	Petrol	198 A4.000	1368	4	72.00	84.00	2
Mito 1.4 TJet	09/08→	Petrol	199 A8.000	1368	4	72.00	84.00	2
Mito 1.4 Turbo MultiAir	10/09→	Petrol	955 A2.000	1368	4	72.00	84.00	3
Mito 1.4 Turbo MultiAir	10/09→	Petrol	955 A7.000	1368	4	72.00	84.00	3
Mito 1.4 Turbo MultiAir	10/09→	Petrol	955 A8.000	1368	4	72.00	84.00	3
Mito 1.6 JTDM	09/08→	Diesel	198 A2.000	1598	4	79.50	80.50	9
Mito 1.6 JTDM	09/08→	Diesel	955 A3.000	1598	4	79.50	80.50	9
Mito 1.6 JTDM	09/08→	Diesel	955 A4.000	1598	4	79.50	80.50	9
Romeo 2 1.3	01/56→12/67	Petrol	AR 00500	1290	4	74.00	75.00	6
RZ 3.0 V6 Zagato	01/92→12/94	Petrol	AR 61501	2959	V6	93.00	72.60	51
Spider 1.8 16V	05/98→04/05	Petrol	AR 32201	1747	4	82.00	82.70	19
Spider 1.8 TBi	05/09→06/10	Petrol	939 B1.000	1742	4	83.00	80.50	28
Spider 2.0	01/74→12/84	Petrol	AR 01615	1962	4	84.00	88.50	38
Spider 2.0 V6 Turbo	05/98→04/05	Petrol	AR 16202	1996	V6	80.00	66.20	12
Spider 2.0 JTDM	04/09→06/10	Diesel	844 A2.000	1956	4	83.00	90.40	30
Spider 2.0 JTS	04/03→04/05	Petrol	937 A1.000	1970	4	83.00	91.00	31
Spider 2.0 T.Spark 16V	06/95→04/05	Petrol	AR 16201	1970	4	83.00	91.00	32
Spider 2.0 T.Spark 16V	05/98→08/00	Petrol	AR 32301	1970	4	83.00	91.00	32
Spider 2.0 T.Spark 16V	06/95→04/05	Petrol	AR 32310	1970	4	83.00	91.00	32
Spider 2.4 JTDM	04/07→06/10	Diesel	939 A3.000	2387	5	82.00	90.40	25
Spider 3.0 V6	06/95→04/05	Petrol	AR 16101	2959	V6	93.00	72.60	51
Spider 3.0 V6	09/94→08/00	Petrol	AR 16105	2959	V6	93.00	72.60	51
Spider 3.0 V6	04/95→04/98	Petrol	AR 16199	2959	V6	93.00	72.60	51
Spider 3.0 V6 24V	01/99→10/03	Petrol	AR 16102	2959	V6	93.00	72.60	51
Spider 1300	01/68→12/77	Petrol	AR 00530	1290	4	74.00	75.00	6
Spider 1600	03/66→12/90	Petrol	AR 00526	1570	4	78.00	82.00	7
Spider 1600	03/66→12/79	Petrol	AR 00536	1570	4	78.00	82.00	7
Spider 1600	01/90→12/93	Petrol	AR 01563	1570	4	78.00	82.00	7
Spider 1600	03/66→12/68	Petrol	AR 01600	1570	4	78.00	82.00	7
Spider 1750	01/67→12/71	Petrol	AR 00548	1779	4	80.00	88.50	15
Spider 2000	01/71→12/77	Petrol	AR 00512	1962	4	84.00	88.50	38
Spider 2000	08/86→12/90	Petrol	AR 00515	1962	4	84.00	88.50	38
Spider 2000	08/86→12/90	Petrol	AR 01544	1962	4	84.00	88.50	38
Spider 2000	01/90→12/93	Petrol	AR 01588	1962	4	84.00	88.50	38
Spider 2000 Veloce	01/77→12/93	Petrol	AR 00515	1962	4	84.00	88.50	38
Spider 2000 Veloce	01/77→12/93	Petrol	AR 01590	1962	4	84.00	88.50	38
Sport 2.0	09/77→12/79	Petrol	AR 01623	1962	4	84.00	88.50	38
Sprint 2.0	09/76→12/79	Petrol	AR 11634	1962	4	84.00	88.50	38
SZ 3.0 V6 Zagato	09/88→08/94	Petrol	AR 61501	2959	V6	93.00	72.60	51

		cm3	x 			
4.108	Diesel	1760	4	79.38	88.60	8
160 D100	Diesel	1929	4	82.60	90.00	26
182 B9.000	Diesel	1910	4	82.00	90.40	20
192 A5.000	Diesel	1910	4	82.00	90.40	21
192 B1.000	Diesel	1910	4	82.00	90.40	21
198 A1.000	Petrol	1368	4	72.00	84.00	2
198 A2.000	Diesel	1598	4	79.50	80.50	9
198 A4.000	Petrol	1368	4	72.00	84.00	2
198 A5.000	Diesel	1956	4	83.00	90.40	29
198 A7.000	Petrol	1368	4	72.00	84.00	2
199 A3.000	Diesel	1248	4	69.60	82.00	1
199 A6.000	Petrol	1368	4	72.00	84.00	3
199 A8.000	Petrol	1368	4	72.00	84.00	2
199 B1.000	Diesel	1248	4	69.60	82.00	1
199 B4.000	Diesel	1248	4	69.60	82.00	1
199 B6.000	Petrol	875	2	80.50	86.00	16
199 B8.000	Diesel	1248	4	69.60	82.00	1
312 A2.000	Petrol	875	2	80.50	86.00	16
350 A1.000	Petrol	1368	4	72.00	84.00	3
839 A6.000	Diesel	2387	5	82.00	90.40	23
841 C000	Diesel	2387	5	82.00	90.40	23
841 G.000	Diesel	2387	5	82.00	90.40	24
841 H.000	Diesel	2387	5	82.00	90.40	24
841 M.000	Diesel	2387	5	82.00	90.40	24
841 N.000	Diesel	2387	5	82.00	90.40	25
844 A1.000	Diesel	1910	4	82.00	90.40	22
844 A2.000	Diesel	1956	4	83.00	90.40	30
932 A2.000	Petrol	1970	4	83.00	91.00	31
936 B.000	Diesel	2387	5	82.00	90.40	25
937 A1.000	Petrol	1970	4	83.00	91.00	31
937 A2.000	Diesel	1910	4	82.00	90.40	20
937 A3.000	Diesel	1910	4	82.00	90.40	21
937 A4.000	Diesel	1910	4	82.00	90.40	21
937 A5.000	Diesel	1910	4	82.00	90.40	21
937 A6.000	Diesel	1910	4	82.00	90.40	21
937 A7.000	Diesel	1910	4	82.00	90.40	21
937 A8.000	Diesel	1910	4	82.00	90.40	21
939 A1.000	Diesel	1910	4	82.00	90.40	20
939 A2.000	Diesel	1910	4	82.00	90.40	21
939 A3.000	Diesel	2387	5	82.00	90.40	25
939 A7.000	Diesel	1910	4	82.00	90.40	20
939 A8.000	Diesel	1910	4	82.00	90.40	21
939 B1.000	Petrol	1742	4	83.00	80.50	28
940 A3.000	Diesel	1598	4	79.50	80.50	9
940 A4.000	Diesel	1956	4	83.00	90.40	29
940 A6.000	Petrol	1368	4	72.00	84.00	3
940 B1.000	Petrol	1368	4	72.00	84.00	2
940 B7.000	Petrol	1368	4	72.00	84.00	2
940 B8.000	Petrol	1368	4	72.00	84.00	2
955 A1.000	Petrol	1368	4	72.00	84.00	3
955 A2.000	Petrol	1368	4	72.00	84.00	3
955 A3.000	Diesel	1598	4	79.50	80.50	9
955 A4.000	Diesel	1598	4	79.50	80.50	9
955 A6.000	Petrol	1368	4	72.00	84.00	3
955 A7.000	Petrol	1368	4	72.00	84.00	3
955 A8.000	Petrol	1368	4	72.00	84.00	3
955 A9.000	Petrol	1368	4	72.00	84.00	4
955 B1.000	Petrol	1368	4	72.00	84.00	3
8140.21.200 D.I.	Diesel	2445	4	93.00	90.00	52
8140.61.200	Diesel	2445	4	93.00	90.00	52
8144.21.220	Diesel	2445	4	93.00	90.00	52
8144.61.200	Diesel	2445	4	93.00	90.00	52
8144.67.220	Diesel	2499	4	93.00	92.00	53
AR 00112	Petrol	1570	4	78.00	82.00	7
AR 00121	Petrol	1570	4	78.00	82.00	7
AR 00500	Petrol	1290	4	74.00	75.00	6
AR 00501	Petrol	1290	4	74.00	75.00	6
AR 00502	Petrol	1290	4	74.00	75.00	6
AR 00504	Petrol	1290	4	74.00	75.00	6

			cm ³	x 			
AR 00506	Petrol		1290	4	74.00	75.00	6
AR 00508	Petrol		1290	4	74.00	75.00	6
AR 00510	Petrol		1290	4	74.00	75.00	6
AR 00512	Petrol		1962	4	84.00	88.50	38
AR 00514	Petrol		1290	4	74.00	75.00	6
AR 00515	Petrol		1962	4	84.00	88.50	38
AR 00516	Petrol		1570	4	78.00	82.00	7
AR 00526	Petrol		1570	4	78.00	82.00	7
AR 00526 S	Petrol		1570	4	78.00	82.00	7
AR 00530	Petrol		1290	4	74.00	75.00	6
AR 00536	Petrol		1570	4	78.00	82.00	7
AR 00548	Petrol		1779	4	80.00	88.50	15
AR 01212	Petrol		1962	4	84.00	88.50	38
AR 01354	Petrol		1779	4	80.00	88.50	15
AR 01544	Petrol		1962	4	84.00	88.50	38
AR 01563	Petrol		1570	4	78.00	82.00	7
AR 01588	Petrol		1962	4	84.00	88.50	38
AR 01590	Petrol		1962	4	84.00	88.50	38
AR 01600	Petrol		1570	4	78.00	82.00	7
AR 01608	Petrol		1779	4	80.00	88.50	15
AR 01608 X	Petrol		1779	4	80.00	88.50	15
AR 01615	Petrol		1962	4	84.00	88.50	38
AR 01623	Petrol		1962	4	84.00	88.50	38
AR 01644	Petrol		1357	4	80.00	67.50	14
AR 01646	Petrol		2492	V6	88.00	68.30	44
AR 01648	Petrol		2492	V6	88.00	68.30	44
AR 01655	Petrol		1962	4	84.00	88.50	38
AR 01678	Petrol		1779	4	80.00	88.50	15
AR 01713	Petrol		1962	4	84.00	88.50	38
AR 01911	Petrol		2492	V6	88.00	68.30	44
AR 01913	Petrol		2492	V6	88.00	68.30	44
AR 01928	Petrol		2492	V6	88.00	68.30	44
AR 01932	Petrol		1997	V6	80.00	66.20	12
AR 06100	Petrol		1567	4	78.00	82.00	7
AR 06120	Petrol		2959	V6	93.00	72.60	51
AR 06124	Petrol		2959	V6	93.00	72.60	51
AR 06134	Petrol		1779	4	80.00	88.50	15
AR 06158	Petrol		1779	4	80.00	88.50	15
AR 06166	Petrol		1962	4	84.00	88.50	38
AR 06168	Petrol		1779	4	80.00	88.50	15
AR 06202	Petrol		1779	4	80.00	88.50	15
AR 06210	Petrol		1997	V6	80.00	66.20	12
AR 06212	Petrol		1962	4	84.00	88.50	38
AR 06224	Petrol		1962	4	84.00	88.50	38
AR 06410	Petrol		2959	V6	93.00	72.60	51
AR 06412	Petrol		2959	V6	93.00	72.60	51
AR 06416	Petrol		1962	4	84.00	88.50	38
AR 06420	Petrol		1995	4	84.00	90.00	39
AR 06430	Petrol		2959	V6	93.00	72.60	51
AR 06476	Petrol		1995	4	84.00	90.00	40
AR 10502	Petrol		1570	4	78.00	82.00	7
AR 10512	Petrol		1962	4	84.00	88.50	38
AR 10520	Petrol		1962	4	84.00	88.50	38
AR 10527	Petrol		1962	4	84.00	88.50	38
AR 10531	Petrol		1290	4	74.00	75.00	6
AR 10534	Petrol		1290	4	74.00	75.00	6
AR 10538	Petrol		1570	4	78.00	82.00	7
AR 10548	Petrol		1779	4	80.00	88.50	15
AR 11633	Petrol		1962	4	84.00	88.50	38
AR 11634	Petrol		1962	4	84.00	88.50	38
AR 11644	Petrol		1357	4	80.00	67.50	14
AR 11650	Petrol		1570	4	78.00	82.00	7
AR 11655	Petrol		1962	4	84.00	88.50	38
AR 11671	Petrol		1962	4	84.00	88.50	38
AR 11900	Petrol		2492	V6	88.00	68.30	44
AR 16101	Petrol		2959	V6	93.00	72.60	51
AR 16102	Petrol		2959	V6	93.00	72.60	51
AR 16105	Petrol		2959	V6	93.00	72.60	51
AR 16199	Petrol		2959	V6	93.00	72.60	51

		cm3	x 			
AR 16201	Petrol	1970	4	83.00	91.00	32
AR 16202	Petrol	1996	V6	80.00	66.20	12
AR 19510	Petrol	1962	4	84.00	88.50	38
AR 19520	Petrol	2959	V6	93.00	72.60	51
AR 30100	Petrol	1351	4	80.00	67.20	13
AR 30102	Petrol	1186	4	80.00	59.00	10
AR 30102 S	Petrol	1186	4	80.00	59.00	10
AR 30104	Petrol	1186	4	80.00	59.00	10
AR 30124	Petrol	1490	4	84.00	67.20	34
AR 30128	Petrol	1490	4	84.00	67.20	34
AR 30143	Petrol	1490	4	84.00	67.20	34
AR 30146	Petrol	1490	4	84.00	67.20	34
AR 30160	Petrol	1351	4	80.00	67.20	13
AR 30164	Petrol	1351	4	80.00	67.20	13
AR 30168	Petrol	1351	4	80.00	67.20	13
AR 30180	Petrol	1286	4	80.00	64.00	11
AR 30182	Petrol	1490	4	84.00	67.20	34
AR 30184	Petrol	1286	4	80.00	64.00	11
AR 30198	Petrol	1490	4	84.00	67.20	34
AR 30500	Petrol	1186	4	80.00	59.00	10
AR 30502	Petrol	1351	4	80.00	67.20	13
AR 30504	Petrol	1490	4	84.00	67.20	34
AR 30508	Petrol	1490	4	73.02	67.20	5
AR 30514	Petrol	1490	4	84.00	67.20	34
AR 30520	Petrol	1490	4	84.00	67.20	34
AR 30550	Petrol	1712	4	87.00	72.20	42
AR 30558	Petrol	1712	4	87.00	72.20	42
AR 30578	Petrol	1712	4	87.00	72.20	42
AR 30585	Petrol	1186	4	80.00	59.00	10
AR 30586	Petrol	1351	4	80.00	67.20	13
AR 30587	Petrol	1351	4	80.00	67.20	13
AR 30588	Petrol	1490	4	84.00	67.20	34
AR 30732	Petrol	1351	4	80.00	67.20	13
AR 30734	Petrol	1490	4	84.00	67.20	34
AR 30736	Petrol	1712	4	87.00	72.20	42
AR 30737	Petrol	1712	4	87.00	72.20	42
AR 30737 A	Petrol	1712	4	87.00	72.20	42
AR 30738	Petrol	1490	4	84.00	67.20	34
AR 30740	Petrol	1712	4	87.00	72.20	42
AR 30743	Petrol	1186	4	80.00	59.00	10
AR 30746	Petrol	1712	4	87.00	72.20	43
AR 30747	Petrol	1712	4	87.00	72.20	43
AR 30750	Petrol	1490	4	84.00	67.20	34
AR 30751	Petrol	1490	4	84.00	67.20	34
AR 30753	Petrol	1351	4	80.00	67.20	13
AR 30755	Petrol	1351	4	80.00	67.20	13
AR 31000	Petrol	1186	4	80.00	59.00	10
AR 31010	Petrol	1351	4	80.00	67.20	13
AR 31016	Petrol	1490	4	84.00	67.20	34
AR 32101	Petrol	1598	4	82.00	75.70	18
AR 32102	Petrol	1598	4	82.00	75.70	18
AR 32103	Petrol	1598	4	82.00	75.70	18
AR 32104	Petrol	1598	4	82.00	75.70	18
AR 32201	Petrol	1747	4	82.00	82.70	19
AR 32205	Petrol	1747	4	82.00	82.70	19
AR 32301	Petrol	1970	4	83.00	91.00	32
AR 32302	Diesel	1910	4	82.00	90.40	20
AR 32303	Petrol	1970	4	83.00	91.00	32
AR 32310	Petrol	1970	4	83.00	91.00	32
AR 32401	Petrol	2492	V6	88.00	68.30	44
AR 32402	Petrol	2492	V6	88.00	68.30	44
AR 32405	Petrol	2492	V6	88.00	68.30	44
AR 32501	Diesel	2387	5	82.00	90.40	23
AR 33201	Petrol	1596	4	84.00	72.00	35
AR 33401	Petrol	1712	4	87.00	72.20	43
AR 33501	Petrol	1351	4	80.00	67.20	13
AR 33503	Petrol	1370	4	82.00	64.90	17
AR 33601	Diesel	1929	4	82.60	90.00	27
AR 34102	Petrol	1996	V6	80.00	66.20	12

			cm ³	x 			
AR 34103	Petrol		1970	4	83.00	91.00	32
AR 34201	Petrol		2492	V6	88.00	68.30	44
AR 34202	Diesel		2387	5	82.00	90.40	23
AR 34301	Petrol		2959	V6	93.00	72.60	51
AR 34302	Petrol		2959	V6	93.00	72.60	51
AR 36101	Petrol		2959	V6	93.00	72.60	51
AR 36201	Petrol		2492	V6	88.00	68.30	44
AR 36202	Diesel		2387	5	82.00	90.40	23
AR 36301	Petrol		1970	4	83.00	91.00	32
AR 37101	Diesel		1910	4	82.00	90.40	20
AR 37203	Petrol		1598	4	82.00	75.70	18
AR 38201	Petrol		1598	4	82.00	75.70	18
AR 38401	Petrol		1747	4	82.00	82.70	19
AR 38501	Petrol		1370	4	82.00	64.90	17
AR 61101	Petrol		1567	4	78.00	82.00	7
AR 61102	Petrol		1779	4	80.00	88.50	15
AR 61201	Petrol		1779	4	80.00	88.50	15
AR 61202	Petrol		1779	4	80.00	88.50	15
AR 61203	Petrol		1779	4	80.00	88.50	15
AR 61501	Petrol		2959	V6	93.00	72.60	51
AR 61503	Petrol		2959	V6	93.00	72.60	51
AR 64101	Petrol		1996	V6	80.00	66.20	12
AR 64102	Petrol		1996	V6	80.00	66.20	12
AR 64103	Petrol		1995	4	84.00	90.00	39
AR 64301	Petrol		2959	V6	93.00	72.60	51
AR 64303	Petrol		2959	V6	93.00	72.60	51
AR 64304	Petrol		2959	V6	93.00	72.60	51
AR 64305	Petrol		2959	V6	93.00	72.60	51
AR 64306	Petrol		2959	V6	93.00	72.60	51
AR 64307	Petrol		2959	V6	93.00	72.60	51
AR 64308	Petrol		2959	V6	93.00	72.60	51
AR 64399	Petrol		2959	V6	93.00	72.60	51
AR 66201	Petrol		2492	V6	88.00	68.30	44
AR 66301	Petrol		2959	V6	93.00	72.60	51
AR 66302	Petrol		2959	V6	93.00	72.60	51
AR 66303	Petrol		2959	V6	93.00	72.60	51
AR 66304	Petrol		2959	V6	93.00	72.60	51
AR 66306	Petrol		2959	V6	93.00	72.60	51
AR 67101	Petrol		1773	4	84.00	80.00	37
AR 67102	Petrol		1773	4	84.00	80.00	37
AR 67103	Petrol		1748	4	83.40	80.00	33
AR 67105	Petrol		1748	4	83.40	80.00	33
AR 67106	Petrol		1747	4	82.00	82.70	19
AR 67199	Petrol		1747	4	82.00	82.70	19
AR 67201	Petrol		1995	4	84.00	90.00	39
AR 67202	Petrol		1995	4	84.00	90.00	39
AR 67203	Petrol		1995	4	84.00	90.00	41
AR 67204	Petrol		1970	4	83.00	91.00	32
AR 67299	Petrol		1970	4	83.00	91.00	32
AR 67301	Petrol		2492	V6	88.00	68.30	44
AR 67302	Petrol		2492	V6	91.35	63.40	47
AR 67303	Petrol		2492	V6	88.00	68.30	44
AR 67402	Petrol		1756	4	84.00	79.20	36
AR 67501	Diesel		1929	4	82.60	90.00	27
AR 67502	Diesel		1929	4	82.60	90.00	27
AR 67601	Petrol		1598	4	82.00	75.70	18
M 624 AA 30.A	Petrol		2959	V6	93.00	72.60	51
M 624 AB 30.A	Petrol		2959	V6	93.00	72.60	51
VM 4 HT	Diesel		1995	4	88.00	82.00	45
VM4HT/2	Diesel		1995	4	88.00	82.00	45
VM4HT 2.4	Diesel		2393	4	92.00	90.00	49
VM 5 HT	Diesel		2494	5	88.00	82.00	46
VM 07 B	Diesel		2499	4	92.00	94.00	50
VM 08 B	Diesel		2499	4	92.00	94.00	50
VM 31 B	Diesel		2499	4	92.00	94.00	50
VM 32 B	Diesel		2499	4	92.00	94.00	50
VM 80 A	Diesel		1995	4	88.00	82.00	45
VM 81 A	Diesel		2393	4	92.00	90.00	49
VM 82 A	Diesel		1779	3	92.00	89.20	48

		cm3	x 			
---	---	-----	--	---	---	---

VM 84 A	Diesel	2499	4	92.00	94.00	50
VM 96 A	Diesel	1779	3	92.00	89.20	48
VM-425 CHIEA 08 B	Diesel	2499	4	92.00	94.00	50
VM-425 SLIRA	Diesel	2500	4	92.00	94.00	50
VM-HR 588 HT	Diesel	2493	5	88.00	82.00	46



1 69.60 x 82.00										
199 A3.000		4 Cyl.	1248cc	66kW (90PS)	Diesel Turbo Intercooler				TD23450	
199 B1.000 Euro 5		4 Cyl.	1248cc	70kW (95PS)	Diesel Turbo Intercooler				TD24590	
199 B4.000 Euro 5		4 Cyl.	1248cc	62kW (84PS)	Diesel Turbo Intercooler				TD24938	
199 B8.000		4 Cyl.	1248cc	59kW (80PS)	Diesel				TD29692	
BE/PL	4	42,582/42,600	45,734/45,744	20,000	1,552	0,030/0,062	BS	71-4033	71-4033/4 STD .010	
MB/HL 1,2,4,5	4	50,982/51,000	54,710/54,722	19,000	1,840	0,026/0,050	AL-LF	02-4034	H1011/5 STD 0.25	
MB/HL 3	1	50,982/51,000	54,710/54,722	23,950	1,840	0,026/0,050	AL-LF	02-4035H		
SE/PB	1	23,000	25,747/25,772	25,000			BS-LF	55-4077	55-4077 SEMI	

2 72.00 x 84.00										
198 A1.000		4 Cyl.	1368cc	110kW (150PS)	Petrol Turbo				TD23452	
198 A4.000		4 Cyl.	1368cc	88kW (120PS)	Petrol Turbo Intercooler				TD23921	
198 A7.000		4 Cyl.	1368cc	103kW (140PS)	Petrol Turbo Intercooler				TD24646	
199 A8.000		4 Cyl.	1368cc	114kW (155PS)	Petrol Turbo				TD21700	
940 B1.000		4 Cyl.	1368cc	77kW (105PS)	Petrol				TD26994	
940 B7.000		4 Cyl.	1368cc	88kW (120PS)	Petrol Turbo				TD28632	
940 B8.000		4 Cyl.	1368cc	77kW (105PS)	Petrol Turbo				TD28633	
BE/PL	4	41,990/42,008	45,128/45,138	19,000	1,548	0,024/0,068	AL-LF	01-4079	01-4079/4 STD	
MB/HL 3	2	52,000/52,200	68,766/69,020		2,325		AL-LF	04-4076	H1092/5 STD 0.25 0.50	
MB/HL 1-5	10	47,980/48,000	51,705/51,718	19,000	1,848	0,020/0,067	AL-LF	4276RA		
SE/PB	1	17,970/17,974	20,775/20,800	22,000			BS-LF	55-4078	55-4078 SEMI	

3 72.00 x 84.00										
199 A6.000		4 Cyl.	1368cc	70kW (95PS)	Petrol				TD23447	
350 A1.000 Euro 4/5		4 Cyl.	1368cc	57kW (78PS)	Petrol				TD26416	
940 A6.000 Euro 5		4 Cyl.	1368cc	85kW (116PS)	Petrol Turbo Intercooler				TD24794	
955 A1.000		4 Cyl.	1368cc	57-58kW (78-79PS)	Petrol				TD23448	
955 A2.000 Euro 5		4 Cyl.	1368cc	99kW (135PS)	Petrol				TD24588	
955 A6.000 Euro 5		4 Cyl.	1368cc	77kW (105PS)	Petrol				TD24587	
955 A7.000		4 Cyl.	1368cc	99kW (135PS)	Petrol Turbo				TD24940	
955 A8.000 Euro 5		4 Cyl.	1368cc	120kW (163PS)	Petrol Turbo				TD24589	
955 B1.000		4 Cyl.	1368cc	103kW (140PS)	Petrol Turbo				TD28716	
BE/PL	4	41,988/42,008	45,127/45,140	19,000	1,548	0,023/0,081	AL-LF	4275RA	01-4154/4 STD 0.25 0.50	
MB/HL 3	2	52,000/52,200	68,766/69,020		2,325		AL-LF	04-4076	H1092/5 STD 0.25 0.50	
MB/HL 1-5	10	47,980/48,000	51,705/51,718	19,000	1,848	0,020/0,067	AL-LF	4276RA		

4 72.00 x 84.00										
955 A9.000		4 Cyl.	1368cc	51kW (69PS)	Petrol				TD26417	
BE/PL	4	41,990/42,008	45,128/45,138	19,000	1,548	0,024/0,068	AL-LF	01-4079	01-4079/4 STD	
MB/HL 3	2	52,000/52,200	68,766/69,020		2,325		AL-LF	04-4076	H1092/5 STD 0.25 0.50	
MB/HL 1-5	10	47,980/48,000	51,705/51,718	19,000	1,848	0,020/0,067	AL-LF	4276RA		



5 73.02 x 67.20										
AR 30508		4 Cyl.		1490cc	77kW (105PS)		Petrol		TD90	
BE/PL	4	49,984/50,000	53,696/53,708	17,800	1,836	0,024/0,077	AL-LF	66325RA	01-4178/4 STD 0.25 0.50	
MB/HL 1-3	3	59,944/59,957	63,663/63,673	23,400	1,841	0,024/0,072	AL-LF	66326RA	H1044/3 STD 0.25 0.50	
TW/A	2	65,790/66,040	82,420/82,680		2,362		BS	66326AF	A205/2 STD	
SE/PB	1	20,996/21,000	23,005/23,020	23,500			BS	66329Y	55-4505 SEMI	

6 74.00 x 75.00										
AR 00500		4 Cyl.		1290cc	37kW (50PS)		Petrol		TD21701	
AR 00501		4 Cyl.		1290cc	48kW (65PS)		Petrol		TD21702	
AR 00502		4 Cyl.		1290cc	46-55kW (63-75PS)		Petrol		TD21704	
AR 00504		4 Cyl.		1290cc	39kW (53PS)		Petrol		TD21705	
AR 00506		4 Cyl.		1290cc	57kW (78PS)		Petrol		TD26425	
AR 00508		4 Cyl.		1290cc	59kW (80PS)		Petrol		TD21709	
AR 00510		4 Cyl.		1290cc	66kW (90PS)		Petrol		TD21711	
AR 00514		4 Cyl.		1290cc	74kW (101PS)		Petrol		TD21712	
AR 00530		4 Cyl.		1290cc	64-65kW (87-89PS)		Petrol		TD23	
AR 10531		4 Cyl.		1290cc	81kW (110PS)		Petrol		TD21724	
AR 10534		4 Cyl.		1290cc	117kW (159PS)		Petrol		TD21725	
BE/PL	4	44,963/44,975	48,658/48,671	23,440	1,829	0,025/0,075	AL-LF	2650RA	01-4307/4 0.25	
MB/HL 1,3,5	3	59,960/59,973	63,657/63,676	25,530	1,837	0,020/0,067	BS	60011CP	H1030/5 STD 0.25 0.50	
MB/HL 2,4	2	59,960/59,973	63,657/63,676	18,360	1,837	0,020/0,067	BS	60012CP		
TW/A	4	65,786/66,040	82,423/82,677		2,362		AL-LF	2777AF	A178/4 STD	
SE/PB	1	21,994/22,000	25,120/25,146	23,720			BS	60014X	55-4280 SEMI	

7 78.00 x 82.00										
AR 00112		4 Cyl.		1570cc	67-68kW (91-92PS)		Petrol		TD26422	
AR 00121		4 Cyl.		1570cc	82-83kW (112-113PS)		Petrol		TD26423	
AR 00516		4 Cyl.		1570cc	82kW (112PS)		Petrol		TD26424	
AR 00526		4 Cyl.		1570cc	71-81kW (97-110PS)		Petrol		TD22	
AR 00526 S		4 Cyl.		1570cc	75-76kW (102-103PS)		Petrol		TD5344	
AR 00536		4 Cyl.		1570cc	80kW (109PS)		Petrol		TD24	
AR 01563		4 Cyl.		1570cc	79kW (107PS)		Petrol		TD29	
AR 01600		4 Cyl.		1570cc	79-80kW (108-109PS)		Petrol		TD32	
AR 06100		4 Cyl.		1567cc	81kW (110PS)		Petrol		TD47	
AR 10502		4 Cyl.		1570cc	68-76kW (92-103PS)		Petrol		TD29615	
AR 10538		4 Cyl.		1570cc	83kW (113PS)		Petrol		TD21726	
AR 11650		4 Cyl.		1570cc	80kW (109PS)		Petrol		TD23341	
AR 61101		4 Cyl.		1567cc	76-81kW (103-110PS)		Petrol		TD102	
BE/PL	4	49,988/49,998	53,695/53,708	23,440	1,838	0,021/0,069	BS	60010CP	71-4168/4 STD 0.25 0.50	
MB/HL 1,3,5	3	59,960/59,973	63,657/63,676	25,530	1,837	0,020/0,067	BS	60011CP	H1030/5 STD 0.25 0.50	
MB/HL 2,4	2	59,960/59,973	63,657/63,676	18,360	1,837	0,020/0,067	BS	60012CP		
TW/A	4	65,786/66,040	82,423/82,677		2,362		AL-LF	2777AF	A178/4 STD	

ALFA ROMEO



SE/PB	1	21,994/22,000	25,120/25,146	23,720			BS	60014X	55-4280 SEMI
-------	---	---------------	---------------	--------	--	--	----	--------	-----------------

8 79.38 x 88.60

4.108			4 Cyl.	1760cc	38kW (52PS)		Diesel		TD141
BE/PL	4	50,787/50,800	54,508/54,521	22,350	1,835	0,038/0,089	AL-LF	2580RA	01-4314/4 STD 0.25 0.50
MB/HL 1-3	3	57,099/57,112	60,833/60,846	31,880	1,836	0,049/0,100	AL-LF	2581RAA	H1138/3 STD 0.25

9 79.50 x 80.50

198 A2.000			4 Cyl.	1598cc	88kW (120PS)		Diesel Turbo Intercooler		TD21698
940 A3.000			4 Cyl.	1598cc	77kW (105PS)		Diesel Turbo Intercooler		TD23923
955 A3.000 Euro 5			4 Cyl.	1598cc	88kW (120PS)		Diesel Turbo Intercooler		TD24591
955 A4.000			4 Cyl.	1598cc	85kW (115PS)		Diesel Turbo		TD23451
BE/PL	4	48,226/48,244	51,354/51,366	19,100	1,540	0,030/0,056	EC-LF	71-4776	71-4776/4 STD 5
MB/HL 1-5	5		56,705/56,718	20,750	1,861		AL-LF	02-4777	H1293/5 STD
TW/A	2	59,000/59,260	73,600/73,850		2,485		AL-LF	04-4778	A291/2 STD
SE/PB	1	26,000	28,939/28,972	22,100			BS-LF	55-4779	55-4779 SEMI

10 80.00 x 59.00

AR 30102			4 Cyl.	1186cc	46kW (63PS)		Petrol		TD5335
AR 30102 S			4 Cyl.	1186cc	44kW (60PS)		Petrol		TD5336
AR 30104			4 Cyl.	1186cc	50kW (68PS)		Petrol		TD77
AR 30500			4 Cyl.	1186cc	44-50kW (60-68PS)		Petrol		TD87
AR 30585			4 Cyl.	1186cc	50kW (68PS)		Petrol		TD10129
AR 30743			4 Cyl.	1186cc	57kW (80PS)		Petrol		TD113
AR 31000			4 Cyl.	1186cc	44-47kW (60-64PS)		Petrol		TD99
BE/PL	4	49,984/50,000	53,696/53,708	17,800	1,836	0,024/0,077	AL-LF	66325RA	01-4178/4 STD 0.25 0.50
MB/HL 1-3	3	59,944/59,957	63,663/63,673	23,400	1,841	0,024/0,072	AL-LF	66326RA	H1044/3 STD 0.25 0.50
TW/A	2	65,790/66,040	82,420/82,680		2,362		BS	66326AF	A205/2 STD
SE/PB	1	20,996/21,000	23,005/23,020	23,500			BS	66329Y	55-4505 SEMI

11 80.00 x 64.00

AR 30180			4 Cyl.	1286cc	48-50kW (65-68PS)		Petrol		TD84
AR 30184			4 Cyl.	1286cc	55kW (75PS)		Petrol		TD85
BE/PL	4	49,984/50,000	53,696/53,708	17,800	1,836	0,024/0,077	AL-LF	66325RA	01-4178/4 STD 0.25 0.50
MB/HL 1-3	3	59,944/59,957	63,663/63,673	23,400	1,841	0,024/0,072	AL-LF	66326RA	H1044/3 STD 0.25 0.50
TW/A	2	65,790/66,040	82,420/82,680		2,362		BS	66326AF	A205/2 STD
SE/PB	1	20,996/21,000	23,005/23,020	23,500			BS	66329Y	55-4505 SEMI

12 80.00 x 66.20

AR 01932			V6 Cyl.	1997cc	99kW (135PS)		Petrol		TD46
AR 06210			V6 Cyl.	1997cc	97kW (132PS)		Petrol		TD56
AR 16202			V6 Cyl.	1996cc	148kW (202PS)		Petrol Turbo Intercooler		TD4189
AR 34102			V6 Cyl.	1996cc	151kW (205PS)		Petrol Turbo Intercooler		TD11600



AR 64101			V6 Cyl.	1996cc	150kW (204PS)	Petrol Turbo		TD5072
AR 64102			V6 Cyl.	1996cc	148-150kW (201-204PS)	Petrol Turbo		TD105
BE/PL	6	51,980/52,000	55,511/55,524	19,100	1,749	0,020/0,071	BS	4080CP 71-4218/6 STD 0.25
MB/HL 1-4	4	59,951/59,971	63,657/63,676	22,350	1,841	0,020/0,068	BS	4081CP H1082/4 STD 0.25
SE/PB	1	21,994/22,000	25,120/25,146	23,720			BS	60014X 55-4280 SEMI

13 80.00 x 67.20

AR 30100			4 Cyl.	1351cc	58kW (79PS)	Petrol		TD76
AR 30160			4 Cyl.	1351cc	51kW (69PS)	Petrol		TD81
AR 30164			4 Cyl.	1351cc	55kW (75PS)	Petrol		TD82
AR 30168			4 Cyl.	1351cc	63-66kW (85-90PS)	Petrol		TD83
AR 30502			4 Cyl.	1351cc	55-58kW (75-79PS)	Petrol		TD88
AR 30586			4 Cyl.	1351cc	55kW (75PS)	Petrol		TD96
AR 30587			4 Cyl.	1351cc	63-66kW (86-90PS)	Petrol		TD97
AR 30732			4 Cyl.	1351cc	66kW (90PS)	Petrol		TD107
AR 30753			4 Cyl.	1351cc	65-66kW (88-90PS)	Petrol		TD119
AR 30755			4 Cyl.	1351cc	65-66kW (88-90PS)	Petrol		TD120
AR 31010			4 Cyl.	1351cc	63kW (86PS)	Petrol		TD100
AR 33501			4 Cyl.	1351cc	66kW (90PS)	Petrol		TD123
BE/PL	4	49,984/50,000	53,696/53,708	17,800	1,836	0,024/0,077	AL-LF	66325RA 01-4178/4 STD 0.25 0.50
MB/HL 1-3	3	59,944/59,957	63,663/63,673	23,400	1,841	0,024/0,072	AL-LF	66326RA H1044/3 STD 0.25 0.50
TW/A	2	65,790/66,040	82,420/82,680		2,362		BS	66326AF A205/2 STD
SE/PB	1	20,996/21,000	23,005/23,020	23,500			BS	66329Y 55-4505 SEMI

14 80.00 x 67.50

AR 01644			4 Cyl.	1357cc	66-70kW (90-95PS)	Petrol		TD35
AR 11644			4 Cyl.	1357cc	66-70kW (90-95PS)	Petrol		TD22399
BE/PL	4	44,963/44,975	48,658/48,671	23,440	1,829	0,025/0,075	AL-LF	2650RA 01-4307/4 0.25
MB/HL 1,3,5	3	59,960/59,973	63,657/63,676	25,530	1,837	0,020/0,067	BS	60011CP H1030/5 STD 0.25 0.50
MB/HL 2,4	2	59,960/59,973	63,657/63,676	18,360	1,837	0,020/0,067	BS	60012CP
TW/A	4	65,786/66,040	82,423/82,677		2,362		AL-LF	2777AF A178/4 STD
SE/PB	1	21,994/22,000	25,120/25,146	23,720			BS	60014X 55-4280 SEMI

15 80.00 x 88.50

AR 00548			4 Cyl.	1779cc	83-97kW (113-132PS)	Petrol		TD18
AR 01354			4 Cyl.	1779cc	110kW (150PS)	Petrol Turbo		TD5343
AR 01608			4 Cyl.	1779cc	87-89kW (118-121PS)	Petrol		TD5340
AR 01608 X			4 Cyl.	1779cc	85kW (115PS)	Petrol		TD33
AR 01678			4 Cyl.	1779cc	88-90kW (120-122PS)	Petrol		TD38
AR 06134			4 Cyl.	1779cc	110-114kW (150-155PS)	Petrol Turbo		TD50
AR 06158			4 Cyl.	1779cc	114kW (155PS)	Petrol Turbo		TD52
AR 06168			4 Cyl.	1779cc	88kW (120PS)	Petrol		TD54
AR 06202			4 Cyl.	1779cc	85-89kW (116-121PS)	Petrol		TD55
AR 10548			4 Cyl.	1779cc	83-90kW (113-122PS)	Petrol		TD5350
AR 61102			4 Cyl.	1779cc	88kW (120PS)	Petrol		TD10149

ALFA ROMEO



AR 61201			4 Cyl.	1779cc	90kW (122PS)		Petrol		TD103
AR 61202			4 Cyl.	1779cc	87-95kW (118-129PS)		Petrol		TD5333
AR 61203			4 Cyl.	1779cc	110-121kW (150-165PS)		Petrol Turbo Intercooler		TD23349
BE/PL	4	49,988/49,998	53,695/53,708	23,440	1,838	0,021/0,069	BS	60010CP	71-4168/4 STD 0.25 0.50
MB/HL 1,3,5	3	59,960/59,973	63,657/63,676	25,530	1,837	0,020/0,067	BS	60011CP	H1030/5 STD 0.25 0.50
MB/HL 2,4	2	59,960/59,973	63,657/63,676	18,360	1,837	0,020/0,067	BS	60012CP	
TW/A	4	65,786/66,040	82,423/82,677		2,362		AL-LF	2777AF	A178/4 STD
SE/PB	1	21,994/22,000	25,120/25,146	23,720			BS	60014X	55-4280 SEMI

16 80.50 x 86.00

199 B6.000 Euro 6			2 Cyl.	875cc	74-77kW (101-105PS)		Petrol Turbo Intercooler		TD27856
312 A2.000 Euro 5			2 Cyl.	875cc	63kW (86PS)		Petrol Turbo Intercooler		TD26187
BE/PL	2	41,982/42,000	45,125/45,135	18,000	1,550	0,025/0,061	AL-LF	01-4967	01-4967/2 STD
MB/HL 1-3	3	47,982/48,000	51,705/51,718	16,150	1,846	0,022/0,069	AL-LF	02-4968	H1337/3 STD
TW/A	2	53.100/53.300	68.766/69.020		2.335	0.105/0.275	AL-LF	04-4969	A321/2 STD
SE/PB	1		23,939/23,972	22,070			BS-LF	55-4970	55-4970 SEMI

17 82.00 x 64.90

AR 33503			4 Cyl.	1370cc	76kW (103PS)		Petrol		TD9752
AR 38501			4 Cyl.	1370cc	76kW (103PS)		Petrol		TD9753
BE/PL	4	40,870/40,890	44,000/44,012	19,100	1,543	0,024/0,081	AL-LF	4400RA	01-4160/4 STD 0.25
BE/PL	4	40,870/40,890	44,000/44,012	19,100	1,543		EC	71-3996	71-3996/4 STD
02/00 →									
MB/HL 1,2,4,5	4	52,982/53,000	56,705/56,718	20,750	1,843	0,019/0,075	AL-LF	4351RA	H1096/5 STD 0.25 0.50
MB/HL 3	1	52,982/53,000	56,705/56,718	20,750	1,838	0,029/0,085	AL-LF	4352RA	
TW/A	2	58,808/59,062	73,486/73,740		2,485		AL-LF	4351AF	A190/2 STD
SE/PB	1	19,993/20,000	22,939/22,972	21,700			BS	4359Y	55-4540 SEMI

18 82.00 x 75.70

AR 32101			4 Cyl.	1598cc	88kW (120PS)		Petrol		TD9461
AR 32102			4 Cyl.	1598cc	82-88kW (112-120PS)		Petrol		TD14369
AR 32103			4 Cyl.	1598cc	88kW (120PS)		Petrol		TD15389
AR 32104			4 Cyl.	1598cc	88kW (120PS)		Petrol		TD15388
AR 37203			4 Cyl.	1598cc	76kW (103PS)		Petrol		TD15508
AR 38201			4 Cyl.	1598cc	88kW (120PS)		Petrol		TD9754
AR 67601			4 Cyl.	1598cc	88kW (120PS)		Petrol		TD19
BE/PL	4	40,870/40,890	44,000/44,012	19,100	1,543		EC	71-3996	71-3996/4 STD
02/00 →									
BE/PL	4	48,226/48,244	51,354/51,366	19,100	1,543	0,020/0,080	BS	4355CP	71-4158/4 STD 0.25

MB/HL 1,2,4,5	4	52,982/53,000	56,705/56,718	20,750	1,843	0,019/0,075	AL-LF	4351RA	H1096/5 STD 0.25 0.50	
MB/HL 3	1	52,982/53,000	56,705/56,718	20,750	1,838	0,029/0,085	AL-LF	4352RA		
TW/A	2	58,808/59,062	73,486/73,740		2,485		AL-LF	4351AF	A190/2 STD	
SE/PB	1	19,993/20,000	22,939/22,972	21,700			BS	4359Y	55-4540 SEMI	

19 82.00 x 82.70

AR 32201	4 Cyl.	1747cc	106kW (144PS)				Petrol			TD9462
AR 32205	4 Cyl.	1747cc	103kW (140PS)				Petrol			TD15390
AR 38401	4 Cyl.	1747cc	103kW (140PS)				Petrol			TD9755
AR 67106	4 Cyl.	1747cc	103kW (140PS)				Petrol			TD5070
AR 67199	4 Cyl.	1747cc	103kW (140PS)				Petrol			TD23350
BE/PL	4	50,787/50,807	53,901/53,913	19,500	1,534	0,028/0,083	BS	4350CP	71-4157/4 STD 0.25 0.50	
MB/HL 1,2,4,5	4	52,982/53,000	56,705/56,718	20,750	1,843	0,019/0,075	AL-LF	4351RA	H1096/5 STD 0.25 0.50	
MB/HL 3	1	52,982/53,000	56,705/56,718	20,750	1,838	0,029/0,085	AL-LF	4352RA		
TW/A	2	58,808/59,062	73,486/73,740		2,485		AL-LF	4351AF	A190/2 STD	
SE/PB	1	19,993/20,000	22,939/22,972	21,700			BS	4359Y	55-4540 SEMI	

20 82.00 x 90.40

182 B9.000 Euro 3	4 Cyl.	1910cc	74-77kW (101-105PS)				Diesel Turbo Intercooler			TD18312
937 A2.000	4 Cyl.	1910cc	85kW (115PS)				Diesel Turbo Intercooler			TD16382
939 A1.000	4 Cyl.	1910cc	88kW (120PS)				Diesel Turbo Intercooler			TD18915
939 A7.000	4 Cyl.	1910cc	85kW (115PS)				Diesel Turbo Intercooler			TD18916
AR 32302	4 Cyl.	1910cc	77kW (105PS)				Diesel Turbo			TD9769
AR 37101	4 Cyl.	1910cc	81kW (110PS)				Diesel			TD15510
BE/PL	1	50,787/50,805	53,901/53,913	19,500	1,534	0,030/0,080	EC	71-3994	71-3994 STD 0.25 4	
MB/HL 1-5	5	59,986/60,000	63,705/63,718	20,750	1,844	0,031/0,075	BS	4356CP	H1095/5 STD 0.25 0.50	
TW/A	2	67,785/68,040	82,425/82,677		2,485		AL-LF	4356AF	A191/2 STD	
SE/PB	1		28,939/28,972	21,700			BS	4369Y	55-4159 SEMI	

21 82.00 x 90.40

192 A5.000 Euro 3	4 Cyl.	1910cc	103kW (140PS)				Diesel Turbo Intercooler			TD17981
192 B1.000	4 Cyl.	1910cc	100kW (136PS)				Diesel Turbo Intercooler			TD19061
937 A3.000	4 Cyl.	1910cc	88kW (120PS)				Diesel Turbo Intercooler			TD20727
937 A4.000	4 Cyl.	1910cc	93-103kW (126-140PS)				Diesel Turbo			TD18844
937 A5.000	4 Cyl.	1910cc	110kW (150PS)				Diesel Turbo Intercooler			TD18078
937 A6.000	4 Cyl.	1910cc	125kW (170PS)				Diesel Turbo Intercooler			TD24643
937 A7.000	4 Cyl.	1910cc	85kW (115PS)				Diesel Turbo Intercooler			TD20933
937 A8.000	4 Cyl.	1910cc	100-100kW (136-136PS)				Diesel Turbo Intercooler			TD20271
939 A2.000	4 Cyl.	1910cc	110kW (150PS)				Diesel Turbo Intercooler			TD18473
939 A8.000	4 Cyl.	1910cc	100kW (136PS)				Diesel Turbo Intercooler			TD18925
BE/PL	1	50,787/50,805	53,901/53,913	19,500	1,534	0,030/0,080	EC	71-3994	71-3994 STD 0.25 4	
MB/HL	1	59,986/60,000	63,705/63,718	20,750	1,844	0,031/0,080	EC	72-3995	72-3995 STD 0.25 0.50	

ALFA ROMEO



TW/A	2	67,785/68,040	82,425/82,677		2,485		AL-LF	4356AF	A191/2 STD
SE/PB	1		28,939/28,972	21,700			BS	4369Y	55-4159 SEMI

22 82.00 x 90.40

844 A1.000			4 Cyl.	1910cc	140kW (190PS)		Diesel Turbo		TD24649
BE/PL	1	50,787/50,805	53,901/53,913	19,500	1,534	0,030/0,080	EC	71-3994	71-3994 STD 0.25 4
BE/PL	1	50,787/50,805	53,901/53,913	19,500	1,534	0,030/0,080	EC-LF	71-4780	71-4780 STD 5

71-3994

71-4780

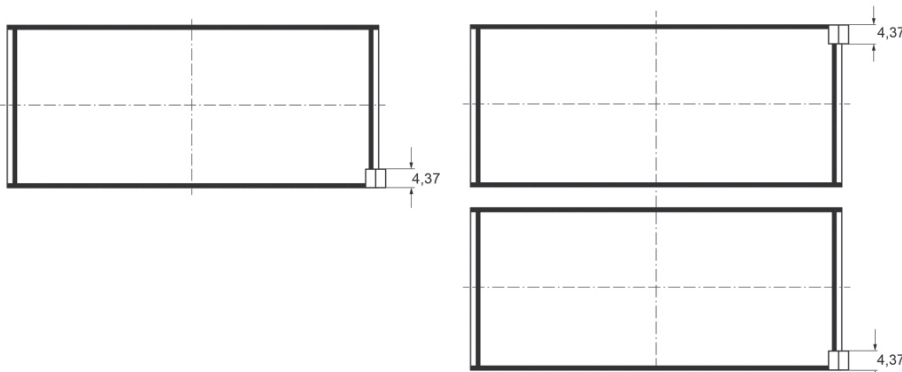

MB/HL	1	59,986/60,000	63,705/63,718	20,750	1,844	0,031/0,080	EC	72-3995	72-3995 STD 0.25 0.50
TW/A	2	67,785/68,040	82,425/82,677		2,485		AL-LF	4356AF	A191/2 STD
SE/PB	1		28,939/28,972	21,700			BS	4369Y	55-4159 SEMI

23 82.00 x 90.40

839 A6.000 Euro 3			5 Cyl.	2387cc	103kW (140PS)		Diesel Turbo Intercooler		TD18819
841 C000			5 Cyl.	2387cc	110kW (150PS)		Diesel Turbo Intercooler		TD16383
AR 32501			5 Cyl.	2387cc	99-100kW (135-136PS)		Diesel Turbo Intercooler		TD9770
AR 34202			5 Cyl.	2387cc	100kW (136PS)		Diesel Turbo Intercooler		TD11604
AR 36202			5 Cyl.	2387cc	103kW (140PS)		Diesel		TD15636

BE/PL	1	50,787/50,805	53,901/53,913	19,500	1,534	0,030/0,080	EC	71-3994	71-3994 STD 0.25 4
MB/HL 1-6	6	59,986/60,000	63,705/63,718	20,750	1,844	0,031/0,075	BS	4356CP	H1095/6 STD 0.25 0.50
TW/A	2	67,785/68,040	82,425/82,677		2,485		AL-LF	4356AF	A191/2 STD
SE/PB	1		28,939/28,972	21,700			BS	4369Y	55-4159 SEMI

24 82.00 x 90.40

841 G.000			5 Cyl.	2387cc	129kW (175PS)		Diesel Turbo Intercooler		TD18292
841 H.000			5 Cyl.	2387cc	129kW (175PS)		Diesel Turbo Intercooler		TD18293
841 M.000			5 Cyl.	2387cc	120-147kW (163-200PS)		Diesel Turbo Intercooler		TD20934

BE/PL	1	50,787/50,805	53,901/53,913	19,500	1,534	0,030/0,080	EC	71-3994	71-3994 STD 0.25 4
MB/HL	1	59,986/60,000	63,705/63,718	20,750	1,844	0,031/0,080	EC	72-3995	72-3995 STD 0.25 0.50
TW/A	2	67,785/68,040	82,425/82,677		2,485		AL-LF	4356AF	A191/2 STD
SE/PB	1		28,939/28,972	21,700			BS	4369Y	55-4159 SEMI

25 82.00 x 90.40

841 N.000			5 Cyl.	2387cc	120-147kW (163-200PS)	Diesel Turbo Intercooler	TD22510		
936 B.000			5 Cyl.	2387cc	136kW (185PS)	Diesel Turbo	TD20761		
939 A3.000 Euro 4			5 Cyl.	2387cc	147-154kW (200-209PS)	Diesel Turbo Intercooler	TD18474		
BE/PL	1	50,787/50,805	53,901/53,913	19,500	1,534	0,030/0,080	EC-LF 71-4780	71-4780 STD	5
MB/HL	1	59,986/60,000	63,705/63,718	20,750	1,844	0,031/0,080	EC 72-3995	72-3995 STD 0.25 0.50	

26 82.60 x 90.00

160 D100			4 Cyl.	1929cc	51kW (69PS)	Diesel	TD10307	
BE/PL	4	50,782/50,802	53,897/53,913	19,500	1,537	0,021/0,082	AL-LF 66240RA	01-4175/4 STD 0.25 0.50 0.75 1.00
MB/HL 1,2,4,5	4	52,985/53,005	56,717/56,730	20,750	1,841	0,030/0,088	AL-LF 66316RA	H1043/5 STD 0.25 0.50 0.75
MB/HL 3	1	52,985/53,005	56,717/56,730	24,250	1,841	0,030/0,088	AL-LF 66317RA	
TW/A	2	59,000/59,250	73,600/73,850		2,362		BS 62037AF	A201/2 STD .005
SE/PB	1	25,004/25,010	26,939/26,972	25,400			BS 66644Y	55-4190 SEMI

27 82.60 x 90.00

AR 33601			4 Cyl.	1929cc	66-68kW (90-92PS)	Diesel Turbo Intercooler	TD5069	
AR 67501			4 Cyl.	1929cc	66-68kW (90-92PS)	Diesel Turbo	TD140	
AR 67502			4 Cyl.	1929cc	66-68kW (90-92PS)	Diesel Turbo Intercooler	TD21140	
BE/PL	4	50,787/50,807	53,901/53,913	19,500	1,534	0,028/0,083	BS 4350CP	71-4157/4 STD 0.25 0.50
MB/HL 1,2,4,5	4	52,990/53,010	56,717/56,735	20,750	1,843	0,020/0,080	BS 4128CP	H1084/5 STD 0.25 0.50
MB/HL 3	1	52,990/53,010	56,717/56,735	24,250	1,843	0,020/0,080	BS 4129CP	
TW/A	2	59,000/59,250	73,600/73,850		2,362		BS 62037AF	A201/2 STD .005
SE/PB	1	26,004/26,010	27,939/27,972	25,400			BS 66644YA	55-4232 SEMI

28 83.00 x 80.50

939 B1.000			4 Cyl.	1742cc	147kW (200PS)	Petrol Turbo	TD22716		
BE/PL	4	48,226/48,244	51,354/51,366	19,100	1,540	0,030/0,056	EC-LF 71-4776	71-4776/4 STD	5
MB/HL 1-5	5		56,705/56,718	20,750	1,861		AL-LF 02-4777	H1293/5 STD	
TW/A	2	59,000/59,260	73,600/73,850		2,485		AL-LF 04-4778	A291/2 STD	
SE/PB	1	26,000	28,939/28,972	22,100			BS-LF 55-4779	55-4779 SEMI	

29 83.00 x 90.40

198 A5.000			4 Cyl.	1956cc	121kW (165PS)	Diesel Turbo Intercooler	TD24647		
940 A4.000			4 Cyl.	1956cc	125kW (170PS)	Diesel Turbo Intercooler	TD23924		
BE/PL	1	50,787/50,805	53,901/53,913	19,500	1,534	0,030/0,080	EC-LF 71-4780	71-4780 STD	5
MB/HL	1	59,986/60,000	63,705/63,718	20,750	1,844	0,031/0,080	EC 72-3995	72-3995 STD 0.25 0.50	
TW/A	2	67,785/68,040	82,425/82,677		2,485		AL-LF 4356AF	A191/2 STD	

ALFA ROMEO



SE/PB	1		28,939/28,972	21,700			BS	4369Y	55-4159 SEMI
-------	---	--	---------------	--------	--	--	----	-------	-----------------

30 83.00 x 90.40

844 A2.000			4 Cyl.	1956cc	120kW (163PS)		Diesel Turbo		TD24594
BE/PL	1	50,787/50,805	53,901/53,913	19,500	1,534	0,030/0,080	EC	71-3994	71-3994 STD 0.25 4
BE/PL	1	50,787/50,805	53,901/53,913	19,500	1,534	0,030/0,080	EC-LF	71-4780	71-4780 STD 5

71-3994

71-4780

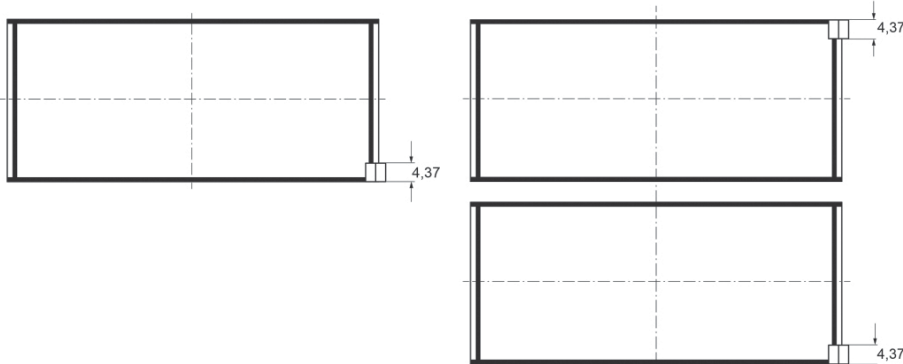

MB/HL	1	59,986/60,000	63,705/63,718	20,750	1,844	0,031/0,080	EC	72-3995	72-3995 STD 0.25 0.50
TW/A	2	67,785/68,040	82,425/82,677		2,485		AL-LF	4356AF	A191/2 STD
SE/PB	1		28,939/28,972	21,700			BS	4369Y	55-4159 SEMI

31 83.00 x 91.00

932 A2.000			4 Cyl.	1970cc	119-121kW (162-165PS)		Petrol		TD18076
937 A1.000			4 Cyl.	1970cc	119-122kW (162-166PS)		Petrol		TD16381
BE/PL	1	50,787/50,805	53,901/53,913	19,500	1,534	0,030/0,080	EC	71-3994	71-3994 STD 0.25 4
MB/HL	1	59,986/60,000	63,705/63,718	20,750	1,844	0,031/0,080	EC	72-3995	72-3995 STD 0.25 0.50
TW/A	2	58,808/59,062	73,486/73,740		2,485		AL-LF	4351AF	A190/2 STD

32 83.00 x 91.00

AR 16201			4 Cyl.	1970cc	110kW (150PS)		Petrol		TD4188
AR 32301			4 Cyl.	1970cc	114kW (155PS)		Petrol		TD9463
AR 32303			4 Cyl.	1970cc	110-118kW (150-160PS)		Petrol		TD19055
AR 32310			4 Cyl.	1970cc	110kW (150PS)		Petrol		TD15391
AR 34103			4 Cyl.	1970cc	114kW (155PS)		Petrol		TD11599
AR 36301			4 Cyl.	1970cc	110kW (150PS)		Petrol		TD15392
AR 67204			4 Cyl.	1970cc	110kW (150PS)		Petrol		TD4190
AR 67299			4 Cyl.	1970cc	110-114kW (150-155PS)		Petrol		TD23351
BE/PL	4	50,787/50,807	53,901/53,913	19,500	1,534	0,028/0,083	BS	4350CP	71-4157/4 STD 0.25 0.50
MB/HL 1,2,4,5	4	52,982/53,000	56,705/56,718	20,750	1,843	0,019/0,075	AL-LF	4351RA	H1096/5 STD 0.25 0.50
MB/HL 3	1	52,982/53,000	56,705/56,718	20,750	1,838	0,029/0,085	AL-LF	4352RA	
TW/A	2	58,808/59,062	73,486/73,740		2,485		AL-LF	4351AF	A190/2 STD
SE/PB	1	19,993/20,000	22,939/22,972	21,700			BS	4359Y	55-4540 SEMI

33 83.40 x 80.00

AR 67103			4 Cyl.	1748cc	83kW (113PS)		Petrol		TD134
AR 67105			4 Cyl.	1748cc	83-85kW (113-115PS)		Petrol		TD135
BE/PL	4	49,988/49,998	53,695/53,708	23,440	1,838	0,021/0,069	BS	60010CP	71-4168/4 STD 0.25 0.50
MB/HL 1,3,5	3	59,960/59,973	63,657/63,676	25,530	1,837	0,020/0,067	BS	60011CP	H1030/5 STD 0.25 0.50
MB/HL 2,4	2	59,960/59,973	63,657/63,676	18,360	1,837	0,020/0,067	BS	60012CP	
TW/A	4	65,786/66,040	82,423/82,677		2,362		AL-LF	2777AF	A178/4 STD
SE/PB	1	21,994/22,000	25,120/25,146	23,720			BS	60014X	55-4280 SEMI

34 84.00 x 67.20

AR 30124			4 Cyl.	1490cc	61-64kW (83-87PS)		Petrol		TD78
AR 30128			4 Cyl.	1490cc	70kW (95PS)		Petrol		TD79
AR 30143			4 Cyl.	1490cc	62kW (84PS)		Petrol		TD10131
AR 30146			4 Cyl.	1490cc	75-77kW (102-105PS)		Petrol		TD80
AR 30182			4 Cyl.	1490cc	70kW (95PS)		Petrol		TD10128
AR 30198			4 Cyl.	1490cc	70kW (95PS)		Petrol		TD86
AR 30504			4 Cyl.	1490cc	62kW (84PS)		Petrol		TD89
AR 30514			4 Cyl.	1490cc	70kW (95PS)		Petrol		TD6373
AR 30520			4 Cyl.	1490cc	66kW (90PS)		Petrol		TD91
AR 30588			4 Cyl.	1490cc	75-77kW (102-105PS)		Petrol		TD98
AR 30734			4 Cyl.	1490cc	77kW (105PS)		Petrol		TD108
AR 30738			4 Cyl.	1490cc	70-77kW (95-105PS)		Petrol		TD23346
AR 30750			4 Cyl.	1490cc	74kW (101PS)		Petrol		TD116
AR 30751			4 Cyl.	1490cc	71-72kW (97-98PS)		Petrol		TD117
AR 31016			4 Cyl.	1490cc	70kW (95PS)		Petrol		TD101
BE/PL	4	49,984/50,000	53,696/53,708	17,800	1,836	0,024/0,077	AL-LF	66325RA	01-4178/4 STD 0.25 0.50
MB/HL 1-3	3	59,944/59,957	63,663/63,673	23,400	1,841	0,024/0,072	AL-LF	66326RA	H1044/3 STD 0.25 0.50
TW/A	2	65,790/66,040	82,420/82,680		2,362		BS	66326AF	A205/2 STD
SE/PB	1	20,996/21,000	23,005/23,020	23,500			BS	66329Y	55-4505 SEMI

35 84.00 x 72.00

AR 33201			4 Cyl.	1596cc	76kW (103PS)		Petrol		TD121
BE/PL	4	48,226/48,244	51,354/51,366	19,100	1,543	0,020/0,080	BS	4355CP	71-4158/4 STD 0.25
MB/HL 1,2,4,5	4	52,982/53,000	56,705/56,718	20,750	1,843	0,019/0,075	AL-LF	4351RA	H1096/5 STD 0.25 0.50
MB/HL 3	1	52,982/53,000	56,705/56,718	20,750	1,838	0,029/0,085	AL-LF	4352RA	
TW/A	2	58,808/59,062	73,486/73,740		2,485		AL-LF	4351AF	A190/2 STD
SE/PB	1	20,996/21,000	23,005/23,020	23,500			BS	66329Y	55-4505 SEMI

36 84.00 x 79.20

AR 67402			4 Cyl.	1756cc	77kW (105PS)		Petrol		TD5071
BE/PL	4	49,988/49,998	53,695/53,708	23,440	1,838	0,021/0,069	BS	60010CP	71-4168/4 STD 0.25 0.50

ALFA ROMEO

MB/HL 1,3,5	3	59,960/59,973	63,657/63,676	25,530	1,837	0,020/0,067	BS	60011CP	H1030/5 STD 0.25 0.50
MB/HL 2,4	2	59,960/59,973	63,657/63,676	18,360	1,837	0,020/0,067	BS	60012CP	
TW/A	4	65,786/66,040	82,423/82,677		2,362		AL-LF	2777AF	A178/4 STD
SE/PB	1	21,994/22,000	25,120/25,146	23,720			BS	60014X	55-4280 SEMI

37

84.00 x 80.00

AR 67101			4 Cyl.	1773cc	93-95kW (126-129PS)		Petrol		TD133
AR 67102			4 Cyl.	1773cc	93kW (127PS)		Petrol		TD5311
BE/PL	4	49,988/49,998	53,695/53,708	23,440	1,838	0,021/0,069	BS	60010CP	71-4168/4 STD 0.25 0.50
MB/HL 1,3,5	3	59,960/59,973	63,657/63,676	25,530	1,837	0,020/0,067	BS	60011CP	H1030/5 STD 0.25 0.50
MB/HL 2,4	2	59,960/59,973	63,657/63,676	18,360	1,837	0,020/0,067	BS	60012CP	
TW/A	4	65,786/66,040	82,423/82,677		2,362		AL-LF	2777AF	A178/4 STD
SE/PB	1	21,994/22,000	25,120/25,146	23,720			BS	60014X	55-4280 SEMI

38

84.00 x 88.50

AR 00512			4 Cyl.	1962cc	96kW (131PS)		Petrol		TD75
AR 00515			4 Cyl.	1962cc	92-93kW (125-126PS)		Petrol		TD21
AR 01212			4 Cyl.	1962cc	94kW (128PS)		Petrol		TD27
AR 01544			4 Cyl.	1962cc	85kW (116PS)		Petrol		TD28
AR 01588			4 Cyl.	1962cc	88kW (120PS)		Petrol		TD30
AR 01590			4 Cyl.	1962cc	93kW (126PS)		Petrol		TD31
AR 01615			4 Cyl.	1962cc	81kW (110PS)		Petrol		TD21716
AR 01623			4 Cyl.	1962cc	89-90kW (121-122PS)		Petrol		TD34
AR 01655			4 Cyl.	1962cc	96kW (131PS)		Petrol		TD37
AR 01713			4 Cyl.	1962cc	94-97kW (128-132PS)		Petrol		TD41
AR 06166			4 Cyl.	1962cc	107kW (146PS)		Petrol		TD53
AR 06212			4 Cyl.	1962cc	94-96kW (128-131PS)		Petrol		TD57
AR 06224			4 Cyl.	1962cc	107-109kW (146-148PS)		Petrol		TD58
AR 06416			4 Cyl.	1962cc	102-105kW (138-143PS)		Petrol		TD62
AR 10512			4 Cyl.	1962cc	96kW (131PS)		Petrol		TD5351
AR 10520			4 Cyl.	1962cc	97kW (132PS)		Petrol		TD10270
AR 10527			4 Cyl.	1962cc	96kW (131PS)		Petrol		TD10127
AR 11633			4 Cyl.	1962cc	82-96kW (112-131PS)		Petrol		TD22398
AR 11634			4 Cyl.	1962cc	82kW (112PS)		Petrol		TD68
AR 11655			4 Cyl.	1962cc	94-109kW (128-148PS)		Petrol		TD23342
AR 11671			4 Cyl.	1962cc	96kW (131PS)		Petrol		TD70
AR 19510			4 Cyl.	1962cc	104-109kW (142-148PS)		Petrol		TD23344
BE/PL	4	49,988/49,998	53,695/53,708	23,440	1,838	0,021/0,069	BS	60010CP	71-4168/4 STD 0.25 0.50
MB/HL 1,3,5	3	59,960/59,973	63,657/63,676	25,530	1,837	0,020/0,067	BS	60011CP	H1030/5 STD 0.25 0.50
MB/HL 2,4	2	59,960/59,973	63,657/63,676	18,360	1,837	0,020/0,067	BS	60012CP	
TW/A	4	65,786/66,040	82,423/82,677		2,362		AL-LF	2777AF	A178/4 STD
SE/PB	1	21,994/22,000	25,120/25,146	23,720			BS	60014X	55-4280 SEMI

39 84.00 x 90.00

AR	Cyl.	cc	kW (PS)	Fuel	TD				
AR 06420	4 Cyl.	1995cc	109kW (148PS)	Petrol	TD63				
AR 64103	4 Cyl.	1995cc	106kW (144PS)	Petrol	TD129				
AR 67201	4 Cyl.	1995cc	106kW (144PS)	Petrol	TD136				
AR 67202	4 Cyl.	1995cc	104kW (141PS)	Petrol	TD137				
BE/PL	4	49,988/49,998	53,695/53,708	23,440	1,838	0,021/0,069	BS	60010CP	71-4168/4 STD 0.25 0.50
MB/HL 1,3,5	3	59,960/59,973	63,657/63,676	25,530	1,837	0,020/0,067	BS	60011CP	H1030/5 STD 0.25 0.50
MB/HL 2,4	2	59,960/59,973	63,657/63,676	18,360	1,837	0,020/0,067	BS	60012CP	
TW/A	4	65,786/66,040	82,423/82,677		2,362		AL-LF	2777AF	A178/4 STD
SE/PB	1	21,994/22,000	25,120/25,146	23,720			BS	60014X	55-4280 SEMI

40 84.00 x 90.00

AR	Cyl.	cc	kW (PS)	Fuel	TD				
AR 06476	4 Cyl.	1995cc	128-129kW (174-175PS)	Petrol Turbo	TD65				
BE/PL	4	50,787/50,807	53,892/53,910	19,500	1,537	0,020/0,070	BS	1040CP	71-4118/4 STD 0.25 0.50
MB/HL 1,2,4,5	4	52,990/53,010	56,717/56,735	20,750	1,843	0,020/0,080	BS	4128CP	H1084/5 STD 0.25 0.50
MB/HL 3	1	52,990/53,010	56,717/56,735	24,250	1,843	0,020/0,080	BS	4129CP	
TW/A	2	59,000/59,250	73,600/73,850		2,362		BS	62037AF	A201/2 STD .005
SE/PB	1	21,539/21,641	25,000/25,021	25,100			BS	66649Y	55-4193 SEMI

41 84.00 x 90.00

AR	Cyl.	cc	kW (PS)	Fuel	TD				
AR 67203	4 Cyl.	1995cc	137-140kW (186-190PS)	Petrol Turbo	TD138				
BE/PL	4	50,787/50,807	53,901/53,913	19,500	1,534	0,028/0,083	BS	4350CP	71-4157/4 STD 0.25 0.50
MB/HL 1,2,4,5	4	52,990/53,010	56,717/56,735	20,750	1,843	0,020/0,080	BS	4128CP	H1084/5 STD 0.25 0.50
MB/HL 3	1	52,990/53,010	56,717/56,735	24,250	1,843	0,020/0,080	BS	4129CP	
TW/A	2	59,000/59,250	73,600/73,850		2,362		BS	62037AF	A201/2 STD .005
SE/PB	1	21,539/21,641	25,000/25,021	25,100			BS	66649Y	55-4193 SEMI

42 87.00 x 72.20

AR	Cyl.	cc	kW (PS)	Fuel	TD				
AR 30550	4 Cyl.	1712cc	84-95kW (114-129PS)	Petrol	TD4186				
AR 30558	4 Cyl.	1712cc	77kW (105PS)	Petrol	TD93				
AR 30578	4 Cyl.	1712cc	79kW (107PS)	Petrol	TD95				
AR 30736	4 Cyl.	1712cc	79kW (107PS)	Petrol	TD109				
AR 30737	4 Cyl.	1712cc	77-79kW (105-107PS)	Petrol	TD110				
AR 30737 A	4 Cyl.	1712cc	77-79kW (105-107PS)	Petrol	TD111				
AR 30740	4 Cyl.	1712cc	77kW (105PS)	Petrol	TD112				
BE/PL	4	49,984/50,000	53,696/53,708	17,800	1,836	0,024/0,077	AL-LF	66325RA	01-4178/4 STD 0.25 0.50
MB/HL 1-3	3	59,944/59,957	63,663/63,673	23,400	1,841	0,024/0,072	AL-LF	66326RA	H1044/3 STD 0.25 0.50
TW/A	2	65,790/66,040	82,420/82,680		2,362		BS	66326AF	A205/2 STD
SE/PB	1	20,996/21,000	23,005/23,020	23,500			BS	66329Y	55-4505 SEMI

ALFA ROMEO



43 87.00 x 72.20									
AR 30746		4 Cyl.		1712cc	101kW (137PS)		Petrol		TD114
AR 30747		4 Cyl.		1712cc	95-97kW (129-132PS)		Petrol		TD115
AR 33401		4 Cyl.		1712cc	95kW (129PS)		Petrol		TD122
BE/PL	4	49,984/50,000	53,696/53,708	17,800	1,836	0,024/0,077	BS	4075CP	71-4250/4 STD 0.25
MB/HL 1-3	3	59,944/59,964	63,663/63,673	23,400	1,842	0,020/0,070	BS	4076CP	H1081/3 STD 0.25
TW/A	2	65,790/66,040	82,420/82,680		2,362		BS	66326AF	A205/2 STD
SE/PB	1	20,996/21,000	23,005/23,020	23,500			BS	66329Y	55-4505 SEMI

44 88.00 x 68.30									
AR 01646		V6 Cyl.		2492cc	110-116kW (150-158PS)		Petrol		TD36
AR 01648		V6 Cyl.		2492cc	113kW (154PS)		Petrol		TD10150
AR 01911		V6 Cyl.		2492cc	110-115kW (150-156PS)		Petrol		TD42
AR 01913		V6 Cyl.		2492cc	116-118kW (158-160PS)		Petrol		TD43
AR 01928		V6 Cyl.		2492cc	110-117kW (150-159PS)		Petrol		TD44
AR 11900		V6 Cyl.		2492cc	115kW (156PS)		Petrol		TD23343
AR 32401		V6 Cyl.		2492cc	140kW (190PS)		Petrol		TD9464
AR 32402		V6 Cyl.		2492cc	140-141kW (191-192PS)		Petrol		TD19056
AR 32405		V6 Cyl.		2492cc	141kW (192PS)		Petrol		TD15634
AR 34201		V6 Cyl.		2492cc	140kW (190PS)		Petrol		TD11601
AR 36201		V6 Cyl.		2492cc	138kW (188PS)		Petrol		TD15635
AR 66201		V6 Cyl.		2492cc	120kW (163PS)		Petrol		TD132
AR 67301		V6 Cyl.		2492cc	121kW (165PS)		Petrol		TD139
AR 67303		V6 Cyl.		2492cc	120kW (163PS)		Petrol		TD9767
BE/PL	6	51,980/52,000	55,511/55,524	19,100	1,749	0,020/0,071	BS	4080CP	71-4218/6 STD 0.25
MB/HL 1-4	4	59,951/59,971	63,657/63,676	22,350	1,841	0,020/0,068	BS	4081CP	H1082/4 STD 0.25
SE/PB	1	21,994/22,000	25,120/25,146	23,720			BS	60014X	55-4280 SEMI

45 88.00 x 82.00									
VM 4 HT		4 Cyl.		1995cc	61kW (83PS)		Diesel Turbo		TD150
VM 80 A		4 Cyl.		1995cc	70kW (95PS)		Diesel Turbo		TD151
VM4HT/2		4 Cyl.		1995cc	60kW (82PS)		Diesel Turbo		TD160
BE/PL	1	53,940/53,955	57,563/57,582	23,250	1,798	0,020/0,071	BS	66655CP	71-4234 STD 0.25 0.50 0.75
TW/A	2	74,250/74,500	88,000/88,100		2,362		AL-LF	61588AF	A227/2 STD
SE/PB	1	29,990/29,996	34,000/34,025	30,120			BS	66659XA	55-4235 SEMI

46 88.00 x 82.00									
VM 5 HT		5 Cyl.		2494cc	77kW (105PS)		Diesel Turbo		TD10148
VM-HR 588 HT		5 Cyl.		2493cc	76-77kW (103-105PS)		Diesel Turbo		TD158
BE/PL	1	53,940/53,955	57,563/57,582	23,250	1,798	0,020/0,071	BS	66655CP	71-4234 STD 0.25 0.50 0.75
TW/A	2	74,250/74,500	88,000/88,100		2,362		AL-LF	61588AF	A227/2 STD
SE/PB	1	29,990/29,996	34,000/34,025	30,120			BS	66659XA	55-4235 SEMI



47 91.35 x 63.40

AR 67302		V6 Cyl.		2492cc	120kW (163PS)		Petrol		TD9468
BE/PL	6	51,980/52,000	55,511/55,524	19,100	1,749	0,020/0,071	BS	4080CP	71-4218/6 STD 0.25
MB/HL 1-4	4	59,951/59,971	63,657/63,676	22,350	1,841	0,020/0,068	BS	4081CP	H1082/4 STD 0.25
SE/PB	1	21,994/22,000	25,120/25,146	23,720			BS	60014X	55-4280 SEMI

48 92.00 x 89.20

VM 82 A		3 Cyl.		1779cc	54kW (73PS)		Diesel Turbo		TD153
VM 96 A		3 Cyl.		1779cc	62kW (84PS)		Diesel Turbo		TD155
BE/PL	1	53,940/53,955	57,563/57,582	23,250	1,798	0,020/0,071	BS	66655CP	71-4234 STD 0.25 0.50 0.75
TW/A	2	74,250/74,500	88,000/88,100		2,362		AL-LF	61588AF	A227/2 STD
SE/PB	1	29,990/29,996	34,000/34,025	30,120			BS	66659XA	55-4235 SEMI

49 92.00 x 90.00

VM 81 A		4 Cyl.		2393cc	81kW (110PS)		Diesel Turbo		TD152
VM4HT 2.4		4 Cyl.		2393cc	69-70kW (94-95PS)		Diesel Turbo		TD159
BE/PL	1	53,940/53,955	57,563/57,582	23,250	1,798	0,020/0,071	BS	66655CP	71-4234 STD 0.25 0.50 0.75
TW/A	2	74,250/74,500	88,000/88,100		2,362		AL-LF	61588AF	A227/2 STD
SE/PB	1	29,990/29,996	34,000/34,025	30,120			BS	66659XA	55-4235 SEMI

50 92.00 x 94.00

VM 07 B		4 Cyl.		2499cc	92kW (125PS)		Diesel Turbo		TD149
VM 08 B		4 Cyl.		2499cc	92kW (125PS)		Diesel Turbo		TD9771
VM 31 B		4 Cyl.		2499cc	92-125kW (125-170PS)		Diesel Turbo		TD9768
VM 32 B		4 Cyl.		2499cc	92kW (125PS)		Diesel Turbo		TD127
VM 84 A		4 Cyl.		2499cc	84kW (114PS)		Diesel Turbo		TD154
VM-425 CHIEA 08 B		4 Cyl.		2499cc	90kW (122PS)		Diesel Turbo Intercooler		TD156
VM-425 SLIRA		4 Cyl.		2500cc	86kW (118PS)		Diesel Turbo Intercooler		TD157
BE/PL	1	53,940/53,955	57,563/57,582	23,250	1,798	0,020/0,071	BS	66655CP	71-4234 STD 0.25 0.50 0.75
TW/A	2	74,250/74,500	88,000/88,100		2,362		AL-LF	61588AF	A227/2 STD
SE/PB	1	29,990/29,996	34,000/34,025	30,120			BS	66659XA	55-4235 SEMI

51 93.00 x 72.60

AR 06120		V6 Cyl.		2959cc	133-136kW (181-185PS)		Petrol		TD48
AR 06124		V6 Cyl.		2959cc	136-138kW (185-188PS)		Petrol		TD49
AR 06410		V6 Cyl.		2959cc	136-141kW (184-192PS)		Petrol		TD59
AR 06412		V6 Cyl.		2959cc	135kW (184PS)		Petrol		TD61
AR 06430		V6 Cyl.		2959cc	147kW (200PS)		Petrol		TD64
AR 16101		V6 Cyl.		2959cc	141kW (192PS)		Petrol		TD4187
AR 16102		V6 Cyl.		2959cc	162kW (220PS)		Petrol		TD5495
AR 16105		V6 Cyl.		2959cc	160kW (218PS)		Petrol		TD15970
AR 16199		V6 Cyl.		2959cc	141kW (192PS)		Petrol		TD23347
AR 19520		V6 Cyl.		2959cc	136kW (185PS)		Petrol		TD23345
AR 34301		V6 Cyl.		2959cc	166kW (226PS)		Petrol		TD11603



AR 34302	V6 Cyl.	2959cc	166kW (226PS)	Petrol	TD23348
AR 36101	V6 Cyl.	2959cc	162kW (220PS)	Petrol	TD15393
AR 61501	V6 Cyl.	2959cc	151-155kW (205-211PS)	Petrol	TD104
AR 61503	V6 Cyl.	2959cc	139-141kW (189-192PS)	Petrol	TD51
AR 64301	V6 Cyl.	2959cc	147kW (200PS)	Petrol	TD106
AR 64303	V6 Cyl.	2959cc	132kW (180PS)	Petrol	TD29541
AR 64304	V6 Cyl.	2959cc	168-171kW (228-233PS)	Petrol	TD124
AR 64305	V6 Cyl.	2959cc	132kW (180PS)	Petrol	TD125
AR 64306	V6 Cyl.	2959cc	132-170kW (180-231PS)	Petrol	TD25829
AR 64307	V6 Cyl.	2959cc	170kW (231PS)	Petrol	TD148
AR 64308	V6 Cyl.	2959cc	150-170kW (204-231PS)	Petrol	TD126
AR 64399	V6 Cyl.	2959cc	132-145kW (180-197PS)	Petrol	TD21728
AR 66301	V6 Cyl.	2959cc	152-155kW (207-211PS)	Petrol	TD130
AR 66302	V6 Cyl.	2959cc	151-155kW (205-211PS)	Petrol	TD131
AR 66303	V6 Cyl.	2959cc	132kW (180PS)	Petrol	TD92
AR 66304	V6 Cyl.	2959cc	169-171kW (230-233PS)	Petrol	TD22624
AR 66306	V6 Cyl.	2959cc	157kW (214PS)	Petrol	TD21729
M 624 AA 30.A	V6 Cyl.	2959cc	132-136kW (180-185PS)	Petrol	TD22432
M 624 AB 30.A	V6 Cyl.	2959cc	147kW (200PS)	Petrol	TD22433

BE/PL	6	51,980/52,000	55,511/55,524	19,100	1,749	0,020/0,071	BS	4080CP	71-4218/6 STD 0.25
MB/HL	4	59,951/59,971	63,657/63,676	22,350	1,841	0,020/0,068	BS	4081CP	H1082/4 STD 0.25
SE/PB	1	21,994/22,000	25,120/25,146	23,720			BS	60014X	55-4280 SEMI

52

93.00 x 90.00

8140.21.200 D.I.	4 Cyl.	2445cc	68kW (92PS)	Diesel Turbo	TD143
8140.61.200	4 Cyl.	2445cc	53kW (72PS)	Diesel	TD144
8144.21.220	4 Cyl.	2445cc	68kW (92PS)	Diesel Turbo	TD145
8144.61.200	4 Cyl.	2445cc	53kW (72PS)	Diesel	TD146

BE/PL	4	56,520/56,535	60,333/60,345	24,700	1,870	0,020/0,072	BS	1870CP	71-4130/4 STD 0.25 0.50 0.75
BE/PL	4	56,520/56,535	60,333/60,345	24,700	1,870	0,020/0,070	BS	66575CP	71-4185/4 STD 0.25 0.50 0.75

1870CP

66575CP

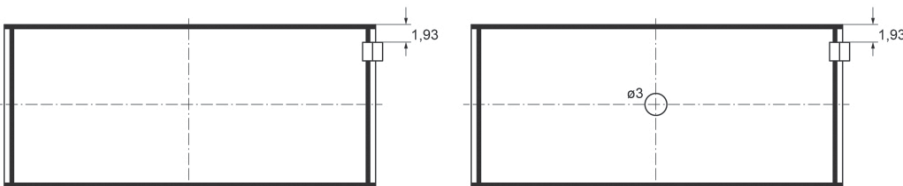

MB/HL 1-4	4	76,187/76,200	80,586/80,607	24,990	2,172	0,042/0,100	BS	66571CP	H1049/5 STD 0.25 0.50 0.75
MB/HL 5	1	76,187/76,200	80,586/80,607	31,950	2,172	0,042/0,100	BS	66572CPH	
MB/HL 1-4	4	76,187/76,200	80,586/80,607	24,990	2,172	0,038/0,097	BS	66573CP	H1094/5 STD 0.25
MB/HL 5	1	76,187/76,200	80,586/80,607	31,950	2,172	0,038/0,097	BS	66574CPH	



66571CP

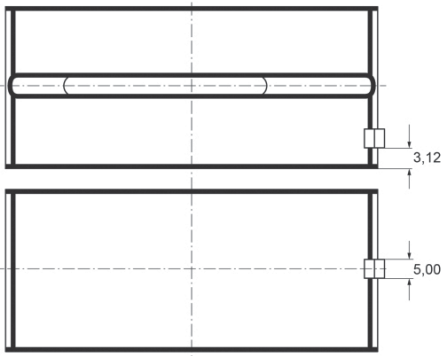

66572CPH

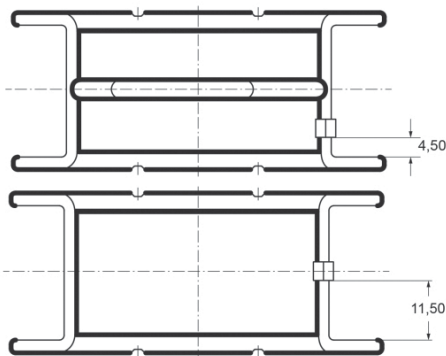

66573CP

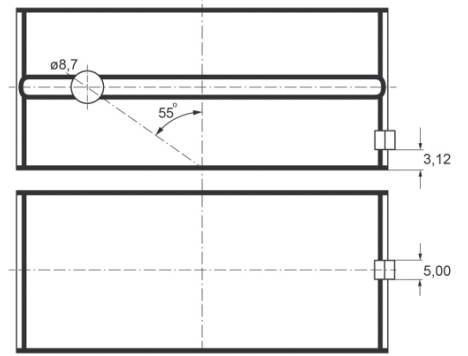

66574CPH

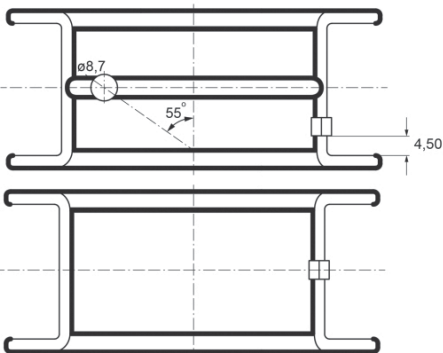

SE/PB	1	31,990/31,996	34,895/34,920	30,700			BS	66579YA	55-4186 SEMI
-------	---	---------------	---------------	--------	--	--	----	---------	------------------------

53

93.00 x 92.00

8144.67.220		4 Cyl. 2499cc 55kW (75PS)					Diesel		TD147
BE/PL	4	56,520/56,535	60,333/60,345	24,700	1,870	0,020/0,072	BS	1870CP	71-4130/4 STD 0.25 0.50 0.75
BE/PL	4	56,520/56,535	60,333/60,345	24,700	1,870	0,020/0,070	BS	66575CP	71-4185/4 STD 0.25 0.50 0.75

1870CP



66575CP

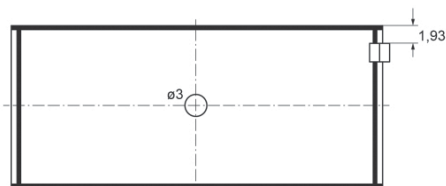

MB/HL 1-4	4	76,187/76,200	80,586/80,607	24,990	2,172	0,042/0,100	BS	66571CP	H1049/5 STD 0.25 0.50 0.75
MB/HL 5	1	76,187/76,200	80,586/80,607	31,950	2,172	0,042/0,100	BS	66572CPH	
MB/HL 1-4	4	76,187/76,200	80,586/80,607	24,990	2,172	0,038/0,097	BS	66573CP	H1094/5 STD 0.25
MB/HL 5	1	76,187/76,200	80,586/80,607	31,950	2,172	0,038/0,097	BS	66574CPH	



66571CP

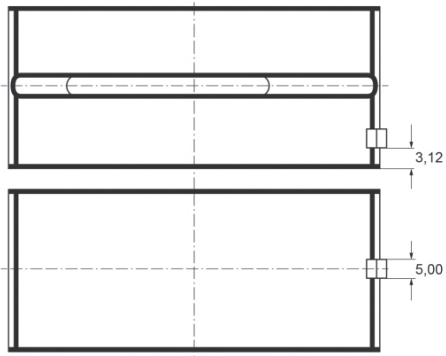

66572CPH

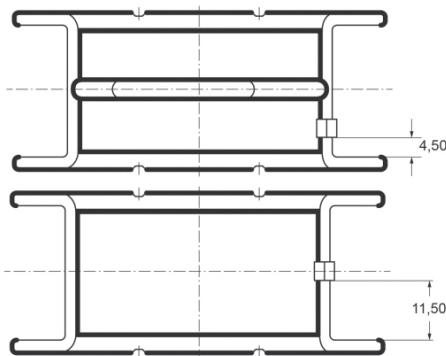



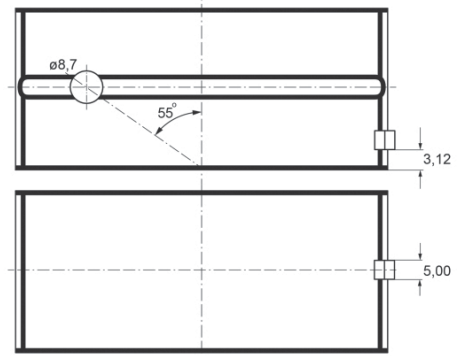



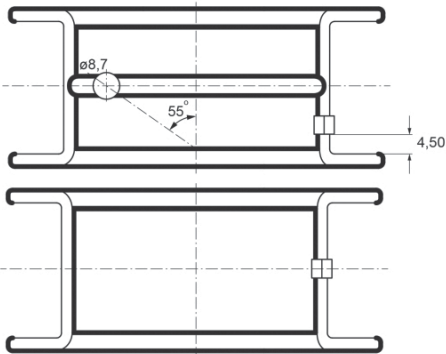

66573CP



66574CPH



SE/PB	1	31,990/31,996	34,895/34,920	30,700		BS	66579YA	55-4186 SEMI
-------	---	---------------	---------------	--------	--	----	---------	-----------------

				cm3				
50 0.8	01/76→07/78	Petrol	HE	771	4	64.50	59.00	1
50 1.1	08/74→07/78	Petrol	HB	1093	4	69.50	72.00	2
50 1.1	08/74→07/77	Petrol	HC	1093	4	69.50	72.00	2
50 1.3	08/77→07/78	Petrol	HH	1272	4	75.00	72.00	4
50 1.3	01/77→07/78	Petrol	HJ	1272	4	75.00	72.00	4
80 1.3	09/78→07/81	Petrol	FY	1272	4	75.00	72.00	4
80 1.3	09/78→07/81	Petrol	FZ	1272	4	75.00	72.00	4
80 1.3	09/78→07/86	Petrol	EP	1297	4	75.00	73.40	5
80 1.3	05/72→07/78	Petrol	ZA	1297	4	75.00	73.40	6
80 1.3	05/72→07/78	Petrol	ZF	1297	4	75.00	73.40	6
80 1.5	05/72→08/75	Petrol	YJ	1471	4	76.50	80.00	9
80 1.5	05/72→08/75	Petrol	ZB	1471	4	76.50	80.00	9
80 1.5	05/72→07/76	Petrol	ZC	1471	4	76.50	80.00	9
80 1.6	01/76→07/78	Petrol	FS	1588	4	79.50	80.00	18
80 1.6	08/78→07/86	Petrol	WV	1588	4	79.50	80.00	18
80 1.6	09/74→12/80	Petrol	YG	1588	4	79.50	80.00	18
80 1.6	09/74→12/80	Petrol	YH	1588	4	79.50	80.00	18
80 1.6	09/75→12/76	Petrol	YK	1588	4	79.50	80.00	18
80 1.6	09/75→07/86	Petrol	YN	1588	4	79.50	80.00	18
80 1.6	09/75→02/83	Petrol	YP	1588	4	79.50	80.00	18
80 1.6	08/78→07/81	Petrol	YT	1588	4	79.50	80.00	18
80 1.6	08/78→07/81	Petrol	YY	1588	4	79.50	80.00	18
80 1.6	08/90→10/91	Petrol	ABB	1595	4	81.00	77.40	48
80 1.6	09/91→12/94	Petrol	ABM	1595	4	81.00	77.40	48
80 1.6	08/78→07/86	Petrol	DT	1595	4	81.00	77.40	51
80 1.6	08/87→09/91	Petrol	PP	1595	4	81.00	77.40	52
80 1.6	09/86→08/91	Petrol	RN	1595	4	81.00	77.40	52
80 1.6	02/86→07/86	Petrol	SA	1595	4	81.00	77.40	53
80 1.6 D	08/80→08/86	Diesel	CR	1588	4	76.50	86.40	11
80 1.6 D	08/80→07/89	Diesel	JK	1588	4	76.50	86.40	11
80 1.6 E	06/93→01/96	Petrol	ADA	1595	4	81.00	77.40	48
80 1.6 GLE	08/78→07/82	Petrol	YZ	1588	4	79.50	80.00	18
80 1.6 GT	09/73→07/76	Petrol	XX	1584	4	79.50	80.00	18
80 1.6 GTE	01/76→07/78	Petrol	YS	1588	4	79.50	80.00	18
80 1.6 TD	08/81→05/86	Diesel	CY	1588	4	76.50	86.40	11
80 1.6 TD	09/86→08/91	Diesel	RA	1588	4	76.50	86.40	12
80 1.6 TD	09/86→08/91	Diesel	SB	1588	4	76.50	86.40	12
80 1.7	09/80→12/83	Petrol	WT	1715	4	79.50	86.40	21
80 1.8	01/83→08/86	Petrol	DS	1781	4	81.00	86.40	77
80 1.8	08/83→08/86	Petrol	JN	1781	4	81.00	86.40	77
80 1.8	01/83→08/86	Petrol	JV	1781	4	81.00	86.40	77
80 1.8	10/86→01/90	Petrol	RU	1781	4	81.00	86.40	79
80 1.8	02/86→07/86	Petrol	SF	1781	4	81.00	86.40	79
80 1.8	09/86→07/88	Petrol	SD	1847	4	82.50	86.40	96
80 1.8 quattro	08/85→08/86	Petrol	JN	1781	4	81.00	86.40	77
80 1.8 quattro	08/84→08/86	Petrol	JV	1781	4	81.00	86.40	77
80 1.8 quattro	08/84→08/86	Petrol	NE	1781	4	81.00	86.40	77
80 1.8 E	06/86→08/91	Petrol	DZ	1781	4	81.00	86.40	78
80 1.8 E quattro	09/86→08/91	Petrol	DZ	1781	4	81.00	86.40	78
80 1.8 GTE	10/84→08/86	Petrol	DZ	1781	4	81.00	86.40	78
80 1.8 GTE	08/85→07/86	Petrol	PV	1781	4	81.00	86.40	77
80 1.8 GTE quattro	08/84→08/86	Petrol	DZ	1781	4	81.00	86.40	78
80 1.8 GTE quattro	03/85→08/86	Petrol	PV	1781	4	81.00	86.40	77
80 1.8 quattro	09/86→08/90	Petrol	SD	1847	4	82.50	86.40	96
80 1.8 S	09/86→10/91	Petrol	JN	1781	4	81.00	86.40	77
80 1.8 S	09/86→10/91	Petrol	NE	1781	4	81.00	86.40	77
80 1.8 S	09/86→10/91	Petrol	PM	1781	4	81.00	86.40	79
80 1.8 S	08/86→01/90	Petrol	SF	1781	4	81.00	86.40	79
80 1.8 S quattro	09/86→09/91	Petrol	JN	1781	4	81.00	86.40	77
80 1.8 S quattro	09/86→09/91	Petrol	NE	1781	4	81.00	86.40	77
80 1.8 S quattro	09/86→09/91	Petrol	PM	1781	4	81.00	86.40	79
80 1.8 S quattro	09/86→07/90	Petrol	SF	1781	4	81.00	86.40	79
80 1.9 CD-5S	09/81→07/83	Petrol	WN	1921	5	79.50	77.40	17
80 1.9 D	08/89→08/91	Diesel	1Y	1896	4	79.50	95.50	32
80 1.9 TD	09/91→12/94	Diesel	AAZ	1896	4	79.50	95.50	33
80 1.9 TDI	09/91→01/96	Diesel	1Z	1896	4	79.50	95.50	33
80 2.0	09/87→12/90	Petrol	3A	1984	4	82.50	92.80	101
80 2.0	10/90→08/91	Petrol	AAD	1984	4	82.50	92.80	102
80 2.0	09/91→01/96	Petrol	ABT	1984	4	82.50	92.80	102



cm3



80 2.0	10/83→09/84	Petrol	HP	1994	5	81.00	77.40	54
80 2.0	10/83→09/84	Petrol	JS	1994	5	81.00	77.40	54
80 2.0 E	08/88→10/90	Petrol	3A	1984	4	82.50	92.80	101
80 2.0 E	09/91→01/96	Petrol	ABK	1984	4	82.50	92.80	102
80 2.0 E 16V	03/90→07/92	Petrol	6A	1984	4	82.50	92.80	101
80 2.0 E 16V	08/92→01/96	Petrol	ACE	1984	4	82.50	92.80	102
80 2.0 E 16V quattro	03/90→08/91	Petrol	6A	1984	4	82.50	92.80	101
80 2.0 E 16V quattro	04/92→07/95	Petrol	ACE	1984	4	82.50	92.80	102
80 2.0 E quattro	08/88→09/90	Petrol	3A	1984	4	82.50	92.80	101
80 2.0 E quattro	09/91→12/94	Petrol	ABK	1984	4	82.50	92.80	102
80 2.0 quattro	08/88→07/90	Petrol	3A	1984	4	82.50	92.80	101
80 2.0 quattro	10/90→08/91	Petrol	AAD	1984	4	82.50	92.80	102
80 2.0 quattro	11/93→01/96	Petrol	ADW	1984	4	82.50	92.80	102
80 2.0 quattro	10/83→09/84	Petrol	JS	1994	5	81.00	77.40	54
80 2.2	09/79→12/84	Petrol	WE	2144	5	79.50	86.40	24
80 2.2	09/84→12/86	Petrol	KX	2226	5	81.00	86.40	83
80 2.2 quattro	08/82→07/84	Petrol	KK	2144	5	79.50	86.40	23
80 2.2 quattro	08/82→07/84	Petrol	KL	2144	5	79.50	86.40	23
80 2.2 quattro	09/83→12/87	Petrol	JT	2226	5	81.00	86.40	83
80 2.3	09/90→12/92	Petrol	NG	2309	5	82.50	86.40	98
80 2.3 E	09/91→01/96	Petrol	NG	2309	5	82.50	86.40	98
80 2.3 E quattro	09/91→12/94	Petrol	NG	2309	5	82.50	86.40	98
80 2.3 quattro	10/87→07/89	Petrol	NG	2309	5	82.50	86.40	98
80 2.6	07/92→01/96	Petrol	ABC	2598	V6	82.50	81.00	95
80 2.6 quattro	06/92→07/95	Petrol	ABC	2598	V6	82.50	81.00	95
80 2.6 quattro	08/94→01/96	Petrol	ACZ	2598	V6	82.50	81.00	95
80 2.8	09/91→01/96	Petrol	AAH	2771	V6	82.50	86.40	99
80 2.8 quattro	09/91→07/95	Petrol	AAH	2771	V6	82.50	86.40	99
80 RS2 quattro	03/94→05/95	Petrol	ADU	2226	5	81.00	86.40	81
80 S2 quattro	02/93→12/94	Petrol	ABY	2226	5	81.00	86.40	81
80 S2 quattro	02/93→07/95	Petrol	ABY	2226	5	81.00	86.40	81
90 1.6 TD	10/85→01/87	Diesel	CY	1588	4	76.50	86.40	11
90 1.6 TD	04/87→09/91	Diesel	RA	1588	4	76.50	86.40	12
90 1.6 TD	04/87→09/91	Diesel	SB	1588	4	76.50	86.40	12
90 2.0	09/87→12/88	Petrol	3A	1984	4	82.50	92.80	101
90 2.0	10/84→03/87	Petrol	HP	1994	5	81.00	77.40	54
90 2.0	10/84→03/87	Petrol	JS	1994	5	81.00	77.40	54
90 2.0	07/88→09/91	Petrol	PS	1994	5	81.00	77.40	56
90 2.0	03/86→03/87	Petrol	SK	1994	5	81.00	77.40	56
90 2.0 20 V	08/89→07/91	Petrol	NM	1994	5	81.00	77.40	56
90 2.0 20 V quattro	08/88→09/91	Petrol	NM	1994	5	81.00	77.40	56
90 2.0 quattro	08/89→07/90	Petrol	6A	1984	4	82.50	92.80	101
90 2.0 quattro	08/84→08/86	Petrol	JS	1994	5	81.00	77.40	54
90 2.2	10/84→03/87	Petrol	HY	2226	5	81.00	86.40	82
90 2.2	10/84→03/87	Petrol	KV	2226	5	81.00	86.40	83
90 2.2	01/85→03/87	Petrol	KX	2226	5	81.00	86.40	83
90 2.2 E	04/87→07/91	Petrol	KV	2226	5	81.00	86.40	83
90 2.2 E quattro	08/85→03/87	Petrol	JT	2226	5	81.00	86.40	83
90 2.2 E quattro	11/84→09/91	Petrol	KV	2226	5	81.00	86.40	83
90 2.3 E	04/87→09/91	Petrol	NG	2309	5	82.50	86.40	98
90 2.3 E 20V	08/88→07/91	Petrol	7A	2309	5	82.50	86.40	97
90 2.3 E 20V quattro	06/88→09/91	Petrol	7A	2309	5	82.50	86.40	97
90 2.3 E quattro	04/87→09/91	Petrol	NG	2309	5	82.50	86.40	98
100 1.6	01/75→07/76	Petrol	YM	1588	4	79.50	80.00	18
100 1.6	08/76→02/83	Petrol	YV	1588	4	79.50	80.00	18
100 1.8	11/68→11/71	Petrol	ZV	1716	4	79.50	86.40	21
100 1.8	08/82→12/87	Petrol	DR	1781	4	81.00	86.40	77
100 1.8	08/83→07/89	Petrol	DS	1781	4	81.00	86.40	77
100 1.8	08/83→07/89	Petrol	JW	1781	4	81.00	86.40	77
100 1.8	08/83→07/89	Petrol	NP	1781	4	81.00	86.40	59
100 1.8	08/82→12/87	Petrol	RS	1781	4	81.00	86.40	59
100 1.8	02/86→07/90	Petrol	SH	1781	4	81.00	86.40	79
100 1.8 CAT	03/85→11/90	Petrol	4B	1781	4	81.00	86.40	59
100 1.8 CAT	03/85→11/90	Petrol	PH	1781	4	81.00	86.40	59
100 1.8 quattro	10/84→07/88	Petrol	JW	1781	4	81.00	86.40	77
100 1.8 quattro	10/84→07/88	Petrol	NP	1781	4	81.00	86.40	59
100 1.8 quattro	08/86→07/90	Petrol	SH	1781	4	81.00	86.40	79
100 1.8 quattro CAT	08/85→11/90	Petrol	4B	1781	4	81.00	86.40	59
100 1.8 quattro CAT	08/85→11/90	Petrol	PH	1781	4	81.00	86.40	59

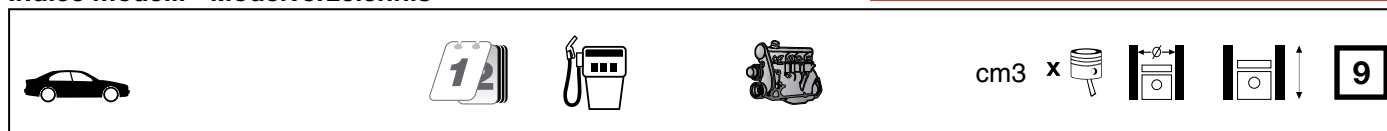

100 1.9	08/80→07/84	Petrol	WH	1921	5	79.50	77.40	16
100 2.0	12/90→06/94	Petrol	AAE	1984	4	82.50	92.80	101
100 2.0	08/84→12/87	Petrol	KP	1994	5	81.00	77.40	55
100 2.0	08/86→11/87	Petrol	SL	1994	5	81.00	77.40	56
100 2.0 CAT	01/88→11/90	Petrol	RT	1994	5	81.00	77.40	56
100 2.0 D	08/78→11/90	Diesel	CN	1986	5	76.50	86.40	13
100 2.0 D Turbo	08/82→02/88	Diesel	DE	1986	5	76.50	86.40	13
100 2.0 D Turbo	03/88→11/90	Diesel	NC	1986	5	76.50	86.40	13
100 2.0 E	12/90→06/94	Petrol	AAD	1984	4	82.50	92.80	102
100 2.0 E	09/91→06/94	Petrol	AAE	1984	4	82.50	92.80	101
100 2.0 E	12/90→06/94	Petrol	ABK	1984	4	82.50	92.80	102
100 2.0 E	01/85→12/87	Petrol	KP	1994	5	81.00	77.40	55
100 2.0 E 16V	01/92→06/94	Petrol	ACE	1984	4	82.50	92.80	102
100 2.0 E 16V quattro	07/92→06/94	Petrol	ACE	1984	4	82.50	92.80	102
100 2.0 E CAT	01/88→11/90	Petrol	RT	1994	5	81.00	77.40	56
100 2.0 E quattro	12/90→07/92	Petrol	AAD	1984	4	82.50	92.80	102
100 2.0 TD	03/83→10/87	Diesel	DE	1986	5	76.50	86.40	13
100 2.0 TD	03/88→11/90	Diesel	NC	1986	5	76.50	86.40	13
100 2.1	08/82→07/84	Petrol	KF	2144	5	79.50	86.40	23
100 2.1	07/77→02/83	Petrol	WB	2144	5	79.50	86.40	26
100 2.1	03/77→07/84	Petrol	WC	2144	5	79.50	86.40	27
100 2.1	08/82→12/84	Petrol	WD	2144	5	79.50	86.40	28
100 2.1	07/77→12/84	Petrol	WE	2144	5	79.50	86.40	24
100 2.1	03/77→02/83	Petrol	WG	2144	5	79.50	86.40	29
100 2.2	08/82→07/84	Petrol	KF	2144	5	79.50	86.40	23
100 2.2	09/83→12/85	Petrol	KH	2144	5	79.50	86.40	22
100 2.2	09/77→07/82	Petrol	WD	2144	5	79.50	86.40	28
100 2.2	09/77→07/82	Petrol	WE	2144	5	79.50	86.40	24
100 2.2	08/82→12/84	Petrol	WU	2144	5	79.50	86.40	23
100 2.2	08/84→12/88	Petrol	KU	2226	5	81.00	86.39	58
100 2.2	10/84→12/87	Petrol	KZ	2226	5	81.00	86.40	83
100 2.2	09/85→12/88	Petrol	MC	2226	5	81.00	86.40	85
100 2.2 CAT	06/89→11/90	Petrol	HX	2226	5	81.00	86.40	82
100 2.2 CAT	06/89→11/90	Petrol	KU	2226	5	81.00	86.39	58
100 2.2 E quattro	08/85→07/86	Petrol	PX	2226	5	81.00	86.40	83
100 2.2 E Turbo quattro	08/86→11/90	Petrol	MC	2226	5	81.00	86.40	85
100 2.2 quattro	09/84→12/85	Petrol	WX	2144	5	79.50	86.40	22
100 2.2 quattro	08/84→12/88	Petrol	KU	2226	5	81.00	86.39	58
100 2.2 quattro	09/85→12/88	Petrol	MC	2226	5	81.00	86.40	85
100 2.2 quattro CAT	06/89→11/90	Petrol	HX	2226	5	81.00	86.40	82
100 2.2 quattro CAT	06/89→11/90	Petrol	KU	2226	5	81.00	86.39	58
100 2.2 Turbo	08/86→11/90	Petrol	MC	2226	5	81.00	86.40	85
100 2.2 Turbo quattro	08/86→11/90	Petrol	MC	2226	5	81.00	86.40	85
100 2.3	08/86→11/90	Petrol	NF	2309	5	82.50	86.40	98
100 2.3 E	12/90→06/94	Petrol	AAR	2309	5	82.50	86.40	97
100 2.3 E	10/86→11/90	Petrol	NF	2309	5	82.50	86.40	98
100 2.3 E quattro	12/90→06/94	Petrol	AAR	2309	5	82.50	86.40	97
100 2.3 E quattro	08/86→11/90	Petrol	NF	2309	5	82.50	86.40	98
100 2.3 quattro	09/86→11/90	Petrol	NF	2309	5	82.50	86.40	98
100 2.4 D	08/89→07/91	Diesel	3D	2370	5	79.50	95.50	46
100 2.4 D	12/90→06/94	Diesel	AAS	2370	5	79.50	95.50	46
100 2.5 TDI	01/90→11/90	Diesel	1T	2461	5	81.00	95.50	93
100 2.5 TDI	12/90→06/94	Diesel	AAT	2461	5	81.00	95.50	93
100 2.5 TDI	12/90→06/94	Diesel	ABP	2461	5	81.00	95.50	93
100 2.6	03/92→06/94	Petrol	ABC	2598	V6	82.50	81.00	95
100 2.6	07/93→06/94	Petrol	ACZ	2598	V6	82.50	81.00	95
100 2.6 E quattro	08/93→07/94	Petrol	ACZ	2598	V6	82.50	81.00	95
100 2.6 quattro	04/92→06/94	Petrol	ABC	2598	V6	82.50	81.00	95
100 2.8 E	12/90→06/94	Petrol	AAH	2771	V6	82.50	86.40	99
100 2.8 E quattro	12/90→06/94	Petrol	AAH	2771	V6	82.50	86.40	99
100 S4 Turbo quattro	08/91→06/94	Petrol	AAN	2226	5	81.00	86.40	81
200 2.1 5E	10/79→07/84	Petrol	WC	2144	5	79.50	86.40	27
200 2.1 5T	10/79→08/82	Petrol	WJ	2144	5	79.50	86.40	30
200 2.1 5T	10/79→09/82	Petrol	WK	2144	5	79.50	86.40	22
200 2.1 Turbo	08/83→01/88	Petrol	KG	2144	5	79.50	86.40	22
200 2.1 Turbo quattro	09/83→01/88	Petrol	JY	2144	5	79.50	86.40	22
200 2.1 Turbo quattro	08/83→01/88	Petrol	KG	2144	5	79.50	86.40	22
200 2.2	08/84→07/85	Petrol	KU	2226	5	81.00	86.39	58
200 2.2	09/88→12/91	Petrol	MC	2226	5	81.00	86.40	85



cm3



9

200 2.2 20V Turbo quattro	03/89→12/90	Petrol	3B	2226	5	81.00	86.40	81
200 2.2 quattro	09/88→12/91	Petrol	MC	2226	5	81.00	86.40	85
200 2.2 Turbo	02/88→12/90	Petrol	1B	2226	5	81.00	86.40	80
200 2.2 Turbo	02/88→12/90	Petrol	2B	2226	5	81.00	86.40	80
200 2.2 Turbo	08/85→09/91	Petrol	MC	2226	5	81.00	86.40	85
200 2.2 Turbo quattro	02/88→12/91	Petrol	1B	2226	5	81.00	86.40	80
200 2.2 Turbo quattro	09/83→12/91	Petrol	MC	2226	5	81.00	86.40	85
200 2.3	11/86→09/91	Petrol	NF	2309	5	82.50	86.40	98
A1 1.2 TFSI	05/10→	Petrol	CBZA	1197	4	71.00	75.60	3
A1 1.4 TFSI	01/11→	Petrol	CAVG	1390	4	76.50	75.60	8
A1 1.4 TFSI	05/10→	Petrol	CAXA	1390	4	76.50	75.60	8
A1 1.4 TFSI	05/10→	Petrol	CNVA	1390	4	76.50	75.60	8
A1 1.4 TFSI	01/11→	Petrol	CTHG	1390	4	76.50	75.60	8
A1 1.4 TFSI	01/11→	Petrol	CTJA	1390	4	76.50	75.60	8
A1 1.6 TDI	03/11→	Diesel	CAYB	1598	4	79.50	80.50	19
A1 1.6 TDI	05/10→	Diesel	CAYC	1598	4	79.50	80.50	19
A1 2.0 TDI	05/12→	Diesel	CFHB	1968	4	81.00	95.50	90
A1 2.0 TDI	09/11→	Diesel	CFHD	1968	4	81.00	95.50	89
A2 1.2 TDI	03/01→08/05	Diesel	ANY	1191	3	76.50	86.40	10
A2 1.4	02/00→08/05	Petrol	AUA	1390	4	76.50	75.60	7
A2 1.4	02/00→08/05	Petrol	BBY	1390	4	76.50	75.60	7
A2 1.4 TDI	02/00→08/05	Diesel	AMF	1422	3	79.50	95.50	31
A2 1.4 TDI	11/03→08/05	Diesel	ATL	1422	3	79.50	95.50	31
A2 1.4 TDI	02/00→08/05	Diesel	BHC	1422	3	79.50	95.50	31
A2 1.6 FSI	05/02→08/05	Petrol	BAD	1598	4	76.50	86.90	14
A3 1.2 TFSI	03/10→05/13	Petrol	CBZB	1197	4	71.00	75.60	3
A3 1.2 TFSI	04/10→03/13	Petrol	CBZB	1197	4	71.00	75.60	3
A3 1.4 TFSI	09/07→05/13	Petrol	CAXC	1390	4	76.50	75.60	8
A3 1.6	09/96→05/03	Petrol	AEH	1595	4	81.00	77.40	49
A3 1.6	09/96→05/03	Petrol	AKL	1595	4	81.00	77.40	49
A3 1.6	09/96→05/03	Petrol	APF	1595	4	81.00	77.40	49
A3 1.6	08/00→05/03	Petrol	AVU	1595	4	81.00	77.40	50
A3 1.6	08/00→05/03	Petrol	BFQ	1595	4	81.00	77.40	50
A3 1.6	05/03→03/13	Petrol	BGU	1595	4	81.00	77.40	50
A3 1.6	05/03→03/13	Petrol	BSE	1595	4	81.00	77.40	50
A3 1.6	05/03→03/13	Petrol	BSF	1595	4	81.00	77.40	50
A3 1.6 E-Power	01/11→03/13	Petrol	CCSA	1595	4	81.00	77.40	50
A3 1.6 E-Power	01/11→03/13	Petrol	CMXA	1595	4	81.00	77.40	50
A3 1.6 FSI	08/03→09/07	Petrol	BAG	1598	4	76.50	86.90	14
A3 1.6 FSI	08/03→09/07	Petrol	BLF	1598	4	76.50	86.90	14
A3 1.6 FSI	08/03→09/07	Petrol	BLP	1598	4	76.50	86.90	14
A3 1.6 TDI	05/09→03/13	Diesel	CAYB	1598	4	79.50	80.50	19
A3 1.6 TDI	05/09→05/13	Diesel	CAYC	1598	4	79.50	80.50	19
A3 1.6 TDI	10/12→	Diesel	CLHA	1598	4	79.50	80.50	20
A3 1.8	09/96→05/03	Petrol	AGN	1781	4	81.00	86.40	63
A3 1.8	09/96→05/03	Petrol	APG	1781	4	81.00	86.40	68
A3 1.8 T	12/96→05/03	Petrol	AGU	1781	4	81.00	86.40	64
A3 1.8 T	12/98→05/03	Petrol	AJQ	1781	4	81.00	86.40	66
A3 1.8 T	12/98→05/03	Petrol	ARY	1781	4	81.00	86.40	71
A3 1.8 T	12/96→05/03	Petrol	ARZ	1781	4	81.00	86.40	64
A3 1.8 T	12/96→05/03	Petrol	AUM	1781	4	81.00	86.40	72
A3 1.8 T	12/98→05/03	Petrol	AUQ	1781	4	81.00	86.40	72
A3 1.8 T quattro	12/96→05/03	Petrol	AGU	1781	4	81.00	86.40	64
A3 1.8 T quattro	10/98→05/03	Petrol	AJQ	1781	4	81.00	86.40	66
A3 1.8 T quattro	12/96→05/03	Petrol	ARX	1781	4	81.00	86.40	70
A3 1.8 T quattro	10/98→05/03	Petrol	ARY	1781	4	81.00	86.40	71
A3 1.9 TDI	09/96→07/01	Diesel	AGR	1896	4	79.50	95.50	36
A3 1.9 TDI	08/97→07/01	Diesel	AHF	1896	4	79.50	95.50	37
A3 1.9 TDI	09/96→07/01	Diesel	ALH	1896	4	79.50	95.50	33
A3 1.9 TDI	08/97→07/01	Diesel	ASV	1896	4	79.50	95.50	37
A3 1.9 TDI	08/00→05/03	Diesel	ASZ	1896	4	79.50	95.50	41
A3 1.9 TDI	10/00→05/03	Diesel	ATD	1896	4	79.50	95.50	42
A3 1.9 TDI	10/00→05/03	Diesel	AXR	1896	4	79.50	95.50	45
A3 1.9 TDI	05/03→05/10	Diesel	BKC	1896	4	79.50	95.50	45
A3 1.9 TDI	05/03→05/10	Diesel	BLS	1896	4	79.50	95.50	45
A3 1.9 TDI	05/03→05/10	Diesel	BXE	1896	4	79.50	95.50	45
A3 1.9 TDI quattro	08/00→05/03	Diesel	ASZ	1896	4	79.50	95.50	41
A3 2.0 FSI	05/03→06/08	Petrol	AXW	1984	4	82.50	92.80	103
A3 2.0 FSI	05/03→06/08	Petrol	BLR	1984	4	82.50	92.80	103

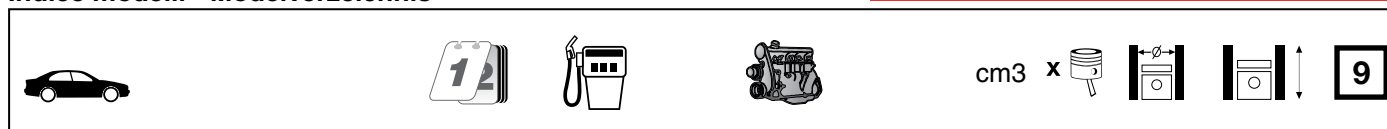









A3 2.0 FSI	05/03→06/08	Petrol	BLX	1984	4	82.50	92.80	103
A3 2.0 FSI	05/03→06/08	Petrol	BLY	1984	4	82.50	92.80	103
A3 2.0 FSI	05/03→06/08	Petrol	BMB	1984	4	82.50	92.80	103
A3 2.0 FSI	05/03→06/08	Petrol	BVY	1984	4	82.50	92.80	103
A3 2.0 FSI	05/03→06/08	Petrol	BVZ	1984	4	82.50	92.80	103
A3 2.0 TDI	05/03→03/13	Diesel	AZV	1968	4	81.00	95.50	89
A3 2.0 TDI	06/05→06/08	Diesel	BMM	1968	4	81.00	95.50	89
A3 2.0 TDI	03/06→03/13	Diesel	BMN	1968	4	81.00	95.50	89
A3 2.0 TDI	06/06→06/08	Diesel	BUY	1968	4	81.00	95.50	89
A3 2.0 TDI	05/03→05/13	Diesel	CBAA	1968	4	81.00	95.50	89
A3 2.0 TDI	04/08→05/13	Diesel	CBAB	1968	4	81.00	95.50	89
A3 2.0 TDI	03/06→03/13	Diesel	CBBB	1968	4	81.00	95.50	90
A3 2.0 TDI	05/03→05/13	Diesel	CFFA	1968	4	81.00	95.50	90
A3 2.0 TDI	04/08→05/13	Diesel	CFFB	1968	4	81.00	95.50	90
A3 2.0 TDI	03/06→03/13	Diesel	CFGB	1968	4	81.00	95.50	90
A3 2.0 TDI	04/12→	Diesel	CRBC	1968	4	81.00	95.50	92
A3 2.0 TDI	01/13→	Diesel	CRFA	1968	4	81.00	95.50	92
A3 2.0 TDI	09/12→	Diesel	CRFC	1968	4	81.00	95.50	92
A3 2.0 TDI	04/12→	Diesel	CRLB	1968	4	81.00	95.50	92
A3 2.0 TDI 16V	05/03→03/13	Diesel	BKD	1968	4	81.00	95.50	89
A3 2.0 TDI 16V	05/03→03/13	Diesel	CBAB	1968	4	81.00	95.50	89
A3 2.0 TDI 16V	05/03→03/13	Diesel	CFFB	1968	4	81.00	95.50	90
A3 2.0 TDI 16V	05/03→03/13	Diesel	CLJA	1968	4	81.00	95.50	90
A3 2.0 TDI 16V quattro	08/04→03/13	Diesel	BKD	1968	4	81.00	95.50	89
A3 2.0 TDI 16V quattro	08/04→03/13	Diesel	CBAB	1968	4	81.00	95.50	89
A3 2.0 TDI 16V quattro	08/04→03/13	Diesel	CFFB	1968	4	81.00	95.50	90
A3 2.0 TDI quattro	05/03→06/08	Diesel	AZV	1968	4	81.00	95.50	89
A3 2.0 TDI quattro	01/06→06/08	Diesel	BMM	1968	4	81.00	95.50	89
A3 2.0 TDI quattro	03/06→03/13	Diesel	BMN	1968	4	81.00	95.50	89
A3 2.0 TDI quattro	03/06→03/13	Diesel	CBBB	1968	4	81.00	95.50	90
A3 2.0 TDI quattro	03/06→03/13	Diesel	CFGB	1968	4	81.00	95.50	90
A3 2.0 TDI quattro	10/12→	Diesel	CRBC	1968	4	81.00	95.50	92
A3 2.0 TDI quattro	02/13→	Diesel	CRLB	1968	4	81.00	95.50	92
A3 3.2 V6 quattro	07/03→05/09	Petrol	BDB	3189	V6	84.00	95.90	107
A3 3.2 V6 quattro	07/03→05/09	Petrol	BMJ	3189	V6	84.00	95.90	107
A3 3.2 V6 quattro	07/03→05/09	Petrol	BUB	3189	V6	84.00	95.90	107
A3 3.2 quattro	09/05→12/09	Petrol	BUB	3189	V6	84.00	95.90	107
A3 S3 quattro	03/99→04/02	Petrol	AMK	1781	4	81.00	86.40	66
A4 1.6	11/94→09/01	Petrol	ADP	1595	4	81.00	77.40	48
A4 1.6	11/94→09/01	Petrol	AHL	1595	4	81.00	77.40	49
A4 1.6	07/00→06/08	Petrol	ALZ	1595	4	81.00	77.40	50
A4 1.6	11/94→09/01	Petrol	ANA	1595	4	81.00	77.40	50
A4 1.6	11/94→09/01	Petrol	ARM	1595	4	81.00	77.40	49
A4 1.8	01/95→09/01	Petrol	ADR	1781	4	81.00	86.40	60
A4 1.8	04/95→09/01	Petrol	AFY	1781	4	81.00	86.40	62
A4 1.8	05/00→09/00	Petrol	AMB	1781	4	81.00	86.40	67
A4 1.8	01/95→09/01	Petrol	APT	1781	4	81.00	86.40	63
A4 1.8	01/95→09/01	Petrol	ARG	1781	4	81.00	86.40	63
A4 1.8	01/95→09/01	Petrol	AVV	1781	4	81.00	86.40	74
A4 1.8 quattro	01/95→09/01	Petrol	ADR	1781	4	81.00	86.40	60
A4 1.8 quattro	07/95→09/01	Petrol	AFY	1781	4	81.00	86.40	62
A4 1.8 quattro	01/95→09/01	Petrol	APT	1781	4	81.00	86.40	63
A4 1.8 quattro	01/95→09/01	Petrol	ARG	1781	4	81.00	86.40	63
A4 1.8 T	01/95→09/01	Petrol	AEB	1781	4	81.00	86.40	61
A4 1.8 T	07/01→10/05	Petrol	AMB	1781	4	81.00	86.40	67
A4 1.8 T	01/95→09/01	Petrol	ANB	1781	4	81.40	86.40	94
A4 1.8 T	01/95→09/01	Petrol	APU	1781	4	81.00	86.40	64
A4 1.8 T	01/95→09/01	Petrol	ARK	1781	4	81.00	86.40	64
A4 1.8 T	11/00→07/02	Petrol	AVJ	1781	4	81.00	86.40	73
A4 1.8 T	01/95→09/01	Petrol	AWT	1781	4	81.00	86.40	72
A4 1.8 T	11/02→12/04	Petrol	BEX	1781	4	81.00	86.40	73
A4 1.8 T	07/02→03/09	Petrol	BFB	1781	4	81.00	86.40	73
A4 1.8 T quattro	01/95→09/01	Petrol	AEB	1781	4	81.00	86.40	61
A4 1.8 T quattro	07/01→12/04	Petrol	AMB	1781	4	81.00	86.40	67
A4 1.8 T quattro	01/95→09/01	Petrol	ANB	1781	4	81.40	86.40	94
A4 1.8 T quattro	01/95→09/01	Petrol	APU	1781	4	81.00	86.40	64
A4 1.8 T quattro	01/95→09/01	Petrol	ARK	1781	4	81.00	86.40	64
A4 1.8 T quattro	11/00→07/02	Petrol	AVJ	1781	4	81.00	86.40	73
A4 1.8 T quattro	01/95→09/01	Petrol	AWT	1781	4	81.00	86.40	72



cm3



A4 1.8 T quattro	11/02→12/04	Petrol	BEX	1781	4	81.00	86.40	73
A4 1.8 T quattro	07/02→03/09	Petrol	BFB	1781	4	81.00	86.40	73
A4 1.9 DUO	03/98→09/01	Diesel	AHU	1896	4	79.50	95.50	38
A4 1.9 TDI	01/95→09/01	Diesel	1Z	1896	4	79.50	95.50	33
A4 1.9 TDI	12/95→09/01	Diesel	AFF	1896	4	79.50	95.50	33
A4 1.9 TDI	10/95→09/01	Diesel	AFN	1896	4	79.50	95.50	35
A4 1.9 TDI	01/95→09/01	Diesel	AHH	1896	4	79.50	95.50	33
A4 1.9 TDI	01/95→09/01	Diesel	AHU	1896	4	79.50	95.50	38
A4 1.9 TDI	03/00→09/01	Diesel	AJM	1896	4	79.50	95.50	39
A4 1.9 TDI	05/01→12/04	Diesel	AVB	1896	4	79.50	95.50	43
A4 1.9 TDI	11/00→12/04	Diesel	AVF	1896	4	79.50	95.50	44
A4 1.9 TDI	10/95→09/01	Diesel	AVG	1896	4	79.50	95.50	35
A4 1.9 TDI	11/00→12/04	Diesel	AWX	1896	4	79.50	95.50	44
A4 1.9 TDI	06/04→06/08	Diesel	BKE	1896	4	79.50	95.50	44
A4 1.9 TDI	11/04→06/08	Diesel	BRB	1896	4	79.50	95.50	41
A4 1.9 TDI quattro	09/96→09/01	Diesel	AFN	1896	4	79.50	95.50	35
A4 1.9 TDI quattro	03/00→09/01	Diesel	AJM	1896	4	79.50	95.50	39
A4 1.9 TDI quattro	03/00→09/01	Diesel	ATJ	1896	4	79.50	95.50	42
A4 1.9 TDI quattro	11/01→12/04	Diesel	AVF	1896	4	79.50	95.50	44
A4 1.9 TDI quattro	09/96→09/01	Diesel	AVG	1896	4	79.50	95.50	35
A4 2.0	11/00→06/08	Petrol	ALT	1984	4	82.50	92.80	103
A4 2.0 FSI	07/02→12/04	Petrol	AWA	1984	4	82.50	92.80	103
A4 2.0 TDI	11/04→06/08	Diesel	BNA	1968	4	81.00	95.50	89
A4 2.0 TDI	11/04→03/09	Diesel	BPW	1968	4	81.00	95.50	89
A4 2.0 TDI	01/06→03/09	Diesel	BRC	1968	4	81.00	95.50	89
A4 2.0 TDI	06/06→06/08	Diesel	BRD	1968	4	81.00	95.50	89
A4 2.0 TDI	11/04→06/08	Diesel	BRF	1968	4	81.00	95.50	89
A4 2.0 TDI	06/06→06/08	Diesel	BVA	1968	4	81.00	95.50	89
A4 2.0 TDI	11/05→11/06	Diesel	BVF	1968	4	81.00	95.50	89
A4 2.0 TDI	09/05→09/06	Diesel	BVG	1968	4	81.00	95.50	89
A4 2.0 TDI	11/07→12/15	Diesel	CAGA	1968	4	81.00	95.50	89
A4 2.0 TDI	11/07→12/15	Diesel	CAGB	1968	4	81.00	95.50	89
A4 2.0 TDI	06/08→12/15	Diesel	CAGC	1968	4	81.00	95.50	89
A4 2.0 TDI	01/08→03/12	Diesel	CAHA	1968	4	81.00	95.50	89
A4 2.0 TDI	08/08→12/15	Diesel	CAHB	1968	4	81.00	95.50	89
A4 2.0 TDI	11/11→12/15	Diesel	CGLC	1968	4	81.00	95.50	89
A4 2.0 TDI	08/08→12/15	Diesel	CGLD	1968	4	81.00	95.50	89
A4 2.0 TDI	11/07→12/15	Diesel	CJCA	1968	4	81.00	95.50	89
A4 2.0 TDI	11/07→12/15	Diesel	CJCB	1968	4	81.00	95.50	89
A4 2.0 TDI	06/08→12/15	Diesel	CJCC	1968	4	81.00	95.50	92
A4 2.0 TDI	05/13→12/15	Diesel	CJCD	1968	4	81.00	95.50	92
A4 2.0 TDI	11/07→12/15	Diesel	CMEA	1968	4	81.00	95.50	89
A4 2.0 TDI	11/07→12/15	Diesel	CMFA	1968	4	81.00	95.50	92
A4 2.0 TDI	11/11→12/15	Diesel	CMGB	1968	4	81.00	95.50	89
A4 2.0 TDI 16V	11/04→06/08	Diesel	BLB	1968	4	81.00	95.50	89
A4 2.0 TDI 16V	11/04→06/08	Diesel	BRE	1968	4	81.00	95.50	89
A4 2.0 TDI quattro	01/06→06/08	Diesel	BPW	1968	4	81.00	95.50	89
A4 2.0 TDI quattro	06/06→06/08	Diesel	BRD	1968	4	81.00	95.50	89
A4 2.0 TDI quattro	06/06→06/08	Diesel	BVA	1968	4	81.00	95.50	89
A4 2.0 TDI quattro	04/08→12/15	Diesel	CAGA	1968	4	81.00	95.50	89
A4 2.0 TDI quattro	01/08→03/12	Diesel	CAHA	1968	4	81.00	95.50	89
A4 2.0 TDI quattro	11/11→12/15	Diesel	CGLC	1968	4	81.00	95.50	89
A4 2.0 TDI quattro	04/08→12/15	Diesel	CJCA	1968	4	81.00	95.50	89
A4 2.0 TDI quattro	05/13→12/15	Diesel	CJCD	1968	4	81.00	95.50	92
A4 2.4	07/95→07/97	Petrol	AFM	2393	V6	81.00	77.40	57
A4 2.4	03/97→09/01	Petrol	AGA	2393	V6	81.00	77.40	57
A4 2.4	08/97→09/01	Petrol	AJG	2393	V6	81.00	77.40	57
A4 2.4	03/97→09/01	Petrol	ALF	2393	V6	81.00	77.40	57
A4 2.4	03/97→09/01	Petrol	AML	2393	V6	81.00	77.40	57
A4 2.4	08/97→12/05	Petrol	AMM	2393	V6	81.00	77.40	57
A4 2.4	03/97→09/01	Petrol	APS	2393	V6	81.00	77.40	57
A4 2.4	08/97→09/01	Petrol	APZ	2393	V6	81.00	77.40	57
A4 2.4	03/97→09/01	Petrol	ARJ	2393	V6	81.00	77.40	57
A4 2.4	09/01→12/05	Petrol	BDV	2393	V6	81.00	77.40	57
A4 2.4 quattro	03/97→09/01	Petrol	AGA	2393	V6	81.00	77.40	57
A4 2.4 quattro	03/97→09/01	Petrol	ALF	2393	V6	81.00	77.40	57
A4 2.4 quattro	03/97→09/01	Petrol	AML	2393	V6	81.00	77.40	57
A4 2.4 quattro	03/97→09/01	Petrol	APS	2393	V6	81.00	77.40	57
A4 2.4 quattro	08/97→09/01	Petrol	APZ	2393	V6	81.00	77.40	57

				cm3	x 			
A4 2.4 quattro	03/97→09/01	Petrol	ARJ	2393	V6	81.00	77.40	57
A4 2.5 TDI	09/97→09/01	Diesel	AFB	2496	V6	78.30	86.40	15
A4 2.5 TDI	09/97→09/01	Diesel	AKN	2496	V6	78.30	86.40	15
A4 2.5 TDI	08/01→07/02	Diesel	AYM	2496	V6	78.30	86.40	15
A4 2.5 TDI	07/02→12/05	Diesel	BCZ	2496	V6	78.30	86.40	15
A4 2.5 TDI	07/02→05/06	Diesel	BDG	2496	V6	78.30	86.40	15
A4 2.5 TDI	07/02→12/05	Diesel	BFC	2496	V6	78.30	86.40	15
A4 2.5 TDI quattro	09/97→09/01	Diesel	AFB	2496	V6	78.30	86.40	15
A4 2.5 TDI quattro	11/00→12/04	Diesel	AKE	2496	V6	78.30	86.40	15
A4 2.5 TDI quattro	09/97→09/01	Diesel	AKN	2496	V6	78.30	86.40	15
A4 2.5 TDI quattro	11/00→12/04	Diesel	BAU	2496	V6	78.30	86.40	15
A4 2.5 TDI quattro	11/00→12/04	Diesel	BDH	2496	V6	78.30	86.40	15
A4 2.6	01/95→09/01	Petrol	ABC	2598	V6	82.50	81.00	95
A4 2.6	01/96→07/97	Petrol	ACZ	2598	V6	82.50	81.00	95
A4 2.6 quattro	01/95→09/01	Petrol	ABC	2598	V6	82.50	81.00	95
A4 2.7 Turbo quattro	02/99→09/00	Petrol	AJK	2671	V6	81.00	86.40	86
A4 2.8	09/95→07/97	Petrol	AAH	2771	V6	82.50	86.40	99
A4 2.8	10/96→09/01	Petrol	ACK	2771	V6	82.50	86.40	99
A4 2.8	10/96→09/01	Petrol	ALG	2771	V6	82.50	86.40	99
A4 2.8	10/96→09/01	Petrol	AMX	2771	V6	82.50	86.40	99
A4 2.8	10/96→09/01	Petrol	APR	2771	V6	82.50	86.40	99
A4 2.8	10/96→09/01	Petrol	AQD	2771	V6	82.50	86.40	99
A4 2.8	03/99→10/00	Petrol	ATX	2771	V6	82.50	86.40	99
A4 2.8 quattro	01/95→07/97	Petrol	AAH	2771	V6	82.50	86.40	99
A4 2.8 quattro	10/96→09/01	Petrol	ACK	2771	V6	82.50	86.40	99
A4 2.8 quattro	10/96→09/01	Petrol	ALG	2771	V6	82.50	86.40	99
A4 2.8 quattro	10/96→09/01	Petrol	AMX	2771	V6	82.50	86.40	99
A4 2.8 quattro	10/96→09/01	Petrol	APR	2771	V6	82.50	86.40	99
A4 2.8 quattro	10/96→09/01	Petrol	AQD	2771	V6	82.50	86.40	99
A4 2.8 quattro	03/99→10/00	Petrol	ATX	2771	V6	82.50	86.40	99
A4 3.0	11/00→12/05	Petrol	ASN	2976	V6	82.50	92.80	105
A4 3.0	11/00→12/04	Petrol	AVK	2976	V6	82.50	92.80	106
A4 3.0	04/01→05/06	Petrol	BBJ	2976	V6	82.50	92.80	106
A4 3.0 quattro	11/00→12/05	Petrol	ASN	2976	V6	82.50	92.80	105
A4 3.0 quattro	11/00→12/04	Petrol	AVK	2976	V6	82.50	92.80	106
A4 3.0 quattro	04/01→07/06	Petrol	BBJ	2976	V6	82.50	92.80	106
A4 3.2 FSI	01/05→03/09	Petrol	AUK	3123	V6	84.50	92.80	111
A4 3.2 FSI quattro	01/05→03/09	Petrol	AUK	3123	V6	84.50	92.80	111
A4 RS4 quattro	05/00→09/01	Petrol	ASJ	2671	V6	81.00	86.40	87
A4 S4 quattro	09/97→09/01	Petrol	AGB	2671	V6	81.00	86.40	86
A4 S4 quattro	09/97→09/01	Petrol	AZB	2671	V6	81.00	86.40	86
A4 Allroad 2.0 TDI quattro	09/09→	Diesel	CAGA	1968	4	81.00	95.50	89
A4 Allroad 2.0 TDI quattro	09/09→	Diesel	CAGB	1968	4	81.00	95.50	89
A4 Allroad 2.0 TDI quattro	04/09→	Diesel	CAHA	1968	4	81.00	95.50	89
A4 Allroad 2.0 TDI quattro	04/09→	Diesel	CAHB	1968	4	81.00	95.50	89
A4 Allroad 2.0 TDI quattro	11/11→	Diesel	CGLC	1968	4	81.00	95.50	89
A4 Allroad 2.0 TDI quattro	04/09→	Diesel	CGLD	1968	4	81.00	95.50	89
A4 Allroad 2.0 TDI quattro	09/09→	Diesel	CJCA	1968	4	81.00	95.50	89
A4 Allroad 2.0 TDI quattro	09/09→	Diesel	CJCB	1968	4	81.00	95.50	89
A4 Allroad 2.0 TDI quattro	05/13→	Diesel	CJCD	1968	4	81.00	95.50	92
A5 2.0 TDI	09/09→	Diesel	CAGA	1968	4	81.00	95.50	89
A5 2.0 TDI	09/09→	Diesel	CAGB	1968	4	81.00	95.50	89
A5 2.0 TDI	08/08→	Diesel	CAHA	1968	4	81.00	95.50	89
A5 2.0 TDI	08/08→	Diesel	CAHB	1968	4	81.00	95.50	89
A5 2.0 TDI	10/11→	Diesel	CGLC	1968	4	81.00	95.50	89
A5 2.0 TDI	08/08→	Diesel	CGLD	1968	4	81.00	95.50	89
A5 2.0 TDI	09/09→	Diesel	CJCA	1968	4	81.00	95.50	89
A5 2.0 TDI	09/09→	Diesel	CJCB	1968	4	81.00	95.50	89
A5 2.0 TDI	05/13→	Diesel	CJCD	1968	4	81.00	95.50	92
A5 2.0 TDI	09/09→	Diesel	CMEA	1968	4	81.00	95.50	89
A5 2.0 TDI	09/09→	Diesel	CMFA	1968	4	81.00	95.50	92
A5 2.0 TDI quattro	08/08→	Diesel	CAHA	1968	4	81.00	95.50	89
A5 2.0 TDI quattro	12/11→	Diesel	CGLC	1968	4	81.00	95.50	89
A6 1.8	12/95→12/97	Petrol	ADR	1781	4	81.00	86.40	60
A6 1.8	05/97→01/05	Petrol	AFY	1781	4	81.00	86.40	62
A6 1.8	07/97→01/05	Petrol	AJP	1781	4	81.00	86.40	65
A6 1.8	07/97→01/05	Petrol	AQE	1781	4	81.00	86.40	69
A6 1.8	07/97→01/05	Petrol	ARH	1781	4	81.00	86.40	69
A6 1.8 quattro	12/95→12/97	Petrol	ADR	1781	4	81.00	86.40	60



cm3



A6 1.8 T	01/97→01/05	Petrol	AEB	1781	4	81.00	86.40	61
A6 1.8 T	01/97→01/05	Petrol	ANB	1781	4	81.40	86.40	94
A6 1.8 T	01/97→01/05	Petrol	APU	1781	4	81.00	86.40	64
A6 1.8 T	01/97→01/05	Petrol	ARK	1781	4	81.00	86.40	64
A6 1.8 T	01/97→01/05	Petrol	AWL	1781	4	81.00	86.40	75
A6 1.8 T	01/97→01/05	Petrol	AWT	1781	4	81.00	86.40	72
A6 1.8 T quattro	02/97→01/05	Petrol	AEB	1781	4	81.00	86.40	61
A6 1.8 T quattro	02/97→01/05	Petrol	ANB	1781	4	81.40	86.40	94
A6 1.8 T quattro	02/97→01/05	Petrol	APU	1781	4	81.00	86.40	64
A6 1.8 T quattro	02/97→01/05	Petrol	ARK	1781	4	81.00	86.40	64
A6 1.8 T quattro	02/97→01/05	Petrol	AWT	1781	4	81.00	86.40	72
A6 1.9 TDI	06/94→12/97	Diesel	1Z	1896	4	79.50	95.50	33
A6 1.9 TDI	04/97→04/01	Diesel	AFN	1896	4	79.50	95.50	35
A6 1.9 TDI	06/94→12/97	Diesel	AHU	1896	4	79.50	95.50	38
A6 1.9 TDI	07/00→01/05	Diesel	AJM	1896	4	79.50	95.50	39
A6 1.9 TDI	08/01→01/05	Diesel	AVF	1896	4	79.50	95.50	44
A6 1.9 TDI	04/97→10/00	Diesel	AVG	1896	4	79.50	95.50	35
A6 1.9 TDI	08/01→01/05	Diesel	AWX	1896	4	79.50	95.50	44
A6 2.0	06/94→12/97	Petrol	AAE	1984	4	82.50	92.80	101
A6 2.0	06/94→12/97	Petrol	ABK	1984	4	82.50	92.80	102
A6 2.0	08/95→07/96	Petrol	ADW	1984	4	82.50	92.80	102
A6 2.0	08/01→01/05	Petrol	ALT	1984	4	82.50	92.80	103
A6 2.0 16V	06/94→12/97	Petrol	ACE	1984	4	82.50	92.80	102
A6 2.0 16V quattro	06/94→12/97	Petrol	ACE	1984	4	82.50	92.80	102
A6 2.0 TDI	07/04→10/08	Diesel	BLB	1968	4	81.00	95.50	89
A6 2.0 TDI	07/04→08/11	Diesel	BNA	1968	4	81.00	95.50	89
A6 2.0 TDI	07/04→10/08	Diesel	BRE	1968	4	81.00	95.50	89
A6 2.0 TDI	07/04→08/11	Diesel	BRF	1968	4	81.00	95.50	89
A6 2.0 TDI	09/05→06/06	Diesel	BVG	1968	4	81.00	95.50	89
A6 2.0 TDI	07/04→08/11	Diesel	CAGB	1968	4	81.00	95.50	89
A6 2.0 TDI	10/08→08/11	Diesel	CAHA	1968	4	81.00	95.50	89
A6 2.0 TDI	04/09→08/11	Diesel	CAHB	1968	4	81.00	95.50	89
A6 2.0 TDI	03/11→	Diesel	CGLC	1968	4	81.00	95.50	89
A6 2.0 TDI	03/11→	Diesel	CGLD	1968	4	81.00	95.50	89
A6 2.0 TDI	01/12→	Diesel	CGLE	1968	4	81.00	95.50	92
A6 2.0 TDI	03/11→	Diesel	CMGB	1968	4	81.00	95.50	89
A6 2.3	06/94→12/95	Petrol	AAR	2309	5	82.50	86.40	97
A6 2.3 quattro	06/94→12/95	Petrol	AAR	2309	5	82.50	86.40	97
A6 2.4	07/95→12/97	Petrol	AFM	2393	V6	81.00	77.40	57
A6 2.4	02/97→01/05	Petrol	AGA	2393	V6	81.00	77.40	57
A6 2.4	02/97→01/05	Petrol	AJG	2393	V6	81.00	77.40	57
A6 2.4	02/97→01/05	Petrol	ALF	2393	V6	81.00	77.40	57
A6 2.4	07/98→01/05	Petrol	ALW	2393	V6	81.00	77.40	57
A6 2.4	02/97→01/05	Petrol	AML	2393	V6	81.00	77.40	57
A6 2.4	02/97→01/05	Petrol	AMM	2393	V6	81.00	77.40	57
A6 2.4	02/97→01/05	Petrol	APC	2393	V6	81.00	77.40	57
A6 2.4	02/97→01/05	Petrol	APS	2393	V6	81.00	77.40	57
A6 2.4	02/97→01/05	Petrol	APZ	2393	V6	81.00	77.40	57
A6 2.4	02/97→01/05	Petrol	ARJ	2393	V6	81.00	77.40	57
A6 2.4	07/98→01/05	Petrol	ARN	2393	V6	81.00	77.40	57
A6 2.4	07/98→01/05	Petrol	ASM	2393	V6	81.00	77.40	57
A6 2.4	08/01→01/05	Petrol	BDV	2393	V6	81.00	77.40	57
A6 2.4 quattro	02/97→01/05	Petrol	AGA	2393	V6	81.00	77.40	57
A6 2.4 quattro	02/97→01/05	Petrol	AJG	2393	V6	81.00	77.40	57
A6 2.4 quattro	02/97→01/05	Petrol	ALF	2393	V6	81.00	77.40	57
A6 2.4 quattro	02/97→01/05	Petrol	AML	2393	V6	81.00	77.40	57
A6 2.4 quattro	08/98→05/01	Petrol	APC	2393	V6	81.00	77.40	57
A6 2.4 quattro	02/97→01/05	Petrol	APS	2393	V6	81.00	77.40	57
A6 2.4 quattro	02/97→01/05	Petrol	APZ	2393	V6	81.00	77.40	57
A6 2.4 quattro	02/97→01/05	Petrol	ARJ	2393	V6	81.00	77.40	57
A6 2.4 quattro	08/01→01/05	Petrol	BDV	2393	V6	81.00	77.40	57
A6 2.5 TDI	06/94→12/97	Diesel	AAT	2461	5	81.00	95.50	93
A6 2.5 TDI	08/94→12/97	Diesel	AEL	2461	5	81.00	95.50	93
A6 2.5 TDI	07/97→01/05	Diesel	AFB	2496	V6	78.30	86.40	15
A6 2.5 TDI	02/00→01/05	Diesel	AKE	2496	V6	78.30	86.40	15
A6 2.5 TDI	07/97→01/05	Diesel	AKN	2496	V6	78.30	86.40	15
A6 2.5 TDI	08/01→01/05	Diesel	AYM	2496	V6	78.30	86.40	15
A6 2.5 TDI	02/00→01/05	Diesel	BAU	2496	V6	78.30	86.40	15
A6 2.5 TDI	07/02→01/05	Diesel	BCZ	2496	V6	78.30	86.40	15

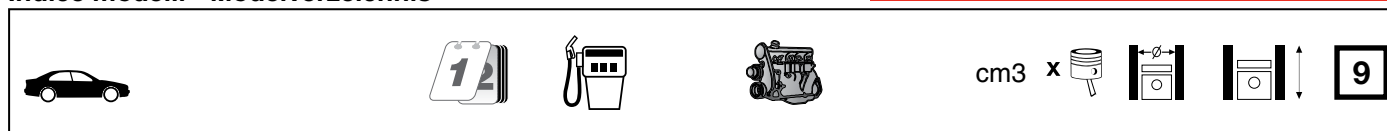









A6 2.5 TDI	07/02→01/05	Diesel	BDG	2496	V6	78.30	86.40	15
A6 2.5 TDI	02/00→01/05	Diesel	BDH	2496	V6	78.30	86.40	15
A6 2.5 TDI	07/02→01/05	Diesel	BFC	2496	V6	78.30	86.40	15
A6 2.5 TDI quattro	07/95→12/97	Diesel	AEL	2461	5	81.00	95.50	93
A6 2.5 TDI quattro	07/97→01/05	Diesel	AFB	2496	V6	78.30	86.40	15
A6 2.5 TDI quattro	02/00→01/05	Diesel	AKE	2496	V6	78.30	86.40	15
A6 2.5 TDI quattro	07/97→01/05	Diesel	AKN	2496	V6	78.30	86.40	15
A6 2.5 TDI quattro	02/00→01/05	Diesel	BAU	2496	V6	78.30	86.40	15
A6 2.5 TDI quattro	02/00→01/05	Diesel	BDH	2496	V6	78.30	86.40	15
A6 2.6	06/94→12/97	Petrol	ABC	2598	V6	82.50	81.00	95
A6 2.6	06/94→10/97	Petrol	ACZ	2598	V6	82.50	81.00	95
A6 2.6 quattro	06/94→12/97	Petrol	ABC	2598	V6	82.50	81.00	95
A6 2.7 T	02/99→01/05	Petrol	AJK	2671	V6	81.00	86.40	86
A6 2.7 T quattro	12/97→01/05	Petrol	AJK	2671	V6	81.00	86.40	86
A6 2.7 T quattro	08/01→01/05	Petrol	ARE	2671	V6	81.00	86.40	86
A6 2.7 T quattro	12/97→01/05	Petrol	AZA	2671	V6	81.00	86.40	86
A6 2.7 T quattro	08/01→01/05	Petrol	BES	2671	V6	81.00	86.40	86
A6 2.8	06/94→12/97	Petrol	AAH	2771	V6	82.50	86.40	99
A6 2.8	12/95→01/05	Petrol	ACK	2771	V6	82.50	86.40	99
A6 2.8	06/94→12/97	Petrol	AEJ	2771	V6	82.50	86.40	99
A6 2.8	06/94→10/97	Petrol	AFC	2771	V6	82.50	86.40	99
A6 2.8	10/97→05/00	Petrol	AGE	2771	V6	82.50	86.40	100
A6 2.8	02/97→01/05	Petrol	ALG	2771	V6	82.50	86.40	99
A6 2.8	02/97→01/05	Petrol	AMX	2771	V6	82.50	86.40	99
A6 2.8	02/97→01/05	Petrol	APR	2771	V6	82.50	86.40	99
A6 2.8	02/97→01/05	Petrol	AQD	2771	V6	82.50	86.40	99
A6 2.8	07/99→01/05	Petrol	ATX	2771	V6	82.50	86.40	99
A6 2.8	07/99→01/05	Petrol	BBG	2771	V6	82.50	86.40	99
A6 2.8 FSI	11/06→10/08	Petrol	BDX	2773	V6	84.50	82.40	108
A6 2.8 FSI	10/08→08/11	Petrol	CCDA	2773	V6	84.50	82.40	108
A6 2.8 FSI	10/08→08/11	Petrol	CCEA	2773	V6	84.50	82.40	108
A6 2.8 FSI	11/10→04/15	Petrol	CHVA	2773	V6	84.50	82.40	108
A6 2.8 FSI quattro	06/07→10/08	Petrol	BDX	2773	V6	84.50	82.40	108
A6 2.8 FSI quattro	10/08→08/11	Petrol	CCDA	2773	V6	84.50	82.40	108
A6 2.8 FSI quattro	10/08→08/11	Petrol	CCEA	2773	V6	84.50	82.40	108
A6 2.8 FSI quattro	11/10→04/15	Petrol	CHVA	2773	V6	84.50	82.40	108
A6 2.8 quattro	06/94→12/97	Petrol	AAH	2771	V6	82.50	86.40	99
A6 2.8 quattro	12/95→01/05	Petrol	ACK	2771	V6	82.50	86.40	99
A6 2.8 quattro	06/94→12/97	Petrol	AEJ	2771	V6	82.50	86.40	99
A6 2.8 quattro	01/98→04/00	Petrol	AGE	2771	V6	82.50	86.40	100
A6 2.8 quattro	02/97→01/05	Petrol	ALG	2771	V6	82.50	86.40	99
A6 2.8 quattro	02/97→01/05	Petrol	AMX	2771	V6	82.50	86.40	99
A6 2.8 quattro	02/97→01/05	Petrol	APR	2771	V6	82.50	86.40	99
A6 2.8 quattro	02/97→01/05	Petrol	AQD	2771	V6	82.50	86.40	99
A6 2.8 quattro	07/99→05/01	Petrol	ATX	2771	V6	82.50	86.40	99
A6 3.0	08/01→01/05	Petrol	ASN	2976	V6	82.50	92.80	105
A6 3.0	06/01→05/06	Petrol	BBJ	2976	V6	82.50	92.80	106
A6 3.0 quattro	08/01→01/05	Petrol	ASN	2976	V6	82.50	92.80	105
A6 3.0 quattro	09/01→12/04	Petrol	AVK	2976	V6	82.50	92.80	106
A6 3.0 quattro	06/01→05/06	Petrol	BBJ	2976	V6	82.50	92.80	106
A6 3.2 FSI	05/04→05/09	Petrol	AUK	3123	V6	84.50	92.80	111
A6 3.2 FSI quattro	05/04→10/08	Petrol	AUK	3123	V6	84.50	92.80	111
A6 3.7	03/99→01/05	Petrol	AQG	3697	V8	84.50	82.40	110
A6 3.7 quattro	03/99→01/05	Petrol	AQG	3697	V8	84.50	82.40	110
A6 S6 Turbo quattro	06/94→12/97	Petrol	AAN	2226	5	81.00	86.40	81
A6 Allroad 3.2 FSI quattro	05/06→10/08	Petrol	AUK	3123	V6	84.50	92.80	111
A7 2.8 FSI	02/11→	Petrol	CHVA	2773	V6	84.50	82.40	108
A7 2.8 FSI quattro	10/10→	Petrol	CHVA	2773	V6	84.50	82.40	108
A7 2.8 FSI quattro	10/10→	Petrol	CNYA	2773	V6	84.50	82.40	108
A8 2.5 TDI	01/97→04/00	Diesel	AFB	2496	V6	78.30	86.40	15
A8 2.5 TDI	09/00→09/02	Diesel	AKE	2496	V6	78.30	86.40	15
A8 2.5 TDI	01/97→04/00	Diesel	AKN	2496	V6	78.30	86.40	15
A8 2.5 TDI quattro	07/97→04/00	Diesel	AFB	2496	V6	78.30	86.40	15
A8 2.5 TDI quattro	09/00→09/02	Diesel	AKE	2496	V6	78.30	86.40	15
A8 2.5 TDI quattro	07/97→04/00	Diesel	AKN	2496	V6	78.30	86.40	15
A8 2.5 TFSI	07/12→	Petrol	CPAA	2498	V6	80.20	82.40	47
A8 2.8	03/94→03/96	Petrol	AAH	2771	V6	82.50	86.40	99
A8 2.8	04/96→09/02	Petrol	ACK	2771	V6	82.50	86.40	99
A8 2.8	07/95→03/96	Petrol	AEJ	2771	V6	82.50	86.40	99















cm3 x















A8 2.8	04/96→09/02	Petrol	ALG	2771	V6	82.50	86.40	99
A8 2.8	04/96→09/02	Petrol	AMX	2771	V6	82.50	86.40	99
A8 2.8	04/96→09/02	Petrol	APR	2771	V6	82.50	86.40	99
A8 2.8	04/96→09/02	Petrol	AQD	2771	V6	82.50	86.40	99
A8 2.8 FSI	08/07→07/10	Petrol	BDX	2773	V6	84.50	82.40	108
A8 2.8 quattro	03/94→03/96	Petrol	AAH	2771	V6	82.50	86.40	99
A8 2.8 quattro	04/96→09/02	Petrol	ACK	2771	V6	82.50	86.40	99
A8 2.8 quattro	07/95→03/96	Petrol	AEJ	2771	V6	82.50	86.40	99
A8 2.8 quattro	04/96→09/02	Petrol	AMX	2771	V6	82.50	86.40	99
A8 2.8 quattro	04/96→09/02	Petrol	APR	2771	V6	82.50	86.40	99
A8 2.8 quattro	04/96→09/02	Petrol	AQD	2771	V6	82.50	86.40	99
A8 3.0	07/03→05/05	Petrol	ASN	2976	V6	82.50	92.80	105
A8 3.0	07/03→05/06	Petrol	BBJ	2976	V6	82.50	92.80	106
A8 3.0 quattro	11/03→05/04	Petrol	BBJ	2976	V6	82.50	92.80	106
A8 3.7	07/95→12/98	Petrol	AEW	3697	V8	84.50	82.40	109
A8 3.7	11/98→09/02	Petrol	AKC	3697	V8	84.50	82.40	110
A8 3.7	11/98→09/02	Petrol	AQG	3697	V8	84.50	82.40	110
A8 3.7 quattro	07/95→11/98	Petrol	AEW	3697	V8	84.50	82.40	109
A8 3.7 quattro	11/98→09/02	Petrol	AKC	3697	V8	84.50	82.40	110
A8 3.7 quattro	11/98→09/02	Petrol	AQG	3697	V8	84.50	82.40	110
Allroad 2.5 TDI quattro	05/00→08/05	Diesel	AKE	2496	V6	78.30	86.40	15
Allroad 2.5 TDI quattro	05/00→08/05	Diesel	BAU	2496	V6	78.30	86.40	15
Allroad 2.5 TDI quattro	05/03→08/05	Diesel	BCZ	2496	V6	78.30	86.40	15
Allroad 2.7 T quattro	05/00→08/05	Petrol	ARE	2671	V6	81.00	86.40	86
Allroad 2.7 T quattro	05/00→08/05	Petrol	BES	2671	V6	81.00	86.40	86
Cabriolet 1.8	01/97→08/00	Petrol	ADR	1781	4	81.00	86.40	60
Cabriolet 1.9 TDI	06/95→08/00	Diesel	1Z	1896	4	79.50	95.50	33
Cabriolet 1.9 TDI	06/95→08/00	Diesel	AHU	1896	4	79.50	95.50	38
Cabriolet 2.0 16V	06/95→07/96	Petrol	ACE	1984	4	82.50	92.80	102
Cabriolet 2.0 E	01/93→07/98	Petrol	ABK	1984	4	82.50	92.80	102
Cabriolet 2.3 E	05/91→07/94	Petrol	NG	2309	5	82.50	86.40	98
Cabriolet 2.6	06/93→08/00	Petrol	ABC	2598	V6	82.50	81.00	95
Cabriolet 2.6	05/95→08/00	Petrol	ACZ	2598	V6	82.50	81.00	95
Cabriolet 2.8	11/92→08/00	Petrol	AAH	2771	V6	82.50	86.40	99
Coupe 1.6	07/80→08/81	Petrol	YN	1588	4	79.50	80.00	18
Coupe 1.8	08/81→07/83	Petrol	DD	1781	4	81.00	86.40	76
Coupe 1.8	08/89→07/91	Petrol	DZ	1781	4	81.00	86.40	78
Coupe 1.8 GT	09/82→10/88	Petrol	DS	1781	4	81.00	86.40	77
Coupe 1.8 GT	08/86→10/88	Petrol	DZ	1781	4	81.00	86.40	78
Coupe 1.8 GT	01/85→07/88	Petrol	JN	1781	4	81.00	86.40	77
Coupe 1.8 GT	09/82→10/88	Petrol	JV	1781	4	81.00	86.40	77
Coupe 1.8 GT	08/86→10/87	Petrol	PV	1781	4	81.00	86.40	77
Coupe 1.8 GT	04/86→10/88	Petrol	SF	1781	4	81.00	86.40	79
Coupe 1.8 GT quattro	12/84→10/88	Petrol	DZ	1781	4	81.00	86.40	78
Coupe 1.9	08/80→07/83	Petrol	WN	1921	5	79.50	77.40	17
Coupe 2.0	05/89→07/90	Petrol	3A	1984	4	82.50	92.80	101
Coupe 2.0	05/89→12/96	Petrol	AAD	1984	4	82.50	92.80	102
Coupe 2.0	05/89→12/96	Petrol	ABK	1984	4	82.50	92.80	102
Coupe 2.0	09/83→07/86	Petrol	HP	1994	5	81.00	77.40	54
Coupe 2.0	09/83→07/86	Petrol	JS	1994	5	81.00	77.40	54
Coupe 2.0	03/86→04/88	Petrol	SK	1994	5	81.00	77.40	56
Coupe 2.0 16 V	01/92→07/92	Petrol	6A	1984	4	82.50	92.80	101
Coupe 2.0 16 V	08/92→12/96	Petrol	ACE	1984	4	82.50	92.80	102
Coupe 2.0 20 V	08/89→07/91	Petrol	NM	1994	5	81.00	77.40	56
Coupe 2.0 20 V quattro	08/89→07/91	Petrol	NM	1994	5	81.00	77.40	56
Coupe 2.1 GT	09/82→10/87	Petrol	KE	2144	5	79.50	86.40	23
Coupe 2.1 GT	09/82→10/87	Petrol	KL	2144	5	79.50	86.40	23
Coupe 2.1 GT	01/81→07/83	Petrol	WE	2144	5	79.50	86.40	24
Coupe 2.2	09/80→12/84	Petrol	WE	2144	5	79.50	86.40	24
Coupe 2.2	09/83→12/87	Petrol	KX	2226	5	81.00	86.40	83
Coupe 2.2 GT	09/84→10/88	Petrol	HY	2226	5	81.00	86.40	82
Coupe 2.2 GT	09/84→10/88	Petrol	KV	2226	5	81.00	86.40	83
Coupe 2.2 GT	07/81→10/87	Petrol	KX	2226	5	81.00	86.40	83
Coupe 2.2 quattro	08/85→10/88	Petrol	JT	2226	5	81.00	86.40	83
Coupe 2.2 quattro	10/84→07/91	Petrol	KV	2226	5	81.00	86.40	83
Coupe 2.3	09/86→12/96	Petrol	NG	2309	5	82.50	86.40	98
Coupe 2.3 20V	08/89→07/91	Petrol	7A	2309	5	82.50	86.40	97
Coupe 2.3 20V quattro	11/88→12/96	Petrol	7A	2309	5	82.50	86.40	97
Coupe 2.3 quattro	01/87→12/96	Petrol	NG	2309	5	82.50	86.40	98







				cm ³				
Coupe 2.6	08/92→12/96	Petrol	ABC	2598	V6	82.50	81.00	95
Coupe 2.6 quattro	08/92→12/96	Petrol	ABC	2598	V6	82.50	81.00	95
Coupe 2.8	09/91→12/96	Petrol	AAH	2771	V6	82.50	86.40	99
Coupe 2.8 quattro	08/91→12/96	Petrol	AAH	2771	V6	82.50	86.40	99
Coupe S2 quattro	09/90→09/92	Petrol	3B	2226	5	81.00	86.40	81
Coupe S2 quattro	10/92→12/96	Petrol	ABY	2226	5	81.00	86.40	81
Q3 2.0 TDI	09/11→	Diesel	CFFA	1968	4	81.00	95.50	90
Q3 2.0 TDI	09/11→	Diesel	CFFB	1968	4	81.00	95.50	90
Q3 2.0 TDI	05/13→	Diesel	CFGC	1968	4	81.00	95.50	90
Q3 2.0 TDI	09/11→	Diesel	CLJA	1968	4	81.00	95.50	90
Q3 2.0 TDI quattro	01/12→	Diesel	CFFB	1968	4	81.00	95.50	90
Q3 2.0 TDI quattro	06/11→	Diesel	CFGC	1968	4	81.00	95.50	90
Q3 2.0 TDI quattro	06/11→	Diesel	CFGD	1968	4	81.00	95.50	91
Q3 2.0 TDI quattro	06/11→	Diesel	CLLB	1968	4	81.00	95.50	92
Q5 2.0 TDI	11/10→	Diesel	CJCA	1968	4	81.00	95.50	89
Q5 2.0 TDI	11/10→	Diesel	CJCB	1968	4	81.00	95.50	89
Q5 2.0 TDI	05/13→	Diesel	CJCD	1968	4	81.00	95.50	92
Q5 2.0 TDI quattro	08/09→	Diesel	CAGA	1968	4	81.00	95.50	89
Q5 2.0 TDI quattro	08/09→	Diesel	CAGB	1968	4	81.00	95.50	89
Q5 2.0 TDI quattro	11/08→	Diesel	CAHA	1968	4	81.00	95.50	89
Q5 2.0 TDI quattro	11/08→	Diesel	CAHB	1968	4	81.00	95.50	89
Q5 2.0 TDI quattro	11/08→	Diesel	CGLA	1968	4	81.00	95.50	89
Q5 2.0 TDI quattro	11/08→	Diesel	CGLB	1968	4	81.00	95.50	89
Q5 2.0 TDI quattro	06/12→	Diesel	CGLC	1968	4	81.00	95.50	89
Q5 2.0 TDI quattro	11/08→	Diesel	CGLD	1968	4	81.00	95.50	89
Q5 2.0 TDI quattro	08/09→	Diesel	CJCA	1968	4	81.00	95.50	89
Q5 2.0 TDI quattro	08/09→	Diesel	CJCB	1968	4	81.00	95.50	89
Q5 2.0 TDI quattro	05/13→	Diesel	CJCD	1968	4	81.00	95.50	92
Q5 2.0 TDI quattro	11/08→	Diesel	CMGA	1968	4	81.00	95.50	89
Q5 2.0 TDI quattro	06/12→	Diesel	CMGB	1968	4	81.00	95.50	89
Quattro 2.1 20V Turbo	05/84→07/87	Petrol	KW	2144	5	79.50	86.40	25
Quattro 2.1 Turbo	07/80→07/87	Petrol	GV	2144	5	79.50	86.40	22
Quattro 2.1 Turbo	07/80→07/87	Petrol	WR	2144	5	79.50	86.40	22
Quattro 2.1 Turbo quattro	02/82→07/89	Petrol	WX	2144	5	79.50	86.40	22
Quattro 2.2 20V Turbo	08/89→07/91	Petrol	RR	2226	5	81.00	86.40	81
Quattro 2.2 quattro	12/84→07/87	Petrol	HY	2226	5	81.00	86.40	82
Quattro 2.2 quattro	12/84→07/87	Petrol	JT	2226	5	81.00	86.40	83
Quattro 2.2 quattro	12/84→07/87	Petrol	KV	2226	5	81.00	86.40	83
Quattro 2.2 Turbo	08/87→07/89	Petrol	MB	2226	5	81.00	86.40	84
TT 1.8 T	10/98→06/06	Petrol	AJQ	1781	4	81.00	86.40	66
TT 1.8 T	01/01→06/06	Petrol	AUM	1781	4	81.00	86.40	72
TT 1.8 T	10/98→06/06	Petrol	AUQ	1781	4	81.00	86.40	72
TT 1.8 T quattro	10/98→06/06	Petrol	AJQ	1781	4	81.00	86.40	66
TT 1.8 T quattro	10/98→06/06	Petrol	ARY	1781	4	81.00	86.40	71
TT 1.8 T quattro	10/98→06/06	Petrol	AUQ	1781	4	81.00	86.40	72
TT 1.8 T quattro	10/99→08/02	Petrol	AWP	1781	4	81.00	86.40	75
TT 2.0 TDI quattro	06/08→06/14	Diesel	CBBB	1968	4	81.00	95.50	90
TT 2.0 TDI quattro	06/08→06/14	Diesel	CFGB	1968	4	81.00	95.50	90
TT 3.2 V6 quattro	08/06→06/10	Petrol	BUB	3189	V6	84.00	95.90	107
TT 3.2 VR6 quattro	07/03→06/06	Petrol	BHE	3189	V6	84.00	95.90	107
TT 3.2 VR6 quattro	07/03→06/06	Petrol	BPF	3189	V6	84.00	95.90	107
V8 3.6 quattro	10/88→02/94	Petrol	PT	3562	V8	81.00	86.40	88

			cm ³	x 			
1B	Petrol		2226	5	81.00	86.40	80
1T	Diesel		2461	5	81.00	95.50	93
1Y	Diesel		1896	4	79.50	95.50	32
1Z	Diesel		1896	4	79.50	95.50	33
2B	Petrol		2226	5	81.00	86.40	80
3A	Petrol		1984	4	82.50	92.80	101
3B	Petrol		2226	5	81.00	86.40	81
3D	Diesel		2370	5	79.50	95.50	46
4B	Petrol		1781	4	81.00	86.40	59
6A	Petrol		1984	4	82.50	92.80	101
7A	Petrol		2309	5	82.50	86.40	97
AAD	Petrol		1984	4	82.50	92.80	102
AAE	Petrol		1984	4	82.50	92.80	101
AAH	Petrol		2771	V6	82.50	86.40	99
AAN	Petrol		2226	5	81.00	86.40	81
AAR	Petrol		2309	5	82.50	86.40	97
AAS	Diesel		2370	5	79.50	95.50	46
AAT	Diesel		2461	5	81.00	95.50	93
AAZ	Diesel		1896	4	79.50	95.50	33
ABB	Petrol		1595	4	81.00	77.40	48
ABC	Petrol		2598	V6	82.50	81.00	95
ABK	Petrol		1984	4	82.50	92.80	102
ABM	Petrol		1595	4	81.00	77.40	48
ABP	Diesel		2461	5	81.00	95.50	93
ABT	Petrol		1984	4	82.50	92.80	102
ABY	Petrol		2226	5	81.00	86.40	81
ACE	Petrol		1984	4	82.50	92.80	102
ACK	Petrol		2771	V6	82.50	86.40	99
ACZ	Petrol		2598	V6	82.50	81.00	95
ADA	Petrol		1595	4	81.00	77.40	48
ADE	Diesel		1896	4	79.50	95.50	34
ADP	Petrol		1595	4	81.00	77.40	48
ADR	Petrol		1781	4	81.00	86.40	60
ADU	Petrol		2226	5	81.00	86.40	81
ADW	Petrol		1984	4	82.50	92.80	102
AEB	Petrol		1781	4	81.00	86.40	61
AEH	Petrol		1595	4	81.00	77.40	49
AEJ	Petrol		2771	V6	82.50	86.40	99
AEL	Diesel		2461	5	81.00	95.50	93
AEW	Petrol		3697	V8	84.50	82.40	109
AFB	Diesel		2496	V6	78.30	86.40	15
AFC	Petrol		2771	V6	82.50	86.40	99
AFF	Diesel		1896	4	79.50	95.50	33
AFM	Petrol		2393	V6	81.00	77.40	57
AFN	Diesel		1896	4	79.50	95.50	35
AFY	Petrol		1781	4	81.00	86.40	62
AGA	Petrol		2393	V6	81.00	77.40	57
AGB	Petrol		2671	V6	81.00	86.40	86
AGE	Petrol		2771	V6	82.50	86.40	100
AGN	Petrol		1781	4	81.00	86.40	63
AGR	Diesel		1896	4	79.50	95.50	36
AGU	Petrol		1781	4	81.00	86.40	64
AHF	Diesel		1896	4	79.50	95.50	37
AHH	Diesel		1896	4	79.50	95.50	33
AHL	Petrol		1595	4	81.00	77.40	49
AHU	Diesel		1896	4	79.50	95.50	38
AJG	Petrol		2393	V6	81.00	77.40	57
AJK	Petrol		2671	V6	81.00	86.40	86
AJM	Diesel		1896	4	79.50	95.50	39
AJP	Petrol		1781	4	81.00	86.40	65
AJQ	Petrol		1781	4	81.00	86.40	66
AKC	Petrol		3697	V8	84.50	82.40	110
AKE	Diesel		2496	V6	78.30	86.40	15
AKL	Petrol		1595	4	81.00	77.40	49
AKN	Diesel		2496	V6	78.30	86.40	15
ALF	Petrol		2393	V6	81.00	77.40	57
ALG	Petrol		2771	V6	82.50	86.40	99
ALH	Diesel		1896	4	79.50	95.50	33
ALT	Petrol		1984	4	82.50	92.80	103







			cm3	x 			
ALW	Petrol		2393	V6	81.00	77.40	57
ALZ	Petrol		1595	4	81.00	77.40	50
AMB	Petrol		1781	4	81.00	86.40	67
AMF	Diesel		1422	3	79.50	95.50	31
AMK	Petrol		1781	4	81.00	86.40	66
AML	Petrol		2393	V6	81.00	77.40	57
AMM	Petrol		2393	V6	81.00	77.40	57
AMX	Petrol		2771	V6	82.50	86.40	99
ANA	Petrol		1595	4	81.00	77.40	50
ANB	Petrol		1781	4	81.40	86.40	94
ANU	Diesel		1896	4	79.50	95.50	40
ANY	Diesel		1191	3	76.50	86.40	10
APC	Petrol		2393	V6	81.00	77.40	57
APF	Petrol		1595	4	81.00	77.40	49
APG	Petrol		1781	4	81.00	86.40	68
APR	Petrol		2771	V6	82.50	86.40	99
APS	Petrol		2393	V6	81.00	77.40	57
APT	Petrol		1781	4	81.00	86.40	63
APU	Petrol		1781	4	81.00	86.40	64
APZ	Petrol		2393	V6	81.00	77.40	57
AQD	Petrol		2771	V6	82.50	86.40	99
AQE	Petrol		1781	4	81.00	86.40	69
AQG	Petrol		3697	V8	84.50	82.40	110
ARE	Petrol		2671	V6	81.00	86.40	86
ARG	Petrol		1781	4	81.00	86.40	63
ARH	Petrol		1781	4	81.00	86.40	69
ARJ	Petrol		2393	V6	81.00	77.40	57
ARK	Petrol		1781	4	81.00	86.40	64
ARM	Petrol		1595	4	81.00	77.40	49
ARN	Petrol		2393	V6	81.00	77.40	57
ARX	Petrol		1781	4	81.00	86.40	70
ARY	Petrol		1781	4	81.00	86.40	71
ARZ	Petrol		1781	4	81.00	86.40	64
ASJ	Petrol		2671	V6	81.00	86.40	87
ASM	Petrol		2393	V6	81.00	77.40	57
ASN	Petrol		2976	V6	82.50	92.80	105
ASV	Diesel		1896	4	79.50	95.50	37
ASZ	Diesel		1896	4	79.50	95.50	41
ATD	Diesel		1896	4	79.50	95.50	42
ATJ	Diesel		1896	4	79.50	95.50	42
ATL	Diesel		1422	3	79.50	95.50	31
ATX	Petrol		2771	V6	82.50	86.40	99
AUA	Petrol		1390	4	76.50	75.60	7
AUK	Petrol		3123	V6	84.50	92.80	111
AUM	Petrol		1781	4	81.00	86.40	72
AUQ	Petrol		1781	4	81.00	86.40	72
AVB	Diesel		1896	4	79.50	95.50	43
AVF	Diesel		1896	4	79.50	95.50	44
AVG	Diesel		1896	4	79.50	95.50	35
AVJ	Petrol		1781	4	81.00	86.40	73
AVK	Petrol		2976	V6	82.50	92.80	106
AVU	Petrol		1595	4	81.00	77.40	50
AVV	Petrol		1781	4	81.00	86.40	74
AWA	Petrol		1984	4	82.50	92.80	103
AWL	Petrol		1781	4	81.00	86.40	75
AWP	Petrol		1781	4	81.00	86.40	75
AWT	Petrol		1781	4	81.00	86.40	72
AWX	Diesel		1896	4	79.50	95.50	44
AXA	Petrol		1984	4	82.50	92.80	104
AXR	Diesel		1896	4	79.50	95.50	45
AXW	Petrol		1984	4	82.50	92.80	103
AYM	Diesel		2496	V6	78.30	86.40	15
AZA	Petrol		2671	V6	81.00	86.40	86
AZB	Petrol		2671	V6	81.00	86.40	86
AZV	Diesel		1968	4	81.00	95.50	89
BAD	Petrol		1598	4	76.50	86.90	14
BAG	Petrol		1598	4	76.50	86.90	14
BAU	Diesel		2496	V6	78.30	86.40	15
BBG	Petrol		2771	V6	82.50	86.40	99

		cm3	x 			
BBJ	Petrol	2976	V6	82.50	92.80	106
BBY	Petrol	1390	4	76.50	75.60	7
BCZ	Diesel	2496	V6	78.30	86.40	15
BDB	Petrol	3189	V6	84.00	95.90	107
BDG	Diesel	2496	V6	78.30	86.40	15
BDH	Diesel	2496	V6	78.30	86.40	15
BDV	Petrol	2393	V6	81.00	77.40	57
BDX	Petrol	2773	V6	84.50	82.40	108
BES	Petrol	2671	V6	81.00	86.40	86
BEX	Petrol	1781	4	81.00	86.40	73
BFB	Petrol	1781	4	81.00	86.40	73
BFC	Diesel	2496	V6	78.30	86.40	15
BFQ	Petrol	1595	4	81.00	77.40	50
BGU	Petrol	1595	4	81.00	77.40	50
BHC	Diesel	1422	3	79.50	95.50	31
BHE	Petrol	3189	V6	84.00	95.90	107
BKB	Petrol	1781	4	81.00	86.40	75
BKC	Diesel	1896	4	79.50	95.50	45
BKD	Diesel	1968	4	81.00	95.50	89
BKE	Diesel	1896	4	79.50	95.50	44
BLB	Diesel	1968	4	81.00	95.50	89
BLF	Petrol	1598	4	76.50	86.90	14
BLP	Petrol	1598	4	76.50	86.90	14
BLR	Petrol	1984	4	82.50	92.80	103
BLS	Diesel	1896	4	79.50	95.50	45
BLX	Petrol	1984	4	82.50	92.80	103
BLY	Petrol	1984	4	82.50	92.80	103
BMB	Petrol	1984	4	82.50	92.80	103
BMJ	Petrol	3189	V6	84.00	95.90	107
BMM	Diesel	1968	4	81.00	95.50	89
BMN	Diesel	1968	4	81.00	95.50	89
BNA	Diesel	1968	4	81.00	95.50	89
BPF	Petrol	3189	V6	84.00	95.90	107
BPW	Diesel	1968	4	81.00	95.50	89
BRB	Diesel	1896	4	79.50	95.50	41
BRC	Diesel	1968	4	81.00	95.50	89
BRD	Diesel	1968	4	81.00	95.50	89
BRE	Diesel	1968	4	81.00	95.50	89
BRF	Diesel	1968	4	81.00	95.50	89
BSE	Petrol	1595	4	81.00	77.40	50
BSF	Petrol	1595	4	81.00	77.40	50
BUB	Petrol	3189	V6	84.00	95.90	107
BUY	Diesel	1968	4	81.00	95.50	89
BVA	Diesel	1968	4	81.00	95.50	89
BVF	Diesel	1968	4	81.00	95.50	89
BVG	Diesel	1968	4	81.00	95.50	89
BVY	Petrol	1984	4	82.50	92.80	103
BVZ	Petrol	1984	4	82.50	92.80	103
BXE	Diesel	1896	4	79.50	95.50	45
CAGA	Diesel	1968	4	81.00	95.50	89
CAGB	Diesel	1968	4	81.00	95.50	89
CAGC	Diesel	1968	4	81.00	95.50	89
CAHA	Diesel	1968	4	81.00	95.50	89
CAHB	Diesel	1968	4	81.00	95.50	89
CAVG	Petrol	1390	4	76.50	75.60	8
CAXA	Petrol	1390	4	76.50	75.60	8
CAXC	Petrol	1390	4	76.50	75.60	8
CAYB	Diesel	1598	4	79.50	80.50	19
CAYC	Diesel	1598	4	79.50	80.50	19
CBAA	Diesel	1968	4	81.00	95.50	89
CBAB	Diesel	1968	4	81.00	95.50	89
CBBB	Diesel	1968	4	81.00	95.50	90
CBZA	Petrol	1197	4	71.00	75.60	3
CBZB	Petrol	1197	4	71.00	75.60	3
CCDA	Petrol	2773	V6	84.50	82.40	108
CCEA	Petrol	2773	V6	84.50	82.40	108
CCSA	Petrol	1595	4	81.00	77.40	50
CFFA	Diesel	1968	4	81.00	95.50	90
CFFB	Diesel	1968	4	81.00	95.50	90

		cm3	x 			
CFGB	Diesel	1968	4	81.00	95.50	90
CFGC	Diesel	1968	4	81.00	95.50	90
CFGD	Diesel	1968	4	81.00	95.50	91
CFHB	Diesel	1968	4	81.00	95.50	90
CFHD	Diesel	1968	4	81.00	95.50	89
CGLA	Diesel	1968	4	81.00	95.50	89
CGLB	Diesel	1968	4	81.00	95.50	89
CGLC	Diesel	1968	4	81.00	95.50	89
CGLD	Diesel	1968	4	81.00	95.50	89
CGLE	Diesel	1968	4	81.00	95.50	92
CHVA	Petrol	2773	V6	84.50	82.40	108
CJCA	Diesel	1968	4	81.00	95.50	89
CJCB	Diesel	1968	4	81.00	95.50	89
CJCC	Diesel	1968	4	81.00	95.50	92
CJCD	Diesel	1968	4	81.00	95.50	92
CLHA	Diesel	1598	4	79.50	80.50	20
CLJA	Diesel	1968	4	81.00	95.50	90
CLLB	Diesel	1968	4	81.00	95.50	92
CMEA	Diesel	1968	4	81.00	95.50	89
CMFA	Diesel	1968	4	81.00	95.50	92
CMGA	Diesel	1968	4	81.00	95.50	89
CMGB	Diesel	1968	4	81.00	95.50	89
CMXA	Petrol	1595	4	81.00	77.40	50
CN	Diesel	1986	5	76.50	86.40	13
CNVA	Petrol	1390	4	76.50	75.60	8
CNYA	Petrol	2773	V6	84.50	82.40	108
CPAA	Petrol	2498	V6	80.20	82.40	47
CR	Diesel	1588	4	76.50	86.40	11
CRBC	Diesel	1968	4	81.00	95.50	92
CRFA	Diesel	1968	4	81.00	95.50	92
CRFC	Diesel	1968	4	81.00	95.50	92
CRLB	Diesel	1968	4	81.00	95.50	92
CTHG	Petrol	1390	4	76.50	75.60	8
CTJA	Petrol	1390	4	76.50	75.60	8
CY	Diesel	1588	4	76.50	86.40	11
DD	Petrol	1781	4	81.00	86.40	76
DE	Diesel	1986	5	76.50	86.40	13
DR	Petrol	1781	4	81.00	86.40	77
DS	Petrol	1781	4	81.00	86.40	77
DT	Petrol	1595	4	81.00	77.40	51
DTA	Petrol	1595	4	81.00	77.40	51
DZ	Petrol	1781	4	81.00	86.40	78
EP	Petrol	1297	4	75.00	73.40	5
FS	Petrol	1588	4	79.50	80.00	18
FY	Petrol	1272	4	75.00	72.00	4
FZ	Petrol	1272	4	75.00	72.00	4
GV	Petrol	2144	5	79.50	86.40	22
HB	Petrol	1093	4	69.50	72.00	2
HC	Petrol	1093	4	69.50	72.00	2
HD	Petrol	1093	4	69.50	72.00	2
HE	Petrol	771	4	64.50	59.00	1
HH	Petrol	1272	4	75.00	72.00	4
HJ	Petrol	1272	4	75.00	72.00	4
HP	Petrol	1994	5	81.00	77.40	54
HX	Petrol	2226	5	81.00	86.40	82
HY	Petrol	2226	5	81.00	86.40	82
JK	Diesel	1588	4	76.50	86.40	11
JN	Petrol	1781	4	81.00	86.40	77
JS	Petrol	1994	5	81.00	77.40	54
JT	Petrol	2226	5	81.00	86.40	83
JU	Petrol	1595	4	81.00	77.40	51
JV	Petrol	1781	4	81.00	86.40	77
JW	Petrol	1781	4	81.00	86.40	77
JY	Petrol	2144	5	79.50	86.40	22
KE	Petrol	2144	5	79.50	86.40	23
KF	Petrol	2144	5	79.50	86.40	23
KG	Petrol	2144	5	79.50	86.40	22
KH	Petrol	2144	5	79.50	86.40	22
KJ	Petrol	2144	5	79.50	86.40	24

		cm ³	x 			
--	---	-----------------	---	---	---	---

KK	Petrol	2144	5	79.50	86.40	23
KL	Petrol	2144	5	79.50	86.40	23
KP	Petrol	1994	5	81.00	77.40	55
KU	Petrol	2226	5	81.00	86.39	58
KV	Petrol	2226	5	81.00	86.40	83
KW	Petrol	2144	5	79.50	86.40	25
KX	Petrol	2226	5	81.00	86.40	83
KZ	Petrol	2226	5	81.00	86.40	83
MB	Petrol	2226	5	81.00	86.40	84
MC	Petrol	2226	5	81.00	86.40	85
NC	Diesel	1986	5	76.50	86.40	13
NE	Petrol	1781	4	81.00	86.40	77
NF	Petrol	2309	5	82.50	86.40	98
NG	Petrol	2309	5	82.50	86.40	98
NM	Petrol	1994	5	81.00	77.40	56
NP	Petrol	1781	4	81.00	86.40	59
PH	Petrol	1781	4	81.00	86.40	59
PM	Petrol	1781	4	81.00	86.40	79
PP	Petrol	1595	4	81.00	77.40	52
PS	Petrol	1994	5	81.00	77.40	56
PT	Petrol	3562	V8	81.00	86.40	88
PV	Petrol	1781	4	81.00	86.40	77
PX	Petrol	2226	5	81.00	86.40	83
RA	Diesel	1588	4	76.50	86.40	12
RN	Petrol	1595	4	81.00	77.40	52
RR	Petrol	2226	5	81.00	86.40	81
RS	Petrol	1781	4	81.00	86.40	59
RT	Petrol	1994	5	81.00	77.40	56
RU	Petrol	1781	4	81.00	86.40	79
SA	Petrol	1595	4	81.00	77.40	53
SB	Diesel	1588	4	76.50	86.40	12
SD	Petrol	1847	4	82.50	86.40	96
SF	Petrol	1781	4	81.00	86.40	79
SH	Petrol	1781	4	81.00	86.40	79
SK	Petrol	1994	5	81.00	77.40	56
SL	Petrol	1994	5	81.00	77.40	56
WB	Petrol	2144	5	79.50	86.40	26
WC	Petrol	2144	5	79.50	86.40	27
WD	Petrol	2144	5	79.50	86.40	28
WE	Petrol	2144	5	79.50	86.40	24
WG	Petrol	2144	5	79.50	86.40	29
WH	Petrol	1921	5	79.50	77.40	16
WJ	Petrol	2144	5	79.50	86.40	30
WK	Petrol	2144	5	79.50	86.40	22
WN	Petrol	1921	5	79.50	77.40	17
WP	Petrol	1588	4	79.50	80.00	18
WR	Petrol	2144	5	79.50	86.40	22
WS	Petrol	2144	5	79.50	86.40	30
WT	Petrol	1715	4	79.50	86.40	21
WU	Petrol	2144	5	79.50	86.40	23
WV	Petrol	1588	4	79.50	80.00	18
WX	Petrol	2144	5	79.50	86.40	22
WY	Petrol	1588	4	79.50	80.00	18
WZ	Petrol	1588	4	79.50	80.00	18
XW	Petrol	1470	4	76.50	80.00	9
XX	Petrol	1584	4	79.50	80.00	18
YG	Petrol	1588	4	79.50	80.00	18
YH	Petrol	1588	4	79.50	80.00	18
YJ	Petrol	1471	4	76.50	80.00	9
YK	Petrol	1588	4	79.50	80.00	18
YM	Petrol	1588	4	79.50	80.00	18
YN	Petrol	1588	4	79.50	80.00	18
YP	Petrol	1588	4	79.50	80.00	18
YS	Petrol	1588	4	79.50	80.00	18
YT	Petrol	1588	4	79.50	80.00	18
YV	Petrol	1588	4	79.50	80.00	18
YY	Petrol	1588	4	79.50	80.00	18
YZ	Petrol	1588	4	79.50	80.00	18
ZA	Petrol	1297	4	75.00	73.40	6

			cm ³	x 			
ZB		Petrol	1471	4	76.50	80.00	9
ZC		Petrol	1471	4	76.50	80.00	9
ZF		Petrol	1297	4	75.00	73.40	6
ZV		Petrol	1716	4	79.50	86.40	21



1 64.50 x 59.00

HE 4 Cyl. **771cc** **25kW (34PS)** **Petrol** **TD16546**

BE/PL	4	41,965/41,980	45,000/45,016	18,000	1,505	0,020/0,066	EC	71-3276	71-3276/4 STD 0.25
MB/HL	8	53,958/53,978	59,000/59,019	18,500	2,502	0,020/0,082	AL-LF	02-3085U	H024/5 STD 0.25
MB/HL	2	53,958/53,978	59,000/59,019	24,930	2,502	0,020/0,082	AL-LF	02-3086HU	

	02-3086HU	STD	25,000/.9843" - 25,040/.9858"
		0.25mm	25,100/.9882" - 25,140/.9898"
		0.50mm	25,100/.9882" - 25,140/.9898"
		0.75mm	25,100/.9882" - 25,140/.9898"

SE/PB	1	20,000	23,000/23,025	24,000			BC	55-3277	55-3277 SEMI
BU	1	42,959/42,975	46,055/46,095	15,000			AL-LF	07-3088	07-3088 STD SEMI 13

Front, For intermediary shaft

BU	1	41,959/41,975	45,000/45,025	15,000			AL-LF	07-3089	07-3089 STD SEMI 13
----	---	---------------	---------------	--------	--	--	-------	---------	--

Rear, For intermediary shaft

2 69.50 x 72.00

HB 4 Cyl. **1093cc** **37kW (50PS)** **Petrol** **TD4207**

HC 4 Cyl. **1093cc** **44kW (60PS)** **Petrol** **TD263**

HD 4 Cyl. **1093cc** **38kW (52PS)** **Petrol** **TD264**

BE/PL	4	41,965/41,980	45,000/45,016	18,000	1,505	0,020/0,066	EC	71-3276	71-3276/4 STD 0.25
MB/HL	8	53,958/53,978	59,000/59,019	18,500	2,502	0,020/0,082	AL-LF	02-3085U	H024/5 STD 0.25
MB/HL	2	53,958/53,978	59,000/59,019	24,930	2,502	0,020/0,082	AL-LF	02-3086HU	

	02-3086HU	STD	25,000/.9843" - 25,040/.9858"
		0.25mm	25,100/.9882" - 25,140/.9898"
		0.50mm	25,100/.9882" - 25,140/.9898"
		0.75mm	25,100/.9882" - 25,140/.9898"

SE/PB	1	20,000	23,000/23,025	24,000			BC	55-3277	55-3277 SEMI
BU	1	42,959/42,975	46,055/46,095	15,000			AL-LF	07-3088	07-3088 STD SEMI 13

Front, For intermediary shaft

BU	1	41,959/41,975	45,000/45,025	15,000			AL-LF	07-3089	07-3089 STD SEMI 13
----	---	---------------	---------------	--------	--	--	-------	---------	--

Rear, For intermediary shaft

3 71.00 x 75.60

CBZA 4 Cyl. **1197cc** **63kW (86PS)** **Petrol Turbo** **TD24385**

CBZB 4 Cyl. **1197cc** **77kW (105PS)** **Petrol Turbo** **TD23907**

BE/PL	4	41,963/41,978	45,000/45,012	15,200	1,503	0,024/0,062	AL-LF	01-4873	01-4873/4 STD
TW/A	2		64,750/65,000		2,475		AL-LF	04-4930	A314/2 STD
SE/PB	1	19,000	21,000/21,033	17,800			BC-LF	55-4875	55-4875 SEMI 6

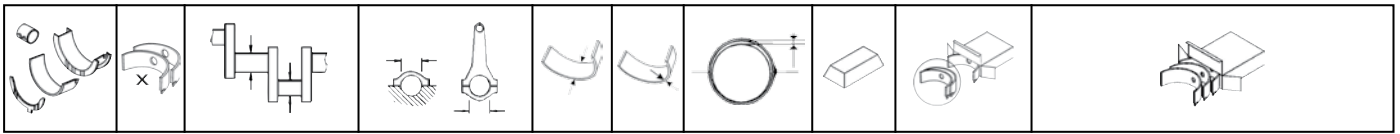

4 75.00 x 72.00

FY	4 Cyl.	1272cc	40-44kW (55-60PS)	Petrol	TD259
FZ	4 Cyl.	1272cc	44kW (60PS)	Petrol	TD260
HH	4 Cyl.	1272cc	44kW (60PS)	Petrol	TD265
HJ	4 Cyl.	1272cc	43kW (58PS)	Petrol	TD16547

BE/PL	4	41,965/41,980	45,000/45,016	18,000	1,505	0,020/0,066	EC	71-3276	71-3276/4 STD 0.25
MB/HL	8	53,958/53,978	59,000/59,019	18,500	2,502	0,020/0,082	AL-LF	02-3085U	H024/5 STD 0.25
MB/HL	2	53,958/53,978	59,000/59,019	24,930	2,502	0,020/0,082	AL-LF	02-3086HU	

	02-3086HU	STD	25,000/.9843" - 25,040/.9858"
		0.25mm	25,100/.9882" - 25,140/.9898"
		0.50mm	25,100/.9882" - 25,140/.9898"
		0.75mm	25,100/.9882" - 25,140/.9898"

MB/HL 1-5	10	53,958/53,978	59,000/59,019	18,500	2,502	0,020/0,082	AL-LF	02-3085U	H026/5 STD 0.25 0.50
--------------	----	---------------	---------------	--------	-------	-------------	-------	----------	--------------------------------

02-3085U

02-3086HU

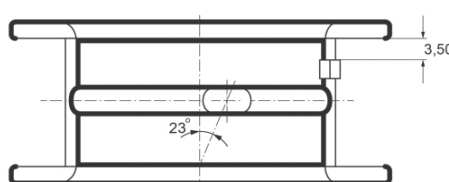
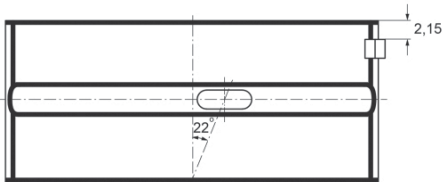

TW/A	2	59,500	73,200		1,975		AL-LF	04-3527	A123/4 STD
TW/A	2	59,500	73,200		1,975		AL-LF	04-3528	
SE/PB	1	20,000	23,000/23,025	24,000			BC	55-3277	55-3277 SEMI
BU	1	42,959/42,975	46,055/46,095	15,000			AL-LF	07-3088	07-3088 STD SEMI

Front, For intermediary shaft

BU	1	41,959/41,975	45,000/45,025	15,000			AL-LF	07-3089	07-3089 STD SEMI
----	---	---------------	---------------	--------	--	--	-------	---------	----------------------------

Rear, For intermediary shaft

5 75.00 x 73.40

EP	4 Cyl.	1297cc	44kW (60PS)	Petrol	TD257
-----------	--------	---------------	--------------------	---------------	--------------

BE/PL	1	45,950/45,970	49,000/49,016	19,000	1,506	0,020/0,078	EC	71-3084	71-3084 STD 0.25
-------	---	---------------	---------------	--------	-------	-------------	----	---------	----------------------------

Mot. → 81D250000

BE/PL	4	47,758/47,778	50,600/50,612	19,000	1,406	0,020/0,067	EC	71-3694	71-3694/4 STD 0.25 0.50
-------	---	---------------	---------------	--------	-------	-------------	----	---------	-----------------------------------

Mot. 81E000001 →

71-3084

71-3694

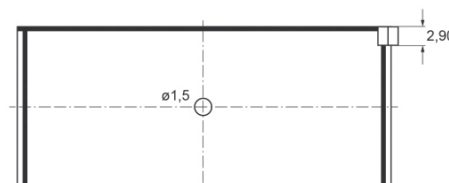



MB/HL	3	53,958/53,978	59,000/59,019	18,500	2,502	0,020/0,082	AL-LF	02-3085L	H025/5 STD 0.25 0.50
MB/HL	5	53,958/53,978	59,000/59,019	18,500	2,502	0,020/0,082	AL-LF	02-3085U	
MB/HL	1	53,958/53,978	59,000/59,019	24,930	2,502	0,020/0,082	AL-LF	02-3086HL	
MB/HL	1	53,958/53,978	59,000/59,019	24,930	2,502	0,020/0,082	AL-LF	02-3086HU	



02-3086HL	STD	25,000/.9843" - 25,040/.9858"
	0.25mm	25,100/.9882" - 25,140/.9898"
	0.50mm	25,100/.9882" - 25,140/.9898"
	0.75mm	25,100/.9882" - 25,140/.9898"
02-3086HU	STD	25,000/.9843" - 25,040/.9858"
	0.25mm	25,100/.9882" - 25,140/.9898"
	0.50mm	25,100/.9882" - 25,140/.9898"
	0.75mm	25,100/.9882" - 25,140/.9898"

MB/HL	4	53,958/53,978	59,000/59,019	18,500	2,502	0,020/0,082	AL-LF	02-3085L	H027/5 STD 0.25 0.50
MB/HL	6	53,958/53,978	59,000/59,019	18,500	2,502	0,020/0,082	AL-LF	02-3085U	

02-3085L

02-3085U

02-3086HL

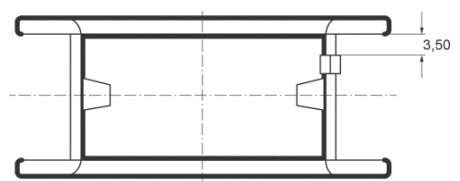
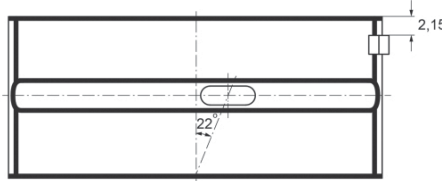

02-3086HU

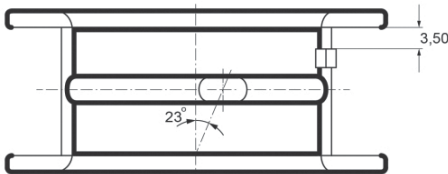

TW/A	2	59,500	73,200		1,975		AL-LF	04-3527	A123/4 STD
TW/A	2	59,500	73,200		1,975		AL-LF	04-3528	
SE/PB	1	20,000	23,000/23,052	25,000			BC	55-3567	55-3567 SEMI

01/83 →

CB/NWB 1-5	5	25,939/25,960	28,250/28,271	17,000	1,138		AL-LF	03-3317	N118/5 STD	[12]
BU	1	42,959/42,975	46,055/46,095	15,000			AL-LF	07-3088	07-3088 STD SEMI	[13]

Front, For intermediary shaft

BU	1	41,959/41,975	45,000/45,025	15,000			AL-LF	07-3089	07-3089 STD SEMI	[13]
----	---	---------------	---------------	--------	--	--	-------	---------	----------------------------	------

Rear, For intermediary shaft

6 75.00 x 73.40										
ZA	4 Cyl.			1297cc	40kW (55PS)	Petrol			TD4214	
ZF	4 Cyl.			1297cc	44kW (60PS)	Petrol			TD368	
BE/PL	1	45,950/45,970	49,000/49,016	19,000	1,506	0,020/0,078	EC	71-3084	71-3084 STD 0.25	

MB/HL	3	53,958/53,978	59,000/59,019	18,500	2,502	0,020/0,082	AL-LF	02-3085L	H025/5 STD 0.25 0.50																								
MB/HL	5	53,958/53,978	59,000/59,019	18,500	2,502	0,020/0,082	AL-LF	02-3085U																									
MB/HL	1	53,958/53,978	59,000/59,019	24,930	2,502	0,020/0,082	AL-LF	02-3086HL																									
MB/HL	1	53,958/53,978	59,000/59,019	24,930	2,502	0,020/0,082	AL-LF	02-3086HU																									
<table border="0"> <tr> <td>02-3086HL</td> <td>STD</td> <td>25,000/.9843" - 25,040/.9858"</td> </tr> <tr> <td></td> <td>0.25mm</td> <td>25,100/.9882" - 25,140/.9898"</td> </tr> <tr> <td></td> <td>0.50mm</td> <td>25,100/.9882" - 25,140/.9898"</td> </tr> <tr> <td></td> <td>0.75mm</td> <td>25,100/.9882" - 25,140/.9898"</td> </tr> <tr> <td>02-3086HU</td> <td>STD</td> <td>25,000/.9843" - 25,040/.9858"</td> </tr> <tr> <td></td> <td>0.25mm</td> <td>25,100/.9882" - 25,140/.9898"</td> </tr> <tr> <td></td> <td>0.50mm</td> <td>25,100/.9882" - 25,140/.9898"</td> </tr> <tr> <td></td> <td>0.75mm</td> <td>25,100/.9882" - 25,140/.9898"</td> </tr> </table>										02-3086HL	STD	25,000/.9843" - 25,040/.9858"		0.25mm	25,100/.9882" - 25,140/.9898"		0.50mm	25,100/.9882" - 25,140/.9898"		0.75mm	25,100/.9882" - 25,140/.9898"	02-3086HU	STD	25,000/.9843" - 25,040/.9858"		0.25mm	25,100/.9882" - 25,140/.9898"		0.50mm	25,100/.9882" - 25,140/.9898"		0.75mm	25,100/.9882" - 25,140/.9898"
02-3086HL	STD	25,000/.9843" - 25,040/.9858"																															
	0.25mm	25,100/.9882" - 25,140/.9898"																															
	0.50mm	25,100/.9882" - 25,140/.9898"																															
	0.75mm	25,100/.9882" - 25,140/.9898"																															
02-3086HU	STD	25,000/.9843" - 25,040/.9858"																															
	0.25mm	25,100/.9882" - 25,140/.9898"																															
	0.50mm	25,100/.9882" - 25,140/.9898"																															
	0.75mm	25,100/.9882" - 25,140/.9898"																															
CB/NWB 1-5	5	25,939/25,960	28,250/28,271	17,000	1,138		AL-LF	03-3317	N118/5 STD	12																							
BU	1	42,959/42,975	46,055/46,095	15,000			AL-LF	07-3088	07-3088 STD SEMI	13																							
Front, For intermediary shaft																																	
BU	1	41,959/41,975	45,000/45,025	15,000			AL-LF	07-3089	07-3089 STD SEMI	13																							
Rear, For intermediary shaft																																	

7										76.50 x 75.60	
AUA			4 Cyl.		1390cc	55kW (75PS)	Petrol			TD15248	
BBY			4 Cyl.		1390cc	55kW (75PS)	Petrol			TD16414	
BE/PL	4	47,763/47,778	50,600/50,612	18,500	1,406	0,020/0,062	AL-LF	01-3867	01-3867/4 STD 0.25		
MB/HL 1-5	5	53,963/53,978	59,000/59,019	18,500	2,504	0,020/0,073	AL-LF	02-4929	H1325/5 STD 0.25 0.50		
TW/A	2	59,500	73,200		1,975		AL-LF	04-3527	A123/4 STD		
TW/A	2	59,500	73,200		1,975		AL-LF	04-3528			
BU	1	42,959/42,975	46,055/46,095	15,000			AL-LF	07-3088	07-3088 STD SEMI	13	
Front, For intermediary shaft											
BU	1	41,959/41,975	45,000/45,025	15,000			AL-LF	07-3089	07-3089 STD SEMI	13	
Rear, For intermediary shaft											

8										76.50 x 75.60	
CAVG			4 Cyl.		1390cc	136kW (185PS)	Petrol Turbo			TD24937	
CAXA			4 Cyl.		1390cc	90kW (122PS)	Petrol Turbo			TD24386	
CAXC			4 Cyl.		1390cc	92kW (125PS)	Petrol Turbo			TD20715	
CNVA			4 Cyl.		1390cc	90kW (122PS)	Petrol Turbo			TD24951	
CTHG			4 Cyl.		1390cc	136kW (185PS)	Petrol Turbo			TD25659	
CTJA			4 Cyl.		1390cc	136kW (185PS)	Petrol Turbo			TD25660	
BE/PL	4	47,763/47,778	50,600/50,612	17,200	1,406	0,023/0,071	AL-LF	01-4100	01-4100/4 STD		
MB/HL 1-5	5	53,963/53,978	59,000/59,019	18,500	2,504	0,020/0,073	AL-LF	02-4929	H1325/5 STD 0.25 0.50		
TW/A	2	59,500	73,200		1,975		AL-LF	04-3527	A123/4 STD		
TW/A	2	59,500	73,200		1,975		AL-LF	04-3528			

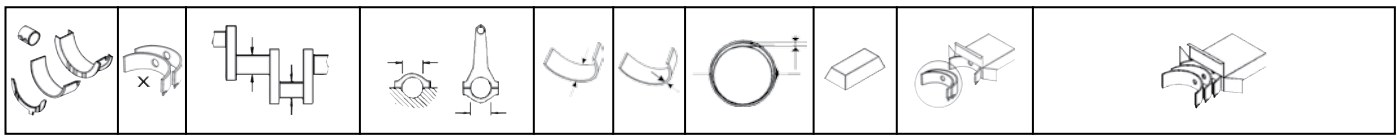

9 76.50 x 80.00

XW	4 Cyl.	1470cc	57kW (78PS)	Petrol	TD350
YJ	4 Cyl.	1471cc	55kW (75PS)	Petrol	TD4213
ZB	4 Cyl.	1471cc	55kW (75PS)	Petrol	TD366
ZC	4 Cyl.	1471cc	63kW (85PS)	Petrol	TD367

BE/PL	1	45,950/45,970	49,000/49,016	19,000	1,506	0,020/0,078	EC	71-3084	71-3084 STD 0.25
MB/HL	3	53,958/53,978	59,000/59,019	18,500	2,502	0,020/0,082	AL-LF	02-3085L	H025/5 STD 0.25 0.50
MB/HL	5	53,958/53,978	59,000/59,019	18,500	2,502	0,020/0,082	AL-LF	02-3085U	
MB/HL	1	53,958/53,978	59,000/59,019	24,930	2,502	0,020/0,082	AL-LF	02-3086HL	
MB/HL	1	53,958/53,978	59,000/59,019	24,930	2,502	0,020/0,082	AL-LF	02-3086HU	



02-3086HL	STD	25,000/.9843" - 25,040/.9858"
	0.25mm	25,100/.9882" - 25,140/.9898"
	0.50mm	25,100/.9882" - 25,140/.9898"
	0.75mm	25,100/.9882" - 25,140/.9898"

02-3086HU	STD	25,000/.9843" - 25,040/.9858"
	0.25mm	25,100/.9882" - 25,140/.9898"
	0.50mm	25,100/.9882" - 25,140/.9898"
	0.75mm	25,100/.9882" - 25,140/.9898"

CB/NWB 1-5	5	25,939/25,960	28,250/28,271	17,000	1,138		AL-LF	03-3317	N118/5 STD	12
BU	1	42,959/42,975	46,055/46,095	15,000			AL-LF	07-3088	07-3088 STD SEMI	13

Front, For intermediary shaft

BU	1	41,959/41,975	45,000/45,025	15,000			AL-LF	07-3089	07-3089 STD SEMI	13
----	---	---------------	---------------	--------	--	--	-------	---------	----------------------------	----

Rear, For intermediary shaft

10 76.50 x 86.40

ANY	3 Cyl.	1191cc	45kW (61PS)	Diesel Turbo Intercooler	TD17157
------------	--------	---------------	--------------------	---------------------------------	----------------

BE/PL	1	47,758/47,778	50,600/50,612	20,000	1,406	0,020/0,067	SP	71-3904	71-3904 STD 0.25 0.50	1
CB/NWB 1-4	4	28,947/28,960	32,000/32,025	25,000	1,513	0,020/0,068	EC	73-3903	N147/4 STD	
BU	1	31,984/32,000	35,000/35,025	22,000			AL-LF	07-4037	07-4037 SEMI	
BU	1	41,984/42,000	45,000/45,025	22,000			AL-LF	07-4038	07-4038 SEMI	

11 76.50 x 86.40

CR	4 Cyl.	1588cc	40kW (54PS)	Diesel	TD248
CY	4 Cyl.	1588cc	51kW (70PS)	Diesel Turbo	TD4205
JK	4 Cyl.	1588cc	40kW (54PS)	Diesel	TD269

BE/PL	4	47,758/47,778	50,600/50,619	19,000	1,406	0,020/0,074	EC	71-3442	71-3442/4 STD 0.25 0.50 0.75
-------	---	---------------	---------------	--------	-------	-------------	----	---------	--

MB/HL	3	53,958/53,978	59,000/59,019	18,500	2,502	0,020/0,082	AL-LF	02-3085L	H025/5 STD 0.25 0.50	
MB/HL	5	53,958/53,978	59,000/59,019	18,500	2,502	0,020/0,082	AL-LF	02-3085U		
MB/HL	1	53,958/53,978	59,000/59,019	24,930	2,502	0,020/0,082	AL-LF	02-3086HL		
MB/HL	1	53,958/53,978	59,000/59,019	24,930	2,502	0,020/0,082	AL-LF	02-3086HU		
		02-3086HL	STD	25,000/.9843" - 25,040/.9858"						
			0.25mm	25,100/.9882" - 25,140/.9898"						
			0.50mm	25,100/.9882" - 25,140/.9898"						
			0.75mm	25,100/.9882" - 25,140/.9898"						
		02-3086HU	STD	25,000/.9843" - 25,040/.9858"						
			0.25mm	25,100/.9882" - 25,140/.9898"						
			0.50mm	25,100/.9882" - 25,140/.9898"						
			0.75mm	25,100/.9882" - 25,140/.9898"						
SE/PB	1	24,000/24,012	27,000/27,021	25,000			BC	55-3443	55-3443 SEMI	
CB/NWB 1-5	5	25,939/25,960	28,250/28,271	17,000	1,138		AL-LF	03-3317	N118/5 STD	

12

12 76.50 x 86.40

RA	4 Cyl.		1588cc	59kW (80PS)	Diesel Turbo Intercooler		TD313	
SB	4 Cyl.		1588cc	59kW (80PS)	Diesel Turbo Intercooler		TD4211	
BE/PL	4	47,758/47,778	50,600/50,619	19,000	1,406	0,020/0,074	EC 71-3442	71-3442/4 STD 0.25 0.50 0.75
MB/HL 1-5	5	53,958/53,978	59,000/59,019	18,500	2,502	0,020/0,082	AL-LF 02-3085L	H084/5 STD 0.25 0.50
MB/HL 1-5	5	53,958/53,978	59,000/59,019	18,500	2,502	0,020/0,082	AL-LF 02-3085U	
TW/A	2	59,500	73,200		1,975		AL-LF 04-3527	A123/4 STD
TW/A	2	59,500	73,200		1,975		AL-LF 04-3528	
SE/PB	1	24,000/24,012	27,000/27,021	25,000			BC 55-3443	55-3443 SEMI

13 76.50 x 86.40

CN	5 Cyl.		1986cc	51kW (69PS)	Diesel		TD247	
DE	5 Cyl.		1986cc	64kW (87PS)	Diesel Turbo		TD251	
NC	5 Cyl.		1986cc	74kW (100PS)	Diesel Turbo Intercooler		TD299	
BE/PL	5	47,758/47,778	50,600/50,619	19,000	1,406	0,020/0,074	EC 71-3442	71-3442/5 STD 0.25 0.50
MB/HL 1,2, 4-6	5	57,958/57,978	63,000/63,019	18,500	2,502	0,020/0,082	EC 72-3400	H941/6 STD 0.25
MB/HL 3	1	57,958/57,978	63,000/63,019	24,930	2,502	0,020/0,082	EC 72-3401H	
		72-3401H	STD	25,000/.9843" - 25,040/.9858"				
			0.25mm	25,100/.9882" - 25,140/.9898"				
			0.50mm	25,100/.9882" - 25,140/.9898"				
			0.75mm	25,100/.9882" - 25,140/.9898"				
MB/HL 1-6	6	57,958/57,978	63,000/63,019	18,500	2,502	0,020/0,082	EC 72-3400	H981/6 STD 0.25
TW/A	2	63,500/63,750	77,200/77,450		1,975		AL-LF 04-3529	A124/4 STD
TW/A	2	63,500/63,750	77,200/77,450		1,975		AL-LF 04-3530	

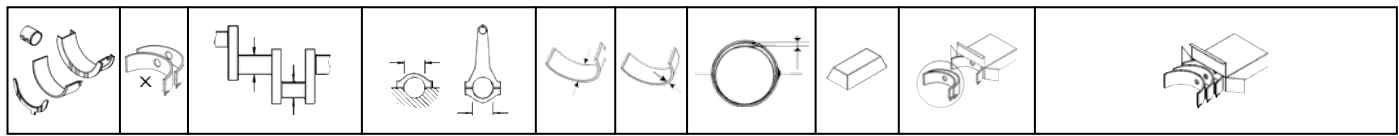

TW/A	2	63,500/63,750	76,950/77,200		1,975		AL-LF	04-4782	A292/4 STD
TW/A	2	63,500/63,750	76,950/77,200		1,975		AL-LF	04-4783	

04-3529

04-3530

04-4782

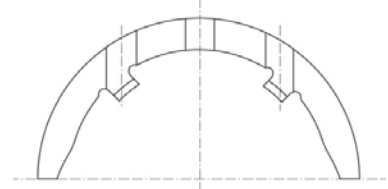
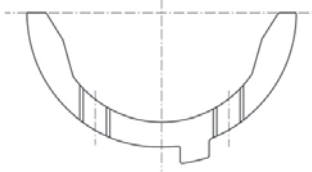
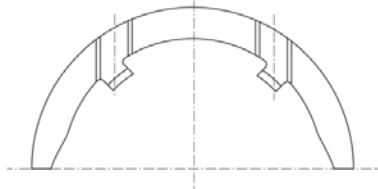

04-4783

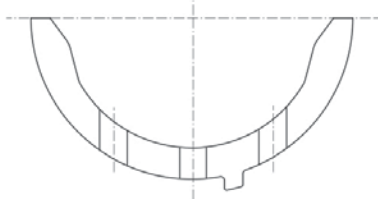

SE/PB	1	24,000/24,012	27,000/27,021	25,000			BC	55-3443	55-3443 SEMI
-------	---	---------------	---------------	--------	--	--	----	---------	------------------------

14

76.50 x 86.90

BAD			4 Cyl.	1598cc	81kW (110PS)		Petrol		TD16415
BAG			4 Cyl.	1598cc	85kW (115PS)		Petrol		TD17069
BLF			4 Cyl.	1598cc	85kW (115PS)		Petrol		TD20713
BLP			4 Cyl.	1598cc	85kW (115PS)		Petrol		TD17401
BE/PL	4	47,763/47,778	50,600/50,612	17,200	1,406	0,023/0,071	AL-LF	01-4100	01-4100/4 STD
MB/HL 1-5	5	53,963/53,978	59,000/59,019	18,500	2,504	0,020/0,073	AL-LF	02-4929	H1325/5 STD 0.25 0.50
TW/A	2	59,500	73,200		1,975		AL-LF	04-3527	A123/4 STD
TW/A	2	59,500	73,200		1,975		AL-LF	04-3528	

15

78.30 x 86.40

AFB			V6 Cyl.	2496cc	110kW (150PS)		Diesel Turbo Intercooler		TD9517
AKE			V6 Cyl.	2496cc	132kW (180PS)		Diesel Bi-Turbo Intercooler		TD15312
AKN			V6 Cyl.	2496cc	110kW (150PS)		Diesel Turbo Intercooler		TD11356
AYM			V6 Cyl.	2496cc	114kW (155PS)		Diesel Turbo Intercooler		TD16384
BAU			V6 Cyl.	2496cc	132kW (180PS)		Diesel Turbo Intercooler		TD17033
BCZ			V6 Cyl.	2496cc	120kW (163PS)		Diesel Turbo Intercooler		TD16859
BDG			V6 Cyl.	2496cc	120kW (163PS)		Diesel Turbo Intercooler		TD16860
BDH			V6 Cyl.	2496cc	132kW (180PS)		Diesel Turbo Intercooler		TD17034
BFC			V6 Cyl.	2496cc	120kW (163PS)		Diesel Turbo Intercooler		TD16858
MB/HL 1-4	4	64,959/64,978	70,000/70,019	18,000	2,508	0,020/0,070	EC	72-3712	H034/4 STD 0.25

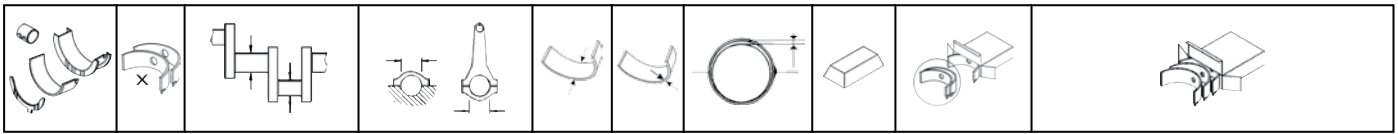

16 **79.50 x 77.40**

WH		5 Cyl.		1921cc	74kW (100PS)		Petrol		TD336
BE/PL	1	45,950/45,970	49,000/49,016	19,000	1,506	0,020/0,078	EC	71-3084	71-3084 STD 0.25
→12/83									
BE/PL	5	47,758/47,778	50,600/50,619	19,000	1,406	0,020/0,074	EC	71-3566	71-3566/5 STD
01/84→									

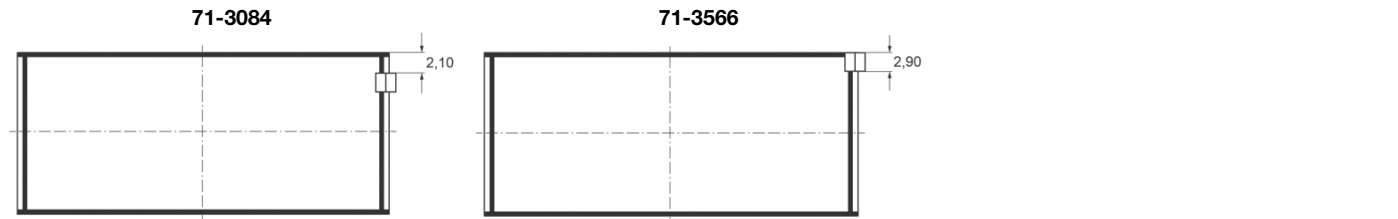

MB/HL 1-6	6	57,958/57,978	63,000/63,019	18,500	2,502	0,020/0,082	EC	72-3400	H981/6 STD 0.25
TW/A	2	63,500/63,750	77,200/77,450		1,975		AL-LF	04-3529	A124/4 STD
TW/A	2	63,500/63,750	77,200/77,450		1,975		AL-LF	04-3530	
TW/A	2	63,500/63,750	76,950/77,200		1,975		AL-LF	04-4782	A292/4 STD
TW/A	2	63,500/63,750	76,950/77,200		1,975		AL-LF	04-4783	

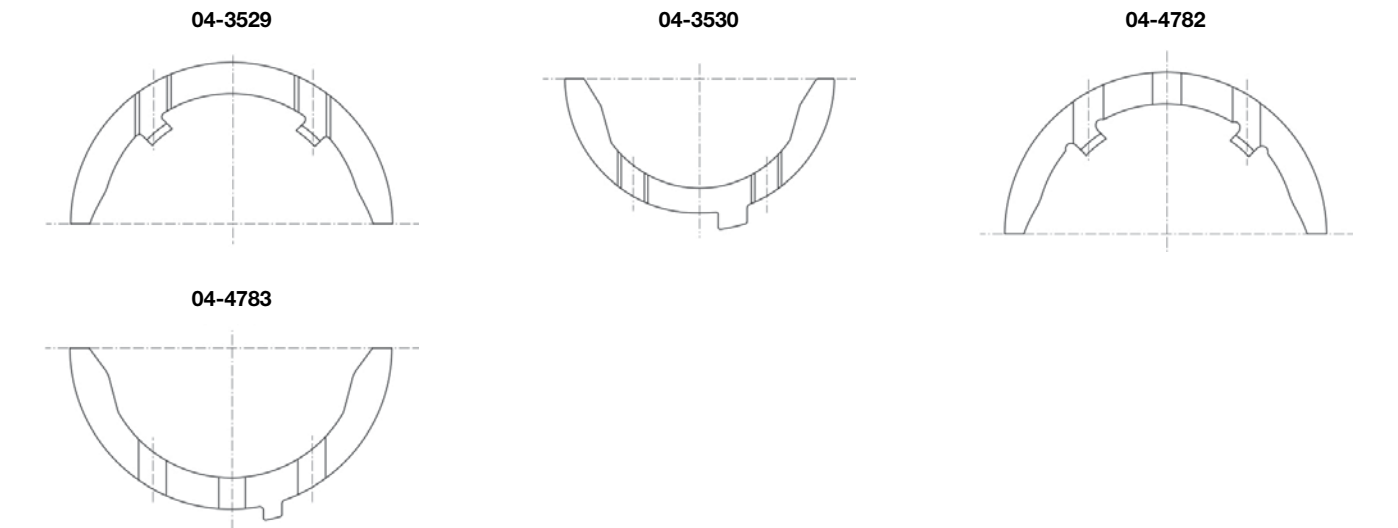

17 **79.50 x 77.40**

WN		5 Cyl.		1921cc	85kW (115PS)		Petrol		TD339
BE/PL	1	45,950/45,970	49,000/49,016	19,000	1,506	0,020/0,078	EC	71-3084	71-3084 STD 0.25
MB/HL 1-6	6	57,958/57,978	63,000/63,019	18,500	2,502	0,020/0,082	EC	72-3400	H981/6 STD 0.25
TW/A	2	63,500/63,750	77,200/77,450		1,975		AL-LF	04-3529	A124/4 STD
TW/A	2	63,500/63,750	77,200/77,450		1,975		AL-LF	04-3530	

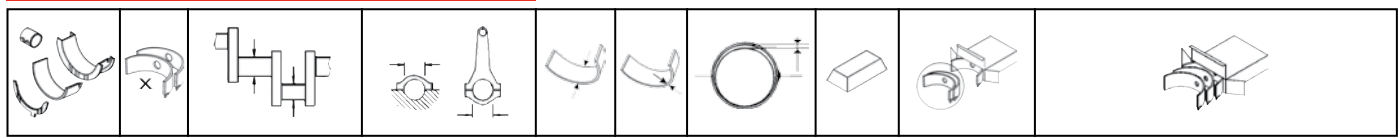

TW/A	2	63,500/63,750	76,950/77,200		1,975		AL-LF	04-4782	A292/4 STD
TW/A	2	63,500/63,750	76,950/77,200		1,975		AL-LF	04-4783	

04-3529

04-3530

04-4782

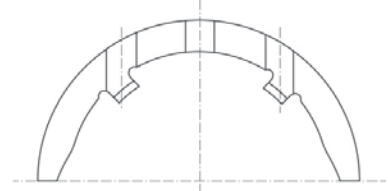
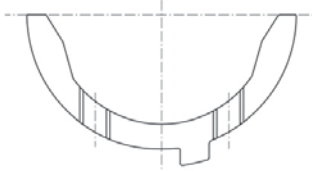
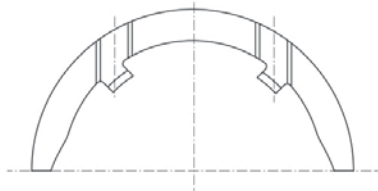

04-4783

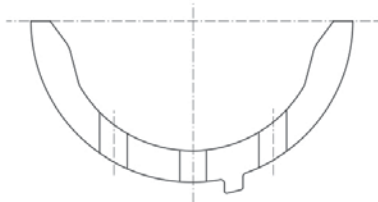

18		79.50 x 80.00							
FS	4 Cyl.	1588cc	53kW (72PS)					Petrol	TD258
WP	4 Cyl.	1588cc	48-51kW (65-69PS)					Petrol	TD340
WV	4 Cyl.	1588cc	55kW (75PS)					Petrol	TD345
WY	4 Cyl.	1588cc	55kW (75PS)					Petrol	TD348
WZ	4 Cyl.	1588cc	55kW (75PS)					Petrol	TD17147
XX	4 Cyl.	1584cc	74kW (100PS)					Petrol	TD351
YG	4 Cyl.	1588cc	57-61kW (78-83PS)					Petrol	TD353
YH	4 Cyl.	1588cc	57-61kW (78-83PS)					Petrol	TD354
YK	4 Cyl.	1588cc	59-61kW (79-83PS)					Petrol	TD356
YM	4 Cyl.	1588cc	63kW (85PS)					Petrol	TD357
YN	4 Cyl.	1588cc	55kW (75PS)					Petrol	TD358
YP	4 Cyl.	1588cc	63kW (85PS)					Petrol	TD359
YS	4 Cyl.	1588cc	81kW (110PS)					Petrol	TD360
YT	4 Cyl.	1588cc	51kW (70PS)					Petrol	TD361
YV	4 Cyl.	1588cc	63kW (85PS)					Petrol	TD362
YY	4 Cyl.	1588cc	51kW (70PS)					Petrol	TD363
YZ	4 Cyl.	1588cc	81kW (110PS)					Petrol	TD364
BE/PL	1	45,950/45,970	49,000/49,016	19,000	1,506	0,020/0,078	EC	71-3084	71-3084 STD 0.25

MB/HL	3	53,958/53,978	59,000/59,019	18,500	2,502	0,020/0,082	AL-LF	02-3085L	H025/5 STD 0.25 0.50	
MB/HL	5	53,958/53,978	59,000/59,019	18,500	2,502	0,020/0,082	AL-LF	02-3085U		
MB/HL	1	53,958/53,978	59,000/59,019	24,930	2,502	0,020/0,082	AL-LF	02-3086HL		
MB/HL	1	53,958/53,978	59,000/59,019	24,930	2,502	0,020/0,082	AL-LF	02-3086HU		
		02-3086HL	STD	25,000/.9843" - 25,040/.9858"						
			0.25mm	25,100/.9882" - 25,140/.9898"						
			0.50mm	25,100/.9882" - 25,140/.9898"						
			0.75mm	25,100/.9882" - 25,140/.9898"						
		02-3086HU	STD	25,000/.9843" - 25,040/.9858"						
			0.25mm	25,100/.9882" - 25,140/.9898"						
			0.50mm	25,100/.9882" - 25,140/.9898"						
			0.75mm	25,100/.9882" - 25,140/.9898"						
CB/NWB 1-5	5	25,939/25,960	28,250/28,271	17,000	1,138		AL-LF	03-3317	N118/5 STD	[12]
BU	1	42,959/42,975	46,055/46,095	15,000			AL-LF	07-3088	07-3088 STD SEMI	[13]
Front, For intermediary shaft										
BU	1	41,959/41,975	45,000/45,025	15,000			AL-LF	07-3089	07-3089 STD SEMI	[13]
Rear, For intermediary shaft										

19 79.50 x 80.50

CAYB	4 Cyl.		1598cc	66kW (90PS)		Diesel Turbo Intercooler			TD22661	
CAYC	4 Cyl.		1598cc	77kW (105PS)		Diesel Turbo Intercooler			TD22662	
BE/PL	1	47,758/47,778	50,600/50,612	20,000	1,406	0,020/0,067	SP	71-3904	71-3904 STD 0.25 0.50	[1]
MB/HL 1-5	5	53,958/53,978	59,000/59,012	18,500	2,501	0,020/0,076	EC	72-3931	H079/5 STD 0.25 0.50	
→11/11										
MB/HL 2-5	4	53,958/53,978	59,000/59,019	18,500	2,502	0,020/0,082	AL-LF	02-3085L	H1328/5 STD	[7]
MB/HL 2-5	4	53,958/53,978	59,000/59,019	18,500	2,502	0,020/0,082	AL-LF	02-3085U		
MB/HL 1	1	53,958/53,978	59,000/59,012	18,500	2,506	0,020/0,062		02-4941L		
MB/HL 1	1	53,958/53,978	59,000/59,012	18,500	2,506	0,020/0,062		02-4941U		
12/11→										

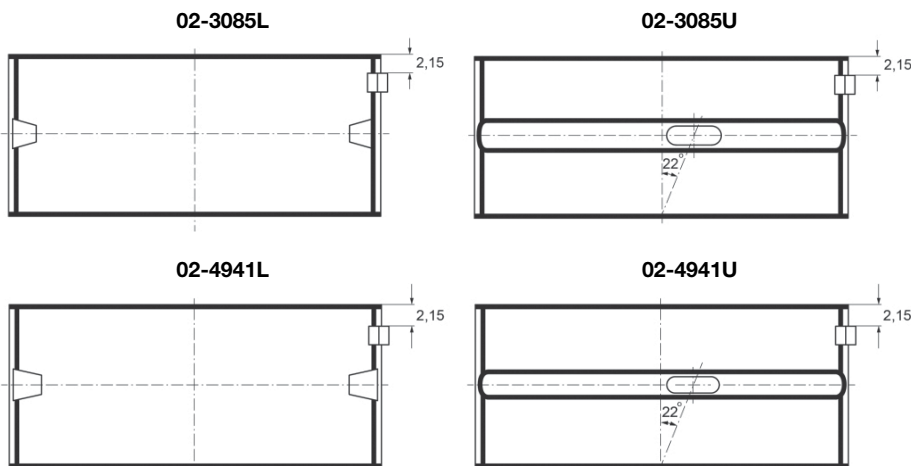

TW/A	2	59,500	73,200		1,975		AL-LF	04-3527	A123/4 STD
TW/A	2	59,500	73,200		1,975		AL-LF	04-3528	

20 79.50 x 80.50

CLHA			4 Cyl.	1598cc	77kW (105PS)		Diesel Turbo Intercooler		TD26721
MB/HL 1-5	5	53,963/53,978	59,000/59,019	18,500	2,504	0,020/0,073	AL-LF	02-4929	H1325/5 STD 0.25 0.50
TW/A	2	59,500	73,200		1,975		AL-LF	04-3527	A123/4 STD
TW/A	2	59,500	73,200		1,975		AL-LF	04-3528	

21 79.50 x 86.40

WT			4 Cyl.	1715cc	55-58kW (74-79PS)		Petrol		TD343
ZV			4 Cyl.	1716cc	59kW (80PS)		Petrol		TD377

BE/PL	1	45,950/45,970	49,000/49,016	19,000	1,506	0,020/0,078	EC	71-3084	71-3084 STD 0.25
MB/HL	3	53,958/53,978	59,000/59,019	18,500	2,502	0,020/0,082	AL-LF	02-3085L	H025/5 STD 0.25 0.50
MB/HL	5	53,958/53,978	59,000/59,019	18,500	2,502	0,020/0,082	AL-LF	02-3085U	
MB/HL	1	53,958/53,978	59,000/59,019	24,930	2,502	0,020/0,082	AL-LF	02-3086HL	
MB/HL	1	53,958/53,978	59,000/59,019	24,930	2,502	0,020/0,082	AL-LF	02-3086HU	



02-3086HL	STD	25,000/.9843" - 25,040/.9858"
	0.25mm	25,100/.9882" - 25,140/.9898"
	0.50mm	25,100/.9882" - 25,140/.9898"
	0.75mm	25,100/.9882" - 25,140/.9898"

02-3086HU	STD	25,000/.9843" - 25,040/.9858"
	0.25mm	25,100/.9882" - 25,140/.9898"
	0.50mm	25,100/.9882" - 25,140/.9898"
	0.75mm	25,100/.9882" - 25,140/.9898"

CB/NWB 1-5	5	25,939/25,960	28,250/28,271	17,000	1,138		AL-LF	03-3317	N118/5 STD	[12]
BU	1	42,959/42,975	46,055/46,095	15,000			AL-LF	07-3088	07-3088 STD SEMI	[13]

Front, For intermediary shaft

BU	1	41,959/41,975	45,000/45,025	15,000			AL-LF	07-3089	07-3089 STD SEMI	[13]
----	---	---------------	---------------	--------	--	--	-------	---------	---------------------	------

Rear, For intermediary shaft

22 79.50 x 86.40

GV			5 Cyl.	2144cc	147kW (200PS)		Petrol Turbo Intercooler		TD261
JY			5 Cyl.	2144cc	134kW (182PS)		Petrol Turbo		TD280
KG			5 Cyl.	2144cc	134kW (182PS)		Petrol Turbo Intercooler		TD283
KH			5 Cyl.	2144cc	100-104kW (136-141PS)		Petrol		TD284
WK			5 Cyl.	2144cc	96-100kW (130-136PS)		Petrol Turbo		TD338
WR			5 Cyl.	2144cc	147kW (200PS)		Petrol Turbo Intercooler		TD341
WX			5 Cyl.	2144cc	118-119kW (160-162PS)		Petrol Turbo		TD347
BE/PL	1	45,950/45,970	49,000/49,016	19,000	1,506	0,020/0,078	EC	71-3084	71-3084 STD 0.25

→12/83

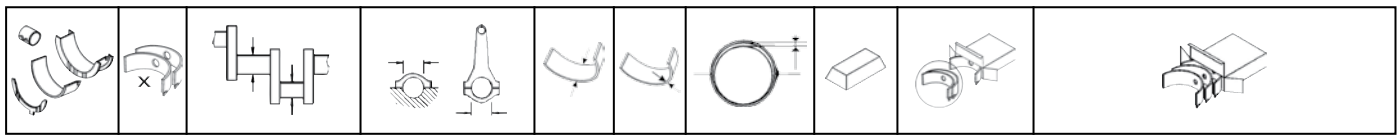

BE/PL	5	47,758/47,778	50,600/50,619	19,000	1,406	0,020/0,074	EC	71-3566	71-3566/5 STD
-------	---	---------------	---------------	--------	-------	-------------	----	---------	-------------------------

01/84 → 12/85

BE/PL	5	47,758/47,778	50,600/50,612	19,000	1,406	0,020/0,067	EC	71-3694	71-3694/5 STD 0.25
-------	---	---------------	---------------	--------	-------	-------------	----	---------	------------------------------

01/86 →

71-3084



71-3566



71-3694

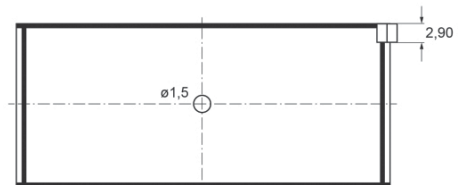

MB/HL 1-6	6	57,958/57,978	63,000/63,019	18,500	2,502	0,020/0,082	EC	72-3400	H981/6 STD 0.25
TW/A	2	63,500/63,750	77,200/77,450		1,975		AL-LF	04-3529	A124/4 STD
TW/A	2	63,500/63,750	77,200/77,450		1,975		AL-LF	04-3530	
TW/A	2	63,500/63,750	76,950/77,200		1,975		AL-LF	04-4782	A292/4 STD
TW/A	2	63,500/63,750	76,950/77,200		1,975		AL-LF	04-4783	

04-3529

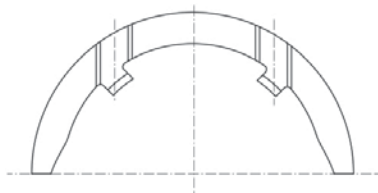

04-3530

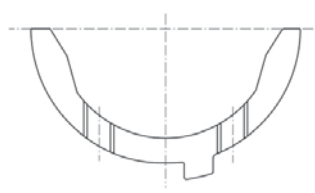

04-4782

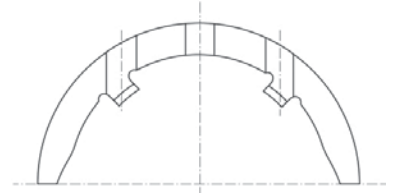

04-4783

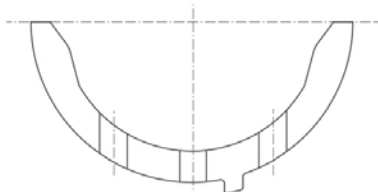

SE/PB	1	20,000	23,000/23,021	25,000			BC	55-3698	55-3698 SEMI
-------	---	--------	---------------	--------	--	--	----	---------	------------------------

23

79.50 x 86.40

KE	5 Cyl.	2144cc	96kW (131PS)	Petrol	TD281
KF	5 Cyl.	2144cc	96kW (130PS)	Petrol	TD282
KK	5 Cyl.	2144cc	100kW (136PS)	Petrol	TD286
KL	5 Cyl.	2144cc	96kW (131PS)	Petrol	TD288
WU	5 Cyl.	2144cc	75-79kW (102-107PS)	Petrol	TD344

BE/PL	1	45,950/45,970	49,000/49,016	19,000	1,506	0,020/0,078	EC	71-3084	71-3084 STD 0.25
-------	---	---------------	---------------	--------	-------	-------------	----	---------	----------------------------

→ 12/83

BE/PL	5	47,758/47,778	50,600/50,619	19,000	1,406	0,020/0,074	EC	71-3566	71-3566/5 STD
-------	---	---------------	---------------	--------	-------	-------------	----	---------	-------------------------

01/84 →

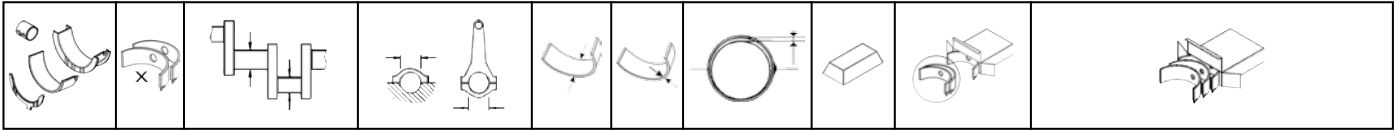

71-3084

71-3566

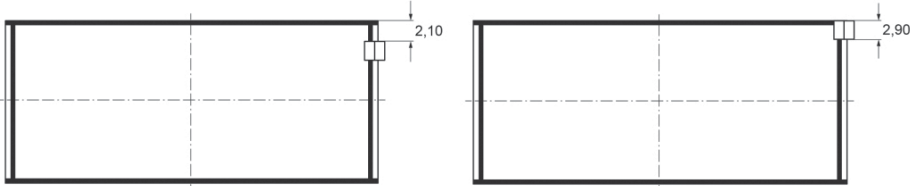

MB/HL 1-6	6	57,958/57,978	63,000/63,019	18,500	2,502	0,020/0,082	EC	72-3400
TW/A	2	63,500/63,750	77,200/77,450		1,975		AL-LF	04-3529
TW/A	2	63,500/63,750	77,200/77,450		1,975		AL-LF	04-3530
TW/A	2	63,500/63,750	76,950/77,200		1,975		AL-LF	04-4782
TW/A	2	63,500/63,750	76,950/77,200		1,975		AL-LF	04-4783

H981/6
STD 0.25
A124/4
STD

A292/4
STD

04-3529

04-3530

04-4782

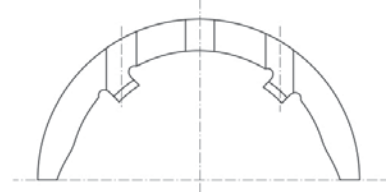
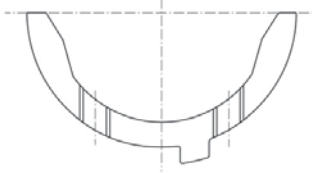
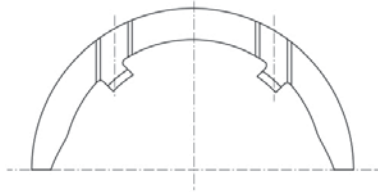

04-4783

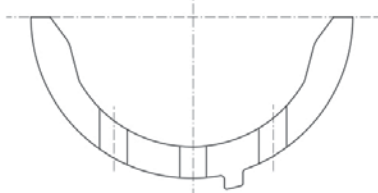

SE/PB	1	20,000	23,000/23,021	25,000			BC	55-3698	55-3698 SEMI
-------	---	--------	---------------	--------	--	--	----	---------	------------------------

24 79.50 x 86.40

KJ			5 Cyl.	2144cc	125kW (170PS)		Petrol		TD285
WE			5 Cyl.	2144cc	75-85kW (102-115PS)		Petrol		TD333
BE/PL	1	45,950/45,970	49,000/49,016	19,000	1,506	0,020/0,078	EC	71-3084	71-3084 STD 0.25
MB/HL 1,2, 4-6	5	57,958/57,978	63,000/63,019	18,500	2,502	0,020/0,082	EC	72-3400	H941/6 STD 0.25
MB/HL 3	1	57,958/57,978	63,000/63,019	24,930	2,502	0,020/0,082	EC	72-3401H	



72-3401H	STD	25,000/.9843" - 25,040/.9858"
	0.25mm	25,100/.9882" - 25,140/.9898"
	0.50mm	25,100/.9882" - 25,140/.9898"
	0.75mm	25,100/.9882" - 25,140/.9898"

25 79.50 x 86.40

KW			5 Cyl.	2144cc	220-225kW (300-306PS)		Petrol Turbo Intercooler		TD292
BE/PL	5	47,758/47,778	50,600/50,619	19,000	1,406	0,020/0,074	EC	71-3566	71-3566/5 STD

→12/85

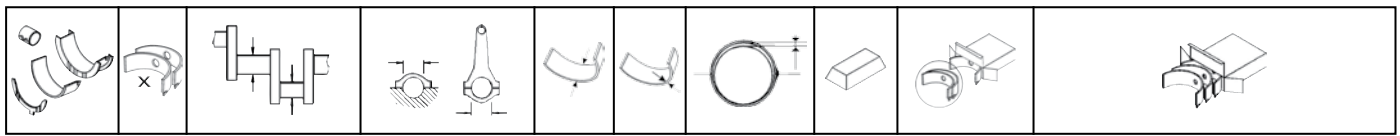

BE/PL	5	47,758/47,778	50,600/50,612	19,000	1,406	0,020/0,067	EC	71-3694	71-3694/5 STD 0.25
-------	---	---------------	---------------	--------	-------	-------------	----	---------	------------------------------

01/86 →

71-3566

71-3694

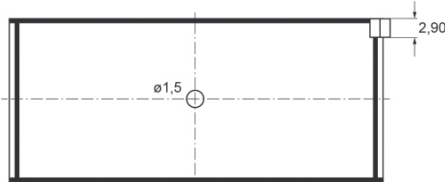

MB/HL 1-6	6	57,958/57,978	63,000/63,019	18,500	2,502	0,020/0,082	EC	72-3400	H981/6 STD 0.25
TW/A	2	63,500/63,750	77,200/77,450		1,975		AL-LF	04-3529	A124/4 STD
TW/A	2	63,500/63,750	77,200/77,450		1,975		AL-LF	04-3530	
TW/A	2	63,500/63,750	76,950/77,200		1,975		AL-LF	04-4782	A292/4 STD
TW/A	2	63,500/63,750	76,950/77,200		1,975		AL-LF	04-4783	

04-3529

04-3530

04-4782

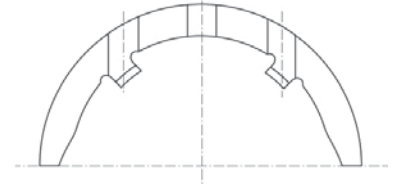
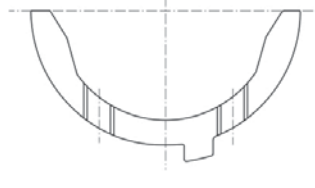
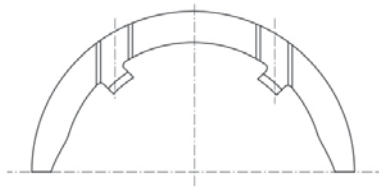

04-4783

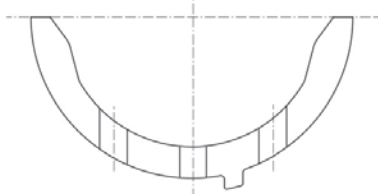

SE/PB	1	20,000	23,000/23,021	25,000			BC	55-3698	55-3698 SEMI
-------	---	--------	---------------	--------	--	--	----	---------	------------------------

26

79.50 x 86.40

WB 5 Cyl. **2144cc** **85kW** (115PS) **Petrol** **TD330**

BE/PL	1	45,950/45,970	49,000/49,016	19,000	1,506	0,020/0,078	EC	71-3084	71-3084 STD 0.25
MB/HL 1,2, 4-6	5	57,958/57,978	63,000/63,019	18,500	2,502	0,020/0,082	EC	72-3400	H941/6 STD 0.25
MB/HL 3	1	57,958/57,978	63,000/63,019	24,930	2,502	0,020/0,082	EC	72-3401H	



72-3401H	STD	25,000/.9843" - 25,040/.9858"
	0.25mm	25,100/.9882" - 25,140/.9898"
	0.50mm	25,100/.9882" - 25,140/.9898"
	0.75mm	25,100/.9882" - 25,140/.9898"

MB/HL 1-6	6	57,958/57,978	63,000/63,019	18,500	2,502	0,020/0,082	EC	72-3400	H981/6 STD 0.25
-----------	---	---------------	---------------	--------	-------	-------------	----	---------	---------------------------

01/79 →

TW/A	2	63,500/63,750	77,200/77,450		1,975		AL-LF	04-3529	A124/4 STD
TW/A	2	63,500/63,750	77,200/77,450		1,975		AL-LF	04-3530	
TW/A	2	63,500/63,750	76,950/77,200		1,975		AL-LF	04-4782	A292/4 STD
TW/A	2	63,500/63,750	76,950/77,200		1,975		AL-LF	04-4783	

04-3529

04-3530

04-4782

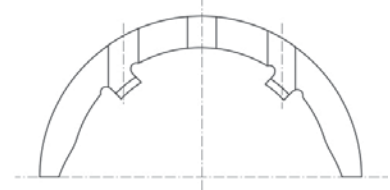
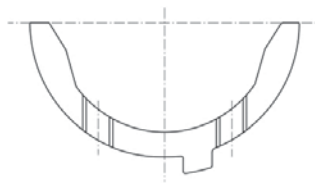
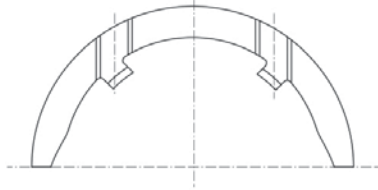

04-4783

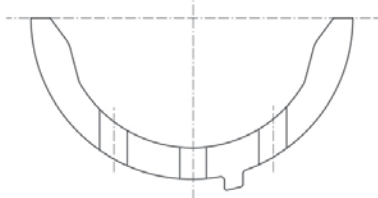

27 79.50 x 86.40

WC			5 Cyl.	2144cc	100kW (136PS)		Petrol		TD331
BE/PL	1	45,950/45,970	49,000/49,016	19,000	1,506	0,020/0,078	EC	71-3084	71-3084 STD 0.25
→12/83									
BE/PL	5	47,758/47,778	50,600/50,619	19,000	1,406	0,020/0,074	EC	71-3566	71-3566/5 STD
01/84→									

71-3084

71-3566



MB/HL 1,2, 4-6	5	57,958/57,978	63,000/63,019	18,500	2,502	0,020/0,082	EC	72-3400	H941/6 STD 0.25												
MB/HL 3	1	57,958/57,978	63,000/63,019	24,930	2,502	0,020/0,082	EC	72-3401H													
<table border="1"> <tr> <td>72-3401H</td> <td>STD</td> <td>25,000/.9843" - 25,040/.9858"</td> </tr> <tr> <td></td> <td>0.25mm</td> <td>25,100/.9882" - 25,140/.9898"</td> </tr> <tr> <td></td> <td>0.50mm</td> <td>25,100/.9882" - 25,140/.9898"</td> </tr> <tr> <td></td> <td>0.75mm</td> <td>25,100/.9882" - 25,140/.9898"</td> </tr> </table>										72-3401H	STD	25,000/.9843" - 25,040/.9858"		0.25mm	25,100/.9882" - 25,140/.9898"		0.50mm	25,100/.9882" - 25,140/.9898"		0.75mm	25,100/.9882" - 25,140/.9898"
72-3401H	STD	25,000/.9843" - 25,040/.9858"																			
	0.25mm	25,100/.9882" - 25,140/.9898"																			
	0.50mm	25,100/.9882" - 25,140/.9898"																			
	0.75mm	25,100/.9882" - 25,140/.9898"																			

MB/HL 1-6	6	57,958/57,978	63,000/63,019	18,500	2,502	0,020/0,082	EC	72-3400	H981/6 STD 0.25
01/79→									

TW/A	2	63,500/63,750	77,200/77,450		1,975		AL-LF	04-3529	A124/4 STD
TW/A	2	63,500/63,750	77,200/77,450		1,975		AL-LF	04-3530	

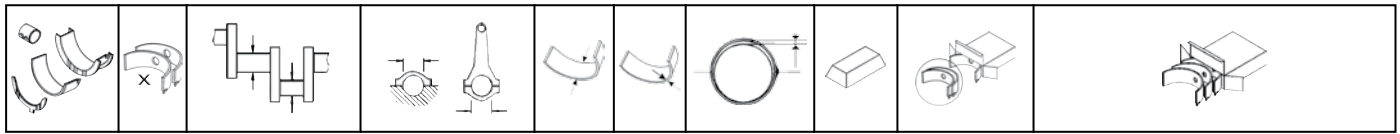

TW/A	2	63,500/63,750	76,950/77,200		1,975		AL-LF	04-4782	A292/4 STD
TW/A	2	63,500/63,750	76,950/77,200		1,975		AL-LF	04-4783	

04-3529

04-3530

04-4782

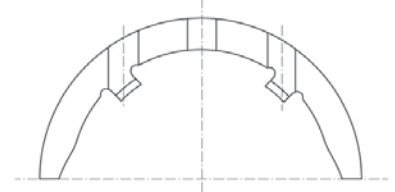
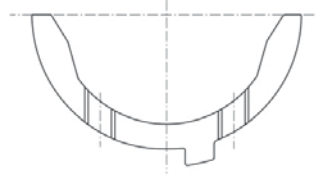
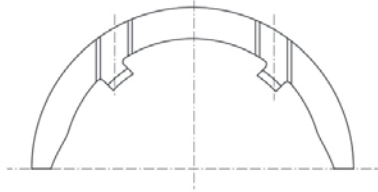

04-4783

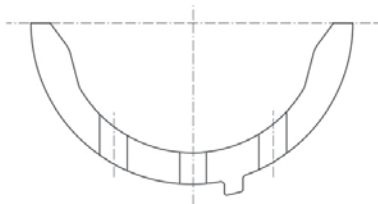

SE/PB	1	20,000	23,000/23,021	25,000			BC	55-3698	55-3698 SEMI
-------	---	--------	---------------	--------	--	--	----	---------	------------------------

28 79.50 x 86.40

WD 5 Cyl. **2144cc 75-79kW (102-107PS)** **Petrol** **TD332**

BE/PL	1	45,950/45,970	49,000/49,016	19,000	1,506	0,020/0,078	EC	71-3084	71-3084 STD 0.25
-------	---	---------------	---------------	--------	-------	-------------	----	---------	----------------------------

→12/83

BE/PL	5	47,758/47,778	50,600/50,619	19,000	1,406	0,020/0,074	EC	71-3566	71-3566/5 STD
-------	---	---------------	---------------	--------	-------	-------------	----	---------	-------------------------

01/84→

71-3084

71-3566



MB/HL 1,2, 4-6	5	57,958/57,978	63,000/63,019	18,500	2,502	0,020/0,082	EC	72-3400	H941/6 STD 0.25
MB/HL 3	1	57,958/57,978	63,000/63,019	24,930	2,502	0,020/0,082	EC	72-3401H	

	72-3401H	STD	25,000/.9843" - 25,040/.9858"
		0.25mm	25,100/.9882" - 25,140/.9898"
		0.50mm	25,100/.9882" - 25,140/.9898"
		0.75mm	25,100/.9882" - 25,140/.9898"

MB/HL 1-6	6	57,958/57,978	63,000/63,019	18,500	2,502	0,020/0,082	EC	72-3400	H981/6 STD 0.25
--------------	---	---------------	---------------	--------	-------	-------------	----	---------	---------------------------

01/79→

TW/A	2	63,500/63,750	77,200/77,450		1,975		AL-LF	04-3529	A124/4 STD
TW/A	2	63,500/63,750	77,200/77,450		1,975		AL-LF	04-3530	

TW/A	2	63,500/63,750	76,950/77,200		1,975		AL-LF	04-4782	A292/4 STD
TW/A	2	63,500/63,750	76,950/77,200		1,975		AL-LF	04-4783	

04-3529

04-3530

04-4782

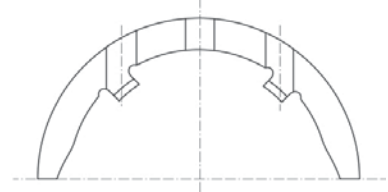
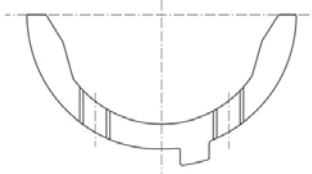
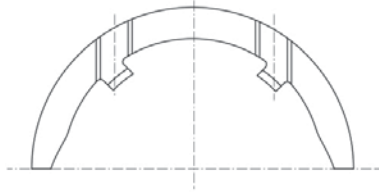

04-4783

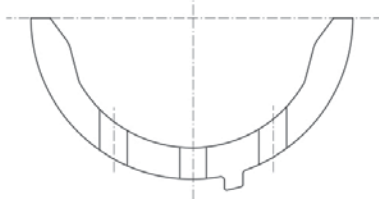

SE/PB	1	20,000	23,000/23,021	25,000			BC	55-3698	55-3698 SEMI
-------	---	--------	---------------	--------	--	--	----	---------	------------------------

29 79.50 x 86.40

WG		5 Cyl.	2144cc	100kW (136PS)		Petrol		TD335	
BE/PL	1	45,950/45,970	49,000/49,016	19,000	1,506	0,020/0,078	EC	71-3084	71-3084 STD 0.25
MB/HL 1,2, 4-6	5	57,958/57,978	63,000/63,019	18,500	2,502	0,020/0,082	EC	72-3400	H941/6 STD 0.25
MB/HL 3	1	57,958/57,978	63,000/63,019	24,930	2,502	0,020/0,082	EC	72-3401H	



72-3401H

STD	25,000/.9843" - 25,040/.9858"
0.25mm	25,100/.9882" - 25,140/.9898"
0.50mm	25,100/.9882" - 25,140/.9898"
0.75mm	25,100/.9882" - 25,140/.9898"

MB/HL 1-6	6	57,958/57,978	63,000/63,019	18,500	2,502	0,020/0,082	EC	72-3400	H981/6 STD 0.25
TW/A	2	63,500/63,750	77,200/77,450		1,975		AL-LF	04-3529	A124/4 STD
TW/A	2	63,500/63,750	77,200/77,450		1,975		AL-LF	04-3530	
TW/A	2	63,500/63,750	76,950/77,200		1,975		AL-LF	04-4782	A292/4 STD
TW/A	2	63,500/63,750	76,950/77,200		1,975		AL-LF	04-4783	

04-3529

04-3530

04-4782

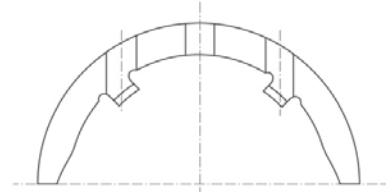
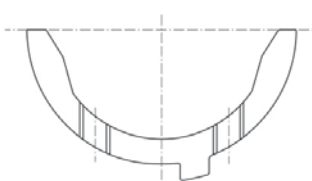
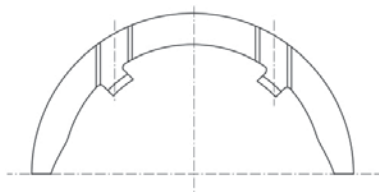

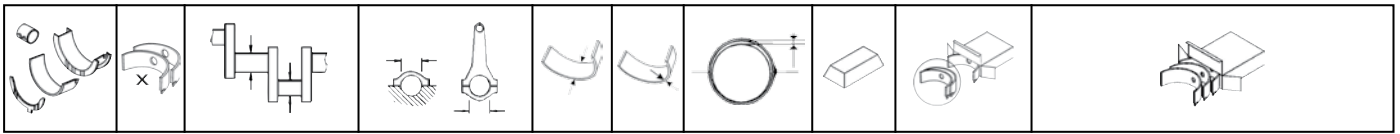

04-4783

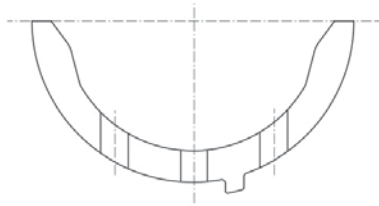

SE/PB	1	20,000	23,000/23,021	25,000			BC	55-3698	55-3698 SEMI
-------	---	--------	---------------	--------	--	--	----	---------	------------------------

30 79.50 x 86.40

WJ			5 Cyl.	2144cc	125kW (170PS)		Petrol Turbo		TD337
WS			5 Cyl.	2144cc	125kW (170PS)		Petrol		TD342
BE/PL	1	45,950/45,970	49,000/49,016	19,000	1,506	0,020/0,078	EC	71-3084	71-3084 STD 0.25
MB/HL 1-6	6	57,958/57,978	63,000/63,019	18,500	2,502	0,020/0,082	EC	72-3400	H981/6 STD 0.25
TW/A	2	63,500/63,750	77,200/77,450		1,975		AL-LF	04-3529	A124/4 STD
TW/A	2	63,500/63,750	77,200/77,450		1,975		AL-LF	04-3530	
TW/A	2	63,500/63,750	76,950/77,200		1,975		AL-LF	04-4782	A292/4 STD
TW/A	2	63,500/63,750	76,950/77,200		1,975		AL-LF	04-4783	

04-3529

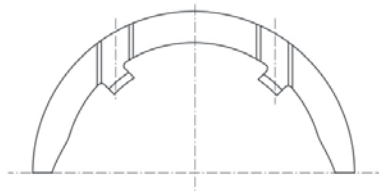

04-3530

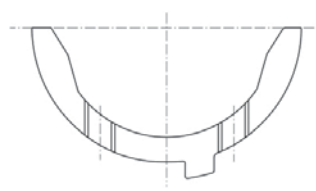

04-4782

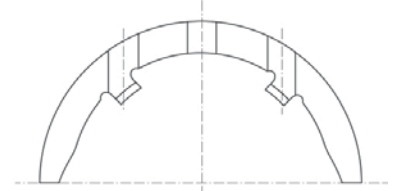

04-4783

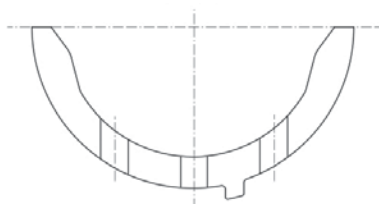

SE/PB	1	20,000	23,000/23,021	25,000			BC	55-3698	55-3698 SEMI
-------	---	--------	---------------	--------	--	--	----	---------	------------------------

31 79.50 x 95.50

AMF			3 Cyl.	1422cc	55kW (75PS)		Diesel Turbo		TD17156
ATL			3 Cyl.	1422cc	66kW (90PS)		Diesel Turbo Intercooler		TD17071
BHC			3 Cyl.	1422cc	55kW (75PS)		Diesel		TD18133
BE/PL	1	47,758/47,778	50,600/50,612	20,000	1,406	0,020/0,067	SP	71-3904	71-3904 STD 0.25 0.50
CB/NWB 1-4	4	28,947/28,960	32,000/32,025	25,000	1,513	0,020/0,068	EC	73-3903	N147/4 STD

BU	1	31,984/32,000	35,000/35,025	22,000			AL-LF	07-4037	07-4037 SEMI
BU	1	41,984/42,000	45,000/45,025	22,000			AL-LF	07-4038	07-4038 SEMI

32 79.50 x 95.50

1Y	4 Cyl.		1896cc	50kW (68PS)	Diesel				TD213
BE/PL	4	47,758/47,778	50,600/50,619	19,000	1,406	0,020/0,074	EC	71-3442	71-3442/4 STD 0.25 0.50 0.75
MB/HL 1-5	5	53,958/53,978	59,000/59,019	18,500	2,502	0,020/0,082	AL-LF	02-3085L	H084/5 STD 0.25 0.50
MB/HL 1-5	5	53,958/53,978	59,000/59,019	18,500	2,502	0,020/0,082	AL-LF	02-3085U	
TW/A	2	59,500	73,200		1,975		AL-LF	04-3527	A123/4 STD
TW/A	2	59,500	73,200		1,975		AL-LF	04-3528	
CB/NWB 1-5	5	28,947/28,960	32,000/32,025	25,000	1,513	0,020/0,068	EC	73-3903	N147/5 STD

33 79.50 x 95.50

1Z	4 Cyl.		1896cc	66kW (90PS)	Diesel Turbo				TD214
AAZ	4 Cyl.		1896cc	55kW (75PS)	Diesel Turbo				TD229
AFF	4 Cyl.		1896cc	55kW (75PS)	Diesel Turbo				TD11597
AHH	4 Cyl.		1896cc	66kW (90PS)	Diesel Turbo				TD16413
ALH	4 Cyl.		1896cc	66kW (90PS)	Diesel Turbo				TD11595
BE/PL	4	47,758/47,778	50,600/50,619	20,000	1,406	0,020/0,074	EC	71-3728	71-3728/4 STD 0.25 0.50
MB/HL 1-5	5	53,958/53,978	59,000/59,019	18,500	2,502	0,020/0,082	AL-LF	02-3085L	H084/5 STD 0.25 0.50
MB/HL 1-5	5	53,958/53,978	59,000/59,019	18,500	2,502	0,020/0,082	AL-LF	02-3085U	
TW/A	2	59,500	73,200		1,975		AL-LF	04-3527	A123/4 STD
TW/A	2	59,500	73,200		1,975		AL-LF	04-3528	
SE/PB	1	26,000	29,000/29,052	25,000			BC	55-3729	55-3729 SEMI
CB/NWB 1-5	5	28,947/28,960	32,000/32,025	25,000	1,513	0,020/0,068	EC	73-3903	N147/5 STD
BU	1	42,959/42,975	46,055/46,095	15,000			AL-LF	07-3088	07-3088 STD SEMI

Front, For intermediary shaft

BU	1	41,959/41,975	45,000/45,025	15,000			AL-LF	07-3089	07-3089 STD SEMI	13
----	---	---------------	---------------	--------	--	--	-------	---------	----------------------------	----

Rear, For intermediary shaft

34 79.50 x 95.50

ADE	4 Cyl.		1896cc	55kW (75PS)	Diesel Turbo				TD22656
BE/PL	4	47,758/47,778	50,600/50,619	20,000	1,406	0,020/0,074	EC	71-3728	71-3728/4 STD 0.25 0.50
MB/HL 1-5	5	53,958/53,978	59,000/59,019	18,500	2,502	0,020/0,082	AL-LF	02-3085L	H084/5 STD 0.25 0.50
MB/HL 1-5	5	53,958/53,978	59,000/59,019	18,500	2,502	0,020/0,082	AL-LF	02-3085U	
TW/A	2	59,500	73,200		1,975		AL-LF	04-3527	A123/4 STD
TW/A	2	59,500	73,200		1,975		AL-LF	04-3528	

SE/PB	1	26,000	29,000/29,052	25,000			BC	55-3729	55-3729 SEMI
CB/NWB 1-5	5	28,947/28,960	32,000/32,025	25,000	1,513	0,020/0,068	EC	73-3903	N147/5 STD

35 79.50 x 95.50

AFN	4 Cyl.		1896cc	81kW (110PS)	Diesel Turbo Intercooler			TD4202		
AVG	4 Cyl.		1896cc	81kW (110PS)	Diesel Turbo Intercooler			TD13774		
BE/PL	4	47,758/47,778	50,600/50,612	20,000	1,406	0,020/0,067	SP	71-3847	71-3847/4 STD 0.25	I
BE/PL	4	47,758/47,778	50,600/50,612	19,000	1,406	0,020/0,067	EC	71-3929	71-3929/4 STD	II

71-3847

71-3929

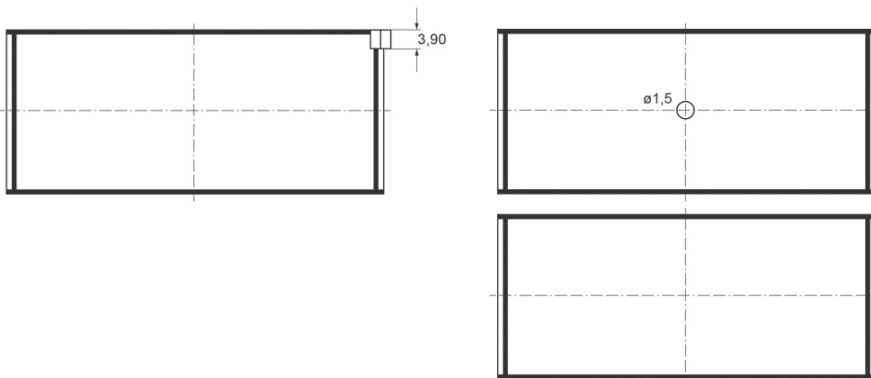

MB/HL 1-5	5	53,958/53,978	59,000/59,019	18,500	2,502	0,020/0,082	AL-LF	02-3085L	H084/5 STD 0.25 0.50
MB/HL 1-5	5	53,958/53,978	59,000/59,019	18,500	2,502	0,020/0,082	AL-LF	02-3085U	
TW/A	2	59,500	73,200		1,975		AL-LF	04-3527	A123/4 STD
TW/A	2	59,500	73,200		1,975		AL-LF	04-3528	
SE/PB	1	26,000	29,000/29,052	25,000			BC	55-3729	55-3729 SEMI
CB/NWB 1-5	5	28,947/28,960	32,000/32,025	25,000	1,513	0,020/0,068	EC	73-3903	N147/5 STD

36 79.50 x 95.50

AGR	4 Cyl.		1896cc	66kW (90PS)	Diesel Turbo Intercooler			TD5076	
BE/PL	4	47,758/47,778	50,600/50,619	20,000	1,406	0,020/0,074	EC	71-3728	71-3728/4 STD 0.25 0.50
MB/HL	4	53,958/53,978	59,000/59,019	18,500	2,502	0,020/0,082	AL-LF	02-3085L	H027/5 STD 0.25 0.50
MB/HL	6	53,958/53,978	59,000/59,019	18,500	2,502	0,020/0,082	AL-LF	02-3085U	
MB/HL 1-5	5	53,958/53,978	59,000/59,019	18,500	2,502	0,020/0,082	AL-LF	02-3085L	H084/5 STD 0.25 0.50
MB/HL 1-5	5	53,958/53,978	59,000/59,019	18,500	2,502	0,020/0,082	AL-LF	02-3085U	

02-3085L

02-3085U

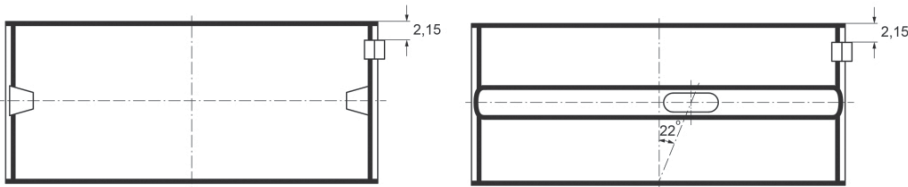

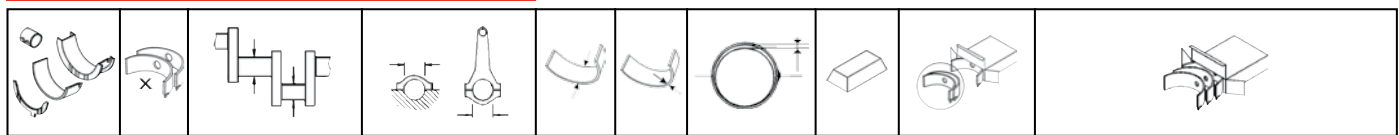

TW/A	2	59,500	73,200		1,975		AL-LF	04-3527	A123/4 STD	
TW/A	2	59,500	73,200		1,975		AL-LF	04-3528		
SE/PB	1	26,000	29,000/29,052	25,000			BC	55-3729	55-3729 SEMI	
CB/NWB 1-5	5	28,947/28,960	32,000/32,025	25,000	1,513	0,020/0,068	EC	73-3903	N147/5 STD	
BU	1	42,959/42,975	46,055/46,095	15,000			AL-LF	07-3088	07-3088 STD SEMI	13

Front, For intermediary shaft

BU	1	41,959/41,975	45,000/45,025	15,000			AL-LF	07-3089	07-3089 STD SEMI	13
----	---	---------------	---------------	--------	--	--	-------	---------	----------------------------	----

Rear, For intermediary shaft

37 79.50 x 95.50

AHF		4 Cyl.	1896cc	81kW (110PS)			Diesel Turbo Intercooler		TD9371
------------	--	--------	---------------	---------------------	--	--	---------------------------------	--	---------------

ASV		4 Cyl.	1896cc	81kW (110PS)			Diesel Turbo Intercooler		TD15354
------------	--	--------	---------------	---------------------	--	--	---------------------------------	--	----------------

BE/PL	4	47,758/47,778	50,600/50,612	20,000	1,406	0,020/0,067	SP	71-3847	71-3847/4 STD 0.25	1
MB/HL 1-5	5	53,958/53,978	59,000/59,019	18,500	2,502	0,020/0,082	AL-LF	02-3085L	H084/5 STD 0.25 0.50	
MB/HL 1-5	5	53,958/53,978	59,000/59,019	18,500	2,502	0,020/0,082	AL-LF	02-3085U		
TW/A	2	59,500	73,200		1,975		AL-LF	04-3527	A123/4 STD	
TW/A	2	59,500	73,200		1,975		AL-LF	04-3528		
SE/PB	1	26,000	29,000/29,052	25,000			BC	55-3729	55-3729 SEMI	
CB/NWB 1-5	5	28,947/28,960	32,000/32,025	25,000	1,513	0,020/0,068	EC	73-3903	N147/5 STD	
BU	1	42,959/42,975	46,055/46,095	15,000			AL-LF	07-3088	07-3088 STD SEMI	13

Front, For intermediary shaft

BU	1	41,959/41,975	45,000/45,025	15,000			AL-LF	07-3089	07-3089 STD SEMI	13
----	---	---------------	---------------	--------	--	--	-------	---------	----------------------------	----

Rear, For intermediary shaft

38 79.50 x 95.50







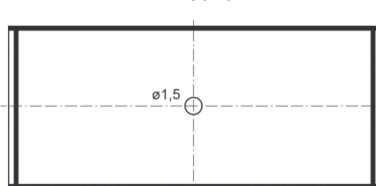

AHU		4 Cyl.	1896cc	66kW (90PS)			Diesel Turbo		TD10814
------------	--	--------	---------------	--------------------	--	--	---------------------	--	----------------

BE/PL	4	47,758/47,778	50,600/50,619	20,000	1,406	0,020/0,074	EC	71-3728	71-3728/4 STD 0.25 0.50	
BE/PL	4	47,758/47,778	50,600/50,612	19,000	1,406	0,020/0,067	EC	71-3929	71-3929/4 STD	11

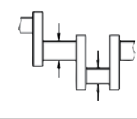
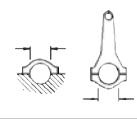
71-3728

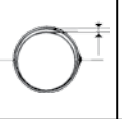
71-3929



										
MB/HL 1-5	5	53,958/53,978	59,000/59,019	18,500	2,502	0,020/0,082	AL-LF	02-3085L	H084/5 STD 0.25 0.50	
MB/HL 1-5	5	53,958/53,978	59,000/59,019	18,500	2,502	0,020/0,082	AL-LF	02-3085U		
TW/A	2	59,500	73,200		1,975		AL-LF	04-3527	A123/4 STD	
TW/A	2	59,500	73,200		1,975		AL-LF	04-3528		
SE/PB	1	26,000	29,000/29,052	25,000			BC	55-3729	55-3729 SEMI	
CB/NWB 1-5	5	28,947/28,960	32,000/32,025	25,000	1,513	0,020/0,068	EC	73-3903	N147/5 STD	
BU	1	42,959/42,975	46,055/46,095	15,000			AL-LF	07-3088	07-3088 STD SEMI 13	
Front, For intermediary shaft										
BU	1	41,959/41,975	45,000/45,025	15,000			AL-LF	07-3089	07-3089 STD SEMI 13	
Rear, For intermediary shaft										

39		79.50 x 95.50									
AJM		4 Cyl. 1896cc 85kW (115PS)				Diesel Turbo Intercooler				TD11527	
BE/PL	1	47,758/47,778	50,600/50,612	20,000	1,406	0,020/0,067	SP	71-3904	71-3904 STD 0.25 0.50 1		
MB/HL 1-5	5	53,958/53,978	59,000/59,019	18,500	2,502	0,020/0,082	AL-LF	02-3085L	H084/5 STD 0.25 0.50		
MB/HL 1-5	5	53,958/53,978	59,000/59,019	18,500	2,502	0,020/0,082	AL-LF	02-3085U			
TW/A	2	59,500	73,200		1,975		AL-LF	04-3527	A123/4 STD		
TW/A	2	59,500	73,200		1,975		AL-LF	04-3528			
CB/NWB 1-5	5	28,947/28,960	32,000/32,025	25,000	1,513	0,020/0,068	EC	73-3903	N147/5 STD		
BU	1	42,959/42,975	46,055/46,095	15,000			AL-LF	07-3088	07-3088 STD SEMI 13		
Front, For intermediary shaft											

40		79.50 x 95.50									
ANU		4 Cyl. 1896cc 66kW (90PS)				Diesel Turbo				TD11596	
BE/PL	1	47,758/47,778	50,600/50,612	20,000	1,406	0,020/0,067	SP	71-3904	71-3904 STD 0.25 0.50 1		
MB/HL 1-5	5	53,958/53,978	59,000/59,019	18,500	2,502	0,020/0,082	AL-LF	02-3085L	H084/5 STD 0.25 0.50		
MB/HL 1-5	5	53,958/53,978	59,000/59,019	18,500	2,502	0,020/0,082	AL-LF	02-3085U			
TW/A	2	59,500	73,200		1,975		AL-LF	04-3527	A123/4 STD		
TW/A	2	59,500	73,200		1,975		AL-LF	04-3528			
CB/NWB 1-5	5	28,947/28,960	32,000/32,025	25,000	1,513	0,020/0,068	EC	73-3903	N147/5 STD		
BU	1	42,959/42,975	46,055/46,095	15,000			AL-LF	07-3088	07-3088 STD SEMI 13		
Front, For intermediary shaft											
BU	1	41,959/41,975	45,000/45,025	15,000			AL-LF	07-3089	07-3089 STD SEMI 13		
Rear, For intermediary shaft											

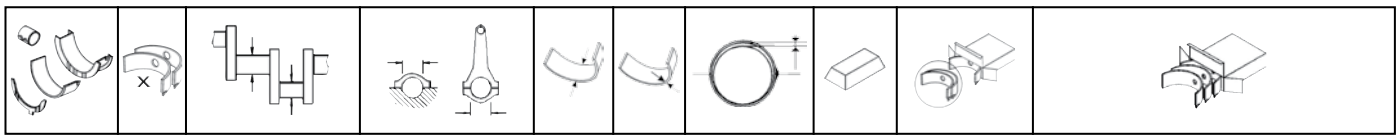

41 79.50 x 95.50									
ASZ		4 Cyl.		1896cc	96kW (130PS)		Diesel Turbo Intercooler		TD15351
BRB		4 Cyl.		1896cc	85kW (116PS)		Diesel Turbo Intercooler		TD20492
BE/PL	1	50,858/50,878	53,700/53,712	20,400	1,403	0,020/0,073	SP	71-3930	71-3930 STD 0.25 0.50 I
MB/HL 1-5	5	53,958/53,978	59,000/59,012	18,500	2,501	0,020/0,076	EC	72-3931	H079/5 STD 0.25 0.50
TW/A	2	59,500	73,200		1,975		AL-LF	04-3527	A123/4 STD
TW/A	2	59,500	73,200		1,975		AL-LF	04-3528	
CB/NWB 1-5	5	28,947/28,960	32,000/32,025	25,000	1,513	0,020/0,068	EC	73-3903	N147/5 STD

42 79.50 x 95.50									
ATD		4 Cyl.		1896cc	74kW (101PS)		Diesel Turbo Intercooler		TD16028
ATJ		4 Cyl.		1896cc	85kW (115PS)		Diesel Turbo Intercooler		TD15989
BE/PL	1	47,758/47,778	50,600/50,612	20,000	1,406	0,020/0,067	SP	71-3904	71-3904 STD 0.25 0.50 I
MB/HL 1-5	5	53,958/53,978	59,000/59,019	18,500	2,502	0,020/0,082	AL-LF	02-3085L	H084/5 STD 0.25 0.50
MB/HL 1-5	5	53,958/53,978	59,000/59,019	18,500	2,502	0,020/0,082	AL-LF	02-3085U	
TW/A	2	59,500	73,200		1,975		AL-LF	04-3527	A123/4 STD
TW/A	2	59,500	73,200		1,975		AL-LF	04-3528	
CB/NWB 1-5	5	28,947/28,960	32,000/32,025	25,000	1,513	0,020/0,068	EC	73-3903	N147/5 STD

43 79.50 x 95.50									
AVB		4 Cyl.		1896cc	74kW (101PS)		Diesel		TD16518
BE/PL	1	47,758/47,778	50,600/50,612	20,000	1,406	0,020/0,067	SP	71-3904	71-3904 STD 0.25 0.50 I
MB/HL 1-5	5	53,958/53,978	59,000/59,019	18,500	2,502	0,020/0,082	AL-LF	02-3085L	H084/5 STD 0.25 0.50
MB/HL 1-5	5	53,958/53,978	59,000/59,019	18,500	2,502	0,020/0,082	AL-LF	02-3085U	
TW/A	2	59,500	73,200		1,975		AL-LF	04-3527	A123/4 STD
TW/A	2	59,500	73,200		1,975		AL-LF	04-3528	
SE/PB	1	26,000	29,000/29,052	25,000			BC	55-3729	55-3729 SEMI
CB/NWB 1-5	5	28,947/28,960	32,000/32,025	25,000	1,513	0,020/0,068	EC	73-3903	N147/5 STD

44 79.50 x 95.50									
AVF		4 Cyl.		1896cc	96kW (130PS)		Diesel Turbo Intercooler		TD15348
AWX		4 Cyl.		1896cc	96kW (130PS)		Diesel Turbo		TD16133
BKE		4 Cyl.		1896cc	85kW (116PS)		Diesel Turbo Intercooler		TD17596
BE/PL	1	50,858/50,878	53,700/53,712	20,400	1,403	0,020/0,073	SP	71-3930	71-3930 STD 0.25 0.50 I
MB/HL 1-5	5	53,958/53,978	59,000/59,012	18,500	2,501	0,020/0,076	EC	72-3931	H079/5 STD 0.25 0.50
TW/A	2	59,500	73,200		1,975		AL-LF	04-3527	A123/4 STD
TW/A	2	59,500	73,200		1,975		AL-LF	04-3528	

SE/PB	1	26,000	29,000/29,052	25,000			BC	55-3729	55-3729 SEMI
CB/NWB 1-5	5	28,947/28,960	32,000/32,025	25,000	1,513	0,020/0,068	EC	73-3903	N147/5 STD

45		79.50 x 95.50								
AXR			4 Cyl.	1896cc	74kW (100PS)		Diesel		TD16416	
BKC			4 Cyl.	1896cc	77kW (105PS)		Diesel Turbo Intercooler		TD17026	
BLS			4 Cyl.	1896cc	77kW (105PS)		Diesel Turbo Intercooler		TD20823	
BXE			4 Cyl.	1896cc	77kW (105PS)		Diesel Turbo Intercooler		TD22657	
BE/PL	1	47,758/47,778	50,600/50,612	20,000	1,406	0,020/0,067	SP	71-3904	71-3904 STD 0.25 0.50	
MB/HL 1-5	5	53,958/53,978	59,000/59,012	18,500	2,501	0,020/0,076	EC	72-3931	H079/5 STD 0.25 0.50	
TW/A	2	59,500	73,200		1,975		AL-LF	04-3527	A123/4 STD	
TW/A	2	59,500	73,200		1,975		AL-LF	04-3528		
CB/NWB 1-5	5	28,947/28,960	32,000/32,025	25,000	1,513	0,020/0,068	EC	73-3903	N147/5 STD	

46		79.50 x 95.50								
3D			5 Cyl.	2370cc	60kW (82PS)		Diesel		TD218	
AAS			5 Cyl.	2370cc	60kW (82PS)		Diesel		TD227	
BE/PL	5	47,758/47,778	50,600/50,619	19,000	1,406	0,020/0,074	EC	71-3442	71-3442/5 STD 0.25 0.50	
MB/HL 1-6	6	57,958/57,978	63,000/63,019	18,500	2,502	0,020/0,082	EC	72-3400	H981/6 STD 0.25	
TW/A	2	63,500/63,750	77,200/77,450		1,975		AL-LF	04-3529	A124/4 STD	
TW/A	2	63,500/63,750	77,200/77,450		1,975		AL-LF	04-3530		
TW/A	2	63,500/63,750	76,950/77,200		1,975		AL-LF	04-4782	A292/4 STD	
TW/A	2	63,500/63,750	76,950/77,200		1,975		AL-LF	04-4783		

04-3529

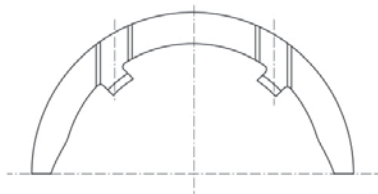

04-3530

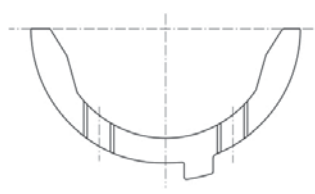

04-4782

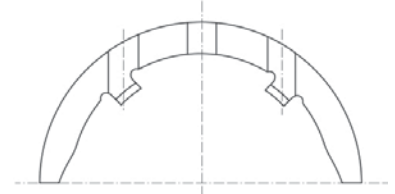

04-4783

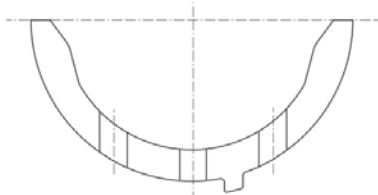

SE/PB	1	24,000/24,012	27,000/27,021	25,000			BC	55-3443	55-3443 SEMI
-------	---	---------------	---------------	--------	--	--	----	---------	------------------------

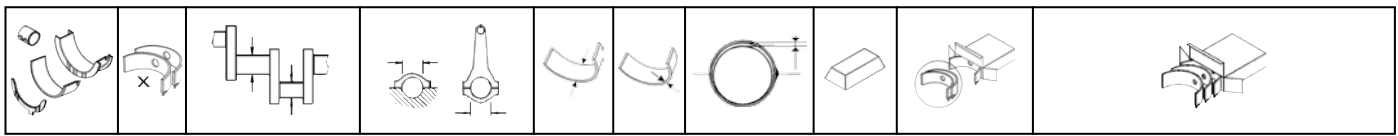

47 80.20 x 82.40

CPAA			V6 Cyl.	2498cc	150kW (204PS)	Petrol		TD27966	
BE/PL	6	53,958/53,978	56,800/56,819	17,000	1,406	0,010/0,069	AL-LF	01-4818	01-4818/6 STD

48 81.00 x 77.40

ABB			4 Cyl.	1595cc	73-75kW (99-102PS)	Petrol		TD230	
ABM			4 Cyl.	1595cc	52kW (71PS)	Petrol		TD234	
ADA			4 Cyl.	1595cc	74kW (101PS)	Petrol		TD240	
ADP			4 Cyl.	1595cc	74kW (101PS)	Petrol		TD4198	

BE/PL	4	47,758/47,778	50,600/50,612	19,000	1,406	0,020/0,067	EC	71-3694	71-3694/4 STD 0.25 0.50
MB/HL	4	53,958/53,978	59,000/59,019	18,500	2,502	0,020/0,082	AL-LF	02-3085L	H027/5 STD 0.25 0.50
MB/HL	6	53,958/53,978	59,000/59,019	18,500	2,502	0,020/0,082	AL-LF	02-3085U	
TW/A	2	59,500	73,200		1,975		AL-LF	04-3527	A123/4 STD
TW/A	2	59,500	73,200		1,975		AL-LF	04-3528	
SE/PB	1	20,000	23,000/23,021	25,000			BC	55-3698	55-3698 SEMI
BU	1	42,959/42,975	46,055/46,095	15,000			AL-LF	07-3088	07-3088 STD SEMI

Front, For intermediary shaft

BU	1	41,959/41,975	45,000/45,025	15,000			AL-LF	07-3089	07-3089 STD SEMI
----	---	---------------	---------------	--------	--	--	-------	---------	----------------------------

Rear, For intermediary shaft

49 81.00 x 77.40

AEH			4 Cyl.	1595cc	74kW (101PS)	Petrol		TD5074	
AHL			4 Cyl.	1595cc	74kW (100PS)	Petrol		TD10816	
AKL			4 Cyl.	1595cc	74kW (101PS)	Petrol		TD9990	
APF			4 Cyl.	1595cc	74kW (101PS)	Petrol		TD11588	
ARM			4 Cyl.	1595cc	74kW (100PS)	Petrol		TD14148	

BE/PL	4	47,758/47,778	50,600/50,612	19,000	1,406	0,020/0,067	EC	71-3694	71-3694/4 STD 0.25 0.50
BE/PL	4	47,758/47,778	50,600/50,612	19,000	1,406	0,020/0,067	EC	71-3929	71-3929/4 STD

71-3694

71-3929

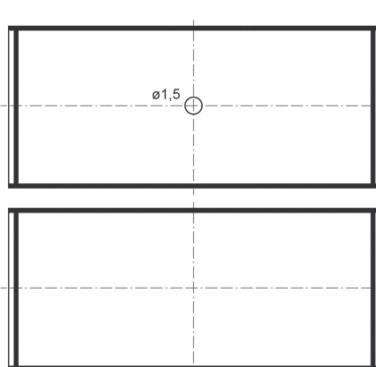
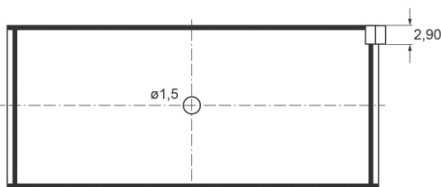

MB/HL 1-5	5	53,958/53,978	59,000/59,019	18,500	2,502	0,020/0,082	AL-LF	02-3085L	H084/5 STD 0.25 0.50
MB/HL 1-5	5	53,958/53,978	59,000/59,019	18,500	2,502	0,020/0,082	AL-LF	02-3085U	
TW/A	2	59,500	73,200		1,975		AL-LF	04-3527	A123/4 STD
TW/A	2	59,500	73,200		1,975		AL-LF	04-3528	
SE/PB	1	20,000	23,000/23,021	25,000			BC	55-3698	55-3698 SEMI
BU	1	42,959/42,975	46,055/46,095	15,000			AL-LF	07-3088	07-3088 STD SEMI
Front, For intermediary shaft									
BU	1	41,959/41,975	45,000/45,025	15,000			AL-LF	07-3089	07-3089 STD SEMI
Rear, For intermediary shaft									

50	81.00 x 77.40								
ALZ			4 Cyl.	1595cc	75kW (102PS)		Petrol		TD15748
ANA			4 Cyl.	1595cc	74kW (100PS)		Petrol		TD14128
AVU			4 Cyl.	1595cc	75kW (102PS)		Petrol		TD15350
BFQ			4 Cyl.	1595cc	75kW (102PS)		Petrol		TD17166
BGU			4 Cyl.	1595cc	75kW (102PS)		Petrol		TD16871
BSE			4 Cyl.	1595cc	75kW (102PS)		Petrol		TD20711
BSF			4 Cyl.	1595cc	75kW (102PS)		Petrol		TD20712
CCSA			4 Cyl.	1595cc	75kW (102PS)		Petrol		TD22665
CMXA			4 Cyl.	1595cc	75kW (102PS)		Petrol		TD23937
BE/PL	4	41,965/41,980	45,000/45,016	19,000	1,505	0,020/0,070	AL-LF	01-3961	01-3961/4 STD

51	81.00 x 77.40								
DT			4 Cyl.	1595cc	55kW (75PS)		Petrol		TD4206
DTA			4 Cyl.	1595cc	51-55kW (69-75PS)		Petrol		TD255
JU			4 Cyl.	1595cc	55kW (75PS)		Petrol		TD277
BE/PL	1	45,950/45,970	49,000/49,016	19,000	1,506	0,020/0,078	EC	71-3084	71-3084 STD 0.25
→12/83									
BE/PL	4	47,758/47,778	50,600/50,619	19,000	1,406	0,020/0,074	EC	71-3566	71-3566/4 STD 0.25
01/84→12/85									
BE/PL	4	47,758/47,778	50,600/50,612	19,000	1,406	0,020/0,067	EC	71-3694	71-3694/4 STD 0.25 0.50
01/86→									

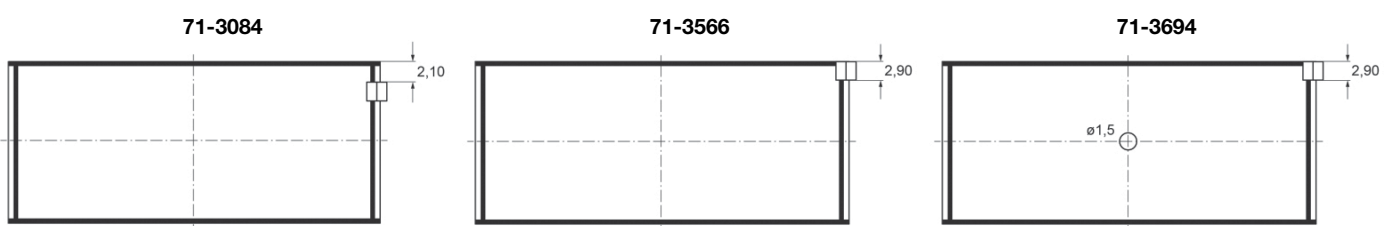

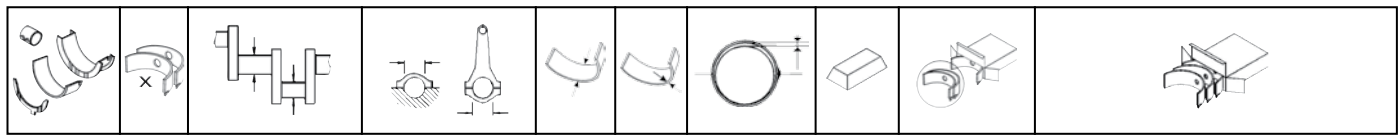

MB/HL	3	53,958/53,978	59,000/59,019	18,500	2,502	0,020/0,082	AL-LF	02-3085L	H025/5 STD 0.25 0.50
MB/HL	5	53,958/53,978	59,000/59,019	18,500	2,502	0,020/0,082	AL-LF	02-3085U	
MB/HL	1	53,958/53,978	59,000/59,019	24,930	2,502	0,020/0,082	AL-LF	02-3086HL	
MB/HL	1	53,958/53,978	59,000/59,019	24,930	2,502	0,020/0,082	AL-LF	02-3086HU	

	02-3086HL	STD	25,000/.9843" - 25,040/.9858"
		0.25mm	25,100/.9882" - 25,140/.9898"
		0.50mm	25,100/.9882" - 25,140/.9898"
		0.75mm	25,100/.9882" - 25,140/.9898"
	02-3086HU	STD	25,000/.9843" - 25,040/.9858"
		0.25mm	25,100/.9882" - 25,140/.9898"
		0.50mm	25,100/.9882" - 25,140/.9898"
		0.75mm	25,100/.9882" - 25,140/.9898"

MB/HL	4	53,958/53,978	59,000/59,019	18,500	2,502	0,020/0,082	AL-LF	02-3085L	H027/5 STD 0.25 0.50
MB/HL	6	53,958/53,978	59,000/59,019	18,500	2,502	0,020/0,082	AL-LF	02-3085U	

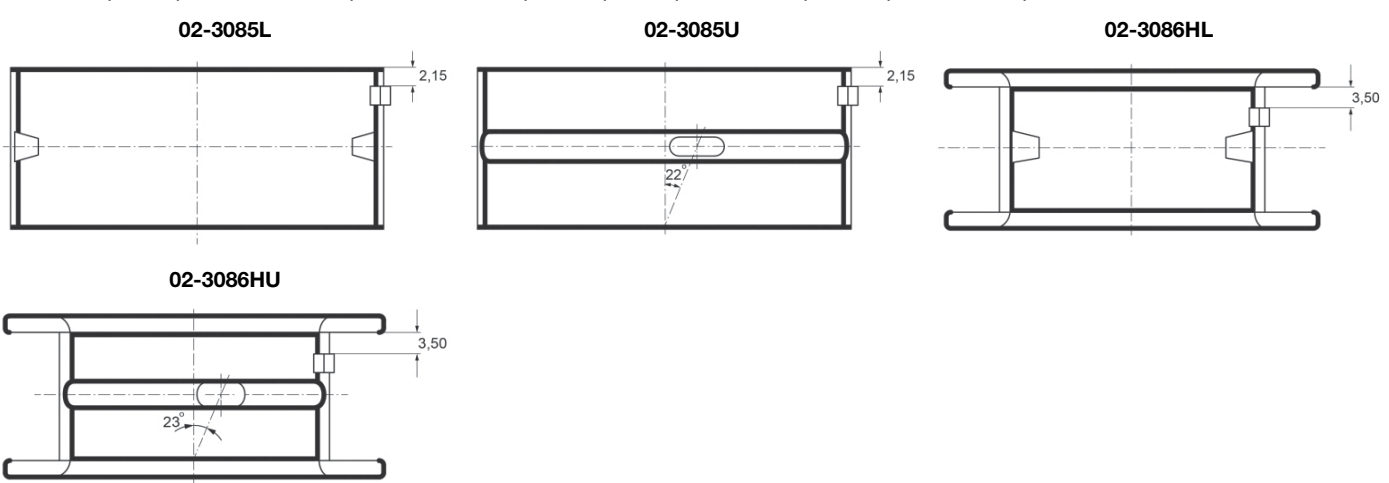

TW/A	2	59,500	73,200		1,975		AL-LF	04-3527	A123/4 STD
TW/A	2	59,500	73,200		1,975		AL-LF	04-3528	
SE/PB	1	20,000	23,000/23,052	25,000			BC	55-3567	55-3567 SEMI
CB/NWB 1-5	5	25,939/25,960	28,250/28,271	17,000	1,138		AL-LF	03-3317	N118/5 STD 12
BU	1	42,959/42,975	46,055/46,095	15,000			AL-LF	07-3088	07-3088 STD SEMI 13

Front, For intermediary shaft

BU	1	41,959/41,975	45,000/45,025	15,000			AL-LF	07-3089	07-3089 STD SEMI 13
----	---	---------------	---------------	--------	--	--	-------	---------	--

Rear, For intermediary shaft

52 81.00 x 77.40

PP	4 Cyl.	1595cc	51kW (70PS)	Petrol	TD307				
RN	4 Cyl.	1595cc	55kW (75PS)	Petrol	TD314				
BE/PL	4	47,758/47,778	50,600/50,612	19,000	1,406	0,020/0,067	EC	71-3694	71-3694/4 STD 0.25 0.50

MB/HL	4	53,958/53,978	59,000/59,019	18,500	2,502	0,020/0,082	AL-LF	02-3085L	H027/5 STD 0.25 0.50
MB/HL	6	53,958/53,978	59,000/59,019	18,500	2,502	0,020/0,082	AL-LF	02-3085U	
TW/A	2	59,500	73,200		1,975		AL-LF	04-3527	A123/4 STD
TW/A	2	59,500	73,200		1,975		AL-LF	04-3528	
SE/PB	1	20,000	23,000/23,052	25,000			BC	55-3567	55-3567 SEMI
CB/NWB 1-5	5	25,939/25,960	28,250/28,271	17,000	1,138		AL-LF	03-3317	N118/5 STD
BU	1	42,959/42,975	46,055/46,095	15,000			AL-LF	07-3088	07-3088 STD SEMI
Front, For intermediary shaft									
BU	1	41,959/41,975	45,000/45,025	15,000			AL-LF	07-3089	07-3089 STD SEMI

Rear, For intermediary shaft

53 81.00 x 77.40

SA			4 Cyl.	1595cc	54kW (73PS)	Petrol		TD321	
BE/PL	4	47,758/47,778	50,600/50,612	19,000	1,406	0,020/0,067	EC	71-3694	71-3694/4 STD 0.25 0.50
MB/HL	3	53,958/53,978	59,000/59,019	18,500	2,502	0,020/0,082	AL-LF	02-3085L	H025/5 STD 0.25 0.50
MB/HL	5	53,958/53,978	59,000/59,019	18,500	2,502	0,020/0,082	AL-LF	02-3085U	
MB/HL	1	53,958/53,978	59,000/59,019	24,930	2,502	0,020/0,082	AL-LF	02-3086HL	
MB/HL	1	53,958/53,978	59,000/59,019	24,930	2,502	0,020/0,082	AL-LF	02-3086HU	
			02-3086HL	STD	25,000/.9843" - 25,040/.9858"				
				0.25mm	25,100/.9882" - 25,140/.9898"				
				0.50mm	25,100/.9882" - 25,140/.9898"				
				0.75mm	25,100/.9882" - 25,140/.9898"				
			02-3086HU	STD	25,000/.9843" - 25,040/.9858"				
				0.25mm	25,100/.9882" - 25,140/.9898"				
				0.50mm	25,100/.9882" - 25,140/.9898"				
				0.75mm	25,100/.9882" - 25,140/.9898"				
SE/PB	1	20,000	23,000/23,052	25,000			BC	55-3567	55-3567 SEMI
CB/NWB 1-5	5	25,939/25,960	28,250/28,271	17,000	1,138		AL-LF	03-3317	N118/5 STD
BU	1	42,959/42,975	46,055/46,095	15,000			AL-LF	07-3088	07-3088 STD SEMI
Front, For intermediary shaft									
BU	1	41,959/41,975	45,000/45,025	15,000			AL-LF	07-3089	07-3089 STD SEMI
Rear, For intermediary shaft									

54 81.00 x 77.40

HP			5 Cyl.	1994cc	85kW (115PS)	Petrol		TD266	
JS			5 Cyl.	1994cc	85kW (115PS)	Petrol		TD274	
BE/PL	1	45,950/45,970	49,000/49,016	19,000	1,506	0,020/0,078	EC	71-3084	71-3084 STD 0.25
→12/83									

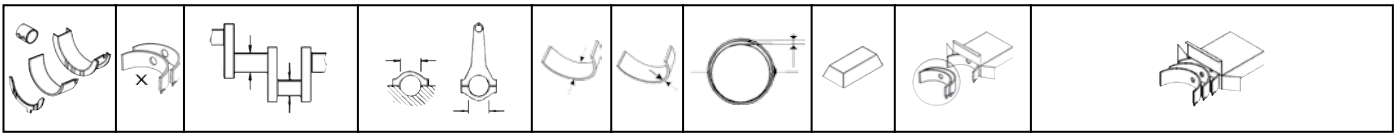

BE/PL	4	47,758/47,778	50,600/50,619	19,000	1,406	0,020/0,074	EC	71-3566	71-3566/4 STD 0.25
-------	---	---------------	---------------	--------	-------	-------------	----	---------	------------------------------

01/84 → 12/85

BE/PL	5	47,758/47,778	50,600/50,619	19,000	1,406	0,020/0,074	EC	71-3566	71-3566/5 STD
-------	---	---------------	---------------	--------	-------	-------------	----	---------	-------------------------

01/84 → 12/85

BE/PL	5	47,758/47,778	50,600/50,612	19,000	1,406	0,020/0,067	EC	71-3694	71-3694/5 STD 0.25
-------	---	---------------	---------------	--------	-------	-------------	----	---------	------------------------------

01/86 →

71-3084

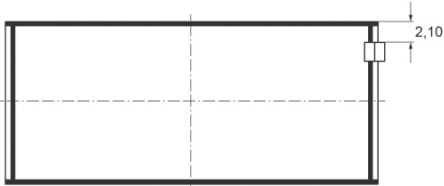

71-3566



71-3694

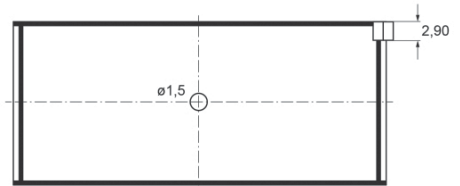

MB/HL 1-6	6	57,958/57,978	63,000/63,019	18,500	2,502	0,020/0,082	EC	72-3400	H981/6 STD 0.25
TW/A	2	63,500/63,750	77,200/77,450		1,975		AL-LF	04-3529	A124/4 STD
TW/A	2	63,500/63,750	77,200/77,450		1,975		AL-LF	04-3530	
TW/A	2	63,500/63,750	76,950/77,200		1,975		AL-LF	04-4782	A292/4 STD
TW/A	2	63,500/63,750	76,950/77,200		1,975		AL-LF	04-4783	

04-3529

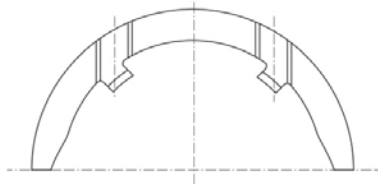

04-3530

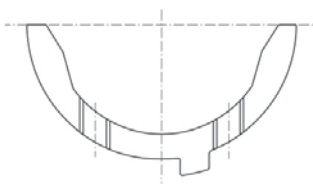

04-4782

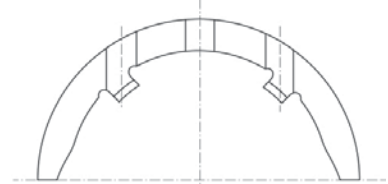

04-4783

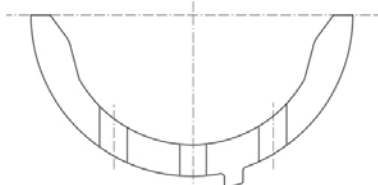

SE/PB	1	20,000	23,000/23,052	25,000			BC	55-3567	55-3567 SEMI
SE/PB	1	20,000	23,000/23,021	25,000			BC	55-3698	55-3698 SEMI

55-3567

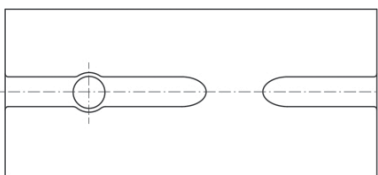

55-3698

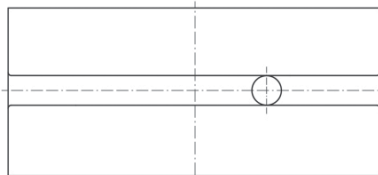



55 81.00 x 77.40

KP 5 Cyl. **1994cc 85kW (115PS)** **Petrol** **TD289**

BE/PL	5	47,758/47,778	50,600/50,619	19,000	1,406	0,020/0,074	EC	71-3566	71-3566/5 STD
-------	---	---------------	---------------	--------	-------	-------------	----	---------	-------------------------

→12/85

BE/PL	5	47,758/47,778	50,600/50,612	19,000	1,406	0,020/0,067	EC	71-3694	71-3694/5 STD 0.25
-------	---	---------------	---------------	--------	-------	-------------	----	---------	------------------------------

01/86→

71-3566



71-3694

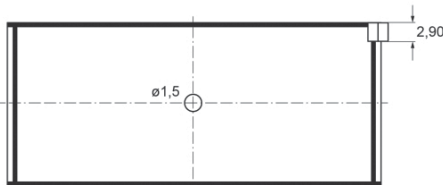

MB/HL 1-6	6	57,958/57,978	63,000/63,019	18,500	2,502	0,020/0,082	EC	72-3400	H981/6 STD 0.25
TW/A	2	63,500/63,750	77,200/77,450		1,975		AL-LF	04-3529	A124/4 STD
TW/A	2	63,500/63,750	77,200/77,450		1,975		AL-LF	04-3530	
TW/A	2	63,500/63,750	76,950/77,200		1,975		AL-LF	04-4782	A292/4 STD
TW/A	2	63,500/63,750	76,950/77,200		1,975		AL-LF	04-4783	

04-3529

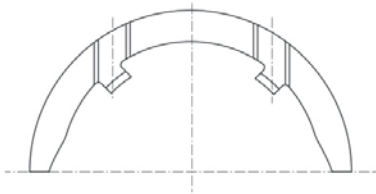

04-3530

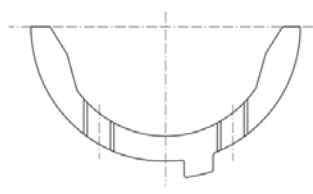

04-4782

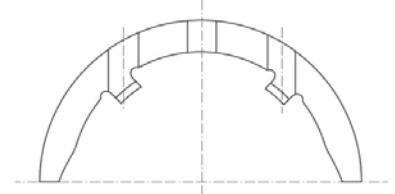

04-4783

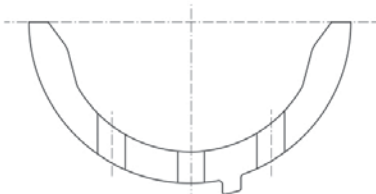

SE/PB	1	20,000	23,000/23,052	25,000			BC	55-3567	55-3567 SEMI
SE/PB	1	20,000	23,000/23,021	25,000			BC	55-3698	55-3698 SEMI

55-3567

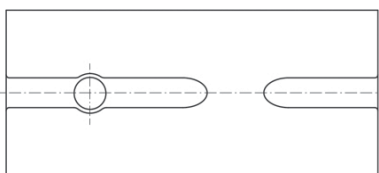

55-3698

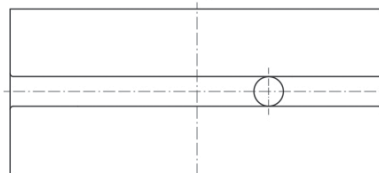



56 **81.00 x 77.40**

NM	5 Cyl.	1994cc	118kW (160PS)	Petrol	TD303
PS	5 Cyl.	1994cc	85kW (115PS)	Petrol	TD308
RT	5 Cyl.	1994cc	85kW (115PS)	Petrol	TD318
SK	5 Cyl.	1994cc	83kW (113PS)	Petrol	TD327
SL	5 Cyl.	1994cc	83kW (113PS)	Petrol	TD328

BE/PL	5	47,758/47,778	50,600/50,612	19,000	1,406	0,020/0,067	EC	71-3694	71-3694/5 STD 0.25
MB/HL 1-6	6	57,958/57,978	63,000/63,019	18,500	2,502	0,020/0,082	EC	72-3400	H981/6 STD 0.25
TW/A	2	63,500/63,750	77,200/77,450		1,975		AL-LF	04-3529	A124/4 STD
TW/A	2	63,500/63,750	77,200/77,450		1,975		AL-LF	04-3530	
TW/A	2	63,500/63,750	76,950/77,200		1,975		AL-LF	04-4782	A292/4 STD
TW/A	2	63,500/63,750	76,950/77,200		1,975		AL-LF	04-4783	

04-3529

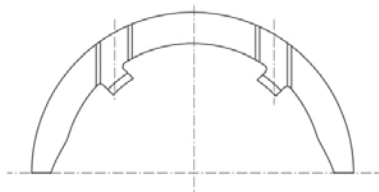

04-3530

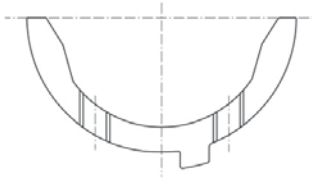

04-4782

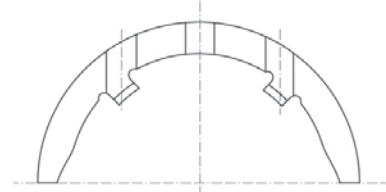

04-4783

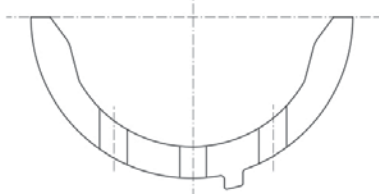

SE/PB	1	20,000	23,000/23,052	25,000			BC	55-3567	55-3567 SEMI
SE/PB	1	20,000	23,000/23,021	25,000			BC	55-3698	55-3698 SEMI

55-3567

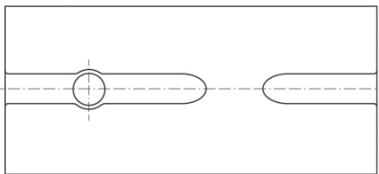

55-3698

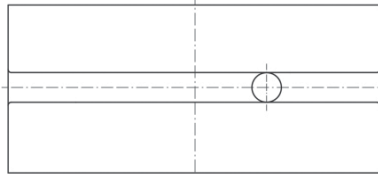

57 **81.00 x 77.40**

AFM	V6 Cyl.	2393cc	110kW (150PS)	Petrol	TD17146
AGA	V6 Cyl.	2393cc	121kW (165PS)	Petrol	TD9515
AJG	V6 Cyl.	2393cc	120kW (163PS)	Petrol	TD13928
ALF	V6 Cyl.	2393cc	121kW (165PS)	Petrol	TD11359
ALW	V6 Cyl.	2393cc	100kW (136PS)	Petrol	TD11088
AML	V6 Cyl.	2393cc	121kW (165PS)	Petrol	TD13951
AMM	V6 Cyl.	2393cc	120kW (163PS)	Petrol	TD15331



APC	V6 Cyl.		2393cc	115kW (156PS)	Petrol		TD11360
APS	V6 Cyl.		2393cc	121kW (165PS)	Petrol		TD13952
APZ	V6 Cyl.		2393cc	120kW (163PS)	Petrol		TD13954
ARJ	V6 Cyl.		2393cc	121kW (165PS)	Petrol		TD13953
ARN	V6 Cyl.		2393cc	100kW (136PS)	Petrol		TD14028
ASM	V6 Cyl.		2393cc	100kW (136PS)	Petrol		TD15330
BDV	V6 Cyl.		2393cc	125kW (170PS)	Petrol		TD16410

BE/PL	6	53,958/53,978	57,600/57,612	17,000	1,806	0,020/0,069	EC	71-3711	71-3711/6 STD
MB/HL 1-4	4	57,959/57,978	63,000/63,019	18,500	2,507		AL-LF	02-3849	H066/4 STD
TW/A	2	70,500	84,900		1,965		AL-LF	04-3713	A138/4 STD
TW/A	2	70,500	84,900		1,965		AL-LF	04-3714	
SE/PB	1	20,995/21,000	23,000/23,052	23,500			BC	55-3715	55-3715 SEMI

58 81.00 x 86.39

KU	5 Cyl.		2226cc	101-103kW (137-140PS)	Petrol		TD9375
-----------	--------	--	---------------	------------------------------	---------------	--	---------------

BE/PL	5	47,758/47,778	50,600/50,619	19,000	1,406	0,020/0,074	EC	71-3566	71-3566/5 STD
-------	---	---------------	---------------	--------	-------	-------------	----	---------	-------------------------

→12/85

BE/PL	5	47,758/47,778	50,600/50,612	19,000	1,406	0,020/0,067	EC	71-3694	71-3694/5 STD 0.25
-------	---	---------------	---------------	--------	-------	-------------	----	---------	------------------------------

01/86 →

71-3566

71-3694

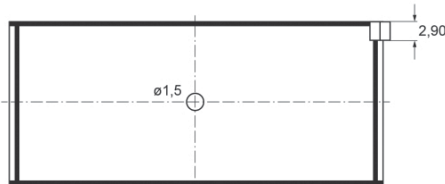

MB/HL 1-6	6	57,958/57,978	63,000/63,019	18,500	2,502	0,020/0,082	EC	72-3400	H981/6 STD 0.25
TW/A	2	63,500/63,750	77,200/77,450		1,975		AL-LF	04-3529	A124/4 STD
TW/A	2	63,500/63,750	77,200/77,450		1,975		AL-LF	04-3530	
TW/A	2	63,500/63,750	76,950/77,200		1,975		AL-LF	04-4782	A292/4 STD
TW/A	2	63,500/63,750	76,950/77,200		1,975		AL-LF	04-4783	

04-3529

04-3530

04-4782

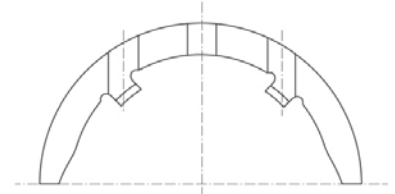
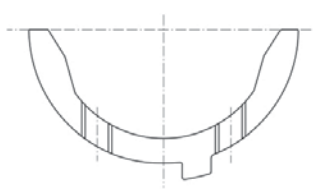
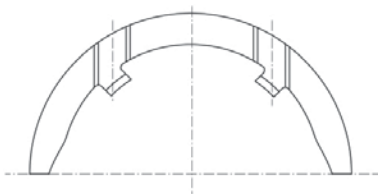



04-4783

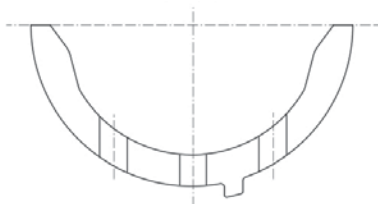

SE/PB	1	20,000	23,000/23,052	25,000			BC	55-3567	55-3567 SEMI
-------	---	--------	---------------	--------	--	--	----	---------	------------------------

59 81.00 x 86.40

4B			4 Cyl.	1781cc	66kW (90PS)		Petrol		TD219
NP			4 Cyl.	1781cc	66kW (90PS)		Petrol		TD304
PH			4 Cyl.	1781cc	66kW (90PS)		Petrol		TD305
RS			4 Cyl.	1781cc	55kW (75PS)		Petrol		TD317

BE/PL	4	47,758/47,778	50,600/50,619	19,000	1,406	0,020/0,074	EC	71-3566	71-3566/4 STD 0.25
-------	---	---------------	---------------	--------	-------	-------------	----	---------	------------------------------

→12/85

BE/PL	4	47,758/47,778	50,600/50,612	19,000	1,406	0,020/0,067	EC	71-3694	71-3694/4 STD 0.25 0.50
-------	---	---------------	---------------	--------	-------	-------------	----	---------	-----------------------------------

01/86→

71-3566

71-3694

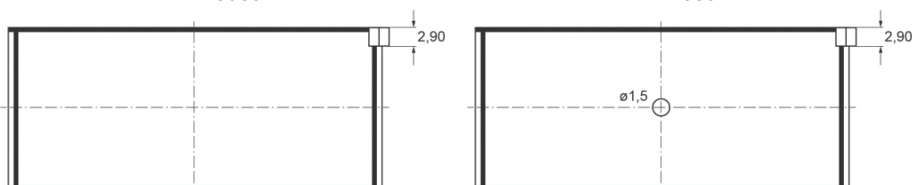

MB/HL	4	53,958/53,978	59,000/59,019	18,500	2,502	0,020/0,082	AL-LF	02-3085L	H027/5 STD 0.25 0.50
MB/HL	6	53,958/53,978	59,000/59,019	18,500	2,502	0,020/0,082	AL-LF	02-3085U	
TW/A	2	59,500	73,200		1,975		AL-LF	04-3527	A123/4 STD
TW/A	2	59,500	73,200		1,975		AL-LF	04-3528	
SE/PB	1	20,000	23,000/23,052	25,000			BC	55-3567	55-3567 SEMI
CB/NWB 1-5	5	25,939/25,960	28,250/28,271	17,000	1,138		AL-LF	03-3317	N118/5 STD 12
BU	1	42,959/42,975	46,055/46,095	15,000			AL-LF	07-3088	07-3088 STD SEMI 13

Front, For intermediary shaft

BU	1	41,959/41,975	45,000/45,025	15,000			AL-LF	07-3089	07-3089 STD SEMI 13
----	---	---------------	---------------	--------	--	--	-------	---------	--

Rear, For intermediary shaft

60 81.00 x 86.40

ADR			4 Cyl.	1781cc	92-95kW (125-129PS)		Petrol		TD241
BE/PL	4	47,758/47,778	50,600/50,612	19,000	1,406	0,020/0,067	EC	71-3694	71-3694/4 STD 0.25 0.50
MB/HL	4	53,958/53,978	59,000/59,019	18,500	2,502	0,020/0,082	AL-LF	02-3085L	H027/5 STD 0.25 0.50
MB/HL	6	53,958/53,978	59,000/59,019	18,500	2,502	0,020/0,082	AL-LF	02-3085U	

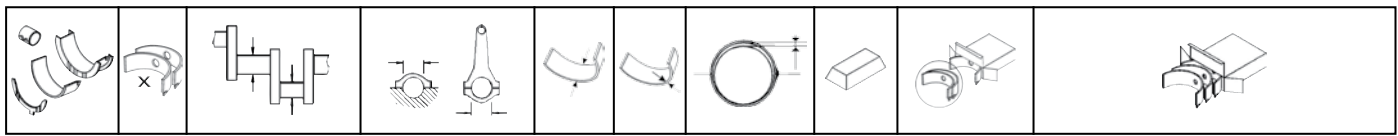

MB/HL 1-5	5	53,958/53,978	59,000/59,019	18,500	2,502	0,020/0,082	AL-LF	02-3085L	H084/5 STD 0.25 0.50
MB/HL 1-5	5	53,958/53,978	59,000/59,019	18,500	2,502	0,020/0,082	AL-LF	02-3085U	

02-3085L

02-3085U

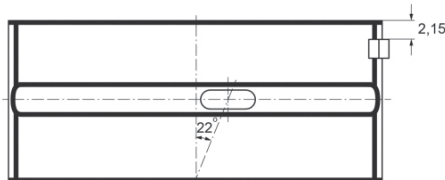

TW/A	2	59,500	73,200		1,975		AL-LF	04-3527	A123/4 STD
TW/A	2	59,500	73,200		1,975		AL-LF	04-3528	
SE/PB	1	20,000	23,000/23,021	25,000			BC	55-3698	55-3698 SEMI

61

81.00 x 86.40

AEB		4 Cyl.		1781cc	110-112kW (150-152PS)		Petrol Turbo Intercooler		TD4199
BE/PL	1	47,758/47,778	50,600/50,612	19,000	1,395	0,032/0,089	SP	71-3732	71-3732 STD 1
MB/HL	4	53,958/53,978	59,000/59,019	18,500	2,502	0,020/0,082	AL-LF	02-3085L	H027/5 STD 0.25 0.50
MB/HL	6	53,958/53,978	59,000/59,019	18,500	2,502	0,020/0,082	AL-LF	02-3085U	
TW/A	2	59,500	73,200		1,975		AL-LF	04-3527	A123/4 STD
TW/A	2	59,500	73,200		1,975		AL-LF	04-3528	
SE/PB	1	20,000	23,000/23,021	25,000			BC	55-3698	55-3698 SEMI

62

81.00 x 86.40

AFY		4 Cyl.		1781cc	85kW (115PS)		Petrol		TD13948
BE/PL	4	47,758/47,778	50,600/50,612	19,000	1,406	0,020/0,067	EC	71-3694	71-3694/4 STD 0.25 0.50
01/86 →									
MB/HL	4	53,958/53,978	59,000/59,019	18,500	2,502	0,020/0,082	AL-LF	02-3085L	H027/5 STD 0.25 0.50
MB/HL	6	53,958/53,978	59,000/59,019	18,500	2,502	0,020/0,082	AL-LF	02-3085U	
Mot. →8DX199999									
MB/HL 1-5	5	53,958/53,978	59,000/59,019	18,500	2,502	0,020/0,082	AL-LF	02-3085L	H084/5 STD 0.25 0.50
MB/HL 1-5	5	53,958/53,978	59,000/59,019	18,500	2,502	0,020/0,082	AL-LF	02-3085U	
Mot.8DX200001 →									

02-3085L

02-3085U

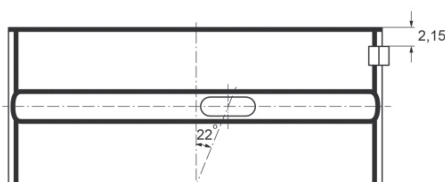

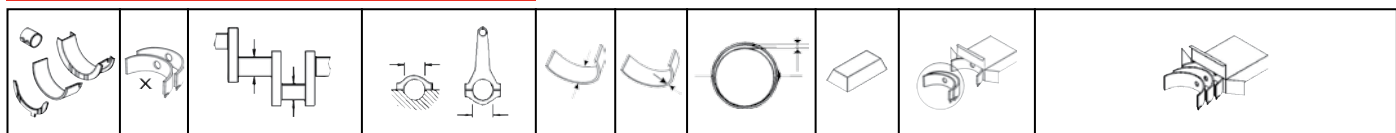

TW/A	2	59,500	73,200		1,975		AL-LF	04-3527	A123/4 STD
TW/A	2	59,500	73,200		1,975		AL-LF	04-3528	
SE/PB	1	20,000	23,000/23,021	25,000			BC	55-3698	55-3698 SEMI
CB/NWB 1-5	5	25,939/25,960	28,250/28,271	17,000	1,138		AL-LF	03-3317	N118/5 STD
BU	1	42,959/42,975	46,055/46,095	15,000			AL-LF	07-3088	07-3088 STD SEMI

Front, For intermediary shaft

BU	1	41,959/41,975	45,000/45,025	15,000			AL-LF	07-3089	07-3089 STD SEMI
----	---	---------------	---------------	--------	--	--	-------	---------	----------------------------

Rear, For intermediary shaft

63 81.00 x 86.40







AGN			4 Cyl.	1781cc	92kW (125PS)		Petrol		TD5073
APT			4 Cyl.	1781cc	92kW (125PS)		Petrol		TD13775
ARG			4 Cyl.	1781cc	92kW (125PS)		Petrol		TD13776
BE/PL	4	47,758/47,778	50,600/50,612	19,000	1,406	0,020/0,067	EC	71-3694	71-3694/4 STD 0.25 0.50
MB/HL 1-5	5	53,958/53,978	59,000/59,019	18,500	2,502	0,020/0,082	AL-LF	02-3085L	H084/5 STD 0.25 0.50
MB/HL 1-5	5	53,958/53,978	59,000/59,019	18,500	2,502	0,020/0,082	AL-LF	02-3085U	
TW/A	2	59,500	73,200		1,975		AL-LF	04-3527	A123/4 STD
TW/A	2	59,500	73,200		1,975		AL-LF	04-3528	
SE/PB	1	20,000	23,000/23,021	25,000			BC	55-3698	55-3698 SEMI

64 81.00 x 86.40

AGU Euro 2			4 Cyl.	1781cc	110kW (150PS)		Petrol Turbo Intercooler		TD5075
APU			4 Cyl.	1781cc	110kW (150PS)		Petrol Turbo Intercooler		TD13950
ARK			4 Cyl.	1781cc	110kW (150PS)		Petrol Turbo Intercooler		TD13929
ARZ			4 Cyl.	1781cc	110kW (150PS)		Petrol Turbo		TD11593
BE/PL	1	47,758/47,778	50,600/50,612	19,000	1,395	0,032/0,089	SP	71-3732	71-3732 STD
MB/HL 1-5	5	53,958/53,978	59,000/59,019	18,500	2,502	0,020/0,082	AL-LF	02-3085L	H084/5 STD 0.25 0.50
MB/HL 1-5	5	53,958/53,978	59,000/59,019	18,500	2,502	0,020/0,082	AL-LF	02-3085U	
TW/A	2	59,500	73,200		1,975		AL-LF	04-3527	A123/4 STD
TW/A	2	59,500	73,200		1,975		AL-LF	04-3528	
SE/PB	1	20,000	23,000/23,021	25,000			BC	55-3698	55-3698 SEMI

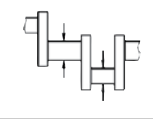
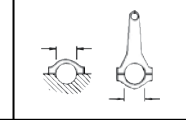
65 81.00 x 86.40

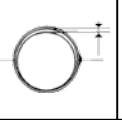
AJP			4 Cyl.	1781cc	92kW (125PS)		Petrol		TD9518
BE/PL	4	47,758/47,778	50,600/50,612	19,000	1,406	0,020/0,067	EC	71-3694	71-3694/4 STD 0.25 0.50
MB/HL 1-5	5	53,958/53,978	59,000/59,019	18,500	2,502	0,020/0,082	AL-LF	02-3085L	H084/5 STD 0.25 0.50
MB/HL 1-5	5	53,958/53,978	59,000/59,019	18,500	2,502	0,020/0,082	AL-LF	02-3085U	

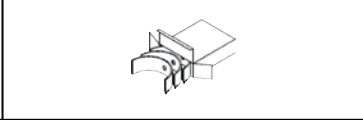
									
SE/PB	1	26,000	29,000/29,052	25,000			BC	55-3729	55-3729 SEMI

66 81.00 x 86.40

AJQ	4 Cyl.		1781cc	132kW (180PS)	Petrol Turbo Intercooler				TD11347
AMK	4 Cyl.		1781cc	154kW (209PS)	Petrol Turbo Intercooler				TD12648
BE/PL	1	47,758/47,778	50,600/50,612	19,000	1,395	0,032/0,089	SP	71-3732	71-3732 STD ①
MB/HL 1-5	5	53,958/53,978	59,000/59,019	18,500	2,502	0,020/0,082	AL-LF	02-3085L	H084/5 STD 0.25 0.50
MB/HL 1-5	5	53,958/53,978	59,000/59,019	18,500	2,502	0,020/0,082	AL-LF	02-3085U	
SE/PB	1	20,000	23,000/23,021	25,000			BC	55-3698	55-3698 SEMI

67 81.00 x 86.40

AMB	4 Cyl.		1781cc	125-127kW (170-173PS)	Petrol Turbo				TD17864
BE/PL	4	47,758/47,778	50,600/50,612	19,000	1,406	0,020/0,067	EC	71-3929	71-3929/4 STD ⑪
MB/HL	3	53,958/53,978	59,000/59,019	18,500	2,502	0,020/0,082	AL-LF	02-3085L	H025/5 STD 0.25 0.50
MB/HL	5	53,958/53,978	59,000/59,019	18,500	2,502	0,020/0,082	AL-LF	02-3085U	
MB/HL	1	53,958/53,978	59,000/59,019	24,930	2,502	0,020/0,082	AL-LF	02-3086HL	
MB/HL	1	53,958/53,978	59,000/59,019	24,930	2,502	0,020/0,082	AL-LF	02-3086HU	
			02-3086HL	STD	25,000/.9843" - 25,040/.9858"				
				0.25mm	25,100/.9882" - 25,140/.9898"				
				0.50mm	25,100/.9882" - 25,140/.9898"				
				0.75mm	25,100/.9882" - 25,140/.9898"				
			02-3086HU	STD	25,000/.9843" - 25,040/.9858"				
				0.25mm	25,100/.9882" - 25,140/.9898"				
				0.50mm	25,100/.9882" - 25,140/.9898"				
				0.75mm	25,100/.9882" - 25,140/.9898"				
SE/PB	1	20,000	23,000/23,021	25,000			BC	55-3698	55-3698 SEMI
CB/NWB 1-5	5	25,939/25,960	28,250/28,271	17,000	1,138		AL-LF	03-3317	N118/5 STD ⑫

68 81.00 x 86.40

APG	4 Cyl.		1781cc	92kW (125PS)	Petrol				TD11589
BE/PL	4	47,758/47,778	50,600/50,612	19,000	1,406	0,020/0,067	EC	71-3694	71-3694/4 STD 0.25 0.50
MB/HL 1-5	5	53,958/53,978	59,000/59,019	18,500	2,502	0,020/0,082	AL-LF	02-3085L	H084/5 STD 0.25 0.50
MB/HL 1-5	5	53,958/53,978	59,000/59,019	18,500	2,502	0,020/0,082	AL-LF	02-3085U	
SE/PB	1	20,000	23,000/23,021	25,000			BC	55-3698	55-3698 SEMI

69 81.00 x 86.40

AQE	4 Cyl.		1781cc	92kW (125PS)	Petrol				TD14029
ARH	4 Cyl.		1781cc	92kW (125PS)	Petrol				TD15329
BE/PL	4	47,758/47,778	50,600/50,612	19,000	1,406	0,020/0,067	EC	71-3694	71-3694/4 STD 0.25 0.50
SE/PB	1	26,000	29,000/29,052	25,000			BC	55-3729	55-3729 SEMI

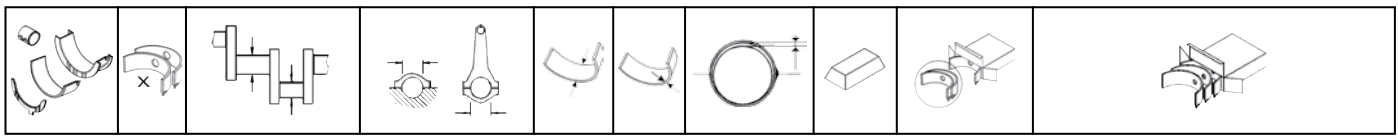

70		81.00 x 86.40							
ARX		4 Cyl.		1781cc	110kW (150PS)		Petrol Turbo Intercooler		TD15988
MB/HL 1-5	5	53,958/53,978	59,000/59,019	18,500	2,502	0,020/0,082	AL-LF	02-3085L	H084/5 STD 0.25 0.50
MB/HL 1-5	5	53,958/53,978	59,000/59,019	18,500	2,502	0,020/0,082	AL-LF	02-3085U	
TW/A	2	59,500	73,200		1,975		AL-LF	04-3527	A123/4 STD
TW/A	2	59,500	73,200		1,975		AL-LF	04-3528	

71		81.00 x 86.40							
ARY		4 Cyl.		1781cc	132kW (180PS)		Petrol Turbo		TD15352
BE/PL	4	47,758/47,778	50,600/50,612	19,000	1,406	0,020/0,067	EC	71-3929	71-3929/4 STD II
MB/HL 1-5	5	53,958/53,978	59,000/59,019	18,500	2,502	0,020/0,082	AL-LF	02-3085L	H084/5 STD 0.25 0.50
MB/HL 1-5	5	53,958/53,978	59,000/59,019	18,500	2,502	0,020/0,082	AL-LF	02-3085U	
TW/A	2	59,500	73,200		1,975		AL-LF	04-3527	A123/4 STD
TW/A	2	59,500	73,200		1,975		AL-LF	04-3528	
SE/PB	1	20,000	23,000/23,021	25,000			BC	55-3698	55-3698 SEMI

72		81.00 x 86.40							
AUM Euro 4		4 Cyl.		1781cc	110kW (150PS)		Petrol Turbo Intercooler		TD15629
AUQ		4 Cyl.		1781cc	132kW (180PS)		Petrol Turbo		TD15353
AWT		4 Cyl.		1781cc	110kW (150PS)		Petrol Turbo		TD15335
BE/PL	4	47,758/47,778	50,600/50,612	19,000	1,406	0,020/0,067	EC	71-3929	71-3929/4 STD II

73		81.00 x 86.40							
AVJ		4 Cyl.		1781cc	110kW (150PS)		Petrol Turbo		TD15349
BEX		4 Cyl.		1781cc	140kW (190PS)		Petrol Turbo Intercooler		TD16730
BFB		4 Cyl.		1781cc	120kW (163PS)		Petrol Turbo Intercooler		TD16728
BE/PL	1	47,758/47,778	50,600/50,612	19,000	1,395	0,032/0,089	SP	71-3732	71-3732 STD I
BE/PL	4	47,758/47,778	50,600/50,612	19,000	1,406	0,020/0,067	EC	71-3929	71-3929/4 STD II

71-3732

71-3929

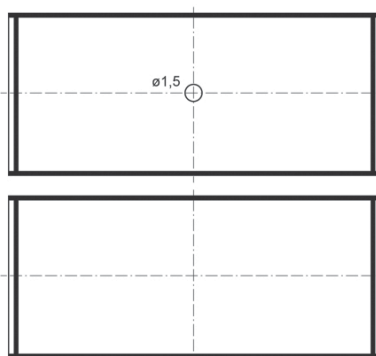
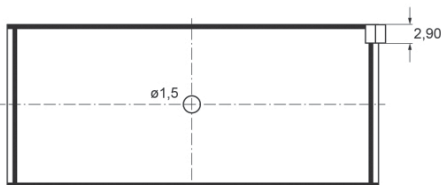

MB/HL	3	53,958/53,978	59,000/59,019	18,500	2,502	0,020/0,082	AL-LF	02-3085L	H025/5 STD 0.25 0.50
MB/HL	5	53,958/53,978	59,000/59,019	18,500	2,502	0,020/0,082	AL-LF	02-3085U	
MB/HL	1	53,958/53,978	59,000/59,019	24,930	2,502	0,020/0,082	AL-LF	02-3086HL	
MB/HL	1	53,958/53,978	59,000/59,019	24,930	2,502	0,020/0,082	AL-LF	02-3086HU	

	02-3086HL	STD	25,000/.9843" - 25,040/.9858"
		0.25mm	25,100/.9882" - 25,140/.9898"
		0.50mm	25,100/.9882" - 25,140/.9898"
		0.75mm	25,100/.9882" - 25,140/.9898"
	02-3086HU	STD	25,000/.9843" - 25,040/.9858"
		0.25mm	25,100/.9882" - 25,140/.9898"
		0.50mm	25,100/.9882" - 25,140/.9898"
		0.75mm	25,100/.9882" - 25,140/.9898"

MB/HL	4	53,958/53,978	59,000/59,019	18,500	2,502	0,020/0,082	AL-LF	02-3085L	H027/5 STD 0.25 0.50
MB/HL	6	53,958/53,978	59,000/59,019	18,500	2,502	0,020/0,082	AL-LF	02-3085U	
MB/HL 1-5	5	53,958/53,978	59,000/59,019	18,500	2,502	0,020/0,082	AL-LF	02-3085L	H084/5 STD 0.25 0.50
MB/HL 1-5	5	53,958/53,978	59,000/59,019	18,500	2,502	0,020/0,082	AL-LF	02-3085U	

02-3085L

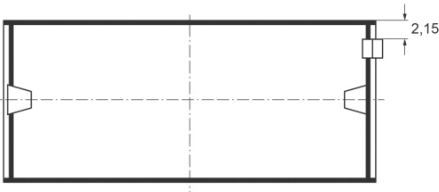

02-3085U

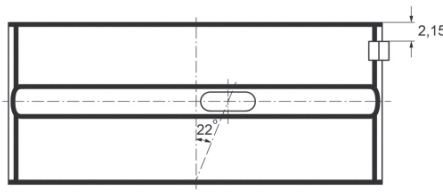

02-3086HL

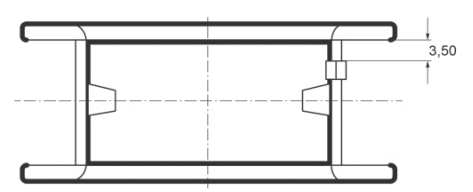

02-3086HU

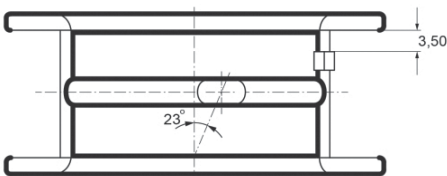

TW/A	2	59,500	73,200		1,975	AL-LF	04-3527	A123/4 STD
TW/A	2	59,500	73,200		1,975	AL-LF	04-3528	
SE/PB	1	20,000	23,000/23,052	25,000		BC	55-3567	55-3567 SEMI
SE/PB	1	20,000	23,000/23,021	25,000		BC	55-3698	

55-3567

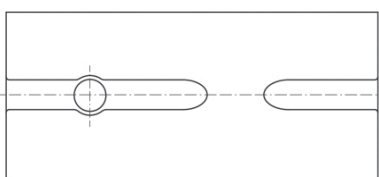

55-3698

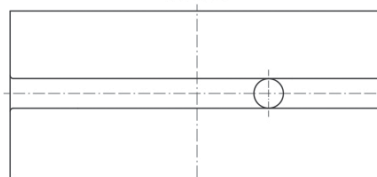



74 81.00 x 86.40

AVV		4 Cyl.		1781cc	92kW (125PS)	Petrol			TD16412
BE/PL	4	47,758/47,778	50,600/50,612	19,000	1,406	0,020/0,067	EC	71-3694	71-3694/4 STD 0.25 0.50
TW/A	2	59,500	73,200		1,975		AL-LF	04-3527	A123/4 STD
TW/A	2	59,500	73,200		1,975		AL-LF	04-3528	

75 81.00 x 86.40

AWL		4 Cyl.		1781cc	110kW (150PS)	Petrol Turbo Intercooler			TD19192
AWP		4 Cyl.		1781cc	132-134kW (180-182PS)	Petrol Turbo Intercooler			TD15356
BKB		4 Cyl.		1781cc	120kW (163PS)	Petrol Turbo			TD19135
BE/PL	4	47,758/47,778	50,600/50,612	19,000	1,406	0,020/0,067	EC	71-3929	71-3929/4 STD [11]
MB/HL 1-5	5	53,958/53,978	59,000/59,019	18,500	2,502	0,020/0,082	AL-LF	02-3085L	H084/5 STD 0.25 0.50
MB/HL 1-5	5	53,958/53,978	59,000/59,019	18,500	2,502	0,020/0,082	AL-LF	02-3085U	
TW/A	2	59,500	73,200		1,975		AL-LF	04-3527	A123/4 STD
TW/A	2	59,500	73,200		1,975		AL-LF	04-3528	

76 81.00 x 86.40

DD		4 Cyl.		1781cc	55kW (75PS)	Petrol			TD250
BE/PL	1	45,950/45,970	49,000/49,016	19,000	1,506	0,020/0,078	EC	71-3084	71-3084 STD 0.25
MB/HL	3	53,958/53,978	59,000/59,019	18,500	2,502	0,020/0,082	AL-LF	02-3085L	H025/5 STD 0.25 0.50
MB/HL	5	53,958/53,978	59,000/59,019	18,500	2,502	0,020/0,082	AL-LF	02-3085U	
MB/HL	1	53,958/53,978	59,000/59,019	24,930	2,502	0,020/0,082	AL-LF	02-3086HL	
MB/HL	1	53,958/53,978	59,000/59,019	24,930	2,502	0,020/0,082	AL-LF	02-3086HU	



02-3086HL	STD	25,000/.9843" - 25,040/.9858"
	0.25mm	25,100/.9882" - 25,140/.9898"
	0.50mm	25,100/.9882" - 25,140/.9898"
	0.75mm	25,100/.9882" - 25,140/.9898"

02-3086HU	STD	25,000/.9843" - 25,040/.9858"
	0.25mm	25,100/.9882" - 25,140/.9898"
	0.50mm	25,100/.9882" - 25,140/.9898"
	0.75mm	25,100/.9882" - 25,140/.9898"

CB/NWB 1-5	5	25,939/25,960	28,250/28,271	17,000	1,138		AL-LF	03-3317	N118/5 STD [12]
BU	1	42,959/42,975	46,055/46,095	15,000			AL-LF	07-3088	07-3088 STD SEMI [13]

Front, For intermediary shaft

BU	1	41,959/41,975	45,000/45,025	15,000			AL-LF	07-3089	07-3089 STD SEMI [13]
----	---	---------------	---------------	--------	--	--	-------	---------	---

Rear, For intermediary shaft

77 81.00 x 86.40

DR		4 Cyl.		1781cc	55kW (75PS)	Petrol			TD252
DS		4 Cyl.		1781cc	66kW (90PS)	Petrol			TD253
JN		4 Cyl.		1781cc	66-68kW (90-93PS)	Petrol			TD4208

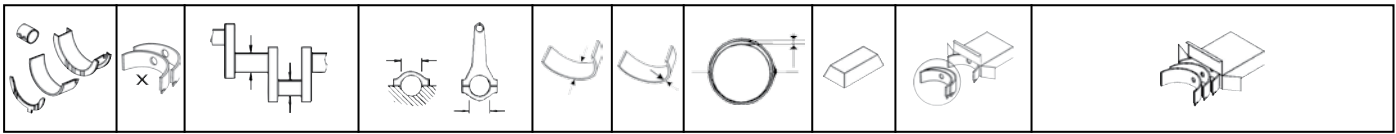

JV	4 Cyl.	1781cc	66kW (90PS)	Petrol	TD278
JW	4 Cyl.	1781cc	66kW (90PS)	Petrol	TD279
NE	4 Cyl.	1781cc	66kW (90PS)	Petrol	TD4210
PV	4 Cyl.	1781cc	79-81kW (107-110PS)	Petrol	TD311

BE/PL	4	47,758/47,778	50,600/50,619	19,000	1,406	0,020/0,074	EC	71-3566	71-3566/4 STD 0.25
-------	---	---------------	---------------	--------	-------	-------------	----	---------	------------------------------

→12/85

BE/PL	4	47,758/47,778	50,600/50,612	19,000	1,406	0,020/0,067	EC	71-3694	71-3694/4 STD 0.25 0.50
-------	---	---------------	---------------	--------	-------	-------------	----	---------	-----------------------------------

01/86→

71-3566



71-3694

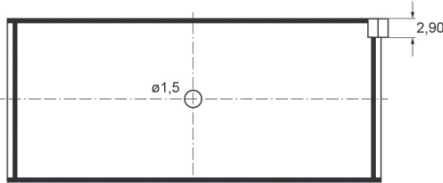

MB/HL	3	53,958/53,978	59,000/59,019	18,500	2,502	0,020/0,082	AL-LF	02-3085L	H025/5 STD 0.25 0.50
MB/HL	5	53,958/53,978	59,000/59,019	18,500	2,502	0,020/0,082	AL-LF	02-3085U	
MB/HL	1	53,958/53,978	59,000/59,019	24,930	2,502	0,020/0,082	AL-LF	02-3086HL	
MB/HL	1	53,958/53,978	59,000/59,019	24,930	2,502	0,020/0,082	AL-LF	02-3086HU	



02-3086HL	STD	25,000/.9843" - 25,040/.9858"
	0.25mm	25,100/.9882" - 25,140/.9898"
	0.50mm	25,100/.9882" - 25,140/.9898"
	0.75mm	25,100/.9882" - 25,140/.9898"

02-3086HU	STD	25,000/.9843" - 25,040/.9858"
	0.25mm	25,100/.9882" - 25,140/.9898"
	0.50mm	25,100/.9882" - 25,140/.9898"
	0.75mm	25,100/.9882" - 25,140/.9898"

MB/HL	4	53,958/53,978	59,000/59,019	18,500	2,502	0,020/0,082	AL-LF	02-3085L	H027/5 STD 0.25 0.50
MB/HL	6	53,958/53,978	59,000/59,019	18,500	2,502	0,020/0,082	AL-LF	02-3085U	

02-3085L



02-3085U

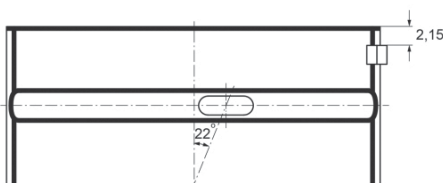

02-3086HL

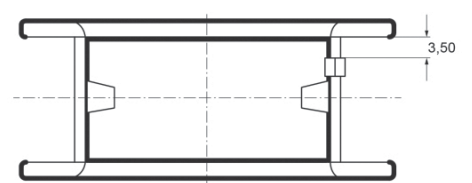

02-3086HU

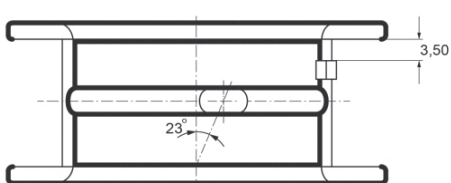

TW/A	2	59,500	73,200		1,975		AL-LF	04-3527	A123/4 STD
TW/A	2	59,500	73,200		1,975		AL-LF	04-3528	

SE/PB	1	20,000	23,000/23,052	25,000			BC	55-3567	55-3567 SEMI	
CB/NWB 1-5	5	25,939/25,960	28,250/28,271	17,000	1,138		AL-LF	03-3317	N118/5 STD	12
BU	1	42,959/42,975	46,055/46,095	15,000			AL-LF	07-3088	07-3088 STD SEMI	13
Front, For intermediary shaft										
BU	1	41,959/41,975	45,000/45,025	15,000			AL-LF	07-3089	07-3089 STD SEMI	13
Rear, For intermediary shaft										

78

81.00 x 86.40

DZ		4 Cyl.	1781cc	82kW (112PS)			Petrol		TD256																								
BE/PL	4	47,758/47,778	50,600/50,612	19,000	1,406	0,020/0,067	EC	71-3694	71-3694/4 STD 0.25 0.50																								
MB/HL	3	53,958/53,978	59,000/59,019	18,500	2,502	0,020/0,082	AL-LF	02-3085L	H025/5 STD 0.25 0.50																								
MB/HL	5	53,958/53,978	59,000/59,019	18,500	2,502	0,020/0,082	AL-LF	02-3085U																									
MB/HL	1	53,958/53,978	59,000/59,019	24,930	2,502	0,020/0,082	AL-LF	02-3086HL																									
MB/HL	1	53,958/53,978	59,000/59,019	24,930	2,502	0,020/0,082	AL-LF	02-3086HU																									
<table border="1"> <tr> <td>02-3086HL</td> <td>STD</td> <td>25,000/.9843" - 25,040/.9858"</td> </tr> <tr> <td></td> <td>0.25mm</td> <td>25,100/.9882" - 25,140/.9898"</td> </tr> <tr> <td></td> <td>0.50mm</td> <td>25,100/.9882" - 25,140/.9898"</td> </tr> <tr> <td></td> <td>0.75mm</td> <td>25,100/.9882" - 25,140/.9898"</td> </tr> <tr> <td>02-3086HU</td> <td>STD</td> <td>25,000/.9843" - 25,040/.9858"</td> </tr> <tr> <td></td> <td>0.25mm</td> <td>25,100/.9882" - 25,140/.9898"</td> </tr> <tr> <td></td> <td>0.50mm</td> <td>25,100/.9882" - 25,140/.9898"</td> </tr> <tr> <td></td> <td>0.75mm</td> <td>25,100/.9882" - 25,140/.9898"</td> </tr> </table>										02-3086HL	STD	25,000/.9843" - 25,040/.9858"		0.25mm	25,100/.9882" - 25,140/.9898"		0.50mm	25,100/.9882" - 25,140/.9898"		0.75mm	25,100/.9882" - 25,140/.9898"	02-3086HU	STD	25,000/.9843" - 25,040/.9858"		0.25mm	25,100/.9882" - 25,140/.9898"		0.50mm	25,100/.9882" - 25,140/.9898"		0.75mm	25,100/.9882" - 25,140/.9898"
02-3086HL	STD	25,000/.9843" - 25,040/.9858"																															
	0.25mm	25,100/.9882" - 25,140/.9898"																															
	0.50mm	25,100/.9882" - 25,140/.9898"																															
	0.75mm	25,100/.9882" - 25,140/.9898"																															
02-3086HU	STD	25,000/.9843" - 25,040/.9858"																															
	0.25mm	25,100/.9882" - 25,140/.9898"																															
	0.50mm	25,100/.9882" - 25,140/.9898"																															
	0.75mm	25,100/.9882" - 25,140/.9898"																															
MB/HL	4	53,958/53,978	59,000/59,019	18,500	2,502	0,020/0,082	AL-LF	02-3085L	H027/5 STD 0.25 0.50																								
MB/HL	6	53,958/53,978	59,000/59,019	18,500	2,502	0,020/0,082	AL-LF	02-3085U																									

02-3085L



02-3085U

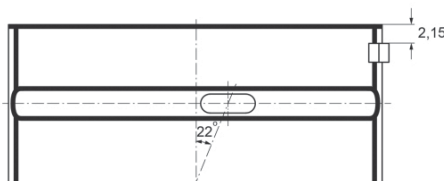

02-3086HL

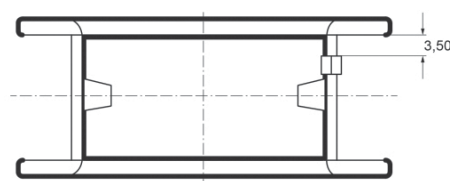

02-3086HU

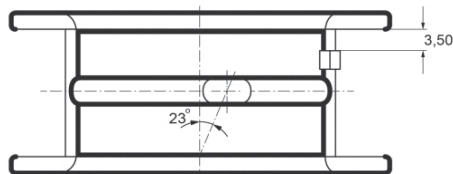

TW/A	2	59,500	73,200		1,975		AL-LF	04-3527	A123/4 STD
TW/A	2	59,500	73,200		1,975		AL-LF	04-3528	
SE/PB	1	20,000	23,000/23,052	25,000			BC	55-3567	55-3567 SEMI

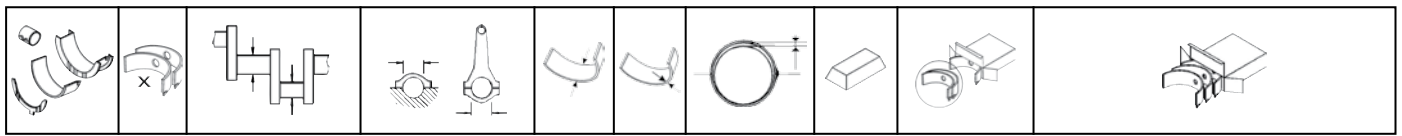

BU	1	42,959/42,975	46,055/46,095	15,000			AL-LF	07-3088	07-3088 STD SEMI	13
----	---	---------------	---------------	--------	--	--	-------	---------	----------------------------	----

Front, For intermediary shaft

BU	1	41,959/41,975	45,000/45,025	15,000			AL-LF	07-3089	07-3089 STD SEMI	13
----	---	---------------	---------------	--------	--	--	-------	---------	----------------------------	----

Rear, For intermediary shaft

79 81.00 x 86.40

PM		4 Cyl.	1781cc	66kW (90PS)			Petrol		TD306
RU		4 Cyl.	1781cc	55kW (75PS)			Petrol		TD320
SF		4 Cyl.	1781cc	65kW (88PS)			Petrol		TD325
SH		4 Cyl.	1781cc	65-66kW (88-90PS)			Petrol		TD326

BE/PL	4	47,758/47,778	50,600/50,612	19,000	1,406	0,020/0,067	EC	71-3694	71-3694/4 STD 0.25 0.50	
MB/HL	4	53,958/53,978	59,000/59,019	18,500	2,502	0,020/0,082	AL-LF	02-3085L	H027/5 STD 0.25 0.50	
MB/HL	6	53,958/53,978	59,000/59,019	18,500	2,502	0,020/0,082	AL-LF	02-3085U		
TW/A	2	59,500	73,200		1,975		AL-LF	04-3527	A123/4 STD	
TW/A	2	59,500	73,200		1,975		AL-LF	04-3528		
SE/PB	1	20,000	23,000/23,052	25,000			BC	55-3567	55-3567 SEMI	
BU	1	42,959/42,975	46,055/46,095	15,000			AL-LF	07-3088	07-3088 STD SEMI	13

Front, For intermediary shaft

BU	1	41,959/41,975	45,000/45,025	15,000			AL-LF	07-3089	07-3089 STD SEMI	13
----	---	---------------	---------------	--------	--	--	-------	---------	----------------------------	----

Rear, For intermediary shaft

80 81.00 x 86.40

1B		5 Cyl.	2226cc	147kW (200PS)			Petrol Turbo		TD211
2B		5 Cyl.	2226cc	140kW (190PS)			Petrol Turbo		TD215

BE/PL	5	47,758/47,778	50,600/50,612	19,000	1,406	0,020/0,067	EC	71-3694	71-3694/5 STD 0.25	
MB/HL 1,2, 4-6	5	57,958/57,978	63,000/63,019	18,500	2,502	0,020/0,082	EC	72-3400	H941/6 STD 0.25	
MB/HL 3	1	57,958/57,978	63,000/63,019	24,930	2,502	0,020/0,082	EC	72-3401H		



72-3401H	STD	25,000/.9843" - 25,040/.9858"
	0.25mm	25,100/.9882" - 25,140/.9898"
	0.50mm	25,100/.9882" - 25,140/.9898"
	0.75mm	25,100/.9882" - 25,140/.9898"

MB/HL 1-6	6	57,958/57,978	63,000/63,019	18,500	2,502	0,020/0,082	EC	72-3400	H981/6 STD 0.25	
TW/A	2	63,500/63,750	77,200/77,450		1,975		AL-LF	04-3529	A124/4 STD	
TW/A	2	63,500/63,750	77,200/77,450		1,975		AL-LF	04-3530		
TW/A	2	63,500/63,750	76,950/77,200		1,975		AL-LF	04-4782	A292/4 STD	
TW/A	2	63,500/63,750	76,950/77,200		1,975		AL-LF	04-4783		

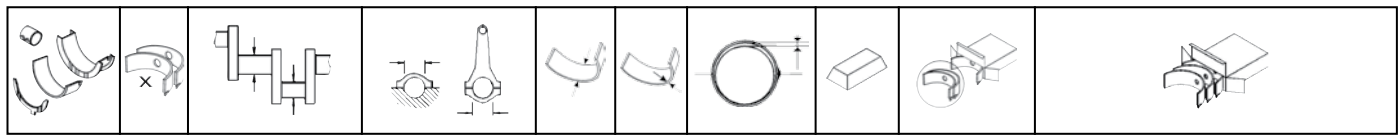

04-3529

04-3530

04-4782

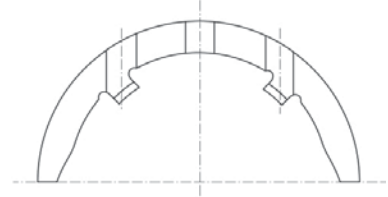
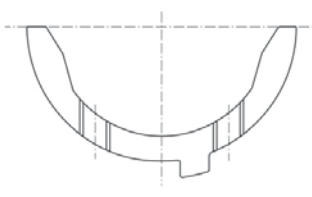
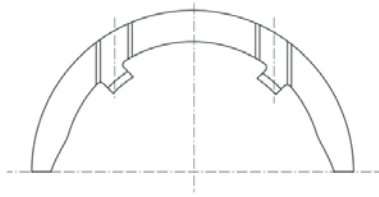

04-4783

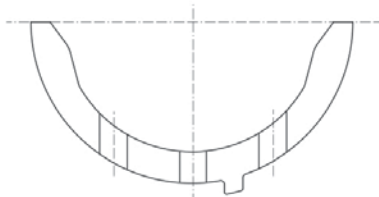

SE/PB	1	20,000	23,000/23,021	25,000		BC	55-3698	55-3698 SEMI
-------	---	--------	---------------	--------	--	----	---------	-----------------

81 81.00 x 86.40

3B	5 Cyl.	2226cc	162kW (220PS)	Petrol Turbo	TD4192
AAN	5 Cyl.	2226cc	169kW (230PS)	Petrol Turbo Intercooler	TD225
ABY	5 Cyl.	2226cc	169kW (230PS)	Petrol Turbo Intercooler	TD237
ADU	5 Cyl.	2226cc	232kW (315PS)	Petrol Turbo Intercooler	TD242
RR	5 Cyl.	2226cc	162kW (220PS)	Petrol Turbo	TD316

BE/PL	1	47,758/47,778	50,600/50,612	19,000	1,395	0,032/0,089	SP	71-3732	71-3732 STD	1
MB/HL 1-6	6	57,958/57,978	63,000/63,019	18,500	2,502	0,020/0,082	EC	72-3400	H981/6 STD 0.25	
TW/A	2	63,500/63,750	77,200/77,450		1,975		AL-LF	04-3529	A124/4 STD	
TW/A	2	63,500/63,750	77,200/77,450		1,975		AL-LF	04-3530		
TW/A	2	63,500/63,750	76,950/77,200		1,975		AL-LF	04-4782	A292/4 STD	
TW/A	2	63,500/63,750	76,950/77,200		1,975		AL-LF	04-4783		

04-3529





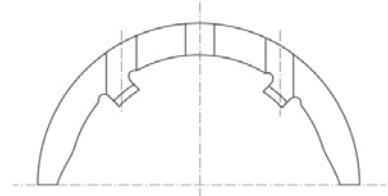
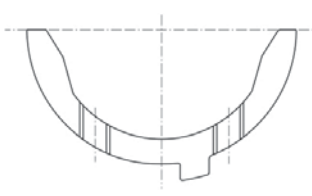
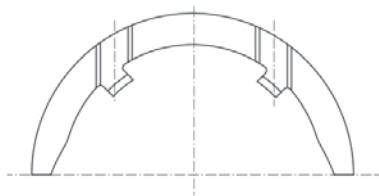

04-3530

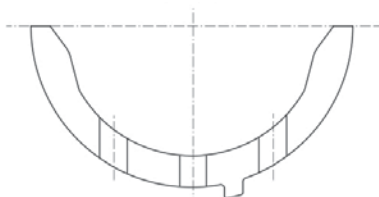
04-4782

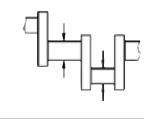
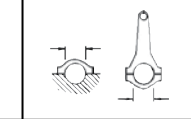

04-4783

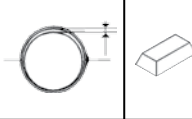

							
SE/PB	1	20,000	23,000/23,021	25,000		BC	55-3698 55-3698 SEMI

82 **81.00 x 86.40**

HX	5 Cyl.	2226cc	101kW (138PS)	Petrol	TD267
HY	5 Cyl.	2226cc	100kW (136PS)	Petrol	TD268

BE/PL	5	47,758/47,778	50,600/50,612	19,000	1,406	0,020/0,067	EC	71-3694	71-3694/5 STD 0.25
MB/HL 1,2, 4-6	5	57,958/57,978	63,000/63,019	18,500	2,502	0,020/0,082	EC	72-3400	H941/6 STD 0.25
MB/HL 3	1	57,958/57,978	63,000/63,019	24,930	2,502	0,020/0,082	EC	72-3401H	

	72-3401H	STD	25,000/.9843" - 25,040/.9858"
		0.25mm	25,100/.9882" - 25,140/.9898"
		0.50mm	25,100/.9882" - 25,140/.9898"
		0.75mm	25,100/.9882" - 25,140/.9898"

MB/HL 1-6	6	57,958/57,978	63,000/63,019	18,500	2,502	0,020/0,082	EC	72-3400	H981/6 STD 0.25
TW/A	2	63,500/63,750	77,200/77,450		1,975		AL-LF	04-3529	A124/4 STD
TW/A	2	63,500/63,750	77,200/77,450		1,975		AL-LF	04-3530	
TW/A	2	63,500/63,750	76,950/77,200		1,975		AL-LF	04-4782	A292/4 STD
TW/A	2	63,500/63,750	76,950/77,200		1,975		AL-LF	04-4783	

04-3529

04-3530

04-4782

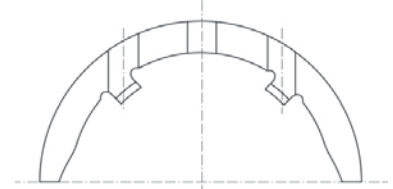
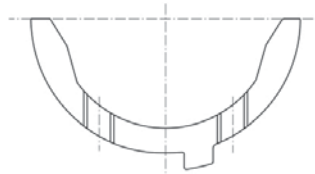
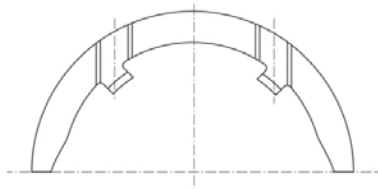

04-4783

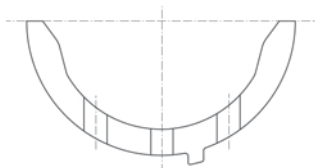

SE/PB	1	20,000	23,000/23,052	25,000			BC	55-3567	55-3567 SEMI
-------	---	--------	---------------	--------	--	--	----	---------	------------------------

83 **81.00 x 86.40**

JT	5 Cyl.	2226cc	82-89kW (112-121PS)	Petrol	TD276
KV	5 Cyl.	2226cc	100kW (136PS)	Petrol	TD4209
KX	5 Cyl.	2226cc	75-85kW (102-116PS)	Petrol	TD293
KZ	5 Cyl.	2226cc	82-85kW (112-116PS)	Petrol	TD294
PX	5 Cyl.	2226cc	88kW (120PS)	Petrol	TD312

BE/PL	5	47,758/47,778	50,600/50,619	19,000	1,406	0,020/0,074	EC	71-3566	71-3566/5 STD
-------	---	---------------	---------------	--------	-------	-------------	----	---------	-------------------------

→12/85

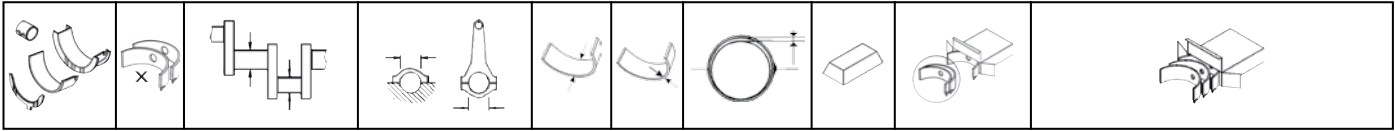

BE/PL	5	47,758/47,778	50,600/50,612	19,000	1,406	0,020/0,067	EC	71-3694	71-3694/5 STD 0.25
-------	---	---------------	---------------	--------	-------	-------------	----	---------	------------------------------

01/86 →

71-3566

71-3694

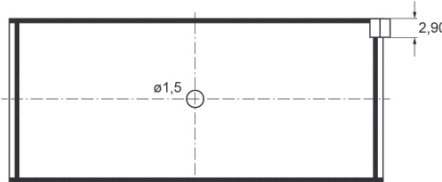

MB/HL 1,2, 4-6	5	57,958/57,978	63,000/63,019	18,500	2,502	0,020/0,082	EC	72-3400	H941/6 STD 0.25
MB/HL 3	1	57,958/57,978	63,000/63,019	24,930	2,502	0,020/0,082	EC	72-3401H	



72-3401H

STD	25,000/.9843" - 25,040/.9858"
0.25mm	25,100/.9882" - 25,140/.9898"
0.50mm	25,100/.9882" - 25,140/.9898"
0.75mm	25,100/.9882" - 25,140/.9898"

MB/HL 1-6	6	57,958/57,978	63,000/63,019	18,500	2,502	0,020/0,082	EC	72-3400	H981/6 STD 0.25
TW/A	2	63,500/63,750	77,200/77,450		1,975		AL-LF	04-3529	A124/4 STD
TW/A	2	63,500/63,750	77,200/77,450		1,975		AL-LF	04-3530	
TW/A	2	63,500/63,750	76,950/77,200		1,975		AL-LF	04-4782	A292/4 STD
TW/A	2	63,500/63,750	76,950/77,200		1,975		AL-LF	04-4783	

04-3529

04-3530

04-4782

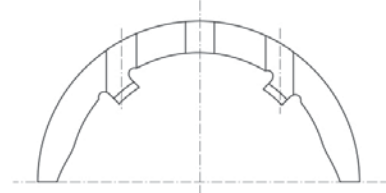
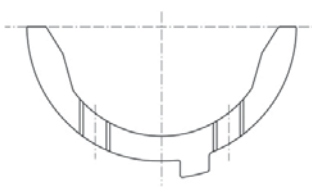
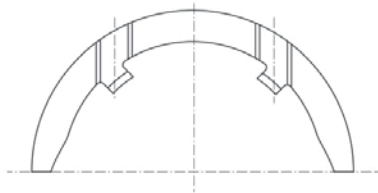

04-4783

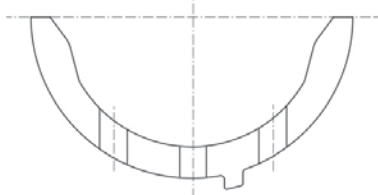

SE/PB	1	20,000	23,000/23,052	25,000			BC	55-3567	55-3567 SEMI
SE/PB	1	20,000	23,000/23,021	25,000			BC	55-3698	55-3698 SEMI

55-3567

55-3698

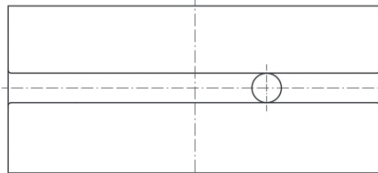
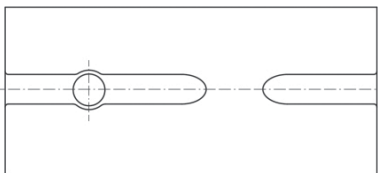



84 81.00 x 86.40

MB		5 Cyl.		2226cc	147kW (200PS)	Petrol Turbo Intercooler			TD295
BE/PL	1	45,950/45,970	49,000/49,016	19,000	1,506	0,020/0,078	EC	71-3084	71-3084 STD 0.25
TW/A	2	63,500/63,750	77,200/77,450		1,975		AL-LF	04-3529	A124/4 STD
TW/A	2	63,500/63,750	77,200/77,450		1,975		AL-LF	04-3530	
TW/A	2	63,500/63,750	76,950/77,200		1,975		AL-LF	04-4782	A292/4 STD
TW/A	2	63,500/63,750	76,950/77,200		1,975		AL-LF	04-4783	

04-3529

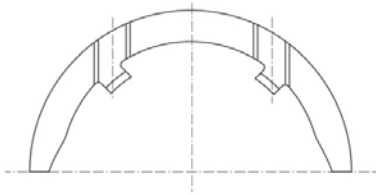

04-3530

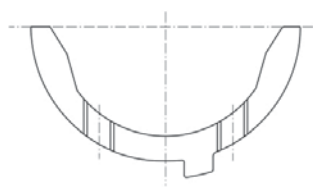

04-4782

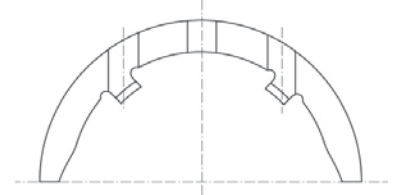

04-4783

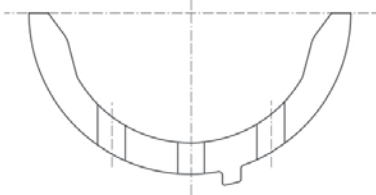

85 81.00 x 86.40

MC		5 Cyl.		2226cc	97-121kW (132-165PS)	Petrol Turbo Intercooler			TD296
BE/PL	1	45,950/45,970	49,000/49,016	19,000	1,506	0,020/0,078	EC	71-3084	71-3084 STD 0.25
MB/HL 1-6	6	57,958/57,978	63,000/63,019	18,500	2,502	0,020/0,082	EC	72-3400	H981/6 STD 0.25
TW/A	2	63,500/63,750	77,200/77,450		1,975		AL-LF	04-3529	A124/4 STD
TW/A	2	63,500/63,750	77,200/77,450		1,975		AL-LF	04-3530	
TW/A	2	63,500/63,750	76,950/77,200		1,975		AL-LF	04-4782	A292/4 STD
TW/A	2	63,500/63,750	76,950/77,200		1,975		AL-LF	04-4783	

04-3529

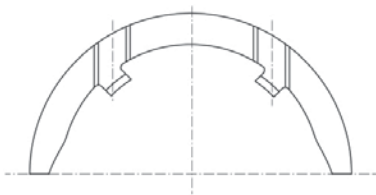

04-3530

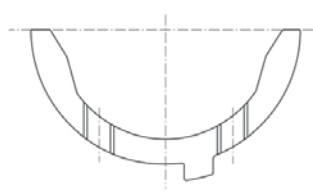

04-4782

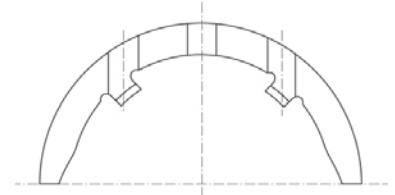



04-4783

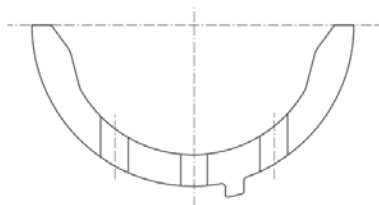

86 81.00 x 86.40

AGB			V6 Cyl.	2671cc	195kW (265PS)			Petrol Turbo	TD11888
AJK			V6 Cyl.	2671cc	169kW (230PS)			Petrol Turbo Intercooler	TD10813
ARE			V6 Cyl.	2671cc	184kW (250PS)			Petrol Turbo	TD15328
AZA			V6 Cyl.	2671cc	169kW (230PS)			Petrol	TD17164
AZB			V6 Cyl.	2671cc	195kW (265PS)			Petrol	TD20534
BES			V6 Cyl.	2671cc	184kW (250PS)			Petrol Turbo Intercooler	TD16432
BE/PL	6	53,958/53,978	57,600/57,612	17,000	1,806	0,020/0,069	EC	71-3711	71-3711/6 STD
TW/A	2	70,500	84,900		1,965		AL-LF	04-3713	A138/4 STD
TW/A	2	70,500	84,900		1,965		AL-LF	04-3714	

87 81.00 x 86.40

ASJ			V6 Cyl.	2671cc	280kW (380PS)			Petrol Bi-Turbo Intercooler	TD14150
BE/PL	6	53,958/53,978	57,600/57,612	17,000	1,806	0,020/0,069	EC	71-3711	71-3711/6 STD
MB/HL 1-4	4	64,959/64,978	70,000/70,019	18,000	2,508	0,020/0,070	EC	72-3712	H034/4 STD 0.25
TW/A	2	70,500	84,900		1,965		AL-LF	04-3713	A138/4 STD
TW/A	2	70,500	84,900		1,965		AL-LF	04-3714	
SE/PB	1	20,995/21,000	23,000/23,052	23,500			BC	55-3715	55-3715 SEMI

88 81.00 x 86.40

PT			V8 Cyl.	3562cc	180-184kW (245-250PS)			Petrol	TD310
BE/PL	8	53,958/53,978	56,800/56,819	17,000	1,406	0,020/0,074	AL-LF	01-3841	01-3841/8 STD
BE/PL	8	49,958/49,978	53,200/53,219	18,000	1,601	0,020/0,084	EC	71-3933	71-3933/8 STD

89 81.00 x 95.50

AZV			4 Cyl.	1968cc	100kW (136PS)			Diesel Turbo Intercooler	TD17027
BKD			4 Cyl.	1968cc	103kW (140PS)			Diesel Turbo Intercooler	TD17025
BLB			4 Cyl.	1968cc	103kW (140PS)			Diesel Turbo Intercooler	TD17377
BMM			4 Cyl.	1968cc	103kW (140PS)			Diesel Turbo Intercooler	TD18203
BMN			4 Cyl.	1968cc	125kW (170PS)			Diesel Turbo Intercooler	TD18991
BNA			4 Cyl.	1968cc	100kW (136PS)			Diesel Turbo Intercooler	TD18009
BPW			4 Cyl.	1968cc	103kW (140PS)			Diesel Turbo Intercooler	TD18010
BRC			4 Cyl.	1968cc	100kW (136PS)			Diesel Turbo Intercooler	TD20672
BRD			4 Cyl.	1968cc	125kW (170PS)			Diesel Turbo Intercooler	TD20402
BRE			4 Cyl.	1968cc	103kW (140PS)			Diesel Turbo Intercooler	TD18029
BRF			4 Cyl.	1968cc	100kW (136PS)			Diesel Turbo Intercooler	TD18748
BUY			4 Cyl.	1968cc	120kW (163PS)			Diesel Turbo Intercooler	TD20403



BVA			4 Cyl.	1968cc	120kW (163PS)		Diesel Turbo Intercooler	TD20529
BVF			4 Cyl.	1968cc	93kW (126PS)		Diesel Turbo Intercooler	TD20497
BVG			4 Cyl.	1968cc	89kW (121PS)		Diesel Turbo Intercooler	TD20496
CAGA			4 Cyl.	1968cc	105kW (143PS)		Diesel Turbo	TD20597
CAGB			4 Cyl.	1968cc	100kW (136PS)		Diesel Turbo Intercooler	TD20598
CAGC			4 Cyl.	1968cc	88kW (120PS)		Diesel Turbo Intercooler	TD21118
CAHA			4 Cyl.	1968cc	125kW (170PS)		Diesel Turbo Intercooler	TD20602
CAHB			4 Cyl.	1968cc	120kW (163PS)		Diesel Turbo Intercooler	TD20864
CBAA			4 Cyl.	1968cc	100kW (136PS)		Diesel Turbo Intercooler	TD20825
CBAB			4 Cyl.	1968cc	103kW (140PS)		Diesel Turbo Intercooler	TD20828
CFHD			4 Cyl.	1968cc	105kW (143PS)		Diesel Turbo Intercooler	TD24939
CGLA			4 Cyl.	1968cc	120kW (163PS)		Diesel Turbo	TD24406
CGLB			4 Cyl.	1968cc	125kW (170PS)		Diesel Turbo	TD24948
CGLC			4 Cyl.	1968cc	130kW (177PS)		Diesel Turbo	TD24870
CGLD			4 Cyl.	1968cc	120kW (163PS)		Diesel Turbo	TD24943
CJCA			4 Cyl.	1968cc	105kW (143PS)		Diesel Turbo	TD24949
CJCB			4 Cyl.	1968cc	100kW (136PS)		Diesel Turbo	TD24941
CMEA			4 Cyl.	1968cc	105kW (143PS)		Diesel Turbo	TD23939
CMGA			4 Cyl.	1968cc	125kW (170PS)		Diesel Turbo	TD25767
CMGB			4 Cyl.	1968cc	130kW (177PS)		Diesel Turbo	TD24871

BE/PL	1	50,858/50,878	53,700/53,712	20,400	1,403	0,020/0,073	SP	71-3930	71-3930 STD 0.25 0.50	1
MB/HL 1-5	5	53,958/53,978	59,000/59,012	18,500	2,501	0,020/0,076	EC	72-3931	H079/5 STD 0.25 0.50	
TW/A	2	59,500	73,200		1,975		AL-LF	04-3527	A123/4 STD	
TW/A	2	59,500	73,200		1,975		AL-LF	04-3528		

90 81.00 x 95.50

CBBB			4 Cyl.	1968cc	125kW (170PS)		Diesel Turbo Intercooler	TD20939
CFFA			4 Cyl.	1968cc	100kW (136PS)		Diesel Turbo Intercooler	TD23858
CFFB			4 Cyl.	1968cc	103kW (140PS)		Diesel Turbo Intercooler	TD23859
CFGB			4 Cyl.	1968cc	125kW (170PS)		Diesel Turbo Intercooler	TD23857
CFGC			4 Cyl.	1968cc	130kW (177PS)		Diesel Turbo	TD25727
CFHB			4 Cyl.	1968cc	100kW (136PS)		Diesel Turbo Intercooler	TD25662
CLJA			4 Cyl.	1968cc	103kW (140PS)		Diesel Turbo Intercooler	TD23938

BE/PL	1	50,858/50,878	53,700/53,712	20,400	1,403	0,020/0,073	SP	71-3930	71-3930 STD 0.25 0.50	1
MB/HL 1-5	5	53,958/53,978	59,000/59,012	18,500	2,501	0,020/0,076	EC	72-3931	H079/5 STD 0.25 0.50	
MB/HL 2-5	4	53,958/53,978	59,000/59,019	18,500	2,502	0,020/0,082	AL-LF	02-3085L	H1328/5 STD	7
MB/HL 2-5	4	53,958/53,978	59,000/59,019	18,500	2,502	0,020/0,082	AL-LF	02-3085U		
MB/HL 1	1	53,958/53,978	59,000/59,012	18,500	2,506	0,020/0,062		02-4941L		
MB/HL 1	1	53,958/53,978	59,000/59,012	18,500	2,506	0,020/0,062		02-4941U		



12/11 →

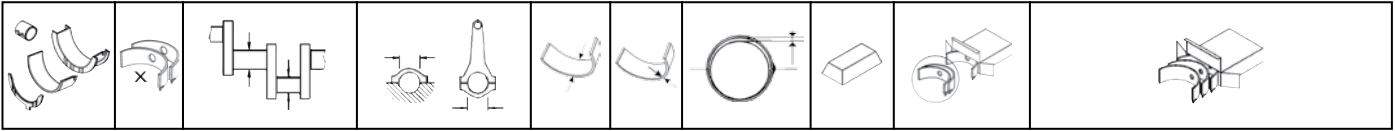

02-3085L

02-3085U

02-4941L

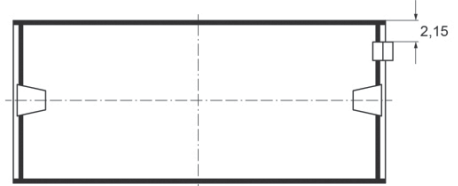
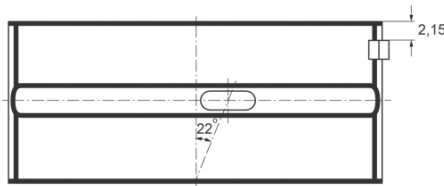
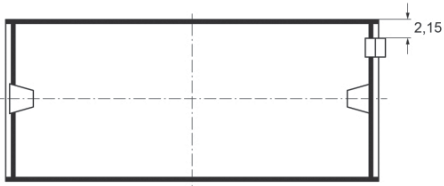

02-4941U

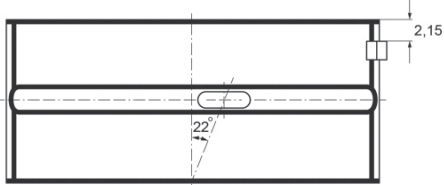

TW/A	2	59,500	73,200	1,975	AL-LF	04-3527	A123/4 STD
TW/A	2	59,500	73,200	1,975	AL-LF	04-3528	

91

81.00 x 95.50

CFGD			4 Cyl.	1968cc	120kW (163PS)		Diesel Turbo		TD25728
MB/HL 1-5	5	53,958/53,978	59,000/59,012	18,500	2,501	0,020/0,076	EC	72-3931	H079/5 STD 0.25 0.50
MB/HL 2-5	4	53,958/53,978	59,000/59,019	18,500	2,502	0,020/0,082	AL-LF	02-3085L	
MB/HL 2-5	4	53,958/53,978	59,000/59,019	18,500	2,502	0,020/0,082	AL-LF	02-3085U	
MB/HL 1	1	53,958/53,978	59,000/59,012	18,500	2,506	0,020/0,062		02-4941L	
MB/HL 1	1	53,958/53,978	59,000/59,012	18,500	2,506	0,020/0,062		02-4941U	

02-3085L

02-3085U

02-4941L

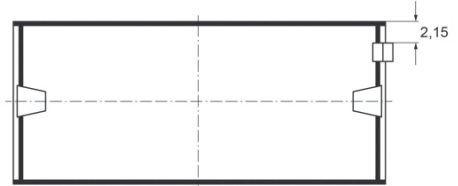
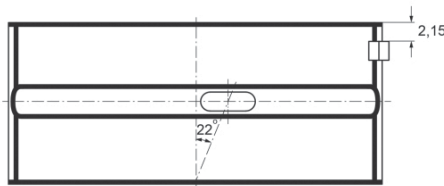
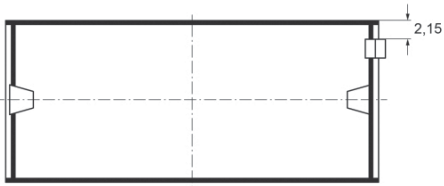

02-4941U



TW/A	2	59,500	73,200	1,975	AL-LF	04-3527	A123/4 STD
TW/A	2	59,500	73,200	1,975	AL-LF	04-3528	

92

81.00 x 95.50

CGLE		4 Cyl.	1968cc	100kW (136PS)		Diesel Turbo	TD26329
CJCC		4 Cyl.	1968cc	88kW (120PS)		Diesel Turbo Intercooler	TD26713
CJCD		4 Cyl.	1968cc	110kW (150PS)		Diesel Turbo	TD27985
CLLB		4 Cyl.	1968cc	130kW (177PS)		Diesel Turbo	TD25729

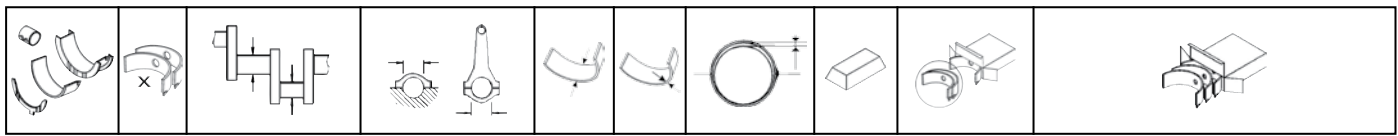

CMFA			4 Cyl.	1968cc	105kW (143PS)		Diesel Turbo		TD26714
CRBC			4 Cyl.	1968cc	110kW (150PS)		Diesel Turbo		TD26724
CRFA			4 Cyl.	1968cc	81kW (110PS)		Diesel Turbo		TD26722
CRFC			4 Cyl.	1968cc	105kW (143PS)		Diesel Turbo		TD26723
CRLB			4 Cyl.	1968cc	110kW (150PS)		Diesel Turbo Intercooler		TD26725

MB/HL 1-5	5	53,958/53,978	59,000/59,012	18,500	2,501	0,020/0,076	EC	72-3931	H079/5 STD 0.25 0.50
MB/HL 2-5	4	53,958/53,978	59,000/59,019	18,500	2,502	0,020/0,082	AL-LF	02-3085L	H1328/5 STD
MB/HL 2-5	4	53,958/53,978	59,000/59,019	18,500	2,502	0,020/0,082	AL-LF	02-3085U	
MB/HL 1	1	53,958/53,978	59,000/59,012	18,500	2,506	0,020/0,062		02-4941L	
MB/HL 1	1	53,958/53,978	59,000/59,012	18,500	2,506	0,020/0,062		02-4941U	



12/11→

02-3085L



02-3085U

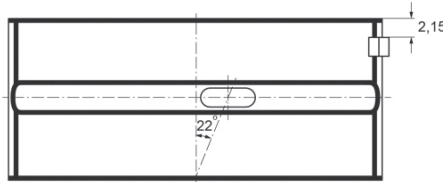

02-4941L



02-4941U

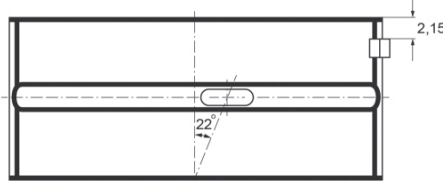

TW/A	2	59,500	73,200		1,975		AL-LF	04-3527	A123/4 STD
TW/A	2	59,500	73,200		1,975		AL-LF	04-3528	

93

81.00 x 95.50

1T			5 Cyl.	2461cc	88kW (120PS)		Diesel Turbo		TD212
AAT			5 Cyl.	2461cc	84-85kW (114-116PS)		Diesel Turbo		TD228
ABP			5 Cyl.	2461cc	85kW (115PS)		Diesel Turbo		TD235
AEL			5 Cyl.	2461cc	103kW (140PS)		Diesel Turbo Intercooler		TD245

BE/PL	1	47,758/47,778	50,600/50,612	19,000	1,395	0,032/0,089	SP	71-3732	71-3732 STD
MB/HL 1-6	6	57,958/57,978	63,000/63,019	18,500	2,502	0,020/0,082	EC	72-3400	H981/6 STD 0.25
TW/A	2	63,500/63,750	77,200/77,450		1,975		AL-LF	04-3529	A124/4 STD
TW/A	2	63,500/63,750	77,200/77,450		1,975		AL-LF	04-3530	
TW/A	2	63,500/63,750	76,950/77,200		1,975		AL-LF	04-4782	A292/4 STD
TW/A	2	63,500/63,750	76,950/77,200		1,975		AL-LF	04-4783	

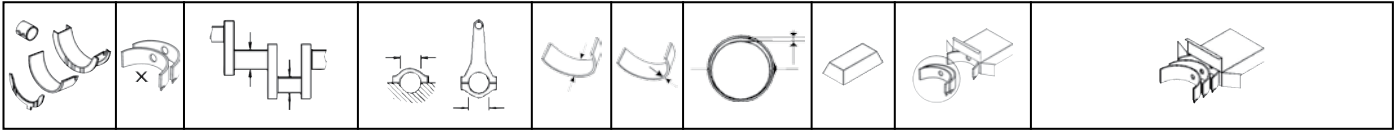

04-3529

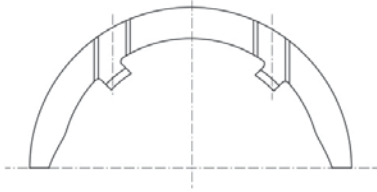

04-3530

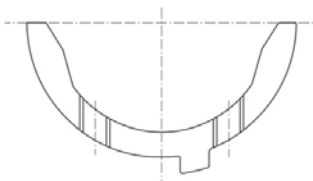

04-4782

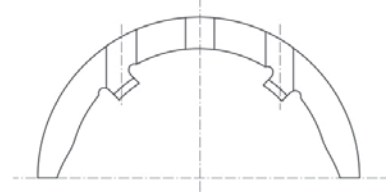

04-4783

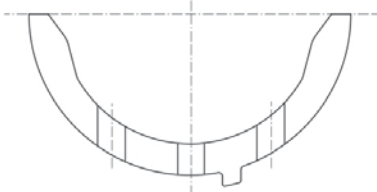

94		81.40 x 86.40							
ANB			4 Cyl.	1781cc	110kW (150PS)		Petrol Turbo Intercooler	TD13949	
BE/PL	1	47,758/47,778	50,600/50,612	19,000	1,395	0,032/0,089	SP 71-3732	71-3732 STD 1	
MB/HL 1-5	5	53,958/53,978	59,000/59,019	18,500	2,502	0,020/0,082	AL-LF 02-3085L	H084/5 STD 0.25 0.50	
MB/HL 1-5	5	53,958/53,978	59,000/59,019	18,500	2,502	0,020/0,082	AL-LF 02-3085U		
TW/A	2	59,500	73,200		1,975		AL-LF 04-3527	A123/4 STD	
TW/A	2	59,500	73,200		1,975		AL-LF 04-3528		
SE/PB	1	20,000	23,000/23,021	25,000			BC 55-3698	55-3698 SEMI	

95		82.50 x 81.00							
ABC			V6 Cyl.	2598cc	110kW (150PS)		Petrol	TD231	
ACZ			V6 Cyl.	2598cc	102kW (139PS)		Petrol	TD239	
BE/PL	6	53,958/53,978	57,600/57,612	17,000	1,806	0,020/0,069	EC 71-3711	71-3711/6 STD	
MB/HL 1-4	4	64,959/64,978	70,000/70,019	18,000	2,508	0,020/0,070	EC 72-3712	H034/4 STD 0.25	
TW/A	2	70,500	84,900		1,965		AL-LF 04-3713		
TW/A	2	70,500	84,900		1,965		AL-LF 04-3714	A138/4 STD	

96		82.50 x 86.40							
SD			4 Cyl.	1847cc	83kW (113PS)		Petrol	TD323	
BE/PL	4	47,758/47,778	50,600/50,612	19,000	1,406	0,020/0,067	EC 71-3694	71-3694/4 STD 0.25 0.50	
MB/HL	4	53,958/53,978	59,000/59,019	18,500	2,502	0,020/0,082	AL-LF 02-3085L	H027/5 STD 0.25 0.50	
MB/HL	6	53,958/53,978	59,000/59,019	18,500	2,502	0,020/0,082	AL-LF 02-3085U		
TW/A	2	59,500	73,200		1,975		AL-LF 04-3527	A123/4 STD	
TW/A	2	59,500	73,200		1,975		AL-LF 04-3528		
SE/PB	1	20,000	23,000/23,052	25,000			BC 55-3567	55-3567 SEMI	

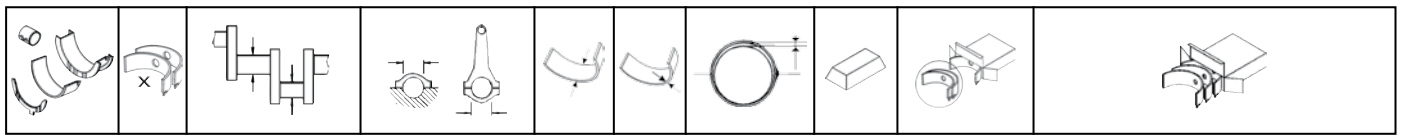

BU	1	42,959/42,975	46,055/46,095	15,000			AL-LF	07-3088	07-3088 STD SEMI	13
----	---	---------------	---------------	--------	--	--	-------	---------	----------------------------	----

Front, For intermediary shaft

BU	1	41,959/41,975	45,000/45,025	15,000			AL-LF	07-3089	07-3089 STD SEMI	13
----	---	---------------	---------------	--------	--	--	-------	---------	----------------------------	----

Rear, For intermediary shaft

97 82.50 x 86.40

7A		5 Cyl.	2309cc	122-125kW (166-170PS)			Petrol			TD221
-----------	--	--------	---------------	------------------------------	--	--	---------------	--	--	--------------

AAR		5 Cyl.	2309cc	98kW (133PS)			Petrol			TD4194
------------	--	--------	---------------	---------------------	--	--	---------------	--	--	---------------

BE/PL	5	47,758/47,778	50,600/50,612	19,000	1,406	0,020/0,067	EC	71-3694	71-3694/5 STD 0.25
MB/HL 1-6	6	57,958/57,978	63,000/63,019	18,500	2,502	0,020/0,082	EC	72-3400	H981/6 STD 0.25
TW/A	2	63,500/63,750	77,200/77,450		1,975		AL-LF	04-3529	A124/4 STD
TW/A	2	63,500/63,750	77,200/77,450		1,975		AL-LF	04-3530	
TW/A	2	63,500/63,750	76,950/77,200		1,975		AL-LF	04-4782	A292/4 STD
TW/A	2	63,500/63,750	76,950/77,200		1,975		AL-LF	04-4783	

04-3529

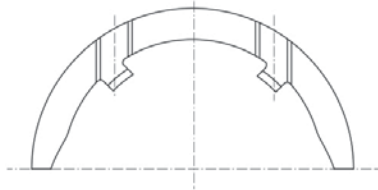

04-3530

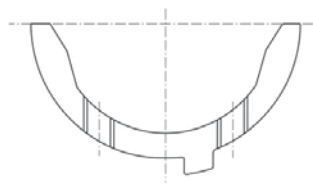

04-4782

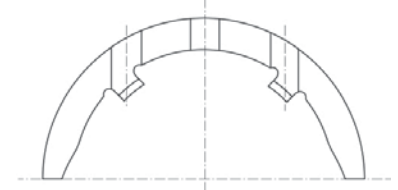

04-4783

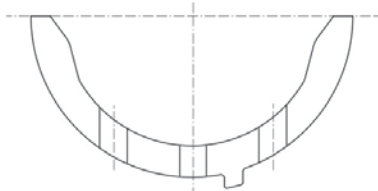

SE/PB	1	20,000	23,000/23,021	25,000			BC	55-3698	55-3698 SEMI
-------	---	--------	---------------	--------	--	--	----	---------	------------------------

98 82.50 x 86.40

NF		5 Cyl.	2309cc	97-100kW (132-136PS)			Petrol			TD301
-----------	--	--------	---------------	-----------------------------	--	--	---------------	--	--	--------------

NG		5 Cyl.	2309cc	97-100kW (132-136PS)			Petrol			TD302
-----------	--	--------	---------------	-----------------------------	--	--	---------------	--	--	--------------

BE/PL	5	47,758/47,778	50,600/50,612	19,000	1,406	0,020/0,067	EC	71-3694	71-3694/5 STD 0.25
MB/HL 1-6	6	57,958/57,978	63,000/63,019	18,500	2,502	0,020/0,082	EC	72-3400	H981/6 STD 0.25
TW/A	2	63,500/63,750	77,200/77,450		1,975		AL-LF	04-3529	A124/4 STD
TW/A	2	63,500/63,750	77,200/77,450		1,975		AL-LF	04-3530	
TW/A	2	63,500/63,750	76,950/77,200		1,975		AL-LF	04-4782	A292/4 STD
TW/A	2	63,500/63,750	76,950/77,200		1,975		AL-LF	04-4783	

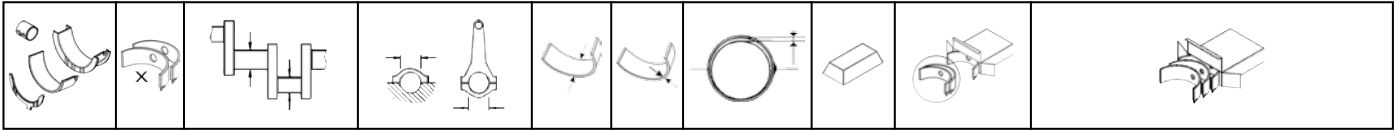

04-3529

04-3530

04-4782

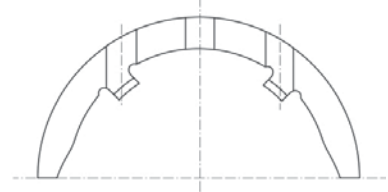
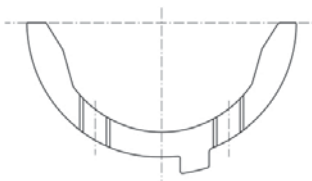
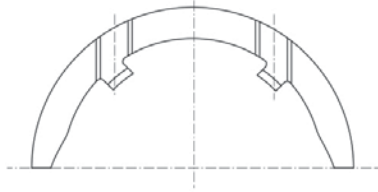

04-4783

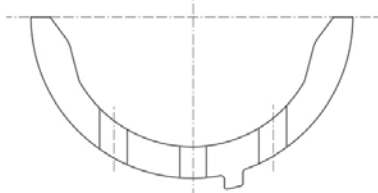

SE/PB	1	20,000	23,000/23,052	25,000			BC	55-3567	55-3567 SEMI
-------	---	--------	---------------	--------	--	--	----	---------	-----------------

Mot. → ch44L300000

SE/PB	1	20,000	23,000/23,021	25,000			BC	55-3698	55-3698 SEMI
-------	---	--------	---------------	--------	--	--	----	---------	-----------------

55-3567

55-3698

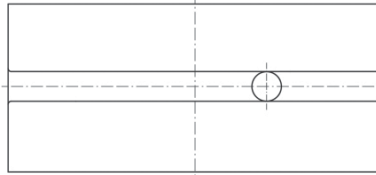
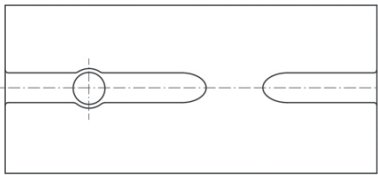

99 82.50 x 86.40

AAH	V6 Cyl.	2771cc	128kW (174PS)	Petrol	TD224
ACK	V6 Cyl.	2771cc	142kW (193PS)	Petrol	TD4197
AEJ	V6 Cyl.	2771cc	120-128kW (163-174PS)	Petrol	TD9541
AFC	V6 Cyl.	2771cc	120-128kW (163-174PS)	Petrol	TD246
ALG	V6 Cyl.	2771cc	142kW (193PS)	Petrol	TD9516
AMX	V6 Cyl.	2771cc	142kW (193PS)	Petrol	TD13930
APR Euro 2	V6 Cyl.	2771cc	142kW (193PS)	Petrol	TD13931
AQD Euro 2	V6 Cyl.	2771cc	142kW (193PS)	Petrol	TD13932
ATX	V6 Cyl.	2771cc	140kW (190PS)	Petrol	TD15617
BBG	V6 Cyl.	2771cc	140kW (190PS)	Petrol	TD19142

BE/PL	6	53,958/53,978	57,600/57,612	17,000	1,806	0,020/0,069	EC	71-3711	71-3711/6 STD
MB/HL 1-4	4	64,959/64,978	70,000/70,019	18,000	2,508	0,020/0,070	EC	72-3712	H034/4 STD 0.25
TW/A	2	70,500	84,900		1,965		AL-LF	04-3713	A138/4 STD
TW/A	2	70,500	84,900		1,965		AL-LF	04-3714	

100 82.50 x 86.40

AGE	V6 Cyl.	2771cc	132kW (180PS)	Petrol	TD15616				
BE/PL	6	53,958/53,978	57,600/57,612	17,000	1,806	0,020/0,069	EC	71-3711	71-3711/6 STD
TW/A	2	70,500	84,900		1,965		AL-LF	04-3713	A138/4 STD
TW/A	2	70,500	84,900		1,965		AL-LF	04-3714	



101 82.50 x 92.80

3A	4 Cyl.	1984cc	80-83kW (109-113PS)	Petrol	TD4191
6A	4 Cyl.	1984cc	101kW (137PS)	Petrol	TD4193
AAE	4 Cyl.	1984cc	74kW (100PS)	Petrol	TD223

BE/PL	4	47,758/47,778	50,600/50,612	19,000	1,406	0,020/0,067	EC	71-3694	71-3694/4 STD 0.25 0.50
MB/HL	4	53,958/53,978	59,000/59,019	18,500	2,502	0,020/0,082	AL-LF	02-3085L	H027/5 STD 0.25 0.50
MB/HL	6	53,958/53,978	59,000/59,019	18,500	2,502	0,020/0,082	AL-LF	02-3085U	
TW/A	2	59,500	73,200		1,975		AL-LF	04-3527	A123/4 STD
TW/A	2	59,500	73,200		1,975		AL-LF	04-3528	
SE/PB	1	20,000	23,000/23,021	25,000			BC	55-3698	55-3698 SEMI
BU	1	42,959/42,975	46,055/46,095	15,000			AL-LF	07-3088	07-3088 STD SEMI

Front, For intermediary shaft

BU	1	41,959/41,975	45,000/45,025	15,000			AL-LF	07-3089	07-3089 STD SEMI
----	---	---------------	---------------	--------	--	--	-------	---------	----------------------------

Rear, For intermediary shaft

102 82.50 x 92.80

AAD	4 Cyl.	1984cc	82-85kW (112-115PS)	Petrol	TD222
ABK	4 Cyl.	1984cc	85kW (115PS)	Petrol	TD233
ABT	4 Cyl.	1984cc	66kW (90PS)	Petrol	TD236
ACE	4 Cyl.	1984cc	101-103kW (137-140PS)	Petrol	TD238
ADW	4 Cyl.	1984cc	79kW (107PS)	Petrol	TD243

BE/PL	4	47,758/47,778	50,600/50,612	19,000	1,406	0,020/0,067	EC	71-3694	71-3694/4 STD 0.25 0.50
MB/HL	4	53,958/53,978	59,000/59,019	18,500	2,502	0,020/0,082	AL-LF	02-3085L	H027/5 STD 0.25 0.50
MB/HL	6	53,958/53,978	59,000/59,019	18,500	2,502	0,020/0,082	AL-LF	02-3085U	
TW/A	2	59,500	73,200		1,975		AL-LF	04-3527	A123/4 STD
TW/A	2	59,500	73,200		1,975		AL-LF	04-3528	
BU	1	42,959/42,975	46,055/46,095	15,000			AL-LF	07-3088	07-3088 STD SEMI

Front, For intermediary shaft

BU	1	41,959/41,975	45,000/45,025	15,000			AL-LF	07-3089	07-3089 STD SEMI
----	---	---------------	---------------	--------	--	--	-------	---------	----------------------------

Rear, For intermediary shaft

103 82.50 x 92.80

ALT	4 Cyl.	1984cc	96kW (130PS)	Petrol	TD15345
AWA	4 Cyl.	1984cc	110kW (150PS)	Petrol	TD17035
AXW	4 Cyl.	1984cc	110kW (150PS)	Petrol	TD16872
BLR	4 Cyl.	1984cc	110kW (150PS)	Petrol	TD18199
BLX	4 Cyl.	1984cc	110kW (150PS)	Petrol	TD17404
BLY	4 Cyl.	1984cc	110kW (150PS)	Petrol	TD17405
BMB	4 Cyl.	1984cc	110kW (150PS)	Petrol	TD17406
BVY	4 Cyl.	1984cc	110kW (150PS)	Petrol	TD18200
BVZ	4 Cyl.	1984cc	110kW (150PS)	Petrol	TD18201

BE/PL	4	47,758/47,778	50,600/50,612	19,000	1,406	0,020/0,067	EC	71-3929	71-3929/4 STD 11
MB/HL 1-5	5	53,958/53,978	59,000/59,019	18,500	2,502	0,020/0,082	AL-LF	02-3085L	H084/5 STD 0.25 0.50
MB/HL 1-5	5	53,958/53,978	59,000/59,019	18,500	2,502	0,020/0,082	AL-LF	02-3085U	

104 82.50 x 92.80

AXA	4 Cyl.		1984cc	85kW (115PS)	Petrol			TD16865
------------	--------	--	---------------	---------------------	---------------	--	--	----------------

BE/PL	4	47,758/47,778	50,600/50,612	19,000	1,406	0,020/0,067	EC	71-3694	71-3694/4 STD 0.25 0.50
-------	---	---------------	---------------	--------	-------	-------------	----	---------	-----------------------------------

Mot.→7J-5-036000

BE/PL	4	47,758/47,778	50,600/50,612	19,000	1,406	0,020/0,067	EC	71-3929	71-3929/4 STD 11
-------	---	---------------	---------------	--------	-------	-------------	----	---------	---

Mot.7J-5-036001→

71-3694

71-3929

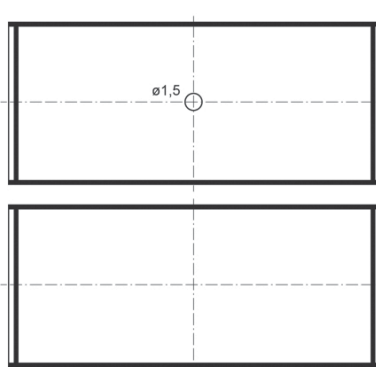
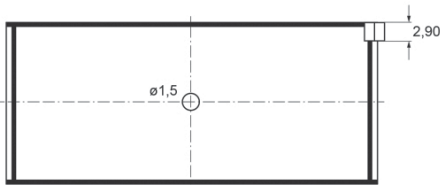

TW/A	2	59,500	73,200		1,975		AL-LF	04-3527	A123/4 STD
TW/A	2	59,500	73,200		1,975		AL-LF	04-3528	
SE/PB	1	20,000	23,000/23,021	25,000			BC	55-3698	55-3698 SEMI
BU	1	42,959/42,975	46,055/46,095	15,000			AL-LF	07-3088	07-3088 STD SEMI 13

Front, For intermediary shaft

BU	1	41,959/41,975	45,000/45,025	15,000			AL-LF	07-3089	07-3089 STD SEMI 13
----	---	---------------	---------------	--------	--	--	-------	---------	--

Rear, For intermediary shaft

105 82.50 x 92.80

ASN	V6 Cyl.		2976cc	162kW (220PS)	Petrol			TD15346
------------	---------	--	---------------	----------------------	---------------	--	--	----------------

BE/PL	6	53,958/53,978	57,600/57,612	17,000	1,806	0,020/0,069	EC	71-3711	71-3711/6 STD
MB/HL 1-4	4	64,959/64,978	70,000/70,019	18,000	2,508	0,020/0,070	EC	72-3712	H034/4 STD 0.25
TW/A	2	70,500	84,900		1,965		AL-LF	04-3713	A138/4 STD
TW/A	2	70,500	84,900		1,965		AL-LF	04-3714	

106 82.50 x 92.80

AVK	V6 Cyl.		2976cc	162-164kW (220-223PS)	Petrol			TD17863
------------	---------	--	---------------	------------------------------	---------------	--	--	----------------

BBJ	V6 Cyl.		2976cc	160-162kW (218-220PS)	Petrol			TD16516
------------	---------	--	---------------	------------------------------	---------------	--	--	----------------

MB/HL 1-4	4	64,959/64,978	70,000/70,019	18,000	2,508	0,020/0,070	EC	72-3712	H034/4 STD 0.25
--------------	---	---------------	---------------	--------	-------	-------------	----	---------	---------------------------



107										84.00 x 95.90									
BDB			V6 Cyl. 3189cc			184kW (250PS)			Petrol			TD17068							
BHE			V6 Cyl. 3189cc			184kW (250PS)			Petrol			TD17029							
BMJ			V6 Cyl. 3189cc			184kW (250PS)			Petrol			TD17407							
BPF			V6 Cyl. 3189cc			184kW (250PS)			Petrol			TD20705							
BUB			V6 Cyl. 3189cc			184-186kW (250-253PS)			Petrol			TD19200							
BE/PL	6	53,958/53,978	56,800/56,819	17,000	1,406	0,020/0,074	AL-LF	01-3841	01-3841/6 STD 0.25										
TW/A	2	65,450	80,000		1,723		AL-LF	04-3717	A139/4 STD										
TW/A	2	65,450	80,000		1,723		AL-LF	04-3718											
BU	1	42,959/42,975	46,055/46,095	15,000			AL-LF	07-3088	07-3088 STD SEMI [13]										
Front, For intermediary shaft																			
BU	1	14,473/14,484	17,500/17,518	20,000			BB	17-3720	17-3720 SEMI [13]										
Rear, For intermediary shaft																			

108										84.50 x 82.40									
BDX			V6 Cyl. 2773cc			154kW (210PS)			Petrol			TD20108							
CCDA			V6 Cyl. 2773cc			140kW (190PS)			Petrol			TD21174							
CCEA			V6 Cyl. 2773cc			162kW (220PS)			Petrol			TD21175							
CHVA Euro 5			V6 Cyl. 2773cc			150kW (204PS)			Petrol Turbo Intercooler			TD24758							
CNYA Euro 5			V6 Cyl. 2773cc			150kW (204PS)			Petrol Turbo Intercooler			TD24757							
BE/PL	6	53,958/53,978	56,800/56,819	17,000	1,406	0,010/0,069	AL-LF	01-4818	01-4818/6 STD										
MB/HL 1-4	4	57,958/57,978	63,000/63,019	18,500	2,503	0,026/0,085	AL-LF	02-4819	H1300/4 STD										

109										84.50 x 82.40									
AEW			V8 Cyl. 3697cc			169kW (230PS)			Petrol			TD4201							
BE/PL	8	53,958/53,978	56,800/56,819	17,000	1,406	0,020/0,074	AL-LF	01-3841	01-3841/8 STD										

110										84.50 x 82.40									
AKC			V8 Cyl. 3697cc			191kW (260PS)			Petrol			TD15343							
AQG			V8 Cyl. 3697cc			191kW (260PS)			Petrol			TD11358							
BE/PL	8	49,958/49,978	53,200/53,219	18,000	1,601	0,020/0,084	EC	71-3933	71-3933/8 STD										
TW/A	2	70,500	84,900		1,965		AL-LF	04-3713	A138/4 STD										
TW/A	2	70,500	84,900		1,965		AL-LF	04-3714											

111										84.50 x 92.80									
AUK			V6 Cyl. 3123cc			188kW (255PS)			Petrol			TD17376							
MB/HL 1-4	4	64,959/64,978	70,000/70,019	18,000	2,508	0,020/0,070	EC	72-3712	H034/4 STD 0.25										
TW/A	2	70,500	84,900		1,965		AL-LF	04-3713	A138/4 STD										
TW/A	2	70,500	84,900		1,965		AL-LF	04-3714											









cm3



9

Allegro 1.0	01/80→10/83	Petrol	99 H	999	4	64.60	76.20	1
Allegro 1.1	05/73→10/81	Petrol	10 H	1098	4	64.60	83.70	4
Allegro 1.3	05/73→12/84	Petrol	12 H	1275	4	70.60	81.40	10
Allegro 1.3	01/75→03/82	Petrol	12 L	1275	4	70.60	81.30	8
Ambassador 1.7	03/82→02/84	Petrol	17 HL	1698	4	84.50	75.80	14
Ambassador 2.0	03/82→10/84	Petrol	20 H	1994	4	84.50	89.00	15
America 1.3	09/67→12/72	Petrol	12 H	1275	4	70.60	81.40	10
Maestro	09/92→01/95	Diesel	Prima 80T	1994	4	84.45	89.00	13
Maestro 1.3	03/83→09/92	Petrol	12 H	1275	4	70.60	81.40	10
Maestro 1.3	03/83→08/85	Petrol	12 H999AA	1275	4	70.60	81.30	7
Maestro 1.3	03/83→08/85	Petrol	12 HC32	1275	4	70.60	81.30	7
Maestro 1.3	01/86→09/92	Petrol	12 HE	1275	4	70.60	81.30	7
Maestro 1.3 LS	03/83→08/90	Petrol	12 H	1275	4	70.60	81.40	10
Maestro 2.0 EFi	10/84→08/90	Petrol	20 HA50AA	1994	4	84.50	89.00	15
Maestro 2.0 EFi	10/84→08/90	Petrol	20 HC51AA	1994	4	84.50	89.00	15
Maestro 2.0 EFi	10/84→08/90	Petrol	20 HC81	1994	4	84.50	89.00	15
Maestro, Montego 2.0 TD DL, DSL	10/88→01/95	Diesel	Prima 80T	1994	4	84.45	89.00	13
Metro 1.0	10/80→04/90	Petrol	99 H	999	4	64.60	76.20	1
Metro 1.0 Surf HLE	10/80→04/90	Petrol	99 HA65P	999	4	64.60	76.20	1
Metro 1.3	10/80→12/85	Petrol	12 H996AA	1275	4	70.60	81.30	6
Metro 1.3	10/80→04/90	Petrol	12 HA83AA	1275	4	70.60	81.30	6
Metro 1.3	10/80→12/83	Petrol	12 HL	1275	4	70.60	81.30	6
Metro 1.3 L,HLE,S	10/80→04/90	Petrol	12 H	1275	4	70.60	81.40	10
Metro 1.3 Surf	11/85→04/90	Petrol	12 HC21AA	1273	4	70.60	81.30	7
Metro 1.3 Turbo	10/83→04/90	Petrol	12 HA85AA	1275	4	70.60	81.30	7
Mini 1.3	04/74→09/80	Petrol	12 H	1275	4	70.60	81.40	10
Mini 1.3	09/69→09/80	Petrol	12 HC	1275	4	70.60	81.30	8
Mini 850	01/67→08/79	Petrol	BMC Serie A	848	4	69.92	68.26	5
Mini 1000	10/67→09/84	Petrol	99 H	999	4	64.60	76.20	1
Mini 1000 Mayfair	08/82→06/93	Petrol	99 H997P	998	4	64.60	76.20	1
Mini 1000 Mayfair	08/82→06/93	Petrol	99 HA53P	998	4	64.60	76.20	1
Mini 1000 Mayfair	08/82→06/93	Petrol	99 HC20P	998	4	64.60	76.20	1
Mini 1000 Mayfair	09/88→06/93	Petrol	99 HD81	999	4	64.60	76.20	2
Mini 1100 Special	01/76→08/81	Petrol	10 H	1098	4	64.60	83.70	4
Mini Cooper S	01/63→12/64	Petrol	A Series	1071	4	80.00	64.00	11
Mini Cooper S 1.1, I	01/63→10/67	Petrol	A Series	1071	4	80.00	64.00	11
Mini Cooper S I	01/63→10/67	Petrol	A Series	1071	4	80.00	64.00	11
Minor 1.0 Series III	01/57→12/62	Diesel	A Series	948	4	62.92	76.20	3
Montego 1.3	04/84→10/88	Petrol	12 HL	1275	4	70.60	81.30	6
Montego 2.0	04/84→08/91	Petrol	20 H	1994	4	84.50	89.00	15
Montego 2.0	04/84→08/91	Petrol	20 HSC	1994	4	84.50	89.00	15
Montego 2.0 HLI	10/84→08/88	Petrol	20 H	1994	4	84.50	89.00	15
Montego 2.0 Mayfair	04/84→08/88	Petrol	20 H(EFI)	1994	4	84.50	89.00	15
Montego 2.0 Turbo	04/84→08/88	Petrol	20 HC85	1994	4	84.50	89.00	15
Montego 2.0 TD DL, DSL	10/88→01/95	Diesel	Prima 80T	1994	4	84.45	89.00	13
Princess 1800 HL	04/76→09/78	Petrol	18 H	1798	4	80.25	88.90	12
Princess 2 1700	10/78→10/82	Petrol	17 HL	1698	4	84.50	75.80	14
Princess 2 2000	10/78→10/82	Petrol	20 H	1994	4	84.50	89.00	15

			cm3	x 			
10 H	Petrol	1098	4	64.60	83.70	4	
12CC	Petrol	1275	4	70.60	81.30	8	
12 H	Petrol	1275	4	70.60	81.40	10	
12H	Petrol	1275	4	70.60	81.40	10	
12 H	Petrol	1275	4	70.60	81.40	10	
12 H	Petrol	1275	4	70.60	81.40	10	
12 H996AA	Petrol	1275	4	70.60	81.30	6	
12 H999AA	Petrol	1275	4	70.60	81.30	7	
12 HA83AA	Petrol	1275	4	70.60	81.30	6	
12 HA85AA	Petrol	1275	4	70.60	81.30	7	
12 HC	Petrol	1275	4	70.60	81.30	8	
12 HC21AA	Petrol	1273	4	70.60	81.30	7	
12 HC32	Petrol	1275	4	70.60	81.30	7	
12 HE	Petrol	1275	4	70.60	81.30	7	
12 HL	Petrol	1275	4	70.60	81.30	6	
12 L	Petrol	1275	4	70.60	81.30	8	
17 HL	Petrol	1698	4	84.50	75.80	14	
18 H	Petrol	1798	4	80.25	88.90	12	
18HH	Petrol	1798	4	80.25	88.90	12	
18HL	Petrol	1798	4	80.25	88.90	12	
20 H	Petrol	1994	4	84.50	89.00	15	
20 H(EFI)	Petrol	1994	4	84.50	89.00	15	
20 HA50AA	Petrol	1994	4	84.50	89.00	15	
20 HC51AA	Petrol	1994	4	84.50	89.00	15	
20 HC81	Petrol	1994	4	84.50	89.00	15	
20 HC85	Petrol	1994	4	84.50	89.00	15	
20 HSC	Petrol	1994	4	84.50	89.00	15	
99 H	Petrol	999	4	64.60	76.20	1	
99 H997P	Petrol	998	4	64.60	76.20	1	
99 HA53P	Petrol	998	4	64.60	76.20	1	
99 HA65P	Petrol	999	4	64.60	76.20	1	
99 HC20P	Petrol	998	4	64.60	76.20	1	
99 HD81	Petrol	999	4	64.60	76.20	2	
99LFD	Petrol	998	4	64.60	76.20	3	
A Series	Petrol	1071	4	80.00	64.00	11	
BLM C 12 H	Petrol	1275	4	70.60	81.30	9	
BLM C 99 H	Petrol	999	4	64.60	76.20	3	
BMC Serie A	Petrol	848	4	69.92	68.26	5	
Prima 80T	Diesel	1994	4	84.45	89.00	13	



1	64.60 x 76.20								
99 H		4 Cyl.	999cc	29-33kW (39-45PS)		Petrol			TD4215
99 H997P		4 Cyl.	998cc	31kW (42PS)		Petrol			TD5473
99 HA53P		4 Cyl.	998cc	31kW (42PS)		Petrol			TD5472
99 HA65P		4 Cyl.	999cc	35kW (48PS)		Petrol			TD383
99 HC20P		4 Cyl.	998cc	31kW (42PS)		Petrol			TD5474

BE/PL	4	41,285/41,298	44,970/44,983	22,350	1,825	0,022/0,073	AL-LF	2965RA	01-4313/4 STD 0.25 0.50 0.75
BE/PL	8	41,285/41,298	44,970/44,983	22,350	1,825	0,024/0,073	BS	71-4869	71-4869/4 STD 0.25

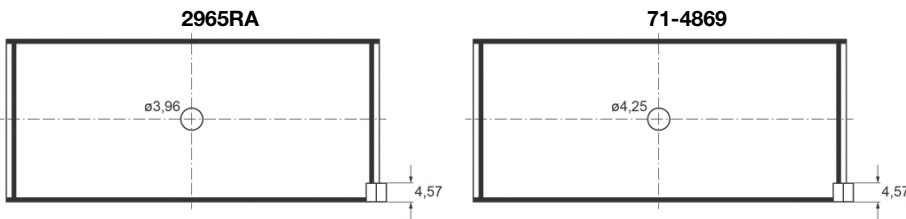

MB/HL 1-3	6	44,463/44,475	48,158/48,171	27,100	1,830		BS	GS705LC	H1310/3 STD 0.25 0.50 0.75
-----------	---	---------------	---------------	--------	-------	--	----	---------	--------------------------------------

→12/82

MB/HL 1-3	3	44,463/44,475	48,158/48,171	27,100	1,830		BS	GS705LC	H1311/3 STD 0.25
MB/HL 1-3	3	44,463/44,475	48,158/48,171	27,100	1,830		BS	GS705LCB	

01/83→

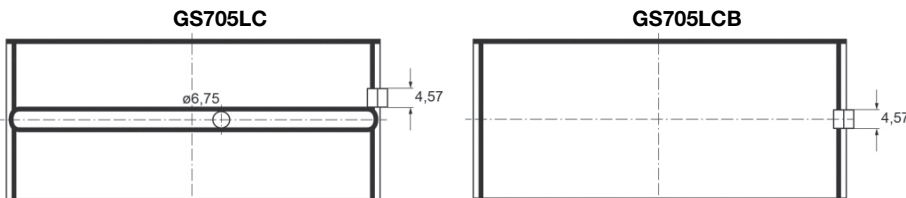

TW/A	2	49,910/50,160	71,750/72,000		2,360		EC	54-2304	A005/4 STD
TW/A	2	49,910/50,160	71,750/72,000		2,360		EC	54-3337	
CB/NWB 1	1	42,279/42,991	45,606/45,631	28,700			BB	2064DR	N162/3 STD
CB/NWB 2	1	41,217/41,229	44,539/44,552	19,180			BB	2066DRI	
CB/NWB 3	1	34,867/34,879	38,189/38,209	13,600			BB	2067DRI	

2	64.60 x 76.20								
99 HD81		4 Cyl.	999cc	30kW (41PS)		Petrol			TD5471

BE/PL	4	41,285/41,298	44,970/44,983	22,350	1,825	0,022/0,073	AL-LF	2965RA	01-4313/4 STD 0.25 0.50 0.75
BE/PL	8	41,285/41,298	44,970/44,983	22,350	1,825	0,024/0,073	BS	71-4869	71-4869/4 STD 0.25

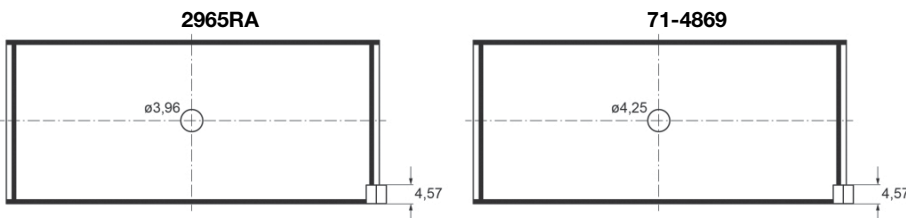

MB/HL 1-3	3	44,463/44,475	48,158/48,171	27,100	1,830		BS	GS705LC	H1311/3 STD 0.25
MB/HL 1-3	3	44,463/44,475	48,158/48,171	27,100	1,830		BS	GS705LCB	
TW/A	2	49,910/50,160	71,750/72,000		2,360		EC	54-2304	A005/4 STD
TW/A	2	49,910/50,160	71,750/72,000		2,360		EC	54-3337	
CB/NWB 1	1	42,279/42,991	45,606/45,631	28,700			BB	2064DR	N162/3 STD
CB/NWB 2	1	41,217/41,229	44,539/44,552	19,180			BB	2066DRI	
CB/NWB 3	1	34,867/34,879	38,189/38,209	13,600			BB	2067DRI	

3

64.60 x 76.20

99LFD			4 Cyl.	998cc	28kW (38PS)		Petrol		TD21768
BLM C 99 H			4 Cyl.	999cc	27-51kW (37-69PS)		Petrol		TD4574
BE/PL	4	41,285/41,298	44,970/44,983	22,350	1,825	0,022/0,073	AL-LF	2965RA	01-4313/4 STD 0.25 0.50 0.75
BE/PL	8	41,285/41,298	44,970/44,983	22,350	1,825	0,024/0,073	BS	71-4869	71-4869/4 STD 0.25

2965RA

71-4869

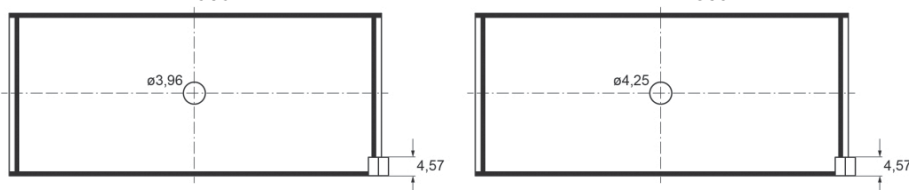

MB/HL 1-3	6	44,463/44,475	48,158/48,171	27,100	1,830		BS	GS705LC	H1310/3 STD 0.25 0.50 0.75
TW/A	2	49,910/50,160	71,750/72,000		2,360		EC	54-2304	A005/4 STD
TW/A	2	49,910/50,160	71,750/72,000		2,360		EC	54-3337	
CB/NWB 1	1	42,279/42,991	45,606/45,631	28,700			BB	2064DR	N162/3 STD
CB/NWB 2	1	41,217/41,229	44,539/44,552	19,180			BB	2066DRI	
CB/NWB 3	1	34,867/34,879	38,189/38,209	13,600			BB	2067DRI	

4

64.60 x 83.70

10 H			4 Cyl.	1098cc	33-36kW (45-49PS)		Petrol		TD384
BE/PL	4	41,285/41,298	44,970/44,983	22,350	1,825	0,022/0,073	AL-LF	2965RA	01-4313/4 STD 0.25 0.50 0.75
BE/PL	8	41,285/41,298	44,970/44,983	22,350	1,825	0,024/0,073	BS	71-4869	71-4869/4 STD 0.25

2965RA

71-4869

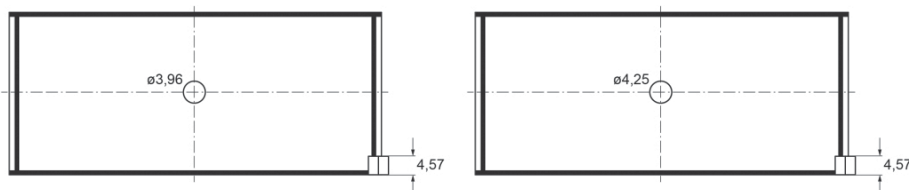

MB/HL 1-3	6	44,463/44,475	48,158/48,171	27,100	1,830		BS	GS705LC	H1310/3 STD 0.25 0.50 0.75
-----------	---	---------------	---------------	--------	-------	--	----	---------	--------------------------------------

AUSTIN

TW/A	2	49,910/50,160	71,750/72,000		2,360		EC	54-2304	A005/4 STD
TW/A	2	49,910/50,160	71,750/72,000		2,360		EC	54-3337	
CB/NWB 1	1	42,279/42,991	45,606/45,631	28,700			BB	2064DR	N162/3 STD
CB/NWB 2	1	41,217/41,229	44,539/44,552	19,180			BB	2066DRI	
CB/NWB 3	1	34,867/34,879	38,189/38,209	13,600			BB	2067DRI	

5 69.92 x 68.26

BMC Serie A		4 Cyl.	848cc	25-26kW (34-35PS)	Petrol			TD13428	
BE/PL	4	41,285/41,298	44,970/44,983	22,350	1,825	0,022/0,073	AL-LF	2965RA	01-4313/4 STD 0.25 0.50 0.75
BE/PL	8	41,285/41,298	44,970/44,983	22,350	1,825	0,024/0,073	BS	71-4869	71-4869/4 STD 0.25

2965RA

71-4869

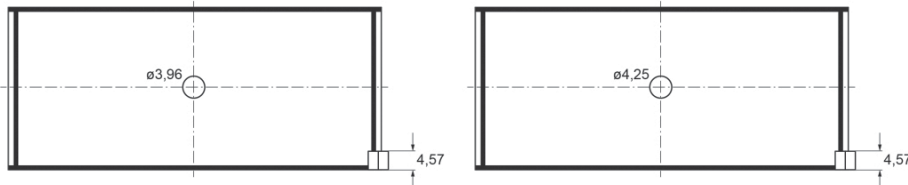

MB/HL 1-3	6	44,463/44,475	48,158/48,171	27,100	1,830		BS	GS705LC	H1310/3 STD 0.25 0.50 0.75
--------------	---	---------------	---------------	--------	-------	--	----	---------	--------------------------------------

01/69 →

CB/NWB 1	1	42,279/42,991	45,606/45,631	28,700			BB	2064DR	N162/3 STD
CB/NWB 2	1	41,217/41,229	44,539/44,552	19,180			BB	2066DRI	
CB/NWB 3	1	34,867/34,879	38,189/38,209	13,600			BB	2067DRI	

6 70.60 x 81.30

12 H996AA		4 Cyl.	1275cc	52kW (71PS)	Petrol			TD13429	
12 HA83AA		4 Cyl.	1275cc	51kW (69PS)	Petrol			TD5468	
12 HL		4 Cyl.	1275cc	46-51kW (63-69PS)	Petrol			TD16446	

BE/PL	4	44,460/44,473	48,146/48,158	21,590	1,830	0,020/0,063	AL-LF	65905RA	01-4331/4 STD 0.25 0.50 0.75
MB/HL 1-3	6	50,813/50,825	54,509/54,521	25,020	1,830	0,025/0,063	BS	AE4691	H1312/3 STD 0.25 0.50 0.75

→12/82

MB/HL 1-3	3	50,813/50,825	54,509/54,521	25,020	1,830	0,025/0,063	BS	AE4691	H1313/3 STD 0.25 0.50
MB/HL 1-3	3	50,830/50,840	54,510/54,520	25,020			BS	AE6568	

01/83 →

AE4691

AE6568

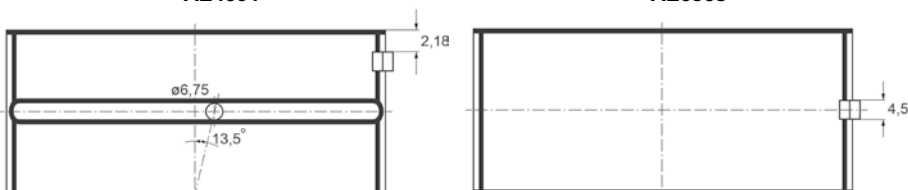

TW/A	2	56,260/56,510	76,073/76,327		2,340			EC	54-2848L	A006/4 STD
TW/A	2	56,260/56,510	76,073/76,327		2,340			EC	54-2848U	
CB/NWB 1	1	42,341/42,392	45,605/45,631	28,830	1,630			BB	1096DR	N181/3 STD
CB/NWB 2	1	41,262/41,300	44,526/44,551	19,300	1,630			BB	1097DR	
CB/NWB 3	1	34,912/34,963	38,176/38,202	19,690	1,630			BB	1098DR	

7 70.60 x 81.30

12 H999AA			4 Cyl.	1275cc	46kW (63PS)			Petrol		TD5458
12 HA85AA			4 Cyl.	1275cc	66kW (90PS)			Petrol Turbo		TD5469
12 HC21AA			4 Cyl.	1273cc	44kW (60PS)			Petrol		TD5470
12 HC32			4 Cyl.	1275cc	46kW (63PS)			Petrol		TD5459
12 HE			4 Cyl.	1275cc	50kW (68PS)			Petrol		TD22435
BE/PL	4	44,460/44,473	48,146/48,158	21,590	1,830	0,020/0,063	AL-LF	65905RA		01-4331/4 STD 0.25 0.50 0.75
MB/HL 1-3	3	50,813/50,825	54,509/54,521	25,020	1,830	0,025/0,063	BS	AE4691		H1313/3 STD 0.25 0.50
MB/HL 1-3	3	50,830/50,840	54,510/54,520	25,020			BS	AE6568		
TW/A	2	56,260/56,510	76,073/76,327		2,340			EC	54-2848L	A006/4 STD
TW/A	2	56,260/56,510	76,073/76,327		2,340			EC	54-2848U	
CB/NWB 1	1	42,341/42,392	45,605/45,631	28,830	1,630			BB	1096DR	N181/3 STD
CB/NWB 2	1	41,262/41,300	44,526/44,551	19,300	1,630			BB	1097DR	
CB/NWB 3	1	34,912/34,963	38,176/38,202	19,690	1,630			BB	1098DR	

8 70.60 x 81.30

12 HC			4 Cyl.	1275cc	53kW (72PS)			Petrol		TD22493
12 L			4 Cyl.	1275cc	43kW (58PS)			Petrol		TD22494
12CC			4 Cyl.	1275cc	48kW (65PS)			Petrol		TD22427
BE/PL	4	44,460/44,473	48,146/48,158	21,590	1,830	0,020/0,063	AL-LF	65905RA		01-4331/4 STD 0.25 0.50 0.75
BE/PL	8	44,460/44,473	48,146/48,158	21,590	1,826	0,020/0,071	BS	71-4870		71-4870/4 0.25
MB/HL 1-3	6	50,813/50,825	54,509/54,521	25,020	1,830	0,025/0,063	BS	AE4691		H1312/3 STD 0.25 0.50 0.75
TW/A	2	56,260/56,510	76,073/76,327		2,340			EC	54-2848L	A006/4 STD
TW/A	2	56,260/56,510	76,073/76,327		2,340			EC	54-2848U	
CB/NWB 1	1	42,341/42,392	45,605/45,631	28,830	1,630			BB	1096DR	N181/3 STD
CB/NWB 2	1	41,262/41,300	44,526/44,551	19,300	1,630			BB	1097DR	
CB/NWB 3	1	34,912/34,963	38,176/38,202	19,690	1,630			BB	1098DR	

AUSTIN



9		70.60 x 81.30								
BLM C 12 H		4 Cyl.				1275cc	47kW (64PS)	Petrol		TD18413
BE/PL	4	44,460/44,473	48,146/48,158	21,590	1,830	0,020/0,063	AL-LF	65905RA	01-4331/4 STD 0.25 0.50 0.75	
MB/HL 1-3	6	50,813/50,825	54,509/54,521	25,020	1,830	0,025/0,063	BS	AE4691	H1312/3 STD 0.25 0.50 0.75	
TW/A	2	56,260/56,510	76,073/76,327		2,340		EC	54-2848L	A006/4 STD	
TW/A	2	56,260/56,510	76,073/76,327		2,340		EC	54-2848U		
CB/NWB 1	1	42,341/42,392	45,605/45,631	28,830	1,630		BB	1096DR	N181/3 STD	
CB/NWB 2	1	41,262/41,300	44,526/44,551	19,300	1,630		BB	1097DR		
CB/NWB 3	1	34,912/34,963	38,176/38,202	19,690	1,630		BB	1098DR		

10		70.60 x 81.40								
12 H		4 Cyl.				1275cc	40-49kW (54-67PS)	Petrol		TD381
12 H		4 Cyl.				1275cc	52kW (71PS)	Petrol		TD26926
12 H		4 Cyl.				1275cc	46-47kW (63-64PS)	Petrol		TD22121
12H		4 Cyl.				1275cc	43-48kW (58-65PS)	Petrol		TD21773
BE/PL	4	44,460/44,473	48,146/48,158	21,590	1,830	0,020/0,063	AL-LF	65905RA	01-4331/4 STD 0.25 0.50 0.75	
MB/HL 1-3	6	50,813/50,825	54,509/54,521	25,020	1,830	0,025/0,063	BS	AE4691	H1312/3 STD 0.25 0.50 0.75	
→12/82										
MB/HL 1-3	3	50,813/50,825	54,509/54,521	25,020	1,830	0,025/0,063	BS	AE4691	H1313/3 STD 0.25 0.50	
MB/HL 1-3	3	50,830/50,840	54,510/54,520	25,020			BS	AE6568		
01/83→										

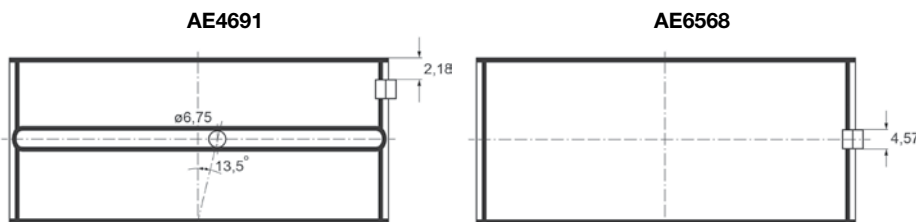

TW/A	2	56,260/56,510	76,073/76,327		2,340		EC	54-2848L	A006/4 STD
TW/A	2	56,260/56,510	76,073/76,327		2,340		EC	54-2848U	
CB/NWB 1	1	42,341/42,392	45,605/45,631	28,830	1,630		BB	1096DR	N181/3 STD
CB/NWB 2	1	41,262/41,300	44,526/44,551	19,300	1,630		BB	1097DR	
CB/NWB 3	1	34,912/34,963	38,176/38,202	19,690	1,630		BB	1098DR	

11		80.00 x 64.00								
A Series		4 Cyl.				1071cc	Petrol		FM84	
BE/PL	4	41,285/41,298	44,970/44,983	22,350	1,825	0,022/0,073	AL-LF	2965RA	01-4313/4 STD 0.25 0.50 0.75	
BE/PL	8	41,285/41,298	44,970/44,983	22,350	1,825	0,024/0,073	BS	71-4869	71-4869/4 STD 0.25	

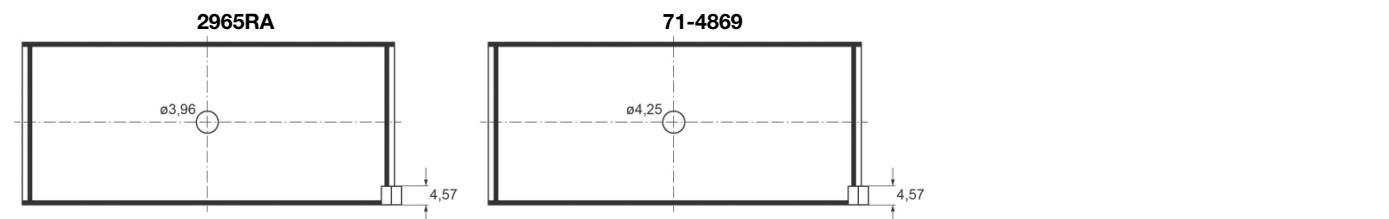

MB/HL 1-3	6	50,813/50,825	54,509/54,521	25,020	1,830	0,025/0,063	BS	AE4691	H1312/3 STD 0.25 0.50 0.75
TW/A	2	56,260/56,510	76,073/76,327		2,340		EC	54-2848L	A006/4 STD
TW/A	2	56,260/56,510	76,073/76,327		2,340		EC	54-2848U	
CB/NWB 1	1	42,341/42,392	45,605/45,631	28,830	1,630		BB	1096DR	N181/3 STD
CB/NWB 2	1	41,262/41,300	44,526/44,551	19,300	1,630		BB	1097DR	
CB/NWB 3	1	34,912/34,963	38,176/38,202	19,690	1,630		BB	1098DR	

12 80.25 x 88.90

18 H	4 Cyl.	1798cc	60kW (82PS)				Petrol		TD5478
18HH	4 Cyl.	1798cc	71kW (97PS)				Petrol		TD21772
18HL	4 Cyl.	1798cc	64kW (87PS)				Petrol		TD21771

BE/PL	4	47,648/47,660	51,333/51,346	19,840	1,830	0,020/0,063	BS	GS2541LC	71-4336/4 STD 0.25 0.50
MB/HL 1,3,5	3	54,013/54,025	57,683/57,696	28,700	1,830	0,025/0,048	AL-LF	65076RA	H1144/5 STD 0.25
MB/HL 2,4	2	54,013/54,025	57,683/57,696	19,560	1,830	0,025/0,048	AL-LF	65077RA	
TW/A	4	59,436/59,960	74,498/74,752		2,340		AL-LF	65077BF	A233/4 STD
CB/NWB 1	1	45,433/45,446	48,641/48,666	37,540			BB	2056DR	N160/3 STD
CB/NWB 2	1	43,909/43,922	47,117/47,142	28,830			BB	2057DR	
CB/NWB 3	1	41,217/41,229	44,425/44,450	20,880			BB	2058DR	

13 84.45 x 89.00

Prima 80T	4 Cyl.	1994cc					Diesel Turbo		FM3878
BE/PL	4	53,990/54,010	57,683/57,696	20,310	1,825	0,023/0,081	BS	1640CP	71-4353/4 STD 0.30
TW/A	4	63,600/63,850	80,250/80,500		2,310		AL-LF	1644AF	A173/4 STD

14 84.50 x 75.80

17 HL	4 Cyl.	1698cc	62-65kW (84-88PS)				Petrol		TD22497
BE/PL	4	47,648/47,660	51,330/51,349	19,840	1,830	0,010/0,066	AL-LF	GS315SA	01-4340/4 STD 0.25
MB/HL 1,3,5	3	54,013/54,025	57,683/57,696	28,700	1,816	0,025/0,063	AL-LF	GS316SA	H1150/5 STD
MB/HL 2,4	2	54,013/54,025	57,683/57,696	19,560	1,816	0,025/0,063	AL-LF	GS317SA	
TW/A	4	59,436/59,960	74,498/74,752		2,340		AL-LF	65077BF	A233/4 STD









AUSTIN







15 84.50 x 89.00

20 H	4 Cyl.	1994cc	69-83kW (94-113PS)	Petrol	TD5475
20 H(EFI)	4 Cyl.	1994cc	83kW (113PS)	Petrol	TD385
20 HA50AA	4 Cyl.	1994cc	83kW (113PS)	Petrol	TD5464
20 HC51AA	4 Cyl.	1994cc	83kW (113PS)	Petrol	TD5465
20 HC81	4 Cyl.	1994cc	83kW (113PS)	Petrol	TD5463
20 HC85	4 Cyl.	1994cc	110kW (150PS)	Petrol Turbo	TD5476
20 HSC	4 Cyl.	1994cc	74kW (101PS)	Petrol	TD4216

BE/PL	4	47,648/47,660	51,330/51,349	19,840	1,830	0,010/0,066	AL-LF	GS315SA	01-4340/4 STD 0.25
MB/HL 1,3,5	3	54,013/54,025	57,683/57,696	28,700	1,816	0,025/0,063	AL-LF	GS316SA	H1150/5 STD
MB/HL 2,4	2	54,013/54,025	57,683/57,696	19,560	1,816	0,025/0,063	AL-LF	GS317SA	
TW/A	4	59,436/59,960	74,498/74,752		2,340		AL-LF	65077BF	A233/4 STD

				cm ³	x 			
Astramax 1.3	09/85→06/90	Petrol	13 NB	1297	4	75.00	73.40	3
Astramax 1.4	09/89→06/90	Petrol	14 NV	1389	4	77.60	73.40	5
Astramax 1.6 D	09/85→08/88	Diesel	16 D	1598	4	80.00	79.50	7
Astramax 1.6 D	09/85→08/88	Diesel	16 DA	1598	4	80.00	79.50	8
Astramax 1.7 D	09/88→06/90	Diesel	17 D	1699	4	82.50	79.50	9
Astravan 1.3	09/84→09/89	Petrol	13 NB	1297	4	75.00	73.40	3
Astravan 1.3	09/84→09/89	Petrol	13 S	1297	4	75.00	73.40	3
Astravan 1.4	09/89→08/91	Petrol	14 NV	1389	4	77.60	73.40	5
Astravan 1.6	09/84→08/91	Petrol	16 SV	1598	4	79.00	81.50	6
Astravan 1.6 D	07/82→08/88	Diesel	16 D	1598	4	80.00	79.50	7
Astravan 1.6 D	09/87→08/89	Diesel	16 DA	1598	4	80.00	79.50	8
Astravan 1.7 D	09/88→08/91	Diesel	17 D	1699	4	82.50	79.50	9
Blitz 2.0	02/85→10/87	Petrol	20 N	1979	4	95.00	69.80	15
Blitz 2.1 D	09/81→10/87	Diesel	21D	2068	4	88.00	85.00	12
Blitz 2.3 D	01/73→10/87	Diesel	23D	2260	4	92.00	85.00	14
Midi 0.9	07/86→06/90	Petrol	CD	843	3	70.00	73.00	2
Midi 1.0 All-wheel Drive	07/86→10/88	Petrol	CB	993	3	76.00	73.00	4
Midi 1.8	09/84→05/88	Petrol	4ZB1	1817	4	84.00	82.00	10
Midi 2.0	09/84→08/92	Petrol	4ZC1	1994	4	88.00	82.00	11
Midi 2.0 4x4	09/84→08/92	Petrol	4ZC1	1994	4	88.00	82.00	11
Midi 2.0 4WD	06/88→08/92	Petrol	4ZC1	1994	4	88.00	82.00	11
Rascal 0.8	07/86→06/90	Petrol	CD	843	3	70.00	73.00	2
Rascal 1.0	06/86→06/90	Petrol	FA10A	970	4	65.50	72.00	1
Rascal 1.0 All-wheel Drive	07/86→06/90	Petrol	CB	993	3	76.00	73.00	4

		cm ³	x 			9
--	---	-----------------	---	---	---	----------

4.154	Diesel	2522	4	88.90	101.60	13
4ZB1	Petrol	1817	4	84.00	82.00	10
4ZC1	Petrol	1994	4	88.00	82.00	11
13 NB	Petrol	1297	4	75.00	73.40	3
13 S	Petrol	1297	4	75.00	73.40	3
14 NV	Petrol	1389	4	77.60	73.40	5
16 D	Diesel	1598	4	80.00	79.50	7
16 DA	Diesel	1598	4	80.00	79.50	8
16 SV	Petrol	1598	4	79.00	81.50	6
17 D	Diesel	1699	4	82.50	79.50	9
20 N	Petrol	1979	4	95.00	69.80	15
20PET	Petrol	1994	4	88.00	82.00	11
20PET	Petrol	1994	4	88.00	82.00	11
21D	Diesel	2068	4	88.00	85.00	12
23D	Diesel	2260	4	92.00	85.00	14
300	Petrol	4928	6	98.40	108.00	16
330	Diesel	5420	6	103.20	108.00	17
380 CID	Diesel	6221	6	107.21	114.90	18
500 PHASE I	Diesel	8197	6	115.88	129.54	19
CB	Petrol	993	3	76.00	73.00	4
CD	Petrol	843	3	70.00	73.00	2
FA10A	Petrol	970	4	65.50	72.00	1



1 65.50 x 72.00

FA10A		4 Cyl.		970cc	34kW (46PS)		Petrol		TD9933
BE/PL	1	37,981/37,991	40,998/41,021	18,011	1,491	0,025/0,083	AL	GS36SA	01-4203 STD 0.25 0.50
MB/HL 1-5	10	49,980	54,020	20,100	1,990		AL-LF	63-651-1	H1062/5 STD 0.25
TW/A	2	57,000	73,000		2,520		BS	65-651-1	A218/2 STD

2 70.00 x 73.00

CD		3 Cyl.		843cc	29-30kW (39-41PS)		Petrol		TD26853
BE/PL	6	39,980	43,020	18,000	1,490		AL	64-255-1	71-4309/3 STD
MB/HL 1-4	8	41,980	46,020	19,500	1,990		AL	63-255-1	H1141/4 STD 0.25

3 75.00 x 73.40

13 NB		4 Cyl.		1297cc	44kW (60PS)		Petrol		TD26852
13 S		4 Cyl.		1297cc	42-55kW (57-75PS)		Petrol		TD410
BE/PL	4	42,971/42,987	46,000/46,012	16,600	1,497	0,020/0,072	EC	71-3639	71-3639/4 STD 0.25 0.50
MB/HL 1,2,4,5	4	54,972/54,985	59,000/59,013	19,500	2,001	0,020/0,064	EC	72-3505	H975/5 STD 0.25 0.50
MB/HL 3	1	54,972/54,985	59,000/59,013	25,900	2,001	0,020/0,064	EC	72-3506H	



72-3506H	STD	25,950/1.0217" - 26,002/1.0237"
	0.25mm	26,150/1.0295" - 26,202/1.0316"
	0.50mm	26,350/1.0374" - 26,402/1.0394"

4 76.00 x 73.00

CB		3 Cyl.		993cc	34kW (46PS)		Petrol		TD26849
BE/PL	6	39,980	43,020	18,000	1,490		AL	64-255-1	71-4309/3 STD
MB/HL 1-4	8	41,980	46,020	19,500	1,990		AL	63-255-1	H1141/4 STD 0.25

5 77.60 x 73.40

14 NV		4 Cyl.		1389cc	44-55kW (60-75PS)		Petrol		TD411
BE/PL	4	42,971/42,987	46,000/46,012	16,600	1,497	0,020/0,072	EC	71-3639	71-3639/4 STD 0.25 0.50
MB/HL 1,2,4,5	4	54,972/54,985	59,000/59,013	19,500	2,001	0,020/0,064	EC	72-3505	H975/5 STD 0.25 0.50
MB/HL 3	1	54,972/54,985	59,000/59,013	25,900	2,001	0,020/0,064	EC	72-3506H	



72-3506H	STD	25,950/1.0217" - 26,002/1.0237"
	0.25mm	26,150/1.0295" - 26,202/1.0316"
	0.50mm	26,350/1.0374" - 26,402/1.0394"

6 79.00 x 81.50

16 SV		4 Cyl.		1598cc	60-66kW (82-90PS)		Petrol		TD413
BE/PL	4	42,971/42,987	46,000/46,012	16,600	1,497	0,020/0,072	EC	71-3639	71-3639/4 STD 0.25 0.50

BEDFORD



MB/HL 1,2,4,5	4	54,972/54,985	59,000/59,013	19,500	2,001	0,020/0,064	EC	72-3505	H975/5 STD 0.25 0.50
MB/HL 3	1	54,972/54,985	59,000/59,013	25,900	2,001	0,020/0,064	EC	72-3506H	

	72-3506H	STD	25,950/1.0217" - 26,002/1.0237"
		0.25mm	26,150/1.0295" - 26,202/1.0316"
		0.50mm	26,350/1.0374" - 26,402/1.0394"

7 80.00 x 79.50

16 D 4 Cyl. **1598cc** **39-40kW (53-54PS)** Diesel **TD412**

BE/PL	4	48,971/48,987	52,000/52,012	19,300	1,500	0,020/0,066	EC	71-3531	71-3531/4 STD
-------	---	---------------	---------------	--------	-------	-------------	----	---------	-------------------------

→08/85, Mot.→14362853

BE/PL	4	48,971/48,987	52,000/52,012	19,300	1,500	0,020/0,066	EC	71-3626	71-3626/4 STD 0.25 0.50
-------	---	---------------	---------------	--------	-------	-------------	----	---------	-----------------------------------

09/85→12/88, Mot.14362854→

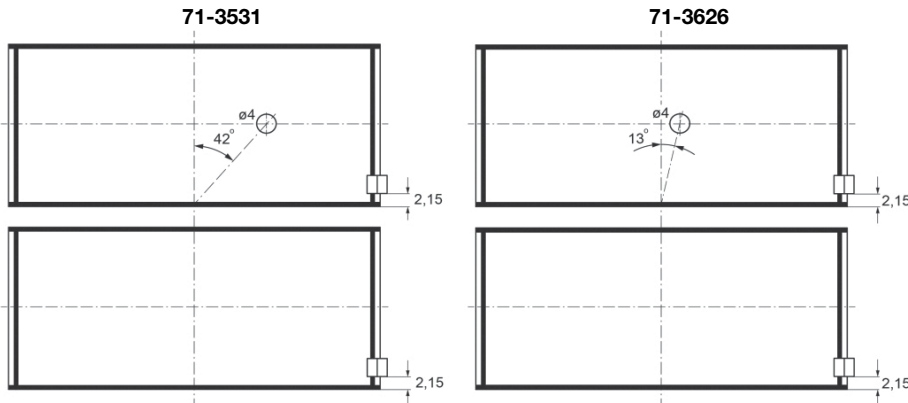

MB/HL 1,2,4,5	4	57,982/57,995	62,000/62,013	19,500	1,995	0,020/0,066	AL-LF	02-3532	H982/5 STD 0.25 0.50
MB/HL 3	1	57,982/57,995	62,000/62,013	25,900	1,995	0,020/0,066	AL-LF	02-3533H	

	02-3533H	STD	25,950/1.0217" - 26,002/1.0237"
		0.25mm	26,150/1.0295" - 26,202/1.0316"
		0.50mm	26,350/1.0374" - 26,402/1.0394"

8 80.00 x 79.50

16 DA 4 Cyl. **1598cc** **40-42kW (54-57PS)** Diesel **TD26851**

BE/PL	4	48,971/48,987	52,000/52,012	19,300	1,500	0,020/0,066	EC	71-3626	71-3626/4 STD 0.25 0.50
MB/HL 1,2,4,5	4	57,982/57,995	62,000/62,013	19,500	1,995	0,020/0,066	AL-LF	02-3532	H982/5 STD 0.25 0.50
MB/HL 3	1	57,982/57,995	62,000/62,013	25,900	1,995	0,020/0,066	AL-LF	02-3533H	

	02-3533H	STD	25,950/1.0217" - 26,002/1.0237"
		0.25mm	26,150/1.0295" - 26,202/1.0316"
		0.50mm	26,350/1.0374" - 26,402/1.0394"

9 82.50 x 79.50

17 D 4 Cyl. **1699cc** **42kW (57PS)** Diesel **TD26850**

BE/PL	4	48,971/48,987	52,000/52,012	19,300	1,500	0,020/0,066	EC	71-3626	71-3626/4 STD 0.25 0.50
-------	---	---------------	---------------	--------	-------	-------------	----	---------	-----------------------------------

MB/HL 1,2,4,5	4	57,982/57,995	62,000/62,013	19,500	1,995	0,020/0,066	AL-LF	02-3532	H982/5 STD 0.25 0.50	
MB/HL 3	1	57,982/57,995	62,000/62,013	25,900	1,995	0,020/0,066	AL-LF	02-3533H		
	02-3533H	STD	25,950/1.0217" - 26,002/1.0237"							
		0.25mm	26,150/1.0295" - 26,202/1.0316"							
		0.50mm	26,350/1.0374" - 26,402/1.0394"							

10 84.00 x 82.00

4ZB1	4 Cyl.		1817cc	63kW (86PS)	Petrol			TD9929		
MB/HL 1-5	5	55,920/55,930	59,979/59,999	21,869	2,009	0,030/0,086	AL	3961RA	H1225/5 STD	

11 88.00 x 82.00

4ZC1	4 Cyl.		1994cc	60-62kW (82-84PS)	Petrol			TD27097		
20PET	4 Cyl.		1994cc	60-62kW (82-84PS)	Petrol			TD9931		
20PET	4 Cyl.		1994cc	60-62kW (82-84PS)	Petrol			TD24119		
MB/HL 1-5	5	55,920/55,930	59,979/59,999	21,869	2,009	0,030/0,086	AL	3961RA	H1225/5 STD	

12 88.00 x 85.00

21D	4 Cyl.		2068cc	44kW (60PS)	Diesel			TD9935		
BE/PL	4	53,971/53,987	57,000/57,012	25,500	1,485	0,043/0,096	EC	71-3174	71-3174/4 STD 0.25 0.50	
MB/HL 1-4	4	57,987/58,000	62,000/62,013	24,500	1,987	0,026/0,077	EC	72-3175	H893/5 STD 0.25	
MB/HL 5	1	57,987/58,000	62,000/62,013	29,420	1,987	0,026/0,077	EC	72-3176H		
	72-3176H	STD	29,450/1.1594" - 29,490/1.1610"							
		0.25mm	29,700/1.1693" - 29,740/1.1610"							
		0.50mm	29,950/1.1791" - 29,990/1.1807"							

13 88.90 x 101.60

4.154	4 Cyl.		2522cc	46-52kW (63-71PS)	Diesel			TD420		
BE/PL	1	57,111/57,124	60,833/60,845	30,230	1,822	0,065/0,115	AL-LF	2015RAA	01-4110 STD 0.25 0.50 0.75 1.00	
BE/PL	1	53,980/54,000	56,820/56,840	16,480	1,407	0,020/0,071	EC	71-2185	71-2185 STD	

14 92.00 x 85.00

23D	4 Cyl.		2260cc	46-48kW (63-65PS)	Diesel			TD418		
BE/PL	4	53,971/53,987	57,000/57,012	25,500	1,485	0,043/0,096	EC	71-3174	71-3174/4 STD 0.25 0.50	
MB/HL 1-4	4	57,987/58,000	62,000/62,013	24,500	1,987	0,026/0,077	EC	72-3175	H893/5 STD 0.25	
MB/HL 5	1	57,987/58,000	62,000/62,013	29,420	1,987	0,026/0,077	EC	72-3176H		
	72-3176H	STD	29,450/1.1594" - 29,490/1.1610"							
		0.25mm	29,700/1.1693" - 29,740/1.1610"							
		0.50mm	29,950/1.1791" - 29,990/1.1807"							

15 95.00 x 69.80

20 N	4 Cyl.		1979cc	56-58kW (76-79PS)	Petrol			TD13433		
BE/PL	1	51,971/51,987	55,000/55,012	19,610	1,449	0,015/0,063	BS	71-3560	71-3560 STD 0.25 0.50	
BE/PL	4	51,971/51,987	55,000/55,012	19,610	1,449	0,015/0,063	BS	71-3560	71-3560/4 STD	

BEDFORD



MB/HL 1-4	4	57,987/58,000	62,000/62,013	22,430	1,989	0,019/0,064	AL-LF	02-2421	H901/5 STD 0.25 0.50
MB/HL 5	1	57,987/58,000	62,000/62,013	27,400	1,989	0,019/0,064	AL-LF	02-2422H	



02-2422H	STD	27,450/1.0807" - 27,510/1.0831"
	0.25mm	27,660/1.0890" - 27,720/1.0913"
	0.50mm	27,860/1.0969" - 27,920/1.0992"
	1.00mm	28,260/1.1126" - 28,320/1.1150"

16 98.40 x 108.00

300		6 Cyl.		4928cc		Petrol			FM134
BE/PL	6	60,300/60,325	63,995/64,008	31,800	1,813	0,044/0,107	AL-LF	2915RA	01-4364/6 STD 0.25 0.50 0.75 1.00 1.25 1.50
MB/HL 1	1	69,837/69,850	74,079/74,091	34,470	2,087	0,055/0,105	AL-LF	2916RA	H1167/7 STD 0.25 0.50 0.75 1.00
MB/HL 2,3,5,6	4	69,837/69,850	74,079/74,091	27,130	2,087	0,055/0,105	AL-LF	2917RA	
MB/HL 4	1	69,837/69,850	74,079/74,091	35,310	2,087	0,055/0,105	AL-LF	2918RA	
MB/HL 7	1	69,837/69,850	74,079/74,091	31,120	2,087	0,055/0,105	AL-LF	2919RA	
TW/A	4	77,597/77,851	90,221/90,474		2,360		BC	GS2664L	A266/4 STD .006 .009
SE/PB	1	34,910/34,930	38,100/38,130	35,050			BS	GS9720L	55-4502 SEMI
CB/NWB 4	1	50,122/50,135	55,093/55,118	26,920	2,460		BB	GS574S	N167/4 STD
CB/NWB 1	1	54,262/54,275	57,379/57,404	36,650	1,530		BB	GS8850S	
CB/NWB 2	1	51,976/51,989	55,093/55,118	25,530	1,530		BB	GS8851S	
CB/NWB 3	1	50,884/50,897	54,000/54,026	25,530	1,530		BB	GS8852S	

17 103.20 x 108.00

330		6 Cyl.		5420cc		72-99kW (98-135PS)		Diesel Turbo		TD6485
BE/PL	6	60,300/60,325	63,995/64,008	31,800	1,813	0,044/0,107	AL-LF	2915RA	01-4364/6 STD 0.25 0.50 0.75 1.00 1.25 1.50	
MB/HL 1	1	69,837/69,850	74,079/74,091	34,470	2,087	0,055/0,105	AL-LF	2916RA	H1167/7 STD 0.25 0.50 0.75 1.00	
MB/HL 2,3,5,6	4	69,837/69,850	74,079/74,091	27,130	2,087	0,055/0,105	AL-LF	2917RA		
MB/HL 4	1	69,837/69,850	74,079/74,091	35,310	2,087	0,055/0,105	AL-LF	2918RA		
MB/HL 7	1	69,837/69,850	74,079/74,091	31,120	2,087	0,055/0,105	AL-LF	2919RA		
TW/A	4	77,597/77,851	90,221/90,474		2,360		BC	GS2664L	A266/4 STD .006 .009	
SE/PB	1	34,910/34,930	38,100/38,130	35,050			BS	GS9720L	55-4502 SEMI	
CB/NWB 4	1	50,122/50,135	55,093/55,118	26,920	2,460		BB	GS574S	N167/4 STD	
CB/NWB 1	1	54,262/54,275	57,379/57,404	36,650	1,530		BB	GS8850S		
CB/NWB 2	1	51,976/51,989	55,093/55,118	25,530	1,530		BB	GS8851S		
CB/NWB 3	1	50,884/50,897	54,000/54,026	25,530	1,530		BB	GS8852S		



18 107.21 x 114.90

380 CID		6 Cyl.		6221cc		77-94kW (105-128PS)		Diesel		TD6467
BE/PL	1	66,655/66,675	70,878/70,891	34,040	2,076	0,051/0,109	AL-LF	65350RAA	01-4448 STD 0.25 0.50 0.75 1.00	
MB/HL 1-3, 5,6	5	76,205/76,225	80,429/80,441	26,670	2,076	0,052/0,109	AL-LF	65351RA	H1169/7 STD 0.25 0.50 0.75 1.00 1.50	
MB/HL 4,7	2	76,205/76,225	80,429/80,441	36,190	2,076	0,052/0,109	AL-LF	65353RA		
TW/A	4	84,201/84,455	98,755/99,009		2,340		AL	GS698SA	A265/4 STD	
CB/NWB 1	1	55,486/55,499	58,750/58,776	26,160	1,580		BS	GS2000L	N171/6 STD	
CB/NWB 2-6	5	55,486/55,499	58,750/58,776	24,130	1,600		BB	GS2001S		

19 115.88 x 129.54

500 PHASE I		6 Cyl.		8197cc		Diesel		FM142	
BE/PL	6	69,810/69,840	73,610/73,620	35,050	1,850		BS	GS463LC	71-4372/6 STD 0.25



cm3



9

1 116 d	11/08→09/12	Diesel	N47 D20 A	1995	4	84.00	90.00	32
1 116 d	11/08→	Diesel	N47 D20 C	1995	4	84.00	90.00	32
1 116 i	11/03→09/12	Petrol	N45 B16 A	1596	4	84.00	72.00	14
1 116 i	03/07→09/12	Petrol	N43 B16 A	1597	4	82.00	75.60	9
1 116 i	11/03→09/12	Petrol	N43 B20 A	1995	4	84.00	90.00	29
1 118 d	11/03→09/12	Diesel	M47 D20 (204D4)	1995	4	84.00	90.00	30
1 118 d	11/03→12/13	Diesel	N47 D20 A	1995	4	84.00	90.00	32
1 118 d	11/03→	Diesel	N47 D20 C	1995	4	84.00	90.00	32
1 118 d xDrive	05/13→	Diesel	N47 D20 C	1995	4	84.00	90.00	32
1 118 i	07/04→12/13	Petrol	N43 B20 A	1995	4	84.00	90.00	29
1 118 i	07/04→12/13	Petrol	N46 B20 B	1995	4	84.00	90.00	28
1 120 d	11/03→09/12	Diesel	M47 D20 (204D4)	1995	4	84.00	90.00	30
1 120 d	11/03→12/13	Diesel	N47 D20 A	1995	4	84.00	90.00	32
1 120 d	11/03→	Diesel	N47 D20 C	1995	4	84.00	90.00	32
1 120 d xDrive	01/11→	Diesel	N47 D20 C	1995	4	84.00	90.00	32
1 120 i	11/03→12/13	Petrol	N43 B20 A	1995	4	84.00	90.00	29
1 120 i	11/03→	Petrol	N46 B20 A	1995	4	84.00	90.00	28
1 120 i	11/03→12/13	Petrol	N46 B20 B	1995	4	84.00	90.00	28
1 120 i	11/03→09/12	Petrol	N46 B20 BD	1995	4	84.00	90.00	28
1 120 i	11/03→12/13	Petrol	N46 B20 C	1995	4	84.00	90.00	28
1 120 i	11/03→09/12	Petrol	N46 B20 CC	1995	4	84.00	90.00	28
1 120 i	03/08→12/13	Petrol	N46 B20 E	1995	4	84.00	90.00	28
1 123 d	03/07→12/13	Diesel	N47 D20 B	1995	4	84.00	90.00	32
1 123 d	03/07→09/12	Diesel	N47 D20 C	1995	4	84.00	90.00	32
1 125i	09/07→12/11	Petrol	N54 B30 A	2979	6	84.00	89.60	27
1 125 i	10/07→12/13	Petrol	N52 B30 A	2996	6	85.00	88.00	38
1 128 i	10/07→10/13	Petrol	N52 B30 A	2996	6	85.00	88.00	38
1 130 i	03/05→09/12	Petrol	N52 B30 A	2996	6	85.00	88.00	38
1 130 i	03/05→09/12	Petrol	N52 B30 BF	2996	6	85.00	88.00	38
1 135 i	10/07→12/13	Petrol	N54 B30 A	2979	6	84.00	89.60	27
1 M	04/11→06/12	Petrol	N54 B30 A	2979	6	84.00	89.60	27
2 218 d	01/14→	Diesel	N47 D20 C	1995	4	84.00	90.00	32
2 220 d	10/13→	Diesel	N47 D20 C	1995	4	84.00	90.00	32
02 1502	01/75→07/77	Petrol	M10 B16	1573	4	84.00	70.96	12
02 1600	05/71→04/73	Petrol	M10 B16	1573	4	84.00	70.96	12
02 1600/2	12/67→12/71	Petrol	M10 B16	1573	4	84.00	70.96	12
02 1600-2	12/67→10/71	Petrol	M10 B16	1573	4	84.00	70.96	12
02 1600 Ti	09/67→11/69	Petrol	M10 B16	1573	4	84.00	70.96	12
02 1602	04/71→07/75	Petrol	M10 B16	1573	4	84.00	70.96	12
02 1802	09/70→07/75	Petrol	M10 B18	1766	4	89.00	71.00	44
02 2002	02/68→07/75	Petrol	M10 B20	1990	4	89.00	80.00	45
02 2002 Ti	09/67→04/72	Petrol	M10 B20	1990	4	89.00	80.00	45
02 2002 Tii	01/71→07/75	Petrol	M10 B20	1990	4	89.00	80.00	45
02 2002 Turbo	01/74→07/75	Petrol	M10 B20 (Turbo)	1990	4	89.00	80.00	45
3 315	09/82→12/91	Petrol	M10 B16	1573	4	84.00	70.96	12
3 315	03/81→03/84	Petrol	M10 B16 (164VB)	1573	4	84.00	70.96	12
3 316	08/75→08/80	Petrol	M10 B16 (164VA)	1573	4	84.00	70.96	12
3 316	09/80→12/87	Petrol	M10 B18 (184VC)	1766	4	89.00	71.00	44
3 316	09/83→12/90	Petrol	M10 B18 (184VD)	1766	4	89.00	71.00	44
3 316 Ci	04/00→07/06	Petrol	M43 B16 (164E3)	1596	4	84.00	72.00	13
3 316 Ci	06/02→07/06	Petrol	N45 B16 A	1596	4	84.00	72.00	14
3 316 d	07/09→	Diesel	N47 D20 C	1995	4	84.00	90.00	32
3 316 g	03/94→08/00	Petrol	M43 B16 (164E2)	1596	4	84.00	72.00	13
3 316 i	09/87→09/93	Petrol	M40 B16 (164E1)	1596	4	84.00	72.00	13
3 316 i	09/90→08/00	Petrol	M43 B16 (164E2)	1596	4	84.00	72.00	13
3 316 i	04/00→02/05	Petrol	M43 B16 (164E3)	1596	4	84.00	72.00	13
3 316 i	06/02→02/05	Petrol	N40 B16 A	1596	4	84.00	72.00	14
3 316 i	06/02→12/11	Petrol	N45 B16 A	1596	4	84.00	72.00	14
3 316 i	09/07→12/13	Petrol	N43 B16 A	1597	4	82.00	75.60	9
3 316 i	08/87→08/88	Petrol	M10 B18 (184KA)	1766	4	89.00	71.00	44
3 316 i	02/02→02/05	Petrol	N42 B18 A	1796	4	84.00	81.00	20
3 316 i	02/02→02/05	Petrol	N46 B18 A	1796	4	84.00	81.00	20
3 316 i	09/98→02/05	Petrol	M43 B19 (194E1)	1895	4	85.00	83.50	36
3 316 ti	06/02→02/05	Petrol	N40 B16 A	1596	4	84.00	72.00	14
3 316 ti	06/02→02/05	Petrol	N45 B16 A	1596	4	84.00	72.00	14
3 316 ti	06/01→02/05	Petrol	N42 B18 A	1796	4	84.00	81.00	20
3 316 ti	06/01→02/05	Petrol	N46 B18 A	1796	4	84.00	81.00	20
3 318	08/75→08/80	Petrol	M10 B18 (184VA)	1766	4	89.00	71.00	44
3 318 Ci	11/99→09/01	Petrol	M43 B19 (194E1)	1895	4	85.00	83.50	36

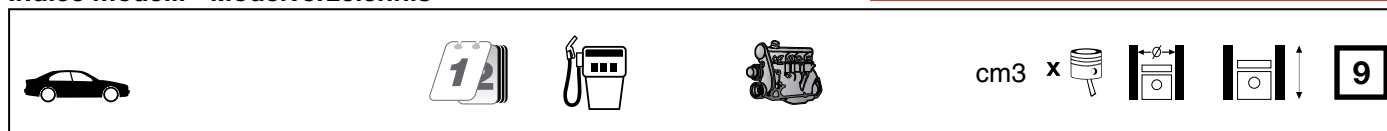

3 318 Ci	09/01→12/07	Petrol	N42 B20 A	1995	4	84.00	90.00	28
3 318 Ci	09/01→12/07	Petrol	N46 B20 A	1995	4	84.00	90.00	28
3 318 Ci	02/05→12/07	Petrol	N46 B20 B	1995	4	84.00	90.00	28
3 318 d	09/01→03/03	Diesel	M47 D20 (204D1)	1951	4	84.00	88.00	23
3 318 d	03/03→12/11	Diesel	M47 D20 (204D4)	1995	4	84.00	90.00	30
3 318 d	09/05→12/11	Diesel	N47 D20 A	1995	4	84.00	90.00	32
3 318 d	09/05→	Diesel	N47 D20 C	1995	4	84.00	90.00	32
3 318 d xDrive	11/12→	Diesel	N47 D20 C	1995	4	84.00	90.00	32
3 318 i	09/82→08/87	Petrol	M10 B18 (184EA)	1766	4	89.00	71.00	44
3 318 i	12/84→08/88	Petrol	M10 B18 (184KA)	1766	4	89.00	71.00	44
3 318 i	11/79→08/82	Petrol	M10 B18 (184VA)	1766	4	89.00	71.00	44
3 318 i	09/87→10/93	Petrol	M40 B18 (184E1)	1796	4	84.00	81.00	19
3 318 i	06/88→02/92	Petrol	M40 B18 C	1796	4	84.00	81.00	19
3 318 i	03/93→12/95	Petrol	M42 B18	1796	4	84.00	81.00	19
3 318 i	09/90→12/95	Petrol	M42 B18 (184S1)	1796	4	84.00	81.00	19
3 318 i	10/93→04/99	Petrol	M43 B18 (184E2)	1796	4	84.00	81.00	19
3 318 i	02/98→09/01	Petrol	M43 B19 (194E1)	1895	4	85.00	83.50	36
3 318 i	09/95→04/99	Petrol	M44 B19 (194S1)	1895	4	85.00	83.50	36
3 318 i	09/01→02/05	Petrol	N42 B20 A	1995	4	84.00	90.00	28
3 318 i	09/07→12/13	Petrol	N43 B20 A	1995	4	84.00	90.00	29
3 318 i	09/01→02/05	Petrol	N46 B20 A	1995	4	84.00	90.00	28
3 318 i	09/05→12/11	Petrol	N46 B20 B	1995	4	84.00	90.00	28
3 318 i	06/07→12/11	Petrol	N46 B20 E	1995	4	84.00	90.00	28
3 318 is	09/89→02/98	Petrol	M42 B18 (184S1)	1796	4	84.00	81.00	19
3 318 is	09/95→04/99	Petrol	M44 B19 (194S1)	1895	4	85.00	83.50	36
3 318 td	03/03→02/05	Diesel	M47 D20 (204D4)	1995	4	84.00	90.00	30
3 318 tds	01/95→08/00	Diesel	M41 D17 (174T1)	1665	4	80.00	82.80	6
3 318 ti	09/94→12/95	Petrol	M42 B18 (184S1)	1796	4	84.00	81.00	19
3 318 ti	07/95→08/00	Petrol	M44 B19 (194S1)	1895	4	85.00	83.50	36
3 318 ti	09/01→02/05	Petrol	N42 B20 A	1995	4	84.00	90.00	28
3 318 ti	09/01→02/05	Petrol	N46 B20 A	1995	4	84.00	90.00	28
3 320	08/75→08/77	Petrol	M10 B20	1990	4	89.00	80.00	45
3 320/6	09/77→08/82	Petrol	M20 B20 (206VA)	1990	6	80.00	66.00	1
3 320 Cd	11/03→12/07	Diesel	M47 D20 (204D4)	1995	4	84.00	90.00	30
3 320 Ci	08/99→09/00	Petrol	M52 B20 (206S4)	1991	6	80.00	66.00	1
3 320 Ci	09/00→12/07	Petrol	M54 B22 (226S1)	2171	6	80.00	72.00	2
3 320 d	02/98→04/05	Diesel	M47 D20 (204D1)	1951	4	84.00	88.00	23
3 320 d	09/01→12/11	Diesel	M47 D20 (204D4)	1995	4	84.00	90.00	30
3 320 d	01/05→12/08	Diesel	M47N 204 D4	1995	4	84.00	90.00	31
3 320 d	03/07→12/13	Diesel	N47 D20 A	1995	4	84.00	90.00	32
3 320 d	01/05→	Diesel	N47 D20 C	1995	4	84.00	90.00	32
3 320 d xDrive	07/08→	Diesel	N47 D20 C	1995	4	84.00	90.00	32
3 320 i	09/79→12/83	Petrol	M10 B18 (184EA)	1766	4	89.00	71.00	44
3 320 i	06/75→08/82	Petrol	M10 B20	1990	4	89.00	80.00	45
3 320 i	04/86→10/93	Petrol	M20 B20	1990	6	80.00	66.00	1
3 320 i	09/82→12/85	Petrol	M20 B20 (206EB)	1990	6	80.00	66.00	1
3 320 i	12/85→10/93	Petrol	M20 B20 (206KA)	1990	6	80.00	66.00	1
3 320 i	09/90→04/99	Petrol	M50 B20 (206S1)	1991	6	80.00	66.00	1
3 320 i	09/90→04/99	Petrol	M50 B20 (206S2)	1991	6	80.00	66.00	1
3 320 i	09/90→04/99	Petrol	M52 B20 (206S3)	1991	6	80.00	66.00	1
3 320 i	03/98→09/00	Petrol	M52 B20 (206S4)	1991	6	80.00	66.00	1
3 320 i	01/07→12/13	Petrol	N43 B20 A	1995	4	84.00	90.00	29
3 320 i	01/05→08/07	Petrol	N46 B20 A	1995	4	84.00	90.00	28
3 320 i	01/05→12/13	Petrol	N46 B20 B	1995	4	84.00	90.00	28
3 320 i	01/05→12/11	Petrol	N46 B20 C	1995	4	84.00	90.00	28
3 320 i	03/07→12/13	Petrol	N46 B20 CC	1995	4	84.00	90.00	28
3 320 i	03/07→12/13	Petrol	N46 B20 CD	1995	4	84.00	90.00	28
3 320 i	03/07→12/13	Petrol	N46 B20 E	1995	4	84.00	90.00	28
3 320 i	09/00→02/05	Petrol	M54 B22 (226S1)	2171	6	80.00	72.00	2
3 320 si	05/06→12/11	Petrol	N45 B20 A	1997	4	85.00	88.00	37
3 320 td	10/01→12/02	Diesel	M47 D20 (204D1)	1951	4	84.00	88.00	23
3 320 td	09/01→02/05	Diesel	M47 D20 (204D4)	1995	4	84.00	90.00	30
3 320 xd	03/07→12/13	Diesel	N47 D20 A	1995	4	84.00	90.00	32
3 320 xd	09/07→12/11	Diesel	N47 D20 C	1995	4	84.00	90.00	32
3 323 Ci	04/99→09/00	Petrol	M52 B25 (256S4)	2494	6	84.00	75.00	15
3 323 i	01/78→08/82	Petrol	M20 B23 (236EA)	2316	6	80.00	76.80	3
3 323 i	09/82→08/86	Petrol	M20 B23 (236EC)	2316	6	80.00	76.80	3
3 323 i	03/95→04/99	Petrol	M52 B25 (256S3)	2494	6	84.00	75.00	15
3 323 i	03/98→09/00	Petrol	M52 B25 (256S4)	2494	6	84.00	75.00	15



cm3





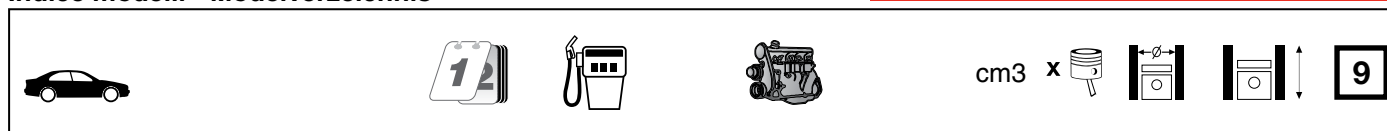



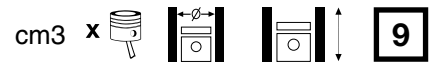

3 323 i	04/06→12/11	Petrol	N52 B25 A	2497	6	82.00	78.80	10
3 323 i	04/06→12/13	Petrol	N52N B25 A	2497	6	82.00	78.80	10
3 323 i 2.5	03/95→02/98	Petrol	M52 B25 (256S3)	2494	6	84.00	75.00	15
3 323 ti	08/97→08/00	Petrol	M52 B25 (256S3)	2494	6	84.00	75.00	15
3 324 d	09/85→08/91	Diesel	M21 D24 (246DA)	2443	6	80.00	81.00	4
3 324 td	09/87→08/91	Diesel	M21 D24 (246TB)	2443	6	80.00	81.00	5
3 325	09/00→04/05	Petrol	M54 B25 (256S5)	2494	6	84.00	75.00	15
3 325 Ci	09/00→12/07	Petrol	M54 B25 (256S5)	2494	6	84.00	75.00	15
3 325 d	09/06→12/13	Diesel	M57 D30 (306D3)	2993	6	84.00	90.00	33
3 325 d	01/10→12/13	Diesel	N57 D30 A	2993	6	84.00	90.00	35
3 325 e 2.7	10/83→12/88	Petrol	M20 B27 (276KA)	2693	6	84.00	81.00	21
3 325 e 2.7	10/83→12/88	Petrol	M20 B27 (276KB)	2693	6	84.00	81.00	21
3 325 i	12/86→06/91	Petrol	M20 B25 (256E1)	2494	6	84.00	75.00	15
3 325 i	09/83→10/93	Petrol	M20 B25 (256E2)	2494	6	84.00	75.00	15
3 325 i	12/86→10/93	Petrol	M20 B25 (256EX)	2494	6	84.00	75.00	15
3 325 i	12/86→10/93	Petrol	M20 B25 (256K1)	2494	6	84.00	75.00	15
3 325 i	09/90→04/99	Petrol	M50 B25 (256S1)	2494	6	84.00	75.00	15
3 325 i	09/90→04/99	Petrol	M50 B25 (256S2)	2494	6	84.00	75.00	15
3 325 i	09/00→02/05	Petrol	M54 B25 (256S5)	2494	6	84.00	75.00	15
3 325 i	09/08→12/09	Petrol	N52 B25	2497	6	82.00	78.80	10
3 325 i	01/05→12/13	Petrol	N52 B25 A	2497	6	82.00	78.80	10
3 325 i	06/06→12/13	Petrol	N53 B30 A	2996	6	85.00	88.00	38
3 325 i X	03/86→08/91	Petrol	M20 B25 (256E1)	2494	6	84.00	75.00	15
3 325 i X	03/86→08/91	Petrol	M20 B25 (256E2)	2494	6	84.00	75.00	15
3 325 i X	03/86→08/91	Petrol	M20 B25 (256EX)	2494	6	84.00	75.00	15
3 325 i X	03/86→08/91	Petrol	M20 B25 (256K1)	2494	6	84.00	75.00	15
3 325 i xDrive	09/06→12/13	Petrol	N52 B25 A	2497	6	82.00	78.80	10
3 325 i xDrive	09/08→12/13	Petrol	N53 B30 A	2996	6	85.00	88.00	38
3 325 xi	09/00→04/05	Petrol	M54 B25 (256S5)	2494	6	84.00	75.00	15
3 325 xi	01/05→12/13	Petrol	N52 B25 A	2497	6	82.00	78.80	10
3 325 xi	09/07→12/13	Petrol	N53 B30 A	2996	6	85.00	88.00	38
3 325 is	09/93→12/94	Petrol	M50 B25 (256S1)	2494	6	84.00	75.00	15
3 325 is	09/93→12/94	Petrol	M50 B25 (256S2)	2494	6	84.00	75.00	15
3 325 td	09/91→02/98	Diesel	M51 D25 (256T1)	2497	6	80.00	82.80	7
3 325 tds	05/93→02/98	Diesel	M51 D25 (256T1)	2497	6	80.00	82.80	7
3 325 ti	06/01→02/05	Petrol	M54 B25 (256S5)	2494	6	84.00	75.00	15
3 328 Ci	04/99→06/00	Petrol	M52 B28 (286S2)	2793	6	84.00	84.00	22
3 328 i	01/95→04/99	Petrol	M52 B28 (286S1)	2793	6	84.00	84.00	22
3 328 i	02/98→06/00	Petrol	M52 B28 (286S2)	2793	6	84.00	84.00	22
3 328 i	07/05→11/07	Petrol	N52N B30 A	2996	6	85.00	88.00	38
3 328 i xDrive	09/08→12/10	Petrol	N52 B30 A	2996	6	85.00	88.00	38
3 330 Cd	03/03→12/07	Diesel	M57 D30 (306D2)	2993	6	84.00	90.00	33
3 330 Ci	06/00→12/07	Petrol	M54 B30 (306S3)	2979	6	84.00	89.60	26
3 330 d	10/99→02/05	Diesel	M57 D30 (306D1)	2926	6	84.00	88.00	24
3 330 d	03/03→02/05	Diesel	M57 D30 (306D2)	2993	6	84.00	90.00	33
3 330 d	09/05→12/13	Diesel	M57 D30 (306D3)	2993	6	84.00	90.00	33
3 330 d	01/09→	Diesel	N57 D30 A	2993	6	84.00	90.00	35
3 330 d xDrive	01/09→	Diesel	N57 D30 A	2993	6	84.00	90.00	35
3 330 i	06/00→04/05	Petrol	M54 B30 (306S3)	2979	6	84.00	89.60	26
3 330 i	01/05→12/13	Petrol	N52 B30 A	2996	6	85.00	88.00	38
3 330 i	01/05→12/11	Petrol	N52 B30 BF	2996	6	85.00	88.00	38
3 330 i	03/07→12/13	Petrol	N52N B30 B	2996	6	85.00	88.00	38
3 330 i	03/07→12/13	Petrol	N53 B30 A	2996	6	85.00	88.00	38
3 330 i xDrive	09/08→12/13	Petrol	N53 B30 A	2996	6	85.00	88.00	38
3 330 xi	06/00→07/06	Petrol	M54 B30 (306S3)	2979	6	84.00	89.60	26
3 330 xi	01/05→12/13	Petrol	N52 B30 A	2996	6	85.00	88.00	38
3 330 xi	09/07→12/11	Petrol	N53 B30 A	2996	6	85.00	88.00	38
3 330 xd	06/00→02/05	Diesel	M57 D30 (306D1)	2926	6	84.00	88.00	24
3 330 xd	03/03→02/05	Diesel	M57 D30 (306D2)	2993	6	84.00	90.00	33
3 330 xd	09/05→12/13	Diesel	M57 D30 (306D3)	2993	6	84.00	90.00	33
3 330 xd	01/09→12/13	Diesel	N57 D30 A	2993	6	84.00	90.00	35
3 335 d	09/08→12/11	Diesel	M57 D30 (306D4)	2993	6	84.00	90.00	33
3 335 d	09/06→12/13	Diesel	M57 D30 (306D5)	2993	6	84.00	90.00	33
3 335 d xDrive	07/13→	Diesel	N57 D30 B	2993	6	84.00	90.00	35
3 335 i	09/06→12/13	Petrol	N54 B30 A	2979	6	84.00	89.60	27
3 335 i	03/07→12/13	Petrol	N54 B30 B	2979	6	84.00	89.60	27
3 335 i xDrive	09/08→12/13	Petrol	N54 B30 A	2979	6	84.00	89.60	27
3 335 xi	09/06→12/13	Petrol	N54 B30 A	2979	6	84.00	89.60	27
3 M3 2.3	07/86→06/91	Petrol	S14 B23 (234EA)	2303	4	93.40	84.00	53



3 M3 2.3	07/86→06/91	Petrol	S14 B23 (234S1)	2303	4	93.40	84.00	53
3 M3 2.3	07/86→06/91	Petrol	S14 B23 (234S2)	2303	4	93.40	84.00	53
3 M3 3.2	09/95→04/99	Petrol	S50 B32 (326S1)	3201	6	86.40	91.00	43
3 M3 EVO I 2.3	10/88→10/90	Petrol	S14 B23 (234EA)	2303	4	93.40	84.00	53
3 Touring 316 d	09/09→	Diesel	N47 D20 C	1995	4	84.00	90.00	32
3 Touring 316 i	09/91→06/94	Petrol	M40 B16 (164E1)	1596	4	84.00	72.00	13
3 Touring 316 i	01/96→10/99	Petrol	M43 B16 (164E2)	1596	4	84.00	72.00	13
3 Touring 316 i	06/02→02/05	Petrol	N45 B16 A	1596	4	84.00	72.00	14
3 Touring 316 i	05/08→05/12	Petrol	N43 B16 A	1597	4	82.00	75.60	9
3 Touring 316 i	03/02→02/05	Petrol	N42 B18 A	1796	4	84.00	81.00	20
3 Touring 316 i	03/02→02/05	Petrol	N46 B18 A	1796	4	84.00	81.00	20
3 Touring 318 d	03/02→02/05	Diesel	M47 D20 (204D1)	1951	4	84.00	88.00	23
3 Touring 318 d	03/03→06/12	Diesel	M47 D20 (204D4)	1995	4	84.00	90.00	30
3 Touring 318 d	09/07→06/12	Diesel	N47 D20 A	1995	4	84.00	90.00	32
3 Touring 318 d	07/07→	Diesel	N47 D20 C	1995	4	84.00	90.00	32
3 Touring 318 d xDrive	01/13→	Diesel	N47 D20 C	1995	4	84.00	90.00	32
3 Touring 318 i	09/87→06/94	Petrol	M40 B18 (184E1)	1796	4	84.00	81.00	19
3 Touring 318 i	07/95→10/99	Petrol	M43 B18 (184E2)	1796	4	84.00	81.00	19
3 Touring 318 i	10/99→09/01	Petrol	M43 B19 (194E1)	1895	4	85.00	83.50	36
3 Touring 318 i	09/01→02/05	Petrol	N42 B20 A	1995	4	84.00	90.00	28
3 Touring 318 i	09/07→06/12	Petrol	N43 B20 A	1995	4	84.00	90.00	29
3 Touring 318 i	09/01→02/05	Petrol	N46 B20 A	1995	4	84.00	90.00	28
3 Touring 318 i	01/06→06/12	Petrol	N46 B20 B	1995	4	84.00	90.00	28
3 Touring 318 tds	01/95→10/99	Diesel	M41 D17 (174T1)	1665	4	80.00	82.80	6
3 Touring 320 d	03/00→09/01	Diesel	M47 D20 (204D1)	1951	4	84.00	88.00	23
3 Touring 320 d	09/01→06/12	Diesel	M47 D20 (204D4)	1995	4	84.00	90.00	30
3 Touring 320 d	09/07→06/12	Diesel	N47 D20 A	1995	4	84.00	90.00	32
3 Touring 320 d	09/05→	Diesel	N47 D20 C	1995	4	84.00	90.00	32
3 Touring 320 d xDrive	09/08→	Diesel	N47 D20 C	1995	4	84.00	90.00	32
3 Touring 320 i	01/88→12/91	Petrol	M20 B20 (206KA)	1990	6	80.00	66.00	1
3 Touring 320 i	01/95→10/99	Petrol	M52 B20 (206S3)	1991	6	80.00	66.00	1
3 Touring 320 i	10/99→09/00	Petrol	M52 B20 (206S4)	1991	6	80.00	66.00	1
3 Touring 320 i	09/07→06/12	Petrol	N43 B20 A	1995	4	84.00	90.00	29
3 Touring 320 i	09/05→06/12	Petrol	N46 B20 A	1995	4	84.00	90.00	28
3 Touring 320 i	09/05→06/12	Petrol	N46 B20 B	1995	4	84.00	90.00	28
3 Touring 320 i	09/05→06/12	Petrol	N46 B20 C	1995	4	84.00	90.00	28
3 Touring 320 i	09/00→02/05	Petrol	M54 B22 (226S1)	2171	6	80.00	72.00	2
3 Touring 320 xd	09/07→06/12	Diesel	N47 D20 A	1995	4	84.00	90.00	32
3 Touring 323 i	09/95→12/00	Petrol	M52 B25 (256S3)	2494	6	84.00	75.00	15
3 Touring 323 i	04/06→07/08	Petrol	N52 B25 A	2497	6	82.00	78.80	10
3 Touring 324 td	01/88→06/93	Diesel	M21 D24 (246TB)	2443	6	80.00	81.00	5
3 Touring 325 d	09/06→06/12	Diesel	M57 D30 (306D3)	2993	6	84.00	90.00	33
3 Touring 325 d	02/10→06/12	Diesel	N57 D30 A	2993	6	84.00	90.00	35
3 Touring 325 i	07/87→03/93	Petrol	M20 B25 (256K1)	2494	6	84.00	75.00	15
3 Touring 325 i	09/00→02/05	Petrol	M54 B25 (256S5)	2494	6	84.00	75.00	15
3 Touring 325 i	09/05→06/12	Petrol	N52 B25 A	2497	6	82.00	78.80	10
3 Touring 325 i	09/07→06/12	Petrol	N53 B30 A	2996	6	85.00	88.00	38
3 Touring 325 i X	06/88→10/93	Petrol	M20 B25 (256K1)	2494	6	84.00	75.00	15
3 Touring 325 i xDrive	09/07→06/12	Petrol	N53 B30 A	2996	6	85.00	88.00	38
3 Touring 325 xi	09/00→02/05	Petrol	M54 B25 (256S5)	2494	6	84.00	75.00	15
3 Touring 325 xi	09/05→06/12	Petrol	N52 B25 A	2497	6	82.00	78.80	10
3 Touring 325 xi	09/07→06/12	Petrol	N53 B30 A	2996	6	85.00	88.00	38
3 Touring 325 tds	01/95→10/99	Diesel	M51 D25 (256T1)	2497	6	80.00	82.80	7
3 Touring 328 i	01/95→10/99	Petrol	M52 B28 (286S1)	2793	6	84.00	84.00	22
3 Touring 328 i	10/99→06/00	Petrol	M52 B28 (286S2)	2793	6	84.00	84.00	22
3 Touring 328 i	03/07→06/12	Petrol	N52 B30 A	2996	6	85.00	88.00	38
3 Touring 330 d	10/99→02/05	Diesel	M57 D30 (306D1)	2926	6	84.00	88.00	24
3 Touring 330 d	03/03→02/05	Diesel	M57 D30 (306D2)	2993	6	84.00	90.00	33
3 Touring 330 d	09/05→06/12	Diesel	M57 D30 (306D3)	2993	6	84.00	90.00	33
3 Touring 330 d	01/09→	Diesel	N57 D30 A	2993	6	84.00	90.00	35
3 Touring 330 d xDrive	01/09→	Diesel	N57 D30 A	2993	6	84.00	90.00	35
3 Touring 330 i	06/00→02/05	Petrol	M54 B30 (306S3)	2979	6	84.00	89.60	26
3 Touring 330 i	09/05→08/07	Petrol	N52 B30 A	2996	6	85.00	88.00	38
3 Touring 330 i	09/07→06/12	Petrol	N53 B30 A	2996	6	85.00	88.00	38
3 Touring 330 i	09/07→06/12	Petrol	N53 B30 A	2996	6	85.00	88.00	38
3 Touring 330 i xDrive	09/07→06/12	Petrol	N53 B30 A	2996	6	85.00	88.00	38
3 Touring 330 xi	06/00→02/05	Petrol	M54 B30 (306S3)	2979	6	84.00	89.60	26
3 Touring 330 xi	09/05→08/07	Petrol	N52 B30 A	2996	6	85.00	88.00	38
3 Touring 330 xi	09/07→06/12	Petrol	N53 B30 A	2996	6	85.00	88.00	38
3 Touring 330 xd	06/00→02/05	Diesel	M57 D30 (306D1)	2926	6	84.00	88.00	24



3 Touring 330 xd	03/03→02/05	Diesel	M57 D30 (306D2)	2993	6	84.00	90.00	33
3 Touring 330 xd	09/05→06/12	Diesel	M57 D30 (306D3)	2993	6	84.00	90.00	33
3 Touring 335 d	09/06→06/12	Diesel	M57 D30 (306D5)	2993	6	84.00	90.00	33
3 Touring 335 d xDrive	09/13→	Diesel	N57 D30 B	2993	6	84.00	90.00	35
3 Touring 335 i	09/06→06/12	Petrol	N54 B30 A	2979	6	84.00	89.60	27
3 Touring 335 i xDrive	09/08→06/12	Petrol	N54 B30 A	2979	6	84.00	89.60	27
3 Touring 335 xi	03/07→06/12	Petrol	N54 B30 A	2979	6	84.00	89.60	27
4 418 d	03/14→	Diesel	N47 D20 C	1995	4	84.00	90.00	32
4 420 d	07/13→	Diesel	N47 D20 C	1995	4	84.00	90.00	32
4 420 d xDrive	11/13→	Diesel	N47 D20 C	1995	4	84.00	90.00	32
4 430 d	10/13→	Diesel	N57 D30 A	2993	6	84.00	90.00	35
4 430 d xDrive	11/13→	Diesel	N57 D30 A	2993	6	84.00	90.00	35
4 435 d xDrive	11/13→	Diesel	N57 D30 B	2993	6	84.00	90.00	35
5 518	07/74→05/81	Petrol	M10 B18 (184VB)	1766	4	89.00	71.00	44
5 518	06/81→08/84	Petrol	M10 B18 (184VC)	1766	4	89.00	71.00	44
5 518	06/81→08/84	Petrol	M10 B18 (184VD)	1766	4	89.00	71.00	44
5 518	12/75→08/77	Petrol	M10 B20	1990	4	89.00	80.00	45
5 518 d	01/13→	Diesel	N47 D20 C	1995	4	84.00	90.00	32
5 518 i	09/83→12/87	Petrol	M10 B18 (184EB)	1766	4	89.00	71.00	44
5 518 i	08/89→09/95	Petrol	M40 B18 (184E1)	1796	4	84.00	81.00	19
5 518 i	08/89→09/95	Petrol	M43 B18 (184E2)	1796	4	84.00	81.00	19
5 518 i	08/77→09/79	Petrol	M10 B20	1990	4	89.00	80.00	45
5 520	08/72→08/77	Petrol	M10 B20	1990	4	89.00	80.00	45
5 520/6	09/77→05/81	Petrol	M20 B20 (206VA)	1990	6	80.00	66.00	1
5 520 d	02/00→06/03	Diesel	M47 D20 (204D1)	1951	4	84.00	88.00	23
5 520 d	07/05→03/10	Diesel	M47 D20 (204D4)	1995	4	84.00	90.00	30
5 520 d	07/05→03/10	Diesel	N47 D20 A	1995	4	84.00	90.00	32
5 520 d	07/05→	Diesel	N47 D20 C	1995	4	84.00	90.00	32
5 520 d xDrive	02/13→	Diesel	N47 D20 C	1995	4	84.00	90.00	32
5 520 i	08/72→05/77	Petrol	M10 B20	1990	4	89.00	80.00	45
5 520 i	06/81→12/87	Petrol	M20 B20 (206EA)	1990	6	80.00	66.00	1
5 520 i	08/85→08/91	Petrol	M20 B20 (206KA)	1990	6	80.00	66.00	1
5 520 i	01/96→06/03	Petrol	M52 B20 (206S3)	1991	6	80.00	66.00	1
5 520 i	12/06→03/10	Petrol	N43 B20 A	1995	4	84.00	90.00	29
5 520 i	04/06→12/09	Petrol	N46 B20 B	1995	4	84.00	90.00	28
5 520 i	09/00→03/10	Petrol	M54 B22 (226S1)	2171	6	80.00	72.00	2
5 520 i 24V	09/89→09/95	Petrol	M50 B20 (206S1)	1991	6	80.00	66.00	1
5 520 i 24V	09/89→09/95	Petrol	M50 B20 (206S2)	1991	6	80.00	66.00	1
5 523 i	11/95→09/00	Petrol	M52 B25 (256S3)	2494	6	84.00	75.00	15
5 523 i	07/05→	Petrol	N52 B25 A	2497	6	82.00	78.80	10
5 523 i	01/07→03/10	Petrol	N53 B25 A	2497	6	82.00	78.80	10
5 523 i	12/09→	Petrol	N53 B30 A	2996	6	85.00	88.00	38
5 524 d	03/86→12/87	Diesel	M21 D24 (246DA)	2443	6	80.00	81.00	4
5 524 td	09/83→12/87	Diesel	M21 D24 (246TA)	2443	6	80.00	81.00	5
5 524 td	03/88→09/95	Diesel	M21 D24 (246TB)	2443	6	80.00	81.00	5
5 525	08/73→10/76	Petrol	M30 B25	2494	6	86.00	71.60	39
5 525	08/76→05/81	Petrol	M30 B25 (256VA)	2494	6	86.00	71.60	39
5 525 d	02/00→03/10	Diesel	M57 D25 (256D1)	2497	6	80.00	82.80	7
5 525 d	06/04→03/10	Diesel	M57 D25 (256D2)	2497	6	84.00	75.10	16
5 525 d	01/07→03/10	Diesel	M57 D30 (306D3)	2993	6	84.00	90.00	33
5 525 d	02/10→	Diesel	N57 D30 A	2993	6	84.00	90.00	35
5 525 d xDrive	09/08→03/10	Diesel	M57 D30 (306D3)	2993	6	84.00	90.00	33
5 525 e	05/83→12/87	Petrol	M20 B27 (276EA)	2693	6	84.00	81.00	21
5 525 e	09/81→12/87	Petrol	M20 B27 (276EB)	2693	6	84.00	81.00	21
5 525 e	09/81→12/87	Petrol	M20 B27 (276KA)	2693	6	84.00	81.00	21
5 525 e	09/81→12/87	Petrol	M20 B27 (276KB)	2693	6	84.00	81.00	21
5 525 i	01/88→08/91	Petrol	M20 B25 (256K1)	2494	6	84.00	75.00	15
5 525 i	06/81→12/87	Petrol	M30 B25 (256EA)	2494	6	86.00	71.60	39
5 525 i	09/00→03/10	Petrol	M54 B25 (256S5)	2494	6	84.00	75.00	15
5 525 i	07/05→03/10	Petrol	N52 B25 A	2497	6	82.00	78.80	10
5 525 i	01/07→03/10	Petrol	N53 B30 A	2996	6	85.00	88.00	38
5 525 i 24V	09/89→09/95	Petrol	M50 B25 (256S2)	2494	6	84.00	75.00	15
5 525 i xDrive	09/08→03/10	Petrol	N53 B30 A	2996	6	85.00	88.00	38
5 525 iX 24V	10/91→09/95	Petrol	M50 B25 (256S1)	2494	6	84.00	75.00	15
5 525 iX 24V	10/91→09/95	Petrol	M50 B25 (256S2)	2494	6	84.00	75.00	15
5 525 xi	07/05→03/10	Petrol	N52 B25 A	2497	6	82.00	78.80	10
5 525 xi	01/07→03/10	Petrol	N53 B30 A	2996	6	85.00	88.00	38
5 525 td	04/93→06/03	Diesel	M51 D25 (256T1)	2497	6	80.00	82.80	7
5 525 tds	09/91→06/03	Diesel	M51 D25 (256T1)	2497	6	80.00	82.80	7









				cm ³				
5 525 xd	01/07→03/10	Diesel	M57 D30 (306D3)	2993	6	84.00	90.00	33
5 528	01/75→08/77	Petrol	M30 B28	2788	6	86.00	80.00	40
5 528 i	04/77→05/81	Petrol	M30 B28	2788	6	86.00	80.00	40
5 528 i	06/81→12/87	Petrol	M30 B28 (286EA)	2788	6	86.00	80.00	40
5 528 i	11/95→09/00	Petrol	M52 B28 (286S1)	2793	6	84.00	84.00	22
5 528 i	11/95→09/00	Petrol	M52 B28 (286S2)	2793	6	84.00	84.00	22
5 528 i	09/07→12/11	Petrol	N52 B30 A	2996	6	85.00	88.00	38
5 528 i	02/10→	Petrol	N53 B30 A	2996	6	85.00	88.00	38
5 528 i xDrive	09/07→03/10	Petrol	N52 B30 A	2996	6	85.00	88.00	38
5 530 d	08/98→06/03	Diesel	M57 D30 (306D1)	2926	6	84.00	88.00	24
5 530 d	07/03→03/10	Diesel	M57 D30 (306D2)	2993	6	84.00	90.00	33
5 530 d	07/03→03/10	Diesel	M57 D30 (306D3)	2993	6	84.00	90.00	33
5 530 d	10/09→	Diesel	N57 D30 A	2993	6	84.00	90.00	35
5 530 d xDrive	09/08→03/10	Diesel	M57 D30 (306D3)	2993	6	84.00	90.00	33
5 530 d xDrive	10/09→	Diesel	N57 D30 A	2993	6	84.00	90.00	35
5 530 i	09/00→03/10	Petrol	M54 B30 (306S3)	2979	6	84.00	89.60	26
5 530 i	09/74→12/78	Petrol	M30 B30	2986	6	89.00	80.00	46
5 530 i	01/88→08/91	Petrol	M30 B30 (306KA)	2986	6	89.00	80.00	46
5 530 i	03/05→03/10	Petrol	N52 B30 A	2996	6	85.00	88.00	38
5 530 i	01/07→03/10	Petrol	N52 B30 BF	2996	6	85.00	88.00	38
5 530 i	01/07→	Petrol	N53 B30 A	2996	6	85.00	88.00	38
5 530 i	09/94→11/95	Petrol	M60 B30 (308S1)	2997	V8	84.00	67.60	11
5 530 i V8	09/92→09/95	Petrol	M60 B30 (308S1)	2997	V8	84.00	67.60	11
5 530 i xDrive	09/08→03/10	Petrol	N53 B30 A	2996	6	85.00	88.00	38
5 530 xi	07/05→03/10	Petrol	N52 B30 A	2996	6	85.00	88.00	38
5 530 xd	07/05→03/10	Diesel	M57 D30 (306D3)	2993	6	84.00	90.00	33
5 533 i	09/82→12/84	Petrol	M30 B32	3210	6	89.00	86.00	48
5 535 d	09/04→03/10	Diesel	M57 D30 (306D4)	2993	6	84.00	90.00	33
5 535 d	01/07→03/10	Diesel	M57 D30 (306D5)	2993	6	84.00	90.00	33
5 535 d	08/10→	Diesel	N57 D30 B	2993	6	84.00	90.00	35
5 535 d xDrive	09/10→	Diesel	N57 D30 B	2993	6	84.00	90.00	35
5 535 i	09/07→03/10	Petrol	N54 B30 A	2979	6	84.00	89.60	27
5 535 i	01/88→09/95	Petrol	M30 B34 (346KB)	3430	6	92.00	86.00	52
5 535 i	04/96→03/99	Petrol	M62 B35 (358S1)	3498	V8	84.00	78.90	18
5 535 i	04/96→06/03	Petrol	M62 B35 (358S2)	3498	V8	84.00	78.90	18
5 535 i, M 535 i	01/85→12/87	Petrol	M30 B34 (346EC)	3430	6	92.00	86.00	52
5 535 i, M 535 i	01/85→12/87	Petrol	M30 B34 (346KA)	3430	6	92.00	86.00	52
5 535 i, M 535 i	01/85→12/87	Petrol	M30 B35 (Motronic)	3430	6	92.00	86.00	52
5 535 i xDrive	09/08→03/10	Petrol	N54 B30 A	2979	6	84.00	89.60	27
5 535 ix	09/08→12/09	Petrol	N54 B30 A	2979	6	84.00	89.60	27
5 535 is	12/87→12/93	Petrol	M30 B34 (346KB)	3430	6	92.00	86.00	52
5 540 i	08/05→03/10	Petrol	N54 B30 A	2979	6	84.00	89.60	27
5 540 i V8	09/92→09/95	Petrol	M60 B40 (408S1)	3982	V8	89.00	80.00	47
5 M5	08/85→12/88	Petrol	S38 B35 (356ED)	3453	6	93.40	84.00	54
5 M5	12/87→12/88	Petrol	S38 B36	3535	6	93.40	86.00	55
5 M535 i	06/80→08/81	Petrol	M30 B35 (Motronic,9.3:1)	3453	6	93.40	84.00	54
5 Touring 518 d	01/13→	Diesel	N47 D20 C	1995	4	84.00	90.00	32
5 Touring 518 g	11/95→06/96	Petrol	M43 B18 (184E2)	1796	4	84.00	81.00	19
5 Touring 518 i	03/93→01/97	Petrol	M43 B18 (184E2)	1796	4	84.00	81.00	19
5 Touring 520 d	02/00→09/03	Diesel	M47 D20 (204D1)	1951	4	84.00	88.00	23
5 Touring 520 d	07/05→12/10	Diesel	M47 D20 (204D4)	1995	4	84.00	90.00	30
5 Touring 520 d	07/05→12/10	Diesel	N47 D20 A	1995	4	84.00	90.00	32
5 Touring 520 d	07/05→	Diesel	N47 D20 C	1995	4	84.00	90.00	32
5 Touring 520 d xDrive	02/13→	Diesel	N47 D20 C	1995	4	84.00	90.00	32
5 Touring 520 i	11/91→01/97	Petrol	M50 B20 (206S1)	1991	6	80.00	66.00	1
5 Touring 520 i	11/91→01/97	Petrol	M50 B20 (206S2)	1991	6	80.00	66.00	1
5 Touring 520 i	01/97→05/04	Petrol	M52 B20 (206S3)	1991	6	80.00	66.00	1
5 Touring 520 i	07/07→12/10	Petrol	N43 B20 A	1995	4	84.00	90.00	29
5 Touring 520 i	09/00→05/04	Petrol	M54 B22 (226S1)	2171	6	80.00	72.00	2
5 Touring 523 i	01/97→09/00	Petrol	M52 B25 (256S3)	2494	6	84.00	75.00	15
5 Touring 523 i	07/05→12/11	Petrol	N52 B25 A	2497	6	82.00	78.80	10
5 Touring 523 i	01/07→12/10	Petrol	N53 B25 A	2497	6	82.00	78.80	10
5 Touring 523 i	09/10→	Petrol	N53 B30 A	2996	6	85.00	88.00	38
5 Touring 525 d	02/00→05/04	Diesel	M57 D25 (256D1)	2497	6	80.00	82.80	7
5 Touring 525 d	06/04→12/10	Diesel	M57 D25 (256D2)	2497	6	84.00	75.10	16
5 Touring 525 d	12/04→12/10	Diesel	M57N 256 D4	2497	6	84.00	75.10	17
5 Touring 525 d	01/07→12/10	Diesel	M57 D30 (306D3)	2993	6	84.00	90.00	33
5 Touring 525 d	09/10→	Diesel	N57 D30 A	2993	6	84.00	90.00	35
5 Touring 525 d xDrive	09/08→12/10	Diesel	M57 D30 (306D3)	2993	6	84.00	90.00	33



cm3

9

5 Touring 525 i	11/91→01/97	Petrol	M50 B25 (256S1)	2494	6	84.00	75.00	15
5 Touring 525 i	11/91→01/97	Petrol	M50 B25 (256S2)	2494	6	84.00	75.00	15
5 Touring 525 i	09/00→12/10	Petrol	M54 B25 (256S5)	2494	6	84.00	75.00	15
5 Touring 525 i	07/05→12/10	Petrol	N52 B25 A	2497	6	82.00	78.80	10
5 Touring 525 i	01/07→12/10	Petrol	N53 B30 A	2996	6	85.00	88.00	38
5 Touring 525 i xDrive	09/08→12/10	Petrol	N53 B30 A	2996	6	85.00	88.00	38
5 Touring 525 ix	02/92→01/97	Petrol	M50 B25 (256S1)	2494	6	84.00	75.00	15
5 Touring 525 ix	02/92→01/97	Petrol	M50 B25 (256S2)	2494	6	84.00	75.00	15
5 Touring 525 xi	07/05→12/10	Petrol	N52 B25 A	2497	6	82.00	78.80	10
5 Touring 525 xi	01/07→12/10	Petrol	N53 B30 A	2996	6	85.00	88.00	38
5 Touring 525 td	03/93→01/97	Diesel	M51 D25 (256T1)	2497	6	80.00	82.80	7
5 Touring 525 tds	12/91→05/04	Diesel	M51 D25 (256T1)	2497	6	80.00	82.80	7
5 Touring 525 xd	01/07→12/10	Diesel	M57 D30 (306D3)	2993	6	84.00	90.00	33
5 Touring 528 i	01/97→09/00	Petrol	M52 B28 (286S1)	2793	6	84.00	84.00	22
5 Touring 528 i	01/97→09/00	Petrol	M52 B28 (286S2)	2793	6	84.00	84.00	22
5 Touring 528 i	09/10→	Petrol	N53 B30 A	2996	6	85.00	88.00	38
5 Touring 530 d	08/98→05/04	Diesel	M57 D30 (306D1)	2926	6	84.00	88.00	24
5 Touring 530 d	06/04→12/10	Diesel	M57 D30 (306D2)	2993	6	84.00	90.00	33
5 Touring 530 d	07/05→12/10	Diesel	M57 D30 (306D3)	2993	6	84.00	90.00	33
5 Touring 530 d	09/10→	Diesel	N57 D30 A	2993	6	84.00	90.00	35
5 Touring 530 d xDrive	09/08→12/10	Diesel	M57 D30 (306D3)	2993	6	84.00	90.00	33
5 Touring 530 d xDrive	09/11→	Diesel	N57 D30 A	2993	6	84.00	90.00	35
5 Touring 530 i	09/00→05/04	Petrol	M54 B30 (306S3)	2979	6	84.00	89.60	26
5 Touring 530 i	07/05→12/10	Petrol	N52 B30 A	2996	6	85.00	88.00	38
5 Touring 530 i	01/07→	Petrol	N53 B30 A	2996	6	85.00	88.00	38
5 Touring 530 i V8	09/92→01/97	Petrol	M60 B30 (308S1)	2997	V8	84.00	67.60	11
5 Touring 530 i xDrive	09/08→12/10	Petrol	N53 B30 A	2996	6	85.00	88.00	38
5 Touring 530 xi	07/05→12/10	Petrol	N52 B30 A	2996	6	85.00	88.00	38
5 Touring 530 xd	07/05→12/10	Diesel	M57 D30 (306D3)	2993	6	84.00	90.00	33
5 Touring 535 d	09/04→12/10	Diesel	M57 D30 (306D4)	2993	6	84.00	90.00	33
5 Touring 535 d	01/07→12/10	Diesel	M57 D30 (306D5)	2993	6	84.00	90.00	33
5 Touring 535 d	09/10→	Diesel	N57 D30 B	2993	6	84.00	90.00	35
5 Touring 535 d xDrive	09/11→	Diesel	N57 D30 B	2993	6	84.00	90.00	35
5 Touring 535 i	09/08→12/10	Petrol	N54 B30 A	2979	6	84.00	89.60	27
5 Touring 535 xi	09/07→12/10	Petrol	N54 B30 A	2979	6	84.00	89.60	27
5 Touring 540 i	09/93→01/97	Petrol	M60 B40 (408S1)	3982	V8	89.00	80.00	47
6 628 CSi	09/79→08/87	Petrol	M30 B28	2788	6	86.00	80.00	40
6 630 CS	04/76→08/79	Petrol	M30 B30	2986	6	89.00	80.00	46
6 630 CSi	09/76→12/78	Petrol	M30 B30	2986	6	89.00	80.00	46
6 630 i	09/04→07/10	Petrol	N52 B30 A	2996	6	85.00	88.00	38
6 630 i	07/07→07/10	Petrol	N52 B30 BF	2996	6	85.00	88.00	38
6 630 i	07/07→07/10	Petrol	N53 B30 A	2996	6	85.00	88.00	38
6 633 CSi	09/77→12/84	Petrol	M30 B32	3210	6	89.00	86.00	48
6 635 CSi	01/85→05/89	Petrol	M30 B34 (346KA)	3430	6	92.00	86.00	52
6 635 CSi	08/87→05/89	Petrol	M30 B34 (346KB)	3430	6	92.00	86.00	52
6 635 CSi	04/85→09/90	Petrol	M30 B35	3430	6	92.00	86.00	52
6 635 CSi	06/78→10/89	Petrol	M30 B35 (Motronic,10:1)	3430	6	92.00	86.00	52
6 635 CSi	06/78→08/88	Petrol	M30 B35 (L-Jetronic,10:1)	3453	6	93.40	84.00	54
6 635 CSi	06/78→08/88	Petrol	M30 B35 (Motronic,9.3:1)	3453	6	93.40	84.00	54
6 635 d	07/07→07/10	Diesel	M57 D30 (306D5)	2993	6	84.00	90.00	33
6 640 d	11/10→	Diesel	N57 D30 B	2993	6	84.00	90.00	35
6 640 d xDrive	09/11→	Diesel	N57 D30 B	2993	6	84.00	90.00	35
6 M 635 CSi	03/84→05/89	Petrol	S38 B35 (356ED)	3453	6	93.40	84.00	54
7 725 i	07/77→06/86	Petrol	M30 B25	2494	6	86.00	71.60	39
7 725 tds	04/96→11/01	Diesel	M51 D25 (256T1)	2497	6	80.00	82.80	7
7 728	05/77→08/79	Petrol	M30 B28	2788	6	86.00	80.00	40
7 728 i	07/78→08/86	Petrol	M30 B28	2788	6	86.00	80.00	40
7 728i X	11/95→09/01	Petrol	M52 B28 (286S1)	2793	6	84.00	84.00	22
7 728 i,iL	08/95→11/01	Petrol	M52 B28 (286S1)	2793	6	84.00	84.00	22
7 728 i,iL	08/95→11/01	Petrol	M52 B28 (286S2)	2793	6	84.00	84.00	22
7 730	05/77→08/79	Petrol	M30 B30	2986	6	89.00	80.00	46
7 730 d	08/98→11/01	Diesel	M57 D30 (306D1)	2926	6	84.00	88.00	24
7 730 d	10/02→07/08	Diesel	M57 D30 (306D2)	2993	6	84.00	90.00	33
7 730 d	10/02→07/08	Diesel	M57 D30 (306D3)	2993	6	84.00	90.00	33
7 730 d	10/08→12/15	Diesel	N57 D30 A	2993	6	84.00	90.00	35
7 730 d xDrive	07/12→12/15	Diesel	N57 D30 A	2993	6	84.00	90.00	35
7 730 i,iL	12/86→09/94	Petrol	M30 B30 (306EA)	2986	6	89.00	80.00	46
7 730 i,iL	12/86→09/94	Petrol	M30 B30 (306KA)	2986	6	89.00	80.00	46
7 730 i,iL	10/94→11/01	Petrol	M60 B30 (308S1)	2997	V8	84.00	67.60	11
7 730 i,iL V8	04/92→09/94	Petrol	M60 B30 (308S1)	2997	V8	84.00	67.60	11

				cm3	x 			
7 730 i, Li	03/03→07/08	Petrol	M54 B30 (306S3)	2979	6	84.00	89.60	26
7 730 i, Li	03/05→07/08	Petrol	N52 B30 A	2996	6	85.00	88.00	38
7 730 i, Li	03/05→12/15	Petrol	N52 B30 A	2996	6	85.00	88.00	38
7 730 i, Li	06/08→12/15	Petrol	N52 B30 BF	2996	6	85.00	88.00	38
7 730 Ld	07/05→12/09	Diesel	M57 D30 (306D3)	2993	6	84.00	90.00	33
7 732 i	09/79→08/86	Petrol	M30 B32	3210	6	89.00	86.00	48
7 733 i	05/77→08/86	Petrol	M30 B32	3210	6	89.00	86.00	48
7 735 i	06/82→06/86	Petrol	M30 B34 (346EC)	3430	6	92.00	86.00	52
7 735 i	01/85→08/86	Petrol	M30 B34 (346KA)	3430	6	92.00	86.00	52
7 735 i	04/85→08/86	Petrol	M30 B35 (Motronic)	3430	6	92.00	86.00	52
7 735 i	09/79→08/86	Petrol	M30 B35 (Motronic,10:1)	3430	6	92.00	86.00	52
7 735 i	09/79→08/86	Petrol	M30 B35 (Motronic,9.3:1)	3453	6	93.40	84.00	54
7 735 i, iL	09/86→09/92	Petrol	M30 B34 (346KB)	3430	6	92.00	86.00	52
7 735 i, iL	09/86→12/87	Petrol	M30 B35 (Motronic,9.2:1)	3430	6	92.00	86.00	52
7 735 i, iL	01/96→11/01	Petrol	M62 B35 (358S1)	3498	V8	84.00	78.90	18
7 735 iL	09/86→12/92	Petrol	M30 B34 (346EC)	3430	6	92.00	86.00	52
7 735 iL	09/86→12/92	Petrol	M30 B34 (346KB)	3430	6	92.00	86.00	52
7 740 d	09/09→12/15	Diesel	N57 D30 B	2993	6	84.00	90.00	35
7 740 d xDrive	09/09→12/15	Diesel	N57 D30 B	2993	6	84.00	90.00	35
7 740 i	10/08→12/15	Petrol	N54 B30 A	2979	6	84.00	89.60	27
7 740 i, iL	10/94→11/01	Petrol	M60 B40 (408S1)	3982	V8	89.00	80.00	47
7 740 i, iL V8	04/92→09/94	Petrol	M60 B40 (408S1)	3982	V8	89.00	80.00	47
7 740 i, Li	09/10→12/15	Petrol	N54 B30 A	2979	6	84.00	89.60	27
7 745 i	04/80→04/83	Petrol	M30 B32 (326TA)	3210	6	89.00	86.00	48
7 745 i	05/83→08/86	Petrol	M30 B35	3430	6	92.00	86.00	52
8 840 i	02/93→02/96	Petrol	M60 B40 (408S1)	3982	V8	89.00	80.00	47
1500-2000 1500	10/62→07/66	Petrol	M10 B15	1499	4	82.00	71.00	8
1500-2000 1500	09/63→07/66	Petrol	M10 B16	1573	4	84.00	70.96	12
1500-2000 1600	09/63→12/71	Petrol	M10 B16	1573	4	84.00	70.96	12
1500-2000 1800	09/65→12/71	Petrol	M10 B18	1766	4	89.00	71.00	44
1500-2000 2000	01/70→11/72	Petrol	M10 B18	1766	4	89.00	71.00	44
1500-2000 2000	09/65→11/72	Petrol	M10 B20	1990	4	89.00	80.00	45
1500-2000 2000 Ti	09/67→12/70	Petrol	M10 B20	1990	4	89.00	80.00	45
1500-2000 2000 Tii	12/69→07/72	Petrol	M10 B20	1990	4	89.00	80.00	45
1500-2000 2000 Ti / Tilux	01/66→07/72	Petrol	M10 B20	1990	4	89.00	80.00	45
1600 GT 1.6	10/67→05/69	Petrol	M10 B16	1573	4	84.00	70.96	12
2000-3.2 2.5 CS	09/74→03/76	Petrol	M30 B25	2494	6	86.00	71.60	39
2000-3.2 3.0 CS	09/70→12/74	Petrol	M30 B30	2986	6	89.00	80.00	46
2000-3.2 3.0 CS	05/71→03/76	Petrol	M30 B30	2986	6	89.00	80.00	46
2000-3.2 3.0 Csi	07/71→03/76	Petrol	M30 B30	2986	6	89.00	80.00	46
2000-3.2 3.2 CSL	01/74→12/75	Petrol	M30 B32 (L-Jetronic)	3153	6	89.25	84.00	50
2000-3.2 2000 C/CA	10/65→06/70	Petrol	M10 B20	1990	4	89.00	80.00	45
2000-3.2 2000 CS	10/65→06/70	Petrol	M10 B20	1990	4	89.00	80.00	45
2000-3.2 2800	09/67→12/74	Petrol	M30 B28	2788	6	86.00	80.00	40
2000-3.2 2800 CS	01/69→04/71	Petrol	M30 B28	2788	6	86.00	80.00	40
2500-3.3 2.8 L	02/75→04/77	Petrol	M30 B28	2788	6	86.00	80.00	40
2500-3.3 3.0 L	02/75→04/77	Petrol	M30 B30	2986	6	89.00	80.00	46
2500-3.3 3.0 S	05/71→04/77	Petrol	M30 B30	2986	6	89.00	80.00	46
2500-3.3 3.0 Si	07/71→04/77	Petrol	M30 B30	2986	6	89.00	80.00	46
2500-3.3 3.3 L	01/74→09/76	Petrol	M30 B33 (35/40 INAT)	3295	6	89.00	88.30	49
2500-3.3 2500	10/68→04/77	Petrol	M30 B25	2494	6	86.00	71.60	39
2500-3.3 2800	10/68→07/75	Petrol	M30 B28	2788	6	86.00	80.00	40
Bavaria 3.0	09/71→12/74	Petrol	M30 B30	2986	6	89.00	80.00	46
X1 sDrive 16 d	04/12→06/15	Diesel	N47 D20 C	1995	4	84.00	90.00	32
X1 sDrive 18 d	03/09→06/15	Diesel	N47 D20 C	1995	4	84.00	90.00	32
X1 sDrive 18 i	03/09→06/15	Petrol	N46 B20 B	1995	4	84.00	90.00	28
X1 sDrive 20 d	10/09→06/15	Diesel	N47 D20 C	1995	4	84.00	90.00	32
X1 sDrive 28 i	09/11→06/15	Petrol	N52 B30 A	2996	6	85.00	88.00	38
X1 xDrive 18 d	03/09→06/15	Diesel	N47 D20 C	1995	4	84.00	90.00	32
X1 xDrive 20 d	10/09→06/15	Diesel	N47 D20 C	1995	4	84.00	90.00	32
X1 xDrive 23 d	10/09→06/15	Diesel	N47 D20 C	1995	4	84.00	90.00	32
X1 xDrive 23 d	10/09→06/15	Diesel	N47S D20 D	1995	4	84.00	90.00	32
X1 xDrive 25 i	01/10→06/15	Petrol	N52 B30 A	2996	6	85.00	88.00	38
X1 xDrive 28 i	10/09→06/15	Petrol	N52 B30 A	2996	6	85.00	88.00	38
X3 2.0 d	10/04→12/10	Diesel	M47 D20 (204D4)	1995	4	84.00	90.00	30
X3 2.0 d	09/07→03/09	Diesel	N47 D20 A	1995	4	84.00	90.00	32
X3 2.0 d	09/07→03/09	Diesel	N47 D20 C	1995	4	84.00	90.00	32
X3 2.0 i	07/05→08/08	Petrol	N46 B20 B	1995	4	84.00	90.00	28
X3 2.5 i	01/04→12/06	Petrol	M54 B25 (256S5)	2494	6	84.00	75.00	15















cm3









9

X3 2.5 si	09/06→08/08	Petrol	N52 B25 A	2497	6	82.00	78.80	10
X3 2.5 si xDrive	07/06→12/08	Petrol	N52 B25 A	2497	6	82.00	78.80	10
X3 3.0 d	01/04→08/05	Diesel	M57 D30 (306D2)	2993	6	84.00	90.00	33
X3 3.0 d	01/04→08/08	Diesel	M57 D30 (306D3)	2993	6	84.00	90.00	33
X3 3.0 i	01/04→12/06	Petrol	M54 B30 (306S3)	2979	6	84.00	89.60	26
X3 3.0 i xDrive	01/04→08/06	Petrol	M54 B30 (306S3)	2979	6	84.00	89.60	26
X3 3.0 i xDrive	09/06→12/10	Petrol	N52 B30 A	2996	6	85.00	88.00	38
X3 3.0 sd	09/06→08/08	Diesel	M57 D30 (306D5)	2993	6	84.00	90.00	33
X3 3.0 si	09/06→08/08	Petrol	N52 B30 A	2996	6	85.00	88.00	38
X3 sDrive 18 d	08/11→	Diesel	N47 D20 C	1995	4	84.00	90.00	32
X3 xDrive 18 d	09/08→12/11	Diesel	N47 D20 C	1995	4	84.00	90.00	32
X3 xDrive 20 d	09/08→	Diesel	N47 D20 C	1995	4	84.00	90.00	32
X3 xDrive 20 i	09/08→08/11	Petrol	N46 B20 B	1995	4	84.00	90.00	28
X3 xDrive 25 i	09/08→12/11	Petrol	N52 B25 A	2497	6	82.00	78.80	10
X3 xDrive 28 d	09/14→	Diesel	N47 D20 C	1995	4	84.00	90.00	32
X3 xDrive 28 i	09/08→	Petrol	N52 B30 A	2996	6	85.00	88.00	38
X3 xDrive 28 i	09/10→	Petrol	N52 B30 BF	2996	6	85.00	88.00	38
X3 xDrive 30 d	09/08→04/11	Diesel	M57 D30 (306D3)	2993	6	84.00	90.00	33
X3 xDrive 30 d	05/11→	Diesel	N57 D30 A	2993	6	84.00	90.00	35
X3 xDrive 30 i	09/08→12/11	Petrol	N52 B30 A	2996	6	85.00	88.00	38
X3 xDrive 30 i	09/08→08/11	Diesel	M57 D30 (306D5)	2993	6	84.00	90.00	33
X3 xDrive 35 d	09/11→	Diesel	N57 D30 B	2993	6	84.00	90.00	35
X4 xDrive 30 d	04/14→	Diesel	N57 D30 A	2993	6	84.00	90.00	35
X4 xDrive 35 d	04/14→	Diesel	N57 D30 B	2993	6	84.00	90.00	35
X5 3.0	06/00→12/06	Petrol	M54 B30 (306S3)	2979	6	84.00	89.60	26
X5 3.0 d	05/01→12/03	Diesel	M57 D30 (306D1)	2926	6	84.00	88.00	24
X5 3.0 d	09/03→12/06	Diesel	M57 D30 (306D2)	2993	6	84.00	90.00	33
X5 3.0 d	02/07→09/08	Diesel	M57 D30 (306D3)	2993	6	84.00	90.00	33
X5 3.0 i	05/00→12/06	Petrol	M54 B30 (306S3)	2979	6	84.00	89.60	26
X5 3.0 sd	09/07→02/09	Diesel	M57 D30 (306D5)	2993	6	84.00	90.00	33
X5 3.0 si	02/07→09/08	Petrol	N52 B30 A	2996	6	85.00	88.00	38
X5 xDrive 25 d	06/15→	Diesel	N57 D30 A	2993	6	84.00	90.00	35
X5 xDrive 30 d	09/08→	Diesel	N57 D30 A	2993	6	84.00	90.00	35
X5 xDrive 30 i	09/08→12/10	Petrol	N52 B30 A	2996	6	85.00	88.00	38
X5 xDrive 35 d	09/08→12/12	Diesel	M57 D30 (306D4)	2993	6	84.00	90.00	33
X5 xDrive 35 d	09/08→06/13	Diesel	M57 D30 (306D5)	2993	6	84.00	90.00	33
X5 xDrive 40 d	09/10→	Diesel	N57 D30 B	2993	6	84.00	90.00	35
X6 30 d	05/08→08/08	Diesel	M57 D30 (306D3)	2993	6	84.00	90.00	33
X6 35 d	05/08→08/08	Diesel	M57 D30 (306D5)	2993	6	84.00	90.00	33
X6 35 i	05/08→08/08	Petrol	N54 B30 A	2979	6	84.00	89.60	27
X6 xDrive 30 d	09/08→	Diesel	N57 D30 A	2993	6	84.00	90.00	35
X6 xDrive 35 d	09/08→06/14	Diesel	M57 D30 (306D5)	2993	6	84.00	90.00	33
X6 xDrive 35 i	09/08→06/14	Petrol	N54 B30 A	2979	6	84.00	89.60	27
X6 xDrive 40 d	10/10→	Diesel	N57 D30 B	2993	6	84.00	90.00	35
Z1 2.5	06/88→06/91	Petrol	M20 B25 (256K1)	2494	6	84.00	75.00	15
Z3 1.8	10/95→10/98	Petrol	M43 B18 (184E2)	1796	4	84.00	81.00	19
Z3 1.9	07/98→01/03	Petrol	M43 B19 (194E1)	1895	4	85.00	83.50	36
Z3 1.9	10/95→03/99	Petrol	M44 B19 (194S1)	1895	4	85.00	83.50	36
Z3 2.0	04/99→01/03	Petrol	M52 B20 (206S4)	1991	6	80.00	66.00	1
Z3 2.2	08/00→01/03	Petrol	M54 B22 (226S1)	2171	6	80.00	72.00	2
Z3 2.5	09/98→12/00	Petrol	M52 B25 TU	2494	6	84.00	75.00	15
Z3 2.5	09/00→12/02	Petrol	M54 B25 (256S5)	2494	6	84.00	75.00	15
Z3 2.8	01/96→07/00	Petrol	M52 B28 (286S1)	2793	6	84.00	84.00	22
Z3 2.8	01/96→07/00	Petrol	M52 B28 (286S2)	2793	6	84.00	84.00	22
Z3 3.0	06/00→06/03	Petrol	M54 B30 (306S3)	2979	6	84.00	89.60	26
Z3 M	02/98→06/01	Petrol	S50 B32 (326S1)	3201	6	86.40	91.00	43
Z3 M 3.2	03/97→06/01	Petrol	S50 B32 (326S1)	3201	6	86.40	91.00	43
Z4 2.0 i	03/05→02/09	Petrol	N46 B20 A	1995	4	84.00	90.00	28
Z4 2.0 i	03/05→02/09	Petrol	N46 B20 B	1995	4	84.00	90.00	28
Z4 2.2 i	10/03→10/05	Petrol	M54 B22 (226S1)	2171	6	80.00	72.00	2
Z4 2.5 i	02/03→12/05	Petrol	M54 B25 (256S5)	2494	6	84.00	75.00	15
Z4 2.5 i	09/05→02/09	Petrol	N52 B25 A	2497	6	82.00	78.80	10
Z4 2.5 si	09/05→02/09	Petrol	N52 B25 A	2497	6	82.00	78.80	10
Z4 3.0 i	02/03→12/05	Petrol	M54 B30 (306S3)	2979	6	84.00	89.60	26
Z4 3.0 si	09/05→12/09	Petrol	N52 B30 A	2996	6	85.00	88.00	38
Z4 sDrive 23 i	05/09→	Petrol	N52 B25 A	2497	6	82.00	78.80	10
Z4 sDrive 25 i	09/09→	Petrol	N52 B25	2497	6	82.00	78.80	10
Z4 sDrive 30 i	05/09→	Petrol	N52 B30 A	2996	6	85.00	88.00	38
Z4 sDrive 35 i	05/09→	Petrol	N54 B30 A	2979	6	84.00	89.60	27
Z4 sDrive 35 i	09/09→	Petrol	N54 B30 A	2979	6	84.00	89.60	27

		cm3	x 			
M10 B15	Petrol	1499	4	82.00	71.00	8
M10 B16	Petrol	1573	4	84.00	70.96	12
M10 B16 (164VA)	Petrol	1573	4	84.00	70.96	12
M10 B16 (164VB)	Petrol	1573	4	84.00	70.96	12
M10 B18	Petrol	1766	4	89.00	71.00	44
M10 B18 (184EA)	Petrol	1766	4	89.00	71.00	44
M10 B18 (184EB)	Petrol	1766	4	89.00	71.00	44
M10 B18 (184EW)	Petrol	1766	4	89.00	71.00	44
M10 B18 (184EY)	Petrol	1766	4	89.00	71.00	44
M10 B18 (184EZ)	Petrol	1766	4	89.00	71.00	44
M10 B18 (184KA)	Petrol	1766	4	89.00	71.00	44
M10 B18 (184VA)	Petrol	1766	4	89.00	71.00	44
M10 B18 (184VB)	Petrol	1766	4	89.00	71.00	44
M10 B18 (184VC)	Petrol	1766	4	89.00	71.00	44
M10 B18 (184VD)	Petrol	1766	4	89.00	71.00	44
M10 B20	Petrol	1990	4	89.00	80.00	45
M10 B20 (Turbo)	Petrol	1990	4	89.00	80.00	45
M20 B20	Petrol	1990	6	80.00	66.00	1
M20 B20 (206EA)	Petrol	1990	6	80.00	66.00	1
M20 B20 (206EB)	Petrol	1990	6	80.00	66.00	1
M20 B20 (206EC)	Petrol	1990	6	80.00	66.00	1
M20 B20 (206EE)	Petrol	1990	6	80.00	66.00	1
M20 B20 (206EY)	Petrol	1990	6	80.00	66.00	1
M20 B20 (206EZ)	Petrol	1990	6	80.00	66.00	1
M20 B20 (206KA)	Petrol	1990	6	80.00	66.00	1
M20 B20 (206VA)	Petrol	1990	6	80.00	66.00	1
M20 B23 (236EA)	Petrol	2316	6	80.00	76.80	3
M20 B23 (236EC)	Petrol	2316	6	80.00	76.80	3
M20 B25 (256E1)	Petrol	2494	6	84.00	75.00	15
M20 B25 (256E2)	Petrol	2494	6	84.00	75.00	15
M20 B25 (256EX)	Petrol	2494	6	84.00	75.00	15
M20 B25 (256K1)	Petrol	2494	6	84.00	75.00	15
M20 B27 (276EA)	Petrol	2693	6	84.00	81.00	21
M20 B27 (276EB)	Petrol	2693	6	84.00	81.00	21
M20 B27 (276KA)	Petrol	2693	6	84.00	81.00	21
M20 B27 (276KB)	Petrol	2693	6	84.00	81.00	21
M21 D24 (246DA)	Diesel	2443	6	80.00	81.00	4
M21 D24 (246TA)	Diesel	2443	6	80.00	81.00	5
M21 D24 (246TB)	Diesel	2443	6	80.00	81.00	5
M21 D24 W	Diesel	2443	6	80.00	81.00	4
M30 B25	Petrol	2494	6	86.00	71.60	39
M30 B25 (256EA)	Petrol	2494	6	86.00	71.60	39
M30 B25 (256VA)	Petrol	2494	6	86.00	71.60	39
M30 B28	Petrol	2788	6	86.00	80.00	40
M30 B28 (286EA)	Petrol	2788	6	86.00	80.00	40
M30 B30	Petrol	2986	6	89.00	80.00	46
M30 B30 (306EA)	Petrol	2986	6	89.00	80.00	46
M30 B30 (306KA)	Petrol	2986	6	89.00	80.00	46
M30 B32	Petrol	3210	6	89.00	86.00	48
M30 B32 (326TA)	Petrol	3210	6	89.00	86.00	48
M30 B32 (L-Jetronic)	Petrol	3153	6	89.25	84.00	50
M30 B33 (35/40 INAT)	Petrol	3295	6	89.00	88.30	49
M30 B34 (346EC)	Petrol	3430	6	92.00	86.00	52
M30 B34 (346KA)	Petrol	3430	6	92.00	86.00	52
M30 B34 (346KB)	Petrol	3430	6	92.00	86.00	52
M30 B35	Petrol	3430	6	92.00	86.00	52
M30 B35 (L-Jetronic,10:1)	Petrol	3453	6	93.40	84.00	54
M30 B35 (Motronic)	Petrol	3430	6	92.00	86.00	52
M30 B35 (Motronic,10:1)	Petrol	3430	6	92.00	86.00	52
M30 B35 (Motronic,9.2:1)	Petrol	3430	6	92.00	86.00	52
M30 B35 (Motronic,9.3:1)	Petrol	3453	6	93.40	84.00	54
M40 B16	Petrol	1596	4	84.00	72.00	13
M40 B16 (164E1)	Petrol	1596	4	84.00	72.00	13
M40 B16 C	Petrol	1596	4	84.00	72.00	13
M40 B18 (184E1)	Petrol	1796	4	84.00	81.00	19
M40 B18 C	Petrol	1796	4	84.00	81.00	19
M41 D17 (174T1)	Diesel	1665	4	80.00	82.80	6
M42 B18	Petrol	1796	4	84.00	81.00	19
M42 B18 (184S1)	Petrol	1796	4	84.00	81.00	19

		cm3	x 			
M43 B16 (164E2)	Petrol	1596	4	84.00	72.00	13
M43 B16 (164E3)	Petrol	1596	4	84.00	72.00	13
M43 B18 (184E2)	Petrol	1796	4	84.00	81.00	19
M43 B19 (194E1)	Petrol	1895	4	85.00	83.50	36
M44 B19 (194S1)	Petrol	1895	4	85.00	83.50	36
M47 D20	Diesel	1951	4	84.00	88.00	23
M47 D20 (204D1)	Diesel	1951	4	84.00	88.00	23
M47 D20 (204D4)	Diesel	1995	4	84.00	90.00	30
M47 D20 TU	Diesel	1951	4	84.00	88.00	23
M47N 204 D4	Diesel	1995	4	84.00	90.00	31
M47N 204 D5	Diesel	1995	4	84.00	90.00	31
M50 B(20 6 S1)	Petrol	1991	6	80.00	66.00	1
M50 B(20 6 S2) Vanos	Petrol	1991	6	80.00	66.00	1
M50 B20	Petrol	1991	6	80.00	66.00	1
M50 B20 (206S1)	Petrol	1991	6	80.00	66.00	1
M50 B20 (206S2)	Petrol	1991	6	80.00	66.00	1
M50 B20 TU	Petrol	1991	6	80.00	66.00	1
M50 B25 (256S1)	Petrol	2494	6	84.00	75.00	15
M50 B25 (256S2)	Petrol	2494	6	84.00	75.00	15
M50 B25 (Vanos)	Petrol	2494	6	84.00	75.00	15
M50 B25 TU	Petrol	2494	6	84.00	75.00	15
M51 D25 (256T1)	Diesel	2497	6	80.00	82.80	7
M51 D25 (Inter.)	Diesel	2497	6	80.00	82.80	7
M52 B(20 6 S3) Vanos	Petrol	1991	6	80.00	66.00	1
M52 B20	Petrol	1991	6	80.00	66.00	1
M52 B20 (206S3)	Petrol	1991	6	80.00	66.00	1
M52 B20 (206S4)	Petrol	1991	6	80.00	66.00	1
M52 B25 (256S3)	Petrol	2494	6	84.00	75.00	15
M52 B25 (256S4)	Petrol	2494	6	84.00	75.00	15
M52 B25 (Vanos)	Petrol	2494	6	84.00	75.00	15
M52 B25 TU	Petrol	2494	6	84.00	75.00	15
M52 B28	Petrol	2793	6	84.00	84.00	22
M52 B28 (286S1)	Petrol	2793	6	84.00	84.00	22
M52 B28 (286S2)	Petrol	2793	6	84.00	84.00	22
M52 B28 TU	Petrol	2793	6	84.00	84.00	22
M54 B22 (226S1)	Petrol	2171	6	80.00	72.00	2
M54 B25 (256S5)	Petrol	2494	6	84.00	75.00	15
M54 B30 (306S3)	Petrol	2979	6	84.00	89.60	26
M57 D25 (256D1)	Diesel	2497	6	80.00	82.80	7
M57 D25 (256D2)	Diesel	2497	6	84.00	75.10	16
M57 D30 (306D1)	Diesel	2926	6	84.00	88.00	24
M57 D30 (306D2)	Diesel	2993	6	84.00	90.00	33
M57 D30 (306D3)	Diesel	2993	6	84.00	90.00	33
M57 D30 (306D4)	Diesel	2993	6	84.00	90.00	33
M57 D30 (306D5)	Diesel	2993	6	84.00	90.00	33
M57 D30 TU2	Diesel	2993	6	84.00	90.00	34
M57N 256 D4	Diesel	2497	6	84.00	75.10	17
M57N 306 D2	Diesel	2993	6	84.00	90.00	33
M57N 306 D4	Diesel	2993	6	84.00	90.00	33
M60 B30	Petrol	2997	V8	84.00	67.60	11
M60 B30 (308S1)	Petrol	2997	V8	84.00	67.60	11
M60 B40 (408S1)	Petrol	3982	V8	89.00	80.00	47
M62 B35 (358S1)	Petrol	3498	V8	84.00	78.90	18
M62 B35 (358S2)	Petrol	3498	V8	84.00	78.90	18
M62 B35 TU	Petrol	3498	V8	84.00	78.90	18
M62 B44	Petrol	4398	V8	92.00	82.70	51
M62 B44 (448S1)	Petrol	4398	V8	92.00	82.70	51
M62 B44 (448S2)	Petrol	4398	V8	92.00	82.70	51
M62 B44 TU	Petrol	4398	V8	92.00	82.70	51
M70 B56	Petrol	5576	V12	86.00	80.00	41
M43 194 E1	Petrol	1895	4	85.00	83.50	36
M47 204 D1	Diesel	1951	4	84.00	88.00	23
M62448S2	Petrol	4398	V8	92.00	82.70	51
N40 B16 A	Petrol	1596	4	84.00	72.00	14
N42 B18 A	Petrol	1796	4	84.00	81.00	20
N42 B20	Petrol	1995	4	84.00	90.00	28
N42 B20 A	Petrol	1995	4	84.00	90.00	28
N42 B20 B	Petrol	1995	4	84.00	90.00	28
N43 B16 A	Petrol	1597	4	82.00	75.60	9

		cm3	x 			
N43 B20 A	Petrol	1995	4	84.00	90.00	29
N45 B16	Petrol	1596	4	84.00	72.00	14
N45 B16 A	Petrol	1596	4	84.00	72.00	14
N45 B16 TU2	Petrol	1596	4	84.00	72.00	14
N45 B20 A	Petrol	1997	4	85.00	88.00	37
N46 B18 A	Petrol	1796	4	84.00	81.00	20
N46 B20	Petrol	1995	4	84.00	90.00	28
N46 B20 A	Petrol	1995	4	84.00	90.00	28
N46 B20 B	Petrol	1995	4	84.00	90.00	28
N46 B20 BD	Petrol	1995	4	84.00	90.00	28
N46 B20 C	Petrol	1995	4	84.00	90.00	28
N46 B20 CC	Petrol	1995	4	84.00	90.00	28
N46 B20 CD	Petrol	1995	4	84.00	90.00	28
N46 B20 E	Petrol	1995	4	84.00	90.00	28
N46N B20 B	Petrol	1995	4	84.00	89.00	25
N47 D20 A	Diesel	1995	4	84.00	90.00	32
N47 D20 B	Diesel	1995	4	84.00	90.00	32
N47 D20 C	Diesel	1995	4	84.00	90.00	32
N47S D20 D	Diesel	1995	4	84.00	90.00	32
N52 B25	Petrol	2497	6	82.00	78.80	10
N52 B25 A	Petrol	2497	6	82.00	78.80	10
N52 B25 C	Petrol	2497	6	82.00	78.80	10
N52 B30	Petrol	2996	6	85.00	88.00	38
N52 B30 A	Petrol	2996	6	85.00	88.00	38
N52 B30 BF	Petrol	2996	6	85.00	88.00	38
N52N B25 A	Petrol	2497	6	82.00	78.80	10
N52N B30 A	Petrol	2996	6	85.00	88.00	38
N52N B30 B	Petrol	2996	6	85.00	88.00	38
N53 B25 A	Petrol	2497	6	82.00	78.80	10
N53 B30	Petrol	2996	6	85.00	88.00	38
N53 B30 A	Petrol	2996	6	85.00	88.00	38
N54 B30 A	Petrol	2979	6	84.00	89.60	27
N54 B30 A	Petrol	2979	6	84.00	89.60	27
N54 B30 B	Petrol	2979	6	84.00	89.60	27
N57 D30 A	Diesel	2993	6	84.00	90.00	35
N57 D30 B	Diesel	2993	6	84.00	90.00	35
N57N 306 D2	Diesel	2993	6	84.00	90.00	35
N57N 306 D3	Diesel	2993	6	84.00	90.00	35
N57N 306 D5	Diesel	2993	6	84.00	90.00	35
N57 306 D2	Diesel	2993	6	84.00	90.00	35
N57 306 D3	Diesel	2993	6	84.00	90.00	35
S14 B23 (234EA)	Petrol	2303	4	93.40	84.00	53
S14 B23 (234S1)	Petrol	2303	4	93.40	84.00	53
S14 B23 (234S2)	Petrol	2303	4	93.40	84.00	53
S14 B23 (EVO I)	Petrol	2302	4	93.40	84.00	53
S38 B35 (356ED)	Petrol	3453	6	93.40	84.00	54
S38 B36	Petrol	3535	6	93.40	86.00	55
S50 B32	Petrol	3201	6	86.40	91.00	42
S50 B32 (326S1)	Petrol	3201	6	86.40	91.00	43

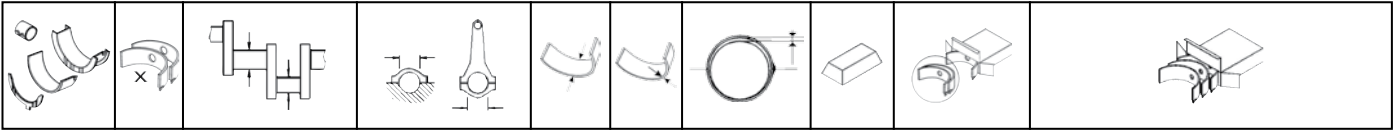

1 80.00 x 66.00

M20 B20	6 Cyl.	1990cc	90-110kW (122-150PS)	Petrol	TD5117
M20 B20 (206EA)	6 Cyl.	1990cc	90-110kW (122-150PS)	Petrol	TD28329
M20 B20 (206EB)	6 Cyl.	1990cc	90-110kW (122-150PS)	Petrol	TD28330
M20 B20 (206EC)	6 Cyl.	1990cc	90-110kW (122-150PS)	Petrol	TD28331
M20 B20 (206EE)	6 Cyl.	1990cc	90-110kW (122-150PS)	Petrol	TD28332
M20 B20 (206EY)	6 Cyl.	1990cc	90-110kW (122-150PS)	Petrol	TD28333
M20 B20 (206EZ)	6 Cyl.	1990cc	90-110kW (122-150PS)	Petrol	TD28334
M20 B20 (206KA)	6 Cyl.	1990cc	90-110kW (122-150PS)	Petrol	TD28335
M20 B20 (206VA)	6 Cyl.	1990cc	90-110kW (122-150PS)	Petrol	TD28336
M50 B(20 6 S1)	6 Cyl.	1991cc	110kW (150PS)	Petrol	TD4227
M50 B(20 6 S2) Vanos	6 Cyl.	1991cc	110kW (150PS)	Petrol	TD10027
M50 B20	6 Cyl.	1991cc	110kW (150PS)	Petrol	TD21402
M50 B20 (206S1)	6 Cyl.	1991cc	110kW (150PS)	Petrol	TD28375
M50 B20 (206S2)	6 Cyl.	1991cc	110kW (150PS)	Petrol	TD28376
M50 B20 TU	6 Cyl.	1991cc	110kW (150PS)	Petrol	TD21239
M52 B(20 6 S3) Vanos	6 Cyl.	1991cc	100-110kW (136-150PS)	Petrol	TD460
M52 B20	6 Cyl.	1991cc	110kW (150PS)	Petrol	TD21403
M52 B20 (206S3)	6 Cyl.	1991cc	100-110kW (136-150PS)	Petrol	TD28380
M52 B20 (206S4)	6 Cyl.	1991cc	110kW (150PS)	Petrol	TD28381

BE/PL	6	44,975/44,991	48,000/48,016	18,000	1,493	0,023/0,080	EC	71-3419	71-3419/6 STD 0.25 0.50
MB/HL 1-5, 7	6	59,971/59,990	65,000/65,019	20,000	2,498	0,020/0,063	AL-LF	02-3646	H023/7 STD 0.25 0.50
MB/HL 6	1	59,971/59,990	65,000/65,019	24,940	2,498	0,020/0,082	AL-LF	02-3647H	

	02-3647H	STD	25,020/.9853" - 25,053/.9863"
		0.25mm	25,220/.9929" - 25,253/.9942"
		0.50mm	25,420/1.0008" - 25,453/1.0021"

MB/HL 1-5, 7	6	59,971/59,990	65,000/65,019	20,000	2,490	0,030/0,093	EC	72-3420	H948/7 STD 0.25
MB/HL 6	1	59,971/59,990	65,000/65,019	24,940	2,490	0,030/0,093	EC	72-3421H	

	72-3421H	STD	25,020/.9853" - 25,053/.9863"
		0.25mm	25,220/.9929" - 25,253/.9942"
		0.50mm	25,420/1.0008" - 25,453/1.0021"

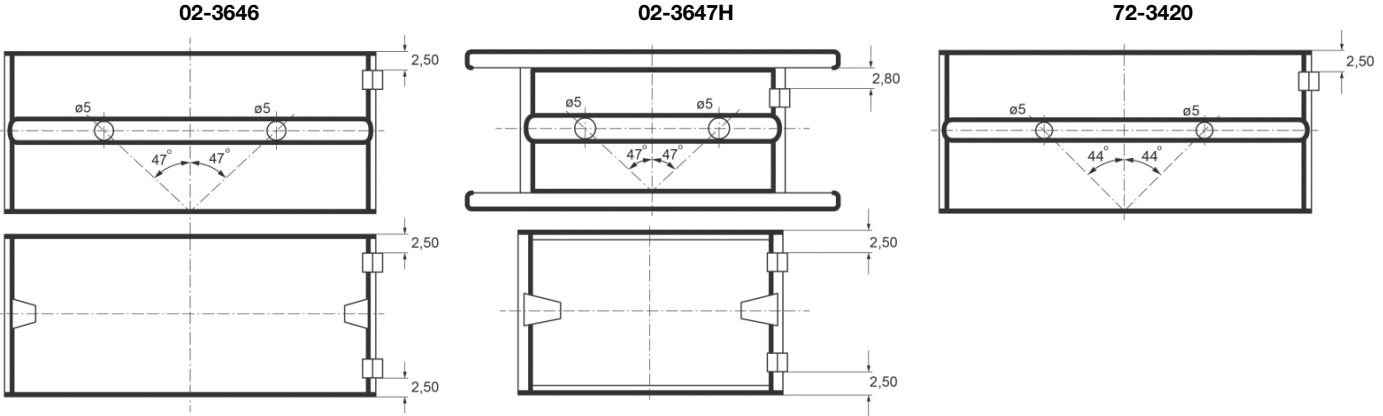

MB/HL 1-5, 7	6	59,971/59,990	65,000/65,019	20,000	2,498	0,020/0,063	AL-LF	02-3646	H023/7 STD 0.25 0.50
MB/HL 6	1	59,971/59,990	65,000/65,019	24,940	2,498	0,020/0,082	AL-LF	02-3647H	
			02-3647H	STD	25,020/.9853" - 25,053/.9863"				
				0.25mm	25,220/.9929" - 25,253/.9942"				
				0.50mm	25,420/1.0008" - 25,453/1.0021"				
SE/PB	1	26,000	28,000/28,021	22,000			BC	55-3576	55-3576 SEMI

6 80.00 x 82.80

M41 D17 (174T1)		4 Cyl.	1665cc	66kW (90PS)	Diesel Turbo Intercooler			TD28369	
BE/PL	4	44,975/44,991	48,000/48,016	18,000	1,497	0,020/0,072	SP	71-3704	71-3704/4 STD 0.25 1
MB/HL 1,2,4,5	4	59,971/59,990	65,000/65,019	20,000	2,498	0,020/0,063	AL-LF	02-3646	H023/5 STD 0.25
MB/HL 3	1	59,971/59,990	65,000/65,019	24,940	2,498	0,020/0,082	AL-LF	02-3647H	
			02-3647H	STD	25,020/.9853" - 25,053/.9863"				
				0.25mm	25,220/.9929" - 25,253/.9942"				
				0.50mm	25,420/1.0008" - 25,453/1.0021"				

7 80.00 x 82.80

M51 D25 (256T1)		6 Cyl.	2497cc	85-105kW (115-143PS)	Diesel Turbo Intercooler			TD28379	
M51 D25 (Inter.)		6 Cyl.	2497cc	105kW (143PS)	Diesel Turbo			TD5285	
M57 D25 (256D1)		6 Cyl.	2497cc	120kW (163PS)	Diesel Turbo Intercooler			TD27988	
BE/PL	6	44,975/44,991	48,000/48,016	18,000	1,497	0,020/0,072	SP	71-3704	71-3704/6 STD 0.25 1
MB/HL 1-5, 7	6	59,971/59,990	65,000/65,019	20,000	2,498	0,020/0,063	AL-LF	02-3646	H023/7 STD 0.25 0.50
MB/HL 6	1	59,971/59,990	65,000/65,019	24,940	2,498	0,020/0,082	AL-LF	02-3647H	
			02-3647H	STD	25,020/.9853" - 25,053/.9863"				
				0.25mm	25,220/.9929" - 25,253/.9942"				
				0.50mm	25,420/1.0008" - 25,453/1.0021"				
SE/PB	1	26,995/27,000	29,000/29,021	22,200			BC	55-3705	55-3705 SEMI

8 82.00 x 71.00

M10 B15		4 Cyl.	1499cc	59kW (80PS)	Petrol			TD5168	
BE/PL	4	47,975/47,991	52,000/52,015	20,000	1,993	0,023/0,078	EC	71-2182	71-2182/4 STD 0.25 0.50
MB/HL 1,2,4,5	4	54,971/54,990	60,000/60,019	24,000	2,490	0,030/0,093	EC	72-2183	H629/5 STD 0.25
MB/HL 3	1	54,971/54,990	60,000/60,019	29,900	2,490	0,030/0,093	EC	72-2184H	
			72-2184H	STD	30,025/1.1821" - 30,064/1.1836"				
				0.25mm	30,225/1.1900" - 30,264/1.1915"				
				0.50mm	30,425/1.1978" - 30,464/1.1994"				
SE/PB	1	22,000	24,000/24,021	24,000			BC	55-2528	55-2528 SEMI

9 82.00 x 75.60

N43 B16 A		4 Cyl.	1597cc	85-90kW (115-122PS)	Petrol			TD20844	
BE/PL	2	49,981/49,997	53,600/53,616	17,550	1,797	0,025/0,083	EC	71-4806	71-4807/2 STD 4
BE/PL	2	49,975/49,991	53,600/53,616	17,550	1,795	0,026/0,082	EC	71-4807	



SE/PB	1	20,000	21,995/22,031	21,300			BC	55-4808	55-4808 SEMI
-------	---	--------	---------------	--------	--	--	----	---------	-----------------

10 82.00 x 78.80

N52 B25			6 Cyl.	2497cc	130-163kW (177-222PS)	Petrol			TD21408
N52 B25 A			6 Cyl.	2497cc	130-160kW (177-218PS)	Petrol			TD18517
N52 B25 C			6 Cyl.	2497cc	160kW (218PS)	Petrol			TD18169
N52N B25 A			6 Cyl.	2497cc	130kW (177PS)	Petrol			TD20960
N53 B25 A			6 Cyl.	2497cc	140kW (190PS)	Petrol			TD20588

BE/PL	6	49,981/49,997	53,600/53,616	17,550	1,797	0,025/0,083	EC	71-4806	71-4806/6 STD
SE/PB	1	20,000	21,995/22,031	21,300			BC	55-4808	55-4808 SEMI

11 84.00 x 67.60

M60 B30			V8 Cyl.	2997cc	155-160kW (211-218PS)	Petrol			TD4232
M60 B30 (308S1)			V8 Cyl.	2997cc	155-160kW (211-218PS)	Petrol			TD28388

BE/PL	8	47,975/47,991	52,000/52,013	17,000	1,997	0,020/0,069	EC	71-3706	71-3706/8 STD
MB/HL 1-5	5	69,971/69,990	75,000/75,019	24,000	2,505	0,020/0,063	AL-LF	02-3707	H033/5 STD

12 84.00 x 70.96

M10 B16			4 Cyl.	1573cc	55-77kW (75-105PS)	Petrol			TD5170
M10 B16 (164VA)			4 Cyl.	1573cc	55-77kW (75-105PS)	Petrol			TD28312
M10 B16 (164VB)			4 Cyl.	1573cc	55-77kW (75-105PS)	Petrol			TD28313

BE/PL	4	47,975/47,991	52,000/52,015	20,000	1,993	0,023/0,078	EC	71-2182	71-2182/4 STD 0.25 0.50
MB/HL 1,2,4,5	4	54,971/54,990	60,000/60,019	24,000	2,490	0,030/0,093	EC	72-2183	H629/5 STD 0.25
MB/HL 3	1	54,971/54,990	60,000/60,019	29,900	2,490	0,030/0,093	EC	72-2184H	



72-2184H	STD	30,025/1.1821" - 30,064/1.1836"
	0.25mm	30,225/1.1900" - 30,264/1.1915"
	0.50mm	30,425/1.1978" - 30,464/1.1994"

SE/PB	1	22,000	24,000/24,021	24,000			BC	55-2528	55-2528 SEMI
-------	---	--------	---------------	--------	--	--	----	---------	-----------------

13 84.00 x 72.00

M40 B16			4 Cyl.	1596cc	73-75kW (99-102PS)	Petrol			TD5255
M40 B16 (164E1)			4 Cyl.	1596cc	73-75kW (99-102PS)	Petrol			TD28367
M40 B16 C			4 Cyl.	1596cc	73kW (99PS)	Petrol			TD21160
M43 B16 (164E2)			4 Cyl.	1596cc	75-77kW (102-105PS)	Petrol			TD28371
M43 B16 (164E3)			4 Cyl.	1596cc	77kW (105PS)	Petrol			TD17055

BE/PL	4	44,975/44,991	48,000/48,016	18,000	1,493	0,023/0,080	EC	71-3419	71-3419/4 STD 0.25 0.50
MB/HL	5	59,971/59,990	65,000/65,019	20,000	2,498	0,020/0,063	AL-LF	02-3646L	H007/5 STD 0.25
MB/HL	4	59,971/59,990	65,000/65,019	20,000	2,498	0,020/0,063	AL-LF	02-3646U	
MB/HL	1	59,971/59,990	65,000/65,019	24,940	2,498	0,020/0,082	AL-LF	02-3647HU	
SE/PB	1	22,000	24,000/24,031	22,000			BC	55-3648	55-3648 SEMI

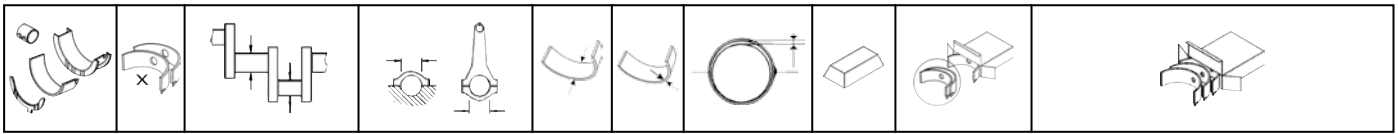

14		84.00 x 72.00								
N40 B16 A			4 Cyl.	1596cc	85kW (115PS)		Petrol		TD18037	
N45 B16			4 Cyl.	1596cc	85kW (115PS)		Petrol		TD21404	
N45 B16 A			4 Cyl.	1596cc	85-90kW (115-122PS)		Petrol		TD18358	
N45 B16 TU2			4 Cyl.	1596cc	85-90kW (115-122PS)		Petrol		TD21221	
BE/PL	4	49,981/49,997		53,600/53,616	17,550	1,797	0,025/0,083	EC	71-4806	71-4806/4 STD
SE/PB	1	20,000		21,995/22,031	21,300			BC	55-4808	55-4808 SEMI

15		84.00 x 75.00								
M20 B25 (256E1)			6 Cyl.	2494cc	125-126kW (170-171PS)		Petrol		TD28341	
M20 B25 (256E2)			6 Cyl.	2494cc	125-126kW (170-171PS)		Petrol		TD28342	
M20 B25 (256EX)			6 Cyl.	2494cc	125-126kW (170-171PS)		Petrol		TD28343	
M20 B25 (256K1)			6 Cyl.	2494cc	125-126kW (170-171PS)		Petrol		TD28344	
M50 B25 (256S1)			6 Cyl.	2494cc	141kW (192PS)		Petrol		TD28377	
M50 B25 (256S2)			6 Cyl.	2494cc	141kW (192PS)		Petrol		TD28378	
M50 B25 (Vanos)			6 Cyl.	2494cc	141kW (192PS)		Petrol		TD18476	
M50 B25 TU			6 Cyl.	2494cc	141kW (192PS)		Petrol		TD21240	
M52 B25 (256S3)			6 Cyl.	2494cc	125-141kW (170-192PS)		Petrol		TD28382	
M52 B25 (256S4)			6 Cyl.	2494cc	125-141kW (170-192PS)		Petrol		TD28383	
M52 B25 (Vanos)			6 Cyl.	2494cc	125-141kW (170-192PS)		Petrol		TD4230	
M52 B25 TU			6 Cyl.	2494cc	125kW (170PS)		Petrol		TD21241	
M54 B25 (256S5)			6 Cyl.	2494cc	137-141kW (186-192PS)		Petrol		TD28217	
BE/PL	6	44,975/44,991		48,000/48,016	18,000	1,493	0,023/0,080	EC	71-3419	71-3419/6 STD 0.25 0.50
MB/HL 1-5, 7	6	59,971/59,990		65,000/65,019	20,000	2,498	0,020/0,063	AL-LF	02-3646	H023/7 STD 0.25 0.50
MB/HL 6	1	59,971/59,990		65,000/65,019	24,940	2,498	0,020/0,082	AL-LF	02-3647H	
				02-3647H	STD	25,020/.9853" - 25,053/.9863"				
					0.25mm	25,220/.9929" - 25,253/.9942"				
					0.50mm	25,420/1.0008" - 25,453/1.0021"				
MB/HL 1-5, 7	6	59,971/59,990		65,000/65,019	20,000	2,490	0,030/0,093	EC	72-3420	H948/7 STD 0.25
MB/HL 6	1	59,971/59,990		65,000/65,019	24,940	2,490	0,030/0,093	EC	72-3421H	
				72-3421H	STD	25,020/.9853" - 25,053/.9863"				
					0.25mm	25,220/.9929" - 25,253/.9942"				
					0.50mm	25,420/1.0008" - 25,453/1.0021"				

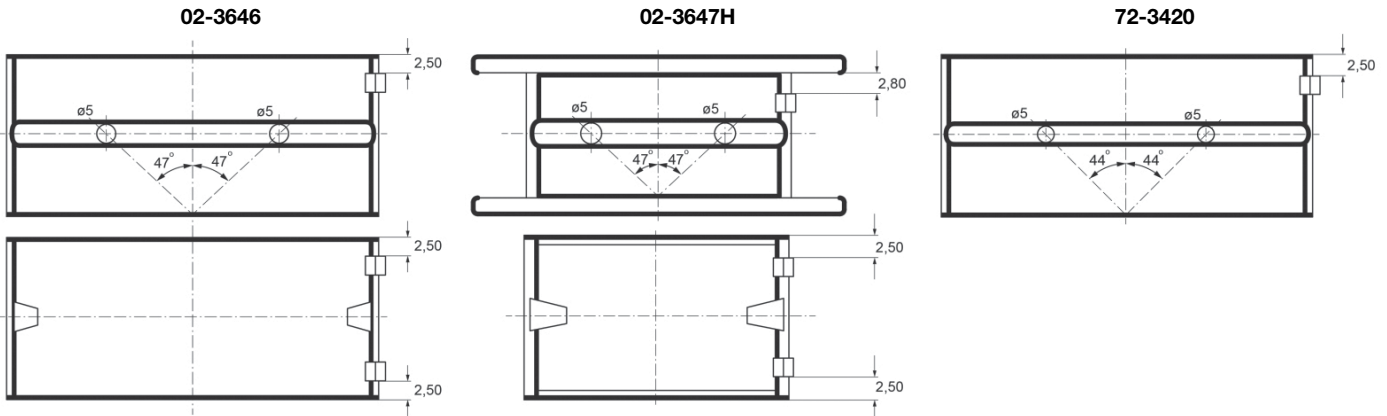



72-3421H

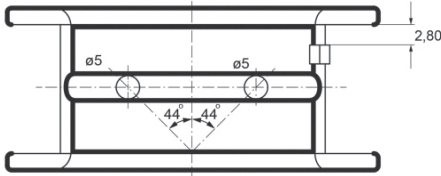

SE/PB	1	22,000	24,000/24,021	22,000			BC	55-3422	55-3422 SEMI
SE/PB	1	22,000	24,000/24,031	22,000			BC	55-3648	55-3648 SEMI

55-3422

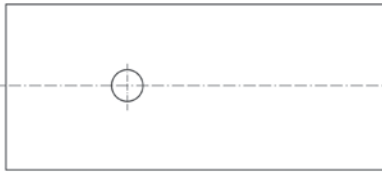

55-3648



16 84.00 x 75.10

M57 D25 (256D2)		6 Cyl.		2497cc	120-130kW (163-177PS)		Diesel Turbo Intercooler	TD30331	
BE/PL	6	44,975/44,991	48,000/48,016	18,000	1,497	0,020/0,072	SP 71-3704	71-3704/6 STD 0.25	[1]
MB/HL	6	59,971/59,990	65,000/65,019	20,000	2,498	0,020/0,063	AL-LF 02-3646	H023/7 STD 0.25 0.50	
MB/HL	1	59,971/59,990	65,000/65,019	24,940	2,498	0,020/0,082	AL-LF 02-3647H		

	02-3647H	STD	25,020/.9853" - 25,053/.9863"
		0.25mm	25,220/.9929" - 25,253/.9942"
		0.50mm	25,420/1.0008" - 25,453/1.0021"

SE/PB	1	29,995/30,000	31,995/32,025	22,200			BC	55-3937	55-3937 SEMI
SE/PB	1	29,995/30,000	31,995/32,025	22,200			BC-LF	55-4572	55-4572 SEMI

55-3937



55-4572

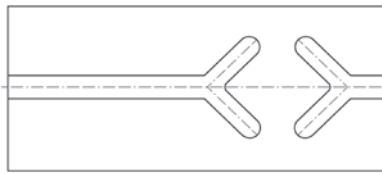

17 84.00 x 75.10

M57N 256 D4		6 Cyl.		2497cc	120-130kW (163-177PS)		Diesel Turbo Intercooler	TD18033	
BE/PL	6	44,975/44,991	48,000/48,016	18,000	1,497	0,020/0,072	SP 71-3704	71-3704/6 STD 0.25	[1]
MB/HL	6	59,971/59,990	65,000/65,019	20,000	2,502		EC 72-4525	H1238/7 STD	
MB/HL	1	59,971/59,990	65,000/65,019	24,890	2,502		EC 72-4526H		

	72-4526H	STD	25,020/.9850" - 25,053/.9863"
		0.25mm	25,220/.9929" - 25,253/.9942"
		0.50mm	25,420/1.0008" - 25,453/1.0021"

SE/PB	1	29,995/30,000	31,995/32,025	22,200			BC	55-3937	55-3937 SEMI
SE/PB	1	29,995/30,000	31,995/32,025	22,200			BC-LF	55-4572	55-4572 SEMI



55-3937



55-4572

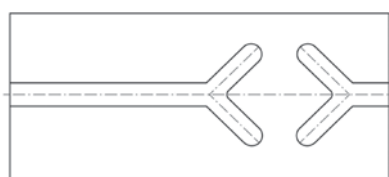

18 84.00 x 78.90

M62 B35 (358S1)		V8 Cyl.	3498cc	173kW (235PS)					Petrol	TD28390
M62 B35 (358S2)		V8 Cyl.	3498cc	173-180kW (235-245PS)					Petrol	TD28391
M62 B35 TU		V8 Cyl.	3498cc	175-180kW (238-245PS)					Petrol	TD21244
BE/PL	8	47,975/47,991	52,000/52,013	17,000	1,997	0,020/0,069	EC	71-3706	71-3706/8 STD	
MB/HL 1-5	5	69,971/69,990	75,000/75,019	24,000	2,505	0,020/0,063	AL-LF	02-3707	H033/5 STD	

19 84.00 x 81.00

M40 B18 (184E1)		4 Cyl.	1796cc	83-85kW (113-116PS)					Petrol	TD28368
M40 B18 C		4 Cyl.	1796cc	103kW (140PS)					Petrol	TD19662
M42 B18		4 Cyl.	1796cc	100-103kW (136-140PS)					Petrol	TD454
M42 B18 (184S1)		4 Cyl.	1796cc	100-103kW (136-140PS)					Petrol	TD28370
M43 B18 (184E2)		4 Cyl.	1796cc	83-85kW (113-116PS)					Petrol	TD28372
BE/PL	4	44,975/44,991	48,000/48,016	18,000	1,493	0,023/0,080	EC	71-3419	71-3419/4 STD 0.25 0.50	
MB/HL	5	59,971/59,990	65,000/65,019	20,000	2,498	0,020/0,063	AL-LF	02-3646L	H007/5 STD 0.25	
MB/HL	4	59,971/59,990	65,000/65,019	20,000	2,498	0,020/0,063	AL-LF	02-3646U		
MB/HL	1	59,971/59,990	65,000/65,019	24,940	2,498	0,020/0,082	AL-LF	02-3647HU		
SE/PB	1	22,000	24,000/24,031	22,000			BC	55-3648	55-3648 SEMI	

20 84.00 x 81.00

N42 B18 A		4 Cyl.	1796cc	85kW (115PS)					Petrol	TD30334
N46 B18 A		4 Cyl.	1796cc	85kW (115PS)					Petrol	TD20538
BE/PL	4	49,981/49,997	53,600/53,616	17,550	1,797	0,025/0,083	EC	71-4806	71-4806/4 STD	
SE/PB	1	20,000	21,995/22,031	21,300			BC	55-4808	55-4808 SEMI	

21 84.00 x 81.00

M20 B27 (276EA)		6 Cyl.	2693cc	90-95kW (122-129PS)					Petrol	TD28345
M20 B27 (276EB)		6 Cyl.	2693cc	90-95kW (122-129PS)					Petrol	TD28346
M20 B27 (276KA)		6 Cyl.	2693cc	90-95kW (122-129PS)					Petrol	TD28347
M20 B27 (276KB)		6 Cyl.	2693cc	90-95kW (122-129PS)					Petrol	TD28348
BE/PL	6	44,975/44,991	48,000/48,016	18,000	1,493	0,023/0,080	EC	71-3419	71-3419/6 STD 0.25 0.50	
MB/HL 1-5, 7	6	59,971/59,990	65,000/65,019	20,000	2,498	0,020/0,063	AL-LF	02-3646	H023/7 STD 0.25 0.50	
MB/HL 6	1	59,971/59,990	65,000/65,019	24,940	2,498	0,020/0,082	AL-LF	02-3647H		

	02-3647H	STD	25,020/.9853" - 25,053/.9863"
		0.25mm	25,220/.9929" - 25,253/.9942"
		0.50mm	25,420/1.0008" - 25,453/1.0021"

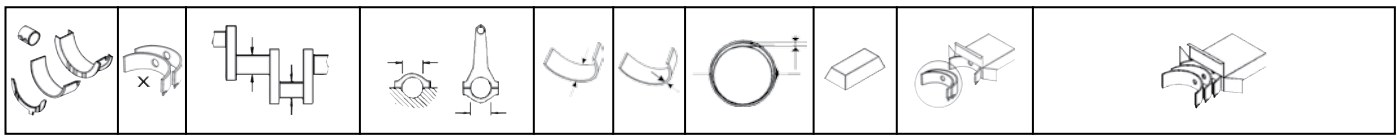

MB/HL 1-5, 7	6	59,971/59,990	65,000/65,019	20,000	2,490	0,030/0,093	EC	72-3420	H948/7 STD 0.25
MB/HL 6	1	59,971/59,990	65,000/65,019	24,940	2,490	0,030/0,093	EC	72-3421H	

	72-3421H	STD	25,020/.9853" - 25,053/.9863"
		0.25mm	25,220/.9929" - 25,253/.9942"
		0.50mm	25,420/1.0008" - 25,453/1.0021"

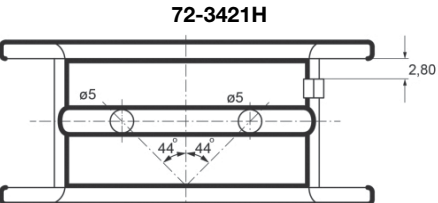
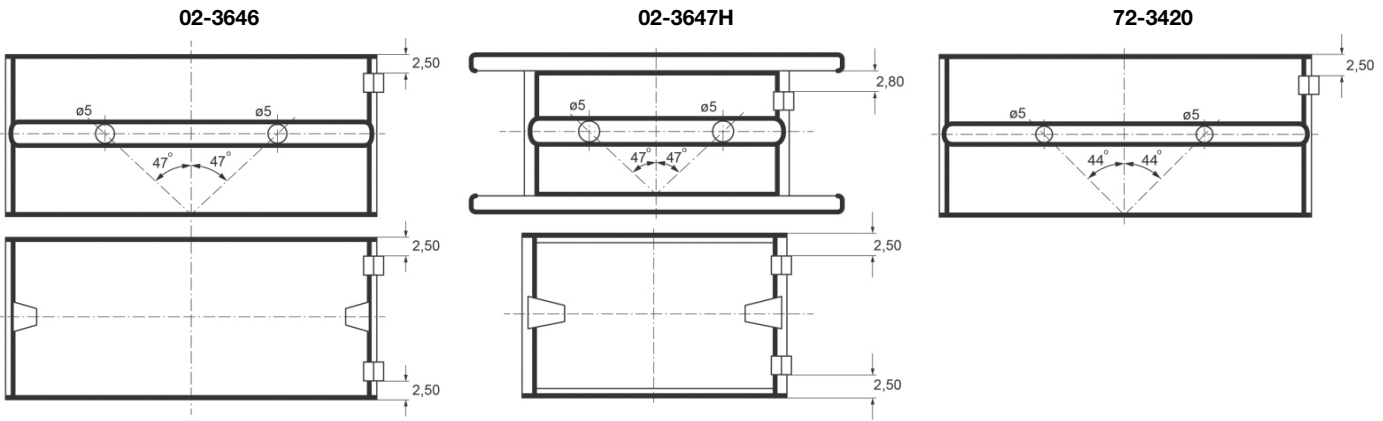

SE/PB	1	22,000	24,000/24,021	22,000			BC	55-3422	55-3422 SEMI
SE/PB	1	22,000	24,000/24,031	22,000			BC	55-3648	55-3648 SEMI

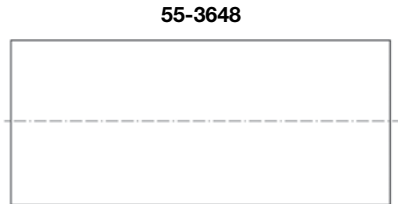
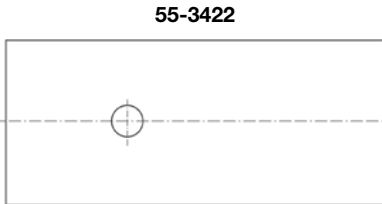

22 84.00 x 84.00

M52 B28	6 Cyl.	2793cc	141-142kW (192-193PS)	Petrol	TD4231
M52 B28 (286S1)	6 Cyl.	2793cc	141-143kW (192-194PS)	Petrol	TD28384
M52 B28 (286S2)	6 Cyl.	2793cc	141-143kW (192-194PS)	Petrol	TD28385
M52 B28 TU	6 Cyl.	2793cc	142kW (193PS)	Petrol	TD21242

BE/PL	6	44,975/44,991	48,000/48,016	18,000	1,493	0,023/0,080	EC	71-3419	71-3419/6 STD 0.25 0.50
MB/HL 1-5, 7	6	59,971/59,990	65,000/65,019	20,000	2,498	0,020/0,063	AL-LF	02-3646	H023/7 STD 0.25 0.50
MB/HL 6	1	59,971/59,990	65,000/65,019	24,940	2,498	0,020/0,082	AL-LF	02-3647H	

	02-3647H	STD	25,020/.9853" - 25,053/.9863"
		0.25mm	25,220/.9929" - 25,253/.9942"
		0.50mm	25,420/1.0008" - 25,453/1.0021"

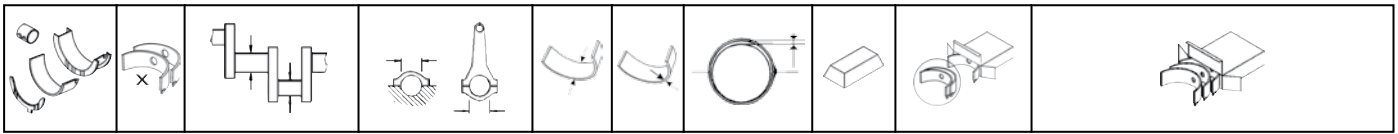

MB/HL 1-5, 7	6	59,971/59,990	65,000/65,019	20,000	2,490	0,030/0,093	EC	72-3420	H948/7 STD 0.25
MB/HL 6	1	59,971/59,990	65,000/65,019	24,940	2,490	0,030/0,093	EC	72-3421H	

	72-3421H	STD	25,020/.9853" - 25,053/.9863"
		0.25mm	25,220/.9929" - 25,253/.9942"
		0.50mm	25,420/1.0008" - 25,453/1.0021"

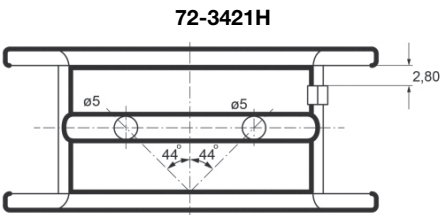
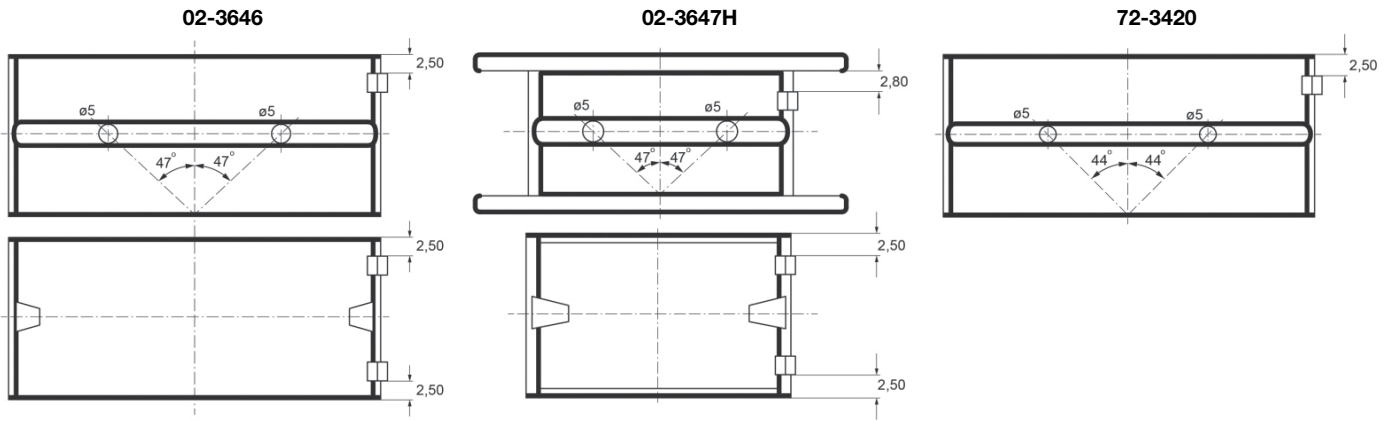

SE/PB	1	22,000	24,000/24,021	22,000			BC	55-3422	55-3422 SEMI
SE/PB	1	22,000	24,000/24,031	22,000			BC	55-3648	55-3648 SEMI

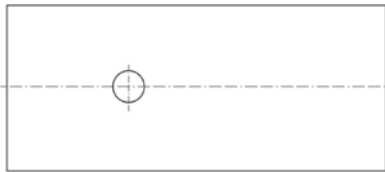

23 84.00 x 88.00

M47 204 D1	4 Cyl.	1951cc	85-100kW (116-136PS)	Diesel	TD18305
M47 D20	4 Cyl.	1951cc	85-100kW (116-136PS)	Diesel Turbo Intercooler	TD9521
M47 D20 (204D1)	4 Cyl.	1951cc	85-100kW (116-136PS)	Diesel Turbo Intercooler	TD28374
M47 D20 TU	4 Cyl.	1951cc	85-110kW (116-150PS)	Diesel Turbo Intercooler	TD21236

BE/PL	4	44,975/44,991	48,000/48,016	18,000	1,497	0,020/0,072	SP	71-3704	71-3704/4 STD 0.25	1
MB/HL 1,2,4,5	4	59,971/59,990	65,000/65,019	20,000	2,498	0,020/0,063	AL-LF	02-3646	H023/5 STD 0.25	
MB/HL 3	1	59,971/59,990	65,000/65,019	24,940	2,498	0,020/0,082	AL-LF	02-3647H		

	02-3647H	STD	25,020/.9853" - 25,053/.9863"
		0.25mm	25,220/.9929" - 25,253/.9942"
		0.50mm	25,420/1.0008" - 25,453/1.0021"

SE/PB	1	29,995/30,000	31,995/32,025	22,200			BC	55-3937	55-3937 SEMI
-------	---	---------------	---------------	--------	--	--	----	---------	------------------------



24 84.00 x 88.00

M57 D30 (306D1)		6 Cyl.		2926cc	135-142kW (184-193PS)			Diesel Turbo Intercooler		TD27992
BE/PL	6	44,975/44,991	48,000/48,016	18,000	1,497	0,020/0,072	SP	71-3704	71-3704/6 STD 0.25	1
MB/HL 1-5, 7	6	59,971/59,990	65,000/65,019	20,000	2,498	0,020/0,063	AL-LF	02-3646	H023/7 STD 0.25 0.50	
MB/HL 6	1	59,971/59,990	65,000/65,019	24,940	2,498	0,020/0,082	AL-LF	02-3647H		
			02-3647H	STD	25,020/.9853" - 25,053/.9863"					
				0.25mm	25,220/.9929" - 25,253/.9942"					
				0.50mm	25,420/1.0008" - 25,453/1.0021"					
SE/PB	1	29,995/30,000	31,995/32,025	22,200			BC	55-3937	55-3937 SEMI	

25 84.00 x 89.00

N46N B20 B		4 Cyl.		1995cc	110kW (150PS)			Petrol		TD20962
BE/PL	4	49,981/49,997	53,600/53,616	17,550	1,797	0,025/0,083	EC	71-4806	71-4806/4 STD	
SE/PB	1	20,000	21,995/22,031	21,300			BC	55-4808	55-4808 SEMI	

26 84.00 x 89.60

M54 B30 (306S3)		6 Cyl.		2979cc	163-170kW (222-231PS)			Petrol		TD28218
BE/PL	6	44,975/44,991	48,000/48,016	18,000	1,498	0,020/0,070	EC	71-3573	71-3573/6 STD	
BE/PL	6	44,975/44,991	48,000/48,016	18,000	1,497	0,020/0,072	SP	71-3704	71-3704/6 STD 0.25	1
MB/HL 1-5, 7	6	59,971/59,990	65,000/65,019	20,000	2,498	0,020/0,063	AL-LF	02-3646	H023/7 STD 0.25 0.50	
MB/HL 6	1	59,971/59,990	65,000/65,019	24,940	2,498	0,020/0,082	AL-LF	02-3647H		
			02-3647H	STD	25,020/.9853" - 25,053/.9863"					
				0.25mm	25,220/.9929" - 25,253/.9942"					
				0.50mm	25,420/1.0008" - 25,453/1.0021"					
SE/PB	1	26,995/27,000	29,000/29,021	22,200			BC	55-3705	55-3705 SEMI	

27 84.00 x 89.60

N54 B30 A		6 Cyl.		2979cc	200-250kW (272-340PS)			Petrol Bi-Turbo Intercooler		TD24989
N54 B30 A		6 Cyl.		2979cc	200-264kW (272-359PS)			Petrol Bi-Turbo Intercooler		TD20342
N54 B30 B		6 Cyl.		2979cc	225kW (306PS)			Petrol Bi-Turbo Intercooler		TD20586
BE/PL	2	49,981/49,997	53,600/53,616	17,550	1,797	0,025/0,083	EC	71-4806	71-4807/2 STD	4
BE/PL	2	49,975/49,991	53,600/53,616	17,550	1,795	0,026/0,082	EC	71-4807		

28 84.00 x 90.00

N42 B20		4 Cyl.		1995cc	105kW (143PS)			Petrol		TD17052
N42 B20 A		4 Cyl.		1995cc	105-110kW (143-150PS)			Petrol		TD18038
N42 B20 B		4 Cyl.		1995cc	95kW (129PS)			Petrol		TD18304
N46 B20		4 Cyl.		1995cc	95-125kW (129-170PS)			Petrol		TD21406
N46 B20 A		4 Cyl.		1995cc	95-125kW (129-170PS)			Petrol		TD18167
N46 B20 B		4 Cyl.		1995cc	95-125kW (129-170PS)			Petrol		TD18945
N46 B20 BD		4 Cyl.		1995cc	95-125kW (129-170PS)			Petrol		TD27479
N46 B20 C		4 Cyl.		1995cc	95-125kW (129-170PS)			Petrol		TD18168
N46 B20 CC		4 Cyl.		1995cc	95-125kW (129-170PS)			Petrol		TD27476
N46 B20 CD		4 Cyl.		1995cc	95-125kW (129-170PS)			Petrol		TD27477



N46 B20 E		4 Cyl.		1995cc	95-125kW (129-170PS)		Petrol		TD27478
BE/PL	4	49,981/49,997	53,600/53,616	17,550	1,797	0,025/0,083	EC	71-4806	71-4806/4 STD
SE/PB	1	20,000	21,995/22,031	21,300			BC	55-4808	55-4808 SEMI

29 84.00 x 90.00

N43 B20 A		4 Cyl.		1995cc	90-125kW (122-170PS)		Petrol		TD20584
BE/PL	2	49,981/49,997	53,600/53,616	17,550	1,797	0,025/0,083	EC	71-4806	71-4807/2 STD [4]
BE/PL	2	49,975/49,991	53,600/53,616	17,550	1,795	0,026/0,082	EC	71-4807	
SE/PB	1	20,000	21,995/22,031	21,300			BC	55-4808	55-4808 SEMI

30 84.00 x 90.00

M47 D20 (204D4)		4 Cyl.		1995cc	85-130kW (116-177PS)		Diesel Turbo Intercooler		TD27472
BE/PL	4	44,975/44,991	48,000/48,016	18,000	1,497	0,020/0,072	SP	71-3704	71-3704/4 STD 0.25 [1]
MB/HL 1-5, 7	6	59,971/59,990	65,000/65,019	20,000	2,498	0,020/0,063	AL-LF	02-3646	H023/7 STD 0.25 0.50
MB/HL 6	1	59,971/59,990	65,000/65,019	24,940	2,498	0,020/0,082	AL-LF	02-3647H	
			02-3647H	STD	25,020/.9853" - 25,053/.9863"				
				0.25mm	25,220/.9929" - 25,253/.9942"				
				0.50mm	25,420/1.0008" - 25,453/1.0021"				
SE/PB	1	29,995/30,000	31,995/32,025	22,200			BC	55-3937	55-3937 SEMI
SE/PB	1	29,995/30,000	31,995/32,025	22,200			BC-LF	55-4572	55-4572 SEMI [6]

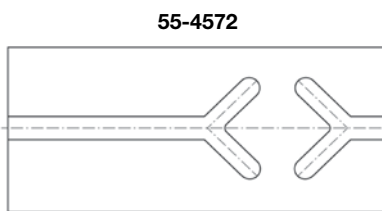
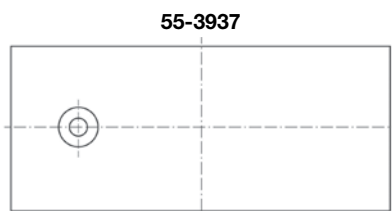

31 84.00 x 90.00

M47N 204 D4		4 Cyl.		1995cc	85-130kW (116-177PS)		Diesel Turbo Intercooler		TD17523
BE/PL	4	44,975/44,991	48,000/48,016	18,000	1,497	0,020/0,072	SP	71-3704	71-3704/4 STD 0.25 [1]
MB/HL 1,2,4,5	4	59,971/59,990	65,000/65,019	20,000	2,498	0,020/0,063	AL-LF	02-3646	H023/5 STD 0.25
MB/HL 3	1	59,971/59,990	65,000/65,019	24,940	2,498	0,020/0,082	AL-LF	02-3647H	
			02-3647H	STD	25,020/.9853" - 25,053/.9863"				
				0.25mm	25,220/.9929" - 25,253/.9942"				
				0.50mm	25,420/1.0008" - 25,453/1.0021"				
SE/PB	1	29,995/30,000	31,995/32,025	22,200			BC	55-3937	55-3937 SEMI
SE/PB	1	29,995/30,000	31,995/32,025	22,200			BC-LF	55-4572	55-4572 SEMI [6]

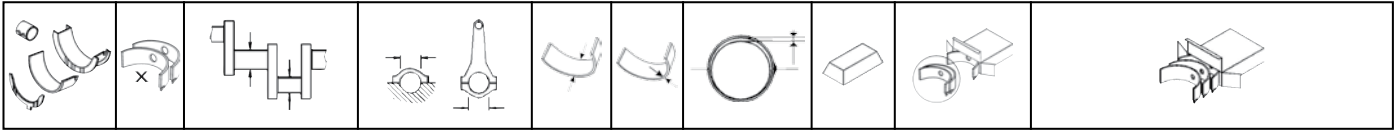

55-3937

55-4572

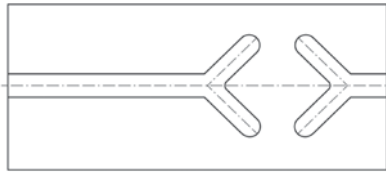

32 84.00 x 90.00

N47 D20 A	4 Cyl.	1995cc	66-130kW (90-177PS)	Diesel Turbo Intercooler	TD19922
N47 D20 B	4 Cyl.	1995cc	150kW (204PS)	Diesel Turbo Intercooler	TD20845
N47 D20 C	4 Cyl.	1995cc	66-150kW (90-204PS)	Diesel Turbo Intercooler	TD24405
N47S D20 D	4 Cyl.	1995cc	150kW (204PS)	Diesel Bi-Turbo Intercooler	TD24642

BE/PL	1	49,975/49,991	53,600/53,619	18,300	1,803	0,026/0,086	SP-LF	71-4805	71-4805 STD	[1]
MB/HL	4	54,971/54,990	60,000/60,019	18,800	2,498	0,023/0,086	EC-LF	72-4803	H1298/5 STD	
MB/HL	1	54,971/54,990	60,000/60,019	23,500	2,498	0,023/0,086	EC-LF	72-4804H		



72-4804H

STD	25,020/.9850" - 25,053/.9863"
0.25mm	25,220/.9929" - 25,253/.9942"
0.50mm	25,420/1.0008" - 25,453/1.0021"

33 84.00 x 90.00

M57 D30 (306D2)	6 Cyl.	2993cc	150-160kW (204-218PS)	Diesel Turbo Intercooler	TD27248
M57 D30 (306D3)	6 Cyl.	2993cc	145-173kW (197-235PS)	Diesel Turbo Intercooler	TD27267
M57 D30 (306D4)	6 Cyl.	2993cc	198-200kW (269-272PS)	Diesel Bi-Turbo Intercooler	TD28386
M57 D30 (306D5)	6 Cyl.	2993cc	210-221kW (286-301PS)	Diesel Bi-Turbo Intercooler	TD28387
M57N 306 D2	6 Cyl.	2993cc	150-155kW (204-211PS)	Diesel Turbo Intercooler	TD17525
M57N 306 D4	6 Cyl.	2993cc	160kW (218PS)	Diesel	TD18306

BE/PL	6	44,975/44,991	48,000/48,016	18,000	1,497	0,020/0,072	SP	71-3704	71-3704/6 STD 0.25	[1]
MB/HL 1-5, 7	6	59,971/59,990	65,000/65,019	20,000	2,498	0,020/0,063	AL-LF	02-3646	H023/7 STD 0.25 0.50	
MB/HL 6	1	59,971/59,990	65,000/65,019	24,940	2,498	0,020/0,082	AL-LF	02-3647H		



02-3647H

STD	25,020/.9853" - 25,053/.9863"
0.25mm	25,220/.9929" - 25,253/.9942"
0.50mm	25,420/1.0008" - 25,453/1.0021"

SE/PB	1	29,995/30,000	31,995/32,025	22,200			BC	55-3937	55-3937 SEMI	
SE/PB	1	29,995/30,000	31,995/32,025	22,200			BC-LF	55-4572	55-4572 SEMI	[6]

55-3937

55-4572

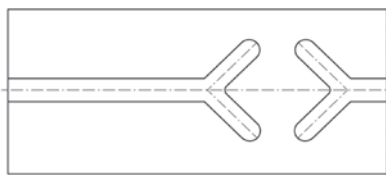
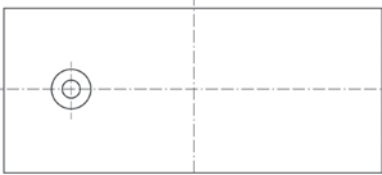

34 84.00 x 90.00

M57 D30 TU2 Euro 4	6 Cyl.	2993cc	145-173kW (197-235PS)	Diesel Turbo Intercooler	TD20843					
BE/PL	6	44,975/44,991	48,000/48,016	18,000	1,497	0,020/0,072	SP	71-3704	71-3704/6 STD 0.25	[1]

MB/HL	6	59,971/59,990	65,000/65,019	20,000	2,502			EC	72-4525	H1238/7 STD
MB/HL	1	59,971/59,990	65,000/65,019	24,890	2,502			EC	72-4526H	
			72-4526H	STD	25,020/.9850" - 25,053/.9863"					
				0.25mm	25,220/.9929" - 25,253/.9942"					
				0.50mm	25,420/1.0008" - 25,453/1.0021"					
SE/PB	1	29,995/30,000	31,995/32,025	22,200				BC	55-3937	55-3937 SEMI
SE/PB	1	29,995/30,000	31,995/32,025	22,200				BC-LF	55-4572	55-4572 SEMI

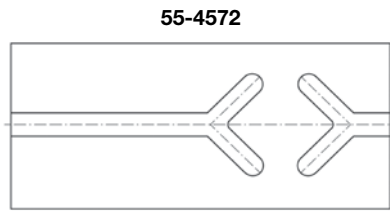
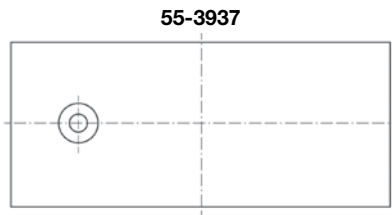

35	84.00 x 90.00									
N57 306 D2			6 Cyl.	2993cc	160kW (218PS)			Diesel		TD18307
N57 306 D3			6 Cyl.	2993cc	145kW (197PS)			Diesel		TD20587
N57 D30 A			6 Cyl.	2993cc	150-210kW (204-286PS)			Diesel Turbo Intercooler		TD24613
N57 D30 B			6 Cyl.	2993cc	220-230kW (299-313PS)			Diesel Turbo Intercooler		TD26305
N57N 306 D2			6 Cyl.	2993cc	170kW (231PS)			Diesel		TD20592
N57N 306 D3			6 Cyl.	2993cc	145-170kW (197-231PS)			Diesel		TD20583
N57N 306 D5			6 Cyl.	2993cc	210kW (286PS)			Diesel		TD20595

BE/PL	1	49,975/49,991	53,600/53,619	18,300	1,803	0,026/0,086	SP-LF	71-4805	71-4805 STD	1
MB/HL	6	54,971/54,990	60,000/60,019	18,800	2,498	0,023/0,086	EC-LF	72-4803	H1298/7 STD	
MB/HL	1	54,971/54,990	60,000/60,019	23,500	2,498	0,023/0,086	EC-LF	72-4804H		
			72-4804H	STD	25,020/.9850" - 25,053/.9863"					
				0.25mm	25,220/.9929" - 25,253/.9942"					
				0.50mm	25,420/1.0008" - 25,453/1.0021"					

36	85.00 x 83.50									
M43 194 E1			4 Cyl.	1895cc	85-87kW (116-118PS)			Petrol		TD18439
M43 B19 (194E1)			4 Cyl.	1895cc	85-87kW (116-118PS)			Petrol		TD27701
M44 B19 (194S1)			4 Cyl.	1895cc	103kW (140PS)			Petrol		TD28373

BE/PL	4	44,975/44,991	48,000/48,016	18,000	1,493	0,023/0,080	EC	71-3419	71-3419/4 STD 0.25 0.50	
MB/HL	5	59,971/59,990	65,000/65,019	20,000	2,498	0,020/0,063	AL-LF	02-3646L	H007/5 STD 0.25	
MB/HL	4	59,971/59,990	65,000/65,019	20,000	2,498	0,020/0,063	AL-LF	02-3646U		
MB/HL	1	59,971/59,990	65,000/65,019	24,940	2,498	0,020/0,082	AL-LF	02-3647HU		
SE/PB	1	22,000	24,000/24,031	22,000			BC	55-3648	55-3648 SEMI	

37	85.00 x 88.00									
N45 B20 A			4 Cyl.	1997cc	127kW (173PS)			Petrol		TD20580
BE/PL	4	49,981/49,997	53,600/53,616	17,550	1,797	0,025/0,083	EC	71-4806	71-4806/4 STD	
SE/PB	1	20,000	21,995/22,031	21,300			BC	55-4808	55-4808 SEMI	



38		85.00 x 88.00								
N52 B30		6 Cyl.		2996cc	190-200kW (258-272PS)			Petrol	TD21409	
N52 B30 A		6 Cyl.		2996cc	160-200kW (218-272PS)			Petrol	TD18170	
N52 B30 BF		6 Cyl.		2996cc	179-200kW (243-272PS)			Petrol	TD26306	
N52N B30 A		6 Cyl.		2996cc	187kW (254PS)			Petrol	TD20582	
N52N B30 B		6 Cyl.		2996cc	190kW (258PS)			Petrol	TD20961	
N53 B30		6 Cyl.		2996cc	160-200kW (218-272PS)			Petrol	TD21410	
N53 B30 A		6 Cyl.		2996cc	150-200kW (204-272PS)			Petrol	TD20585	
BE/PL	6	49,981/49,997	53,600/53,616	17,550	1,797	0,025/0,083	EC	71-4806	71-4806/6 STD	
SE/PB	1	20,000	21,995/22,031	21,300			BC	55-4808	55-4808 SEMI	

39		86.00 x 71.60								
M30 B25		6 Cyl.		2494cc	107-110kW (145-150PS)			Petrol	TD5204	
M30 B25 (256EA)		6 Cyl.		2494cc	107-110kW (145-150PS)			Petrol	TD28352	
M30 B25 (256VA)		6 Cyl.		2494cc	107-110kW (145-150PS)			Petrol	TD28353	
BE/PL	6	47,975/47,991	52,000/52,015	20,000	1,993	0,023/0,078	EC	71-2182	71-2182/6 STD 0.25	
MB/HL 1-3, 5-7	6	59,971/59,990	65,000/65,019	24,000	2,490	0,030/0,093	EC	72-3498	H973/7 STD 0.25	
MB/HL 4	1	59,971/59,990	65,000/65,019	29,940	2,490	0,030/0,093	EC	72-3499H		
				72-3499H	STD	30,025/1.1821" - 30,064/1.1836"				
					0.25mm	30,225/1.1900" - 30,264/1.1915"				
SE/PB	1	22,000	24,000/24,021	24,000			BC	55-2528	55-2528 SEMI	

40		86.00 x 80.00								
M30 B28		6 Cyl.		2788cc	121-141kW (165-192PS)			Petrol	TD5215	
M30 B28 (286EA)		6 Cyl.		2788cc	135kW (184PS)			Petrol	TD30327	
BE/PL	6	47,975/47,991	52,000/52,015	20,000	1,993	0,023/0,078	EC	71-2182	71-2182/6 STD 0.25	
MB/HL 1-3, 5-7	6	59,971/59,990	65,000/65,019	24,000	2,490	0,030/0,093	EC	72-3498	H973/7 STD 0.25	
MB/HL 4	1	59,971/59,990	65,000/65,019	29,940	2,490	0,030/0,093	EC	72-3499H		
				72-3499H	STD	30,025/1.1821" - 30,064/1.1836"				
					0.25mm	30,225/1.1900" - 30,264/1.1915"				
SE/PB	1	22,000	24,000/24,021	24,000			BC	55-2528	55-2528 SEMI	

41		86.00 x 80.00								
M70 B56		V12 Cyl.		5576cc	280kW (380PS)			Petrol	TD4237	
MB/HL	6	74,971/74,990	80,000/80,016	22,600	2,505	0,020/0,060	EC	72-3681	H017/7 STD	
MB/HL	1	74,971/74,990	80,000/80,016	30,940	2,505	0,020/0,060	EC	72-3682H		
				72-3682H	STD	31,025/1.2215" - 31,064/1.2230"				
SE/PB	1	22,000	24,000/24,031	22,000			BC	55-3648	55-3648 SEMI	



42											86.40 x 91.00		
S50 B32			6 Cyl.		3201cc	236kW (321PS)		Petrol		TD4242			
MB/HL 1-3, 5-7	6	59,971/59,990	65,000/65,019	24,000	2,490	0,030/0,093	EC	72-3498	H973/7 STD 0.25				
MB/HL 4	1	59,971/59,990	65,000/65,019	29,940	2,490	0,030/0,093	EC	72-3499H					
			72-3499H	STD	30,025/1.1821" - 30,064/1.1836"								
				0.25mm	30,225/1.1900" - 30,264/1.1915"								

43											86.40 x 91.00		
S50 B32 (326S1)			6 Cyl.		3201cc	236kW (321PS)		Petrol		TD28413			
MB/HL 1-5, 7	6	59,971/59,990	65,000/65,019	20,000	2,498	0,020/0,063	AL-LF	02-3646	H023/7 STD				
MB/HL 6	1	59,971/59,990	65,000/65,019	24,940	2,498	0,020/0,082	AL-LF	02-3647H					
			02-3647H	STD	25,020/9853" - 25,053/9863"								
				0.25mm	25,220/9929" - 25,253/9942"								
				0.50mm	25,420/1.0008" - 25,453/1.0021"								

44											89.00 x 71.00		
M10 B18			4 Cyl.		1766cc	66-77kW (90-105PS)		Petrol		TD5174			
M10 B18 (184EA)			4 Cyl.		1766cc	66-77kW (90-105PS)		Petrol		TD28314			
M10 B18 (184EB)			4 Cyl.		1766cc	66-77kW (90-105PS)		Petrol		TD28315			
M10 B18 (184EW)			4 Cyl.		1766cc	66-77kW (90-105PS)		Petrol		TD28316			
M10 B18 (184EY)			4 Cyl.		1766cc	66-77kW (90-105PS)		Petrol		TD28317			
M10 B18 (184EZ)			4 Cyl.		1766cc	66-77kW (90-105PS)		Petrol		TD28318			
M10 B18 (184KA)			4 Cyl.		1766cc	66-77kW (90-105PS)		Petrol		TD28319			
M10 B18 (184VA)			4 Cyl.		1766cc	66-77kW (90-105PS)		Petrol		TD28320			
M10 B18 (184VB)			4 Cyl.		1766cc	66-77kW (90-105PS)		Petrol		TD28321			
M10 B18 (184VC)			4 Cyl.		1766cc	66-77kW (90-105PS)		Petrol		TD28322			
M10 B18 (184VD)			4 Cyl.		1766cc	66-77kW (90-105PS)		Petrol		TD28323			
BE/PL	4	47,975/47,991	52,000/52,015	20,000	1,993	0,023/0,078	EC	71-2182	71-2182/4 STD 0.25 0.50				
MB/HL 1,2,4,5	4	54,971/54,990	60,000/60,019	24,000	2,490	0,030/0,093	EC	72-2183	H629/5 STD 0.25				
MB/HL 3	1	54,971/54,990	60,000/60,019	29,900	2,490	0,030/0,093	EC	72-2184H					
			72-2184H	STD	30,025/1.1821" - 30,064/1.1836"								
				0.25mm	30,225/1.1900" - 30,264/1.1915"								
				0.50mm	30,425/1.1978" - 30,464/1.1994"								
SE/PB	1	22,000	24,000/24,021	24,000			BC	55-2528	55-2528 SEMI				

45											89.00 x 80.00		
M10 B20			4 Cyl.		1990cc	74-101kW (101-137PS)		Petrol		TD432			
M10 B20 (Turbo)			4 Cyl.		1990cc	125kW (170PS)		Petrol Turbo		TD5198			
BE/PL	4	47,975/47,991	52,000/52,015	20,000	1,993	0,023/0,078	EC	71-2182	71-2182/4 STD 0.25 0.50				
MB/HL 1,2,4,5	4	54,971/54,990	60,000/60,019	24,000	2,490	0,030/0,093	EC	72-2183	H629/5 STD 0.25				
MB/HL 3	1	54,971/54,990	60,000/60,019	29,900	2,490	0,030/0,093	EC	72-2184H					
			72-2184H	STD	30,025/1.1821" - 30,064/1.1836"								
				0.25mm	30,225/1.1900" - 30,264/1.1915"								
				0.50mm	30,425/1.1978" - 30,464/1.1994"								



SE/PB	1	22,000	24,000/24,021	24,000			BC	55-2528	55-2528 SEMI
-------	---	--------	---------------	--------	--	--	----	---------	-----------------

46 89.00 x 80.00

M30 B30	6 Cyl.	2986cc	131-147kW (176-200PS)	Petrol	TD5276
M30 B30 (306EA)	6 Cyl.	2986cc	131-147kW (178-200PS)	Petrol	TD28360
M30 B30 (306KA)	6 Cyl.	2986cc	131-147kW (178-200PS)	Petrol	TD28361

BE/PL	6	47,975/47,991	52,000/52,015	20,000	1,993	0,023/0,078	EC	71-2182	71-2182/6 STD 0.25
MB/HL 1-3, 5-7	6	59,971/59,990	65,000/65,019	24,000	2,490	0,030/0,093	EC	72-3498	H973/7 STD 0.25
MB/HL 4	1	59,971/59,990	65,000/65,019	29,940	2,490	0,030/0,093	EC	72-3499H	

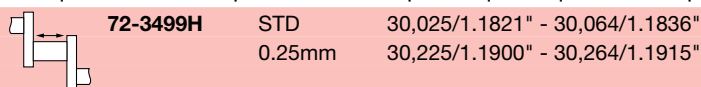

SE/PB	1	22,000	24,000/24,021	24,000			BC	55-2528	55-2528 SEMI
-------	---	--------	---------------	--------	--	--	----	---------	-----------------

47 89.00 x 80.00

M60 B40 (408S1)	V8 Cyl.	3982cc	210kW (286PS)	Petrol	TD28389
------------------------	---------	---------------	----------------------	---------------	----------------

BE/PL	8	47,975/47,991	52,000/52,013	17,000	1,997	0,020/0,069	EC	71-3706	71-3706/8 STD
MB/HL 1-5	5	69,971/69,990	75,000/75,019	24,000	2,505	0,020/0,063	AL-LF	02-3707	H033/5 STD

48 89.00 x 86.00

M30 B32	6 Cyl.	3210cc	130-152kW (197-207PS)	Petrol	TD4220
M30 B32 (326TA)	6 Cyl.	3210cc	185kW (252PS)	Petrol Turbo	TD28362

BE/PL	6	47,975/47,991	52,000/52,015	20,000	1,993	0,023/0,078	EC	71-2182	71-2182/6 STD 0.25
MB/HL 1-3, 5-7	6	59,971/59,990	65,000/65,019	24,000	2,490	0,030/0,093	EC	72-3498	H973/7 STD 0.25
MB/HL 4	1	59,971/59,990	65,000/65,019	29,940	2,490	0,030/0,093	EC	72-3499H	

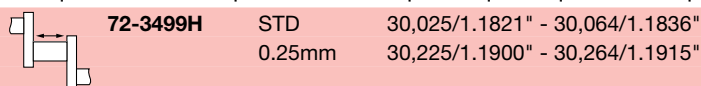

SE/PB	1	22,000	24,000/24,021	24,000			BC	55-2528	55-2528 SEMI
-------	---	--------	---------------	--------	--	--	----	---------	-----------------

49 89.00 x 88.30

M30 B33 (35/40 INAT)	6 Cyl.	3295cc	140kW (190PS)	Petrol	TD5213
-----------------------------	--------	---------------	----------------------	---------------	---------------

BE/PL	6	47,975/47,991	52,000/52,015	20,000	1,993	0,023/0,078	EC	71-2182	71-2182/6 STD 0.25
MB/HL 1-3, 5-7	6	59,971/59,990	65,000/65,019	24,000	2,490	0,030/0,093	EC	72-3498	H973/7 STD 0.25
MB/HL 4	1	59,971/59,990	65,000/65,019	29,940	2,490	0,030/0,093	EC	72-3499H	

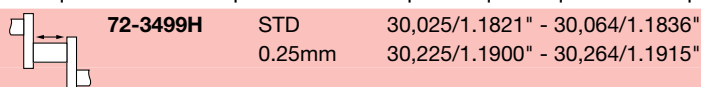

SE/PB	1	22,000	24,000/24,021	24,000			BC	55-2528	55-2528 SEMI
-------	---	--------	---------------	--------	--	--	----	---------	-----------------

50 89.25 x 84.00

M30 B32 (L-Jetronic)	6 Cyl.	3153cc	152kW (206PS)	Petrol	TD5208
-----------------------------	--------	---------------	----------------------	---------------	---------------

BE/PL	6	47,975/47,991	52,000/52,015	20,000	1,993	0,023/0,078	EC	71-2182	71-2182/6 STD 0.25
-------	---	---------------	---------------	--------	-------	-------------	----	---------	------------------------------

MB/HL 1-3, 5-7	6	59,971/59,990	65,000/65,019	24,000	2,490	0,030/0,093	EC	72-3498	H973/7 STD 0.25	
MB/HL 4	1	59,971/59,990	65,000/65,019	29,940	2,490	0,030/0,093	EC	72-3499H		
			72-3499H	STD	30,025/1.1821" - 30,064/1.1836"					
				0.25mm	30,225/1.1900" - 30,264/1.1915"					
SE/PB	1	22,000	24,000/24,021	24,000			BC	55-2528	55-2528 SEMI	

51	92.00 x 82.70								
M62 B44			V8 Cyl.	4398cc	210kW (286PS)			Petrol	TD4235
M62 B44 (448S1)			V8 Cyl.	4398cc	210kW (286PS)			Petrol	TD28392
M62 B44 (448S2)			V8 Cyl.	4398cc	210kW (286PS)			Petrol	TD28393
M62 B44 TU			V8 Cyl.	4398cc	210kW (286PS)			Petrol	TD21245
M62448S2			V8 Cyl.	4398cc	210kW (286PS)			Petrol	TD21094
BE/PL	8	47,975/47,991	52,000/52,013	17,000	1,997	0,020/0,069	EC	71-3706	71-3706/8 STD
MB/HL 1-5	5	69,971/69,990	75,000/75,019	24,000	2,505	0,020/0,063	AL-LF	02-3707	H033/5 STD

52	92.00 x 86.00								
M30 B34 (346EC)			6 Cyl.	3430cc	136-160kW (185-218PS)			Petrol	TD28417
M30 B34 (346KA)			6 Cyl.	3430cc	136-160kW (185-218PS)			Petrol	TD28419
M30 B34 (346KB)			6 Cyl.	3430cc	136-160kW (185-218PS)			Petrol	TD28420
M30 B35			6 Cyl.	3430cc	136-185kW (185-252PS)			Petrol Turbo	TD4221
M30 B35 (Motronic,9.2:1)			6 Cyl.	3430cc	162kW (220PS)			Petrol	TD5278
M30 B35 (Motronic)			6 Cyl.	3430cc	141-162kW (192-220PS)			Petrol	TD5272
M30 B35 (Motronic,10:1)			6 Cyl.	3430cc	160kW (218PS)			Petrol	TD5246
BE/PL	6	47,975/47,991	52,000/52,015	20,000	1,993	0,023/0,078	EC	71-2182	71-2182/6 STD 0.25
MB/HL 1-3, 5-7	6	59,971/59,990	65,000/65,019	24,000	2,490	0,030/0,093	EC	72-3498	H973/7 STD 0.25
MB/HL 4	1	59,971/59,990	65,000/65,019	29,940	2,490	0,030/0,093	EC	72-3499H	
			72-3499H	STD	30,025/1.1821" - 30,064/1.1836"				
				0.25mm	30,225/1.1900" - 30,264/1.1915"				
SE/PB	1	22,000	24,000/24,021	24,000			BC	55-2528	55-2528 SEMI

53	93.40 x 84.00								
S14 B23 (234EA)			4 Cyl.	2303cc	143-162kW (195-220PS)			Petrol	TD28400
S14 B23 (234S1)			4 Cyl.	2303cc	143-162kW (195-220PS)			Petrol	TD28401
S14 B23 (234S2)			4 Cyl.	2303cc	143-162kW (195-220PS)			Petrol	TD28402
S14 B23 (EVO I)			4 Cyl.	2302cc	162kW (220PS)			Petrol	TD5265
BE/PL	1	47,970/47,990	52,000/52,010	20,000	1,986	0,024/0,064	EC	71-3652	71-3652 STD

54	93.40 x 84.00								
M30 B35 (L-Jetronic,10:1)			6 Cyl.	3453cc	160kW (218PS)			Petrol	TD5245
M30 B35 (Motronic,9.3:1)			6 Cyl.	3453cc	160kW (218PS)			Petrol	TD447
S38 B35 (356ED)			6 Cyl.	3453cc	191-211kW (260-287PS)			Petrol	TD28405
BE/PL	6	47,975/47,991	52,000/52,015	20,000	1,993	0,023/0,078	EC	71-2182	71-2182/6 STD 0.25

BMW

MB/HL 1-3, 5-7	6	59,971/59,990	65,000/65,019	24,000	2,490	0,030/0,093	EC	72-3498	H973/7 STD 0.25	
MB/HL 4	1	59,971/59,990	65,000/65,019	29,940	2,490	0,030/0,093	EC	72-3499H		
			72-3499H	STD	30,025/1.1821" - 30,064/1.1836"					
				0.25mm	30,225/1.1900" - 30,264/1.1915"					
SE/PB	1	22,000	24,000/24,021	24,000			BC	55-2528	55-2528 SEMI	





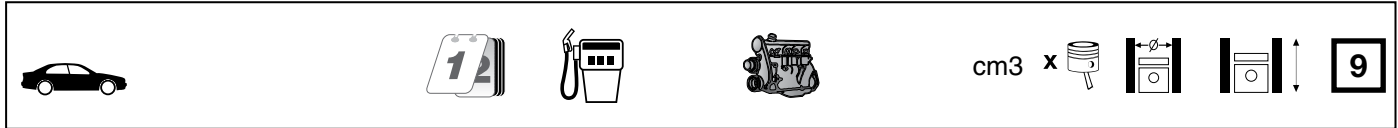

55

93.40 x 86.00

S38 B36			6 Cyl.	3535cc	210-232kW (286-316PS)		Petrol			TD5283
MB/HL 1-3, 5-7	6	59,971/59,990	65,000/65,019	24,000	2,490	0,030/0,093	EC	72-3498	H973/7 STD 0.25	
MB/HL 4	1	59,971/59,990	65,000/65,019	29,940	2,490	0,030/0,093	EC	72-3499H		
			72-3499H	STD	30,025/1.1821" - 30,064/1.1836"					
				0.25mm	30,225/1.1900" - 30,264/1.1915"					



R45	01/78→	Petrol	R45	473	2	70.00	61.50	2
R50	01/69→	Petrol	R50	498	2	67.00	70.60	1
R60/5	01/69→12/78	Petrol	R60	599	2	73.50	70.60	3
R60/6	01/69→12/78	Petrol	R60	599	2	73.50	70.60	3
R60/7	01/69→12/78	Petrol	R60	599	2	73.50	70.60	3
R60T/C	01/69→12/78	Petrol	R60	599	2	73.50	70.60	3
R65	01/69→	Petrol	R65	650	2	82.00	61.50	4
R65 LS	08/80→	Petrol	R65	650	2	82.00	61.50	4
R65 T	08/80→	Petrol	R65	650	2	82.00	61.50	4
R75/5	01/69→12/77	Petrol	R75	746	2	82.00	70.60	5
R75/6	01/69→12/77	Petrol	R75	746	2	82.00	70.60	5
R75/7	01/69→12/77	Petrol	R75	746	2	82.00	70.60	5
R75 C	01/69→12/77	Petrol	R75	746	2	82.00	70.60	5
R75 T	01/69→12/77	Petrol	R75	746	2	82.00	70.60	5
R80	01/77→	Petrol	R80	782	2	84.00	70.60	6
R80	01/77→	Petrol	R246 Boxer	797	2	84.80	70.60	7
R80 C	01/77→	Petrol	R246 Boxer	797	2	84.80	70.60	7
R80 GS	01/92→	Petrol	R246 Boxer	797	2	84.80	70.60	7
R80 R	01/92→	Petrol	R246 Boxer	797	2	84.80	70.60	7
R80 RT	01/92→	Petrol	R246 Boxer	797	2	84.80	70.60	7
R80 T	01/77→	Petrol	R246 Boxer	797	2	84.80	70.60	7
R90/6	01/73→12/80	Petrol	900	898	2	90.00	70.60	8
R90 S	01/73→12/80	Petrol	900	898	2	90.00	70.60	8
R100 RS	01/76→12/85	Petrol	R246 Boxer	980	2	94.00	70.60	9
R100 RT	01/76→12/85	Petrol	R246 Boxer	980	2	94.00	70.60	9
R100 S	01/76→12/85	Petrol	R246 Boxer	980	2	94.00	70.60	9
R100 T	01/76→12/85	Petrol	R246 Boxer	980	2	94.00	70.60	9

			cm ³	x 			
900		Petrol	898	2	90.00	70.60	8
R45		Petrol	473	2	70.00	61.50	2
R50		Petrol	498	2	67.00	70.60	1
R60		Petrol	599	2	73.50	70.60	3
R65		Petrol	650	2	82.00	61.50	4
R75		Petrol	746	2	82.00	70.60	5
R80		Petrol	782	2	84.00	70.60	6
R246 Boxer		Petrol	797	2	84.80	70.60	7
R246 Boxer		Petrol	980	2	94.00	70.60	9



1											67.00 x 70.60	
R50		2 Cyl.		498cc	24kW (32PS)		Petrol		FM5823			
MB/HL 1,2	2	59,971/59,990	65,000/65,019	22,000	2,510	0,020/0,053	EC	72-3495	H971/2 STD	14		
2											70.00 x 61.50	
R45		2 Cyl.		473cc	20-26kW (27-35PS)		Petrol		FM5822			
MB/HL 1,2	2	59,971/59,990	65,000/65,019	22,000	2,510	0,020/0,053	EC	72-3495	H971/2 STD	14		
3											73.50 x 70.60	
R60		2 Cyl.		599cc	29kW (40PS)		Petrol		FM5824			
MB/HL 1,2	2	59,971/59,990	65,000/65,019	22,000	2,510	0,020/0,053	EC	72-3495	H971/2 STD	14		
4											82.00 x 61.50	
R65		2 Cyl.		650cc	33kW (44PS)		Petrol		FM5825			
MB/HL 1,2	2	59,971/59,990	65,000/65,019	22,000	2,510	0,020/0,053	EC	72-3495	H971/2 STD	14		
5											82.00 x 70.60	
R75		2 Cyl.		746cc	37-44kW (50-60PS)		Petrol		FM5827			
MB/HL 1,2	2	59,971/59,990	65,000/65,019	22,000	2,510	0,020/0,053	EC	72-3495	H971/2 STD	14		
6											84.00 x 70.60	
R80		2 Cyl.		782cc	37-40kW (50-55PS)		Petrol		FM5828			
MB/HL 1,2	2	59,971/59,990	65,000/65,019	22,000	2,510	0,020/0,053	EC	72-3495	H971/2 STD	14		
7											84.80 x 70.60	
R246 Boxer		2 Cyl.		797cc	37-40kW (50-55PS)		Petrol		FM5829			
MB/HL 1,2	2	59,971/59,990	65,000/65,019	22,000	2,510	0,020/0,053	EC	72-3495	H971/2 STD	14		
8											90.00 x 70.60	
900		2 Cyl.		898cc	44-50kW (60-68PS)		Petrol		FM5830			
MB/HL 1,2	2	59,971/59,990	65,000/65,019	22,000	2,510	0,020/0,053	EC	72-3495	H971/2 STD	14		
9											94.00 x 70.60	
R246 Boxer		2 Cyl.		980cc	44-51kW (60-69PS)		Petrol		FM5831			
MB/HL 1,2	2	59,971/59,990	65,000/65,019	22,000	2,510	0,020/0,053	EC	72-3495	H971/2 STD	14		



cm3







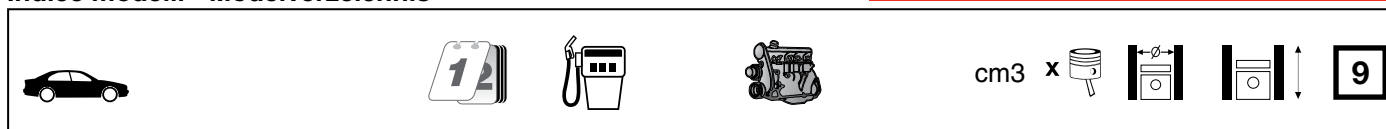

9

Agile 1.4	10/09→	Petrol	X 14 YEH	1389	4	77.60	73.40	6
Astra 1.7 Di	08/00→08/03	Diesel	Y 17 DT	1686	4	79.00	86.00	11
Astra 1.8	09/98→	Petrol	C 18 NE	1796	4	84.80	79.50	19
Astra 1.8	08/02→06/05	Petrol	Z 18 XE	1796	4	80.50	88.20	15
Astra 2.0	02/96→	Petrol	C 20 NE	1998	4	86.00	86.00	20
Astra 2.0	08/02→	Petrol	C 20 SEL	1998	4	86.00	86.00	21
Astra 2.0	04/04→02/09	Petrol	X 20 XE	1998	4	86.00	86.00	20
Astra 2.0	03/99→07/02	Petrol	X 20 XEV	1998	4	86.00	86.00	20
Astra 2.0 DTi	08/02→	Diesel	Y 20 DTH	1995	4	84.00	90.00	18
Astra 2.0 DTi GLS	08/02→12/11	Diesel	Y 20 DTH	1995	4	84.00	90.00	18
Astra 2.0 Flex	04/04→	Petrol	X 20 XE	1998	4	86.00	86.00	20
Astra 2.0 GLS	08/02→12/11	Petrol	C 20 SEL	1998	4	86.00	86.00	21
Astra 2.0 GLS	03/99→07/02	Petrol	X 20 XEV	1998	4	86.00	86.00	20
Astra 2.2	08/00→08/04	Petrol	Z 22 SE	2198	4	86.00	94.60	23
Aveo 1.3 D	07/11→	Diesel	LDV	1248	4	69.60	82.00	2
Aveo 1.3 D	07/11→	Diesel	LSF	1248	4	69.60	82.00	2
Aveo 1.4	03/06→12/07	Petrol	L14	1399	4	77.90	73.40	7
Blazer S10 2.5 D	10/94→05/05	Diesel	4JA1	2499	4	93.00	92.00	24
Calibra 2.0	10/93→03/96	Petrol	C 20 XE	1998	4	86.00	86.00	21
Chevy 1.4	12/95→07/06	Petrol	C 14 NZ	1389	4	77.60	73.40	6
Chevy 1.4	08/02→09/06	Petrol	Z 14 XE	1389	4	77.60	73.40	6
Chevy 1.6	08/95→07/02	Petrol	C 16 SEI	1598	4	79.00	81.50	10
Chevy 1.6	08/02→	Petrol	Z 16 XE	1598	4	79.00	81.50	10
Cobalt 1.4 Flex	01/11→	Petrol	X 14 YFL	1389	4	77.60	73.40	6
Cobalt 1.8	01/11→	Petrol	N18XFH	1796	4	80.50	88.20	14
Cobalt 1.8 Econoflex	01/11→	Petrol	N18XFH	1796	4	80.50	88.20	14
Combo 1.6	04/01→	Petrol	Z 16 SE	1598	4	79.00	81.50	10
Corsa 1.0	03/94→07/00	Petrol	X 10 E	999	4	71.00	62.90	3
Corsa 1.4	01/09→	Petrol	X 14 YEH	1389	4	77.60	73.40	6
Corsa 1.4	09/01→07/02	Petrol	Z 14 XE	1389	4	77.60	73.40	6
Corsa 1.4 Flex	06/07→	Petrol	X 14 YEH	1389	4	77.60	73.40	6
Corsa 1.4 GLS	08/94→07/97	Petrol	C 14 NZ	1389	4	77.60	73.40	6
Corsa 1.6	08/94→07/02	Petrol	C 16 NE	1598	4	79.00	81.50	10
Corsa 1.6	08/01→	Petrol	Z 16 SE	1598	4	79.00	81.50	10
Corsa 1.6 GLS	08/94→07/02	Petrol	C 16 NE	1598	4	79.00	81.50	10
Corsa 1.6 GS	08/97→07/02	Petrol	X 16 XE	1598	4	79.00	81.50	10
Corsa 1.6 GSI	08/94→07/97	Petrol	C 16 XE	1598	4	79.00	81.50	10
Corsa 1.6 GSI	08/94→07/97	Petrol	X 16 XE	1598	4	79.00	81.50	10
Corsa 1.7 DTi	08/01→	Diesel	Y 17 DT	1686	4	79.00	86.00	11
Corsa 1.8	08/02→	Petrol	C 18 NE	1796	4	84.80	79.50	19
Cruze 1.3	07/00→09/08	Petrol	M13A	1328	4	78.00	69.50	8
Cruze 1.3 AWD	07/00→09/08	Petrol	M13A	1328	4	78.00	69.50	8
Cruze 1.5	08/03→09/08	Petrol	M15A	1490	4	78.00	78.10	9
Cruze 1.5 AWD	08/03→09/08	Petrol	M15A	1490	4	78.00	78.10	9
Cruze 1.6	05/09→	Petrol	LDE	1598	4	79.00	81.50	10
Grand Vitara 2.0 4WD	09/99→12/06	Petrol	J20A	1995	4	84.00	90.00	17
Ipanema 2.0	03/91→12/97	Petrol	C 20 NE	1998	4	86.00	86.00	20
Ipanema 2.0 Álcool	03/91→12/97	Petrol	C 20 NE	1998	4	86.00	86.00	20
Kadett 2.0	03/91→12/98	Petrol	C 20 NE	1998	4	86.00	86.00	20
Kadett 2.0 Álcool	03/91→12/97	Petrol	C 20 NE	1998	4	86.00	86.00	20
Lanos 1.5	11/05→	Petrol	A15SMS	1498	4	76.50	81.50	5
LUV 2.2	09/96→12/05	Petrol	C 22 NE	2198	4	86.00	94.60	22
LUV 2.5 TD	02/92→08/01	Diesel	4JA1-T	2499	4	93.00	92.00	25
LUV 2.5 TD AWD	01/99→08/01	Diesel	4JA1-T	2499	4	93.00	92.00	25
Matiz 0.8	03/05→	Petrol	F8CV	796	3	68.50	72.00	1
Matiz 0.8 LPG	03/05→	Petrol	F8CV	796	3	68.50	72.00	1
Meriva 1.4	07/07→07/12	Petrol	X 14 YEH	1389	4	77.60	73.40	6
Meriva 1.4 Flex	07/07→07/12	Petrol	X 14 YEH	1389	4	77.60	73.40	6
Meriva 1.8	02/02→	Petrol	C 18 NE	1796	4	84.80	79.50	19
Meriva 1.8	05/03→05/08	Petrol	Z 18 XE	1796	4	80.50	88.20	15
Montana 1.4	01/11→	Petrol	X 14 YEH	1389	4	77.60	73.40	6
Monza 1.4	12/95→09/02	Petrol	C 14 NZ	1389	4	77.60	73.40	6
Monza 1.6	01/82→12/86	Petrol	16S	1598	4	80.00	79.50	13
MW 1.3	01/00→12/10	Petrol	M13A	1328	4	78.00	69.50	8
Niva 1.8 4x4	01/07→12/09	Petrol	Z 18 XE	1796	4	80.50	88.20	15
Omega 2.0	01/92→12/94	Petrol	C 20 NE	1998	4	86.00	86.00	20
Omega 2.0 Álcool	03/93→12/95	Petrol	C 20 NE	1998	4	86.00	86.00	20
Omega 2.0 Flex	09/91→07/97	Petrol	C 20 NE	1998	4	86.00	86.00	20
Omega 2.2	04/94→09/00	Petrol	C 22 NE	2198	4	86.00	94.60	22



Omega 2.2 GL	09/91→07/97	Petrol	X 22 XE	2198	4	86.00	94.60	22
Omega 3.0	09/92→12/94	Petrol	C 30 NE	2969	6	95.00	69.80	26
Omega Suprema 2.0	09/91→07/97	Petrol	C 20 NE	1998	4	86.00	86.00	20
Omega Suprema 2.2	10/94→09/00	Petrol	C 22 NE	2198	4	86.00	94.60	22
Omega Suprema 2.2	09/91→07/97	Petrol	X 22 XE	2198	4	86.00	94.60	22
Omega Suprema 3.0	04/93→12/94	Petrol	C 30 NE	2969	6	95.00	69.80	26
Optra 2.0	09/05→12/07	Petrol	C 20 XE	1998	4	86.00	86.00	21
Prisma 1.4	09/11→11/13	Petrol	X 14 YFL	1389	4	77.60	73.40	6
Prisma 1.4 Flex	01/11→	Petrol	X 14 YFL	1389	4	77.60	73.40	6
Prizm 1.8	05/97→08/01	Petrol	7A-FE	1762	4	81.00	85.50	16
Sail 1.2	01/12→	Petrol	Z 12 XE	1199	4	72.50	72.60	4
Sail 1.3 D	01/13→	Diesel	LDV	1248	4	69.60	82.00	2
Spark 0.8	09/00→	Petrol	F8CV	796	3	68.50	72.00	1
Spark 1.2	12/09→	Petrol	Z 12 XE	1199	4	72.50	72.60	4
Spark 1.2 LPG	01/11→	Petrol	Z 12 XE	1199	4	72.50	72.60	4
Spin 1.3 D	01/12→	Diesel	Z 13 DTJ	1248	4	69.60	82.00	2
Spin 1.8	07/12→	Petrol	N18XFH	1796	4	80.50	88.20	14
Spin 1.8 Econoflex	01/13→	Petrol	N18XFH	1796	4	80.50	88.20	14
Tavera 2.5 TD	05/04→	Diesel	4JA1-T	2499	4	93.00	92.00	25
Tigra 1.6	08/97→12/99	Petrol	C 16 SE	1598	4	79.00	81.50	10
Tornado 1.8	09/03→12/10	Petrol	N18XFH	1796	4	80.50	88.20	14
Tracker 2.0	09/98→10/08	Petrol	J20A	1995	4	84.00	90.00	17
Tracker 2.0 4WD	09/98→12/03	Petrol	J20A	1995	4	84.00	90.00	17
Trax 1.6	12/12→	Petrol	LDE	1598	4	79.00	81.50	10
Vectra 2.0	03/96→12/05	Petrol	20 NEJ	1998	4	86.00	86.00	20
Vectra 2.0	03/96→12/05	Petrol	C 20 NE	1998	4	86.00	86.00	20
Vectra 2.0	03/96→02/12	Petrol	C 20 SEL	1998	4	86.00	86.00	21
Vectra 2.0	11/05→01/09	Petrol	X 20 XE	1998	4	86.00	86.00	20
Vectra 2.0 Flex	01/07→06/11	Petrol	X 20 XE	1998	4	86.00	86.00	20
Vectra 2.0 Flexpower	10/05→	Petrol	X 20 XE	1998	4	86.00	86.00	20
Vectra 2.0 GSi	10/93→03/96	Petrol	C 20 XE	1998	4	86.00	86.00	21
Vectra 2.2	05/98→07/04	Petrol	C 22 NE	2198	4	86.00	94.60	22
Vectra 2.2	04/02→04/04	Petrol	Z 22 SE	2198	4	86.00	94.60	23
Vectra 2.2	01/05→07/06	Petrol	Z 22 YH	2198	4	86.00	94.60	23
Viva 1.8	09/03→03/08	Petrol	Z 18 XE	1796	4	80.50	88.20	15
Zafira 1.8	07/00→06/05	Petrol	Z 18 XE	1796	4	80.50	88.20	15
Zafira 2.0	04/01→07/04	Petrol	C 20 NE	1998	4	86.00	86.00	20
Zafira 2.0	04/01→	Petrol	C 20 SEL	1998	4	86.00	86.00	21
Zafira 2.0	08/04→	Petrol	X 20 XE	1998	4	86.00	86.00	20
Zafira 2.0 Flex	08/05→01/09	Petrol	X 20 XE	1998	4	86.00	86.00	20
Zafira 2.0 Flexpower	08/04→07/05	Petrol	X 20 XE	1998	4	86.00	86.00	20
Zafira 2.2	09/01→12/05	Petrol	Z 22 SE	2198	4	86.00	94.60	23
Zafira 2.2	07/05→	Petrol	Z 22 YH	2198	4	86.00	94.60	23

			cm ³	x 			
1ZZ-FE	Petrol		1794	4	79.00	91.50	12
4.236 V	Diesel		3864	4	98.48	126.80	28
4JA1	Diesel		2499	4	93.00	92.00	24
4JA1-T	Diesel		2499	4	93.00	92.00	25
7A-FE	Petrol		1762	4	81.00	85.50	16
16S	Petrol		1598	4	80.00	79.50	13
20 NEJ	Petrol		1998	4	86.00	86.00	20
A15MF	Petrol		1498	4	76.50	81.50	5
A15SMS	Petrol		1498	4	76.50	81.50	5
A15SMS	Petrol		1498	4	76.50	81.50	5
C 14 NZ	Petrol		1389	4	77.60	73.40	6
C 16 NE	Petrol		1598	4	79.00	81.50	10
C 16 SE	Petrol		1598	4	79.00	81.50	10
C 16 SEI	Petrol		1598	4	79.00	81.50	10
C 16 XE	Petrol		1598	4	79.00	81.50	10
C 18 NE	Petrol		1796	4	84.80	79.50	19
C 20 NE	Petrol		1998	4	86.00	86.00	20
C 20 SEL	Petrol		1998	4	86.00	86.00	21
C 20 XE	Petrol		1998	4	86.00	86.00	21
C 22 NE	Petrol		2198	4	86.00	94.60	22
C 24 NE	Petrol		2405	4	95.00	85.00	27
C 30 NE	Petrol		2969	6	95.00	69.80	26
F8CV	Petrol		796	3	68.50	72.00	1
F8CV	Petrol		796	3	68.50	72.00	1
J20A	Petrol		1995	4	84.00	90.00	17
L14	Petrol		1399	4	77.90	73.40	7
LDE	Petrol		1598	4	79.00	81.50	10
LDV	Diesel		1248	4	69.60	82.00	2
LSF	Diesel		1248	4	69.60	82.00	2
M13A	Petrol		1328	4	78.00	69.50	8
M15A	Petrol		1490	4	78.00	78.10	9
N18XFH	Petrol		1796	4	80.50	88.20	14
X 10 E	Petrol		999	4	71.00	62.90	3
X 14 YEH	Petrol		1389	4	77.60	73.40	6
X 14 YFL	Petrol		1389	4	77.60	73.40	6
X 16 XE	Petrol		1598	4	79.00	81.50	10
X 20 XE	Petrol		1998	4	86.00	86.00	20
X 20 XEV	Petrol		1998	4	86.00	86.00	20
X 22 XE	Petrol		2198	4	86.00	94.60	22
Y 17 DT	Diesel		1686	4	79.00	86.00	11
Y 20 DTH	Diesel		1995	4	84.00	90.00	18
Z 12 XE	Petrol		1199	4	72.50	72.60	4
Z 13 DTJ	Diesel		1248	4	69.60	82.00	2
Z 14 XE	Petrol		1389	4	77.60	73.40	6
Z 16 SE	Petrol		1598	4	79.00	81.50	10
Z 16 XE	Petrol		1598	4	79.00	81.50	10
Z 18 XE	Petrol		1796	4	80.50	88.20	15
Z 22 SE	Petrol		2198	4	86.00	94.60	23
Z 22 YH	Petrol		2198	4	86.00	94.60	23



1 68.50 x 72.00

F8CV		3 Cyl.		796cc	38kW (52PS)	Petrol		TD18851
F8CV		3 Cyl.		796cc	38kW (52PS)	Petrol		TD18521
BE/PL	1	37,981/37,991	40,998/41,021	18,011	1,491	0,025/0,083	AL	GS36SA 01-4203 STD 0.25 0.50
TW/A	2	57,000	73,000		2,520		BS	65-651-1 A218/2 STD

2 69.60 x 82.00

LDV Euro 5		4 Cyl.		1248cc	55-57kW (75-78PS)	Diesel Turbo		TD26193
LSF Euro 4		4 Cyl.		1248cc	70kW (95PS)	Diesel Turbo		TD26189
Z 13 DTJ Euro 4		4 Cyl.		1248cc	55kW (75PS)	Diesel Turbo		TD29414
BE/PL	4	42,582/42,600	45,734/45,744	20,000	1,552	0,030/0,062	BS	71-4033 71-4033/4 STD .010
MB/HL 1,2,4,5	4	50,982/51,000	54,710/54,722	19,000	1,840	0,026/0,050	AL-LF	02-4034 H1011/5 STD 0.25
MB/HL 3	1	50,982/51,000	54,710/54,722	23,950	1,840	0,026/0,050	AL-LF	02-4035H
SE/PB	1	23,000	25,747/25,772	25,000			BS-LF	55-4077 55-4077 SEMI

3 71.00 x 62.90

X 10 E		4 Cyl.		999cc	44kW (60PS)	Petrol		TD22482
BE/PL	3	42,971/42,987	46,000/46,012	13,200	1,501	0,021/0,069	AL-LF	01-4872 01-4872/3 STD
MB/HL	3	49,984/49,997	54,000/54,013	17,100	1,995	0,022/0,070	AL-LF	02-4797 H1295/4 STD
MB/HL	1	49,984/49,997	54,000/54,013	22,900	1,995	0,022/0,070	AL-LF	02-4798H

4 72.50 x 72.60

Z 12 XE		4 Cyl.		1199cc	59-63kW (80-86PS)	Petrol		TD26428
BE/PL	4	42,971/42,987	46,000/46,012	13,200	1,501	0,021/0,069	AL-LF	01-4872 01-4872/4 STD
MB/HL	4	49,984/49,997	54,000/54,013	17,100	1,995	0,022/0,070	AL-LF	02-4797 H1295/5 STD
MB/HL	1	49,984/49,997	54,000/54,013	22,900	1,995	0,022/0,070	AL-LF	02-4798H

5 76.50 x 81.50

A15MF		4 Cyl.		1498cc	65-66kW (88-90PS)	Petrol		TD742
A15SMS		4 Cyl.		1498cc	62-73kW (84-99PS)	Petrol		TD9507
A15SMS		4 Cyl.		1498cc	63kW (86PS)	Petrol		TD26129
BE/PL	4	42,971/42,987	46,000/46,012	16,600	1,497	0,020/0,072	EC	71-3639 71-3639/4 STD 0.25 0.50
MB/HL 1,2,4,5	4	54,972/54,985	59,000/59,013	19,500	2,001	0,020/0,064	EC	72-3505 H975/5 STD 0.25 0.50
MB/HL 3	1	54,972/54,985	59,000/59,013	25,900	2,001	0,020/0,064	EC	72-3506H





72-3506H	STD	25,950/1.0217" - 26,002/1.0237"
	0.25mm	26,150/1.0295" - 26,202/1.0316"
	0.50mm	26,350/1.0374" - 26,402/1.0394"

6 77.60 x 73.40

C 14 NZ		4 Cyl.		1389cc	44kW (60PS)	Petrol		TD19861
X 14 YE H		4 Cyl.		1389cc	68-77kW (92-105PS)	Petrol		TD26868
X 14 YFL		4 Cyl.		1389cc	63-75kW (86-102PS)	Petrol		TD27390

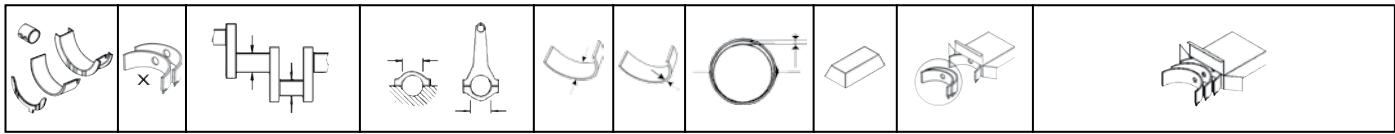
CHEVROLET



Z 14 XE		4 Cyl.		1389cc	66kW (90PS)		Petrol		TD28086
BE/PL	4	42,971/42,987	46,000/46,012	16,600	1,497	0,020/0,072	EC	71-3639	71-3639/4 STD 0.25 0.50
MB/HL 1,2,4,5	4	54,972/54,985	59,000/59,013	19,500	2,001	0,020/0,064	EC	72-3505	H975/5 STD 0.25 0.50
MB/HL 3	1	54,972/54,985	59,000/59,013	25,900	2,001	0,020/0,064	EC	72-3506H	
		72-3506H	STD	25,950/1.0217" - 26,002/1.0237"					
			0.25mm	26,150/1.0295" - 26,202/1.0316"					
			0.50mm	26,350/1.0374" - 26,402/1.0394"					

7 77.90 x 73.40

L14		4 Cyl.		1399cc	69-70kW (94-95PS)		Petrol		TD28024
BE/PL	8	49,960	53,010	22,130	1,500		BS	64-054-1	71-4205/4 STD

8 78.00 x 69.50

M13A		4 Cyl.		1328cc	60-69kW (82-94PS)		Petrol		TD19864
BE/PL	8	41,980	45,020	16,000	1,493		AL-LF	64-664-1	01-4946/4 STD
MB/HL 1-5	5	44,980	49,020	18,000	2,000		AL-LF	63-664-1	H1330/5 STD
MB/HL 1-5	5	44,980	49,020	18,000	2,000		AL-LF	63-664-2	
TW/A	2	59,000	75,000		2,520		AL-LF	65-664-1	A316/2 STD

9 78.00 x 78.10

M15A		4 Cyl.		1490cc	73-80kW (99-109PS)		Petrol		TD19865
BE/PL	8	41,980	45,020	18,000	1,490		AL-LF	64-665-1	01-4947/4 STD
MB/HL 1-5	5	51,980	56,020	18,000	2,000		AL-LF	63-665-1	H1331/5 STD
MB/HL 1-5	5	51,980	56,020	18,000	2,000		AL-LF	63-665-2	
TW/A	2	59,000	75,000		2,520		AL-LF	65-664-1	A316/2 STD

10 79.00 x 81.50

C 16 NE		4 Cyl.		1598cc	68kW (92PS)		Petrol		TD29516
C 16 SE		4 Cyl.		1598cc	74kW (100PS)		Petrol		TD28280
C 16 SEI		4 Cyl.		1598cc	72kW (98PS)		Petrol		TD27249
C 16 XE		4 Cyl.		1598cc	80kW (109PS)		Petrol		TD23209
LDE Euro 5		4 Cyl.		1598cc	83-91kW (113-124PS)		Petrol		TD26188
X 16 XE		4 Cyl.		1598cc	75-80kW (102-108PS)		Petrol		TD19866
Z 16 SE		4 Cyl.		1598cc	62-64kW (84-87PS)		Petrol		TD19869
Z 16 XE		4 Cyl.		1598cc	74kW (101PS)		Petrol		TD27250

BE/PL	4	42,971/42,987	46,000/46,012	16,600	1,497	0,020/0,072	EC	71-3639	71-3639/4 STD 0.25 0.50
MB/HL 1,2,4,5	4	54,972/54,985	59,000/59,013	19,500	2,001	0,020/0,064	EC	72-3505	H975/5 STD 0.25 0.50
MB/HL 3	1	54,972/54,985	59,000/59,013	25,900	2,001	0,020/0,064	EC	72-3506H	
		72-3506H	STD	25,950/1.0217" - 26,002/1.0237"					
			0.25mm	26,150/1.0295" - 26,202/1.0316"					
			0.50mm	26,350/1.0374" - 26,402/1.0394"					



11 79.00 x 86.00

Y 17 DT		4 Cyl.		1686cc	55kW (75PS)		Diesel Turbo		TD19867
BE/PL	4	45,936/45,956	48,976/49,000	16,700	1,500	0,020/0,089	BS	4285CP	71-4297/4 STD 0.25 0.50
MB/HL 1-5	5	51,920	56,000	15,530	2,006		AL	63-194-1	H1127/5 STD 0.25 0.50
MB/HL 1-5	5	51,920	56,000	15,530	2,006		AL	63-194-2	
TW/A	2	59,000	73,700		2,110		AL	04-4496	A261/2 STD

12 79.00 x 91.50

1ZZ-FE		4 Cyl.		1794cc	92-105kW (125-143PS)		Petrol		TD21155
BE/PL	8	43,990	47,020	15,700	1,488		AL-LF	64-715-1	01-4894/4 STD
MB/HL 1-5	5	47,990	52,020	17,000	1,997		AL-LF	63-715-1	H1322/5 STD
MB/HL 1-5	5	47,990	52,020	17,000	1,997		AL-LF	63-715-2	
TW/A	2	53,500	70,000		2,480		AL-LF	65-715-1	A276/2 STD

13 80.00 x 79.50

16S		4 Cyl.		1598cc	53-55kW (72-75PS)		Petrol		TD495
BE/PL	4	48,971/48,987	52,000/52,012	19,300	1,500	0,020/0,066	EC	71-3531	71-3531/4 STD
→08/85									
BE/PL	4	48,971/48,987	52,000/52,012	19,300	1,500	0,020/0,066	EC	71-3626	71-3626/4 STD 0.25 0.50
09/85→									

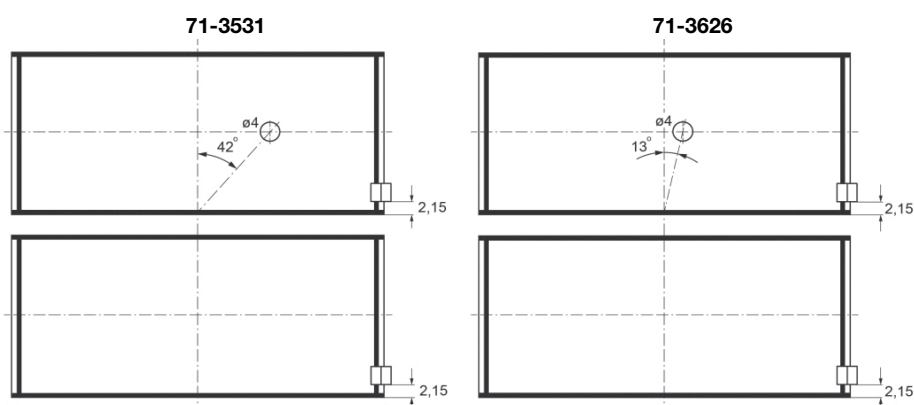

MB/HL 1,2,4,5	4	57,982/57,995	62,000/62,013	19,500	1,995	0,020/0,066	AL-LF	02-3532	H982/5 STD 0.25 0.50
MB/HL 3	1	57,982/57,995	62,000/62,013	25,900	1,995	0,020/0,066	AL-LF	02-3533H	



02-3533H	STD	25,950/1.0217" - 26,002/1.0237"
	0.25mm	26,150/1.0295" - 26,202/1.0316"
	0.50mm	26,350/1.0374" - 26,402/1.0394"

14 80.50 x 88.20

N18XFH		4 Cyl.		1796cc	77-80kW (105-109PS)		Petrol		TD28032
BE/PL	4	42,971/42,987	46,000/46,012	16,600	1,497	0,020/0,072	EC	71-3639	71-3639/4 STD 0.25 0.50

CHEVROLET

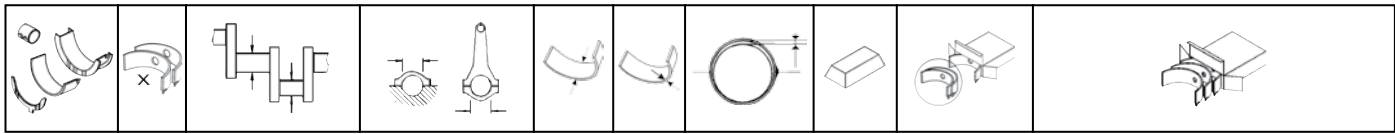

MB/HL 1,2,4,5	4	57,982/57,995	62,000/62,013	19,500	1,995	0,020/0,066	AL-LF	02-3532	H982/5 STD 0.25 0.50
MB/HL 3	1	57,982/57,995	62,000/62,013	25,900	1,995	0,020/0,066	AL-LF	02-3533H	

	02-3533H	STD	25,950/1.0217" - 26,002/1.0237"
		0.25mm	26,150/1.0295" - 26,202/1.0316"
		0.50mm	26,350/1.0374" - 26,402/1.0394"

15 80.50 x 88.20

Z 18 XE		4 Cyl.	1796cc	90-92kW (122-125PS)		Petrol		TD21857
----------------	--	--------	---------------	----------------------------	--	---------------	--	----------------

BE/PL	4	42,971/42,987	46,000/46,012	16,600	1,497	0,020/0,072	EC	71-3639	71-3639/4 STD 0.25 0.50
MB/HL 1,2,4,5	4	54,972/54,985	59,000/59,013	19,500	2,001	0,020/0,064	EC	72-3505	H975/5 STD 0.25 0.50
MB/HL 3	1	54,972/54,985	59,000/59,013	25,900	2,001	0,020/0,064	EC	72-3506H	

	72-3506H	STD	25,950/1.0217" - 26,002/1.0237"
		0.25mm	26,150/1.0295" - 26,202/1.0316"
		0.50mm	26,350/1.0374" - 26,402/1.0394"

16 81.00 x 85.50

7A-FE		4 Cyl.	1762cc	92kW (125PS)		Petrol		TD21849
--------------	--	--------	---------------	---------------------	--	---------------	--	----------------

BE/PL	4	47,990	51,020	17,100	1,490		AL-LF	64-714-1	01-5041/4 STD
MB/HL 1-5	5	47,980	52,040	19,900	2,005		AL	63-043-1	H1068/5 STD 0.25 0.50
MB/HL 1-5	5	47,980	52,040	19,900	2,005		AL	63-043-2	
TW/A	2	53,500	66,000		2,490		AL-LF	65-022-1	A186/4 STD
TW/A	2	53,500	66,000		2,490		AL-LF	65-022-2	

17 84.00 x 90.00

J20A		4 Cyl.	1995cc	88-95kW (120-129PS)		Petrol		TD27269
-------------	--	--------	---------------	----------------------------	--	---------------	--	----------------

BE/PL	8	49,980	53,020	16,100	1,485		AL-LF	64-661-1	71-4732/4 STD
MB/HL 1-5	5	57,980	62,020	19,100	1,994		AL	63-661-1	H1277/5 STD
MB/HL 1-5	5	57,980	62,020	19,100	1,994		AL	63-661-2	
TW/A	2	71,000	85,000		2,475		AL-LF	65-661-1	A287/2 STD

18 84.00 x 90.00

Y 20 DTH		4 Cyl.	1995cc	74kW (101PS)		Diesel Turbo Intercooler		TD19868
-----------------	--	--------	---------------	---------------------	--	---------------------------------	--	----------------

BE/PL	4	48,971/48,990	52,000/52,012	20,300	1,500	0,020/0,066	BS	71-3869	71-3869/4 STD
MB/HL 1,2,4,5	4	67,980/67,996	72,000/72,013	19,500	1,995	0,020/0,068	AL-LF	02-3909	H077/5 STD
MB/HL 3	1	67,980/67,996	72,000/72,013	25,900	1,995	0,020/0,068	AL-LF	02-3910H	

	02-3910H	STD	25,950/1.0217" - 26,002/1.0237"
--	-----------------	-----	---------------------------------

SE/PB	1	28,995/29,000	32,000/32,051	26,800			BC	55-3873	55-3873 SEMI
-------	---	---------------	---------------	--------	--	--	----	---------	------------------------



19 84.80 x 79.50

C 18 NE		4 Cyl.		1796cc	75kW (102PS)	Petrol		TD28275	
BE/PL	4	48,971/48,987	52,000/52,012	19,300	1,500	0,020/0,066	EC	71-3531	71-3531/4 STD
→08/85									
BE/PL	4	48,971/48,987	52,000/52,012	19,300	1,500	0,020/0,066	EC	71-3626	71-3626/4 STD 0.25 0.50
09/85→									

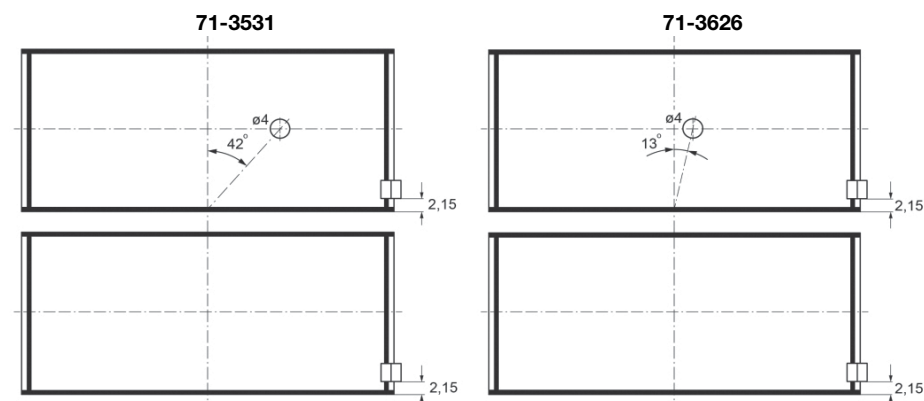

MB/HL 1,2,4,5	4	57,982/57,995	62,000/62,013	19,500	1,995	0,020/0,066	AL-LF	02-3532	H982/5 STD 0.25 0.50
MB/HL 3	1	57,982/57,995	62,000/62,013	25,900	1,995	0,020/0,066	AL-LF	02-3533H	



02-3533H	STD	25,950/1.0217" - 26,002/1.0237"
	0.25mm	26,150/1.0295" - 26,202/1.0316"
	0.50mm	26,350/1.0374" - 26,402/1.0394"

20 86.00 x 86.00

20 NEJ		4 Cyl.		1998cc	81kW (110PS)	Petrol		TD26438	
C 20 NE		4 Cyl.		1998cc	81-90kW (110-122PS)	Petrol		TD28278	
X 20 XE		4 Cyl.		1998cc	89-103kW (121-140PS)	Petrol		TD28219	
X 20 XEV		4 Cyl.		1998cc	94kW (128PS)	Petrol		TD26430	
BE/PL	4	48,971/48,987	52,000/52,012	19,300	1,500	0,020/0,066	EC	71-3626	71-3626/4 STD 0.25 0.50
MB/HL 1,2,4,5	4	57,982/57,995	62,000/62,013	19,500	1,995	0,020/0,066	AL-LF	02-3532	H982/5 STD 0.25 0.50
MB/HL 3	1	57,982/57,995	62,000/62,013	25,900	1,995	0,020/0,066	AL-LF	02-3533H	



02-3533H	STD	25,950/1.0217" - 26,002/1.0237"
	0.25mm	26,150/1.0295" - 26,202/1.0316"
	0.50mm	26,350/1.0374" - 26,402/1.0394"

21 86.00 x 86.00

C 20 SEL		4 Cyl.		1998cc	100kW (136PS)	Petrol		TD19856	
C 20 XE		4 Cyl.		1998cc	89-110kW (121-150PS)	Petrol		TD28273	
BE/PL	4	48,971/48,987	52,000/52,012	19,300	1,500	0,020/0,066	EC	71-3626	71-3626/4 STD 0.25 0.50
BE/PL	4	48,971/48,987	52,000/52,012	20,300	1,500	0,020/0,070	EC	71-3764	71-3764/4 STD 0.25

CHEVROLET



71-3626

71-3764

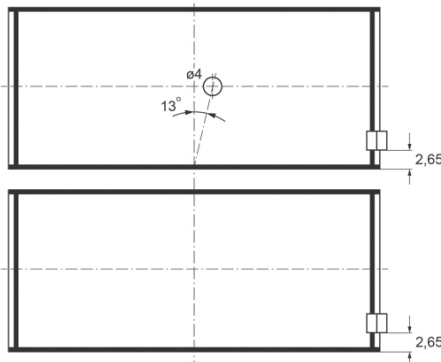
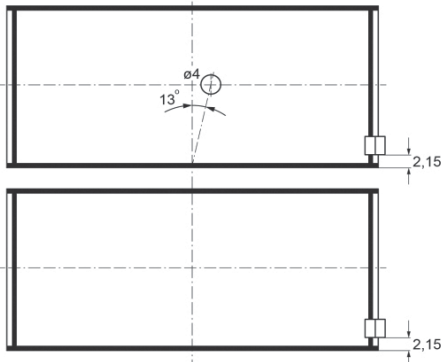

MB/HL 1,2,4,5	4	57,982/57,995	62,000/62,013	19,500	1,995	0,020/0,066	AL-LF	02-3532	H982/5 STD 0.25 0.50
MB/HL 3	1	57,982/57,995	62,000/62,013	25,900	1,995	0,020/0,066	AL-LF	02-3533H	



02-3533H	STD	25,950/1.0217" - 26,002/1.0237"
	0.25mm	26,150/1.0295" - 26,202/1.0316"
	0.50mm	26,350/1.0374" - 26,402/1.0394"

22

86.00 x 94.60

C 22 NE	4 Cyl.	2198cc	81-91kW (110-124PS)	Petrol	TD22564				
X 22 XE	4 Cyl.	2198cc	94-104kW (128-141PS)	Petrol	TD27421				
BE/PL	4	48,971/48,987	52,000/52,012	19,300	1,500	0,020/0,066	EC	71-3626	71-3626/4 STD 0.25 0.50
BE/PL	4	48,971/48,987	52,000/52,012	20,300	1,500	0,020/0,070	EC	71-3764	71-3764/4 STD 0.25

71-3626

71-3764

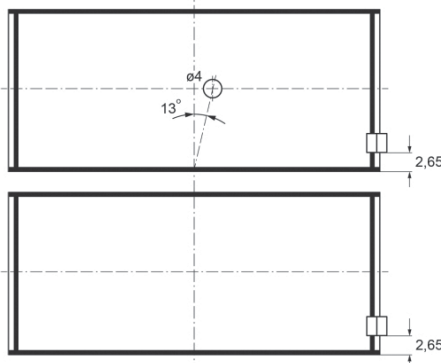
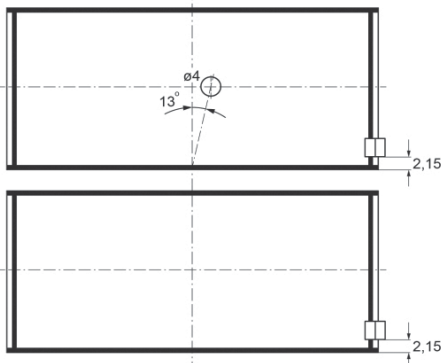

MB/HL 1,2,4,5	4	57,982/57,995	62,000/62,013	19,500	1,995	0,020/0,066	AL-LF	02-3532	H982/5 STD 0.25 0.50
MB/HL 3	1	57,982/57,995	62,000/62,013	25,900	1,995	0,020/0,066	AL-LF	02-3533H	



02-3533H	STD	25,950/1.0217" - 26,002/1.0237"
	0.25mm	26,150/1.0295" - 26,202/1.0316"
	0.50mm	26,350/1.0374" - 26,402/1.0394"

23

86.00 x 94.60

Z 22 SE	4 Cyl.	2198cc	108-110kW (147-150PS)	Petrol	TD21854				
Z 22 YH	4 Cyl.	2198cc	110-114kW (150-155PS)	Petrol	TD21853				
BE/PL	4	49,000/49,014	52,118/52,134	20,300	1,542	0,020/0,066	AL-LF	01-4729	01-4729/4 STD



24 93.00 x 92.00

4JA1		4 Cyl.		2499cc	81kW (110PS)			Diesel		TD26440
BE/PL	8	52,920	56,000	25,800	1,513		AL-LF	64-184-1	01-4131/4 STD 0.25 0.50	
MB/HL 1-5	5	59,920/59,932	63,987/64,000	23,030	2,004	0,035/0,080	BS	GS70221LC/B	H1160/5 STD 0.25	
MB/HL 1-5	5	59,920/59,932	63,987/64,000	23,030	2,004	0,035/0,080	BS	GS70221LC/T		
TW/A	2	72,700	86,950		2,480		BS	65-157-1	A219/2 STD	
CB/NWB	1	49,950	54,040	25,000	2,010		AL-LF	62-184-1	N178/3 STD	
CB/NWB	2	49,950	54,040	22,000	2,010		AL-LF	62-184-2		

25 93.00 x 92.00

4JA1-T		4 Cyl.		2499cc	59kW (80PS)			Diesel Turbo		TD23998
BE/PL	8	52,920	56,000	25,800	1,513		AL-LF	64-184-1	01-4131/4 STD 0.25 0.50	
MB/HL 1-5	5	59,920/59,932	63,987/64,000	23,030	2,004	0,035/0,080	BS	GS70221LC/B	H1160/5 STD 0.25	
MB/HL 1-5	5	59,920/59,932	63,987/64,000	23,030	2,004	0,035/0,080	BS	GS70221LC/T		
TW/A	2	72,700	86,950		2,480		BS	65-157-1	A219/2 STD	

26 95.00 x 69.80

C 30 NE		6 Cyl.		2969cc	125kW (170PS)			Petrol		TD28279
BE/PL	1	51,971/51,987	55,000/55,012	19,610	1,449	0,015/0,063	BS	71-3560	71-3560 STD 0.25 0.50	
BE/PL	6	51,971/51,987	55,000/55,012	19,610	1,449	0,015/0,063	BS	71-3560	71-3560/6 STD 0.50	
MB/HL	6	57,987/58,000	62,000/62,013	22,430	1,989	0,019/0,064	AL-LF	02-2421	H901/7 STD	
MB/HL	1	57,987/58,000	62,000/62,013	27,400	1,989	0,019/0,064	AL-LF	02-2422H		



02-2422H		STD	27,450/1.0807" - 27,510/1.0831"
		0.25mm	27,660/1.0890" - 27,720/1.0913"
		0.50mm	27,860/1.0969" - 27,920/1.0992"
		1.00mm	28,260/1.1126" - 28,320/1.1150"

27 95.00 x 85.00

C 24 NE		4 Cyl.		2405cc	94kW (128PS)			Petrol		TD28227
BE/PL	4	51,971/51,987	55,000/55,012	19,610	1,499	0,015/0,063	EC	71-3753	71-3753/4 STD 0.25	
MB/HL 1-4	4	57,987/58,000	62,000/62,013	22,430	1,989	0,019/0,064	AL-LF	02-2421	H901/5 STD 0.25 0.50	
MB/HL 5	1	57,987/58,000	62,000/62,013	27,400	1,989	0,019/0,064	AL-LF	02-2422H		













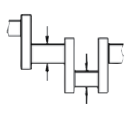
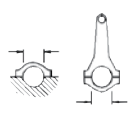



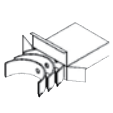

02-2422H		STD	27,450/1.0807" - 27,510/1.0831"
		0.25mm	27,660/1.0890" - 27,720/1.0913"
		0.50mm	27,860/1.0969" - 27,920/1.0992"
		1.00mm	28,260/1.1126" - 28,320/1.1150"



28 98.48 x 126.80

4.236 V		4 Cyl.		3864cc	57kW (77PS)			Diesel		TD522
BE/PL	1	63,475/63,487	67,208/67,221	31,880	1,841	0,038/0,089	AL-LF	3135RA	01-4115 STD 0.25 0.50 0.75 1.00	

CHEVROLET

									
BE/PL	4	63,475/63,487	67,208/67,221	31,880	1,841	0,038/0,089	AL-LF	3135RA	01-4115/4 STD 0.25
MB/HL 1,2,4,5	4	76,162/76,175	80,416/80,441	31,880	2,090	0,061/0,124	AL-LF	3136RA	H1037/5 STD 0.25 0.50 0.75 1.00
MB/HL 3	1	76,162/76,175	80,416/80,441	36,700	2,090	0,061/0,124	AL-LF	3137RA	
TW/A	4	86,870/87,120	103,850/104,100		2,310		AL-LF	3137BFA	A184/4 STD .0075
Mot.4203049 →									
SE/PB	1	34,920/34,925	38,895/38,920	33,930			AL-LF	3139Y15	05-4521 STD

				cm3				
Delta 1.4	08/11→	Petrol	198 A4.000	1368	4	72.00	84.00	3
Delta 1.4 16V	08/11→	Petrol	198 A7.000	1368	4	72.00	84.00	3
Delta 1.6 D Multijet	08/11→	Diesel	198 A2.000	1598	4	79.50	80.50	6
Delta 2.0 D Multijet	08/11→	Diesel	198 A5.000	1956	4	83.00	90.40	8
Grand Caravan 2.5 TDi	02/06→05/07	Diesel	ENC	2499	4	92.00	94.00	10
Voyager II 2.5 TD	01/92→09/95	Diesel	VM HR 425 CLIEE	2499	4	92.00	94.00	10
Voyager III 2.5 TD	01/95→03/01	Diesel	425 CLIRS/X	2499	4	92.00	94.00	10
Voyager III 2.5 TD	01/95→03/01	Diesel	ENC	2499	4	92.00	94.00	10
Voyager III 2.5 TDiC AWD	10/95→03/01	Diesel	ENC	2499	4	92.00	94.00	10
Ypsilon 0.9 Twinair	05/11→	Petrol	312 A2.000	875	2	80.50	86.00	7
Ypsilon 1.2	05/11→	Petrol	169 A4.000	1242	4	70.80	78.90	2
Ypsilon 1.3 Multijet	05/11→	Diesel	199 B1.000	1248	4	69.60	82.00	1

		cm ³	x 			
--	---	-----------------	---	---	---	---

Engine Code	Fuel Type	Capacity (cm ³)	Cylinders	Bore (mm)	Stroke (mm)	Gears
3E1	Petrol	1118	4	74.00	65.00	4
6Y2	Petrol	1442	4	76.70	78.00	5
169 A4.000	Petrol	1242	4	70.80	78.90	2
198 A2.000	Diesel	1598	4	79.50	80.50	6
198 A4.000	Petrol	1368	4	72.00	84.00	3
198 A5.000	Diesel	1956	4	83.00	90.40	8
198 A7.000	Petrol	1368	4	72.00	84.00	3
199 B1.000	Diesel	1248	4	69.60	82.00	1
312 A2.000	Petrol	875	2	80.50	86.00	7
425 CLIRS/X	Diesel	2499	4	92.00	94.00	10
ENC	Diesel	2499	4	92.00	94.00	10
HR 425 CLI	Diesel	2498	4	92.00	94.00	10
J8S	Diesel	2068	4	86.00	89.00	9
J8S 890	Diesel	2068	4	86.00	89.00	9
M51	Diesel	2499	4	92.00	94.00	10
M52	Diesel	2499	4	92.00	94.00	10
VM HR 425 CLIEE	Diesel	2499	4	92.00	94.00	10
Y2	Petrol	1442	4	76.70	78.00	5



1 69.60 x 82.00

199 B1.000 Euro 5		4 Cyl.		1248cc	70kW (95PS)		Diesel Turbo Intercooler		TD26556
BE/PL	4	42,582/42,600	45,734/45,744	20,000	1,552	0,030/0,062	BS	71-4033	71-4033/4 STD .010
MB/HL 1-5	5	54,785/54,795	58,731/58,744	18,500	1,945	0,050/0,090	AL-LF	66741RAB	H1101/5 STD 0.25 0.50
SE/PB	1	23,000	25,747/25,772	25,000			BS-LF	55-4077	55-4077 SEMI

2 70.80 x 78.90

169 A4.000		4 Cyl.		1242cc	51kW (69PS)		Petrol		TD26555
BE/PL	4	41,988/42,008	45,127/45,140	19,000	1,548	0,023/0,081	AL-LF	4275RA	01-4154/4 STD 0.25 0.50
MB/HL 3	2	52,000/52,200	68,766/69,020		2,325		AL-LF	04-4076	H1092/5 STD 0.25 0.50
MB/HL 1-5	10	47,980/48,000	51,705/51,718	19,000	1,848	0,020/0,067	AL-LF	4276RA	

3 72.00 x 84.00

198 A4.000		4 Cyl.		1368cc	88kW (120PS)		Petrol Turbo		TD26558
198 A7.000		4 Cyl.		1368cc	103kW (140PS)		Petrol Turbo Intercooler		TD26559
BE/PL	4	41,990/42,008	45,128/45,138	19,000	1,548	0,024/0,068	AL-LF	01-4079	01-4079/4 STD
MB/HL	2	52,000/52,200	68,766/69,020		2,325		AL-LF	04-4076	H1092/5 STD 0.25 0.50
MB/HL 1-5	10	47,980/48,000	51,705/51,718	19,000	1,848	0,020/0,067	AL-LF	4276RA	
SE/PB	1	17,970/17,974	20,775/20,800	22,000			BS-LF	55-4078	55-4078 SEMI

4 74.00 x 65.00

3E1		4 Cyl.		1118cc	37kW (50PS)		Petrol		TD536
BE/PL	4	40,959/40,967	44,005/44,013	19,240	1,509	0,020/0,061	AL-LF	61820RA	01-4172/4 STD 0.20
MB/HL	2	51,966/51,976	55,882/55,892	18,680	1,924	0,058/0,103	AL-LF	61821RA	H1031/5 STD
MB/HL	6	51,966/51,976	55,882/55,892	18,680	1,924	0,058/0,103	AL-LF	61822RA	
MB/HL	1	51,966/51,976	55,882/55,892	24,680	1,924	0,058/0,103	AL-LF	61823RA	

5 76.70 x 78.00

6Y2		4 Cyl.		1442cc	62kW (85PS)		Petrol		TD545
Y2		4 Cyl.		1442cc	62kW (85PS)		Petrol		TD557
BE/PL	4	40,959/40,967	44,005/44,013	19,240	1,509	0,020/0,061	AL-LF	61820RA	01-4172/4 STD 0.20
MB/HL	2	51,966/51,976	55,882/55,892	18,680	1,924	0,058/0,103	AL-LF	61821RA	H1031/5 STD
MB/HL	6	51,966/51,976	55,882/55,892	18,680	1,924	0,058/0,103	AL-LF	61822RA	
MB/HL	1	51,966/51,976	55,882/55,892	24,680	1,924	0,058/0,103	AL-LF	61823RA	

6 79.50 x 80.50

198 A2.000		4 Cyl.		1598cc	88kW (120PS)		Diesel Turbo Intercooler		TD26557
BE/PL	4	48,226/48,244	51,354/51,366	19,100	1,540	0,030/0,056	EC-LF	71-4776	71-4776/4 STD

CHRYSLER

MB/HL 1-5	5		56,705/56,718	20,750	1,861		AL-LF	02-4777	H1293/5 STD
TW/A	2	59,000/59,260	73,600/73,850		2,485		AL-LF	04-4778	A291/2 STD
SE/PB	1	26,000	28,939/28,972	22,100			BS-LF	55-4779	55-4779 SEMI

7 80.50 x 86.00

312 A2.000 Euro 5		2 Cyl.		875cc	63kW (86PS)		Petrol Turbo Intercooler		TD26554
BE/PL	2	41,982/42,000	45,125/45,135	18,000	1,550	0,025/0,061	AL-LF	01-4967	01-4967/2 STD
MB/HL 1-3	3	47,982/48,000	51,705/51,718	16,150	1,846	0,022/0,069	AL-LF	02-4968	H1337/3 STD
TW/A	2	53.100/53.300	68.766/69.020		2.335	0.105/0.275	AL-LF	04-4969	A321/2 STD
SE/PB	1		23,939/23,972	22,070			BS-LF	55-4970	55-4970 SEMI

8 83.00 x 90.40

198 A5.000		4 Cyl.		1956cc	121kW (165PS)		Diesel Turbo Intercooler		TD26560
BE/PL	1	50,787/50,805	53,901/53,913	19,500	1,534	0,030/0,080	EC	71-3994	71-3994 STD 0.25 4
BE/PL	1	50,787/50,805	53,901/53,913	19,500	1,534	0,030/0,080	EC-LF	71-4780	71-4780 STD 5

71-3994

71-4780

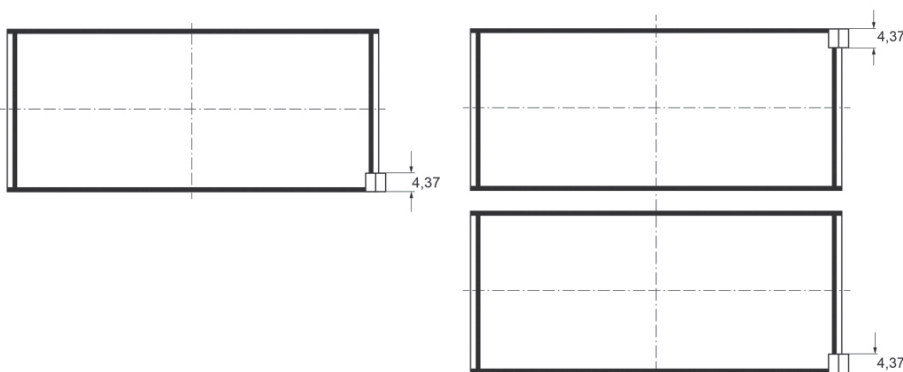

MB/HL	1	59,986/60,000	63,705/63,718	20,750	1,844	0,031/0,080	EC	72-3995	72-3995 STD 0.25 0.50
TW/A	2	67,785/68,040	82,425/82,677		2,485		AL-LF	4356AF	A191/2 STD
SE/PB	1		28,939/28,972	21,700			BS	4369Y	55-4159 SEMI

9 86.00 x 89.00

J8S		4 Cyl.		2068cc	59-64kW (80-87PS)		Diesel		TD4254
J8S 890		4 Cyl.		2068cc	64kW (87PS)		Diesel Turbo		TD4255
BE/PL	4	56,267/56,286	60,005/60,019	20,750	1,842	0,035/0,093	AL-LF	66635RA	01-4189/4 STD 0.25
BE/PL	4	56,267/56,286	60,005/60,019	20,750	1,842	0,035/0,093	AL-LF	66645RA	01-4191/4 STD 0.25
BE/PL	4	56,267/56,286	60,005/60,019	20,750	1,842	0,035/0,093	AL-LF	66645RAA	01-4192/4 STD



66635RA

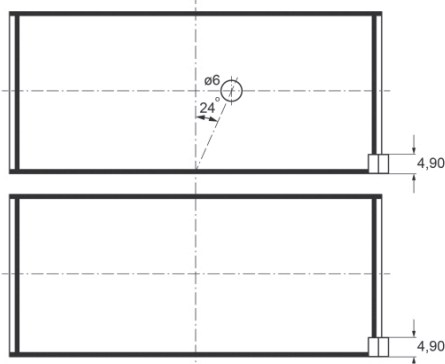

66645RA

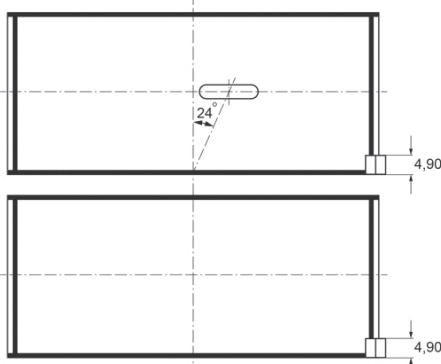

66645RAA

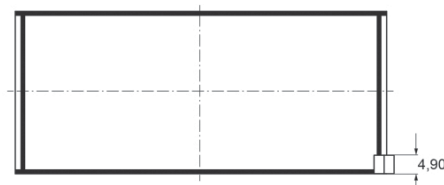

MB/HL 1-5	5	62,873/62,892	66,668/66,687	23,500	1,884	0,020/0,071	AL-LF	66507RA	H1052/5 STD 0.25
MB/HL 1-5	5	62,861/62,880	66,668/66,687	23,250	1,884	0,030/0,093	AL-LF	66646RA	H1058/5 STD 0.25

66507RA

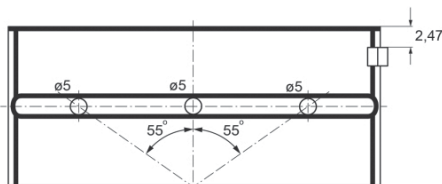

66646RA

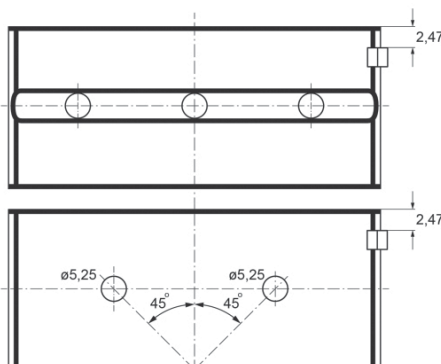

TW/A	2	71,450	88,090	2,850	BS	66506BF	A208/2 STD
TW/A	2	71,450	88,090	2,850	BS	66646BF	A210/2 STD

66506BF

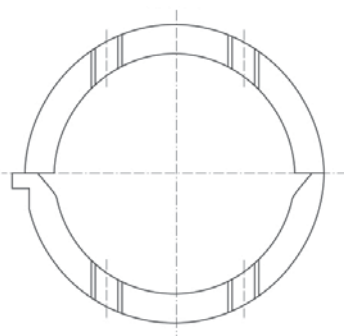

66646BF

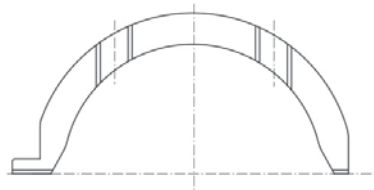









SE/PB	1	28,002/28,010	30,000/30,021	25,250	BS	66649RY	55-4294 SEMI
-------	---	---------------	---------------	--------	----	---------	------------------------

10

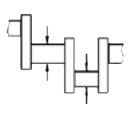
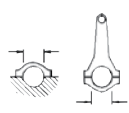
92.00 x 94.00

425 CLIRS/X	4 Cyl.	2499cc	85kW (116PS)	Diesel Turbo	TD15088
ENC	4 Cyl.	2499cc	85-105kW (116-141PS)	Diesel Turbo	TD18322
HR 425 CLI	4 Cyl.	2498cc	88kW (120PS)	Diesel Turbo	TD552
M51	4 Cyl.	2499cc	85-89kW (115-121PS)	Diesel Turbo	TD4257
M52	4 Cyl.	2499cc	85kW (115PS)	Diesel Turbo	TD535
VM HR 425 CLIEE	4 Cyl.	2499cc	85kW (116PS)	Diesel Turbo	TD4256

CHRYSLER

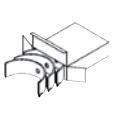
									
BE/PL	1	53,940/53,955	57,563/57,582	23,250	1,798	0,020/0,071	BS	66655CP	71-4234 STD 0.25 0.50 0.75
TW/A	2	74,250/74,500	88,000/88,100		2,362		AL-LF	61588AF	A227/2 STD
SE/PB	1	29,990/29,996	34,000/34,025	30,120			BS	66659XA	55-4235 SEMI

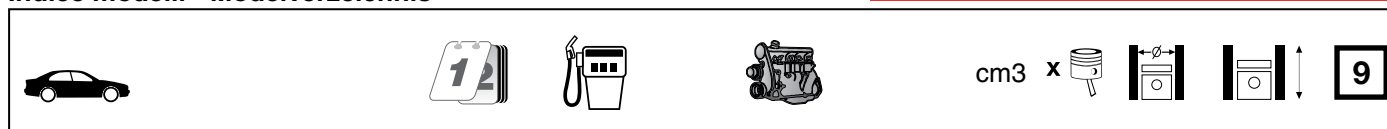

AX 1.3	04/87→12/88	Petrol	M4A	1294	4	75.00	73.20	13
AX 1.4 4x4	08/92→04/94	Petrol	K1F	1360	4	75.00	77.00	15
AX 1.4 4x4	09/86→07/92	Petrol	K2A	1360	4	75.00	77.00	15
AX 1.4 Allure	08/92→04/94	Petrol	K1F	1360	4	75.00	77.00	15
AX 1.4 D 4x4	06/91→07/92	Diesel	K9A (TUD3)	1360	4	75.00	77.00	19
AX 1.4 GTi	08/91→12/96	Petrol	KFY (TU3FJ2)	1360	4	75.00	77.00	16
AX 1.4 GTi	06/91→12/96	Petrol	KFZ (TU3FJ2)	1360	4	75.00	77.00	16
AX 10	09/86→06/92	Petrol	C1A	954	4	70.00	62.00	3
AX 10	07/86→12/98	Petrol	CDY (TU9M)	954	4	70.00	62.00	3
AX 10	02/87→12/98	Petrol	CDZ (TU9M)	954	4	70.00	62.00	3
AX 10 E	12/86→12/88	Petrol	C3A	954	4	70.00	62.00	3
AX 11	12/86→04/94	Petrol	H1A	1124	4	72.00	69.00	8
AX 11	09/86→12/97	Petrol	H1B	1124	4	72.00	69.00	9
AX 11	09/86→12/97	Petrol	HDZ (TU1M)	1124	4	72.00	69.00	8
AX 11 4x4	06/91→07/92	Petrol	H1A	1124	4	72.00	69.00	8
AX 11 CAT	09/88→12/89	Petrol	HAZ (TU1CP)	1124	4	72.00	69.00	8
AX 14	06/88→12/89	Petrol	K1F	1360	4	75.00	77.00	15
AX 14	01/89→12/91	Petrol	K1G	1360	4	75.00	77.00	15
AX 14	01/88→12/92	Petrol	K2A	1360	4	75.00	77.00	15
AX 14	01/88→12/92	Petrol	K2B	1360	4	75.00	77.00	15
AX 14	12/86→12/88	Petrol	KAY (TU3CP)	1360	4	75.00	77.00	15
AX 14	04/87→04/97	Petrol	KDX (TU3M/Z)	1360	4	75.00	77.00	15
AX 14	04/87→04/97	Petrol	KDY (TU3FM)	1360	4	75.00	77.00	16
AX 14	04/87→04/97	Petrol	KDY (TU3M)	1360	4	75.00	77.00	15
AX 14	04/87→04/97	Petrol	KDZ (TU3M/Z)	1360	4	75.00	77.00	15
AX 14 4x4	08/91→12/96	Petrol	KDX (TU3M/Z)	1360	4	75.00	77.00	15
AX 14 4x4	08/91→12/96	Petrol	KDY (TU3FM)	1360	4	75.00	77.00	16
AX 14 4x4	08/91→12/96	Petrol	KDY (TU3M)	1360	4	75.00	77.00	15
AX 14 4x4	08/91→12/96	Petrol	KDZ (TU3M/Z)	1360	4	75.00	77.00	15
AX 14 D	09/88→06/92	Diesel	K9A (TUD3)	1360	4	75.00	77.00	19
AX 14 D	08/91→12/97	Diesel	K9Y (TUD3Y)	1360	4	75.00	77.00	19
AX 14 GT	01/89→12/91	Petrol	KDZ (TU3M/Z)	1360	4	75.00	77.00	15
AX 15 D	08/94→12/97	Diesel	VJY (TUD5)	1527	4	77.00	82.00	23
AX 15 D	08/94→12/97	Diesel	VJZ (TUD5)	1527	4	77.00	82.00	23
Berlingo 1.1 i	07/96→	Petrol	HDZ (TU1M)	1124	4	72.00	69.00	8
Berlingo 1.1 i	07/96→	Petrol	HFX (TU1JP)	1124	4	72.00	69.00	10
Berlingo 1.4	11/02→	Petrol	KFW (TU3JP)	1360	4	75.00	77.00	18
Berlingo 1.4 bivalent	11/02→	Petrol	KFW (TU3JP)	1360	4	75.00	77.00	18
Berlingo 1.4 i	07/96→	Petrol	KFW (TU3JP)	1360	4	75.00	77.00	18
Berlingo 1.4 i	07/96→	Petrol	KFX (TU3JP)	1360	4	75.00	77.00	18
Berlingo 1.4 i bivalent	04/03→	Petrol	KFW (TU3JP)	1360	4	75.00	77.00	18
Berlingo 1.6	04/08→	Petrol	NFR (TU5JP4B)	1587	4	78.50	82.00	24
Berlingo 1.6	04/08→	Petrol	NFU (TU5JP4)	1587	4	78.50	82.00	24
Berlingo 1.6 16V	10/00→	Petrol	NFU (TU5JP4)	1587	4	78.50	82.00	24
Berlingo 1.6 BlueHDi 75	04/15→	Diesel	9HN (DV6ETED)	1560	4	75.00	88.30	20
Berlingo 1.6 BlueHDi 75	04/15→	Diesel	BHW (DV6FE)	1560	4	75.00	88.30	20
Berlingo 1.6 BlueHDi 100	12/14→	Diesel	BHY (DV6FD)	1560	4	75.00	88.30	20
Berlingo 1.6 HDi 75	04/08→	Diesel	9HT (DV6BTED4)	1560	4	75.00	88.30	20
Berlingo 1.6 HDi 75	04/08→	Diesel	9HT (DV6BUTED4)	1560	4	75.00	88.30	20
Berlingo 1.6 HDi 75	07/05→	Diesel	9HW (DV6BTED4)	1560	4	75.00	88.30	20
Berlingo 1.6 HDi 75	07/05→	Diesel	DV6B	1560	4	75.00	88.30	20
Berlingo 1.6 HDi 90	07/10→	Diesel	9HF (DV6DTED)	1560	4	75.00	88.30	20
Berlingo 1.6 HDi 90	07/10→	Diesel	9HP (DV6DTED)	1560	4	75.00	88.30	20
Berlingo 1.6 HDi 90	07/05→	Diesel	9HX (DV6ATED4)	1560	4	75.00	88.30	20
Berlingo 1.6 HDi 90 16V	04/08→	Diesel	9HS (DV6TED4BU)	1560	4	75.00	88.30	20
Berlingo 1.6 HDi 90 16V	04/08→	Diesel	9HX (DV6ATED4)	1560	4	75.00	88.30	20
Berlingo 1.6 HDi 92	07/10→	Diesel	9HJ (DV6DTEDM)	1560	4	75.00	88.30	20
Berlingo 1.6 HDi 110	07/10→	Diesel	9HL (DV6C)	1560	4	75.00	88.30	20
Berlingo 1.6 HDi 110	07/10→	Diesel	9HR (DV6C)	1560	4	75.00	88.30	20
Berlingo 1.6 HDi 110	08/05→	Diesel	9HZ (DV6TED4)	1560	4	75.00	88.30	20
Berlingo 1.6 HDi 115	07/10→	Diesel	9HL (DV6C)	1560	4	75.00	88.30	20
Berlingo 1.6 HDi 115	07/10→	Diesel	9HR (DV6C)	1560	4	75.00	88.30	20
Berlingo 1.8 D	07/96→	Diesel	A9A (XUD7)	1769	4	80.00	88.00	25
Berlingo 1.8 i	05/97→	Petrol	LFX (XU7JB)	1761	4	83.00	81.40	35
Berlingo 1.8 i 4WD	04/97→	Petrol	LFX (XU7JB)	1761	4	83.00	81.40	35
Berlingo 1.9 D	07/98→12/11	Diesel	WJY (DW8B)	1868	4	82.20	88.00	28
Berlingo 1.9 D	07/98→10/05	Diesel	WJZ (DW8)	1868	4	82.20	88.00	28
Berlingo 1.9 D	07/96→	Diesel	D9B (XUD9A/L)	1905	4	83.00	88.00	43
Berlingo 1.9 D	07/96→	Diesel	DJY (XUD9A)	1905	4	83.00	88.00	43

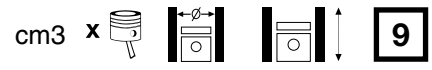

Berlingo 1.9 D 4WD	07/98→	Diesel	WJY (DW8B)	1868	4	82.20	88.00	28
Berlingo 1.9 D 4WD	07/98→	Diesel	WJZ (DW8)	1868	4	82.20	88.00	28
Berlingo 1.9 D 70	04/99→	Diesel	WJY (DW8B)	1868	4	82.20	88.00	28
Berlingo 1.9 D 70	04/99→	Diesel	WJZ (DW8)	1868	4	82.20	88.00	28
Berlingo 1.9 D 70 4WD	07/98→	Diesel	WJY (DW8B)	1868	4	82.20	88.00	28
Berlingo 1.9 D 70 4WD	07/98→	Diesel	WJZ (DW8)	1868	4	82.20	88.00	28
Berlingo 2.0 HDi 4x4	11/02→10/05	Diesel	RHY (DW10TD)	1997	4	85.00	88.00	48
Berlingo 2.0 HDi 90	12/99→	Diesel	RHY (DW10TD)	1997	4	85.00	88.00	48
Berlingo 2.0 HDi 90 4WD	11/00→	Diesel	RHY (DW10TD)	1997	4	85.00	88.00	48
BX 1.6	01/87→01/92	Petrol	B6D	1580	4	83.00	73.00	33
BX 1.6	01/87→01/92	Petrol	B6E	1580	4	83.00	73.00	33
BX 1.6	01/91→06/94	Petrol	BDY (XU5M)	1580	4	83.00	73.00	34
BX 1.8 D	10/85→09/93	Diesel	161 (XUD7)	1769	4	80.00	88.00	25
BX 11	10/86→06/92	Petrol	H1A	1124	4	72.00	69.00	8
BX 11	10/88→06/92	Petrol	HDZ (TU1M)	1124	4	72.00	69.00	8
BX 14	01/89→12/89	Petrol	K1H (TU3A)	1360	4	75.00	77.00	15
BX 14	01/89→02/93	Petrol	KDY (TU3M)	1360	4	75.00	77.00	15
BX 14	01/89→02/93	Petrol	KDZ (TU3M/Z)	1360	4	75.00	77.00	15
BX 14 E	10/82→06/88	Petrol	150A	1360	4	75.00	77.00	14
BX 14 E	04/83→02/93	Petrol	150C	1360	4	75.00	77.00	14
BX 14 E	09/85→02/93	Petrol	150F	1360	4	75.00	77.00	14
BX 14 E	04/83→07/89	Petrol	K1G	1360	4	75.00	77.00	15
BX 15	10/87→05/92	Petrol	B1E (XU51C)	1580	4	83.00	73.00	30
BX 16	10/82→06/88	Petrol	171A	1580	4	83.00	73.00	30
BX 16	10/82→06/94	Petrol	171B	1580	4	83.00	73.00	30
BX 16	10/82→06/88	Petrol	171C	1580	4	83.00	73.00	30
BX 16	07/85→02/93	Petrol	171D	1580	4	83.00	73.00	31
BX 16	03/86→02/93	Petrol	180Z	1580	4	83.00	73.00	33
BX 16	09/87→02/93	Petrol	B1A (XU51C/K)	1580	4	83.00	73.00	34
BX 16	01/87→02/93	Petrol	B1E (XU51C)	1580	4	83.00	73.00	30
BX 16	09/88→02/93	Petrol	BAY (XU5CP)	1580	4	83.00	73.00	34
BX 16	09/88→02/93	Petrol	BAZ (XU5CP)	1580	4	83.00	73.00	34
BX 16	10/82→12/92	Petrol	XU52C	1580	4	83.00	73.00	30
BX 16 E	05/89→02/93	Petrol	BDY (XU5M)	1580	4	83.00	73.00	34
BX 16 E	05/89→02/93	Petrol	BDZ (XU5M)	1580	4	83.00	73.00	34
BX 19	07/86→05/89	Petrol	159A	1905	4	83.00	88.00	36
BX 19	07/86→05/89	Petrol	D2A (XU92C)	1905	4	83.00	88.00	36
BX 19	09/86→11/89	Petrol	D2C (XU92C)	1905	4	83.00	88.00	36
BX 19 D	09/83→09/93	Diesel	162 (XUD9)	1905	4	83.00	88.00	40
BX 19 D	09/83→09/93	Diesel	D9A (XUD9)	1905	4	83.00	88.00	40
BX 19 D	03/87→10/93	Diesel	D9B (XUD9A/U)	1905	4	83.00	88.00	43
BX 19 D	09/83→09/93	Diesel	DJZ (XUD9Y)	1905	4	83.00	88.00	40
BX 19 E	06/88→02/93	Petrol	DDZ (XU9M)	1905	4	83.00	88.00	39
BX 19 E 4x4	04/89→02/93	Petrol	D2F	1905	4	83.00	88.00	37
BX 19 GTi	07/86→02/93	Petrol	D6A (XU9J2)	1905	4	83.00	88.00	38
BX 19 GTi	06/88→02/93	Petrol	DKZ (XU9JA)	1905	4	83.00	88.00	39
BX 19 GTi 4x4	06/88→02/93	Petrol	DKZ (XU9JA)	1905	4	83.00	88.00	39
BX 19 GTi 16V	09/87→12/88	Petrol	D6C (XU9J4)	1905	4	83.00	88.00	39
BX 19 GTi 16V	03/88→02/93	Petrol	DFW (XU9J4)	1905	4	83.00	88.00	39
BX TRD Turbo	03/88→02/93	Diesel	A8A (XUD7TE)	1769	4	80.00	88.00	27
BX TRD Turbo	03/88→02/93	Diesel	AJZ (XUD7TE)	1769	4	80.00	88.00	27
BX Break 1.4	01/87→01/92	Petrol	150C	1360	4	75.00	77.00	14
BX Break 1.6	01/87→01/92	Petrol	B6D	1580	4	83.00	73.00	33
BX Break 1.6	01/87→01/92	Petrol	B6E	1580	4	83.00	73.00	33
BX Break 1.9 TZi	02/92→12/94	Petrol	D6A (XU9J2)	1905	4	83.00	88.00	38
BX Break 14	01/86→02/93	Petrol	150C	1360	4	75.00	77.00	14
BX Break 14	01/89→12/89	Petrol	K1H (TU3A)	1360	4	75.00	77.00	15
BX Break 14	01/89→02/93	Petrol	KDY (TU3M)	1360	4	75.00	77.00	15
BX Break 15	10/87→05/92	Petrol	B1E (XU51C)	1580	4	83.00	73.00	30
BX Break 16	06/85→06/88	Petrol	171A	1580	4	83.00	73.00	30
BX Break 16	06/85→06/88	Petrol	171B	1580	4	83.00	73.00	30
BX Break 16	04/83→01/92	Petrol	171C	1580	4	83.00	73.00	30
BX Break 16	07/85→12/94	Petrol	171D	1580	4	83.00	73.00	31
BX Break 16	03/86→12/94	Petrol	180Z	1580	4	83.00	73.00	33
BX Break 16	09/88→12/94	Petrol	B1E (XU51C)	1580	4	83.00	73.00	30
BX Break 16	09/88→12/94	Petrol	BAY (XU5CP)	1580	4	83.00	73.00	34
BX Break 16	09/88→12/94	Petrol	BAZ (XU5CP)	1580	4	83.00	73.00	34
BX Break 16	05/89→12/94	Petrol	BDY (XU5M)	1580	4	83.00	73.00	34
BX Break 16	05/89→12/94	Petrol	BDZ (XU5M)	1580	4	83.00	73.00	34

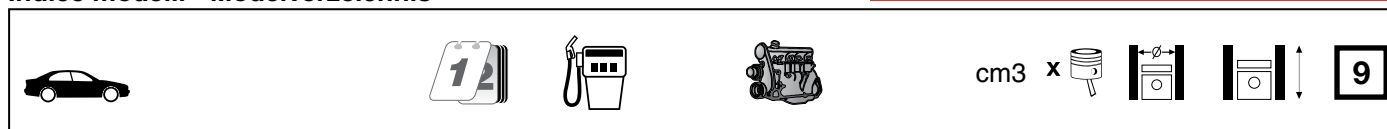

BX Break 18 D	10/85→09/93	Diesel	161A (XUD7)	1769	4	80.00	88.00	26
BX Break 19	07/86→12/94	Petrol	D2A (XU92C)	1905	4	83.00	88.00	36
BX Break 19	12/87→12/89	Petrol	D2C (XU92C)	1905	4	83.00	88.00	36
BX Break 19	07/86→01/92	Petrol	D6A (XU9J2)	1905	4	83.00	88.00	38
BX Break 19	06/88→12/94	Petrol	DDZ (XU9M)	1905	4	83.00	88.00	39
BX Break 19	06/88→12/94	Petrol	DKZ (XU9JA)	1905	4	83.00	88.00	39
BX Break 19 4x4	06/89→05/91	Petrol	D2E	1905	4	83.00	88.00	37
BX Break 19 4x4	10/90→05/91	Petrol	DDZ (XU9M)	1905	4	83.00	88.00	39
BX Break 19 CAT	07/86→12/94	Petrol	DFZ (XU9J1)	1905	4	83.00	88.00	38
BX Break 19 D	09/83→11/94	Diesel	162 (XUD9)	1905	4	83.00	88.00	40
BX Break 19 D	09/83→11/94	Diesel	D9A (XUD9)	1905	4	83.00	88.00	40
BX Break 19 D	03/87→12/94	Diesel	D9B (XUD9A/U)	1905	4	83.00	88.00	43
BX Break 19 D	09/83→11/94	Diesel	DJZ (XUD9Y)	1905	4	83.00	88.00	40
BX Break TRD Turbo	03/88→12/94	Diesel	A8A (XUD7TE)	1769	4	80.00	88.00	27
BX Break TRD Turbo	03/88→12/94	Diesel	AJZ (XUD7TE)	1769	4	80.00	88.00	27
C1 1.0	06/05→	Petrol	1KR-FE	998	3	71.00	84.00	4
C1 1.4 HDi	06/05→	Diesel	8HT (DV4TD)	1398	4	73.70	82.00	12
C1 II 1.0 VTi 68	04/14→	Petrol	1KR-FE	998	3	71.00	84.00	4
C2 1.1	09/03→	Petrol	HFX (TU1JP)	1124	4	72.00	69.00	10
C2 1.4	09/03→	Petrol	KFV (TU3JP)	1360	4	75.00	77.00	17
C2 1.4 16V	06/06→	Petrol	KFU (ET3J4)	1360	4	75.00	77.00	15
C2 1.4 HDi	09/03→	Diesel	8HX (DV4TD)	1398	4	73.70	82.00	12
C2 1.4 HDi	09/03→	Diesel	8HZ (DV4TD)	1398	4	73.70	82.00	12
C2 1.6	09/03→	Petrol	NFU (TU5JP4)	1587	4	78.50	82.00	24
C2 1.6 HDi	09/05→	Diesel	9HZ (DV6TED4)	1560	4	75.00	88.30	20
C2 1.6 VTS	01/05→	Petrol	NFS (TU5JP4S)	1587	4	78.50	82.00	24
C3 I 1.1 i	02/02→	Petrol	HFX (TU1A)	1124	4	72.00	69.00	8
C3 I 1.1 i	02/02→	Petrol	HFX (TU1JP)	1124	4	72.00	69.00	10
C3 I 1.4	12/05→07/12	Petrol	KFV (TU3A)	1360	4	75.00	77.00	15
C3 I 1.4 16V	12/03→	Petrol	KFU (ET3J4)	1360	4	75.00	77.00	15
C3 I 1.4 16V HDi	02/02→	Diesel	8HY (DV4TED4)	1398	4	73.70	82.00	12
C3 I 1.4 Bioflex	01/09→	Petrol	KFV (TU3JP)	1360	4	75.00	77.00	17
C3 I 1.4 Flex	12/05→07/12	Petrol	KFV (TU3JP)	1360	4	75.00	77.00	17
C3 I 1.4 HDi	02/02→	Diesel	8HX (DV4TD)	1398	4	73.70	82.00	12
C3 I 1.4 HDi	07/03→	Diesel	8HZ (DV4TD)	1398	4	73.70	82.00	12
C3 I 1.4 i	02/02→	Petrol	KFV (TU3A)	1360	4	75.00	77.00	15
C3 I 1.4 i	02/02→	Petrol	KFV (TU3JP)	1360	4	75.00	77.00	17
C3 I 1.4 i Bivalent	02/02→	Petrol	KFV (TU3JP)	1360	4	75.00	77.00	17
C3 I 1.6 16V	02/02→	Petrol	NFU (TU5JP4)	1587	4	78.50	82.00	24
C3 I 1.6 16V HDi	10/05→	Diesel	9HX (DV6ATED4)	1560	4	75.00	88.30	20
C3 I 1.6 16V HDi	09/05→	Diesel	9HZ (DV6TED4)	1560	4	75.00	88.30	20
C3 I 1.6 Bioflex	06/05→	Petrol	NFU (TU5JP4)	1587	4	78.50	82.00	24
C3 II 1.1	11/09→	Petrol	HFX (TU1JP)	1124	4	72.00	69.00	10
C3 II 1.1 BiFuel	11/10→	Petrol	HFX (TU1A)	1124	4	72.00	69.00	8
C3 II 1.2 THP 110	10/14→	Petrol	HNZ (EB2DT)	1199	3	75.00	90.50	21
C3 II 1.4	11/09→	Petrol	KFT (TU3A)	1360	4	75.00	77.00	15
C3 II 1.4	11/09→	Petrol	KFV (TU3A)	1360	4	75.00	77.00	15
C3 II 1.4 HDi 70	11/09→	Diesel	8HR (DV4C)	1398	4	73.70	82.00	12
C3 II 1.4 HDi 70	11/09→	Diesel	8HZ (DV4TD)	1398	4	73.70	82.00	12
C3 II 1.6 BlueHDi 75	04/15→	Diesel	BHW (DV6FE)	1560	4	75.00	88.30	20
C3 II 1.6 BlueHDi 100	07/14→	Diesel	BHY (DV6FD)	1560	4	75.00	88.30	20
C3 II 1.6 Flex	11/09→	Petrol	NFX (TU5JP4)	1587	4	78.50	82.00	24
C3 II 1.6 HDi	11/09→	Diesel	9HP (DV6DTED)	1560	4	75.00	88.30	20
C3 II 1.6 HDi 90	11/09→	Diesel	9HX (DV6ATED4)	1560	4	75.00	88.30	20
C3 II 1.6 HDi 110	11/09→	Diesel	9HR (DV6C)	1560	4	75.00	88.30	20
C3 II 1.6 HDi 115	09/12→	Diesel	9HD (DV6C)	1560	4	75.00	88.30	20
C3 Picasso 1.2 THP 110	01/15→	Petrol	HNZ (EB2DT)	1199	3	75.00	90.50	21
C3 Picasso 1.6	05/11→	Petrol	NFX (TU5JP4)	1587	4	78.50	82.00	24
C3 Picasso 1.6 BlueHDi 100	01/15→	Diesel	BHY (DV6FD)	1560	4	75.00	88.30	20
C3 Picasso 1.6 Flex	05/11→	Petrol	NFX (TU5JP4)	1587	4	78.50	82.00	24
C3 Picasso 1.6 HDi	02/09→	Diesel	9HX (DV6ATED4)	1560	4	75.00	88.30	20
C3 Picasso 1.6 HDi	02/09→	Diesel	9HZ (DV6TED4)	1560	4	75.00	88.30	20
C3 Picasso 1.6 HDi 90	07/10→	Diesel	9HP (DV6DTED)	1560	4	75.00	88.30	20
C3 Picasso 1.6 HDi 110	05/10→	Diesel	9HR (DV6C)	1560	4	75.00	88.30	20
C3 Picasso 1.6 HDi 115	01/13→	Diesel	9HD (DV6C)	1560	4	75.00	88.30	20
C3 Pluriel 1.4	05/03→	Petrol	KFV (TU3JP)	1360	4	75.00	77.00	17
C3 Pluriel 1.4 HDi	04/04→	Diesel	8HX (DV4TD)	1398	4	73.70	82.00	12
C3 Pluriel 1.4 Hybrid	05/05→	Petrol	KFV (TU3JP)	1360	4	75.00	77.00	17
C3 Pluriel 1.6	05/03→	Petrol	NFU (TU5JP4)	1587	4	78.50	82.00	24











cm3



9

C4 1.4 16V	11/04→07/11	Petrol	KFU (ET3J4)	1360	4	75.00	77.00	15
C4 1.6 16V	11/04→07/11	Petrol	NFU (TU5JP4)	1587	4	78.50	82.00	24
C4 1.6 HDi	11/04→07/11	Diesel	9HX (DV6ATED4)	1560	4	75.00	88.30	20
C4 1.6 HDi	11/04→	Diesel	9HY (DV6TED4)	1560	4	75.00	88.30	20
C4 1.6 HDi	11/04→07/11	Diesel	9HZ (DV6TED4)	1560	4	75.00	88.30	20
C4 2.0 16V	07/06→	Petrol	RFJ (EW10A)	1997	4	85.00	88.00	47
C4 2.0 16V	11/04→12/10	Petrol	RFK (EW10J4S)	1997	4	85.00	88.00	47
C4 2.0 16V	11/04→09/08	Petrol	RFN (EW10J4)	1997	4	85.00	88.00	47
C4 2.0 Flex	07/06→	Petrol	RFJ (EW10A)	1997	4	85.00	88.00	47
C4 2.0 HDi	06/07→07/11	Diesel	RHF (DW10BTED4)	1997	4	85.00	88.00	48
C4 2.0 HDi	11/04→12/10	Diesel	RHR (DW10BTED4)	1997	4	85.00	88.00	49
C4 2.0 HDi	04/07→12/11	Diesel	RHZ (DW10ATED)	1997	4	85.00	88.00	49
C4 2.0 VTR	10/06→12/07	Petrol	RFJ (EW10A)	1997	4	85.00	88.00	47
C4 Aircross 1.6 Flex	08/10→	Petrol	NFX (TU5JP4)	1587	4	78.50	82.00	24
C4 Aircross 1.6 HDi 115	04/12→	Diesel	9HL (DV6C)	1560	4	75.00	88.30	20
C4 Aircross 1.6 HDi 115 AWC	05/12→	Diesel	9HL (DV6C)	1560	4	75.00	88.30	20
C4 Cactus 1.2 THP 110	09/14→	Petrol	HNZ (EB2DT)	1199	3	75.00	90.50	21
C4 Cactus 1.6 BlueHDi 100	09/14→	Diesel	BHY (DV6FD)	1560	4	75.00	88.30	20
C4 Cactus 1.6 HDi 90	09/14→	Diesel	9HP (DV6DTEd)	1560	4	75.00	88.30	20
C4 Grand Picasso I 1.6 HDi	10/06→	Diesel	9HY (DV6TED4)	1560	4	75.00	88.30	20
C4 Grand Picasso I 1.6 HDi	10/06→	Diesel	9HZ (DV6TED4)	1560	4	75.00	88.30	20
C4 Grand Picasso I 1.6 HDi 110	09/10→	Diesel	9HL (DV6C)	1560	4	75.00	88.30	20
C4 Grand Picasso I 1.6 HDi 110	09/10→	Diesel	9HR (DV6C)	1560	4	75.00	88.30	20
C4 Grand Picasso I 1.8 i 16V	10/06→	Petrol	6FY (EW7A)	1749	4	82.70	81.40	29
C4 Grand Picasso I 2.0 HDi 138	10/06→	Diesel	RHJ (DW10BTED4)	1997	4	85.00	88.00	48
C4 Grand Picasso I 2.0 HDi 138	10/06→	Diesel	RHR (DW10BTED4)	1997	4	85.00	88.00	49
C4 Grand Picasso I 2.0 HDi 150	07/09→	Diesel	RHE (DW10CTED4)	1997	4	85.00	88.00	48
C4 Grand Picasso I 2.0 HDi 165	09/10→	Diesel	RHH (DW10CTED4)	1997	4	85.00	88.00	48
C4 Grand Picasso I 2.0 i 16V	10/06→	Petrol	RFJ (EW10A)	1997	4	85.00	88.00	47
C4 Grand Picasso II 1.6 BlueHDi 100	01/15→	Diesel	BHY (DV6FD)	1560	4	75.00	88.30	20
C4 Grand Picasso II 1.6 HDi 90	09/13→	Diesel	9HP (DV6DTEd)	1560	4	75.00	88.30	20
C4 Grand Picasso II 1.6 HDi / BlueHDi 115	09/13→	Diesel	9HC (DV6C)	1560	4	75.00	88.30	20
C4 I 1.4 16V	11/04→07/11	Petrol	KFU (ET3J4)	1360	4	75.00	77.00	15
C4 I 1.6 16V	11/04→07/11	Petrol	NFU (TU5JP4)	1587	4	78.50	82.00	24
C4 I 1.6 16V Bio-Flex	09/07→07/08	Petrol	NFU (TU5JP4)	1587	4	78.50	82.00	24
C4 I 1.6 HDi	11/04→07/11	Diesel	9HX (DV6ATED4)	1560	4	75.00	88.30	20
C4 I 1.6 HDi	11/04→07/11	Diesel	9HY (DV6TED4)	1560	4	75.00	88.30	20
C4 I 1.6 HDi	11/04→07/11	Diesel	9HZ (DV6TED4)	1560	4	75.00	88.30	20
C4 I 2.0 16V	11/04→07/11	Petrol	RFJ (EW10A)	1997	4	85.00	88.00	47
C4 I 2.0 16V	11/04→07/08	Petrol	RFK (EW10J4S)	1997	4	85.00	88.00	47
C4 I 2.0 16V	11/04→07/07	Petrol	RFN (EW10J4)	1997	4	85.00	88.00	47
C4 I 2.0 HDi	07/08→07/11	Diesel	RHF (DW10BTED4)	1997	4	85.00	88.00	48
C4 I 2.0 HDi	11/04→07/11	Diesel	RHR (DW10BTED4)	1997	4	85.00	88.00	49
C4 I 2.0 HDi	04/07→07/08	Diesel	RHZ (DW10ATED)	1997	4	85.00	88.00	49
C4 II 1.2 THP 110	02/15→	Petrol	HNZ (EB2DT)	1199	3	75.00	90.50	21
C4 II 1.6 BlueHDi 100	07/14→	Diesel	BHY (DV6FD)	1560	4	75.00	88.30	20
C4 II 1.6 Flex	11/09→	Petrol	NFX (TU5JP4)	1587	4	78.50	82.00	24
C4 II 1.6 HDi 90	11/09→	Diesel	9HP (DV6DTEd)	1560	4	75.00	88.30	20
C4 II 1.6 HDi 110	11/09→	Diesel	9HR (DV6C)	1560	4	75.00	88.30	20
C4 II 1.6 HDi 115	07/12→	Diesel	9HD (DV6C)	1560	4	75.00	88.30	20
C4 II 1.6 HDi 115	07/12→	Diesel	9HR (DV6C)	1560	4	75.00	88.30	20
C4 II 2.0 BlueHDi 150	11/09→	Diesel	RHE (DW10CTED4)	1997	4	85.00	88.00	48
C4 II 2.0 Flex	11/09→	Petrol	RFJ (EW10A)	1997	4	85.00	88.00	47
C4 Picasso I 1.6 HDi	02/07→08/13	Diesel	9HY (DV6TED4)	1560	4	75.00	88.30	20
C4 Picasso I 1.6 HDi	02/07→08/13	Diesel	9HZ (DV6TED4)	1560	4	75.00	88.30	20
C4 Picasso I 1.6 HDi 110	09/10→08/13	Diesel	9HR (DV6C)	1560	4	75.00	88.30	20
C4 Picasso I 1.8 Bifule	01/09→10/12	Petrol	6FY (EW7A)	1749	4	82.70	81.40	29
C4 Picasso I 1.8 i 16V	02/07→12/11	Petrol	6FY (EW7A)	1749	4	82.70	81.40	29
C4 Picasso I 2.0 HDi 138	02/07→08/13	Diesel	RHJ (DW10BTED4)	1997	4	85.00	88.00	48
C4 Picasso I 2.0 HDi 138	02/07→08/13	Diesel	RHR (DW10BTED4)	1997	4	85.00	88.00	49
C4 Picasso I 2.0 HDi 150	07/09→08/13	Diesel	RHE (DW10CTED4)	1997	4	85.00	88.00	48
C4 Picasso I 2.0 HDi 165	09/10→08/13	Diesel	RHH (DW10CTED4)	1997	4	85.00	88.00	48
C4 Picasso I 2.0 i 16V	02/07→08/13	Petrol	RFJ (EW10A)	1997	4	85.00	88.00	47
C4 Picasso I 2.0 i 16V	05/08→05/13	Petrol	RFN (EW10J4)	1997	4	85.00	88.00	47
C4 Picasso II 1.6 BlueHDi 100	12/14→	Diesel	BHY (DV6FD)	1560	4	75.00	88.30	20
C4 Picasso II 1.6 HDi 90	02/13→	Diesel	9HP (DV6DTEd)	1560	4	75.00	88.30	20
C4 Picasso II 1.6 HDi / BlueHDi 115	02/13→	Diesel	9HC (DV6C)	1560	4	75.00	88.30	20
C5 I 1.8 16V	03/01→08/04	Petrol	6FZ (EW7J4)	1749	4	82.70	81.40	29

				cm ³	x				
C5 I 2.0 16V	03/01→08/04	Petrol	RFN (EW10J4)	1997	4	85.00	88.00	47	
C5 I 2.0 16V HPi	03/01→08/04	Petrol	RLZ (EW10D)	1997	4	85.00	88.00	47	
C5 I 2.0 HDi	03/01→08/04	Diesel	RHS (DW10ATED)	1997	4	85.00	88.00	48	
C5 I 2.0 HDi	03/01→08/04	Diesel	RHY (DW10TD)	1997	4	85.00	88.00	48	
C5 I 2.0 HDi	03/01→08/04	Diesel	RHZ (DW10ATED)	1997	4	85.00	88.00	49	
C5 I 2.2 HDi	03/01→08/04	Diesel	4HX (DW12TED4/FAP)	2179	4	85.00	96.00	51	
C5 I Break 1.8 16V	06/01→08/04	Petrol	6FZ (EW7J4)	1749	4	82.70	81.40	29	
C5 I Break 2.0 16V	06/01→08/04	Petrol	RFN (EW10J4)	1997	4	85.00	88.00	47	
C5 I Break 2.0 16V HPi	06/01→08/04	Petrol	RLZ (EW10D)	1997	4	85.00	88.00	47	
C5 I Break 2.0 HDi	06/01→08/04	Diesel	RHS (DW10ATED)	1997	4	85.00	88.00	48	
C5 I Break 2.0 HDi	06/01→08/04	Diesel	RHY (DW10TD)	1997	4	85.00	88.00	48	
C5 I Break 2.0 HDi	06/01→08/04	Diesel	RHZ (DW10ATED)	1997	4	85.00	88.00	49	
C5 I Break 2.2 HDi	06/01→08/04	Diesel	4HX (DW12TED4/FAP)	2179	4	85.00	96.00	51	
C5 II 1.6 HDi	09/04→	Diesel	9HY (DV6TED4)	1560	4	75.00	88.30	20	
C5 II 1.6 HDi	09/04→	Diesel	9HZ (DV6TED4)	1560	4	75.00	88.30	20	
C5 II 1.8 16V	09/05→	Petrol	6FY (EW7A)	1749	4	82.70	81.40	29	
C5 II 1.8 16V	09/04→	Petrol	6FZ (EW7J4)	1749	4	82.70	81.40	29	
C5 II 2.0 16V	09/04→	Petrol	RFJ (EW10A)	1997	4	85.00	88.00	47	
C5 II 2.0 HDi	09/04→	Diesel	RHR (DW10BTED4)	1997	4	85.00	88.00	49	
C5 II 2.2 HDi	05/06→	Diesel	4HP (DW12BTED4)	2179	4	85.00	96.00	51	
C5 II 2.2 HDi	05/06→	Diesel	4HR (DW12BTED4)	2179	4	85.00	96.00	51	
C5 II 2.2 HDi	04/06→	Diesel	4HT (DW12BTED4)	2179	4	85.00	96.00	51	
C5 II 2.2 HDi	09/04→	Diesel	4HX (DW12TED4/FAP)	2179	4	85.00	96.00	51	
C5 II Break 1.6 HDi	09/04→	Diesel	9HY (DV6TED4)	1560	4	75.00	88.30	20	
C5 II Break 1.6 HDi	09/04→	Diesel	9HZ (DV6TED4)	1560	4	75.00	88.30	20	
C5 II Break 1.8 16V	09/05→	Petrol	6FY (EW7A)	1749	4	82.70	81.40	29	
C5 II Break 1.8 16V	09/04→	Petrol	6FZ (EW7J4)	1749	4	82.70	81.40	29	
C5 II Break 2.0 16V	09/04→	Petrol	RFJ (EW10A)	1997	4	85.00	88.00	47	
C5 II Break 2.0 HDi	09/04→	Diesel	RHR (DW10BTED4)	1997	4	85.00	88.00	49	
C5 II Break 2.2 HDi	05/06→	Diesel	4HP (DW12BTED4)	2179	4	85.00	96.00	51	
C5 II Break 2.2 HDi	05/06→	Diesel	4HR (DW12BTED4)	2179	4	85.00	96.00	51	
C5 II Break 2.2 HDi	04/06→	Diesel	4HT (DW12BTED4)	2179	4	85.00	96.00	51	
C5 II Break 2.2 HDi	09/04→	Diesel	4HX (DW12TED4/FAP)	2179	4	85.00	96.00	51	
C5 III 1.6 HDi	02/08→	Diesel	9HZ (DV6TED4)	1560	4	75.00	88.30	20	
C5 III 1.6 HDi 110	07/10→	Diesel	9HL (DV6C)	1560	4	75.00	88.30	20	
C5 III 1.6 HDi 110	07/10→	Diesel	9HR (DV6C)	1560	4	75.00	88.30	20	
C5 III 1.6 HDi 115	01/12→	Diesel	9HL (DV6C)	1560	4	75.00	88.30	20	
C5 III 1.6 HDi 115	01/12→	Diesel	9HR (DV6C)	1560	4	75.00	88.30	20	
C5 III 1.8 16V	02/08→	Petrol	6FY (EW7A)	1749	4	82.70	81.40	29	
C5 III 2.0 16V	02/08→	Petrol	RFJ (EW10A)	1997	4	85.00	88.00	47	
C5 III 2.0 16V BioFlex	02/08→	Petrol	RFJ (EW10A)	1997	4	85.00	88.00	47	
C5 III 2.0 HDi	02/08→	Diesel	RHF (DW10BTED4)	1997	4	85.00	88.00	48	
C5 III 2.0 HDi	02/08→	Diesel	RHR (DW10BTED4)	1997	4	85.00	88.00	49	
C5 III 2.0 HDi 140	04/09→	Diesel	RHF (DW10BTED4)	1997	4	85.00	88.00	48	
C5 III 2.0 HDi 150 / BlueHDi 150	04/09→	Diesel	AHR (DW10FD)	1997	4	85.00	88.00	48	
C5 III 2.0 HDi 150 / BlueHDi 150	04/09→	Diesel	RHE (DW10CTED4)	1997	4	85.00	88.00	48	
C5 III 2.0 HDi 165	04/09→	Diesel	RHH (DW10CTED4)	1997	4	85.00	88.00	48	
C5 III 2.0 HDi 180	03/15→	Diesel	AHW (DW10FC)	1997	4	85.00	88.00	48	
C5 III 2.2 HDi	02/08→	Diesel	4HT (DW12BTED4)	2179	4	85.00	96.00	51	
C5 III 2.2 HDi 200	07/10→	Diesel	4HL (DW12C)	2179	4	85.00	96.00	51	
C5 III Break 1.6 HDi	02/08→	Diesel	9HZ (DV6TED4)	1560	4	75.00	88.30	20	
C5 III Break 1.6 HDi 110	07/10→	Diesel	9HL (DV6C)	1560	4	75.00	88.30	20	
C5 III Break 1.6 HDi 110	07/10→	Diesel	9HR (DV6C)	1560	4	75.00	88.30	20	
C5 III Break 1.6 HDi 115	01/12→	Diesel	9HL (DV6C)	1560	4	75.00	88.30	20	
C5 III Break 1.6 HDi 115	01/12→	Diesel	9HR (DV6C)	1560	4	75.00	88.30	20	
C5 III Break 1.8 16V	02/08→	Petrol	6FY (EW7A)	1749	4	82.70	81.40	29	
C5 III Break 2.0 16V	02/08→	Petrol	RFJ (EW10A)	1997	4	85.00	88.00	47	
C5 III Break 2.0 16V BioFlex	02/08→	Petrol	RFJ (EW10A)	1997	4	85.00	88.00	47	
C5 III Break 2.0 HDi	02/08→	Diesel	RHR (DW10BTED4)	1997	4	85.00	88.00	49	
C5 III Break 2.0 HDi 140	04/09→	Diesel	RHF (DW10BTED4)	1997	4	85.00	88.00	48	
C5 III Break 2.0 HDi 150 / BlueHDi 150	04/09→	Diesel	AHR (DW10FD)	1997	4	85.00	88.00	48	
C5 III Break 2.0 HDi 150 / BlueHDi 150	04/09→	Diesel	RHE (DW10CTED4)	1997	4	85.00	88.00	48	
C5 III Break 2.0 HDi 165	04/09→	Diesel	RHH (DW10CTED4)	1997	4	85.00	88.00	48	
C5 III Break 2.0 HDi 180	03/15→	Diesel	AHW (DW10FC)	1997	4	85.00	88.00	48	
C5 III Break 2.2 HDi	02/08→	Diesel	4HT (DW12BTED4)	2179	4	85.00	96.00	51	
C5 III Break 2.2 HDi 165	02/08→	Diesel	4HP (DW12BTED4)	2179	4	85.00	96.00	51	
C5 III Break 2.2 HDi 200	07/10→	Diesel	4HL (DW12C)	2179	4	85.00	96.00	51	
C6 2.2 HDi	06/06→	Diesel	4HP (DW12BTED4)	2179	4	85.00	96.00	51	
C6 2.2 HDi	06/06→	Diesel	4HT (DW12BTED4)	2179	4	85.00	96.00	51	



cm3 x



9

C8 2.0	07/02→	Petrol	RFN (EW10J4)	1997	4	85.00	88.00	47
C8 2.0 16V	09/05→	Petrol	RFJ (EW10A)	1997	4	85.00	88.00	47
C8 2.0 HDi	02/07→	Diesel	RHK (DW10UTED4)	1997	4	85.00	88.00	49
C8 2.0 HDi	07/02→	Diesel	RHM (DW10ATED4)	1997	4	85.00	88.00	49
C8 2.0 HDi	07/02→	Diesel	RHT (DW10ATED4)	1997	4	85.00	88.00	48
C8 2.0 HDi	07/02→	Diesel	RHW (DW10ATED4)	1997	4	85.00	88.00	49
C8 2.0 HDi 135	03/06→	Diesel	RHD (DW10CB)	1997	4	85.00	88.00	48
C8 2.0 HDi 135	03/06→	Diesel	RHD (DW10CTED4)	1997	4	85.00	88.00	48
C8 2.0 HDi 135	03/06→	Diesel	RHR (DW10BTED4)	1997	4	85.00	88.00	49
C8 2.0 HDi 165	03/06→	Diesel	RHE (DW10CTED4)	1997	4	85.00	88.00	48
C8 2.0 HDi 165	03/06→	Diesel	RHH (DW10CTED4)	1997	4	85.00	88.00	48
C8 2.2 HDi	06/07→	Diesel	4HP (DW12BTED4)	2179	4	85.00	96.00	51
C8 2.2 HDi	06/07→	Diesel	4HR (DW12BTED4)	2179	4	85.00	96.00	51
C8 2.2 HDi	06/06→	Diesel	4HT (DW12BTED4)	2179	4	85.00	96.00	51
C8 2.2 HDi	07/02→	Diesel	4HW (DW12TED4)	2179	4	85.00	96.00	51
C15 1.0	10/84→12/97	Petrol	TU9	954	4	70.00	62.00	3
C15 1.0	10/84→12/97	Petrol	XV8	954	4	70.00	62.00	2
C15 1.0 E	11/92→07/96	Petrol	TU9K	954	4	70.00	62.00	3
C15 1.1	10/84→12/96	Petrol	109K	1124	4	72.00	69.00	5
C15 1.1	10/84→12/96	Petrol	E1A	1124	4	72.00	69.00	7
C15 1.1	11/88→07/96	Petrol	H1A	1124	4	72.00	69.00	8
C15 1.1	08/88→07/96	Petrol	HDZ (TU1M)	1124	4	72.00	69.00	8
C15 1.1 i	07/88→12/96	Petrol	HDZ (TU1M)	1124	4	72.00	69.00	8
C15 1.3	07/87→05/88	Petrol	G1A	1294	4	76.70	70.00	22
C15 1.4	05/87→10/92	Petrol	150D (XY7)	1360	4	75.00	77.00	14
C15 1.4	07/87→12/96	Petrol	K1H (TU3A)	1360	4	75.00	77.00	15
C15 1.4	05/91→07/96	Petrol	KDY (TU3M)	1360	4	75.00	77.00	15
C15 1.4 E	05/87→12/96	Petrol	150D (XY7)	1360	4	75.00	77.00	14
C15 1.4 E	07/87→12/96	Petrol	K3A	1360	4	75.00	77.00	15
C15 1.4 i	05/91→12/96	Petrol	KDY (TU3FM)	1360	4	75.00	77.00	16
C15 1.4 i	05/91→12/96	Petrol	KDY (TU3M)	1360	4	75.00	77.00	15
C15 1.8 D	07/86→12/00	Diesel	161A (XUD7)	1769	4	80.00	88.00	26
C15 1.9 D	12/00→12/05	Diesel	WJX (DW8B)	1868	4	82.20	88.00	28
C15 1.9 D	10/00→10/02	Diesel	WJY (DW8B)	1868	4	82.20	88.00	28
C25 1.8	11/81→01/94	Petrol	169 (XM7T)	1796	4	84.00	81.00	45
C25 1.8 E	07/87→02/94	Petrol	169 (XM7T)	1796	4	84.00	81.00	45
C25 1.9 D	07/87→02/94	Diesel	D9B (XUD9A/U)	1905	4	83.00	88.00	43
C25 1.9 D 1400	01/88→01/94	Diesel	DJY (XUD9A)	1905	4	83.00	88.00	43
C25 2.0	01/87→03/94	Petrol	170C (XN1T)	1971	4	88.00	81.00	60
C25 2.0 E	09/81→03/94	Petrol	170A (XN1T)	1971	4	88.00	81.00	59
C25 2.0 E	09/81→03/94	Petrol	170B (XN1T)	1971	4	88.00	81.00	59
C25 2.5 D	11/81→02/94	Diesel	CRD93L (U25-661)	2500	4	93.00	92.00	68
C25 2.5 D 4x4	01/87→02/94	Diesel	CRD93L (U25-661)	2500	4	93.00	92.00	68
C25 2.5 DT	01/87→01/94	Diesel	CRD93LS (U25-673)	2500	4	93.00	92.00	69
C25 2.5 DT 4x4	08/91→01/94	Diesel	CRD93LS (U25-673)	2500	4	93.00	92.00	69
C25 2.5 D Turbo	08/87→02/94	Diesel	CRD93LS (U25-673)	2500	4	93.00	92.00	69
C25 2.5 D Turbo 4x4	08/87→02/94	Diesel	CRD93LS (U25-673)	2500	4	93.00	92.00	69
C35 2.2 D	11/73→01/80	Diesel	B22615	2175	4	90.00	85.50	63
C35 2.5 D	02/80→01/94	Diesel	B25637	2498	4	93.00	92.00	67
C-Crosser 2.2 HDi	02/07→	Diesel	4HN (DW12MTED4)	2179	4	85.00	96.00	51
C-Elysee 1.6 BlueHDi 100	11/14→	Diesel	BHY (DV6FD)	1560	4	75.00	88.30	20
C-Elysee 1.6 HDi 92	11/12→	Diesel	9HJ (DV6DTEDM)	1560	4	75.00	88.30	20
C-Elysee 1.6 HDi 92	11/12→	Diesel	9HP (DV6DTEDE)	1560	4	75.00	88.30	20
CX I 25 D Turbo	04/83→08/85	Diesel	M25-648	2500	4	93.00	92.00	70
CX I 2000	06/79→08/85	Petrol	829 A5	1995	4	88.00	82.00	61
CX I 2200	06/81→08/85	Petrol	J6T A500	2165	4	88.00	89.00	62
CX I 2200 D	10/75→02/79	Diesel	M22-621	2175	4	90.00	85.50	63
CX I 2500 D	02/78→06/82	Diesel	M25-629	2500	4	93.00	92.00	67
CX I Break 2000	06/79→08/85	Petrol	829 A5	1995	4	88.00	82.00	61
CX I Break 2200	06/81→08/85	Petrol	J6T A500	2165	4	88.00	89.00	62
CX I Break 2200 D	08/76→02/79	Diesel	M22-621	2175	4	90.00	85.50	63
CX I Break 2500 D	02/78→08/85	Diesel	M25-629	2500	4	93.00	92.00	67
CX I Break 2500 D Turbo	04/83→08/85	Diesel	M25-648	2500	4	93.00	92.00	70
CX II 20 RE	08/85→12/92	Petrol	829 A5	1995	4	88.00	82.00	61
CX II 22 TRS	07/85→12/92	Petrol	J6T A500	2165	4	88.00	89.00	62
CX II 25 D	08/85→12/92	Diesel	M25-660	2500	4	93.00	92.00	68
CX II 25 D Turbo	08/85→12/86	Diesel	M25-648	2500	4	93.00	92.00	70
CX II 25 D Turbo	01/87→12/92	Diesel	M25-669	2500	4	93.00	92.00	69
CX II Break 20	08/85→08/86	Petrol	829 A5	1995	4	88.00	82.00	61

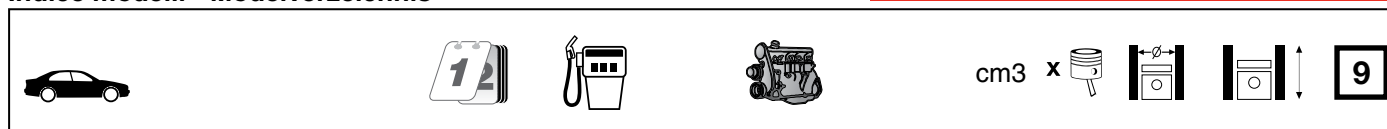

CX II Break 22TRS	07/85→07/89	Petrol	J6T A500	2165	4	88.00	89.00	62
CX II Break 22 TRS	07/85→12/92	Petrol	J6T A500	2165	4	88.00	89.00	62
CX II Break 25 D	05/86→12/92	Diesel	M25-660	2500	4	93.00	92.00	68
CX II Break 25 D Turbo 2	01/87→12/92	Diesel	M25-669	2500	4	93.00	92.00	69
CX II Break 2500 D Turbo	08/85→12/86	Diesel	M25-648	2500	4	93.00	92.00	70
DS3 1.2 THP 110	10/14→07/15	Petrol	HNZ (EB2DT)	1199	3	75.00	90.50	21
DS3 1.4 HDi 70	04/10→07/15	Diesel	8HR (DV4C)	1398	4	73.70	82.00	12
DS3 1.6 BlueHDi 75	03/15→07/15	Diesel	BHW (DV6FE)	1560	4	75.00	88.30	20
DS3 1.6 BlueHDi 100	07/14→07/15	Diesel	BHY (DV6FD)	1560	4	75.00	88.30	20
DS3 1.6 HDi 90	11/09→07/15	Diesel	9HP (DV6DTED)	1560	4	75.00	88.30	20
DS3 1.6 HDi 110	11/09→07/15	Diesel	9HR (DV6C)	1560	4	75.00	88.30	20
DS3 1.6 HDi 115	08/12→07/15	Diesel	9HD (DV6C)	1560	4	75.00	88.30	20
DS3 1.6 HDi 115	08/12→07/15	Diesel	9HL (DV6C)	1560	4	75.00	88.30	20
DS4 1.6 HDi 90	05/11→07/15	Diesel	9HP (DV6DTED)	1560	4	75.00	88.30	20
DS4 1.6 HDi 110	04/11→07/15	Diesel	9HR (DV6C)	1560	4	75.00	88.30	20
DS4 1.6 HDi 115	08/12→07/15	Diesel	9HD (DV6C)	1560	4	75.00	88.30	20
DS4 1.6 HDi 115	08/12→07/15	Diesel	9HL (DV6C)	1560	4	75.00	88.30	20
DS4 2.0 BlueHDi 150 Hybrid	07/14→07/15	Diesel	AHR (DW10FD)	1997	4	85.00	88.00	48
DS4 2.0 BlueHDi 180	07/14→07/15	Diesel	AHW (DW10FC)	1997	4	85.00	88.00	48
DS4 2.0 HDi 135	09/11→07/15	Diesel	RHE (DW10CTED4)	1997	4	85.00	88.00	48
DS4 2.0 HDi 165	04/11→07/15	Diesel	RHH (DW10CTED4)	1997	4	85.00	88.00	48
DS5 1.6 HDi 110	11/11→07/15	Diesel	9HR (DV6C)	1560	4	75.00	88.30	20
DS5 1.6 HDi 115	06/12→07/15	Diesel	9HD (DV6C)	1560	4	75.00	88.30	20
DS5 2.0 BlueHDi 180	08/13→07/15	Diesel	AHW (DW10FC)	1997	4	85.00	88.00	48
DS5 2.0 HDi 135	11/11→07/15	Diesel	RHD (DW10CB)	1997	4	85.00	88.00	48
DS5 2.0 HDi 165	11/11→07/15	Diesel	RHH (DW10CTED4)	1997	4	85.00	88.00	48
DS5 2.0 HDi 165 Hybrid4 4x4	12/11→07/15	Diesel	RHC (DW10CTED4)	1997	4	85.00	88.00	48
Evasion 1.8	05/97→07/02	Petrol	LFZ (XU7JP)	1761	4	83.00	81.40	35
Evasion 1.9 TD	11/94→07/02	Diesel	D8B (XUD9TF)	1905	4	83.00	88.00	41
Evasion 1.9 TD	11/94→07/02	Diesel	DHX (XUD9TF/BTF)	1905	4	83.00	88.00	41
Evasion 2.0	06/94→07/02	Petrol	RFU (XU10J2/C)	1998	4	86.00	86.00	53
Evasion 2.0 16V	05/00→07/02	Petrol	RFN (EW10J4)	1997	4	85.00	88.00	47
Evasion 2.0 16V	05/98→04/00	Petrol	RFV (XU10J4R)	1998	4	86.00	86.00	52
Evasion 2.0 HDi	08/99→07/02	Diesel	RHZ (DW10ATED)	1997	4	85.00	88.00	49
Evasion 2.0 HDi 16V	09/99→07/02	Diesel	RHW (DW10ATED4)	1997	4	85.00	88.00	49
Evasion 2.0 Turbo C.T.	06/94→07/02	Petrol	RGX (XU10J2TE)	1998	4	86.00	86.00	54
Evasion 2.1 TD	05/96→07/02	Diesel	P8C (XUD11BTE)	2088	4	85.00	92.00	50
Jumper 1.9 D	02/94→04/02	Diesel	D9B (XUD9A/U)	1905	4	83.00	88.00	43
Jumper 1.9 D	07/99→04/02	Diesel	DJY (XUD9A)	1905	4	83.00	88.00	43
Jumper 1.9 TD	02/94→04/02	Diesel	D8C (XUD9UTF)	1905	4	83.00	88.00	42
Jumper 1.9 TD	03/94→04/02	Diesel	DHX (XUD9TF/BTF)	1905	4	83.00	88.00	41
Jumper 1.9 TD 4x4	08/96→04/02	Diesel	D8C (XUD9UTF)	1905	4	83.00	88.00	42
Jumper 2.0	02/94→04/02	Petrol	RFW (XU10J2U)	1998	4	86.00	86.00	53
Jumper 2.0	04/02→	Petrol	XU10J2	1998	4	86.00	86.00	53
Jumper 2.0 4x4	08/96→04/02	Petrol	RFW (XU10J2U)	1998	4	86.00	86.00	53
Jumper 2.0 bivalent	02/03→	Petrol	XU10J2	1998	4	86.00	86.00	53
Jumper 2.0 HDi	04/02→	Diesel	RHV (DW10TD)	1997	4	85.00	88.00	48
Jumper 2.0 HDi	11/01→	Diesel	RHV (DW10UTD)	1997	4	85.00	88.00	48
Jumper 2.2 HDi	02/02→	Diesel	4HY (DW12UTED)	2179	4	85.00	96.00	51
Jumper 2.2 HDi 100	04/06→	Diesel	4HV (P22DTE)	2198	4	86.00	94.60	57
Jumper 2.2 HDi 120	04/06→	Diesel	4HU (P22DTE)	2198	4	86.00	94.60	57
Jumper 2.2 HDi 130	07/11→	Diesel	4HH (P22DTE)	2198	4	86.00	94.60	57
Jumper 2.5 D	03/94→04/02	Diesel	T9A (DJ5)	2446	4	92.00	92.00	65
Jumper 2.5 D 4x4	08/96→04/02	Diesel	T9A (DJ5)	2446	4	92.00	92.00	65
Jumper 2.5 DT 4x4	10/96→08/97	Diesel	THZ (DJ5T)	2446	4	92.00	92.00	64
Jumper 2.5 TD	03/94→04/02	Diesel	T8A (DJ5T)	2446	4	92.00	92.00	64
Jumper 2.5 TD 4x4	08/96→04/02	Diesel	T8A (DJ5T)	2446	4	92.00	92.00	64
Jumper 2.5 TDi	12/96→04/02	Diesel	THX (DJ5TED)	2446	4	92.00	92.00	64
Jumper 2.5 TDi 4x4	12/96→04/02	Diesel	THX (DJ5TED)	2446	4	92.00	92.00	64
Jumper 2.8 D	01/99→02/02	Diesel	8140.63 (F28D)	2798	4	94.40	100.00	72
Jumper 2.8 HDi	05/04→	Diesel	8140.43N	2798	4	94.40	100.00	72
Jumper 2.8 HDi	09/00→	Diesel	8140.43S	2798	4	94.40	100.00	72
Jumper 2.8 HDi 4x4	09/00→	Diesel	8140.43S	2798	4	94.40	100.00	72
Jumper 2.8 HDi 4x4	02/02→06/06	Diesel	F28TDCR	2798	4	94.40	100.00	72
Jumper 2.8 HDi All-wheel Drive	04/02→	Diesel	8140.43S	2798	4	94.40	100.00	72
Jumpy 1.6	10/95→	Petrol	220 A2.000	1581	4	86.40	67.40	58
Jumpy 1.6	10/95→	Petrol	1580 SPI	1581	4	86.40	67.40	58
Jumpy 1.6 HDi 90 8V	01/07→	Diesel	9HH (DV6DUM)	1560	4	75.00	88.30	20
Jumpy 1.6 HDi 90 8V	01/07→	Diesel	9HM (DV6UC)	1560	4	75.00	88.30	20











cm3



9

Jumpy 1.6 HDi 90 16V	01/07→	Diesel	9HU (DV6UTED4)	1560	4	75.00	88.30	20
Jumpy 1.6 i	10/95→	Petrol	220 A2.000	1581	4	86.40	67.40	58
Jumpy 1.6 i	10/95→	Petrol	1580 SPI	1581	4	86.40	67.40	58
Jumpy 1.9 D	10/95→08/98	Diesel	D9B (XUD9A/U)	1905	4	83.00	88.00	43
Jumpy 1.9 D 70	04/98→	Diesel	WJY (DW8B)	1868	4	82.20	88.00	28
Jumpy 1.9 D 70	04/98→	Diesel	WJZ (DW8)	1868	4	82.20	88.00	28
Jumpy 1.9 TD	04/96→	Diesel	D8B (XUD9TF)	1905	4	83.00	88.00	41
Jumpy 1.9 TD	10/95→	Diesel	DHX (XUD9TF/BTF)	1905	4	83.00	88.00	41
Jumpy 2.0	04/00→12/06	Petrol	RFN (EW10J4)	1997	4	85.00	88.00	47
Jumpy 2.0 HDi 95	07/11→	Diesel	AHY (DW10CE)	1997	4	85.00	88.00	48
Jumpy 2.0 HDi 95	10/99→	Diesel	RHX (DW10BTED)	1997	4	85.00	88.00	49
Jumpy 2.0 HDi 110	03/00→	Diesel	RHW (DW10ATED4)	1997	4	85.00	88.00	49
Jumpy 2.0 HDi 110	03/00→	Diesel	RHZ (DW10ATED)	1997	4	85.00	88.00	49
Jumpy 2.0 HDi 110 16V	12/03→10/06	Diesel	RHW (DW10ATED4)	1997	4	85.00	88.00	49
Jumpy 2.0 HDi 120	01/07→	Diesel	RHK (DW10UTED4)	1997	4	85.00	88.00	49
Jumpy 2.0 HDi 120 4x4	01/10→	Diesel	RHK (DW10UTED4)	1997	4	85.00	88.00	49
Jumpy 2.0 HDi 125	07/11→	Diesel	AHZ (DW10CD)	1997	4	85.00	88.00	48
Jumpy 2.0 HDi 140	01/07→	Diesel	RHR (DW10BTED4)	1997	4	85.00	88.00	49
Jumpy 2.0 HDi 165	07/10→	Diesel	RHH (DW10CTED4)	1997	4	85.00	88.00	48
Jumpy 2.0 i	01/07→	Petrol	RFH (EW10A)	1997	4	85.00	88.00	47
Jumpy 2.0 i 16V	03/00→	Petrol	RFN (EW10J4)	1997	4	85.00	88.00	47
LNA 1.0	07/84→10/86	Petrol	108C	954	4	70.00	62.00	2
LNA 1.1	07/82→04/85	Petrol	109/5E	1124	4	72.00	69.00	6
Nemo 1.3 HDi 75	10/10→	Diesel	FHZ (F13DTE5)	1248	4	69.60	75.00	1
Nemo 1.4	04/09→	Petrol	KFT (TU3A)	1360	4	75.00	77.00	15
Nemo 1.4	02/08→	Petrol	KFV (TU3A)	1360	4	75.00	77.00	15
Nemo 1.4 HDi	02/08→	Diesel	8HS (DV4TED)	1398	4	73.70	82.00	12
Saxo 1.0 X	05/96→06/03	Petrol	CDZ (TU9M)	954	4	70.00	62.00	3
Saxo 1.1 BiFuel	07/00→06/03	Petrol	HDZ (TU1M)	1124	4	72.00	69.00	8
Saxo 1.1 X,SX	05/96→09/03	Petrol	HDZ (TU1M)	1124	4	72.00	69.00	8
Saxo 1.1 X,SX	05/96→09/03	Petrol	HFX (TU1JP)	1124	4	72.00	69.00	10
Saxo 1.4 VTS	05/96→06/03	Petrol	KFW (TU3JP)	1360	4	75.00	77.00	18
Saxo 1.4 VTS	05/96→06/03	Petrol	KFX (TU3JP)	1360	4	75.00	77.00	18
Saxo 1.5 D	09/96→09/03	Diesel	VJY (TUD5)	1527	4	77.00	82.00	23
Saxo 1.5 D	09/96→06/01	Diesel	VJZ (TUD5)	1527	4	77.00	82.00	23
Saxo 1.6	02/96→04/04	Petrol	NFX (TU5JP4)	1587	4	78.50	82.00	24
Saxo 1.6	02/96→06/03	Petrol	NFZ (TU5JP)	1587	4	78.50	82.00	24
Saxo 1.6 VTL,VTR	05/96→06/03	Petrol	NFX (TU5JP)	1587	4	78.50	82.00	24
Saxo 1.6 VTR	05/96→07/99	Petrol	NFX (TU5JP4)	1587	4	78.50	82.00	24
Saxo 1.6 VTS	06/96→09/03	Petrol	NFX (TU5JP4)	1587	4	78.50	82.00	24
Visa 1.0	09/84→06/88	Petrol	XV8	954	4	70.00	62.00	2
Visa 11 E	09/78→03/91	Petrol	109/5	1124	4	72.00	69.00	5
Visa 11 E	09/78→03/91	Petrol	109/5F	1124	4	72.00	69.00	6
Visa 11 E	09/78→06/88	Petrol	109K	1124	4	72.00	69.00	5
Visa 11 RE	03/83→10/88	Petrol	109/5F	1124	4	72.00	69.00	6
Visa 14	07/84→03/91	Petrol	150D (XY7)	1360	4	75.00	77.00	14
Visa 14 GT	03/82→03/91	Petrol	150B (XY8)	1360	4	75.00	77.00	14
Visa 16 GTI	01/85→06/86	Petrol	180A (XU5J)	1580	4	83.00	73.00	32
Visa 16 GTI	06/86→03/91	Petrol	B6D	1580	4	83.00	73.00	33
Visa 17 D	04/84→03/91	Diesel	161A (XUD7)	1769	4	80.00	88.00	26
Xantia 1.6 i	03/93→01/98	Petrol	BFZ (XU5JP)	1580	4	83.00	73.00	34
Xantia 1.6 i SX	01/98→03/01	Petrol	BFZ (XU5JP)	1580	4	83.00	73.00	34
Xantia 1.8 i	04/97→04/03	Petrol	LFX (XU7JB)	1761	4	83.00	81.40	35
Xantia 1.8 i	03/93→01/98	Petrol	LFZ (XU7JP)	1761	4	83.00	81.40	35
Xantia 1.8 i 16V	06/95→04/03	Petrol	LFY (XU7JP4)	1762	4	83.00	81.40	35
Xantia 1.9 D	06/94→01/98	Diesel	D9B (XUD9A/L)	1905	4	83.00	88.00	43
Xantia 1.9 D	06/94→01/98	Diesel	DJZ (XUD9Y)	1905	4	83.00	88.00	40
Xantia 1.9 SD	02/96→04/03	Diesel	DHW (XUD9SD)	1905	4	83.00	88.00	41
Xantia 1.9 Turbo D	10/94→04/03	Diesel	DHX (XUD9TF/BTF)	1905	4	83.00	88.00	41
Xantia 1.9 Turbo D	10/94→04/03	Diesel	DHY (XUD9TE/Y)	1905	4	83.00	88.00	44
Xantia 2.0	03/93→05/95	Petrol	RFX XU10J2C/Z L3	1998	4	86.00	86.00	52
Xantia 2.0 HDI 90	03/99→04/03	Diesel	RHY (DW10TD)	1997	4	85.00	88.00	48
Xantia 2.0 HDI 109	02/99→04/03	Diesel	RHZ (DW10ATED)	1997	4	85.00	88.00	49
Xantia 2.0 i	03/93→04/03	Petrol	RFX (XU10J2C)	1998	4	86.00	86.00	52
Xantia 2.0 i 16V	06/94→01/98	Petrol	RFT (XU10J4/Z)	1998	4	86.00	86.00	52
Xantia 2.0 i 16V	06/95→04/03	Petrol	RFV (XU10J4R)	1998	4	86.00	86.00	52
Xantia 2.0 i 16V	03/93→01/98	Petrol	RFY (XU10J4/Z)	1998	4	86.00	86.00	52
Xantia 2.0 Turbo	06/95→04/03	Petrol	RGX (XU10J2TE)	1998	4	86.00	86.00	54
Xantia 2.1 Turbo D 12V	06/95→02/99	Diesel	P8C (XUD11BTE)	2088	4	85.00	92.00	50

				cm ³	x 			
Xantia Break 1.8 i	04/97→04/03	Petrol	LFX (XU7JB)	1761	4	83.00	81.40	35
Xantia Break 1.8 i	06/95→01/98	Petrol	LFZ (XU7JP)	1761	4	83.00	81.40	35
Xantia Break 1.8 i 16V	06/95→04/03	Petrol	LFY (XU7JP4)	1762	4	83.00	81.40	35
Xantia Break 1.9 SD	04/97→04/03	Diesel	DHW (XUD9SD)	1905	4	83.00	88.00	41
Xantia Break 1.9 Turbo D	06/95→04/03	Diesel	D8B (XUD9TF)	1905	4	83.00	88.00	41
Xantia Break 1.9 Turbo D	06/95→04/03	Diesel	DHX (XUD9TF/BTF)	1905	4	83.00	88.00	41
Xantia Break 1.9 Turbo D	06/95→01/98	Diesel	DHY (XUD9TE/Y)	1905	4	83.00	88.00	44
Xantia Break 2.0 HDI 90	03/99→04/03	Diesel	RHY (DW10TD)	1997	4	85.00	88.00	48
Xantia Break 2.0 HDI 109	02/99→04/03	Diesel	RHZ (DW10ATED)	1997	4	85.00	88.00	49
Xantia Break 2.0 i	06/95→04/03	Petrol	RFX (XU10J2C)	1998	4	86.00	86.00	52
Xantia Break 2.0 i 16V	06/95→04/03	Petrol	RFV (XU10J4R)	1998	4	86.00	86.00	52
Xantia Break 2.0 Turbo	06/95→04/03	Petrol	RGX (XU10J2TE)	1998	4	86.00	86.00	54
Xantia Break 2.1 Turbo D 12V	06/96→02/99	Diesel	P8C (XUD11BTE)	2088	4	85.00	92.00	50
XM 2.0	05/89→06/94	Petrol	R6A	1998	4	86.00	86.00	52
XM 2.0 i	05/89→04/94	Petrol	RDZ (XU10MZ)	1998	4	86.00	86.00	52
XM 2.0 i	05/89→06/94	Petrol	RFV (XU10J4R)	1998	4	86.00	86.00	52
XM 2.0 i	05/89→06/94	Petrol	RFZ (XU10J2)	1998	4	86.00	86.00	52
XM 2.0 i 16V	05/94→10/00	Petrol	RFV (XU10J4R)	1998	4	86.00	86.00	52
XM 2.0 i Turbo	09/92→06/94	Petrol	RGY (XU10J2TE/Z)	1998	4	86.00	86.00	55
XM 2.0 Turbo	05/94→10/00	Petrol	RGX (XU10J2TE)	1998	4	86.00	86.00	54
XM 2.1 D 12V	05/89→06/94	Diesel	P9A (XUD11A)	2138	4	86.00	92.00	56
XM 2.1 D12 V SX	03/96→08/96	Diesel	P9A (XUD11A)	2138	4	86.00	92.00	56
XM 2.1 TD 12V	05/89→10/00	Diesel	P8A (XUD11ATE)	2088	4	85.00	92.00	50
XM 2.1 TD 12V	05/94→10/00	Diesel	P8C (XUD11BTE)	2088	4	85.00	92.00	50
XM 2.1 TD 12V	05/89→10/00	Diesel	PHZ (XUD11ATE)	2088	4	85.00	92.00	50
XM 2.1 TD 12V	05/89→10/00	Diesel	PJZ (XUD11ATE)	2088	4	85.00	92.00	50
XM 2.5 TD	05/94→10/00	Diesel	THY (DK5ATE)	2446	4	92.00	92.00	64
XM 3.0	05/89→05/94	Petrol	UFZ (ZPJ/Z)	2963	V6	93.00	73.00	66
XM 3.0 V6	05/89→10/00	Petrol	SFZ (ZPJ/Z)	2963	V6	93.00	73.00	66
XM 3.0 V6	05/89→10/00	Petrol	UFZ (ZPJ/Z)	2963	V6	93.00	73.00	66
XM 3.0 V6 24V	07/90→10/00	Petrol	SKZ (ZPJ4/Z)	2963	V6	93.00	73.00	66
XM 3.0 V6 24V	07/90→10/00	Petrol	UKZ (ZPJ4/Z)	2963	V6	93.00	73.00	66
XM Break 2.0	05/89→06/94	Petrol	R6A	1998	4	86.00	86.00	52
XM Break 2.0 i	11/91→04/94	Petrol	RDZ (XU10MZ)	1998	4	86.00	86.00	52
XM Break 2.0 i	11/91→04/94	Petrol	RFZ (XU10J2)	1998	4	86.00	86.00	52
XM Break 2.0 i	11/91→04/94	Petrol	XU102C	1998	4	86.00	86.00	52
XM Break 2.0 i 16V	05/94→10/00	Petrol	RFV (XU10J4R)	1998	4	86.00	86.00	52
XM Break 2.0 Turbo	05/94→10/00	Petrol	RGX (XU10J2TE)	1998	4	86.00	86.00	54
XM Break 2.0 Turbo	09/92→10/00	Petrol	RGY (XU10J2TE/Z)	1998	4	86.00	86.00	55
XM Break 2.1 D12	07/94→06/96	Diesel	P9A (XUD11A)	2138	4	86.00	92.00	56
XM Break 2.1 D 12V	11/91→04/94	Diesel	P9A (XUD11A)	2138	4	86.00	92.00	56
XM Break 2.1 TD 12V	11/91→04/94	Diesel	P8A (XUD11ATE)	2088	4	85.00	92.00	50
XM Break 2.1 TD 12V	11/91→10/00	Diesel	P8C (XUD11BTE)	2088	4	85.00	92.00	50
XM Break 2.1 TD 12V	11/91→10/00	Diesel	PHZ (XUD11ATE)	2088	4	85.00	92.00	50
XM Break 2.1 TD 12V	11/91→10/00	Diesel	PJZ (XUD11ATE)	2088	4	85.00	92.00	50
XM Break 2.5 TD	05/94→10/00	Diesel	THY (DK5ATE)	2446	4	92.00	92.00	64
XM Break 3.0 V6	11/91→10/00	Petrol	SFZ (ZPJ/Z)	2963	V6	93.00	73.00	66
XM Break 3.0 V6	11/91→10/00	Petrol	UFZ (ZPJ/Z)	2963	V6	93.00	73.00	66
Xsara 1.4 HDi	01/03→03/05	Diesel	8HX (DV4TD)	1398	4	73.70	82.00	12
Xsara 1.4 i	04/97→03/05	Petrol	KFW (TU3JP)	1360	4	75.00	77.00	18
Xsara 1.4 i	04/97→03/05	Petrol	KFX (TU3JP)	1360	4	75.00	77.00	18
Xsara 1.4 LPG	05/98→08/00	Petrol	KFW (TU3JP)	1360	4	75.00	77.00	18
Xsara 1.5 D	04/97→09/00	Diesel	VJZ (TUD5)	1527	4	77.00	82.00	23
Xsara 1.6 16V	09/00→03/05	Petrol	NFU (TU5JP4)	1587	4	78.50	82.00	24
Xsara 1.6 i	04/97→09/00	Petrol	NFZ (TU5JP)	1587	4	78.50	82.00	24
Xsara 1.8 BiFuel	07/97→08/00	Petrol	LFY (XU7JP4)	1762	4	83.00	81.40	35
Xsara 1.8 D	04/97→09/00	Diesel	161A (XUD7)	1769	4	80.00	88.00	26
Xsara 1.8 D	04/97→09/00	Diesel	A9A (XUD7)	1769	4	80.00	88.00	25
Xsara 1.8 i	04/97→09/00	Petrol	LFX (XU7JB)	1761	4	83.00	81.40	35
Xsara 1.8 i	02/98→09/00	Petrol	LFZ (XU7JP)	1761	4	83.00	81.40	35
Xsara 1.8 i 16V	04/97→09/00	Petrol	LFY (XU7JP4)	1762	4	83.00	81.40	35
Xsara 1.8 i Aut.	04/97→09/00	Petrol	LFZ (XU7JP)	1761	4	83.00	81.40	35
Xsara 1.8 LPG	01/98→08/00	Petrol	LFY (XU7JP4)	1762	4	83.00	81.40	35
Xsara 1.8 VTS	09/00→10/04	Petrol	6FZ (EW7J4)	1749	4	82.70	81.40	29
Xsara 1.9 D	07/98→03/05	Diesel	WJY (DW8B)	1868	4	82.20	88.00	28
Xsara 1.9 D	07/98→03/05	Diesel	WJZ (DW8)	1868	4	82.20	88.00	28
Xsara 1.9 D	04/97→09/00	Diesel	DJY (XUD9A)	1905	4	83.00	88.00	43
Xsara 1.9 SD	01/98→09/00	Diesel	DHV (XUD9BSD)	1905	4	83.00	88.00	41
Xsara 1.9 TD	04/97→09/00	Diesel	DHY (XUD9TE/Y)	1905	4	83.00	88.00	44

















cm3









9







Xsara 2.0	08/98→08/00	Petrol	RFV (XU10J4R)	1998	4	86.00	86.00	52
Xsara 2.0 16V	09/00→03/05	Petrol	RFN (EW10J4)	1997	4	85.00	88.00	47
Xsara 2.0 16V	04/97→09/00	Petrol	RFS (XU10J4RS)	1998	4	86.00	86.00	53
Xsara 2.0 16V	07/98→09/00	Petrol	RFV (XU10J4R)	1998	4	86.00	86.00	52
Xsara 2.0 HDi	09/00→03/05	Diesel	RHY (DW10TD)	1997	4	85.00	88.00	48
Xsara 2.0 HDi 90	02/99→03/05	Diesel	RHY (DW10TD)	1997	4	85.00	88.00	48
Xsara 2.0 HDi 109	05/01→03/05	Diesel	RHZ (DW10ATED)	1997	4	85.00	88.00	49
Xsara 2.0 i 16V	02/98→03/05	Petrol	RFS (XU10J4RS)	1998	4	86.00	86.00	53
Xsara Break 1.4 HDi	01/03→08/05	Diesel	8HX (DV4TD)	1398	4	73.70	82.00	12
Xsara Break 1.4 i	10/97→08/05	Petrol	KFW (TU3JP)	1360	4	75.00	77.00	18
Xsara Break 1.4 i	10/97→08/05	Petrol	KFX (TU3JP)	1360	4	75.00	77.00	18
Xsara Break 1.4 LPG	05/98→08/00	Petrol	KFW (TU3JP)	1360	4	75.00	77.00	18
Xsara Break 1.5 D	10/97→09/00	Diesel	VJZ (TUD5)	1527	4	77.00	82.00	23
Xsara Break 1.6 16V	09/00→08/05	Petrol	NFU (TU5JP4)	1587	4	78.50	82.00	24
Xsara Break 1.6 i	10/97→09/00	Petrol	NFZ (TU5JP)	1587	4	78.50	82.00	24
Xsara Break 1.8 D	10/97→09/00	Diesel	A9A (XUD7)	1769	4	80.00	88.00	25
Xsara Break 1.8 i	10/97→09/00	Petrol	LFX (XU7JB)	1761	4	83.00	81.40	35
Xsara Break 1.8 i 16V	10/97→09/00	Petrol	LFY (XU7JP4)	1762	4	83.00	81.40	35
Xsara Break 1.8 i Aut.	10/97→09/00	Petrol	LFZ (XU7JP)	1761	4	83.00	81.40	35
Xsara Break 1.8 LPG	05/98→08/00	Petrol	LFY (XU7JP4)	1762	4	83.00	81.40	35
Xsara Break 1.9 D	07/98→08/05	Diesel	WJY (DW8B)	1868	4	82.20	88.00	28
Xsara Break 1.9 D	07/98→08/05	Diesel	WJZ (DW8)	1868	4	82.20	88.00	28
Xsara Break 1.9 D	01/98→09/00	Diesel	DHV (XUD9BSD)	1905	4	83.00	88.00	41
Xsara Break 1.9 D	10/97→09/00	Diesel	DJY (XUD9A)	1905	4	83.00	88.00	43
Xsara Break 1.9 TD	10/97→09/00	Diesel	DHY (XUD9TE/Y)	1905	4	83.00	88.00	44
Xsara Break 2.0 16V	09/00→08/05	Petrol	RFN (EW10J4)	1997	4	85.00	88.00	47
Xsara Break 2.0 16V	07/98→09/00	Petrol	RFV (XU10J4R)	1998	4	86.00	86.00	52
Xsara Break 2.0 HDi 90	02/99→08/05	Diesel	RHY (DW10TD)	1997	4	85.00	88.00	48
Xsara Break 2.0 HDi 109	05/01→08/05	Diesel	RHZ (DW10ATED)	1997	4	85.00	88.00	49
Xsara Picasso 1.6	12/99→	Petrol	NFV (TU5JP)	1587	4	78.50	82.00	24
Xsara Picasso 1.6	12/99→	Petrol	NFZ (TU5JP)	1587	4	78.50	82.00	24
Xsara Picasso 1.6 16V	06/05→	Petrol	NFU (TU5JP4)	1587	4	78.50	82.00	24
Xsara Picasso 1.6 Flex	10/06→	Petrol	NFU (TU5JP4)	1587	4	78.50	82.00	24
Xsara Picasso 1.6 HDi	09/05→	Diesel	9HX (DV6ATED4)	1560	4	75.00	88.30	20
Xsara Picasso 1.6 HDi	05/04→	Diesel	9HY (DV6TED4)	1560	4	75.00	88.30	20
Xsara Picasso 1.6 HDi	05/04→	Diesel	9HZ (DV6TED4)	1560	4	75.00	88.30	20
Xsara Picasso 1.8 16V	02/00→	Petrol	6FZ (EW7J4)	1749	4	82.70	81.40	29
Xsara Picasso 2.0 16V	01/03→	Petrol	RFN (EW10J4)	1997	4	85.00	88.00	47
Xsara Picasso 2.0 HDi	12/99→	Diesel	RHY (DW10TD)	1997	4	85.00	88.00	48
Xsara Picasso 2.0 HDi	12/99→	Diesel	RHZ (DW10ATED)	1997	4	85.00	88.00	49
ZX 1.1	03/91→08/93	Petrol	H1A	1124	4	72.00	69.00	8
ZX 1.1	03/91→08/93	Petrol	H1B	1124	4	72.00	69.00	9
ZX 1.1	03/91→06/97	Petrol	HDZ (TU1M)	1124	4	72.00	69.00	8
ZX 1.4	03/91→06/97	Petrol	KDZ (TU3M/Z)	1360	4	75.00	77.00	15
ZX 1.4 D	07/94→10/97	Diesel	K9Y (TUD3Y)	1360	4	75.00	77.00	19
ZX 1.4 i	03/91→06/97	Petrol	KDX (TU3M/Z)	1360	4	75.00	77.00	15
ZX 1.4 i	03/91→06/97	Petrol	KDZ (TU3M/Z)	1360	4	75.00	77.00	15
ZX 1.4 i	03/91→06/97	Petrol	KFX (TU3JP)	1360	4	75.00	77.00	18
ZX 1.6	07/94→10/97	Petrol	BDY (XU5M)	1580	4	83.00	73.00	34
ZX 1.6	07/94→10/97	Petrol	BFZ (XU5JP)	1580	4	83.00	73.00	34
ZX 1.6 i	03/91→06/97	Petrol	BDY (XU5M)	1580	4	83.00	73.00	34
ZX 1.6 i	03/91→06/97	Petrol	BFZ (XU5JP)	1580	4	83.00	73.00	34
ZX 1.8	07/94→10/97	Petrol	LFZ (XU7JP)	1761	4	83.00	81.40	35
ZX 1.8	04/96→10/97	Petrol	LFY (XU7JP4)	1762	4	83.00	81.40	35
ZX 1.8 D	06/93→06/97	Diesel	161A (XUD7)	1769	4	80.00	88.00	26
ZX 1.8 i	07/92→06/97	Petrol	LFZ (XU7JP)	1761	4	83.00	81.40	35
ZX 1.8 i 16V	01/96→06/97	Petrol	LFY (XU7JP4)	1762	4	83.00	81.40	35
ZX 1.9	03/91→06/97	Petrol	D6E (XU9JA)	1905	4	83.00	88.00	39
ZX 1.9 D	07/93→06/97	Diesel	D9B (XUD9A/U)	1905	4	83.00	88.00	43
ZX 1.9 D	07/93→06/97	Diesel	DJY (XUD9A)	1905	4	83.00	88.00	43
ZX 1.9 D	03/91→06/97	Diesel	DJZ (XUD9Y)	1905	4	83.00	88.00	40
ZX 1.9 DT	06/92→06/94	Diesel	DHY (XUD9TE/Y)	1905	4	83.00	88.00	44
ZX 1.9 i	03/91→06/97	Petrol	DKZ (XU9JA)	1905	4	83.00	88.00	39
ZX 1.9 TD	07/92→06/97	Diesel	DHY (XUD9TE/Y)	1905	4	83.00	88.00	44
ZX 2.0	09/96→10/97	Petrol	RFS (XU10J4RS)	1998	4	86.00	86.00	53
ZX 2.0	07/94→10/97	Petrol	RFX (XU10J2C)	1998	4	86.00	86.00	52
ZX 2.0 i	07/92→06/97	Petrol	RFX (XU10J2C)	1998	4	86.00	86.00	52
ZX 2.0 i 16V	05/96→06/97	Petrol	RFS (XU10J4RS)	1998	4	86.00	86.00	53
ZX 2.0 i 16V	07/92→10/97	Petrol	RFT (XU10J4/Z)	1998	4	86.00	86.00	52







				cm ³				
ZX 2.0 i 16V	07/92→10/97	Petrol	RFY (XU10J4/Z)	1998	4	86.00	86.00	52
ZX Break 1.4 i	10/93→10/97	Petrol	KDX (TU3M/Z)	1360	4	75.00	77.00	15
ZX Break 1.4 i	10/93→10/97	Petrol	KDY (TU3M)	1360	4	75.00	77.00	15
ZX Break 1.4 i	10/93→10/97	Petrol	KFX (TU3JP)	1360	4	75.00	77.00	18
ZX Break 1.5 D	06/96→02/98	Diesel	VJY (TUD5)	1527	4	77.00	82.00	23
ZX Break 1.6 i	10/93→10/97	Petrol	BDY (XU5M)	1580	4	83.00	73.00	34
ZX Break 1.6 i	10/93→10/97	Petrol	BFZ (XU5JP)	1580	4	83.00	73.00	34
ZX Break 1.8 D	10/93→10/97	Diesel	161A (XUD7)	1769	4	80.00	88.00	26
ZX Break 1.8 i	10/93→10/97	Petrol	LFZ (XU7JP)	1761	4	83.00	81.40	35
ZX Break 1.8 i 16V	01/96→02/98	Petrol	LFY (XU7JP4)	1762	4	83.00	81.40	35
ZX Break 1.9 D	06/94→10/97	Diesel	D9B (XUD9A/U)	1905	4	83.00	88.00	43
ZX Break 1.9 D	10/93→10/97	Diesel	DJZ (XUD9Y)	1905	4	83.00	88.00	40
ZX Break 1.9 TD	10/93→10/97	Diesel	DHY (XUD9TE/Y)	1905	4	83.00	88.00	44

		cm ³	x 			
--	---	-----------------	---	---	---	---

1KR-FE	Petrol	998	3	71.00	84.00	4
4HH (P22DTE)	Diesel	2198	4	86.00	94.60	57
4HL (DW12C)	Diesel	2179	4	85.00	96.00	51
4HN (DW12MTED4)	Diesel	2179	4	85.00	96.00	51
4HP (DW12BTED4)	Diesel	2179	4	85.00	96.00	51
4HR (DW12BTED4)	Diesel	2179	4	85.00	96.00	51
4HT (DW12BTED4)	Diesel	2179	4	85.00	96.00	51
4HU (P22DTE)	Diesel	2198	4	86.00	94.60	57
4HV (P22DTE)	Diesel	2198	4	86.00	94.60	57
4HW (DW12TED4)	Diesel	2179	4	85.00	96.00	51
4HX (DW12TED4/FAP)	Diesel	2179	4	85.00	96.00	51
4HY (DW12UTED)	Diesel	2179	4	85.00	96.00	51
6FY (EW7A)	Petrol	1749	4	82.70	81.40	29
6FZ (EW7A)	Petrol	1749	4	82.70	81.40	29
6FZ (EW7J4)	Petrol	1749	4	82.70	81.40	29
8HR (DV4C)	Diesel	1398	4	73.70	82.00	12
8HS (DV4TED)	Diesel	1398	4	73.70	82.00	12
8HT (DV4TD)	Diesel	1398	4	73.70	82.00	12
8HX (DV4TD)	Diesel	1398	4	73.70	82.00	12
8HY (DV4TED4)	Diesel	1398	4	73.70	82.00	12
8HZ (DV4TD)	Diesel	1398	4	73.70	82.00	12
9HC (DV6C)	Diesel	1560	4	75.00	88.30	20
9HD (DV6C)	Diesel	1560	4	75.00	88.30	20
9HE (DV6DBM)	Diesel	1560	4	75.00	88.30	20
9HF (DV6DTED)	Diesel	1560	4	75.00	88.30	20
9HH (DV6DUM)	Diesel	1560	4	75.00	88.30	20
9HJ (DV6DTEDM)	Diesel	1560	4	75.00	88.30	20
9HK (DV6ETEDM)	Diesel	1560	4	75.00	88.30	20
9HL (DV6C)	Diesel	1560	4	75.00	88.30	20
9HM (DV6UC)	Diesel	1560	4	75.00	88.30	20
9HN (DV6ETED)	Diesel	1560	4	75.00	88.30	20
9HN (DV6ETED4)	Diesel	1560	4	75.00	88.30	20
9HP (DV6DTED)	Diesel	1560	4	75.00	88.30	20
9HR (DV6C)	Diesel	1560	4	75.00	88.30	20
9HS (DV6TED4BU)	Diesel	1560	4	75.00	88.30	20
9HT (DV6BTED4)	Diesel	1560	4	75.00	88.30	20
9HT (DV6BUTED4)	Diesel	1560	4	75.00	88.30	20
9HU (DV6UTED4)	Diesel	1560	4	75.00	88.30	20
9HW (DV6BTED4)	Diesel	1560	4	75.00	88.30	20
9HW (DV6ETED)	Diesel	1560	4	75.00	88.30	20
9HX (DV6ATED4)	Diesel	1560	4	75.00	88.30	20
9HX (DV6AUTED4)	Diesel	1560	4	75.00	88.30	20
9HY (DV6TED4)	Diesel	1560	4	75.00	88.30	20
9HZ (DV6TED4)	Diesel	1560	4	75.00	88.30	20
108C	Petrol	954	4	70.00	62.00	2
109/5	Petrol	1124	4	72.00	69.00	5
109/5E	Petrol	1124	4	72.00	69.00	6
109/5F	Petrol	1124	4	72.00	69.00	6
109K	Petrol	1124	4	72.00	69.00	5
150A	Petrol	1360	4	75.00	77.00	14
150B (XY8)	Petrol	1360	4	75.00	77.00	14
150C	Petrol	1360	4	75.00	77.00	14
150D	Petrol	1360	4	75.00	77.00	14
150D (XY7)	Petrol	1360	4	75.00	77.00	14
150F	Petrol	1360	4	75.00	77.00	14
159A	Petrol	1905	4	83.00	88.00	36
159B	Petrol	1905	4	83.00	88.00	36
161 (XUD7)	Diesel	1769	4	80.00	88.00	25
161A (XUD7)	Diesel	1769	4	80.00	88.00	26
162 (XUD9)	Diesel	1905	4	83.00	88.00	40
169 (XM7T)	Petrol	1796	4	84.00	81.00	45
169B	Petrol	1796	4	84.00	81.00	46
170A (XN1T)	Petrol	1971	4	88.00	81.00	59
170B (XN1T)	Petrol	1971	4	88.00	81.00	59
170C (XN1T)	Petrol	1971	4	88.00	81.00	60
171A	Petrol	1580	4	83.00	73.00	30
171B	Petrol	1580	4	83.00	73.00	30
171C	Petrol	1580	4	83.00	73.00	30
171D	Petrol	1580	4	83.00	73.00	31

		cm3	x 			
180A (XU5J)	Petrol	1580	4	83.00	73.00	32
180Z	Petrol	1580	4	83.00	73.00	33
220 A2.000	Petrol	1581	4	86.40	67.40	58
829 A5	Petrol	1995	4	88.00	82.00	61
1580 SPI	Petrol	1581	4	86.40	67.40	58
8140.43N	Diesel	2798	4	94.40	100.00	72
8140.43S	Diesel	2798	4	94.40	100.00	72
8140.63 (F28D)	Diesel	2798	4	94.40	100.00	72
A8A (XUD7TE)	Diesel	1769	4	80.00	88.00	27
A9A (XUD7)	Diesel	1769	4	80.00	88.00	25
AHR (DW10FD)	Diesel	1997	4	85.00	88.00	48
AHW (DW10FC)	Diesel	1997	4	85.00	88.00	48
AHY (DW10CE)	Diesel	1997	4	85.00	88.00	48
AHZ (DW10CD)	Diesel	1997	4	85.00	88.00	48
AJZ (XUD7TE)	Diesel	1769	4	80.00	88.00	27
B1A (XU51C/K)	Petrol	1580	4	83.00	73.00	34
B1E (XU51C)	Petrol	1580	4	83.00	73.00	30
B6D	Petrol	1580	4	83.00	73.00	33
B6E	Petrol	1580	4	83.00	73.00	33
B22615	Diesel	2175	4	90.00	85.50	63
B25637	Diesel	2498	4	93.00	92.00	67
BAY (XU5CP)	Petrol	1580	4	83.00	73.00	34
BAZ (XU5CP)	Petrol	1580	4	83.00	73.00	34
BDY (XU5M)	Petrol	1580	4	83.00	73.00	34
BDZ (XU5M)	Petrol	1580	4	83.00	73.00	34
BFZ (XU5JP)	Petrol	1580	4	83.00	73.00	34
BHW (DV6FE)	Diesel	1560	4	75.00	88.30	20
BHY (DV6FD)	Diesel	1560	4	75.00	88.30	20
C1A	Petrol	954	4	70.00	62.00	3
C3A	Petrol	954	4	70.00	62.00	3
CDY (TU9M)	Petrol	954	4	70.00	62.00	3
CDZ (TU9M)	Petrol	954	4	70.00	62.00	3
CFA (384F)	Petrol	998	3	71.00	84.00	4
CRD90	Diesel	2175	4	90.00	85.50	63
CRD93B	Diesel	2499	4	93.00	92.00	67
CRD93L (U25-661)	Diesel	2500	4	93.00	92.00	68
CRD93LS (U25-673)	Diesel	2500	4	93.00	92.00	69
D2A (XU92C)	Petrol	1905	4	83.00	88.00	36
D2C (XU92C)	Petrol	1905	4	83.00	88.00	36
D2E	Petrol	1905	4	83.00	88.00	37
D2F	Petrol	1905	4	83.00	88.00	37
D6A (XU9J2)	Petrol	1905	4	83.00	88.00	38
D6C (XU9J4)	Petrol	1905	4	83.00	88.00	39
D6E (XU9JA)	Petrol	1905	4	83.00	88.00	39
D8B (XUD9TF)	Diesel	1905	4	83.00	88.00	41
D8C (XUD9UTF)	Diesel	1905	4	83.00	88.00	42
D9A (XUD9)	Diesel	1905	4	83.00	88.00	40
D9B (XUD9A/L)	Diesel	1905	4	83.00	88.00	43
D9B (XUD9A/U)	Diesel	1905	4	83.00	88.00	43
DDZ (XU9M)	Petrol	1905	4	83.00	88.00	39
DFW (XU9J4)	Petrol	1905	4	83.00	88.00	39
DFZ (XU9J1)	Petrol	1905	4	83.00	88.00	38
DHV (XUD9BSD)	Diesel	1905	4	83.00	88.00	41
DHW (XUD9SD)	Diesel	1905	4	83.00	88.00	41
DHX (XUD9TF/BTF)	Diesel	1905	4	83.00	88.00	41
DHY (XUD9TE/Y)	Diesel	1905	4	83.00	88.00	44
DJY (XUD9A)	Diesel	1905	4	83.00	88.00	43
DJZ (XUD9Y)	Diesel	1905	4	83.00	88.00	40
DKZ (XU9JA)	Petrol	1905	4	83.00	88.00	39
DV4D	Diesel	1398	4	73.50	82.30	11
DV6B	Diesel	1560	4	75.00	88.30	20
E1A	Petrol	1124	4	72.00	69.00	7
F28TDCR	Diesel	2798	4	94.40	100.00	72
FHZ (F13DTE5)	Diesel	1248	4	69.60	75.00	1
G1A	Petrol	1294	4	76.70	70.00	22
H1A	Petrol	1124	4	72.00	69.00	8
H1B	Petrol	1124	4	72.00	69.00	9
HAZ (TU1CP)	Petrol	1124	4	72.00	69.00	8
HDY (TU1M+)	Petrol	1124	4	72.00	69.00	8

		cm3	x 			
HDZ (TU1M)	Petrol	1124	4	72.00	69.00	8
HFX (TU1A)	Petrol	1124	4	72.00	69.00	8
HFX (TU1JP)	Petrol	1124	4	72.00	69.00	10
HNZ (EB2DT)	Petrol	1199	3	75.00	90.50	21
J6T A500	Petrol	2165	4	88.00	89.00	62
K1B	Petrol	1360	4	75.00	77.00	15
K1F	Petrol	1360	4	75.00	77.00	15
K1G	Petrol	1360	4	75.00	77.00	15
K1H (TU3A)	Petrol	1360	4	75.00	77.00	15
K2A	Petrol	1360	4	75.00	77.00	15
K2B	Petrol	1360	4	75.00	77.00	15
K2D	Petrol	1360	4	75.00	77.00	15
K3A	Petrol	1360	4	75.00	77.00	15
K6D (TU3A)	Petrol	1360	4	75.00	77.00	15
K6E (TU3A)	Petrol	1360	4	75.00	77.00	15
K6F (TU3A)	Petrol	1360	4	75.00	77.00	15
K9A (TUD3)	Diesel	1360	4	75.00	77.00	19
K9Y (TUD3Y)	Diesel	1360	4	75.00	77.00	19
KAY (TU3CP)	Petrol	1360	4	75.00	77.00	15
KAZ	Petrol	1360	4	75.00	77.00	15
KDX (TU3M/Z)	Petrol	1360	4	75.00	77.00	15
KDY (TU3FM)	Petrol	1360	4	75.00	77.00	16
KDY (TU3M)	Petrol	1360	4	75.00	77.00	15
KDZ (TU3M/Z)	Petrol	1360	4	75.00	77.00	15
KFT (TU3A)	Petrol	1360	4	75.00	77.00	15
KFU (ET3J4)	Petrol	1360	4	75.00	77.00	15
KFV (TU3A)	Petrol	1360	4	75.00	77.00	15
KFV (TU3JP)	Petrol	1360	4	75.00	77.00	17
KFW (TU3A)	Petrol	1360	4	75.00	77.00	15
KFW (TU3JP)	Petrol	1360	4	75.00	77.00	18
KFX (TU3A)	Petrol	1360	4	75.00	77.00	15
KFX (TU3JP)	Petrol	1360	4	75.00	77.00	18
KFY (TU3FJ2)	Petrol	1360	4	75.00	77.00	16
KFZ (TU3FJ2)	Petrol	1360	4	75.00	77.00	16
LFX (XU7JB)	Petrol	1761	4	83.00	81.40	35
LFY (XU7JP4)	Petrol	1762	4	83.00	81.40	35
LFZ (XU7JP)	Petrol	1761	4	83.00	81.40	35
M4A	Petrol	1294	4	75.00	73.20	13
M22-621	Diesel	2175	4	90.00	85.50	63
M22-629	Diesel	2499	4	93.00	92.00	67
M25-629	Diesel	2500	4	93.00	92.00	67
M25-637	Diesel	2499	4	93.00	92.00	67
M25-648	Diesel	2500	4	93.00	92.00	70
M25-660	Diesel	2500	4	93.00	92.00	68
M25-661	Diesel	2499	4	93.00	92.00	67
M25-669	Diesel	2500	4	93.00	92.00	69
N6A (TU5JP4)	Petrol	1587	4	78.50	82.00	24
NFR (TU5JP4B)	Petrol	1587	4	78.50	82.00	24
NFS (TU5JP4S)	Petrol	1587	4	78.50	82.00	24
NFT	Petrol	1587	4	78.50	82.00	24
NFU (TU5JP4)	Petrol	1587	4	78.50	82.00	24
NFV (TU5JP)	Petrol	1587	4	78.50	82.00	24
NFX (TU5JP4)	Petrol	1587	4	78.50	82.00	24
NFZ (TU5JP)	Petrol	1587	4	78.50	82.00	24
P8A (XUD11ATE)	Diesel	2088	4	85.00	92.00	50
P8C (XUD11BTE)	Diesel	2088	4	85.00	92.00	50
P9A (XUD11A)	Diesel	2138	4	86.00	92.00	56
PHZ (XUD11ATE)	Diesel	2088	4	85.00	92.00	50
PJZ (XUD11ATE)	Diesel	2088	4	85.00	92.00	50
R6A	Petrol	1998	4	86.00	86.00	52
RDZ (XU10MZ)	Petrol	1998	4	86.00	86.00	52
RFH (EW10A)	Petrol	1997	4	85.00	88.00	47
RFJ (EW10A)	Petrol	1997	4	85.00	88.00	47
RFK (EW10A)	Petrol	1997	4	85.00	88.00	47
RFK (EW10J4S)	Petrol	1997	4	85.00	88.00	47
RFN (EW10A)	Petrol	1997	4	85.00	88.00	47
RFN (EW10J4)	Petrol	1997	4	85.00	88.00	47
RFR (EW10A)	Petrol	1997	4	85.00	88.00	47
RFS (XU10J4RS)	Petrol	1998	4	86.00	86.00	53

		cm3	x 			
RFT (XU10J4/Z)	Petrol	1998	4	86.00	86.00	52
RFU (XU10J2/C)	Petrol	1998	4	86.00	86.00	53
RFV (XU10J4R)	Petrol	1998	4	86.00	86.00	52
RFW (XU10J2U)	Petrol	1998	4	86.00	86.00	53
RFX (XU10J2C)	Petrol	1998	4	86.00	86.00	52
RFX XU10J2C/Z L3	Petrol	1998	4	86.00	86.00	52
RFY (XU10J4/Z)	Petrol	1998	4	86.00	86.00	52
RFZ (XU10J2)	Petrol	1998	4	86.00	86.00	52
RGX (XU10J2TE)	Petrol	1998	4	86.00	86.00	54
RGY (XU10J2TE/Z)	Petrol	1998	4	86.00	86.00	55
RHB (DW10DTEd4)	Diesel	1997	4	85.00	88.00	48
RHC (DW10CTED4)	Diesel	1997	4	85.00	88.00	48
RHD (DW10CB)	Diesel	1997	4	85.00	88.00	48
RHD (DW10CTED4)	Diesel	1997	4	85.00	88.00	48
RHE (DW10CTED4)	Diesel	1997	4	85.00	88.00	48
RHF (DW10BTED4)	Diesel	1997	4	85.00	88.00	48
RHH (DW10CTED4)	Diesel	1997	4	85.00	88.00	48
RHJ (DW10BTED4)	Diesel	1997	4	85.00	88.00	48
RHK (DW10UTED4)	Diesel	1997	4	85.00	88.00	49
RHM (DW10ATED4)	Diesel	1997	4	85.00	88.00	49
RHR (DW10BTED4)	Diesel	1997	4	85.00	88.00	49
RHS (DW10ATED)	Diesel	1997	4	85.00	88.00	48
RHT (DW10ATED4)	Diesel	1997	4	85.00	88.00	48
RHV (DW10TD)	Diesel	1997	4	85.00	88.00	48
RHV (DW10UTD)	Diesel	1997	4	85.00	88.00	48
RHW (DW10ATED4)	Diesel	1997	4	85.00	88.00	49
RHX (DW10BTED)	Diesel	1997	4	85.00	88.00	49
RHY (DW10TD)	Diesel	1997	4	85.00	88.00	48
RHZ (DW10ATED)	Diesel	1997	4	85.00	88.00	49
RLZ (EW10D)	Petrol	1997	4	85.00	88.00	47
SFZ (ZPJ/Z)	Petrol	2963	V6	93.00	73.00	66
SKZ (ZPJ4/Z)	Petrol	2963	V6	93.00	73.00	66
T8A (DJ5T)	Diesel	2446	4	92.00	92.00	64
T9A (DJ5)	Diesel	2446	4	92.00	92.00	65
THX (DJ5TED)	Diesel	2446	4	92.00	92.00	64
THY (DK5ATE)	Diesel	2446	4	92.00	92.00	64
THZ (DJ5T)	Diesel	2446	4	92.00	92.00	64
TU3JP4	Petrol	1360	4	75.00	77.00	15
TU9	Petrol	954	4	70.00	62.00	3
TU9K	Petrol	954	4	70.00	62.00	3
UFZ (ZPJ/Z)	Petrol	2963	V6	93.00	73.00	66
UKZ (ZPJ4/Z)	Petrol	2963	V6	93.00	73.00	66
VJY (TUD5)	Diesel	1527	4	77.00	82.00	23
VJZ (TUD5)	Diesel	1527	4	77.00	82.00	23
WJX (DW8B)	Diesel	1868	4	82.20	88.00	28
WJY (DW8B)	Diesel	1868	4	82.20	88.00	28
WJZ (DW8)	Diesel	1868	4	82.20	88.00	28
XD3TP	Diesel	2498	4	94.00	90.00	71
XU10J2	Petrol	1998	4	86.00	86.00	53
XU52C	Petrol	1580	4	83.00	73.00	30
XU102C	Petrol	1998	4	86.00	86.00	52
XUD11 A	Diesel	2138	4	86.00	92.00	56
XV8	Petrol	954	4	70.00	62.00	2



1 69.60 x 75.00

FHZ (F13DTE5)		4 Cyl.		1248cc	55kW (75PS)		Diesel Turbo		TD25689
BE/PL	4	42,582/42,600	45,734/45,744	20,000	1,552	0,030/0,062	BS	71-4033	71-4033/4 STD .010
MB/HL 1,2,4,5	4	50,982/51,000	54,710/54,722	19,000	1,840	0,026/0,050	AL-LF	02-4034	H1011/5 STD 0.25
MB/HL 3	1	50,982/51,000	54,710/54,722	23,950	1,840	0,026/0,050	AL-LF	02-4035H	
SE/PB	1	23,000	25,747/25,772	25,000			BS-LF	55-4077	55-4077 SEMI

2 70.00 x 62.00

108C		4 Cyl.		954cc	30-33kW (41-45PS)		Petrol		TD6560
XV8		4 Cyl.		954cc	33kW (45PS)		Petrol		TD18544
BE/PL	4	44,975/44,991	48,655/48,671	19,750	1,820	0,024/0,081	AL-LF	62045RA	01-4173/4 STD 0.30 0.50
MB/HL 2,4	2	49,965/49,981	53,655/53,674	17,290	1,832	0,020/0,070	AL-LF	62046RA	H996/5 STD 0.30 0.50
MB/HL 1,3,5	3	49,965/49,981	53,655/53,674	17,290	1,832	0,020/0,070	AL-LF	62047RA	
TW/A	2	55,250/55,500	71,450/71,700		2,450		BS	62047BFA	A203/2 STD 0.10

3 70.00 x 62.00

C1A		4 Cyl.		954cc	32-34kW (44-46PS)		Petrol		TD6559
C3A		4 Cyl.		954cc	30-33kW (42-45PS)		Petrol		TD619
CDY (TU9M)		4 Cyl.		954cc	33-37kW (45-50PS)		Petrol		TD5095
CDZ (TU9M)		4 Cyl.		954cc	33-37kW (45-50PS)		Petrol		TD10787
TU9		4 Cyl.		954cc	33kW (45PS)		Petrol		TD18545
TU9K		4 Cyl.		954cc	37kW (50PS)		Petrol		TD26984
BE/PL	4	37,992/38,008	41,128/41,144	16,300	1,548	0,024/0,081	AL-LF	1260RAA	01-4123/4 STD 0.30
MB/HL 2-4	3	49,965/49,981	53,655/53,674	17,290	1,832	0,020/0,070	AL-LF	1261RA	H1071/5 STD 0.30 0.50
MB/HL 1,5	2	49,965/49,981	53,655/53,674	17,290	1,832	0,020/0,070	AL-LF	1262RA	
TW/A	2	55,250/55,500	71,450/71,700		2,450		BS	62047BFA	A203/2 STD 0.10

4 71.00 x 84.00

1KR-FE Euro 4		3 Cyl.		998cc	50-51kW (68-69PS)		Petrol		TD18548
CFA (384F)		3 Cyl.		998cc	50kW (68PS)		Petrol		TD25073
BE/PL	6	40,000	43,020	13,600	1,495		AL-LF	64-735-1	01-4980/3 STD
MB/HL 1-4	4	43,990	48,020	14,900	1,997		AL-LF	63-735-1	H1338/4 STD
MB/HL 1-4	4	43,990	48,020	14,900	1,997		AL-LF	63-735-2	
TW/A	2	52,000	63,000		1,990		AL-LF	65-735-1	A322/2 STD

5 72.00 x 69.00

109/5		4 Cyl.		1124cc	37-42kW (50-57PS)		Petrol		TD564
109K		4 Cyl.		1124cc	34-36kW (48-50PS)		Petrol		TD563
BE/PL	4	44,975/44,991	48,655/48,671	19,750	1,820	0,024/0,081	AL-LF	62045RA	01-4173/4 STD 0.30 0.50



MB/HL 2-4	3	49,965/49,981	53,655/53,674	17,290	1,832	0,020/0,070	AL-LF	1261RA	H1071/5 STD 0.30 0.50
MB/HL 1,5	2	49,965/49,981	53,655/53,674	17,290	1,832	0,020/0,070	AL-LF	1262RA	

01/85 →

MB/HL 2,4	2	49,965/49,981	53,655/53,674	17,290	1,832	0,020/0,070	AL-LF	62046RA	H996/5 STD 0.30 0.50
MB/HL 1,3,5	3	49,965/49,981	53,655/53,674	17,290	1,832	0,020/0,070	AL-LF	62047RA	

07/82 → 12/84

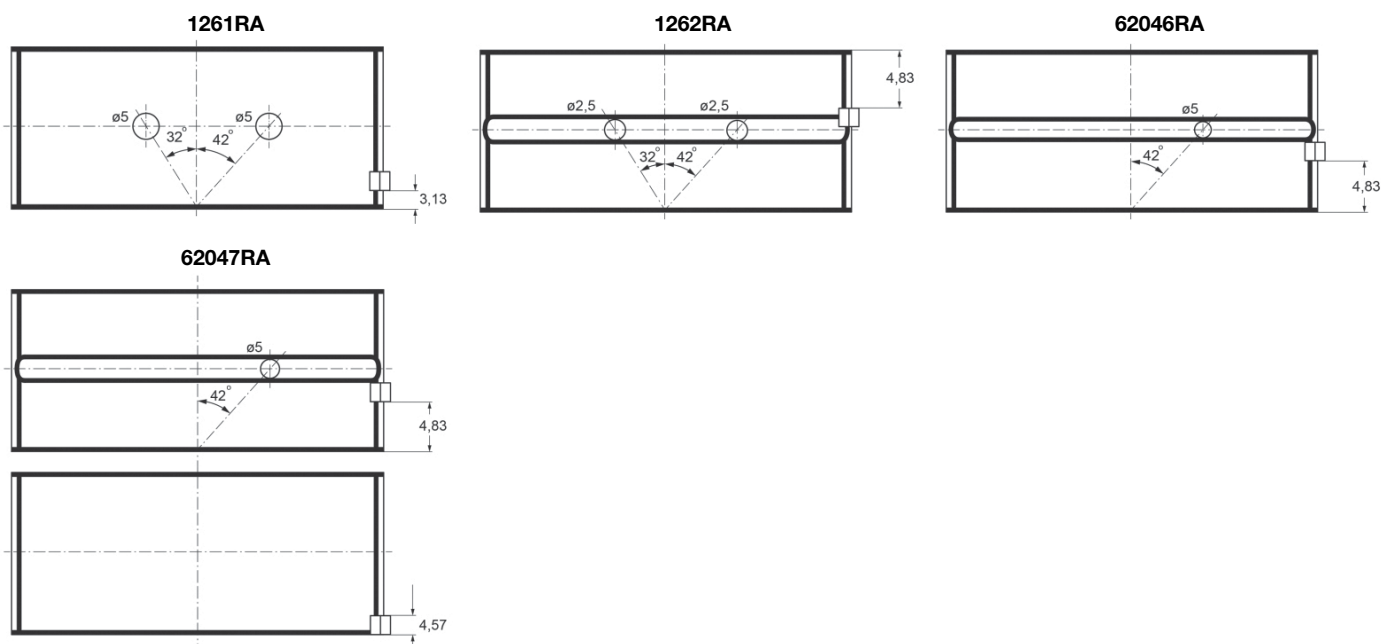

TW/A	2	55,250/55,500	71,450/71,700	2,350	BS	62047BF	A202/2 STD 0.15
------	---	---------------	---------------	-------	----	---------	---------------------------

→ 03/81

TW/A	2	55,250/55,500	71,450/71,700	2,450	BS	62047BFA	A203/2 STD 0.10
------	---	---------------	---------------	-------	----	----------	---------------------------

04/81 →

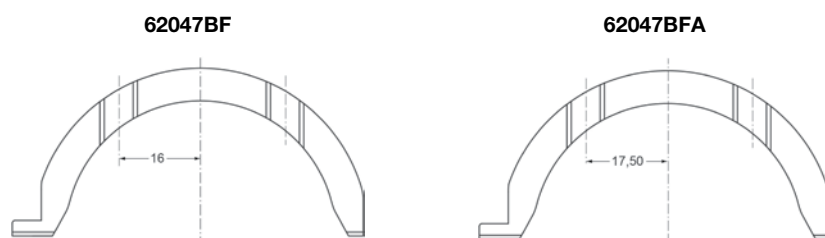

6 72.00 x 69.00

109/5E	4 Cyl.	1124cc	33-37kW (45-50PS)	Petrol	TD565				
109/5F	4 Cyl.	1124cc	33-37kW (45-50PS)	Petrol	TD566				
BE/PL	4	44,975/44,991	48,655/48,671	19,750	1,820	0,024/0,081	AL-LF	62045RA	01-4173/4 STD 0.30 0.50
MB/HL 2-4	3	49,965/49,981	53,655/53,674	17,290	1,832	0,020/0,070	AL-LF	1261RA	
MB/HL 1,5	2	49,965/49,981	53,655/53,674	17,290	1,832	0,020/0,070	AL-LF	1262RA	

01/85 →



MB/HL 2,4	2	49,965/49,981	53,655/53,674	17,290	1,832	0,020/0,070	AL-LF	62046RA	H996/5 STD 0.30 0.50
MB/HL 1,3,5	3	49,965/49,981	53,655/53,674	17,290	1,832	0,020/0,070	AL-LF	62047RA	

→12/84

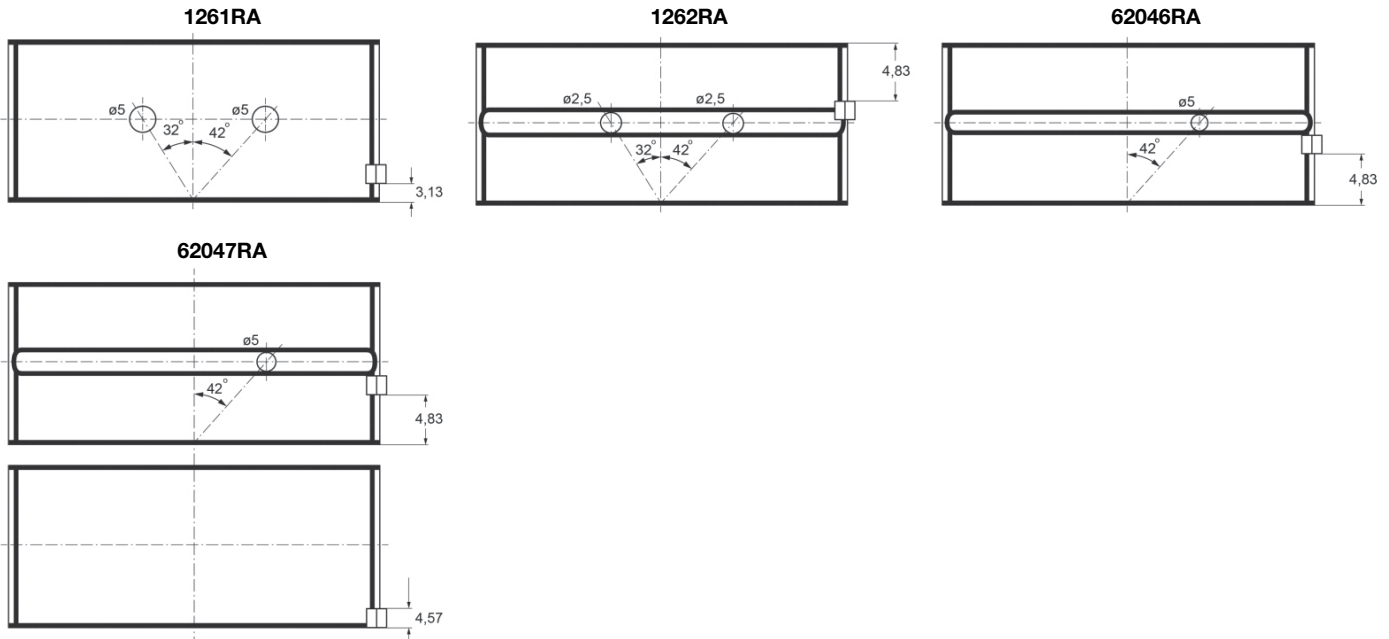

TW/A	2	55,250/55,500	71,450/71,700		2,450		BS	62047BFA	A203/2 STD 0.10
------	---	---------------	---------------	--	-------	--	----	----------	---------------------------

7 72.00 x 69.00

E1A			4 Cyl.	1124cc	35kW (48PS)		Petrol		TD648
BE/PL	4	44,975/44,991	48,655/48,671	19,750	1,820	0,024/0,081	AL-LF	62045RA	01-4173/4 STD 0.30 0.50
MB/HL 2,4	2	49,965/49,981	53,655/53,674	17,290	1,832	0,020/0,070	AL-LF	62046RA	H996/5 STD 0.30 0.50
MB/HL 1,3,5	3	49,965/49,981	53,655/53,674	17,290	1,832	0,020/0,070	AL-LF	62047RA	
TW/A	2	55,250/55,500	71,450/71,700		2,350		BS	62047BF	A202/2 STD 0.15

8 72.00 x 69.00

H1A			4 Cyl.	1124cc	40-44kW (54-60PS)		Petrol		TD6562
HAZ (TU1CP)			4 Cyl.	1124cc	40kW (54PS)		Petrol		TD5083
HDY (TU1M+)			4 Cyl.	1124cc	40kW (54PS)		Petrol		TD26411
HDZ (TU1M)			4 Cyl.	1124cc	40-44kW (55-60PS)		Petrol		TD661
HFX (TU1A)			4 Cyl.	1124cc	44kW (60PS)		Petrol		TD30658
BE/PL	4	44,975/44,991	48,655/48,671	19,750	1,820	0,024/0,081	AL-LF	62045RA	01-4173/4 STD 0.30 0.50
MB/HL 2-4	3	49,965/49,981	53,655/53,674	17,290	1,832	0,020/0,070	AL-LF	1261RA	H1071/5 STD 0.30 0.50
MB/HL 1,5	2	49,965/49,981	53,655/53,674	17,290	1,832	0,020/0,070	AL-LF	1262RA	
TW/A	2	55,250/55,500	71,450/71,700		2,450		BS	62047BFA	A203/2 STD 0.10

9 72.00 x 69.00

H1B		4 Cyl.		1124cc	40-44kW (55-60PS)		Petrol		TD658
BE/PL	4	44,975/44,991	48,655/48,671	19,750	1,820	0,024/0,081	AL-LF	62045RA	01-4173/4 STD 0.30 0.50
MB/HL 2-4	3	49,965/49,981	53,655/53,674	17,290	1,832	0,020/0,070	AL-LF	1261RA	H1071/5 STD 0.50
MB/HL 1,5	2	49,965/49,981	53,655/53,674	17,290	1,832	0,020/0,070	AL-LF	1262RA	
TW/A	2	55,250/55,500	71,450/71,700		2,450		BS	62047BFA	A203/2 STD 0.10

10 72.00 x 69.00

HFX (TU1JP)		4 Cyl.		1124cc	44kW (60PS)		Petrol		TD14730
BE/PL	4	44,975/44,991	48,655/48,671	19,750	1,820	0,020/0,080	AL-LF	4650RA	01-4163/4 STD
10/97 →									
BE/PL	4	44,975/44,991	48,655/48,671	19,750	1,820	0,024/0,081	AL-LF	62045RA	01-4173/4 STD 0.30 0.50
→09/97									

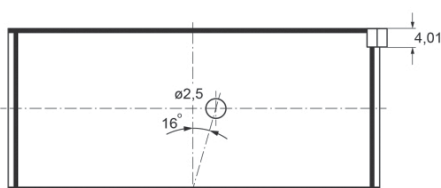
4650RA
62045RA

MB/HL 2-4	3	49,965/49,981	53,655/53,674	17,290	1,832	0,020/0,070	AL-LF	1261RA	H1071/5 STD 0.30 0.50
MB/HL 1,5	2	49,965/49,981	53,655/53,674	17,290	1,832	0,020/0,070	AL-LF	1262RA	
TW/A	2	55,250/55,500	71,450/71,700		2,450		BS	62047BFA	A203/2 STD 0.10

11 73.50 x 82.30

DV4D		4 Cyl.		1398cc	40kW (54PS)		Diesel		TD18550
BE/PL	1	44,975/44,991	48,665/48,671	17,050	1,820	0,029/0,081	SP	71-3986	71-3986 STD 0.30 ①
MB/HL 1-5	5	49,962/49,981	53,655/53,674	19,900	1,833	0,008/0,046	AL	02-4244	H1066/5 STD 0.30 0.50
TW/A	2	55,200/55,480	71,350/71,700		2,460		AL	04-4245	A217/2 STD
SE/PB	1	24,995/25,000	28,000/28,021	19,980			BS	55-3987	55-3987 SEMI

12 73.70 x 82.00

8HR (DV4C)		4 Cyl.		1398cc	50kW (68PS)		Diesel Turbo		TD25061
8HS (DV4TED) Euro 4		4 Cyl.		1398cc	50kW (68PS)		Diesel Turbo Intercooler		TD25063
8HT (DV4TD)		4 Cyl.		1398cc	40kW (54PS)		Diesel Turbo		TD25062
8HX (DV4TD) Euro 3/4		4 Cyl.		1398cc	50-55kW (68-75PS)		Diesel Turbo		TD16425
8HY (DV4TED4)		4 Cyl.		1398cc	66kW (90PS)		Diesel		TD16426
8HZ (DV4TD)		4 Cyl.		1398cc	50-52kW (68-71PS)		Diesel Turbo		TD23773
BE/PL	1	44,975/44,991	48,665/48,671	17,050	1,820	0,029/0,081	SP	71-3986	71-3986 STD 0.30 ①
MB/HL 1-5	5	49,962/49,981	53,655/53,674	19,900	1,833	0,008/0,046	AL	02-4244	H1066/5 STD 0.30 0.50

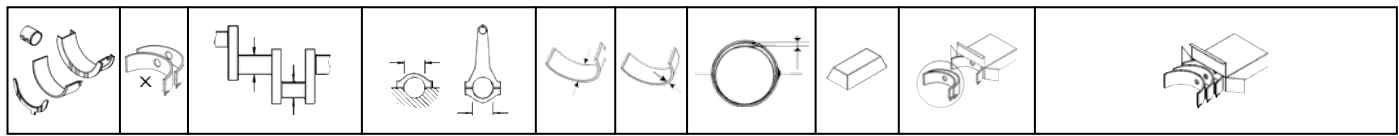

TW/A	2	55,200/55,480	71,350/71,700		2,460		AL	04-4245	A217/2 STD
SE/PB	1	24,995/25,000	28,000/28,021	19,980			BS	55-3987	55-3987 SEMI

13 75.00 x 73.20

M4A	4 Cyl.		1294cc	69-70kW (94-95PS)		Petrol		TD706	
BE/PL	4	44,975/44,991	48,655/48,671	19,750	1,820	0,024/0,081	AL-LF	62045RA	01-4173/4 STD 0.30 0.50
MB/HL 2-4	3	49,965/49,981	53,655/53,674	17,290	1,832	0,020/0,070	AL-LF	1261RA	H1071/5 STD 0.30 0.50
MB/HL 1,5	2	49,965/49,981	53,655/53,674	17,290	1,832	0,020/0,070	AL-LF	1262RA	
TW/A	2	55,250/55,500	71,450/71,700		2,450		BS	62047BFA	A203/2 STD 0.10

14 75.00 x 77.00

150A	4 Cyl.		1360cc	45kW (62PS)		Petrol		TD576	
150B (XY8)	4 Cyl.		1360cc	55-58kW (75-79PS)		Petrol		TD577	
150C	4 Cyl.		1360cc	52-53kW (71-72PS)		Petrol		TD582	
150D	4 Cyl.		1360cc	44kW (60PS)		Petrol		TD6570	
150D (XY7)	4 Cyl.		1360cc	44kW (60PS)		Petrol		TD5091	
150F	4 Cyl.		1360cc	49-52kW (67-72PS)		Petrol		TD578	
BE/PL	4	44,975/44,991	48,655/48,671	19,750	1,820	0,024/0,081	AL-LF	62045RA	01-4173/4 STD 0.30 0.50
MB/HL 2,4	2	49,965/49,981	53,655/53,674	17,290	1,832	0,020/0,070	AL-LF	62046RA	H996/5 STD 0.30 0.50
MB/HL 1,3,5	3	49,965/49,981	53,655/53,674	17,290	1,832	0,020/0,070	AL-LF	62047RA	
TW/A	2	55,250/55,500	71,450/71,700		2,450		BS	62047BFA	A203/2 STD 0.10

15 75.00 x 77.00

K1B	4 Cyl.	1360cc	44kW (61PS)	Petrol		TD665			
K1F	4 Cyl.	1360cc	48-49kW (65-67PS)	Petrol		TD666			
K1G	4 Cyl.	1360cc	51-52kW (69-71PS)	Petrol		TD6567			
K1H (TU3A)	4 Cyl.	1360cc	47-49kW (64-67PS)	Petrol		TD4272			
K2A	4 Cyl.	1360cc	61-65kW (84-88PS)	Petrol		TD668			
K2B	4 Cyl.	1360cc	62-65kW (85-89PS)	Petrol		TD669			
K2D	4 Cyl.	1360cc	55kW (75PS)	Petrol		TD6568			
K3A	4 Cyl.	1360cc	40-46kW (54-63PS)	Petrol		TD6569			
K6D (TU3A)	4 Cyl.	1360cc	53kW (72PS)	Petrol		TD25067			
K6E (TU3A)	4 Cyl.	1360cc	53kW (72PS)	Petrol		TD25069			
K6F (TU3A)	4 Cyl.	1360cc	53kW (72PS)	Petrol		TD25068			
KAY (TU3CP)	4 Cyl.	1360cc	44kW (60PS)	Petrol		TD9546			
KAZ	4 Cyl.	1360cc	44-55kW (54-75PS)	Petrol		TD6566			
KDX (TU3M/Z)	4 Cyl.	1360cc	55kW (75PS)	Petrol		TD5080			
KDY (TU3M)	4 Cyl.	1360cc	55-58kW (75-79PS)	Petrol		TD5160			
KDZ (TU3M/Z)	4 Cyl.	1360cc	55-59kW (75-80PS)	Petrol		TD683			
KFT (TU3A)	4 Cyl.	1360cc	54kW (73PS)	Petrol		TD25070			
KFU (ET3J4)	4 Cyl.	1360cc	65kW (88PS)	Petrol		TD17977			
KFV (TU3A)	4 Cyl.	1360cc	49-59kW (67-80PS)	Petrol		TD23774			
KFW (TU3A)	4 Cyl.	1360cc	55kW (75PS)	Petrol		TD25066			
KFX (TU3A)	4 Cyl.	1360cc	55kW (75PS)	Petrol		TD25074			
TU3JP4	4 Cyl.	1360cc	65kW (88PS)	Petrol		TD18164			
BE/PL	4	44,975/44,991	48,655/48,671	19,750	1,820	0,024/0,081	AL-LF	62045RA	01-4173/4 STD 0.30 0.50

MB/HL 2,4	2	49,965/49,981	53,655/53,674	17,290	1,832	0,020/0,070	AL-LF	62046RA	H996/5 STD 0.30 0.50	
MB/HL 1,3,5	3	49,965/49,981	53,655/53,674	17,290	1,832	0,020/0,070	AL-LF	62047RA		
TW/A	2	55,250/55,500	71,450/71,700		2,450		BS	62047BFA	A203/2 STD 0.10	

16 75.00 x 77.00

KDY (TU3FM)	4 Cyl.	1360cc	55-58kW (75-79PS)	Petrol	TD4277
KFY (TU3FJ2)	4 Cyl.	1360cc	66kW (90PS)	Petrol	TD5078
KFZ (TU3FJ2)	4 Cyl.	1360cc	69-74kW (94-100PS)	Petrol	TD5096

BE/PL	4	44,975/44,991	48,655/48,671	19,750	1,820	0,024/0,081	AL-LF	62045RA	O1-4173/4 STD 0.30 0.50
MB/HL 2-4	3	49,965/49,981	53,712/53,731	17,290	1,854	0,023/0,086	AL-LF	4151RA	H1087/5 STD 0.30
MB/HL 1,5	2	49,965/49,981	53,712/53,731	17,290	1,854	0,023/0,086	AL-LF	4152RA	

4151RA

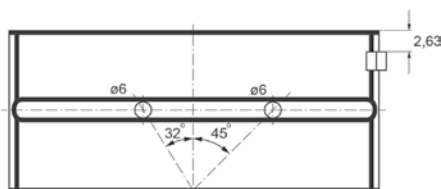

4152RA

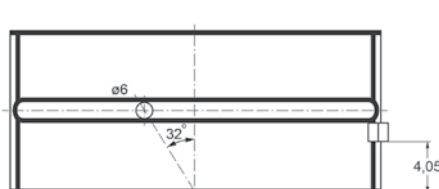

MB/HL 2,4	2	49,965/49,981	53,655/53,674	17,290	1,832	0,020/0,070	AL-LF	62046RA	H996/5 STD 0.30 0.50
MB/HL 1,3,5	3	49,965/49,981	53,655/53,674	17,290	1,832	0,020/0,070	AL-LF	62047RA	

62046RA

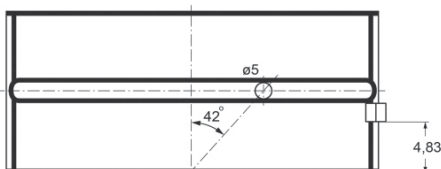

62047RA

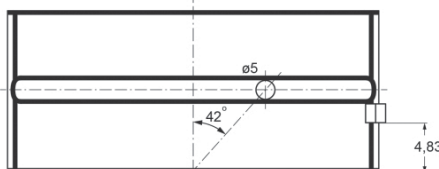

TW/A	2	55,250/55,500	71,450/71,700		2,450		BS	62047BFA	A203/2 STD 0.10
------	---	---------------	---------------	--	-------	--	----	----------	---------------------------

17 75.00 x 77.00

KFV (TU3JP)	4 Cyl.	1360cc	54-59kW (73-80PS)	Petrol	TD16464				
BE/PL	4	44,975/44,991	48,655/48,671	19,750	1,820	0,020/0,080	AL-LF	4650RA	O1-4163/4 STD
MB/HL 2,4	2	49,965/49,981	53,655/53,674	17,290	1,832	0,020/0,070	AL-LF	62046RA	H996/5 STD 0.30 0.50
MB/HL 1,3,5	3	49,965/49,981	53,655/53,674	17,290	1,832	0,020/0,070	AL-LF	62047RA	
TW/A	2	55,250/55,500	71,450/71,700		2,450		BS	62047BFA	A203/2 STD 0.10



18 75.00 x 77.00

KFW (TU3JP)	4 Cyl.	1360cc	47-55kW (64-75PS)	Petrol	TD14731
--------------------	--------	---------------	--------------------------	---------------	----------------

KFX (TU3JP)	4 Cyl.	1360cc	53-55kW (72-75PS)	Petrol	TD6554
--------------------	--------	---------------	--------------------------	---------------	---------------

BE/PL	4	44,975/44,991	48,655/48,671	19,750	1,820	0,020/0,080	AL-LF	4650RA	01-4163/4 STD
-------	---	---------------	---------------	--------	-------	-------------	-------	--------	-------------------------

10/97→

BE/PL	4	44,975/44,991	48,655/48,671	19,750	1,820	0,024/0,081	AL-LF	62045RA	01-4173/4 STD 0.30 0.50
-------	---	---------------	---------------	--------	-------	-------------	-------	---------	-----------------------------------

→09/97

4650RA

62045RA

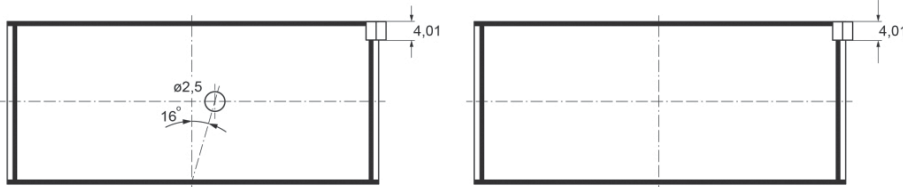

MB/HL 2,4	2	49,965/49,981	53,655/53,674	17,290	1,832	0,020/0,070	AL-LF	62046RA	H996/5 STD 0.30 0.50
MB/HL 1,3,5	3	49,965/49,981	53,655/53,674	17,290	1,832	0,020/0,070	AL-LF	62047RA	
TW/A	2	55,250/55,500	71,450/71,700		2,450		BS	62047BFA	A203/2 STD 0.10

19 75.00 x 77.00

K9A (TUD3)	4 Cyl.	1360cc	38-39kW (52-53PS)	Diesel	TD5079
-------------------	--------	---------------	--------------------------	---------------	---------------

K9Y (TUD3Y)	4 Cyl.	1360cc	37-39kW (50-53PS)	Diesel	TD5092
--------------------	--------	---------------	--------------------------	---------------	---------------

BE/PL	4	44,975/44,991	48,655/48,671	19,650	1,820	0,020/0,080	AL-LF	4665RA	01-4165/4 STD
-------	---	---------------	---------------	--------	-------	-------------	-------	--------	-------------------------

MB/HL 2-4	3	49,965/49,981	53,655/53,674	17,290	1,832	0,020/0,070	AL-LF	1261RA	H1071/5 STD 0.30 0.50
--------------	---	---------------	---------------	--------	-------	-------------	-------	--------	---------------------------------

MB/HL 1,5	2	49,965/49,981	53,655/53,674	17,290	1,832	0,020/0,070	AL-LF	1262RA	
--------------	---	---------------	---------------	--------	-------	-------------	-------	--------	--

TW/A	2	55,250/55,500	71,450/71,700		2,450		BS	62047BFA	A203/2 STD 0.10
------	---	---------------	---------------	--	-------	--	----	----------	---------------------------

20 75.00 x 88.30

9HC (DV6C)	4 Cyl.	1560cc	82-85kW (112-116PS)	Diesel Turbo	TD31490
-------------------	--------	---------------	----------------------------	---------------------	----------------

9HD (DV6C)	4 Cyl.	1560cc	82-84kW (112-114PS)	Diesel Turbo	TD29578
-------------------	--------	---------------	----------------------------	---------------------	----------------

9HE (DV6DBM) Euro 4	4 Cyl.	1560cc	66kW (90PS)	Diesel Turbo Intercooler	TD25095
----------------------------	--------	---------------	--------------------	---------------------------------	----------------

9HF (DV6DTED) Euro 4	4 Cyl.	1560cc	66kW (90PS)	Diesel Turbo Intercooler	TD25094
-----------------------------	--------	---------------	--------------------	---------------------------------	----------------

9HH (DV6DUM)	4 Cyl.	1560cc	66kW (90PS)	Diesel Turbo Intercooler	TD29698
---------------------	--------	---------------	--------------------	---------------------------------	----------------

9HJ (DV6DTEDM) Euro 4	4 Cyl.	1560cc	68kW (92PS)	Diesel Turbo Intercooler	TD25093
------------------------------	--------	---------------	--------------------	---------------------------------	----------------

9HK (DV6ETEDM) Euro 4	4 Cyl.	1560cc	55kW (75PS)	Diesel Turbo Intercooler	TD25097
------------------------------	--------	---------------	--------------------	---------------------------------	----------------

9HL (DV6C)	4 Cyl.	1560cc	82-84kW (112-114PS)	Diesel Turbo	TD26985
-------------------	--------	---------------	----------------------------	---------------------	----------------

9HM (DV6UC)	4 Cyl.	1560cc	66kW (90PS)	Diesel Turbo Intercooler	TD28622
--------------------	--------	---------------	--------------------	---------------------------------	----------------

9HN (DV6ETED) Euro 4	4 Cyl.	1560cc	55kW (75PS)	Diesel Turbo Intercooler	TD25096
-----------------------------	--------	---------------	--------------------	---------------------------------	----------------

9HN (DV6ETED4) Euro 4	4 Cyl.	1560cc	55kW (75PS)	Diesel Turbo Intercooler	TD29850
------------------------------	--------	---------------	--------------------	---------------------------------	----------------

9HP (DV6DTED) Euro 4	4 Cyl.	1560cc	68-69kW (92-94PS)	Diesel Turbo Intercooler	TD25092
-----------------------------	--------	---------------	--------------------------	---------------------------------	----------------

9HR (DV6C)	4 Cyl.	1560cc	82-84kW (112-114PS)	Diesel Turbo	TD25690
-------------------	--------	---------------	----------------------------	---------------------	----------------

9HS (DV6TED4BU) Euro 4	4 Cyl.	1560cc	66kW (90PS)	Diesel Turbo Intercooler	TD29161
-------------------------------	--------	---------------	--------------------	---------------------------------	----------------

9HT (DV6BTED4) Euro 4	4 Cyl.	1560cc	55kW (75PS)	Diesel Turbo Intercooler	TD21321
------------------------------	--------	---------------	--------------------	---------------------------------	----------------

9HT (DV6BUTED4) Euro 4	4 Cyl.	1560cc	55kW (75PS)	Diesel Turbo Intercooler	TD21322
-------------------------------	--------	---------------	--------------------	---------------------------------	----------------

9HU (DV6UTED4)	4 Cyl.	1560cc	66kW (90PS)	Diesel Turbo Intercooler	TD24692
-----------------------	--------	---------------	--------------------	---------------------------------	----------------

9HW (DV6BTED4) Euro 4	4 Cyl.	1560cc	55kW (75PS)	Diesel Turbo Intercooler	TD27840
------------------------------	--------	---------------	--------------------	---------------------------------	----------------



9HW (DV6ETED) Euro 4	4 Cyl.	1560cc	55kW (75PS)	Diesel Turbo Intercooler	TD25632
9HX (DV6ATED4) Euro 4	4 Cyl.	1560cc	66-68kW (90-92PS)	Diesel Turbo Intercooler	TD19913
9HX (DV6AUTED4) Euro 4	4 Cyl.	1560cc	66kW (90PS)	Diesel Turbo Intercooler	TD25064
9HY (DV6TED4)	4 Cyl.	1560cc	80-85kW (109-116PS)	Diesel Turbo Intercooler	TD19911
9HZ (DV6TED4) Euro 4	4 Cyl.	1560cc	80kW (109PS)	Diesel Turbo Intercooler	TD19824
BHW (DV6FE)	4 Cyl.	1560cc	55kW (75PS)	Diesel Turbo Intercooler	TD31068
BHY (DV6FD)	4 Cyl.	1560cc	73kW (99PS)	Diesel Turbo Intercooler	TD31067
DV6B Euro 4	4 Cyl.	1560cc	55kW (75PS)	Diesel Turbo	TD18832

BE/PL	4	46,975/46,991	50,655/50,674	17,000	1,818	0,028/0,063	BS	71-4246	71-4246/4 STD 0.30 0.50
-------	---	---------------	---------------	--------	-------	-------------	----	---------	-----------------------------------

USE ONLY UP TO 92HP

MB/HL 1-5	5	49,962/49,981	53,655/53,674	19,900	1,833	0,008/0,046	AL	02-4244	H1066/5 STD 0.30 0.50
TW/A	2	55,200/55,480	71,350/71,700		2,460		AL	04-4245	A217/2 STD
SE/PB	1	26,000	29,000/29,021	19,980			BS	55-4102	55-4102 SEMI

21 75.00 x 90.50

HNZ (EB2DT) Euro 6	3 Cyl.	1199cc	81kW (110PS)	Petrol Turbo	TD29366				
BE/PL	3	41,984/42,000	45,000/45,016	16,000	1,492	0,023/0,071	AL-LF	01-4990	01-4990/3 STD
MB/HL	4	41,984/42,000	45,600/45,619	16,190	1,795	0,019/0,070	AL-LF	02-4991	H1345/4 STD
MB/HL	2	41,984/42,000	45,600/45,619	16,190	1,795	0,019/0,070	AL-LF	02-4992	
MB/HL	2	41,984/42,000	45,600/45,619	16,190	1,795	0,019/0,070	AL-LF	02-4993	

22 76.70 x 70.00

G1A	4 Cyl.	1294cc	47kW (64PS)	Petrol	TD6565				
BE/PL	4	40,959/40,967	44,005/44,013	19,240	1,509	0,020/0,061	AL-LF	61820RA	01-4172/4 STD 0.20
MB/HL	2	51,966/51,976	55,882/55,892	18,680	1,924	0,058/0,103	AL-LF	61821RA	H1031/5 STD
MB/HL	6	51,966/51,976	55,882/55,892	18,680	1,924	0,058/0,103	AL-LF	61822RA	
MB/HL 3	1	51,966/51,976	55,882/55,892	24,680	1,924	0,058/0,103	AL-LF	61823RA	

23 77.00 x 82.00

VJY (TUD5)	4 Cyl.	1527cc	40-42kW (54-57PS)	Diesel	TD11890				
VJZ (TUD5)	4 Cyl.	1527cc	42-43kW (57-58PS)	Diesel	TD4296				
BE/PL	4	44,975/44,991	48,655/48,671	17,400	1,820	0,024/0,081	AL-LF	4630RA	01-4362/4 STD
MB/HL 2-4	3	49,965/49,981	53,712/53,731	17,290	1,854	0,023/0,086	AL-LF	4151RA	H1087/5 STD 0.30
MB/HL 1,5	2	49,965/49,981	53,712/53,731	17,290	1,854	0,023/0,086	AL-LF	4152RA	
TW/A	2	55,250/55,500	71,450/71,700		2,450		BS	62047BFA	A203/2 STD 0.10
SE/PB	1	23,000/23,012	25,200/25,221	19,900			BS	4154Y	55-4150 SEMI

24 78.50 x 82.00

N6A (TU5JP4)	4 Cyl.	1587cc	78-80kW (106-109PS)	Petrol	TD21504
NFR (TU5JP4B)	4 Cyl.	1587cc	66kW (90PS)	Petrol	TD21320
NFS (TU5JP4S)	4 Cyl.	1587cc	90kW (122PS)	Petrol	TD18551

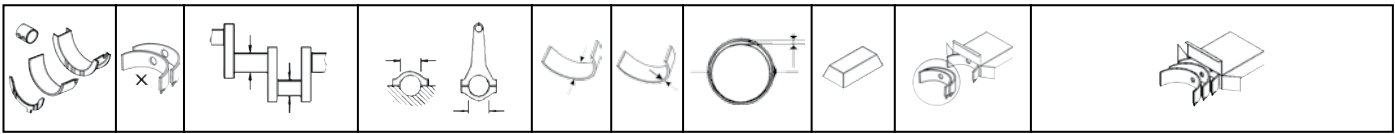

NFT	4 Cyl.	1587cc	72-74kW (98-101PS)	Petrol	TD18103				
NFU (TU5JP4)	4 Cyl.	1587cc	80-81kW (109-110PS)	Petrol	TD15308				
NFV (TU5JP)	4 Cyl.	1587cc	70kW (95PS)	Petrol	TD23392				
NFX (TU5JP4)	4 Cyl.	1587cc	82-88kW (112-120PS)	Petrol	TD10788				
NFZ (TU5JP)	4 Cyl.	1587cc	65-66kW (88-90PS)	Petrol	TD9458				
BE/PL	4	44,975/44,991	48,655/48,671	19,750	1,820	0,024/0,081	AL-LF	62045RA	01-4173/4 STD 0.30 0.50
MB/HL 2-4	3	49,965/49,981	53,712/53,731	17,290	1,854	0,023/0,086	AL-LF	4151RA	H1087/5 STD 0.30
MB/HL 1,5	2	49,965/49,981	53,712/53,731	17,290	1,854	0,023/0,086	AL-LF	4152RA	
TW/A	2	55,250/55,500	71,450/71,700		2,450		BS	62047BFA	A203/2 STD 0.10

25 80.00 x 88.00

161 (XUD7)	4 Cyl.	1769cc	44kW (60PS)	Diesel	TD586				
A9A (XUD7)	4 Cyl.	1769cc	43-44kW (58-60PS)	Diesel	TD6555				
BE/PL	4	49,984/50,000	53,695/53,708	20,050	1,830	0,040/0,090	AL-LF	66725RA	01-4200/4 STD 0.30 0.50
MB/HL 1-5	5	59,981/60,000	63,731/63,750	20,290	1,845	0,040/0,100	AL-LF	66726RA	H1057/5 STD 0.30 0.50
TW/A	4	67,050/67,300	83,050/83,300		2,330		BS	66721BF	A214/4 STD 0.10
SE/PB	1	25,007/25,020	27,200/27,221	24,050			BS	66729YA	55-4201 SEMI

26 80.00 x 88.00

161A (XUD7)	4 Cyl.	1769cc	43-44kW (58-60PS)	Diesel	TD4258				
BE/PL	4	49,984/50,000	53,695/53,708	20,050	1,830	0,040/0,090	AL-LF	66725RA	01-4200/4 STD 0.30 0.50
MB/HL 1-5	5	59,981/60,000	63,731/63,750	20,290	1,845	0,040/0,100	AL-LF	66726RA	H1057/5 STD 0.30 0.50
TW/A	4	67,050/67,300	83,050/83,300		2,330		BS	66721BF	A214/4 STD 0.10
SE/PB	1	25,007/25,020	27,200/27,221	24,050			BS	66729YA	55-4201 SEMI

12/84 →

SE/PB	1	25,007/25,020	27,000/27,021	24,150			BS	66729Y	55-4266 STD
-------	---	---------------	---------------	--------	--	--	----	--------	-----------------------

→11/84

66729YA

66729Y

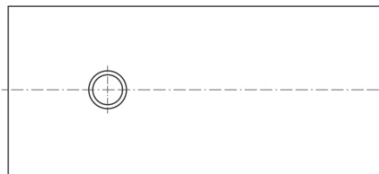
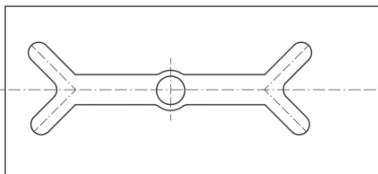

27 80.00 x 88.00

A8A (XUD7TE)	4 Cyl.	1769cc	66kW (90PS)	Diesel Turbo Intercooler	TD602				
AJZ (XUD7TE)	4 Cyl.	1769cc	66kW (90PS)	Diesel Turbo Intercooler	TD604				
BE/PL	4	49,984/50,000	53,695/53,708	20,000	1,838	0,039/0,073	EC	71-3730	71-3730/4 STD 0.30
MB/HL 1-5	5	59,981/60,000	63,731/63,750	20,290	1,845	0,040/0,100	AL-LF	66726RA	H1057/5 STD 0.30 0.50
TW/A	4	67,050/67,300	83,050/83,300		1,880		AL-LF	4141AF	A188/4 STD
SE/PB	1	28,007/28,020	30,200/30,221	23,100			BS	41450.500	55-4499 SEMI



28 82.20 x 88.00

WJX (DW8B)		4 Cyl.	1868cc	44kW (60PS)				Diesel	TD26981
WJY (DW8B)		4 Cyl.	1868cc	51-52kW (69-70PS)				Diesel	TD15310
WJZ (DW8)		4 Cyl.	1868cc	51-52kW (69-70PS)				Diesel	TD10708
BE/PL	4	49,984/50,000	53,695/53,708	20,050	1,830	0,040/0,090	AL-LF	66725RA	01-4200/4 STD 0.30 0.50
MB/HL 1-5	5	59,981/60,000	63,731/63,750	20,290	1,845	0,040/0,100	AL-LF	66726RA	H1057/5 STD 0.30 0.50
TW/A	2	67,050/67,300	83,050/83,300		2,330		BS	54-3954	A160/4 STD
TW/A	2	67,050/67,300	83,050/83,300		2,330		BS	54-3955	
SE/PB	1	25,007/25,020	27,200/27,221	24,050			BS	66729YA	55-4201 SEMI

29 82.70 x 81.40

6FY (EW7A) Euro 4		4 Cyl.	1749cc	92kW (125PS)				Petrol	TD19822
6FZ (EW7A)		4 Cyl.	1749cc	85kW (115PS)				Petrol	TD25085
6FZ (EW7J4)		4 Cyl.	1749cc	85kW (115PS)				Petrol	TD13548
BE/PL	4	44,975/44,991	48,655/48,671	22,500	1,825	0,020/0,070	AL	4300RA	01-4155/4 STD 0.30
MB/HL 1-5	5	59,981/60,000	63,708/63,727	21,000	1,862	0,020/0,083	AL-LF	02-3957	H086/5 STD
TW/A	2	67,050/67,300	83,050/83,300		2,330		AL	04-3980	A161/2 STD
CB/NWB	4	27,982/28,000	31,200/31,218	18,150	1,594		AL-LF	03-3981	N151/6 STD
CB/NWB	8	27,982/28,000	31,200/31,218	18,150	1,594		AL-LF	03-3982	

30 83.00 x 73.00

171A		4 Cyl.	1580cc	66-67kW (90-92PS)				Petrol	TD591
171B		4 Cyl.	1580cc	66-67kW (90-92PS)				Petrol	TD592
171C		4 Cyl.	1580cc	66-68kW (90-92PS)				Petrol	TD593
B1E (XU51C)		4 Cyl.	1580cc	53-59kW (72-80PS)				Petrol	TD607
XU52C		4 Cyl.	1580cc	65-85kW (88-116PS)				Petrol	TD14648
BE/PL	4	44,975/44,991	48,655/48,671	20,250	1,820	0,024/0,081	AL-LF	66720RA	01-4199/4 STD 0.30
MB/HL 1-5	5	59,990/60,000	63,718/63,727	20,290	1,845	0,028/0,072	AL-LF	66721RA	H1074/5 STD 0.30
MB/HL 1-5	5	59,990/60,000	63,718/63,727	20,290	1,845	0,028/0,072	AL-LF	66722RA	
06/87 →									
MB/HL	4	59,990/60,000	63,718/63,727	20,290	1,845	0,028/0,072	AL-LF	66721RA	H1113/5 STD 0.30
MB/HL	6	59,990/60,000	63,718/63,727	20,290	1,845	0,028/0,072	AL-LF	66722RA	
11/83 → 05/87									

66721RA

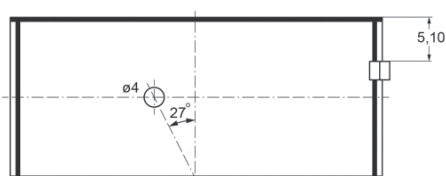

66722RA

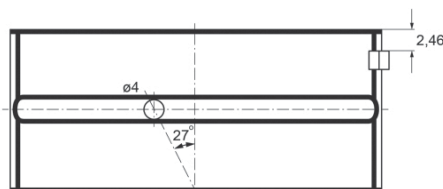



TW/A	4	67,050/67,300	83,050/83,300		2,330		BS	66721BF	A214/4 STD 0.10
------	---	---------------	---------------	--	-------	--	----	---------	---------------------------

31 83.00 x 73.00

171D	4 Cyl.		1580cc	64kW (87PS)			Petrol		TD594
BE/PL	4	44,975/44,991	48,655/48,671	20,250	1,820	0,024/0,081	AL-LF	66720RA	01-4199/4 STD 0.30
MB/HL 1-5	5	59,990/60,000	63,718/63,727	20,290	1,845	0,028/0,072	AL-LF	66721RA	H1074/5 STD 0.30
MB/HL 1-5	5	59,990/60,000	63,718/63,727	20,290	1,845	0,028/0,072	AL-LF	66722RA	
06/87 →									
MB/HL	4	59,990/60,000	63,718/63,727	20,290	1,845	0,028/0,072	AL-LF	66721RA	H1113/5 STD 0.30
MB/HL	6	59,990/60,000	63,718/63,727	20,290	1,845	0,028/0,072	AL-LF	66722RA	

→05/87

66721RA

66722RA

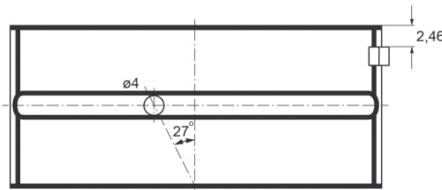
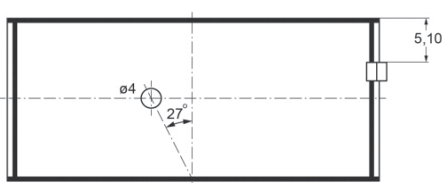

TW/A	4	67,050/67,300	83,050/83,300		2,330		BS	66721BF	A214/4 STD 0.10
------	---	---------------	---------------	--	-------	--	----	---------	---------------------------

32 83.00 x 73.00

180A (XU5J)	4 Cyl.		1580cc	76kW (103PS)			Petrol		TD596
BE/PL	4	44,975/44,991	48,655/48,671	20,250	1,822	0,020/0,077	EC	71-3627	71-3627/4 STD
MB/HL	4	59,990/60,000	63,718/63,727	20,290	1,845	0,028/0,072	AL-LF	66721RA	H1113/5 STD 0.30
MB/HL	6	59,990/60,000	63,718/63,727	20,290	1,845	0,028/0,072	AL-LF	66722RA	
TW/A	4	67,050/67,300	83,050/83,300		2,330		BS	66721BF	A214/4 STD 0.10

33 83.00 x 73.00

180Z	4 Cyl.		1580cc	76kW (103PS)			Petrol		TD597
B6D	4 Cyl.		1580cc	83-85kW (113-116PS)			Petrol		TD4262
B6E	4 Cyl.		1580cc	85kW (116PS)			Petrol		TD21866
BE/PL	4	44,975/44,991	48,655/48,671	20,250	1,822	0,020/0,077	EC	71-3627	71-3627/4 STD
MB/HL 1-5	5	59,990/60,000	63,718/63,727	20,290	1,845	0,028/0,072	AL-LF	66721RA	H1074/5 STD 0.30
MB/HL 1-5	5	59,990/60,000	63,718/63,727	20,290	1,845	0,028/0,072	AL-LF	66722RA	

06/87 →

MB/HL	4	59,990/60,000	63,718/63,727	20,290	1,845	0,028/0,072	AL-LF	66721RA	H1113/5 STD 0.30
MB/HL	6	59,990/60,000	63,718/63,727	20,290	1,845	0,028/0,072	AL-LF	66722RA	

→05/87



66721RA

66722RA

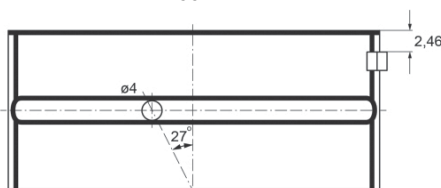
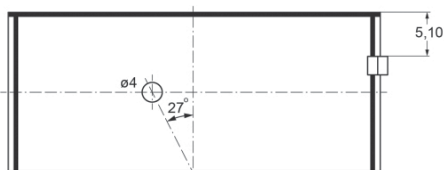

TW/A	4	67,050/67,300	83,050/83,300	2,330	BS	66721BF	A214/4 STD 0.10
------	---	---------------	---------------	-------	----	---------	---------------------------

34 83.00 x 73.00

B1A (XU51C/K)	4 Cyl.	1580cc	58-59kW (79-80PS)	Petrol	TD12428				
BAY (XU5CP)	4 Cyl.	1580cc	55kW (75PS)	Petrol	TD9550				
BAZ (XU5CP)	4 Cyl.	1580cc	55kW (75PS)	Petrol	TD9551				
BDY (XU5M)	4 Cyl.	1580cc	65kW (88PS)	Petrol	TD5097				
BDZ (XU5M)	4 Cyl.	1580cc	65kW (89PS)	Petrol	TD615				
BFZ (XU5JP)	4 Cyl.	1580cc	65kW (88PS)	Petrol	TD5101				
BE/PL	4	44,975/44,991	48,655/48,671	20,250	1,820	0,024/0,081	AL-LF	66720RA	01-4199/4 STD 0.30
MB/HL 1-5	5	59,990/60,000	63,718/63,727	20,290	1,845	0,028/0,072	AL-LF	66721RA	H1074/5 STD 0.30
MB/HL 1-5	5	59,990/60,000	63,718/63,727	20,290	1,845	0,028/0,072	AL-LF	66722RA	
TW/A	4	67,050/67,300	83,050/83,300	2,330			BS	66721BF	A214/4 STD 0.10

35 83.00 x 81.40

LFX (XU7JB)	4 Cyl.	1761cc	66kW (90PS)	Petrol	TD9457				
LFY (XU7JP4)	4 Cyl.	1762cc	81-85kW (110-116PS)	Petrol	TD4279				
LFZ (XU7JP)	4 Cyl.	1761cc	73-76kW (99-103PS)	Petrol	TD5116				
BE/PL	4	44,975/44,991	48,655/48,671	22,500	1,825	0,020/0,070	AL	4300RA	01-4155/4 STD 0.30
MB/HL 1-5	5	59,990/60,000	63,718/63,727	20,290	1,845	0,028/0,072	AL-LF	66721RA	H1074/5 STD 0.30
MB/HL 1-5	5	59,990/60,000	63,718/63,727	20,290	1,845	0,028/0,072	AL-LF	66722RA	
TW/A	4	67,050/67,300	83,050/83,300	2,330			BS	66721BF	A214/4 STD 0.10

36 83.00 x 88.00

159A	4 Cyl.	1905cc	75-77kW (102-105PS)	Petrol	TD584				
159B	4 Cyl.	1905cc	74kW (101PS)	Petrol	TD21529				
D2A (XU92C)	4 Cyl.	1905cc	75-77kW (102-105PS)	Petrol	TD628				
D2C (XU92C)	4 Cyl.	1905cc	70kW (95PS)	Petrol	TD629				
BE/PL	4	49,984/50,000	53,695/53,708	20,250	1,836	0,023/0,077	AL-LF	1305RA	01-4125/4 STD 0.30
MB/HL 1-5	5	59,990/60,000	63,718/63,727	20,290	1,845	0,028/0,072	AL-LF	66721RA	H1074/5 STD 0.30
MB/HL 1-5	5	59,990/60,000	63,718/63,727	20,290	1,845	0,028/0,072	AL-LF	66722RA	
06/87 →									
MB/HL	4	59,990/60,000	63,718/63,727	20,290	1,845	0,028/0,072	AL-LF	66721RA	H1113/5 STD 0.30
MB/HL	6	59,990/60,000	63,718/63,727	20,290	1,845	0,028/0,072	AL-LF	66722RA	
→05/87									

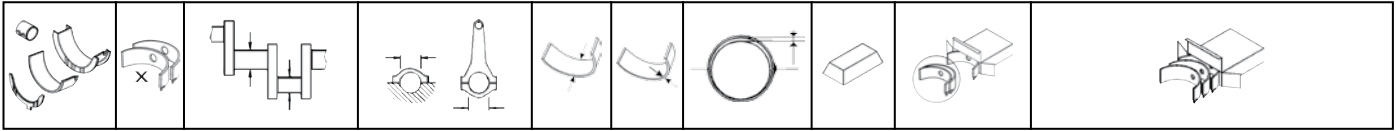

66721RA

66722RA

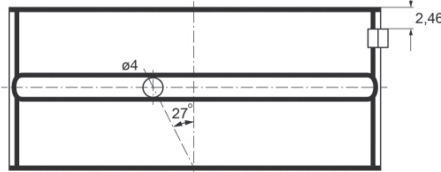
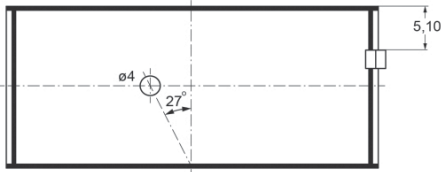

TW/A	4	67,050/67,300	83,050/83,300		2,330		BS	66721BF	A214/4 STD 0.10
------	---	---------------	---------------	--	-------	--	----	---------	--------------------

37 83.00 x 88.00

D2E		4 Cyl.	1905cc	78-79kW (107-108PS)			Petrol		TD22449
D2F		4 Cyl.	1905cc	80kW (109PS)			Petrol		TD630
BE/PL	4	49,984/50,000	53,695/53,708	20,250	1,836	0,023/0,077	AL-LF	1305RA	O1-4125/4 STD 0.30
MB/HL 1-5	5	59,990/60,000	63,718/63,727	20,290	1,845	0,028/0,072	AL-LF	66721RA	H1074/5 STD 0.30
MB/HL 1-5	5	59,990/60,000	63,718/63,727	20,290	1,845	0,028/0,072	AL-LF	66722RA	
TW/A	4	67,050/67,300	83,050/83,300		2,330		BS	66721BF	A214/4 STD 0.10

38 83.00 x 88.00

D6A (XU9J2)		4 Cyl.	1905cc	90-92kW (122-125PS)			Petrol		TD631
DFZ (XU9J1)		4 Cyl.	1905cc	75kW (102PS)			Petrol		TD9548
BE/PL	4	49,984/50,000	53,695/53,708	20,250	1,842	0,020/0,065	EC	71-3628	71-3628/4 STD 0.30
MB/HL 1-5	5	59,990/60,000	63,718/63,727	20,290	1,845	0,028/0,072	AL-LF	66721RA	H1074/5 STD 0.30
MB/HL 1-5	5	59,990/60,000	63,718/63,727	20,290	1,845	0,028/0,072	AL-LF	66722RA	
06/87 →									
MB/HL	4	59,990/60,000	63,718/63,727	20,290	1,845	0,028/0,072	AL-LF	66721RA	H1113/5 STD 0.30
MB/HL	6	59,990/60,000	63,718/63,727	20,290	1,845	0,028/0,072	AL-LF	66722RA	
→05/87									

66721RA

66722RA

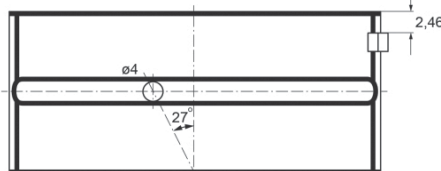
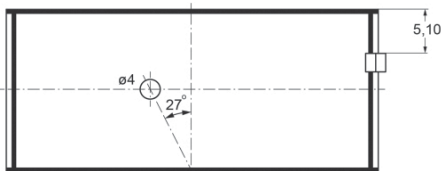

TW/A	4	67,050/67,300	83,050/83,300		2,330		BS	66721BF	A214/4 STD 0.10
------	---	---------------	---------------	--	-------	--	----	---------	--------------------

39 83.00 x 88.00

D6C (XU9J4)		4 Cyl.	1905cc	116kW (158PS)			Petrol		TD632
D6E (XU9JA)		4 Cyl.	1905cc	93kW (126PS)			Petrol		TD22622
DDZ (XU9M)		4 Cyl.	1905cc	80kW (109PS)			Petrol		TD639
DFW (XU9J4)		4 Cyl.	1905cc	108-110kW (147-150PS)			Petrol		TD640
DKZ (XU9JA)		4 Cyl.	1905cc	88kW (120PS)			Petrol		TD647
BE/PL	4	49,984/50,000	53,695/53,708	20,250	1,842	0,020/0,065	EC	71-3628	71-3628/4 STD 0.30

MB/HL 1-5	5	59,990/60,000	63,718/63,727	20,290	1,845	0,028/0,072	AL-LF	66721RA	H1074/5 STD 0.30
MB/HL 1-5	5	59,990/60,000	63,718/63,727	20,290	1,845	0,028/0,072	AL-LF	66722RA	
TW/A	4	67,050/67,300	83,050/83,300		2,330		BS	66721BF	A214/4 STD 0.10

40 83.00 x 88.00

162 (XUD9)			4 Cyl.	1905cc	47kW (65PS)		Diesel		TD587
D9A (XUD9)			4 Cyl.	1905cc	47kW (64PS)		Diesel		TD4265
DJZ (XUD9Y)			4 Cyl.	1905cc	47-50kW (65-68PS)		Diesel		TD646
BE/PL	4	49,984/50,000	53,695/53,708	20,050	1,830	0,040/0,090	AL-LF	66725RA	01-4200/4 STD 0.30 0.50
MB/HL 1-5	5	59,981/60,000	63,731/63,750	20,290	1,845	0,040/0,100	AL-LF	66726RA	H1057/5 STD 0.30 0.50
TW/A	4	67,050/67,300	83,050/83,300		2,330		BS	66721BF	A214/4 STD 0.10
SE/PB	1	25,007/25,020	27,200/27,221	24,050			BS	66729YA	55-4201 SEMI
12/84→									
SE/PB	1	25,007/25,020	27,000/27,021	24,150			BS	66729Y	55-4266 STD
→11/84									

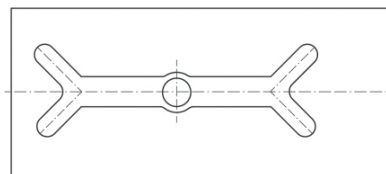
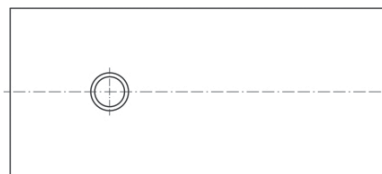
66729YA

66729Y

41 83.00 x 88.00

D8B (XUD9TF)			4 Cyl.	1905cc	66-68kW (90-92PS)		Diesel Turbo		TD5046
DHV (XUD9BSD)			4 Cyl.	1905cc	55kW (75PS)		Diesel		TD22991
DHW (XUD9SD)			4 Cyl.	1905cc	50-55kW (68-75PS)		Diesel Turbo Intercooler		TD10689
DHX (XUD9TF/BTF)			4 Cyl.	1905cc	66-68kW (90-92PS)		Diesel Turbo Intercooler		TD4268
BE/PL	4	49,984/50,000	53,695/53,708	20,000	1,838	0,039/0,073	EC	71-3730	71-3730/4 STD 0.30
MB/HL 1-5	5	59,981/60,000	63,731/63,750	20,290	1,845	0,040/0,100	AL-LF	66726RA	H1057/5 STD 0.30 0.50
TW/A	4	67,050/67,300	83,050/83,300		1,880		AL-LF	4141AF	A188/4 STD
SE/PB	1	28,007/28,020	30,200/30,221	23,100			BS	41450.500	55-4499 SEMI

42 83.00 x 88.00

D8C (XUD9UTF)			4 Cyl.	1905cc	66-68kW (90-92PS)		Diesel Turbo		TD4264
BE/PL	4	49,984/50,000	53,695/53,708	20,000	1,838	0,020/0,073	EC	71-3899	71-3899/4 STD 0.30
MB/HL 1-5	5	59,981/60,000	63,731/63,750	20,290	1,845	0,040/0,100	AL-LF	66726RA	H1057/5 STD 0.30 0.50
TW/A	4	67,050/67,300	83,050/83,300		1,880		AL-LF	4141AF	A188/4 STD
SE/PB	1	28,007/28,020	30,200/30,221	23,100			BS	41450.500	55-4499 SEMI



43 83.00 x 88.00

D9B (XUD9A/L)		4 Cyl.		1905cc	50-51kW (68-69PS)		Diesel		TD4267
D9B (XUD9A/U)		4 Cyl.		1905cc	50-51kW (68-69PS)		Diesel		TD4266
DJY (XUD9A)		4 Cyl.		1905cc	50-52kW (68-71PS)		Diesel		TD6556
BE/PL	4	49,984/50,000	53,695/53,708	20,050	1,830	0,040/0,090	AL-LF	66725RA	01-4200/4 STD 0.30 0.50
MB/HL 1-5	5	59,981/60,000	63,731/63,750	20,290	1,845	0,040/0,100	AL-LF	66726RA	H1057/5 STD 0.30 0.50
TW/A	4	67,050/67,300	83,050/83,300		2,330		BS	66721BF	A214/4 STD 0.10
SE/PB	1	25,007/25,020	27,200/27,221	24,050			BS	66729YA	55-4201 SEMI

44 83.00 x 88.00

DHY (XUD9TE/Y)		4 Cyl.		1905cc	66kW (90PS)		Diesel Turbo Intercooler		TD4269
BE/PL	4	49,984/50,000	53,695/53,708	20,000	1,838	0,039/0,073	EC	71-3730	71-3730/4 STD 0.30
BE/PL	4	49,984/50,000	53,695/53,708	20,000	1,838	0,020/0,073	EC	71-3899	71-3899/4 STD 0.30

71-3730

71-3899

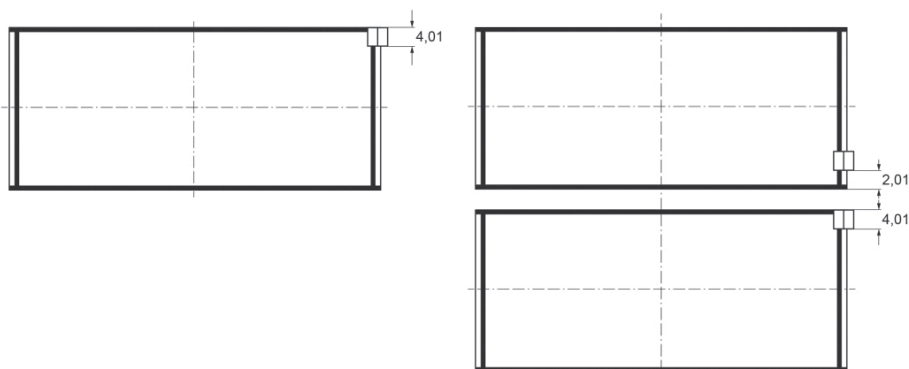

MB/HL 1-5	5	59,981/60,000	63,731/63,750	20,290	1,845	0,040/0,100	AL-LF	66726RA	H1057/5 STD 0.30 0.50
TW/A	4	67,050/67,300	83,050/83,300		1,880		AL-LF	4141AF	A188/4 STD
SE/PB	1	28,007/28,020	30,200/30,221	23,100			BS	41450.500	55-4499 SEMI

45 84.00 x 81.00

169 (XM7T)		4 Cyl.		1796cc	49-51kW (67-69PS)		Petrol		TD588
BE/PL	4	49,975/49,991	53,655/53,674	23,400	1,818	0,030/0,080	AL-LF	2865RA	01-4558/4 STD 0.30 0.50 0.80
MB/HL 5	1	54,905/54,920	58,731/58,750	29,350	1,900	0,040/0,080	AL-LF	66696RA	H1241/5 STD 0.30 0.50 0.80
MB/HL 4	1	56,140/56,165	59,976/59,995	21,500	1,900	0,040/0,080	AL-LF	66697RA	
MB/HL 3	1	57,174/57,189	61,000/61,019	29,500	1,900	0,040/0,080	AL-LF	66698RA	
MB/HL 2	1	58,548/58,573	62,384/62,403	21,500	1,900	0,040/0,080	AL-LF	66699RA	
MB/HL 1	1	59,401/59,416	63,227/63,246	29,500	1,900	0,040/0,080	AL-LF	66699RAA	
TW/A	4	61,400/61,650	72,550/72,800		2,330		AL-LF	61904BF	A199/4 STD 0.10 0.15 0.20

46
84.00 x 81.00

169B		4 Cyl.		1796cc	49-51kW (69-69PS)		Petrol		TD6575
BE/PL	4	49,975/49,991	53,655/53,674	23,400	1,818	0,030/0,080	AL-LF	2865RA	01-4558/4 STD 0.30 0.50 0.80
MB/HL 1	1	59,401/59,416	63,227/63,246	29,500	1,888	0,040/0,080	AL-LF	2866RA	H1240/5 STD 0.30 0.50 0.80
MB/HL 2	1	58,548/58,573	62,384/62,403	21,500	1,888	0,040/0,080	AL-LF	61902RA	
MB/HL 3	1	57,174/57,189	61,000/61,019	29,500	1,888	0,040/0,080	AL-LF	61903RA	
MB/HL 4	1	56,140/56,165	59,976/59,995	21,500	1,888	0,040/0,080	AL-LF	61903RAA	
MB/HL 5	1	54,905/54,920	58,731/58,750	29,350	1,888	0,040/0,080	AL-LF	61904RA	
08/71→10/81									
MB/HL 5	1	54,905/54,920	58,731/58,750	29,350	1,900	0,040/0,080	AL-LF	66696RA	H1241/5 STD 0.30 0.50 0.80
MB/HL 4	1	56,140/56,165	59,976/59,995	21,500	1,900	0,040/0,080	AL-LF	66697RA	
MB/HL 3	1	57,174/57,189	61,000/61,019	29,500	1,900	0,040/0,080	AL-LF	66698RA	
MB/HL 2	1	58,548/58,573	62,384/62,403	21,500	1,900	0,040/0,080	AL-LF	66699RA	
MB/HL 1	1	59,401/59,416	63,227/63,246	29,500	1,900	0,040/0,080	AL-LF	66699RAA	
11/81→									
TW/A	4	61,400/61,650	72,550/72,800		2,330		AL-LF	61904BF	A199/4 STD 0.10 0.15 0.20

47
85.00 x 88.00

RFH (EW10A) Euro 4		4 Cyl.		1997cc	103kW (140PS)		Petrol		TD24145
RFJ (EW10A)		4 Cyl.		1997cc	103-105kW (140-143PS)		Petrol		TD19823
RFK (EW10A)		4 Cyl.		1997cc	130kW (177PS)		Petrol		TD25086
RFK (EW10J4S)		4 Cyl.		1997cc	130kW (177PS)		Petrol		TD19910
RFN (EW10A)		4 Cyl.		1997cc	100kW (136PS)		Petrol		TD25087
RFN (EW10J4)		4 Cyl.		1997cc	100-105kW (136-143PS)		Petrol		TD15309
RFR (EW10A)		4 Cyl.		1997cc	100kW (136PS)		Petrol		TD25088
RLZ (EW10D)		4 Cyl.		1997cc	103kW (140PS)		Petrol		TD16233
BE/PL	4	44,975/44,991	48,655/48,671	22,500	1,825	0,020/0,070	AL	4300RA	01-4155/4 STD 0.30
MB/HL 1-5	5	59,981/60,000	63,708/63,727	21,000	1,862	0,020/0,083	AL-LF	02-3957	H086/5 STD
TW/A	2	67,050/67,300	83,050/83,300		2,330		AL	04-3980	A161/2 STD
CB/NWB	4	27,982/28,000	31,200/31,218	18,150	1,594		AL-LF	03-3981	N151/6 STD
CB/NWB	8	27,982/28,000	31,200/31,218	18,150	1,594		AL-LF	03-3982	

48
85.00 x 88.00

AHR (DW10FD) Euro 5		4 Cyl.		1997cc	110kW (150PS)		Diesel Turbo Intercooler		TD31846
AHW (DW10FC) Euro 5		4 Cyl.		1997cc	133kW (181PS)		Diesel Turbo Intercooler		TD28616
AHY (DW10CE) Euro 5		4 Cyl.		1997cc	72kW (98PS)		Diesel Turbo Intercooler		TD29730
AHZ (DW10CD) Euro 5		4 Cyl.		1997cc	94kW (128PS)		Diesel Turbo Intercooler		TD29729
RHB (DW10DTE4) Euro 5		4 Cyl.		1997cc	110kW (150PS)		Diesel Turbo Intercooler		TD29731
RHC (DW10CTE4) Euro 5		4 Cyl.		1997cc	120kW (163PS)		Diesel Turbo Intercooler		TD28242
RHD (DW10CB) Euro 4		4 Cyl.		1997cc	100kW (136PS)		Diesel Turbo Intercooler		TD29779



RHD (DW10CTED4) Euro 4	4 Cyl.	1997cc	100kW (136PS)	Diesel Turbo Intercooler	TD29706
RHE (DW10CTED4)	4 Cyl.	1997cc	110-120kW (150-163PS)	Diesel Turbo Intercooler	TD24935
RHF (DW10BTED4)	4 Cyl.	1997cc	100-103kW (136-140PS)	Diesel Turbo Intercooler	TD26795
RHH (DW10CTED4) Euro 5	4 Cyl.	1997cc	120kW (163PS)	Diesel Turbo Intercooler	TD23770
RHJ (DW10BTED4) Euro 4	4 Cyl.	1997cc	100kW (136PS)	Diesel Turbo Intercooler	TD19825
RHS (DW10ATED)	4 Cyl.	1997cc	79kW (107PS)	Diesel Turbo Intercooler	TD20782
RHT (DW10ATED4)	4 Cyl.	1997cc	79kW (107PS)	Diesel Turbo Intercooler	TD20785
RHV (DW10TD)	4 Cyl.	1997cc	62kW (84PS)	Diesel Turbo Intercooler	TD24877
RHV (DW10UTD)	4 Cyl.	1997cc	62kW (84PS)	Diesel Turbo	TD16739
RHY (DW10TD)	4 Cyl.	1997cc	66kW (90PS)	Diesel Turbo Intercooler	TD15311

BE/PL	4	49,984/50,000	53,695/53,708	20,000	1,838	0,020/0,070	SP	71-3952	71-3952/4 STD 0.30	1
MB/HL 1-5	5	59,981/60,000	63,731/63,750	20,290	1,845	0,040/0,100	AL-LF	66726RA	H1057/5 STD 0.30 0.50	
TW/A	4	67,050/67,300	83,050/83,300		2,330		BS	66721BF	A214/4 STD 0.10	
SE/PB	1	27,997/28,000	30,200/30,225	24,050			BS-LF	55-3985	55-3985 SEMI	

49 85.00 x 88.00

RHK (DW10UTED4) Euro 4	4 Cyl.	1997cc	79-88kW (107-120PS)	Diesel Turbo Intercooler	TD20787
RHM (DW10ATED4)	4 Cyl.	1997cc	79kW (107PS)	Diesel Turbo Intercooler	TD20786
RHR (DW10BTED4) Euro 4	4 Cyl.	1997cc	100kW (136PS)	Diesel Turbo Intercooler	TD19912
RHW (DW10ATED4)	4 Cyl.	1997cc	79-80kW (107-109PS)	Diesel Turbo Intercooler	TD20784
RHX (DW10BTED)	4 Cyl.	1997cc	69kW (94PS)	Diesel Turbo Intercooler	TD21039
RHZ (DW10ATED)	4 Cyl.	1997cc	79-81kW (107-110PS)	Diesel Turbo	TD12829

BE/PL	4	49,984/50,000	53,695/53,708	20,000	1,838	0,020/0,070	SP	71-3952	71-3952/4 STD 0.30	1
MB/HL 1-5	5	59,981/60,000	63,731/63,750	20,290	1,845	0,040/0,100	AL-LF	66726RA	H1057/5 STD 0.30 0.50	
TW/A	4	67,050/67,300	83,050/83,300		2,330		BS	66721BF	A214/4 STD 0.10	
SE/PB	1	27,997/28,000	30,200/30,225	24,050			BS-LF	55-3985	55-3985 SEMI	

50 85.00 x 92.00

P8A (XUD11ATE)	4 Cyl.	2088cc	80-81kW (109-110PS)	Diesel Turbo Intercooler	TD711
P8C (XUD11BTE)	4 Cyl.	2088cc	80kW (109PS)	Diesel Turbo Intercooler	TD4281
PHZ (XUD11ATE)	4 Cyl.	2088cc	80-81kW (109-110PS)	Diesel Turbo Intercooler	TD717
PJZ (XUD11ATE)	4 Cyl.	2088cc	80kW (109PS)	Diesel Turbo Intercooler	TD718

BE/PL	4	49,984/50,000	53,695/53,708	21,950	1,843	0,020/0,064	BS	4255CP	71-4279/4 STD 0.30	
MB/HL 1-5	5	59,981/60,000	63,731/63,750	20,290	1,845	0,040/0,100	AL-LF	66726RA	H1057/5 STD 0.30 0.50	
TW/A	4	67,050/67,300	83,050/83,300		1,880		AL-LF	4141AF	A188/4 STD	

51 85.00 x 96.00

4HL (DW12C)	4 Cyl.	2179cc	150kW (204PS)	Diesel Turbo Intercooler	TD26899
4HN (DW12MTED4)	4 Cyl.	2179cc	115kW (156PS)	Diesel Turbo Intercooler	TD24713
4HP (DW12BTED4) Euro 4	4 Cyl.	2179cc	120kW (163PS)	Diesel Bi-Turbo Intercooler	TD29271
4HR (DW12BTED4) Euro 4	4 Cyl.	2179cc	120kW (163PS)	Diesel Bi-Turbo Intercooler	TD29272
4HT (DW12BTED4) Euro 4	4 Cyl.	2179cc	125kW (170PS)	Diesel Bi-Turbo Intercooler	TD20812
4HW (DW12TED4)	4 Cyl.	2179cc	94kW (128PS)	Diesel Turbo Intercooler	TD20024
4HX (DW12TED4/FAP)	4 Cyl.	2179cc	94-98kW (128-133PS)	Diesel	TD16165
4HY (DW12UTED)	4 Cyl.	2179cc	74kW (101PS)	Diesel	TD24468

BE/PL	4	49,984/50,000	53,695/53,708	20,000	1,838	0,020/0,070	SP	71-3952	71-3952/4 STD 0.30	1
MB/HL 1-5	5	59,981/60,000	63,731/63,750	20,290	1,845	0,040/0,100	AL-LF	66726RA	H1057/5 STD 0.30 0.50	
TW/A	4	67,050/67,300	83,050/83,300		2,330		BS	66721BF	A214/4 STD 0.10	
SE/PB	1	29,995/30,000	33,000/33,025	24,050			BS-LF	55-3984	55-3984 SEMI	
CB/NWB	4	27,982/28,000	31,200/31,218	18,150	1,594		AL-LF	03-3981	N151/6 STD	
CB/NWB	8	27,982/28,000	31,200/31,218	18,150	1,594		AL-LF	03-3982		

52
86.00 x 86.00

R6A			4 Cyl.	1998cc	90-96kW (122-130PS)		Petrol			TD22606
RDZ (XU10MZ)			4 Cyl.	1998cc	79kW (107PS)		Petrol			TD9552
RFT (XU10J4/Z)			4 Cyl.	1998cc	110-114kW (150-155PS)		Petrol			TD5066
RFV (XU10J4R)			4 Cyl.	1998cc	97-99kW (132-135PS)		Petrol			TD11667
RFX XU10J2C/Z L3			4 Cyl.	1998cc	89-95kW (121-129PS)		Petrol			TD4286
RFX (XU10J2C)			4 Cyl.	1998cc	89-90kW (120-122PS)		Petrol			TD727
RFY (XU10J4/Z)			4 Cyl.	1998cc	110-114kW (150-155PS)		Petrol			TD4288
RFZ (XU10J2)			4 Cyl.	1998cc	89-90kW (121-122PS)		Petrol			TD729
XU102C			4 Cyl.	1998cc	79kW (107PS)		Petrol			TD12830
BE/PL	4	49,984/50,000	53,695/53,708	21,950	1,834	0,027/0,081	AL-LF	4150RA	01-4149/4 STD 0.30	
→08/92										
BE/PL	4	49,984/50,000	53,695/53,708	20,250	1,837	0,021/0,075	AL	4305RA	01-4298/4 STD 0.30	
09/92→										
MB/HL 1-5	5	59,981/60,000	63,731/63,750	20,290	1,845	0,040/0,100	AL-LF	66726RA	H1057/5 STD 0.30 0.50	
TW/A	4	67,050/67,300	83,050/83,300		1,880		AL-LF	4141AF	A188/4 STD	

53
86.00 x 86.00

RFS (XU10J4RS)			4 Cyl.	1998cc	120-122kW (163-166PS)		Petrol			TD10668
RFU (XU10J2/C)			4 Cyl.	1998cc	89kW (121PS)		Petrol			TD4284
RFW (XU10J2U)			4 Cyl.	1998cc	80kW (109PS)		Petrol			TD4285
XU10J2			4 Cyl.	1998cc	81kW (110PS)		Petrol			TD16738
BE/PL	4	49,984/50,000	53,695/53,708	20,250	1,837	0,021/0,075	AL	4305RA	01-4298/4 STD 0.30	
MB/HL 1-5	5	59,981/60,000	63,731/63,750	20,290	1,845	0,040/0,100	AL-LF	66726RA	H1057/5 STD 0.30 0.50	
TW/A	4	67,050/67,300	83,050/83,300		1,880		AL-LF	4141AF	A188/4 STD	

54
86.00 x 86.00

RGX (XU10J2TE)			4 Cyl.	1998cc	108kW (147PS)		Petrol Turbo Intercooler			TD4290
BE/PL	4	49,984/50,000	53,695/53,708	20,250	1,837	0,021/0,075	AL	4305RA	01-4298/4 STD 0.30	
BE/PL	4	49,984/50,000	53,695/53,708	21,950	1,843	0,020/0,064	BS	4255CP	71-4279/4 STD 0.30	
MB/HL 1-5	5	59,981/60,000	63,731/63,750	20,290	1,845	0,040/0,100	AL-LF	66726RA	H1057/5 STD 0.30 0.50	
TW/A	4	67,050/67,300	83,050/83,300		1,880		AL-LF	4141AF	A188/4 STD	



55 86.00 x 86.00

RGY (XU10J2TE/Z)		4 Cyl.		1998cc	104-108kW (141-147PS)			Petrol Turbo		TD4291
BE/PL	4	49,984/50,000	53,695/53,708	21,950	1,843	0,020/0,064	BS	4255CP	71-4279/4 STD 0.30	
MB/HL 1-5	5	59,981/60,000	63,731/63,750	20,290	1,845	0,040/0,100	AL-LF	66726RA	H1057/5 STD 0.30 0.50	
TW/A	4	67,050/67,300	83,050/83,300		1,880		AL-LF	4141AF	A188/4 STD	

56 86.00 x 92.00

P9A (XUD11A)		4 Cyl.		2138cc	60-61kW (82-83PS)			Diesel		TD713
XUD11 A		4 Cyl.		2138cc	61kW (83PS)			Diesel		TD22087
MB/HL 1-5	5	59,981/60,000	63,731/63,750	20,290	1,845	0,040/0,100	AL-LF	66726RA	H1057/5 STD 0.30 0.50	
TW/A	4	67,050/67,300	83,050/83,300		1,880		AL-LF	4141AF	A188/4 STD	

57 86.00 x 94.60







4HH (P22DTE) Euro 4		4 Cyl.		2198cc	96kW (130PS)			Diesel Turbo Intercooler		TD30660
4HU (P22DTE) Euro 4		4 Cyl.		2198cc	88kW (120PS)			Diesel Turbo Intercooler		TD24538
4HV (P22DTE) Euro 4		4 Cyl.		2198cc	74kW (101PS)			Diesel Turbo Intercooler		TD24537
BE/PL	4	52,980/53,000	55,996/56,016	24,450	1,487	0,026/0,084	BS	71-4066	71-4066/4 STD 0.25 0.50	
MB/HL	4	64,940	69,520	23,280	2,250		AL-LF	02-4067	H1018/5 STD 0.25 0.50	
MB/HL	3	64,940	69,520	24,080	2,250		AL-LF	02-4068		
MB/HL	2	69,940	74,520	19,580	2,250		AL-LF	02-4069		
MB/HL	1	64,940	69,520	30,150	2,250		AL-LF	02-4070H		

58 86.40 x 67.40

220 A2.000		4 Cyl.		1581cc	59-60kW (80-81PS)			Petrol		TD6587
1580 SPI		4 Cyl.		1581cc	58kW (79PS)			Petrol		TD12808
BE/PL	4	45,508/45,528	48,629/48,646	19,200	1,547	0,020/0,069	AL-LF	1645RA	01-4127/4 STD 0.25 0.50	
MB/HL 1,2,4,5	4	50,780/50,800	54,507/54,520	20,250	1,849	0,020/0,067	AL-LF	1646RA	H1075/5 STD 0.25 0.50	
MB/HL 3	1	50,780/50,800	54,507/54,520	22,750	1,849	0,020/0,067	AL-LF	1647RA		
TW/A	2	56,610/56,864	69,596/69,850		2,362		AL-LF	60987AFA	A198/2 STD .005	
SE/PB	1	21,539/21,641	23,939/23,972	25,100			BS	62039Y	55-4288 SEMI	

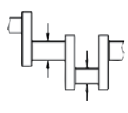
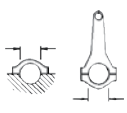
59 88.00 x 81.00

170A (XN1T)		4 Cyl.		1971cc	58kW (79PS)			Petrol		TD5164
170B (XN1T)		4 Cyl.		1971cc	58-62kW (79-84PS)			Petrol		TD589
BE/PL	4	49,975/49,991	53,655/53,674	23,400	1,818	0,030/0,080	AL-LF	2865RA	01-4558/4 STD 0.30 0.50 0.80	

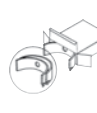
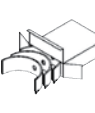
									
MB/HL 1	1	59,401/59,416	63,227/63,246	29,500	1,888	0,040/0,080	AL-LF	2866RA	H1240/5 STD 0.30 0.50 0.80
MB/HL 2	1	58,548/58,573	62,384/62,403	21,500	1,888	0,040/0,080	AL-LF	61902RA	
MB/HL 3	1	57,174/57,189	61,000/61,019	29,500	1,888	0,040/0,080	AL-LF	61903RA	
MB/HL 4	1	56,140/56,165	59,976/59,995	21,500	1,888	0,040/0,080	AL-LF	61903RAA	
MB/HL 5	1	54,905/54,920	58,731/58,750	29,350	1,888	0,040/0,080	AL-LF	61904RA	
→10/81									
MB/HL 5	1	54,905/54,920	58,731/58,750	29,350	1,900	0,040/0,080	AL-LF	66696RA	H1241/5 STD 0.30 0.50 0.80
MB/HL 4	1	56,140/56,165	59,976/59,995	21,500	1,900	0,040/0,080	AL-LF	66697RA	
MB/HL 3	1	57,174/57,189	61,000/61,019	29,500	1,900	0,040/0,080	AL-LF	66698RA	
MB/HL 2	1	58,548/58,573	62,384/62,403	21,500	1,900	0,040/0,080	AL-LF	66699RA	
MB/HL 1	1	59,401/59,416	63,227/63,246	29,500	1,900	0,040/0,080	AL-LF	66699RAA	
11/81→									
TW/A	4	61,400/61,650	72,550/72,800		2,330		AL-LF	61904BF	A199/4 STD 0.10 0.15 0.20

60
88.00 x 81.00

170C (XN1T)		4 Cyl.		1971cc	62kW (84PS)	Petrol			TD590
BE/PL	4	49,975/49,991	53,655/53,674	23,400	1,818	0,030/0,080	AL-LF	2865RA	01-4558/4 STD 0.30 0.50 0.80
MB/HL 5	1	54,905/54,920	58,731/58,750	29,350	1,900	0,040/0,080	AL-LF	66696RA	H1241/5 STD 0.30 0.50 0.80
MB/HL 4	1	56,140/56,165	59,976/59,995	21,500	1,900	0,040/0,080	AL-LF	66697RA	
MB/HL 3	1	57,174/57,189	61,000/61,019	29,500	1,900	0,040/0,080	AL-LF	66698RA	
MB/HL 2	1	58,548/58,573	62,384/62,403	21,500	1,900	0,040/0,080	AL-LF	66699RA	
MB/HL 1	1	59,401/59,416	63,227/63,246	29,500	1,900	0,040/0,080	AL-LF	66699RAA	
TW/A	4	61,400/61,650	72,550/72,800		2,330		AL-LF	61904BF	A199/4 STD 0.10 0.15 0.20

61
88.00 x 82.00

829 A5		4 Cyl.		1995cc	75-78kW (102-106PS)	Petrol			TD4259
BE/PL	4	52,267/52,286	56,000/56,019	18,750	1,852	0,020/0,073	AL-LF	66600RA	01-4187/4 STD
MB/HL 1-5	5	62,873/62,892	66,668/66,687	23,500	1,884	0,020/0,071	AL-LF	66507RA	H1052/5 STD 0.25
→06/82									
MB/HL 1-5	5	62,861/62,880	66,668/66,687	23,250	1,884	0,030/0,093	AL-LF	66646RA	H1058/5 STD 0.25
07/82→									



66507RA

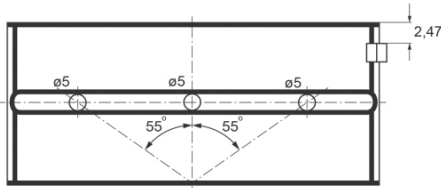

66646RA

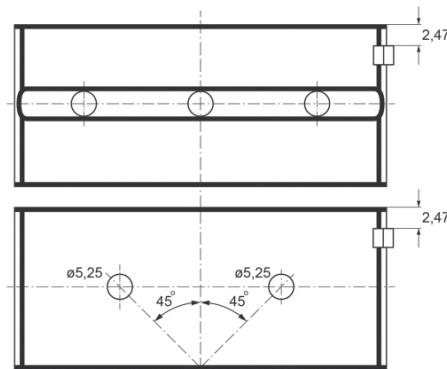

TW/A	2	71,450	88,090		2,850	BS	66506BF	A208/2 STD
------	---	--------	--------	--	-------	----	---------	---------------

→06/82

TW/A	2	71,450	88,090		2,850	BS	66646BF	A210/2 STD
------	---	--------	--------	--	-------	----	---------	---------------

07/82→

66506BF

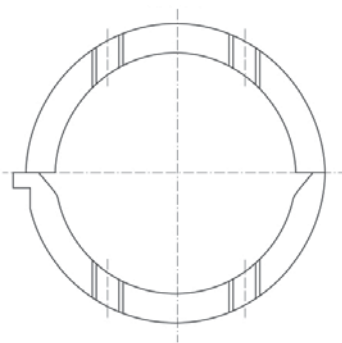

66646BF

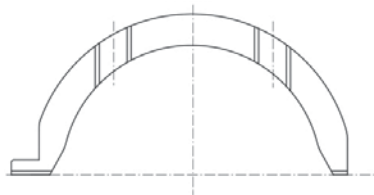

62

88.00 x 89.00

J6T A500	4 Cyl.	2165cc	83-85kW (113-115PS)	Petrol	TD663				
BE/PL	4	56,267/56,286	60,005/60,019	20,750	1,842	0,035/0,093	AL-LF	66635RA	01-4189/4 STD 0.25
BE/PL	4	56,267/56,286	60,005/60,019	20,750	1,842	0,035/0,093	AL-LF	66645RA	01-4191/4 STD 0.25
BE/PL	4	56,267/56,286	60,005/60,019	20,750	1,842	0,035/0,093	AL-LF	66645RAA	01-4192/4 STD

66635RA

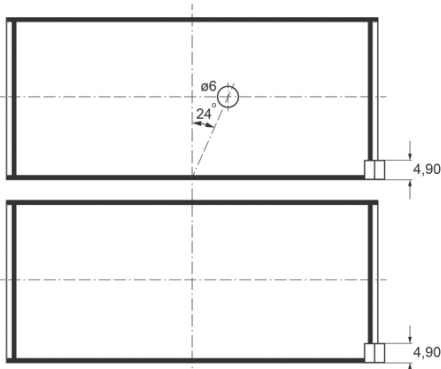

66645RA

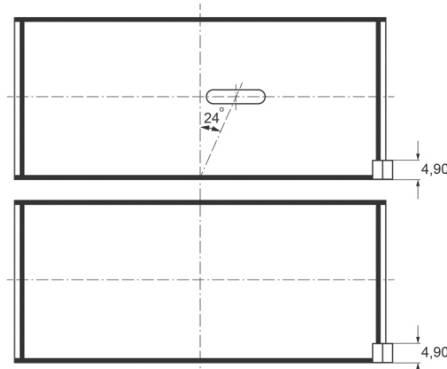

66645RAA

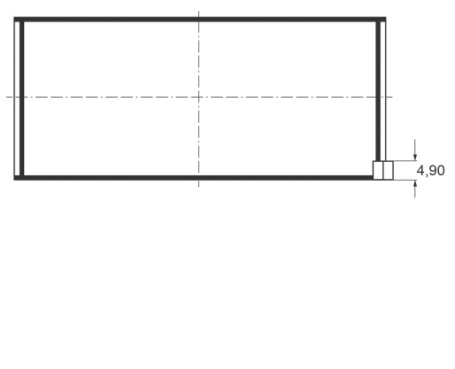

MB/HL 1-5	5	62,873/62,892	66,668/66,687	23,500	1,884	0,020/0,071	AL-LF	66507RA	H1052/5 STD 0.25
--------------	---	---------------	---------------	--------	-------	-------------	-------	---------	---------------------



MB/HL 1-5	5	62,861/62,880	66,668/66,687	23,250	1,884	0,030/0,093	AL-LF	66646RA	H1058/5 STD 0.25
--------------	---	---------------	---------------	--------	-------	-------------	-------	---------	----------------------------

66507RA

66646RA

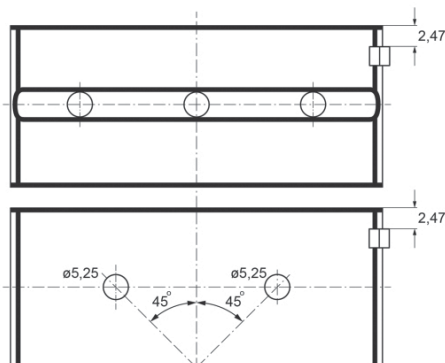
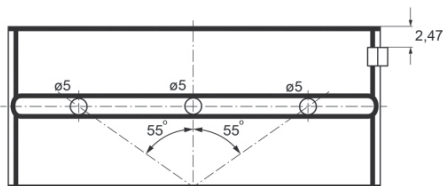

TW/A	2	71,450	88,090	2,850	BS	66506BF	A208/2 STD
TW/A	2	71,450	88,090	2,850	BS	66646BF	A210/2 STD

66506BF

66646BF

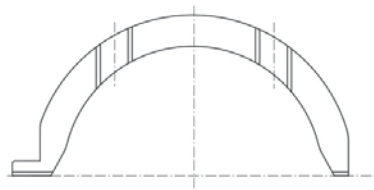
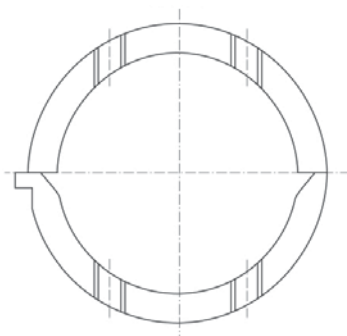

63	90.00 x 85.50								
B22615		4 Cyl.	2175cc	45-46kW (61-63PS)	Diesel				TD6897
CRD90		4 Cyl.	2175cc	46kW (62PS)	Diesel				TD6576
M22-621		4 Cyl.	2175cc	49kW (66PS)	Diesel				TD689

BE/PL	4	53,990/54,005	57,675/57,685	24,500	1,826	0,020/0,069	AL-LF	66440RAA	01-4181/4 STD 0.25 0.50
SE/PB	1	30,008/30,014	33,000/33,033	31,900			BS	66444X	55-4393 SEMI

64	92.00 x 92.00								
T8A (DJ5T)		4 Cyl.	2446cc	76kW (103PS)	Diesel Turbo				TD4292
THX (DJ5TED)		4 Cyl.	2446cc	79kW (107PS)	Diesel Turbo				TD11889
THY (DK5ATE)		4 Cyl.	2446cc	95kW (129PS)	Diesel Turbo Intercooler				TD4294
THZ (DJ5T)		4 Cyl.	2446cc	76kW (103PS)	Diesel Turbo Intercooler				TD6585

BE/PL	4	53,981/54,000	57,675/57,695	22,700	1,823	0,030/0,090	SP	71-3951	71-3951/4 STD 1
-------	---	---------------	---------------	--------	-------	-------------	----	---------	--

65	92.00 x 92.00								
T9A (DJ5)		4 Cyl.	2446cc	63kW (86PS)	Diesel				TD4293

BE/PL	4	53,981/54,000	57,675/57,695	22,650	1,823	0,030/0,090	EC	71-3781	71-3781/4 STD 0.30
-------	---	---------------	---------------	--------	-------	-------------	----	---------	------------------------------



66		93.00 x 73.00							
SFZ (ZPJ/Z)		V6 Cyl.		2963cc	123-125kW (167-170PS)		Petrol		TD731
SKZ (ZPJ4/Z)		V6 Cyl.		2963cc	147kW (200PS)		Petrol		TD732
UFZ (ZPJ/Z)		V6 Cyl.		2963cc	123-125kW (167-170PS)		Petrol		TD735
UKZ (ZPJ4/Z)		V6 Cyl.		2963cc	147kW (200PS)		Petrol		TD736
BE/PL	6	59,971/59,990	63,704/63,723	17,720	1,846	0,022/0,085	EC	71-3733	71-3733/6 STD
MB/HL 1-4	4	70,043/70,062	74,000/74,019	23,470	1,967	0,020/0,067	AL-LF	66311RA	H1041/4 STD

67		93.00 x 92.00							
B25637		4 Cyl.		2498cc	51kW (69PS)		Diesel		TD6895
CRD93B		4 Cyl.		2499cc	50kW (70PS)		Diesel		TD6577
M22-629		4 Cyl.		2499cc	55kW (75PS)		Diesel		TD23453
M25-629		4 Cyl.		2500cc	55kW (75PS)		Diesel		TD693
M25-637		4 Cyl.		2499cc	55kW (75PS)		Diesel		TD23454
M25-661		4 Cyl.		2499cc	55kW (75PS)		Diesel		TD23455
BE/PL	4	53,990/54,005	57,675/57,685	24,500	1,826	0,020/0,069	AL-LF	66440RAA	01-4181/4 STD 0.25 0.50
MB/HL 1-5	5	67,035/67,050	71,695/71,705	28,700	2,317	0,020/0,061	AL-LF	66716RAA	H1089/5 STD 0.25 0.50
11/83 →									
TW/A	4	75,500/75,750	89,000/89,100		3,140		BS	66716BF	A213/4 STD
11/83 →									
SE/PB	1	30,008/30,014	33,000/33,033	31,900			BS	66444X	55-4393 SEMI

68		93.00 x 92.00							
CRD93L (U25-661)		4 Cyl.		2500cc	54-55kW (73-75PS)		Diesel		TD625
M25-660		4 Cyl.		2500cc	54kW (75PS)		Diesel		TD696
BE/PL	4	53,990/54,005	57,675/57,685	24,500	1,826	0,020/0,069	AL-LF	66440RAA	01-4181/4 STD 0.25 0.50
MB/HL 1-5	5	67,035/67,050	71,695/71,705	28,700	2,317	0,020/0,061	AL-LF	66716RAA	H1089/5 STD 0.25 0.50
TW/A	4	75,500/75,750	89,000/89,100		3,140		BS	66716BF	A213/4 STD
SE/PB	1	30,008/30,014	33,000/33,033	31,900			BS	66444X	55-4393 SEMI

69		93.00 x 92.00							
CRD93LS (U25-673)		4 Cyl.		2500cc	70kW (95PS)		Diesel Turbo		TD626
M25-669		4 Cyl.		2500cc	88kW (120PS)		Diesel Turbo		TD702
BE/PL	4	53,975/53,990	57,685/57,695	22,500	1,826	0,043/0,093	BS	66715CPA	71-4198/4 STD
MB/HL 1-5	5	67,035/67,050	71,695/71,705	28,700	2,317	0,020/0,061	AL-LF	66716RAA	H1089/5 STD 0.25 0.50
TW/A	4	75,500/75,750	89,000/89,100		3,140		BS	66716BF	A213/4 STD
SE/PB	1	30,008/30,014	33,000/33,033	31,900			BS	66444X	55-4393 SEMI

70		93.00 x 92.00							
M25-648		4 Cyl.		2500cc	70kW (95PS)		Diesel Turbo		TD694
BE/PL	4	53,975/53,990	57,685/57,695	22,500	1,826	0,043/0,093	BS	66715CPA	71-4198/4 STD

MB/HL 1-5	5	67,035/67,050	71,695/71,705	28,700	2,317	0,020/0,061	AL-LF	66716RAA	H1089/5 STD 0.25 0.50
11/83 →									
TW/A	4	75,500/75,750	89,000/89,100		3,140		BS	66716BF	A213/4 STD
11/83 →									
SE/PB	1	30,008/30,014	33,000/33,033	31,900			BS	66444X	55-4393 SEMI

71
94.00 x 90.00

XD3TP		4 Cyl.		2498cc	70kW (95PS)		Diesel Turbo		TD203
BE/PL	4	54,994/55,021	58,737/58,750	29,000	1,838	0,040/0,105	AL-LF	66690RA	01-4195/4 STD 0.30 0.50 0.80
MB/HL 1,3,5	3	59,994/60,021	63,737/63,750	30,000	1,837	0,042/0,107	AL-LF	66691RA	H1056/5 STD 0.30 0.50
MB/HL 2,4	2	59,994/60,021	63,737/63,750	24,000	1,837	0,042/0,107	AL-LF	66692RA	
TW/A	4	67,000/67,250	84,750/85,000		2,330		BS	66691BF	A211/4 STD 0.20
SE/PB	1	32,009/32,025	35,000/35,025	29,700			BS	66694YA	55-4197 SEMI

72
94.40 x 100.00









8140.43N Euro 3		4 Cyl.		2798cc	107kW (146PS)		Diesel Turbo Intercooler		TD18297
8140.43S		4 Cyl.		2798cc	92-94kW (125-128PS)		Diesel Turbo Intercooler		TD17849
8140.63 (F28D)		4 Cyl.		2798cc	64kW (87PS)		Diesel		TD24977
F28TDCR		4 Cyl.		2798cc	94kW (128PS)		Diesel Turbo		TD16741
BE/PL	4	56,520/56,535	60,333/60,345	24,700	1,870	0,020/0,072	BS	1870CP	71-4130/4 STD 0.25 0.50 0.75
MB/HL 5	1	86,182/86,208	90,588/90,614	30,950	2,164	0,052/0,129	BS	4691CPH	H1104/5 STD 0.25 0.50
MB/HL 1-4	4	80,182/80,208	84,588/84,614	23,800	2,164	0,052/0,129	BS	4692CP	
SE/PB	1	31,990/31,996	34,895/34,920	30,700			BS	66579YA	55-4186 SEMI









cm3



1300 1.3	12/72→05/83	Petrol	810-02/-99	1289	4	73.00	77.00	2
1304 1.3	06/83→08/90	Petrol	810-02/-99	1289	4	73.00	77.00	2
1310 1.3	05/83→07/04	Petrol	810-02/-99	1289	4	73.00	77.00	2
1310 1.9 D	01/03→07/04	Diesel	F8Q 630	1870	4	80.00	93.00	9
Dokker 1.5 dCi	11/12→	Diesel	K9K 612	1461	4	76.00	80.50	4
Dokker 1.6	11/12→	Petrol	K7M 812	1598	4	79.50	80.50	7
Dokker 1.6	11/12→	Petrol	K7M 828	1598	4	79.50	80.50	7
Dokker 1.6 LPG	11/13→	Petrol	K7M 812	1598	4	79.50	80.50	7
Dokker 1.6 LPG	11/13→	Petrol	K7M 828	1598	4	79.50	80.50	7
Dokker Express 1.5 dCi	12/12→	Diesel	K9K 612	1461	4	76.00	80.50	4
Dokker Express 1.6	12/12→	Petrol	K7M 812	1598	4	79.50	80.50	7
Dokker Express 1.6	12/12→	Petrol	K7M 828	1598	4	79.50	80.50	7
Dokker Express 1.6 LPG	11/13→	Petrol	K7M 812	1598	4	79.50	80.50	7
Dokker Express 1.6 LPG	11/13→	Petrol	K7M 828	1598	4	79.50	80.50	7
Duster 1.5 dCi	04/10→	Diesel	K9K 796	1461	4	76.00	80.50	4
Duster 1.5 dCi	04/10→	Diesel	K9K 830	1461	4	76.00	80.50	4
Duster 1.5 dCi	04/13→	Diesel	K9K 856	1461	4	76.00	80.50	4
Duster 1.5 dCi	10/10→	Diesel	K9K 884	1461	4	76.00	80.50	4
Duster 1.5 dCi	10/10→	Diesel	K9K 892	1461	4	76.00	80.50	4
Duster 1.5 dCi	06/10→	Diesel	K9K 896	1461	4	76.00	80.50	4
Duster 1.5 dCi 4x4	04/13→	Diesel	K9K 858	1461	4	76.00	80.50	4
Duster 1.5 dCi 4x4	10/10→	Diesel	K9K 884	1461	4	76.00	80.50	4
Duster 1.5 dCi 4x4	04/11→	Diesel	K9K 892	1461	4	76.00	80.50	4
Duster 1.5 dCi 4x4	10/10→	Diesel	K9K 894	1461	4	76.00	80.50	4
Duster 1.5 dCi 4x4	06/10→	Diesel	K9K 898	1461	4	76.00	80.50	4
Duster 1.6 16V	04/10→	Petrol	K4M 690	1598	4	79.50	80.50	6
Duster 1.6 16V	04/10→	Petrol	K4M 696	1598	4	79.50	80.50	6
Duster 1.6 16V 4x4	06/10→	Petrol	K4M 606	1598	4	79.50	80.50	6
Duster 1.6 16V Hi-Flex	08/10→	Petrol	K4M 696	1598	4	79.50	80.50	6
Duster 1.6 16V LPG	04/11→	Petrol	K4M 696	1598	4	79.50	80.50	6
Lodgy 1.5 dCi	03/12→	Diesel	K9K 612	1461	4	76.00	80.50	4
Lodgy 1.5 dCi	01/13→	Diesel	K9K 846	1461	4	76.00	80.50	4
Lodgy 1.6	03/12→	Petrol	K7M 812	1598	4	79.50	80.50	7
Lodgy 1.6	03/12→	Petrol	K7M 828	1598	4	79.50	80.50	7
Lodgy 1.6 LPG	11/13→	Petrol	K7M 812	1598	4	79.50	80.50	7
Lodgy 1.6 LPG	11/13→	Petrol	K7M 828	1598	4	79.50	80.50	7
Logan 1.2 16V	02/06→	Petrol	D4F 732	1149	4	69.00	76.80	1
Logan 1.2 16V LPG	02/06→	Petrol	D4F 734	1149	4	69.00	76.80	1
Logan 1.4	09/04→	Petrol	K7J 710	1390	4	79.50	70.00	5
Logan 1.4 MPI LPG	02/06→	Petrol	K7J 710	1390	4	79.50	70.00	5
Logan 1.4 MPI LPG	02/06→	Petrol	K7J 714	1390	4	79.50	70.00	5
Logan 1.5 dCi	09/05→	Diesel	K9K 790	1461	4	76.00	80.50	4
Logan 1.5 dCi	01/06→	Diesel	K9K 792	1461	4	76.00	80.50	4
Logan 1.5 dCi	09/07→	Diesel	K9K 796	1461	4	76.00	80.50	4
Logan 1.5 dCi	05/10→	Diesel	K9K 892	1461	4	76.00	80.50	4
Logan 1.6	09/04→	Petrol	K7M 710	1598	4	79.50	80.50	7
Logan 1.6 16V	02/06→	Petrol	K4M 690	1598	4	79.50	80.50	6
Logan 1.6 16V	02/06→	Petrol	K4M 696	1598	4	79.50	80.50	6
Logan 1.6 16V Flexifuel	07/10→	Petrol	K4M 696	1598	4	79.50	80.50	6
Logan 1.6 Bifuel	05/10→	Petrol	K7M 718	1598	4	79.50	80.50	7
Logan 1.6 Bifuel	05/10→	Petrol	K7M 800	1598	4	79.50	80.50	7
Logan 1.6 MPI 85	05/10→	Petrol	K7M 800	1598	4	79.50	80.50	7
Logan Express 1.4	03/09→	Petrol	K7J 710	1390	4	79.50	70.00	5
Logan Express 1.5 dCi	03/09→	Diesel	K9K 792	1461	4	76.00	80.50	4
Logan Express 1.5 dCi	03/09→	Diesel	K9K 796	1461	4	76.00	80.50	4
Logan Express 1.5 dCi	05/10→	Diesel	K9K 892	1461	4	76.00	80.50	4
Logan Express 1.6	03/09→	Petrol	K7M 710	1598	4	79.50	80.50	7
Logan Express 1.6 MPI 85	05/10→	Petrol	K7M 800	1598	4	79.50	80.50	7
Logan II 1.2	10/12→	Petrol	D4F 732	1149	4	69.00	76.80	1
Logan II 1.2 LPG	10/12→	Petrol	D4F 734	1149	4	69.00	76.80	1
Logan II 1.5 dCi	10/12→	Diesel	K9K 612	1461	4	76.00	80.50	4
Logan II 1.5 dCi	01/13→	Diesel	K9K 830	1461	4	76.00	80.50	4
Logan MCV 1.4	02/07→	Petrol	K7J 710	1390	4	79.50	70.00	5
Logan MCV 1.5 dCi	02/07→	Diesel	K9K 792	1461	4	76.00	80.50	4
Logan MCV 1.5 dCi	09/07→	Diesel	K9K 796	1461	4	76.00	80.50	4
Logan MCV 1.5 dCi	05/10→	Diesel	K9K 892	1461	4	76.00	80.50	4
Logan MCV 1.6	02/07→	Petrol	K7M 710	1598	4	79.50	80.50	7
Logan MCV 1.6 16V	02/07→	Petrol	K4M 690	1598	4	79.50	80.50	6
Logan MCV 1.6 16V	02/07→	Petrol	K4M 696	1598	4	79.50	80.50	6

				cm ³	x				
Logan MCV 1.6 16V Hi-Flex	11/09→	Petrol	K4M 690	1598	4	79.50	80.50	6	
Logan MCV 1.6 16V Hi-Flex	11/09→	Petrol	K4M 694	1598	4	79.50	80.50	6	
Logan MCV 1.6 Bifuel	11/08→	Petrol	K7M 710	1598	4	79.50	80.50	7	
Logan MCV 1.6 MPI 85	05/10→	Petrol	K7M 800	1598	4	79.50	80.50	7	
Logan MCV II 1.2	02/13→	Petrol	D4F 732	1149	4	69.00	76.80	1	
Logan MCV II 1.2 LPG	02/13→	Petrol	D4F 734	1149	4	69.00	76.80	1	
Logan MCV II 1.5 dCi	02/13→	Diesel	K9K 612	1461	4	76.00	80.50	4	
Logan MCV II 1.5 dCi	02/13→	Diesel	K9K 830	1461	4	76.00	80.50	4	
Nova 1.4	04/96→03/01	Petrol	C2J	1397	4	76.00	77.00	3	
Sandero 1.2 16V	11/08→	Petrol	D4F 732	1149	4	69.00	76.80	1	
Sandero 1.2 16V LPG	11/08→	Petrol	D4F 732	1149	4	69.00	76.80	1	
Sandero 1.4	06/08→	Petrol	K7J 710	1390	4	79.50	70.00	5	
Sandero 1.4 MPI LPG	01/09→	Petrol	K7J 714	1390	4	79.50	70.00	5	
Sandero 1.5 dCi	11/08→	Diesel	K9K 792	1461	4	76.00	80.50	4	
Sandero 1.5 dCi	11/08→	Diesel	K9K 796	1461	4	76.00	80.50	4	
Sandero 1.5 dCi	05/10→	Diesel	K9K 892	1461	4	76.00	80.50	4	
Sandero 1.6	06/08→	Petrol	K7M 710	1598	4	79.50	80.50	7	
Sandero 1.6 16V	07/11→	Petrol	K4M 690	1598	4	79.50	80.50	6	
Sandero 1.6 16V Bifuel	01/11→	Petrol	K4M 690	1598	4	79.50	80.50	6	
Sandero 1.6 16V Bifuel	01/11→	Petrol	K4M 694	1598	4	79.50	80.50	6	
Sandero 1.6 16V Bifuel	01/11→	Petrol	K4M 696	1598	4	79.50	80.50	6	
Sandero 1.6 MPI 85	05/10→	Petrol	K7M 800	1598	4	79.50	80.50	7	
Sandero II 1.2	10/12→	Petrol	D4F 732	1149	4	69.00	76.80	1	
Sandero II 1.2 LPG	10/12→	Petrol	D4F 732	1149	4	69.00	76.80	1	
Sandero II 1.5 dCi	10/12→	Diesel	K9K 612	1461	4	76.00	80.50	4	
Sandero II 1.5 dCi	01/13→	Diesel	K9K 830	1461	4	76.00	80.50	4	
Sandero II 1.6	11/12→	Petrol	K7M 812	1598	4	79.50	80.50	7	
Solenza 1.4	02/03→	Petrol	K7J 710	1390	4	79.50	70.00	5	
Solenza 1.9 D	02/03→	Diesel	F8Q 630	1870	4	80.00	93.00	9	

			cm3	x 			
810-02/-99	Petrol		1289	4	73.00	77.00	2
C2J	Petrol		1397	4	76.00	77.00	3
D4F 732	Petrol		1149	4	69.00	76.80	1
D4F 734	Petrol		1149	4	69.00	76.80	1
F8Q 600	Diesel		1870	4	80.00	93.00	8
F8Q 630	Diesel		1870	4	80.00	93.00	9
K4M 606	Petrol		1598	4	79.50	80.50	6
K4M 690	Petrol		1598	4	79.50	80.50	6
K4M 694	Petrol		1598	4	79.50	80.50	6
K4M 696	Petrol		1598	4	79.50	80.50	6
K7J 710	Petrol		1390	4	79.50	70.00	5
K7J 714	Petrol		1390	4	79.50	70.00	5
K7M 690	Petrol		1598	4	79.50	80.50	7
K7M 710	Petrol		1598	4	79.50	80.50	7
K7M 718	Petrol		1598	4	79.50	80.50	7
K7M 732	Petrol		1598	4	79.50	80.50	7
K7M 800	Petrol		1598	4	79.50	80.50	7
K7M 812	Petrol		1598	4	79.50	80.50	7
K7M 828	Petrol		1598	4	79.50	80.50	7
K7MA8	Petrol		1598	4	79.50	80.50	7
K9K 612	Diesel		1461	4	76.00	80.50	4
K9K 790	Diesel		1461	4	76.00	80.50	4
K9K 792	Diesel		1461	4	76.00	80.50	4
K9K 796	Diesel		1461	4	76.00	80.50	4
K9K 830	Diesel		1461	4	76.00	80.50	4
K9K 846	Diesel		1461	4	76.00	80.50	4
K9K 856	Diesel		1461	4	76.00	80.50	4
K9K 858	Diesel		1461	4	76.00	80.50	4
K9K 884	Diesel		1461	4	76.00	80.50	4
K9K 892	Diesel		1461	4	76.00	80.50	4
K9K 894	Diesel		1461	4	76.00	80.50	4
K9K 896	Diesel		1461	4	76.00	80.50	4
K9K 898	Diesel		1461	4	76.00	80.50	4



1 69.00 x 76.80

D4F 732 4 Cyl. **1149cc 55kW (75PS)** **Petrol** **TD23529**

D4F 734 4 Cyl. **1149cc 55kW (75PS)** **Petrol** **TD28221**

BE/PL	4	39,984/40,000	43,639/43,650	16,250	1,810	0,020/0,065	AL-LF	01-3977	01-3977/4 STD 0.25 0.50
MB/HL 1,2,4,5	4	43,990/44,010	47,612/47,625	18,800	1,795	0,006/0,064	AL-LF	02-3978	H097/5 STD
MB/HL 3	1	43,990/44,010	47,612/47,625	23,900	1,795	0,006/0,064	AL-LF	02-3979H	



02-3979H STD 24,000/.9449" - 24,045/.9467"

2 73.00 x 77.00

810-02/-99 4 Cyl. **1289cc 40kW (54PS)** **Petrol** **TD13436**

BE/PL	4	43,964/43,980	47,614/47,625	17,750	1,806	0,020/0,074	AL-LF	2950RAA	01-4138/4 STD 0.25 0.50 0.75
MB/HL 1-5	5	54,785/54,805	58,731/58,750	19,500	1,950	0,026/0,090	AL-LF	62013RA	H1042/5 STD 0.25 0.50 0.75

01/75→

MB/HL 1,3	2	45,990/46,000	49,874/49,890	24,500	1,932	0,020/0,061	AL-LF	62011RA	H1107/5 STD 0.25 0.50 0.75
MB/HL 2,4,5	3	45,990/46,000	49,874/49,890	19,500	1,932	0,020/0,061	AL-LF	62012RA	

→**12/74**

TW/A	2	60,500/60,750	79,750/80,000		2,850		AL-LF	60476BF	A195/2 STD 0.10
------	---	---------------	---------------	--	-------	--	-------	---------	---------------------------

01/75→

3 76.00 x 77.00

C2J 4 Cyl. **1397cc 48kW (65PS)** **Petrol** **TD24574**

BE/PL	4	43,964/43,980	47,614/47,625	17,750	1,806	0,020/0,074	AL-LF	2950RAA	01-4138/4 STD 0.25 0.50 0.75
MB/HL 1-5	5	54,785/54,805	58,731/58,750	19,500	1,950	0,026/0,090	AL-LF	62013RA	H1042/5 STD 0.25 0.50 0.75
TW/A	2	60,500/60,750	79,750/80,000		2,850		AL-LF	60476BF	A195/2 STD 0.10

4 76.00 x 80.50

K9K 612 4 Cyl. **1461cc 55-66kW (75-90PS)** **Diesel** **TD28005**

K9K 790 4 Cyl. **1461cc 48kW (65PS)** **Diesel Turbo Intercooler** **TD18514**

K9K 792 4 Cyl. **1461cc 50kW (68PS)** **Diesel Turbo Intercooler** **TD19223**

K9K 796 4 Cyl. **1461cc 63kW (86PS)** **Diesel Turbo Intercooler** **TD22403**

K9K 830 4 Cyl. **1461cc 63kW (86PS)** **Diesel Turbo** **TD31047**

K9K 846 4 Cyl. **1461cc 79kW (107PS)** **Diesel Turbo** **TD31425**

K9K 856 Euro 5 4 Cyl. **1461cc 80kW (109PS)** **Diesel Turbo** **TD28611**

K9K 858 Euro 5 4 Cyl. **1461cc 80kW (109PS)** **Diesel Turbo** **TD28610**

K9K 884 Euro 5 4 Cyl. **1461cc 66kW (90PS)** **Diesel Turbo** **TD31046**

K9K 892 4 Cyl. **1461cc 55-66kW (75-90PS)** **Diesel Turbo** **TD24780**

K9K 894 4 Cyl. **1461cc 66-67kW (90-91PS)** **Diesel Turbo** **TD24783**

K9K 896 4 Cyl. **1461cc 79kW (107PS)** **Diesel Turbo** **TD24784**

K9K 898 4 Cyl. **1461cc 79-81kW (107-110PS)** **Diesel Turbo** **TD24785**

BE/PL	4	43,964/43,980	47,614/47,625	17,750	1,807	0,020/0,047	BS	71-4243L	71-4243/4 STD 0.25 0.50
BE/PL	4	43,964/43,980	47,614/47,625	20,750	1,807	0,020/0,047	BS	71-4243U	

MB/HL 1-5	5	47,990/48,010	51,936/51,949	19,500	1,950	0,026/0,059	AL-LF	02-4241	H1065/5 STD 0.25 0.50
TW/A	2	53,000/53,250	73,670/73,920		2,850		AL-LF	04-4048	A168/2 STD
SE/PB	1	25,995/26,000	28,500/28,521	22,500			BC-LF	55-4856	55-4856 SEMI

6

5 79.50 x 70.00

K7J 710			4 Cyl.	1390cc	55kW (75PS)		Petrol		TD18140
K7J 714			4 Cyl.	1390cc	53-55kW (72-75PS)		Petrol		TD23531
BE/PL	4	43,964/43,980	47,614/47,625	17,750	1,806	0,020/0,074	AL-LF	2950RAA	01-4138/4 STD 0.25 0.50 0.75
MB/HL 1-5	5	47,990/48,010	51,936/51,949	19,500	1,950	0,026/0,059	AL-LF	02-4241	H1065/5 STD 0.25 0.50
TW/A	2	53,000/53,250	73,670/73,920		2,850		AL-LF	04-4048	A168/2 STD

6 79.50 x 80.50

K4M 606			4 Cyl.	1598cc	77kW (105PS)		Petrol		TD24782
K4M 690			4 Cyl.	1598cc	77kW (105PS)		Petrol		TD20941
K4M 694			4 Cyl.	1598cc	77kW (105PS)		Petrol		TD24876
K4M 696			4 Cyl.	1598cc	77kW (105PS)		Petrol		TD24781
BE/PL	4	43,964/43,980	47,614/47,625	17,750	1,806	0,020/0,074	AL-LF	2950RAA	01-4138/4 STD 0.25 0.50 0.75
MB/HL 1-5	5	47,990/48,010	51,936/51,949	19,500	1,950	0,026/0,059	AL-LF	02-4241	H1065/5 STD 0.25 0.50
TW/A	2	53,000/53,250	73,670/73,920		2,850		AL-LF	04-4048	A168/2 STD

7 79.50 x 80.50

K7M 690			4 Cyl.	1598cc	77kW (105PS)		Petrol		TD22402
K7M 710			4 Cyl.	1598cc	64kW (87PS)		Petrol		TD18141
K7M 718 Euro 4			4 Cyl.	1598cc	62kW (84PS)		Petrol		TD23535
K7M 732 Euro 4			4 Cyl.	1598cc	64kW (87PS)		Petrol		TD23533
K7M 800			4 Cyl.	1598cc	62kW (84PS)		Petrol		TD24779
K7M 812 Euro 4			4 Cyl.	1598cc	61kW (83PS)		Petrol		TD29265
K7M 828 Euro 4			4 Cyl.	1598cc	61kW (83PS)		Petrol		TD31423
K7MA8			4 Cyl.	1598cc	61kW (83PS)		Petrol		TD26980
BE/PL	4	43,964/43,980	47,614/47,625	17,750	1,806	0,020/0,074	AL-LF	2950RAA	01-4138/4 STD 0.25 0.50 0.75
MB/HL	3	47,990/48,010	51,936/51,949	19,500	1,950	0,026/0,059	AL-LF	02-4241L	H1014/5 STD 0.25
MB/HL	7	47,990/48,010	51,936/51,949	19,500	1,950	0,026/0,059	AL-LF	02-4241U	
TW/A	2	53,000/53,250	73,670/73,920		2,850		AL-LF	04-4048	A168/2 STD

8 80.00 x 93.00

F8Q 600			4 Cyl.	1870cc	44-48kW (60-65PS)		Diesel		TD22200
BE/PL	4	48,000/48,020	51,587/51,606	20,250	1,776	0,015/0,079	EC	71-3988L	71-3988/4 STD 0.25 0.50
BE/PL	4	48,000/48,020	51,587/51,606	20,500	1,776	0,015/0,079	EC	71-3988U	
01/98 →									
BE/PL	4	48,000/48,020	51,587/51,600	20,500	1,768	0,031/0,089	BS	4060CP	71-4311/4 STD 0.25 0.50

→12/97



71-3988L

71-3988U

4060CP



MB/HL 1-5	5	54,785/54,805	58,731/58,744	18,500	1,947	0,032/0,090	EC	72-3989	H098/5 STD 0.25 0.50
--------------	---	---------------	---------------	--------	-------	-------------	----	---------	--------------------------------

01/98→

MB/HL 1-5	5	54,785/54,795	58,731/58,744	18,500	1,945	0,046/0,094	AL-LF	66741RA	H1080/5 STD 0.25 0.50
--------------	---	---------------	---------------	--------	-------	-------------	-------	---------	---------------------------------

→12/97

72-3989

66741RA

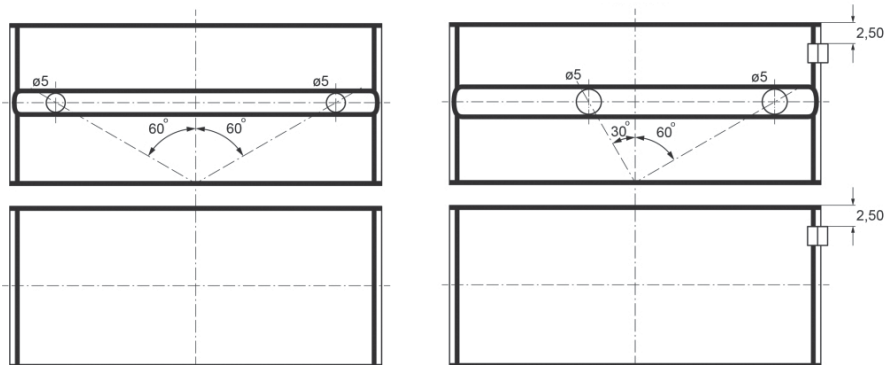







TW/A	2	60,500/60,750	79,750/80,000		2,350		AL-LF	66741AF	A215/2 STD 0.10
SE/PB	1	24,005/24,012	26,000/26,021	24,750			BC	55-3875	55-3875 SEMI







9







80.00 x 93.00

F8Q 630		4 Cyl.			1870cc	46-48kW (63-65PS)	Diesel		TD22401
BE/PL	4	48,000/48,020	51,587/51,606	20,250	1,776	0,015/0,079	EC	71-3988L	71-3988/4 STD 0.25 0.50
BE/PL	4	48,000/48,020	51,587/51,606	20,500	1,776	0,015/0,079	EC	71-3988U	
MB/HL 1-5	5	54,785/54,805	58,731/58,744	18,500	1,947	0,032/0,090	EC	72-3989	H098/5 STD 0.25 0.50
TW/A	2	60,500/60,750	79,750/80,000		2,350		AL-LF	66741AF	A215/2 STD 0.10
SE/PB	1	24,005/24,012	26,000/26,021	24,750			BC	55-3875	55-3875 SEMI

		cm3	x 			
--	---	-----	---	---	---	---

110E	Petrol	1108	4	70.00	72.00	1
110F	Petrol	1108	4	70.00	72.00	2
110G	Petrol	1108	4	70.00	72.00	1
B13,0S	Petrol	1298	4	73.00	77.00	3
BE 99 C Euro 3	Diesel	3920	4	102.00	120.00	9
BE 110 C Euro 3	Diesel	3920	4	102.00	120.00	9
BE 123 C Euro 3	Diesel	3920	4	102.00	120.00	9
CB 107	Diesel	5880	6	102.00	120.00	10
CB 108	Diesel	5880	6	102.00	120.00	10
CD 85	Diesel	5880	6	102.00	120.00	10
CE 130 C Euro 3	Diesel	3920	4	102.00	120.00	9
CE 136 C Euro 3	Diesel	5880	6	102.00	120.00	10
CE 150 C Euro 3	Diesel	3920	4	102.00	120.00	9
CE 162 C Euro 3	Diesel	5880	6	102.00	120.00	10
CE 170 C Euro 3	Diesel	3920	4	102.00	120.00	9
CE 180 C Euro 3	Diesel	5880	6	102.00	120.00	10
CE 184 C Euro 3	Diesel	5880	6	102.00	120.00	10
CE 220 C Euro 3	Diesel	5880	6	102.00	120.00	10
CE 250 C Euro 3	Diesel	5880	6	102.00	120.00	10
CN 95 Euro 1	Diesel	5880	6	102.00	120.00	10
CN 96	Diesel	5880	6	102.00	120.00	10
CS 97 M Euro 2	Diesel	5880	6	102.00	120.00	10
CS 107 M Euro 2	Diesel	5880	6	102.00	120.00	10
CS 119	Diesel	5880	6	102.00	120.00	10
CS 119 L Euro 1	Diesel	5880	6	102.00	120.00	10
CS 133 M Euro 2	Diesel	5880	6	102.00	120.00	10
CS134	Diesel	5880	6	102.00	120.00	10
CS156	Diesel	5880	6	102.00	120.00	10
CS 158 M Euro 2	Diesel	5880	6	102.00	120.00	10
CS 173 M Euro 2	Diesel	5880	6	102.00	120.00	10
CT 97	Diesel	5880	6	102.00	120.00	10
CT 97 L Euro 1	Diesel	5880	6	102.00	120.00	10
CT 108	Diesel	5880	6	102.00	120.00	10
CT 108 L Euro 1	Diesel	5880	6	102.00	120.00	10
CT 119	Diesel	5880	6	102.00	120.00	10
CT 119 G	Diesel	5880	6	102.00	120.00	10
DA 475	Diesel	4770	6	100.00	100.00	7
DD 575	Diesel	5750	6	100.61	120.65	8
DF 615	Diesel	6150	6	104.00	120.00	11
DF 825	Diesel	8250	6	118.00	126.00	12
DH 825	Diesel	8250	6	118.00	126.00	12
DHB 825	Diesel	8250	6	118.00	126.00	12
DHR 825	Diesel	8250	6	118.00	126.00	12
DHS 825	Diesel	8250	6	118.00	126.00	12
DHS 825SM	Diesel	8250	6	118.00	126.00	12
DHT 825	Diesel	8250	6	118.00	126.00	12
DHTD 825	Diesel	8250	6	118.00	126.00	12
DHU 825	Diesel	8250	6	118.00	126.00	12
DJ5T	Diesel	2446	4	92.00	92.00	5
DK 1160	Diesel	11630	6	130.00	146.00	15
DKA 1160	Diesel	11600	6	130.00	146.00	15
DKB 1160	Diesel	11600	6	130.00	146.00	16
DKCL 1160	Diesel	11630	6	130.00	146.00	17
DKD 1160	Diesel	11630	6	130.00	146.00	17
DKDL 1160	Diesel	11630	6	130.00	146.00	17
DKFL 1160	Diesel	11630	6	130.00	146.00	17
DKL 1160	Diesel	11630	6	130.00	146.00	17
DKS 1160	Diesel	11600	6	130.00	146.00	17
DKS 1160 E	Diesel	11600	6	130.00	146.00	17
DKSB 1160	Diesel	11630	6	130.00	146.00	17
DKSE 1160	Diesel	11630	6	130.00	146.00	17
DKT 1160	Diesel	11600	6	130.00	146.00	17
DKTD 1160	Diesel	11600	6	130.00	146.00	17
DKTL 1160	Diesel	11600	6	130.00	146.00	17
DKV 1160	Diesel	11600	6	130.00	146.00	17
DKVL 1160	Diesel	11600	6	130.00	146.00	17
DKX 1160	Diesel	11600	6	130.00	146.00	17
DKX 1160 ATi	Diesel	11600	6	130.00	146.00	18
DKXE 1160	Diesel	11600	6	130.00	146.00	17

		cm3	x 			
DKXE 1160 ATI	Diesel	11630	6	130.00	146.00	18
DKZ 1160	Diesel	11630	6	130.00	146.00	17
DKZ 1160 ATI	Diesel	11600	6	130.00	146.00	18
DKZE 1160	Diesel	11600	6	130.00	146.00	18
DS 575	Diesel	5760	6	100.61	120.65	8
DT 615	Diesel	6150	6	104.00	120.00	11
DT 825	Diesel	8250	6	118.00	126.00	12
DTD 615	Diesel	6150	6	104.00	120.00	11
DU 825	Diesel	8250	6	118.00	126.00	12
EN 55	Diesel	2498	4	94.00	90.00	6
ET 70	Diesel	2498	4	94.00	90.00	6
HS 200	Diesel	8250	6	118.00	126.00	12
HS 825	Diesel	8250	6	118.00	126.00	12
HT 168	Diesel	8250	6	118.00	126.00	12
HT 825	Diesel	8250	6	118.00	126.00	12
KS 1160	Diesel	11600	6	130.00	146.00	18
KV 1160	Diesel	11600	6	130.00	146.00	18
LT 160	Diesel	11630	6	130.00	146.00	19
LT 210	Diesel	11630	6	130.00	146.00	19
LT 195 1160	Diesel	11627	6	76.90	86.00	4
MX 265 Euro 4/5	Diesel	12900	6	130.00	162.00	25
MX 300 Euro 4/5	Diesel	12900	6	130.00	162.00	25
MX 340 Euro 4/5	Diesel	12900	6	130.00	162.00	25
MX 375 Euro 4/5	Diesel	12900	6	130.00	162.00	25
PF 183 M Euro 2	Diesel	9200	6	118.00	140.00	14
PF 212 M Euro 2	Diesel	9200	6	118.00	140.00	14
PF 235 M Euro 2	Diesel	9200	6	118.00	140.00	14
RS 180	Diesel	8650	6	118.00	132.00	13
RS 180 L Euro 1	Diesel	8650	6	118.00	132.00	13
RS 180 M Euro 2	Diesel	8650	6	118.00	132.00	13
RS 200	Diesel	8650	6	118.00	132.00	13
RS 200 L Euro 1	Diesel	8650	6	118.00	132.00	13
RS 200 M Euro 2	Diesel	8650	6	118.00	132.00	13
RS 222	Diesel	8650	6	118.00	132.00	13
RS 222 L Euro 1	Diesel	8650	6	118.00	132.00	13
RS 222 M Euro 2	Diesel	8650	6	118.00	132.00	13
WS 222 G	Diesel	11630	6	130.00	146.00	20
WS 222 L	Diesel	11630	6	130.00	146.00	20
WS 222 M	Diesel	11630	6	130.00	146.00	20
WS 225	Diesel	11600	6	130.00	146.00	21
WS 225 ATi	Diesel	11630	6	130.00	146.00	20
WS 242	Diesel	11600	6	130.00	146.00	22
WS 242 G	Diesel	11630	6	130.00	146.00	20
WS 242 L Euro 1	Diesel	11600	6	130.00	146.00	22
WS 242 M Euro 2	Diesel	11600	6	130.00	146.00	22
WS 259	Diesel	11600	6	130.00	146.00	21
WS 259 ATi	Diesel	11630	6	130.00	146.00	20
WS 268	Diesel	11600	6	130.00	146.00	22
WS 268 G	Diesel	11600	6	130.00	146.00	22
WS 268 L Euro 1	Diesel	11600	6	130.00	146.00	22
WS 268 M Euro 2	Diesel	11600	6	130.00	146.00	22
WS 270	Diesel	11630	6	130.00	146.00	17
WS 282	Diesel	11600	6	130.00	146.00	21
WS 282 ATi	Diesel	11630	6	130.00	146.00	20
WS 282 L	Diesel	11630	6	130.00	146.00	20
WS 295	Diesel	11600	6	130.00	146.00	22
WS 295 G	Diesel	11600	6	130.00	146.00	22
WS 295 L Euro 1	Diesel	11600	6	130.00	146.00	22
WS 295 M ATi	Diesel	11627	6	130.00	146.00	20
WS 295 M Euro 2	Diesel	11600	6	130.00	146.00	22
WS 315	Diesel	11600	6	130.00	146.00	22
WS 315 G	Diesel	11627	6	130.00	146.00	22
WS 315 L Euro 1	Diesel	11600	6	130.00	146.00	22
WS 315 M Euro 2	Diesel	11600	6	130.00	146.00	22
XD3P	Diesel	2497	4	94.00	90.00	6
XD3T	Diesel	2497	4	94.00	90.00	6
XE 250 C Euro 3	Diesel	12580	6	130.00	158.00	23
XE 280 C1 Euro 3	Diesel	12580	6	130.00	158.00	23
XE 280 C Euro 3	Diesel	12580	6	130.00	158.00	23

		cm3	x 			
XE 315 C1 Euro 3	Diesel	12580	6	130.00	158.00	23
XE 315 C Euro 3	Diesel	12580	6	130.00	158.00	23
XE 340 C Euro 3	Diesel	12580	6	130.00	158.00	23
XE 355 C1 Euro 3	Diesel	12580	6	130.00	158.00	23
XE 355 C Euro 3	Diesel	12580	6	130.00	158.00	23
XE 380 C Euro 3	Diesel	12580	6	130.00	158.00	23
XE 390 C1 Euro 3	Diesel	12580	6	130.00	158.00	23
XE 390 C Euro 3	Diesel	12580	6	130.00	158.00	23
XE 430 C Euro 3	Diesel	12580	6	130.00	158.00	23
XF 250 M Euro 2	Diesel	12580	6	130.00	158.00	24
XF 280 M Euro 2	Diesel	12580	6	130.00	158.00	24
XF 315 M Euro 2	Diesel	12580	6	130.00	158.00	24
XF 355 M Euro 2	Diesel	12580	6	130.00	158.00	24

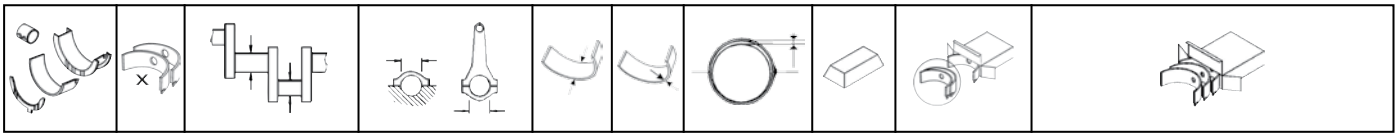

1 70.00 x 72.00

110E 4 Cyl. **1108cc** **35kW** (48PS) **Petrol** **TD21909**

110G 4 Cyl. **1108cc** **40kW** (54PS) **Petrol** **TD21911**

BE/PL	4	43,964/43,980	47,614/47,625	20,750	1,810	0,022/0,074	AL-LF	2950RA	01-4137/4 STD 0.25 0.50 0.75
-------	---	---------------	---------------	--------	-------	-------------	-------	--------	--

→12/74

BE/PL	4	43,964/43,980	47,614/47,625	17,750	1,806	0,020/0,074	AL-LF	2950RAA	01-4138/4 STD 0.25 0.50 0.75
-------	---	---------------	---------------	--------	-------	-------------	-------	---------	--

01/75→

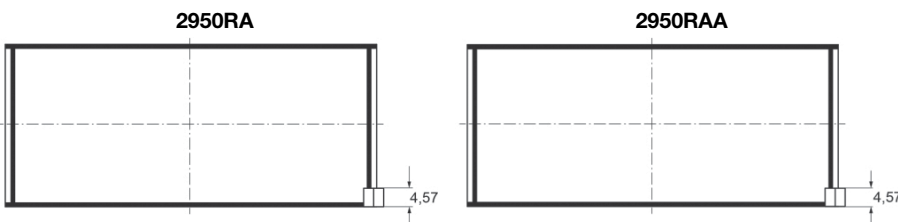

MB/HL 1-5	5	54,785/54,805	58,731/58,750	19,500	1,950	0,026/0,090	AL-LF	62013RA	H1042/5 STD 0.25 0.50 0.75
--------------	---	---------------	---------------	--------	-------	-------------	-------	---------	--------------------------------------

01/75→

MB/HL 1,3	2	45,990/46,000	49,874/49,890	24,500	1,932	0,020/0,061	AL-LF	62011RA	H1107/5 STD 0.25 0.50 0.75
--------------	---	---------------	---------------	--------	-------	-------------	-------	---------	--------------------------------------

MB/HL 2,4,5	3	45,990/46,000	49,874/49,890	19,500	1,932	0,020/0,061	AL-LF	62012RA	
----------------	---	---------------	---------------	--------	-------	-------------	-------	---------	--

→12/74

TW/A	2	60,500/60,750	79,750/80,000		2,850		AL-LF	60476BF	A195/2 STD 0.10
------	---	---------------	---------------	--	-------	--	-------	---------	---------------------------

01/75→

2 70.00 x 72.00

110F 4 Cyl. **1108cc** **40kW** (54PS) **Petrol** **TD21910**

BE/PL	4	43,964/43,980	47,614/47,625	20,750	1,810	0,022/0,074	AL-LF	2950RA	01-4137/4 STD 0.25 0.50 0.75
-------	---	---------------	---------------	--------	-------	-------------	-------	--------	--

MB/HL 1,3	2	45,990/46,000	49,874/49,890	24,500	1,932	0,020/0,061	AL-LF	62011RA	H1107/5 STD 0.25 0.50 0.75
--------------	---	---------------	---------------	--------	-------	-------------	-------	---------	--------------------------------------

MB/HL 2,4,5	3	45,990/46,000	49,874/49,890	19,500	1,932	0,020/0,061	AL-LF	62012RA	
----------------	---	---------------	---------------	--------	-------	-------------	-------	---------	--

3 73.00 x 77.00

B13,0S 4 Cyl. **1298cc** **42kW** (57PS) **Petrol** **TD5226**

BE/PL	4	43,964/43,980	47,614/47,625	17,750	1,806	0,020/0,074	AL-LF	2950RAA	01-4138/4 STD 0.25 0.50 0.75
-------	---	---------------	---------------	--------	-------	-------------	-------	---------	--

MB/HL 1-5	5	54,785/54,805	58,731/58,750	19,500	1,950	0,026/0,090	AL-LF	62013RA	H1042/5 STD 0.25 0.50 0.75
--------------	---	---------------	---------------	--------	-------	-------------	-------	---------	--------------------------------------

01/75→12/75

MB/HL 1,3	2	45,990/46,000	49,874/49,890	24,500	1,932	0,020/0,061	AL-LF	62011RA	H1107/5 STD 0.25 0.50 0.75
--------------	---	---------------	---------------	--------	-------	-------------	-------	---------	--------------------------------------

MB/HL 2,4,5	3	45,990/46,000	49,874/49,890	19,500	1,932	0,020/0,061	AL-LF	62012RA	
----------------	---	---------------	---------------	--------	-------	-------------	-------	---------	--

→12/74

TW/A	2	60,500/60,750	79,750/80,000		2,850		AL-LF	60476BF	A195/2 STD 0.10
------	---	---------------	---------------	--	-------	--	-------	---------	---------------------------

01/75→12/75

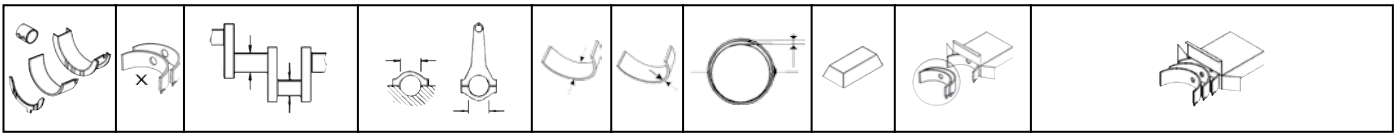

4 76.90 x 86.00

LT 195 1160		6 Cyl.		11627cc	195kW (265PS)	Diesel			FM5310
BE/PL	6	82,980/83,020	86,625/86,637	42,500	1,787	0,031/0,108	EC	71-3791	71-3791/6 STD
04/94 →									
TW/A	2	102,320	126,620		2,362		EC	54-2828	A023/4 STD
TW/A	2	102,320	126,620		2,362		EC	54-3346	
TW/A	2	108,200	126,512		2,362		EC	54-3762	A142/4 STD
TW/A	2	108,200	126,512		2,362		EC	54-3763	
SE/PB	1		52,087/52,113	44,100			BC	55-3792	55-3792 SEMI
SE/PB	1		56,087/56,113	41,550			BC	55-3793	55-3793 SEMI
CB/NWB	5	63,188/63,212	67,305/67,335	25,450	2,026		BC	53-2837	N095/5 STD

5 92.00 x 92.00

DJ5T		4 Cyl.		2446cc	76-96kW (103-131PS)		Diesel Turbo Intercooler		TD22210
BE/PL	4	53,981/54,000	57,675/57,695	22,650	1,823	0,030/0,090	EC	71-3781	71-3781/4 STD 0.30
BE/PL	4	53,981/54,000	57,675/57,695	22,700	1,823	0,030/0,090	SP	71-3951	71-3951/4 STD 1

6 94.00 x 90.00

EN 55		4 Cyl.		2498cc	53kW (72PS)		Diesel		TD763
ET 70		4 Cyl.		2498cc	71kW (96PS)		Diesel Turbo Intercooler		TD764
XD3P		4 Cyl.		2497cc	51-58kW (70-79PS)		Diesel		TD22215
XD3T		4 Cyl.		2497cc	54-70kW (73-95PS)		Diesel Turbo Intercooler		TD22216
BE/PL	4	54,994/55,021	58,737/58,750	29,000	1,838	0,040/0,105	AL-LF	66690RA	01-4195/4 STD 0.30 0.50 0.80
MB/HL 1,3,5	3	59,994/60,021	63,737/63,750	30,000	1,837	0,042/0,107	AL-LF	66691RA	H1056/5 STD 0.30 0.50
MB/HL 2,4	2	59,994/60,021	63,737/63,750	24,000	1,837	0,042/0,107	AL-LF	66692RA	
TW/A	4	67,000/67,250	84,750/85,000		2,330		BS	66691BF	A211/4 STD 0.20
SE/PB	1	32,009/32,025	35,000/35,025	29,700			BS	66694YA	55-4197 SEMI

7 100.00 x 100.00

DA 475		6 Cyl.		4770cc	66-100kW (90-136PS)		Diesel Turbo Intercooler		TD6599
BE/PL	6	60,955/60,973	64,592/64,604	34,798	1,788	0,042/0,099	BS	71-1739	71-1739/6 STD

8 100.61 x 120.65

DD 575		6 Cyl.		5750cc	77kW (105PS)		Diesel		TD6609
DS 575		6 Cyl.		5760cc	97kW (132PS)		Diesel		TD6610
BE/PL	6	60,955/60,973	64,592/64,604	34,798	1,788	0,042/0,099	BS	71-1739	71-1739/6 STD

9 102.00 x 120.00

BE 99 C Euro 3		4 Cyl.		3920cc	99kW (135PS)		Diesel Turbo Intercooler		TD16709
BE 110 C Euro 3		4 Cyl.		3920cc	110kW (150PS)		Diesel Turbo Intercooler		TD16714

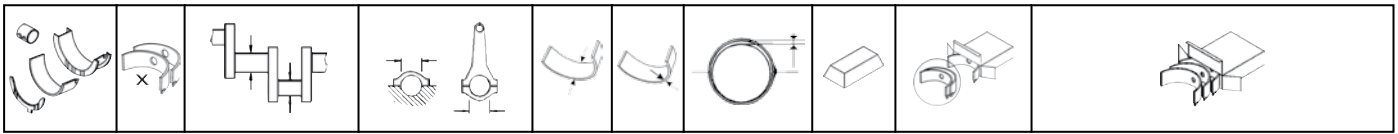

BE 123 C Euro 3	4 Cyl.	3920cc	123kW (167PS)	Diesel Turbo Intercooler	TD16715
CE 130 C Euro 3	4 Cyl.	3920cc	99kW (135PS)	Diesel Turbo Intercooler	TD22790
CE 150 C Euro 3	4 Cyl.	3920cc	110kW (150PS)	Diesel Turbo Intercooler	TD22791
CE 170 C Euro 3	4 Cyl.	3920cc	123kW (167PS)	Diesel Turbo Intercooler	TD22792

BE/PL	1	68,987/69,013	72,987/73,013	31,130	1,968	0,038/0,114	EC	71-4573	71-4573 STD 0.25 0.50
BE/PL	1	68,987/69,013	72,987/73,013	31,130	1,968	0,038/0,114	EC	71-4573	71-4708 STD 0.25 0.50
BE/PL	1	68,987/69,013	72,987/73,013	31,130	1,968	0,038/0,114	EC	71-4708	

71-4573

71-4708

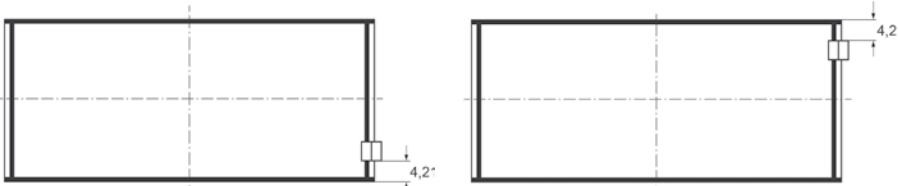

MB/HL	1	82,993/83,013	87,977/88,013	37,348	2,464	0,036/0,116	AL-LF	02-4574H	02-4575H STD 0.25 0.50
MB/HL	1	82,993/83,013	87,977/88,013	37,348	2,464	0,036/0,116	AL-LF	02-4575H	
MB/HL	1	82,993/83,013	87,982/88,008	29,030	2,464	0,041/0,111	AL-LF	02-4576	02-4576 STD 0.25 0.50

02-4574H

02-4575H

02-4576

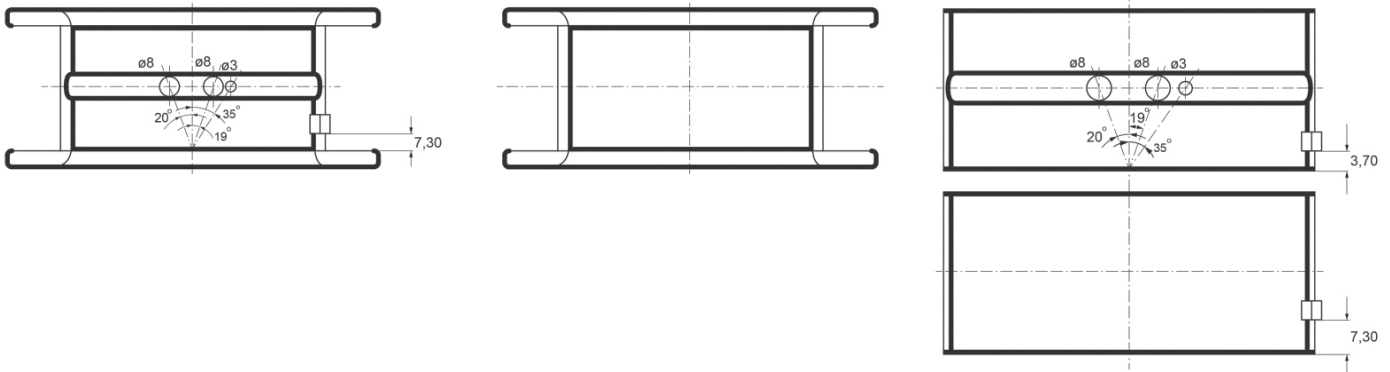

SE/PB	1	40,000	42,987/43,013	38,100			BS	55-4706	55-4706 SEMI
CB/NWB	1		59,228/59,248	25,400			BS	53-4707	53-4707 SEMI

10

102.00 x 120.00

CB 107	6 Cyl.	5880cc	107kW (146PS)	Diesel Turbo	TD6645
CB 108	6 Cyl.	5880cc	108kW (147PS)	Diesel Turbo	TD12560
CD 85	6 Cyl.	5880cc	85kW (116PS)	Diesel	TD12556
CE 136 C Euro 3	6 Cyl.	5880cc	136kW (185PS)	Diesel Turbo Intercooler	TD16712
CE 162 C Euro 3	6 Cyl.	5880cc	162kW (220PS)	Diesel Turbo Intercooler	TD16711
CE 180 C Euro 3	6 Cyl.	5880cc	136kW (185PS)	Diesel Turbo Intercooler	TD22802
CE 184 C Euro 3	6 Cyl.	5880cc	184kW (250PS)	Diesel Turbo Intercooler	TD16710
CE 220 C Euro 3	6 Cyl.	5880cc	162kW (220PS)	Diesel Turbo Intercooler	TD22803
CE 250 C Euro 3	6 Cyl.	5880cc	184kW (250PS)	Diesel Turbo Intercooler	TD22804
CN 95 Euro 1	6 Cyl.	5880cc	96kW (130PS)	Diesel	TD6644
CN 96	6 Cyl.	5880cc	96kW (131PS)	Diesel	TD12559
CS 97 M Euro 2	6 Cyl.	5880cc	97kW (132PS)	Diesel Turbo Intercooler	TD12558
CS 107 M Euro 2	6 Cyl.	5880cc	107kW (146PS)	Diesel Turbo Intercooler	TD12550
CS 119	6 Cyl.	5880cc	119kW (162PS)	Diesel Turbo Intercooler	TD12563



CS 119 L Euro 1	6 Cyl.	5880cc	119kW (162PS)	Diesel Turbo Intercooler	TD22205
CS 133 M Euro 2	6 Cyl.	5880cc	133kW (181PS)	Diesel Turbo Intercooler	TD12548
CS 158 M Euro 2	6 Cyl.	5880cc	158kW (215PS)	Diesel Turbo Intercooler	TD12549
CS 173 M Euro 2	6 Cyl.	5880cc	173kW (235PS)	Diesel Turbo Intercooler	TD12551
CS134	6 Cyl.	5880cc	134kW (182PS)	Diesel Turbo Intercooler	TD6648
CS156	6 Cyl.	5880cc	156kW (215PS)	Diesel Turbo Intercooler	TD6649
CT 97	6 Cyl.	5880cc	97kW (132PS)	Diesel Turbo	TD12557
CT 97 L Euro 1	6 Cyl.	5880cc	97kW (132PS)	Diesel Turbo	TD22209
CT 108	6 Cyl.	5880cc	108kW (147PS)	Diesel Turbo	TD12562
CT 108 L Euro 1	6 Cyl.	5880cc	95-120kW (129-163PS)	Diesel Turbo	TD22208
CT 119	6 Cyl.	5880cc	119kW (162PS)	Diesel Turbo	TD6646
CT 119 G	6 Cyl.	5880cc	120kW (163PS)	Diesel Turbo	TD6647

BE/PL	1	68,987/69,013	72,987/73,013	31,130	1,968	0,038/0,114	EC	71-4573	71-4573 STD 0.25 0.50
BE/PL	1	68,987/69,013	72,987/73,013	31,130	1,968	0,038/0,114	EC	71-4573	71-4708 STD 0.25 0.50
BE/PL	1	68,987/69,013	72,987/73,013	31,130	1,968	0,038/0,114	EC	71-4708	

71-4573

71-4708

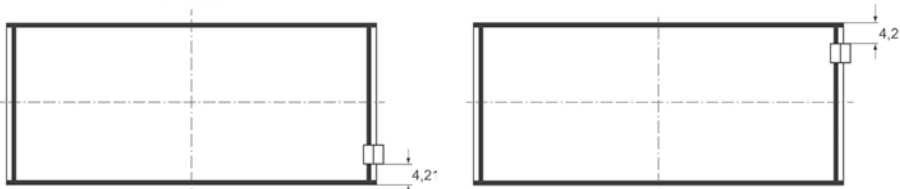

MB/HL	1	82,993/83,013	87,977/88,013	37,348	2,464	0,036/0,116	AL-LF	02-4574H	02-4575H STD 0.25 0.50
MB/HL	1	82,993/83,013	87,977/88,013	37,348	2,464	0,036/0,116	AL-LF	02-4575H	
MB/HL	1	82,993/83,013	87,982/88,008	29,030	2,464	0,041/0,111	AL-LF	02-4576	02-4576 STD 0.25 0.50

02-4574H

02-4575H

02-4576

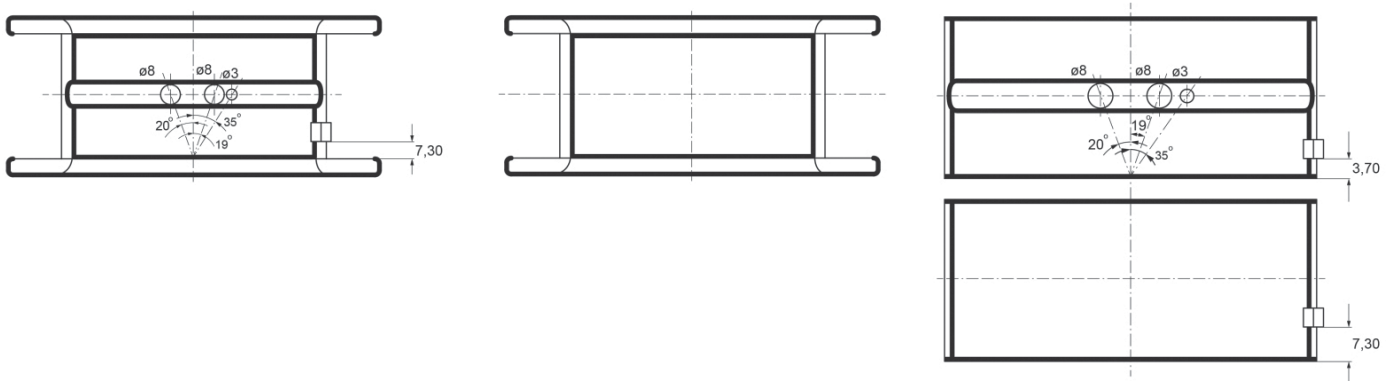

SE/PB	1	40,000	42,987/43,013	38,100			BS	55-4706	55-4706 SEMI
CB/NWB	1		59,228/59,248	25,400			BS	53-4707	53-4707 SEMI

11 104.00 x 120.00

DF 615	6 Cyl.	6150cc	85kW (115PS)	Diesel	TD6601				
DT 615	6 Cyl.	6150cc	111kW (151PS)	Diesel Turbo	TD6602				
DTD 615	6 Cyl.	6150cc	101-123kW (137-167PS)	Diesel Turbo	TD6616				
BE/PL	6	60,955/60,973	64,592/64,604	34,798	1,788	0,042/0,099	BS	71-1739	71-1739/6 STD

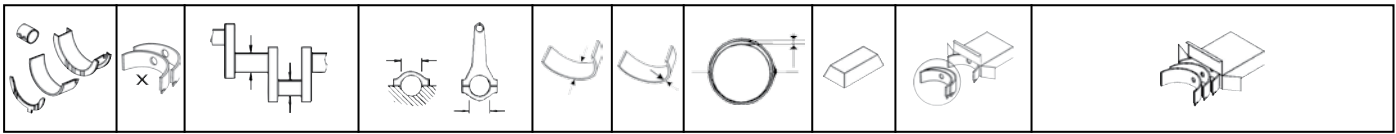

12 118.00 x 126.00

DF 825	6 Cyl.	8250cc	115-121kW (156-165PS)	Diesel	TD22800
DH 825	6 Cyl.	8250cc	115-121kW (156-165PS)	Diesel	TD6603
DHB 825	6 Cyl.	8250cc	148kW (201PS)	Diesel Turbo	TD13229
DHR 825	6 Cyl.	8250cc	150kW (204PS)	Diesel Turbo	TD6619
DHS 825	6 Cyl.	8250cc	184-195kW (250-265PS)	Diesel Turbo Intercooler	TD6625
DHS 825SM	6 Cyl.	8250cc	217kW (294PS)	Diesel Turbo Intercooler	TD6626
DHT 825	6 Cyl.	8250cc	162-167kW (220-228PS)	Diesel Turbo	TD6620
DHTD 825	6 Cyl.	8250cc	151kW (205PS)	Diesel Turbo	TD6621
DHU 825	6 Cyl.	8250cc	169kW (230PS)	Diesel Turbo	TD6623
DT 825	6 Cyl.	8250cc	151kW (205PS)	Diesel Turbo	TD22801
DU 825	6 Cyl.	8250cc	159kW (216PS)	Diesel Turbo	TD6618
HS 200	6 Cyl.	8250cc	200kW (272PS)	Diesel Turbo Intercooler	TD6628
HS 825	6 Cyl.	8250cc	200kW (272PS)	Diesel Turbo Intercooler	TD12890
HT 168	6 Cyl.	8250cc	168kW (228PS)	Diesel Turbo	TD6624
HT 825	6 Cyl.	8250cc	168kW (228PS)	Diesel Turbo	TD12891

BE/PL	6	74,990/75,010	78,564/78,576	40,000	1,754	0,046/0,094	EC	71-2829	71-4383/6 STD 0.25
MB/HL 2,3,5,6	4	87,990/88,010	92,050/92,075	30,050	1,990	0,060/0,105	BC	GS2894LC	H1254/7 STD
MB/HL 1	1	87,990/88,010	92,050/92,075	46,000	1,990	0,060/0,105	BC	GS2895LC	
MB/HL 4,7	2	87,990/88,010	92,050/92,075	38,000	1,990	0,060/0,105	BC	GS2896LC	

Mot.→D62165

TW/A	2	97,866/98,120	117,221/117,475		2,380		BC	54-2833	A022/4 STD
TW/A	2	97,866/98,120	117,221/117,475		2,380		BC	54-3345	

13 118.00 x 132.00

RS 180	6 Cyl.	8650cc	180kW (245PS)	Diesel Turbo Intercooler	TD12553
RS 180 L Euro 1	6 Cyl.	8650cc	180kW (245PS)	Diesel Turbo Intercooler	TD6654
RS 180 M Euro 2	6 Cyl.	8650cc	180kW (245PS)	Diesel Turbo Intercooler	TD6655
RS 200	6 Cyl.	8650cc	200kW (272PS)	Diesel Turbo Intercooler	TD12554
RS 200 L Euro 1	6 Cyl.	8650cc	200kW (272PS)	Diesel Turbo Intercooler	TD6656
RS 200 M Euro 2	6 Cyl.	8650cc	200kW (272PS)	Diesel Turbo Intercooler	TD6657
RS 222	6 Cyl.	8650cc	222kW (302PS)	Diesel Turbo Intercooler	TD12555
RS 222 L Euro 1	6 Cyl.	8650cc	222kW (302PS)	Diesel Turbo Intercooler	TD6658
RS 222 M Euro 2	6 Cyl.	8650cc	222kW (302PS)	Diesel Turbo Intercooler	TD6659

BE/PL	6	79,980/80,020	83,564/83,576	38,200	1,748	0,048/0,125	EC	71-3794	71-3794/6 STD
MB/HL 1,7	2	87,980/88,020	92,050/92,075	36,200	1,990	0,050/0,140	EC	72-3795	H054/7 STD
MB/HL 2,3,5,6	4	87,980/88,020	92,050/92,075	28,700	1,990	0,050/0,140	EC	72-3796	
MB/HL 4	1	87,980/88,020	92,050/92,075	44,200	1,990	0,050/0,140	EC	72-3797	
TW/A	2	97,880/98,120	117,230/117,470		2,336		EC	54-3766	A145/4 STD
TW/A	2	97,880/98,120	117,230/117,470		2,336		EC	54-3798	
SE/PB	1	47,994/48,000	52,087/52,113	36,750			BC	55-3800	55-3800 SEMI

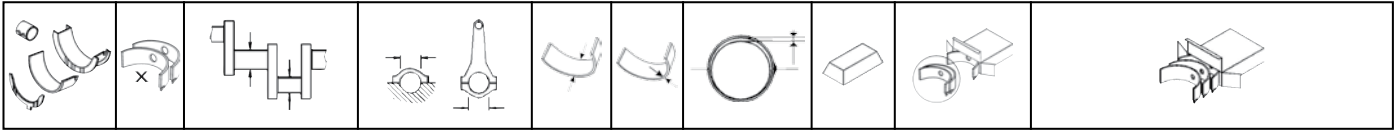

14										118.00 x 140.00	
PF 183 M Euro 2		6 Cyl.		9200cc	183kW (249PS)		Diesel Turbo Intercooler		TD11909		
PF 212 M Euro 2		6 Cyl.		9200cc	191-212kW (260-288PS)		Diesel Turbo Intercooler		TD11910		
PF 235 M Euro 2		6 Cyl.		9200cc	235kW (320PS)		Diesel Turbo Intercooler		TD11911		
BE/PL	6	81,980/82,020	85,564/85,576	38,200	1,748	0,048/0,125	EC	71-3914	71-3914/6 0.25		

15										130.00 x 146.00	
DKA 1160		6 Cyl.		11600cc	169kW (230PS)		Diesel		TD6608		
DK 1160		6 Cyl.		11630cc	156kW (212PS)		Diesel Turbo Intercooler		TD6606		
BE/PL	6	79,195/79,215	82,830/82,845	45,400	1,787	0,041/0,101	EC	71-3291	71-3291/6P STD 0.25 0.50		

01/73 → 09/84

MB/HL	1	97,990/98,010	103,072/103,098	39,150	2,496	0,069/0,141	EC	72-3632	H005/7P STD 0.25 0.50	
MB/HL	4	97,990/98,010	103,072/103,098	32,050	2,496	0,069/0,141	EC	72-3633		
MB/HL	2	97,990/98,010	103,072/103,098	52,150	2,496	0,069/0,141	EC	72-3634		

Mot.F65302 →

MB/HL	1	97,990/98,010	103,072/103,098	39,150	2,496	0,069/0,141	EC	72-3632	H022/7P STD 0.25 0.50	
MB/HL	4	97,990/98,010	103,072/103,098	32,050	2,496	0,069/0,141	EC	72-3691		
MB/HL	2	97,990/98,010	103,072/103,098	52,000	2,496	0,069/0,141	EC	72-3692		

Mot. → F65301

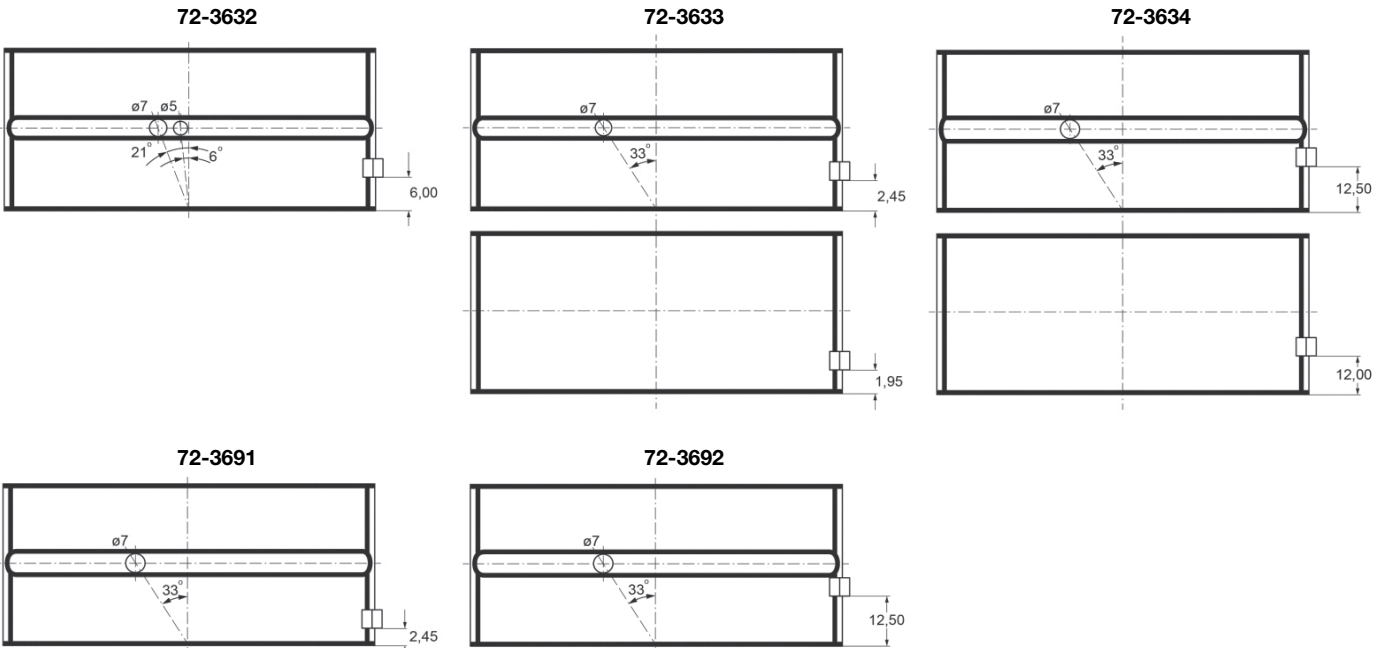

TW/A	2	102,320	126,620		2,362	EC	54-2828	A023/4 STD	
TW/A	2	102,320	126,620		2,362	EC	54-3346		
SE/PB	1		52,087/52,113	44,100		BC	55-3792	55-3792 SEMI	
SE/PB	1		56,087/56,113	41,550		BC	55-3793	55-3793 SEMI	

CB/NWB	5	63,188/63,212	67,305/67,335	25,450	2,026		BC	53-2837	N095/5 STD

16 **130.00 x 146.00**

DKB 1160			6 Cyl.	11600cc	226kW (308PS)		Diesel Turbo		TD6627
BE/PL	6	79,195/79,215	82,830/82,845	45,400	1,787	0,041/0,101	EC	71-3291	71-3291/6P STD 0.25 0.50
01/73 →									
MB/HL	1	97,990/98,010	103,072/103,098	39,150	2,496	0,069/0,141	EC	72-3632	H005/7P STD 0.25 0.50
MB/HL	4	97,990/98,010	103,072/103,098	32,050	2,496	0,069/0,141	EC	72-3633	
MB/HL	2	97,990/98,010	103,072/103,098	52,150	2,496	0,069/0,141	EC	72-3634	
Mot.F65302 →									
MB/HL	1	97,990/98,010	103,072/103,098	39,150	2,496	0,069/0,141	EC	72-3632	H022/7P STD 0.25 0.50
MB/HL	4	97,990/98,010	103,072/103,098	32,050	2,496	0,069/0,141	EC	72-3691	
MB/HL	2	97,990/98,010	103,072/103,098	52,000	2,496	0,069/0,141	EC	72-3692	
Mot. → F65301									

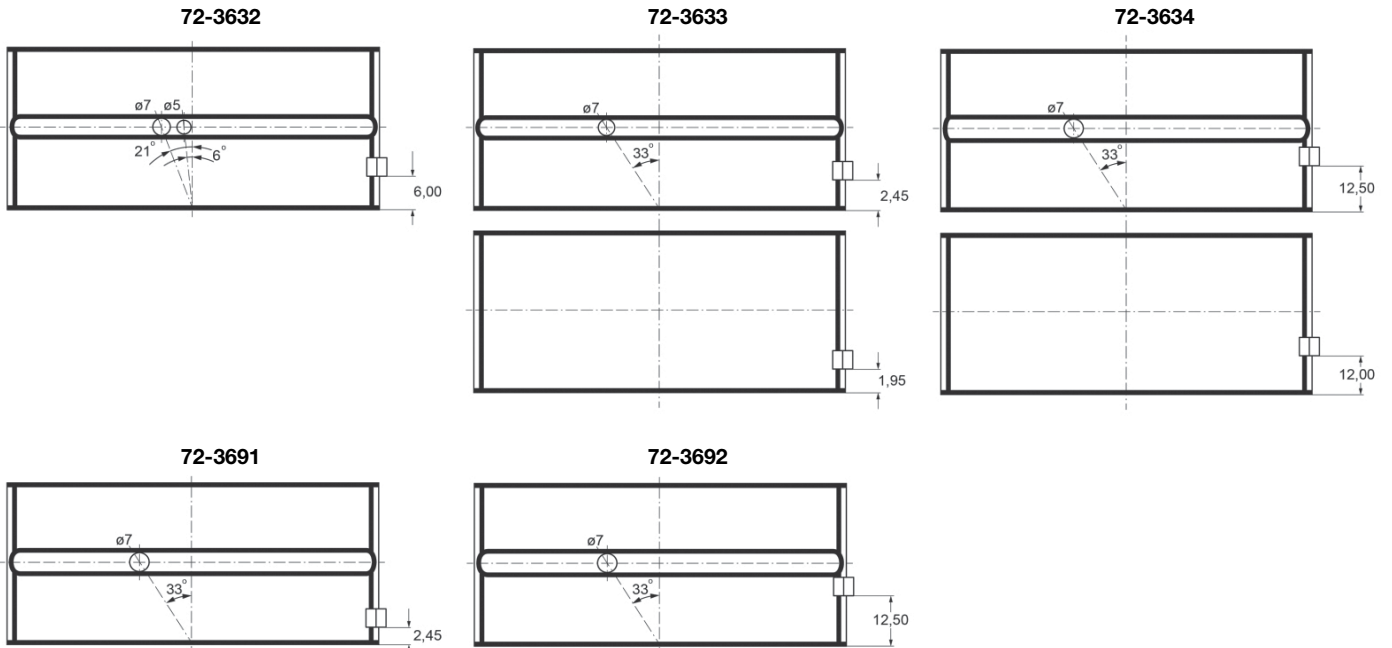

TW/A	2	102,320	126,620		2,362		EC	54-2828	A023/4 STD
TW/A	2	102,320	126,620		2,362		EC	54-3346	
SE/PB	1		52,087/52,113	44,100			BC	55-3792	55-3792 SEMI
SE/PB	1		56,087/56,113	41,550			BC	55-3793	55-3793 SEMI
CB/NWB	5	63,188/63,212	67,305/67,335	25,450	2,026		BC	53-2837	N095/5 STD

17 **130.00 x 146.00**

DKCL 1160			6 Cyl.	11630cc	156kW (212PS)		Diesel Turbo Intercooler		TD20105
DKD 1160			6 Cyl.	11630cc	121kW (165PS)		Diesel Turbo		TD6605
DKDL 1160			6 Cyl.	11630cc	121kW (164PS)		Diesel Turbo Intercooler		TD6640

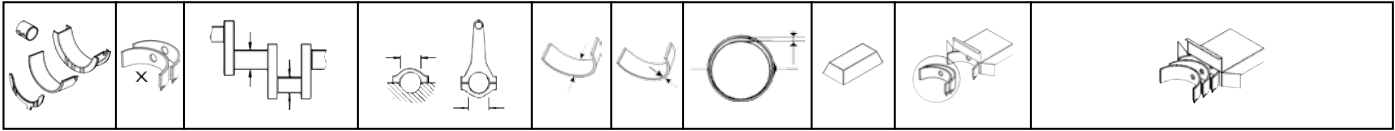

DKFL 1160	6 Cyl.	11630cc	191kW (260PS)	Diesel Turbo Intercooler	TD20107
DKL 1160	6 Cyl.	11630cc	148-151kW (201-205PS)	Diesel Turbo Intercooler	TD6641
DKS 1160	6 Cyl.	11600cc	228kW (310PS)	Diesel Turbo	TD6629
DKS 1160 E	6 Cyl.	11600cc	206kW (280PS)	Diesel Turbo Intercooler	TD6630
DKSB 1160	6 Cyl.	11630cc	228kW (310PS)	Diesel Turbo Intercooler	TD20106
DKSE 1160	6 Cyl.	11630cc	206kW (280PS)	Diesel Turbo Intercooler	TD22211
DKT 1160	6 Cyl.	11600cc	213kW (290PS)	Diesel Turbo	TD6631
DKTD 1160	6 Cyl.	11600cc	188-191kW (256-260PS)	Diesel Turbo	TD6632
DKTL 1160	6 Cyl.	11600cc	185kW (252PS)	Diesel Turbo	TD6642
DKV 1160	6 Cyl.	11600cc	212kW (280PS)	Diesel Turbo	TD6633
DKVL 1160	6 Cyl.	11600cc	206kW (280PS)	Diesel Turbo	TD13288
DKX 1160	6 Cyl.	11600cc	243kW (330PS)	Diesel Turbo Intercooler	TD6637
DKXE 1160	6 Cyl.	11600cc	212kW (280PS)	Diesel Turbo Intercooler	TD6634
DKZ 1160	6 Cyl.	11630cc	139-274kW (189-373PS)	Diesel Turbo Intercooler	TD22213
WS 270	6 Cyl.	11630cc	270kW (367PS)	Diesel Turbo Intercooler	TD6673

BE/PL	6	79,195/79,215	82,830/82,845	45,400	1,787	0,041/0,101	EC	71-3291	71-3291/6P STD 0.25 0.50
-------	---	---------------	---------------	--------	-------	-------------	----	---------	------------------------------------

→09/84

BE/PL	6	82,980/83,020	86,625/86,637	42,700	1,787	0,031/0,108	EC	71-3631	71-3631/6P STD 0.25 0.50
-------	---	---------------	---------------	--------	-------	-------------	----	---------	------------------------------------

10/84→

71-3631

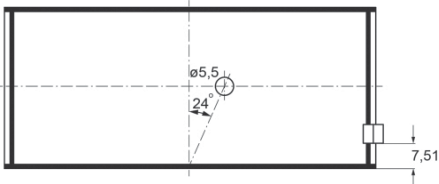

MB/HL	1	97,990/98,010	103,072/103,098	39,150	2,496	0,069/0,141	EC	72-3632	H005/7P STD 0.25 0.50
MB/HL	4	97,990/98,010	103,072/103,098	32,050	2,496	0,069/0,141	EC	72-3633	
MB/HL	2	97,990/98,010	103,072/103,098	52,150	2,496	0,069/0,141	EC	72-3634	

Mot.F65302→

MB/HL	1	97,990/98,010	103,072/103,098	39,150	2,496	0,069/0,141	EC	72-3632	H022/7P STD 0.25 0.50
MB/HL	4	97,990/98,010	103,072/103,098	32,050	2,496	0,069/0,141	EC	72-3691	
MB/HL	2	97,990/98,010	103,072/103,098	52,000	2,496	0,069/0,141	EC	72-3692	

Mot.→F65301

72-3632

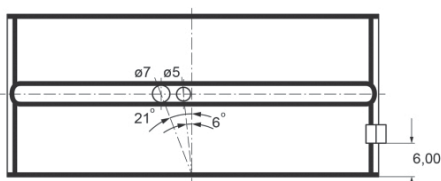

72-3633

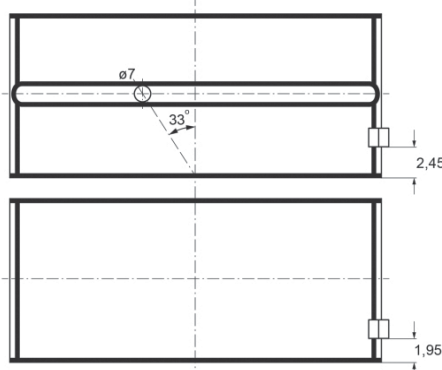

72-3634

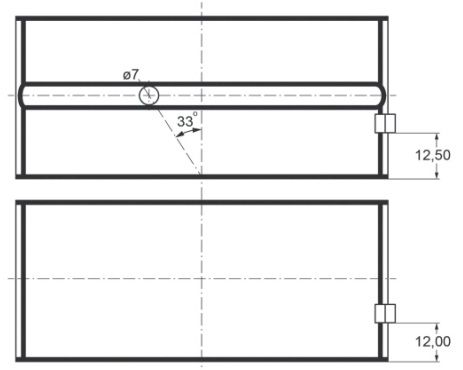

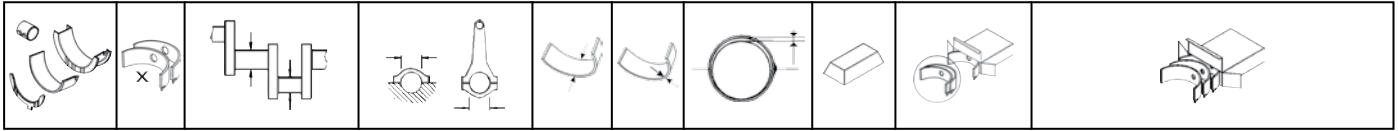

72-3691

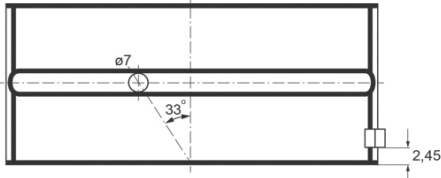

72-3692

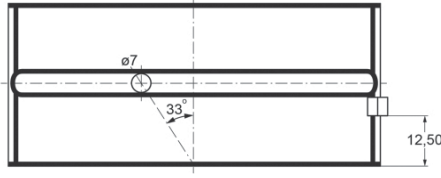

TW/A	2	102,320	126,620		2,362		EC	54-2828	A023/4 STD
TW/A	2	102,320	126,620		2,362		EC	54-3346	
SE/PB	1		52,087/52,113	44,100			BC	55-3792	55-3792 SEMI
SE/PB	1		56,087/56,113	41,550			BC	55-3793	
CB/NWB	5	63,188/63,212	67,305/67,335	25,450	2,026		BC	53-2837	N095/5 STD

18

130.00 x 146.00

DKX 1160 ATi	6 Cyl.	11600cc	260kW (354PS)					Diesel Turbo Intercooler	TD6638
DKXE 1160 ATI	6 Cyl.	11630cc	139-274kW (189-373PS)					Diesel Turbo Intercooler	TD22212
DKZ 1160 ATI	6 Cyl.	11600cc	274kW (373PS)					Diesel Turbo Intercooler	TD6639
DKZE 1160	6 Cyl.	11600cc	226kW (307PS)					Diesel Turbo Intercooler	TD12828
KS 1160	6 Cyl.	11600cc	238kW (324PS)					Diesel Turbo Intercooler	TD12889
KV 1160	6 Cyl.	11600cc	212kW (288PS)					Diesel Turbo	TD12888

BE/PL	6	82,980/83,020	86,625/86,637	42,700	1,787	0,031/0,108	EC	71-3631	71-3631/6P STD 0.25 0.50
MB/HL	1	97,990/98,010	103,072/103,098	39,150	2,496	0,069/0,141	EC	72-3632	H005/7P STD 0.25 0.50
MB/HL	4	97,990/98,010	103,072/103,098	32,050	2,496	0,069/0,141	EC	72-3633	
MB/HL	2	97,990/98,010	103,072/103,098	52,150	2,496	0,069/0,141	EC	72-3634	

Mot.F65302 →

MB/HL	1	97,990/98,010	103,072/103,098	39,150	2,496	0,069/0,141	EC	72-3632	H022/7P STD 0.25 0.50
MB/HL	4	97,990/98,010	103,072/103,098	32,050	2,496	0,069/0,141	EC	72-3691	
MB/HL	2	97,990/98,010	103,072/103,098	52,000	2,496	0,069/0,141	EC	72-3692	

Mot. → F65301

72-3632

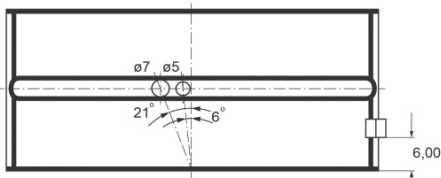

72-3633

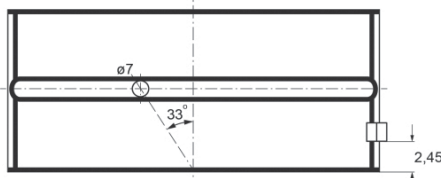

72-3634

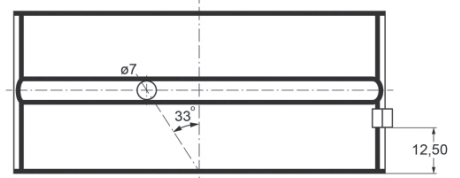

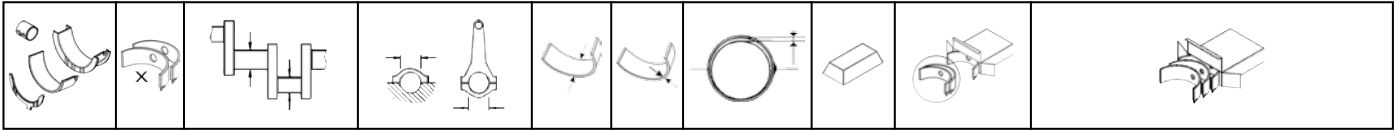

72-3691

72-3692

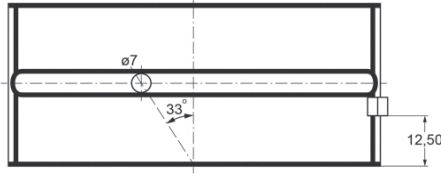
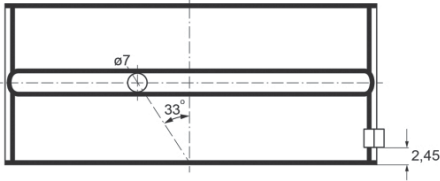

TW/A	2	102,320	126,620		2,362		EC	54-2828	A023/4 STD
TW/A	2	102,320	126,620		2,362		EC	54-3346	
SE/PB	1		52,087/52,113	44,100			BC	55-3792	55-3792 SEMI
SE/PB	1		56,087/56,113	41,550			BC	55-3793	55-3793 SEMI
CB/NWB	5	63,188/63,212	67,305/67,335	25,450	2,026		BC	53-2837	N095/5 STD

19 130.00 x 146.00

LT 160 6 Cyl. **11630cc 160-170kW (218-231PS)** Diesel Turbo Intercooler **TD24104**

LT 210 6 Cyl. **11630cc 206-210kW (280-286PS)** Diesel Turbo Intercooler **TD7173**

BE/PL	6	79,195/79,215	82,830/82,845	45,400	1,787	0,041/0,101	EC	71-3291	71-3291/6P STD 0.25 0.50
-------	---	---------------	---------------	--------	-------	-------------	----	---------	------------------------------------

01/73 → 09/84

BE/PL	6	82,980/83,020	86,625/86,637	42,700	1,787	0,031/0,108	EC	71-3631	71-3631/6P STD 0.25 0.50
-------	---	---------------	---------------	--------	-------	-------------	----	---------	------------------------------------

10/84 → 03/94

BE/PL	6	82,980/83,020	86,625/86,637	42,500	1,787	0,031/0,108	EC	71-3791	71-3791/6 STD
-------	---	---------------	---------------	--------	-------	-------------	----	---------	-------------------------

04/94 →

71-3631

71-3791

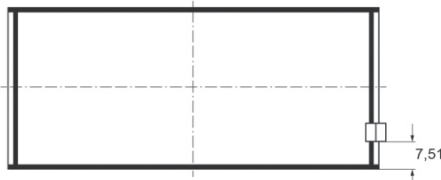
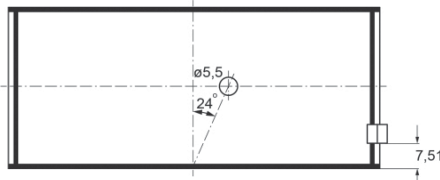

MB/HL	1	97,990/98,010	103,072/103,098	39,150	2,496	0,069/0,141	EC	72-3632	H005/7P STD 0.25 0.50
MB/HL	4	97,990/98,010	103,072/103,098	32,050	2,496	0,069/0,141	EC	72-3633	
MB/HL	2	97,990/98,010	103,072/103,098	52,150	2,496	0,069/0,141	EC	72-3634	

Mot.F65302 →

MB/HL	1	97,990/98,010	103,072/103,098	39,150	2,496	0,069/0,141	EC	72-3632	H022/7P STD 0.25 0.50
MB/HL	4	97,990/98,010	103,072/103,098	32,050	2,496	0,069/0,141	EC	72-3691	
MB/HL	2	97,990/98,010	103,072/103,098	52,000	2,496	0,069/0,141	EC	72-3692	

Mot. → F65301

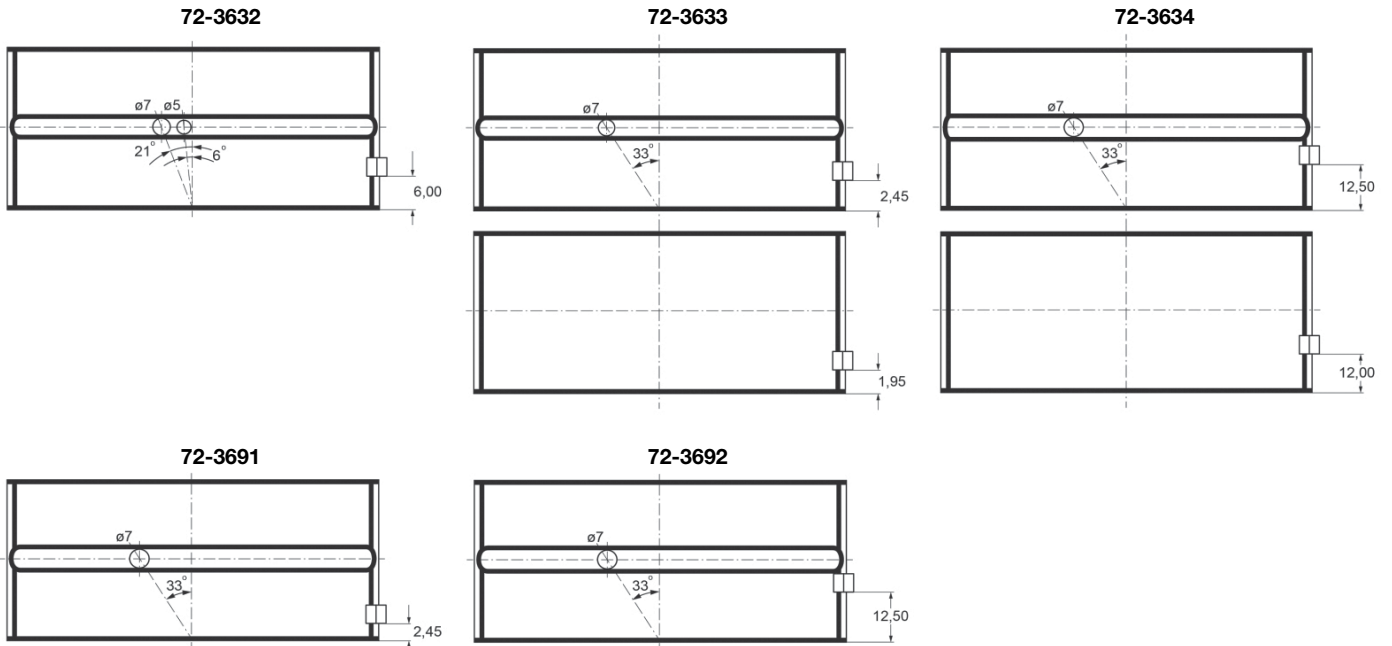
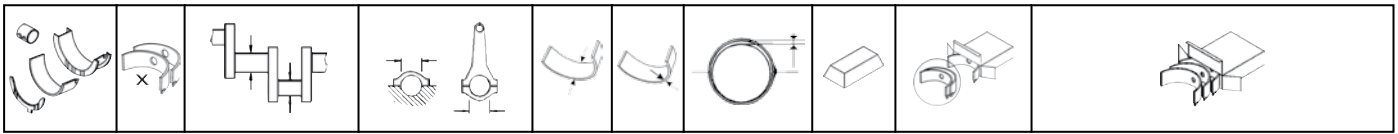

TW/A	2	102,320	126,620		2,362	EC	54-2828	A023/4 STD
TW/A	2	102,320	126,620		2,362	EC	54-3346	
TW/A	2	108,200	126,512		2,362	EC	54-3762	A142/4 STD
TW/A	2	108,200	126,512		2,362	EC	54-3763	
SE/PB	1		52,087/52,113	44,100		BC	55-3792	55-3792 SEMI
SE/PB	1		56,087/56,113	41,550		BC	55-3793	55-3793 SEMI
CB/NWB	5	63,188/63,212	67,305/67,335	25,450	2,026	BC	53-2837	N095/5 STD

20

130.00 x 146.00

WS 222 G			6 Cyl.	11630cc	222kW (302PS)		Diesel Turbo Intercooler	TD6667	
WS 222 L			6 Cyl.	11630cc	222kW (302PS)		Diesel Turbo Intercooler	TD6660	
WS 222 M			6 Cyl.	11630cc	222kW (302PS)		Diesel Turbo Intercooler	TD6661	
WS 225 ATi			6 Cyl.	11630cc	225kW (306PS)		Diesel Turbo Intercooler	TD7517	
WS 242 G			6 Cyl.	11630cc	242kW (330PS)		Diesel Turbo Intercooler	TD22214	
WS 259 ATi			6 Cyl.	11630cc	259kW (352PS)		Diesel Turbo Intercooler	TD7518	
WS 282 ATi			6 Cyl.	11630cc	282kW (383PS)		Diesel Turbo Intercooler	TD7519	
WS 282 L			6 Cyl.	11630cc	282kW (383PS)		Diesel Turbo Intercooler	TD6674	
WS 295 M Ati			6 Cyl.	11627cc	295kW (401PS)		Diesel Turbo Intercooler	TD6666	
BE/PL	6	82,980/83,020	86,625/86,637	42,700	1,787	0,031/0,108	EC	71-3631	71-3631/6P STD 0.25 0.50
10/84 → 03/94									
BE/PL	6	82,980/83,020	86,625/86,637	42,500	1,787	0,031/0,108	EC	71-3791	71-3791/6 STD
04/94 →									

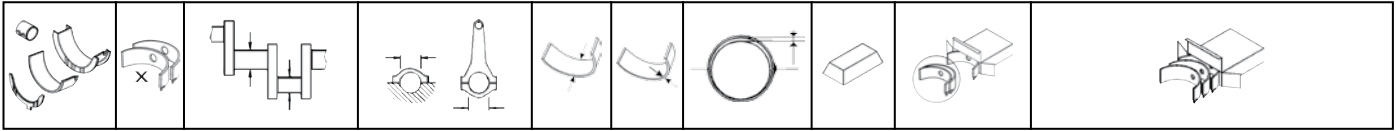

71-3631

71-3791

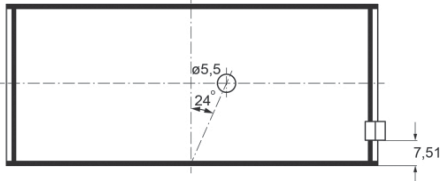

MB/HL	1	97,990/98,010	103,072/103,098	39,150	2,496	0,069/0,141	EC	72-3632
MB/HL	4	97,990/98,010	103,072/103,098	32,050	2,496	0,069/0,141	EC	72-3633
MB/HL	2	97,990/98,010	103,072/103,098	52,150	2,496	0,069/0,141	EC	72-3634

H005/7P
STD 0.25 0.50

Mot.F65302 →

MB/HL	1	97,990/98,010	103,072/103,098	39,150	2,496	0,069/0,141	EC	72-3632
MB/HL	4	97,990/98,010	103,072/103,098	32,050	2,496	0,069/0,141	EC	72-3691
MB/HL	2	97,990/98,010	103,072/103,098	52,000	2,496	0,069/0,141	EC	72-3692

H022/7P
STD 0.25 0.50

Mot. → F65301

72-3632

72-3633

72-3634

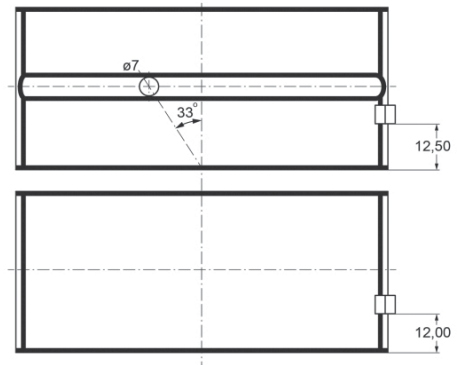
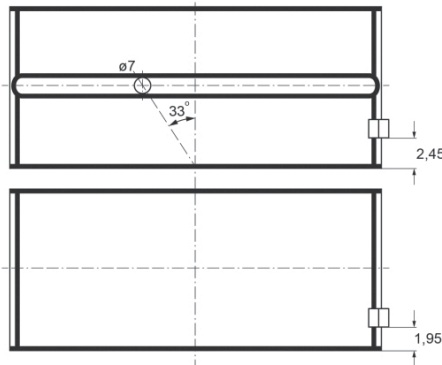
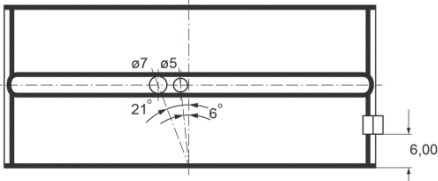

72-3691

72-3692

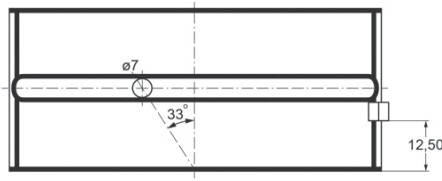
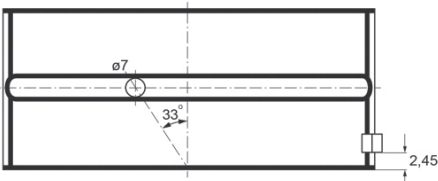

TW/A	2	102,320	126,620		2,362		EC	54-2828
TW/A	2	102,320	126,620		2,362		EC	54-3346
TW/A	2	108,200	126,512		2,362		EC	54-3762
TW/A	2	108,200	126,512		2,362		EC	54-3763
SE/PB	1		56,087/56,113	41,550			BC	55-3793
CB/NWB	5	63,188/63,212	67,305/67,335	25,450	2,026		BC	53-2837

A023/4
STD

A142/4
STD

55-3793
SEMI

N095/5
STD

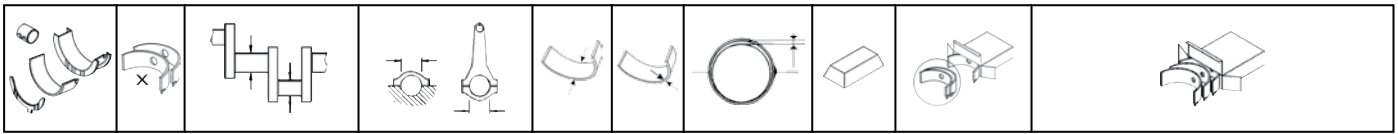

21		130.00 x 146.00							
WS 225	6 Cyl.	11600cc	225kW (306PS)					Diesel Turbo Intercooler	TD6668
WS 259	6 Cyl.	11600cc	259kW (352PS)					Diesel Turbo Intercooler	TD6670
WS 282	6 Cyl.	11600cc	282kW (384PS)					Diesel Turbo Intercooler	TD11907

BE/PL	6	82,980/83,020	86,625/86,637	42,700	1,787	0,031/0,108	EC	71-3631	71-3631/6P STD 0.25 0.50
MB/HL	1	97,990/98,010	103,072/103,098	39,150	2,496	0,069/0,141	EC	72-3632	H005/7P STD 0.25 0.50
MB/HL	4	97,990/98,010	103,072/103,098	32,050	2,496	0,069/0,141	EC	72-3633	
MB/HL	2	97,990/98,010	103,072/103,098	52,150	2,496	0,069/0,141	EC	72-3634	

Mot.F65302 →

MB/HL	1	97,990/98,010	103,072/103,098	39,150	2,496	0,069/0,141	EC	72-3632	H022/7P STD 0.25 0.50
MB/HL	4	97,990/98,010	103,072/103,098	32,050	2,496	0,069/0,141	EC	72-3691	
MB/HL	2	97,990/98,010	103,072/103,098	52,000	2,496	0,069/0,141	EC	72-3692	

Mot. → F65301

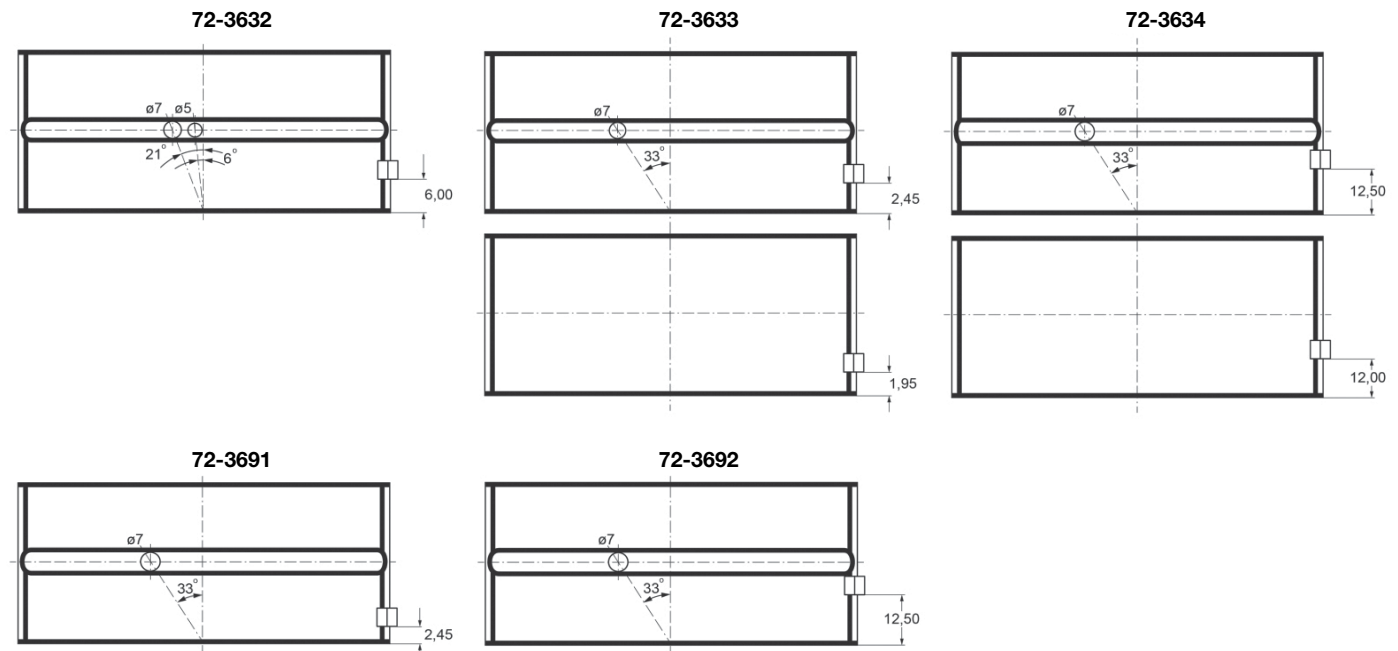

TW/A	2	102,320	126,620		2,362		EC	54-2828	A023/4 STD
TW/A	2	102,320	126,620		2,362		EC	54-3346	
TW/A	2	108,200	126,512		2,362		EC	54-3762	A142/4 STD
TW/A	2	108,200	126,512		2,362		EC	54-3763	
SE/PB	1		56,087/56,113	41,550			BC	55-3793	55-3793 SEMI
CB/NWB	5	63,188/63,212	67,305/67,335	25,450	2,026		BC	53-2837	N095/5 STD

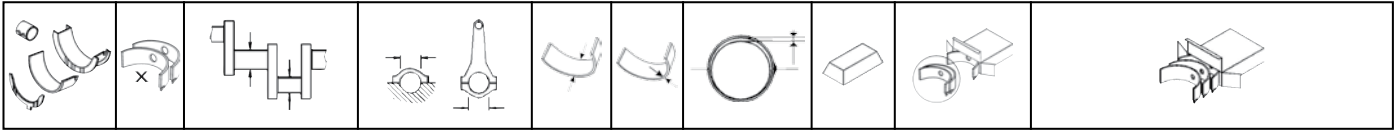

22 130.00 x 146.00

WS 242	6 Cyl.	11600cc	242kW (330PS)	Diesel Turbo Intercooler	TD6669
WS 242 L Euro 1	6 Cyl.	11600cc	242kW (330PS)	Diesel Turbo Intercooler	TD6662
WS 242 M Euro 2	6 Cyl.	11600cc	242kW (330PS)	Diesel Turbo Intercooler	TD6663
WS 268	6 Cyl.	11600cc	268kW (365PS)	Diesel Turbo Intercooler	TD6671
WS 268 G	6 Cyl.	11600cc	268kW (364PS)	Diesel Turbo Intercooler	TD6672
WS 268 L Euro 1	6 Cyl.	11600cc	268kW (365PS)	Diesel Turbo Intercooler	TD6664
WS 268 M Euro 2	6 Cyl.	11600cc	268kW (365PS)	Diesel Turbo Intercooler	TD6665
WS 295	6 Cyl.	11600cc	295kW (401PS)	Diesel Turbo Intercooler	TD6675
WS 295 G	6 Cyl.	11600cc	295kW (401PS)	Diesel Turbo Intercooler	TD6676
WS 295 L Euro 1	6 Cyl.	11600cc	295kW (401PS)	Diesel Turbo Intercooler	TD6677
WS 295 M Euro 2	6 Cyl.	11600cc	295kW (401PS)	Diesel Turbo Intercooler	TD6678
WS 315	6 Cyl.	11600cc	315kW (428PS)	Diesel Turbo Intercooler	TD11908
WS 315 G	6 Cyl.	11627cc	315kW (428PS)	Diesel Turbo	TD6679
WS 315 L Euro 1	6 Cyl.	11600cc	315kW (428PS)	Diesel Turbo Intercooler	TD6680
WS 315 M Euro 2	6 Cyl.	11600cc	315kW (428PS)	Diesel Turbo Intercooler	TD6681

BE/PL	6	82,980/83,020	86,625/86,637	42,700	1,787	0,031/0,108	EC	71-3631	71-3631/6P STD 0.25 0.50
-------	---	---------------	---------------	--------	-------	-------------	----	---------	-----------------------------

→03/94

BE/PL	6	82,980/83,020	86,625/86,637	42,500	1,787	0,031/0,108	EC	71-3791	71-3791/6 STD
-------	---	---------------	---------------	--------	-------	-------------	----	---------	------------------

04/94→

71-3631

71-3791

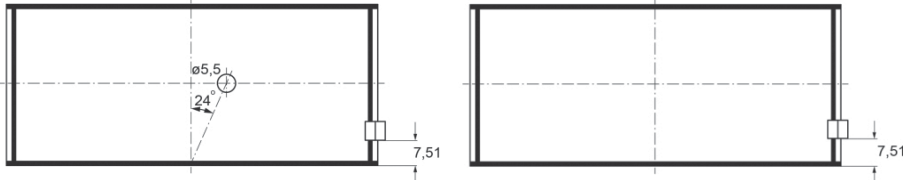

MB/HL	1	97,990/98,010	103,072/103,098	39,150	2,496	0,069/0,141	EC	72-3632	H005/7P STD 0.25 0.50
MB/HL	4	97,990/98,010	103,072/103,098	32,050	2,496	0,069/0,141	EC	72-3633	
MB/HL	2	97,990/98,010	103,072/103,098	52,150	2,496	0,069/0,141	EC	72-3634	

Mot.F65302→

MB/HL	1	97,990/98,010	103,072/103,098	39,150	2,496	0,069/0,141	EC	72-3632	H022/7P STD 0.25 0.50
MB/HL	4	97,990/98,010	103,072/103,098	32,050	2,496	0,069/0,141	EC	72-3691	
MB/HL	2	97,990/98,010	103,072/103,098	52,000	2,496	0,069/0,141	EC	72-3692	

Mot.→F65301

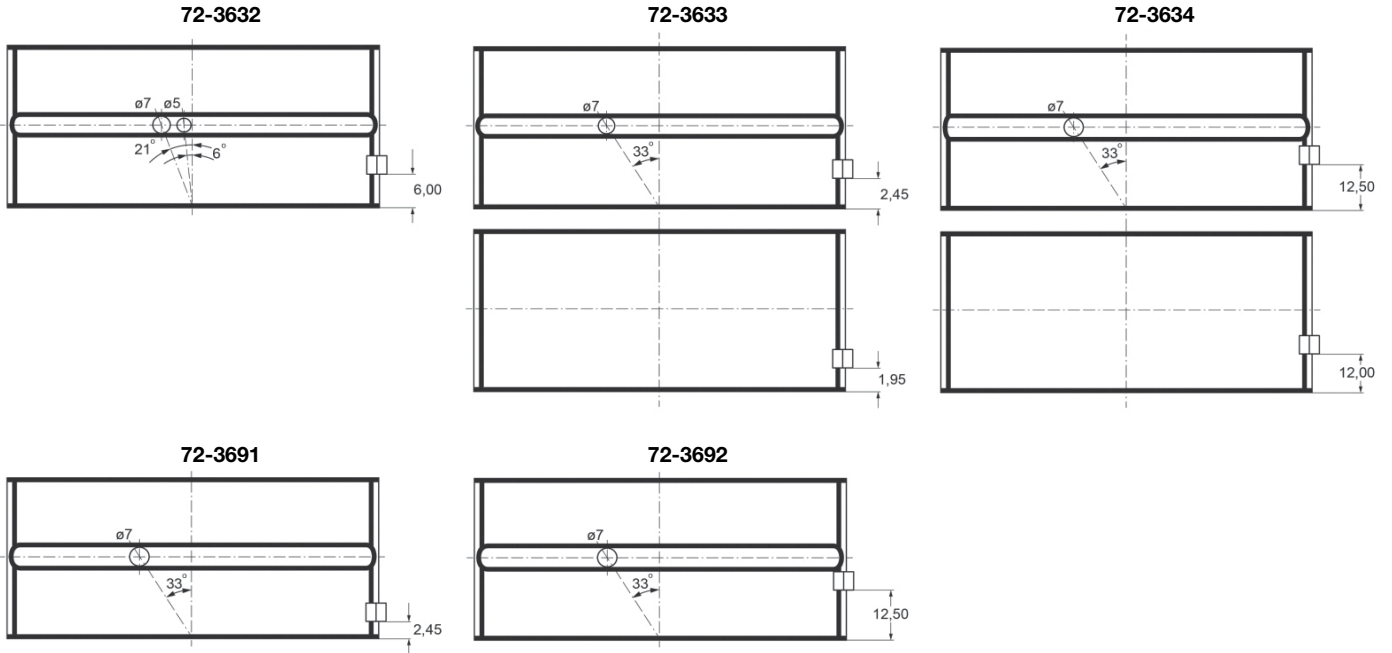
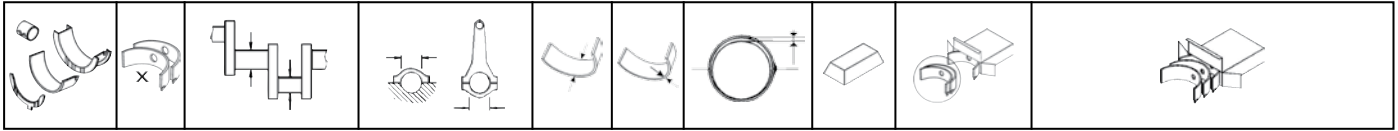

TW/A	2	102,320	126,620		2,362	EC	54-2828	A023/4 STD
TW/A	2	102,320	126,620		2,362	EC	54-3346	
TW/A	2	108,200	126,512		2,362	EC	54-3762	A142/4 STD
TW/A	2	108,200	126,512		2,362	EC	54-3763	
SE/PB	1		56,087/56,113	41,550		BC	55-3793	55-3793 SEMI
CB/NWB	5	63,188/63,212	67,305/67,335	25,450	2,026	BC	53-2837	N095/5 STD

23

130.00 x 158.00

XE 250 C Euro 3			6 Cyl.	12580cc	250kW (340PS)		Diesel Turbo Intercooler	TD13331	
XE 280 C Euro 3			6 Cyl.	12580cc	280kW (381PS)		Diesel Turbo Intercooler	TD13332	
XE 280 C1 Euro 3			6 Cyl.	12580cc	280kW (381PS)		Diesel Turbo Intercooler	TD22217	
XE 315 C Euro 3			6 Cyl.	12580cc	315kW (428PS)		Diesel Turbo Intercooler	TD13333	
XE 315 C1 Euro 3			6 Cyl.	12580cc	315kW (428PS)		Diesel Turbo Intercooler	TD22218	
XE 340 C Euro 3			6 Cyl.	12580cc	250kW (340PS)		Diesel Turbo Intercooler	TD22780	
XE 355 C Euro 3			6 Cyl.	12580cc	355kW (483PS)		Diesel Turbo Intercooler	TD13334	
XE 355 C1 Euro 3			6 Cyl.	12580cc	355kW (483PS)		Diesel Turbo Intercooler	TD22219	
XE 380 C Euro 3			6 Cyl.	12580cc	280kW (381PS)		Diesel Turbo Intercooler	TD22781	
XE 390 C Euro 3			6 Cyl.	12580cc	390kW (530PS)		Diesel Turbo Intercooler	TD13335	
XE 390 C1 Euro 3			6 Cyl.	12580cc	390kW (530PS)		Diesel Turbo Intercooler	TD22220	
XE 430 C Euro 3			6 Cyl.	12580cc	315kW (430PS)		Diesel Turbo Intercooler	TD22782	
BE/PL	6	91,980/92,020	96,594/96,606	33,000	2,260	0,130	EC	71-3919	71-3919/6 STD
MB/HL	1	97,990/98,010	103,072/103,098	39,150	2,496	0,069/0,141	EC	72-3632	H005/7P STD 0.25 0.50
MB/HL	4	97,990/98,010	103,072/103,098	32,050	2,496	0,069/0,141	EC	72-3633	
MB/HL	2	97,990/98,010	103,072/103,098	52,150	2,496	0,069/0,141	EC	72-3634	

TW/A	2	108,200	126,512		2,362		EC	54-3762	A142/4 STD	
TW/A	2	108,200	126,512		2,362		EC	54-3763		
SE/PB	1	51,992/52,000	56,087/56,113	45,900			BC	55-3950	55-3950 SEMI	
CB/NWB 1-4	4	75,990/76,010	80,000/80,035	22,000			AL-LF	03-4786	N194/4 STD	

24 130.00 x 158.00

XF 250 M Euro 2			6 Cyl.	12580cc	250kW (340PS)		Diesel Turbo Intercooler		TD11912
XF 280 M Euro 2			6 Cyl.	12580cc	280kW (381PS)		Diesel Turbo Intercooler		TD11913
XF 315 M Euro 2			6 Cyl.	12580cc	315kW (428PS)		Diesel Turbo Intercooler		TD11914
XF 355 M Euro 2			6 Cyl.	12580cc	355kW (483PS)		Diesel Turbo Intercooler		TD11915
BE/PL	6	87,980/88,020	92,594/92,606	39,000	2,260	0,070/0,142	EC	71-3866	71-3866/6 STD
BE/PL	1	87,980/88,020	92,594/92,606	39,000	2,260	0,070/0,142	SP	71-4785	71-4785 STD I

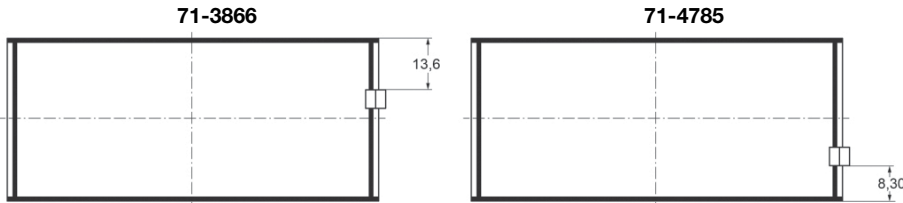





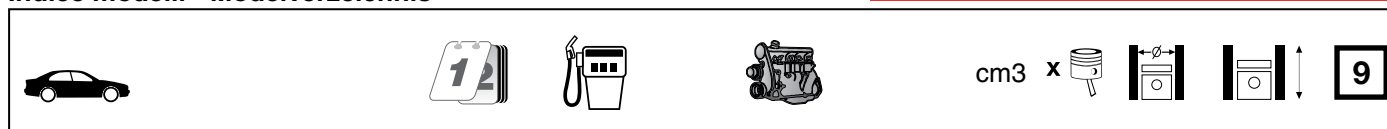

MB/HL	1	97,990/98,010	103,072/103,098	39,150	2,496	0,069/0,141	EC	72-3632	H005/7P STD 0.25 0.50
MB/HL	4	97,990/98,010	103,072/103,098	32,050	2,496	0,069/0,141	EC	72-3633	
MB/HL	2	97,990/98,010	103,072/103,098	52,150	2,496	0,069/0,141	EC	72-3634	
TW/A	2	108,200	126,512		2,362		EC	54-3762	A142/4 STD
TW/A	2	108,200	126,512		2,362		EC	54-3763	
SE/PB	1	51,992/52,000	56,087/56,113	45,900			BC	55-3950	55-3950 SEMI
CB/NWB 1-4	4	75,990/76,010	80,000/80,035	22,000			AL-LF	03-4786	N194/4 STD

25 130.00 x 162.00

MX 265 Euro 4/5			6 Cyl.	12900cc	265kW (360PS)		Diesel Turbo Intercooler		TD20056
MX 300 Euro 4/5			6 Cyl.	12900cc	300kW (408PS)		Diesel Turbo Intercooler		TD18902
MX 340 Euro 4/5			6 Cyl.	12900cc	340kW (462PS)		Diesel Turbo Intercooler		TD18903
MX 375 Euro 4/5			6 Cyl.	12900cc	375kW (510PS)		Diesel Turbo Intercooler		TD18904
BE/PL	1	91,986/92,008	97,000/97,022	38,000	2,464	0,064/0,132	SP	71-4787	71-4787 STD 0.25 0.50 I
MB/HL	1	124,981/125,006	131,000/131,025	35,000	2,962	0,070/0,144	EC	72-4788	72-4788 STD 0.25 0.50
TW/A	4	136,500	158,500		2,500		AL-LF	04-4789	A293/4 STD
SE/PB	1	55,000	60,000/60,030	49,200			BS-LF	55-4790	55-4790 SEMI
CB/NWB 1-7	7	99,935/99,965	105,000/105,035	28,000			AL-LF	03-4791	N195/7 STD



1000	01/84→	Diesel	CB11	993	3	76.00	73.00	7
1000 1.0	07/86→10/97	Petrol	CB 10	993	3	76.00	73.00	7
1000 1.0 4x4	07/86→12/89	Petrol	CB 10	993	3	76.00	73.00	7
1000 Minibus S85	01/86→	Diesel	CB11	993	3	76.00	73.00	7
1000 Van G100V	01/85	Diesel	CB11	993	3	76.00	73.00	7
1000 Van, Cab, S75, S75V, S76,S76V	01/84→12/85	Diesel	CB11	993	3	76.00	73.00	7
Charade 1.0	03/03→	Petrol	1KR-FE	998	3	71.00	84.00	2
Charade 1000 G11 Turbo	01/84→12/86	Diesel	CB11	993	3	76.00	73.00	7
Charade 1000 G11, Turbo	01/84→12/86	Diesel	CB11	993	3	76.00	73.00	7
Charade 1000 G1000	01/85→	Diesel	CB11	993	3	76.00	73.00	7
Charade I 1.0	10/77→02/83	Petrol	CB 20	993	3	76.00	73.00	7
Charade I 1.0	02/81→02/83	Petrol	CB 22	993	3	76.00	73.00	7
Charade II 1.0	10/83→03/87	Petrol	CB 20	993	3	76.00	73.00	7
Charade II 1.0	10/83→03/87	Petrol	CB 22	993	3	76.00	73.00	7
Charade II 1.0 D	10/83→03/87	Diesel	CL 10	993	3	76.00	73.00	7
Charade II 1.0 Duet	04/83→05/87	Petrol	CB 22	993	3	76.00	73.00	7
Charade II 1.0 TD	02/85→03/87	Diesel	CL 60	993	3	76.00	73.00	7
Charade II 1.0 Turbo	10/83→03/87	Petrol	CB 60	993	3	76.00	73.00	7
Charade III 1.0	03/87→12/92	Petrol	CB 23	993	3	76.00	73.00	7
Charade III 1.0 D	03/87→12/92	Diesel	CL 11	993	3	76.00	73.00	7
Charade III 1.0 GTi	03/87→12/92	Petrol	CB 80 T	993	3	76.00	73.00	7
Charade III 1.0 TD	03/87→12/92	Diesel	CL	993	3	76.00	73.00	7
Charade III 1.0 TD	03/87→12/92	Diesel	CL 61	993	3	76.00	73.00	7
Charade III 1.0 Turbo	03/87→10/90	Petrol	CB 61	993	3	76.00	73.00	7
Charade IV 1.0	09/94→03/96	Petrol	CB 22	993	3	76.00	73.00	7
Charmant 1.3	11/81→07/87	Petrol	4K	1290	4	75.00	73.00	5
Charmant 1.6	08/83→07/87	Petrol	4A	1587	4	81.00	77.00	9
Charmant 1.6	12/81→09/84	Petrol	2T	1588	4	85.00	70.00	10
Cuore I 0.5	10/80→09/85	Petrol	AB 30	547	2	71.60	68.00	3
Cuore VII 1.0	04/07→	Petrol	1KR-FE	998	3	71.00	84.00	2
Delta Wide 1.3	09/84→09/91	Petrol	4KJ	1290	4	75.00	73.00	5
Delta Wide 3.7 D	09/88→04/99	Diesel	14B	3661	4	102.00	112.00	15
G10 Charade 1.0	01/79→12/80	Petrol	CB31	993	3	76.00	73.00	7
G10 Charade 1.0	01/79→12/83	Petrol	CB32	993	3	76.00	73.00	7
G11 Charade 1.0	04/83→12/84	Petrol	CB34	993	3	76.00	73.00	7
G11 Charade 1.0	01/85→12/86	Petrol	CB35	993	3	76.00	73.00	7
G100S Charade 1.0	01/87→	Petrol	CB36	993	3	76.00	73.00	7
Handivan I 0.6	01/82→01/86	Petrol	AD	617	2	76.00	68.00	6
Hijet 0.5	10/94→12/95	Petrol	AB 30	547	2	71.60	68.00	3
Hijet 0.8	06/86→10/90	Petrol	CD	843	3	70.00	73.00	1
Hijet 1.0	09/83→12/89	Petrol	CB	993	3	76.00	73.00	7
Hijet 1.0	12/92→05/98	Petrol	CB41	993	3	76.00	73.00	7
Hijet 1.0	10/94→05/98	Petrol	CB42	993	3	76.00	73.00	7
Hijet 1.0 4x4	09/83→05/86	Petrol	CB	993	3	76.00	73.00	7
Hijet 1.0 4x4	07/86→10/90	Petrol	CB 10	993	3	76.00	73.00	7
Hijet 1.0 i	07/94→05/98	Petrol	CB42	993	3	76.00	73.00	7
Hijet 1.0 Touring	06/86→10/90	Petrol	CB 10	993	3	76.00	73.00	7
Hijet 1.0 Touring 4x4	07/86→10/90	Petrol	CB 10	993	3	76.00	73.00	7
Hi Jet 1000	01/86→	Diesel	CB11	993	3	76.00	73.00	7
Hi Jet 1000 Van, Truck S8 5,S86V	01/86→	Diesel	CB11	993	3	76.00	73.00	7
Sirion 1.0	01/05→	Petrol	1KR-FE	998	3	71.00	84.00	2
Sirion 1.0 All-wheel Drive	01/10→	Petrol	1KR-FE	998	3	71.00	84.00	2
Sirion 1.0 DVVT 4WD	04/05→	Petrol	1KR-FE	998	3	71.00	84.00	2
Skywing 1.0	02/87→02/93	Petrol	CB 22	993	3	76.00	73.00	7
Skywing 1.0	02/87→02/93	Petrol	CB 23	993	3	76.00	73.00	7
Skywing 1.0	02/87→10/90	Petrol	CB 80 T	993	3	76.00	73.00	7
Sparcar 0.8	09/83→05/86	Petrol	CD	843	3	70.00	73.00	1
Sparcar 1.0	09/83→05/86	Petrol	CB	993	3	76.00	73.00	7
Storia 1.0	04/05→	Petrol	1KR-FE	998	3	71.00	84.00	2
Taft 1.6 D 4x4	09/76→02/85	Diesel	12R	1587	4	80.50	78.00	8
Zebra 0.8	04/86→05/98	Petrol	CD	843	3	70.00	73.00	1
Zebra 1.0	07/87→05/98	Petrol	CB 10	993	3	76.00	73.00	7

			cm3	x 			
1KR-FE	Petrol		998	3	71.00	84.00	2
2T	Petrol		1588	4	85.00	70.00	10
3K	Petrol		1166	4	75.00	66.00	4
3KJ	Petrol		1166	4	75.00	66.00	4
4A	Petrol		1587	4	81.00	77.00	9
4K	Petrol		1290	4	75.00	73.00	5
4KC	Petrol		1290	4	75.00	73.00	5
4KJ	Petrol		1290	4	75.00	73.00	5
11B	Diesel		2977	4	95.00	105.00	12
12R	Diesel		1587	4	80.50	78.00	8
12T	Petrol		1588	4	85.00	70.00	10
13B	Diesel		3431	4	102.00	105.00	14
14B	Diesel		3661	4	102.00	112.00	15
AB 30	Petrol		547	2	71.60	68.00	3
AD	Petrol		617	2	76.00	68.00	6
AD	Petrol		617	2	76.00	68.00	6
B	Diesel		2977	4	95.00	105.00	13
CB	Petrol		993	3	76.00	73.00	7
CB	Petrol		993	3	76.00	73.00	7
CB 10	Petrol		993	3	76.00	73.00	7
CB11	Diesel		993	3	76.00	73.00	7
CB 20	Petrol		993	3	76.00	73.00	7
CB 22	Petrol		993	3	76.00	73.00	7
CB 23	Petrol		993	3	76.00	73.00	7
CB31	Petrol		993	3	76.00	73.00	7
CB32	Petrol		993	3	76.00	73.00	7
CB33	Petrol		993	3	76.00	73.00	7
CB34	Petrol		993	3	76.00	73.00	7
CB35	Petrol		993	3	76.00	73.00	7
CB36	Petrol		993	3	76.00	73.00	7
CB41	Petrol		993	3	76.00	73.00	7
CB42	Petrol		993	3	76.00	73.00	7
CB 51	Petrol		993	3	76.00	73.00	7
CB 60	Petrol		993	3	76.00	73.00	7
CB 61	Petrol		993	3	76.00	73.00	7
CB 80 T	Petrol		993	3	76.00	73.00	7
CD	Petrol		843	3	70.00	73.00	1
CL	Diesel		993	3	76.00	73.00	7
CL 10	Diesel		993	3	76.00	73.00	7
CL 11	Diesel		993	3	76.00	73.00	7
CL 50	Diesel		993	3	76.00	73.00	7
CL 60	Diesel		993	3	76.00	73.00	7
CL 60	Diesel		993	3	76.00	73.00	7
CL 61	Diesel		993	3	76.00	73.00	7
FE	Petrol		1998	4	86.00	86.00	11



1 70.00 x 73.00

CD		3 Cyl.		843cc	29kW (39PS)		Petrol		TD6699
BE/PL	6	39,980	43,020	18,000	1,490		AL	64-255-1	71-4309/3 STD
MB/HL 1-4	8	41,980	46,020	19,500	1,990		AL	63-255-1	H1141/4 STD 0.25

2 71.00 x 84.00

1KR-FE Euro 4		3 Cyl.		998cc	50-51kW (68-70PS)		Petrol		TD20287
BE/PL	6	40,000	43,020	13,600	1,495		AL-LF	64-735-1	01-4980/3 STD
MB/HL 1-4	4	43,990	48,020	14,900	1,997		AL-LF	63-735-1	H1338/4 STD
MB/HL 1-4	4	43,990	48,020	14,900	1,997		AL-LF	63-735-2	
TW/A	2	52,000	63,000		1,990		AL-LF	65-735-1	A322/2 STD

3 71.60 x 68.00

AB 30		2 Cyl.		547cc	20kW (27PS)		Petrol		TD4306
BE/PL	6	39,980	43,020	18,000	1,490		AL	64-255-1	71-4309/3 STD
MB/HL 1-4	8	41,980	46,020	19,500	1,990		AL	63-255-1	H1141/4 STD 0.25

4 75.00 x 66.00

3K		4 Cyl.		1166cc	40kW (54PS)		Petrol		TD770
3KJ		4 Cyl.		1166cc	40-46kW (54-63PS)		Petrol		TD6689
BE/PL	8	41,980	45,020	18,900	1,492		AL	64-021-1	71-4261/4 STD
MB/HL 1-5	5	49,974/49,999	54,002/54,028	21,844	1,994	0,020/0,091	BS	67271CP	H1176/5 STD
TW/A	2	55,820	67,820		2,464		BS	67271BFL	A235/4 STD
TW/A	2	55,820	67,820		2,464		BS	67271BFU	

5 75.00 x 73.00

4K		4 Cyl.		1290cc	48-53kW (65-72PS)		Petrol		TD774
4KC		4 Cyl.		1290cc	48kW (65PS)		Petrol		TD775
4KJ		4 Cyl.		1290cc	40kW (54PS)		Petrol		TD6690
BE/PL	8	41,980	45,020	18,900	1,492		AL	64-021-1	71-4261/4 STD
MB/HL 1-5	5	49,974/49,999	54,002/54,028	21,844	1,994	0,020/0,091	BS	67271CP	H1176/5 STD
TW/A	2	55,820	67,820		2,464		BS	67271BFL	A235/4 STD
TW/A	2	55,820	67,820		2,464		BS	67271BFU	

6 76.00 x 68.00

AD		2 Cyl.		617cc	22kW (30PS)		Petrol		TD25246
AD		2 Cyl.		617cc	23kW (31PS)		Petrol		TD1646
BE/PL	6	39,980	43,020	18,000	1,490		AL	64-255-1	71-4309/3 STD
MB/HL 1-4	8	41,980	46,020	19,500	1,990		AL	63-255-1	H1141/4 STD 0.25



7 76.00 x 73.00

CB	3 Cyl.	993cc	33kW (45PS)	Petrol	TD782
CB 10	3 Cyl.	993cc	33kW (45PS)	Petrol	TD18852
CB 20	3 Cyl.	993cc	37-38kW (50-52PS)	Petrol	TD4308
CB 22	3 Cyl.	993cc	38kW (52PS)	Petrol	TD4309
CB 23	3 Cyl.	993cc	38kW (52PS)	Petrol	TD4310
CB 51	3 Cyl.	993cc	50kW (68PS)	Petrol	TD4311
CB 60	3 Cyl.	993cc	50kW (68PS)	Petrol Turbo	TD783
CB 61	3 Cyl.	993cc	50kW (68PS)	Petrol Turbo	TD4312
CB 80 T	3 Cyl.	993cc	74kW (101PS)	Petrol Turbo	TD4313
CB31	3 Cyl.	993cc		Petrol	FM9796
CB32	3 Cyl.	993cc		Petrol	FM9797
CB33	3 Cyl.	993cc		Petrol	FM9798
CB34	3 Cyl.	993cc		Petrol	FM9799
CB35	3 Cyl.	993cc		Petrol	FM9801
CB36	3 Cyl.	993cc		Petrol	FM9802
CB41	3 Cyl.	993cc	33kW (45PS)	Petrol	TD789
CB42	3 Cyl.	993cc	35kW (48PS)	Petrol	TD9601
Daihatsu CB	3 Cyl.	993cc	38kW (52PS)	Petrol	TD1647
CB11	3 Cyl.	993cc		Diesel	FM3256
CL	3 Cyl.	993cc	27-35kW (37-48PS)	Diesel	TD4316
CL 10	3 Cyl.	993cc	27kW (37PS)	Diesel	TD4317
CL 11	3 Cyl.	993cc	27kW (37PS)	Diesel	TD5440
CL 50	3 Cyl.	993cc	34kW (46PS)	Diesel	TD4318
CL 60	3 Cyl.	993cc	34kW (46PS)	Diesel Turbo	TD5439
CL 60	3 Cyl.	993cc	27kW (37PS)	Diesel	TD18939
CL 61	3 Cyl.	993cc	35kW (48PS)	Diesel Turbo	TD4319

BE/PL	6	39,980	43,020	18,000	1,490		AL	64-255-1	71-4309/3 STD
MB/HL 1-4	8	41,980	46,020	19,500	1,990		AL	63-255-1	H1141/4 STD 0.25

8 80.50 x 78.00

12R	4 Cyl.	1587cc	49kW (67PS)	Diesel	TD767				
BE/PL	4	49,985/50,000	53,010/53,030	27,000	1,500	0,020/0,061	AL-LF	GS1971SA	01-4330/4 0.50

9 81.00 x 77.00

4A	4 Cyl.	1587cc	57-61kW (78-83PS)	Petrol	TD4305				
BE/PL	8	39,990	43,020	17,100	1,491		AL-LF	64-043-1	01-4117/4 STD 0.25
MB/HL 1-5	5	47,980	52,040	19,900	2,005		AL	63-043-1	H1068/5 STD 0.25 0.50
MB/HL 1-5	5	47,980	52,040	19,900	2,005		AL	63-043-2	
TW/A	2	53,500	66,000		2,490		AL-LF	65-022-1	A186/4 STD
TW/A	2	53,500	66,000		2,490		AL-LF	65-022-2	

10 85.00 x 70.00

2T	4 Cyl.	1588cc	55kW (75PS)	Petrol	TD4302				
12T	4 Cyl.	1588cc	65kW (88PS)	Petrol	TD768				
MB/HL 1-5	10	57,980	62,020	20,930	2,004		BS	63-018-1	H1148/5 STD 0.25

TW/A	2	63,800	76,000	2,490			AL-LF	65-018-1	A229/4 STD
TW/A	2	63,800	76,000	2,490			AL-LF	65-018-2	

11 86.00 x 86.00

FE	4 Cyl.			1998cc	75kW (102PS)	Petrol			TD802
BE/PL	4	50,934/50,949	53,997/54,018	21,132	1,509	0,030/0,091	BS	3975P	71-4278/4 STD 0.25 0.50

12 95.00 x 105.00

11B	4 Cyl.			2977cc	61kW (83PS)	Diesel			TD6696
BE/PL	4	60,980	64,020	30,000	1,490		AL	64-040-1	01-4346/4 STD 0.25
→07/88									
MB/HL 1-5	5	69,979/69,999	75,003/75,018	26,898	2,489	0,026/0,086	AL	1153RA	H1125/5 STD
08/88 →									
MB/HL 1-5	5	69,980/70,000	75,000/75,024	26,900	2,490	0,020/0,090	BS	GS70571SA	H1193/5 0.25
→07/88									
TW/A	2	76,000	90,700				AL-LF	65-040-1	A172/4 STD
TW/A	2	76,000	90,700	2,480			AL-LF	65-040-2	

13 95.00 x 105.00

B	4 Cyl.			2977cc	57-59kW (78-80PS)	Diesel			TD6695
BE/PL	8	58,980	62,020	30,000	1,490		AL	64-035-1	71-4342/4 STD 0.25
MB/HL 1-5	5	69,979/69,999	75,003/75,018	26,898	2,489	0,026/0,086	AL	1153RA	H1125/5 STD
04/84 →									
TW/A	2	76,000	90,700				AL-LF	65-040-1	A172/4 STD
TW/A	2	76,000	90,700	2,480			AL-LF	65-040-2	
04/84 →									



14 102.00 x 105.00

13B	4 Cyl.			3431cc	66kW (90PS)	Diesel			TD6697
BE/PL	4	60,980	64,020	30,000	1,490		AL	64-040-1	01-4346/4 STD 0.25
MB/HL 1-5	5	69,979/69,999	75,003/75,018	26,898	2,489	0,026/0,086	AL	1153RA	H1125/5 STD
04/84 →									
TW/A	2	76,000	90,700				AL-LF	65-040-1	A172/4 STD
TW/A	2	76,000	90,700	2,480			AL-LF	65-040-2	

15 102.00 x 112.00

14B	4 Cyl.			3661cc	75kW (102PS)	Diesel			TD22404
MB/HL 1-5	5	69,980/70,000	75,000/75,024	26,900	2,490	0,020/0,090	BS	GS70571SA	H1193/5 0.25

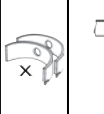
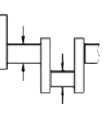
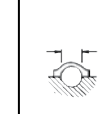
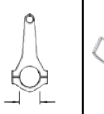
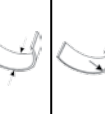
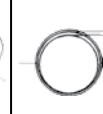
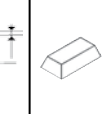
DAIHATSU

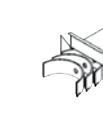
										
TW/A	2	76,000	90,700				AL-LF	65-040-1	A172/4 STD	
TW/A	2	76,000	90,700		2,480		AL-LF	65-040-2		

		cm ³				
---	---	-----------------	--	---	---	---

AD4/47	Diesel	3045	4	92.07	114.30	1
AD4/49	Diesel	3195	4	100.04	101.60	2
AD4/55	Diesel	3594	4	100.04	114.30	3

DAVID BROWN

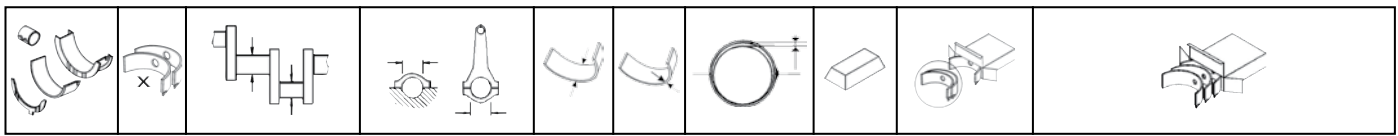

1 92.07 x 114.30







AD4/47		4 Cyl.		3045cc			Diesel			FM427
MB/HL 1-3	3	63,475/63,487	67,716/67,742	44,580	2,080	0,069/0,107	AL-LF	GS1216SA	H1137/3 0.25	
TW/A	4	68,961/69,215	85,598/85,852		2,360		AL-LF	04-0044	A031/4 STD	





2 100.04 x 101.60

AD4/49		4 Cyl.		3195cc			Diesel			FM429
BE/PL	4	60,274/60,287	63,995/64,021	29,210	1,830	0,048/0,087	AL-LF	GS1793SA	01-4334/4 STD 0.25 0.50 0.75	
MB/HL 1-3	3	63,475/63,487	67,716/67,742	44,580	2,080	0,069/0,107	AL-LF	GS1216SA	H1137/3 0.25	
TW/A	4	68,961/69,215	85,598/85,852		2,360		AL-LF	04-0044	A031/4 STD	







3 100.04 x 114.30





AD4/55		4 Cyl.		3594cc			Diesel			FM431
BE/PL	4	60,274/60,287	63,995/64,021	29,210	1,830	0,048/0,087	AL-LF	GS1793SA	01-4334/4 STD 0.25 0.50 0.75	
MB/HL 1-3	3	63,475/63,487	67,716/67,742	44,580	2,080	0,069/0,107	AL-LF	GS1216SA	H1137/3 0.25	

		cm3	x 			
A/BA16M816	Diesel	40522	V16	142.00	160.00	61
A/BA16M816C/CR	Diesel	40522	V16	142.00	160.00	61
A/BA16M816C/CR/U/W/R	Diesel	40522	V16	142.00	160.00	61
BA 12M 816	Diesel	30408	V12	142.00	160.00	60
BA 12M 816 C	Diesel	30408	V12	142.00	160.00	60
BA 12M 816 CR	Diesel	30408	V12	142.00	160.00	60
BA 12M 816 R	Diesel	30408	V12	142.00	160.00	60
BA 12M 816 U	Diesel	30408	V12	142.00	160.00	60
BA 12M 816 W	Diesel	30408	V12	142.00	160.00	60
BF 3L 2011	Diesel	2332	3	94.00	112.00	8
BF 3M 1011 F	Diesel	2184	3	91.00	112.00	5
BF 3M 2011	Diesel	2332	3	94.00	112.00	8
BF 4 L 1011	Diesel	2731	4	91.00	105.00	4
BF 4L 1011 F	Diesel	2731	4	91.00	105.00	4
BF 4 L 1011 F	Diesel	2731	4	91.00	105.00	4
BF 4L 1011 FT	Diesel	2732	4	91.00	105.00	4
BF 4L 2011	Diesel	3110	4	94.00	112.00	9
BF 4M 1011 F	Diesel	2912	4	91.00	112.00	6
BF 4M 2011	Diesel	3110	4	94.00	112.00	9
BF 4M 2011 M	Diesel	3110	4	94.00	112.00	9
BF 6L 413	Diesel	8478	V6	120.00	125.00	34
BF 6L 413 F	Diesel	9572	V6	125.00	130.00	40
BF 6L 413 FR	Diesel	9572	V6	125.00	130.00	40
BF 6L 413 FRC	Diesel	9572	V6	125.00	130.00	40
BF 6L 413 FW	Diesel	9572	V6	125.00	130.00	40
BF 6L 513	Diesel	9572	V6	125.00	130.00	40
BF 6L 513 C	Diesel	9572	V6	125.00	130.00	40
BF 6 L 912	Diesel	5655	6	100.00	120.00	22
BF 6L 912	Diesel	5655	6	100.00	120.00	22
BF 6 L 913	Diesel	6128	6	102.00	125.00	28
BF 6 L 913	Diesel	6128	6	102.00	125.00	28
BF 6L 913	Diesel	6128	6	102.00	125.00	28
BF 6L 913 C	Diesel	6128	6	102.00	125.00	28
BF 6 L 913 T	Diesel	6128	6	102.00	125.00	28
BF 6L 913 T	Diesel	6128	6	102.00	125.00	28
BF 6M 1013	Diesel	7146	6	108.00	130.00	31
BF 6M 1013 C	Diesel	7146	6	108.00	130.00	31
BF 6M 1013 CP	Diesel	7146	6	108.00	130.00	31
BF 6M 1013 E	Diesel	7146	6	108.00	130.00	31
BF 6M 1013 EC	Diesel	7146	6	108.00	130.00	31
BF 6M 1013E CP Euro 3	Diesel	7146	6	108.00	130.00	31
BF 6M 1013 ECW	Diesel	7146	6	108.00	130.00	31
BF 6M 1013 EW	Diesel	7146	6	108.00	130.00	31
BF 6M 1013 FC Euro 2/3	Diesel	7146	6	108.00	130.00	31
BF 6M 1015	Diesel	11905	V6	132.00	145.00	50
BF 6M 1015 C	Diesel	11905	V6	132.00	145.00	50
BF 6M 1015 CP	Diesel	11905	V6	132.00	145.00	50
BF 6M 1015 CU	Diesel	11905	V6	132.00	145.00	50
BF 8L 413	Diesel	11310	V8	120.00	125.00	35
BF 8L 413 F	Diesel	12763	V8	125.00	130.00	41
BF 8 L 413 F	Diesel	12763	V8	125.00	130.00	41
BF 8L 513	Diesel	12763	V8	125.00	130.00	41
BF 8 L 513-225	Diesel	12763	V8	125.00	130.00	41
BF 8 L 513-243	Diesel	12763	V8	125.00	130.00	41
BF 8L 513 C	Diesel	13738	V8	125.00	140.00	44
BF 8 L 513 LC	Diesel	13745	V8	125.00	140.00	44
BF 8M 1015	Diesel	15874	V8	132.00	145.00	52
BF 8M 1015 C	Diesel	15874	V8	132.00	145.00	52
BF 8M 1015 CP	Diesel	15874	V8	132.00	145.00	52
BF 8M 1015 M Euro 2	Diesel	15874	V8	132.00	145.00	52
BF 8 M 716	Diesel	18320	V8	135.00	160.00	57
BF10L413	Diesel	14137	V10	120.00	125.00	36
BF 10L 413 F	Diesel	15953	V10	125.00	130.00	42
BF 10 L 413 F	Diesel	15953	V10	125.00	130.00	42
BF 10L 413 FW	Diesel	15953	V10	125.00	130.00	42
BF 10L 513	Diesel	15954	V10	125.00	130.00	42
BF 10L 513 C	Diesel	15954	V10	125.00	130.00	42
BF 10L 513 F	Diesel	15945	V10	125.00	130.00	42
BF 12L 413	Diesel	16964	V12	120.00	125.00	37

		cm ³	x 			9
--	---	-----------------	---	---	---	----------

BF 12 L 413	Diesel	16964	V12	120.00	125.00	37
BF 12L 413 F	Diesel	19144	V12	125.00	130.00	43
BF 12 L 413 F	Diesel	19144	V12	125.00	130.00	43
BF 12 L 413 FC	Diesel	19144	V12	125.00	130.00	43
BF 12 L 413 FW	Diesel	19144	V12	125.00	130.00	43
BF 12L 513	Diesel	19144	V12	125.00	130.00	43
BF 12L 513 C	Diesel	19144	V12	125.00	130.00	43
BF 12L 513 CP	Diesel	19144	V12	125.00	130.00	43
BF 12L 513 F	Diesel	19144	V12	125.00	130.00	43
BF12M716	Diesel	27480	V12	135.00	160.00	58
BF 16 M 716	Diesel	36640	V16	135.00	160.00	59
D 2011 L2	Diesel	1554	2	94.00	112.00	7
D 2011 L3	Diesel	2331	3	94.00	112.00	8
F 1L 812	Diesel	850	1	95.00	120.00	10
F 2L 1011	Diesel	1366	2	91.00	105.00	2
F 2L 1011 F	Diesel	1366	2	91.00	105.00	2
F 2L 2011	Diesel	1554	2	94.00	112.00	7
F 2L 812	Diesel	1700	2	95.00	120.00	11
F 2L 912	Diesel	1885	2	100.00	120.00	18
F 2L 912 D	Diesel	1885	2	100.00	120.00	18
F 2L 912 W	Diesel	1885	2	100.00	120.00	18
F 2L 913	Diesel	1884	2	100.00	120.00	18
F 2M 1011	Diesel	1366	2	91.00	105.00	2
F 2M 1011 F	Diesel	1366	2	91.00	105.00	2
F 2M 2011	Diesel	1555	2	94.00	112.00	7
F 3L 1011	Diesel	2049	3	91.00	105.00	3
F 3L 1011 F	Diesel	2049	3	91.00	105.00	3
F 3L 2011	Diesel	2332	3	94.00	112.00	8
F 3L 612	Diesel	2290	3	90.00	120.00	1
F 3L 812	Diesel	2552	3	95.00	120.00	12
F 3L 911	Diesel	2474	3	100.00	105.00	15
F 3L 912	Diesel	2827	3	100.00	120.00	19
F 3L 912 D	Diesel	2826	3	100.00	120.00	19
F3L912F	Diesel	3064	3	102.00	125.00	25
F 3L 912 W	Diesel	2826	3	100.00	120.00	19
F 3L 913	Diesel	3064	3	102.00	125.00	25
F 3M 1011	Diesel	2185	3	91.00	112.00	5
F 3M 1011 F	Diesel	2185	3	91.00	112.00	5
F 3M 2011	Diesel	2332	3	94.00	112.00	8
F 4 L 1011	Diesel	2731	4	91.00	105.00	4
F 4L 1011 F	Diesel	2732	4	91.00	105.00	4
F 4L 1011 FL	Diesel	2914	4	91.00	112.00	6
F 4L 2011	Diesel	3110	4	94.00	112.00	9
F 4L 812	Diesel	3400	4	95.00	120.00	13
F 4L 911	Diesel	3299	4	100.00	105.00	16
F 4 L 912	Diesel	3770	4	100.00	120.00	20
F 4L 912	Diesel	3770	4	100.00	120.00	20
F 4L 912 D	Diesel	3770	4	100.00	120.00	20
F 4L 912 F	Diesel	4086	4	102.00	125.00	26
F 4L 912 W	Diesel	3770	4	100.00	120.00	20
F 4 L 913	Diesel	4086	4	102.00	125.00	26
F 4 L 913	Diesel	4086	4	102.00	125.00	26
F 4L 913	Diesel	4086	4	102.00	125.00	26
F 4M 1011 F	Diesel	2732	4	91.00	105.00	4
F 4M 2011	Diesel	3110	4	94.00	112.00	9
F 5L 912	Diesel	4712	5	100.00	120.00	21
F 5L 912 D	Diesel	4712	5	100.00	120.00	21
F 5L 912 F	Diesel	5107	5	102.00	125.00	27
F5L912W	Diesel	5107	5	102.00	125.00	27
F 6L 413	Diesel	8478	V6	120.00	125.00	34
F 6 L 413	Diesel	8478	V6	120.00	125.00	34
F 6 L 413 F	Diesel	8480	V6	120.00	125.00	34
F 6 L 413 F	Diesel	9570	V6	125.00	130.00	40
F 6 L 413 F	Diesel	9572	V6	125.00	130.00	40
F 6L 413 F	Diesel	9572	V6	125.00	130.00	40
F 6L 413 FR	Diesel	9572	V6	125.00	130.00	40
F 6L 413 FW	Diesel	9572	V6	125.00	130.00	40
F6L413L	Diesel	8482	V6	120.00	125.00	34
F 6L 413 R	Diesel	8822	V6	120.00	130.00	38

		cm3	x 			
F 6 L 413 V	Diesel	8822	V6	120.00	130.00	38
F6L513	Diesel	10038	V6	128.00	130.00	45
F 6 L 812	Diesel	5104	6	95.00	120.00	14
F 6 L 812	Diesel	5104	6	95.00	120.00	14
F 6 L 812 D	Diesel	5100	6	95.00	120.00	14
F 6L 911	Diesel	4948	6	100.00	105.00	17
F 6L 912	Diesel	5655	6	100.00	120.00	22
F 6 L 912	Diesel	5660	6	100.00	120.00	22
F 6 L 912	Diesel	5660	6	100.00	120.00	22
F 6L 912 D	Diesel	5655	6	100.00	120.00	22
F 6L 912 T	Diesel	5655	6	100.00	120.00	22
F 6L 912 W	Diesel	5655	6	100.00	120.00	22
F 6 L 913	Diesel	6128	6	102.00	125.00	29
F 6 L 913	Diesel	6128	6	102.00	125.00	29
F 6L 913	Diesel	6128	6	102.00	125.00	29
F 6L 913 T	Diesel	6128	6	102.00	125.00	29
F 8 L 413	Diesel	11310	V8	120.00	125.00	35
F 8 L 413	Diesel	11310	V8	120.00	125.00	35
F 8L 413	Diesel	11310	V8	120.00	125.00	35
F 8 L 413 F	Diesel	12763	V8	125.00	130.00	41
F 8L 413 F	Diesel	12763	V8	125.00	130.00	41
F 8 L 413 F	Diesel	12763	V8	125.00	130.00	41
F 8L 413 FW	Diesel	12763	V8	125.00	130.00	41
F 8L 413 FZ	Diesel	12763	V8	125.00	130.00	41
F8L413L	Diesel	11309	V8	120.00	125.00	35
F 8 L 413 W	Diesel	11310	V8	120.00	125.00	35
F 8 L 413 W	Diesel	11310	V8	120.00	125.00	35
F 8L 513	Diesel	13382	V8	128.00	130.00	46
F 8 L 513	Diesel	13383	V8	128.00	130.00	46
F8L513L	Diesel	14412	V8	128.00	140.00	49
F8M716	Diesel	18320	8	135.00	160.00	57
F 8 M 716	Diesel	18320	V8	135.00	160.00	57
F 10 L 413	Diesel	14140	V10	120.00	125.00	36
F 10L 413	Diesel	14140	V10	120.00	125.00	36
F 10 L 413	Diesel	14140	V10	120.00	125.00	36
F 10L 413 F	Diesel	15953	V10	125.00	130.00	42
F 10 L 413 F	Diesel	15953	V10	125.00	130.00	42
F 10 L 413 F	Diesel	15953	V10	125.00	130.00	42
F 10L 413 FW	Diesel	15953	V10	125.00	130.00	42
F 10L 413 FZ	Diesel	15953	V10	125.00	130.00	42
F 10L 413 L	Diesel	14700	V10	120.00	130.00	39
F 10 L 413 L	Diesel	14702	V10	120.00	130.00	39
F 10L 513	Diesel	16728	V10	128.00	130.00	47
F 10L 513 F	Diesel	15953	V10	125.00	130.00	42
F 10L 513 L	Diesel	16728	V10	128.00	130.00	47
F 10L 513 T	Diesel	16728	V10	128.00	130.00	47
F 12L 413	Diesel	16960	V12	120.00	125.00	37
F 12 L 413	Diesel	16960	V12	120.00	125.00	37
F 12 L 413	Diesel	16960	V12	120.00	125.00	37
F 12 L 413 F	Diesel	19144	V12	125.00	130.00	43
F 12L 413 F	Diesel	19144	V12	125.00	130.00	43
F 12L 413 FW	Diesel	19144	V12	125.00	130.00	43
F12L413L	Diesel	16965	V12	120.00	125.00	37
F 12 L 513	Diesel	20074	V12	128.00	130.00	48
F 12L 513	Diesel	20074	V12	128.00	130.00	48
F 12L 513 F Euro 1	Diesel	19144	V12	125.00	130.00	43
F 12L 513 L Euro 1	Diesel	20074	V12	128.00	130.00	48
F12M716	Diesel	27480	V12	135.00	160.00	58
F16M716	Diesel	36644	V16	135.00	160.00	59
TBD616V12	Diesel	26277	V12	132.00	160.00	55
TBD616V16	Diesel	35033	V16	132.00	160.00	56
TBD616V8	Diesel	17516	V8	132.00	160.00	54
TCD 4.1 L04 4V Euro 3	Diesel	4038	4	101.00	126.00	23
TCD 6.1 L06 4V Euro 3	Diesel	6057	6	101.00	126.00	24
TCD 2012 L4 2V	Diesel	4038	4	101.00	126.00	23
TCD 2012 L4 4V Euro 3	Diesel	4038	4	101.00	126.00	23
TCD 2012 L6 2V	Diesel	6057	6	101.00	126.00	24
TCD 2012 L6 4V	Diesel	6057	6	101.00	126.00	24
TCD 2013 L06 4V Euro 4	Diesel	7146	6	108.00	130.00	32

		cm ³	x 			9
--	---	-----------------	---	---	---	----------

TCD 2013 L4 4V Euro 4	Diesel	4764	4	108.00	130.00	30
TCD 2013 L6 2V	Diesel	7146	6	108.00	130.00	33
TCD 2013 L6 4V Euro 4	Diesel	7146	6	108.00	130.00	32
TCD 2015 V6	Diesel	11906	V6	132.00	145.00	51
TCD 2015 V8	Diesel	15874	V8	132.00	145.00	53



1 90.00 x 120.00

F 3L 612		3 Cyl.		2290cc	24kW (33PS)	Diesel		TD25761
MB/HL	1	69,971/69,990	74,500/74,519	27,000	2,229	0,052/0,115	AL-LF	02-2228 02-2228 STD 0.25 0.50 0.75
SE/PB	1	34,995/35,000	38,000/38,016	33,800	1,482		BC	55-2650 55-2650 STD
BU	1	17,983/17,994	21,000/21,021	13,800	1,501		BC	56-2651 56-2651 STD

2 91.00 x 105.00

F 2L 1011		2 Cyl.		1366cc	18-22kW (24-30PS)	Diesel		TD29643
F 2L 1011 F		2 Cyl.		1366cc	20-22kW (27-30PS)	Diesel		TD17224
F 2M 1011		2 Cyl.		1366cc	21-23kW (29-31PS)	Diesel		TD17231
F 2M 1011 F		2 Cyl.		1366cc	22kW (30PS)	Diesel		TD29644
BE/PL	1	54,970/54,990	58,500/58,520	25,600	1,748	0,020/0,079	AL-LF	01-3688 01-3688 STD
MB/HL	1	69,970/69,990	75,000/75,019	28,000	2,490	0,030/0,094	AL-LF	02-3689 02-3689 STD

3 91.00 x 105.00

F 3L 1011		3 Cyl.		2049cc	27-33kW (37-45PS)	Diesel		TD29645
F 3L 1011 F		3 Cyl.		2049cc	16-33kW (22-45PS)	Diesel		TD17225
BE/PL	1	54,970/54,990	58,500/58,520	25,600	1,748	0,020/0,079	AL-LF	01-3688 01-3688 STD
MB/HL	1	69,970/69,990	75,000/75,019	28,000	2,490	0,030/0,094	AL-LF	02-3689 02-3689 STD

4 91.00 x 105.00

BF 4 L 1011		4 Cyl.		2731cc	50-56kW (68-76PS)	Diesel Turbo		TD26015
BF 4 L 1011 F		4 Cyl.		2731cc	28-56kW (38-76PS)	Diesel Turbo		TD26016
BF 4L 1011 F		4 Cyl.		2731cc	28-55kW (38-75PS)	Diesel Turbo		TD17230
BF 4L 1011 FT		4 Cyl.		2732cc	46kW (63PS)	Diesel Turbo		TD17228
F 4 L 1011		4 Cyl.		2731cc	36-44kW (49-60PS)	Diesel		TD26022
F 4L 1011 F		4 Cyl.		2732cc	24-47kW (33-64PS)	Diesel		TD17227
F 4M 1011 F		4 Cyl.		2732cc	24-48kW (33-65PS)	Diesel		TD18488
BE/PL	1	54,970/54,990	58,500/58,520	25,600	1,748	0,020/0,079	AL-LF	01-3688 01-3688 STD
MB/HL	1	69,970/69,990	75,000/75,019	28,000	2,490	0,030/0,094	AL-LF	02-3689 02-3689 STD

5 91.00 x 112.00

BF 3M 1011 F		3 Cyl.		2184cc	40-46kW (54-63PS)	Diesel Turbo		TD18487
F 3M 1011		3 Cyl.		2185cc	32-36kW (44-49PS)	Diesel		TD29647
F 3M 1011 F		3 Cyl.		2185cc	17-36kW (23-49PS)	Diesel		TD17232
BE/PL	1	54,970/54,990	58,500/58,520	25,600	1,748	0,020/0,079	AL-LF	01-3688 01-3688 STD
MB/HL	1	69,970/69,990	75,000/75,019	28,000	2,490	0,030/0,094	AL-LF	02-3689 02-3689 STD

6 91.00 x 112.00

BF 4M 1011 F		4 Cyl.		2912cc	28-61kW (38-83PS)	Diesel Turbo		TD18489
F 4L 1011 FL		4 Cyl.		2914cc	46kW (63PS)	Diesel		TD17229
BE/PL	1	54,970/54,990	58,500/58,520	25,600	1,748	0,020/0,079	AL-LF	01-3688 01-3688 STD
MB/HL	1	69,970/69,990	75,000/75,019	28,000	2,490	0,030/0,094	AL-LF	02-3689 02-3689 STD



7 94.00 x 112.00									
D 2011 L2		2 Cyl.		1554cc	23kW (31PS)		Diesel		TD1991
F 2L 2011		2 Cyl.		1554cc	21-23kW (29-31PS)		Diesel		TD17387
F 2M 2011		2 Cyl.		1555cc	23-24kW (31-33PS)		Diesel		TD17382
BE/PL	1	54,970/54,990	58,500/58,520	25,600	1,748	0,020/0,079	AL-LF	01-3688	01-3688 STD
MB/HL	1	69,970/69,990	75,000/75,019	28,000	2,490	0,030/0,094	AL-LF	02-3689	02-3689 STD

8 94.00 x 112.00									
BF 3L 2011		3 Cyl.		2332cc	42-45kW (57-61PS)		Diesel Turbo		TD17389
BF 3M 2011		3 Cyl.		2332cc	46-49kW (63-67PS)		Diesel Turbo		TD17384
D 2011 L3		3 Cyl.		2331cc	36kW (49PS)		Diesel		TD19992
F 3L 2011		3 Cyl.		2332cc	34-36kW (46-49PS)		Diesel		TD17388
F 3M 2011		3 Cyl.		2332cc	34-37kW (46-50PS)		Diesel		TD17383
BE/PL	1	54,970/54,990	58,500/58,520	25,600	1,748	0,020/0,079	AL-LF	01-3688	01-3688 STD
MB/HL	1	69,970/69,990	75,000/75,019	28,000	2,490	0,030/0,094	AL-LF	02-3689	02-3689 STD

9 94.00 x 112.00									
BF 4L 2011		4 Cyl.		3110cc	55-58kW (75-79PS)		Diesel Turbo		TD17391
BF 4M 2011		4 Cyl.		3110cc	62-65kW (84-88PS)		Diesel Turbo		TD17386
BF 4M 2011 M		4 Cyl.		3110cc	47-49kW (64-67PS)		Diesel Turbo		TD29620
F 4L 2011		4 Cyl.		3110cc	45-48kW (61-65PS)		Diesel		TD17390
F 4M 2011		4 Cyl.		3110cc	46-49kW (63-67PS)		Diesel		TD17385
BE/PL	1	54,970/54,990	58,500/58,520	25,600	1,748	0,020/0,079	AL-LF	01-3688	01-3688 STD
MB/HL	1	69,970/69,990	75,000/75,019	28,000	2,490	0,030/0,094	AL-LF	02-3689	02-3689 STD

10 95.00 x 120.00									
F 1L 812		1 Cyl.		850cc	9-10kW (12-14PS)		Diesel		TD17871
MB/HL	1	69,971/69,990	74,500/74,519	27,000	2,229	0,052/0,115	AL-LF	02-2228	02-2228 STD 0.25 0.50 0.75
SE/PB	1	34,995/35,000	38,000/38,016	33,800	1,482		BC	55-2650	55-2650 STD
BU	1	17,983/17,994	21,000/21,021	13,800	1,501		BC	56-2651	56-2651 STD

11 95.00 x 120.00									
F 2L 812		2 Cyl.		1700cc	15-22kW (20-30PS)		Diesel		TD17875
MB/HL	1	69,971/69,990	74,500/74,519	27,000	2,229	0,052/0,115	AL-LF	02-2228	02-2228 STD 0.25 0.50 0.75
SE/PB	1	34,995/35,000	38,000/38,016	33,800	1,482		BC	55-2650	55-2650 STD
BU	1	17,983/17,994	21,000/21,021	13,800	1,501		BC	56-2651	56-2651 STD

12 95.00 x 120.00									
F 3L 812		3 Cyl.		2552cc	25-32kW (34-44PS)		Diesel		TD17878
MB/HL	1	69,971/69,990	74,500/74,519	27,000	2,229	0,052/0,115	AL-LF	02-2228	02-2228 STD 0.25 0.50 0.75
SE/PB	1	34,995/35,000	38,000/38,016	33,800	1,482		BC	55-2650	55-2650 STD
BU	1	17,983/17,994	21,000/21,021	13,800	1,501		BC	56-2651	56-2651 STD



13 95.00 x 120.00

F 4L 812		4 Cyl.		3400cc	33-39kW (45-53PS)		Diesel		TD17880
MB/HL	1	69,971/69,990	74,500/74,519	27,000	2,229	0,052/0,115	AL-LF	02-2228	02-2228 STD 0.25 0.50 0.75
SE/PB	1	34,995/35,000	38,000/38,016	33,800	1,482		BC	55-2650	55-2650 STD
BU	1	17,983/17,994	21,000/21,021	13,800	1,501		BC	56-2651	56-2651 STD

14 95.00 x 120.00

F 6 L 812		6 Cyl.		5104cc	55-74kW (75-101PS)		Diesel		TD7447
F 6 L 812		6 Cyl.		5104cc	59-74kW (80-101PS)		Diesel		TD26418
F 6 L 812 D		6 Cyl.		5100cc	74kW (100PS)		Diesel		TD7448
MB/HL	1	69,971/69,990	74,500/74,519	27,000	2,229	0,052/0,115	AL-LF	02-2228	02-2228 STD 0.25 0.50 0.75
SE/PB	1	34,995/35,000	38,000/38,016	33,800	1,482		BC	55-2650	55-2650 STD
BU	1	17,983/17,994	21,000/21,021	13,800	1,501		BC	56-2651	56-2651 STD

15 100.00 x 105.00

F 3L 911		3 Cyl.		2474cc	29-37kW (40-50PS)		Diesel		FM1943
BE/PL	1	59,941/59,960	64,000/64,019	25,000	2,000	0,040/0,103	AL-LF	01-2800	01-2800 STD 0.25 0.50 0.75
MB/HL	1	69,971/69,990	74,500/74,519	27,000	2,229	0,052/0,115	AL-LF	02-2228	02-2228 STD 0.25 0.50 0.75
TW/A	1	79,300	94,964		2,985		AL-LF	04-3405	A110/4 STD
TW/A	1	79,300	94,964		2,985		AL-LF	04-3406	
TW/A	1	79,000/79,300	101,614/101,964		2,985		AL-LF	04-3407	
TW/A	1	79,000/79,300	101,614/101,964		2,985		AL-LF	04-3408	
SE/PB	1	34,995/35,000	38,000/38,016	33,800	1,482		BC	55-2650	55-2650 STD
BU	1	17,983/17,994	21,000/21,021	13,800	1,501		BC	56-2651	56-2651 STD

16 100.00 x 105.00

F 4L 911		4 Cyl.		3299cc	39-49kW (53-67PS)		Diesel		FM4266
BE/PL	1	59,941/59,960	64,000/64,019	25,000	2,000	0,040/0,103	AL-LF	01-2800	01-2800 STD 0.25 0.50 0.75
MB/HL	1	69,971/69,990	74,500/74,519	27,000	2,229	0,052/0,115	AL-LF	02-2228	02-2228 STD 0.25 0.50 0.75
TW/A	1	79,300	94,964		2,985		AL-LF	04-3405	A110/4 STD
TW/A	1	79,300	94,964		2,985		AL-LF	04-3406	
TW/A	1	79,000/79,300	101,614/101,964		2,985		AL-LF	04-3407	
TW/A	1	79,000/79,300	101,614/101,964		2,985		AL-LF	04-3408	
SE/PB	1	34,995/35,000	38,000/38,016	33,800	1,482		BC	55-2650	55-2650 STD
BU	1	17,983/17,994	21,000/21,021	13,800	1,501		BC	56-2651	56-2651 STD



17 100.00 x 105.00

F 6L 911		6 Cyl.		4948cc	51-74kW (80-100PS)		Diesel		FM4270
BE/PL	1	59,941/59,960	64,000/64,019	25,000	2,000	0,040/0,103	AL-LF	01-2800	01-2800 STD 0.25 0.50 0.75
MB/HL	1	69,971/69,990	74,500/74,519	27,000	2,229	0,052/0,115	AL-LF	02-2228	02-2228 STD 0.25 0.50 0.75
TW/A	1	79,300	94,964		2,985		AL-LF	04-3405	A110/4 STD
TW/A	1	79,300	94,964		2,985		AL-LF	04-3406	
TW/A	1	79,000/79,300	101,614/101,964		2,985		AL-LF	04-3407	
TW/A	1	79,000/79,300	101,614/101,964		2,985		AL-LF	04-3408	
SE/PB	1	34,995/35,000	38,000/38,016	33,800	1,482		BC	55-2650	55-2650 STD
BU	1	17,983/17,994	21,000/21,021	13,800	1,501		BC	56-2651	56-2651 STD

18 100.00 x 120.00

F 2L 912		2 Cyl.		1885cc	16-28kW (22-38PS)		Diesel		TD18128
F 2L 912 D		2 Cyl.		1885cc	21-28kW (29-38PS)		Diesel		FM7020
F 2L 912 W		2 Cyl.		1885cc	22kW (30PS)		Diesel		FM6565
F 2L 913		2 Cyl.		1884cc	37kW (50PS)		Diesel		TD26613
BE/PL	1	59,941/59,960	64,000/64,019	25,000	2,000	0,040/0,103	AL-LF	01-2800	01-2800 STD 0.25 0.50 0.75
MB/HL	1	69,971/69,990	74,500/74,519	27,000	2,229	0,052/0,115	AL-LF	02-2228	02-2228 STD 0.25 0.50 0.75
SE/PB	1	34,995/35,000	38,000/38,016	33,800	1,482		BC	55-2650	55-2650 STD
BU	1	17,983/17,994	21,000/21,021	13,800	1,501		BC	56-2651	56-2651 STD

19 100.00 x 120.00

F 3L 912		3 Cyl.		2827cc	24-48kW (33-65PS)		Diesel		TD17207
F 3L 912 D		3 Cyl.		2826cc	24-44kW (33-60PS)		Diesel		TD19020
F 3L 912 W		3 Cyl.		2826cc	25-43kW (34-58PS)		Diesel		TD19019
BE/PL	1	59,941/59,960	64,000/64,019	25,000	2,000	0,040/0,103	AL-LF	01-2800	01-2800 STD 0.25 0.50 0.75
MB/HL	1	69,971/69,990	74,500/74,519	27,000	2,229	0,052/0,115	AL-LF	02-2228	02-2228 STD 0.25 0.50 0.75
TW/A	1	79,300	94,964		2,985		AL-LF	04-3405	A110/4 STD
TW/A	1	79,300	94,964		2,985		AL-LF	04-3406	
TW/A	1	79,000/79,300	101,614/101,964		2,985		AL-LF	04-3407	
TW/A	1	79,000/79,300	101,614/101,964		2,985		AL-LF	04-3408	
SE/PB	1	34,995/35,000	38,000/38,016	33,800	1,482		BC	55-2650	55-2650 STD
BU	1	17,983/17,994	21,000/21,021	13,800	1,501		BC	56-2651	56-2651 STD

20 100.00 x 120.00

F 4L 912		4 Cyl.		3770cc	55kW (75PS)		Diesel		TD7445
F 4L 912		4 Cyl.		3770cc	32-54kW (44-73PS)		Diesel		TD17208
F 4L 912 D		4 Cyl.		3770cc	38-62kW (52-84PS)		Diesel		TD19021







F 4L 912 W		4 Cyl.		3770cc	38-49kW (52-67PS)		Diesel		TD19022
BE/PL	1	59,941/59,960	64,000/64,019	25,000	2,000	0,040/0,103	AL-LF	01-2800	01-2800 STD 0.25 0.50 0.75
MB/HL	1	69,971/69,990	74,500/74,519	27,000	2,229	0,052/0,115	AL-LF	02-2228	02-2228 STD 0.25 0.50 0.75
TW/A	1	79,300	94,964		2,985		AL-LF	04-3405	A110/4 STD
TW/A	1	79,300	94,964		2,985		AL-LF	04-3406	
TW/A	1	79,000/79,300	101,614/101,964		2,985		AL-LF	04-3407	
TW/A	1	79,000/79,300	101,614/101,964		2,985		AL-LF	04-3408	
SE/PB	1	34,995/35,000	38,000/38,016	33,800	1,482		BC	55-2650	55-2650 STD
BU	1	17,983/17,994	21,000/21,021	13,800	1,501		BC	56-2651	56-2651 STD

21 100.00 x 120.00

F 5L 912		5 Cyl.		4712cc	40-68kW (54-92PS)		Diesel		TD17209
F 5L 912 D		5 Cyl.		4712cc	58-78kW (79-106PS)		Diesel		TD19023
BE/PL	1	59,941/59,960	64,000/64,019	25,000	2,000	0,040/0,103	AL-LF	01-2800	01-2800 STD 0.25 0.50 0.75
MB/HL	1	69,971/69,990	74,500/74,519	27,000	2,229	0,052/0,115	AL-LF	02-2228	02-2228 STD 0.25 0.50 0.75
TW/A	1	79,300	94,964		2,985		AL-LF	04-3405	A110/4 STD
TW/A	1	79,300	94,964		2,985		AL-LF	04-3406	
TW/A	1	79,000/79,300	101,614/101,964		2,985		AL-LF	04-3407	
TW/A	1	79,000/79,300	101,614/101,964		2,985		AL-LF	04-3408	
SE/PB	1	34,995/35,000	38,000/38,016	33,800	1,482		BC	55-2650	55-2650 STD
BU	1	17,983/17,994	21,000/21,021	13,800	1,501		BC	56-2651	56-2651 STD

22 100.00 x 120.00

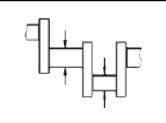
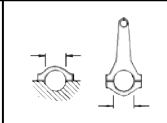
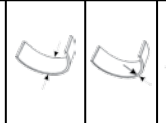
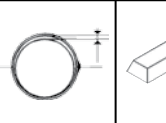
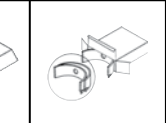
BF 6 L 912		6 Cyl.		5655cc	88-100kW (120-136PS)		Diesel Turbo		TD7053
BF 6L 912		6 Cyl.		5655cc	88-100kW (120-136PS)		Diesel Turbo		TD18348
F 6 L 912		6 Cyl.		5660cc	88kW (120PS)		Diesel		TD7562
F 6 L 912		6 Cyl.		5660cc	48-82kW (65-112PS)		Diesel		TD7449
F 6L 912		6 Cyl.		5655cc	48-82kW (65-112PS)		Diesel		TD17210
F 6L 912 D		6 Cyl.		5655cc	42-92kW (57-125PS)		Diesel		TD19030
F 6L 912 T		6 Cyl.		5655cc	81kW (110PS)		Diesel Turbo		TD26619
F 6L 912 W		6 Cyl.		5655cc	57-74kW (78-101PS)		Diesel		TD19024
BE/PL	1	59,941/59,960	64,000/64,019	25,000	2,000	0,040/0,103	AL-LF	01-2800	01-2800 STD 0.25 0.50 0.75
MB/HL	1	69,971/69,990	74,500/74,519	27,000	2,229	0,052/0,115	AL-LF	02-2228	02-2228 STD 0.25 0.50 0.75
TW/A	1	79,300	94,964		2,985		AL-LF	04-3405	A110/4 STD
TW/A	1	79,300	94,964		2,985		AL-LF	04-3406	
TW/A	1	79,000/79,300	101,614/101,964		2,985		AL-LF	04-3407	
TW/A	1	79,000/79,300	101,614/101,964		2,985		AL-LF	04-3408	

									
SE/PB	1	34,995/35,000	38,000/38,016	33,800	1,482		BC	55-2650	55-2650 STD
BU	1	17,983/17,994	21,000/21,021	13,800	1,501		BC	56-2651	56-2651 STD

23 101.00 x 126.00

TCD 4.1 L04 4V Euro 3	4 Cyl.	4038cc	70-122kW (95-166PS)	Diesel Turbo Intercooler	TD27645				
TCD 2012 L4 2V	4 Cyl.	4038cc	66-103kW (133-140PS)	Diesel Turbo Intercooler	TD19989				
TCD 2012 L4 4V Euro 3	4 Cyl.	4038cc	98kW (133PS)	Diesel Turbo Intercooler	TD29651				
BE/PL	1	69,980/70,000	73,600/73,619	24,000	1,787	0,036/0,095	EC	71-4723	71-4723 STD 4

24 101.00 x 126.00

TCD 6.1 L06 4V Euro 3	6 Cyl.	6057cc	110-190kW (149-258PS)	Diesel Turbo Intercooler	TD27644				
TCD 2012 L6 2V	6 Cyl.	6057cc	147kW (200PS)	Diesel Turbo Intercooler	TD19990				
TCD 2012 L6 4V	6 Cyl.	6057cc	155kW (208PS)	Diesel Turbo Intercooler	FM9999001				
BE/PL	1	69,980/70,000	73,600/73,619	24,000	1,787	0,036/0,095	EC	71-4723	71-4723 STD 4

25 102.00 x 125.00

F 3L 913	3 Cyl.	3064cc	25-44kW (34-60PS)	Diesel	TD17201				
F3L912F	3 Cyl.	3064cc	24-43kW (33-58PS)	Diesel	FM5919				
BE/PL	1	59,941/59,960	64,000/64,019	25,000	2,000	0,040/0,103	AL-LF	01-2800	01-2800 STD 0.25 0.50 0.75
MB/HL	1	69,971/69,990	74,500/74,519	27,000	2,229	0,052/0,115	AL-LF	02-2228	02-2228 STD 0.25 0.50 0.75
TW/A	1	79,300	94,964		2,985		AL-LF	04-3405	A110/4 STD
TW/A	1	79,300	94,964		2,985		AL-LF	04-3406	
TW/A	1	79,000/79,300	101,614/101,964		2,985		AL-LF	04-3407	
TW/A	1	79,000/79,300	101,614/101,964		2,985		AL-LF	04-3408	
SE/PB	1	34,995/35,000	38,000/38,016	33,800	1,482		BC	55-2650	55-2650 STD
BU	1	17,983/17,994	21,000/21,021	13,800	1,501		BC	56-2651	56-2651 STD

26 102.00 x 125.00

F 4 L 913	4 Cyl.	4086cc	64-66kW (87-90PS)	Diesel	TD7561				
F 4 L 913	4 Cyl.	4086cc	50-78kW (68-106PS)	Diesel	TD7277				
F 4L 912 F	4 Cyl.	4086cc	62kW (84PS)	Diesel	FM5922				
F 4L 913	4 Cyl.	4086cc	34-66kW (46-90PS)	Diesel	TD17202				
BE/PL	1	59,941/59,960	64,000/64,019	25,000	2,000	0,040/0,103	AL-LF	01-2800	01-2800 STD 0.25 0.50 0.75
MB/HL	1	69,971/69,990	74,500/74,519	27,000	2,229	0,052/0,115	AL-LF	02-2228	02-2228 STD 0.25 0.50 0.75
TW/A	1	79,300	94,964		2,985		AL-LF	04-3405	A110/4 STD
TW/A	1	79,300	94,964		2,985		AL-LF	04-3406	
TW/A	1	79,000/79,300	101,614/101,964		2,985		AL-LF	04-3407	
TW/A	1	79,000/79,300	101,614/101,964		2,985		AL-LF	04-3408	

SE/PB	1	34,995/35,000	38,000/38,016	33,800	1,482		BC	55-2650	55-2650 STD
BU	1	17,983/17,994	21,000/21,021	13,800	1,501		BC	56-2651	56-2651 STD

27 102.00 x 125.00

F 5L 912 F			5 Cyl.	5107cc	78kW (106PS)		Diesel		FM5925
F5L912W			5 Cyl.	5107cc	41-74kW (56-101PS)		Diesel		FM15925
BE/PL	1	59,941/59,960	64,000/64,019	25,000	2,000	0,040/0,103	AL-LF	01-2800	01-2800 STD 0.25 0.50 0.75
MB/HL	1	69,971/69,990	74,500/74,519	27,000	2,229	0,052/0,115	AL-LF	02-2228	02-2228 STD 0.25 0.50 0.75
TW/A	1	79,300	94,964		2,985		AL-LF	04-3405	A110/4 STD
TW/A	1	79,300	94,964		2,985		AL-LF	04-3406	
TW/A	1	79,000/79,300	101,614/101,964		2,985		AL-LF	04-3407	
TW/A	1	79,000/79,300	101,614/101,964		2,985		AL-LF	04-3408	
SE/PB	1	34,995/35,000	38,000/38,016	33,800	1,482		BC	55-2650	55-2650 STD
BU	1	17,983/17,994	21,000/21,021	13,800	1,501		BC	56-2651	56-2651 STD

28 102.00 x 125.00

BF 6 L 913			6 Cyl.	6128cc	109-118kW (148-160PS)		Diesel Turbo		TD7564
BF 6 L 913			6 Cyl.	6128cc	118-124kW (160-169PS)		Diesel Turbo		TD7289
BF 6 L 913 T			6 Cyl.	6128cc	85-112kW (115-152PS)		Diesel Turbo		TD7286
BF 6L 913			6 Cyl.	6128cc	70-125kW (95-170PS)		Diesel Turbo		TD17205
BF 6L 913 C			6 Cyl.	6128cc	81-162kW (110-220PS)		Diesel Turbo Intercooler		TD17206
BF 6L 913 T			6 Cyl.	6128cc	85-112kW (115-152PS)		Diesel Turbo		TD18350
MB/HL 1-7	7	74,971/74,990	79,000/79,019	25,000	1,985	0,040/0,103	AL-LF	02-3168	H085/7 STD 0.25
TW/A	1	87,350	107,964		2,985		AL-LF	04-3169	A087/4 STD
TW/A	1	87,350	100,964		2,985		AL-LF	04-3186	
TW/A	1	87,350	107,964		2,985		AL-LF	04-3385	
TW/A	1	87,350	100,964		2,985		AL-LF	04-3386	
SE/PB	1	39,995/40,000	43,000/43,016	33,300	1,487		BC	55-3170	55-3170 STD
BU	1	17,983/17,994	21,000/21,021	13,800	1,501		BC	56-2651	56-2651 STD

29 102.00 x 125.00

F 6 L 913			6 Cyl.	6128cc	85-96kW (115-131PS)		Diesel		TD7563
F 6 L 913			6 Cyl.	6128cc	96kW (130PS)		Diesel		TD7451
F 6L 913			6 Cyl.	6128cc	51-101kW (69-138PS)		Diesel		TD17204
F 6L 913 T			6 Cyl.	6128cc	91kW (124PS)		Diesel Turbo		TD26622
BE/PL	1	59,941/59,960	64,000/64,019	25,000	2,000	0,040/0,103	AL-LF	01-2800	01-2800 STD 0.25 0.50 0.75
MB/HL	1	69,971/69,990	74,500/74,519	27,000	2,229	0,052/0,115	AL-LF	02-2228	02-2228 STD 0.25 0.50 0.75

TW/A	1	79,300	94,964		2,985		AL-LF	04-3405	A110/4 STD	
TW/A	1	79,300	94,964		2,985		AL-LF	04-3406		
TW/A	1	79,000/79,300	101,614/101,964		2,985		AL-LF	04-3407		
TW/A	1	79,000/79,300	101,614/101,964		2,985		AL-LF	04-3408		
SE/PB	1	34,995/35,000	38,000/38,016	33,800	1,482		BC	55-2650	55-2650 STD	
BU	1	17,983/17,994	21,000/21,021	13,800	1,501		BC	56-2651	56-2651 STD	

30

108.00 x 130.00

TCD 2013 L4 4V Euro 4		4 Cyl. 4764cc		140-158kW (190-215PS)			Diesel Turbo Intercooler		TD20769
BE/PL	1	74,980/75,000	80,000/80,020	29,200	2,482	0,036/0,100	SP	71-4716	71-4716 STD 1
MB/HL	1	84,980/85,000	90,500/90,520	26,500	2,735	0,030/0,094	EC	72-4717	72-4717 STD 4
TW/A	2	91,400	114,000		2,950		AL-LF	04-4718	A285/4 STD
TW/A	2	91,400	114,000		2,950		AL-LF	04-4719	
SE/PB	1	44,994/45,000	48,000/48,020	36,700			BC-LF	55-4720	55-4720 SEMI 6
CB/NWB 1	1	72,930/72,950	77,000/77,019	27,000			BC	53-4721	N192/5 STD
CB/NWB 2-5	4	72,930/72,950	77,000/77,019	22,000			BC	53-4722	

31

108.00 x 130.00

BF 6M 1013			6 Cyl. 7146cc	126-141kW (171-192PS)			Diesel Turbo		TD17248
BF 6M 1013 C			6 Cyl. 7146cc	153-170kW (208-231PS)			Diesel Turbo Intercooler		TD17249
BF 6M 1013 CP			6 Cyl. 7146cc	171-190kW (233-258PS)			Diesel Turbo Intercooler		TD17250
BF 6M 1013 E			6 Cyl. 7146cc	85-145kW (115-197PS)			Diesel Turbo		TD17245
BF 6M 1013 EC			6 Cyl. 7146cc	139-191kW (189-260PS)			Diesel Turbo Intercooler		TD17242
BF 6M 1013 ECW			6 Cyl. 7146cc	123-195kW (167-265PS)			Diesel Turbo Intercooler		TD29625
BF 6M 1013 EW			6 Cyl. 7146cc	123-195kW (167-265PS)			Diesel Turbo Intercooler		TD29626
BF 6M 1013 FC Euro 2/3			6 Cyl. 7146cc	147-210kW (200-286PS)			Diesel Turbo Intercooler		TD20768
BF 6M 1013E CP Euro 3			6 Cyl. 7146cc	176-195kW (239-265PS)			Diesel Turbo Intercooler		TD17243
BE/PL	6	67,980/68,000	72,500/72,520	30,000	2,232	0,036/0,101	EC	71-3922	71-3922/6 STD
MB/HL 1-7	7	84,980/85,000	90,500/90,520	31,000	2,735	0,030/0,095	AL-LF	02-3808	H056/7 STD
SE/PB	1	41,994/42,000	45,500/45,520	29,800			BC	55-3811	55-3811 SEMI

32

108.00 x 130.00

TCD 2013 L06 4V Euro 4		6 Cyl. 7146cc		147-243kW (200-330PS)			Diesel Turbo Intercooler		TD29652
TCD 2013 L6 4V Euro 4		6 Cyl. 7146cc		147-243kW (200-330PS)			Diesel Turbo Intercooler		TD20765
BE/PL	1	74,980/75,000	80,000/80,020	29,200	2,482	0,036/0,100	SP	71-4716	71-4716 STD 1
MB/HL	1	84,980/85,000	90,500/90,520	26,500	2,735	0,030/0,094	EC	72-4717	72-4717 STD 4
TW/A	2	91,400	114,000		2,950		AL-LF	04-4718	A285/4 STD
TW/A	2	91,400	114,000		2,950		AL-LF	04-4719	
SE/PB	1	44,994/45,000	48,000/48,020	36,700			BC-LF	55-4720	55-4720 SEMI 6

CB/NWB 1	1	72,930/72,950	77,000/77,019	27,000				BC	53-4721	N192/7 STD
CB/NWB 2-7	6	72,930/72,950	77,000/77,019	22,000				BC	53-4722	

33 108.00 x 130.00

TCD 2013 L6 2V		6 Cyl.		7146cc	139-200kW (189-272PS)		Diesel Turbo Intercooler		TD19988
BE/PL	6	73,831/73,850	77,740/77,753	37,100	1,922	0,050/0,100	EC	71-3964	71-3964/6 STD
SE/PB	1	47,000/47,004	52,000/52,046	36,600			BC	55-3965	55-3965 SEMI

34 120.00 x 125.00

BF 6L 413		V6 Cyl.		8478cc	99-154kW (135-209PS)		Diesel Turbo		TD19027
F 6 L 413		V6 Cyl.		8480cc	125-129kW (170-176PS)		Diesel		TD7565
F 6 L 413		V6 Cyl.		8478cc	99-130kW (135-177PS)		Diesel		TD7444
F 6 L 413		V6 Cyl.		8478cc	99-130kW (135-177PS)		Diesel		TD18362
F6L413L		V6 Cyl.		8482cc	137kW (183PS)		Diesel		FM5381
BE/PL	1	74,971/74,990	80,000/80,019	27,800	2,475	0,060/0,123	EC	71-2834	71-2834 STD 0.25 0.50
SE/PB	1	44,995/45,000	48,000/48,016	39,600	1,484		BC	55-2640	55-2640 STD

35 120.00 x 125.00

BF 8L 413		V8 Cyl.		11310cc	99-206kW (135-280PS)		Diesel Turbo		TD19025
F 8 L 413		V8 Cyl.		11310cc	169-171kW (230-233PS)		Diesel		TD7566
F 8 L 413		V8 Cyl.		11310cc	169kW (230PS)		Diesel		TD7459
F 8 L 413 W		V8 Cyl.		11310cc	132-162kW (180-220PS)		Diesel		TD7567
F 8 L 413 W		V8 Cyl.		11310cc	132-162kW (180-220PS)		Diesel		TD7462
F 8L 413		V8 Cyl.		11310cc	169kW (230PS)		Diesel		TD18363
F8L413L		V8 Cyl.		11309cc	179kW (243PS)		Diesel		FM5382
BE/PL	1	74,971/74,990	80,000/80,019	27,800	2,475	0,060/0,123	EC	71-2834	71-2834 STD 0.25 0.50
SE/PB	1	44,995/45,000	48,000/48,016	39,600	1,484		BC	55-2640	55-2640 STD
CB/NWB	4	59,910/59,940	64,000/64,019	24,000	2,000		BB	13-2865	N120/5 STD
CB/NWB	1	59,910/59,940	64,000/64,019	39,000	2,000		EC	53-2864	

36 120.00 x 125.00

BF10L413		V10 Cyl.		14137cc	199kW (271PS)		Diesel Turbo		FM5387
F 10 L 413		V10 Cyl.		14140cc	199-224kW (270-305PS)		Diesel		TD7570
F 10 L 413		V10 Cyl.		14140cc	167-224kW (227-305PS)		Diesel		TD7468
F 10L 413		V10 Cyl.		14140cc	167-224kW (227-305PS)		Diesel		TD18352
BE/PL	1	74,971/74,990	80,000/80,019	27,800	2,475	0,060/0,123	EC	71-2834	71-2834 STD 0.25 0.50
SE/PB	1	44,995/45,000	48,000/48,016	39,600	1,484		BC	55-2640	55-2640 STD

37 120.00 x 125.00

BF 12 L 413		V12 Cyl.		16964cc	305kW (415PS)		Diesel Turbo		TD6771
BF 12L 413		V12 Cyl.		16964cc	305kW (415PS)		Diesel Turbo		TD18345
F 12 L 413		V12 Cyl.		16960cc	250kW (340PS)		Diesel		TD7571
F 12 L 413		V12 Cyl.		16960cc	250kW (340PS)		Diesel		TD7469
F 12L 413		V12 Cyl.		16960cc	250kW (340PS)		Diesel		TD18354
F12L413L		V12 Cyl.		16965cc	269kW (366PS)		Diesel		FM5384



BE/PL	1	74,971/74,990	80,000/80,019	27,800	2,475	0,060/0,123	EC	71-2834	71-2834 STD 0.25 0.50
SE/PB	1	44,995/45,000	48,000/48,016	39,600	1,484		BC	55-2640	55-2640 STD

38 120.00 x 130.00

F 6 L 413 V V6 Cyl. **8822cc** **125kW** (170PS) **Diesel** **TD7458**

F 6 L 413 R V6 Cyl. **8822cc** **100-135kW** (136-184PS) **Diesel** **TD17884**

BE/PL	1	74,971/74,990	80,000/80,019	27,800	2,475	0,060/0,123	EC	71-2834	71-2834 STD 0.25 0.50
SE/PB	1	44,995/45,000	48,000/48,016	39,600	1,484		BC	55-2640	55-2640 STD

39 120.00 x 130.00

F 10 L 413 L V10 Cyl. **14702cc** **199-225kW** (270-306PS) **Diesel** **TD26627**

F 10 L 413 L V10 Cyl. **14700cc** **198-225kW** (269-306PS) **Diesel** **TD29640**

BE/PL	1	74,971/74,990	80,000/80,019	27,800	2,475	0,060/0,123	EC	71-2834	71-2834 STD 0.25 0.50
SE/PB	1	44,995/45,000	48,000/48,016	39,600	1,484		BC	55-2640	55-2640 STD

40 125.00 x 130.00

BF 6 L 413 F V6 Cyl. **9572cc** **112-177kW** (152-241PS) **Diesel Turbo** **TD29623**

BF 6 L 413 FR V6 Cyl. **9572cc** **143-177kW** (194-241PS) **Diesel Turbo** **TD19028**

BF 6 L 413 FRC V6 Cyl. **9572cc** **160-199kW** (218-271PS) **Diesel Turbo** **TD29624**

BF 6 L 413 FW V6 Cyl. **9572cc** **112-121kW** (152-165PS) **Diesel Turbo** **TD21276**

BF 6 L 513 V6 Cyl. **9572cc** **141-210kW** (192-286PS) **Diesel Turbo** **TD19240**

BF 6 L 513 C V6 Cyl. **9572cc** **112-177kW** (152-241PS) **Diesel Turbo Intercooler** **TD21275**

F 6 L 413 F V6 Cyl. **9570cc** **141kW** (192PS) **Diesel** **TD7573**

F 6 L 413 F V6 Cyl. **9572cc** **125-141kW** (170-192PS) **Diesel** **TD6960**

F 6 L 413 F V6 Cyl. **9572cc** **104-188kW** (141-256PS) **Diesel** **TD18341**

F 6 L 413 FR V6 Cyl. **9572cc** **112-141kW** (152-192PS) **Diesel** **TD21274**

F 6 L 413 FW V6 Cyl. **9572cc** **96-121kW** (131-165PS) **Diesel** **TD17883**

BE/PL	1	74,971/74,990	80,000/80,019	27,800	2,475	0,060/0,123	EC	71-2834	71-2834 STD 0.25 0.50
SE/PB	1	44,995/45,000	48,000/48,016	39,600	1,484		BC	55-2640	55-2640 STD

41 125.00 x 130.00

BF 8 L 413 F V8 Cyl. **12763cc** **212-235kW** (288-320PS) **Diesel Turbo** **TD7329**

BF 8 L 513-225 V8 Cyl. **12763cc** **225kW** (306PS) **Diesel Turbo** **TD16483**

BF 8 L 513-243 V8 Cyl. **12763cc** **243kW** (330PS) **Diesel Turbo** **TD7313**

BF 8 L 413 F V8 Cyl. **12763cc** **212-235kW** (288-320PS) **Diesel Turbo** **TD18351**

BF 8 L 513 V8 Cyl. **12763cc** **235-250kW** (320-340PS) **Diesel Turbo** **TD18495**

F 8 L 413 F V8 Cyl. **12763cc** **188kW** (256PS) **Diesel** **TD7569**

F 8 L 413 F V8 Cyl. **12763cc** **147-188kW** (200-256PS) **Diesel** **TD7256**

F 8 L 413 F V8 Cyl. **12763cc** **147-188kW** (200-256PS) **Diesel** **TD18342**

F 8 L 413 FW V8 Cyl. **12763cc** **129-150kW** (175-204PS) **Diesel** **TD17885**

F 8 L 413 FZ V8 Cyl. **12763cc** **188kW** (256PS) **Diesel** **FM7023**

BE/PL	1	74,971/74,990	80,000/80,019	27,800	2,475	0,060/0,123	EC	71-2834	71-2834 STD 0.25 0.50
-------	---	---------------	---------------	--------	-------	-------------	----	---------	---------------------------------



MB/HL	4	94,966/94,988	101,000/101,022	29,000	2,970		EC	72-3313	H931/5 0.25
MB/HL	1	94,966/94,988	101,000/101,022	40,825	2,970		EC	72-3314H	
			72-3314H	0.25mm	41,250/1.6240" - 41,312/1.6265"				
SE/PB	1	44,995/45,000	48,000/48,016	39,600	1,484		BC	55-2640	55-2640 STD N120/5 STD
CB/NWB	4	59,910/59,940	64,000/64,019	24,000	2,000		BB	13-2865	
CB/NWB	1	59,910/59,940	64,000/64,019	39,000	2,000		EC	53-2864	

42 125.00 x 130.00

BF 10 L 413 F			V10 Cyl.	15953cc	265kW (360PS)		Diesel Turbo		TD7355
BF 10L 413 F			V10 Cyl.	15953cc	265-294kW (360-400PS)		Diesel Turbo		TD18344
BF 10L 413 FW			V10 Cyl.	15953cc	265-294kW (360-400PS)		Diesel Turbo		TD21061
BF 10L 513			V10 Cyl.	15954cc	218-305kW (296-415PS)		Diesel Turbo		TD18127
BF 10L 513 C			V10 Cyl.	15954cc	265-294kW (360-400PS)		Diesel Turbo Intercooler		TD21060
BF 10L 513 F			V10 Cyl.	15945cc	253-294kW (344-400PS)		Diesel Turbo		TD19241
F 10 L 413 F			V10 Cyl.	15953cc	235kW (320PS)		Diesel		TD7575
F 10 L 413 F			V10 Cyl.	15953cc	235kW (320PS)		Diesel		TD7331
F 10L 413 F			V10 Cyl.	15953cc	235kW (320PS)		Diesel		TD18353
F 10L 413 FW			V10 Cyl.	15953cc	161-202kW (219-275PS)		Diesel		TD17886
F 10L 413 FZ			V10 Cyl.	15953cc	161-294kW (219-400PS)		Diesel		TD29639
F 10L 513 F			V10 Cyl.	15953cc	235-294kW (320-400PS)		Diesel		TD19242
BE/PL	1	74,971/74,990	80,000/80,019	27,800	2,475	0,060/0,123	EC	71-2834	71-2834 STD 0.25 0.50
SE/PB	1	44,995/45,000	48,000/48,016	39,600	1,484		BC	55-2640	

43 125.00 x 130.00

BF 12 L 413 F			V12 Cyl.	19144cc	268-353kW (364-480PS)		Diesel Turbo		TD6772
BF 12 L 413 FC			V12 Cyl.	19144cc	268-386kW (364-525PS)		Diesel Turbo Intercooler		TD26011
BF 12 L 413 FW			V12 Cyl.	19144cc	228-287kW (310-390PS)		Diesel Turbo Intercooler		TD26012
BF 12L 413 F			V12 Cyl.	19144cc	268-353kW (364-480PS)		Diesel Turbo		TD18346
BF 12L 513			V12 Cyl.	19144cc	353-367kW (480-499PS)		Diesel Turbo		TD18496
BF 12L 513 C			V12 Cyl.	19144cc	386-405kW (525-551PS)		Diesel Turbo Intercooler		TD18498
BF 12L 513 CP			V12 Cyl.	19144cc	411kW (558PS)		Diesel Turbo Intercooler		TD26621
BF 12L 513 F			V12 Cyl.	19144cc	282-353kW (384-480PS)		Diesel Turbo		TD19029
F 12 L 413 F			V12 Cyl.	19144cc	224-282kW (305-384PS)		Diesel		TD6770
F 12L 413 F			V12 Cyl.	19144cc	224-282kW (305-384PS)		Diesel		TD18355
F 12L 413 FW			V12 Cyl.	19144cc	193-243kW (262-330PS)		Diesel		TD17888
F 12L 513 F Euro 1			V12 Cyl.	19144cc	193-405kW (262-551PS)		Diesel		TD21062
BE/PL	1	74,971/74,990	80,000/80,019	27,800	2,475	0,060/0,123	EC	71-2834	71-2834 STD 0.25 0.50
SE/PB	1	44,995/45,000	48,000/48,016	39,600	1,484		BC	55-2640	

44 125.00 x 140.00

BF 8 L 513 LC			V8 Cyl.	13745cc	265-274kW (360-373PS)		Diesel Turbo Intercooler		TD9035
BF 8L 513 C			V8 Cyl.	13738cc	265kW (360PS)		Diesel Turbo Intercooler		TD26618
BE/PL	1	74,971/74,990	80,000/80,019	27,800	2,475	0,060/0,123	EC	71-2834	71-2834 STD 0.25 0.50



MB/HL	4	94,966/94,988	101,000/101,022	29,000	2,970		EC	72-3313	H931/5 0.25
MB/HL	1	94,966/94,988	101,000/101,022	40,825	2,970		EC	72-3314H	



SE/PB	1	44,995/45,000	48,000/48,016	39,600	1,484		BC	55-2640	55-2640 STD
CB/NWB	4	59,910/59,940	64,000/64,019	24,000	2,000		BB	13-2865	N120/5 STD
CB/NWB	1	59,910/59,940	64,000/64,019	39,000	2,000		EC	53-2864	

45 128.00 x 130.00

F6L513 V6 Cyl. **10038cc 141kW** (192PS) **Diesel** **FM6032**

BE/PL	1	74,971/74,990	80,000/80,019	27,800	2,475	0,060/0,123	EC	71-2834	71-2834 STD 0.25 0.50
SE/PB	1	44,995/45,000	48,000/48,016	39,600	1,484		BC	55-2640	55-2640 STD

46 128.00 x 130.00

F 8 L 513 V8 Cyl. **13383cc 168-177kW** (228-241PS) **Diesel** **TD7314**

F 8L 513 V8 Cyl. **13382cc 155-194kW** (211-264PS) **Diesel** **TD18343**

BE/PL	1	74,971/74,990	80,000/80,019	27,800	2,475	0,060/0,123	EC	71-2834	71-2834 STD 0.25 0.50
MB/HL	4	94,966/94,988	101,000/101,022	29,000	2,970		EC	72-3313	H931/5 0.25
MB/HL	1	94,966/94,988	101,000/101,022	40,825	2,970		EC	72-3314H	

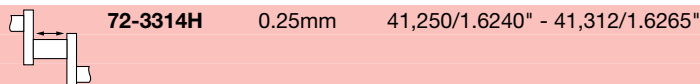

SE/PB	1	44,995/45,000	48,000/48,016	39,600	1,484		BC	55-2640	55-2640 STD
CB/NWB	4	59,910/59,940	64,000/64,019	24,000	2,000		BB	13-2865	N120/5 STD
CB/NWB	1	59,910/59,940	64,000/64,019	39,000	2,000		EC	53-2864	

47 128.00 x 130.00

F 10L 513 V10 Cyl. **16728cc 188-242kW** (256-329PS) **Diesel** **TD17887**

F 10L 513 L V10 Cyl. **16728cc 204-242kW** (277-329PS) **Diesel** **TD29642**

F 10L 513 T V10 Cyl. **16728cc 204-242kW** (277-329PS) **Diesel** **TD29641**

BE/PL	1	74,971/74,990	80,000/80,019	27,800	2,475	0,060/0,123	EC	71-2834	71-2834 STD 0.25 0.50
SE/PB	1	44,995/45,000	48,000/48,016	39,600	1,484		BC	55-2640	55-2640 STD

48 128.00 x 130.00

F 12 L 513 V12 Cyl. **20074cc 282kW** (384PS) **Diesel** **TD26017**

F 12L 513 V12 Cyl. **20074cc 282kW** (384PS) **Diesel** **TD18492**

F 12L 513 L Euro 1 V12 Cyl. **20074cc 231-291kW** (318-396PS) **Diesel** **TD21058**

BE/PL	1	74,971/74,990	80,000/80,019	27,800	2,475	0,060/0,123	EC	71-2834	71-2834 STD 0.25 0.50
SE/PB	1	44,995/45,000	48,000/48,016	39,600	1,484		BC	55-2640	55-2640 STD



49											
128.00 x 140.00											
F8L513L											
V8 Cyl. 14412cc 80-115kW (157-245PS) Diesel FM5930											
BE/PL	1	74,971/74,990	80,000/80,019	27,800	2,475	0,060/0,123	EC	71-2834	71-2834 STD 0.25 0.50		
MB/HL	4	94,966/94,988	101,000/101,022	29,000	2,970		EC	72-3313	H931/5 0.25		
MB/HL	1	94,966/94,988	101,000/101,022	40,825	2,970		EC	72-3314H			
			72-3314H	0.25mm	41,250/1.6240" - 41,312/1.6265"						
SE/PB	1	44,995/45,000	48,000/48,016	39,600	1,484		BC	55-2640	55-2640 STD		
CB/NWB	4	59,910/59,940	64,000/64,019	24,000	2,000		BB	13-2865	N120/5 STD		
CB/NWB	1	59,910/59,940	64,000/64,019	39,000	2,000		EC	53-2864			

50										
132.00 x 145.00										
BF 6M 1015										
V6 Cyl. 11905cc 195-250kW (265-340PS) Diesel Turbo TD17254										
BF 6M 1015 C										
V6 Cyl. 11905cc 250-345kW (340-469PS) Diesel Turbo Intercooler TD17252										
BF 6M 1015 CP										
V6 Cyl. 11905cc 300-384kW (408-522PS) Diesel Turbo Intercooler TD17255										
BF 6M 1015 CU										
V6 Cyl. 11905cc 226-305kW (307-415PS) Diesel Turbo TD29627										
BE/PL	1	87,966/87,988	91,998/92,028	25,000	1,975	0,060/0,136	SP	71-4823	71-4823 STD 0.25 0.50 ①	
MB/HL	1	102,996/102,988	108,000/108,022	30,000	2,470	0,072/0,136	EC	72-4826	72-4826 STD 0.25 0.50 ④	
TW/A	2	114,800/115,200	139,700/139,950		3,410		AL-LF	04-4824	A298/4 STD 0.125 0.25	
TW/A	2	114,800/115,200	139,700/139,950		3,410		AL-LF	04-4825		

51										
132.00 x 145.00										
TCD 2015 V6										
V6 Cyl. 11906cc 360kW (490PS) Diesel Turbo Intercooler TD20091										
BE/PL	1	90,966/90,988	94,998/95,028	25,000	1,975	0,060/0,136	SP	71-4755	71-4755 0.25 ①	
MB/HL	1	107,966/107,988	113,000/113,022	30,000	2,470	0,072/0,136	SP	72-4756	72-4756 0.25 0.50 ②	
TW/A	2	118,800/119,200	143,700/143,950		3,410		AL-LF	04-4833	A299/4 STD 0.25	
TW/A	2	118,800/119,200	143,700/143,950		3,410		AL-LF	04-4834		
CB/NWB	1	69,910/69,940	75,000/75,030	32,500			BC	53-4757	53-4757 STD	
CB/NWB	1	69,910/69,940	75,000/75,030	25,000			BC	53-4758	53-4758 STD	

52										
132.00 x 145.00										
BF 8M 1015										
V8 Cyl. 15874cc 290kW (394PS) Diesel TD18499										
BF 8M 1015 C										
V8 Cyl. 15874cc 333-459kW (453-624PS) Diesel Bi-Turbo Intercooler TD17253										
BF 8M 1015 CP										
V8 Cyl. 15874cc 399-517kW (543-703PS) Diesel Bi-Turbo Intercooler TD17256										
BF 8M 1015 M Euro 2										
V8 Cyl. 15874cc 290-304kW (394-413PS) Diesel Turbo TD29638										
BE/PL	1	87,966/87,988	91,998/92,028	25,000	1,975	0,060/0,136	SP	71-4823	71-4823 STD 0.25 0.50 ①	
MB/HL	1	102,996/102,988	108,000/108,022	30,000	2,470	0,072/0,136	EC	72-4826	72-4826 STD 0.25 0.50 ④	

TW/A	2	114,800/115,200	139,700/139,950		3,410		AL-LF	04-4824	A298/4 STD 0.125 0.25
TW/A	2	114,800/115,200	139,700/139,950		3,410		AL-LF	04-4825	

53 132.00 x 145.00

TCD 2015 V8		V8 Cyl.		15874cc	500kW (680PS)	Diesel Turbo Intercooler			TD20092
BE/PL	1	90,966/90,988	94,998/95,028	25,000	1,975	0,060/0,136	SP	71-4755	71-4755 0.25 ①
MB/HL	1	107,966/107,988	113,000/113,022	30,000	2,470	0,072/0,136	SP	72-4756	72-4756 0.25 0.50 ②
TW/A	2	118,800/119,200	143,700/143,950		3,410		AL-LF	04-4833	A299/4 STD 0.25
TW/A	2	118,800/119,200	143,700/143,950		3,410		AL-LF	04-4834	
CB/NWB	1	69,910/69,940	75,000/75,030	32,500			BC	53-4757	53-4757 STD
CB/NWB	1	69,910/69,940	75,000/75,030	25,000			BC	53-4758	53-4758 STD

54 132.00 x 160.00

TBD616V8		V8 Cyl.		17516cc	480kW (653PS)	Diesel Turbo Intercooler			TD17394
BE/PL	1	91,942/91,964	98,000/98,022	30,000	2,992	0,052/0,121	AL-LF	01-3814	01-3814 STD

55 132.00 x 160.00

TBD616V12		V12 Cyl.		26277cc	480-720kW (653-979PS)	Diesel Turbo Intercooler			TD17395
BE/PL	1	91,942/91,964	98,000/98,022	30,000	2,992	0,052/0,121	AL-LF	01-3814	01-3814 STD

56 132.00 x 160.00

TBD616V16		V16 Cyl.		35033cc	640-960kW (870-1306PS)	Diesel Turbo Intercooler			TD17396
BE/PL	1	91,942/91,964	98,000/98,022	30,000	2,992	0,052/0,121	AL-LF	01-3814	01-3814 STD

57 135.00 x 160.00

BF 8 M 716		V8 Cyl.		18320cc	246-312kW (335-424PS)	Diesel Turbo			TD26019
F 8 M 716		V8 Cyl.		18320cc	97-184kW (132-250PS)	Diesel			TD26020
F8M716		8 Cyl.		18320cc		Diesel			FM5393
MB/HL	1	118,966/118,988	125,000/125,025	38,750	2,962		EC	72-2658	72-2658 STD 0.25

58 135.00 x 160.00

BF12M716		V12 Cyl.		27480cc		Diesel Turbo			FM6153
F12M716		V12 Cyl.		27480cc		Diesel			FM5395
MB/HL	1	118,966/118,988	125,000/125,025	38,750	2,962		EC	72-2658	72-2658 STD 0.25

59 135.00 x 160.00

BF 16 M 716		V16 Cyl.		36640cc	566-625kW (770-850PS)	Diesel Turbo			TD26014
F16M716		V16 Cyl.		36644cc	283-684kW	Diesel			FM899925
MB/HL	1	118,966/118,988	125,000/125,025	38,750	2,962		EC	72-2658	72-2658 STD 0.25

60 142.00 x 160.00

BA 12M 816		V12 Cyl.		30408cc	247-564kW (336-767PS)	Diesel Turbo			TD21051
BA 12M 816 C		V12 Cyl.		30408cc	608-770kW (827-1047PS)	Diesel Turbo Intercooler			TD21052
BA 12M 816 CR		V12 Cyl.		30408cc	850-950kW (1156-1292PS)	Diesel Turbo Intercooler			TD21053









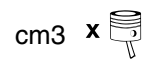

BA 12M 816 R		V12 Cyl. 30408cc		720-866kW (979-1178PS)		Diesel Turbo Intercooler		TD21054	
BA 12M 816 U		V12 Cyl. 30408cc		615-650kW (836-884PS)		Diesel Turbo Intercooler		TD21055	
BA 12M 816 W		V12 Cyl. 30408cc		665-710kW (904-966PS)		Diesel Turbo Intercooler		TD21056	
BE/PL	1	97,996/97,988	103,000/103,022	35,800	2,475	0,078/0,146	EC	71-3251	71-3251 STD 0.25

61	142.00 x 160.00								
-----------	------------------------	--	--	--	--	--	--	--	--

A/BA16M816		V16 Cyl. 40522cc				Diesel Turbo		FM5403	
A/BA16M816C/CR		V16 Cyl. 40522cc				Diesel Turbo		FM5404	
A/BA16M816C/CR/U/W/R		V16 Cyl. 40522cc				Diesel Turbo Intercooler		FM899936	
BE/PL	1	97,996/97,988	103,000/103,022	35,800	2,475	0,078/0,146	EC	71-3251	71-3251 STD 0.25



124 1.4	10/69→12/71	Petrol	124 AC.000	1438	4	80.00	71.50	39
124 1.4	09/67→05/71	Petrol	124 B.000	1438	4	80.00	71.50	39
124 1200	07/66→07/75	Petrol	124 A.000	1197	4	73.00	71.50	17
124 1400	09/67→12/73	Petrol	124 B2.000	1438	4	80.00	71.50	39
124 1400	06/67→10/72	Petrol	124 AC.000	1438	4	80.00	71.50	39
124 1500	01/71→07/75	Petrol	124 AC.000	1438	4	80.00	71.50	39
124 1500	01/73→07/75	Petrol	124 B2.000	1438	4	80.00	71.50	39
124 1500	01/66→12/72	Petrol	124 AC.000	1438	4	80.00	71.50	39
124 1600	09/70→07/75	Petrol	132 AC.000	1592	4	80.00	79.20	42
124 1600	04/70→10/73	Petrol	125 B.000	1608	4	80.00	80.00	44
124 1600	01/69→12/75	Petrol	132 AC.000	1592	4	80.00	79.20	42
124 1600	01/69→12/74	Petrol	125 B.000	1608	4	80.00	80.00	44
124 1800 Rally Abarth	09/72→07/75	Petrol	132 AC1.000	1756	4	84.00	79.20	76
124 1800	01/72→12/77	Petrol	132 AC1.000	1756	4	84.00	79.20	76
124 2000	09/78→11/85	Petrol	132 C3.031	1995	4	84.00	90.00	86
125 1.3	06/68→11/82	Petrol	131 A.000	1297	4	76.00	71.50	25
125 1.6	07/67→03/74	Petrol	125 A.000	1608	4	80.00	80.00	44
125 1.6	05/69→10/73	Petrol	125 B.000	1608	4	80.00	80.00	44
126 600	09/72→06/77	Petrol	126 A.000	594	2	73.50	70.00	19
126 650	07/77→09/87	Petrol	126 A1.000	652	2	77.00	70.00	31
126 650	07/77→09/00	Petrol	126 A1.048	652	2	77.00	70.00	31
126 700	09/87→06/96	Petrol	126 A2.000	704	2	80.00	70.00	38
126 700	09/87→06/96	Petrol	126 A2.048	704	2	80.00	70.00	38
127	01/79→12/83	Petrol	147A5.000	1049	4	76.00	57.80	23
127 0.9	06/71→12/86	Petrol	100 GL.000	903	4	65.00	68.00	4
127 0.9	06/71→05/83	Petrol	100 GL.048	903	4	65.00	68.00	4
127 1.0	01/77→05/96	Petrol	127 A.000	1049	4	65.00	68.00	4
127 1.0	07/78→02/82	Petrol	127 A1.000	1049	4	76.00	57.80	23
127 1.3 D	06/81→12/86	Diesel	127 A5.000	1302	4	76.10	71.50	30
127 1.3 Diesel	04/81→12/86	Diesel	127 A5.000	1302	4	76.10	71.50	30
127 1.3	12/81→05/83	Petrol	127 A3.000	1301	4	76.10	71.50	29
127C/CL/L/TOP(50Hp)	01/77→12/83	Petrol	147A5.000	1049	4	76.00	57.80	23
128 1.1	03/69→12/84	Petrol	128 A.000	1116	4	80.00	55.50	37
128 1.1	02/75→09/81	Petrol	128 A.048	1116	4	80.00	55.50	37
128 1.1	03/72→02/81	Petrol	128 AC5.000	1116	4	80.00	55.50	37
128 1.3	03/72→10/82	Petrol	128 A1.000	1290	4	86.00	55.50	98
128 1.3	03/72→12/79	Petrol	128 AC.000	1290	4	86.00	55.50	98
128 1.3	09/73→12/79	Petrol	128 AR.000	1290	4	86.00	55.50	98
128 1.3 Berlinetta	06/75→12/79	Petrol	128 AC.000	1290	4	86.00	55.50	98
128 1.3 Rally	09/71→02/76	Petrol	128 AR.000	1290	4	86.00	55.50	98
128 1.3	08/74→12/84	Petrol	128 A1.000	1290	4	86.00	55.50	98
131 1.3 Mirafiori	10/74→12/82	Petrol	131 A.000	1297	4	76.00	71.50	25
131 1.3 Mirafiori	10/74→09/81	Petrol	131 A6.000	1297	4	76.00	71.60	27
131 1.3 Super Mirafiori	03/78→12/80	Petrol	131 B.000	1297	4	76.00	71.50	25
131 1.4 Mirafiori	11/80→01/84	Petrol	131 C.000	1367	4	78.00	71.50	32
131 1.4 Mirafiori	11/80→01/84	Petrol	131 C1.000	1367	4	78.00	71.50	32
131 1.4 Super Mirafiori	04/81→12/83	Petrol	131 C1.000	1367	4	78.00	71.50	32
131 1.6	10/74→09/81	Petrol	131 A1.000	1585	4	84.00	71.50	74
131 1.6	11/76→12/84	Petrol	131 C2.000	1585	4	84.00	71.50	75
131 1.6 CL	03/75→12/78	Petrol	131 A1.000	1585	4	84.00	71.50	74
131 1.6 Super	03/78→01/84	Petrol	131 C3.000	1585	4	84.00	71.50	75
131 1.6 Super Mirafiori	03/79→03/82	Petrol	131 B1.000	1585	4	84.00	71.50	75
131 2.0 Abarth Rally	01/76→07/80	Petrol	131 B2.000	1995	4	84.00	90.00	83
131 2.0 D	07/78→08/84	Diesel	8144.65	1995	4	88.00	82.00	109
131 2.0 Racing	06/78→12/81	Petrol	131 B2.000	1995	4	84.00	90.00	83
131 2.0 Super	01/81→12/84	Petrol	131 C4.000	1995	4	84.00	90.00	84
131 2.5 D	06/78→02/84	Diesel	8144.61	2428	4	93.00	90.00	112
131 2.5 Super Diesel	03/79→12/84	Diesel	8144.61	2428	4	93.00	90.00	112
132 1.6	01/76→12/82	Petrol	132 C.000	1585	4	84.00	71.50	75
132 1.6	03/77→12/81	Petrol	132 C6.000	1585	4	84.00	71.50	75
132 1.6	04/72→01/76	Petrol	132 BB OA O	1592	4	80.00	79.20	43
132 1.7 GLS	04/74→01/77	Petrol	132 B1.000	1756	4	84.00	79.20	78
132 1.7 Special	04/72→01/74	Petrol	132 B1.000	1756	4	84.00	79.20	78
132 2.0	05/77→06/81	Petrol	132 C2.000	1995	4	84.00	90.00	86
132 2.0 D	07/78→07/82	Diesel	8144.65	1995	4	88.00	82.00	109
132 2.0 i.e.	01/80→12/82	Petrol	132 C3.000	1995	4	84.00	90.00	86
132 2.5 D	07/78→07/82	Diesel	8144.61	2428	4	93.00	90.00	112
133 0.65	06/74→12/76	Petrol	126 A1.048	652	2	77.00	70.00	31
147 0.9	04/77→12/81	Petrol	100 GL.000	903	4	65.00	68.00	4

				cm ³	x 			
147 1.0	10/76→12/95	Petrol	127 A.000	1049	4	65.00	68.00	4
147 1.0	11/76→02/87	Petrol	156 A.000	1049	4	76.10	57.80	28
147 1.1	10/84→08/89	Petrol	128 A 064	1116	4	80.00	55.50	37
147 1.3	10/78→02/87	Petrol	127 A2.011	1297	4	76.00	71.50	25
147 1.3 D	10/80→10/95	Diesel	127 A5.000	1302	4	76.10	71.50	30
147 1.3 Flex	10/78→02/87	Petrol	127 A2.011	1297	4	76.00	71.50	25
147 1.3 Rallye	07/80→07/83	Petrol	127 A2.011	1297	4	76.00	71.50	25
238-Serie 1.4	09/66→06/82	Petrol	131 AZ.000	1440	4	80.00	71.50	40
238-Serie 1.4	06/76→06/82	Petrol	131 BZ 0C0	1440	4	80.00	71.50	40
238-Serie 1.4	06/76→06/82	Petrol	131 FZ	1440	4	80.00	71.50	40
241 1.4 T		Petrol	124AZ2.000	1438	4	80.00	71.50	39
242-Serie 1.6	10/75→07/82	Petrol	124 B3.000	1585	4	84.00	71.50	73
242-Serie 1.9	10/75→07/82	Petrol	132 AZ2.000	1995	4	84.00	90.00	85
242-Serie 2.5 D	08/80→07/82	Diesel	B 25.637	2498	4	93.00	92.00	114
500 0.5	01/65→12/75	Petrol	110 F.000	499	2	67.40	70.00	9
500 0.5	01/60→12/75	Petrol	120.000	499	2	67.40	70.00	9
500 0.9	10/13→	Petrol	199 B6.000	875	2	80.50	86.00	48
500 0.9	07/10→	Petrol	312 A2.000	875	2	80.50	86.00	48
500 1.2	10/07→	Petrol	169 A4.000	1242	4	70.80	78.90	13
500 1.2 LPG	12/10→	Petrol	169 A4.000	1242	4	70.80	78.90	13
500 1.3 D Multijet	10/07→	Diesel	169 A1.000	1248	4	69.60	82.00	10
500 1.3 D Multijet	12/09→	Diesel	199 B1.000	1248	4	69.60	82.00	10
500 1.4	10/07→	Petrol	169 A3.000	1368	4	72.00	84.00	15
500 1.4 Flex	08/11→	Petrol	169 A3.000	1368	4	72.00	84.00	15
500 1.4 Turbo	09/13→	Petrol	EAF	1368	4	72.00	84.00	16
500 C 0.9	12/13→	Petrol	199 B6.000	875	2	80.50	86.00	48
500 C 0.9	09/09→	Petrol	312 A2.000	875	2	80.50	86.00	48
500 C 1.2	09/09→	Petrol	169 A4.000	1242	4	70.80	78.90	13
500 C 1.3 D Multijet	09/09→	Diesel	169 A1.000	1248	4	69.60	82.00	10
500 C 1.3 D Multijet	09/09→	Diesel	199 B1.000	1248	4	69.60	82.00	10
500 C 1.4	09/09→	Petrol	169 A3.000	1368	4	72.00	84.00	15
500 C 1.4 Flex	08/11→	Petrol	169 A3.000	1368	4	72.00	84.00	15
500X 1.3 D Multijet	06/15→	Diesel	5526963	1248	4	69.60	82.00	10
500X 1.4	05/15→	Petrol	55263623	1368	4	72.00	84.00	16
500X 1.4	09/14→	Petrol	55263624	1368	4	72.00	84.00	16
500X 1.4 4x4	02/15→	Petrol	55263623	1368	4	72.00	84.00	16
500X 1.6 D Multijet	09/14→	Diesel	55260384	1598	4	79.50	80.50	36
500X 2.0 D Multijet 4x4	09/14→	Diesel	55263087	1956	4	83.00	90.40	72
500X 2.0 D Multijet 4x4	09/14→	Diesel	55263088	1956	4	83.00	90.40	72
500i 0.9	09/12→	Petrol	199 B6.000	875	2	80.50	86.00	48
500i 0.9 Natural Power	03/13→	Petrol	312 A2.000	875	2	80.50	86.00	48
500i 1.3 D Multijet	09/12→	Diesel	199 B4.000	1248	4	69.60	82.00	10
500i 1.4	09/13→	Petrol	312 A1.000	1368	4	72.00	84.00	15
500i 1.4	09/12→	Petrol	843 A1.000	1368	4	72.00	84.00	15
500i 1.4	10/13→	Petrol	940 B7.000	1368	4	72.00	84.00	16
500i 1.4 Flex	07/14→	Petrol	843 A1.000	1368	4	72.00	84.00	15
500i 1.4 LPG	02/14→	Petrol	940 B7.000	1368	4	72.00	84.00	16
500i 1.6 D Multijet	09/12→	Diesel	199 B5.000	1598	4	79.50	80.50	36
500i 1.6 D Multijet	09/13→	Diesel	940 C1.000	1598	4	79.50	80.50	36
500i 1.6 D Multijet	09/13→	Diesel	955 A3.000	1598	4	79.50	80.50	36
500 N500	01/57→12/60	Petrol	110.000	479	2	66.00	70.00	6
850 0.8	07/64→10/72	Petrol	100 G.000	843	4	65.00	63.50	3
850 0.8	07/64→10/72	Petrol	100 G.002	843	4	65.00	63.50	3
850 0.8 Special	03/68→10/72	Petrol	100 GB.000	843	4	65.00	63.50	3
850 0.9	02/68→12/73	Petrol	100 GL.040	903	4	65.00	68.00	4
900 0.9	01/78→01/86	Petrol	100 GF 000	903	4	65.00	68.00	4
1100 T4		Petrol	124AZ2.000	1438	4	80.00	71.50	39
Argenta 1600	04/81→12/85	Petrol	132 D.000	1585	4	84.00	71.50	75
Argenta 1600 i.e	04/81→12/85	Petrol	132 D.000	1585	4	84.00	71.50	75
Argenta 2000	06/78→12/85	Petrol	132 C2.000	1995	4	84.00	90.00	86
Argenta 2000	06/78→12/85	Petrol	132 D1.000	1995	4	84.00	90.00	86
Argenta 2000 i.e.	06/81→07/86	Petrol	132 C3.000	1995	4	84.00	90.00	86
Argenta 2000 Volumex	06/84→07/85	Petrol	132 C3.000	1995	4	84.00	90.00	86
Argenta 2500 Diesel	06/81→11/85	Diesel	8144.61	2428	4	93.00	90.00	112
Argenta 2500 Turbodiesel	07/83→08/85	Diesel	8144.61.500.81	2445	4	93.00	90.00	112
Barchetta 1.8 16V	04/95→05/05	Petrol	183 A1.000	1747	4	82.00	82.70	51
Barchetta 1.8 16V	04/95→05/05	Petrol	188 A6.000	1747	4	82.00	82.70	51
Brava 1.2 16V	12/98→12/02	Petrol	182 B2.000	1242	4	70.80	78.90	13
Brava 1.2 16V 80	12/98→12/02	Petrol	182 B2.000	1242	4	70.80	78.90	13



cm3

9

Brava 1.2 16V 80	10/00→10/01	Petrol	188 A5.000	1242	4	70.80	78.90	13
Brava 1.4	10/95→10/01	Petrol	182 A5.000	1370	4	82.00	64.90	49
Brava 1.4 12 V	10/95→08/98	Petrol	182 A3.000	1370	4	82.00	64.90	49
Brava 1.6 16V	02/96→10/01	Petrol	182 A4.000	1581	4	86.40	67.40	106
Brava 1.6 16V	10/95→10/01	Petrol	182 A6.000	1581	4	86.40	67.40	106
Brava 1.6 16V	01/99→12/02	Petrol	182 B6.000	1596	4	80.50	78.40	47
Brava 1.8 16V	02/00→06/03	Petrol	183 A1.000	1747	4	82.00	82.70	51
Brava 1.8 GT 16V	10/95→10/01	Petrol	182 A2.000	1747	4	82.00	82.70	51
Brava 1.9 D	10/95→10/01	Diesel	160 A7.000	1929	4	82.60	90.00	61
Brava 1.9 JTD	01/01→12/02	Diesel	182 B4.000	1910	4	82.00	90.40	53
Brava 1.9 JTD	09/00→10/01	Diesel	182 B9.000	1910	4	82.00	90.40	53
Brava 1.9 JTD 105	12/98→10/01	Diesel	182 B4.000	1910	4	82.00	90.40	53
Brava 1.9 TD 75 S	03/96→10/01	Diesel	182 A8.000	1910	4	82.00	90.40	52
Brava 1.9 TD 100 S	03/96→10/01	Diesel	182 A7.000	1910	4	82.00	90.40	52
Brava 2.0	09/98→08/00	Petrol	182 B7.000	1998	5	82.00	75.70	50
Bravo 1.6 D Multijet	03/08→	Diesel	198 A3.000	1598	4	79.50	80.50	36
Bravo I 1.2 16V 80	12/98→10/01	Petrol	182 B2.000	1242	4	70.80	78.90	13
Bravo I 1.2 16V 80	10/00→10/01	Petrol	188 A5.000	1242	4	70.80	78.90	13
Bravo I 1.4	10/95→10/01	Petrol	182 A3.000	1370	4	82.00	64.90	49
Bravo I 1.4	10/95→10/01	Petrol	182 A5.000	1370	4	82.00	64.90	49
Bravo I 1.6	09/00→10/01	Petrol	182 B6.000	1596	4	80.50	78.40	47
Bravo I 1.6 16V	03/96→10/01	Petrol	182 A4.000	1581	4	86.40	67.40	106
Bravo I 1.6 16V	10/95→10/01	Petrol	182 A6.000	1581	4	86.40	67.40	106
Bravo I 1.8 GT	10/95→10/01	Petrol	182 A2.000	1747	4	82.00	82.70	51
Bravo I 1.9 D	10/95→10/01	Diesel	160 A7.000	1929	4	82.60	90.00	61
Bravo I 1.9 JTD	09/00→10/01	Diesel	182 B9.000	1910	4	82.00	90.40	53
Bravo I 1.9 JTD 105	12/98→10/01	Diesel	182 B4.000	1910	4	82.00	90.40	53
Bravo I 1.9 TD 75 S	03/96→10/01	Diesel	182 A8.000	1910	4	82.00	90.40	52
Bravo I 1.9 TD 100 S	03/96→10/01	Diesel	182 A7.000	1910	4	82.00	90.40	52
Bravo I 2.0 HGT 20V	10/95→07/98	Petrol	182 A1.000	1998	5	82.00	75.70	50
Bravo I 2.0 HGT 20V	07/98→10/01	Petrol	182 B7.000	1998	5	82.00	75.70	50
Bravo II 1.4	04/07→	Petrol	192 B2.000	1368	4	72.00	84.00	15
Bravo II 1.4 16V	03/08→	Petrol	198 A7.000	1368	4	72.00	84.00	16
Bravo II 1.4 LPG	11/09→	Petrol	192 B2.000	1368	4	72.00	84.00	15
Bravo II 1.4 T-Jet	09/07→	Petrol	198 A1.000	1368	4	72.00	84.00	16
Bravo II 1.4 T-Jet	09/07→	Petrol	198 A4.000	1368	4	72.00	84.00	16
Bravo II 1.6 D Multijet	03/08→	Diesel	198 A2.000	1598	4	79.50	80.50	36
Bravo II 1.6 D Multijet	09/07→	Diesel	198 A3.000	1598	4	79.50	80.50	36
Bravo II 1.6 D Multijet	03/08→	Diesel	198 A6.000	1598	4	79.50	80.50	36
Bravo II 1.6 D Multijet	09/07→	Diesel	844 A3.000	1598	4	79.50	80.50	36
Bravo II 1.6 D Multijet	11/08→	Diesel	955 A4.000	1598	4	79.50	80.50	36
Bravo II 1.9 D Multijet	11/06→	Diesel	192 A1.000	1910	4	82.00	90.40	53
Bravo II 1.9 D Multijet	04/07→	Diesel	192 A8.000	1910	4	82.00	90.40	55
Bravo II 1.9 D Multijet	11/06→	Diesel	192 B4.000	1910	4	82.00	90.40	55
Bravo II 1.9 D Multijet	04/07→12/08	Diesel	192 B5.000	1910	4	82.00	90.40	55
Bravo II 1.9 D Multijet	04/07→	Diesel	937 A5.000	1910	4	82.00	90.40	55
Bravo II 2.0 D Multijet	09/08→	Diesel	198 A5.000	1956	4	83.00	90.40	71
Bravo II 2.0 D Multijet	09/08→	Diesel	844 A2.000	1956	4	83.00	90.40	71
Campagnola 2.0	06/74→10/89	Petrol	6132 AZ 2.000	1995	4	84.00	90.00	93
Campagnola 2.4 D	06/74→10/89	Diesel	8144.61.200	2445	4	93.00	90.00	112
Cinquecento 0.7	12/91→01/96	Petrol	170 A.000	704	2	80.00	70.00	38
Cinquecento 0.7 i	07/94→01/98	Petrol	170 A.046	704	2	80.00	70.00	38
Cinquecento 0.9	07/91→12/93	Petrol	170 A1.000	903	4	65.00	68.00	4
Cinquecento 0.9 i.e.	07/91→12/93	Petrol	170 A1.046	903	4	65.00	68.00	4
Cinquecento 0.9 i.e. S	07/91→07/99	Petrol	1170 A1.000	899	4	65.00	68.00	4
Cinquecento 0.9 i.e. S	07/91→07/99	Petrol	1170 A1.046	899	4	65.00	68.00	4
Cinquecento 1.1 Sporting	10/94→01/98	Petrol	176 B2.000	1108	4	70.00	72.00	12
Coupe 1.8 16V	03/96→08/00	Petrol	183 A1.000	1747	4	82.00	82.70	51
Coupe 2.0 16V	11/93→08/96	Petrol	836 A3.000	1995	4	84.00	90.00	90
Coupe 2.0 16V Turbo	11/93→08/96	Petrol	175 A1.000	1995	4	84.00	90.00	90
Coupe 2.0 20V	08/96→04/98	Petrol	182 A1.000	1998	5	82.00	75.70	50
Coupe 2.0 20V	04/98→08/00	Petrol	182 B3.000	1998	5	82.00	75.70	50
Coupe 2.0 20V Turbo	08/96→08/00	Petrol	175 A3.000	1998	5	82.00	75.70	50
Croma 1.9 D Multijet	06/05→	Diesel	939 A1.000	1910	4	82.00	90.40	53
Croma 1.9 D Multijet	06/05→	Diesel	939 A2.000	1910	4	82.00	90.40	55
Croma 1.9 D Multijet	06/05→	Diesel	939 A7.000	1910	4	82.00	90.40	53
Croma 1.9 D Multijet	12/05→	Diesel	939 A8.000	1910	4	82.00	90.40	53
Croma 2.4 D Multijet	06/05→	Diesel	939 A3.000	2387	5	82.00	90.40	57
Croma 1600	12/85→12/90	Petrol	154 A.048	1585	4	84.00	71.50	75

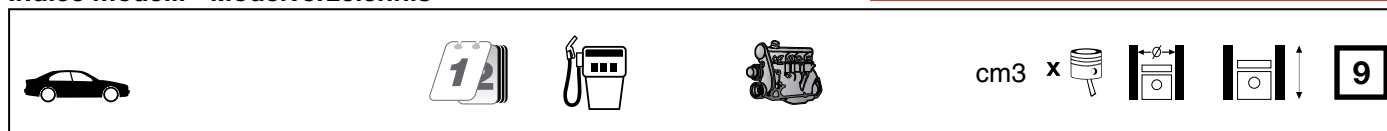

Croma 1900 Turbo D i.d.	05/89→10/92	Diesel	154 C6.000	1929	4	82.60	90.00	62
Croma 1900 Turbo D i.d.	11/92→12/96	Diesel	154 D1.000	1929	4	82.60	90.00	62
Croma 2000 16V	08/92→08/96	Petrol	154 E1.000	1995	4	84.00	90.00	90
Croma 2000 CHT	12/85→09/92	Petrol	154 A1.000	1995	4	84.00	90.00	87
Croma 2000 CHT	01/91→09/92	Petrol	154 C5.000	1995	4	84.00	90.00	87
Croma 2000 i.e.	03/87→09/92	Petrol	154 C3.000	1995	4	84.00	90.00	89
Croma 2000 i.e.	10/87→08/96	Petrol	154 C3.046	1995	4	84.00	90.00	89
Croma 2000 i.e.	03/87→09/92	Petrol	834 B.000	1995	4	84.00	90.00	92
Croma 2000 i.e.	03/86→09/90	Petrol	834 B.048	1995	4	84.00	90.00	92
Croma 2000 i.e.	10/87→08/96	Petrol	834 B.146	1995	4	84.00	90.00	92
Croma 2000 i.e. Turbo	12/85→06/90	Petrol	154 A2.000	1995	4	84.00	90.00	88
Croma 2000 i.e. Turbo	06/87→08/96	Petrol	154 C4.046	1995	4	84.00	90.00	88
Croma 2000 i.e. Turbo	11/86→08/96	Petrol	834 C.146	1995	4	84.00	90.00	88
Croma 2500 D	12/85→12/89	Diesel	8144.67	2500	4	93.00	92.00	113
Croma 2500 V6	06/93→08/96	Petrol	834 G.000	2492	V6	88.00	68.30	107
Croma 2500 TD	12/85→08/89	Diesel	8144.91.2000	2445	4	93.00	90.00	112
Croma 2500 TD	05/89→08/96	Diesel	8144.97	2499	4	93.00	92.00	113
Croma 2500 TD	05/89→08/96	Diesel	8144.97.2400	2499	4	93.00	92.00	113
Croma 2500 TD	05/89→08/96	Diesel	8144.97 Y	2500	4	93.00	92.00	113
Croma 2500 TDE	12/91→08/96	Diesel	8144.97 S	2500	4	93.00	92.00	113
Doblo 1.2	03/01→	Petrol	223 A5.000	1242	4	70.80	78.90	13
Doblo 1.3 D Multijet	10/05→01/10	Diesel	199 A2.000	1248	4	69.60	82.00	10
Doblo 1.3 D Multijet	02/10→	Diesel	199 A3.000	1248	4	69.60	82.00	10
Doblo 1.3 D Multijet	02/10→	Diesel	263 A2.000	1248	4	69.60	82.00	10
Doblo 1.3 D Multijet	11/13→	Diesel	263 A6.000	1248	4	69.60	82.00	10
Doblo 1.3 JTD 16V	05/04→12/06	Diesel	188 A8.000	1248	4	69.60	82.00	10
Doblo 1.3 JTD 16V	05/04→12/06	Diesel	188 A9.000	1248	4	69.60	82.00	10
Doblo 1.3 JTD 16V Multijet	08/06→	Diesel	223 A9.000	1248	4	69.60	82.00	10
Doblo 1.4	10/11→	Petrol	198 A4.000	1368	4	72.00	84.00	16
Doblo 1.4	10/05→	Petrol	350 A1.000	1368	4	72.00	84.00	15
Doblo 1.4	02/10→	Petrol	843 A1.000	1368	4	72.00	84.00	15
Doblo 1.4 Flex	01/14→	Flexfuel	310 A2.011	1368	4	72.00	84.00	15
Doblo 1.4 Flexfuel	08/09→	Flexfuel	310 A2.011	1368	4	72.00	84.00	15
Doblo 1.4 Natural Power	06/10→	Petrol	198 A4.000	1368	4	72.00	84.00	16
Doblo 1.6 16V	10/01→	Petrol	182 B6.000	1596	4	80.50	78.40	47
Doblo 1.6 D Multijet	02/10→	Diesel	198 A3.000	1598	4	79.50	80.50	36
Doblo 1.6 D Multijet	02/10→	Diesel	263 A3.000	1598	4	79.50	80.50	36
Doblo 1.6 D Multijet	02/10→	Diesel	263 A4.000	1598	4	79.50	80.50	36
Doblo 1.6 D Multijet	02/10→	Diesel	263 A5.000	1598	4	79.50	80.50	36
Doblo 1.6 Natural Power	09/02→	Petrol	182 B6.000	1596	4	80.50	78.40	47
Doblo 1.9 D	03/01→	Diesel	223 A6.000	1910	4	82.00	90.40	54
Doblo 1.9 JTD	10/01→	Diesel	182 B9.000	1910	4	82.00	90.40	53
Doblo 1.9 JTD	07/03→	Diesel	223 A7.000	1910	4	82.00	90.40	53
Doblo 1.9 JTD	07/03→	Diesel	223 B1.000	1910	4	82.00	90.40	53
Doblo 1.9 JTD Multijet	12/06→	Diesel	186 A9.000	1910	4	82.00	90.40	53
Doblo MPV 1.2	03/01→	Petrol	223 A5.000	1242	4	70.80	78.90	13
Doblo MPV 1.3 D Multijet	02/10→	Diesel	199 A3.000	1248	4	69.60	82.00	10
Doblo MPV 1.3 D Multijet	10/05→	Diesel	223 A9.000	1248	4	69.60	82.00	10
Doblo MPV 1.3 D Multijet	02/10→	Diesel	263 A2.000	1248	4	69.60	82.00	10
Doblo MPV 1.3 JTD	05/05→	Diesel	199 A2.000	1248	4	69.60	82.00	10
Doblo MPV 1.3 JTD 16V	12/04→05/05	Diesel	188 A9.000	1248	4	69.60	82.00	10
Doblo MPV 1.4	10/11→	Petrol	198 A4.000	1368	4	72.00	84.00	16
Doblo MPV 1.4	10/05→	Petrol	350 A1.000	1368	4	72.00	84.00	15
Doblo MPV 1.4	02/10→	Petrol	843 A1.000	1368	4	72.00	84.00	15
Doblo MPV 1.4 Flex	08/09→	Flexfuel	310 A2.011	1368	4	72.00	84.00	15
Doblo MPV 1.4 Natural Power	02/10→	Petrol	198 A4.000	1368	4	72.00	84.00	16
Doblo MPV 1.6	09/02→	Petrol	182 B6.000	1596	4	80.50	78.40	47
Doblo MPV 1.6 16V	10/01→	Petrol	182 B6.000	1596	4	80.50	78.40	47
Doblo MPV 1.6 D Multijet	02/10→	Diesel	198 A3.000	1598	4	79.50	80.50	36
Doblo MPV 1.6 D Multijet	02/10→	Diesel	263 A4.000	1598	4	79.50	80.50	36
Doblo MPV 1.6 D Multijet	03/15→	Diesel	263 A7.000	1598	4	79.50	80.50	36
Doblo MPV 1.6 D Multijet	03/15→	Diesel	940 C1.000	1598	4	79.50	80.50	36
Doblo MPV 1.6 Natural Power	09/02→	Petrol	182 B6.000	1596	4	80.50	78.40	47
Doblo MPV 1.9 D	03/01→	Diesel	223 A6.000	1910	4	82.00	90.40	54
Doblo MPV 1.9 D Multijet	10/05→	Diesel	186 A9.000	1910	4	82.00	90.40	53
Doblo MPV 1.9 JTD	10/01→	Diesel	182 B9.000	1910	4	82.00	90.40	53
Doblo MPV 1.9 JTD	07/03→	Diesel	223 A7.000	1910	4	82.00	90.40	53
Doblo MPV 1.9 JTD	07/03→	Diesel	223 B1.000	1910	4	82.00	90.40	53
Doblo MPV 1.9 JTD	10/01→	Diesel	223 B2.000	1910	4	82.00	90.40	53



cm3 x



Ducato 1.8	01/82→10/88	Petrol	169 B	1796	4	84.00	81.00	81
Ducato 1.8	07/82→12/88	Petrol	XM7T	1796	4	84.00	81.00	82
Ducato 1.9 D	04/98→04/02	Diesel	D9B	1905	4	83.00	88.00	69
Ducato 1.9 D	04/98→04/02	Diesel	D9B (XUD9A)	1905	4	83.00	88.00	69
Ducato 1.9 D	04/98→04/02	Diesel	DJY	1905	4	83.00	88.00	69
Ducato 1.9 D	02/87→05/94	Diesel	149 B1.000	1929	4	82.60	90.00	61
Ducato 1.9 D	03/94→04/02	Diesel	230 A2.000	1929	4	82.60	90.00	64
Ducato 1.9 D Combinato	06/95→04/02	Diesel	230 A2.000	1929	4	82.60	90.00	64
Ducato 1.9 TD	04/98→04/02	Diesel	DHX (XUD9TF/L)	1905	4	83.00	88.00	68
Ducato 1.9 TD	03/94→04/02	Diesel	230 A3.000	1929	4	82.60	90.00	63
Ducato 1.9 TD	03/89→03/94	Diesel	280 A1.000	1929	4	82.60	90.00	63
Ducato 1.9 TD CAT	08/94→04/02	Diesel	230 A4.000	1929	4	82.60	90.00	63
Ducato 1.9 TD Combinato	08/94→04/02	Diesel	230 A4.000	1929	4	82.60	90.00	63
Ducato 1.9 TD Panorama/Combinato	03/94→04/02	Diesel	230 A3.000	1929	4	82.60	90.00	63
Ducato 2.0	07/85→08/90	Petrol	170 B	1971	4	88.00	81.00	108
Ducato 2.0	08/88→05/94	Petrol	170 D	1971	4	88.00	81.00	108
Ducato 2.0	01/82→08/90	Petrol	XN 1T	1971	4	88.00	81.00	108
Ducato 2.0	04/02→	Petrol	RFL	1998	4	86.00	86.00	99
Ducato 2.0	03/94→04/02	Petrol	RFW	1998	4	86.00	86.00	99
Ducato 2.0 4x4	06/90→05/94	Petrol	170 D	1971	4	88.00	81.00	108
Ducato 2.0 4x4	05/02→07/06	Petrol	RFL	1998	4	86.00	86.00	99
Ducato 2.0 4x4	11/94→04/02	Petrol	RFW	1998	4	86.00	86.00	99
Ducato 2.0 Bipower	11/02→	Petrol	RFL	1998	4	86.00	86.00	99
Ducato 2.0 JTD	07/01→	Diesel	RHV (DW10)	1997	4	85.00	88.00	95
Ducato 2.0 Panorama/Combinato	03/94→04/02	Petrol	RFW	1998	4	86.00	86.00	99
Ducato 2.3 JTD	04/02→	Diesel	F1AE0481C	2286	4	88.00	94.00	110
Ducato 2.3 JTD	12/09→	Diesel	F1AE0481T	2286	4	88.00	94.00	110
Ducato 2.4 D	01/82→08/90	Diesel	8144.61	2428	4	93.00	90.00	112
Ducato 2.5 D	09/86→05/90	Diesel	8140.61	2445	4	93.00	90.00	112
Ducato 2.5 D	09/86→05/90	Diesel	8140.27	2500	4	93.00	92.00	113
Ducato 2.5 D	03/94→04/02	Diesel	8140.67	2500	4	93.00	92.00	113
Ducato 2.5 D	01/82→05/94	Diesel	8144.67	2500	4	93.00	92.00	113
Ducato 2.5 D	01/82→08/90	Diesel	CRD93L (U25-661)	2500	4	93.00	92.00	114
Ducato 2.5 D 4x4	09/86→05/90	Diesel	8144.61	2428	4	93.00	90.00	112
Ducato 2.5 D 4x4	09/86→05/90	Diesel	8140.61	2445	4	93.00	90.00	112
Ducato 2.5 D 4x4	09/86→05/90	Diesel	8140.27	2500	4	93.00	92.00	113
Ducato 2.5 D 4x4	03/94→04/02	Diesel	8140.67	2500	4	93.00	92.00	113
Ducato 2.5 D 4x4	01/87→03/94	Diesel	8144.67	2500	4	93.00	92.00	113
Ducato 2.5 D Combinato	08/94→04/02	Diesel	8140.67	2500	4	93.00	92.00	113
Ducato 2.5 TD	01/86→08/90	Diesel	8144.21	2445	4	93.00	90.00	112
Ducato 2.5 TD	01/87→08/90	Diesel	8144.21.220	2445	4	93.00	90.00	112
Ducato 2.5 TD	09/86→04/02	Diesel	8140.27	2500	4	93.00	92.00	113
Ducato 2.5 TD	06/94→09/01	Diesel	8140.47	2500	4	93.00	92.00	113
Ducato 2.5 TD 4x4	01/86→09/90	Diesel	8144.21	2445	4	93.00	90.00	112
Ducato 2.5 TD 4x4	09/86→05/94	Diesel	8140.27	2500	4	93.00	92.00	113
Ducato 2.5 TD 4x4	06/94→09/01	Diesel	8140.47	2500	4	93.00	92.00	113
Ducato 2.5 TDI	03/94→04/02	Diesel	8140.47	2500	4	93.00	92.00	113
Ducato 2.5 TDI	03/94→04/02	Diesel	8140.47R	2500	4	93.00	92.00	113
Ducato 2.5 TDI 4x4	04/97→04/02	Diesel	8140.47	2500	4	93.00	92.00	113
Ducato 2.5 TDI Panorama/Combinato	03/94→04/02	Diesel	8140.47	2500	4	93.00	92.00	113
Ducato 2.5 TDI Panorama/Combinato	07/94→04/02	Diesel	8140.47R	2500	4	93.00	92.00	113
Ducato 2.8 D	02/98→04/02	Diesel	8140.63	2800	4	94.40	100.00	115
Ducato 2.8 D 4x4	08/98→04/02	Diesel	8140.63	2800	4	94.40	100.00	115
Ducato 2.8 iDTD 4x4	05/98→09/01	Diesel	8140.43	2800	4	94.40	100.00	115
Ducato 2.8 JTD	10/99→07/06	Diesel	8140.43N	2798	4	94.40	100.00	115
Ducato 2.8 JTD	11/00→	Diesel	8140.43S	2798	4	94.40	100.00	115
Ducato 2.8 JTD	11/03→07/06	Diesel	8140.43	2800	4	94.40	100.00	115
Ducato 2.8 JTD 4x4	11/00→	Diesel	8140.43S	2798	4	94.40	100.00	115
Ducato 2.8 JTD 4x4	11/03→07/06	Diesel	8140.43	2800	4	94.40	100.00	115
Ducato 2.8 JTD Power	05/04→	Diesel	8140.43N	2798	4	94.40	100.00	115
Ducato 2.8 TD	11/03→07/06	Diesel	8140.43	2800	4	94.40	100.00	115
Ducato 2.8 TD 4x4	05/98→07/06	Diesel	8140.43	2800	4	94.40	100.00	115
Ducato 2.8 TD 4x4	05/98→11/01	Diesel	8140.63	2800	4	94.40	100.00	115
Ducato 2.8 TDI	10/97→04/02	Diesel	8140.43	2800	4	94.40	100.00	115
Ducato 2.8 TDI 4x4	06/99→04/02	Diesel	8140.43	2800	4	94.40	100.00	115
Ducato 100 Multijet 2,2 D	07/06→	Diesel	4HV	2198	4	86.00	94.60	100
Ducato 110 Multijet 2,3 D	10/11→	Diesel	F1AE3481G	2287	4	88.00	94.00	110
Ducato 120 Multijet 2,3 D	07/06→	Diesel	F1AE0481D	2287	4	88.00	94.00	110
Ducato 120 Multijet 2,3 D	07/06→	Diesel	FPT	2287	4	88.00	94.00	110

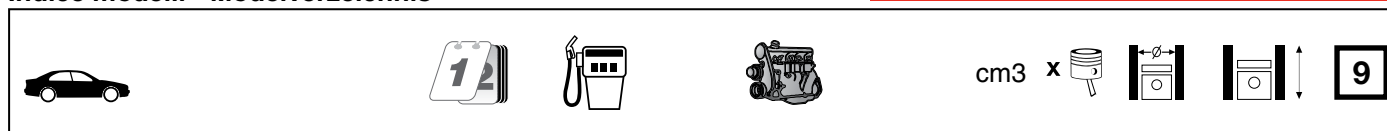

Ducato 120 Multijet 2,3 D 4x4	03/10→	Diesel	F1AE0481D	2287	4	88.00	94.00	110
Ducato 130 Multijet 2,3 D	08/06→	Diesel	F1AE0481T	2286	4	88.00	94.00	110
Ducato 130 Multijet 2,3 D	01/07→	Diesel	F1AE0481N	2287	4	88.00	94.00	110
Ducato 130 Multijet 2,3 D	01/07→	Diesel	F1AE3481D	2287	4	88.00	94.00	110
Ducato 150 Multijet 2,3 D	06/11→	Diesel	F1AE3481E	2287	4	88.00	94.00	110
Duna		Petrol	147A5.000	1049	4	76.00	57.80	23
Duna 0.9	07/91→10/95	Petrol	146 A.048	903	4	65.00	68.00	4
Duna 1.1	07/91→07/96	Petrol	146 A4.048	1116	4	80.00	55.50	37
Duna 1.4	07/91→07/96	Petrol	160 A1.046	1372	4	80.50	67.40	46
Duna 1.4 Turbo	07/91→10/95	Petrol	146 A8.000	1372	4	80.50	67.40	46
Duna 1.6	02/96→09/00	Petrol	159 A3.000	1581	4	86.40	67.40	106
Duna 1.7 DS	01/87→12/91	Diesel	149 B3.000	1698	4	82.60	79.20	59
Duna 60 1.1	01/87→12/91	Petrol	146 A6.000	1116	4	76.00	61.50	24
Duna 70 1.3	01/87→12/91	Petrol	146 A5.000	1301	4	76.00	71.50	26
Elba 1.3	04/86→12/93	Petrol	127 A2.011	1297	4	76.00	71.50	25
Elba 1.3	04/91→02/95	Petrol	146 A5.000	1301	4	76.00	71.50	26
Elba 1.3 Álcool	10/85→11/89	Petrol	127 A2.011	1297	4	76.00	71.50	25
Elba 1.3 D	04/86→10/92	Diesel	127 A5.000	1302	4	76.10	71.50	30
Elba 1.4	10/93→02/95	Petrol	146 D5.000	1372	4	80.50	67.40	46
Elba 1.5	04/86→12/96	Petrol	149 C1.000	1499	4	86.40	63.90	103
Elba 1.5 Álcool	10/85→09/93	Flexfuel	146 A3.011	1497	4	86.40	63.90	103
Elba 1.5 Álcool	01/92→12/96	Flexfuel	146 D1.011	1497	4	86.40	63.90	105
Elba 1.6	03/88→02/97	Petrol	146 B7.011	1581	4	86.40	67.40	106
Elba 1.6	01/94→12/96	Petrol	146 C6.000	1581	4	86.40	67.40	106
Elba 1.6	01/94→12/96	Petrol	146 D6.000	1581	4	86.40	67.40	106
Elba 1.6	04/89→12/93	Petrol	159 A3.000	1581	4	86.40	67.40	106
Elba 1.6 Álcool	11/89→10/94	Petrol	146 B6.011	1581	4	86.40	67.40	106
Elba 1.7 D	04/89→10/97	Diesel	146 B2.000	1698	4	82.60	79.20	59
Fiorino	01/79→12/88	Petrol	147A5.000	1049	4	76.00	57.80	23
Fiorino 1.0	08/95→11/95	Petrol	146 A7.011	994	4	76.00	54.80	22
Fiorino 1.0	01/80→12/87	Petrol	127 A.000	1049	4	65.00	68.00	4
Fiorino 1.0	10/82→04/88	Petrol	156 A.000	1049	4	76.10	57.80	28
Fiorino 1.0 iE	11/92→04/96	Petrol	156 A2.246	999	4	70.00	64.90	11
Fiorino 1.1	09/87→12/88	Petrol	156 A.000	1049	4	76.10	57.80	28
Fiorino 1.1 60	11/86→04/88	Petrol	146 A9.000	1116	4	76.00	61.50	24
Fiorino 1.2	01/04→	Petrol	178 B5.000	1242	4	70.80	78.90	13
Fiorino 1.2 Flex	02/08→	Flexfuel	178 E9.011	1242	4	70.80	78.90	13
Fiorino 1.3	12/78→06/88	Petrol	127 A2.011	1297	4	76.00	71.50	25
Fiorino 1.3	12/87→12/94	Petrol	146 A5.000	1301	4	76.00	71.50	26
Fiorino 1.3 Álcool	09/81→04/88	Petrol	127 A2.011	1297	4	76.00	71.50	25
Fiorino 1.3 D	03/82→12/88	Diesel	127 A5.000	1302	4	76.10	71.50	30
Fiorino 1.3 D Multijet	11/07→	Diesel	199 A2.000	1248	4	69.60	82.00	10
Fiorino 1.3 D Multijet	11/07→	Diesel	199 A9.000	1248	4	69.60	82.00	10
Fiorino 1.3 D Multijet	07/09→	Diesel	199 B1.000	1248	4	69.60	82.00	10
Fiorino 1.4	11/07→	Petrol	KFT	1360	4	75.00	77.00	20
Fiorino 1.4	11/07→	Petrol	KFV	1360	4	75.00	77.00	20
Fiorino 1.4	10/09→	Petrol	350 A1.000	1368	4	72.00	84.00	15
Fiorino 1.4	01/89→03/00	Petrol	146 C5.000	1372	4	80.50	67.40	46
Fiorino 1.4	01/89→05/01	Petrol	146 D5.000	1372	4	80.50	67.40	46
Fiorino 1.4 Natural Power	10/09→	Petrol	350 A1.000	1368	4	72.00	84.00	15
Fiorino 1.5	05/88→12/04	Flexfuel	146 A3.011	1497	4	86.40	63.90	103
Fiorino 1.5	01/88→11/93	Petrol	149 C1.000	1499	4	86.40	63.90	103
Fiorino 1.5 Álcool	05/88→11/93	Flexfuel	146 A3.011	1497	4	86.40	63.90	103
Fiorino 1.5 Álcool	11/94→09/96	Flexfuel	146 D1.011	1497	4	86.40	63.90	105
Fiorino 1.5 Bipower	01/04→12/05	Flexfuel	146 A3.011	1497	4	86.40	63.90	103
Fiorino 1.5 iE	01/88→10/92	Petrol	149 C1.000	1499	4	86.40	63.90	103
Fiorino 1.5 SPI	11/94→09/96	Flexfuel	146 A3.011	1497	4	86.40	63.90	103
Fiorino 1.5 SPI	11/94→09/96	Petrol	149 C1.000	1499	4	86.40	63.90	103
Fiorino 1.6	05/91→10/96	Petrol	146 B7.011	1581	4	86.40	67.40	106
Fiorino 1.6	01/88→05/01	Petrol	146 C6.000	1581	4	86.40	67.40	106
Fiorino 1.6	01/88→05/01	Petrol	146 D6.000	1581	4	86.40	67.40	106
Fiorino 1.6	05/91→10/96	Petrol	160 A2.011	1581	4	86.40	67.40	106
Fiorino 1.6 Álcool	05/91→10/94	Petrol	160 A2.011	1581	4	86.40	67.40	106
Fiorino 1.7 D	01/88→10/93	Diesel	149 B2.000	1697	4	82.60	79.20	59
Fiorino 1.7 D	01/88→10/99	Diesel	146 B2.000	1698	4	82.60	79.20	59
Fiorino 1.7 D	12/87→10/99	Diesel	149 B3.000	1698	4	82.60	79.20	59
Fiorino 1.7 TD	11/96→05/01	Diesel	146 D7.000	1698	4	82.60	79.20	60
Fiorino 1.7 TD	01/04→12/05	Diesel	176 A3.000	1698	4	82.60	79.20	60
Fiorino 60 1.1	05/88→12/93	Petrol	146 A9.000	1116	4	76.00	61.50	24



cm3

x



Fiorino 60 1.7 D	05/88→10/96	Diesel	146 B2.000	1698	4	82.60	79.20	59
Fiorino 60 1.7 D	05/88→05/00	Diesel	149 B3.000	1698	4	82.60	79.20	59
Fiorino 65 1.7 TD	01/97→05/01	Diesel	146 D7.000	1698	4	82.60	79.20	60
Fiorino 70 1.3	01/88→12/94	Petrol	146 A5.000	1301	4	76.00	71.50	26
Fiorino 70 i.e. 1.4	05/94→05/01	Petrol	146 C5.000	1372	4	80.50	67.40	46
Fiorino 70 i.e. 1.4	05/94→05/01	Petrol	146 D5.000	1372	4	80.50	67.40	46
Fiorino 75 i.e. 1.5	05/88→12/93	Petrol	149 C1.000	1499	4	86.40	63.90	103
Fiorino 75 i.e. 1.6	10/93→05/01	Petrol	146 C6.000	1581	4	86.40	67.40	106
Fiorino 75 i.e. 1.6	10/93→05/01	Petrol	146 D6.000	1581	4	86.40	67.40	106
Fiorino 900	10/77→12/84	Petrol	100 GL.000	903	4	65.00	68.00	4
Fiorino 1050	01/80→12/87	Petrol	127 A.000	1049	4	65.00	68.00	4
Grande Punto 1.2	09/10→	Petrol	169 A4.000	1242	4	70.80	78.90	13
Grande Punto 1.2	10/05→	Petrol	199 A4.000	1242	4	70.80	78.90	13
Grande Punto 1.2 LPG	07/08→	Petrol	199 A4.000	1242	4	70.80	78.90	13
Grande Punto 1.3 D Multijet	10/05→	Diesel	199 A2.000	1248	4	69.60	82.00	10
Grande Punto 1.3 D Multijet	10/05→	Diesel	199 A3.000	1248	4	69.60	82.00	10
Grande Punto 1.3 D Multijet	07/08→	Diesel	199 B2.000	1248	4	69.60	82.00	10
Grande Punto 1.3 D Multijet	04/10→	Diesel	199 B4.000	1248	4	69.60	82.00	10
Grande Punto 1.3 D Multijet	04/10→	Diesel	223 A9.000	1248	4	69.60	82.00	10
Grande Punto 1.4	06/06→	Petrol	199 A7.000	1368	4	72.00	84.00	15
Grande Punto 1.4	10/05→	Petrol	350 A1.000	1368	4	72.00	84.00	15
Grande Punto 1.4 16V	09/07→07/12	Petrol	198 A1.000	1368	4	72.00	84.00	16
Grande Punto 1.4 16V	10/05→	Petrol	199 A6.000	1368	4	72.00	84.00	15
Grande Punto 1.4 Flex	08/07→06/10	Flexfuel	310 A2.011	1368	4	72.00	84.00	15
Grande Punto 1.4 LPG	12/08→	Petrol	350 A1.000	1368	4	72.00	84.00	15
Grande Punto 1.4 Natural Power	07/08→	Petrol	350 A1.000	1368	4	72.00	84.00	15
Grande Punto 1.4 T-Jet	09/07→	Petrol	198 A4.000	1368	4	72.00	84.00	16
Grande Punto 1.6 D Multijet	07/08→	Diesel	955 A3.000	1598	4	79.50	80.50	36
Grande Punto 1.9 D Multijet	10/05→	Diesel	199 A5.000	1910	4	82.00	90.40	53
Grande Punto 1.9 D Multijet	10/05→	Diesel	939 A1.000	1910	4	82.00	90.40	53
Grande Punto 1.9 D Multijet	06/06→	Diesel	939 A7.000	1910	4	82.00	90.40	53
Idea 1.2 16V	01/04→	Petrol	188 A5.000	1242	4	70.80	78.90	13
Idea 1.3 D Multijet	10/05→	Diesel	199 A3.000	1248	4	69.60	82.00	10
Idea 1.3 D Multijet	05/08→	Diesel	199 B1.000	1248	4	69.60	82.00	10
Idea 1.3 JTD	01/04→	Diesel	188 A9.000	1248	4	69.60	82.00	10
Idea 1.4	01/06→	Flexfuel	178 F3.011	1368	4	72.00	84.00	15
Idea 1.4	12/03→	Petrol	192 B2.000	1368	4	72.00	84.00	15
Idea 1.4	10/05→	Petrol	350 A1.000	1368	4	72.00	84.00	15
Idea 1.4 16V	01/04→	Petrol	843 A1.000	1368	4	72.00	84.00	15
Idea 1.4 Flex	09/05→	Flexfuel	178 F3.011	1368	4	72.00	84.00	15
Idea 1.4 LPG	03/09→	Petrol	350 A1.000	1368	4	72.00	84.00	15
Idea 1.6 D Multijet	05/08→	Diesel	350 A2.000	1598	4	79.50	80.50	36
Idea 1.9 JTD	01/04→	Diesel	188 B2.000	1910	4	82.00	90.40	53
Linea 1.3 D Multijet	01/08→	Diesel	199 A2.000	1248	4	69.60	82.00	10
Linea 1.3 D Multijet	06/07→	Diesel	199 A3.000	1248	4	69.60	82.00	10
Linea 1.3 L Multijet	01/13→	Diesel	199 A2.000	1248	4	69.60	82.00	10
Linea 1.4	06/07→	Petrol	350 A1.000	1368	4	72.00	84.00	15
Linea 1.4 T-Jet	10/08→	Petrol	198 A1.000	1368	4	72.00	84.00	16
Linea 1.4 T-Jet	09/07→	Petrol	198 A4.000	1368	4	72.00	84.00	16
Linea 1.6 D Multijet	06/09→	Diesel	198 A3.000	1598	4	79.50	80.50	36
Marea 1.2 16V	10/98→05/02	Petrol	182 B2.000	1242	4	70.80	78.90	13
Marea 1.4 80 12V	09/96→05/02	Petrol	182 A3.000	1370	4	82.00	64.90	49
Marea 1.6	03/99→08/00	Petrol	185 A3.000	1581	4	86.40	67.40	106
Marea 1.6	09/00→12/07	Petrol	182 B6.000	1596	4	80.50	78.40	47
Marea 1.6 16V	04/97→02/99	Petrol	185 A3.000	1581	4	86.40	67.40	106
Marea 1.6 100 16V	09/96→05/02	Petrol	182 A4.000	1581	4	86.40	67.40	106
Marea 1.6 100 16V Bipower	04/99→05/02	Petrol	185 A3.000	1581	4	86.40	67.40	106
Marea 1.6 100 16V Bipower	04/99→05/02	Petrol	186 A4.000	1581	4	86.40	67.40	106
Marea 1.6 SX	09/00→08/02	Petrol	182 B5.098	1581	4	86.40	67.40	106
Marea 1.8	09/96→12/07	Petrol	183 A1.000	1747	4	82.00	82.70	51
Marea 1.8 115 16V	09/96→05/02	Petrol	182 A2.000	1747	4	82.00	82.70	51
Marea 1.9 JTD	01/01→12/07	Diesel	182 B4.000	1910	4	82.00	90.40	53
Marea 1.9 JTD	01/01→12/07	Diesel	182 B9.000	1910	4	82.00	90.40	53
Marea 1.9 JTD 105	04/99→05/02	Diesel	182 B4.000	1910	4	82.00	90.40	53
Marea 1.9 JTD 110	01/01→05/02	Diesel	186 A6.000	1910	4	82.00	90.40	53
Marea 1.9 TD 75	09/96→05/02	Diesel	182 A8.000	1910	4	82.00	90.40	52
Marea 1.9 TD 100	09/96→05/02	Diesel	182 A7.000	1910	4	82.00	90.40	52
Marea 1.9 TD 100	09/96→05/02	Diesel	182 B9.000	1910	4	82.00	90.40	53
Marea 2.0 150 20V	09/96→04/99	Petrol	182 A1.000	1998	5	82.00	75.70	50

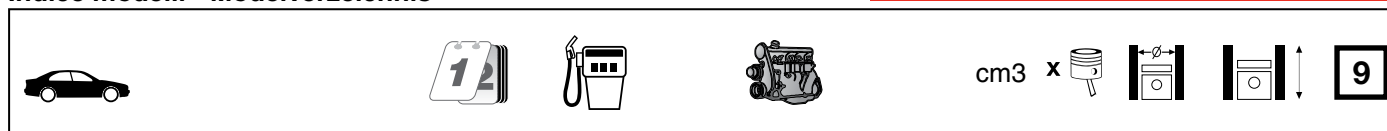

Marea 2.0 150 20V	01/01→05/02	Petrol	185 A8.000	1998	5	82.00	75.70	50
Marea 2.0 155 20V	04/99→02/03	Petrol	182 B7.000	1998	5	82.00	75.70	50
Marea 2.4 JTD 130	04/99→05/02	Diesel	185 A6.000	2387	5	82.00	90.40	56
Marea 2.4 JTD 130	04/99→05/02	Diesel	839 A5.000	2387	5	82.00	90.40	56
Marea 2.4 TD 125	09/96→04/99	Diesel	185 A2.000	2387	5	82.00	90.40	56
Multipla 1.6	09/00→06/10	Petrol	182 B6.000	1596	4	80.50	78.40	47
Multipla 1.6 16V	04/02→06/10	Petrol	182 B6.000	1596	4	80.50	78.40	47
Multipla 1.6 16V Bipower	04/99→06/10	Petrol	186 A4.000	1581	4	86.40	67.40	106
Multipla 1.6 16V Bipower	10/01→06/10	Petrol	182 B6.000	1596	4	80.50	78.40	47
Multipla 1.6 16V Blupower	04/99→06/10	LPG	186 A3.000	1581	4	86.40	67.40	106
Multipla 1.6 16V GPL	10/01→06/10	Petrol	182 B6.000	1596	4	80.50	78.40	47
Multipla 1.6 100 16V	04/99→06/10	Petrol	182 A4.000	1581	4	86.40	67.40	106
Multipla 1.9 JTD	04/02→06/10	Diesel	186 A9.000	1910	4	82.00	90.40	53
Multipla 1.9 JTD 105	04/99→06/10	Diesel	182 B4.000	1910	4	82.00	90.40	53
Multipla 1.9 JTD 110	03/01→07/02	Diesel	186 A6.000	1910	4	82.00	90.40	53
Multipla 1.9 JTD 115	07/02→06/10	Diesel	186 A8.000	1910	4	82.00	90.40	53
Oggi 1.3 Flex	02/83→12/85	Petrol	127 A2.011	1297	4	76.00	71.50	25
Oggi 1300	02/83→12/85	Petrol	127 A2.011	1297	4	76.00	71.50	25
Palio 1.0	03/00→	Petrol	178 D9.011	999	4	70.00	64.90	11
Palio 1.0	09/00→	Petrol	178 F1.011	999	4	70.00	64.90	11
Palio 1.0 Biopower	10/03→12/08	Petrol	178 D9.011	999	4	70.00	64.90	11
Palio 1.0 Biopower	10/03→12/08	Petrol	178 F1.011	999	4	70.00	64.90	11
Palio 1.1	06/06→	Petrol	187 A1.000	1108	4	70.00	72.00	12
Palio 1.2	06/98→	Petrol	176 A8.000	1242	4	70.80	78.90	13
Palio 1.2	04/96→	Petrol	178 B5.000	1242	4	70.80	78.90	13
Palio 1.2	07/97→08/02	Petrol	178 B7.045	1242	4	70.80	78.90	13
Palio 1.2	07/97→	Petrol	178 C4.066	1242	4	70.80	78.90	13
Palio 1.2	06/98→	Petrol	178 E2.000	1242	4	70.80	78.90	13
Palio 1.2	06/04→	Flexfuel	178 E9.011	1242	4	70.80	78.90	13
Palio 1.2	07/97→	Petrol	188 A4.000	1242	4	70.80	78.90	13
Palio 1.2	09/01→	Petrol	188 A5.000	1242	4	70.80	78.90	13
Palio 1.2 Flex	11/03→12/05	Flexfuel	178 E9.011	1242	4	70.80	78.90	13
Palio 1.2 Flex	07/97→08/02	Petrol	188 A4.000	1242	4	70.80	78.90	13
Palio 1.2 LPG	07/97→08/02	Petrol	188 A4.000	1242	4	70.80	78.90	13
Palio 1.3 D Multijet	03/08→	Diesel	188 A9.000	1248	4	69.60	82.00	10
Palio 1.3 JTD Multijet	06/03→	Diesel	188 A9.000	1248	4	69.60	82.00	10
Palio 1.4	04/05→	Flexfuel	178 F3.011	1368	4	72.00	84.00	15
Palio 1.4	10/05→	Petrol	350 A1.000	1368	4	72.00	84.00	15
Palio 1.4	04/96→	Petrol	178 B2.000	1372	4	80.50	67.40	46
Palio 1.4 CAT	04/96→	Petrol	178 B2.016	1372	4	80.50	67.40	46
Palio 1.4 Flex	04/05→	Flexfuel	178 F3.011	1368	4	72.00	84.00	15
Palio 1.4 Flex	02/05→	Flexfuel	310 A2.011	1368	4	72.00	84.00	15
Palio 1.6	04/96→02/03	Petrol	178 B3.000	1581	4	86.40	67.40	106
Palio 1.6	07/97→	Petrol	178 C7.098	1581	4	86.40	67.40	106
Palio 1.6	04/96→	Petrol	178 D2.011	1581	4	86.40	67.40	106
Palio 1.6	06/96→	Petrol	182 B6.000	1596	4	80.50	78.40	47
Palio 1.6 16V	04/96→	Petrol	178 B3.000	1581	4	86.40	67.40	106
Palio 1.6 16V	02/01→	Petrol	182 B6.000	1596	4	80.50	78.40	47
Palio 1.7 TD	04/96→	Diesel	176 A3.000	1698	4	82.60	79.20	60
Palio 1.7 TD	02/97→	Diesel	176 A5.000	1698	4	82.60	79.20	60
Palio 1.9 D	09/00→	Diesel	223 A6.000	1910	4	82.00	90.40	54
Palio 1.9 JTD	09/01→	Diesel	188 A2.000	1910	4	82.00	90.40	53
Panda 0.9	02/12→	Petrol	312 A2.000	875	2	80.50	86.00	48
Panda 0.9 4x4	09/12→	Petrol	312 A2.000	875	2	80.50	86.00	48
Panda 0.9 Fire S All-wheel Drive	10/80→04/86	Petrol	146 A.048	903	4	65.00	68.00	4
Panda 0.9 Natural Power	07/12→	Petrol	312 A2.000	875	2	80.50	86.00	48
Panda 1.1	05/91→03/95	Petrol	156 C.046	1108	4	70.00	72.00	12
Panda 1.1	09/00→	Petrol	187 A1.000	1108	4	70.00	72.00	12
Panda 1.1 4x4	09/00→02/04	Petrol	187 A1.000	1108	4	70.00	72.00	12
Panda 1.2	03/10→	Petrol	169 A4.000	1242	4	70.80	78.90	13
Panda 1.2	09/03→	Petrol	188 A4.000	1242	4	70.80	78.90	13
Panda 1.2 4x4	11/09→	Petrol	169 A4.000	1242	4	70.80	78.90	13
Panda 1.2 4x4	09/04→	Petrol	188 A4.000	1242	4	70.80	78.90	13
Panda 1.2 LPG	09/10→	Petrol	169 A4.000	1242	4	70.80	78.90	13
Panda 1.2 LPG	04/09→	Petrol	188 A4.000	1242	4	70.80	78.90	13
Panda 1.2 Natural Power	01/07→11/09	Petrol	188 A4.000	1242	4	70.80	78.90	13
Panda 1.3 D Multijet	01/06→	Diesel	169 A1.000	1248	4	69.60	82.00	10
Panda 1.3 D Multijet	06/06→	Diesel	169 A5.000	1248	4	69.60	82.00	10
Panda 1.3 D Multijet	09/03→	Diesel	188 A8.000	1248	4	69.60	82.00	10











cm3



9

Panda 1.3 D Multijet	09/03→	Diesel	188 A9.000	1248	4	69.60	82.00	10
Panda 1.3 D Multijet	02/12→	Diesel	199 A1.000	1248	4	69.60	82.00	10
Panda 1.3 D Multijet	02/12→	Diesel	199 A9.000	1248	4	69.60	82.00	10
Panda 1.3 D Multijet	04/15→	Diesel	199 B1.000	1248	4	69.60	82.00	10
Panda 1.3 D Multijet	12/15→	Diesel	312 A8.000	1248	4	69.60	82.00	10
Panda 1.3 D Multijet 4x4	01/06→	Diesel	169 A1.000	1248	4	69.60	82.00	10
Panda 1.3 D Multijet 4x4	09/10→	Diesel	169 A5.000	1248	4	69.60	82.00	10
Panda 1.3 D Multijet 4x4	10/04→	Diesel	188 A8.000	1248	4	69.60	82.00	10
Panda 1.3 D Multijet 4x4	10/04→	Diesel	188 A9.000	1248	4	69.60	82.00	10
Panda 1.3 D Multijet 4x4	06/12→	Diesel	199 A1.000	1248	4	69.60	82.00	10
Panda 1.3 D Multijet 4x4	06/12→	Diesel	199 A9.000	1248	4	69.60	82.00	10
Panda 1.3 D Multijet 4x4	04/15→	Diesel	199 B1.000	1248	4	69.60	82.00	10
Panda 1.3 D Multijet 4x4	06/14→	Diesel	312 A8.000	1248	4	69.60	82.00	10
Panda 1.4	10/06→	Petrol	169 A3.000	1368	4	72.00	84.00	15
Panda 1.4 Natural Power	10/09→	Petrol	350 A1.000	1368	4	72.00	84.00	15
Panda 650	01/82→07/04	Petrol	141 A.000	652	2	77.00	70.00	31
Panda 750	01/86→01/95	Petrol	141 B.000	769	4	65.00	58.00	1
Panda 750	01/86→01/95	Petrol	156 A4.000	770	4	65.00	58.00	2
Panda 750	01/86→10/03	Petrol	156 A4.048	770	4	65.00	58.00	2
Panda 800	02/81→12/85	Petrol	100 GL6.000	843	4	65.00	63.50	3
Panda 900	04/92→12/96	Petrol	1170 A1.046	899	4	65.00	68.00	4
Panda 900	10/80→06/94	Petrol	100 GL3.000	903	4	65.00	68.00	4
Panda 900	10/80→06/94	Petrol	146 A.000	903	4	65.00	68.00	4
Panda 950	09/82→08/83	Petrol	A 112 B1.054	965	4	67.20	68.00	7
Panda 950 4x4	09/83→12/86	Petrol	A 112 B1.054	965	4	67.20	68.00	7
Panda 1000	01/86→04/92	Petrol	156 A2.100	999	4	70.00	64.90	11
Panda 1000	01/85→12/92	Petrol	156 A3.000	999	4	70.00	64.90	11
Panda 1000	01/86→02/92	Petrol	156 A3.100	999	4	70.00	64.90	11
Panda 1000 4x4	05/86→12/94	Petrol	141 C2.000	999	4	70.00	64.90	11
Panda 1000 4x4	01/86→07/89	Petrol	156 A2.100	999	4	70.00	64.90	11
Panda 1000 4x4	05/86→12/94	Petrol	156 A2.246	999	4	70.00	64.90	11
Panda 1000 4x4	01/86→12/92	Petrol	156 A3.000	999	4	70.00	64.90	11
Panda 1000 4x4	01/86→07/89	Petrol	156 A3.100	999	4	70.00	64.90	11
Panda 1000 i.e	08/92→02/04	Petrol	156 A2.246	999	4	70.00	64.90	11
Panda 1000 i.e. CAT	10/87→08/98	Petrol	141 C2.000	999	4	70.00	64.90	11
Panda 1000 i.e. CAT	10/87→08/98	Petrol	156 A2.246	999	4	70.00	64.90	11
Panda 1100	05/91→12/99	Petrol	156 C.046	1108	4	70.00	72.00	12
Panda 1100	02/95→09/03	Petrol	176 B2.000	1108	4	70.00	72.00	12
Panda 1100	02/95→09/03	Petrol	187 A1.000	1108	4	70.00	72.00	12
Panda 1100 4x4	02/95→07/04	Petrol	176 B2.000	1108	4	70.00	72.00	12
Panda 1100 Trekking 4x4	10/91→07/04	Petrol	156 C.046	1108	4	70.00	72.00	12
Panda 1300 D	04/86→12/92	Diesel	156 A5.000	1302	4	76.10	71.50	30
Panorama 1.3	03/80→11/86	Petrol	127 A2.011	1297	4	76.00	71.50	25
Panorama 1.3 Álcool	03/80→11/86	Petrol	127 A2.011	1297	4	76.00	71.50	25
Penny 1.1	01/86→12/90	Petrol	146 A6.000	1116	4	76.00	61.50	24
Penny 1.3	01/86→12/90	Petrol	146 A5.000	1301	4	76.00	71.50	26
Penny 1.7 D	01/86→12/90	Diesel	149 B3.000	1698	4	82.60	79.20	59
Premio 1.3	03/85→09/92	Petrol	127 A2.011	1297	4	76.00	71.50	25
Premio 1.3 Álcool	03/85→09/92	Petrol	127 A2.011	1297	4	76.00	71.50	25
Premio 1.5	03/85→12/96	Flexfuel	146 D1.011	1497	4	86.40	63.90	105
Premio 1.5	10/85→09/93	Petrol	138 B3.011	1498	4	86.40	63.90	104
Premio 1.5 Álcool	06/92→09/93	Flexfuel	146 D1.011	1497	4	86.40	63.90	105
Premio 1.5 Álcool	10/85→09/93	Petrol	138 B3.011	1498	4	86.40	63.90	104
Premio 1.5 i.e.	06/92→12/96	Petrol	138 B3.011	1498	4	86.40	63.90	104
Premio 1.6	03/85→12/96	Petrol	159 A3.000	1581	4	86.40	67.40	106
Premio 1.6 Álcool	11/89→06/94	Petrol	146 B6.011	1581	4	86.40	67.40	106
Premio 1.6 i.e.	08/93→12/96	Petrol	146 B7.011	1581	4	86.40	67.40	106
Premio 1.6 i.e.	08/93→12/96	Petrol	160 A2.011	1581	4	86.40	67.40	106
Punto 0.9	07/13→	Petrol	199 B6.000	875	2	80.50	86.00	48
Punto 0.9 Bifuel	03/12→	Petrol	312 A2.000	875	2	80.50	86.00	48
Punto 0.9 Twinair Turbo	03/12→	Petrol	312 A2.000	875	2	80.50	86.00	48
Punto 1.1	04/96→02/00	Petrol	176 B2.000	1108	4	70.00	72.00	12
Punto 1.2	03/12→	Petrol	169 A4.000	1242	4	70.80	78.90	13
Punto 1.2	02/14→	Petrol	199 B9.000	1242	4	70.80	78.90	13
Punto 1.2 16V	04/97→09/99	Petrol	176 B9.000	1242	4	70.80	78.90	13
Punto 1.2 16V 80	09/99→	Petrol	188 A5.000	1242	4	70.80	78.90	13
Punto 1.2 60	09/99→	Petrol	188 A4.000	1242	4	70.80	78.90	13
Punto 1.2 Bifuel	08/07→	Petrol	188 A4.000	1242	4	70.80	78.90	13
Punto 1.2 Natural Power	09/03→	Petrol	188 A4.000	1242	4	70.80	78.90	13

				cm3	x				
Punto 1.3 D Multijet	02/05→10/09	Diesel	188 A9.000	1248	4	69.60	82.00		10
Punto 1.3 D Multijet	04/08→	Diesel	199 A2.000	1248	4	69.60	82.00		10
Punto 1.3 D Multijet	01/10→02/12	Diesel	199 A3.000	1248	4	69.60	82.00		10
Punto 1.3 D Multijet	04/08→	Diesel	199 A9.000	1248	4	69.60	82.00		10
Punto 1.3 D Multijet	03/09→	Diesel	199 B1.000	1248	4	69.60	82.00		10
Punto 1.3 D Multijet	03/12→	Diesel	199 B4.000	1248	4	69.60	82.00		10
Punto 1.3 D Multijet	12/13→	Diesel	199 B8.000	1248	4	69.60	82.00		10
Punto 1.3 JTD	06/03→10/05	Diesel	188 A9.000	1248	4	69.60	82.00		10
Punto 1.3 JTD 16V	06/03→	Diesel	188 A9.000	1248	4	69.60	82.00		10
Punto 1.4	11/05→	Petrol	199 A6.000	1368	4	72.00	84.00		15
Punto 1.4	03/12→	Petrol	199 A7.000	1368	4	72.00	84.00		15
Punto 1.4	07/07→	Flexfuel	310 A2.011	1368	4	72.00	84.00		15
Punto 1.4	04/08→	Petrol	350 A1.000	1368	4	72.00	84.00		15
Punto 1.4	09/03→	Petrol	843 A1.000	1368	4	72.00	84.00		15
Punto 1.4	09/12→	Petrol	955 A2.000	1368	4	72.00	84.00		15
Punto 1.4 Bifuel	03/12→	Petrol	350 A1.000	1368	4	72.00	84.00		15
Punto 1.4 Flex	08/07→	Flexfuel	310 A2.011	1368	4	72.00	84.00		15
Punto 1.4 GT Turbo	01/94→09/96	Petrol	176 A4.000	1372	4	80.50	67.40		46
Punto 1.4 GT Turbo	09/96→09/99	Petrol	176 B6.000	1372	4	80.50	67.40		46
Punto 1.4 LPG	03/09→	Petrol	350 A1.000	1368	4	72.00	84.00		15
Punto 1.4 Multi Air	03/12→	Petrol	955 A6.000	1368	4	72.00	84.00		15
Punto 1.4 Natural Power	03/09→	Petrol	350 A1.000	1368	4	72.00	84.00		15
Punto 1.4 Turbo Multi Air	03/12→	Petrol	955 A2.000	1368	4	72.00	84.00		15
Punto 1.6	01/94→04/97	Petrol	176 A9.000	1581	4	86.40	67.40		106
Punto 1.7 D	04/94→02/00	Diesel	176 B3.000	1698	4	82.60	79.20		59
Punto 1.7 TD	01/94→09/99	Diesel	176 A3.000	1698	4	82.60	79.20		60
Punto 1.7 TD	01/94→02/00	Diesel	176 A5.000	1698	4	82.60	79.20		60
Punto 1.7 TD	09/96→09/99	Diesel	176 B7.000	1698	4	82.60	79.20		60
Punto 1.8 130 HGT	09/99→	Petrol	183 A1.000	1747	4	82.00	82.70		51
Punto 1.8 130 HGT	09/99→	Petrol	188 A6.000	1747	4	82.00	82.70		51
Punto 1.9 D 60	02/00→10/09	Diesel	188 A3.000	1910	4	82.00	90.40		54
Punto 1.9 DS 60	09/99→	Diesel	188 A3.000	1910	4	82.00	90.40		54
Punto 1.9 JTD	02/00→	Diesel	188 A7.000	1910	4	82.00	90.40		53
Punto 1.9 JTD	06/03→	Diesel	188 B2.000	1910	4	82.00	90.40		53
Punto 1.9 JTD 80	09/99→	Diesel	188 A2.000	1910	4	82.00	90.40		53
Punto 55 1.1	09/93→09/99	Petrol	176 A6.000	1108	4	70.00	72.00		12
Punto 55 1.1	09/93→09/99	Petrol	176 B2.000	1108	4	70.00	72.00		12
Punto 60 1.2	01/94→06/00	Petrol	176 A7.000	1242	4	70.80	78.90		13
Punto 60 1.2	03/94→06/00	Petrol	176 B1.000	1242	4	70.80	78.90		13
Punto 60 1.2	03/94→06/00	Petrol	176 B4.000	1242	4	70.80	78.90		13
Punto 75 1.2	10/93→09/99	Petrol	176 A8.000	1242	4	70.80	78.90		13
Punto 85 16V 1.2	04/97→06/00	Petrol	176 B9.000	1242	4	70.80	78.90		13
Punto 90 1.6	04/94→04/97	Petrol	176 A9.000	1581	4	86.40	67.40		106
Punto Evo 1.2	10/09→02/12	Petrol	169 A4.000	1242	4	70.80	78.90		13
Punto Evo 1.2	10/09→02/12	Petrol	199 A4.000	1242	4	70.80	78.90		13
Punto Evo 1.3 D Multijet	10/09→	Diesel	199 A2.000	1248	4	69.60	82.00		10
Punto Evo 1.3 D Multijet	10/09→	Diesel	199 A3.000	1248	4	69.60	82.00		10
Punto Evo 1.3 D Multijet	10/09→02/12	Diesel	199 A9.000	1248	4	69.60	82.00		10
Punto Evo 1.3 D Multijet	10/09→02/12	Diesel	199 B1.000	1248	4	69.60	82.00		10
Punto Evo 1.3 D Multijet	07/08→02/12	Diesel	199 B2.000	1248	4	69.60	82.00		10
Punto Evo 1.3 D Multijet	10/09→02/12	Diesel	199 B4.000	1248	4	69.60	82.00		10
Punto Evo 1.3 D Multijet	10/09→02/12	Diesel	223 A9.000	1248	4	69.60	82.00		10
Punto Evo 1.4	07/09→02/12	Petrol	199 A7.000	1368	4	72.00	84.00		15
Punto Evo 1.4	10/09→02/12	Petrol	350 A1.000	1368	4	72.00	84.00		15
Punto Evo 1.4 16V	10/09→02/12	Petrol	955 A2.000	1368	4	72.00	84.00		15
Punto Evo 1.4 16V	10/09→02/12	Petrol	955 A6.000	1368	4	72.00	84.00		15
Punto Evo 1.4 LPG	06/09→02/12	Petrol	350 A1.000	1368	4	72.00	84.00		15
Punto Evo 1.4 Natural Power	10/09→02/12	Petrol	350 A1.000	1368	4	72.00	84.00		15
Punto Evo 1.6 D Multijet	10/09→02/12	Diesel	955 A3.000	1598	4	79.50	80.50		36
Qubo 1.3 D Multijet	02/08→	Diesel	199 A2.000	1248	4	69.60	82.00		10
Qubo 1.3 D Multijet	02/08→	Diesel	199 A9.000	1248	4	69.60	82.00		10
Qubo 1.3 D Multijet	07/10→	Diesel	199 B1.000	1248	4	69.60	82.00		10
Qubo 1.4	02/08→	Petrol	KFT	1360	4	75.00	77.00		20
Qubo 1.4	02/08→	Petrol	KFV	1360	4	75.00	77.00		20
Qubo 1.4	10/09→	Petrol	350 A1.000	1368	4	72.00	84.00		15
Qubo 1.4 Natural Power	10/09→	Petrol	350 A1.000	1368	4	72.00	84.00		15
Regata 60 Diesel 1.7	01/84→12/89	Diesel	149 B3.000	1698	4	82.60	79.20		59
Regata 60 Diesel 1.7	09/83→12/86	Diesel	138 B6.000	1714	4	83.00	79.20		66
Regata 65 Diesel 1.9	04/84→07/89	Diesel	149 A1.000	1929	4	82.60	90.00		61



cm3



Regata 70 1.3	09/83→07/89	Petrol	149 A3.000	1301	4	86.40	55.50	101
Regata 70 1.3	09/83→07/89	Petrol	138 B2.000	1302	4	86.40	55.50	101
Regata 70 1.3	09/83→07/89	Petrol	149 A7.000	1302	4	86.40	55.50	101
Regata 75 1.5	12/83→07/89	Petrol	138 B3.048	1498	4	86.40	63.90	103
Regata 75 1.5	12/83→07/89	Petrol	138 C3.048	1498	4	86.40	63.90	103
Regata 75 1.5	12/83→07/89	Petrol	138 C2.048	1499	4	86.40	63.90	103
Regata 75 1.5	12/83→12/87	Petrol	149 C1.000	1499	4	86.40	63.90	103
Regata 75 1.5 i.e. CAT	12/86→07/89	Petrol	138 C2.048	1499	4	86.40	63.90	103
Regata 75 i.e. 1.5	07/85→07/89	Petrol	138 C2.048	1499	4	86.40	63.90	103
Regata 75 i.e. 1.5	07/85→07/89	Petrol	149 C1.000	1499	4	86.40	63.90	103
Regata 80 Turbo Diesel 1.9	05/86→07/89	Diesel	831 D1.000	1929	4	82.60	90.00	65
Regata 85 1.5	06/83→08/86	Petrol	138 B3.000	1498	4	86.40	63.90	103
Regata 85 1.5	01/84→04/89	Petrol	138 B3.000	1498	4	86.40	63.90	103
Regata 85 1.5	05/85→12/87	Petrol	149 A5.000	1498	4	86.40	63.90	103
Regata 85 1.6	10/83→06/90	Petrol	149 A.000	1585	4	84.00	71.50	75
Regata 85 Super 1.5	09/83→04/85	Petrol	138 B3.000	1498	4	86.40	63.90	103
Regata 90 i.e. 1.6	01/87→07/89	Petrol	149 C2.000	1595	4	84.00	71.50	75
Regata 100 1.6	09/84→12/86	Petrol	149 A4.000	1585	4	84.00	71.50	75
Regata 100 1.6	09/84→12/86	Petrol	149 C3.000	1585	4	84.00	71.50	75
Regata 100 i.e. 1.6	01/87→12/90	Petrol	149 C3.000	1585	4	84.00	71.50	75
Regata 100 Super 1.6	10/83→12/90	Petrol	149 A2.000	1585	4	84.00	71.50	75
Regata 100 Super 1.6	10/83→12/90	Petrol	149 A4.000	1585	4	84.00	71.50	75
Regata 100 Super 1.6	10/83→07/89	Petrol	149 C3.000	1585	4	84.00	71.50	75
Ritmo	01/79→12/88	Petrol	147A5.000	1049	4	76.00	57.80	23
Ritmo 1.3	10/79→09/83	Petrol	138 A1.000	1301	4	86.40	55.50	101
Ritmo 50 1.3	10/85→12/87	Petrol	138 B2.000	1302	4	86.40	55.50	101
Ritmo 85 1.5	01/80→07/89	Petrol	138 A4.000	1498	4	86.40	63.90	103
Ritmo 85 1.5	03/83→12/86	Petrol	138 B3.000	1498	4	86.40	63.90	103
Ritmo 100 1.6	10/85→12/87	Petrol	138 AR.000	1585	4	84.00	71.50	75
Ritmo 100 1.6	10/85→12/87	Petrol	138 AR.048	1585	4	84.00	71.50	75
Ritmo I 55 Diesel 1.7	10/79→09/82	Diesel	138 A5.000	1714	4	83.00	79.20	66
Ritmo I 60 1.0	09/78→09/82	Petrol	127 A6.000	1049	4	76.00	57.80	23
Ritmo I 65 1.3	01/78→09/82	Petrol	138 A1.000	1301	4	86.40	55.50	101
Ritmo I 65 1.3	01/78→09/82	Petrol	149 A3.000	1301	4	86.40	55.50	101
Ritmo I 65 1.3	01/78→09/82	Petrol	149 A7.000	1302	4	86.40	55.50	101
Ritmo I 70 1.3	11/83→08/85	Petrol	149 A3.000	1301	4	86.40	55.50	101
Ritmo I 70 1.3	11/83→08/85	Petrol	149 A7.000	1302	4	86.40	55.50	101
Ritmo I 75 1.3	01/81→09/82	Petrol	138 A3.000	1301	4	86.40	55.50	101
Ritmo I 75 1.5	01/78→10/82	Petrol	138 A2.000	1498	4	86.40	63.90	103
Ritmo I 75 1.5	01/78→10/82	Petrol	138 C3.048	1498	4	86.40	63.90	103
Ritmo I 75 1.5	01/78→10/82	Petrol	138 C2.048	1499	4	86.40	63.90	103
Ritmo I 75 1.5	01/78→10/82	Petrol	149 C1.000	1499	4	86.40	63.90	103
Ritmo I 75 i.e. 1.5	10/85→05/87	Petrol	138 C2.048	1499	4	86.40	63.90	103
Ritmo I 75 i.e. 1.5	10/85→05/87	Petrol	149 C1.000	1499	4	86.40	63.90	103
Ritmo I 85 1.5	01/81→05/87	Petrol	138 A4.000	1498	4	86.40	63.90	103
Ritmo I 90 i.e. 1.6	09/85→12/87	Petrol	149 C2.000	1595	4	84.00	71.50	75
Ritmo I 105	05/81→12/82	Petrol	138 AR.000	1585	4	84.00	71.50	75
Ritmo I 125 TC Abarth 2.0	11/81→09/82	Petrol	138 AR1.000	1995	4	84.00	90.00	86
Ritmo II 60 1.1	10/82→12/87	Petrol	138 B.000	1116	4	80.00	55.50	37
Ritmo II 60 1.1	10/82→12/87	Petrol	138 B1.000	1116	4	80.00	55.50	37
Ritmo II 60 1.1	10/82→12/87	Petrol	138 C1.000	1116	4	80.00	55.50	37
Ritmo II 60 1.1	04/85→12/87	Petrol	146 A4.048	1116	4	80.00	55.50	37
Ritmo II 60 Diesel 1.7	05/85→12/87	Diesel	138 C.000	1698	4	82.60	79.20	59
Ritmo II 60 Diesel 1.7	05/85→12/87	Diesel	149 B3.000	1698	4	82.60	79.20	59
Ritmo II 60 Diesel 1.7	10/82→10/85	Diesel	138 B6.000	1714	4	83.00	79.20	66
Ritmo II 70 1.3	01/83→04/85	Petrol	138 B2.000	1302	4	86.40	55.50	101
Ritmo II 75 1.5	09/85→12/88	Petrol	138 A2.000	1498	4	86.40	63.90	103
Ritmo II 75 1.5 CAT	09/85→12/88	Petrol	138 A2.000	1498	4	86.40	63.90	103
Ritmo II 75 1.5 CAT	09/85→12/88	Petrol	138 C2.048	1499	4	86.40	63.90	103
Ritmo II 75 1.5 CAT	09/85→12/88	Petrol	149 C1.000	1499	4	86.40	63.90	103
Ritmo II 80 Turbo Diesel 1.9	12/85→12/87	Diesel	831 D1.000	1929	4	82.60	90.00	65
Ritmo II 85 1.5	01/83→12/87	Petrol	138 B3.000	1498	4	86.40	63.90	103
Ritmo II 85 1.5	08/85→05/87	Petrol	149 A5.000	1498	4	86.40	63.90	103
Ritmo II 90 1.6 i.e.	12/85→12/87	Petrol	138 AR.000	1585	4	84.00	71.50	75
Ritmo II 100 1.6	01/83→12/87	Petrol	149 A4.000	1585	4	84.00	71.50	75
Ritmo II 105 1.6	01/83→12/87	Petrol	138 AR.000	1585	4	84.00	71.50	75
Scudo 1.6	02/96→12/06	Petrol	220 A 2.000	1581	4	86.40	67.40	106
Scudo 1.6 D Multijet	01/07→	Diesel	9HU	1560	4	75.00	88.30	21
Scudo 1.9 D	04/98→12/06	Diesel	WJY (DW8B)	1868	4	82.20	88.00	58

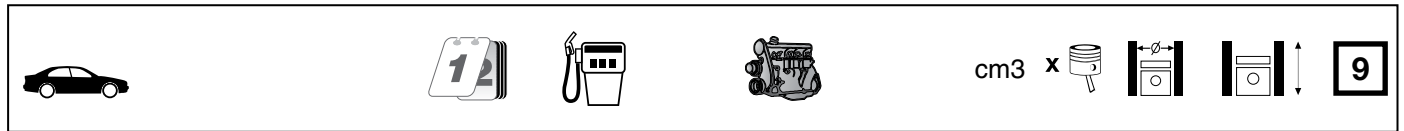

Scudo 1.9 D	04/98→12/06	Diesel	WJZ (DW8)	1868	4	82.20	88.00	58
Scudo 1.9 D	02/96→12/06	Diesel	D9B	1905	4	83.00	88.00	69
Scudo 1.9 TD	02/96→12/06	Diesel	D8B	1905	4	83.00	88.00	68
Scudo 1.9 TD	02/96→12/06	Diesel	DHX (XUD9TF/L)	1905	4	83.00	88.00	68
Scudo 1.9 TD Eco	02/96→12/06	Diesel	DHX (XUD9TF/L)	1905	4	83.00	88.00	68
Scudo 2.0	05/00→12/06	Petrol	RFN (EW10J4)	1997	4	85.00	88.00	94
Scudo 2.0 16V	06/00→12/06	Petrol	RFN (EW10J4)	1997	4	85.00	88.00	94
Scudo 2.0 D Multijet	01/07→	Diesel	DW10BTED4	1997	4	85.00	88.00	95
Scudo 2.0 D Multijet	07/10→	Diesel	RHH	1997	4	85.00	88.00	95
Scudo 2.0 D Multijet	01/07→	Diesel	RHK	1997	4	85.00	88.00	95
Scudo 2.0 D Multijet	01/07→	Diesel	RHR	1997	4	85.00	88.00	95
Scudo 2.0 D Multijet 4x4	01/07→	Diesel	RHK	1997	4	85.00	88.00	95
Scudo 2.0 JTD	12/99→12/06	Diesel	RHX	1997	4	85.00	88.00	95
Scudo 2.0 JTD	12/99→12/06	Diesel	RHZ	1997	4	85.00	88.00	95
Scudo 2.0 JTD 16V	05/99→12/06	Diesel	RHM (DW10ATED4)	1997	4	85.00	88.00	95
Scudo 2.0 JTD 16V	05/99→12/06	Diesel	RHW (DW10ATED4)	1997	4	85.00	88.00	95
Sedici 1.6 16V	06/06→	Petrol	M16A	1586	4	78.00	83.00	34
Sedici 1.6 16V 4x4	06/06→	Petrol	M16A	1586	4	78.00	83.00	34
Sedici 1.9 D Multijet	06/06→	Diesel	D19AA	1910	4	82.00	90.40	53
Sedici 1.9 D Multijet 4x4	06/06→	Diesel	D19AA	1910	4	82.00	90.40	53
Seicento / 600 0.9	01/98→01/10	Petrol	1170 A1.046	899	4	65.00	68.00	4
Seicento / 600 1.1	01/98→01/10	Petrol	176 B2.000	1108	4	70.00	72.00	12
Seicento / 600 1.1	01/98→01/10	Petrol	187 A1.000	1108	4	70.00	72.00	12
Siena 1.0	03/00→02/05	Petrol	178 D9.011	999	4	70.00	64.90	11
Siena 1.0 Bipower	03/04→12/05	Petrol	178 D9.011	999	4	70.00	64.90	11
Siena 1.0 Bipower	03/04→12/05	Petrol	178 F1.011	999	4	70.00	64.90	11
Siena 1.0 Flex	09/00→12/09	Petrol	178 D9.011	999	4	70.00	64.90	11
Siena 1.0 Flex	09/00→06/12	Petrol	178 F1.011	999	4	70.00	64.90	11
Siena 1.2	09/98→12/09	Petrol	178 B5.000	1242	4	70.80	78.90	13
Siena 1.2	09/01→12/09	Petrol	178 C4.066	1242	4	70.80	78.90	13
Siena 1.2	06/04→12/09	Flexfuel	178 E9.011	1242	4	70.80	78.90	13
Siena 1.2	09/01→12/09	Petrol	188 A4.000	1242	4	70.80	78.90	13
Siena 1.2	09/01→12/09	Petrol	188 A5.000	1242	4	70.80	78.90	13
Siena 1.2 Flex	03/04→05/05	Flexfuel	178 E9.011	1242	4	70.80	78.90	13
Siena 1.3 JTD	09/03→	Diesel	188 A9.000	1248	4	69.60	82.00	10
Siena 1.4	01/07→	Flexfuel	178 F3.011	1368	4	72.00	84.00	15
Siena 1.4	01/07→12/09	Petrol	350 A1.000	1368	4	72.00	84.00	15
Siena 1.4	04/96→12/09	Petrol	178 B2.000	1372	4	80.50	67.40	46
Siena 1.4 CAT	04/96→12/09	Petrol	178 B2.016	1372	4	80.50	67.40	46
Siena 1.4 Flex	06/04→10/07	Flexfuel	178 F3.011	1368	4	72.00	84.00	15
Siena 1.4 Flex	07/05→06/12	Flexfuel	310 A2.011	1368	4	72.00	84.00	15
Siena 1.6	09/97→10/98	Petrol	146 C6.000	1581	4	86.40	67.40	106
Siena 1.6	09/97→03/00	Petrol	146 D6.000	1581	4	86.40	67.40	106
Siena 1.6	05/04→12/06	Petrol	178 B3.000	1581	4	86.40	67.40	106
Siena 1.6	11/00→12/09	Petrol	182 B6.000	1596	4	80.50	78.40	47
Siena 1.6 16V	09/98→12/09	Petrol	178 B3.000	1581	4	86.40	67.40	106
Siena 1.6 16V	08/03→12/05	Petrol	182 B6.000	1596	4	80.50	78.40	47
Siena 1.7 D	03/02→12/09	Diesel	176 A3.000	1698	4	82.60	79.20	60
Siena 1.7 D	05/99→12/09	Diesel	176 B7.000	1698	4	82.60	79.20	60
Siena 1.7 D	05/99→12/09	Diesel	178 C9.066	1698	4	82.60	79.20	60
Siena 1.7 TD	02/06→12/09	Diesel	176 A3.000	1698	4	82.60	79.20	60
Siena 1.9 D	11/00→12/09	Diesel	223 A6.000	1910	4	82.00	90.40	54
Stilo 1.2 16V	02/02→11/06	Petrol	188 A5.000	1242	4	70.80	78.90	13
Stilo 1.4 16V	03/05→08/08	Petrol	192 B2.000	1368	4	72.00	84.00	15
Stilo 1.4 16V	01/04→08/08	Petrol	843 A1.000	1368	4	72.00	84.00	15
Stilo 1.6	04/05→11/06	Petrol	182 B6.000	1596	4	80.50	78.40	47
Stilo 1.6 16V	10/01→08/08	Petrol	182 B6.000	1596	4	80.50	78.40	47
Stilo 1.6 16V	03/05→12/07	Petrol	192 B3.000	1598	4	79.00	81.50	35
Stilo 1.8 16V	10/01→08/08	Petrol	192 A4.000	1747	4	82.00	82.70	51
Stilo 1.9 D	09/04→08/08	Diesel	192 B5.000	1910	4	82.00	90.40	55
Stilo 1.9 D Multijet	09/05→08/08	Diesel	192 A8.000	1910	4	82.00	90.40	55
Stilo 1.9 D Multijet	09/05→08/08	Diesel	192 A9.000	1910	4	82.00	90.40	55
Stilo 1.9 D Multijet	09/05→08/08	Diesel	937 A5.000	1910	4	82.00	90.40	55
Stilo 1.9 JTD	10/01→08/08	Diesel	192 A1.000	1910	4	82.00	90.40	53
Stilo 1.9 JTD	02/02→08/08	Diesel	192 A3.000	1910	4	82.00	90.40	53
Stilo 1.9 JTD	01/04→08/08	Diesel	192 A5.000	1910	4	82.00	90.40	55
Stilo 1.9 JTD	04/04→08/08	Diesel	192 B1.000	1910	4	82.00	90.40	55
Stilo 1.9 JTD	09/04→11/06	Diesel	192 B5.000	1910	4	82.00	90.40	55
Stilo 1.9 JTD	09/03→08/08	Diesel	937 A4.000	1910	4	82.00	90.40	55



cm3 x



Stilo 1.9 JTD	10/01→08/08	Diesel	937 A7.000	1910	4	82.00	90.40	55
Strada 1.2	06/99→	Petrol	178 B5.000	1242	4	70.80	78.90	13
Strada 1.2	04/03→	Petrol	188 A4.000	1242	4	70.80	78.90	13
Strada 1.2 Trekking	11/05→	Petrol	178 B7.045	1242	4	70.80	78.90	13
Strada 1.3 D Multijet	10/10→	Diesel	199 B1.000	1248	4	69.60	82.00	10
Strada 1.3 D Multijet	05/06→	Diesel	223 A9.000	1248	4	69.60	82.00	10
Strada 1.4	01/06→	Flexfuel	178 F3.011	1368	4	72.00	84.00	15
Strada 1.4	01/10→06/12	Flexfuel	310 A2.011	1368	4	72.00	84.00	15
Strada 1.4 Flex	06/05→	Flexfuel	178 F3.011	1368	4	72.00	84.00	15
Strada 1.4 Flex	06/05→	Flexfuel	310 A2.011	1368	4	72.00	84.00	15
Strada 1.6 Trekking	11/05→	Petrol	178 D2.011	1581	4	86.40	67.40	106
Strada 1.7 TD	06/99→	Diesel	176 A3.000	1698	4	82.60	79.20	60
Strada 1.8 Flex	11/13→	Petrol	192 A4.000	1747	4	82.00	82.70	51
Strada 1.9 D	12/00→	Diesel	223 A6.000	1910	4	82.00	90.40	54
Strada 1.9 JTD	04/03→	Diesel	188 A2.000	1910	4	82.00	90.40	53
Talento 1.9 D	03/89→03/94	Diesel	149 B1.000	1929	4	82.60	90.00	61
Talento 2.0	03/89→03/94	Petrol	170 B	1971	4	88.00	81.00	108
Tempra 1.4 i.e.	03/91→08/96	Petrol	159 A2.000	1372	4	80.50	67.40	46
Tempra 1.4 i.e.	03/92→08/96	Petrol	160 A1.046	1372	4	80.50	67.40	46
Tempra 1.4 i.e.	03/92→08/96	Petrol	836 A4.000	1372	4	80.50	67.40	46
Tempra 1.6	03/90→04/93	Petrol	159 A3.000	1581	4	86.40	67.40	106
Tempra 1.6	04/90→07/96	Petrol	159 A3.048	1581	4	86.40	67.40	106
Tempra 1.6	03/90→04/93	Petrol	159 B9.000	1581	4	86.40	67.40	106
Tempra 1.6 i.e.	06/90→08/96	Petrol	159 A3.046	1581	4	86.40	67.40	106
Tempra 1.6 i.e.	06/92→08/96	Petrol	159 A3.048	1581	4	86.40	67.40	106
Tempra 1.6 i.e.	06/94→08/96	Petrol	159 B9.000	1581	4	86.40	67.40	106
Tempra 1.6 i.e.	10/90→08/96	Petrol	835 C1.000	1581	4	86.40	67.40	106
Tempra 1.8	07/94→12/98	Petrol	836 A5.000	1756	4	84.00	79.20	79
Tempra 1.8 i.e.	03/90→08/96	Petrol	159 A4.000	1756	4	84.00	79.20	79
Tempra 1.8 i.e.	03/92→08/96	Petrol	159 A4.046	1756	4	84.00	79.20	79
Tempra 1.8 i.e.	09/93→08/96	Petrol	835 C2.000	1756	4	84.00	79.20	79
Tempra 1.8 i.e.	09/93→08/96	Petrol	835 C4.000	1756	4	84.00	79.20	79
Tempra 1.8 i.e.	10/94→08/96	Petrol	836 A5.000	1756	4	84.00	79.20	79
Tempra 1.9 D	07/91→08/96	Diesel	149 A1.000	1929	4	82.60	90.00	61
Tempra 1.9 D	07/91→08/96	Diesel	160 A7.000	1929	4	82.60	90.00	61
Tempra 1.9 TD	05/90→08/96	Diesel	160 A6.000	1929	4	82.60	90.00	63
Tempra 1.9 TD	03/92→08/96	Diesel	160 B6.046	1929	4	82.60	90.00	63
Tempra 1.9 TD	05/90→08/96	Diesel	160 D1.000	1929	4	82.60	90.00	63
Tempra 2.0	11/92→04/94	Petrol	149 E1.011	1995	4	84.00	90.00	85
Tempra 2.0	10/95→12/98	Petrol	154 E1.000	1995	4	84.00	90.00	90
Tempra 2.0	05/94→12/98	Petrol	159 A6.046	1995	4	84.00	90.00	91
Tempra 2.0 Álcool	11/92→04/94	Petrol	149 E1.011	1995	4	84.00	90.00	85
Tempra 2.0 Álcool	05/94→12/98	Petrol	159 B2.011	1995	4	84.00	90.00	85
Tempra 2.0 i.e.	10/90→08/96	Petrol	159 A6.046	1995	4	84.00	90.00	91
Tempra 2.0 i.e. 4x4	03/92→03/95	Petrol	159 A6.046	1995	4	84.00	90.00	91
Tempra 2.0 Turbo	11/94→05/98	Petrol	154 C4.000	1995	4	84.00	90.00	88
Tipo 1.1	01/88→10/91	Petrol	160 A3.000	1108	4	70.00	72.00	12
Tipo 1.3 D Multijet	10/15→	Diesel	199 B1.000	1248	4	69.60	82.00	10
Tipo 1.3 D Multijet	10/15→	Diesel	55266963	1248	4	69.60	82.00	10
Tipo 1.4	10/15→	Petrol	843 A1.000	1368	4	72.00	84.00	15
Tipo 1.4	07/87→12/89	Petrol	160 A1.000	1372	4	80.50	67.40	46
Tipo 1.4	07/87→10/92	Petrol	160 A1.048	1372	4	80.50	67.40	46
Tipo 1.4 i.e.	05/89→04/95	Petrol	159 A2.000	1372	4	80.50	67.40	46
Tipo 1.4 i.e.	05/89→04/95	Petrol	160 A1.046	1372	4	80.50	67.40	46
Tipo 1.4 i.e.	05/89→04/95	Petrol	836 A4.000	1372	4	80.50	67.40	46
Tipo 1.6	03/93→10/95	Petrol	159 A3.046	1581	4	86.40	67.40	106
Tipo 1.6	03/93→10/95	Petrol	159 A3.048	1581	4	86.40	67.40	106
Tipo 1.6	01/88→10/92	Petrol	160 A2.000	1581	4	86.40	67.40	106
Tipo 1.6	03/93→10/95	Petrol	835 C1.000	1581	4	86.40	67.40	106
Tipo 1.6 D Multijet	10/15→	Diesel	940 C1.000	1598	4	79.50	80.50	36
Tipo 1.6 D Multijet	10/15→	Diesel	55260384	1598	4	79.50	80.50	36
Tipo 1.6 i.e.	07/90→01/93	Petrol	159 A3.046	1581	4	86.40	67.40	106
Tipo 1.6 i.e.	10/92→04/95	Petrol	159 A3.048	1581	4	86.40	67.40	106
Tipo 1.6 i.e.	10/92→04/95	Petrol	835 C1.000	1581	4	86.40	67.40	106
Tipo 1.6 i.e.	02/88→05/91	Petrol	149 C2.046	1595	4	84.00	71.50	75
Tipo 1.6 SX DGT	05/89→10/95	Petrol	159 A3.000	1581	4	86.40	67.40	106
Tipo 1.7 D	01/88→10/95	Diesel	149 B4.000	1697	4	82.60	79.20	59
Tipo 1.8 i.e	03/93→04/95	Petrol	836 A5.000	1756	4	84.00	79.20	79
Tipo 1.8 i.e.	10/90→10/95	Petrol	159 A4.000	1756	4	84.00	79.20	79

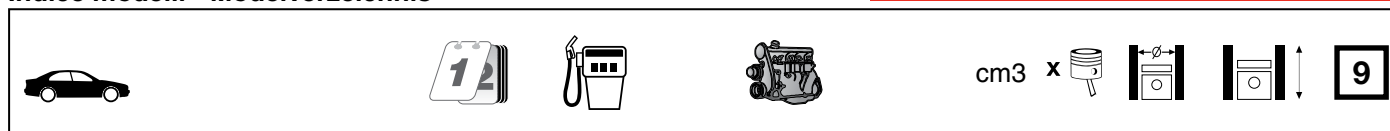

Tipo 1.8 i.e.	10/90→06/93	Petrol	159 A4.046	1756	4	84.00	79.20	79
Tipo 1.8 i.e.	04/93→04/95	Petrol	835 C2.000	1756	4	84.00	79.20	79
Tipo 1.8 i.e.	09/93→04/95	Petrol	835 C4.000	1756	4	84.00	79.20	79
Tipo 1.8 i.e.	10/94→10/95	Petrol	836 A5.000	1756	4	84.00	79.20	79
Tipo 1.8 i.e.16V	11/89→06/92	Petrol	160 A5.000	1756	4	84.00	79.20	80
Tipo 1.9 D	07/91→08/95	Diesel	149 A1.000	1929	4	82.60	90.00	61
Tipo 1.9 D	07/91→08/95	Diesel	160 A7.000	1929	4	82.60	90.00	61
Tipo 1.9 TD	09/90→04/95	Diesel	160 A6.000	1929	4	82.60	90.00	63
Tipo 1.9 TD	09/90→04/95	Diesel	160 A6.046	1929	4	82.60	90.00	63
Tipo 1.9 TD	03/92→06/93	Diesel	160 B6.046	1929	4	82.60	90.00	63
Tipo 1.9 TD	09/90→04/95	Diesel	160 D1.000	1929	4	82.60	90.00	63
Tipo 2.0	10/90→10/92	Petrol	159 A5.046	1995	4	84.00	90.00	91
Tipo 2.0	10/90→10/92	Petrol	159 A6.046	1995	4	84.00	90.00	91
Tipo 2.0	03/93→04/95	Petrol	836 A3.011	1995	4	84.00	90.00	90
Tipo 2.0 16V	07/91→04/95	Petrol	160 A8.046	1995	4	84.00	90.00	90
Tipo 2.0 i.e.	06/90→03/92	Petrol	159 A5.046	1995	4	84.00	90.00	91
Tipo 2.0 i.e.	03/90→04/95	Petrol	159 A6.046	1995	4	84.00	90.00	91
Tipo 2.0 i.e. 16V	03/93→04/95	Petrol	836 A3.000	1995	4	84.00	90.00	90
Ulysse 1.8	05/97→08/02	Petrol	LFW	1761	4	83.00	81.40	67
Ulysse 1.9 TD	02/95→08/02	Diesel	DHX (XUD9TF/L)	1905	4	83.00	88.00	68
Ulysse 2.0	08/02→06/11	Petrol	RFN (EW10J4)	1997	4	85.00	88.00	94
Ulysse 2.0	06/94→08/02	Petrol	RFU (XU10J2C)	1998	4	86.00	86.00	99
Ulysse 2.0 16V	09/00→08/02	Petrol	RFN (EW10J4)	1997	4	85.00	88.00	94
Ulysse 2.0 16V	05/98→09/00	Petrol	RFV	1998	4	86.00	86.00	99
Ulysse 2.0 D Multijet	05/06→06/11	Diesel	RHK	1997	4	85.00	88.00	95
Ulysse 2.0 D Multijet	05/06→06/11	Diesel	RHR	1997	4	85.00	88.00	95
Ulysse 2.0 JTD	05/03→08/06	Diesel	RHM (DW10ATED4)	1997	4	85.00	88.00	95
Ulysse 2.0 JTD	08/02→08/06	Diesel	RHW (DW10ATED4)	1997	4	85.00	88.00	95
Ulysse 2.0 JTD	10/99→08/02	Diesel	RHZ	1997	4	85.00	88.00	95
Ulysse 2.0 JTD 16V	05/99→08/02	Diesel	RHW (DW10ATED4)	1997	4	85.00	88.00	95
Ulysse 2.0 Turbo	06/94→08/02	Petrol	RGX (XU10J2CTE)	1998	4	86.00	86.00	99
Ulysse 2.1 TD	03/96→10/99	Diesel	P8C	2088	4	85.00	92.00	96
Ulysse 2.2 D Multijet	03/08→06/11	Diesel	4HS	2179	4	85.00	96.00	97
Ulysse 2.2 D Multijet	03/08→06/11	Diesel	4HT (DW12BTED4)	2179	4	85.00	96.00	97
Ulysse 2.2 JTD	03/08→06/11	Diesel	4HP	2179	4	85.00	96.00	97
Ulysse 2.2 JTD	03/08→06/11	Diesel	4HR	2179	4	85.00	96.00	97
Ulysse 2.2 JTD	08/02→08/06	Diesel	4HW (DW12ATED4)	2179	4	85.00	96.00	97
Uno 0.9	02/84→08/89	Petrol	100 GL.000	903	4	65.00	68.00	4
Uno 1.0	08/90→06/01	Petrol	146 A2.166	994	4	76.00	54.80	22
Uno 1.0	11/94→06/01	Petrol	146 A7.011	994	4	76.00	54.80	22
Uno 1.0	06/89→02/92	Petrol	156 A2.000	999	4	70.00	64.90	11
Uno 1.0	01/04→04/10	Petrol	178 D9.011	999	4	70.00	64.90	11
Uno 1,3	08/84→09/91	Petrol	127 A2.011	1297	4	76.00	71.50	25
Uno 1.0 Álcool	09/98→12/03	Petrol	156 A2.246	999	4	70.00	64.90	11
Uno 1.0 Álcool	09/98→12/03	Petrol	178 D9.011	999	4	70.00	64.90	11
Uno 1.0 Bipower	03/06→12/09	Petrol	178 D9.011	999	4	70.00	64.90	11
Uno 1.0 Flex	03/05→12/08	Petrol	178 F1.011	999	4	70.00	64.90	11
Uno 1.0 iE	05/98→08/00	Petrol	156 A2.246	999	4	70.00	64.90	11
Uno 1.0 MPI	09/98→12/03	Petrol	156 A2.246	999	4	70.00	64.90	11
Uno 1.0 MPI	09/98→12/03	Petrol	178 D9.011	999	4	70.00	64.90	11
Uno 1.1	10/88→06/06	Petrol	160 A3.000	1108	4	70.00	72.00	12
Uno 1.1	10/88→06/06	Petrol	146 A4.048	1116	4	80.00	55.50	37
Uno 1.2	11/05→	Flexfuel	178 E9.011	1242	4	70.80	78.90	13
Uno 1.2	08/00→04/10	Petrol	188 A4.000	1242	4	70.80	78.90	13
Uno 1.2 Bipower	10/06→04/10	Flexfuel	178 E9.011	1242	4	70.80	78.90	13
Uno 1.2 Flex	01/07→	Flexfuel	178 E9.011	1242	4	70.80	78.90	13
Uno 1.2 Flexfuel	01/09→04/10	Flexfuel	178 E9.011	1242	4	70.80	78.90	13
Uno 1.3 Álcool	06/84→09/91	Petrol	127 A2.011	1297	4	76.00	71.50	25
Uno 1.3 MPI	08/84→10/05	Petrol	127 A2.011	1297	4	76.00	71.50	25
Uno 1.3 Super Diesel	06/83→03/92	Diesel	146 B1.000	1301	4	76.10	71.50	30
Uno 1.3 Super Diesel	06/83→03/92	Diesel	127 A5.000	1302	4	76.10	71.50	30
Uno 1.3 Turbo i.e.	04/85→08/89	Petrol	146 A2.000	1301	4	80.50	63.90	45
Uno 1.3 Turbo i.e.	01/87→12/87	Petrol	146 A2.146	1301	4	80.50	63.90	45
Uno 1.3 Turbo i.e.	09/89→03/91	Petrol	146 A2.246	1301	4	80.50	63.90	45
Uno 1.4	01/89→12/91	Petrol	146 A8.000	1372	4	80.50	67.40	46
Uno 1.4	05/92→08/94	Petrol	146 C1.000	1372	4	80.50	67.40	46
Uno 1.4	10/88→03/01	Petrol	160 A1.046	1372	4	80.50	67.40	46
Uno 1.4	05/92→08/94	Petrol	160 A1.048	1372	4	80.50	67.40	46
Uno 1.4 Turbo	10/88→08/00	Petrol	146 A8.000	1372	4	80.50	67.40	46















cm3







x















Uno 1.4 Turbo i.e.	12/89→12/96	Petrol	146 A8.000	1372	4	80.50	67.40	46
Uno 1.4 Turbo i.e.	09/89→09/93	Petrol	146 A8.046	1372	4	80.50	67.40	46
Uno 1.5	03/87→09/93	Petrol	138 B3.011	1498	4	86.40	63.90	104
Uno 1.5 Álcool	03/87→09/93	Petrol	138 B3.011	1498	4	86.40	63.90	104
Uno 1.5 Álcool	10/93→01/96	Petrol	149 C1.000	1499	4	86.40	63.90	103
Uno 1.5 SPI	03/87→01/96	Petrol	149 C1.000	1499	4	86.40	63.90	103
Uno 1.6	12/89→12/93	Petrol	159 A3.046	1581	4	86.40	67.40	106
Uno 1.6	11/89→04/93	Petrol	160 A2.011	1581	4	86.40	67.40	106
Uno 1.6 Álcool	11/89→04/93	Petrol	160 A2.011	1581	4	86.40	67.40	106
Uno 1.6 R	12/92→12/95	Petrol	159 A3.048	1581	4	86.40	67.40	106
Uno 1.7 D	02/88→02/92	Diesel	149 B4.046	1697	4	82.60	79.20	59
Uno 1.7 D	02/88→08/00	Diesel	146 B2.000	1698	4	82.60	79.20	59
Uno 1.9 D	09/89→03/94	Diesel	149 B5.046	1929	4	82.60	90.00	62
Uno 45 0.9	03/83→07/96	Petrol	146 A.000	903	4	65.00	68.00	4
Uno 45 0.9	03/83→07/96	Petrol	146 A1.000	903	4	65.00	68.00	4
Uno 45 1.0	06/86→12/93	Petrol	156 A2.048	999	4	73.02	64.90	18
Uno 45 1.0	06/86→12/93	Petrol	156 A2.100	999	4	70.00	64.90	11
Uno 45 i.e. 1.0	04/84→10/95	Petrol	156 A2.246	999	4	70.00	64.90	11
Uno 50 1.1	01/90→12/93	Petrol	156 C.046	1108	4	70.00	72.00	12
Uno 50 1.1	01/86→12/89	Petrol	146 A4.044	1116	4	80.00	55.50	37
Uno 50 i.e. 1.1	06/92→12/93	Petrol	146 C3.000	1116	4	80.00	55.50	37
Uno 55 1.1	01/83→08/89	Petrol	138 B.000	1116	4	80.00	55.50	37
Uno 60 1.1	04/89→12/92	Petrol	160 A3.000	1108	4	70.00	72.00	12
Uno 60 1.1	05/85→02/92	Petrol	146 A4.048	1116	4	80.00	55.50	37
Uno 60 1.1	02/88→02/92	Petrol	146 A6.000	1116	4	76.00	61.50	24
Uno 60 Diesel 1.7	09/89→12/93	Diesel	146 B2.000	1698	4	82.60	79.20	59
Uno 60 Diesel 1.7	07/86→08/89	Diesel	149 B3.000	1698	4	82.60	79.20	59
Uno 70 1.3	01/83→04/85	Petrol	138 B2.000	1302	4	86.40	55.50	101
Uno 70 1.3	05/85→08/89	Petrol	149 A7.000	1302	4	86.40	55.50	101
Uno 70 i.e. 1.4	09/89→12/93	Petrol	146 C1.000	1372	4	80.50	67.40	46
Uno 70 i.e. 1.4	09/89→12/93	Petrol	160 A1.046	1372	4	80.50	67.40	46
Uno 70 S 1.4	09/89→10/92	Petrol	160 A1.048	1372	4	80.50	67.40	46
Uno 70 TD 1.4	10/86→10/90	Diesel	146 B.000	1367	4	78.00	71.50	33
Uno 70 TD 1.4	10/86→10/90	Diesel	146 B3.000	1367	4	78.00	71.50	33
Uno 75 i.e. 1.5	10/85→12/93	Petrol	138 C2.048	1499	4	86.40	63.90	103
Uno 75 i.e. 1.5	10/85→12/93	Petrol	149 C1.000	1499	4	86.40	63.90	103
Uno 1300	06/84→09/91	Petrol	127 A2.011	1297	4	76.00	71.50	25
X 1/9 1.3	05/73→12/79	Petrol	128 AS.000	1290	4	86.00	55.50	98
X 1/9 1.5	11/78→12/89	Petrol	138 AS.000	1499	4	86.40	63.90	103
X 1/9 1.5	09/78→12/89	Petrol	138 BS.031	1499	4	86.40	63.90	103







		cm3	x 			
4HP	Diesel	2179	4	85.00	96.00	97
4HR	Diesel	2179	4	85.00	96.00	97
4HS	Diesel	2179	4	85.00	96.00	97
4HT (DW12BTED4)	Diesel	2179	4	85.00	96.00	97
4HU	Diesel	2198	4	86.00	94.60	100
4HV	Diesel	2198	4	86.00	94.60	100
4HW (DW12ATED4)	Diesel	2179	4	85.00	96.00	97
4HX (DW12TED4)	Diesel	2179	4	85.00	96.00	97
9A	Petrol	903	4	65.00	68.00	4
9HU	Diesel	1560	4	75.00	88.30	21
100 G.000	Petrol	843	4	65.00	63.50	3
100 G.002	Petrol	843	4	65.00	63.50	3
100 GB.000	Petrol	843	4	65.00	63.50	3
100 GBC.000	Petrol	903	4	65.00	68.00	4
100 GBC.040	Petrol	903	4	65.00	68.00	4
100 GBS.000	Petrol	903	4	65.00	68.00	4
100 GC.000	Petrol	843	4	65.00	63.50	3
100 GF 000	Petrol	903	4	65.00	68.00	4
100 GL. 0.64	Petrol	903	4	65.00	68.00	4
100 GL.000	Petrol	903	4	65.00	68.00	4
100 GL.040	Petrol	903	4	65.00	68.00	4
100 GL.048	Petrol	903	4	65.00	68.00	4
100 GL.064	Petrol	903	4	65.00	68.00	4
100 GL 064	Petrol	903	4	65.00	68.00	4
100 GL3.000	Petrol	903	4	65.00	68.00	4
100 GL6.000	Petrol	843	4	65.00	63.50	3
110.000	Petrol	479	2	66.00	70.00	6
110 D.000	Petrol	499	2	67.40	70.00	9
110 F.000	Petrol	499	2	67.40	70.00	9
112 A .000	Petrol	903	4	65.00	68.00	4
120.000	Petrol	499	2	67.40	70.00	9
124 A.000	Petrol	1197	4	73.00	71.50	17
124 A.000	Petrol	1197	4	73.00	71.50	17
124 AC.000	Petrol	1438	4	80.00	71.50	39
124AZ2.000	Petrol	1438	4	80.00	71.50	39
124 B.000	Petrol	1438	4	80.00	71.50	39
124 B2.000	Petrol	1438	4	80.00	71.50	39
124 B3.000	Petrol	1585	4	84.00	71.50	73
124 BL.016	Petrol	1197	4	73.00	71.50	17
124 BL 1.016	Petrol	1438	4	80.00	71.50	39
125 A.000	Petrol	1608	4	80.00	80.00	44
125 B.000	Petrol	1608	4	80.00	80.00	44
126 A.000	Petrol	594	2	73.50	70.00	19
126 A1.000	Petrol	652	2	77.00	70.00	31
126 A1.048	Petrol	652	2	77.00	70.00	31
126 A2.000	Petrol	704	2	80.00	70.00	38
126 A2.048	Petrol	704	2	80.00	70.00	38
126 AB.0C.0	Petrol	594	2	73.50	70.00	19
126 AB.5C.0	Petrol	594	2	73.50	70.00	19
126G100	Petrol	843	4	65.00	63.50	3
127 A.000	Petrol	1049	4	65.00	68.00	4
127 A1.000	Petrol	1049	4	76.00	57.80	23
127 A2.011	Petrol	1297	4	76.00	71.50	25
127 A3.000	Petrol	1301	4	76.10	71.50	29
127 A5.000	Diesel	1302	4	76.10	71.50	30
127 A6.000	Petrol	1049	4	76.00	57.80	23
128 A.000	Petrol	1116	4	80.00	55.50	37
128 A.000	Petrol	1116	4	80.00	55.50	37
128 A.048	Petrol	1116	4	80.00	55.50	37
128 A.064	Petrol	1116	4	80.00	55.50	37
128 A.064	Petrol	1116	4	80.00	55.50	37
128 A 064	Petrol	1116	4	80.00	55.50	37
128 A1.000	Petrol	1290	4	86.00	55.50	98
128 A3.000	Petrol	1301	4	86.40	55.50	101
128 A5.000	Petrol	1499	4	86.40	63.90	103
128 AC.000	Petrol	1290	4	86.00	55.50	98
128 AC5.000	Petrol	1116	4	80.00	55.50	37
128 AC5.000	Petrol	1116	4	80.00	55.50	37
128 AR.000	Petrol	1290	4	86.00	55.50	98







			cm ³	x 			
128 AR.000	Petrol		1290	4	86.00	55.50	98
128 AS.000	Petrol		1290	4	86.00	55.50	98
128 BB.0A0	Petrol		1116	4	80.00	55.50	37
131 A.000	Petrol		1297	4	76.00	71.50	25
131 A1.000	Petrol		1585	4	84.00	71.50	74
131 A6.000	Petrol		1297	4	76.00	71.60	27
131 AB.1A.0	Petrol		1585	4	84.00	71.50	74
131 AZ.000	Petrol		1440	4	80.00	71.50	40
131 B.000	Petrol		1297	4	76.00	71.50	25
131 B1.000	Petrol		1585	4	84.00	71.50	75
131 B2.000	Petrol		1995	4	84.00	90.00	83
131 BZ 0C0	Petrol		1440	4	80.00	71.50	40
131 C.000	Petrol		1367	4	78.00	71.50	32
131 C1.000	Petrol		1367	4	78.00	71.50	32
131 C2.000	Petrol		1585	4	84.00	71.50	75
131 C3.000	Petrol		1585	4	84.00	71.50	75
131 C4.000	Petrol		1995	4	84.00	90.00	84
131 FZ	Petrol		1440	4	80.00	71.50	40
132 A.000	Petrol		1592	4	80.00	79.20	41
132 A.9000	Petrol		1592	4	80.00	79.20	41
132 A1.000	Petrol		1756	4	84.00	79.20	76
132 AB.000	Petrol		1756	4	84.00	79.20	76
132 AB.0A.0	Petrol		1592	4	84.00	71.50	73
132 AB.1A.0	Petrol		1756	4	84.00	79.20	76
132 AC.000	Petrol		1592	4	80.00	79.20	42
132 AC1.000	Petrol		1756	4	84.00	79.20	76
132 AZ2.000	Petrol		1995	4	84.00	90.00	85
132 B.000	Petrol		1756	4	84.00	79.20	77
132 B1.000	Petrol		1756	4	84.00	79.20	76
132 B1.000	Petrol		1756	4	84.00	79.20	78
132 B2.000	Petrol		1995	4	84.00	90.00	86
132 BB.1A 0	Petrol		1756	4	84.00	79.20	76
132 BB OA 0	Petrol		1592	4	80.00	79.20	43
132 C.000	Petrol		1585	4	84.00	71.50	75
132 C1.000	Petrol		1756	4	84.00	79.20	76
132 C2.000	Petrol		1995	4	84.00	90.00	86
132 C2.031	Petrol		1995	4	84.00	90.00	86
132 C2.040	Petrol		1995	4	84.00	90.00	86
132 C3.000	Petrol		1995	4	84.00	90.00	86
132 C3.000	Petrol		1995	4	84.00	90.00	86
132 C3.031	Petrol		1995	4	84.00	90.00	86
132 C3.040	Petrol		1995	4	84.00	90.00	86
132 C6.000	Petrol		1585	4	84.00	71.50	75
132 CB.0A.0	Petrol		1585	4	84.00	71.50	75
132 CB.1A	Petrol		1756	4	84.00	79.20	76
132 D.000	Petrol		1585	4	84.00	71.50	75
132 D.000	Petrol		1585	4	84.00	71.50	75
132 D1.000	Petrol		1995	4	84.00	90.00	86
132 DB.2A.0	Petrol		1995	4	84.00	90.00	86
138 A.000	Petrol		1302	4	86.40	55.50	101
138 A1.000	Petrol		1301	4	86.40	55.50	101
138 A2.000	Petrol		1498	4	86.40	63.90	103
138 A3.000	Petrol		1301	4	86.40	55.50	101
138 A4.000	Petrol		1498	4	86.40	63.90	103
138 A5.000	Diesel		1714	4	83.00	79.20	66
138 AE 0A.0	Petrol		1116	4	80.00	55.50	37
138 AR.000	Petrol		1585	4	84.00	71.50	75
138 AR.048	Petrol		1585	4	84.00	71.50	75
138 AR1.000	Petrol		1995	4	84.00	90.00	86
138 AR2.000	Petrol		1995	4	84.00	90.00	86
138 AS.000	Petrol		1499	4	86.40	63.90	103
138 B.000	Petrol		1116	4	80.00	55.50	37
138 B.0000	Petrol		1116	4	80.00	55.50	37
138 B1.000	Petrol		1116	4	80.00	55.50	37
138 B2.000	Petrol		1302	4	86.40	55.50	101
138 B3.000	Petrol		1498	4	86.40	63.90	103
138 B3.011	Petrol		1498	4	86.40	63.90	104
138 B3.048	Petrol		1498	4	86.40	63.90	103
138 B5.000	Diesel		1714	4	83.00	79.20	66







		cm3	x 			
138 B6.000	Diesel	1714	4	83.00	79.20	66
138 BS.031	Petrol	1499	4	86.40	63.90	103
138 C.000	Diesel	1698	4	82.60	79.20	59
138 C.048	Petrol	1498	4	86.40	63.90	103
138 C1.000	Petrol	1116	4	80.00	55.50	37
138 C2.048	Petrol	1499	4	86.40	63.90	103
138 C3.048	Petrol	1498	4	86.40	63.90	103
141 A.000	Petrol	652	2	77.00	70.00	31
141 A4.000	Petrol	769	4	65.00	58.00	1
141 A4.048	Petrol	770	4	65.00	58.00	1
141 B.000	Petrol	769	4	65.00	58.00	1
141 C2.000	Petrol	999	4	70.00	64.90	11
146 A.000	Petrol	903	4	65.00	68.00	4
146 A.048	Petrol	903	4	65.00	68.00	4
146 A1.000	Petrol	903	4	65.00	68.00	4
146 A2.000	Petrol	1301	4	80.50	63.90	45
146 A2.146	Petrol	1301	4	80.50	63.90	45
146 A2.166	Petrol	994	4	76.00	54.80	22
146 A2.246	Petrol	1301	4	80.50	63.90	45
146 A3.011	Flexfuel	1497	4	86.40	63.90	103
146 A4.000	Petrol	1116	4	80.00	55.50	37
146 A4.044	Petrol	1116	4	80.00	55.50	37
146 A4.048	Petrol	1116	4	80.00	55.50	37
146 A5.000	Petrol	1301	4	76.00	71.50	26
146 A5.000	Petrol	1301	4	76.00	71.50	26
146A5.046	Petrol	1297	4	76.00	71.50	26
146 A6.000	Petrol	1116	4	76.00	61.50	24
146 A6.000	Petrol	1116	4	76.00	61.50	24
146 A7.011	Petrol	994	4	76.00	54.80	22
146 A8.000	Petrol	1372	4	80.50	67.40	46
146 A8.046	Petrol	1372	4	80.50	67.40	46
146 A9.000	Petrol	1116	4	76.00	61.50	24
146 B.000	Diesel	1367	4	78.00	71.50	33
146 B1.000	Diesel	1301	4	76.10	71.50	30
146 B2.000	Diesel	1697	4	82.60	79.20	59
146 B2.000	Diesel	1698	4	82.60	79.20	59
146 B3.000	Diesel	1367	4	78.00	71.50	33
146 B4.000	Petrol	999	4	70.00	64.90	11
146 B6.011	Petrol	1581	4	86.40	67.40	106
146 B7.011	Petrol	1581	4	86.40	67.40	106
146 C1.000	Petrol	1372	4	80.50	67.40	46
146 C3.000	Petrol	1116	4	80.00	55.50	37
146 C4.011	Petrol	994	4	76.00	54.80	22
146 C5.000	Petrol	1372	4	80.50	67.40	46
146 C5.000	Petrol	1372	4	80.50	67.40	46
146 C6.000	Petrol	1580	4	86.40	67.40	106
146 C6.000	Petrol	1581	4	86.40	67.40	106
146 D1.011	Flexfuel	1497	4	86.40	63.90	105
146 D5.000	Petrol	1372	4	80.50	67.40	46
146 D5.000	Petrol	1372	4	80.50	67.40	46
146 D6.000	Petrol	1580	4	86.40	67.40	106
146 D6.000	Petrol	1581	4	86.40	67.40	106
146 D7.000	Diesel	1698	4	82.60	79.20	60
147A5.000	Petrol	1049	4	76.00	57.80	23
149 A.000	Petrol	1585	4	84.00	71.50	75
149 A.000	Petrol	1585	4	84.00	71.50	75
149 A1.000	Diesel	1929	4	82.60	90.00	61
149 A2.000	Petrol	1585	4	84.00	71.50	75
149 A3.000	Petrol	1301	4	86.40	55.50	101
149 A4.000	Petrol	1585	4	84.00	71.50	75
149 A5.000	Petrol	1498	4	86.40	63.90	103
149 A5.046	Petrol	1498	4	86.40	63.90	103
149 A7.000	Petrol	1302	4	86.40	55.50	101
149 A7.003	Petrol	1301	4	86.40	55.50	101
149 A7.046	Petrol	1302	4	86.40	55.50	102
149 B1.000	Diesel	1929	4	82.60	90.00	61
149 B2.000	Diesel	1697	4	82.60	79.20	59
149 B3.000	Diesel	1698	4	82.60	79.20	59
149 B4.000	Diesel	1697	4	82.60	79.20	59







		cm ³	x 			
149 B4.046	Diesel	1697	4	82.60	79.20	59
149 B5.046	Diesel	1929	4	82.60	90.00	62
149 C1.000	Petrol	1498	4	86.40	63.90	103
149 C1.000	Petrol	1499	4	86.40	63.90	103
149 C2.000	Petrol	1595	4	84.00	71.50	75
149 C2.046	Petrol	1595	4	84.00	71.50	75
149 C3.000	Petrol	1585	4	84.00	71.50	75
149 E1.011	Petrol	1995	4	84.00	90.00	85
154 A.048	Petrol	1585	4	84.00	71.50	75
154 A1.000	Petrol	1995	4	84.00	90.00	87
154 A2.000	Petrol	1995	4	84.00	90.00	88
154 B.000	Diesel	1929	4	82.60	90.00	62
154 C3.000	Petrol	1995	4	84.00	90.00	89
154 C3.046	Petrol	1995	4	84.00	90.00	89
154 C4.000	Petrol	1995	4	84.00	90.00	88
154 C4.046	Petrol	1995	4	84.00	90.00	88
154 C5.000	Petrol	1995	4	84.00	90.00	87
154 C6.000	Diesel	1929	4	82.60	90.00	62
154 D1.000	Diesel	1929	4	82.60	90.00	62
154 E1.000	Petrol	1995	4	84.00	90.00	90
156 A.000	Petrol	1049	4	76.10	57.80	28
156A.000	Petrol	1049	4	76.00	57.80	23
156A1.000	Petrol	1049	4	76.00	57.80	23
156A2.000	Petrol	999	4	70.00	64.90	11
156 A2.000	Petrol	999	4	70.00	64.90	11
156 A2.0157	Petrol	999	4	70.00	64.90	11
156 A2.048	Petrol	999	4	73.02	64.90	18
156 A2.050	Petrol	999	4	70.00	64.90	11
156 A2.100	Petrol	999	4	70.00	64.90	11
156 A2.100	Petrol	999	4	70.00	64.90	11
156A2.146	Petrol	999	4	70.00	64.90	11
156 A2.146	Petrol	999	4	70.00	64.90	11
156 A2.246	Petrol	999	4	70.00	64.90	11
156A2.246	Petrol	999	4	70.00	64.90	11
156A2.256	Petrol	999	4	70.00	64.90	11
156 A3.000	Petrol	999	4	70.00	64.90	11
156A3.000	Petrol	999	4	70.00	64.90	11
156 A3.100	Petrol	999	4	70.00	64.90	11
156 A4.000	Petrol	770	4	65.00	58.00	2
156 A4.048	Petrol	770	4	65.00	58.00	2
156 A5.000	Diesel	1302	4	76.10	71.50	30
156B.000	Petrol	1301	4	76.10	71.50	29
156C.000	Petrol	1108	4	70.00	72.00	12
156 C.046	Petrol	1108	4	70.00	72.00	12
156C.046	Petrol	1108	4	70.00	72.00	12
159 A2.000	Petrol	1372	4	80.50	67.40	46
159 A3.000	Petrol	1581	4	86.40	67.40	106
159 A3.046	Petrol	1581	4	86.40	67.40	106
159 A3.048	Petrol	1581	4	86.40	67.40	106
159 A4.000	Petrol	1756	4	84.00	79.20	79
159 A4.046	Petrol	1756	4	84.00	79.20	79
159 A5.046	Petrol	1995	4	84.00	90.00	91
159 A6.046	Petrol	1995	4	84.00	90.00	91
159 B2.011	Petrol	1995	4	84.00	90.00	85
159 B9.000	Petrol	1581	4	86.40	67.40	106
160 A1.000	Petrol	1372	4	80.50	67.40	46
160 A1.000	Petrol	1372	4	80.50	67.40	46
160 A1.046	Petrol	1372	4	80.50	67.40	46
160 A1.048	Petrol	1372	4	80.50	67.40	46
160 A2.000	Petrol	1581	4	86.40	67.40	106
160 A2.011	Petrol	1581	4	86.40	67.40	106
160 A3.000	Petrol	1108	4	70.00	72.00	12
160 A5.000	Petrol	1756	4	84.00	79.20	80
160 A6.000	Diesel	1929	4	82.60	90.00	63
160 A6.046	Diesel	1929	4	82.60	90.00	63
160 A7.000	Diesel	1929	4	82.60	90.00	61
160 A8.046	Petrol	1995	4	84.00	90.00	90
160 B6.046	Diesel	1929	4	82.60	90.00	63
160 D1.000	Diesel	1929	4	82.60	90.00	63







		cm3	x 			
169 A1.000	Diesel	1248	4	69.60	82.00	10
169 A3.000	Petrol	1368	4	72.00	84.00	15
169 A4.000	Petrol	1242	4	70.80	78.90	13
169 A5.000	Diesel	1248	4	69.60	82.00	10
169 B	Petrol	1796	4	84.00	81.00	81
170 A.000	Petrol	704	2	80.00	70.00	38
170 A.046	Petrol	704	2	80.00	70.00	38
170 A1.000	Petrol	903	4	65.00	68.00	4
170 A1.046	Petrol	903	4	65.00	68.00	4
170 B	Petrol	1971	4	88.00	81.00	108
170 D	Petrol	1971	4	88.00	81.00	108
175 A1.000	Petrol	1995	4	84.00	90.00	90
175 A3.000	Petrol	1998	5	82.00	75.70	50
176 A3.000	Diesel	1698	4	82.60	79.20	60
176 A4.000	Petrol	1372	4	80.50	67.40	46
176 A5.000	Diesel	1698	4	82.60	79.20	60
176 A6.000	Petrol	1108	4	70.00	72.00	12
176 A7.000	Petrol	1242	4	70.80	78.90	13
176 A8.000	Petrol	1242	4	70.80	78.90	13
176 A9.000	Petrol	1581	4	86.40	67.40	106
176 B1.000	Petrol	1242	4	70.80	78.90	13
176 B2.000	Petrol	1108	4	70.00	72.00	12
176 B3.000	Diesel	1698	4	82.60	79.20	59
176 B4.000	Petrol	1242	4	70.80	78.90	13
176 B6.000	Petrol	1372	4	80.50	67.40	46
176 B7.000	Diesel	1698	4	82.60	79.20	60
176 B9.000	Petrol	1242	4	70.80	78.90	13
178 B2.000	Petrol	1372	4	80.50	67.40	46
178 B2.016	Petrol	1372	4	80.50	67.40	46
178 B3.000	Petrol	1581	4	86.40	67.40	106
178 B5.000	Petrol	1242	4	70.80	78.90	13
178 B7.045	Petrol	1242	4	70.80	78.90	13
178 C4.066	Petrol	1242	4	70.80	78.90	13
178 C7.098	Petrol	1581	4	86.40	67.40	106
178 C9.066	Diesel	1698	4	82.60	79.20	60
178 D2.011	Petrol	1581	4	86.40	67.40	106
178 D9.011	Petrol	999	4	70.00	64.90	11
178 E2.000	Petrol	1242	4	70.80	78.90	13
178 E9.011	Flexfuel	1242	4	70.80	78.90	13
178 F1.011	Petrol	999	4	70.00	64.90	11
178 F3.011	Flexfuel	1368	4	72.00	84.00	15
182 A1.000	Petrol	1998	5	82.00	75.70	50
182 A2.000	Petrol	1747	4	82.00	82.70	51
182 A3.000	Petrol	1370	4	82.00	64.90	49
182 A4.000	Petrol	1581	4	86.40	67.40	106
182 A5.000	Petrol	1370	4	82.00	64.90	49
182 A6.000	Petrol	1581	4	86.40	67.40	106
182 A7.000	Diesel	1910	4	82.00	90.40	52
182 A8.000	Diesel	1910	4	82.00	90.40	52
182 B2.000	Petrol	1242	4	70.80	78.90	13
182 B3.000	Petrol	1998	5	82.00	75.70	50
182 B4.000	Diesel	1910	4	82.00	90.40	53
182 B5.098	Petrol	1581	4	86.40	67.40	106
182 B6.000	Petrol	1596	4	80.50	78.40	47
182 B7.000	Petrol	1998	5	82.00	75.70	50
182 B9.000	Diesel	1910	4	82.00	90.40	53
183 A1.000	Petrol	1747	4	82.00	82.70	51
185 A2.000	Diesel	2387	5	82.00	90.40	56
185 A3.000	Petrol	1581	4	86.40	67.40	106
185 A6.000	Diesel	2387	5	82.00	90.40	56
185 A8.000	Petrol	1998	5	82.00	75.70	50
185 B4.000	Diesel	1910	4	82.00	90.40	53
186 A3.000	LPG	1581	4	86.40	67.40	106
186 A4.000	Petrol	1581	4	86.40	67.40	106
186 A6.000	Diesel	1910	4	82.00	90.40	53
186 A8.000	Diesel	1910	4	82.00	90.40	53
186 A9.000	Diesel	1910	4	82.00	90.40	53
187 A1.000	Petrol	1108	4	70.00	72.00	12
188 A2.000	Diesel	1910	4	82.00	90.40	53







		cm3	x 			
188 A3.000	Diesel	1910	4	82.00	90.40	54
188 A4.000	Petrol	1242	4	70.80	78.90	13
188 A4.000	Petrol	1242	4	70.80	78.90	13
188 A5.000	Petrol	1242	4	70.80	78.90	13
188 A6.000	Petrol	1747	4	82.00	82.70	51
188 A7.000	Diesel	1910	4	82.00	90.40	53
188 A8.000	Diesel	1248	4	69.60	82.00	10
188 A9.000	Diesel	1248	4	69.60	82.00	10
188 B2.000	Diesel	1910	4	82.00	90.40	53
192 A1.000	Diesel	1910	4	82.00	90.40	53
192 A3.000	Diesel	1910	4	82.00	90.40	53
192 A4.000	Petrol	1747	4	82.00	82.70	51
192 A5.000	Diesel	1910	4	82.00	90.40	55
192 A8.000	Diesel	1910	4	82.00	90.40	55
192 A9.000	Diesel	1910	4	82.00	90.40	55
192 B1.000	Diesel	1910	4	82.00	90.40	55
192 B2.000	Petrol	1368	4	72.00	84.00	15
192 B3.000	Petrol	1598	4	79.00	81.50	35
192 B4.000	Diesel	1910	4	82.00	90.40	55
192 B5.000	Diesel	1910	4	82.00	90.40	55
198 A1.000	Petrol	1368	4	72.00	84.00	16
198 A2.000	Diesel	1598	4	79.50	80.50	36
198 A3.000	Diesel	1598	4	79.50	80.50	36
198 A4.000	Petrol	1368	4	72.00	84.00	16
198 A4.000	Petrol	1368	4	72.00	84.00	16
198 A5.000	Diesel	1956	4	83.00	90.40	71
198 A6.000	Diesel	1598	4	79.50	80.50	36
198 A7.000	Petrol	1368	4	72.00	84.00	16
199 A1.000	Diesel	1248	4	69.60	82.00	10
199 A2.000	Diesel	1248	4	69.60	82.00	10
199 A3.000	Diesel	1248	4	69.60	82.00	10
199 A4.000	Petrol	1242	4	70.80	78.90	13
199 A5.000	Diesel	1910	4	82.00	90.40	53
199 A6.000	Petrol	1368	4	72.00	84.00	15
199 A7.000	Petrol	1368	4	72.00	84.00	15
199 A8.000	Petrol	1368	4	72.00	84.00	16
199 A9.000	Diesel	1248	4	69.60	82.00	10
199 B1.000	Diesel	1248	4	69.60	82.00	10
199 B2.000	Diesel	1248	4	69.60	82.00	10
199 B4.000	Diesel	1248	4	69.60	82.00	10
199 B5.000	Diesel	1598	4	79.50	80.50	36
199 B6.000	Petrol	875	2	80.50	86.00	48
199 B8.000	Diesel	1248	4	69.60	82.00	10
199 B9.000	Petrol	1242	4	70.80	78.90	13
203 A/61	Diesel	11548	6	130.00	145.00	160
203 A/61.000	Diesel	11548	6	130.00	145.00	160
203 H/61..	Diesel	11548	6	130.00	145.00	160
220 A 2.000	Petrol	1581	4	86.40	67.40	106
223 A5.000	Petrol	1242	4	70.80	78.90	13
223 A6.000	Diesel	1910	4	82.00	90.40	54
223 A7.000	Diesel	1910	4	82.00	90.40	53
223 A9.000	Diesel	1248	4	69.60	82.00	10
223 B1.000	Diesel	1910	4	82.00	90.40	53
223 B2.000	Diesel	1910	4	82.00	90.40	53
230 A2.000	Diesel	1929	4	82.60	90.00	64
230 A3.000	Diesel	1929	4	82.60	90.00	63
230 A4.000	Diesel	1929	4	82.60	90.00	63
263 A2.000	Diesel	1248	4	69.60	82.00	10
263 A3.000	Diesel	1598	4	79.50	80.50	36
263 A4.000	Diesel	1598	4	79.50	80.50	36
263 A5.000	Diesel	1598	4	79.50	80.50	36
263 A6.000	Diesel	1248	4	69.60	82.00	10
263 A7.000	Diesel	1598	4	79.50	80.50	36
280 A1.000	Diesel	1929	4	82.60	90.00	63
310 A2.011	Flexfuel	1368	4	72.00	84.00	15
312 A1.000	Petrol	1368	4	72.00	84.00	15
312 A2.000	Petrol	875	2	80.50	86.00	48
312 A8.000	Diesel	1248	4	69.60	82.00	10
350 A1.000	Petrol	1368	4	72.00	84.00	15







		cm3	x 			
350 A2.000	Diesel	1598	4	79.50	80.50	36
828A.B2.000	Petrol	1438	4	80.00	71.50	39
831 D1.000	Diesel	1929	4	82.60	90.00	65
834 B.000	Petrol	1995	4	84.00	90.00	92
834 B.048	Petrol	1995	4	84.00	90.00	92
834 B.146	Petrol	1995	4	84.00	90.00	92
834 C.146	Petrol	1995	4	84.00	90.00	88
834 G.000	Petrol	2492	V6	88.00	68.30	107
835 C1.000	Petrol	1581	4	86.40	67.40	106
835 C2.000	Petrol	1756	4	84.00	79.20	79
835 C4.000	Petrol	1756	4	84.00	79.20	79
836 A3.000	Petrol	1995	4	84.00	90.00	90
836 A3.011	Petrol	1995	4	84.00	90.00	90
836 A4.000	Petrol	1372	4	80.50	67.40	46
836 A5.000	Petrol	1756	4	84.00	79.20	79
836 A6.000	Petrol	1756	4	84.00	79.20	79
839 A5.000	Diesel	2387	5	82.00	90.40	56
843 A1.000	Petrol	1368	4	72.00	84.00	15
843 A1.000	Petrol	1368	4	72.00	84.00	15
844 A2.000	Diesel	1956	4	83.00	90.40	71
844 A3.000	Diesel	1598	4	79.50	80.50	36
903	Petrol	903	4	65.00	68.00	4
937 A4.000	Diesel	1910	4	82.00	90.40	55
937 A5.000	Diesel	1910	4	82.00	90.40	55
937 A7.000	Diesel	1910	4	82.00	90.40	55
939 A1.000	Diesel	1910	4	82.00	90.40	53
939 A2.000	Diesel	1910	4	82.00	90.40	55
939 A3.000	Diesel	2387	5	82.00	90.40	57
939 A7.000	Diesel	1910	4	82.00	90.40	53
939 A8.000	Diesel	1910	4	82.00	90.40	53
940 B7.000	Petrol	1368	4	72.00	84.00	16
940 C1.000	Diesel	1598	4	79.50	80.50	36
955 A2.000	Petrol	1368	4	72.00	84.00	15
955 A3.000	Diesel	1598	4	79.50	80.50	36
955 A4.000	Diesel	1598	4	79.50	80.50	36
955 A6.000	Petrol	1368	4	72.00	84.00	15
955 A8.000	Petrol	1368	4	72.00	84.00	15
1170 A1.000	Petrol	899	4	65.00	68.00	4
1170 A1.046	Petrol	899	4	65.00	68.00	4
6132 AZ 2.000	Petrol	1995	4	84.00	90.00	93
8030.00	Diesel	2340	3	95.00	110.00	116
8030.02	Diesel	2592	3	100.00	110.00	120
8035.01	Diesel	2338	3	95.00	110.00	117
8035.02	Diesel	2592	3	100.00	110.00	121
8035.04.265	Diesel	2749	3	103.00	110.00	130
8035.04.270	Diesel	2749	3	103.00	110.00	130
8035.05.214	Diesel	2931	3	104.00	115.00	140
8035.05.215	Diesel	2931	3	104.00	115.00	141
8035.06.200	Diesel	2708	3	100.00	115.00	128
8035.06.206	Diesel	2708	3	100.00	115.00	128
8035.06.208	Diesel	2708	3	100.00	115.00	128
8035.06.216	Diesel	2708	3	100.00	115.00	128
8035.06.220	Diesel	2708	3	100.00	115.00	128
8035.06.222	Diesel	2708	3	100.00	115.00	128
8035.06.223	Diesel	2708	3	100.00	115.00	128
8035.06.306	Diesel	2708	3	100.00	115.00	128
8035.06.307	Diesel	2708	3	100.00	115.00	128
8035.06.308	Diesel	2708	3	100.00	115.00	128
8035.06.309	Diesel	2708	3	100.00	115.00	128
8035.06.317	Diesel	2708	3	100.00	115.00	128
8035.06.320	Diesel	2708	3	100.00	115.00	128
8035.06.321	Diesel	2708	3	100.00	115.00	128
8035.06.322	Diesel	2708	3	100.00	115.00	128
8035.06.323	Diesel	2708	3	100.00	115.00	128
8040.00	Diesel	3120	4	95.00	110.00	118
8040.02	Diesel	3456	4	100.00	110.00	122
8040.02.	Diesel	3456	4	100.00	110.00	123
8040.02.041	Diesel	3456	4	100.00	110.00	122
8040.02.267	Diesel	3456	4	100.00	110.00	122







		cm3	x 			
8040.02.360	Diesel	3456	4	100.00	110.00	122
8040.02.367	Diesel	3456	4	100.00	110.00	122
8040.04.200	Diesel	3666	4	103.00	110.00	131
8040.04.280	Diesel	3666	4	103.00	110.00	131
8040.05.200	Diesel	3908	4	104.00	115.00	142
8040.05.230	Diesel	3908	4	104.00	115.00	142
8040.05.4990	Diesel	3908	4	104.00	115.00	142
8040.25.000	Diesel	3908	4	104.00	115.00	142
8040.25.200	Diesel	3908	4	104.00	115.00	142
8040.25.220	Diesel	3908	4	104.00	115.00	142
8040.25.230	Diesel	3908	4	104.00	115.00	142
8040.25B.4200 (LTC)	Diesel	3908	4	104.00	115.00	142
8040.25X.4000	Diesel	3908	4	104.00	115.00	142
8040.45.261	Diesel	3908	4	104.00	115.00	143
8040.45.271	Diesel	3908	4	104.00	115.00	143
8040.45.4000 (TCA)	Diesel	3908	4	104.00	115.00	143
8040.45.4180 (TCA)	Diesel	3908	4	104.00	115.00	143
8040.45.5200 Euro 2	Diesel	3908	4	104.00	115.00	143
8040.45.5281 Euro 2	Diesel	3908	4	104.00	115.00	143
8040.45D.5100 Euro 2	Diesel	3908	4	104.00	115.00	143
8040.45D.5103 Euro 2	Diesel	3908	4	104.00	115.00	143
8041.05	Diesel	3908	4	104.00	115.00	144
8045.02	Diesel	3456	4	100.00	110.00	124
8045.04.270	Diesel	3666	4	103.00	110.00	132
8045.05.000	Diesel	3908	4	104.00	115.00	145
8045.05.200	Diesel	3908	4	104.00	115.00	145
8045.05.204	Diesel	3908	4	104.00	115.00	145
8045.05.213	Diesel	3908	4	104.00	115.00	145
8045.05.215	Diesel	3908	4	104.00	115.00	145
8045.05.216	Diesel	3908	4	104.00	115.00	145
8045.05.217	Diesel	3908	4	104.00	115.00	145
8045.05.300	Diesel	3908	4	104.00	115.00	145
8045.05.304	Diesel	3908	4	104.00	115.00	145
8045.05.308	Diesel	3908	4	104.00	115.00	145
8045.05.317	Diesel	3908	4	104.00	115.00	145
8045.05.359	Diesel	3908	4	104.00	115.00	145
8045.05.370	Diesel	3908	4	104.00	115.00	145
8045.05.376	Diesel	3908	4	104.00	115.00	145
8045.05.389	Diesel	3908	4	104.00	115.00	145
8045.05.393	Diesel	3908	4	104.00	115.00	145
8045.05.395	Diesel	3908	4	104.00	115.00	145
8045.06.200	Diesel	3613	4	100.00	115.00	129
8045.06.208	Diesel	3613	4	100.00	115.00	129
8045.06.213	Diesel	3613	4	100.00	115.00	129
8045.06.214	Diesel	3613	4	100.00	115.00	129
8045.06.215	Diesel	3613	4	100.00	115.00	129
8045.06.225	Diesel	3613	4	100.00	115.00	129
8045.06.319	Diesel	3613	4	100.00	115.00	129
8045.06.326	Diesel	3613	4	100.00	115.00	129
8045.25.210	Diesel	3908	4	104.00	115.00	146
8055.04.200	Diesel	4583	5	103.00	110.00	133
8055.05.000	Diesel	4885	5	104.00	115.00	147
8060.02.000	Diesel	5184	6	100.00	110.00	125
8060.02.001	Diesel	5184	6	100.00	110.00	125
8060.02.003	Diesel	5184	6	100.00	110.00	125
8060.02.070	Diesel	5184	6	100.00	110.00	125
8060.04.000	Diesel	5499	6	103.00	110.00	134
8060.04.051	Diesel	5499	6	103.00	110.00	135
8060.04.052	Diesel	5499	6	103.00	110.00	134
8060.04.055	Diesel	5499	6	103.00	110.00	134
8060.04.060	Diesel	5499	6	103.00	110.00	134
8060.04.070	Diesel	5499	6	103.00	110.00	134
8060.04.620	Diesel	5499	6	103.00	110.00	134
8060.04.621	Diesel	5499	6	103.00	110.00	134
8060.04.630	Diesel	5499	6	103.00	110.00	134
8060.04.639	Diesel	5499	6	103.00	110.00	134
8060.04.658	Diesel	5499	6	103.00	110.00	134
8060.04.660	Diesel	5499	6	103.00	110.00	134
8060.04.661	Diesel	5499	6	103.00	110.00	134

		cm3	x 			
8060.04.662	Diesel	5499	6	103.00	110.00	134
8060.04.669	Diesel	5499	6	103.00	110.00	134
8060.04.670	Diesel	5499	6	103.00	110.00	134
8060.04.672	Diesel	5499	6	103.00	110.00	134
8060.04.675	Diesel	5499	6	103.00	110.00	134
8060.04.689	Diesel	5499	6	103.00	110.00	136
8060.05.000	Diesel	5861	6	104.00	115.00	148
8060.05.200	Diesel	5861	6	104.00	115.00	148
8060.05.246	Diesel	5861	6	104.00	115.00	148
8060.05.270	Diesel	5861	6	104.00	115.00	148
8060.05.280	Diesel	5861	6	104.00	115.00	148
8060.05.285	Diesel	5861	6	104.00	115.00	148
8060.05.289	Diesel	5861	6	104.00	115.00	148
8060.05.661	Diesel	5861	6	104.00	115.00	148
8060.05.662	Diesel	5861	6	104.00	115.00	148
8060.05.663	Diesel	5861	6	104.00	115.00	148
8060.05.673	Diesel	5861	6	104.00	115.00	148
8060.12	Diesel	5184	6	100.00	110.00	125
8060.12.031	Diesel	5184	6	100.00	110.00	125
8060.24.601	Diesel	5499	6	103.00	110.00	134
8060.24.643	Diesel	5499	6	103.00	110.00	134
8060.24.652	Diesel	5499	6	103.00	110.00	134
8060.24.661	Diesel	5500	6	103.00	110.00	134
8060.24.662	Diesel	5499	6	103.00	110.00	134
8060.24.664	Diesel	5499	6	103.00	110.00	134
8060.24.670	Diesel	5499	6	103.00	110.00	134
8060.24.671	Diesel	5499	6	103.00	110.00	134
8060.24.673	Diesel	5499	6	103.00	110.00	134
8060.24.678	Diesel	5500	6	103.00	110.00	134
8060.25.221	Diesel	5861	6	104.00	115.00	148
8060.25.241	Diesel	5861	6	104.00	115.00	148
8060.25.243	Diesel	5861	6	104.00	115.00	148
8060.25.246	Diesel	5861	6	104.00	115.00	148
8060.25.4600	Diesel	5499	6	103.00	110.00	137
8060.25.600	Diesel	5861	6	104.00	115.00	148
8060.25.621	Diesel	5861	6	104.00	115.00	148
8060.25.630	Diesel	5861	6	104.00	115.00	148
8060.25.631	Diesel	5861	6	104.00	115.00	148
8060.25.641	Diesel	5861	6	104.00	115.00	148
8060.25.661	Diesel	5861	6	104.00	115.00	148
8060.25.662	Diesel	5861	6	104.00	115.00	148
8060.25.663	Diesel	5861	6	104.00	115.00	148
8060.25.669	Diesel	5861	6	104.00	115.00	148
8060.25.670	Diesel	5861	6	104.00	115.00	148
8060.25.673	Diesel	5861	6	104.00	115.00	148
8060.25.678	Diesel	5861	6	104.00	115.00	148
8060.25.679	Diesel	5861	6	104.00	115.00	148
8060.25R.4200	Diesel	5861	6	104.00	115.00	148
8060.25R.4280	Diesel	5861	6	104.00	115.00	148
8060.25V.4000	Diesel	5861	6	104.00	115.00	148
8060.25V.4080	Diesel	5861	6	104.00	115.00	148
8060.45.4100 Euro 1	Diesel	5861	6	104.00	115.00	148
8060.45.4180 Euro 1	Diesel	5861	6	104.00	115.00	148
8060.45.600	Diesel	5861	6	104.00	115.00	148
8060.45.6090	Diesel	5861	6	104.00	115.00	148
8060.45S.6000	Diesel	5861	6	104.00	115.00	148
8060.45S.6700 Euro 1	Diesel	5861	6	104.00	115.00	148
8060.45S.6800 Euro 1	Diesel	5861	6	104.00	115.00	148
8062.24.070	Diesel	5499	6	103.00	110.00	134
8065.02.007	Diesel	5184	6	100.00	110.00	126
8065.02.200	Diesel	5184	6	100.00	110.00	127
8065.04.200	Diesel	5499	6	103.00	110.00	138
8065.05.000	Diesel	5863	6	104.00	115.00	149
8065.05.210	Diesel	5863	6	104.00	115.00	149
8065.05.220	Diesel	5863	6	104.00	115.00	149
8065.05.290	Diesel	5863	6	104.00	115.00	149
8065.05.295	Diesel	5863	6	104.00	115.00	149
8065.05.297	Diesel	5863	6	104.00	115.00	149
8065.05.300	Diesel	5863	6	104.00	115.00	149

		cm ³	x 			
8065.05.330	Diesel	5863	6	104.00	115.00	149
8065.24.000	Diesel	5499	6	103.00	110.00	139
8065.24.300	Diesel	5499	6	103.00	110.00	139
8065.25.000	Diesel	5863	6	104.00	115.00	150
8065.25.010	Diesel	5863	6	104.00	115.00	150
8065.25.080	Diesel	5863	6	104.00	115.00	150
8065.25.320	Diesel	5863	6	104.00	115.00	150
8140.27	Diesel	2500	4	93.00	92.00	113
8140.27.2100	Diesel	2500	4	93.00	92.00	113
8140.27S.3700	Diesel	2499	4	93.00	92.00	113
8140.43	Diesel	2800	4	94.40	100.00	115
8140.43N	Diesel	2798	4	94.40	100.00	115
8140.43S	Diesel	2798	4	94.40	100.00	115
8140.47	Diesel	2500	4	93.00	92.00	113
8140.47.3700	Diesel	2499	4	93.00	92.00	113
8140.47R	Diesel	2500	4	93.00	92.00	113
8140.47R.2210	Diesel	2499	4	93.00	92.00	113
8140.61	Diesel	2440	4	93.00	90.00	112
8140.61	Diesel	2445	4	93.00	90.00	112
8140.61.204	Diesel	2445	4	93.00	90.00	112
8140.63	Diesel	2800	4	94.40	100.00	115
8140.67	Diesel	2500	4	93.00	92.00	113
8140.67.2700	Diesel	2499	4	93.00	92.00	113
8142.61	Diesel	2445	4	93.00	90.00	112
8144.21	Diesel	2445	4	93.00	90.00	112
8144.21.220	Diesel	2445	4	93.00	90.00	112
8144.61	Diesel	2428	4	93.00	90.00	112
8144.61.200	Diesel	2445	4	93.00	90.00	112
8144.61.500.81	Diesel	2445	4	93.00	90.00	112
8144.65	Diesel	1995	4	88.00	82.00	109
8144.67	Diesel	2500	4	93.00	92.00	113
8144.67.220	Diesel	2499	4	93.00	92.00	113
8144.81.2000	Diesel	2445	4	93.00	90.00	112
8144.91.2000	Diesel	2445	4	93.00	90.00	112
8144.97	Diesel	2499	4	93.00	92.00	113
8144.97.2200	Diesel	2499	4	93.00	92.00	113
8144.97.2400	Diesel	2499	4	93.00	92.00	113
8144.97.2500	Diesel	2500	4	93.00	92.00	113
8144.97 S	Diesel	2500	4	93.00	92.00	113
8144.97 Y	Diesel	2500	4	93.00	92.00	113
8210.02.000	Diesel	13798	6	137.00	156.00	161
8210.02.020	Diesel	13798	6	137.00	156.00	161
8210.02.022	Diesel	13798	6	137.00	156.00	161
8210.02.032	Diesel	13798	6	137.00	156.00	161
8210.02.033	Diesel	13798	6	137.00	156.00	161
8210.02.053	Diesel	13798	6	137.00	156.00	161
8210.02.067	Diesel	13798	6	137.00	156.00	161
8210.02.069	Diesel	13798	6	137.00	156.00	161
8210.02.081	Diesel	13798	6	137.00	156.00	161
8210.02.266	Diesel	13798	6	137.00	156.00	161
8210.02.267	Diesel	13798	6	137.00	156.00	161
8210.02.290	Diesel	13798	6	137.00	156.00	161
8210.02.371	Diesel	13798	6	137.00	156.00	161
8210.02.373	Diesel	13798	6	137.00	156.00	161
8210.02.377	Diesel	13798	6	137.00	156.00	161
8210.02.385	Diesel	13798	6	137.00	156.00	161
8210.02.393	Diesel	13798	6	137.00	156.00	161
8210.02.405	Diesel	13798	6	137.00	156.00	161
8210.02.426	Diesel	13798	6	137.00	156.00	161
8210.02.440	Diesel	13798	6	137.00	156.00	161
8210.02.441	Diesel	13798	6	137.00	156.00	161
8210.02.731	Diesel	13798	6	137.00	156.00	161
8210.02.791	Diesel	13798	6	137.00	156.00	161
8210.02.793	Diesel	13798	6	137.00	156.00	161
8210.22.000	Diesel	13798	6	137.00	156.00	161
8210.22.069	Diesel	13798	6	137.00	156.00	161
8210.22.101	Diesel	13798	6	137.00	156.00	161
8210.22.105	Diesel	13798	6	137.00	156.00	161
8210.22.171	Diesel	13798	6	137.00	156.00	161

		cm3	x 			
8210.22.175	Diesel	13798	6	137.00	156.00	161
8210.22.183	Diesel	13798	6	137.00	156.00	161
8210.22.235	Diesel	13798	6	137.00	156.00	161
8210.22.269	Diesel	13798	6	137.00	156.00	161
8210.22.290	Diesel	13798	6	137.00	156.00	161
8210.22.317	Diesel	13798	6	137.00	156.00	161
8210.22.327	Diesel	13798	6	137.00	156.00	161
8210.22.373	Diesel	13798	6	137.00	156.00	161
8210.22.385	Diesel	13798	6	137.00	156.00	161
8210.22.406	Diesel	13798	6	137.00	156.00	162
8210.22.569	Diesel	13798	6	137.00	156.00	162
8210.22.869	Diesel	13798	6	137.00	156.00	161
8210.22X.069	Diesel	13798	6	137.00	156.00	161
8210.22X.235	Diesel	13798	6	137.00	156.00	161
8210.22X.523	Diesel	13798	6	137.00	156.00	161
8210.22X.575	Diesel	13798	6	137.00	156.00	161
8210.42(TCA)	Diesel	13798	6	137.00	156.00	161
8210.42.009	Diesel	13798	6	137.00	156.00	161
8210.42.061	Diesel	13798	6	137.00	156.00	161
8210.42.073	Diesel	13798	6	137.00	156.00	161
8210.42.101	Diesel	13798	6	137.00	156.00	161
8210.42.115	Diesel	13798	6	137.00	156.00	161
8210.42.151	Diesel	13798	6	137.00	156.00	161
8210.42.152	Diesel	13798	6	137.00	156.00	161
8210.42.154	Diesel	13798	6	137.00	156.00	161
8210.42.155	Diesel	13798	6	137.00	156.00	161
8210.42.161	Diesel	13798	6	137.00	156.00	161
8210.42.162	Diesel	13798	6	137.00	156.00	161
8210.42.165	Diesel	13798	6	137.00	156.00	161
8210.42.171	Diesel	13798	6	137.00	156.00	161
8210.42.172	Diesel	13798	6	137.00	156.00	161
8210.42.173	Diesel	13798	6	137.00	156.00	161
8210.42.174	Diesel	13798	6	137.00	156.00	161
8210.42.175	Diesel	13798	6	137.00	156.00	161
8210.42.176	Diesel	13798	6	137.00	156.00	161
8210.42.177	Diesel	13798	6	137.00	156.00	161
8210.42.181	Diesel	13798	6	137.00	156.00	161
8210.42.182	Diesel	13798	6	137.00	156.00	161
8210.42.185	Diesel	13798	6	137.00	156.00	161
8210.42.186	Diesel	13798	6	137.00	156.00	161
8210.42.191	Diesel	13798	6	137.00	156.00	161
8210.42.192	Diesel	13798	6	137.00	156.00	161
8210.42.195	Diesel	13798	6	137.00	156.00	161
8210.42.196	Diesel	13798	6	137.00	156.00	161
8210.42.290	Diesel	13798	6	137.00	156.00	161
8210.42 K	Diesel	13798	6	137.00	156.00	161
8210.42K.(TCA)	Diesel	13798	6	137.00	156.00	161
8210.42L.(TCA) Euro 1	Diesel	13798	6	137.00	156.00	161
8210.42L.400	Diesel	13798	6	137.00	156.00	161
8210.42L.TCA	Diesel	13798	6	137.00	156.00	161
8210.42M.(TCA) Euro 2	Diesel	13798	6	137.00	156.00	161
8210.42R.269	Diesel	13798	6	137.00	156.00	161
8211.02.032	Diesel	13798	6	137.00	156.00	163
8220.02.701	Diesel	9572	6	125.00	130.00	159
8220.02.834	Diesel	9572	6	125.00	130.00	159
8220.02.842	Diesel	9570	6	125.00	130.00	159
8220.02.842	Diesel	9572	6	125.00	130.00	159
8220.02.847	Diesel	9572	6	125.00	130.00	159
8220.02.856	Diesel	9572	6	125.00	130.00	159
8220.02.870	Diesel	9572	6	125.00	130.00	159
8220.12.001	Diesel	9570	6	125.00	130.00	159
8220.12.709	Diesel	9572	6	125.00	130.00	159
8220.22.002	Diesel	9572	6	125.00	130.00	159
8220.22.102	Diesel	9572	6	125.00	130.00	159
8220.22.104	Diesel	9572	6	125.00	130.00	159
8220.22.106	Diesel	9572	6	125.00	130.00	159
8220.22.708	Diesel	9570	6	125.00	130.00	159
8220.22.709	Diesel	9570	6	125.00	130.00	159
8220.32.701	Diesel	9572	6	125.00	130.00	159

		cm3	x 			
8220.32.721	Diesel	9570	6	125.00	130.00	159
8220.32.723	Diesel	9570	6	125.00	130.00	159
8260.02.405	Diesel	12880	6	145.00	130.00	164
8280.01.000	Diesel	17174	V8	145.00	130.00	165
8280.02.000	Diesel	17174	V8	145.00	130.00	165
8280.02.024	Diesel	17174	V8	145.00	130.00	165
8280.02.082	Diesel	17174	V8	145.00	130.00	165
8280.02.109	Diesel	17174	V8	145.00	130.00	165
8280.02.120	Diesel	17174	V8	145.00	130.00	165
8280.02.125-135	Diesel	17174	V8	145.00	130.00	165
8280.02.128	Diesel	17174	V8	145.00	130.00	165
8280.02.269	Diesel	17174	V8	145.00	130.00	165
8280.02.274	Diesel	17174	V8	145.00	130.00	165
8280.02.275	Diesel	17174	V8	145.00	130.00	165
8280.02.289	Diesel	17174	V8	145.00	130.00	165
8280.02.405	Diesel	17174	V8	145.00	130.00	165
8280.22.007	Diesel	17174	V8	145.00	130.00	165
8280.22.009	Diesel	17174	V8	145.00	130.00	165
8280.22.033	Diesel	17174	V8	145.00	130.00	165
8280.22.048	Diesel	17174	V8	145.00	130.00	165
8280.22.054	Diesel	17174	V8	145.00	130.00	165
8280.22.154	Diesel	17174	V8	145.00	130.00	165
8280.22.201	Diesel	17174	V8	145.00	130.00	165
8280.22.205	Diesel	17174	V8	145.00	130.00	165
8280.42.001	Diesel	17174	V8	145.00	130.00	166
8280.42.050	Diesel	17174	V8	145.00	130.00	166
8280.42S.(TCA)	Diesel	17173	V8	145.00	130.00	166
8280.42S.350	Diesel	17174	V8	145.00	130.00	166
8281.22.201	Diesel	17174	V8	145.00	130.00	165
8282.02.000	Diesel	17174	V8	145.00	130.00	165
8282.02.109	Diesel	17174	V8	145.00	130.00	165
8340.05	Diesel	5400	4	115.00	130.00	154
8360.05	Diesel	8100	6	115.00	130.00	155
8360.05.B	Diesel	8100	6	115.00	130.00	156
8360.46B.4591	Diesel	7684	6	112.00	130.00	153
8365.05.500	Diesel	8101	6	115.00	130.00	157
8365.05.590	Diesel	8101	6	115.00	130.00	157
8365.25.500	Diesel	8101	6	115.00	130.00	157
8365.25.501	Diesel	8101	6	115.00	130.00	157
8365.25.502	Diesel	8101	6	115.00	130.00	157
8365.25.503	Diesel	8101	6	115.00	130.00	157
8460.21.002	Diesel	9498	6	120.00	140.00	158
55260384	Diesel	1598	4	79.50	80.50	36
55263087	Diesel	1956	4	83.00	90.40	72
55263088	Diesel	1956	4	83.00	90.40	72
55263623	Petrol	1368	4	72.00	84.00	16
55263624	Petrol	1368	4	72.00	84.00	16
55266963	Diesel	1248	4	69.60	82.00	10
A112A1.000	Petrol	982	4	65.00	74.00	5
A112A2.000	Petrol	1050	4	67.20	74.00	8
A112A 5.000	Petrol	903	4	65.00	68.00	4
A 112 AB.2C.0	Petrol	1050	4	67.20	74.00	8
A112B1.000	Petrol	965	4	67.20	68.00	7
A 112 B1.054	Petrol	965	4	67.20	68.00	7
A112B1.054	Petrol	965	4	67.20	68.00	7
A112B2.000	Petrol	903	4	65.00	68.00	4
B 25.637	Diesel	2498	4	93.00	92.00	114
C 03	Diesel	4940	4	110.00	130.00	151
C 03-36	Diesel	4940	4	110.00	130.00	151
C 03-80	Diesel	4940	4	110.00	130.00	151
CP 3	Diesel	7412	6	110.00	130.00	152
CP 3/32.1.200	Diesel	7412	6	110.00	130.00	152
CP 3-100	Diesel	7412	6	110.00	130.00	152
CRD93L (U25-661)	Diesel	2500	4	93.00	92.00	114
D8B	Diesel	1905	4	83.00	88.00	68
D8B (XUD9TE)	Diesel	1905	4	83.00	88.00	68
D9B	Diesel	1905	4	83.00	88.00	69
D9B (XUD9A)	Diesel	1905	4	83.00	88.00	69
D19AA	Diesel	1910	4	82.00	90.40	53

		cm3	x 			
DHX (XUD9TE)	Diesel	1905	4	83.00	88.00	68
DHX (XUD9TF/L)	Diesel	1905	4	83.00	88.00	68
DJY (XUD9)	Diesel	1905	4	83.00	88.00	70
DJY	Diesel	1905	4	83.00	88.00	69
DW10BTED4	Diesel	1997	4	85.00	88.00	95
EAF	Petrol	1368	4	72.00	84.00	16
F1AE0481C	Diesel	2286	4	88.00	94.00	110
F1AE0481D	Diesel	2287	4	88.00	94.00	110
F1AE0481N	Diesel	2287	4	88.00	94.00	110
F1AE0481T	Diesel	2286	4	88.00	94.00	110
F1AE3481D	Diesel	2287	4	88.00	94.00	110
F1AE3481E	Diesel	2287	4	88.00	94.00	110
F1AE3481G	Diesel	2287	4	88.00	94.00	110
F1CE0481D Euro 4	Diesel	2999	4	95.80	104.00	119
F1CE3481E Euro 5	Diesel	2999	4	95.80	104.00	119
F1CE3481M Euro 5	Diesel	2999	4	95.80	104.00	119
F1CE3481N Euro 5	Diesel	2999	4	95.80	104.00	119
F1CFA401A Euro 6	Petrol	2998	4	95.80	104.00	119
FPT	Diesel	2287	4	88.00	94.00	110
KFT	Petrol	1360	4	75.00	77.00	20
KFV	Petrol	1360	4	75.00	77.00	20
LFW	Petrol	1761	4	83.00	81.40	67
M16A	Petrol	1586	4	78.00	83.00	34
M020 AA.09.0	Petrol	903	4	65.00	68.00	4
P8C	Diesel	2088	4	85.00	92.00	96
RFH (EW10A)	Petrol	1997	4	85.00	88.00	94
RFL	Petrol	1998	4	86.00	86.00	99
RFN (EW10J4)	Petrol	1997	4	85.00	88.00	94
RFU (XU10J2C)	Petrol	1998	4	86.00	86.00	99
RFV	Petrol	1998	4	86.00	86.00	99
RFW	Petrol	1998	4	86.00	86.00	99
RGX (XU10J2CTE)	Petrol	1998	4	86.00	86.00	99
RHH	Diesel	1997	4	85.00	88.00	95
RHK	Diesel	1997	4	85.00	88.00	95
RHM (DW10ATED4)	Diesel	1997	4	85.00	88.00	95
RHR	Diesel	1997	4	85.00	88.00	95
RHV (DW10)	Diesel	1997	4	85.00	88.00	95
RHW (DW10ATED4)	Diesel	1997	4	85.00	88.00	95
RHX	Diesel	1997	4	85.00	88.00	95
RHZ	Diesel	1997	4	85.00	88.00	95
THY (DK5ATE)	Diesel	2446	4	92.00	92.00	111
TU1JP	Petrol	1124	4	72.00	69.00	14
WJY (DW8)	Diesel	1868	4	82.20	88.00	58
WJY (DW8B)	Diesel	1868	4	82.20	88.00	58
WJZ (DW8)	Diesel	1868	4	82.20	88.00	58
XM7T	Petrol	1796	4	84.00	81.00	82
XN 1T	Petrol	1971	4	88.00	81.00	108

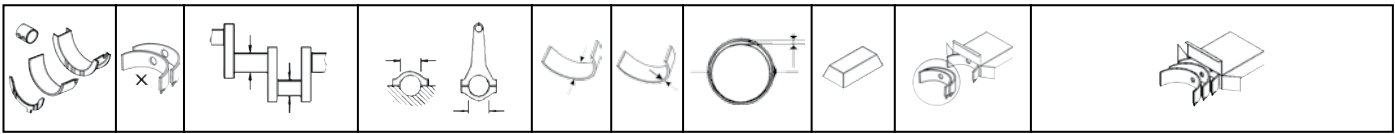

1										65.00 x 58.00	
141 A4.000		4 Cyl.		769cc	25kW (34PS)	Petrol				TD931	
141 A4.048		4 Cyl.		770cc	25kW (34PS)	Petrol				TD930	
141 B.000		4 Cyl.		769cc	25kW (34PS)	Petrol				TD4370	
BE/PL	4	39,985/40,005	43,657/43,670	16,550	1,813	0,026/0,084	AL-LF	3025RA	01-4139/4 STD 0.25 0.50		
MB/HL 1,3	2	50,785/50,805	54,507/54,520	20,620	1,837	0,028/0,086	AL-LF	62006RA	H1039/3 STD 0.25 0.50		
MB/HL 2	1	50,790/50,810	54,507/54,520	22,780	1,837	0,028/0,086	AL-LF	62007RA			
TW/A	2	54,610/54,864	69,596/69,850		2,362		AL-LF	2897AFF	A182/2 STD		
2										65.00 x 58.00	
156 A4.000		4 Cyl.		770cc	25kW (34PS)	Petrol				TD11307	
156 A4.048		4 Cyl.		770cc	25kW (34PS)	Petrol				TD11308	
BE/PL	4	37,998/38,008	41,128/41,140	19,000	1,549	0,022/0,069	AL-LF	1015RA	01-4116/4 STD 0.25 0.50		
MB/HL 3	2	48,000/48,100	63,800/64,000		2,325		AL-LF	04-4075	H1067/5 STD 0.25 0.50		
MB/HL 1-5	5	43,990/44,000	47,705/47,718	19,000	1,841	0,023/0,081	AL-LF	1016RA			
MB/HL 1-5	9	43,990/44,000	47,705/47,718	19,000	1,848	0,020/0,057	AL-LF	4271RA	H1091/5 STD		
MB/HL 3	1	43,990/44,000	47,705/47,718	23,910	1,848	0,020/0,057	AL-LF	4272RAH			
3										65.00 x 63.50	
100 G.000		4 Cyl.		843cc	25kW (34PS)	Petrol				TD863	
100 G.002		4 Cyl.		843cc	27kW (37PS)	Petrol				TD864	
100 GB.000		4 Cyl.		843cc	35kW (47PS)	Petrol				TD865	
100 GC.000		4 Cyl.		843cc	38kW (52PS)	Petrol				TD868	
100 GL6.000		4 Cyl.		843cc	25kW (34PS)	Petrol				TD21449	
126G100		4 Cyl.		843cc	26kW (35PS)	Petrol				TD31689	
BE/PL	4	39,985/40,005	43,657/43,670	16,550	1,813	0,026/0,084	AL-LF	3025RA	01-4139/4 STD 0.25 0.50		
MB/HL 1,3	2	50,785/50,805	54,507/54,520	20,620	1,837	0,028/0,086	AL-LF	62006RA	H1039/3 STD 0.25 0.50		
MB/HL 2	1	50,790/50,810	54,507/54,520	22,780	1,837	0,028/0,086	AL-LF	62007RA			
TW/A	2	54,610/54,864	69,596/69,850		2,362		AL-LF	2897AFF	A182/2 STD		
4										65.00 x 68.00	
9A		4 Cyl.		903cc	33kW (45PS)	Petrol				TD21688	
100 GBC.000		4 Cyl.		903cc	38kW (52PS)	Petrol				TD866	
100 GBC.040		4 Cyl.		903cc	38kW (52PS)	Petrol				TD23115	
100 GBS.000		4 Cyl.		903cc	38kW (52PS)	Petrol				TD867	
100 GF 000		4 Cyl.		903cc	26kW (35PS)	Petrol				TD6939	
100 GL 064		4 Cyl.		903cc	33kW (45PS)	Petrol				TD1643	
100 GL. 0.64		4 Cyl.		903cc	44kW (60PS)	Petrol				TD9410	
100 GL.000		4 Cyl.		903cc	30-33kW (41-45PS)	Petrol				TD870	
100 GL.040		4 Cyl.		903cc	38kW (52PS)	Petrol				TD22509	
100 GL.048		4 Cyl.		903cc	29kW (40PS)	Petrol				TD4413	
100 GL.064		4 Cyl.		903cc	33kW (45PS)	Petrol				TD23116	
100 GL3.000		4 Cyl.		903cc	33kW (45PS)	Petrol				TD869	

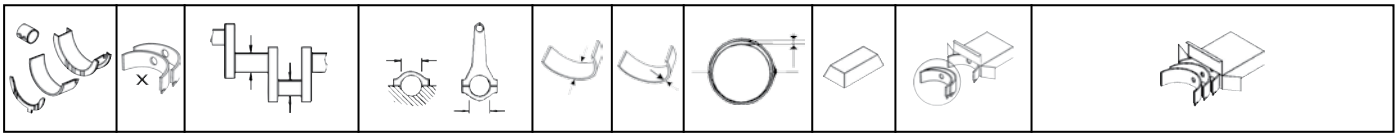

112 A .000			4 Cyl.	903cc	29-35kW (39-48PS)		Petrol		TD23355
127 A.000			4 Cyl.	1049cc	37-41kW (50-56PS)		Petrol		TD887
146 A.000			4 Cyl.	903cc	33kW (45PS)		Petrol		TD4371
146 A.048			4 Cyl.	903cc	33kW (45PS)		Petrol		TD934
146 A1.000			4 Cyl.	903cc	33kW (45PS)		Petrol		TD4372
170 A1.000			4 Cyl.	903cc	30kW (41PS)		Petrol		TD15810
170 A1.046			4 Cyl.	903cc	30kW (41PS)		Petrol		TD15811
903			4 Cyl.	903cc	33kW (45PS)		Petrol		TD6824
1170 A1.000			4 Cyl.	899cc	29-30kW (40-41PS)		Petrol		TD1030
1170 A1.046			4 Cyl.	899cc	29kW (39PS)		Petrol		TD872
A112A 5.000			4 Cyl.	903cc	31-34kW (42-46PS)		Petrol		TD5111
A112B2.000			4 Cyl.	903cc	31kW (42PS)		Petrol		TD13430
M020 AA.09.0			4 Cyl.	903cc	33kW (45PS)		Petrol		TD22241

BE/PL	4	39,985/40,005	43,657/43,670	16,550	1,813	0,026/0,084	AL-LF	3025RA	01-4139/4 STD 0.25 0.50
MB/HL 1,3	2	50,785/50,805	54,507/54,520	20,620	1,837	0,028/0,086	AL-LF	62006RA	H1039/3 STD 0.25 0.50
MB/HL 2	1	50,790/50,810	54,507/54,520	22,780	1,837	0,028/0,086	AL-LF	62007RA	
TW/A	2	54,610/54,864	69,596/69,850		2,362		AL-LF	2897AFF	A182/2 STD

5 65.00 x 74.00

A112A1.000			4 Cyl.	982cc	43kW (58PS)		Petrol		TD5114
BE/PL	4	39,985/40,005	43,657/43,670	16,550	1,813	0,026/0,084	AL-LF	3025RA	01-4139/4 STD 0.25 0.50
MB/HL 1,3	2	50,785/50,805	54,507/54,520	20,620	1,837	0,028/0,086	AL-LF	62006RA	H1039/3 STD 0.25 0.50
MB/HL 2	1	50,790/50,810	54,507/54,520	22,780	1,837	0,028/0,086	AL-LF	62007RA	
TW/A	2	54,610/54,864	69,596/69,850		2,362		AL-LF	2897AFF	A182/2 STD

6 66.00 x 70.00

110.000			2 Cyl.	479cc			Petrol		FM522
BE/PL	2	44,013/44,033	47,130/47,142	19,200	1,543	0,011/0,068	AL-LF	60005RA	01-4112/2 STD 0.25 0.50
SE/PB	1	19,507/19,609	22,009/22,034	20,830			BS	60009X	55-4210 SEMI

7 67.20 x 68.00

A 112 B1.054			4 Cyl.	965cc	35-36kW (48-49PS)		Petrol		TD4412
A112B1.000			4 Cyl.	965cc	35kW (48PS)		Petrol		TD5113
A112B1.054			4 Cyl.	965cc	30-36kW (40-48PS)		Petrol		TD404
BE/PL	4	39,985/40,005	43,657/43,670	16,550	1,813	0,026/0,084	AL-LF	3025RA	01-4139/4 STD 0.25 0.50
MB/HL 1,3	2	50,785/50,805	54,507/54,520	20,620	1,837	0,028/0,086	AL-LF	62006RA	H1039/3 STD 0.25 0.50
MB/HL 2	1	50,790/50,810	54,507/54,520	22,780	1,837	0,028/0,086	AL-LF	62007RA	
TW/A	2	54,610/54,864	69,596/69,850		2,362		AL-LF	2897AFF	A182/2 STD

8 67.20 x 74.00

A 112 AB.2C.0			4 Cyl.	1050cc	51kW (70PS)		Petrol		TD22319
A112A2.000			4 Cyl.	1050cc	51kW (70PS)		Petrol		TD5112
BE/PL	4	39,985/40,005	43,657/43,670	16,550	1,813	0,026/0,084	AL-LF	3025RA	01-4139/4 STD 0.25 0.50

MB/HL 1,3	2	53,910/53,930	57,548/57,561	20,620	1,797		AL-LF	66446RA	H1178/3 STD 0.25
MB/HL 2	1	53,910/53,930	57,548/57,561	21,340	1,797		AL-LF	66447RA	
TW/A	2	59,436/59,960	72,771/73,025		2,320		AL-LF	66447BF	A206/2 STD

9	67.40 x 70.00								
110 D.000			2 Cyl.	499cc	13kW (18PS)		Petrol		TD23456
110 F.000			2 Cyl.	499cc	13kW (18PS)		Petrol		TD871
120.000			2 Cyl.	499cc	13kW (18PS)		Petrol		TD873
BE/PL	2	44,013/44,033	47,130/47,142	19,200	1,543	0,011/0,068	AL-LF	60005RA	01-4112/2 STD 0.25 0.50
SE/PB	1	19,507/19,609	22,009/22,034	20,830			BS	60009X	55-4210 SEMI

10	69.60 x 82.00								
169 A1.000			4 Cyl.	1248cc	55kW (75PS)		Diesel		TD20236
169 A5.000			4 Cyl.	1248cc	55kW (75PS)		Diesel Turbo Intercooler		TD24711
188 A8.000			4 Cyl.	1248cc	51kW (70PS)		Diesel Turbo Intercooler		TD23866
188 A9.000			4 Cyl.	1248cc	51-55kW (70-75PS)		Diesel Turbo Intercooler		TD17456
199 A1.000			4 Cyl.	1248cc	55kW (75PS)		Diesel Turbo		TD29726
199 A2.000			4 Cyl.	1248cc	55-56kW (75-76PS)		Diesel Turbo Intercooler		TD20240
199 A3.000			4 Cyl.	1248cc	66-70kW (90-95PS)		Diesel Turbo Intercooler		TD20241
199 A9.000 Euro 5			4 Cyl.	1248cc	55kW (75PS)		Diesel Turbo Intercooler		TD23573
199 B1.000 Euro 5			4 Cyl.	1248cc	70kW (95PS)		Diesel Turbo Intercooler		TD23574
199 B2.000 Euro 5			4 Cyl.	1248cc	51kW (69PS)		Diesel Turbo Intercooler		TD23578
199 B4.000 Euro 5/6			4 Cyl.	1248cc	62kW (84PS)		Diesel Turbo Intercooler		TD24898
199 B8.000			4 Cyl.	1248cc	59kW (80PS)		Diesel		TD29432
223 A9.000			4 Cyl.	1248cc	62kW (84PS)		Diesel Turbo Intercooler		TD20243
263 A2.000			4 Cyl.	1248cc	66kW (90PS)		Diesel Turbo Intercooler		TD24796
263 A6.000			4 Cyl.	1248cc	55kW (75PS)		Diesel Turbo Intercooler		TD31011
312 A8.000 Euro 6			4 Cyl.	1248cc	59kW (80PS)		Diesel Turbo Intercooler		TD29720
55266963			4 Cyl.	1248cc	70kW (95PS)		Diesel Turbo Intercooler		TD31788
BE/PL	4	42,582/42,600	45,734/45,744	20,000	1,552	0,030/0,062	BS	71-4033	71-4033/4 STD .010
MB/HL 1,2,4,5	4	50,982/51,000	54,710/54,722	19,000	1,840	0,026/0,050	AL-LF	02-4034	H1011/5 STD 0.25
MB/HL 3	1	50,982/51,000	54,710/54,722	23,950	1,840	0,026/0,050	AL-LF	02-4035H	
SE/PB	1	23,000	25,747/25,772	25,000			BS-LF	55-4077	55-4077 SEMI

11	70.00 x 64.90								
141 C2.000			4 Cyl.	999cc	31-33kW (42-45PS)		Petrol		TD1070
146 B4.000			4 Cyl.	999cc	31-35kW (42-48PS)		Petrol		TD18820
156 A2.000			4 Cyl.	999cc	31-37kW (42-50PS)		Petrol		TD16230
156 A2.0157			4 Cyl.	999cc	33kW (45PS)		Petrol		TD22227
156 A2.050			4 Cyl.	999cc	33kW (45PS)		Petrol		TD22228
156 A2.100			4 Cyl.	999cc	31-33kW (42-45PS)		Petrol		TD394
156 A2.100			4 Cyl.	999cc	32-33kW (44-45PS)		Petrol		TD4387
156 A2.146			4 Cyl.	999cc	33kW (45PS)		Petrol		TD993
156 A2.246			4 Cyl.	999cc	33kW (45PS)		Petrol		TD994
156 A3.000			4 Cyl.	999cc	37kW (50PS)		Petrol		TD16209
156 A3.100			4 Cyl.	999cc	32-33kW (44-45PS)		Petrol		TD4386
156A2.000			4 Cyl.	999cc	33kW (45PS)		Petrol		TD393

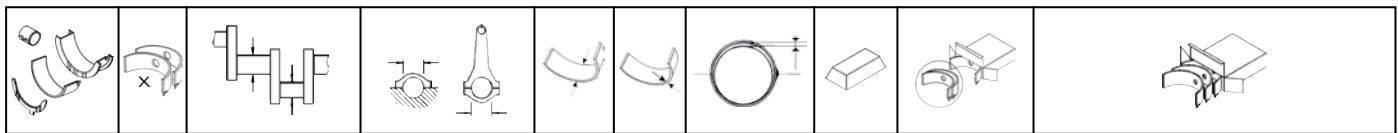

156A2.146			4 Cyl.	999cc	33kW (43PS)		Petrol		TD395
156A2.246			4 Cyl.	999cc	33kW (45PS)		Petrol		TD16210
156A2.256			4 Cyl.	999cc	33kW (45PS)		Petrol		TD396
156A3.000			4 Cyl.	999cc	32-37kW (44-50PS)		Petrol		TD397
178 D9.011			4 Cyl.	999cc	40-52kW (54-71PS)		Petrol		TD25000
178 F1.011			4 Cyl.	999cc	48-55kW (65-75PS)		Petrol		TD25003

BE/PL	4	37,998/38,008	41,128/41,140	19,000	1,549	0,022/0,069	AL-LF	1015RA	01-4116/4 STD 0.25 0.50
MB/HL 3	2	48,000/48,100	63,800/64,000		2,325		AL-LF	04-4075	H1067/5 STD 0.25 0.50
MB/HL 1-5	5	43,990/44,000	47,705/47,718	19,000	1,841	0,023/0,081	AL-LF	1016RA	
MB/HL 1-5	9	43,990/44,000	47,705/47,718	19,000	1,848	0,020/0,057	AL-LF	4271RA	H1091/5 STD
MB/HL 3	1	43,990/44,000	47,705/47,718	23,910	1,848	0,020/0,057	AL-LF	4272RAH	

12 70.00 x 72.00

156 C.046			4 Cyl.	1108cc	37-43kW (50-58PS)		Petrol		TD4389
156C.000			4 Cyl.	1108cc	42kW (57PS)		Petrol		TD398
156C.046			4 Cyl.	1108cc	42kW (57PS)		Petrol		TD399
160 A3.000			4 Cyl.	1108cc	41-42kW (56-57PS)		Petrol		TD10189
176 A6.000			4 Cyl.	1108cc	40kW (54PS)		Petrol		TD1036
176 B2.000			4 Cyl.	1108cc	40kW (54PS)		Petrol		TD4396
187 A1.000			4 Cyl.	1108cc	40-42kW (54-57PS)		Petrol		TD17847

BE/PL	4	37,998/38,008	41,128/41,140	19,000	1,549	0,022/0,069	AL-LF	1015RA	01-4116/4 STD 0.25 0.50
MB/HL 3	2	48,000/48,100	63,800/64,000		2,325		AL-LF	04-4075	H1067/5 STD 0.25 0.50
MB/HL 1-5	5	43,990/44,000	47,705/47,718	19,000	1,841	0,023/0,081	AL-LF	1016RA	
MB/HL 1-5	9	43,990/44,000	47,705/47,718	19,000	1,848	0,020/0,057	AL-LF	4271RA	H1091/5 STD
MB/HL 3	1	43,990/44,000	47,705/47,718	23,910	1,848	0,020/0,057	AL-LF	4272RAH	

13 70.80 x 78.90

169 A4.000			4 Cyl.	1242cc	51kW (69PS)		Petrol		TD20928
176 A7.000			4 Cyl.	1242cc	43-44kW (58-60PS)		Petrol		TD1037
176 A8.000			4 Cyl.	1242cc	54kW (73PS)		Petrol		TD1038
176 B1.000			4 Cyl.	1242cc	44kW (60PS)		Petrol		TD1032
176 B4.000			4 Cyl.	1242cc	44kW (60PS)		Petrol		TD1076
176 B9.000			4 Cyl.	1242cc	63kW (86PS)		Petrol		TD9727
178 B5.000			4 Cyl.	1242cc	50-55kW (68-75PS)		Petrol		TD10188
178 B7.045			4 Cyl.	1242cc	44-60kW (60-82PS)		Petrol		TD18895
178 C4.066			4 Cyl.	1242cc	44-46kW (60-63PS)		Petrol		TD20237
178 E2.000			4 Cyl.	1242cc	50-54kW (68-73PS)		Petrol		TD16737
182 B2.000			4 Cyl.	1242cc	60-64kW (82-87PS)		Petrol		TD11807
188 A4.000			4 Cyl.	1242cc	44kW (60PS)		Petrol		TD24580
188 A4.000			4 Cyl.	1242cc	44kW (60PS)		Petrol		TD12790
188 A5.000			4 Cyl.	1242cc	57-59kW (78-80PS)		Petrol		TD12791
199 A4.000 Euro 4			4 Cyl.	1242cc	48-51kW (65-69PS)		Petrol		TD20242
199 B9.000			4 Cyl.	1242cc	49kW (67PS)		Petrol		TD29691
223 A5.000			4 Cyl.	1242cc	48kW (65PS)		Petrol		TD15828
178 E9.011			4 Cyl.	1242cc	50-52kW (68-71PS)		Flexfuel		

TD24630

BE/PL	4	41,988/42,008	45,127/45,140	19,000	1,548	0,023/0,081	AL-LF	4275RA	01-4154/4 STD 0.25 0.50
MB/HL 3	2	52,000/52,200	68,766/69,020		2,325		AL-LF	04-4076	H1092/5 STD 0.25 0.50
MB/HL 1-5	10	47,980/48,000	51,705/51,718	19,000	1,848	0,020/0,067	AL-LF	4276RA	

14 72.00 x 69.00

TU1JP	4 Cyl.		1124cc	44kW (60PS)		Petrol		TD26420	
BE/PL	4	44,975/44,991	48,655/48,671	19,750	1,820	0,020/0,080	AL-LF	4650RA	01-4163/4 STD
MB/HL 2-4	3	49,965/49,981	53,655/53,674	17,290	1,832	0,020/0,070	AL-LF	1261RA	H1071/5 STD 0.30 0.50
MB/HL 1,5	2	49,965/49,981	53,655/53,674	17,290	1,832	0,020/0,070	AL-LF	1262RA	
TW/A	2	55,250/55,500	71,450/71,700		2,450		BS	62047BFA	A203/2 STD 0.10

15 72.00 x 84.00

169 A3.000	4 Cyl.		1368cc	74kW (100PS)		Petrol		TD20277	
192 B2.000	4 Cyl.		1368cc	66kW (90PS)		Petrol		TD18571	
199 A6.000	4 Cyl.		1368cc	70-71kW (95-97PS)		Petrol		TD20929	
199 A7.000	4 Cyl.		1368cc	55kW (75PS)		Petrol		TD23572	
312 A1.000	4 Cyl.		1368cc	99-140kW (135-190PS)		Petrol Turbo Intercooler		TD21036	
350 A1.000 Euro 4/5	4 Cyl.		1368cc	51-57kW (69-78PS)		Petrol		TD20248	
843 A1.000	4 Cyl.		1368cc	70kW (95PS)		Petrol		TD26415	
843 A1.000	4 Cyl.		1368cc	66-70kW (90-95PS)		Petrol		TD17978	
955 A2.000 Euro 5	4 Cyl.		1368cc	99kW (135PS)		Petrol		TD23576	
955 A6.000 Euro 5	4 Cyl.		1368cc	77kW (105PS)		Petrol		TD23577	
955 A8.000 Euro 5	4 Cyl.		1368cc	120-132kW (163-180PS)		Petrol Turbo		TD24767	
178 F3.011	4 Cyl.		1368cc	59-60kW (80-82PS)		Flexfuel		TD24633	
310 A2.011	4 Cyl.		1368cc	60-63kW (82-86PS)		Flexfuel		TD24631	
BE/PL	4	41,988/42,008	45,127/45,140	19,000	1,548	0,023/0,081	AL-LF	4275RA	01-4154/4 STD 0.25 0.50
MB/HL 3	2	52,000/52,200	68,766/69,020		2,325		AL-LF	04-4076	H1092/5 STD 0.25 0.50
MB/HL 1-5	10	47,980/48,000	51,705/51,718	19,000	1,848	0,020/0,067	AL-LF	4276RA	

16 72.00 x 84.00

198 A1.000	4 Cyl.		1368cc	110-112kW (150-152PS)		Petrol Turbo		TD21045	
198 A4.000	4 Cyl.		1368cc	88kW (120PS)		Petrol		TD26414	
198 A4.000	4 Cyl.		1368cc	88kW (120PS)		Petrol Turbo		TD21046	
198 A7.000	4 Cyl.		1368cc	103kW (140PS)		Petrol Turbo		TD24595	
199 A8.000	4 Cyl.		1368cc	114-132kW (155-180PS)		Petrol Turbo		TD24567	
940 B7.000	4 Cyl.		1368cc	88kW (120PS)		Petrol Turbo		TD28883	
55263623	4 Cyl.		1368cc	120-125kW (163-170PS)		Petrol Turbo		TD31786	
55263624	4 Cyl.		1368cc	100-103kW (136-140PS)		Petrol Turbo Intercooler		TD31785	
EAF	4 Cyl.		1368cc	101kW (137PS)		Petrol Turbo		TD29570	
BE/PL	4	41,990/42,008	45,128/45,138	19,000	1,548	0,024/0,068	AL-LF	01-4079	01-4079/4 STD
MB/HL 3	2	52,000/52,200	68,766/69,020		2,325		AL-LF	04-4076	H1092/5 STD 0.25 0.50
MB/HL 1-5	10	47,980/48,000	51,705/51,718	19,000	1,848	0,020/0,067	AL-LF	4276RA	
SE/PB	1	17,970/17,974	20,775/20,800	22,000			BS-LF	55-4078	55-4078 SEMI



17										73.00 x 71.50									
124 A.000			4 Cyl.			1197cc		44-48kW (60-65PS)		Petrol		TD874							
124 A.000			4 Cyl.			1197cc		43kW (58PS)		Petrol		TD18845							
124 BL.016			4 Cyl.			1197cc		34-44kW (46-60PS)		Petrol		TD21452							

BE/PL	4	45,508/45,528	48,629/48,646	19,200	1,547	0,020/0,069	AL-LF	1645RA	01-4127/4 STD 0.25 0.50	
BE/PL	4	45,508/45,528	48,629/48,646	19,200	1,538	0,025/0,087	AL-LF	60985RA	01-4171/4 STD	

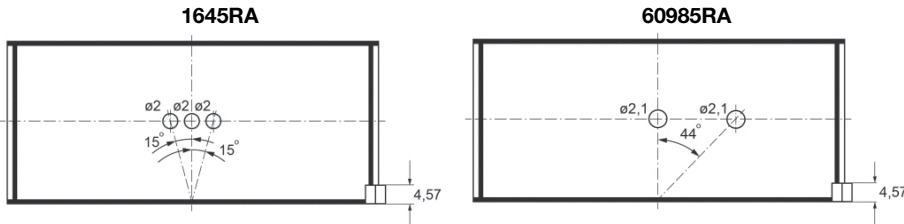

MB/HL 1,2,4,5	4	50,785/50,805	54,507/54,520	20,250	1,831	0,040/0,098	AL-LF	60986RA	H1028/5 STD 0.25	
MB/HL 3	1	50,785/50,805	54,507/54,520	22,750	1,831	0,040/0,098	AL-LF	60987RA		
TW/A	2	56,610/56,684	69,596/69,850		2,362		AL-LF	60987AF	A197/2 STD .005	
TW/A	2	56,610/56,864	69,596/69,850		2,362		AL-LF	60987AFA	A198/2 STD .005	

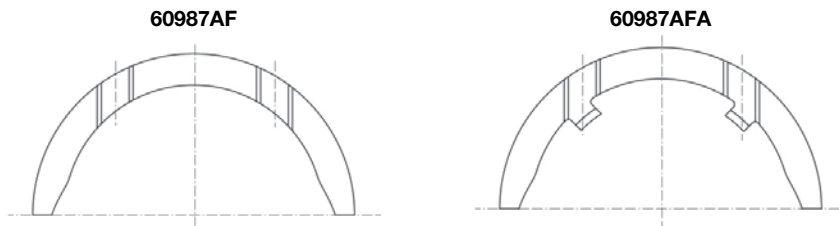

SE/PB	1	21,539/21,641	23,939/23,972	25,100			BS	62039Y	55-4288 SEMI	
-------	---	---------------	---------------	--------	--	--	----	--------	------------------------	--

18										73.02 x 64.90									
156 A2.048			4 Cyl.			999cc		32kW (44PS)		Petrol		TD992							

BE/PL	4	37,998/38,008	41,128/41,140	19,000	1,549	0,022/0,069	AL-LF	1015RA	01-4116/4 STD 0.25 0.50	
MB/HL 3	2	48,000/48,100	63,800/64,000		2,325		AL-LF	04-4075	H1067/5 STD 0.25 0.50	
MB/HL 1-5	5	43,990/44,000	47,705/47,718	19,000	1,841	0,023/0,081	AL-LF	1016RA		
MB/HL 1-5	9	43,990/44,000	47,705/47,718	19,000	1,848	0,020/0,057	AL-LF	4271RA	H1091/5 STD	
MB/HL 3	1	43,990/44,000	47,705/47,718	23,910	1,848	0,020/0,057	AL-LF	4272RAH		

19										73.50 x 70.00									
126 A.000			2 Cyl.			594cc		17kW (23PS)		Petrol		TD880							
126 AB.0C.0			2 Cyl.			594cc		17kW (23PS)		Petrol		TD22224							
126 AB.5C.0			2 Cyl.			594cc		13kW (18PS)		Petrol		TD22225							

BE/PL	2	44,013/44,033	47,130/47,142	19,200	1,543	0,011/0,068	AL-LF	60005RA	01-4112/2 STD 0.25 0.50	
SE/PB	1	19,507/19,609	22,009/22,034	20,830			BS	60009X	55-4210 SEMI	

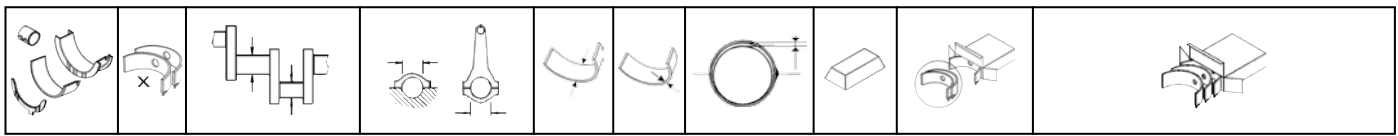

20 75.00 x 77.00									
KFT		4 Cyl.		1360cc	54kW (73PS)	Petrol			TD24950
KFV		4 Cyl.		1360cc	54kW (73PS)	Petrol			TD24771
BE/PL	4	44,975/44,991	48,655/48,671	19,750	1,820	0,020/0,080	AL-LF	4650RA	01-4163/4 STD
MB/HL 2-4	3	49,965/49,981	53,655/53,674	17,290	1,832	0,020/0,070	AL-LF	1261RA	H1071/5 STD 0.30 0.50
MB/HL 1,5	2	49,965/49,981	53,655/53,674	17,290	1,832	0,020/0,070	AL-LF	1262RA	
TW/A	2	55,250/55,500	71,450/71,700		2,450		BS	62047BFA	A203/2 STD 0.10

21 75.00 x 88.30									
9HU		4 Cyl.		1560cc	66kW (90PS)	Diesel Turbo Intercooler			TD24776
BE/PL	4	46,975/46,991	50,655/50,674	17,000	1,818	0,028/0,063	BS	71-4246	71-4246/4 STD 0.30 0.50
MB/HL 1-5	5	49,962/49,981	53,655/53,674	19,900	1,833	0,008/0,046	AL	02-4244	H1066/5 STD 0.30 0.50
TW/A	2	55,200/55,480	71,350/71,700		2,460		AL	04-4245	A217/2 STD
SE/PB	1	26,000	29,000/29,021	19,980			BS	55-4102	55-4102 SEMI

22 76.00 x 54.80									
146 A2.166		4 Cyl.		994cc	35kW (48PS)	Petrol			TD19059
146 A7.011		4 Cyl.		994cc	42kW (57PS)	Petrol			TD29509
146 C4.011		4 Cyl.		994cc	41kW (56PS)	Petrol			TD29388
BE/PL	4	43,988/44,008	47,130/47,142	18,500	1,546	0,030/0,087	AL-LF	68090RA	01-4207/4 STD 0.25 0.50
MB/HL 1,2,4,5	4	48,189/48,209	51,921/51,934	17,650	1,841	0,030/0,088	AL-LF	68091RA	H1069/5 STD 0.25 0.50
MB/HL 3	1	48,189/48,209	51,921/51,934	25,250	1,841	0,030/0,088	AL-LF	68092RA	
TW/A	2	54,224/54,478	66,996/67,520		2,362		AL-LF	68092AF	A221/2 STD
SE/PB	1	21,539/21,641	23,939/23,972	25,100			BS	62039Y	55-4288 SEMI

23 76.00 x 57.80									
127 A1.000		4 Cyl.		1049cc	51kW (70PS)	Petrol			TD4345
127 A6.000		4 Cyl.		1049cc	44kW (60PS)	Petrol			TD4347
147A5.000		4 Cyl.		1049cc	38-41kW (52-56PS)	Petrol			FM10530
156A.000		4 Cyl.		1049cc	38-41kW (52-56PS)	Petrol			TD391
156A1.000		4 Cyl.		1049cc	63kW (85PS)	Petrol Turbo			TD392
BE/PL	4	43,988/44,008	47,130/47,142	18,500	1,546	0,030/0,087	AL-LF	68090RA	01-4207/4 STD 0.25 0.50
MB/HL 1,2,4,5	4	48,189/48,209	51,921/51,934	17,650	1,841	0,030/0,088	AL-LF	68091RA	H1069/5 STD 0.25 0.50
MB/HL 3	1	48,189/48,209	51,921/51,934	25,250	1,841	0,030/0,088	AL-LF	68092RA	
TW/A	2	54,224/54,478	66,996/67,520		2,362		AL-LF	68092AF	A221/2 STD
SE/PB	1	21,539/21,641	23,939/23,972	25,100			BS	62039Y	55-4288 SEMI

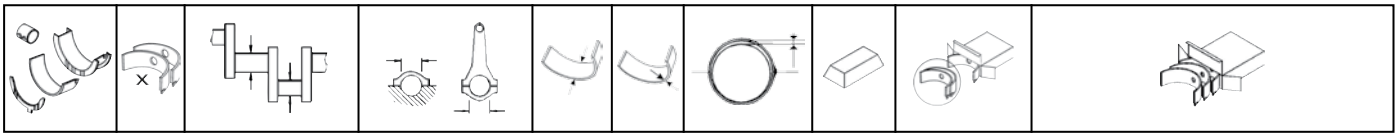

24										76.00 x 61.50	
146 A6.000		4 Cyl.		1116cc	43kW (58PS)	Petrol				TD9493	
146 A6.000		4 Cyl.		1116cc	40kW (54PS)	Petrol				TD26927	
146 A9.000		4 Cyl.		1116cc	40kW (55PS)	Petrol				TD945	
BE/PL	4	43,988/44,008	47,130/47,142	18,500	1,546	0,030/0,087	AL-LF	68090RA	01-4207/4 STD 0.25 0.50		
MB/HL 1,2,4,5	4	48,189/48,209	51,921/51,934	17,650	1,841	0,030/0,088	AL-LF	68091RA	H1069/5 STD 0.25 0.50		
MB/HL 3	1	48,189/48,209	51,921/51,934	25,250	1,841	0,030/0,088	AL-LF	68092RA			
TW/A	2	54,224/54,478	66,996/67,520		2,362		AL-LF	68092AF	A221/2 STD		
SE/PB	1	21,539/21,641	23,939/23,972	25,100			BS	62039Y	55-4288 SEMI		

25										76.00 x 71.50	
127 A2.011		4 Cyl.		1297cc	43-46kW (58-63PS)	Petrol				TD29350	
131 A.000		4 Cyl.		1297cc	48kW (65PS)	Petrol				TD26093	
131 B.000		4 Cyl.		1297cc	57-60kW (78-82PS)	Petrol				TD899	
BE/PL	4	48,224/48,244	51,330/51,346	19,500	1,540	0,020/0,067	AL-LF	66315RA	01-4176/4 STD 0.25 0.50		
MB/HL 1,2,4,5	4	52,985/53,005	56,717/56,730	20,750	1,841	0,030/0,088	AL-LF	66316RA	H1043/5 STD 0.25 0.50 0.75		
MB/HL 3	1	52,985/53,005	56,717/56,730	24,250	1,841	0,030/0,088	AL-LF	66317RA			
TW/A	2	59,000/59,250	73,600/73,850		2,362		BS	62037AF	A201/2 STD .005		
SE/PB	1	21,539/21,641	23,939/23,972	25,100			BS	62039Y	55-4288 SEMI		

26										76.00 x 71.50	
146 A5.000		4 Cyl.		1301cc	49kW (67PS)	Petrol				TD4376	
146 A5.000		4 Cyl.		1301cc	49kW (67PS)	Petrol				TD16222	
146A5.046		4 Cyl.		1297cc	54kW (73PS)	Petrol				TD390	
BE/PL	4	43,988/44,008	47,130/47,142	18,500	1,546	0,030/0,087	AL-LF	68090RA	01-4207/4 STD 0.25 0.50		
MB/HL 1,2,4,5	4	48,189/48,209	51,921/51,934	17,650	1,841	0,030/0,088	AL-LF	68091RA	H1069/5 STD 0.25 0.50		
MB/HL 3	1	48,189/48,209	51,921/51,934	25,250	1,841	0,030/0,088	AL-LF	68092RA			
TW/A	2	54,224/54,478	66,996/67,520		2,362		AL-LF	68092AF	A221/2 STD		
SE/PB	1	21,539/21,641	23,939/23,972	25,100			BS	62039Y	55-4288 SEMI		

27										76.00 x 71.60	
131 A6.000		4 Cyl.		1297cc	40kW (54PS)	Petrol				TD897	
BE/PL	4	48,224/48,244	51,330/51,346	19,500	1,540	0,020/0,067	AL-LF	66315RA	01-4176/4 STD 0.25 0.50		
MB/HL 1,2,4,5	4	52,985/53,005	56,717/56,730	20,750	1,841	0,030/0,088	AL-LF	66316RA	H1043/5 STD 0.25 0.50 0.75		
MB/HL 3	1	52,985/53,005	56,717/56,730	24,250	1,841	0,030/0,088	AL-LF	66317RA			
TW/A	2	59,000/59,250	73,600/73,850		2,362		BS	62037AF	A201/2 STD .005		
SE/PB	1	21,539/21,641	23,939/23,972	25,100			BS	62039Y	55-4288 SEMI		

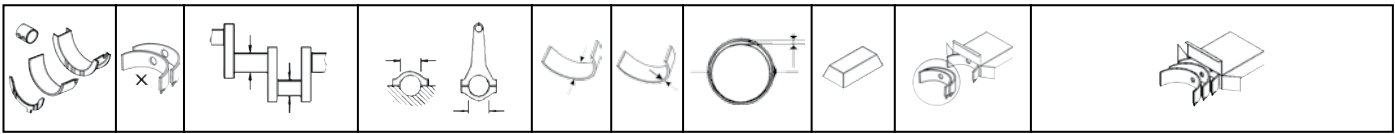

28		76.10 x 57.80							
156 A.000		4 Cyl.		1049cc	40-41kW (54-56PS)		Petrol		TD4411
BE/PL	4	43,988/44,008	47,130/47,142	18,500	1,546	0,030/0,087	AL-LF	68090RA	01-4207/4 STD 0.25 0.50
MB/HL 1,2,4,5	4	48,189/48,209	51,921/51,934	17,650	1,841	0,030/0,088	AL-LF	68091RA	H1069/5 STD 0.25 0.50
MB/HL 3	1	48,189/48,209	51,921/51,934	25,250	1,841	0,030/0,088	AL-LF	68092RA	
TW/A	2	54,224/54,478	66,996/67,520		2,362		AL-LF	68092AF	A221/2 STD
SE/PB	1	21,539/21,641	23,939/23,972	25,100			BS	62039Y	55-4288 SEMI

29		76.10 x 71.50							
127 A3.000		4 Cyl.		1301cc	55kW (75PS)		Petrol		TD4415
156B.000		4 Cyl.		1301cc	57kW (78PS)		Petrol		TD16212
BE/PL	4	43,988/44,008	47,130/47,142	18,500	1,546	0,030/0,087	AL-LF	68090RA	01-4207/4 STD 0.25 0.50
MB/HL 1,2,4,5	4	48,189/48,209	51,921/51,934	17,650	1,841	0,030/0,088	AL-LF	68091RA	H1069/5 STD 0.25 0.50
MB/HL 3	1	48,189/48,209	51,921/51,934	25,250	1,841	0,030/0,088	AL-LF	68092RA	
TW/A	2	54,224/54,478	66,996/67,520		2,362		AL-LF	68092AF	A221/2 STD
SE/PB	1	21,539/21,641	23,939/23,972	25,100			BS	62039Y	55-4288 SEMI

30		76.10 x 71.50							
127 A5.000		4 Cyl.		1302cc	33kW (45PS)		Diesel		TD4346
146 B1.000		4 Cyl.		1301cc	33kW (45PS)		Diesel		TD948
156 A5.000		4 Cyl.		1302cc	27kW (37PS)		Diesel		TD999
BE/PL	4	43,988/44,008	47,130/47,142	18,500	1,546	0,030/0,087	AL-LF	68090RA	01-4207/4 STD 0.25 0.50
MB/HL 1,2,4,5	4	48,189/48,209	51,921/51,934	17,650	1,841	0,030/0,088	AL-LF	68091RA	H1069/5 STD 0.25 0.50
MB/HL 3	1	48,189/48,209	51,921/51,934	25,250	1,841	0,030/0,088	AL-LF	68092RA	
TW/A	2	54,224/54,478	66,996/67,520		2,362		AL-LF	68092AF	A221/2 STD

31		77.00 x 70.00							
126 A1.000		2 Cyl.		652cc	17kW (23PS)		Petrol		TD4343
126 A1.048		2 Cyl.		652cc	17-20kW (23-27PS)		Petrol		TD881
141 A.000		2 Cyl.		652cc	22kW (30PS)		Petrol		TD9385
BE/PL	2	44,013/44,033	47,130/47,142	19,200	1,543	0,011/0,068	AL-LF	60005RA	01-4112/2 STD 0.25 0.50
SE/PB	1	19,507/19,609	22,009/22,034	20,830			BS	60009X	55-4210 SEMI

32		78.00 x 71.50							
131 C.000		4 Cyl.		1367cc	51kW (70PS)		Petrol		TD902
131 C1.000		4 Cyl.		1367cc	51-55kW (69-75PS)		Petrol		TD903
BE/PL	4	48,224/48,244	51,330/51,346	19,500	1,540	0,020/0,067	AL-LF	66315RA	01-4176/4 STD 0.25 0.50
MB/HL 1,2,4,5	4	52,985/53,005	56,717/56,730	20,750	1,841	0,030/0,088	AL-LF	66316RA	H1043/5 STD 0.25 0.50 0.75
MB/HL 3	1	52,985/53,005	56,717/56,730	24,250	1,841	0,030/0,088	AL-LF	66317RA	

TW/A	2	59,000/59,250	73,600/73,850		2,362			BS	62037AF	A201/2 STD .005
SE/PB	1	21,539/21,641	23,939/23,972	25,100				BS	62039Y	55-4288 SEMI

33 78.00 x 71.50

146 B.000			4 Cyl.	1367cc	52kW (71PS)			Diesel Turbo Intercooler		TD947
146 B3.000			4 Cyl.	1367cc	52kW (70PS)			Diesel Turbo Intercooler		TD950
BE/PL	4	48,227/48,240	51,330/51,348	19,500	1,530	0,030/0,086	BS	1170CP	71-4121/4 STD 0.25	
MB/HL 1,2,4,5	4	52,990/53,010	56,717/56,735	20,750	1,843	0,020/0,080	BS	4128CP	H1084/5 STD 0.25 0.50	
MB/HL 3	1	52,990/53,010	56,717/56,735	24,250	1,843	0,020/0,080	BS	4129CP		
TW/A	2	59,000/59,250	73,600/73,850		2,362		BS	62037AF	A201/2 STD .005	

34 78.00 x 83.00

M16A Euro 4/5			4 Cyl.	1586cc	78-88kW (106-120PS)			Petrol		TD20932
BE/PL	8	41,980	45,020	18,000	1,490		AL-LF	64-665-1	01-4947/4 STD	
MB/HL 1-5	5	51,980	56,020	18,000	2,000		AL-LF	63-665-1	H1331/5 STD	
MB/HL 1-5	5	51,980	56,020	18,000	2,000		AL-LF	63-665-2		
TW/A	2	59,000	75,000		2,520		AL-LF	65-664-1	A316/2 STD	

35 79.00 x 81.50

192 B3.000			4 Cyl.	1598cc	77kW (105PS)			Petrol		TD22147
BE/PL	4	45,508/45,528	48,629/48,646	19,200	1,547	0,020/0,069	AL-LF	1645RA	01-4127/4 STD 0.25 0.50	
BE/PL	4	45,498/45,518	48,630/48,646	19,200	1,544	0,020/0,085	BS	1645CP	71-4126/4 STD	
MB/HL 1,2,4,5	4	50,780/50,800	54,507/54,520	20,250	1,849	0,020/0,067	AL-LF	1646RA	H1075/5 STD 0.25 0.50	
MB/HL 3	1	50,780/50,800	54,507/54,520	22,750	1,849	0,020/0,067	AL-LF	1647RA		
TW/A	2	56,610/56,864	69,596/69,850		2,362		AL-LF	60987AFA	A198/2 STD .005	
SE/PB	1	21,539/21,641	23,939/23,972	25,100			BS	62039Y	55-4288 SEMI	

36 79.50 x 80.50

198 A2.000			4 Cyl.	1598cc	88kW (120PS)			Diesel Turbo Intercooler		TD21047
198 A3.000			4 Cyl.	1598cc	77kW (105PS)			Diesel Turbo Intercooler		TD24568
198 A6.000			4 Cyl.	1598cc	66kW (90PS)			Diesel Turbo Intercooler		TD24596
199 B5.000 Euro 5			4 Cyl.	1598cc	77kW (105PS)			Diesel Turbo Intercooler		TD27727
263 A3.000			4 Cyl.	1598cc	74kW (101PS)			Diesel		TD24768
263 A4.000			4 Cyl.	1598cc	66kW (90PS)			Diesel Turbo Intercooler		TD24769
263 A5.000			4 Cyl.	1598cc	66kW (90PS)			Diesel Turbo Intercooler		TD31012
263 A7.000			4 Cyl.	1598cc	70kW (95PS)			Diesel Turbo Intercooler		TD31013
350 A2.000			4 Cyl.	1598cc	85-88kW (116-120PS)			Diesel Turbo Intercooler		TD24899
844 A3.000			4 Cyl.	1598cc	77kW (105PS)			Diesel Turbo Intercooler		TD31284
940 C1.000			4 Cyl.	1598cc	88kW (120PS)			Diesel Turbo Intercooler		TD31014
955 A3.000 Euro 5			4 Cyl.	1598cc	88kW (120PS)			Diesel Turbo Intercooler		TD23575
955 A4.000			4 Cyl.	1598cc	85kW (115PS)			Diesel Turbo		TD25735
55260384			4 Cyl.	1598cc	84-88kW (114-120PS)			Diesel Turbo Intercooler		TD31789

BE/PL	4	48,226/48,244	51,354/51,366	19,100	1,540	0,030/0,056	EC-LF	71-4776	71-4776/4 STD	5
MB/HL	5		56,705/56,718	20,750	1,861		AL-LF	02-4777	H1293/5 STD	
TW/A	2	59,000/59,260	73,600/73,850		2,485		AL-LF	04-4778	A291/2 STD	
SE/PB	1	26,000	28,939/28,972	22,100			BS-LF	55-4779	55-4779 SEMI	

37 80.00 x 55.50

128 A.064	4 Cyl.	1116cc	40-44kW (54-60PS)	Petrol	TD23118
128 A.000	4 Cyl.	1116cc	33-48kW (45-65PS)	Petrol	TD888
128 A.000	4 Cyl.	1116cc	37-47kW (50-64PS)	Petrol	TD4183
128 A.048	4 Cyl.	1116cc	33kW (45PS)	Petrol	TD5378
128 A.064	4 Cyl.	1116cc	40-45kW (54-61PS)	Petrol	TD9409
128 A.064	4 Cyl.	1116cc	41kW (55PS)	Petrol	TD1644
128 AC5.000	4 Cyl.	1116cc	47kW (64PS)	Petrol	TD5045
128 AC5.000	4 Cyl.	1116cc	48kW (65PS)	Petrol	TD891
128 BB.0A0	4 Cyl.	1116cc	48kW (65PS)	Petrol	TD23459
138 AE 0A.0	4 Cyl.	1116cc	44kW (60PS)	Petrol	TD23461
138 B.000	4 Cyl.	1116cc	40-44kW (55-60PS)	Petrol	TD923
138 B.0000	4 Cyl.	1116cc	44kW (60PS)	Petrol	TD21703
138 B1.000	4 Cyl.	1116cc	40kW (55PS)	Petrol	TD924
138 C1.000	4 Cyl.	1116cc	40-42kW (55-57PS)	Petrol	TD18371
146 A4.000	4 Cyl.	1116cc	43kW (58PS)	Petrol	TD22226
146 A4.044	4 Cyl.	1116cc	37kW (50PS)	Petrol	TD9469
146 A4.048	4 Cyl.	1116cc	43kW (58PS)	Petrol	TD4375
146 C3.000	4 Cyl.	1116cc	36kW (49PS)	Petrol	TD4348

BE/PL	4	45,508/45,528	48,629/48,646	19,200	1,547	0,020/0,069	AL-LF	1645RA	01-4127/4 STD 0.25 0.50
BE/PL	4	45,508/45,528	48,629/48,646	19,200	1,538	0,025/0,087	AL-LF	60985RA	01-4171/4 STD

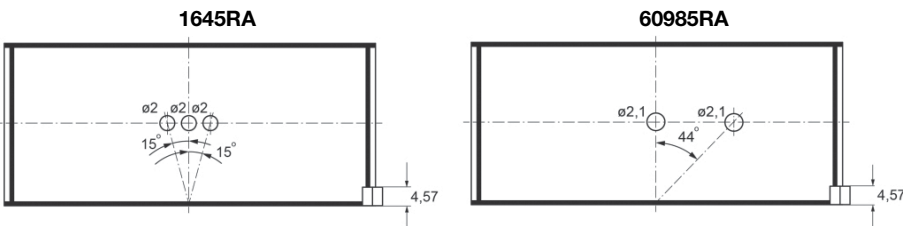

MB/HL 1,2,4,5	4	50,785/50,805	54,507/54,520	20,250	1,831	0,040/0,098	AL-LF	60986RA	H1028/5 STD 0.25
MB/HL 3	1	50,785/50,805	54,507/54,520	22,750	1,831	0,040/0,098	AL-LF	60987RA	
TW/A	2	56,610/56,864	69,596/69,850		2,362		AL-LF	60987AFA	A198/2 STD .005
SE/PB	1	21,539/21,641	23,939/23,972	25,100			BS	62039Y	55-4288 SEMI

38 80.00 x 70.00

126 A2.000	2 Cyl.	704cc	19kW (26PS)	Petrol	TD4342
126 A2.048	2 Cyl.	704cc	19kW (26PS)	Petrol	TD4344
170 A.000	2 Cyl.	704cc	23kW (31PS)	Petrol	TD1028
170 A.046	2 Cyl.	704cc	22kW (30PS)	Petrol	TD15809

BE/PL	2	44,013/44,033	47,130/47,142	19,200	1,543	0,011/0,068	AL-LF	60005RA	01-4112/2 STD 0.25 0.50
-------	---	---------------	---------------	--------	-------	-------------	-------	---------	-----------------------------------

SE/PB	1	19,507/19,609	22,009/22,034	20,830				BS	60009X	55-4210 SEMI

39	80.00 x 71.50									
124 AC.000			4 Cyl.	1438cc	59-66kW (80-90PS)		Petrol			TD13413
124 B.000			4 Cyl.	1438cc	51kW (69PS)		Petrol			TD18853
124 B2.000			4 Cyl.	1438cc	51-55kW (70-75PS)		Petrol			TD13412
124 BL 1.016			4 Cyl.	1438cc	34kW (46PS)		Petrol			TD6890
124AZ2.000			4 Cyl.	1438cc			Petrol			FM20542
828A.B2.000			4 Cyl.	1438cc			Petrol			FM931

BE/PL	4	45,508/45,528	48,629/48,646	19,200	1,547	0,020/0,069	AL-LF	1645RA	01-4127/4 STD 0.25 0.50
BE/PL	4	45,508/45,528	48,629/48,646	19,200	1,538	0,025/0,087	AL-LF	60985RA	01-4171/4 STD

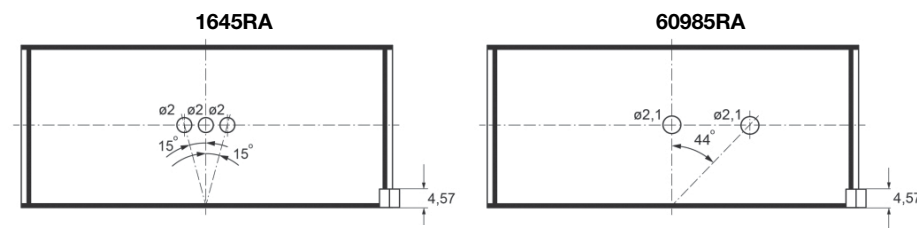

MB/HL 1,2,4,5	4	50,785/50,805	54,507/54,520	20,250	1,831	0,040/0,098	AL-LF	60986RA	H1028/5 STD 0.25
MB/HL 3	1	50,785/50,805	54,507/54,520	22,750	1,831	0,040/0,098	AL-LF	60987RA	
TW/A	2	56,610/56,864	69,596/69,850		2,362		AL-LF	60987AFA	A198/2 STD .005
SE/PB	1	21,539/21,641	23,939/23,972	25,100			BS	62039Y	55-4288 SEMI

40	80.00 x 71.50									
131 AZ.000			4 Cyl.	1440cc	34-38kW (46-52PS)		Petrol			TD6893
131 BZ 0C0			4 Cyl.	1440cc	38kW (52PS)		Petrol			TD6891
131 FZ			4 Cyl.	1440cc	38kW (52PS)		Petrol			TD6892

BE/PL	4	48,224/48,244	51,330/51,346	19,500	1,540	0,020/0,067	AL-LF	66315RA	01-4176/4 STD 0.25 0.50
MB/HL 1,2,4,5	4	52,985/53,005	56,717/56,730	20,750	1,841	0,030/0,088	AL-LF	66316RA	H1043/5 STD 0.25 0.50 0.75
MB/HL 3	1	52,985/53,005	56,717/56,730	24,250	1,841	0,030/0,088	AL-LF	66317RA	
TW/A	2	59,000/59,250	73,600/73,850		2,362		BS	62037AF	A201/2 STD .005
SE/PB	1	21,539/21,641	23,939/23,972	25,100			BS	62039Y	55-4288 SEMI

41	80.00 x 79.20									
132 A.000			4 Cyl.	1592cc	72kW (98PS)		Petrol			TD19053
132 A.9000			4 Cyl.	1592cc	70kW (95PS)		Petrol			TD21277

BE/PL	4	50,782/50,802	53,897/53,913	19,500	1,537	0,021/0,082	AL-LF	66240RA	01-4175/4 STD 0.25 0.50 0.75 1.00
-------	---	---------------	---------------	--------	-------	-------------	-------	---------	---

01/75 →

MB/HL 1,2,4,5	4	52,985/53,005	56,717/56,730	20,750	1,841	0,030/0,088	AL-LF	66316RA	H1043/5 STD 0.25 0.50 0.75
MB/HL 3	1	52,985/53,005	56,717/56,730	24,250	1,841	0,030/0,088	AL-LF	66317RA	
TW/A	2	59,000/59,250	73,600/73,850		2,362		BS	62037AF	A201/2 STD .005



SE/PB	1	21,539/21,641	23,939/23,972	25,100			BS	62039Y	55-4288 SEMI
-------	---	---------------	---------------	--------	--	--	----	--------	------------------------

42 80.00 x 79.20

132 AC.000 4 Cyl. **1592cc** **74-81kW** (100-110PS) **Petrol** **TD907**

BE/PL	4	50,782/50,802	53,897/53,913	19,500	1,537	0,021/0,082	AL-LF	66240RA	01-4175/4 STD 0.25 0.50 0.75 1.00
MB/HL 1,2,4,5	4	52,985/53,005	56,717/56,730	20,750	1,841	0,030/0,088	AL-LF	66316RA	H1043/5 STD 0.25 0.50 0.75
MB/HL 3	1	52,985/53,005	56,717/56,730	24,250	1,841	0,030/0,088	AL-LF	66317RA	
TW/A	2	59,000/59,250	73,600/73,850		2,362		BS	62037AF	A201/2 STD .005
SE/PB	1	21,539/21,641	25,000/25,021	25,100			BS	66649Y	55-4193 SEMI

43 80.00 x 79.20

132 BB OA O 4 Cyl. **1592cc** **71-72kW** (97-98PS) **Petrol** **TD6825**

BE/PL	4	50,782/50,802	53,897/53,913	19,500	1,537	0,021/0,082	AL-LF	66240RA	01-4175/4 STD 0.25 0.50 0.75 1.00
01/75 →									
MB/HL 1,2,4,5	4	52,985/53,005	56,717/56,730	20,750	1,841	0,030/0,088	AL-LF	66316RA	H1043/5 STD 0.25 0.50 0.75
MB/HL 3	1	52,985/53,005	56,717/56,730	24,250	1,841	0,030/0,088	AL-LF	66317RA	
TW/A	2	59,000/59,250	73,600/73,850		2,362		BS	62037AF	A201/2 STD .005
SE/PB	1	21,539/21,641	25,000/25,021	25,100			BS	66649Y	55-4193 SEMI
SE/PB	1	21,539/21,641	23,939/23,972	25,100			BS	62039Y	55-4288 SEMI

44 80.00 x 80.00

125 A.000 4 Cyl. **1608cc** **66kW** (90PS) **Petrol** **TD878**

125 B.000 4 Cyl. **1608cc** **74kW** (100PS) **Petrol** **TD879**

BE/PL	4	45,508/45,528	48,629/48,646	19,200	1,547	0,020/0,069	AL-LF	1645RA	01-4127/4 STD 0.25 0.50
MB/HL 1,2,4,5	4	50,785/50,805	54,507/54,520	20,250	1,831	0,040/0,098	AL-LF	60986RA	H1028/5 STD 0.25
MB/HL 3	1	50,785/50,805	54,507/54,520	22,750	1,831	0,040/0,098	AL-LF	60987RA	
TW/A	2	56,610/56,864	69,596/69,850		2,362		AL-LF	60987AFA	A198/2 STD .005
SE/PB	1	21,539/21,641	23,939/23,972	25,100			BS	62039Y	55-4288 SEMI

45 80.50 x 63.90

146 A2.000 4 Cyl. **1301cc** **77kW** (105PS) **Petrol Turbo Intercooler** **TD4373**

146 A2.146 4 Cyl. **1301cc** **73kW** (100PS) **Petrol Turbo** **TD938**

146 A2.246 4 Cyl. **1301cc** **74kW** (100PS) **Petrol Turbo** **TD932**

BE/PL	4	45,498/45,518	48,630/48,646	19,200	1,544	0,020/0,085	BS	1645CP	71-4126/4 STD
MB/HL 1,2,4,5	4	50,780/50,800	54,507/54,520	20,250	1,849	0,020/0,067	AL-LF	1646RA	H1075/5 STD 0.25 0.50
MB/HL 3	1	50,780/50,800	54,507/54,520	22,750	1,849	0,020/0,067	AL-LF	1647RA	
TW/A	2	56,610/56,864	69,596/69,850		2,362		AL-LF	60987AFA	A198/2 STD .005
SE/PB	1	21,539/21,641	23,939/23,972	25,100			BS	62039Y	55-4288 SEMI



46		80.50 x 67.40								
146 A8.000	4 Cyl.	1372cc	74-87kW (101-118PS)	Petrol Turbo						TD18372
146 A8.046	4 Cyl.	1372cc	82kW (112PS)	Petrol Turbo						TD944
146 C1.000	4 Cyl.	1372cc	51-53kW (69-72PS)	Petrol						TD18821
146 C5.000	4 Cyl.	1372cc	49-52kW (67-71PS)	Petrol						TD6816
146 C5.000	4 Cyl.	1372cc	49kW (67PS)	Petrol						TD16224
146 D5.000	4 Cyl.	1372cc	49kW (67PS)	Petrol						TD6817
146 D5.000	4 Cyl.	1372cc	49kW (67PS)	Petrol						TD16225
159 A2.000	4 Cyl.	1372cc	57kW (78PS)	Petrol						TD9728
160 A1.000	4 Cyl.	1372cc	52-56kW (71-76PS)	Petrol						TD1015
160 A1.000	4 Cyl.	1372cc	52kW (71PS)	Petrol						TD21694
160 A1.046	4 Cyl.	1372cc	49-51kW (67-69PS)	Petrol						TD1016
160 A1.048	4 Cyl.	1372cc	50-52kW (69-71PS)	Petrol						TD4393
176 A4.000	4 Cyl.	1372cc	96-98kW (131-136PS)	Petrol Turbo Intercooler						TD1034
176 B6.000	4 Cyl.	1372cc	96kW (131PS)	Petrol Turbo Intercooler						TD5492
178 B2.000	4 Cyl.	1372cc	51kW (69PS)	Petrol						TD16173
178 B2.016	4 Cyl.	1372cc	51kW (69PS)	Petrol						TD16174
836 A4.000	4 Cyl.	1372cc	51kW (69PS)	Petrol						TD893

BE/PL	4	45,508/45,528	48,629/48,646	19,200	1,547	0,020/0,069	AL-LF	1645RA	01-4127/4 STD 0.25 0.50
MB/HL 1,2,4,5	4	50,780/50,800	54,507/54,520	20,250	1,849	0,020/0,067	AL-LF	1646RA	H1075/5 STD 0.25 0.50
MB/HL 3	1	50,780/50,800	54,507/54,520	22,750	1,849	0,020/0,067	AL-LF	1647RA	
TW/A	2	56,610/56,864	69,596/69,850		2,362		AL-LF	60987AFA	A198/2 STD .005
SE/PB	1	21,539/21,641	23,939/23,972	25,100			BS	62039Y	55-4288 SEMI

47		80.50 x 78.40								
182 B6.000	4 Cyl.	1596cc	68-100kW (92-136PS)	Petrol						TD16166
BE/PL	4	45,508/45,528	48,629/48,646	19,200	1,547	0,020/0,069	AL-LF	1645RA	01-4127/4 STD 0.25 0.50	
MB/HL 1,2,4,5	4	50,780/50,800	54,507/54,520	20,250	1,849	0,020/0,067	AL-LF	1646RA	H1075/5 STD 0.25 0.50	
MB/HL 3	1	50,780/50,800	54,507/54,520	22,750	1,849	0,020/0,067	AL-LF	1647RA		
TW/A	2	56,610/56,864	69,596/69,850		2,362		AL-LF	60987AFA	A198/2 STD .005	
SE/PB	1	21,539/21,641	23,939/23,972	25,100			BS	62039Y	55-4288 SEMI	

48		80.50 x 86.00								
199 B6.000 Euro 6	2 Cyl.	875cc	74-77kW (101-105PS)	Petrol Turbo Intercooler						TD26735
312 A2.000 Euro 5	2 Cyl.	875cc	57-63kW (77-86PS)	Petrol Turbo Intercooler						TD24763
BE/PL	2	41,982/42,000	45,125/45,135	18,000	1,550	0,025/0,061	AL-LF	01-4967	01-4967/2 STD	
MB/HL	3	47,982/48,000	51,705/51,718	16,150	1,846	0,022/0,069	AL-LF	02-4968	H1337/3 STD	
TW/A	2	53.100/53.300	68.766/69.020		2.335	0.105/0.275	AL-LF	04-4969	A321/2 STD	
SE/PB	1		23,939/23,972	22,070			BS-LF	55-4970	55-4970 SEMI	

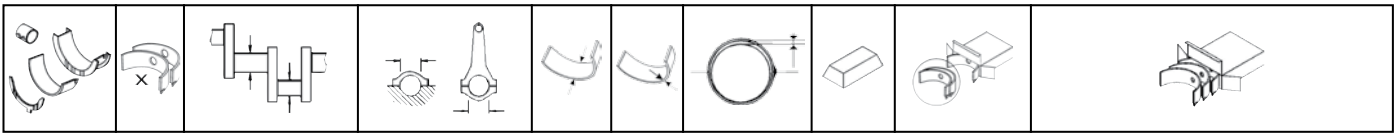

49		82.00 x 64.90								
182 A3.000		4 Cyl.		1370cc	59kW (80PS)		Petrol		TD4399	
182 A5.000		4 Cyl.		1370cc	55kW (75PS)		Petrol		TD4401	
BE/PL	4	40,870/40,890	44,000/44,012	19,100	1,543	0,024/0,081	AL-LF	4400RA	01-4160/4 STD 0.25	
MB/HL 1,2,4,5	4	52,982/53,000	56,705/56,718	20,750	1,843	0,019/0,075	AL-LF	4351RA	H1096/5 STD 0.25 0.50	
MB/HL 3	1	52,982/53,000	56,705/56,718	20,750	1,838	0,029/0,085	AL-LF	4352RA		
TW/A	2	58,808/59,062	73,486/73,740		2,485		AL-LF	4351AF	A190/2 STD	
SE/PB	1	19,993/20,000	22,939/22,972	21,700			BS	4359Y	55-4540 SEMI	

50		82.00 x 75.70								
175 A3.000		5 Cyl.		1998cc	162kW (220PS)		Petrol Turbo Intercooler		TD5491	
182 A1.000		5 Cyl.		1998cc	108kW (147PS)		Petrol		TD4397	
182 B3.000		5 Cyl.		1998cc	113kW (154PS)		Petrol		TD11789	
182 B7.000		5 Cyl.		1998cc	113kW (154PS)		Petrol		TD15498	
185 A8.000 Euro 3		5 Cyl.		1998cc	110kW (150PS)		Petrol		TD15830	
BE/PL	5	48,226/48,244	51,354/51,366	19,100	1,543	0,020/0,080	BS	4355CP	71-4209/5 STD 0.25 0.50	
MB/HL 1-6	6	59,986/60,000	63,705/63,718	20,750	1,844	0,031/0,075	BS	4356CP	H1095/6 STD 0.25 0.50	
TW/A	2	67,785/68,040	82,425/82,677		2,485		AL-LF	4356AF	A191/2 STD	
SE/PB	1	19,993/20,000	22,939/22,972	21,700			BS	4359Y	55-4540 SEMI	

51		82.00 x 82.70								
182 A2.000		4 Cyl.		1747cc	83kW (113PS)		Petrol		TD4398	
183 A1.000		4 Cyl.		1747cc	92-97kW (125-132PS)		Petrol		TD4405	
188 A6.000		4 Cyl.		1747cc	96kW (130PS)		Petrol		TD16408	
192 A4.000		4 Cyl.		1747cc	96-98kW (130-133PS)		Petrol		TD16395	
BE/PL	4	50,787/50,807	53,901/53,913	19,500	1,534	0,028/0,083	BS	4350CP	71-4157/4 STD 0.25 0.50	
MB/HL 1,2,4,5	4	52,982/53,000	56,705/56,718	20,750	1,843	0,019/0,075	AL-LF	4351RA	H1096/5 STD 0.25 0.50	
MB/HL 3	1	52,982/53,000	56,705/56,718	20,750	1,838	0,029/0,085	AL-LF	4352RA		
TW/A	2	58,808/59,062	73,486/73,740		2,485		AL-LF	4351AF	A190/2 STD	
SE/PB	1	19,993/20,000	22,939/22,972	21,700			BS	4359Y	55-4540 SEMI	

52		82.00 x 90.40								
182 A7.000		4 Cyl.		1910cc	74kW (100PS)		Diesel Turbo Intercooler		TD4403	
182 A8.000		4 Cyl.		1910cc	55kW (75PS)		Diesel Turbo Intercooler		TD4404	
BE/PL	4	50,787/50,807	53,901/53,913	19,500	1,534	0,028/0,083	BS	4350CP	71-4157/4 STD 0.25 0.50	
MB/HL 1,2,4,5	4	52,982/53,000	56,705/56,718	20,750	1,843	0,019/0,075	AL-LF	4351RA	H1096/5 STD 0.25 0.50	
MB/HL 3	1	52,982/53,000	56,705/56,718	20,750	1,838	0,029/0,085	AL-LF	4352RA		
TW/A	2	58,808/59,062	73,486/73,740		2,485		AL-LF	4351AF	A190/2 STD	
SE/PB	1		28,939/28,972	21,700			BS	4369Y	55-4159 SEMI	

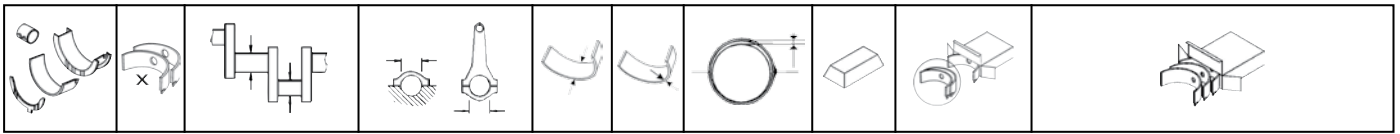

53 82.00 x 90.40

182 B4.000	4 Cyl.	1910cc	77-79kW (105-107PS)	Diesel Turbo Intercooler	TD11168
182 B9.000 Euro 3	4 Cyl.	1910cc	74-77kW (100-105PS)	Diesel Turbo Intercooler	TD16399
185 B4.000	4 Cyl.	1910cc	77kW (105PS)	Diesel Turbo Intercooler	TD23359
186 A6.000	4 Cyl.	1910cc	81kW (110PS)	Diesel Turbo Intercooler	TD15831
186 A8.000	4 Cyl.	1910cc	85kW (115PS)	Diesel Turbo Intercooler	TD18309
186 A9.000	4 Cyl.	1910cc	88kW (120PS)	Diesel Turbo Intercooler	TD19306
188 A2.000	4 Cyl.	1910cc	59kW (80PS)	Diesel Turbo Intercooler	TD12788
188 A7.000	4 Cyl.	1910cc	63kW (86PS)	Diesel Turbo Intercooler	TD16409
188 B2.000	4 Cyl.	1910cc	74kW (101PS)	Diesel Turbo Intercooler	TD18291
192 A1.000	4 Cyl.	1910cc	85kW (115PS)	Diesel Turbo Intercooler	TD16398
192 A3.000	4 Cyl.	1910cc	59kW (80PS)	Diesel Turbo Intercooler	TD16397
199 A5.000	4 Cyl.	1910cc	96kW (131PS)	Diesel Turbo Intercooler	TD20762
223 A7.000	4 Cyl.	1910cc	77kW (105PS)	Diesel Turbo Intercooler	TD18318
223 B1.000	4 Cyl.	1910cc	77kW (105PS)	Diesel Turbo Intercooler	TD20245
223 B2.000	4 Cyl.	1910cc	74kW (100PS)	Diesel Turbo Intercooler	TD20246
939 A1.000	4 Cyl.	1910cc	88kW (120PS)	Diesel Turbo Intercooler	TD18448
939 A7.000	4 Cyl.	1910cc	85kW (115PS)	Diesel Turbo Intercooler	TD20263
939 A8.000	4 Cyl.	1910cc	100kW (136PS)	Diesel Turbo Intercooler	TD25733
D19AA	4 Cyl.	1910cc	88kW (120PS)	Diesel Turbo Intercooler	TD20930

BE/PL	1	50,787/50,805	53,901/53,913	19,500	1,534	0,030/0,080	EC	71-3994	71-3994 STD 0.25	[4]
MB/HL 1-5	5	59,986/60,000	63,705/63,718	20,750	1,844	0,031/0,075	BS	4356CP	H1095/5 STD 0.25 0.50	
TW/A	2	67,785/68,040	82,425/82,677		2,485		AL-LF	4356AF	A191/2 STD	
SE/PB	1		28,939/28,972	21,700			BS	4369Y	55-4159 SEMI	

54 82.00 x 90.40

188 A3.000	4 Cyl.	1910cc	44kW (60PS)	Diesel	TD12789
223 A6.000 Euro 3	4 Cyl.	1910cc	46-48kW (63-65PS)	Diesel	TD15829

BE/PL	4	50,787/50,807	53,901/53,913	19,500	1,534	0,028/0,083	BS	4350CP	71-4157/4 STD 0.25 0.50	
MB/HL 1,2,4,5	4	52,982/53,000	56,705/56,718	20,750	1,843	0,019/0,075	AL-LF	4351RA	H1096/5 STD 0.25 0.50	
MB/HL 3	1	52,982/53,000	56,705/56,718	20,750	1,838	0,029/0,085	AL-LF	4352RA		
TW/A	2	58,808/59,062	73,486/73,740		2,485		AL-LF	4351AF	A190/2 STD	

55 82.00 x 90.40

192 A5.000	4 Cyl.	1910cc	103kW (140PS)	Diesel Turbo Intercooler	TD17980
192 A8.000	4 Cyl.	1910cc	88kW (120PS)	Diesel Turbo Intercooler	TD20238
192 A9.000	4 Cyl.	1910cc	74kW (100PS)	Diesel Turbo Intercooler	TD18451
192 B1.000	4 Cyl.	1910cc	100kW (136PS)	Diesel Turbo Intercooler	TD18944
192 B4.000	4 Cyl.	1910cc	85kW (116PS)	Diesel Turbo Intercooler	TD24592
192 B5.000	4 Cyl.	1910cc	66kW (90PS)	Diesel Turbo Intercooler	TD19308
937 A4.000	4 Cyl.	1910cc	93kW (126PS)	Diesel Turbo Intercooler	TD18943
937 A5.000	4 Cyl.	1910cc	110kW (150PS)	Diesel Turbo Intercooler	TD18929
937 A7.000	4 Cyl.	1910cc	85kW (115PS)	Diesel Turbo Intercooler	TD19307
939 A2.000	4 Cyl.	1910cc	110kW (150PS)	Diesel Turbo Intercooler	TD18449

BE/PL	1	50,787/50,805	53,901/53,913	19,500	1,534	0,030/0,080	EC	71-3994	71-3994 STD 0.25	[4]
-------	---	---------------	---------------	--------	-------	-------------	----	---------	----------------------------	-----

MB/HL	1	59,986/60,000	63,705/63,718	20,750	1,844	0,031/0,080	EC	72-3995	72-3995 STD 0.25 0.50	
TW/A	2	67,785/68,040	82,425/82,677		2,485		AL-LF	4356AF	A191/2 STD	
SE/PB	1		28,939/28,972	21,700			BS	4369Y	55-4159 SEMI	

56 82.00 x 90.40

185 A2.000			5 Cyl.	2387cc	91kW (125PS)		Diesel Turbo Intercooler		TD4406
185 A6.000			5 Cyl.	2387cc	96kW (130PS)		Diesel Turbo Intercooler		TD18145
839 A5.000			5 Cyl.	2387cc	96-99kW (131-135PS)		Diesel Turbo Intercooler		TD14408
BE/PL	1	50,787/50,805	53,901/53,913	19,500	1,534	0,030/0,080	EC	71-3994	71-3994 STD 0.25 [4]
MB/HL 1-6	6	59,986/60,000	63,705/63,718	20,750	1,844	0,031/0,075	BS	4356CP	H1095/6 STD 0.25 0.50
TW/A	2	67,785/68,040	82,425/82,677		2,485		AL-LF	4356AF	A191/2 STD
SE/PB	1		28,939/28,972	21,700			BS	4369Y	55-4159 SEMI

57 82.00 x 90.40

939 A3.000			5 Cyl.	2387cc	147kW (200PS)		Diesel Turbo Intercooler		TD18450
BE/PL	1	50,787/50,805	53,901/53,913	19,500	1,534	0,030/0,080	EC-LF	71-4780	71-4780 STD [5]
MB/HL	1	59,986/60,000	63,705/63,718	20,750	1,844	0,031/0,080	EC	72-3995	72-3995 STD 0.25 0.50
TW/A	2	67,785/68,040	82,425/82,677		2,485		AL-LF	4356AF	A191/2 STD

58 82.20 x 88.00

WJY (DW8)			4 Cyl.	1868cc	51kW (69PS)		Diesel		TD21266
WJY (DW8B)			4 Cyl.	1868cc	51kW (69PS)		Diesel		TD22240
WJZ (DW8)			4 Cyl.	1868cc	51-52kW (69-71PS)		Diesel		TD16300
BE/PL	4	49,984/50,000	53,695/53,708	20,050	1,830	0,040/0,090	AL-LF	66725RA	01-4200/4 STD 0.30 0.50
MB/HL 1-5	5	59,981/60,000	63,731/63,750	20,290	1,845	0,040/0,100	AL-LF	66726RA	H1057/5 STD 0.30 0.50
TW/A	2	67,050/67,300	83,050/83,300		2,330		BS	54-3954	A160/4 STD
TW/A	2	67,050/67,300	83,050/83,300		2,330		BS	54-3955	
SE/PB	1	25,007/25,020	27,200/27,221	24,050			BS	66729YA	55-4201 SEMI

59 82.60 x 79.20

138 C.000			4 Cyl.	1698cc	44kW (60PS)		Diesel		TD925
146 B2.000			4 Cyl.	1698cc	42-44kW (57-60PS)		Diesel		TD949
146 B2.000			4 Cyl.	1697cc	42kW (57PS)		Diesel		TD16228
149 B2.000			4 Cyl.	1697cc	42kW (57PS)		Diesel		TD16864
149 B3.000			4 Cyl.	1698cc	44kW (60PS)		Diesel		TD967
149 B4.000			4 Cyl.	1697cc	42-45kW (57-61PS)		Diesel		TD968
149 B4.046			4 Cyl.	1697cc	42-44kW (57-60PS)		Diesel		TD969
176 B3.000			4 Cyl.	1698cc	42kW (57PS)		Diesel		TD9477
BE/PL	4	50,782/50,802	53,897/53,913	19,500	1,537	0,021/0,082	AL-LF	66240RA	01-4175/4 STD 0.25 0.50 0.75 1.00
MB/HL 1,2,4,5	4	52,985/53,005	56,717/56,730	20,750	1,841	0,030/0,088	AL-LF	66316RA	H1043/5 STD 0.25 0.50 0.75
MB/HL 3	1	52,985/53,005	56,717/56,730	24,250	1,841	0,030/0,088	AL-LF	66317RA	

TW/A	2	59,000/59,250	73,600/73,850		2,362		BS	62037AF	A201/2 STD .005
SE/PB	1	25,004/25,010	26,939/26,972	25,400			BS	66644Y	55-4190 SEMI

60		82.60 x 79.20								
146 D7.000			4 Cyl.	1698cc	46kW (63PS)		Diesel Turbo		TD9472	
176 A3.000			4 Cyl.	1698cc	51-53kW (69-72PS)		Diesel Turbo		TD1033	
176 A5.000			4 Cyl.	1698cc	52-59kW (71-80PS)		Diesel Turbo		TD1035	
176 B7.000			4 Cyl.	1698cc	46-47kW (63-64PS)		Diesel Turbo		TD5493	
178 C9.066			4 Cyl.	1698cc	46-52kW (63-71PS)		Diesel Turbo Intercooler		TD23865	
BE/PL	4	50,787/50,807		53,901/53,913	19,500	1,534	0,028/0,083	BS	4350CP	71-4157/4 STD 0.25 0.50
MB/HL 1,2,4,5	4	52,990/53,010		56,717/56,735	20,750	1,843	0,020/0,080	BS	4128CP	H1084/5 STD 0.25 0.50
MB/HL 3	1	52,990/53,010		56,717/56,735	24,250	1,843	0,020/0,080	BS	4129CP	
TW/A	2	59,000/59,250		73,600/73,850		2,362		BS	62037AF	A201/2 STD .005
SE/PB	1	25,500/25,640		27,939/27,972	23,800			BS	66644YB	55-4233 SEMI

61		82.60 x 90.00								
149 A1.000			4 Cyl.	1929cc	48kW (65PS)		Diesel		TD4378	
149 B1.000			4 Cyl.	1929cc	51-52kW (70-71PS)		Diesel		TD963	
160 A7.000			4 Cyl.	1929cc	48kW (65PS)		Diesel		TD1023	
BE/PL	4	50,782/50,802		53,897/53,913	19,500	1,537	0,021/0,082	AL-LF	66240RA	01-4175/4 STD 0.25 0.50 0.75 1.00
MB/HL 1,2,4,5	4	52,985/53,005		56,717/56,730	20,750	1,841	0,030/0,088	AL-LF	66316RA	H1043/5 STD 0.25 0.50 0.75
MB/HL 3	1	52,985/53,005		56,717/56,730	24,250	1,841	0,030/0,088	AL-LF	66317RA	
TW/A	2	59,000/59,250		73,600/73,850		2,362		BS	62037AF	A201/2 STD .005
SE/PB	1	25,004/25,010		26,939/26,972	25,400			BS	66644Y	55-4190 SEMI

62		82.60 x 90.00								
149 B5.046			4 Cyl.	1929cc	44kW (60PS)		Diesel		TD9602	
154 B.000			4 Cyl.	1929cc	68kW (92PS)		Diesel Turbo Intercooler		TD21460	
154 C6.000			4 Cyl.	1929cc	66-68kW (90-92PS)		Diesel Turbo Intercooler		TD9621	
154 D1.000			4 Cyl.	1929cc	69kW (94PS)		Diesel Turbo Intercooler		TD9622	
BE/PL	4	50,787/50,807		53,901/53,913	19,500	1,534	0,028/0,083	BS	4350CP	71-4157/4 STD 0.25 0.50
MB/HL 1,2,4,5	4	52,990/53,010		56,717/56,735	20,750	1,843	0,020/0,080	BS	4128CP	H1084/5 STD 0.25 0.50
MB/HL 3	1	52,990/53,010		56,717/56,735	24,250	1,843	0,020/0,080	BS	4129CP	
TW/A	2	59,000/59,250		73,600/73,850		2,362		BS	62037AF	A201/2 STD .005
SE/PB	1	25,500/25,640		27,939/27,972	23,800			BS	66644YB	55-4233 SEMI

63		82.60 x 90.00								
160 A6.000			4 Cyl.	1929cc	66-68kW (90-92PS)		Diesel Turbo Intercooler		TD4394	
160 A6.046			4 Cyl.	1929cc	66kW (90PS)		Diesel Turbo Intercooler		TD1022	
160 B6.046			4 Cyl.	1929cc	59kW (82PS)		Diesel Turbo Intercooler		TD1025	
160 D1.000			4 Cyl.	1929cc	65-66kW (88-90PS)		Diesel Turbo Intercooler		TD1026	



230 A3.000	4 Cyl.			1929cc	60kW (82PS)	Diesel Turbo			TD5481
230 A4.000 Euro 2	4 Cyl.			1929cc	59kW (80PS)	Diesel Turbo			TD4407
280 A1.000	4 Cyl.			1929cc	60kW (82PS)	Diesel Turbo			TD1043
BE/PL	4	50,787/50,807	53,901/53,913	19,500	1,534	0,028/0,083	BS	4350CP	71-4157/4 STD 0.25 0.50
MB/HL 1,2,4,5	4	52,990/53,010	56,717/56,735	20,750	1,843	0,020/0,080	BS	4128CP	H1084/5 STD 0.25 0.50
MB/HL 3	1	52,990/53,010	56,717/56,735	24,250	1,843	0,020/0,080	BS	4129CP	
TW/A	2	59,000/59,250	73,600/73,850		2,362		BS	62037AF	A201/2 STD .005
SE/PB	1	26,004/26,010	27,939/27,972	25,400			BS	66644YA	55-4232 SEMI

64 82.60 x 90.00

230 A2.000	4 Cyl.			1929cc	51kW (70PS)	Diesel			TD862
BE/PL	4	50,787/50,807	53,901/53,913	19,500	1,534	0,028/0,083	BS	4350CP	71-4157/4 STD 0.25 0.50
MB/HL 1,2,4,5	4	52,985/53,005	56,717/56,730	20,750	1,841	0,030/0,088	AL-LF	66316RA	H1043/5 STD 0.25 0.50 0.75
MB/HL 3	1	52,985/53,005	56,717/56,730	24,250	1,841	0,030/0,088	AL-LF	66317RA	
TW/A	2	59,000/59,250	73,600/73,850		2,362		BS	62037AF	A201/2 STD .005
SE/PB	1	26,004/26,010	27,939/27,972	25,400			BS	66644YA	55-4232 SEMI
SE/PB	1	25,500/25,640	27,939/27,972	23,800			BS	66644YB	55-4233 SEMI

66644YA

66644YB

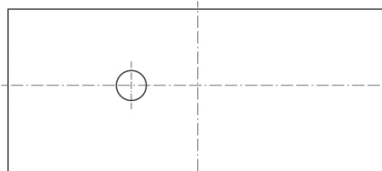
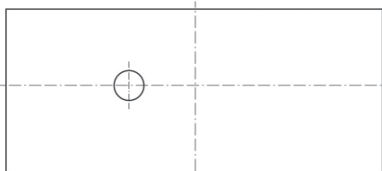

65 82.60 x 90.00

831 D1.000	4 Cyl.			1929cc	59kW (80PS)	Diesel Turbo			TD4410
BE/PL	4	50,787/50,807	53,892/53,910	19,500	1,537	0,020/0,070	BS	1040CP	71-4118/4 STD 0.25 0.50
MB/HL 1,2,4,5	4	52,990/53,010	56,717/56,735	20,750	1,843	0,020/0,080	BS	4128CP	H1084/5 STD 0.25 0.50
MB/HL 3	1	52,990/53,010	56,717/56,735	24,250	1,843	0,020/0,080	BS	4129CP	
TW/A	2	59,000/59,250	73,600/73,850		2,362		BS	62037AF	A201/2 STD .005
SE/PB	1	25,004/25,010	26,939/26,972	25,400			BS	66644Y	55-4190 SEMI

66 83.00 x 79.20

138 A5.000	4 Cyl.			1714cc	40-43kW (55-58PS)	Diesel			TD4358
138 B5.000	4 Cyl.			1714cc	40-43kW (54-58PS)	Diesel			TD23462
138 B6.000	4 Cyl.			1714cc	43kW (58PS)	Diesel			TD922
BE/PL	4	50,782/50,802	53,897/53,913	19,500	1,537	0,021/0,082	AL-LF	66240RA	01-4175/4 STD 0.25 0.50 0.75 1.00
MB/HL 1,2,4,5	4	52,985/53,005	56,717/56,730	20,750	1,841	0,030/0,088	AL-LF	66316RA	H1043/5 STD 0.25 0.50 0.75
MB/HL 3	1	52,985/53,005	56,717/56,730	24,250	1,841	0,030/0,088	AL-LF	66317RA	

TW/A	2	59,000/59,250	73,600/73,850		2,362		BS	62037AF	A201/2 STD .005
SE/PB	1	25,004/25,010	26,939/26,972	25,400			BS	66644Y	55-4190 SEMI

67 83.00 x 81.40

LFW			4 Cyl.	1761cc	73kW (99PS)		Petrol		TD10167
BE/PL	4	44,975/44,991	48,655/48,671	22,500	1,825	0,020/0,070	AL	4300RA	01-4155/4 STD 0.30
MB/HL 1,3,5	5	59,990/60,000	63,718/63,727	20,290	1,845	0,028/0,072	AL-LF	66721RA	H1074/5 STD 0.30
MB/HL 2,4	5	59,990/60,000	63,718/63,727	20,290	1,845	0,028/0,072	AL-LF	66722RA	
TW/A	4	67,050/67,300	83,050/83,300		2,330		BS	66721BF	A214/4 STD 0.10

68 83.00 x 88.00

D8B			4 Cyl.	1905cc	68kW (92PS)		Diesel Turbo		TD6828
D8B (XUD9TE)			4 Cyl.	1905cc	66-69kW (90-94PS)		Diesel Turbo Intercooler		TD21263
DHX (XUD9TE)			4 Cyl.	1905cc	66-69kW (90-94PS)		Diesel Turbo Intercooler		TD21264
DHX (XUD9TF/L)			4 Cyl.	1905cc	66-68kW (90-92PS)		Diesel Turbo Intercooler		TD4352
BE/PL	4	49,984/50,000	53,695/53,708	20,000	1,838	0,039/0,073	EC	71-3730	71-3730/4 STD 0.30
BE/PL	4	49,984/50,000	53,695/53,708	20,000	1,838	0,020/0,073	EC	71-3899	71-3899/4 STD 0.30

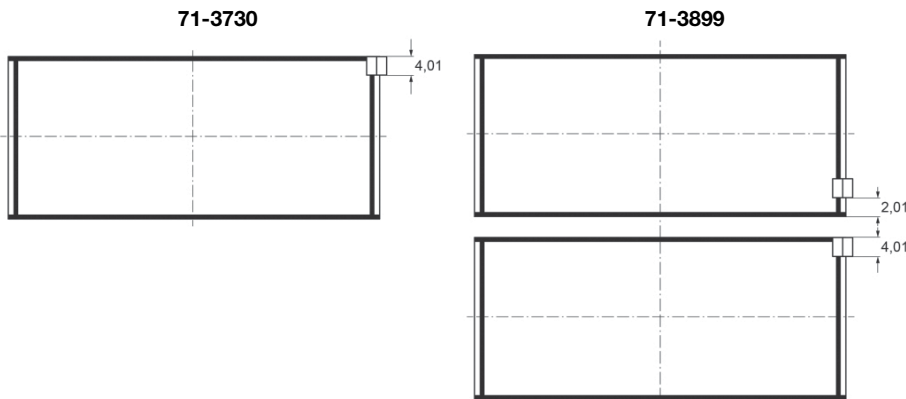

MB/HL 1-5	5	59,981/60,000	63,731/63,750	20,290	1,845	0,040/0,100	AL-LF	66726RA	H1057/5 STD 0.30 0.50
TW/A	4	67,050/67,300	83,050/83,300		1,880		AL-LF	4141AF	A188/4 STD
SE/PB	1	28,007/28,020	30,200/30,221	23,100			BS	41450.500	55-4499 SEMI

69 83.00 x 88.00

D9B			4 Cyl.	1905cc	50-51kW (68-69PS)		Diesel		TD6827
D9B (XUD9A)			4 Cyl.	1905cc	47-52kW (64-71PS)		Diesel		TD21265
DJY			4 Cyl.	1905cc	50kW (68PS)		Diesel		TD12748
BE/PL	4	49,984/50,000	53,695/53,708	20,050	1,830	0,040/0,090	AL-LF	66725RA	01-4200/4 STD 0.30 0.50
MB/HL 1-5	5	59,981/60,000	63,731/63,750	20,290	1,845	0,040/0,100	AL-LF	66726RA	H1057/5 STD 0.30 0.50
TW/A	4	67,050/67,300	83,050/83,300		2,330		BS	66721BF	A214/4 STD 0.10
SE/PB	1	25,007/25,020	27,200/27,221	24,050			BS	66729YA	55-4201 SEMI



70		83.00 x 88.00							
DJY (XUD9)		4 Cyl.		1905cc	50-52kW (68-71PS)		Diesel		TD21267
BE/PL	4	49,984/50,000	53,695/53,708	20,050	1,830	0,040/0,090	AL-LF	66725RA	01-4200/4 STD 0.30 0.50
MB/HL 1-5	5	59,981/60,000	63,731/63,750	20,290	1,845	0,040/0,100	AL-LF	66726RA	H1057/5 STD 0.30 0.50
TW/A	4	67,050/67,300	83,050/83,300		2,330		BS	66721BF	A214/4 STD 0.10
SE/PB	1	25,007/25,020	27,200/27,221	24,050			BS	66729YA	55-4201 SEMI

71		83.00 x 90.40							
198 A5.000		4 Cyl.		1956cc	121kW (165PS)		Diesel Turbo		TD24569
844 A2.000		4 Cyl.		1956cc	120kW (163PS)		Diesel Turbo		TD24593
BE/PL	1	50,787/50,805	53,901/53,913	19,500	1,534	0,030/0,080	EC	71-3994	71-3994 STD 0.25 4
BE/PL	1	50,787/50,805	53,901/53,913	19,500	1,534	0,030/0,080	EC-LF	71-4780	71-4780 STD 5

71-3994

71-4780

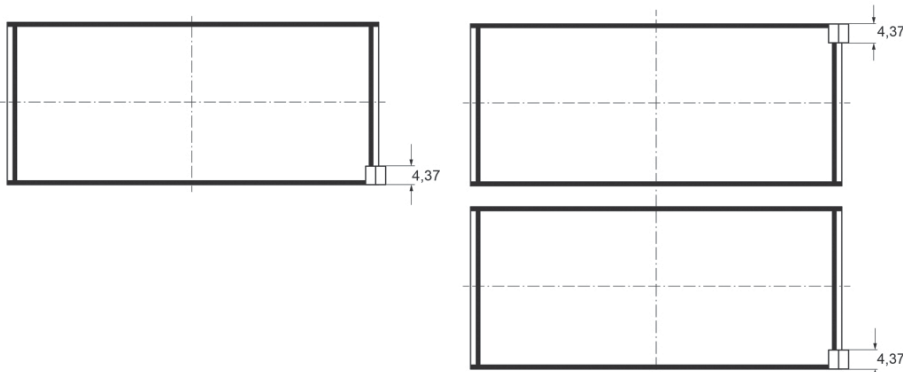

MB/HL	1	59,986/60,000	63,705/63,718	20,750	1,844	0,031/0,080	EC	72-3995	72-3995 STD 0.25 0.50
TW/A	2	67,785/68,040	82,425/82,677		2,485		AL-LF	4356AF	A191/2 STD
SE/PB	1		28,939/28,972	21,700			BS	4369Y	55-4159 SEMI

72		83.00 x 90.40							
55263087		4 Cyl.		1956cc	100-103kW (136-140PS)		Diesel Turbo		TD31790
55263088		4 Cyl.		1956cc	100-103kW (136-140PS)		Diesel Turbo		TD31791
BE/PL	4	48,226/48,244	51,354/51,366	19,100	1,540	0,030/0,056	EC-LF	71-4776	71-4776/4 STD 5
MB/HL	5		56,705/56,718	20,750	1,861		AL-LF	02-4777	H1293/5 STD
TW/A	2	59,000/59,260	73,600/73,850		2,485		AL-LF	04-4778	A291/2 STD
SE/PB	1	26,000	28,939/28,972	22,100			BS-LF	55-4779	55-4779 SEMI

73		84.00 x 71.50							
124 B3.000		4 Cyl.		1585cc	46kW (63PS)		Petrol		TD6898
132 AB.0A.0		4 Cyl.		1592cc	72kW (98PS)		Petrol		TD21455
BE/PL	4	50,782/50,802	53,897/53,913	19,500	1,537	0,021/0,082	AL-LF	66240RA	01-4175/4 STD 0.25 0.50 0.75 1.00

Mot.402353 →

MB/HL 1,2,4,5	4	52,985/53,005	56,717/56,730	20,750	1,841	0,030/0,088	AL-LF	66316RA	H1043/5 STD 0.25 0.50 0.75	
MB/HL 3	1	52,985/53,005	56,717/56,730	24,250	1,841	0,030/0,088	AL-LF	66317RA		
TW/A	2	59,000/59,250	73,600/73,850		2,362		BS	62037AF	A201/2 STD .005	
SE/PB	1	21,539/21,641	23,939/23,972	25,100			BS	62039Y	55-4288 SEMI	

74

84.00 x 71.50

131 A1.000	4 Cyl.		1585cc	55kW (75PS)	Petrol				TD896	
131 AB.1A.0	4 Cyl.		1585cc	55kW (75PS)	Petrol				TD21454	
BE/PL	4	48,224/48,244	51,330/51,346	19,500	1,540	0,020/0,067	AL-LF	66315RA	01-4176/4 STD 0.25 0.50	
MB/HL 1,2,4,5	4	52,985/53,005	56,717/56,730	20,750	1,841	0,030/0,088	AL-LF	66316RA	H1043/5 STD 0.25 0.50 0.75	
MB/HL 3	1	52,985/53,005	56,717/56,730	24,250	1,841	0,030/0,088	AL-LF	66317RA		
TW/A	2	59,000/59,250	73,600/73,850		2,362		BS	62037AF	A201/2 STD .005	
SE/PB	1	21,539/21,641	25,000/25,021	25,100			BS	66649Y	55-4193 SEMI	

75

84.00 x 71.50

131 B1.000	4 Cyl.		1585cc	72kW (98PS)	Petrol				TD901	
131 C2.000	4 Cyl.		1585cc	63kW (85PS)	Petrol				TD4351	
131 C3.000	4 Cyl.		1585cc	71-72kW (96-98PS)	Petrol				TD904	
132 C.000	4 Cyl.		1585cc	65-72kW (89-98PS)	Petrol				TD909	
132 C6.000	4 Cyl.		1585cc	66kW (90PS)	Petrol				TD912	
132 CB.0A.0	4 Cyl.		1585cc	72kW (98PS)	Petrol				TD21458	
132 D.000	4 Cyl.		1585cc	72kW (98PS)	Petrol				TD911	
132 D.000	4 Cyl.		1585cc	72kW (98PS)	Petrol				TD2375	
138 AR.000	4 Cyl.		1585cc	66-77kW (90-105PS)	Petrol				TD919	
138 AR.048	4 Cyl.		1585cc	74kW (100PS)	Petrol				TD920	
149 A.000	4 Cyl.		1585cc	60kW (82PS)	Petrol				TD962	
149 A.000	4 Cyl.		1585cc	62kW (84PS)	Petrol				TD21697	
149 A2.000	4 Cyl.		1585cc	74kW (101PS)	Petrol				TD4379	
149 A4.000	4 Cyl.		1585cc	74kW (101PS)	Petrol				TD4380	
149 C2.000	4 Cyl.		1595cc	66kW (90PS)	Petrol				TD4384	
149 C2.046	4 Cyl.		1595cc	66kW (90PS)	Petrol				TD978	
149 C3.000	4 Cyl.		1585cc	61-76kW (83-103PS)	Petrol				TD18856	
154 A.048	4 Cyl.		1585cc	61kW (83PS)	Petrol				TD11754	
BE/PL	4	48,224/48,244	51,330/51,346	19,500	1,540	0,020/0,067	AL-LF	66315RA	01-4176/4 STD 0.25 0.50	
MB/HL 1,2,4,5	4	52,985/53,005	56,717/56,730	20,750	1,841	0,030/0,088	AL-LF	66316RA	H1043/5 STD 0.25 0.50 0.75	
MB/HL 3	1	52,985/53,005	56,717/56,730	24,250	1,841	0,030/0,088	AL-LF	66317RA		
TW/A	2	59,000/59,250	73,600/73,850		2,362		BS	62037AF	A201/2 STD .005	
SE/PB	1	21,539/21,641	23,939/23,972	25,100			BS	62039Y	55-4288 SEMI	

76

84.00 x 79.20

132 A1.000	4 Cyl.		1756cc	77-82kW (105-112PS)	Petrol				TD21453
132 AB.000	4 Cyl.		1756cc	77-82kW (105-112PS)	Petrol				TD23120
132 AB.1A.0	4 Cyl.		1756cc	77-82kW (105-112PS)	Petrol				TD21456



132 AC1.000	4 Cyl.	1756cc	87kW (118PS)	Petrol	TD23121
132 B1.000	4 Cyl.	1756cc	77-82kW (105-112PS)	Petrol	TD21377
132 BB.1A 0	4 Cyl.	1756cc	77-82kW (105-112PS)	Petrol	TD21457
132 C1.000	4 Cyl.	1756cc	77-82kW (105-112PS)	Petrol	TD19054
132 CB.1A	4 Cyl.	1756cc	77-82kW (105-112PS)	Petrol	TD21459

BE/PL	4	50,782/50,802	53,897/53,913	19,500	1,537	0,021/0,082	AL-LF	66240RA	01-4175/4 STD 0.25 0.50 0.75 1.00
MB/HL 1,2,4,5	4	52,985/53,005	56,717/56,730	20,750	1,841	0,030/0,088	AL-LF	66316RA	H1043/5 STD 0.25 0.50 0.75
MB/HL 3	1	52,985/53,005	56,717/56,730	24,250	1,841	0,030/0,088	AL-LF	66317RA	
TW/A	2	59,000/59,250	73,600/73,850		2,362		BS	62037AF	A201/2 STD .005
SE/PB	1	21,539/21,641	25,000/25,021	25,100			BS	66649Y	55-4193 SEMI

→06/84

SE/PB	1	21,539/21,641	23,939/23,972	25,100			BS	62039Y	55-4288 SEMI
-------	---	---------------	---------------	--------	--	--	----	--------	------------------------

07/84→

77

84.00 x 79.20

132 B.000	4 Cyl.	1756cc	79kW (107PS)	Petrol	TD18854
------------------	--------	---------------	---------------------	---------------	----------------

BE/PL	4	50,782/50,802	53,897/53,913	19,500	1,537	0,021/0,082	AL-LF	66240RA	01-4175/4 STD 0.25 0.50 0.75 1.00
MB/HL 1,2,4,5	4	52,985/53,005	56,717/56,730	20,750	1,841	0,030/0,088	AL-LF	66316RA	H1043/5 STD 0.25 0.50 0.75
MB/HL 3	1	52,985/53,005	56,717/56,730	24,250	1,841	0,030/0,088	AL-LF	66317RA	
TW/A	2	59,000/59,250	73,600/73,850		2,362		BS	62037AF	A201/2 STD .005
SE/PB	1	21,539/21,641	25,000/25,021	25,100			BS	66649Y	55-4193 SEMI

01/75→

→06/84

SE/PB	1	21,539/21,641	23,939/23,972	25,100			BS	62039Y	55-4288 SEMI
-------	---	---------------	---------------	--------	--	--	----	--------	------------------------

07/84→

78

84.00 x 79.20

132 B1.000	4 Cyl.	1756cc	77-82kW (105-112PS)	Petrol	TD906
-------------------	--------	---------------	----------------------------	---------------	--------------

BE/PL	4	50,782/50,802	53,897/53,913	19,500	1,537	0,021/0,082	AL-LF	66240RA	01-4175/4 STD 0.25 0.50 0.75 1.00
MB/HL 1,2,4,5	4	52,985/53,005	56,717/56,730	20,750	1,841	0,030/0,088	AL-LF	66316RA	H1043/5 STD 0.25 0.50 0.75
MB/HL 3	1	52,985/53,005	56,717/56,730	24,250	1,841	0,030/0,088	AL-LF	66317RA	
TW/A	2	59,000/59,250	73,600/73,850		2,362		BS	62037AF	A201/2 STD .005
SE/PB	1	21,539/21,641	25,000/25,021	25,100			BS	66649Y	55-4193 SEMI

79

84.00 x 79.20

159 A4.000	4 Cyl.	1756cc	74-81kW (101-110PS)	Petrol	TD1008
159 A4.046	4 Cyl.	1756cc	77kW (105PS)	Petrol	TD1009
835 C2.000	4 Cyl.	1756cc	76kW (103PS)	Petrol	TD1068
835 C4.000	4 Cyl.	1756cc	66kW (90PS)	Petrol	TD1069
836 A5.000	4 Cyl.	1756cc	71-74kW (97-101PS)	Petrol	TD892

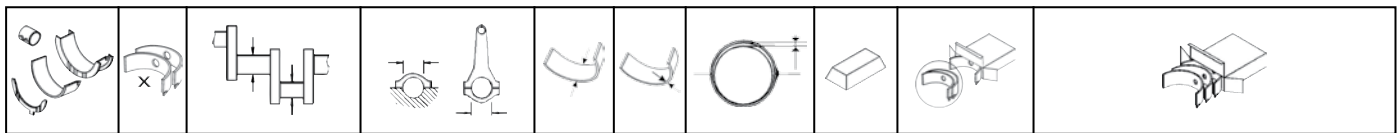

836 A6.000		4 Cyl.		1756cc	66kW (90PS)	Petrol			TD18890
BE/PL	4	50,792/50,805	53,892/53,910	19,500	1,537	0,010/0,070	BS	1150CP	71-4120/4 STD 0.25 0.50
MB/HL 1,2,4,5	4	52,985/53,005	56,717/56,730	20,750	1,841	0,030/0,088	AL-LF	66316RA	H1043/5 STD 0.25 0.50 0.75
MB/HL 3	1	52,985/53,005	56,717/56,730	24,250	1,841	0,030/0,088	AL-LF	66317RA	
TW/A	2	59,000/59,250	73,600/73,850		2,362		BS	62037AF	A201/2 STD .005
SE/PB	1	28,002/28,010	30,000/30,021	25,250			BS	66649RY	55-4294 SEMI

80 84.00 x 79.20

160 A5.000		4 Cyl.		1756cc	100kW (136PS)	Petrol			TD13669
BE/PL	4	50,787/50,807	53,901/53,913	19,500	1,534	0,028/0,083	BS	4350CP	71-4157/4 STD 0.25 0.50
MB/HL 1,2,4,5	4	52,990/53,010	56,717/56,735	20,750	1,843	0,020/0,080	BS	4128CP	H1084/5 STD 0.25 0.50
MB/HL 3	1	52,990/53,010	56,717/56,735	24,250	1,843	0,020/0,080	BS	4129CP	
TW/A	2	59,000/59,250	73,600/73,850		2,362		BS	62037AF	A201/2 STD .005
SE/PB	1	21,539/21,641	25,000/25,021	25,100			BS	66649Y	55-4193 SEMI

81 84.00 x 81.00

169 B		4 Cyl.		1796cc	49kW (67PS)	Petrol			TD12750
BE/PL	4	49,975/49,991	53,655/53,674	23,400	1,818	0,030/0,080	AL-LF	2865RA	01-4558/4 STD 0.30 0.50 0.80
MB/HL 1	1	59,401/59,416	63,227/63,246	29,500	1,888	0,040/0,080	AL-LF	2866RA	H1240/5 STD 0.30 0.50 0.80
MB/HL 2	1	58,548/58,573	62,384/62,403	21,500	1,888	0,040/0,080	AL-LF	61902RA	
MB/HL 3	1	57,174/57,189	61,000/61,019	29,500	1,888	0,040/0,080	AL-LF	61903RA	
MB/HL 4	1	56,140/56,165	59,976/59,995	21,500	1,888	0,040/0,080	AL-LF	61903RAA	
MB/HL 5	1	54,905/54,920	58,731/58,750	29,350	1,888	0,040/0,080	AL-LF	61904RA	
MB/HL 5	1	54,905/54,920	58,731/58,750	29,350	1,900	0,040/0,080	AL-LF	66696RA	H1241/5 STD 0.30 0.50 0.80
MB/HL 4	1	56,140/56,165	59,976/59,995	21,500	1,900	0,040/0,080	AL-LF	66697RA	
MB/HL 3	1	57,174/57,189	61,000/61,019	29,500	1,900	0,040/0,080	AL-LF	66698RA	
MB/HL 2	1	58,548/58,573	62,384/62,403	21,500	1,900	0,040/0,080	AL-LF	66699RA	
MB/HL 1	1	59,401/59,416	63,227/63,246	29,500	1,900	0,040/0,080	AL-LF	66699RAA	
TW/A	4	61,400/61,650	72,550/72,800		2,330		AL-LF	61904BF	A199/4 STD 0.10 0.15 0.20

82 84.00 x 81.00

XM7T		4 Cyl.		1796cc	50-51kW (68-69PS)	Petrol			TD28853
BE/PL	4	49,975/49,991	53,655/53,674	23,400	1,818	0,030/0,080	AL-LF	2865RA	01-4558/4 STD 0.30 0.50 0.80

MB/HL 5	1	54,905/54,920	58,731/58,750	29,350	1,900	0,040/0,080	AL-LF	66696RA	H1241/5 STD 0.30 0.50 0.80
MB/HL 4	1	56,140/56,165	59,976/59,995	21,500	1,900	0,040/0,080	AL-LF	66697RA	
MB/HL 3	1	57,174/57,189	61,000/61,019	29,500	1,900	0,040/0,080	AL-LF	66698RA	
MB/HL 2	1	58,548/58,573	62,384/62,403	21,500	1,900	0,040/0,080	AL-LF	66699RA	
MB/HL 1	1	59,401/59,416	63,227/63,246	29,500	1,900	0,040/0,080	AL-LF	66699RAA	

83

84.00 x 90.00

131 B2.000		4 Cyl.		1995cc	85-103kW (115-140PS)		Petrol		TD900
BE/PL	4	50,782/50,802	53,897/53,913	19,500	1,537	0,021/0,082	AL-LF	66240RA	01-4175/4 STD 0.25 0.50 0.75 1.00
Mot.402353 →									
MB/HL 1,2,4,5	4	52,985/53,005	56,717/56,730	20,750	1,841	0,030/0,088	AL-LF	66316RA	H1043/5 STD 0.25 0.50 0.75
MB/HL 3	1	52,985/53,005	56,717/56,730	24,250	1,841	0,030/0,088	AL-LF	66317RA	
TW/A	2	59,000/59,250	73,600/73,850		2,362		BS	62037AF	A201/2 STD .005
SE/PB	1	21,539/21,641	23,939/23,972	25,100			BS	62039Y	55-4288 SEMI

84

84.00 x 90.00

131 C4.000		4 Cyl.		1995cc	83-85kW (113-116PS)		Petrol		TD4350
BE/PL	4	50,782/50,802	53,897/53,913	19,500	1,537	0,021/0,082	AL-LF	66240RA	01-4175/4 STD 0.25 0.50 0.75 1.00
Mot.402353 →									
MB/HL 1,2,4,5	4	52,985/53,005	56,717/56,730	20,750	1,841	0,030/0,088	AL-LF	66316RA	H1043/5 STD 0.25 0.50 0.75
MB/HL 3	1	52,985/53,005	56,717/56,730	24,250	1,841	0,030/0,088	AL-LF	66317RA	
TW/A	2	59,000/59,250	73,600/73,850		2,362		BS	62037AF	A201/2 STD .005
SE/PB	1	21,539/21,641	23,939/23,972	25,100			BS	62039Y	55-4288 SEMI
CB/NWB	4	27,982/28,000	31,200/31,218	18,150	1,594		AL-LF	03-3981	N151/6 STD
CB/NWB	8	27,982/28,000	31,200/31,218	18,150	1,594		AL-LF	03-3982	

85

84.00 x 90.00

132 AZ2.000		4 Cyl.		1995cc	51kW (69PS)		Petrol		TD13028
149 E1.011		4 Cyl.		1995cc	71kW (99PS)		Petrol		TD29390
159 B2.011		4 Cyl.		1995cc	81kW (110PS)		Petrol		TD29391
BE/PL	4	48,224/48,244	51,330/51,346	19,500	1,540	0,020/0,067	AL-LF	66315RA	01-4176/4 STD 0.25 0.50
MB/HL 1,2,4,5	4	52,985/53,005	56,717/56,730	20,750	1,841	0,030/0,088	AL-LF	66316RA	H1043/5 STD 0.25 0.50 0.75
MB/HL 3	1	52,985/53,005	56,717/56,730	24,250	1,841	0,030/0,088	AL-LF	66317RA	
TW/A	2	59,000/59,250	73,600/73,850		2,362		BS	62037AF	A201/2 STD .005
SE/PB	1	21,539/21,641	23,939/23,972	25,100			BS	62039Y	55-4288 SEMI

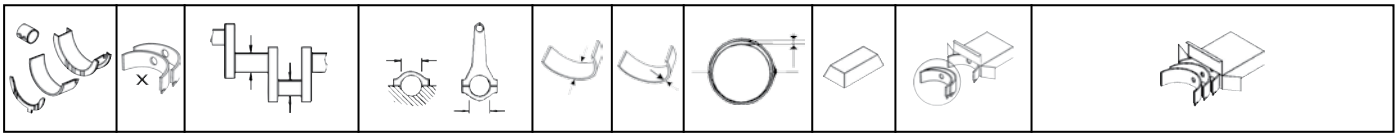

86 84.00 x 90.00

132 B2.000	4 Cyl.	1995cc	83kW (113PS)	Petrol	TD23356
132 C2.000	4 Cyl.	1995cc	82-84kW (112-115PS)	Petrol	TD910
132 C2.031	4 Cyl.	1995cc	59kW (80PS)	Petrol	TD20757
132 C2.040	4 Cyl.	1995cc	63kW (86PS)	Petrol	TD20756
132 C3.000	4 Cyl.	1995cc	88-90kW (120-122PS)	Petrol	TD4353
132 C3.000	4 Cyl.	1995cc	90kW (122PS)	Petrol	TD2374
132 C3.031	4 Cyl.	1995cc	76-77kW (103-105PS)	Petrol	TD908
132 C3.040	4 Cyl.	1995cc	59kW (80PS)	Petrol	TD20758
132 D1.000	4 Cyl.	1995cc	83kW (113PS)	Petrol	TD4354
132 DB.2A.O	4 Cyl.	1995cc	82kW (112PS)	Petrol	TD23460
138 AR1.000	4 Cyl.	1995cc	92kW (125PS)	Petrol	TD4360
138 AR2.000	4 Cyl.	1995cc	96kW (130PS)	Petrol	TD4361

BE/PL	4	50,782/50,802	53,897/53,913	19,500	1,537	0,021/0,082	AL-LF	66240RA	01-4175/4 STD 0.25 0.50 0.75 1.00
-------	---	---------------	---------------	--------	-------	-------------	-------	---------	---

Mot.402353 →

MB/HL 1,2,4,5	4	52,985/53,005	56,717/56,730	20,750	1,841	0,030/0,088	AL-LF	66316RA	H1043/5 STD 0.25 0.50 0.75
MB/HL 3	1	52,985/53,005	56,717/56,730	24,250	1,841	0,030/0,088	AL-LF	66317RA	
TW/A	2	59,000/59,250	73,600/73,850		2,362		BS	62037AF	A201/2 STD .005
SE/PB	1	21,539/21,641	25,000/25,021	25,100			BS	66649Y	55-4193 SEMI

01/85 →

SE/PB	1	21,539/21,641	23,939/23,972	25,100			BS	62039Y	55-4288 SEMI
-------	---	---------------	---------------	--------	--	--	----	--------	------------------------

→**12/84**

87 84.00 x 90.00

154 A1.000	4 Cyl.	1995cc	66kW (90PS)	Petrol Turbo	TD1077
154 C5.000	4 Cyl.	1995cc	66kW (90PS)	Petrol	TD23358

BE/PL	4	50,792/50,805	53,892/53,910	19,500	1,537	0,010/0,070	BS	1150CP	71-4120/4 STD 0.25 0.50
MB/HL 1,2,4,5	4	52,990/53,010	56,717/56,735	20,750	1,843	0,020/0,080	BS	4128CP	H1084/5 STD 0.25 0.50
MB/HL 3	1	52,990/53,010	56,717/56,735	24,250	1,843	0,020/0,080	BS	4129CP	
TW/A	2	59,000/59,250	73,600/73,850		2,362		BS	62037AF	A201/2 STD .005
SE/PB	1	21,539/21,641	25,000/25,021	25,100			BS	66649Y	55-4193 SEMI

88 84.00 x 90.00

154 A2.000	4 Cyl.	1995cc	114kW (155PS)	Petrol Turbo Intercooler	TD1083
154 C4.000	4 Cyl.	1995cc	114kW (155PS)	Petrol Turbo Intercooler	TD18823
154 C4.046	4 Cyl.	1995cc	110kW (150PS)	Petrol Turbo Intercooler	TD986
834 C.146	4 Cyl.	1995cc	110-112kW (150-152PS)	Petrol Turbo Intercooler	TD1064

BE/PL	4	50,787/50,807	53,892/53,910	19,500	1,537	0,020/0,070	BS	1040CP	71-4118/4 STD 0.25 0.50
MB/HL 1,2,4,5	4	52,990/53,010	56,717/56,735	20,750	1,843	0,020/0,080	BS	4128CP	H1084/5 STD 0.25 0.50
MB/HL 3	1	52,990/53,010	56,717/56,735	24,250	1,843	0,020/0,080	BS	4129CP	
TW/A	2	59,000/59,250	73,600/73,850		2,362		BS	62037AF	A201/2 STD .005

SE/PB	1	21,539/21,641	25,000/25,021	25,100			BS	66649Y	55-4193 SEMI

89	84.00 x 90.00								
154 C3.000			4 Cyl.	1995cc	88kW (120PS)		Petrol		TD18822
154 C3.046			4 Cyl.	1995cc	85kW (116PS)		Petrol		TD984
BE/PL	4	50,787/50,807	53,901/53,913	19,500	1,534	0,028/0,083	BS	4350CP	71-4157/4 STD 0.25 0.50
MB/HL 1,2,4,5	4	52,985/53,005	56,717/56,730	20,750	1,841	0,030/0,088	AL-LF	66316RA	H1043/5 STD 0.25 0.50 0.75
MB/HL 3	1	52,985/53,005	56,717/56,730	24,250	1,841	0,030/0,088	AL-LF	66317RA	
TW/A	2	59,000/59,250	73,600/73,850		2,362		BS	62037AF	A201/2 STD .005
SE/PB	1	21,539/21,641	25,000/25,021	25,100			BS	66649Y	55-4193 SEMI

90	84.00 x 90.00								
154 E1.000			4 Cyl.	1995cc	101kW (137PS)		Petrol		TD989
160 A8.046			4 Cyl.	1995cc	107kW (146PS)		Petrol		TD1024
175 A1.000			4 Cyl.	1995cc	140kW (190PS)		Petrol Turbo Intercooler		TD4395
836 A3.000			4 Cyl.	1995cc	102kW (139PS)		Petrol		TD1071
836 A3.011			4 Cyl.	1995cc	102-104kW (139-141PS)		Petrol		TD26168
BE/PL	4	50,787/50,807	53,901/53,913	19,500	1,534	0,028/0,083	BS	4350CP	71-4157/4 STD 0.25 0.50
MB/HL 1,2,4,5	4	52,990/53,010	56,717/56,735	20,750	1,843	0,020/0,080	BS	4128CP	H1084/5 STD 0.25 0.50
MB/HL 3	1	52,990/53,010	56,717/56,735	24,250	1,843	0,020/0,080	BS	4129CP	
TW/A	2	59,000/59,250	73,600/73,850		2,362		BS	62037AF	A201/2 STD .005
SE/PB	1	21,539/21,641	25,000/25,021	25,100			BS	66649Y	55-4193 SEMI

91	84.00 x 90.00								
159 A5.046			4 Cyl.	1995cc	80-85kW (109-116PS)		Petrol		TD1011
159 A6.046			4 Cyl.	1995cc	83-85kW (113-116PS)		Petrol		TD1012
BE/PL	4	50,787/50,807	53,892/53,910	19,500	1,537	0,020/0,070	BS	1040CP	71-4118/4 STD 0.25 0.50
MB/HL 1,2,4,5	4	52,985/53,005	56,717/56,730	20,750	1,841	0,030/0,088	AL-LF	66316RA	H1043/5 STD 0.25 0.50 0.75
MB/HL 3	1	52,985/53,005	56,717/56,730	24,250	1,841	0,030/0,088	AL-LF	66317RA	
TW/A	2	59,000/59,250	73,600/73,850		2,362		BS	62037AF	A201/2 STD .005
SE/PB	1	21,539/21,641	25,000/25,021	25,100			BS	66649Y	55-4193 SEMI

92	84.00 x 90.00								
834 B.000			4 Cyl.	1995cc	88kW (120PS)		Petrol		TD1084
834 B.048			4 Cyl.	1995cc	83kW (113PS)		Petrol		TD1085
834 B.146			4 Cyl.	1995cc	85kW (116PS)		Petrol		TD11707
BE/PL	4	50,792/50,805	53,892/53,910	19,500	1,537	0,010/0,070	BS	1150CP	71-4120/4 STD 0.25 0.50
MB/HL 1,2,4,5	4	52,985/53,005	56,717/56,730	20,750	1,841	0,030/0,088	AL-LF	66316RA	H1043/5 STD 0.25 0.50 0.75
MB/HL 3	1	52,985/53,005	56,717/56,730	24,250	1,841	0,030/0,088	AL-LF	66317RA	

TW/A	2	59,000/59,250	73,600/73,850		2,362			BS	62037AF	A201/2 STD .005
SE/PB	1	21,539/21,641	25,000/25,021	25,100				BS	66649Y	55-4193 SEMI

93 84.00 x 90.00										
6132 AZ 2.000 4 Cyl. 1995cc 59kW (80PS) Petrol TD13508										
BE/PL	4	50,782/50,802	53,897/53,913	19,500	1,537	0,021/0,082	AL-LF	66240RA	01-4175/4 STD 0.25 0.50 0.75 1.00	
MB/HL 1,2,4,5	4	52,985/53,005	56,717/56,730	20,750	1,841	0,030/0,088	AL-LF	66316RA	H1043/5 STD 0.25 0.50 0.75	
MB/HL 3	1	52,985/53,005	56,717/56,730	24,250	1,841	0,030/0,088	AL-LF	66317RA		
TW/A	2	59,000/59,250	73,600/73,850		2,362			BS	62037AF	A201/2 STD .005
SE/PB	1	21,539/21,641	25,000/25,021	25,100				BS	66649Y	55-4193 SEMI
SE/PB	1	21,539/21,641	23,939/23,972	25,100				BS	62039Y	55-4288 SEMI

94 85.00 x 88.00										
RFH (EW10A) Euro 4 4 Cyl. 1997cc 103kW (140PS) Petrol TD25732										
RFN (EW10J4) 4 Cyl. 1997cc 100kW (136PS) Petrol TD16788										
BE/PL	4	44,975/44,991	48,655/48,671	22,500	1,825	0,020/0,070	AL	4300RA	01-4155/4 STD 0.30	
MB/HL 1-5	5	59,981/60,000	63,708/63,727	21,000	1,862	0,020/0,083	AL-LF	02-3957	H086/5 STD	
TW/A	2	67,050/67,300	83,050/83,300		2,330			AL	04-3980	A161/2 STD
CB/NWB	4	27,982/28,000	31,200/31,218	18,150	1,594		AL-LF	03-3981	N151/6 STD	
CB/NWB	8	27,982/28,000	31,200/31,218	18,150	1,594		AL-LF	03-3982		

95 85.00 x 88.00										
DW10BTED4 4 Cyl. 1997cc 100kW (136PS) Diesel Turbo Intercooler TD25755										
RHH Euro 5 4 Cyl. 1997cc 120kW (163PS) Diesel Turbo Intercooler TD24777										
RHK 4 Cyl. 1997cc 88kW (120PS) Diesel Turbo Intercooler TD20267										
RHM (DW10ATED4) 4 Cyl. 1997cc 79kW (107PS) Diesel Turbo Intercooler TD18906										
RHR 4 Cyl. 1997cc 100kW (136PS) Diesel Turbo Intercooler TD20268										
RHV (DW10) 4 Cyl. 1997cc 62kW (84PS) Diesel Turbo Intercooler TD16406										
RHW (DW10ATED4) 4 Cyl. 1997cc 80kW (109PS) Diesel Turbo Intercooler TD16789										
RHX 4 Cyl. 1997cc 69kW (94PS) Diesel Turbo Intercooler TD16299										
RHZ 4 Cyl. 1997cc 80kW (109PS) Diesel Turbo Intercooler TD16324										
BE/PL	4	49,984/50,000	53,695/53,708	20,000	1,838	0,020/0,070	SP	71-3952	71-3952/4 STD 0.30	
MB/HL 1-5	5	59,981/60,000	63,731/63,750	20,290	1,845	0,040/0,100	AL-LF	66726RA	H1057/5 STD 0.30 0.50	
TW/A	4	67,050/67,300	83,050/83,300		2,330			BS	66721BF	A214/4 STD 0.10
SE/PB	1	27,997/28,000	30,200/30,225	24,050				BS-LF	55-3985	55-3985 SEMI
CB/NWB	4	27,982/28,000	31,200/31,218	18,150	1,594		AL-LF	03-3981	N151/6 STD	
CB/NWB	8	27,982/28,000	31,200/31,218	18,150	1,594		AL-LF	03-3982		

1

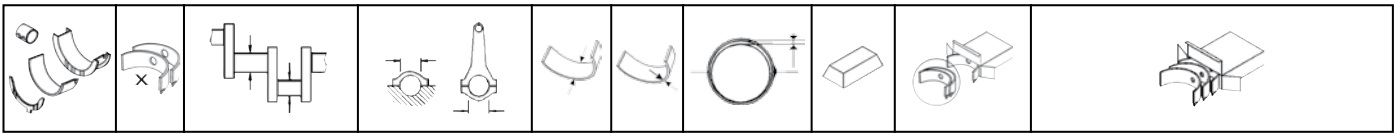

96 85.00 x 92.00									
P8C		4 Cyl.		2088cc	80kW (109PS)	Diesel Turbo Intercooler			TD960
BE/PL	4	49,984/50,000	53,695/53,708	21,950	1,843	0,020/0,064	BS	4255CP	71-4279/4 STD 0.30
MB/HL 1-5	5	59,981/60,000	63,731/63,750	20,290	1,845	0,040/0,100	AL-LF	66726RA	H1057/5 STD 0.30 0.50
TW/A	4	67,050/67,300	83,050/83,300		1,880		AL-LF	4141AF	A188/4 STD

97 85.00 x 96.00									
4HP		4 Cyl.		2179cc	120kW (163PS)		Diesel Turbo Intercooler		TD24945
4HR		4 Cyl.		2179cc	120kW (163PS)		Diesel Turbo Intercooler		TD24946
4HS Euro 4		4 Cyl.		2179cc	125kW (170PS)		Diesel Turbo Intercooler		TD24775
4HT (DW12BTED4) Euro 4		4 Cyl.		2179cc	125kW (170PS)		Diesel Bi-Turbo Intercooler		TD25656
4HW (DW12ATED4)		4 Cyl.		2179cc	94kW (128PS)		Diesel Turbo Intercooler		TD16790
4HX (DW12TED4)		4 Cyl.		2179cc	94-100kW (128-136PS)		Diesel Turbo Intercooler		TD22230
BE/PL	4	49,984/50,000	53,695/53,708	20,000	1,838	0,020/0,070	SP	71-3952	71-3952/4 STD 0.30 1
MB/HL 1-5	5	59,981/60,000	63,731/63,750	20,290	1,845	0,040/0,100	AL-LF	66726RA	H1057/5 STD 0.30 0.50
TW/A	4	67,050/67,300	83,050/83,300		2,330		BS	66721BF	A214/4 STD 0.10
SE/PB	1	29,995/30,000	33,000/33,025	24,050			BS-LF	55-3984	55-3984 SEMI
CB/NWB	4	27,982/28,000	31,200/31,218	18,150	1,594		AL-LF	03-3981	N151/6 STD
CB/NWB	8	27,982/28,000	31,200/31,218	18,150	1,594		AL-LF	03-3982	

98 86.00 x 55.50									
128 A1.000		4 Cyl.		1290cc	44kW (60PS)		Petrol		TD889
128 AC.000		4 Cyl.		1290cc	55kW (75PS)		Petrol		TD890
128 AR.000		4 Cyl.		1290cc	50kW (68PS)		Petrol		TD21448
128 AR.000		4 Cyl.		1290cc	48-49kW (65-67PS)		Petrol		TD18319
128 AS.000		4 Cyl.		1290cc	54-55kW (73-75PS)		Petrol		TD995
BE/PL	4	45,508/45,528	48,629/48,646	19,200	1,547	0,020/0,069	AL-LF	1645RA	01-4127/4 STD 0.25 0.50
BE/PL	4	45,508/45,528	48,629/48,646	19,200	1,538	0,025/0,087	AL-LF	60985RA	01-4171/4 STD

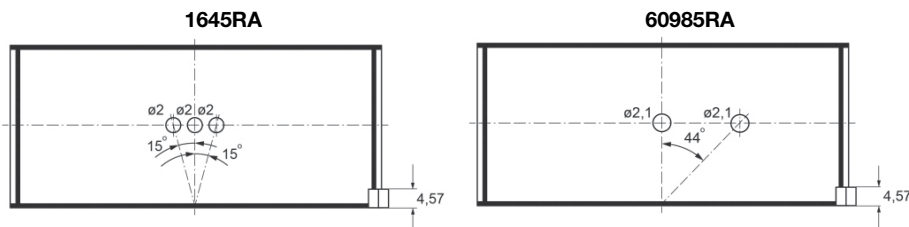

MB/HL 1,2,4,5	4	50,785/50,805	54,507/54,520	20,250	1,831	0,040/0,098	AL-LF	60986RA	H1028/5 STD 0.25
MB/HL 3	1	50,785/50,805	54,507/54,520	22,750	1,831	0,040/0,098	AL-LF	60987RA	
TW/A	2	56,610/56,864	69,596/69,850		2,362		AL-LF	60987AFA	A198/2 STD .005
SE/PB	1	21,539/21,641	23,939/23,972	25,100			BS	62039Y	55-4288 SEMI

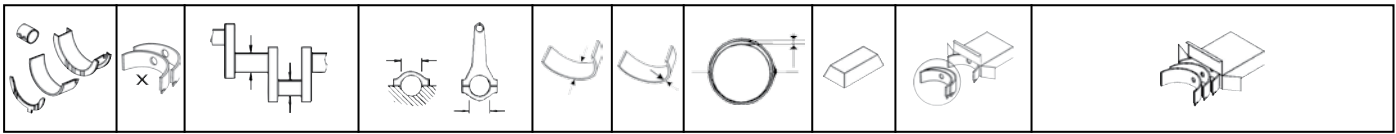

99		86.00 x 86.00							
RFL		4 Cyl.	1998cc	81kW (110PS)		Petrol			TD16405
RFU (XU10J2C)		4 Cyl.	1998cc	89kW (121PS)		Petrol			TD4349
RFV		4 Cyl.	1998cc	97-100kW (132-136PS)		Petrol			TD18824
RFW		4 Cyl.	1998cc	80kW (109PS)		Petrol			TD6808
RGX (XU10J2CTE)		4 Cyl.	1998cc	108kW (147PS)		Petrol Turbo Intercooler			TD4355

BE/PL	4	49,984/50,000	53,695/53,708	21,950	1,834	0,027/0,081	AL-LF	4150RA	01-4149/4 STD 0.30
BE/PL	4	49,984/50,000	53,695/53,708	20,250	1,837	0,021/0,075	AL	4305RA	01-4298/4 STD 0.30

4150RA

4305RA

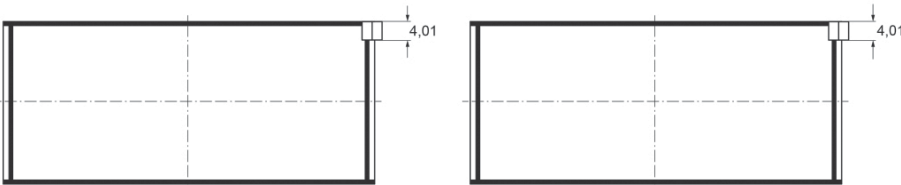

MB/HL 1-5	5	59,981/60,000	63,731/63,750	20,290	1,845	0,040/0,100	AL-LF	66726RA	H1057/5 STD 0.30 0.50
TW/A	4	67,050/67,300	83,050/83,300		1,880		AL-LF	4141AF	A188/4 STD
TW/A	2	56,800/57,050	73,300/73,550		2,400		AL-LF	4131AF	A241/2 STD

100		86.00 x 94.60							
4HU Euro 4		4 Cyl.	2198cc	88kW (120PS)		Diesel Turbo Intercooler			TD25655
4HV Euro 4		4 Cyl.	2198cc	74kW (101PS)		Diesel Turbo Intercooler			TD20266

BE/PL	4	52,980/53,000	55,996/56,016	24,450	1,487	0,026/0,084	BS	71-4066	71-4066/4 STD 0.25 0.50
MB/HL	4	64,940	69,520	23,280	2,250		AL-LF	02-4067	H1018/5 STD 0.25 0.50
MB/HL	3	64,940	69,520	24,080	2,250		AL-LF	02-4068	
MB/HL	2	69,940	74,520	19,580	2,250		AL-LF	02-4069	
MB/HL	1	64,940	69,520	30,150	2,250		AL-LF	02-4070H	

101		86.40 x 55.50							
128 A3.000		4 Cyl.	1301cc	55kW (75PS)		Petrol			TD21446
138 A.000		4 Cyl.	1302cc	37-48kW (50-65PS)		Petrol			TD18855
138 A1.000		4 Cyl.	1301cc	48kW (65PS)		Petrol			TD4368
138 A3.000		4 Cyl.	1301cc	55kW (75PS)		Petrol			TD4362
138 B2.000		4 Cyl.	1302cc	50-51kW (68-69PS)		Petrol			TD4363
149 A3.000		4 Cyl.	1301cc	48kW (65PS)		Petrol			TD958
149 A7.000		4 Cyl.	1302cc	48kW (65PS)		Petrol			TD4382
149 A7.003		4 Cyl.	1301cc	48-50kW (65-68PS)		Petrol			TD23357

BE/PL	4	45,508/45,528	48,629/48,646	19,200	1,547	0,020/0,069	AL-LF	1645RA	01-4127/4 STD 0.25 0.50
BE/PL	4	45,508/45,528	48,629/48,646	19,200	1,538	0,025/0,087	AL-LF	60985RA	01-4171/4 STD



1645RA

60985RA

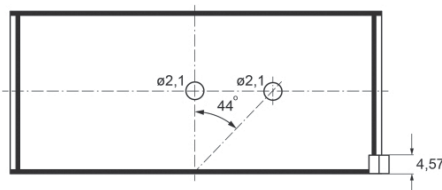
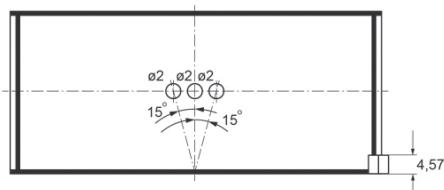

MB/HL 1,2,4,5	4	50,785/50,805	54,507/54,520	20,250	1,831	0,040/0,098	AL-LF	60986RA	H1028/5 STD 0.25
MB/HL 3	1	50,785/50,805	54,507/54,520	22,750	1,831	0,040/0,098	AL-LF	60987RA	
TW/A	2	56,610/56,864	69,596/69,850		2,362		AL-LF	60987AFA	A198/2 STD .005
SE/PB	1	21,539/21,641	23,939/23,972	25,100			BS	62039Y	55-4288 SEMI

102 86.40 x 55.50

149 A7.046			4 Cyl.	1302cc	50kW (68PS)		Petrol		TD23864
BE/PL	4	43,988/44,008	47,130/47,142	18,500	1,546	0,030/0,087	AL-LF	68090RA	01-4207/4 STD 0.25 0.50
MB/HL 1,2,4,5	4	48,189/48,209	51,921/51,934	17,650	1,841	0,030/0,088	AL-LF	68091RA	H1069/5 STD 0.25 0.50
MB/HL 3	1	48,189/48,209	51,921/51,934	25,250	1,841	0,030/0,088	AL-LF	68092RA	
TW/A	2	54,224/54,478	66,996/67,520		2,362		AL-LF	68092AF	A221/2 STD
SE/PB	1	21,539/21,641	23,939/23,972	25,100			BS	62039Y	55-4288 SEMI

103 86.40 x 63.90

128 A5.000			4 Cyl.	1499cc	55-63kW (75-86PS)		Petrol		TD21447
138 A2.000			4 Cyl.	1498cc	55-57kW (75-78PS)		Petrol		TD916
138 A4.000			4 Cyl.	1498cc	63kW (86PS)		Petrol		TD4357
138 AS.000			4 Cyl.	1499cc	63kW (85PS)		Petrol		TD4359
138 B3.000			4 Cyl.	1498cc	55-61kW (75-83PS)		Petrol		TD4365
138 B3.048			4 Cyl.	1498cc	55-57kW (75-78PS)		Petrol		TD4364
138 BS.031			4 Cyl.	1499cc	56kW (76PS)		Petrol		TD918
138 C.048			4 Cyl.	1498cc	55-57kW (75-78PS)		Petrol		TD4367
138 C2.048			4 Cyl.	1499cc	55kW (75PS)		Petrol		TD926
138 C3.048			4 Cyl.	1498cc	55-57kW (75-78PS)		Petrol		TD4366
149 A5.000			4 Cyl.	1498cc	58kW (79PS)		Petrol		TD4381
149 A5.046			4 Cyl.	1498cc	58-63kW (79-86PS)		Petrol		TD23863
149 C1.000			4 Cyl.	1499cc	49-55kW (67-75PS)		Petrol		TD973
149 C1.000			4 Cyl.	1498cc	55kW (75PS)		Petrol		TD16223
146 A3.011			4 Cyl.	1497cc	52kW (71PS)		Flexfuel		

TD29510									
BE/PL	4	45,508/45,528	48,629/48,646	19,200	1,547	0,020/0,069	AL-LF	1645RA	01-4127/4 STD 0.25 0.50
MB/HL 1,2,4,5	4	52,982/53,000	56,705/56,718	20,750	1,843	0,019/0,075	AL-LF	4351RA	H1096/5 STD 0.25 0.50
MB/HL 3	1	52,982/53,000	56,705/56,718	20,750	1,838	0,029/0,085	AL-LF	4352RA	
TW/A	2	56,610/56,864	69,596/69,850		2,362		AL-LF	60987AFA	A198/2 STD .005
SE/PB	1	21,539/21,641	23,939/23,972	25,100			BS	62039Y	55-4288 SEMI

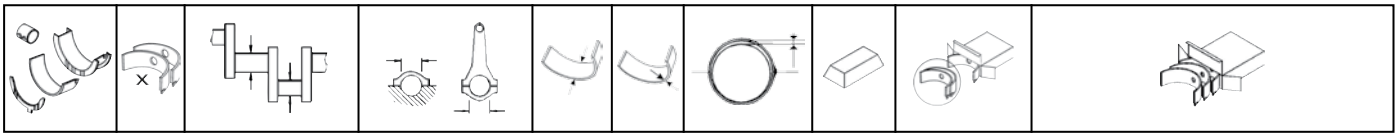

104 86.40 x 63.90

138 B3.011		4 Cyl.		1498cc	52-53kW (70-72PS)		Petrol		TD29352
BE/PL	4	45,508/45,528	48,629/48,646	19,200	1,547	0,020/0,069	AL-LF	1645RA	01-4127/4 STD 0.25 0.50
MB/HL 1,2,4,5	4	50,780/50,800	54,507/54,520	20,250	1,849	0,020/0,067	AL-LF	1646RA	H1075/5 STD 0.25 0.50
MB/HL 3	1	50,780/50,800	54,507/54,520	22,750	1,849	0,020/0,067	AL-LF	1647RA	
MB/HL 1,2,4,5	4	52,982/53,000	56,705/56,718	20,750	1,843	0,019/0,075	AL-LF	4351RA	H1096/5 STD 0.25 0.50
MB/HL 3	1	52,982/53,000	56,705/56,718	20,750	1,838	0,029/0,085	AL-LF	4352RA	
TW/A	2	56,610/56,864	69,596/69,850		2,362		AL-LF	60987AFA	A198/2 STD .005
SE/PB	1	21,539/21,641	23,939/23,972	25,100			BS	62039Y	55-4288 SEMI

105 86.40 x 63.90

146 D1.011		4 Cyl.		1497cc	49kW (67PS)		Flexfuel		TD29389
BE/PL	4	45,508/45,528	48,629/48,646	19,200	1,547	0,020/0,069	AL-LF	1645RA	01-4127/4 STD 0.25 0.50
MB/HL 1,2,4,5	4	52,982/53,000	56,705/56,718	20,750	1,843	0,019/0,075	AL-LF	4351RA	H1096/5 STD 0.25 0.50
MB/HL 3	1	52,982/53,000	56,705/56,718	20,750	1,838	0,029/0,085	AL-LF	4352RA	
TW/A	2	54,224/54,478	66,996/67,520		2,362		AL-LF	68092AF	A221/2 STD
SE/PB	1	21,539/21,641	23,939/23,972	25,100			BS	62039Y	55-4288 SEMI

106 86.40 x 67.40

146 B6.011	4 Cyl.	1581cc	63-65kW (86-88PS)		Petrol	TD29387
146 B7.011	4 Cyl.	1581cc	59-66kW (80-90PS)		Petrol	TD29351
146 C6.000	4 Cyl.	1581cc	55kW (75PS)		Petrol	TD954
146 C6.000	4 Cyl.	1580cc	55kW (75PS)		Petrol	TD16226
146 D6.000	4 Cyl.	1580cc	55kW (75PS)		Petrol	TD16227
146 D6.000	4 Cyl.	1581cc	55kW (75PS)		Petrol	TD959
159 A3.000	4 Cyl.	1581cc	62-66kW (84-90PS)		Petrol	TD9787
159 A3.046	4 Cyl.	1581cc	57-65kW (78-88PS)		Petrol	TD1006
159 A3.048	4 Cyl.	1581cc	51-66kW (69-90PS)		Petrol	TD1007
159 B9.000	4 Cyl.	1581cc	63-66kW (86-90PS)		Petrol	TD965
160 A2.000	4 Cyl.	1581cc	58-62kW (79-84PS)		Petrol	TD1019
160 A2.011	4 Cyl.	1581cc	60-66kW (82-90PS)		Petrol	TD29508
176 A9.000	4 Cyl.	1581cc	65kW (88PS)		Petrol	TD1039
178 B3.000	4 Cyl.	1581cc	74-78kW (100-106PS)		Petrol	TD10187
178 C7.098	4 Cyl.	1581cc	68-76kW (92-103PS)		Petrol	TD18896
178 D2.011	4 Cyl.	1581cc	68-76kW (92-103PS)		Petrol	TD18897
182 A4.000	4 Cyl.	1581cc	76kW (103PS)		Petrol	TD4400
182 A6.000	4 Cyl.	1581cc	66kW (90PS)		Petrol	TD4402
182 B5.098	4 Cyl.	1581cc	72kW (98PS)		Petrol	TD19060
185 A3.000 Euro 3	4 Cyl.	1581cc	68-76kW (92-103PS)		Petrol	TD15650
186 A3.000	4 Cyl.	1581cc	70kW (95PS)		LPG	TD11787
186 A4.000	4 Cyl.	1581cc	68-76kW (92-103PS)		Petrol	TD11788
220 A 2.000	4 Cyl.	1581cc	58kW (79PS)		Petrol	TD6826
835 C1.000	4 Cyl.	1581cc	55-57kW (75-78PS)		Petrol	TD1067

BE/PL	4	45,508/45,528	48,629/48,646	19,200	1,547	0,020/0,069	AL-LF	1645RA	01-4127/4 STD 0.25 0.50
MB/HL 1,2,4,5	4	50,780/50,800	54,507/54,520	20,250	1,849	0,020/0,067	AL-LF	1646RA	H1075/5 STD 0.25 0.50
MB/HL 3	1	50,780/50,800	54,507/54,520	22,750	1,849	0,020/0,067	AL-LF	1647RA	
TW/A	2	56,610/56,864	69,596/69,850		2,362		AL-LF	60987AFA	A198/2 STD .005
SE/PB	1	21,539/21,641	23,939/23,972	25,100			BS	62039Y	55-4288 SEMI

107 88.00 x 68.30

834 G.000	V6 Cyl.		2492cc	119kW (162PS)	Petrol			TD1066	
BE/PL	6	51,980/52,000	55,511/55,524	19,100	1,749	0,020/0,071	BS	4080CP	71-4218/6 STD 0.25
MB/HL	4	59,951/59,971	63,657/63,676	22,350	1,841	0,020/0,068	BS	4081CP	H1082/4 STD 0.25
SE/PB	1	21,994/22,000	25,120/25,146	23,720			BS	60014X	55-4280 SEMI

108 88.00 x 81.00

170 B	4 Cyl.		1971cc	55kW (75PS)	Petrol			TD4417	
170 D	4 Cyl.		1971cc	62kW (84PS)	Petrol			TD5102	
XN 1T	4 Cyl.		1971cc	58-60kW (79-82PS)	Petrol			TD4418	
BE/PL	4	49,975/49,991	53,655/53,674	23,400	1,818	0,030/0,080	AL-LF	2865RA	01-4558/4 STD 0.30 0.50 0.80
MB/HL 1	1	59,401/59,416	63,227/63,246	29,500	1,888	0,040/0,080	AL-LF	2866RA	H1240/5 STD 0.30 0.50 0.80
MB/HL 2	1	58,548/58,573	62,384/62,403	21,500	1,888	0,040/0,080	AL-LF	61902RA	
MB/HL 3	1	57,174/57,189	61,000/61,019	29,500	1,888	0,040/0,080	AL-LF	61903RA	
MB/HL 4	1	56,140/56,165	59,976/59,995	21,500	1,888	0,040/0,080	AL-LF	61903RAA	
MB/HL 5	1	54,905/54,920	58,731/58,750	29,350	1,888	0,040/0,080	AL-LF	61904RA	
→12/80									
MB/HL 5	1	54,905/54,920	58,731/58,750	29,350	1,900	0,040/0,080	AL-LF	66696RA	H1241/5 STD 0.30 0.50 0.80
MB/HL 4	1	56,140/56,165	59,976/59,995	21,500	1,900	0,040/0,080	AL-LF	66697RA	
MB/HL 3	1	57,174/57,189	61,000/61,019	29,500	1,900	0,040/0,080	AL-LF	66698RA	
MB/HL 2	1	58,548/58,573	62,384/62,403	21,500	1,900	0,040/0,080	AL-LF	66699RA	
MB/HL 1	1	59,401/59,416	63,227/63,246	29,500	1,900	0,040/0,080	AL-LF	66699RAA	
01/81→									
TW/A	4	61,400/61,650	72,550/72,800		2,330		AL-LF	61904BF	A199/4 STD 0.10 0.15 0.20

109 88.00 x 82.00

8144.65	4 Cyl.		1995cc	44kW (60PS)	Diesel			TD1055	
MB/HL 1-4	4	76,187/76,200	80,586/80,607	24,990	2,172	0,042/0,100	BS	66571CP	H1049/5 STD 0.25 0.50 0.75
MB/HL 5	1	76,187/76,200	80,586/80,607	31,950	2,172	0,042/0,100	BS	66572CPH	
Mot.→1846776									

MB/HL 1-4	4	76,187/76,200	80,586/80,607	24,990	2,172	0,038/0,097	BS	66573CP	H1094/5 STD 0.25	
MB/HL 5	1	76,187/76,200	80,586/80,607	31,950	2,172	0,038/0,097	BS	66574CPH		

Mot.1846777→

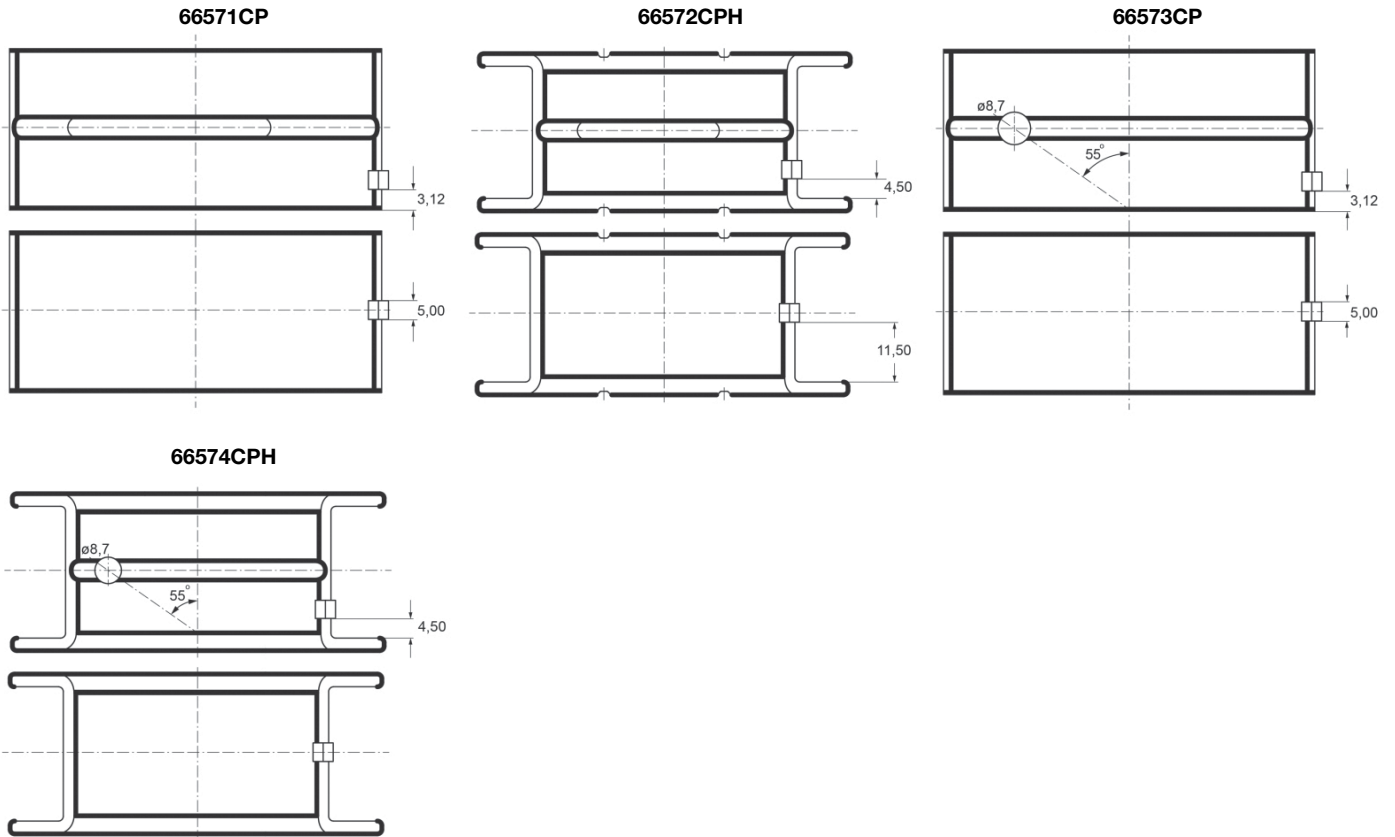

110		88.00 x 94.00								
F1AE0481C	4 Cyl.	2286cc	81kW (110PS)					Diesel Turbo Intercooler	TD16407	
F1AE0481D Euro 4	4 Cyl.	2287cc	88kW (120PS)					Diesel Turbo Intercooler	TD20264	
F1AE0481N	4 Cyl.	2287cc	96kW (131PS)					Diesel Turbo Intercooler	TD24778	
F1AE0481T	4 Cyl.	2286cc	93kW (126PS)					Diesel Turbo Intercooler	TD24632	
F1AE3481D	4 Cyl.	2287cc	96kW (131PS)					Diesel Turbo Intercooler	TD25174	
F1AE3481E	4 Cyl.	2287cc	109kW (148PS)					Diesel Turbo Intercooler	TD25175	
F1AE3481G	4 Cyl.	2287cc	83kW (113PS)					Diesel Turbo Intercooler	TD26313	
FPT	4 Cyl.	2287cc	88kW (120PS)					Diesel Turbo Intercooler	TD31437	
BE/PL	4	59,015/59,038	62,833/62,848	23,750	1,884	0,027/0,065	BS	71-4080	71-4080/4 STD 0.25 0.50	
MB/HL 1-4	4	71,182/71,208	75,588/75,614	27,000	2,174	0,032/0,084	AL-LF	02-4083	H1020/5 STD 0.25 0.50	
MB/HL 1,2,4	3	71,182/71,208	75,588/75,614	27,000	2,174	0,032/0,084	AL-LF	02-4084		
MB/HL 3	1	71,182/71,208	75,588/75,614	27,000	2,174	0,032/0,084	AL-LF	02-4085H		
MB/HL	1	76,182/76,208	80,588/80,614	27,000	2,174	0,032/0,084	AL-LF	02-4086L		
MB/HL	1	76,182/76,208	80,588/80,614	27,000	2,174	0,032/0,084	AL-LF	02-4086U		

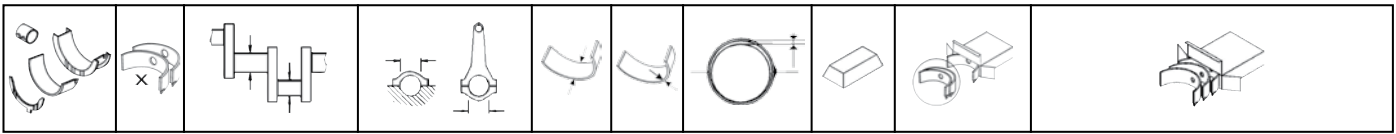

111 92.00 x 92.00

THY (DK5ATE)		4 Cyl.		2446cc	96kW (131PS)	Diesel Turbo Intercooler			TD22239
BE/PL	4	53,981/54,000	57,675/57,695	22,700	1,823	0,030/0,090	SP	71-3951	71-3951/4 STD

112 93.00 x 90.00

8140.61			4 Cyl.	2440cc	53kW (72PS)	Diesel			TD8363
8140.61			4 Cyl.	2445cc	53-55kW (72-75PS)	Diesel			TD1050
8140.61.204			4 Cyl.	2445cc	53kW (72PS)	Diesel			TD1051
8142.61			4 Cyl.	2445cc	53kW (72PS)	Diesel			TD1053
8144.21			4 Cyl.	2445cc	68kW (92PS)	Diesel Turbo			TD4419
8144.21.220			4 Cyl.	2445cc	68kW (92PS)	Diesel Turbo			TD6803
8144.61			4 Cyl.	2428cc	53-55kW (72-75PS)	Diesel			TD4408
8144.61.200			4 Cyl.	2445cc	53kW (72PS)	Diesel			TD6796
8144.61.500.81			4 Cyl.	2445cc	66kW (90PS)	Diesel Turbo			TD1054
8144.81.2000			4 Cyl.	2445cc	66-74kW (90-101PS)	Diesel			TD1057
8144.91.2000			4 Cyl.	2445cc	74kW (101PS)	Diesel Turbo Intercooler			TD1058

BE/PL	4	56,520/56,535	60,333/60,345	24,700	1,870	0,020/0,072	BS	1870CP	71-4130/4 STD 0.25 0.50 0.75
BE/PL	4	56,520/56,535	60,333/60,345	24,700	1,870	0,020/0,070	BS	66575CP	71-4185/4 STD 0.25 0.50 0.75

1870CP

66575CP

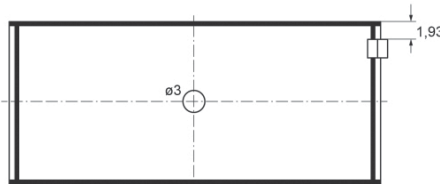

MB/HL 1-4	4	76,187/76,200	80,586/80,607	24,990	2,172	0,042/0,100	BS	66571CP	H1049/5 STD 0.25 0.50 0.75
MB/HL 5	1	76,187/76,200	80,586/80,607	31,950	2,172	0,042/0,100	BS	66572CPH	
MB/HL 1-4	4	76,187/76,200	80,586/80,607	24,990	2,172	0,038/0,097	BS	66573CP	H1094/5 STD 0.25
MB/HL 5	1	76,187/76,200	80,586/80,607	31,950	2,172	0,038/0,097	BS	66574CPH	

66571CP

66572CPH

66573CP

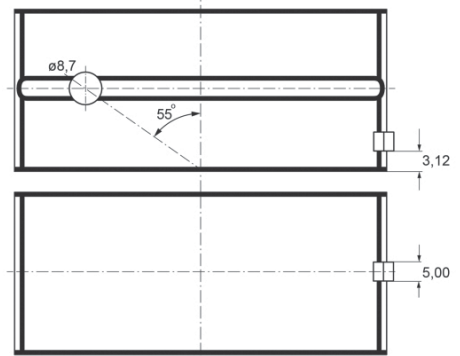
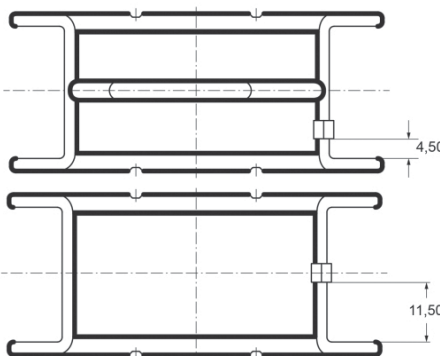
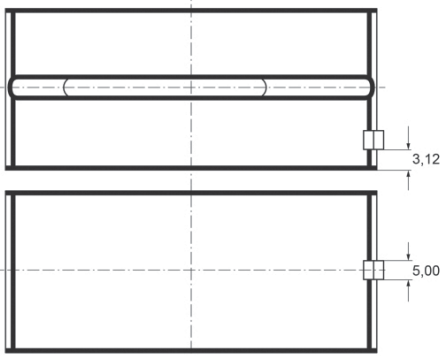

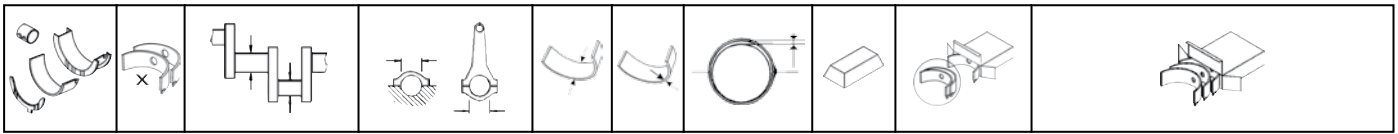

66574CPH

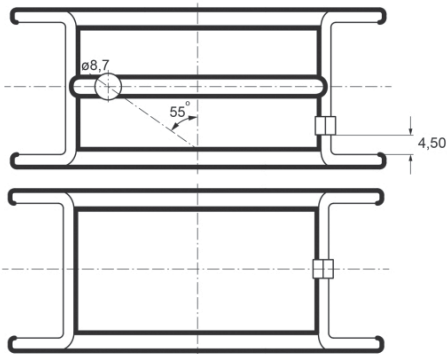

SE/PB	1	31,990/31,996	34,895/34,920	30,700			BS	66579YA	55-4186 SEMI
-------	---	---------------	---------------	--------	--	--	----	---------	-----------------

113 93.00 x 92.00

8140.27	4 Cyl.	2500cc	70kW (95PS)	Diesel Turbo	TD1047
8140.27.2100	4 Cyl.	2500cc	70kW (95PS)	Diesel Turbo	TD6800
8140.27S.3700 Euro 1	4 Cyl.	2499cc	77kW (105PS)	Diesel Turbo	TD20152
8140.47	4 Cyl.	2500cc	80-85kW (109-116PS)	Diesel Turbo	TD1048
8140.47.3700	4 Cyl.	2499cc	85kW (116PS)	Diesel Turbo Intercooler	TD6809
8140.47R	4 Cyl.	2500cc	80kW (110PS)	Diesel Turbo	TD1049
8140.47R.2210	4 Cyl.	2499cc	80kW (110PS)	Diesel Turbo Intercooler	TD6811
8140.67	4 Cyl.	2500cc	55-62kW (75-84PS)	Diesel	TD1052
8140.67.2700	4 Cyl.	2499cc	62kW (85PS)	Diesel	TD6810
8144.67	4 Cyl.	2500cc	55kW (75PS)	Diesel	TD1056
8144.67.220	4 Cyl.	2499cc	55kW (75PS)	Diesel	TD6797
8144.97	4 Cyl.	2499cc	85kW (115PS)	Diesel Turbo Intercooler	TD1061
8144.97 S	4 Cyl.	2500cc	77kW (105PS)	Diesel Turbo Intercooler	TD1059
8144.97 Y	4 Cyl.	2500cc	85kW (115PS)	Diesel Turbo Intercooler	TD1060
8144.97.2200	4 Cyl.	2499cc	86-87kW (117-118PS)	Diesel Turbo Intercooler	TD1062
8144.97.2400	4 Cyl.	2499cc	83-87kW (113-118PS)	Diesel Turbo Intercooler	TD22316
8144.97.2500	4 Cyl.	2500cc	85kW (118PS)	Diesel Turbo Intercooler	TD1063

BE/PL	4	56,520/56,535	60,333/60,345	24,700	1,870	0,020/0,072	BS	1870CP	71-4130/4 STD 0.25 0.50 0.75
BE/PL	4	56,520/56,535	60,333/60,345	24,700	1,870	0,020/0,070	BS	66575CP	71-4185/4 STD 0.25 0.50 0.75

1870CP

66575CP

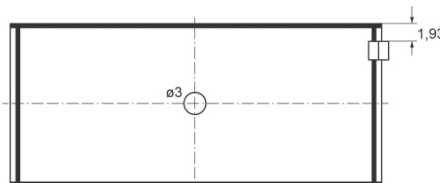

MB/HL 1-4	4	76,187/76,200	80,586/80,607	24,990	2,172	0,042/0,100	BS	66571CP	H1049/5 STD 0.25 0.50 0.75
MB/HL 5	1	76,187/76,200	80,586/80,607	31,950	2,172	0,042/0,100	BS	66572CPH	
MB/HL 1-4	4	76,187/76,200	80,586/80,607	24,990	2,172	0,038/0,097	BS	66573CP	H1094/5 STD 0.25
MB/HL 5	1	76,187/76,200	80,586/80,607	31,950	2,172	0,038/0,097	BS	66574CPH	



66571CP

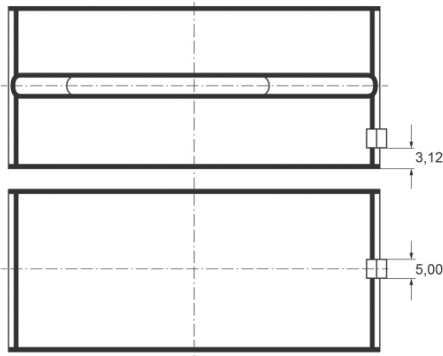

66572CPH

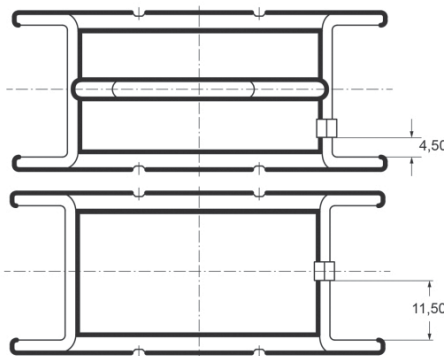

66573CP

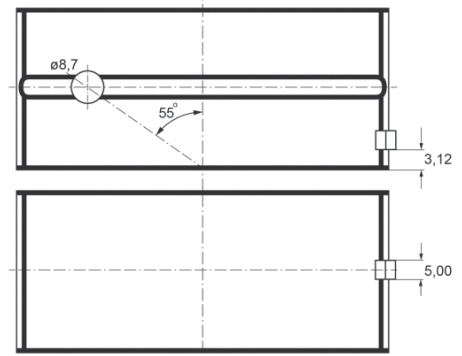

66574CPH

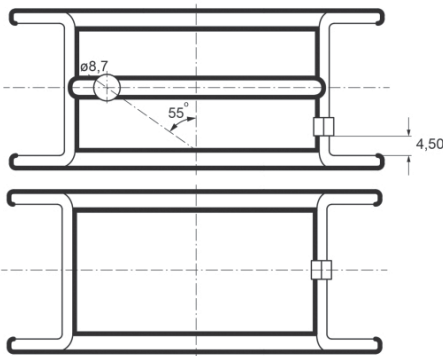

SE/PB	1	31,990/31,996	34,895/34,920	30,700			BS	66579YA	55-4186 SEMI
-------	---	---------------	---------------	--------	--	--	----	---------	-----------------

114 93.00 x 92.00

B 25.637			4 Cyl.	2498cc	51kW (69PS)			Diesel		TD21463
CRD93L (U25-661)			4 Cyl.	2500cc	54-55kW (73-75PS)			Diesel		TD22981
BE/PL	4	53,990/54,005	57,675/57,685	24,500	1,826	0,020/0,069	AL-LF	66440RAA	01-4181/4 STD 0.25 0.50	
MB/HL 1-5	5	67,035/67,050	71,695/71,705	28,700	2,317	0,020/0,061	AL-LF	66716RAA	H1089/5 STD 0.25 0.50	
TW/A	4	75,500/75,750	89,000/89,100		3,140		BS	66716BF	A213/4 STD	
SE/PB	1	30,008/30,014	33,000/33,033	31,900			BS	66444X	55-4393 SEMI	

115 94.40 x 100.00

8140.43			4 Cyl.	2800cc	90kW (122PS)			Diesel Turbo		TD11769
8140.43N Euro 3			4 Cyl.	2798cc	107kW (146PS)			Diesel Turbo Intercooler		TD20450
8140.43S			4 Cyl.	2798cc	94kW (128PS)			Diesel Turbo Intercooler		TD16196
8140.63			4 Cyl.	2800cc	64kW (87PS)			Diesel		TD12749
BE/PL	4	56,520/56,535	60,333/60,345	24,700	1,870	0,020/0,072	BS	1870CP	71-4130/4 STD 0.25 0.50 0.75	
MB/HL 5	1	86,182/86,208	90,588/90,614	30,950	2,164	0,052/0,129	BS	4691CPH	H1104/5 STD 0.25 0.50	
MB/HL 1-4	4	80,182/80,208	84,588/84,614	23,800	2,164	0,052/0,129	BS	4692CP		
SE/PB	1	31,990/31,996	34,895/34,920	30,700			BS	66579YA	55-4186 SEMI	

116 95.00 x 110.00

8030.00			3 Cyl.	2340cc	28-38kW (38-51PS)			Diesel		TD22232
----------------	--	--	--------	---------------	--------------------------	--	--	---------------	--	----------------



MB/HL	1	76,187/76,200	80,587/80,607	25,000	2,172	0,043/0,101	BS	66631CPA	72-4547 STD 0.25 0.50 0.75 1.00
-------	---	---------------	---------------	--------	-------	-------------	----	----------	---

01/80 →

MB/HL	1	76,187/76,200	80,587/80,607	25,000	2,172	0,043/0,101	BS	60076CP	72-4550 STD 0.25
-------	---	---------------	---------------	--------	-------	-------------	----	---------	----------------------------

→12/79

66631CPA

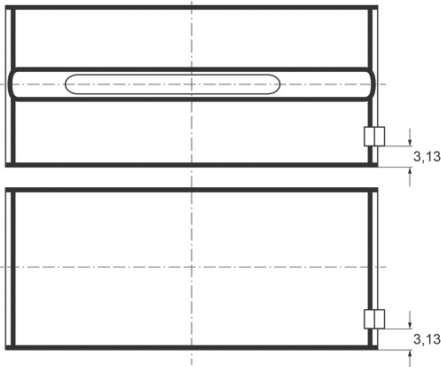

60076CP



117

95.00 x 110.00

8035.01			3 Cyl.	2338cc	28-35kW (38-48PS)		Diesel		TD25193
----------------	--	--	--------	---------------	--------------------------	--	---------------	--	----------------

BE/PL	1	58,730/58,743	62,408/62,420	28,700	1,816	0,033/0,083	BS	66630CP	71-4229 STD 0.25 0.50 0.75 1.00
-------	---	---------------	---------------	--------	-------	-------------	----	---------	---

01/80 →

BE/PL	1	58,730/58,743	62,408/62,420	28,700	1,822	0,021/0,071	BS	60990CP	71-4281 STD 0.25 0.75
-------	---	---------------	---------------	--------	-------	-------------	----	---------	---------------------------------

→12/79

66630CP

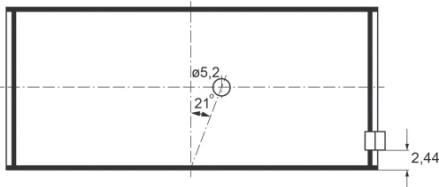

60990CP

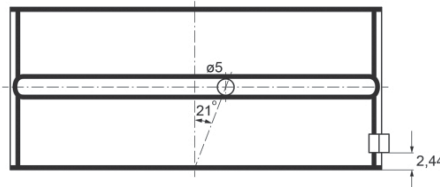

MB/HL	1	76,187/76,200	80,587/80,607	25,000	2,172	0,043/0,101	BS	66631CPA	72-4547 STD 0.25 0.50 0.75 1.00
-------	---	---------------	---------------	--------	-------	-------------	----	----------	---

01/80 →

MB/HL	1	76,187/76,200	80,587/80,607	25,000	2,172	0,043/0,101	BS	60076CP	72-4550 STD 0.25
-------	---	---------------	---------------	--------	-------	-------------	----	---------	----------------------------

→01/79

66631CPA

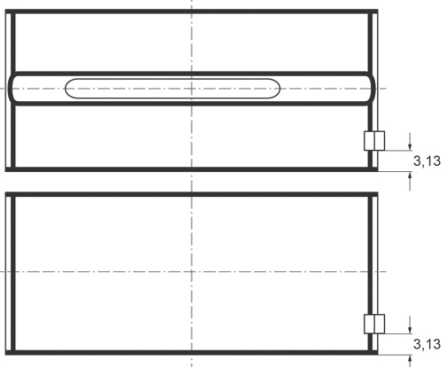

60076CP

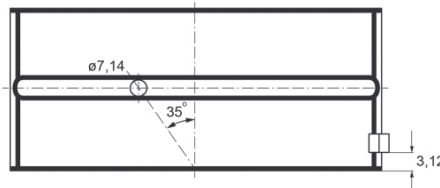



TW/A	4	85,090/85,340	101,600/101,850		3,429		AL-LF	60076AFA	A192/4 STD .005
TW/A	4	85,090/85,340	106,550/106,800		3,429		AL-LF	60076AFF	A193/4 STD .005

60076AFA

60076AFF

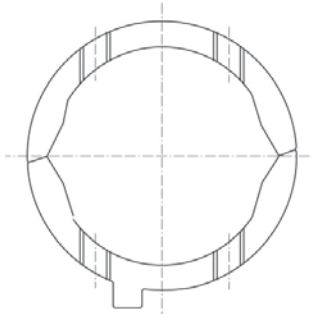
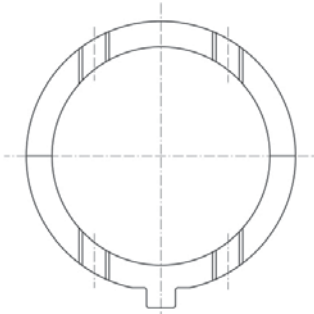

SE/PB	1	32,005/32,012	35,877/35,916	16,690			BS	60079X	55-4211 SEMI
→12/77									
SE/PB	1	34,005/34,012	37,846/37,884	34,800			BS	66634YA	55-4230 SEMI
01/78→									
SE/PB	1	32,005/32,012	35,877/35,916	34,800			BS	66634YC	55-4231 SEMI
→12/77									
SE/PB	1	34,005/34,012	37,846/37,884	16,690			BS	66634Y	55-4275 SEMI
01/78→									
CB/NWB 2	1	50,975/51,000	54,780/54,805	28,000	1,875		AL-LF	66231DR	N154/4 STD
CB/NWB 4	1	49,975/50,000	53,780/53,805	24,000	1,875		AL-LF	66232DR	
CB/NWB 3	1	50,475/50,500	54,280/54,305	28,000	1,875		AL-LF	66233DR	
CB/NWB 1	1	51,475/51,500	55,280/55,305	28,000	1,875		AL-LF	66234DR	

118 95.00 x 110.00

8040.00			4 Cyl.	3120cc	51kW (70PS)		Diesel		TD24575
BE/PL	1	58,730/58,743	62,408/62,420	28,700	1,816	0,033/0,083	BS	66630CP	71-4229 STD 0.25 0.50 0.75 1.00
MB/HL	1	76,187/76,200	80,587/80,607	25,000	2,172	0,043/0,101	BS	66631CPA	72-4547 STD 0.25 0.50 0.75 1.00
01/80→									
MB/HL	1	76,187/76,200	80,587/80,607	25,000	2,172	0,043/0,101	BS	60076CP	72-4550 STD 0.25
→12/79									

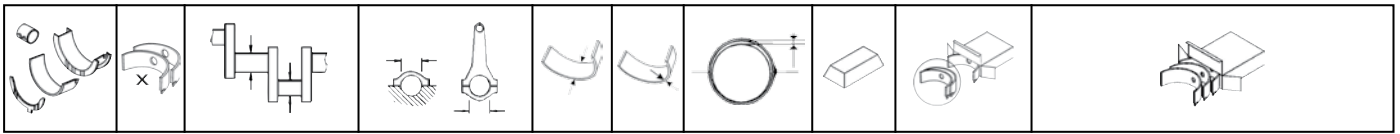

66631CPA

60076CP

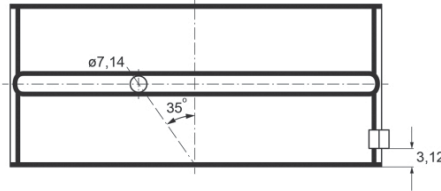
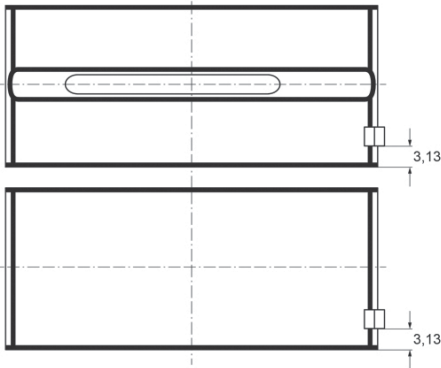

119	95.80 x 104.00									
F1CFA401A Euro 6	4 Cyl.	2998cc	100kW (136PS)	Petrol Turbo Intercooler	TD31469					
F1CE0481D Euro 4	4 Cyl.	2999cc	115-116kW (156-158PS)	Diesel Turbo Intercooler	TD20265					
F1CE3481E Euro 5	4 Cyl.	2999cc	130kW (177PS)	Diesel Turbo Intercooler	TD25176					
F1CE3481M Euro 5	4 Cyl.	2999cc	115kW (156PS)	Diesel Turbo Intercooler	TD24897					
F1CE3481N Euro 5	4 Cyl.	2999cc	107kW (146PS)	Diesel Turbo Intercooler	TD24896					
BE/PL	4	64,015/64,038	67,833/67,848	26,800	0,034/0,062	EC-LF	71-4082	71-4082/4	STD 0.25	5

120	100.00 x 110.00									
8030.02	3 Cyl.	2592cc	46kW (62PS)	Diesel	TD6922					
BE/PL	1	58,730/58,743	62,408/62,420	28,700	1,816	0,033/0,083	BS	66630CP	71-4229	STD 0.25 0.50 0.75 1.00
01/80 →										
MB/HL	1	76,187/76,200	80,587/80,607	25,000	2,172	0,043/0,101	BS	66631CPA	72-4547	STD 0.25 0.50 0.75 1.00
→12/79										
MB/HL	1	76,187/76,200	80,587/80,607	25,000	2,172	0,043/0,101	BS	60076CP	72-4550	STD 0.25
01/80 →										

66631CPA

60076CP

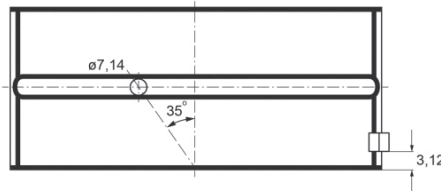
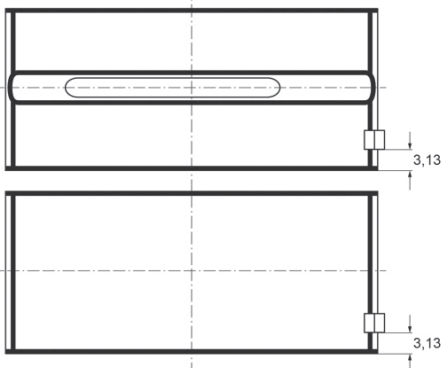

TW/A	4	85,090/85,340	101,600/101,850	3,429	AL-LF	60076AFA	A192/4	STD .005		
Mot. → 645690										
TW/A	4	85,090/85,340	106,550/106,800	3,429	AL-LF	60076AFF	A193/4	STD .005		
Mot. 645691 →										



60076AFA

60076AFF

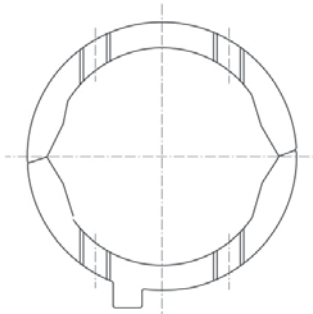
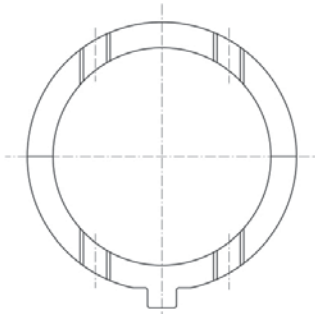

SE/PB	1	32,005/32,012	35,877/35,916	16,690			BS	60079X	55-4211 SEMI
→12/77									
SE/PB	1	34,005/34,012	37,846/37,884	34,800			BS	66634YA	55-4230 SEMI
01/78→									
SE/PB	1	32,005/32,012	35,877/35,916	34,800			BS	66634YC	55-4231 SEMI
→12/77									
SE/PB	1	34,005/34,012	37,846/37,884	16,690			BS	66634Y	55-4275 SEMI
01/78→									

121 100.00 x 110.00

8035.02			3 Cyl.	2592cc	33-40kW (45-54PS)		Diesel		TD25194
BE/PL	1	58,730/58,743	62,408/62,420	28,700	1,816	0,033/0,083	BS	66630CP	71-4229 STD 0.25 0.50 0.75 1.00
01/80→									
BE/PL	1	58,730/58,743	62,408/62,420	28,700	1,822	0,021/0,071	BS	60990CP	71-4281 STD 0.25 0.75
→12/79									

66630CP

60990CP

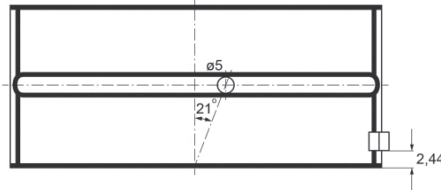
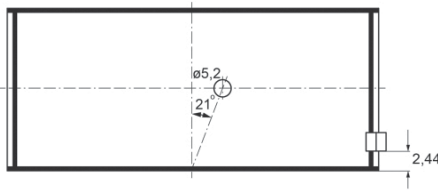

MB/HL	1	76,187/76,200	80,587/80,607	25,000	2,172	0,043/0,101	BS	66631CPA	72-4547 STD 0.25 0.50 0.75 1.00
01/80→									
MB/HL	1	76,187/76,200	80,587/80,607	25,000	2,172	0,043/0,101	BS	60076CP	72-4550 STD 0.25
→12/79									

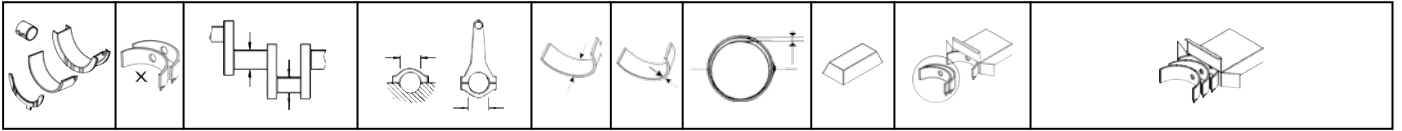

66631CPA

60076CP

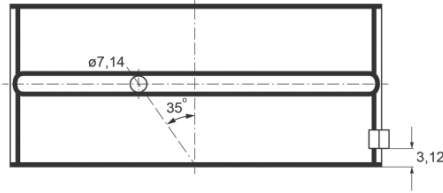
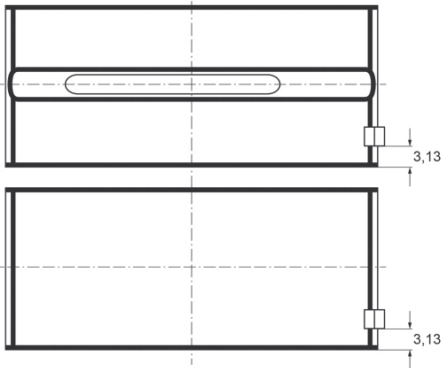

TW/A	4	85,090/85,340	101,600/101,850	3,429	AL-LF	60076AFA	A192/4 STD .005
TW/A	4	85,090/85,340	106,550/106,800	3,429	AL-LF	60076AFF	A193/4 STD .005

60076AFA

60076AFF

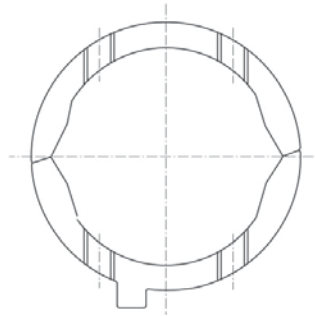
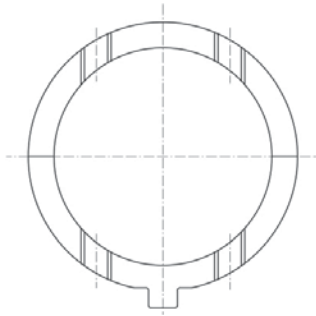

SE/PB	1	32,005/32,012	35,877/35,916	16,690	BS	60079X	55-4211 SEMI
-------	---	---------------	---------------	--------	----	--------	-----------------

→12/77

SE/PB	1	34,005/34,012	37,846/37,884	34,800	BS	66634YA	55-4230 SEMI
-------	---	---------------	---------------	--------	----	---------	-----------------

01/78→

SE/PB	1	32,005/32,012	35,877/35,916	34,800	BS	66634YC	55-4231 SEMI
-------	---	---------------	---------------	--------	----	---------	-----------------

→12/77

SE/PB	1	34,005/34,012	37,846/37,884	16,690	BS	66634Y	55-4275 SEMI
-------	---	---------------	---------------	--------	----	--------	-----------------

01/78→

CB/NWB 2	1	50,975/51,000	54,780/54,805	28,000	1,875	AL-LF	66231DR	N154/4 STD
CB/NWB 4	1	49,975/50,000	53,780/53,805	24,000	1,875	AL-LF	66232DR	
CB/NWB 3	1	50,475/50,500	54,280/54,305	28,000	1,875	AL-LF	66233DR	
CB/NWB 1	1	51,475/51,500	55,280/55,305	28,000	1,875	AL-LF	66234DR	



122 100.00 x 110.00

8040.02	4 Cyl.	3456cc	60kW (82PS)	Diesel	TD6840
8040.02.041	4 Cyl.	3456cc	56kW (76PS)	Diesel	TD6925
8040.02.267	4 Cyl.	3456cc	56kW (76PS)	Diesel	TD5606
8040.02.360	4 Cyl.	3456cc	56kW (76PS)	Diesel	TD5944
8040.02.367	4 Cyl.	3456cc	56kW (76PS)	Diesel	TD5945

BE/PL	1	58,730/58,743	62,408/62,420	28,700	1,816	0,033/0,083	BS	66630CP	71-4229 STD 0.25 0.50 0.75 1.00
-------	---	---------------	---------------	--------	-------	-------------	----	---------	------------------------------------

01/80 →

MB/HL	1	76,187/76,200	80,587/80,607	25,000	2,172	0,043/0,101	BS	66631CPA	72-4547 STD 0.25 0.50 0.75 1.00
-------	---	---------------	---------------	--------	-------	-------------	----	----------	------------------------------------

→12/79

MB/HL	1	76,187/76,200	80,587/80,607	25,000	2,172	0,043/0,101	BS	60076CP	72-4550 STD 0.25
-------	---	---------------	---------------	--------	-------	-------------	----	---------	---------------------

01/80 →

66631CPA

60076CP

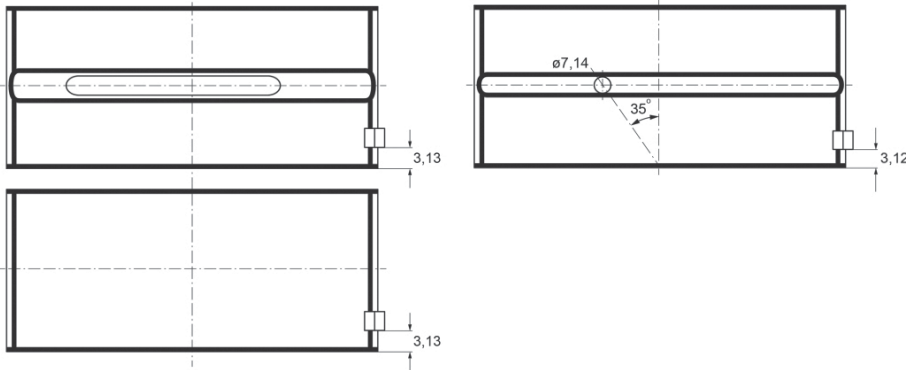

TW/A	4	85,090/85,340	101,600/101,850	3,429	AL-LF	60076AFA	A192/4 STD .005
------	---	---------------	-----------------	-------	-------	----------	--------------------

Mot. → 645690

TW/A	4	85,090/85,340	106,550/106,800	3,429	AL-LF	60076AFF	A193/4 STD .005
------	---	---------------	-----------------	-------	-------	----------	--------------------

Mot. 645691 →

60076AFA

60076AFF

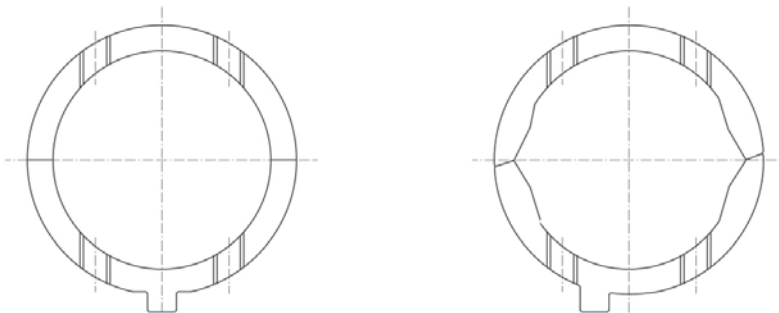

SE/PB	1	32,005/32,012	35,877/35,916	16,690	BS	60079X	55-4211 SEMI
-------	---	---------------	---------------	--------	----	--------	-----------------

→12/77

SE/PB	1	34,005/34,012	37,846/37,884	34,800	BS	66634YA	55-4230 SEMI
-------	---	---------------	---------------	--------	----	---------	-----------------

01/78 →

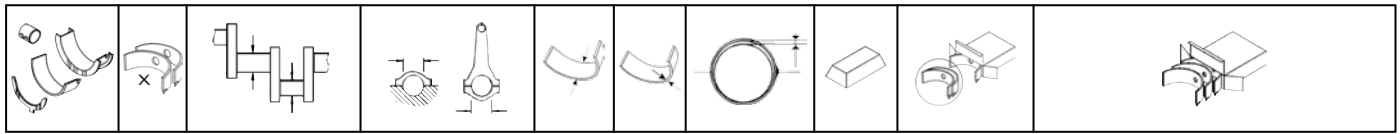

SE/PB	1	32,005/32,012	35,877/35,916	34,800			BS	66634YC	55-4231 SEMI
-------	---	---------------	---------------	--------	--	--	----	---------	------------------------

→12/77

SE/PB	1	34,005/34,012	37,846/37,884	16,690			BS	66634Y	55-4275 SEMI
-------	---	---------------	---------------	--------	--	--	----	--------	------------------------

01/78→

123 100.00 x 110.00

8040.02.			4 Cyl.	3456cc	60kW (82PS)		Diesel		TD9082
BE/PL	1	58,730/58,743	62,408/62,420	28,700	1,816	0,033/0,083	BS	66630CP	71-4229 STD 0.25 0.50 0.75 1.00
MB/HL	1	76,187/76,200	80,587/80,607	25,000	2,172	0,043/0,101	BS	66631CPA	72-4547 STD 0.25 0.50 0.75 1.00
TW/A	4	85,090/85,340	101,600/101,850		3,429		AL-LF	60076AFA	A192/4 STD .005
TW/A	4	85,090/85,340	106,550/106,800		3,429		AL-LF	60076AFF	A193/4 STD .005

60076AFA

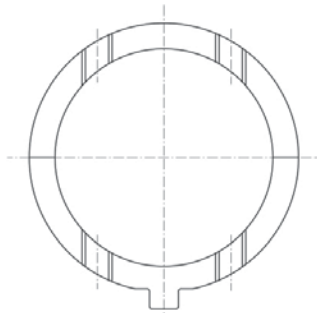

60076AFF

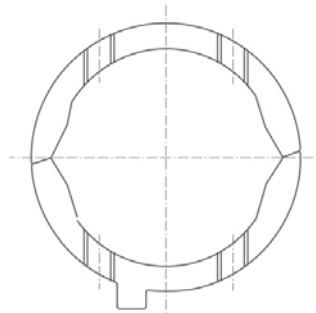

SE/PB	1	32,005/32,012	35,877/35,916	16,690			BS	60079X	55-4211 SEMI
SE/PB	1	34,005/34,012	37,846/37,884	34,800			BS	66634YA	55-4230 SEMI
SE/PB	1	32,005/32,012	35,877/35,916	34,800			BS	66634YC	55-4231 SEMI
SE/PB	1	34,005/34,012	37,846/37,884	16,690			BS	66634Y	55-4275 SEMI

124 100.00 x 110.00

8045.02			4 Cyl.	3456cc	44-50kW (60-68PS)		Diesel		TD25195
BE/PL	1	58,730/58,743	62,408/62,420	28,700	1,816	0,033/0,083	BS	66630CP	71-4229 STD 0.25 0.50 0.75 1.00
01/80→									
BE/PL	1	58,730/58,743	62,408/62,420	28,700	1,822	0,021/0,071	BS	60990CP	71-4281 STD 0.25 0.75
→12/79									

66630CP

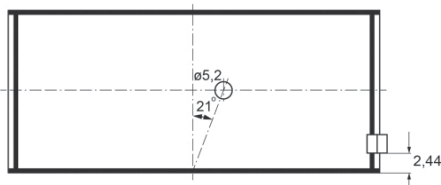

60990CP

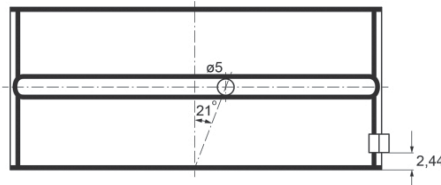

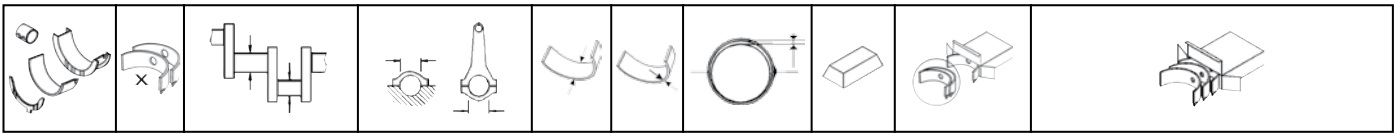

MB/HL	1	76,187/76,200	80,587/80,607	25,000	2,172	0,043/0,101	BS	66631CPA	72-4547 STD 0.25 0.50 0.75 1.00
-------	---	---------------	---------------	--------	-------	-------------	----	----------	---

01/80 →

MB/HL	1	76,187/76,200	80,587/80,607	25,000	2,172	0,043/0,101	BS	60076CP	72-4550 STD 0.25
-------	---	---------------	---------------	--------	-------	-------------	----	---------	----------------------------

→12/79

66631CPA

60076CP

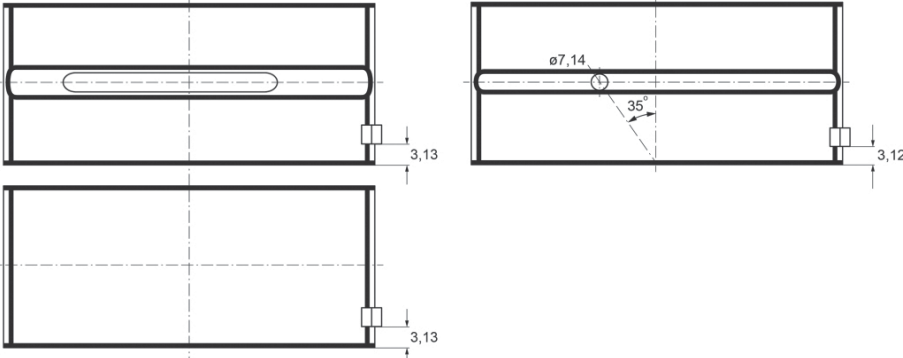

TW/A	4	85,090/85,340	101,600/101,850	3,429	AL-LF	60076AFA	A192/4 STD .005
TW/A	4	85,090/85,340	106,550/106,800	3,429	AL-LF	60076AFF	A193/4 STD .005

60076AFA

60076AFF

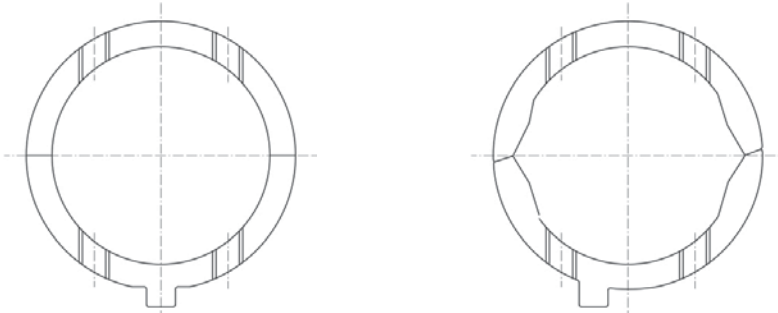

SE/PB	1	32,005/32,012	35,877/35,916	16,690	BS	60079X	55-4211 SEMI
-------	---	---------------	---------------	--------	----	--------	------------------------

→12/77

SE/PB	1	34,005/34,012	37,846/37,884	34,800	BS	66634YA	55-4230 SEMI
-------	---	---------------	---------------	--------	----	---------	------------------------

01/78 →

SE/PB	1	32,005/32,012	35,877/35,916	34,800	BS	66634YC	55-4231 SEMI
-------	---	---------------	---------------	--------	----	---------	------------------------

→12/77

SE/PB	1	34,005/34,012	37,846/37,884	16,690	BS	66634Y	55-4275 SEMI
-------	---	---------------	---------------	--------	----	--------	------------------------

01/78 →

125	100.00 x 110.00							
8060.02.000		6 Cyl.	5184cc	90kW (122PS)		Diesel		TD6852
8060.02.001		6 Cyl.	5184cc	90kW (122PS)		Diesel		TD5614
8060.02.003		6 Cyl.	5184cc	90kW (122PS)		Diesel		TD5953
8060.02.070		6 Cyl.	5184cc	90kW (122PS)		Diesel		TD6843
8060.12		6 Cyl.	5184cc	88kW (120PS)		Diesel		TD6908
8060.12.031		6 Cyl.	5184cc	81kW (110PS)		Diesel		TD6909

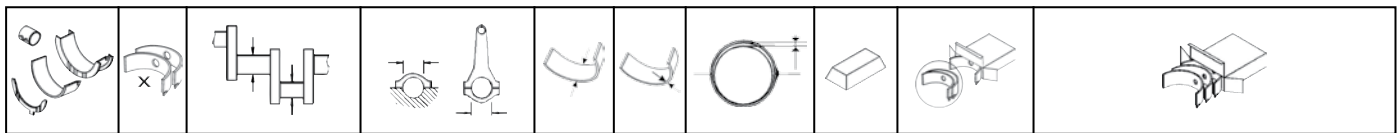

BE/PL	1	58,730/58,743	62,408/62,420	28,700	1,816	0,033/0,083	BS	66630CP	71-4229 STD 0.25 0.50 0.75 1.00
MB/HL	1	76,187/76,200	80,587/80,607	25,000	2,172	0,043/0,101	BS	66631CPA	72-4547 STD 0.25 0.50 0.75 1.00

→12/79

MB/HL	1	76,187/76,200	80,587/80,607	25,000	2,172	0,043/0,101	BS	60076CP	72-4550 STD 0.25
-------	---	---------------	---------------	--------	-------	-------------	----	---------	----------------------------

01/80→

66631CPA

60076CP

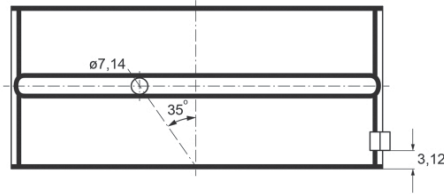
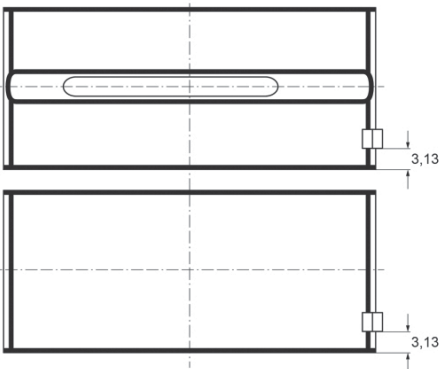

TW/A	4	85,090/85,340	101,600/101,850	3,429		AL-LF	60076AFA	A192/4 STD .005
------	---	---------------	-----------------	-------	--	-------	----------	---------------------------

Mot.→645690

TW/A	4	85,090/85,340	106,550/106,800	3,429		AL-LF	60076AFF	A193/4 STD .005
------	---	---------------	-----------------	-------	--	-------	----------	---------------------------

Mot.645691→

60076AFA

60076AFF

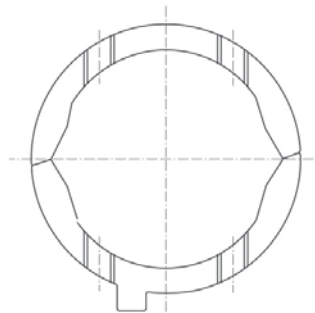
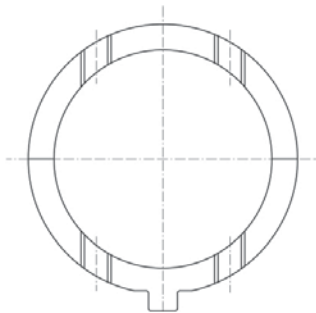

SE/PB	1	32,005/32,012	35,877/35,916	16,690		BS	60079X	55-4211 SEMI
-------	---	---------------	---------------	--------	--	----	--------	------------------------

→12/77

SE/PB	1	34,005/34,012	37,846/37,884	34,800		BS	66634YA	55-4230 SEMI
-------	---	---------------	---------------	--------	--	----	---------	------------------------

01/78→

SE/PB	1	32,005/32,012	35,877/35,916	34,800		BS	66634YC	55-4231 SEMI
-------	---	---------------	---------------	--------	--	----	---------	------------------------

→12/77

SE/PB	1	34,005/34,012	37,846/37,884	16,690		BS	66634Y	55-4275 SEMI
-------	---	---------------	---------------	--------	--	----	--------	------------------------

01/78→

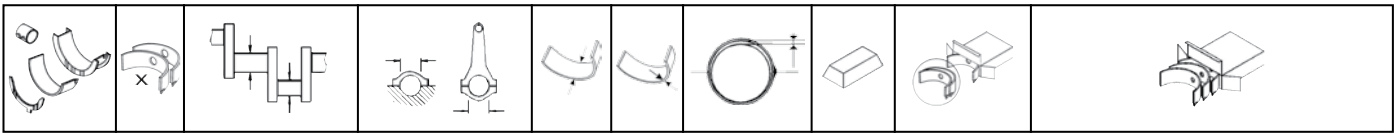

126		100.00 x 110.00								
8065.02.007		6 Cyl.			5184cc	74kW (101PS)		Diesel		TD25315
BE/PL	1	58,730/58,743	62,408/62,420	28,700	1,816	0,033/0,083	BS	66630CP	71-4229 STD 0.25 0.50 0.75 1.00	
MB/HL	1	76,187/76,200	80,587/80,607	25,000	2,172	0,043/0,101	BS	66631CPA	72-4547 STD 0.25 0.50 0.75 1.00	

127		100.00 x 110.00								
8065.02.200		6 Cyl.			5184cc	70-74kW (95-101PS)		Diesel		TD25316
BE/PL	1	58,730/58,743	62,408/62,420	28,700	1,816	0,033/0,083	BS	66630CP	71-4229 STD 0.25 0.50 0.75 1.00	
MB/HL	1	76,187/76,200	80,587/80,607	25,000	2,172	0,043/0,101	BS	66631CPA	72-4547 STD 0.25 0.50 0.75 1.00	
MB/HL	1	76,187/76,200	80,587/80,607	25,000	2,172	0,043/0,101	BS	60076CP	72-4550 STD 0.25	

66631CPA

60076CP

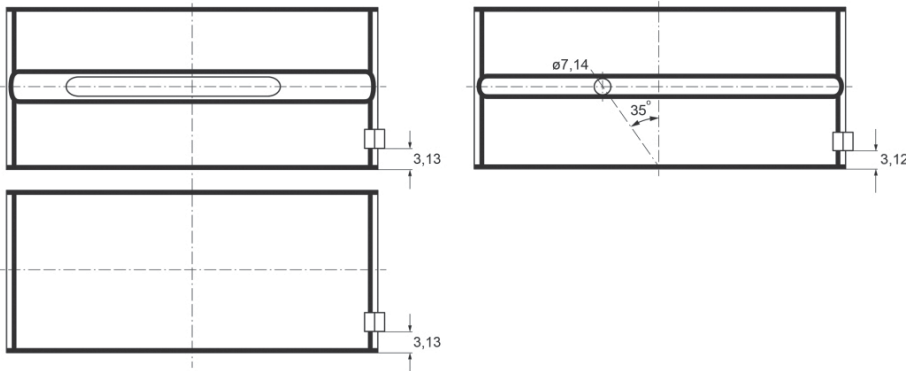

128		100.00 x 115.00								
8035.06.200		3 Cyl.			2708cc	33-41kW (45-56PS)		Diesel		TD25535
8035.06.206		3 Cyl.			2708cc	38-40kW (52-54PS)		Diesel		TD25536
8035.06.208		3 Cyl.			2708cc	38-40kW (52-54PS)		Diesel		TD25537
8035.06.216		3 Cyl.			2708cc	38-40kW (52-55PS)		Diesel		TD25538
8035.06.220		3 Cyl.			2708cc	33kW (45PS)		Diesel		TD25539
8035.06.222		3 Cyl.			2708cc	33-40kW (45-54PS)		Diesel		TD25540
8035.06.223		3 Cyl.			2708cc	38kW (52PS)		Diesel		TD25541
8035.06.306		3 Cyl.			2708cc	38kW (52PS)		Diesel		TD25542
8035.06.307		3 Cyl.			2708cc	38-40kW (52-54PS)		Diesel		TD25543
8035.06.308		3 Cyl.			2708cc	38-40kW (52-54PS)		Diesel		TD25544
8035.06.309		3 Cyl.			2708cc	38kW (52PS)		Diesel		TD25545
8035.06.317		3 Cyl.			2708cc	38-40kW (52-55PS)		Diesel		TD25546
8035.06.320		3 Cyl.			2708cc	34kW (46PS)		Diesel		TD25547
8035.06.321		3 Cyl.			2708cc	33-34kW (45-46PS)		Diesel		TD25548
8035.06.322		3 Cyl.			2708cc	38kW (52PS)		Diesel		TD25549
8035.06.323		3 Cyl.			2708cc	33-40kW (45-54PS)		Diesel		TD25550
BE/PL	1	63,725/63,744	67,407/67,422	28,700	1,815	0,033/0,092	BS	1010CP	71-4104 STD 0.25 0.50 0.75	
MB/HL	1	79,791/79,810	84,200/84,230	25,000	2,179	0,032/0,106	BS	1011CP	72-4546 STD 0.25 0.50 0.75	
TW/A	4	87,779/88,033	111,510/111,764		3,429		BS	1011BF	A169/4 STD .005	
SE/PB	1	38,004/38,014	41,846/41,884	34,800			BS	1014Y	55-4105 SEMI	
SE/PB	1	38,005/38,012	41,846/41,884	34,800			BS	1014YA	55-4106 SEMI	

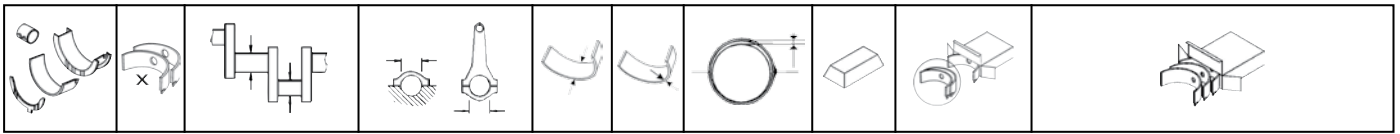

1014Y

1014YA

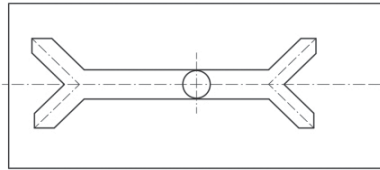
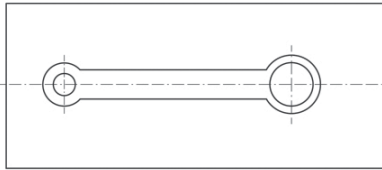

CB/NWB 2	1	50,975/51,000	54,780/54,805	28,000	1,875		AL-LF	66231DR	N154/4 STD
CB/NWB 4	1	49,975/50,000	53,780/53,805	24,000	1,875		AL-LF	66232DR	
CB/NWB 3	1	50,475/50,500	54,280/54,305	28,000	1,875		AL-LF	66233DR	
CB/NWB 1	1	51,475/51,500	55,280/55,305	28,000	1,875		AL-LF	66234DR	

129 100.00 x 115.00

8045.06.200			4 Cyl.	3613cc	51kW (69PS)		Diesel		TD25521
8045.06.208			4 Cyl.	3613cc	51kW (69PS)		Diesel		TD25522
8045.06.213			4 Cyl.	3613cc	48-51kW (65-69PS)		Diesel		TD25523
8045.06.214			4 Cyl.	3613cc	73kW (99PS)		Diesel		TD25524
8045.06.215			4 Cyl.	3613cc	73kW (99PS)		Diesel		TD25525
8045.06.225			4 Cyl.	3613cc	48kW (65PS)		Diesel		TD25526
8045.06.319			4 Cyl.	3613cc	48kW (65PS)		Diesel		TD25527
8045.06.326			4 Cyl.	3613cc	48kW (65PS)		Diesel		TD25528
BE/PL	1	63,725/63,744	67,407/67,422	28,700	1,815	0,033/0,092	BS	1010CP	71-4104 STD 0.25 0.50 0.75
MB/HL	1	79,791/79,810	84,200/84,230	25,000	2,179	0,032/0,106	BS	1011CP	72-4546 STD 0.25 0.50 0.75
TW/A	4	87,779/88,033	111,510/111,764		3,429		BS	1011BF	A169/4 STD .005
SE/PB	1	38,004/38,014	41,846/41,884	34,800			BS	1014Y	55-4105 SEMI
SE/PB	1	38,005/38,012	41,846/41,884	34,800			BS	1014YA	55-4106 SEMI

1014Y

1014YA

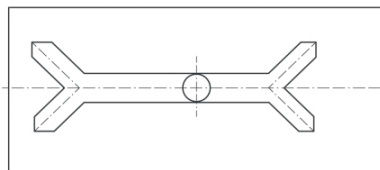
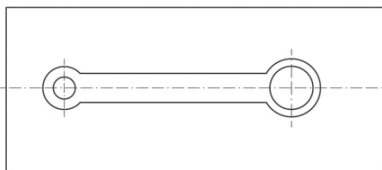

130 103.00 x 110.00

8035.04.265			3 Cyl.	2749cc	35-37kW (48-50PS)		Diesel		TD25325
8035.04.270			3 Cyl.	2749cc	43kW (58PS)		Diesel		TD25326
MB/HL	1	76,187/76,200	80,587/80,607	25,000	2,172	0,043/0,101	BS	66631CPA	72-4547 STD 0.25 0.50 0.75 1.00
01/80 →									
MB/HL	1	76,187/76,200	80,587/80,607	25,000	2,172	0,043/0,101	BS	60076CP	72-4550 STD 0.25
→12/79									



66631CPA

60076CP

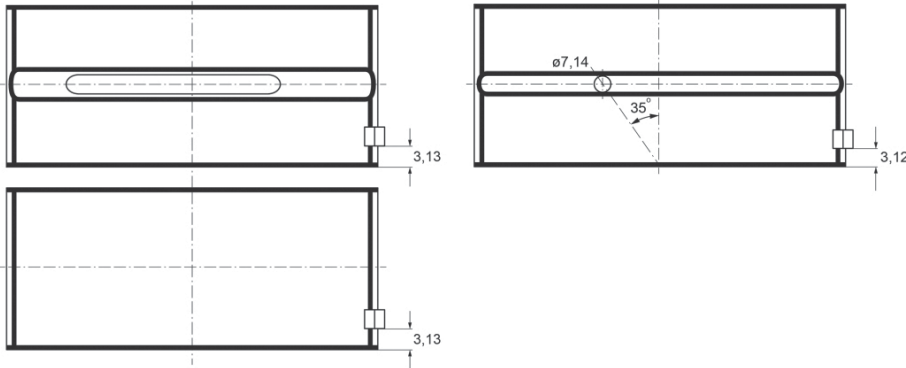

131

103.00 x 110.00

8040.04.200			4 Cyl.	3666cc	63kW (85PS)		Diesel		TD7263
8040.04.280			4 Cyl.	3666cc	63kW (86PS)		Diesel		TD6841
BE/PL	1	58,730/58,743	62,408/62,420	28,700	1,816	0,033/0,083	BS	66630CP	71-4229 STD 0.25 0.50 0.75 1.00
MB/HL	1	76,187/76,200	80,587/80,607	25,000	2,172	0,043/0,101	BS	66631CPA	72-4547 STD 0.25 0.50 0.75 1.00
→12/79									
MB/HL	1	76,187/76,200	80,587/80,607	25,000	2,172	0,043/0,101	BS	60076CP	72-4550 STD 0.25
01/80 →									

66631CPA

60076CP

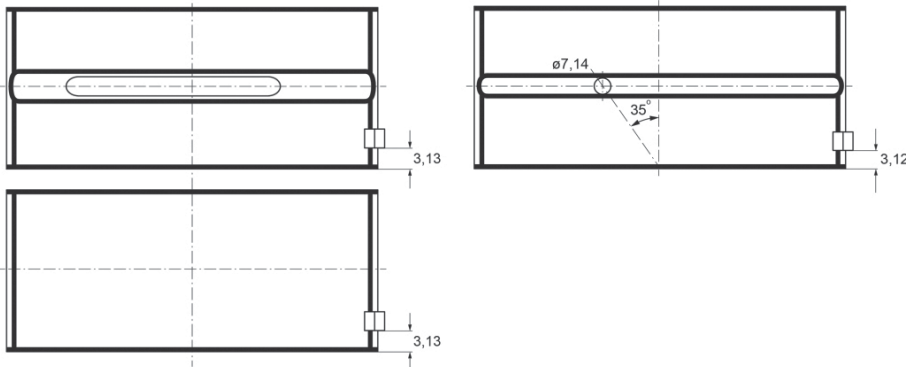

TW/A	4	85,090/85,340	101,600/101,850		3,429		AL-LF	60076AFA	A192/4 STD .005
------	---	---------------	-----------------	--	-------	--	-------	----------	--------------------

Mot. →645690

TW/A	4	85,090/85,340	106,550/106,800		3,429		AL-LF	60076AFF	A193/4 STD .005
------	---	---------------	-----------------	--	-------	--	-------	----------	--------------------

Mot.645691 →

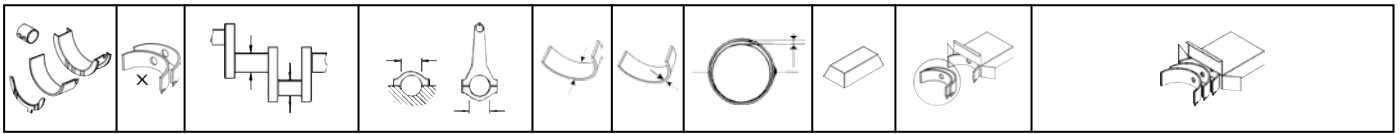

60076AFA

60076AFF

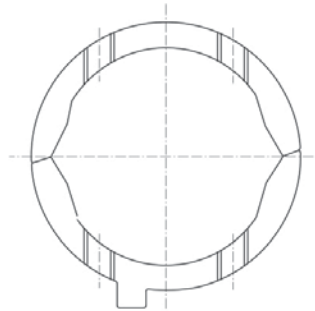
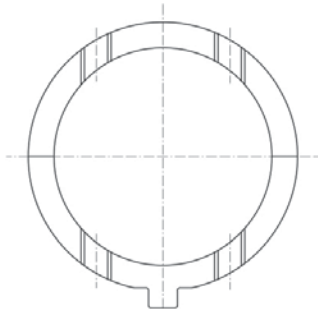

SE/PB	1	32,005/32,012	35,877/35,916	16,690			BS	60079X	55-4211 SEMI
→12/77									
SE/PB	1	34,005/34,012	37,846/37,884	34,800			BS	66634YA	55-4230 SEMI
01/78→									
SE/PB	1	32,005/32,012	35,877/35,916	34,800			BS	66634YC	55-4231 SEMI
→12/77									
SE/PB	1	34,005/34,012	37,846/37,884	16,690			BS	66634Y	55-4275 SEMI
01/78→									

132 103.00 x 110.00

8045.04.270		4 Cyl.		3666cc	57kW (78PS)	Diesel		TD25335	
BE/PL	1	58,730/58,743	62,408/62,420	28,700	1,816	0,033/0,083	BS	66630CP	71-4229 STD 0.25 0.50 0.75 1.00
01/80→									
BE/PL	1	58,730/58,743	62,408/62,420	28,700	1,822	0,021/0,071	BS	60990CP	71-4281 STD 0.25 0.75
→12/79									

66630CP

60990CP

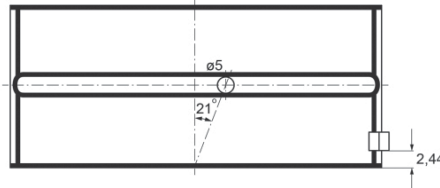
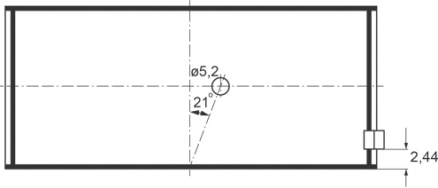

MB/HL	1	76,187/76,200	80,587/80,607	25,000	2,172	0,043/0,101	BS	66631CPA	72-4547 STD 0.25 0.50 0.75 1.00
01/80→									
MB/HL	1	76,187/76,200	80,587/80,607	25,000	2,172	0,043/0,101	BS	60076CP	72-4550 STD 0.25
→12/79									

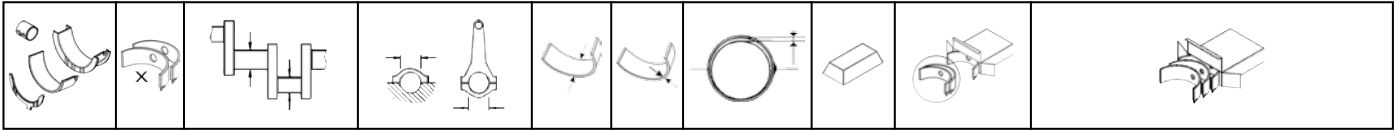

66631CPA

60076CP

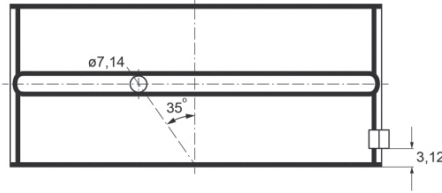
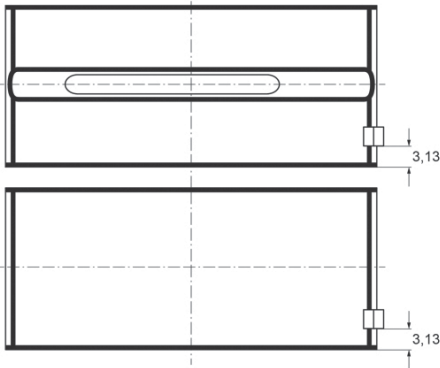

TW/A	4	85,090/85,340	101,600/101,850	3,429	AL-LF	60076AFA	A192/4 STD .005
TW/A	4	85,090/85,340	106,550/106,800	3,429	AL-LF	60076AFF	A193/4 STD .005

60076AFA

60076AFF

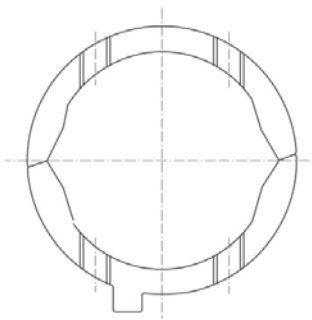
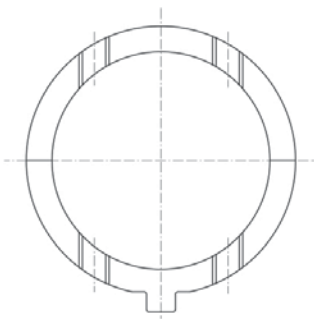

SE/PB	1	32,005/32,012	35,877/35,916	16,690		BS	60079X	55-4211 SEMI
→12/77								
SE/PB	1	34,005/34,012	37,846/37,884	34,800		BS	66634YA	55-4230 SEMI
01/78→								
SE/PB	1	32,005/32,012	35,877/35,916	34,800		BS	66634YC	55-4231 SEMI
→12/77								
SE/PB	1	34,005/34,012	37,846/37,884	16,690		BS	66634Y	55-4275 SEMI
01/78→								

133 103.00 x 110.00

8055.04.200		5 Cyl.		4583cc		63-66kW (86-90PS)		Diesel		TD25345
BE/PL	1	58,730/58,743	62,408/62,420	28,700	1,816	0,033/0,083	BS	66630CP	71-4229 STD 0.25 0.50 0.75 1.00	
MB/HL	1	76,187/76,200	80,587/80,607	25,000	2,172	0,043/0,101	BS	66631CPA	72-4547 STD 0.25 0.50 0.75 1.00	
01/80→										
MB/HL	1	76,187/76,200	80,587/80,607	25,000	2,172	0,043/0,101	BS	60076CP	72-4550 STD 0.25	
→12/79										



66631CPA

60076CP

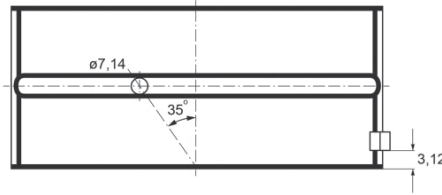
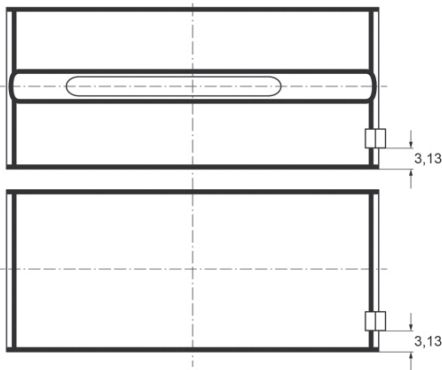

134		103.00 x 110.00								
8060.04.000	6 Cyl.	5499cc	99kW (135PS)	Diesel	TD6853					
8060.04.052	6 Cyl.	5499cc	92kW (125PS)	Diesel	TD7351					
8060.04.055	6 Cyl.	5499cc	96kW (130PS)	Diesel	TD5612					
8060.04.060	6 Cyl.	5499cc	96kW (131PS)	Diesel	TD5916					
8060.04.070	6 Cyl.	5499cc	99kW (135PS)	Diesel	TD7279					
8060.04.620	6 Cyl.	5499cc	99kW (135PS)	Diesel	TD5608					
8060.04.621	6 Cyl.	5499cc	99kW (135PS)	Diesel	TD5948					
8060.04.630	6 Cyl.	5499cc	99-100kW (135-136PS)	Diesel	TD7298					
8060.04.639	6 Cyl.	5499cc	99kW (135PS)	Diesel	TD5615					
8060.04.658	6 Cyl.	5499cc	99kW (135PS)	Diesel	TD7261					
8060.04.660	6 Cyl.	5499cc	96-102kW (131-139PS)	Diesel	TD6255					
8060.04.661	6 Cyl.	5499cc	81kW (110PS)	Diesel	TD7257					
8060.04.662	6 Cyl.	5499cc	96kW (120PS)	Diesel	TD7258					
8060.04.669	6 Cyl.	5499cc	99-102kW (135-139PS)	Diesel	TD7292					
8060.04.670	6 Cyl.	5499cc	99kW (135PS)	Diesel	TD5610					
8060.04.672	6 Cyl.	5499cc	99kW (135PS)	Diesel	TD5950					
8060.04.675	6 Cyl.	5499cc	99kW (135PS)	Diesel	TD5954					
8060.24.601	6 Cyl.	5499cc	124kW (168PS)	Diesel Turbo	TD7300					
8060.24.643	6 Cyl.	5499cc	103kW (140PS)	Diesel Turbo	TD7259					
8060.24.652	6 Cyl.	5499cc	123kW (168PS)	Diesel Turbo	TD7251					
8060.24.661	6 Cyl.	5500cc	90kW (122PS)	Diesel Turbo	TD6832					
8060.24.662	6 Cyl.	5499cc	96kW (130PS)	Diesel Turbo	TD5603					
8060.24.664	6 Cyl.	5499cc	96kW (120PS)	Diesel Turbo	TD5941					
8060.24.670	6 Cyl.	5499cc	118kW (160PS)	Diesel Turbo	TD5611					
8060.24.671	6 Cyl.	5499cc	118kW (160PS)	Diesel Turbo	TD5951					
8060.24.673	6 Cyl.	5499cc	96kW (130PS)	Diesel Turbo	TD5942					
8060.24.678	6 Cyl.	5500cc	123kW (168PS)	Diesel Turbo	TD7297					
8062.24.070	6 Cyl.	5499cc	118kW (160PS)	Diesel	TD7291					
BE/PL	1	58,730/58,743	62,408/62,420	28,700	1,816	0,033/0,083	BS	66630CP	71-4229 STD 0.25 0.50 0.75 1.00	
MB/HL	1	76,187/76,200	80,587/80,607	25,000	2,172	0,043/0,101	BS	66631CPA	72-4547 STD 0.25 0.50 0.75 1.00	
TW/A	4	85,090/85,340	106,550/106,800		3,429		AL-LF	60076AFF	A193/4 STD .005	
SE/PB	1	34,005/34,012	37,846/37,884	34,800			BS	66634YA	55-4230 SEMI	
SE/PB	1	34,005/34,012	37,846/37,884	16,690			BS	66634Y	55-4275 SEMI	



135 103.00 x 110.00

8060.04.051 6 Cyl. 5499cc 95-96kW (130-131PS) Diesel TD7349

BE/PL	1	58,730/58,743	62,408/62,420	28,700	1,816	0,033/0,083	BS	66630CP	71-4229 STD 0.25 0.50 0.75 1.00
MB/HL	1	76,187/76,200	80,587/80,607	25,000	2,172	0,043/0,101	BS	66631CPA	72-4547 STD 0.25 0.50 0.75 1.00

→12/79

MB/HL	1	76,187/76,200	80,587/80,607	25,000	2,172	0,043/0,101	BS	60076CP	72-4550 STD 0.25
-------	---	---------------	---------------	--------	-------	-------------	----	---------	----------------------------

01/80→

66631CPA

60076CP

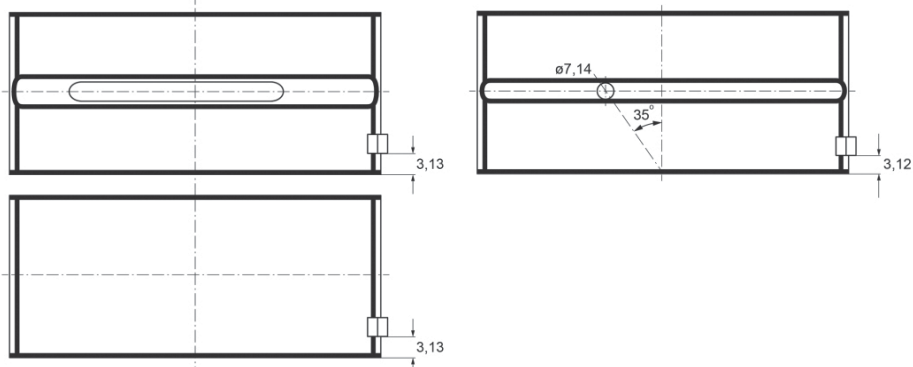

TW/A	4	85,090/85,340	101,600/101,850	3,429	AL-LF	60076AFA	A192/4 STD .005
------	---	---------------	-----------------	-------	-------	----------	---------------------------

Mot.→645690

TW/A	4	85,090/85,340	106,550/106,800	3,429	AL-LF	60076AFF	A193/4 STD .005
------	---	---------------	-----------------	-------	-------	----------	---------------------------

Mot.645691→

60076AFA

60076AFF

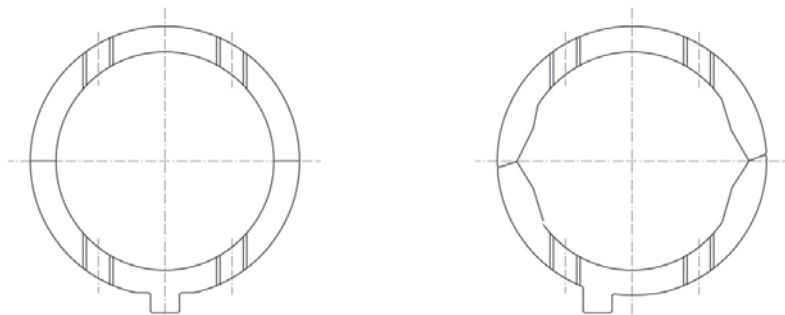

SE/PB	1	32,005/32,012	35,877/35,916	16,690	BS	60079X	55-4211 SEMI
-------	---	---------------	---------------	--------	----	--------	------------------------

01/67→12/77

SE/PB	1	34,005/34,012	37,846/37,884	34,800	BS	66634YA	55-4230 SEMI
-------	---	---------------	---------------	--------	----	---------	------------------------

01/78→

SE/PB	1	32,005/32,012	35,877/35,916	34,800	BS	66634YC	55-4231 SEMI
-------	---	---------------	---------------	--------	----	---------	------------------------

01/67→12/77

SE/PB	1	34,005/34,012	37,846/37,884	16,690	BS	66634Y	55-4275 SEMI
-------	---	---------------	---------------	--------	----	--------	------------------------

01/78→

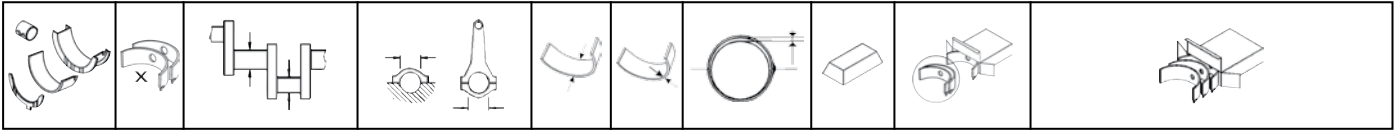

136 103.00 x 110.00

8060.04.689		6 Cyl.		5499cc	99-102kW (135-139PS)		Diesel	TD7296	
BE/PL	1	58,730/58,743	62,408/62,420	28,700	1,816	0,033/0,083	BS	66630CP	71-4229 STD 0.25 0.50 0.75 1.00
MB/HL	1	76,187/76,200	80,587/80,607	25,000	2,172	0,043/0,101	BS	66631CPA	72-4547 STD 0.25 0.50 0.75 1.00
→12/79									
MB/HL	1	76,187/76,200	80,587/80,607	25,000	2,172	0,043/0,101	BS	60076CP	72-4550 STD 0.25
01/80→									

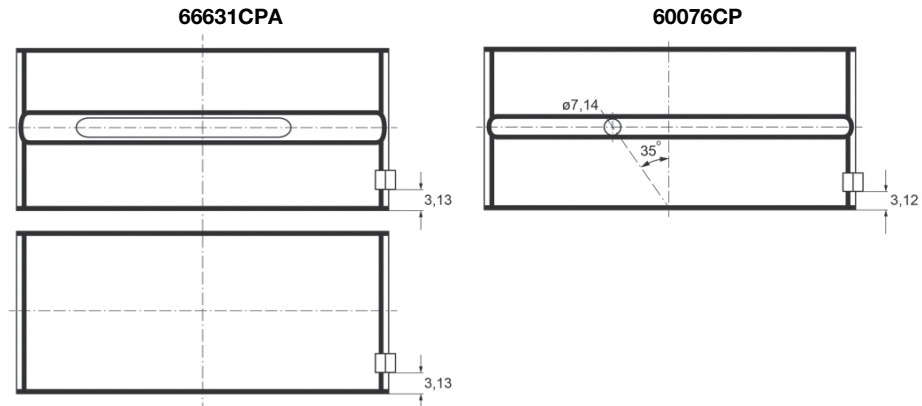

TW/A	4	85,090/85,340	101,600/101,850	3,429	AL-LF	60076AFA	A192/4 STD .005
Mot.→645690							
TW/A	4	85,090/85,340	106,550/106,800	3,429	AL-LF	60076AFF	A193/4 STD .005
Mot.645691→							

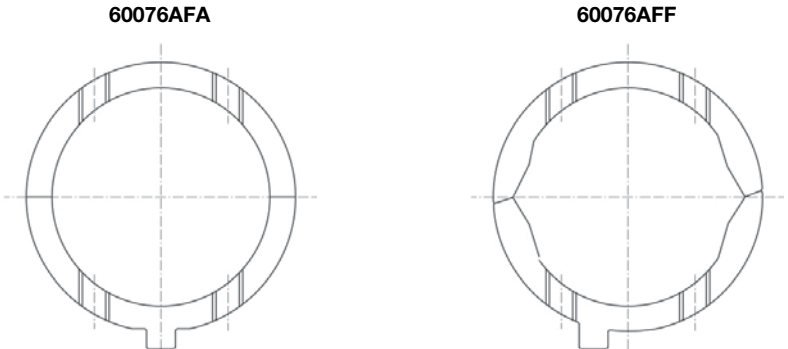

SE/PB	1	32,005/32,012	35,877/35,916	16,690	BS	60079X	55-4211 SEMI
01/67→12/77							
SE/PB	1	34,005/34,012	37,846/37,884	34,800	BS	66634YA	55-4230 SEMI
01/78→							
SE/PB	1	32,005/32,012	35,877/35,916	34,800	BS	66634YC	55-4231 SEMI
01/67→12/77							
SE/PB	1	34,005/34,012	37,846/37,884	16,690	BS	66634Y	55-4275 SEMI
01/78→							

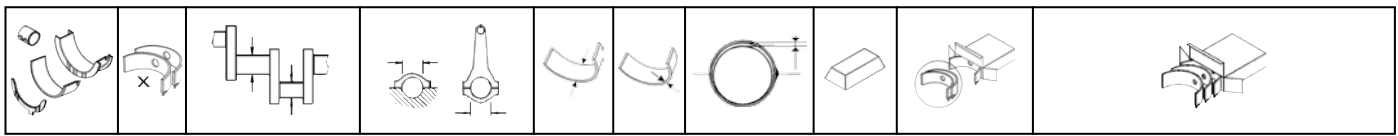

137 103.00 x 110.00

8060.25.4600		6 Cyl.		5499cc	130kW (177PS)	Diesel Turbo		TD7350	
BE/PL	1	63,725/63,744	67,407/67,422	28,700	1,815	0,033/0,092	BS	1010CP	71-4104 STD 0.25 0.50 0.75
BE/PL	1	63,725/63,744	67,407/67,422	28,700	1,815	0,033/0,092	BS	1010CPA	71-4389 STD 0.25 0.50

1010CP

1010CPA

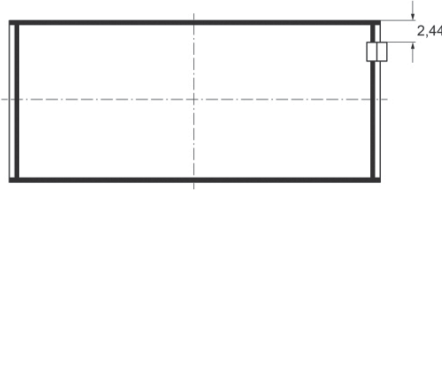
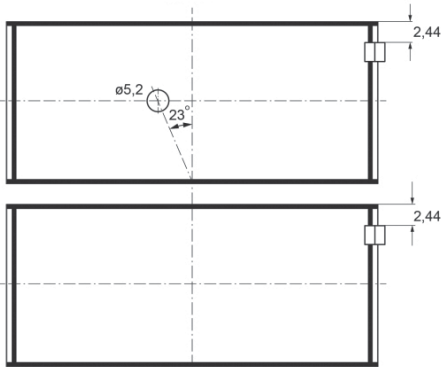

MB/HL	1	79,791/79,810	84,200/84,230	25,000	2,179	0,032/0,106	BS	1011CP	72-4546 STD 0.25 0.50 0.75
MB/HL	1	79,782/79,800	84,206/84,226	32,500	2,178	0,050/0,113	BS	66552CP	72-4556 STD 0.25 0.50

1011CP

66552CP

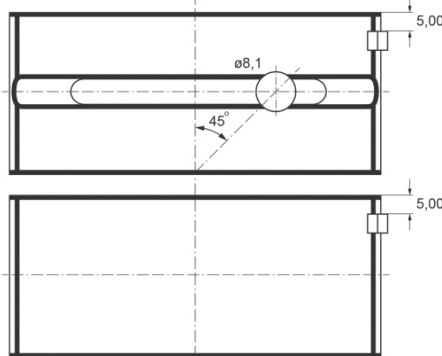
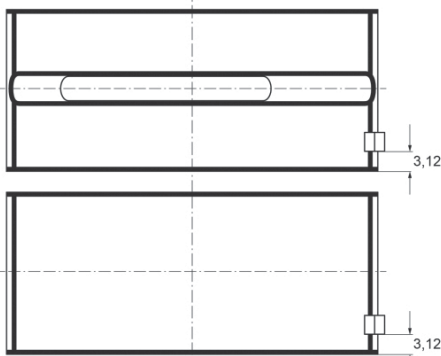

TW/A	4	87,779/88,033	111,510/111,764		3,429		BS	1011BF	A169/4 STD .005
SE/PB	1	38,004/38,014	41,846/41,884	34,800			BS	1014Y	55-4105 SEMI
SE/PB	1	38,005/38,012	41,846/41,884	34,800			BS	1014YA	55-4106 SEMI

1014Y

1014YA

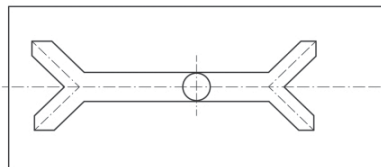
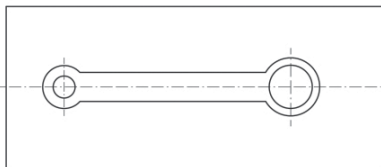

138 103.00 x 110.00

8065.04.200		6 Cyl.		5499cc	81-85kW (110-116PS)	Diesel		TD25322	
BE/PL	1	58,730/58,743	62,408/62,420	28,700	1,816	0,033/0,083	BS	66630CP	71-4229 STD 0.25 0.50 0.75 1.00
MB/HL	1	76,187/76,200	80,587/80,607	25,000	2,172	0,043/0,101	BS	66631CPA	72-4547 STD 0.25 0.50 0.75 1.00

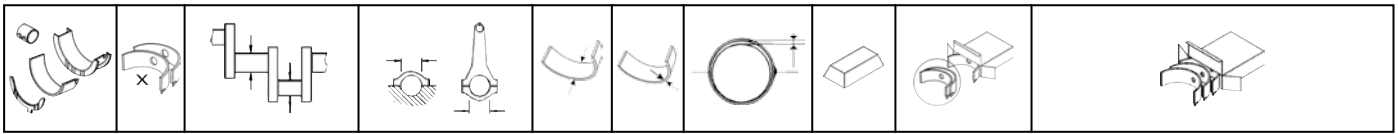

MB/HL	1	76,187/76,200	80,587/80,607	25,000	2,172	0,043/0,101	BS	60076CP	72-4550 STD 0.25
-------	---	---------------	---------------	--------	-------	-------------	----	---------	----------------------------

66631CPA

60076CP

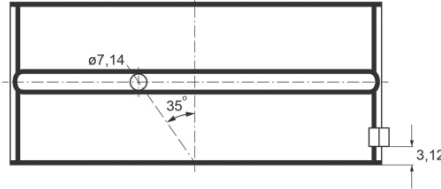
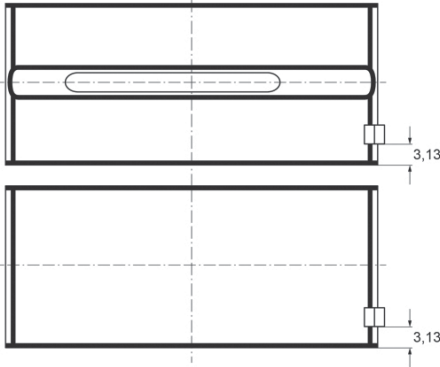

139

103.00 x 110.00

8065.24.000	6 Cyl.	5499cc	99kW (135PS)	Diesel	TD25348
8065.24.300	6 Cyl.	5499cc	90-91kW (121-124PS)	Diesel	TD25352

MB/HL	1	76,187/76,200	80,587/80,607	25,000	2,172	0,043/0,101	BS	66631CPA	72-4547 STD 0.25 0.50 0.75 1.00
MB/HL	1	76,187/76,200	80,587/80,607	25,000	2,172	0,043/0,101	BS	60076CP	72-4550 STD 0.25

66631CPA

60076CP

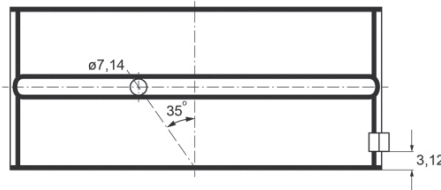
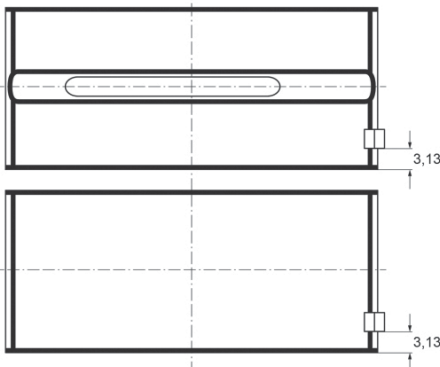

140

104.00 x 115.00

8035.05.214	3 Cyl.	2931cc	37-44kW (50-60PS)	Diesel	TD22233				
MB/HL	1	79,791/79,810	84,200/84,230	25,000	2,179	0,032/0,106	BS	1011CP	72-4546 STD 0.25 0.50 0.75

141

104.00 x 115.00

8035.05.215	3 Cyl.	2931cc	37-44kW (50-60PS)	Diesel	TD22234				
BE/PL	1	50,787/50,805	53,901/53,913	19,500	1,534	0,030/0,080	EC	71-3994	71-3994 STD 0.25
MB/HL 1-6	6	59,986/60,000	63,705/63,718	20,750	1,844	0,031/0,075	BS	4356CP	H1095/6 STD 0.25 0.50
TW/A	2	67,785/68,040	82,425/82,677		2,485		AL-LF	4356AF	A191/2 STD
SE/PB	1		28,939/28,972	21,700			BS	4369Y	55-4159 SEMI

142

104.00 x 115.00

8040.05.200	4 Cyl.	3908cc	65kW (88PS)	Diesel	TD7265
8040.05.230	4 Cyl.	3908cc	65kW (88PS)	Diesel	TD7264
8040.05.4990	4 Cyl.	3908cc	80kW (109PS)	Diesel Turbo	TD22235

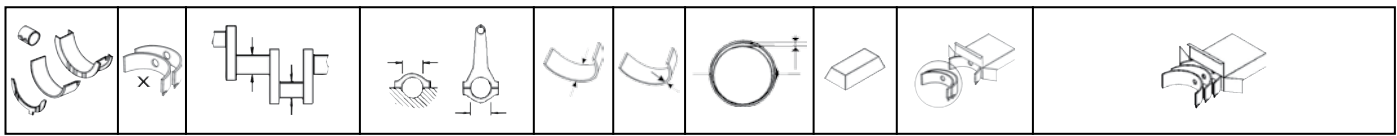

8040.25.000	4 Cyl.	3908cc	74-85kW (101-116PS)	Diesel Turbo	TD21461
8040.25.200	4 Cyl.	3908cc	85kW (115PS)	Diesel Turbo	TD7272
8040.25.220	4 Cyl.	3908cc	85kW (115PS)	Diesel Turbo	TD7280
8040.25.230	4 Cyl.	3908cc	74kW (101PS)	Diesel Turbo	TD7271
8040.25B.4200 (LTC)	4 Cyl.	3908cc	75kW (102PS)	Diesel Turbo	TD7267
8040.25X.4000	4 Cyl.	3908cc	85kW (116PS)	Diesel Turbo	TD7268

BE/PL	1	63,725/63,744	67,407/67,422	28,700	1,815	0,033/0,092	BS	1010CP	71-4104 STD 0.25 0.50 0.75
BE/PL	1	63,725/63,744	67,407/67,422	28,700	1,815	0,033/0,092	BS	1010CPA	71-4389 STD 0.25 0.50

1010CP

1010CPA

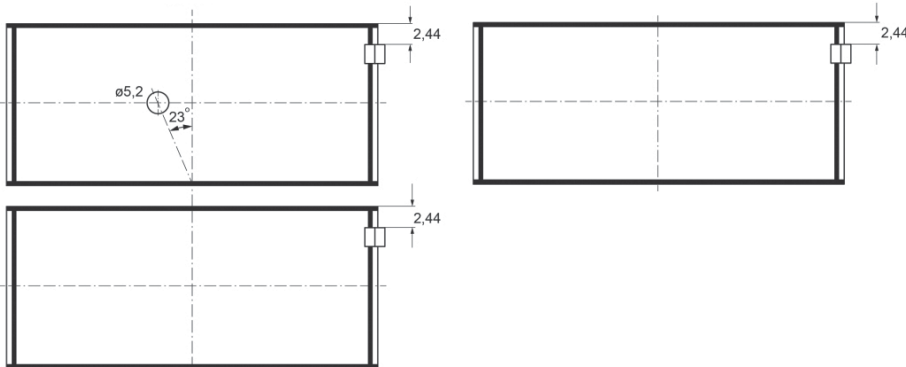

MB/HL	1	79,791/79,810	84,200/84,230	25,000	2,179	0,032/0,106	BS	1011CP	72-4546 STD 0.25 0.50 0.75
MB/HL	1	79,782/79,800	84,206/84,226	32,500	2,178	0,050/0,113	BS	66552CP	72-4556 STD 0.25 0.50

1011CP

66552CP

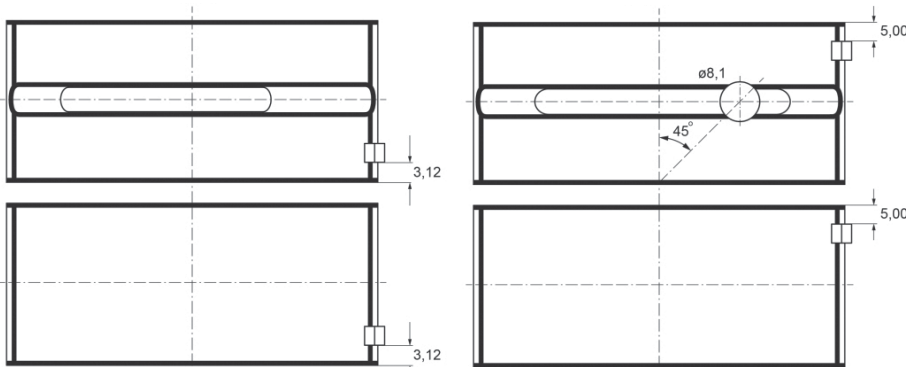

TW/A	4	87,779/88,033	111,510/111,764	3,429			BS	1011BF	A169/4 STD .005
SE/PB	1	38,004/38,014	41,846/41,884	34,800			BS	1014Y	55-4105 SEMI
SE/PB	1	38,005/38,012	41,846/41,884	34,800			BS	1014YA	55-4106 SEMI

1014Y

1014YA

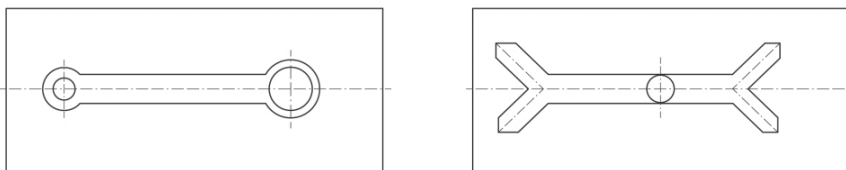

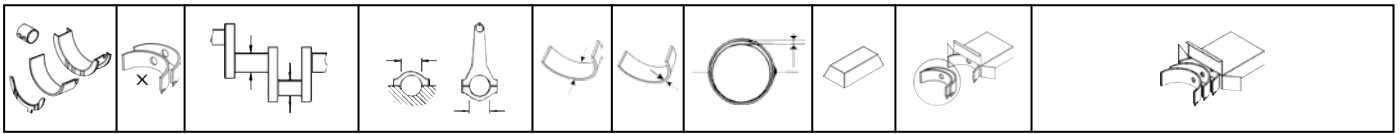

143 104.00 x 115.00										
8040.45.261			4 Cyl.	3908cc	77kW (105PS)				Diesel Turbo	TD7245
8040.45.271			4 Cyl.	3908cc	77kW (105PS)				Diesel Turbo	TD7246
8040.45.4000 (TCA)			4 Cyl.	3908cc	100kW (136PS)				Diesel Turbo Intercooler	TD7269
8040.45.4180 (TCA)			4 Cyl.	3908cc	100kW (136PS)				Diesel Turbo Intercooler	TD7275
8040.45.5200 Euro 2			4 Cyl.	3908cc	100kW (136PS)				Diesel Turbo Intercooler	TD21462
8040.45.5281 Euro 2			4 Cyl.	3908cc	100kW (136PS)				Diesel Turbo Intercooler	TD22236
8040.45D.5100 Euro 2			4 Cyl.	3908cc	85kW (116PS)				Diesel Turbo Intercooler	TD22237
8040.45D.5103 Euro 2			4 Cyl.	3908cc	85kW (116PS)				Diesel Turbo Intercooler	TD22238
BE/PL	1	63,725/63,744	67,407/67,422	28,700	1,815	0,033/0,092	BS	1010CPA	71-4389 STD 0.25 0.50	
MB/HL	1	79,782/79,800	84,206/84,226	32,500	2,178	0,050/0,113	BS	66552CP	72-4556 STD 0.25 0.50	
TW/A	4	87,779/88,033	111,510/111,764		3,429		BS	1011BF	A169/4 STD .005	
SE/PB	1	38,004/38,014	41,846/41,884	34,800			BS	1014Y	55-4105 SEMI	

144 104.00 x 115.00										
8041.05			4 Cyl.	3908cc					Diesel	FM34012
BE/PL	1	63,725/63,744	67,407/67,422	28,700	1,815	0,033/0,092	BS	1010CP	71-4104 STD 0.25 0.50 0.75	
MB/HL	1	79,791/79,810	84,200/84,230	25,000	2,179	0,032/0,106	BS	1011CP	72-4546 STD 0.25 0.50 0.75	
TW/A	4	87,779/88,033	111,510/111,764		3,429		BS	1011BF	A169/4 STD .005	
SE/PB	1	38,004/38,014	41,846/41,884	34,800			BS	1014Y	55-4105 SEMI	

145 104.00 x 115.00										
8045.05.000			4 Cyl.	3908cc	59kW (80PS)				Diesel	TD25496
8045.05.200			4 Cyl.	3908cc	59kW (80PS)				Diesel	TD25497
8045.05.204			4 Cyl.	3908cc	59kW (80PS)				Diesel	TD25498
8045.05.213			4 Cyl.	3908cc	55kW (75PS)				Diesel	TD25500
8045.05.215			4 Cyl.	3908cc	55kW (75PS)				Diesel	TD25501
8045.05.216			4 Cyl.	3908cc	59kW (80PS)				Diesel	TD25502
8045.05.217			4 Cyl.	3908cc	59kW (80PS)				Diesel	TD25503
8045.05.300			4 Cyl.	3908cc	59kW (80PS)				Diesel	TD25504
8045.05.304			4 Cyl.	3908cc	59kW (80PS)				Diesel	TD25505
8045.05.308			4 Cyl.	3908cc	57kW (78PS)				Diesel	TD25506
8045.05.317			4 Cyl.	3908cc	59kW (80PS)				Diesel	TD25507
8045.05.359			4 Cyl.	3908cc	60kW (82PS)				Diesel	TD25508
8045.05.370			4 Cyl.	3908cc	54kW (73PS)				Diesel	TD25509
8045.05.376			4 Cyl.	3908cc	54kW (73PS)				Diesel	TD25510
8045.05.389			4 Cyl.	3908cc	57kW (78PS)				Diesel	TD25511
8045.05.393			4 Cyl.	3908cc	57kW (78PS)				Diesel	TD25512
8045.05.395			4 Cyl.	3908cc	58kW (79PS)				Diesel	TD25513
BE/PL	1	63,725/63,744	67,407/67,422	28,700	1,815	0,033/0,092	BS	1010CP	71-4104 STD 0.25 0.50 0.75	
MB/HL	1	79,791/79,810	84,200/84,230	25,000	2,179	0,032/0,106	BS	1011CP	72-4546 STD 0.25 0.50 0.75	
TW/A	4	87,779/88,033	111,510/111,764		3,429		BS	1011BF	A169/4 STD .005	
SE/PB	1	38,004/38,014	41,846/41,884	34,800			BS	1014Y	55-4105 SEMI	



SE/PB	1	38,005/38,012	41,846/41,884	34,800			BS	1014YA	55-4106 SEMI
-------	---	---------------	---------------	--------	--	--	----	--------	------------------------

1014Y

1014YA

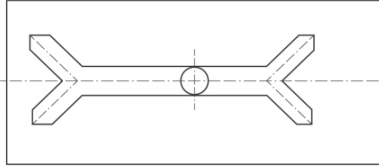
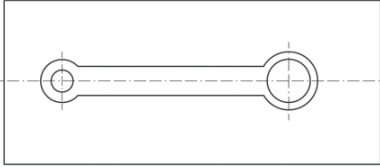

146 104.00 x 115.00

8045.25.210			4 Cyl.	3908cc	63kW (85PS)		Diesel Turbo		TD25363
--------------------	--	--	--------	---------------	--------------------	--	---------------------	--	----------------

BE/PL	1	63,725/63,744	67,407/67,422	28,700	1,815	0,033/0,092	BS	1010CP	71-4104 STD 0.25 0.50 0.75
BE/PL	1	63,725/63,744	67,407/67,422	28,700	1,815	0,033/0,092	BS	1010CPA	71-4389 STD 0.25 0.50

1010CP

1010CPA

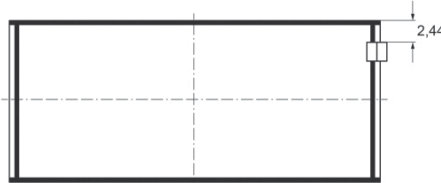
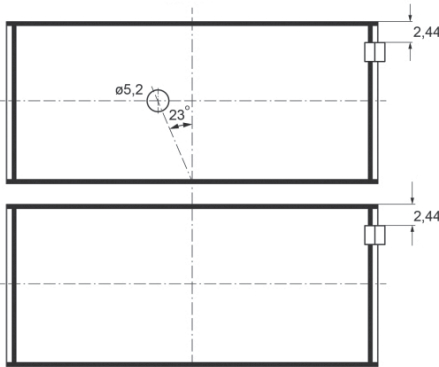

MB/HL	1	79,791/79,810	84,200/84,230	25,000	2,179	0,032/0,106	BS	1011CP	72-4546 STD 0.25 0.50 0.75
TW/A	4	87,779/88,033	111,510/111,764		3,429		BS	1011BF	A169/4 STD .005
SE/PB	1	38,004/38,014	41,846/41,884	34,800			BS	1014Y	55-4105 SEMI

147 104.00 x 115.00

8055.05.000			5 Cyl.	4885cc	66kW (90PS)		Diesel		TD25384
--------------------	--	--	--------	---------------	--------------------	--	---------------	--	----------------

BE/PL	1	58,730/58,743	62,408/62,420	28,700	1,816	0,033/0,083	BS	66630CP	71-4229 STD 0.25 0.50 0.75 1.00
MB/HL	1	76,187/76,200	80,587/80,607	25,000	2,172	0,043/0,101	BS	66631CPA	72-4547 STD 0.25 0.50 0.75 1.00

01/80 →

MB/HL	1	76,187/76,200	80,587/80,607	25,000	2,172	0,043/0,101	BS	60076CP	72-4550 STD 0.25
-------	---	---------------	---------------	--------	-------	-------------	----	---------	----------------------------

→ **12/79**



66631CPA

60076CP

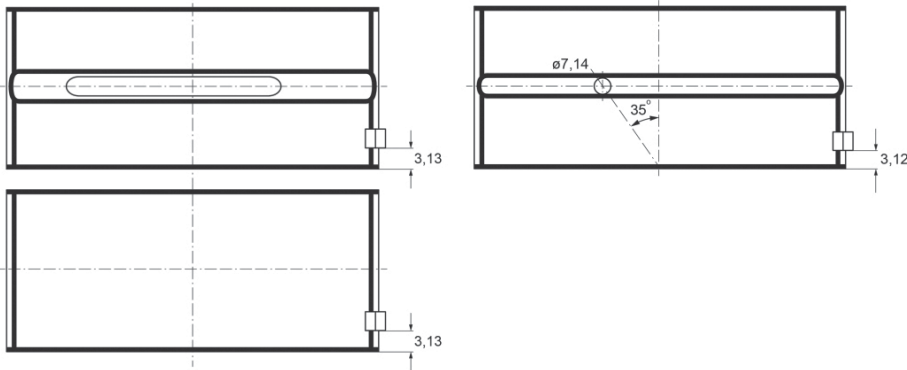

148	104.00 x 115.00					
8060.05.000	6 Cyl.	5861cc	79-102kW (108-139PS)	Diesel		TD7282
8060.05.200	6 Cyl.	5861cc	99-102kW (135-139PS)	Diesel		TD7299
8060.05.246	6 Cyl.	5861cc	101kW (138PS)	Diesel		TD7262
8060.05.270	6 Cyl.	5861cc	101-102kW (138-139PS)	Diesel		TD7278
8060.05.280	6 Cyl.	5861cc	102kW (139PS)	Diesel		TD7281
8060.05.285	6 Cyl.	5861cc	101kW (138PS)	Diesel		TD7274
8060.05.289	6 Cyl.	5861cc	102kW (139PS)	Diesel		TD7293
8060.05.661	6 Cyl.	5861cc	81kW (110PS)	Diesel		TD5596
8060.05.662	6 Cyl.	5861cc	96kW (120PS)	Diesel		TD5598
8060.05.663	6 Cyl.	5861cc	81kW (110PS)	Diesel		TD5935
8060.05.673	6 Cyl.	5861cc	96kW (120PS)	Diesel		TD5937
8060.25.221	6 Cyl.	5861cc	116kW (155PS)	Diesel Turbo		TD7247
8060.25.241	6 Cyl.	5861cc	100kW (135PS)	Diesel Turbo		TD5600
8060.25.243	6 Cyl.	5861cc	100kW (135PS)	Diesel Turbo		TD7244
8060.25.246	6 Cyl.	5861cc	100kW (135PS)	Diesel Turbo		TD5939
8060.25.600	6 Cyl.	5861cc	130kW (175PS)	Diesel Turbo		TD7301
8060.25.621	6 Cyl.	5861cc	110kW (150PS)	Diesel Turbo		TD7243
8060.25.630	6 Cyl.	5861cc	100kW (135PS)	Diesel Turbo		TD5604
8060.25.631	6 Cyl.	5861cc	100kW (135PS)	Diesel Turbo		TD5943
8060.25.641	6 Cyl.	5861cc	103kW (140PS)	Diesel Turbo		TD7242
8060.25.661	6 Cyl.	5861cc	88-96kW (120-131PS)	Diesel		TD5597
8060.25.662	6 Cyl.	5861cc	96kW (130PS)	Diesel Turbo		TD5599
8060.25.663	6 Cyl.	5861cc	88-96kW (118-131PS)	Diesel Turbo		TD5936
8060.25.669	6 Cyl.	5861cc	125kW (170PS)	Diesel Turbo		TD5613
8060.25.670	6 Cyl.	5861cc	125kW (170PS)	Diesel Turbo		TD5952
8060.25.673	6 Cyl.	5861cc	96kW (130PS)	Diesel Turbo		TD5938
8060.25.678	6 Cyl.	5861cc	130kW (177PS)	Diesel Turbo		TD5616
8060.25.679	6 Cyl.	5861cc	130kW (177PS)	Diesel Turbo		TD5955
8060.25R.4200	6 Cyl.	5861cc	105kW (143PS)	Diesel Turbo Intercooler		TD7276
8060.25R.4280	6 Cyl.	5861cc	105kW (143PS)	Diesel Turbo Intercooler		TD7302
8060.25V.4000	6 Cyl.	5861cc	130kW (177PS)	Diesel Turbo Intercooler		TD7283
8060.25V.4080	6 Cyl.	5861cc	130kW (177PS)	Diesel Turbo Intercooler		TD7303
8060.45.4100 Euro 1	6 Cyl.	5861cc	152kW (207PS)	Diesel Turbo Intercooler		TD7284
8060.45.4180 Euro 1	6 Cyl.	5861cc	152kW (207PS)	Diesel Turbo Intercooler		TD7285
8060.45.600	6 Cyl.	5861cc	152kW (207PS)	Diesel Turbo Intercooler		TD7295
8060.45.6090	6 Cyl.	5861cc	167kW (227PS)	Diesel Turbo Intercooler		TD7304
8060.45S.6000	6 Cyl.	5861cc	167kW (227PS)	Diesel Turbo Intercooler		TD7307
8060.45S.6700 Euro 1	6 Cyl.	5861cc	167kW (227PS)	Diesel Turbo Intercooler		TD7343
8060.45S.6800 Euro 1	6 Cyl.	5861cc	167kW (227PS)	Diesel Turbo Intercooler		TD7305



BE/PL	1	63,725/63,744	67,407/67,422	28,700	1,815	0,033/0,092	BS	1010CP	71-4104 STD 0.25 0.50 0.75
BE/PL	1	63,725/63,744	67,407/67,422	28,700	1,815	0,033/0,092	BS	1010CPA	71-4389 STD 0.25 0.50

1010CP

1010CPA

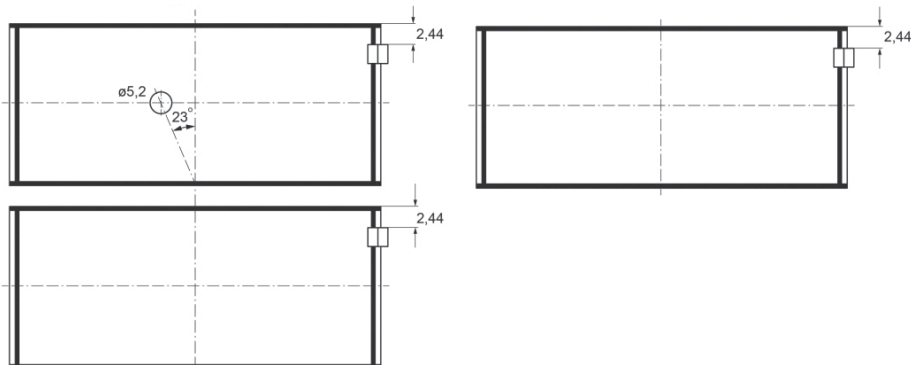

MB/HL	1	79,791/79,810	84,200/84,230	25,000	2,179	0,032/0,106	BS	1011CP	72-4546 STD 0.25 0.50 0.75
MB/HL	1	79,782/79,800	84,206/84,226	32,500	2,178	0,050/0,113	BS	66552CP	72-4556 STD 0.25 0.50

1011CP

66552CP

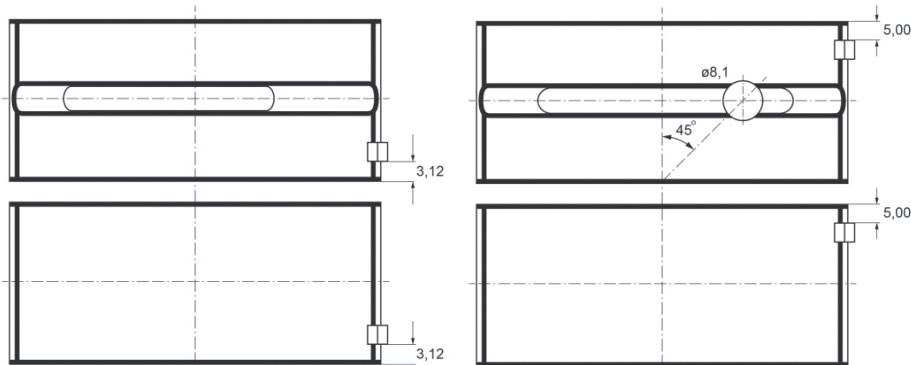

TW/A	4	87,779/88,033	111,510/111,764		3,429		BS	1011BF	A169/4 STD .005
SE/PB	1	38,004/38,014	41,846/41,884	34,800			BS	1014Y	55-4105 SEMI
SE/PB	1	38,005/38,012	41,846/41,884	34,800			BS	1014YA	55-4106 SEMI

1014Y

1014YA

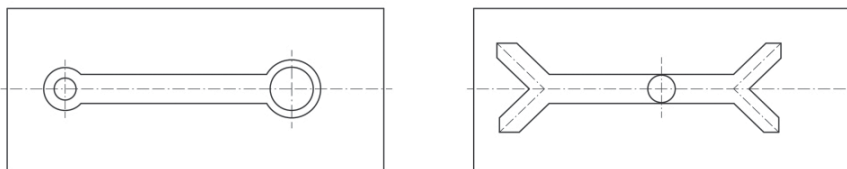

149 104.00 x 115.00

8065.05.000	6 Cyl.	5863cc	85kW (116PS)	Diesel	TD25488
8065.05.210	6 Cyl.	5863cc	73kW (99PS)	Diesel	TD25489
8065.05.220	6 Cyl.	5863cc	81kW (110PS)	Diesel	TD25491
8065.05.290	6 Cyl.	5863cc	86kW (117PS)	Diesel	TD25490
8065.05.295	6 Cyl.	5863cc	73kW (99PS)	Diesel	TD25492
8065.05.297	6 Cyl.	5863cc	73kW (99PS)	Diesel	TD25493
8065.05.300	6 Cyl.	5863cc	81kW (110PS)	Diesel	TD25494
8065.05.330	6 Cyl.	5863cc	73kW (99PS)	Diesel	TD25495

BE/PL	1	63,725/63,744	67,407/67,422	28,700	1,815	0,033/0,092	BS	1010CP	71-4104 STD 0.25 0.50 0.75	
MB/HL	1	79,791/79,810	84,200/84,230	25,000	2,179	0,032/0,106	BS	1011CP	72-4546 STD 0.25 0.50 0.75	
TW/A	4	87,779/88,033	111,510/111,764		3,429		BS	1011BF	A169/4 STD .005	
SE/PB	1	38,004/38,014	41,846/41,884	34,800			BS	1014Y	55-4105 SEMI	
SE/PB	1	38,005/38,012	41,846/41,884	34,800			BS	1014YA	55-4106 SEMI	

1014Y

1014YA

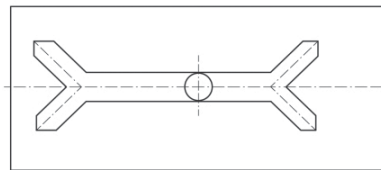
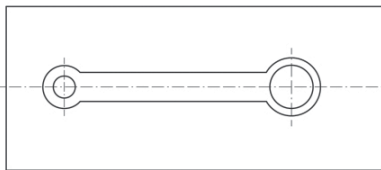

150	104.00 x 115.00									
8065.25.000			6 Cyl.	5863cc	107kW (146PS)		Diesel		TD25473	
8065.25.010			6 Cyl.	5863cc	94-96kW (128-131PS)		Diesel		TD25474	
8065.25.080			6 Cyl.	5863cc	103-105kW (140-143PS)		Diesel		TD25475	
8065.25.320			6 Cyl.	5863cc	105-110kW (143-150PS)		Diesel		TD25477	
BE/PL	1	63,725/63,744	67,407/67,422	28,700	1,815	0,033/0,092	BS	1010CPA	71-4389 STD 0.25 0.50	
MB/HL	1	79,791/79,810	84,200/84,230	25,000	2,179	0,032/0,106	BS	1011CP	72-4546 STD 0.25 0.50 0.75	
TW/A	4	87,779/88,033	111,510/111,764		3,429		BS	1011BF	A169/4 STD .005	
SE/PB	1	38,004/38,014	41,846/41,884	34,800			BS	1014Y	55-4105 SEMI	

151	110.00 x 130.00									
C 03			4 Cyl.	4940cc	55-67kW (75-91PS)		Diesel		TD6844	
C 03-36			4 Cyl.	4940cc	76kW (103PS)		Diesel		TD6845	
C 03-80			4 Cyl.	4940cc	62-66kW (84-90PS)		Diesel		TD26518	
BE/PL	1	69,843/69,855	73,710/73,729	35,700	1,892	0,071/0,127	BS	60115CP	71-4212 STD 0.25 0.50 0.75 1.00	
MB/HL 1,3,5	3	76,200/76,220	80,626/80,646	40,500	2,182	0,042/0,107	BS	66556CP	H1175/5 STD 0.25 0.50 0.75 1.00	
MB/HL 2,4	2	76,200/76,220	80,626/80,646	30,500	2,182	0,042/0,107	BS	66557CP		
TW/A	4	82,500/82,650	101,600/101,850		2,362		AL-LF	60116AF	A194/4 STD .004	
SE/PB	1	39,967/40,015	43,946/43,971	36,000			BS	60116YA	55-4282 SEMI	

152	110.00 x 130.00									
CP 3			6 Cyl.	7412cc	107kW (145PS)		Diesel		TD6861	
CP 3/32.1.200			6 Cyl.	7412cc	107-110kW (145-150PS)		Diesel		TD6855	
CP 3-100			6 Cyl.	7412cc	95-110kW (129-150PS)		Diesel		TD26540	
BE/PL	1	69,843/69,855	73,710/73,729	35,700	1,892	0,071/0,127	BS	60115CP	71-4212 STD 0.25 0.50 0.75 1.00	
MB/HL 1,4,7	3	76,200/76,220	80,626/80,646	40,500	2,182	0,042/0,107	BS	66556CP	H1175/7 STD 0.25 0.50	
MB/HL 2,3,5,6	4	76,200/76,220	80,626/80,646	30,500	2,182	0,042/0,107	BS	66557CP		

TW/A	4	82,500/82,650	101,600/101,850		2,362		AL-LF	60116AF	A194/4 STD .004
SE/PB	1	39,967/40,015	43,946/43,971	36,000			BS	60116YA	55-4282 SEMI

153 112.00 x 130.00

8360.46B.4591			6 Cyl.	7684cc	162-196kW (220-267PS)		Diesel Turbo Intercooler		TD24862
MB/HL 1,4,7	3	79,782/79,800	84,206/84,226	42,500	2,178	0,050/0,113	BS	66551CP	H1048/7 STD 0.25 0.50
MB/HL 2,3,5,6	4	79,782/79,800	84,206/84,226	32,500	2,178	0,050/0,113	BS	66552CP	

154 115.00 x 130.00

8340.05			4 Cyl.	5400cc	63kW (86PS)		Diesel		TD6849
BE/PL	1	72,482/72,500	76,695/76,713	34,930	2,070	0,055/0,116	BS	66550CP	71-4227 STD 0.25 0.50 0.75
→12/82									
BE/PL	1	72,482/72,500	76,695/76,713	34,930	2,070	0,055/0,115	BC	AE6563	71-4390 STD 0.25 0.50 0.75 1.00
01/83→									

66550CP

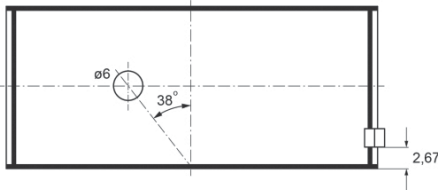

MB/HL 1,3,5	3	79,782/79,800	84,206/84,226	42,500	2,178	0,050/0,113	BS	66551CP	H1048/5 STD 0.25 0.50 0.75
MB/HL 2,4	2	79,782/79,800	84,206/84,226	32,500	2,178	0,050/0,113	BS	66552CP	
TW/A	4	87,779/88,033	111,510/111,764		3,429		BS	1011BF	A169/4 STD .005
SE/PB	1	42,000/42,006	45,946/45,971	37,800			BS	66554Y	55-4293 SEMI

155 115.00 x 130.00

8360.05			6 Cyl.	8100cc	95-124kW (129-169PS)		Diesel		TD6854
BE/PL	1	72,482/72,500	76,695/76,713	34,930	2,070	0,055/0,116	BS	66550CP	71-4227 STD 0.25 0.50 0.75
→12/82									
BE/PL	1	72,482/72,500	76,695/76,713	34,930	2,070	0,055/0,115	BC	AE6563	71-4390 STD 0.25 0.50 0.75 1.00
01/83→									

66550CP

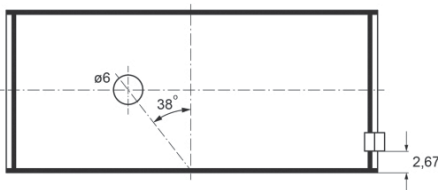

MB/HL 1,4,7	3	79,782/79,800	84,206/84,226	42,500	2,178	0,050/0,113	BS	66551CP	H1048/7 STD 0.25 0.50
MB/HL 2,3,5,6	4	79,782/79,800	84,206/84,226	32,500	2,178	0,050/0,113	BS	66552CP	

TW/A	4	87,779/88,033	111,510/111,764		3,429			BS	1011BF	A169/4 STD .005
SE/PB	1	39,967/40,015	43,946/43,971	36,000				BS	60116YA	55-4282 SEMI
SE/PB	1	42,000/42,006	45,946/45,971	37,800				BS	66554Y	55-4293 SEMI

156 115.00 x 130.00

8360.05.B			6 Cyl.	8100cc	101-110kW (137-150PS)	Diesel				TD6856
BE/PL	1	72,482/72,500	76,695/76,713	34,930	2,070	0,055/0,116	BS	66550CP	71-4227 STD 0.25 0.50 0.75	
→12/82										
BE/PL	1	72,482/72,500	76,695/76,713	34,930	2,070	0,055/0,115	BC	AE6563	71-4390 STD 0.25 0.50 0.75 1.00	
01/83→										

66550CP

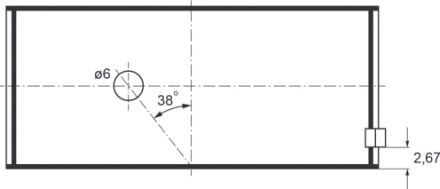

MB/HL 1,4,7	3	79,782/79,800	84,206/84,226	42,500	2,178	0,050/0,113	BS	66551CP	H1048/7 STD 0.25 0.50
MB/HL 2,3,5,6	4	79,782/79,800	84,206/84,226	32,500	2,178	0,050/0,113	BS	66552CP	
TW/A	4	87,779/88,033	111,510/111,764		3,429		BS	1011BF	A169/4 STD .005
SE/PB	1	39,967/40,015	43,946/43,971	36,000			BS	60116YA	55-4282 SEMI
SE/PB	1	42,000/42,006	45,946/45,971	37,800			BS	66554Y	55-4293 SEMI

157 115.00 x 130.00

8365.05.500			6 Cyl.	8101cc	114kW (155PS)	Diesel				TD25353
8365.05.590			6 Cyl.	8101cc	94kW (128PS)	Diesel				TD25361
8365.25.500			6 Cyl.	8101cc	132kW (180PS)	Diesel				TD26505
8365.25.501			6 Cyl.	8101cc	118kW (160PS)	Diesel				TD26506
8365.25.502			6 Cyl.	8101cc	118-133kW (160-181PS)	Diesel				TD26507
8365.25.503			6 Cyl.	8101cc	118kW (160PS)	Diesel				TD26508
BE/PL	1	72,482/72,500	76,695/76,713	34,930	2,070	0,055/0,116	BS	66550CP	71-4227 STD 0.25 0.50 0.75	
BE/PL	1	72,482/72,500	76,695/76,713	34,930	2,070	0,055/0,115	BC	AE6563	71-4390 STD 0.25 0.50 0.75 1.00	

66550CP

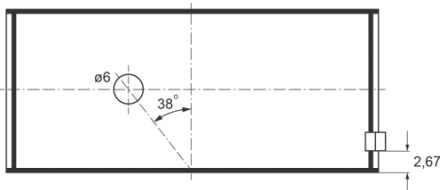

MB/HL 1,4,7	3	79,782/79,800	84,206/84,226	42,500	2,178	0,050/0,113	BS	66551CP	H1048/7 STD 0.25 0.50
MB/HL 2,3,5,6	4	79,782/79,800	84,206/84,226	32,500	2,178	0,050/0,113	BS	66552CP	

TW/A	4	87,779/88,033	111,510/111,764		3,429		BS	1011BF	A169/4 STD .005
SE/PB	1	39,967/40,015	43,946/43,971	36,000			BS	60116YA	55-4282 SEMI
SE/PB	1	42,000/42,006	45,946/45,971	37,800			BS	66554Y	55-4293 SEMI

158 120.00 x 140.00

8460.21.002			6 Cyl.	9498cc	154-192kW (209-261PS)		Diesel Turbo		TD24863
BE/PL	1	81,978/82,000	86,213/86,235	35,400	2,089	0,040/0,100	BS	1230CP	71-4284 STD 0.25 0.50
MB/HL 1-3, 5-7	6	89,958/89,980	96,000/96,022	32,750	2,991	0,038/0,107	BS	1231CP	H1072/7 STD 0.25 0.50
MB/HL 4	1	89,958/89,980	96,000/96,022	44,500	2,991	0,038/0,107	BS	1232CP	
TW/A	4	99,800/100,200	123,650/124,000		3,920		BS	1232BF	A171/4 STD
SE/PB	1	48,023/48,033	52,114/52,122	43,000			BS	1234Y	55-4285 SEMI

159 125.00 x 130.00

8220.02.701			6 Cyl.	9572cc	148kW (201PS)		Diesel		TD7252
8220.02.834			6 Cyl.	9572cc	148kW (201PS)		Diesel		TD7361
8220.02.842			6 Cyl.	9570cc	148kW (201PS)		Diesel Turbo		TD6887
8220.02.842			6 Cyl.	9572cc	154kW (210PS)		Diesel		TD7574
8220.02.847			6 Cyl.	9572cc	151kW (205PS)		Diesel		TD6866
8220.02.856			6 Cyl.	9572cc	151kW (205PS)		Diesel		TD6867
8220.02.870			6 Cyl.	9572cc	148kW (201PS)		Diesel		TD7327
8220.12.001			6 Cyl.	9570cc	148kW (201PS)		Diesel		TD6917
8220.12.709			6 Cyl.	9572cc	149kW (203PS)		Diesel		TD7370
8220.22.002			6 Cyl.	9572cc	177kW (240PS)		Diesel Turbo		TD5618
8220.22.102			6 Cyl.	9572cc	177kW (240PS)		Diesel Turbo		TD5601
8220.22.104			6 Cyl.	9572cc	177kW (240PS)		Diesel Turbo		TD5940
8220.22.106			6 Cyl.	9572cc	177kW (240PS)		Diesel Turbo		TD6258
8220.22.708			6 Cyl.	9570cc	177kW (240PS)		Diesel Turbo		TD5640
8220.22.709			6 Cyl.	9570cc	177kW (240PS)		Diesel Turbo		TD5981
8220.32.701			6 Cyl.	9572cc	177kW (240PS)		Diesel Turbo		TD7379
8220.32.721			6 Cyl.	9570cc	177kW (240PS)		Diesel Turbo		TD7380
8220.32.723			6 Cyl.	9570cc	177kW (240PS)		Diesel Turbo		TD7373
BE/PL	6	76,191/76,210	80,423/80,442	36,300	2,083	0,047/0,110	BS	66545CP	71-4386/6 STD

160 130.00 x 145.00

203 A/61			6 Cyl.	11548cc	130-132kW (177-180PS)		Diesel		TD22229
203 A/61.000			6 Cyl.	11548cc	132kW (179PS)		Diesel		TD6933
203 H/61..			6 Cyl.	11548cc	132kW (180PS)		Diesel		TD6904
BE/PL	6	81,800/81,826	85,585/85,598	43,250	1,835	0,089/0,153	BS	60065CP	71-4221/6 STD 0.25 0.50 0.75
MB/HL 1	1	92,062/92,087	96,583/96,596	54,990	2,190	0,116/0,179	BS	60061CP	H1132/7 STD 0.25 0.50 0.75
MB/HL 4	1	92,062/92,087	96,583/96,596	67,000	2,190	0,116/0,179	BS	60062CP	
MB/HL 2,3,5,6	4	92,062/92,087	96,583/96,596	32,990	2,190	0,116/0,179	BS	60063CP	
MB/HL 7	1	92,062/92,087	96,583/96,596	70,990	2,190	0,116/0,179	BS	60064CP	

TW/A	4	103,378/103,632	119,888/120,142		2,362		AL-LF	60062AF	A244/4 STD .005	
SE/PB	1	47,983/47,998	53,010/53,061	50,000			BS	61929XA	55-4217 SEMI	

161		137.00 x 156.00								
8210.02.000	6 Cyl.	13798cc	191kW (260PS)	Diesel						TD6868
8210.02.020	6 Cyl.	13798cc	191kW (260PS)	Diesel						TD6864
8210.02.022	6 Cyl.	13798cc	191kW (260PS)	Diesel						TD6877
8210.02.032	6 Cyl.	13798cc	191kW (260PS)	Diesel						TD6923
8210.02.033	6 Cyl.	13798cc	191kW (260PS)	Diesel						TD5975
8210.02.053	6 Cyl.	13798cc	191kW (260PS)	Diesel						TD6266
8210.02.067	6 Cyl.	13798cc	191kW (260PS)	Diesel						TD5622
8210.02.069	6 Cyl.	13798cc	191kW (260PS)	Diesel						TD5959
8210.02.081	6 Cyl.	13798cc	191kW (260PS)	Diesel						TD6865
8210.02.266	6 Cyl.	13798cc	191kW (260PS)	Diesel						TD5635
8210.02.267	6 Cyl.	13798cc	191kW (260PS)	Diesel						TD5976
8210.02.290	6 Cyl.	13798cc	191kW (260PS)	Diesel						TD6384
8210.02.371	6 Cyl.	13798cc	191kW (260PS)	Diesel						TD5619
8210.02.373	6 Cyl.	13798cc	191kW (260PS)	Diesel						TD5621
8210.02.377	6 Cyl.	13798cc	191kW (260PS)	Diesel						TD5958
8210.02.385	6 Cyl.	13798cc	191kW (260PS)	Diesel						TD6899
8210.02.393	6 Cyl.	13798cc	191kW (260PS)	Diesel						TD6259
8210.02.405	6 Cyl.	13798cc	191kW (260PS)	Diesel						TD7254
8210.02.426	6 Cyl.	13798cc	191kW (260PS)	Diesel						TD7359
8210.02.440	6 Cyl.	13798cc	191kW (260PS)	Diesel						TD5617
8210.02.441	6 Cyl.	13798cc	191kW (260PS)	Diesel						TD5956
8210.02.731	6 Cyl.	13798cc	191kW (260PS)	Diesel						TD5973
8210.02.791	6 Cyl.	13798cc	191kW (260PS)	Diesel						TD6380
8210.02.793	6 Cyl.	13798cc	191kW (260PS)	Diesel						TD6381
8210.22.000	6 Cyl.	13798cc	224kW (305PS)	Diesel Turbo						TD22223
8210.22.069	6 Cyl.	13798cc	221-224kW (300-305PS)	Diesel						TD6885
8210.22.101	6 Cyl.	13798cc	224kW (305PS)	Diesel Turbo						TD6881
8210.22.105	6 Cyl.	13798cc	243kW (330PS)	Diesel Turbo Intercooler						TD7335
8210.22.171	6 Cyl.	13798cc	224kW (304PS)	Diesel Turbo						TD5623
8210.22.175	6 Cyl.	13798cc	224kW (304PS)	Diesel Turbo						TD5960
8210.22.183	6 Cyl.	13798cc	224kW (304PS)	Diesel Turbo						TD7340
8210.22.235	6 Cyl.	13798cc	224kW (304PS)	Diesel Turbo						TD7352
8210.22.269	6 Cyl.	13798cc	224kW (304PS)	Diesel Turbo						TD5630
8210.22.290	6 Cyl.	13798cc	224kW (304PS)	Diesel Turbo						TD6385
8210.22.317	6 Cyl.	13798cc	224kW (304PS)	Diesel Turbo						TD6260
8210.22.327	6 Cyl.	13798cc	224kW (304PS)	Diesel Turbo						TD5968
8210.22.373	6 Cyl.	13798cc	224kW (305PS)	Diesel Turbo						TD6878
8210.22.385	6 Cyl.	13798cc	224kW (304PS)	Diesel Turbo						TD6264
8210.22.869	6 Cyl.	13798cc	235kW (320PS)	Diesel Turbo						TD7333
8210.22X.069	6 Cyl.	13798cc	224kW (304PS)	Diesel Turbo						TD5637
8210.22X.235	6 Cyl.	13798cc	224kW (304PS)	Diesel Turbo						TD5636
8210.22X.523	6 Cyl.	13798cc	224kW (304PS)	Diesel Turbo						TD5977
8210.22X.575	6 Cyl.	13798cc	224kW (304PS)	Diesel Turbo						TD5978
8210.42 K	6 Cyl.	13798cc	272kW (370PS)	Diesel						TD7358
8210.42(TCA)	6 Cyl.	13798cc	272kW (370PS)	Diesel Turbo						TD7322
8210.42.009	6 Cyl.	13798cc	265kW (360PS)	Diesel Turbo Intercooler						TD7356
8210.42.061	6 Cyl.	13798cc	277kW (377PS)	Diesel Turbo Intercooler						TD5627
8210.42.073	6 Cyl.	13798cc	277kW (377PS)	Diesel Turbo Intercooler						TD5964



8210.42.101	6 Cyl.	13798cc	265kW (360PS)	Diesel	Turbo Intercooler	TD7336
8210.42.115	6 Cyl.	13798cc	265kW (360PS)	Diesel	Turbo Intercooler	TD7341
8210.42.151	6 Cyl.	13798cc	277kW (377PS)	Diesel	Turbo Intercooler	TD5624
8210.42.152	6 Cyl.	13798cc	277kW (377PS)	Diesel	Turbo Intercooler	TD5625
8210.42.154	6 Cyl.	13798cc	277kW (377PS)	Diesel	Turbo Intercooler	TD5962
8210.42.155	6 Cyl.	13798cc	277kW (377PS)	Diesel	Turbo Intercooler	TD5631
8210.42.161	6 Cyl.	13798cc	277kW (377PS)	Diesel	Turbo Intercooler	TD5961
8210.42.162	6 Cyl.	13798cc	277kW (377PS)	Diesel	Turbo Intercooler	TD6262
8210.42.165	6 Cyl.	13798cc	277kW (377PS)	Diesel	Turbo	TD5970
8210.42.171	6 Cyl.	13798cc	277kW (377PS)	Diesel	Turbo Intercooler	TD6261
8210.42.172	6 Cyl.	13798cc	277kW (377PS)	Diesel	Turbo Intercooler	TD5969
8210.42.173	6 Cyl.	13798cc	277kW (377PS)	Diesel	Turbo Intercooler	TD6314
8210.42.174	6 Cyl.	13798cc	277kW (377PS)	Diesel	Turbo Intercooler	TD6328
8210.42.175	6 Cyl.	13798cc	277kW (377PS)	Diesel	Turbo Intercooler	TD5974
8210.42.176	6 Cyl.	13798cc	277kW (377PS)	Diesel	Turbo Intercooler	TD6329
8210.42.177	6 Cyl.	13798cc	277kW (377PS)	Diesel	Turbo Intercooler	TD6316
8210.42.181	6 Cyl.	13798cc	277kW (377PS)	Diesel	Turbo Intercooler	TD5626
8210.42.182	6 Cyl.	13798cc	277kW (377PS)	Diesel	Turbo Intercooler	TD5963
8210.42.185	6 Cyl.	13798cc	277kW (377PS)	Diesel	Turbo Intercooler	TD5632
8210.42.186	6 Cyl.	13798cc	277kW (377PS)	Diesel	Turbo Intercooler	TD5971
8210.42.191	6 Cyl.	13798cc	277kW (377PS)	Diesel	Turbo Intercooler	TD6263
8210.42.192	6 Cyl.	13798cc	277kW (377PS)	Diesel	Turbo Intercooler	TD6315
8210.42.195	6 Cyl.	13798cc	277kW (377PS)	Diesel	Turbo Intercooler	TD6265
8210.42.196	6 Cyl.	13798cc	277kW (377PS)	Diesel	Turbo Intercooler	TD6317
8210.42.290	6 Cyl.	13798cc	265kW (360PS)	Diesel	Turbo Intercooler	TD6386
8210.42K.(TCA)	6 Cyl.	13798cc	272kW (370PS)	Diesel		TD7367
8210.42L.(TCA) Euro 1	6 Cyl.	13798cc	309kW (420PS)	Diesel	Turbo Intercooler	TD7366
8210.42L.400	6 Cyl.	13798cc	309kW (420PS)	Diesel	Turbo Intercooler	TD7320
8210.42L.TCA	6 Cyl.	13798cc	345kW (470PS)	Diesel	Turbo Intercooler	TD7324
8210.42M.(TCA) Euro 2	6 Cyl.	13798cc	345kW (470PS)	Diesel	Turbo Intercooler	TD7325
8210.42R.269	6 Cyl.	13798cc	265kW (360PS)	Diesel	Turbo Intercooler	TD7357

BE/PL	6	84,713/84,735	88,482/88,504	40,250	1,836	0,140/0,144	BS	1675CP	71-4215/6 STD 0.25 0.50
-------	---	---------------	---------------	--------	-------	-------------	----	--------	----------------------------

Mot.184188 →

BE/PL	6	84,713/84,735	88,482/88,504	41,250	1,836	0,140/0,144	BS	66520CP	71-4385/6 STD 0.25 0.50 0.75
-------	---	---------------	---------------	--------	-------	-------------	----	---------	---------------------------------

Mot.→184187

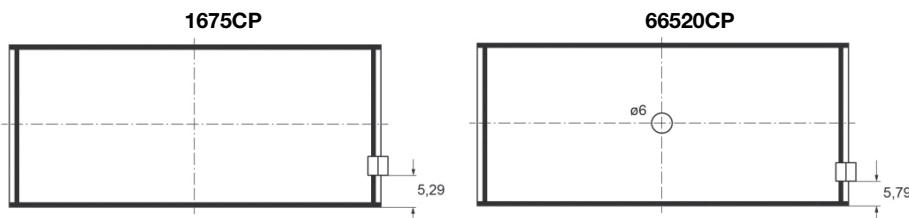

MB/HL 4	1	102,879/102,901	107,976/108,001	54,380	2,490	0,085/0,156	BS	AE6046	H1047/7 STD 0.25 0.50	
MB/HL 7	1	102,879/102,901	107,976/108,001	37,410	2,490	0,085/0,156	BS	AE6047		
MB/HL 2,3,5,6	4	102,879/102,901	107,976/108,001	34,820	2,490	0,085/0,156	BS	AE6048		
MB/HL 1	1	102,879/102,901	107,976/108,001	37,410	2,490	0,085/0,156	BS	AE6049		
MB/HL 1,7	2	102,879/102,901	107,976/108,001	37,410	2,490	0,085/0,156	BS	AE6050		
MB/HL 4	1	102,879/102,901	107,976/108,001	54,380	2,490	0,085/0,156	BS	AE6051		
MB/HL 2,3,5,6	4	102,879/102,901	107,976/108,001	34,820	2,490	0,085/0,156	BS	AE6052		
TW/A	4	114,884/115,138	133,383/134,137		2,362		BS	62022BFA	A200/4 STD .005	
SE/PB	1	49,995/50,000	54,852/54,899	50,400			BS	1679Y	55-4107 SEMI	
SE/PB	1	47,983/47,998	53,010/53,061	50,000			BS	61929XA	55-4217 SEMI	
CB/NWB 1	1	62,500/62,530	68,515/68,550	42,240	2,958		AL-LF	62021DR	N174/4 STD	
CB/NWB 2	1	62,000/62,030	68,015/68,050	32,250	2,958		AL-LF	62022DR		
CB/NWB 3	1	61,500/61,530	67,515/67,550	32,250	2,958		AL-LF	62023DR		
CB/NWB 4	1	61,000/61,030	67,015/67,050	32,250	2,958		AL-LF	62024DR		

162 137.00 x 156.00

8210.22.406	6 Cyl.	13798cc	224kW (304PS)	Diesel Turbo	TD7255
8210.22.569	6 Cyl.	13798cc	224kW (304PS)	Diesel Turbo	TD7330

BE/PL	6	84,713/84,735	88,482/88,504	40,250	1,836	0,140/0,144	BS	1675CP	71-4215/6 STD 0.25 0.50
-------	---	---------------	---------------	--------	-------	-------------	----	--------	-----------------------------------

Mot.184188 →

BE/PL	6	84,713/84,735	88,482/88,504	41,250	1,836	0,140/0,144	BS	66520CP	71-4385/6 STD 0.25 0.50 0.75
-------	---	---------------	---------------	--------	-------	-------------	----	---------	--

Mot. →184187

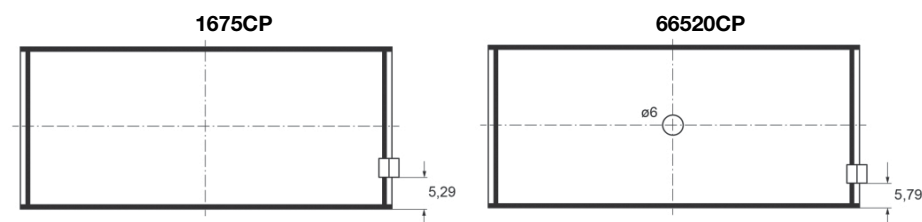

MB/HL 4	1	102,879/102,901	107,976/108,001	54,380	2,490	0,085/0,156	BS	AE6046	H1047/7 STD 0.25 0.50	
MB/HL 7	1	102,879/102,901	107,976/108,001	37,410	2,490	0,085/0,156	BS	AE6047		
MB/HL 2,3,5,6	4	102,879/102,901	107,976/108,001	34,820	2,490	0,085/0,156	BS	AE6048		
MB/HL 1	1	102,879/102,901	107,976/108,001	37,410	2,490	0,085/0,156	BS	AE6049		
MB/HL 1,7	2	102,879/102,901	107,976/108,001	37,410	2,490	0,085/0,156	BS	AE6050		
MB/HL 4	1	102,879/102,901	107,976/108,001	54,380	2,490	0,085/0,156	BS	AE6051		
MB/HL 2,3,5,6	4	102,879/102,901	107,976/108,001	34,820	2,490	0,085/0,156	BS	AE6052		

TW/A	4	114,884/115,138	133,383/134,137		2,362		BS	62022BFA	A200/4 STD .005
SE/PB	1	49,995/50,000	54,852/54,899	50,400			BS	1679Y	55-4107 SEMI
SE/PB	1	47,983/47,998	53,010/53,061	50,000			BS	61929XA	55-4217 SEMI
CB/NWB 1	1	62,500/62,530	68,515/68,550	42,240	2,958		AL-LF	62021DR	N174/4 STD
CB/NWB 2	1	62,000/62,030	68,015/68,050	32,250	2,958		AL-LF	62022DR	
CB/NWB 3	1	61,500/61,530	67,515/67,550	32,250	2,958		AL-LF	62023DR	
CB/NWB 4	1	61,000/61,030	67,015/67,050	32,250	2,958		AL-LF	62024DR	

163 137.00 x 156.00

8211.02.032			6 Cyl.	13798cc	191kW (260PS)		Diesel		TD6376
BE/PL	6	84,713/84,735	88,482/88,504	40,250	1,836	0,140/0,144	BS	1675CP	71-4215/6 STD 0.25 0.50
BE/PL	6	84,713/84,735	88,482/88,504	41,250	1,836	0,140/0,144	BS	66520CP	71-4385/6 STD 0.25 0.50 0.75

1675CP

66520CP

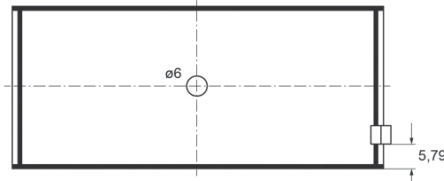
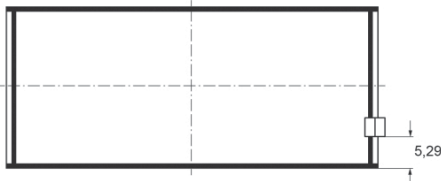

MB/HL 4	1	102,879/102,901	107,976/108,001	54,380	2,490	0,085/0,156	BS	AE6046	H1047/7 STD 0.25 0.50	
MB/HL 7	1	102,879/102,901	107,976/108,001	37,410	2,490	0,085/0,156	BS	AE6047		
MB/HL 2,3,5,6	4	102,879/102,901	107,976/108,001	34,820	2,490	0,085/0,156	BS	AE6048		
MB/HL 1	1	102,879/102,901	107,976/108,001	37,410	2,490	0,085/0,156	BS	AE6049		
MB/HL 1,7	2	102,879/102,901	107,976/108,001	37,410	2,490	0,085/0,156	BS	AE6050		
MB/HL 4	1	102,879/102,901	107,976/108,001	54,380	2,490	0,085/0,156	BS	AE6051		
MB/HL 2,3,5,6	4	102,879/102,901	107,976/108,001	34,820	2,490	0,085/0,156	BS	AE6052		
TW/A	4	114,884/115,138	133,383/134,137		2,362		BS	62022BFA		A200/4 STD .005
SE/PB	1	47,983/47,998	53,010/53,061	50,000			BS	61929XA		55-4217 SEMI
CB/NWB 1	1	62,500/62,530	68,515/68,550	42,240	2,958		AL-LF	62021DR		N174/4 STD
CB/NWB 2	1	62,000/62,030	68,015/68,050	32,250	2,958		AL-LF	62022DR		
CB/NWB 3	1	61,500/61,530	67,515/67,550	32,250	2,958		AL-LF	62023DR		
CB/NWB 4	1	61,000/61,030	67,015/67,050	32,250	2,958		AL-LF	62024DR		

164 145.00 x 130.00

8260.02.405			6 Cyl.	12880cc	191kW (260PS)		Diesel		TD7362
BE/PL	1	94,219/94,242	97,950/97,972	33,770	1,819	0,070/0,140	BS	66705CP	71-4238 STD 0.25 0.50
MB/HL	1	112,975/112,995	118,000/118,022	40,550	2,469	0,067/0,134	BS	66706CP	72-4548 STD 0.25 0.50

TW/A	4	123,750/124,000	146,050/146,304		3,429		BS	66706BF	A212/4 STD
SE/PB	1	54,982/54,990	59,963/59,994	44,000			BS	66499Y	55-4507 SEMI

165 145.00 x 130.00

8280.01.000	V8 Cyl.	17174cc	246kW (335PS)	Diesel	TD6869
8280.02.000	V8 Cyl.	17174cc	259kW (352PS)	Diesel	TD6879
8280.02.024	V8 Cyl.	17174cc	259kW (352PS)	Diesel	TD6873
8280.02.082	V8 Cyl.	17174cc	259kW (352PS)	Diesel	TD6882
8280.02.109	V8 Cyl.	17174cc	259kW (352PS)	Diesel	TD6382
8280.02.120	V8 Cyl.	17174cc	259kW (352PS)	Diesel	TD6383
8280.02.125-135	V8 Cyl.	17174cc	259kW (352PS)	Diesel	TD5638
8280.02.128	V8 Cyl.	17174cc	259kW (352PS)	Diesel	TD6900
8280.02.269	V8 Cyl.	17174cc	259kW (352PS)	Diesel	TD5979
8280.02.274	V8 Cyl.	17174cc	259kW (352PS)	Diesel	TD5639
8280.02.275	V8 Cyl.	17174cc	259kW (352PS)	Diesel	TD5980
8280.02.289	V8 Cyl.	17174cc	259kW (352PS)	Diesel	TD7354
8280.02.405	V8 Cyl.	17174cc	259kW (352PS)	Diesel	TD7360
8280.22.007	V8 Cyl.	17174cc	280kW (381PS)	Diesel Turbo	TD5628
8280.22.009	V8 Cyl.	17174cc	280kW (380PS)	Diesel Turbo	TD5967
8280.22.033	V8 Cyl.	17174cc	280kW (381PS)	Diesel Turbo	TD5633
8280.22.048	V8 Cyl.	17174cc	279kW (380PS)	Diesel Turbo	TD6901
8280.22.054	V8 Cyl.	17174cc	280kW (381PS)	Diesel Turbo	TD5965
8280.22.154	V8 Cyl.	17174cc	280kW (381PS)	Diesel Turbo	TD5972
8280.22.201	V8 Cyl.	17174cc	309kW (420PS)	Diesel Turbo Intercooler	TD5629
8280.22.205	V8 Cyl.	17174cc	309kW (420PS)	Diesel Turbo Intercooler	TD5966
8281.22.201	V8 Cyl.	17174cc	309kW (420PS)	Diesel Turbo	TD6378
8282.02.000	V8 Cyl.	17174cc	259kW (352PS)	Diesel Turbo	TD5568
8282.02.109	V8 Cyl.	17174cc	259kW (352PS)	Diesel Turbo	TD5908

BE/PL	1	94,219/94,242	97,950/97,972	33,770	1,819	0,070/0,140	BS	1685CP	71-4108 STD
BE/PL	1	94,219/94,242	97,950/97,972	33,770	1,819	0,070/0,140	BS	66705CP	71-4238 STD 0.25 0.50

1685CP

66705CP

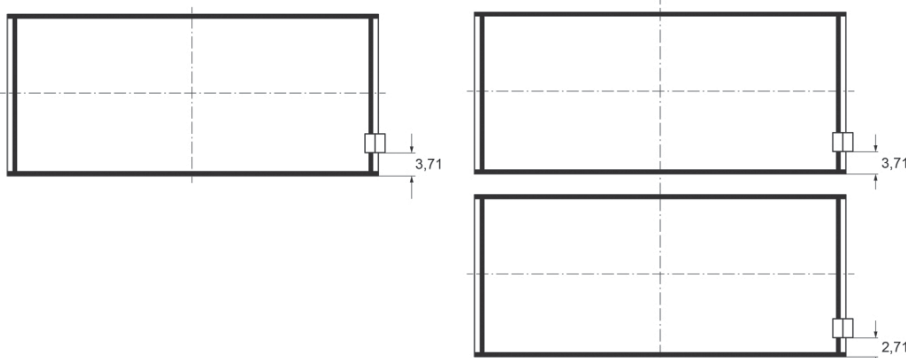



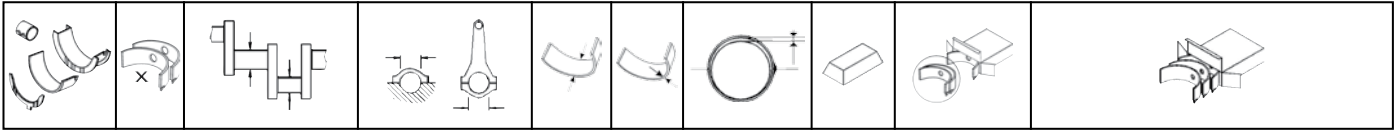





MB/HL	1	112,975/112,995	118,000/118,022	40,550	2,469	0,067/0,134	BS	66706CP	72-4548 STD 0.25 0.50
TW/A	4	123,750/124,000	146,050/146,304		3,429		BS	66706BF	A212/4 STD
SE/PB	1	54,982/54,990	59,963/59,994	44,000			BS	66499Y	55-4507 SEMI



166 145.00 x 130.00

8280.42.001	V8 Cyl.	17174cc	350kW (476PS)	Diesel Turbo Intercooler	TD7339
8280.42.050	V8 Cyl.	17174cc	350kW (480PS)	Diesel Turbo Intercooler	TD7338
8280.42S.(TCA)	V8 Cyl.	17173cc	378kW (514PS)	Diesel Turbo Intercooler	TD7326
8280.42S.350	V8 Cyl.	17174cc	375kW (514PS)	Diesel Turbo Intercooler	TD7321

BE/PL	1	94,219/94,242	97,950/97,972	33,770	1,819	0,070/0,140	BS	1685CP	71-4108 STD
MB/HL	1	112,975/112,995	118,000/118,022	40,550	2,469	0,067/0,134	BS	66706CP	72-4548 STD 0.25 0.50
TW/A	4	123,750/124,000	146,050/146,304		3,429		BS	66706BF	A212/4 STD
SE/PB	1	54,982/54,990	59,963/59,994	44,000			BS	66499Y	55-4507 SEMI

				cm3	x 			
4/4 Series III	01/60→12/61	Petrol	105E, 107E,307E	997	4	80.95	48.42	54
Anglia 1.0	01/60→12/68	Petrol	105E, 107E,307E	997	4	80.95	48.42	54
Bantam 1.3	09/01→08/06	Petrol	A9JA	1299	4	74.00	75.50	19
Bantam 1.3	09/90→09/94	Petrol	JBE	1299	4	74.00	75.50	19
Bantam 1.6	11/94→08/01	Petrol	F6	1587	4	81.00	77.00	64
Bantam 1.6	03/86→08/90	Petrol	LUG	1597	4	80.00	79.50	47
Bantam 1.6	11/94→08/01	Petrol	B6	1598	4	78.00	83.60	31
Bantam 1.6	09/90→10/94	Petrol	LJF	1598	4	79.96	79.52	43
Bantam 1.6	09/90→10/94	Petrol	LUJ	1598	4	80.00	79.50	48
Bantam 1.8 TDdi	09/01→08/06	Diesel	RTP	1753	4	82.50	82.00	71
B-Max 1.6 TDCi	10/12→	Diesel	T3JB	1560	4	75.00	88.30	21
B-Max 1.6 Ti	10/12→	Petrol	IQJA	1596	4	79.00	81.40	35
Capri	01/67→12/72	Petrol	2737E	1599	4	80.98	77.60	60
Capri 1.3 I 109E	09/61→07/62	Petrol	109E	1340	4	80.95	65.09	55
Capri 1.5 I 116E	07/62→07/64	Petrol	116E, 120E, 122E	1499	4	80.95	72.62	56
Capri 1300	01/69→12/70	Petrol	KL 13 H	1298	4	81.00	63.00	63
Capri 1300	01/72→12/72	Petrol	KL 13 HC	1298	4	81.00	63.00	63
Capri 1300	01/69→12/73	Petrol	KL 13 L	1298	4	81.00	63.00	63
Capri 1600	08/72→02/74	Petrol	LE	1593	4	87.65	66.00	98
Capri 1600	08/72→02/74	Petrol	OHC TL 16 H	1593	4	87.65	66.00	98
Capri 1600	01/68→12/72	Petrol	2737E	1599	4	80.98	77.60	60
Capri 1600 GT	01/67→12/70	Petrol	2737E	1599	4	80.98	77.60	60
Capri 1700	12/68→08/72	Petrol	TV 17 H	1699	V4	90.00	66.80	106
Capri 2300	02/69→02/74	Petrol	TV 23 H	2293	V6	90.00	60.10	104
Capri 2600	08/70→02/74	Petrol	UY	2550	V6	90.00	66.80	107
Capri I	09/61→07/62	Petrol	109E	1340	4	80.95	65.09	55
Capri I	07/62→07/64	Petrol	116E, 120E, 122E	1499	4	80.95	72.62	56
Capri II 1.3	02/74→08/77	Petrol	J1E	1298	4	81.00	63.00	63
Capri II 1.6	09/74→12/77	Petrol	LAC	1593	4	87.65	66.00	98
Capri II 1.6	02/74→12/77	Petrol	LCE	1593	4	87.65	66.00	98
Capri II 1.6	02/74→12/77	Petrol	LEC	1593	4	87.65	66.00	98
Capri II 2.0	04/74→12/77	Petrol	OHC TL 20 H	1993	4	90.80	76.90	112
Capri II 2.3	02/74→12/77	Petrol	YYE	2294	V6	90.00	60.10	104
Capri III 1.3	01/78→06/85	Petrol	J1E	1298	4	81.00	63.00	63
Capri III 1.6	01/78→04/87	Petrol	LCN	1593	4	87.65	66.00	97
Capri III 2.0	01/78→12/85	Petrol	NEN	1993	4	90.80	76.90	112
Capri III 2.0	01/78→12/85	Petrol	OHC TL 20 H	1993	4	90.80	76.90	112
Capri III 2.3 Super	06/79→12/85	Petrol	YYN	2294	V6	90.00	60.10	104
Capri III 2.8 i Turbo	01/82→04/87	Petrol	PYN	2792	V6	93.00	68.50	119
Capri III 2.8 Super Injection	01/81→04/87	Petrol	PRN	2792	V6	93.00	68.50	119
Classic	06/61→07/62	Petrol	109E	1340	4	80.95	65.09	55
Classic	07/62→07/63	Petrol	116E, 120E, 122E	1499	4	80.95	72.62	56
Classic 1.5 116E	07/62→07/63	Petrol	116E, 120E, 122E	1499	4	80.95	72.62	56
C-Max 1.6	02/07→09/10	Petrol	HWDA	1596	4	79.00	81.40	34
C-Max 1.6	02/07→09/10	Petrol	HWDB	1596	4	79.00	81.40	34
C-Max 1.6	04/07→09/10	Petrol	HXDA	1596	4	79.00	81.40	34
C-Max 1.6	04/07→09/10	Petrol	HXDB	1596	4	79.00	81.40	34
C-Max 1.6	02/07→09/10	Petrol	SHDA	1596	4	79.00	81.40	34
C-Max 1.6	02/07→09/10	Petrol	SHDB	1596	4	79.00	81.40	34
C-Max 1.6	02/07→09/10	Petrol	SHDC	1596	4	79.00	81.40	34
C-Max 1.6	04/07→09/10	Petrol	SIDA	1596	4	79.00	81.40	35
C-Max 1.6 TDCi	02/07→09/10	Diesel	G8DA	1560	4	75.00	88.30	21
C-Max 1.6 TDCi	02/07→09/10	Diesel	G8DB	1560	4	75.00	88.30	21
C-Max 1.6 TDCi	02/07→09/10	Diesel	G8DC	1560	4	75.00	88.30	21
C-Max 1.6 TDCi	02/07→09/10	Diesel	G8DD	1560	4	75.00	88.30	21
C-Max 1.6 TDCi	02/07→09/10	Diesel	GPDA	1560	4	75.00	88.30	22
C-Max 1.6 TDCi	02/07→09/10	Diesel	HHDA	1560	4	75.00	88.30	22
C-Max 1.6 TDCi	02/07→09/10	Diesel	HHDB	1560	4	75.00	88.30	22
C-Max 1.6 TDCi	02/07→09/10	Diesel	MTDA	1560	4	75.00	88.30	21
C-Max 1.8	02/07→09/10	Petrol	QQDA	1798	4	83.00	83.10	74
C-Max 1.8	02/07→09/10	Petrol	QQDB	1798	4	83.00	83.10	74
C-Max 1.8	02/07→09/10	Petrol	QQDC	1798	4	83.00	83.10	74
C-Max 1.8 Flexifuel	02/07→09/10	Petrol	Q7DA	1798	4	83.00	83.10	74
C-Max 1.8 TDCi	02/07→09/10	Diesel	KKDA	1753	4	82.50	82.00	72
C-Max 2.0 TDCi	02/07→09/10	Diesel	G6DA	1997	4	85.00	88.00	80
C-Max 2.0 TDCi	02/07→09/10	Diesel	G6DB	1997	4	85.00	88.00	80
C-Max 2.0 TDCi	02/07→09/10	Diesel	G6DC	1997	4	85.00	88.00	80
C-Max 2.0 TDCi	02/07→09/10	Diesel	G6DD	1997	4	85.00	88.00	80
C-Max 2.0 TDCi	02/07→09/10	Diesel	G6DE	1997	4	85.00	88.00	80



cm3



9

C-Max 2.0 TDCi	02/07→09/10	Diesel	G6DF	1997	4	85.00	88.00	80
C-Max 2.0 TDCi	02/07→09/10	Diesel	G6DG	1997	4	85.00	88.00	80
C-Max 2.0 TDCi	02/08→09/10	Diesel	IXDA	1997	4	85.00	88.00	80
C-Max II 1.6 CNG	01/13→	Petrol	MUDA	1596	4	79.00	81.40	35
C-Max II 1.6 Flexifuel	02/11→	Petrol	MUDA	1596	4	79.00	81.40	35
C-Max II 1.6 LPG	02/12→	Petrol	MUDA	1596	4	79.00	81.40	35
C-Max II 1.6 TDCi	12/10→	Diesel	T1DA	1560	4	75.00	88.30	21
C-Max II 1.6 TDCi	12/10→	Diesel	T1DB	1560	4	75.00	88.30	21
C-Max II 1.6 TDCi	12/10→	Diesel	T3DA	1560	4	75.00	88.30	21
C-Max II 1.6 TDCi	12/10→	Diesel	T3DB	1560	4	75.00	88.30	21
C-Max II 1.6 Ti	12/10→	Petrol	IQDA	1596	4	79.00	81.40	35
C-Max II 1.6 Ti	12/10→	Petrol	IQDB	1596	4	79.00	81.40	35
C-Max II 1.6 Ti	02/12→	Petrol	MUDA	1596	4	79.00	81.40	35
C-Max II 1.6 Ti	12/10→	Petrol	PNDA	1596	4	79.00	81.40	35
C-Max II 1.6 Ti	12/10→	Petrol	XTDA	1596	4	79.00	81.40	35
C-Max II 2.0 TDCi	03/15→	Diesel	T7DB	1997	4	85.00	88.00	80
C-Max II 2.0 TDCi	03/15→	Diesel	T8DE	1997	4	85.00	88.00	80
C-Max II 2.0 TDCi	12/10→	Diesel	TXDB	1997	4	85.00	88.00	80
C-Max II 2.0 TDCi	02/11→	Diesel	TYDA	1997	4	85.00	88.00	80
C-Max II 2.0 TDCi	02/11→	Diesel	UFDB	1997	4	85.00	88.00	80
C-Max II 2.0 TDCi	02/11→	Diesel	UKDB	1997	4	85.00	88.00	80
Consul 1700	01/72→12/75	Petrol	TV 17 HC	1699	V4	90.00	66.80	106
Consul 1700	01/72→12/75	Petrol	TV 17 L	1699	V4	90.00	66.80	106
Corsair	10/63→01/65	Petrol	116E, 120E, 122E	1499	4	80.95	72.62	56
Corsair 1.5 120E	10/63→01/65	Petrol	116E, 120E, 122E	1499	4	80.95	72.62	56
Corsair 1.5 GT	10/63→11/66	Petrol	120GT	1499	4	80.95	72.62	56
Corsair GT	10/63→11/66	Petrol	120GT	1499	4	80.95	72.62	56
Cortina	01/67→12/73	Petrol	2737E	1599	4	80.98	77.60	60
Cortina	01/70→12/73	Petrol	2737E	1599	4	80.98	77.60	60
Cortina 1.5 I	01/63→12/66	Petrol	118E, 118E GT	1499	4	80.95	72.62	56
Cortina 1.5 I GT	04/63→09/66	Petrol	118E, 118E GT	1499	4	80.95	72.62	56
Cortina 1300	10/66→03/72	Petrol	KL 13 H	1298	4	81.00	63.00	63
Cortina 1300	10/66→03/72	Petrol	KL 13 L	1298	4	81.00	63.00	63
Cortina 1600	10/67→12/69	Petrol	KL 16 L	1598	4	81.00	77.60	65
Cortina 1600 II, 1600GT	01/67→12/70	Petrol	2737E	1599	4	80.98	77.60	60
Cortina 1600 GT	10/70→03/72	Petrol	LCJ	1593	4	87.65	66.00	98
Cortina I	01/63→11/66	Petrol	118E, 118E GT	1499	4	80.95	72.62	56
Cortina I GT	04/63→09/66	Petrol	118E, 118E GT	1499	4	80.95	72.62	56
Cougar 2.0 16V	08/98→12/01	Petrol	EDBA	1988	4	84.80	88.00	78
Cougar 2.0 16V	08/98→12/01	Petrol	EDBB	1988	4	84.80	88.00	78
Cougar 2.0 16V	08/98→12/01	Petrol	EDBC	1988	4	84.80	88.00	78
County 1164		Diesel	401 cu.in.	6571	6	111.77	111.76	151
County 754		Diesel	BSD442	4195	4	111.77	106.89	149
County 944/964/974		Diesel	BSD 444T	4391	4	111.77	111.89	154
Cougar 2.0 16V	08/98→12/01	Petrol	EDBD	1988	4	84.80	88.00	78
Courier 1.8	03/98→02/02	Petrol	RKA	1796	4	80.60	88.00	53
Courier 1.8 D	06/99→02/02	Diesel	RTK	1753	4	82.50	82.00	73
Econovan 1.4	03/86→03/92	Petrol	UC	1416	4	77.00	76.00	27
Econovan 2.0 D	03/86→03/92	Diesel	RF	1998	4	86.00	86.00	87
Ecosport 1.6 Ti-VCT	08/12→	Petrol	HXJD	1596	4	79.00	81.40	34
Ecosport 1.6 Ti-VCT	08/12→	Petrol	IQJB	1596	4	79.00	81.40	34
Escort	01/68→12/74	Petrol	KL09H (711M)	940	4	80.98	45.61	57
Escort 1.1	03/81→02/86	Petrol	GLB	1117	4	74.00	65.00	16
Escort 1.1	05/86→07/90	Petrol	GSG	1117	4	73.90	65.00	9
Escort 1.3	03/81→02/86	Petrol	JPA	1296	4	80.00	64.50	46
Escort 1.3	07/88→07/90	Petrol	JBA	1297	4	73.96	75.48	12
Escort 1.3	02/86→07/90	Petrol	JBB	1297	4	73.96	75.48	12
Escort 1.3	07/90→12/94	Petrol	JBD	1297	4	74.00	75.50	19
Escort 1.3	02/86→07/90	Petrol	JLA	1297	4	73.96	75.48	13
Escort 1.3	02/86→07/90	Petrol	JLB	1297	4	73.96	75.48	12
Escort 1.4	07/90→12/94	Petrol	F6F	1392	4	77.25	74.30	28
Escort 1.4	07/90→12/94	Petrol	F6G	1392	4	77.25	74.30	28
Escort 1.4 i	02/86→07/90	Petrol	F6B	1392	4	77.25	74.30	29
Escort 1.4 i	02/86→07/90	Petrol	F6D	1392	4	77.25	74.30	29
Escort 1.4 i	02/86→07/90	Petrol	FUC	1392	4	77.25	74.30	29
Escort 1.6	02/86→07/90	Petrol	LUC	1597	4	80.00	79.50	47
Escort 1.6 16V	10/98→07/00	Petrol	L1E	1597	4	76.00	88.00	25
Escort 1.6 D	02/84→07/90	Diesel	LTA	1608	4	80.00	80.00	50
Escort 1.8 D	07/88→07/90	Diesel	RTA	1753	4	82.50	82.00	73

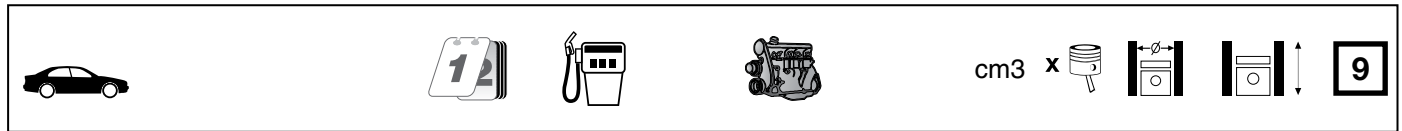

Escort 1.8 D	07/88→07/90	Diesel	RTB	1753	4	82.50	82.00	73
Escort 1.8 D	07/90→12/94	Diesel	RTH	1753	4	82.50	82.00	73
Escort 1.8 TD	10/98→07/00	Diesel	RFD	1753	4	82.50	82.00	71
Escort 1.8 TD	10/98→07/00	Diesel	RFK	1753	4	82.50	82.00	71
Escort 2.0 16V RS Cosworth 4WD	06/92→08/96	Petrol	CH20	1993	4	90.80	76.90	109
Escort 940	01/68→12/74	Petrol	KL09H (711M)	940	4	80.98	45.61	57
Escort '95 1.4	01/95→	Petrol	F4B	1391	4	77.25	74.30	28
Escort '95 1.8 D	01/95→	Diesel	RTF	1753	4	82.50	82.00	73
Escort '95 1.8 D	01/95→	Diesel	RTH	1753	4	82.50	82.00	73
Escort '95 1.8 TD	01/95→	Diesel	RFD	1753	4	82.50	82.00	71
Escort '95 1.8 TD	01/95→	Diesel	RFK	1753	4	82.50	82.00	71
Escort '95 1.8 TD	01/95→	Diesel	RFS	1753	4	82.50	82.00	71
Escort '95 1.8 Turbo D	12/95→06/01	Diesel	RVA	1753	4	82.50	82.00	71
Escort I 1.6	08/69→11/74	Petrol	TL 16M	1593	4	87.65	66.00	98
Escort I 1100	01/68→02/76	Petrol	G1	1098	4	81.00	53.30	62
Escort I 1100	06/70→02/76	Petrol	G2	1098	4	80.98	53.30	58
Escort I 1100	06/68→06/71	Petrol	KL11	1098	4	81.00	53.30	62
Escort I 1300	09/73→02/76	Petrol	J1F	1298	4	81.00	63.00	63
Escort I 1300	06/70→02/76	Petrol	J2	1298	4	81.00	63.00	63
Escort I 1300	06/70→02/76	Petrol	J3D	1298	4	81.00	63.00	63
Escort I 1300	06/68→06/71	Petrol	KL 13 L	1298	4	81.00	63.00	63
Escort I 1300 GT	06/68→06/71	Petrol	KL 13 H	1298	4	81.00	63.00	63
Escort I Mexico	01/70→10/75	Petrol	KL 16 R	1601	4	81.00	77.70	66
Escort II 1.1	12/74→08/80	Petrol	G1	1098	4	81.00	53.30	62
Escort II 1.1	12/74→08/80	Petrol	G2	1098	4	80.98	53.30	58
Escort II 1.3	12/74→08/80	Petrol	J1F	1298	4	81.00	63.00	63
Escort II 1.3	12/74→08/80	Petrol	J2	1298	4	81.00	63.00	63
Escort II 1.3	12/74→08/80	Petrol	J3	1298	4	81.00	63.00	63
Escort II 1.3	04/75→01/79	Petrol	KL 13 H	1298	4	81.00	63.00	63
Escort II 1.6 RS	12/74→08/80	Petrol	LC	1599	4	81.00	77.60	65
Escort II 2.0 RS	08/75→08/80	Petrol	NE	1993	4	90.80	76.90	112
Escort III 1.1	09/80→08/83	Petrol	GLB	1117	4	74.00	65.00	16
Escort III 1.1	09/80→08/83	Petrol	GMA	1117	4	74.00	65.00	17
Escort III 1.1	09/80→08/83	Petrol	GPA	1117	4	74.00	65.00	17
Escort III 1.1	08/83→12/85	Petrol	GSE	1117	4	74.00	65.00	17
Escort III 1.3	09/80→12/85	Petrol	JPA	1296	4	80.00	64.50	46
Escort III 1.6	09/80→12/85	Petrol	LP1	1597	4	80.00	79.50	49
Escort III 1.6	09/80→12/85	Petrol	LPA	1597	4	80.00	79.50	49
Escort III 1.6	09/80→10/82	Petrol	LUA	1597	4	80.00	79.50	49
Escort III 1.6 D	02/84→12/85	Diesel	LTA	1608	4	80.00	80.00	50
Escort III 1.6 i	09/83→12/85	Petrol	LR1	1597	4	80.00	79.50	49
Escort III 1.6 i	09/83→12/85	Petrol	LRA	1597	4	80.00	79.50	49
Escort III 1.6 i	07/85→12/85	Petrol	L4B	1598	4	80.00	79.50	47
Escort III 1.6 RS Turbo	11/84→12/85	Petrol	LNA	1597	4	79.96	79.52	44
Escort III 1.6 XR3i	10/82→12/85	Petrol	LR1	1597	4	80.00	79.50	49
Escort III 1.6 XR3i	10/82→12/85	Petrol	LRA	1597	4	80.00	79.50	49
Escort III RS 1600i	05/82→12/85	Petrol	LUAE	1597	4	80.00	79.50	47
Escort IV 1.1	10/85→09/90	Petrol	GSG	1117	4	73.90	65.00	9
Escort IV 1.3	11/86→07/88	Petrol	JPA	1296	4	80.00	64.50	46
Escort IV 1.3	07/88→10/90	Petrol	JBA	1297	4	73.96	75.48	12
Escort IV 1.3	01/86→07/90	Petrol	JBB	1297	4	73.96	75.48	12
Escort IV 1.3	01/86→07/90	Petrol	JLA	1297	4	73.96	75.48	13
Escort IV 1.3	01/86→07/90	Petrol	JLB	1297	4	73.96	75.48	12
Escort IV 1.4	01/86→07/90	Petrol	F6B	1392	4	77.25	74.30	29
Escort IV 1.4	01/86→07/90	Petrol	F6D	1392	4	77.25	74.30	29
Escort IV 1.4	01/86→07/90	Petrol	FUA	1392	4	77.25	74.30	29
Escort IV 1.4	10/85→10/90	Petrol	FUAA	1392	4	77.25	74.30	29
Escort IV 1.4	01/86→07/90	Petrol	FUC	1392	4	77.25	74.30	29
Escort IV 1.6	01/86→07/90	Petrol	LP2	1597	4	80.00	79.50	47
Escort IV 1.6	01/86→12/87	Petrol	LPA	1597	4	80.00	79.50	49
Escort IV 1.6	04/89→07/90	Petrol	LUG	1597	4	80.00	79.50	47
Escort IV 1.6 D	01/86→01/89	Diesel	LTC	1608	4	80.00	80.00	50
Escort IV 1.6 i	08/89→07/90	Petrol	LJB	1597	4	80.00	79.50	47
Escort IV 1.6 i	01/86→07/90	Petrol	L4B	1598	4	80.00	79.50	47
Escort IV 1.6 Turbo RS	01/86→07/90	Petrol	LNB	1597	4	79.96	79.52	42
Escort IV 1.6 XR3i	01/86→07/90	Petrol	LR2	1597	4	80.00	79.50	47
Escort IV 1.6 XR3i	01/86→07/90	Petrol	LRB	1597	4	80.00	79.50	47
Escort IV 1.8 D	01/89→07/90	Diesel	RTA	1753	4	82.50	82.00	73
Escort IV 1.8 D	01/89→07/90	Diesel	RTB	1753	4	82.50	82.00	73



cm3



9

Escort V 1.3	07/90→09/92	Petrol	J4B	1299	4	74.00	75.50	19
Escort V 1.3	07/90→09/92	Petrol	J6A	1299	4	74.00	75.50	19
Escort V 1.4	07/90→12/92	Petrol	F6F	1392	4	77.25	74.30	28
Escort V 1.4	07/90→12/92	Petrol	F6G	1392	4	77.25	74.30	28
Escort V 1.6	07/90→12/92	Petrol	LJF	1598	4	79.96	79.52	43
Escort V 1.6	07/90→08/92	Petrol	LUJ	1598	4	80.00	79.50	48
Escort V 1.6	07/90→08/92	Petrol	LUK	1598	4	80.00	79.50	48
Escort V 1.8 16V	02/92→12/92	Petrol	RDA	1796	4	80.60	88.00	53
Escort V 1.8 16V XR3i	02/92→12/92	Petrol	RDA	1796	4	80.60	88.00	53
Escort V 1.8 16V XR3i	02/92→12/92	Petrol	RQB	1796	4	80.60	88.00	53
Escort V 1.8 D	07/90→12/92	Diesel	RTE	1753	4	82.50	82.00	73
Escort V 1.8 D	07/90→12/92	Diesel	RTF	1753	4	82.50	82.00	73
Escort V 1.8 D	07/90→12/92	Diesel	RTH	1753	4	82.50	82.00	73
Escort V RS 2000	05/91→12/92	Petrol	N7A	1998	4	86.00	86.00	83
Escort VI 1.3	09/92→01/95	Petrol	J4B	1299	4	74.00	75.50	19
Escort VI 1.3	09/92→01/95	Petrol	J6A	1299	4	74.00	75.50	19
Escort VI 1.4	08/93→01/95	Petrol	F4B	1391	4	77.25	74.30	28
Escort VI 1.4	09/92→01/95	Petrol	F6F	1392	4	77.25	74.30	28
Escort VI 1.4	09/92→01/95	Petrol	F6G	1392	4	77.25	74.30	28
Escort VI 1.4	08/93→01/95	Petrol	FUH	1392	4	77.25	74.30	28
Escort VI 1.4 i	07/93→01/95	Petrol	F4B	1391	4	77.25	74.30	28
Escort VI 1.6 16V XR3i	12/92→01/95	Petrol	L1E	1597	4	76.00	88.00	25
Escort VI 1.6 i 16V	09/92→01/95	Petrol	L1E	1597	4	76.00	88.00	25
Escort VI 1.6 i 16V	01/94→01/95	Petrol	L1H	1597	4	76.00	88.00	25
Escort VI 1.6 i 16V	08/93→01/95	Petrol	L1K	1597	4	76.00	88.00	25
Escort VI 1.8 16V XR3i	12/92→01/95	Petrol	RDA	1796	4	80.60	88.00	53
Escort VI 1.8 16V XR3i	09/92→01/95	Petrol	RQB	1796	4	80.60	88.00	53
Escort VI 1.8 D	09/92→01/95	Diesel	RTE	1753	4	82.50	82.00	73
Escort VI 1.8 D	09/92→01/95	Diesel	RTF	1753	4	82.50	82.00	73
Escort VI 1.8 D	09/92→01/95	Diesel	RTH	1753	4	82.50	82.00	73
Escort VI 1.8 i 16V	09/92→01/95	Petrol	RDA	1796	4	80.60	88.00	53
Escort VI 1.8 i 16V	02/93→01/95	Petrol	RQB	1796	4	80.60	88.00	53
Escort VI 1.8 TD	02/93→01/95	Diesel	RFD	1753	4	82.50	82.00	71
Escort VI 1.8 TD	02/93→01/95	Diesel	RFK	1753	4	82.50	82.00	71
Escort VI 1.8 TD	02/93→01/95	Diesel	RFS	1753	4	82.50	82.00	71
Escort VI 1.8 XR3i 16V 4x4	08/93→01/95	Petrol	RDA	1796	4	80.60	88.00	53
Escort VI 1.8 XR3i 16V 4x4	08/93→01/95	Petrol	RQB	1796	4	80.60	88.00	53
Escort VI RS 2000	09/92→01/95	Petrol	N7A	1998	4	86.00	86.00	83
Escort VI RS 2000 4x4	08/93→01/95	Petrol	N7A	1998	4	86.00	86.00	83
Escort VII 1.3	01/95→02/99	Petrol	J4B	1299	4	74.00	75.50	19
Escort VII 1.3	01/95→02/99	Petrol	J6A	1299	4	74.00	75.50	19
Escort VII 1.4	01/95→12/99	Petrol	F4B	1391	4	77.25	74.30	28
Escort VII 1.4	01/95→02/99	Petrol	FUH	1392	4	77.25	74.30	28
Escort VII 1.6	01/01→08/02	Petrol	L1K	1597	4	76.00	88.00	25
Escort VII 1.6 16V	01/95→02/99	Petrol	L1E	1597	4	76.00	88.00	25
Escort VII 1.6 16V 4x4	01/95→10/98	Petrol	L1E	1597	4	76.00	88.00	25
Escort VII 1.6 16V XR3i	02/95→09/99	Petrol	L1E	1597	4	76.00	88.00	25
Escort VII 1.6 16V XR3i	02/95→12/96	Petrol	L1H	1597	4	76.00	88.00	25
Escort VII 1.6 i 16V	01/95→02/99	Petrol	L1E	1597	4	76.00	88.00	25
Escort VII 1.6 i 16V	01/95→08/95	Petrol	L1H	1597	4	76.00	88.00	25
Escort VII 1.6 i 16V	01/95→02/99	Petrol	L1K	1597	4	76.00	88.00	25
Escort VII 1.8 16V	01/95→08/95	Petrol	RDA	1796	4	80.60	88.00	53
Escort VII 1.8 16V	01/95→02/99	Petrol	RKC	1796	4	80.60	88.00	53
Escort VII 1.8 16V XR3i	02/95→08/98	Petrol	RDA	1796	4	80.60	88.00	53
Escort VII 1.8 16V XR3i	10/95→08/98	Petrol	RKC	1796	4	80.60	88.00	53
Escort VII 1.8 16V XR3i	02/95→08/00	Petrol	RQB	1796	4	80.60	88.00	53
Escort VII 1.8 D	01/95→02/99	Diesel	RTE	1753	4	82.50	82.00	73
Escort VII 1.8 D	01/95→02/99	Diesel	RTF	1753	4	82.50	82.00	73
Escort VII 1.8 D	01/95→02/99	Diesel	RTH	1753	4	82.50	82.00	73
Escort VII 1.8 TD	01/95→02/99	Diesel	RFD	1753	4	82.50	82.00	71
Escort VII 1.8 TD	01/95→02/99	Diesel	RFK	1753	4	82.50	82.00	71
Escort VII 1.8 Turbo D	12/95→08/99	Diesel	RVA	1753	4	82.50	82.00	71
Escort VII RS 2000	02/95→02/98	Petrol	N7A	1998	4	86.00	86.00	83
Escort VII RS 2000 4x4	02/95→10/98	Petrol	N7A	1998	4	86.00	86.00	83
Escort RS Cosworth	06/92→08/96	Petrol	CH20	1993	4	90.80	76.90	109
Fiesta	10/75→08/80	Petrol	105E, 107E,307E	997	4	80.95	48.42	54
Fiesta 1.0	10/75→08/80	Petrol	105E, 107E,307E	997	4	80.95	48.42	54
Fiesta 1.0	10/77→11/86	Petrol	TKA	957	4	73.96	55.70	10
Fiesta 1.0	08/83→11/89	Petrol	TKB	957	4	74.00	55.70	14

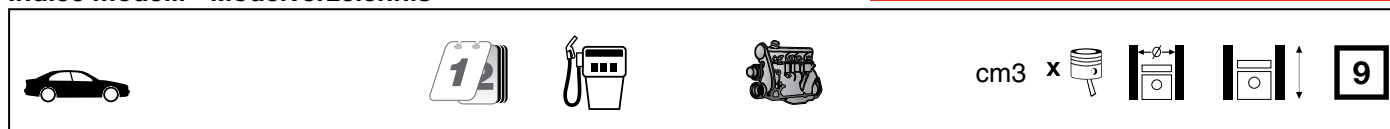

Fiesta 1.1	10/77→11/86	Petrol	GLA	1117	4	73.96	64.98	11
Fiesta 1.25	10/12→	Petrol	STJB	1242	4	71.90	76.50	6
Fiesta 1.3	02/96→	Petrol	J4C	1299	4	74.00	75.50	19
Fiesta 1.3	09/91→02/96	Petrol	J6B	1299	4	74.00	75.50	19
Fiesta 1.4	09/86→09/89	Petrol	F6A	1393	4	77.25	74.30	29
Fiesta 1.4 i	04/96→10/99	Petrol	FHA	1388	4	76.00	76.50	23
Fiesta 1.4 TDCi	01/03→03/10	Diesel	F6JC	1399	4	73.70	82.00	8
Fiesta 1.6	10/10→	Petrol	HXJA	1596	4	79.00	81.40	35
Fiesta 1.6 D	09/83→09/89	Diesel	LTB	1608	4	80.00	80.00	50
Fiesta 1.6 TDCi	10/10→	Diesel	HHJC	1560	4	75.00	88.30	22
Fiesta 1.8 D	03/89→02/96	Diesel	RTC	1753	4	82.50	82.00	73
Fiesta 1.8 D	03/89→02/96	Diesel	RTD	1753	4	82.50	82.00	73
Fiesta 1.8 D	03/89→02/96	Diesel	RTG	1753	4	82.50	82.00	73
Fiesta 1.8 D	02/96→04/02	Diesel	RTK	1753	4	82.50	82.00	73
Fiesta 1.8 DI	09/00→08/03	Diesel	RTN	1753	4	82.50	82.00	71
Fiesta 1.8 DI	09/00→08/03	Diesel	RTP	1753	4	82.50	82.00	71
Fiesta D 1.8	05/98→04/02	Diesel	RTJ	1753	4	82.50	82.00	73
Fiesta D 1.8	05/98→04/02	Diesel	RTK	1753	4	82.50	82.00	73
Fiesta TD 1.8	03/00→08/03	Diesel	RTN	1753	4	82.50	82.00	71
Fiesta TD 1.8	03/00→08/03	Diesel	RTP	1753	4	82.50	82.00	71
Fiesta TD 1.8	03/00→08/03	Diesel	RTQ	1753	4	82.50	82.00	71
Fiesta I 0.9	05/76→08/83	Petrol	TKA	957	4	73.96	55.70	10
Fiesta I 0.9	05/76→08/83	Petrol	TKW	957	4	74.00	55.70	15
Fiesta I 0.9	05/76→08/83	Petrol	TLA	957	4	73.96	55.70	10
Fiesta I 1.1	05/76→08/83	Petrol	GLA	1117	4	73.96	64.98	11
Fiesta I 1.1	02/81→08/83	Petrol	GLW	1117	4	74.00	65.00	16
Fiesta I 1.3	08/77→08/83	Petrol	J3E	1297	4	80.98	62.99	59
Fiesta I 1.6 XR2	08/81→08/83	Petrol	L3E	1599	4	81.00	77.60	65
Fiesta II 1.0	09/83→02/89	Petrol	TKB	957	4	74.00	55.70	14
Fiesta II 1.0	09/83→11/89	Petrol	TLB	999	4	68.70	67.50	1
Fiesta II 1.1	09/83→02/89	Petrol	GLC	1117	4	74.00	65.00	16
Fiesta II 1.1	09/83→02/89	Petrol	GSF	1117	4	74.00	65.00	18
Fiesta II 1.1	05/86→02/89	Petrol	GSH	1117	4	73.90	65.00	9
Fiesta II 1.3	09/83→09/89	Petrol	JPC	1297	4	80.00	64.50	46
Fiesta II 1.4	10/86→02/89	Petrol	F6C	1392	4	77.25	74.30	29
Fiesta II 1.4	10/85→11/89	Petrol	FUB	1392	4	77.25	74.30	29
Fiesta II 1.4	09/83→01/87	Petrol	FUBA	1392	4	77.25	74.30	30
Fiesta II 1.4	02/87→02/89	Petrol	FUD	1392	4	77.25	74.30	29
Fiesta II 1.4	10/86→02/89	Petrol	F6A	1393	4	77.25	74.30	29
Fiesta II 1.6	01/85→11/89	Petrol	LP3	1597	4	80.00	79.50	47
Fiesta II 1.6 D	04/84→02/89	Diesel	LTB	1608	4	80.00	80.00	50
Fiesta II 1.6 XR2	04/84→02/89	Petrol	LUB	1597	4	80.00	79.50	47
Fiesta II 1.6 XR2	03/84→02/89	Petrol	LUD	1597	4	80.00	79.50	47
Fiesta III 1.0	03/89→12/95	Petrol	TLB	999	4	68.70	67.50	1
Fiesta III 1.1	03/89→12/95	Petrol	G6A	1119	4	68.70	75.50	2
Fiesta III 1.1	03/89→12/95	Petrol	GUD	1119	4	68.70	75.50	2
Fiesta III 1.1	03/89→12/95	Petrol	GUE	1119	4	68.70	75.50	2
Fiesta III 1.3	03/89→12/92	Petrol	JBC	1299	4	74.00	75.50	19
Fiesta III 1.3 CAT	05/91→01/97	Petrol	J6B	1299	4	74.00	75.50	19
Fiesta III 1.4	03/89→12/95	Petrol	F6E	1392	4	77.25	74.30	28
Fiesta III 1.4	11/92→12/96	Petrol	FUF	1392	4	77.25	74.30	28
Fiesta III 1.4	03/89→12/95	Petrol	FUG	1392	4	77.25	74.30	28
Fiesta III 1.4	03/89→12/95	Petrol	FUJ	1392	4	77.25	74.30	28
Fiesta III 1.4 CAT	03/89→12/95	Petrol	F4A	1391	4	77.25	74.30	28
Fiesta III 1.6	01/89→01/94	Petrol	LUH	1597	4	76.00	88.00	26
Fiesta III 1.6 i 16V	01/94→12/95	Petrol	L1G	1597	4	76.00	88.00	25
Fiesta III 1.6 Turbo	03/90→10/92	Petrol	LHA	1598	4	80.00	79.50	48
Fiesta III 1.6 XR2i	03/89→01/94	Petrol	LJC	1597	4	80.00	79.50	47
Fiesta III 1.6 XR2i	03/89→03/93	Petrol	LJD	1598	4	80.00	79.50	48
Fiesta III 1.8 16V	02/92→12/95	Petrol	RDB	1796	4	80.60	88.00	53
Fiesta III 1.8 D	03/89→12/95	Diesel	RTC	1753	4	82.50	82.00	73
Fiesta III 1.8 D	03/89→12/95	Diesel	RTD	1753	4	82.50	82.00	73
Fiesta III 1.8 D	03/89→12/95	Diesel	RTG	1753	4	82.50	82.00	73
Fiesta III 1.8 TD	03/93→12/95	Diesel	RFL	1753	4	82.50	82.00	71
Fiesta III 1.8 XR2i 16V	02/92→12/95	Petrol	RQC	1796	4	80.60	88.00	53
Fiesta IV 1.0 i	02/97→09/99	Petrol	ZH10JRB	999	4	68.70	67.50	1
Fiesta IV 1.25 i 16V	08/95→01/02	Petrol	DHA	1242	4	71.90	76.50	5
Fiesta IV 1.25 i 16V	08/95→01/02	Petrol	DHB	1242	4	71.90	76.50	5
Fiesta IV 1.25 i 16V	08/95→01/02	Petrol	DHC	1242	4	71.90	76.50	5



cm3



Fiesta IV 1.25 i 16V	08/95→01/02	Petrol	DHD	1242	4	71.90	76.50	5
Fiesta IV 1.25 i 16V	08/95→01/02	Petrol	DHE	1242	4	71.90	76.50	5
Fiesta IV 1.25 i 16V	08/95→01/02	Petrol	DHF	1242	4	71.90	76.50	5
Fiesta IV 1.25 i 16V	08/95→01/02	Petrol	DHG	1242	4	71.90	76.50	5
Fiesta IV 1.3 i	08/95→01/02	Petrol	J4C	1299	4	74.00	75.50	19
Fiesta IV 1.3 i	08/95→01/02	Petrol	J4J	1299	4	74.00	75.50	19
Fiesta IV 1.3 i	08/95→01/02	Petrol	J4L	1299	4	74.00	75.50	19
Fiesta IV 1.3 i	08/95→01/02	Petrol	J4Q	1299	4	74.00	75.50	19
Fiesta IV 1.3 i	08/95→01/02	Petrol	J4R	1299	4	74.00	75.50	19
Fiesta IV 1.3 i	08/95→01/02	Petrol	J4T	1299	4	74.00	75.50	19
Fiesta IV 1.3 i	08/95→01/02	Petrol	JBC	1299	4	74.00	75.50	19
Fiesta IV 1.3 i	08/95→01/02	Petrol	JJA	1299	4	74.00	75.50	19
Fiesta IV 1.3 i	08/95→01/02	Petrol	JJC	1299	4	74.00	75.50	19
Fiesta IV 1.3 i	08/95→01/02	Petrol	JJE	1299	4	74.00	75.50	19
Fiesta IV 1.3 i	08/95→01/02	Petrol	JJJ	1299	4	74.00	75.50	19
Fiesta IV 1.3 i	08/95→01/02	Petrol	JKK	1299	4	74.00	75.50	19
Fiesta IV 1.3 i	08/95→01/02	Petrol	JJM	1299	4	74.00	75.50	19
Fiesta IV 1.4 i 16V	04/96→01/02	Petrol	FHA	1388	4	76.00	76.50	23
Fiesta IV 1.4 i 16V	04/96→01/02	Petrol	FHE	1388	4	76.00	76.50	23
Fiesta IV 1.6 16V	02/00→01/02	Petrol	L1V	1596	4	76.00	88.00	25
Fiesta IV 1.6 16V	02/00→01/02	Petrol	L1T	1596	4	76.00	88.00	25
Fiesta IV 1.8 D	08/95→04/00	Diesel	RTJ	1753	4	82.50	82.00	73
Fiesta IV 1.8 D	08/95→04/00	Diesel	RTK	1753	4	82.50	82.00	73
Fiesta IV 1.8 DI	04/00→01/02	Diesel	RTN	1753	4	82.50	82.00	71
Fiesta IV 1.8 DI	04/00→01/02	Diesel	RTP	1753	4	82.50	82.00	71
Fiesta IV 1.8 DI	04/00→01/02	Diesel	RTQ	1753	4	82.50	82.00	71
Fiesta V 1.25 16V	05/02→06/08	Petrol	FUJA	1242	4	71.90	76.50	5
Fiesta V 1.25 16V	05/02→06/08	Petrol	FUJB	1242	4	71.90	76.50	5
Fiesta V 1.25 16V	03/03→06/08	Petrol	M7JA	1242	4	71.90	76.50	5
Fiesta V 1.25 16V	03/03→06/08	Petrol	M7JB	1242	4	71.90	76.50	5
Fiesta V 1.3	11/01→06/08	Petrol	A9JA	1299	4	74.00	75.50	19
Fiesta V 1.3	11/01→06/08	Petrol	A9JB	1299	4	74.00	75.50	19
Fiesta V 1.3	11/01→06/08	Petrol	BAJA	1299	4	74.00	75.50	19
Fiesta V 1.4 16V	11/01→06/08	Petrol	FXJA	1388	4	76.00	76.50	23
Fiesta V 1.4 16V	11/01→06/08	Petrol	FXJB	1388	4	76.00	76.50	23
Fiesta V 1.4 TDCi	11/01→12/10	Diesel	F6JA	1399	4	73.70	82.00	8
Fiesta V 1.4 TDCi	11/01→12/10	Diesel	F6JB	1399	4	73.70	82.00	8
Fiesta V 1.6 16V	11/01→06/08	Petrol	FYJA	1596	4	79.00	81.40	34
Fiesta V 1.6 16V	11/01→06/08	Petrol	FYJB	1596	4	79.00	81.40	34
Fiesta V 1.6 TDCi	11/04→09/09	Diesel	HHJA	1560	4	75.00	88.30	22
Fiesta V 1.6 TDCi	11/04→09/09	Diesel	HHJB	1560	4	75.00	88.30	22
Fiesta VI 1.25	06/08→	Petrol	SNJA	1242	4	71.90	76.50	6
Fiesta VI 1.25	06/08→	Petrol	SNJB	1242	4	71.90	76.50	7
Fiesta VI 1.25	06/08→	Petrol	STJA	1242	4	71.90	76.50	6
Fiesta VI 1.25	06/08→	Petrol	STJB	1242	4	71.90	76.50	6
Fiesta VI 1.4	06/08→	Petrol	SPJA	1388	4	76.00	76.50	24
Fiesta VI 1.4	06/08→	Petrol	SPJC	1388	4	76.00	76.50	24
Fiesta VI 1.4 LPG	01/09→	Petrol	RTJA	1388	4	76.00	76.50	23
Fiesta VI 1.4 LPG	01/09→	Petrol	RTJB	1388	4	76.00	76.50	23
Fiesta VI 1.4 TDCi	01/09→	Diesel	F6JB	1399	4	73.70	82.00	8
Fiesta VI 1.4 TDCi	07/10→	Diesel	F6JD	1399	4	73.70	82.00	8
Fiesta VI 1.4 TDCi	07/10→	Diesel	KVJA	1399	4	73.70	82.00	8
Fiesta VI 1.6 TDCi	06/08→	Diesel	HHJC	1560	4	75.00	88.30	22
Fiesta VI 1.6 TDCi	06/08→	Diesel	HHJD	1560	4	75.00	88.30	22
Fiesta VI 1.6 TDCi	06/08→	Diesel	HHJE	1560	4	75.00	88.30	22
Fiesta VI 1.6 TDCi	06/08→	Diesel	HHJF	1560	4	75.00	88.30	22
Fiesta VI 1.6 TDCi	02/10→	Diesel	T3JA	1560	4	75.00	88.30	21
Fiesta VI 1.6 TDCi	02/10→	Diesel	TZJA	1560	4	75.00	88.30	21
Fiesta VI 1.6 TDCi	02/10→	Diesel	TZJB	1560	4	75.00	88.30	21
Fiesta VI 1.6 TDCi	06/08→	Diesel	UBJA	1560	4	75.00	88.30	22
Fiesta VI 1.6 Ti	06/08→	Petrol	HXJA	1596	4	79.00	81.40	35
Fiesta VI 1.6 Ti	06/08→	Petrol	HXJB	1596	4	79.00	81.40	35
Fiesta VI 1.6 Ti	09/12→	Petrol	IQJA	1596	4	79.00	81.40	35
Focus 1.4 16V	10/98→11/04	Petrol	FXDA	1388	4	76.00	76.50	23
Focus 1.4 16V	10/98→11/04	Petrol	FXDB	1388	4	76.00	76.50	23
Focus 1.4 16V	10/98→11/04	Petrol	FXDC	1388	4	76.00	76.50	23
Focus 1.4 16V	10/98→11/04	Petrol	FXDD	1388	4	76.00	76.50	23
Focus 1.6 16V	10/98→11/04	Petrol	FYDA	1596	4	79.00	81.40	34
Focus 1.6 16V	10/98→11/04	Petrol	FYDB	1596	4	79.00	81.40	34

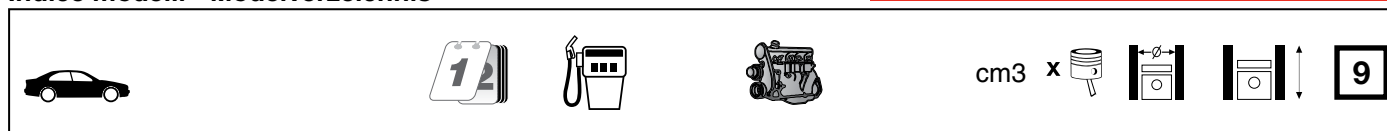









Focus 1.6 16V	10/98→11/04	Petrol	FYDC	1596	4	79.00	81.40	34
Focus 1.6 16V	10/98→11/04	Petrol	FYDD	1596	4	79.00	81.40	34
Focus 1.6 16V	10/98→11/04	Petrol	FYDH	1596	4	79.00	81.40	34
Focus 1.6 16V Flexifuel	01/02→11/04	Petrol	FYDH	1596	4	79.00	81.40	34
Focus 1.8 16V	10/98→11/04	Petrol	EYDB	1796	4	80.60	88.00	53
Focus 1.8 16V	10/98→11/04	Petrol	EYDC	1796	4	80.60	88.00	53
Focus 1.8 16V	10/98→11/04	Petrol	EYDD	1796	4	80.60	88.00	53
Focus 1.8 16V	10/98→11/04	Petrol	EYDE	1796	4	80.60	88.00	53
Focus 1.8 16V	10/98→11/04	Petrol	EYDF	1796	4	80.60	88.00	53
Focus 1.8 16V	10/98→11/04	Petrol	EYDG	1796	4	80.60	88.00	53
Focus 1.8 16V	10/98→11/04	Petrol	EYDI	1796	4	80.60	88.00	53
Focus 1.8 16V	10/98→11/04	Petrol	EYDJ	1796	4	80.60	88.00	53
Focus 1.8 16V	10/98→11/04	Petrol	EYDL	1796	4	80.60	88.00	53
Focus 1.8 DI / TDDi	08/99→11/04	Diesel	BHDA	1753	4	82.50	82.00	71
Focus 1.8 DI / TDDi	08/99→11/04	Diesel	BHDB	1753	4	82.50	82.00	71
Focus 1.8 TDCi	03/01→11/04	Diesel	F9DA	1753	4	82.50	82.00	71
Focus 1.8 TDCi	03/01→11/04	Diesel	F9DB	1753	4	82.50	82.00	71
Focus 1.8 TDCi	08/02→11/04	Diesel	FFDA	1753	4	82.50	82.00	71
Focus 1.8 Turbo DI / TDDi	08/01→03/05	Diesel	BHDA	1753	4	82.50	82.00	71
Focus 1.8 Turbo DI / TDDi	08/01→03/05	Diesel	BHDB	1753	4	82.50	82.00	71
Focus 1.8 Turbo DI / TDDi	10/98→11/04	Diesel	C9DA	1753	4	82.50	82.00	71
Focus 1.8 Turbo DI / TDDi	10/98→11/04	Diesel	C9DB	1753	4	82.50	82.00	71
Focus 1.8 Turbo DI / TDDi	10/98→11/04	Diesel	C9DC	1753	4	82.50	82.00	71
Focus 2.0 16V	10/98→11/04	Petrol	EDDB	1988	4	84.80	88.00	78
Focus 2.0 16V	10/98→11/04	Petrol	EDDC	1988	4	84.80	88.00	78
Focus 2.0 16V	10/98→11/04	Petrol	EDDD	1988	4	84.80	88.00	78
Focus 2.0 16V	10/98→11/04	Petrol	EDDF	1988	4	84.80	88.00	78
Focus C-Max 1.6	10/03→03/07	Petrol	HWDA	1596	4	79.00	81.40	34
Focus C-Max 1.6	10/03→03/07	Petrol	HWDB	1596	4	79.00	81.40	34
Focus C-Max 1.6 TDCi	10/03→03/07	Diesel	G8DA	1560	4	75.00	88.30	21
Focus C-Max 1.6 TDCi	10/03→03/07	Diesel	G8DB	1560	4	75.00	88.30	21
Focus C-Max 1.6 TDCi	02/05→03/07	Diesel	HHDA	1560	4	75.00	88.30	22
Focus C-Max 1.6 TDCi	02/05→03/07	Diesel	HHDB	1560	4	75.00	88.30	22
Focus C-Max 1.6 Ti	08/04→03/07	Petrol	HXDA	1596	4	79.00	81.40	34
Focus C-Max 1.6 Ti	08/04→03/07	Petrol	SIDA	1596	4	79.00	81.40	35
Focus C-Max 1.8	10/03→03/07	Petrol	CSDA	1798	4	83.00	83.10	74
Focus C-Max 1.8	10/03→03/07	Petrol	CSDB	1798	4	83.00	83.10	74
Focus C-Max 1.8	04/04→03/07	Petrol	Q7DA	1798	4	83.00	83.10	74
Focus C-Max 1.8	04/04→03/07	Petrol	QQDA	1798	4	83.00	83.10	74
Focus C-Max 1.8	04/04→03/07	Petrol	QQDB	1798	4	83.00	83.10	74
Focus C-Max 1.8	09/05→03/07	Petrol	QQDC	1798	4	83.00	83.10	74
Focus C-Max 1.8 Flexifuel	01/06→03/07	Petrol	Q7DA	1798	4	83.00	83.10	74
Focus C-Max 1.8 TDCi	01/05→03/07	Diesel	KKDA	1753	4	82.50	82.00	72
Focus C-Max 2.0 TDCi	10/03→03/07	Diesel	G6DA	1997	4	85.00	88.00	80
Focus C-Max 2.0 TDCi	10/03→03/07	Diesel	G6DB	1997	4	85.00	88.00	80
Focus C-Max 2.0 TDCi	10/03→03/07	Diesel	G6DC	1997	4	85.00	88.00	80
Focus C-Max 2.0 TDCi	10/03→03/07	Diesel	G6DD	1997	4	85.00	88.00	80
Focus C-Max 2.0 TDCi	10/03→03/07	Diesel	G6DE	1997	4	85.00	88.00	80
Focus C-Max 2.0 TDCi	10/03→03/07	Diesel	G6DF	1997	4	85.00	88.00	80
Focus C-Max 2.0 TDCi	10/03→03/07	Diesel	G6DG	1997	4	85.00	88.00	80
Focus II 1.4	07/04→09/12	Petrol	ASDA	1388	4	76.00	76.50	23
Focus II 1.4	07/04→09/12	Petrol	ASDB	1388	4	76.00	76.50	23
Focus II 1.6	07/04→09/12	Petrol	HWDA	1596	4	79.00	81.40	34
Focus II 1.6	07/04→09/12	Petrol	HWDB	1596	4	79.00	81.40	34
Focus II 1.6	07/04→09/12	Petrol	SHDA	1596	4	79.00	81.40	34
Focus II 1.6	07/04→09/12	Petrol	SHDB	1596	4	79.00	81.40	34
Focus II 1.6	07/04→09/12	Petrol	SHDC	1596	4	79.00	81.40	34
Focus II 1.6 LPG	10/09→09/12	Petrol	SIDA	1596	4	79.00	81.40	35
Focus II 1.6 TDCi	07/04→09/12	Diesel	G8DA	1560	4	75.00	88.30	21
Focus II 1.6 TDCi	07/04→09/12	Diesel	G8DB	1560	4	75.00	88.30	21
Focus II 1.6 TDCi	07/04→09/12	Diesel	G8DC	1560	4	75.00	88.30	21
Focus II 1.6 TDCi	07/04→09/12	Diesel	G8DD	1560	4	75.00	88.30	21
Focus II 1.6 TDCi	07/04→09/12	Diesel	G8DE	1560	4	75.00	88.30	21
Focus II 1.6 TDCi	07/04→09/12	Diesel	G8DF	1560	4	75.00	88.30	21
Focus II 1.6 TDCi	07/04→09/12	Diesel	GPDA	1560	4	75.00	88.30	22
Focus II 1.6 TDCi	01/05→09/12	Diesel	GPDB	1560	4	75.00	88.30	22
Focus II 1.6 TDCi	07/04→09/12	Diesel	GPDC	1560	4	75.00	88.30	22
Focus II 1.6 TDCi	07/04→09/12	Diesel	HHDA	1560	4	75.00	88.30	22
Focus II 1.6 TDCi	07/04→09/12	Diesel	HHDB	1560	4	75.00	88.30	22



cm3



Focus II 1.6 TDCi	07/04→09/12	Diesel	MTDA	1560	4	75.00	88.30	21
Focus II 1.6 Ti	07/04→09/12	Petrol	HXDA	1596	4	79.00	81.40	34
Focus II 1.6 Ti	07/04→09/12	Petrol	HXDB	1596	4	79.00	81.40	34
Focus II 1.6 Ti	07/04→09/12	Petrol	SIDA	1596	4	79.00	81.40	35
Focus II 1.8	03/06→09/12	Petrol	Q7DA	1798	4	83.00	83.10	74
Focus II 1.8	03/06→09/12	Petrol	QQDB	1798	4	83.00	83.10	74
Focus II 1.8 Flexifuel	01/06→09/12	Petrol	Q7DA	1798	4	83.00	83.10	74
Focus II 1.8 Flexifuel	12/05→01/08	Petrol	QQDD	1798	4	83.00	83.10	74
Focus II 1.8 TDCi	07/04→09/12	Diesel	KKDA	1753	4	82.50	82.00	72
Focus II 1.8 TDCi	07/04→09/12	Diesel	KKDB	1753	4	82.50	82.00	72
Focus II 2.0 TDCi	07/04→09/12	Diesel	G6DA	1997	4	85.00	88.00	80
Focus II 2.0 TDCi	07/04→09/12	Diesel	G6DB	1997	4	85.00	88.00	80
Focus II 2.0 TDCi	07/04→09/12	Diesel	G6DD	1997	4	85.00	88.00	80
Focus II 2.0 TDCi	07/04→01/08	Diesel	G6DE	1997	4	85.00	88.00	80
Focus II 2.0 TDCi	07/04→01/08	Diesel	G6DF	1997	4	85.00	88.00	80
Focus II 2.0 TDCi	02/08→07/11	Diesel	IXDA	1997	4	85.00	88.00	80
Focus III 1.6 EcoBoost	07/10→	Petrol	YUDA	1596	4	79.00	81.40	34
Focus III 1.6 Flexifuel	07/10→	Petrol	MUDA	1596	4	79.00	81.40	35
Focus III 1.6 Flexifuel	07/13→	Petrol	YUDA	1596	4	79.00	81.40	34
Focus III 1.6 LPG	02/12→	Petrol	MUDA	1596	4	79.00	81.40	35
Focus III 1.6 TDCi	05/12→	Diesel	NGDA	1560	4	75.00	88.30	21
Focus III 1.6 TDCi	05/12→	Diesel	NGDB	1560	4	75.00	88.30	21
Focus III 1.6 TDCi	07/10→	Diesel	T1DA	1560	4	75.00	88.30	21
Focus III 1.6 TDCi	07/10→	Diesel	T1DB	1560	4	75.00	88.30	21
Focus III 1.6 TDCi	07/10→	Diesel	T3DA	1560	4	75.00	88.30	21
Focus III 1.6 TDCi	07/10→	Diesel	T3DB	1560	4	75.00	88.30	21
Focus III 1.6 TDCi ECONetic	05/12→	Diesel	NGDA	1560	4	75.00	88.30	21
Focus III 1.6 TDCi ECONetic	05/12→	Diesel	NGDB	1560	4	75.00	88.30	21
Focus III 1.6 Ti	07/10→	Petrol	IQDB	1596	4	79.00	81.40	35
Focus III 1.6 Ti	02/12→	Petrol	MUDA	1596	4	79.00	81.40	35
Focus III 1.6 Ti	07/10→	Petrol	PNDA	1596	4	79.00	81.40	35
Focus III 1.6 Ti	08/11→	Petrol	XTDA	1596	4	79.00	81.40	35
Focus III 2.0 TDCi	11/14→	Diesel	T7DB	1997	4	85.00	88.00	80
Focus III 2.0 TDCi	11/14→	Diesel	T8DA	1997	4	85.00	88.00	80
Focus III 2.0 TDCi	07/10→	Diesel	TXDB	1997	4	85.00	88.00	80
Focus III 2.0 TDCi	07/10→	Diesel	TYDA	1997	4	85.00	88.00	80
Focus III 2.0 TDCi	07/10→	Diesel	UFDB	1997	4	85.00	88.00	80
Focus III 2.0 TDCi	07/10→	Diesel	UKDB	1997	4	85.00	88.00	80
Fusion 1.25	08/04→12/12	Petrol	FUJA	1242	4	71.90	76.50	5
Fusion 1.25	08/04→12/12	Petrol	FUJB	1242	4	71.90	76.50	5
Fusion 1.3	11/02→07/05	Petrol	BAJA	1299	4	74.00	75.50	19
Fusion 1.4	08/02→12/12	Petrol	FXJA	1388	4	76.00	76.50	23
Fusion 1.4	08/02→12/12	Petrol	FXJB	1388	4	76.00	76.50	23
Fusion 1.4	08/02→12/12	Petrol	FXJC	1388	4	76.00	76.50	23
Fusion 1.4 LPG	01/10→12/12	Petrol	UTJA	1388	4	76.00	76.50	23
Fusion 1.4 TDCi	08/02→07/05	Diesel	F6JA	1399	4	73.70	82.00	8
Fusion 1.4 TDCi	08/02→07/05	Diesel	F6JB	1399	4	73.70	82.00	8
Fusion 1.6	08/02→11/08	Petrol	FYJA	1596	4	79.00	81.40	34
Fusion 1.6	08/02→11/08	Petrol	FYJB	1596	4	79.00	81.40	34
Fusion 1.6	08/02→11/08	Petrol	FYJC	1596	4	79.00	81.40	34
Fusion 1.6 TDCi	11/04→12/12	Diesel	HHJA	1560	4	75.00	88.30	22
Fusion 1.6 TDCi	11/04→12/12	Diesel	HHJB	1560	4	75.00	88.30	22
Galaxy 1.6 TDCi	02/11→06/15	Diesel	T1WA	1560	4	75.00	88.30	21
Galaxy 1.6 TDCi	02/11→06/15	Diesel	T1WB	1560	4	75.00	88.30	21
Galaxy 1.8 TDCi	05/06→06/15	Diesel	FFWA	1753	4	82.50	82.00	71
Galaxy 1.8 TDCi	05/06→06/15	Diesel	QYWA	1753	4	82.50	82.00	72
Galaxy 1.9 TDI	03/95→05/06	Diesel	1Z	1896	4	79.50	95.50	36
Galaxy 1.9 TDI	08/97→04/00	Diesel	AFN	1896	4	79.50	95.50	37
Galaxy 1.9 TDI	03/95→05/06	Diesel	AHU	1896	4	79.50	95.50	38
Galaxy 1.9 TDI	03/95→05/06	Diesel	ANU	1896	4	79.50	95.50	39
Galaxy 1.9 TDI	02/03→05/06	Diesel	ASZ	1896	4	79.50	95.50	40
Galaxy 1.9 TDI	04/00→05/06	Diesel	AUY	1896	4	79.50	95.50	39
Galaxy 1.9 TDI	08/97→04/00	Diesel	AVG	1896	4	79.50	95.50	41
Galaxy 1.9 TDI	05/05→05/06	Diesel	BTB	1896	4	79.50	95.50	40
Galaxy 2.0 i	11/95→05/06	Petrol	NSE	1998	4	86.00	86.00	82
Galaxy 2.0 i	11/95→05/06	Petrol	ZVSA	1998	4	86.00	86.00	82
Galaxy 2.0 TDCi	05/06→06/15	Diesel	AZWA	1997	4	85.00	88.00	80
Galaxy 2.0 TDCi	05/06→06/15	Diesel	AZWC	1997	4	85.00	88.00	80
Galaxy 2.0 TDCi	11/07→06/15	Diesel	KLWA	1997	4	85.00	88.00	80

				cm3	x 			
Galaxy 2.0 TDCi	05/06→06/15	Diesel	QXWA	1997	4	85.00	88.00	80
Galaxy 2.0 TDCi	05/06→06/15	Diesel	QXWB	1997	4	85.00	88.00	80
Galaxy 2.0 TDCi	05/06→06/15	Diesel	QXWC	1997	4	85.00	88.00	80
Galaxy 2.0 TDCi	01/15→	Diesel	T7CI	1997	4	85.00	88.00	80
Galaxy 2.0 TDCi	01/15→	Diesel	T7CJ	1997	4	85.00	88.00	80
Galaxy 2.0 TDCi	01/15→	Diesel	T7CK	1997	4	85.00	88.00	80
Galaxy 2.0 TDCi	01/15→	Diesel	T7CL	1997	4	85.00	88.00	80
Galaxy 2.0 TDCi	01/15→	Diesel	T8CG	1997	4	85.00	88.00	80
Galaxy 2.0 TDCi	01/15→	Diesel	T8CH	1997	4	85.00	88.00	80
Galaxy 2.0 TDCi	01/15→	Diesel	T8CI	1997	4	85.00	88.00	80
Galaxy 2.0 TDCi	01/15→	Diesel	T8CJ	1997	4	85.00	88.00	80
Galaxy 2.0 TDCi	03/10→06/15	Diesel	TXWA	1997	4	85.00	88.00	80
Galaxy 2.0 TDCi	11/07→06/15	Diesel	TYWA	1997	4	85.00	88.00	80
Galaxy 2.0 TDCi	01/15→	Diesel	UFCA	1997	4	85.00	88.00	80
Galaxy 2.0 TDCi	01/15→	Diesel	UFCB	1997	4	85.00	88.00	80
Galaxy 2.0 TDCi	05/06→06/15	Diesel	UFWA	1997	4	85.00	88.00	80
Galaxy 2.0 TDCi	05/06→06/15	Diesel	UKWA	1997	4	85.00	88.00	80
Galaxy 2.0 TDCi 4x4	05/15→	Diesel	T8CG	1997	4	85.00	88.00	80
Galaxy 2.0 TDCi 4x4	05/15→	Diesel	T8CH	1997	4	85.00	88.00	80
Galaxy 2.0 TDCi 4x4	05/15→	Diesel	T8CI	1997	4	85.00	88.00	80
Galaxy 2.0 TDCi 4x4	05/15→	Diesel	T8CJ	1997	4	85.00	88.00	80
Galaxy 2.0 TDCi Bi-Turbo	01/15→	Diesel	T9CB	1997	4	85.00	88.00	80
Galaxy 2.0 TDCi Bi-Turbo	01/15→	Diesel	T9CC	1997	4	85.00	88.00	80
Galaxy 2.2 TDCi	03/08→12/12	Diesel	Q4BA	2179	4	85.00	96.00	81
Galaxy 2.2 TDCi	03/08→12/12	Diesel	Q4WA	2179	4	85.00	96.00	81
Galaxy 2.3 4x4	09/96→04/00	Petrol	Y5B	2295	4	89.60	91.00	100
Galaxy 2.3 16V	01/97→05/06	Petrol	E5SA	2295	4	89.60	91.00	100
Galaxy 2.3 16V	09/01→05/06	Petrol	E5SB	2295	4	89.60	91.00	100
Galaxy 2.3 16V	01/97→05/06	Petrol	Y5B	2295	4	89.60	91.00	100
Galaxy 2.8 i V6	11/95→04/00	Petrol	AAA	2792	6	81.00	90.30	67
Galaxy 2.8 i V6	11/95→04/00	Petrol	AMY	2792	6	81.00	90.30	67
Galaxy 2.8 i V6 4x4	04/96→04/00	Petrol	AAA	2792	6	81.00	90.30	67
Galaxy 2.8 i V6 4x4	04/96→04/00	Petrol	AMY	2792	6	81.00	90.30	67
Galaxy 2.8 V6	04/00→05/06	Petrol	AYL	2792	6	81.00	90.30	67
Granada	01/87→08/89	Petrol	TV24	2394	V6	84.00	72.00	77
Granada 1.6	07/81→08/85	Petrol	LCK	1593	4	87.65	66.00	98
Granada 1.7	12/74→08/77	Petrol	MWB	1699	4	90.00	66.80	106
Granada 1.7	08/77→07/81	Petrol	MY	1699	4	90.00	66.80	106
Granada 1.7	08/77→07/81	Petrol	MYE	1699	4	90.00	66.80	106
Granada 1.7	03/72→02/75	Petrol	TV 17 H	1699	V4	90.00	66.80	106
Granada 1.7	03/72→02/75	Petrol	TV 17 HC	1699	V4	90.00	66.80	106
Granada 1.7	03/72→05/82	Petrol	TV 17 LC	1699	V4	90.00	66.80	106
Granada 2.0	08/81→08/85	Petrol	NEK	1993	4	90.80	76.90	112
Granada 2.0	08/79→08/85	Petrol	NEP	1993	4	90.80	76.90	112
Granada 2.0	01/76→07/79	Petrol	OHC LC	1994	4	90.80	76.90	112
Granada 2.0	01/75→07/79	Petrol	TL 20 LC	1994	4	90.80	76.90	112
Granada 2.3	01/75→06/79	Petrol	YYH	2294	V6	90.00	60.10	104
Granada 2.3	06/79→08/85	Petrol	YYP	2294	V6	90.00	60.10	104
Granada 2.3	06/81→08/85	Petrol	YYU	2294	V6	90.00	60.10	104
Granada 2.4 EFi Ghia	01/87→08/89	Petrol	TV24	2394	V6	84.00	72.00	77
Granada 2.4 EFi Ghia X	01/87→08/89	Petrol	TV24	2394	V6	84.00	72.00	77
Granada 2.4 EFi GL	01/87→08/89	Petrol	TV24	2394	V6	84.00	72.00	77
Granada 2.5 D	08/82→08/85	Diesel	STP	2499	4	94.00	90.00	128
Granada 2.6	01/72→02/76	Petrol	UY	2550	V6	90.00	66.80	107
Granada 2.6	12/75→08/77	Petrol	TV 26 L	2551	V6	90.00	66.80	107
Granada 2.8	08/77→08/85	Petrol	PYA	2792	V6	93.00	68.50	119
Granada 2.8	06/81→08/85	Petrol	PYU	2792	V6	93.00	68.50	119
Granada 2.8 i	08/77→08/81	Petrol	PRB	2792	V6	93.00	68.50	119
Granada 2.8 i	10/82→08/85	Petrol	PRC	2792	V6	93.00	68.50	119
Granada 2.8 i	08/77→08/85	Petrol	PRD	2792	V6	93.00	68.50	119
Grand C-Max 1.6 TDCi	12/10→	Diesel	T1DA	1560	4	75.00	88.30	21
Grand C-Max 1.6 TDCi	12/10→	Diesel	T1DB	1560	4	75.00	88.30	21
Grand C-Max 1.6 TDCi	12/10→	Diesel	T3DA	1560	4	75.00	88.30	21
Grand C-Max 1.6 TDCi	12/10→	Diesel	T3DB	1560	4	75.00	88.30	21
Grand C-Max 1.6 Ti	12/10→	Petrol	IQDA	1596	4	79.00	81.40	35
Grand C-Max 1.6 Ti	12/10→	Petrol	IQDB	1596	4	79.00	81.40	35
Grand C-Max 1.6 Ti	12/10→	Petrol	PNDA	1596	4	79.00	81.40	35
Grand C-Max 2.0 TDCi	03/15→	Diesel	T7DB	1997	4	85.00	88.00	80
Grand C-Max 2.0 TDCi	03/15→	Diesel	T8DE	1997	4	85.00	88.00	80



cm3



Grand C-Max 2.0 TDCi	12/10→	Diesel	TXDB	1997	4	85.00	88.00	80
Grand C-Max 2.0 TDCi	02/11→	Diesel	TYDA	1997	4	85.00	88.00	80
Grand C-Max 2.0 TDCi	12/10→	Diesel	UFDB	1997	4	85.00	88.00	80
Grand C-Max 2.0 TDCi	02/11→	Diesel	UKDB	1997	4	85.00	88.00	80
Husky 2.0	01/86→08/98	Petrol	4G63	1997	4	85.00	88.00	79
Ka 1.0 i	07/97→09/99	Petrol	ZH10JRB	999	4	68.70	67.50	1
Ka 1.2	10/08→	Petrol	FP4	1242	4	70.80	78.90	3
Ka 1.3 i	08/02→11/08	Petrol	A9A	1299	4	74.00	75.50	19
Ka 1.3 i	08/02→11/08	Petrol	A9B	1299	4	74.00	75.50	19
Ka 1.3 i	09/96→11/08	Petrol	BAA	1299	4	74.00	75.50	19
Ka 1.3 i	09/96→11/08	Petrol	J4D	1299	4	74.00	75.50	19
Ka 1.3 i	09/96→11/08	Petrol	J4K	1299	4	74.00	75.50	19
Ka 1.3 i	09/96→11/08	Petrol	J4M	1299	4	74.00	75.50	19
Ka 1.3 i	09/96→11/08	Petrol	J4N	1299	4	74.00	75.50	19
Ka 1.3 i	09/96→11/08	Petrol	J4P	1299	4	74.00	75.50	19
Ka 1.3 i	09/96→11/08	Petrol	J4S	1299	4	74.00	75.50	19
Ka 1.3 i	09/96→10/02	Petrol	JJB	1299	4	74.00	75.50	19
Ka 1.3 i	06/98→11/08	Petrol	JJD	1299	4	74.00	75.50	19
Ka 1.3 i	06/98→11/08	Petrol	JJF	1299	4	74.00	75.50	19
Ka 1.3 i	06/98→11/08	Petrol	JJG	1299	4	74.00	75.50	19
Ka 1.3 i	06/98→11/08	Petrol	JJH	1299	4	74.00	75.50	19
Ka 1.3 i	06/98→11/08	Petrol	JJL	1299	4	74.00	75.50	19
Kuga I 2.0 TDCi	03/08→11/12	Diesel	G6DG	1997	4	85.00	88.00	80
Kuga I 2.0 TDCi	03/10→11/12	Diesel	UFDA	1997	4	85.00	88.00	80
Kuga I 2.0 TDCi	03/08→11/12	Diesel	UKDA	1997	4	85.00	88.00	80
Kuga I 2.0 TDCi 4x4	03/08→11/12	Diesel	G6DG	1997	4	85.00	88.00	80
Kuga I 2.0 TDCi 4x4	03/10→11/12	Diesel	UFDA	1997	4	85.00	88.00	80
Kuga I 2.0 TDCi 4x4	03/08→11/12	Diesel	UKDA	1997	4	85.00	88.00	80
Kuga I 2.0 TDCi 4x4	03/10→11/12	Diesel	TXDA	1998	4	85.00	88.00	80
Kuga II 1.6 EcoBoost	03/13→	Petrol	JQMA	1596	4	79.00	81.40	34
Kuga II 1.6 EcoBoost	03/13→	Petrol	JQMB	1596	4	79.00	81.40	34
Kuga II 1.6 EcoBoost 4x4	03/13→	Petrol	JQMA	1596	4	79.00	81.40	34
Kuga II 1.6 EcoBoost 4x4	03/13→	Petrol	JQMB	1596	4	79.00	81.40	34
Kuga II 1.6 EcoBoost 4x4	03/13→	Petrol	JTMA	1596	4	79.00	81.40	34
Kuga II 2.0 TDCi	03/13→	Diesel	UFMA	1997	4	85.00	88.00	80
Kuga II 2.0 TDCi	03/13→	Diesel	UKMA	1997	4	85.00	88.00	80
Kuga II 2.0 TDCi	09/14→	Diesel	T7MA	1998	4	85.00	88.00	80
Kuga II 2.0 TDCi	09/14→	Diesel	T7MB	1998	4	85.00	88.00	80
Kuga II 2.0 TDCi	03/13→	Diesel	TYMA	1998	4	86.00	94.60	92
Kuga II 2.0 TDCi	09/14→	Diesel	XRMA	1998	4	85.00	88.00	80
Kuga II 2.0 TDCi	09/14→	Diesel	XRMB	1998	4	85.00	88.00	80
Kuga II 2.0 TDCi 4x4	03/13→	Diesel	UFMA	1997	4	85.00	88.00	80
Kuga II 2.0 TDCi 4x4	03/13→	Diesel	UKMA	1997	4	85.00	88.00	80
Kuga II 2.0 TDCi 4x4	09/14→	Diesel	T7MA	1998	4	85.00	88.00	80
Kuga II 2.0 TDCi 4x4	09/14→	Diesel	T7MB	1998	4	85.00	88.00	80
Kuga II 2.0 TDCi 4x4	09/14→	Diesel	T8MA	1998	4	85.00	88.00	80
Kuga II 2.0 TDCi 4x4	09/14→	Diesel	T8MB	1998	4	85.00	88.00	80
Kuga II 2.0 TDCi 4x4	03/13→	Diesel	TXDA	1998	4	85.00	88.00	80
Kuga II 2.0 TDCi 4x4	03/13→	Diesel	TXMA	1998	4	85.00	88.00	80
Laser 1.3	01/91→12/95	Petrol	B3	1324	4	71.00	83.60	4
Laser 1.6	01/91→12/95	Petrol	B6	1598	4	78.00	83.60	31
Maverick 2.0 16V	02/01→	Petrol	YF	1989	4	84.80	88.00	78
Maverick 2.7 TD	02/93→04/98	Diesel	TD27	2663	4	96.00	92.00	131
Maverick 2.7 TD	06/96→04/98	Diesel	TD27E	2664	4	96.00	92.00	131
Meteor 1.6	03/83→08/90	Petrol	LUG	1597	4	80.00	79.50	47
Meteor 1.6	09/90→11/93	Petrol	LJF	1598	4	79.96	79.52	43
Mondeo I 1.6 i 16V	02/93→08/96	Petrol	L1F	1597	4	76.00	88.00	25
Mondeo I 1.6 i 16V	07/94→08/96	Petrol	L1J	1597	4	76.00	88.00	25
Mondeo I 1.8 4x4	02/93→08/96	Petrol	RKA	1796	4	80.60	88.00	53
Mondeo I 1.8 i 16V	02/93→08/96	Petrol	RKA	1796	4	80.60	88.00	53
Mondeo I 1.8 i 16V	01/94→08/96	Petrol	RKB	1796	4	80.60	88.00	53
Mondeo I 1.8 i 16V 4x4	02/93→08/96	Petrol	RKA	1796	4	80.60	88.00	53
Mondeo I 1.8 TD	06/93→08/96	Diesel	RFM	1753	4	82.50	82.00	71
Mondeo I 1.8 TD	06/93→08/96	Diesel	RFN	1753	4	82.50	82.00	71
Mondeo I 2.0 i 16V	01/93→08/96	Petrol	NGA	1988	4	84.80	88.00	78
Mondeo I 2.0 i 16V 4x4	02/93→08/96	Petrol	NGA	1988	4	84.80	88.00	78
Mondeo II 1.6 i	08/96→09/00	Petrol	L1J	1597	4	76.00	88.00	25
Mondeo II 1.6 i 16V	05/98→09/00	Petrol	L1L	1597	4	76.00	88.00	25
Mondeo II 1.6 i 16V	05/98→09/00	Petrol	L1N	1597	4	76.00	88.00	25

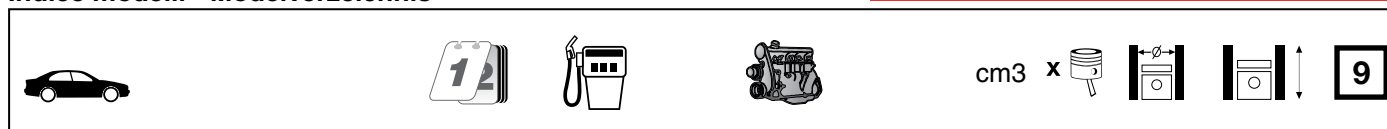









Mondeo II 1.6 i 16V	05/98→09/00	Petrol	L1Q	1597	4	76.00	88.00	25
Mondeo II 1.8 i	08/96→09/00	Petrol	RKB	1796	4	80.60	88.00	53
Mondeo II 1.8 i	08/96→09/00	Petrol	RKF	1796	4	80.60	88.00	53
Mondeo II 1.8 i	08/96→09/00	Petrol	RKH	1796	4	80.60	88.00	53
Mondeo II 1.8 i	08/96→09/00	Petrol	RKJ	1796	4	80.60	88.00	53
Mondeo II 1.8 i	08/96→09/00	Petrol	RKK	1796	4	80.60	88.00	53
Mondeo II 1.8 TD	08/96→09/00	Diesel	RFN	1753	4	82.50	82.00	71
Mondeo II 2.0 i	08/96→09/00	Petrol	NGA	1988	4	84.80	88.00	78
Mondeo II 2.0 i	08/96→09/00	Petrol	NGB	1988	4	84.80	88.00	78
Mondeo II 2.0 i	08/96→09/00	Petrol	NGC	1988	4	84.80	88.00	78
Mondeo II 2.0 i	08/96→09/00	Petrol	NGD	1988	4	84.80	88.00	78
Mondeo III 1.8 16V	10/00→03/07	Petrol	CGBA	1798	4	83.00	83.10	75
Mondeo III 1.8 16V	10/00→03/07	Petrol	CGBB	1798	4	83.00	83.10	75
Mondeo III 1.8 16V	10/00→03/07	Petrol	CHBA	1798	4	83.00	83.10	75
Mondeo III 1.8 16V	10/00→03/07	Petrol	CHBB	1798	4	83.00	83.10	75
Mondeo III 1.8 SCi	06/03→03/07	Petrol	CFBA	1798	4	83.00	83.10	74
Mondeo III 2.0	10/00→03/07	Petrol	CJBA	1999	4	87.50	83.10	95
Mondeo III 2.0 16V	10/00→03/07	Petrol	CJBA	1999	4	87.50	83.10	95
Mondeo III 2.0 16V	10/00→03/07	Petrol	CJBB	1999	4	87.50	83.10	95
Mondeo III 2.0 16V DI / TDDi / TDCi	10/00→03/07	Diesel	D5BA	1998	4	86.00	86.00	85
Mondeo III 2.0 16V DI / TDDi / TDCi	10/00→03/07	Diesel	SDBA	1998	4	86.00	86.00	85
Mondeo III 2.0 16V TDDi / TDCi	10/00→03/07	Diesel	D6BA	1998	4	86.00	86.00	85
Mondeo III 2.0 16V TDDi / TDCi	10/00→03/07	Diesel	HJBA	1998	4	86.00	86.00	85
Mondeo III 2.0 16V TDDi / TDCi	10/00→03/07	Diesel	HJBB	1998	4	86.00	86.00	85
Mondeo III 2.0 16V TDDi / TDCi	10/00→03/07	Diesel	HJBC	1998	4	86.00	86.00	85
Mondeo III 2.0 TDCi	10/01→03/07	Diesel	FMBA	1998	4	86.00	86.00	86
Mondeo III 2.0 TDCi	10/01→03/07	Diesel	N7BA	1998	4	86.00	86.00	85
Mondeo III 2.2 TDCi	09/04→03/07	Diesel	QJBA	2198	4	86.00	94.60	91
Mondeo III 2.2 TDCi	09/04→03/07	Diesel	QJBB	2198	4	86.00	94.60	91
Mondeo III 2.2 TDCi	09/04→03/07	Diesel	QJBC	2198	4	86.00	94.60	91
Mondeo III 2.2 TDCi	09/04→03/07	Diesel	QJBD	2198	4	86.00	94.60	91
Mondeo IV 1.6 TDCi	12/10→09/14	Diesel	T1BA	1560	4	75.00	88.30	21
Mondeo IV 1.6 TDCi	12/10→09/14	Diesel	T1BB	1560	4	75.00	88.30	21
Mondeo IV 1.6 TDCi	12/10→09/14	Diesel	T1BC	1560	4	75.00	88.30	21
Mondeo IV 1.6 Ti	03/07→09/14	Petrol	PNBA	1596	4	79.00	81.40	35
Mondeo IV 1.6 Ti	03/07→09/14	Petrol	RHBA	1596	4	79.00	81.40	35
Mondeo IV 1.8 TDCi	03/07→09/14	Diesel	FFBA	1753	4	82.50	82.00	71
Mondeo IV 1.8 TDCi	06/07→	Diesel	KHBA	1753	4	82.50	82.00	71
Mondeo IV 1.8 TDCi	06/07→	Diesel	QYBA	1753	4	82.50	82.00	71
Mondeo IV 2.0 TDCi	03/07→09/14	Diesel	AZBA	1997	4	85.00	88.00	80
Mondeo IV 2.0 TDCi	03/07→09/14	Diesel	AZBC	1997	4	85.00	88.00	80
Mondeo IV 2.0 TDCi	11/07→09/14	Diesel	KLBA	1997	4	85.00	88.00	80
Mondeo IV 2.0 TDCi	11/07→09/14	Diesel	LPBA	1997	4	85.00	88.00	80
Mondeo IV 2.0 TDCi	03/07→09/14	Diesel	QXBA	1997	4	85.00	88.00	80
Mondeo IV 2.0 TDCi	03/07→09/14	Diesel	QXBB	1997	4	85.00	88.00	80
Mondeo IV 2.0 TDCi	03/10→09/14	Diesel	TXBA	1997	4	85.00	88.00	80
Mondeo IV 2.0 TDCi	03/10→09/14	Diesel	TXBB	1997	4	85.00	88.00	80
Mondeo IV 2.0 TDCi	11/07→09/14	Diesel	TYBA	1997	4	86.00	86.00	85
Mondeo IV 2.0 TDCi	03/07→09/14	Diesel	UFBA	1997	4	85.00	88.00	80
Mondeo IV 2.0 TDCi	03/07→09/14	Diesel	UFBB	1997	4	85.00	88.00	80
Mondeo IV 2.0 TDCi	03/07→09/14	Diesel	UKBA	1997	4	85.00	88.00	80
Mondeo IV 2.0 TDCi	03/07→09/14	Diesel	UKBB	1997	4	85.00	88.00	80
Mondeo IV 2.2 TDCi	07/10→09/14	Diesel	KNBA	2179	4	85.00	96.00	81
Mondeo IV 2.2 TDCi	03/08→10/10	Diesel	Q4BA	2179	4	85.00	96.00	81
Mondeo V 1.6 TDCi	09/14→	Diesel	NGCA	1560	4	75.00	88.30	21
Mondeo V 1.6 TDCi	09/14→	Diesel	U3CA	1560	4	75.00	88.30	21
Mondeo V 2.0 TDCi	09/14→	Diesel	T7CE	1998	4	85.00	88.00	80
Mondeo V 2.0 TDCi	09/14→	Diesel	T8CC	1998	4	85.00	88.00	80
Mondeo V 2.0 TDCi 4x4	02/15→	Diesel	T7CE	1998	4	85.00	88.00	80
Mondeo V 2.0 TDCi 4x4	02/15→	Diesel	T8CC	1998	4	85.00	88.00	80
Mondeo V 2.0 TDCi Bi-Turbo	03/15→	Diesel	T9CA	1998	4	86.00	94.60	92
Morgan Series III	01/60→12/61	Petrol	105E, 107E,307E	997	4	80.95	48.42	54
Morgan Series III 4/4	01/60→12/61	Petrol	105E, 107E,307E	997	4	80.95	48.42	54
Morgan Series IV	01/62→12/63	Petrol	109E	1340	4	80.95	65.09	55
Morgan Series IV 4/4	01/62→12/63	Petrol	109E	1340	4	80.95	65.09	55
Morgan Series V	01/63→12/67	Petrol	116E, 120E, 122E	1499	4	80.95	72.62	56
Morgan Series V 4/4	01/63→12/67	Petrol	116E, 120E, 122E	1499	4	80.95	72.62	56
Orion I 1.3	07/83→03/86	Petrol	JPA	1296	4	80.00	64.50	46
Orion I 1.6	07/83→03/86	Petrol	LP1	1597	4	80.00	79.50	49



cm3



Orion I 1.6	07/83→03/86	Petrol	LPA	1597	4	80.00	79.50	49
Orion I 1.6 D	02/84→03/86	Diesel	LTA	1608	4	80.00	80.00	50
Orion I 1.6 i	07/83→03/86	Petrol	LR1	1597	4	80.00	79.50	49
Orion I 1.6 i	07/83→03/86	Petrol	LRA	1597	4	80.00	79.50	49
Orion II 1.3	11/86→07/88	Petrol	JPA	1296	4	80.00	64.50	46
Orion II 1.3	12/85→07/90	Petrol	JBB	1297	4	73.96	75.48	12
Orion II 1.3	12/85→07/90	Petrol	JLA	1297	4	73.96	75.48	13
Orion II 1.3	12/85→07/90	Petrol	JLB	1297	4	73.96	75.48	12
Orion II 1.4	12/85→07/90	Petrol	FUA	1392	4	77.25	74.30	29
Orion II 1.4	03/86→07/90	Petrol	FUAA	1392	4	77.25	74.30	29
Orion II 1.4	01/86→07/90	Petrol	FUC	1392	4	77.25	74.30	29
Orion II 1.4 CAT	02/87→07/90	Petrol	F6B	1392	4	77.25	74.30	29
Orion II 1.4 CAT	02/87→07/90	Petrol	F6D	1392	4	77.25	74.30	29
Orion II 1.6	04/86→12/88	Petrol	LP2	1597	4	80.00	79.50	47
Orion II 1.6	12/85→07/90	Petrol	LUC	1597	4	80.00	79.50	47
Orion II 1.6	03/86→08/90	Petrol	LUG	1597	4	80.00	79.50	47
Orion II 1.6 D	12/85→01/89	Diesel	LTC	1608	4	80.00	80.00	50
Orion II 1.6 i	08/89→07/90	Petrol	LJB	1597	4	80.00	79.50	47
Orion II 1.6 i	03/86→07/90	Petrol	LRB	1597	4	80.00	79.50	47
Orion II 1.6 i CAT	03/86→07/90	Petrol	L4B	1598	4	80.00	79.50	47
Orion II 1.8 D	01/89→07/90	Diesel	RTA	1753	4	82.50	82.00	73
Orion II 1.8 D	01/89→07/90	Diesel	RTB	1753	4	82.50	82.00	73
Orion III 1.3	07/90→12/93	Petrol	J4B	1299	4	74.00	75.50	19
Orion III 1.3	07/90→12/93	Petrol	J6A	1299	4	74.00	75.50	19
Orion III 1.4	07/90→12/93	Petrol	F6F	1392	4	77.25	74.30	28
Orion III 1.4	07/90→12/93	Petrol	F6G	1392	4	77.25	74.30	28
Orion III 1.4	07/90→12/93	Petrol	FUH	1392	4	77.25	74.30	28
Orion III 1.6	07/90→12/92	Petrol	LUJ	1598	4	80.00	79.50	48
Orion III 1.6	07/90→12/92	Petrol	LUK	1598	4	80.00	79.50	48
Orion III 1.6 i	07/90→09/92	Petrol	LJF	1598	4	79.96	79.52	43
Orion III 1.6 i 16V	07/92→12/93	Petrol	L1E	1597	4	76.00	88.00	25
Orion III 1.6 i 16V	07/92→12/93	Petrol	L1K	1597	4	76.00	88.00	25
Orion III 1.8 D	11/90→12/93	Diesel	RTE	1753	4	82.50	82.00	73
Orion III 1.8 D	11/90→12/93	Diesel	RTF	1753	4	82.50	82.00	73
Orion III 1.8 D	11/90→12/93	Diesel	RTH	1753	4	82.50	82.00	73
Orion III 1.8 i 16V	02/92→12/93	Petrol	RDA	1796	4	80.60	88.00	53
Orion III 1.8 i 16V	01/92→12/93	Petrol	RQB	1796	4	80.60	88.00	53
Orion III 1.8 TD	03/92→12/93	Diesel	RFD	1753	4	82.50	82.00	71
Orion III 1.8 TD	03/92→12/93	Diesel	RFK	1753	4	82.50	82.00	71
P 100 I 1.6	04/82→09/87	Petrol	LCR	1598	4	87.65	66.00	97
P 100 II 1.8 TD	10/87→12/92	Diesel	RFA	1753	4	82.50	82.00	71
P 100 II 2.0	10/87→12/92	Petrol	NAE	1993	4	90.80	76.90	110
Prefect	01/60→12/68	Petrol	105E, 107E,307E	997	4	80.95	48.42	54
Prefect 1.0	01/60→12/68	Petrol	105E, 107E,307E	997	4	80.95	48.42	54
Puma 1.4 16V	11/97→10/00	Petrol	FHD	1388	4	76.00	76.50	23
Puma 1.4 16V	11/97→10/00	Petrol	FHF	1388	4	76.00	76.50	23
Puma 1.6 16V	08/00→06/02	Petrol	L1W	1596	4	79.00	81.40	34
Puma 1.7 16V	03/97→06/02	Petrol	MHA	1679	4	80.00	83.50	51
Puma 1.7 16V	03/97→06/02	Petrol	MHB	1679	4	80.00	83.50	51
Ranger 1.8	06/99→02/02	Petrol	RKA	1796	4	80.60	88.00	53
Ranger 2.2	01/09→07/12	Petrol	F2Y4	2184	4	86.00	94.00	88
Ranger 2.2 TDCi	04/11→	Diesel	GBVAJPF	2198	4	86.00	94.60	90
Ranger 2.2 TDCi	11/11→	Diesel	GBVAJQJ	2198	4	86.00	94.60	90
Ranger 2.2 TDCi	04/11→	Diesel	GBVAJQW	2198	4	86.00	94.60	90
Ranger 2.2 TDCi 4x4	04/11→	Diesel	GBVAJQJ	2198	4	86.00	94.60	90
Ranger 2.2 TDCi 4x4	04/11→	Diesel	GBVAJQW	2198	4	86.00	94.60	90
Sapphire Cosworth	07/86→04/93	Petrol	CH20	1993	4	90.80	76.90	109
Sapphire Cosworth 2.0 16V 4WD	07/86→04/93	Petrol	CH20	1993	4	90.80	76.90	109
Scorpio	01/86→12/94	Petrol	TV24	2394	V6	84.00	72.00	77
Scorpio 2.4 EFI	01/86→12/94	Petrol	TV24	2394	V6	84.00	72.00	77
Scorpio I 1.8	04/85→02/92	Petrol	REC	1796	4	86.20	77.00	93
Scorpio I 1.9	11/92→09/93	Petrol	NRA	1993	4	90.80	76.90	111
Scorpio I 2.0	04/85→08/89	Petrol	N8D	1993	4	86.00	86.00	84
Scorpio I 2.0	04/85→08/89	Petrol	NEL	1993	4	90.80	76.90	108
Scorpio I 2.0	11/88→10/92	Petrol	N8A	1998	4	86.00	86.00	84
Scorpio I 2.0	06/89→03/93	Petrol	N8B	1998	4	86.00	86.00	83
Scorpio I 2.0 i	04/85→09/94	Petrol	NRA	1993	4	90.80	76.90	111
Scorpio I 2.0 i	10/85→12/90	Petrol	NRC	1993	4	90.80	76.90	111
Scorpio I 2.0 i	04/85→09/94	Petrol	NRI	1993	4	90.80	76.90	111









				cm3	x 			
Scorpio I 2.0 i	10/90→10/92	Petrol	N9A	1998	4	86.00	86.00	84
Scorpio I 2.0 i	05/89→02/92	Petrol	N9B	1998	4	86.00	86.00	84
Scorpio I 2.0 i	05/89→09/94	Petrol	N9D	1998	4	86.00	86.00	83
Scorpio I 2.0 i	09/91→09/94	Petrol	N9F	1998	4	86.00	86.00	83
Scorpio I 2.4 i	09/86→09/88	Petrol	ARC	2394	V6	84.00	72.00	77
Scorpio I 2.4 i	10/88→10/94	Petrol	ARD	2394	V6	84.00	72.00	77
Scorpio I 2.4 i CAT	10/88→09/94	Petrol	ARD	2394	V6	84.00	72.00	77
Scorpio I 2.5 D	12/85→12/94	Diesel	STR	2498	4	94.00	90.00	128
Scorpio I 2.5 TD	06/88→07/93	Diesel	SFA	2498	4	94.00	90.00	128
Scorpio I 2.5 TD	06/88→07/93	Diesel	SFB	2498	4	94.00	90.00	128
Scorpio I 2.5 TD	08/93→09/94	Diesel	SCB	2500	4	92.00	94.00	118
Scorpio I 2.8 i	04/85→11/86	Petrol	PRE	2792	V6	93.00	68.50	119
Scorpio I 2.8 i 4x4	10/85→11/86	Petrol	PRE	2792	V6	93.00	68.50	119
Scorpio I 2.9 24V	08/93→09/94	Petrol	BOA	2933	V6	93.00	72.00	120
Scorpio I 2.9 i	09/86→09/94	Petrol	BRC	2933	V6	93.00	72.00	120
Scorpio I 2.9 i	09/86→12/94	Petrol	BRD	2933	V6	93.00	72.00	120
Scorpio I 2.9 i	09/86→12/94	Petrol	BRE	2933	V6	93.00	72.00	120
Scorpio I 2.9 i	09/86→12/94	Petrol	BRF	2933	V6	93.00	72.00	120
Scorpio I 2.9 i 4x4	09/86→09/94	Petrol	BRC	2933	V6	93.00	72.00	120
Scorpio I 2.9 i 4x4	05/88→10/94	Petrol	BRD	2933	V6	93.00	72.00	120
Scorpio I 2.9 i 4x4	05/88→10/94	Petrol	BRE	2933	V6	93.00	72.00	120
Scorpio I 2.9 i 4x4	05/88→10/94	Petrol	BRF	2933	V6	93.00	72.00	120
Scorpio I 2.9 i 24V	04/91→09/94	Petrol	BOA	2933	V6	93.00	72.00	120
Scorpio I 2.9 i CAT	10/87→09/94	Petrol	BRE	2933	V6	93.00	72.00	120
Scorpio II 2.0 i	10/94→08/98	Petrol	NSD	1998	4	86.00	86.00	82
Scorpio II 2.0 i 16V	10/94→08/98	Petrol	N3A	1998	4	86.00	86.00	82
Scorpio II 2.3 i 16V	06/96→08/98	Petrol	Y5A	2295	4	89.60	91.00	100
Scorpio II 2.5 TD	10/94→08/98	Diesel	SCC	2500	4	92.00	94.00	118
Scorpio II 2.5 TD	09/96→08/98	Diesel	VM	2500	4	92.00	94.00	118
Scorpio II 2.9 i	02/95→08/98	Petrol	BRG	2933	V6	93.00	72.00	120
Scorpio II 2.9 i 24V	10/94→08/98	Petrol	BOB	2933	V6	93.00	72.00	120
Sierra 1.3	08/82→12/86	Petrol	JCT	1294	4	79.00	66.00	33
Sierra 1.6	08/82→12/86	Petrol	LCS	1593	4	87.65	66.00	97
Sierra 1.6	08/82→12/86	Petrol	LCT	1593	4	87.65	66.00	97
Sierra 1.6	08/82→12/86	Petrol	LSD	1597	4	81.32	76.95	69
Sierra 1.6	01/87→02/93	Petrol	LSE	1597	4	81.32	76.95	70
Sierra 1.6	01/88→02/93	Petrol	LSF	1597	4	81.32	76.90	68
Sierra 1.6 i	10/89→02/93	Petrol	L6B	1598	4	80.00	79.50	48
Sierra 1.8	05/88→02/93	Petrol	R2C	1769	4	80.00	88.00	52
Sierra 1.8	05/88→02/93	Petrol	R6A	1769	4	80.00	88.00	52
Sierra 1.8	01/87→05/88	Petrol	R2A	1796	4	86.20	77.00	93
Sierra 1.8	10/84→12/86	Petrol	REB	1796	4	86.20	77.00	93
Sierra 1.8	01/87→09/89	Petrol	RED	1796	4	86.20	77.00	93
Sierra 1.8	10/87→09/89	Petrol	REF	1796	4	86.20	77.00	93
Sierra 1.8 TD	08/88→02/93	Diesel	RFA	1753	4	82.50	82.00	71
Sierra 1.8 TD	08/88→02/93	Diesel	RFB	1753	4	82.50	82.00	71
Sierra 1.8 TD	08/88→02/93	Diesel	RFL	1753	4	82.50	82.00	71
Sierra 1.9	10/88→09/91	Petrol	N8A	1998	4	86.00	86.00	84
Sierra 2.0	01/87→02/93	Petrol	N8C	1993	4	86.00	86.00	84
Sierra 2.0	01/87→02/93	Petrol	NES	1993	4	90.80	76.90	110
Sierra 2.0	08/82→12/86	Petrol	NET	1993	4	90.80	76.90	108
Sierra 2.0	03/85→12/86	Petrol	NR2	1993	4	90.80	76.90	112
Sierra 2.0	03/85→12/86	Petrol	NRB	1993	4	90.80	76.90	112
Sierra 2.0	10/85→12/86	Petrol	NRD	1993	4	90.80	76.90	112
Sierra 2.0 16V Cosworth 4WD	07/86→04/93	Petrol	CH20	1993	4	90.80	76.90	109
Sierra 2.0	07/89→12/92	Petrol	N8A	1998	4	86.00	86.00	84
Sierra 2.0 4x4	05/89→03/93	Petrol	N9C	1998	4	86.00	86.00	83
Sierra 2.0 i	01/87→02/93	Petrol	N4A	1993	4	90.80	76.90	110
Sierra 2.0 i	01/87→02/93	Petrol	N4I	1993	4	90.80	76.90	111
Sierra 2.0 i	01/87→02/93	Petrol	NE5	1993	4	90.80	76.90	110
Sierra 2.0 i	01/87→02/93	Petrol	NEJ	1993	4	90.80	76.90	110
Sierra 2.0 i	03/85→12/86	Petrol	NR2	1993	4	90.80	76.90	112
Sierra 2.0 i	03/85→12/86	Petrol	NRB	1993	4	90.80	76.90	112
Sierra 2.0 i	06/89→02/93	Petrol	N8A	1998	4	86.00	86.00	84
Sierra 2.0 i	01/90→02/93	Petrol	N9A	1998	4	86.00	86.00	84
Sierra 2.0 i	06/89→02/93	Petrol	N9B	1998	4	86.00	86.00	84
Sierra 2.0 i	05/89→02/93	Petrol	N9C	1998	4	86.00	86.00	83
Sierra 2.0 i CAT	01/87→02/93	Petrol	N4B	1993	4	90.80	76.90	110
Sierra 2.0 i DOHC	12/91→02/93	Petrol	N9E	1998	4	86.00	86.00	83



cm3



Sierra 2.3	08/82→12/86	Petrol	YYT	2294	V6	90.00	60.10	104
Sierra 2.3 D	01/87→02/93	Diesel	YTR	2304	4	94.00	83.00	126
Sierra 2.3 D	08/82→09/89	Diesel	YTT	2304	4	94.00	83.00	126
Sierra 2.8 4x4	01/87→08/88	Petrol	PRG	2792	V6	93.00	68.50	119
Sierra 2.8 i	01/87→02/93	Petrol	PR7	2792	V6	93.00	68.50	119
Sierra 2.8 i	01/87→02/93	Petrol	PR8	2792	V6	93.00	68.50	119
Sierra 2.8 i 4x4	08/82→12/86	Petrol	PR6	2792	V6	93.00	68.50	119
Sierra 2.8 i 4x4	01/87→02/93	Petrol	PR7	2792	V6	93.00	68.50	119
Sierra 2.8 i XR 4x4	09/83→12/86	Petrol	PR5	2792	V6	93.00	68.50	119
Sierra 2.8 i XR 4x4	09/83→12/86	Petrol	PR6	2792	V6	93.00	68.50	119
Sierra 2.8 i XR 4x4	01/87→02/93	Petrol	PR7	2792	V6	93.00	68.50	119
Sierra 2.8 i XR 4x4	01/87→08/88	Petrol	PRG	2792	V6	93.00	68.50	119
Sierra 2.8 XR4i	08/82→12/86	Petrol	PR5	2792	V6	93.00	68.50	119
Sierra 2.8 XR4i	08/82→12/86	Petrol	PR6	2792	V6	93.00	68.50	119
Sierra 2.8 XR4i	08/82→12/86	Petrol	PRT	2792	V6	93.00	68.50	119
Sierra 2.8 XR 4x4	02/85→12/86	Petrol	PRT	2792	V6	93.00	68.50	119
Sierra 2.9	08/88→02/93	Petrol	B4B	2936	V6	93.00	72.00	120
Sierra 2.9	08/88→02/93	Petrol	B4C	2936	V6	93.00	72.00	120
Sierra 2.9 4x4	08/88→02/93	Petrol	B4B	2936	V6	93.00	72.00	120
Sierra 2.9 4x4	08/88→02/93	Petrol	B4C	2936	V6	93.00	72.00	120
Sierra 2.9 i	08/88→02/93	Petrol	B4B	2936	V6	93.00	72.00	120
Sierra 2.9 i	08/88→02/93	Petrol	B4C	2936	V6	93.00	72.00	120
Sierra 2.9 i XR 4x4	08/88→02/93	Petrol	B4A	2936	V6	93.00	72.00	120
Sierra 2.9 i XR 4x4	08/88→02/93	Petrol	B4B	2936	V6	93.00	72.00	120
Sierra 2.9 i XR 4x4	08/88→02/93	Petrol	B4C	2936	V6	93.00	72.00	120
Sierra Cosworth	07/86→04/93	Petrol	CH20	1993	4	90.80	76.90	109
S-Max 1.6 TDCi	02/11→	Diesel	T1WA	1560	4	75.00	88.30	21
S-Max 1.6 TDCi	02/11→	Diesel	T1WB	1560	4	75.00	88.30	21
S-Max 1.8 TDCi	01/07→	Diesel	FFWA	1753	4	82.50	82.00	71
S-Max 1.8 TDCi	05/06→	Diesel	QYWA	1753	4	82.50	82.00	72
S-Max 2.0 TDCi	05/06→	Diesel	AZWA	1997	4	85.00	88.00	80
S-Max 2.0 TDCi	05/06→	Diesel	AZWC	1997	4	85.00	88.00	80
S-Max 2.0 TDCi	11/07→	Diesel	KLWA	1997	4	85.00	88.00	80
S-Max 2.0 TDCi	05/06→	Diesel	QXWA	1997	4	85.00	88.00	80
S-Max 2.0 TDCi	05/06→	Diesel	QXWB	1997	4	85.00	88.00	80
S-Max 2.0 TDCi	05/06→	Diesel	QXWC	1997	4	85.00	88.00	80
S-Max 2.0 TDCi	02/15→	Diesel	T7CI	1997	4	85.00	88.00	80
S-Max 2.0 TDCi	02/15→	Diesel	T7CJ	1997	4	85.00	88.00	80
S-Max 2.0 TDCi	02/15→	Diesel	T7CK	1997	4	85.00	88.00	80
S-Max 2.0 TDCi	02/15→	Diesel	T7CL	1997	4	85.00	88.00	80
S-Max 2.0 TDCi	02/15→	Diesel	T8CG	1997	4	85.00	88.00	80
S-Max 2.0 TDCi	02/15→	Diesel	T8CH	1997	4	85.00	88.00	80
S-Max 2.0 TDCi	02/15→	Diesel	T8CI	1997	4	85.00	88.00	80
S-Max 2.0 TDCi	02/15→	Diesel	T8CJ	1997	4	85.00	88.00	80
S-Max 2.0 TDCi	03/10→	Diesel	TXWA	1997	4	85.00	88.00	80
S-Max 2.0 TDCi	11/07→	Diesel	TYWA	1997	4	85.00	88.00	80
S-Max 2.0 TDCi	02/15→	Diesel	UFCA	1997	4	85.00	88.00	80
S-Max 2.0 TDCi	02/15→	Diesel	UFCB	1997	4	85.00	88.00	80
S-Max 2.0 TDCi	05/06→	Diesel	UFWA	1997	4	85.00	88.00	80
S-Max 2.0 TDCi	05/06→	Diesel	UKWA	1997	4	85.00	88.00	80
S-Max 2.0 TDCi 4x4	02/15→	Diesel	T7CI	1997	4	85.00	88.00	80
S-Max 2.0 TDCi 4x4	02/15→	Diesel	T7CJ	1997	4	85.00	88.00	80
S-Max 2.0 TDCi 4x4	02/15→	Diesel	T7CK	1997	4	85.00	88.00	80
S-Max 2.0 TDCi 4x4	02/15→	Diesel	T7CL	1997	4	85.00	88.00	80
S-Max 2.0 TDCi 4x4	02/15→	Diesel	T8CG	1997	4	85.00	88.00	80
S-Max 2.0 TDCi 4x4	02/15→	Diesel	T8CH	1997	4	85.00	88.00	80
S-Max 2.0 TDCi 4x4	02/15→	Diesel	T8CI	1997	4	85.00	88.00	80
S-Max 2.0 TDCi 4x4	02/15→	Diesel	T8CJ	1997	4	85.00	88.00	80
S-Max 2.0 TDCi BI-Turbo	02/15→	Diesel	T9CB	1997	4	85.00	88.00	80
S-Max 2.0 TDCi BI-Turbo	02/15→	Diesel	T9CC	1997	4	85.00	88.00	80
S-Max 2.2 TDCi	03/08→	Diesel	Q4WA	2179	4	85.00	96.00	81
Taurus 1.3	05/75→07/79	Petrol	JAC	1297	4	74.00	75.50	20
Taurus 1.5	09/66→07/71	Petrol	TV 15 H	1498	V4	90.00	59.00	103
Taurus 1.5	08/66→06/71	Petrol	TV 15 HC	1498	V4	90.00	59.00	103
Taurus 1.6	05/75→07/79	Petrol	LAD	1593	4	87.65	66.00	98
Taurus 1.6	07/79→07/82	Petrol	LAR	1593	4	87.65	66.00	98
Taurus 1.6	05/75→07/82	Petrol	LCJ	1593	4	87.65	66.00	98
Taurus 1.6	08/76→07/79	Petrol	LE	1593	4	87.65	66.00	98
Taurus 1.7	01/68→06/71	Petrol	TV 17 H	1699	V4	90.00	66.80	106

				cm3	x 			
Taurus 1.7	07/68→06/71	Petrol	TV 17 HC	1699	V4	90.00	66.80	106
Taurus 2.0	08/76→07/79	Petrol	NEG	1993	4	90.80	76.90	113
Taurus 2.0	07/79→07/82	Petrol	NER	1993	4	90.80	76.90	112
Taurus 2.0	08/76→07/79	Petrol	OHC TL 20 H	1993	4	90.80	76.90	112
Taurus 2.0	12/75→07/76	Petrol	OHC LC	1994	4	90.80	76.90	112
Taurus 2.3	05/75→07/79	Petrol	YYF	2294	V6	90.00	60.10	104
Taurus 2.3	07/79→07/82	Petrol	YYR	2294	V6	90.00	60.10	104
Taurus 2.5	10/69→04/74	Petrol	TV 26 H	2523	V6	90.00	66.10	105
Taurus 2.6	09/67→08/71	Petrol	TV 26 H	2523	V6	90.00	66.10	105
Taurus 1300	01/70→05/75	Petrol	JAC	1297	4	74.00	75.50	20
Taurus 1600	01/74→05/75	Petrol	LAD	1593	4	87.65	66.00	98
Taurus 1600	01/70→02/76	Petrol	LCJ	1593	4	87.65	66.00	98
Taurus 2000	08/73→02/76	Petrol	NEE	1993	4	90.80	76.90	113
Taurus 2000	08/73→02/76	Petrol	NEG	1993	4	90.80	76.90	113
Taurus 12M 1.3	08/66→06/71	Petrol	KL 13 L	1298	4	81.00	63.00	63
Taurus 12M 1.5	08/66→06/71	Petrol	TV 15 H	1498	V4	90.00	59.00	103
Taurus 15M 1.5	08/66→06/71	Petrol	TV 15 H	1498	V4	90.00	59.00	103
Taurus 15M 1.5 XL/RS	01/68→06/71	Petrol	TV 15 H	1498	V4	90.00	59.00	103
Taurus 15M 1.5 XL/RS	08/66→06/71	Petrol	TV 15 HC	1498	V4	90.00	59.00	103
Taurus 15M 1.7 XL/RS	01/68→06/71	Petrol	TV 17 H	1699	V4	90.00	66.80	106
Taurus 15M 1.7 XL/RS	07/68→06/71	Petrol	TV 17 HC	1699	V4	90.00	66.80	106
Taurus 20M 2.6	09/67→08/71	Petrol	TV 26 H	2523	V6	90.00	66.10	105
Taurus '80 1.3	07/79→07/82	Petrol	JCC	1294	4	79.00	66.00	32
Taurus '80 1.6	07/79→07/82	Petrol	LAR	1593	4	87.65	66.00	98
Taurus '80 1.6	07/79→07/82	Petrol	LCJ	1593	4	87.65	66.00	98
Taurus '80 1.6	07/79→07/82	Petrol	LE	1593	4	87.65	66.00	98
Taurus '80 2.0	07/79→07/82	Petrol	NER	1993	4	90.80	76.90	112
Taurus '80 2.3	07/79→07/82	Petrol	YYR	2294	V6	90.00	60.10	104
Thames	01/60→12/68	Petrol	105E, 107E,307E	997	4	80.95	48.42	54
Thames 5-7Cwt Van	01/60→12/68	Petrol	105E, 107E,307E	997	4	80.95	48.42	54
Tourneo 1.6 TDCi	02/14→	Diesel	T3CA	1560	4	75.00	88.30	21
Tourneo 1.6 TDCi	02/14→	Diesel	T3CB	1560	4	75.00	88.30	21
Tourneo 1.6 TDCi	02/14→	Diesel	T3CC	1560	4	75.00	88.30	21
Tourneo 1.8 16V	06/02→12/13	Petrol	EYPA	1796	4	80.60	88.00	53
Tourneo 1.8 16V	06/02→12/13	Petrol	EYPC	1796	4	80.60	88.00	53
Tourneo 1.8 16V	06/02→12/13	Petrol	EYPD	1796	4	80.60	88.00	53
Tourneo 1.8 TDCi	06/02→12/13	Diesel	HCPA	1753	4	82.50	82.00	72
Tourneo 1.8 TDCi	06/02→12/13	Diesel	HCPB	1753	4	82.50	82.00	72
Tourneo 1.8 TDCi	06/02→12/13	Diesel	P9PA	1753	4	82.50	82.00	72
Tourneo 1.8 TDCi	06/02→12/13	Diesel	P9PB	1753	4	82.50	82.00	72
Tourneo 1.8 TDCi	06/02→12/13	Diesel	P9PC	1753	4	82.50	82.00	72
Tourneo 1.8 TDCi	06/02→12/13	Diesel	P9PD	1753	4	82.50	82.00	72
Tourneo 1.8 TDCi	06/02→12/13	Diesel	R3PA	1753	4	82.50	82.00	72
Tourneo 1.8 TDCi	08/06→12/13	Diesel	RWPA	1753	4	82.50	82.00	72
Tourneo 1.8 TDCi	08/06→12/13	Diesel	RWPC	1753	4	82.50	82.00	72
Tourneo 1.8 TDCi	08/06→12/13	Diesel	RWPD	1753	4	82.50	82.00	72
Tourneo 1.8 TDCi	06/02→12/13	Diesel	RWPE	1753	4	82.50	82.00	72
Tourneo 1.8 TDCi	06/02→12/13	Diesel	RWPF	1753	4	82.50	82.00	72
Tourneo 1.8 TDCi /TDDi /DI	06/02→12/13	Diesel	BHPA	1753	4	82.50	82.00	71
Tourneo 1.8 TDCi /TDDi /DI	06/02→12/13	Diesel	P7PA	1753	4	82.50	82.00	72
Tourneo 1.8 TDCi /TDDi /DI	06/02→12/13	Diesel	P7PB	1753	4	82.50	82.00	72
Tourneo 1.8 TDCi /TDDi /DI	06/02→12/13	Diesel	R2PA	1753	4	82.50	82.00	72
Tourneo Custom 2.2 TDCi	04/12→	Diesel	CVFF	2198	4	86.00	94.60	89
Tourneo Custom 2.2 TDCi	04/12→	Diesel	CYF4	2198	4	86.00	94.60	89
Tourneo Custom 2.2 TDCi	04/12→	Diesel	CYFF	2198	4	86.00	94.60	89
Tourneo Custom 2.2 TDCi	04/12→	Diesel	DRF4	2198	4	86.00	94.60	89
Tourneo Custom 2.2 TDCi	04/12→	Diesel	DRFF	2198	4	86.00	94.60	89
Tourneo Custom 2.2 TDCi	04/12→	Diesel	DRFG	2198	4	86.00	94.60	89
Transit	09/99→	Diesel	DT24N Duratorq	2402	4	89.90	94.60	101
Transit 1.6	11/77→10/86	Petrol	4RB	1593	4	87.65	66.00	97
Transit 1.6	11/77→10/86	Petrol	B	1593	4	87.65	66.00	97
Transit 1.6	09/85→09/92	Petrol	LAT	1593	4	87.65	66.00	99
Transit 1.6 TDCi	02/14→	Diesel	T3CA	1560	4	75.00	88.30	21
Transit 1.6 TDCi	02/14→	Diesel	T3CB	1560	4	75.00	88.30	21
Transit 1.6 TDCi	02/14→	Diesel	T3CC	1560	4	75.00	88.30	21
Transit 1.7 FT 100	04/71→03/78	Petrol	EY	1699	4	90.00	66.80	106
Transit 1.8 16V	06/02→12/13	Petrol	EYPA	1796	4	80.60	88.00	53
Transit 1.8 16V	06/02→12/13	Petrol	EYPC	1796	4	80.60	88.00	53
Transit 1.8 16V	06/02→12/13	Petrol	EYPD	1796	4	80.60	88.00	53



cm3



Transit 1.8 16V LPG	06/02→12/13	Petrol	EYPC	1796	4	80.60	88.00	53
Transit 1.8 Di	06/02→12/13	Diesel	BHPA	1753	4	82.50	82.00	71
Transit 1.8 Di	06/02→12/13	Diesel	P7PA	1753	4	82.50	82.00	72
Transit 1.8 Di	06/02→12/13	Diesel	P7PB	1753	4	82.50	82.00	72
Transit 1.8 Di	06/02→12/13	Diesel	R2PA	1753	4	82.50	82.00	72
Transit 1.8 TDCi	06/02→12/13	Diesel	HCPA	1753	4	82.50	82.00	72
Transit 1.8 TDCi	06/02→12/13	Diesel	HCPB	1753	4	82.50	82.00	72
Transit 1.8 TDCi	06/02→12/13	Diesel	P9PA	1753	4	82.50	82.00	72
Transit 1.8 TDCi	06/02→12/13	Diesel	P9PB	1753	4	82.50	82.00	72
Transit 1.8 TDCi	06/02→12/13	Diesel	P9PC	1753	4	82.50	82.00	72
Transit 1.8 TDCi	06/02→12/13	Diesel	P9PD	1753	4	82.50	82.00	72
Transit 1.8 TDCi	06/02→12/13	Diesel	R3PA	1753	4	82.50	82.00	72
Transit 1.8 TDCi	08/06→12/13	Diesel	RWPA	1753	4	82.50	82.00	72
Transit 1.8 TDCi	08/06→12/13	Diesel	RWPC	1753	4	82.50	82.00	72
Transit 1.8 TDCi	08/06→12/13	Diesel	RWPD	1753	4	82.50	82.00	72
Transit 1.8 TDCi	06/02→12/13	Diesel	RWPE	1753	4	82.50	82.00	72
Transit 1.8 TDCi	06/02→12/13	Diesel	RWPF	1753	4	82.50	82.00	72
Transit 2.0	11/77→10/86	Petrol	4RC	1993	4	90.80	76.90	108
Transit 2.0	11/85→09/92	Petrol	N6T	1993	4	90.80	76.90	108
Transit 2.0	10/85→03/91	Petrol	N6TS	1993	4	90.80	76.90	108
Transit 2.0	10/85→03/91	Petrol	NAW	1993	4	90.80	76.90	108
Transit 2.0	04/91→09/94	Petrol	NBA	1993	4	90.80	76.90	110
Transit 2.0	09/85→09/92	Petrol	NAT	1994	4	90.80	76.90	108
Transit 2.0	09/85→09/92	Petrol	NAV	1994	4	90.80	76.90	108
Transit 2.0	09/91→08/94	Petrol	NCA	1994	4	90.80	76.90	110
Transit 2.0	06/94→03/06	Petrol	NSF	1998	4	86.00	86.00	82
Transit 2.0	06/94→03/00	Petrol	NSG	1998	4	86.00	86.00	82
Transit 2.0	11/94→12/00	Petrol	NSH	1998	4	86.00	86.00	84
Transit 2.0 CNG	06/94→03/00	Petrol	NSH	1998	4	86.00	86.00	84
Transit 2.0 DI	08/00→05/06	Diesel	ABFA	1998	4	86.00	86.00	85
Transit 2.0 DI	08/00→05/06	Diesel	D3FA	1998	4	86.00	86.00	85
Transit 2.0 DI	08/00→05/06	Diesel	F3FA	1998	4	86.00	86.00	85
Transit 2.0 i	09/91→07/94	Petrol	NCA	1994	4	90.80	76.90	110
Transit 2.0 L	10/85→03/91	Petrol	NAW	1993	4	90.80	76.90	108
Transit 2.0 L	10/85→03/91	Petrol	NAX	1993	4	90.80	76.90	108
Transit 2.0 TDCi	08/02→05/06	Diesel	FIFA	1998	4	86.00	86.00	85
Transit 2.2 TDCi	08/13→	Diesel	CVF5	2198	4	86.00	94.60	89
Transit 2.2 TDCi	04/12→	Diesel	CVFF	2198	4	86.00	94.60	89
Transit 2.2 TDCi	08/13→	Diesel	CY14	2198	4	86.00	94.60	89
Transit 2.2 TDCi	04/12→	Diesel	CYF4	2198	4	86.00	94.60	89
Transit 2.2 TDCi	08/13→	Diesel	CYF5	2198	4	86.00	94.60	89
Transit 2.2 TDCi	10/11→08/14	Diesel	CYFA	2198	4	86.00	94.60	89
Transit 2.2 TDCi	10/11→08/14	Diesel	CYFB	2198	4	86.00	94.60	89
Transit 2.2 TDCi	10/11→08/14	Diesel	CYFC	2198	4	86.00	94.60	89
Transit 2.2 TDCi	10/11→08/14	Diesel	CYFD	2198	4	86.00	94.60	89
Transit 2.2 TDCi	04/12→	Diesel	CYFF	2198	4	86.00	94.60	89
Transit 2.2 TDCi	08/13→	Diesel	CYFG	2198	4	86.00	94.60	89
Transit 2.2 TDCi	04/12→	Diesel	DRF4	2198	4	86.00	94.60	89
Transit 2.2 TDCi	08/13→	Diesel	DRF5	2198	4	86.00	94.60	89
Transit 2.2 TDCi	10/11→08/14	Diesel	DRFA	2198	4	86.00	94.60	89
Transit 2.2 TDCi	10/11→08/14	Diesel	DRFB	2198	4	86.00	94.60	89
Transit 2.2 TDCi	10/11→08/14	Diesel	DRFC	2198	4	86.00	94.60	89
Transit 2.2 TDCi	10/11→08/14	Diesel	DRFD	2198	4	86.00	94.60	89
Transit 2.2 TDCi	10/11→08/14	Diesel	DRFE	2198	4	86.00	94.60	89
Transit 2.2 TDCi	04/12→	Diesel	DRFF	2198	4	86.00	94.60	89
Transit 2.2 TDCi	04/12→	Diesel	DRFG	2198	4	86.00	94.60	89
Transit 2.2 TDCi	04/06→08/14	Diesel	P8FA	2198	4	86.00	94.60	89
Transit 2.2 TDCi	04/06→08/14	Diesel	P8FB	2198	4	86.00	94.60	89
Transit 2.2 TDCi	10/07→08/14	Diesel	PGFA	2198	4	86.00	94.60	89
Transit 2.2 TDCi	10/07→08/14	Diesel	PGFB	2198	4	86.00	94.60	89
Transit 2.2 TDCi	04/06→08/14	Diesel	QVFA	2198	4	86.00	94.60	89
Transit 2.2 TDCi	04/06→08/14	Diesel	QWFA	2198	4	86.00	94.60	89
Transit 2.2 TDCi	10/08→08/14	Diesel	SRFA	2198	4	86.00	94.60	89
Transit 2.2 TDCi	10/08→08/14	Diesel	SRFB	2198	4	86.00	94.60	89
Transit 2.2 TDCi	10/08→08/14	Diesel	SRFC	2198	4	86.00	94.60	89
Transit 2.2 TDCi	10/08→08/14	Diesel	SRFD	2198	4	86.00	94.60	89
Transit 2.2 TDCi	10/08→08/14	Diesel	SRFE	2198	4	86.00	94.60	89
Transit 2.2 TDCi	10/07→08/14	Diesel	UHFA	2198	4	86.00	94.60	89
Transit 2.2 TDCi	10/07→08/14	Diesel	UHFB	2198	4	86.00	94.60	89

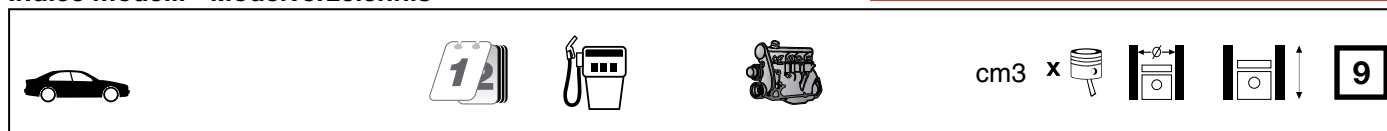







Transit 2.2 TDCi	10/07→08/14	Diesel	UHFC	2198	4	86.00	94.60	89
Transit 2.2 TDCi	08/13→	Diesel	USF6	2198	4	86.00	94.60	89
Transit 2.2 TDCi [RWD]	08/13→	Diesel	CV24	2198	4	86.00	94.60	89
Transit 2.2 TDCi [RWD]	08/13→	Diesel	CVR5	2198	4	86.00	94.60	89
Transit 2.2 TDCi [RWD]	10/11→08/14	Diesel	CVRA	2198	4	86.00	94.60	89
Transit 2.2 TDCi [RWD]	10/11→08/14	Diesel	CVRB	2198	4	86.00	94.60	89
Transit 2.2 TDCi [RWD]	10/11→08/14	Diesel	CVRC	2198	4	86.00	94.60	89
Transit 2.2 TDCi [RWD]	10/11→08/14	Diesel	CYRA	2198	4	86.00	94.60	90
Transit 2.2 TDCi [RWD]	10/11→08/14	Diesel	CYRB	2198	4	86.00	94.60	89
Transit 2.2 TDCi [RWD]	08/13→	Diesel	DRR5	2198	4	86.00	94.60	89
Transit 2.2 TDCi [RWD]	10/11→08/14	Diesel	DRRA	2198	4	86.00	94.60	89
Transit 2.2 TDCi [RWD]	10/11→08/14	Diesel	DRRB	2198	4	86.00	94.60	89
Transit 2.2 TDCi [RWD]	10/11→08/14	Diesel	DRRC	2198	4	86.00	94.60	89
Transit 2.2 TDCi [RWD]	08/13→	Diesel	UHR5	2198	4	86.00	94.60	89
Transit 2.2 TDCi [RWD]	08/13→	Diesel	USR6	2198	4	86.00	94.60	89
Transit 2.2 TDCi [RWD]	09/11→08/14	Diesel	USRA	2198	4	86.00	94.60	89
Transit 2.2 TDCi [RWD]	09/11→08/14	Diesel	USRB	2198	4	86.00	94.60	89
Transit 2.2 TDCi [RWD]	08/13→	Diesel	UYR6	2198	4	86.00	94.60	89
Transit 2.2 TDCi 4x4	08/13→	Diesel	CY24	2198	4	86.00	94.60	89
Transit 2.2 TDCi 4x4	08/13→	Diesel	CYR5	2198	4	86.00	94.60	89
Transit 2.2 TDCi 4x4	10/11→08/14	Diesel	CYRB	2198	4	86.00	94.60	89
Transit 2.2 TDCi 4x4	10/11→08/14	Diesel	CYRC	2198	4	86.00	94.60	89
Transit 2.3	08/00→03/06	Petrol	E5FA	2295	4	89.60	91.00	100
Transit 2.3	03/01→03/06	Petrol	E5FC	2295	4	89.60	91.00	100
Transit 2.3 16V	04/01→05/06	Petrol	E5FA	2295	4	89.60	91.00	100
Transit 2.3 16V	04/01→05/06	Petrol	E5FC	2295	4	89.60	91.00	100
Transit 2.3 16V [RWD]	04/06→08/14	Petrol	GZFA	2261	4	87.50	94.00	96
Transit 2.3 16V [RWD]	08/00→05/06	Petrol	E5FA	2295	4	89.60	91.00	100
Transit 2.3 16V [RWD]	08/00→05/06	Petrol	E5FC	2295	4	89.60	91.00	100
Transit 2.3 16V [RWD]	04/06→08/14	Petrol	GZFC	2295	4	89.60	91.00	100
Transit 2.3 16V CNG [RWD]	04/06→08/14	Petrol	GZFC	2295	4	89.60	91.00	100
Transit 2.3 16V LPG [RWD]	04/06→08/14	Petrol	GZFC	2295	4	89.60	91.00	100
Transit 2.4 D	11/77→10/86	Diesel	4AA	2358	4	93.67	85.60	125
Transit 2.4 D	08/94→06/00	Diesel	4HA	2496	4	93.64	90.54	124
Transit 2.4 DI	01/00→05/06	Diesel	D2FA	2402	4	89.90	94.60	101
Transit 2.4 DI	01/00→05/06	Diesel	D2FB	2402	4	89.90	94.60	101
Transit 2.4 DI	01/00→05/06	Diesel	D2FE	2402	4	89.90	94.60	101
Transit 2.4 DI	01/00→05/06	Diesel	D4FA	2402	4	89.90	94.60	101
Transit 2.4 DI	01/00→05/06	Diesel	F4FA	2402	4	89.90	94.60	101
Transit 2.4 DI [RWD]	01/00→05/06	Diesel	D4FA	2402	4	89.90	94.60	101
Transit 2.4 DI [RWD]	01/00→05/06	Diesel	F4FA	2402	4	89.90	94.60	101
Transit 2.4 TD	08/00→08/03	Diesel	F4FA	2402	4	89.90	94.60	101
Transit 2.4 TD All-wheel Drive	08/00→08/03	Diesel	F4FA	2402	4	89.90	94.60	101
Transit 2.4 TDCi	03/04→05/06	Diesel	H9FA	2402	4	89.90	94.60	102
Transit 2.4 TDCi	04/06→08/14	Diesel	H9FD	2402	4	89.90	94.60	102
Transit 2.4 TDCi	04/06→08/14	Diesel	JXFA	2402	4	89.90	94.60	102
Transit 2.4 TDCi	04/06→08/14	Diesel	JXFC	2402	4	89.90	94.60	102
Transit 2.4 TDCi	04/06→08/14	Diesel	PHFA	2402	4	89.90	94.60	102
Transit 2.4 TDCi	04/06→08/14	Diesel	PHFC	2402	4	89.90	94.60	102
Transit 2.4 TDCi [RWD]	04/06→08/14	Diesel	H9FB	2402	4	89.90	94.60	102
Transit 2.4 TDCi [RWD]	04/06→08/14	Diesel	H9FD	2402	4	89.90	94.60	102
Transit 2.4 TDCi [RWD]	04/06→08/14	Diesel	JXFA	2402	4	89.90	94.60	102
Transit 2.4 TDCi [RWD]	04/06→08/14	Diesel	JXFC	2402	4	89.90	94.60	102
Transit 2.4 TDCi [RWD]	04/06→08/14	Diesel	PHFA	2402	4	89.90	94.60	102
Transit 2.4 TDCi [RWD]	04/06→08/14	Diesel	PHFC	2402	4	89.90	94.60	102
Transit 2.4 TDCi 4x4	11/06→08/14	Diesel	H9FB	2402	4	89.90	94.60	102
Transit 2.4 TDDi	10/01→03/06	Diesel	D2FE	2402	4	89.90	94.60	101
Transit 2.4 TDDi	08/00→08/03	Diesel	D4FA	2402	4	89.90	94.60	101
Transit 2.4 TDE	07/01→05/06	Diesel	DOFA	2402	4	89.90	94.60	101
Transit 2.4 TDE	03/04→05/06	Diesel	FXFA	2402	4	89.90	94.60	101
Transit 2.5 D	10/83→09/92	Diesel	4AB	2496	4	93.64	90.54	122
Transit 2.5 D	09/88→09/92	Diesel	4BA	2496	4	93.64	90.54	122
Transit 2.5 D	09/88→09/92	Diesel	4CA	2496	4	93.64	90.54	122
Transit 2.5 DI	09/91→08/94	Diesel	4AB	2496	4	93.64	90.54	122
Transit 2.5 DI	09/88→09/92	Diesel	4BA	2496	4	93.64	90.54	122
Transit 2.5 DI	05/91→08/94	Diesel	4BC	2496	4	93.64	90.54	122
Transit 2.5 DI	09/88→09/92	Diesel	4CA	2496	4	93.64	90.54	122
Transit 2.5 DI	05/91→08/94	Diesel	4CC	2496	4	94.00	90.00	127
Transit 2.5 DI	05/91→08/94	Diesel	4DA	2496	4	93.64	90.54	122















cm3















Transit 2.5 DI	08/97→03/00	Diesel	4ED	2496	4	93.64	90.54	123
Transit 2.5 DI	05/91→12/00	Diesel	4FA	2496	4	94.00	90.00	127
Transit 2.5 DI	06/94→12/00	Diesel	4FB	2496	4	93.64	90.54	122
Transit 2.5 DI	06/94→12/00	Diesel	4FC	2496	4	93.64	90.54	122
Transit 2.5 DI	06/94→12/00	Diesel	4FD	2496	4	93.64	90.54	122
Transit 2.5 DI	10/92→06/94	Diesel	4GA	2496	4	93.64	90.54	123
Transit 2.5 DI	11/94→12/00	Diesel	4HA	2496	4	93.64	90.54	124
Transit 2.5 DI	06/94→12/00	Diesel	4HB	2496	4	93.64	90.54	122
Transit 2.5 DI	06/94→12/00	Diesel	4HC	2496	4	93.64	90.54	122
Transit 2.5 TD	05/91→08/94	Diesel	4EA	2496	4	93.64	90.54	123
Transit 2.5 TD	07/94→12/00	Diesel	4EB	2496	4	93.64	90.54	123
Transit 2.5 TD	07/94→12/00	Diesel	4EC	2496	4	93.64	90.54	123
Transit 2.5 TD	10/92→12/00	Diesel	4GA	2496	4	93.64	90.54	123
Transit 2.5 TD	10/92→12/00	Diesel	4GB	2496	4	93.64	90.54	123
Transit 2.5 TD	10/92→12/00	Diesel	4GC	2496	4	93.64	90.54	123
Transit 2.5 TD	06/94→03/00	Diesel	4GD	2496	4	93.64	90.54	123
Transit 2.5 TD	06/94→03/00	Diesel	4GE	2496	4	93.64	90.54	123
Transit 2.5 TD	06/94→03/00	Diesel	4GF	2496	4	93.64	90.54	123
Transit 2.5 TD	08/94→07/00	Diesel	4HA	2496	4	93.64	90.54	124
Transit 2.5 TD	08/94→07/00	Diesel	4HD	2496	4	93.64	90.54	124
Transit 2.5 TDI	06/94→03/00	Diesel	4EB	2496	4	93.64	90.54	123
Transit 2.5 TDI	06/94→03/00	Diesel	4EC	2496	4	93.64	90.54	123
Transit 2.9 i	01/91→09/94	Petrol	BRT	2935	V6	93.00	72.00	120
Transit Courier 1.6 TDCi	02/14→	Diesel	T3CA	1560	4	75.00	88.30	21
Transit Courier 1.6 TDCi	02/14→	Diesel	T3CB	1560	4	75.00	88.30	21
Transit Courier 1.6 TDCi	02/14→	Diesel	T3CC	1560	4	75.00	88.30	21
Transit Custom 2.2 TDCi	04/12→	Diesel	CVFF	2198	4	86.00	94.60	89
Transit TD	09/99→	Diesel	DT24N Duratorq	2402	4	89.90	94.60	101
Transit Custom 2.2 TDCi	04/12→	Diesel	CYF4	2198	4	86.00	94.60	89
Transit Custom 2.2 TDCi	04/12→	Diesel	CYFF	2198	4	86.00	94.60	89
Transit Custom 2.2 TDCi	04/12→	Diesel	DRF4	2198	4	86.00	94.60	89
Transit Custom 2.2 TDCi	04/12→	Diesel	DRFF	2198	4	86.00	94.60	89
Transit Custom 2.2 TDCi	04/12→	Diesel	DRFG	2198	4	86.00	94.60	89
Triton 2.4	11/95→07/99	Petrol	4G64	2350	4	86.50	100.00	94
Triton 2.5 D	06/86→12/96	Diesel	4D56 (8V)	2477	4	91.10	95.00	115
Triton 2.5 TD	01/95→12/97	Diesel	4D56 T	2477	4	91.10	95.00	116
Triton 2.6	11/94→05/97	Petrol	G54B	2555	4	91.10	98.00	117







		cm3	x 			
1Z	Diesel	1896	4	79.50	95.50	36
4AA	Diesel	2358	4	93.67	85.60	125
4AB	Diesel	2496	4	93.64	90.54	122
4BA	Diesel	2496	4	93.64	90.54	122
4BC	Diesel	2496	4	93.64	90.54	122
4CA	Diesel	2496	4	93.64	90.54	122
4CC	Diesel	2496	4	94.00	90.00	127
4 D 55 T	Diesel	2347	4	91.10	90.00	114
4D56 (8V)	Diesel	2477	4	91.10	95.00	115
4D56 T	Diesel	2477	4	91.10	95.00	116
4DA	Diesel	2496	4	93.64	90.54	122
4EA	Diesel	2496	4	93.64	90.54	123
4EB	Diesel	2496	4	93.64	90.54	123
4EC	Diesel	2496	4	93.64	90.54	123
4ED	Diesel	2496	4	93.64	90.54	123
4FA	Diesel	2496	4	94.00	90.00	127
4FB	Diesel	2496	4	93.64	90.54	122
4FC	Diesel	2496	4	93.64	90.54	122
4FD	Diesel	2496	4	93.64	90.54	122
4G63	Petrol	1997	4	85.00	88.00	79
4G64	Petrol	2350	4	86.50	100.00	94
4GA	Diesel	2496	4	93.64	90.54	123
4GB	Diesel	2496	4	93.64	90.54	123
4GC	Diesel	2496	4	93.64	90.54	123
4GD	Diesel	2496	4	93.64	90.54	123
4GE	Diesel	2496	4	93.64	90.54	123
4GF	Diesel	2496	4	93.64	90.54	123
4HA	Diesel	2496	4	93.64	90.54	124
4HB	Diesel	2496	4	93.64	90.54	122
4HC	Diesel	2496	4	93.64	90.54	122
4HD	Diesel	2496	4	93.64	90.54	124
4RB	Petrol	1593	4	87.65	66.00	97
4RC	Petrol	1993	4	90.80	76.90	108
5 AA/254 CID	Diesel	4160	4	107.21	114.96	145
7A, 2504E	Diesel	2861	3	106.69	106.68	140
7 AA/380 CID	Diesel	6220	6	107.21	114.90	144
32D	Diesel	2949	3	106.69	109.97	143
56D	Diesel	3815	4	106.69	106.68	141
56G	Diesel	3815	4	106.69	106.68	141
90/5 AA-Dover	Diesel	4162	4	107.21	114.96	146
105E, 107E,307E	Petrol	997	4	80.95	48.42	54
109E	Petrol	1340	4	80.95	65.09	55
110/6 AA-Dover	Diesel	5944	6	104.78	114.90	138
116E, 120E, 122E	Petrol	1499	4	80.95	72.62	56
118E, 118E GT	Petrol	1499	4	80.95	72.62	56
120GT	Petrol	1499	4	80.95	72.62	56
130/7 AA-Dover	Diesel	6223	6	107.21	114.90	144
380 CID	Diesel	6223	6	107.21	114.90	144
401 cu.in.	Diesel	6571	6	111.77	111.76	151
401 cu.in. Turbo	Diesel	6571	6	111.77	111.76	152
530E	Diesel	3613	4	100.00	115.00	133
589E	Petrol	4888	6	95.00	115.00	130
590E	Diesel	5416	6	100.00	115.00	134
591E	Diesel	3613	4	100.00	115.00	133
592E	Diesel	3610	4	100.00	115.00	133
630E	Diesel	3613	4	100.00	115.00	133
2501E/2502E/2503	Diesel	2589	3	106.69	96.52	139
2504E	Diesel	2868	3	106.69	106.93	142
2505E	Diesel	3146	3	111.77	106.89	148
2506E	Diesel	3294	3	111.77	111.89	153
2508E/2514E	Diesel	4187	4	111.77	106.68	147
2701E, 2706E	Diesel	3933	4	104.77	114.80	135
2704E, 2709E	Diesel	5942	6	104.77	114.80	136
2708E, 2703E (330 cu.in.)	Diesel	5410	6	100.00	114.80	132
2713E (365)	Diesel	5938	6	104.77	114.80	137
2737E	Petrol	1599	4	80.98	77.60	60
A9A	Petrol	1299	4	74.00	75.50	19
A9B	Petrol	1299	4	74.00	75.50	19
A9JA	Petrol	1299	4	74.00	75.50	19

			cm3	x 			
A9JB	Petrol		1299	4	74.00	75.50	19
AAA	Petrol		2792	6	81.00	90.30	67
ABFA	Diesel		1998	4	86.00	86.00	85
AFN	Diesel		1896	4	79.50	95.50	37
AHU	Diesel		1896	4	79.50	95.50	38
AJM	Diesel		1896	4	79.50	95.50	39
AMY	Petrol		2792	6	81.00	90.30	67
ANU	Diesel		1896	4	79.50	95.50	39
ARC	Petrol		2394	V6	84.00	72.00	77
ARD	Petrol		2394	V6	84.00	72.00	77
ASDA	Petrol		1388	4	76.00	76.50	23
ASDB	Petrol		1388	4	76.00	76.50	23
ASZ	Diesel		1896	4	79.50	95.50	40
AUY	Diesel		1896	4	79.50	95.50	39
AVG	Diesel		1896	4	79.50	95.50	41
AYL	Petrol		2792	6	81.00	90.30	67
AZBA	Diesel		1997	4	86.00	86.00	85
AZBC	Diesel		1997	4	85.00	88.00	80
AZWA	Diesel		1997	4	85.00	88.00	80
AZWC	Diesel		1997	4	85.00	88.00	80
B	Petrol		1593	4	87.65	66.00	97
B3	Petrol		1324	4	71.00	83.60	4
B4A	Petrol		2936	V6	93.00	72.00	120
B4B	Petrol		2936	V6	93.00	72.00	120
B4C	Petrol		2936	V6	93.00	72.00	120
B4T	Petrol		2935	V6	93.00	72.00	120
B6	Petrol		1598	4	78.00	83.60	31
BAA	Petrol		1299	4	74.00	75.50	19
BAJA	Petrol		1299	4	74.00	75.50	19
BHDA	Diesel		1753	4	82.50	82.00	71
BHDB	Diesel		1753	4	82.50	82.00	71
BHPA	Diesel		1753	4	82.50	82.00	71
BOA	Petrol		2933	V6	93.00	72.00	120
BOB	Petrol		2933	V6	93.00	72.00	120
BRC	Petrol		2933	V6	93.00	72.00	120
BRD	Petrol		2933	V6	93.00	72.00	120
BRE	Petrol		2933	V6	93.00	72.00	120
BRF	Petrol		2933	V6	93.00	72.00	120
BRG	Petrol		2933	V6	93.00	72.00	120
BRT	Petrol		2935	V6	93.00	72.00	120
BSD333H	Diesel		3289	3	111.77	111.76	150
BSD442	Diesel		4195	4	111.77	106.89	149
BSD444	Diesel		4386	4	93.00	78.00	121
BSD 444T	Diesel		4391	4	111.77	111.89	154
BTB	Diesel		1896	4	79.50	95.50	40
C9DA	Diesel		1753	4	82.50	82.00	71
C9DB	Diesel		1753	4	82.50	82.00	71
C9DC	Diesel		1753	4	82.50	82.00	71
CFBA	Petrol		1798	4	83.00	83.10	74
CGBA	Petrol		1798	4	83.00	83.10	75
CGBB	Petrol		1798	4	83.00	83.10	75
CH20	Petrol		1993	4	90.80	76.90	109
CHBA	Petrol		1798	4	83.00	83.10	75
CHBB	Petrol		1798	4	83.00	83.10	75
CJBA	Petrol		1999	4	87.50	83.10	95
CJBB	Petrol		1999	4	87.50	83.10	95
CSDA	Petrol		1798	4	83.00	83.10	74
CSDB	Petrol		1798	4	83.00	83.10	74
CV24	Diesel		2198	4	86.00	94.60	89
CVF5	Diesel		2198	4	86.00	94.60	89
CVFF	Diesel		2198	4	86.00	94.60	89
CVR5	Diesel		2198	4	86.00	94.60	89
CVRA	Diesel		2198	4	86.00	94.60	89
CVRB	Diesel		2198	4	86.00	94.60	89
CVRC	Diesel		2198	4	86.00	94.60	89
CY14	Diesel		2198	4	86.00	94.60	89
CY24	Diesel		2198	4	86.00	94.60	89
CYF4	Diesel		2198	4	86.00	94.60	89
CYF5	Diesel		2198	4	86.00	94.60	89







		cm3	x 			
CYFA	Diesel	2198	4	86.00	94.60	89
CYFB	Diesel	2198	4	86.00	94.60	89
CYFC	Diesel	2198	4	86.00	94.60	89
CYFD	Diesel	2198	4	86.00	94.60	89
CYFF	Diesel	2198	4	86.00	94.60	89
CYFG	Diesel	2198	4	86.00	94.60	89
CYR5	Diesel	2198	4	86.00	94.60	89
CYRA	Diesel	2198	4	86.00	94.60	90
CYRB	Diesel	2198	4	86.00	94.60	89
CYRC	Diesel	2198	4	86.00	94.60	89
D2FA	Diesel	2402	4	89.90	94.60	101
D2FB	Diesel	2402	4	89.90	94.60	101
D2FE	Diesel	2402	4	89.90	94.60	101
D3FA	Diesel	1998	4	86.00	86.00	85
D4FA	Diesel	2402	4	89.90	94.60	101
D5BA	Diesel	1998	4	86.00	86.00	85
D6BA	Diesel	1998	4	86.00	86.00	85
DHA	Petrol	1242	4	71.90	76.50	5
DHB	Petrol	1242	4	71.90	76.50	5
DHC	Petrol	1242	4	71.90	76.50	5
DHD	Petrol	1242	4	71.90	76.50	5
DHE	Petrol	1242	4	71.90	76.50	5
DHF	Petrol	1242	4	71.90	76.50	5
DHG	Petrol	1242	4	71.90	76.50	5
DOFA	Diesel	2402	4	89.90	94.60	101
DRF4	Diesel	2198	4	86.00	94.60	89
DRF5	Diesel	2198	4	86.00	94.60	89
DRFA	Diesel	2198	4	86.00	94.60	89
DRFB	Diesel	2198	4	86.00	94.60	89
DRFC	Diesel	2198	4	86.00	94.60	89
DRFD	Diesel	2198	4	86.00	94.60	89
DRFE	Diesel	2198	4	86.00	94.60	89
DRFF	Diesel	2198	4	86.00	94.60	89
DRFG	Diesel	2198	4	86.00	94.60	89
DRR5	Diesel	2198	4	86.00	94.60	89
DRRA	Diesel	2198	4	86.00	94.60	89
DRRB	Diesel	2198	4	86.00	94.60	89
DRRC	Diesel	2198	4	86.00	94.60	89
DT24H Duratorq	Diesel	2402	4	89.90	94.60	101
DT24N Duratorq	Diesel	2402	4	89.90	94.60	101
DT24P Duratorq	Diesel	2402	4	89.90	94.60	101
E1 ADDN-B	Diesel	3611	4	100.00	115.00	133
E1ADKN-B	Petrol	3260	4	95.00	115.00	129
E5FA	Petrol	2295	4	89.60	91.00	100
E5FC	Petrol	2295	4	89.60	91.00	100
E5SA	Petrol	2295	4	89.60	91.00	100
E5SB	Petrol	2295	4	89.60	91.00	100
EDBA	Petrol	1988	4	84.80	88.00	78
EDBB	Petrol	1988	4	84.80	88.00	78
EDBC	Petrol	1988	4	84.80	88.00	78
EDBD	Petrol	1988	4	84.80	88.00	78
EDDB	Petrol	1988	4	84.80	88.00	78
EDDC	Petrol	1988	4	84.80	88.00	78
EDDD	Petrol	1988	4	84.80	88.00	78
EDDF	Petrol	1988	4	84.80	88.00	78
EY	Petrol	1699	4	90.00	66.80	106
EYDB	Petrol	1796	4	80.60	88.00	53
EYDC	Petrol	1796	4	80.60	88.00	53
EYDD	Petrol	1796	4	80.60	88.00	53
EYDE	Petrol	1796	4	80.60	88.00	53
EYDF	Petrol	1796	4	80.60	88.00	53
EYDG	Petrol	1796	4	80.60	88.00	53
EYDI	Petrol	1796	4	80.60	88.00	53
EYDJ	Petrol	1796	4	80.60	88.00	53
EYDL	Petrol	1796	4	80.60	88.00	53
EYPA	Petrol	1796	4	80.60	88.00	53
EYPC	Petrol	1796	4	80.60	88.00	53
EYPD	Petrol	1796	4	80.60	88.00	53
F2Y4	Petrol	2184	4	86.00	94.00	88







		cm ³	x 			
F3FA	Diesel	1998	4	86.00	86.00	85
F4A	Petrol	1391	4	77.25	74.30	28
F4B	Petrol	1391	4	77.25	74.30	28
F4FA	Diesel	2402	4	89.90	94.60	101
F6	Petrol	1587	4	81.00	77.00	64
F6A	Petrol	1393	4	77.25	74.30	29
F6B	Petrol	1392	4	77.25	74.30	29
F6C	Petrol	1392	4	77.25	74.30	29
F6D	Petrol	1392	4	77.25	74.30	29
F6E	Petrol	1392	4	77.25	74.30	28
F6F	Petrol	1392	4	77.25	74.30	28
F6G	Petrol	1392	4	77.25	74.30	28
F6JA	Diesel	1399	4	73.70	82.00	8
F6JB	Diesel	1399	4	73.70	82.00	8
F6JC	Diesel	1399	4	73.70	82.00	8
F6JD	Diesel	1399	4	73.70	82.00	8
F9DA	Diesel	1753	4	82.50	82.00	71
F9DB	Diesel	1753	4	82.50	82.00	71
FFBA	Diesel	1753	4	82.50	82.00	71
FFDA	Diesel	1753	4	82.50	82.00	71
FFWA	Diesel	1753	4	82.50	82.00	71
FHA	Petrol	1388	4	76.00	76.50	23
FHD	Petrol	1388	4	76.00	76.50	23
FHE	Petrol	1388	4	76.00	76.50	23
FHF	Petrol	1388	4	76.00	76.50	23
FIFA	Diesel	1998	4	86.00	86.00	85
FMBA	Diesel	1998	4	86.00	86.00	86
FP4	Petrol	1242	4	70.80	78.90	3
FS	Petrol	1991	4	83.00	92.00	76
FUA	Petrol	1392	4	77.25	74.30	29
FUAA	Petrol	1392	4	77.25	74.30	29
FUB	Petrol	1392	4	77.25	74.30	29
FUBA	Petrol	1392	4	77.25	74.30	30
FUC	Petrol	1392	4	77.25	74.30	29
FUD	Petrol	1392	4	77.25	74.30	29
FUF	Petrol	1392	4	77.25	74.30	28
FUG	Petrol	1392	4	77.25	74.30	28
FUH	Petrol	1392	4	77.25	74.30	28
FUJ	Petrol	1392	4	77.25	74.30	28
FUJA	Petrol	1242	4	71.90	76.50	5
FUJB	Petrol	1242	4	71.90	76.50	5
FXDA	Petrol	1388	4	76.00	76.50	23
FXDB	Petrol	1388	4	76.00	76.50	23
FXDC	Petrol	1388	4	76.00	76.50	23
FXDD	Petrol	1388	4	76.00	76.50	23
FXFA	Diesel	2402	4	89.90	94.60	101
FXJA	Petrol	1388	4	76.00	76.50	23
FXJB	Petrol	1388	4	76.00	76.50	23
FXJC	Petrol	1388	4	76.00	76.50	23
FYDA	Petrol	1596	4	79.00	81.40	34
FYDB	Petrol	1596	4	79.00	81.40	34
FYDC	Petrol	1596	4	79.00	81.40	34
FYDD	Petrol	1596	4	79.00	81.40	34
FYDH	Petrol	1596	4	79.00	81.40	34
FYJA	Petrol	1596	4	79.00	81.40	34
FYJB	Petrol	1596	4	79.00	81.40	34
FYJC	Petrol	1596	4	79.00	81.40	34
G1	Petrol	1098	4	81.00	53.30	62
G2	Petrol	1098	4	80.98	53.30	58
G6A	Petrol	1119	4	68.70	75.50	2
G6DA	Diesel	1997	4	85.00	88.00	80
G6DB	Diesel	1997	4	85.00	88.00	80
G6DC	Diesel	1997	4	85.00	88.00	80
G6DD	Diesel	1997	4	85.00	88.00	80
G6DE	Diesel	1997	4	85.00	88.00	80
G6DF	Diesel	1997	4	85.00	88.00	80
G6DG	Diesel	1997	4	85.00	88.00	80
G8DA	Diesel	1560	4	75.00	88.30	21
G8DB	Diesel	1560	4	75.00	88.30	21







		cm3	x 			
G8DC	Diesel	1560	4	75.00	88.30	21
G8DD	Diesel	1560	4	75.00	88.30	21
G8DE	Diesel	1560	4	75.00	88.30	21
G8DF	Diesel	1560	4	75.00	88.30	21
G54B	Petrol	2555	4	91.10	98.00	117
GBVAJPF	Diesel	2198	4	86.00	94.60	90
GBVAJQJ	Diesel	2198	4	86.00	94.60	90
GBVAJQW	Diesel	2198	4	86.00	94.60	90
GLA	Petrol	1117	4	73.96	64.98	11
GLB	Petrol	1117	4	74.00	65.00	16
GLC	Petrol	1117	4	74.00	65.00	16
GLW	Petrol	1117	4	74.00	65.00	16
GMA	Petrol	1117	4	74.00	65.00	17
GPA	Petrol	1117	4	74.00	65.00	17
GPDA	Diesel	1560	4	75.00	88.30	22
GPDB	Diesel	1560	4	75.00	88.30	22
GPDC	Diesel	1560	4	75.00	88.30	22
GSE	Petrol	1117	4	74.00	65.00	17
GSF	Petrol	1117	4	74.00	65.00	18
GSG	Petrol	1117	4	73.90	65.00	9
GSH	Petrol	1117	4	73.90	65.00	9
GUB	Petrol	1117	4	68.70	75.50	2
GUC	Petrol	1119	4	68.70	75.50	2
GUD	Petrol	1119	4	68.70	75.50	2
GUE	Petrol	1119	4	68.70	75.50	2
GZFA	Petrol	2261	4	87.50	94.00	96
GZFC	Petrol	2295	4	89.60	91.00	100
H9FA	Diesel	2402	4	89.90	94.60	102
H9FB	Diesel	2402	4	89.90	94.60	102
H9FD	Diesel	2402	4	89.90	94.60	102
HCPA	Diesel	1753	4	82.50	82.00	72
HCPB	Diesel	1753	4	82.50	82.00	72
HHDA	Diesel	1560	4	75.00	88.30	22
HHDB	Diesel	1560	4	75.00	88.30	22
HHJA	Diesel	1560	4	75.00	88.30	22
HHJB	Diesel	1560	4	75.00	88.30	22
HHJC	Diesel	1560	4	75.00	88.30	22
HHJD	Diesel	1560	4	75.00	88.30	22
HHJE	Diesel	1560	4	75.00	88.30	22
HHJF	Diesel	1560	4	75.00	88.30	22
HJBA	Diesel	1998	4	86.00	86.00	85
HJBB	Diesel	1998	4	86.00	86.00	85
HJBC	Diesel	1998	4	86.00	86.00	85
HWDA	Petrol	1596	4	79.00	81.40	34
HWDB	Petrol	1596	4	79.00	81.40	34
HXDA	Petrol	1596	4	79.00	81.40	34
HXDB	Petrol	1596	4	79.00	81.40	34
HXJA	Petrol	1596	4	79.00	81.40	35
HXJB	Petrol	1596	4	79.00	81.40	35
HXJD	Petrol	1596	4	79.00	81.40	34
IQDA	Petrol	1596	4	79.00	81.40	35
IQDB	Petrol	1596	4	79.00	81.40	35
IQJA	Petrol	1596	4	79.00	81.40	35
IQJB	Petrol	1596	4	79.00	81.40	34
IXDA	Diesel	1997	4	85.00	88.00	80
J1E	Petrol	1298	4	81.00	63.00	63
J1F	Petrol	1298	4	81.00	63.00	63
J2	Petrol	1298	4	81.00	63.00	63
J2F	Petrol	1298	4	81.00	63.00	63
J2N	Petrol	1298	4	81.00	63.00	63
J3	Petrol	1298	4	81.00	63.00	63
J3C	Petrol	1298	4	81.00	63.00	63
J3D	Petrol	1298	4	81.00	63.00	63
J3E	Petrol	1297	4	80.98	62.99	59
J3N	Petrol	1298	4	81.00	63.00	63
J4B	Petrol	1299	4	74.00	75.50	19
J4C	Petrol	1299	4	74.00	75.50	19
J4D	Petrol	1299	4	74.00	75.50	19
J4J	Petrol	1299	4	74.00	75.50	19





		cm ³				
--	---	-----------------	---	---	---	---







J4K	Petrol	1299	4	74.00	75.50	19
J4L	Petrol	1299	4	74.00	75.50	19
J4M	Petrol	1299	4	74.00	75.50	19
J4N	Petrol	1299	4	74.00	75.50	19
J4P	Petrol	1299	4	74.00	75.50	19
J4Q	Petrol	1299	4	74.00	75.50	19
J4R	Petrol	1299	4	74.00	75.50	19
J4S	Petrol	1299	4	74.00	75.50	19
J4T	Petrol	1299	4	74.00	75.50	19
J6A	Petrol	1299	4	74.00	75.50	19
J6B	Petrol	1299	4	74.00	75.50	19
JAC	Petrol	1297	4	74.00	75.50	20
JBA	Petrol	1297	4	73.96	75.48	12
JBB	Petrol	1297	4	73.96	75.48	12
JBC	Petrol	1299	4	74.00	75.50	19
JBD	Petrol	1297	4	74.00	75.50	19
JBE	Petrol	1299	4	74.00	75.50	19
JCC	Petrol	1294	4	79.00	66.00	32
JCT	Petrol	1294	4	79.00	66.00	33
JJA	Petrol	1299	4	74.00	75.50	19
JJB	Petrol	1299	4	74.00	75.50	19
JJC	Petrol	1299	4	74.00	75.50	19
JJD	Petrol	1299	4	74.00	75.50	19
JJE	Petrol	1299	4	74.00	75.50	19
JJF	Petrol	1299	4	74.00	75.50	19
JJG	Petrol	1299	4	74.00	75.50	19
JJH	Petrol	1299	4	74.00	75.50	19
JJJ	Petrol	1299	4	74.00	75.50	19
JJK	Petrol	1299	4	74.00	75.50	19
JJL	Petrol	1299	4	74.00	75.50	19
JJM	Petrol	1299	4	74.00	75.50	19
JLA	Petrol	1297	4	73.96	75.48	13
JLB	Petrol	1297	4	73.96	75.48	12
JPA	Petrol	1296	4	80.00	64.50	46
JPC	Petrol	1297	4	80.00	64.50	46
JQMA	Petrol	1596	4	79.00	81.40	34
JQMB	Petrol	1596	4	79.00	81.40	34
JTMA	Petrol	1596	4	79.00	81.40	34
JXFA	Diesel	2402	4	89.90	94.60	102
JXFC	Diesel	2402	4	89.90	94.60	102
KHBA	Diesel	1753	4	82.50	82.00	71
KKDA	Diesel	1753	4	82.50	82.00	72
KKDB	Diesel	1753	4	82.50	82.00	72
KL09H (711M)	Petrol	940	4	80.98	45.61	57
KL11	Petrol	1098	4	81.00	53.30	62
KL 13 H	Petrol	1298	4	81.00	63.00	63
KL 13 HC	Petrol	1298	4	81.00	63.00	63
KL 13 L	Petrol	1298	4	81.00	63.00	63
KL 16 L	Petrol	1598	4	81.00	77.60	65
KL 16 R	Petrol	1601	4	81.00	77.70	66
KLBA	Diesel	1997	4	85.00	88.00	80
KLWA	Diesel	1997	4	85.00	88.00	80
KNBA	Diesel	2179	4	85.00	96.00	81
KVJA	Diesel	1399	4	73.70	82.00	8
L1C	Petrol	1598	4	80.98	77.62	61
L1E	Petrol	1597	4	76.00	88.00	25
L1F	Petrol	1597	4	76.00	88.00	25
L1G	Petrol	1597	4	76.00	88.00	25
L1H	Petrol	1597	4	76.00	88.00	25
L1J	Petrol	1597	4	76.00	88.00	25
L1K	Petrol	1597	4	76.00	88.00	25
L1L	Petrol	1597	4	76.00	88.00	25
L1N	Petrol	1597	4	76.00	88.00	25
L1Q	Petrol	1597	4	76.00	88.00	25
L1T	Petrol	1596	4	76.00	88.00	25
L1V	Petrol	1596	4	76.00	88.00	25
L1W	Petrol	1596	4	79.00	81.40	34
L3E	Petrol	1599	4	81.00	77.60	65
L4B	Petrol	1598	4	80.00	79.50	47





		cm3	x 			
L6B	Petrol	1598	4	80.00	79.50	48
LAC	Petrol	1593	4	87.65	66.00	98
LAD	Petrol	1593	4	87.65	66.00	98
LAN	Petrol	1593	4	87.65	66.00	98
LAR	Petrol	1593	4	87.65	66.00	98
LAT	Petrol	1593	4	87.65	66.00	99
LC	Petrol	1599	4	81.00	77.60	65
LCE	Petrol	1593	4	87.65	66.00	98
LCJ	Petrol	1593	4	87.65	66.00	98
LCK	Petrol	1593	4	87.65	66.00	98
LCN	Petrol	1593	4	87.65	66.00	97
LCR	Petrol	1598	4	87.65	66.00	97
LCS	Petrol	1593	4	87.65	66.00	97
LCT	Petrol	1593	4	87.65	66.00	97
LE	Petrol	1593	4	87.65	66.00	98
LEC	Petrol	1593	4	87.65	66.00	98
LEN	Petrol	1593	4	87.65	66.00	98
LHA	Petrol	1598	4	80.00	79.50	48
LJA	Petrol	1597	4	79.96	79.52	42
LJA	Petrol	1598	4	79.96	79.52	42
LJB	Petrol	1597	4	80.00	79.50	47
LJC	Petrol	1597	4	80.00	79.50	47
LJD	Petrol	1598	4	80.00	79.50	48
LJE	Petrol	1598	4	80.00	79.50	47
LJF	Petrol	1598	4	79.96	79.52	43
LNA	Petrol	1597	4	79.96	79.52	44
LNB	Petrol	1597	4	79.96	79.52	42
LP1	Petrol	1597	4	80.00	79.50	49
LP2	Petrol	1597	4	80.00	79.50	47
LP3	Petrol	1597	4	80.00	79.50	47
LPA	Petrol	1597	4	80.00	79.50	49
LPBA	Diesel	1997	4	86.00	86.00	85
LR1	Petrol	1597	4	80.00	79.50	49
LR2	Petrol	1597	4	80.00	79.50	47
LRA	Petrol	1597	4	80.00	79.50	49
LRB	Petrol	1597	4	80.00	79.50	47
LSD	Petrol	1597	4	81.32	76.95	69
LSE	Petrol	1597	4	81.32	76.95	70
LSF	Petrol	1597	4	81.32	76.90	68
LTA	Diesel	1608	4	80.00	80.00	50
LTB	Diesel	1608	4	80.00	80.00	50
LTC	Diesel	1608	4	80.00	80.00	50
LUA	Petrol	1597	4	80.00	79.50	49
LUA	Petrol	1597	4	80.00	79.50	49
LUAE	Petrol	1597	4	80.00	79.50	47
LUB	Petrol	1597	4	80.00	79.50	47
LUC	Petrol	1597	4	80.00	79.50	47
LUD	Petrol	1597	4	80.00	79.50	47
LUG	Petrol	1597	4	80.00	79.50	47
LUH	Petrol	1597	4	76.00	88.00	26
LUJ	Petrol	1598	4	80.00	79.50	48
LUK	Petrol	1598	4	80.00	79.50	48
M7JA	Petrol	1242	4	71.90	76.50	5
M7JB	Petrol	1242	4	71.90	76.50	5
MHA	Petrol	1679	4	80.00	83.50	51
MHB	Petrol	1679	4	80.00	83.50	51
MTDA	Diesel	1560	4	75.00	88.30	21
MUDA	Petrol	1596	4	79.00	81.40	35
MWB	Petrol	1699	4	90.00	66.80	106
MY	Petrol	1699	4	90.00	66.80	106
MYE	Petrol	1699	4	90.00	66.80	106
N3A	Petrol	1998	4	86.00	86.00	82
N4A	Petrol	1993	4	90.80	76.90	110
N4B	Petrol	1993	4	90.80	76.90	110
N4I	Petrol	1993	4	90.80	76.90	111
N6T	Petrol	1993	4	90.80	76.90	108
N6TS	Petrol	1993	4	90.80	76.90	108
N7A	Petrol	1998	4	86.00	86.00	83
N7BA	Diesel	1998	4	86.00	86.00	85

		cm ³	x 			
N7BB	Diesel	1997	4	86.00	86.00	85
N8A	Petrol	1998	4	86.00	86.00	84
N8B	Petrol	1998	4	86.00	86.00	83
N8C	Petrol	1993	4	86.00	86.00	84
N8D	Petrol	1993	4	86.00	86.00	84
N9A	Petrol	1998	4	86.00	86.00	84
N9B	Petrol	1998	4	86.00	86.00	84
N9C	Petrol	1998	4	86.00	86.00	83
N9D	Petrol	1998	4	86.00	86.00	83
N9E	Petrol	1998	4	86.00	86.00	83
N9F	Petrol	1998	4	86.00	86.00	83
N9K	Petrol	1998	4	86.00	86.00	83
NAE	Petrol	1993	4	90.80	76.90	110
NAT	Petrol	1994	4	90.80	76.90	108
NAV	Petrol	1994	4	90.80	76.90	108
NAW	Petrol	1993	4	90.80	76.90	108
NAX	Petrol	1993	4	90.80	76.90	108
NBA	Petrol	1993	4	90.80	76.90	110
NCA	Petrol	1994	4	90.80	76.90	110
NE	Petrol	1993	4	90.80	76.90	112
NE1	Petrol	1993	4	90.80	76.90	108
NE2	Petrol	1993	4	90.80	76.90	108
NE3	Petrol	1993	4	90.80	76.90	108
NE4	Petrol	1993	4	90.80	76.90	108
NE5	Petrol	1993	4	90.80	76.90	110
NEC	Petrol	1993	4	90.80	76.90	108
NEE	Petrol	1993	4	90.80	76.90	113
NEG	Petrol	1993	4	90.80	76.90	113
NEJ	Petrol	1993	4	90.80	76.90	110
NEK	Petrol	1993	4	90.80	76.90	112
NEL	Petrol	1993	4	90.80	76.90	108
NEN	Petrol	1993	4	90.80	76.90	112
NEP	Petrol	1993	4	90.80	76.90	112
NER	Petrol	1993	4	90.80	76.90	112
NES	Petrol	1993	4	90.80	76.90	110
NET	Petrol	1993	4	90.80	76.90	108
NGA	Petrol	1988	4	84.80	88.00	78
NGB	Petrol	1988	4	84.80	88.00	78
NGC	Petrol	1988	4	84.80	88.00	78
NGCA	Diesel	1560	4	75.00	88.30	21
NGD	Petrol	1988	4	84.80	88.00	78
NGDA	Diesel	1560	4	75.00	88.30	21
NGDB	Diesel	1560	4	75.00	88.30	21
NR2	Petrol	1993	4	90.80	76.90	112
NRA	Petrol	1993	4	90.80	76.90	111
NRB	Petrol	1993	4	90.80	76.90	112
NRC	Petrol	1993	4	90.80	76.90	111
NRD	Petrol	1993	4	90.80	76.90	112
NRI	Petrol	1993	4	90.80	76.90	111
NSD	Petrol	1998	4	86.00	86.00	82
NSE	Petrol	1998	4	86.00	86.00	82
NSF	Petrol	1998	4	86.00	86.00	82
NSG	Petrol	1998	4	86.00	86.00	82
NSH	Petrol	1998	4	86.00	86.00	84
NUT	Petrol	1993	4	90.80	76.90	108
OHC LC	Petrol	1994	4	90.80	76.90	112
OHC TL 16 H	Petrol	1593	4	87.65	66.00	98
OHC TL 16 L	Petrol	1593	4	87.65	66.00	98
OHC TL 20 H	Petrol	1993	4	90.80	76.90	112
OHV KL 13 G	Petrol	1298	4	81.00	63.00	63
OHV KL 13 H	Petrol	1298	4	81.00	63.00	63
OHV KL 13 L	Petrol	1298	4	81.00	63.00	63
OHV KL 16 G	Petrol	1599	4	81.00	77.60	65
OHV KL 16 H	Petrol	1599	4	81.00	77.60	65
OHV KL 16 L	Petrol	1599	4	81.00	77.60	65
P7PA	Diesel	1753	4	82.50	82.00	72
P7PB	Diesel	1753	4	82.50	82.00	72
P8FA	Diesel	2198	4	86.00	94.60	89
P8FB	Diesel	2198	4	86.00	94.60	89

		cm3	x 			
P9PA	Diesel	1753	4	82.50	82.00	72
P9PB	Diesel	1753	4	82.50	82.00	72
P9PC	Diesel	1753	4	82.50	82.00	72
P9PD	Diesel	1753	4	82.50	82.00	72
PGFA	Diesel	2198	4	86.00	94.60	89
PGFB	Diesel	2198	4	86.00	94.60	89
PHFA	Diesel	2402	4	89.90	94.60	102
PHFC	Diesel	2402	4	89.90	94.60	102
PNBA	Petrol	1596	4	79.00	81.40	35
PNDA	Petrol	1596	4	79.00	81.40	35
PR	Petrol	2792	V6	93.00	68.50	119
PR3	Petrol	2792	V6	93.00	68.50	119
PR4	Petrol	2792	V6	93.00	68.50	119
PR5	Petrol	2792	V6	93.00	68.50	119
PR6	Petrol	2792	V6	93.00	68.50	119
PR7	Petrol	2792	V6	93.00	68.50	119
PR8	Petrol	2792	V6	93.00	68.50	119
PRB	Petrol	2792	V6	93.00	68.50	119
PRC	Petrol	2792	V6	93.00	68.50	119
PRD	Petrol	2792	V6	93.00	68.50	119
PRE	Petrol	2792	V6	93.00	68.50	119
PRG	Petrol	2792	V6	93.00	68.50	119
PRI	Petrol	2792	V6	93.00	68.50	119
PRN	Petrol	2792	V6	93.00	68.50	119
PRT	Petrol	2792	V6	93.00	68.50	119
PYA	Petrol	2792	V6	93.00	68.50	119
PYN	Petrol	2792	V6	93.00	68.50	119
PYU	Petrol	2792	V6	93.00	68.50	119
Q4BA	Diesel	2179	4	85.00	96.00	81
Q4WA	Diesel	2179	4	85.00	96.00	81
Q7DA	Petrol	1798	4	83.00	83.10	74
QJBA	Diesel	2198	4	86.00	94.60	91
QJBB	Diesel	2198	4	86.00	94.60	91
QJBC	Diesel	2198	4	86.00	94.60	91
QJBD	Diesel	2198	4	86.00	94.60	91
QQDA	Petrol	1798	4	83.00	83.10	74
QQDB	Petrol	1798	4	83.00	83.10	74
QQDC	Petrol	1798	4	83.00	83.10	74
QQDD	Petrol	1798	4	83.00	83.10	74
QVFA	Diesel	2198	4	86.00	94.60	89
QWFA	Diesel	2198	4	86.00	94.60	89
QXBA	Diesel	1997	4	85.00	88.00	80
QXBB	Diesel	1997	4	85.00	88.00	80
QXWA	Diesel	1997	4	85.00	88.00	80
QXWB	Diesel	1997	4	85.00	88.00	80
QXWC	Diesel	1997	4	85.00	88.00	80
QYBA	Diesel	1753	4	82.50	82.00	71
QYWA	Diesel	1753	4	82.50	82.00	72
R2A	Petrol	1796	4	86.20	77.00	93
R2C	Petrol	1769	4	80.00	88.00	52
R2PA	Diesel	1753	4	82.50	82.00	72
R3PA	Diesel	1753	4	82.50	82.00	72
R6A	Petrol	1769	4	80.00	88.00	52
RDA	Petrol	1796	4	80.60	88.00	53
RDB	Petrol	1796	4	80.60	88.00	53
REB	Petrol	1796	4	86.20	77.00	93
REC	Petrol	1796	4	86.20	77.00	93
RED	Petrol	1796	4	86.20	77.00	93
REF	Petrol	1796	4	86.20	77.00	93
RF	Diesel	1998	4	86.00	86.00	87
RFA	Diesel	1753	4	82.50	82.00	71
RFB	Diesel	1753	4	82.50	82.00	71
RFD	Diesel	1753	4	82.50	82.00	71
RFK	Diesel	1753	4	82.50	82.00	71
RFL	Diesel	1753	4	82.50	82.00	71
RFM	Diesel	1753	4	82.50	82.00	71
RFN	Diesel	1753	4	82.50	82.00	71
RFS	Diesel	1753	4	82.50	82.00	71
RFU	Diesel	1753	4	82.50	82.00	71

			cm ³	x 			9
RHBA	Petrol		1596	4	79.00	81.40	35
RKA	Petrol		1796	4	80.60	88.00	53
RKB	Petrol		1796	4	80.60	88.00	53
RKC	Petrol		1796	4	80.60	88.00	53
RKF	Petrol		1796	4	80.60	88.00	53
RKH	Petrol		1796	4	80.60	88.00	53
RKJ	Petrol		1796	4	80.60	88.00	53
RKK	Petrol		1796	4	80.60	88.00	53
RQB	Petrol		1796	4	80.60	88.00	53
RQB	Petrol		1796	4	80.60	88.00	53
RQC	Petrol		1796	4	80.60	88.00	53
RRN	Petrol		2792	V6	93.00	68.50	119
RTA	Diesel		1753	4	82.50	82.00	73
RTB	Diesel		1753	4	82.50	82.00	73
RTC	Diesel		1753	4	82.50	82.00	73
RTD	Diesel		1753	4	82.50	82.00	73
RTE	Diesel		1753	4	82.50	82.00	73
RTF	Diesel		1753	4	82.50	82.00	73
RTG	Diesel		1753	4	82.50	82.00	73
RTH	Diesel		1753	4	82.50	82.00	73
RTJ	Diesel		1753	4	82.50	82.00	73
RTJA	Petrol		1388	4	76.00	76.50	23
RTJB	Petrol		1388	4	76.00	76.50	23
RTK	Diesel		1753	4	82.50	82.00	73
RTN	Diesel		1753	4	82.50	82.00	71
RTP	Diesel		1753	4	82.50	82.00	71
RTQ	Diesel		1753	4	82.50	82.00	71
RVA	Diesel		1753	4	82.50	82.00	71
RWPA	Diesel		1753	4	82.50	82.00	72
RWPC	Diesel		1753	4	82.50	82.00	72
RWPD	Diesel		1753	4	82.50	82.00	72
RWPE	Diesel		1753	4	82.50	82.00	72
RWPF	Diesel		1753	4	82.50	82.00	72
RY	Petrol		1814	V6	80.00	60.10	45
SCB	Diesel		2500	4	92.00	94.00	118
SCC	Diesel		2500	4	92.00	94.00	118
SDBA	Diesel		1998	4	86.00	86.00	85
SFA	Diesel		2498	4	94.00	90.00	128
SFB	Diesel		2498	4	94.00	90.00	128
SHDA	Petrol		1596	4	79.00	81.40	34
SHDB	Petrol		1596	4	79.00	81.40	34
SHDC	Petrol		1596	4	79.00	81.40	34
SIDA	Petrol		1596	4	79.00	81.40	35
SNJA	Petrol		1242	4	71.90	76.50	6
SNJB	Petrol		1242	4	71.90	76.50	7
SPJA	Petrol		1388	4	76.00	76.50	24
SPJC	Petrol		1388	4	76.00	76.50	24
SRFA	Diesel		2198	4	86.00	94.60	89
SRFB	Diesel		2198	4	86.00	94.60	89
SRFC	Diesel		2198	4	86.00	94.60	89
SRFD	Diesel		2198	4	86.00	94.60	89
SRFE	Diesel		2198	4	86.00	94.60	89
STJA	Petrol		1242	4	71.90	76.50	6
STJB	Petrol		1242	4	71.90	76.50	6
STP	Diesel		2499	4	94.00	90.00	128
STR	Diesel		2498	4	94.00	90.00	128
T1BA	Diesel		1560	4	75.00	88.30	21
T1BB	Diesel		1560	4	75.00	88.30	21
T1BC	Diesel		1560	4	75.00	88.30	21
T1DA	Diesel		1560	4	75.00	88.30	21
T1DB	Diesel		1560	4	75.00	88.30	21
T1WA	Diesel		1560	4	75.00	88.30	21
T1WB	Diesel		1560	4	75.00	88.30	21
T3CA	Diesel		1560	4	75.00	88.30	21
T3CB	Diesel		1560	4	75.00	88.30	21
T3CC	Diesel		1560	4	75.00	88.30	21
T3DA	Diesel		1560	4	75.00	88.30	21
T3DB	Diesel		1560	4	75.00	88.30	21
T3JA	Diesel		1560	4	75.00	88.30	21

		cm3	x 			
T3JB	Diesel	1560	4	75.00	88.30	21
T7CE	Diesel	1998	4	85.00	88.00	80
T7CI	Diesel	1997	4	85.00	88.00	80
T7CJ	Diesel	1997	4	85.00	88.00	80
T7CK	Diesel	1997	4	85.00	88.00	80
T7CL	Diesel	1997	4	85.00	88.00	80
T7DB	Diesel	1997	4	85.00	88.00	80
T7MA	Diesel	1998	4	85.00	88.00	80
T7MB	Diesel	1998	4	85.00	88.00	80
T8CC	Diesel	1998	4	85.00	88.00	80
T8CG	Diesel	1997	4	85.00	88.00	80
T8CH	Diesel	1997	4	85.00	88.00	80
T8CI	Diesel	1997	4	85.00	88.00	80
T8CJ	Diesel	1997	4	85.00	88.00	80
T8DA	Diesel	1997	4	85.00	88.00	80
T8DE	Diesel	1997	4	85.00	88.00	80
T8MA	Diesel	1998	4	85.00	88.00	80
T8MB	Diesel	1998	4	85.00	88.00	80
T9CA	Diesel	1998	4	86.00	94.60	92
T9CB	Diesel	1997	4	85.00	88.00	80
T9CC	Diesel	1997	4	85.00	88.00	80
TD27	Diesel	2663	4	96.00	92.00	131
TD27E	Diesel	2664	4	96.00	92.00	131
TD 27 T	Diesel	2664	4	96.00	92.00	131
TKA	Petrol	957	4	73.96	55.70	10
TKB	Petrol	957	4	74.00	55.70	14
TKW	Petrol	957	4	74.00	55.70	15
TL 16M	Petrol	1593	4	87.65	66.00	98
TL 20 LC	Petrol	1994	4	90.80	76.90	112
TLA	Petrol	957	4	73.96	55.70	10
TLB	Petrol	999	4	68.70	67.50	1
TV 15 H	Petrol	1498	V4	90.00	59.00	103
TV 15 HC	Petrol	1498	V4	90.00	59.00	103
TV 15 L	Petrol	1498	V4	90.00	59.00	103
TV 17 H	Petrol	1699	V4	90.00	66.80	106
TV 17 HC	Petrol	1699	V4	90.00	66.80	106
TV 17 L	Petrol	1699	V4	90.00	66.80	106
TV 17 LC	Petrol	1699	V4	90.00	66.80	106
TV 23 H	Petrol	2293	V6	90.00	60.10	104
TV24	Petrol	2394	V6	84.00	72.00	77
TV 26 H	Petrol	2523	V6	90.00	66.10	105
TV 26 L	Petrol	2551	V6	90.00	66.80	107
TV 29 EFI	Petrol	2935	V6	93.00	72.00	120
TXBA	Diesel	1997	4	85.00	88.00	80
TXBB	Diesel	1997	4	85.00	88.00	80
TXDA	Diesel	1998	4	85.00	88.00	80
TXDB	Diesel	1997	4	85.00	88.00	80
TXMA	Diesel	1998	4	85.00	88.00	80
TXWA	Diesel	1997	4	85.00	88.00	80
TYBA	Diesel	1997	4	86.00	86.00	85
TYDA	Diesel	1997	4	85.00	88.00	80
TYMA	Diesel	1998	4	86.00	94.60	92
TYWA	Diesel	1997	4	85.00	88.00	80
TZJA	Diesel	1560	4	75.00	88.30	21
TZJB	Diesel	1560	4	75.00	88.30	21
U3CA	Diesel	1560	4	75.00	88.30	21
UBJA	Diesel	1560	4	75.00	88.30	22
UC	Petrol	1416	4	77.00	76.00	27
UFBA	Diesel	1997	4	85.00	88.00	80
UFBB	Diesel	1997	4	85.00	88.00	80
UFCA	Diesel	1997	4	85.00	88.00	80
UFCB	Diesel	1997	4	85.00	88.00	80
UFDA	Diesel	1997	4	85.00	88.00	80
UFDB	Diesel	1997	4	85.00	88.00	80
UFMA	Diesel	1997	4	85.00	88.00	80
UFWA	Diesel	1997	4	85.00	88.00	80
UHFA	Diesel	2198	4	86.00	94.60	89
UHFB	Diesel	2198	4	86.00	94.60	89
UHFC	Diesel	2198	4	86.00	94.60	89

		cm ³	x 			9
UHR5	Diesel	2198	4	86.00	94.60	89
UKBA	Diesel	1997	4	85.00	88.00	80
UKBB	Diesel	1997	4	85.00	88.00	80
UKDA	Diesel	1997	4	85.00	88.00	80
UKDB	Diesel	1997	4	85.00	88.00	80
UKMA	Diesel	1997	4	85.00	88.00	80
UKWA	Diesel	1997	4	85.00	88.00	80
USF6	Diesel	2198	4	86.00	94.60	89
USR6	Diesel	2198	4	86.00	94.60	89
USRA	Diesel	2198	4	86.00	94.60	89
USRB	Diesel	2198	4	86.00	94.60	89
UTJA	Petrol	1388	4	76.00	76.50	23
UY	Petrol	2550	V6	90.00	66.80	107
UYR6	Diesel	2198	4	86.00	94.60	89
VM	Diesel	2500	4	92.00	94.00	118
VM 492 HR, VM 492 HS	Diesel	2500	4	92.00	94.00	118
XD3P	Diesel	2497	4	94.00	90.00	128
XD3T	Diesel	2497	4	94.00	90.00	128
XRMA	Diesel	1998	4	85.00	88.00	80
XRMB	Diesel	1998	4	85.00	88.00	80
XTDA	Petrol	1596	4	79.00	81.40	35
Y5A	Petrol	2295	4	89.60	91.00	100
Y5B	Petrol	2295	4	89.60	91.00	100
YF	Petrol	1989	4	84.80	88.00	78
YTR	Diesel	2304	4	94.00	83.00	126
YTT	Diesel	2304	4	94.00	83.00	126
YUDA	Petrol	1596	4	79.00	81.40	34
YYE	Petrol	2294	V6	90.00	60.10	104
YYF	Petrol	2294	V6	90.00	60.10	104
YYH	Petrol	2294	V6	90.00	60.10	104
YYN	Petrol	2294	V6	90.00	60.10	104
YYP	Petrol	2294	V6	90.00	60.10	104
YYR	Petrol	2294	V6	90.00	60.10	104
YYT	Petrol	2294	V6	90.00	60.10	104
YYU	Petrol	2294	V6	90.00	60.10	104
ZH10JRB	Petrol	999	4	68.70	67.50	1
ZVSA	Petrol	1998	4	86.00	86.00	82



1 68.70 x 67.50

TLB			4 Cyl.	999cc	33kW (45PS)		Petrol		TD1454
ZH10JRB			4 Cyl.	999cc	38kW (52PS)		Petrol		TD24108
BE/PL	4	40,990/41,010	43,990/44,010	17,950	1,450	0,080/0,145	AL-LF	4165RA	01-4153/4 STD 0.25 0.75
MB/HL	1	56,990/57,000	60,623/60,636	18,690	1,807	0,020/0,057	AL-LF	4166RA	02-4549 STD 0.25
TW/A	2	63,600	78,100		2,850		AL-LF	66526AF	A209/2 STD
CB/NWB 2,3	2	39,615/39,635	42,888/42,913	17,270	1,600		BB	GS128S	N182/3 STD
CB/NWB 1	1	39,615/39,635	42,888/42,913	20,320	1,600		BB	GS129S	

2 68.70 x 75.50

G6A			4 Cyl.	1119cc	37kW (50PS)		Petrol		TD4455
GUB			4 Cyl.	1117cc	35kW (48PS)		Petrol		TD1207
GUC			4 Cyl.	1119cc	40kW (54PS)		Petrol		TD1208
GUD			4 Cyl.	1119cc	40kW (55PS)		Petrol		TD1209
GUE			4 Cyl.	1119cc	40kW (55PS)		Petrol		TD1210
BE/PL	4	40,990/41,010	43,990/44,010	17,950	1,450	0,080/0,145	AL-LF	4165RA	01-4153/4 STD 0.25 0.75
MB/HL	1	56,990/57,000	60,623/60,636	18,690	1,807	0,020/0,057	AL-LF	4166RA	02-4549 STD 0.25
TW/A	2	63,600	78,100		2,850		AL-LF	66526AF	A209/2 STD
CB/NWB 2,3	2	39,615/39,635	42,888/42,913	17,270	1,600		BB	GS128S	N182/3 STD
CB/NWB 1	1	39,615/39,635	42,888/42,913	20,320	1,600		BB	GS129S	

3 70.80 x 78.90

FP4			4 Cyl.	1242cc	51kW (69PS)		Petrol		TD24408
BE/PL	4	39,980/40,000	43,025/43,045	15,000	1,506	0,020/0,052	AL	4415RA	01-4162/4 STD 0.25
MB/HL 1,2,4,5	4	47,980/48,000	54,020/54,038	16,100	3,013	0,020/0,057	AL-LF	4416RA	H1100/5 STD
MB/HL 3	1	47,980/48,000	54,020/54,038	23,750	3,013	0,020/0,057	AL-LF	4417RAH	

	4417RAH	STD	24,000/.9449" - 24,050/.9469"
		0.25mm	24,000/.9449" - 24,050/.9469"

4 71.00 x 83.60

B3			4 Cyl.	1324cc	40-47kW (54-64PS)		Petrol		TD27820
BE/PL	8	39,940	43,020	17,130	1,510		AL-LF	64-313-1	01-4343/4 STD
MB/HL 1-5	5	49,940	54,020	17,500	2,010		AL	63-317-1	H1192/5 STD
MB/HL 1-5	5	49,940	54,020	17,500	2,010		AL	63-317-2	

03/89→

5 71.90 x 76.50

DHA			4 Cyl.	1242cc	55kW (75PS)		Petrol		TD12069
DHB			4 Cyl.	1242cc	55kW (75PS)		Petrol		TD12070
DHC			4 Cyl.	1242cc	55kW (75PS)		Petrol		TD15921



DHD	4 Cyl.	1242cc	55kW (75PS)	Petrol	TD15922
DHE	4 Cyl.	1242cc	55kW (75PS)	Petrol	TD15923
DHF	4 Cyl.	1242cc	55kW (75PS)	Petrol	TD15924
DHG	4 Cyl.	1242cc	55kW (75PS)	Petrol	TD15925
FUJA	4 Cyl.	1242cc	55kW (75PS)	Petrol	TD17159
FUJB	4 Cyl.	1242cc	55kW (75PS)	Petrol	TD17160
M7JA	4 Cyl.	1242cc	51kW (70PS)	Petrol	TD17161
M7JB	4 Cyl.	1242cc	51kW (70PS)	Petrol	TD17162

BE/PL	4	39,980/40,000	43,025/43,045	15,000	1,506	0,020/0,052	AL	4415RA	01-4162/4 STD 0.25
MB/HL 1,2,4,5	4	47,980/48,000	54,020/54,038	16,100	3,013	0,020/0,057	AL-LF	4416RA	H1100/5 STD
MB/HL 3	1	47,980/48,000	54,020/54,038	23,750	3,013	0,020/0,057	AL-LF	4417RAH	

	4417RAH	STD	24,000/.9449" - 24,050/.9469"
		0.25mm	24,000/.9449" - 24,050/.9469"

6 71.90 x 76.50

SNJA	4 Cyl.	1242cc	60kW (82PS)	Petrol	TD23540
STJA	4 Cyl.	1242cc	44kW (60PS)	Petrol	TD23539
STJB	4 Cyl.	1242cc	44kW (60PS)	Petrol	TD24410

MB/HL	4	47,980/48,000	54,000/54,018	16,100	2,103	0,024/0,082	AL-LF	02-5014	H1350/5 STD
MB/HL	2	47,980/48,000	54,000/54,018	16,100	2,103	0,024/0,082	AL-LF	02-5015	

7 71.90 x 76.50

SNJB	4 Cyl.	1242cc	60kW (82PS)	Petrol	TD24411				
MB/HL 1,2,4,5	4	47,980/48,000	54,020/54,038	16,100	3,013	0,020/0,057	AL-LF	4416RA	H1100/5 STD
MB/HL 3	1	47,980/48,000	54,020/54,038	23,750	3,013	0,020/0,057	AL-LF	4417RAH	

	4417RAH	STD	24,000/.9449" - 24,050/.9469"
		0.25mm	24,000/.9449" - 24,050/.9469"

8 73.70 x 82.00

F6JA	4 Cyl.	1399cc	50-51kW (68-69PS)	Diesel Turbo	TD17307
F6JB	4 Cyl.	1399cc	50kW (68PS)	Diesel Turbo	TD17346
F6JC	4 Cyl.	1399cc	50kW (68PS)	Diesel Turbo	TD26167
F6JD	4 Cyl.	1399cc	51kW (70PS)	Diesel Turbo Intercooler	TD23542
KVJA	4 Cyl.	1399cc	51kW (70PS)	Diesel Turbo Intercooler	TD26332

BE/PL	1	44,975/44,991	48,665/48,671	17,050	1,820	0,029/0,081	SP	71-3986	71-3986 STD 0.30
MB/HL 1-5	5	49,962/49,981	53,655/53,674	19,900	1,833	0,008/0,046	AL	02-4244	H1066/5 STD 0.30 0.50
TW/A	2	55,200/55,480	71,350/71,700		2,460		AL	04-4245	A217/2 STD
SE/PB	1	24,995/25,000	28,000/28,021	19,980			BS	55-3987	55-3987 SEMI

9 73.90 x 65.00

GSG	4 Cyl.	1117cc	37kW (50PS)	Petrol	TD1205
GSH	4 Cyl.	1117cc	36kW (49PS)	Petrol	TD1206

BE/PL	4	42,990/43,010	46,680/46,700	17,250	1,833	0,020/0,069	AL-LF	66525RA	01-4184/4 STD
-------	---	---------------	---------------	--------	-------	-------------	-------	---------	-------------------------

MB/HL 1-3	3	56,980/57,000	60,623/60,636	21,600	1,807	0,020/0,067	AL-LF	66526RA	H1133/3 STD	
TW/A	2	63,600	78,100		2,850		AL-LF	66526AF	A209/2 STD	

10 73.96 x 55.70

TKA	4 Cyl.		957cc	29kW (40PS)	Petrol				TD4495	
TLA	4 Cyl.		957cc	33kW (45PS)	Petrol				TD1453	
BE/PL	4	42,990/43,010	46,680/46,700	17,250	1,833	0,020/0,069	AL-LF	66525RA	01-4184/4 STD	
MB/HL 1-3	3	56,980/57,000	60,623/60,636	21,600	1,807	0,020/0,067	AL-LF	66526RA	H1133/3 STD	
→12/82										
TW/A	2	63,600	78,100		2,850		AL-LF	66526AF	A209/2 STD	
CB/NWB 2,3	2	39,615/39,635	42,888/42,913	17,270	1,600		BB	GS128S	N182/3 STD	
CB/NWB 1	1	39,615/39,635	42,888/42,913	20,320	1,600		BB	GS129S		

11 73.96 x 64.98

GLA	4 Cyl.		1117cc	39-40kW (53-54PS)	Petrol				TD1196
BE/PL	4	42,990/43,010	46,680/46,700	17,250	1,833	0,020/0,069	AL-LF	66525RA	01-4184/4 STD
MB/HL 1-5	5	57,990/58,000	62,287/62,300	22,400	2,138	0,020/0,059	AL-LF	1926RA	H1079/5 STD 0.25 0.50
TW/A	2	64,850	81,100		2,351		AL-LF	04-3559	A127/2 STD

12 73.96 x 75.48

JBA	4 Cyl.		1297cc	44-46kW (60-63PS)	Petrol				TD1227
JBB	4 Cyl.		1297cc	44kW (60PS)	Petrol				TD4459
JLB	4 Cyl.		1297cc	44kW (60PS)	Petrol				TD1237
BE/PL	4	40,990/41,010	43,990/44,010	17,950	1,450	0,080/0,145	AL-LF	4165RA	01-4153/4 STD 0.25 0.75
MB/HL	1	56,990/57,000	60,623/60,636	18,690	1,807	0,020/0,057	AL-LF	4166RA	02-4549 STD 0.25
TW/A	2	63,600	78,100		2,850		AL-LF	66526AF	A209/2 STD
CB/NWB 2,3	2	39,615/39,635	42,888/42,913	17,270	1,600		BB	GS128S	N182/3 STD
CB/NWB 1	1	39,615/39,635	42,888/42,913	20,320	1,600		BB	GS129S	

13 73.96 x 75.48

JLA	4 Cyl.		1297cc	44kW (60PS)	Petrol				TD1236
BE/PL	4	40,990/41,010	43,990/44,010	17,950	1,450	0,080/0,145	AL-LF	4165RA	01-4153/4 STD 0.25 0.75
BE/PL	4	42,990/43,010	46,680/46,700	17,250	1,833	0,020/0,069	AL-LF	66525RA	01-4184/4 STD
MB/HL	1	56,990/57,000	60,623/60,636	18,690	1,807	0,020/0,057	AL-LF	4166RA	02-4549 STD 0.25
TW/A	2	63,600	78,100		2,850		AL-LF	66526AF	A209/2 STD
CB/NWB 2,3	2	39,615/39,635	42,888/42,913	17,270	1,600		BB	GS128S	N182/3 STD
CB/NWB 1	1	39,615/39,635	42,888/42,913	20,320	1,600		BB	GS129S	

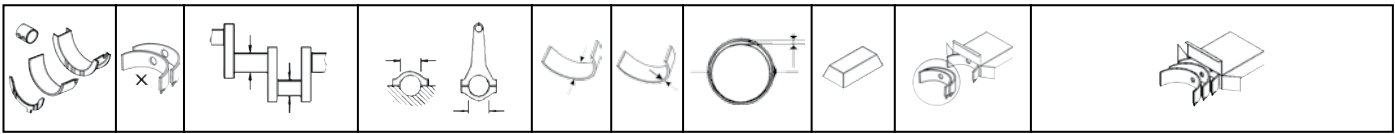

14 74.00 x 55.70

TKB		4 Cyl.		957cc	33kW (45PS)		Petrol		TD1452
BE/PL	4	42,990/43,010	46,680/46,700	17,250	1,833	0,020/0,069	AL-LF	66525RA	01-4184/4 STD
→12/88									
TW/A	2	63,600	78,100		2,850		AL-LF	66526AF	A209/2 STD
CB/NWB 2,3	2	39,615/39,635	42,888/42,913	17,270	1,600		BB	GS128S	N182/3 STD
CB/NWB 1	1	39,615/39,635	42,888/42,913	20,320	1,600		BB	GS129S	

15 74.00 x 55.70

TKW		4 Cyl.		957cc	29kW (40PS)		Petrol		TD4496
BE/PL	4	42,990/43,010	46,680/46,700	17,250	1,833	0,020/0,069	AL-LF	66525RA	01-4184/4 STD
MB/HL 1-3	3	56,980/57,000	60,623/60,636	21,600	1,807	0,020/0,067	AL-LF	66526RA	H1133/3 STD
→12/82									
TW/A	2	63,600	78,100		2,850		AL-LF	66526AF	A209/2 STD
CB/NWB 2,3	2	39,615/39,635	42,888/42,913	17,270	1,600		BB	GS128S	N182/3 STD
CB/NWB 1	1	39,615/39,635	42,888/42,913	20,320	1,600		BB	GS129S	

16 74.00 x 65.00

GLB		4 Cyl.		1117cc	37-40kW (50-55PS)		Petrol		TD1197
GLC		4 Cyl.		1117cc	37kW (50PS)		Petrol		TD1198
GLW		4 Cyl.		1117cc	39-40kW (53-55PS)		Petrol		TD1199
BE/PL	4	42,990/43,010	46,680/46,700	17,250	1,833	0,020/0,069	AL-LF	66525RA	01-4184/4 STD
MB/HL 1-5	5	57,990/58,000	62,287/62,300	22,400	2,138	0,020/0,059	AL-LF	1926RA	H1079/5 STD 0.25 0.50
TW/A	2	63,600	78,100		2,850		AL-LF	66526AF	A209/2 STD
CB/NWB 2,3	2	39,615/39,635	42,888/42,913	17,270	1,600		BB	GS128S	N182/3 STD
CB/NWB 1	1	39,615/39,635	42,888/42,913	20,320	1,600		BB	GS129S	

17 74.00 x 65.00

GMA		4 Cyl.		1117cc	40kW (55PS)		Petrol		TD1200
GPA		4 Cyl.		1117cc	43kW (59PS)		Petrol		TD1201
GSE		4 Cyl.		1117cc	37-40kW (50-55PS)		Petrol		TD1203
BE/PL	4	42,990/43,010	46,680/46,700	17,250	1,833	0,020/0,069	AL-LF	66525RA	01-4184/4 STD
MB/HL 1-5	5	57,990/58,000	62,287/62,300	22,400	2,138	0,020/0,059	AL-LF	1926RA	H1079/5 STD 0.25 0.50
TW/A	2	64,850	81,100		2,351		AL-LF	04-3559	A127/2 STD
CB/NWB 2,3	2	39,615/39,635	42,888/42,913	17,270	1,600		BB	GS128S	N182/3 STD
CB/NWB 1	1	39,615/39,635	42,888/42,913	20,320	1,600		BB	GS129S	



18 74.00 x 65.00

GSF		4 Cyl.		1117cc	37kW (50PS)	Petrol		TD1204	
BE/PL	4	42,990/43,010	46,680/46,700	17,250	1,833	0,020/0,069	AL-LF	66525RA	01-4184/4 STD
→12/88									
TW/A	2	63,600	78,100		2,850		AL-LF	66526AF	A209/2 STD
CB/NWB 2,3	2	39,615/39,635	42,888/42,913	17,270	1,600		BB	GS128S	N182/3 STD
CB/NWB 1	1	39,615/39,635	42,888/42,913	20,320	1,600		BB	GS129S	

19 74.00 x 75.50

A9A			4 Cyl.	1299cc	51kW (70PS)		Petrol		TD18764
A9B			4 Cyl.	1299cc	51kW (70PS)		Petrol		TD18765
A9JA			4 Cyl.	1299cc	51kW (69PS)		Petrol		TD17302
A9JB			4 Cyl.	1299cc	51kW (69PS)		Petrol		TD17303
BAA			4 Cyl.	1299cc	44kW (60PS)		Petrol		TD17169
BAJA			4 Cyl.	1299cc	44kW (60PS)		Petrol		TD17301
J4B			4 Cyl.	1299cc	44kW (60PS)		Petrol		TD4458
J4C			4 Cyl.	1299cc	44kW (60PS)		Petrol		TD11087
J4D			4 Cyl.	1299cc	44kW (60PS)		Petrol		TD12084
J4J			4 Cyl.	1299cc	44kW (60PS)		Petrol		TD12073
J4K			4 Cyl.	1299cc	44kW (60PS)		Petrol		TD12085
J4L			4 Cyl.	1299cc	44kW (60PS)		Petrol		TD15930
J4M			4 Cyl.	1299cc	44kW (60PS)		Petrol		TD15952
J4N			4 Cyl.	1299cc	44kW (60PS)		Petrol		TD15953
J4P			4 Cyl.	1299cc	44kW (60PS)		Petrol		TD15954
J4Q			4 Cyl.	1299cc	44kW (60PS)		Petrol		TD15931
J4R			4 Cyl.	1299cc	44kW (60PS)		Petrol		TD15932
J4S			4 Cyl.	1299cc	44kW (60PS)		Petrol		TD15955
J4T			4 Cyl.	1299cc	44kW (60PS)		Petrol		TD15933
J6A			4 Cyl.	1299cc	44kW (60PS)		Petrol		TD1223
J6B			4 Cyl.	1299cc	44kW (60PS)		Petrol		TD1224
JBC			4 Cyl.	1299cc	44kW (60PS)		Petrol		TD1229
JBD			4 Cyl.	1297cc	46kW (63PS)		Petrol		TD1230
JBE			4 Cyl.	1299cc	44kW (60PS)		Petrol		TD1231
JJA			4 Cyl.	1299cc	37kW (50PS)		Petrol		TD12071
JJB			4 Cyl.	1299cc	37kW (50PS)		Petrol		TD12083
JJC			4 Cyl.	1299cc	37kW (50PS)		Petrol		TD12072
JJD			4 Cyl.	1299cc	36kW (49PS)		Petrol		TD12082
JJE			4 Cyl.	1299cc	37kW (50PS)		Petrol		TD15926
JJF			4 Cyl.	1299cc	36kW (49PS)		Petrol		TD15948
JJG			4 Cyl.	1299cc	36kW (49PS)		Petrol		TD15949
JJH			4 Cyl.	1299cc	36kW (49PS)		Petrol		TD15950
JJJ			4 Cyl.	1299cc	37kW (50PS)		Petrol		TD15927
JJK			4 Cyl.	1299cc	37kW (50PS)		Petrol		TD15928
JJL			4 Cyl.	1299cc	36kW (49PS)		Petrol		TD15951
JJM			4 Cyl.	1299cc	37kW (50PS)		Petrol		TD15929
BE/PL	4	40,990/41,010	43,990/44,010	17,950	1,450	0,080/0,145	AL-LF	4165RA	01-4153/4 STD 0.25 0.75
MB/HL	1	56,990/57,000	60,623/60,636	18,690	1,807	0,020/0,057	AL-LF	4166RA	02-4549 STD 0.25

FORD

TW/A	2	63,600	78,100		2,850		AL-LF	66526AF	A209/2 STD	
CB/NWB 2,3	2	39,615/39,635	42,888/42,913	17,270	1,600		BB	GS128S	N182/3 STD	
CB/NWB 1	1	39,615/39,635	42,888/42,913	20,320	1,600		BB	GS129S		

20 74.00 x 75.50

JAC		4 Cyl.	1297cc	40-43kW (55-58PS)	Petrol				TD1226
BE/PL	4	51,980/52,000	55,000/55,020	20,000	1,497	0,020/0,071	AL-LF	3460RA	01-4142/4 STD 0.25 0.50 0.75 1.00
MB/HL 1-5	5	56,970/56,990	60,620/60,640	23,600	1,810	0,020/0,075	AL-LF	02-2985	H853/5 STD 0.25 0.50 0.75
TW/A	2	63,850	80,500		2,330		AL-LF	04-2988	A045/4 STD
TW/A	2	63,850	80,500		2,330		AL-LF	04-3362	

21 75.00 x 88.30

G8DA		4 Cyl.	1560cc	80kW (109PS)	Diesel Turbo Intercooler	TD18508			
G8DB		4 Cyl.	1560cc	80kW (109PS)	Diesel Turbo Intercooler	TD18509			
G8DC		4 Cyl.	1560cc	74kW (100PS)	Diesel Turbo Intercooler	TD25205			
G8DD		4 Cyl.	1560cc	80kW (109PS)	Diesel Turbo Intercooler	TD24351			
G8DE		4 Cyl.	1560cc	80kW (109PS)	Diesel Turbo Intercooler	TD25790			
G8DF		4 Cyl.	1560cc	80kW (109PS)	Diesel Turbo Intercooler	TD25791			
MTDA		4 Cyl.	1560cc	74kW (100PS)	Diesel Turbo Intercooler	TD25206			
NGCA		4 Cyl.	1560cc	85kW (115PS)	Diesel Turbo	TD30545			
NGDA		4 Cyl.	1560cc	77kW (105PS)	Diesel Turbo Intercooler	TD26481			
NGDB		4 Cyl.	1560cc	77kW (105PS)	Diesel Turbo Intercooler	TD31042			
T1BA		4 Cyl.	1560cc	85kW (116PS)	Diesel Turbo Intercooler	TD26475			
T1BB		4 Cyl.	1560cc	85kW (116PS)	Diesel Turbo Intercooler	TD26476			
T1BC		4 Cyl.	1560cc	85kW (115PS)	Diesel Turbo Intercooler	TD26477			
T1DA		4 Cyl.	1560cc	85kW (116PS)	Diesel Turbo Intercooler	TD25883			
T1DB		4 Cyl.	1560cc	85kW (116PS)	Diesel Turbo Intercooler	TD25884			
T1WA		4 Cyl.	1560cc	85kW (115PS)	Diesel Turbo Intercooler	TD29369			
T1WB		4 Cyl.	1560cc	85kW (115PS)	Diesel Turbo Intercooler	TD29370			
T3CA		4 Cyl.	1560cc	70kW (95PS)	Diesel Turbo	TD29696			
T3CB		4 Cyl.	1560cc	70kW (95PS)	Diesel Turbo	TD29697			
T3CC		4 Cyl.	1560cc	70kW (95PS)	Diesel Turbo Intercooler	TD31108			
T3DA		4 Cyl.	1560cc	70kW (95PS)	Diesel Turbo Intercooler	TD25881			
T3DB		4 Cyl.	1560cc	70kW (95PS)	Diesel Turbo Intercooler	TD25882			
T3JA		4 Cyl.	1560cc	70kW (95PS)	Diesel Turbo	TD26473			
T3JB		4 Cyl.	1560cc	70kW (95PS)	Diesel Turbo	TD28069			
TZJA		4 Cyl.	1560cc	70kW (95PS)	Diesel Turbo	TD24420			
TZJB		4 Cyl.	1560cc	70kW (95PS)	Diesel Turbo	TD24421			
U3CA		4 Cyl.	1560cc	85kW (115PS)	Diesel Turbo	TD30544			
MB/HL 1-5	5	49,962/49,981	53,655/53,674	19,900	1,833	0,008/0,046	AL	02-4244	H1066/5 STD 0.30 0.50
TW/A	2	55,200/55,480	71,350/71,700		2,460		AL	04-4245	A217/2 STD
SE/PB	1	26,000	29,000/29,021	19,980			BS	55-4102	55-4102 SEMI

22 75.00 x 88.30

GPDA Euro 4		4 Cyl.	1560cc	66kW (90PS)	Diesel Turbo Intercooler	TD24348
GPDB		4 Cyl.	1560cc	66kW (90PS)	Diesel Turbo Intercooler	TD31040



GPDC Euro 4			4 Cyl.	1560cc	66kW (90PS)		Diesel Turbo Intercooler	TD24660	
HHDA Euro 4			4 Cyl.	1560cc	66kW (90PS)		Diesel Turbo Intercooler	TD18478	
HHDB Euro 4			4 Cyl.	1560cc	66kW (90PS)		Diesel Turbo Intercooler	TD18479	
HHJA			4 Cyl.	1560cc	66kW (90PS)		Diesel Turbo	TD17988	
HHJB			4 Cyl.	1560cc	66kW (90PS)		Diesel Turbo	TD17989	
HHJC			4 Cyl.	1560cc	66kW (90PS)		Diesel Turbo Intercooler	TD24416	
HHJD			4 Cyl.	1560cc	66kW (90PS)		Diesel Turbo Intercooler	TD23543	
HHJE			4 Cyl.	1560cc	66kW (90PS)		Diesel Turbo Intercooler	TD24417	
HHJF			4 Cyl.	1560cc	55kW (75PS)		Diesel Turbo	TD24418	
UBJA			4 Cyl.	1560cc	55kW (75PS)		Diesel Turbo	TD24419	
BE/PL	4	46,975/46,991	50,655/50,674	17,000	1,818	0,028/0,063	BS	71-4246	71-4246/4 STD 0.30 0.50
MB/HL 1-5	5	49,962/49,981	53,655/53,674	19,900	1,833	0,008/0,046	AL	02-4244	H1066/5 STD 0.30 0.50
TW/A	2	55,200/55,480	71,350/71,700		2,460		AL	04-4245	A217/2 STD
SE/PB	1	26,000	29,000/29,021	19,980			BS	55-4102	55-4102 SEMI

23

76.00 x 76.50

ASDA			4 Cyl.	1388cc	59kW (80PS)		Petrol	TD18501	
ASDB			4 Cyl.	1388cc	59kW (80PS)		Petrol	TD18502	
FHA			4 Cyl.	1388cc	66kW (90PS)		Petrol	TD12074	
FHD			4 Cyl.	1388cc	66kW (90PS)		Petrol	TD11327	
FHE			4 Cyl.	1388cc	66kW (90PS)		Petrol	TD15934	
FHF			4 Cyl.	1388cc	66kW (90PS)		Petrol	TD15919	
FXDA			4 Cyl.	1388cc	55kW (75PS)		Petrol	TD12075	
FXDB			4 Cyl.	1388cc	55kW (75PS)		Petrol	TD15892	
FXDC			4 Cyl.	1388cc	55kW (75PS)		Petrol	TD12076	
FXDD			4 Cyl.	1388cc	55kW (75PS)		Petrol	TD15893	
FXJA			4 Cyl.	1388cc	59kW (80PS)		Petrol	TD17304	
FXJB			4 Cyl.	1388cc	59kW (80PS)		Petrol	TD17305	
FXJC			4 Cyl.	1388cc	59kW (80PS)		Petrol	TD26945	
RTJA			4 Cyl.	1388cc	68-71kW (92-97PS)		Petrol	TD24413	
RTJB			4 Cyl.	1388cc	68-71kW (92-97PS)		Petrol	TD24414	
UTJA			4 Cyl.	1388cc	59kW (80PS)		Petrol	TD26946	
BE/PL	4	39,980/40,000	43,025/43,045	15,000	1,506	0,020/0,052	AL	4415RA	01-4162/4 STD 0.25
MB/HL 1,2,4,5	4	47,980/48,000	54,020/54,038	16,100	3,013	0,020/0,057	AL-LF	4416RA	H1100/5 STD
MB/HL 3	1	47,980/48,000	54,020/54,038	23,750	3,013	0,020/0,057	AL-LF	4417RAH	



4417RAH

STD 24,000/.9449" - 24,050/.9469"
0.25mm 24,000/.9449" - 24,050/.9469"

24

76.00 x 76.50

SPJA			4 Cyl.	1388cc	71kW (97PS)		Petrol	TD23538	
SPJC			4 Cyl.	1388cc	71kW (97PS)		Petrol	TD24412	
BE/PL	4	39,980/40,000	43,025/43,045	15,000	1,506	0,020/0,052	AL	4415RA	01-4162/4 STD 0.25
MB/HL	4	47,980/48,000	54,000/54,018	16,100	2,103	0,024/0,082	AL-LF	02-5014	H1350/5 STD
MB/HL	2	47,980/48,000	54,000/54,018	16,100	2,103	0,024/0,082	AL-LF	02-5015	

FORD

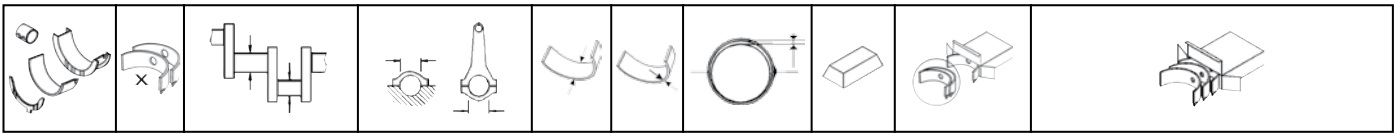

25 76.00 x 88.00

L1E	4 Cyl.	1597cc	66kW (90PS)	Petrol	TD1249
L1F	4 Cyl.	1597cc	66kW (90PS)	Petrol	TD10069
L1G	4 Cyl.	1597cc	65-66kW (88-90PS)	Petrol	TD9467
L1H	4 Cyl.	1597cc	65kW (88PS)	Petrol	TD5105
L1J	4 Cyl.	1597cc	65-66kW (88-90PS)	Petrol	TD4464
L1K	4 Cyl.	1597cc	66-70kW (90-95PS)	Petrol	TD10849
L1L	4 Cyl.	1597cc	70kW (95PS)	Petrol	TD12087
L1N	4 Cyl.	1597cc	70kW (95PS)	Petrol	TD15990
L1Q	4 Cyl.	1597cc	70kW (95PS)	Petrol	TD16010
L1T	4 Cyl.	1596cc	76kW (103PS)	Petrol	TD15935
L1V	4 Cyl.	1596cc	76kW (103PS)	Petrol	TD15936

BE/PL	4	46,890/46,910	49,890/49,910	20,100	1,475	0,030/0,095	AL	4135RA	01-4148/4 STD 0.25
MB/HL 1,2,4,5	4	57,980/58,000	62,287/62,300	19,210	2,131	0,025/0,083	AL	4136RA	H1086/5 STD 0.25
MB/HL 3	1	57,980/58,000	62,287/62,300	24,680	2,131	0,025/0,083	AL	4137RAH	

26 76.00 x 88.00

LUH	4 Cyl.	1597cc	65-66kW (88-90PS)	Petrol	TD1305				
BE/PL	4	47,890/47,910	50,890/50,910	19,300	1,487	0,020/0,071	AL-LF	01-3557	01-3557/4 STD 0.25
MB/HL 1-5	5	57,990/58,000	62,287/62,300	22,400	2,138	0,020/0,059	AL-LF	02-3734	H039/5 STD 0.25
TW/A	2	64,850	81,100		2,351		AL-LF	04-3559	A127/2 STD

27 77.00 x 76.00

UC	4 Cyl.	1416cc	48kW (65PS)	Petrol	TD1469				
BE/PL	8	39,940	43,020	17,130	1,510		AL-LF	64-313-1	01-4343/4 STD

28 77.25 x 74.30

F4A	4 Cyl.	1391cc	54kW (73PS)	Petrol	TD10007
F4B	4 Cyl.	1391cc	54-55kW (73-75PS)	Petrol	TD4447
F6E	4 Cyl.	1392cc	52kW (71PS)	Petrol	TD4451
F6F	4 Cyl.	1392cc	52kW (71PS)	Petrol	TD1177
F6G	4 Cyl.	1392cc	52kW (71PS)	Petrol	TD1178
FUF	4 Cyl.	1392cc	55kW (75PS)	Petrol	TD1186
FUG	4 Cyl.	1392cc	54kW (73PS)	Petrol	TD1187
FUH	4 Cyl.	1392cc	54-55kW (71-75PS)	Petrol	TD1188
FUJ	4 Cyl.	1392cc	54kW (73PS)	Petrol	TD1189

BE/PL	4	47,890/47,910	50,890/50,910	19,300	1,487	0,020/0,071	AL-LF	01-3557	01-3557/4 STD 0.25
MB/HL 1-5	5	57,990/58,000	62,287/62,300	22,400	2,138	0,020/0,059	AL-LF	02-3734	H039/5 STD 0.25
TW/A	2	64,850	81,100		2,351		AL-LF	04-3559	A127/2 STD

29 77.25 x 74.30

F6A	4 Cyl.	1393cc	52-54kW (71-73PS)	Petrol	TD4448
F6B	4 Cyl.	1392cc	52-54kW (71-73PS)	Petrol	TD1171
F6C	4 Cyl.	1392cc	52kW (71PS)	Petrol	TD4450
F6D	4 Cyl.	1392cc	54kW (73PS)	Petrol	TD1174



FUA	4 Cyl.	1392cc	55kW (75PS)	Petrol	TD4453
FUAA	4 Cyl.	1392cc	51-55kW (69-75PS)	Petrol	TD1181
FUB	4 Cyl.	1392cc	55kW (75PS)	Petrol	TD1182
FUC	4 Cyl.	1392cc	54kW (73PS)	Petrol	TD1184
FUD	4 Cyl.	1392cc	54kW (73PS)	Petrol	TD1185

BE/PL	4	47,890/47,910	50,890/50,910	19,300	1,487	0,020/0,071	AL-LF	01-3557	01-3557/4 STD 0.25
MB/HL 1-5	5	57,990/58,000	62,287/62,300	22,400	2,138	0,020/0,059	AL-LF	02-3734	H039/5 STD 0.25
01/88 →									
MB/HL 1-5	5	57,990/58,000	62,287/62,300	22,400	2,138	0,020/0,059	AL-LF	1926RA	H1079/5 STD 0.25 0.50
→12/87									

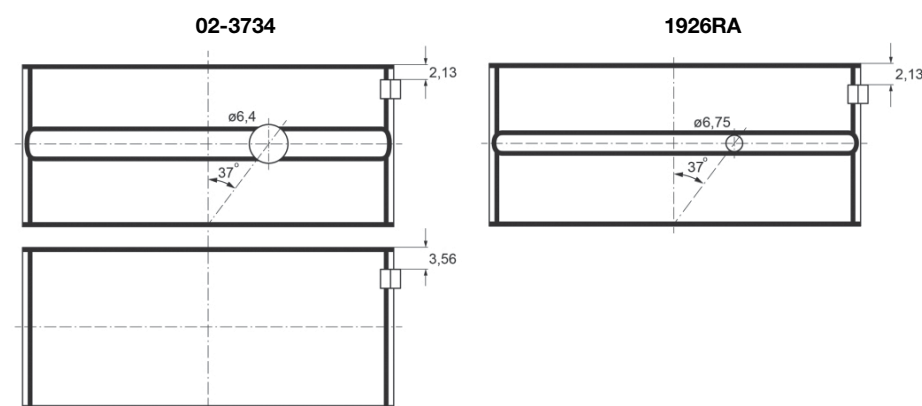

TW/A	2	64,850	81,100	2,351	AL-LF	04-3559	A127/2 STD
------	---	--------	--------	-------	-------	---------	----------------------

30 77.25 x 74.30

FUBA	4 Cyl.	1392cc	51kW (69PS)	Petrol	TD1183				
BE/PL	4	47,890/47,910	50,890/50,910	19,300	1,487	0,020/0,071	AL-LF	01-3557	01-3557/4 STD 0.25
MB/HL 1-5	5	57,990/58,000	62,287/62,300	22,400	2,138	0,020/0,059	AL-LF	1926RA	H1079/5 STD 0.25 0.50
TW/A	2	64,850	81,100	2,351	AL-LF	04-3559	A127/2 STD		

31 78.00 x 83.60

B6	4 Cyl.	1598cc	79kW (107PS)	Petrol	TD27818				
BE/PL	8	44,940	48,020	17,000	1,510		AL-LF	64-317-1	01-4359/4 STD
MB/HL 1-5	5	49,940	54,020	17,500	2,010		AL	63-317-1	H1192/5 STD
MB/HL 1-5	5	49,940	54,020	17,500	2,010		AL	63-317-2	

32 79.00 x 66.00

JCC	4 Cyl.	1294cc	43kW (58PS)	Petrol	TD1232				
BE/PL	4	51,980/52,000	55,000/55,020	20,000	1,497	0,020/0,071	AL-LF	3460RA	01-4142/4 STD 0.25 0.50 0.75 1.00
MB/HL 1-5	5	56,970/56,990	60,620/60,640	23,600	1,810	0,020/0,075	AL-LF	02-2985	H853/5 STD 0.25 0.50 0.75
TW/A	2	63,850	80,500	2,330			AL-LF	04-2988	A045/4 STD
TW/A	2	63,850	80,500	2,330			AL-LF	04-3362	

FORD

CB/NWB 1	1	41,995/42,010	45,072/45,102	20,000	1,521		BC	53-2989	N145/3 STD
CB/NWB 2	1	44,615/44,630	47,692/47,722	17,000	1,521		BC	53-2990	
CB/NWB 3	1	44,995/45,010	48,072/48,102	16,000	1,521		BC	53-2991	

33

79.00 x 66.00

JCT		4 Cyl.		1294cc	44kW (60PS)	Petrol			TD1233
BE/PL	4	51,980/52,000	55,000/55,020	20,000	1,497	0,020/0,071	AL-LF	3460RA	01-4142/4 STD 0.25 0.50 0.75 1.00
BE/PL	4	51,980/52,000	55,000/55,020	20,000	1,470	0,006/0,069	BS	AE5792	71-4382/4 STD 0.25 0.50
MB/HL 1-5	5	56,970/56,990	60,620/60,640	23,600	1,810	0,020/0,075	AL-LF	02-2985	H1222/5 STD 0.25
MB/HL 1-5	5	56,970/56,990	60,620/60,640	23,600	1,810	0,020/0,075	AL-LF	02-2985L	
01/86→									
MB/HL 1-5	5	56,980/57,000	60,620/60,640	23,620	1,810		BS	72-2985	H1235/5 STD 0.25 0.50
10/82→12/85									
MB/HL 1-5	5	56,970/56,990	60,620/60,640	23,600	1,810	0,020/0,075	AL-LF	02-2985	H853/5 STD 0.25 0.50 0.75
10/82→12/85									
TW/A	2	63,850	80,500		2,330		AL-LF	04-2988	A045/4 STD
TW/A	2	63,850	80,500		2,330		AL-LF	04-3362	
CB/NWB 1	1	41,995/42,010	45,072/45,102	20,000	1,521		BC	53-2989	N145/3 STD
CB/NWB 2	1	44,615/44,630	47,692/47,722	17,000	1,521		BC	53-2990	
CB/NWB 3	1	44,995/45,010	48,072/48,102	16,000	1,521		BC	53-2991	

34

79.00 x 81.40

FYDA	4 Cyl.	1596cc	74-75kW (100-102PS)	Petrol	TD12077
FYDB	4 Cyl.	1596cc	74kW (100PS)	Petrol	TD15894
FYDC	4 Cyl.	1596cc	74kW (100PS)	Petrol	TD12078
FYDD	4 Cyl.	1596cc	74kW (100PS)	Petrol	TD15895
FYDH	4 Cyl.	1596cc	74-75kW (100-102PS)	Petrol	TD18776
FYJA	4 Cyl.	1596cc	74kW (100PS)	Petrol	TD17306
FYJB	4 Cyl.	1596cc	74kW (100PS)	Petrol	TD18778
FYJC	4 Cyl.	1596cc	74kW (100PS)	Petrol	TD31039
HWDA	4 Cyl.	1596cc	74kW (100PS)	Petrol	TD18503
HWDB	4 Cyl.	1596cc	74kW (100PS)	Petrol	TD18504
HXDA	4 Cyl.	1596cc	85kW (115PS)	Petrol	TD18505
HXDB	4 Cyl.	1596cc	85kW (115PS)	Petrol	TD23365
HXJD	4 Cyl.	1596cc	90kW (122PS)	Petrol Turbo	TD31022
IQJB	4 Cyl.	1596cc	90kW (122PS)	Petrol Turbo	TD31023
JQMA	4 Cyl.	1596cc	110kW (150PS)	Petrol Turbo	TD29490
JQMB	4 Cyl.	1596cc	110kW (150PS)	Petrol Turbo	TD29491
JTMA	4 Cyl.	1596cc	134kW (182PS)	Petrol Turbo	TD29492
L1W	4 Cyl.	1596cc	76kW (103PS)	Petrol	TD18770
SHDA	4 Cyl.	1596cc	74kW (101PS)	Petrol	TD21247
SHDB	4 Cyl.	1596cc	74kW (101PS)	Petrol	TD24345
SHDC	4 Cyl.	1596cc	74kW (101PS)	Petrol	TD24346

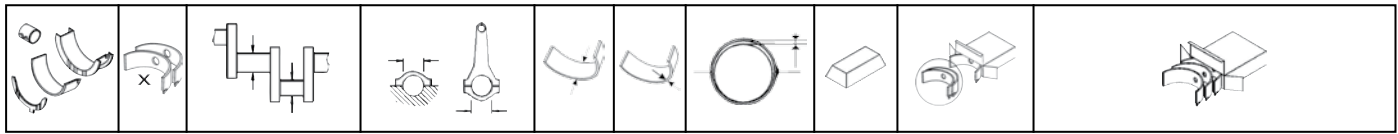

YUDA		4 Cyl.		1596cc	110kW (150PS)		Petrol Turbo		TD31050
BE/PL	4	43,985/44,000	47,035/47,045	15,270	1,516	0,020/0,050	AL-LF	01-4040	01-4040/4 STD 0.25
MB/HL 1,2,4,5	4	47,980/48,000	54,020/54,038	16,100	3,013	0,020/0,057	AL-LF	4416RA	H1100/5 STD
MB/HL 3	1	47,980/48,000	54,020/54,038	23,750	3,013	0,020/0,057	AL-LF	4417RAH	
			4417RAH	STD	24,000/.9449" - 24,050/.9469"				
				0.25mm	24,000/.9449" - 24,050/.9469"				

35		79.00 x 81.40							
HXJA	4 Cyl.		1596cc	88-89kW (120-121PS)		Petrol		TD23541	
HXJB	4 Cyl.		1596cc	88kW (120PS)		Petrol		TD24415	
IQDA	4 Cyl.		1596cc	77kW (105PS)		Petrol		TD25873	
IQDB	4 Cyl.		1596cc	77kW (105PS)		Petrol		TD25874	
IQJA	4 Cyl.		1596cc	77kW (105PS)		Petrol		TD27832	
MUDA	4 Cyl.		1596cc	86-88kW (117-120PS)		Petrol		TD25876	
PNBA	4 Cyl.		1596cc	92kW (125PS)		Petrol		TD23302	
PNDA	4 Cyl.		1596cc	92kW (125PS)		Petrol		TD25875	
RHBA	4 Cyl.		1596cc	81kW (110PS)		Petrol		TD23301	
SIDA	4 Cyl.		1596cc	85kW (115PS)		Petrol		TD23366	
XTDA	4 Cyl.		1596cc	63kW (85PS)		Petrol		TD26480	
BE/PL	4	43,985/44,000	47,035/47,045	15,270	1,516	0,020/0,050	AL-LF	01-4040	01-4040/4 STD 0.25
MB/HL	4	47,980/48,000	54,000/54,018	16,100	2,103	0,024/0,082	AL-LF	02-5014	H1350/5 STD
MB/HL	2	47,980/48,000	54,000/54,018	16,100	2,103	0,024/0,082	AL-LF	02-5015	

36		79.50 x 95.50							
1Z	4 Cyl.		1896cc	66kW (90PS)		Diesel Turbo Intercooler		TD11370	
BE/PL	4	47,758/47,778	50,600/50,619	20,000	1,406	0,020/0,074	EC	71-3728	71-3728/4 STD 0.25 0.50
MB/HL 1-5	5	53,958/53,978	59,000/59,019	18,500	2,502	0,020/0,082	AL-LF	02-3085L	H084/5 STD 0.25 0.50
MB/HL 1-5	5	53,958/53,978	59,000/59,019	18,500	2,502	0,020/0,082	AL-LF	02-3085U	
TW/A	2	59,500	73,200		1,975		AL-LF	04-3527	A123/4 STD
TW/A	2	59,500	73,200		1,975		AL-LF	04-3528	
SE/PB	1	26,000	29,000/29,052	25,000			BC	55-3729	55-3729 SEMI
BU	1	42,959/42,975	46,055/46,095	15,000			AL-LF	07-3088	07-3088 STD SEMI [13]
Front, For intermediary shaft									
BU	1	41,959/41,975	45,000/45,025	15,000			AL-LF	07-3089	07-3089 STD SEMI [13]
Rear, For intermediary shaft									

37		79.50 x 95.50							
AFN	4 Cyl.		1896cc	81kW (110PS)		Diesel Turbo Intercooler		TD11368	
BE/PL	4	47,758/47,778	50,600/50,612	20,000	1,406	0,020/0,067	SP	71-3847	71-3847/4 STD 0.25 [1]
BE/PL	4	47,758/47,778	50,600/50,612	19,000	1,406	0,020/0,067	EC	71-3929	71-3929/4 STD [11]

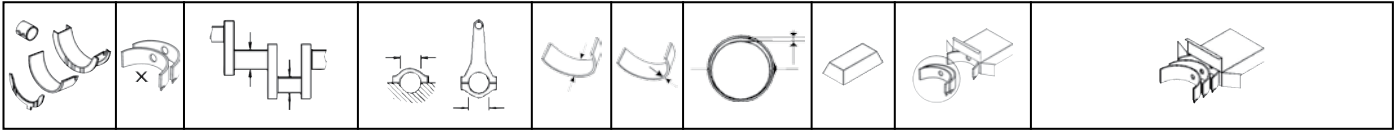

71-3847

71-3929

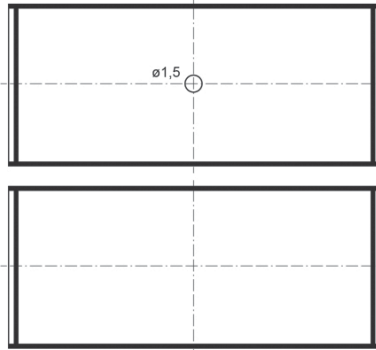
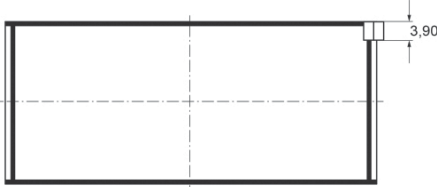

MB/HL 1-5	5	53,958/53,978	59,000/59,019	18,500	2,502	0,020/0,082	AL-LF	02-3085L	H084/5 STD 0.25 0.50
MB/HL 1-5	5	53,958/53,978	59,000/59,019	18,500	2,502	0,020/0,082	AL-LF	02-3085U	
TW/A	2	59,500	73,200		1,975		AL-LF	04-3527	A123/4 STD
TW/A	2	59,500	73,200		1,975		AL-LF	04-3528	
SE/PB	1	26,000	29,000/29,052	25,000			BC	55-3729	55-3729 SEMI

38

79.50 x 95.50

AHU			4 Cyl.	1896cc	66kW (90PS)		Diesel	Turbo	Intercooler	TD11369
BE/PL	4	47,758/47,778	50,600/50,619	20,000	1,406	0,020/0,074	EC	71-3728	71-3728/4 STD 0.25 0.50	
BE/PL	4	47,758/47,778	50,600/50,612	19,000	1,406	0,020/0,067	EC	71-3929	71-3929/4 STD	II

71-3728

71-3929

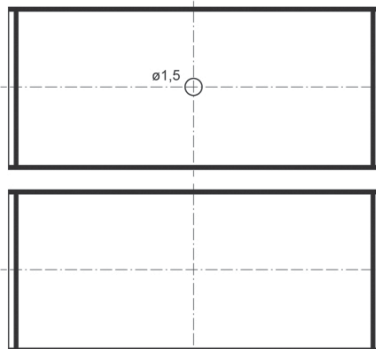

MB/HL 1-5	5	53,958/53,978	59,000/59,019	18,500	2,502	0,020/0,082	AL-LF	02-3085L	H084/5 STD 0.25 0.50
MB/HL 1-5	5	53,958/53,978	59,000/59,019	18,500	2,502	0,020/0,082	AL-LF	02-3085U	
TW/A	2	59,500	73,200		1,975		AL-LF	04-3527	A123/4 STD
TW/A	2	59,500	73,200		1,975		AL-LF	04-3528	
SE/PB	1	26,000	29,000/29,052	25,000			BC	55-3729	55-3729 SEMI
BU	1	42,959/42,975	46,055/46,095	15,000			AL-LF	07-3088	07-3088 STD SEMI

Front, For intermediary shaft



BU	1	41,959/41,975	45,000/45,025	15,000			AL-LF	07-3089	07-3089 STD SEMI	13
----	---	---------------	---------------	--------	--	--	-------	---------	----------------------------	----

Rear, For intermediary shaft

39 79.50 x 95.50

AJM	4 Cyl. 1896cc 85kW (116PS)			Diesel Turbo		TD14108
ANU	4 Cyl. 1896cc 66kW (90PS)			Diesel Turbo Intercooler		TD14917
AUY	4 Cyl. 1896cc 85kW (115PS)			Diesel Turbo Intercooler		TD14918

BE/PL	1	47,758/47,778	50,600/50,612	20,000	1,406	0,020/0,067	SP	71-3904	71-3904 STD 0.25 0.50	11
MB/HL 1-5	5	53,958/53,978	59,000/59,019	18,500	2,502	0,020/0,082	AL-LF	02-3085L	H084/5 STD 0.25 0.50	
MB/HL 1-5	5	53,958/53,978	59,000/59,019	18,500	2,502	0,020/0,082	AL-LF	02-3085U		
TW/A	2	59,500	73,200		1,975		AL-LF	04-3527	A123/4 STD	
TW/A	2	59,500	73,200		1,975		AL-LF	04-3528		
SE/PB	1	26,000	29,000/29,052	25,000			BC	55-3729	55-3729 SEMI	
CB/NWB 1-5	5	28,947/28,960	32,000/32,025	25,000	1,513	0,020/0,068	EC	73-3903	N147/5 STD	
BU	1	42,959/42,975	46,055/46,095	15,000			AL-LF	07-3088	07-3088 STD SEMI	13

Front, For intermediary shaft

BU	1	41,959/41,975	45,000/45,025	15,000			AL-LF	07-3089	07-3089 STD SEMI	13
----	---	---------------	---------------	--------	--	--	-------	---------	----------------------------	----

Rear, For intermediary shaft

40 79.50 x 95.50

ASZ	4 Cyl. 1896cc 96kW (130PS)			Diesel Turbo Intercooler		TD17167
BTB	4 Cyl. 1896cc 110kW (150PS)			Diesel Turbo Intercooler		TD18795

BE/PL	1	50,858/50,878	53,700/53,712	20,400	1,403	0,020/0,073	SP	71-3930	71-3930 STD 0.25 0.50	11
MB/HL 1-5	5	53,958/53,978	59,000/59,012	18,500	2,501	0,020/0,076	EC	72-3931	H079/5 STD 0.25 0.50	
TW/A	2	59,500	73,200		1,975		AL-LF	04-3527	A123/4 STD	
TW/A	2	59,500	73,200		1,975		AL-LF	04-3528		
CB/NWB 1-5	5	28,947/28,960	32,000/32,025	25,000	1,513	0,020/0,068	EC	73-3903	N147/5 STD	

41 79.50 x 95.50

AVG	4 Cyl. 1896cc 81kW (110PS)			Diesel Turbo		TD17557
------------	--	--	--	---------------------	--	----------------

BE/PL	4	47,758/47,778	50,600/50,612	20,000	1,406	0,020/0,067	SP	71-3847	71-3847/4 STD 0.25	11
BE/PL	4	47,758/47,778	50,600/50,612	19,000	1,406	0,020/0,067	EC	71-3929	71-3929/4 STD	11

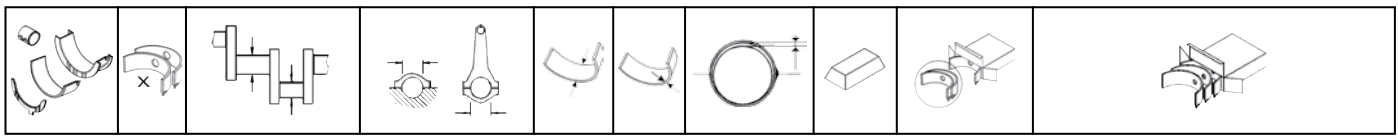

71-3847

71-3929

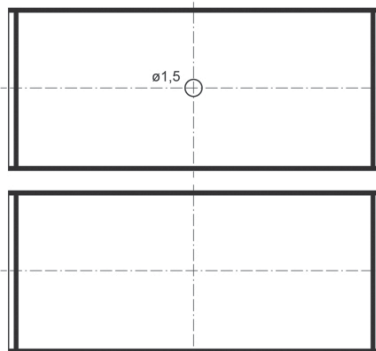

MB/HL 1-5	5	53,958/53,978	59,000/59,019	18,500	2,502	0,020/0,082	AL-LF	02-3085L	H084/5 STD 0.25 0.50
MB/HL 1-5	5	53,958/53,978	59,000/59,019	18,500	2,502	0,020/0,082	AL-LF	02-3085U	
TW/A	2	59,500	73,200		1,975		AL-LF	04-3527	A123/4 STD
TW/A	2	59,500	73,200		1,975		AL-LF	04-3528	
SE/PB	1	26,000	29,000/29,052	25,000			BC	55-3729	55-3729 SEMI
CB/NWB 1-5	5	28,947/28,960	32,000/32,025	25,000	1,513	0,020/0,068	EC	73-3903	N147/5 STD

42 79.96 x 79.52

LJA	4 Cyl.	1597cc	77kW (105PS)	Petrol	TD27756
LJA	4 Cyl.	1598cc	77kW (105PS)	Petrol	TD1274
LNB	4 Cyl.	1597cc	97kW (132PS)	Petrol Turbo Intercooler	TD1282

BE/PL	4	47,890/47,910	50,890/50,910	19,300	1,487	0,020/0,071	AL-LF	01-3557	01-3557/4 STD 0.25
MB/HL 1-5	5	57,990/58,000	62,287/62,300	22,400	2,138	0,020/0,059	AL-LF	02-3734	H039/5 STD 0.25

01/88 →

MB/HL 1-5	5	57,990/58,000	62,287/62,300	22,400	2,138	0,020/0,059	AL-LF	1926RA	H1079/5 STD 0.25 0.50
-----------	---	---------------	---------------	--------	-------	-------------	-------	--------	---------------------------------

→12/87

02-3734

1926RA

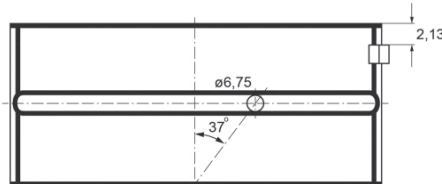
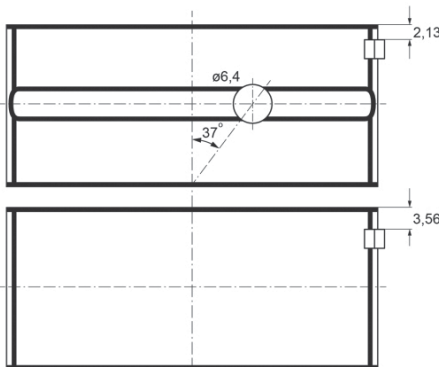

TW/A	2	64,850	81,100		2,351		AL-LF	04-3559	A127/2 STD
------	---	--------	--------	--	-------	--	-------	---------	----------------------



43 79.96 x 79.52

LJF		4 Cyl.		1598cc	77kW (105PS)		Petrol		TD4466
BE/PL	4	47,890/47,910	50,890/50,910	19,300	1,487	0,020/0,071	AL-LF	01-3557	01-3557/4 STD 0.25
MB/HL 1-5	5	57,990/58,000	62,287/62,300	22,400	2,138	0,020/0,059	AL-LF	02-3734	H039/5 STD 0.25
TW/A	2	64,850	81,100		2,351		AL-LF	04-3559	A127/2 STD

44 79.96 x 79.52

LNA		4 Cyl.		1597cc	97kW (132PS)		Petrol Turbo Intercooler		TD1281
BE/PL	4	47,890/47,910	50,890/50,910	19,300	1,487	0,020/0,071	AL-LF	01-3557	01-3557/4 STD 0.25
MB/HL 1-5	5	57,990/58,000	62,287/62,300	22,400	2,138	0,020/0,059	AL-LF	1926RA	H1079/5 STD 0.25 0.50
TW/A	2	64,850	81,100		2,351		AL-LF	04-3559	A127/2 STD

45 80.00 x 60.10

RY		V6 Cyl.		1814cc	60kW (82PS)		Petrol		TD1442
BE/PL	1	53,980/54,000	56,820/56,840	16,480	1,407	0,020/0,071	EC	71-2185	71-2185 STD

46 80.00 x 64.50

JPA		4 Cyl.		1296cc	51kW (69PS)		Petrol		TD1238
JPC		4 Cyl.		1297cc	51kW (69PS)		Petrol		TD1239
BE/PL	4	47,890/47,910	50,890/50,910	19,300	1,487	0,020/0,071	AL-LF	01-3557	01-3557/4 STD 0.25
MB/HL 1-5	5	57,990/58,000	62,287/62,300	22,400	2,138	0,020/0,059	AL-LF	02-3734	H039/5 STD 0.25
01/88 →									
MB/HL 1-5	5	57,990/58,000	62,287/62,300	22,400	2,138	0,020/0,059	AL-LF	1926RA	H1079/5 STD 0.25 0.50
→12/87									

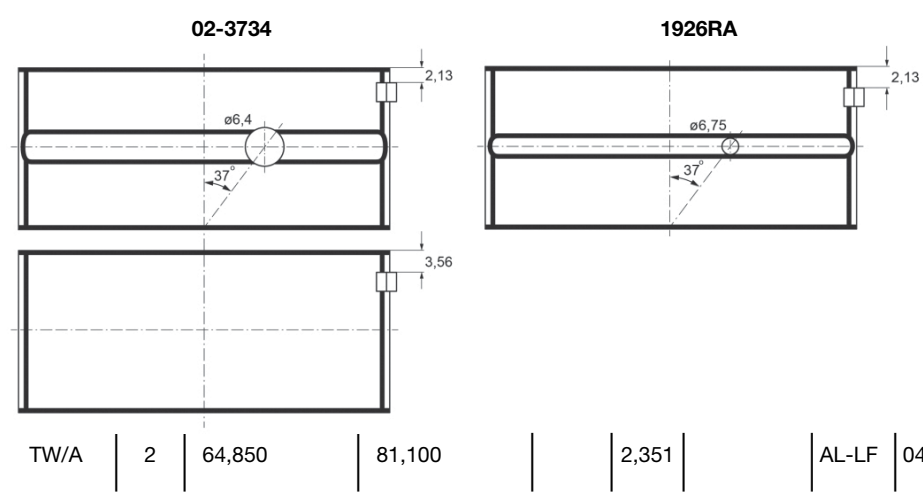

TW/A	2	64,850	81,100		2,351		AL-LF	04-3559	A127/2 STD
------	---	--------	--------	--	-------	--	-------	---------	----------------------

47 80.00 x 79.50

L4B	4 Cyl.	1598cc	66kW (90PS)		Petrol		TD1252
LJB	4 Cyl.	1597cc	75kW (102PS)		Petrol		TD1275
LJC	4 Cyl.	1597cc	81kW (110PS)		Petrol		TD1277
LJE	4 Cyl.	1598cc	79kW (108PS)		Petrol		TD1279
LP2	4 Cyl.	1597cc	58kW (79PS)		Petrol		TD1284



LP3	4 Cyl.	1597cc	58kW (79PS)	Petrol	TD1285
LR2	4 Cyl.	1597cc	77kW (105PS)	Petrol	TD1288
LRB	4 Cyl.	1597cc	77kW (105PS)	Petrol	TD1290
LUAE	4 Cyl.	1597cc	85kW (115PS)	Petrol	TD1299
LUB	4 Cyl.	1597cc	70-71kW (95-97PS)	Petrol	TD1300
LUC	4 Cyl.	1597cc	60-66kW (81-90PS)	Petrol	TD1301
LUD	4 Cyl.	1597cc	70kW (95PS)	Petrol	TD1302
LUG	4 Cyl.	1597cc	65-66kW (88-90PS)	Petrol	TD1304

BE/PL	4	47,890/47,910	50,890/50,910	19,300	1,487	0,020/0,071	AL-LF	01-3557	01-3557/4 STD 0.25
MB/HL 1-5	5	57,990/58,000	62,287/62,300	22,400	2,138	0,020/0,059	AL-LF	02-3734	H039/5 STD 0.25

01/88 →

MB/HL 1-5	5	57,990/58,000	62,287/62,300	22,400	2,138	0,020/0,059	AL-LF	1926RA	H1079/5 STD 0.25 0.50
--------------	---	---------------	---------------	--------	-------	-------------	-------	--------	---------------------------------

→12/87

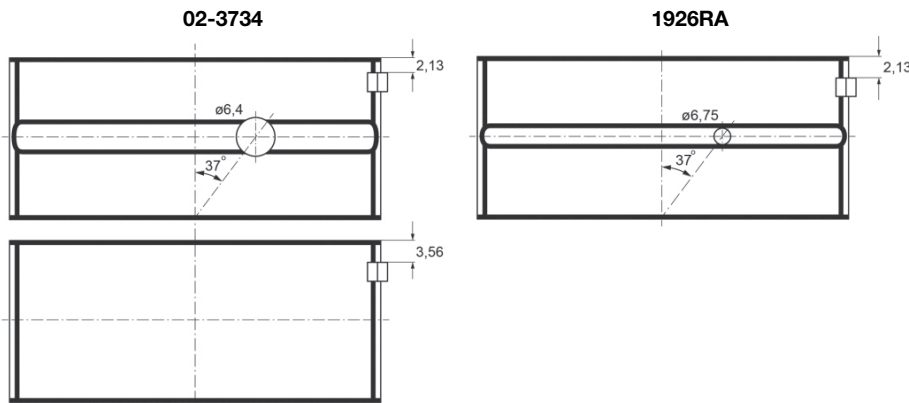

TW/A	2	64,850	81,100		2,351		AL-LF	04-3559	A127/2 STD
------	---	--------	--------	--	-------	--	-------	---------	----------------------

48 80.00 x 79.50

L6B	4 Cyl.	1598cc	59kW (80PS)	Petrol	TD1254
LHA	4 Cyl.	1598cc	96-98kW (131-133PS)	Petrol Turbo	TD1273
LJD	4 Cyl.	1598cc	76kW (103PS)	Petrol	TD4465
LUJ	4 Cyl.	1598cc	65-66kW (88-90PS)	Petrol	TD1306
LUK	4 Cyl.	1598cc	65-66kW (88-90PS)	Petrol	TD1308

BE/PL	4	47,890/47,910	50,890/50,910	19,300	1,487	0,020/0,071	AL-LF	01-3557	01-3557/4 STD 0.25
MB/HL 1-5	5	57,990/58,000	62,287/62,300	22,400	2,138	0,020/0,059	AL-LF	02-3734	H039/5 STD 0.25
TW/A	2	64,850	81,100		2,351		AL-LF	04-3559	A127/2 STD

49 80.00 x 79.50

LP1	4 Cyl.	1597cc	52-58kW (71-79PS)	Petrol	TD1283
LPA	4 Cyl.	1597cc	58kW (79PS)	Petrol	TD1286
LR1	4 Cyl.	1597cc	77kW (105PS)	Petrol	TD1287
LRA	4 Cyl.	1597cc	77kW (105PS)	Petrol	TD1289
LUA	4 Cyl.	1597cc	71kW (96PS)	Petrol	TD27755
LUA	4 Cyl.	1597cc	71kW (96PS)	Petrol	TD1298

BE/PL	4	47,890/47,910	50,890/50,910	19,300	1,487	0,020/0,071	AL-LF	01-3557	01-3557/4 STD 0.25
MB/HL 1-5	5	57,990/58,000	62,287/62,300	22,400	2,138	0,020/0,059	AL-LF	1926RA	H1079/5 STD 0.25 0.50

TW/A	2	64,850	81,100		2,351		AL-LF	04-3559	A127/2 STD

50	80.00 x 80.00								
LTA			4 Cyl.	1608cc	40kW (54PS)			Diesel	TD1295
LTB			4 Cyl.	1608cc	40kW (54PS)			Diesel	TD1296
LTC			4 Cyl.	1608cc	40kW (54PS)			Diesel	TD1297
BE/PL	4	48,970/48,990	52,000/52,020	20,500	1,490	0,030/0,095	AL-LF	2090RA	01-4132/4 STD
TW/A	2	59,346/59,690	74,498/74,752		2,362		AL-LF	2786BF	A180/2 STD .005

51	80.00 x 83.50								
MHA			4 Cyl.	1679cc	92kW (125PS)			Petrol	TD5498
MHB			4 Cyl.	1679cc	92kW (125PS)			Petrol	TD15920
BE/PL	4	39,980/40,000	43,025/43,045	15,000	1,506	0,020/0,052	AL	4415RA	01-4162/4 STD 0.25
MB/HL 1,2,4,5	4	47,980/48,000	54,020/54,038	16,100	3,013	0,020/0,057	AL-LF	4416RA	H1100/5 STD
MB/HL 3	1	47,980/48,000	54,020/54,038	23,750	3,013	0,020/0,057	AL-LF	4417RAH	
	4417RAH	STD	24,000/.9449" - 24,050/.9469"						
		0.25mm	24,000/.9449" - 24,050/.9469"						

52	80.00 x 88.00								
R2C			4 Cyl.	1769cc	64kW (87PS)			Petrol	TD1418
R6A			4 Cyl.	1769cc	64-66kW (87-90PS)			Petrol	TD17422
BE/PL	4	43,889/43,909	46,888/46,909	19,510	1,488	0,020/0,069	BS	1400CP	71-4446/4 STD 0.25
MB/HL 1,2,4,5	4	57,981/58,001	62,286/62,301	22,580	2,129	0,027/0,087	BS	3806CPA	H1111/5 STD 0.25
MB/HL 3	1	57,981/58,001	62,286/62,301	28,725	2,129	0,027/0,087	BS	3807CPAH	

53	80.60 x 88.00								
EYDB			4 Cyl.	1796cc	85kW (115PS)			Petrol	TD15896
EYDC			4 Cyl.	1796cc	85kW (115PS)			Petrol	TD12079
EYDD			4 Cyl.	1796cc	85kW (115PS)			Petrol	TD15897
EYDE			4 Cyl.	1796cc	85kW (115PS)			Petrol	TD15898
EYDF			4 Cyl.	1796cc	85kW (115PS)			Petrol	TD15899
EYDG			4 Cyl.	1796cc	85kW (115PS)			Petrol	TD18772
EYDI			4 Cyl.	1796cc	85kW (115PS)			Petrol	TD18774
EYDJ			4 Cyl.	1796cc	85kW (115PS)			Petrol	TD18775
EYDL			4 Cyl.	1796cc	85kW (115PS)			Petrol	TD18784
EYPA			4 Cyl.	1796cc	85kW (116PS)			Petrol	TD18773
EYPC			4 Cyl.	1796cc	85kW (116PS)			Petrol	TD18843
EYPD			4 Cyl.	1796cc	85kW (115PS)			Petrol	TD24464
RDA			4 Cyl.	1796cc	77kW (105PS)			Petrol	TD1419
RDB			4 Cyl.	1796cc	77kW (105PS)			Petrol	TD1420
RKA			4 Cyl.	1796cc	85kW (115PS)			Petrol	TD4487
RKB			4 Cyl.	1796cc	82-85kW (111-116PS)			Petrol	TD12091
RKC			4 Cyl.	1796cc	85kW (115PS)			Petrol	TD5107
RKF			4 Cyl.	1796cc	85kW (115PS)			Petrol	TD12088
RKH			4 Cyl.	1796cc	85kW (115PS)			Petrol	TD15991
RKJ			4 Cyl.	1796cc	85kW (115PS)			Petrol	TD12089



RKK	4 Cyl.	1796cc	85kW (115PS)	Petrol	TD16011
RQB	4 Cyl.	1796cc	96kW (130PS)	Petrol	TD1431
RQB	4 Cyl.	1796cc	96kW (131PS)	Petrol	TD26933
RQC	4 Cyl.	1796cc	96kW (130PS)	Petrol	TD1432

BE/PL	4	46,890/46,910	49,890/49,910	20,100	1,475	0,030/0,095	AL	4135RA	01-4148/4 STD 0.25
MB/HL 1,2,4,5	4	57,980/58,000	62,287/62,300	19,210	2,131	0,025/0,083	AL	4136RA	H1086/5 STD 0.25
MB/HL 3	1	57,980/58,000	62,287/62,300	24,680	2,131	0,025/0,083	AL	4137RAH	

54 80.95 x 48.42

105E, 107E, 307E	4 Cyl.	997cc	Petrol	FM2213
-------------------------	--------	--------------	---------------	---------------

BE/PL	4	49,200/49,213	52,896/52,908	22,350	1,834	0,020/0,065	AL-LF	2785RA	01-4316/4 STD 0.25 0.50 0.75
BE/PL	4	49,199/49,212	52,896/52,908	22,350	1,830	0,012/0,055	EC	AE5795	71-4379/4 STD 0.25 0.50
TW/A	2	59,346/59,690	74,498/74,752		2,362		AL-LF	2786BF	A180/2 STD .005
CB/NWB 1	1	39,616/39,637	42,888/42,913	20,320			AL-LF	2786DRA	N161/3 STD
CB/NWB 2	1	39,616/39,637	42,888/42,913	17,520			AL-LF	2787DRA	
CB/NWB 3	1	39,616/39,637	42,888/42,913	18,670			AL-LF	2788DRA	

55 80.95 x 65.09

109E	4 Cyl.	1340cc	Petrol	FM2224
-------------	--------	---------------	---------------	---------------

BE/PL	4	49,200/49,213	52,896/52,908	22,350	1,834	0,020/0,065	AL-LF	2785RA	01-4316/4 STD 0.25 0.50 0.75
BE/PL	4	49,199/49,212	52,896/52,908	22,350	1,830	0,012/0,055	EC	AE5795	71-4379/4 STD 0.25 0.50
TW/A	2	59,346/59,690	74,498/74,752		2,362		AL-LF	2786BF	A180/2 STD .005
CB/NWB 1	1	39,616/39,637	42,888/42,913	20,320			AL-LF	2786DRA	N161/3 STD
CB/NWB 2	1	39,616/39,637	42,888/42,913	17,520			AL-LF	2787DRA	
CB/NWB 3	1	39,616/39,637	42,888/42,913	18,670			AL-LF	2788DRA	

56 80.95 x 72.62

116E, 120E, 122E	4 Cyl.	1499cc	Petrol	FM2226
-------------------------	--------	---------------	---------------	---------------

118E, 118E GT	4 Cyl.	1499cc	Petrol	FM22226
----------------------	--------	---------------	---------------	----------------

120GT	4 Cyl.	1499cc	Petrol	FM12226
--------------	--------	---------------	---------------	----------------

BE/PL	4	49,200/49,213	52,896/52,908	22,350	1,834	0,020/0,065	AL-LF	2785RA	01-4316/4 STD 0.25 0.50 0.75
BE/PL	4	49,199/49,212	52,896/52,908	22,350	1,830	0,012/0,055	EC	AE5795	71-4379/4 STD 0.25 0.50
MB/HL 1-5	5	53,988/54,000	57,683/57,696	25,520	1,834	0,020/0,065	AL-LF	2786RA	H1143/5 STD 0.25 0.50
TW/A	2	59,346/59,690	74,498/74,752		2,362		AL-LF	2786BF	A180/2 STD .005
CB/NWB 1	1	39,616/39,637	42,888/42,913	20,320			AL-LF	2786DRA	N161/3 STD
CB/NWB 2	1	39,616/39,637	42,888/42,913	17,520			AL-LF	2787DRA	
CB/NWB 3	1	39,616/39,637	42,888/42,913	18,670			AL-LF	2788DRA	

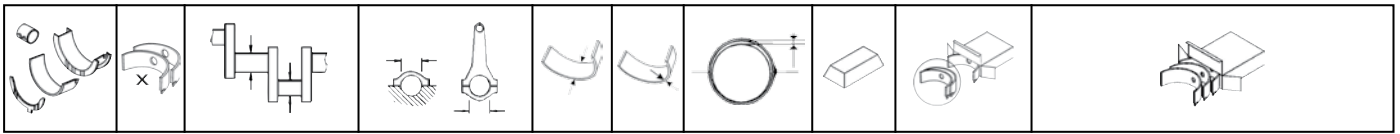

57		80.98 x 45.61								
KL09H (711M)		4 Cyl.			940cc	26kW (35PS)	Petrol		FM655	
BE/PL	4	49,200/49,213	52,896/52,908	22,350	1,834	0,020/0,065	AL-LF	2785RA	01-4316/4 STD 0.25 0.50 0.75	
BE/PL	4	49,199/49,212	52,896/52,908	22,350	1,830	0,012/0,055	EC	AE5795	71-4379/4 STD 0.25 0.50	
MB/HL 1-5	5	53,988/54,000	57,683/57,696	25,520	1,834	0,020/0,065	AL-LF	2786RA	H1143/5 STD 0.25 0.50	
MB/HL 1-5	5	53,988/54,000	57,683/57,696	25,530	1,830		BS	AE4477	H1200/5 STD 0.25 0.50	
TW/A	2	59,346/59,690	74,498/74,752		2,362		AL-LF	2786BF	A180/2 STD .005	
CB/NWB 1	1	39,616/39,637	42,888/42,913	20,320			AL-LF	2786DRA	N161/3 STD	
CB/NWB 2	1	39,616/39,637	42,888/42,913	17,520			AL-LF	2787DRA		
CB/NWB 3	1	39,616/39,637	42,888/42,913	18,670			AL-LF	2788DRA		

58		80.98 x 53.30								
G2		4 Cyl.			1098cc	35kW (48PS)	Petrol		TD1191	
BE/PL	4	49,200/49,213	52,896/52,908	22,350	1,834	0,020/0,065	AL-LF	2785RA	01-4316/4 STD 0.25 0.50 0.75	
BE/PL	4	49,199/49,212	52,896/52,908	22,350	1,830	0,012/0,055	EC	AE5795	71-4379/4 STD 0.25 0.50	
MB/HL 1-5	5	53,988/54,000	57,683/57,696	25,520	1,834	0,020/0,065	AL-LF	2786RA	H1143/5 STD 0.25 0.50	
MB/HL 1-5	5	53,988/54,000	57,683/57,696	25,530	1,830		BS	AE4477	H1200/5 STD 0.25 0.50	
TW/A	2	59,346/59,690	74,498/74,752		2,362		AL-LF	2786BF	A180/2 STD .005	
CB/NWB 1	1	39,616/39,637	42,888/42,913	20,320			AL-LF	2786DRA	N161/3 STD	
CB/NWB 2	1	39,616/39,637	42,888/42,913	17,520			AL-LF	2787DRA		
CB/NWB 3	1	39,616/39,637	42,888/42,913	18,670			AL-LF	2788DRA		

59		80.98 x 62.99								
J3E		4 Cyl.			1297cc	49kW (66PS)	Petrol		TD1221	
BE/PL	4	49,200/49,213	52,896/52,908	22,350	1,834	0,020/0,065	AL-LF	2785RA	01-4316/4 STD 0.25 0.50 0.75	
BE/PL	4	49,199/49,212	52,896/52,908	22,350	1,830	0,012/0,055	EC	AE5795	71-4379/4 STD 0.25 0.50	
MB/HL 1-5	5	53,988/54,000	57,683/57,696	25,520	1,834	0,020/0,065	AL-LF	2786RA	H1143/5 STD 0.25 0.50	
MB/HL 1-5	5	53,988/54,000	57,683/57,696	25,530	1,830		BS	AE4477	H1200/5 STD 0.25 0.50	
TW/A	2	59,346/59,690	74,498/74,752		2,362		AL-LF	2786BF	A180/2 STD .005	
CB/NWB 1	1	39,616/39,637	42,888/42,913	20,320			AL-LF	2786DRA	N161/3 STD	
CB/NWB 2	1	39,616/39,637	42,888/42,913	17,520			AL-LF	2787DRA		
CB/NWB 3	1	39,616/39,637	42,888/42,913	18,670			AL-LF	2788DRA		

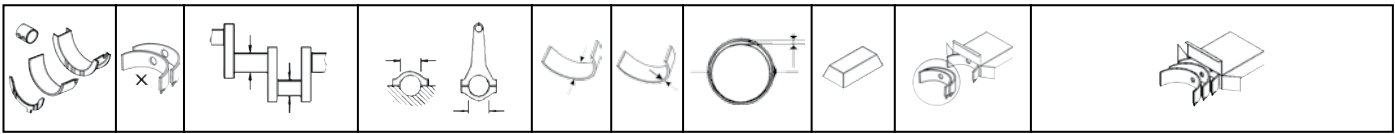

60										80.98 x 77.60
2737E			4 Cyl.	1599cc				Petrol		FM2405
BE/PL	4	49,200/49,213	52,896/52,908	22,350	1,834	0,020/0,065	AL-LF	2785RA	01-4316/4 STD 0.25 0.50 0.75	
BE/PL	4	49,199/49,212	52,896/52,908	22,350	1,830	0,012/0,055	EC	AE5795	71-4379/4 STD 0.25 0.50	
MB/HL 1-5	5	53,988/54,000	57,683/57,696	25,520	1,834	0,020/0,065	AL-LF	2786RA	H1143/5 STD 0.25 0.50	
MB/HL 1-5	5	53,988/54,000	57,683/57,696	25,530	1,830		BS	AE4477	H1200/5 STD 0.25 0.50	
TW/A	2	59,346/59,690	74,498/74,752		2,362		AL-LF	2786BF	A180/2 STD .005	
CB/NWB 1	1	39,616/39,637	42,888/42,913	20,320			AL-LF	2786DRA	N161/3 STD	
CB/NWB 2	1	39,616/39,637	42,888/42,913	17,520			AL-LF	2787DRA		
CB/NWB 3	1	39,616/39,637	42,888/42,913	18,670			AL-LF	2788DRA		

61										80.98 x 77.62
L1C			4 Cyl.	1598cc	47kW (63PS)			Petrol		TD17091
BE/PL	4	49,200/49,213	52,896/52,908	22,350	1,834	0,020/0,065	AL-LF	2785RA	01-4316/4 STD 0.25 0.50 0.75	
BE/PL	4	49,199/49,212	52,896/52,908	22,350	1,830	0,012/0,055	EC	AE5795	71-4379/4 STD 0.25 0.50	
MB/HL 1-5	5	53,988/54,000	57,683/57,696	25,520	1,834	0,020/0,065	AL-LF	2786RA	H1143/5 STD 0.25 0.50	
MB/HL 1-5	5	53,988/54,000	57,683/57,696	25,530	1,830		BS	AE4477	H1200/5 STD 0.25 0.50	
TW/A	2	59,346/59,690	74,498/74,752		2,362		AL-LF	2786BF	A180/2 STD .005	
CB/NWB 1	1	39,616/39,637	42,888/42,913	20,320			AL-LF	2786DRA	N161/3 STD	
CB/NWB 2	1	39,616/39,637	42,888/42,913	17,520			AL-LF	2787DRA		
CB/NWB 3	1	39,616/39,637	42,888/42,913	18,670			AL-LF	2788DRA		

62										81.00 x 53.30
G1			4 Cyl.	1098cc	32-34kW (45-46PS)			Petrol		TD4454
KL11			4 Cyl.	1098cc	29kW (39PS)			Petrol		TD22407
BE/PL	4	49,200/49,213	52,896/52,908	22,350	1,834	0,020/0,065	AL-LF	2785RA	01-4316/4 STD 0.25 0.50 0.75	
BE/PL	4	49,199/49,212	52,896/52,908	22,350	1,830	0,012/0,055	EC	AE5795	71-4379/4 STD 0.25 0.50	
MB/HL 1-5	5	53,988/54,000	57,683/57,696	25,520	1,834	0,020/0,065	AL-LF	2786RA	H1143/5 STD 0.25 0.50	
MB/HL 1-5	5	53,988/54,000	57,683/57,696	25,530	1,830		BS	AE4477	H1200/5 STD 0.25 0.50	
TW/A	2	59,346/59,690	74,498/74,752		2,362		AL-LF	2786BF	A180/2 STD .005	
CB/NWB 1	1	39,616/39,637	42,888/42,913	20,320			AL-LF	2786DRA	N161/3 STD	
CB/NWB 2	1	39,616/39,637	42,888/42,913	17,520			AL-LF	2787DRA		
CB/NWB 3	1	39,616/39,637	42,888/42,913	18,670			AL-LF	2788DRA		



63 81.00 x 63.00

J1E	4 Cyl.	1298cc	40kW (54PS)	Petrol	TD1216
J1F	4 Cyl.	1298cc	40kW (54PS)	Petrol	TD4457
J2	4 Cyl.	1298cc	42-44kW (57-60PS)	Petrol	TD1217
J2F	4 Cyl.	1298cc	42kW (57PS)	Petrol	TD1218
J2N	4 Cyl.	1298cc	42kW (57PS)	Petrol	TD1110
J3	4 Cyl.	1298cc	51kW (70PS)	Petrol	TD1219
J3C	4 Cyl.	1298cc	52-54kW (70-73PS)	Petrol	TD1220
J3D	4 Cyl.	1298cc	52-54kW (71-73PS)	Petrol	TD5480
J3N	4 Cyl.	1298cc	52-54kW (70-73PS)	Petrol	TD1222
KL 13 H	4 Cyl.	1298cc	40-48kW (54-65PS)	Petrol	TD22533
KL 13 HC	4 Cyl.	1298cc	53kW (72PS)	Petrol	TD22534
KL 13 L	4 Cyl.	1298cc	35-41kW (48-56PS)	Petrol	TD22535
OHV KL 13 G	4 Cyl.	1298cc	51kW (69PS)	Petrol	TD1393
OHV KL 13 H	4 Cyl.	1298cc	41-48kW (56-65PS)	Petrol	TD1394
OHV KL 13 L	4 Cyl.	1298cc	37-42kW (50-57PS)	Petrol	TD1395

BE/PL	4	49,200/49,213	52,896/52,908	22,350	1,834	0,020/0,065	AL-LF	2785RA	01-4316/4 STD 0.25 0.50 0.75
BE/PL	4	49,199/49,212	52,896/52,908	22,350	1,830	0,012/0,055	EC	AE5795	71-4379/4 STD 0.25 0.50
MB/HL 1-5	5	53,988/54,000	57,683/57,696	25,520	1,834	0,020/0,065	AL-LF	2786RA	H1143/5 STD 0.25 0.50
MB/HL 1-5	5	53,988/54,000	57,683/57,696	25,530	1,830		BS	AE4477	H1200/5 STD 0.25 0.50
TW/A	2	59,346/59,690	74,498/74,752		2,362		AL-LF	2786BF	A180/2 STD .005
CB/NWB 1	1	39,616/39,637	42,888/42,913	20,320			AL-LF	2786DRA	N161/3 STD
CB/NWB 2	1	39,616/39,637	42,888/42,913	17,520			AL-LF	2787DRA	
CB/NWB 3	1	39,616/39,637	42,888/42,913	18,670			AL-LF	2788DRA	

64 81.00 x 77.00

F6	4 Cyl.	1587cc	59kW (80PS)	Petrol	TD27819				
BE/PL	4	50,934/50,949	53,997/54,018	21,132	1,509	0,030/0,091	BS	3975P	71-4278/4 STD 0.25 0.50

65 81.00 x 77.60

KL 16 L	4 Cyl.	1598cc	47kW (64PS)	Petrol	TD22536
L3E	4 Cyl.	1599cc	62kW (84PS)	Petrol	TD1251
LC	4 Cyl.	1599cc	62kW (84PS)	Petrol	TD1261
OHV KL 16 G	4 Cyl.	1599cc	65kW (89PS)	Petrol	TD1396
OHV KL 16 H	4 Cyl.	1599cc	52-62kW (71-84PS)	Petrol	TD1397
OHV KL 16 L	4 Cyl.	1599cc	52kW (71PS)	Petrol	TD1398

BE/PL	4	49,200/49,213	52,896/52,908	22,350	1,834	0,020/0,065	AL-LF	2785RA	01-4316/4 STD 0.25 0.50 0.75
BE/PL	4	49,199/49,212	52,896/52,908	22,350	1,830	0,012/0,055	EC	AE5795	71-4379/4 STD 0.25 0.50
MB/HL 1-5	5	53,988/54,000	57,683/57,696	25,520	1,834	0,020/0,065	AL-LF	2786RA	H1143/5 STD 0.25 0.50
MB/HL 1-5	5	53,988/54,000	57,683/57,696	25,530	1,830		BS	AE4477	H1200/5 STD 0.25 0.50
TW/A	2	59,346/59,690	74,498/74,752		2,362		AL-LF	2786BF	A180/2 STD .005

FORD

CB/NWB 1	1	39,616/39,637	42,888/42,913	20,320			AL-LF	2786DRA	N161/3 STD
CB/NWB 2	1	39,616/39,637	42,888/42,913	17,520			AL-LF	2787DRA	
CB/NWB 3	1	39,616/39,637	42,888/42,913	18,670			AL-LF	2788DRA	

66 81.00 x 77.70

KL 16 R		4 Cyl.		1601cc	63kW (86PS)		Petrol		TD22537
BE/PL	4	49,200/49,213	52,896/52,908	22,350	1,834	0,020/0,065	AL-LF	2785RA	01-4316/4 STD 0.25 0.50 0.75
BE/PL	4	49,199/49,212	52,896/52,908	22,350	1,830	0,012/0,055	EC	AE5795	71-4379/4 STD 0.25 0.50
MB/HL 1-5	5	53,988/54,000	57,683/57,696	25,520	1,834	0,020/0,065	AL-LF	2786RA	H1143/5 STD 0.25 0.50
MB/HL 1-5	5	53,988/54,000	57,683/57,696	25,530	1,830		BS	AE4477	H1200/5 STD 0.25 0.50
TW/A	2	59,346/59,690	74,498/74,752		2,362		AL-LF	2786BF	A180/2 STD .005
CB/NWB 1	1	39,616/39,637	42,888/42,913	20,320			AL-LF	2786DRA	N161/3 STD
CB/NWB 2	1	39,616/39,637	42,888/42,913	17,520			AL-LF	2787DRA	
CB/NWB 3	1	39,616/39,637	42,888/42,913	18,670			AL-LF	2788DRA	

67 81.00 x 90.30

AAA		6 Cyl.		2792cc	128kW (174PS)		Petrol		TD5106
AMY		6 Cyl.		2792cc	128kW (174PS)		Petrol		TD17559
AYL		6 Cyl.		2792cc	150kW (204PS)		Petrol		TD14919
BE/PL	6	53,958/53,978	56,800/56,819	17,000	1,406	0,020/0,074	AL-LF	01-3841	01-3841/6 STD 0.25
MB/HL 1-7	7	59,958/59,978	65,000/65,010	17,000	2,501	0,020/0,075	AL-LF	02-3716	H035/7 STD 0.25
TW/A	2	65,450	80,000		1,723		AL-LF	04-3717	A139/4 STD
TW/A	2	65,450	80,000		1,723		AL-LF	04-3718	
BU	1	42,959/42,975	46,055/46,095	15,000			AL-LF	07-3088	07-3088 STD SEMI 13
Front, For intermediary shaft									
BU	1	14,473/14,484	17,500/17,518	20,000			BB	17-3720	17-3720 SEMI 13
Rear, For intermediary shaft									

68 81.32 x 76.90

LSF		4 Cyl.		1597cc	53kW (72PS)		Petrol		TD1294
BE/PL	4	51,980/52,000	55,000/55,020	20,000	1,497	0,020/0,071	AL-LF	3460RA	01-4142/4 STD 0.25 0.50 0.75 1.00
TW/A	2	63,850	80,500		2,330		AL-LF	04-2988	A045/4 STD
TW/A	2	63,850	80,500		2,330		AL-LF	04-3362	
CB/NWB 1	1	41,995/42,010	45,072/45,102	20,000	1,521		BC	53-2989	N145/3 STD
CB/NWB 2	1	44,615/44,630	47,692/47,722	17,000	1,521		BC	53-2990	
CB/NWB 3	1	44,995/45,010	48,072/48,102	16,000	1,521		BC	53-2991	



69		81.32 x 76.95							
LSD		4 Cyl.		1597cc	55-58kW (75-79PS)		Petrol		TD1291
BE/PL	4	51,980/52,000	55,000/55,020	20,000	1,497	0,020/0,071	AL-LF	3460RA	01-4142/4 STD 0.25 0.50 0.75 1.00
MB/HL 1-5	5	56,970/56,990	60,620/60,640	23,600	1,810	0,020/0,075	AL-LF	02-2985	H853/5 STD 0.25 0.50 0.75
→12/85									
TW/A	2	63,850	80,500		2,330		AL-LF	04-2988	A045/4 STD
TW/A	2	63,850	80,500		2,330		AL-LF	04-3362	
CB/NWB 1	1	41,995/42,010	45,072/45,102	20,000	1,521		BC	53-2989	N145/3 STD
CB/NWB 2	1	44,615/44,630	47,692/47,722	17,000	1,521		BC	53-2990	
CB/NWB 3	1	44,995/45,010	48,072/48,102	16,000	1,521		BC	53-2991	

70		81.32 x 76.95							
LSE		4 Cyl.		1597cc	55kW (75PS)		Petrol		TD1293
BE/PL	4	51,980/52,000	55,000/55,020	20,000	1,497	0,020/0,071	AL-LF	3460RA	01-4142/4 STD 0.25 0.50 0.75 1.00
TW/A	2	63,850	80,500		2,330		AL-LF	04-2988	A045/4 STD
TW/A	2	63,850	80,500		2,330		AL-LF	04-3362	
CB/NWB 1	1	41,995/42,010	45,072/45,102	20,000	1,521		BC	53-2989	N145/3 STD
CB/NWB 2	1	44,615/44,630	47,692/47,722	17,000	1,521		BC	53-2990	
CB/NWB 3	1	44,995/45,010	48,072/48,102	16,000	1,521		BC	53-2991	

71		82.50 x 82.00							
BHDA			4 Cyl.	1753cc	55-57kW (75-78PS)		Diesel Turbo		TD15903
BHDB			4 Cyl.	1753cc	55-57kW (75-78PS)		Diesel Turbo		TD15904
BHPA			4 Cyl.	1753cc	55-57kW (75-78PS)		Diesel Turbo Intercooler		TD20062
C9DA			4 Cyl.	1753cc	66kW (90PS)		Diesel Turbo Intercooler		TD15905
C9DB			4 Cyl.	1753cc	66kW (90PS)		Diesel Turbo Intercooler		TD15906
C9DC			4 Cyl.	1753cc	66kW (90PS)		Diesel Turbo		TD12081
F9DA			4 Cyl.	1753cc	85kW (115PS)		Diesel Turbo Intercooler		TD17524
F9DB			4 Cyl.	1753cc	85kW (115PS)		Diesel Turbo Intercooler		TD17526
FFBA			4 Cyl.	1753cc	74kW (100PS)		Diesel Turbo Intercooler		TD23304
FFDA			4 Cyl.	1753cc	74kW (100PS)		Diesel Turbo Intercooler		TD17521
FFWA			4 Cyl.	1753cc	74kW (100PS)		Diesel Turbo		TD20047
KHBA			4 Cyl.	1753cc	92kW (125PS)		Diesel Turbo Intercooler		TD23372
QYBA			4 Cyl.	1753cc	92kW (125PS)		Diesel Turbo Intercooler		TD23371
RFA			4 Cyl.	1753cc	55-57kW (75-78PS)		Diesel Turbo		TD1426
RFB			4 Cyl.	1753cc	55-57kW (75-78PS)		Diesel Turbo		TD1427
RFD			4 Cyl.	1753cc	66kW (90PS)		Diesel Turbo Intercooler		TD4484
RFK			4 Cyl.	1753cc	66kW (90PS)		Diesel Turbo Intercooler		TD4485
RFL			4 Cyl.	1753cc	55-57kW (75-78PS)		Diesel Turbo		TD4486
RFM			4 Cyl.	1753cc	65-66kW (88-90PS)		Diesel Turbo Intercooler		TD1428
RFN			4 Cyl.	1753cc	65-66kW (88-90PS)		Diesel Turbo Intercooler		TD1429
RFS			4 Cyl.	1753cc	66kW (90PS)		Diesel Turbo Intercooler		TD16143
RFU			4 Cyl.	1753cc	57kW (78PS)		Diesel Turbo		TD23181



RTN			4 Cyl.	1753cc	55-57kW (75-78PS)	Diesel Turbo Intercooler	TD15937	
RTP			4 Cyl.	1753cc	55-57kW (75-78PS)	Diesel Turbo Intercooler	TD15938	
RTQ			4 Cyl.	1753cc	55-57kW (75-78PS)	Diesel Turbo Intercooler	TD15939	
RVA			4 Cyl.	1753cc	51kW (70PS)	Diesel Turbo	TD5104	
BE/PL	4	48,970/48,990	52,000/52,020	21,590	1,495	0,020/0,085	BS 4160CP	71-4151/4 STD 0.25 0.50
MB/HL 1	1	53,970/53,990	57,683/57,696	22,150	1,830	0,033/0,091	AL-LF 4163RA	H1105/5 STD 0.25
MB/HL 2-5	4	53,970/53,990	57,683/57,696	22,150	1,830	0,033/0,091	AL-LF 4164RAL	
MB/HL 2-5	4	53,970/53,990	57,683/57,696	22,900	1,830	0,033/0,091	AL-LF 4164RAU	
TW/A	2	59,346/59,690	74,498/74,752		2,362		AL-LF 2786BF	A180/2 STD .005

72 82.50 x 82.00

HCPA			4 Cyl.	1753cc	66kW (90PS)	Diesel Turbo Intercooler	TD18779	
HCPB			4 Cyl.	1753cc	66kW (90PS)	Diesel Turbo Intercooler	TD18780	
KKDA Euro 4			4 Cyl.	1753cc	85kW (115PS)	Diesel Turbo Intercooler	TD18480	
KKDB Euro 4			4 Cyl.	1753cc	85kW (115PS)	Diesel Turbo Intercooler	TD23303	
P7PA			4 Cyl.	1753cc	55kW (75PS)	Diesel Turbo	TD24465	
P7PB			4 Cyl.	1753cc	55kW (75PS)	Diesel Turbo	TD24466	
P9PA			4 Cyl.	1753cc	66kW (90PS)	Diesel Turbo Intercooler	TD25795	
P9PB			4 Cyl.	1753cc	66kW (90PS)	Diesel Turbo Intercooler	TD25796	
P9PC			4 Cyl.	1753cc	66kW (90PS)	Diesel Turbo Intercooler	TD25797	
P9PD			4 Cyl.	1753cc	66kW (90PS)	Diesel Turbo Intercooler	TD25798	
QYWA			4 Cyl.	1753cc	92kW (125PS)	Diesel Turbo Intercooler	TD19112	
R2PA			4 Cyl.	1753cc	55kW (75PS)	Diesel Turbo	TD24467	
R3PA			4 Cyl.	1753cc	66kW (90PS)	Diesel Turbo Intercooler	TD25799	
RWPA			4 Cyl.	1753cc	81kW (110PS)	Diesel Turbo Intercooler	TD20063	
RWPC			4 Cyl.	1753cc	81kW (110PS)	Diesel Turbo Intercooler	TD25793	
RWPD			4 Cyl.	1753cc	81kW (110PS)	Diesel Turbo Intercooler	TD25794	
RWPE			4 Cyl.	1753cc	66kW (90PS)	Diesel Turbo Intercooler	TD25800	
RWPF			4 Cyl.	1753cc	66kW (90PS)	Diesel Turbo Intercooler	TD25801	
MB/HL 1	1	53,970/53,990	57,683/57,696	22,150	1,830	0,033/0,091	AL-LF 4163RA	H1105/5 STD 0.25
MB/HL 2-5	4	53,970/53,990	57,683/57,696	22,150	1,830	0,033/0,091	AL-LF 4164RAL	
MB/HL 2-5	4	53,970/53,990	57,683/57,696	22,900	1,830	0,033/0,091	AL-LF 4164RAU	
TW/A	2	59,346/59,690	74,498/74,752		2,362		AL-LF 2786BF	A180/2 STD .005

73 82.50 x 82.00

RTA			4 Cyl.	1753cc	44kW (60PS)	Diesel	TD1434	
RTB			4 Cyl.	1753cc	44kW (60PS)	Diesel	TD1435	
RTC			4 Cyl.	1753cc	43-44kW (58-60PS)	Diesel	TD4489	
RTD			4 Cyl.	1753cc	43-44kW (58-60PS)	Diesel	TD1437	
RTE			4 Cyl.	1753cc	44kW (60PS)	Diesel	TD1438	
RTF			4 Cyl.	1753cc	44kW (60PS)	Diesel	TD1439	
RTG			4 Cyl.	1753cc	43-44kW (58-60PS)	Diesel	TD1440	
RTH			4 Cyl.	1753cc	44kW (60PS)	Diesel	TD1441	
RTJ			4 Cyl.	1753cc	44kW (60PS)	Diesel	TD10068	
RTK			4 Cyl.	1753cc	44kW (60PS)	Diesel	TD10067	
BE/PL	4	48,970/48,990	52,000/52,020	21,590	1,495	0,020/0,085	AL-LF 4160RA	01-4152/4 STD 0.25 0.50

MB/HL 1	1	53,970/53,990	57,683/57,696	22,150	1,830	0,033/0,091	AL-LF	4163RA	H1105/5 STD 0.25	
MB/HL 2-5	4	53,970/53,990	57,683/57,696	22,150	1,830	0,033/0,091	AL-LF	4164RAL		
MB/HL 2-5	4	53,970/53,990	57,683/57,696	22,900	1,830	0,033/0,091	AL-LF	4164RAU		
TW/A	2	59,346/59,690	74,498/74,752		2,362		AL-LF	2786BF	A180/2 STD .005	

74 83.00 x 83.10

CFBA		4 Cyl.	1798cc	96kW (130PS)		Petrol			TD18758
CSDA		4 Cyl.	1798cc	88kW (120PS)		Petrol			TD18975
CSDB		4 Cyl.	1798cc	88kW (120PS)		Petrol			TD18976
Q7DA		4 Cyl.	1798cc	92kW (125PS)		Petrol			TD18974
QQDA		4 Cyl.	1798cc	92kW (125PS)		Petrol			TD18788
QQDB		4 Cyl.	1798cc	92kW (125PS)		Petrol			TD18787
QQDC		4 Cyl.	1798cc	90kW (122PS)		Petrol			TD18789
QQDD		4 Cyl.	1798cc	96kW (131PS)		Petrol			TD25792
MB/HL 1,2,4,5	4	57,980/58,000	62,287/62,300	19,210	2,131	0,025/0,083	AL	4136RA	H1086/5 STD 0.25
MB/HL 3	1	57,980/58,000	62,287/62,300	24,680	2,131	0,025/0,083	AL	4137RAH	

75 83.00 x 83.10

CGBA		4 Cyl.	1798cc	81kW (110PS)		Petrol			TD15907
CGBB		4 Cyl.	1798cc	81kW (110PS)		Petrol			TD15908
CHBA		4 Cyl.	1798cc	92kW (125PS)		Petrol			TD15909
CHBB		4 Cyl.	1798cc	92kW (125PS)		Petrol			TD15910
BE/PL	4	43,985/44,000	47,035/47,045	15,270	1,516	0,020/0,050	AL-LF	01-4040	01-4040/4 STD 0.25
MB/HL 1,2,4,5	4	57,980/58,000	62,287/62,300	19,210	2,131	0,025/0,083	AL	4136RA	H1086/5 STD 0.25
MB/HL 3	1	57,980/58,000	62,287/62,300	24,680	2,131	0,025/0,083	AL	4137RAH	

76 83.00 x 92.00

FS		4 Cyl.	1991cc	85kW (116PS)		Petrol			TD4452
BE/PL	4	47,940	51,020	17,100	1,510		AL-LF	64-325-1	01-5044/4 STD
MB/HL	5	49.980	54.020	19.130	1.990		AL-LF	63-135-1	H1358/5 STD
MB/HL	5	49.980	54.020	19.130	1.990		AL-LF	63-135-2	
TW/A	2				2.550		AL-LF	65-325-1	A336/2 STD

77 84.00 x 72.00

ARC		V6 Cyl.	2394cc	96kW (130PS)		Petrol			TD1144
ARD		V6 Cyl.	2394cc	92kW (125PS)		Petrol			TD1145
TV24		V6 Cyl.	2394cc			Petrol			FM5486
BE/PL	1	53,980/54,000	56,820/56,840	16,480	1,407	0,020/0,071	EC	71-2185	71-2185 STD

78 84.80 x 88.00

EDBA		4 Cyl.	1988cc	96kW (131PS)		Petrol			TD12068
EDBB		4 Cyl.	1988cc	96kW (131PS)		Petrol			TD15916
EDBC		4 Cyl.	1988cc	96kW (131PS)		Petrol			TD15917
EDBD		4 Cyl.	1988cc	96kW (131PS)		Petrol			TD15918

FORD



EDDB			4 Cyl.	1988cc	96kW (131PS)		Petrol		TD15900
EDDC			4 Cyl.	1988cc	96kW (131PS)		Petrol		TD12080
EDDD			4 Cyl.	1988cc	96kW (131PS)		Petrol		TD15901
EDDF			4 Cyl.	1988cc	96kW (131PS)		Petrol		TD15902
NGA			4 Cyl.	1988cc	96-100kW (131-136PS)		Petrol		TD4475
NGB			4 Cyl.	1988cc	96kW (131PS)		Petrol		TD12090
NGC			4 Cyl.	1988cc	96kW (131PS)		Petrol		TD15994
NGD			4 Cyl.	1988cc	96kW (131PS)		Petrol		TD16012
YF			4 Cyl.	1989cc	91kW (124PS)		Petrol		TD18794
BE/PL	4	46,890/46,910	49,890/49,910	20,100	1,475	0,030/0,095	AL	4135RA	01-4148/4 STD 0.25
MB/HL 1,2,4,5	4	57,980/58,000	62,287/62,300	19,210	2,131	0,025/0,083	AL	4136RA	H1086/5 STD 0.25
MB/HL 3	1	57,980/58,000	62,287/62,300	24,680	2,131	0,025/0,083	AL	4137RAH	

79

85.00 x 88.00

4G63			4 Cyl.	1997cc	78kW (106PS)		Petrol		TD26856
BE/PL	8	44,980	48,020	23,600	1,493		BS	64-111-1	71-4143/4 STD 0.25 0.50
MB/HL 3	2	56,980	61,020	28,950	1,990		AL	63-111-(2)	H1032/5 STD 0.25 0.50
MB/HL 1,2,4,5	4	56,980	61,020	23,100	1,990		AL	63-111-1	
MB/HL 1,2,4,5	4	56,980	61,020	23,130	1,990		AL	63-111-3	

80

85.00 x 88.00

AZBC			4 Cyl.	1997cc	100-103kW (136-140PS)		Diesel Turbo Intercooler		TD24653
AZWA			4 Cyl.	1997cc	96kW (130PS)		Diesel Turbo Intercooler		TD20040
AZWC			4 Cyl.	1997cc	100kW (136PS)		Diesel Turbo Intercooler		TD24655
G6DA			4 Cyl.	1997cc	100kW (136PS)		Diesel Turbo Intercooler		TD18510
G6DB			4 Cyl.	1997cc	100kW (136PS)		Diesel Turbo Intercooler		TD18511
G6DC			4 Cyl.	1997cc	98kW (133PS)		Diesel Turbo Intercooler		TD18791
G6DD			4 Cyl.	1997cc	100kW (136PS)		Diesel Turbo Intercooler		TD18790
G6DE			4 Cyl.	1997cc	98kW (133PS)		Diesel Turbo Intercooler		TD18792
G6DF			4 Cyl.	1997cc	98kW (133PS)		Diesel Turbo Intercooler		TD18793
G6DG			4 Cyl.	1997cc	100kW (136PS)		Diesel Turbo Intercooler		TD24352
IXDA			4 Cyl.	1997cc	81kW (110PS)		Diesel Turbo Intercooler		TD24353
KLBA Euro 4			4 Cyl.	1997cc	85kW (116PS)		Diesel Turbo Intercooler		TD23305
KLWA			4 Cyl.	1997cc	85kW (115PS)		Diesel		TD24436
QXBA Euro 4			4 Cyl.	1997cc	103kW (140PS)		Diesel Turbo Intercooler		TD23306
QXBB Euro 4			4 Cyl.	1997cc	103kW (140PS)		Diesel Turbo Intercooler		TD23307
QXWA			4 Cyl.	1997cc	103kW (140PS)		Diesel Turbo Intercooler		TD20041
QXWB Euro 4			4 Cyl.	1997cc	103kW (140PS)		Diesel Turbo Intercooler		TD20046
QXWC Euro 4			4 Cyl.	1997cc	103kW (140PS)		Diesel Turbo Intercooler		TD24437
T7CE			4 Cyl.	1998cc	110kW (150PS)		Diesel Turbo		TD30546
T7CI			4 Cyl.	1997cc	110kW (150PS)		Diesel Turbo Intercooler		TD31089
T7CJ			4 Cyl.	1997cc	110kW (150PS)		Diesel Turbo Intercooler		TD31090
T7CK			4 Cyl.	1997cc	110kW (150PS)		Diesel Turbo Intercooler		TD31092
T7CL			4 Cyl.	1997cc	110kW (150PS)		Diesel Turbo Intercooler		TD31091
T7DB			4 Cyl.	1997cc	110kW (150PS)		Diesel Turbo		TD31019
T7MA			4 Cyl.	1998cc	110kW (150PS)		Diesel Turbo		TD30562
T7MB			4 Cyl.	1998cc	110kW (150PS)		Diesel Turbo		TD30554
T8CC			4 Cyl.	1998cc	132kW (180PS)		Diesel Turbo		TD30548



T8CG				4 Cyl.	1997cc	132kW (180PS)		Diesel Turbo Intercooler	TD31097
T8CH				4 Cyl.	1997cc	132kW (180PS)		Diesel Turbo Intercooler	TD31094
T8CI				4 Cyl.	1997cc	132kW (180PS)		Diesel Turbo Intercooler	TD31096
T8CJ				4 Cyl.	1997cc	132kW (180PS)		Diesel Turbo Intercooler	TD31095
T8DA				4 Cyl.	1997cc	136kW (185PS)		Diesel Turbo Intercooler	TD31080
T8DE				4 Cyl.	1997cc	125kW (170PS)		Diesel Turbo	TD31020
T8MA				4 Cyl.	1998cc	132kW (180PS)		Diesel Turbo	TD30563
T8MB				4 Cyl.	1998cc	132kW (180PS)		Diesel Turbo	TD30557
T9CB				4 Cyl.	1997cc	154kW (210PS)		Diesel Turbo Intercooler	TD31098
T9CC				4 Cyl.	1997cc	154kW (210PS)		Diesel Turbo Intercooler	TD31099
TXBA				4 Cyl.	1997cc	118-120kW (160-163PS)		Diesel Turbo Intercooler	TD25804
TXBB				4 Cyl.	1997cc	120kW (163PS)		Diesel Turbo Intercooler	TD31045
TXDA				4 Cyl.	1998cc	118-120kW (160-163PS)		Diesel Turbo Intercooler	TD25805
TXDB				4 Cyl.	1997cc	120kW (163PS)		Diesel Turbo Intercooler	TD25803
TXMA				4 Cyl.	1998cc	120kW (163PS)		Diesel Turbo	TD30566
TXWA				4 Cyl.	1997cc	118-120kW (160-163PS)		Diesel Turbo Intercooler	TD25806
TYDA				4 Cyl.	1997cc	85kW (116PS)		Diesel Turbo Intercooler	TD25885
TYWA				4 Cyl.	1997cc	85kW (115PS)		Diesel Turbo	TD24435
UFBA				4 Cyl.	1997cc	103kW (140PS)		Diesel Turbo Intercooler	TD24426
UFBB				4 Cyl.	1997cc	103kW (140PS)		Diesel Turbo Intercooler	TD31049
UFCA				4 Cyl.	1997cc	88kW (120PS)		Diesel Turbo Intercooler	TD31087
UFCB				4 Cyl.	1997cc	88kW (120PS)		Diesel Turbo Intercooler	TD31088
UFDA				4 Cyl.	1997cc	103kW (140PS)		Diesel Turbo Intercooler	TD24429
UFDB				4 Cyl.	1997cc	103kW (140PS)		Diesel Turbo Intercooler	TD25886
UFMA				4 Cyl.	1997cc	103kW (140PS)		Diesel Turbo	TD29483
UFWA				4 Cyl.	1997cc	103kW (140PS)		Diesel Turbo Intercooler	TD24438
UKBA				4 Cyl.	1997cc	100kW (136PS)		Diesel Turbo Intercooler	TD25802
UKBB				4 Cyl.	1997cc	100kW (136PS)		Diesel Turbo Intercooler	TD31051
UKDA				4 Cyl.	1997cc	100kW (136PS)		Diesel Turbo Intercooler	TD24428
UKDB				4 Cyl.	1997cc	100kW (136PS)		Diesel Turbo Intercooler	TD25887
UKMA				4 Cyl.	1997cc	100kW (136PS)		Diesel Turbo	TD29484
UKWA				4 Cyl.	1997cc	100kW (136PS)		Diesel	TD24654
XRMA				4 Cyl.	1998cc	88kW (120PS)		Diesel Turbo	TD30560
XRMB				4 Cyl.	1998cc	88kW (120PS)		Diesel Turbo	TD30550

BE/PL	4	49,984/50,000	53,695/53,708	20,000	1,838	0,020/0,070	SP	71-3952	71-3952/4 STD 0.30	<input type="checkbox"/>
BE/PL	4	52,980/53,000	55,996/56,016	24,450	1,487	0,026/0,084	BS	71-4066	71-4066/4 STD 0.25 0.50	
MB/HL	4	64,940	69,520	23,280	2,250		AL-LF	02-4067	H1018/5 STD 0.25 0.50	
MB/HL	3	64,940	69,520	24,080	2,250		AL-LF	02-4068		
MB/HL	2	69,940	74,520	19,580	2,250		AL-LF	02-4069		
MB/HL	1	64,940	69,520	30,150	2,250		AL-LF	02-4070H		
MB/HL 1-5	5	59,981/60,000	63,731/63,750	20,290	1,845	0,040/0,100	AL-LF	66726RA	H1057/5 STD 0.30 0.50	
TW/A	4	67,050/67,300	83,050/83,300		2,330		BS	66721BF	A214/4 STD 0.10	

81 **85.00 x 96.00**

KNBA				4 Cyl.	2179cc	147kW (200PS)		Diesel Turbo Intercooler	TD26808
Q4BA Euro 4				4 Cyl.	2179cc	129kW (175PS)		Diesel Turbo Intercooler	TD20838
Q4WA Euro 4				4 Cyl.	2179cc	129kW (175PS)		Diesel Turbo Intercooler	TD24439

FORD



BE/PL	4	49,984/50,000	53,695/53,708	20,000	1,838	0,020/0,070	SP	71-3952	71-3952/4 STD 0.30	I
MB/HL 1-5	5	59,981/60,000	63,731/63,750	20,290	1,845	0,040/0,100	AL-LF	66726RA	H1057/5 STD 0.30 0.50	

82	86.00 x 86.00									
N3A			4 Cyl.	1998cc	100kW (136PS)		Petrol			TD4470
NSD			4 Cyl.	1998cc	85kW (115PS)		Petrol			TD4476
NSE			4 Cyl.	1998cc	85kW (116PS)		Petrol			TD5109
NSF			4 Cyl.	1998cc	84kW (114PS)		Petrol			TD4477
NSG			4 Cyl.	1998cc	84kW (114PS)		Petrol			TD4478
ZVSA			4 Cyl.	1998cc	85kW (116PS)		Petrol			TD17158
MB/HL 1-5	5	54,980/55,000	59,287/59,300	18,600	2,138	0,020/0,069	AL-LF	4672RA	H1163/5 STD 0.25 0.50	
TW/A	2	61,000	74,500		2,360	0,090/0,240	AL	GS70353SA	A270/2 STD	

83	86.00 x 86.00									
N7A			4 Cyl.	1998cc	110kW (150PS)		Petrol			TD1328
N8B			4 Cyl.	1998cc	77-92kW (105-125PS)		Petrol			TD1330
N9C			4 Cyl.	1998cc	88-92kW (120-125PS)		Petrol			TD1337
N9D			4 Cyl.	1998cc	88kW (120PS)		Petrol			TD1338
N9E			4 Cyl.	1998cc	85kW (115PS)		Petrol			TD4471
N9F			4 Cyl.	1998cc	85kW (115PS)		Petrol			TD1339
N9K			4 Cyl.	1998cc	84kW (114PS)		Petrol			TD7014
BE/PL	4	50,890/50,910	53,890/53,910	20,600	1,480	0,020/0,069	AL-LF	4670RA	01-4166/4 STD 0.25 0.50	
→05/94										
MB/HL 1-5	5	54,980/55,000	59,287/59,300	18,600	2,138	0,020/0,069	AL-LF	4672RA	H1163/5 STD 0.25 0.50	
TW/A	2	61,000	74,500		2,360	0,090/0,240	AL	GS70353SA	A270/2 STD	

84	86.00 x 86.00									
N8A			4 Cyl.	1998cc	80kW (109PS)		Petrol			TD1329
N8C			4 Cyl.	1993cc	77kW (105PS)		Petrol			TD1332
N8D			4 Cyl.	1993cc	77kW (105PS)		Petrol			TD1334
N9A			4 Cyl.	1998cc	90kW (122PS)		Petrol			TD1335
N9B			4 Cyl.	1998cc	92kW (125PS)		Petrol			TD1336
NSH			4 Cyl.	1998cc	74-84kW (101-114PS)		Petrol			TD16364
BE/PL	4	50,890/50,910	53,890/53,910	20,600	1,480	0,020/0,069	AL-LF	4670RA	01-4166/4 STD 0.25 0.50	
MB/HL 1-5	5	54,980/55,000	59,287/59,300	18,600	2,138	0,020/0,069	AL-LF	4672RA	H1163/5 STD 0.25 0.50	
TW/A	2	61,000	74,500		2,360	0,090/0,240	AL	GS70353SA	A270/2 STD	

85	86.00 x 86.00									
ABFA			4 Cyl.	1998cc	74kW (100PS)		Diesel Turbo Intercooler			TD15888
AZBA			4 Cyl.	1997cc	96kW (131PS)		Diesel Turbo Intercooler			TD23367
D3FA			4 Cyl.	1998cc	55kW (75PS)		Diesel			TD15551
D5BA			4 Cyl.	1998cc	66kW (90PS)		Diesel Turbo			TD15914
D6BA			4 Cyl.	1998cc	85kW (115PS)		Diesel			TD15915
F3FA			4 Cyl.	1998cc	63kW (86PS)		Diesel Turbo			TD18777
FIFA			4 Cyl.	1998cc	92kW (125PS)		Diesel Turbo			TD18839
HJBA			4 Cyl.	1998cc	85kW (115PS)		Diesel Turbo Intercooler			TD17547



HJBB	4 Cyl.	1998cc	85kW (115PS)	Diesel Turbo Intercooler	TD17548
HJBC	4 Cyl.	1998cc	85kW (115PS)	Diesel Turbo Intercooler	TD17549
LPBA	4 Cyl.	1997cc	85kW (115PS)	Diesel Turbo Intercooler	TD23354
N7BA	4 Cyl.	1998cc	96kW (130PS)	Diesel Turbo	TD18762
N7BB	4 Cyl.	1997cc	96kW (131PS)	Diesel Turbo Intercooler	TD23353
SDBA	4 Cyl.	1998cc	66kW (90PS)	Diesel Turbo	TD18763
TYBA	4 Cyl.	1997cc	85kW (115PS)	Diesel Turbo Intercooler	TD24425

BE/PL	4	52,980/53,000	55,996/56,016	24,450	1,487	0,026/0,084	BS	71-4066	71-4066/4 STD 0.25 0.50
MB/HL	4	64,940	69,520	23,280	2,250		AL-LF	02-4067	H1018/5 STD 0.25 0.50
MB/HL	3	64,940	69,520	24,080	2,250		AL-LF	02-4068	
MB/HL	2	69,940	74,520	19,580	2,250		AL-LF	02-4069	
MB/HL	1	64,940	69,520	30,150	2,250		AL-LF	02-4070H	

86 86.00 x 86.00

FMBA	4 Cyl.	1998cc	96kW (130PS)	Diesel Turbo	TD18761
-------------	--------	---------------	---------------------	---------------------	----------------

BE/PL	4	52,980/53,000	55,996/56,016	24,450	1,487	0,026/0,084	BS	71-4066	71-4066/4 STD 0.25 0.50
01/04 → 12/06									
MB/HL	4	64,940	69,520	23,280	2,250		AL-LF	02-4067	H1018/5 STD 0.25 0.50
MB/HL	3	64,940	69,520	24,080	2,250		AL-LF	02-4068	
MB/HL	2	69,940	74,520	19,580	2,250		AL-LF	02-4069	
MB/HL	1	64,940	69,520	30,150	2,250		AL-LF	02-4070H	
01/04 → 12/06									

87 86.00 x 86.00

RF	4 Cyl.	1998cc	41-55kW (56-75PS)	Diesel	TD1425
-----------	--------	---------------	--------------------------	---------------	---------------

BE/PL	4	50,934/50,949	53,997/54,018	21,132	1,509	0,030/0,091	BS	3975P	71-4278/4 STD 0.25 0.50
→ 06/86									
MB/HL 1,2,4,5	4	59,938/59,964	63,997/64,018	19,126	2,007	0,020/0,092	AL	3976RA	H1161/5 STD 0.25
MB/HL 3	1	59,938/59,964	63,997/64,018	21,132	2,007	0,020/0,092	AL	3977RA	
SE/PB	1	24,990	28,030	26,500			BS	67-316-1S	55-4270 SEMI

88 86.00 x 94.00

F2Y4	4 Cyl.	2184cc	62kW (84PS)	Petrol	TD28039
-------------	--------	---------------	--------------------	---------------	----------------

BE/PL	4	50,934/50,949	53,997/54,018	21,132	1,509	0,030/0,091	BS	3975P	71-4278/4 STD 0.25 0.50
-------	---	---------------	---------------	--------	-------	-------------	----	-------	-----------------------------------

89 86.00 x 94.60

CV24	4 Cyl.	2198cc	114kW (155PS)	Diesel Turbo Intercooler	TD29669
CVF5	4 Cyl.	2198cc	114kW (155PS)	Diesel Turbo Intercooler	TD29676
CVFF	4 Cyl.	2198cc	114kW (155PS)	Diesel Turbo Intercooler	TD29681
CVR5	4 Cyl.	2198cc	114kW (155PS)	Diesel Turbo Intercooler	TD29667
CVRA	4 Cyl.	2198cc	114kW (155PS)	Diesel Turbo Intercooler	TD26453
CVRB	4 Cyl.	2198cc	114kW (155PS)	Diesel Turbo Intercooler	TD26454

FORD



CVRC	4 Cyl.	2198cc	114kW (155PS)	Diesel	Turbo Intercooler	TD26455
CY14	4 Cyl.	2198cc	92kW (125PS)	Diesel	Turbo Intercooler	TD29674
CY24	4 Cyl.	2198cc	92kW (125PS)	Diesel	Turbo Intercooler	TD29672
CYF4	4 Cyl.	2198cc	92kW (125PS)	Diesel	Turbo Intercooler	TD29679
CYF5	4 Cyl.	2198cc	92kW (125PS)	Diesel	Turbo Intercooler	TD29666
CYFA	4 Cyl.	2198cc	92kW (125PS)	Diesel	Turbo Intercooler	TD26461
CYFB	4 Cyl.	2198cc	92kW (125PS)	Diesel	Turbo Intercooler	TD26462
CYFC	4 Cyl.	2198cc	92kW (125PS)	Diesel	Turbo Intercooler	TD26463
CYFD	4 Cyl.	2198cc	92kW (125PS)	Diesel	Turbo Intercooler	TD26464
CYFF	4 Cyl.	2198cc	92kW (125PS)	Diesel	Turbo Intercooler	TD29680
CYFG	4 Cyl.	2198cc	92kW (125PS)	Diesel	Turbo Intercooler	TD29673
CYR5	4 Cyl.	2198cc	92kW (125PS)	Diesel	Turbo	TD29671
CYRB	4 Cyl.	2198cc	92kW (125PS)	Diesel	Turbo Intercooler	TD26465
CYRC	4 Cyl.	2198cc	92kW (125PS)	Diesel	Turbo Intercooler	TD26466
DRF4	4 Cyl.	2198cc	74kW (101PS)	Diesel	Turbo Intercooler	TD29678
DRF5	4 Cyl.	2198cc	74kW (100PS)	Diesel	Turbo	TD29442
DRFA	4 Cyl.	2198cc	74kW (101PS)	Diesel	Turbo Intercooler	TD26456
DRFB	4 Cyl.	2198cc	74kW (101PS)	Diesel	Turbo Intercooler	TD26457
DRFC	4 Cyl.	2198cc	74kW (101PS)	Diesel	Turbo Intercooler	TD26458
DRFD	4 Cyl.	2198cc	74kW (101PS)	Diesel	Turbo Intercooler	TD26459
DRFE	4 Cyl.	2198cc	74kW (101PS)	Diesel	Turbo Intercooler	TD26460
DRFF	4 Cyl.	2198cc	74kW (100PS)	Diesel	Turbo Intercooler	TD29677
DRFG	4 Cyl.	2198cc	74kW (100PS)	Diesel	Turbo Intercooler	TD29656
DRR5	4 Cyl.	2198cc	74kW (100PS)	Diesel	Turbo	TD29655
DRRA	4 Cyl.	2198cc	74kW (101PS)	Diesel	Turbo Intercooler	TD26450
DRRB	4 Cyl.	2198cc	74kW (101PS)	Diesel	Turbo Intercooler	TD26451
DRRC	4 Cyl.	2198cc	74kW (101PS)	Diesel	Turbo Intercooler	TD26452
P8FA	4 Cyl.	2198cc	63kW (85PS)	Diesel	Turbo	TD20042
P8FB	4 Cyl.	2198cc	63kW (85PS)	Diesel	Turbo	TD21066
PGFA Euro 4	4 Cyl.	2198cc	103kW (140PS)	Diesel	Turbo Intercooler	TD21067
PGFB	4 Cyl.	2198cc	103kW (140PS)	Diesel	Turbo Intercooler	TD24463
QVFA Euro 4	4 Cyl.	2198cc	81kW (110PS)	Diesel	Turbo	TD20043
QWFA	4 Cyl.	2198cc	96kW (130PS)	Diesel	Turbo	TD20044
SRFA	4 Cyl.	2198cc	85kW (115PS)	Diesel	Turbo Intercooler	TD24458
SRFB	4 Cyl.	2198cc	85kW (115PS)	Diesel	Turbo Intercooler	TD24459
SRFC	4 Cyl.	2198cc	85kW (115PS)	Diesel	Turbo Intercooler	TD24460
SRFD	4 Cyl.	2198cc	85kW (115PS)	Diesel	Turbo Intercooler	TD24461
SRFE	4 Cyl.	2198cc	85kW (115PS)	Diesel	Turbo Intercooler	TD24462
UHFA	4 Cyl.	2198cc	103kW (140PS)	Diesel	Turbo Intercooler	TD26467
UHFB	4 Cyl.	2198cc	103kW (140PS)	Diesel	Turbo Intercooler	TD26468
UHFC	4 Cyl.	2198cc	103kW (140PS)	Diesel	Turbo Intercooler	TD26469
UHR5	4 Cyl.	2198cc	99kW (135PS)	Diesel	Turbo Intercooler	TD31052
USF6	4 Cyl.	2198cc	92kW (125PS)	Diesel	Turbo Intercooler	TD29675
USR6	4 Cyl.	2198cc	92kW (125PS)	Diesel	Turbo Intercooler	TD29670
USRA	4 Cyl.	2198cc	100kW (136PS)	Diesel	Turbo Intercooler	TD26470
USRB	4 Cyl.	2198cc	100kW (136PS)	Diesel	Turbo Intercooler	TD26471
UYR6	4 Cyl.	2198cc	114kW (155PS)	Diesel	Turbo Intercooler	TD29668

BE/PL	4	52,980/53,000	55,996/56,016	24,450	1,487	0,026/0,084	BS	71-4066	71-4066/4 STD 0.25 0.50
-------	---	---------------	---------------	--------	-------	-------------	----	---------	----------------------------

MB/HL	4	64,940	69,520	23,280	2,250		AL-LF	02-4067	H1018/5 STD 0.25 0.50
MB/HL	3	64,940	69,520	24,080	2,250		AL-LF	02-4068	
MB/HL	2	69,940	74,520	19,580	2,250		AL-LF	02-4069	
MB/HL	1	64,940	69,520	30,150	2,250		AL-LF	02-4070H	

90 86.00 x 94.60									
CYRA			4 Cyl.	2198cc	92kW (125PS)		Diesel Turbo Intercooler		TD26716
GBVAJPF			4 Cyl.	2198cc	88kW (120PS)		Diesel Turbo Intercooler		TD26487
GBVAJQJ			4 Cyl.	2198cc	110kW (150PS)		Diesel Turbo Intercooler		TD26483
GBVAJQW			4 Cyl.	2198cc	92kW (125PS)		Diesel Turbo Intercooler		TD26486
MB/HL 1-5	5	59,981/60,000	63,731/63,750	20,290	1,845	0,040/0,100	AL-LF	66726RA	H1057/5 STD 0.30 0.50

91 86.00 x 94.60									
QJBA			4 Cyl.	2198cc	114kW (155PS)		Diesel Turbo Intercooler		TD18756
QJBB			4 Cyl.	2198cc	114kW (155PS)		Diesel Turbo Intercooler		TD18757
QJBC			4 Cyl.	2198cc	110kW (150PS)		Diesel Turbo Intercooler		TD18782
QJBD			4 Cyl.	2198cc	110kW (150PS)		Diesel Turbo Intercooler		TD18783
BE/PL	4	52,980/53,000	55,996/56,016	24,450	1,487	0,026/0,084	BS	71-4066	71-4066/4 STD 0.25 0.50
01/04→12/06									
MB/HL	4	64,940	69,520	23,280	2,250		AL-LF	02-4067	H1018/5 STD 0.25 0.50
MB/HL	3	64,940	69,520	24,080	2,250		AL-LF	02-4068	
MB/HL	2	69,940	74,520	19,580	2,250		AL-LF	02-4069	
MB/HL	1	64,940	69,520	30,150	2,250		AL-LF	02-4070H	
01/04→12/06									

92 86.00 x 94.60									
T9CA			4 Cyl.	1998cc	154kW (210PS)		Diesel Bi-Turbo Intercooler		TD31064
TYMA			4 Cyl.	1998cc	85kW (115PS)		Diesel Turbo Intercooler		TD31053
BE/PL	4	49,984/50,000	53,695/53,708	20,000	1,838	0,020/0,070	SP	71-3952	71-3952/4 STD 0.30
BE/PL	4	52,980/53,000	55,996/56,016	24,450	1,487	0,026/0,084	BS	71-4066	71-4066/4 STD 0.25 0.50
MB/HL	4	64,940	69,520	23,280	2,250		AL-LF	02-4067	H1018/5 STD 0.25 0.50
MB/HL	3	64,940	69,520	24,080	2,250		AL-LF	02-4068	
MB/HL	2	69,940	74,520	19,580	2,250		AL-LF	02-4069	
MB/HL	1	64,940	69,520	30,150	2,250		AL-LF	02-4070H	
MB/HL 1-5	5	59,981/60,000	63,731/63,750	20,290	1,845	0,040/0,100	AL-LF	66726RA	H1057/5 STD 0.30 0.50
TW/A	4	67,050/67,300	83,050/83,300		2,330		BS	66721BF	A214/4 STD 0.10

93 86.20 x 77.00									
R2A			4 Cyl.	1796cc	66kW (90PS)		Petrol		TD4483
REB			4 Cyl.	1796cc	66kW (90PS)		Petrol		TD1421

FORD



REC			4 Cyl.	1796cc	66kW (90PS)	Petrol			TD1422
RED			4 Cyl.	1796cc	59-66kW (80-90PS)	Petrol			TD1423
REF			4 Cyl.	1796cc	59kW (80PS)	Petrol			TD1424
BE/PL	4	51,980/52,000	55,000/55,020	20,000	1,497	0,020/0,071	AL-LF	3460RA	01-4142/4 STD 0.25 0.50 0.75 1.00
BE/PL	4	51,980/52,000	55,000/55,020	20,000	1,470	0,006/0,069	BS	AE5792	71-4382/4 STD 0.25 0.50
MB/HL 1-5	5	56,970/56,990	60,620/60,640	23,600	1,810	0,020/0,075	AL-LF	02-2985	H853/5 STD 0.25 0.50 0.75
TW/A	2	63,850	80,500		2,330		AL-LF	04-2988	A045/4 STD
TW/A	2	63,850	80,500		2,330		AL-LF	04-3362	
CB/NWB 1	1	41,995/42,010	45,072/45,102	20,000	1,521		BC	53-2989	N145/3 STD
CB/NWB 2	1	44,615/44,630	47,692/47,722	17,000	1,521		BC	53-2990	
CB/NWB 3	1	44,995/45,010	48,072/48,102	16,000	1,521		BC	53-2991	

94 86.50 x 100.00

4G64			4 Cyl.	2350cc	97kW (132PS)	Petrol			TD26869
MB/HL 3	2	56,980	61,020	28,950	1,990		AL	63-111-(2)	H1032/5 STD 0.25 0.50
MB/HL 1,2,4,5	4	56,980	61,020	23,100	1,990		AL	63-111-1	
MB/HL 1,2,4,5	4	56,980	61,020	23,130	1,990		AL	63-111-3	

95 87.50 x 83.10

CJBA			4 Cyl.	1999cc	106-107kW (144-146PS)	Petrol			TD15911
CJBB			4 Cyl.	1999cc	107kW (146PS)	Petrol			TD15912
MB/HL 1,2,4,5	4	57,980/58,000	62,287/62,300	19,210	2,131	0,025/0,083	AL	4136RA	H1086/5 STD 0.25
MB/HL 3	1	57,980/58,000	62,287/62,300	24,680	2,131	0,025/0,083	AL	4137RAH	

96 87.50 x 94.00

GZFA			4 Cyl.	2261cc	100-107kW (136-145PS)	Petrol			TD20045
BE/PL	4	50,890/50,910	53,890/53,910	20,600	1,480	0,020/0,069	AL-LF	4670RA	01-4166/4 STD 0.25 0.50
MB/HL 1-5	5	54,980/55,000	59,287/59,300	18,600	2,138	0,020/0,069	AL-LF	4672RA	H1163/5 STD 0.25 0.50
TW/A	2	61,000	74,500		2,360	0,090/0,240	AL	GS70353SA	A270/2 STD

97 87.65 x 66.00

4RB			4 Cyl.	1593cc	48kW (65PS)	Petrol			TD9440
B			4 Cyl.	1593cc	48kW (65PS)	Petrol			TD4439
LCN			4 Cyl.	1593cc	54kW (73PS)	Petrol			TD1266
LCR			4 Cyl.	1598cc	54kW (73PS)	Petrol			TD1267
LCS			4 Cyl.	1593cc	55kW (75PS)	Petrol			TD1268
LCT			4 Cyl.	1593cc	55kW (75PS)	Petrol			TD1269
BE/PL	4	51,980/52,000	55,000/55,020	20,000	1,497	0,020/0,071	AL-LF	3460RA	01-4142/4 STD 0.25 0.50 0.75 1.00
MB/HL 1-5	5	56,970/56,990	60,620/60,640	23,600	1,810	0,020/0,075	AL-LF	02-2985	H1222/5 STD 0.25
MB/HL 1-5	5	56,970/56,990	60,620/60,640	23,600	1,810	0,020/0,075	AL-LF	02-2985L	



01/86 →

MB/HL 1-5	5	56,970/56,990	60,620/60,640	23,600	1,810	0,020/0,075	AL-LF	02-2985	H853/5 STD 0.25 0.50 0.75
→12/85									
TW/A	2	63,850	80,500		2,330		AL-LF	04-2988	A045/4 STD
TW/A	2	63,850	80,500		2,330		AL-LF	04-3362	
CB/NWB 1	1	41,995/42,010	45,072/45,102	20,000	1,521		BC	53-2989	N145/3 STD
CB/NWB 2	1	44,615/44,630	47,692/47,722	17,000	1,521		BC	53-2990	
CB/NWB 3	1	44,995/45,010	48,072/48,102	16,000	1,521		BC	53-2991	

98

87.65 x 66.00

LAC			4 Cyl.	1593cc	50kW (68PS)		Petrol		TD1256
LAD			4 Cyl.	1593cc	50-51kW (68-70PS)		Petrol		TD1258
LAN			4 Cyl.	1593cc	51kW (70PS)		Petrol		TD1259
LAR			4 Cyl.	1593cc	51kW (69PS)		Petrol		TD11328
LCE			4 Cyl.	1593cc	53kW (72PS)		Petrol		TD1263
LCJ			4 Cyl.	1593cc	53-63kW (72-86PS)		Petrol		TD1264
LCK			4 Cyl.	1593cc	55kW (75PS)		Petrol		TD1265
LE			4 Cyl.	1593cc	65kW (88PS)		Petrol		TD1270
LEC			4 Cyl.	1593cc	65kW (88PS)		Petrol		TD11229
LEN			4 Cyl.	1593cc	65-67kW (88-91PS)		Petrol		TD1271
OHC TL 16 H			4 Cyl.	1593cc	53kW (73PS)		Petrol		TD1388
OHC TL 16 L			4 Cyl.	1593cc	44-50kW (60-68PS)		Petrol		TD1389
TL 16M			4 Cyl.	1593cc	62kW (84PS)		Petrol		TD24561
BE/PL	4	51,980/52,000	55,000/55,020	20,000	1,497	0,020/0,071	AL-LF	3460RA	01-4142/4 STD 0.25 0.50 0.75 1.00
MB/HL 1-5	5	56,970/56,990	60,620/60,640	23,600	1,810	0,020/0,075	AL-LF	02-2985	H853/5 STD 0.25 0.50 0.75
TW/A	2	63,850	80,500		2,330		AL-LF	04-2988	A045/4 STD
TW/A	2	63,850	80,500		2,330		AL-LF	04-3362	
CB/NWB 1	1	41,995/42,010	45,072/45,102	20,000	1,521		BC	53-2989	N145/3 STD
CB/NWB 2	1	44,615/44,630	47,692/47,722	17,000	1,521		BC	53-2990	
CB/NWB 3	1	44,995/45,010	48,072/48,102	16,000	1,521		BC	53-2991	

99

87.65 x 66.00

LAT			4 Cyl.	1593cc	46-48kW (63-65PS)		Petrol		TD17086
BE/PL	4	51,980/52,000	55,000/55,020	20,000	1,497	0,020/0,071	AL-LF	3460RA	01-4142/4 STD 0.25 0.50 0.75 1.00
MB/HL 1-5	5	56,970/56,990	60,620/60,640	23,600	1,810	0,020/0,075	AL-LF	02-2985	H853/5 STD 0.25 0.50 0.75
→12/85									

FORD

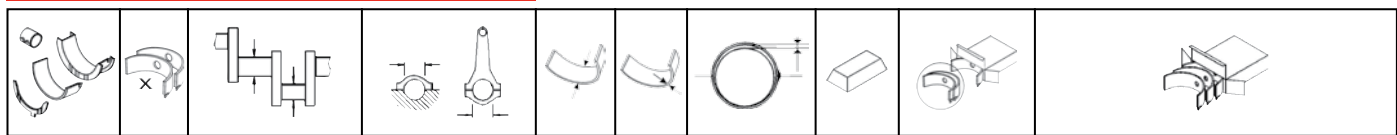

TW/A	2	63,850	80,500		2,330		AL-LF	04-2988	A045/4 STD
TW/A	2	63,850	80,500		2,330		AL-LF	04-3362	

→12/82

CB/NWB 1	1	41,995/42,010	45,072/45,102	20,000	1,521		BC	53-2989	N145/3 STD
CB/NWB 2	1	44,615/44,630	47,692/47,722	17,000	1,521		BC	53-2990	
CB/NWB 3	1	44,995/45,010	48,072/48,102	16,000	1,521		BC	53-2991	

100

89.60 x 91.00

E5FA			4 Cyl.	2295cc	107kW (146PS)		Petrol		TD16167
E5FC			4 Cyl.	2295cc	103-107kW (140-146PS)		Petrol		TD20058
E5SA			4 Cyl.	2295cc	107kW (146PS)		Petrol		TD15889
E5SB			4 Cyl.	2295cc	103kW (140PS)		Petrol		TD17168
GZFC			4 Cyl.	2295cc	107kW (145PS)		Petrol		TD23370
Y5A			4 Cyl.	2295cc	108kW (147PS)		Petrol		TD12092
Y5B			4 Cyl.	2295cc	107kW (146PS)		Petrol		TD5497
BE/PL	4	50,890/50,910	53,890/53,910	20,600	1,480	0,020/0,069	AL-LF	4670RA	01-4166/4 STD 0.25 0.50
MB/HL 1-5	5	54,980/55,000	59,287/59,300	18,600	2,138	0,020/0,069	AL-LF	4672RA	H1163/5 STD 0.25 0.50
TW/A	2	61,000	74,500		2,360	0,090/0,240	AL	GS70353SA	A270/2 STD

101

89.90 x 94.60

D2FA			4 Cyl.	2402cc	66kW (90PS)		Diesel Turbo		TD15549
D2FB			4 Cyl.	2402cc	66kW (90PS)		Diesel Turbo		TD20037
D2FE			4 Cyl.	2402cc	66kW (90PS)		Diesel		TD15552
D4FA			4 Cyl.	2402cc	88kW (120PS)		Diesel Turbo		TD15550
DOFA			4 Cyl.	2402cc	92kW (125PS)		Diesel Turbo Intercooler		TD20038
DT24H Duratorq			4 Cyl.	2402cc	88kW (120PS)		Diesel Turbo Intercooler		FM5710
DT24N Duratorq			4 Cyl.	2402cc	55kW (75PS)		Diesel Turbo		FM5702
DT24P Duratorq			4 Cyl.	2402cc			Diesel Turbo Intercooler		FM5709
F4FA			4 Cyl.	2402cc	55kW (75PS)		Diesel Turbo Intercooler		TD15548
FXFA			4 Cyl.	2402cc	85kW (115PS)		Diesel Turbo		TD18798
BE/PL	4	52,980/53,000	55,996/56,016	24,450	1,487	0,026/0,084	BS	71-4066	71-4066/4 STD 0.25 0.50
MB/HL	4	64,940	69,520	23,280	2,250		AL-LF	02-4067	H1018/5 STD 0.25 0.50
MB/HL	3	64,940	69,520	24,080	2,250		AL-LF	02-4068	
MB/HL	2	69,940	74,520	19,580	2,250		AL-LF	02-4069	
MB/HL	1	64,940	69,520	30,150	2,250		AL-LF	02-4070H	

102

89.90 x 94.60

H9FA Euro 4			4 Cyl.	2402cc	101kW (137PS)		Diesel Turbo Intercooler		TD20036
H9FB Euro 4			4 Cyl.	2402cc	103kW (140PS)		Diesel Turbo Intercooler		TD20033
H9FD			4 Cyl.	2402cc	103kW (140PS)		Diesel Turbo Intercooler		TD24457
JXFA Euro 4			4 Cyl.	2402cc	85kW (115PS)		Diesel Turbo Intercooler		TD20034
JXFC			4 Cyl.	2402cc	85kW (115PS)		Diesel Turbo Intercooler		TD24456
PHFA			4 Cyl.	2402cc	74kW (100PS)		Diesel Turbo Intercooler		TD20035
PHFC Euro 4			4 Cyl.	2402cc	74kW (100PS)		Diesel Turbo Intercooler		TD21068

MB/HL	4	64,940	69,520	23,280	2,250		AL-LF	02-4067	H1018/5 STD 0.25 0.50
MB/HL	3	64,940	69,520	24,080	2,250		AL-LF	02-4068	
MB/HL	2	69,940	74,520	19,580	2,250		AL-LF	02-4069	
MB/HL	1	64,940	69,520	30,150	2,250		AL-LF	02-4070H	

103	90.00 x 59.00								
TV 15 H			V4 Cyl.	1498cc	40kW (54PS)		Petrol		TD1457
TV 15 HC			V4 Cyl.	1498cc	48kW (65PS)		Petrol		TD22541
TV 15 L			V4 Cyl.	1498cc	44kW (60PS)		Petrol		TD1458
BE/PL	1	53,980/54,000	56,820/56,840	16,480	1,407	0,020/0,071	EC	71-2185	71-2185 STD

104	90.00 x 60.10								
TV 23 H			V6 Cyl.	2293cc	79kW (107PS)		Petrol		TD1463
YYE			V6 Cyl.	2294cc	79kW (108PS)		Petrol		TD1484
YYF			V6 Cyl.	2294cc	79kW (107PS)		Petrol		TD1485
YYH			V6 Cyl.	2294cc	79kW (107PS)		Petrol		TD4497
YYN			V6 Cyl.	2294cc	84kW (114PS)		Petrol		TD1487
YYP			V6 Cyl.	2294cc	82-84kW (111-114PS)		Petrol		TD1488
YYR			V6 Cyl.	2294cc	84kW (114PS)		Petrol		TD1489
YYT			V6 Cyl.	2294cc	84kW (114PS)		Petrol		TD1490
YYU			V6 Cyl.	2294cc	82-84kW (111-114PS)		Petrol		TD1491
BE/PL	1	53,980/54,000	56,820/56,840	16,480	1,407	0,020/0,071	EC	71-2185	71-2185 STD

105	90.00 x 66.10								
TV 26 H			V6 Cyl.	2523cc	92kW (125PS)		Petrol		TD1465
BE/PL	1	53,980/54,000	56,820/56,840	16,480	1,407	0,020/0,071	EC	71-2185	71-2185 STD

106	90.00 x 66.80								
EY			4 Cyl.	1699cc	48kW (65PS)		Petrol		TD4446
MWB			4 Cyl.	1699cc	51kW (69PS)		Petrol		TD11687
MY			4 Cyl.	1699cc	54kW (73PS)		Petrol		TD4469
MYE			4 Cyl.	1699cc	54kW (74PS)		Petrol		TD1317
TV 17 H			V4 Cyl.	1699cc	51-55kW (69-75PS)		Petrol		TD1459
TV 17 HC			V4 Cyl.	1699cc	48-55kW (65-75PS)		Petrol		TD22543
TV 17 L			V4 Cyl.	1699cc	48kW (65PS)		Petrol		TD1460
TV 17 LC			V4 Cyl.	1699cc	48-51kW (65-69PS)		Petrol		TD22544
BE/PL	1	53,980/54,000	56,820/56,840	16,480	1,407	0,020/0,071	EC	71-2185	71-2185 STD

107	90.00 x 66.80								
TV 26 L			V6 Cyl.	2551cc	79kW (107PS)		Petrol		TD1466
UY			V6 Cyl.	2550cc	92kW (125PS)		Petrol		TD1470
BE/PL	1	53,980/54,000	56,820/56,840	16,480	1,407	0,020/0,071	EC	71-2185	71-2185 STD

108	90.80 x 76.90								
4RC			4 Cyl.	1993cc	43-57kW (59-78PS)		Petrol		TD9441
N6T			4 Cyl.	1993cc	57kW (78PS)		Petrol		TD1327
N6TS			4 Cyl.	1993cc	60kW (82PS)		Petrol		TD22540

FORD



NAT	4 Cyl.	1994cc	57kW (78PS)	Petrol	TD4472
NAV	4 Cyl.	1994cc	55-57kW (75-78PS)	Petrol	TD1344
NAW	4 Cyl.	1993cc	57kW (78PS)	Petrol	TD17074
NAX	4 Cyl.	1993cc	57kW (78PS)	Petrol	TD17075
NE1	4 Cyl.	1993cc	74-77kW (101-105PS)	Petrol	TD1347
NE2	4 Cyl.	1993cc	72kW (98PS)	Petrol	TD1348
NE3	4 Cyl.	1993cc	72kW (98PS)	Petrol	TD1349
NE4	4 Cyl.	1993cc	74kW (100PS)	Petrol	TD1350
NEC	4 Cyl.	1993cc	72kW (98PS)	Petrol	TD1352
NEL	4 Cyl.	1993cc	77kW (105PS)	Petrol	TD1357
NET	4 Cyl.	1993cc	74-77kW (101-105PS)	Petrol	TD1362
NUT	4 Cyl.	1993cc	43kW (58PS)	Petrol	TD17073

BE/PL	4	51,980/52,000	55,000/55,020	20,000	1,497	0,020/0,071	AL-LF	3460RA	01-4142/4 STD 0.25 0.50 0.75 1.00
BE/PL	4	51,980/52,000	55,000/55,020	20,000	1,470	0,006/0,069	BS	AE5792	71-4382/4 STD 0.25 0.50
MB/HL 1-5	5	56,970/56,990	60,620/60,640	23,600	1,810	0,020/0,075	AL-LF	02-2985	H1222/5 STD 0.25
MB/HL 1-5	5	56,970/56,990	60,620/60,640	23,600	1,810	0,020/0,075	AL-LF	02-2985L	

01/86 →

MB/HL 1-5	5	56,980/57,000	60,620/60,640	23,620	1,810		BS	72-2985	H1235/5 STD 0.25 0.50
--------------	---	---------------	---------------	--------	-------	--	----	---------	---------------------------------

→12/85

MB/HL 1-5	5	56,970/56,990	60,620/60,640	23,600	1,810	0,020/0,075	AL-LF	02-2985	H853/5 STD 0.25 0.50 0.75
--------------	---	---------------	---------------	--------	-------	-------------	-------	---------	-------------------------------------

→12/85

TW/A	2	63,850	80,500		2,330		AL-LF	04-2988	A045/4 STD
TW/A	2	63,850	80,500		2,330		AL-LF	04-3362	
CB/NWB 1	1	41,995/42,010	45,072/45,102	20,000	1,521		BC	53-2989	N145/3 STD
CB/NWB 2	1	44,615/44,630	47,692/47,722	17,000	1,521		BC	53-2990	
CB/NWB 3	1	44,995/45,010	48,072/48,102	16,000	1,521		BC	53-2991	

109 90.80 x 76.90

CH20	4 Cyl.	1993cc	Petrol Turbo	FM6872
-------------	--------	---------------	---------------------	---------------

BE/PL	4	51,980/52,000	55,000/55,020	20,000	1,497	0,020/0,071	AL-LF	3460RA	01-4142/4 STD 0.25 0.50 0.75 1.00
MB/HL 1-5	5	56,970/56,990	60,620/60,640	23,600	1,810	0,020/0,075	AL-LF	02-2985	H1222/5 STD 0.25
MB/HL 1-5	5	56,970/56,990	60,620/60,640	23,600	1,810	0,020/0,075	AL-LF	02-2985L	

01/86 →

MB/HL 1-5	5	56,980/57,000	60,620/60,640	23,620	1,810		BS	72-2985	H1235/5 STD 0.25 0.50
--------------	---	---------------	---------------	--------	-------	--	----	---------	---------------------------------

→12/85

MB/HL 1-5	5	56,970/56,990	60,620/60,640	23,600	1,810	0,020/0,075	AL-LF	02-2985	H853/5 STD 0.25 0.50 0.75
--------------	---	---------------	---------------	--------	-------	-------------	-------	---------	-------------------------------------

→12/85

TW/A	2	63,850	80,500		2,330		AL-LF	04-2988	A045/4 STD
TW/A	2	63,850	80,500		2,330		AL-LF	04-3362	

CB/NWB 1	1	41,995/42,010	45,072/45,102	20,000	1,521			BC	53-2989	N145/3 STD
CB/NWB 2	1	44,615/44,630	47,692/47,722	17,000	1,521			BC	53-2990	
CB/NWB 3	1	44,995/45,010	48,072/48,102	16,000	1,521			BC	53-2991	

110 90.80 x 76.90

N4A	4 Cyl.	1993cc	85kW (115PS)	Petrol	TD1318
N4B	4 Cyl.	1993cc	74kW (100PS)	Petrol	TD1319
NAE	4 Cyl.	1993cc	57kW (78PS)	Petrol	TD1342
NBA	4 Cyl.	1993cc	66kW (90PS)	Petrol	TD1345
NCA	4 Cyl.	1994cc	72kW (98PS)	Petrol	TD1346
NE5	4 Cyl.	1993cc	74kW (100PS)	Petrol	TD1351
NEJ	4 Cyl.	1993cc	74kW (100PS)	Petrol	TD1355
NES	4 Cyl.	1993cc	77kW (105PS)	Petrol	TD1361

BE/PL	4	51,980/52,000	55,000/55,020	20,000	1,497	0,020/0,071	AL-LF	3460RA	01-4142/4 STD 0.25 0.50 0.75 1.00
BE/PL	4	51,980/52,000	55,000/55,020	20,000	1,470	0,006/0,069	BS	AE5792	71-4382/4 STD 0.25 0.50
MB/HL 1-5	5	56,970/56,990	60,620/60,640	23,600	1,810	0,020/0,075	AL-LF	02-2985	H1222/5 STD 0.25
MB/HL 1-5	5	56,970/56,990	60,620/60,640	23,600	1,810	0,020/0,075	AL-LF	02-2985L	
TW/A	2	63,850	80,500		2,330		AL-LF	04-2988	A045/4 STD
TW/A	2	63,850	80,500		2,330		AL-LF	04-3362	
CB/NWB 1	1	41,995/42,010	45,072/45,102	20,000	1,521		BC	53-2989	N145/3 STD
CB/NWB 2	1	44,615/44,630	47,692/47,722	17,000	1,521		BC	53-2990	
CB/NWB 3	1	44,995/45,010	48,072/48,102	16,000	1,521		BC	53-2991	

111 90.80 x 76.90

N4I	4 Cyl.	1993cc	85kW (115PS)	Petrol	TD1320
NRA	4 Cyl.	1993cc	85kW (115PS)	Petrol	TD1365
NRC	4 Cyl.	1993cc	74kW (100PS)	Petrol	TD1368
NRI	4 Cyl.	1993cc	85kW (115PS)	Petrol	TD1370

BE/PL	4	51,980/52,000	55,000/55,020	20,000	1,497	0,020/0,071	AL-LF	3460RA	01-4142/4 STD 0.25 0.50 0.75 1.00
BE/PL	4	51,980/52,000	55,000/55,020	20,000	1,470	0,006/0,069	BS	AE5792	71-4382/4 STD 0.25 0.50
MB/HL 1-5	5	56,970/56,990	60,620/60,640	23,600	1,810	0,020/0,075	AL-LF	02-2985	H1222/5 STD 0.25
MB/HL 1-5	5	56,970/56,990	60,620/60,640	23,600	1,810	0,020/0,075	AL-LF	02-2985L	
MB/HL 1-5	5	56,980/57,000	60,620/60,640	23,620	1,810		BS	72-2985	H1235/5 STD 0.25 0.50
MB/HL 1-5	5	56,970/56,990	60,620/60,640	23,600	1,810	0,020/0,075	AL-LF	02-2985	H853/5 STD 0.25 0.50 0.75
TW/A	2	63,850	80,500		2,330		AL-LF	04-2988	A045/4 STD
TW/A	2	63,850	80,500		2,330		AL-LF	04-3362	

FORD

CB/NWB 1	1	41,995/42,010	45,072/45,102	20,000	1,521			BC	53-2989	N145/3 STD
CB/NWB 2	1	44,615/44,630	47,692/47,722	17,000	1,521			BC	53-2990	
CB/NWB 3	1	44,995/45,010	48,072/48,102	16,000	1,521			BC	53-2991	

112 90.80 x 76.90

NE			4 Cyl.	1993cc	77-80kW (105-110PS)		Petrol			TD4473
NEK			4 Cyl.	1993cc	74-77kW (101-105PS)		Petrol			TD1356
NEN			4 Cyl.	1993cc	73-74kW (99-101PS)		Petrol			TD1358
NEP			4 Cyl.	1993cc	74-77kW (101-105PS)		Petrol			TD1359
NER			4 Cyl.	1993cc	74kW (100PS)		Petrol			TD4474
NR2			4 Cyl.	1993cc	85kW (115PS)		Petrol			TD1364
NRB			4 Cyl.	1993cc	85kW (115PS)		Petrol			TD1367
NRD			4 Cyl.	1993cc	74kW (100PS)		Petrol			TD1369
OHC LC			4 Cyl.	1994cc	64kW (87PS)		Petrol			TD16538
OHC TL 20 H			4 Cyl.	1993cc	70-74kW (95-101PS)		Petrol			TD1391
TL 20 LC			4 Cyl.	1994cc	64-73kW (87-99PS)		Petrol			TD19004
BE/PL	4	51,980/52,000	55,000/55,020	20,000	1,497	0,020/0,071	AL-LF	3460RA		01-4142/4 STD 0.25 0.50 0.75 1.00
BE/PL	4	51,980/52,000	55,000/55,020	20,000	1,470	0,006/0,069	BS	AE5792		71-4382/4 STD 0.25 0.50
MB/HL 1-5	5	56,980/57,000	60,620/60,640	23,620	1,810		BS	72-2985		H1235/5 STD 0.25 0.50
MB/HL 1-5	5	56,970/56,990	60,620/60,640	23,600	1,810	0,020/0,075	AL-LF	02-2985		H853/5 STD 0.25 0.50 0.75
TW/A	2	63,850	80,500		2,330		AL-LF	04-2988		A045/4 STD
TW/A	2	63,850	80,500		2,330		AL-LF	04-3362		
CB/NWB 1	1	41,995/42,010	45,072/45,102	20,000	1,521			BC	53-2989	N145/3 STD
CB/NWB 2	1	44,615/44,630	47,692/47,722	17,000	1,521			BC	53-2990	
CB/NWB 3	1	44,995/45,010	48,072/48,102	16,000	1,521			BC	53-2991	

113 90.80 x 76.90

NEE			4 Cyl.	1993cc	72kW (98PS)		Petrol			TD1353
NEG			4 Cyl.	1993cc	70-73kW (95-99PS)		Petrol			TD1354
BE/PL	4	51,980/52,000	55,000/55,020	20,000	1,497	0,020/0,071	AL-LF	3460RA		01-4142/4 STD 0.25 0.50 0.75 1.00
BE/PL	4	51,980/52,000	55,000/55,020	20,000	1,470	0,006/0,069	BS	AE5792		71-4382/4 STD 0.25 0.50
MB/HL 1-5	5	56,970/56,990	60,620/60,640	23,600	1,810	0,020/0,075	AL-LF	02-2985		H853/5 STD 0.25 0.50 0.75
TW/A	2	63,850	80,500		2,330		AL-LF	04-2988		A045/4 STD
TW/A	2	63,850	80,500		2,330		AL-LF	04-3362		
CB/NWB 1	1	41,995/42,010	45,072/45,102	20,000	1,521			BC	53-2989	N145/3 STD
CB/NWB 2	1	44,615/44,630	47,692/47,722	17,000	1,521			BC	53-2990	
CB/NWB 3	1	44,995/45,010	48,072/48,102	16,000	1,521			BC	53-2991	



114 91.10 x 90.00

4 D 55 T			4 Cyl.	2347cc	62-70kW (84-95PS)			Diesel Turbo		TD21262
BE/PL	8	52,980	56,020	25,130	1,493		AL	64-113-1	71-4194/4 STD 0.25 0.50 0.75	
MB/HL 3	2	65,980	70,020	30,950	1,990		AL	63-113-(2)	H1055/5 STD 0.25 0.50	
MB/HL 1,2,4,5	4	65,980	70,020	25,130	1,990		AL	63-113-1		
MB/HL 1,2,4,5	4	65,980	70,020	25,130	1,990		AL	63-113-3		
SE/PB	1	29,000	32,030	32,000			BS	67-113-1S	55-4208 SEMI	
CB/NWB 1,2	2	42,980	46,050	20,250	1,480		AL-LF	68-113-1	N156/2 STD	

115 91.10 x 95.00

4D56 (8V)			4 Cyl.	2477cc	51-58kW (69-79PS)			Diesel		TD28196
BE/PL	8	52,980	56,020	25,130	1,493		AL	64-113-1	71-4194/4 STD 0.25 0.50 0.75	
MB/HL 3	2	65,980	70,020	30,950	1,990		AL	63-113-(2)	H1055/5 STD 0.25 0.50	
MB/HL 1,2,4,5	4	65,980	70,020	25,130	1,990		AL	63-113-1		
MB/HL 1,2,4,5	4	65,980	70,020	25,130	1,990		AL	63-113-3		
SE/PB	1	29,000	32,030	32,000			BS	67-113-1S	55-4208 SEMI	
CB/NWB 1,2	2	42,980	46,050	20,250	1,480		AL-LF	68-113-1	N156/2 STD	

116 91.10 x 95.00

4D56 T			4 Cyl.	2477cc	62-110kW (84-150PS)			Diesel Turbo Intercooler		TD28195
BE/PL	8	52,980	56,020	25,130	1,493		AL	64-113-1	71-4194/4 STD 0.25 0.50 0.75	
MB/HL 1-5	5						BC	66676RA	H1248/5 STD 0.25 0.50	
→12/02										
TW/A	2	72,000	90,000		2,500		AL-LF	65-140-1	A284/2 STD	
→12/02										
SE/PB	1	29,000	32,030	32,000			BS	67-113-1S	55-4208 SEMI	
CB/NWB 1,2	2	42,980	46,050	20,250	1,480		AL-LF	68-113-1	N156/2 STD	

117 91.10 x 98.00

G54B			4 Cyl.	2555cc	76-114kW (103-155PS)			Petrol		TD26871
BE/PL	8	52,980	56,020	25,130	1,493		AL	64-113-1	71-4194/4 STD 0.25 0.50 0.75	
CB/NWB 1,2	2	42,980	46,050	20,250	1,480		AL-LF	68-113-1	N156/2 STD	

118 92.00 x 94.00

SCB	4 Cyl.	2500cc	85kW (115PS)			Diesel Turbo Intercooler		TD1443
SCC	4 Cyl.	2500cc	85kW (115PS)			Diesel Turbo Intercooler		TD4490
VM	4 Cyl.	2500cc	92kW (125PS)			Diesel Turbo Intercooler		TD5496
VM 492 HR, VM 492 HS	4 Cyl.	2500cc	91kW (124PS)			Diesel Turbo		FM9171

FORD

BE/PL	1	53,940/53,955	57,563/57,582	23,250	1,798	0,020/0,071	BS	66655CP	71-4234 STD 0.25 0.50 0.75	
TW/A	2	74,250/74,500	88,000/88,100		2,362		AL-LF	61588AF	A227/2 STD	
SE/PB	1	29,990/29,996	34,000/34,025	30,120			BS	66659XA	55-4235 SEMI	

119 93.00 x 68.50









PR	V6 Cyl.	2792cc	109-111kW (148-151PS)	Petrol	TD1401				
PR3	V6 Cyl.	2792cc	105-107kW (143-145PS)	Petrol	TD1402				
PR4	V6 Cyl.	2792cc	105-107kW (143-145PS)	Petrol	TD1403				
PR5	V6 Cyl.	2792cc	107kW (145PS)	Petrol	TD1404				
PR6	V6 Cyl.	2792cc	105-107kW (143-146PS)	Petrol	TD1405				
PR7	V6 Cyl.	2792cc	107kW (146PS)	Petrol	TD1406				
PR8	V6 Cyl.	2792cc	105-107kW (143-145PS)	Petrol	TD1407				
PRB	V6 Cyl.	2792cc	118kW (160PS)	Petrol	TD4481				
PRC	V6 Cyl.	2792cc	108-110kW (147-150PS)	Petrol	TD1408				
PRD	V6 Cyl.	2792cc	108-110kW (147-150PS)	Petrol	TD1410				
PRE	V6 Cyl.	2792cc	110kW (150PS)	Petrol	TD1411				
PRG	V6 Cyl.	2792cc	110kW (150PS)	Petrol	TD1412				
PRI	V6 Cyl.	2792cc	109-111kW (148-151PS)	Petrol	TD1413				
PRN	V6 Cyl.	2792cc	118kW (160PS)	Petrol	TD4482				
PRT	V6 Cyl.	2792cc	110kW (150PS)	Petrol	TD1414				
PYA	V6 Cyl.	2792cc	97-99kW (132-135PS)	Petrol	TD1415				
PYN	V6 Cyl.	2792cc	138kW (188PS)	Petrol Turbo	TD1416				
PYU	V6 Cyl.	2792cc	97-99kW (132-135PS)	Petrol	TD1417				
RRN	V6 Cyl.	2792cc	118kW (160PS)	Petrol	TD1433				
BE/PL	1	53,980/54,000	56,820/56,840	16,480	1,407	0,020/0,071	EC	71-2185	71-2185 STD

120 93.00 x 72.00

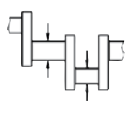
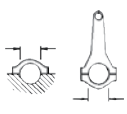
B4A	V6 Cyl.	2936cc	110kW (150PS)	Petrol	TD5108				
B4B	V6 Cyl.	2936cc	107-110kW (145-150PS)	Petrol	TD1147				
B4C	V6 Cyl.	2936cc	107-110kW (145-150PS)	Petrol	TD4440				
B4T	V6 Cyl.	2935cc	110kW (150PS)	Petrol	TD1148				
BOA	V6 Cyl.	2933cc	143kW (195PS)	Petrol	TD1151				
BOB	V6 Cyl.	2933cc	152kW (207PS)	Petrol	TD4441				
BRC	V6 Cyl.	2933cc	110kW (150PS)	Petrol	TD4442				
BRD	V6 Cyl.	2933cc	107kW (145PS)	Petrol	TD4443				
BRE	V6 Cyl.	2933cc	107kW (145PS)	Petrol	TD1153				
BRF	V6 Cyl.	2933cc	107kW (145PS)	Petrol	TD1154				
BRG	V6 Cyl.	2933cc	110kW (150PS)	Petrol	TD4444				
BRT	V6 Cyl.	2935cc	104-107kW (141-145PS)	Petrol	TD1155				
TV 29 EFI	V6 Cyl.	2935cc	107-110kW (146-150PS)	Petrol	TD1467				
BE/PL	1	53,980/54,000	56,820/56,840	16,480	1,407	0,020/0,071	EC	71-2185	71-2185 STD

121 93.00 x 78.00

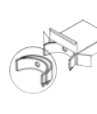
BSD444	4 Cyl.	4386cc					Diesel		FM3521
BE/PL	4	69,840/69,860	74,706/74,726	35,810	2,400	0,046/0,111	AL-LF	3105RA	01-4114/4 STD 0.25 0.50 0.75 1.00 1.25 1.50
MB/HL 1,2,4,5	4	85,633/85,654	92,055/92,075	28,190	3,177	0,047/0,113	BS	3106RA	H1033/5 STD 0.25 0.50 0.75 1.00
MB/HL 3	1	85,633/85,654	92,055/92,075	36,910	3,177	0,047/0,113	BS	3107RAH	

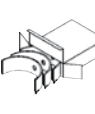
										
SE/PB	1	38,092/38,100	41,275	40,890				BC	55-4522	55-4522 SEMI
CB/NWB 1-5	5	60,757/60,782	64,376/64,402	19,560				AL-LF	3106DR	N166/5 STD 0.25

122 93.64 x 90.54

4AB			4 Cyl.	2496cc	50-52kW (68-71PS)					Diesel	TD1113
4BA			4 Cyl.	2496cc	52kW (71PS)					Diesel	TD1114
4BC			4 Cyl.	2496cc	52kW (70PS)					Diesel	TD1115
4CA			4 Cyl.	2496cc	52kW (71PS)					Diesel	TD1116
4DA			4 Cyl.	2496cc	59kW (80PS)					Diesel	TD1118
4FB			4 Cyl.	2496cc	51kW (70PS)					Diesel	TD4426
4FC			4 Cyl.	2496cc	51kW (70PS)					Diesel	TD4428
4FD			4 Cyl.	2496cc	51kW (69PS)					Diesel	TD15209
4HB			4 Cyl.	2496cc	56kW (76PS)					Diesel	TD4436
4HC			4 Cyl.	2496cc	56kW (76PS)					Diesel	TD15210
BE/PL	4	59,980/60,000		63,506/63,520	26,110	1,738	0,030/0,089	AL-LF	66490RA		01-4183/4 STD 0.25 0.50
MB/HL 1,2,4	3	69,990/70,000		74,000/74,010	23,130	1,972	0,056/0,101	AL-LF	1686RA		H1076/5 STD 0.25 0.50
MB/HL 3	1	69,990/70,000		74,000/74,010	27,000	1,972	0,056/0,101	AL-LF	1687RA		
MB/HL 5	1	76,990/77,000		81,000/81,010	22,000	1,972	0,056/0,101	AL-LF	1688RA		
TW/A	4	78,750/79,000		94,000/94,250		2,850		AL-LF	1686AF		A174/4 STD 0.06
SE/PB	1	28,992/28,997		32,000/32,025	32,000			BS	66494Y		55-4444 SEMI

123 93.64 x 90.54

4EA			4 Cyl.	2496cc	74kW (100PS)					Diesel Turbo	TD1119
4EB			4 Cyl.	2496cc	74kW (101PS)					Diesel Turbo	TD4424
4EC			4 Cyl.	2496cc	74kW (101PS)					Diesel Turbo	TD15214
4ED			4 Cyl.	2496cc	85kW (116PS)					Diesel Turbo	TD12093
4GA			4 Cyl.	2496cc	63kW (85PS)					Diesel Turbo	TD4430
4GB			4 Cyl.	2496cc	63kW (85PS)					Diesel Turbo	TD4432
4GC			4 Cyl.	2496cc	63kW (85PS)					Diesel Turbo	TD4433
4GD			4 Cyl.	2496cc	63kW (86PS)					Diesel Turbo	TD15211
4GE			4 Cyl.	2496cc	63kW (86PS)					Diesel Turbo	TD15212
4GF			4 Cyl.	2496cc	63kW (85PS)					Diesel Turbo	TD15213
BE/PL	4	59,980/60,000		63,506/63,520	26,110	1,738	0,030/0,089	BS	4680CP		71-4167/4 STD 0.25 0.50 0.75
MB/HL 1,2,4	3	69,990/70,000		74,000/74,010	23,130	1,972	0,056/0,101	AL-LF	1686RA		H1076/5 STD 0.25 0.50
MB/HL 3	1	69,990/70,000		74,000/74,010	27,000	1,972	0,056/0,101	AL-LF	1687RA		
MB/HL 5	1	76,990/77,000		81,000/81,010	22,000	1,972	0,056/0,101	AL-LF	1688RA		
TW/A	4	78,750/79,000		94,000/94,250		2,850		AL-LF	1686AF		A174/4 STD 0.06
SE/PB	1	28,992/28,997		32,000/32,025	32,000			BS	66494Y		55-4444 SEMI

124 93.64 x 90.54

4HA			4 Cyl.	2496cc	55-56kW (75-76PS)					Diesel	TD4434
4HD			4 Cyl.	2496cc	55kW (75PS)					Diesel	TD16250

FORD

MB/HL 1,2,4	3	69,990/70,000	74,000/74,010	23,130	1,972	0,056/0,101	AL-LF	1686RA	H1076/5 STD 0.25 0.50
MB/HL 3	1	69,990/70,000	74,000/74,010	27,000	1,972	0,056/0,101	AL-LF	1687RA	
MB/HL 5	1	76,990/77,000	81,000/81,010	22,000	1,972	0,056/0,101	AL-LF	1688RA	
TW/A	4	78,750/79,000	94,000/94,250		2,850		AL-LF	1686AF	A174/4 STD 0.06
SE/PB	1	28,992/28,997	32,000/32,025	32,000			BS	66494Y	55-4444 SEMI

125 93.67 x 85.60

4AA			4 Cyl.	2358cc	46kW (62PS)		Diesel		TD17094
BE/PL	4	59,980/60,000	63,506/63,520	26,110	1,738	0,030/0,089	AL-LF	66490RA	01-4183/4 STD 0.25 0.50
MB/HL 1,2,4	3	69,990/70,000	74,000/74,010	23,130	1,972	0,056/0,101	AL-LF	66491RA	H1146/5 STD 0.25
MB/HL 3	1	69,990/70,000	74,000/74,010	27,000	1,972	0,056/0,101	AL-LF	66492RA	
MB/HL 5	1	76,990/77,000	81,000/81,010	22,130	1,972	0,056/0,101	AL-LF	66493RA	
SE/PB	1	28,992/28,997	32,000/32,025	32,000			BS	66494Y	55-4444 SEMI

126 94.00 x 83.00

YTR			4 Cyl.	2304cc	49kW (67PS)		Diesel		TD1482
YTT			4 Cyl.	2304cc	49kW (67PS)		Diesel		TD1483
BE/PL	4	54,994/55,021	58,737/58,750	29,000	1,838	0,040/0,105	AL-LF	66690RA	01-4195/4 STD 0.30 0.50 0.80
MB/HL 1,3,5	3	59,994/60,021	63,737/63,750	30,000	1,837	0,042/0,107	AL-LF	66691RA	H1056/5 STD 0.30 0.50
MB/HL 2,4	2	59,994/60,021	63,737/63,750	24,000	1,837	0,042/0,107	AL-LF	66692RA	
TW/A	4	67,000/67,250	84,750/85,000		2,330		BS	66691BF	A211/4 STD 0.20
SE/PB	1	30,007/30,020	33,000/33,025	29,700			BS	66694Y	55-4196 SEMI

127 94.00 x 90.00

4CC			4 Cyl.	2496cc	52kW (70PS)		Diesel		TD1117
4FA			4 Cyl.	2496cc	51-52kW (69-70PS)		Diesel		TD1120
BE/PL	4	59,980/60,000	63,506/63,520	26,110	1,738	0,030/0,089	AL-LF	66490RA	01-4183/4 STD 0.25 0.50
MB/HL 1,2,4	3	69,990/70,000	74,000/74,010	23,130	1,972	0,056/0,101	AL-LF	1686RA	H1076/5 STD 0.25 0.50
MB/HL 3	1	69,990/70,000	74,000/74,010	27,000	1,972	0,056/0,101	AL-LF	1687RA	
MB/HL 5	1	76,990/77,000	81,000/81,010	22,000	1,972	0,056/0,101	AL-LF	1688RA	
TW/A	4	78,750/79,000	94,000/94,250		2,850		AL-LF	1686AF	A174/4 STD 0.06
SE/PB	1	28,992/28,997	32,000/32,025	32,000			BS	66494Y	55-4444 SEMI

128 94.00 x 90.00

SFA			4 Cyl.	2498cc	68kW (92PS)		Diesel Turbo		TD4492
SFB			4 Cyl.	2498cc	68kW (92PS)		Diesel Turbo		TD4493
STP			4 Cyl.	2499cc	51kW (69PS)		Diesel		TD1448
STR			4 Cyl.	2498cc	51kW (69PS)		Diesel		TD1449
XD3P			4 Cyl.	2497cc	53-58kW (72-79PS)		Diesel		TD22249

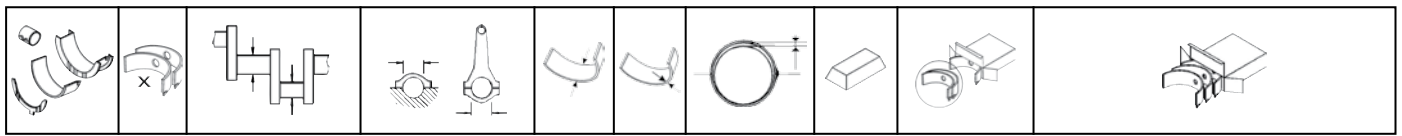

XD3T		4 Cyl.		2497cc	66-70kW (90-95PS)		Diesel Turbo Intercooler		TD22250
BE/PL	4	54,994/55,021	58,737/58,750	29,000	1,838	0,040/0,105	AL-LF	66690RA	01-4195/4 STD 0.30 0.50 0.80
MB/HL 1,3,5	3	59,994/60,021	63,737/63,750	30,000	1,837	0,042/0,107	AL-LF	66691RA	H1056/5 STD 0.30 0.50
MB/HL 2,4	2	59,994/60,021	63,737/63,750	24,000	1,837	0,042/0,107	AL-LF	66692RA	
TW/A	4	67,000/67,250	84,750/85,000		2,330		BS	66691BF	A211/4 STD 0.20
SE/PB	1	32,009/32,025	35,000/35,025	29,700			BS	66694YA	55-4197 SEMI

129 95.00 x 115.00

E1ADKN-B		4 Cyl.		3260cc			Petrol		FM2500
BE/PL	1	63,492/63,505	67,208/67,221	34,030	1,837	0,029/0,080	AL-LF	2245RAA	01-4312 STD 0.25 0.50 0.75 1.00 1.25 1.50
MB/HL 1,2,4	3	76,205/76,225	80,429/80,442	26,670	2,079	0,046/0,104	AL-LF	2246RA	H1116/5 STD 0.25 0.50
MB/HL 3,5	2	76,205/76,225	80,429/80,442	36,190	2,079	0,046/0,104	AL-LF	2247RA	
TW/A	4	84,201/84,455	98,755/99,009		2,362		AL-LF	2248AF	A176/4 STD .005 0.25

130 95.00 x 115.00

589E		6 Cyl.		4888cc			Petrol		FM2501
BE/PL	1	63,492/63,505	67,208/67,221	34,030	1,837	0,029/0,080	AL-LF	2245RAA	01-4312 STD 0.25 0.50 0.75 1.00 1.25 1.50
TW/A	4	84,201/84,455	98,755/99,009		2,362		AL-LF	2248AF	A176/4 STD .005 0.25

131 96.00 x 92.00

TD 27 T		4 Cyl.		2664cc	73-74kW (100-101PS)		Diesel Turbo		TD1450
TD27		4 Cyl.		2663cc	74kW (100PS)		Diesel Turbo		TD4494
TD27E		4 Cyl.		2664cc	92kW (125PS)		Diesel Turbo Intercooler		TD9466
BE/PL	8	56,910	60,010	26,100	1,513		BS	64-089-1	71-4156/4 STD
BE/PL	1	52,910/52,926	55,986/55,999	26,009	1,499	0,063/0,117	BS	67260CP	71-4206 STD
MB/HL 1-5	5	70,900	75,000	26,000	2,013		BS	63-087-1	H1093/5 STD 0.25
MB/HL 1-5	5	70,900	75,000	26,000	2,013		BS	63-087-2	
TW/A	2	78,700	93,700		2,325		BS	65-080-1	A220/4 STD
TW/A	2	78,700	93,700		2,325		BS	65-080-2	

132 100.00 x 114.80

2708E, 2703E (330 cu.in.)		6 Cyl.		5410cc			Diesel		FM2509
BE/PL	1	63,492/63,505	67,208/67,221	34,030	1,837	0,029/0,080	AL-LF	2245RAA	01-4312 STD 0.25 0.50 0.75 1.00 1.25 1.50
MB/HL 1-3, 5,6	5	76,205/76,225	80,429/80,441	26,670	2,076	0,052/0,109	AL-LF	65351RA	H1169/7 STD 0.25 0.50 0.75 1.00 1.50
MB/HL 4,7	2	76,205/76,225	80,429/80,441	36,190	2,076	0,052/0,109	AL-LF	65353RA	
TW/A	4	84,201/84,455	98,755/99,009		2,362		AL-LF	2248AF	A176/4 STD .005 0.25

FORD



CB/NWB 1	1	55,486/55,499	58,750/58,776	26,160	1,580		BS	GS2000L	N171/6 STD
CB/NWB 2-6	5	55,486/55,499	58,750/58,776	24,130	1,600		BB	GS2001S	

133 100.00 x 115.00

530E			4 Cyl.	3613cc				Diesel		FM6462
591E			4 Cyl.	3613cc				Diesel		FM16462
592E			4 Cyl.	3610cc				Diesel		FM2503
630E			4 Cyl.	3613cc				Diesel		FM26462
E1 ADDN-B			4 Cyl.	3611cc				Diesel		FM36462
BE/PL	1	63,492/63,505	67,208/67,221	34,030	1,837	0,029/0,080	AL-LF	2245RAA	01-4312 STD 0.25 0.50 0.75 1.00 1.25 1.50	
MB/HL 1,2,4	3	76,205/76,225	80,429/80,442	26,670	2,079	0,046/0,104	AL-LF	2246RA	H1116/5 STD 0.25 0.50	
MB/HL 3,5	2	76,205/76,225	80,429/80,442	36,190	2,079	0,046/0,104	AL-LF	2247RA		
TW/A	4	84,201/84,455	98,755/99,009		2,362		AL-LF	2248AF	A176/4 STD .005 0.25	

134 100.00 x 115.00

590E			6 Cyl.	5416cc				Diesel		FM2506
BE/PL	1	63,492/63,505	67,208/67,221	34,030	1,837	0,029/0,080	AL-LF	2245RAA	01-4312 STD 0.25 0.50 0.75 1.00 1.25 1.50	
TW/A	4	84,201/84,455	98,755/99,009		2,362		AL-LF	2248AF	A176/4 STD .005 0.25	

135 104.77 x 114.80

2701E, 2706E			4 Cyl.	3933cc				Diesel		FM2512
BE/PL	1	66,655/66,675	70,878/70,891	34,040	2,076	0,051/0,109	AL-LF	65350RAA	01-4448 STD 0.25 0.50 0.75 1.00	
MB/HL 1,2,4	3	76,205/76,225	80,429/80,441	26,670	2,076	0,052/0,109	AL-LF	65351RA	H1242/5 STD 0.25 0.50 0.75	
MB/HL 3,5	2	76,205/76,225	80,429/80,441	36,190	2,076	0,052/0,109	AL-LF	65353RA		
TW/A	4	84,201/84,455	98,755/99,009		2,362		AL-LF	2248AF	A176/4 STD .005 0.25	

136 104.77 x 114.80

2704E, 2709E			6 Cyl.	5942cc				Diesel		FM2514
BE/PL	1	66,655/66,675	70,878/70,891	34,040	2,076	0,051/0,109	AL-LF	65350RAA	01-4448 STD 0.25 0.50 0.75 1.00	
MB/HL 1-3, 5,6	5	76,205/76,225	80,429/80,441	26,670	2,076	0,052/0,109	AL-LF	65351RA	H1169/7 STD 0.25 0.50 0.75 1.00 1.50	
MB/HL 4,7	2	76,205/76,225	80,429/80,441	36,190	2,076	0,052/0,109	AL-LF	65353RA		
TW/A	4	84,201/84,455	98,755/99,009		2,362		AL-LF	2248AF	A176/4 STD .005 0.25	
CB/NWB 1	1	55,486/55,499	58,750/58,776	26,160	1,580		BS	GS2000L	N171/6 STD	
CB/NWB 2-6	5	55,486/55,499	58,750/58,776	24,130	1,600		BB	GS2001S		

137 104.77 x 114.80

2713E (365)			6 Cyl.	5938cc				Diesel		FM2542
BE/PL	1	63,492/63,505	67,208/67,221	34,030	1,837	0,029/0,080	AL-LF	2245RAA	01-4312 STD 0.25 0.50 0.75 1.00 1.25 1.50	

MB/HL 1-3, 5,6	5	76,205/76,225	80,429/80,441	26,670	2,076	0,052/0,109	AL-LF	65351RA	H1169/7 STD 0.25 0.50 0.75 1.00 1.50	
MB/HL 4,7	2	76,205/76,225	80,429/80,441	36,190	2,076	0,052/0,109	AL-LF	65353RA		
TW/A	4	84,201/84,455	98,755/99,009		2,362		AL-LF	2248AF	A176/4 STD .005 0.25	
CB/NWB 1	1	55,486/55,499	58,750/58,776	26,160	1,580		BS	GS2000L	N171/6 STD	
CB/NWB 2-6	5	55,486/55,499	58,750/58,776	24,130	1,600		BB	GS2001S		

138 104.78 x 114.90

110/6 AA-Dover		6 Cyl.		5944cc	81kW (110PS)		Diesel		TD22248	
BE/PL	1	63,492/63,505	67,208/67,221	34,030	1,837	0,029/0,080	AL-LF	2245RAA	01-4312 STD 0.25 0.50 0.75 1.00 1.25 1.50	
03/81→12/85										
BE/PL	6	66,655/66,675	70,878/70,891	34,040	2,076	0,051/0,109	AL-LF	65350RAA	01-4448/6 1.50	
01/85→01/93										
MB/HL 1-3, 5,6	5	76,205/76,225	80,429/80,441	26,670	2,076	0,052/0,109	AL-LF	65351RA	H1169/7 STD 0.25 0.50 0.75 1.00 1.50	
MB/HL 4,7	2	76,205/76,225	80,429/80,441	36,190	2,076	0,052/0,109	AL-LF	65353RA		
TW/A	4	84,201/84,455	98,755/99,009		2,340		AL	GS698SA	A265/4 STD	
CB/NWB 1	1	55,486/55,499	58,750/58,776	26,160	1,580		BS	GS2000L	N171/6 STD	
CB/NWB 2-6	5	55,486/55,499	58,750/58,776	24,130	1,600		BB	GS2001S		

139 106.69 x 96.52

2501E/2502E/2503		3 Cyl.		2589cc			Diesel		FM6738	
BE/PL	1	69,840/69,860	74,706/74,726	35,810	2,400	0,046/0,111	AL-LF	3105RA	01-4114 STD 0.25 0.50 0.75 1.00	
MB/HL 1,3,4	3	85,633/85,654	92,055/92,075	28,190	3,177	0,047/0,113	BS	3106RA	H1033/4 STD 0.25 0.50 0.75	
MB/HL 2	1	85,633/85,654	92,055/92,075	36,910	3,177	0,047/0,113	BS	3107RAH		

140 106.69 x 106.68

7A, 2504E		3 Cyl.		2861cc			Diesel		FM6734	
BE/PL	1	69,840/69,860	74,706/74,726	35,810	2,400	0,046/0,111	AL-LF	3105RA	01-4114 STD 0.25 0.50 0.75 1.00	
MB/HL 1,3,4	3	85,633/85,654	92,055/92,075	28,190	3,177	0,047/0,113	BS	3106RA	H1033/4 STD 0.25 0.50 0.75	
MB/HL 2	1	85,633/85,654	92,055/92,075	36,910	3,177	0,047/0,113	BS	3107RAH		

141 106.69 x 106.68

56D		4 Cyl.		3815cc			Diesel		FM2970	
56G		4 Cyl.		3815cc			Diesel		FM2969	
BE/PL	4	69,840/69,860	74,706/74,726	35,810	2,400	0,046/0,111	AL-LF	3105RA	01-4114/4 STD 0.25 0.50 0.75 1.00 1.25 1.50	
MB/HL 1,2,4,5	4	85,633/85,654	92,055/92,075	28,190	3,177	0,047/0,113	BS	3106RA	H1033/5 STD 0.25 0.50 0.75 1.00	
MB/HL 3	1	85,633/85,654	92,055/92,075	36,910	3,177	0,047/0,113	BS	3107RAH		
SE/PB	1	38,092/38,100	41,275	40,890			BC	55-4522	55-4522 SEMI	

FORD



CB/NWB 1-5	5	60,757/60,782	64,376/64,402	19,560			AL-LF	3106DR	N166/5 STD 0.25
---------------	---	---------------	---------------	--------	--	--	-------	--------	---------------------------

142 106.69 x 106.93

2504E		3 Cyl.			2868cc		Diesel		FM6732
BE/PL	1	69,840/69,860	74,706/74,726	35,810	2,400	0,046/0,111	AL-LF	3105RA	01-4114 STD 0.25 0.50 0.75 1.00
MB/HL 1,3,4	3	85,633/85,654	92,055/92,075	28,190	3,177	0,047/0,113	BS	3106RA	H1033/4 STD 0.25 0.50 0.75
MB/HL 2	1	85,633/85,654	92,055/92,075	36,910	3,177	0,047/0,113	BS	3107RAH	

143 106.69 x 109.97

32D		3 Cyl.			2949cc		Diesel		FM6735
BE/PL	1	69,840/69,860	74,706/74,726	35,810	2,400	0,046/0,111	AL-LF	3105RA	01-4114 STD 0.25 0.50 0.75 1.00
MB/HL 1,3,4	3	85,633/85,654	92,055/92,075	28,190	3,177	0,047/0,113	BS	3106RA	H1033/4 STD 0.25 0.50 0.75
MB/HL 2	1	85,633/85,654	92,055/92,075	36,910	3,177	0,047/0,113	BS	3107RAH	

144 107.21 x 114.90

7 AA/380 CID		6 Cyl.			6220cc		89kW (121PS)		Diesel	TD6952
130/7 AA-Dover		6 Cyl.			6223cc		94kW (128PS)		Diesel	TD6956
380 CID		6 Cyl.			6223cc		85-94kW (116-128PS)		Diesel	TD6985
BE/PL	1	66,655/66,675	70,878/70,891	34,040	2,076	0,051/0,109	AL-LF	65350RAA	01-4448 STD 0.25 0.50 0.75 1.00	
MB/HL 1-3, 5,6	5	76,205/76,225	80,429/80,441	26,670	2,076	0,052/0,109	AL-LF	65351RA	H1169/7 STD 0.25 0.50 0.75 1.00 1.50	
MB/HL 4,7	2	76,205/76,225	80,429/80,441	36,190	2,076	0,052/0,109	AL-LF	65353RA		
TW/A	4	84,201/84,455	98,755/99,009		2,340		AL	GS698SA	A265/4 STD	
CB/NWB 1	1	55,486/55,499	58,750/58,776	26,160	1,580		BS	GS2000L	N171/6 STD	
CB/NWB 2-6	5	55,486/55,499	58,750/58,776	24,130	1,600		BB	GS2001S		

145 107.21 x 114.96

5 AA/254 CID		4 Cyl.			4160cc		59-66kW (80-90PS)		Diesel	TD6950
BE/PL	1	66,655/66,675	70,878/70,891	34,040	2,076	0,051/0,109	AL-LF	65350RAA	01-4448 STD 0.25 0.50 0.75 1.00	
MB/HL 1,2,4	3	76,205/76,225	80,429/80,441	26,670	2,076	0,052/0,109	AL-LF	65351RA	H1242/5 STD 0.25 0.50 0.75	
MB/HL 3,5	2	76,205/76,225	80,429/80,441	36,190	2,076	0,052/0,109	AL-LF	65353RA		
TW/A	4	84,201/84,455	98,755/99,009		2,362		AL-LF	2248AF	A176/4 STD .005 0.25	

146 107.21 x 114.96

90/5 AA-Dover		4 Cyl.			4162cc		63-66kW (86-90PS)		Diesel	TD6954
BE/PL	1	66,655/66,675	70,878/70,891	34,040	2,076	0,051/0,109	AL-LF	65350RAA	01-4448 STD 0.25 0.50 0.75 1.00	
MB/HL 1,2,4	3	76,205/76,225	80,429/80,441	26,670	2,076	0,052/0,109	AL-LF	65351RA	H1242/5 STD 0.25 0.50 0.75	
MB/HL 3,5	2	76,205/76,225	80,429/80,441	36,190	2,076	0,052/0,109	AL-LF	65353RA		
TW/A	4	84,201/84,455	98,755/99,009		2,340		AL	GS698SA	A265/4 STD	



147 111.77 x 106.68

2508E/2514E		4 Cyl.		4187cc		Diesel			FM2971
BE/PL	4	69,840/69,860	74,706/74,726	35,810	2,400	0,046/0,111	AL-LF	3105RA	01-4114/4 STD 0.25 0.50 0.75 1.00 1.25 1.50
MB/HL 1,2,4,5	4	85,633/85,654	92,055/92,075	28,190	3,177	0,047/0,113	BS	3106RA	H1033/5 STD 0.25 0.50 0.75 1.00
MB/HL 3	1	85,633/85,654	92,055/92,075	36,910	3,177	0,047/0,113	BS	3107RAH	
SE/PB	1	38,092/38,100	41,275	40,890			BC	55-4522	55-4522 SEMI
CB/NWB 1-5	5	60,757/60,782	64,376/64,402	19,560			AL-LF	3106DR	N166/5 STD 0.25

148 111.77 x 106.89

2505E		3 Cyl.		3146cc		Diesel			FM3456
BE/PL	1	69,840/69,860	74,706/74,726	35,810	2,400	0,046/0,111	AL-LF	3105RA	01-4114 STD 0.25 0.50 0.75 1.00
MB/HL 1,3,4	3	85,633/85,654	92,055/92,075	28,190	3,177	0,047/0,113	BS	3106RA	H1033/4 STD 0.25 0.50 0.75
MB/HL 2	1	85,633/85,654	92,055/92,075	36,910	3,177	0,047/0,113	BS	3107RAH	

149 111.77 x 106.89

BSD442		4 Cyl.		4195cc		Diesel			FM6747
BE/PL	4	69,840/69,860	74,706/74,726	35,810	2,400	0,046/0,111	AL-LF	3105RA	01-4114/4 STD 0.25 0.50 0.75 1.00 1.25 1.50
MB/HL 1,2,4,5	4	85,633/85,654	92,055/92,075	28,190	3,177	0,047/0,113	BS	3106RA	H1033/5 STD 0.25 0.50 0.75 1.00
MB/HL 3	1	85,633/85,654	92,055/92,075	36,910	3,177	0,047/0,113	BS	3107RAH	
SE/PB	1	38,092/38,100	41,275	40,890			BC	55-4522	55-4522 SEMI
CB/NWB 1-5	5	60,757/60,782	64,376/64,402	19,560			AL-LF	3106DR	N166/5 STD 0.25

150 111.77 x 111.76

BSD333H		3 Cyl.		3289cc		Diesel			FM3519
BE/PL	1	69,840/69,860	74,706/74,726	35,810	2,400	0,046/0,111	AL-LF	3105RA	01-4114 STD 0.25 0.50 0.75 1.00
MB/HL 1,3,4	3	85,633/85,654	92,055/92,075	28,190	3,177	0,047/0,113	BS	3106RA	H1033/4 STD 0.25 0.50 0.75
MB/HL 2	1	85,633/85,654	92,055/92,075	36,910	3,177	0,047/0,113	BS	3107RAH	

151 111.77 x 111.76

401 cu.in.		6 Cyl.		6571cc		Diesel			FM2568
BE/PL	1	69,840/69,860	74,706/74,726	35,810	2,400	0,046/0,111	AL-LF	3105RA	01-4114 STD 0.25 0.50 0.75 1.00
MB/HL 1-3, 5-7	6	85,633/85,654	92,055/92,075	28,190	3,177	0,047/0,113	BS	3106RA	H1033/7 STD 0.25
MB/HL 4	1	85,633/85,654	92,055/92,075	36,910	3,177	0,047/0,113	BS	3107RAH	

152 111.77 x 111.76

401 cu.in. Turbo		6 Cyl.		6571cc		Diesel Turbo			FM2572
BE/PL	1	69,840/69,860	74,706/74,726	35,810	2,400	0,046/0,111	BS	3105CPA	71-4114 STD 0.25 0.50

FORD









MB/HL 1-3, 5-7	6	85,633/85,654	92,055/92,075	28,190	3,177	0,047/0,113	BS	3106RA	H1033/7 STD 0.25
MB/HL 4	1	85,633/85,654	92,055/92,075	36,910	3,177	0,047/0,113	BS	3107RAH	

153 111.77 x 111.89

2506E		3 Cyl.		3294cc		Diesel		FM3518	
BE/PL	1	69,840/69,860	74,706/74,726	35,810	2,400	0,046/0,111	AL-LF	3105RA	01-4114 STD 0.25 0.50 0.75 1.00
MB/HL 1,3,4	3	85,633/85,654	92,055/92,075	28,190	3,177	0,047/0,113	BS	3106RA	H1033/4 STD 0.25 0.50 0.75
MB/HL 2	1	85,633/85,654	92,055/92,075	36,910	3,177	0,047/0,113	BS	3107RAH	

154 111.77 x 111.89

BSD 444T		4 Cyl.		4391cc		Diesel Turbo		FM3522	
BE/PL	1	69,840/69,860	74,706/74,726	35,810	2,400	0,046/0,111	BS	3105CPA	71-4114 STD 0.25 0.50
MB/HL 1,2,4,5	4	85,633/85,654	92,055/92,075	28,190	3,177	0,047/0,113	BS	3106RA	H1033/5 STD 0.25 0.50 0.75 1.00
MB/HL 3	1	85,633/85,654	92,055/92,075	36,910	3,177	0,047/0,113	BS	3107RAH	
CB/NWB 1-5	5	60,757/60,782	64,376/64,402	19,560			AL-LF	3106DR	N166/5 STD 0.25

		cm3	x 			
J05C-TI Euro 2	Diesel	5307	4	114.00	130.00	5
J05D-TA	Diesel	4728	4	112.00	120.00	2
J05D-TF	Diesel	4728	4	112.00	120.00	2
J05D-TG Euro 4	Diesel	4728	4	112.00	120.00	2
J07C-NA Euro 1	Diesel	6634	5	114.00	130.00	6
J07E-TN Euro 5	Diesel	6403	5	112.00	130.00	3
J07E-TP	Diesel	6403	5	112.00	130.00	3
J07E-TR	Diesel	6403	5	112.00	130.00	3
J08C-NA Euro 1	Diesel	7961	6	114.00	130.00	7
J08C-TI Euro 2	Diesel	7961	6	114.00	130.00	7
J08C-TK Euro 2	Diesel	7961	6	114.00	130.00	7
J08C-TM	Diesel	7961	6	114.00	130.00	7
J08C-TP	Diesel	7961	6	114.00	130.00	7
J08C-TR	Diesel	7961	6	114.00	130.00	7
J08E-TA	Diesel	7684	6	112.00	130.00	4
J08E-TB	Diesel	7684	6	112.00	130.00	4
J08E-TE	Diesel	7684	6	112.00	130.00	4
J08E-TI Euro 4	Diesel	7684	6	112.00	130.00	4
J08E-TV	Diesel	7684	6	112.00	130.00	4
J08E-TW	Diesel	7684	6	112.00	130.00	4
J08E-UA Euro 4	Diesel	7684	6	112.00	130.00	4
J08E-VD	Diesel	7684	6	112.00	130.00	4
N04C-TI Euro 4	Diesel	4009	4	104.00	118.00	1
N04C-TN Euro 5	Diesel	4009	4	104.00	118.00	1
N04C-UH Euro 5	Diesel	4009	4	104.00	118.00	1
N04C-UM	Diesel	4009	4	104.00	118.00	1
N04C-UR Euro 5	Diesel	4009	4	104.00	118.00	1
N04C-US Euro 5	Diesel	4009	4	104.00	118.00	1
N04C-UT Euro 5	Diesel	4009	4	104.00	118.00	1
N04C-VA	Diesel	4009	4	104.00	118.00	1
N04C-VB Euro 3	Diesel	4009	4	104.00	118.00	1
W04C-TI	Diesel	4009	4	104.00	118.00	1
W04D Euro 1	Diesel	4009	4	104.00	118.00	1
W04D-J	Diesel	4009	4	104.00	118.00	1
W04D-T	Diesel	4009	4	104.00	118.00	1
W04D-TI Euro 2	Diesel	4009	4	104.00	118.00	1
W04D-TN	Diesel	4009	4	104.00	118.00	1

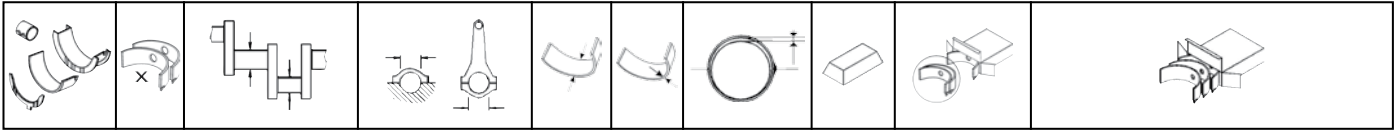

1										104.00 x 118.00	
N04C-TI Euro 4		4 Cyl.	4009cc	85-114kW (115-155PS)		Diesel Turbo Intercooler				TD27006	
N04C-TN Euro 5		4 Cyl.	4009cc	100kW (136PS)		Diesel Turbo Intercooler				TD27009	
N04C-UH Euro 5		4 Cyl.	4009cc	110kW (150PS)		Diesel Turbo Intercooler				TD27016	
N04C-UM		4 Cyl.	4009cc	85-114kW (116-155PS)		Diesel Turbo Intercooler				TD26901	
N04C-UR Euro 5		4 Cyl.	4009cc	110kW (150PS)		Diesel Turbo Intercooler				TD27008	
N04C-US Euro 5		4 Cyl.	4009cc	110kW (150PS)		Diesel Turbo Intercooler				TD27010	
N04C-UT Euro 5		4 Cyl.	4009cc	121kW (165PS)		Diesel Turbo Intercooler				TD27015	
N04C-VA		4 Cyl.	4009cc	100kW (136PS)		Diesel Turbo Intercooler				TD26900	
N04C-VB Euro 3		4 Cyl.	4009cc	110kW (150PS)		Diesel Turbo Intercooler				TD27012	
W04C-TI		4 Cyl.	4009cc	114kW (155PS)		Diesel Turbo Intercooler				TD26702	
W04D Euro 1		4 Cyl.	4009cc	77-96kW (105-131PS)		Diesel				TD7137	
W04D-J		4 Cyl.	4009cc	73kW (99PS)		Diesel				TD26705	
W04D-T		4 Cyl.	4009cc	68-75kW (92-102PS)		Diesel Turbo				TD27467	
W04D-TI Euro 2		4 Cyl.	4009cc	77-96kW (105-131PS)		Diesel Turbo Intercooler				TD26703	
W04D-TN		4 Cyl.	4009cc	103kW (140PS)		Diesel Turbo Intercooler				TD26704	
MB/HL 1-5	10	72,940		78,000	25,130	2,493		BS	63-216-1	H1246/5 STD 0.50	
TW/A	2	82,000		98,900		2,500		BS	65-216-1	A303/4 STD	
TW/A	2	82,000		98,900		2,500		BS	65-216-2		
SE/PB	1	34,990		39,030	29,800	1,992		BS	67-216-1	55-4886 STD	
CB/NWB 1	1	56,950		60,030	27,000			BB	62-216-1	N203/3 STD	
CB/NWB 2	1	56,750		59,830	27,000			BB	62-216-2		
CB/NWB 3	1	56,550		59,630	27,000			BB	62-216-3		

2										112.00 x 120.00	
J05D-TA		4 Cyl.	4728cc	130kW (177PS)			Diesel Turbo Intercooler				TD20300
J05D-TF		4 Cyl.	4728cc	130kW (177PS)			Diesel Turbo Intercooler				TD19996
J05D-TG Euro 4		4 Cyl.	4728cc	130kW (177PS)			Diesel Turbo Intercooler				TD27018
BE/PL	1	64,940		69,000	27,930	1,997		BS	64-226-1	71-4889 STD	
BE/PL	1	64,940		69,000	27,930	1,997		BS	64-226-2		
MB/HL	1	79,940		85,000	28,130	2,487		BS	63-218-3	72-4887 STD	
MB/HL	1	79,940		85,000	28,130	2,487		BS	63-218-4		
TW/A	2	85,000		104,900		2,500		BS	65-218-1	A304/4 STD	
TW/A	2	85,000		104,900		2,500		BS	65-218-2		

3										112.00 x 130.00	
J07E-TN Euro 5		5 Cyl.	6403cc	191-195kW (260-265PS)			Diesel Turbo Intercooler				TD26829
J07E-TP		5 Cyl.	6403cc	176-180kW (239-245PS)			Diesel Turbo Intercooler				TD26828
J07E-TR		5 Cyl.	6403cc	162-165kW (220-224PS)			Diesel Turbo Intercooler				TD26827
BE/PL	1	64,940		69,000	27,930	1,997		BS	64-226-1	71-4889 STD	
BE/PL	1	64,940		69,000	27,930	1,997		BS	64-226-2		

MB/HL	1	79,940	85,000	28,130	2,487		BS	63-218-3	72-4887 STD
MB/HL	1	79,940	85,000	28,130	2,487		BS	63-218-4	
TW/A	2	85,000	104,900		2,500		BS	65-218-1	A304/4 STD
TW/A	2	85,000	104,900		2,500		BS	65-218-2	

4 112.00 x 130.00

J08E-TA			6 Cyl.	7684cc	162kW (220PS)		Diesel Turbo Intercooler	TD20301	
J08E-TB			6 Cyl.	7684cc	190-193kW (258-262PS)		Diesel Turbo Intercooler	TD20302	
J08E-TE			6 Cyl.	7684cc	168-173kW (228-235PS)		Diesel Turbo Intercooler	TD26823	
J08E-TI Euro 4			6 Cyl.	7684cc	173-191kW (235-260PS)		Diesel Turbo Intercooler	TD26973	
J08E-TV			6 Cyl.	7684cc	164kW (223PS)		Diesel Turbo Intercooler	TD19998	
J08E-TW			6 Cyl.	7684cc	119kW (162PS)		Diesel Turbo Intercooler	TD19997	
J08E-UA Euro 4			6 Cyl.	7684cc	158kW (215PS)		Diesel Turbo Intercooler	TD27020	
J08E-VD			6 Cyl.	7684cc	206-210kW (280-286PS)		Diesel Turbo Intercooler	TD26838	
BE/PL	1	64,940	69,000	27,930	1,997		BS	64-226-1	71-4889 STD
BE/PL	1	64,940	69,000	27,930	1,997		BS	64-226-2	
MB/HL	1	79,940	85,000	28,130	2,487		BS	63-218-3	72-4887 STD
MB/HL	1	79,940	85,000	28,130	2,487		BS	63-218-4	
TW/A	2	85,000	104,900		2,500		BS	65-218-1	A304/4 STD
TW/A	2	85,000	104,900		2,500		BS	65-218-2	

5 114.00 x 130.00

J05C-TI Euro 2			4 Cyl.	5307cc	125kW (170PS)		Diesel Turbo Intercooler	TD26971	
BE/PL	1	64,940	69,000	27,930	1,997		BS	64-226-1	71-4889 STD
BE/PL	1	64,940	69,000	27,930	1,997		BS	64-226-2	
MB/HL	1	79,940	85,000	28,130	2,487		BS	63-218-3	72-4887 STD
MB/HL	1	79,940	85,000	28,130	2,487		BS	63-218-4	
TW/A	2	85,000	104,900		2,500		BS	65-218-1	A304/4 STD
TW/A	2	85,000	104,900		2,500		BS	65-218-2	

6 114.00 x 130.00

J07C-NA Euro 1			5 Cyl.	6634cc	121kW (165PS)		Diesel	TD26963	
BE/PL	1	64,940	69,000	27,930	1,997		BS	64-226-1	71-4889 STD
BE/PL	1	64,940	69,000	27,930	1,997		BS	64-226-2	
MB/HL	1	79,940	85,000	28,130	2,487		BS	63-218-3	72-4887 STD
MB/HL	1	79,940	85,000	28,130	2,487		BS	63-218-4	
TW/A	2	85,000	104,900		2,500		BS	65-218-1	A304/4 STD
TW/A	2	85,000	104,900		2,500		BS	65-218-2	

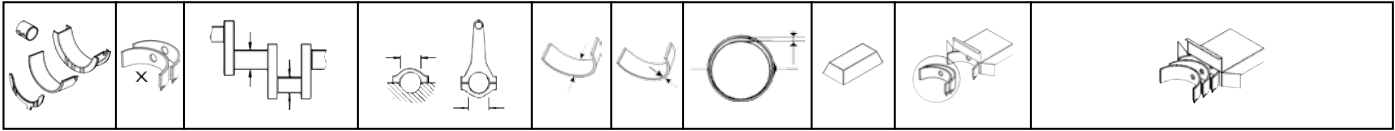

7 114.00 x 130.00

J08C-NA Euro 1			6 Cyl.	7961cc	155kW (210PS)		Diesel		TD26965
J08C-TI Euro 2			6 Cyl.	7961cc	158-191kW (215-260PS)		Diesel Turbo Intercooler		TD26969
J08C-TK Euro 2			6 Cyl.	7961cc	184kW (250PS)		Diesel Turbo Intercooler		TD28302
J08C-TM			6 Cyl.	7961cc	191kW (260PS)		Diesel Turbo Intercooler		TD24321
J08C-TP			6 Cyl.	7961cc	159kW (216PS)		Diesel Turbo Intercooler		TD20298
J08C-TR			6 Cyl.	7961cc	188kW (256PS)		Diesel Turbo Intercooler		TD20299
BE/PL	1	64,940		69,000	25,130	1,997	BS	64-224-1	71-4888 STD
BE/PL	1	64,940		69,000	25,130	1,997	BS	64-224-2	
MB/HL	1	79,940		85,000	28,130	2,487	BS	63-218-3	72-4887 STD
MB/HL	1	79,940		85,000	28,130	2,487	BS	63-218-4	
TW/A	2	85,000		104,900		2,500	BS	65-218-1	A304/4 STD
TW/A	2	85,000		104,900		2,500	BS	65-218-2	

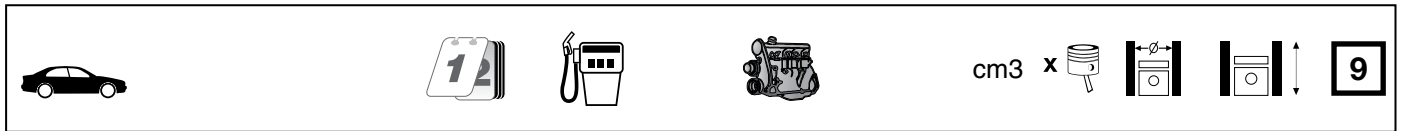









Accord 2.4	07/03→03/06	Petrol	K24A4	2354	4	87.00	99.00	24
Accord 2.4	04/06→07/08	Petrol	K24A8	2354	4	87.00	99.00	24
Accord II 1.8 EX	09/83→10/85	Petrol	ET1	1829	4	80.00	91.00	13
Accord III 2.0	01/86→12/86	Petrol	A20A2	1955	4	82.70	91.00	17
Accord III 2.0 12V	11/85→12/89	Petrol	A20A1	1955	4	82.70	91.00	17
Accord III 2.0 12V	03/85→12/89	Petrol	A20A3	1955	4	82.70	91.00	17
Accord III 2.0 EX	11/85→12/89	Petrol	A20A1	1955	4	82.70	91.00	17
Accord III 2.0 EX	11/85→05/89	Petrol	A20A2	1955	4	82.70	91.00	17
Accord III 2.0 EXi	01/86→12/89	Petrol	A20A3	1955	4	82.70	91.00	17
Accord III 2.0 EXi	11/85→12/87	Petrol	A20A4	1955	4	82.70	91.00	17
Accord III 2.0 i 16V	10/87→12/89	Petrol	B20A8	1958	4	81.00	95.00	16
Accord IV 2.0 16V	01/90→03/93	Petrol	F20A2	1997	4	85.00	88.00	21
Accord IV 2.0 16V	01/90→03/93	Petrol	F20A6	1997	4	85.00	88.00	21
Accord IV 2.0 i 16V	01/90→03/93	Petrol	F20A4	1997	4	85.00	88.00	21
Accord IV 2.0 i 16V	01/92→09/93	Petrol	F20A7	1997	4	85.00	88.00	21
Accord IV 2.0 i 16V	01/90→03/93	Petrol	F20A8	1997	4	85.00	88.00	21
Accord IV 2.2	09/89→12/93	Petrol	F22A1	2156	4	85.00	95.00	22
Accord IV 2.2 16V	01/90→12/93	Petrol	F22A1	2156	4	85.00	95.00	22
Accord IV 2.2 i 16V	01/90→03/93	Petrol	F22A3	2156	4	85.00	95.00	22
Accord IV 2.2 i 16V	01/91→12/93	Petrol	F22A7	2156	4	85.00	95.00	22
Accord IV 2.2 i 16V	01/91→12/93	Petrol	F22A8	2156	4	85.00	95.00	22
Accord IV 2.2 i 16V Automatic	01/90→03/93	Petrol	F22A3	2156	4	85.00	95.00	22
Accord V 2.0	09/93→12/97	Petrol	F20B3	1997	4	85.00	88.00	21
Accord V 2.0 i LS 16V	09/93→02/98	Petrol	F20B3	1997	4	85.00	88.00	21
Accord V 2.0 TDi	04/96→10/98	Diesel	20T2N	1994	4	84.50	88.90	19
Accord VI 1.6	12/99→12/02	Petrol	D16B6	1590	4	75.00	90.00	11
Accord VI 1.6 i	10/98→12/02	Petrol	D16B6	1590	4	75.00	90.00	11
Accord VI 1.6 LS	10/98→12/02	Petrol	D16B7	1590	4	75.00	90.00	11
Accord VI 1.8 i	10/98→12/02	Petrol	F18B2	1850	4	85.00	81.50	20
Accord VI 2.0	12/99→12/02	Petrol	F20B6	1997	4	85.00	88.00	21
Accord VI 2.0	11/99→10/02	Petrol	F20B7	1997	4	85.00	88.00	21
Accord VI 2.0 i	10/98→01/01	Petrol	F20B6	1997	4	85.00	88.00	21
Accord VI 2.0 i 16V	02/98→06/03	Petrol	F20B5	1997	4	85.00	88.00	21
Accord VI 2.0 i 16V	02/98→06/03	Petrol	F20B7	1997	4	85.00	88.00	21
Accord VI 2.0 TDi	12/99→10/00	Diesel	20T2N	1994	4	84.50	88.90	19
Accord VI 2.0 Turbo DI	02/99→12/02	Diesel	20T2N	1994	4	84.50	88.90	19
Accord VI 2.4 Vtec E	09/03→09/05	Petrol	K24A2	2354	4	87.00	99.00	24
Accord VII 2.0	01/06→	Petrol	F20B	1997	4	85.00	88.00	21
Accord VII 2.0	02/03→05/08	Petrol	K20A6	1998	4	86.00	86.00	23
Accord VII 2.0 All-wheel Drive	02/03→05/08	Petrol	K20A6	1998	4	86.00	86.00	23
Accord VII 2.4	02/03→	Petrol	K24A	2354	4	87.00	99.00	24
Accord VII 2.4	02/03→05/08	Petrol	K24A3	2354	4	87.00	99.00	24
Accord VII 2.4	01/06→07/08	Petrol	K24A8	2354	4	87.00	99.00	24
Accord VII 2.4 i 16V	02/03→	Petrol	K24A3	2354	4	87.00	99.00	24
Accord VII 2.4 Vtec	01/03→12/05	Petrol	K24A4	2354	4	87.00	99.00	24
Accord VII 2.4 Vtec	04/06→07/08	Petrol	K24A8	2354	4	87.00	99.00	24
Accord VII 2.4 Vtec E	09/02→12/05	Petrol	K24A2	2354	4	87.00	99.00	24
Accord VII 2.4 Vtec E	09/02→01/08	Petrol	K24A4	2354	4	87.00	99.00	24
Accord VII 2.4 Vtec T	09/03→05/08	Petrol	K24A1	2354	4	87.00	99.00	24
Airwave 1.5	06/04→	Petrol	L15A2	1497	4	73.00	89.40	5
Airwave 1.5 iDSi MDS 4x4	06/04→	Petrol	L15A2	1497	4	73.00	89.40	5
Ascot 2.2 EX	11/90→10/96	Petrol	F22A7	2156	4	85.00	95.00	22
Ascot 2.2 EX	11/90→10/96	Petrol	F22A8	2156	4	85.00	95.00	22
Capa 1.5 4x4	01/98→09/02	Petrol	D15B	1493	4	75.00	84.50	7
Capa 1.5 16V	04/98→09/02	Petrol	D15B	1493	4	75.00	84.50	7
City 1.3	10/05→	Petrol	L13A3	1339	4	73.00	80.00	4
City 1.3 4WD	11/02→10/04	Petrol	L13A1	1339	4	73.00	80.00	4
City 1.3 SES	05/03→09/05	Petrol	L13A1	1339	4	73.00	80.00	4
City 1.4 i-V TEC	09/08→	Petrol	L13Z1	1339	4	73.00	80.00	4
City 1.5	12/99→09/03	Petrol	D15B	1493	4	75.00	84.50	7
City 1.5	02/97→09/03	Petrol	D15B7	1493	4	75.00	84.50	7
City 1.5	02/09→	Petrol	L15A7	1497	4	73.00	89.40	5
City 1.5	01/05→	Petrol	L15AV	1497	4	73.00	89.40	5
City 1.5 CNG	01/14→	Petrol	L15A7	1497	4	73.00	89.40	5
City 1.5 FF	09/04→	Petrol	L15A1	1497	4	73.00	89.40	5
City 1.5 Flex	08/09→	Petrol	L15A	1497	4	73.00	89.40	5
City 1.5 Flex	09/14→	Petrol	L15A7	1497	4	73.00	89.40	5
City 1.5 i-VTEC	01/14→	Petrol	L15A7	1497	4	73.00	89.40	5
City 1.5 Vtec	09/04→	Petrol	L15A2	1497	4	73.00	89.40	5



cm3



City 1.5 Vtec	08/00→09/03	Petrol	L15A4	1497	4	73.00	89.40	5
City 1.5 Vtec	11/02→	Petrol	L15AV	1497	4	73.00	89.40	5
City 1.8 D	02/97→11/99	Diesel	XUD7T	1769	4	80.00	88.00	12
Civic 1.2	09/74→12/79	Petrol	EB2	1238	4	72.00	76.00	2
Civic 1.8	09/05→12/11	Petrol	R18A1	1799	4	81.00	87.30	14
Civic I 1.2	09/75→12/79	Petrol	EB2	1238	4	72.00	76.00	2
Civic I 1.3	03/81→12/83	Petrol	EN	1335	4	72.00	82.00	3
Civic I 1.5	09/83→10/87	Petrol	EW2	1488	4	74.00	86.50	6
Civic I 1.5 4WD	01/85→10/87	Petrol	EW2	1488	4	74.00	86.50	6
Civic I 1200	07/72→02/77	Petrol	EB1	1169	4	70.00	76.00	1
Civic I 1200	03/77→12/80	Petrol	EB2	1238	4	72.00	76.00	2
Civic I 1200	09/77→12/80	Petrol	EB3	1238	4	72.00	76.00	2
Civic I 1300 L	09/80→09/83	Petrol	EN1	1335	4	72.00	82.00	3
Civic I 1300 L	09/80→09/83	Petrol	EN2	1335	4	72.00	82.00	3
Civic I 1300 S	10/79→12/84	Petrol	EN4	1335	4	72.00	82.00	3
Civic II 1.5 i 16V	01/88→11/91	Petrol	D15B2	1493	4	75.00	84.50	9
Civic II 1.5 i 16V 4WD	01/88→12/89	Petrol	D15B4	1493	4	75.00	84.50	9
Civic II 1.6 4x4	01/88→12/92	Petrol	D16A	1590	4	75.00	90.00	10
Civic II 1.6 4x4	01/88→12/92	Petrol	D16A7	1590	4	75.00	90.00	11
Civic II 1.6 i 16V 4WD	01/88→02/95	Petrol	D16A6	1590	4	75.00	90.00	11
Civic II 1.8	01/88→02/95	Petrol	B18B6	1834	4	81.00	89.00	15
Civic II 1300	09/79→09/83	Petrol	EN1	1335	4	72.00	82.00	3
Civic II 1300 L	09/79→09/83	Petrol	EN1	1335	4	72.00	82.00	3
Civic III 1.5 GL	10/83→10/87	Petrol	EW2	1488	4	74.00	86.50	6
Civic III 1.5 GT	01/85→10/87	Petrol	EW3	1488	4	74.00	86.50	6
Civic III 1.5 GTI	03/86→10/87	Petrol	EW4	1488	4	74.00	86.50	6
Civic IV 1.5	01/88→08/88	Petrol	EW3	1488	4	74.00	86.50	6
Civic IV 1.5	01/88→12/89	Petrol	D15B1	1493	4	75.00	84.50	8
Civic IV 1.5 i 16V	09/87→10/93	Petrol	D15B1	1493	4	75.00	84.50	8
Civic IV 1.5 i 16V	10/87→09/91	Petrol	D15B2	1493	4	75.00	84.50	9
Civic IV 1.5 i 16V	10/87→10/93	Petrol	D15B4	1493	4	75.00	84.50	9
Civic IV 1.6	01/88→12/89	Petrol	D16Z5	1590	4	75.00	90.00	11
Civic IV 1.6 4x4	01/89→12/89	Petrol	D16Z5	1590	4	75.00	90.00	11
Civic IV 1.6 16V 4x4	11/87→09/91	Petrol	D16A6	1590	4	75.00	90.00	11
Civic IV 1.6 i 16V	10/87→09/91	Petrol	D16A6	1590	4	75.00	90.00	11
Civic IV 1.6 i 16V	09/87→12/91	Petrol	D16A7	1590	4	75.00	90.00	11
Civic IV 1.6 i 16V	09/87→09/91	Petrol	D16A9	1590	4	75.00	90.00	11
Civic IV 1.6 i 16V	10/87→09/91	Petrol	D16Z2	1590	4	75.00	90.00	11
Civic IV 1.6 i 16V 4x4	10/89→09/91	Petrol	D16A6	1590	4	75.00	90.00	11
Civic V 1.5	01/92→12/95	Petrol	D15B2	1493	4	75.00	84.50	9
Civic V 1.5	10/91→12/95	Petrol	D15B7	1493	4	75.00	84.50	7
Civic V 1.5	06/93→12/95	Petrol	D15Z1	1493	4	75.00	84.50	7
Civic V 1.5 i 16V	10/91→11/95	Petrol	D15B2	1493	4	75.00	84.50	9
Civic V 1.5 i 16V	10/91→11/95	Petrol	D15Z1	1493	4	75.00	84.50	7
Civic V 1.5 i 16V	10/91→11/95	Petrol	D15Z2	1493	4	75.00	84.50	7
Civic V 1.5 i LSi	08/93→11/95	Petrol	D15B7	1493	4	75.00	84.50	7
Civic V 1.6	10/91→09/95	Petrol	D16A9	1590	4	75.00	90.00	11
Civic V 1.6	10/91→09/95	Petrol	D16Z2	1590	4	75.00	90.00	11
Civic V 1.6	10/91→03/96	Petrol	D16Z6	1590	4	75.00	90.00	10
Civic V 1.6 4x4	01/92→10/95	Petrol	D16Z7	1590	4	75.00	90.00	11
Civic V 1.6 16V Vtec	10/91→11/95	Petrol	D16Z6	1590	4	75.00	90.00	10
Civic V 1.6 16V Vtec	10/91→11/95	Petrol	D16Z7	1590	4	75.00	90.00	11
Civic V 1.6 EX	08/93→10/95	Petrol	D16A7	1590	4	75.00	90.00	11
Civic V 1.6 i	01/94→03/96	Petrol	D16Y7	1590	4	75.00	90.00	11
Civic V 1.6 i Vtec	01/94→03/96	Petrol	D16Y6	1590	4	75.00	90.00	11
Civic V 1.6 i Vtec	01/94→03/96	Petrol	D16Z9	1590	4	75.00	90.00	11
Civic V 1.6 si 16V	10/91→10/93	Petrol	D16A8	1590	4	75.00	90.00	10
Civic VI 1.5	11/95→12/96	Petrol	D15Z3	1493	4	75.00	84.50	7
Civic VI 1.5 16V	01/97→02/01	Petrol	D15Z8	1493	4	75.00	84.50	7
Civic VI 1.5 i	10/95→03/01	Petrol	D15B2	1493	4	75.00	84.50	9
Civic VI 1.5 i	10/93→12/95	Petrol	D15B7	1493	4	75.00	84.50	7
Civic VI 1.5 i	11/95→02/01	Petrol	D15Z6	1493	4	75.00	84.50	7
Civic VI 1.5 i Vtec-E	09/94→01/97	Petrol	D15Z3	1493	4	75.00	84.50	7
Civic VI 1.6	10/95→09/00	Petrol	D16A7	1590	4	75.00	90.00	11
Civic VI 1.6	11/98→10/00	Petrol	D16W4	1590	4	75.00	90.00	11
Civic VI 1.6	10/95→12/00	Petrol	D16Y2	1590	4	75.00	90.00	11
Civic VI 1.6	09/97→12/99	Petrol	D16Y5	1590	4	75.00	90.00	11
Civic VI 1.6	10/95→12/00	Petrol	D16Y7	1590	4	75.00	90.00	11
Civic VI 1.6	09/95→12/00	Petrol	D16Y8	1590	4	75.00	90.00	11









				cm3				
Civic VI 1.6 16V	01/97→02/01	Petrol	D16B2	1590	4	75.00	90.00	11
Civic VI 1.6 16V	04/98→02/01	Petrol	D16W4	1590	4	75.00	90.00	11
Civic VI 1.6 i	09/94→01/97	Petrol	D16Y3	1590	4	75.00	90.00	11
Civic VI 1.6 i	11/95→02/01	Petrol	D16Y5	1590	4	75.00	90.00	11
Civic VI 1.6 i	03/96→03/00	Petrol	D16Y7	1590	4	75.00	90.00	11
Civic VI 1.6 i Vtec	09/94→01/97	Petrol	D16Y2	1590	4	75.00	90.00	11
Civic VI 1.6 i Vtec	11/95→02/01	Petrol	D16Y6	1590	4	75.00	90.00	11
Civic VI 1.6 i Vtec	11/95→02/01	Petrol	D16Y8	1590	4	75.00	90.00	11
Civic VI 1.6 i Vtec 4x4	11/95→02/01	Petrol	D16Z7	1590	4	75.00	90.00	11
Civic VI 2.0	06/95→10/99	Petrol	F20B3	1997	4	85.00	88.00	21
Civic VI 2.0 i D	04/98→02/01	Diesel	20T2N	1994	4	84.50	88.90	19
Civic VI 2.0 i TD	01/97→02/01	Diesel	20T2R	1994	4	84.50	88.90	19
Civic VI 2.0 TDiC	11/98→10/00	Diesel	20T2N	1994	4	84.50	88.90	19
Civic VII 1.3 Hybrid	09/02→12/05	Petrol	LDA1	1339	4	73.00	80.00	4
Civic VII 1.3 IMA	01/04→09/05	Petrol	LDA1	1339	4	73.00	80.00	4
Civic VII 1.6	02/01→09/05	Petrol	D16V1	1590	4	75.00	90.00	11
Civic VII 1.6 i	02/01→12/05	Petrol	D16V1	1590	4	75.00	90.00	11
Civic VII 1.8	02/01→09/05	Petrol	R18A1	1799	4	81.00	87.30	14
Civic VII 2.0	10/03→09/05	Petrol	K20A3	1998	4	86.00	86.00	23
Civic VII 2.0 i	09/01→09/05	Petrol	K20A3	1998	4	86.00	86.00	23
Civic VII 2.0 Type-R	09/01→09/05	Petrol	K20A2	1998	4	86.00	86.00	23
Civic VIII 1.3	02/06→	Petrol	L13A6	1339	4	73.00	80.00	4
Civic VIII 1.3 Hybrid	09/05→	Petrol	LDA2	1339	4	73.00	80.00	4
Civic VIII 1.4	09/05→	Petrol	L13A7	1339	4	73.00	80.00	4
Civic VIII 1.4	10/08→	Petrol	L13Z1	1339	4	73.00	80.00	4
Civic VIII 1.5	03/11→	Petrol	L15A7	1497	4	73.00	89.40	5
Civic VIII 1.8	09/05→	Petrol	R18A1	1799	4	81.00	87.30	14
Civic VIII 1.8	09/05→	Petrol	R18A2	1799	4	81.00	87.30	14
Civic VIII 1.8 Flex	11/06→	Petrol	R18A1	1799	4	81.00	87.30	14
Civic VIII 2.0	02/06→02/12	Petrol	K20A3	1998	4	86.00	86.00	23
Civic IX 1.4 i-VTEC	02/12→	Petrol	L13Z4	1339	4	73.00	80.00	4
Civic IX 1.8	09/11→	Petrol	R18A1	1799	4	81.00	87.30	14
Civic IX 1.8 CNG	09/11→12/12	Petrol	R18A9	1799	4	81.00	87.30	14
Civic IX 1.8 Flex	06/14→	Petrol	R18A1	1799	4	81.00	87.30	14
Concerto 1.5 i 16V	08/89→05/95	Petrol	D15B2	1493	4	75.00	84.50	9
Concerto 1.6	10/89→10/92	Petrol	D16A9	1590	4	75.00	90.00	11
Concerto 1.6 16V	08/89→03/95	Petrol	D16Z2	1590	4	75.00	90.00	11
Concerto 1.6 i 16V	08/89→03/95	Petrol	D16A8	1590	4	75.00	90.00	10
Concerto 1.6 i 16V	08/89→03/95	Petrol	D16Z2	1590	4	75.00	90.00	11
Crossroad 1.8 i-VTEC	02/07→08/10	Petrol	R18A2	1799	4	81.00	87.30	14
CR-V I 2.0	09/96→12/98	Petrol	B20B4	1973	4	84.00	89.00	18
CR-V I 2.0	04/99→02/02	Petrol	B20Z1	1973	4	84.00	89.00	18
CR-V I 2.0	09/98→12/01	Petrol	B20Z2	1973	4	84.00	89.00	18
CR-V I 2.0 4WD	09/98→12/01	Petrol	B20Z2	1973	4	84.00	89.00	18
CR-V I 2.0 16V	01/99→02/02	Petrol	B20Z1	1973	4	84.00	89.00	18
CR-V I 2.0 16V 4WD	10/95→12/01	Petrol	B20B	1973	4	84.00	89.00	18
CR-V II 2.0	09/01→09/06	Petrol	K20A4	1998	4	86.00	86.00	23
CR-V II 2.4	09/01→12/05	Petrol	K24A1	2354	4	87.00	99.00	24
CR-V II 2.4 Vtec 4WD	09/01→09/06	Petrol	K24A1	2354	4	87.00	99.00	24
CR-V III 2.4	06/06→06/12	Petrol	K24A	2354	4	87.00	99.00	24
CR-V III 2.4	04/07→	Petrol	K24A1	2354	4	87.00	99.00	24
CR-V III 2.4 4WD	09/06→	Petrol	K24A	2354	4	87.00	99.00	24
CR-V III 2.4 i-VTEC	10/06→	Petrol	K24A1	2354	4	87.00	99.00	24
CR-V IV 2.4	09/12→	Petrol	K24A	2354	4	87.00	99.00	24
CRX I 1.5 i	10/83→11/86	Petrol	EW3	1488	4	74.00	86.50	6
CRX I 1.6 i 16V	03/86→10/87	Petrol	ZC1	1590	4	75.00	90.00	10
CRX II 1.5	10/87→12/91	Petrol	D15B2	1493	4	75.00	84.50	9
CRX II 1.6 i 16V	10/87→05/88	Petrol	D16A	1590	4	75.00	90.00	10
CRX II 1.6 i 16V	10/87→05/88	Petrol	D16A6	1590	4	75.00	90.00	11
CRX II 1.6 i 16V	10/87→12/89	Petrol	D16A8	1590	4	75.00	90.00	10
CRX II 1.6 i 16V	10/87→12/89	Petrol	D16A9	1590	4	75.00	90.00	11
CRX II 1.6 i 16V	10/87→02/92	Petrol	D16Z5	1590	4	75.00	90.00	11
CRX II 1.6 Si	09/88→12/91	Petrol	D16A6	1590	4	75.00	90.00	11
CRX III 1.5	01/94→04/98	Petrol	D15B7	1493	4	75.00	84.50	7
CRX III 1.6 ESi	03/92→12/98	Petrol	D16Y8	1590	4	75.00	90.00	11
CRX III 1.6 ESi	03/92→12/98	Petrol	D16Z6	1590	4	75.00	90.00	10
CR-Z 1.5 Hybrid	06/10→	Petrol	LEA1	1497	4	73.00	89.40	5
CR-Z 1.5 Hybrid	11/12→	Petrol	LEA3	1497	4	73.00	89.40	5
Domani 1.5	10/92→09/00	Petrol	D15B3	1493	4	75.00	84.50	7









cm3









Domani 1.6	10/95→09/99	Petrol	D16A	1590	4	75.00	90.00	10
Domani 1.6	11/88→12/97	Petrol	D16Z2	1590	4	75.00	90.00	11
Domani 1.6 All-wheel Drive	10/95→09/99	Petrol	D16A	1590	4	75.00	90.00	10
Domani 1.8	10/94→09/00	Petrol	B18B6	1834	4	81.00	89.00	15
Element 2.4	09/05→12/06	Petrol	K24A4	2354	4	87.00	99.00	24
Element 2.4	09/06→12/11	Petrol	K24A8	2354	4	87.00	99.00	24
Element 2.4 4WD	09/05→12/06	Petrol	K24A4	2354	4	87.00	99.00	24
Element 2.4 4WD	09/06→12/11	Petrol	K24A8	2354	4	87.00	99.00	24
Element 2.4 Vtec	07/02→12/11	Petrol	K24A6	2354	4	87.00	99.00	24
Element 2.4 Vtec 4x4	07/02→12/11	Petrol	K24A6	2354	4	87.00	99.00	24
Elysion 2.4 i-VTEC	05/04→	Petrol	K24A1	2354	4	87.00	99.00	24
Freed 1.5	03/09→	Petrol	L15A7	1497	4	73.00	89.40	5
FR-V 1.8	01/07→	Petrol	R18A1	1799	4	81.00	87.30	14
FR-V 2.0	08/04→	Petrol	K20A9	1998	4	86.00	86.00	23
FR-V 2.0 4x4	08/04→09/06	Petrol	K20A9	1998	4	86.00	86.00	23
HR-V 1.6 16V	03/99→	Petrol	D16W1	1590	4	75.00	90.00	11
HR-V 1.6 16V 4WD	03/99→	Petrol	D16W1	1590	4	75.00	90.00	11
HR-V 1.6 16V 4WD	10/99→	Petrol	D16W5	1590	4	75.00	90.00	11
HR-V 1.8	01/15→	Petrol	R18Z9	1799	4	81.00	87.30	14
HR-V 1.8	01/15→	Petrol	R18ZF	1799	4	81.00	87.30	14
HR-V 1.8 AWD	01/15→	Petrol	R18Z9	1799	4	81.00	87.30	14
HR-V 1.8 Flex	06/15→	Petrol	R18A1	1799	4	81.00	87.30	14
Insight 1.3 Hybrid	04/09→	Petrol	LDA3	1339	4	73.00	80.00	4
Integra 1.5	10/85→08/89	Petrol	D15A1	1488	4	74.00	86.50	6
Integra 1.5	09/95→08/99	Petrol	D15B	1493	4	75.00	84.50	7
Integra 1.6	03/86→08/89	Petrol	D16A3	1590	4	75.00	90.00	11
Integra 1.6	09/93→08/01	Petrol	ZC1	1590	4	75.00	90.00	10
Integra 1.8	06/89→07/93	Petrol	B18A1	1834	4	81.00	89.00	15
Integra 2.0	10/04→	Petrol	K20A2	1998	4	86.00	86.00	23
Integra 2.0	02/02→	Petrol	K20A3	1998	4	86.00	86.00	23
Jazz 1.3	05/03→	Petrol	L13A1	1339	4	73.00	80.00	4
Jazz 1.5	05/03→	Petrol	L15A1	1497	4	73.00	89.40	5
Jazz 1.5	10/04→	Petrol	L15A2	1497	4	73.00	89.40	5
Jazz II 1.3	03/02→07/08	Petrol	L13A1	1339	4	73.00	80.00	4
Jazz II 1.3 iDSi	03/02→09/07	Petrol	L13A1	1339	4	73.00	80.00	4
Jazz II 1.4	04/05→07/08	Petrol	L13A5	1339	4	73.00	80.00	4
Jazz II 1.4 Flex	12/06→10/08	Petrol	L13A1	1339	4	73.00	80.00	4
Jazz II 1.5	04/02→12/08	Petrol	L15A	1497	4	73.00	89.40	5
Jazz II 1.5	02/05→12/08	Petrol	L15A1	1497	4	73.00	89.40	5
Jazz II 1.5 FF	03/02→09/07	Petrol	L15A1	1497	4	73.00	89.40	5
Jazz III 1.3 Hybrid	04/11→	Petrol	LDA3	1339	4	73.00	80.00	4
Jazz III 1.3 i	07/08→	Petrol	L13Z1	1339	4	73.00	80.00	4
Jazz III 1.4	11/08→	Petrol	L13Z1	1339	4	73.00	80.00	4
Jazz III 1.5	09/08→	Petrol	L15A7	1497	4	73.00	89.40	5
Jazz III 1.5 Flex	10/07→	Petrol	L15A	1497	4	73.00	89.40	5
Jazz III 1.5 Flex	10/07→	Petrol	L15A3	1497	4	73.00	89.40	5
Jazz III 1.5 Flexfuel	07/08→	Petrol	L15A3	1497	4	73.00	89.40	5
Jazz III 1.5 i	07/08→	Petrol	L15A3	1497	4	73.00	89.40	5
Jazz III 1.5 i	07/08→	Petrol	L15A7	1497	4	73.00	89.40	5
Jazz IV 1.5	09/14→	Petrol	L15A	1497	4	73.00	89.40	5
Mobilio 1.5	12/01→10/08	Petrol	L15A	1497	4	73.00	89.40	5
Mobilio 1.5	12/01→10/08	Petrol	L15A1	1497	4	73.00	89.40	5
Mobilio 1.5 4WD	12/01→10/08	Petrol	L15A	1497	4	73.00	89.40	5
Mobilio 1.5 4WD	12/01→10/08	Petrol	L15A1	1497	4	73.00	89.40	5
Odyssey 2.4	04/09→12/13	Petrol	K24A	2354	4	87.00	99.00	24
Odyssey 2.4	10/05→	Petrol	K24A4	2354	4	87.00	99.00	24
Odyssey 2.4	10/03→	Petrol	K24A5	2354	4	87.00	99.00	24
Odyssey 2.4 i-VTEC	11/08→	Petrol	K24A	2354	4	87.00	99.00	24
Odyssey 2.4 i-VTEC 4x4	11/08→	Petrol	K24A	2354	4	87.00	99.00	24
Orthia 1.8 Front Wheel Drive	10/95→09/01	Petrol	B18B6	1834	4	81.00	89.00	15
Orthia 2.0 Front Wheel Drive	10/95→09/01	Petrol	B20B	1973	4	84.00	89.00	18
Prelude II 1.8 EX	11/83→04/87	Petrol	ET2	1829	4	80.00	91.00	13
Prelude II 1.8 EX	11/83→04/87	Petrol	ET3	1829	4	80.00	91.00	13
Prelude II 1.8 EX	11/85→04/87	Petrol	ET4	1829	4	80.00	91.00	13
Prelude II 2.0 i	01/86→09/87	Petrol	A20A4	1955	4	82.70	91.00	17
Prelude III 2.0	09/87→12/91	Petrol	B20A3	1958	4	81.00	95.00	16
Prelude III 2.0	08/87→01/92	Petrol	B20A4	1958	4	81.00	95.00	16
Prelude III 2.0 EX	04/87→01/92	Petrol	B20A3	1958	4	81.00	95.00	16
Prelude III 2.0 i EX 16V	04/86→12/87	Petrol	B20A1	1958	4	81.00	95.00	16

				cm ³ x 			
---	---	---	---	---	---	---	---

Prelude III 2.0 i EX 16V	04/87→01/92	Petrol	B20A5	1958	4	81.00	95.00	16
Prelude III 2.0 i EX 16V	10/87→12/90	Petrol	B20A7	1958	4	81.00	95.00	16
Prelude III 2.0 i EX 16V	04/90→01/92	Petrol	B20A9	1958	4	81.00	95.00	16
Prelude III 2.2 S	01/91→11/96	Petrol	F22A1	2156	4	85.00	95.00	22
Prelude IV 2.0 i 16V	02/92→09/96	Petrol	F20A4	1997	4	85.00	88.00	21
Prelude IV 2.2	12/91→12/96	Petrol	F22A1	2156	4	85.00	95.00	22
Prelude V 2.0 16V	10/96→10/00	Petrol	F20A4	1997	4	85.00	88.00	21
SMX 2.0 Lowdown	10/99→09/02	Petrol	B20B1	1973	4	84.00	89.00	18
Stepwgn 2.0	05/96→09/00	Petrol	B20B	1973	4	84.00	89.00	18
Stepwgn 2.0	10/05→	Petrol	K20A6	1998	4	86.00	86.00	23
Stepwgn 2.0	10/00→09/05	Petrol	K20A9	1998	4	86.00	86.00	23
Stepwgn 2.0 4WD	10/00→09/05	Petrol	K20A9	1998	4	86.00	86.00	23
Stepwgn 2.4	10/00→09/05	Petrol	K24A3	2354	4	87.00	99.00	24
Stepwgn 2.4 Z FF	10/05→	Petrol	K24A3	2354	4	87.00	99.00	24
Stream 1.8 Vtec	10/05→	Petrol	R18A2	1799	4	81.00	87.30	14
Stream 2.0 16V	05/01→	Petrol	K20A1	1998	4	86.00	86.00	23
Torneo 1.6	10/99→09/02	Petrol	D16B6	1590	4	75.00	90.00	11
Torneo 1.8	10/99→09/02	Petrol	F18B	1850	4	85.00	81.50	20
Torneo 2.0	10/99→09/03	Petrol	F20B	1997	4	85.00	88.00	21
Torneo 2.0 SiR	10/99→09/03	Petrol	F20B4	1997	4	85.00	88.00	21
Torneo 2.0 VTS	01/98→09/03	Petrol	F20B1	1997	4	85.00	88.00	21
Torneo 2.0 VTS 4x4	01/98→09/03	Petrol	F20B1	1997	4	85.00	88.00	21

		cm3	x 			
--	---	-----	---	---	---	---

20T2N	Diesel	1994	4	84.50	88.90	19
20T2R	Diesel	1994	4	84.50	88.90	19
A20A1	Petrol	1955	4	82.70	91.00	17
A20A2	Petrol	1955	4	82.70	91.00	17
A20A3	Petrol	1955	4	82.70	91.00	17
A20A4	Petrol	1955	4	82.70	91.00	17
B18A1	Petrol	1834	4	81.00	89.00	15
B18B6	Petrol	1834	4	81.00	89.00	15
B20A1	Petrol	1958	4	81.00	95.00	16
B20A3	Petrol	1958	4	81.00	95.00	16
B20A4	Petrol	1958	4	81.00	95.00	16
B20A5	Petrol	1958	4	81.00	95.00	16
B20A7	Petrol	1958	4	81.00	95.00	16
B20A8	Petrol	1958	4	81.00	95.00	16
B20A9	Petrol	1958	4	81.00	95.00	16
B20B	Petrol	1973	4	84.00	89.00	18
B20B3	Petrol	1973	4	84.00	89.00	18
B20B4	Petrol	1973	4	84.00	89.00	18
B20B1	Petrol	1973	4	84.00	89.00	18
B20Z1	Petrol	1973	4	84.00	89.00	18
B20Z2	Petrol	1973	4	84.00	89.00	18
D15A1	Petrol	1488	4	74.00	86.50	6
D15B	Petrol	1493	4	75.00	84.50	7
D15B1	Petrol	1493	4	75.00	84.50	8
D15B2	Petrol	1493	4	75.00	84.50	9
D15B3	Petrol	1493	4	75.00	84.50	7
D15B4	Petrol	1493	4	75.00	84.50	9
D15B7	Petrol	1493	4	75.00	84.50	7
D15Z1	Petrol	1493	4	75.00	84.50	7
D15Z2	Petrol	1493	4	75.00	84.50	7
D15Z3	Petrol	1493	4	75.00	84.50	7
D15Z6	Petrol	1493	4	75.00	84.50	7
D15Z8	Petrol	1493	4	75.00	84.50	7
D16A	Petrol	1590	4	75.00	90.00	10
D16A3	Petrol	1590	4	75.00	90.00	11
D16A6	Petrol	1590	4	75.00	90.00	11
D16A7	Petrol	1590	4	75.00	90.00	11
D16A8	Petrol	1590	4	75.00	90.00	10
D16A9	Petrol	1590	4	75.00	90.00	11
D16B2	Petrol	1590	4	75.00	90.00	11
D16B6	Petrol	1590	4	75.00	90.00	11
D16B7	Petrol	1590	4	75.00	90.00	11
D16V1	Petrol	1590	4	75.00	90.00	11
D16W1	Petrol	1590	4	75.00	90.00	11
D16W4	Petrol	1590	4	75.00	90.00	11
D16W5	Petrol	1590	4	75.00	90.00	11
D16Y2	Petrol	1590	4	75.00	90.00	11
D16Y3	Petrol	1590	4	75.00	90.00	11
D16Y5	Petrol	1590	4	75.00	90.00	11
D16Y6	Petrol	1590	4	75.00	90.00	11
D16Y7	Petrol	1590	4	75.00	90.00	11
D16Y8	Petrol	1590	4	75.00	90.00	11
D16Z	Petrol	1590	4	75.00	90.00	11
D16Z1	Petrol	1590	4	75.00	90.00	11
D16Z2	Petrol	1590	4	75.00	90.00	11
D16Z5	Petrol	1590	4	75.00	90.00	11
D16Z6	Petrol	1590	4	75.00	90.00	10
D16Z7	Petrol	1590	4	75.00	90.00	11
D16Z9	Petrol	1590	4	75.00	90.00	11
EB1	Petrol	1169	4	70.00	76.00	1
EB2	Petrol	1238	4	72.00	76.00	2
EB3	Petrol	1238	4	72.00	76.00	2
EN	Petrol	1335	4	72.00	82.00	3
EN1	Petrol	1335	4	72.00	82.00	3
EN2	Petrol	1335	4	72.00	82.00	3
EN4	Petrol	1335	4	72.00	82.00	3
ET1	Petrol	1829	4	80.00	91.00	13
ET2	Petrol	1829	4	80.00	91.00	13
ET3	Petrol	1829	4	80.00	91.00	13

			cm3	x 			
ET4	Petrol		1829	4	80.00	91.00	13
EW2	Petrol		1488	4	74.00	86.50	6
EW3	Petrol		1488	4	74.00	86.50	6
EW4	Petrol		1488	4	74.00	86.50	6
F18B	Petrol		1850	4	85.00	81.50	20
F18B2	Petrol		1850	4	85.00	81.50	20
F20A	Petrol		1997	4	85.00	88.00	21
F20A2	Petrol		1997	4	85.00	88.00	21
F20A4	Petrol		1997	4	85.00	88.00	21
F20A6	Petrol		1997	4	85.00	88.00	21
F20A7	Petrol		1997	4	85.00	88.00	21
F20A8	Petrol		1997	4	85.00	88.00	21
F20B	Petrol		1997	4	85.00	88.00	21
F20B1	Petrol		1997	4	85.00	88.00	21
F20B2	Petrol		1997	4	85.00	88.00	21
F20B3	Petrol		1997	4	85.00	88.00	21
F20B4	Petrol		1997	4	85.00	88.00	21
F20B5	Petrol		1997	4	85.00	88.00	21
F20B6	Petrol		1997	4	85.00	88.00	21
F20B7	Petrol		1997	4	85.00	88.00	21
F22A1	Petrol		2156	4	85.00	95.00	22
F22A3	Petrol		2156	4	85.00	95.00	22
F22A7	Petrol		2156	4	85.00	95.00	22
F22A8	Petrol		2156	4	85.00	95.00	22
K20A	Petrol		1998	4	86.00	86.00	23
K20A1	Petrol		1998	4	86.00	86.00	23
K20A2	Petrol		1998	4	86.00	86.00	23
K20A3	Petrol		1998	4	86.00	86.00	23
K20A4	Petrol		1998	4	86.00	86.00	23
K20A6	Petrol		1998	4	86.00	86.00	23
K20A9	Petrol		1998	4	86.00	86.00	23
K24A	Petrol		2354	4	87.00	99.00	24
K24A1	Petrol		2354	4	87.00	99.00	24
K24A2	Petrol		2354	4	87.00	99.00	24
K24A3	Petrol		2354	4	87.00	99.00	24
K24A4	Petrol		2354	4	87.00	99.00	24
K24A5	Petrol		2354	4	87.00	99.00	24
K24A6	Petrol		2354	4	87.00	99.00	24
K24A8	Petrol		2354	4	87.00	99.00	24
L13A1	Petrol		1339	4	73.00	80.00	4
L13A3	Petrol		1339	4	73.00	80.00	4
L13A5	Petrol		1339	4	73.00	80.00	4
L13A6	Petrol		1339	4	73.00	80.00	4
L13A7	Petrol		1339	4	73.00	80.00	4
L13A8	Petrol		1339	4	73.00	80.00	4
L13Z1	Petrol		1339	4	73.00	80.00	4
L13Z4	Petrol		1339	4	73.00	80.00	4
L15A	Petrol		1497	4	73.00	89.40	5
L15A1	Petrol		1497	4	73.00	89.40	5
L15A2	Petrol		1497	4	73.00	89.40	5
L15A3	Petrol		1497	4	73.00	89.40	5
L15A4	Petrol		1497	4	73.00	89.40	5
L15A7	Petrol		1497	4	73.00	89.40	5
L15AV	Petrol		1497	4	73.00	89.40	5
LDA1	Petrol		1339	4	73.00	80.00	4
LDA2	Petrol		1339	4	73.00	80.00	4
LDA3	Petrol		1339	4	73.00	80.00	4
LEA1	Petrol		1497	4	73.00	89.40	5
LEA3	Petrol		1497	4	73.00	89.40	5
R18A1	Petrol		1799	4	81.00	87.30	14
R18A2	Petrol		1799	4	81.00	87.30	14
R18A9	Petrol		1799	4	81.00	87.30	14
R18Z9	Petrol		1799	4	81.00	87.30	14
R18ZF	Petrol		1799	4	81.00	87.30	14
XUD7T	Diesel		1769	4	80.00	88.00	12
ZC1	Petrol		1590	4	75.00	90.00	10



1 70.00 x 76.00

EB1			4 Cyl.	1169cc	40-44kW (54-60PS)			Petrol	TD4526
BE/PL	4	39,977/39,999	42,999/43,025	17,500	1,490	0,020/0,071	BS	GS700LC	71-4339/4 0.25 0.50

2 72.00 x 76.00

EB2			4 Cyl.	1238cc	39-41kW (53-56PS)			Petrol	TD5391
EB3			4 Cyl.	1238cc	44kW (60PS)			Petrol	TD1569
BE/PL	4	39,977/39,999	42,999/43,025	17,500	1,490	0,020/0,071	BS	GS700LC	71-4339/4 0.25 0.50

3 72.00 x 82.00

EN			4 Cyl.	1335cc	44-51kW (60-69PS)			Petrol	TD1577
EN1			4 Cyl.	1335cc	44kW (60PS)			Petrol	TD4529
EN2			4 Cyl.	1335cc	33kW (45PS)			Petrol	TD4530
EN4			4 Cyl.	1335cc	52kW (71PS)			Petrol	TD4531
BE/PL	4	39,977/39,999	42,999/43,025	17,500	1,490	0,020/0,071	BS	GS700LC	71-4339/4 0.25 0.50

4 73.00 x 80.00

L13A1			4 Cyl.	1339cc	59-63kW (80-86PS)			Petrol	TD18259
L13A3			4 Cyl.	1339cc	60kW (82PS)			Petrol	TD22061
L13A5			4 Cyl.	1339cc	65kW (88PS)			Petrol	TD22062
L13A6			4 Cyl.	1339cc	85kW (116PS)			Petrol	TD26664
L13A7			4 Cyl.	1339cc	61kW (83PS)			Petrol	TD20328
L13A8			4 Cyl.	1339cc	74-85kW (101-116PS)			Petrol	TD22063
L13Z1 Euro 5			4 Cyl.	1339cc	73-74kW (99-101PS)			Petrol	TD23844
L13Z4 Euro 5			4 Cyl.	1339cc	73kW (99PS)			Petrol	TD26223
LDA1			4 Cyl.	1339cc	61-69kW (83-94PS)			Petrol	TD18254
LDA2			4 Cyl.	1339cc	70-85kW (95-116PS)			Petrol	TD20325
LDA3			4 Cyl.	1339cc	65-73kW (88-99PS)			Petrol	TD24571
BE/PL	4	39,980	43,020	13,500	1,495		AL-LF	64-468-1	01-5040/4 STD
MB/HL 1-5	5	49,980	54,020	17,000	1,999		AL-LF	63-468-1	H1355/5 STD
MB/HL 1-5	5	49,980	54,020	17,000	1,999		AL-LF	63-468-2	
TW/A	2	61,000	82,000		2,500		AL-LF	65-468-1	A332/2 STD

5 73.00 x 89.40

L15A			4 Cyl.	1497cc	74-85kW (110-116PS)			Petrol	TD22064
L15A1			4 Cyl.	1497cc	66-79kW (90-107PS)			Petrol	TD19286
L15A2			4 Cyl.	1497cc	81kW (110PS)			Petrol	TD22065
L15A3			4 Cyl.	1497cc	85-88kW (116-120PS)			Petrol	TD23847
L15A4			4 Cyl.	1497cc	65kW (88PS)			Petrol	TD26987
L15A7			4 Cyl.	1497cc	86-88kW (117-120PS)			Petrol	TD24274
L15AV			4 Cyl.	1497cc	56-65kW (76-88PS)			Petrol	TD24323
LEA1			4 Cyl.	1497cc	83-91kW (113-124PS)			Petrol	TD26132
LEA3			4 Cyl.	1497cc	89kW (121PS)			Petrol	TD27984
BE/PL	4	39,980	43,020	13,500	1,495		AL-LF	64-468-1	01-5040/4 STD
MB/HL 1-5	5	49,980	54,020	17,000	1,999		AL-LF	63-468-1	H1355/5 STD
MB/HL 1-5	5	49,980	54,020	17,000	1,999		AL-LF	63-468-2	



TW/A	2	61.000	82.000	2.500		AL-LF	65-468-1	A332/2 STD
------	---	--------	--------	-------	--	-------	----------	----------------------

6	74.00 x 86.50								
D15A1			4 Cyl.	1488cc	63kW (86PS)		Petrol	TD17263	
EW2			4 Cyl.	1488cc	63-66kW (86-90PS)		Petrol	TD4539	
EW3			4 Cyl.	1488cc	74kW (101PS)		Petrol	TD4540	
EW4			4 Cyl.	1488cc	66kW (90PS)		Petrol	TD1589	
BE/PL	8	41,980	45,020	18,400	1,498		BS	64-456-1	71-4357/4 STD

7	75.00 x 84.50								
D15B			4 Cyl.	1493cc	66-96kW (90-131PS)		Petrol	TD4514	
D15B3			4 Cyl.	1493cc	69kW (94PS)		Petrol	TD22044	
D15B7			4 Cyl.	1493cc	67-77kW (91-105PS)		Petrol	TD1550	
D15Z1			4 Cyl.	1493cc	66-88kW (90-120PS)		Petrol	TD1551	
D15Z2			4 Cyl.	1493cc	66kW (90PS)		Petrol	TD23834	
D15Z3			4 Cyl.	1493cc	66kW (90PS)		Petrol	TD4517	
D15Z6			4 Cyl.	1493cc	84kW (114PS)		Petrol	TD5392	
D15Z8			4 Cyl.	1493cc	84kW (114PS)		Petrol	TD9809	
BE/PL	4	44,980/45,000	48,021/48,042	18,500	1,500		BS	XGS10474LC	71-4358/4 STD 0.25

8	75.00 x 84.50								
D15B1			4 Cyl.	1493cc	60kW (82PS)		Petrol	TD18859	
BE/PL	8	41,980	45,020	18,400	1,498		BS	64-456-1	71-4357/4 STD

9	75.00 x 84.50								
D15B2			4 Cyl.	1493cc	61-74kW (83-101PS)		Petrol	TD4516	
D15B4			4 Cyl.	1493cc	72kW (98PS)		Petrol	TD23848	
BE/PL	8	41,980	45,020	18,400	1,498		BS	64-456-1	71-4357/4 STD
	→09/91								
BE/PL	4	44,980/45,000	48,021/48,042	18,500	1,500		BS	XGS10474LC	71-4358/4 STD 0.25
	09/91→								

10	75.00 x 90.00								
D16A			4 Cyl.	1590cc	79-91kW (107-124PS)		Petrol	TD17638	
D16A8			4 Cyl.	1590cc	90-96kW (122-131PS)		Petrol	TD1552	
D16Z6			4 Cyl.	1590cc	91-96kW (124-131PS)		Petrol	TD4525	
ZC1			4 Cyl.	1590cc	88-92kW (120-125PS)		Petrol	TD4556	
BE/PL	4	44,980/45,000	48,021/48,042	18,500	1,500		BS	XGS10474LC	71-4358/4 STD 0.25

11	75.00 x 90.00							
D16A3			4 Cyl.	1590cc	88kW (120PS)		Petrol	TD17264
D16A6			4 Cyl.	1590cc	79-81kW (107-110PS)		Petrol	TD4518
D16A7			4 Cyl.	1590cc	85-96kW (115-131PS)		Petrol	TD1558
D16A9			4 Cyl.	1590cc	96kW (131PS)		Petrol	TD1553
D16B2			4 Cyl.	1590cc	85kW (116PS)		Petrol	TD9810
D16B6			4 Cyl.	1590cc	85kW (116PS)		Petrol	TD14254
D16B7			4 Cyl.	1590cc	79kW (107PS)		Petrol	TD22045
D16V1			4 Cyl.	1590cc	78-81kW (106-110PS)		Petrol	TD18257

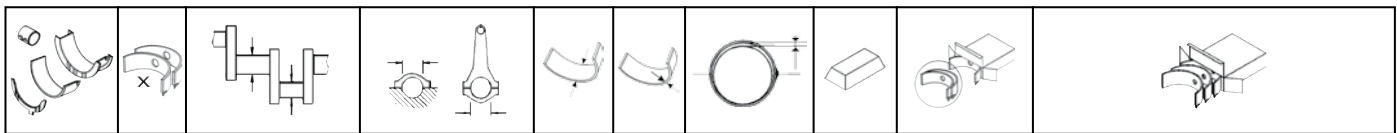

D16W1	4 Cyl.	1590cc	77kW (105PS)	Petrol	TD14248
D16W4	4 Cyl.	1590cc	92kW (125PS)	Petrol	TD19664
D16W5	4 Cyl.	1590cc	91kW (124PS)	Petrol	TD18262
D16Y2	4 Cyl.	1590cc	93kW (126PS)	Petrol	TD4519
D16Y3	4 Cyl.	1590cc	83kW (113PS)	Petrol	TD4520
D16Y5	4 Cyl.	1590cc	84-86kW (114-117PS)	Petrol	TD14488
D16Y6	4 Cyl.	1590cc	92kW (125PS)	Petrol	TD14268
D16Y7	4 Cyl.	1590cc	77-79kW (105-107PS)	Petrol	TD11128
D16Y8	4 Cyl.	1590cc	84-95kW (114-129PS)	Petrol	TD4521
D16Z	4 Cyl.	1590cc	92kW (125PS)	Petrol	TD4522
D16Z1	4 Cyl.	1590cc	81kW (110PS)	Petrol	TD23122
D16Z2	4 Cyl.	1590cc	78-82kW (106-112PS)	Petrol	TD1561
D16Z5	4 Cyl.	1590cc	91kW (124PS)	Petrol	TD4524
D16Z7	4 Cyl.	1590cc	88-92kW (120-125PS)	Petrol	TD1564
D16Z9	4 Cyl.	1590cc	92kW (125PS)	Petrol	TD1565

BE/PL	4	44,980/45,000	48,021/48,042	18,500	1,500		BS	XGS10474LC	71-4358/4 STD 0.25
-------	---	---------------	---------------	--------	-------	--	----	------------	------------------------------

12 80.00 x 88.00

XUD7T	4 Cyl.	1769cc	58-65kW (79-88PS)	Diesel Turbo	TD18393				
BE/PL	4	49,984/50,000	53,695/53,708	20,000	1,838	0,039/0,073	EC	71-3730	71-3730/4 STD 0.30
MB/HL 1-5	5	59,981/60,000	63,731/63,750	20,290	1,845	0,040/0,100	AL-LF	66726RA	H1057/5 STD 0.30 0.50
TW/A	4	67,050/67,300	83,050/83,300		1,880		AL-LF	4141AF	A188/4 STD
SE/PB	1	28,007/28,020	30,200/30,221	23,100			BS	41450.500	55-4499 SEMI

13 80.00 x 91.00

ET1	4 Cyl.	1829cc	74kW (101PS)	Petrol	TD4535				
ET2	4 Cyl.	1829cc	77kW (105PS)	Petrol	TD4536				
ET3	4 Cyl.	1829cc	74-77kW (101-105PS)	Petrol	TD1583				
ET4	4 Cyl.	1829cc	74kW (101PS)	Petrol	TD4537				
BE/PL	8	44,980	48,020	19,400	1,498		BS	64-454-1	71-4253/4 STD

14 81.00 x 87.30

R18A1	4 Cyl.	1799cc	97-104kW (132-141PS)	Petrol	TD19281				
R18A2	4 Cyl.	1799cc	103kW (140PS)	Petrol	TD20326				
R18A9	4 Cyl.	1799cc	82kW (112PS)	Petrol	TD29772				
R18Z9 Euro 5	4 Cyl.	1799cc	105kW (143PS)	Petrol	TD31143				
R18ZF	4 Cyl.	1799cc	105kW (143PS)	Petrol	TD30784				
BE/PL	8	44,980	48,020	14,900	1,497		AL-LF	64-457-1	01-4976/4 STD
MB/HL 1-5	5	54,980	59,020	18,000	2,004		AL-LF	63-457-1	H1339/5 STD
MB/HL 1-5	5	54,980	59,020	18,000	2,004		AL-LF	63-457-2	

15 81.00 x 89.00

B18A1	4 Cyl.	1834cc	96kW (131PS)	Petrol	TD25282				
B18B6	4 Cyl.	1834cc	96-103kW (131-140PS)	Petrol	TD22040				
BE/PL	8	44,980	48,020	19,400	1,498		BS	64-454-1	71-4253/4 STD



16		81.00 x 95.00								
B20A1				4 Cyl.	1958cc	101kW (137PS)		Petrol		TD4502
B20A3				4 Cyl.	1958cc	80kW (109PS)		Petrol		TD4504
B20A4				4 Cyl.	1958cc	84kW (114PS)		Petrol		TD1526
B20A5				4 Cyl.	1958cc	101kW (137PS)		Petrol		TD1524
B20A7				4 Cyl.	1958cc	110kW (150PS)		Petrol		TD10967
B20A8				4 Cyl.	1958cc	98kW (133PS)		Petrol		TD4505
B20A9				4 Cyl.	1958cc	103kW (140PS)		Petrol		TD1525
BE/PL	8	44,980		48,020	19,400	1,498		BS	64-454-1	71-4253/4 STD

17		82.70 x 91.00								
A20A1				4 Cyl.	1955cc	73-76kW (99-103PS)		Petrol		TD4498
A20A2				4 Cyl.	1955cc	78-101kW (106-137PS)		Petrol		TD1515
A20A3				4 Cyl.	1955cc	82-90kW (112-122PS)		Petrol		TD4499
A20A4				4 Cyl.	1955cc	85-90kW (116-122PS)		Petrol		TD1517
BE/PL	8	44,980		48,020	19,400	1,498		BS	64-454-1	71-4253/4 STD

18		84.00 x 89.00								
B20B				4 Cyl.	1973cc	94-96kW (128-131PS)		Petrol		TD9398
B20B3				4 Cyl.	1973cc	94-99kW (128-135PS)		Petrol		TD25830
B20B4				4 Cyl.	1973cc	94kW (128PS)		Petrol		TD25582
B20BI				4 Cyl.	1973cc	103kW (140PS)		Petrol		TD22041
B20Z1				4 Cyl.	1973cc	98-108kW (133-147PS)		Petrol		TD18256
B20Z2				4 Cyl.	1973cc	108-109kW (147-148PS)		Petrol		TD25583
BE/PL	8	44,980		48,020	19,400	1,498		BS	64-454-1	71-4253/4 STD

19		84.50 x 88.90								
20T2N				4 Cyl.	1994cc	74-77kW (101-105PS)		Diesel Turbo		TD5390
20T2R				4 Cyl.	1994cc	63kW (86PS)		Diesel Turbo		TD22035
BE/PL	4	53,990/54,010	57,683/57,696	21,800	1,825	0,023/0,081		BS	4660CP	71-4164/4 STD
MB/HL 1-5	5	56,990/57,010	60,703/60,719	22,600	1,835	0,023/0,084		AL-LF	4392RA	H1098/5 STD
TW/A	4	63,600/63,850	80,250/80,500		2,310			AL-LF	1644AF	A173/4 STD

20		85.00 x 81.50								
F18B				4 Cyl.	1850cc	103kW (140PS)		Petrol		TD22082
F18B2				4 Cyl.	1850cc	100kW (136PS)		Petrol		TD14251
BE/PL	8	44,980		48,020	19,400	1,498		BS	64-454-1	71-4253/4 STD

21		85.00 x 88.00								
F20A				4 Cyl.	1997cc	85kW (116PS)		Petrol		TD23182
F20A2				4 Cyl.	1997cc	81kW (110PS)		Petrol		TD1596
F20A4				4 Cyl.	1997cc	98kW (133PS)		Petrol		TD1597
F20A6				4 Cyl.	1997cc	66kW (90PS)		Petrol		TD1599
F20A7				4 Cyl.	1997cc	98kW (133PS)		Petrol		TD4543
F20A8				4 Cyl.	1997cc	98kW (133PS)		Petrol		TD1598
F20B				4 Cyl.	1997cc	110kW (150PS)		Petrol		TD22083
F20B1				4 Cyl.	1997cc	107kW (146PS)		Petrol		TD22084



F20B2	4 Cyl.	1997cc	110kW (150PS)	Petrol	TD20677			
F20B3	4 Cyl.	1997cc	98-100kW (133-136PS)	Petrol	TD4544			
F20B4	4 Cyl.	1997cc	132kW (180PS)	Petrol	TD22086			
F20B5	4 Cyl.	1997cc	108kW (147PS)	Petrol	TD14249			
F20B6	4 Cyl.	1997cc	108kW (147PS)	Petrol	TD14252			
F20B7	4 Cyl.	1997cc	107-108kW (145-147PS)	Petrol	TD18737			
BE/PL	8	44,980	48,020	19,400	1,498	BS	64-454-1	71-4253/4 STD

22 85.00 x 95.00

F22A1	4 Cyl.	2156cc	93-101kW (126-137PS)	Petrol	TD20743			
F22A3	4 Cyl.	2156cc	108-110kW (147-150PS)	Petrol	TD1604			
F22A7	4 Cyl.	2156cc	110kW (150PS)	Petrol	TD4547			
F22A8	4 Cyl.	2156cc	108kW (147PS)	Petrol	TD4548			
BE/PL	8	44,980	48,020	19,400	1,498	BS	64-454-1	71-4253/4 STD

23 86.00 x 86.00

K20A	4 Cyl.	1998cc	114-115kW (155-156PS)	Petrol	TD17179			
K20A1	4 Cyl.	1998cc	114-118kW (155-160PS)	Petrol	TD22056			
K20A2	4 Cyl.	1998cc	147kW (200PS)	Petrol	TD19246			
K20A3	4 Cyl.	1998cc	114-118kW (155-160PS)	Petrol	TD18369			
K20A4	4 Cyl.	1998cc	110kW (150PS)	Petrol	TD20678			
K20A6	4 Cyl.	1998cc	114kW (155PS)	Petrol	TD22073			
K20A9	4 Cyl.	1998cc	110-118kW (150-160PS)	Petrol	TD18736			
BE/PL	8	44,980	48,020	15,500	1,495	BS	64-469-1	71-4890/4 STD
MB/HL 1-5	5	54,980	59,020	20,000	1,997	AL-LF	63-469-1	H1320/5 STD
MB/HL 1-5	5	54,980	59,020	20,000	1,997	AL-LF	63-469-2	
TW/A	2	62,500	82,000		2,500	AL-LF	65-469-1	A305/2 STD

24 87.00 x 99.00

K24A	4 Cyl.	2354cc	124-147kW (168-200PS)	Petrol	TD17180			
K24A1	4 Cyl.	2354cc	116-147kW (158-200PS)	Petrol	TD22049			
K24A2	4 Cyl.	2354cc	118kW (160PS)	Petrol	TD19247			
K24A3	4 Cyl.	2354cc	110-150kW (150-204PS)	Petrol	TD22051			
K24A4	4 Cyl.	2354cc	116-140kW (158-190PS)	Petrol	TD19248			
K24A5	4 Cyl.	2354cc	118kW (160PS)	Petrol	TD22053			
K24A6	4 Cyl.	2354cc	118kW (160PS)	Petrol	TD22054			
K24A8	4 Cyl.	2354cc	113-124kW (154-169PS)	Petrol	TD19249			
BE/PL	8	47,980	50,020	15,500	1,492	BS	64-470-1	71-4891/4 STD
MB/HL 1-5	5	54,980	59,020	20,000	1,997	AL-LF	63-469-1	H1320/5 STD
MB/HL 1-5	5	54,980	59,020	20,000	1,997	AL-LF	63-469-2	
TW/A	2	62,500	82,000		2,500	AL-LF	65-469-1	A305/2 STD

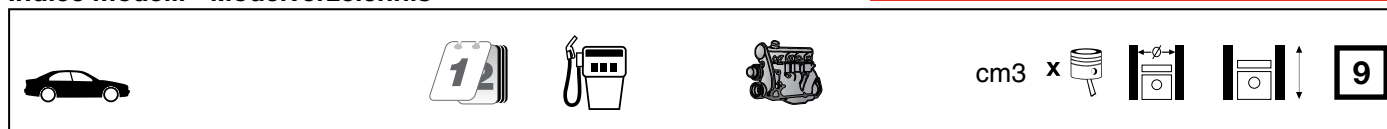

Accent 1.3	10/94→01/00	Petrol	G4EH	1341	4	71.50	83.50	2
Accent 1.3 i 12V	10/94→01/00	Petrol	G4EH	1341	4	71.50	83.50	2
Accent 1.5	10/94→12/99	Petrol	G4EK	1495	4	75.50	83.50	5
Accent 1.5 i 12V	10/94→01/00	Petrol	G4EK	1495	4	75.50	83.50	5
Accent 1.5 i 16V	10/95→01/00	Petrol	G4ER	1495	4	75.50	83.50	5
Accent i	10/91→11/94	Petrol	G4DJ	1468	4	75.50	82.00	4
Accent I 1.3	10/94→01/00	Petrol	G4EH	1341	4	71.50	83.50	2
Accent I 1.3 i 12V	10/94→01/00	Petrol	G4EH	1341	4	71.50	83.50	2
Accent I 1.5	10/94→12/97	Petrol	G4EK	1495	4	75.50	83.50	5
Accent I 1.5 16V	10/94→01/00	Petrol	G4FK	1495	4	75.50	83.50	5
Accent I 1.5 i 12V	10/94→01/00	Petrol	G4EK	1495	4	75.50	83.50	5
Accent I 1.5 i 16V	12/95→01/00	Petrol	G4ER	1495	4	75.50	83.50	5
Accent II 1.3	01/00→11/05	Petrol	G4EA	1341	4	71.50	83.50	2
Accent II 1.3	08/02→11/05	Petrol	G4EH	1341	4	71.50	83.50	2
Accent II 1.5	01/00→11/05	Petrol	G4EB	1495	4	75.50	83.50	5
Accent II 1.5	09/00→11/05	Petrol	G4EC-G	1495	4	75.50	83.50	5
Accent II 1.5	09/99→	Petrol	G4EK	1495	4	75.50	83.50	5
Accent II 1.5	09/99→10/02	Petrol	G4FK	1495	4	75.50	83.50	5
Accent II 1.5 CRDi	01/02→11/05	Diesel	D3EA	1493	3	83.00	92.00	16
Accent II 1.5 LPG	01/00→	Petrol	G4EK	1495	4	75.50	83.50	5
Accent II 1.6	01/00→12/05	Petrol	G4ED	1599	4	76.50	87.00	6
Accent II 1.6	12/02→11/05	Petrol	G4ED-G	1599	4	76.50	87.00	6
Accent III 1.5	01/08→11/10	Petrol	G4EK	1495	4	75.50	83.50	5
Accent III 1.5 CNG	01/09→01/10	Petrol	G4EK	1495	4	75.50	83.50	5
Accent III 1.5 LPG	01/08→11/10	Petrol	G4EK	1495	4	75.50	83.50	5
Accent III 1.6 GLS	11/05→11/10	Petrol	G4ED	1599	4	76.50	87.00	6
Accent IV 1.4	11/10→	Petrol	G4FA	1396	4	77.00	75.00	8
Accent IV 1.6	08/10→	Petrol	G4ED	1599	4	76.50	87.00	6
Coupe 1.6 16V	03/02→08/09	Petrol	G4ED-G	1599	4	76.50	87.00	6
Coupe 1.6 i 16V	12/96→04/02	Petrol	4G61	1599	4	82.30	75.00	14
Coupe 1.6 i 16V	08/00→01/02	Petrol	G4ED-G	1599	4	76.50	87.00	6
Creta 1.6	01/16→	Petrol	G4FG	1591	4	77.00	85.44	9
Elantra 1.5 16V	09/00→07/06	Petrol	G4EC-G	1495	4	75.50	83.50	5
Elantra 1.6	06/11→	Petrol	G4FG	1591	4	77.00	85.44	9
Elantra 1.6	06/00→07/06	Petrol	G4ED-G	1599	4	76.50	87.00	6
Elantra 1.8	06/00→	Petrol	G4NB	1797	4	81.00	87.20	11
Elantra 1.8	09/10→	Petrol	G4NB-B	1797	4	81.00	87.20	11
Elantra 1.8 Flex	02/11→	Petrol	G4NB	1797	4	81.00	87.20	11
Elantra 2.0	06/15→	Petrol	G4NA	1797	4	81.00	87.20	11
Elantra 2.0 GDI	01/16→	Petrol	G4NA	1797	4	81.00	87.20	11
Galopper I 2.5 TD	08/91→07/98	Diesel	4D56T	2477	4	91.10	95.00	21
Galopper I 2.5 TD intercooler	08/91→07/98	Diesel	4D56T	2477	4	91.10	95.00	21
Galopper II 2.5 Tci D	08/98→12/03	Diesel	D4BH	2476	4	91.10	95.00	22
Galopper II 2.5 TD	08/98→12/03	Diesel	D4BA	2477	4	91.10	95.00	22
Galopper II 2.5 TD intercooler	08/98→12/03	Diesel	D4BH	2476	4	91.10	95.00	22
Getz 1.3	09/03→06/09	Petrol	G4EA	1341	4	71.50	83.50	2
Getz 1.3 i	09/02→03/04	Petrol	G4EA	1341	4	71.50	83.50	2
Getz 1.5 CRDi	03/03→09/05	Diesel	D3EA	1493	3	83.00	92.00	16
Getz 1.5 i	03/03→09/05	Petrol	G4EC-G	1495	4	75.50	83.50	5
Getz 1.5 i	03/03→09/05	Petrol	G4ER	1495	4	75.50	83.50	5
Getz 1.6	09/02→	Petrol	G4ED-G	1599	4	76.50	87.00	6
Grace 2.4	07/93→12/04	Petrol	G4CS	2351	4	86.50	100.00	20
Grace 2.5 D	07/93→06/94	Diesel	D4BA	2477	4	91.10	95.00	22
Grand Avega 1.4	05/11→	Petrol	G4FA	1396	4	77.00	75.00	8
Grand Avega 1.4 CVVT	05/11→	Petrol	G4FA	1396	4	77.00	75.00	8
Grandeur 2.2 D	01/11→	Diesel	D4HB	2199	4	85.40	96.00	19
Grandeur 2.4	10/88→07/92	Petrol	G4CS	2351	4	86.50	100.00	20
Grand Santa Fé 2.2 CRDi All-wheel Drive	06/13→	Diesel	D4HB	2199	4	85.40	96.00	19
H-1 2.4	03/00→04/04	Petrol	G4CS	2351	4	86.50	100.00	20
H-1 2.5 D	06/00→10/05	Diesel	D4BH	2476	4	91.10	95.00	22
H-1 2.5 TD	03/00→04/04	Diesel	D4BH	2476	4	91.10	95.00	22
H-1 / Starex 2.4	06/97→04/04	Petrol	G4CS	2351	4	86.50	100.00	20
H-1 / Starex 2.4 4WD	02/98→04/04	Petrol	G4CS	2351	4	86.50	100.00	20
H-1 / Starex 2.5 Tci	10/97→12/07	Diesel	D4BH	2476	4	91.10	95.00	22
H-1 / Starex 2.5 TD 4WD	03/01→04/04	Diesel	D4BH	2476	4	91.10	95.00	22
H100 2.4	07/93→12/04	Petrol	G4CS	2351	4	86.50	100.00	20
H100 2.4 TD	07/93→07/97	Petrol	G4CS	2351	4	86.50	100.00	20
H100 2.5 D	07/93→10/01	Diesel	D4BA	2477	4	91.10	95.00	22
H100 2.5 Tci	01/04→	Diesel	D4BH	2476	4	91.10	95.00	22

















cm3 x



9

H100 2.5 TD	11/06→	Diesel	4D56T	2477	4	91.10	95.00	21
i20 1.4	09/08→	Petrol	G4FA	1396	4	77.00	75.00	8
I30 1.4	10/07→	Petrol	G4FA	1396	4	77.00	75.00	8
I30 1.6 GDI	12/11→	Petrol	G4FG	1591	4	77.00	85.44	9
I30 1.8	01/12→	Petrol	G4NB	1797	4	81.00	87.20	11
I30 1.8	01/12→	Petrol	G4NB-B	1797	4	81.00	87.20	11
I30 2.0	08/13→	Petrol	G4NC	1999	4	81.00	97.00	12
I30 CW 1.4	10/07→	Petrol	G4FA	1396	4	77.00	75.00	8
I30 CW 1.6	06/12→	Petrol	G4FG	1591	4	77.00	85.44	9
i40 2.0	03/12→	Petrol	G4NC	1999	4	81.00	97.00	12
i40 2.0 CVVT	10/12→	Petrol	G4NA	1797	4	81.00	87.20	11
i40 2.0 GDi	03/12→	Petrol	G4NA	1797	4	81.00	87.20	11
i40 2.0 GDI	03/12→	Petrol	G4NC	1999	4	81.00	97.00	12
i40 CW 2.0	03/12→	Petrol	G4NC	1999	4	81.00	97.00	12
i40 CW 2.0 CVVT	10/12→	Petrol	G4NA	1797	4	81.00	87.20	11
i40 CW 2.0 GDi	03/12→	Petrol	G4NA	1797	4	81.00	87.20	11
i40 CW 2.0 GDI	07/11→	Petrol	G4NC	1999	4	81.00	97.00	12
IX20 1.4	11/10→	Petrol	G4FA	1396	4	77.00	75.00	8
IX35 2.0	09/14→	Petrol	G4NA	1797	4	81.00	87.20	11
IX35 2.0 CRDi	01/10→	Diesel	D4HA	1995	4	84.00	90.00	17
IX35 2.0 CRDi 4WD	01/10→	Diesel	D4HA	1995	4	84.00	90.00	17
IX35 2.0 GDi	08/13→	Petrol	G4NC	1999	4	81.00	97.00	12
IX35 2.0 GDi 4WD	08/13→	Petrol	G4NC	1999	4	81.00	97.00	12
Lantra I 1.5 i.e.	10/90→11/95	Petrol	G4DJ	1468	4	75.50	82.00	4
Lantra I 1.5 i.e.	10/90→11/95	Petrol	G15B	1468	4	75.50	82.00	4
Lantra I 1.8 i.e. 16V	10/90→11/95	Petrol	G4CN	1836	4	81.50	88.00	13
Lantra II 1.5 12V	12/96→10/00	Petrol	G4EK	1495	4	75.50	83.50	5
Lantra II 1.5 16V	11/95→10/00	Petrol	G4FK	1495	4	75.50	83.50	5
Lantra II 1.6 16V	11/95→10/00	Petrol	4G61	1599	4	82.30	75.00	14
Lantra II 1.6 16V	11/95→10/00	Petrol	G4ED	1599	4	76.50	87.00	6
Lantra II 1.8	09/97→12/98	Petrol	G4CN	1836	4	81.50	88.00	13
Lantra II 1.9 D	03/98→10/00	Diesel	DJY	1905	4	83.00	88.00	15
Marcia 1.8	05/93→05/96	Petrol	G62B	1796	4	80.60	88.00	10
Marcia 2.0	05/93→05/98	Petrol	G4CP-D	1997	4	85.00	88.00	18
Matrix 1.5	06/01→08/10	Petrol	G4EC-G	1495	4	75.50	83.50	5
Matrix 1.5 CRDi	10/01→08/10	Diesel	D3EA	1493	3	83.00	92.00	16
Matrix 1.6	06/01→08/10	Petrol	G4ED-G	1599	4	76.50	87.00	6
Matrix 1.6	01/02→12/05	Petrol	G4ED-L	1599	4	76.50	87.00	6
Pony 1.3	10/89→01/95	Petrol	G4DG	1299	4	71.00	82.00	1
Pony 1.3	10/85→09/89	Petrol	G13B	1299	4	71.00	82.00	1
Pony 1.4	08/77→	Petrol	4G33	1439	4	73.00	86.00	3
Pony 1.5	09/85→01/95	Petrol	G4DJ	1468	4	75.50	82.00	4
Pony 1.5	10/85→01/95	Petrol	G15B	1468	4	75.50	82.00	4
Pony 1.5 i	10/89→01/95	Petrol	G4DJ	1468	4	75.50	82.00	4
Pony 1.5 i	10/89→01/95	Petrol	G15B	1468	4	75.50	82.00	4
Pony / Excel 1.3	09/89→01/95	Petrol	G4DG	1299	4	71.00	82.00	1
Pony / Excel 1.5	01/90→01/95	Petrol	G4DJ	1468	4	75.50	82.00	4
Pony / Excel 1.5	01/90→01/95	Petrol	G15B	1468	4	75.50	82.00	4
Pony / Excel 1.5 i	01/90→01/95	Petrol	G4DJ	1468	4	75.50	82.00	4
Pony / Excel 1.5 i	01/90→01/95	Petrol	G15B	1468	4	75.50	82.00	4
Porter 2.4	03/96→04/04	Petrol	G4CS	2351	4	86.50	100.00	20
Porter 2.5 D	04/07→	Diesel	D4BH	2476	4	91.10	95.00	22
Porter 2.5 TCi	05/04→	Diesel	D4BH	2476	4	91.10	95.00	22
Porter 2.5 TD	07/94→04/04	Diesel	D4BH	2476	4	91.10	95.00	22
Porter 2.5 TD	07/94→04/04	Diesel	D4BA	2477	4	91.10	95.00	22
S 1.5	09/90→12/92	Petrol	G4DJ	1468	4	75.50	82.00	4
S 1.5 GS	03/90→12/92	Petrol	G4DJ	1468	4	75.50	82.00	4
S 1.5 i	02/90→05/96	Petrol	G4DJ	1468	4	75.50	82.00	4
S 1.5 i	02/90→05/96	Petrol	G15B	1468	4	75.50	82.00	4
S 1.5 i	04/92→05/96	Petrol	G4EK	1495	4	75.50	83.50	5
S 1.5 i Turbo	04/91→05/96	Petrol	G4EK-TC	1495	4	75.50	83.50	5
S 1.5 Turbo	09/92→12/95	Petrol	G4EK	1495	4	75.50	83.50	5
Santa Fé II 2.0 CRDi	12/10→	Diesel	D4HA	1995	4	84.00	90.00	17
Santa Fé II 2.0 CRDi 4x4	03/06→	Diesel	D4HA	1995	4	84.00	90.00	17
Santa Fé II 2.2 CRDi	01/09→	Diesel	D4HB	2199	4	85.40	96.00	19
Santa Fé II 2.2 CRDi 4x4	01/09→	Diesel	D4HB	2199	4	85.40	96.00	19
Santa Fé III 2.0 CRDi	09/12→	Diesel	D4HA	1995	4	84.00	90.00	17
Santa Fé III 2.0 CRDi 4WD	09/12→	Diesel	D4HA	1995	4	84.00	90.00	17
Santa Fé III 2.2 CRDi	09/12→	Diesel	D4HB	2199	4	85.40	96.00	19

				cm ³	x 			
Santa Fé III 2.2 CRDi 4WD	09/12→	Diesel	D4HB	2199	4	85.40	96.00	19
Santamo 2.0	10/98→10/02	Petrol	G4CP	1997	4	85.00	88.00	18
Santamo 2.0 16V 4x4	05/99→	Petrol	G4CP	1997	4	85.00	88.00	18
Sonata II 1.8 i	09/88→10/93	Petrol	4G62	1796	4	80.60	88.00	10
Sonata II 2.0 i	09/88→08/91	Petrol	G4CP	1997	4	85.00	88.00	18
Sonata II 2.0 i	01/91→10/93	Petrol	G4CP-U	1997	4	85.00	88.00	18
Sonata II 2.0 i 16V	01/91→10/93	Petrol	G4CP-D	1997	4	85.00	88.00	18
Sonata II 2.4 i	09/88→12/91	Petrol	G4CS	2351	4	86.50	100.00	20
Sonata III 2.0	07/94→10/94	Petrol	G4CP	1997	4	85.00	88.00	18
Sonata III 2.0 i	06/94→08/96	Petrol	G4CP	1997	4	85.00	88.00	18
Sonata III 2.0 i 16V	05/93→06/98	Petrol	G4CP-D	1997	4	85.00	88.00	18
Sonata III 2.0 i 16V	06/96→06/98	Petrol	G4CP-DM	1997	4	85.00	88.00	18
Sonata IV 2.0 16V	10/01→11/04	Petrol	G4CP	1997	4	85.00	88.00	18
Sonata VI 2.0	09/10→	Petrol	G4NA	1797	4	81.00	87.20	11
Sonata VI 2.0 Hybrid	09/14→	Petrol	G4NA	1797	4	81.00	87.20	11
Stellar 1.4	10/83→08/86	Petrol	4G33	1439	4	73.00	86.00	3
Stellar 1.6	10/83→12/91	Petrol	G32B	1597	4	76.90	86.00	7
Stellar 2.0	09/86→12/87	Petrol	4G63	1997	4	85.00	88.00	18
Stellar 2.0 GSL	05/84→12/89	Petrol	4G63	1997	4	85.00	88.00	18
Terracan 2.5 D	06/01→10/03	Diesel	D4BH	2476	4	91.10	95.00	22
Terracan 2.5 TD	12/01→12/06	Diesel	D4BH	2476	4	91.10	95.00	22
Tiburon 1.6 CVVT	10/06→12/08	Petrol	G4ED-G	1599	4	76.50	87.00	6
Tiburon 2.0	09/97→12/01	Petrol	G4CP-D	1997	4	85.00	88.00	18
Trajet 2.0	03/01→10/03	Petrol	G4CP-D	1997	4	85.00	88.00	18
Tucson 2.0 CRDi	06/15→	Diesel	D4HA	1995	4	84.00	90.00	17
Tucson 2.0 CRDi All-wheel Drive	06/15→	Diesel	D4HA	1995	4	84.00	90.00	17
Tucson 2.0 CRDi FWD	06/15→	Diesel	D4HA	1995	4	84.00	90.00	17
Tucson 2.0 GDi	05/15→	Petrol	G4NA	1797	4	81.00	87.20	11
Tucson 2.0 GDi	09/15→	Petrol	G4NC	1999	4	81.00	97.00	12
Tucson 2.0 GDi 4WD	05/15→	Petrol	G4NA	1797	4	81.00	87.20	11
Tucson 2.0 GDi All-wheel Drive	09/15→	Petrol	G4NC	1999	4	81.00	97.00	12
Veloster 1.6	06/11→	Petrol	G4FG	1591	4	77.00	85.44	9
Veloster 1.6 MPI	04/11→	Petrol	G4FG	1591	4	77.00	85.44	9

		cm3	x 			
4D56T	Diesel	2477	4	91.10	95.00	21
4G33	Petrol	1439	4	73.00	86.00	3
4G61	Petrol	1599	4	82.30	75.00	14
4G62	Petrol	1796	4	80.60	88.00	10
4G63	Petrol	1997	4	85.00	88.00	18
D3EA	Diesel	1493	3	83.00	92.00	16
D4BA	Diesel	2477	4	91.10	95.00	22
D4BH	Diesel	2476	4	91.10	95.00	22
D4HA	Diesel	1995	4	84.00	90.00	17
D4HB	Diesel	2199	4	85.40	96.00	19
DJY	Diesel	1905	4	83.00	88.00	15
G4BG	Petrol	1341	4	71.50	83.50	2
G4CN	Petrol	1836	4	81.50	88.00	13
G4CP	Petrol	1997	4	85.00	88.00	18
G4CP-D	Petrol	1997	4	85.00	88.00	18
G4CP-DM	Petrol	1997	4	85.00	88.00	18
G4CP-U	Petrol	1997	4	85.00	88.00	18
G4CS	Petrol	2351	4	86.50	100.00	20
G4DG	Petrol	1299	4	71.00	82.00	1
G4DJ	Petrol	1468	4	75.50	82.00	4
G4EA	Petrol	1341	4	71.50	83.50	2
G4EB	Petrol	1495	4	75.50	83.50	5
G4EC-G	Petrol	1495	4	75.50	83.50	5
G4ED	Petrol	1599	4	76.50	87.00	6
G4ED-G	Petrol	1599	4	76.50	87.00	6
G4ED-L	Petrol	1599	4	76.50	87.00	6
G4EH	Petrol	1341	4	71.50	83.50	2
G4EK	Petrol	1495	4	75.50	83.50	5
G4EK-TC	Petrol	1495	4	75.50	83.50	5
G4ER	Petrol	1495	4	75.50	83.50	5
G4FA	Petrol	1396	4	77.00	75.00	8
G4FG	Petrol	1591	4	77.00	85.44	9
G4FK	Petrol	1495	4	75.50	83.50	5
G4NA	Petrol	1797	4	81.00	87.20	11
G4NB	Petrol	1797	4	81.00	87.20	11
G4NB-B	Petrol	1797	4	81.00	87.20	11
G4NC	Petrol	1999	4	81.00	97.00	12
G13B	Petrol	1299	4	71.00	82.00	1
G15B	Petrol	1468	4	75.50	82.00	4
G32B	Petrol	1597	4	76.90	86.00	7
G62B	Petrol	1796	4	80.60	88.00	10



1 71.00 x 82.00

G4DG			4 Cyl.	1299cc	43-51kW (58-69PS)	Petrol		TD4565
G13B			4 Cyl.	1299cc	50-55kW (68-75PS)	Petrol		TD12988
BE/PL	8	41,980		45,020	17,630	1,493	AL-LF 64-119-1	01-4257/4 STD 0.25

2 71.50 x 83.50

G4BG			4 Cyl.	1341cc	44kW (60PS)	Petrol		TD4560
G4EA			4 Cyl.	1341cc	55-63kW (75-86PS)	Petrol		TD16149
G4EH			4 Cyl.	1341cc	44-62kW (60-84PS)	Petrol		TD4568
BE/PL	8	44,975/44,990		48,000/48,020	19,030	1,500	AL-LF GS70839SA	01-4943/4 STD
MB/HL	4	49,977/49,992		54,000/54,020	17,650	2,000	AL-LF GS70837SA	H1329/5 STD
MB/HL	1	49,977/49,992		54,020/54,000	22,920	2,000	AL-LF GS70838SA	

3 73.00 x 86.00

4G33			4 Cyl.	1439cc	50kW (68PS)	Petrol		TD25028
BE/PL	8	44,980		48,020	23,600	1,493	BS 64-111-1	71-4143/4 STD 0.25 0.50
MB/HL	2	56,980		61,020	28,950	1,990	AL 63-111-(2)	H1032/5 STD 0.25 0.50
MB/HL	3							
MB/HL	4	56,980		61,020	23,100	1,990	AL 63-111-1	
MB/HL	4	56,980		61,020	23,130	1,990	AL 63-111-3	

4 75.50 x 82.00

G4DJ			4 Cyl.	1468cc	53-63kW (72-86PS)	Petrol		TD9400
G15B			4 Cyl.	1468cc	53-63kW (72-86PS)	Petrol		TD1636
BE/PL	8	41,980		45,020	17,630	1,493	AL-LF 64-119-1	01-4257/4 STD 0.25

5 75.50 x 83.50

G4EB			4 Cyl.	1495cc	66kW (90PS)	Petrol		TD16371
G4EC-G			4 Cyl.	1495cc	73-75kW (99-102PS)	Petrol		TD16148
G4EK			4 Cyl.	1495cc	63-70kW (85-95PS)	Petrol		TD4569
G4EK-TC			4 Cyl.	1495cc	85kW (116PS)	Petrol Turbo		TD4570
G4ER			4 Cyl.	1495cc	73kW (99PS)	Petrol		TD18938
G4FK			4 Cyl.	1495cc	73-77kW (99-105PS)	Petrol		TD23961
BE/PL	8	44,975/44,990		48,000/48,020	19,030	1,500	AL-LF GS70839SA	01-4943/4 STD
MB/HL	4	49,977/49,992		54,000/54,020	17,650	2,000	AL-LF GS70837SA	H1329/5 STD
MB/HL	1	49,977/49,992		54,020/54,000	22,920	2,000	AL-LF GS70838SA	

6 76.50 x 87.00

G4ED Euro 4			4 Cyl.	1599cc	76-82kW (104-112PS)	Petrol		TD20721
G4ED-G			4 Cyl.	1599cc	76-79kW (103-107PS)	Petrol		TD16146
G4ED-L			4 Cyl.	1599cc	66kW (90PS)	Petrol		TD22586
BE/PL	8	44,975/44,990		48,000/48,020	19,030	1,500	AL-LF GS70839SA	01-4943/4 STD

HYUNDAI

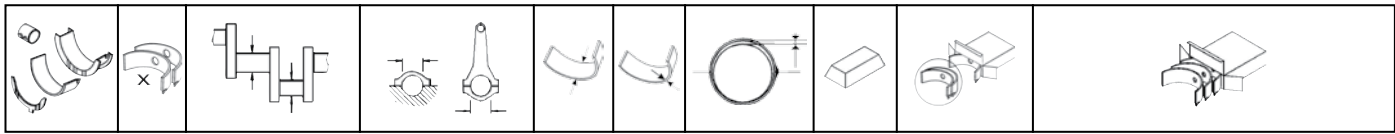

MB/HL	4	49,977/49,992	54,000/54,020	17,650	2,000		AL-LF	GS70837SA	H1329/5 STD
MB/HL	1	49,977/49,992	54,020/54,000	22,920	2,000		AL-LF	GS70838SA	

7 76.90 x 86.00

G32B		4 Cyl.		1597cc	55-74kW (75-101PS)		Petrol		TD1637
BE/PL	8	44,980	48,020	23,600	1,493		BS	64-111-1	71-4143/4 STD 0.25 0.50
MB/HL 3	2	56,980	61,020	28,950	1,990		AL	63-111-(2)	H1032/5 STD 0.25 0.50
MB/HL 1,2,4,5	4	56,980	61,020	23,100	1,990		AL	63-111-1	
MB/HL 1,2,4,5	4	56,980	61,020	23,130	1,990		AL	63-111-3	

8 77.00 x 75.00

G4FA Euro 4		4 Cyl.		1396cc	66-80kW (90-109PS)		Petrol		TD24881
BE/PL	4	41,954/41,972	45,000/45,018	14,400	1,505	0,018/0,036	AL-LF	01-4999	01-4999/4 STD
MB/HL 1-5	5	47,948/47,960	52,000/52,018	16,000	2,017	0,006/0,052	AL-LF	02-5000	H1346/5 STD
TW/A	2	54.000/54.250	70.750/71.000		1.975		AL-LF	04-5001	A326/2 STD

9 77.00 x 85.44

G4FG Euro 4		4 Cyl.		1591cc	88-97kW (120-132PS)		Petrol		TD27227
BE/PL	4	41,954/41,972	45,000/45,018	14,400	1,505	0,018/0,036	AL-LF	01-4999	01-4999/4 STD
MB/HL 1-5	5	47,948/47,960	52,000/52,018	16,000	2,017	0,006/0,052	AL-LF	02-5000	H1346/5 STD
TW/A	2	54.000/54.250	70.750/71.000		1.975		AL-LF	04-5001	A326/2 STD

10 80.60 x 88.00

4G62		4 Cyl.		1796cc	60-87kW (82-118PS)		Petrol		TD26092
G62B		4 Cyl.		1796cc	70-72kW (95-98PS)		Petrol		TD1638
BE/PL	8	44,980	48,020	23,600	1,493		BS	64-111-1	71-4143/4 STD 0.25 0.50
MB/HL 3	2	56,980	61,020	28,950	1,990		AL	63-111-(2)	H1032/5 STD 0.25 0.50
MB/HL 1,2,4,5	4	56,980	61,020	23,100	1,990		AL	63-111-1	
MB/HL 1,2,4,5	4	56,980	61,020	23,130	1,990		AL	63-111-3	

11 81.00 x 87.20

G4NA		4 Cyl.		1797cc	110-121kW (150-165PS)		Petrol		TD28571
G4NB		4 Cyl.		1797cc	108-118kW (147-160PS)		Petrol		TD26884
G4NB-B		4 Cyl.		1797cc	110kW (150PS)		Petrol		TD26341
BE/PL	4	44,954/44,972	48,000/48,018	16,130	1,509	0,020/0,080	AL-LF	71-5002	71-5002/4 STD
MB/HL 1-5	5	54,942/54,960	59,000/59,018	18,130	2,018	0,017/0,077	AL-LF	02-5003	H1347/5 STD
TW/A	2	61.000/61.250	80.750/81.000		1.965	0.07/0.27	AL-LF	04-5004	A327/2 STD



12 81.00 x 97.00

G4NC		4 Cyl.		1999cc	120-131kW (163-178PS)			Petrol		TD26342
BE/PL	4	44,954/44,972	48,000/48,018	16,130	1,509	0,020/0,080	AL-LF	71-5002	71-5002/4 STD	
MB/HL 1-5	5	54,942/54,960	59,000/59,018	18,130	2,018	0,017/0,077	AL-LF	02-5003	H1347/5 STD	
TW/A	2	61.000/61.250	80.750/81.000		1.965	0.07/0.27	AL-LF	04-5004	A327/2 STD	

13 81.50 x 88.00

G4CN		4 Cyl.		1836cc	93-97kW (127-132PS)			Petrol		TD4561
BE/PL	8	44,980	48,020	23,600	1,493		BS	64-111-1	71-4143/4 STD 0.25 0.50	
MB/HL 3	2	56,980	61,020	28,950	1,990		AL	63-111-(2)	H1032/5 STD 0.25 0.50	
MB/HL 1,2,4,5	4	56,980	61,020	23,100	1,990		AL	63-111-1		
MB/HL 1,2,4,5	4	56,980	61,020	23,130	1,990		AL	63-111-3		

14 82.30 x 75.00

4G61		4 Cyl.		1599cc	84kW (114PS)			Petrol		TD9399
BE/PL	8	44,980	48,020	23,600	1,493		BS	64-111-1	71-4143/4 STD 0.25 0.50	
MB/HL 3	2	56,980	61,020	28,950	1,990		AL	63-111-(2)	H1032/5 STD 0.25 0.50	
MB/HL 1,2,4,5	4	56,980	61,020	23,100	1,990		AL	63-111-1		
MB/HL 1,2,4,5	4	56,980	61,020	23,130	1,990		AL	63-111-3		

15 83.00 x 88.00







DJY		4 Cyl.		1905cc	50-52kW (68-71PS)			Diesel		TD22267
BE/PL	4	49,984/50,000	53,695/53,708	20,050	1,830	0,040/0,090	AL-LF	66725RA	01-4200/4 STD 0.30 0.50	
MB/HL 1-5	5	59,981/60,000	63,731/63,750	20,290	1,845	0,040/0,100	AL-LF	66726RA	H1057/5 STD 0.30 0.50	
TW/A	4	67,050/67,300	83,050/83,300		1,880		AL-LF	4141AF	A188/4 STD	
SE/PB	1	25,007/25,020	27,200/27,221	24,050			BS	66729YA	55-4201 SEMI	

16 83.00 x 92.00

D3EA		3 Cyl.		1493cc	60kW (82PS)			Diesel		TD16283
BE/PL	1	49,940/49,965	53,600/53,614	20,400	1,813	0,020/0,072	SP	71-4013	71-4013 STD	①
MB/HL	1	54,940/54,965	59,000/59,019	18,000	2,018	0,020/0,077	SP	72-4014	72-4014 STD	②
TW/A	2	61,250	76,750		2,200		AL-LF	04-4004	A163/4 STD	
TW/A	2	61,250	76,750		2,200		AL-LF	04-4005		

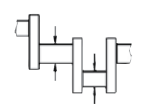
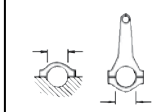
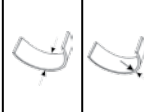
17 84.00 x 90.00

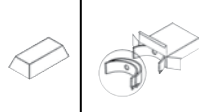
D4HA		4 Cyl.		1995cc	100-136kW (136-185PS)			Diesel Turbo		TD25694
BE/PL	4	48,000/48,018	51,000/51,018	20,930	1,482	0,026/0,084	AL-LF	71-5006	71-5006/4 STD	⑦
MB/HL 1-5	5	60,000/60,018	64,000/64,018	18,930	1,985	0,026/0,086	EC-LF	72-5005	H1348/5 STD	

							
TW/A	2	66,000/66,250	87,750/88,000	1,965	AL-LF	04-5008	A328/2 STD

18 85.00 x 88.00

4G63	4 Cyl.	1997cc	61-74kW (83-101PS)	Petrol	TD26745
G4CP	4 Cyl.	1997cc	74-104kW (101-141PS)	Petrol	TD4562
G4CP-D	4 Cyl.	1997cc	96-103kW (131-140PS)	Petrol	TD4563
G4CP-DM	4 Cyl.	1997cc	92kW (125PS)	Petrol	TD4559
G4CP-U	4 Cyl.	1997cc	80kW (109PS)	Petrol	TD1616

BE/PL	8	44,980	48,020	23,600	1,493	BS	64-111-1	71-4143/4 STD 0.25 0.50
MB/HL 3	2	56,980	61,020	28,950	1,990	AL	63-111-(2)	H1032/5 STD 0.25 0.50
MB/HL 1,2,4,5	4	56,980	61,020	23,100	1,990	AL	63-111-1	
MB/HL 1,2,4,5	4	56,980	61,020	23,130	1,990	AL	63-111-3	

19 85.40 x 96.00

D4HB	4 Cyl.	2199cc	145-147kW (197-200PS)	Diesel	TD24884
-------------	--------	---------------	------------------------------	---------------	----------------

BE/PL	4	52,000/52,018	55,000/55,018	20,930	1,484	0,024/0,084	AL-LF	71-5007	71-5007/4 STD	7
MB/HL 1-5	5	60,000/60,018	64,000/64,018	18,930	1,985	0,026/0,086	EC-LF	72-5005	H1348/5 STD	
TW/A	2	66,000/66,250	87,750/88,000		1,965		AL-LF	04-5008	A328/2 STD	

20 86.50 x 100.00

G4CS	4 Cyl.	2351cc	82-90kW (112-122PS)	Petrol	TD16109
-------------	--------	---------------	----------------------------	---------------	----------------

BE/PL	8	44,980	48,020	23,600	1,493	BS	64-111-1	71-4143/4 STD 0.25 0.50
MB/HL 3	2	56,980	61,020	28,950	1,990	AL	63-111-(2)	H1032/5 STD 0.25 0.50
MB/HL 1,2,4,5	4	56,980	61,020	23,100	1,990	AL	63-111-1	
MB/HL 1,2,4,5	4	56,980	61,020	23,130	1,990	AL	63-111-3	

21 91.10 x 95.00

4D56T	4 Cyl.	2477cc	62-74kW (84-101PS)	Diesel Turbo	TD18860
--------------	--------	---------------	---------------------------	---------------------	----------------

BE/PL	8	52,980	56,020	25,130	1,493	AL	64-113-1	71-4194/4 STD 0.25 0.50 0.75
MB/HL 1-5	5					BC	66676RA	H1248/5 STD 0.25 0.50

→12/02

TW/A	2	72,000	90,000		2,500	AL-LF	65-140-1	A284/2 STD
------	---	--------	--------	--	-------	-------	----------	----------------------

01/02→







SE/PB	1	29,000	32,030	32,000		BS	67-113-1S	55-4208 SEMI
CB/NWB 1,2	2	42,980	46,050	20,250	1,480	AL-LF	68-113-1	N156/2 STD





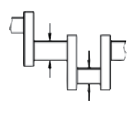
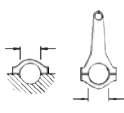

22 91.10 x 95.00

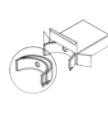
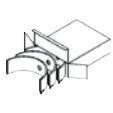
D4BA	4 Cyl.	2477cc	55-65kW (75-88PS)	Diesel	TD7147
-------------	--------	---------------	--------------------------	---------------	---------------

D4BH	4 Cyl.	2476cc	59-78kW (80-106PS)	Diesel Turbo	TD11429
-------------	--------	---------------	---------------------------	---------------------	----------------

BE/PL	8	52,980	56,020	25,130	1,493	AL	64-113-1	71-4194/4 STD 0.25 0.50 0.75
-------	---	--------	--------	--------	-------	----	----------	--

									
MB/HL 3	2	65,980	70,020	30,950	1,990		AL	63-113-(2)	H1055/5 STD 0.25 0.50
MB/HL 1,2,4,5	4	65,980	70,020	25,130	1,990		AL	63-113-1	
MB/HL 1,2,4,5	4	65,980	70,020	25,130	1,990		AL	63-113-3	
CB/NWB 1,2	2	42,980	46,050	20,250	1,480		AL-LF	68-113-1	N156/2 STD

		cm ³	x 			
--	---	-----------------	---	---	---	---

BC-144	Diesel	2358	4	85.72	102.15	4
BD-154	Diesel	2713	4	88.90	109.26	7
D-155	Diesel	2536	3	98.43	111.10	9
D-179	Diesel	2933	3	98.43	128.50	12
D-206	Diesel	3382	4	98.43	111.10	10
D-239	Diesel	3911	4	98.43	128.50	13
D-246	Diesel	4037	4	100.00	128.50	17
D-268	Diesel	4389	4	100.00	139.70	18
D-310	Diesel	5070	6	98.43	111.10	11
D-358	Diesel	5867	6	98.43	128.50	15
DT-239	Diesel	3911	4	98.43	128.50	14
DT-358	Diesel	5867	6	98.43	128.50	16
DT-402	Diesel	6588	6	100.00	139.70	19
DU-66D	Diesel	1088	2	82.60	101.60	1
DU-74D	Diesel	1224	2	87.60	101.60	5
DU-99D	Diesel	1632	3	82.60	101.60	2
DU-111D	Diesel	1836	3	98.43	101.60	8
DU-132D	Diesel	2177	4	82.60	101.60	3
DU-148D	Diesel	2448	4	87.60	101.60	6



1										82.60 x 101.60		
DU-66D		2 Cyl.		1088cc	17-22kW (13-16PS)		Diesel		FM5899			
BE/PL	1	44,425/44,450	47,638/47,650	27,270	1,576	0,036/0,098	EC	51-1302	51-1302 STD .010 .020			
2										82.60 x 101.60		
DU-99D		3 Cyl.		1632cc	5-19kW (14-26PS)		Diesel		FM5901			
BE/PL	1	44,425/44,450	47,638/47,650	27,270	1,576	0,036/0,098	EC	51-1302	51-1302 STD .010 .020			
3										82.60 x 101.60		
DU-132D		4 Cyl.		2177cc	4-29kW (14-40PS)		Diesel		FM5903			
BE/PL	1	44,425/44,450	47,638/47,650	27,270	1,576	0,036/0,098	EC	51-1302	51-1302 STD .010 .020			
4										85.72 x 102.15		
BC-144		4 Cyl.		2358cc			Diesel		FM849			
BE/PL	1	44,425/44,450	47,638/47,650	27,270	1,576	0,036/0,098	EC	51-1302	51-1302 STD .010 .020			
5										87.60 x 101.60		
DU-74D		2 Cyl.		1224cc	7-13kW (15-17PS)		Diesel		FM5900			
BE/PL	1	44,425/44,450	47,638/47,650	27,270	1,576	0,036/0,098	EC	51-1302	51-1302 STD .010 .020			
6										87.60 x 101.60		
DU-148D		4 Cyl.		2448cc	4-23kW (4-45PS)		Diesel		FM5904			
BE/PL	1	44,425/44,450	47,638/47,650	27,270	1,576	0,036/0,098	EC	51-1302	51-1302 STD .010 .020			
7										88.90 x 109.26		
BD-154		4 Cyl.		2713cc			Diesel		FM852			
BE/PL	1	44,425/44,450	47,638/47,650	27,270	1,576	0,036/0,098	EC	51-1302	51-1302 STD .010 .020			
8										98.43 x 101.60		
DU-111D		3 Cyl.		1836cc	5-25kW (21-34PS)		Diesel		FM5902			
BE/PL	1	44,425/44,450	47,638/47,650	27,270	1,576	0,036/0,098	EC	51-1302	51-1302 STD .010 .020			
9										98.43 x 111.10		
D-155		3 Cyl.		2536cc	25-36kW (34-49PS)		Diesel		TD18801			
BE/PL	1	63,971/63,990	68,000/68,019	32,100	1,975	0,060/0,123	EC	71-2438	71-2438 STD 0.25 0.50 0.75			
→01/75												
MB/HL	1	79,971/79,990	86,000/86,022	25,800	2,972	0,066/0,123	EC	72-2439	72-2439 STD 0.25			
MB/HL	1	79,971/79,990	86,000/86,022	36,500	2,972	0,066/0,123	EC	72-2440H	72-2440H STD 0.25			
				72-2440H		STD		36,655/1.4429" - 36,689/1.4444"				
						0.25mm		36,900/1.4528" - 36,939/1.4543"				
SE/PB	1	35,996/36,000	39,700/39,750	34,000				BC	55-2641	55-2641 SEMI		
SE/PB	1	37,991/37,997	41,200/41,250	34,000				BC	55-3327	55-3327 SEMI		

CB/NWB	1	57,971/57,990	63,000/63,030	30,500			BC	53-2441	53-2441 SEMI
CB/NWB	1	57,971/57,990	63,000/63,030	18,000			BC	53-2442	53-2442 SEMI

10 98.43 x 111.10

D-206		4 Cyl.		3382cc	40-44kW (54-60PS)		Diesel		TD18803
BE/PL	1	63,971/63,990	68,000/68,019	32,100	1,975	0,060/0,123	EC	71-2438	71-2438 STD 0.25 0.50 0.75
→01/75									
MB/HL	1	79,971/79,990	86,000/86,022	25,800	2,972	0,066/0,123	EC	72-2439	72-2439 STD 0.25
MB/HL	1	79,971/79,990	86,000/86,022	36,500	2,972	0,066/0,123	EC	72-2440H	72-2440H STD 0.25
		72-2440H	STD	36,655/1.4429" - 36,689/1.4444"					
			0.25mm	36,900/1.4528" - 36,939/1.4543"					
SE/PB	1	35,996/36,000	39,700/39,750	34,000			BC	55-2641	55-2641 SEMI
SE/PB	1	37,991/37,997	41,200/41,250	34,000			BC	55-3327	55-3327 SEMI
CB/NWB	1	57,971/57,990	63,000/63,030	30,500			BC	53-2441	53-2441 SEMI
CB/NWB	1	57,971/57,990	63,000/63,030	18,000			BC	53-2442	53-2442 SEMI

11 98.43 x 111.10

D-310		6 Cyl.		5070cc	62-88kW (84-120PS)		Diesel		TD18806
BE/PL	1	63,971/63,990	68,000/68,019	32,100	1,975	0,060/0,123	EC	71-2438	71-2438 STD 0.25 0.50 0.75
→01/75									
MB/HL	1	79,971/79,990	86,000/86,022	25,800	2,972	0,066/0,123	EC	72-2439	72-2439 STD 0.25
MB/HL	1	79,971/79,990	86,000/86,022	36,500	2,972	0,066/0,123	EC	72-2440H	72-2440H STD 0.25
		72-2440H	STD	36,655/1.4429" - 36,689/1.4444"					
			0.25mm	36,900/1.4528" - 36,939/1.4543"					
SE/PB	1	35,996/36,000	39,700/39,750	34,000			BC	55-2641	55-2641 SEMI
SE/PB	1	37,991/37,997	41,200/41,250	34,000			BC	55-3327	55-3327 SEMI
CB/NWB	1	57,971/57,990	63,000/63,030	30,500			BC	53-2441	53-2441 SEMI
CB/NWB	1	57,971/57,990	63,000/63,030	18,000			BC	53-2442	53-2442 SEMI

12 98.43 x 128.50

D-179		3 Cyl.		2933cc	33-38kW (45-52PS)		Diesel		TD18802
BE/PL	1	63,971/63,990	68,000/68,019	32,100	1,975	0,060/0,123	EC	71-2438	71-2438 STD 0.25 0.50 0.75
→01/75									
MB/HL	1	79,971/79,990	86,000/86,022	25,800	2,972	0,066/0,123	EC	72-2439	72-2439 STD 0.25
MB/HL	1	79,971/79,990	86,000/86,022	36,500	2,972	0,066/0,123	EC	72-2440H	72-2440H STD 0.25
		72-2440H	STD	36,655/1.4429" - 36,689/1.4444"					
			0.25mm	36,900/1.4528" - 36,939/1.4543"					

SE/PB	1	35,996/36,000	39,700/39,750	34,000			BC	55-2641	55-2641 SEMI
SE/PB	1	37,991/37,997	41,200/41,250	34,000			BC	55-3327	55-3327 SEMI
CB/NWB	1	57,971/57,990	63,000/63,030	30,500			BC	53-2441	53-2441 SEMI
CB/NWB	1	57,971/57,990	63,000/63,030	18,000			BC	53-2442	53-2442 SEMI

13 98.43 x 128.50

D-239		4 Cyl.		3911cc	45-56kW (61-76PS)		Diesel		TD18804
BE/PL	1	63,971/63,990	68,000/68,019	32,100	1,975	0,060/0,123	EC	71-2438	71-2438 STD 0.25 0.50 0.75
→01/75									
MB/HL	1	79,971/79,990	86,000/86,022	25,800	2,972	0,066/0,123	EC	72-2439	72-2439 STD 0.25
MB/HL	1	79,971/79,990	86,000/86,022	36,500	2,972	0,066/0,123	EC	72-2440H	72-2440H STD 0.25
	72-2440H	STD	36,655/1.4429" - 36,689/1.4444"						
		0.25mm	36,900/1.4528" - 36,939/1.4543"						
SE/PB	1	35,996/36,000	39,700/39,750	34,000			BC	55-2641	55-2641 SEMI
SE/PB	1	37,991/37,997	41,200/41,250	34,000			BC	55-3327	55-3327 SEMI
CB/NWB	1	57,971/57,990	63,000/63,030	30,500			BC	53-2441	53-2441 SEMI
CB/NWB	1	57,971/57,990	63,000/63,030	18,000			BC	53-2442	53-2442 SEMI

14 98.43 x 128.50

DT-239		4 Cyl.		3911cc	59-63kW (80-86PS)		Diesel Turbo		TD18810
MB/HL	1	79,971/79,990	86,000/86,022	25,800	2,972	0,066/0,123	EC	72-2439	72-2439 STD 0.25
MB/HL	1	79,971/79,990	86,000/86,022	36,500	2,972	0,066/0,123	EC	72-2440H	72-2440H STD 0.25
	72-2440H	STD	36,655/1.4429" - 36,689/1.4444"						
		0.25mm	36,900/1.4528" - 36,939/1.4543"						
SE/PB	1	35,996/36,000	39,700/39,750	34,000			BC	55-2641	55-2641 SEMI
SE/PB	1	37,991/37,997	41,200/41,250	34,000			BC	55-3327	55-3327 SEMI
CB/NWB	1	57,971/57,990	63,000/63,030	30,500			BC	53-2441	53-2441 SEMI
CB/NWB	1	57,971/57,990	63,000/63,030	18,000			BC	53-2442	53-2442 SEMI

15 98.43 x 128.50

D-358		6 Cyl.		5867cc	66-101kW (90-137PS)		Diesel		TD18807
BE/PL	1	63,971/63,990	68,000/68,019	32,100	1,975	0,060/0,123	EC	71-2438	71-2438 STD 0.25 0.50 0.75
→01/75									
MB/HL	1	79,971/79,990	86,000/86,022	25,800	2,972	0,066/0,123	EC	72-2439	72-2439 STD 0.25

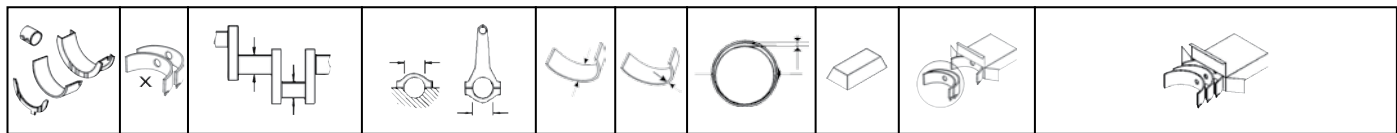

MB/HL	1	79,971/79,990	86,000/86,022	36,500	2,972	0,066/0,123	EC	72-2440H	72-2440H STD 0.25	
			72-2440H	STD	36,655/1.4429" - 36,689/1.4444"					
				0.25mm	36,900/1.4528" - 36,939/1.4543"					
SE/PB	1	35,996/36,000	39,700/39,750	34,000				BC	55-2641	55-2641 SEMI
SE/PB	1	37,991/37,997	41,200/41,250	34,000				BC	55-3327	55-3327 SEMI
CB/NWB	1	57,971/57,990	63,000/63,030	30,500				BC	53-2441	53-2441 SEMI
CB/NWB	1	57,971/57,990	63,000/63,030	18,000				BC	53-2442	53-2442 SEMI

16 98.43 x 128.50

DT-358		6 Cyl.		5867cc	88-100kW (120-136PS)		Diesel Turbo		TD18808	
MB/HL	1	79,971/79,990	86,000/86,022	25,800	2,972	0,066/0,123	EC	72-2439	72-2439 STD 0.25	
MB/HL	1	79,971/79,990	86,000/86,022	36,500	2,972	0,066/0,123	EC	72-2440H	72-2440H STD 0.25	
			72-2440H	STD	36,655/1.4429" - 36,689/1.4444"					
				0.25mm	36,900/1.4528" - 36,939/1.4543"					
SE/PB	1	35,996/36,000	39,700/39,750	34,000				BC	55-2641	55-2641 SEMI
SE/PB	1	37,991/37,997	41,200/41,250	34,000				BC	55-3327	55-3327 SEMI
CB/NWB	1	57,971/57,990	63,000/63,030	30,500				BC	53-2441	53-2441 SEMI
CB/NWB	1	57,971/57,990	63,000/63,030	18,000				BC	53-2442	53-2442 SEMI

17 100.00 x 128.50

D-246		4 Cyl.		4037cc	53-60kW (72-82PS)		Diesel		TD18805	
BE/PL	1	63,971/63,990	68,000/68,019	32,100	1,975	0,060/0,123	EC	71-2438	71-2438 STD 0.25 0.50 0.75	
→01/75										
MB/HL	1	79,971/79,990	86,000/86,022	25,800	2,972	0,066/0,123	EC	72-2439	72-2439 STD 0.25	
MB/HL	1	79,971/79,990	86,000/86,022	36,500	2,972	0,066/0,123	EC	72-2440H	72-2440H STD 0.25	
			72-2440H	STD	36,655/1.4429" - 36,689/1.4444"					
				0.25mm	36,900/1.4528" - 36,939/1.4543"					
SE/PB	1	35,996/36,000	39,700/39,750	34,000				BC	55-2641	55-2641 SEMI
SE/PB	1	37,991/37,997	41,200/41,250	34,000				BC	55-3327	55-3327 SEMI
CB/NWB	1	57,971/57,990	63,000/63,030	30,500				BC	53-2441	53-2441 SEMI
CB/NWB	1	57,971/57,990	63,000/63,030	18,000				BC	53-2442	53-2442 SEMI

18 100.00 x 139.70

D-268		4 Cyl.		4389cc	57-63kW (78-86PS)		Diesel		TD18811
BE/PL	1	63,971/63,990	68,000/68,019	32,100	1,975	0,060/0,123	EC	71-2438	71-2438 STD 0.25 0.50 0.75
→01/75									

MB/HL	1	79,971/79,990	86,000/86,022	25,800	2,972	0,066/0,123	EC	72-2439	72-2439 STD 0.25
MB/HL	1	79,971/79,990	86,000/86,022	36,500	2,972	0,066/0,123	EC	72-2440H	72-2440H STD 0.25
			72-2440H	STD	36,655/1.4429" - 36,689/1.4444"				
				0.25mm	36,900/1.4528" - 36,939/1.4543"				
SE/PB	1	35,996/36,000	39,700/39,750	34,000			BC	55-2641	55-2641 SEMI
SE/PB	1	37,991/37,997	41,200/41,250	34,000			BC	55-3327	55-3327 SEMI
CB/NWB	1	57,971/57,990	63,000/63,030	30,500			BC	53-2441	53-2441 SEMI
CB/NWB	1	57,971/57,990	63,000/63,030	18,000			BC	53-2442	53-2442 SEMI

19

100.00 x 139.70

DT-402		6 Cyl.		6588cc	107-120kW (145-163PS)		Diesel Turbo		TD18809
MB/HL	1	79,971/79,990	86,000/86,022	25,800	2,972	0,066/0,123	EC	72-2439	72-2439 STD 0.25
MB/HL	1	79,971/79,990	86,000/86,022	36,500	2,972	0,066/0,123	EC	72-2440H	72-2440H STD 0.25
			72-2440H	STD	36,655/1.4429" - 36,689/1.4444"				
				0.25mm	36,900/1.4528" - 36,939/1.4543"				
SE/PB	1	35,996/36,000	39,700/39,750	34,000			BC	55-2641	55-2641 SEMI
SE/PB	1	37,991/37,997	41,200/41,250	34,000			BC	55-3327	55-3327 SEMI
CB/NWB	1	57,971/57,990	63,000/63,030	30,500			BC	53-2441	53-2441 SEMI
CB/NWB	1	57,971/57,990	63,000/63,030	18,000			BC	53-2442	53-2442 SEMI

















cm3 x



9

Amigo 2.3	09/88→12/93	Petrol	4ZD1	2254	4	89.30	90.00	17
Amigo 2.3 4WD	09/88→12/93	Petrol	4ZD1	2254	4	89.30	90.00	17
Aska I 1.8	04/83→06/89	Petrol	4ZB1	1817	4	84.00	82.00	8
Aska I 2.0 ZL	04/83→06/89	Petrol	4ZC1-T	1995	4	88.00	82.00	15
Aska III 1.8 LF	10/95→09/01	Petrol	F18B	1850	4	85.00	81.50	9
Aska III 2.0 LF	10/95→09/96	Petrol	F20B	1997	4	85.00	88.00	10
Aska III 2.0 LJ	10/96→09/01	Petrol	F20B	1997	4	85.00	88.00	10
Aska III 2.3	10/97→09/01	Petrol	4ZD1	2254	4	89.30	90.00	17
Bison 2.5 D	09/14→	Diesel	4JA1-L Euro 2	2499	4	93.00	92.00	18
Campo 2.0	01/83→03/88	Petrol	4ZC1	1994	4	88.00	82.00	15
Campo 2.0 4WD	01/83→03/88	Petrol	4ZC1	1994	4	88.00	82.00	15
Campo 2.2	01/89→12/90	Petrol	4ZD1	2254	4	89.30	90.00	17
Campo 2.2 D	01/83→12/91	Diesel	C223	2238	4	88.00	92.00	16
Campo 2.2 D 4WD	01/83→12/90	Diesel	C223	2238	4	88.00	92.00	16
Campo 2.5 D	01/83→12/90	Diesel	4JA1	2499	4	93.00	92.00	18
Campo 2.5 D 4WD	01/83→12/90	Diesel	4JA1	2499	4	93.00	92.00	18
D-Max 2.5 CRDi	06/12→	Diesel	4JA1-L Euro 2	2499	4	93.00	92.00	18
D-Max 2.5 D	01/07→	Diesel	4JA1-L Euro 2	2499	4	93.00	92.00	18
D-Max 2.5 D	10/02→	Diesel	4JA1-TC	2499	4	93.00	92.00	18
D-Max 2.5 D 4x4	05/02→	Diesel	4JA1-TC	2499	4	93.00	92.00	18
Elf 2.7 TD	10/99→09/01	Diesel	TD27	2663	4	96.00	92.00	21
Elf 2.7 TD All-wheel Drive	10/99→09/01	Diesel	TD27	2663	4	96.00	92.00	21
Elf 2.8 D	10/85→09/03	Diesel	4JB1	2771	4	93.00	102.00	19
Elf 2.8 TD	10/85→09/92	Diesel	4JB1T	2771	4	93.00	102.00	19
Elf 2.8 TD	10/03→	Diesel	4JB1-TC	2771	4	93.00	102.00	19
Elf 3.1 TD	09/93→12/01	Diesel	4JG2	3059	4	95.40	107.00	20
Elf 3.1 TD All-wheel Drive	09/93→09/01	Diesel	4JG2	3059	4	95.40	107.00	20
Elf 4.3 DiTD	09/99→	Diesel	4HF1	4334	4	112.00	110.00	25
Elf 4.3 TD	09/92→09/99	Diesel	4HF1	4334	4	112.00	110.00	25
Elf 4.6 DiTD	10/99→09/03	Diesel	4HG1	4570	4	115.00	110.00	26
Elf 4.6 DiTD 4x4	10/99→09/03	Diesel	4HG1	4570	4	115.00	110.00	26
Elf 4.6 TD	10/92→09/00	Diesel	4HG1	4570	4	115.00	110.00	26
Elf 4.8 TD	10/94→09/00	Diesel	4HE1-T Euro 3	4751	4	110.00	125.00	23
Elf 5.2 Di	10/03→	Diesel	4HK1-TCN Euro 4	5193	4	115.00	125.00	27
Elf 2200	01/68→12/74	Diesel	C221	2207	4	83.00	102.00	7
Fargo 1.8	01/83→12/86	Petrol	4ZB1	1817	4	84.00	82.00	8
Fargo 2.0	08/82→12/88	Petrol	4ZC1	1994	4	88.00	82.00	15
Filly 3.0 D	01/00→12/02	Diesel	ZD30DDTi	2953	4	96.00	102.00	22
Filly 3.0 D AWD	01/00→12/02	Diesel	ZD30DDTi	2953	4	96.00	102.00	22
Frontier 2.8 D	11/97→08/03	Diesel	4JB1	2771	4	93.00	102.00	19
Frontier 2.8 D 4x4	11/97→08/03	Diesel	4JB1	2771	4	93.00	102.00	19
Gemini 1.5 D	09/80→12/90	Diesel	4EC1	1488	4	76.00	82.00	1
Gemini 1.5 TD	02/88→12/90	Diesel	4EC1T	1488	4	76.00	82.00	2
Gemini 1.7 TD	01/90→12/93	Diesel	4EE1	1686	4	79.00	86.00	3
Impulse 2.0	09/84→12/89	Petrol	4ZC1-T	1995	4	88.00	82.00	15
KB 2.0	07/02→06/04	Petrol	C 20 NE	1998	4	86.00	86.00	12
KB 2.0 4WD	08/86→03/88	Petrol	4ZC1	1994	4	88.00	82.00	15
KB 2.0 4WD	07/02→06/04	Petrol	C 20 NE	1998	4	86.00	86.00	12
KB 2.2	01/98→09/03	Petrol	X 22 SE	2198	4	86.00	94.60	13
KB 2.2 D	01/83→07/86	Diesel	C223	2238	4	88.00	92.00	16
KB 2.3	12/90→09/03	Petrol	4ZD1	2254	4	89.30	90.00	17
KB 2.3 4WD	04/88→04/00	Petrol	4ZD1	2254	4	89.30	90.00	17
KB 2.5 D 4WD	01/83→11/90	Diesel	4JA1	2499	4	93.00	92.00	18
KB 2.5 DiTD	07/02→09/08	Diesel	4JA1	2499	4	93.00	92.00	18
KB 2.5 DiTD 4WD	07/02→09/08	Diesel	4JA1	2499	4	93.00	92.00	18
KB 2.5 TDi	12/90→	Diesel	4JA1T	2499	4	93.00	92.00	18
KB 2.8 TD	12/90→09/03	Diesel	4JB1-TC	2771	4	93.00	102.00	19
KB 2.8 TD 4WD	12/90→04/00	Diesel	4JB1-TC	2771	4	93.00	102.00	19
KB 3.1 TD	12/94→04/00	Diesel	4JG2	3059	4	95.40	107.00	20
KB 3.1 TD 4WD	12/94→09/03	Diesel	4JG2	3059	4	95.40	107.00	20
LUV 2.3	10/93→09/05	Petrol	4ZD1	2254	4	89.30	90.00	17
Midi 2.0	06/88→	Petrol	4ZC1	1994	4	88.00	82.00	15
Midi 2.0 4WD	09/88→	Petrol	4ZC1	1994	4	88.00	82.00	15
MU 2.8 TD All-wheel Drive 4x4	05/90→07/93	Diesel	4JB1T	2771	4	93.00	102.00	19
MU 3.1 TD 4x4	08/93→05/98	Diesel	4JG2 TC	3059	4	95.40	107.00	20
Panther 2.5 D	09/14→	Diesel	4JA1-L Euro 2	2499	4	93.00	92.00	18
Panther 2.5 TD	01/14→	Diesel	4JA1-L Euro 2	2499	4	93.00	92.00	18
Piazza 2.0 Turbo	06/85→12/90	Petrol	4ZC1-T	1995	4	88.00	82.00	15
Pickup 1.8	08/79→07/82	Petrol	4ZB1	1817	4	84.00	82.00	8

				cm ³				
Pickup 1.8 4x4	08/79→07/82	Petrol	4ZB1	1817	4	84.00	82.00	8
Pickup 2.2 D	08/80→09/87	Diesel	C223T	2238	4	88.00	92.00	16
Pickup 2.2 D 4x4	08/80→09/87	Diesel	C223T	2238	4	88.00	92.00	16
Pickup 2.3	08/85→08/96	Petrol	4ZD1	2254	4	89.30	90.00	17
Pickup 2.3 4x4	08/85→08/96	Petrol	4ZD1	2254	4	89.30	90.00	17
Pickup 2.5 TD	07/96→	Diesel	4JA1-L Euro 2	2499	4	93.00	92.00	18
Pickup 2.5 TD	06/92→	Diesel	4JA1T	2499	4	93.00	92.00	18
Pickup 2.8 TD	07/96→	Diesel	4JB1T	2771	4	93.00	102.00	19
Pickup 3.1 TD	05/97→	Diesel	4JG2 T	3059	4	95.40	107.00	20
Refrigeration Units (Truck& Rail)	01/69→	Diesel	C201 PT	2010	4	83.00	92.90	6
Rodeo 2.2	09/97→12/03	Petrol	X 22 SE	2198	4	86.00	94.60	13
Rodeo 2.2 4WD	09/97→12/03	Petrol	X 22 SE	2198	4	86.00	94.60	13
Rodeo 2.5 D	08/06→04/07	Diesel	4JA1	2499	4	93.00	92.00	18
TF 2.3	05/00→09/03	Petrol	4ZD1	2254	4	89.30	90.00	17
TF 2.8 TD	05/00→09/03	Diesel	4JB1T	2771	4	93.00	102.00	19
TFR/TFS 2.5 D	07/94→08/99	Diesel	4JA1	2499	4	93.00	92.00	18
TFR/TFS 2.5 TD All-wheel Drive	09/88→08/91	Diesel	4JA1T	2499	4	93.00	92.00	18
TFR/TFS 2.8 D	09/91→08/99	Diesel	4JB1	2771	4	93.00	102.00	19
TFR/TFS 2.8 D All-wheel Drive	09/91→08/99	Diesel	4JB1	2771	4	93.00	102.00	19
Trooper 2.2 D	01/83→12/83	Diesel	C223T	2238	4	88.00	92.00	16
Trooper 2.2 D 4x4	05/84→12/89	Diesel	C223	2238	4	88.00	92.00	16
Trooper 2.2 TD	03/84→12/91	Diesel	C223T	2238	4	88.00	92.00	16
Trooper 2.3	11/85→12/91	Petrol	4ZD1	2254	4	89.30	90.00	17
Trooper 2.3 4WD	09/85→12/87	Petrol	4ZD1	2254	4	89.30	90.00	17
Trooper 2.8 TD	10/87→12/91	Diesel	4JB1T	2771	4	93.00	102.00	19
Trooper 2.8 TD	10/88→12/91	Diesel	4JB1-TC	2771	4	93.00	102.00	19
Trooper 3.1 TD	08/91→07/98	Diesel	4JG2 T	3059	4	95.40	107.00	20
Vega 2.8 TD 4x4	08/98→12/02	Diesel	4JB1T	2771	4	93.00	102.00	19
Wizard 3.1 TD 4x4	09/97→05/00	Diesel	4JG2 TC	3059	4	95.40	107.00	20

		cm ³	x 			
4EC1	Diesel	1488	4	76.00	82.00	1
4EC1T	Diesel	1488	4	76.00	82.00	2
4EE1	Diesel	1686	4	79.00	86.00	3
4EE2-TC Euro 3	Diesel	1686	4	79.00	86.00	3
4HE1-TC Euro 3	Diesel	4751	4	110.00	125.00	23
4HE1-T Euro 3	Diesel	4751	4	110.00	125.00	23
4HF1	Diesel	4334	4	112.00	110.00	25
4HF1-II	Diesel	4334	4	112.00	110.00	25
4HG1	Diesel	4570	4	115.00	110.00	26
4HK1-E5C Euro 5 EEV	Diesel	5193	4	115.00	125.00	27
4HK1-E5N Euro 5 EEV	Diesel	5193	4	115.00	125.00	27
4HK1-E5S Euro 5 EEV	Diesel	5193	4	115.00	125.00	27
4HK1-TCN Euro 4	Diesel	5193	4	115.00	125.00	27
4HK1-XS Euro 4	Diesel	5193	4	115.00	125.00	27
4JA1	Diesel	2499	4	93.00	92.00	18
4JA1AG	Diesel	2499	4	93.00	92.00	18
4JA1-L Euro 2	Diesel	2499	4	93.00	92.00	18
4JA1T	Diesel	2499	4	93.00	92.00	18
4JA1-TC	Diesel	2499	4	93.00	92.00	18
4JB1	Diesel	2771	4	93.00	102.00	19
4JB1T	Diesel	2771	4	93.00	102.00	19
4JB1-TC	Diesel	2771	4	93.00	102.00	19
4JG2	Diesel	3059	4	95.40	107.00	20
4JG2 T	Diesel	3059	4	95.40	107.00	20
4JG2 TC	Diesel	3059	4	95.40	107.00	20
4ZA1	Petrol	1584	4	82.00	75.00	5
4ZB1	Petrol	1817	4	84.00	82.00	8
4ZC1	Petrol	1994	4	88.00	82.00	15
4ZC1-T	Petrol	1995	4	88.00	82.00	15
4ZD1	Petrol	2254	4	89.30	90.00	17
6HE1-T	Diesel	7127	6	110.00	125.00	24
6HH1-N	Diesel	8226	6	115.00	132.00	29
6HH1-S	Diesel	8226	6	115.00	132.00	29
6HK1-TCC	Diesel	7790	6	115.00	125.00	28
6HK1-TCN	Diesel	7790	6	115.00	125.00	28
6HK1-TCS	Diesel	7790	6	115.00	125.00	28
6WF1-TC	Diesel	14256	6	147.00	140.00	30
6WF1-TCC	Diesel	14256	6	147.00	140.00	30
6WG1-T	Diesel	15682	6	147.00	154.00	31
6WG1-TC	Diesel	15682	6	147.00	154.00	31
C 20 NE	Petrol	1998	4	86.00	86.00	12
C190	Diesel	1951	4	86.00	84.00	11
C201 PT	Diesel	2010	4	83.00	92.90	6
C221	Diesel	2207	4	83.00	102.00	7
C223	Diesel	2238	4	88.00	92.00	16
C223T	Diesel	2238	4	88.00	92.00	16
C240	Diesel	2369	4	86.00	102.00	14
F18B	Petrol	1850	4	85.00	81.50	9
F20B	Petrol	1997	4	85.00	88.00	10
TD27	Diesel	2663	4	96.00	92.00	21
X 1.7 D 4EE1 OHC	Diesel	1686	4	79.00	86.00	4
X 22 SE	Petrol	2198	4	86.00	94.60	13
ZD30DDTi	Diesel	2953	4	96.00	102.00	22



1 76.00 x 82.00

4EC1		4 Cyl.		1488cc	37kW (50PS)		Diesel		TD4575
BE/PL	4	45,936/45,972	48,976/49,000	16,700	1,500	0,020/0,089	AL-LF	4280RA	01-4361/4 STD
BE/PL	4	45,936/45,956	48,976/49,000	16,700	1,500	0,020/0,089	BS	4285CP	71-4297/4 STD 0.25 0.50 [9]

2 76.00 x 82.00

4EC1T		4 Cyl.		1488cc	49-54kW (67-73PS)		Diesel Turbo		TD4576
BE/PL	4	45,936/45,956	48,976/49,000	16,700	1,500	0,020/0,089	BS	4285CP	71-4297/4 STD 0.25 0.50 [9]
MB/HL 1-5	5	51,920	56,000	15,530	2,006		AL	63-194-1	H1127/5 STD 0.25 0.50
MB/HL 1-5	5	51,920	56,000	15,530	2,006		AL	63-194-2	
TW/A	2	59,000	69,950		2,210		BS	4251AF	A226/2 STD
SE/PB	1	25,000	28,000	23,800			BS	4253Y	55-4501 STD

3 79.00 x 86.00

4EE1		4 Cyl.		1686cc	65kW (88PS)		Diesel		TD26233
4EE2-TC Euro 3		4 Cyl.		1686cc	55kW (75PS)		Diesel		TD19380
BE/PL	4	45,936/45,956	48,976/49,000	16,700	1,500	0,020/0,089	BS	4285CP	71-4297/4 STD 0.25 0.50 [9]
MB/HL 1-5	5	51,920	56,000	15,530	2,006		AL	63-194-1	H1127/5 STD 0.25 0.50
MB/HL 1-5	5	51,920	56,000	15,530	2,006		AL	63-194-2	
TW/A	2	59,000	73,700		2,110		AL	04-4496	A261/2 STD
SE/PB	1	26,000	29,520	26,350			BS	68144Y	55-4247 SEMI

4 79.00 x 86.00

X 1.7 D 4EE1 OHC		4 Cyl.		1686cc	44kW (60PS)		Diesel		TD8407
BE/PL	4	45,936/45,972	48,976/49,000	16,700	1,500	0,020/0,089	AL-LF	4280RA	01-4361/4 STD
MB/HL 1-5	5	51,920	56,000	15,530	2,006		AL	63-194-1	H1127/5 STD 0.25 0.50
MB/HL 1-5	5	51,920	56,000	15,530	2,006		AL	63-194-2	
TW/A	2	59,000	73,700		2,110		AL	04-4496	A261/2 STD

5 82.00 x 75.00

4ZA1		4 Cyl.		1584cc	56-59kW (76-80PS)		Petrol		TD21261
MB/HL 1-5	5	55,920/55,930	59,979/59,999	21,869	2,009	0,030/0,086	AL	3961RA	H1225/5 STD

6 83.00 x 92.90

C201 PT		4 Cyl.		2010cc			Diesel		FM880
BE/PL	8	52,920	56,000	22,530	1,510		BS	64-160-1	71-4258/4 STD

MB/HL 1,5	4	69,920	74,000	30,630	2,015		BS	63-160-1	H1149/5 STD 0.25	
MB/HL 2,4	4	69,920	74,000	21,530	2,015		BS	63-160-2		
MB/HL 3	2	69,920	74,000	36,130	2,015		BS	63-160-4		

7 83.00 x 102.00

C221		4 Cyl.		2207cc		Diesel		FM881	
BE/PL	8	52,920	56,000	22,530	1,510		BS	64-160-1	71-4258/4 STD
MB/HL 1,5	4	69,920	74,000	30,630	2,015		BS	63-160-1	H1149/5 STD 0.25
MB/HL 2,4	4	69,920	74,000	21,530	2,015		BS	63-160-2	
MB/HL 3	2	69,920	74,000	36,130	2,015		BS	63-160-4	

8 84.00 x 82.00

4ZB1		4 Cyl.		1817cc		56-77kW (76-105PS)		Petrol		TD1679	
MB/HL 1-5	5	55,920/55,930	59,979/59,999	21,869	2,009	0,030/0,086	AL	3961RA	H1225/5 STD		

9 85.00 x 81.50

F18B		4 Cyl.		1850cc		103kW (140PS)		Petrol		TD26234	
BE/PL	8	44,980	48,020	19,400	1,498		BS	64-454-1	71-4253/4 STD		

10 85.00 x 88.00

F20B		4 Cyl.		1997cc		100-110kW (136-150PS)		Petrol		TD22130	
BE/PL	8	44,980	48,020	19,400	1,498		BS	64-454-1	71-4253/4 STD		

11 86.00 x 84.00

C190		4 Cyl.		1951cc		40kW (54PS)		Diesel		TD1685	
BE/PL	8	52,920	56,000	22,530	1,510		BS	64-160-1	71-4258/4 STD		
TW/A	2	72,700	86,950		2,480		BS	65-157-1	A219/2 STD		

12 86.00 x 86.00

C 20 NE		4 Cyl.		1998cc		85kW (115PS)		Petrol		TD26802	
BE/PL	4	48,971/48,987	52,000/52,012	19,300	1,500	0,020/0,066	EC	71-3626	71-3626/4 STD 0.25 0.50		
MB/HL 1,2,4,5	4	57,982/57,995	62,000/62,013	19,500	1,995	0,020/0,066	AL-LF	02-3532	H982/5 STD 0.25 0.50		
MB/HL 3	1	57,982/57,995	62,000/62,013	25,900	1,995	0,020/0,066	AL-LF	02-3533H			

	02-3533H	STD	25,950/1.0217" - 26,002/1.0237"
		0.25mm	26,150/1.0295" - 26,202/1.0316"
		0.50mm	26,350/1.0374" - 26,402/1.0394"

13 86.00 x 94.60

X 22 SE		4 Cyl.		2198cc		85-97kW (116-132PS)		Petrol		TD25588	
BE/PL	4	48,971/48,987	52,000/52,012	19,300	1,500	0,020/0,066	EC	71-3626	71-3626/4 STD 0.25 0.50		
BE/PL	4	48,971/48,987	52,000/52,012	20,300	1,500	0,020/0,070	EC	71-3764	71-3764/4 STD 0.25		

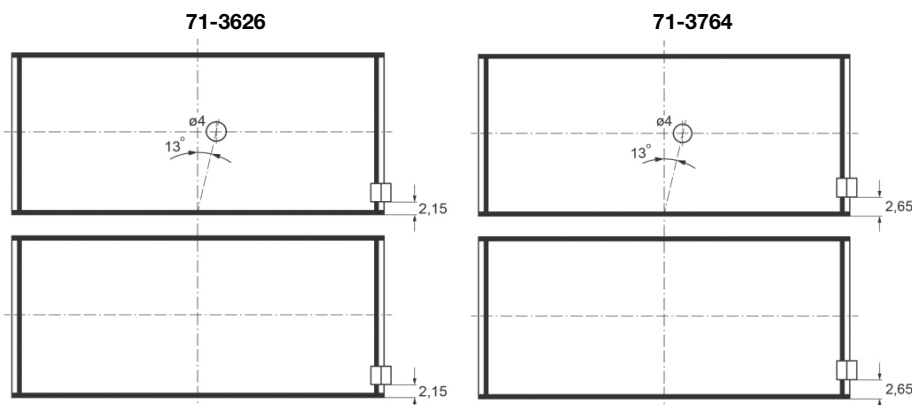

MB/HL 1,2,4,5	4	57,982/57,995	62,000/62,013	19,500	1,995	0,020/0,066	AL-LF	02-3532	H982/5 STD 0.25 0.50
MB/HL 3	1	57,982/57,995	62,000/62,013	25,900	1,995	0,020/0,066	AL-LF	02-3533H	



02-3533H	STD	25,950/1.0217" - 26,002/1.0237"
	0.25mm	26,150/1.0295" - 26,202/1.0316"
	0.50mm	26,350/1.0374" - 26,402/1.0394"

14 86.00 x 102.00

C240			4 Cyl.	2369cc	44-55kW (60-75PS)		Diesel		TD26269
BE/PL	8	52,920		56,000	22,530	1,510	BS	64-160-1	71-4258/4 STD
MB/HL 1,5	4	69,920		74,000	30,630	2,015	BS	63-160-1	H1149/5 STD 0.25
MB/HL 2,4	4	69,920		74,000	21,530	2,015	BS	63-160-2	
MB/HL 3	2	69,920		74,000	36,130	2,015	BS	63-160-4	
TW/A	2					2,480	BS	65-160-1	A240/2 STD
SE/PB	1	27,000		30,020	34,000		BS	67-160-1	55-4271 SEMI

→12/81

15 88.00 x 82.00

4ZC1			4 Cyl.	1994cc	52-81kW (71-110PS)		Petrol		TD7221	
4ZC1-T			4 Cyl.	1995cc	104-110kW (141-150PS)		Petrol Turbo Intercooler		TD1681	
MB/HL 1-5	5	55,920/55,930		59,979/59,999	21,869	2,009	0,030/0,086	AL	3961RA	H1225/5 STD

16 88.00 x 92.00

C223			4 Cyl.	2238cc	39-54kW (53-73PS)		Diesel		TD1686	
C223T			4 Cyl.	2238cc	45-53kW (61-72PS)		Diesel Turbo		TD1687	
BE/PL	8	52,920		56,000	22,530	1,510		BS	64-160-1	71-4258/4 STD
TW/A	2	72,700		86,950		2,480		BS	65-157-1	A219/2 STD

17 89.30 x 90.00

4ZD1			4 Cyl.	2254cc	64-75kW (87-102PS)		Petrol		TD1683	
MB/HL 1-5	5	55,920/55,930		59,979/59,999	21,869	2,009	0,030/0,086	AL	3961RA	H1225/5 STD



18 93.00 x 92.00										
4JA1		4 Cyl.		2499cc	50-94kW (68-128PS)		Diesel		TD1668	
4JA1AG		4 Cyl.		2499cc	50-57kW (68-78PS)		Diesel		TD1669	
4JA1-L Euro 2		4 Cyl.		2499cc	58-63kW (79-85PS)		Diesel Turbo		TD23595	
4JA1T		4 Cyl.		2499cc	56-66kW (76-90PS)		Diesel Turbo		TD8401	
4JA1-TC		4 Cyl.		2499cc	74kW (101PS)		Diesel		TD22069	
BE/PL	8	52,920		56,000	25,800	1,513	AL-LF	64-184-1	01-4131/4 STD 0.25 0.50	
MB/HL 1-5	5	59,920/59,932		63,987/64,000	23,030	2,004	0,035/0,080	BS	GS70221LC/B	H1160/5 STD 0.25
MB/HL 1-5	5	59,920/59,932		63,987/64,000	23,030	2,004	0,035/0,080	BS	GS70221LC/T	
TW/A	2	72,700		86,950		2,480		BS	65-157-1	A219/2 STD
CB/NWB	1	49,950		54,040	25,000	2,010		AL-LF	62-184-1	N178/3 STD
CB/NWB	2	49,950		54,040	22,000	2,010		AL-LF	62-184-2	

19 93.00 x 102.00										
4JB1		4 Cyl.		2771cc	42-74kW (57-101PS)		Diesel		TD1670	
4JB1T		4 Cyl.		2771cc	57-88kW (77-120PS)		Diesel Turbo		TD1671	
4JB1-TC		4 Cyl.		2771cc	67-85kW (91-116PS)		Diesel Turbo Intercooler		TD1672	
BE/PL	8	52,920		56,000	25,800	1,513		AL-LF	64-184-1	01-4131/4 STD 0.25 0.50
MB/HL 1-5	5	69,920		74,000	23,030	2,006		AL	63-185-1	H1078/5 STD 0.25
MB/HL 1-5	5	69,920		74,000	23,030	2,006		AL	63-185-2	
TW/A	2	77,800		92,950		2,480		AL-LF	65-185-1	A225/2 STD
CB/NWB	1	49,950		54,040	25,000	2,010		AL-LF	62-184-1	N178/3 STD
CB/NWB	2	49,950		54,040	22,000	2,010		AL-LF	62-184-2	

20 95.40 x 107.00										
4JG2		4 Cyl.		3059cc	61-72kW (82-98PS)		Diesel		TD21157	
4JG2 T		4 Cyl.		3059cc	80-85kW (109-116PS)		Diesel Turbo Intercooler		TD8402	
4JG2 TC		4 Cyl.		3059cc	84-92kW (109-125PS)		Diesel Turbo Intercooler		TD21081	
BE/PL	8	52,920		56,000	25,800	1,513		AL-LF	64-184-1	01-4131/4 STD 0.25 0.50
MB/HL 1-5	5	69,920		74,000	23,030	2,006		AL	63-185-1	H1078/5 STD 0.25
MB/HL 1-5	5	69,920		74,000	23,030	2,006		AL	63-185-2	
TW/A	2	77,800		92,950		2,480		AL-LF	65-185-1	A225/2 STD
CB/NWB	1	49,950		54,040	25,000	2,010		AL-LF	62-184-1	N178/3 STD
CB/NWB	2	49,950		54,040	22,000	2,010		AL-LF	62-184-2	

21 96.00 x 92.00										
TD27		4 Cyl.		2663cc	58-73kW (79-99PS)		Diesel		TD21156	
BE/PL	8	56,910		60,010	26,100	1,513		BS	64-089-1	71-4156/4 STD

MB/HL 1-5	5	70,900	75,000	26,000	2,013		BS	63-087-1	H1093/5 STD 0.25	
MB/HL 1-5	5	70,900	75,000	26,000	2,013		BS	63-087-2		
TW/A	2	78,700	93,700		2,325		BS	65-080-1	A220/4 STD	
TW/A	2	78,700	93,700		2,325		BS	65-080-2		

22 96.00 x 102.00

ZD30DDTi	4 Cyl.		2953cc	126kW (170PS)		Diesel Turbo Intercooler	TD29793
BE/PL	8	56,900	60,000	26,100	1,508	AL-LF 64-1051-1	01-4977/4 STD
MB/HL 1-5	5	70,900	75,000	25,000	2,010	AL-LF 63-1051-1	H1342/5 STD
MB/HL 1-5	5	70,900	75,000	25,000	2,010	AL-LF 63-1051-2	
TW/A	2	78,750	93,500		2,300	AL-LF 65-1051-1	A323/2 STD

23 110.00 x 125.00

4HE1-T Euro 3	4 Cyl.		4751cc	104kW (141PS)		Diesel Turbo Intercooler	TD18749
4HE1-TC Euro 3	4 Cyl.		4751cc	107kW (146PS)		Diesel Turbo Intercooler	TD17198
BE/PL	4	72,902/72,922	77,985/78,000	30,270	2,518	BS GS70861LC	71-4856/4 STD
MB/HL 1-5	5	81,905/81,920	87,000/87,020	27,030	2,529	BS GS70862LC	H1307/5 STD
TW/A	2	92,500	109,75		3,000	AL-LF 65-801-1	A307/3 STD
TW/A	1	92,500	109,75		3,000	AL-LF 65-801-2	

24 110.00 x 125.00

6HE1-T	6 Cyl.		7127cc	169kW (230PS)		Diesel Turbo Intercooler	TD20293
BE/PL	6	72,902/72,922	77,985/78,000	30,270	2,518	BS GS70861LC	71-4856/6 STD
MB/HL 1-7	7	81,905/81,920	87,000/87,020	27,030	2,529	BS GS70862LC	H1307/7 STD
TW/A	2	92,500	109,75		3,000	AL-LF 65-801-1	A307/3 STD
TW/A	1	92,500	109,75		3,000	AL-LF 65-801-2	

25 112.00 x 110.00

4HF1	4 Cyl.		4334cc	78-96kW (106-131PS)		Diesel	TD7050
4HF1-II	4 Cyl.		4334cc	76kW (103PS)		Diesel	TD27981
MB/HL 1-5	5	81,905/81,920	87,000/87,020	27,030	2,529	BS GS70862LC	H1307/5 STD
TW/A	2	92,500	109,75		3,000	AL-LF 65-801-1	A307/3 STD
TW/A	1	92,500	109,75		3,000	AL-LF 65-801-2	
SE/PB	1	35,990	40,020	29,800	2,040	BS 67-801-1	55-4895 STD

26 115.00 x 110.00

4HG1	4 Cyl.		4570cc	96-103kW (130-140PS)		Diesel	TD22127
MB/HL 1-5	5	81,905/81,920	87,000/87,020	27,030	2,529	BS GS70862LC	H1307/5 STD

TW/A	2	92,500	109,75		3,000		AL-LF	65-801-1	A307/3 STD	
TW/A	1	92,500	109,75		3,000		AL-LF	65-801-2		
SE/PB	1	35,990	40,020	29,800	2,040		BS	67-801-1	55-4895 STD	

27 115.00 x 125.00

4HK1-E5C Euro 5 EEV	4 Cyl.	5193cc	140kW (190PS)				Diesel Turbo Intercooler		TD24382
4HK1-E5N Euro 5 EEV	4 Cyl.	5193cc	114kW (155PS)				Diesel Turbo Intercooler		TD24381
4HK1-E5S Euro 5 EEV	4 Cyl.	5193cc	204kW (277PS)				Diesel Turbo Intercooler		TD24383
4HK1-TCN Euro 4	4 Cyl.	5193cc	110kW (150PS)				Diesel Turbo Intercooler		TD23721
4HK1-XS Euro 4	4 Cyl.	5193cc	129-140kW (175-190PS)				Diesel Turbo Intercooler		TD19389
MB/HL 1-5	5	81,905/81,920	87,000/87,020	27,030	2,529		BS	GS70862LC	H1307/5 STD
TW/A	2	92,500	109,75		3,000		AL-LF	65-801-1	A307/3 STD
TW/A	1	92,500	109,75		3,000		AL-LF	65-801-2	

28 115.00 x 125.00

6HK1-TCC	6 Cyl.	7790cc	164kW (223PS)				Diesel Turbo Intercooler		TD20296
6HK1-TCN	6 Cyl.	7790cc	141kW (192PS)				Diesel Turbo Intercooler		TD20295
6HK1-TCS	6 Cyl.	7790cc	191kW (260PS)				Diesel Turbo Intercooler		TD20297
BE/PL	6	72,902/72,922	77,985/78,000	30,270	2,518		BS	GS70861LC	71-4856/6 STD
MB/HL 1-7	7	81,905/81,920	87,000/87,020	27,030	2,529		BS	GS70862LC	H1307/7 STD
TW/A	2	92,500	109,75		3,000		AL-LF	65-801-1	A307/3 STD
TW/A	1	92,500	109,75		3,000		AL-LF	65-801-2	

29 115.00 x 132.00

6HH1-N	6 Cyl.	8226cc	129kW (175PS)				Diesel		TD20291
6HH1-S	6 Cyl.	8226cc	147kW (200PS)				Diesel		TD20292
MB/HL 1-7	7	81,905/81,920	87,000/87,020	27,030	2,529		BS	GS70862LC	H1307/7 STD
TW/A	2	92,500	109,75		3,000		AL-LF	65-801-1	A307/3 STD
TW/A	1	92,500	109,75		3,000		AL-LF	65-801-2	
SE/PB	1	35,990	40,020	29,800	2,040		BS	67-801-1	55-4895 STD

30 147.00 x 140.00

6WF1-TC	6 Cyl.	14256cc	265-287kW (360-390PS)				Diesel Turbo Intercooler		TD24296
6WF1-TCC	6 Cyl.	14256cc	287kW (390PS)				Diesel Turbo Intercooler		TD24297
BE/PL	6	91,900	98,000	44,500	3,011		BS	64-811-1	71-4948/6 STD
BE/PL	6	91,900	98,000	44,500	3,011		BS	64-811-2	
MB/HL 1-7	7	104,900	111,000	37,500	3,010		BS	63-811-1	H1333/7 STD
MB/HL 1-7	7	104,900	111,000	37,500	3,010		BS	63-811-2	

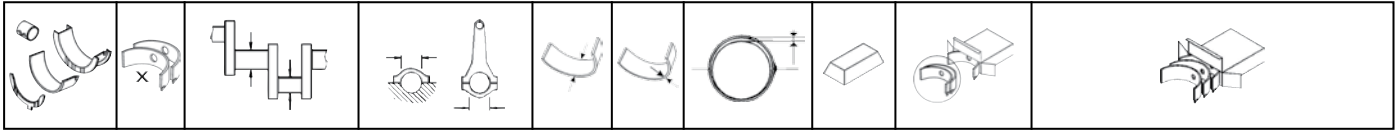

31 **147.00 x 154.00**

6WG1-T 6 Cyl. **15682cc** **235kW** (320PS) **Diesel Turbo** **TD24298**

6WG1-TC 6 Cyl. **15682cc** **338kW** (460PS) **Diesel Turbo Intercooler** **TD24299**









BE/PL	6	91,900	98,000	44,500	3,011	BS	64-811-1	71-4948/6 STD
BE/PL	6	91,900	98,000	44,500	3,011	BS	64-811-2	
MB/HL 1-7	7	104,900	111,000	37,500	3,010	BS	63-811-1	H1333/7 STD
MB/HL 1-7	7	104,900	111,000	37,500	3,010	BS	63-811-2	



cm3



616 N2	01/68→12/71	Diesel	8030.01 (803A)	2339	3	95.00	110.00	17
616 N3		Diesel	853A	2600	3	100.00	110.00	22
Daily 35-11 2.8 CNG Metano	07/99→	Diesel	8149.03.3971	1995	4	94.00	100.00	15
Daily 49-11 2.8 CNG Metano	07/99→	Diesel	8149.03.3971	1995	4	94.00	100.00	15
Daily Citys 3.0	06/14→	Diesel	F1CFL411E Euro 6	2998	4	95.80	104.00	21
Daily Citys 3.0	06/14→	Diesel	F1CFL411F Euro 6	2998	4	95.80	104.00	21
Daily I 30-8	01/78→12/89	Diesel	8140.61.200	2445	4	93.00	90.00	5
Daily I 35-8	01/78→12/89	Diesel	8140.61.200	2445	4	93.00	90.00	5
Daily I 35-10	01/85→12/89	Diesel	8140.21.200	2445	4	93.00	90.00	2
Daily I 40-8	01/83→06/89	Diesel	8140.61.200	2445	4	93.00	90.00	5
Daily I 40-8 V	01/83→06/89	Diesel	8140.61.200	2445	4	93.00	90.00	5
Daily I 40-10	01/85→12/89	Diesel	8140.27 S	2445	4	93.00	90.00	5
Daily I 40-10 V	01/85→12/89	Diesel	8140.27 S	2445	4	93.00	90.00	5
Daily I 45-10	01/85→12/89	Diesel	8140.21.200	2445	4	93.00	90.00	2
Daily I 45-10 V	01/85→12/89	Diesel	8140.21.200	2445	4	93.00	90.00	2
Daily I 49-10	01/85→12/89	Diesel	8140.21.200	2445	4	93.00	90.00	2
Daily I 49-10 V	01/85→12/89	Diesel	8140.21.200	2445	4	93.00	90.00	2
Daily II 2.5 4x4	11/89→05/96	Diesel	8140.47R.2790	2499	4	93.00	92.00	11
Daily II 2.5 4x4	11/89→05/96	Diesel	8140.27.2700	2499	4	93.00	92.00	10
Daily II 2.8 4x4	02/95→05/99	Diesel	8140.43. Euro 2	2798	4	94.40	100.00	16
Daily II 30-8	01/89→08/98	Diesel	8140.67F. Euro 2	2499	4	93.00	92.00	14
Daily II 30-8	01/89→08/98	Diesel	8140.67F.3710 Euro 2	2499	4	93.00	92.00	12
Daily II 30-8	01/89→08/98	Diesel	8140.67F.3711 Euro 2	2499	4	93.00	92.00	12
Daily II 30-8	01/89→08/98	Diesel	8140.67F.3713 Euro 2	2499	4	93.00	92.00	12
Daily II 30-8	01/89→08/98	Diesel	8140.67F.3721 Euro 2	2499	4	93.00	92.00	12
Daily II 30-8	01/89→08/98	Diesel	8140.07.2700	2499	4	93.00	92.00	6
Daily II 30-8	01/89→08/98	Diesel	8140.07.2712	2499	4	93.00	92.00	7
Daily II 30-8	09/98→05/99	Diesel	8140.63. Euro 2	2798	4	94.40	100.00	16
Daily II 30-8 V	09/98→05/99	Diesel	8140.63. Euro 2	2798	4	94.40	100.00	16
Daily II 30-10	01/97→05/99	Diesel	8140.23.	2798	4	94.40	100.00	16
Daily II 30-10 C	01/97→05/99	Diesel	8140.23.	2798	4	94.40	100.00	16
Daily II 35-8	01/89→08/98	Diesel	8140.67F. Euro 2	2499	4	93.00	92.00	14
Daily II 35-8	01/91→08/98	Diesel	8140.67F.3701 Euro 2	2499	4	93.00	92.00	12
Daily II 35-8	01/91→08/98	Diesel	8140.67F.3710 Euro 2	2499	4	93.00	92.00	12
Daily II 35-8	01/91→08/98	Diesel	8140.67F.3711 Euro 2	2499	4	93.00	92.00	12
Daily II 35-8	01/91→08/98	Diesel	8140.67F.3713 Euro 2	2499	4	93.00	92.00	12
Daily II 35-8	01/91→08/98	Diesel	8140.67F.3721 Euro 2	2499	4	93.00	92.00	12
Daily II 35-8	01/89→08/98	Diesel	8140.07.2700	2499	4	93.00	92.00	6
Daily II 35-8	01/89→08/98	Diesel	8140.07.2712	2499	4	93.00	92.00	7
Daily II 35-8	09/98→05/99	Diesel	8140.63. Euro 2	2798	4	94.40	100.00	16
Daily II 35-8 K	09/98→05/99	Diesel	8140.63. Euro 2	2798	4	94.40	100.00	16
Daily II 35-10	01/89→08/98	Diesel	8140.47R	2499	4	93.00	92.00	6
Daily II 35-10	01/89→08/98	Diesel	8140.47R.2790	2499	4	93.00	92.00	11
Daily II 35-10	01/89→08/98	Diesel	8140.97.2781	2499	4	93.00	92.00	6
Daily II 35-10	01/96→05/99	Diesel	8140.23.	2798	4	94.40	100.00	16
Daily II 35-10 K	01/97→05/99	Diesel	8140.23.	2798	4	94.40	100.00	16
Daily II 35-12	01/90→04/96	Diesel	8140.47S Euro 1	2499	4	93.00	92.00	6
Daily II 35-12	01/90→04/96	Diesel	8140.47.2700 Euro 1	2499	4	93.00	92.00	10
Daily II 35-12	02/95→05/99	Diesel	8140.43. Euro 2	2798	4	94.40	100.00	16
Daily II 35-12 K	09/96→08/98	Diesel	8140.43. Euro 2	2798	4	94.40	100.00	16
Daily II 40-10 4x4	01/97→05/99	Diesel	8140.23.	2798	4	94.40	100.00	16
Daily II 40-10 V	01/90→04/96	Diesel	8140.27.2720	2499	4	93.00	92.00	11
Daily II 40-10 W 4x4	01/97→05/99	Diesel	8140.23.	2798	4	94.40	100.00	16
Daily II 45-10	01/89→04/96	Diesel	8140.27.2720	2499	4	93.00	92.00	11
Daily II 45-10 V	01/89→04/96	Diesel	8140.27.2720	2499	4	93.00	92.00	11
Daily II 49-10	01/89→04/96	Diesel	8140.47R.2790	2499	4	93.00	92.00	11
Daily II 49-10	01/89→04/96	Diesel	8140.27.2700	2499	4	93.00	92.00	10
Daily II 49-10	05/96→05/99	Diesel	8140.23.	2798	4	94.40	100.00	16
Daily II 49-10 V	01/89→04/96	Diesel	8140.47R.2790	2499	4	93.00	92.00	11
Daily II 49-10 V	01/89→04/96	Diesel	8140.27.2700	2499	4	93.00	92.00	10
Daily II 49-10 K	01/89→04/96	Diesel	8140.47R.2790	2499	4	93.00	92.00	11
Daily II 49-10 K	01/89→04/96	Diesel	8140.27.2700	2499	4	93.00	92.00	10
Daily II 49-10 K	05/96→05/99	Diesel	8140.23.	2798	4	94.40	100.00	16
Daily II 49-12	06/90→04/96	Diesel	8140.47.2711 Euro 1	2499	4	93.00	92.00	11
Daily II 49-12	06/90→04/96	Diesel	8140.47.2721 Euro 1	2499	4	93.00	92.00	10
Daily II 49-12	05/96→05/99	Diesel	8140.43. Euro 2	2798	4	94.40	100.00	16
Daily II 49-12 V	06/90→04/96	Diesel	8140.47.2711 Euro 1	2499	4	93.00	92.00	11
Daily II 49-12 V	06/90→04/96	Diesel	8140.47.2721 Euro 1	2499	4	93.00	92.00	10
Daily II 49-12 V	05/96→05/99	Diesel	8140.43. Euro 2	2798	4	94.40	100.00	16

				cm3	x 			
Daily II 49-12 K	06/90→04/96	Diesel	8140.47.2711 Euro 1	2499	4	93.00	92.00	11
Daily II 49-12 K	06/90→04/96	Diesel	8140.47.2721 Euro 1	2499	4	93.00	92.00	10
Daily II 49-12 K	05/96→05/99	Diesel	8140.43. Euro 2	2798	4	94.40	100.00	16
Daily II 59-12	05/91→04/96	Diesel	8140.47.2700 Euro 1	2499	4	93.00	92.00	10
Daily II 59-12	05/91→04/96	Diesel	8140.47.2711 Euro 1	2499	4	93.00	92.00	11
Daily II 59-12	05/96→05/99	Diesel	8140.43. Euro 2	2798	4	94.40	100.00	16
Daily II 59-12 V	05/91→04/96	Diesel	8140.47S Euro 1	2499	4	93.00	92.00	6
Daily II 59-12 V	05/91→04/96	Diesel	8140.47.2700 Euro 1	2499	4	93.00	92.00	10
Daily II 59-12 V	05/91→04/96	Diesel	8140.47.2711 Euro 1	2499	4	93.00	92.00	11
Daily II 59-12 V	05/96→05/99	Diesel	8140.43. Euro 2	2798	4	94.40	100.00	16
Daily II 59-12 K	05/91→04/96	Diesel	8140.47.2700 Euro 1	2499	4	93.00	92.00	10
Daily II 59-12 K	05/91→04/96	Diesel	8140.47.2711 Euro 1	2499	4	93.00	92.00	11
Daily II 59-12 K	05/96→05/99	Diesel	8140.43. Euro 2	2798	4	94.40	100.00	16
Daily II A 40-10	01/91→12/96	Diesel	8140.27.2720	2499	4	93.00	92.00	11
Daily II A 40-10	09/96→05/99	Diesel	8140.23.	2798	4	94.40	100.00	16
Daily II A 40-12	05/96→05/99	Diesel	8140.43. Euro 2	2798	4	94.40	100.00	16
Daily II A 45-10	01/91→04/96	Diesel	8140.27.2720	2499	4	93.00	92.00	11
Daily II A 45-10	05/96→05/99	Diesel	8140.23.	2798	4	94.40	100.00	16
Daily II A 45-12	06/90→04/96	Diesel	8140.47.2711 Euro 1	2499	4	93.00	92.00	11
Daily II A 45-12	06/90→04/96	Diesel	8140.47.2721 Euro 1	2499	4	93.00	92.00	10
Daily II A 45-12	05/96→05/99	Diesel	8140.43. Euro 2	2798	4	94.40	100.00	16
Daily III 2.8 CNG	05/99→07/07	Gas	8149.03	2798	4	94.40	100.00	16
Daily III 2.8 D	11/97→07/07	Diesel	8140.23.	2798	4	94.40	100.00	16
Daily III 2.8 D	11/97→07/07	Diesel	8140.43. Euro 2	2798	4	94.40	100.00	16
Daily III 29 L 9	11/01→04/06	Diesel	8140.43R Euro 3	2798	4	94.40	100.00	16
Daily III 29 L 9	05/99→04/06	Diesel	8140.63. Euro 2	2798	4	94.40	100.00	16
Daily III 29 L 9 V	11/01→04/06	Diesel	8140.43R Euro 3	2798	4	94.40	100.00	16
Daily III 29 L 9 V	05/99→07/07	Diesel	8140.63. Euro 2	2798	4	94.40	100.00	16
Daily III 29 L 10	09/02→04/06	Diesel	F1AE0481A Euro 3	2287	4	88.00	94.00	1
Daily III 29 L 10 V	09/02→07/07	Diesel	F1AE0481A Euro 3	2287	4	88.00	94.00	1
Daily III 29 L 11	05/99→04/06	Diesel	8140.43B Euro 3	2798	4	94.40	100.00	16
Daily III 29 L 11	05/99→04/06	Diesel	8140.43C Euro 2	2798	4	94.40	100.00	16
Daily III 29 L 11 V	05/99→07/07	Diesel	8140.43C Euro 2	2798	4	94.40	100.00	16
Daily III 29 L 12	09/02→04/06	Diesel	F1AE0481B Euro 3	2287	4	88.00	94.00	1
Daily III 29 L 12 V	09/02→07/07	Diesel	F1AE0481B Euro 3	2287	4	88.00	94.00	1
Daily III 29 L 13	05/01→07/07	Diesel	8140.43S Euro 3	2798	4	94.40	100.00	16
Daily III 29 L 14	01/05→04/06	Diesel	F1AE0481M	2287	4	88.00	94.00	1
Daily III 35 C 9, 35 S 9	11/01→04/06	Diesel	8140.43R Euro 3	2798	4	94.40	100.00	16
Daily III 35 C 10 V, 35 S 10 V	09/02→04/06	Diesel	F1AE0481A Euro 3	2287	4	88.00	94.00	1
Daily III 35 C 12, 35 S 12	09/02→04/06	Diesel	F1AE0481B Euro 3	2287	4	88.00	94.00	1
Daily III 35 C 12 V, 35 S 12 V	09/02→07/07	Diesel	F1AE0481B Euro 3	2287	4	88.00	94.00	1
Daily III 35 C 14	09/04→04/06	Diesel	F1CE0481A	2998	4	95.80	104.00	20
Daily III 35 C 14, 35 S 14	01/05→04/06	Diesel	F1AE0481M	2287	4	88.00	94.00	1
Daily III 35 C 15	11/01→04/06	Diesel	8140.43N Euro 3	2798	4	94.40	100.00	16
Daily III 35 C 17, 35 S 17	01/05→04/06	Diesel	F1CE0481B Euro 3	2998	4	95.80	104.00	20
Daily III 35 S 9,35 C 9	05/99→04/06	Diesel	8140.63. Euro 2	2798	4	94.40	100.00	16
Daily III 35 S 9 V	11/01→04/06	Diesel	8140.43R Euro 3	2798	4	94.40	100.00	16
Daily III 35 S 9 V,35 C 9 V	05/99→07/07	Diesel	8140.63. Euro 2	2798	4	94.40	100.00	16
Daily III 35 S 10	09/02→07/07	Diesel	F1AE0481A Euro 3	2287	4	88.00	94.00	1
Daily III 35 S 11,35 C 11	05/99→04/06	Diesel	8140.43C Euro 2	2798	4	94.40	100.00	16
Daily III 35 S 11 V,35 C 11 V	05/99→07/07	Diesel	8140.43C Euro 2	2798	4	94.40	100.00	16
Daily III 35 S 12	01/03→05/06	Diesel	F1AE0481B Euro 3	2287	4	88.00	94.00	1
Daily III 35 S 13,35 C 13	05/99→04/06	Diesel	8140.43S Euro 3	2798	4	94.40	100.00	16
Daily III 35 S 13, 40 C 13, 50 C 13	05/99→05/06	Diesel	8140.43S Euro 3	2798	4	94.40	100.00	16
Daily III 35 S 13 V,35 C 13 V	05/99→07/07	Diesel	8140.43S Euro 3	2798	4	94.40	100.00	16
Daily III 35 S 14, 50 C 14	01/04→05/06	Diesel	F1CE0481A	2998	4	95.80	104.00	20
Daily III 35 S 15 V, 35 C 15 V	11/02→07/07	Diesel	8140.43N Euro 3	2798	4	94.40	100.00	16
Daily III 40 C 10	09/02→04/06	Diesel	F1AE0481A Euro 3	2287	4	88.00	94.00	1
Daily III 40 C 11, 50 C 11	05/99→05/06	Diesel	8140.43B Euro 3	2798	4	94.40	100.00	16
Daily III 40 C 11, 50 C 11	05/99→05/06	Diesel	8140.43C Euro 2	2798	4	94.40	100.00	16
Daily III 40 C 13	05/99→04/06	Diesel	8140.43S Euro 3	2798	4	94.40	100.00	16
Daily III 40 C 14	01/05→04/06	Diesel	F1AE0481M	2287	4	88.00	94.00	1
Daily III 40 C 14	09/04→04/06	Diesel	F1CE0481A	2998	4	95.80	104.00	20
Daily III 40 C 15	11/01→04/06	Diesel	8140.43N Euro 3	2798	4	94.40	100.00	16
Daily III 40 C 15, 50 C 15	05/99→05/06	Diesel	8140.43N Euro 3	2798	4	94.40	100.00	16
Daily III 40 C 17, 40 S 17	01/05→04/06	Diesel	F1CE0481B Euro 3	2998	4	95.80	104.00	20
Daily III 40 C 17, 50 C 17	01/04→05/06	Diesel	F1CE0481B Euro 3	2998	4	95.80	104.00	20
Daily III 45 C 14	07/99→04/06	Diesel	F1CE0481A	2998	4	95.80	104.00	20
Daily III 50 C 11	05/99→07/07	Diesel	8140.43C Euro 2	2798	4	94.40	100.00	16



cm3 x



9

Daily III 50 C 11 Natural Power	05/99→05/06	Gas	8149.03	2798	4	94.40	100.00	16
Daily III 50 C 13	05/99→07/07	Diesel	8140.43S Euro 3	2798	4	94.40	100.00	16
Daily III 50 C 14	09/04→04/06	Diesel	F1CE0481A	2998	4	95.80	104.00	20
Daily III 50 C 15	01/01→04/06	Diesel	8140.43N Euro 3	2798	4	94.40	100.00	16
Daily III 50 C 17	09/04→04/06	Diesel	F1CE0481B Euro 3	2998	4	95.80	104.00	20
Daily III 65 C 13	07/99→04/06	Diesel	8140.43.K	2798	4	94.40	100.00	16
Daily III 65 C 14	09/04→04/06	Diesel	F1CE0481A	2998	4	95.80	104.00	20
Daily III 65 C 15	11/01→04/06	Diesel	8140.43N Euro 3	2798	4	94.40	100.00	16
Daily III 65 C 17	09/04→04/06	Diesel	F1CE0481B Euro 3	2998	4	95.80	104.00	20
Daily IV 3.0 D	07/07→03/12	Diesel	F1CE0481A	2998	4	95.80	104.00	20
Daily IV 29L10	05/06→08/11	Diesel	F1AE0481FA Euro 4	2287	4	88.00	94.00	1
Daily IV 29L10 V	05/06→08/11	Diesel	F1AE0481FA Euro 4	2287	4	88.00	94.00	1
Daily IV 29L12	05/06→08/11	Diesel	F1AE0481GA Euro 4	2287	4	88.00	94.00	1
Daily IV 29L12 V, 29L12 V/P	05/06→08/11	Diesel	F1AE0481GA Euro 4	2287	4	88.00	94.00	1
Daily IV 29L14	05/06→08/11	Diesel	F1AE0481HA Euro 4	2287	4	88.00	94.00	1
Daily IV 29L14 C, 29L14 C/P, 29L14 V, 29L14 V/P	05/06→08/11	Diesel	F1AE0481HA Euro 4	2287	4	88.00	94.00	1
Daily IV 35C10, 35S10	05/06→08/11	Diesel	F1AE0481FA Euro 4	2287	4	88.00	94.00	1
Daily IV 35C10 K	05/06→08/11	Diesel	F1AE0481FA Euro 4	2287	4	88.00	94.00	1
Daily IV 35C11, 35S11, 35S11 D, 35S11 /P	07/07→08/11	Diesel	F1AE0481FA Euro 4	2287	4	88.00	94.00	1
Daily IV 35C11 V, 35S11 V	07/07→08/11	Diesel	F1AE0481FA Euro 4	2287	4	88.00	94.00	1
Daily IV 35C11 K, 35C11 DK, 35S11 K, 35S11 DK	07/07→08/11	Diesel	F1AE0481FA Euro 4	2287	4	88.00	94.00	1
Daily IV 35C12	05/06→08/11	Diesel	F1AE0481GA Euro 4	2287	4	88.00	94.00	1
Daily IV 35C12, 35S12	05/06→08/11	Diesel	F1AE0481GA Euro 4	2287	4	88.00	94.00	1
Daily IV 35C12 V, 35C12 V/P, 35S12 V, 35S12 V/P	05/06→08/11	Diesel	F1AE0481GA Euro 4	2287	4	88.00	94.00	1
Daily IV 35C13, 35C13 /P, 35S13 D, 35S13, 35S13 /P	07/07→08/11	Diesel	F1AE0481GA Euro 4	2287	4	88.00	94.00	1
Daily IV 35C13 V, 35C13 V/P, 35S13 V, 35S13 V/P	07/07→08/11	Diesel	F1AE0481GA Euro 4	2287	4	88.00	94.00	1
Daily IV 35C13 K, 35C13 DK, 35S13 K, 35S13 DK	07/07→08/11	Diesel	F1AE0481GA Euro 4	2287	4	88.00	94.00	1
Daily IV 35C14, 35C14 /P, 35S14, 35S14 /P, 35S14 D, 35S14 D/P	07/07→08/11	Diesel	F1CE3481LC	2998	4	95.80	104.00	20
Daily IV 35C14, 35S14, 35S14 /P	05/06→08/11	Diesel	F1AE0481HA Euro 4	2287	4	88.00	94.00	1
Daily IV 35C14 V, 35C14 V/P, 35S14 V, 35S14 V/P	07/07→08/11	Diesel	F1CE3481LC	2998	4	95.80	104.00	20
Daily IV 35C14 K, 35C14 DK, 35S14 K, 35S14 DK	07/07→08/11	Diesel	F1CE3481LC	2998	4	95.80	104.00	20
Daily IV 35C15	05/06→08/11	Diesel	F1CE0481FA Euro 4	2998	4	95.80	104.00	20
Daily IV 35C15 V, 35C15 V/P	05/06→08/11	Diesel	F1CE0481FA Euro 4	2998	4	95.80	104.00	20
Daily IV 35C17, 35C17 /P, 35S17, 35S17 /P, 35S17 D	07/07→08/11	Diesel	F1CE0481HA	2998	4	95.80	104.00	20
Daily IV 35C17 V, 35C17 V/P, 35S17 V, 35S17 V/P	07/07→08/11	Diesel	F1CE0481HA	2998	4	95.80	104.00	20
Daily IV 35C17 K, 35C17 DK, 35S17 K, 35S17 DK	07/07→08/11	Diesel	F1CE0481HA	2998	4	95.80	104.00	20
Daily IV 35C18	05/06→08/11	Diesel	F1CE0481HA	2998	4	95.80	104.00	20
Daily IV 35C18, 35S18	05/06→08/11	Diesel	F1CE0481HA	2998	4	95.80	104.00	20
Daily IV 35C18 V, 35C18 V/P, 35S18 V, 35S18 V/P	05/06→08/11	Diesel	F1CE0481HA	2998	4	95.80	104.00	20
Daily IV 35S14, 35S14 /P	05/06→08/11	Diesel	F1AE0481HA Euro 4	2287	4	88.00	94.00	1
Daily IV 35S14 C, 35S14 C/P, 35S14 V, 35S14 V/P, 35C14 V, 35C14 V/P	05/06→08/11	Diesel	F1AE0481HA Euro 4	2287	4	88.00	94.00	1
Daily IV 35S14 K, 35S14 DK	07/07→08/11	Diesel	F1AE0481HA Euro 4	2287	4	88.00	94.00	1
Daily IV 35S15	06/06→08/11	Diesel	F1CE0481L Euro 4	2998	4	95.80	104.00	20
Daily IV 35S17 W, 35S17 WD	07/07→08/11	Diesel	F1CE0481HA	2998	4	95.80	104.00	20
Daily IV 40C10	05/06→08/11	Diesel	F1AE0481FA Euro 4	2287	4	88.00	94.00	1
Daily IV 40C10 V	05/06→08/11	Diesel	F1AE0481FA Euro 4	2287	4	88.00	94.00	1
Daily IV 40C11, 40C11 D	07/07→08/11	Diesel	F1AE0481FA Euro 4	2287	4	88.00	94.00	1
Daily IV 40C11 V	07/07→08/11	Diesel	F1AE0481FA Euro 4	2287	4	88.00	94.00	1
Daily IV 40C12	05/06→08/11	Diesel	F1AE0481GA Euro 4	2287	4	88.00	94.00	1
Daily IV 40C12 V, 40C14 V/P	05/06→08/11	Diesel	F1AE0481GA Euro 4	2287	4	88.00	94.00	1
Daily IV 40C13, 40C13 /P	07/07→08/11	Diesel	F1AE0481GA Euro 4	2287	4	88.00	94.00	1
Daily IV 40C13 V, 40C13 V/P	07/07→08/11	Diesel	F1AE0481GA Euro 4	2287	4	88.00	94.00	1
Daily IV 40C14, 40C14 /P	07/07→08/11	Diesel	F1CE3481LC	2998	4	95.80	104.00	20
Daily IV 40C14 V, 40C14 V/P	07/07→08/11	Diesel	F1CE3481LC	2998	4	95.80	104.00	20

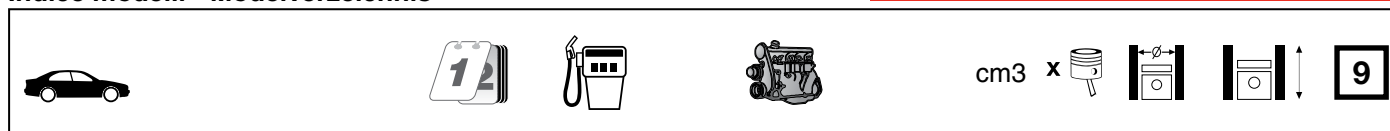







Daily IV 40C14 K, 40C14 DK	07/07→08/11	Diesel	F1CE3481LC	2998	4	95.80	104.00	20
Daily IV 40C15	05/06→08/11	Diesel	F1CE0481FA Euro 4	2998	4	95.80	104.00	20
Daily IV 40C15 V, 40C15 V/P	05/06→08/11	Diesel	F1CE0481FA Euro 4	2998	4	95.80	104.00	20
Daily IV 40C17, 40C17 /P	07/07→08/11	Diesel	F1CE0481HA	2998	4	95.80	104.00	20
Daily IV 40C17 V, 40C17 V/P	07/07→08/11	Diesel	F1CE0481HA	2998	4	95.80	104.00	20
Daily IV 40C17 K, 40C17 DK	07/07→08/11	Diesel	F1CE0481HA	2998	4	95.80	104.00	20
Daily IV 40C18	05/06→08/11	Diesel	F1CE0481HA	2998	4	95.80	104.00	20
Daily IV 40C18 V, 40C18 V/P	05/06→08/11	Diesel	F1CE0481HA	2998	4	95.80	104.00	20
Daily IV 45C14, 45C14 /P	07/07→08/11	Diesel	F1CE3481LC	2998	4	95.80	104.00	20
Daily IV 45C15	05/06→08/11	Diesel	F1CE0481FA Euro 4	2998	4	95.80	104.00	20
Daily IV 45C15 V	05/06→08/11	Diesel	F1CE0481FA Euro 4	2998	4	95.80	104.00	20
Daily IV 45C17, 45C17 /P	07/07→08/11	Diesel	F1CE0481HA	2998	4	95.80	104.00	20
Daily IV 45C17 V, 45C17 V/P	07/07→08/11	Diesel	F1CE0481HA	2998	4	95.80	104.00	20
Daily IV 45C18	05/06→08/11	Diesel	F1CE0481HA	2998	4	95.80	104.00	20
Daily IV 45C18, 45C18 /P, 45C18 D, 45C18 D/P	05/06→08/11	Diesel	F1CE0481HA	2998	4	95.80	104.00	20
Daily IV 50C14, 50C14 /P	07/07→08/11	Diesel	F1CE3481LC	2998	4	95.80	104.00	20
Daily IV 50C14 V, 50C14 V/P	07/07→08/11	Diesel	F1CE3481LC	2998	4	95.80	104.00	20
Daily IV 50C14 K, 50C14 DK	07/07→08/11	Diesel	F1CE3481LC	2998	4	95.80	104.00	20
Daily IV 50C15	05/06→08/11	Diesel	F1CE0481FA Euro 4	2998	4	95.80	104.00	20
Daily IV 50C15 V, 50C15 V/P	05/06→08/11	Diesel	F1CE0481FA Euro 4	2998	4	95.80	104.00	20
Daily IV 50C17, 50C17 /P	07/07→08/11	Diesel	F1CE0481HA	2998	4	95.80	104.00	20
Daily IV 50C17 V, 50C17 V/P	07/07→08/11	Diesel	F1CE0481HA	2998	4	95.80	104.00	20
Daily IV 50C17 K, 50C17 DK	07/07→08/11	Diesel	F1CE0481HA	2998	4	95.80	104.00	20
Daily IV 50C18	05/06→08/11	Diesel	F1CE0481HA	2998	4	95.80	104.00	20
Daily IV 50C18 V, 50C18 V/P	05/06→08/11	Diesel	F1CE0481HA	2998	4	95.80	104.00	20
Daily IV 55C17	08/07→03/12	Diesel	F1CE3481C	2998	4	95.80	104.00	20
Daily IV 55S17 W, 55S17 WD	07/07→08/11	Diesel	F1CE0481HA	2998	4	95.80	104.00	20
Daily IV 60C14, 60C14 /P	07/07→08/11	Diesel	F1CE3481LC	2998	4	95.80	104.00	20
Daily IV 60C14 K, 60C14 DK	07/07→08/11	Diesel	F1CE3481LC	2998	4	95.80	104.00	20
Daily IV 60C15	05/06→08/11	Diesel	F1CE0481FA Euro 4	2998	4	95.80	104.00	20
Daily IV 60C15, 60C15 /P, 60C15 D, 60C15 D/P	05/06→08/11	Diesel	F1CE0481FA Euro 4	2998	4	95.80	104.00	20
Daily IV 60C15 V	05/06→08/11	Diesel	F1CE0481FA Euro 4	2998	4	95.80	104.00	20
Daily IV 60C17, 60C17 /P	07/07→08/11	Diesel	F1CE0481HA	2998	4	95.80	104.00	20
Daily IV 60C17 V, 60C17 V/P	07/07→08/11	Diesel	F1CE0481HA	2998	4	95.80	104.00	20
Daily IV 60C17 K, 60C17 DK	07/07→08/11	Diesel	F1CE0481HA	2998	4	95.80	104.00	20
Daily IV 60C18	05/06→08/11	Diesel	F1CE0481HC Euro 4	2998	4	95.80	104.00	20
Daily IV 65C14, 65C14 /P	07/07→08/11	Diesel	F1CE3481LC	2998	4	95.80	104.00	20
Daily IV 65C14 V, 65C14 V/P	07/07→08/11	Diesel	F1CE3481LC	2998	4	95.80	104.00	20
Daily IV 65C14 K, 65C14 DK	07/07→08/11	Diesel	F1CE3481LC	2998	4	95.80	104.00	20
Daily IV 65C15	05/06→08/11	Diesel	F1CE0481FA Euro 4	2998	4	95.80	104.00	20
Daily IV 65C15, 65C15 /P, 65C15 D, 65C15 D/P	05/06→08/11	Diesel	F1CE0481FA Euro 4	2998	4	95.80	104.00	20
Daily IV 65C17, 65C17 /P	07/07→08/11	Diesel	F1CE0481HA	2998	4	95.80	104.00	20
Daily IV 65C17 V, 65C17 V/P	07/07→08/11	Diesel	F1CE0481HA	2998	4	95.80	104.00	20
Daily IV 65C17 K, 65C17 DK, 65C17KK	07/07→08/11	Diesel	F1CE0481HA	2998	4	95.80	104.00	20
Daily IV 65C18	05/06→08/11	Diesel	F1CE0481HC Euro 4	2998	4	95.80	104.00	20
Daily IV 70C14, 70C14 /P	07/07→08/11	Diesel	F1CE3481LC	2998	4	95.80	104.00	20
Daily IV 70C14 V, 70C14 V/P	07/07→08/11	Diesel	F1CE3481LC	2998	4	95.80	104.00	20
Daily IV 70C14 K, 70C14 DK, 70C14 KK	07/07→08/11	Diesel	F1CE3481LC	2998	4	95.80	104.00	20
Daily IV 70C15	07/08→08/11	Diesel	F1CE0481FA Euro 4	2998	4	95.80	104.00	20
Daily IV 70C17, 70C17 /P	07/07→08/11	Diesel	F1CE0481HA	2998	4	95.80	104.00	20
Daily IV 70C17V, 70C17 V/P	07/07→08/11	Diesel	F1CE0481HA	2998	4	95.80	104.00	20
Daily IV 70C17 K, 70C17 DK, 70C17 KK	07/07→08/11	Diesel	F1CE0481HA	2998	4	95.80	104.00	20
Daily V 26L11, 26L11D, 35C11D, 35S11, 40C11	09/11→02/14	Diesel	F1AE3481A Euro 5	2287	4	88.00	94.00	1
Daily V 29L11 V, 35C11 V, 35S11 V, 40C11 V	09/11→02/14	Diesel	F1AE3481A Euro 5	2287	4	88.00	94.00	1
Daily V 29L13, 29L13D, 35C13D, 40C13	09/11→02/14	Diesel	F1AE3481B Euro 5	2287	4	88.00	94.00	1
Daily V 29L13 V, 35C13 V, 35S13 V, 40C13 V, 40S13 V	09/11→02/14	Diesel	F1AE3481B Euro 5	2287	4	88.00	94.00	1
Daily V 29L15 V, 35C15L V, 40C15L V, 50C15L V	09/11→02/14	Diesel	F1AE3481C Euro 5	2287	4	88.00	94.00	1
Daily V 35C11K, 35S11DKP	09/11→02/14	Diesel	F1AE3481A Euro 5	2287	4	88.00	94.00	1
Daily V 35C13K, 35C13DKP	09/11→02/14	Diesel	F1AE3481B Euro 5	2287	4	88.00	94.00	1
Daily V 35C15, 35C15D, 35S15, 40C15, 45C15, 50C15, 60C15, 70C15	09/11→02/14	Diesel	F1CE3481J Euro 5	2998	4	95.80	104.00	20
Daily V 35C15, 35C15D, 35S15, 40C15,	09/11→02/14	Diesel	F1CE3481L	2998	4	95.80	104.00	20













cm3 x















45C15, 50C15, 60C15, 70C15									
Daily V 35C15 V, 40C15 V	09/11→02/14	Diesel	F1CE3481J Euro 5	2998	4	95.80	104.00	20	
Daily V 35C15 V, 40C15 V	09/11→02/14	Diesel	F1CE3481L	2998	4	95.80	104.00	20	
Daily V 35C15K, 35S15DKP, 50C15K, 60C15K, 65C15DK, 70C15K	09/11→02/14	Diesel	F1CE3481L	2998	4	95.80	104.00	20	
Daily V 35C17, 35C17D, 35S17, 40C17, 45C17, 50C17, 60C17, 70C17	09/11→02/14	Diesel	F1CE3481C	2998	4	95.80	104.00	20	
Daily V 35C17, 35C17D, 35S17, 40C17, 45C17, 50C17, 60C17, 70C17	09/11→02/14	Diesel	F1CE3481K Euro 5	2998	4	95.80	104.00	20	
Daily V 35C17 V, 35S17 V, 40C17 V, 45C17 V, 50C17 V, 60C17 V	09/11→02/14	Diesel	F1CE3481C	2998	4	95.80	104.00	20	
Daily V 35C17 V, 35S17 V, 40C17 V, 45C17 V, 50C17 V, 60C17 V	09/11→02/14	Diesel	F1CE3481K Euro 5	2998	4	95.80	104.00	20	
Daily V 35C17K, 35S17DKP, 50C17K, 65C17DK 70C17K	09/11→02/14	Diesel	F1CE3481C	2998	4	95.80	104.00	20	
Daily V 35C17K, 35S17DKP, 50C17K, 65C17DK 70C17K	09/11→02/14	Diesel	F1CE3481K Euro 5	2998	4	95.80	104.00	20	
Daily V 35C21, 35S21, 40C21, 45C21, 50C21, 60C21, 70C21	09/11→02/14	Diesel	F1CE3481D Euro 5	2998	4	95.80	104.00	20	
Daily V 35C21 V, 35S21 V, 40C21 V, 45C21 V, 50C21 V	09/11→02/14	Diesel	F1CE3481D Euro 5	2998	4	95.80	104.00	20	
Daily V 35 S 14	04/12→02/14	Diesel	F1CE3481L	2998	4	95.80	104.00	20	
Daily V 35S21DKP	09/11→02/14	Diesel	F1CE3481D Euro 5	2998	4	95.80	104.00	20	
Daily VI 3.0 Natural Power 35S14, 35C14, 40C14, 50C14, 65C14, 70C14	03/14→	Petrol	F1CFA401A Euro 6	2998	4	95.80	104.00	21	
Daily VI 3.0 Natural Power 35S14, 35C14, 40C14, 50C14, 65C14, 70C14	03/14→	Gas	F1CFA401B Euro 6	2998	4	95.80	104.00	21	
Daily VI 33S11, 35S11, 35C11	03/14→	Diesel	F1AE3481A Euro 5	2287	4	88.00	94.00	1	
Daily VI 33S11, 35S11, 35C11	03/14→	Diesel	F1AFL411A Euro 5	2287	4	88.00	94.00	1	
Daily VI 33S13, 35S13, 35C13	03/14→	Diesel	F1AE3481B Euro 5	2287	4	88.00	94.00	1	
Daily VI 33S13, 35S13, 35C13	03/14→	Diesel	F1AFL411B Euro 5	2287	4	88.00	94.00	1	
Daily VI 33S15, 35S15, 35C15	03/14→	Diesel	F1AE3481C Euro 5	2287	4	88.00	94.00	1	
Daily VI 33S15, 35S15, 35C15	03/14→	Diesel	F1AFL411C Euro 5	2287	4	88.00	94.00	1	
Daily VI 35S15, 35C15, 40C15, 50C15, 65C15, 70C15	03/14→	Diesel	F1CE3481J Euro 5	2998	4	95.80	104.00	20	
Daily VI 35S15, 35C15, 40C15, 50C15, 65C15, 70C15	03/14→	Diesel	F1CFL411E Euro 6	2998	4	95.80	104.00	21	
Daily VI 35S15, 35C15, 40C15, 50C15, 65C15, 70C15	03/14→	Diesel	F1CFL411J Euro 5	2998	4	95.80	104.00	21	
Daily VI 35S17, 35C17, 40C17, 50C17, 65C17, 70C17	03/14→	Diesel	F1CE3481K Euro 5	2998	4	95.80	104.00	20	
Daily VI 35S17, 35C17, 40C17, 50C17, 65C17, 70C17	03/14→	Diesel	F1CFL411F Euro 6	2998	4	95.80	104.00	21	
Daily VI 35S17, 35C17, 40C17, 50C17, 65C17, 70C17	03/14→	Diesel	F1CFL411H Euro 5	2998	4	95.80	104.00	21	
Daily VI 35S17 HW, 35S17 HWD, 55S17 HW, 55S17 HWD 4x4	08/15→	Diesel	F1CFL411H Euro 5	2998	4	95.80	104.00	21	
Daily VI 35S21, 35C21, 40C21, 50C21, 65C21, 70C21	03/14→	Diesel	F1CE3481D Euro 5	2998	4	95.80	104.00	20	
Daily VI 35S21, 35C21, 40C21, 50C21, 65C21, 70C21	03/14→	Diesel	F1CFL411G Euro 5	2998	4	95.80	104.00	21	
Daily VI Natural Power 35S14, 35C14, 40C14, 50C14, 65C14, 70C14	03/14→	Petrol	F1CFA401A Euro 6	2998	4	95.80	104.00	21	
Daily Line 3.0	06/14→	Diesel	F1CFL411E Euro 6	2998	4	95.80	104.00	21	
Daily Line 3.0	06/14→	Diesel	F1CFL411F Euro 6	2998	4	95.80	104.00	21	
Daily Line 3.0 CNG	06/14→	Petrol	F1CFA401A Euro 6	2998	4	95.80	104.00	21	
Daily Tourys 3.0	06/14→	Diesel	F1CFL411F Euro 6	2998	4	95.80	104.00	21	
Massif 3.0 HPI	10/08→02/11	Diesel	F1CE0481FA Euro 4	2998	4	95.80	104.00	20	
Massif 3.0 HPT	10/08→02/11	Diesel	F1CE0481HA	2998	4	95.80	104.00	20	





		cm3	x 			
203	Diesel	10676	6	125.00	145.00	76
203 A/61	Diesel	11548	6	130.00	145.00	78
203 A/61.000	Diesel	11548	6	130.00	145.00	78
203 H 61	Diesel	11548	6	130.00	145.00	78
310 H/61	Diesel	11548	6	130.00	145.00	78
853A	Diesel	2600	3	100.00	110.00	22
8030.01 (803A)	Diesel	2339	3	95.00	110.00	17
8040.01 (804A)	Diesel	3119	4	95.00	110.00	18
8040.04.200	Diesel	3666	4	103.00	110.00	32
8040.05.200	Diesel	3908	4	104.00	115.00	36
8040.05.203	Diesel	3908	4	104.00	115.00	36
8040.05.230	Diesel	3908	4	104.00	115.00	37
8040.05.232	Diesel	3908	4	104.00	115.00	37
8040.05.233	Diesel	3908	4	104.00	115.00	36
8040.05.235	Diesel	3908	4	104.00	115.00	36
8040.05.4990	Diesel	3908	4	104.00	115.00	36
8040.06	Diesel	3908	4	104.00	115.00	36
8040.25.200	Diesel	3908	4	104.00	115.00	38
8040.25.201	Diesel	3908	4	104.00	115.00	39
8040.25.202	Diesel	3908	4	104.00	115.00	38
8040.25.203	Diesel	3908	4	104.00	115.00	38
8040.25.207	Diesel	3908	4	104.00	115.00	38
8040.25.208	Diesel	3908	4	104.00	115.00	38
8040.25.220	Diesel	3908	4	104.00	115.00	38
8040.25.222	Diesel	3908	4	104.00	115.00	38
8040.25.223	Diesel	3908	4	104.00	115.00	38
8040.25.225	Diesel	3908	4	104.00	115.00	38
8040.25.229	Diesel	3908	4	104.00	115.00	38
8040.25.230 R	Diesel	3908	4	104.00	115.00	38
8040.25.231	Diesel	3908	4	104.00	115.00	38
8040.25.233	Diesel	3908	4	104.00	115.00	38
8040.25.234	Diesel	3908	4	104.00	115.00	38
8040.25B.4200	Diesel	3908	4	104.00	115.00	36
8040.25B.4220	Diesel	3908	4	104.00	115.00	38
8040.25X.4000	Diesel	3908	4	104.00	115.00	40
8040.25X.4010	Diesel	3908	4	104.00	115.00	40
8040.25X.4020	Diesel	3908	4	104.00	115.00	40
8040.25X.4030	Diesel	3908	4	104.00	115.00	40
8040.25X.4035	Diesel	3908	4	104.00	115.00	40
8040.25X.4040	Diesel	3908	4	104.00	115.00	40
8040.25X.4045	Diesel	3908	4	104.00	115.00	40
8040.45	Diesel	3908	4	104.00	115.00	36
8040.45.4000	Diesel	3908	4	104.00	115.00	36
8040.45.4010	Diesel	3908	4	104.00	115.00	36
8040.45.4020	Diesel	3908	4	104.00	115.00	36
8040.45.4030	Diesel	3908	4	104.00	115.00	36
8040.45.4035	Diesel	3908	4	104.00	115.00	36
8040.45.4050	Diesel	3908	4	104.00	115.00	36
8040.45.4180	Diesel	3908	4	104.00	115.00	36
8040.45.4303	Diesel	3908	4	104.00	115.00	36
8040.45.4380	Diesel	3908	4	104.00	115.00	36
8040.45.5200 Euro 2	Diesel	3908	4	104.00	115.00	36
8040.45.5201 Euro 2	Diesel	3908	4	104.00	115.00	36
8040.45.5203 Euro 2	Diesel	3908	4	104.00	115.00	36
8040.45.5205 Euro 2	Diesel	3908	4	104.00	115.00	36
8040.45.5280 Euro 2	Diesel	3908	4	104.00	115.00	36
8040.45.5281 Euro 2	Diesel	3908	4	104.00	115.00	36
8040.45D.5100 Euro 2	Diesel	3908	4	104.00	115.00	36
8040.45D.5101 Euro 2	Diesel	3908	4	104.00	115.00	36
8040.45D.5103 Euro 2	Diesel	3908	4	104.00	115.00	36
8040.45D.5105 Euro 2	Diesel	3908	4	104.00	115.00	36
8040.45X.4180	Diesel	3908	4	104.00	115.00	36
8045.05	Diesel	3908	4	104.00	115.00	41
8045.06	Diesel	3613	4	100.00	115.00	25
8051.05	Diesel	4885	5	104.00	115.00	42
8060.01/.11 (806A)	Diesel	4678	6	95.00	110.00	19
8060.02.001	Diesel	5184	6	100.00	110.00	24
8060.02.003	Diesel	5184	6	100.00	110.00	24
8060.04.051	Diesel	5499	6	103.00	110.00	33

		cm ³	x 			9
8060.04.055	Diesel	5499	6	103.00	110.00	33
8060.04.060	Diesel	5500	6	103.00	110.00	33
8060.04.070	Diesel	5499	6	103.00	110.00	33
8060.04.620	Diesel	5499	6	103.00	110.00	33
8060.04.621	Diesel	5499	6	103.00	110.00	33
8060.04.630	Diesel	5500	6	103.00	110.00	33
8060.04.639	Diesel	5500	6	103.00	110.00	33
8060.04.658	Diesel	5499	6	103.00	110.00	33
8060.04.660	Diesel	5500	6	103.00	110.00	33
8060.04.669	Diesel	5500	6	103.00	110.00	33
8060.04.670	Diesel	5500	6	103.00	110.00	33
8060.04.672	Diesel	5500	6	103.00	110.00	33
8060.04.675	Diesel	5500	6	103.00	110.00	33
8060.04.689	Diesel	5500	6	103.00	110.00	33
8060.05.000	Diesel	5861	6	104.00	115.00	43
8060.05.200	Diesel	5861	6	104.00	115.00	43
8060.05.201	Diesel	5861	6	104.00	115.00	43
8060.05.203	Diesel	5861	6	104.00	115.00	43
8060.05.246	Diesel	5861	6	104.00	115.00	43
8060.05.270	Diesel	5861	6	104.00	115.00	43
8060.05.280	Diesel	5861	6	104.00	115.00	43
8060.05.284	Diesel	5861	6	104.00	115.00	43
8060.05.285	Diesel	5861	6	104.00	115.00	43
8060.05.286	Diesel	5861	6	104.00	115.00	43
8060.05.288	Diesel	5861	6	104.00	115.00	43
8060.05.289	Diesel	5861	6	104.00	115.00	43
8060.06	Diesel	5858	6	104.00	115.00	43
8060.24.601	Diesel	5500	6	103.00	110.00	34
8060.24.670	Diesel	5499	6	103.00	110.00	34
8060.24.671	Diesel	5499	6	103.00	110.00	34
8060.24.678	Diesel	5500	6	103.00	110.00	34
8060.25.600	Diesel	5861	6	104.00	115.00	43
8060.25.601	Diesel	5861	6	104.00	115.00	43
8060.25.602	Diesel	5861	6	104.00	115.00	43
8060.25.603	Diesel	5861	6	104.00	115.00	43
8060.25.604	Diesel	5861	6	104.00	115.00	43
8060.25.669	Diesel	5861	6	104.00	115.00	43
8060.25.670	Diesel	5861	6	104.00	115.00	43
8060.25.678	Diesel	5861	6	104.00	115.00	43
8060.25.679	Diesel	5861	6	104.00	115.00	43
8060.25R.4200 Euro 1	Diesel	5861	6	104.00	115.00	43
8060.25R.4200 LTC	Diesel	5861	6	104.00	115.00	43
8060.25R.4210 Euro 1	Diesel	5861	6	104.00	115.00	43
8060.25R.4220 Euro 1	Diesel	5861	6	104.00	115.00	43
8060.25R.4225 Euro 1	Diesel	5861	6	104.00	115.00	43
8060.25R.4230 Euro 1	Diesel	5861	6	104.00	115.00	43
8060.25R.4240 Euro 1	Diesel	5861	6	104.00	115.00	43
8060.25R.4250 Euro 1	Diesel	5861	6	104.00	115.00	43
8060.25R.4280	Diesel	5861	6	104.00	115.00	43
8060.25R.4285 Euro 1	Diesel	5861	6	104.00	115.00	43
8060.25R.4290 Euro 1	Diesel	5861	6	104.00	115.00	43
8060.25R.4295 Euro 1	Diesel	5861	6	104.00	115.00	43
8060.25R.4300	Diesel	5861	6	104.00	115.00	43
8060.25R.4360 Euro 1	Diesel	5861	6	104.00	115.00	43
8060.25R.4362 Euro 1	Diesel	5861	6	104.00	115.00	43
8060.25R.4750	Diesel	5861	6	104.00	115.00	43
8060.25R.4755	Diesel	5861	6	104.00	115.00	43
8060.25R.4760	Diesel	5861	6	104.00	115.00	43
8060.25R.4764	Diesel	5861	6	104.00	115.00	43
8060.25R.4960 Euro 1	Diesel	5861	6	104.00	115.00	43
8060.25R.4967 Euro 1	Diesel	5861	6	104.00	115.00	43
8060.25R.4968 Euro 1	Diesel	5861	6	104.00	115.00	43
8060.25R.4970 Euro 1	Diesel	5861	6	104.00	115.00	43
8060.25R.4973 Euro 1	Diesel	5861	6	104.00	115.00	43
8060.25R.4980 Euro 1	Diesel	5861	6	104.00	115.00	43
8060.25V.4000 Euro 1	Diesel	5861	6	104.00	115.00	43
8060.25V.4010 Euro 1	Diesel	5861	6	104.00	115.00	43
8060.25V.4020 Euro 1	Diesel	5861	6	104.00	115.00	43
8060.25V.4025 Euro 1	Diesel	5861	6	104.00	115.00	43







		cm3	x 			
8060.25V.4030 Euro 1	Diesel	5861	6	104.00	115.00	43
8060.25V.4040 Euro 1	Diesel	5861	6	104.00	115.00	43
8060.25V.4050 Euro 1	Diesel	5861	6	104.00	115.00	43
8060.25V.4060 Euro 1	Diesel	5861	6	104.00	115.00	43
8060.25V.4080	Diesel	5861	6	104.00	115.00	43
8060.25V.4090 Euro 1	Diesel	5861	6	104.00	115.00	43
8060.25V.4100 Euro 1	Diesel	5861	6	104.00	115.00	43
8060.25V.4105 Euro 1	Diesel	5861	6	104.00	115.00	43
8060.25V.4110 Euro 1	Diesel	5861	6	104.00	115.00	43
8060.25V.4160 Euro 1	Diesel	5861	6	104.00	115.00	43
8060.25V.4165 Euro 1	Diesel	5861	6	104.00	115.00	43
8060.25V.4170 Euro 1	Diesel	5861	6	104.00	115.00	43
8060.25V.4175 Euro 1	Diesel	5861	6	104.00	115.00	43
8060.25V.4720 Euro 1	Diesel	5861	6	104.00	115.00	43
8060.25V.4722 Euro 1	Diesel	5861	6	104.00	115.00	43
8060.25V.4724 Euro 1	Diesel	5861	6	104.00	115.00	43
8060.25V.4725 Euro 1	Diesel	5861	6	104.00	115.00	43
8060.25V.4800	Diesel	5861	6	104.00	115.00	43
8060.25V.4900 Euro 1	Diesel	5861	6	104.00	115.00	43
8060.25V.4920 Euro 1	Diesel	5861	6	104.00	115.00	43
8060.25V.4925 Euro 1	Diesel	5861	6	104.00	115.00	43
8060.25V.4950 Euro 1	Diesel	5861	6	104.00	115.00	43
8060.25V.4952 Euro 1	Diesel	5861	6	104.00	115.00	43
8060.25V.4953 Euro 1	Diesel	5861	6	104.00	115.00	43
8060.45.4100 Euro 1	Diesel	5861	6	104.00	115.00	43
8060.45.4100 TCA Euro 1	Diesel	5861	6	104.00	115.00	44
8060.45.4110 Euro 1	Diesel	5861	6	104.00	115.00	44
8060.45.4120 Euro 1	Diesel	5861	6	104.00	115.00	44
8060.45.4130 Euro 1	Diesel	5861	6	104.00	115.00	44
8060.45.4150 Euro 1	Diesel	5861	6	104.00	115.00	44
8060.45.4180 Euro 1	Diesel	5861	6	104.00	115.00	43
8060.45.4403 Euro 1	Diesel	5861	6	104.00	115.00	44
8060.45.4700	Diesel	5861	6	104.00	115.00	43
8060.45.4702 Euro 1	Diesel	5861	6	104.00	115.00	45
8060.45.4704 Euro 1	Diesel	5861	6	104.00	115.00	45
8060.45.4706 Euro 1	Diesel	5861	6	104.00	115.00	45
8060.45.4708	Diesel	5861	6	104.00	115.00	45
8060.45.5200 Euro 2	Diesel	5861	6	104.00	115.00	44
8060.45.5201 Euro 2	Diesel	5861	6	104.00	115.00	44
8060.45.5203 Euro 2	Diesel	5861	6	104.00	115.00	44
8060.45.5205 Euro 2	Diesel	5861	6	104.00	115.00	44
8060.45.5210 Euro 2	Diesel	5861	6	104.00	115.00	44
8060.45.5211 Euro 2	Diesel	5861	6	104.00	115.00	44
8060.45.5220 Euro 2	Diesel	5861	6	104.00	115.00	44
8060.45.5221 Euro 2	Diesel	5861	6	104.00	115.00	44
8060.45.5223 Euro 2	Diesel	5861	6	104.00	115.00	44
8060.45.5232 Euro 2	Diesel	5861	6	104.00	115.00	44
8060.45.5233 Euro 2	Diesel	5861	6	104.00	115.00	44
8060.45.5234 Euro 2	Diesel	5861	6	104.00	115.00	44
8060.45.5235 Euro 2	Diesel	5861	6	104.00	115.00	44
8060.45.5250 Euro 2	Diesel	5861	6	104.00	115.00	45
8060.45.5251	Diesel	5861	6	104.00	115.00	45
8060.45.5255	Diesel	5861	6	104.00	115.00	45
8060.45.6090	Diesel	5861	6	104.00	115.00	43
8060.45A.4100	Diesel	5861	6	104.00	115.00	45
8060.45B.4385 Euro 2	Diesel	5861	6	104.00	115.00	44
8060.45B.4386 Euro 2	Diesel	5861	6	104.00	115.00	44
8060.45B.5100 Euro 2	Diesel	5861	6	104.00	115.00	44
8060.45B.5101 Euro 2	Diesel	5861	6	104.00	115.00	44
8060.45B.5103 Euro 2	Diesel	5861	6	104.00	115.00	44
8060.45B.5105 Euro 2	Diesel	5861	6	104.00	115.00	44
8060.45B.5110 Euro 2	Diesel	5861	6	104.00	115.00	44
8060.45B.5111 Euro 2	Diesel	5861	6	104.00	115.00	44
8060.45B.5112 Euro 2	Diesel	5861	6	104.00	115.00	44
8060.45B.5113 Euro 2	Diesel	5861	6	104.00	115.00	44
8060.45B.5120 Euro 2	Diesel	5861	6	104.00	115.00	44
8060.45B.5121 Euro 2	Diesel	5861	6	104.00	115.00	44
8060.45B.5123 Euro 2	Diesel	5861	6	104.00	115.00	44
8060.45B.5124 Euro 2	Diesel	5861	6	104.00	115.00	44







		cm ³	x 			
8060.45B.5145 Euro 2	Diesel	5861	6	104.00	115.00	44
8060.45B.5146 Euro 2	Diesel	5861	6	104.00	115.00	44
8060.45B.5150 Euro 2	Diesel	5861	6	104.00	115.00	44
8060.45B.5151 Euro 2	Diesel	5861	6	104.00	115.00	44
8060.45B.5153 Euro 2	Diesel	5861	6	104.00	115.00	44
8060.45B.5155 Euro 2	Diesel	5861	6	104.00	115.00	44
8060.45B.5185 Euro 2	Diesel	5861	6	104.00	115.00	44
8060.45B.5186 Euro 2	Diesel	5861	6	104.00	115.00	44
8060.45B Euro 2	Diesel	5861	6	104.00	115.00	43
8060.45 Euro 1	Diesel	5861	6	104.00	115.00	43
8060.45K.6090 Euro 1	Diesel	5861	6	104.00	115.00	43
8060.45L.4485 Euro 2	Diesel	5861	6	104.00	115.00	44
8060.45L.4486 Euro 2	Diesel	5861	6	104.00	115.00	44
8060.45L Euro 2	Diesel	5861	6	104.00	115.00	43
8060.45M.7281 Euro 2	Diesel	5861	6	104.00	115.00	44
8060.45M.7285 Euro 2	Diesel	5861	6	104.00	115.00	44
8060.45M.7286 Euro 2	Diesel	5861	6	104.00	115.00	44
8060.45M Euro 2	Diesel	5861	6	104.00	115.00	43
8060.45R.4245 Euro 2	Diesel	5861	6	104.00	115.00	44
8060.45R.5000 Euro 2	Diesel	5861	6	104.00	115.00	43
8060.45R.5001 Euro 2	Diesel	5861	6	104.00	115.00	43
8060.45R.5003 Euro 2	Diesel	5861	6	104.00	115.00	43
8060.45R.5005 Euro 2	Diesel	5861	6	104.00	115.00	43
8060.45R.5010 Euro 2	Diesel	5861	6	104.00	115.00	44
8060.45R.5011 Euro 2	Diesel	5861	6	104.00	115.00	44
8060.45R.5013 Euro 2	Diesel	5861	6	104.00	115.00	44
8060.45R.5015 Euro 2	Diesel	5861	6	104.00	115.00	44
8060.45R.5050	Diesel	5861	6	104.00	115.00	43
8060.45R.5051	Diesel	5861	6	104.00	115.00	43
8060.45S.6000 Euro 1	Diesel	5861	6	104.00	115.00	44
8060.45S.6010 Euro 1	Diesel	5861	6	104.00	115.00	44
8060.45S.6020 Euro 1	Diesel	5861	6	104.00	115.00	44
8060.45S.6030 Euro 1	Diesel	5861	6	104.00	115.00	44
8060.45S.6040 Euro 1	Diesel	5861	6	104.00	115.00	44
8060.45S.6045 Euro 1	Diesel	5861	6	104.00	115.00	44
8060.45S.6052 Euro 1	Diesel	5861	6	104.00	115.00	44
8060.45S.6110 Euro 1	Diesel	5861	6	104.00	115.00	44
8060.45S.6120 Euro 1	Diesel	5861	6	104.00	115.00	44
8060.45S.6130 Euro 1	Diesel	5861	6	104.00	115.00	44
8060.45S.6140 Euro 1	Diesel	5861	6	104.00	115.00	44
8060.45S.6150 Euro 1	Diesel	5861	6	104.00	115.00	44
8060.45S.6203 Euro 1	Diesel	5861	6	104.00	115.00	44
8060.45S.6700 Euro 1	Diesel	5861	6	104.00	115.00	44
8060.45S.6705 Euro 1	Diesel	5861	6	104.00	115.00	44
8060.45S.6706 Euro 1	Diesel	5861	6	104.00	115.00	44
8060.45S.6707 Euro 1	Diesel	5861	6	104.00	115.00	44
8060.45S.6710 Euro 1	Diesel	5861	6	104.00	115.00	44
8060.45S.6711 Euro 1	Diesel	5861	6	104.00	115.00	44
8060.45S.6800 Euro 1	Diesel	5861	6	104.00	115.00	44
8060.45S.6912 Euro 1	Diesel	5861	6	104.00	115.00	44
8060.45S.7200 Euro 2	Diesel	5861	6	104.00	115.00	44
8060.45S.7201 Euro 2	Diesel	5861	6	104.00	115.00	44
8060.45S.7203 Euro 2	Diesel	5861	6	104.00	115.00	44
8060.45S.7205 Euro 2	Diesel	5861	6	104.00	115.00	44
8060.45S.7210 Euro 2	Diesel	5861	6	104.00	115.00	44
8060.45S.7211 Euro 2	Diesel	5861	6	104.00	115.00	44
8060.45S.7213 Euro 2	Diesel	5861	6	104.00	115.00	44
8060.45S.7215 Euro 2	Diesel	5861	6	104.00	115.00	44
8060.45S.7250 Euro 2	Diesel	5861	6	104.00	115.00	44
8060.45S.7251 Euro 2	Diesel	5861	6	104.00	115.00	44
8060.45S.7253 Euro 2	Diesel	5861	6	104.00	115.00	44
8060.45S.7255 Euro 2	Diesel	5861	6	104.00	115.00	44
8060.45S TCA	Diesel	5861	6	104.00	115.00	44
8060.45X.4180 Euro 2	Diesel	5861	6	104.00	115.00	44
8061.04	Diesel	5499	6	103.00	110.00	35
8061.05	Diesel	5861	6	104.00	115.00	46
8061.25	Diesel	5868	6	104.00	115.00	44
8062.24.070	Diesel	5499	6	103.00	110.00	34
8140.07.2585 Euro 1	Diesel	2500	4	93.00	92.00	6







		cm3	x 			
8140.07.2700	Diesel	2499	4	93.00	92.00	6
8140.07.2701	Diesel	2499	4	93.00	92.00	6
8140.07.2710	Diesel	2499	4	93.00	92.00	6
8140.07.2711	Diesel	2499	4	93.00	92.00	6
8140.07.2712	Diesel	2499	4	93.00	92.00	7
8140.07.2713	Diesel	2499	4	93.00	92.00	6
8140.07.3700 Euro 1	Diesel	2499	4	93.00	92.00	6
8140.07.3710 Euro 1	Diesel	2499	4	93.00	92.00	6
8140.07.3711 Euro 1	Diesel	2499	4	93.00	92.00	6
8140.07.3712 Euro 1	Diesel	2499	4	93.00	92.00	6
8140.07.3713 Euro 1	Diesel	2499	4	93.00	92.00	6
8140.21.200	Diesel	2445	4	93.00	90.00	2
8140.21.201	Diesel	2445	4	93.00	90.00	3
8140.21.202	Diesel	2445	4	93.00	90.00	3
8140.21.203	Diesel	2445	4	93.00	90.00	3
8140.21.212	Diesel	2445	4	93.00	90.00	3
8140.21.214	Diesel	2445	4	93.00	90.00	4
8140.21.290	Diesel	2445	4	93.00	90.00	3
8140.23.	Diesel	2798	4	94.40	100.00	16
8140.23.2585 Euro 2	Diesel	2799	4	94.40	100.00	16
8140.23.3700 Euro 2	Diesel	2798	4	94.40	100.00	16
8140.23.3701 Euro 2	Diesel	2798	4	94.40	100.00	16
8140.23.3710 Euro 2	Diesel	2798	4	94.40	100.00	16
8140.23.3711 Euro 2	Diesel	2798	4	94.40	100.00	16
8140.23.3713 Euro 2	Diesel	2798	4	94.40	100.00	16
8140.23.3720 Euro 2	Diesel	2798	4	94.40	100.00	16
8140.23.3721 Euro 2	Diesel	2798	4	94.40	100.00	16
8140.23.3730 Euro 2	Diesel	2798	4	94.40	100.00	16
8140.23.3731 Euro 2	Diesel	2798	4	94.40	100.00	16
8140.23.3750 Euro 2	Diesel	2798	4	94.40	100.00	16
8140.23.3751 Euro 2	Diesel	2798	4	94.40	100.00	16
8140.23.3760 Euro 2	Diesel	2798	4	94.40	100.00	16
8140.23.3801 Euro 2	Diesel	2798	4	94.40	100.00	16
8140.23.3811 Euro 2	Diesel	2798	4	94.40	100.00	16
8140.23.3821 Euro 2	Diesel	2798	4	94.40	100.00	16
8140.27.215	Diesel	2499	4	93.00	92.00	6
8140.27.218	Diesel	2499	4	93.00	92.00	8
8140.27.2582	Diesel	2499	4	93.00	92.00	9
8140.27.2700	Diesel	2499	4	93.00	92.00	10
8140.27.2720	Diesel	2499	4	93.00	92.00	11
8140.27R.2700	Diesel	2499	4	93.00	92.00	6
8140.27R.2780	Diesel	2499	4	93.00	92.00	6
8140.27R.2786	Diesel	2499	4	93.00	92.00	6
8140.27R.2787	Diesel	2499	4	93.00	92.00	6
8140.27 S	Diesel	2445	4	93.00	90.00	5
8140.27S.2700	Diesel	2499	4	93.00	92.00	6
8140.27S.2701	Diesel	2499	4	93.00	92.00	6
8140.27S.2710	Diesel	2499	4	93.00	92.00	6
8140.27S.2711	Diesel	2499	4	93.00	92.00	6
8140.27S.2720	Diesel	2499	4	93.00	92.00	6
8140.27S.2721	Diesel	2499	4	93.00	92.00	6
8140.27S.2730	Diesel	2499	4	93.00	92.00	6
8140.27S.2731	Diesel	2499	4	93.00	92.00	6
8140.27S.2750	Diesel	2499	4	93.00	92.00	6
8140.27S.2751	Diesel	2499	4	93.00	92.00	6
8140.27S.2760	Diesel	2499	4	93.00	92.00	6
8140.27S.2761	Diesel	2499	4	93.00	92.00	6
8140.27S.2770	Diesel	2499	4	93.00	92.00	6
8140.27S.2771	Diesel	2499	4	93.00	92.00	6
8140.27S.2801	Diesel	2499	4	93.00	92.00	6
8140.27S.2811	Diesel	2499	4	93.00	92.00	6
8140.27S.2885	Diesel	2499	4	93.00	92.00	6
8140.27S.3700	Diesel	2499	4	93.00	92.00	6
8140.27S.3701	Diesel	2499	4	93.00	92.00	6
8140.27S.3711	Diesel	2499	4	93.00	92.00	6
8140.27S.3720	Diesel	2499	4	93.00	92.00	6
8140.27S.3721	Diesel	2499	4	93.00	92.00	6
8140.27S.3750	Diesel	2499	4	93.00	92.00	6
8140.27S.3751	Diesel	2499	4	93.00	92.00	6

		cm ³	x 			9
--	---	-----------------	---	---	---	----------

8140.27S.3760	Diesel	2499	4	93.00	92.00	6
8140.27S.3761	Diesel	2499	4	93.00	92.00	6
8140.27S.3770	Diesel	2499	4	93.00	92.00	6
8140.27S.3771	Diesel	2499	4	93.00	92.00	6
8140.27S.3780	Diesel	2499	4	93.00	92.00	6
8140.27S.3781	Diesel	2499	4	93.00	92.00	6
8140.27S.3811	Diesel	2499	4	93.00	92.00	6
8140.43.2585 Euro 2	Diesel	2798	4	94.40	100.00	16
8140.43.3700 Euro 2	Diesel	2798	4	94.40	100.00	16
8140.43.3711 Euro 2	Diesel	2798	4	94.40	100.00	16
8140.43.3713 Euro 2	Diesel	2798	4	94.40	100.00	16
8140.43.3718 Euro 2	Diesel	2798	4	94.40	100.00	16
8140.43.3721 Euro 2	Diesel	2798	4	94.40	100.00	16
8140.43.3723 Euro 2	Diesel	2798	4	94.40	100.00	16
8140.43.3728 Euro 2	Diesel	2798	4	94.40	100.00	16
8140.43.3731 Euro 2	Diesel	2798	4	94.40	100.00	16
8140.43.3900 Euro 2	Diesel	2798	4	94.40	100.00	16
8140.43.3911 Euro 2	Diesel	2798	4	94.40	100.00	16
8140.43.3921 Euro 2	Diesel	2798	4	94.40	100.00	16
8140.43.3931 Euro 2	Diesel	2798	4	94.40	100.00	16
8140.43. Euro 2	Diesel	2798	4	94.40	100.00	16
8140.43.K	Diesel	2798	4	94.40	100.00	16
8140.43B.4300 Euro 3	Diesel	2798	4	94.40	100.00	16
8140.43B.4305 Euro 3	Diesel	2798	4	94.40	100.00	16
8140.43B.4320 Euro 3	Diesel	2798	4	94.40	100.00	16
8140.43B.4325 Euro 3	Diesel	2798	4	94.40	100.00	16
8140.43B.4330 Euro 3	Diesel	2798	4	94.40	100.00	16
8140.43B.4335 Euro 3	Diesel	2798	4	94.40	100.00	16
8140.43B Euro 3	Diesel	2798	4	94.40	100.00	16
8140.43C.4000 Euro 3	Diesel	2798	4	94.40	100.00	16
8140.43C.4005 Euro 3	Diesel	2798	4	94.40	100.00	16
8140.43C.4020 Euro 3	Diesel	2798	4	94.40	100.00	16
8140.43C.4021 Euro 3	Diesel	2798	4	94.40	100.00	16
8140.43C.4025 Euro 3	Diesel	2798	4	94.40	100.00	16
8140.43C.4026 Euro 3	Diesel	2798	4	94.40	100.00	16
8140.43C.4030 Euro 3	Diesel	2798	4	94.40	100.00	16
8140.43C.4031 Euro 3	Diesel	2798	4	94.40	100.00	16
8140.43C.4035 Euro 3	Diesel	2798	4	94.40	100.00	16
8140.43C.4036 Euro 3	Diesel	2798	4	94.40	100.00	16
8140.43C Euro 2	Diesel	2798	4	94.40	100.00	16
8140.43K.4020 Euro 3	Diesel	2798	4	94.40	100.00	16
8140.43K.4030 Euro 3	Diesel	2798	4	94.40	100.00	16
8140.43N.4300 Euro 3	Diesel	2798	4	94.40	100.00	16
8140.43N.4320 Euro 3	Diesel	2798	4	94.40	100.00	16
8140.43N.4330 Euro 3	Diesel	2798	4	94.40	100.00	16
8140.43N.4400 Euro 3	Diesel	2798	4	94.40	100.00	16
8140.43N.4430 Euro 3	Diesel	2798	4	94.40	100.00	16
8140.43N Euro 3	Diesel	2798	4	94.40	100.00	16
8140.43R.4300 Euro 3	Diesel	2798	4	94.40	100.00	16
8140.43R.4320 Euro 3	Diesel	2798	4	94.40	100.00	16
8140.43R.4330 Euro 3	Diesel	2798	4	94.40	100.00	16
8140.43R.4400 Euro 3	Diesel	2798	4	94.40	100.00	16
8140.43R.4420 Euro 3	Diesel	2798	4	94.40	100.00	16
8140.43R.4430 Euro 3	Diesel	2798	4	94.40	100.00	16
8140.43R Euro 3	Diesel	2798	4	94.40	100.00	16
8140.43S.4000 Euro 3	Diesel	2798	4	94.40	100.00	16
8140.43S.4020 Euro 3	Diesel	2798	4	94.40	100.00	16
8140.43S.4030 Euro 3	Diesel	2798	4	94.40	100.00	16
8140.43S.4140 Euro 3	Diesel	2798	4	94.40	100.00	16
8140.43S.4300 Euro 3	Diesel	2798	4	94.40	100.00	16
8140.43S.4320 Euro 3	Diesel	2798	4	94.40	100.00	16
8140.43S.4330 Euro 3	Diesel	2798	4	94.40	100.00	16
8140.43S.4400 Euro 3	Diesel	2798	4	94.40	100.00	16
8140.43S.4420 Euro 3	Diesel	2798	4	94.40	100.00	16
8140.43S.4430 Euro 3	Diesel	2798	4	94.40	100.00	16
8140.43S Euro 3	Diesel	2798	4	94.40	100.00	16
8140.47.2700 Euro 1	Diesel	2499	4	93.00	92.00	10
8140.47.2711 Euro 1	Diesel	2499	4	93.00	92.00	11
8140.47.2721 Euro 1	Diesel	2499	4	93.00	92.00	10







		cm3	x 			
8140.47.2785 Euro 1	Diesel	2499	4	93.00	92.00	10
8140.47.3700 Euro 1	Diesel	2499	4	93.00	92.00	12
8140.47.3711 Euro 1	Diesel	2499	4	93.00	92.00	12
8140.47.3721 Euro 1	Diesel	2499	4	93.00	92.00	12
8140.47.3731 Euro 1	Diesel	2499	4	93.00	92.00	12
8140.47B.3790 Euro 1	Diesel	2499	4	93.00	92.00	12
8140.47B.3795 Euro 1	Diesel	2499	4	93.00	92.00	12
8140.47R	Diesel	2499	4	93.00	92.00	6
8140.47R.2790	Diesel	2499	4	93.00	92.00	11
8140.47R.2795	Diesel	2499	4	93.00	92.00	12
8140.47S Euro 1	Diesel	2499	4	93.00	92.00	6
8140.61.200	Diesel	2445	4	93.00	90.00	5
8140.61.300	Diesel	2445	4	93.00	90.00	4
8140.63.4000 Euro 3	Diesel	2798	4	94.40	100.00	16
8140.63. Euro 2	Diesel	2798	4	94.40	100.00	16
8140.67.2585 Euro 2	Diesel	2500	4	93.00	92.00	13
8140.67F.3701 Euro 2	Diesel	2499	4	93.00	92.00	12
8140.67F.3710 Euro 2	Diesel	2499	4	93.00	92.00	12
8140.67F.3711 Euro 2	Diesel	2499	4	93.00	92.00	12
8140.67F.3713 Euro 2	Diesel	2499	4	93.00	92.00	12
8140.67F.3721 Euro 2	Diesel	2499	4	93.00	92.00	12
8140.67F. Euro 2	Diesel	2499	4	93.00	92.00	14
8140.97.2781	Diesel	2499	4	93.00	92.00	6
8144.61.200	Diesel	2445	4	93.00	90.00	4
8149.03	Gas	2798	4	94.40	100.00	16
8149.03.3971	Diesel	1995	4	94.00	100.00	15
8210.02	Diesel	13800	6	137.00	156.00	80
8210.02.	Diesel	13800	6	137.00	156.00	80
8210.02.067	Diesel	13798	6	137.00	156.00	80
8210.02.069	Diesel	13798	6	137.00	156.00	80
8210.02.371	Diesel	13798	6	137.00	156.00	80
8210.02.373	Diesel	13798	6	137.00	156.00	80
8210.02.377	Diesel	13798	6	137.00	156.00	80
8210.02.393	Diesel	13798	6	137.00	156.00	80
8210.02.440	Diesel	13798	6	137.00	156.00	80
8210.02.441	Diesel	13798	6	137.00	156.00	80
8210.02.731	Diesel	13798	6	137.00	156.00	80
8210.12.000	Diesel	13798	6	137.00	156.00	80
8210.22.105	Diesel	13798	6	137.00	156.00	81
8210.22.171	Diesel	13798	6	137.00	156.00	81
8210.22.175	Diesel	13798	6	137.00	156.00	81
8210.22.183	Diesel	13798	6	137.00	156.00	81
8210.22.210	Diesel	13798	6	137.00	156.00	81
8210.22.236	Diesel	13798	6	137.00	156.00	81
8210.22.269	Diesel	13798	6	137.00	156.00	81
8210.22.317	Diesel	13798	6	137.00	156.00	81
8210.22.327	Diesel	13798	6	137.00	156.00	81
8210.22.385	Diesel	13798	6	137.00	156.00	81
8210.22.511	Diesel	13798	6	137.00	156.00	81
8210.22.521	Diesel	13798	6	137.00	156.00	81
8210.22.523	Diesel	13798	6	137.00	156.00	81
8210.22.525	Diesel	13798	6	137.00	156.00	81
8210.22.535	Diesel	13798	6	137.00	156.00	81
8210.22.537	Diesel	13798	6	137.00	156.00	80
8210.22.569	Diesel	13798	6	137.00	156.00	81
8210.22.869	Diesel	13798	6	137.00	156.00	81
8210.22X.069	Diesel	13798	6	137.00	156.00	81
8210.22X.235	Diesel	13798	6	137.00	156.00	81
8210.22X.523	Diesel	13798	6	137.00	156.00	81
8210.22X.575	Diesel	13798	6	137.00	156.00	81
8210.42.	Diesel	13798	6	137.00	156.00	81
8210.42.061	Diesel	13798	6	137.00	156.00	81
8210.42.073	Diesel	13798	6	137.00	156.00	81
8210.42.101	Diesel	13798	6	137.00	156.00	81
8210.42.115	Diesel	13798	6	137.00	156.00	81
8210.42.151	Diesel	13798	6	137.00	156.00	81
8210.42.152	Diesel	13798	6	137.00	156.00	81
8210.42.154	Diesel	13798	6	137.00	156.00	81
8210.42.155	Diesel	13798	6	137.00	156.00	81

		cm ³	x 			
8210.42.161	Diesel	13798	6	137.00	156.00	81
8210.42.162	Diesel	13798	6	137.00	156.00	81
8210.42.165	Diesel	13798	6	137.00	156.00	81
8210.42.171	Diesel	13798	6	137.00	156.00	81
8210.42.172	Diesel	13798	6	137.00	156.00	81
8210.42.175	Diesel	13798	6	137.00	156.00	81
8210.42.181	Diesel	13798	6	137.00	156.00	81
8210.42.182	Diesel	13798	6	137.00	156.00	81
8210.42.185	Diesel	13798	6	137.00	156.00	81
8210.42.186	Diesel	13798	6	137.00	156.00	81
8210.42.191	Diesel	13798	6	137.00	156.00	81
8210.42.195	Diesel	13798	6	137.00	156.00	81
8210.42.210	Diesel	13798	6	137.00	156.00	81
8210.42.235	Diesel	13798	6	137.00	156.00	81
8210.42.237	Diesel	13798	6	137.00	156.00	81
8210.42.269	Diesel	13798	6	137.00	156.00	81
8210.42.270	Diesel	13798	6	137.00	156.00	81
8210.42.271	Diesel	13798	6	137.00	156.00	81
8210.42.500 Euro 2	Diesel	13798	6	137.00	156.00	81
8210.42K(TCA) Euro 1	Diesel	13798	6	137.00	156.00	81
8210.42K.(TCA)	Diesel	13798	6	137.00	156.00	81
8210.42K. Euro 2	Diesel	13798	6	137.00	156.00	81
8210.42L(TCA) Euro 2	Diesel	13798	6	137.00	156.00	81
8210.42L.400 Euro 1	Diesel	13798	6	137.00	156.00	81
8210.42L. Euro 2	Diesel	13798	6	137.00	156.00	81
8210.42M	Diesel	13798	6	137.00	156.00	81
8210.42M. TCA Euro 2	Diesel	13798	6	137.00	156.00	81
8210.42 TCA	Diesel	13798	6	137.00	156.00	81
8211.22	Diesel	13798	6	137.00	156.00	81
8215.02	Diesel	13798	6	137.00	156.00	81
8215.22.520	Diesel	13798	6	137.00	156.00	81
8217.32	Diesel	13798	6	137.00	156.00	81
8220.02.870	Diesel	9572	6	125.00	130.00	71
8220.22.002	Diesel	9572	6	125.00	130.00	71
8220.22.102	Diesel	9572	6	125.00	130.00	71
8261.02.002	Diesel	12880	6	145.00	130.00	82
8280.02.109	Diesel	17174	V8	145.00	130.00	83
8280.02.269	Diesel	17174	V8	145.00	130.00	83
8280.22.000	Diesel	17174	V8	145.00	130.00	83
8280.22.007	Diesel	17174	V8	145.00	130.00	83
8280.22.009	Diesel	17200	V8	145.00	130.00	83
8280.22.033	Diesel	17174	V8	145.00	130.00	83
8280.22.054	Diesel	17174	V8	145.00	130.00	83
8280.22.154	Diesel	17174	V8	145.00	130.00	83
8280.22.201	Diesel	17174	V8	145.00	130.00	83
8280.22.205	Diesel	17174	V8	145.00	130.00	83
8280.42.001	Diesel	17174	V8	145.00	130.00	84
8280.42.050	Diesel	17174	V8	145.00	130.00	84
8280.42B Euro 2	Diesel	17173	V8	145.00	130.00	84
8280.42S.342 Euro 2	Diesel	17174	V8	145.00	130.00	84
8280.42S.350 Euro 2	Diesel	17174	V8	145.00	130.00	84
8280.42S.352 Euro 2	Diesel	17174	V8	145.00	130.00	84
8280.42S.362 Euro 2	Diesel	17174	V8	145.00	130.00	84
8280.42S. TCA	Diesel	17173	V8	145.00	130.00	84
8281.02	Diesel	17174	8	145.00	130.00	83
8281SRi27	Diesel	17174	8	145.00	130.00	85
8281SRM50	Diesel	17174	8	145.00	130.00	84
8285.02	Diesel	17174	8	145.00	130.00	83
8285.22	Diesel	17174	8	145.00	130.00	83
8340.04.000	Diesel	4570	4	115.00	110.00	53
8340.04.040	Diesel	4570	4	115.00	110.00	54
8340.04.200	Diesel	4570	4	115.00	110.00	54
8340.04.250	Diesel	4570	4	115.00	110.00	54
8340.04.250	Diesel	4570	4	115.00	110.00	54
8340.04.300	Diesel	4570	4	115.00	110.00	54
8340.04.350	Diesel	4570	4	115.00	110.00	54
8340.04.352	Diesel	4570	4	115.00	110.00	54
8340.04.362	Diesel	4570	4	115.00	110.00	54
8340.04.362	Diesel	4570	4	115.00	110.00	54

		cm3	x 			
8340.05.200	Diesel	5401	4	115.00	130.00	57
8360.03	Diesel	8102	6	115.00	130.00	59
8360.05	Diesel	8100	6	115.00	130.00	60
8360.05.254	Diesel	8102	6	115.00	130.00	61
8360.46	Diesel	7685	6	112.00	130.00	52
8361.04	Diesel	6850	6	115.00	110.00	55
8361.05	Diesel	8102	6	115.00	130.00	62
8361.25	Diesel	8101	6	115.00	130.00	62
8361.45	Diesel	8101	6	115.00	130.00	62
8361Si10, 8361Si11, 8361Si12	Diesel	8100	6	115.00	130.00	63
8365.05.500	Diesel	8102	6	115.00	130.00	60
8365.05.590	Diesel	8102	6	115.00	130.00	60
8365.25.500	Diesel	8102	6	115.00	130.00	60
8365.25.501	Diesel	8102	6	115.00	130.00	62
8365.25.502	Diesel	8102	6	115.00	130.00	62
8365.25.503	Diesel	8102	6	115.00	130.00	62
8365.25.533	Diesel	8102	6	115.00	130.00	62
8460.21.002	Diesel	9500	6	120.00	140.00	66
8460.21.002	Diesel	9500	6	120.00	140.00	66
8460.21.010	Diesel	9500	6	120.00	140.00	66
8460.21.010	Diesel	9500	6	120.00	140.00	66
8460.21.102	Diesel	9500	6	120.00	140.00	66
8460.21.102	Diesel	9500	6	120.00	140.00	66
8460.21.202	Diesel	9498	6	120.00	140.00	66
8460.21.202	Diesel	9500	6	120.00	140.00	66
8460.21.206	Diesel	9498	6	120.00	140.00	66
8460.21.206	Diesel	9500	6	120.00	140.00	66
8460.21.601	Diesel	9498	6	120.00	140.00	66
8460.21.601	Diesel	9500	6	120.00	140.00	66
8460.21.611	Diesel	9498	6	120.00	140.00	66
8460.41	Diesel	9500	6	120.00	140.00	66
8460.41.102	Diesel	9500	6	120.00	140.00	69
8460.41 B	Diesel	9500	6	120.00	140.00	67
8460.41C.	Diesel	9500	6	120.00	140.00	66
8460.41C.320	Diesel	9500	6	120.00	140.00	68
8460.41C. TCA	Diesel	9500	6	120.00	140.00	69
8460.41K.406	Diesel	9500	6	120.00	140.00	68
8460.41K.410	Diesel	9500	6	120.00	140.00	68
8460.41K. Euro 2	Diesel	9500	6	120.00	140.00	66
8460.41L.5020	Diesel	9500	6	120.00	140.00	69
8460.41L TCA	Diesel	9500	6	120.00	140.00	68
8460.41 M	Diesel	9500	6	120.00	140.10	70
8460.41N Euro 2	Diesel	9500	6	120.00	140.00	66
8460.41 R	Diesel	9500	6	120.00	140.00	66
8460.41 S	Diesel	9500	6	120.00	140.00	66
8460.41 T	Diesel	9500	6	120.00	140.00	68
BF6L 913	Diesel	6128	6	102.00	125.00	30
BF6L 913 /U	Diesel	6128	6	102.00	125.00	30
BF6L 913 T	Diesel	6128	6	102.00	125.00	30
BF8L 413 F	Diesel	12763	V8	125.00	130.00	73
BF8L 513	Diesel	12763	V8	125.00	130.00	73
CN 3	Diesel	3706	3	110.00	130.00	50
CO1D	Diesel	4156	4	105.00	120.00	47
CO 2 D	Diesel	4397	4	108.00	120.00	48
CO 3/40	Diesel	4560	4	110.00	120.00	49
CO 3/41	Diesel	4560	4	110.00	120.00	49
CO 3/7.200	Diesel	4940	4	110.00	130.00	51
CO 3/7.300	Diesel	4940	4	110.00	130.00	51
CO3-130T	Diesel	5401	4	115.00	130.00	58
CO 3 C	Diesel	4940	4	110.00	130.00	51
CO 3 D 130 VAR.1	Diesel	4940	4	110.00	130.00	51
CO 3 D VAR.1	Diesel	4940	4	110.00	130.00	51
CO 3 D VAR.15	Diesel	4940	4	110.00	130.00	51
CO 3 D VAR.2	Diesel	4940	4	110.00	130.00	51
CO 3 D VAR.4	Diesel	4940	4	110.00	130.00	51
CO 3 VAR.20	Diesel	4940	4	110.00	130.00	51
CO 3 VAR.21	Diesel	4940	4	110.00	130.00	51
CO 3 VAR.22	Diesel	4940	4	110.00	130.00	51
CO 3 VAR.3	Diesel	4940	4	110.00	130.00	51

		cm3	x 			
--	---	-----	---	---	---	---

F1AE0481A	Diesel	2287	4	88.00	94.00	1
F1AE0481A Euro 3	Diesel	2287	4	88.00	94.00	1
F1AE0481B Euro 3	Diesel	2287	4	88.00	94.00	1
F1AE0481FA Euro 4	Diesel	2287	4	88.00	94.00	1
F1AE0481GA Euro 4	Diesel	2287	4	88.00	94.00	1
F1AE0481HA Euro 4	Diesel	2287	4	88.00	94.00	1
F1AE0481M	Diesel	2287	4	88.00	94.00	1
F1AE0481U Euro 4	Diesel	2287	4	88.00	94.00	1
F1AE0481V Euro 4	Diesel	2287	4	88.00	94.00	1
F1AE3481A Euro 5	Diesel	2287	4	88.00	94.00	1
F1AE3481B Euro 5	Diesel	2287	4	88.00	94.00	1
F1AE3481C Euro 5	Diesel	2287	4	88.00	94.00	1
F1AFL411A Euro 5	Diesel	2287	4	88.00	94.00	1
F1AFL411B Euro 5	Diesel	2287	4	88.00	94.00	1
F1AFL411C Euro 5	Diesel	2287	4	88.00	94.00	1
F1CE0481A	Diesel	2998	4	95.80	104.00	20
F1CE0481B Euro 3	Diesel	2998	4	95.80	104.00	20
F1CE0481D (F30DT)	Diesel	2999	4	95.80	104.00	20
F1CE0481FA Euro 4	Diesel	2998	4	95.80	104.00	20
F1CE0481HA	Diesel	2998	4	95.80	104.00	20
F1CE0481HC Euro 4	Diesel	2998	4	95.80	104.00	20
F1CE0481L Euro 4	Diesel	2998	4	95.80	104.00	20
F1CE3481C	Diesel	2998	4	95.80	104.00	20
F1CE3481D Euro 5	Diesel	2998	4	95.80	104.00	20
F1CE3481J Euro 5	Diesel	2998	4	95.80	104.00	20
F1CE3481K Euro 5	Diesel	2998	4	95.80	104.00	20
F1CE3481L	Diesel	2998	4	95.80	104.00	20
F1CE3481LC	Diesel	2998	4	95.80	104.00	20
F1CFA401A Euro 6	Petrol	2998	4	95.80	104.00	21
F1CFA401B Euro 6	Gas	2998	4	95.80	104.00	21
F1CFL411E Euro 6	Diesel	2998	4	95.80	104.00	21
F1CFL411F Euro 6	Diesel	2998	4	95.80	104.00	21
F1CFL411G Euro 5	Diesel	2998	4	95.80	104.00	21
F1CFL411H Euro 5	Diesel	2998	4	95.80	104.00	21
F1CFL411J Euro 5	Diesel	2998	4	95.80	104.00	21
F2BE0641	Gas	7790	6	115.00	125.00	56
F2BE0681A Euro 2	Diesel	7790	6	115.00	125.00	56
F2BE0681B Euro 2	Diesel	7790	6	115.00	125.00	56
F2BE0681C Euro 2	Diesel	7790	6	115.00	125.00	56
F2BE0681D Euro 2	Diesel	7790	6	115.00	125.00	56
F2BE0681E Euro 2	Diesel	7790	6	115.00	125.00	56
F2BE0681F Euro 2	Diesel	7790	6	115.00	125.00	56
F2BE1682G Euro 3	Diesel	7790	6	115.00	125.00	56
F2BE3681A Euro 4/5	Diesel	7790	6	115.00	125.00	56
F2BE3681B Euro 4/5	Diesel	7790	6	115.00	125.00	56
F2BE3681C Euro 4/5	Diesel	7790	6	115.00	125.00	56
F2BE3682B Euro 5	Diesel	7790	6	115.00	125.00	56
F2CE0681A	Diesel	8708	6	117.00	135.00	64
F2CE0682A	Diesel	8708	6	117.00	135.00	64
F2CE0683A	Diesel	8708	6	117.00	135.00	64
F2CE0684A	Diesel	8708	6	117.00	135.00	64
F3AE0681B Euro 3	Diesel	10300	6	125.00	140.00	75
F3AE0681D Euro 2	Diesel	10300	6	125.00	140.00	75
F3AE0681E Euro 2	Diesel	10300	6	125.00	140.00	75
F3AE0681H Euro 3	Diesel	10300	6	125.00	140.00	75
F3AE3681A Euro 4/5	Diesel	10300	6	125.00	140.00	75
F3AE3681B Euro 4/5	Diesel	10300	6	125.00	140.00	75
F3AE3681D Euro 4/5	Diesel	10300	6	125.00	140.00	75
F3AE3681Y Euro 4/5	Diesel	10300	6	125.00	140.00	75
F3B3681A Euro 4/5	Diesel	12880	6	135.00	150.00	79
F3B3681B Euro 4/5	Diesel	12882	6	135.00	150.00	79
F3B3681C Euro 4/5	Diesel	12880	6	135.00	150.00	79
F3B3681D Euro 4/5	Diesel	12880	6	135.00	150.00	79
F3B3681E Euro 4/5	Diesel	12880	6	135.00	150.00	79
F3B3681G Euro 4/5	Diesel	12880	6	135.00	150.00	79
F3BE0681A Euro 3	Diesel	12880	6	135.00	150.00	79
F3BE0681B Euro 3	Diesel	12880	6	135.00	150.00	79
F3BE0681C Euro 3	Diesel	12880	6	135.00	150.00	79
F3BE0681D	Diesel	12882	6	135.00	150.00	79

		cm3	x 			
F3BE0681E Euro 3	Diesel	12880	6	135.00	150.00	79
F3BE0681F	Diesel	12882	6	135.00	150.00	79
F3BE0681G Euro 3	Diesel	12880	6	135.00	150.00	79
F3BE0681H	Diesel	12882	6	135.00	150.00	79
F3BE0681J	Diesel	12882	6	135.00	150.00	79
F3BE0681K	Diesel	12882	6	135.00	150.00	79
F3BE0681V Euro 3	Diesel	12880	6	135.00	150.00	79
F3BE3681A Euro 4/5	Diesel	12882	6	135.00	150.00	79
F3BE3681B Euro 4/5	Diesel	12880	6	135.00	150.00	79
F3BE3681C Euro 4/5	Diesel	12880	6	135.00	150.00	79
F3BE3681D Euro 4/5	Diesel	12882	6	135.00	150.00	79
F3BE3681E Euro 4/5	Diesel	12882	6	135.00	150.00	79
F3BE3681F Euro 4/5	Diesel	12882	6	135.00	150.00	79
F3BE3681G Euro 4/5	Diesel	12882	6	135.00	150.00	79
F4AE0481A Euro 3	Diesel	3920	4	102.00	120.00	26
F4AE0481C Euro 3	Diesel	3920	4	102.00	120.00	26
F4AE0481D Euro 3	Diesel	3920	4	102.00	120.00	26
F4AE0681A Euro 3	Diesel	5880	6	102.00	120.00	27
F4AE0681B Euro 3	Diesel	5880	6	102.00	120.00	27
F4AE0681D Euro 3	Diesel	5880	6	102.00	120.00	27
F4AE0681E Euro 3	Diesel	5880	6	102.00	120.00	27
F4AE3481A Euro 4/5	Diesel	3920	4	102.00	120.00	26
F4AE3481B Euro 4/5	Diesel	3920	4	102.00	120.00	26
F4AE3481C Euro 4/5	Diesel	3920	4	102.00	120.00	26
F4AE3481D Euro 4/5	Diesel	3920	4	102.00	120.00	26
F4AE3681A Euro 4/5	Diesel	5880	6	102.00	120.00	28
F4AE3681B Euro 4/5	Diesel	5880	6	102.00	120.00	28
F4AE3681C Euro 4/5	Diesel	5880	6	102.00	120.00	28
F4AE3681D Euro 4/5	Diesel	5880	6	102.00	120.00	28
F4AE3681E Euro 4/5	Diesel	5880	6	102.00	120.00	28
F4L 913	Diesel	4086	4	102.00	125.00	29
F6L 413	Diesel	8478	V6	120.00	125.00	65
F6L 413 F	Diesel	9570	V6	125.00	130.00	72
F6L 913	Diesel	6128	6	102.00	125.00	31
F8L 413 F	Diesel	12763	V8	125.00	130.00	73
F8L 513	Diesel	13383	V8	128.00	130.00	77
F10L 413 F	Diesel	15953	V10	125.00	130.00	74
Fiat-8040.02..	Diesel	3460	4	100.00	110.00	23



1 88.00 x 94.00

F1AE0481A	4 Cyl.	2287cc	85kW (116PS)	Diesel	TD26962
F1AE0481A Euro 3	4 Cyl.	2287cc	70kW (95PS)	Diesel Turbo Intercooler	TD17144
F1AE0481B Euro 3	4 Cyl.	2287cc	85kW (116PS)	Diesel Turbo Intercooler	TD17145
F1AE0481FA Euro 4	4 Cyl.	2287cc	70-78kW (95-106PS)	Diesel Turbo Intercooler	TD19231
F1AE0481GA Euro 4	4 Cyl.	2287cc	85-93kW (116-126PS)	Diesel Turbo Intercooler	TD19232
F1AE0481HA Euro 4	4 Cyl.	2287cc	100kW (136PS)	Diesel Turbo Intercooler	TD19233
F1AE0481M	4 Cyl.	2287cc	100kW (136PS)	Diesel Turbo Intercooler	TD19156
F1AE0481U Euro 4	4 Cyl.	2287cc	78kW (106PS)	Diesel Turbo Intercooler	TD26638
F1AE0481V Euro 4	4 Cyl.	2287cc	93kW (126PS)	Diesel Turbo Intercooler	TD26637
F1AE3481A Euro 5	4 Cyl.	2287cc	78kW (106PS)	Diesel Turbo Intercooler	TD26934
F1AE3481B Euro 5	4 Cyl.	2287cc	93kW (126PS)	Diesel Turbo Intercooler	TD26935
F1AE3481C Euro 5	4 Cyl.	2287cc	107kW (146PS)	Diesel Turbo Intercooler	TD26943
F1AFL411A Euro 5	4 Cyl.	2287cc	78kW (106PS)	Diesel Turbo Intercooler	TD29628
F1AFL411B Euro 5	4 Cyl.	2287cc	93kW (126PS)	Diesel Turbo Intercooler	TD29629
F1AFL411C Euro 5	4 Cyl.	2287cc	107kW (146PS)	Diesel Turbo Intercooler	TD29630

BE/PL	4	59,015/59,038	62,833/62,848	23,750	1,884	0,027/0,065	BS	71-4080	71-4080/4 STD 0.25 0.50
MB/HL 1-4	4	71,182/71,208	75,588/75,614	27,000	2,174	0,032/0,084	AL-LF	02-4083	H1020/5 STD 0.25 0.50
MB/HL 1,2,4	3	71,182/71,208	75,588/75,614	27,000	2,174	0,032/0,084	AL-LF	02-4084	
MB/HL 3	1	71,182/71,208	75,588/75,614	27,000	2,174	0,032/0,084	AL-LF	02-4085H	
MB/HL	1	76,182/76,208	80,588/80,614	27,000	2,174	0,032/0,084	AL-LF	02-4086L	
MB/HL	1	76,182/76,208	80,588/80,614	27,000	2,174	0,032/0,084	AL-LF	02-4086U	

2 93.00 x 90.00

8140.21.200	4 Cyl.	2445cc	68kW (92PS)	Diesel Turbo	TD1703				
BE/PL	4	56,520/56,535	60,333/60,345	24,700	1,870	0,020/0,070	BS	66575CP	71-4185/4 STD 0.25 0.50 0.75
MB/HL 1-4	4	76,187/76,200	80,586/80,607	24,990	2,172	0,042/0,100	BS	66571CP	H1049/5 STD 0.25 0.50 0.75
MB/HL 5	1	76,187/76,200	80,586/80,607	31,950	2,172	0,042/0,100	BS	66572CPH	

Mot. → 1846776

MB/HL 1-4	4	76,187/76,200	80,586/80,607	24,990	2,172	0,038/0,097	BS	66573CP	H1094/5 STD 0.25
MB/HL 5	1	76,187/76,200	80,586/80,607	31,950	2,172	0,038/0,097	BS	66574CPH	

Mot. 1846777 →

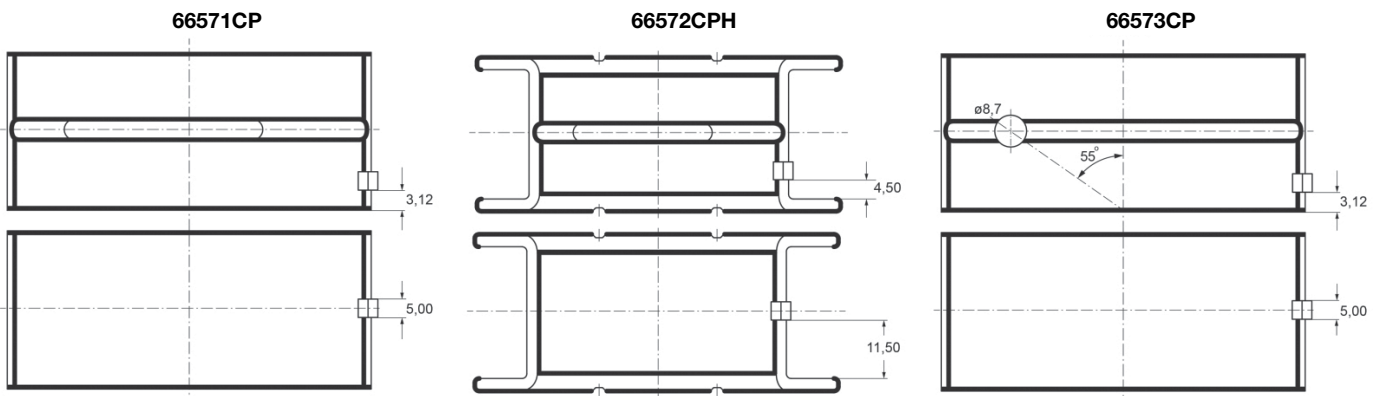



66574CPH

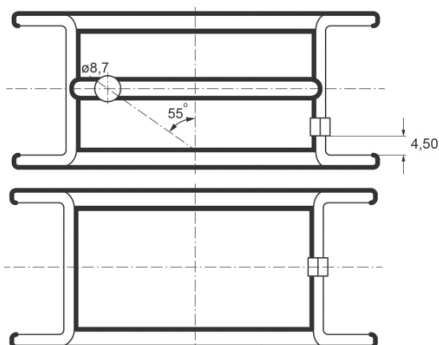

SE/PB	1	31,990/31,996	34,895/34,920	30,700			BS	66579YA	55-4186 SEMI
-------	---	---------------	---------------	--------	--	--	----	---------	------------------------

3 93.00 x 90.00

8140.21.201			4 Cyl.	2445cc	68kW (92PS)			Diesel Turbo	TD27368
8140.21.202			4 Cyl.	2445cc	68kW (92PS)			Diesel Turbo	TD27369
8140.21.203			4 Cyl.	2445cc	68kW (92PS)			Diesel Turbo	TD27370
8140.21.212			4 Cyl.	2445cc	68kW (92PS)			Diesel Turbo	TD27371
8140.21.290			4 Cyl.	2445cc	68kW (92PS)			Diesel Turbo	TD27372

BE/PL	4	56,520/56,535	60,333/60,345	24,700	1,870	0,020/0,072	BS	1870CP	71-4130/4 STD 0.25 0.50 0.75
-------	---	---------------	---------------	--------	-------	-------------	----	--------	--

10/02 →

BE/PL	4	56,520/56,535	60,333/60,345	24,700	1,870	0,020/0,070	BS	66575CP	71-4185/4 STD 0.25 0.50 0.75
-------	---	---------------	---------------	--------	-------	-------------	----	---------	--

→ **09/02**

1870CP



66575CP

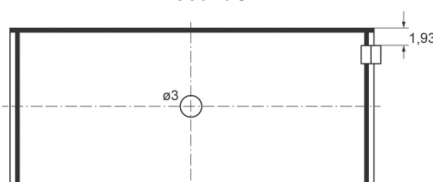

MB/HL 1-4	4	76,187/76,200	80,586/80,607	24,990	2,172	0,042/0,100	BS	66571CP	H1049/5 STD 0.25 0.50 0.75
MB/HL 5	1	76,187/76,200	80,586/80,607	31,950	2,172	0,042/0,100	BS	66572CPH	

Mot. → 1846776

MB/HL 1-4	4	76,187/76,200	80,586/80,607	24,990	2,172	0,038/0,097	BS	66573CP	H1094/5 STD 0.25
MB/HL 5	1	76,187/76,200	80,586/80,607	31,950	2,172	0,038/0,097	BS	66574CPH	

Mot. 1846777 →

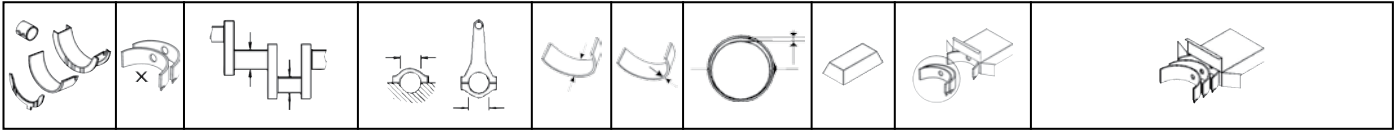

66571CP

66572CPH

66573CP

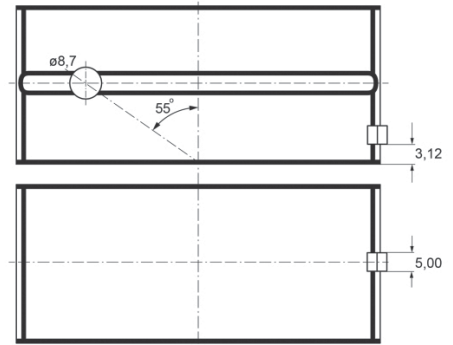
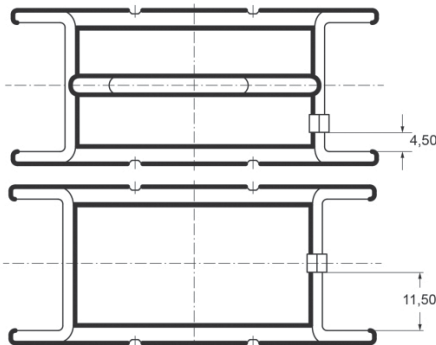
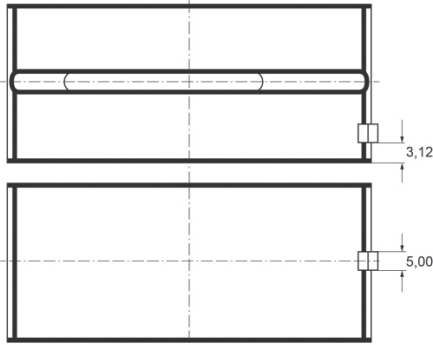

66574CPH

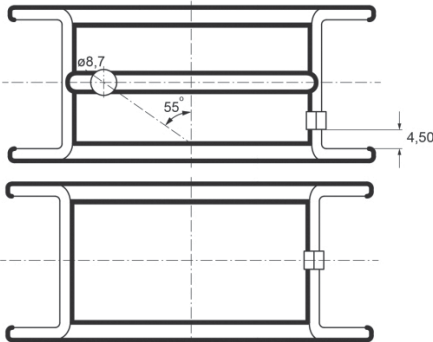

SE/PB	1	31,990/31,996	34,895/34,920	30,700			BS	66579YA	55-4186 SEMI
-------	---	---------------	---------------	--------	--	--	----	---------	-----------------

09/82 →, Mot.344183 →

4

93.00 x 90.00

8140.21.214	4 Cyl.	2445cc	77kW (105PS)	Diesel Turbo	TD1704
8140.61.300	4 Cyl.	2445cc	53kW (72PS)	Diesel	TD20426
8144.61.200	4 Cyl.	2445cc	53kW (72PS)	Diesel	TD20429

BE/PL	4	56,520/56,535	60,333/60,345	24,700	1,870	0,020/0,072	BS	1870CP	71-4130/4 STD 0.25 0.50 0.75
-------	---	---------------	---------------	--------	-------	-------------	----	--------	---------------------------------

10/02 →

BE/PL	4	56,520/56,535	60,333/60,345	24,700	1,870	0,020/0,070	BS	66575CP	71-4185/4 STD 0.25 0.50 0.75
-------	---	---------------	---------------	--------	-------	-------------	----	---------	---------------------------------

→09/02

1870CP

66575CP

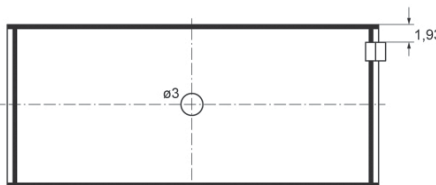

MB/HL 1-4	4	76,187/76,200	80,586/80,607	24,990	2,172	0,042/0,100	BS	66571CP	H1049/5 STD 0.25 0.50 0.75
MB/HL 5	1	76,187/76,200	80,586/80,607	31,950	2,172	0,042/0,100	BS	66572CPH	

Mot. →1846776



MB/HL 1-4	4	76,187/76,200	80,586/80,607	24,990	2,172	0,038/0,097	BS	66573CP	H1094/5 STD 0.25
MB/HL 5	1	76,187/76,200	80,586/80,607	31,950	2,172	0,038/0,097	BS	66574CPH	

Mot.1846777→

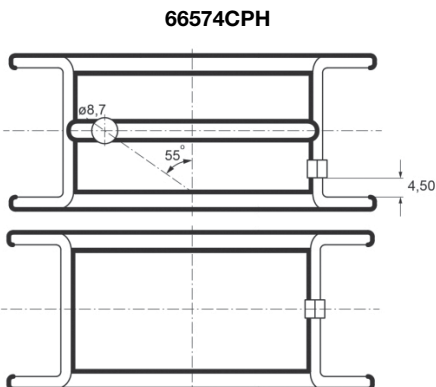
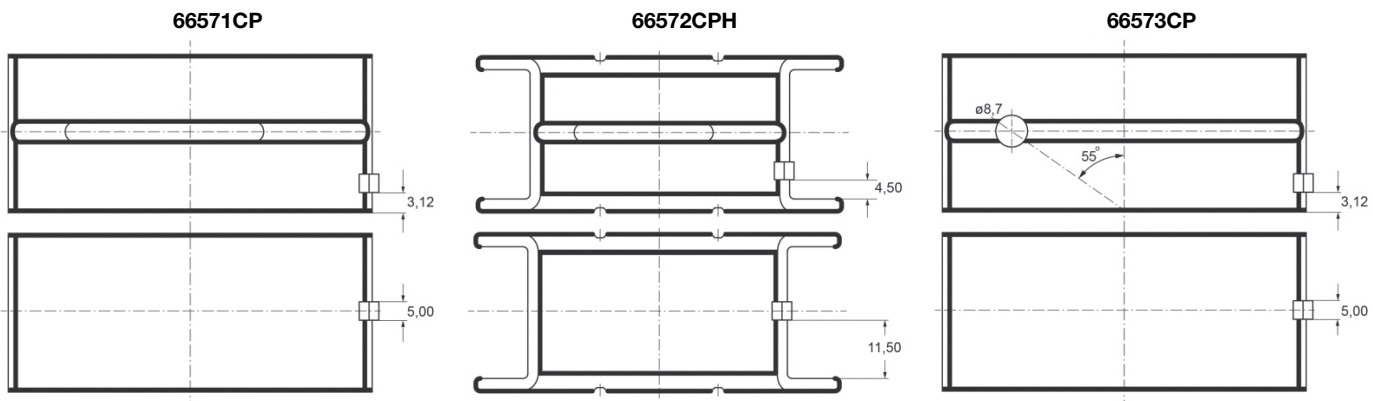

SE/PB	1	31,990/31,996	34,895/34,920	30,700			BS	66579YA	55-4186 SEMI
-------	---	---------------	---------------	--------	--	--	----	---------	------------------------

09/82→, Mot.344183→

5

93.00 x 90.00

8140.27 S	4 Cyl.	2445cc	68kW (92PS)	Diesel Turbo	TD1705
8140.61.200	4 Cyl.	2445cc	53kW (72PS)	Diesel	TD7225

BE/PL	4	56,520/56,535	60,333/60,345	24,700	1,870	0,020/0,070	BS	66575CP	71-4185/4 STD 0.25 0.50 0.75
-------	---	---------------	---------------	--------	-------	-------------	----	---------	--

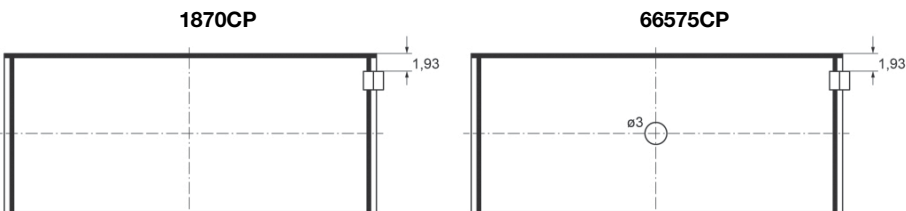

MB/HL 1-4	4	76,187/76,200	80,586/80,607	24,990	2,172	0,042/0,100	BS	66571CP	H1049/5 STD 0.25 0.50 0.75
MB/HL 5	1	76,187/76,200	80,586/80,607	31,950	2,172	0,042/0,100	BS	66572CPH	

Mot.1846776→

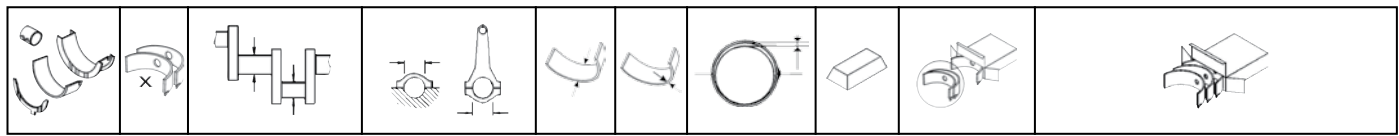

MB/HL 1-4	4	76,187/76,200	80,586/80,607	24,990	2,172	0,038/0,097	BS	66573CP	H1094/5 STD 0.25
MB/HL 5	1	76,187/76,200	80,586/80,607	31,950	2,172	0,038/0,097	BS	66574CPH	

Mot.1846777→

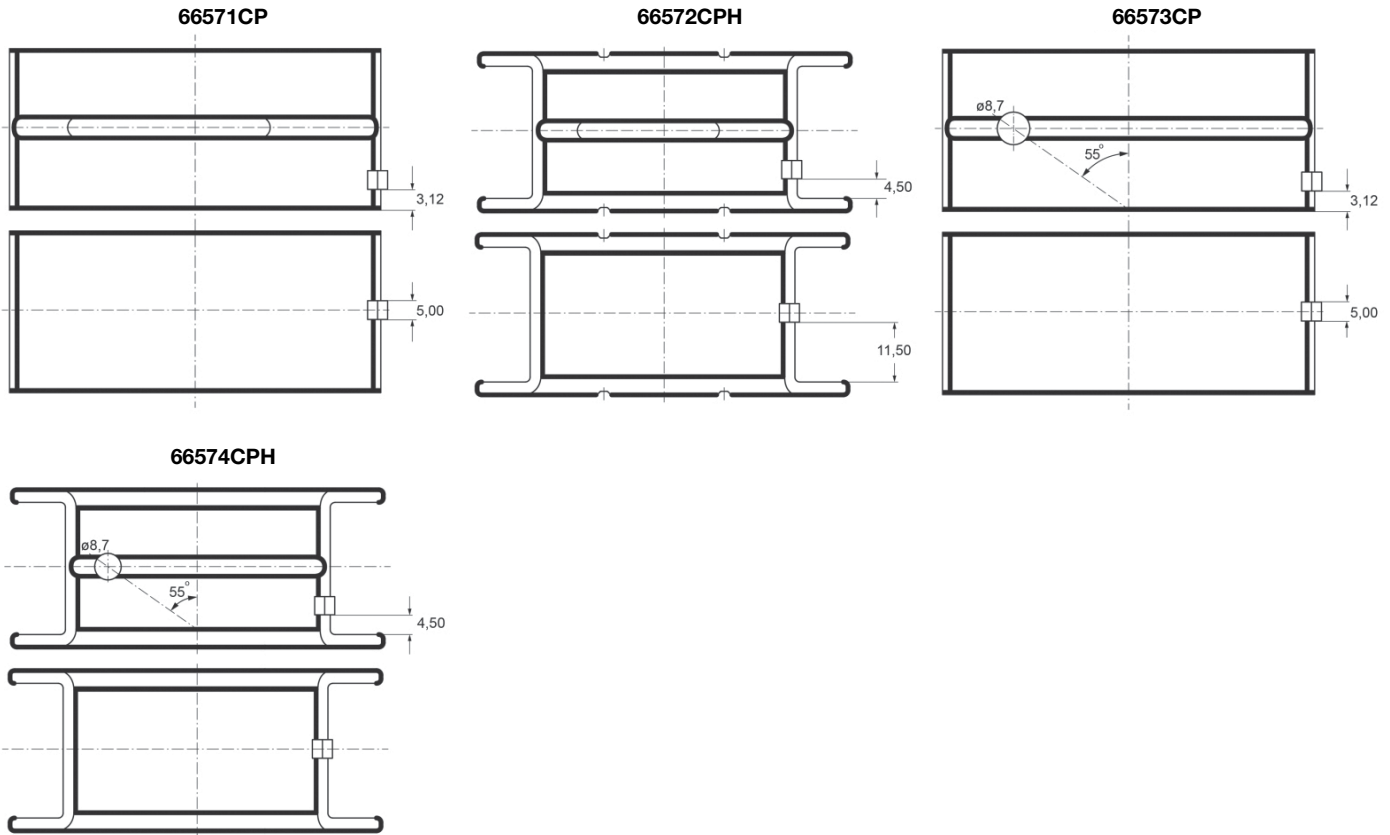

SE/PB	1	31,990/31,996	34,895/34,920	30,700			BS	66579YA	55-4186 SEMI
-------	---	---------------	---------------	--------	--	--	----	---------	------------------------

09/82→, Mot.344183→

6	93.00 x 92.00					
8140.07.2585 Euro 1	4 Cyl.	2500cc	55kW (75PS)	Diesel		TD20437
8140.07.2700	4 Cyl.	2499cc	55kW (75PS)	Diesel		TD1700
8140.07.2701	4 Cyl.	2499cc	55kW (75PS)	Diesel		TD1701
8140.07.2710	4 Cyl.	2499cc	55kW (75PS)	Diesel		TD27358
8140.07.2711	4 Cyl.	2499cc	55kW (75PS)	Diesel		TD27359
8140.07.2713	4 Cyl.	2499cc	55kW (75PS)	Diesel		TD27360
8140.07.3700 Euro 1	4 Cyl.	2499cc	53kW (72PS)	Diesel		TD27364
8140.07.3710 Euro 1	4 Cyl.	2499cc	53kW (72PS)	Diesel		TD20418
8140.07.3711 Euro 1	4 Cyl.	2499cc	53kW (72PS)	Diesel		TD27365
8140.07.3712 Euro 1	4 Cyl.	2499cc	53kW (72PS)	Diesel		TD27366
8140.07.3713 Euro 1	4 Cyl.	2499cc	53kW (72PS)	Diesel		TD27367
8140.27.215	4 Cyl.	2499cc	76kW (103PS)	Diesel Turbo		TD27387
8140.27R.2700	4 Cyl.	2499cc	67-70kW (92-95PS)	Diesel Turbo		TD20420
8140.27R.2780	4 Cyl.	2499cc	67-70kW (91-95PS)	Diesel Turbo		TD27393
8140.27R.2786	4 Cyl.	2499cc	67-70kW (91-95PS)	Diesel Turbo		TD27394
8140.27R.2787	4 Cyl.	2499cc	67-70kW (91-95PS)	Diesel Turbo		TD27395
8140.27S.2700	4 Cyl.	2499cc	76kW (103PS)	Diesel Turbo		TD20421
8140.27S.2701	4 Cyl.	2499cc	76kW (103PS)	Diesel Turbo		TD27396



8140.27S.2710	4 Cyl.	2499cc	76kW (103PS)	Diesel Turbo	TD27397
8140.27S.2711	4 Cyl.	2499cc	76kW (103PS)	Diesel Turbo	TD27398
8140.27S.2720	4 Cyl.	2499cc	76kW (103PS)	Diesel Turbo	TD27399
8140.27S.2721	4 Cyl.	2499cc	76kW (103PS)	Diesel Turbo	TD27400
8140.27S.2730	4 Cyl.	2499cc	76kW (103PS)	Diesel Turbo	TD27401
8140.27S.2731	4 Cyl.	2499cc	76kW (103PS)	Diesel Turbo	TD27402
8140.27S.2750	4 Cyl.	2499cc	76kW (103PS)	Diesel Turbo	TD27403
8140.27S.2751	4 Cyl.	2499cc	76kW (103PS)	Diesel Turbo	TD27404
8140.27S.2760	4 Cyl.	2499cc	76kW (103PS)	Diesel Turbo	TD27405
8140.27S.2761	4 Cyl.	2499cc	76kW (103PS)	Diesel Turbo	TD27406
8140.27S.2770	4 Cyl.	2499cc	76kW (103PS)	Diesel Turbo	TD27407
8140.27S.2771	4 Cyl.	2499cc	76kW (103PS)	Diesel Turbo	TD27408
8140.27S.2801	4 Cyl.	2499cc	76kW (103PS)	Diesel Turbo	TD20419
8140.27S.2811	4 Cyl.	2499cc	76kW (103PS)	Diesel Turbo	TD27409
8140.27S.2885	4 Cyl.	2499cc	76kW (103PS)	Diesel Turbo	TD20422
8140.27S.3700	4 Cyl.	2499cc	77kW (104PS)	Diesel Turbo	TD27410
8140.27S.3701	4 Cyl.	2499cc	77kW (104PS)	Diesel Turbo	TD27411
8140.27S.3711	4 Cyl.	2499cc	77kW (104PS)	Diesel Turbo	TD27412
8140.27S.3720	4 Cyl.	2499cc	77kW (104PS)	Diesel Turbo	TD27413
8140.27S.3721	4 Cyl.	2499cc	77kW (104PS)	Diesel Turbo	TD27414
8140.27S.3750	4 Cyl.	2499cc	77kW (104PS)	Diesel Turbo	TD27415
8140.27S.3751	4 Cyl.	2499cc	77kW (104PS)	Diesel Turbo	TD27416
8140.27S.3760	4 Cyl.	2499cc	77kW (104PS)	Diesel Turbo	TD27419
8140.27S.3761	4 Cyl.	2499cc	77kW (104PS)	Diesel Turbo	TD27420
8140.27S.3770	4 Cyl.	2499cc	77kW (104PS)	Diesel Turbo	TD27422
8140.27S.3771	4 Cyl.	2499cc	77kW (104PS)	Diesel Turbo	TD27423
8140.27S.3780	4 Cyl.	2499cc	77kW (104PS)	Diesel Turbo	TD27424
8140.27S.3781	4 Cyl.	2499cc	77kW (104PS)	Diesel Turbo	TD27425
8140.27S.3811	4 Cyl.	2499cc	77kW (104PS)	Diesel Turbo	TD27426
8140.47R	4 Cyl.	2499cc	80kW (109PS)	Diesel Turbo	TD7234
8140.47S Euro 1	4 Cyl.	2499cc	85kW (116PS)	Diesel Turbo Intercooler	TD20453
8140.97.2781	4 Cyl.	2499cc	68kW (92PS)	Diesel Turbo Intercooler	TD1717

BE/PL	4	56,520/56,535	60,333/60,345	24,700	1,870	0,020/0,072	BS	1870CP	71-4130/4 STD 0.25 0.50 0.75
MB/HL 1-4	4	76,187/76,200	80,586/80,607	24,990	2,172	0,042/0,100	BS	66571CP	H1049/5 STD 0.25 0.50 0.75
MB/HL 5	1	76,187/76,200	80,586/80,607	31,950	2,172	0,042/0,100	BS	66572CPH	

Mot.→1846776

MB/HL 1-4	4	76,187/76,200	80,586/80,607	24,990	2,172	0,038/0,097	BS	66573CP	H1094/5 STD 0.25
MB/HL 5	1	76,187/76,200	80,586/80,607	31,950	2,172	0,038/0,097	BS	66574CPH	

Mot.1846777→



66571CP

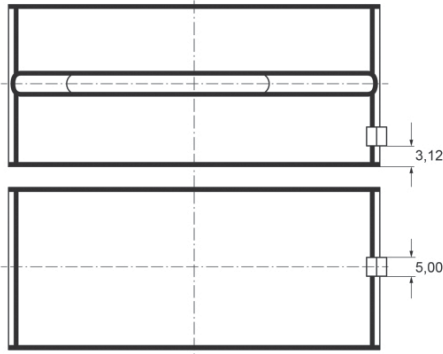

66572CPH

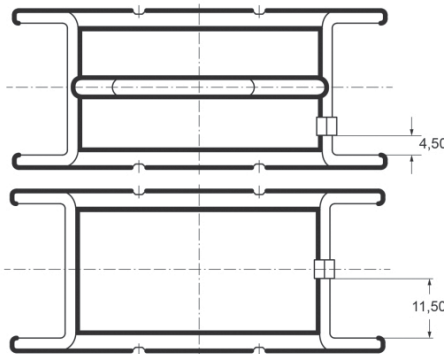

66573CP

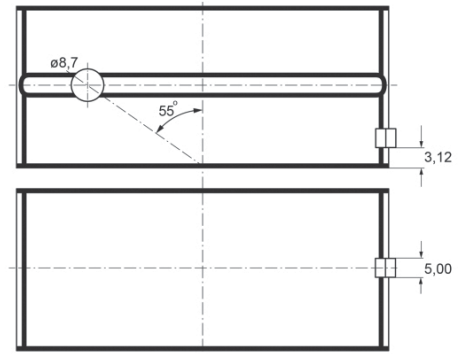

66574CPH

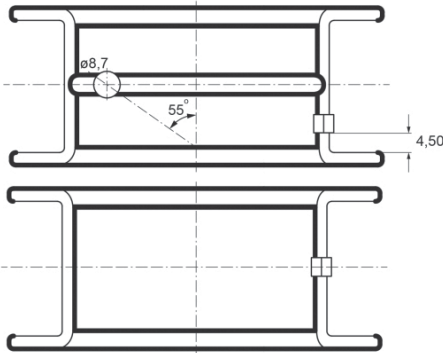

SE/PB	1	31,990/31,996	34,895/34,920	30,700		BS	66579YA	55-4186 SEMI
-------	---	---------------	---------------	--------	--	----	---------	-----------------

7

93.00 x 92.00

8140.07.2712		4 Cyl.		2499cc	55kW (75PS)	Diesel			TD1702
BE/PL	4	56,520/56,535	60,333/60,345	24,700	1,870	0,020/0,072	BS	1870CP	71-4130/4 STD 0.25 0.50 0.75
MB/HL 1-4	4	76,187/76,200	80,586/80,607	24,990	2,172	0,042/0,100	BS	66571CP	H1049/5 STD 0.25 0.50 0.75
MB/HL 5	1	76,187/76,200	80,586/80,607	31,950	2,172	0,042/0,100	BS	66572CPH	
01/93 → 12/94									
MB/HL 5	1	86,182/86,208	90,588/90,614	30,950	2,164	0,052/0,129	BS	4691CPH	H1104/5 STD 0.25 0.50
MB/HL 1-4	4	80,182/80,208	84,588/84,614	23,800	2,164	0,052/0,129	BS	4692CP	
01/95 →									

66571CP

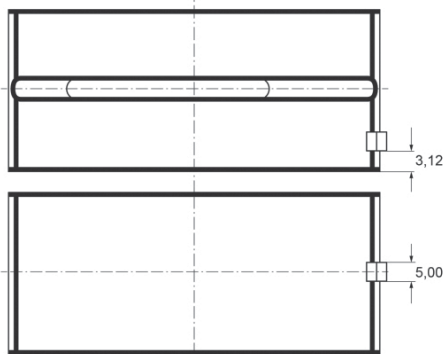

66572CPH

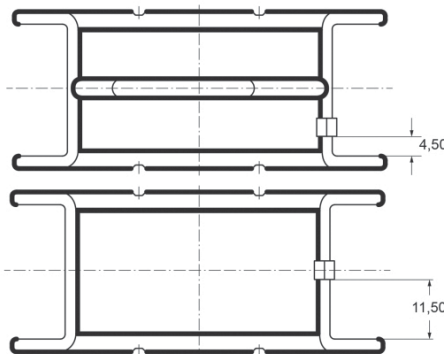

4691CPH

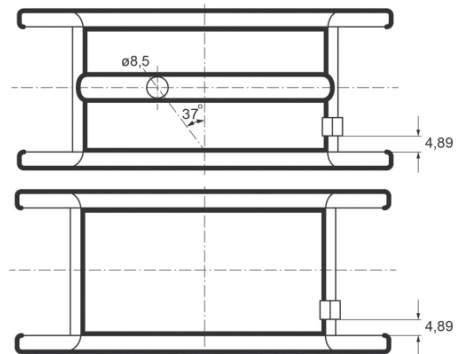



4692CP

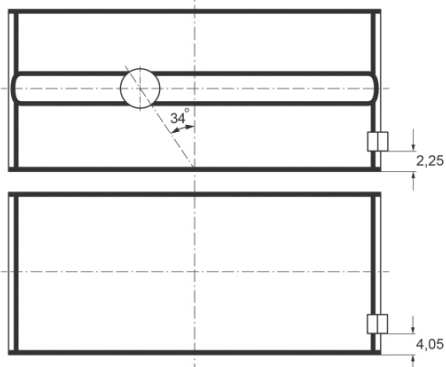

8 93.00 x 92.00

8140.27.218		4 Cyl.		2499cc	76kW (103PS)	Diesel Turbo		TD26268	
BE/PL	4	56,520/56,535	60,333/60,345	24,700	1,870	0,020/0,072	BS	1870CP	71-4130/4 STD 0.25 0.50 0.75
BE/PL	4	56,520/56,535	60,333/60,345	24,700	1,870	0,020/0,070	BS	66575CP	71-4185/4 STD 0.25 0.50 0.75

1870CP



66575CP

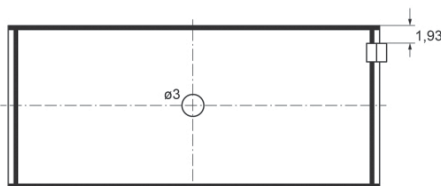

MB/HL 1-4	4	76,187/76,200	80,586/80,607	24,990	2,172	0,042/0,100	BS	66571CP	H1049/5 STD 0.25 0.50 0.75
MB/HL 5	1	76,187/76,200	80,586/80,607	31,950	2,172	0,042/0,100	BS	66572CPH	

Mot.→1846776

MB/HL 1-4	4	76,187/76,200	80,586/80,607	24,990	2,172	0,038/0,097	BS	66573CP	H1094/5 STD 0.25
MB/HL 5	1	76,187/76,200	80,586/80,607	31,950	2,172	0,038/0,097	BS	66574CPH	

Mot.1846777→

66571CP

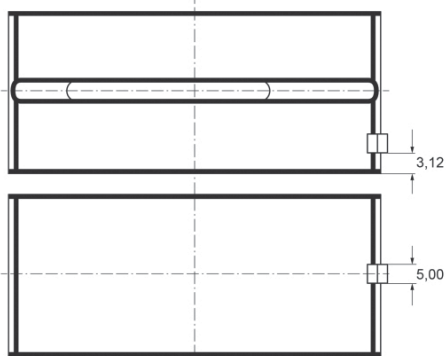

66572CPH

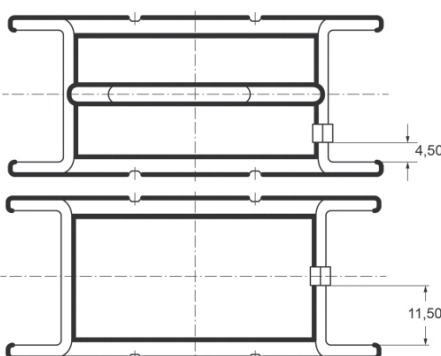

66573CP

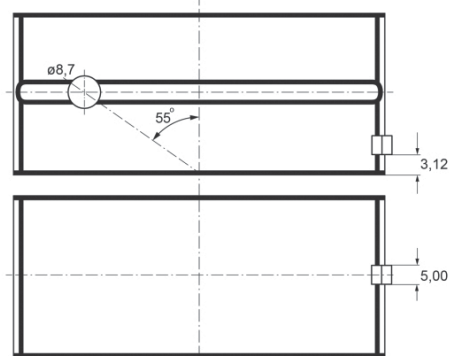



66574CPH

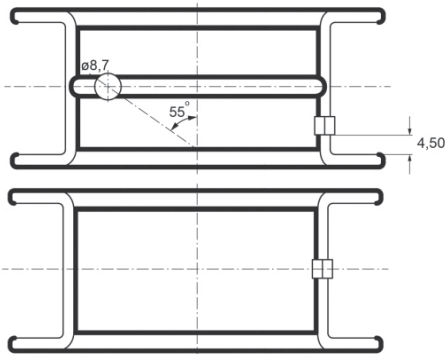

SE/PB	1	31,990/31,996	34,895/34,920	30,700			BS	66579YA	55-4186 SEMI
-------	---	---------------	---------------	--------	--	--	----	---------	------------------------

9 93.00 x 92.00

8140.27.2582		4 Cyl.		2499cc	74-79kW (101-107PS)		Diesel Turbo		TD7260
BE/PL	4	56,520/56,535	60,333/60,345	24,700	1,870	0,020/0,072	BS	1870CP	71-4130/4 STD 0.25 0.50 0.75
MB/HL 1-4	4	76,187/76,200	80,586/80,607	24,990	2,172	0,042/0,100	BS	66571CP	H1049/5 STD 0.25 0.50 0.75
MB/HL 5	1	76,187/76,200	80,586/80,607	31,950	2,172	0,042/0,100	BS	66572CPH	
→12/92									
MB/HL 5	1	86,182/86,208	90,588/90,614	30,950	2,164	0,052/0,129	BS	4691CPH	H1104/5 STD 0.25 0.50
MB/HL 1-4	4	80,182/80,208	84,588/84,614	23,800	2,164	0,052/0,129	BS	4692CP	

09/85 →

66571CP

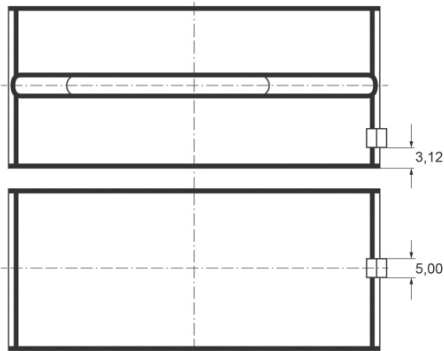

66572CPH

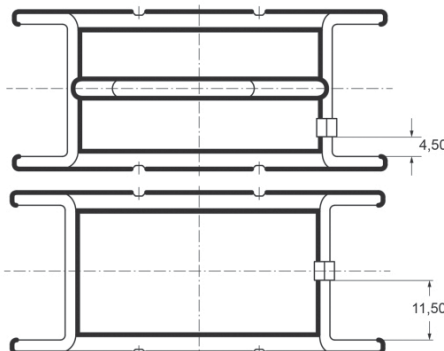

4691CPH

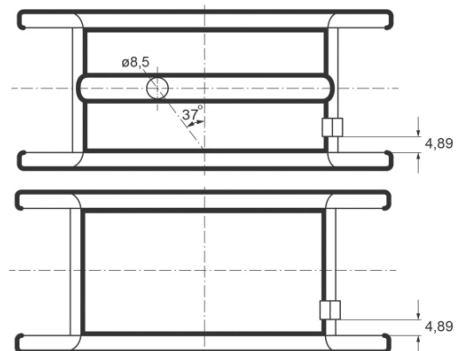

4692CP

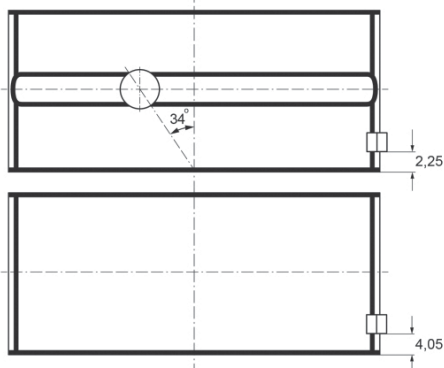



SE/PB	1	31,990/31,996	34,895/34,920	30,700			BS	66579YA	55-4186 SEMI
-------	---	---------------	---------------	--------	--	--	----	---------	------------------------

Mot.344183 →

10 93.00 x 92.00

8140.27.2700	4 Cyl.	2499cc	76kW (103PS)	Diesel	TD1706
8140.47.2700 Euro 1	4 Cyl.	2499cc	85kW (116PS)	Diesel Turbo	TD1711
8140.47.2721 Euro 1	4 Cyl.	2499cc	85kW (116PS)	Diesel Turbo	TD1713
8140.47.2785 Euro 1	4 Cyl.	2499cc	85kW (116PS)	Diesel Turbo	TD1715

BE/PL	4	56,520/56,535	60,333/60,345	24,700	1,870	0,020/0,072	BS	1870CP	71-4130/4 STD 0.25 0.50 0.75
MB/HL 1-4	4	76,187/76,200	80,586/80,607	24,990	2,172	0,042/0,100	BS	66571CP	H1049/5 STD 0.25 0.50 0.75
MB/HL 5	1	76,187/76,200	80,586/80,607	31,950	2,172	0,042/0,100	BS	66572CPH	

→12/92

MB/HL 1-4	4	76,187/76,200	80,586/80,607	24,990	2,172	0,038/0,097	BS	66573CP	H1094/5 STD 0.25
MB/HL 5	1	76,187/76,200	80,586/80,607	31,950	2,172	0,038/0,097	BS	66574CPH	

01/93 → 08/95

MB/HL 5	1	86,182/86,208	90,588/90,614	30,950	2,164	0,052/0,129	BS	4691CPH	H1104/5 STD 0.25 0.50
MB/HL 1-4	4	80,182/80,208	84,588/84,614	23,800	2,164	0,052/0,129	BS	4692CP	

09/95 →

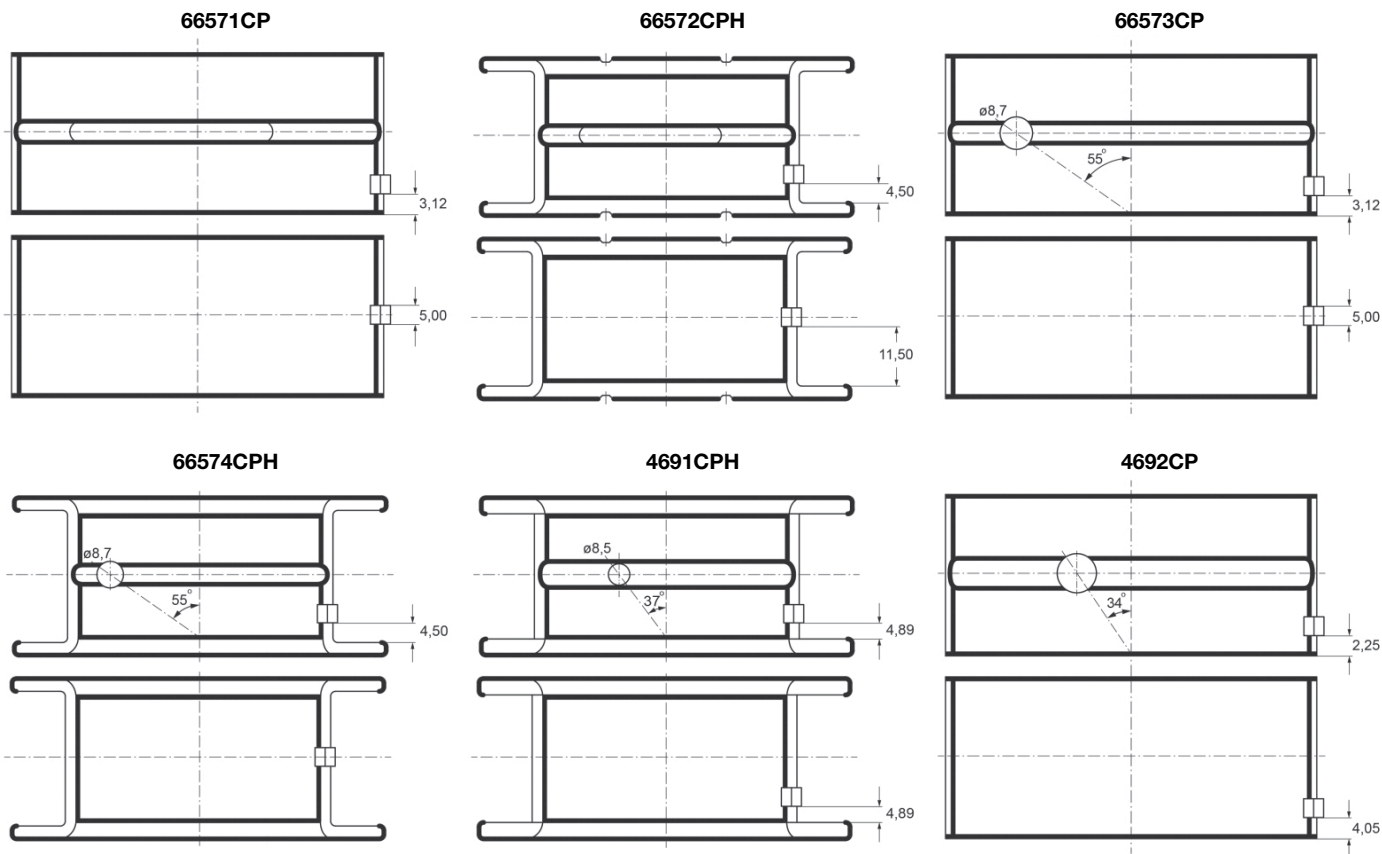

SE/PB	1	31,990/31,996	34,895/34,920	30,700			BS	66579YA	55-4186 SEMI
-------	---	---------------	---------------	--------	--	--	----	---------	------------------------

Mot.344183 →



11 93.00 x 92.00

8140.27.2720	4 Cyl.	2499cc	76kW (103PS)	Diesel	TD1707
8140.47.2711 Euro 1	4 Cyl.	2499cc	85kW (116PS)	Diesel Turbo	TD1712
8140.47R.2790	4 Cyl.	2499cc	76-80kW (103-109PS)	Diesel Turbo Intercooler	TD1716

BE/PL	4	56,520/56,535	60,333/60,345	24,700	1,870	0,020/0,072	BS	1870CP	71-4130/4 STD 0.25 0.50 0.75
MB/HL 1-4	4	76,187/76,200	80,586/80,607	24,990	2,172	0,042/0,100	BS	66571CP	H1049/5 STD 0.25 0.50 0.75
MB/HL 5	1	76,187/76,200	80,586/80,607	31,950	2,172	0,042/0,100	BS	66572CPH	

Mot. → 1846776

MB/HL 1-4	4	76,187/76,200	80,586/80,607	24,990	2,172	0,038/0,097	BS	66573CP	H1094/5 STD 0.25
MB/HL 5	1	76,187/76,200	80,586/80,607	31,950	2,172	0,038/0,097	BS	66574CPH	

Mot. 1846777 →

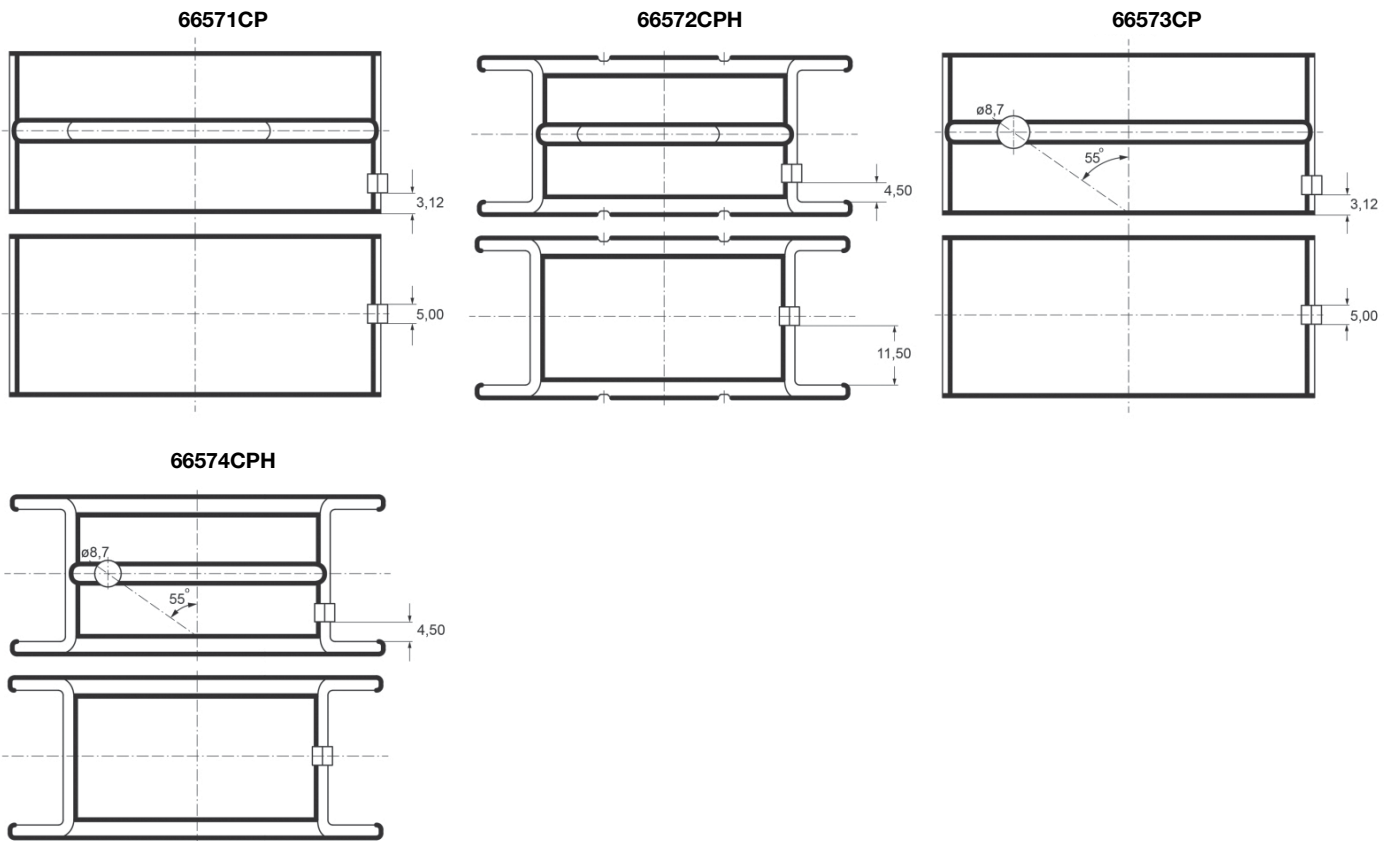

12 93.00 x 92.00

8140.47.3700 Euro 1	4 Cyl.	2499cc	85kW (116PS)	Diesel Turbo Intercooler	TD20477
8140.47.3711 Euro 1	4 Cyl.	2499cc	85kW (116PS)	Diesel Turbo Intercooler	TD26005
8140.47.3721 Euro 1	4 Cyl.	2499cc	85kW (116PS)	Diesel Turbo Intercooler	TD26006
8140.47.3731 Euro 1	4 Cyl.	2499cc	85kW (116PS)	Diesel Turbo Intercooler	TD26007
8140.47B.3790 Euro 1	4 Cyl.	2499cc	78-83kW (106-113PS)	Diesel Turbo Intercooler	TD26008
8140.47B.3795 Euro 1	4 Cyl.	2499cc	78-83kW (106-113PS)	Diesel Turbo Intercooler	TD26009
8140.47R.2795	4 Cyl.	2499cc	80kW (109PS)	Diesel Turbo Intercooler	TD26010
8140.67F.3701 Euro 2	4 Cyl.	2499cc	60kW (82PS)	Diesel	TD26292
8140.67F.3710 Euro 2	4 Cyl.	2499cc	60kW (82PS)	Diesel	TD26293
8140.67F.3711 Euro 2	4 Cyl.	2499cc	60kW (82PS)	Diesel	TD26294



8140.67F.3713 Euro 2 4 Cyl. **2499cc** **60kW (82PS)** **Diesel** **TD26295**

8140.67F.3721 Euro 2 4 Cyl. **2499cc** **60kW (82PS)** **Diesel** **TD26296**

BE/PL	4	56,520/56,535	60,333/60,345	24,700	1,870	0,020/0,072	BS	1870CP	71-4130/4 STD 0.25 0.50 0.75
BE/PL	4	56,520/56,535	60,333/60,345	24,700	1,870	0,020/0,070	BS	66575CP	71-4185/4 STD 0.25 0.50 0.75

1870CP

66575CP

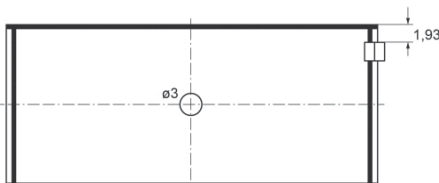

MB/HL 1-4	4	76,187/76,200	80,586/80,607	24,990	2,172	0,042/0,100	BS	66571CP	H1049/5 STD 0.25 0.50 0.75
MB/HL 5	1	76,187/76,200	80,586/80,607	31,950	2,172	0,042/0,100	BS	66572CPH	
MB/HL 1-4	4	76,187/76,200	80,586/80,607	24,990	2,172	0,038/0,097	BS	66573CP	H1094/5 STD 0.25
MB/HL 5	1	76,187/76,200	80,586/80,607	31,950	2,172	0,038/0,097	BS	66574CPH	

66571CP

66572CPH

66573CP

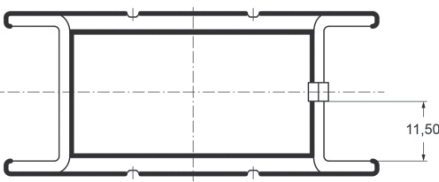
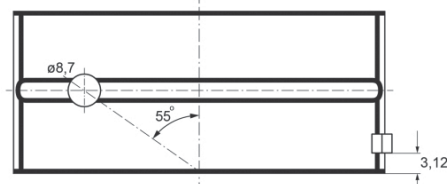
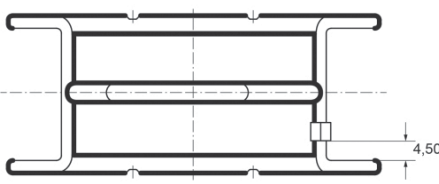

66574CPH

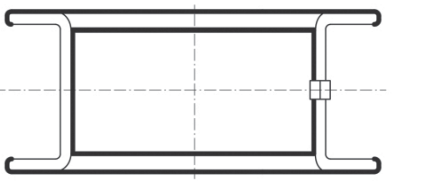
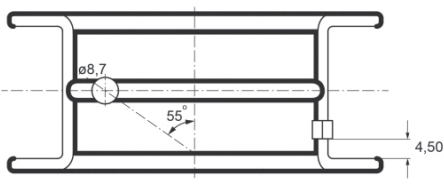

SE/PB	1	31,990/31,996	34,895/34,920	30,700			BS	66579YA	55-4186 SEMI
-------	---	---------------	---------------	--------	--	--	----	---------	------------------------

13

93.00 x 92.00

8140.67.2585 Euro 2 4 Cyl. **2500cc** **55-63kW (75-86PS)** **Diesel Turbo Intercooler** **TD20427**

BE/PL	4	56,520/56,535	60,333/60,345	24,700	1,870	0,020/0,072	BS	1870CP	71-4130/4 STD 0.25 0.50 0.75
-------	---	---------------	---------------	--------	-------	-------------	----	--------	--

MB/HL 5	1	86,182/86,208	90,588/90,614	30,950	2,164	0,052/0,129	BS	4691CPH	H1104/5 STD 0.25 0.50	
MB/HL 1-4	4	80,182/80,208	84,588/84,614	23,800	2,164	0,052/0,129	BS	4692CP		
09/95 →										
SE/PB	1	31,990/31,996	34,895/34,920	30,700			BS	66579YA	55-4186 SEMI	
Mot.344183 →										

14 93.00 x 92.00

8140.67F. Euro 2		4 Cyl.		2499cc	60kW (82PS)		Diesel		TD7226	
BE/PL	4	56,520/56,535	60,333/60,345	24,700	1,870	0,020/0,072	BS	1870CP	71-4130/4 STD 0.25 0.50 0.75	
MB/HL 5	1	86,182/86,208	90,588/90,614	30,950	2,164	0,052/0,129	BS	4691CPH	H1104/5 STD 0.25 0.50	
MB/HL 1-4	4	80,182/80,208	84,588/84,614	23,800	2,164	0,052/0,129	BS	4692CP		
SE/PB	1	31,990/31,996	34,895/34,920	30,700			BS	66579YA	55-4186 SEMI	

15 94.00 x 100.00

8149.03.3971		4 Cyl.		1995cc	84-66kW (114-90PS)		Diesel		FM25530	
BE/PL	4	56,520/56,535	60,333/60,345	24,700	1,870	0,020/0,072	BS	1870CP	71-4130/4 STD 0.25 0.50 0.75	
MB/HL 5	1	86,182/86,208	90,588/90,614	30,950	2,164	0,052/0,129	BS	4691CPH	H1104/5 STD 0.25 0.50	
MB/HL 1-4	4	80,182/80,208	84,588/84,614	23,800	2,164	0,052/0,129	BS	4692CP		
SE/PB	1	31,990/31,996	34,895/34,920	30,700			BS	66579YA	55-4186 SEMI	

16 94.40 x 100.00

8140.23.			4 Cyl.	2798cc	76kW (103PS)		Diesel Turbo Intercooler		TD7229	
8140.23.2585 Euro 2			4 Cyl.	2799cc	78kW (106PS)		Diesel Turbo Intercooler		TD16183	
8140.23.3700 Euro 2			4 Cyl.	2798cc	76kW (103PS)		Diesel Turbo Intercooler		TD10387	
8140.23.3701 Euro 2			4 Cyl.	2798cc	76kW (103PS)		Diesel Turbo Intercooler		TD27373	
8140.23.3710 Euro 2			4 Cyl.	2798cc	76kW (103PS)		Diesel Turbo Intercooler		TD27374	
8140.23.3711 Euro 2			4 Cyl.	2798cc	76kW (103PS)		Diesel Turbo Intercooler		TD27375	
8140.23.3713 Euro 2			4 Cyl.	2798cc	76kW (103PS)		Diesel Turbo Intercooler		TD27376	
8140.23.3720 Euro 2			4 Cyl.	2798cc	76kW (103PS)		Diesel Turbo Intercooler		TD27377	
8140.23.3721 Euro 2			4 Cyl.	2798cc	76kW (103PS)		Diesel Turbo Intercooler		TD27378	
8140.23.3730 Euro 2			4 Cyl.	2798cc	76kW (103PS)		Diesel Turbo Intercooler		TD27379	
8140.23.3731 Euro 2			4 Cyl.	2798cc	76kW (103PS)		Diesel Turbo Intercooler		TD27380	
8140.23.3750 Euro 2			4 Cyl.	2798cc	76kW (103PS)		Diesel Turbo Intercooler		TD27381	
8140.23.3751 Euro 2			4 Cyl.	2798cc	76kW (103PS)		Diesel Turbo Intercooler		TD27382	
8140.23.3760 Euro 2			4 Cyl.	2798cc	76kW (103PS)		Diesel Turbo Intercooler		TD27383	
8140.23.3801 Euro 2			4 Cyl.	2798cc	76kW (103PS)		Diesel Turbo Intercooler		TD27384	
8140.23.3811 Euro 2			4 Cyl.	2798cc	76kW (103PS)		Diesel Turbo Intercooler		TD27385	
8140.23.3821 Euro 2			4 Cyl.	2798cc	76kW (103PS)		Diesel Turbo Intercooler		TD27386	
8140.43. Euro 2			4 Cyl.	2798cc	90kW (122PS)		Diesel Turbo Intercooler		TD7235	
8140.43.2585 Euro 2			4 Cyl.	2798cc	84-90kW (114-122PS)		Diesel Turbo Intercooler		TD20423	
8140.43.3700 Euro 2			4 Cyl.	2798cc	85kW (116PS)		Diesel Turbo Intercooler		TD20424	
8140.43.3711 Euro 2			4 Cyl.	2798cc	90kW (122PS)		Diesel Turbo Intercooler		TD27427	
8140.43.3713 Euro 2			4 Cyl.	2798cc	90kW (122PS)		Diesel Turbo Intercooler		TD27428	
8140.43.3718 Euro 2			4 Cyl.	2798cc	90kW (122PS)		Diesel Turbo Intercooler		TD27429	
8140.43.3721 Euro 2			4 Cyl.	2798cc	90kW (122PS)		Diesel Turbo Intercooler		TD27430	



8140.43.3723 Euro 2	4 Cyl.	2798cc	90kW (122PS)	Diesel Turbo Intercooler	TD27431
8140.43.3728 Euro 2	4 Cyl.	2798cc	77-85kW (105-116PS)	Diesel Turbo Intercooler	TD27432
8140.43.3731 Euro 2	4 Cyl.	2798cc	90kW (122PS)	Diesel Turbo Intercooler	TD27433
8140.43.3900 Euro 2	4 Cyl.	2798cc	84-90kW (114-122PS)	Diesel Turbo Intercooler	TD20425
8140.43.3911 Euro 2	4 Cyl.	2798cc	90kW (122PS)	Diesel Turbo Intercooler	TD27434
8140.43.3921 Euro 2	4 Cyl.	2798cc	90kW (122PS)	Diesel Turbo Intercooler	TD27435
8140.43.3931 Euro 2	4 Cyl.	2798cc	90kW (122PS)	Diesel Turbo Intercooler	TD27436
8140.43.K	4 Cyl.	2798cc	103kW (140PS)	Diesel Turbo Intercooler	TD28051
8140.43B Euro 3	4 Cyl.	2798cc	78kW (105PS)	Diesel Turbo Intercooler	TD16514
8140.43B.4300 Euro 3	4 Cyl.	2798cc	77kW (105PS)	Diesel Turbo Intercooler	TD25968
8140.43B.4305 Euro 3	4 Cyl.	2798cc	77kW (105PS)	Diesel Turbo Intercooler	TD25966
8140.43B.4320 Euro 3	4 Cyl.	2798cc	77kW (105PS)	Diesel Turbo Intercooler	TD25967
8140.43B.4325 Euro 3	4 Cyl.	2798cc	77kW (105PS)	Diesel Turbo Intercooler	TD25969
8140.43B.4330 Euro 3	4 Cyl.	2798cc	77kW (105PS)	Diesel Turbo Intercooler	TD25970
8140.43B.4335 Euro 3	4 Cyl.	2798cc	77kW (105PS)	Diesel Turbo Intercooler	TD25971
8140.43C Euro 2	4 Cyl.	2798cc	78kW (106PS)	Diesel Turbo Intercooler	TD14449
8140.43C.4000 Euro 3	4 Cyl.	2798cc	77kW (105PS)	Diesel Turbo Intercooler	TD25972
8140.43C.4005 Euro 3	4 Cyl.	2798cc	77kW (105PS)	Diesel Turbo Intercooler	TD25973
8140.43C.4020 Euro 3	4 Cyl.	2798cc	77kW (105PS)	Diesel Turbo Intercooler	TD25974
8140.43C.4021 Euro 3	4 Cyl.	2798cc	77kW (105PS)	Diesel Turbo Intercooler	TD25975
8140.43C.4025 Euro 3	4 Cyl.	2798cc	77kW (105PS)	Diesel Turbo Intercooler	TD25976
8140.43C.4026 Euro 3	4 Cyl.	2798cc	77kW (105PS)	Diesel Turbo Intercooler	TD25977
8140.43C.4030 Euro 3	4 Cyl.	2798cc	77kW (105PS)	Diesel Turbo Intercooler	TD25978
8140.43C.4031 Euro 3	4 Cyl.	2798cc	77kW (105PS)	Diesel Turbo Intercooler	TD25979
8140.43C.4035 Euro 3	4 Cyl.	2798cc	77kW (105PS)	Diesel Turbo Intercooler	TD25980
8140.43C.4036 Euro 3	4 Cyl.	2798cc	77kW (105PS)	Diesel Turbo Intercooler	TD25981
8140.43K.4020 Euro 3	4 Cyl.	2798cc	92kW (125PS)	Diesel Turbo Intercooler	TD25982
8140.43K.4030 Euro 3	4 Cyl.	2798cc	92kW (125PS)	Diesel Turbo Intercooler	TD25983
8140.43N Euro 3	4 Cyl.	2798cc	107kW (146PS)	Diesel Turbo Intercooler	TD16873
8140.43N.4300 Euro 3	4 Cyl.	2798cc	108kW (147PS)	Diesel Turbo Intercooler	TD25984
8140.43N.4320 Euro 3	4 Cyl.	2798cc	108kW (147PS)	Diesel Turbo Intercooler	TD25985
8140.43N.4330 Euro 3	4 Cyl.	2798cc	108kW (147PS)	Diesel Turbo Intercooler	TD25986
8140.43N.4400 Euro 3	4 Cyl.	2798cc	108kW (147PS)	Diesel Turbo Intercooler	TD25987
8140.43N.4430 Euro 3	4 Cyl.	2798cc	108kW (147PS)	Diesel Turbo Intercooler	TD25988
8140.43R Euro 3	4 Cyl.	2798cc	66kW (90PS)	Diesel Turbo Intercooler	TD18570
8140.43R.4300 Euro 3	4 Cyl.	2798cc	66kW (90PS)	Diesel Turbo Intercooler	TD25989
8140.43R.4320 Euro 3	4 Cyl.	2798cc	66kW (90PS)	Diesel Turbo Intercooler	TD25990
8140.43R.4330 Euro 3	4 Cyl.	2798cc	66kW (90PS)	Diesel Turbo Intercooler	TD25991
8140.43R.4400 Euro 3	4 Cyl.	2798cc	66kW (90PS)	Diesel Turbo Intercooler	TD25992
8140.43R.4420 Euro 3	4 Cyl.	2798cc	66kW (90PS)	Diesel Turbo Intercooler	TD25993
8140.43R.4430 Euro 3	4 Cyl.	2798cc	66kW (90PS)	Diesel Turbo Intercooler	TD25994
8140.43S Euro 3	4 Cyl.	2798cc	92-100kW (125-136PS)	Diesel Turbo Intercooler	TD16874
8140.43S.4000 Euro 3	4 Cyl.	2798cc	92kW (125PS)	Diesel Turbo Intercooler	TD25995
8140.43S.4020 Euro 3	4 Cyl.	2798cc	92kW (125PS)	Diesel Turbo Intercooler	TD25996
8140.43S.4030 Euro 3	4 Cyl.	2798cc	92kW (125PS)	Diesel Turbo Intercooler	TD25997
8140.43S.4140 Euro 3	4 Cyl.	2798cc	92kW (125PS)	Diesel Turbo Intercooler	TD25998
8140.43S.4300 Euro 3	4 Cyl.	2798cc	92kW (125PS)	Diesel Turbo Intercooler	TD25999
8140.43S.4320 Euro 3	4 Cyl.	2798cc	92kW (125PS)	Diesel Turbo Intercooler	TD26000
8140.43S.4330 Euro 3	4 Cyl.	2798cc	92kW (125PS)	Diesel Turbo Intercooler	TD26001
8140.43S.4400 Euro 3	4 Cyl.	2798cc	92kW (125PS)	Diesel Turbo Intercooler	TD26002
8140.43S.4420 Euro 3	4 Cyl.	2798cc	92kW (125PS)	Diesel Turbo Intercooler	TD26003
8140.43S.4430 Euro 3	4 Cyl.	2798cc	92kW (125PS)	Diesel Turbo Intercooler	TD26004
8140.63. Euro 2	4 Cyl.	2798cc	62kW (84PS)	Diesel	TD10389



8140.63.4000 Euro 3		4 Cyl.		2798cc	62kW (84PS)		Diesel Turbo Intercooler		TD20478
8149.03		4 Cyl.		2798cc	78kW (106PS)		Gas		TD31263
BE/PL	4	56,520/56,535	60,333/60,345	24,700	1,870	0,020/0,072	BS	1870CP	71-4130/4 STD 0.25 0.50 0.75
MB/HL 5	1	86,182/86,208	90,588/90,614	30,950	2,164	0,052/0,129	BS	4691CPH	H1104/5 STD 0.25 0.50
MB/HL 1-4	4	80,182/80,208	84,588/84,614	23,800	2,164	0,052/0,129	BS	4692CP	
SE/PB	1	31,990/31,996	34,895/34,920	30,700			BS	66579YA	55-4186 SEMI

17 95.00 x 110.00

8030.01 (803A)		3 Cyl.		2339cc			Diesel		FM570
BE/PL	1	58,730/58,743	62,408/62,420	28,700	1,822	0,021/0,071	BS	60990CP	71-4281 STD 0.25 0.75
MB/HL	1	76,187/76,200	80,587/80,607	25,000	2,172	0,043/0,101	BS	60076CP	72-4550 STD 0.25
TW/A	4	85,090/85,340	101,600/101,850		3,429		AL-LF	60076AFA	A192/4 STD .005
TW/A	4	85,090/85,340	106,550/106,800		3,429		AL-LF	60076AFF	A193/4 STD .005

60076AFA

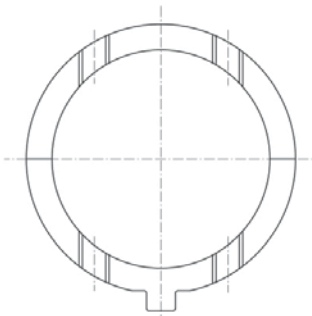

60076AFF

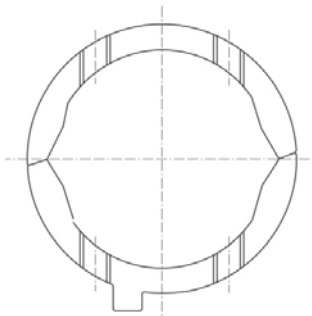

SE/PB	1	32,005/32,012	35,877/35,916	16,690			BS	60079X	55-4211 SEMI
SE/PB	1	32,005/32,012	35,877/35,916	34,800			BS	66634YC	55-4231 SEMI
CB/NWB 2	1	50,975/51,000	54,780/54,805	28,000	1,875		AL-LF	66231DR	N154/4 STD
CB/NWB 4	1	49,975/50,000	53,780/53,805	24,000	1,875		AL-LF	66232DR	
CB/NWB 3	1	50,475/50,500	54,280/54,305	28,000	1,875		AL-LF	66233DR	
CB/NWB 1	1	51,475/51,500	55,280/55,305	28,000	1,875		AL-LF	66234DR	

18 95.00 x 110.00

8040.01 (804A)		4 Cyl.		3119cc			Diesel		FM4009
BE/PL	1	58,730/58,743	62,408/62,420	28,700	1,822	0,021/0,071	BS	60990CP	71-4281 STD 0.25 0.75
MB/HL	1	76,187/76,200	80,587/80,607	25,000	2,172	0,043/0,101	BS	60076CP	72-4550 STD 0.25
TW/A	4	85,090/85,340	101,600/101,850		3,429		AL-LF	60076AFA	A192/4 STD .005
TW/A	4	85,090/85,340	106,550/106,800		3,429		AL-LF	60076AFF	A193/4 STD .005



60076AFA

60076AFF

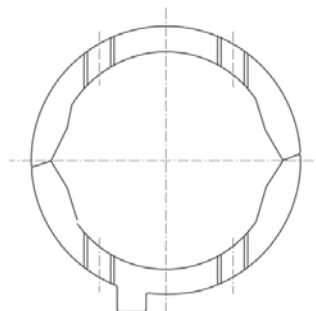
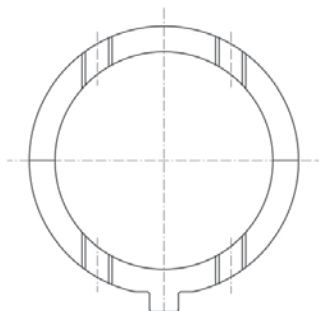

SE/PB	1	32,005/32,012	35,877/35,916	16,690		BS	60079X	55-4211 SEMI
SE/PB	1	32,005/32,012	35,877/35,916	34,800		BS	66634YC	55-4231 SEMI

19

95.00 x 110.00

8060.01/.11 (806A)		6 Cyl.		4678cc		Diesel		FM572
BE/PL	1	58,730/58,743	62,408/62,420	28,700	1,822	0,021/0,071	BS 60990CP	71-4281 STD 0.25 0.75
MB/HL	1	76,187/76,200	80,587/80,607	25,000	2,172	0,043/0,101	BS 60076CP	72-4550 STD 0.25
TW/A	4	85,090/85,340	101,600/101,850		3,429		AL-LF 60076AFA	A192/4 STD .005
TW/A	4	85,090/85,340	106,550/106,800		3,429		AL-LF 60076AFF	A193/4 STD .005

60076AFA

60076AFF

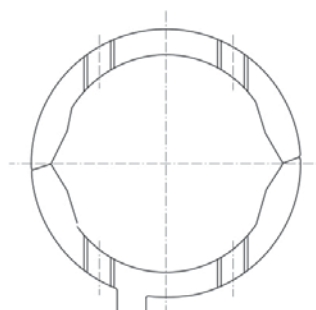
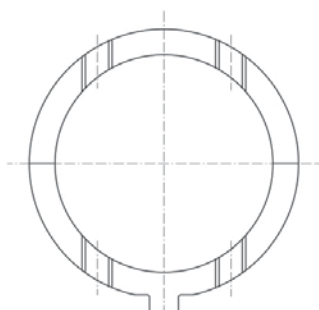

SE/PB	1	32,005/32,012	35,877/35,916	16,690		BS	60079X	55-4211 SEMI
-------	---	---------------	---------------	--------	--	----	--------	------------------------

20

95.80 x 104.00

F1CE0481A	4 Cyl.	2998cc	100-114kW (136-155PS)	Diesel Turbo Intercooler	TD19195
F1CE0481B Euro 3	4 Cyl.	2998cc	122kW (166PS)	Diesel Turbo Intercooler	TD22675
F1CE0481D (F30DT)	4 Cyl.	2999cc	115-130kW (156-177PS)	Diesel	TD24616
F1CE0481FA Euro 4	4 Cyl.	2998cc	107kW (146PS)	Diesel Turbo Intercooler	TD19224
F1CE0481HA	4 Cyl.	2998cc	125-130kW (170-177PS)	Diesel Turbo Intercooler	TD19225
F1CE0481HC Euro 4	4 Cyl.	2998cc	130kW (176PS)	Diesel Turbo Intercooler	TD19230
F1CE0481L Euro 4	4 Cyl.	2998cc	107-110kW (146-150PS)	Diesel Turbo Intercooler	TD27239
F1CE3481C	4 Cyl.	2998cc	125kW (170PS)	Diesel Turbo Intercooler	TD26636
F1CE3481D Euro 5	4 Cyl.	2998cc	150kW (205PS)	Diesel Turbo Intercooler	TD26942
F1CE3481J Euro 5	4 Cyl.	2998cc	107kW (146PS)	Diesel Turbo Intercooler	TD26940
F1CE3481K Euro 5	4 Cyl.	2998cc	125kW (170PS)	Diesel Turbo Intercooler	TD26941
F1CE3481L	4 Cyl.	2998cc	104-107kW (140-146PS)	Diesel Turbo Intercooler	TD26939
F1CE3481LC	4 Cyl.	2998cc	103kW (140PS)	Diesel Turbo Intercooler	TD24072

BE/PL	4	64,015/64,038	67,833/67,848	26,800		0,034/0,062	EC-LF	71-4082	71-4082/4 STD 0.25	5

21 95.80 x 104.00

F1CFA401A Euro 6	4 Cyl.	2998cc	100kW (136PS)	Petrol Turbo Intercooler	TD29636
F1CFL411E Euro 6	4 Cyl.	2998cc	107kW (146PS)	Diesel Turbo Intercooler	TD29634
F1CFL411F Euro 6	4 Cyl.	2998cc	125kW (170PS)	Diesel Turbo Intercooler	TD29635
F1CFL411G Euro 5	4 Cyl.	2998cc	150kW (205PS)	Diesel Turbo Intercooler	TD29633
F1CFL411H Euro 5	4 Cyl.	2998cc	125kW (170PS)	Diesel Turbo Intercooler	TD29632
F1CFL411J Euro 5	4 Cyl.	2998cc	107kW (146PS)	Diesel Turbo Intercooler	TD29631
F1CFA401B Euro 6	4 Cyl.	2998cc	100kW (136PS)	Gas Turbo Intercooler	TD29637

BE/PL	4	59,015/59,038	62,833/62,848	23,750	1,884	0,027/0,065	BS	71-4080	71-4080/4 STD 0.25 0.50
MB/HL 1-4	4	71,182/71,208	75,588/75,614	27,000	2,174	0,032/0,084	AL-LF	02-4083	H1020/5 STD 0.25 0.50
MB/HL 1,2,4	3	71,182/71,208	75,588/75,614	27,000	2,174	0,032/0,084	AL-LF	02-4084	
MB/HL 3	1	71,182/71,208	75,588/75,614	27,000	2,174	0,032/0,084	AL-LF	02-4085H	
MB/HL	1	76,182/76,208	80,588/80,614	27,000	2,174	0,032/0,084	AL-LF	02-4086L	
MB/HL	1	76,182/76,208	80,588/80,614	27,000	2,174	0,032/0,084	AL-LF	02-4086U	

22 100.00 x 110.00

853A			3 Cyl.	2600cc			Diesel		FM3478
BE/PL	1	58,730/58,743	62,408/62,420	28,700	1,816	0,033/0,083	BS	66630CP	71-4229 STD 0.25 0.50 0.75 1.00
MB/HL	1	76,187/76,200	80,587/80,607	25,000	2,172	0,043/0,101	BS	66631CPA	72-4547 STD 0.25 0.50 0.75 1.00
TW/A	4	85,090/85,340	101,600/101,850		3,429		AL-LF	60076AFA	A192/4 STD .005

Mot.→645690

TW/A	4	85,090/85,340	106,550/106,800		3,429		AL-LF	60076AFF	A193/4 STD .005
------	---	---------------	-----------------	--	-------	--	-------	----------	---------------------------

Mot.645691→

60076AFA

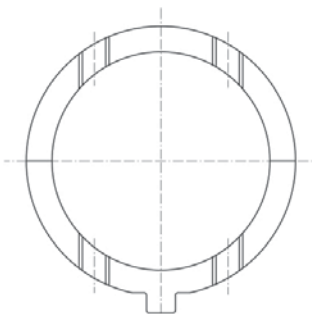

60076AFF

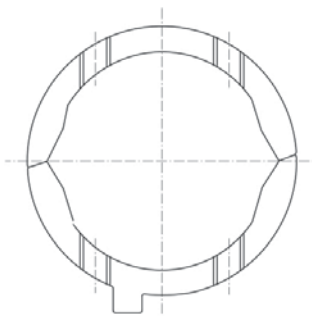

SE/PB	1	32,005/32,012	35,877/35,916	16,690			BS	60079X	55-4211 SEMI
SE/PB	1	34,005/34,012	37,846/37,884	16,690			BS	66634Y	55-4275 SEMI

CB/NWB 2	1	50,975/51,000	54,780/54,805	28,000	1,875			AL-LF	66231DR	N154/4 STD
CB/NWB 4	1	49,975/50,000	53,780/53,805	24,000	1,875			AL-LF	66232DR	
CB/NWB 3	1	50,475/50,500	54,280/54,305	28,000	1,875			AL-LF	66233DR	
CB/NWB 1	1	51,475/51,500	55,280/55,305	28,000	1,875			AL-LF	66234DR	

23

100.00 x 110.00

Fiat-8040.02..		4 Cyl.		3460cc	60kW (82PS)			Diesel	TD2575	
BE/PL	1	58,730/58,743	62,408/62,420	28,700	1,816	0,033/0,083	BS	66630CP	71-4229 STD 0.25 0.50 0.75 1.00	
MB/HL	1	76,187/76,200	80,587/80,607	25,000	2,172	0,043/0,101	BS	66631CPA	72-4547 STD 0.25 0.50 0.75 1.00	
MB/HL	1	76,187/76,200	80,587/80,607	25,000	2,172	0,043/0,101	BS	60076CP	72-4550 STD 0.25	

66631CPA

60076CP

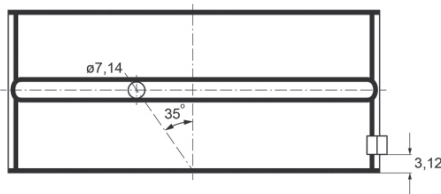
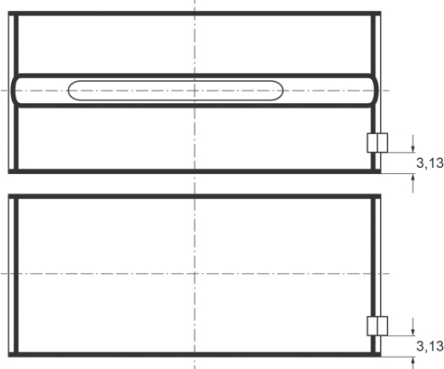

TW/A	4	85,090/85,340	101,600/101,850		3,429		AL-LF	60076AFA	A192/4 STD .005	
TW/A	4	85,090/85,340	106,550/106,800		3,429		AL-LF	60076AFF	A193/4 STD .005	

60076AFA

60076AFF

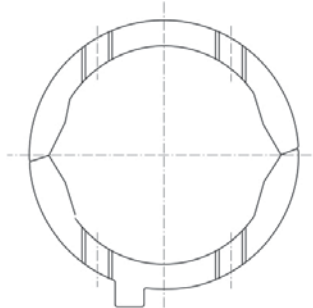
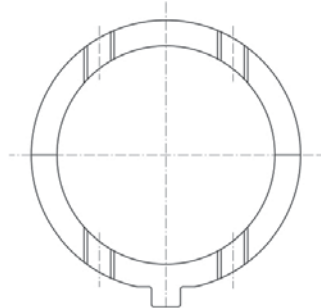

SE/PB	1	32,005/32,012	35,877/35,916	16,690			BS	60079X	55-4211 SEMI	
SE/PB	1	34,005/34,012	37,846/37,884	34,800			BS	66634YA	55-4230 SEMI	
SE/PB	1	32,005/32,012	35,877/35,916	34,800			BS	66634YC	55-4231 SEMI	
SE/PB	1	34,005/34,012	37,846/37,884	16,690			BS	66634Y	55-4275 SEMI	

24

100.00 x 110.00

8060.02.001		6 Cyl.		5184cc	90kW (122PS)			Diesel	TD10468	
8060.02.003		6 Cyl.		5184cc	90kW (122PS)			Diesel	TD10469	



BE/PL	1	58,730/58,743	62,408/62,420	28,700	1,816	0,033/0,083	BS	66630CP	71-4229 STD 0.25 0.50 0.75 1.00
-------	---	---------------	---------------	--------	-------	-------------	----	---------	---

01/80 →

BE/PL	1	58,730/58,743	62,408/62,420	28,700	1,822	0,021/0,071	BS	60990CP	71-4281 STD 0.25 0.75
-------	---	---------------	---------------	--------	-------	-------------	----	---------	---------------------------------

→12/79

66630CP

60990CP

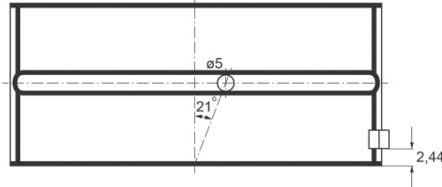
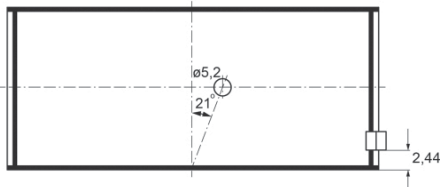

MB/HL	1	76,187/76,200	80,587/80,607	25,000	2,172	0,043/0,101	BS	66631CPA	72-4547 STD 0.25 0.50 0.75 1.00
-------	---	---------------	---------------	--------	-------	-------------	----	----------	---

01/80 →

MB/HL	1	76,187/76,200	80,587/80,607	25,000	2,172	0,043/0,101	BS	60076CP	72-4550 STD 0.25
-------	---	---------------	---------------	--------	-------	-------------	----	---------	----------------------------

→12/79

66631CPA

60076CP

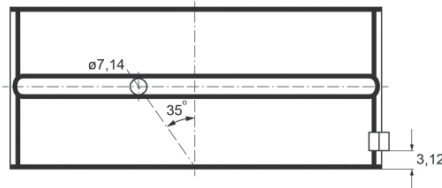
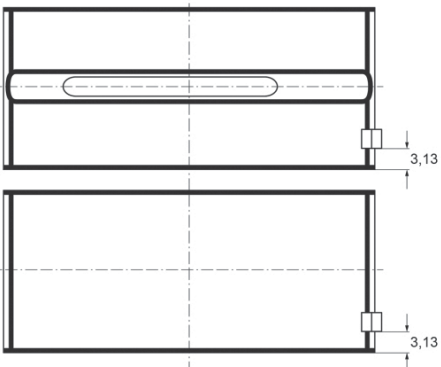

TW/A	4	85,090/85,340	101,600/101,850	3,429			AL-LF	60076AFA	A192/4 STD .005
------	---	---------------	-----------------	-------	--	--	-------	----------	---------------------------

Mot. →645690

TW/A	4	85,090/85,340	106,550/106,800	3,429			AL-LF	60076AFF	A193/4 STD .005
------	---	---------------	-----------------	-------	--	--	-------	----------	---------------------------

Mot.645691 →

60076AFA

60076AFF

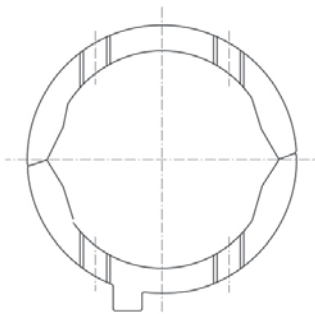
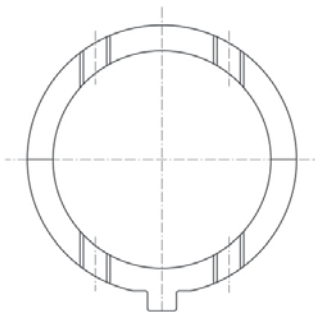

SE/PB	1	32,005/32,012	35,877/35,916	16,690			BS	60079X	55-4211 SEMI
-------	---	---------------	---------------	--------	--	--	----	--------	------------------------

→12/77

SE/PB	1	34,005/34,012	37,846/37,884	34,800			BS	66634YA	55-4230 SEMI
01/78 →									
SE/PB	1	32,005/32,012	35,877/35,916	34,800			BS	66634YC	55-4231 SEMI
→12/77									
SE/PB	1	34,005/34,012	37,846/37,884	16,690			BS	66634Y	55-4275 SEMI
01/78 →									
CB/NWB 2	1	50,975/51,000	54,780/54,805	28,000	1,875		AL-LF	66231DR	N154/4 STD
CB/NWB 4	1	49,975/50,000	53,780/53,805	24,000	1,875		AL-LF	66232DR	
CB/NWB 3	1	50,475/50,500	54,280/54,305	28,000	1,875		AL-LF	66233DR	
CB/NWB 1	1	51,475/51,500	55,280/55,305	28,000	1,875		AL-LF	66234DR	

25 100.00 x 115.00

8045.06			4 Cyl.	3613cc	44-73kW (60-99PS)		Diesel		TD28623
BE/PL	1	63,725/63,744	67,407/67,422	28,700	1,815	0,033/0,092	BS	1010CP	71-4104 STD 0.25 0.50 0.75
MB/HL	1	79,791/79,810	84,200/84,230	25,000	2,179	0,032/0,106	BS	1011CP	72-4546 STD 0.25 0.50 0.75
TW/A	4	87,779/88,033	111,510/111,764		3,429		BS	1011BF	A169/4 STD .005
SE/PB	1	38,004/38,014	41,846/41,884	34,800			BS	1014Y	55-4105 SEMI
SE/PB	1	38,005/38,012	41,846/41,884	34,800			BS	1014YA	55-4106 SEMI

1014Y

1014YA

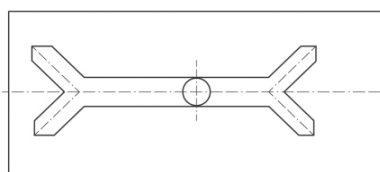
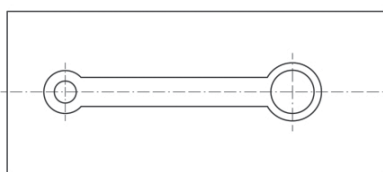

CB/NWB 1	1	50,975/51,000	54,780/54,805	28,000	1,875		AL-LF	66231DR	N153/3 STD
CB/NWB 3	1	49,975/50,000	53,780/53,805	24,000	1,875		AL-LF	66232DR	
CB/NWB 2	1	50,475/50,500	54,280/54,305	28,000	1,875		AL-LF	66233DR	

26 102.00 x 120.00

F4AE0481A Euro 3			4 Cyl.	3920cc	125kW (170PS)		Diesel Turbo Intercooler		TD16294
F4AE0481C Euro 3			4 Cyl.	3920cc	110kW (149PS)		Diesel Turbo Intercooler		TD16293
F4AE0481D Euro 3			4 Cyl.	3920cc	95kW (130PS)		Diesel Turbo Intercooler		TD16292
F4AE3481A Euro 4/5			4 Cyl.	3920cc	134kW (182PS)		Diesel Turbo Intercooler		TD21097
F4AE3481B Euro 4/5			4 Cyl.	3920cc	130kW (177PS)		Diesel Turbo Intercooler		TD21096
F4AE3481C Euro 4/5			4 Cyl.	3920cc	103kW (140PS)		Diesel Turbo Intercooler		TD21092
F4AE3481D Euro 4/5			4 Cyl.	3920cc	118kW (160PS)		Diesel Turbo Intercooler		TD21095
BE/PL	1	68,987/69,013	72,987/73,013	31,130	1,968	0,038/0,114	EC	71-4573	71-4573 STD 0.25 0.50
BE/PL	1	68,987/69,013	72,987/73,013	31,130	1,968	0,038/0,114	EC	71-4573	71-4708 STD 0.25 0.50
BE/PL	1	68,987/69,013	72,987/73,013	31,130	1,968	0,038/0,114	EC	71-4708	

II

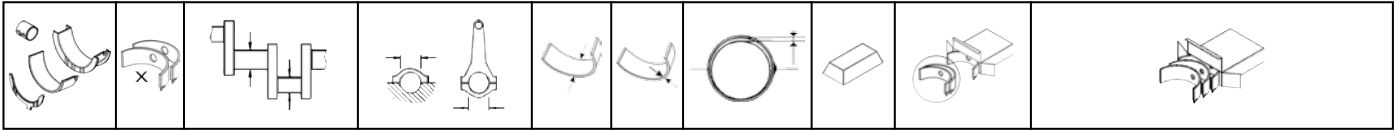

71-4573

71-4708



MB/HL	1	82,993/83,013	87,977/88,013	37,348	2,464	0,036/0,116	AL-LF	02-4574H
MB/HL	1	82,993/83,013	87,977/88,013	37,348	2,464	0,036/0,116	AL-LF	02-4575H
MB/HL	1	82,993/83,013	87,982/88,008	29,030	2,464	0,041/0,111	AL-LF	02-4576

02-4575H
STD 0.25 0.50

02-4576
STD 0.25 0.50

02-4574H

02-4575H

02-4576

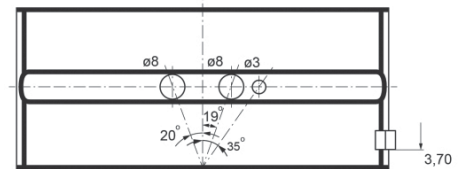
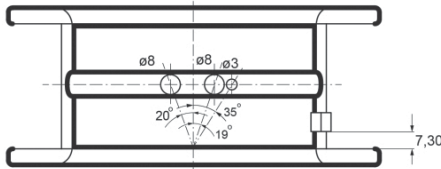

SE/PB	1	40,000	42,987/43,013	38,100			BS	55-4706
CB/NWB	1		59,228/59,248	25,400			BS	53-4707

55-4706
SEMI

53-4707
SEMI

27

102.00 x 120.00

F4AE0681A Euro 3	6 Cyl.	5880cc	202-220kW (275-299PS)	Diesel Turbo Intercooler	TD16520
F4AE0681B Euro 3	6 Cyl.	5880cc	176kW (240PS)	Diesel Turbo Intercooler	TD16519
F4AE0681D Euro 3	6 Cyl.	5880cc	132-155kW (180-211PS)	Diesel Turbo Intercooler	TD16296
F4AE0681E Euro 3	6 Cyl.	5880cc	132-134kW (180-181PS)	Diesel Turbo Intercooler	TD16295

BE/PL	1	68,987/69,013	72,987/73,013	31,130	1,968	0,038/0,114	EC	71-4573
BE/PL	1	68,987/69,013	72,987/73,013	31,130	1,968	0,038/0,114	EC	71-4573
BE/PL	1	68,987/69,013	72,987/73,013	31,130	1,968	0,038/0,114	EC	71-4708

71-4573
STD 0.25 0.50

71-4708
STD 0.25 0.50



71-4573

71-4708



MB/HL	1	82,993/83,013	87,977/88,013	37,348	2,464	0,036/0,116	AL-LF	02-4574H
MB/HL	1	82,993/83,013	87,977/88,013	37,348	2,464	0,036/0,116	AL-LF	02-4575H
MB/HL	1	82,993/83,013	87,982/88,008	29,030	2,464	0,041/0,111	AL-LF	02-4576

02-4575H
STD 0.25 0.50

02-4576
STD 0.25 0.50



02-4574H

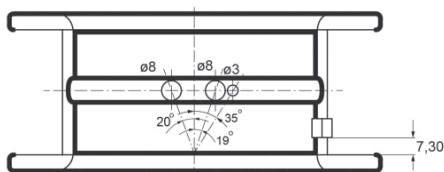

02-4575H



02-4576

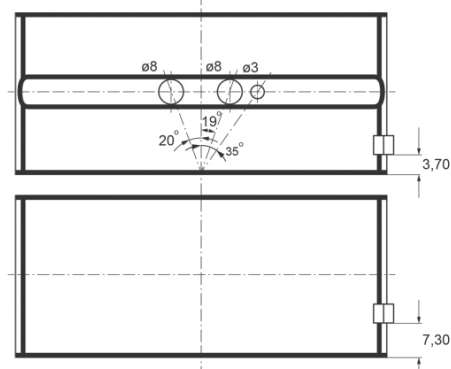

SE/PB	1	40,000	42,987/43,013	38,100			BS	55-4706	55-4706 SEMI
CB/NWB	1		59,228/59,248	25,400			BS	53-4707	53-4707 SEMI

28

102.00 x 120.00

F4AE3681A Euro 4/5	6 Cyl.	5880cc	220kW (299PS)	Diesel Turbo Intercooler	TD22585
F4AE3681B Euro 4/5	6 Cyl.	5880cc	160kW (218PS)	Diesel Turbo Intercooler	TD21098
F4AE3681C Euro 4/5	6 Cyl.	5880cc	135kW (183PS)	Diesel Turbo Intercooler	TD22602
F4AE3681D Euro 4/5	6 Cyl.	5880cc	185kW (251PS)	Diesel Turbo Intercooler	TD21099
F4AE3681E Euro 4/5	6 Cyl.	5880cc	205-206kW (279-280PS)	Diesel Turbo Intercooler	TD21100

BE/PL	1	68,987/69,013	72,987/73,013	31,130	1,968	0,038/0,114	EC	71-4573	71-4573 STD 0.25 0.50
MB/HL	1	82,993/83,013	87,977/88,013	37,348	2,464	0,036/0,116	AL-LF	02-4574H	02-4575H STD 0.25 0.50
MB/HL	1	82,993/83,013	87,977/88,013	37,348	2,464	0,036/0,116	AL-LF	02-4575H	
MB/HL	1	82,993/83,013	87,982/88,008	29,030	2,464	0,041/0,111	AL-LF	02-4576	02-4576 STD 0.25 0.50

02-4574H

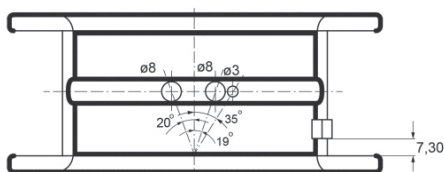

02-4575H



02-4576

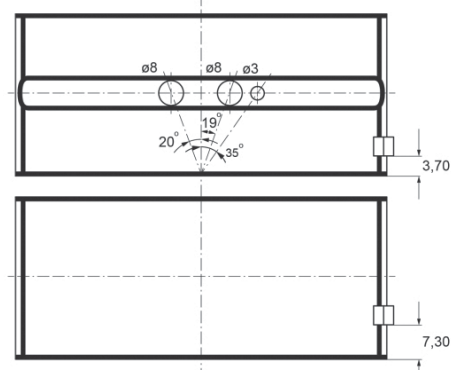

SE/PB	1	40,000	42,987/43,013	38,100			BS	55-4706	55-4706 SEMI
CB/NWB	1		59,228/59,248	25,400			BS	53-4707	53-4707 SEMI

29

102.00 x 125.00

F4L 913	4 Cyl.	4086cc	64kW (87PS)	Diesel	TD10414				
BE/PL	1	59,941/59,960	64,000/64,019	25,000	2,000	0,040/0,103	AL-LF	01-2800	01-2800 STD 0.25 0.50 0.75
MB/HL	1	69,971/69,990	74,500/74,519	27,000	2,229	0,052/0,115	AL-LF	02-2228	02-2228 STD 0.25 0.50 0.75

TW/A	1	79,300	94,964		2,985		AL-LF	04-3405	A110/4 STD
TW/A	1	79,300	94,964		2,985		AL-LF	04-3406	
TW/A	1	79,000/79,300	101,614/101,964		2,985		AL-LF	04-3407	
TW/A	1	79,000/79,300	101,614/101,964		2,985		AL-LF	04-3408	
SE/PB	1	34,995/35,000	38,000/38,016	33,800	1,482		BC	55-2650	55-2650 STD
BU	1	17,983/17,994	21,000/21,021	13,800	1,501		BC	56-2651	56-2651 STD

30

102.00 x 125.00

BF6L 913		6 Cyl.		6128cc	118-124kW (160-169PS)		Diesel Turbo		TD10451
BF6L 913 /U		6 Cyl.		6128cc	124kW (169PS)		Diesel Turbo		TD10474
BF6L 913 T		6 Cyl.		6128cc	96-112kW (131-152PS)		Diesel Turbo		TD10425
MB/HL 1-7	7	74,971/74,990	79,000/79,019	25,000	1,985	0,040/0,103	AL-LF	02-3168	H085/7 STD 0.25
TW/A	1	87,350	107,964		2,985		AL-LF	04-3169	A087/4 STD
TW/A	1	87,350	100,964		2,985		AL-LF	04-3186	
TW/A	1	87,350	107,964		2,985		AL-LF	04-3385	
TW/A	1	87,350	100,964		2,985		AL-LF	04-3386	
SE/PB	1	39,995/40,000	43,000/43,016	33,300	1,487		BC	55-3170	55-3170 STD
BU	1	17,983/17,994	21,000/21,021	13,800	1,501		BC	56-2651	56-2651 STD

31

102.00 x 125.00

F6L 913		6 Cyl.		6128cc	96-124kW (131-169PS)		Diesel		TD10427
BE/PL	1	59,941/59,960	64,000/64,019	25,000	2,000	0,040/0,103	AL-LF	01-2800	01-2800 STD 0.25 0.50 0.75
MB/HL	1	69,971/69,990	74,500/74,519	27,000	2,229	0,052/0,115	AL-LF	02-2228	02-2228 STD 0.25 0.50 0.75
TW/A	1	79,300	94,964		2,985		AL-LF	04-3405	A110/4 STD
TW/A	1	79,300	94,964		2,985		AL-LF	04-3406	
TW/A	1	79,000/79,300	101,614/101,964		2,985		AL-LF	04-3407	
TW/A	1	79,000/79,300	101,614/101,964		2,985		AL-LF	04-3408	
SE/PB	1	34,995/35,000	38,000/38,016	33,800	1,482		BC	55-2650	55-2650 STD
BU	1	17,983/17,994	21,000/21,021	13,800	1,501		BC	56-2651	56-2651 STD

32

103.00 x 110.00

8040.04.200		4 Cyl.		3666cc	63kW (86PS)		Diesel		TD10397
BE/PL	1	58,730/58,743	62,408/62,420	28,700	1,816	0,033/0,083	BS	66630CP	71-4229 STD 0.25 0.50 0.75 1.00
BE/PL	1	58,730/58,743	62,408/62,420	28,700	1,822	0,021/0,071	BS	60990CP	71-4281 STD 0.25 0.75

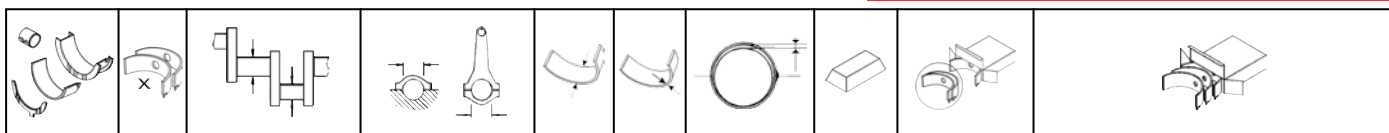

66630CP

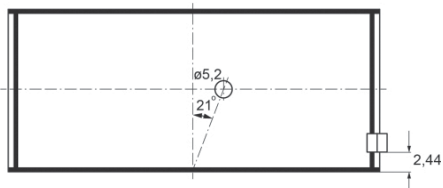

60990CP

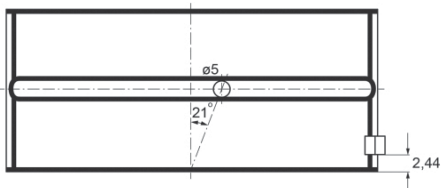

MB/HL	1	76,187/76,200	80,587/80,607	25,000	2,172	0,043/0,101	BS	66631CPA	72-4547 STD 0.25 0.50 0.75 1.00
MB/HL	1	76,187/76,200	80,587/80,607	25,000	2,172	0,043/0,101	BS	60076CP	72-4550 STD 0.25

66631CPA

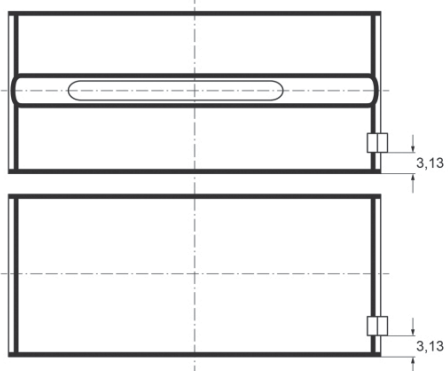

60076CP

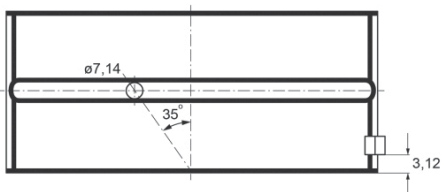

TW/A	4	85,090/85,340	101,600/101,850	3,429	AL-LF	60076AFA	A192/4 STD .005
TW/A	4	85,090/85,340	106,550/106,800	3,429	AL-LF	60076AFF	A193/4 STD .005

60076AFA

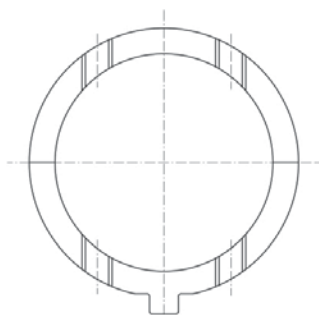

60076AFF

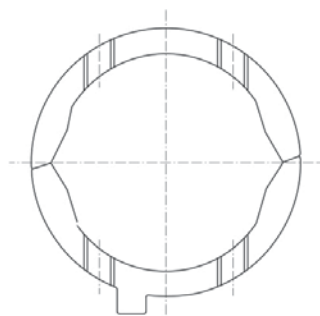

SE/PB	1	32,005/32,012	35,877/35,916	16,690	BS	60079X	55-4211 SEMI
SE/PB	1	34,005/34,012	37,846/37,884	34,800	BS	66634YA	55-4230 SEMI
SE/PB	1	32,005/32,012	35,877/35,916	34,800	BS	66634YC	55-4231 SEMI
SE/PB	1	34,005/34,012	37,846/37,884	16,690	BS	66634Y	55-4275 SEMI

33 103.00 x 110.00

8060.04.051	6 Cyl.	5499cc	96kW (131PS)	Diesel	TD10457
8060.04.055	6 Cyl.	5499cc	96kW (131PS)	Diesel	TD10420
8060.04.060	6 Cyl.	5500cc	96kW (131PS)	Diesel	TD10417
8060.04.070	6 Cyl.	5499cc	99kW (135PS)	Diesel	TD10413
8060.04.620	6 Cyl.	5499cc	99kW (135PS)	Diesel	TD10408
8060.04.621	6 Cyl.	5499cc	99kW (135PS)	Diesel	TD10409



8060.04.630			6 Cyl.	5500cc	99kW (135PS)		Diesel		TD10470
8060.04.639			6 Cyl.	5500cc	99kW (135PS)		Diesel		TD10463
8060.04.658			6 Cyl.	5499cc	99kW (135PS)		Diesel		TD10390
8060.04.660			6 Cyl.	5500cc	96-99kW (131-135PS)		Diesel		TD10421
8060.04.669			6 Cyl.	5500cc	99-102kW (135-139PS)		Diesel		TD10460
8060.04.670			6 Cyl.	5500cc	99kW (135PS)		Diesel		TD10449
8060.04.672			6 Cyl.	5500cc	73kW (99PS)		Diesel		TD10450
8060.04.675			6 Cyl.	5500cc	99kW (135PS)		Diesel		TD10464
8060.04.689			6 Cyl.	5500cc	99-102kW (135-139PS)		Diesel		TD10462

BE/PL	1	58,730/58,743	62,408/62,420	28,700	1,816	0,033/0,083	BS	66630CP	71-4229 STD 0.25 0.50 0.75 1.00
MB/HL	1	76,187/76,200	80,587/80,607	25,000	2,172	0,043/0,101	BS	66631CPA	72-4547 STD 0.25 0.50 0.75 1.00
TW/A	4	85,090/85,340	101,600/101,850		3,429		AL-LF	60076AFA	A192/4 STD .005
TW/A	4	85,090/85,340	106,550/106,800		3,429		AL-LF	60076AFF	A193/4 STD .005

60076AFA

60076AFF

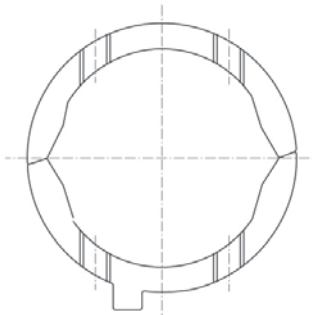
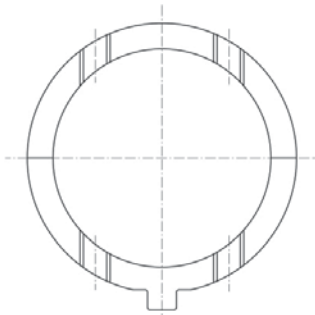

SE/PB	1	32,005/32,012	35,877/35,916	16,690			BS	60079X	55-4211 SEMI
SE/PB	1	34,005/34,012	37,846/37,884	34,800			BS	66634YA	55-4230 SEMI
SE/PB	1	32,005/32,012	35,877/35,916	34,800			BS	66634YC	55-4231 SEMI
SE/PB	1	34,005/34,012	37,846/37,884	16,690			BS	66634Y	55-4275 SEMI

34

103.00 x 110.00

8060.24.601			6 Cyl.	5500cc	124kW (169PS)		Diesel Turbo		TD10472
8060.24.670			6 Cyl.	5499cc	118kW (160PS)		Diesel Turbo		TD10447
8060.24.671			6 Cyl.	5499cc	118kW (160PS)		Diesel Turbo		TD10448
8060.24.678			6 Cyl.	5500cc	123kW (167PS)		Diesel Turbo		TD10465
8062.24.070			6 Cyl.	5499cc	118kW (160PS)		Diesel		TD10458

BE/PL	1	58,730/58,743	62,408/62,420	28,700	1,816	0,033/0,083	BS	66630CP	71-4229 STD 0.25 0.50 0.75 1.00
MB/HL	1	76,187/76,200	80,587/80,607	25,000	2,172	0,043/0,101	BS	66631CPA	72-4547 STD 0.25 0.50 0.75 1.00
TW/A	4	85,090/85,340	106,550/106,800		3,429		AL-LF	60076AFF	A193/4 STD .005
SE/PB	1	34,005/34,012	37,846/37,884	34,800			BS	66634YA	55-4230 SEMI
SE/PB	1	34,005/34,012	37,846/37,884	16,690			BS	66634Y	55-4275 SEMI



35 103.00 x 110.00

8061.04		6 Cyl.		5499cc		Diesel		FM23487	
BE/PL	1	58,730/58,743	62,408/62,420	28,700	1,816	0,033/0,083	BS	66630CP	71-4229 STD 0.25 0.50 0.75 1.00
MB/HL	1	76,187/76,200	80,587/80,607	25,000	2,172	0,043/0,101	BS	66631CPA	72-4547 STD 0.25 0.50 0.75 1.00
TW/A	4	85,090/85,340	106,550/106,800		3,429		AL-LF	60076AFF	A193/4 STD .005

36 104.00 x 115.00

8040.05.200			4 Cyl.	3908cc	65kW (88PS)		Diesel		TD10399
8040.05.203			4 Cyl.	3908cc	65kW (88PS)		Diesel		TD16721
8040.05.233			4 Cyl.	3908cc	65kW (88PS)		Diesel		TD16723
8040.05.235			4 Cyl.	3908cc	65kW (88PS)		Diesel		TD16724
8040.05.4990			4 Cyl.	3908cc	80kW (109PS)		Diesel Turbo		TD16725
8040.06			4 Cyl.	3908cc	65-100kW (88-136PS)		Diesel		FM4011
8040.25B.4200			4 Cyl.	3908cc	75kW (102PS)		Diesel Turbo		TD10403
8040.45			4 Cyl.	3908cc	100kW (136PS)		Diesel Turbo Intercooler		TD27447
8040.45.4000			4 Cyl.	3908cc	100kW (136PS)		Diesel Turbo Intercooler		TD10405
8040.45.4010			4 Cyl.	3908cc	100kW (136PS)		Diesel Turbo Intercooler		TD27284
8040.45.4020			4 Cyl.	3908cc	100kW (136PS)		Diesel Turbo Intercooler		TD27285
8040.45.4030			4 Cyl.	3908cc	100kW (136PS)		Diesel Turbo Intercooler		TD27286
8040.45.4035			4 Cyl.	3908cc	100kW (136PS)		Diesel Turbo Intercooler		TD27287
8040.45.4050			4 Cyl.	3908cc	100kW (136PS)		Diesel Turbo Intercooler		TD27288
8040.45.4180			4 Cyl.	3908cc	100kW (136PS)		Diesel Turbo Intercooler		TD10406
8040.45.4303			4 Cyl.	3908cc	100kW (136PS)		Diesel Turbo Intercooler		TD27289
8040.45.4380			4 Cyl.	3908cc	100kW (136PS)		Diesel Turbo Intercooler		TD20438
8040.45.5200 Euro 2			4 Cyl.	3908cc	100kW (136PS)		Diesel Turbo Intercooler		TD20439
8040.45.5201 Euro 2			4 Cyl.	3908cc	100kW (136PS)		Diesel Turbo Intercooler		TD27290
8040.45.5203 Euro 2			4 Cyl.	3908cc	100kW (136PS)		Diesel Turbo Intercooler		TD27291
8040.45.5205 Euro 2			4 Cyl.	3908cc	100kW (136PS)		Diesel Turbo Intercooler		TD27292
8040.45.5280 Euro 2			4 Cyl.	3908cc	100kW (136PS)		Diesel Turbo Intercooler		TD27293
8040.45.5281 Euro 2			4 Cyl.	3908cc	100kW (136PS)		Diesel Turbo Intercooler		TD27294
8040.45D.5100 Euro 2			4 Cyl.	3908cc	85-100kW (116-136PS)		Diesel Turbo Intercooler		TD20440
8040.45D.5101 Euro 2			4 Cyl.	3908cc	85kW (116PS)		Diesel Turbo Intercooler		TD27295
8040.45D.5103 Euro 2			4 Cyl.	3908cc	85kW (116PS)		Diesel Turbo Intercooler		TD27296
8040.45D.5105 Euro 2			4 Cyl.	3908cc	85kW (116PS)		Diesel Turbo Intercooler		TD27297
8040.45X.4180			4 Cyl.	3908cc	100kW (136PS)		Diesel Turbo Intercooler		TD20441
BE/PL	1	63,725/63,744	67,407/67,422	28,700	1,815	0,033/0,092	BS	1010CP	71-4104 STD 0.25 0.50 0.75
BE/PL	1	63,725/63,744	67,407/67,422	28,700	1,815	0,033/0,092	BS	1010CPA	71-4389 STD 0.25 0.50



1010CP

1010CPA

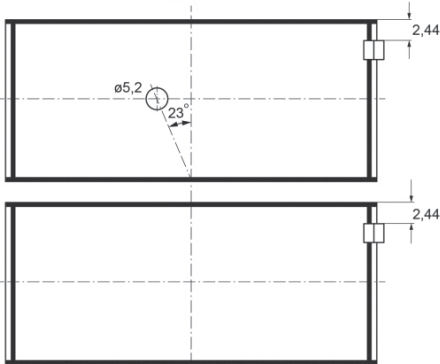

MB/HL	1	79,791/79,810	84,200/84,230	25,000	2,179	0,032/0,106	BS	1011CP	72-4546 STD 0.25 0.50 0.75
MB/HL	1	79,782/79,800	84,206/84,226	32,500	2,178	0,050/0,113	BS	66552CP	72-4556 STD 0.25 0.50

1011CP

66552CP

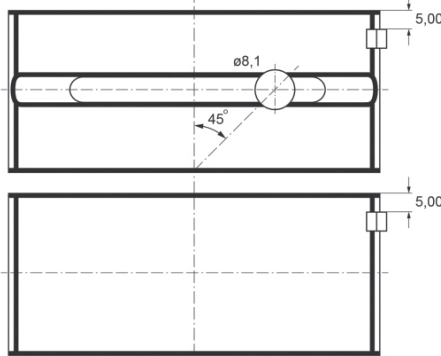
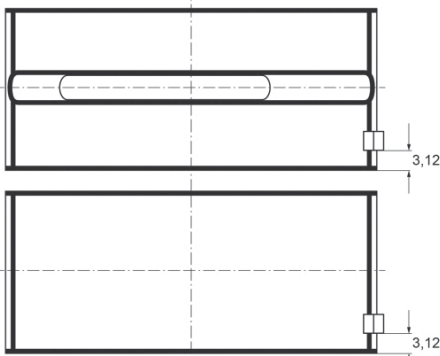

TW/A	4	87,779/88,033	111,510/111,764	3,429			BS	1011BF	A169/4 STD .005
SE/PB	1	38,004/38,014	41,846/41,884	34,800			BS	1014Y	55-4105 SEMI
SE/PB	1	38,005/38,012	41,846/41,884	34,800			BS	1014YA	55-4106 SEMI

1014Y

1014YA

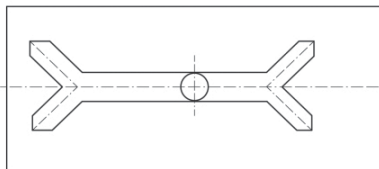
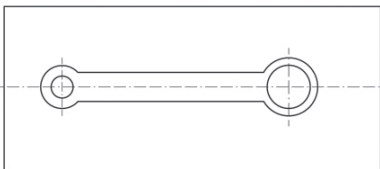

37

104.00 x 115.00

8040.05.230			4 Cyl.	3908cc	65kW (88PS)		Diesel		TD10398
8040.05.232			4 Cyl.	3908cc	65kW (88PS)		Diesel		TD16722
BE/PL	1	63,725/63,744	67,407/67,422	28,700	1,815	0,033/0,092	BS	1010CP	71-4104 STD 0.25 0.50 0.75
BE/PL	1	63,725/63,744	67,407/67,422	28,700	1,815	0,033/0,092	BS	1010CPA	71-4389 STD 0.25 0.50



1010CP

1010CPA

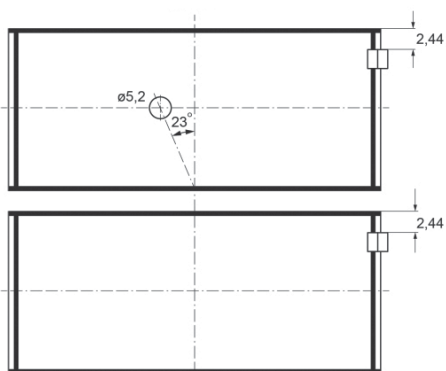

MB/HL	1	79,791/79,810	84,200/84,230	25,000	2,179	0,032/0,106	BS	1011CP	72-4546 STD 0.25 0.50 0.75
MB/HL	1	79,782/79,800	84,206/84,226	32,500	2,178	0,050/0,113	BS	66552CP	72-4556 STD 0.25 0.50

1011CP

66552CP

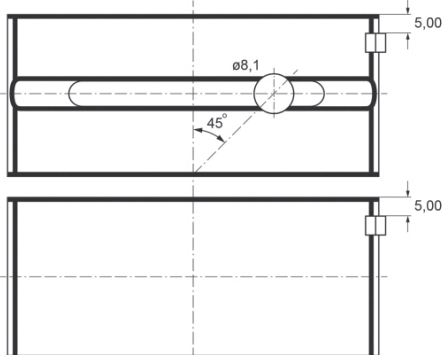
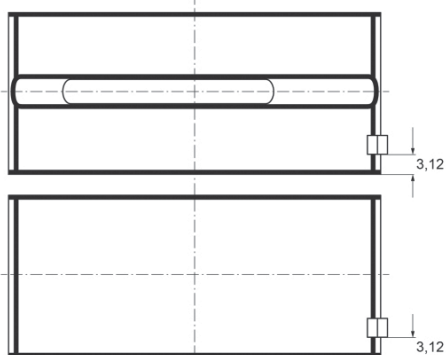

TW/A	4	87,779/88,033	111,510/111,764		3,429		BS	1011BF	A169/4 STD .005
SE/PB	1	38,004/38,014	41,846/41,884	34,800			BS	1014Y	55-4105 SEMI
SE/PB	1	38,005/38,012	41,846/41,884	34,800			BS	1014YA	55-4106 SEMI

1014Y

1014YA

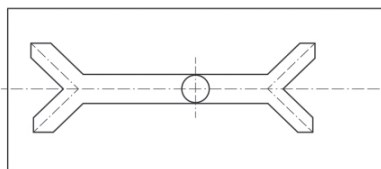
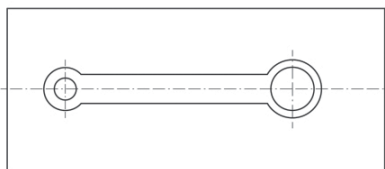

CB/NWB 1	1	50,975/51,000	54,780/54,805	28,000	1,875		AL-LF	66231DR	N153/3 STD
CB/NWB 3	1	49,975/50,000	53,780/53,805	24,000	1,875		AL-LF	66232DR	
CB/NWB 2	1	50,475/50,500	54,280/54,305	28,000	1,875		AL-LF	66233DR	

38

104.00 x 115.00

8040.25.200	4 Cyl.	3908cc	85kW (116PS)	Diesel Turbo	TD10407
8040.25.202	4 Cyl.	3908cc	85kW (116PS)	Diesel Turbo	TD27213
8040.25.203	4 Cyl.	3908cc	85kW (116PS)	Diesel Turbo	TD27214
8040.25.207	4 Cyl.	3908cc	85kW (116PS)	Diesel Turbo	TD27215
8040.25.208	4 Cyl.	3908cc	85kW (116PS)	Diesel Turbo	TD27216

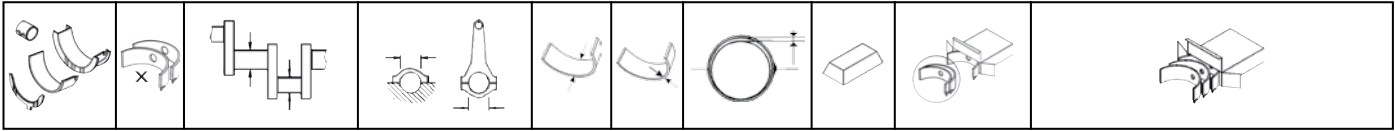

8040.25.220	4 Cyl.	3908cc	85kW (116PS)	Diesel Turbo	TD10416
8040.25.222	4 Cyl.	3908cc	85kW (116PS)	Diesel Turbo	TD27217
8040.25.223	4 Cyl.	3908cc	85kW (116PS)	Diesel Turbo	TD27218
8040.25.225	4 Cyl.	3908cc	85kW (116PS)	Diesel Turbo	TD27219
8040.25.229	4 Cyl.	3908cc	85kW (116PS)	Diesel Turbo	TD27230
8040.25.230 R	4 Cyl.	3908cc	74kW (101PS)	Diesel Turbo	TD10401
8040.25.231	4 Cyl.	3908cc	74kW (101PS)	Diesel Turbo	TD27231
8040.25.233	4 Cyl.	3908cc	74kW (101PS)	Diesel Turbo	TD27233
8040.25.234	4 Cyl.	3908cc	74kW (101PS)	Diesel Turbo	TD27232
8040.25B.4220	4 Cyl.	3908cc	75kW (102PS)	Diesel Turbo	TD23360

BE/PL	1	63,725/63,744	67,407/67,422	28,700	1,815	0,033/0,092	BS	1010CP	71-4104 STD 0.25 0.50 0.75
BE/PL	1	63,725/63,744	67,407/67,422	28,700	1,815	0,033/0,092	BS	1010CPA	71-4389 STD 0.25 0.50

1010CP

1010CPA

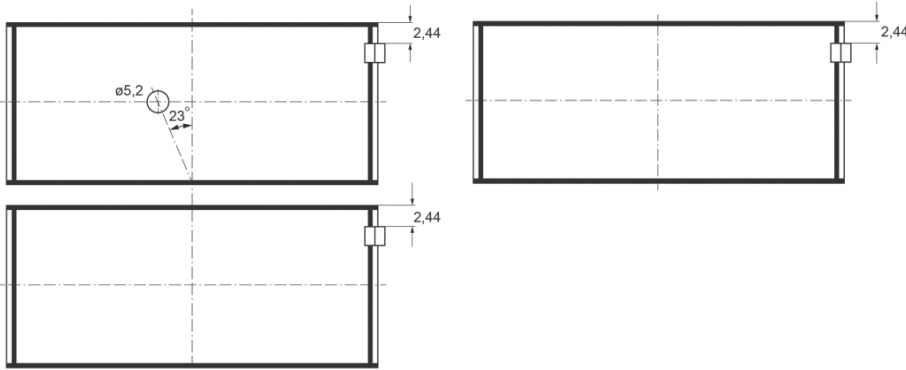

MB/HL	1	79,791/79,810	84,200/84,230	25,000	2,179	0,032/0,106	BS	1011CP	72-4546 STD 0.25 0.50 0.75
TW/A	4	87,779/88,033	111,510/111,764		3,429		BS	1011BF	A169/4 STD .005
SE/PB	1	38,004/38,014	41,846/41,884	34,800			BS	1014Y	55-4105 SEMI
SE/PB	1	38,005/38,012	41,846/41,884	34,800			BS	1014YA	55-4106 SEMI

1014Y

1014YA

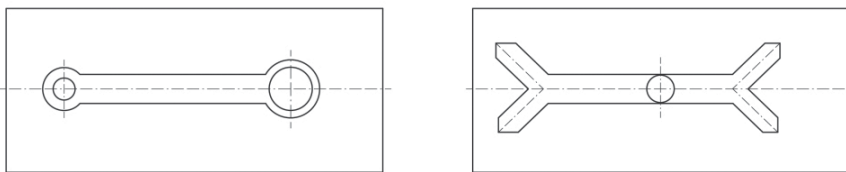

39

104.00 x 115.00

8040.25.201	4 Cyl.	3908cc	85kW (116PS)	Diesel Turbo	TD27212				
BE/PL	1	63,725/63,744	67,407/67,422	28,700	1,815	0,033/0,092	BS	1010CP	71-4104 STD 0.25 0.50 0.75
BE/PL	1	63,725/63,744	67,407/67,422	28,700	1,815	0,033/0,092	BS	1010CPA	71-4389 STD 0.25 0.50



1010CP

1010CPA

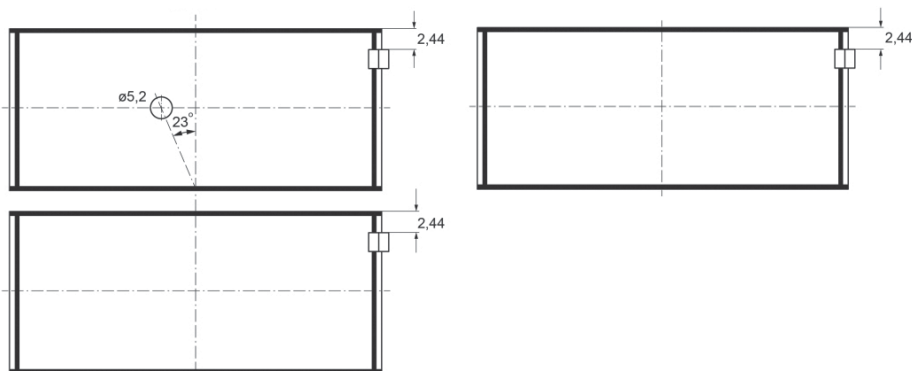

MB/HL	1	79,791/79,810	84,200/84,230	25,000	2,179	0,032/0,106	BS	1011CP	72-4546 STD 0.25 0.50 0.75
TW/A	4	87,779/88,033	111,510/111,764		3,429		BS	1011BF	A169/4 STD .005
SE/PB	1	38,004/38,014	41,846/41,884	34,800			BS	1014Y	55-4105 SEMI
SE/PB	1	38,005/38,012	41,846/41,884	34,800			BS	1014YA	55-4106 SEMI

1014Y

1014YA

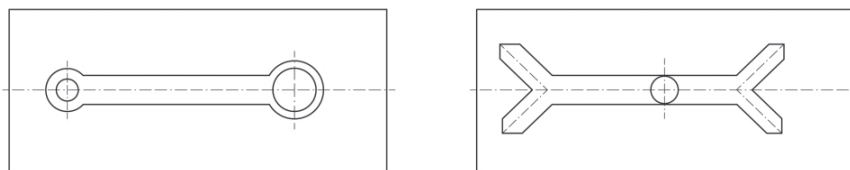

CB/NWB 1	1	50,975/51,000	54,780/54,805	28,000	1,875		AL-LF	66231DR	N153/3 STD
CB/NWB 3	1	49,975/50,000	53,780/53,805	24,000	1,875		AL-LF	66232DR	
CB/NWB 2	1	50,475/50,500	54,280/54,305	28,000	1,875		AL-LF	66233DR	

40 104.00 x 115.00

8040.25X.4000	4 Cyl.	3908cc	85kW (116PS)	Diesel Turbo	TD10404
8040.25X.4010	4 Cyl.	3908cc	85kW (116PS)	Diesel Turbo	TD27277
8040.25X.4020	4 Cyl.	3908cc	85kW (116PS)	Diesel Turbo	TD27278
8040.25X.4030	4 Cyl.	3908cc	85kW (116PS)	Diesel Turbo	TD27279
8040.25X.4035	4 Cyl.	3908cc	85kW (116PS)	Diesel Turbo	TD27280
8040.25X.4040	4 Cyl.	3908cc	85kW (116PS)	Diesel Turbo	TD27281
8040.25X.4045	4 Cyl.	3908cc	85kW (116PS)	Diesel Turbo	TD27282

BE/PL	1	63,725/63,744	67,407/67,422	28,700	1,815	0,033/0,092	BS	1010CP	71-4104 STD 0.25 0.50 0.75
BE/PL	1	63,725/63,744	67,407/67,422	28,700	1,815	0,033/0,092	BS	1010CPA	71-4389 STD 0.25 0.50

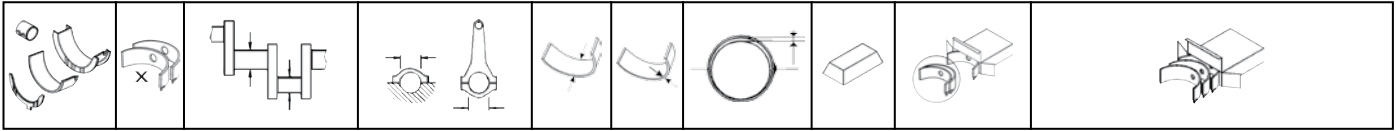

1010CP

1010CPA

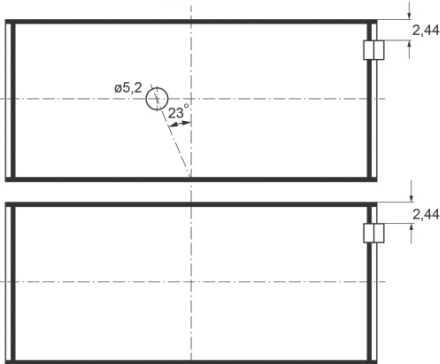

MB/HL	1	79,791/79,810	84,200/84,230	25,000	2,179	0,032/0,106	BS	1011CP	72-4546 STD 0.25 0.50 0.75
MB/HL	1	79,782/79,800	84,206/84,226	32,500	2,178	0,050/0,113	BS	66552CP	72-4556 STD 0.25 0.50

1011CP

66552CP

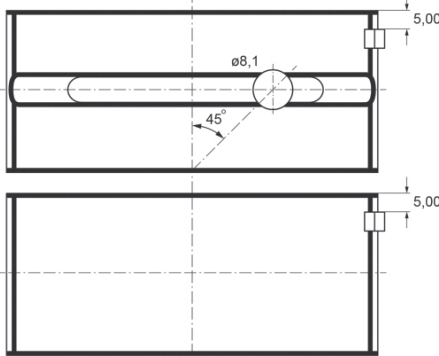
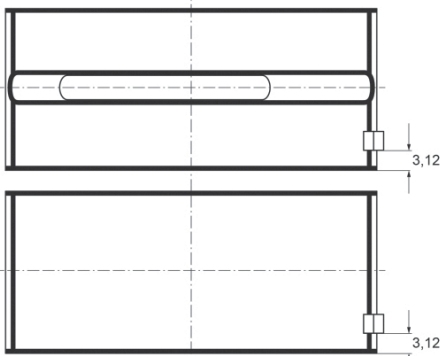

TW/A	4	87,779/88,033	111,510/111,764	3,429			BS	1011BF	A169/4 STD .005
SE/PB	1	38,004/38,014	41,846/41,884	34,800			BS	1014Y	55-4105 SEMI

41 104.00 x 115.00

8045.05		4 Cyl.	3908cc	54-60kW (73-82PS)	Diesel	TD28624			
BE/PL	1	63,725/63,744	67,407/67,422	28,700	1,815	0,033/0,092	BS	1010CP	71-4104 STD 0.25 0.50 0.75
MB/HL	1	79,791/79,810	84,200/84,230	25,000	2,179	0,032/0,106	BS	1011CP	72-4546 STD 0.25 0.50 0.75
TW/A	4	87,779/88,033	111,510/111,764	3,429			BS	1011BF	A169/4 STD .005
SE/PB	1	38,004/38,014	41,846/41,884	34,800			BS	1014Y	55-4105 SEMI
SE/PB	1	38,005/38,012	41,846/41,884	34,800			BS	1014YA	55-4106 SEMI

1014Y

1014YA

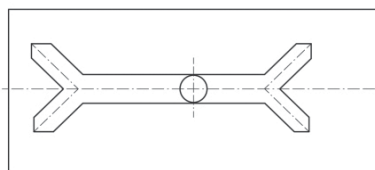
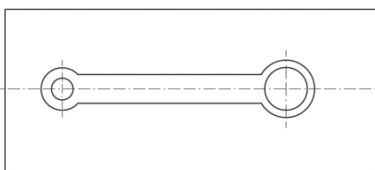



42		104.00 x 115.00							
8051.05		5 Cyl.		4885cc		Diesel		FM104014	
BE/PL	1	63,725/63,744	67,407/67,422	28,700	1,815	0,033/0,092	BS	1010CP	71-4104 STD 0.25 0.50 0.75
MB/HL	1	79,791/79,810	84,200/84,230	25,000	2,179	0,032/0,106	BS	1011CP	72-4546 STD 0.25 0.50 0.75
TW/A	4	87,779/88,033	111,510/111,764		3,429		BS	1011BF	A169/4 STD .005
SE/PB	1	38,005/38,012	41,846/41,884	34,800			BS	1014YA	55-4106 SEMI

43		104.00 x 115.00							
8060.05.000		6 Cyl.	5861cc	101kW (137PS)		Diesel			TD10424
8060.05.200		6 Cyl.	5861cc	99-102kW (135-139PS)		Diesel			TD10471
8060.05.201		6 Cyl.	5861cc	102kW (139PS)		Diesel			TD27298
8060.05.203		6 Cyl.	5861cc	102kW (139PS)		Diesel			TD27299
8060.05.246		6 Cyl.	5861cc	101kW (137PS)		Diesel			TD10391
8060.05.270		6 Cyl.	5861cc	101kW (137PS)		Diesel			TD10412
8060.05.280		6 Cyl.	5861cc	101kW (137PS)		Diesel			TD10423
8060.05.284		6 Cyl.	5861cc	101kW (137PS)		Diesel			TD27300
8060.05.285		6 Cyl.	5861cc	101kW (137PS)		Diesel			TD10411
8060.05.286		6 Cyl.	5861cc	101kW (137PS)		Diesel			TD27301
8060.05.288		6 Cyl.	5861cc	101kW (137PS)		Diesel			TD27302
8060.05.289		6 Cyl.	5861cc	101kW (137PS)		Diesel			TD10461
8060.06		6 Cyl.	5858cc	102-167kW (138-227PS)		Diesel			FM4015
8060.25.600		6 Cyl.	5861cc	130kW (177PS)		Diesel Turbo			TD10473
8060.25.601		6 Cyl.	5861cc	130kW (177PS)		Diesel Turbo			TD27303
8060.25.602		6 Cyl.	5861cc	130kW (177PS)		Diesel Turbo			TD27304
8060.25.603		6 Cyl.	5861cc	130kW (177PS)		Diesel Turbo			TD27305
8060.25.604		6 Cyl.	5861cc	130kW (177PS)		Diesel Turbo			TD27306
8060.25.669		6 Cyl.	5861cc	125kW (170PS)		Diesel Turbo			TD10459
8060.25.670		6 Cyl.	5861cc	125kW (170PS)		Diesel Turbo			TD10453
8060.25.678		6 Cyl.	5861cc	130kW (177PS)		Diesel Turbo			TD10466
8060.25.679		6 Cyl.	5861cc	130kW (177PS)		Diesel Turbo			TD10467
8060.25R.4200 Euro 1		6 Cyl.	5861cc	105kW (143PS)		Diesel Turbo			TD10479
8060.25R.4200 LTC		6 Cyl.	5861cc	105kW (143PS)		Diesel Turbo			TD10415
8060.25R.4210 Euro 1		6 Cyl.	5861cc	105kW (143PS)		Diesel Turbo			TD27309
8060.25R.4220 Euro 1		6 Cyl.	5861cc	105kW (143PS)		Diesel Turbo			TD27310
8060.25R.4225 Euro 1		6 Cyl.	5861cc	105kW (143PS)		Diesel Turbo			TD27311
8060.25R.4230 Euro 1		6 Cyl.	5861cc	105kW (143PS)		Diesel Turbo			TD27312
8060.25R.4240 Euro 1		6 Cyl.	5861cc	105kW (143PS)		Diesel Turbo			TD27313
8060.25R.4250 Euro 1		6 Cyl.	5861cc	105kW (143PS)		Diesel Turbo			TD27314
8060.25R.4280		6 Cyl.	5861cc	105kW (143PS)		Diesel Turbo			TD10475
8060.25R.4285 Euro 1		6 Cyl.	5861cc	105kW (143PS)		Diesel Turbo			TD27315
8060.25R.4290 Euro 1		6 Cyl.	5861cc	105kW (143PS)		Diesel Turbo			TD27316
8060.25R.4295 Euro 1		6 Cyl.	5861cc	105kW (143PS)		Diesel Turbo			TD27317
8060.25R.4300		6 Cyl.	5861cc	105kW (143PS)		Diesel Turbo Intercooler			TD20414
8060.25R.4360 Euro 1		6 Cyl.	5861cc	105kW (143PS)		Diesel Turbo			TD27318
8060.25R.4362 Euro 1		6 Cyl.	5861cc	105kW (143PS)		Diesel Turbo			TD27319
8060.25R.4750		6 Cyl.	5861cc	105kW (143PS)		Diesel Turbo Intercooler			TD10907
8060.25R.4755		6 Cyl.	5861cc	105kW (143PS)		Diesel Turbo			TD10908
8060.25R.4760		6 Cyl.	5861cc	105kW (143PS)		Diesel Turbo Intercooler			TD10909
8060.25R.4764		6 Cyl.	5861cc	105kW (143PS)		Diesel Turbo Intercooler			TD10910



8060.25R.4960 Euro 1	6 Cyl.	5861cc	105kW (143PS)	Diesel Turbo	TD27321
8060.25R.4967 Euro 1	6 Cyl.	5861cc	105kW (143PS)	Diesel Turbo	TD27322
8060.25R.4968 Euro 1	6 Cyl.	5861cc	105kW (143PS)	Diesel Turbo	TD27323
8060.25R.4970 Euro 1	6 Cyl.	5861cc	105kW (143PS)	Diesel Turbo	TD27324
8060.25R.4973 Euro 1	6 Cyl.	5861cc	105kW (143PS)	Diesel Turbo	TD27325
8060.25R.4980 Euro 1	6 Cyl.	5861cc	105kW (143PS)	Diesel Turbo	TD27326
8060.25V.4000 Euro 1	6 Cyl.	5861cc	130kW (177PS)	Diesel Turbo Intercooler	TD10454
8060.25V.4010 Euro 1	6 Cyl.	5861cc	130kW (177PS)	Diesel Turbo Intercooler	TD27330
8060.25V.4020 Euro 1	6 Cyl.	5861cc	130kW (177PS)	Diesel Turbo Intercooler	TD27331
8060.25V.4025 Euro 1	6 Cyl.	5861cc	130kW (177PS)	Diesel Turbo Intercooler	TD27332
8060.25V.4030 Euro 1	6 Cyl.	5861cc	130kW (177PS)	Diesel Turbo Intercooler	TD27333
8060.25V.4040 Euro 1	6 Cyl.	5861cc	130kW (177PS)	Diesel Turbo Intercooler	TD27334
8060.25V.4050 Euro 1	6 Cyl.	5861cc	130kW (177PS)	Diesel Turbo Intercooler	TD27336
8060.25V.4060 Euro 1	6 Cyl.	5861cc	130kW (177PS)	Diesel Turbo Intercooler	TD27335
8060.25V.4080	6 Cyl.	5861cc	130kW (177PS)	Diesel Turbo Intercooler	TD10476
8060.25V.4090 Euro 1	6 Cyl.	5861cc	130kW (177PS)	Diesel Turbo Intercooler	TD27337
8060.25V.4100 Euro 1	6 Cyl.	5861cc	130kW (177PS)	Diesel Turbo Intercooler	TD27338
8060.25V.4105 Euro 1	6 Cyl.	5861cc	130kW (177PS)	Diesel Turbo Intercooler	TD27339
8060.25V.4110 Euro 1	6 Cyl.	5861cc	130kW (177PS)	Diesel Turbo Intercooler	TD27340
8060.25V.4160 Euro 1	6 Cyl.	5861cc	130kW (177PS)	Diesel Turbo Intercooler	TD27341
8060.25V.4165 Euro 1	6 Cyl.	5861cc	130kW (177PS)	Diesel Turbo Intercooler	TD27342
8060.25V.4170 Euro 1	6 Cyl.	5861cc	130kW (177PS)	Diesel Turbo Intercooler	TD27343
8060.25V.4175 Euro 1	6 Cyl.	5861cc	130kW (177PS)	Diesel Turbo Intercooler	TD27344
8060.25V.4720 Euro 1	6 Cyl.	5861cc	130kW (177PS)	Diesel Turbo Intercooler	TD27345
8060.25V.4722 Euro 1	6 Cyl.	5861cc	130kW (177PS)	Diesel Turbo Intercooler	TD27346
8060.25V.4724 Euro 1	6 Cyl.	5861cc	130kW (177PS)	Diesel Turbo Intercooler	TD27347
8060.25V.4725 Euro 1	6 Cyl.	5861cc	130kW (177PS)	Diesel Turbo Intercooler	TD27348
8060.25V.4800	6 Cyl.	5861cc	130kW (177PS)	Diesel Turbo Intercooler	TD10481
8060.25V.4900 Euro 1	6 Cyl.	5861cc	130kW (177PS)	Diesel Turbo Intercooler	TD27349
8060.25V.4920 Euro 1	6 Cyl.	5861cc	130kW (177PS)	Diesel Turbo Intercooler	TD27350
8060.25V.4925 Euro 1	6 Cyl.	5861cc	130kW (177PS)	Diesel Turbo Intercooler	TD27351
8060.25V.4950 Euro 1	6 Cyl.	5861cc	130kW (177PS)	Diesel Turbo Intercooler	TD27352
8060.25V.4952 Euro 1	6 Cyl.	5861cc	130kW (177PS)	Diesel Turbo Intercooler	TD27353
8060.25V.4953 Euro 1	6 Cyl.	5861cc	130kW (177PS)	Diesel Turbo Intercooler	TD27354
8060.45 Euro 1	6 Cyl.	5861cc	152kW (207PS)	Diesel Turbo Intercooler	TD27439
8060.45.4100 Euro 1	6 Cyl.	5861cc	152kW (207PS)	Diesel Turbo Intercooler	TD10497
8060.45.4180 Euro 1	6 Cyl.	5861cc	152kW (207PS)	Diesel Turbo Intercooler	TD10456
8060.45.4700	6 Cyl.	5861cc	152kW (207PS)	Diesel Turbo	TD10913
8060.45.6090	6 Cyl.	5861cc	167kW (227PS)	Diesel Turbo	TD10477
8060.45B Euro 2	6 Cyl.	5861cc	130kW (177PS)	Diesel Turbo Intercooler	TD27442
8060.45K.6090 Euro 1	6 Cyl.	5861cc	167kW (227PS)	Diesel Turbo Intercooler	TD20471
8060.45L Euro 2	6 Cyl.	5861cc	160kW (218PS)	Diesel Turbo Intercooler	TD27451
8060.45M Euro 2	6 Cyl.	5861cc	179kW (243PS)	Diesel Turbo Intercooler	TD27450
8060.45R.5000 Euro 2	6 Cyl.	5861cc	105kW (143PS)	Diesel Turbo	TD16717
8060.45R.5001 Euro 2	6 Cyl.	5861cc	105kW (143PS)	Diesel Turbo	TD16718
8060.45R.5003 Euro 2	6 Cyl.	5861cc	105kW (143PS)	Diesel Turbo	TD16719
8060.45R.5005 Euro 2	6 Cyl.	5861cc	105kW (143PS)	Diesel Turbo	TD16720
8060.45R.5050	6 Cyl.	5861cc	105kW (143PS)	Diesel Turbo	TD10911
8060.45R.5051	6 Cyl.	5861cc	105kW (143PS)	Diesel Turbo	TD10912

BE/PL	1	63,725/63,744	67,407/67,422	28,700	1,815	0,033/0,092	BS	1010CP	71-4104 STD 0.25 0.50 0.75
BE/PL	1	63,725/63,744	67,407/67,422	28,700	1,815	0,033/0,092	BS	1010CPA	71-4389 STD 0.25 0.50



1010CP

1010CPA

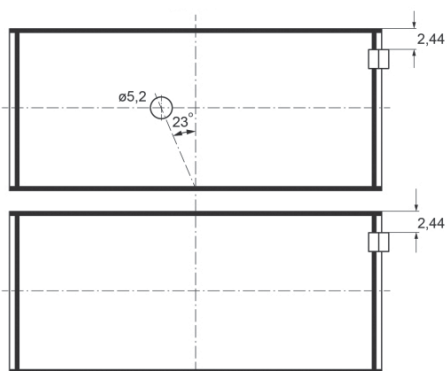

MB/HL	1	79,791/79,810	84,200/84,230	25,000	2,179	0,032/0,106	BS	1011CP	72-4546 STD 0.25 0.50 0.75
MB/HL	1	79,782/79,800	84,206/84,226	32,500	2,178	0,050/0,113	BS	66552CP	72-4556 STD 0.25 0.50

1011CP

66552CP

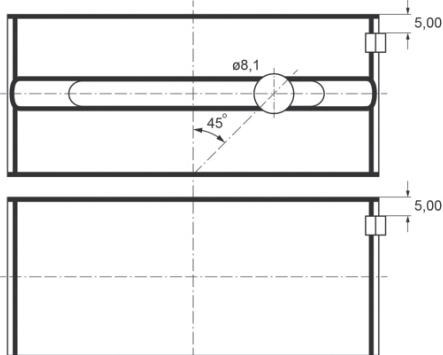
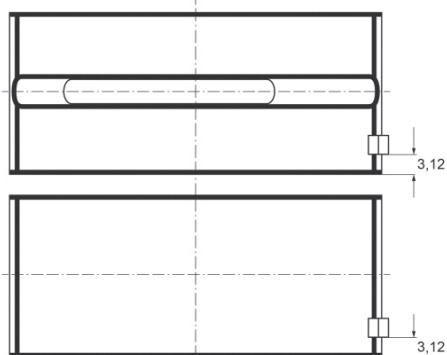

TW/A	4	87,779/88,033	111,510/111,764		3,429		BS	1011BF	A169/4 STD .005
SE/PB	1	38,004/38,014	41,846/41,884	34,800			BS	1014Y	55-4105 SEMI
SE/PB	1	38,005/38,012	41,846/41,884	34,800			BS	1014YA	55-4106 SEMI

1014Y

1014YA

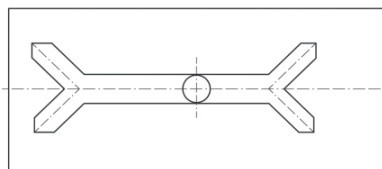
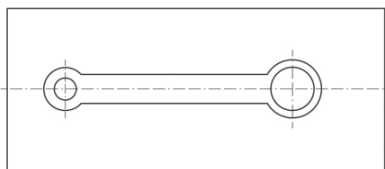

44

104.00 x 115.00

8060.45.4100 TCA Euro 1	6 Cyl.	5861cc	152kW (207PS)	Diesel Turbo	TD10455
8060.45.4110 Euro 1	6 Cyl.	5861cc	152kW (207PS)	Diesel Turbo Intercooler	TD27101
8060.45.4120 Euro 1	6 Cyl.	5861cc	152kW (207PS)	Diesel Turbo Intercooler	TD27102
8060.45.4130 Euro 1	6 Cyl.	5861cc	152kW (207PS)	Diesel Turbo Intercooler	TD27103
8060.45.4150 Euro 1	6 Cyl.	5861cc	152kW (207PS)	Diesel Turbo Intercooler	TD27104
8060.45.4403 Euro 1	6 Cyl.	5861cc	152kW (207PS)	Diesel Turbo Intercooler	TD27105
8060.45.5200 Euro 2	6 Cyl.	5861cc	152-169kW (207-230PS)	Diesel Turbo Intercooler	TD27106
8060.45.5201 Euro 2	6 Cyl.	5861cc	152kW (207PS)	Diesel Turbo Intercooler	TD27107
8060.45.5203 Euro 2	6 Cyl.	5861cc	152kW (207PS)	Diesel Turbo Intercooler	TD27108
8060.45.5205 Euro 2	6 Cyl.	5861cc	152kW (207PS)	Diesel Turbo Intercooler	TD27109
8060.45.5210 Euro 2	6 Cyl.	5861cc	152kW (207PS)	Diesel Turbo Intercooler	TD27110



8060.45.5211 Euro 2	6 Cyl.	5861cc	152kW (207PS)	Diesel Turbo Intercooler	TD27111
8060.45.5220 Euro 2	6 Cyl.	5861cc	152kW (207PS)	Diesel Turbo Intercooler	TD27112
8060.45.5221 Euro 2	6 Cyl.	5861cc	152kW (207PS)	Diesel Turbo Intercooler	TD27113
8060.45.5223 Euro 2	6 Cyl.	5861cc	152kW (207PS)	Diesel Turbo Intercooler	TD27114
8060.45.5232 Euro 2	6 Cyl.	5861cc	152kW (207PS)	Diesel Turbo Intercooler	TD27115
8060.45.5233 Euro 2	6 Cyl.	5861cc	152kW (207PS)	Diesel Turbo Intercooler	TD27116
8060.45.5234 Euro 2	6 Cyl.	5861cc	152kW (207PS)	Diesel Turbo Intercooler	TD27117
8060.45.5235 Euro 2	6 Cyl.	5861cc	152kW (207PS)	Diesel Turbo Intercooler	TD27118
8060.45B.4385 Euro 2	6 Cyl.	5861cc	130kW (177PS)	Diesel Turbo Intercooler	TD27119
8060.45B.4386 Euro 2	6 Cyl.	5861cc	130kW (177PS)	Diesel Turbo Intercooler	TD27120
8060.45B.5100 Euro 2	6 Cyl.	5861cc	130-152kW (177-207PS)	Diesel Turbo Intercooler	TD20415
8060.45B.5101 Euro 2	6 Cyl.	5861cc	130kW (177PS)	Diesel Turbo Intercooler	TD27121
8060.45B.5103 Euro 2	6 Cyl.	5861cc	130kW (177PS)	Diesel Turbo Intercooler	TD27122
8060.45B.5105 Euro 2	6 Cyl.	5861cc	130kW (177PS)	Diesel Turbo Intercooler	TD27123
8060.45B.5110 Euro 2	6 Cyl.	5861cc	130kW (177PS)	Diesel Turbo Intercooler	TD27124
8060.45B.5111 Euro 2	6 Cyl.	5861cc	130kW (177PS)	Diesel Turbo Intercooler	TD27125
8060.45B.5112 Euro 2	6 Cyl.	5861cc	130kW (177PS)	Diesel Turbo Intercooler	TD27126
8060.45B.5113 Euro 2	6 Cyl.	5861cc	130kW (177PS)	Diesel Turbo Intercooler	TD27127
8060.45B.5120 Euro 2	6 Cyl.	5861cc	130kW (177PS)	Diesel Turbo Intercooler	TD27128
8060.45B.5121 Euro 2	6 Cyl.	5861cc	130kW (177PS)	Diesel Turbo Intercooler	TD27129
8060.45B.5123 Euro 2	6 Cyl.	5861cc	130kW (177PS)	Diesel Turbo Intercooler	TD27130
8060.45B.5124 Euro 2	6 Cyl.	5861cc	130kW (177PS)	Diesel Turbo Intercooler	TD27131
8060.45B.5145 Euro 2	6 Cyl.	5861cc	130kW (177PS)	Diesel Turbo Intercooler	TD27132
8060.45B.5146 Euro 2	6 Cyl.	5861cc	130kW (177PS)	Diesel Turbo Intercooler	TD27133
8060.45B.5150 Euro 2	6 Cyl.	5861cc	130kW (177PS)	Diesel Turbo Intercooler	TD27134
8060.45B.5151 Euro 2	6 Cyl.	5861cc	130kW (177PS)	Diesel Turbo Intercooler	TD27136
8060.45B.5153 Euro 2	6 Cyl.	5861cc	130kW (177PS)	Diesel Turbo Intercooler	TD27137
8060.45B.5155 Euro 2	6 Cyl.	5861cc	130kW (177PS)	Diesel Turbo Intercooler	TD27138
8060.45B.5185 Euro 2	6 Cyl.	5861cc	130kW (177PS)	Diesel Turbo Intercooler	TD27139
8060.45B.5186 Euro 2	6 Cyl.	5861cc	130kW (177PS)	Diesel Turbo Intercooler	TD27140
8060.45L.4485 Euro 2	6 Cyl.	5861cc	160kW (218PS)	Diesel Turbo Intercooler	TD27141
8060.45L.4486 Euro 2	6 Cyl.	5861cc	160kW (218PS)	Diesel Turbo Intercooler	TD27142
8060.45M.7281 Euro 2	6 Cyl.	5861cc	179kW (243PS)	Diesel Turbo Intercooler	TD27143
8060.45M.7285 Euro 2	6 Cyl.	5861cc	179kW (243PS)	Diesel Turbo Intercooler	TD27144
8060.45M.7286 Euro 2	6 Cyl.	5861cc	179kW (243PS)	Diesel Turbo Intercooler	TD27145
8060.45R.4245 Euro 2	6 Cyl.	5861cc	105kW (143PS)	Diesel Turbo	TD27146
8060.45R.5010 Euro 2	6 Cyl.	5861cc	105kW (143PS)	Diesel Turbo	TD27147
8060.45R.5011 Euro 2	6 Cyl.	5861cc	105kW (143PS)	Diesel Turbo	TD27148
8060.45R.5013 Euro 2	6 Cyl.	5861cc	105kW (143PS)	Diesel Turbo	TD27149
8060.45R.5015 Euro 2	6 Cyl.	5861cc	105kW (143PS)	Diesel Turbo	TD27150
8060.45S TCA	6 Cyl.	5861cc	167kW (227PS)	Diesel Turbo Intercooler	TD10482
8060.45S.6000 Euro 1	6 Cyl.	5861cc	167kW (227PS)	Diesel Turbo	TD10480
8060.45S.6010 Euro 1	6 Cyl.	5861cc	167kW (227PS)	Diesel Turbo	TD27154
8060.45S.6020 Euro 1	6 Cyl.	5861cc	167kW (227PS)	Diesel Turbo	TD27155
8060.45S.6030 Euro 1	6 Cyl.	5861cc	167kW (227PS)	Diesel Turbo	TD27156
8060.45S.6040 Euro 1	6 Cyl.	5861cc	167kW (227PS)	Diesel Turbo	TD27157
8060.45S.6045 Euro 1	6 Cyl.	5861cc	167kW (227PS)	Diesel Turbo	TD27158
8060.45S.6052 Euro 1	6 Cyl.	5861cc	167kW (227PS)	Diesel Turbo	TD27159
8060.45S.6110 Euro 1	6 Cyl.	5861cc	167kW (227PS)	Diesel Turbo	TD27160
8060.45S.6120 Euro 1	6 Cyl.	5861cc	167kW (227PS)	Diesel Turbo	TD27161
8060.45S.6130 Euro 1	6 Cyl.	5861cc	167kW (227PS)	Diesel Turbo	TD27162
8060.45S.6140 Euro 1	6 Cyl.	5861cc	167kW (227PS)	Diesel Turbo	TD27163
8060.45S.6150 Euro 1	6 Cyl.	5861cc	167kW (227PS)	Diesel Turbo	TD27164



8060.45S.6203 Euro 1			6 Cyl.	5861cc	167kW (227PS)		Diesel Turbo	TD27165
8060.45S.6700 Euro 1			6 Cyl.	5861cc	167kW (227PS)		Diesel Turbo	TD27166
8060.45S.6705 Euro 1			6 Cyl.	5861cc	167kW (227PS)		Diesel Turbo	TD27167
8060.45S.6706 Euro 1			6 Cyl.	5861cc	167kW (227PS)		Diesel Turbo	TD27168
8060.45S.6707 Euro 1			6 Cyl.	5861cc	167kW (227PS)		Diesel Turbo	TD27169
8060.45S.6710 Euro 1			6 Cyl.	5861cc	167kW (227PS)		Diesel Turbo	TD27170
8060.45S.6711 Euro 1			6 Cyl.	5861cc	167kW (227PS)		Diesel Turbo	TD27171
8060.45S.6800 Euro 1			6 Cyl.	5861cc	167kW (227PS)		Diesel Turbo	TD10478
8060.45S.6912 Euro 1			6 Cyl.	5861cc	167kW (227PS)		Diesel Turbo	TD27172
8060.45S.7200 Euro 2			6 Cyl.	5861cc	167kW (227PS)		Diesel Turbo Intercooler	TD20472
8060.45S.7201 Euro 2			6 Cyl.	5861cc	167kW (227PS)		Diesel Turbo Intercooler	TD27176
8060.45S.7203 Euro 2			6 Cyl.	5861cc	167kW (227PS)		Diesel Turbo Intercooler	TD27177
8060.45S.7205 Euro 2			6 Cyl.	5861cc	167kW (227PS)		Diesel Turbo Intercooler	TD27178
8060.45S.7210 Euro 2			6 Cyl.	5861cc	167kW (227PS)		Diesel Turbo Intercooler	TD27179
8060.45S.7211 Euro 2			6 Cyl.	5861cc	167kW (227PS)		Diesel Turbo Intercooler	TD27180
8060.45S.7213 Euro 2			6 Cyl.	5861cc	167kW (227PS)		Diesel Turbo Intercooler	TD27181
8060.45S.7215 Euro 2			6 Cyl.	5861cc	167kW (227PS)		Diesel Turbo Intercooler	TD27182
8060.45S.7250 Euro 2			6 Cyl.	5861cc	167kW (227PS)		Diesel Turbo Intercooler	TD27183
8060.45S.7251 Euro 2			6 Cyl.	5861cc	167kW (227PS)		Diesel Turbo Intercooler	TD27184
8060.45S.7253 Euro 2			6 Cyl.	5861cc	167kW (227PS)		Diesel Turbo Intercooler	TD27185
8060.45S.7255 Euro 2			6 Cyl.	5861cc	167kW (227PS)		Diesel Turbo Intercooler	TD27186
8060.45X.4180 Euro 2			6 Cyl.	5861cc	152kW (207PS)		Diesel Turbo Intercooler	TD27187
8061.25			6 Cyl.	5868cc			Diesel Turbo	FM23485

BE/PL	1	63,725/63,744	67,407/67,422	28,700	1,815	0,033/0,092	BS	1010CP	71-4104 STD 0.25 0.50 0.75
BE/PL	1	63,725/63,744	67,407/67,422	28,700	1,815	0,033/0,092	BS	1010CPA	71-4389 STD 0.25 0.50

1010CP

1010CPA

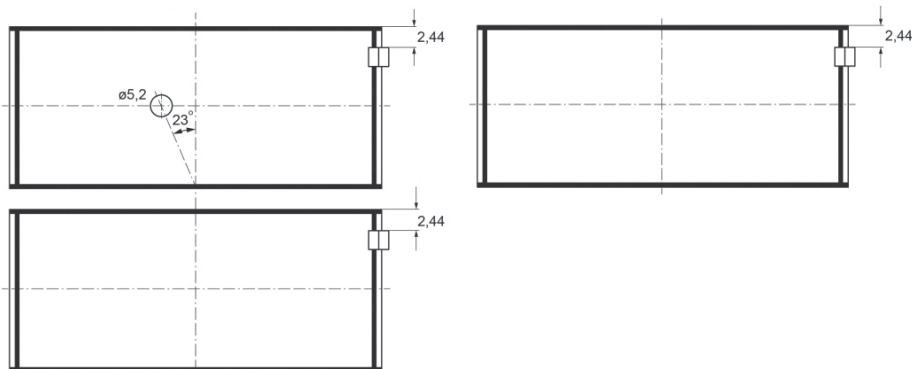

MB/HL	1	79,791/79,810	84,200/84,230	25,000	2,179	0,032/0,106	BS	1011CP	72-4546 STD 0.25 0.50 0.75
MB/HL	1	79,782/79,800	84,206/84,226	32,500	2,178	0,050/0,113	BS	66552CP	72-4556 STD 0.25 0.50

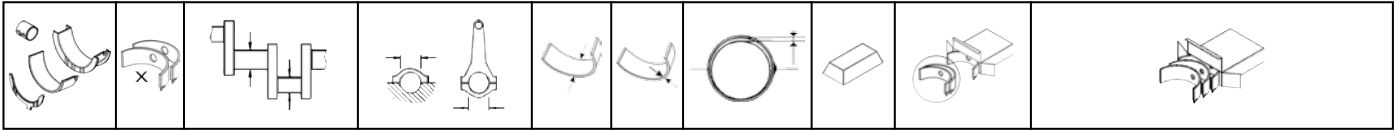

1011CP

66552CP

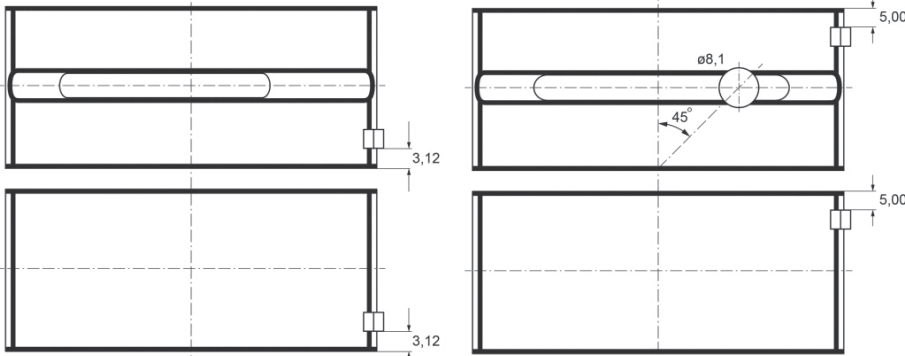

TW/A	4	87,779/88,033	111,510/111,764		3,429	BS	1011BF	A169/4 STD .005
SE/PB	1	38,004/38,014	41,846/41,884	34,800		BS	1014Y	55-4105 SEMI

45 104.00 x 115.00

8060.45.4702 Euro 1			6 Cyl.	5861cc	152kW (207PS)			Diesel Turbo	TD10914
8060.45.4704 Euro 1			6 Cyl.	5861cc	152kW (207PS)			Diesel Turbo	TD10915
8060.45.4706 Euro 1			6 Cyl.	5861cc	152kW (207PS)			Diesel Turbo	TD10916
8060.45.4708			6 Cyl.	5861cc	152kW (207PS)			Diesel Turbo	TD10917
8060.45.5250 Euro 2			6 Cyl.	5861cc	152kW (207PS)			Diesel Turbo Intercooler	TD10918
8060.45.5251			6 Cyl.	5861cc	152kW (207PS)			Diesel Turbo	TD10919
8060.45.5255			6 Cyl.	5861cc	152kW (207PS)			Diesel Turbo	TD10920
8060.45A.4100			6 Cyl.	5861cc	152kW (207PS)			Diesel Turbo Intercooler	TD10498

MB/HL	1	79,791/79,810	84,200/84,230	25,000	2,179	0,032/0,106	BS	1011CP	72-4546 STD 0.25 0.50 0.75
MB/HL	1	79,782/79,800	84,206/84,226	32,500	2,178	0,050/0,113	BS	66552CP	72-4556 STD 0.25 0.50

1011CP

66552CP

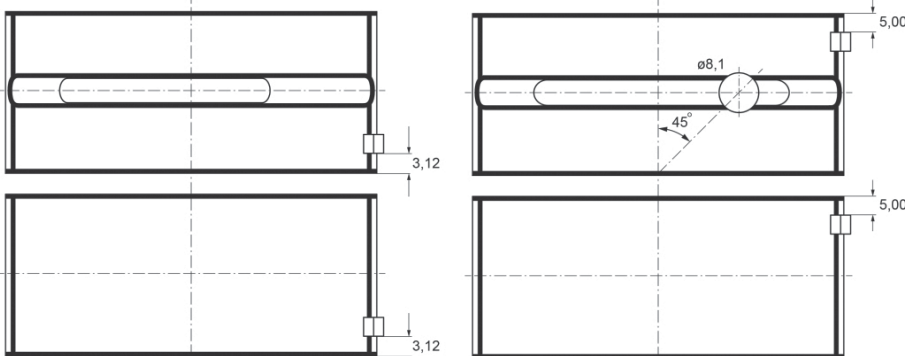

46 104.00 x 115.00

8061.05			6 Cyl.	5861cc	82kW (112PS)			Diesel	TD28429
BE/PL	1	63,725/63,744	67,407/67,422	28,700	1,815	0,033/0,092	BS	1010CP	71-4104 STD 0.25 0.50 0.75
MB/HL	1	79,791/79,810	84,200/84,230	25,000	2,179	0,032/0,106	BS	1011CP	72-4546 STD 0.25 0.50 0.75
TW/A	4	87,779/88,033	111,510/111,764		3,429		BS	1011BF	A169/4 STD .005
SE/PB	1	38,005/38,012	41,846/41,884	34,800			BS	1014YA	55-4106 SEMI



47 105.00 x 120.00

CO1D		4 Cyl.		4156cc		Diesel		FM9112	
BE/PL	1	69,843/69,855	73,710/73,729	35,700	1,892	0,071/0,127	BS	60115CP	71-4212 STD 0.25 0.50 0.75 1.00
TW/A	4	82,500/82,650	101,600/101,850		2,362		AL-LF	60116AF	A194/4 STD .004
SE/PB	1	39,967/40,015	43,946/43,971	36,000			BS	60116YA	55-4282 SEMI

48 108.00 x 120.00

CO 2 D		4 Cyl.		4397cc		62kW (84PS)		Diesel		TD8361	
BE/PL	1	69,843/69,855	73,710/73,729	35,700	1,892	0,071/0,127	BS	60115CP	71-4212 STD 0.25 0.50 0.75 1.00		
TW/A	4	82,500/82,650	101,600/101,850		2,362		AL-LF	60116AF	A194/4 STD .004		
SE/PB	1	39,967/40,015	43,946/43,971	36,000			BS	60116YA	55-4282 SEMI		

49 110.00 x 120.00

CO 3/40		4 Cyl.		4560cc		66kW (90PS)		Diesel		TD5842	
CO 3/41		4 Cyl.		4560cc		66kW (90PS)		Diesel		TD6195	
BE/PL	1	69,843/69,855	73,710/73,729	35,700	1,892	0,071/0,127	BS	60115CP	71-4212 STD 0.25 0.50 0.75 1.00		
MB/HL 1,3,5	3	76,200/76,220	80,626/80,646	40,500	2,182	0,042/0,107	BS	66556CP	H1175/5 STD 0.25 0.50 0.75 1.00		
MB/HL 2,4	2	76,200/76,220	80,626/80,646	30,500	2,182	0,042/0,107	BS	66557CP			
TW/A	4	82,500/82,650	101,600/101,850		2,362		AL-LF	60116AF	A194/4 STD .004		
SE/PB	1	39,967/40,015	43,946/43,971	36,000			BS	60116YA	55-4282 SEMI		

50 110.00 x 130.00

CN 3		3 Cyl.		3706cc		Diesel		FM4028	
BE/PL	1	69,843/69,855	73,710/73,729	35,700	1,892	0,071/0,127	BS	60115CP	71-4212 STD 0.25 0.50 0.75 1.00
TW/A	4	82,500/82,650	101,600/101,850		2,362		AL-LF	60116AF	A194/4 STD .004
SE/PB	1	39,967/40,015	43,946/43,971	36,000			BS	60116YA	55-4282 SEMI
CB/NWB 1	1	50,975/51,000	54,780/54,805	28,000	1,875		AL-LF	66231DR	N153/3 STD
CB/NWB 3	1	49,975/50,000	53,780/53,805	24,000	1,875		AL-LF	66232DR	
CB/NWB 2	1	50,475/50,500	54,280/54,305	28,000	1,875		AL-LF	66233DR	

51 110.00 x 130.00

CO 3 C		4 Cyl.	4940cc	60kW (82PS)		Diesel		TD8362
CO 3 D 130 VAR.1		4 Cyl.	4940cc	63kW (86PS)		Diesel		TD8372
CO 3 D VAR.1		4 Cyl.	4940cc	63kW (86PS)		Diesel		TD5841
CO 3 D VAR.15		4 Cyl.	4940cc	63kW (86PS)		Diesel		TD6194
CO 3 D VAR.2		4 Cyl.	4940cc	63kW (86PS)		Diesel		TD6193
CO 3 D VAR.4		4 Cyl.	4940cc	63kW (86PS)		Diesel		TD6310
CO 3 VAR.20		4 Cyl.	4940cc	63kW (86PS)		Diesel		TD8367
CO 3 VAR.21		4 Cyl.	4940cc	63kW (86PS)		Diesel		TD5838
CO 3 VAR.22		4 Cyl.	4940cc	63kW (86PS)		Diesel		TD6190
CO 3 VAR.3		4 Cyl.	4940cc	63kW (86PS)		Diesel		TD8364



CO 3/7.200		4 Cyl.		4940cc	76kW (103PS)	Diesel			TD8379
CO 3/7.300		4 Cyl.		4940cc	76kW (103PS)	Diesel			TD8380
BE/PL	1	69,843/69,855	73,710/73,729	35,700	1,892	0,071/0,127	BS	60115CP	71-4212 STD 0.25 0.50 0.75 1.00
MB/HL 1,3,5	3	76,200/76,220	80,626/80,646	40,500	2,182	0,042/0,107	BS	66556CP	H1175/5 STD 0.25 0.50 0.75 1.00
MB/HL 2,4	2	76,200/76,220	80,626/80,646	30,500	2,182	0,042/0,107	BS	66557CP	
TW/A	4	82,500/82,650	101,600/101,850		2,362		AL-LF	60116AF	A194/4 STD .004
SE/PB	1	39,967/40,015	43,946/43,971	36,000			BS	60116YA	55-4282 SEMI

52 112.00 x 130.00

8360.46		6 Cyl.		7685cc	196kW (267PS)	Diesel Turbo			TD27452
MB/HL 1,4,7	3	79,782/79,800	84,206/84,226	42,500	2,178	0,050/0,113	BS	66551CP	H1048/7 STD 0.25 0.50
MB/HL 2,3,5,6	4	79,782/79,800	84,206/84,226	32,500	2,178	0,050/0,113	BS	66552CP	

53 115.00 x 110.00

8340.04.000		4 Cyl.		4570cc	74kW (100PS)	Diesel			TD8374
BE/PL	1	72,482/72,500	76,695/76,713	34,930	2,070	0,055/0,116	BS	66550CP	71-4227 STD 0.25 0.50 0.75
BE/PL	1	72,482/72,500	76,695/76,713	34,930	2,070	0,055/0,115	BC	AE6563	71-4390 STD 0.25 0.50 0.75 1.00

01/83 →

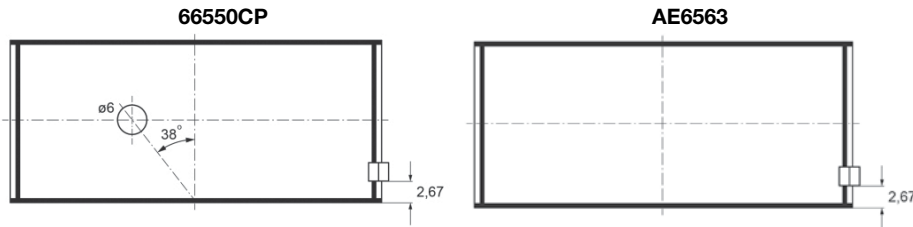

MB/HL 1,3,5	3	79,782/79,800	84,206/84,226	42,500	2,178	0,050/0,113	BS	66551CP	H1048/5 STD 0.25 0.50 0.75
MB/HL 2,4	2	79,782/79,800	84,206/84,226	32,500	2,178	0,050/0,113	BS	66552CP	
TW/A	4	87,779/88,033	111,510/111,764		3,429		BS	1011BF	A169/4 STD .005
SE/PB	1	42,000/42,006	45,946/45,971	37,800			BS	66554Y	55-4293 SEMI

54 115.00 x 110.00

8340.04.040		4 Cyl.		4570cc	73kW (99PS)	Diesel			TD10400
8340.04.200		4 Cyl.		4570cc	74kW (101PS)	Diesel			TD10392
8340.04.250		4 Cyl.		4570cc	74kW (100PS)	Diesel			TD8375
8340.04.250		4 Cyl.		4570cc	74kW (101PS)	Diesel			TD10393
8340.04.300		4 Cyl.		4570cc	74kW (101PS)	Diesel			TD10394
8340.04.350		4 Cyl.		4570cc	74kW (101PS)	Diesel			TD10395
8340.04.352		4 Cyl.		4570cc	74kW (100PS)	Diesel			TD8376
8340.04.362		4 Cyl.		4570cc	74kW (100PS)	Diesel			TD8377
8340.04.362		4 Cyl.		4570cc	74kW (101PS)	Diesel			TD10396
BE/PL	1	72,482/72,500	76,695/76,713	34,930	2,070	0,055/0,116	BS	66550CP	71-4227 STD 0.25 0.50 0.75
BE/PL	1	72,482/72,500	76,695/76,713	34,930	2,070	0,055/0,115	BC	AE6563	71-4390 STD 0.25 0.50 0.75 1.00



66550CP

AE6563

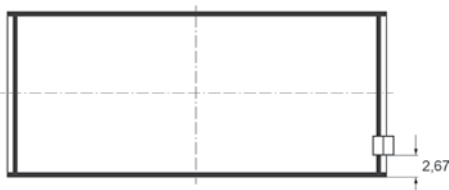
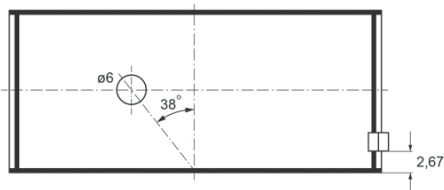

MB/HL 1,3,5	3	79,782/79,800	84,206/84,226	42,500	2,178	0,050/0,113	BS	66551CP	H1048/5 STD 0.25 0.50 0.75
MB/HL 2,4	2	79,782/79,800	84,206/84,226	32,500	2,178	0,050/0,113	BS	66552CP	
TW/A	4	87,779/88,033	111,510/111,764		3,429		BS	1011BF	A169/4 STD .005
SE/PB	1	42,000/42,006	45,946/45,971	37,800			BS	66554Y	55-4293 SEMI

55

115.00 x 110.00

8361.04			6 Cyl.	6850cc			Diesel		FM4951
BE/PL	1	72,482/72,500	76,695/76,713	34,930	2,070	0,055/0,116	BS	66550CP	71-4227 STD 0.25 0.50 0.75
→12/81									
BE/PL	1	72,482/72,500	76,695/76,713	34,930	2,070	0,055/0,115	BC	AE6563	71-4390 STD 0.25 0.50 0.75 1.00
01/82→									

66550CP

AE6563

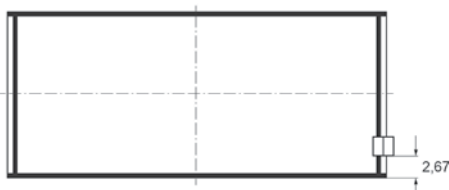
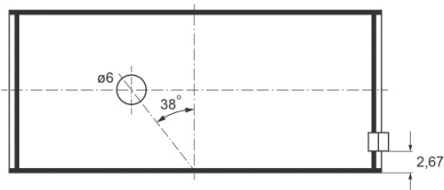

MB/HL 1,4,7	3	79,782/79,800	84,206/84,226	42,500	2,178	0,050/0,113	BS	66551CP	H1048/7 STD 0.25 0.50
MB/HL 2,3,5,6	4	79,782/79,800	84,206/84,226	32,500	2,178	0,050/0,113	BS	66552CP	
TW/A	4	87,779/88,033	111,510/111,764		3,429		BS	1011BF	A169/4 STD .005
SE/PB	1	39,967/40,015	43,946/43,971	36,000			BS	60116YA	55-4282 SEMI
SE/PB	1	42,000/42,006	45,946/45,971	37,800			BS	66554Y	55-4293 SEMI

56

115.00 x 125.00

F2BE0681A Euro 2	6 Cyl.	7790cc	259kW (352PS)	Diesel Turbo Intercooler	TD10828
F2BE0681B Euro 2	6 Cyl.	7790cc	228kW (310PS)	Diesel Turbo Intercooler	TD10829
F2BE0681C Euro 2	6 Cyl.	7790cc	200kW (272PS)	Diesel Turbo Intercooler	TD10832
F2BE0681D Euro 2	6 Cyl.	7790cc	180kW (245PS)	Diesel Turbo Intercooler	TD10833
F2BE0681E Euro 2	6 Cyl.	7790cc	218kW (296PS)	Diesel Turbo Intercooler	TD10830
F2BE0681F Euro 2	6 Cyl.	7790cc	200kW (272PS)	Diesel Turbo Intercooler	TD10831
F2BE1682G Euro 3	6 Cyl.	7790cc	228-259kW (310-352PS)	Diesel Turbo Intercooler	TD20019
F2BE3681A Euro 4/5	6 Cyl.	7790cc	265kW (360PS)	Diesel Turbo Intercooler	TD20466
F2BE3681B Euro 4/5	6 Cyl.	7790cc	243kW (330PS)	Diesel Turbo Intercooler	TD20465
F2BE3681C Euro 4/5	6 Cyl.	7790cc	228kW (310PS)	Diesel Turbo Intercooler	TD20464
F2BE3682B Euro 5	6 Cyl.	7790cc	243kW (330PS)	Diesel Turbo Intercooler	TD29646



F2BE0641		6 Cyl.		7790cc	200-243kW (272-330PS)			Gas	Turbo Intercooler	TD29857
BE/PL	6	72,915/72,945	77,000/77,030	35,500	2,010	0,035/0,095	EC	71-4087	71-4087/6 STD 0.25 0.50	
MB/HL	6	82,910/82,940	89,000/89,030	33,000	3,020	0,040/0,124	EC	72-4088	H1021/7 STD 0.25 0.50	
MB/HL	1	82,910/82,940	89,000/89,030	39,850	3,010	0,040/0,124	BB	72-4089H		
			72-4089H	STD	39,960/1.5732" - 40,000/1.5748"					
				0.25mm	39,960/1.5732" - 40,000/1.5748"					
				0.50mm	39,960/1.5732" - 40,000/1.5748"					
SE/PB	1		49,975/50,000	43,550			BS-LF	55-4090	55-4090 SEMI	

57 115.00 x 130.00

8340.05.200		4 Cyl.		5401cc	84kW (114PS)			Diesel	TD10410
BE/PL	1	72,482/72,500	76,695/76,713	34,930	2,070	0,055/0,115	BC	AE6563	71-4390 STD 0.25 0.50 0.75 1.00
MB/HL	3	79,782/79,800	84,206/84,226	42,500	2,178	0,050/0,113	BS	66551CP	H1048/5 STD 0.25 0.50 0.75
MB/HL	2	79,782/79,800	84,206/84,226	32,500	2,178	0,050/0,113	BS	66552CP	
TW/A	4	87,779/88,033	111,510/111,764		3,429		BS	1011BF	A169/4 STD .005
SE/PB	1	42,000/42,006	45,946/45,971	37,800			BS	66554Y	55-4293 SEMI

58 115.00 x 130.00

CO3-130T		4 Cyl.		5401cc	Diesel			FM4030	
BE/PL	1	72,482/72,500	76,695/76,713	34,930	2,070	0,055/0,116	BS	66550CP	71-4227 STD 0.25 0.50 0.75
BE/PL	1	72,482/72,500	76,695/76,713	34,930	2,070	0,055/0,115	BC	AE6563	71-4390 STD 0.25 0.50 0.75 1.00

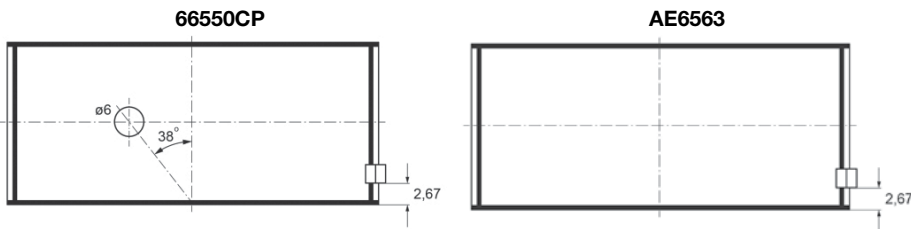

MB/HL	3	79,782/79,800	84,206/84,226	42,500	2,178	0,050/0,113	BS	66551CP	H1048/5 STD 0.25 0.50 0.75
MB/HL	2	79,782/79,800	84,206/84,226	32,500	2,178	0,050/0,113	BS	66552CP	
TW/A	4	87,779/88,033	111,510/111,764		3,429		BS	1011BF	A169/4 STD .005
SE/PB	1	39,967/40,015	43,946/43,971	36,000			BS	60116YA	55-4282 SEMI

59 115.00 x 130.00

8360.03		6 Cyl.		8102cc	Diesel			FM5052	
BE/PL	1	72,482/72,500	76,695/76,713	34,930	2,070	0,055/0,116	BS	66550CP	71-4227 STD 0.25 0.50 0.75
BE/PL	1	72,482/72,500	76,695/76,713	34,930	2,070	0,055/0,115	BC	AE6563	71-4390 STD 0.25 0.50 0.75 1.00



66550CP

AE6563

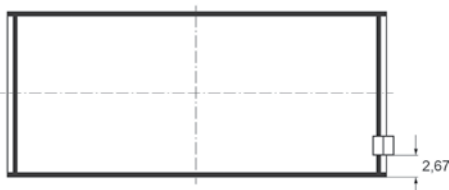
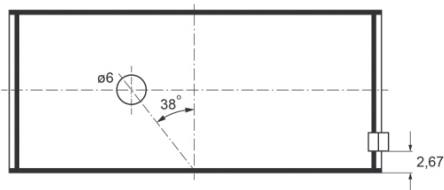

MB/HL 1,4,7	3	79,782/79,800	84,206/84,226	42,500	2,178	0,050/0,113	BS	66551CP	H1048/7 STD 0.25 0.50
MB/HL 2,3,5,6	4	79,782/79,800	84,206/84,226	32,500	2,178	0,050/0,113	BS	66552CP	
TW/A	4	87,779/88,033	111,510/111,764		3,429		BS	1011BF	A169/4 STD .005
SE/PB	1	39,967/40,015	43,946/43,971	36,000			BS	60116YA	55-4282 SEMI
SE/PB	1	42,000/42,006	45,946/45,971	37,800			BS	66554Y	55-4293 SEMI

60 115.00 x 130.00

8360.05		6 Cyl.	8100cc	103-124kW (140-169PS)	Diesel	TD8384			
8365.05.500		6 Cyl.	8102cc	114kW (155PS)	Diesel	TD18683			
8365.05.590		6 Cyl.	8102cc	94kW (128PS)	Diesel	TD18684			
8365.25.500		6 Cyl.	8102cc	132kW (180PS)	Diesel Turbo	TD18678			
BE/PL	1	72,482/72,500	76,695/76,713	34,930	2,070	0,055/0,116	BS	66550CP	71-4227 STD 0.25 0.50 0.75
BE/PL	1	72,482/72,500	76,695/76,713	34,930	2,070	0,055/0,115	BC	AE6563	71-4390 STD 0.25 0.50 0.75 1.00

66550CP

AE6563

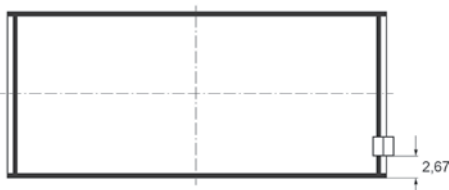
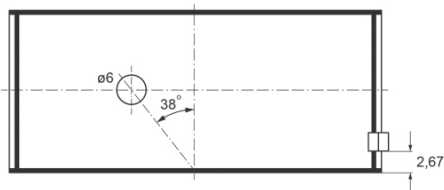

MB/HL 1,4,7	3	79,782/79,800	84,206/84,226	42,500	2,178	0,050/0,113	BS	66551CP	H1048/7 STD 0.25 0.50
MB/HL 2,3,5,6	4	79,782/79,800	84,206/84,226	32,500	2,178	0,050/0,113	BS	66552CP	
TW/A	4	87,779/88,033	111,510/111,764		3,429		BS	1011BF	A169/4 STD .005
SE/PB	1	42,000/42,006	45,946/45,971	37,800			BS	66554Y	55-4293 SEMI

61 115.00 x 130.00

8360.05.254		6 Cyl.	8102cc	124kW (169PS)	Diesel	TD10488			
BE/PL	1	72,482/72,500	76,695/76,713	34,930	2,070	0,055/0,116	BS	66550CP	71-4227 STD 0.25 0.50 0.75
→12/82									
BE/PL	1	72,482/72,500	76,695/76,713	34,930	2,070	0,055/0,115	BC	AE6563	71-4390 STD 0.25 0.50 0.75 1.00
01/83→									



66550CP

AE6563

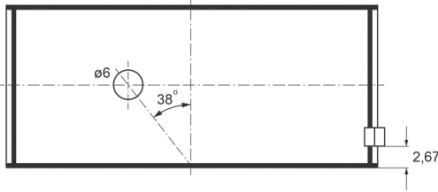

MB/HL 1,4,7	3	79,782/79,800	84,206/84,226	42,500	2,178	0,050/0,113	BS	66551CP	H1048/7 STD 0.25 0.50
MB/HL 2,3,5,6	4	79,782/79,800	84,206/84,226	32,500	2,178	0,050/0,113	BS	66552CP	
TW/A	4	87,779/88,033	111,510/111,764		3,429		BS	1011BF	A169/4 STD .005
SE/PB	1	39,967/40,015	43,946/43,971	36,000			BS	60116YA	55-4282 SEMI
SE/PB	1	42,000/42,006	45,946/45,971	37,800			BS	66554Y	55-4293 SEMI

62 115.00 x 130.00

8361.05	6 Cyl.	8102cc	Diesel	FM4952
8361.25	6 Cyl.	8101cc	Diesel Turbo	FM19113
8361.45	6 Cyl.	8101cc	Diesel Turbo Intercooler	FM9113
8365.25.501	6 Cyl.	8102cc 118kW (160PS)	Diesel Turbo	TD18679
8365.25.502	6 Cyl.	8102cc 118-133kW (160-181PS)	Diesel Turbo	TD18680
8365.25.503	6 Cyl.	8102cc 118kW (160PS)	Diesel Turbo	TD18681
8365.25.533	6 Cyl.	8102cc 133kW (181PS)	Diesel Turbo	TD18682

BE/PL	1	72,482/72,500	76,695/76,713	34,930	2,070	0,055/0,116	BS	66550CP	71-4227 STD 0.25 0.50 0.75
-------	---	---------------	---------------	--------	-------	-------------	----	---------	--------------------------------------

→12/81

BE/PL	1	72,482/72,500	76,695/76,713	34,930	2,070	0,055/0,115	BC	AE6563	71-4390 STD 0.25 0.50 0.75 1.00
-------	---	---------------	---------------	--------	-------	-------------	----	--------	---

01/82→

66550CP

AE6563

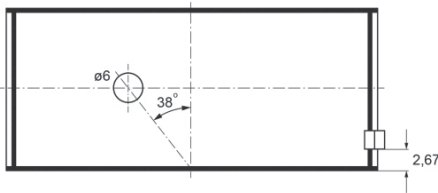

MB/HL 1,4,7	3	79,782/79,800	84,206/84,226	42,500	2,178	0,050/0,113	BS	66551CP	H1048/7 STD 0.25 0.50
MB/HL 2,3,5,6	4	79,782/79,800	84,206/84,226	32,500	2,178	0,050/0,113	BS	66552CP	
TW/A	4	87,779/88,033	111,510/111,764		3,429		BS	1011BF	A169/4 STD .005
SE/PB	1	39,967/40,015	43,946/43,971	36,000			BS	60116YA	55-4282 SEMI
SE/PB	1	42,000/42,006	45,946/45,971	37,800			BS	66554Y	55-4293 SEMI

63 115.00 x 130.00

8361Si10, 8361Si11, 8361Si12	6 Cyl.	8100cc	198kW (270PS)	Diesel Turbo	FM13493
-------------------------------------	--------	---------------	----------------------	---------------------	----------------

BE/PL	1	72,482/72,500	76,695/76,713	34,930	2,070	0,055/0,115	BC	AE6563	71-4390 STD 0.25 0.50 0.75 1.00
-------	---	---------------	---------------	--------	-------	-------------	----	--------	---

MB/HL 1,4,7	3	79,782/79,800	84,206/84,226	42,500	2,178	0,050/0,113	BS	66551CP	H1048/7 STD 0.25 0.50	
MB/HL 2,3,5,6	4	79,782/79,800	84,206/84,226	32,500	2,178	0,050/0,113	BS	66552CP		
TW/A	4	87,779/88,033	111,510/111,764		3,429		BS	1011BF	A169/4 STD .005	
SE/PB	1	39,967/40,015	43,946/43,971	36,000			BS	60116YA	55-4282 SEMI	
SE/PB	1	42,000/42,006	45,946/45,971	37,800			BS	66554Y	55-4293 SEMI	

64 117.00 x 135.00

F2CE0681A	6 Cyl.	8708cc	294kW (400PS)	Diesel Turbo Intercooler	TD25715
F2CE0682A	6 Cyl.	8708cc	294kW (400PS)	Diesel Turbo Intercooler	TD25716
F2CE0683A	6 Cyl.	8708cc	294kW (400PS)	Diesel Turbo Intercooler	TD25717
F2CE0684A	6 Cyl.	8708cc	294kW (400PS)	Diesel Turbo Intercooler	TD25718

BE/PL	6	81,915/81,945	85,987/86,013	35,050	1,202	0,038/0,118	EC	71-4936	71-4936/6 STD 0.25 0.50	
MB/HL 1-7	7	92,970/93,000	99,000/99,030	33,000	2,975	0,050/0,09	AL-LF	02-4933	H1326/7 STD 0.25 0.50	
MB/HL 1,4,7	3	92,970/93,000	99,000/99,030	33,000	2,975	0,050/0,090	AL-LF	02-4934		
MB/HL 2,3,5,6	4	92,970/93,000	99,000/99,030	33,000	2,975	0,050/0,090	AL-LF	02-4935		
TW/A	4	101,300/101,550	120,800/121,000		3,380		AL-LF	04-4931	A315/4 STD	
SE/PB	1	51,994/52,000	55,700/55,730	41,500			BS	55-4932	55-4932 SEMI	
CB/NWB 1-7	7	64,924/64,940	69,000/69,030	24,500	1,205	0,060/0,142	AL-LF	03-4971	N207/7 STD	

65 120.00 x 125.00

F6L 413	V6 Cyl.	8478cc	132kW (180PS)	Diesel	TD10485					
BE/PL	1	74,971/74,990	80,000/80,019	27,800	2,475	0,060/0,123	EC	71-2834	71-2834 STD 0.25 0.50	
SE/PB	1	44,995/45,000	48,000/48,016	39,600	1,484		BC	55-2640	55-2640 STD	

66 120.00 x 140.00

8460.21.002	6 Cyl.	9500cc	177kW (240PS)	Diesel Turbo	TD7315
8460.21.002	6 Cyl.	9500cc	177kW (241PS)	Diesel Turbo	TD10502
8460.21.010	6 Cyl.	9500cc	177kW (240PS)	Diesel Turbo	TD18226
8460.21.010	6 Cyl.	9500cc	177kW (241PS)	Diesel Turbo	TD10503
8460.21.102	6 Cyl.	9500cc	192kW (260PS)	Diesel Turbo	TD7328
8460.21.102	6 Cyl.	9500cc	191kW (260PS)	Diesel Turbo	TD10521
8460.21.202	6 Cyl.	9498cc	177kW (241PS)	Diesel Turbo	TD10518
8460.21.202	6 Cyl.	9500cc	177kW (240PS)	Diesel Turbo	TD5620
8460.21.206	6 Cyl.	9498cc	177kW (241PS)	Diesel Turbo	TD10519
8460.21.206	6 Cyl.	9500cc	177kW (240PS)	Diesel Turbo	TD5957
8460.21.601	6 Cyl.	9498cc	191kW (260PS)	Diesel Turbo	TD20435
8460.21.601	6 Cyl.	9500cc	191kW (260PS)	Diesel Turbo	TD7374
8460.21.611	6 Cyl.	9498cc	154kW (209PS)	Diesel Turbo	TD20436
8460.41	6 Cyl.	9500cc	221-254kW (301-345PS)	Diesel Turbo Intercooler	TD7363
8460.41 R	6 Cyl.	9500cc	214-276kW (290-375PS)	Diesel Turbo Intercooler	TD7248
8460.41 S	6 Cyl.	9500cc	254kW (345PS)	Diesel	TD7249
8460.41C.	6 Cyl.	9500cc	221kW (301PS)	Diesel Turbo	TD10807
8460.41K. Euro 2	6 Cyl.	9500cc	254kW (345PS)	Diesel Turbo	TD10808



8460.41N Euro 2		6 Cyl.		9500cc	276kW (375PS)	Diesel Turbo			TD10707
BE/PL	1	81,978/82,000	86,213/86,235	35,400	2,089	0,040/0,100	BS	1230CP	71-4284 STD 0.25 0.50
MB/HL 1-3, 5-7	6	89,958/89,980	96,000/96,022	32,750	2,991	0,038/0,107	BS	1231CP	H1072/7 STD 0.25 0.50
MB/HL 4	1	89,958/89,980	96,000/96,022	44,500	2,991	0,038/0,107	BS	1232CP	
TW/A	4	99,800/100,200	123,650/124,000		3,920		BS	1232BF	A171/4 STD
SE/PB	1	48,023/48,033	52,114/52,122	43,000			BS	1234Y	55-4285 SEMI

67 120.00 x 140.00

8460.41 B		6 Cyl.		9500cc	214kW (290PS)	Diesel Turbo Intercooler			TD29814
BE/PL	1	81,978/82,000	86,213/86,235	35,400	2,089	0,040/0,100	BS	1230CP	71-4284 STD 0.25 0.50
MB/HL 1	1	69,812/69,825	74,079/74,105	33,150	2,089	0,076/0,140	AL-LF	2781RA	H1027/5 STD 0.25 0.50 0.75 1.00
MB/HL 2,4	2	69,825/69,840	74,070/74,091	25,400	2,089	0,052/0,113	AL-LF	2782RA	
MB/HL 3,5	2	69,812/69,825	74,079/74,105	40,767	2,089	0,076/0,140	AL-LF	2783RA	
TW/A	4	99,800/100,200	123,650/124,000		3,920		BS	1232BF	A171/4 STD
SE/PB	1	48,023/48,033	52,114/52,122	43,000			BS	1234Y	55-4285 SEMI

68 120.00 x 140.00

8460.41 T		6 Cyl.		9500cc	185kW (251PS)	Diesel			TD24262
8460.41C.320		6 Cyl.		9500cc	221kW (301PS)	Diesel Turbo			TD10512
8460.41K.406		6 Cyl.		9500cc	254kW (345PS)	Diesel Turbo			TD10513
8460.41K.410		6 Cyl.		9500cc	254kW (345PS)	Diesel Turbo			TD10709
8460.41L TCA		6 Cyl.		9500cc	276kW (375PS)	Diesel Turbo			TD10573
MB/HL 1-3, 5-7	6	89,958/89,980	96,000/96,022	32,750	2,991	0,038/0,107	BS	1231CP	H1072/7 STD 0.25 0.50
MB/HL 4	1	89,958/89,980	96,000/96,022	44,500	2,991	0,038/0,107	BS	1232CP	

69 120.00 x 140.00

8460.41.102		6 Cyl.		9500cc	234kW (318PS)	Diesel Turbo Intercooler			TD10548
8460.41C. TCA		6 Cyl.		9500cc	221kW (301PS)	Diesel Turbo Intercooler			TD10595
8460.41L.5020		6 Cyl.		9500cc	276kW (375PS)	Diesel Turbo			TD10514
BE/PL	1	81,978/82,000	86,213/86,235	35,400	2,089	0,040/0,100	BS	1230CP	71-4284 STD 0.25 0.50
MB/HL 1-3, 5-7	6	89,958/89,980	96,000/96,022	32,750	2,991	0,038/0,107	BS	1231CP	H1072/7 STD 0.25 0.50
MB/HL 4	1	89,958/89,980	96,000/96,022	44,500	2,991	0,038/0,107	BS	1232CP	
TW/A	4	99,800/100,200	123,650/124,000		3,920		BS	1232BF	A171/4 STD

70 120.00 x 140.10

8460.41 M		6 Cyl.		9500cc	278kW (378PS)	Diesel Turbo Intercooler			TD7250
BE/PL	1	81,978/82,000	86,213/86,235	35,400	2,089	0,040/0,100	BS	1230CP	71-4284 STD 0.25 0.50
MB/HL 1-3, 5-7	6	89,958/89,980	96,000/96,022	32,750	2,991	0,038/0,107	BS	1231CP	H1072/7 STD 0.25 0.50
MB/HL 4	1	89,958/89,980	96,000/96,022	44,500	2,991	0,038/0,107	BS	1232CP	

TW/A	4	99,800/100,200	123,650/124,000		3,920			BS	1232BF	A171/4 STD
SE/PB	1	48,023/48,033	52,114/52,122	43,000				BS	1234Y	55-4285 SEMI

71	125.00 x 130.00									
8220.02.870			6 Cyl.	9572cc	148kW (201PS)			Diesel		TD10517
8220.22.002			6 Cyl.	9572cc	177kW (241PS)			Diesel Turbo		TD10495
8220.22.102			6 Cyl.	9572cc	177kW (241PS)			Diesel Turbo		TD10496
BE/PL	6	76,191/76,210		80,423/80,442	36,300	2,083	0,047/0,110	BS	66545CP	71-4386/6 STD

72	125.00 x 130.00									
F6L 413 F			V6 Cyl.	9570cc	141kW (192PS)			Diesel		TD10483
BE/PL	1	74,971/74,990		80,000/80,019	27,800	2,475	0,060/0,123	EC	71-2834	71-2834 STD 0.25 0.50
SE/PB	1	44,995/45,000		48,000/48,016	39,600	1,484		BC	55-2640	55-2640 STD

73	125.00 x 130.00									
BF8L 413 F			V8 Cyl.	12763cc	212kW (288PS)			Diesel Turbo		TD10578
BF8L 513			V8 Cyl.	12763cc	225-250kW (306-340PS)			Diesel Turbo		TD10501
F8L 413 F			V8 Cyl.	12763cc	162-212kW (220-288PS)			Diesel		TD10522
BE/PL	1	74,971/74,990		80,000/80,019	27,800	2,475	0,060/0,123	EC	71-2834	71-2834 STD 0.25 0.50
MB/HL	4	94,966/94,988		101,000/101,022	29,000	2,970		EC	72-3313	H931/5 0.25
MB/HL	1	94,966/94,988		101,000/101,022	40,825	2,970		EC	72-3314H	
				72-3314H	0.25mm	41,250/1.6240" - 41,312/1.6265"				
SE/PB	1	44,995/45,000		48,000/48,016	39,600	1,484		BC	55-2640	55-2640 STD
CB/NWB	4	59,910/59,940		64,000/64,019	24,000	2,000		BB	13-2865	N120/5 STD
CB/NWB	1	59,910/59,940		64,000/64,019	39,000	2,000		EC	53-2864	

74	125.00 x 130.00									
F10L 413 F			V10 Cyl.	15953cc	235kW (320PS)			Diesel Turbo		TD10527
BE/PL	1	74,971/74,990		80,000/80,019	27,800	2,475	0,060/0,123	EC	71-2834	71-2834 STD 0.25 0.50
SE/PB	1	44,995/45,000		48,000/48,016	39,600	1,484		BC	55-2640	55-2640 STD

75	125.00 x 140.00									
F3AE0681B Euro 3			6 Cyl.	10300cc	294kW (400PS)			Diesel Turbo Intercooler		TD16551
F3AE0681D Euro 2			6 Cyl.	10300cc	316kW (430PS)			Diesel Turbo Intercooler		TD14970
F3AE0681E Euro 2			6 Cyl.	10300cc	287kW (390PS)			Diesel Turbo Intercooler		TD14968
F3AE0681H Euro 3			6 Cyl.	10300cc	294kW (400PS)			Diesel Turbo Intercooler		TD24541
F3AE3681A Euro 4/5			6 Cyl.	10300cc	331kW (450PS)			Diesel Turbo Intercooler		TD20468
F3AE3681B Euro 4/5			6 Cyl.	10300cc	310kW (422PS)			Diesel Turbo Intercooler		TD20467
F3AE3681D Euro 4/5			6 Cyl.	10300cc	310kW (422PS)			Diesel Turbo Intercooler		TD24603
F3AE3681Y Euro 4/5			6 Cyl.	10300cc	331kW (450PS)			Diesel Turbo Intercooler		TD20469
BE/PL	6	82,970/83,000		87,000/87,030	40,500	1,980	0,040/0,008	EC	71-4091	71-4091/6 STD 0.25 0.50

MB/HL	6	92,970/93,000	99,000/99,030	37,000	2,980	0,050/0,090	EC	71-4092	H1022/7 STD 0.25 0.50	
MB/HL	1	92,970/93,000	99,000/99,030	45,750	2,980	0,052/0,136	BB	72-4093H		
SE/PB	1	49,994/50,000	54,000/54,030	49,150			BS-LF	55-4094	55-4094 SEMI	

76 125.00 x 145.00

203.000	6 Cyl.	10676cc						Diesel	FM596
BE/PL	6	81,800/81,826	85,585/85,598	43,250	1,835	0,089/0,153	BS	60065CP	71-4221/6 STD 0.25 0.50 0.75
MB/HL 1	1	92,062/92,087	96,583/96,596	54,990	2,190	0,116/0,179	BS	60061CP	H1132/7 STD 0.25 0.50 0.75
MB/HL 4	1	92,062/92,087	96,583/96,596	67,000	2,190	0,116/0,179	BS	60062CP	
MB/HL 2,3,5,6	4	92,062/92,087	96,583/96,596	32,990	2,190	0,116/0,179	BS	60063CP	
MB/HL 7	1	92,062/92,087	96,583/96,596	70,990	2,190	0,116/0,179	BS	60064CP	
TW/A	4	103,378/103,632	119,888/120,142		2,362		AL-LF	60062AF	A244/4 STD .005

77 128.00 x 130.00

F8L 513	V8 Cyl.	13383cc	168-194kW (228-264PS)						Diesel	TD10499
BE/PL	1	74,971/74,990	80,000/80,019	27,800	2,475	0,060/0,123	EC	71-2834	71-2834 STD 0.25 0.50	
MB/HL	4	94,966/94,988	101,000/101,022	29,000	2,970		EC	72-3313	H931/5 0.25	
MB/HL	1	94,966/94,988	101,000/101,022	40,825	2,970		EC	72-3314H		
			72-3314H	0.25mm	41,250/1.6240" - 41,312/1.6265"					
SE/PB	1	44,995/45,000	48,000/48,016	39,600	1,484		BC	55-2640	55-2640 STD	
CB/NWB	4	59,910/59,940	64,000/64,019	24,000	2,000		BB	13-2865	N120/5 STD	
CB/NWB	1	59,910/59,940	64,000/64,019	39,000	2,000		EC	53-2864		

78 130.00 x 145.00

203 A/61	6 Cyl.	11548cc	130kW (177PS)						Diesel	TD7375
203 A/61.000	6 Cyl.	11548cc	132kW (179PS)						Diesel	TD7376
203 H 61	6 Cyl.	11548cc	132kW (180PS)						Diesel	TD7348
310 H/61	6 Cyl.	11548cc						Diesel	FM3512	
BE/PL	6	81,800/81,826	85,585/85,598	43,250	1,835	0,089/0,153	BS	60065CP	71-4221/6 STD 0.25 0.50 0.75	
MB/HL 1	1	92,062/92,087	96,583/96,596	54,990	2,190	0,116/0,179	BS	60061CP	H1132/7 STD 0.25 0.50 0.75	
MB/HL 4	1	92,062/92,087	96,583/96,596	67,000	2,190	0,116/0,179	BS	60062CP		
MB/HL 2,3,5,6	4	92,062/92,087	96,583/96,596	32,990	2,190	0,116/0,179	BS	60063CP		
MB/HL 7	1	92,062/92,087	96,583/96,596	70,990	2,190	0,116/0,179	BS	60064CP		
TW/A	4	103,378/103,632	119,888/120,142		2,362		AL-LF	60062AF	A244/4 STD .005	
SE/PB	1	47,983/47,998	53,010/53,061	50,000			BS	61929XA	55-4217 SEMI	

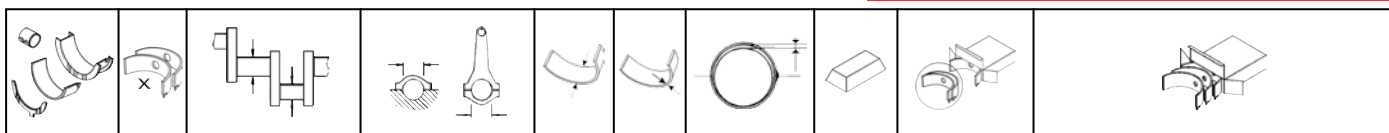

79 135.00 x 150.00

F3B3681A Euro 4/5	6 Cyl.	12880cc	412kW (560PS)	Diesel Turbo Intercooler	TD20481
F3B3681B Euro 4/5	6 Cyl.	12882cc	368kW (500PS)	Diesel Turbo Intercooler	TD20480
F3B3681C Euro 4/5	6 Cyl.	12880cc	332kW (450PS)	Diesel Turbo Intercooler	TD20474
F3B3681D Euro 4/5	6 Cyl.	12880cc	301kW (410PS)	Diesel Turbo Intercooler	TD20470
F3B3681E Euro 4/5	6 Cyl.	12880cc	382kW (520PS)	Diesel Turbo Intercooler	TD20479
F3B3681G Euro 4/5	6 Cyl.	12880cc	324kW (440PS)	Diesel Turbo Intercooler	TD20473
F3BE0681A Euro 3	6 Cyl.	12880cc	397kW (540PS)	Diesel Turbo Intercooler	TD16505
F3BE0681B Euro 3	6 Cyl.	12880cc	368kW (500PS)	Diesel Turbo Intercooler	TD16550
F3BE0681C Euro 3	6 Cyl.	12880cc	324kW (440PS)	Diesel Turbo Intercooler	TD16507
F3BE0681D	6 Cyl.	12882cc	330kW (450PS)	Diesel Turbo Intercooler	TD20620
F3BE0681E Euro 3	6 Cyl.	12880cc	353kW (480PS)	Diesel Turbo Intercooler	TD16506
F3BE0681F	6 Cyl.	12882cc	367kW (500PS)	Diesel Turbo Intercooler	TD20622
F3BE0681G Euro 3	6 Cyl.	12880cc	280kW (380PS)	Diesel Turbo Intercooler	TD16591
F3BE0681H	6 Cyl.	12882cc	294kW (400PS)	Diesel Turbo Intercooler	TD20619
F3BE0681J	6 Cyl.	12882cc	265kW (360PS)	Diesel Turbo Intercooler	TD20618
F3BE0681K	6 Cyl.	12882cc	367kW (500PS)	Diesel Turbo Intercooler	TD20626
F3BE0681V Euro 3	6 Cyl.	12880cc	309kW (420PS)	Diesel Turbo Intercooler	TD24331
F3BE3681A Euro 4/5	6 Cyl.	12882cc	412kW (560PS)	Diesel Turbo Intercooler	TD20645
F3BE3681B Euro 4/5	6 Cyl.	12880cc	368kW (500PS)	Diesel Turbo Intercooler	TD21089
F3BE3681C Euro 4/5	6 Cyl.	12880cc	332kW (450PS)	Diesel Turbo Intercooler	TD21057
F3BE3681D Euro 4/5	6 Cyl.	12882cc	302kW (410PS)	Diesel Turbo Intercooler	TD20632
F3BE3681E Euro 4/5	6 Cyl.	12882cc	382kW (520PS)	Diesel Turbo Intercooler	TD20644
F3BE3681F Euro 4/5	6 Cyl.	12882cc	353kW (480PS)	Diesel Turbo Intercooler	TD20641
F3BE3681G Euro 4/5	6 Cyl.	12882cc	324kW (440PS)	Diesel Turbo Intercooler	TD20633

BE/PL	6	89,970/90,000	94,000/94,030	43,500	1,980	0,040/0,100	EC	71-4095	71-4095/6 STD 0.25 0.50
MB/HL	6	99,970/100,000	106,300/106,330	39,000	3,130	0,060/0,140	EC	72-4096	H1023/7 STD 0.25 0.50
MB/HL	1	99,970/100,000	106,300/106,330	47,850	3,130	0,060/0,140	BB	72-4097H	



72-4097H	STD	47,960/1.8882" - 48,000/1.8898"
	0.25mm	47,960/1.8882" - 48,000/1.8898"
	0.50mm	47,960/1.8882" - 48,000/1.8898"

SE/PB	1		59,000/59,030	53,100			BS-LF	55-4098	55-4098 SEMI
-------	---	--	---------------	--------	--	--	-------	---------	------------------------

80 137.00 x 156.00

8210.02	6 Cyl.	13800cc	191kW (260PS)	Diesel	TD9085
8210.02.	6 Cyl.	13800cc	191kW (260PS)	Diesel	TD10598
8210.02.067	6 Cyl.	13798cc	191kW (260PS)	Diesel	TD10523
8210.02.069	6 Cyl.	13798cc	191kW (260PS)	Diesel	TD10525
8210.02.371	6 Cyl.	13798cc	191kW (260PS)	Diesel	TD10507
8210.02.373	6 Cyl.	13798cc	191kW (260PS)	Diesel	TD10508
8210.02.377	6 Cyl.	13798cc	191kW (260PS)	Diesel	TD10509
8210.02.393	6 Cyl.	13798cc	191kW (260PS)	Diesel	TD10510
8210.02.440	6 Cyl.	13798cc	191kW (260PS)	Diesel	TD10491
8210.02.441	6 Cyl.	13798cc	191kW (260PS)	Diesel	TD10492
8210.02.731	6 Cyl.	13798cc	191kW (260PS)	Diesel	TD10524
8210.12.000	6 Cyl.	13798cc	59kW (80PS)	Diesel	FM3517
8210.22.537	6 Cyl.	13798cc	224kW (305PS)	Diesel Turbo	TD11394

BE/PL	6	84,713/84,735	88,482/88,504	40,250	1,836	0,140/0,144	BS	1675CP	71-4215/6 STD 0.25 0.50
-------	---	---------------	---------------	--------	-------	-------------	----	--------	-----------------------------------

Mot.184188 →



BE/PL	6	84,713/84,735	88,482/88,504	41,250	1,836	0,140/0,144	BS	66520CP	71-4385/6 STD 0.25 0.50 0.75
-------	---	---------------	---------------	--------	-------	-------------	----	---------	--

Mot. → 184187

1675CP

66520CP

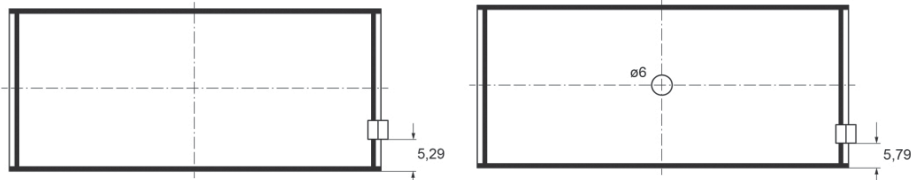

MB/HL 4	1	102,879/102,901	107,976/108,001	54,380	2,490	0,085/0,156	BS	AE6046	H1047/7 STD 0.25 0.50
MB/HL 7	1	102,879/102,901	107,976/108,001	37,410	2,490	0,085/0,156	BS	AE6047	
MB/HL 2,3,5,6	4	102,879/102,901	107,976/108,001	34,820	2,490	0,085/0,156	BS	AE6048	
MB/HL 1	1	102,879/102,901	107,976/108,001	37,410	2,490	0,085/0,156	BS	AE6049	
MB/HL 1,7	2	102,879/102,901	107,976/108,001	37,410	2,490	0,085/0,156	BS	AE6050	
MB/HL 4	1	102,879/102,901	107,976/108,001	54,380	2,490	0,085/0,156	BS	AE6051	
MB/HL 2,3,5,6	4	102,879/102,901	107,976/108,001	34,820	2,490	0,085/0,156	BS	AE6052	
TW/A	4	114,884/115,138	133,383/134,137		2,362		BS	62022BFA	A200/4 STD .005
SE/PB	1	49,995/50,000	54,852/54,899	50,400			BS	1679Y	55-4107 SEMI
SE/PB	1	47,983/47,998	53,010/53,061	50,000			BS	61929XA	55-4217 SEMI
CB/NWB 1	1	62,500/62,530	68,515/68,550	42,240	2,958		AL-LF	62021DR	N174/4 STD
CB/NWB 2	1	62,000/62,030	68,015/68,050	32,250	2,958		AL-LF	62022DR	
CB/NWB 3	1	61,500/61,530	67,515/67,550	32,250	2,958		AL-LF	62023DR	
CB/NWB 4	1	61,000/61,030	67,015/67,050	32,250	2,958		AL-LF	62024DR	

81

137.00 x 156.00

8210.22.105	6 Cyl.	13798cc	243kW (330PS)	Diesel Turbo Intercooler	TD10550
8210.22.171	6 Cyl.	13798cc	224kW (305PS)	Diesel Turbo	TD10530
8210.22.175	6 Cyl.	13798cc	224kW (305PS)	Diesel Turbo	TD10528
8210.22.183	6 Cyl.	13798cc	224kW (305PS)	Diesel Turbo	TD10579
8210.22.210	6 Cyl.	13798cc	224kW (305PS)	Diesel Turbo	TD11387
8210.22.236	6 Cyl.	13798cc	224kW (305PS)	Diesel Turbo	TD11388
8210.22.269	6 Cyl.	13798cc	224kW (305PS)	Diesel Turbo	TD10584
8210.22.317	6 Cyl.	13798cc	224kW (305PS)	Diesel Turbo	TD10531
8210.22.327	6 Cyl.	13798cc	224kW (305PS)	Diesel Turbo	TD10585
8210.22.385	6 Cyl.	13798cc	224kW (305PS)	Diesel Turbo	TD10586
8210.22.511	6 Cyl.	13798cc	224kW (305PS)	Diesel Turbo	TD11389
8210.22.521	6 Cyl.	13798cc	224kW (305PS)	Diesel Turbo	TD11390
8210.22.523	6 Cyl.	13798cc	224kW (305PS)	Diesel Turbo	TD11391
8210.22.525	6 Cyl.	13798cc	224kW (305PS)	Diesel Turbo	TD11392
8210.22.535	6 Cyl.	13798cc	224kW (305PS)	Diesel Turbo	TD11393
8210.22.569	6 Cyl.	13798cc	224kW (305PS)	Diesel Turbo	TD10529
8210.22.869	6 Cyl.	13798cc	235kW (320PS)	Diesel Turbo	TD10549



8210.22X.069			6 Cyl.	13798cc	224kW (305PS)	Diesel Turbo	TD11329
8210.22X.235			6 Cyl.	13798cc	224kW (305PS)	Diesel Turbo	TD11407
8210.22X.523			6 Cyl.	13798cc	224kW (305PS)	Diesel Turbo	TD11408
8210.22X.575			6 Cyl.	13798cc	224kW (305PS)	Diesel Turbo	TD11330
8210.42 TCA			6 Cyl.	13798cc	272kW (370PS)	Diesel Turbo Intercooler	TD10574
8210.42.			6 Cyl.	13798cc	277kW (377PS)	Diesel Turbo Intercooler	TD10564
8210.42.061			6 Cyl.	13798cc	277kW (377PS)	Diesel Turbo Intercooler	TD10561
8210.42.073			6 Cyl.	13798cc	277kW (377PS)	Diesel Turbo Intercooler	TD10562
8210.42.101			6 Cyl.	13798cc	265kW (360PS)	Diesel Turbo Intercooler	TD10563
8210.42.115			6 Cyl.	13798cc	265kW (360PS)	Diesel Turbo Intercooler	TD10582
8210.42.151			6 Cyl.	13798cc	277kW (377PS)	Diesel Turbo Intercooler	TD10552
8210.42.152			6 Cyl.	13798cc	277kW (377PS)	Diesel Turbo Intercooler	TD10555
8210.42.154			6 Cyl.	13798cc	277kW (377PS)	Diesel Turbo Intercooler	TD10556
8210.42.155			6 Cyl.	13798cc	277kW (377PS)	Diesel Turbo Intercooler	TD10580
8210.42.161			6 Cyl.	13798cc	277kW (377PS)	Diesel Turbo Intercooler	TD10553
8210.42.162			6 Cyl.	13798cc	277kW (377PS)	Diesel Turbo Intercooler	TD10557
8210.42.165			6 Cyl.	13798cc	277kW (377PS)	Diesel Turbo Intercooler	TD10588
8210.42.171			6 Cyl.	13798cc	277kW (377PS)	Diesel Turbo Intercooler	TD10554
8210.42.172			6 Cyl.	13798cc	277kW (377PS)	Diesel Turbo Intercooler	TD10581
8210.42.175			6 Cyl.	13798cc	277kW (377PS)	Diesel Turbo Intercooler	TD10590
8210.42.181			6 Cyl.	13798cc	277kW (377PS)	Diesel Turbo Intercooler	TD10558
8210.42.182			6 Cyl.	13798cc	277kW (377PS)	Diesel Turbo Intercooler	TD10559
8210.42.185			6 Cyl.	13798cc	277kW (377PS)	Diesel Turbo Intercooler	TD10591
8210.42.186			6 Cyl.	13798cc	277kW (377PS)	Diesel Turbo Intercooler	TD10592
8210.42.191			6 Cyl.	13798cc	277kW (377PS)	Diesel Turbo Intercooler	TD10560
8210.42.195			6 Cyl.	13798cc	277kW (377PS)	Diesel Turbo Intercooler	TD10593
8210.42.210			6 Cyl.	13798cc	265kW (360PS)	Diesel Turbo Intercooler	TD11512
8210.42.235			6 Cyl.	13798cc	265kW (360PS)	Diesel Turbo Intercooler	TD11511
8210.42.237			6 Cyl.	13798cc	265kW (360PS)	Diesel Turbo Intercooler	TD11510
8210.42.269			6 Cyl.	13798cc	265kW (360PS)	Diesel Turbo Intercooler	TD11507
8210.42.270			6 Cyl.	13798cc	265kW (360PS)	Diesel Turbo	TD11508
8210.42.271			6 Cyl.	13798cc	265kW (360PS)	Diesel Turbo	TD11509
8210.42.500 Euro 2			6 Cyl.	13798cc	346kW (471PS)	Diesel Turbo Intercooler	TD18332
8210.42K(TCA) Euro 1			6 Cyl.	13798cc	272kW (370PS)	Diesel Turbo	TD7377
8210.42K. Euro 2			6 Cyl.	13798cc	272kW (370PS)	Diesel Turbo	TD10809
8210.42K.(TCA)			6 Cyl.	13798cc	272kW (370PS)	Diesel Turbo	TD7365
8210.42L(TCA) Euro 2			6 Cyl.	13798cc	309kW (420PS)	Diesel Turbo Intercooler	TD7378
8210.42L. Euro 2			6 Cyl.	13798cc	309kW (420PS)	Diesel Turbo	TD10812
8210.42L.400 Euro 1			6 Cyl.	13798cc	309kW (420PS)	Diesel Turbo	TD10515
8210.42M			6 Cyl.	13798cc	346kW (470PS)	Diesel	TD20617
8210.42M. TCA Euro 2			6 Cyl.	13798cc	345kW (469PS)	Diesel Turbo Intercooler	TD10576
8211.22			6 Cyl.	13798cc		Diesel Turbo	FM24024
8215.02			6 Cyl.	13798cc		Diesel	FM3514
8215.22.520			6 Cyl.	13798cc		Diesel Turbo	FM9116
8217.32			6 Cyl.	13798cc		Diesel Turbo	FM19116

BE/PL	6	84,713/84,735	88,482/88,504	40,250	1,836	0,140/0,144	BS	1675CP	71-4215/6 STD 0.25 0.50
BE/PL	6	84,713/84,735	88,482/88,504	41,250	1,836	0,140/0,144	BS	66520CP	71-4385/6 STD 0.25 0.50 0.75



1675CP

66520CP

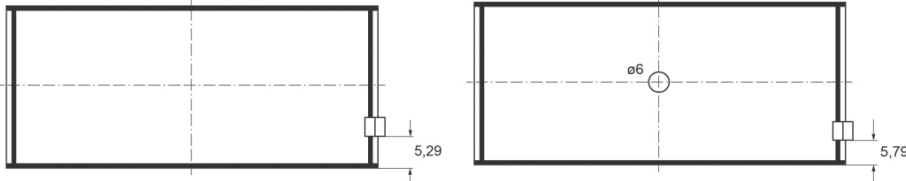

MB/HL 4	1	102,879/102,901	107,976/108,001	54,380	2,490	0,085/0,156	BS	AE6046	H1047/7 STD 0.25 0.50	
MB/HL 7	1	102,879/102,901	107,976/108,001	37,410	2,490	0,085/0,156	BS	AE6047		
MB/HL 2,3,5,6	4	102,879/102,901	107,976/108,001	34,820	2,490	0,085/0,156	BS	AE6048		
MB/HL 1	1	102,879/102,901	107,976/108,001	37,410	2,490	0,085/0,156	BS	AE6049		
MB/HL 1,7	2	102,879/102,901	107,976/108,001	37,410	2,490	0,085/0,156	BS	AE6050		
MB/HL 4	1	102,879/102,901	107,976/108,001	54,380	2,490	0,085/0,156	BS	AE6051		
MB/HL 2,3,5,6	4	102,879/102,901	107,976/108,001	34,820	2,490	0,085/0,156	BS	AE6052		
TW/A	4	114,884/115,138	133,383/134,137		2,362		BS	62022BFA		A200/4 STD .005
SE/PB	1	49,995/50,000	54,852/54,899	50,400			BS	1679Y		
SE/PB	1	47,983/47,998	53,010/53,061	50,000			BS	61929XA		55-4107 SEMI
CB/NWB 1	1	62,500/62,530	68,515/68,550	42,240	2,958		AL-LF	62021DR	55-4217 SEMI	
CB/NWB 2	1	62,000/62,030	68,015/68,050	32,250	2,958		AL-LF	62022DR		
CB/NWB 3	1	61,500/61,530	67,515/67,550	32,250	2,958		AL-LF	62023DR		
CB/NWB 4	1	61,000/61,030	67,015/67,050	32,250	2,958		AL-LF	62024DR		
									N174/4 STD	

82

145.00 x 130.00

8261.02.002		6 Cyl.		12880cc	165kW (224PS)	Diesel			TD20430
BE/PL	1	94,219/94,242	97,950/97,972	33,770	1,819	0,070/0,140	BS	66705CP	71-4238 STD 0.25 0.50
MB/HL	1	112,975/112,995	118,000/118,022	40,550	2,469	0,067/0,134	BS	66706CP	72-4548 STD 0.25 0.50
TW/A	4	123,750/124,000	146,050/146,304		3,429		BS	66706BF	A212/4 STD
SE/PB	1	54,982/54,990	59,963/59,994	44,000			BS	66499Y	55-4507 SEMI

83

145.00 x 130.00

8280.02.109	V8 Cyl.	17174cc	259kW (352PS)	Diesel	TD10551
8280.02.269	V8 Cyl.	17174cc	259kW (352PS)	Diesel	TD20431
8280.22.000	V8 Cyl.	17174cc	280kW (381PS)	Diesel Turbo	TD10565
8280.22.007	V8 Cyl.	17174cc	280kW (381PS)	Diesel Turbo	TD10566
8280.22.009	V8 Cyl.	17200cc	280kW (381PS)	Diesel Turbo	TD10583
8280.22.033	V8 Cyl.	17174cc	280kW (381PS)	Diesel Turbo	TD10594
8280.22.054	V8 Cyl.	17174cc	280kW (381PS)	Diesel Turbo	TD10567
8280.22.154	V8 Cyl.	17174cc	280kW (381PS)	Diesel Turbo Intercooler	TD10568
8280.22.201	V8 Cyl.	17174cc	309kW (420PS)	Diesel Turbo Intercooler	TD10569
8280.22.205	V8 Cyl.	17174cc	309kW (420PS)	Diesel Turbo Intercooler	TD10570
8281.02	8 Cyl.	17174cc		Diesel	FM14026



8285.02		8 Cyl.		17174cc		Diesel		FM9234	
8285.22		8 Cyl.		17174cc		Diesel Turbo		FM14027	
BE/PL	1	94,219/94,242	97,950/97,972	33,770	1,819	0,070/0,140	BS	1685CP	71-4108 STD
BE/PL	1	94,219/94,242	97,950/97,972	33,770	1,819	0,070/0,140	BS	66705CP	71-4238 STD 0.25 0.50

1685CP

66705CP

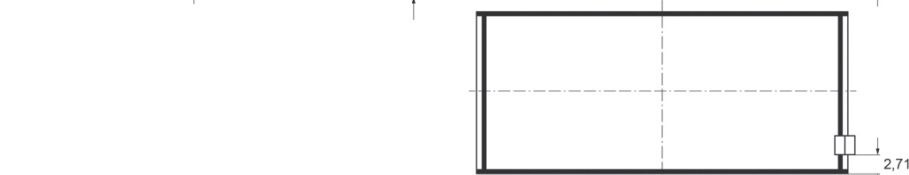
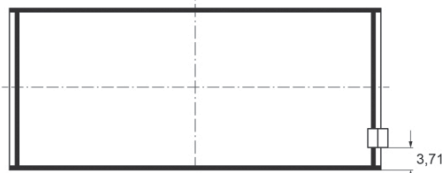

MB/HL	1	112,975/112,995	118,000/118,022	40,550	2,469	0,067/0,134	BS	66706CP	72-4548 STD 0.25 0.50
TW/A	4	123,750/124,000	146,050/146,304		3,429		BS	66706BF	A212/4 STD
SE/PB	1	54,982/54,990	59,963/59,994	44,000			BS	66499Y	55-4507 SEMI

84

145.00 x 130.00

8280.42.001		V8 Cyl.		17174cc 350kW (476PS)		Diesel Turbo		TD10572	
8280.42.050		V8 Cyl.		17174cc 350kW (476PS)		Diesel Turbo		TD10571	
8280.42B Euro 2		V8 Cyl.		17173cc 324kW (440PS)		Diesel Turbo Intercooler		TD20616	
8280.42S. TCA		V8 Cyl.		17173cc 378kW (514PS)		Diesel Turbo Intercooler		TD10577	
8280.42S.342 Euro 2		V8 Cyl.		17174cc 378kW (514PS)		Diesel Turbo Intercooler		TD20432	
8280.42S.350 Euro 2		V8 Cyl.		17174cc 375kW (510PS)		Diesel Turbo Intercooler		TD10516	
8280.42S.352 Euro 2		V8 Cyl.		17174cc 378kW (514PS)		Diesel Turbo Intercooler		TD20433	
8280.42S.362 Euro 2		V8 Cyl.		17174cc 378kW (514PS)		Diesel Turbo Intercooler		TD20434	
8281SRM50		8 Cyl.		17174cc		Diesel		FM24026	

BE/PL	1	94,219/94,242	97,950/97,972	33,770	1,819	0,070/0,140	BS	1685CP	71-4108 STD
MB/HL	1	112,975/112,995	118,000/118,022	40,550	2,469	0,067/0,134	BS	66706CP	72-4548 STD 0.25 0.50
TW/A	4	123,750/124,000	146,050/146,304		3,429		BS	66706BF	A212/4 STD
SE/PB	1	54,982/54,990	59,963/59,994	44,000			BS	66499Y	55-4507 SEMI

85

145.00 x 130.00

8281SRi27		8 Cyl.		17174cc		Diesel Turbo		FM99903	
BE/PL	1	94,219/94,242	97,950/97,972	33,770	1,819	0,070/0,140	BS	1685CP	71-4108 STD
MB/HL	1	112,975/112,995	118,000/118,022	40,550	2,469	0,067/0,134	BS	66706CP	72-4548 STD 0.25 0.50
TW/A	4	123,750/124,000	146,050/146,304		3,429		BS	66706BF	A212/4 STD









cm3



9

240 Mk II	01/56→12/69	Petrol	XK6 2.4	2483	6	83.00	76.50	2
D-Type 3.4	09/53→12/56	Petrol	XK 3.4 (82-86)	3442	6	82.99	105.99	1
E-Type 4.2	03/71→04/75	Petrol	8L (85-87)	4235	6	92.07	106.00	7
E-Type 4.2	05/64→05/71	Petrol	XK 4.2 (82-87)	4235	6	92.07	106.00	7
E Type Series I	01/61→12/65	Petrol	XK6 3.8	3781	6	87.00	105.99	5
Mk II, Mk IX, Mk X 3.8	01/59→12/68	Petrol	XK6 3.8	3781	6	87.00	105.99	5
Mk IX 3.8	01/58→12/68	Petrol	XK6 3.8	3781	6	87.00	105.99	5
Mk X 3.8	01/61→12/65	Petrol	XK6 3.8	3781	6	87.00	105.99	5
XJ 5.3	01/86→12/89	Petrol	V 12 (90-93, 197KW)	5343	V12	90.00	70.00	6
XJ 5.3	01/88→06/91	Petrol	8C (88-92)	5344	V12	90.00	70.00	6
XJ 5.3	05/91→08/93	Petrol	8S (92-93)	5344	V12	90.00	70.00	6
XJ 5.3	09/73→05/92	Petrol	V 12 (90-93, 211KW)	5344	V12	90.00	70.00	6
XJ 5.3 H.E.	01/86→12/89	Petrol	8S (86-88)	5343	V12	90.00	70.00	6
XJ 5.3 H.E.	07/81→12/87	Petrol	V 12 (82-90)	5343	V12	90.00	70.00	6
XJ 6 3.4	05/75→10/86	Petrol	XK 3.4 (82-86)	3442	6	82.99	105.99	1
XJ 6 4.2	01/75→12/86	Petrol	8L (85-87)	4235	6	92.07	106.00	7
XJ 6 4.2	10/69→09/79	Petrol	XK 4.2 (-79)	4235	6	92.07	106.00	7
XJ 6 4.2	09/79→12/87	Petrol	XK 4.2 (82-87)	4235	6	92.07	106.00	7
XJ 12 5.3	05/75→12/82	Petrol	V 12 (75-79)	5343	V12	90.00	70.00	6
XJ 12 5.3	06/72→09/89	Petrol	7P	5344	V12	90.00	70.00	6
XJ 12 H.E.	09/81→12/92	Petrol	V 12 (82-90)	5343	V12	90.00	70.00	6
XJ Sovereign V12	07/85→12/92	Petrol	V 12 (90-93, 197KW)	5343	V12	90.00	70.00	6
XJ Sovereign V12	10/86→12/92	Petrol	7P	5344	V12	90.00	70.00	6
XJSC 5.3	09/87→12/88	Petrol	8S (86-88)	5343	V12	90.00	70.00	6
XJSC 5.3	01/86→05/88	Petrol	V 12 (90-93, 197KW)	5343	V12	90.00	70.00	6
XJSC 5.3	07/86→05/88	Petrol	7P	5344	V12	90.00	70.00	6
XJSC 5.3	01/88→09/91	Petrol	8C (88-92)	5344	V12	90.00	70.00	6
XJSC 5.3	05/91→08/93	Petrol	8S (92-93)	5344	V12	90.00	70.00	6
XJSC 5.3	01/88→05/92	Petrol	V 12 (90-93, 211KW)	5344	V12	90.00	70.00	6
XJSC 5.3 H.E.	07/85→05/92	Petrol	8S (86-88)	5343	V12	90.00	70.00	6
XJSC 5.3 H.E.	09/85→12/90	Petrol	V 12 (82-90)	5343	V12	90.00	70.00	6
XK 120	01/48→12/57	Petrol	XK (3.4)	3442	6	82.99	105.99	1
XK 140	01/48→12/57	Petrol	XK (3.4)	3442	6	82.99	105.99	1
XK 150	01/57→12/61	Petrol	XK (3.4)	3442	6	82.99	105.99	1
XK 150 S-type	01/58→12/61	Petrol	XK (3.4)	3442	6	82.99	105.99	1
XK150 3.8	01/59→12/68	Petrol	XK6 3.8	3781	6	87.00	105.99	5
X-Type 2.0 D	07/03→12/09	Diesel	FMBA	1998	4	86.00	86.00	3
X-Type 2.0 D	07/03→12/09	Diesel	FMBB	1998	4	86.00	86.00	3

		cm3	x 			
7P	Petrol	5344	V12	90.00	70.00	6
8C (88-92)	Petrol	5344	V12	90.00	70.00	6
8L (85-87)	Petrol	4235	6	92.07	106.00	7
8S (86-88)	Petrol	5343	V12	90.00	70.00	6
8S (88-91)	Petrol	5343	V12	90.00	70.00	6
8S (92-93)	Petrol	5344	V12	90.00	70.00	6
FMBA	Diesel	1998	4	86.00	86.00	3
FMBB	Diesel	1998	4	86.00	86.00	3
QJBA	Diesel	2198	4	86.00	94.60	4
V 12 (75-79)	Petrol	5343	V12	90.00	70.00	6
V 12 (78-82)	Petrol	5343	V12	90.00	70.00	6
V 12 (82-90)	Petrol	5343	V12	90.00	70.00	6
V 12 (90-93, 197KW)	Petrol	5343	V12	90.00	70.00	6
V 12 (90-93, 211KW)	Petrol	5344	V12	90.00	70.00	6
XK (3.4)	Petrol	3442	6	82.99	105.99	1
XK 3.4 (82-86)	Petrol	3442	6	82.99	105.99	1
XK 4.2 (-79)	Petrol	4235	6	92.07	106.00	7
XK 4.2 (82-87)	Petrol	4235	6	92.07	106.00	7
XK6 2.4	Petrol	2483	6	83.00	76.50	2
XK6 3.8	Petrol	3781	6	87.00	105.99	5

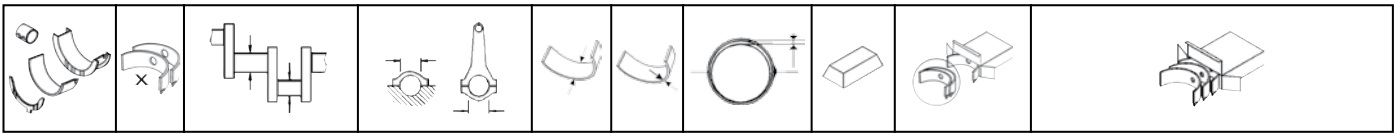

1 82.99 x 105.99

XK (3.4)		6 Cyl.		3442cc		Petrol		FM895		
XK 3.4 (82-86)		6 Cyl.		3442cc		119kW (162PS)		Petrol		TD4587
BE/PL	6	52,974/52,987	56,718/56,731	24,380	1,830		BS	GS426LC	71-4371/6 STD 0.25 0.50	
MB/HL 2,3,5,6	4	69,842/69,855	74,079/74,092	25,400	2,102	0,020/0,064	BS	GS2337LC	H1196/7 STD 0.25 0.50	
MB/HL 1,4,7	3	69,837/69,850	74,079/74,090	37,970	2,080		BS	GS7065LC		
TW/A	2	75,311/75,311	91,950/92,200		2,360		AL	04-4463	A253/2 STD	
SE/PB	1	22,225/22,230	25,387/25,400	27,560	1,740		BC	55-4543	55-4543 SEMI	
CB/NWB 1-8	8	25,375/25,387	29,233/29,235	33,450	1,910		BB	13-4472	N180/8 STD	

2 83.00 x 76.50

XK6 2.4		6 Cyl.		2483cc		Petrol		FM893	
BE/PL	6	52,974/52,987	56,718/56,731	24,380	1,830		BS	GS426LC	71-4371/6 STD 0.25 0.50
SE/PB	1	22,225/22,230	25,387/25,400	27,560	1,740		BC	55-4543	55-4543 SEMI
CB/NWB 1-8	8	25,375/25,387	29,233/29,235	33,450	1,910		BB	13-4472	N180/8 STD

3 86.00 x 86.00

FMBA		4 Cyl.		1998cc		96kW (130PS)		Diesel Turbo		TD24398
FMBB		4 Cyl.		1998cc		96kW (130PS)		Diesel Turbo		TD24399
BE/PL	4	52,980/53,000	55,996/56,016	24,450	1,487	0,026/0,084	BS	71-4066	71-4066/4 STD 0.25 0.50	
01/04→12/06										
MB/HL	4	64,940	69,520	23,280	2,250		AL-LF	02-4067	H1018/5 STD 0.25 0.50	
MB/HL	3	64,940	69,520	24,080	2,250		AL-LF	02-4068		
MB/HL	2	69,940	74,520	19,580	2,250		AL-LF	02-4069		
MB/HL	1	64,940	69,520	30,150	2,250		AL-LF	02-4070H		
01/04→12/06										

4 86.00 x 94.60

QJBA		4 Cyl.		2198cc		114kW (155PS)		Diesel Turbo Intercooler		TD24400
BE/PL	4	52,980/53,000	55,996/56,016	24,450	1,487	0,026/0,084	BS	71-4066	71-4066/4 STD 0.25 0.50	
01/04→12/06										
MB/HL	4	64,940	69,520	23,280	2,250		AL-LF	02-4067	H1018/5 STD 0.25 0.50	
MB/HL	3	64,940	69,520	24,080	2,250		AL-LF	02-4068		
MB/HL	2	69,940	74,520	19,580	2,250		AL-LF	02-4069		
MB/HL	1	64,940	69,520	30,150	2,250		AL-LF	02-4070H		
01/04→12/06										



5 87.00 x 105.99

XK6 3.8		6 Cyl.		3781cc				Petrol		FM896
BE/PL	6	52,974/52,987	56,718/56,731	24,380	1,830			BS	GS426LC	71-4371/6 STD 0.25 0.50
MB/HL 2,3,5,6	4	69,842/69,855	74,079/74,092	25,400	2,102	0,020/0,064		BS	GS2337LC	H1196/7 STD 0.25 0.50
MB/HL 1,4,7	3	69,837/69,850	74,079/74,090	37,970	2,080			BS	GS7065LC	
TW/A	2	75,311/75,311	91,950/92,200		2,360			AL	04-4463	A253/2 STD
SE/PB	1	22,225/22,230	25,387/25,400	27,560	1,740			BC	55-4543	55-4543 SEMI
CB/NWB 1-8	8	25,375/25,387	29,233/29,235	33,450	1,910			BB	13-4472	N180/8 STD

6 90.00 x 70.00

7P			V12 Cyl.	5344cc	187-194kW	(254-264PS)		Petrol		TD5203
8C (88-92)			V12 Cyl.	5344cc	202kW	(275PS)		Petrol		TD1736
8S (86-88)			V12 Cyl.	5343cc	194kW	(264PS)		Petrol		TD5216
8S (88-91)			V12 Cyl.	5343cc	202kW	(275PS)		Petrol		TD5217
8S (92-93)			V12 Cyl.	5344cc	207kW	(282PS)		Petrol		TD1735
V 12 (75-79)			V12 Cyl.	5343cc	211kW	(287PS)		Petrol		TD1731
V 12 (78-82)			V12 Cyl.	5343cc	211-217kW	(287-295PS)		Petrol		TD1728
V 12 (82-90)			V12 Cyl.	5343cc	217-220kW	(295-300PS)		Petrol		TD1732
V 12 (90-93, 197KW)			V12 Cyl.	5343cc	197kW	(268PS)		Petrol		TD4583
V 12 (90-93, 211KW)			V12 Cyl.	5344cc	211kW	(287PS)		Petrol		TD4585
BE/PL	12	58,405/58,420	62,000/62,013	18,160	1,760			BS	GS2775LC	71-4510/12 STD
MB/HL 1-3, 5,6	5	76,211/76,230	80,441/80,429	24,640	2,083	0,033/0,082		BS	GS2771LC	H1199/7 STD
MB/HL 4	1	76,211/76,230	80,441/80,429	30,410	2,083	0,033/0,082		BS	GS2772LC	
MB/HL 7	1	76,211/76,230	80,441/80,429	30,410	2,083	0,033/0,082		BS	GS2773LC	

7 92.07 x 106.00

8L (85-87)			6 Cyl.	4235cc	127-133kW	(173-181PS)		Petrol		TD5202
XK 4.2 (-79)			6 Cyl.	4235cc	124kW	(169PS)		Petrol		TD1737
XK 4.2 (82-87)			6 Cyl.	4235cc	151kW	(205PS)		Petrol		TD5199
BE/PL	6	52,974/52,987	56,718/56,731	24,380	1,830			BS	GS426LC	71-4371/6 STD 0.25 0.50
MB/HL 1,7	2	69,842/69,855	74,079/74,092	34,700	2,102	0,020/0,064		BS	GS2335LC	H1198/7 STD 0.25
MB/HL 4	1	69,842/69,855	74,079/74,092	28,500	2,102	0,020/0,064		BS	GS2336LC	
MB/HL 2,3,5,6	4	69,842/69,855	74,079/74,092	25,400	2,102	0,020/0,064		BS	GS2337LC	
TW/A	2	75,311/75,311	91,950/92,200		2,360			AL	04-4463	A253/2 STD
SE/PB	1	22,225/22,230	25,387/25,400	27,560	1,740			BC	55-4543	55-4543 SEMI
CB/NWB 1-8	8	25,375/25,387	29,233/29,235	33,450	1,910			BB	13-4472	N180/8 STD



cm3



9

Cherokee 2.1 D 4x4	10/86→09/92	Diesel	J8S 742	2068	4	86.00	89.00	4
Cherokee 2.1 TD	10/84→09/01	Diesel	J8S	2068	4	86.00	89.00	4
Cherokee 2.5 CRD 4x4	09/01→01/08	Diesel	R 425 DOHC	2499	4	92.00	94.00	7
Cherokee 2.5 TD	01/88→09/01	Diesel	ENC	2499	4	92.00	94.00	7
Cherokee 2.5 Tdi 4x4	10/96→09/01	Diesel	ENC	2499	4	92.00	94.00	7
CJ5 - CJ8 2.0	01/83→12/87	Petrol	J5R-800	1995	4	88.00	82.00	5
CJ5 - CJ8 2.1 D	01/83→12/87	Diesel	J8S-800	2068	4	86.00	89.00	4
Comanche 2.1 D	10/86→09/90	Diesel	J8S-814	2068	4	86.00	89.00	4
Comanche 2.1 D 4x4	01/86→09/90	Diesel	J8S-814	2068	4	86.00	89.00	4
Compass 2.2 CRD 4x4	12/10→	Diesel	OM 651.925	2143	4	83.00	99.00	3
Grand Cherokee I 2.5 TD 4x4	10/95→04/99	Diesel	M51	2499	4	92.00	94.00	7
Grand Cherokee I 2.5 TD 4x4	10/95→04/99	Diesel	M52	2499	4	92.00	94.00	7
Grand Cherokee II 3.1 TD 4x4	04/99→12/01	Diesel	EXA	3125	5	92.00	94.00	8

		cm3	x 			
---	---	-----	--	---	---	---

4.108	Diesel	1760	4	79.40	88.90	1
4.203	Diesel	3335	4	91.40	127.00	6
BMM	Diesel	1968	4	81.00	95.50	2
ENC	Diesel	2499	4	92.00	94.00	7
EXA	Diesel	3125	5	92.00	94.00	8
J5R-800	Petrol	1995	4	88.00	82.00	5
J8S	Diesel	2068	4	86.00	89.00	4
J8S 742	Diesel	2068	4	86.00	89.00	4
J8S-800	Diesel	2068	4	86.00	89.00	4
J8S-814	Diesel	2068	4	86.00	89.00	4
M51	Diesel	2499	4	92.00	94.00	7
M52	Diesel	2499	4	92.00	94.00	7
OM 651.925	Diesel	2143	4	83.00	99.00	3
R 425 DOHC	Diesel	2499	4	92.00	94.00	7

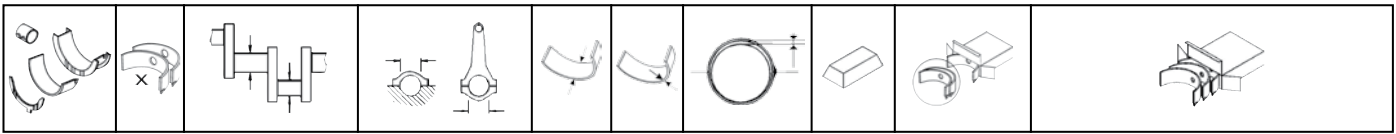

1 79.40 x 88.90

4.108		4 Cyl.		1760cc	42kW (57PS)		Diesel		TD1756
BE/PL	4	50,787/50,800	54,508/54,521	22,350	1,835	0,038/0,089	AL-LF	2580RA	01-4314/4 STD 0.25 0.50
MB/HL 1-3	3	57,099/57,112	60,833/60,846	31,880	1,836	0,049/0,100	AL-LF	2581RAA	H1138/3 STD 0.25

2 81.00 x 95.50

BMM		4 Cyl.		1968cc	103kW (140PS)		Diesel Turbo Intercooler		TD24007
BE/PL	1	50,858/50,878	53,700/53,712	20,400	1,403	0,020/0,073	SP	71-3930	71-3930 STD 0.25 0.50 [1]
MB/HL 1-5	5	53,958/53,978	59,000/59,012	18,500	2,501	0,020/0,076	EC	72-3931	H079/5 STD 0.25 0.50
TW/A	2	59,500	73,200		1,975		AL-LF	04-3527	A123/4 STD
TW/A	2	59,500	73,200		1,975		AL-LF	04-3528	

3 83.00 x 99.00

OM 651.925		4 Cyl.		2143cc	100-120kW (136-163PS)		Diesel Turbo		TD25244
BE/PL	1	51,940/51,965	55,600/55,614	20,500	1,809	0,027/0,091	SP-LF	71-4724	71-4724 STD [1]
MB/HL	1	59,940/59,965	64,000/64,019	20,500	2,008	0,028/0,096	SP-LF	72-4725	72-4725 STD [2]
MB/HL	1	59,940/59,965	64,000/64,019	26,240	2,008	0,028/0,096	SP-LF	72-4726H	72-4726H STD [2]
			72-4726H	STD	26,500/1.0433" - 26,540/1.0449"				
				0.25mm	26,500/1.0433" - 26,540/1.0449"				

4 86.00 x 89.00

J8S		4 Cyl.		2068cc	59-64kW (80-87PS)		Diesel		TD22946
J8S 742		4 Cyl.		2068cc	59kW (80PS)		Diesel Turbo		TD22464
J8S-800		4 Cyl.		2068cc	44kW (60PS)		Diesel		TD1750
J8S-814		4 Cyl.		2068cc	63-65kW (86-88PS)		Diesel Turbo Intercooler		TD1745
BE/PL	4	56,267/56,286	60,005/60,019	20,750	1,842	0,035/0,093	AL-LF	66635RA	01-4189/4 STD 0.25
BE/PL	4	56,267/56,286	60,005/60,019	20,750	1,842	0,035/0,093	AL-LF	66645RA	01-4191/4 STD 0.25
BE/PL	4	56,267/56,286	60,005/60,019	20,750	1,842	0,035/0,093	AL-LF	66645RAA	01-4192/4 STD

66635RA

66645RA

66645RAA

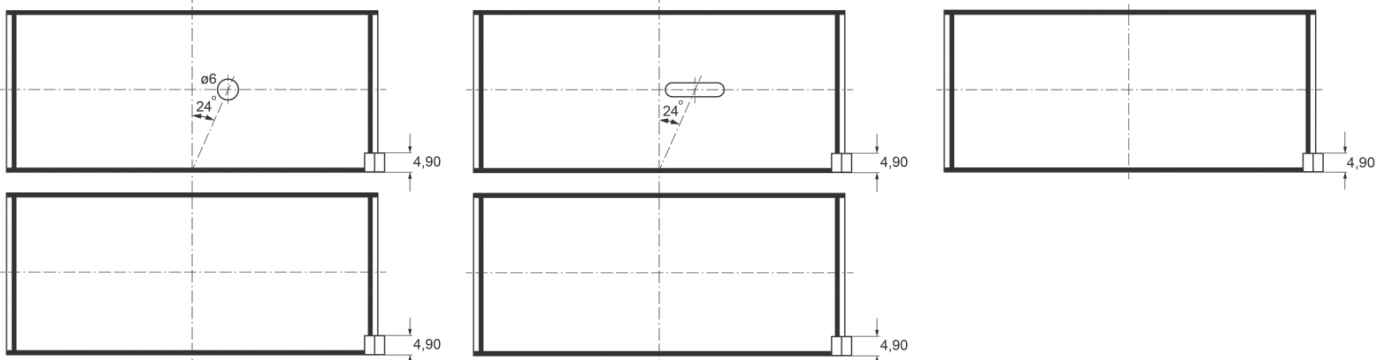

MB/HL 1-5	5	62,873/62,892	66,668/66,687	23,500	1,884	0,020/0,071	AL-LF	66507RA	H1052/5 STD 0.25
--------------	---	---------------	---------------	--------	-------	-------------	-------	---------	----------------------------

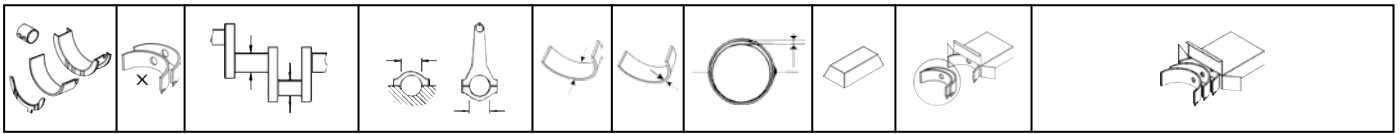

MB/HL 1-5	5	62,861/62,880	66,668/66,687	23,250	1,884	0,030/0,093	AL-LF	66646RA	H1058/5 STD 0.25
--------------	---	---------------	---------------	--------	-------	-------------	-------	---------	----------------------------

66507RA

66646RA

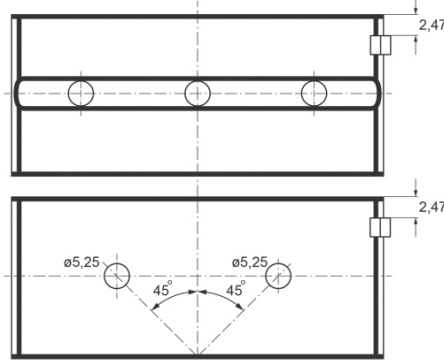
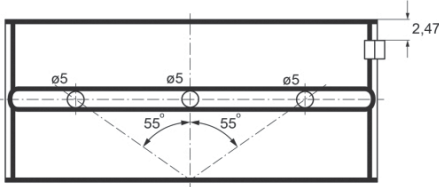

TW/A	2	71,450	88,090	2,850	BS	66506BF	A208/2 STD
TW/A	2	71,450	88,090	2,850	BS	66646BF	A210/2 STD

66506BF

66646BF

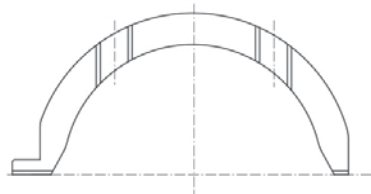
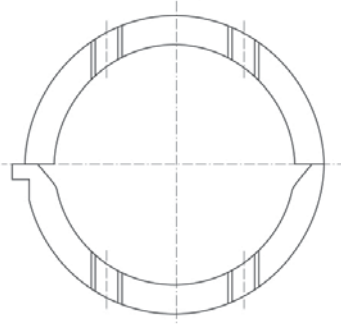

SE/PB	1	28,002/28,010	30,000/30,021	25,250	BS	66649RY	55-4294 SEMI
-------	---	---------------	---------------	--------	----	---------	------------------------

5 88.00 x 82.00

J5R-800		4 Cyl.		1995cc	61-63kW (85-86PS)		Petrol		TD1747
BE/PL	4	52,267/52,286	56,000/56,019	18,750	1,852	0,020/0,073	AL-LF	66600RA	01-4187/4 STD
MB/HL 1-5	5	62,861/62,880	66,668/66,687	23,250	1,884	0,030/0,093	AL-LF	66646RA	H1058/5 STD 0.25
TW/A	2	71,450	88,090	2,850			BS	66646BF	A210/2 STD

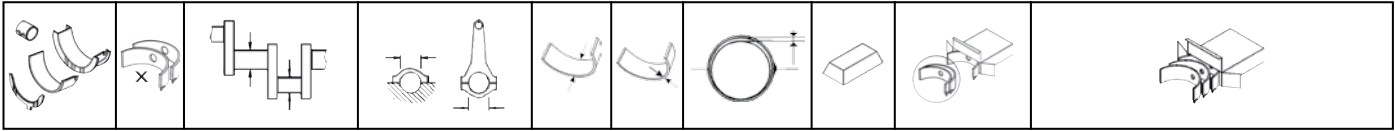

6 91.40 x 127.00

4.203		4 Cyl.		3335cc	52kW (71PS)		Diesel		TD1755
BE/PL	1	57,111/57,124	60,833/60,845	30,230	1,822	0,065/0,115	AL-LF	2015RAA	01-4110 STD 0.25 0.50 0.75 1.00
MB/HL 1	1	69,812/69,825	74,079/74,105	33,150	2,089	0,076/0,140	AL-LF	2781RA	H1027/5 STD 0.25 0.50 0.75 1.00
MB/HL 2,4	2	69,825/69,840	74,070/74,091	25,400	2,089	0,052/0,113	AL-LF	2782RA	
MB/HL 3,5	2	69,812/69,825	74,079/74,105	40,767	2,089	0,076/0,140	AL-LF	2783RA	
TW/A	4	77,343/77,597	90,221/90,475	3,120			AL-LF	2783AFA	A179/4 STD .005 0.25
SE/PB	1	31,743/31,750	34,919/34,955	26,850			BS	2019Y	55-4111 SEMI



7		92.00 x 94.00								
ENC			4 Cyl.	2499cc	85kW (116PS)		Diesel Turbo			TD26068
M51			4 Cyl.	2499cc	85-89kW (115-121PS)		Diesel Turbo			TD22949
M52			4 Cyl.	2499cc	85kW (115PS)		Diesel Turbo			TD22950
R 425 DOHC			4 Cyl.	2499cc	105-125kW (143-170PS)		Diesel Turbo Intercooler			TD22945
BE/PL	1	53,940/53,955	57,563/57,582	23,250	1,798	0,020/0,071	BS	66655CP	71-4234 STD 0.25 0.50 0.75	
TW/A	2	74,250/74,500	88,000/88,100		2,362		AL-LF	61588AF	A227/2 STD	
SE/PB	1	29,990/29,996	34,000/34,025	30,120			BS	66659XA	55-4235 SEMI	

8		92.00 x 94.00								
EXA			5 Cyl.	3125cc	103kW (140PS)		Diesel			TD26736
BE/PL	1	53,940/53,955	57,563/57,582	23,250	1,798	0,020/0,071	BS	66655CP	71-4234 STD 0.25 0.50 0.75	
TW/A	2	74,250/74,500	88,000/88,100		2,362		AL-LF	61588AF	A227/2 STD	
SE/PB	1	29,990/29,996	34,000/34,025	30,120			BS	66659XA	55-4235 SEMI	

		cm3	x 			
---	---	-----	--	---	---	---

1020 SERIES	Diesel	2500	3	98.43	109.54	4
2020/2510	Petrol	2996	4	98.43	98.43	3
2510	Petrol	3346	4	98.43	109.93	5
3152D	Diesel	2491	3	98.04	109.98	1
3164 DL 03	Diesel	2687	3	102.00	109.61	6
3179D	Diesel	2935	3	106.43	109.98	13
4180G/4202G	Petrol	2996	4	98.43	98.43	3
4219 DL 01	Diesel	3588	4	102.00	110.00	7
4219 DL 03	Diesel	3588	4	102.00	110.00	7
4219G	Petrol	3601	4	102.11	109.93	9
4219T	Diesel	3601	4	102.11	109.93	9
4239D	Diesel	3913	4	106.43	109.98	14
4276D	Diesel	4515	4	106.38	127.00	11
4276T	Diesel	4515	4	106.38	127.00	11
6303D	Diesel	4981	6	98.04	109.98	2
6303G	Petrol	4982	6	98.04	109.98	2
6303L	LPG	4982	6	98.04	109.98	2
6329 DL 03	Diesel	5395	6	102.00	110.00	8
6329G	Petrol	5403	6	102.11	109.98	10
6359D	Diesel	5870	6	106.43	109.98	15
6414D	Diesel	6773	6	106.38	127.00	12



1 98.04 x 109.98

3152D		3 Cyl.		2491cc		Diesel			FM3164
BE/PL	1	69,700/69,800	73,685/73,900	30,120	1,905		BS	3325APA	71-4277 0.25
MB/HL	1	79,324/79,349	84,454/84,480	29,464	2,530		AL-LF	02-4516	02-4516 STD

2 98.04 x 109.98

6303G		6 Cyl.		4982cc		Petrol			FM3166
6303L		6 Cyl.		4982cc		LPG			FM3167
6303D		6 Cyl.		4981cc		Diesel			FM4539
BE/PL	1	69,700/69,800	73,685/73,900	30,120	1,905		BS	3325APA	71-4277 0.25
BE/PL	6	69,700/69,800	73,685/73,900	30,120	1,905		BS	3325APA	71-4498/6 STD
MB/HL	1	79,324/79,349	84,454/84,480	29,464	2,530		AL-LF	02-4516	02-4516 STD
MB/HL	6	79,324/79,349	84,454/84,480	29,464	2,530		AL-LF	3326AP	H1234/7 STD
MB/HL	1	79,324/79,349	84,454/84,480	38,862	2,530		AL-LF	3327APH	

3 98.43 x 98.43

2020/2510		4 Cyl.		2996cc		Petrol			FM4512
4180G/4202G		4 Cyl.		2996cc		Petrol			FM4526
MB/HL	1	79,324/79,349	84,454/84,480	29,464	2,530		AL-LF	02-4516	02-4516 STD

4 98.43 x 109.54

1020 SERIES		3 Cyl.		2500cc		Diesel			FM3169
MB/HL	1	79,324/79,349	84,454/84,480	29,464	2,530		AL-LF	02-4516	02-4516 STD

5 98.43 x 109.93

2510		4 Cyl.		3346cc		Petrol			FM4515
BE/PL	1	69,700/69,800	73,685/73,900	30,120	1,905		BS	3325APA	71-4277 0.25
MB/HL	1	79,324/79,349	84,454/84,480	29,464	2,530		AL-LF	02-4516	02-4516 STD

6 102.00 x 109.61

3164 DL 03		3 Cyl.		2687cc		Diesel			FM3173
BE/PL	1	69,700/69,800	73,685/73,900	30,120	1,905		BS	3325APA	71-4277 0.25
MB/HL	1	79,324/79,349	84,454/84,480	29,464	2,530		AL-LF	02-4516	02-4516 STD

7 102.00 x 110.00

4219 DL 01		4 Cyl.		3588cc		50-53kW (68-72PS)		Diesel		TD19035
4219 DL 03		4 Cyl.		3588cc		50-53kW (68-72PS)		Diesel		TD19033
BE/PL	1	69,700/69,800	73,685/73,900	30,120	1,905		BS	3325APA	71-4277 0.25	
MB/HL	1	79,324/79,349	84,454/84,480	29,464	2,530		AL-LF	02-4516	02-4516 STD	

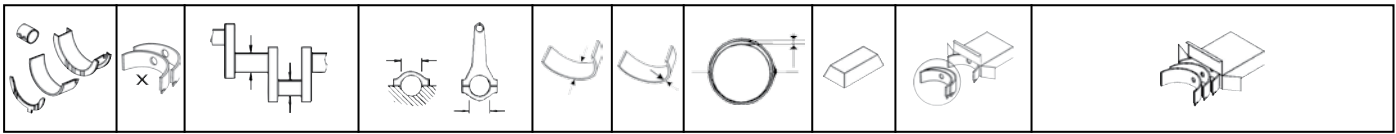

8 102.00 x 110.00

6329 DL 03		6 Cyl.		5395cc	63-68kW (86-92PS)		Diesel		TD19034
BE/PL	1	69,700/69,800	73,685/73,900	30,120	1,905		BS	3325APA	71-4277 0.25
BE/PL	6	69,700/69,800	73,685/73,900	30,120	1,905		BS	3325APA	71-4498/6 STD
MB/HL	1	79,324/79,349	84,454/84,480	29,464	2,530		AL-LF	02-4516	02-4516 STD
MB/HL	6	79,324/79,349	84,454/84,480	29,464	2,530		AL-LF	3326AP	H1234/7 STD
MB/HL	1	79,324/79,349	84,454/84,480	38,862	2,530		AL-LF	3327APH	

9 102.11 x 109.93

4219G		4 Cyl.		3601cc		Petrol		FM4527	
4219T		4 Cyl.		3601cc		Diesel Turbo		FM4528	
MB/HL	1	79,324/79,349	84,454/84,480	29,464	2,530		AL-LF	02-4516	02-4516 STD

10 102.11 x 109.98

6329G		6 Cyl.		5403cc		Petrol		FM3176	
BE/PL	1	69,700/69,800	73,685/73,900	30,120	1,905		BS	3325APA	71-4277 0.25
BE/PL	6	69,700/69,800	73,685/73,900	30,120	1,905		BS	3325APA	71-4498/6 STD
MB/HL	1	79,324/79,349	84,454/84,480	29,464	2,530		AL-LF	02-4516	02-4516 STD
MB/HL	6	79,324/79,349	84,454/84,480	29,464	2,530		AL-LF	3326AP	H1234/7 STD
MB/HL	1	79,324/79,349	84,454/84,480	38,862	2,530		AL-LF	3327APH	

11 106.38 x 127.00

4276D		4 Cyl.		4515cc		Diesel		FM4529	
4276T		4 Cyl.		4515cc		Diesel Turbo		FM4530	
MB/HL	1	79,324/79,349	84,454/84,480	29,464	2,530		AL-LF	02-4516	02-4516 STD

12 106.38 x 127.00

6414D		6 Cyl.		6773cc		Diesel		FM4547	
MB/HL	1	79,324/79,349	84,454/84,480	29,464	2,530		AL-LF	02-4516	02-4516 STD
MB/HL	6	79,324/79,349	84,454/84,480	29,464	2,530		AL-LF	3326AP	H1234/7 STD
MB/HL	1	79,324/79,349	84,454/84,480	38,862	2,530		AL-LF	3327APH	





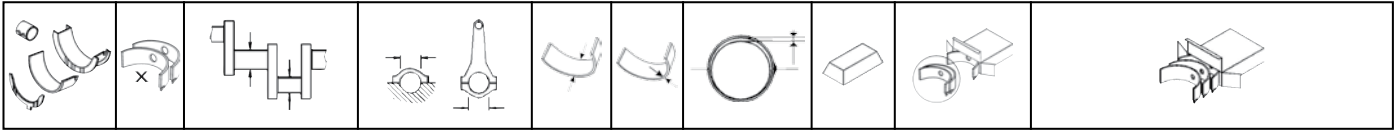

13 106.43 x 109.98

3179D		3 Cyl.		2935cc		Diesel		FM3180	
BE/PL	1	69,700/69,800	73,685/73,900	30,120	1,905		BS	3325APA	71-4277 0.25
MB/HL	1	79,324/79,349	84,454/84,480	29,464	2,530		AL-LF	02-4516	02-4516 STD



14		106.43 x 109.98							
4239D		4 Cyl.		3913cc		Diesel		FM3182	
BE/PL	1	69,700/69,800	73,685/73,900	30,120	1,905		BS	3325APA	71-4277 0.25
MB/HL	1	79,324/79,349	84,454/84,480	29,464	2,530		AL-LF	02-4516	02-4516 STD









15		106.43 x 109.98							
6359D		6 Cyl.		5870cc		Diesel		FM3185	
BE/PL	1	69,700/69,800	73,685/73,900	30,120	1,905		BS	3325APA	71-4277 0.25
BE/PL	6	69,700/69,800	73,685/73,900	30,120	1,905		BS	3325APA	71-4498/6 STD
MB/HL	1	79,324/79,349	84,454/84,480	29,464	2,530		AL-LF	02-4516	02-4516 STD
MB/HL	6	79,324/79,349	84,454/84,480	29,464	2,530		AL-LF	3326AP	H1234/7 STD
MB/HL	1	79,324/79,349	84,454/84,480	38,862	2,530		AL-LF	3327APH	

		cm3	x 			
740.1	Diesel	10850	V8	120.00	120.00	1
740.11 Euro 1	Diesel	10850	V8	120.00	120.00	1
740.13 Euro 1	Diesel	10850	V8	120.00	120.00	1
740.14	Diesel	10850	V8	120.00	120.00	1
740.30 Euro 2	Diesel	10850	V8	120.00	120.00	1
740.31 Euro 2	Diesel	10850	V8	120.00	120.00	1
740.51 Euro 2	Diesel	11760	V8	120.00	130.00	2
740.52 Euro 2	Diesel	11760	V8	120.00	130.00	2
740.53 Euro 2	Diesel	11760	V8	120.00	130.00	2
7403.1	Diesel	10850	V8	120.00	120.00	1



1		120.00 x 120.00								
740.10			V8 Cyl.	10850cc	154-155kW (209-211PS)	Diesel Turbo				TD26761
740.11 Euro 1			V8 Cyl.	10850cc	176-177kW (239-241PS)	Diesel Turbo				TD24499
740.13 Euro 1			V8 Cyl.	10850cc	191kW (260PS)	Diesel Turbo				TD24500
740.14			V8 Cyl.	10850cc	220kW (300PS)	Diesel Turbo				TD24505
740.30 Euro 2			V8 Cyl.	10850cc	191kW (260PS)	Diesel Turbo Intercooler				TD24482
740.31 Euro 2			V8 Cyl.	10850cc	176-177kW (239-241PS)	Diesel Turbo				TD24483
7403.10			V8 Cyl.	10850cc	191kW (260PS)	Diesel Turbo				TD24504
BE/PL	1	79,985/80,015	85,000/85,022	28,000	2,465	0,055/0,131	BS	71-4909	71-4909	STD 0.25 0.50 1.00
MB/HL	1	94,985/95,015	100,00/100,02	28,000	2,452	0,081/0,157	BS	72-4910	72-4910	0.25 0.50 1.00

2		120.00 x 130.00								
740.51 Euro 2			V8 Cyl.	11760cc	235kW (320PS)	Diesel Turbo				TD24486
740.52 Euro 2			V8 Cyl.	11760cc	191kW (260PS)	Diesel Turbo				TD24487
740.53 Euro 2			V8 Cyl.	11760cc	213kW (290PS)	Diesel Turbo				TD24488
BE/PL	1	79,985/80,015	85,000/85,022	28,000	2,465	0,055/0,131	BS	71-4909	71-4909	STD 0.25 0.50 1.00
MB/HL	1	94,985/95,015	100,00/100,02	28,000	2,452	0,081/0,157	BS	72-4910	72-4910	0.25 0.50 1.00

				cm3				
Avella 1.3	11/95→12/01	Petrol	B3	1324	4	71.00	83.60	3
Besta 2.2 D	07/92→12/03	Diesel	R2	2184	4	86.00	94.00	16
Bongo 2.4 TDCi	10/03→	Diesel	D4BH	2477	4	91.10	95.00	17
Bongo 2.5 TDCi	10/03→	Diesel	D4BH	2477	4	91.10	95.00	17
Bongo MPV 2.4 TDCi	10/03→	Diesel	D4BH	2477	4	91.10	95.00	17
Carens III 1.6 CVVT	08/09→	Petrol	G4FC	1591	4	77.00	85.44	6
Carens IV 2.0 GDi	03/13→	Petrol	G4NC	1999	4	81.00	97.00	9
Carnival / Grand Carnival III 2.2 CRDi	01/10→	Diesel	D4HB	2199	4	85.40	96.00	12
Cee'd 1.4 CVVT	09/12→	Petrol	G4FA	1396	4	77.00	75.00	5
Cee'd 1.4	12/06→12/12	Petrol	G4FA	1396	4	77.00	75.00	5
Cee'd 1.4 CVVT	05/12→	Petrol	G4FA	1396	4	77.00	75.00	5
Cee'd 1.4 CVVT	06/10→	Petrol	G4FA-L	1396	4	77.00	75.00	5
Cee'd 1.6	12/06→12/12	Petrol	G4FC	1591	4	77.00	85.44	6
Cee'd 1.6 CVVT	10/10→	Petrol	G4FC	1591	4	77.00	85.44	6
Cee'd SW 1.4	09/07→12/12	Petrol	G4FA	1396	4	77.00	75.00	5
Cee'd SW 1.4 CVVT	10/10→12/12	Petrol	G4FA-L	1396	4	77.00	75.00	5
Cee'd SW 1.6	09/07→12/12	Petrol	G4FC	1591	4	77.00	85.44	6
Cee'd SW 1.6 CVVT	06/09→12/12	Petrol	G4FC	1591	4	77.00	85.44	6
Cerato 1.6	05/06→	Petrol	G4FC	1591	4	77.00	85.44	6
Cerato 1.6	04/04→	Petrol	G4ED	1599	4	76.50	87.00	4
Cerato 1.6 MPi	06/13→	Petrol	G4FC	1591	4	77.00	85.44	6
Cerato 2.0 GDI	06/13→	Petrol	G4NC	1999	4	81.00	97.00	9
Cerato II 1.6	02/09→	Petrol	G4FC	1591	4	77.00	85.44	6
Cerato II 1.6 CVVT	02/09→	Petrol	G4FC	1591	4	77.00	85.44	6
Cerato Koup 1.6 CVVT	10/09→	Petrol	G4FC	1591	4	77.00	85.44	6
Clarus 2.0 i 16V	07/96→	Petrol	FE (16V)	1998	4	86.00	86.00	14
Joice 2.0	02/00→	Petrol	G4CP	1997	4	85.00	88.00	11
K2500 2.5 D	01/03→	Diesel	D4BH	2477	4	91.10	95.00	17
Pregio 2.5 D	08/95→09/04	Diesel	D4BH	2477	4	91.10	95.00	17
Pregio 2.5 Tci D	09/02→	Diesel	D4BH	2477	4	91.10	95.00	17
Pride 1.1 i	01/91→	Petrol	B1	1139	4	68.00	78.40	2
Pride 1.3 16V	01/90→	Petrol	B3	1324	4	71.00	83.60	3
Pride 1.6 CVVT LX	03/05→	Petrol	G4ED	1599	4	76.50	87.00	4
Pro Cee'd 1.4	02/08→09/12	Petrol	G4FA	1396	4	77.00	75.00	5
Pro Cee'd 1.4 CVVT	03/13→	Petrol	G4FA	1396	4	77.00	75.00	5
Pro Cee'd 1.4 CVVT	06/10→09/12	Petrol	G4FA-L	1396	4	77.00	75.00	5
Pro Cee'd 1.6	02/08→09/12	Petrol	G4FC	1591	4	77.00	85.44	6
Pro Cee'd 1.6 CVVT	10/10→02/13	Petrol	G4FC	1591	4	77.00	85.44	6
Retona 2.0 16V	05/00→	Petrol	FE (16V)	1998	4	86.00	86.00	14
Retona 2.0 TD	06/99→	Diesel	RF	1998	4	86.00	86.00	15
Rio II 1.6 16V	03/05→	Petrol	G4ED	1599	4	76.50	87.00	4
Rio II 1.6 CVVT	03/05→	Petrol	G4ED	1599	4	76.50	87.00	4
Rio III 1.4 CVVT	06/11→	Petrol	G4FA	1396	4	77.00	75.00	5
Rio III 1.6 CVVT	06/12→	Petrol	G4FC	1591	4	77.00	85.44	6
Sedona 2.2 TD	07/15→	Diesel	D4HB	2199	4	85.40	96.00	12
Sephia 1.5 i	02/96→10/97	Petrol	B5	1498	4	78.00	78.40	7
Sephia 1.6 i	09/93→10/97	Petrol	B6	1598	4	78.00	83.60	8
Shuma 1.6	01/10→12/14	Petrol	G4FC	1591	4	77.00	85.44	6
Sorento II 2.0 CRDi	11/10→	Diesel	D4HA	1995	4	84.00	90.00	10
Sorento II 2.0 CRDi 4WD	11/10→	Diesel	D4HA	1995	4	84.00	90.00	10
Sorento II 2.2 CRDi	11/09→	Diesel	D4HB	2199	4	85.40	96.00	12
Sorento II 2.2 CRDi 4WD	11/09→	Diesel	D4HB	2199	4	85.40	96.00	12
Sorento III 2.2 CRDi	01/15→	Diesel	D4HB	2199	4	85.40	96.00	12
Sorento III 2.2 CRDi 4WD	01/15→	Diesel	D4HB	2199	4	85.40	96.00	12
Soul 1.6 CVVT	02/09→	Petrol	G4FC	1591	4	77.00	85.44	6
Soul 1.6 Flex	01/11→	Petrol	G4FC	1591	4	77.00	85.44	6
Sportage 2.0	09/94→12/95	Petrol	FE (8V)	1998	4	86.00	86.00	14
Sportage 2.0	04/94→08/03	Petrol	FE (16V)	1998	4	86.00	86.00	14
Sportage 2.0 4WD	04/94→08/03	Petrol	FE (16V)	1998	4	86.00	86.00	14
Sportage 2.0 CRDi	07/10→	Diesel	D4HA	1995	4	84.00	90.00	10
Sportage 2.0 CRDi AWD	07/10→	Diesel	D4HA	1995	4	84.00	90.00	10
Sportage 2.0 GDI	02/14→	Petrol	G4NC	1999	4	81.00	97.00	9
Sportage 2.0 GDI AWD	02/14→	Petrol	G4NC	1999	4	81.00	97.00	9
Sportage 2.0 i 4WD	04/94→08/99	Petrol	FE (8V)	1998	4	86.00	86.00	14
Sportage 2.0 i 16V	10/99→08/03	Petrol	FE (16V)	1998	4	86.00	86.00	14
Sportage 2.0 i 16V 4WD	04/94→08/03	Petrol	FE (16V)	1998	4	86.00	86.00	14
Sportage 2.0 TD 4WD	10/97→08/03	Diesel	RF	1998	4	86.00	86.00	15
Towner	01/92→	Petrol	JADE	752	3	68.00	69.00	1
Venga 1.4 CVVT	02/10→	Petrol	G4FA-L	1396	4	77.00	75.00	5
Venga 1.6 CVVT	02/10→	Petrol	G4FC	1591	4	77.00	85.44	6

		cm3	x 			
--	---	-----	---	---	---	---

B1	Petrol	1139	4	68.00	78.40	2
B3	Petrol	1324	4	71.00	83.60	3
B5	Petrol	1498	4	78.00	78.40	7
B6	Petrol	1598	4	78.00	83.60	8
D4BH	Diesel	2477	4	91.10	95.00	17
D4HA	Diesel	1995	4	84.00	90.00	10
D4HB	Diesel	2199	4	85.40	96.00	12
F8	Petrol	1789	4	86.00	77.00	13
FE (8V)	Petrol	1998	4	86.00	86.00	14
FE (16V)	Petrol	1998	4	86.00	86.00	14
G4CP	Petrol	1997	4	85.00	88.00	11
G4ED	Petrol	1599	4	76.50	87.00	4
G4FA	Petrol	1396	4	77.00	75.00	5
G4FA-L	Petrol	1396	4	77.00	75.00	5
G4FC	Petrol	1591	4	77.00	85.44	6
G4NC	Petrol	1999	4	81.00	97.00	9
JADE	Petrol	752	3	68.00	69.00	1
R2	Diesel	2184	4	86.00	94.00	16
RF	Diesel	1998	4	86.00	86.00	15
SH	Diesel	3456	4	100.00	110.00	18



1 68.00 x 69.00

JADE		3 Cyl. 752cc			Petrol		FM9361	
BE/PL	6	39,980	43,020	18,000	1,490	AL	64-255-1	71-4309/3 STD
MB/HL 1-4	8	41,980	46,020	19,500	1,990	AL	63-255-1	H1141/4 STD 0.25

2 68.00 x 78.40

B1		4 Cyl. 1139cc 38kW (52PS)			Petrol		TD1762	
BE/PL	8	39,940	43,020	17,130	1,510	AL-LF	64-313-1	01-4343/4 STD
MB/HL 1-5	5	49,940	54,020	17,500	2,010	AL	63-317-1	H1192/5 STD
MB/HL 1-5	5	49,940	54,020	17,500	2,010	AL	63-317-2	

3 71.00 x 83.60

B3		4 Cyl. 1324cc 44-55kW (60-75PS)			Petrol		TD5503	
BE/PL	8	39,940	43,020	17,130	1,510	AL-LF	64-313-1	01-4343/4 STD
MB/HL 1-5	5	49,940	54,020	17,500	2,010	AL	63-317-1	H1192/5 STD
MB/HL 1-5	5	49,940	54,020	17,500	2,010	AL	63-317-2	

03/89 →

4 76.50 x 87.00

G4ED Euro 4		4 Cyl. 1599cc 77-82kW (105-112PS)			Petrol		TD18452	
BE/PL	8	44,975/44,990	48,000/48,020	19,030	1,500	AL-LF	GS70839SA	01-4943/4 STD
MB/HL	4	49,977/49,992	54,000/54,020	17,650	2,000	AL-LF	GS70837SA	H1329/5 STD
MB/HL	1	49,977/49,992	54,020/54,000	22,920	2,000	AL-LF	GS70838SA	

5 77.00 x 75.00

G4FA Euro 4		4 Cyl. 1396cc 73-80kW (100-109PS)			Petrol		TD19226		
G4FA-L Euro 5		4 Cyl. 1396cc 66kW (90PS)			Petrol		TD25018		
BE/PL	4	41,954/41,972	45,000/45,018	14,400	1,505	0,018/0,036	AL-LF	01-4999	01-4999/4 STD
MB/HL 1-5	5	47,948/47,960	52,000/52,018	16,000	2,017	0,006/0,052	AL-LF	02-5000	H1346/5 STD
TW/A	2	54,000/54,250	70,750/71,000		1,975		AL-LF	04-5001	A326/2 STD

6 77.00 x 85.44

G4FC Euro 4		4 Cyl. 1591cc 77-97kW (105-132PS)			Petrol		TD19227		
BE/PL	4	41,954/41,972	45,000/45,018	14,400	1,505	0,018/0,036	AL-LF	01-4999	01-4999/4 STD
MB/HL 1-5	5	47,948/47,960	52,000/52,018	16,000	2,017	0,006/0,052	AL-LF	02-5000	H1346/5 STD
TW/A	2	54,000/54,250	70,750/71,000		1,975		AL-LF	04-5001	A326/2 STD



7 78.00 x 78.40

B5		4 Cyl.		1498cc	59kW (80PS)		Petrol		TD1763
BE/PL	8	39,940	43,020	17,130	1,510		AL-LF	64-313-1	01-4343/4 STD
MB/HL 1-5	5	49,940	54,020	17,500	2,010		AL	63-317-1	H1192/5 STD
MB/HL 1-5	5	49,940	54,020	17,500	2,010		AL	63-317-2	

8 78.00 x 83.60

B6		4 Cyl.		1598cc	59kW (80PS)		Petrol		TD4588
BE/PL	8	44,940	48,020	17,000	1,510		AL-LF	64-317-1	01-4359/4 STD
MB/HL 1-5	5	49,940	54,020	17,500	2,010		AL	63-317-1	H1192/5 STD
MB/HL 1-5	5	49,940	54,020	17,500	2,010		AL	63-317-2	

9 81.00 x 97.00

G4NC		4 Cyl.		1999cc	118-130kW (160-177PS)		Petrol		TD27987
BE/PL	4	44,954/44,972	48,000/48,018	16,130	1,509	0,020/0,080	AL-LF	71-5002	71-5002/4 STD
MB/HL 1-5	5	54,942/54,960	59,000/59,018	18,130	2,018	0,017/0,077	AL-LF	02-5003	H1347/5 STD
TW/A	2	61.000/61.250	80.750/81.000		1.965	0.07/0.27	AL-LF	04-5004	A327/2 STD

10 84.00 x 90.00

D4HA		4 Cyl.		1995cc	100-135kW (136-184PS)		Diesel Turbo		TD26131
BE/PL	4	48,000/48,018	51,000/51,018	20,930	1,482	0,026/0,084	AL-LF	71-5006	71-5006/4 STD [7]
MB/HL 1-5	5	60,000/60,018	64,000/64,018	18,930	1,985	0,026/0,086	EC-LF	72-5005	H1348/5 STD
TW/A	2	66,000/66,250	87,750/88,000		1,965		AL-LF	04-5008	A328/2 STD

11 85.00 x 88.00

G4CP		4 Cyl.		1997cc	88-102kW (120-139PS)		Petrol		TD26094
BE/PL	8	44,980	48,020	23,600	1,493		BS	64-111-1	71-4143/4 STD 0.25 0.50
MB/HL 3	2	56,980	61,020	28,950	1,990		AL	63-111-(2)	H1032/5 STD 0.25 0.50
MB/HL 1,2,4,5	4	56,980	61,020	23,100	1,990		AL	63-111-1	
MB/HL 1,2,4,5	4	56,980	61,020	23,130	1,990		AL	63-111-3	

12 85.40 x 96.00

D4HB		4 Cyl.		2199cc	110-147kW (150-200PS)		Diesel Turbo		TD26070
BE/PL	4	52,000/52,018	55,000/55,018	20,930	1,484	0,024/0,084	AL-LF	71-5007	71-5007/4 STD [7]
MB/HL 1-5	5	60,000/60,018	64,000/64,018	18,930	1,985	0,026/0,086	EC-LF	72-5005	H1348/5 STD
TW/A	2	66,000/66,250	87,750/88,000		1,965		AL-LF	04-5008	A328/2 STD



13 86.00 x 77.00

F8			4 Cyl.	1789cc	70kW (95PS)			Petrol	TD1764
BE/PL	4	50,934/50,949	53,997/54,018	21,132	1,509	0,030/0,091	BS	3975P	71-4278/4 STD 0.25 0.50

14 86.00 x 86.00

FE (8V)			4 Cyl.	1998cc	70kW (95PS)			Petrol	TD9379
FE (16V)			4 Cyl.	1998cc	87-109kW (118-148PS)			Petrol	TD1766
BE/PL	4	50,934/50,949	53,997/54,018	21,132	1,509	0,030/0,091	BS	3975P	71-4278/4 STD 0.25 0.50

15 86.00 x 86.00

RF			4 Cyl.	1998cc	61kW (83PS)			Diesel Turbo	TD11135
BE/PL	4	50,934/50,949	53,997/54,018	21,132	1,509	0,030/0,091	BS	3975P	71-4278/4 STD 0.25 0.50
→06/86									
MB/HL 1,2,4,5	4	59,938/59,964	63,997/64,018	19,126	2,007	0,020/0,092	AL	3976RA	H1161/5 STD 0.25
MB/HL 3	1	59,938/59,964	63,997/64,018	21,132	2,007	0,020/0,092	AL	3977RA	
SE/PB	1	24,990	28,030	26,500			BS	67-316-1S	55-4270 SEMI

16 86.00 x 94.00

R2			4 Cyl.	2184cc	48kW (65PS)			Diesel	TD11132
BE/PL	4	50,934/50,949	53,997/54,018	21,132	1,509	0,030/0,091	BS	3975P	71-4278/4 STD 0.25 0.50
MB/HL 1,2,4,5	4	59,938/59,964	63,997/64,018	19,126	2,007	0,020/0,092	AL	3976RA	H1161/5 STD 0.25
MB/HL 3	1	59,938/59,964	63,997/64,018	21,132	2,007	0,020/0,092	AL	3977RA	
SE/PB	1	24,990	28,030	26,500			BS	67-316-1S	55-4270 SEMI

17 91.10 x 95.00

D4BH			4 Cyl.	2477cc	69kW (94PS)			Diesel Turbo Intercooler	TD17409
BE/PL	8	52,980	56,020	25,130	1,493		AL	64-113-1	71-4194/4 STD 0.25 0.50 0.75
MB/HL 3	2	65,980	70,020	30,950	1,990		AL	63-113-(2)	H1055/5 STD 0.25 0.50
MB/HL 1,2,4,5	4	65,980	70,020	25,130	1,990		AL	63-113-1	
MB/HL 1,2,4,5	4	65,980	70,020	25,130	1,990		AL	63-113-3	
CB/NWB 1,2	2	42,980	46,050	20,250	1,480		AL-LF	68-113-1	N156/2 STD

18 100.00 x 110.00

SH			4 Cyl.	3456cc			Diesel		FM13814
MB/HL 1-5	5	75,808/75,824	80,071/80,091	28,600	2,103	0,041/0,102	BS	2061CP	H1191/5 STD

















cm3



9

1.2 LE,SE,SE	01/72→	Petrol	BA31/38A/LB02-2102/3/ 21012/21022/21051	1198	4	76.00	66.00	2
110 1.5	01/95→	Petrol	BA3 2111	1499	4	82.00	71.00	8
110 1.5	01/95→	Petrol	VAZ-2111	1499	4	82.00	71.00	8
110 1.5 16V	01/95→	Petrol	VAZ-2112	1499	4	82.00	71.00	8
110 1.6	01/95→	Petrol	VAZ-21114	1596	4	82.00	75.60	9
110 1.6	01/00→	Petrol	VAZ-21124	1596	4	82.00	75.60	9
110 1.6 16V	10/04→12/10	Petrol	VAZ-21124	1596	4	82.00	75.60	9
110 1.6 LPG	10/04→03/07	Petrol	VAZ-21114	1596	4	82.00	75.60	9
110 2.0 i	08/96→	Petrol	C 20 XE	1998	4	86.00	86.00	11
111 1.5	01/97→	Petrol	BA3 2111	1499	4	82.00	71.00	8
111 1.5	01/96→	Petrol	VAZ-2111	1499	4	82.00	71.00	8
111 1.5 16V	01/95→	Petrol	VAZ-2112	1499	4	82.00	71.00	8
111 1.6	01/05→	Petrol	VAZ-21114	1596	4	82.00	75.60	9
111 1.6	03/06→	Petrol	VAZ-21124	1596	4	82.00	75.60	9
112 1.5	01/95→	Petrol	VAZ-2111	1499	4	82.00	71.00	8
112 1.5 16V	01/95→	Petrol	VAZ-2112	1499	4	82.00	71.00	8
112 1.6	01/05→	Petrol	VAZ-21114	1596	4	82.00	75.60	9
112 1.6	03/06→	Petrol	VAZ-21124	1596	4	82.00	75.60	9
1200-1500 1200	09/73→08/84	Petrol	BA3 2101	1198	4	76.00	66.00	2
1200-1500 1300	01/81→12/82	Petrol	BA3 2105	1294	4	79.00	66.00	6
1200-1500 1500	09/73→06/85	Petrol	BA3 2103	1452	4	76.00	80.00	4
1200-1600 1200 L/S	01/70→06/86	Petrol	BA3 2101	1198	4	76.00	66.00	2
1200-1600 1300	05/78→01/87	Petrol	BA3 21011	1285	4	76.00	71.00	3
1200-1600 1300	08/74→08/84	Petrol	BA3 2105	1294	4	79.00	66.00	6
1200-1600 1500	09/72→08/84	Petrol	BA3 2103	1452	4	76.00	80.00	4
1200-1600 1500 N/S	11/75→10/86	Petrol	BA3 2103	1452	4	76.00	80.00	4
1200-1600 1600	01/84→01/90	Petrol	BA3 2103	1452	4	76.00	80.00	4
1200-1600 1600	09/72→08/84	Petrol	BA3 2106	1570	4	79.00	80.00	7
1200-1600 1600 N/L	03/79→10/86	Petrol	BA3 2106	1570	4	79.00	80.00	7
1200 E/L/N/S/Special	01/70→07/90	Petrol	BA31/38A/LB02-2102/3/ 21012/21022/21051	1198	4	76.00	66.00	2
1200 LE/SE, 2101	01/72→	Petrol	BA31/38A/LB02-2102/3/ 21012/21022/21051	1198	4	76.00	66.00	2
2105 E/JR/L/N	11/80→07/93	Petrol	BA31/38A/LB02-2102/3/ 21012/21022/21051	1198	4	76.00	66.00	2
2107 1.3	05/82→	Petrol	BA3 2105	1294	4	79.00	66.00	6
2107 1.6	05/82→	Petrol	BA3 2106	1570	4	79.00	80.00	7
Estate 1.2 LE,SE,SE	01/72→	Petrol	BA31/38A/LB02-2102/3/ 21012/21022/21051	1198	4	76.00	66.00	2
21051	01/82→	Petrol	BA31/38A/LB02-2102/3/ 21012/21022/21051	1198	4	76.00	66.00	2
Granta 1.6	10/11→	Petrol	VAZ-21126	1597	4	82.00	75.60	9
Kalina 1.4 16V	11/08→	Petrol	VAZ-11194	1390	4	76.50	75.60	5
Kalina 1.4 16V LPG	11/08→	Petrol	VAZ-11194	1390	4	76.50	75.60	5
Kalina 1.6	10/04→	Petrol	VAZ-21114	1596	4	82.00	75.60	9
Kalina 1.6	10/04→	Petrol	VAZ-21124	1596	4	82.00	75.60	9
Kalina 1.6	06/13→	Petrol	VAZ-21126	1597	4	82.00	75.60	9
Niva 1600	12/76→03/95	Petrol	BA3 2121	1569	4	79.00	80.00	7
Niva 1600 4x4	10/86→12/93	Petrol	BA3 2121	1569	4	79.00	80.00	7
Niva 1900 Diesel	01/93→	Diesel	XUD9A	1905	4	83.00	88.00	10
Niva 1900 Diesel	01/99→	Diesel	XUD9SD	1905	4	83.00	88.00	10
Nova 1.5 1500	10/86→04/98	Petrol	BA3 2103	1452	4	76.00	80.00	4
Nova 1.6	02/93→10/98	Petrol	BA3 2106	1570	4	79.00	80.00	7
Nova 1200 Junior/L	09/81→	Petrol	BA3 2101	1198	4	76.00	66.00	2
Nova 1300	09/83→12/91	Petrol	BA3 2105	1294	4	79.00	66.00	6
Nova 1300 Spezial/L	05/81→	Petrol	BA3 2105	1294	4	79.00	66.00	6
Nova 1500	09/87→12/88	Petrol	BA3 2103 (KAT)	1451	4	76.00	80.00	4
Nova 1500	09/85→	Petrol	BA3 2103	1452	4	76.00	80.00	4
Nova 1500 S	06/89→	Petrol	BA3 21083	1499	4	82.00	71.00	8
Nova 1500 Special	03/85→	Petrol	BA3 2103	1452	4	76.00	80.00	4
Nova 1600	01/88→10/01	Petrol	BA3 2106	1570	4	79.00	80.00	7
Priora 1.6	12/08→	Petrol	VAZ-21126	1597	4	82.00	75.60	9
Priora 1.6 LPG	12/08→	Petrol	VAZ-21126	1597	4	82.00	75.60	9
Riva	01/70→07/90	Petrol	BA31/38A/LB02-2102/3/ 21012/21022/21051	1198	4	76.00	66.00	2
Riva 1200, 1200 L	01/82→	Petrol	BA31/38A/LB02-2102/3/ 21012/21022/21051	1198	4	76.00	66.00	2
Samara 1.5	04/96→	Petrol	VAZ-2111	1499	4	82.00	71.00	8

				cm ³	x 			
Samara 1100	02/88→	Petrol	BA3 21081	1100	4	76.00	60.60	1
Samara 1300	01/86→	Petrol	BA3 2108	1288	4	76.00	71.00	3
Samara 1300	02/96→	Petrol	BA3 21115	1288	4	76.00	71.00	3
Samara 1500	02/95→	Petrol	BA3 2111	1499	4	82.00	71.00	8
Samara 1500	01/86→	Petrol	BA3 21083	1499	4	82.00	71.00	8
Samara Forma 1.5	01/00→	Petrol	VAZ-2111	1499	4	82.00	71.00	8
Samara Forma 1100	07/91→	Petrol	BA3 21081	1100	4	76.00	60.60	1
Samara Forma 1300	05/89→	Petrol	BA3 2108	1288	4	76.00	71.00	3
Samara Forma 1300	02/96→	Petrol	BA3 21115	1288	4	76.00	71.00	3
Samara Forma 1500	11/94→	Petrol	BA3 2111	1499	4	82.00	71.00	8
Samara Forma 1500	07/91→	Petrol	BA3 21083	1499	4	82.00	71.00	8
SE21022 1200	01/72→	Petrol	BA31/38A/LB02-2102/3/ 21012/21022/21051	1198	4	76.00	66.00	2
SE21022 1200 Estate	01/72→	Petrol	BA31/38A/LB02-2102/3/ 21012/21022/21051	1198	4	76.00	66.00	2
Toscana 1300	12/85→05/12	Petrol	BA3 2105	1294	4	79.00	66.00	6
Toscana 1500	09/83→02/93	Petrol	BA3 2103	1452	4	76.00	80.00	4

		cm ³	x 			
BA31/38A/LB02-2102/3/21012/21022/21051	Petrol	1198	4	76.00	66.00	2
BA3 2101	Petrol	1198	4	76.00	66.00	2
BA3 2103	Petrol	1452	4	76.00	80.00	4
BA3 2103 (KAT)	Petrol	1451	4	76.00	80.00	4
BA3 2105	Petrol	1294	4	79.00	66.00	6
BA3 2106	Petrol	1570	4	79.00	80.00	7
BA3 2108	Petrol	1288	4	76.00	71.00	3
BA3 2108 (KAT)	Petrol	1288	4	76.00	71.00	3
BA3 2111	Petrol	1499	4	82.00	71.00	8
BA3 2121	Petrol	1569	4	79.00	80.00	7
BA3 2121 (KAT)	Petrol	1569	4	79.00	80.00	7
BA3 21011	Petrol	1285	4	76.00	71.00	3
BA3 21081	Petrol	1100	4	76.00	60.60	1
BA3 21081 (KAT)	Petrol	1099	4	76.00	60.60	1
BA3 21083	Petrol	1499	4	82.00	71.00	8
BA3 21083 (KAT)	Petrol	1500	4	82.00	71.00	8
BA3 21115	Petrol	1288	4	76.00	71.00	3
C 20 XE	Petrol	1998	4	86.00	86.00	11
VAZ-2111	Petrol	1499	4	82.00	71.00	8
VAZ-2112	Petrol	1499	4	82.00	71.00	8
VAZ-2121.4	Petrol	1568	4	79.00	80.00	7
VAZ-11194	Petrol	1390	4	76.50	75.60	5
VAZ-21114	Petrol	1596	4	82.00	75.60	9
VAZ-21116	Petrol	1597	4	82.00	75.60	9
VAZ-21124	Petrol	1596	4	82.00	75.60	9
VAZ-21126	Petrol	1597	4	82.00	75.60	9
XUD9A	Diesel	1905	4	83.00	88.00	10
XUD9SD	Diesel	1905	4	83.00	88.00	10

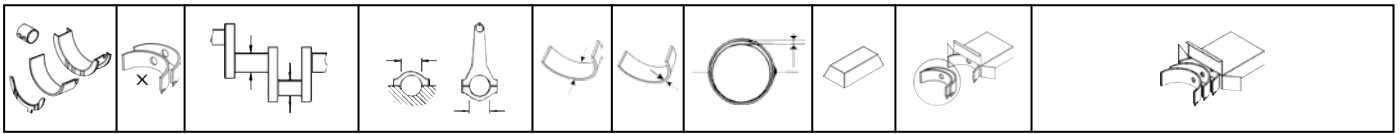

1											76.00 x 60.60										
BA3 21081											4 Cyl. 1100cc 39-50kW (53-68PS) Petrol TD5185										
BA3 21081 (KAT)											4 Cyl. 1099cc 39-43kW (53-58PS) Petrol TD5384										
BE/PL	4	47,814/47,834	51,330/51,346	20,700	1,730	0,036/0,097	AL-LF	66415RA	01-4180/4 STD												
TW/A	2	56,610/56,864	69,596/69,850		2,362		AL-LF	60987AFA	A198/2 STD .005												

2											76.00 x 66.00										
BA3 2101											4 Cyl. 1198cc 44kW (60PS) Petrol TD5182										
BA31/38A/LB02-2102/3/21012/21022/21051											4 Cyl. 1198cc 44-46kW (60-63PS) Petrol FM918										
BE/PL	4	47,814/47,834	51,330/51,346	20,700	1,730	0,036/0,097	AL-LF	66415RA	01-4180/4 STD												
MB/HL 3	1	50,785/50,805	54,507/54,520	22,750	1,831	0,040/0,098	AL-LF	60987RA	H1045/5 STD 0.25												
MB/HL 1,2,4,5	4	50,785/50,805	54,507/54,520	21,250	1,831	0,040/0,098	AL-LF	66416RA													
TW/A	2	56,610/56,684	69,596/69,850		2,362		AL-LF	60987AF	A197/2 STD .005												
TW/A	2	56,610/56,864	69,596/69,850		2,362		AL-LF	60987AFA	A198/2 STD .005												

60987AF

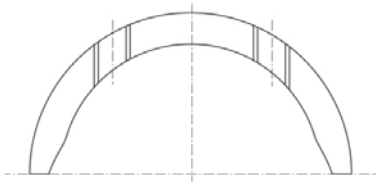

60987AFA

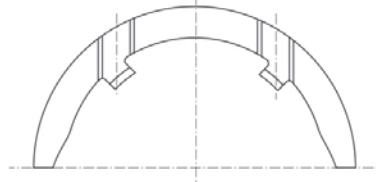

3											76.00 x 71.00										
BA3 21011											4 Cyl. 1285cc 48kW (65PS) Petrol TD5189										
BA3 2108											4 Cyl. 1288cc 44-48kW (60-65PS) Petrol TD5186										
BA3 2108 (KAT)											4 Cyl. 1288cc 44-45kW (60-62PS) Petrol TD5387										
BA3 21115											4 Cyl. 1288cc 50kW (68PS) Petrol TD13352										
BE/PL	4	47,814/47,834	51,330/51,346	20,700	1,730	0,036/0,097	AL-LF	66415RA	01-4180/4 STD												
TW/A	2	56,610/56,684	69,596/69,850		2,362		AL-LF	60987AF	A197/2 STD .005												
TW/A	2	56,610/56,864	69,596/69,850		2,362		AL-LF	60987AFA	A198/2 STD .005												

60987AF

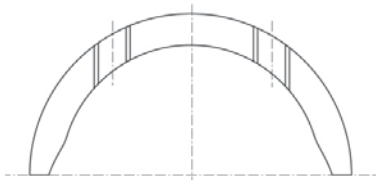

60987AFA

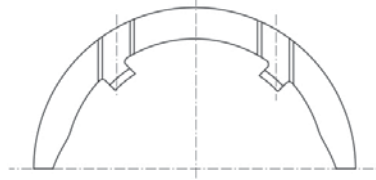

4											76.00 x 80.00										
BA3 2103											4 Cyl. 1452cc 49-56kW (66-76PS) Petrol TD5181										
BA3 2103 (KAT)											4 Cyl. 1451cc 49-55kW (67-75PS) Petrol TD5389										
BE/PL	4	47,814/47,834	51,330/51,346	20,700	1,730	0,036/0,097	AL-LF	66415RA	01-4180/4 STD												

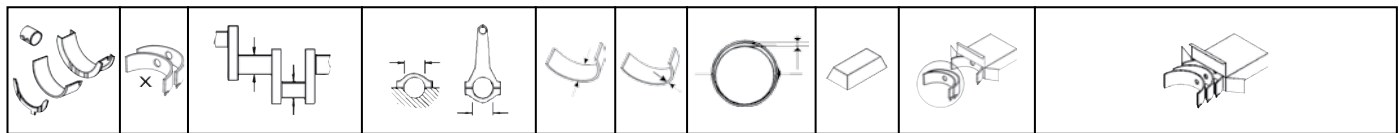

MB/HL 3	1	50,785/50,805	54,507/54,520	22,750	1,831	0,040/0,098	AL-LF	60987RA	H1045/5 STD 0.25
MB/HL 1,2,4,5	4	50,785/50,805	54,507/54,520	21,250	1,831	0,040/0,098	AL-LF	66416RA	
TW/A	2	56,610/56,684	69,596/69,850		2,362		AL-LF	60987AF	A197/2 STD .005
TW/A	2	56,610/56,864	69,596/69,850		2,362		AL-LF	60987AFA	A198/2 STD .005

60987AF

60987AFA

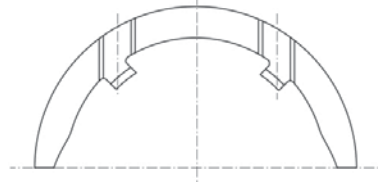
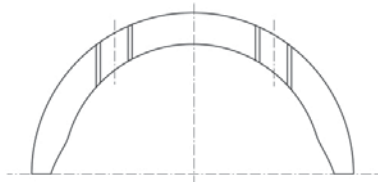

5 76.50 x 75.60

VAZ-11194 Euro 4		4 Cyl.	1390cc	60-71kW (82-96PS)	Petrol			TD24875	
BE/PL	4	47,830/47,850	51,600/51,616	17,200	1,870	0,200/0,076	AL-LF	01-4937	01-4937/4 STD
SE/PB	1	17,995/18,000	21,000/21,021	19,000			BS	55-4938	55-4938 SEMI

6 79.00 x 66.00

BA3 2105		4 Cyl.	1294cc	48-51kW (65-70PS)	Petrol			TD5183	
BE/PL	4	47,814/47,834	51,330/51,346	20,700	1,730	0,036/0,097	AL-LF	66415RA	01-4180/4 STD
MB/HL 3	1	50,785/50,805	54,507/54,520	22,750	1,831	0,040/0,098	AL-LF	60987RA	H1045/5 STD 0.25
MB/HL 1,2,4,5	4	50,785/50,805	54,507/54,520	21,250	1,831	0,040/0,098	AL-LF	66416RA	
TW/A	2	56,610/56,684	69,596/69,850		2,362		AL-LF	60987AF	A197/2 STD .005
TW/A	2	56,610/56,864	69,596/69,850		2,362		AL-LF	60987AFA	A198/2 STD .005

60987AF

60987AFA

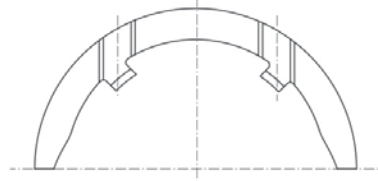
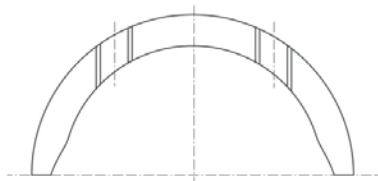

7 79.00 x 80.00

BA3 2106		4 Cyl.	1570cc	54-58kW (73-79PS)	Petrol			TD5190	
BA3 2121		4 Cyl.	1569cc	51-63kW (69-86PS)	Petrol			TD5184	
BA3 2121 (KAT)		4 Cyl.	1569cc	51-53kW (69-72PS)	Petrol			TD5388	
VAZ-2121.4		4 Cyl.	1568cc	59kW (80PS)	Petrol			TD11751	
BE/PL	4	47,814/47,834	51,330/51,346	20,700	1,730	0,036/0,097	AL-LF	66415RA	01-4180/4 STD
MB/HL 3	1	50,785/50,805	54,507/54,520	22,750	1,831	0,040/0,098	AL-LF	60987RA	H1045/5 STD 0.25
MB/HL 1,2,4,5	4	50,785/50,805	54,507/54,520	21,250	1,831	0,040/0,098	AL-LF	66416RA	
TW/A	2	56,610/56,684	69,596/69,850		2,362		AL-LF	60987AF	A197/2 STD .005
TW/A	2	56,610/56,864	69,596/69,850		2,362		AL-LF	60987AFA	A198/2 STD .005



60987AF

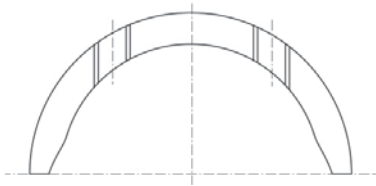

60987AFA

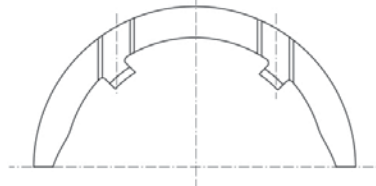

8 82.00 x 71.00

BA3 21083	4 Cyl.	1499cc	50-55kW (68-75PS)	Petrol	TD5188
BA3 21083 (KAT)	4 Cyl.	1500cc	50kW (68PS)	Petrol	TD5386
BA3 2111	4 Cyl.	1499cc	52-54kW (71-73PS)	Petrol	TD13353
VAZ-2111	4 Cyl.	1499cc	56-59kW (76-80PS)	Petrol	TD11748
VAZ-2112	4 Cyl.	1499cc	67-70kW (91-95PS)	Petrol	TD11749

BE/PL	4	47,814/47,834	51,330/51,346	20,700	1,730	0,036/0,097	AL-LF	66415RA	01-4180/4 STD
TW/A	2	56,610/56,864	69,596/69,850		2,362		AL-LF	60987AFA	A198/2 STD .005

9 82.00 x 75.60

VAZ-21114 Euro 4	4 Cyl.	1596cc	60kW (82PS)	Petrol	TD24874
VAZ-21116	4 Cyl.	1597cc	66kW (90PS)	Petrol	TD26322
VAZ-21124	4 Cyl.	1596cc	60-66kW (82-90PS)	Petrol	TD26109
VAZ-21126	4 Cyl.	1597cc	71-72kW (96-98PS)	Petrol	TD22996

BE/PL	4	47,830/47,850	51,600/51,616	17,200	1,870	0,200/0,076	AL-LF	01-4937	01-4937/4 STD
SE/PB	1	17,995/18,000	21,000/21,021	19,000			BS	55-4938	55-4938 SEMI

10 83.00 x 88.00

XUD9A	4 Cyl.	1905cc	47-52kW (64-71PS)	Diesel	TD13350
XUD9SD	4 Cyl.	1905cc	55kW (75PS)	Diesel	TD17345

BE/PL	4	49,984/50,000	53,695/53,708	20,050	1,830	0,040/0,090	AL-LF	66725RA	01-4200/4 STD 0.30 0.50
MB/HL 1-5	5	59,981/60,000	63,731/63,750	20,290	1,845	0,040/0,100	AL-LF	66726RA	H1057/5 STD 0.30 0.50
TW/A	4	67,050/67,300	83,050/83,300		2,330		BS	66721BF	A214/4 STD 0.10
SE/PB	1	25,007/25,020	27,200/27,221	24,050			BS	66729YA	55-4201 SEMI

11 86.00 x 86.00

C 20 XE	4 Cyl.	1998cc	110kW (150PS)	Petrol	TD22868
----------------	--------	---------------	----------------------	---------------	----------------

BE/PL	4	48,971/48,987	52,000/52,012	19,300	1,500	0,020/0,066	EC	71-3626	71-3626/4 STD 0.25 0.50
BE/PL	4	48,971/48,987	52,000/52,012	20,300	1,500	0,020/0,070	EC	71-3764	71-3764/4 STD 0.25

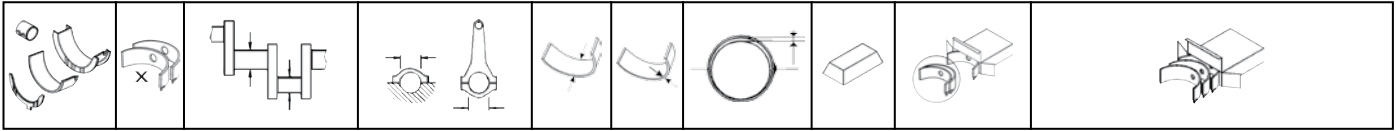

71-3626

71-3764

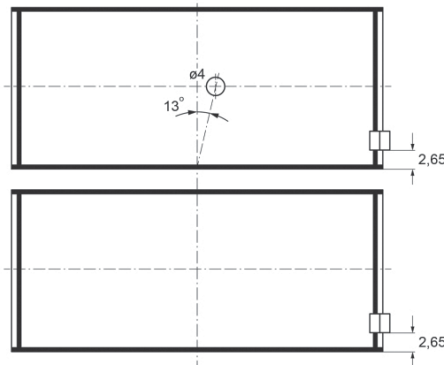
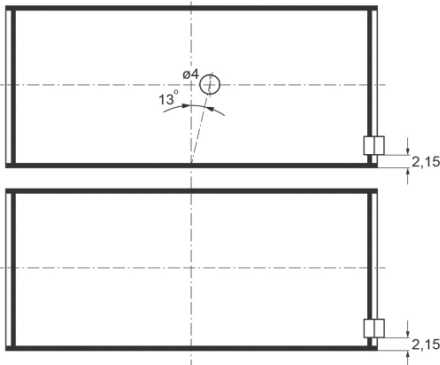

MB/HL 1,2,4,5	4	57,982/57,995	62,000/62,013	19,500	1,995	0,020/0,066	AL-LF	02-3532	H982/5 STD 0.25 0.50
MB/HL 3	1	57,982/57,995	62,000/62,013	25,900	1,995	0,020/0,066	AL-LF	02-3533H	



02-3533H	STD	25,950/1.0217" - 26,002/1.0237"
	0.25mm	26,150/1.0295" - 26,202/1.0316"
	0.50mm	26,350/1.0374" - 26,402/1.0394"

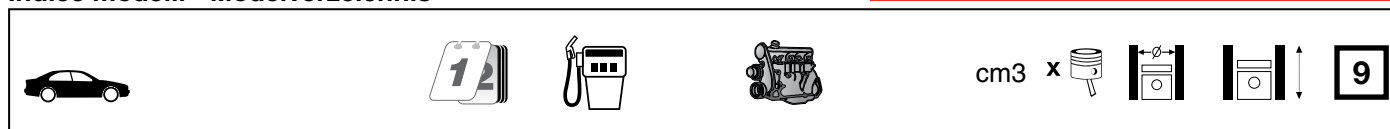









A 112 0.9 Junior	03/81→06/86	Petrol	A112 A.000	903	4	65.00	68.00	1
A 112 0.9 Junior	03/81→06/86	Petrol	A112 A5.000	903	4	65.00	68.00	1
A 112 0.9 Junior	03/81→06/86	Petrol	A112 B2.000	903	4	65.00	68.00	1
A 112 1.0 Abarth	03/78→02/84	Petrol	A112 A2.000	1050	4	67.20	74.00	3
A 112 1.0 LX	03/84→12/86	Petrol	A112 B1.000	965	4	67.20	68.00	2
Beta 1300	12/81→12/84	Petrol	828 D3.000	1367	4	78.00	71.50	13
Beta 1400	08/73→07/76	Petrol	828 A2.000	1438	4	80.00	71.50	17
Beta 1600	08/73→12/84	Petrol	828 B.000	1585	4	84.00	71.50	36
Beta 1800	08/73→12/76	Petrol	828 A1.000	1756	4	84.00	79.20	39
Beta 2000	04/76→10/86	Petrol	828 B1.000	1995	4	84.00	90.00	43
Beta 2000 i.e.	12/81→12/84	Petrol	828 B4.000	1995	4	84.00	90.00	41
Beta 2000 VX	07/83→12/84	Petrol	828 B7.000	1995	4	84.00	90.00	41
Beta 1300	→12/81	Petrol	828 AC.3	1297	4	76.00	71.50	12
Beta 1300 (78Hp)	→12/81	Petrol	BA31/38A/LB02-2102/3/ 21012/21022/21051	1198	4	76.00	66.00	2
Beta 1400	01/72→12/75	Petrol	828A.B2.000	1438	4	80.00	71.50	39
Beta H.P.E. 1600	08/80→09/84	Petrol	828 B.000	1585	4	84.00	71.50	36
Beta H.P.E. 2000	05/76→09/84	Petrol	828 B1.000	1995	4	84.00	90.00	43
Beta H.P.E. 2000 i.e.	05/81→09/84	Petrol	828 B4.000	1995	4	84.00	90.00	41
Beta H.P.E. 2000 Volumex	07/83→09/84	Petrol	828 B7.000	1995	4	84.00	90.00	41
Beta Monte Carlo 2.0	09/75→05/81	Petrol	134 AS.000	1995	4	84.00	90.00	41
Dedra 1.6 16V	01/96→07/99	Petrol	182 A4.000	1581	4	86.40	67.40	57
Dedra 1.6 i.e.	08/89→06/94	Petrol	835 A1.000	1581	4	86.40	67.40	57
Dedra 1.6 i.e.	08/89→03/93	Petrol	835 A1.046	1581	4	86.40	67.40	57
Dedra 1.6 i.e.	04/93→07/99	Petrol	835 C1.000	1581	4	86.40	67.40	57
Dedra 1.6 LE	07/94→07/99	Petrol	159 B9.000	1581	4	86.40	67.40	57
Dedra 1.8 16V LE	03/96→07/99	Petrol	182 A2.000	1747	4	82.00	82.70	24
Dedra 1.8 GT 16V	03/96→07/99	Petrol	183 A1.000	1747	4	82.00	82.70	24
Dedra 1.8 i.e.	09/89→06/94	Petrol	835 A2.000	1756	4	84.00	79.20	40
Dedra 1.8 i.e.	09/89→07/99	Petrol	835 A2.046	1756	4	84.00	79.20	40
Dedra 1.8 i.e.	08/93→07/99	Petrol	835 C5.000	1756	4	84.00	79.20	40
Dedra 1.8 i.e.	07/94→07/99	Petrol	836 A5.000	1756	4	84.00	79.20	40
Dedra 1.9 TDS	04/89→07/99	Diesel	160 D1.000	1929	4	82.60	90.00	30
Dedra 1.9 TDS	04/89→07/99	Diesel	835 A4.000	1929	4	82.60	90.00	30
Dedra 1.9 TDS	04/89→07/99	Diesel	835 A4.046	1929	4	82.60	90.00	30
Dedra 2.0 16V	07/94→07/99	Petrol	836 A3.000	1995	4	84.00	90.00	42
Dedra 2.0 HF Integrale	11/90→07/94	Petrol	835 A7.046	1995	4	84.00	90.00	45
Dedra 2.0 i.e.	09/89→07/92	Petrol	835 A5.000	1995	4	84.00	90.00	46
Dedra 2.0 i.e.	09/89→07/99	Petrol	835 A5.046	1995	4	84.00	90.00	45
Dedra 2.0 i.e. Turbo	04/91→07/99	Petrol	835 A8.046	1995	4	84.00	90.00	42
Dedra 2.0 i.e. Turbo Integrale	05/90→07/94	Petrol	835 A7.000	1995	4	84.00	90.00	45
Dedra 2.0 Turbo	11/90→06/94	Petrol	835 A8.000	1995	4	84.00	90.00	45
Dedra SW 1.6	10/94→07/99	Petrol	159 B9.000	1581	4	86.40	67.40	57
Dedra SW 1.6 16V	01/96→07/99	Petrol	182 A4.000	1581	4	86.40	67.40	57
Dedra SW 1.8 16V LE	03/96→07/99	Petrol	182 A2.000	1747	4	82.00	82.70	24
Dedra SW 1.8 GT 16V	03/96→07/99	Petrol	183 A1.000	1747	4	82.00	82.70	24
Dedra SW 1.8 i.e.	07/94→07/99	Petrol	836 A5.000	1756	4	84.00	79.20	40
Dedra SW 1.9 TDS	07/94→07/99	Diesel	160 D1.000	1929	4	82.60	90.00	30
Dedra SW 1.9 TDS	07/94→07/99	Diesel	835 A4.000	1929	4	82.60	90.00	30
Dedra SW 2.0 16V	07/94→07/99	Petrol	836 A3.000	1995	4	84.00	90.00	42
Dedra SW 2.0 Integrale	07/94→07/99	Petrol	836 A3.000	1995	4	84.00	90.00	42
Delta I 1.1	01/86→12/90	Petrol	831 B8.000	1116	4	80.00	55.50	16
Delta I 1.3	09/79→08/92	Petrol	831 A2.000	1301	4	86.40	55.50	54
Delta I 1.3	09/79→08/92	Petrol	831 B.000	1301	4	86.40	55.50	54
Delta I 1.5	09/79→12/92	Petrol	831 A1.000	1498	4	86.40	63.90	56
Delta I 1.5	09/79→12/92	Petrol	831 B1.000	1498	4	86.40	63.90	55
Delta I 1.6 GT	11/82→04/86	Petrol	831 A4.000	1585	4	84.00	71.50	36
Delta I 1.6 GT i.e.	05/87→08/92	Petrol	149 C2.000	1585	4	84.00	71.50	36
Delta I 1.6 GT i.e.	08/86→08/88	Petrol	831 B7.000	1585	4	84.00	71.50	36
Delta I 1.6 HF Turbo	10/83→12/86	Petrol	831 A7.000	1585	4	84.00	71.50	37
Delta I 1.6 HF Turbo	08/86→08/88	Petrol	831 B3.000	1585	4	84.00	71.50	37
Delta I 1.6 HF Turbo	04/87→03/89	Petrol	831 B7.046	1585	4	84.00	71.50	37
Delta I 1.9 Turbo DS	10/86→12/89	Diesel	831 D1.000	1929	4	82.60	90.00	31
Delta I 2.0 16V HF Evo Integrale	06/93→01/94	Petrol	831 E5.000	1995	4	84.00	90.00	42
Delta I 2.0 16V HF Evo Integrale	06/93→01/94	Petrol	831 E5.046	1995	4	84.00	90.00	42
Delta I 2.0 16V HF Integrale	03/89→09/91	Petrol	831 D5.000	1995	4	84.00	90.00	42
Delta I 2.0 HF Integrale	11/86→08/88	Petrol	831 B5.000	1995	4	84.00	90.00	45
Delta I 2.0 HF Integrale	10/87→02/89	Petrol	831 C5.000	1995	4	84.00	90.00	45
Delta I 2.0 HF Integrale	12/86→12/92	Petrol	831 C5.046	1995	4	84.00	90.00	45



cm3







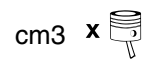





Delta II 1.4 i.e.	10/94→08/99	Petrol	160 A1.046	1372	4	80.50	67.40	18
Delta II 1.4 i.e.	10/94→08/99	Petrol	836 A4.000	1372	4	80.50	67.40	18
Delta II 1.6 i.e.	03/96→08/99	Petrol	182 A6.000	1581	4	86.40	67.40	57
Delta II 1.6 i.e.	06/93→08/99	Petrol	835 C1.000	1581	4	86.40	67.40	57
Delta II 1.6 i.e. 16V	01/96→08/99	Petrol	182 A4.000	1581	4	86.40	67.40	57
Delta II 1.8	02/96→09/99	Petrol	182 A2.000	1747	4	82.00	82.70	24
Delta II 1.8 i.e.	06/93→08/99	Petrol	835 C2.000	1756	4	84.00	79.20	40
Delta II 1.8 i.e.	07/94→08/99	Petrol	835 C4.000	1756	4	84.00	79.20	40
Delta II 1.8 i.e.	07/94→08/99	Petrol	836 A6.000	1756	4	84.00	79.20	40
Delta II 1.8 i.e.	07/94→08/99	Petrol	836 C4.000	1756	4	84.00	79.20	40
Delta II 1.8 i.e. 16V	03/96→08/99	Petrol	182 A2.000	1747	4	82.00	82.70	24
Delta II 1.8 i.e. 16V GT	03/96→08/99	Petrol	183 A1.000	1747	4	82.00	82.70	24
Delta II 1.9 TD	10/94→08/99	Diesel	160 D1.000	1929	4	82.60	90.00	30
Delta II 1.9 TD	10/94→08/99	Diesel	835 A4.000	1929	4	82.60	90.00	30
Delta II 2.0 16V	06/93→08/99	Petrol	836 A3.000	1995	4	84.00	90.00	42
Delta II 2.0 16V Turbo	07/96→08/99	Petrol	175 A4.000	1995	4	84.00	90.00	42
Delta II 2.0 16V Turbo	06/93→08/99	Petrol	836 A2.000	1995	4	84.00	90.00	42
Delta III 1.4	09/08→08/14	Petrol	198 A1.000	1368	4	72.00	84.00	9
Delta III 1.4	09/08→08/14	Petrol	198 A4.000	1368	4	72.00	84.00	9
Delta III 1.4 16V	07/10→08/14	Petrol	198 A7.000	1368	4	72.00	84.00	9
Delta III 1.4 Bifuel	07/11→08/14	Petrol	198 A4.000	1368	4	72.00	84.00	9
Delta III 1.6 D Multijet	09/08→08/14	Diesel	198 A2.000	1598	4	79.50	80.50	14
Delta III 1.6 D Multijet	04/11→08/14	Diesel	944 A 3.000	1598	4	79.50	80.50	14
Delta III 1.6 D Multijet	08/08→08/14	Diesel	955 A4.000	1598	4	79.50	80.50	14
Delta III 1.8	01/09→08/14	Petrol	939 B1.000	1742	4	83.00	80.50	32
Delta III 1.9 D Multijet	01/09→08/14	Diesel	844 A1.000	1910	4	82.00	90.40	26
Delta III 2.0 D Multijet	09/08→08/14	Diesel	198 A5.000	1956	4	83.00	90.40	33
Delta III 2.0 D Multijet	09/08→08/14	Diesel	844 A2.000	1956	4	83.00	90.40	34
Kappa 2.0 16V Turbo	02/95→10/01	Petrol	838 A4.000	1995	4	84.00	90.00	42
Kappa 2.0 20V	10/94→10/01	Petrol	838 A1.000	1998	5	82.00	75.65	22
Kappa 2.0 20V	07/96→10/01	Petrol	838 A6.000	1998	5	82.00	75.65	22
Kappa 2.0 20V Turbo	06/98→10/01	Petrol	175 A3.000	1998	5	82.00	75.65	22
Kappa 2.4 20V	08/94→10/01	Petrol	838 A2.000	2446	5	83.00	90.40	35
Kappa 2.4 20V	08/94→10/01	Petrol	838 A2.027	2446	5	83.00	90.40	35
Kappa 2.4 JTD	06/98→10/01	Diesel	838 A8.000	2387	5	82.00	90.40	27
Kappa 2.4 T.DS	08/94→10/01	Diesel	838 A3.000	2387	5	82.00	90.40	27
Kappa 2.4 T.DS	08/94→10/01	Diesel	838 A7.000	2387	5	82.00	90.40	27
Kappa 3.0 24V	08/94→10/01	Petrol	838 B.000	2959	V6	93.00	72.60	59
Kappa SW 2.0 16V Turbo	07/96→10/01	Petrol	838 A4.000	1995	4	84.00	90.00	42
Kappa SW 2.0 20V	07/96→10/01	Petrol	838 A6.000	1998	5	82.00	75.65	22
Kappa SW 2.0 20V Turbo	06/98→10/01	Petrol	175 A3.000	1998	5	82.00	75.65	22
Kappa SW 2.4 20V	07/96→10/01	Petrol	838 A2.000	2446	5	83.00	90.40	35
Kappa SW 2.4 JTD	06/98→10/01	Diesel	838 A8.000	2387	5	82.00	90.40	27
Kappa SW 2.4 T.DS	07/96→10/01	Diesel	838 A3.000	2387	5	82.00	90.40	27
Kappa SW 2.4 T.DS	07/96→10/01	Diesel	838 A7.000	2387	5	82.00	90.40	27
Kappa SW 3.0 24V	07/96→10/01	Petrol	838 B.000	2959	V6	93.00	72.60	59
Lybra 1.6	10/00→10/05	Petrol	182 B6.000	1596	4	80.50	78.40	19
Lybra 1.6 16V	07/99→10/05	Petrol	182 A4.000	1581	4	86.40	67.40	57
Lybra 1.8 16V	07/99→10/05	Petrol	839 A4.000	1747	4	82.00	82.70	24
Lybra 1.8 16V	07/99→10/05	Petrol	839 A7.000	1747	4	82.00	82.70	24
Lybra 1.8 16V	07/99→10/05	Petrol	839 A9.000	1747	4	82.00	82.70	24
Lybra 1.9 JTD	05/01→10/05	Diesel	937 A2.000	1910	4	82.00	90.40	25
Lybra 1.9 JTD	07/99→09/00	Diesel	AR 32302	1910	4	82.00	90.40	25
Lybra 1.9 JTD	09/00→05/01	Diesel	AR 37101	1910	4	82.00	90.40	25
Lybra 2.0 20V	07/99→09/00	Petrol	182 B7.000	1998	5	82.00	75.65	22
Lybra 2.0 20V	09/00→10/05	Petrol	185 A8.000	1998	5	82.00	75.70	23
Lybra 2.4 JTD	07/99→02/01	Diesel	839 A5.000	2387	5	82.00	90.40	27
Lybra 2.4 JTD	09/00→05/02	Diesel	839 A6.000	2387	5	82.00	90.40	27
Lybra 2.4 JTD	05/02→10/05	Diesel	841 C.000	2387	5	82.00	90.40	27
Lybra 2.4 JTD	07/99→02/01	Diesel	AR 32501	2387	5	82.00	90.40	27
Lybra SW 1.6	10/00→10/05	Petrol	182 B6.000	1596	4	80.50	78.40	19
Lybra SW 1.6 16V	07/99→10/05	Petrol	182 A4.000	1581	4	86.40	67.40	57
Lybra SW 1.8 16V	07/99→10/05	Petrol	839 A4.000	1747	4	82.00	82.70	24
Lybra SW 1.8 16V	07/99→10/05	Petrol	839 A7.000	1747	4	82.00	82.70	24
Lybra SW 1.9 JTD	05/01→10/05	Diesel	937 A2.000	1910	4	82.00	90.40	25
Lybra SW 1.9 JTD	07/99→09/00	Diesel	AR 32302	1910	4	82.00	90.40	25
Lybra SW 1.9 JTD	09/00→05/01	Diesel	AR 37101	1910	4	82.00	90.40	25
Lybra SW 2.0 20V	07/99→09/00	Petrol	182 B7.000	1998	5	82.00	75.65	22
Lybra SW 2.0 20V	09/00→10/05	Petrol	185 A8.000	1998	5	82.00	75.70	23







				cm3				
Lybra SW 2.4 JTD	10/99→09/00	Diesel	839 A5.000	2387	5	82.00	90.40	27
Lybra SW 2.4 JTD	09/00→10/05	Diesel	839 A6.000	2387	5	82.00	90.40	27
Lybra SW 2.4 JTD	05/02→10/05	Diesel	841 C.000	2387	5	82.00	90.40	27
Lybra SW 2.4 JTD	10/99→09/00	Diesel	AR 32501	2387	5	82.00	90.40	27
Musa 1.3 D Multijet	10/04→09/12	Diesel	188 A9.000	1248	4	69.60	82.00	4
Musa 1.3 D Multijet	09/06→09/12	Diesel	199 A3.000	1248	4	69.60	82.00	4
Musa 1.3 D Multijet	03/09→09/12	Diesel	199 B1.000	1248	4	69.60	82.00	4
Musa 1.4	10/07→09/12	Petrol	192 B2.000	1368	4	72.00	84.00	8
Musa 1.4	09/05→09/12	Petrol	350 A1.000	1368	4	72.00	84.00	8
Musa 1.4	10/04→09/12	Petrol	843 A 1.000	1368	4	72.00	84.00	8
Musa 1.4 LPG	11/10→09/12	Petrol	350 A1.000	1368	4	72.00	84.00	8
Musa 1.6 D Multijet	07/08→09/12	Diesel	350 A2.000	1598	4	79.50	80.50	15
Musa 1.6 D Multijet	07/08→09/12	Diesel	350 A3.000	1598	4	79.50	80.50	14
Musa 1.9 D Multijet	10/04→09/12	Diesel	188 B2.000	1910	4	82.00	90.40	25
Phedra 2.0	09/02→11/10	Petrol	RFN (EW10J4)	1997	4	85.00	88.00	48
Phedra 2.0 D Multijet	07/06→11/10	Diesel	RHR (DW10BTED4)	1997	4	85.00	88.00	49
Phedra 2.0 JTD	06/06→11/10	Diesel	RHK (DW10UTED4)	1997	4	85.00	88.00	49
Phedra 2.0 JTD	07/03→11/10	Diesel	RHM (DW10ATED4)	1997	4	85.00	88.00	49
Phedra 2.0 JTD	09/02→11/10	Diesel	RHW (DW10ATED4)	1997	4	85.00	88.00	49
Phedra 2.2 D Multijet	03/08→11/10	Diesel	4HS	2179	4	85.00	96.00	51
Phedra 2.2 D Multijet	03/08→11/10	Diesel	4HT	2179	4	85.00	96.00	51
Phedra 2.2 JTD	04/06→11/10	Diesel	4HP	2179	4	85.00	96.00	51
Phedra 2.2 JTD	04/06→11/10	Diesel	4HR	2179	4	85.00	96.00	51
Phedra 2.2 JTD	09/02→11/10	Diesel	4HW (DW12ATED4)	2179	4	85.00	96.00	51
Prisma 1.3	01/83→02/92	Petrol	831 A2.000	1301	4	86.40	55.50	54
Prisma 1.5	09/85→02/92	Petrol	138 C2.048	1498	4	86.40	63.90	55
Prisma 1.5	01/83→04/86	Petrol	831 A1.000	1498	4	86.40	63.90	56
Prisma 1.5	08/86→02/92	Petrol	831 B1.000	1498	4	86.40	63.90	55
Prisma 1.5	09/85→02/92	Petrol	831 B1.048	1498	4	86.40	63.90	55
Prisma 1.6	01/83→04/86	Petrol	831 A4.000	1585	4	84.00	71.50	36
Prisma 1.6	08/86→02/92	Petrol	831 B6.000	1585	4	84.00	71.50	36
Prisma 1.6 i.e.	05/86→12/89	Petrol	831 B7.000	1585	4	84.00	71.50	36
Prisma 1.6 i.e. Super	05/87→12/89	Petrol	149 C2.000	1585	4	84.00	71.50	36
Prisma 1.9 Diesel	01/83→02/92	Diesel	831 D.000	1911	4	82.60	90.00	31
Prisma 1.9 Turbo Diesel	05/85→12/89	Diesel	831 D1.000	1929	4	82.60	90.00	31
Prisma 2.0 i.e. All-wheel Drive	04/86→12/89	Petrol	831 B4.000	1995	4	84.00	90.00	44
Thema 2000 16V	08/92→12/93	Petrol	834 F1.000	1995	4	84.00	90.00	42
Thema 2000 16V Turbo	12/88→06/90	Petrol	834 C1.000	1995	4	84.00	90.00	42
Thema 2000 16V Turbo	10/92→07/94	Petrol	834 F2.000	1995	4	84.00	90.00	42
Thema 2000 i.e	09/88→05/92	Petrol	834 B1.000	1995	4	84.00	90.00	44
Thema 2000 i.e.	11/84→09/88	Petrol	834 B.000	1995	4	84.00	90.00	44
Thema 2000 i.e.	03/86→09/88	Petrol	834 B.048	1995	4	84.00	90.00	44
Thema 2000 i.e.	09/87→05/92	Petrol	834 B.146	1995	4	84.00	90.00	44
Thema 2000 i.e. 16V	05/88→08/92	Petrol	834 B2.000	1995	4	84.00	90.00	46
Thema 2000 i.e. 16V	02/89→05/92	Petrol	834 B2.246	1995	4	84.00	90.00	46
Thema 2000 i.e. 16V Turbo	04/89→05/92	Petrol	834 C1.246	1995	4	84.00	90.00	42
Thema 2000 i.e. Turbo	11/84→12/87	Petrol	834 C.000	1995	4	84.00	90.00	45
Thema 2000 i.e. Turbo	07/86→05/90	Petrol	834 C.146	1995	4	84.00	90.00	45
Thema 2500 Turbo D	11/84→09/88	Diesel	8144.91	2445	4	93.00	90.00	60
Thema 2500 Turbo DS	06/88→05/92	Diesel	8144.97	2499	4	93.00	92.00	61
Thema 2500 Turbo DS	05/88→07/92	Diesel	8144. 97S	2500	4	93.00	92.00	61
Thema 2500 Turbo DS	05/92→07/94	Diesel	8144.97 Y	2500	4	93.00	92.00	61
Thema 2850 V6 i.e.	11/84→09/88	Petrol	834 E.000	2849	V6	91.00	73.00	58
Thema 2850 V6 i.e.	06/88→05/92	Petrol	834 E.146	2849	V6	91.00	73.00	58
Thema 3000 V6	08/92→07/94	Petrol	834 F.000	2959	V6	93.00	72.60	59
Thema SW 2000 16V	05/92→07/94	Petrol	834 F1.000	1995	4	84.00	90.00	42
Thema SW 2000 i.e. 16V	05/89→08/92	Petrol	834 B2.000	1995	4	84.00	90.00	46
Thema SW 2000 i.e. 16V	02/89→05/92	Petrol	834 B2.246	1995	4	84.00	90.00	46
Thema SW 2000 i.e. 16V Turbo	12/88→06/90	Petrol	834 C1.000	1995	4	84.00	90.00	42
Thema SW 2000 i.e. 16V Turbo	04/89→03/93	Petrol	834 C1.246	1995	4	84.00	90.00	42
Thema SW 2000 Turbo	01/89→03/92	Petrol	834 C.146	1995	4	84.00	90.00	45
Thema SW 2000 Turbo 16V	11/92→07/94	Petrol	834 F2.000	1995	4	84.00	90.00	42
Thema SW 2500 Turbo DS	03/87→09/90	Diesel	8144.91	2445	4	93.00	90.00	60
Thema SW 2500 Turbo DS	06/88→05/92	Diesel	8144.97	2499	4	93.00	92.00	61
Thema SW 2500 Turbo DS	05/88→07/92	Diesel	8144. 97S	2500	4	93.00	92.00	61
Thema SW 2500 Turbo DS	09/92→07/94	Diesel	8144.97 Y	2500	4	93.00	92.00	61
Thema SW 3000 V6	09/92→07/94	Petrol	834 F.000	2959	V6	93.00	72.60	59
Thesis 2.0 Turbo	07/02→07/09	Petrol	841 E.000	1998	5	82.00	75.65	22
Thesis 2.4 D Multijet	04/06→07/09	Diesel	841 P.000	2387	5	82.00	90.40	29



Thesis 2.4 JTD	07/02→07/09	Diesel	841 C.000	2387	5	82.00	90.40	27
Thesis 2.4 JTD	05/03→07/09	Diesel	841 G.000	2387	5	82.00	90.40	28
Thesis 2.4 JTD	09/03→07/09	Diesel	841 M.000	2387	5	82.00	90.40	28
Thesis 2.4 JTD	09/03→07/09	Diesel	841 N.000	2387	5	82.00	90.40	29
Thesis 3.0 V6	07/02→07/09	Petrol	841 A.000	2959	V6	93.00	72.60	59
Trevi 1600	05/80→01/87	Petrol	828 B.000	1585	4	84.00	71.50	36
Trevi 2000 i.e.	05/80→01/87	Petrol	828 B4.000	1995	4	84.00	90.00	41
Trevi 2000 Volumex	08/83→05/85	Petrol	828 B7.000	1995	4	84.00	90.00	41
Y 1.1	11/95→09/03	Petrol	176 B2.000	1108	4	70.00	72.00	6
Y 1.2	03/96→09/03	Petrol	188 A4.000	1242	4	70.80	78.90	7
Y 1.2	03/96→09/03	Petrol	840 A3.000	1242	4	70.80	78.90	7
Y 1.2 16V	04/97→09/03	Petrol	176 B9.000	1242	4	70.80	78.90	7
Y 1.2 16V	10/00→09/03	Petrol	188 A5.000	1242	4	70.80	78.90	7
Y 1.4 12V	10/96→09/03	Petrol	840 A2.000	1370	4	82.00	64.90	21
Y 1.4 12V	03/96→09/03	Petrol	840 A4.000	1370	4	82.00	64.90	21
Y10 1.0	03/85→07/89	Petrol	156 A.000	1049	4	76.00	57.80	10
Y10 1.0 Fire	03/85→02/90	Petrol	156 A2.000	999	4	70.00	64.90	5
Y10 1.0 Fire	06/85→06/91	Petrol	156 A2.100	999	4	70.00	64.90	5
Y10 1.0 Fire	10/87→02/92	Petrol	156 A2.246	999	4	70.00	64.90	5
Y10 1.0 Fire All-wheel Drive	12/87→02/92	Petrol	156 A2.000	999	4	70.00	64.90	5
Y10 1.0 Fire All-wheel Drive	12/86→02/89	Petrol	156 A2.100	999	4	70.00	64.90	5
Y10 1.0 Fire All-wheel Drive	12/87→02/92	Petrol	156 A2.246	999	4	70.00	64.90	5
Y10 1.0 Turbo	03/85→02/89	Petrol	156 A1.000	1049	4	76.00	57.80	10
Y10 1.1 Fire	01/95→12/95	Petrol	176 B2.000	1108	4	70.00	72.00	6
Y10 1.1 Fire All-wheel Drive	01/95→12/95	Petrol	176 B2.000	1108	4	70.00	72.00	6
Y10 1.1 i.e. Fire	07/89→09/95	Petrol	156 C.046	1108	4	70.00	72.00	6
Y10 1.1 i.e. Fire All-wheel Drive	09/92→12/95	Petrol	156 C.046	1108	4	70.00	72.00	6
Y10 1.1 i.e. Fire	08/89→06/92	Petrol	156 C.000	1108	4	70.00	72.00	6
Y10 1.1 i.e. Fire All-wheel Drive	08/89→06/92	Petrol	156 C.000	1108	4	70.00	72.00	6
Y10 1.3 i.e.	02/89→12/95	Petrol	146 A 5.046	1297	4	76.00	71.50	11
Y10 1.3 i.e.	11/87→12/95	Petrol	156 B.000	1301	4	76.00	71.50	11
Ypsilon 0.9 CNG	05/11→	Petrol	312 A2.000	875	2	80.50	86.00	20
Ypsilon 0.9 Twinair	05/11→	Petrol	312 A2.000	875	2	80.50	86.00	20
Ypsilon 0.9 Twinair	12/13→	Petrol	312 A5.000	875	2	80.50	86.00	20
Ypsilon 1.2	08/10→	Petrol	169 A4.000	1242	4	70.80	78.90	7
Ypsilon 1.2	10/03→12/11	Petrol	188 A4.000	1242	4	70.80	78.90	7
Ypsilon 1.2	10/03→12/11	Petrol	188 A5.000	1242	4	70.80	78.90	7
Ypsilon 1.2 Bifuel	05/11→	Petrol	169 A4.000	1242	4	70.80	78.90	7
Ypsilon 1.3 D Multijet	09/06→12/11	Diesel	199 A2.000	1248	4	69.60	82.00	4
Ypsilon 1.3 D Multijet	09/06→12/11	Diesel	199 A3.000	1248	4	69.60	82.00	4
Ypsilon 1.3 JTD	10/03→12/11	Diesel	188 A9.000	1248	4	69.60	82.00	4
Ypsilon 1.3 Multijet	05/11→	Diesel	199 B1.000	1248	4	69.60	82.00	4
Ypsilon 1.4	02/06→12/11	Petrol	350 A1.000	1368	4	72.00	84.00	8
Ypsilon 1.4 16V	10/03→12/11	Petrol	843 A 1.000	1368	4	72.00	84.00	8
Ypsilon 1.4 LPG	11/10→12/11	Petrol	350 A1.000	1368	4	72.00	84.00	8
Zeta 2.0 16V	07/00→09/02	Petrol	RFN	1997	4	85.00	88.00	47
Zeta 2.0 16V	05/98→07/00	Petrol	RFV (XU10J4R)	1998	4	86.00	86.00	52
Zeta 2.0 JTD	04/00→09/02	Diesel	RHZ (DW10ATED)	1997	4	85.00	88.00	49
Zeta 2.0 JTD 16V	09/99→09/02	Diesel	RHW (DW10ATED4)	1997	4	85.00	88.00	49
Zeta 2.0 Turbo	05/95→09/02	Petrol	RGX (XU10J2TE)	1998	4	86.00	86.00	53
Zeta 2.1 TD	05/96→09/99	Diesel	P 8 C	2088	4	85.00	92.00	50

		cm3	x 			
4HP	Diesel	2179	4	85.00	96.00	51
4HR	Diesel	2179	4	85.00	96.00	51
4HS	Diesel	2179	4	85.00	96.00	51
4HT	Diesel	2179	4	85.00	96.00	51
4HW (DW12ATED4)	Diesel	2179	4	85.00	96.00	51
132 B1.000	Petrol	1756	4	84.00	79.20	38
132 BB.1A 0	Petrol	1756	4	84.00	79.20	38
134 AS.000	Petrol	1995	4	84.00	90.00	41
138 C2.048	Petrol	1498	4	86.40	63.90	55
146 A 5.046	Petrol	1297	4	76.00	71.50	11
149 C2.000	Petrol	1585	4	84.00	71.50	36
156 A.000	Petrol	1049	4	76.00	57.80	10
156 A1.000	Petrol	1049	4	76.00	57.80	10
156 A2.000	Petrol	999	4	70.00	64.90	5
156 A2.048	Petrol	999	4	70.00	64.90	5
156 A2.100	Petrol	999	4	70.00	64.90	5
156 A2.146	Petrol	999	4	70.00	64.90	5
156 A2.246	Petrol	999	4	70.00	64.90	5
156 A2.256	Petrol	999	4	70.00	64.90	5
156 B.000	Petrol	1301	4	76.00	71.50	11
156 C.000	Petrol	1108	4	70.00	72.00	6
156 C.046	Petrol	1108	4	70.00	72.00	6
159 B9.000	Petrol	1581	4	86.40	67.40	57
160 A1.046	Petrol	1372	4	80.50	67.40	18
160 D1.000	Diesel	1929	4	82.60	90.00	30
169 A4.000	Petrol	1242	4	70.80	78.90	7
169 A5.000	Diesel	1248	4	69.60	82.00	4
175 A3.000	Petrol	1998	5	82.00	75.65	22
175 A4.000	Petrol	1995	4	84.00	90.00	42
176 B2.000	Petrol	1108	4	70.00	72.00	6
176 B9.000	Petrol	1242	4	70.80	78.90	7
182 A2.000	Petrol	1747	4	82.00	82.70	24
182 A4.000	Petrol	1581	4	86.40	67.40	57
182 A6.000	Petrol	1581	4	86.40	67.40	57
182 B6.000	Petrol	1596	4	80.50	78.40	19
182 B7.000	Petrol	1998	5	82.00	75.65	22
183 A1.000	Petrol	1747	4	82.00	82.70	24
185 A8.000	Petrol	1998	5	82.00	75.70	23
188 A4.000	Petrol	1242	4	70.80	78.90	7
188 A5.000	Petrol	1242	4	70.80	78.90	7
188 A9.000	Diesel	1248	4	69.60	82.00	4
188 B2.000	Diesel	1910	4	82.00	90.40	25
192 B2.000	Petrol	1368	4	72.00	84.00	8
198 A1.000	Petrol	1368	4	72.00	84.00	9
198 A2.000	Diesel	1598	4	79.50	80.50	14
198 A4.000	Petrol	1368	4	72.00	84.00	9
198 A5.000	Diesel	1956	4	83.00	90.40	33
198 A7.000	Petrol	1368	4	72.00	84.00	9
199 A2.000	Diesel	1248	4	69.60	82.00	4
199 A3.000	Diesel	1248	4	69.60	82.00	4
199 B1.000	Diesel	1248	4	69.60	82.00	4
312 A2.000	Petrol	875	2	80.50	86.00	20
312 A5.000	Petrol	875	2	80.50	86.00	20
350 A1.000	Petrol	1368	4	72.00	84.00	8
350 A2.000	Diesel	1598	4	79.50	80.50	15
350 A3.000	Diesel	1598	4	79.50	80.50	14
828 A1.000	Petrol	1756	4	84.00	79.20	39
828 A2.000	Petrol	1438	4	80.00	71.50	17
828 AC.3	Petrol	1297	4	76.00	71.50	12
828 B.000	Petrol	1585	4	84.00	71.50	36
828 B1.000	Petrol	1995	4	84.00	90.00	43
828 B4.000	Petrol	1995	4	84.00	90.00	41
828 B7.000	Petrol	1995	4	84.00	90.00	41
828 D3.000	Petrol	1367	4	78.00	71.50	13
831 A1.000	Petrol	1498	4	86.40	63.90	56
831 A2.000	Petrol	1301	4	86.40	55.50	54
831 A4.000	Petrol	1585	4	84.00	71.50	36
831 A7.000	Petrol	1585	4	84.00	71.50	37
831 B.000	Petrol	1301	4	86.40	55.50	54

		cm3	x 			
831 B1.000	Petrol	1498	4	86.40	63.90	55
831 B1.048	Petrol	1498	4	86.40	63.90	55
831 B3.000	Petrol	1585	4	84.00	71.50	37
831 B4.000	Petrol	1995	4	84.00	90.00	44
831 B5.000	Petrol	1995	4	84.00	90.00	45
831 B6.000	Petrol	1585	4	84.00	71.50	36
831 B7.000	Petrol	1585	4	84.00	71.50	36
831 B7.046	Petrol	1585	4	84.00	71.50	37
831 B8.000	Petrol	1116	4	80.00	55.50	16
831 C5.000	Petrol	1995	4	84.00	90.00	45
831 C5.046	Petrol	1995	4	84.00	90.00	45
831 D.000	Diesel	1911	4	82.60	90.00	31
831 D1.000	Diesel	1929	4	82.60	90.00	31
831 D5.000	Petrol	1995	4	84.00	90.00	42
831 E5.000	Petrol	1995	4	84.00	90.00	42
831 E5.046	Petrol	1995	4	84.00	90.00	42
834 A.000	Petrol	2849	V6	91.00	73.00	58
834 B.000	Petrol	1995	4	84.00	90.00	44
834 B.048	Petrol	1995	4	84.00	90.00	44
834 B.146	Petrol	1995	4	84.00	90.00	44
834 B1.000	Petrol	1995	4	84.00	90.00	44
834 B2.000	Petrol	1995	4	84.00	90.00	46
834 B2.246	Petrol	1995	4	84.00	90.00	46
834 C.000	Petrol	1995	4	84.00	90.00	45
834 C.146	Petrol	1995	4	84.00	90.00	45
834 C1.000	Petrol	1995	4	84.00	90.00	42
834 C1.246	Petrol	1995	4	84.00	90.00	42
834 E.000	Petrol	2849	V6	91.00	73.00	58
834 E.146	Petrol	2849	V6	91.00	73.00	58
834 F.000	Petrol	2959	V6	93.00	72.60	59
834 F1.000	Petrol	1995	4	84.00	90.00	42
834 F2.000	Petrol	1995	4	84.00	90.00	42
835 A1.000	Petrol	1581	4	86.40	67.40	57
835 A1.046	Petrol	1581	4	86.40	67.40	57
835 A2.000	Petrol	1756	4	84.00	79.20	40
835 A2.046	Petrol	1756	4	84.00	79.20	40
835 A4.000	Diesel	1929	4	82.60	90.00	30
835 A4.046	Diesel	1929	4	82.60	90.00	30
835 A5.000	Petrol	1995	4	84.00	90.00	46
835 A5.046	Petrol	1995	4	84.00	90.00	45
835 A7.000	Petrol	1995	4	84.00	90.00	45
835 A7.046	Petrol	1995	4	84.00	90.00	45
835 A8.000	Petrol	1995	4	84.00	90.00	45
835 A8.046	Petrol	1995	4	84.00	90.00	42
835 C1.000	Petrol	1581	4	86.40	67.40	57
835 C2.000	Petrol	1756	4	84.00	79.20	40
835 C4.000	Petrol	1756	4	84.00	79.20	40
835 C5.000	Petrol	1756	4	84.00	79.20	40
836 A2.000	Petrol	1995	4	84.00	90.00	42
836 A2.046	Petrol	1756	4	84.00	79.20	40
836 A3.000	Petrol	1995	4	84.00	90.00	42
836 A4.000	Petrol	1372	4	80.50	67.40	18
836 A5.000	Petrol	1756	4	84.00	79.20	40
836 A6.000	Petrol	1756	4	84.00	79.20	40
836 C4.000	Petrol	1756	4	84.00	79.20	40
838 A1.000	Petrol	1998	5	82.00	75.65	22
838 A2.000	Petrol	2446	5	83.00	90.40	35
838 A2.027	Petrol	2446	5	83.00	90.40	35
838 A3.000	Diesel	2387	5	82.00	90.40	27
838 A4.000	Petrol	1995	4	84.00	90.00	42
838 A6.000	Petrol	1998	5	82.00	75.65	22
838 A7.000	Diesel	2387	5	82.00	90.40	27
838 A8.000	Diesel	2387	5	82.00	90.40	27
838 B.000	Petrol	2959	V6	93.00	72.60	59
839 A4.000	Petrol	1747	4	82.00	82.70	24
839 A5.000	Diesel	2387	5	82.00	90.40	27
839 A6.000	Diesel	2387	5	82.00	90.40	27
839 A7.000	Petrol	1747	4	82.00	82.70	24
839 A9.000	Petrol	1747	4	82.00	82.70	24

		cm3	x 			
840 A2.000	Petrol	1370	4	82.00	64.90	21
840 A3.000	Petrol	1242	4	70.80	78.90	7
840 A4.000	Petrol	1370	4	82.00	64.90	21
841 A.000	Petrol	2959	V6	93.00	72.60	59
841 C.000	Diesel	2387	5	82.00	90.40	27
841 E.000	Petrol	1998	5	82.00	75.65	22
841 G.000	Diesel	2387	5	82.00	90.40	28
841 H.000	Diesel	2387	5	82.00	90.40	28
841 M.000	Diesel	2387	5	82.00	90.40	28
841 N.000	Diesel	2387	5	82.00	90.40	29
841 P.000	Diesel	2387	5	82.00	90.40	29
843 A 1.000	Petrol	1368	4	72.00	84.00	8
844 A1.000	Diesel	1910	4	82.00	90.40	26
844 A2.000	Diesel	1956	4	83.00	90.40	34
937 A2.000	Diesel	1910	4	82.00	90.40	25
937 A5.000	Diesel	1910	4	82.00	90.40	26
939 B1.000	Petrol	1742	4	83.00	80.50	32
944 A 3.000	Diesel	1598	4	79.50	80.50	14
955 A4.000	Diesel	1598	4	79.50	80.50	14
8144.91	Diesel	2445	4	93.00	90.00	60
8144.97	Diesel	2499	4	93.00	92.00	61
8144.97.2200	Diesel	2499	4	93.00	92.00	61
8144.97.2400	Diesel	2499	4	93.00	92.00	61
8144. 97S	Diesel	2500	4	93.00	92.00	61
8144.97 Y	Diesel	2500	4	93.00	92.00	61
A112 A.000	Petrol	903	4	65.00	68.00	1
A112 A2.000	Petrol	1050	4	67.20	74.00	3
A112 A5.000	Petrol	903	4	65.00	68.00	1
A 112 AB.2C.0	Petrol	1050	4	67.20	74.00	3
A112 B1.000	Petrol	965	4	67.20	68.00	2
A112 B2.000	Petrol	903	4	65.00	68.00	1
AR 32302	Diesel	1910	4	82.00	90.40	25
AR 32501	Diesel	2387	5	82.00	90.40	27
AR 37101	Diesel	1910	4	82.00	90.40	25
P 8 C	Diesel	2088	4	85.00	92.00	50
RFN (EW10J4)	Petrol	1997	4	85.00	88.00	48
RFN	Petrol	1997	4	85.00	88.00	47
RFV (XU10J4R)	Petrol	1998	4	86.00	86.00	52
RGX (XU10J2TE)	Petrol	1998	4	86.00	86.00	53
RHK (DW10UTED4)	Diesel	1997	4	85.00	88.00	49
RHM (DW10ATED4)	Diesel	1997	4	85.00	88.00	49
RHR (DW10BTED4)	Diesel	1997	4	85.00	88.00	49
RHW (DW10ATED4)	Diesel	1997	4	85.00	88.00	49
RHZ (DW10ATED)	Diesel	1997	4	85.00	88.00	49



1 65.00 x 68.00									
A112 A.000		4 Cyl.	903cc	21-32kW (29-44PS)			Petrol		TD1856
A112 A5.000		4 Cyl.	903cc	29-31kW (40-42PS)			Petrol		TD1803
A112 B2.000		4 Cyl.	903cc	29-32kW (40-44PS)			Petrol		TD4622
BE/PL	4	39,985/40,005	43,657/43,670	16,550	1,813	0,026/0,084	AL-LF	3025RA	01-4139/4 STD 0.25 0.50
MB/HL 1,3	2	50,785/50,805	54,507/54,520	20,620	1,837	0,028/0,086	AL-LF	62006RA	H1039/3 STD 0.25 0.50
MB/HL 2	1	50,790/50,810	54,507/54,520	22,780	1,837	0,028/0,086	AL-LF	62007RA	
TW/A	2	54,610/54,864	69,596/69,850		2,362		AL-LF	2897AFF	A182/2 STD
2 67.20 x 68.00									
A112 B1.000		4 Cyl.	965cc	35kW (48PS)			Petrol		TD1824
BE/PL	4	39,985/40,005	43,657/43,670	16,550	1,813	0,026/0,084	AL-LF	3025RA	01-4139/4 STD 0.25 0.50
MB/HL 1,3	2	50,785/50,805	54,507/54,520	20,620	1,837	0,028/0,086	AL-LF	62006RA	H1039/3 STD 0.25 0.50
MB/HL 2	1	50,790/50,810	54,507/54,520	22,780	1,837	0,028/0,086	AL-LF	62007RA	
TW/A	2	54,610/54,864	69,596/69,850		2,362		AL-LF	2897AFF	A182/2 STD
3 67.20 x 74.00									
A 112 AB.2C.0		4 Cyl.	1050cc	51kW (70PS)			Petrol		TD22321
A112 A2.000		4 Cyl.	1050cc	51kW (69PS)			Petrol		TD4621
BE/PL	4	39,985/40,005	43,657/43,670	16,550	1,813	0,026/0,084	AL-LF	3025RA	01-4139/4 STD 0.25 0.50
MB/HL 1,3	2	53,910/53,930	57,548/57,561	20,620	1,797		AL-LF	66446RA	H1178/3 STD 0.25
MB/HL 2	1	53,910/53,930	57,548/57,561	21,340	1,797		AL-LF	66447RA	
TW/A	2	59,436/59,960	72,771/73,025		2,320		AL-LF	66447BF	A206/2 STD
4 69.60 x 82.00									
169 A5.000		4 Cyl.	1248cc	55kW (75PS)			Diesel Turbo Intercooler		TD24712
188 A9.000		4 Cyl.	1248cc	51kW (70PS)			Diesel		TD18314
199 A2.000		4 Cyl.	1248cc	55kW (75PS)			Diesel Turbo Intercooler		TD20272
199 A3.000		4 Cyl.	1248cc	66-77kW (90-105PS)			Diesel Turbo Intercooler		TD20273
199 B1.000 Euro 5		4 Cyl.	1248cc	70kW (95PS)			Diesel Turbo Intercooler		TD24672
BE/PL	4	42,582/42,600	45,734/45,744	20,000	1,552	0,030/0,062	BS	71-4033	71-4033/4 STD .010
MB/HL 1,2,4,5	4	50,982/51,000	54,710/54,722	19,000	1,840	0,026/0,050	AL-LF	02-4034	H1011/5 STD 0.25
MB/HL 3	1	50,982/51,000	54,710/54,722	23,950	1,840	0,026/0,050	AL-LF	02-4035H	
SE/PB	1	23,000	25,747/25,772	25,000			BS-LF	55-4077	55-4077 SEMI
5 70.00 x 64.90									
156 A2.000		4 Cyl.	999cc	33-37kW (45-50PS)			Petrol		TD4592
156 A2.048		4 Cyl.	999cc	32kW (44PS)			Petrol		TD1782
156 A2.100		4 Cyl.	999cc	32kW (44PS)			Petrol		TD4593
156 A2.146		4 Cyl.	999cc	33kW (45PS)			Petrol		TD4594
156 A2.246		4 Cyl.	999cc	33kW (45PS)			Petrol		TD5423



156 A2.256		4 Cyl.		999cc	33kW (45PS)	Petrol		TD4595
BE/PL	4	37,998/38,008	41,128/41,140	19,000	1,549	0,022/0,069	AL-LF 1015RA	01-4116/4 STD 0.25 0.50
MB/HL 3	2	48,000/48,100	63,800/64,000		2,325		AL-LF 04-4075	H1067/5 STD 0.25 0.50
MB/HL 1-5	5	43,990/44,000	47,705/47,718	19,000	1,841	0,023/0,081	AL-LF 1016RA	
MB/HL 1-5	9	43,990/44,000	47,705/47,718	19,000	1,848	0,020/0,057	AL-LF 4271RA	H1091/5 STD
MB/HL 3	1	43,990/44,000	47,705/47,718	23,910	1,848	0,020/0,057	AL-LF 4272RAH	

6 70.00 x 72.00

156 C.000		4 Cyl.		1108cc	42kW (57PS)	Petrol		TD1854
156 C.046		4 Cyl.		1108cc	37-40kW (50-54PS)	Petrol		TD4597
176 B2.000		4 Cyl.		1108cc	40kW (54PS)	Petrol		TD11847
BE/PL	4	37,998/38,008	41,128/41,140	19,000	1,549	0,022/0,069	AL-LF 1015RA	01-4116/4 STD 0.25 0.50
MB/HL 3	2	48,000/48,100	63,800/64,000		2,325		AL-LF 04-4075	H1067/5 STD 0.25 0.50
MB/HL 1-5	5	43,990/44,000	47,705/47,718	19,000	1,841	0,023/0,081	AL-LF 1016RA	
MB/HL 1-5	9	43,990/44,000	47,705/47,718	19,000	1,848	0,020/0,057	AL-LF 4271RA	H1091/5 STD
MB/HL 3	1	43,990/44,000	47,705/47,718	23,910	1,848	0,020/0,057	AL-LF 4272RAH	

7 70.80 x 78.90

169 A4.000		4 Cyl.		1242cc	49-51kW (67-69PS)	Petrol		TD25192
176 B9.000		4 Cyl.		1242cc	63kW (86PS)	Petrol		TD11849
188 A4.000		4 Cyl.		1242cc	44kW (60PS)	Petrol		TD15501
188 A5.000 Euro 3		4 Cyl.		1242cc	59kW (80PS)	Petrol		TD15500
840 A3.000		4 Cyl.		1242cc	44kW (60PS)	Petrol		TD1839
BE/PL	4	41,988/42,008	45,127/45,140	19,000	1,548	0,023/0,081	AL-LF 4275RA	01-4154/4 STD 0.25 0.50
MB/HL 3	2	52,000/52,200	68,766/69,020		2,325		AL-LF 04-4076	H1092/5 STD 0.25 0.50
MB/HL 1-5	10	47,980/48,000	51,705/51,718	19,000	1,848	0,020/0,067	AL-LF 4276RA	

8 72.00 x 84.00

192 B2.000		4 Cyl.		1368cc	66kW (90PS)	Petrol		TD20952
350 A1.000		4 Cyl.		1368cc	55-57kW (75-78PS)	Petrol		TD20274
843 A 1.000		4 Cyl.		1368cc	70kW (95PS)	Petrol		TD17979
BE/PL	4	41,988/42,008	45,127/45,140	19,000	1,548	0,023/0,081	AL-LF 4275RA	01-4154/4 STD 0.25 0.50
MB/HL 3	2	52,000/52,200	68,766/69,020		2,325		AL-LF 04-4076	H1092/5 STD 0.25 0.50
MB/HL 1-5	10	47,980/48,000	51,705/51,718	19,000	1,848	0,020/0,067	AL-LF 4276RA	

9 72.00 x 84.00

198 A1.000		4 Cyl.		1368cc	110kW (150PS)	Petrol Turbo		TD21041
198 A4.000		4 Cyl.		1368cc	88kW (120PS)	Petrol Turbo		TD21040
198 A7.000		4 Cyl.		1368cc	103kW (140PS)	Petrol Turbo Intercooler		TD24650
BE/PL	4	41,990/42,008	45,128/45,138	19,000	1,548	0,024/0,068	AL-LF 01-4079	01-4079/4 STD

MB/HL 3	2	52,000/52,200	68,766/69,020		2,325		AL-LF	04-4076	H1092/5 STD 0.25 0.50
MB/HL 1-5	10	47,980/48,000	51,705/51,718	19,000	1,848	0,020/0,067	AL-LF	4276RA	
SE/PB	1	17,970/17,974	20,775/20,800	22,000			BS-LF	55-4078	55-4078 SEMI

10 76.00 x 57.80

156 A.000	4 Cyl.		1049cc	40-41kW (54-56PS)		Petrol		TD21222	
156 A1.000	4 Cyl.		1049cc	62kW (84PS)		Petrol Turbo Intercooler		TD1783	
BE/PL	4	43,988/44,008	47,130/47,142	18,500	1,546	0,030/0,087	AL-LF	68090RA	01-4207/4 STD 0.25 0.50
MB/HL 1,2,4,5	4	48,189/48,209	51,921/51,934	17,650	1,841	0,030/0,088	AL-LF	68091RA	H1069/5 STD 0.25 0.50
MB/HL 3	1	48,189/48,209	51,921/51,934	25,250	1,841	0,030/0,088	AL-LF	68092RA	
TW/A	2	54,224/54,478	66,996/67,520		2,362		AL-LF	68092AF	A221/2 STD
SE/PB	1	21,539/21,641	23,939/23,972	25,100			BS	62039Y	55-4288 SEMI

11 76.00 x 71.50

146 A 5.046	4 Cyl.		1297cc	53kW (72PS)		Petrol		TD4591	
156 B.000	4 Cyl.		1301cc	53-56kW (72-76PS)		Petrol		TD1853	
BE/PL	4	43,988/44,008	47,130/47,142	18,500	1,546	0,030/0,087	AL-LF	68090RA	01-4207/4 STD 0.25 0.50
MB/HL 1,2,4,5	4	48,189/48,209	51,921/51,934	17,650	1,841	0,030/0,088	AL-LF	68091RA	H1069/5 STD 0.25 0.50
MB/HL 3	1	48,189/48,209	51,921/51,934	25,250	1,841	0,030/0,088	AL-LF	68092RA	
TW/A	2	54,224/54,478	66,996/67,520		2,362		AL-LF	68092AF	A221/2 STD
SE/PB	1	21,539/21,641	23,939/23,972	25,100			BS	62039Y	55-4288 SEMI

12 76.00 x 71.50

828 AC.3	4 Cyl.		1297cc	57kW (77PS)		Petrol		FM928	
BE/PL	4	48,224/48,244	51,330/51,346	19,500	1,540	0,020/0,067	AL-LF	66315RA	01-4176/4 STD 0.25 0.50
MB/HL 1,2,4,5	4	52,985/53,005	56,717/56,730	20,750	1,841	0,030/0,088	AL-LF	66316RA	H1043/5 STD 0.25 0.50 0.75
MB/HL 3	1	52,985/53,005	56,717/56,730	24,250	1,841	0,030/0,088	AL-LF	66317RA	
TW/A	2	59,000/59,250	73,600/73,850		2,362		BS	62037AF	A201/2 STD .005
SE/PB	1	21,539/21,641	23,939/23,972	25,100			BS	62039Y	55-4288 SEMI

13 78.00 x 71.50

828 D3.000	4 Cyl.		1367cc	62kW (84PS)		Petrol		TD1798	
BE/PL	4	48,224/48,244	51,330/51,346	19,500	1,540	0,020/0,067	AL-LF	66315RA	01-4176/4 STD 0.25 0.50
MB/HL 1,2,4,5	4	52,985/53,005	56,717/56,730	20,750	1,841	0,030/0,088	AL-LF	66316RA	H1043/5 STD 0.25 0.50 0.75
MB/HL 3	1	52,985/53,005	56,717/56,730	24,250	1,841	0,030/0,088	AL-LF	66317RA	
TW/A	2	59,000/59,250	73,600/73,850		2,362		BS	62037AF	A201/2 STD .005
SE/PB	1	21,539/21,641	23,939/23,972	25,100			BS	62039Y	55-4288 SEMI



14 79.50 x 80.50

				4 Cyl.	1598cc	88kW (120PS)	Diesel Turbo Intercooler		TD21042
198 A2.000				4 Cyl.	1598cc	85kW (116PS)	Diesel Turbo Intercooler		TD24974
350 A3.000				4 Cyl.	1598cc	77kW (105PS)	Diesel Turbo Intercooler		TD25422
944 A 3.000				4 Cyl.	1598cc	85kW (116PS)	Diesel Turbo Intercooler		TD24651
BE/PL	4	48,226/48,244	51,354/51,366	19,100	1,540	0,030/0,056	EC-LF	71-4776	71-4776/4 STD
MB/HL	5		56,705/56,718	20,750	1,861		AL-LF	02-4777	H1293/5 STD
TW/A	2	59,000/59,260	73,600/73,850		2,485		AL-LF	04-4778	A291/2 STD
SE/PB	1	26,000	28,939/28,972	22,100			BS-LF	55-4779	55-4779 SEMI

15 79.50 x 80.50

				4 Cyl.	1598cc	85-88kW (116-120PS)	Diesel Turbo Intercooler		TD22138
350 A2.000				4 Cyl.	1598cc	85-88kW (116-120PS)	Diesel Turbo Intercooler		TD22138
BE/PL	4	48,226/48,244	51,354/51,366	19,100	1,540	0,030/0,056	EC-LF	71-4776	71-4776/4 STD
MB/HL	4	76,187/76,200	80,586/80,607	24,990	2,172	0,038/0,097	BS	66573CP	H1094/5 STD 0.25
MB/HL	1	76,187/76,200	80,586/80,607	31,950	2,172	0,038/0,097	BS	66574CPH	
MB/HL	5		56,705/56,718	20,750	1,861		AL-LF	02-4777	H1293/5 STD

66573CP

66574CPH

02-4777

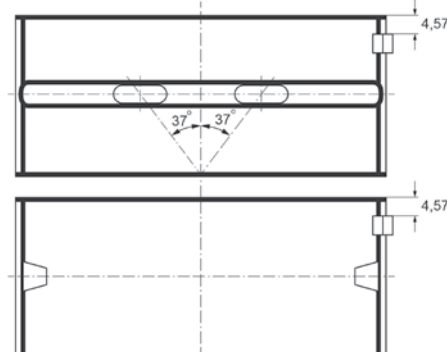
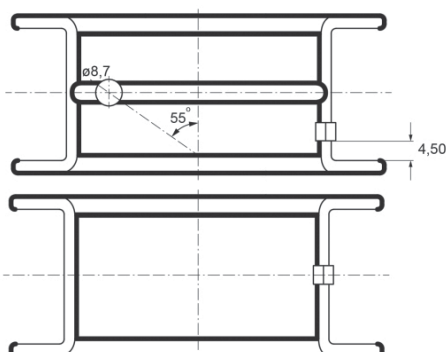
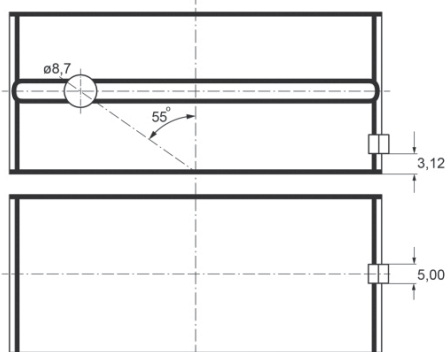

TW/A	2	59,000/59,260	73,600/73,850		2,485		AL-LF	04-4778	A291/2 STD
SE/PB	1	31,990/31,996	34,895/34,920	30,700			BS	66579YA	55-4186 SEMI
SE/PB	1	26,000	28,939/28,972	22,100			BS-LF	55-4779	55-4779 SEMI

16 80.00 x 55.50

				4 Cyl.	1116cc	47kW (64PS)	Petrol		TD1819
831 B8.000				4 Cyl.	1116cc	47kW (64PS)	Petrol		TD1819
BE/PL	4	45,508/45,528	48,629/48,646	19,200	1,547	0,020/0,069	AL-LF	1645RA	01-4127/4 STD 0.25 0.50
MB/HL	4	50,785/50,805	54,507/54,520	20,250	1,831	0,040/0,098	AL-LF	60986RA	H1028/5 STD 0.25
MB/HL	1	50,785/50,805	54,507/54,520	22,750	1,831	0,040/0,098	AL-LF	60987RA	
TW/A	2	56,610/56,864	69,596/69,850		2,362		AL-LF	60987AFA	A198/2 STD .005
SE/PB	1	21,539/21,641	23,939/23,972	25,100			BS	62039Y	55-4288 SEMI

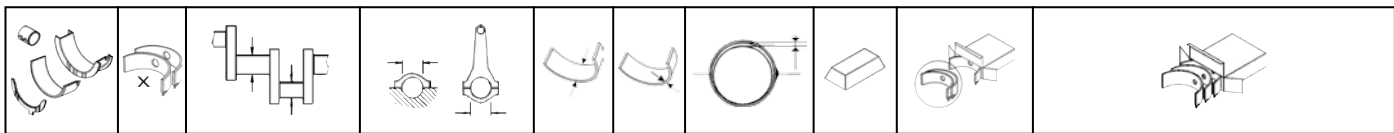

17 80.00 x 71.50

828 A2.000		4 Cyl.		1438cc	66kW (90PS)	Petrol			TD1793
BE/PL	4	45,508/45,528	48,629/48,646	19,200	1,547	0,020/0,069	AL-LF	1645RA	01-4127/4 STD 0.25 0.50
BE/PL	4	45,508/45,528	48,629/48,646	19,200	1,538	0,025/0,087	AL-LF	60985RA	01-4171/4 STD

1645RA

60985RA

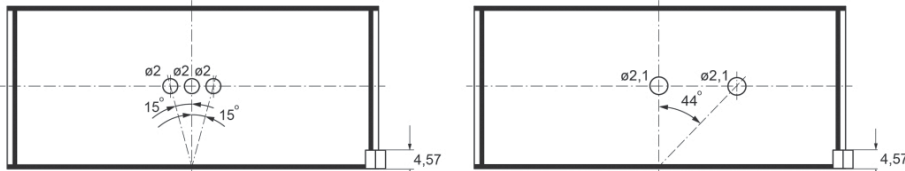

MB/HL 1,2,4,5	4	50,785/50,805	54,507/54,520	20,250	1,831	0,040/0,098	AL-LF	60986RA	H1028/5 STD 0.25
MB/HL 3	1	50,785/50,805	54,507/54,520	22,750	1,831	0,040/0,098	AL-LF	60987RA	
TW/A	2	56,610/56,864	69,596/69,850		2,362		AL-LF	60987AFA	A198/2 STD .005
SE/PB	1	21,539/21,641	23,939/23,972	25,100			BS	62039Y	55-4288 SEMI

18 80.50 x 67.40

160 A1.046		4 Cyl.		1372cc	51kW (69PS)	Petrol			TD4599
836 A4.000		4 Cyl.		1372cc	51kW (69PS)	Petrol			TD14568
BE/PL	4	45,508/45,528	48,629/48,646	19,200	1,547	0,020/0,069	AL-LF	1645RA	01-4127/4 STD 0.25 0.50
MB/HL 1,2,4,5	4	50,780/50,800	54,507/54,520	20,250	1,849	0,020/0,067	AL-LF	1646RA	H1075/5 STD 0.25 0.50
MB/HL 3	1	50,780/50,800	54,507/54,520	22,750	1,849	0,020/0,067	AL-LF	1647RA	
TW/A	2	56,610/56,864	69,596/69,850		2,362		AL-LF	60987AFA	A198/2 STD .005
SE/PB	1	21,539/21,641	23,939/23,972	25,100			BS	62039Y	55-4288 SEMI

19 80.50 x 78.40

182 B6.000		4 Cyl.		1596cc	76kW (103PS)	Petrol			TD15632
BE/PL	4	45,508/45,528	48,629/48,646	19,200	1,547	0,020/0,069	AL-LF	1645RA	01-4127/4 STD 0.25 0.50
MB/HL 1,2,4,5	4	50,780/50,800	54,507/54,520	20,250	1,849	0,020/0,067	AL-LF	1646RA	H1075/5 STD 0.25 0.50
MB/HL 3	1	50,780/50,800	54,507/54,520	22,750	1,849	0,020/0,067	AL-LF	1647RA	
TW/A	2	56,610/56,864	69,596/69,850		2,362		AL-LF	60987AFA	A198/2 STD .005
SE/PB	1	21,539/21,641	23,939/23,972	25,100			BS	62039Y	55-4288 SEMI

20 80.50 x 86.00

312 A2.000 Euro 5		2 Cyl.		875cc	59-63kW (80-86PS)	Petrol Turbo Intercooler			TD25191
312 A5.000 Euro 6		2 Cyl.		875cc	57-63kW (77-86PS)	Petrol Turbo Intercooler			TD31269
BE/PL	2	41,982/42,000	45,125/45,135	18,000	1,550	0,025/0,061	AL-LF	01-4967	01-4967/2 STD
MB/HL 1-3	3	47,982/48,000	51,705/51,718	16,150	1,846	0,022/0,069	AL-LF	02-4968	H1337/3 STD
TW/A	2	53,100/53,300	68,766/69,020		2,335	0,105/0,275	AL-LF	04-4969	A321/2 STD



SE/PB	1		23,939/23,972	22,070			BS-LF	55-4970	55-4970 SEMI
-------	---	--	---------------	--------	--	--	-------	---------	------------------------

21 82.00 x 64.90

840 A2.000			4 Cyl.	1370cc	55-59kW (75-80PS)		Petrol		TD1858
840 A4.000			4 Cyl.	1370cc	55kW (75PS)		Petrol		TD4596
BE/PL	4	40,870/40,890	44,000/44,012	19,100	1,543	0,024/0,081	AL-LF	4400RA	01-4160/4 STD 0.25
MB/HL 1,2,4,5	4	52,982/53,000	56,705/56,718	20,750	1,843	0,019/0,075	AL-LF	4351RA	H1096/5 STD 0.25 0.50
MB/HL 3	1	52,982/53,000	56,705/56,718	20,750	1,838	0,029/0,085	AL-LF	4352RA	
TW/A	2	58,808/59,062	73,486/73,740		2,485		AL-LF	4351AF	A190/2 STD
SE/PB	1	19,993/20,000	22,939/22,972	21,700			BS	4359Y	55-4540 SEMI

22 82.00 x 75.65

175 A3.000			5 Cyl.	1998cc	162kW (220PS)		Petrol Turbo		TD11550
182 B7.000			5 Cyl.	1998cc	113kW (154PS)		Petrol		TD14389
838 A1.000			5 Cyl.	1998cc	107kW (146PS)		Petrol		TD4616
838 A6.000			5 Cyl.	1998cc	114kW (155PS)		Petrol		TD5436
841 E.000			5 Cyl.	1998cc	136kW (185PS)		Petrol Turbo Intercooler		TD16731
BE/PL	5	48,226/48,244	51,354/51,366	19,100	1,543	0,020/0,080	BS	4355CP	71-4209/5 STD 0.25 0.50
MB/HL 1-6	6	59,986/60,000	63,705/63,718	20,750	1,844	0,031/0,075	BS	4356CP	H1095/6 STD 0.25 0.50
TW/A	2	67,785/68,040	82,425/82,677		2,485		AL-LF	4356AF	A191/2 STD
SE/PB	1	19,993/20,000	22,939/22,972	21,700			BS	4359Y	55-4540 SEMI

23 82.00 x 75.70

185 A8.000			5 Cyl.	1998cc	110kW (150PS)		Petrol		TD15630
BE/PL	5	48,226/48,244	51,354/51,366	19,100	1,543	0,020/0,080	BS	4355CP	71-4209/5 STD 0.25 0.50
MB/HL 1-6	6	59,986/60,000	63,705/63,718	20,750	1,844	0,031/0,075	BS	4356CP	H1095/6 STD 0.25 0.50
TW/A	2	67,785/68,040	82,425/82,677		2,485		AL-LF	4356AF	A191/2 STD
SE/PB	1	19,993/20,000	22,939/22,972	21,700			BS	4359Y	55-4540 SEMI

24 82.00 x 82.70

182 A2.000			4 Cyl.	1747cc	83kW (113PS)		Petrol		TD9473
183 A1.000			4 Cyl.	1747cc	96kW (131PS)		Petrol		TD9474
839 A4.000			4 Cyl.	1747cc	96kW (131PS)		Petrol		TD14468
839 A7.000			4 Cyl.	1747cc	96kW (131PS)		Petrol		TD15633
839 A9.000			4 Cyl.	1747cc	96kW (131PS)		Petrol		TD17508
BE/PL	4	50,787/50,807	53,901/53,913	19,500	1,534	0,028/0,083	BS	4350CP	71-4157/4 STD 0.25 0.50
MB/HL 1,2,4,5	4	52,982/53,000	56,705/56,718	20,750	1,843	0,019/0,075	AL-LF	4351RA	H1096/5 STD 0.25 0.50
MB/HL 3	1	52,982/53,000	56,705/56,718	20,750	1,838	0,029/0,085	AL-LF	4352RA	
TW/A	2	58,808/59,062	73,486/73,740		2,485		AL-LF	4351AF	A190/2 STD
SE/PB	1	19,993/20,000	22,939/22,972	21,700			BS	4359Y	55-4540 SEMI



25		82.00 x 90.40								
188 B2.000		4 Cyl.		1910cc	74kW (101PS)	Diesel Turbo Intercooler			TD18316	
937 A2.000		4 Cyl.		1910cc	85kW (116PS)	Diesel Turbo Intercooler			TD18313	
AR 32302		4 Cyl.		1910cc	77kW (105PS)	Diesel Turbo			TD17398	
AR 37101		4 Cyl.		1910cc	80-85kW (109-116PS)	Diesel Turbo Intercooler			TD17890	
BE/PL	1	50,787/50,805	53,901/53,913	19,500	1,534	0,030/0,080	EC	71-3994	71-3994 STD 0.25 [4]	
MB/HL 1-5	5	59,986/60,000	63,705/63,718	20,750	1,844	0,031/0,075	BS	4356CP	H1095/5 STD 0.25 0.50	
TW/A	2	67,785/68,040	82,425/82,677		2,485		AL-LF	4356AF	A191/2 STD	
SE/PB	1		28,939/28,972	21,700			BS	4369Y	55-4159 SEMI	

26		82.00 x 90.40								
844 A1.000		4 Cyl.		1910cc	140kW (190PS)	Diesel Bi-Turbo Intercooler			TD21044	
937 A5.000		4 Cyl.		1910cc	110kW (150PS)	Diesel Turbo Intercooler			TD21086	
BE/PL	1	50,787/50,805	53,901/53,913	19,500	1,534	0,030/0,080	EC	71-3994	71-3994 STD 0.25 [4]	
BE/PL	1	50,787/50,805	53,901/53,913	19,500	1,534	0,030/0,080	EC-LF	71-4780	71-4780 STD [5]	

71-3994

71-4780

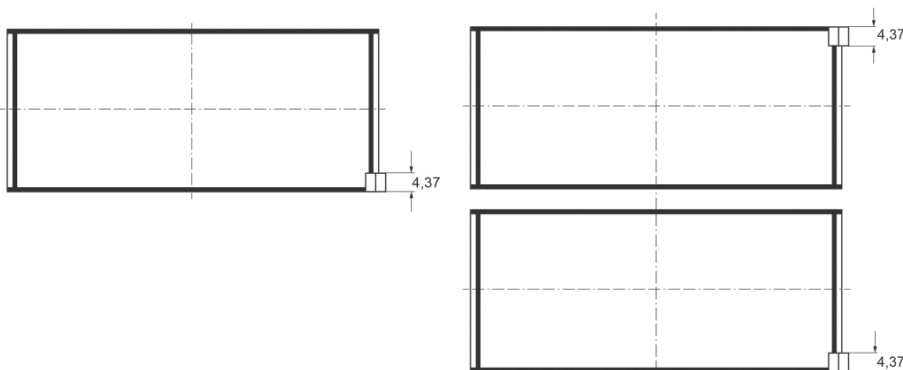

MB/HL	1	59,986/60,000	63,705/63,718	20,750	1,844	0,031/0,080	EC	72-3995	72-3995 STD 0.25 0.50
TW/A	2	67,785/68,040	82,425/82,677		2,485		AL-LF	4356AF	A191/2 STD
SE/PB	1		28,939/28,972	21,700			BS	4369Y	55-4159 SEMI

27		82.00 x 90.40								
838 A3.000		5 Cyl.		2387cc	91kW (124PS)	Diesel Turbo Intercooler			TD4618	
838 A7.000		5 Cyl.		2387cc	91kW (124PS)	Diesel Turbo Intercooler			TD5437	
838 A8.000		5 Cyl.		2387cc	100kW (136PS)	Diesel Turbo			TD11551	
839 A5.000		5 Cyl.		2387cc	96-99kW (131-135PS)	Diesel Turbo Intercooler			TD17399	
839 A6.000 Euro 3		5 Cyl.		2387cc	103kW (140PS)	Diesel Turbo Intercooler			TD15631	
841 C.000		5 Cyl.		2387cc	110kW (150PS)	Diesel Turbo Intercooler			TD16472	
AR 32501		5 Cyl.		2387cc	99-100kW (135-136PS)	Diesel Turbo Intercooler			TD17400	
BE/PL	1	50,787/50,805	53,901/53,913	19,500	1,534	0,030/0,080	EC	71-3994	71-3994 STD 0.25 [4]	
MB/HL 1-6	6	59,986/60,000	63,705/63,718	20,750	1,844	0,031/0,075	BS	4356CP	H1095/6 STD 0.25 0.50	
TW/A	2	67,785/68,040	82,425/82,677		2,485		AL-LF	4356AF	A191/2 STD	
SE/PB	1		28,939/28,972	21,700			BS	4369Y	55-4159 SEMI	



28 82.00 x 90.40

841 G.000			5 Cyl.	2387cc	129kW (175PS)		Diesel Turbo Intercooler	TD18317		
841 H.000			5 Cyl.	2387cc	129kW (175PS)		Diesel Turbo Intercooler	TD20953		
841 M.000			5 Cyl.	2387cc	120-147kW (163-200PS)		Diesel Turbo Intercooler	TD19057		
BE/PL	1	50,787/50,805	53,901/53,913	19,500	1,534	0,030/0,080	EC	71-3994	71-3994 STD 0.25	[4]
MB/HL	1	59,986/60,000	63,705/63,718	20,750	1,844	0,031/0,080	EC	72-3995	72-3995 STD 0.25 0.50	
TW/A	2	67,785/68,040	82,425/82,677		2,485		AL-LF	4356AF	A191/2 STD	
SE/PB	1		28,939/28,972	21,700			BS	4369Y	55-4159 SEMI	

29 82.00 x 90.40

841 N.000			5 Cyl.	2387cc	120kW (163PS)		Diesel Turbo Intercooler	TD19058		
841 P.000			5 Cyl.	2387cc	136kW (185PS)		Diesel Turbo Intercooler	TD20954		
BE/PL	1	50,787/50,805	53,901/53,913	19,500	1,534	0,030/0,080	EC-LF	71-4780	71-4780 STD	[5]
MB/HL	1	59,986/60,000	63,705/63,718	20,750	1,844	0,031/0,080	EC	72-3995	72-3995 STD 0.25 0.50	

30 82.60 x 90.00

160 D1.000			4 Cyl.	1929cc	66kW (90PS)		Diesel Turbo Intercooler	TD4610		
835 A4.000			4 Cyl.	1929cc	66kW (90PS)		Diesel Turbo	TD1846		
835 A4.046			4 Cyl.	1929cc	66kW (90PS)		Diesel Turbo	TD5425		
MB/HL 1,2,4,5	4	52,990/53,010	56,717/56,735	20,750	1,843	0,020/0,080	BS	4128CP	H1084/5 STD 0.25 0.50	
MB/HL 3	1	52,990/53,010	56,717/56,735	24,250	1,843	0,020/0,080	BS	4129CP		
TW/A	2	59,000/59,250	73,600/73,850		2,362		BS	62037AF	A201/2 STD .005	
SE/PB	1	25,004/25,010	26,939/26,972	25,400			BS	66644Y	55-4190 SEMI	
SE/PB	1	26,004/26,010	27,939/27,972	25,400			BS	66644YA	55-4232 SEMI	
SE/PB	1	25,500/25,640	27,939/27,972	23,800			BS	66644YB	55-4233 SEMI	

66644Y

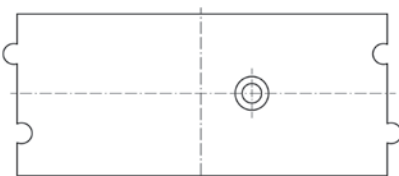

66644YA

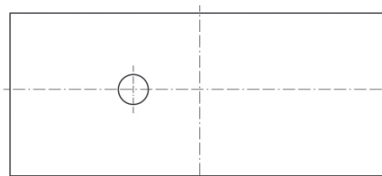

66644YB

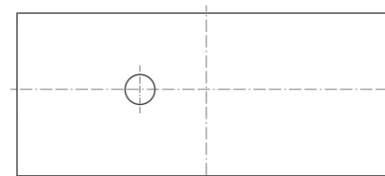

31 82.60 x 90.00

831 D.000			4 Cyl.	1911cc	48kW (65PS)		Diesel	TD1813		
831 D1.000			4 Cyl.	1929cc	48-59kW (55-80PS)		Diesel Turbo Intercooler	TD4607		
BE/PL	4	50,787/50,807	53,892/53,910	19,500	1,537	0,020/0,070	BS	1040CP	71-4118/4 STD 0.25 0.50	
→02/89										
MB/HL 1,2,4,5	4	52,990/53,010	56,717/56,735	20,750	1,843	0,020/0,080	BS	4128CP	H1084/5 STD 0.25 0.50	
MB/HL 3	1	52,990/53,010	56,717/56,735	24,250	1,843	0,020/0,080	BS	4129CP		

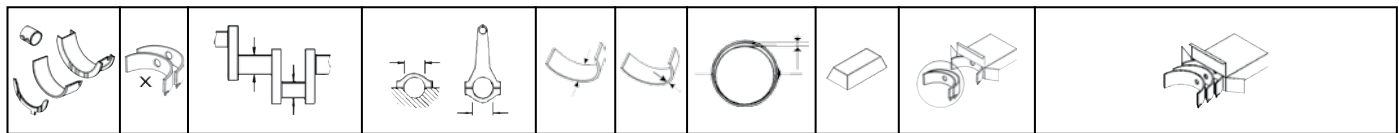

TW/A	2	59,000/59,250	73,600/73,850		2,362		BS	62037AF	A201/2 STD .005
SE/PB	1	25,004/25,010	26,939/26,972	25,400			BS	66644Y	55-4190 SEMI
SE/PB	1	26,004/26,010	27,939/27,972	25,400			BS	66644YA	55-4232 SEMI
SE/PB	1	25,500/25,640	27,939/27,972	23,800			BS	66644YB	55-4233 SEMI

66644Y

66644YA

66644YB

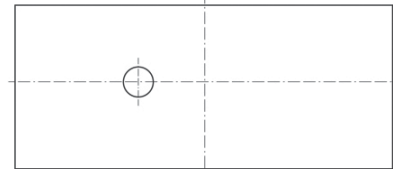
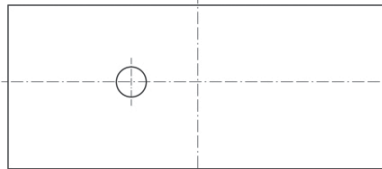
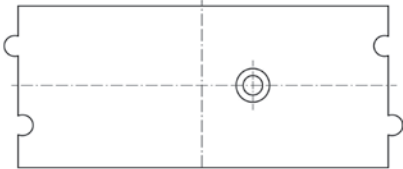

32 83.00 x 80.50

939 B1.000		4 Cyl.		1742cc	147kW (200PS)	Petrol Turbo		TD24691
BE/PL	4	48,226/48,244	51,354/51,366	19,100	1,540	0,030/0,056	EC-LF 71-4776	71-4776/4 STD [5]
MB/HL	5		56,705/56,718	20,750	1,861		AL-LF 02-4777	H1293/5 STD
TW/A	2	59,000/59,260	73,600/73,850		2,485		AL-LF 04-4778	A291/2 STD
SE/PB	1	26,000	28,939/28,972	22,100			BS-LF 55-4779	55-4779 SEMI

33 83.00 x 90.40

198 A5.000		4 Cyl.		1956cc	121kW (165PS)	Diesel Turbo Intercooler		TD21043
BE/PL	1	50,787/50,805	53,901/53,913	19,500	1,534	0,030/0,080	EC-LF 71-4780	71-4780 STD [5]
MB/HL	1	59,986/60,000	63,705/63,718	20,750	1,844	0,031/0,080	EC 72-3995	72-3995 STD 0.25 0.50
TW/A	2	67,785/68,040	82,425/82,677		2,485		AL-LF 4356AF	A191/2 STD
SE/PB	1		28,939/28,972	21,700			BS 4369Y	55-4159 SEMI

34 83.00 x 90.40

844 A2.000		4 Cyl.		1956cc	120kW (163PS)	Diesel Turbo		TD24652
BE/PL	1	50,787/50,805	53,901/53,913	19,500	1,534	0,030/0,080	EC 71-3994	71-3994 STD 0.25 [4]
BE/PL	1	50,787/50,805	53,901/53,913	19,500	1,534	0,030/0,080	EC-LF 71-4780	71-4780 STD [5]

71-3994

71-4780



MB/HL	1	59,986/60,000	63,705/63,718	20,750	1,844	0,031/0,080	EC 72-3995	72-3995 STD 0.25 0.50
-------	---	---------------	---------------	--------	-------	-------------	------------	---------------------------------

TW/A	2	67,785/68,040	82,425/82,677		2,485		AL-LF	4356AF	A191/2 STD
SE/PB	1		28,939/28,972	21,700			BS	4369Y	55-4159 SEMI

35 83.00 x 90.40

838 A2.000			5 Cyl.	2446cc	129kW (175PS)		Petrol		TD4617
838 A2.027			5 Cyl.	2446cc	129kW (175PS)		Petrol		TD14528
BE/PL	5	50,787/50,807	53,901/53,913	19,500	1,534	0,028/0,083	BS	4350CP	71-4157/5 STD 0.25
MB/HL 1-6	6	59,986/60,000	63,705/63,718	20,750	1,844	0,031/0,075	BS	4356CP	H1095/6 STD 0.25 0.50
TW/A	2	67,785/68,040	82,425/82,677		2,485		AL-LF	4356AF	A191/2 STD
SE/PB	1	19,993/20,000	22,939/22,972	21,700			BS	4359Y	55-4540 SEMI

36 84.00 x 71.50

149 C2.000			4 Cyl.	1585cc	66kW (90PS)		Petrol		TD5432
828 B.000			4 Cyl.	1585cc	74kW (100PS)		Petrol		TD1796
831 A4.000			4 Cyl.	1585cc	77kW (105PS)		Petrol		TD4604
831 B6.000			4 Cyl.	1585cc	73kW (99PS)		Petrol		TD1815
831 B7.000			4 Cyl.	1585cc	80kW (109PS)		Petrol		TD1817
BE/PL	4	48,224/48,244	51,330/51,346	19,500	1,540	0,020/0,067	AL-LF	66315RA	01-4176/4 STD 0.25 0.50
MB/HL 1,2,4,5	4	52,985/53,005	56,717/56,730	20,750	1,841	0,030/0,088	AL-LF	66316RA	H1043/5 STD 0.25 0.50 0.75
MB/HL 3	1	52,985/53,005	56,717/56,730	24,250	1,841	0,030/0,088	AL-LF	66317RA	
TW/A	2	59,000/59,250	73,600/73,850		2,362		BS	62037AF	A201/2 STD .005
SE/PB	1	21,539/21,641	23,939/23,972	25,100			BS	62039Y	55-4288 SEMI

37 84.00 x 71.50

831 A7.000			4 Cyl.	1585cc	96kW (130PS)		Petrol Turbo Intercooler		TD1808
831 B3.000			4 Cyl.	1585cc	103kW (140PS)		Petrol Turbo Intercooler		TD1807
831 B7.046			4 Cyl.	1585cc	97kW (132PS)		Petrol Turbo Intercooler		TD4606
BE/PL	4	48,224/48,244	51,330/51,346	19,500	1,540	0,020/0,067	AL-LF	66315RA	01-4176/4 STD 0.25 0.50
MB/HL 1,2,4,5	4	52,990/53,010	56,717/56,735	20,750	1,843	0,020/0,080	BS	4128CP	H1084/5 STD 0.25 0.50
MB/HL 3	1	52,990/53,010	56,717/56,735	24,250	1,843	0,020/0,080	BS	4129CP	
TW/A	2	59,000/59,250	73,600/73,850		2,362		BS	62037AF	A201/2 STD .005
SE/PB	1	21,539/21,641	23,939/23,972	25,100			BS	62039Y	55-4288 SEMI

38 84.00 x 79.20

132 B1.000			4 Cyl.	1756cc	77-82kW (105-112PS)		Petrol		TD21378
132 BB.1A 0			4 Cyl.	1756cc	77-82kW (105-112PS)		Petrol		TD22281
BE/PL	4	50,782/50,802	53,897/53,913	19,500	1,537	0,021/0,082	AL-LF	66240RA	01-4175/4 STD 0.25 0.50 0.75 1.00

MB/HL 1,2,4,5	4	52,985/53,005	56,717/56,730	20,750	1,841	0,030/0,088	AL-LF	66316RA	H1043/5 STD 0.25 0.50 0.75	
MB/HL 3	1	52,985/53,005	56,717/56,730	24,250	1,841	0,030/0,088	AL-LF	66317RA		
TW/A	2	59,000/59,250	73,600/73,850		2,362		BS	62037AF	A201/2 STD .005	
SE/PB	1	21,539/21,641	25,000/25,021	25,100			BS	66649Y	55-4193 SEMI	
SE/PB	1	21,539/21,641	23,939/23,972	25,100			BS	62039Y	55-4288 SEMI	

39
84.00 x 79.20

828 A1.000		4 Cyl.	1756cc	81kW (110PS)		Petrol			TD1792
BE/PL	4	50,782/50,802	53,897/53,913	19,500	1,537	0,021/0,082	AL-LF	66240RA	01-4175/4 STD 0.25 0.50 0.75 1.00
MB/HL 1,2,4,5	4	52,985/53,005	56,717/56,730	20,750	1,841	0,030/0,088	AL-LF	66316RA	H1043/5 STD 0.25 0.50 0.75
MB/HL 3	1	52,985/53,005	56,717/56,730	24,250	1,841	0,030/0,088	AL-LF	66317RA	
TW/A	2	59,000/59,250	73,600/73,850		2,362		BS	62037AF	A201/2 STD .005
SE/PB	1	21,539/21,641	23,939/23,972	25,100			BS	62039Y	55-4288 SEMI

40
84.00 x 79.20

835 A2.000		4 Cyl.	1756cc	80kW (108PS)		Petrol			TD1845
835 A2.046		4 Cyl.	1756cc	74-77kW (101-105PS)		Petrol			TD1844
835 C2.000		4 Cyl.	1756cc	76kW (103PS)		Petrol			TD4612
835 C4.000		4 Cyl.	1756cc	66kW (90PS)		Petrol			TD5433
835 C5.000		4 Cyl.	1756cc	66kW (90PS)		Petrol			TD1847
836 A2.046		4 Cyl.	1756cc	74kW (101PS)		Petrol			TD4613
836 A5.000		4 Cyl.	1756cc	74kW (101PS)		Petrol			TD4615
836 A6.000		4 Cyl.	1756cc	66kW (90PS)		Petrol			TD11918
836 C4.000		4 Cyl.	1756cc	66kW (90PS)		Petrol			TD5434
BE/PL	4	50,792/50,805	53,892/53,910	19,500	1,537	0,010/0,070	BS	1150CP	71-4120/4 STD 0.25 0.50
MB/HL 1,2,4,5	4	52,985/53,005	56,717/56,730	20,750	1,841	0,030/0,088	AL-LF	66316RA	H1043/5 STD 0.25 0.50 0.75
MB/HL 3	1	52,985/53,005	56,717/56,730	24,250	1,841	0,030/0,088	AL-LF	66317RA	
TW/A	2	59,000/59,250	73,600/73,850		2,362		BS	62037AF	A201/2 STD .005
SE/PB	1	21,539/21,641	25,000/25,021	25,100			BS	66649Y	55-4193 SEMI

41
84.00 x 90.00

134 AS.000		4 Cyl.	1995cc	88kW (120PS)		Petrol			TD1781
828 B4.000		4 Cyl.	1995cc	90kW (122PS)		Petrol			TD4602
828 B7.000		4 Cyl.	1995cc	99kW (135PS)		Petrol			TD1800
BE/PL	4	50,782/50,802	53,897/53,913	19,500	1,537	0,021/0,082	AL-LF	66240RA	01-4175/4 STD 0.25 0.50 0.75 1.00
MB/HL 1,2,4,5	4	52,985/53,005	56,717/56,730	20,750	1,841	0,030/0,088	AL-LF	66316RA	H1043/5 STD 0.25 0.50 0.75
MB/HL 3	1	52,985/53,005	56,717/56,730	24,250	1,841	0,030/0,088	AL-LF	66317RA	
TW/A	2	59,000/59,250	73,600/73,850		2,362		BS	62037AF	A201/2 STD .005
SE/PB	1	21,539/21,641	25,000/25,021	25,100			BS	66649Y	55-4193 SEMI



SE/PB	1	21,539/21,641	23,939/23,972	25,100				BS	62039Y	55-4288 SEMI
-------	---	---------------	---------------	--------	--	--	--	----	--------	------------------------

42 84.00 x 90.00

175 A4.000			4 Cyl.	1995cc	142kW (193PS)				Petrol Turbo	TD11827
831 D5.000			4 Cyl.	1995cc	144kW (196PS)				Petrol Turbo	TD1825
831 E5.000			4 Cyl.	1995cc	155kW (211PS)				Petrol Turbo	TD1827
831 E5.046			4 Cyl.	1995cc	155kW (211PS)				Petrol Turbo	TD1826
834 C1.000			4 Cyl.	1995cc	133kW (181PS)				Petrol Turbo Intercooler	TD1835
834 C1.246			4 Cyl.	1995cc	130kW (177PS)				Petrol Turbo Intercooler	TD1836
834 F1.000			4 Cyl.	1995cc	110-112kW (150-152PS)				Petrol	TD1831
834 F2.000			4 Cyl.	1995cc	148kW (202PS)				Petrol Turbo Intercooler	TD1840
835 A8.046			4 Cyl.	1995cc	119kW (162PS)				Petrol Turbo	TD1852
836 A2.000			4 Cyl.	1995cc	137kW (186PS)				Petrol Turbo Intercooler	TD5435
836 A3.000			4 Cyl.	1995cc	102-108kW (139-147PS)				Petrol	TD4614
838 A4.000			4 Cyl.	1995cc	151kW (205PS)				Petrol Turbo	TD4619

BE/PL	4	50,787/50,807	53,901/53,913	19,500	1,534	0,028/0,083	BS	4350CP	71-4157/4 STD 0.25 0.50
MB/HL 1,2,4,5	4	52,990/53,010	56,717/56,735	20,750	1,843	0,020/0,080	BS	4128CP	H1084/5 STD 0.25 0.50
MB/HL 3	1	52,990/53,010	56,717/56,735	24,250	1,843	0,020/0,080	BS	4129CP	
TW/A	2	59,000/59,250	73,600/73,850		2,362		BS	62037AF	A201/2 STD .005
SE/PB	1	21,539/21,641	25,000/25,021	25,100			BS	66649Y	55-4193 SEMI

43 84.00 x 90.00

828 B1.000			4 Cyl.	1995cc	85-88kW (116-119PS)				Petrol	TD1797
BE/PL	4	48,224/48,244	51,330/51,346	19,500	1,540	0,020/0,067	AL-LF	66315RA	01-4176/4 STD 0.25 0.50	
MB/HL 1,2,4,5	4	52,985/53,005	56,717/56,730	20,750	1,841	0,030/0,088	AL-LF	66316RA	H1043/5 STD 0.25 0.50 0.75	
MB/HL 3	1	52,985/53,005	56,717/56,730	24,250	1,841	0,030/0,088	AL-LF	66317RA		
TW/A	2	59,000/59,250	73,600/73,850		2,362		BS	62037AF	A201/2 STD .005	
SE/PB	1	21,539/21,641	23,939/23,972	25,100			BS	62039Y	55-4288 SEMI	

44 84.00 x 90.00

831 B4.000			4 Cyl.	1995cc	85kW (115PS)				Petrol	TD1812
834 B.000			4 Cyl.	1995cc	88kW (120PS)				Petrol	TD1833
834 B.048			4 Cyl.	1995cc	83-85kW (112-113PS)				Petrol	TD1829
834 B.146			4 Cyl.	1995cc	85kW (116PS)				Petrol	TD1818
834 B1.000			4 Cyl.	1995cc	86kW (117PS)				Petrol	TD1830

BE/PL	4	50,792/50,805	53,892/53,910	19,500	1,537	0,010/0,070	BS	1150CP	71-4120/4 STD 0.25 0.50
MB/HL 1,2,4,5	4	52,985/53,005	56,717/56,730	20,750	1,841	0,030/0,088	AL-LF	66316RA	H1043/5 STD 0.25 0.50 0.75
MB/HL 3	1	52,985/53,005	56,717/56,730	24,250	1,841	0,030/0,088	AL-LF	66317RA	
TW/A	2	59,000/59,250	73,600/73,850		2,362		BS	62037AF	A201/2 STD .005
SE/PB	1	21,539/21,641	25,000/25,021	25,100			BS	66649Y	55-4193 SEMI



45										84.00 x 90.00	
831 B5.000			4 Cyl.	1995cc	122kW	(166PS)		Petrol Turbo Intercooler		TD1823	
831 C5.000			4 Cyl.	1995cc	133kW	(181PS)		Petrol Turbo		TD1821	
831 C5.046			4 Cyl.	1995cc	130kW	(177PS)		Petrol Turbo		TD1822	
834 C.000			4 Cyl.	1995cc	122kW	(166PS)		Petrol Turbo Intercooler		TD1834	
834 C.146			4 Cyl.	1995cc	110kW	(150PS)		Petrol Turbo Intercooler		TD1837	
835 A5.046			4 Cyl.	1995cc	82-83kW	(112-113PS)		Petrol		TD1848	
835 A7.000			4 Cyl.	1995cc	121kW	(165PS)		Petrol Turbo Intercooler		TD1849	
835 A7.046			4 Cyl.	1995cc	124kW	(169PS)		Petrol Turbo		TD1850	
835 A8.000			4 Cyl.	1995cc	130-132kW	(177-180PS)		Petrol Turbo		TD14588	
BE/PL	4	50,787/50,807	53,892/53,910	19,500	1,537	0,020/0,070	BS	1040CP	71-4118/4 STD 0.25 0.50		
MB/HL 1,2,4,5	4	52,990/53,010	56,717/56,735	20,750	1,843	0,020/0,080	BS	4128CP	H1084/5 STD 0.25 0.50		
MB/HL 3	1	52,990/53,010	56,717/56,735	24,250	1,843	0,020/0,080	BS	4129CP			
TW/A	2	59,000/59,250	73,600/73,850		2,362		BS	62037AF	A201/2 STD .005		
SE/PB	1	21,539/21,641	25,000/25,021	25,100			BS	66649Y	55-4193 SEMI		

46										84.00 x 90.00	
834 B2.000			4 Cyl.	1995cc	108kW	(147PS)		Petrol		TD14549	
834 B2.246			4 Cyl.	1995cc	104kW	(141PS)		Petrol Turbo		TD1832	
835 A5.000			4 Cyl.	1995cc	86kW	(117PS)		Petrol		TD14589	
BE/PL	4	50,787/50,807	53,901/53,913	19,500	1,534	0,028/0,083	BS	4350CP	71-4157/4 STD 0.25 0.50		
MB/HL 1,2,4,5	4	52,985/53,005	56,717/56,730	20,750	1,841	0,030/0,088	AL-LF	66316RA	H1043/5 STD 0.25 0.50 0.75		
MB/HL 3	1	52,985/53,005	56,717/56,730	24,250	1,841	0,030/0,088	AL-LF	66317RA			
TW/A	2	59,000/59,250	73,600/73,850		2,362		BS	62037AF	A201/2 STD .005		
SE/PB	1	21,539/21,641	25,000/25,021	25,100			BS	66649Y	55-4193 SEMI		

47										85.00 x 88.00	
RFN			4 Cyl.	1997cc	100kW	(136PS)		Petrol		TD16322	
BE/PL	4	44,975/44,991	48,655/48,671	22,500	1,825	0,020/0,070	AL	4300RA	01-4155/4 STD 0.30		
MB/HL 1-5	5	59,981/60,000	63,708/63,727	21,000	1,862	0,020/0,083	AL-LF	02-3957	H086/5 STD		
TW/A	2	67,050/67,300	83,050/83,300		2,330		AL	04-3980	A161/2 STD		

48										85.00 x 88.00	
RFN (EW10J4)			4 Cyl.	1997cc	100kW	(136PS)		Petrol		TD16734	
BE/PL	4	44,975/44,991	48,655/48,671	22,500	1,825	0,020/0,070	AL	4300RA	01-4155/4 STD 0.30		
MB/HL 1-5	5	59,981/60,000	63,708/63,727	21,000	1,862	0,020/0,083	AL-LF	02-3957	H086/5 STD		
TW/A	2	67,050/67,300	83,050/83,300		2,330		AL	04-3980	A161/2 STD		
CB/NWB	4	27,982/28,000	31,200/31,218	18,150	1,594		AL-LF	03-3981	N151/6 STD		
CB/NWB	8	27,982/28,000	31,200/31,218	18,150	1,594		AL-LF	03-3982			



49 85.00 x 88.00

RHK (DW10UTED4) Euro 4		4 Cyl.	1997cc	79-88kW (107-120PS)	Diesel Turbo Intercooler	TD26952				
RHM (DW10ATED4)		4 Cyl.	1997cc	79kW (107PS)	Diesel Turbo Intercooler	TD26957				
RHR (DW10BTED4) Euro 4		4 Cyl.	1997cc	100kW (136PS)	Diesel Turbo Intercooler	TD26955				
RHW (DW10ATED4)		4 Cyl.	1997cc	80kW (109PS)	Diesel Turbo Intercooler	TD16735				
RHZ (DW10ATED)		4 Cyl.	1997cc	80kW (109PS)	Diesel Turbo	TD26954				
BE/PL	4	49,984/50,000	53,695/53,708	20,000	1,838	0,020/0,070	SP	71-3952	71-3952/4 STD 0.30	1
MB/HL 1-5	5	59,981/60,000	63,731/63,750	20,290	1,845	0,040/0,100	AL-LF	66726RA	H1057/5 STD 0.30 0.50	
TW/A	4	67,050/67,300	83,050/83,300		2,330		BS	66721BF	A214/4 STD 0.10	
SE/PB	1	27,997/28,000	30,200/30,225	24,050			BS-LF	55-3985	55-3985 SEMI	
CB/NWB	4	27,982/28,000	31,200/31,218	18,150	1,594		AL-LF	03-3981	N151/6 STD	
CB/NWB	8	27,982/28,000	31,200/31,218	18,150	1,594		AL-LF	03-3982		

50 85.00 x 92.00

P 8 C		4 Cyl.	2088cc	80kW (109PS)	Diesel Turbo	TD1859				
BE/PL	4	49,984/50,000	53,695/53,708	21,950	1,843	0,020/0,064	BS	4255CP	71-4279/4 STD 0.30	
MB/HL 1-5	5	59,981/60,000	63,731/63,750	20,290	1,845	0,040/0,100	AL-LF	66726RA	H1057/5 STD 0.30 0.50	
TW/A	4	67,050/67,300	83,050/83,300		1,880		AL-LF	4141AF	A188/4 STD	

51 85.00 x 96.00

4HP		4 Cyl.	2179cc	120kW (163PS)	Diesel Turbo Intercooler	TD24689				
4HR		4 Cyl.	2179cc	120kW (163PS)	Diesel Turbo Intercooler	TD24690				
4HS Euro 4		4 Cyl.	2179cc	125kW (170PS)	Diesel Turbo Intercooler	TD24688				
4HT Euro 4		4 Cyl.	2179cc	125kW (170PS)	Diesel Bi-Turbo Intercooler	TD24686				
4HW (DW12ATED4)		4 Cyl.	2179cc	94kW (128PS)	Diesel Turbo Intercooler	TD16736				
BE/PL	4	49,984/50,000	53,695/53,708	20,000	1,838	0,020/0,070	SP	71-3952	71-3952/4 STD 0.30	1
MB/HL 1-5	5	59,981/60,000	63,731/63,750	20,290	1,845	0,040/0,100	AL-LF	66726RA	H1057/5 STD 0.30 0.50	
TW/A	4	67,050/67,300	83,050/83,300		2,330		BS	66721BF	A214/4 STD 0.10	
SE/PB	1	29,995/30,000	33,000/33,025	24,050			BS-LF	55-3984	55-3984 SEMI	
CB/NWB	4	27,982/28,000	31,200/31,218	18,150	1,594		AL-LF	03-3981	N151/6 STD	
CB/NWB	8	27,982/28,000	31,200/31,218	18,150	1,594		AL-LF	03-3982		

52 86.00 x 86.00

RFV (XU10J4R)		4 Cyl.	1998cc	97kW (132PS)	Petrol	TD26959				
BE/PL	4	49,984/50,000	53,695/53,708	21,950	1,834	0,027/0,081	AL-LF	4150RA	01-4149/4 STD 0.30	
BE/PL	4	49,984/50,000	53,695/53,708	20,250	1,837	0,021/0,075	AL	4305RA	01-4298/4 STD 0.30	
MB/HL 1-5	5	59,981/60,000	63,731/63,750	20,290	1,845	0,040/0,100	AL-LF	66726RA	H1057/5 STD 0.30 0.50	
TW/A	4	67,050/67,300	83,050/83,300		1,880		AL-LF	4141AF	A188/4 STD	



TW/A	2	56,800/57,050	73,300/73,550		2,400		AL-LF	4131AF	A241/2 STD
------	---	---------------	---------------	--	-------	--	-------	--------	----------------------

53 86.00 x 86.00

RGX (XU10J2TE)		4 Cyl.		1998cc	108kW (147PS)		Petrol Turbo		TD26958
BE/PL	4	49,984/50,000	53,695/53,708	21,950	1,843	0,020/0,064	BS	4255CP	71-4279/4 STD 0.30
MB/HL 1-5	5	59,981/60,000	63,731/63,750	20,290	1,845	0,040/0,100	AL-LF	66726RA	H1057/5 STD 0.30 0.50
TW/A	4	67,050/67,300	83,050/83,300		1,880		AL-LF	4141AF	A188/4 STD

54 86.40 x 55.50

831 A2.000		4 Cyl.		1301cc	55-58kW (75-79PS)		Petrol		TD4605
831 B.000		4 Cyl.		1301cc	55kW (75PS)		Petrol		TD1809
BE/PL	4	45,508/45,528	48,629/48,646	19,200	1,547	0,020/0,069	AL-LF	1645RA	01-4127/4 STD 0.25 0.50
BE/PL	4	45,508/45,528	48,629/48,646	19,200	1,538	0,025/0,087	AL-LF	60985RA	01-4171/4 STD

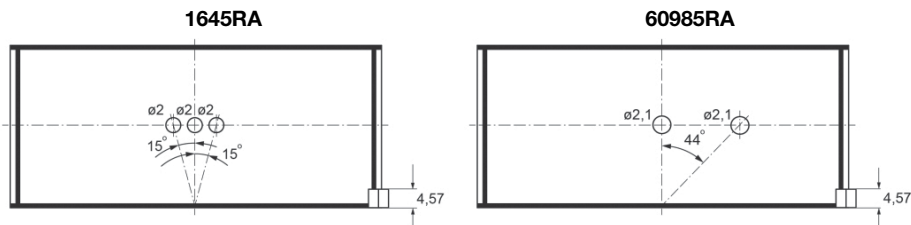

MB/HL 1,2,4,5	4	50,785/50,805	54,507/54,520	20,250	1,831	0,040/0,098	AL-LF	60986RA	H1028/5 STD 0.25
MB/HL 3	1	50,785/50,805	54,507/54,520	22,750	1,831	0,040/0,098	AL-LF	60987RA	
TW/A	2	56,610/56,864	69,596/69,850		2,362		AL-LF	60987AFA	A198/2 STD .005
SE/PB	1	21,539/21,641	23,939/23,972	25,100			BS	62039Y	55-4288 SEMI

55 86.40 x 63.90

138 C2.048		4 Cyl.		1498cc	55kW (75PS)		Petrol		TD5424
831 B1.000		4 Cyl.		1498cc	59-63kW (80-86PS)		Petrol		TD1811
831 B1.048		4 Cyl.		1498cc	55kW (75PS)		Petrol		TD1810
BE/PL	4	45,508/45,528	48,629/48,646	19,200	1,547	0,020/0,069	AL-LF	1645RA	01-4127/4 STD 0.25 0.50
MB/HL 1,2,4,5	4	52,982/53,000	56,705/56,718	20,750	1,843	0,019/0,075	AL-LF	4351RA	H1096/5 STD 0.25 0.50
MB/HL 3	1	52,982/53,000	56,705/56,718	20,750	1,838	0,029/0,085	AL-LF	4352RA	
TW/A	2	56,610/56,864	69,596/69,850		2,362		AL-LF	60987AFA	A198/2 STD .005
SE/PB	1	21,539/21,641	23,939/23,972	25,100			BS	62039Y	55-4288 SEMI

56 86.40 x 63.90

831 A1.000		4 Cyl.		1498cc	63kW (86PS)		Petrol		TD1805
BE/PL	4	45,508/45,528	48,629/48,646	19,200	1,547	0,020/0,069	AL-LF	1645RA	01-4127/4 STD 0.25 0.50
MB/HL 1,2,4,5	4	50,780/50,800	54,507/54,520	20,250	1,849	0,020/0,067	AL-LF	1646RA	H1075/5 STD 0.25 0.50
MB/HL 3	1	50,780/50,800	54,507/54,520	22,750	1,849	0,020/0,067	AL-LF	1647RA	

TW/A	2	56,610/56,864	69,596/69,850		2,362		AL-LF	60987AFA	A198/2 STD .005
SE/PB	1	21,539/21,641	23,939/23,972	25,100			BS	62039Y	55-4288 SEMI

57 86.40 x 67.40

159 B9.000			4 Cyl.	1581cc	66kW (90PS)		Petrol		TD4598
182 A4.000			4 Cyl.	1581cc	76kW (103PS)		Petrol		TD9476
182 A6.000			4 Cyl.	1581cc	66kW (90PS)		Petrol		TD9475
835 A1.000			4 Cyl.	1581cc	65-66kW (88-90PS)		Petrol		TD1842
835 A1.046			4 Cyl.	1581cc	57kW (77PS)		Petrol		TD1843
835 C1.000			4 Cyl.	1581cc	55kW (75PS)		Petrol		TD4611
BE/PL	4	45,508/45,528	48,629/48,646	19,200	1,547	0,020/0,069	AL-LF	1645RA	01-4127/4 STD 0.25 0.50
MB/HL 1,2,4,5	4	50,780/50,800	54,507/54,520	20,250	1,849	0,020/0,067	AL-LF	1646RA	H1075/5 STD 0.25 0.50
MB/HL 3	1	50,780/50,800	54,507/54,520	22,750	1,849	0,020/0,067	AL-LF	1647RA	
TW/A	2	56,610/56,864	69,596/69,850		2,362		AL-LF	60987AFA	A198/2 STD .005
SE/PB	1	21,539/21,641	23,939/23,972	25,100			BS	62039Y	55-4288 SEMI

58 91.00 x 73.00

834 A.000			V6 Cyl.	2849cc	110kW (150PS)		Petrol		TD18863
834 E.000			V6 Cyl.	2849cc	110kW (150PS)		Petrol		TD4623
834 E.146			V6 Cyl.	2849cc	108kW (147PS)		Petrol		TD4609
MB/HL 1-4	4	70,043/70,062	74,000/74,019	23,470	1,967	0,020/0,067	AL-LF	66311RA	H1041/4 STD

59 93.00 x 72.60

834 F.000			V6 Cyl.	2959cc	126kW (171PS)		Petrol		TD1841
838 B.000			V6 Cyl.	2959cc	150kW (204PS)		Petrol		TD4620
841 A.000			V6 Cyl.	2959cc	158kW (215PS)		Petrol		TD16733
BE/PL	6	51,980/52,000	55,511/55,524	19,100	1,749	0,020/0,071	BS	4080CP	71-4218/6 STD 0.25
MB/HL	4	59,951/59,971	63,657/63,676	22,350	1,841	0,020/0,068	BS	4081CP	H1082/4 STD 0.25
SE/PB	1	21,994/22,000	25,120/25,146	23,720			BS	60014X	55-4280 SEMI

60 93.00 x 90.00

8144.91			4 Cyl.	2445cc	74kW (101PS)		Diesel Turbo		TD4600
BE/PL	4	56,520/56,535	60,333/60,345	24,700	1,870	0,020/0,072	BS	1870CP	71-4130/4 STD 0.25 0.50 0.75
BE/PL	4	56,520/56,535	60,333/60,345	24,700	1,870	0,020/0,070	BS	66575CP	71-4185/4 STD 0.25 0.50 0.75

1870CP

66575CP

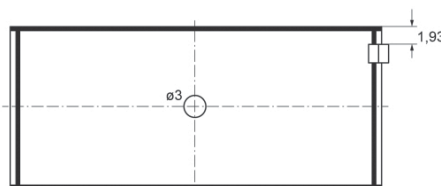

MB/HL 1-4	4	76,187/76,200	80,586/80,607	24,990	2,172	0,042/0,100	BS	66571CP	H1049/5 STD 0.25 0.50 0.75
MB/HL 5	1	76,187/76,200	80,586/80,607	31,950	2,172	0,042/0,100	BS	66572CPH	

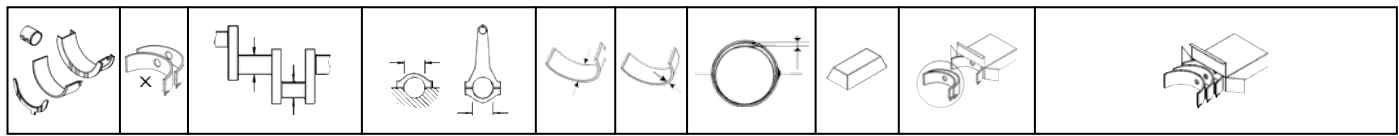

MB/HL 1-4	4	76,187/76,200	80,586/80,607	24,990	2,172	0,038/0,097	BS	66573CP	H1094/5 STD 0.25
MB/HL 5	1	76,187/76,200	80,586/80,607	31,950	2,172	0,038/0,097	BS	66574CPH	

66571CP

66572CPH

66573CP

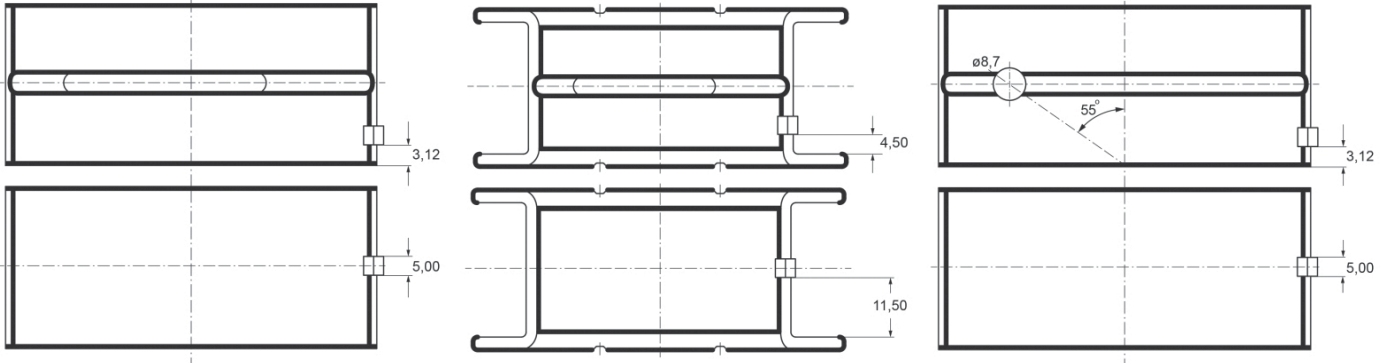

66574CPH

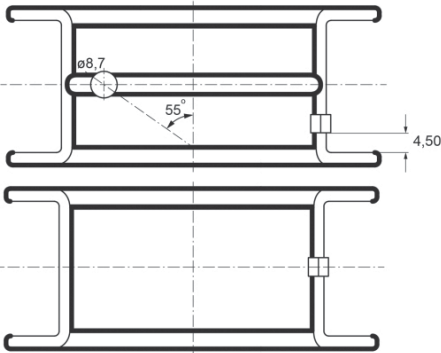

SE/PB	1	31,990/31,996	34,895/34,920	30,700			BS	66579YA	55-4186 SEMI
-------	---	---------------	---------------	--------	--	--	----	---------	------------------------

61 93.00 x 92.00

8144.97S	4 Cyl.	2500cc	77kW (105PS)	Diesel Turbo	TD1785
8144.97	4 Cyl.	2499cc	85kW (115PS)	Diesel Turbo	TD4601
8144.97 Y	4 Cyl.	2500cc	85kW (115PS)	Diesel Turbo	TD1786
8144.97.2200	4 Cyl.	2499cc	85-87kW (116-118PS)	Diesel Turbo Intercooler	TD19036
8144.97.2400	4 Cyl.	2499cc	83-87kW (113-118PS)	Diesel Turbo Intercooler	TD22318

BE/PL	4	56,520/56,535	60,333/60,345	24,700	1,870	0,020/0,072	BS	1870CP	71-4130/4 STD 0.25 0.50 0.75
BE/PL	4	56,520/56,535	60,333/60,345	24,700	1,870	0,020/0,070	BS	66575CP	71-4185/4 STD 0.25 0.50 0.75

1870CP

66575CP

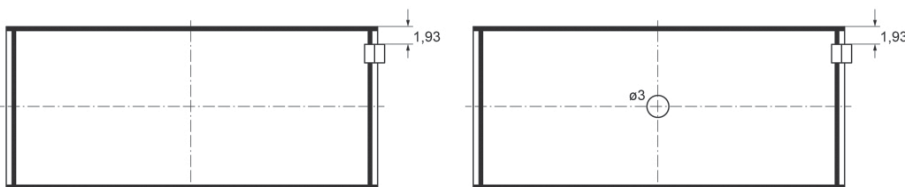

MB/HL 1-4	4	76,187/76,200	80,586/80,607	24,990	2,172	0,042/0,100	BS	66571CP	H1049/5 STD 0.25 0.50 0.75
MB/HL 5	1	76,187/76,200	80,586/80,607	31,950	2,172	0,042/0,100	BS	66572CPH	

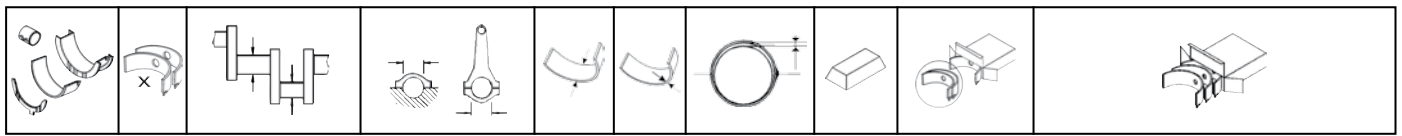

MB/HL 1-4	4	76,187/76,200	80,586/80,607	24,990	2,172	0,038/0,097	BS	66573CP	H1094/5 STD 0.25
MB/HL 5	1	76,187/76,200	80,586/80,607	31,950	2,172	0,038/0,097	BS	66574CPH	

66571CP

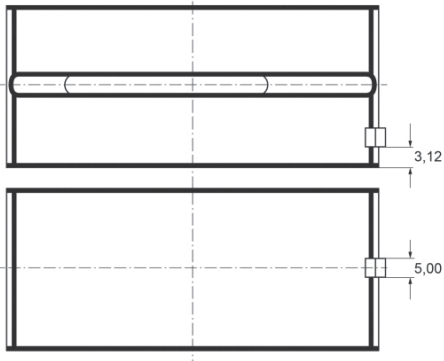

66572CPH

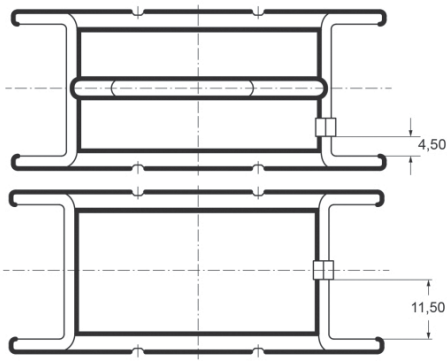

66573CP

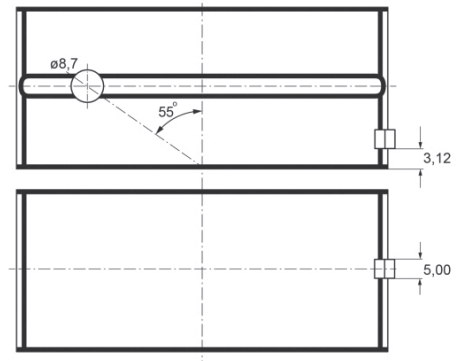

66574CPH

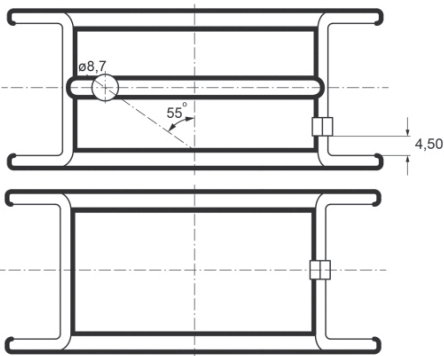

SE/PB	1	31,990/31,996	34,895/34,920	30,700			BS	66579YA	55-4186 SEMI
-------	---	---------------	---------------	--------	--	--	----	---------	------------------------









cm3



9

88/109 2.3 D 4x4	09/63→12/86	Diesel	10 J	2286	4	90.50	88.90	11
90/110 2.3 D 4x4	06/84→08/87	Diesel	10 J	2286	4	90.50	88.90	11
90/110 2.5 4x4	09/85→07/90	Petrol	17 H	2495	4	90.50	97.00	12
90/110 2.5 D 4x4	09/83→07/90	Diesel	12 J	2495	4	90.40	97.20	9
90/110 2.5 TD 4x4	09/86→07/90	Diesel	19 J	2495	4	90.40	97.20	9
Defender 2.5 4x4	09/90→12/94	Petrol	17 H	2495	4	90.50	97.00	12
Defender 2.5 90,110 TDI 4x4	09/90→12/98	Diesel	11 L	2495	4	90.48	97.00	10
Defender 2.5 90,110 TDI 4x4	09/90→12/98	Diesel	16 L	2495	4	90.48	97.00	10
Defender 2.5 90,110 TDI 4x4	09/90→12/98	Diesel	23 L	2495	4	90.48	97.00	10
Defender 2.5 D 4x4	09/90→09/01	Diesel	12 J	2495	4	90.40	97.20	9
Defender 2.5 TD 4x4	08/98→12/05	Diesel	11 L	2495	4	90.48	97.00	10
Defender 2.5 TD 4x4	08/98→12/05	Diesel	23 L	2495	4	90.48	97.00	10
Defender 3.5 4x4	09/90→08/93	Petrol	11 D	3528	V8	88.86	71.10	8
Defender 3.5 4x4	09/90→12/98	Petrol	22 D	3531	V8	88.86	71.10	8
Defender 3.9 4x4	04/98→09/00	Petrol	37 L	3947	V8	94.00	71.10	15
Defender 3.9 V8 4x4	11/98→	Petrol	37 L	3947	V8	94.00	71.10	15
Defender 4.0 4x4	04/98→09/00	Petrol	37 L	3947	V8	94.00	71.10	15
Defender Cabrio 2.5 90 TDI 4x4	09/90→	Diesel	11 L	2495	4	90.48	97.00	10
Defender Cabrio 2.5 90 TDI 4x4	09/90→	Diesel	16 L	2495	4	90.48	97.00	10
Defender Cabrio 2.5 90 TDI 4x4	09/90→	Diesel	23 L	2495	4	90.48	97.00	10
Defender Cabrio 2.5 D 4x4	09/90→09/01	Diesel	12 J	2495	4	90.40	97.20	9
Defender Cabrio 3.9 4x4	04/98→09/00	Petrol	37 L	3947	V8	94.00	71.10	15
Discovery	01/90→09/93	Petrol	3.5L EFi	3528	V8	88.86	71.10	8
Discovery I 2.5 D 4x4	07/94→10/98	Diesel	22 L	2495	4	90.48	97.00	10
Discovery I 2.5 D 4x4	10/93→10/98	Diesel	19 L	2496	4	90.50	97.00	13
Discovery I 2.5 TDI 4x4	10/89→10/98	Diesel	17 L	2495	4	90.48	97.00	10
Discovery I 2.5 TDI 4x4	10/89→10/98	Diesel	21 L	2495	4	90.50	97.00	13
Discovery I 2.5 TDI 4x4	10/89→10/98	Diesel	12 L	2496	4	90.50	97.00	13
Discovery I 2.5 TDI 4x4	10/89→10/98	Diesel	19 L	2496	4	90.50	97.00	13
Discovery I 3.5 4x4	06/89→06/94	Petrol	22 D	3531	V8	88.86	71.10	8
Discovery I 3.9 V8 4x4	09/93→10/98	Petrol	35 D	3950	V8	94.00	71.10	14
Discovery I 3.9 V8 4x4	09/93→10/98	Petrol	36 D	3950	V8	94.00	71.10	14
Discovery I 4.0 4x4	09/95→10/98	Petrol	35 D	3950	V8	94.00	71.10	14
Discovery I 4.0 4x4	09/95→10/98	Petrol	36 D	3950	V8	94.00	71.10	14
Discovery II 4.0 4x4	11/98→12/02	Petrol	56 D	3950	V8	94.00	71.10	14
Discovery II 4.0 V8 4x4	11/98→06/04	Petrol	56 D	3950	V8	94.00	71.10	14
Discovery V8i, V8iS	01/90→09/93	Petrol	3.5L Efi	3528	V8	88.86	71.10	8
Freelander 1.8 4x4	10/00→09/03	Petrol	18 K4F	1796	4	80.00	89.30	2
Freelander 1.8 16V 4x4	11/00→10/06	Petrol	18 K4F	1796	4	80.00	89.30	2
Freelander 1.8 i 16V 4x4	02/98→10/06	Petrol	18 K4F	1796	4	80.00	89.30	2
Freelander 2.0 DI 4x4	02/98→10/06	Diesel	20 T2N	1994	4	84.50	88.90	6
Freelander 2.0 Td4 4x4	10/00→10/06	Diesel	204D3	1951	4	84.00	88.00	3
Freelander 2.0 Td4 4x4	11/00→10/06	Diesel	M 47	1951	4	84.00	88.00	4
Freelander 2 2.2 eD4	08/10→10/14	Diesel	DW12BTED4	2179	4	85.00	96.00	7
Freelander 2 2.2 TD4 4x4	10/06→10/14	Diesel	DW12BTED4	2179	4	85.00	96.00	7
Range Rover	01/85→12/89	Petrol	3.5L EFi	3528	V8	88.86	71.10	8
Range Rover	01/94→	Petrol	V8	3950	V8	94.00	71.10	14
Range Rover 4.6 V8, SE, HSE	09/94→	Petrol	V8	3950	V8	94.00	71.10	14
Range Rover I 2.5 TD 4x4	10/89→04/94	Diesel	14 L	2495	4	90.50	97.00	13
Range Rover I 2.5 TD 4x4	10/89→04/94	Diesel	21 L	2495	4	90.50	97.00	13
Range Rover I 2.5 TDi 4x4	09/91→04/94	Diesel	14 L	2495	4	90.50	97.00	13
Range Rover I 3.5 4x4	07/70→08/91	Petrol	11 D	3528	V8	88.86	71.10	8
Range Rover I 3.5 4x4	01/87→09/90	Petrol	31 D	3528	V8	88.86	71.10	8
Range Rover I 3.5 Vogue 4x4	08/81→09/90	Petrol	11 D	3528	V8	88.86	71.10	8
Range Rover I 3.5 Vogue 4x4	10/85→09/90	Petrol	24 D	3528	V8	88.86	71.10	8
Range Rover I 3.5 Vogue 4x4	10/85→09/90	Petrol	25 D	3528	V8	88.86	71.10	8
Range Rover I 3.9 4x4	11/88→12/92	Petrol	35 D	3950	V8	94.00	71.10	14
Range Rover I 3.9 4x4 CAT	11/88→07/94	Petrol	37 D	3950	V8	94.00	71.10	14
Range Rover I 3.9 4x4 CAT	11/88→07/94	Petrol	38 D	3950	V8	94.00	71.10	14
Range Rover I 3.9 Vogue SEI 4x4	11/88→07/94	Petrol	35 D	3950	V8	94.00	71.10	14
Range Rover I 3.9 Vogue SEI 4x4	11/88→07/94	Petrol	36 D	3950	V8	94.00	71.10	14
Range Rover II 2.5 D 4x4	08/94→03/02	Diesel	22 L	2495	4	90.48	97.00	10
Range Rover II 2.5 D 4x4	08/94→03/02	Diesel	19 L	2496	4	90.50	97.00	13
Range Rover II 2.5 D 4x4	07/94→03/02	Diesel	25 6T (BMW)	2497	6	80.00	82.80	1
Range Rover II 3.9 4x4	07/94→03/02	Petrol	42 D	3947	V8	94.00	71.10	15
Range Rover II 4.0 4x4	06/98→03/02	Petrol	42 D	3947	V8	94.00	71.10	15
Range Rover Vogue SE, Efi	01/85→12/89	Petrol	3.5L Efi	3528	V8	88.86	71.10	8

			cm3	x 			
3.5L EFi	Petrol		3528	V8	88.86	71.10	8
10 J	Diesel		2286	4	90.50	88.90	11
11 D	Petrol		3528	V8	88.86	71.10	8
11 L	Diesel		2495	4	90.48	97.00	10
12 J	Diesel		2495	4	90.40	97.20	9
12 L	Diesel		2496	4	90.50	97.00	13
14 L	Diesel		2495	4	90.50	97.00	13
16 L	Diesel		2495	4	90.48	97.00	10
17 H	Petrol		2495	4	90.50	97.00	12
17 L	Diesel		2495	4	90.48	97.00	10
18 K4F	Petrol		1796	4	80.00	89.30	2
19 J	Diesel		2495	4	90.40	97.20	9
19 L	Diesel		2496	4	90.50	97.00	13
20 T2N	Diesel		1994	4	84.50	88.90	6
21 G	Petrol		3528	V8	88.86	71.10	8
21 L	Diesel		2495	4	90.50	97.00	13
22 D	Petrol		3531	V8	88.86	71.10	8
22 L	Diesel		2495	4	90.48	97.00	10
23 L	Diesel		2495	4	90.48	97.00	10
24 D	Petrol		3528	V8	88.86	71.10	8
25 D	Petrol		3528	V8	88.86	71.10	8
31 D	Petrol		3528	V8	88.86	71.10	8
35 D	Petrol		3950	V8	94.00	71.10	14
36 D	Petrol		3950	V8	94.00	71.10	14
37 D	Petrol		3950	V8	94.00	71.10	14
37 L	Petrol		3947	V8	94.00	71.10	15
38 D	Petrol		3950	V8	94.00	71.10	14
40 D	Petrol		4275	V8	94.00	77.00	16
42 D	Petrol		3947	V8	94.00	71.10	15
46 D	Petrol		4553	V8	94.00	82.00	17
56 D	Petrol		3950	V8	94.00	71.10	14
204D3	Diesel		1951	4	84.00	88.00	3
25 6T (BMW)	Diesel		2497	6	80.00	82.80	1
DW12BTED4	Diesel		2179	4	85.00	96.00	7
M 47	Diesel		1951	4	84.00	88.00	4
M 47 R	Diesel		1950	4	84.00	88.00	4
M 57 D 30	Diesel		2926	6	84.00	88.00	5
V8	Petrol		3950	V8	94.00	71.10	14

LAND ROVER



1 80.00 x 82.80

25 6T (BMW)		6 Cyl.		2497cc	100kW (136PS)		Diesel		TD22933
BE/PL	6	44,975/44,991	48,000/48,016	18,000	1,497	0,020/0,072	SP	71-3704	71-3704/6 STD 1
MB/HL 1-5, 7	6	59,971/59,990	65,000/65,019	20,000	2,498	0,020/0,063	AL-LF	02-3646	H023/7 STD 0.25 0.50
MB/HL 6	1	59,971/59,990	65,000/65,019	24,940	2,498	0,020/0,082	AL-LF	02-3647H	
			02-3647H	STD	25,020/.9853" - 25,053/.9863"				
				0.25mm	25,220/.9929" - 25,253/.9942"				
				0.50mm	25,420/1.0008" - 25,453/1.0021"				
SE/PB	1	29,995/30,000	31,995/32,025	22,200			BC	55-3937	55-3937 SEMI

2 80.00 x 89.30

18 K4F		4 Cyl.		1796cc	85-88kW (116-120PS)		Petrol		TD20740
BE/PL	4	47,992/48,007	51,666/51,687	18,420	1,826	0,020/0,055	AL-LF	01-4039	01-4039/4 STD 0.25
MB/HL 1,3,5	3	47,993/48,000	51,579/51,600	17,450	1,789	0,020/0,054	AL-LF	4131RA	H1085/5 STD 0.25
MB/HL 2,4	2	47,993/48,000	51,579/51,600	17,450	1,789	0,020/0,054	AL-LF	4132RA	
TW/A	2	56,800/57,050	73,300/73,550		2,400		AL-LF	4131AF	A241/2 STD

3 84.00 x 88.00

204D3		4 Cyl.		1951cc	80-82kW (109-112PS)		Diesel		TD26631
BE/PL	4	44,975/44,991	48,000/48,016	18,000	1,497	0,020/0,072	SP	71-3704	71-3704/4 STD 0.25 1
MB/HL 1,2,4,5	4	59,971/59,990	65,000/65,019	20,000	2,498	0,020/0,063	AL-LF	02-3646	H023/5 STD 0.25
MB/HL 3	1	59,971/59,990	65,000/65,019	24,940	2,498	0,020/0,082	AL-LF	02-3647H	
			02-3647H	STD	25,020/.9853" - 25,053/.9863"				
				0.25mm	25,220/.9929" - 25,253/.9942"				
				0.50mm	25,420/1.0008" - 25,453/1.0021"				
SE/PB	1	29,995/30,000	31,995/32,025	22,200			BC-LF	55-4572	55-4572 SEMI 6

4 84.00 x 88.00

M 47		4 Cyl.		1951cc	80-82kW (109-112PS)		Diesel Turbo Intercooler		TD26848
M 47 R		4 Cyl.		1950cc	85kW (116PS)		Diesel Turbo Intercooler		TD24392
BE/PL	4	44,975/44,991	48,000/48,016	18,000	1,497	0,020/0,072	SP	71-3704	71-3704/4 STD 0.25 1
MB/HL 1,2,4,5	4	59,971/59,990	65,000/65,019	20,000	2,498	0,020/0,063	AL-LF	02-3646	H023/5 STD 0.25
MB/HL 3	1	59,971/59,990	65,000/65,019	24,940	2,498	0,020/0,082	AL-LF	02-3647H	
			02-3647H	STD	25,020/.9853" - 25,053/.9863"				
				0.25mm	25,220/.9929" - 25,253/.9942"				
				0.50mm	25,420/1.0008" - 25,453/1.0021"				
SE/PB	1	29,995/30,000	31,995/32,025	22,200			BC	55-3937	55-3937 SEMI

5 84.00 x 88.00

M 57 D 30		6 Cyl.		2926cc	130-142kW (177-193PS)		Diesel Turbo Intercooler		TD22322
BE/PL	6	44,975/44,991	48,000/48,016	18,000	1,497	0,020/0,072	SP	71-3704	71-3704/6 STD 0.25 1

MB/HL 1-5, 7	6	59,971/59,990	65,000/65,019	20,000	2,498	0,020/0,063	AL-LF	02-3646	H023/7 STD 0.25 0.50
MB/HL 6	1	59,971/59,990	65,000/65,019	24,940	2,498	0,020/0,082	AL-LF	02-3647H	
			02-3647H	STD	25,020/.9853" - 25,053/.9863"				
				0.25mm	25,220/.9929" - 25,253/.9942"				
				0.50mm	25,420/1.0008" - 25,453/1.0021"				
SE/PB	1	29,995/30,000	31,995/32,025	22,200			BC	55-3937	55-3937 SEMI

6 84.50 x 88.90

20 T2N		4 Cyl.		1994cc	72kW (98PS)	Diesel Turbo		TD26632	
BE/PL	4	53,990/54,010	57,683/57,696	21,800	1,825	0,023/0,081	BS	4660CP	71-4164/4 STD
MB/HL 1-5	5	56,990/57,010	60,703/60,719	22,600	1,835	0,023/0,084	AL-LF	4392RA	H1098/5 STD
TW/A	4	63,600/63,850	80,250/80,500		2,310		AL-LF	1644AF	A173/4 STD

7 85.00 x 96.00

DW12BTED4 Euro 4		4 Cyl.		2179cc	110kW (150PS)	Diesel Bi-Turbo Intercooler		TD26064	
BE/PL	4	49,984/50,000	53,695/53,708	20,000	1,838	0,020/0,070	SP	71-3952	71-3952/4 STD 0.30 ①
MB/HL 1-5	5	59,981/60,000	63,731/63,750	20,290	1,845	0,040/0,100	AL-LF	66726RA	H1057/5 STD 0.30 0.50
TW/A	4	67,050/67,300	83,050/83,300		2,330		BS	66721BF	A214/4 STD 0.10
SE/PB	1	29,995/30,000	33,000/33,025	24,050			BS-LF	55-3984	55-3984 SEMI
CB/NWB	4	27,982/28,000	31,200/31,218	18,150	1,594		AL-LF	03-3981	N151/6 STD
CB/NWB	8	27,982/28,000	31,200/31,218	18,150	1,594		AL-LF	03-3982	

8 88.86 x 71.10

3.5L EFi		V8 Cyl.		3528cc			Petrol		FM5059
11 D		V8 Cyl.		3528cc	86-97kW (117-132PS)		Petrol		TD22941
21 G		V8 Cyl.		3528cc	86-93kW (117-126PS)		Petrol		TD25826
22 D		V8 Cyl.		3531cc	100-122kW (136-166PS)		Petrol		TD22934
24 D		V8 Cyl.		3528cc	120kW (163PS)		Petrol		TD22939
25 D		V8 Cyl.		3528cc	120kW (163PS)		Petrol		TD22940
31 D		V8 Cyl.		3528cc	107kW (146PS)		Petrol		TD22942
BE/PL	8	50,787/50,813	53,967/53,980	18,850	1,575	0,020/0,068	BS	2500RAA	01-4377/8 STD 0.25
MB/HL 1,2,4,5	4	58,377/58,402	63,261/63,287	20,500	2,421	0,020/0,093	AL-LF	GS9955SA	H1189/5 STD 0.25 0.50
MB/HL 3	1	58,387/58,412	63,261/63,287	26,870	2,421	0,020/0,083	AL-LF	GS9956SA	
CB/NWB 3	1	43,815/43,840	47,130/47,181	19,050	1,641		BS	2103DR	N170/5 STD
CB/NWB 4	1	43,053/43,079	46,368/46,419	19,050	1,641		BS	2103DRI	
CB/NWB 5	1	42,291/42,316	45,606/45,657	19,050	1,641		BS	2104DR	
CB/NWB 2	1	44,577/44,602	47,892/47,943	19,050	1,641		BS	2502DR	
CB/NWB 1	1	45,339/45,364	48,654/48,705	19,300	1,638		BS	3321DRI	

LAND ROVER

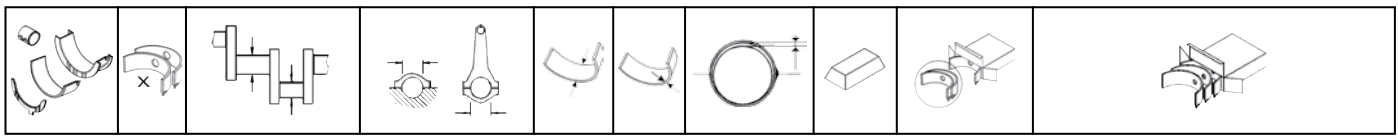

9 90.40 x 97.20

12 J	4 Cyl.	2495cc	51kW (69PS)	Diesel Turbo	TD24370
-------------	--------	---------------	--------------------	---------------------	----------------

19 J	4 Cyl.	2495cc	63kW (86PS)	Diesel Turbo	TD24369
-------------	--------	---------------	--------------------	---------------------	----------------

BE/PL	4	58,725/58,744	62,433/62,446	25,070	1,830	0,020/0,086	BS	4170CP	71-4396/4 STD 0.25 0.50
MB/HL 1-4	4	63,487/63,500	67,703/67,716	24,400	2,080	0,043/0,094	EC	8053CP	H1106/5 STD 0.25
MB/HL 5	1	63,487/63,500	67,703/67,716	35,000	2,080	0,043/0,094	EC	8054CP	

Mot. → 12J43824C

MB/HL 1-4	4	63,487/63,500	67,703/67,716	24,390	2,080	0,020/0,056	BS	GS604LC	H1279/5 STD 0.25 0.50
MB/HL 1-4	4	63,487/63,500	67,703/67,716	24,390	2,080	0,018/0,061	BS	GS604LCB	
MB/HL 5	1	63,487/63,500	67,703/67,716	35,130	2,080	0,020/0,056	BS	GS605LC	
MB/HL 5	1	63,487/63,500	67,703/67,716	35,130	2,080	0,026/0,076	BS	GS605LCB	

Mot. 12J43825C →

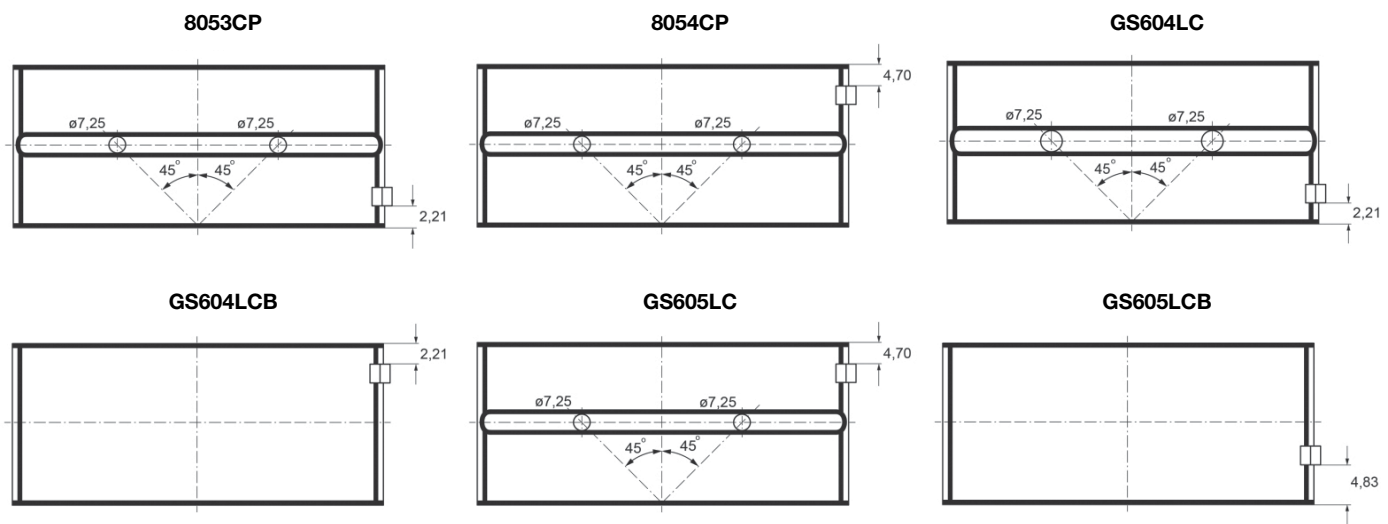

TW/A	2	70,739/70,993	85,598/85,852		2,340		BS	65192BF	A204/2 STD .005
SE/PB	1	30,166/30,176	34,130/34,155	32,530			BS	8059Y	55-4545 SEMI
CB/NWB 1	1	46,500	50,000	24,500	1,594		BS	8061DR	N165/4 STD
CB/NWB 2-4	3	46,500	50,000	19,000	1,594		BS	8062DR	

10 90.48 x 97.00

11 L	4 Cyl.	2495cc	79-83kW (107-113PS)	Diesel Turbo Intercooler	TD20407
-------------	--------	---------------	----------------------------	---------------------------------	----------------

16 L	4 Cyl.	2495cc	83kW (113PS)	Diesel	TD20411
-------------	--------	---------------	---------------------	---------------	----------------

17 L	4 Cyl.	2495cc	83kW (113PS)	Diesel	TD20412
-------------	--------	---------------	---------------------	---------------	----------------

22 L	4 Cyl.	2495cc	83-92kW (113-125PS)	Diesel	TD20413
-------------	--------	---------------	----------------------------	---------------	----------------

23 L	4 Cyl.	2495cc	83-86kW (113-117PS)	Diesel Turbo	TD20406
-------------	--------	---------------	----------------------------	---------------------	----------------

BE/PL	4	58,725/58,744	62,433/62,446	25,070	1,830	0,020/0,086	BS	4170CP	71-4396/4 STD 0.25 0.50
-------	---	---------------	---------------	--------	-------	-------------	----	--------	-----------------------------------

MB/HL 1-4	4	63,487/63,500	67,703/67,716	24,390	2,080	0,020/0,056	BS	GS604LC	H1279/5 STD 0.25 0.50
MB/HL 1-4	4	63,487/63,500	67,703/67,716	24,390	2,080	0,018/0,061	BS	GS604LCB	
MB/HL 5	1	63,487/63,500	67,703/67,716	35,130	2,080	0,020/0,056	BS	GS605LC	
MB/HL 5	1	63,487/63,500	67,703/67,716	35,130	2,080	0,026/0,076	BS	GS605LCB	
TW/A	2	70,739/70,993	85,598/85,852		2,340		BS	65192BF	A204/2 STD .005
SE/PB	1	30,166/30,176	34,130/34,155	32,530			BS	8059Y	55-4545 SEMI
CB/NWB 1	1	46,500	50,000	24,500	1,594		BS	8061DR	N165/4 STD
CB/NWB 2-4	3	46,500	50,000	19,000	1,594		BS	8062DR	

11 90.50 x 88.90

10 J 4 Cyl. **2286cc** **46-51kW (63-69PS)** Diesel **TD25822**

BE/PL	4	43,000/43,007	46,666/46,687	21,610	1,824	0,020/0,064	AL-LF	4130RA	01-4147/4 STD 0.25
01/62→08/86									
MB/HL 1-4	4	63,487/63,500	67,703/67,716	24,400	2,080	0,043/0,094	EC	8053CP	H1106/5 STD 0.25
MB/HL 5	1	63,487/63,500	67,703/67,716	35,000	2,080	0,043/0,094	EC	8054CP	
01/80→									
MB/HL 1,2	2	63,475/63,487	67,704/67,716	25,580	2,080	0,057/0,106	BS	65191CP	H1136/3 STD 0.25
MB/HL 3	1	63,475/63,487	67,704/67,716	39,880	2,080	0,057/0,106	BS	65192CP	
01/61→12/79									

8053CP

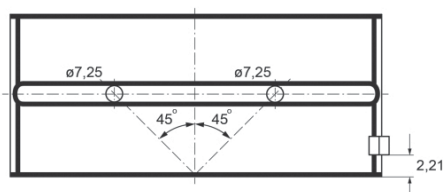

8054CP

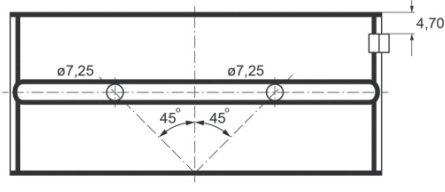

65191CP

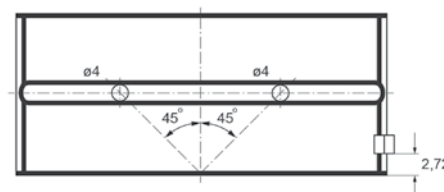

65192CP

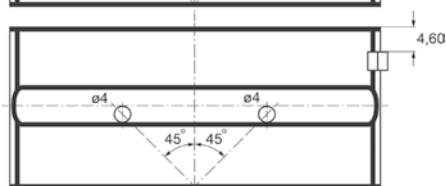
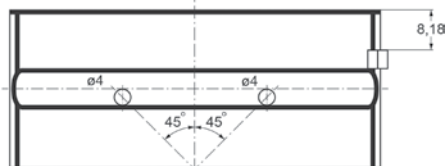

TW/A	2	70,739/70,993	85,598/85,852		2,340		BS	65192BF	A204/2 STD .005
SE/PB	1	30,166/30,176	34,130/34,155	32,530			BS	8059Y	55-4545 SEMI

LAND ROVER

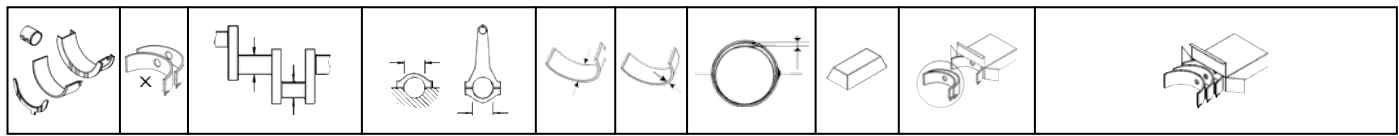

CB/NWB 1	1	46,500	50,000	24,500	1,594		BS	8061DR	N165/4 STD
CB/NWB 2-4	3	46,500	50,000	19,000	1,594		BS	8062DR	

12 90.50 x 97.00

17 H 4 Cyl. 2495cc 61kW (83PS) Petrol TD19656

BE/PL	4	58,725/58,744	62,433/62,446	25,070	1,830	0,020/0,086	BS	4170CP	71-4396/4 STD 0.25 0.50
MB/HL 1-4	4	63,487/63,500	67,703/67,716	24,400	2,080	0,043/0,094	EC	8053CP	H1106/5 STD 0.25
MB/HL 5	1	63,487/63,500	67,703/67,716	35,000	2,080	0,043/0,094	EC	8054CP	

Mot. → 17H25700C

MB/HL 1-4	4	63,487/63,500	67,703/67,716	24,390	2,080	0,020/0,056	BS	GS604LC	H1279/5 STD 0.25 0.50
MB/HL 1-4	4	63,487/63,500	67,703/67,716	24,390	2,080	0,018/0,061	BS	GS604LCB	
MB/HL 5	1	63,487/63,500	67,703/67,716	35,130	2,080	0,020/0,056	BS	GS605LC	
MB/HL 5	1	63,487/63,500	67,703/67,716	35,130	2,080	0,026/0,076	BS	GS605LCB	

Mot. 17H25701C →

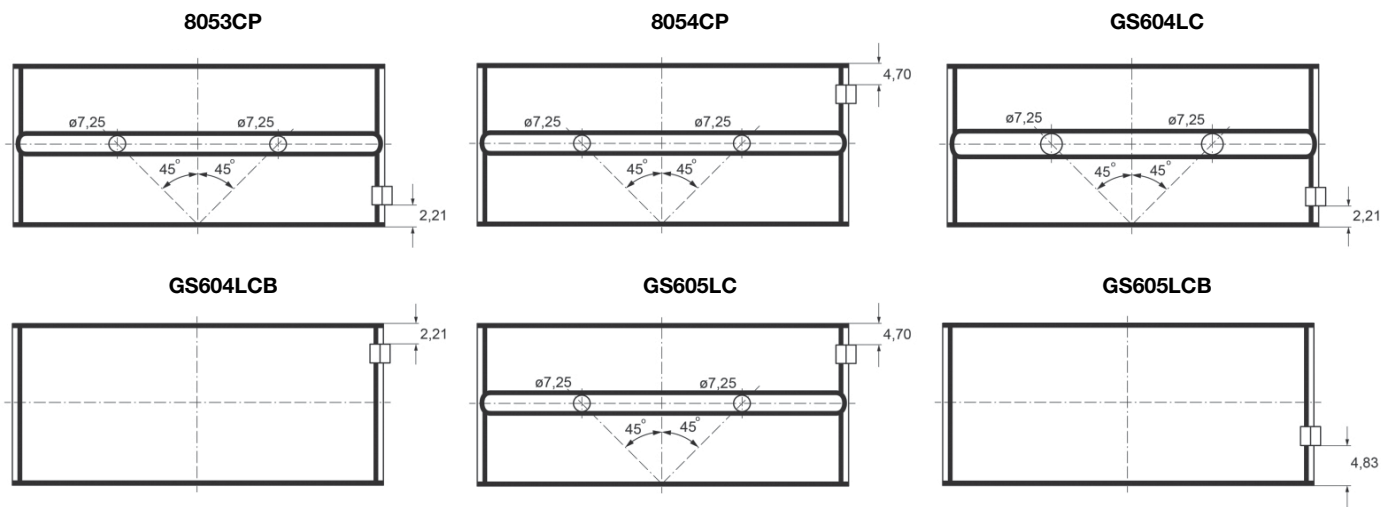

TW/A	2	70,739/70,993	85,598/85,852		2,340		BS	65192BF	A204/2 STD .005
SE/PB	1	25,000	28,600	32,250			BS	8064Y	55-4248 SEMI
CB/NWB 1	1	46,500	50,000	24,500	1,594		BS	8061DR	N165/4 STD
CB/NWB 2-4	3	46,500	50,000	19,000	1,594		BS	8062DR	

13 90.50 x 97.00

12 L 4 Cyl. 2496cc 83kW (113PS) Diesel Turbo Intercooler TD20408
 14 L 4 Cyl. 2495cc 83kW (113PS) Diesel Turbo TD19655
 19 L 4 Cyl. 2496cc 83-90kW (113-122PS) Diesel Turbo TD20409
 21 L 4 Cyl. 2495cc 83kW (113PS) Diesel Turbo Intercooler TD20410

BE/PL	4	58,725/58,744	62,433/62,446	25,070	1,830	0,020/0,086	BS	4170CP	71-4396/4 STD 0.25 0.50
-------	---	---------------	---------------	--------	-------	-------------	----	--------	----------------------------

MB/HL 1-4	4	63,487/63,500	67,703/67,716	24,390	2,080	0,020/0,056	BS	GS604LC	H1279/5 STD 0.25 0.50
MB/HL 1-4	4	63,487/63,500	67,703/67,716	24,390	2,080	0,018/0,061	BS	GS604LCB	
MB/HL 5	1	63,487/63,500	67,703/67,716	35,130	2,080	0,020/0,056	BS	GS605LC	
MB/HL 5	1	63,487/63,500	67,703/67,716	35,130	2,080	0,026/0,076	BS	GS605LCB	
TW/A	2	70,739/70,993	85,598/85,852		2,340		BS	65192BF	A204/2 STD .005
SE/PB	1	30,166/30,176	34,130/34,155	32,530			BS	8059Y	55-4545 SEMI
CB/NWB 1	1	46,500	50,000	24,500	1,594		BS	8061DR	N165/4 STD
CB/NWB 2-4	3	46,500	50,000	19,000	1,594		BS	8062DR	

14 94.00 x 71.10

35 D			V8 Cyl.	3950cc	134kW (182PS)		Petrol		TD22930
36 D			V8 Cyl.	3950cc	134kW (182PS)		Petrol		TD22929
37 D			V8 Cyl.	3950cc	127kW (173PS)		Petrol		TD22937
38 D			V8 Cyl.	3950cc	127kW (173PS)		Petrol		TD22938
56 D			V8 Cyl.	3950cc	136kW (185PS)		Petrol		TD26647
V8			V8 Cyl.	3950cc			Petrol		FM6884
BE/PL	8	50,787/50,813	53,967/53,980	18,850	1,575	0,020/0,068	BS	2500RAA	01-4377/8 STD 0.25
MB/HL 1,2,4,5	4	58,377/58,402	63,261/63,287	20,500	2,421	0,020/0,093	AL-LF	GS9955SA	H1189/5 STD 0.25 0.50
MB/HL 3	1	58,387/58,412	63,261/63,287	26,870	2,421	0,020/0,083	AL-LF	GS9956SA	
CB/NWB 3	1	43,815/43,840	47,130/47,181	19,050	1,641		BS	2103DR	N170/5 STD
CB/NWB 4	1	43,053/43,079	46,368/46,419	19,050	1,641		BS	2103DRI	
CB/NWB 5	1	42,291/42,316	45,606/45,657	19,050	1,641		BS	2104DR	
CB/NWB 2	1	44,577/44,602	47,892/47,943	19,050	1,641		BS	2502DR	
CB/NWB 1	1	45,339/45,364	48,654/48,705	19,300	1,638		BS	3321DRI	

15 94.00 x 71.10

37 L			V8 Cyl.	3947cc	134-136kW (182-185PS)		Petrol		TD26837
42 D			V8 Cyl.	3947cc	136-140kW (185-190PS)		Petrol		TD22932
BE/PL	8	55,500/55,513	58,750/58,768	17,600	1,580	0,015/0,055	BS	GS70710LC	71-4378/8 STD 0.25 0.50
MB/HL	4	63,487/63,500	67,704/67,716	20,350	2,080	0,010/0,048	AL-LF	GS70711SA/B	H1142/5 STD 0.25
MB/HL	5	63,487/63,500	67,704/67,716	20,350	2,080	0,010/0,048	AL-LF	GS70711SAT	
MB/HL	1	63,487/63,500	67,704/67,716	26,800	2,080	0,010/0,048	AL-LF	GS70712SA	

16 94.00 x 77.00

40 D			V8 Cyl.	4275cc	149kW (203PS)		Petrol		TD22935
BE/PL	8	50,787/50,813	53,967/53,980	18,850	1,575	0,020/0,068	BS	2500RAA	01-4377/8 STD 0.25

LAND ROVER

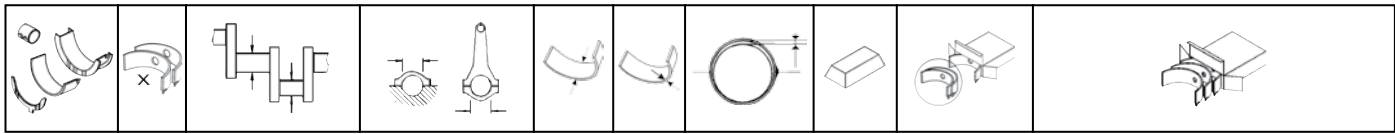







MB/HL 1,2,4,5	4	58,377/58,402	63,261/63,287	20,500	2,421	0,020/0,093	AL-LF	GS9955SA	H1189/5 STD 0.25 0.50
MB/HL 3	1	58,387/58,412	63,261/63,287	26,870	2,421	0,020/0,083	AL-LF	GS9956SA	

17

94.00 x 82.00

46 D			V8 Cyl.	4553cc	165-168kW (224-228PS)		Petrol			TD22931
BE/PL	8	55,500/55,513	58,750/58,768	17,600	1,580	0,015/0,055	BS	GS70710LC	71-4378/8 STD 0.25 0.50	
MB/HL	4	63,487/63,500	67,704/67,716	20,350	2,080	0,010/0,048	AL-LF	GS70711SA/B		
MB/HL	5	63,487/63,500	67,704/67,716	20,350	2,080	0,010/0,048	AL-LF	GS70711SA/T	H1142/5 STD 0.25	
MB/HL	1	63,487/63,500	67,704/67,716	26,800	2,080	0,010/0,048	AL-LF	GS70712SA		

		cm3	x 			
3.4T/TA	Diesel	3400	4	95.00	119.90	10
4.98 NV	Diesel	3771	4	98.00	125.00	12
4/98 TV	Diesel	3770	4	98.00	125.00	12
6.98 DV	Diesel	5655	6	98.00	125.00	13
6.98 NV	Diesel	5655	6	98.00	125.00	13
8 AM	Petrol	848	4	62.90	68.30	2
16AA, 16GF	Diesel	1622	4	76.20	88.92	5
38TD	Diesel	3770	4	100.00	120.00	14
51UD	Diesel	5103	6	95.00	119.99	11
57J	Diesel	5655	6	100.00	120.00	15
375	Diesel	6170	6	104.18	120.65	16
A Series	Diesel	948	4	62.92	76.20	3
A Series	Diesel	997	4	62.42	81.33	1
BL Series	Diesel	1892	4	82.30	88.90	7
B Series	Diesel	1489	4	73.02	88.87	4
B Series	Diesel	1798	4	80.25	87.98	6
O.400 P.P.MK1/2	Diesel	6540	6	107.19	120.65	17
O.401	Diesel	6540	6	107.19	120.65	17
O.410	Diesel	6540	6	107.19	120.65	17
O-Series 17V	Petrol	1700	4	84.50	75.90	9
Prima 65	Diesel	1993	4	84.45	89.00	8
WS 225 ATi	Diesel	11630	6	130.00	146.00	18
WS 259 ATi	Diesel	11630	6	130.00	146.00	18
WS 282 ATi	Diesel	11630	6	130.00	146.00	18
WS 295 ATi	Diesel	11630	6	130.00	146.00	18



1 62.42 x 81.33

A Series		4 Cyl.		997cc			Diesel		FM71
BE/PL	4	41,285/41,298	44,970/44,983	22,350	1,825	0,022/0,073	AL-LF	2965RA	01-4313/4 STD 0.25 0.50 0.75
BE/PL	8	41,285/41,298	44,970/44,983	22,350	1,825	0,024/0,073	BS	71-4869	71-4869/4 STD 0.25

2965RA

71-4869

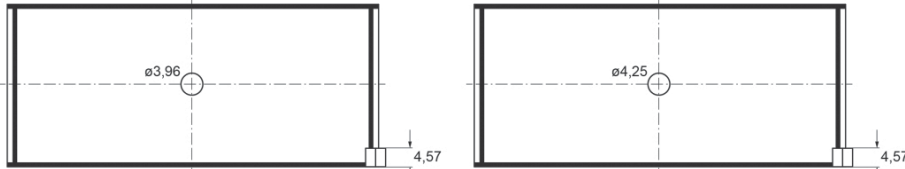

MB/HL 1-3	6	44,463/44,475	48,158/48,171	27,100	1,830		BS	GS705LC	H1310/3 STD 0.25 0.50 0.75
TW/A	2	49,910/50,160	71,750/72,000		2,360		EC	54-2304	A005/4 STD
TW/A	2	49,910/50,160	71,750/72,000		2,360		EC	54-3337	
CB/NWB 1	1	42,279/42,991	45,606/45,631	28,700			BB	2064DR	N162/3 STD
CB/NWB 2	1	41,217/41,229	44,539/44,552	19,180			BB	2066DRI	
CB/NWB 3	1	34,867/34,879	38,189/38,209	13,600			BB	2067DRI	

2 62.90 x 68.30

8 AM		4 Cyl.		848cc	25kW (34PS)	Petrol		TD1655	
BE/PL	4	41,285/41,298	44,970/44,983	22,350	1,825	0,022/0,073	AL-LF	2965RA	01-4313/4 STD 0.25 0.50 0.75
BE/PL	8	41,285/41,298	44,970/44,983	22,350	1,825	0,024/0,073	BS	71-4869	71-4869/4 STD 0.25

2965RA

71-4869

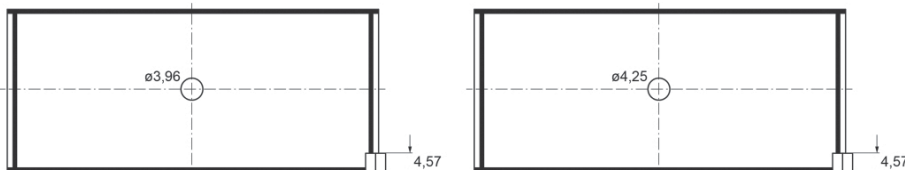

MB/HL 1-3	6	44,463/44,475	48,158/48,171	27,100	1,830		BS	GS705LC	H1310/3 STD 0.25 0.50 0.75
01/69→									
CB/NWB 1	1	42,279/42,991	45,606/45,631	28,700			BB	2064DR	N162/3 STD
CB/NWB 2	1	41,217/41,229	44,539/44,552	19,180			BB	2066DRI	
CB/NWB 3	1	34,867/34,879	38,189/38,209	13,600			BB	2067DRI	

3 62.92 x 76.20

A Series		4 Cyl.		948cc			Diesel		FM73
BE/PL	4	41,285/41,298	44,970/44,983	22,350	1,825	0,022/0,073	AL-LF	2965RA	01-4313/4 STD 0.25 0.50 0.75
BE/PL	8	41,285/41,298	44,970/44,983	22,350	1,825	0,024/0,073	BS	71-4869	71-4869/4 STD 0.25



2965RA				71-4869						
CB/NWB 1	1	42,279/42,991	45,606/45,631	28,700			BB	2064DR	N162/3 STD	
CB/NWB 2	1	41,217/41,229	44,539/44,552	19,180			BB	2066DRI		
CB/NWB 3	1	34,867/34,879	38,189/38,209	13,600			BB	2067DRI		

4 73.02 x 88.87

B Series		4 Cyl. 1489cc			Diesel			FM90
TW/A	2	56,500	69,500	2,300	BS	65-051-1	A231/4 STD	
TW/A	2	56,500	69,500	2,300	BS	65-051-2		
CB/NWB 1	1	45,433/45,446	48,641/48,666	37,540	BB	2056DR	N160/3 STD	
CB/NWB 2	1	43,909/43,922	47,117/47,142	28,830	BB	2057DR		
CB/NWB 3	1	41,217/41,229	44,425/44,450	20,880	BB	2058DR		

5 76.20 x 88.92

16AA, 16GF		4 Cyl. 1622cc			Diesel			FM92
TW/A	2	56,500	69,500	2,300	BS	65-051-1	A231/4 STD	
TW/A	2	56,500	69,500	2,300	BS	65-051-2		
CB/NWB 1	1	45,433/45,446	48,641/48,666	37,540	BB	2056DR	N160/3 STD	
CB/NWB 2	1	43,909/43,922	47,117/47,142	28,830	BB	2057DR		
CB/NWB 3	1	41,217/41,229	44,425/44,450	20,880	BB	2058DR		

6 80.25 x 87.98

B Series		4 Cyl. 1798cc			Diesel			FM996	
BE/PL	4	47,648/47,660	51,333/51,346	19,840	1,830	0,020/0,063	BS	GS2541LC	71-4336/4 STD 0.25 0.50
MB/HL 1,3,5	3	54,013/54,025	57,683/57,696	28,700	1,830	0,025/0,048	AL-LF	65076RA	H1144/5 STD 0.25
MB/HL 2,4	2	54,013/54,025	57,683/57,696	19,560	1,830	0,025/0,048	AL-LF	65077RA	
TW/A	4	59,436/59,960	74,498/74,752		2,340		AL-LF	65077BF	A233/4 STD
CB/NWB 1	1	45,433/45,446	48,641/48,666	37,540			BB	2056DR	N160/3 STD
CB/NWB 2	1	43,909/43,922	47,117/47,142	28,830			BB	2057DR	
CB/NWB 3	1	41,217/41,229	44,425/44,450	20,880			BB	2058DR	

Mot.D101→D19000



7 82.30 x 88.90

BL Series		4 Cyl.		1892cc		Diesel		FM1242	
BE/PL	4	47,648/47,660	51,333/51,346	19,840	1,830	0,020/0,063	BS	GS2541LC	71-4336/4 STD 0.25 0.50
MB/HL 1,3,5	3	54,013/54,025	57,683/57,696	28,700	1,830	0,025/0,048	AL-LF	65076RA	H1144/5 STD 0.25
MB/HL 2,4	2	54,013/54,025	57,683/57,696	19,560	1,830	0,025/0,048	AL-LF	65077RA	
TW/A	4	59,436/59,960	74,498/74,752		2,340		AL-LF	65077BF	A233/4 STD
CB/NWB 1	1	45,433/45,446	48,641/48,666	37,540			BB	2056DR	N160/3 STD
CB/NWB 2	1	43,909/43,922	47,117/47,142	28,830			BB	2057DR	
CB/NWB 3	1	41,217/41,229	44,425/44,450	20,880			BB	2058DR	

→12/67

8 84.45 x 89.00

Prima 65		4 Cyl.		1993cc		46kW (62PS)		Diesel		TD1868	
BE/PL	4	53,990/54,010	57,683/57,696	20,310	1,825	0,023/0,081	BS	1640CP	71-4353/4 STD 0.30		
TW/A	4	63,600/63,850	80,250/80,500		2,310		AL-LF	1644AF	A173/4 STD		

9 84.50 x 75.90

O-Series 17V		4 Cyl.		1700cc		52kW (71PS)		Petrol		TD1865	
BE/PL	4	47,648/47,660	51,330/51,349	19,840	1,830	0,010/0,066	AL-LF	GS315SA	01-4340/4 STD 0.25		
MB/HL 1,3,5	3	54,013/54,025	57,683/57,696	28,700	1,816	0,025/0,063	AL-LF	GS316SA	H1150/5 STD		
MB/HL 2,4	2	54,013/54,025	57,683/57,696	19,560	1,816	0,025/0,063	AL-LF	GS317SA			
TW/A	4	59,436/59,960	74,498/74,752		2,340		AL-LF	65077BF	A233/4 STD		

10 95.00 x 119.90

3.4T/TA		4 Cyl.		3400cc		Diesel		FM1005	
BE/PL	4	66,662/66,675	70,396/70,409	31,120	1,828	0,065/0,116	AL-LF	66305RA	01-4177/4 STD 0.25 0.50 0.75 1.00
MB/HL 1,3,5	3	82,537/82,550	86,804/86,830	40,770	2,083	0,088/0,152	AL-LF	66306RA	H1120/5 0.25 0.50 0.75
MB/HL 2,4	2	82,537/82,550	86,804/86,830	28,700	2,083	0,088/0,152	AL-LF	66307RA	
TW/A	4	90,424/90,678	107,800/107,930		2,360		AL-LF	8061AF	A234/4 STD

11 95.00 x 119.99

51UD		6 Cyl.		5103cc		Diesel		FM1006	
BE/PL	6	66,662/66,675	70,396/70,409	31,120	1,828	0,065/0,116	AL-LF	66305RA	01-4177/6 STD 0.25 0.50 0.75 1.00 1.50
MB/HL	4	82,537/82,550	86,804/86,830	40,770	2,083	0,088/0,152	AL-LF	66306RA	H1119/7 STD 0.25 0.50 0.75 1.00 1.50
MB/HL	3	82,537/82,550	86,804/86,830	28,700	2,083	0,088/0,152	AL-LF	66307RA	
TW/A	4	90,424/90,678	107,800/107,930		2,360		AL-LF	8061AF	A234/4 STD
SE/PB	1	34,920/34,930	39,690/39,700	32,000			BS	GS9075L	55-4542 SEMI



12 98.00 x 125.00

4/98 TV		4 Cyl.		3770cc					Diesel Turbo	FM3750
4.98 NV		4 Cyl.		3771cc	46-55kW (63-75PS)			Diesel	TD7513	
BE/PL	4	66,662/66,675	70,396/70,409	31,120	1,828	0,065/0,116	AL-LF	66305RA	01-4177/4 STD 0.25 0.50 0.75 1.00	
MB/HL 1,3,5	3	82,537/82,550	86,804/86,830	40,770	2,083	0,088/0,152	AL-LF	66306RA	H1120/5 0.25 0.50 0.75	
MB/HL 2,4	2	82,537/82,550	86,804/86,830	28,700	2,083	0,088/0,152	AL-LF	66307RA		
TW/A	4	90,424/90,678	107,800/107,930		2,360		AL-LF	8061AF	A234/4 STD	

13 98.00 x 125.00

6.98 DV		6 Cyl.		5655cc	71-84kW (97-114PS)			Diesel	TD7488
6.98 NV		6 Cyl.		5655cc	71-86kW (97-117PS)			Diesel	TD7490
BE/PL	6	66,662/66,675	70,396/70,409	31,120	1,828	0,065/0,116	AL-LF	66305RA	01-4177/6 STD 0.25 0.50 0.75 1.00 1.50
MB/HL	4	82,537/82,550	86,804/86,830	40,770	2,083	0,088/0,152	AL-LF	66306RA	H1119/7 STD 0.25 0.50 0.75 1.00 1.50
MB/HL	3	82,537/82,550	86,804/86,830	28,700	2,083	0,088/0,152	AL-LF	66307RA	
TW/A	4	90,424/90,678	107,800/107,930		2,360		AL-LF	8061AF	A234/4 STD
SE/PB	1	34,920/34,930	39,690/39,700	32,000			BS	GS9075L	55-4542 SEMI

14 100.00 x 120.00

38TD		4 Cyl.		3770cc					Diesel	FM6807
BE/PL	4	66,662/66,675	70,396/70,409	31,120	1,828	0,065/0,116	AL-LF	66305RA	01-4177/4 STD 0.25 0.50 0.75 1.00	
MB/HL 1,3,5	3	82,537/82,550	86,804/86,830	40,770	2,083	0,088/0,152	AL-LF	66306RA	H1120/5 0.25 0.50 0.75	
MB/HL 2,4	2	82,537/82,550	86,804/86,830	28,700	2,083	0,088/0,152	AL-LF	66307RA		
TW/A	4	90,424/90,678	107,800/107,930		2,360		AL-LF	8061AF	A234/4 STD	

15 100.00 x 120.00

57J		6 Cyl.		5655cc					Diesel	FM1012
BE/PL	6	66,662/66,675	70,396/70,409	31,120	1,828	0,065/0,116	AL-LF	66305RA	01-4177/6 STD 0.25 0.50 0.75 1.00 1.50	
MB/HL	4	82,537/82,550	86,804/86,830	40,770	2,083	0,088/0,152	AL-LF	66306RA	H1119/7 STD 0.25 0.50 0.75 1.00 1.50	
MB/HL	3	82,537/82,550	86,804/86,830	28,700	2,083	0,088/0,152	AL-LF	66307RA		
TW/A	4	90,424/90,678	107,800/107,930		2,360		AL-LF	8061AF	A234/4 STD	
SE/PB	1	34,920/34,930	39,690/39,700	32,000			BS	GS9075L	55-4542 SEMI	

16 104.18 x 120.65

0375		6 Cyl.		6170cc					Diesel	FM1016
BE/PL	6	60,955/60,973	64,592/64,604	34,798	1,788	0,042/0,099	BS	71-1739	71-1739/6 STD	



17 107.19 x 120.65

O.400 P.P.MK1/2		6 Cyl.	6540cc						Diesel	FM1017
O.401		6 Cyl.	6540cc						Diesel Turbo	FM1021
O.410		6 Cyl.	6540cc						Diesel Turbo	FM1020
BE/PL	6	60,955/60,973	64,592/64,605	34,800	1,780	0,038/0,081	AL-LF	GS1919SA	01-4366/6 STD 0.25 0.50	
BE/PL	6	60,954/60,972	64,592/64,604	34,540	1,780		BS	GS2668LC	71-4368/6 STD	

GS1919SA

GS2668LC

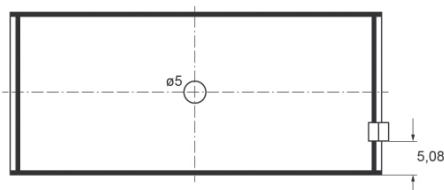
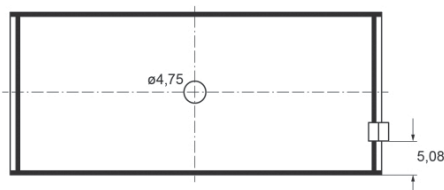

18 130.00 x 146.00

WS 225 ATi		6 Cyl.	11630cc	225kW (306PS)						Diesel Turbo Intercooler	TD7533
WS 259 ATi		6 Cyl.	11630cc	259kW (352PS)						Diesel Turbo Intercooler	TD7534
WS 282 ATi		6 Cyl.	11630cc	282kW (383PS)						Diesel Turbo Intercooler	TD7535
WS 295 ATi		6 Cyl.	11630cc	295kW (401PS)						Diesel Turbo Intercooler	TD7536
BE/PL	6	82,980/83,020	86,625/86,637	42,700	1,787	0,031/0,108	EC	71-3631	71-3631/6P STD 0.25 0.50		

10/84 → 03/94

BE/PL	6	82,980/83,020	86,625/86,637	42,500	1,787	0,031/0,108	EC	71-3791	71-3791/6 STD
-------	---	---------------	---------------	--------	-------	-------------	----	---------	-------------------------

04/94 →

71-3631

71-3791

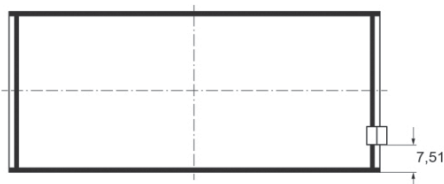
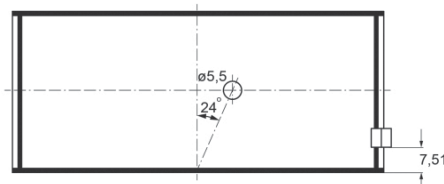

MB/HL	1	97,990/98,010	103,072/103,098	39,150	2,496	0,069/0,141	EC	72-3632	H005/7P STD 0.25 0.50
MB/HL	4	97,990/98,010	103,072/103,098	32,050	2,496	0,069/0,141	EC	72-3633	
MB/HL	2	97,990/98,010	103,072/103,098	52,150	2,496	0,069/0,141	EC	72-3634	

Mot.F65302 →

MB/HL	1	97,990/98,010	103,072/103,098	39,150	2,496	0,069/0,141	EC	72-3632	H022/7P STD 0.25 0.50
MB/HL	4	97,990/98,010	103,072/103,098	32,050	2,496	0,069/0,141	EC	72-3691	
MB/HL	2	97,990/98,010	103,072/103,098	52,000	2,496	0,069/0,141	EC	72-3692	

Mot. → F65301



72-3632

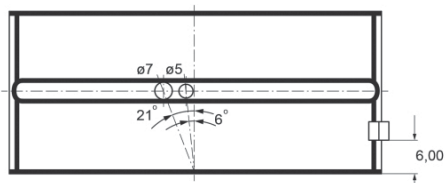

72-3633

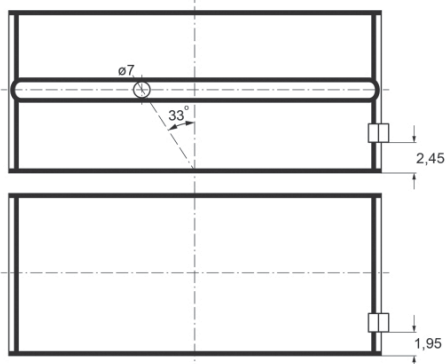

72-3634

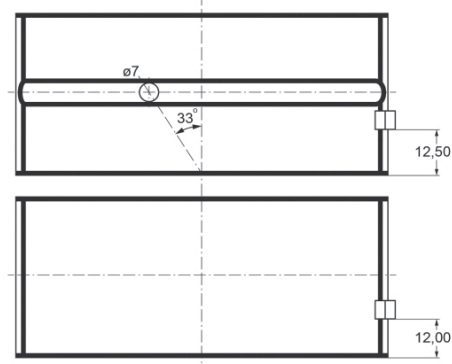



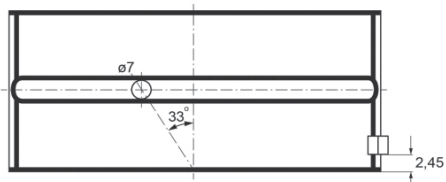

72-3691

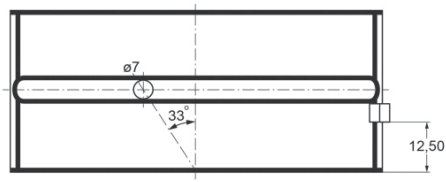

72-3692



TW/A	2	102,320	126,620		2,362	EC	54-2828	A023/4 STD
TW/A	2	102,320	126,620		2,362	EC	54-3346	
TW/A	2	108,200	126,512		2,362	EC	54-3762	A142/4 STD
TW/A	2	108,200	126,512		2,362	EC	54-3763	
SE/PB	1		56,087/56,113	41,550		BC	55-3793	55-3793 SEMI
CB/NWB	5	63,188/63,212	67,305/67,335	25,450	2,026	BC	53-2837	N095/5 STD

		cm ³	x 			9
--	---	-----------------	---	---	---	----------

HL4	Diesel	4184	4	107.95	114.30	13
HL6	Diesel	6277	6	107.95	114.30	14
HR2	Diesel	2090	2	108.00	114.30	15
HR3	Diesel	3140	3	108.00	114.30	16
HR4	Diesel	4180	4	108.00	114.30	17
HR6	Diesel	6270	6	108.00	114.30	18
PH1	Diesel	659	1	87.32	109.98	2
PH2	Diesel	1318	2	87.32	109.68	1
PJ1	Diesel	813	1	96.96	110.10	9
PJ2	Diesel	1625	2	96.96	110.10	10
PJ3	Diesel	2438	3	96.96	110.10	11
PJ4	Diesel	3239	4	96.96	110.10	12
SR1	Diesel	552	1	88.90	88.90	3
SR2	Diesel	1103	2	88.90	88.90	4
SR3	Diesel	1655	3	88.90	88.90	5
ST1	Diesel	630	1	95.25	88.90	6
ST2	Diesel	1270	2	95.25	88.90	7
ST3	Diesel	1900	3	95.25	88.90	8



1 87.32 x 109.68

PH2			2 Cyl.	1318cc				Diesel			FM3856
BE/PL	1	60,310/60,330	64,030/64,050	31,880	1,830	0,050/0,070	AL-LF	GS1221SA	01-4301 STD 0.25 0.50 0.75		

2 87.32 x 109.98

PH1			1 Cyl.	659cc				Diesel			FM2516
BE/PL	1	60,310/60,330	64,030/64,050	31,880	1,830	0,050/0,070	AL-LF	GS1221SA	01-4301 STD 0.25 0.50 0.75		
TW/A	2	65,130/65,380	84,860/85,120		2,340		BB	54-4537	A268/2 STD		

3 88.90 x 88.90

SR1			1 Cyl.	552cc				Diesel			FM957
BE/PL	1	57,099/57,114	60,823/60,848	31,880	1,830		BS	71-4302	71-4302 0.25 0.50		

4 88.90 x 88.90

SR2			2 Cyl.	1103cc				Diesel			FM3850
BE/PL	1	57,099/57,114	60,823/60,848	31,880	1,830		BS	71-4302	71-4302 0.25 0.50		

5 88.90 x 88.90

SR3			3 Cyl.	1655cc				Diesel			FM3851
BE/PL	1	57,099/57,114	60,823/60,848	31,880	1,830		BS	71-4302	71-4302 0.25 0.50		

6 95.25 x 88.90

ST1			1 Cyl.	630cc				Diesel			FM965
BE/PL	1	63,490/63,500	67,210/67,220	31,750	1,830	0,050/0,070	BS	GS2985LC	71-4305 STD		
TW/A	4	68,961/69,215	85,598/85,852		2,360		AL-LF	04-0044	A031/4 STD		

7 95.25 x 88.90

ST2			2 Cyl.	1270cc				Diesel			FM5323
BE/PL	1	63,490/63,500	67,210/67,220	31,750	1,830	0,050/0,070	BS	GS2985LC	71-4305 STD		
TW/A	4	68,961/69,215	85,598/85,852		2,360		AL-LF	04-0044	A031/4 STD		

8 95.25 x 88.90

ST3			3 Cyl.	1900cc				Diesel			FM5324
BE/PL	1	63,490/63,500	67,210/67,220	31,750	1,830	0,050/0,070	BS	GS2985LC	71-4305 STD		
TW/A	4	68,961/69,215	85,598/85,852		2,360		AL-LF	04-0044	A031/4 STD		

9 96.96 x 110.10

PJ1			1 Cyl.	813cc				Diesel			FM2519
BE/PL	1	60,310/60,330	64,030/64,050	31,880	1,830	0,050/0,070	AL-LF	GS1221SA	01-4301 STD 0.25 0.50 0.75		
TW/A	2	65,130/65,380	84,860/85,120		2,340		BB	54-4537	A268/2 STD		



10 96.96 x 110.10

PJ2		2 Cyl.		1625cc		Diesel		FM3861	
BE/PL	1	60,310/60,330	64,030/64,050	31,880	1,830	0,050/0,070	AL-LF	GS1221SA	01-4301 STD 0.25 0.50 0.75
TW/A	2	65,130/65,380	84,860/85,120		2,340		BB	54-4537	A268/2 STD

11 96.96 x 110.10

PJ3		3 Cyl.		2438cc		Diesel		FM3862	
BE/PL	1	60,310/60,330	64,030/64,050	31,880	1,830	0,050/0,070	AL-LF	GS1221SA	01-4301 STD 0.25 0.50 0.75
TW/A	2	65,130/65,380	84,860/85,120		2,340		BB	54-4537	A268/2 STD

12 96.96 x 110.10

PJ4		4 Cyl.		3239cc		Diesel		FM3863	
BE/PL	1	60,310/60,330	64,030/64,050	31,880	1,830	0,050/0,070	AL-LF	GS1221SA	01-4301 STD 0.25 0.50 0.75
TW/A	2	65,130/65,380	84,860/85,120		2,340		BB	54-4537	A268/2 STD

13 107.95 x 114.30

HL4		4 Cyl.		4184cc 67PS		Diesel		FM6888	
BE/PL	1	69,817/69,830	74,054/74,066	36,370	2,080		BS	GS2487LC	71-4304 0.25

14 107.95 x 114.30

HL6		6 Cyl.		6277cc 101PS		Diesel		FM6889	
BE/PL	1	69,817/69,830	74,054/74,066	36,370	2,080		BS	GS2487LC	71-4304 0.25

15 108.00 x 114.30

HR2		2 Cyl.		2090cc		Diesel		FM973	
BE/PL	1	69,817/69,830	74,054/74,066	36,370	2,080		BS	GS2487LC	71-4304 0.25
MB/HL	1	82,525/82,537	86,766/86,792	36,630	2,808		BS	GS2485LC	72-4557 STD 0.25

16 108.00 x 114.30







HR3		3 Cyl.		3140cc		Diesel		FM974	
BE/PL	1	69,817/69,830	74,054/74,066	36,370	2,080		BS	GS2487LC	71-4304 0.25
MB/HL	1	82,525/82,537	86,766/86,792	36,630	2,808		BS	GS2485LC	72-4557 STD 0.25







17 108.00 x 114.30

HR4		4 Cyl.		4180cc		Diesel		FM975	
BE/PL	1	69,817/69,830	74,054/74,066	36,370	2,080		BS	GS2487LC	71-4304 0.25







18 108.00 x 114.30







HR6		6 Cyl.		6270cc		Diesel		FM976	
BE/PL	1	69,817/69,830	74,054/74,066	36,370	2,080		BS	GS2487LC	71-4304 0.25

		cm ³	x 			
D 0226 M	Diesel	5687	6	102.00	116.00	1
D 0226 MC	Diesel	5687	6	102.00	116.00	1
D 0226 MCFO/170	Diesel	5687	6	102.00	116.00	1
D 0226 ME	Diesel	5687	6	102.00	116.00	1
D 0226 MF	Diesel	5687	6	102.00	116.00	1
D 0226 MFA	Diesel	5687	6	102.00	116.00	1
D 0226 MFM	Diesel	5687	6	102.00	116.00	1
D 0226 MFO	Diesel	5687	6	102.00	116.00	1
D 0226 MH	Diesel	5687	6	102.00	116.00	1
D 0226 MK	Diesel	5687	6	102.00	116.00	1
D 0226 MKF	Diesel	5687	6	102.00	116.00	1
D 0226 MKF/170	Diesel	5687	6	102.00	116.00	1
D 0226 MKFA	Diesel	5687	6	102.00	116.00	1
D 0226 MKFO	Diesel	5687	6	102.00	116.00	1
D 0226 MKH	Diesel	5687	6	102.00	116.00	1
D 0226 ML	Diesel	5687	6	102.00	116.00	1
D 0226 MLE	Diesel	5687	6	102.00	116.00	1
D 0226 MT	Diesel	5687	6	102.00	116.00	1
D 0226 MTE Euro 3	Diesel	5687	6	102.00	116.00	1
D 0824 FL 01 Euro 1	Diesel	4580	4	108.00	125.00	3
D 0824 GF	Diesel	4580	4	108.00	125.00	4
D 0824 GF01	Diesel	4580	4	108.00	125.00	4
D 0824 GF02 Euro 1	Diesel	4580	4	108.00	125.00	4
D 0824 GF03 Euro 1	Diesel	4580	4	108.00	125.00	4
D 0824 GF04 Euro 1	Diesel	4580	4	108.00	125.00	4
D 0824 LF 01 Euro 1	Diesel	4580	4	108.00	125.00	3
D 0824 LF 02 Euro 2	Diesel	4580	4	108.00	125.00	3
D 0824 LF 03 Euro 1	Diesel	4580	4	108.00	125.00	3
D 0824 LF 04 Euro 1	Diesel	4580	4	108.00	125.00	3
D 0824 LF 05 Euro 1	Diesel	4580	4	108.00	125.00	3
D 0824 LF 06 Euro 1	Diesel	4580	4	108.00	125.00	3
D 0824 LF 07 Euro 1	Diesel	4580	4	108.00	125.00	3
D 0824 LF 08 Euro 1	Diesel	4580	4	108.00	125.00	3
D 0824 LF 09 Euro 1	Diesel	4580	4	108.00	125.00	3
D 0824 LF 10 Euro 1	Diesel	4580	4	108.00	125.00	3
D 0824 LFG 01 Euro 2	Diesel	4580	4	108.00	125.00	3
D 0824 LFL 01 Euro 1	Diesel	4580	4	108.00	125.00	3
D 0824 LFL 02 Euro 2	Diesel	4580	4	108.00	125.00	3
D 0824 LFL 03 Euro 2	Diesel	4580	4	108.00	125.00	3
D 0824 LFL 04 Euro 2	Diesel	4580	4	108.00	125.00	3
D 0824 LFL 05 Euro 1	Diesel	4580	4	108.00	125.00	3
D 0824 LFL 06 Euro 2	Diesel	4580	4	108.00	125.00	3
D 0824 LFL 07 Euro 2	Diesel	4580	4	108.00	125.00	3
D 0824 LFL 08 Euro 2	Diesel	4580	4	108.00	125.00	3
D 0824 LFL 09 Euro 1	Diesel	4580	4	108.00	125.00	3
D 0824 LFL 10 Euro 2	Diesel	4580	4	108.00	125.00	3
D 0824 LFO 01 Euro 1	Diesel	4580	4	108.00	125.00	3
D 0824 LFO 02	Diesel	4580	4	108.00	125.00	3
D 0824 LFO Euro 1	Diesel	4580	4	108.00	125.00	3
D 0824 LOH 01 Euro 1	Diesel	4580	4	108.00	125.00	3
D 0824 LOH 02 Euro 1	Diesel	4580	4	108.00	125.00	3
D 0824 LOH 03 Euro 1	Diesel	4580	4	108.00	125.00	3
D 0824 LOH 04 Euro 1	Diesel	4580	4	108.00	125.00	3
D 0824 LOH 05 Euro 2	Diesel	4580	4	108.00	125.00	3
D 0824 LUE 521	Diesel	4580	4	108.00	125.00	3
D 0824 LUE 522	Diesel	4580	4	108.00	125.00	3
D 0824 LUE 523	Diesel	4580	4	108.00	125.00	3
D 0824 LUE 524	Diesel	4580	4	108.00	125.00	3
D 0826 F01	Diesel	6871	6	108.00	125.00	7
D 0826 F02	Diesel	6871	6	108.00	125.00	7
D 0826 FG001	Diesel	6871	6	108.00	125.00	7
D 0826 FG002	Diesel	6871	6	108.00	125.00	7
D 0826 FO	Diesel	6871	6	108.00	125.00	8
D 0826 FO 01	Diesel	6871	6	108.00	125.00	7
D 0826 FO 02	Diesel	6871	6	108.00	125.00	7
D 0826 FO 03 Euro 1	Diesel	6871	6	108.00	125.00	8
D 0826 FR	Diesel	6871	6	108.00	125.00	8
D 0826 FR 01	Diesel	6871	6	108.00	125.00	8
D 0826 GF	Diesel	6871	6	108.00	125.00	7







		cm ³	x 			
--	---	-----------------	---	---	---	---







D 0826 GF01	Diesel	6871	6	108.00	125.00	7
D 0826 GF02	Diesel	6871	6	108.00	125.00	7
D 0826 GF03	Diesel	6871	6	108.00	125.00	7
D 0826 GF04 Euro 1	Diesel	6871	6	108.00	125.00	7
D 0826 GFA	Diesel	6871	6	108.00	125.00	7
D 0826 GFA 01	Diesel	6871	6	108.00	125.00	7
D 0826 GFA 02	Diesel	6871	6	108.00	125.00	7
D 0826 GFA 03	Diesel	6871	6	108.00	125.00	7
D 0826 GFA 04 Euro 1	Diesel	6871	6	108.00	125.00	7
D 0826 LE 51	Diesel	6871	6	108.00	125.00	7
D 0826 LE 52	Diesel	6871	6	108.00	125.00	7
D 0826 LE 521	Diesel	6871	6	108.00	125.00	7
D 0826 LE 522 Euro 1	Diesel	6871	6	108.00	125.00	7
D 0826 LE 523 Euro 1	Diesel	6871	6	108.00	125.00	7
D 0826 LE 524 Euro 1	Diesel	6871	6	108.00	125.00	7
D 0826 LE 527 Euro 1	Diesel	6871	6	108.00	125.00	7
D 0826 LE 530 Euro 1	Diesel	6871	6	108.00	125.00	7
D 0826 LE 531 Euro 1	Diesel	6871	6	108.00	125.00	7
D 0826 LF/217/Silent	Diesel	6870	6	108.00	125.00	8
D 0826 LF01	Diesel	6871	6	108.00	125.00	7
D 0826 LF02 Euro 1	Diesel	6871	6	108.00	125.00	7
D 0826 LF04 Euro 1	Diesel	6871	6	108.00	125.00	8
D 0826 LF05	Diesel	6871	6	108.00	125.00	7
D 0826 LF06	Diesel	6871	6	108.00	125.00	7
D 0826 LF07 Euro 1	Diesel	6871	6	108.00	125.00	7
D 0826 LF08 Euro 1	Diesel	6871	6	108.00	125.00	7
D 0826 LF09 Euro 1	Diesel	6871	6	108.00	125.00	7
D 0826 LF10 Euro 2	Diesel	6871	6	108.00	125.00	7
D 0826 LF11 Euro 2	Diesel	6871	6	108.00	125.00	8
D 0826 LF12 Euro 2	Diesel	6871	6	108.00	125.00	8
D 0826 LF13 Euro 2	Diesel	6871	6	108.00	125.00	8
D 0826 LF15 Euro 2	Diesel	6871	6	108.00	125.00	8
D 0826 LF17 Euro 2	Diesel	6871	6	108.00	125.00	8
D 0826 LF18 Euro 2	Diesel	6871	6	108.00	125.00	8
D 0826 LFG 01	Diesel	6871	6	108.00	125.00	7
D 0826 LFG 02	Diesel	6871	6	108.00	125.00	7
D 0826 LFG 06 Euro 1	Diesel	6871	6	108.00	125.00	7
D 0826 LFG 15 Euro 2	Diesel	6871	6	108.00	125.00	8
D 0826 LFG 16 Euro 2	Diesel	6871	6	108.00	125.00	8
D 0826 LFL01 Euro 1	Diesel	6871	6	108.00	125.00	8
D 0826 LFL02 Euro 1	Diesel	6871	6	108.00	125.00	8
D 0826 LFL03 Euro 1	Diesel	6871	6	108.00	125.00	8
D 0826 LFL05 Euro 1	Diesel	6871	6	108.00	125.00	8
D 0826 LFL06 Euro 1	Diesel	6871	6	108.00	125.00	8
D 0826 LFL07 Euro 1	Diesel	6871	6	108.00	125.00	8
D 0826 LFL08 Euro 1	Diesel	6871	6	108.00	125.00	8
D 0826 LFL09 Euro 2	Diesel	6871	6	108.00	125.00	8
D 0826 LFL10 Euro 1	Diesel	6871	6	108.00	125.00	8
D 0826 LFL Euro 1	Diesel	6871	6	108.00	125.00	8
D 0826 LOH 01	Diesel	6871	6	108.00	125.00	7
D 0826 LOH 02	Diesel	6871	6	108.00	125.00	8
D 0826 LOH 03	Diesel	6871	6	108.00	125.00	8
D 0826 LOH 04	Diesel	6871	6	108.00	125.00	8
D 0826 LOH 05	Diesel	6871	6	108.00	125.00	7
D 0826 LOH 06 Euro 1	Diesel	6871	6	108.00	125.00	8
D 0826 LOH 07 Euro 1	Diesel	6871	6	108.00	125.00	7
D 0826 LOH 08 Euro 1	Diesel	6871	6	108.00	125.00	7
D 0826 LOH 09 Euro 1	Diesel	6871	6	108.00	125.00	7
D 0826 LOH 10 Euro 1	Diesel	6871	6	108.00	125.00	7
D 0826 LOH 11 Euro 1	Diesel	6871	6	108.00	125.00	7
D 0826 LOH 12	Diesel	6871	6	108.00	125.00	7
D 0826 LOH 13 Euro 1	Diesel	6871	6	108.00	125.00	7
D 0826 LOH 15 Euro 2	Diesel	6871	6	108.00	125.00	7
D 0826 LOH 17 Euro 2	Diesel	6871	6	108.00	125.00	8
D 0826 LOH 18 Euro 2	Diesel	6871	6	108.00	125.00	8
D 0826 LOH 19 Euro 2	Diesel	6871	6	108.00	125.00	8
D 0826 LUE 51 Euro 1	Diesel	6870	6	108.00	125.00	7
D 0826 LUH/213	Diesel	6871	6	108.00	125.00	7
D 0826 LUH 01 Euro 1	Diesel	6871	6	108.00	125.00	8

		cm3	x 			
D 0826 LUH 02 Euro 1	Diesel	6871	6	108.00	125.00	8
D 0826 LUH 03 Euro 1	Diesel	6871	6	108.00	125.00	8
D 0826 LUH 04	Diesel	6871	6	108.00	125.00	8
D 0826 LUH 05 Euro 1	Diesel	6871	6	108.00	125.00	8
D 0826 LUH 06 Euro 1	Diesel	6871	6	108.00	125.00	8
D 0826 LUH 08 Euro 2	Diesel	6871	6	108.00	125.00	8
D 0826 LUH 09 Euro 2	Diesel	6871	6	108.00	125.00	8
D 0826 LUH 10 Euro 1	Diesel	6871	6	108.00	125.00	8
D 0826 LUH 11 Euro 2	Diesel	6871	6	108.00	125.00	8
D 0826 LUH 12 Euro 1	Diesel	6870	6	108.00	125.00	8
D 0826 LUH 13 Euro 2	Diesel	6871	6	108.00	125.00	8
D 0826 LUH Euro 1	Diesel	6870	6	108.00	125.00	8
D 0826 OH	Diesel	6871	6	108.00	125.00	7
D 0826 OH01	Diesel	6871	6	108.00	125.00	7
D 0826 OH02	Diesel	6871	6	108.00	125.00	7
D 0826 OH03 Euro 1	Diesel	6871	6	108.00	125.00	8
D 0826 TE 520	Diesel	6596	6	108.00	120.00	2
D 0826 TF	Diesel	6596	6	108.00	120.00	2
D 0826 TOH	Diesel	6596	6	108.00	120.00	2
D 0826 TOH 01	Diesel	6596	6	108.00	120.00	2
D 0826 TUE 51	Diesel	6871	6	108.00	125.00	7
D 0834 LFL 01 Euro 3	Diesel	4580	4	108.00	125.00	6
D 0834 LFL 02 Euro 3	Diesel	4580	4	108.00	125.00	6
D 0834 LFL 03 Euro 3	Diesel	4580	4	108.00	125.00	6
D 0834 LFL 04 Euro 3	Diesel	4580	4	108.00	125.00	6
D 0834 LFL 07 Euro 3	Diesel	4580	4	108.00	125.00	6
D 0834 LFL 10 Euro 3	Diesel	4580	4	108.00	125.00	6
D 0834 LFL 11 Euro 3	Diesel	4580	4	108.00	125.00	6
D 0834 LFL 20 Euro 3	Diesel	4580	4	108.00	125.00	6
D 0834 LFL 40 Euro 3	Diesel	4580	4	108.00	125.00	6
D 0834 LFL 41 Euro 3	Diesel	4580	4	108.00	125.00	6
D 0834 LFL 42 Euro 3	Diesel	4580	4	108.00	125.00	6
D 0834 LFL 50 Euro 4	Diesel	4580	4	108.00	125.00	5
D 0834 LFL 51 Euro 4	Diesel	4580	4	108.00	125.00	5
D 0834 LFL 52 Euro 4	Diesel	4580	4	108.00	125.00	5
D 0834 LFL 53 Euro 4	Diesel	4580	4	108.00	125.00	5
D 0834 LFL 54 Euro 4	Diesel	4580	4	108.00	125.00	5
D 0834 LFL 55 Euro 4	Diesel	4580	4	108.00	125.00	5
D 0834 LFL 60	Diesel	4580	4	108.00	125.00	5
D 0834 LFL 61	Diesel	4580	4	108.00	125.00	5
D 0834 LFL 62	Diesel	4580	4	108.00	125.00	5
D 0834 LFL 63 Euro 5	Diesel	4580	4	108.00	125.00	5
D 0834 LFL 64 Euro 5	Diesel	4580	4	108.00	125.00	5
D 0834 LFL 65 Euro 5	Diesel	4580	4	108.00	125.00	5
D 0834 LFL 66 Euro 6	Diesel	4580	4	108.00	125.00	5
D 0834 LFL 67 Euro 6	Diesel	4580	4	108.00	125.00	5
D 0834 LFL 68 Euro 6	Diesel	4580	4	108.00	125.00	5
D 0834 LOH 01 Euro 3	Diesel	4580	4	108.00	125.00	6
D 0834 LOH 02 Euro 3	Diesel	4580	4	108.00	125.00	6
D 0834 LOH 03 Euro 3	Diesel	4580	4	108.00	125.00	6
D 0834 LOH 40 Euro 3	Diesel	4580	4	108.00	125.00	5
D 0834 LOH 50 Euro 4	Diesel	4580	4	108.00	125.00	5
D 0834 LOH 51 Euro 4	Diesel	4580	4	108.00	125.00	5
D 0834 LOH 52 Euro 4	Diesel	4580	4	108.00	125.00	5
D 0834 LOH 53 Euro 4	Diesel	4580	4	108.00	125.00	5
D 0834 LOH 60	Diesel	4580	4	108.00	125.00	5
D 0834 LOH 61 Euro 5	Diesel	4580	4	108.00	125.00	5
D 0834 LOH 63 Euro 5	Diesel	4580	4	108.00	125.00	5
D 0836 HM 3 U	Diesel	7030	6	108.00	128.00	12
D 0836 HM 4	Diesel	7030	6	108.00	128.00	12
D 0836 HM 5 U	Diesel	7030	6	108.00	128.00	12
D 0836 HM 7	Diesel	7030	6	108.00	128.00	12
D 0836 HM 70	Diesel	7030	6	108.00	128.00	12
D 0836 HM 71	Diesel	7030	6	108.00	128.00	12
D 0836 HM 7 U	Diesel	7030	6	108.00	128.00	12
D 0836 HM 8 U	Diesel	7030	6	108.00	128.00	12
D 0836 HM 9 H	Diesel	7030	6	108.00	128.00	12
D 0836 HM 9 U	Diesel	7030	6	108.00	128.00	12
D 0836 HMN 70	Diesel	7030	6	108.00	128.00	12







		cm ³	x 			
--	---	-----------------	---	---	---	---







D 0836 LF 01	Diesel	6871	6	108.00	125.00	10
D 0836 LF 02 Euro 3	Diesel	6871	6	108.00	125.00	10
D 0836 LF 03 Euro 3	Diesel	6871	6	108.00	125.00	10
D 0836 LF 04 Euro 3	Diesel	6871	6	108.00	125.00	10
D 0836 LF 05 Euro 3	Diesel	6871	6	108.00	125.00	10
D 0836 LF 06 Euro 3	Diesel	6871	6	108.00	125.00	10
D 0836 LF 10 Euro 3	Diesel	6871	6	108.00	125.00	10
D 0836 LF 41 Euro 3	Diesel	6871	6	108.00	125.00	10
D 0836 LF 44 Euro 3	Diesel	6871	6	108.00	125.00	10
D 0836 LFG 50 Euro 4/5	Diesel	6871	6	108.00	125.00	9
D 0836 LFL 01 Euro 3	Diesel	6871	6	108.00	125.00	10
D 0836 LFL 02 Euro 3	Diesel	6871	6	108.00	125.00	10
D 0836 LFL 03 Euro 3	Diesel	6871	6	108.00	125.00	10
D 0836 LFL 04 Euro 3	Diesel	6871	6	108.00	125.00	10
D 0836 LFL 05 Euro 3	Diesel	6871	6	108.00	125.00	10
D 0836 LFL 06 Euro 3	Diesel	6871	6	108.00	125.00	10
D 0836 LFL 07 Euro 3	Diesel	6871	6	108.00	125.00	10
D 0836 LFL 08 Euro 3	Diesel	6871	6	108.00	125.00	10
D 0836 LFL 10 Euro 3	Diesel	6871	6	108.00	125.00	10
D 0836 LFL 40 Euro 3	Diesel	6871	6	108.00	125.00	10
D 0836 LFL 41 Euro 3	Diesel	6871	6	108.00	125.00	10
D 0836 LFL 44 Euro 3	Diesel	6871	6	108.00	125.00	10
D 0836 LFL 50 Euro 4	Diesel	6871	6	108.00	125.00	9
D 0836 LFL 51 Euro 4	Diesel	6871	6	108.00	125.00	9
D 0836 LFL 52 Euro 4	Diesel	6871	6	108.00	125.00	9
D 0836 LFL 53 Euro 4	Diesel	6871	6	108.00	125.00	9
D 0836 LFL 54 Euro 4	Diesel	6871	6	108.00	125.00	9
D 0836 LFL 55 Euro 4	Diesel	6871	6	108.00	125.00	9
D 0836 LFL 60	Diesel	6871	6	108.00	125.00	9
D 0836 LFL 61	Diesel	6871	6	108.00	125.00	9
D 0836 LFL 62	Diesel	6871	6	108.00	125.00	9
D 0836 LFL 63 Euro 5	Diesel	6871	6	108.00	125.00	9
D 0836 LFL 64 Euro 5	Diesel	6871	6	108.00	125.00	9
D 0836 LFL 65 Euro 5	Diesel	6871	6	108.00	125.00	9
D 0836 LFL 66 Euro 6	Diesel	6871	6	108.00	125.00	9
D 0836 LFL 67 Euro 6	Diesel	6871	6	108.00	125.00	9
D 0836 LFL 68 Euro 6	Diesel	6871	6	108.00	125.00	9
D 0836 LFL 69 Euro 5	Diesel	6871	6	108.00	125.00	9
D 0836 LFL 70 Euro 5	Diesel	6871	6	108.00	125.00	9
D 0836 LFL 71 Euro 5	Diesel	6871	6	108.00	125.00	9
D 0836 LOH 01 Euro 3	Diesel	6871	6	108.00	125.00	10
D 0836 LOH 02 Euro 3	Diesel	6871	6	108.00	125.00	10
D 0836 LOH 03 Euro 3	Diesel	6871	6	108.00	125.00	10
D 0836 LOH 40 Euro 3	Diesel	6871	6	108.00	125.00	10
D 0836 LOH 41 Euro 3	Diesel	6871	6	108.00	125.00	10
D 0836 LOH 51 Euro 4	Diesel	6871	6	108.00	125.00	9
D 0836 LOH 52 Euro 4	Diesel	6871	6	108.00	125.00	9
D 0836 LOH 55 Euro 4	Diesel	6871	6	108.00	125.00	9
D 0836 LOH 56 Euro 4	Diesel	6871	6	108.00	125.00	9
D 0836 LOH 60	Diesel	6871	6	108.00	125.00	9
D 0836 LOH 61	Diesel	6871	6	108.00	125.00	9
D 0836 LOH 62 Euro 4	Diesel	6871	6	108.00	125.00	9
D 0836 LOH 63	Diesel	6871	6	108.00	125.00	9
D 0836 LOH 64 Euro 5	Diesel	6871	6	108.00	125.00	9
D 0836 LOH 65 Euro 5	Diesel	6871	6	108.00	125.00	9
D 0836 LOH 69 Euro 5	Diesel	6871	6	108.00	125.00	9
D 0836 LOH 70	Diesel	6871	6	108.00	125.00	9
D 0836 LOH 71	Diesel	6871	6	108.00	125.00	9
D 0836 LUH 01 Euro 3	Diesel	6871	6	108.00	125.00	10
D 0836 LUH 02 Euro 3	Diesel	6871	6	108.00	125.00	10
D 0836 LUH 40 Euro 3	Diesel	6871	6	108.00	125.00	10
D 0836 LUH 41 Euro 3	Diesel	6871	6	108.00	125.00	10
D 0836 M 2	Diesel	7030	6	108.00	128.00	12
D 0836 M 2 A	Diesel	7030	6	108.00	128.00	12
D 0836 M 2 U	Diesel	7030	6	108.00	128.00	12
D 0836 M 3 H	Diesel	7030	6	108.00	128.00	12
D 2066 LE 621	Diesel	10518	6	120.00	155.00	13
D 2066 LF 01 Euro 3	Diesel	10518	6	120.00	155.00	14
D 2066 LF 02 Euro 3	Diesel	10518	6	120.00	155.00	14

		cm3	x 			
D 2066 LF 03 Euro 3	Diesel	10518	6	120.00	155.00	14
D 2066 LF 04 Euro 3	Diesel	10518	6	120.00	155.00	14
D 2066 LF 06 Euro 3	Diesel	10518	6	120.00	155.00	14
D 2066 LF 07 Euro 3	Diesel	10518	6	120.00	155.00	14
D 2066 LF 11 Euro 4	Diesel	10518	6	120.00	155.00	14
D 2066 LF 12 Euro 4	Diesel	10518	6	120.00	155.00	14
D 2066 LF 13 Euro 4	Diesel	10518	6	120.00	155.00	14
D 2066 LF 14 Euro 4	Diesel	10518	6	120.00	155.00	14
D 2066 LF 17 Euro 5	Diesel	10518	6	120.00	155.00	13
D 2066 LF 18 Euro 5	Diesel	10518	6	120.00	155.00	13
D 2066 LF 19 Euro 5	Diesel	10518	6	120.00	155.00	13
D 2066 LF 20 Euro 5	Diesel	10518	6	120.00	155.00	13
D 2066 LF 21 Euro 5	Diesel	10518	6	120.00	155.00	13
D 2066 LF 22 Euro 5	Diesel	10518	6	120.00	155.00	13
D 2066 LF 23 Euro 5	Diesel	10518	6	120.00	155.00	14
D 2066 LF 24 Euro 5	Diesel	10518	6	120.00	155.00	14
D 2066 LF 25 Euro 5	Diesel	10518	6	120.00	155.00	13
D 2066 LF 26 Euro 5	Diesel	10518	6	120.00	155.00	13
D 2066 LF 27 Euro 5	Diesel	10518	6	120.00	155.00	13
D 2066 LF 28 Euro 5	Diesel	10518	6	120.00	155.00	13
D 2066 LF 29	Diesel	10518	6	120.00	155.00	14
D 2066 LF 30	Diesel	10518	6	120.00	155.00	14
D 2066 LF 31 Euro 4	Diesel	10518	6	120.00	155.00	14
D 2066 LF 32 Euro 4	Diesel	10518	6	120.00	155.00	14
D 2066 LF 33 Euro 4	Diesel	10518	6	120.00	155.00	14
D 2066 LF 34	Diesel	10518	6	120.00	155.00	14
D 2066 LF 35 Euro 4	Diesel	10518	6	120.00	155.00	14
D 2066 LF 36 Euro 4	Diesel	10518	6	120.00	155.00	13
D 2066 LF 37 Euro 4	Diesel	10518	6	120.00	155.00	13
D 2066 LF 38 Euro 4	Diesel	10518	6	120.00	155.00	13
D 2066 LF 39 Euro 4	Diesel	10518	6	120.00	155.00	13
D 2066 LF 40 Euro 5	Diesel	10518	6	120.00	155.00	15
D 2066 LF 41 Euro 5	Diesel	10518	6	120.00	155.00	15
D 2066 LF 42 Euro 5	Diesel	10518	6	120.00	155.00	15
D 2066 LF 43 Euro 5	Diesel	10518	6	120.00	155.00	15
D 2066 LF 44 Euro 5	Diesel	10518	6	120.00	155.00	14
D 2066 LF 45 Euro 5	Diesel	10518	6	120.00	155.00	14
D 2066 LF 46 Euro 5	Diesel	10518	6	120.00	155.00	14
D 2066 LF 47 Euro 5	Diesel	10518	6	120.00	155.00	14
D 2066 LF 48 Euro 3	Diesel	10518	6	120.00	155.00	15
D 2066 LF 49 Euro 3	Diesel	10518	6	120.00	155.00	15
D 2066 LF 50 Euro 3	Diesel	10518	6	120.00	155.00	15
D 2066 LF 51 Euro 5	Diesel	10518	6	120.00	155.00	15
D 2066 LF 52 Euro 5	Diesel	10518	6	120.00	155.00	15
D 2066 LF 53 Euro 5	Diesel	10518	6	120.00	155.00	15
D 2066 LF 54	Diesel	10518	6	120.00	155.00	14
D 2066 LF 55	Diesel	10518	6	120.00	155.00	14
D 2066 LF 56	Diesel	10518	6	120.00	155.00	14
D 2066 LF 57	Diesel	10518	6	120.00	155.00	15
D 2066 LF 58	Diesel	10518	6	120.00	155.00	14
D 2066 LF 59	Diesel	10518	6	120.00	155.00	13
D 2066 LF 60	Diesel	10518	6	120.00	155.00	13
D 2066 LF 61 Euro 6	Diesel	10518	6	120.00	155.00	15
D 2066 LF 62 Euro 4	Diesel	10518	6	120.00	155.00	15
D 2066 LF 63 Euro 4	Diesel	10518	6	120.00	155.00	15
D 2066 LF 64 Euro 4	Diesel	10518	6	120.00	155.00	15
D 2066 LF 65 Euro 4	Diesel	10518	6	120.00	155.00	14
D 2066 LF 67 Euro 6	Diesel	10518	6	120.00	155.00	15
D 2066 LF 68 Euro 6	Diesel	10518	6	120.00	155.00	15
D 2066 LF 69 Euro 4	Diesel	10518	6	120.00	155.00	14
D 2066 LF 70 Euro 4	Diesel	10518	6	120.00	155.00	14
D 2066 LF 71 Euro 4	Diesel	10518	6	120.00	155.00	14
D 2066 LF 72 Euro 4	Diesel	10518	6	120.00	155.00	14
D 2066 LOH 01 Euro 4	Diesel	10520	6	120.00	155.00	13
D 2066 LOH 02 Euro 4	Diesel	10518	6	120.00	155.00	15
D 2066 LOH 03 Euro 4	Diesel	10518	6	120.00	155.00	15
D 2066 LOH 04 Euro 4	Diesel	10518	6	120.00	155.00	15
D 2066 LOH 05 Euro 4	Diesel	10518	6	120.00	155.00	13
D 2066 LOH 06 Euro 4	Diesel	10518	6	120.00	155.00	15







		cm3	x 			
--	---	-----	---	---	---	---







D 2066 LOH 07 Euro 4	Diesel	10518	6	120.00	155.00	13
D 2066 LOH 08 Euro 4	Diesel	10518	6	120.00	155.00	15
D 2066 LOH 10 Euro 3	Diesel	10518	6	120.00	155.00	15
D 2066 LOH 11 Euro 3	Diesel	10518	6	120.00	155.00	13
D 2066 LOH 12 Euro 3	Diesel	10518	6	120.00	155.00	13
D 2066 LOH 13 Euro 4	Diesel	10518	6	120.00	155.00	13
D 2066 LOH 26	Diesel	10518	6	120.00	155.00	13
D 2066 LOH 27	Diesel	10518	6	120.00	155.00	15
D 2066 LOH 28	Diesel	10518	6	120.00	155.00	13
D 2066 LOH 35 Euro 4	Diesel	10518	6	120.00	155.00	14
D 2066 LUH 07 Euro 3	Diesel	10520	6	120.00	155.00	13
D 2066 LUH 08 Euro 3	Diesel	10520	6	120.00	155.00	13
D 2066 LUH 09 Euro 3	Diesel	10520	6	120.00	155.00	13
D 2066 LUH 11 Euro 4	Diesel	10520	6	120.00	155.00	15
D 2066 LUH 12 Euro 4	Diesel	10520	6	120.00	155.00	15
D 2066 LUH 13 Euro 4	Diesel	10520	6	120.00	155.00	15
D 2066 LUH 14 Euro 4	Diesel	10520	6	120.00	155.00	13
D 2066 LUH 15 Euro 4	Diesel	10520	6	120.00	155.00	13
D 2066 LUH 21 Euro 4	Diesel	10518	6	120.00	155.00	13
D 2066 LUH 22 Euro 4	Diesel	10518	6	120.00	155.00	13
D 2066 LUH 23 Euro 4	Diesel	10518	6	120.00	155.00	15
D 2066 LUH 24 Euro 4	Diesel	10518	6	120.00	155.00	13
D 2066 LUH 32 Euro 5	Diesel	10518	6	120.00	155.00	13
D 2066 LUH 33 Euro 5	Diesel	10518	6	120.00	155.00	13
D 2066 LUH 34 Euro 5	Diesel	10518	6	120.00	155.00	13
D 2066 LUH 41	Diesel	10518	6	120.00	155.00	13
D 2066 LUH 42	Diesel	10518	6	120.00	155.00	14
D 2066 LUH 43	Diesel	10518	6	120.00	155.00	13
D 2066 LUH 46	Diesel	10518	6	120.00	155.00	13
D 2066 LUH 47	Diesel	10518	6	120.00	155.00	13
D 2066 LUH 48	Diesel	10518	6	120.00	155.00	15
D 2156 HM 1 U	Diesel	10344	6	121.00	150.00	16
D 2156 HM 2	Diesel	10344	6	121.00	150.00	16
D 2156 HM 3	Diesel	10344	6	121.00	150.00	16
D 2156 HM 51 U	Diesel	10344	6	121.00	150.00	16
D 2156 HM 52 U	Diesel	10344	6	121.00	150.00	16
D 2156 HM 5 U	Diesel	10344	6	121.00	150.00	16
D 2156 HM 6 H	Diesel	10344	6	121.00	150.00	16
D 2156 HM 6 HDK	Diesel	10344	6	121.00	150.00	16
D 2156 HM 9	Diesel	10344	6	121.00	150.00	16
D 2156 HMN 1	Diesel	10344	6	121.00	150.00	16
D 2156 HMN-5	Diesel	10344	6	121.00	150.00	16
D 2156 HMN 6	Diesel	10344	6	121.00	150.00	16
D 2156 HMX-032	Diesel	10344	6	121.00	150.00	16
D 2156 HMXU-037	Diesel	10344	6	121.00	150.00	16
D 2156 HMXU-038	Diesel	10344	6	121.00	150.00	16
D 2156 HNY	Diesel	10344	6	121.00	150.00	16
D 2156 MGN	Diesel	10344	6	121.00	150.00	16
D 2156 MNY	Diesel	10344	6	121.00	150.00	16
D 2156 MTN 1	Diesel	10344	6	121.00	150.00	16
D 2156 MTN 5	Diesel	10344	6	121.00	150.00	16
D 2156 MTX	Diesel	10344	6	121.00	150.00	16
D 2156 MTX-034	Diesel	10344	6	121.00	150.00	16
D 2156 MTXN-035	Diesel	10344	6	121.00	150.00	16
D 2356 HM 2	Diesel	10700	6	123.00	150.00	17
D 2356 HM 51 U	Diesel	10694	6	123.00	150.00	17
D 2356 HM 5 H	Diesel	10700	6	123.00	150.00	17
D 2356 HM 9	Diesel	10700	6	123.00	150.00	17
D 2356 HMN 2	Diesel	10700	6	123.00	150.00	17
D 2356 HMN 5	Diesel	10700	6	123.00	150.00	17
D 2356 HMX-060	Diesel	10700	6	123.00	150.00	17
D 2356 HMXN-061	Diesel	10700	6	123.00	150.00	17
D 2356 HMXU-062	Diesel	10700	6	123.00	150.00	17
D 2356 HMXU-066	Diesel	10700	6	123.00	150.00	17
D 2356 HMXU-067	Diesel	10700	6	123.00	150.00	17
D 2356 HMXU-069	Diesel	10700	6	123.00	150.00	17
D 2530 ME	Diesel	15945	V10	125.00	130.00	20
D 2530 MF	Diesel	15945	V10	125.00	130.00	20
D 2530 MTE	Diesel	15953	V10	125.00	130.00	21

		cm3	x 			
D 2530 MTXF	Diesel	15953	V10	125.00	130.00	21
D 2530 MTXF/360	Diesel	15900	V10	125.00	130.00	21
D 2530 MXF	Diesel	15945	V10	125.00	130.00	20
D 2538 M	Diesel	12763	V8	125.00	130.00	18
D 2538 ME	Diesel	12763	V8	125.00	130.00	18
D 2538 MF	Diesel	12763	V8	125.00	130.00	18
D 2538 MT	Diesel	12763	V8	125.00	130.00	19
D 2538 MTE	Diesel	12763	V8	125.00	130.00	19
D 2540 MT	Diesel	17426	V10	125.00	142.00	22
D 2540 MTF	Diesel	17426	V10	125.00	142.00	22
D 2540 MTF/390	Diesel	17426	V10	125.00	142.00	22
D 2542 MLE	Diesel	20911	V12	125.00	142.00	23
D 2542 MTE	Diesel	20911	V12	125.00	142.00	23
D2548	Diesel	12756	V8	125.00	130.00	18
D 2555 M	Diesel	9200	5	125.00	150.00	24
D 2555 MF	Diesel	9200	5	125.00	150.00	24
D 2555 MX	Diesel	9200	5	125.00	150.00	24
D 2555 MXF	Diesel	9200	5	125.00	150.00	24
D 2555 MXUL	Diesel	9200	5	125.00	150.00	24
D 2556 M	Diesel	11045	6	125.00	150.00	25
D 2556 MF	Diesel	11045	6	125.00	150.00	25
D 2556 MTE	Diesel	11045	6	125.00	150.00	25
D 2556 MX	Diesel	11045	6	125.00	150.00	25
D 2556 MXF	Diesel	11045	6	125.00	150.00	25
D 2556 MXUH/175	Diesel	11045	6	125.00	150.00	25
D 2556 MXUH/192	Diesel	11045	6	125.00	150.00	25
D 2556 MXUH/240	Diesel	11045	6	125.00	150.00	25
D 2556 MXUM	Diesel	11045	6	125.00	150.00	25
D 2565 HM	Diesel	9510	5	125.00	155.00	26
D 2565 M	Diesel	9510	5	125.00	155.00	26
D 2565 M/168	Diesel	9510	5	125.00	155.00	26
D 2565 ME	Diesel	9510	5	125.00	155.00	26
D 2565 MF	Diesel	9510	5	125.00	155.00	26
D 2565 MF/168	Diesel	9510	5	125.00	155.00	26
D 2565 MFR	Diesel	9510	5	125.00	155.00	26
D 2565 MH	Diesel	9510	5	125.00	155.00	26
D 2565 MK	Diesel	9510	5	125.00	155.00	26
D 2565 MKUL	Diesel	9510	5	125.00	155.00	26
D 2565 MR	Diesel	9510	5	125.00	155.00	26
D 2565 MSFV	Diesel	9510	5	125.00	155.00	26
D 2565 MT	Diesel	9510	5	125.00	155.00	26
D 2565 MUE	Diesel	9510	5	125.00	155.00	26
D 2565 MUH	Diesel	9510	5	125.00	155.00	26
D 2565 MUL	Diesel	9510	5	125.00	155.00	26
D 2566	Diesel	11413	6	125.00	155.00	27
D 2566 M	Diesel	11413	6	125.00	155.00	27
D 2566 ME	Diesel	11413	6	125.00	155.00	27
D 2566 MF	Diesel	11413	6	125.00	155.00	27
D 2566 MF/220	Diesel	11413	6	125.00	155.00	27
D 2566 MFO	Diesel	11413	6	125.00	155.00	27
D 2566 MH	Diesel	11413	6	125.00	155.00	27
D 2566 MHO	Diesel	11413	6	125.00	155.00	27
D 2566 MK	Diesel	11413	6	125.00	155.00	27
D 2566 MK/280	Diesel	11413	6	125.00	155.00	27
D 2566 MKF	Diesel	11413	6	125.00	155.00	27
D 2566 MKF/280	Diesel	11413	6	125.00	155.00	27
D 2566 MKUH/320	Diesel	11413	6	125.00	155.00	27
D 2566 MKUL	Diesel	11413	6	125.00	155.00	27
D 2566 MLUH	Diesel	11413	6	125.00	155.00	27
D 2566 MLUM	Diesel	11413	6	125.00	155.00	27
D 2566 MLUM/US	Diesel	11413	6	125.00	155.00	27
D 2566 MSFV	Diesel	11413	6	125.00	155.00	27
D 2566 MT	Diesel	11413	6	125.00	155.00	27
D 2566 MTE	Diesel	11413	6	125.00	155.00	27
D 2566 MTF	Diesel	11413	6	125.00	155.00	27
D 2566 MTFG	Diesel	11413	6	125.00	155.00	27
D 2566 MTH	Diesel	11413	6	125.00	155.00	27
D 2566 MTHO	Diesel	11413	6	125.00	155.00	27
D 2566 MTSF	Diesel	11413	6	125.00	155.00	27







		cm ³	x 			
--	---	-----------------	---	---	---	---

D 2566 MTUH	Diesel	11413	6	125.00	155.00	27
D 2566 MUE	Diesel	11413	6	125.00	155.00	27
D 2566 MUH	Diesel	11413	6	125.00	155.00	27
D 2566 MUH/175	Diesel	11413	6	125.00	155.00	27
D 2566 MUH/192	Diesel	11413	6	125.00	155.00	27
D 2566 MUH/200	Diesel	11413	6	125.00	155.00	27
D 2566 MUH/220	Diesel	11413	6	125.00	155.00	27
D 2566 MUH/240	Diesel	11413	6	125.00	155.00	27
D 2566 MUL	Diesel	11413	6	125.00	155.00	27
D 2566 MUM	Diesel	11413	6	125.00	155.00	27
D 2566 MUM/200	Diesel	11413	6	125.00	155.00	27
D 2566 MUM/220	Diesel	11413	6	125.00	155.00	27
D 2566 MUM/240	Diesel	11413	6	125.00	155.00	27
D 2566 MXF	Diesel	11413	6	125.00	155.00	27
D 2566 UH	Diesel	11413	6	125.00	155.00	27
D 2566 UH/205	Diesel	11413	6	125.00	155.00	27
D 2676 LE 621	Diesel	12412	6	126.00	166.00	28
D 2676 LE 622	Diesel	12412	6	126.00	166.00	28
D 2676 LF 01 Euro 4	Diesel	12412	6	126.00	166.00	28
D 2676 LF 02 Euro 3	Diesel	12412	6	126.00	166.00	28
D 2676 LF 03 Euro 2	Diesel	12412	6	126.00	166.00	28
D 2676 LF 04 Euro 2	Diesel	12412	6	126.00	166.00	28
D 2676 LF 05 Euro 4	Diesel	12412	6	126.00	166.00	28
D 2676 LF 06 Euro 5	Diesel	12412	6	126.00	166.00	28
D 2676 LF 07 Euro 5	Diesel	12412	6	126.00	166.00	28
D 2676 LF 08 Euro 5	Diesel	12412	6	126.00	166.00	28
D 2676 LF 09 Euro 5	Diesel	12412	6	126.00	166.00	28
D 2676 LF 10 Euro 4	Diesel	12412	6	126.00	166.00	28
D 2676 LF 11 Euro 4	Diesel	12412	6	126.00	166.00	28
D 2676 LF 12 Euro 4	Diesel	12412	6	126.00	166.00	28
D 2676 LF 13 Euro 5	Diesel	12412	6	126.00	166.00	28
D 2676 LF 14 Euro 5	Diesel	12412	6	126.00	166.00	28
D 2676 LF 15 Euro 5	Diesel	12412	6	126.00	166.00	28
D 2676 LF 16 Euro 5	Diesel	12412	6	126.00	166.00	28
D 2676 LF 17	Diesel	12412	6	126.00	166.00	28
D 2676 LF 18	Diesel	12412	6	126.00	166.00	28
D 2676 LF 19 Euro 4	Diesel	12412	6	126.00	166.00	28
D 2676 LF 20 Euro 4	Diesel	12412	6	126.00	166.00	28
D 2676 LF 21 Euro 5	Diesel	12412	6	126.00	166.00	28
D 2676 LF 22 Euro 5	Diesel	12412	6	126.00	166.00	28
D 2676 LF 23	Diesel	12412	6	126.00	166.00	28
D 2676 LF 24	Diesel	12412	6	126.00	166.00	28
D 2676 LF 25 Euro 6	Diesel	12412	6	126.00	166.00	28
D 2676 LF 26 Euro 6	Diesel	12412	6	126.00	166.00	28
D 2676 LF 28 Euro 5	Diesel	12412	6	126.00	166.00	28
D 2676 LF 32 Euro 4	Diesel	12412	6	126.00	166.00	28
D 2676 LF 33 Euro 4	Diesel	12412	6	126.00	166.00	28
D 2676 LOH 01 Euro 4	Diesel	12412	6	126.00	166.00	28
D 2676 LOH 02 Euro 4	Diesel	12412	6	126.00	166.00	28
D 2676 LOH 03 Euro 4	Diesel	12412	6	126.00	166.00	28
D 2676 LOH 04 Euro 4	Diesel	12412	6	126.00	166.00	28
D 2676 LOH 10 Euro 3	Diesel	12412	6	126.00	166.00	28
D 2676 LOH 18 Euro 3	Diesel	12412	6	126.00	166.00	28
D 2676 LOH 26	Diesel	12412	6	126.00	166.00	28
D 2676 LOH 27	Diesel	12412	6	126.00	166.00	28
D 2676 LOH 28	Diesel	12412	6	126.00	166.00	28
D 2676 LOH 30 Euro 6	Diesel	12412	6	126.00	166.00	28
D 2676 LOH 31 Euro 6	Diesel	12412	6	126.00	166.00	28
D 2676 LOH 32 Euro 6	Diesel	12412	6	126.00	166.00	28
D 2676 LOH 33 Euro 4	Diesel	12412	6	126.00	166.00	28
D 2676 LOH 34	Diesel	12412	6	126.00	166.00	28
D 2840 LE	Diesel	18273	V10	128.00	142.00	31
D 2840 LE 403	Diesel	18273	V10	128.00	142.00	31
D 2840 LE 423	Diesel	18270	V10	128.00	142.00	31
D 2840 LF01	Diesel	18273	V10	128.00	142.00	31
D 2840 LF03	Diesel	18273	V10	128.00	142.00	31
D 2840 LF04 Euro 1	Diesel	18273	V10	128.00	142.00	31
D 2840 LF06 Euro 1	Diesel	18273	V10	128.00	142.00	31
D 2840 LF20 Euro 2	Diesel	18273	V10	128.00	142.00	31

		cm3	x 			
D 2840 LF21 Euro 2	Diesel	18273	V10	128.00	142.00	31
D 2840 LF25 Euro 3	Diesel	18273	V10	128.00	142.00	31
D 2840 LF 460	Diesel	18273	V10	128.00	142.00	31
D 2840 LXE	Diesel	18273	V10	128.00	142.00	31
D 2840 LXF	Diesel	18273	V10	128.00	142.00	31
D 2840 LYE	Diesel	18273	V10	128.00	142.00	31
D 2840 ME	Diesel	18273	V10	128.00	142.00	32
D 2840 MF	Diesel	18273	V10	128.00	142.00	32
D 2840 MFG	Diesel	18273	V10	128.00	142.00	32
D 2840 MFR	Diesel	18273	V10	128.00	142.00	32
D 2840 MH	Diesel	18273	V10	128.00	142.00	32
D 2842 LE 202	Diesel	21930	V12	128.00	142.00	33
D 2842 LE 211	Diesel	21930	V12	128.00	142.00	33
D 2842 LE 401	Diesel	21930	V12	128.00	142.00	33
D 2842 LE 402	Diesel	21930	V12	128.00	142.00	33
D 2842 LE 403	Diesel	21930	V12	128.00	142.00	33
D 2842 LE 404	Diesel	21930	V12	128.00	142.00	33
D 2842 LE 405	Diesel	21930	V12	128.00	142.00	33
D 2842 LE 406	Diesel	21930	V12	128.00	142.00	33
D 2842 LE 407	Diesel	21930	V12	128.00	142.00	33
D 2842 LE 408	Diesel	21930	V12	128.00	142.00	33
D 2842 LE 409	Diesel	21930	V12	128.00	142.00	33
D 2842 LE 410	Diesel	21930	V12	128.00	142.00	33
D 2842 LE 412	Diesel	21930	V12	128.00	142.00	33
D 2842 LE 413	Diesel	21930	V12	128.00	142.00	33
D 2842 LE 419	Diesel	21930	V12	128.00	142.00	33
D 2842 LE 423	Diesel	21930	V12	128.00	142.00	33
D 2842 LE 433	Diesel	21930	V12	128.00	142.00	33
D 2842 LE 443	Diesel	21930	V12	128.00	142.00	33
D 2842 LE 604	Diesel	21930	V12	128.00	142.00	33
D 2842 LE 606	Diesel	21930	V12	128.00	142.00	33
D 2842 LE 607	Diesel	21930	V12	128.00	142.00	33
D 2842 LE 620	Diesel	21927	V12	128.00	142.00	33
D 2842 LE 622	Diesel	21927	V12	128.00	142.00	33
D 2842 LF10 Euro 3	Diesel	21927	V12	128.00	142.00	33
D 2842 LXE	Diesel	21927	V12	128.00	142.00	33
D 2842 LYE	Diesel	21927	V12	128.00	142.00	33
D 2842 LZE	Diesel	21927	V12	128.00	142.00	33
D 2842 ME	Diesel	21927	V12	128.00	142.00	34
D 2848 LE 422	Diesel	14618	V8	128.00	142.00	29
D 2848 LE 423	Diesel	14618	V8	128.00	142.00	29
D 2848 LXE	Diesel	14618	V8	128.00	142.00	29
D 2848 LYE	Diesel	14618	V8	128.00	142.00	29
D 2848 M	Diesel	14618	V8	128.00	142.00	30
D 2848 MH	Diesel	14618	V8	128.00	142.00	30
D 2865 LF/260	Diesel	9973	5	128.00	155.00	36
D 2865 LF01	Diesel	9973	5	128.00	155.00	36
D 2865 LF02	Diesel	9973	5	128.00	155.00	36
D 2865 LF03	Diesel	9973	5	128.00	155.00	36
D 2865 LF05 Euro 1	Diesel	9973	5	128.00	155.00	36
D 2865 LF06 Euro 1	Diesel	9973	5	128.00	155.00	36
D 2865 LF09	Diesel	9973	5	128.00	155.00	36
D 2865 LF10	Diesel	9973	5	128.00	155.00	36
D 2865 LF20	Diesel	9973	5	128.00	155.00	36
D 2865 LF21 Euro 2	Diesel	9973	5	128.00	155.00	36
D 2865 LF22 Euro 1	Diesel	9973	5	128.00	155.00	36
D 2865 LF23 Euro 1	Diesel	9973	5	128.00	155.00	36
D 2865 LF24 Euro 2	Diesel	9973	5	128.00	155.00	36
D 2865 LFR	Diesel	9973	5	128.00	155.00	36
D 2865 LFR 01	Diesel	9973	5	128.00	155.00	36
D 2865 LOH 01 Euro 1	Diesel	9973	5	128.00	155.00	36
D 2865 LOH 02 Euro 1	Diesel	9973	5	128.00	155.00	36
D 2865 LOH 05 Euro 1	Diesel	9973	5	128.00	155.00	36
D 2865 LOH 06 Euro 1	Diesel	9973	5	128.00	155.00	36
D 2865 LOH 07 Euro 2	Diesel	9973	5	128.00	155.00	36
D 2865 LOH 08 Euro 2	Diesel	9973	5	128.00	155.00	36
D 2865 LOH 09 Euro 2	Diesel	9973	5	128.00	155.00	36
D 2865 LOH 10 Euro 2	Diesel	9973	5	128.00	155.00	36
D 2865 LU 01 Euro 1	Diesel	9973	5	128.00	155.00	36







		cm ³	x 			
--	---	-----------------	---	---	---	---

D 2865 LU 02	Diesel	9973	5	128.00	155.00	36
D 2865 LU 03	Diesel	9973	5	128.00	155.00	36
D 2865 LU 04 Euro 1	Diesel	9973	5	128.00	155.00	36
D 2865 LU 05 Euro 1	Diesel	9973	5	128.00	155.00	36
D 2865 LU 06 Euro 1	Diesel	9973	5	128.00	155.00	36
D 2865 LUH 02 Euro 1	Diesel	9973	5	128.00	155.00	36
D 2865 LUH 03 Euro 1	Diesel	9973	5	128.00	155.00	36
D 2865 LUH 05 Euro 1	Diesel	9973	5	128.00	155.00	36
D 2865 LUH 06 Euro 1	Diesel	9973	5	128.00	155.00	36
D 2865 LUH 07 Euro 2	Diesel	9973	5	128.00	155.00	36
D 2865 LUH 08 Euro 1	Diesel	9973	5	128.00	155.00	36
D 2865 LUH 09 Euro 2	Diesel	9973	5	128.00	155.00	36
D 2865 LXF	Diesel	9973	5	128.00	155.00	36
D 2865 LXFR	Diesel	9973	5	128.00	155.00	36
D 2866 E	Diesel	11967	6	128.00	155.00	37
D 2866 F/240	Diesel	11967	6	128.00	155.00	38
D 2866 FG	Diesel	11967	6	128.00	155.00	37
D 2866 FR	Diesel	11967	6	128.00	155.00	37
D 2866 KF	Diesel	11967	6	128.00	155.00	39
D 2866 KFZ	Diesel	11967	6	128.00	155.00	40
D 2866 KOH/360	Diesel	11967	6	128.00	155.00	40
D 2866 KOH/373	Diesel	11967	6	128.00	155.00	40
D 2866 KUH/360 Euro 1	Diesel	11967	6	128.00	155.00	39
D 2866 KUL	Diesel	11967	6	128.00	155.00	39
D 2866 LE	Diesel	11967	6	128.00	155.00	37
D 2866 LF	Diesel	11967	6	128.00	155.00	40
D 2866 LF/290	Diesel	11967	6	128.00	155.00	39
D 2866 LF/330	Diesel	11967	6	128.00	155.00	39
D 2866 LF01	Diesel	11967	6	128.00	155.00	40
D 2866 LF02	Diesel	11967	6	128.00	155.00	40
D 2866 LF03	Diesel	11967	6	128.00	155.00	39
D 2866 LF04	Diesel	11967	6	128.00	155.00	39
D 2866 LF05 Euro 1	Diesel	11967	6	128.00	155.00	39
D 2866 LF06	Diesel	11967	6	128.00	155.00	39
D 2866 LF07	Diesel	11967	6	128.00	155.00	40
D 2866 LF08	Diesel	11967	6	128.00	155.00	40
D 2866 LF09 Euro 1	Diesel	11967	6	128.00	155.00	39
D 2866 LF10 Euro 1	Diesel	11967	6	128.00	155.00	39
D 2866 LF14 Euro 2	Diesel	11967	6	128.00	155.00	41
D 2866 LF15 Euro 1	Diesel	11967	6	128.00	155.00	39
D 2866 LF16 Euro 2	Diesel	11967	6	128.00	155.00	42
D 2866 LF17 Euro 2	Diesel	11967	6	128.00	155.00	41
D 2866 LF20 Euro 2	Diesel	11967	6	128.00	155.00	41
D 2866 LF21 Euro 1	Diesel	11967	6	128.00	155.00	40
D 2866 LF22 Euro 1	Diesel	11967	6	128.00	155.00	40
D 2866 LF23 Euro 3	Diesel	11967	6	128.00	155.00	41
D 2866 LF24 Euro 3	Diesel	11967	6	128.00	155.00	43
D 2866 LF25 Euro 3	Diesel	11967	6	128.00	155.00	41
D 2866 LF26 Euro 3	Diesel	11967	6	128.00	155.00	43
D 2866 LF27 Euro 3	Diesel	11967	6	128.00	155.00	43
D 2866 LF28 Euro 3	Diesel	11967	6	128.00	155.00	43
D 2866 LF29 Euro 2	Diesel	11967	6	128.00	155.00	41
D 2866 LF30 Euro 2	Diesel	11967	6	128.00	155.00	41
D 2866 LF31 Euro 2	Diesel	11967	6	128.00	155.00	41
D 2866 LF32 Euro 2	Diesel	11967	6	128.00	155.00	43
D 2866 LF34 Euro 2	Diesel	11967	6	128.00	155.00	41
D 2866 LF35 Euro 2	Diesel	11967	6	128.00	155.00	41
D 2866 LF36 Euro 2	Diesel	11967	6	128.00	155.00	43
D 2866 LF37 Euro 2	Diesel	11967	6	128.00	155.00	43
D 2866 LF39 Euro 2	Diesel	11967	6	128.00	155.00	41
D 2866 LF40 Euro 2	Diesel	11967	6	128.00	155.00	41
D 2866 LF41 Euro 2	Diesel	11967	6	128.00	155.00	41
D 2866 LF43 Euro 2	Diesel	11967	6	128.00	155.00	41
D 2866 LFG	Diesel	11967	6	128.00	155.00	40
D 2866 LFG 03 Euro 1	Diesel	11967	6	128.00	155.00	40
D 2866 LFG 04 Euro 1	Diesel	11967	6	128.00	155.00	40
D 2866 LFG 05 Euro 2	Diesel	11967	6	128.00	155.00	41
D 2866 LFG 06 Euro 3	Diesel	11967	6	128.00	155.00	41
D 2866 LFG 07 Euro 3	Diesel	11967	6	128.00	155.00	41

		cm3	x 			
D 2866 LFZ/290	Diesel	11967	6	128.00	155.00	39
D 2866 LFZ/330	Diesel	11967	6	128.00	155.00	39
D 2866 LH 01	Diesel	11967	6	128.00	155.00	40
D 2866 LOH	Diesel	11967	6	128.00	155.00	40
D 2866 LOH 02	Diesel	11967	6	128.00	155.00	40
D 2866 LOH 03	Diesel	11967	6	128.00	155.00	40
D 2866 LOH 06 Euro 1	Diesel	11967	6	128.00	155.00	40
D 2866 LOH 07	Diesel	11967	6	128.00	155.00	40
D 2866 LOH 09 Euro 1	Diesel	11967	6	128.00	155.00	40
D 2866 LOH 20 Euro 1	Diesel	11967	6	128.00	155.00	40
D 2866 LOH 21 Euro 1	Diesel	11967	6	128.00	155.00	40
D 2866 LOH 22 Euro 1	Diesel	11967	6	128.00	155.00	40
D 2866 LOH 23 Euro 2	Diesel	11967	6	128.00	155.00	41
D 2866 LOH 24 Euro 1	Diesel	11970	6	128.00	155.00	40
D 2866 LOH 25 Euro 2	Diesel	11967	6	128.00	155.00	41
D 2866 LOH 26 Euro 2	Diesel	11967	6	128.00	155.00	41
D 2866 LOH 27 Euro 3	Diesel	11967	6	128.00	155.00	41
D 2866 LOH 28 Euro 3	Diesel	11967	6	128.00	155.00	43
D 2866 LOH 29 Euro 3	Diesel	11967	6	128.00	155.00	43
D 2866 LOH 31 Euro 2	Diesel	11967	6	128.00	155.00	41
D 2866 LOH 32 Euro 3	Diesel	11967	6	128.00	155.00	41
D 2866 LOH 33 Euro 3	Diesel	11967	6	128.00	155.00	41
D 2866 LOH 34 Euro 3	Diesel	11967	6	128.00	155.00	43
D 2866 LOH 35 Euro 3	Diesel	11967	6	128.00	155.00	41
D 2866 LOH 36 Euro 3	Diesel	11967	6	128.00	155.00	41
D 2866 LU	Diesel	11967	6	128.00	155.00	40
D 2866 LU/330	Diesel	11967	6	128.00	155.00	40
D 2866 LU 01	Diesel	11967	6	128.00	155.00	40
D 2866 LU 02	Diesel	11967	6	128.00	155.00	40
D 2866 LU 03 Euro 1	Diesel	11967	6	128.00	155.00	40
D 2866 LU 04	Diesel	11967	6	128.00	155.00	40
D 2866 LU 07	Diesel	11967	6	128.00	155.00	40
D 2866 LU 08	Diesel	11967	6	128.00	155.00	40
D 2866 LUH	Diesel	11967	6	128.00	155.00	40
D 2866 LUH/330	Diesel	11967	6	128.00	155.00	40
D 2866 LUH 04 Euro 1	Diesel	11967	6	128.00	155.00	40
D 2866 LUH 05 Euro 1	Diesel	11967	6	128.00	155.00	40
D 2866 LUH 20 Euro 2	Diesel	11967	6	128.00	155.00	41
D 2866 LUH 21 Euro 2	Diesel	11967	6	128.00	155.00	41
D 2866 LUH 22 Euro 2	Diesel	11967	6	128.00	155.00	41
D 2866 LUH 23 Euro 3	Diesel	11967	6	128.00	155.00	41
D 2866 LUH 24 Euro 3	Diesel	11967	6	128.00	155.00	43
D 2866 LUH 25 Euro 3	Diesel	11967	6	128.00	155.00	43
D 2866 LUH 26 Euro 2	Diesel	11967	6	128.00	155.00	41
D 2866 LUH 27 Euro 3	Diesel	11967	6	128.00	155.00	41
D 2866 LUH 28 Euro 3	Diesel	11967	6	128.00	155.00	41
D 2866 LUH 29 Euro 3	Diesel	11967	6	128.00	155.00	43
D 2866 LUH 30 Euro 3	Diesel	11967	6	128.00	155.00	41
D 2866 LUH 34 Euro 3	Diesel	11967	6	128.00	155.00	41
D 2866 LUH 35 Euro 3	Diesel	11967	6	128.00	155.00	41
D 2866 LUH 36 Euro 3	Diesel	11967	6	128.00	155.00	41
D 2866 LUH 37 Euro 3	Diesel	11967	6	128.00	155.00	41
D 2866 LUH 50 Euro 4	Diesel	11967	6	128.00	155.00	41
D 2866 LUH 52 Euro 4	Diesel	11967	6	128.00	155.00	41
D 2866 LUL/330	Diesel	11967	6	128.00	155.00	39
D 2866 LX	Diesel	11967	6	128.00	155.00	40
D 2866 LXE 40	Diesel	11967	6	128.00	155.00	40
D 2866 LXE 47	Diesel	11967	6	128.00	155.00	40
D 2866 LXF	Diesel	11967	6	128.00	155.00	39
D 2866 LXFG	Diesel	11967	6	128.00	155.00	40
D 2866 LXOH	Diesel	11967	6	128.00	155.00	39
D 2866 LXU	Diesel	11967	6	128.00	155.00	40
D 2866 LXUH	Diesel	11967	6	128.00	155.00	40
D 2866 OH	Diesel	11967	6	128.00	155.00	37
D 2866 T	Diesel	11967	6	128.00	155.00	40
D 2866 TOH	Diesel	11967	6	128.00	155.00	39
D 2866 TOH/290	Diesel	11967	6	128.00	155.00	39
D 2866 TOH/310	Diesel	11967	6	128.00	155.00	39
D 2866 TUH	Diesel	11967	6	128.00	155.00	39

		cm3	x 			
--	---	-----	---	---	---	---

D 2866 TUH/290	Diesel	11967	6	128.00	155.00	39
D 2866 TUH 01	Diesel	11967	6	128.00	155.00	39
D 2866 U	Diesel	11967	6	128.00	155.00	37
D 2866 UH	Diesel	11967	6	128.00	155.00	38
D 2866 UH/240	Diesel	11967	6	128.00	155.00	39
D 2866 UM	Diesel	11967	6	128.00	155.00	37
D 2868 LE 421 Euro 5	Diesel	16200	V8	128.00	157.00	46
D 2868 LE 422 Euro 5	Diesel	16200	V8	128.00	157.00	46
D 2868 LF02 Euro 5	Diesel	16200	V8	128.00	157.00	46
D 2868 LF03 Euro 5	Diesel	16200	V8	128.00	157.00	46
D 2868 LF04 Euro 5	Diesel	16200	V8	128.00	157.00	46
D 2868 LF05	Diesel	16200	V8	128.00	157.00	46
D 2868 LF06 Euro 5	Diesel	16200	V8	128.00	157.00	46
D 2868 LF07 Euro 5	Diesel	16200	V8	128.00	157.00	46
D 2876 LE 121	Diesel	12816	6	128.00	166.00	48
D 2876 LE 122	Diesel	12816	6	128.00	166.00	48
D 2876 LE 123	Diesel	12816	6	128.00	166.00	48
D 2876 LE 124	Diesel	12816	6	128.00	166.00	48
D 2876 LE 402	Diesel	12816	6	128.00	166.00	48
D 2876 LE 403	Diesel	12816	6	128.00	166.00	48
D 2876 LE 406	Diesel	12816	6	128.00	166.00	48
D 2876 LE 407	Diesel	12816	6	128.00	166.00	48
D 2876 LF 01 Euro 2	Diesel	12816	6	128.00	166.00	48
D 2876 LF 02 Euro 2	Diesel	12816	6	128.00	166.00	48
D 2876 LF 03 Euro 3	Diesel	12816	6	128.00	166.00	49
D 2876 LF 04 Euro 3	Diesel	12816	6	128.00	166.00	49
D 2876 LF 05 Euro 3	Diesel	12816	6	128.00	166.00	49
D 2876 LF 06 Euro 2	Diesel	12816	6	128.00	166.00	48
D 2876 LF 07 Euro 2	Diesel	12816	6	128.00	166.00	49
D 2876 LF 10 Euro 2	Diesel	12816	6	128.00	166.00	48
D 2876 LF 11 Euro 2	Diesel	12816	6	128.00	166.00	48
D 2876 LF 12 Euro 3	Diesel	12816	6	128.00	166.00	49
D 2876 LF 13 Euro 3	Diesel	12816	6	128.00	166.00	49
D 2876 LF 17	Diesel	12816	6	128.00	166.00	48
D 2876 LF 18 Euro 3	Diesel	12816	6	128.00	166.00	48
D 2876 LF 19 Euro 3	Diesel	12816	6	128.00	166.00	48
D 2876 LF 20 Euro 3	Diesel	12816	6	128.00	166.00	48
D 2876 LF 23 Euro 3	Diesel	12816	6	128.00	166.00	48
D 2876 LF 25 Euro 2	Diesel	12816	6	128.00	166.00	49
D 2876 LFG 01 Euro 3	Diesel	12816	6	128.00	166.00	48
D 2876 LOH 01 Euro 2	Diesel	12816	6	128.00	166.00	48
D 2876 LOH 02 Euro 3	Diesel	12816	6	128.00	166.00	49
D 2876 LOH 03 Euro 3	Diesel	12816	6	128.00	166.00	49
D 2876 LOH 20 Euro 3	Diesel	12816	6	128.00	166.00	49
D 2876 LOH 21 Euro 3	Diesel	12816	6	128.00	166.00	49
D 2876 LUE 604	Diesel	12816	6	128.00	166.00	48
D 2876 LUE 605	Diesel	12816	6	128.00	166.00	48
D 2876 LUE 606	Diesel	12816	6	128.00	166.00	48
D 2876 LUE 621	Diesel	12816	6	128.00	166.00	48
D 2876 LUE 622	Diesel	12816	6	128.00	166.00	48
D 2876 LUE 623	Diesel	12816	6	128.00	166.00	48
D 2876 LUE 631	Diesel	12816	6	128.00	166.00	48
D 2876 LUE 632	Diesel	12816	6	128.00	166.00	48
D 2876 LUE 633	Diesel	12816	6	128.00	166.00	48
D 2876 LUH 01 Euro 2	Diesel	12816	6	128.00	166.00	48
D 2876 LUH 02 Euro 2	Diesel	12816	6	128.00	166.00	48
D 0834 190	Diesel	4580	4	108.00	125.00	5
D 0834 230 Euro 4	Diesel	4580	4	108.00	125.00	5
D 0836 280 Euro 4	Diesel	6871	6	108.00	125.00	9
D 2676 440 Euro 5	Diesel	12412	6	126.00	166.00	28
E 0836 E 302	Gas	6871	6	108.00	125.00	11
E 0836 E 312	Gas	6871	6	108.00	125.00	11
E 0836 LE 202	Gas	6871	6	108.00	125.00	11
E 0836 LE 302	Gas	6871	6	108.00	125.00	11
E 0836 LOH 01	Gas	6871	6	108.00	125.00	11
E 0836 LOH 02	Gas	6871	6	108.00	125.00	11
E 0836 LOH 03	Gas	6871	6	108.00	125.00	11
E 0836 LOH 04 Euro 6	Gas	6871	6	108.00	125.00	11
E 0836 LOH 05 Euro 6	Gas	6871	6	108.00	125.00	11

		cm ³	x 			
E 0836 LOH 06 Euro 6	Gas	6871	6	108.00	125.00	11
E 2842 LE 312	Gas	21927	V12	128.00	142.00	35
E 2842 LE 322	Gas	21927	V12	128.00	142.00	35
E 2866	Natural Gas	11967	6	128.00	155.00	44
E 2866 DE	Natural Gas	11967	6	128.00	155.00	44
E 2866 DF 01	Natural Gas	11967	6	128.00	155.00	44
E 2866 DF 02 Euro 3	Natural Gas	11967	6	128.00	155.00	44
E 2866 DF 03	Natural Gas	11967	6	128.00	155.00	44
E 2866 DF 04	Natural Gas	11967	6	128.00	155.00	44
E 2866 DOH 02 Euro 3	Natural Gas	11967	6	128.00	155.00	44
E 2866 DOH 03 Euro 3	Natural Gas	11967	6	128.00	155.00	44
E 2866 DOH 04 Euro 3	Natural Gas	11967	6	128.00	155.00	44
E 2866 DUH	Natural Gas	11970	6	128.00	155.00	44
E 2866 DUH 01	Natural Gas	11967	6	128.00	155.00	44
E 2866 DUH 03	Natural Gas	11967	6	128.00	155.00	45
E 2866 DUH 04	Natural Gas	11967	6	128.00	155.00	45
E 2866 LUH 02	Natural Gas	11967	6	128.00	155.00	44
E 2876 LUH 02	Gas	12816	6	128.00	166.00	50
E 2876 LUH 03	Gas	12816	6	128.00	166.00	50
E 2876 LUH 04	Gas	12816	6	128.00	166.00	47
G 2866 DOH 02 Euro 3	LPG	11967	6	128.00	155.00	44
G 2866 DOH 03 Euro 3	LPG	11967	6	128.00	155.00	44
G 2866 DUH 01	Gas	11967	6	128.00	155.00	44
G 2866 DUH 02	Gas	11967	6	128.00	155.00	44
G 2866 DUH 03	Gas	11967	6	128.00	155.00	44
G 2866 DUH 04 Euro 3	LPG	11967	6	128.00	155.00	44
G 2866 DUH 05 Euro 3	LPG	11967	6	128.00	155.00	44
G 2876 DUH 01	LPG	12816	6	128.00	166.00	47



1 102.00 x 116.00

D 0226 M	6 Cyl.	5687cc	66-100kW (90-136PS)	Diesel		TD19433
D 0226 MC	6 Cyl.	5687cc	125-154kW (170-209PS)	Diesel Turbo Intercooler		TD23123
D 0226 MCFO/170	6 Cyl.	5687cc	125-131kW (170-178PS)	Diesel Turbo Intercooler		TD7652
D 0226 ME	6 Cyl.	5687cc	66-100kW (90-136PS)	Diesel		TD19079
D 0226 MF	6 Cyl.	5687cc	92-100kW (125-136PS)	Diesel		TD7645
D 0226 MFA	6 Cyl.	5687cc	66-100kW (90-136PS)	Diesel		TD19080
D 0226 MFM	6 Cyl.	5687cc	66-100kW (90-136PS)	Diesel		TD19081
D 0226 MFO	6 Cyl.	5687cc	90-100kW (122-136PS)	Diesel		TD19434
D 0226 MH	6 Cyl.	5687cc	90-100kW (122-136PS)	Diesel		TD19435
D 0226 MK	6 Cyl.	5687cc	125-154kW (170-209PS)	Diesel Turbo Intercooler		TD19077
D 0226 MKF	6 Cyl.	5687cc	141kW (192PS)	Diesel Turbo Intercooler		TD7685
D 0226 MKF/170	6 Cyl.	5687cc	125kW (170PS)	Diesel Turbo Intercooler		TD7684
D 0226 MKFA	6 Cyl.	5687cc	125-154kW (170-209PS)	Diesel Turbo Intercooler		TD19436
D 0226 MKFO	6 Cyl.	5687cc	100-125kW (136-170PS)	Diesel Turbo Intercooler		TD23124
D 0226 MKH	6 Cyl.	5687cc	125-154kW (170-209PS)	Diesel Turbo Intercooler		TD19078
D 0226 ML	6 Cyl.	5687cc	125-154kW (170-209PS)	Diesel Turbo Intercooler		TD19437
D 0226 MLE	6 Cyl.	5687cc	125-154kW (170-209PS)	Diesel Turbo Intercooler		TD19438
D 0226 MT	6 Cyl.	5687cc	110-135kW (150-184PS)	Diesel Turbo		TD19439
D 0226 MTE Euro 3	6 Cyl.	5687cc	81-135kW (110-184PS)	Diesel Turbo		TD19071

BE/PL	6	62,981/63,000	67,000/67,019	29,000	1,987	0,026/0,089	EC	71-3482	71-3482/6 STD
SE/PB	1	39,994/40,000	43,000/43,025	31,700			BC	55-3486	55-3486 SEMI
CB/NWB 1-4	4	50,910/50,940	55,000/55,030	25,000			BC	53-3485	N125/4 STD SEMI

2 108.00 x 120.00

D 0826 TE 520	6 Cyl.	6596cc	121-125kW (165-170PS)	Diesel Turbo		TD23159
D 0826 TF	6 Cyl.	6596cc	137kW (186PS)	Diesel Turbo		TD7689
D 0826 TOH	6 Cyl.	6596cc	132-137kW (180-186PS)	Diesel Turbo		TD7600
D 0826 TOH 01	6 Cyl.	6596cc	130kW (177PS)	Diesel Turbo		TD23160

BE/PL	6	64,981/65,000	69,000/69,019	31,000	1,987	0,026/0,089	EC	71-3660	71-3660/6 STD 0.25
MB/HL 1-3, 5-7	6	76,981/77,000	82,000/82,022	26,000	2,480	0,040/0,106	EC	72-3772	H049/7 STD 0.25
MB/HL 4	1	76,981/77,000	82,000/82,022	33,850	2,480	0,040/0,106	EC	72-3773H	

01/90 →



72-3773H STD 34,000/1.3386" - 34,100/1.3426"
0.25mm 34,500/1.3583" - 34,600/1.2623"

CB/NWB 1-4	4	50,910/50,940	55,000/55,030	25,000			BC	53-3485	N125/4 STD SEMI
---------------	---	---------------	---------------	--------	--	--	----	---------	--------------------

3 108.00 x 125.00

D 0824 FL 01 Euro 1	4 Cyl.	4580cc	75kW (102PS)	Diesel Turbo Intercooler		TD7655
D 0824 LF 01 Euro 1	4 Cyl.	4580cc	114kW (155PS)	Diesel Turbo Intercooler		TD7680
D 0824 LF 02 Euro 2	4 Cyl.	4580cc	118kW (160PS)	Diesel Turbo Intercooler		TD7683
D 0824 LF 03 Euro 1	4 Cyl.	4580cc	118kW (160PS)	Diesel Turbo Intercooler		TD21278
D 0824 LF 04 Euro 1	4 Cyl.	4580cc	118kW (160PS)	Diesel Turbo Intercooler		TD21279
D 0824 LF 05 Euro 1	4 Cyl.	4580cc	118kW (160PS)	Diesel Turbo Intercooler		TD21280
D 0824 LF 06 Euro 1	4 Cyl.	4580cc	118kW (160PS)	Diesel Turbo Intercooler		TD21281
D 0824 LF 07 Euro 1	4 Cyl.	4580cc	118kW (160PS)	Diesel Turbo Intercooler		TD21282

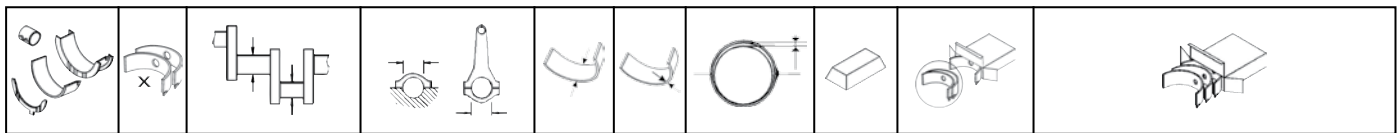

D 0824 LF 08 Euro 1	4 Cyl.	4580cc	118kW (160PS)	Diesel Turbo Intercooler	TD21283
D 0824 LF 09 Euro 1	4 Cyl.	4580cc	118kW (160PS)	Diesel Turbo Intercooler	TD21284
D 0824 LF 10 Euro 1	4 Cyl.	4580cc	118kW (160PS)	Diesel Turbo Intercooler	TD21285
D 0824 LFG 01 Euro 2	4 Cyl.	4580cc	114kW (155PS)	Diesel Turbo Intercooler	TD23127
D 0824 LFL 01 Euro 1	4 Cyl.	4580cc	114kW (155PS)	Diesel Turbo Intercooler	TD7658
D 0824 LFL 02 Euro 2	4 Cyl.	4580cc	118kW (160PS)	Diesel Turbo Intercooler	TD7660
D 0824 LFL 03 Euro 2	4 Cyl.	4580cc	114kW (155PS)	Diesel Turbo Intercooler	TD23128
D 0824 LFL 04 Euro 2	4 Cyl.	4580cc	81kW (110PS)	Diesel Turbo Intercooler	TD7656
D 0824 LFL 05 Euro 1	4 Cyl.	4580cc	114kW (155PS)	Diesel Turbo Intercooler	TD7659
D 0824 LFL 06 Euro 2	4 Cyl.	4580cc	114kW (155PS)	Diesel Turbo Intercooler	TD7661
D 0824 LFL 07 Euro 2	4 Cyl.	4580cc	104kW (141PS)	Diesel Turbo Intercooler	TD7662
D 0824 LFL 08 Euro 2	4 Cyl.	4580cc	83kW (113PS)	Diesel Turbo Intercooler	TD16523
D 0824 LFL 09 Euro 1	4 Cyl.	4580cc	114kW (155PS)	Diesel Turbo Intercooler	TD9707
D 0824 LFL 10 Euro 2	4 Cyl.	4580cc	92-162kW (125-220PS)	Diesel Turbo Intercooler	TD21286
D 0824 LFO 01 Euro 1	4 Cyl.	4580cc	114kW (155PS)	Diesel Turbo Intercooler	TD23129
D 0824 LFO 02	4 Cyl.	4580cc	118kW (160PS)	Diesel Turbo Intercooler	TD16245
D 0824 LFO Euro 1	4 Cyl.	4580cc	118kW (160PS)	Diesel Turbo Intercooler	TD7657
D 0824 LOH 01 Euro 1	4 Cyl.	4580cc	114kW (155PS)	Diesel Turbo Intercooler	TD7598
D 0824 LOH 02 Euro 1	4 Cyl.	4580cc	114kW (155PS)	Diesel Turbo Intercooler	TD21288
D 0824 LOH 03 Euro 1	4 Cyl.	4580cc	114kW (155PS)	Diesel Turbo Intercooler	TD21289
D 0824 LOH 04 Euro 1	4 Cyl.	4580cc	114kW (155PS)	Diesel Turbo Intercooler	TD21290
D 0824 LOH 05 Euro 2	4 Cyl.	4580cc	114kW (155PS)	Diesel Turbo	TD20537
D 0824 LUE 521	4 Cyl.	4580cc	103kW (140PS)	Diesel Turbo Intercooler	TD23130
D 0824 LUE 522	4 Cyl.	4580cc	92kW (125PS)	Diesel Turbo Intercooler	TD23131
D 0824 LUE 523	4 Cyl.	4580cc	81kW (110PS)	Diesel Turbo Intercooler	TD23132
D 0824 LUE 524	4 Cyl.	4580cc	108kW (147PS)	Diesel Turbo Intercooler	TD23133

BE/PL	4	64,981/65,000	69,000/69,019	31,000	1,987	0,026/0,089	EC	71-3660	71-3660/4 STD
MB/HL 1,2,4,5	4	76,981/77,000	82,000/82,022	26,000	2,480	0,040/0,106	EC	72-3772	H049/5 STD
MB/HL 3	1	76,981/77,000	82,000/82,022	33,850	2,480	0,040/0,106	EC	72-3773H	



72-3773H STD 34,000/1.3386" - 34,100/1.3426"
0.25mm 34,500/1.3583" - 34,600/1.2623"

4 108.00 x 125.00

D 0824 GF	4 Cyl.	4580cc	75kW (102PS)	Diesel	TD5648
D 0824 GF01	4 Cyl.	4580cc	75kW (102PS)	Diesel	TD5988
D 0824 GF02 Euro 1	4 Cyl.	4580cc	75kW (102PS)	Diesel	TD7639
D 0824 GF03 Euro 1	4 Cyl.	4580cc	75kW (102PS)	Diesel	TD21287
D 0824 GF04 Euro 1	4 Cyl.	4580cc	75kW (102PS)	Diesel	TD23126

BE/PL	4	64,981/65,000	69,000/69,019	31,000	1,987	0,026/0,089	EC	71-3660	71-3660/4 STD
MB/HL 1,2,4,5	4	76,981/77,000	82,000/82,022	26,000	2,480	0,040/0,106	EC	72-3772	H049/5 STD
MB/HL 3	1	76,981/77,000	82,000/82,022	33,850	2,480	0,040/0,106	EC	72-3773H	

01/90 →



72-3773H STD 34,000/1.3386" - 34,100/1.3426"
0.25mm 34,500/1.3583" - 34,600/1.2623"



5 108.00 x 125.00

D 0834 190	4 Cyl.	4580cc	137kW (186PS)	Diesel Turbo Intercooler	TD30275
D 0834 230 Euro 4	4 Cyl.	4580cc	165-166kW (224-226PS)	Diesel Turbo Intercooler	TD30286
D 0834 LFL 50 Euro 4	4 Cyl.	4580cc	110kW (150PS)	Diesel Turbo Intercooler	TD18182
D 0834 LFL 51 Euro 4	4 Cyl.	4580cc	132kW (180PS)	Diesel Turbo Intercooler	TD18183
D 0834 LFL 52 Euro 4	4 Cyl.	4580cc	151kW (206PS)	Diesel Turbo Intercooler	TD18184
D 0834 LFL 53 Euro 4	4 Cyl.	4580cc	110kW (150PS)	Diesel Turbo Intercooler	TD22957
D 0834 LFL 54 Euro 4	4 Cyl.	4580cc	132kW (180PS)	Diesel Turbo Intercooler	TD22958
D 0834 LFL 55 Euro 4	4 Cyl.	4580cc	151kW (206PS)	Diesel Turbo Intercooler	TD22969
D 0834 LFL 60	4 Cyl.	4580cc	110kW (150PS)	Diesel Turbo Intercooler	TD22962
D 0834 LFL 61	4 Cyl.	4580cc	132kW (180PS)	Diesel Turbo Intercooler	TD22963
D 0834 LFL 62	4 Cyl.	4580cc	162kW (220PS)	Diesel Turbo Intercooler	TD22965
D 0834 LFL 63 Euro 5	4 Cyl.	4580cc	110kW (150PS)	Diesel Turbo Intercooler	TD22959
D 0834 LFL 64 Euro 5	4 Cyl.	4580cc	132kW (180PS)	Diesel Turbo Intercooler	TD22960
D 0834 LFL 65 Euro 5	4 Cyl.	4580cc	162kW (220PS)	Diesel Turbo Intercooler	TD22961
D 0834 LFL 66 Euro 6	4 Cyl.	4580cc	110kW (150PS)	Diesel Turbo Intercooler	TD27703
D 0834 LFL 67 Euro 6	4 Cyl.	4580cc	132kW (180PS)	Diesel Turbo Intercooler	TD27704
D 0834 LFL 68 Euro 6	4 Cyl.	4580cc	162kW (220PS)	Diesel Turbo Intercooler	TD27705
D 0834 LOH 40 Euro 3	4 Cyl.	4580cc	132kW (180PS)	Diesel Turbo Intercooler	TD23680
D 0834 LOH 50 Euro 4	4 Cyl.	4580cc	132kW (180PS)	Diesel Turbo Intercooler	TD19968
D 0834 LOH 51 Euro 4	4 Cyl.	4580cc	151kW (205PS)	Diesel Turbo Intercooler	TD19969
D 0834 LOH 52 Euro 4	4 Cyl.	4580cc	132kW (180PS)	Diesel Turbo Intercooler	TD23057
D 0834 LOH 53 Euro 4	4 Cyl.	4580cc	151kW (206PS)	Diesel Turbo Intercooler	TD23058
D 0834 LOH 60	4 Cyl.	4580cc	132kW (180PS)	Diesel Turbo Intercooler	TD23669
D 0834 LOH 61 Euro 5	4 Cyl.	4580cc	132kW (180PS)	Diesel Turbo Intercooler	TD23679
D 0834 LOH 63 Euro 5	4 Cyl.	4580cc	162kW (220PS)	Diesel Turbo Intercooler	TD30623

BE/PL	1	69,981/70,000	74,000/74,019	29,000	1,987	0,036/0,100	SP	71-4748	71-4748 STD 0.25 0.50	1
MB/HL	1	86,978/87,000	92,000/92,022	26,000	2,480	0,054/0,122	EC	72-4749	72-4749 STD 0.25 0.50	
TW/A	2	94,500	112,800		2,900		AL-LF	04-4750	A290/4 STD	
TW/A	2	94,500	112,800		2,900		AL-LF	04-4751		
SE/PB	1	43,940/44,000	48,000/48,025	37,000			BS-LF	55-4752	55-4752 SEMI	
CB/NWB	1	54,910/54,940	59,000/59,030	25,000			BC	53-3944	53-3944 SEMI	
CB/NWB	1	54,910/54,940	59,000/59,030	25,000			BC	53-4753	53-4753 SEMI	

53-3944

53-4753

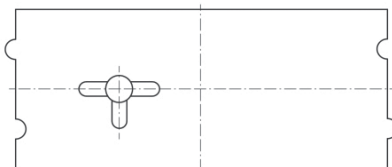
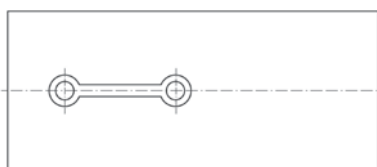

6 108.00 x 125.00

D 0834 LFL 01 Euro 3	4 Cyl.	4580cc	103kW (140PS)	Diesel Turbo Intercooler	TD17044
D 0834 LFL 02 Euro 3	4 Cyl.	4580cc	103kW (140PS)	Diesel Turbo Intercooler	TD6591
D 0834 LFL 03 Euro 3	4 Cyl.	4580cc	132kW (180PS)	Diesel Turbo Intercooler	TD16498
D 0834 LFL 04 Euro 3	4 Cyl.	4580cc	110kW (150PS)	Diesel Turbo Intercooler	TD18096
D 0834 LFL 07 Euro 3	4 Cyl.	4580cc	132kW (180PS)	Diesel Turbo Intercooler	TD24975
D 0834 LFL 10 Euro 3	4 Cyl.	4580cc	125kW (170PS)	Diesel Turbo Intercooler	TD28896

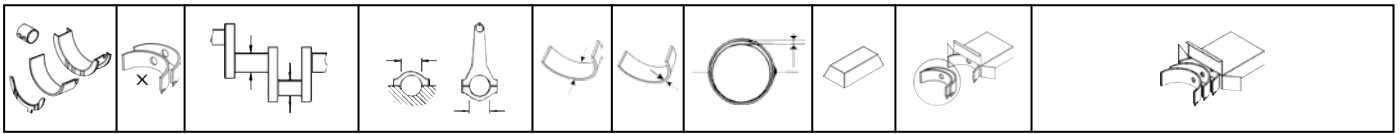

D 0834 LFL 11 Euro 3	4 Cyl.	4580cc	103kW (140PS)	Diesel Turbo Intercooler	TD28897
D 0834 LFL 20 Euro 3	4 Cyl.	4580cc	125kW (170PS)	Diesel Turbo Intercooler	TD16829
D 0834 LFL 40 Euro 3	4 Cyl.	4580cc	110kW (150PS)	Diesel Turbo Intercooler	TD18179
D 0834 LFL 41 Euro 3	4 Cyl.	4580cc	132kW (180PS)	Diesel Turbo Intercooler	TD18180
D 0834 LFL 42 Euro 3	4 Cyl.	4580cc	151kW (206PS)	Diesel Turbo Intercooler	TD18181
D 0834 LOH 01 Euro 3	4 Cyl.	4580cc	125kW (170PS)	Diesel Turbo Intercooler	TD16748
D 0834 LOH 02 Euro 3	4 Cyl.	4580cc	125kW (170PS)	Diesel Turbo Intercooler	TD16749
D 0834 LOH 03 Euro 3	4 Cyl.	4580cc	125kW (170PS)	Diesel Turbo Intercooler	TD16750

BE/PL	1	69,981/70,000	74,000/74,019	27,000	1,987	0,026/0,089	SP	71-3939	71-3939 STD 0.25	1
-------	---	---------------	---------------	--------	-------	-------------	----	---------	---------------------	---

Underfloor Engine

MB/HL 1-5	5	76,981/77,000	82,000/82,022	26,000	2,480	0,040/0,106	SP	72-3941	H082/5 STD	2
-----------	---	---------------	---------------	--------	-------	-------------	----	---------	---------------	---

Underfloor Engine

TW/A	2	84,500/84,850	102,450/102,800		2,900		AL-LF	04-3942	A158/4 STD	
TW/A	2	84,500/84,850	102,450/102,800		2,900		AL-LF	04-3943		
SE/PB	1	42,000	46,000/46,025	35,100			BC	55-3946	55-3946 SEMI	8
CB/NWB	4	54,910/54,940	59,000/59,030	25,000			BC	53-3944	N150/5 SEMI	
CB/NWB	1	54,910/54,940	59,000/59,030	25,000			BC	53-3945		

7 108.00 x 125.00

D 0826 F01	6 Cyl.	6871cc	110-114kW (150-155PS)	Diesel	TD7681
D 0826 F02	6 Cyl.	6871cc	110kW (150PS)	Diesel	TD7682
D 0826 FG001	6 Cyl.	6871cc	169kW (230PS)	Diesel	TD22324
D 0826 FG002	6 Cyl.	6871cc	169kW (230PS)	Diesel	TD22326
D 0826 FO 01	6 Cyl.	6871cc	114kW (155PS)	Diesel	TD23134
D 0826 FO 02	6 Cyl.	6871cc	110kW (150PS)	Diesel	TD23135
D 0826 GF	6 Cyl.	6871cc	110-114kW (150-155PS)	Diesel Turbo	TD7647
D 0826 GF01	6 Cyl.	6871cc	110-114kW (150-155PS)	Diesel	TD7649
D 0826 GF02	6 Cyl.	6871cc	169kW (230PS)	Diesel	TD22328
D 0826 GF03	6 Cyl.	6871cc	110kW (150PS)	Diesel	TD7648
D 0826 GF04 Euro 1	6 Cyl.	6871cc	110-114kW (150-155PS)	Diesel	TD19440
D 0826 GFA	6 Cyl.	6871cc	114kW (155PS)	Diesel	TD23139
D 0826 GFA 01	6 Cyl.	6871cc	114kW (155PS)	Diesel	TD23140
D 0826 GFA 02	6 Cyl.	6871cc	114kW (155PS)	Diesel	TD23141
D 0826 GFA 03	6 Cyl.	6871cc	110kW (150PS)	Diesel	TD23142
D 0826 GFA 04 Euro 1	6 Cyl.	6871cc	107kW (146PS)	Diesel	TD23143
D 0826 LE 51	6 Cyl.	6871cc	132kW (180PS)	Diesel Turbo Intercooler	TD19441
D 0826 LE 52	6 Cyl.	6871cc	132kW (180PS)	Diesel Turbo Intercooler	TD19442
D 0826 LE 521	6 Cyl.	6871cc	140kW (190PS)	Diesel Turbo Intercooler	TD22331
D 0826 LE 522 Euro 1	6 Cyl.	6871cc	154kW (209PS)	Diesel Turbo Intercooler	TD23144
D 0826 LE 523 Euro 1	6 Cyl.	6871cc	169kW (230PS)	Diesel Turbo Intercooler	TD23146
D 0826 LE 524 Euro 1	6 Cyl.	6871cc	125kW (170PS)	Diesel Turbo Intercooler	TD23147
D 0826 LE 527 Euro 1	6 Cyl.	6871cc	169kW (230PS)	Diesel Turbo Intercooler	TD23148
D 0826 LE 530 Euro 1	6 Cyl.	6871cc	147kW (200PS)	Diesel Turbo Intercooler	TD23149
D 0826 LE 531 Euro 1	6 Cyl.	6871cc	191kW (260PS)	Diesel Turbo Intercooler	TD23150
D 0826 LF01	6 Cyl.	6871cc	140kW (190PS)	Diesel Turbo Intercooler	TD7686
D 0826 LF02 Euro 1	6 Cyl.	6871cc	169kW (230PS)	Diesel Turbo Intercooler	TD7691
D 0826 LF05	6 Cyl.	6871cc	140kW (190PS)	Diesel Turbo Intercooler	TD7687
D 0826 LF06	6 Cyl.	6871cc	169kW (230PS)	Diesel Turbo Intercooler	TD7692

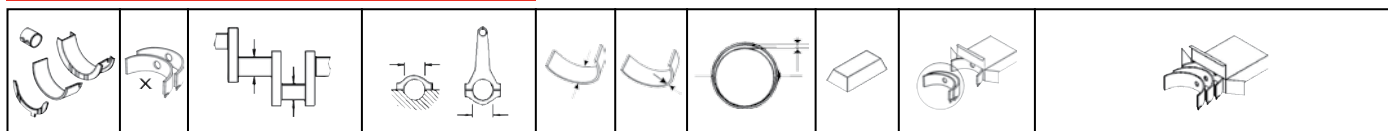

D 0826 LF07 Euro 1	6 Cyl.	6871cc	140kW (190PS)	Diesel Turbo Intercooler	TD7688
D 0826 LF08 Euro 1	6 Cyl.	6871cc	169kW (230PS)	Diesel Turbo Intercooler	TD7693
D 0826 LF09 Euro 1	6 Cyl.	6871cc	169kW (230PS)	Diesel Turbo Intercooler	TD22332
D 0826 LF10 Euro 2	6 Cyl.	6871cc	142-169kW (193-230PS)	Diesel Turbo Intercooler	TD22335
D 0826 LFG 01	6 Cyl.	6871cc	140kW (190PS)	Diesel Turbo Intercooler	TD23151
D 0826 LFG 02	6 Cyl.	6871cc	140kW (190PS)	Diesel Turbo Intercooler	TD23152
D 0826 LFG 06 Euro 1	6 Cyl.	6871cc	169kW (230PS)	Diesel Turbo Intercooler	TD23153
D 0826 LOH 01	6 Cyl.	6871cc	140kW (190PS)	Diesel Turbo Intercooler	TD7601
D 0826 LOH 05	6 Cyl.	6871cc	169kW (230PS)	Diesel Turbo Intercooler	TD21295
D 0826 LOH 07 Euro 1	6 Cyl.	6871cc	169kW (230PS)	Diesel Turbo Intercooler	TD16246
D 0826 LOH 08 Euro 1	6 Cyl.	6871cc	198kW (269PS)	Diesel Turbo Intercooler	TD21296
D 0826 LOH 09 Euro 1	6 Cyl.	6871cc	169kW (230PS)	Diesel Turbo Intercooler	TD21297
D 0826 LOH 10 Euro 1	6 Cyl.	6871cc	184kW (250PS)	Diesel Turbo Intercooler	TD16247
D 0826 LOH 11 Euro 1	6 Cyl.	6871cc	140kW (190PS)	Diesel Turbo Intercooler	TD21298
D 0826 LOH 12	6 Cyl.	6871cc	140kW (190PS)	Diesel Turbo Intercooler	TD21299
D 0826 LOH 13 Euro 1	6 Cyl.	6871cc	151kW (205PS)	Diesel Turbo Intercooler	TD21300
D 0826 LOH 15 Euro 2	6 Cyl.	6871cc	162kW (220PS)	Diesel Turbo Intercooler	TD7588
D 0826 LUE 51 Euro 1	6 Cyl.	6870cc	132kW (180PS)	Diesel Turbo Intercooler	TD19444
D 0826 LUH/213	6 Cyl.	6871cc	157kW (213PS)	Diesel Turbo Intercooler	TD7597
D 0826 OH	6 Cyl.	6871cc	110kW (150PS)	Diesel	TD19445
D 0826 OH01	6 Cyl.	6871cc	114kW (155PS)	Diesel	TD23157
D 0826 OH02	6 Cyl.	6871cc	110-114kW (150-155PS)	Diesel	TD7599
D 0826 TUE 51	6 Cyl.	6871cc	132kW (180-180PS)	Diesel Turbo	TD23162

BE/PL	6	64,981/65,000	69,000/69,019	31,000	1,987	0,026/0,089	EC	71-3660	71-3660/6 STD 0.25
MB/HL 1-3, 5-7	6	76,981/77,000	82,000/82,022	26,000	2,480	0,040/0,106	EC	72-3772	H049/7 STD 0.25
MB/HL 4	1	76,981/77,000	82,000/82,022	33,850	2,480	0,040/0,106	EC	72-3773H	

01/90 →



72-3773H STD 34,000/1.3386" - 34,100/1.3426"
0.25mm 34,500/1.3583" - 34,600/1.2623"

CB/NWB 1-4	4	50,910/50,940	55,000/55,030	25,000			BC	53-3485	N125/4 STD SEMI
---------------	---	---------------	---------------	--------	--	--	----	---------	--------------------

8 108.00 x 125.00

D 0826 FO	6 Cyl.	6871cc	110-114kW (150-155PS)	Diesel	TD25847
D 0826 FO 03 Euro 1	6 Cyl.	6871cc	107kW (146PS)	Diesel	TD25846
D 0826 FR	6 Cyl.	6871cc	110kW (150PS)	Diesel	TD25848
D 0826 FR 01	6 Cyl.	6871cc	110kW (150PS)	Diesel	TD25849
D 0826 LF/217/Silent	6 Cyl.	6870cc	160kW (217PS)	Diesel Turbo Intercooler	TD7723
D 0826 LF04 Euro 1	6 Cyl.	6871cc	198kW (270PS)	Diesel Turbo Intercooler	TD7695
D 0826 LF11 Euro 2	6 Cyl.	6871cc	162kW (220PS)	Diesel Turbo Intercooler	TD7690
D 0826 LF12 Euro 2	6 Cyl.	6871cc	140kW (190PS)	Diesel Turbo Intercooler	TD22337
D 0826 LF13 Euro 2	6 Cyl.	6871cc	191kW (260PS)	Diesel Turbo Intercooler	TD7694
D 0826 LF15 Euro 2	6 Cyl.	6871cc	162kW (220PS)	Diesel Turbo Intercooler	TD7726
D 0826 LF17 Euro 2	6 Cyl.	6871cc	191kW (260PS)	Diesel Turbo Intercooler	TD7727
D 0826 LF18 Euro 2	6 Cyl.	6871cc	162kW (220PS)	Diesel Turbo Intercooler	TD10227
D 0826 LFG 15 Euro 2	6 Cyl.	6871cc	162kW (220PS)	Diesel Turbo Intercooler	TD23154
D 0826 LFG 16 Euro 2	6 Cyl.	6871cc	191kW (260PS)	Diesel Turbo Intercooler	TD23155
D 0826 LFL Euro 1	6 Cyl.	6871cc	162-165kW (220-224PS)	Diesel Turbo Intercooler	TD19443
D 0826 LFL01 Euro 1	6 Cyl.	6871cc	114kW (155PS)	Diesel Turbo Intercooler	TD28895
D 0826 LFL02 Euro 1	6 Cyl.	6871cc	169kW (230PS)	Diesel Turbo Intercooler	TD7664

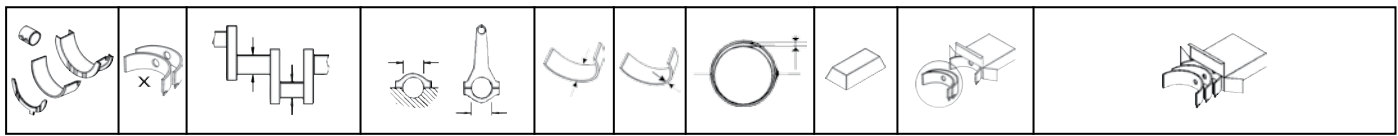

D 0826 LFL03 Euro 1	6 Cyl.	6871cc	162kW (220PS)	Diesel Turbo Intercooler	TD7663
D 0826 LFL05 Euro 1	6 Cyl.	6871cc	114kW (155PS)	Diesel Turbo Intercooler	TD21291
D 0826 LFL06 Euro 1	6 Cyl.	6871cc	162kW (220PS)	Diesel Turbo Intercooler	TD7665
D 0826 LFL07 Euro 1	6 Cyl.	6871cc	188kW (256PS)	Diesel Turbo Intercooler	TD21292
D 0826 LFL08 Euro 1	6 Cyl.	6871cc	162kW (220PS)	Diesel Turbo Intercooler	TD21293
D 0826 LFL09 Euro 2	6 Cyl.	6871cc	191kW (260PS)	Diesel Turbo Intercooler	TD7725
D 0826 LFL10 Euro 1	6 Cyl.	6871cc	162kW (220PS)	Diesel Turbo Intercooler	TD10207
D 0826 LOH 02	6 Cyl.	6871cc	140kW (190PS)	Diesel Turbo Intercooler	TD7679
D 0826 LOH 03	6 Cyl.	6871cc	169kW (230PS)	Diesel Turbo Intercooler	TD16465
D 0826 LOH 04	6 Cyl.	6871cc	169kW (230PS)	Diesel Turbo Intercooler	TD16466
D 0826 LOH 06 Euro 1	6 Cyl.	6871cc	140kW (190PS)	Diesel Turbo Intercooler	TD7587
D 0826 LOH 17 Euro 2	6 Cyl.	6871cc	162kW (220PS)	Diesel Turbo Intercooler	TD17419
D 0826 LOH 18 Euro 2	6 Cyl.	6871cc	191kW (260PS)	Diesel Turbo Intercooler	TD17420
D 0826 LOH 19 Euro 2	6 Cyl.	6871cc	162kW (220PS)	Diesel Turbo Intercooler	TD23156
D 0826 LUH 01 Euro 1	6 Cyl.	6871cc	198kW (270PS)	Diesel Turbo Intercooler	TD7596
D 0826 LUH 02 Euro 1	6 Cyl.	6871cc	169-198kW (230-269PS)	Diesel Turbo Intercooler	TD21301
D 0826 LUH 03 Euro 1	6 Cyl.	6871cc	157kW (213PS)	Diesel Turbo Intercooler	TD7584
D 0826 LUH 04	6 Cyl.	6871cc	157-169kW (214-230PS)	Diesel Turbo Intercooler	TD21302
D 0826 LUH 05 Euro 1	6 Cyl.	6871cc	169kW (230PS)	Diesel Turbo Intercooler	TD7585
D 0826 LUH 06 Euro 1	6 Cyl.	6871cc	169-198kW (230-269PS)	Diesel Turbo Intercooler	TD21303
D 0826 LUH 08 Euro 2	6 Cyl.	6871cc	162-169kW (220-230PS)	Diesel Turbo Intercooler	TD21304
D 0826 LUH 09 Euro 2	6 Cyl.	6871cc	169-206kW (230-280PS)	Diesel Turbo Intercooler	TD21305
D 0826 LUH 10 Euro 1	6 Cyl.	6871cc	169-198kW (230-269PS)	Diesel Turbo Intercooler	TD21306
D 0826 LUH 11 Euro 2	6 Cyl.	6871cc	162kW (220PS)	Diesel Turbo Intercooler	TD21307
D 0826 LUH 12 Euro 1	6 Cyl.	6870cc	162kW (220PS)	Diesel Turbo Intercooler	TD7586
D 0826 LUH 13 Euro 2	6 Cyl.	6871cc	191kW (260PS)	Diesel Turbo Intercooler	TD16248
D 0826 LUH Euro 1	6 Cyl.	6870cc	184kW (250PS)	Diesel Turbo Intercooler	TD7583
D 0826 OH03 Euro 1	6 Cyl.	6871cc	107kW (146PS)	Diesel	TD23158

BE/PL	6	64,981/65,000	69,000/69,019	31,000	1,987	0,026/0,089	EC	71-3660	71-3660/6 STD 0.25
MB/HL 1-3, 5-7	6	76,981/77,000	82,000/82,022	26,000	2,480	0,040/0,106	EC	72-3772	H049/7 STD 0.25
MB/HL 4	1	76,981/77,000	82,000/82,022	33,850	2,480	0,040/0,106	EC	72-3773H	

	72-3773H	STD	34,000/1.3386" - 34,100/1.3426"
		0.25mm	34,500/1.3583" - 34,600/1.2623"

CB/NWB 1-4	4	50,910/50,940	55,000/55,030	25,000			BC	53-3485	N125/4 STD SEMI
---------------	---	---------------	---------------	--------	--	--	----	---------	--------------------

9 108.00 x 125.00

D 0836 280 Euro 4	6 Cyl.	6871cc	202-206kW (275-280PS)	Diesel Turbo Intercooler	TD30276
D 0836 LFG 50 Euro 4/5	6 Cyl.	6871cc	240kW (326PS)	Diesel Turbo Intercooler	TD20228
D 0836 LFL 50 Euro 4	6 Cyl.	6871cc	176kW (240PS)	Diesel Turbo Intercooler	TD18186
D 0836 LFL 51 Euro 4	6 Cyl.	6871cc	206kW (280PS)	Diesel Turbo Intercooler	TD19114
D 0836 LFL 52 Euro 4	6 Cyl.	6871cc	240kW (326PS)	Diesel Turbo Intercooler	TD19113
D 0836 LFL 53 Euro 4	6 Cyl.	6871cc	176kW (240PS)	Diesel Turbo Intercooler	TD22970
D 0836 LFL 54 Euro 4	6 Cyl.	6871cc	206kW (280PS)	Diesel Turbo Intercooler	TD22971
D 0836 LFL 55 Euro 4	6 Cyl.	6871cc	240kW (326PS)	Diesel Turbo Intercooler	TD22972
D 0836 LFL 60	6 Cyl.	6871cc	184kW (250PS)	Diesel Turbo Intercooler	TD22966
D 0836 LFL 61	6 Cyl.	6871cc	213kW (290PS)	Diesel Turbo Intercooler	TD23686
D 0836 LFL 62	6 Cyl.	6871cc	250kW (340PS)	Diesel Turbo Intercooler	TD23687
D 0836 LFL 63 Euro 5	6 Cyl.	6871cc	184kW (250PS)	Diesel Turbo Intercooler	TD22967
D 0836 LFL 64 Euro 5	6 Cyl.	6871cc	213kW (290PS)	Diesel Turbo Intercooler	TD22984



D 0836 LFL 65 Euro 5	6 Cyl.	6871cc	250kW (340PS)	Diesel Turbo Intercooler	TD22995
D 0836 LFL 66 Euro 6	6 Cyl.	6871cc	184kW (250PS)	Diesel Turbo Intercooler	TD27706
D 0836 LFL 67 Euro 6	6 Cyl.	6871cc	213kW (290PS)	Diesel Turbo Intercooler	TD27707
D 0836 LFL 68 Euro 6	6 Cyl.	6871cc	250kW (340PS)	Diesel Turbo Intercooler	TD27724
D 0836 LFL 69 Euro 5	6 Cyl.	6871cc	184kW (250PS)	Diesel Turbo Intercooler	TD27708
D 0836 LFL 70 Euro 5	6 Cyl.	6871cc	213kW (290PS)	Diesel Turbo Intercooler	TD27709
D 0836 LFL 71 Euro 5	6 Cyl.	6871cc	250kW (340PS)	Diesel Turbo Intercooler	TD27710
D 0836 LOH 51 Euro 4	6 Cyl.	6871cc	206kW (280PS)	Diesel Turbo Intercooler	TD19971
D 0836 LOH 52 Euro 4	6 Cyl.	6871cc	177kW (240PS)	Diesel Turbo Intercooler	TD19970
D 0836 LOH 55 Euro 4	6 Cyl.	6871cc	206kW (280PS)	Diesel Turbo Intercooler	TD23060
D 0836 LOH 56 Euro 4	6 Cyl.	6871cc	177kW (240PS)	Diesel Turbo Intercooler	TD23059
D 0836 LOH 60	6 Cyl.	6871cc	213kW (290PS)	Diesel Turbo Intercooler	TD23671
D 0836 LOH 61	6 Cyl.	6871cc	184kW (250PS)	Diesel Turbo Intercooler	TD23670
D 0836 LOH 62 Euro 4	6 Cyl.	6871cc	191kW (260PS)	Diesel Turbo Intercooler	TD23164
D 0836 LOH 63	6 Cyl.	6871cc	191kW (260PS)	Diesel Turbo Intercooler	TD23962
D 0836 LOH 64 Euro 5	6 Cyl.	6871cc	213kW (290PS)	Diesel Turbo Intercooler	TD23682
D 0836 LOH 65 Euro 5	6 Cyl.	6871cc	184kW (250PS)	Diesel Turbo Intercooler	TD23681
D 0836 LOH 69 Euro 5	6 Cyl.	6871cc	240kW (326PS)	Diesel Turbo Intercooler	TD30440
D 0836 LOH 70	6 Cyl.	6871cc	213kW (290PS)	Diesel Turbo Intercooler	TD30442
D 0836 LOH 71	6 Cyl.	6871cc	184kW (250PS)	Diesel Turbo Intercooler	TD30441

BE/PL	1	69,981/70,000	74,000/74,019	29,000	1,987	0,036/0,100	SP	71-4748	71-4748 STD 0.25 0.50	1
MB/HL	1	86,978/87,000	92,000/92,022	26,000	2,480	0,054/0,122	EC	72-4749	72-4749 STD 0.25 0.50	
TW/A	2	94,500	112,800		2,900		AL-LF	04-4750	A290/4 STD	
TW/A	2	94,500	112,800		2,900		AL-LF	04-4751		
SE/PB	1	43,940/44,000	48,000/48,025	37,000			BS-LF	55-4752	55-4752 SEMI	
CB/NWB	1	54,910/54,940	59,000/59,030	25,000			BC	53-3944	53-3944 SEMI	
CB/NWB	1	54,910/54,940	59,000/59,030	25,000			BC	53-4753	53-4753 SEMI	

53-3944

53-4753

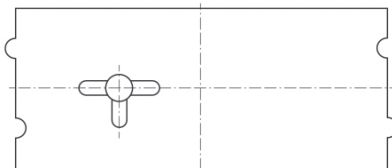
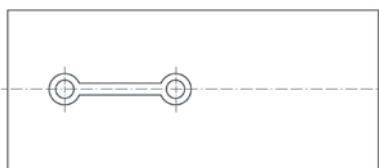

10

108.00 x 125.00

D 0836 LF 01	6 Cyl.	6871cc	206kW (280PS)	Diesel Turbo Intercooler	TD14289
D 0836 LF 02 Euro 3	6 Cyl.	6871cc	162kW (220PS)	Diesel Turbo Intercooler	TD17045
D 0836 LF 03 Euro 3	6 Cyl.	6871cc	206kW (280PS)	Diesel Turbo Intercooler	TD16503
D 0836 LF 04 Euro 3	6 Cyl.	6871cc	162kW (220PS)	Diesel Turbo Intercooler	TD16500
D 0836 LF 05 Euro 3	6 Cyl.	6871cc	180kW (245PS)	Diesel Turbo Intercooler	TD16504
D 0836 LF 06 Euro 3	6 Cyl.	6871cc	260kW (354PS)	Diesel Turbo Intercooler	TD28898
D 0836 LF 10 Euro 3	6 Cyl.	6871cc	260kW (354PS)	Diesel Turbo Intercooler	TD28899
D 0836 LF 41 Euro 3	6 Cyl.	6871cc	206kW (280PS)	Diesel Turbo Intercooler	TD16827
D 0836 LF 44 Euro 3	6 Cyl.	6871cc	240kW (326PS)	Diesel Turbo Intercooler	TD16828
D 0836 LFL 01 Euro 3	6 Cyl.	6871cc	206-215kW (280-292PS)	Diesel Turbo Intercooler	TD16875
D 0836 LFL 02 Euro 3	6 Cyl.	6871cc	162kW (220PS)	Diesel Turbo Intercooler	TD16499
D 0836 LFL 03 Euro 3	6 Cyl.	6871cc	206kW (280PS)	Diesel Turbo Intercooler	TD16502
D 0836 LFL 04 Euro 3	6 Cyl.	6871cc	162kW (220PS)	Diesel Turbo Intercooler	TD17049

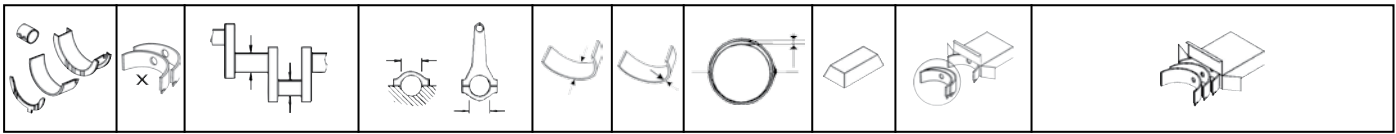

D 0836 LFL 05 Euro 3	6 Cyl.	6871cc	180kW (245PS)	Diesel Turbo Intercooler	TD16501
D 0836 LFL 06 Euro 3	6 Cyl.	6871cc	162kW (220PS)	Diesel Turbo Intercooler	TD23163
D 0836 LFL 07 Euro 3	6 Cyl.	6871cc	162kW (220PS)	Diesel Turbo Intercooler	TD16830
D 0836 LFL 08 Euro 3	6 Cyl.	6871cc	206kW (280PS)	Diesel Turbo Intercooler	TD24953
D 0836 LFL 10 Euro 3	6 Cyl.	6871cc	162kW (220PS)	Diesel Turbo Intercooler	TD16831
D 0836 LFL 40 Euro 3	6 Cyl.	6871cc	176kW (240PS)	Diesel Turbo Intercooler	TD18185
D 0836 LFL 41 Euro 3	6 Cyl.	6871cc	206kW (280PS)	Diesel Turbo Intercooler	TD18703
D 0836 LFL 44 Euro 3	6 Cyl.	6871cc	240kW (326PS)	Diesel Turbo Intercooler	TD18704
D 0836 LOH 01 Euro 3	6 Cyl.	6871cc	206kW (280PS)	Diesel Turbo Intercooler	TD16753
D 0836 LOH 02 Euro 3	6 Cyl.	6871cc	206kW (280PS)	Diesel Turbo Intercooler	TD16752
D 0836 LOH 03 Euro 3	6 Cyl.	6871cc	162kW (220PS)	Diesel Turbo Intercooler	TD16751
D 0836 LOH 40 Euro 3	6 Cyl.	6871cc	206kW (280PS)	Diesel Turbo Intercooler	TD16754
D 0836 LOH 41 Euro 3	6 Cyl.	6871cc	177kW (240PS)	Diesel Turbo Intercooler	TD16755
D 0836 LUH 01 Euro 3	6 Cyl.	6871cc	206kW (280PS)	Diesel Turbo Intercooler	TD16756
D 0836 LUH 02 Euro 3	6 Cyl.	6871cc	162kW (220PS)	Diesel Turbo Intercooler	TD16757
D 0836 LUH 40 Euro 3	6 Cyl.	6871cc	206kW (280PS)	Diesel Turbo Intercooler	TD16758
D 0836 LUH 41 Euro 3	6 Cyl.	6871cc	177kW (240PS)	Diesel Turbo Intercooler	TD16759

BE/PL	6	69,981/70,000	74,000/74,019	27,000	1,987	0,026/0,089	EC	71-3938	71-3938/6 STD
BE/PL	1	69,981/70,000	74,000/74,019	27,000	1,987	0,026/0,089	SP	71-3939	71-3939 STD 0.25

Underfloor Engine

71-3938

71-3939

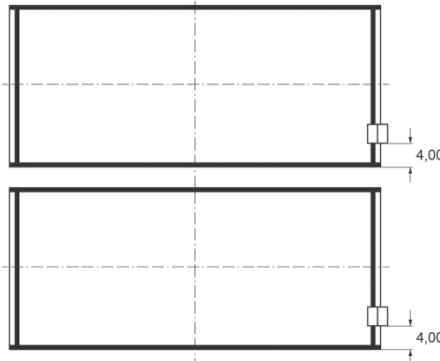
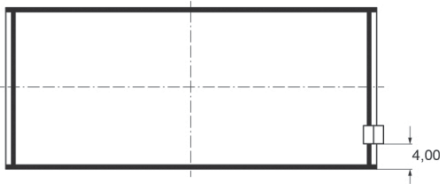

MB/HL 1-7	7	76,981/77,000	82,000/82,022	26,000	2,480	0,040/0,106	SP	72-3941	H082/7 STD
-----------	---	---------------	---------------	--------	-------	-------------	----	---------	---------------

Underfloor Engine

TW/A	2	84,500/84,850	102,450/102,800		2,900		AL-LF	04-3942	A158/4 STD
TW/A	2	84,500/84,850	102,450/102,800		2,900		AL-LF	04-3943	
SE/PB	1	42,000	46,000/46,025	35,100			BC	55-3946	55-3946 SEMI
CB/NWB	6	54,910/54,940	59,000/59,030	25,000			BC	53-3944	N150/7 STD SEMI
CB/NWB	1	54,910/54,940	59,000/59,030	25,000			BC	53-3945	

11

108.00 x 125.00

E 0836 E 302	6 Cyl.	6871cc	75kW (102PS)	Gas	TD23749
E 0836 E 312	6 Cyl.	6871cc	56-64kW (76-87PS)	Gas	TD23748
E 0836 LE 202	6 Cyl.	6871cc	110kW (150PS)	Gas Turbo Intercooler	TD23747
E 0836 LE 302	6 Cyl.	6871cc	85kW (116PS)	Gas Turbo Intercooler	TD23750
E 0836 LOH 01	6 Cyl.	6871cc	206kW (280PS)	Gas Turbo	TD23746
E 0836 LOH 02	6 Cyl.	6871cc	184kW (250PS)	Gas Turbo	TD25457

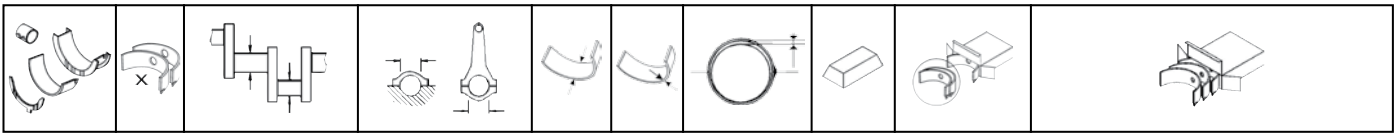

E 0836 LOH 03	6 Cyl.	6871cc	162kW (220PS)	Gas Turbo	TD25458
E 0836 LOH 04 Euro 6	6 Cyl.	6871cc	206kW (280PS)	Gas Turbo	TD30451
E 0836 LOH 05 Euro 6	6 Cyl.	6871cc	184kW (250PS)	Gas Turbo	TD30452
E 0836 LOH 06 Euro 6	6 Cyl.	6871cc	162kW (220PS)	Gas Turbo	TD30453

BE/PL	1	69,981/70,000	74,000/74,019	27,000	1,987	0,026/0,089	SP	71-3939	71-3939 STD 0.25	①
-------	---	---------------	---------------	--------	-------	-------------	----	---------	----------------------------	---

Underfloor Engine

MB/HL 1-7	7	76,981/77,000	82,000/82,022	26,000	2,480	0,040/0,106	SP	72-3941	H082/7 STD	②
--------------	---	---------------	---------------	--------	-------	-------------	----	---------	----------------------	---

Underfloor Engine

TW/A	2	84,500/84,850	102,450/102,800		2,900		AL-LF	04-3942	A158/4 STD
TW/A	2	84,500/84,850	102,450/102,800		2,900		AL-LF	04-3943	
CB/NWB	6	54,910/54,940	59,000/59,030	25,000			BC	53-3944	N150/7 STD SEMI
CB/NWB	1	54,910/54,940	59,000/59,030	25,000			BC	53-3945	

12 108.00 x 128.00

D 0836 HM 3 U	6 Cyl.	7030cc	110kW (150PS)	Diesel	TD7824
D 0836 HM 4	6 Cyl.	7030cc	110-115kW (150-156PS)	Diesel	TD5652
D 0836 HM 5 U	6 Cyl.	7030cc	110kW (150PS)	Diesel	TD8761
D 0836 HM 7	6 Cyl.	7030cc	114-117kW (156-160PS)	Diesel	TD5990
D 0836 HM 7 U	6 Cyl.	7030cc	117kW (160PS)	Diesel	TD7825
D 0836 HM 70	6 Cyl.	7030cc	110-114kW (150-156PS)	Diesel	TD6268
D 0836 HM 71	6 Cyl.	7030cc	114kW (156PS)	Diesel	TD7668
D 0836 HM 8 U	6 Cyl.	7030cc	117kW (160PS)	Diesel	TD8762
D 0836 HM 9 H	6 Cyl.	7030cc	117kW (160PS)	Diesel	TD7817
D 0836 HM 9 U	6 Cyl.	7030cc	117kW (160PS)	Diesel	TD7821
D 0836 HMN 70	6 Cyl.	7030cc	114kW (156PS)	Diesel	TD7650
D 0836 M 2	6 Cyl.	7030cc	99kW (135PS)	Diesel	TD7644
D 0836 M 2 A	6 Cyl.	7030cc	99kW (135PS)	Diesel	TD7819
D 0836 M 2 U	6 Cyl.	7030cc	99kW (135PS)	Diesel	TD7820
D 0836 M 3 H	6 Cyl.	7030cc	99kW (135PS)	Diesel	TD7816

BE/PL	6	69,981/70,000	74,000/74,019	27,000	1,987	0,026/0,089	EC	71-3938	71-3938/6 STD	
BE/PL	1	69,981/70,000	74,000/74,019	27,000	1,987	0,026/0,089	SP	71-3939	71-3939 STD 0.25	①

Underfloor Engine

71-3938

71-3939

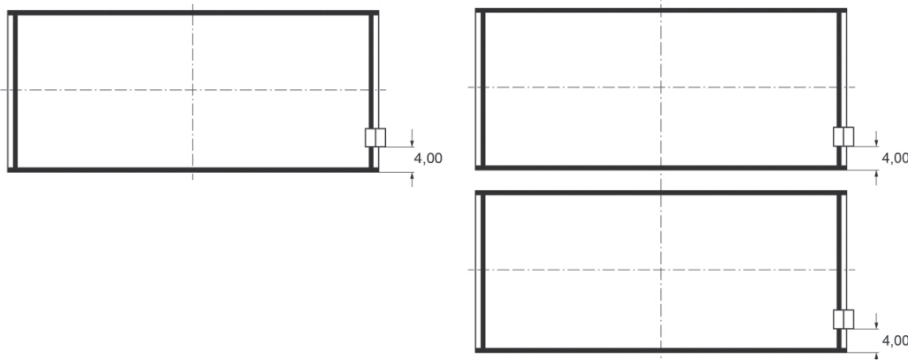

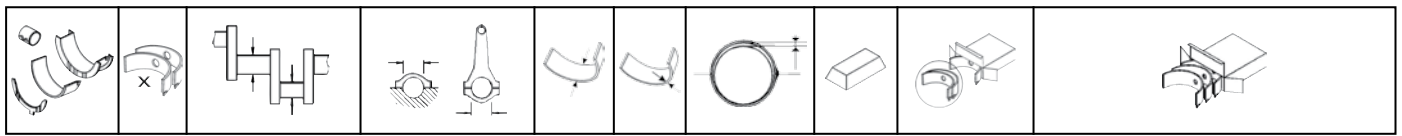

MB/HL 1-7	7	76,981/77,000	82,000/82,022	26,000	2,480	0,040/0,106	SP	72-3941	H082/7 STD	[2]
-----------	---	---------------	---------------	--------	-------	-------------	----	---------	------------	-----

Underfloor Engine

TW/A	2	84,500/84,850	102,450/102,800		2,900		AL-LF	04-3942	A158/4 STD	
TW/A	2	84,500/84,850	102,450/102,800		2,900		AL-LF	04-3943		
SE/PB	1	42,000	46,000/46,025	35,100			BC	55-3946	55-3946 SEMI	[8]
CB/NWB	6	54,910/54,940	59,000/59,030	25,000			BC	53-3944	N150/7 STD SEMI	
CB/NWB	1	54,910/54,940	59,000/59,030	25,000			BC	53-3945		

13 120.00 x 155.00

D 2066 LE 621	6 Cyl.	10518cc	265kW (360PS)	Diesel Turbo Intercooler	TD27953
D 2066 LF 17 Euro 5	6 Cyl.	10518cc	324kW (440PS)	Diesel Turbo Intercooler	TD23081
D 2066 LF 18 Euro 5	6 Cyl.	10518cc	294kW (400PS)	Diesel Turbo Intercooler	TD23083
D 2066 LF 19 Euro 5	6 Cyl.	10518cc	265kW (360PS)	Diesel Turbo Intercooler	TD23084
D 2066 LF 20 Euro 5	6 Cyl.	10518cc	235kW (320PS)	Diesel Turbo Intercooler	TD23085
D 2066 LF 21 Euro 5	6 Cyl.	10518cc	321kW (437PS)	Diesel Turbo Intercooler	TD20230
D 2066 LF 22 Euro 5	6 Cyl.	10518cc	294kW (400PS)	Diesel Turbo Intercooler	TD20229
D 2066 LF 25 Euro 5	6 Cyl.	10518cc	324kW (440PS)	Diesel Turbo Intercooler	TD20363
D 2066 LF 26 Euro 5	6 Cyl.	10518cc	294kW (400PS)	Diesel Turbo Intercooler	TD20364
D 2066 LF 27 Euro 5	6 Cyl.	10518cc	265kW (360PS)	Diesel Turbo Intercooler	TD20365
D 2066 LF 28 Euro 5	6 Cyl.	10518cc	235kW (320PS)	Diesel Turbo Intercooler	TD20366
D 2066 LF 36 Euro 4	6 Cyl.	10518cc	324kW (440PS)	Diesel Turbo Intercooler	TD20368
D 2066 LF 37 Euro 4	6 Cyl.	10518cc	294kW (400PS)	Diesel Turbo Intercooler	TD20369
D 2066 LF 38 Euro 4	6 Cyl.	10518cc	265kW (360PS)	Diesel Turbo Intercooler	TD20370
D 2066 LF 39 Euro 4	6 Cyl.	10518cc	235kW (320PS)	Diesel Turbo Intercooler	TD20396
D 2066 LF 59	6 Cyl.	10518cc	265kW (360PS)	Diesel Turbo Intercooler	TD23688
D 2066 LF 60	6 Cyl.	10518cc	235kW (320PS)	Diesel Turbo Intercooler	TD23689
D 2066 LOH 01 Euro 4	6 Cyl.	10520cc	235kW (320PS)	Diesel Turbo Intercooler	TD19972
D 2066 LOH 05 Euro 4	6 Cyl.	10518cc	225kW (320PS)	Diesel Turbo Intercooler	TD23061
D 2066 LOH 07 Euro 4	6 Cyl.	10518cc	294kW (400PS)	Diesel Turbo Intercooler	TD23063
D 2066 LOH 11 Euro 3	6 Cyl.	10518cc	287kW (390PS)	Diesel Turbo Intercooler	TD23072
D 2066 LOH 12 Euro 3	6 Cyl.	10518cc	257kW (350PS)	Diesel Turbo Intercooler	TD23070
D 2066 LOH 13 Euro 4	6 Cyl.	10518cc	257kW (350PS)	Diesel Turbo Intercooler	TD23979
D 2066 LOH 26	6 Cyl.	10518cc	235kW (320PS)	Diesel Turbo Intercooler	TD23672
D 2066 LOH 28	6 Cyl.	10518cc	294kW (400PS)	Diesel Turbo Intercooler	TD23396
D 2066 LUH 07 Euro 3	6 Cyl.	10520cc	228kW (310PS)	Diesel Turbo Intercooler	TD23074
D 2066 LUH 08 Euro 3	6 Cyl.	10520cc	257kW (350PS)	Diesel Turbo Intercooler	TD23075
D 2066 LUH 09 Euro 3	6 Cyl.	10520cc	287kW (390PS)	Diesel Turbo Intercooler	TD23076
D 2066 LUH 14 Euro 4	6 Cyl.	10520cc	287kW (390PS)	Diesel Turbo Intercooler	TD19979
D 2066 LUH 15 Euro 4	6 Cyl.	10520cc	316kW (430PS)	Diesel Turbo Intercooler	TD19980
D 2066 LUH 21 Euro 4	6 Cyl.	10518cc	199kW (271PS)	Diesel Turbo Intercooler	TD22860
D 2066 LUH 22 Euro 4	6 Cyl.	10518cc	228kW (310PS)	Diesel Turbo Intercooler	TD23065
D 2066 LUH 24 Euro 4	6 Cyl.	10518cc	287kW (390PS)	Diesel Turbo Intercooler	TD23067
D 2066 LUH 32 Euro 5	6 Cyl.	10518cc	235kW (320PS)	Diesel Turbo Intercooler	TD23683
D 2066 LUH 33 Euro 5	6 Cyl.	10518cc	265kW (360PS)	Diesel Turbo Intercooler	TD23684
D 2066 LUH 34 Euro 5	6 Cyl.	10518cc	294kW (400PS)	Diesel Turbo Intercooler	TD23685
D 2066 LUH 41	6 Cyl.	10518cc	206kW (280PS)	Diesel Turbo Intercooler	TD23963
D 2066 LUH 43	6 Cyl.	10518cc	257kW (350PS)	Diesel Turbo Intercooler	TD23965
D 2066 LUH 46	6 Cyl.	10518cc	206kW (280PS)	Diesel Turbo Intercooler	TD23674
D 2066 LUH 47	6 Cyl.	10518cc	235kW (320PS)	Diesel Turbo Intercooler	TD23675



BE/PL	1	89,980/90,000	95,000/95,022	36,200	2,478	0,070/0,137	SP	71-4529	71-4529 STD 0.25	1
-------	---	---------------	---------------	--------	-------	-------------	----	---------	----------------------------	---

01/06 →

BE/PL	1	89,980/90,000	95,000/95,022	36,200	2,478	0,060/0,122	SP	71-4746	71-4746 STD 0.25	1
-------	---	---------------	---------------	--------	-------	-------------	----	---------	----------------------------	---

01/02 → 12/05

71-4529

71-4746

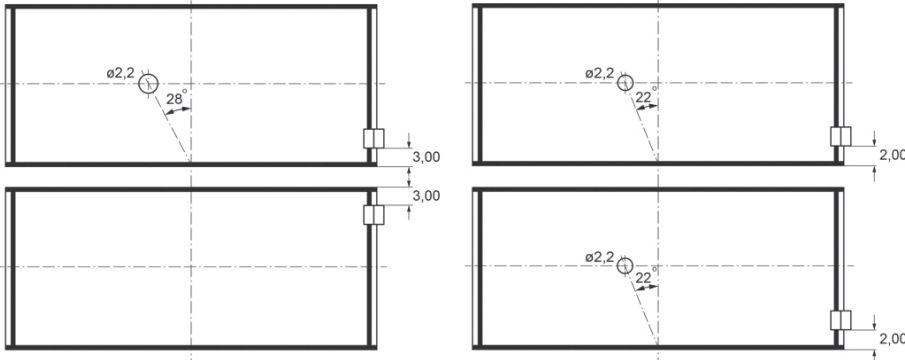

MB/HL 1-7	7	103,980/104,000	111,000/111,022	36,000	3,478	0,060/0,126	EC	72-4527	H1239/7 STD 0.25 0.50	4
TW/A	2	114,400/114,750	137,650/138,000		3,400		AL-LF	04-3947	A159/4 STD	
TW/A	2	114,400/114,750	137,650/138,000		3,400		AL-LF	04-3948		
SE/PB	1	51,992/51,998	56,000/56,030	45,500			BC-LF	55-4532	55-4532 SEMI	6 8
CB/NWB	1	39,934/39,950	44,000/44,016	26,000	2,085		AL-LF	03-4727	03-4727 STD	
BU	1	96,853/96,888	102,00/102,04	18,000	2,488	0,100/0,210	AL-LF	07-4997	07-4997 STD	

14

120.00 x 155.00

D 2066 LF 01 Euro 3	6 Cyl.	10518cc	316kW (430PS)	Diesel Turbo Intercooler	TD17370
D 2066 LF 02 Euro 3	6 Cyl.	10518cc	287kW (390PS)	Diesel Turbo Intercooler	TD17371
D 2066 LF 03 Euro 3	6 Cyl.	10518cc	257kW (350PS)	Diesel Turbo Intercooler	TD17372
D 2066 LF 04 Euro 3	6 Cyl.	10518cc	228kW (310PS)	Diesel Turbo Intercooler	TD17373
D 2066 LF 06 Euro 3	6 Cyl.	10518cc	294kW (400PS)	Diesel Turbo Intercooler	TD19951
D 2066 LF 07 Euro 3	6 Cyl.	10518cc	265kW (360PS)	Diesel Turbo Intercooler	TD22899
D 2066 LF 11 Euro 4	6 Cyl.	10518cc	316kW (430PS)	Diesel Turbo Intercooler	TD18098
D 2066 LF 12 Euro 4	6 Cyl.	10518cc	287kW (390PS)	Diesel Turbo Intercooler	TD18097
D 2066 LF 13 Euro 4	6 Cyl.	10518cc	257kW (350PS)	Diesel Turbo Intercooler	TD19111
D 2066 LF 14 Euro 4	6 Cyl.	10518cc	228kW (310PS)	Diesel Turbo Intercooler	TD19109
D 2066 LF 23 Euro 5	6 Cyl.	10518cc	324kW (440PS)	Diesel Turbo Intercooler	TD19098
D 2066 LF 24 Euro 5	6 Cyl.	10518cc	294kW (400PS)	Diesel Turbo Intercooler	TD19099
D 2066 LF 29	6 Cyl.	10518cc	265kW (360PS)	Diesel Turbo Intercooler	TD25603
D 2066 LF 30	6 Cyl.	10518cc	235kW (320PS)	Diesel Turbo Intercooler	TD25604
D 2066 LF 31 Euro 4	6 Cyl.	10518cc	324kW (440PS)	Diesel Turbo Intercooler	TD19094
D 2066 LF 32 Euro 4	6 Cyl.	10518cc	294kW (400PS)	Diesel Turbo Intercooler	TD19095
D 2066 LF 33 Euro 4	6 Cyl.	10518cc	265kW (360PS)	Diesel Turbo Intercooler	TD19096
D 2066 LF 34	6 Cyl.	10518cc	324kW (441PS)	Diesel Turbo Intercooler	TD28904
D 2066 LF 35 Euro 4	6 Cyl.	10518cc	235kW (320PS)	Diesel Turbo Intercooler	TD19097
D 2066 LF 44 Euro 5	6 Cyl.	10518cc	324kW (440PS)	Diesel Turbo Intercooler	TD25456
D 2066 LF 45 Euro 5	6 Cyl.	10518cc	294kW (400PS)	Diesel Turbo Intercooler	TD25455
D 2066 LF 46 Euro 5	6 Cyl.	10518cc	265kW (360PS)	Diesel Turbo Intercooler	TD25454

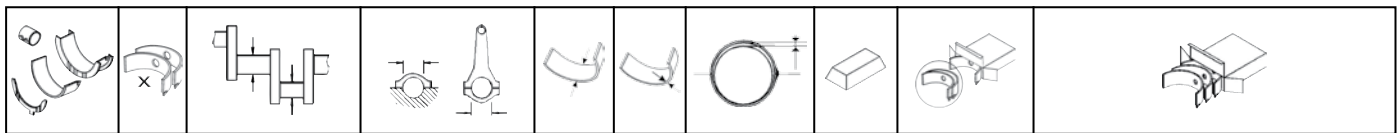

D 2066 LF 47 Euro 5	6 Cyl.	10518cc	235kW (320PS)	Diesel Turbo Intercooler	TD25453
D 2066 LF 54	6 Cyl.	10518cc	294kW (400PS)	Diesel Turbo Intercooler	TD25607
D 2066 LF 55	6 Cyl.	10518cc	265kW (360PS)	Diesel Turbo Intercooler	TD25606
D 2066 LF 56	6 Cyl.	10518cc	235kW (320PS)	Diesel Turbo Intercooler	TD25605
D 2066 LF 58	6 Cyl.	10518cc	294kW (400PS)	Diesel Turbo Intercooler	TD25451
D 2066 LF 65 Euro 4	6 Cyl.	10518cc	235kW (320PS)	Diesel Turbo Intercooler	TD25611
D 2066 LF 69 Euro 4	6 Cyl.	10518cc	324kW (440PS)	Diesel Turbo Intercooler	TD25620
D 2066 LF 70 Euro 4	6 Cyl.	10518cc	294kW (400PS)	Diesel Turbo Intercooler	TD25619
D 2066 LF 71 Euro 4	6 Cyl.	10518cc	265kW (360PS)	Diesel Turbo Intercooler	TD25618
D 2066 LF 72 Euro 4	6 Cyl.	10518cc	235kW (320PS)	Diesel Turbo Intercooler	TD25617
D 2066 LOH 35 Euro 4	6 Cyl.	10518cc	294kW (400PS)	Diesel Turbo Intercooler	TD30607
D 2066 LUH 42	6 Cyl.	10518cc	235kW (320PS)	Diesel Turbo Intercooler	TD23964

BE/PL	1	89,980/90,000	95,000/95,022	36,200	2,478	0,070/0,137	SP	71-4529	71-4529 STD 0.25	1
-------	---	---------------	---------------	--------	-------	-------------	----	---------	---------------------	---

01/06 →

BE/PL	1	89,980/90,000	95,000/95,022	36,200	2,478	0,060/0,122	SP	71-4746	71-4746 STD 0.25	1
-------	---	---------------	---------------	--------	-------	-------------	----	---------	---------------------	---

→12/05

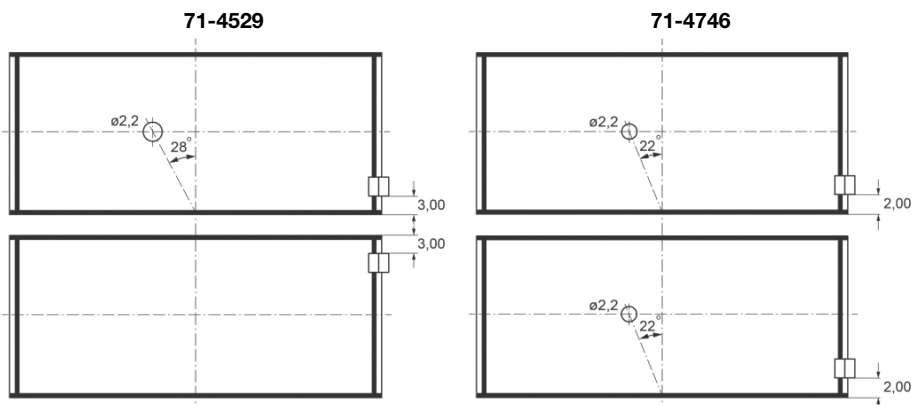

MB/HL 1-7	7	103,980/104,000	111,000/111,022	36,000	3,478	0,060/0,126	EC	72-4527	H1239/7 STD 0.25 0.50	4
TW/A	2	114,400/114,750	137,650/138,000		3,400		AL-LF	04-3947	A159/4 STD	
TW/A	2	114,400/114,750	137,650/138,000		3,400		AL-LF	04-3948		
SE/PB	1	51,992/51,998	56,000/56,030	45,500			BC-LF	55-4532	55-4532 SEMI	6 8
CB/NWB	1	39,934/39,950	44,000/44,016	26,000	2,085		AL-LF	03-4727	03-4727 STD	
BU	1	96,853/96,888	102,00/102,04	18,000	2,488	0,100/0,210	AL-LF	07-4997	07-4997 STD	

15

120.00 x 155.00

D 2066 LF 40 Euro 5	6 Cyl.	10518cc	324kW (440PS)	Diesel Turbo Intercooler	TD23119
D 2066 LF 41 Euro 5	6 Cyl.	10518cc	294kW (400PS)	Diesel Turbo Intercooler	TD23104
D 2066 LF 42 Euro 5	6 Cyl.	10518cc	265kW (360PS)	Diesel Turbo Intercooler	TD23094
D 2066 LF 43 Euro 5	6 Cyl.	10518cc	235kW (320PS)	Diesel Turbo Intercooler	TD23003
D 2066 LF 48 Euro 3	6 Cyl.	10518cc	265kW (360PS)	Diesel Turbo Intercooler	TD25598
D 2066 LF 49 Euro 3	6 Cyl.	10518cc	294kW (400PS)	Diesel Turbo Intercooler	TD25599
D 2066 LF 50 Euro 3	6 Cyl.	10518cc	324kW (441PS)	Diesel Turbo Intercooler	TD25600
D 2066 LF 51 Euro 5	6 Cyl.	10518cc	294kW (400PS)	Diesel Turbo Intercooler	TD23436
D 2066 LF 52 Euro 5	6 Cyl.	10518cc	265kW (360PS)	Diesel Turbo Intercooler	TD23437
D 2066 LF 53 Euro 5	6 Cyl.	10518cc	235kW (320PS)	Diesel Turbo Intercooler	TD23438

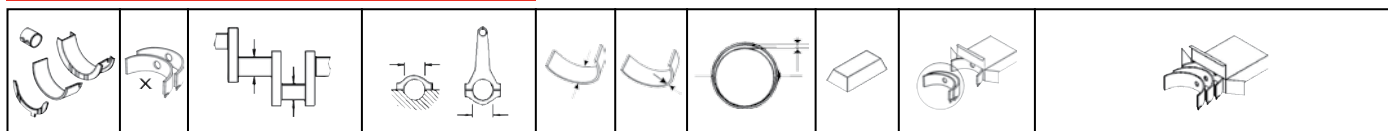

D 2066 LF 57	6 Cyl.	10518cc	324kW (440PS)	Diesel Turbo Intercooler	TD25452
D 2066 LF 61 Euro 6	6 Cyl.	10518cc	294kW (400PS)	Diesel Turbo Intercooler	TD27711
D 2066 LF 62 Euro 4	6 Cyl.	10518cc	324kW (441PS)	Diesel Turbo Intercooler	TD25612
D 2066 LF 63 Euro 4	6 Cyl.	10518cc	294kW (400PS)	Diesel Turbo Intercooler	TD25613
D 2066 LF 64 Euro 4	6 Cyl.	10518cc	265kW (360PS)	Diesel Turbo Intercooler	TD25614
D 2066 LF 67 Euro 6	6 Cyl.	10518cc	265kW (360PS)	Diesel Turbo Intercooler	TD27712
D 2066 LF 68 Euro 6	6 Cyl.	10518cc	235kW (320PS)	Diesel Turbo Intercooler	TD27717
D 2066 LOH 02 Euro 4	6 Cyl.	10518cc	265kW (360PS)	Diesel Turbo Intercooler	TD19973
D 2066 LOH 03 Euro 4	6 Cyl.	10518cc	294kW (400PS)	Diesel Turbo Intercooler	TD19974
D 2066 LOH 04 Euro 4	6 Cyl.	10518cc	324kW (440PS)	Diesel Turbo Intercooler	TD19975
D 2066 LOH 06 Euro 4	6 Cyl.	10518cc	265kW (360PS)	Diesel Turbo Intercooler	TD23062
D 2066 LOH 08 Euro 4	6 Cyl.	10518cc	324kW (440PS)	Diesel Turbo Intercooler	TD23064
D 2066 LOH 10 Euro 3	6 Cyl.	10518cc	316kW (430PS)	Diesel Turbo Intercooler	TD23073
D 2066 LOH 27	6 Cyl.	10518cc	265kW (360PS)	Diesel Turbo Intercooler	TD23673
D 2066 LUH 11 Euro 4	6 Cyl.	10520cc	199kW (271PS)	Diesel Turbo Intercooler	TD19976
D 2066 LUH 12 Euro 4	6 Cyl.	10520cc	228kW (310PS)	Diesel Turbo Intercooler	TD19977
D 2066 LUH 13 Euro 4	6 Cyl.	10520cc	257kW (350PS)	Diesel Turbo Intercooler	TD19978
D 2066 LUH 23 Euro 4	6 Cyl.	10518cc	257kW (350PS)	Diesel Turbo Intercooler	TD23066
D 2066 LUH 48	6 Cyl.	10518cc	265kW (360PS)	Diesel Turbo Intercooler	TD23676

BE/PL	1	89,980/90,000	95,000/95,022	36,200	2,478	0,070/0,137	SP	71-4529	71-4529 STD 0.25	[1]
MB/HL 1-7	7	103,980/104,000	111,000/111,022	36,000	3,478	0,060/0,126	EC	72-4527	H1239/7 STD 0.25 0.50	[4]
TW/A	2	114,400/114,750	137,650/138,000		3,400		AL-LF	04-3947	A159/4 STD	
TW/A	2	114,400/114,750	137,650/138,000		3,400		AL-LF	04-3948		
SE/PB	1	51,992/51,998	56,000/56,030	45,500			BC-LF	55-4532	55-4532 SEMI	[6] [8]
CB/NWB	1	39,934/39,950	44,000/44,016	26,000	2,085		AL-LF	03-4727	03-4727 STD	
BU	1	96,853/96,888	102,00/102,04	18,000	2,488	0,100/0,210	AL-LF	07-4997	07-4997 STD	

16

121.00 x 150.00

D 2156 HM 1 U	6 Cyl.	10344cc	141kW (192PS)	Diesel	TD5653
D 2156 HM 2	6 Cyl.	10344cc	141-173kW (192-235PS)	Diesel	TD23165
D 2156 HM 3	6 Cyl.	10344cc	158-169kW (215-230PS)	Diesel	TD7675
D 2156 HM 5 U	6 Cyl.	10344cc	141kW (192PS)	Diesel	TD5991
D 2156 HM 51 U	6 Cyl.	10344cc	141kW (192PS)	Diesel	TD7828
D 2156 HM 52 U	6 Cyl.	10344cc	141kW (192PS)	Diesel	TD7832
D 2156 HM 6 H	6 Cyl.	10344cc	155kW (212PS)	Diesel	TD7672
D 2156 HM 6 HDK	6 Cyl.	10344cc	173kW (235PS)	Diesel	TD8746
D 2156 HM 9	6 Cyl.	10344cc	158-169kW (215-230PS)	Diesel	TD7734
D 2156 HMN 1	6 Cyl.	10344cc	158kW (215PS)	Diesel	TD7700
D 2156 HMN 6	6 Cyl.	10344cc	172kW (235PS)	Diesel	TD8783
D 2156 HMN-5	6 Cyl.	10344cc	141kW (192PS)	Diesel	TD8782
D 2156 HMX-032	6 Cyl.	10344cc	158kW (216PS)	Diesel	TD7701
D 2156 HMXU-037	6 Cyl.	10344cc	141kW (192PS)	Diesel	TD7630
D 2156 HMXU-038	6 Cyl.	10344cc	141kW (192PS)	Diesel	TD7617
D 2156 HNY	6 Cyl.	10344cc	141-169kW (192-230PS)	Diesel	TD19066
D 2156 MGN	6 Cyl.	10344cc	141-169kW (192-230PS)	Diesel	TD19067
D 2156 MNY	6 Cyl.	10344cc	141-169kW (192-230PS)	Diesel	TD19068
D 2156 MTN 1	6 Cyl.	10344cc	188kW (256PS)	Diesel Turbo Intercooler	TD7715
D 2156 MTN 5	6 Cyl.	10344cc	209kW (285PS)	Diesel Turbo	TD8787

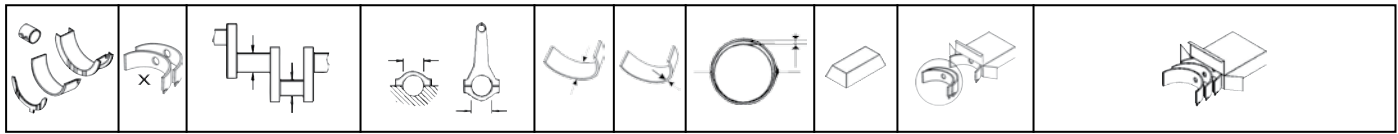

D 2156 MTX			6 Cyl.	10344cc	188kW (256PS)	Diesel Turbo			TD19116
D 2156 MTX-034			6 Cyl.	10344cc	188kW (256PS)	Diesel Turbo			TD7742
D 2156 MTXN-035			6 Cyl.	10344cc	188kW (256PS)	Diesel Turbo			TD7736
BE/PL	1	31,989/32,000	34,400/34,416	16,000	1,194	0,022/0,069	EC	71-3004	71-3004 STD 10

17 123.00 x 150.00

D 2356 HM 2			6 Cyl.	10700cc	169kW (230PS)	Diesel			TD7712
D 2356 HM 5 H			6 Cyl.	10700cc	169kW (230PS)	Diesel			TD8747
D 2356 HM 51 U			6 Cyl.	10694cc	169kW (230PS)	Diesel			TD7826
D 2356 HM 9			6 Cyl.	10700cc	169kW (230PS)	Diesel			TD7713
D 2356 HMN 2			6 Cyl.	10700cc	169kW (230PS)	Diesel			TD7716
D 2356 HMN 5			6 Cyl.	10700cc	173kW (235PS)	Diesel			TD8786
D 2356 HMX-060			6 Cyl.	10700cc	169kW (230PS)	Diesel			TD7714
D 2356 HMXN-061			6 Cyl.	10700cc	169kW (230PS)	Diesel			TD7717
D 2356 HMXU-062			6 Cyl.	10700cc	169kW (230PS)	Diesel			TD7605
D 2356 HMXU-066			6 Cyl.	10700cc	169kW (230PS)	Diesel			TD7618
D 2356 HMXU-067			6 Cyl.	10700cc	154kW (210PS)	Diesel			TD7619
D 2356 HMXU-069			6 Cyl.	10700cc	161kW (220PS)	Diesel			TD7620
BE/PL	1	31,989/32,000	34,400/34,416	16,000	1,194	0,022/0,069	EC	71-3004	71-3004 STD 10

18 125.00 x 130.00

D 2538 M			V8 Cyl.	12763cc	188kW (256PS)	Diesel			TD7743
D 2538 ME			V8 Cyl.	12763cc	188kW (256PS)	Diesel			TD19447
D 2538 MF			V8 Cyl.	12763cc	188kW (256PS)	Diesel			TD7737
D2548			V8 Cyl.	12756cc	235kW (320PS)	Diesel			FM5943
BE/PL	1	31,959/31,975	36,000/36,016	19,000	2,011	0,020/0,059	EC	71-2965	71-2965 STD 10
BE/PL	2	31,959/31,975	36,000/36,016	15,000	2,011	0,020/0,060	EC	71-3289	71-3289/2 STD 10
BE/PL	1	89,980/90,000	95,000/95,022	31,000	2,473	0,064/0,126	EC	71-3324	71-3324 STD 0.25 1.50
BE/PL	1	89,980/90,000	95,000/95,022	31,000	2,473	0,054/0,121	SP	71-3638	71-3638 STD 0.25 0.50 1 3
MB/HL	4	103,980/104,000	111,000/111,022	30,500	3,472	0,056/0,123	EC	72-3564	H993/5 STD 0.25 0.50 0.75
MB/HL	1	103,980/104,000	111,000/111,022	37,810	3,472	0,056/0,123	EC	72-3565H	
			72-3565H	STD	38,000/1.4961" - 38,062/1.4985"				
				0.25mm	38,500/1.5157" - 38,562/1.5182"				
				0.50mm	38,500/1.5157" - 38,562/1.5182"				
				0.75mm	39,000/1.5354" - 39,062/1.5379"				
SE/PB	1	45,595/46,000	50,000/50,025	38,700			BC	55-2862	55-2862 SEMI
SE/PB	1	45,995/46,000	50,600/50,630	38,700			BC	55-3328	55-3328 SEMI
CB/NWB	4	69,910/69,940	75,000/75,030	28,000	2,500		BB	13-2861	N110/5L STD SEMI 13
CB/NWB	1	69,910/69,940	76,000/76,030	35,000	3,000		EC	53-3098H	
BU	1	30,000	34,000/34,025	21,000			EC	52-3097	52-3097 SEMI 10
BU	1	25,000	28,000/28,052	17,800			BC	56-3042	56-3042 SEMI

19 125.00 x 130.00

D 2538 MT			V8 Cyl.	12763cc	178-235kW (242-320PS)	Diesel Turbo			TD7748
------------------	--	--	---------	----------------	------------------------------	---------------------	--	--	---------------



D 2538 MTE		V8 Cyl.		12763cc	178-235kW (242-320PS)			Diesel Turbo		TD19064
BE/PL	1	31,959/31,975	36,000/36,016	19,000	2,011	0,020/0,059	EC	71-2965	71-2965 STD	10
BE/PL	2	31,959/31,975	36,000/36,016	15,000	2,011	0,020/0,060	EC	71-3289	71-3289/2 STD	10
BE/PL	1	89,980/90,000	95,000/95,022	31,000	2,473	0,054/0,121	SP	71-3638	71-3638 STD 0.25 0.50	1 3
MB/HL	4	103,980/104,000	111,000/111,022	30,500	3,472	0,056/0,123	EC	72-3564	H993/5 STD 0.25 0.50 0.75	
MB/HL	1	103,980/104,000	111,000/111,022	37,810	3,472	0,056/0,123	EC	72-3565H		
			72-3565H	STD	38,000/1.4961" - 38,062/1.4985"					
				0.25mm	38,500/1.5157" - 38,562/1.5182"					
				0.50mm	38,500/1.5157" - 38,562/1.5182"					
				0.75mm	39,000/1.5354" - 39,062/1.5379"					
SE/PB	1	45,595/46,000	50,000/50,025	38,700			BC	55-2862	55-2862 SEMI	
SE/PB	1	45,995/46,000	50,600/50,630	38,700			BC	55-3328	55-3328 SEMI	
CB/NWB	4	69,910/69,940	75,000/75,030	28,000	2,500		BB	13-2861	N110/5L STD SEMI	13
CB/NWB	1	69,910/69,940	76,000/76,030	35,000	3,000		EC	53-3098H		
BU	1	30,000	34,000/34,025	21,000			EC	52-3097	52-3097 SEMI	10
BU	1	25,000	28,000/28,052	17,800			BC	56-3042	56-3042 SEMI	

20

125.00 x 130.00

D 2530 ME		V10 Cyl.		15945cc	156-235kW (212-320PS)			Diesel		TD19446
D 2530 MF		V10 Cyl.		15945cc	235kW (320PS)			Diesel		TD5650
D 2530 MXF		V10 Cyl.		15945cc	156-235kW (212-320PS)			Diesel		TD19038
BE/PL	1	31,959/31,975	36,000/36,016	19,000	2,011	0,020/0,059	EC	71-2965	71-2965 STD	10
BE/PL	2	31,959/31,975	36,000/36,016	15,000	2,011	0,020/0,060	EC	71-3289	71-3289/2 STD	10
BE/PL	1	89,980/90,000	95,000/95,022	31,000	2,473	0,064/0,126	EC	71-3324	71-3324 STD 0.25 1.50	
BE/PL	1	89,980/90,000	95,000/95,022	31,000	2,473	0,054/0,121	SP	71-3638	71-3638 STD 0.25 0.50	1 3
MB/HL	5	103,980/104,000	111,000/111,022	30,500	3,472	0,056/0,123	EC	72-3564	H993/6 STD	
MB/HL	1	103,980/104,000	111,000/111,022	37,810	3,472	0,056/0,123	EC	72-3565H		
			72-3565H	STD	38,000/1.4961" - 38,062/1.4985"					
				0.25mm	38,500/1.5157" - 38,562/1.5182"					
				0.50mm	38,500/1.5157" - 38,562/1.5182"					
				0.75mm	39,000/1.5354" - 39,062/1.5379"					
SE/PB	1	45,595/46,000	50,000/50,025	38,700			BC	55-2862	55-2862 SEMI	
SE/PB	1	45,995/46,000	50,600/50,630	38,700			BC	55-3328	55-3328 SEMI	
CB/NWB	5	69,910/69,940	75,000/75,030	28,000	2,500		BB	13-2861	N110/6L STD SEMI	13
CB/NWB	1	69,910/69,940	76,000/76,030	35,000	3,000		EC	53-3098H		
BU	1	30,000	34,000/34,025	21,000			EC	52-3097	52-3097 SEMI	10
BU	1	25,000	28,000/28,052	17,800			BC	56-3042	56-3042 SEMI	



21		125.00 x 130.00									
D 2530 MTE		V10 Cyl. 15953cc 223-294kW (303-400PS)					Diesel Turbo		TD19065		
D 2530 MTXF		V10 Cyl. 15953cc 294kW (400PS)					Diesel Turbo		TD7813		
D 2530 MTXF/360		V10 Cyl. 15900cc 265kW (360PS)					Diesel Turbo		TD7760		
BE/PL	1	31,959/31,975	36,000/36,016	19,000	2,011	0,020/0,059	EC	71-2965	71-2965 STD	10	
BE/PL	2	31,959/31,975	36,000/36,016	15,000	2,011	0,020/0,060	EC	71-3289	71-3289/2 STD	10	
BE/PL	1	89,980/90,000	95,000/95,022	31,000	2,473	0,054/0,121	SP	71-3638	71-3638 STD 0.25 0.50	1 3	
MB/HL	5	103,980/104,000	111,000/111,022	30,500	3,472	0,056/0,123	EC	72-3564	H993/6 STD		
MB/HL	1	103,980/104,000	111,000/111,022	37,810	3,472	0,056/0,123	EC	72-3565H			
				72-3565H		STD 38,000/1.4961" - 38,062/1.4985"					
						0.25mm 38,500/1.5157" - 38,562/1.5182"					
						0.50mm 38,500/1.5157" - 38,562/1.5182"					
						0.75mm 39,000/1.5354" - 39,062/1.5379"					
SE/PB	1	45,595/46,000	50,000/50,025	38,700			BC	55-2862	55-2862 SEMI		
SE/PB	1	45,995/46,000	50,600/50,630	38,700			BC	55-3328	55-3328 SEMI		
CB/NWB	5	69,910/69,940	75,000/75,030	28,000	2,500		BB	13-2861	N110/6L STD SEMI	13	
CB/NWB	1	69,910/69,940	76,000/76,030	35,000	3,000		EC	53-3098H			
BU	1	30,000	34,000/34,025	21,000			EC	52-3097	52-3097 SEMI	10	
BU	1	25,000	28,000/28,052	17,800			BC	56-3042	56-3042 SEMI		

22		125.00 x 142.00									
D 2540 MT		V10 Cyl. 17426cc 287-324kW (390-441PS)					Diesel Turbo		TD19448		
D 2540 MTF		V10 Cyl. 17426cc 324kW (440PS)					Diesel Turbo		TD7814		
D 2540 MTF/390		V10 Cyl. 17426cc 287kW (390PS)					Diesel Turbo		TD7762		
BE/PL	1	31,959/31,975	36,000/36,016	19,000	2,011	0,020/0,059	EC	71-2965	71-2965 STD	10	
BE/PL	2	31,959/31,975	36,000/36,016	15,000	2,011	0,020/0,060	EC	71-3289	71-3289/2 STD	10	
BE/PL	1	89,980/90,000	95,000/95,022	31,000	2,473	0,054/0,121	SP	71-3638	71-3638 STD 0.25 0.50	1 3	
MB/HL	5	103,980/104,000	111,000/111,022	30,500	3,472	0,056/0,123	EC	72-3564	H993/6 STD		
MB/HL	1	103,980/104,000	111,000/111,022	37,810	3,472	0,056/0,123	EC	72-3565H			
				72-3565H		STD 38,000/1.4961" - 38,062/1.4985"					
						0.25mm 38,500/1.5157" - 38,562/1.5182"					
						0.50mm 38,500/1.5157" - 38,562/1.5182"					
						0.75mm 39,000/1.5354" - 39,062/1.5379"					
SE/PB	1	45,595/46,000	50,000/50,025	38,700			BC	55-2862	55-2862 SEMI		
SE/PB	1	45,995/46,000	50,600/50,630	38,700			BC	55-3328	55-3328 SEMI		
CB/NWB	5	69,910/69,940	75,000/75,030	28,000	2,500		BB	13-2861	N110/6L STD SEMI	13	
CB/NWB	1	69,910/69,940	76,000/76,030	35,000	3,000		EC	53-3098H			
BU	1	30,000	34,000/34,025	21,000			EC	52-3097	52-3097 SEMI	10	



BU	1	25,000	28,000/28,052	17,800			BC	56-3042	56-3042 SEMI
----	---	--------	---------------	--------	--	--	----	---------	------------------------

23 125.00 x 142.00

D 2542 MLE		V12 Cyl.		20911cc	420-515kW (571-700PS)		Diesel Turbo Intercooler	TD19449	
D 2542 MTE		V12 Cyl.		20911cc	283-405kW (385-551PS)		Diesel Turbo	TD19450	
BE/PL	1	31,959/31,975	36,000/36,016	19,000	2,011	0,020/0,059	EC	71-2965	71-2965 STD 10
BE/PL	2	31,959/31,975	36,000/36,016	15,000	2,011	0,020/0,060	EC	71-3289	71-3289/2 STD 10
BE/PL	1	89,980/90,000	95,000/95,022	31,000	2,473	0,054/0,121	SP	71-3638	71-3638 STD 0.25 0.50 1 3
SE/PB	1	45,595/46,000	50,000/50,025	38,700			BC	55-2862	55-2862 SEMI
SE/PB	1	45,995/46,000	50,600/50,630	38,700			BC	55-3328	55-3328 SEMI
CB/NWB	6	69,910/69,940	75,000/75,030	28,000	2,500		BB	13-2861	N110/7 STD 13
CB/NWB	1	69,910/69,940	76,000/76,030	35,000	3,000		EC	53-3098H	
BU	1	30,000	34,000/34,025	21,000			EC	52-3097	52-3097 SEMI 10
BU	1	25,000	28,000/28,052	17,800			BC	56-3042	56-3042 SEMI

24 125.00 x 150.00

D 2555 M		5 Cyl.		9200cc	123kW (168PS)		Diesel	TD7708	
D 2555 MF		5 Cyl.		9200cc	123kW (168PS)		Diesel	TD7703	
D 2555 MX		5 Cyl.		9200cc	141kW (192PS)		Diesel	TD7710	
D 2555 MXF		5 Cyl.		9200cc	141kW (192PS)		Diesel	TD7705	
D 2555 MXUL		5 Cyl.		9200cc	141kW (192PS)		Diesel	TD7720	
BE/PL	1	31,959/31,975	36,000/36,016	19,000	2,011	0,020/0,059	EC	71-2965	71-2965 STD 10
BE/PL	5	89,980/90,000	95,000/95,022	36,200	2,476	0,048/0,115	EC	71-3561	71-3561/5 STD
MB/HL	5	103,980/104,000	111,000/111,022	36,000	3,478	0,060/0,126	EC	72-3562	H992/6 STD
MB/HL	1	103,980/104,000	111,000/111,022	45,810	3,478	0,060/0,126	EC	72-3563H	
 72-3563H		STD	46,000/1.8110" - 46,062/1.8135"						
		0.25mm	46,500/1.8307" - 46,562/1.8331"						
		0.50mm	46,500/1.8307" - 46,562/1.8331"						
		0.75mm	47,000/1.8504" - 47,062/1.8528"						
		1.00mm	47,000/1.8504" - 47,062/1.8528"						
SE/PB	1	45,595/46,000	50,000/50,025	38,700			BC	55-2862	55-2862 SEMI
SE/PB	1	45,995/46,000	50,600/50,630	38,700			BC	55-3328	55-3328 SEMI
BU	1	30,000	34,000/34,025	21,000			EC	52-3097	52-3097 SEMI 10
BU	1	25,000	28,000/28,052	17,800			BC	56-3042	56-3042 SEMI

25 125.00 x 150.00

D 2556 M		6 Cyl.		11045cc	147kW (200PS)		Diesel	TD7730
D 2556 MF		6 Cyl.		11045cc	147kW (200PS)		Diesel	TD7729
D 2556 MTE		6 Cyl.		11045cc	191kW (260PS)		Diesel Turbo	TD23166
D 2556 MX		6 Cyl.		11045cc	147-194kW (200-264PS)		Diesel	TD7733
D 2556 MXF		6 Cyl.		11045cc	172-177kW (232-240PS)		Diesel	TD7731

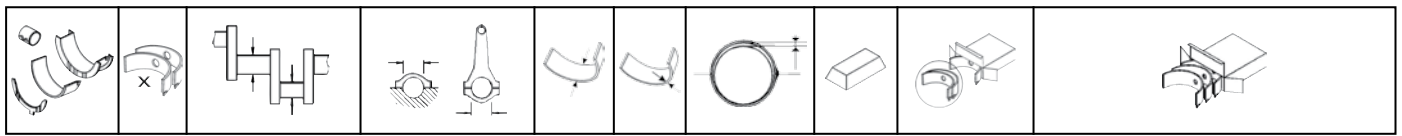

D 2556 MXUH/175		6 Cyl.	11045cc	129kW (175PS)			Diesel		TD7613
D 2556 MXUH/192		6 Cyl.	11045cc	141kW (192PS)			Diesel		TD7606
D 2556 MXUH/240		6 Cyl.	11045cc	177kW (240PS)			Diesel		TD7607
D 2556 MXUM		6 Cyl.	11045cc	161kW (220PS)			Diesel		TD7439
BE/PL	1	31,959/31,975	36,000/36,016	19,000	2,011	0,020/0,059	EC	71-2965	71-2965 STD 10
BE/PL	6	89,980/90,000	95,000/95,022	36,200	2,476	0,048/0,115	EC	71-3561	71-3561/6 STD 0.25 0.50 0.75 1.00
MB/HL	6	103,980/104,000	111,000/111,022	36,000	3,478	0,060/0,126	EC	72-3562	H992/7 STD 0.25 0.50 0.75
MB/HL	1	103,980/104,000	111,000/111,022	45,810	3,478	0,060/0,126	EC	72-3563H	
		72-3563H	STD	46,000/1.8110" - 46,062/1.8135"					
			0.25mm	46,500/1.8307" - 46,562/1.8331"					
			0.50mm	46,500/1.8307" - 46,562/1.8331"					
			0.75mm	47,000/1.8504" - 47,062/1.8528"					
			1.00mm	47,000/1.8504" - 47,062/1.8528"					
SE/PB	1	45,595/46,000	50,000/50,025	38,700			BC	55-2862	55-2862 SEMI
SE/PB	1	45,995/46,000	50,600/50,630	38,700			BC	55-3328	55-3328 SEMI
CB/NWB	1	69,910/69,940	75,000/75,030	36,000	2,500		BB	13-3102	N109/7L STD SEMI 13
CB/NWB	5	69,910/69,940	75,000/75,030	28,000	2,500		BB	13-3103	
CB/NWB	1	69,910/69,940	76,000/76,030	39,000	3,000		EC	53-3104H	
BU	1	30,000	34,000/34,025	21,000			EC	52-3097	52-3097 SEMI 10
BU	1	25,000	28,000/28,052	17,800			BC	56-3042	56-3042 SEMI

26 125.00 x 155.00

D 2565 HM		5 Cyl.	9510cc	92-141kW (125-192PS)			Diesel		TD19039
D 2565 M		5 Cyl.	9510cc	141kW (192PS)			Diesel		TD7711
D 2565 M/168		5 Cyl.	9510cc	123kW (168PS)			Diesel		TD7709
D 2565 ME		5 Cyl.	9510cc	84-141kW (114-192PS)			Diesel		TD19040
D 2565 MF		5 Cyl.	9510cc	141kW (192PS)			Diesel		TD7706
D 2565 MF/168		5 Cyl.	9510cc	123kW (168PS)			Diesel		TD7704
D 2565 MFR		5 Cyl.	9510cc	92-141kW (125-192PS)			Diesel		TD19041
D 2565 MH		5 Cyl.	9510cc	141kW (192PS)			Diesel		TD23167
D 2565 MK		5 Cyl.	9510cc	169kW (230PS)			Diesel Turbo		TD19117
D 2565 MKUL		5 Cyl.	9510cc	169kW (230PS)			Diesel Turbo		TD19072
D 2565 MR		5 Cyl.	9510cc	141kW (192PS)			Diesel		TD23168
D 2565 MSFV		5 Cyl.	9510cc	136kW (186PS)			Diesel		TD8749
D 2565 MT		5 Cyl.	9510cc	169kW (230PS)			Diesel Turbo		TD19073
D 2565 MUE		5 Cyl.	9510cc	141kW (192PS)			Diesel		TD23169
D 2565 MUH		5 Cyl.	9510cc	92-141kW (125-192PS)			Diesel		TD19042
D 2565 MUL		5 Cyl.	9510cc	141kW (192PS)			Diesel		TD7721

BE/PL	1	31,959/31,975	36,000/36,016	19,000	2,011	0,020/0,059	EC	71-2965	71-2965 STD 10
BE/PL	5	89,980/90,000	95,000/95,022	36,200	2,476	0,048/0,115	EC	71-3561	71-3561/5 STD

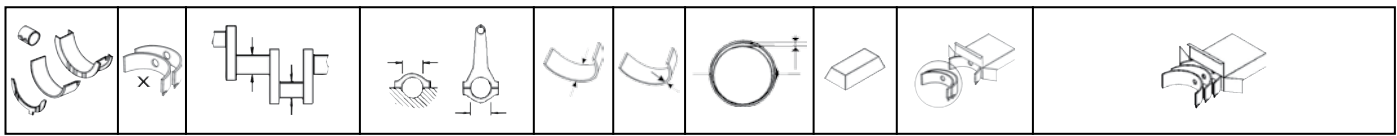

MB/HL	5	103,980/104,000	111,000/111,022	36,000	3,478	0,060/0,126	EC	72-3562	H992/6 STD
MB/HL	1	103,980/104,000	111,000/111,022	45,810	3,478	0,060/0,126	EC	72-3563H	

	72-3563H	STD	46,000/1.8110" - 46,062/1.8135"
		0.25mm	46,500/1.8307" - 46,562/1.8331"
		0.50mm	46,500/1.8307" - 46,562/1.8331"
		0.75mm	47,000/1.8504" - 47,062/1.8528"
		1.00mm	47,000/1.8504" - 47,062/1.8528"

SE/PB	1	45,595/46,000	50,000/50,025	38,700			BC	55-2862	55-2862 SEMI
SE/PB	1	45,995/46,000	50,600/50,630	38,700			BC	55-3328	55-3328 SEMI
BU	1	30,000	34,000/34,025	21,000			EC	52-3097	52-3097 SEMI
BU	1	25,000	28,000/28,052	17,800			BC	56-3042	56-3042 SEMI

10

27

125.00 x 155.00

D 2566	6 Cyl.	11413cc	235kW (320PS)	Diesel Turbo	TD7413
D 2566 M	6 Cyl.	11413cc	177kW (240PS)	Diesel	TD7735
D 2566 ME	6 Cyl.	11413cc	125-177kW (170-241PS)	Diesel	TD19451
D 2566 MF	6 Cyl.	11413cc	177kW (240PS)	Diesel	TD7732
D 2566 MF/220	6 Cyl.	11413cc	162kW (220PS)	Diesel	TD7722
D 2566 MFO	6 Cyl.	11413cc	125kW (170PS)	Diesel	TD28911
D 2566 MH	6 Cyl.	11413cc	177kW (240PS)	Diesel	TD7414
D 2566 MHO	6 Cyl.	11413cc	177kW (240PS)	Diesel	TD7741
D 2566 MK	6 Cyl.	11413cc	235kW (320PS)	Diesel Turbo	TD7801
D 2566 MK/280	6 Cyl.	11413cc	206kW (280PS)	Diesel Turbo Intercooler	TD7800
D 2566 MKF	6 Cyl.	11413cc	235kW (320PS)	Diesel Turbo Intercooler	TD7758
D 2566 MKF/280	6 Cyl.	11413cc	206kW (280PS)	Diesel Turbo Intercooler	TD7756
D 2566 MKUH/320	6 Cyl.	11413cc	235kW (320PS)	Diesel Turbo Intercooler	TD7633
D 2566 MKUL	6 Cyl.	11413cc	235kW (320PS)	Diesel Turbo Intercooler	TD7804
D 2566 MLUH	6 Cyl.	11413cc	192kW (260PS)	Diesel Turbo Intercooler	TD7632
D 2566 MLUM	6 Cyl.	11413cc	227kW (310PS)	Diesel Turbo Intercooler	TD7625
D 2566 MLUM/US	6 Cyl.	11413cc	222kW (305PS)	Diesel Turbo Intercooler	TD7621
D 2566 MSFV	6 Cyl.	11413cc	161kW (220PS)	Diesel	TD8750
D 2566 MT	6 Cyl.	11413cc	206kW (280PS)	Diesel Turbo	TD7799
D 2566 MTE	6 Cyl.	11413cc	162-235kW (220-320PS)	Diesel Turbo	TD19074
D 2566 MTF	6 Cyl.	11413cc	206kW (280PS)	Diesel Turbo	TD7738
D 2566 MTFG	6 Cyl.	11413cc	206kW (280PS)	Diesel Turbo	TD7805
D 2566 MTH	6 Cyl.	11413cc	213kW (290PS)	Diesel Turbo	TD7418
D 2566 MTHO	6 Cyl.	11413cc	206-235kW (280-320PS)	Diesel Turbo	TD7744
D 2566 MTSF	6 Cyl.	11413cc	206kW (280PS)	Diesel Turbo	TD8756
D 2566 MTUH	6 Cyl.	11413cc	206-235kW (280-320PS)	Diesel Turbo	TD7603
D 2566 MUE	6 Cyl.	11413cc	125-177kW (170-241PS)	Diesel	TD19452
D 2566 MUH	6 Cyl.	11413cc	177kW (240PS)	Diesel Turbo	TD7407
D 2566 MUH/175	6 Cyl.	11413cc	128kW (175PS)	Diesel	TD7614
D 2566 MUH/192	6 Cyl.	11413cc	141kW (192PS)	Diesel	TD7608
D 2566 MUH/200	6 Cyl.	11413cc	147kW (200PS)	Diesel	TD7609
D 2566 MUH/220	6 Cyl.	11413cc	162kW (220PS)	Diesel	TD7615
D 2566 MUH/240	6 Cyl.	11413cc	177kW (240PS)	Diesel	TD7610
D 2566 MUL	6 Cyl.	11413cc	177kW (240PS)	Diesel	TD7803
D 2566 MUM	6 Cyl.	11413cc	147-177kW (200-241PS)	Diesel	TD7440
D 2566 MUM/200	6 Cyl.	11413cc	147kW (200PS)	Diesel	TD7622

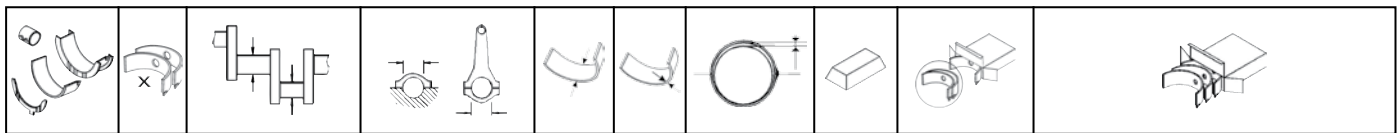

D 2566 MUM/220	6 Cyl.	11413cc	162kW (220PS)	Diesel	TD7623
D 2566 MUM/240	6 Cyl.	11413cc	177kW (240PS)	Diesel	TD7624
D 2566 MXF	6 Cyl.	11413cc	125-177kW (211-241PS)	Diesel	TD19043
D 2566 UH	6 Cyl.	11413cc	155kW (211PS)	Diesel	TD7616
D 2566 UH/205	6 Cyl.	11413cc	147-150kW (200-205PS)	Diesel	TD7611

BE/PL	1	31,959/31,975	36,000/36,016	19,000	2,011	0,020/0,059	EC	71-2965	71-2965 STD	10
BE/PL	6	89,980/90,000	95,000/95,022	36,200	2,476	0,048/0,115	EC	71-3561	71-3561/6 STD 0.25 0.50 0.75 1.00	
MB/HL	6	103,980/104,000	111,000/111,022	36,000	3,478	0,060/0,126	EC	72-3562	H992/7 STD 0.25 0.50 0.75	
MB/HL	1	103,980/104,000	111,000/111,022	45,810	3,478	0,060/0,126	EC	72-3563H		

	72-3563H	STD	46,000/1.8110" - 46,062/1.8135"
		0.25mm	46,500/1.8307" - 46,562/1.8331"
		0.50mm	46,500/1.8307" - 46,562/1.8331"
		0.75mm	47,000/1.8504" - 47,062/1.8528"
		1.00mm	47,000/1.8504" - 47,062/1.8528"

SE/PB	1	45,595/46,000	50,000/50,025	38,700			BC	55-2862	55-2862 SEMI	
SE/PB	1	45,995/46,000	50,600/50,630	38,700			BC	55-3328	55-3328 SEMI	
CB/NWB	1	69,910/69,940	75,000/75,030	36,000	2,500		BB	13-3102	N109/7L STD SEMI	13
CB/NWB	5	69,910/69,940	75,000/75,030	28,000	2,500		BB	13-3103		
CB/NWB	1	69,910/69,940	76,000/76,030	39,000	3,000		EC	53-3104H		
BU	1	30,000	34,000/34,025	21,000			EC	52-3097	52-3097 SEMI	10
BU	1	25,000	28,000/28,052	17,800			BC	56-3042	56-3042 SEMI	

28 126.00 x 166.00

D 2676 440 Euro 5	6 Cyl.	12412cc	324kW (440PS)	Diesel Turbo Intercooler	TD30292
D 2676 LE 621	6 Cyl.	12412cc	338kW (460PS)	Diesel Turbo Intercooler	TD27946
D 2676 LE 622	6 Cyl.	12412cc	353kW (480PS)	Diesel Turbo Intercooler	TD27954
D 2676 LF 01 Euro 4	6 Cyl.	12412cc	353kW (480PS)	Diesel Turbo Intercooler	TD19100
D 2676 LF 02 Euro 3	6 Cyl.	12412cc	353kW (480PS)	Diesel Turbo Intercooler	TD20542
D 2676 LF 03 Euro 2	6 Cyl.	12412cc	353kW (480PS)	Diesel Turbo Intercooler	TD20543
D 2676 LF 04 Euro 2	6 Cyl.	12412cc	324-324kW (440-441PS)	Diesel Turbo Intercooler	TD22906
D 2676 LF 05 Euro 4	6 Cyl.	12412cc	353kW (480PS)	Diesel Turbo Intercooler	TD20371
D 2676 LF 06 Euro 5	6 Cyl.	12412cc	397kW (540PS)	Diesel Turbo Intercooler	TD23145
D 2676 LF 07 Euro 5	6 Cyl.	12412cc	353kW (480PS)	Diesel Turbo Intercooler	TD23137
D 2676 LF 08 Euro 5	6 Cyl.	12412cc	397kW (540PS)	Diesel Turbo Intercooler	TD25462
D 2676 LF 09 Euro 5	6 Cyl.	12412cc	353kW (480PS)	Diesel Turbo Intercooler	TD25463
D 2676 LF 10 Euro 4	6 Cyl.	12412cc	324kW (440PS)	Diesel Turbo Intercooler	TD27718
D 2676 LF 11 Euro 4	6 Cyl.	12412cc	397kW (540PS)	Diesel Turbo Intercooler	TD19104
D 2676 LF 12 Euro 4	6 Cyl.	12412cc	353kW (480PS)	Diesel Turbo Intercooler	TD19103
D 2676 LF 13 Euro 5	6 Cyl.	12412cc	397kW (540PS)	Diesel Turbo Intercooler	TD20372
D 2676 LF 14 Euro 5	6 Cyl.	12412cc	353kW (480PS)	Diesel Turbo Intercooler	TD20373
D 2676 LF 15 Euro 5	6 Cyl.	12412cc	397kW (540PS)	Diesel Turbo Intercooler	TD23087
D 2676 LF 16 Euro 5	6 Cyl.	12412cc	353kW (480PS)	Diesel Turbo Intercooler	TD23088
D 2676 LF 17	6 Cyl.	12412cc	397kW (540PS)	Diesel Turbo Intercooler	TD25460
D 2676 LF 18	6 Cyl.	12412cc	353kW (480PS)	Diesel Turbo Intercooler	TD25461
D 2676 LF 19 Euro 4	6 Cyl.	12412cc	397kW (540PS)	Diesel Turbo Intercooler	TD25615
D 2676 LF 20 Euro 4	6 Cyl.	12412cc	353kW (480PS)	Diesel Turbo Intercooler	TD25616



D 2676 LF 21 Euro 5	6 Cyl.	12412cc	353kW (480PS)	Diesel Turbo Intercooler	TD23691
D 2676 LF 22 Euro 5	6 Cyl.	12412cc	324kW (440PS)	Diesel Turbo Intercooler	TD23692
D 2676 LF 23	6 Cyl.	12412cc	353kW (480PS)	Diesel Turbo Intercooler	TD25609
D 2676 LF 24	6 Cyl.	12412cc	324kW (440PS)	Diesel Turbo Intercooler	TD25608
D 2676 LF 25 Euro 6	6 Cyl.	12412cc	353kW (480PS)	Diesel Turbo Intercooler	TD27720
D 2676 LF 26 Euro 6	6 Cyl.	12412cc	324kW (440PS)	Diesel Turbo Intercooler	TD27722
D 2676 LF 28 Euro 5	6 Cyl.	12412cc	324kW (440PS)	Diesel Turbo Intercooler	TD27723
D 2676 LF 32 Euro 4	6 Cyl.	12412cc	397kW (540PS)	Diesel Turbo Intercooler	TD25621
D 2676 LF 33 Euro 4	6 Cyl.	12412cc	353kW (480PS)	Diesel Turbo Intercooler	TD25623
D 2676 LOH 01 Euro 4	6 Cyl.	12412cc	338kW (460PS)	Diesel Turbo Intercooler	TD19102
D 2676 LOH 02 Euro 4	6 Cyl.	12412cc	353kW (480PS)	Diesel Turbo Intercooler	TD19101
D 2676 LOH 03 Euro 4	6 Cyl.	12412cc	338kW (460PS)	Diesel Turbo Intercooler	TD23068
D 2676 LOH 04 Euro 4	6 Cyl.	12412cc	353kW (480PS)	Diesel Turbo Intercooler	TD23069
D 2676 LOH 10 Euro 3	6 Cyl.	12412cc	338kW (460PS)	Diesel Turbo Intercooler	TD23077
D 2676 LOH 18 Euro 3	6 Cyl.	12412cc	338kW (460PS)	Diesel Turbo Intercooler	TD23966
D 2676 LOH 26	6 Cyl.	12412cc	324kW (440PS)	Diesel Turbo Intercooler	TD23400
D 2676 LOH 27	6 Cyl.	12412cc	353kW (480PS)	Diesel Turbo Intercooler	TD23401
D 2676 LOH 28	6 Cyl.	12412cc	371kW (505PS)	Diesel Turbo Intercooler	TD23678
D 2676 LOH 30 Euro 6	6 Cyl.	12412cc	324kW (440PS)	Diesel Turbo Intercooler	TD30484
D 2676 LOH 31 Euro 6	6 Cyl.	12412cc	353kW (480PS)	Diesel Turbo Intercooler	TD30485
D 2676 LOH 32 Euro 6	6 Cyl.	12412cc	371kW (505PS)	Diesel Turbo Intercooler	TD30486
D 2676 LOH 33 Euro 4	6 Cyl.	12412cc	353kW (480PS)	Diesel Turbo Intercooler	TD30487
D 2676 LOH 34	6 Cyl.	12412cc	353kW (480PS)	Diesel Turbo Intercooler	TD30488

BE/PL	1	89,980/90,000	95,000/95,022	36,200	2,478	0,070/0,137	SP	71-4529	71-4529 STD 0.25	<input type="checkbox"/>
MB/HL 1-7	7	103,980/104,000	111,000/111,022	36,000	3,478	0,060/0,126	EC	72-4527	H1239/7 STD 0.25 0.50	<input type="checkbox"/>
TW/A	2	114,400/114,750	137,650/138,000		3,400		AL-LF	04-3947	A159/4 STD	
TW/A	2	114,400/114,750	137,650/138,000		3,400		AL-LF	04-3948		
SE/PB	1	51,992/51,998	56,000/56,030	45,500			BC-LF	55-4563	55-4563 SEMI	<input type="checkbox"/> <input type="checkbox"/>
CB/NWB	1	39,934/39,950	44,000/44,016	26,000	2,085		AL-LF	03-4727	03-4727 STD	
BU	1	96,853/96,888	102,00/102,04	18,000	2,488	0,100/0,210	AL-LF	07-4997	07-4997 STD	

29

128.00 x 142.00

D 2848 LE 422	V8 Cyl.	14618cc	551kW (749PS)	Diesel Turbo Intercooler	TD27928
D 2848 LE 423	V8 Cyl.	14618cc	662kW (900PS)	Diesel Turbo Intercooler	TD27920
D 2848 LXE	V8 Cyl.	14618cc	500kW (680PS)	Diesel Turbo Intercooler	TD19118
D 2848 LYE	V8 Cyl.	14618cc	500kW (680PS)	Diesel Turbo Intercooler	TD19119

BE/PL	1	31,959/31,975	36,000/36,016	19,000	2,011	0,020/0,059	EC	71-2965	71-2965 STD	<input type="checkbox"/>
BE/PL	2	31,959/31,975	36,000/36,016	15,000	2,011	0,020/0,060	EC	71-3289	71-3289/2 STD	<input type="checkbox"/>
BE/PL	1	89,980/90,000	95,000/95,022	31,000	2,473	0,054/0,121	SP	71-3638	71-3638 STD 0.25 0.50	<input type="checkbox"/> <input type="checkbox"/>
MB/HL	4	103,980/104,000	111,000/111,022	30,500	3,472	0,056/0,123	EC	72-3564	H993/5 STD 0.25 0.50 0.75	
MB/HL	1	103,980/104,000	111,000/111,022	37,810	3,472	0,056/0,123	EC	72-3565H		



72-3565H	STD	38,000/1.4961" - 38,062/1.4985"
	0.25mm	38,500/1.5157" - 38,562/1.5182"
	0.50mm	38,500/1.5157" - 38,562/1.5182"
	0.75mm	39,000/1.5354" - 39,062/1.5379"

SE/PB	1	45,595/46,000	50,000/50,025	38,700					BC	55-2862	55-2862 SEMI	
SE/PB	1	45,995/46,000	50,600/50,630	38,700					BC	55-3328	55-3328 SEMI	
CB/NWB	4	69,910/69,940	75,000/75,030	28,000	2,500				BB	13-2861	N110/5L STD SEMI	13
CB/NWB	1	69,910/69,940	76,000/76,030	35,000	3,000				EC	53-3098H		
BU	1	30,000	34,000/34,025	21,000					EC	52-3097	52-3097 SEMI	10
BU	1	25,000	28,000/28,052	17,800					BC	56-3042	56-3042 SEMI	

30 128.00 x 142.00

D 2848 M		V8 Cyl.		14618cc	206kW (280PS)		Diesel		TD19075	
D 2848 MH		V8 Cyl.		14618cc	206kW (280PS)		Diesel		TD19076	
BE/PL	1	31,959/31,975	36,000/36,016	19,000	2,011	0,020/0,059	EC	71-2965	71-2965 STD	10
BE/PL	2	31,959/31,975	36,000/36,016	15,000	2,011	0,020/0,060	EC	71-3289	71-3289/2 STD	10
BE/PL	1	89,980/90,000	95,000/95,022	31,000	2,473	0,064/0,126	EC	71-3324	71-3324 STD 0.25 1.50	
BE/PL	1	89,980/90,000	95,000/95,022	31,000	2,473	0,054/0,121	SP	71-3638	71-3638 STD 0.25 0.50	1 3
MB/HL	4	103,980/104,000	111,000/111,022	30,500	3,472	0,056/0,123	EC	72-3564	H993/5 STD 0.25 0.50 0.75	
MB/HL	1	103,980/104,000	111,000/111,022	37,810	3,472	0,056/0,123	EC	72-3565H		



72-3565H	STD	38,000/1.4961" - 38,062/1.4985"
	0.25mm	38,500/1.5157" - 38,562/1.5182"
	0.50mm	38,500/1.5157" - 38,562/1.5182"
	0.75mm	39,000/1.5354" - 39,062/1.5379"

SE/PB	1	45,595/46,000	50,000/50,025	38,700					BC	55-2862	55-2862 SEMI	
SE/PB	1	45,995/46,000	50,600/50,630	38,700					BC	55-3328	55-3328 SEMI	
CB/NWB	4	69,910/69,940	75,000/75,030	28,000	2,500				BB	13-2861	N110/5L STD SEMI	13
CB/NWB	1	69,910/69,940	76,000/76,030	35,000	3,000				EC	53-3098H		
BU	1	30,000	34,000/34,025	21,000					EC	52-3097	52-3097 SEMI	10
BU	1	25,000	28,000/28,052	17,800					BC	56-3042	56-3042 SEMI	

31 128.00 x 142.00

D 2840 LE	V10 Cyl.	18273cc	346-460kW (471-626PS)	Diesel Turbo Intercooler	TD19453
D 2840 LE 403	V10 Cyl.	18273cc	772kW (1050PS)	Diesel Turbo Intercooler	TD27911
D 2840 LE 423	V10 Cyl.	18270cc	809kW (1100PS)	Diesel Turbo Intercooler	TD27921
D 2840 LF 460	V10 Cyl.	18273cc	338kW (460PS)	Diesel Turbo Intercooler	TD7795
D 2840 LF01	V10 Cyl.	18273cc	368kW (500PS)	Diesel Turbo Intercooler	TD7796
D 2840 LF03	V10 Cyl.	18273cc	346kW (471PS)	Diesel Turbo Intercooler	TD28916
D 2840 LF04 Euro 1	V10 Cyl.	18273cc	368kW (500PS)	Diesel Turbo Intercooler	TD7797
D 2840 LF06 Euro 1	V10 Cyl.	18273cc	368kW (500PS)	Diesel Turbo Intercooler	TD7798
D 2840 LF20 Euro 2	V10 Cyl.	18273cc	441kW (600PS)	Diesel Turbo Intercooler	TD7774
D 2840 LF21 Euro 2	V10 Cyl.	18273cc	441kW (600PS)	Diesel Turbo Intercooler	TD18099
D 2840 LF25 Euro 3	V10 Cyl.	18273cc	485-515kW (660-700PS)	Diesel Turbo Intercooler	TD16824
D 2840 LXE	V10 Cyl.	18273cc	603kW (820PS)	Diesel Turbo Intercooler	TD19454
D 2840 LXF	V10 Cyl.	18273cc	338kW (460PS)	Diesel Turbo Intercooler	TD19455
D 2840 LYE	V10 Cyl.	18273cc	603-670kW (820-911PS)	Diesel Turbo Intercooler	TD19124



BE/PL	1	31,959/31,975	36,000/36,016	19,000	2,011	0,020/0,059	EC	71-2965	71-2965 STD	10
BE/PL	2	31,959/31,975	36,000/36,016	15,000	2,011	0,020/0,060	EC	71-3289	71-3289/2 STD	10
BE/PL	1	89,980/90,000	95,000/95,022	31,000	2,473	0,054/0,121	SP	71-3638	71-3638 STD 0.25 0.50	1 3
MB/HL	5	103,980/104,000	111,000/111,022	30,500	3,472	0,056/0,123	EC	72-3564	H993/6 STD	
MB/HL	1	103,980/104,000	111,000/111,022	37,810	3,472	0,056/0,123	EC	72-3565H		

	72-3565H	STD	38,000/1.4961" - 38,062/1.4985"
		0.25mm	38,500/1.5157" - 38,562/1.5182"
		0.50mm	38,500/1.5157" - 38,562/1.5182"
		0.75mm	39,000/1.5354" - 39,062/1.5379"

SE/PB	1	45,595/46,000	50,000/50,025	38,700			BC	55-2862	55-2862 SEMI	
SE/PB	1	45,995/46,000	50,600/50,630	38,700			BC	55-3328	55-3328 SEMI	
CB/NWB	5	69,910/69,940	75,000/75,030	28,000	2,500		BB	13-2861	N110/6L STD SEMI	13
CB/NWB	1	69,910/69,940	76,000/76,030	35,000	3,000		EC	53-3098H		
BU	1	30,000	34,000/34,025	21,000			EC	52-3097	52-3097 SEMI	10
BU	1	25,000	28,000/28,052	17,800			BC	56-3042	56-3042 SEMI	

32 128.00 x 142.00

D 2840 ME	V10 Cyl.	18273cc	244-268kW (332-364PS)	Diesel	TD19125
D 2840 MF	V10 Cyl.	18273cc	268kW (365PS)	Diesel	TD7811
D 2840 MFG	V10 Cyl.	18273cc	268kW (365PS)	Diesel	TD7812
D 2840 MFR	V10 Cyl.	18273cc	245-268kW (333-364PS)	Diesel	TD19456
D 2840 MH	V10 Cyl.	18273cc	244-268kW (332-364PS)	Diesel	TD19126

BE/PL	1	31,959/31,975	36,000/36,016	19,000	2,011	0,020/0,059	EC	71-2965	71-2965 STD	10
BE/PL	2	31,959/31,975	36,000/36,016	15,000	2,011	0,020/0,060	EC	71-3289	71-3289/2 STD	10
BE/PL	1	89,980/90,000	95,000/95,022	31,000	2,473	0,064/0,126	EC	71-3324	71-3324 STD 0.25 1.50	
BE/PL	1	89,980/90,000	95,000/95,022	31,000	2,473	0,054/0,121	SP	71-3638	71-3638 STD 0.25 0.50	1 3
MB/HL	5	103,980/104,000	111,000/111,022	30,500	3,472	0,056/0,123	EC	72-3564	H993/6 STD	
MB/HL	1	103,980/104,000	111,000/111,022	37,810	3,472	0,056/0,123	EC	72-3565H		

	72-3565H	STD	38,000/1.4961" - 38,062/1.4985"
		0.25mm	38,500/1.5157" - 38,562/1.5182"
		0.50mm	38,500/1.5157" - 38,562/1.5182"
		0.75mm	39,000/1.5354" - 39,062/1.5379"

SE/PB	1	45,595/46,000	50,000/50,025	38,700			BC	55-2862	55-2862 SEMI	
SE/PB	1	45,995/46,000	50,600/50,630	38,700			BC	55-3328	55-3328 SEMI	
CB/NWB	5	69,910/69,940	75,000/75,030	28,000	2,500		BB	13-2861	N110/6L STD SEMI	13
CB/NWB	1	69,910/69,940	76,000/76,030	35,000	3,000		EC	53-3098H		
BU	1	30,000	34,000/34,025	21,000			EC	52-3097	52-3097 SEMI	10
BU	1	25,000	28,000/28,052	17,800			BC	56-3042	56-3042 SEMI	



33

128.00 x 142.00

D 2842 LE 202	V12 Cyl.	21930cc	446-587kW (607-798PS)	Diesel Turbo Intercooler	TD25682
D 2842 LE 211	V12 Cyl.	21930cc	446kW (607PS)	Diesel Turbo Intercooler	TD27955
D 2842 LE 401	V12 Cyl.	21930cc	588kW (800PS)	Diesel Turbo Intercooler	TD27860
D 2842 LE 402	V12 Cyl.	21930cc	809kW (1100PS)	Diesel Turbo Intercooler	TD27861
D 2842 LE 403	V12 Cyl.	21930cc	529kW (805PS)	Diesel Turbo Intercooler	TD27862
D 2842 LE 404	V12 Cyl.	21930cc	956kW (1300PS)	Diesel Turbo Intercooler	TD27702
D 2842 LE 405	V12 Cyl.	21930cc	662kW (900PS)	Diesel Turbo Intercooler	TD27863
D 2842 LE 406	V12 Cyl.	21930cc	882kW (1200PS)	Diesel Turbo Intercooler	TD27864
D 2842 LE 407	V12 Cyl.	21930cc	882kW (1200PS)	Diesel Turbo Intercooler	TD27865
D 2842 LE 408	V12 Cyl.	21930cc	735kW (1000PS)	Diesel Turbo Intercooler	TD27866
D 2842 LE 409	V12 Cyl.	21930cc	1103kW (1500PS)	Diesel Turbo Intercooler	TD27867
D 2842 LE 410	V12 Cyl.	21930cc	809kW (1100PS)	Diesel Turbo Intercooler	TD27868
D 2842 LE 412	V12 Cyl.	21930cc	588kW (800PS)	Diesel Turbo Intercooler	TD27870
D 2842 LE 413	V12 Cyl.	21930cc	735kW (1000PS)	Diesel Turbo Intercooler	TD27871
D 2842 LE 419	V12 Cyl.	21930cc	440kW (598PS)	Diesel Turbo Intercooler	TD27869
D 2842 LE 423	V12 Cyl.	21930cc	1000kW (1360PS)	Diesel Turbo Intercooler	TD27922
D 2842 LE 433	V12 Cyl.	21930cc	1140kW (1550PS)	Diesel Turbo Intercooler	TD27923
D 2842 LE 443	V12 Cyl.	21930cc	900kW (1224PS)	Diesel Turbo Intercooler	TD27924
D 2842 LE 604	V12 Cyl.	21930cc	480kW (653PS)	Diesel Turbo Intercooler	TD27918
D 2842 LE 606	V12 Cyl.	21930cc	662kW (900PS)	Diesel Turbo Intercooler	TD27947
D 2842 LE 607	V12 Cyl.	21930cc	500kW (680PS)	Diesel Turbo Intercooler	TD27919
D 2842 LE 620	V12 Cyl.	21927cc	662kW (900PS)	Diesel Turbo Intercooler	TD27948
D 2842 LE 622	V12 Cyl.	21927cc	588kW (800PS)	Diesel Turbo Intercooler	TD20231
D 2842 LF10 Euro 3	V12 Cyl.	21927cc	735kW (1000PS)	Diesel Turbo Intercooler	TD20177
D 2842 LXE	V12 Cyl.	21927cc	662-735kW (900-1000PS)	Diesel Turbo Intercooler	TD19121
D 2842 LYE	V12 Cyl.	21927cc	735-808kW (100-1099PS)	Diesel Turbo Intercooler	TD19122
D 2842 LZE	V12 Cyl.	21927cc	735-808kW (100-1099PS)	Diesel Turbo Intercooler	TD19123

BE/PL	1	31,959/31,975	36,000/36,016	19,000	2,011	0,020/0,059	EC	71-2965	71-2965 STD	10
BE/PL	2	31,959/31,975	36,000/36,016	15,000	2,011	0,020/0,060	EC	71-3289	71-3289/2 STD	10
BE/PL	1	89,980/90,000	95,000/95,022	31,000	2,473	0,054/0,121	SP	71-3638	71-3638 STD 0.25 0.50	1 3
SE/PB	1	45,595/46,000	50,000/50,025	38,700			BC	55-2862	55-2862 SEMI	
SE/PB	1	45,995/46,000	50,600/50,630	38,700			BC	55-3328	55-3328 SEMI	
CB/NWB	6	69,910/69,940	75,000/75,030	28,000	2,500		BB	13-2861	N110/7 STD	13
CB/NWB	1	69,910/69,940	76,000/76,030	35,000	3,000		EC	53-3098H		
BU	1	30,000	34,000/34,025	21,000			EC	52-3097	52-3097 SEMI	10
BU	1	25,000	28,000/28,052	17,800			BC	56-3042	56-3042 SEMI	

34

128.00 x 142.00

D 2842 ME	V12 Cyl.	21927cc	275-338kW (374-460PS)	Diesel	TD19120					
BE/PL	1	31,959/31,975	36,000/36,016	19,000	2,011	0,020/0,059	EC	71-2965	71-2965 STD	10
BE/PL	2	31,959/31,975	36,000/36,016	15,000	2,011	0,020/0,060	EC	71-3289	71-3289/2 STD	10
BE/PL	1	89,980/90,000	95,000/95,022	31,000	2,473	0,064/0,126	EC	71-3324	71-3324 STD 0.25 1.50	

BE/PL	1	89,980/90,000	95,000/95,022	31,000	2,473	0,054/0,121	SP	71-3638	71-3638 STD 0.25 0.50	
SE/PB	1	45,595/46,000	50,000/50,025	38,700			BC	55-2862	55-2862 SEMI	
SE/PB	1	45,995/46,000	50,600/50,630	38,700			BC	55-3328	55-3328 SEMI	
CB/NWB	6	69,910/69,940	75,000/75,030	28,000	2,500		BB	13-2861	N110/7 STD	
CB/NWB	1	69,910/69,940	76,000/76,030	35,000	3,000		EC	53-3098H		
BU	1	30,000	34,000/34,025	21,000			EC	52-3097	52-3097 SEMI	
BU	1	25,000	28,000/28,052	17,800			BC	56-3042	56-3042 SEMI	

35 128.00 x 142.00

E 2842 LE 312		V12 Cyl. 21927cc		360-420kW (490-571PS)		Gas	Turbo Intercooler	TD27925		
E 2842 LE 322		V12 Cyl. 21927cc		380-420kW (517-571PS)		Gas	Turbo Intercooler	TD27639		
BE/PL	1	31,959/31,975	36,000/36,016	19,000	2,011	0,020/0,059	EC	71-2965	71-2965 STD	
BE/PL	2	31,959/31,975	36,000/36,016	15,000	2,011	0,020/0,060	EC	71-3289	71-3289/2 STD	
BE/PL	1	89,980/90,000	95,000/95,022	31,000	2,473	0,054/0,121	SP	71-3638	71-3638 STD 0.25 0.50	
CB/NWB	6	69,910/69,940	75,000/75,030	28,000	2,500		BB	13-2861	N110/7 STD	
CB/NWB	1	69,910/69,940	76,000/76,030	35,000	3,000		EC	53-3098H		
BU	1	30,000	34,000/34,025	21,000			EC	52-3097	52-3097 SEMI	
BU	1	25,000	28,000/28,052	17,800			BC	56-3042	56-3042 SEMI	

36 128.00 x 155.00

D 2865 LF/260	5 Cyl.	9973cc	191kW (260PS)	Diesel	Turbo Intercooler	TD7776
D 2865 LF01	5 Cyl.	9973cc	191-235kW (260-320PS)	Diesel	Turbo Intercooler	TD25850
D 2865 LF02	5 Cyl.	9973cc	198kW (270PS)	Diesel	Turbo Intercooler	TD7696
D 2865 LF03	5 Cyl.	9973cc	235kW (320PS)	Diesel	Turbo Intercooler	TD7780
D 2865 LF05 Euro 1	5 Cyl.	9973cc	198kW (270PS)	Diesel	Turbo Intercooler	TD7777
D 2865 LF06 Euro 1	5 Cyl.	9973cc	235kW (320PS)	Diesel	Turbo Intercooler	TD7781
D 2865 LF09	5 Cyl.	9973cc	250kW (340PS)	Diesel	Turbo Intercooler	TD7784
D 2865 LF10	5 Cyl.	9973cc	235kW (320PS)	Diesel	Turbo Intercooler	TD28917
D 2865 LF20	5 Cyl.	9973cc	213kW (290PS)	Diesel	Turbo Intercooler	TD7765
D 2865 LF21 Euro 2	5 Cyl.	9973cc	110-250kW (290-340PS)	Diesel	Turbo Intercooler	TD7769
D 2865 LF22 Euro 1	5 Cyl.	9973cc	198kW (270PS)	Diesel	Turbo Intercooler	TD7764
D 2865 LF23 Euro 1	5 Cyl.	9973cc	235kW (320PS)	Diesel	Turbo Intercooler	TD7767
D 2865 LF24 Euro 2	5 Cyl.	9973cc	213kW (290PS)	Diesel	Turbo Intercooler	TD7766
D 2865 LFR	5 Cyl.	9973cc	191-235kW (260-320PS)	Diesel	Turbo Intercooler	TD25851
D 2865 LFR 01	5 Cyl.	9973cc	191-235kW (260-320PS)	Diesel	Turbo Intercooler	TD25852
D 2865 LOH 01 Euro 1	5 Cyl.	9973cc	198kW (270PS)	Diesel	Turbo Intercooler	TD9087
D 2865 LOH 02 Euro 1	5 Cyl.	9973cc	235kW (320PS)	Diesel	Turbo Intercooler	TD7754
D 2865 LOH 05 Euro 1	5 Cyl.	9973cc	191-235kW (260-320PS)	Diesel	Turbo Intercooler	TD25854
D 2865 LOH 06 Euro 1	5 Cyl.	9973cc	191-235kW (260-320PS)	Diesel	Turbo Intercooler	TD25856
D 2865 LOH 07 Euro 2	5 Cyl.	9973cc	191-250kW (260-340PS)	Diesel	Turbo Intercooler	TD25855
D 2865 LOH 08 Euro 2	5 Cyl.	9973cc	191kW (260PS)	Diesel	Turbo Intercooler	TD25857
D 2865 LOH 09 Euro 2	5 Cyl.	9973cc	228kW (310PS)	Diesel	Turbo Intercooler	TD25858
D 2865 LOH 10 Euro 2	5 Cyl.	9973cc	213kW (290PS)	Diesel	Turbo Intercooler	TD25859

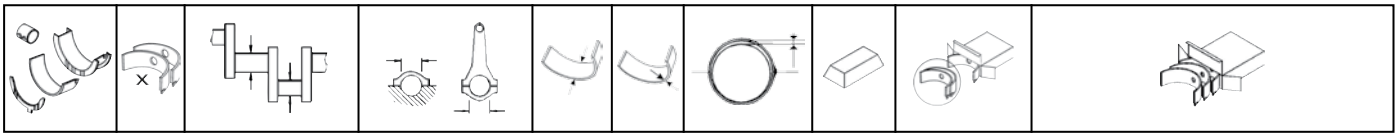

D 2865 LU 01 Euro 1	5 Cyl.	9973cc	198kW (270PS)	Diesel Turbo Intercooler	TD7724
D 2865 LU 02	5 Cyl.	9973cc	198kW (270PS)	Diesel Turbo Intercooler	TD28918
D 2865 LU 03	5 Cyl.	9973cc	235kW (320PS)	Diesel Turbo Intercooler	TD28919
D 2865 LU 04 Euro 1	5 Cyl.	9973cc	198kW (270PS)	Diesel Turbo Intercooler	TD28920
D 2865 LU 05 Euro 1	5 Cyl.	9973cc	198kW (270PS)	Diesel Turbo Intercooler	TD16484
D 2865 LU 06 Euro 1	5 Cyl.	9973cc	235kW (320PS)	Diesel Turbo Intercooler	TD28921
D 2865 LUH 02 Euro 1	5 Cyl.	9973cc	198kW (270PS)	Diesel Turbo Intercooler	TD7578
D 2865 LUH 03 Euro 1	5 Cyl.	9973cc	235kW (320PS)	Diesel Turbo Intercooler	TD28922
D 2865 LUH 05 Euro 1	5 Cyl.	9973cc	198kW (270PS)	Diesel Turbo Intercooler	TD7579
D 2865 LUH 06 Euro 1	5 Cyl.	9973cc	191kW (260PS)	Diesel Turbo Intercooler	TD28923
D 2865 LUH 07 Euro 2	5 Cyl.	9973cc	228kW (310PS)	Diesel Turbo Intercooler	TD7581
D 2865 LUH 08 Euro 1	5 Cyl.	9973cc	235kW (320PS)	Diesel Turbo Intercooler	TD7612
D 2865 LUH 09 Euro 2	5 Cyl.	9973cc	191kW (260PS)	Diesel Turbo Intercooler	TD7594
D 2865 LXF	5 Cyl.	9973cc	191-235kW (260-320PS)	Diesel Turbo Intercooler	TD25860
D 2865 LXFR	5 Cyl.	9973cc	191-235kW (260-320PS)	Diesel Turbo Intercooler	TD25861

BE/PL	1	31,959/31,975	36,000/36,016	19,000	2,011	0,020/0,059	EC	71-2965	71-2965 STD	10	
BE/PL	1	89,980/90,000	95,000/95,022	36,200	2,478	0,044/0,111	SP	71-3637	71-3637 STD 0.25	1 3	
MB/HL	5	103,980/104,000	111,000/111,022	36,000	3,478	0,060/0,126	EC	72-3562	H992/6 STD		
MB/HL	1	103,980/104,000	111,000/111,022	45,810	3,478	0,060/0,126	EC	72-3563H			
											
		72-3563H	STD	46,000/1.8110" - 46,062/1.8135"							
			0.25mm	46,500/1.8307" - 46,562/1.8331"							
			0.50mm	46,500/1.8307" - 46,562/1.8331"							
			0.75mm	47,000/1.8504" - 47,062/1.8528"							
			1.00mm	47,000/1.8504" - 47,062/1.8528"							
SE/PB	1	45,595/46,000	50,000/50,025	38,700			BC	55-2862	55-2862 SEMI		
SE/PB	1	45,995/46,000	50,600/50,630	38,700			BC	55-3328	55-3328 SEMI		
BU	1	30,000	34,000/34,025	21,000			EC	52-3097	52-3097 SEMI	10	
BU	1	25,000	28,000/28,052	17,800			BC	56-3042	56-3042 SEMI		

37

128.00 x 155.00

D 2866 E	6 Cyl.	11967cc	122-344kW (166-468PS)	Diesel	FM17029
D 2866 FG	6 Cyl.	11967cc	185kW (252PS)	Diesel	TD28924
D 2866 FR	6 Cyl.	11967cc	177-213kW (241-290PS)	Diesel	TD19127
D 2866 LE	6 Cyl.	11967cc	122-344kW (166-468PS)	Diesel	FM37029
D 2866 OH	6 Cyl.	11967cc	177-213kW (241-290PS)	Diesel	TD23745
D 2866 U	6 Cyl.	11967cc	160-180kW (218-245PS)	Diesel	TD28964
D 2866 UM	6 Cyl.	11967cc	152-177kW (206-241PS)	Diesel	TD7174

BE/PL	1	31,959/31,975	36,000/36,016	19,000	2,011	0,020/0,059	EC	71-2965	71-2965 STD	10
BE/PL	6	89,980/90,000	95,000/95,022	36,200	2,476	0,048/0,115	EC	71-3561	71-3561/6 STD 0.25 0.50 0.75 1.00	
BE/PL	1	89,980/90,000	95,000/95,022	36,200	2,478	0,044/0,111	SP	71-3637	71-3637 STD 0.25	1 3
MB/HL 1-7	7	103,980/104,000	111,000/111,022	36,000	3,478	0,060/0,126	EC	72-4527	H1239/7 STD 0.25 0.50	4

06/99 →



MB/HL	6	103,980/104,000	111,000/111,022	36,000	3,478	0,060/0,126	EC	72-3562	H992/7 STD 0.25 0.50 0.75
MB/HL	1	103,980/104,000	111,000/111,022	45,810	3,478	0,060/0,126	EC	72-3563H	

→05/99



72-3563H	STD	46,000/1.8110" - 46,062/1.8135"
	0.25mm	46,500/1.8307" - 46,562/1.8331"
	0.50mm	46,500/1.8307" - 46,562/1.8331"
	0.75mm	47,000/1.8504" - 47,062/1.8528"
	1.00mm	47,000/1.8504" - 47,062/1.8528"

TW/A	2	114,400/114,750	137,650/138,000		3,400		AL-LF	04-3947	A159/4 STD
TW/A	2	114,400/114,750	137,650/138,000		3,400		AL-LF	04-3948	

06/99→

SE/PB	1	45,595/46,000	50,000/50,025	38,700			BC	55-2862	55-2862 SEMI	
SE/PB	1	45,995/46,000	50,600/50,630	38,700			BC	55-3328	55-3328 SEMI	
CB/NWB	1	69,910/69,940	75,000/75,030	36,000	2,500		BB	13-3102	N109/7L STD SEMI	13
CB/NWB	5	69,910/69,940	75,000/75,030	28,000	2,500		BB	13-3103		
CB/NWB	1	69,910/69,940	76,000/76,030	39,000	3,000		EC	53-3104H		
BU	1	30,000	34,000/34,025	21,000			EC	52-3097	52-3097 SEMI	10
BU	1	25,000	28,000/28,052	17,800			BC	56-3042	56-3042 SEMI	

38

128.00 x 155.00







D 2866 F/240	6 Cyl.	11967cc	177kW (240PS)	Diesel	TD7775
D 2866 UH	6 Cyl.	11967cc	177-186kW (241-253PS)	Diesel	TD7419

BE/PL	1	31,959/31,975	36,000/36,016	19,000	2,011	0,020/0,059	EC	71-2965	71-2965 STD	10
BE/PL	6	89,980/90,000	95,000/95,022	36,200	2,476	0,048/0,115	EC	71-3561	71-3561/6 STD 0.25 0.50 0.75 1.00	
BE/PL	1	89,980/90,000	95,000/95,022	36,200	2,478	0,044/0,111	SP	71-3637	71-3637 STD 0.25	1 3
MB/HL	6	103,980/104,000	111,000/111,022	36,000	3,478	0,060/0,126	EC	72-3562	H992/7 STD 0.25 0.50 0.75	
MB/HL	1	103,980/104,000	111,000/111,022	45,810	3,478	0,060/0,126	EC	72-3563H		

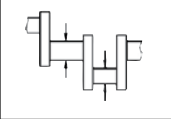
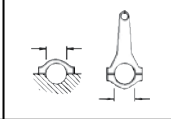

72-3563H	STD	46,000/1.8110" - 46,062/1.8135"
	0.25mm	46,500/1.8307" - 46,562/1.8331"
	0.50mm	46,500/1.8307" - 46,562/1.8331"
	0.75mm	47,000/1.8504" - 47,062/1.8528"
	1.00mm	47,000/1.8504" - 47,062/1.8528"

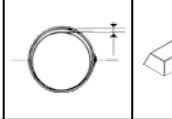
SE/PB	1	45,595/46,000	50,000/50,025	38,700			BC	55-2862	55-2862 SEMI	
SE/PB	1	45,995/46,000	50,600/50,630	38,700			BC	55-3328	55-3328 SEMI	
CB/NWB	1	69,910/69,940	75,000/75,030	36,000	2,500		BB	13-3102	N109/7L STD SEMI	13
CB/NWB	5	69,910/69,940	75,000/75,030	28,000	2,500		BB	13-3103		
CB/NWB	1	69,910/69,940	76,000/76,030	39,000	3,000		EC	53-3104H		
BU	1	30,000	34,000/34,025	21,000			EC	52-3097	52-3097 SEMI	10

							
BU	1	25,000	28,000/28,052	17,800		BC	56-3042 56-3042 SEMI

39 **128.00 x 155.00**

D 2866 KF	6 Cyl.	11967cc	265kW (360PS)	Diesel Turbo Intercooler	TD5651
D 2866 KUH/360 Euro 1	6 Cyl.	11967cc	265kW (360PS)	Diesel Turbo Intercooler	TD7591
D 2866 KUL	6 Cyl.	11967cc	265kW (360PS)	Diesel Turbo Intercooler	TD7786
D 2866 LF/290	6 Cyl.	11967cc	213kW (290PS)	Diesel Turbo Intercooler	TD7778
D 2866 LF/330	6 Cyl.	11967cc	243kW (330PS)	Diesel Turbo Intercooler	TD7782
D 2866 LF03	6 Cyl.	11967cc	272kW (370PS)	Diesel Turbo Intercooler	TD7787
D 2866 LF04	6 Cyl.	11967cc	220kW (300PS)	Diesel Turbo Intercooler	TD7779
D 2866 LF05 Euro 1	6 Cyl.	11967cc	272kW (370PS)	Diesel Turbo Intercooler	TD7788
D 2866 LF06	6 Cyl.	11967cc	309kW (420PS)	Diesel Turbo Intercooler	TD7792
D 2866 LF09 Euro 1	6 Cyl.	11967cc	309kW (420PS)	Diesel Turbo Intercooler	TD7793
D 2866 LF10 Euro 1	6 Cyl.	11967cc	309kW (420PS)	Diesel Turbo Intercooler	TD7794
D 2866 LF15 Euro 1	6 Cyl.	11967cc	272kW (370PS)	Diesel Turbo Intercooler	TD7789
D 2866 LFZ/290	6 Cyl.	11967cc	213kW (290PS)	Diesel Turbo Intercooler	TD7757
D 2866 LFZ/330	6 Cyl.	11967cc	243kW (330PS)	Diesel Turbo Intercooler	TD7759
D 2866 LUL/330	6 Cyl.	11967cc	243kW (330PS)	Diesel Turbo Intercooler	TD7783
D 2866 LXF	6 Cyl.	11967cc	198-274kW (269-372PS)	Diesel Turbo Intercooler	TD7785
D 2866 LXOH	6 Cyl.	11967cc	265-274kW (360-373PS)	Diesel Turbo Intercooler	TD6728
D 2866 TOH	6 Cyl.	11967cc	229kW (311PS)	Diesel Turbo	TD7745
D 2866 TOH/290	6 Cyl.	11967cc	213kW (290PS)	Diesel Turbo	TD7746
D 2866 TOH/310	6 Cyl.	11967cc	229kW (311PS)	Diesel Turbo	TD7747
D 2866 TUH	6 Cyl.	11967cc	224-229kW (305-311PS)	Diesel Turbo	TD7186
D 2866 TUH 01	6 Cyl.	11967cc	222kW (302PS)	Diesel Turbo	TD7176
D 2866 TUH/290	6 Cyl.	11967cc	213-224kW (290-305PS)	Diesel Turbo	TD7589
D 2866 UH/240	6 Cyl.	11967cc	177kW (240PS)	Diesel Turbo	TD7577

BE/PL	1	31,959/31,975	36,000/36,016	19,000	2,011	0,020/0,059	EC	71-2965	71-2965 STD	¹⁰
BE/PL	1	89,980/90,000	95,000/95,022	36,200	2,478	0,044/0,111	SP	71-3637	71-3637 STD 0.25	¹ ³
MB/HL	6	103,980/104,000	111,000/111,022	36,000	3,478	0,060/0,126	EC	72-3562	H992/7 STD 0.25 0.50 0.75	
MB/HL	1	103,980/104,000	111,000/111,022	45,810	3,478	0,060/0,126	EC	72-3563H		

	72-3563H	STD	46,000/1.8110" - 46,062/1.8135"
		0.25mm	46,500/1.8307" - 46,562/1.8331"
		0.50mm	46,500/1.8307" - 46,562/1.8331"
		0.75mm	47,000/1.8504" - 47,062/1.8528"
		1.00mm	47,000/1.8504" - 47,062/1.8528"

SE/PB	1	45,595/46,000	50,000/50,025	38,700			BC	55-2862	55-2862 SEMI	
SE/PB	1	45,995/46,000	50,600/50,630	38,700			BC	55-3328	55-3328 SEMI	
CB/NWB	1	69,910/69,940	75,000/75,030	36,000	2,500		BB	13-3102	N109/7L STD SEMI	¹³
CB/NWB	5	69,910/69,940	75,000/75,030	28,000	2,500		BB	13-3103		
CB/NWB	1	69,910/69,940	76,000/76,030	39,000	3,000		EC	53-3104H		
BU	1	30,000	34,000/34,025	21,000			EC	52-3097	52-3097 SEMI	¹⁰
BU	1	25,000	28,000/28,052	17,800			BC	56-3042	56-3042 SEMI	



40 128.00 x 155.00

D 2866 KFZ	6 Cyl.	11967cc	265kW (360PS)	Diesel Turbo Intercooler	TD7761
D 2866 KOH/360	6 Cyl.	11967cc	265kW (360PS)	Diesel Turbo Intercooler	TD16487
D 2866 KOH/373	6 Cyl.	11967cc	274kW (373PS)	Diesel Turbo Intercooler	TD7415
D 2866 LF	6 Cyl.	11967cc	243kW (330PS)	Diesel Turbo Intercooler	TD28926
D 2866 LF01	6 Cyl.	11967cc	265kW (360PS)	Diesel Turbo Intercooler	TD28927
D 2866 LF02	6 Cyl.	11967cc	250kW (340PS)	Diesel Turbo Intercooler	TD28928
D 2866 LF07	6 Cyl.	11967cc	213kW (290PS)	Diesel Turbo Intercooler	TD28929
D 2866 LF08	6 Cyl.	11967cc	243kW (330PS)	Diesel Turbo Intercooler	TD28930
D 2866 LF21 Euro 1	6 Cyl.	11967cc	272kW (370PS)	Diesel Turbo Intercooler	TD7770
D 2866 LF22 Euro 1	6 Cyl.	11967cc	309kW (420PS)	Diesel Turbo Intercooler	TD7772
D 2866 LFG	6 Cyl.	11967cc	243kW (330PS)	Diesel Turbo Intercooler	TD28932
D 2866 LFG 03 Euro 1	6 Cyl.	11967cc	272kW (370PS)	Diesel Turbo Intercooler	TD28933
D 2866 LFG 04 Euro 1	6 Cyl.	11967cc	309kW (420PS)	Diesel Turbo Intercooler	TD28934
D 2866 LH 01	6 Cyl.	11967cc	220kW (299PS)	Diesel Turbo Intercooler	TD28938
D 2866 LOH	6 Cyl.	11967cc	243-309kW (330-420PS)	Diesel Turbo Intercooler	TD7750
D 2866 LOH 02	6 Cyl.	11967cc	272kW (370PS)	Diesel Turbo Intercooler	TD28939
D 2866 LOH 03	6 Cyl.	11967cc	309kW (420PS)	Diesel Turbo Intercooler	TD7808
D 2866 LOH 06 Euro 1	6 Cyl.	11967cc	309kW (420PS)	Diesel Turbo Intercooler	TD7755
D 2866 LOH 07	6 Cyl.	11967cc	272kW (370PS)	Diesel Turbo Intercooler	TD7602
D 2866 LOH 09 Euro 1	6 Cyl.	11967cc	230kW (313PS)	Diesel Turbo Intercooler	TD28940
D 2866 LOH 20 Euro 1	6 Cyl.	11967cc	309kW (420PS)	Diesel Turbo Intercooler	TD5647
D 2866 LOH 21 Euro 1	6 Cyl.	11967cc	309kW (420PS)	Diesel Turbo Intercooler	TD28941
D 2866 LOH 22 Euro 1	6 Cyl.	11967cc	272kW (370PS)	Diesel Turbo Intercooler	TD7420
D 2866 LOH 24 Euro 1	6 Cyl.	11970cc	230kW (310PS)	Diesel Turbo Intercooler	TD7752
D 2866 LU	6 Cyl.	11967cc	243kW (330PS)	Diesel Turbo Intercooler	TD28945
D 2866 LU 01	6 Cyl.	11967cc	272kW (370PS)	Diesel Turbo Intercooler	TD21312
D 2866 LU 02	6 Cyl.	11967cc	309kW (420PS)	Diesel Turbo Intercooler	TD28946
D 2866 LU 03 Euro 1	6 Cyl.	11967cc	272kW (370PS)	Diesel Turbo Intercooler	TD21313
D 2866 LU 04	6 Cyl.	11967cc	309kW (420PS)	Diesel Turbo Intercooler	TD28947
D 2866 LU 07	6 Cyl.	11967cc	272kW (370PS)	Diesel Turbo Intercooler	TD28948
D 2866 LU 08	6 Cyl.	11967cc	230kW (313PS)	Diesel Turbo Intercooler	TD28949
D 2866 LU/330	6 Cyl.	11967cc	243kW (330PS)	Diesel Turbo Intercooler	TD7809
D 2866 LUH	6 Cyl.	11967cc	243kW (330PS)	Diesel Turbo Intercooler	TD28950
D 2866 LUH 04 Euro 1	6 Cyl.	11967cc	272kW (370PS)	Diesel Turbo Intercooler	TD28951
D 2866 LUH 05 Euro 1	6 Cyl.	11967cc	272kW (370PS)	Diesel Turbo Intercooler	TD28952
D 2866 LUH/330	6 Cyl.	11967cc	243kW (330PS)	Diesel Turbo Intercooler	TD7593
D 2866 LX	6 Cyl.	11967cc	198-344kW (269-468PS)	Diesel Turbo Intercooler	TD19128
D 2866 LXE 40	6 Cyl.	11967cc	190-294kW (258-400PS)	Diesel Turbo Intercooler	TD27926
D 2866 LXE 47	6 Cyl.	11967cc	221kW (301PS)	Diesel Turbo Intercooler	TD27929
D 2866 LXFG	6 Cyl.	11967cc	274kW (372PS)	Diesel Turbo Intercooler	TD28961
D 2866 LXU	6 Cyl.	11967cc	265kW (360PS)	Diesel Turbo Intercooler	TD28962
D 2866 LXUH	6 Cyl.	11967cc	265kW (360PS)	Diesel Turbo Intercooler	TD28963
D 2866 T	6 Cyl.	11967cc	213kW (290PS)	Diesel Turbo	TD7580

BE/PL	1	31,959/31,975	36,000/36,016	19,000	2,011	0,020/0,059	EC	71-2965	71-2965 STD	10
BE/PL	1	89,980/90,000	95,000/95,022	36,200	2,478	0,044/0,111	SP	71-3637	71-3637 STD 0.25	1 3
MB/HL 1-7	7	103,980/104,000	111,000/111,022	36,000	3,478	0,060/0,126	EC	72-4527	H1239/7 STD 0.25 0.50	4

06/99→

MB/HL	6	103,980/104,000	111,000/111,022	36,000	3,478	0,060/0,126	EC	72-3562	H992/7 STD 0.25 0.50 0.75	
MB/HL	1	103,980/104,000	111,000/111,022	45,810	3,478	0,060/0,126	EC	72-3563H		

→05/99

	72-3563H	STD	46,000/1.8110" - 46,062/1.8135"
		0.25mm	46,500/1.8307" - 46,562/1.8331"
		0.50mm	46,500/1.8307" - 46,562/1.8331"
		0.75mm	47,000/1.8504" - 47,062/1.8528"
		1.00mm	47,000/1.8504" - 47,062/1.8528"

TW/A	2	114,400/114,750	137,650/138,000		3,400		AL-LF	04-3947	A159/4 STD
TW/A	2	114,400/114,750	137,650/138,000		3,400		AL-LF	04-3948	

06/99→

SE/PB	1	45,595/46,000	50,000/50,025	38,700			BC	55-2862	55-2862 SEMI	
SE/PB	1	45,995/46,000	50,600/50,630	38,700			BC	55-3328	55-3328 SEMI	
CB/NWB	1	69,910/69,940	75,000/75,030	36,000	2,500		BB	13-3102	N109/7L STD SEMI	[13]
CB/NWB	5	69,910/69,940	75,000/75,030	28,000	2,500		BB	13-3103		
CB/NWB	1	69,910/69,940	76,000/76,030	39,000	3,000		EC	53-3104H		
BU	1	30,000	34,000/34,025	21,000			EC	52-3097	52-3097 SEMI	[10]
BU	1	25,000	28,000/28,052	17,800			BC	56-3042	56-3042 SEMI	

41

128.00 x 155.00

D 2866 LF14 Euro 2	6 Cyl.	11967cc	294-309kW (400-420PS)	Diesel Turbo Intercooler	TD21308
D 2866 LF17 Euro 2	6 Cyl.	11967cc	260kW (354PS)	Diesel Turbo Intercooler	TD21309
D 2866 LF20 Euro 2	6 Cyl.	11967cc	294-309kW (400-420PS)	Diesel Turbo Intercooler	TD7771
D 2866 LF23 Euro 3	6 Cyl.	11967cc	228kW (310PS)	Diesel Turbo Intercooler	TD16521
D 2866 LF25 Euro 3	6 Cyl.	11967cc	301kW (410PS)	Diesel Turbo Intercooler	TD16467
D 2866 LF29 Euro 2	6 Cyl.	11967cc	294kW (400PS)	Diesel Turbo Intercooler	TD21310
D 2866 LF30 Euro 2	6 Cyl.	11967cc	301kW (409PS)	Diesel Turbo Intercooler	TD21311
D 2866 LF31 Euro 2	6 Cyl.	11967cc	301kW (409PS)	Diesel Turbo Intercooler	TD14312
D 2866 LF34 Euro 2	6 Cyl.	11967cc	228kW (310PS)	Diesel Turbo Intercooler	TD14308
D 2866 LF35 Euro 2	6 Cyl.	11967cc	265kW (360PS)	Diesel Turbo Intercooler	TD14311
D 2866 LF39 Euro 2	6 Cyl.	11967cc	265kW (360PS)	Diesel Turbo Intercooler	TD28931
D 2866 LF40 Euro 2	6 Cyl.	11967cc	301kW (410PS)	Diesel Turbo Intercooler	TD23662
D 2866 LF41 Euro 2	6 Cyl.	11967cc	301kW (410PS)	Diesel Turbo Intercooler	TD23005
D 2866 LF43 Euro 2	6 Cyl.	11967cc	265kW (360PS)	Diesel Turbo Intercooler	TD23004
D 2866 LFG 05 Euro 2	6 Cyl.	11967cc	294kW (400PS)	Diesel Turbo Intercooler	TD28935
D 2866 LFG 06 Euro 3	6 Cyl.	11967cc	301kW (409PS)	Diesel Turbo Intercooler	TD28936
D 2866 LFG 07 Euro 3	6 Cyl.	11967cc	301kW (409PS)	Diesel Turbo Intercooler	TD28937
D 2866 LOH 23 Euro 2	6 Cyl.	11967cc	294kW (400PS)	Diesel Turbo Intercooler	TD7592
D 2866 LOH 25 Euro 2	6 Cyl.	11967cc	228kW (310PS)	Diesel Turbo Intercooler	TD7753
D 2866 LOH 26 Euro 2	6 Cyl.	11967cc	257kW (350PS)	Diesel Turbo Intercooler	TD7590
D 2866 LOH 27 Euro 3	6 Cyl.	11967cc	228kW (310PS)	Diesel Turbo Intercooler	TD16760
D 2866 LOH 31 Euro 2	6 Cyl.	11967cc	191kW (260PS)	Diesel Turbo Intercooler	TD28942
D 2866 LOH 32 Euro 3	6 Cyl.	11967cc	228kW (310PS)	Diesel Turbo Intercooler	TD16746
D 2866 LOH 33 Euro 3	6 Cyl.	11967cc	265kW (360PS)	Diesel Turbo Intercooler	TD16747
D 2866 LOH 35 Euro 3	6 Cyl.	11967cc	191kW (260PS)	Diesel Turbo Intercooler	TD28943
D 2866 LOH 36 Euro 3	6 Cyl.	11967cc	191kW (260PS)	Diesel Turbo Intercooler	TD28944



D 2866 LUH 20 Euro 2	6 Cyl.	11967cc	228kW (310PS)	Diesel Turbo Intercooler	TD7582
D 2866 LUH 21 Euro 2	6 Cyl.	11967cc	257kW (350PS)	Diesel Turbo	TD11167
D 2866 LUH 22 Euro 2	6 Cyl.	11967cc	191kW (260PS)	Diesel Turbo	TD11133
D 2866 LUH 23 Euro 3	6 Cyl.	11967cc	191kW (260PS)	Diesel Turbo Intercooler	TD16764
D 2866 LUH 26 Euro 2	6 Cyl.	11967cc	228kW (310PS)	Diesel Turbo	TD11134
D 2866 LUH 27 Euro 3	6 Cyl.	11967cc	191kW (260PS)	Diesel Turbo Intercooler	TD28953
D 2866 LUH 28 Euro 3	6 Cyl.	11967cc	228kW (310PS)	Diesel Turbo Intercooler	TD28954
D 2866 LUH 30 Euro 3	6 Cyl.	11967cc	301kW (410PS)	Diesel Turbo Intercooler	TD16767
D 2866 LUH 34 Euro 3	6 Cyl.	11967cc	191kW (260PS)	Diesel Turbo Intercooler	TD28955
D 2866 LUH 35 Euro 3	6 Cyl.	11967cc	228kW (310PS)	Diesel Turbo Intercooler	TD28956
D 2866 LUH 36 Euro 3	6 Cyl.	11967cc	265kW (360PS)	Diesel Turbo Intercooler	TD28957
D 2866 LUH 37 Euro 3	6 Cyl.	11967cc	301kW (409PS)	Diesel Turbo Intercooler	TD28958
D 2866 LUH 50 Euro 4	6 Cyl.	11967cc	191kW (260PS)	Diesel Turbo Intercooler	TD28959
D 2866 LUH 52 Euro 4	6 Cyl.	11967cc	265kW (360PS)	Diesel Turbo Intercooler	TD28960

BE/PL	1	31,959/31,975	36,000/36,016	19,000	2,011	0,020/0,059	EC	71-2965	71-2965 STD	10
BE/PL	1	89,980/90,000	95,000/95,022	36,200	2,478	0,044/0,111	SP	71-3637	71-3637 STD 0.25	1 3
MB/HL 1-7	7	103,980/104,000	111,000/111,022	36,000	3,478	0,060/0,126	EC	72-4527	H1239/7 STD 0.25 0.50	4

06/99 →

MB/HL	6	103,980/104,000	111,000/111,022	36,000	3,478	0,060/0,126	EC	72-3562	H992/7 STD 0.25 0.50 0.75
MB/HL	1	103,980/104,000	111,000/111,022	45,810	3,478	0,060/0,126	EC	72-3563H	

→ **05/99**



72-3563H	STD	46,000/1.8110" - 46,062/1.8135"
	0.25mm	46,500/1.8307" - 46,562/1.8331"
	0.50mm	46,500/1.8307" - 46,562/1.8331"
	0.75mm	47,000/1.8504" - 47,062/1.8528"
	1.00mm	47,000/1.8504" - 47,062/1.8528"

TW/A	2	114,400/114,750	137,650/138,000		3,400		AL-LF	04-3947	A159/4 STD
TW/A	2	114,400/114,750	137,650/138,000		3,400		AL-LF	04-3948	

06/99 →

SE/PB	1	45,595/46,000	50,000/50,025	38,700			BC	55-2862	55-2862 SEMI
SE/PB	1	45,995/46,000	50,600/50,630	38,700			BC	55-3328	55-3328 SEMI
SE/PB	1	45,995/46,000	50,600/50,630	38,700			BC	55-4747	55-4747 SEMI



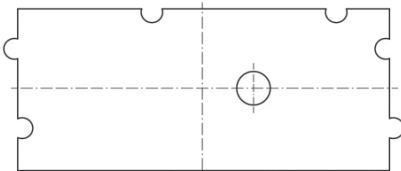



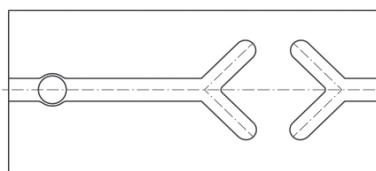



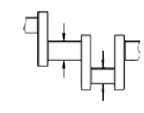
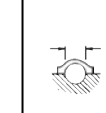
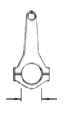

55-3328

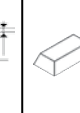

55-4747

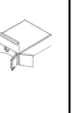

CB/NWB	1	69,910/69,940	75,000/75,030	36,000	2,500		BB	13-3102	N109/7L STD SEMI	13
CB/NWB	5	69,910/69,940	75,000/75,030	28,000	2,500		BB	13-3103		
CB/NWB	1	69,910/69,940	76,000/76,030	39,000	3,000		EC	53-3104H		
BU	1	30,000	34,000/34,025	21,000			EC	52-3097	52-3097 SEMI	10

													
BU	1	25,000	28,000/28,052	17,800			BC	56-3042	56-3042 SEMI				

42 128.00 x 155.00

D 2866 LF16 Euro 2		6 Cyl.		11967cc	294-309kW (400-420PS)		Diesel Turbo Intercooler		TD7791
BE/PL	1	31,959/31,975	36,000/36,016	19,000	2,011	0,020/0,059	EC	71-2965	71-2965 STD 10
BE/PL	1	89,980/90,000	95,000/95,022	36,200	2,478	0,044/0,111	SP	71-3637	71-3637 STD 0.25 1 3
MB/HL	6	103,980/104,000	111,000/111,022	36,000	3,478	0,060/0,126	EC	72-3562	H992/7 STD 0.25 0.50 0.75
MB/HL	1	103,980/104,000	111,000/111,022	45,810	3,478	0,060/0,126	EC	72-3563H	

	72-3563H	STD	46,000/1.8110" - 46,062/1.8135"
		0.25mm	46,500/1.8307" - 46,562/1.8331"
		0.50mm	46,500/1.8307" - 46,562/1.8331"
		0.75mm	47,000/1.8504" - 47,062/1.8528"
		1.00mm	47,000/1.8504" - 47,062/1.8528"

SE/PB	1	45,595/46,000	50,000/50,025	38,700			BC	55-2862	55-2862 SEMI
SE/PB	1	45,995/46,000	50,600/50,630	38,700			BC	55-3328	55-3328 SEMI
SE/PB	1	45,995/46,000	50,600/50,630	38,700			BC	55-4747	55-4747 SEMI

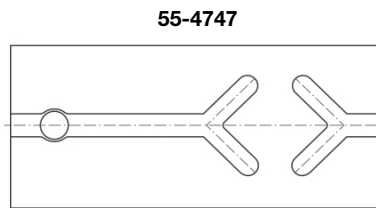
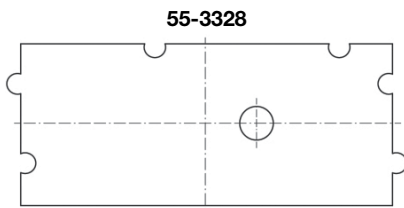

CB/NWB	1	69,910/69,940	75,000/75,030	36,000	2,500		BB	13-3102	N109/7L STD SEMI 13
CB/NWB	5	69,910/69,940	75,000/75,030	28,000	2,500		BB	13-3103	
CB/NWB	1	69,910/69,940	76,000/76,030	39,000	3,000		EC	53-3104H	
BU	1	30,000	34,000/34,025	21,000			EC	52-3097	52-3097 SEMI 10
BU	1	25,000	28,000/28,052	17,800			BC	56-3042	56-3042 SEMI

43 128.00 x 155.00

D 2866 LF24 Euro 3		6 Cyl.		11967cc	265kW (360PS)		Diesel Turbo Intercooler		TD16522
D 2866 LF26 Euro 3		6 Cyl.		11967cc	228kW (310PS)		Diesel Turbo Intercooler		TD16204
D 2866 LF27 Euro 3		6 Cyl.		11967cc	265kW (360PS)		Diesel Turbo Intercooler		TD16205
D 2866 LF28 Euro 3		6 Cyl.		11967cc	301kW (410PS)		Diesel Turbo Intercooler		TD15050
D 2866 LF32 Euro 2		6 Cyl.		11967cc	301kW (410PS)		Diesel Turbo Intercooler		TD15048
D 2866 LF36 Euro 2		6 Cyl.		11967cc	228kW (310PS)		Diesel Turbo Intercooler		TD16202
D 2866 LF37 Euro 2		6 Cyl.		11967cc	265kW (360PS)		Diesel Turbo Intercooler		TD16203
D 2866 LOH 28 Euro 3		6 Cyl.		11967cc	265kW (360PS)		Diesel Turbo Intercooler		TD16761
D 2866 LOH 29 Euro 3		6 Cyl.		11967cc	301kW (410PS)		Diesel Turbo Intercooler		TD16493
D 2866 LOH 34 Euro 3		6 Cyl.		11967cc	301kW (410PS)		Diesel Turbo Intercooler		TD16297
D 2866 LUH 24 Euro 3		6 Cyl.		11967cc	228kW (310PS)		Diesel Turbo Intercooler		TD16765
D 2866 LUH 25 Euro 3		6 Cyl.		11967cc	265kW (360PS)		Diesel Turbo Intercooler		TD16766
D 2866 LUH 29 Euro 3		6 Cyl.		11967cc	265kW (360PS)		Diesel Turbo Intercooler		TD18040

BE/PL	1	31,959/31,975	36,000/36,016	19,000	2,011	0,020/0,059	EC	71-2965	71-2965 STD 10
-------	---	---------------	---------------	--------	-------	-------------	----	---------	---

BE/PL	1	89,980/90,000	95,000/95,022	36,200	2,478	0,044/0,111	SP	71-3637	71-3637 STD 0.25	1 3
MB/HL 1-7	7	103,980/104,000	111,000/111,022	36,000	3,478	0,060/0,126	EC	72-4527	H1239/7 STD 0.25 0.50	4
TW/A	2	114,400/114,750	137,650/138,000		3,400		AL-LF	04-3947	A159/4 STD	
TW/A	2	114,400/114,750	137,650/138,000		3,400		AL-LF	04-3948		
SE/PB	1	45,595/46,000	50,000/50,025	38,700			BC	55-2862	55-2862 SEMI	
SE/PB	1	45,995/46,000	50,600/50,630	38,700			BC	55-3328	55-3328 SEMI	
SE/PB	1	45,995/46,000	50,600/50,630	38,700			BC	55-4747	55-4747 SEMI	

55-3328

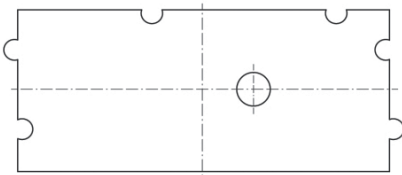

55-4747

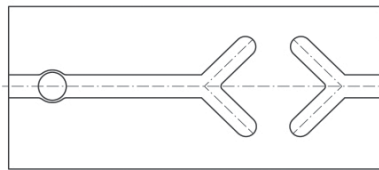

CB/NWB	1	69,910/69,940	75,000/75,030	36,000	2,500		BB	13-3102	N109/7L STD SEMI	13
CB/NWB	5	69,910/69,940	75,000/75,030	28,000	2,500		BB	13-3103		
CB/NWB	1	69,910/69,940	76,000/76,030	39,000	3,000		EC	53-3104H		
BU	1	30,000	34,000/34,025	21,000			EC	52-3097	52-3097 SEMI	10
BU	1	25,000	28,000/28,052	17,800			BC	56-3042	56-3042 SEMI	

44

128.00 x 155.00

G 2866 DOH 02 Euro 3	6 Cyl.	11967cc	180kW (245PS)	LPG	TD16775
G 2866 DOH 03 Euro 3	6 Cyl.	11967cc	180kW (245PS)	LPG	TD16776
G 2866 DUH 04 Euro 3	6 Cyl.	11967cc	175kW (238PS)	LPG	TD16770
G 2866 DUH 05 Euro 3	6 Cyl.	11967cc	175kW (238PS)	LPG	TD16771
E 2866	6 Cyl.	11967cc	170kW (230PS)	Natural Gas	TD7768
E 2866 DE	6 Cyl.	11967cc	122-240kW (166-326PS)	Natural Gas	TD19457
E 2866 DF 01	6 Cyl.	11967cc	170kW (231PS)	Natural Gas	TD7763
E 2866 DF 02 Euro 3	6 Cyl.	11967cc	174kW (236PS)	Natural Gas	TD16777
E 2866 DF 03	6 Cyl.	11967cc	174kW (236PS)	Natural Gas	TD16778
E 2866 DF 04	6 Cyl.	11967cc	174kW (236PS)	Natural Gas	TD16779
E 2866 DOH 02 Euro 3	6 Cyl.	11967cc	178kW (242PS)	Natural Gas	TD16772
E 2866 DOH 03 Euro 3	6 Cyl.	11967cc	178kW (242PS)	Natural Gas	TD16773
E 2866 DOH 04 Euro 3	6 Cyl.	11967cc	178kW (242PS)	Natural Gas	TD16774
E 2866 DUH	6 Cyl.	11970cc	170kW (231PS)	Natural Gas	TD7595
E 2866 DUH 01	6 Cyl.	11967cc	170kW (231PS)	Natural Gas	TD7626
E 2866 LUH 02	6 Cyl.	11967cc	228kW (310PS)	Natural Gas Turbo Intercooler	TD16769
G 2866 DUH 01	6 Cyl.	11967cc	151kW (205PS)	Gas	TD28971
G 2866 DUH 02	6 Cyl.	11967cc	177kW (241PS)	Gas	TD28972
G 2866 DUH 03	6 Cyl.	11967cc	177kW (241PS)	Gas	TD28973

BE/PL	1	31,959/31,975	36,000/36,016	19,000	2,011	0,020/0,059	EC	71-2965	71-2965 STD	10
BE/PL	1	89,980/90,000	95,000/95,022	36,200	2,478	0,044/0,111	SP	71-3637	71-3637 STD 0.25	1 3

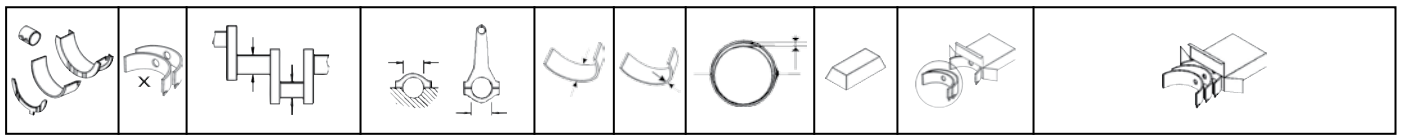

MB/HL 1-7	7	103,980/104,000	111,000/111,022	36,000	3,478	0,060/0,126	EC	72-4527	H1239/7 STD 0.25 0.50	[4]	
06/99 →											
MB/HL	6	103,980/104,000	111,000/111,022	36,000	3,478	0,060/0,126	EC	72-3562	H992/7 STD 0.25 0.50 0.75		
MB/HL	1	103,980/104,000	111,000/111,022	45,810	3,478	0,060/0,126	EC	72-3563H			
→05/99											
		 72-3563H	STD	46,000/1.8110" - 46,062/1.8135"							
			0.25mm	46,500/1.8307" - 46,562/1.8331"							
			0.50mm	46,500/1.8307" - 46,562/1.8331"							
			0.75mm	47,000/1.8504" - 47,062/1.8528"							
			1.00mm	47,000/1.8504" - 47,062/1.8528"							
TW/A	2	114,400/114,750	137,650/138,000		3,400		AL-LF	04-3947	A159/4 STD		
TW/A	2	114,400/114,750	137,650/138,000		3,400		AL-LF	04-3948			
06/99 →											
CB/NWB	1	69,910/69,940	75,000/75,030	36,000	2,500		BB	13-3102	N109/7L STD SEMI	[13]	
CB/NWB	5	69,910/69,940	75,000/75,030	28,000	2,500		BB	13-3103			
CB/NWB	1	69,910/69,940	76,000/76,030	39,000	3,000		EC	53-3104H			
BU	1	30,000	34,000/34,025	21,000			EC	52-3097	52-3097 SEMI	[10]	
BU	1	25,000	28,000/28,052	17,800			BC	56-3042	56-3042 SEMI		

45 128.00 x 155.00

E 2866 DUH 03		6 Cyl.		11967cc	180kW (245PS)	Natural Gas			TD16768	
E 2866 DUH 04		6 Cyl.		11967cc	180kW (245PS)	Natural Gas			TD22859	
BE/PL	1	31,959/31,975	36,000/36,016	19,000	2,011	0,020/0,059	EC	71-2965	71-2965 STD	[10]
BE/PL	1	89,980/90,000	95,000/95,022	36,200	2,478	0,044/0,111	SP	71-3637	71-3637 STD 0.25	[1][3]
MB/HL 1-7	7	103,980/104,000	111,000/111,022	36,000	3,478	0,060/0,126	EC	72-4527	H1239/7 STD 0.25 0.50	[4]
TW/A	2	114,400/114,750	137,650/138,000		3,400		AL-LF	04-3947	A159/4 STD	
TW/A	2	114,400/114,750	137,650/138,000		3,400		AL-LF	04-3948		
CB/NWB	1	69,910/69,940	75,000/75,030	36,000	2,500		BB	13-3102	N109/7L STD SEMI	[13]
CB/NWB	5	69,910/69,940	75,000/75,030	28,000	2,500		BB	13-3103		
CB/NWB	1	69,910/69,940	76,000/76,030	39,000	3,000		EC	53-3104H		
BU	1	30,000	34,000/34,025	21,000			EC	52-3097	52-3097 SEMI	[10]
BU	1	25,000	28,000/28,052	17,800			BC	56-3042	56-3042 SEMI	

46 128.00 x 157.00

D 2868 LE 421 Euro 5	V8 Cyl.	16200cc	441kW (600PS)	Diesel Turbo Intercooler			TD27932
D 2868 LE 422 Euro 5	V8 Cyl.	16200cc	588kW (800PS)	Diesel Turbo Intercooler			TD27931
D 2868 LF02 Euro 5	V8 Cyl.	16200cc	500kW (680PS)	Diesel Turbo Intercooler			TD20374
D 2868 LF03 Euro 5	V8 Cyl.	16200cc	500kW (680PS)	Diesel Turbo Intercooler			TD20375
D 2868 LF04 Euro 5	V8 Cyl.	16200cc	500kW (680PS)	Diesel			TD23161

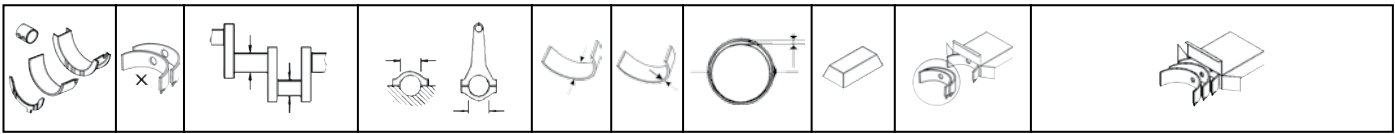

D 2868 LF05		V8 Cyl.	16200cc	500kW (680PS)	Diesel Turbo Intercooler			TD23442
D 2868 LF06 Euro 5		V8 Cyl.	16200cc	500kW (680PS)	Diesel Turbo Intercooler			TD25464
D 2868 LF07 Euro 5		V8 Cyl.	16200cc	500kW (680PS)	Diesel Turbo Intercooler			TD25465
MB/HL	1	111,966/111,988	118,000/118,022	28,800	2,971	0,075/0,143	SP 72-4793	72-4793 STD 0.25 0.50 [2]
TW/A	1	121,000/121,350	141,650/142,000		3,400		AL-LF 04-4794	A294/2 STD
TW/A	1	121,000/121,350	141,650/142,000		3,400		AL-LF 04-4795	
CB/NWB 1-5	5	79,910/79,940	85,000/85,035	31,000			AL-LF 03-4796	N196/5 SEMI

47 128.00 x 166.00

G 2876 DUH 01		6 Cyl.	12816cc	200kW (272PS)	LPG			TD19967
E 2876 LUH 04		6 Cyl.	12816cc	200kW (272PS)	Gas Turbo Intercooler			TD25459

BE/PL	1	89,980/90,000	95,000/95,022	36,200	2,478	0,060/0,122	SP 71-4746	71-4746 STD 0.25 [1]
MB/HL 1-7	7	103,980/104,000	111,000/111,022	36,000	3,478	0,060/0,126	EC 72-4527	H1239/7 STD 0.25 0.50 [4]

06/99→

MB/HL	6	103,980/104,000	111,000/111,022	36,000	3,478	0,060/0,126	EC 72-3562	H992/7 STD 0.25 0.50 0.75
MB/HL	1	103,980/104,000	111,000/111,022	45,810	3,478	0,060/0,126	EC 72-3563H	

→05/99



72-3563H	STD	46,000/1.8110" - 46,062/1.8135"
	0.25mm	46,500/1.8307" - 46,562/1.8331"
	0.50mm	46,500/1.8307" - 46,562/1.8331"
	0.75mm	47,000/1.8504" - 47,062/1.8528"
	1.00mm	47,000/1.8504" - 47,062/1.8528"

TW/A	2	114,400/114,750	137,650/138,000		3,400		AL-LF 04-3947	A159/4 STD
TW/A	2	114,400/114,750	137,650/138,000		3,400		AL-LF 04-3948	

06/99→

SE/PB	1	51,992/51,998	56,000/56,030	45,500			BC-LF 55-4584	55-4584 SEMI [6]
CB/NWB	1	69,910/69,940	75,000/75,030	36,000	2,500		BB 13-3102	N109/7L STD SEMI [13]
CB/NWB	5	69,910/69,940	75,000/75,030	28,000	2,500		BB 13-3103	
CB/NWB	1	69,910/69,940	76,000/76,030	39,000	3,000		EC 53-3104H	
BU	1	28,000	31,000/31,062	22,500			BC 56-3949	56-3949 SEMI

48 128.00 x 166.00

D 2876 LE 121		6 Cyl.	12816cc	280kW (381PS)	Diesel Turbo Intercooler			TD20232
D 2876 LE 122		6 Cyl.	12816cc	316kW (430PS)	Diesel Turbo Intercooler			TD20233
D 2876 LE 123		6 Cyl.	12816cc	353kW (480PS)	Diesel Turbo Intercooler			TD20234
D 2876 LE 124		6 Cyl.	12816cc	382kW (520PS)	Diesel Turbo Intercooler			TD20235
D 2876 LE 402		6 Cyl.	12816cc	412kW (560PS)	Diesel Turbo Intercooler			TD27927
D 2876 LE 403		6 Cyl.	12816cc	331kW (450PS)	Diesel Turbo Intercooler			TD27930
D 2876 LE 406		6 Cyl.	12816cc	230kW (313PS)	Diesel Turbo Intercooler			TD27933
D 2876 LE 407		6 Cyl.	12816cc	360kW (490PS)	Diesel Turbo Intercooler			TD27934
D 2876 LF 01 Euro 2		6 Cyl.	12816cc	338kW (460PS)	Diesel Turbo Intercooler			TD28965
D 2876 LF 02 Euro 2		6 Cyl.	12816cc	338kW (460PS)	Diesel Turbo Intercooler			TD7773
D 2876 LF 06 Euro 2		6 Cyl.	12816cc	338kW (460PS)	Diesel Turbo Intercooler			TD14313

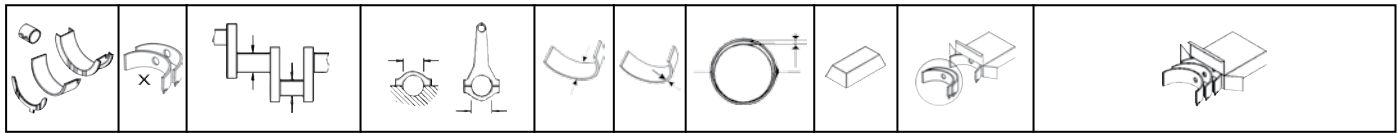

D 2876 LF 10 Euro 2	6 Cyl.	12816cc	338kW (460PS)	Diesel Turbo Intercooler	TD28966
D 2876 LF 11 Euro 2	6 Cyl.	12816cc	338kW (460PS)	Diesel Turbo Intercooler	TD20603
D 2876 LF 17	6 Cyl.	12816cc	338kW (460PS)	Diesel Turbo Intercooler	TD28967
D 2876 LF 18 Euro 3	6 Cyl.	12816cc	265kW (360PS)	Diesel Turbo Intercooler	TD23078
D 2876 LF 19 Euro 3	6 Cyl.	12816cc	265kW (360PS)	Diesel Turbo Intercooler	TD23080
D 2876 LF 20 Euro 3	6 Cyl.	12816cc	375kW (510PS)	Diesel Turbo Intercooler	TD23008
D 2876 LF 23 Euro 3	6 Cyl.	12816cc	324kW (440PS)	Diesel Turbo Intercooler	TD23079
D 2876 LFG 01 Euro 3	6 Cyl.	12816cc	338kW (460PS)	Diesel Turbo Intercooler	TD28968
D 2876 LOH 01 Euro 2	6 Cyl.	12816cc	338kW (460PS)	Diesel Turbo Intercooler	TD16249
D 2876 LUE 604	6 Cyl.	12816cc	375kW (510PS)	Diesel Turbo Intercooler	TD27939
D 2876 LUE 605	6 Cyl.	12816cc	338kW (460PS)	Diesel Turbo Intercooler	TD27938
D 2876 LUE 606	6 Cyl.	12816cc	301kW (409PS)	Diesel Turbo Intercooler	TD27937
D 2876 LUE 621	6 Cyl.	12816cc	257kW (350PS)	Diesel Turbo Intercooler	TD27940
D 2876 LUE 622	6 Cyl.	12816cc	338kW (460PS)	Diesel Turbo Intercooler	TD27941
D 2876 LUE 623	6 Cyl.	12816cc	382kW (520PS)	Diesel Turbo Intercooler	TD27942
D 2876 LUE 631	6 Cyl.	12816cc	390kW (530PS)	Diesel Turbo Intercooler	TD27945
D 2876 LUE 632	6 Cyl.	12816cc	353kW (480PS)	Diesel Turbo Intercooler	TD27944
D 2876 LUE 633	6 Cyl.	12816cc	294kW (400PS)	Diesel Turbo Intercooler	TD27943
D 2876 LUH 01 Euro 2	6 Cyl.	12816cc	294kW (400PS)	Diesel Turbo Intercooler	TD28969
D 2876 LUH 02 Euro 2	6 Cyl.	12816cc	316kW (430PS)	Diesel Turbo Intercooler	TD28970

BE/PL	1	89,980/90,000	95,000/95,022	36,200	2,478	0,060/0,122	SP	71-4746	71-4746 STD 0.25	[1]
MB/HL 1-7	7	103,980/104,000	111,000/111,022	36,000	3,478	0,060/0,126	EC	72-4527	H1239/7 STD 0.25 0.50	[4]

06/99 →

MB/HL	6	103,980/104,000	111,000/111,022	36,000	3,478	0,060/0,126	EC	72-3562	H992/7 STD 0.25 0.50 0.75	
MB/HL	1	103,980/104,000	111,000/111,022	45,810	3,478	0,060/0,126	EC	72-3563H		

→05/99



72-3563H	STD	46,000/1.8110" - 46,062/1.8135"
	0.25mm	46,500/1.8307" - 46,562/1.8331"
	0.50mm	46,500/1.8307" - 46,562/1.8331"
	0.75mm	47,000/1.8504" - 47,062/1.8528"
	1.00mm	47,000/1.8504" - 47,062/1.8528"

TW/A	2	114,400/114,750	137,650/138,000		3,400		AL-LF	04-3947	A159/4 STD	
TW/A	2	114,400/114,750	137,650/138,000		3,400		AL-LF	04-3948		

06/99 →

SE/PB	1	49,994/50,000	54,000/54,030	38,700			BC	55-3813	55-3813 SEMI	
SE/PB	1	51,992/51,998	56,000/56,030	45,500			BC-LF	55-4584	55-4584 SEMI	[6]
SE/PB	1	49,994/50,000	54,000/54,030	41,220			BC	55-4832	55-4832 SEMI	[8]
CB/NWB	1	69,910/69,940	75,000/75,030	36,000	2,500		BB	13-3102	N109/7L STD SEMI	[13]
CB/NWB	5	69,910/69,940	75,000/75,030	28,000	2,500		BB	13-3103		
CB/NWB	1	69,910/69,940	76,000/76,030	39,000	3,000		EC	53-3104H		
BU	1	28,000	31,000/31,062	22,500			BC	56-3949	56-3949 SEMI	

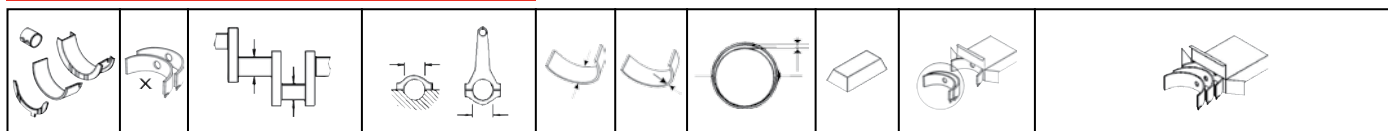

49 128.00 x 166.00









D 2876 LF 03 Euro 3	6 Cyl.	12816cc	338kW (460PS)	Diesel Turbo Intercooler	TD17050
D 2876 LF 04 Euro 3	6 Cyl.	12816cc	338kW (460PS)	Diesel Turbo Intercooler	TD15051
D 2876 LF 05 Euro 3	6 Cyl.	12816cc	375kW (510PS)	Diesel Turbo Intercooler	TD16206
D 2876 LF 07 Euro 2	6 Cyl.	12816cc	338kW (460PS)	Diesel Turbo Intercooler	TD15049
D 2876 LF 12 Euro 3	6 Cyl.	12816cc	353kW (480PS)	Diesel Turbo Intercooler	TD16825
D 2876 LF 13 Euro 3	6 Cyl.	12816cc	390kW (530PS)	Diesel Turbo Intercooler	TD16826
D 2876 LF 25 Euro 2	6 Cyl.	12816cc	353kW (480PS)	Diesel Turbo Intercooler	TD19115
D 2876 LOH 02 Euro 3	6 Cyl.	12816cc	338kW (460PS)	Diesel Turbo Intercooler	TD16509
D 2876 LOH 03 Euro 3	6 Cyl.	12816cc	338kW (460PS)	Diesel Turbo Intercooler	TD16298
D 2876 LOH 20 Euro 3	6 Cyl.	12816cc	353kW (480PS)	Diesel Turbo Intercooler	TD16762
D 2876 LOH 21 Euro 3	6 Cyl.	12816cc	390kW (530PS)	Diesel Turbo Intercooler	TD18041

BE/PL	1	89,980/90,000	95,000/95,022	36,200	2,478	0,060/0,122	SP	71-4746	71-4746 STD 0.25	[1]
MB/HL 1-7	7	103,980/104,000	111,000/111,022	36,000	3,478	0,060/0,126	EC	72-4527	H1239/7 STD 0.25 0.50	[4]
TW/A	2	114,400/114,750	137,650/138,000		3,400		AL-LF	04-3947	A159/4 STD	
TW/A	2	114,400/114,750	137,650/138,000		3,400		AL-LF	04-3948		
SE/PB	1	49,994/50,000	54,000/54,030	38,700			BC	55-3813	55-3813 SEMI	
SE/PB	1	51,992/51,998	56,000/56,030	45,500			BC-LF	55-4584	55-4584 SEMI	[6]
SE/PB	1	49,994/50,000	54,000/54,030	41,220			BC	55-4832	55-4832 SEMI	[8]
CB/NWB	1	69,910/69,940	75,000/75,030	36,000	2,500		BB	13-3102	N109/7L STD SEMI	[13]
CB/NWB	5	69,910/69,940	75,000/75,030	28,000	2,500		BB	13-3103		
CB/NWB	1	69,910/69,940	76,000/76,030	39,000	3,000		EC	53-3104H		
BU	1	28,000	31,000/31,062	22,500			BC	56-3949	56-3949 SEMI	

50 128.00 x 166.00

E 2876 LUH 02	6 Cyl.	12816cc	228kW (310PS)	Gas Turbo Intercooler	TD19966
E 2876 LUH 03	6 Cyl.	12816cc	228-235kW (310-320PS)	Gas Turbo Intercooler	TD23804

BE/PL	1	89,980/90,000	95,000/95,022	36,200	2,478	0,060/0,122	SP	71-4746	71-4746 STD 0.25	[1]
MB/HL 1-7	7	103,980/104,000	111,000/111,022	36,000	3,478	0,060/0,126	EC	72-4527	H1239/7 STD 0.25 0.50	[4]
TW/A	2	114,400/114,750	137,650/138,000		3,400		AL-LF	04-3947	A159/4 STD	
TW/A	2	114,400/114,750	137,650/138,000		3,400		AL-LF	04-3948		
SE/PB	1	51,992/51,998	56,000/56,030	45,500			BC-LF	55-4584	55-4584 SEMI	[6]
CB/NWB	1	69,910/69,940	75,000/75,030	36,000	2,500		BB	13-3102	N109/7L STD SEMI	[13]
CB/NWB	5	69,910/69,940	75,000/75,030	28,000	2,500		BB	13-3103		
CB/NWB	1	69,910/69,940	76,000/76,030	39,000	3,000		EC	53-3104H		
BU	1	28,000	31,000/31,062	22,500			BC	56-3949	56-3949 SEMI	









				cm3	x				
2 1.2	02/03→	Petrol	FUJA	1242	4	71.90	76.50	5	
2 1.25	04/03→	Petrol	FUJA	1242	4	71.90	76.50	5	
2 1.4	02/03→	Petrol	FXJA	1388	4	76.00	76.50	10	
2 1.4 CD	04/03→	Diesel	F6JA	1399	4	73.70	82.00	7	
2 1.4 CD	04/03→	Diesel	F6JB	1399	4	73.70	82.00	7	
2 1.6	02/03→	Petrol	FYJA	1596	4	79.00	81.40	19	
3 1.4	02/04→06/09	Petrol	FXJA	1388	4	76.00	76.50	10	
121 I 1.1	10/87→10/90	Petrol	B1	1139	4	68.00	78.40	1	
121 I 1.1	10/87→10/90	Petrol	B116	1139	4	68.00	78.40	1	
121 I 1.3	10/87→11/90	Petrol	B3	1324	4	71.00	83.60	3	
121 I 1.3	11/87→10/90	Petrol	B3A5	1324	4	71.00	83.60	3	
121 I 1.5	11/87→03/89	Petrol	B518	1498	4	78.00	78.40	15	
121 I 1.5	11/87→03/89	Petrol	B573	1498	4	78.00	78.40	15	
121 II 1.1	11/90→10/93	Petrol	B1	1139	4	68.00	78.40	1	
121 II 1.3 16V	11/90→03/96	Petrol	B3 (16V)	1324	4	71.00	83.60	4	
121 II 1.3 i 16V	11/90→03/96	Petrol	B3 (16V)	1324	4	71.00	83.60	4	
121 II 1.5 i	01/94→05/97	Petrol	B5C4	1498	4	78.00	78.40	15	
121 III 1.25	03/96→04/03	Petrol	DHF	1242	4	71.90	76.50	5	
121 III 1.25	03/96→04/03	Petrol	DHG	1242	4	71.90	76.50	5	
121 III 1.3	03/96→04/03	Petrol	J4R	1299	4	74.00	75.50	8	
121 III 1.3	03/96→04/03	Petrol	J4T	1299	4	74.00	75.50	8	
121 III 1.3	03/96→04/03	Petrol	JJK	1299	4	74.00	75.50	9	
121 III 1.3	03/96→04/03	Petrol	JJM	1299	4	74.00	75.50	9	
121 III 1.8 D	03/96→04/03	Diesel	RTJ	1753	4	82.50	82.00	22	
121 III 1.8 D	03/96→04/03	Diesel	RTK	1753	4	82.50	82.00	22	
323 C IV 1.3	09/89→07/94	Petrol	B3E	1324	4	71.00	83.60	3	
323 C IV 1.3 16V	09/89→07/94	Petrol	B3 (16V)	1324	4	71.00	83.60	4	
323 C IV 1.6	09/93→09/00	Petrol	B67K	1597	4	78.00	83.60	17	
323 C IV 1.6	09/89→06/91	Petrol	B6E	1598	4	78.00	83.60	17	
323 C IV 1.6 16V	03/91→10/94	Petrol	B6	1598	4	78.00	83.60	17	
323 C IV 1.8 16V 4WD	11/91→12/93	Petrol	BP	1840	4	83.00	85.00	23	
323 C IV 1.8 16V GT	09/89→03/93	Petrol	BP (DOHC)	1840	4	83.00	85.00	23	
323 C IV 1.8 16V Turbo 4WD	09/90→07/94	Petrol	BP Turbo	1840	4	83.00	85.00	23	
323 C V 1.3 16V	08/94→09/98	Petrol	B3 (16V)	1324	4	71.00	83.60	4	
323 C V 1.8	08/94→09/98	Petrol	BP (DOHC)	1840	4	83.00	85.00	23	
323 C V 1.8 16V	08/94→09/98	Petrol	BP-ZE	1840	4	83.00	85.00	23	
323 F IV 1.6	04/91→04/94	Petrol	B67J	1597	4	78.00	83.60	17	
323 F IV 1.6	04/91→04/94	Petrol	B67K	1597	4	78.00	83.60	17	
323 F IV 1.6	04/91→04/94	Petrol	B67L	1597	4	78.00	83.60	17	
323 F IV 1.6	04/87→08/93	Petrol	B6 (SOHC)	1598	4	78.00	83.60	17	
323 F IV 1.6	09/89→06/91	Petrol	B6E	1598	4	78.00	83.60	17	
323 F IV 1.6	04/87→08/93	Petrol	B6T	1598	4	78.00	83.60	18	
323 F IV 1.6 16V	03/91→10/94	Petrol	B6	1598	4	78.00	83.60	17	
323 F IV 1.8 16V	08/89→07/94	Petrol	BP	1840	4	83.00	85.00	23	
323 F IV 1.8 16V GT	08/89→07/94	Petrol	BP (DOHC)	1840	4	83.00	85.00	23	
323 F V 1.8 16V	08/94→09/98	Petrol	BP (DOHC)	1840	4	83.00	85.00	23	
323 F V 1.8 16V	08/94→09/98	Petrol	BP-ZE	1840	4	83.00	85.00	23	
323 F VI 1.4	09/98→05/04	Petrol	B3 (16V)	1324	4	71.00	83.60	4	
323 F VI 1.6	09/98→05/04	Petrol	B6 (SOHC)	1598	4	78.00	83.60	17	
323 F VI 1.8 Astina	09/98→05/04	Petrol	BP (DOHC)	1840	4	83.00	85.00	23	
323 F VI 1.9 16V	09/98→01/01	Petrol	FP	1840	4	83.00	85.00	24	
323 F VI 1.9 16V	09/98→01/01	Petrol	FP55	1840	4	83.00	85.00	24	
323 F VI 2.0	02/00→05/04	Petrol	FS	1991	4	83.00	92.00	25	
323 F VI 2.0	01/01→05/04	Petrol	FS7E	1991	4	83.00	92.00	25	
323 F VI 2.0	01/01→05/04	Petrol	FS7G	1991	4	83.00	92.00	25	
323 F VI 2.0 TD	01/01→05/04	Diesel	RF4F	1998	4	86.00	86.00	29	
323 I 1.3	01/77→05/86	Petrol	TC	1272	4	73.00	76.00	6	
323 I 1.4	05/78→08/82	Petrol	UC	1415	4	77.00	76.00	12	
323 I 1.5	01/82→05/86	Petrol	D5	1490	4	77.00	80.00	13	
323 II 1.1	11/80→10/85	Petrol	E1	1071	4	70.00	69.60	2	
323 II 1.3	11/80→10/89	Petrol	E3	1296	4	77.00	69.60	11	
323 II 1.3	04/87→05/89	Petrol	B335	1324	4	71.00	83.60	3	
323 II 1.5	08/82→04/85	Petrol	D5	1490	4	77.00	80.00	13	
323 II 1.5	10/80→09/86	Petrol	E5	1490	4	77.00	80.00	13	
323 III 1.1	08/85→04/90	Petrol	E1	1071	4	70.00	69.60	2	
323 III 1.3	08/85→04/90	Petrol	E3	1296	4	77.00	69.60	11	
323 III 1.3	04/87→05/89	Petrol	B315	1324	4	71.00	83.60	3	
323 III 1.3 i	09/85→08/89	Petrol	B3E	1324	4	71.00	83.60	3	
323 III 1.4	04/87→10/89	Petrol	B3	1324	4	71.00	83.60	3	









cm3 x









323 III 1.5	08/85→05/89	Petrol	E5	1490	4	77.00	80.00	13
323 III 1.5	01/87→09/91	Petrol	B5	1498	4	78.00	78.40	15
323 III 1.5	05/86→05/89	Petrol	B53	1498	4	78.00	78.40	15
323 III 1.5 i	08/85→05/89	Petrol	E5E3	1490	4	77.00	80.00	13
323 III 1.5 i Turbo	08/85→05/89	Petrol	E5E2	1490	4	77.00	80.00	13
323 III 1.5 LX	01/86→06/87	Petrol	E5	1490	4	77.00	80.00	13
323 III 1.6	09/86→10/95	Petrol	B6 (SOHC)	1598	4	78.00	83.60	17
323 III 1.6	09/86→10/95	Petrol	B6E	1598	4	78.00	83.60	17
323 III 1.6 4x4	05/90→03/93	Petrol	B6E	1598	4	78.00	83.60	17
323 III 1.6 4WD	06/86→03/87	Petrol	B6T	1598	4	78.00	83.60	18
323 III 1.6 GT	08/85→08/93	Petrol	B6 (SOHC)	1598	4	78.00	83.60	17
323 III 1.6 GT Turbo	10/85→08/93	Petrol	B6T	1598	4	78.00	83.60	18
323 III 1.6 GT Turbo 4WD	10/87→11/91	Petrol	B6T	1598	4	78.00	83.60	18
323 III 1.6 Turbo	09/87→12/88	Petrol	B6T	1598	4	78.00	83.60	18
323 III 1.8	09/92→10/98	Petrol	BPF1	1840	4	83.00	85.00	23
323 P V 1.3 16V	10/96→09/98	Petrol	B3 (16V)	1324	4	71.00	83.60	4
323 S IV 1.3	09/89→06/91	Petrol	B3E	1324	4	71.00	83.60	3
323 S IV 1.3 16V	04/91→07/94	Petrol	B3 (16V)	1324	4	71.00	83.60	4
323 S IV 1.6	06/89→03/91	Petrol	B61V	1597	4	78.00	83.60	17
323 S IV 1.6	04/91→10/94	Petrol	B6	1598	4	78.00	83.60	17
323 S IV 1.6	06/89→	Petrol	B6 (SOHC)	1598	4	78.00	83.60	17
323 S IV 1.6	09/89→06/91	Petrol	B6E	1598	4	78.00	83.60	17
323 S IV 1.6 16V	08/89→10/94	Petrol	B6	1598	4	78.00	83.60	17
323 S IV 1.8 16V	08/89→07/94	Petrol	BP52	1840	4	83.00	85.00	23
323 S IV 1.8 16V 4WD	09/91→07/94	Petrol	BP52	1840	4	83.00	85.00	23
323 S IV 1.8 16V GT	06/89→07/94	Petrol	BP (DOHC)	1840	4	83.00	85.00	23
323 S IV 1.8 16V Turbo 4WD	01/91→07/94	Petrol	BP Turbo	1840	4	83.00	85.00	23
323 S V 1.3 16V	08/94→09/98	Petrol	B3 (16V)	1324	4	71.00	83.60	4
323 S V 1.6	08/94→09/98	Petrol	B6 (DOHC)	1598	4	78.00	83.60	17
323 S V 1.6 TD	05/94→09/98	Diesel	4EE1-T	1686	4	79.00	86.00	20
323 S V 1.8	07/94→09/98	Petrol	BP (DOHC)	1840	4	83.00	85.00	23
323 S V 1.8 16V	08/94→09/98	Petrol	BP-ZE	1840	4	83.00	85.00	23
323 S VI 1.4	01/01→05/04	Petrol	B3 (16V)	1324	4	71.00	83.60	4
323 S VI 1.6	09/98→02/01	Petrol	B6 (DOHC)	1598	4	78.00	83.60	17
323 S VI 1.8 Protege	05/98→05/04	Petrol	BP (DOHC)	1840	4	83.00	85.00	23
323 S VI 1.9 16V	09/98→05/04	Petrol	FP	1840	4	83.00	85.00	24
323 S VI 1.9 16V	09/98→05/04	Petrol	FP55	1840	4	83.00	85.00	24
323 S VI 2.0	02/00→05/04	Petrol	FS	1991	4	83.00	92.00	25
323 S VI 2.0	01/01→05/04	Petrol	FS7E	1991	4	83.00	92.00	25
323 S VI 2.0	01/01→05/04	Petrol	FS7G	1991	4	83.00	92.00	25
323 S VI 2.0 DiTD	10/00→10/02	Diesel	RF4F	1998	4	86.00	86.00	29
626 II 1.6	11/82→09/87	Petrol	F6	1587	4	81.00	77.00	21
626 II 1.6	03/83→09/87	Petrol	F603	1587	4	81.00	77.00	21
626 II 1.6	03/83→09/87	Petrol	F658	1587	4	81.00	77.00	21
626 II 2.0	02/83→10/87	Petrol	FE (8V)	1998	4	86.00	86.00	28
626 II 2.0 D	11/82→06/87	Diesel	RF46	1998	4	86.00	86.00	29
626 III 1.6	06/87→05/92	Petrol	F6	1587	4	81.00	77.00	21
626 III 1.8	09/87→05/92	Petrol	F8 (12V)	1789	4	86.00	77.00	27
626 III 2.0	09/87→09/97	Petrol	FE (8V)	1998	4	86.00	86.00	28
626 III 2.0	10/87→07/89	Petrol	FE4J	1998	4	86.00	86.00	28
626 III 2.0	10/87→07/89	Petrol	FE4K	1998	4	86.00	86.00	28
626 III 2.0 4x4	08/89→07/91	Petrol	FEFL	1998	4	86.00	86.00	28
626 III 2.0 16V	06/87→05/92	Petrol	FE (16V)	1998	4	86.00	86.00	28
626 III 2.0 D	07/87→07/91	Diesel	RF-N	1998	4	86.00	86.00	29
626 III 2.0 D Compreh	05/93→11/96	Diesel	RF-CX	1998	4	86.00	86.00	29
626 III 2.0 GLX	04/92→02/95	Petrol	FS	1991	4	83.00	92.00	25
626 III 2.0 i 16V	11/94→09/97	Petrol	FECM	1998	4	86.00	86.00	28
626 III 2.2 12V	11/87→11/96	Petrol	F2	2184	4	86.00	94.00	30
626 III 2.2 12V 4WD	11/87→11/92	Petrol	F2	2184	4	86.00	94.00	30
626 III 2.2 12V 4WD	05/91→11/92	Petrol	F2L1	2184	4	86.00	94.00	30
626 IV 1.8	08/91→04/97	Petrol	FP	1840	4	83.00	85.00	24
626 IV 1.8 i	01/92→06/97	Petrol	FP	1840	4	83.00	85.00	24
626 IV 2.0 D GLX Compreh	10/92→04/97	Diesel	RF OHC	1998	4	86.00	86.00	29
626 IV 2.0 i	08/91→04/97	Petrol	FS	1991	4	83.00	92.00	25
626 IV 2.0 i 4WD	04/92→04/97	Petrol	FS	1991	4	83.00	92.00	25
626 V 1.6	07/97→07/99	Petrol	B6EW	1598	4	78.00	83.60	17
626 V 1.8	12/99→10/02	Petrol	FP	1840	4	83.00	85.00	24
626 V 1.8	12/99→10/02	Petrol	FP9A	1840	4	83.00	85.00	24
626 V 1.8	05/97→01/00	Petrol	FPY3	1840	4	83.00	85.00	24

				cm ³	x 			
626 V 2.0	05/97→10/02	Petrol	FS	1991	4	83.00	92.00	25
626 V 2.0	04/98→10/02	Petrol	FS2C	1991	4	83.00	92.00	25
626 V 2.0 H.P.	02/98→10/02	Petrol	FS2C	1991	4	83.00	92.00	25
626 V 2.0 Turbo DI	04/98→10/02	Diesel	RF4F	1998	4	86.00	86.00	29
818 1.3	01/74→10/78	Petrol	TC	1272	4	73.00	76.00	6
929 II 2.0	03/84→07/87	Petrol	FE (8V)	1998	4	86.00	86.00	28
929 II 2.0 i GLX	10/84→07/87	Petrol	FE (8V)	1998	4	86.00	86.00	28
929 III 2.0	06/87→12/88	Petrol	FE (8V)	1998	4	86.00	86.00	28
929 III 2.2 12V	01/88→04/89	Petrol	F2	2184	4	86.00	94.00	30
929 III 2.2 12V	04/89→06/91	Petrol	F2-C	2184	4	86.00	94.00	30
929 III 2.2 12V	01/88→04/89	Petrol	F2E	2184	4	86.00	94.00	30
929 III 2.2 12V	01/88→04/89	Petrol	F21	2184	4	86.00	94.00	30
929 III 2.2 i	05/87→12/88	Petrol	F2-EGI	2184	4	86.00	94.00	30
1300 1.3	01/75→01/77	Petrol	TC	1272	4	73.00	76.00	6
B-Serie 1.6	01/85→03/96	Petrol	F6	1587	4	81.00	77.00	21
B-Serie 1.6	10/81→12/84	Petrol	H629	1587	4	78.00	83.00	16
B-Serie 1.8	04/94→	Petrol	F8 (8V)	1789	4	86.00	77.00	27
B-Serie 2.0	01/85→03/96	Petrol	FE (8V)	1998	4	86.00	86.00	28
B-Serie 2.2	07/93→05/94	Petrol	F2IB	2184	4	86.00	94.00	30
B-Serie 2.2	08/91→12/96	Petrol	F2L8	2184	4	86.00	94.00	30
B-Serie 2.2 D	03/85→10/89	Diesel	R2	2184	4	86.00	94.00	31
B-Serie 2.2 i	03/88→11/91	Petrol	F2IB	2184	4	86.00	94.00	30
B-Serie 2.2 i	03/88→11/91	Petrol	F2L5	2184	4	86.00	94.00	30
B-Serie 2.6 4WD	01/87→10/90	Petrol	4G54	2555	4	91.10	98.00	32
B-Serie 2.6 4WD	03/87→10/91	Petrol	G54B	2555	4	91.10	98.00	32
B-Serie 2.6 i 4x4	01/87→10/91	Petrol	4G54	2555	4	91.10	98.00	32
Demio 1.3 i 16V	08/98→04/00	Petrol	B3 (16V)	1324	4	71.00	83.60	4
E-Serie E1400	05/78→06/84	Petrol	UC	1415	4	77.00	76.00	12
E-Serie E1400	07/84→03/88	Petrol	E5	1490	4	77.00	80.00	13
E-Serie E1800	02/84→01/88	Petrol	F8 (12V)	1789	4	86.00	77.00	27
E-Serie E1800i	02/03→12/06	Petrol	F8 (8V)	1789	4	86.00	77.00	27
E-Serie E2000	01/84→07/06	Petrol	FE (8V)	1998	4	86.00	86.00	28
E-Serie E2000 4WD	10/88→09/89	Petrol	FE (8V)	1998	4	86.00	86.00	28
E-Serie E2200 D	02/97→08/02	Diesel	R2	2184	4	86.00	94.00	31
E-Serie E2200 D 4WD	01/84→05/03	Diesel	R2	2184	4	86.00	94.00	31
E-Serie MPV 2.0 i	06/95→09/99	Petrol	FE (8V)	1998	4	86.00	86.00	28
Familia 1.8	01/07→	Petrol	MR18DE	1798	4	84.00	81.10	26
Festiva 1.3	04/89→10/90	Petrol	B3A5	1324	4	71.00	83.60	3
J80 1.4	10/82→06/89	Petrol	UC17	1415	4	77.00	76.00	12
MPV II 2.0	08/00→07/02	Petrol	FS	1991	4	83.00	92.00	25
MX-5 I 1.8	02/94→04/98	Petrol	BP (DOHC)	1840	4	83.00	85.00	23
MX-5 I 1.8	09/93→04/98	Petrol	BPF1	1840	4	83.00	85.00	23
MX-5 II 1.8	08/02→10/05	Petrol	BP6J	1839	4	83.00	85.00	23
MX-5 II 1.8 16V	05/98→10/05	Petrol	BP-ZE	1840	4	83.00	85.00	23
MX-5 II 1.8 i	04/02→10/05	Petrol	BP4W	1840	4	83.00	85.00	23
MX-5 II 1.8 i Turbo	01/02→10/05	Petrol	BP Turbo	1840	4	83.00	85.00	23
MX-6 1.8	12/95→02/97	Petrol	FP9A	1840	4	83.00	85.00	24
MX-6 2.0	02/92→02/97	Petrol	FS	1991	4	83.00	92.00	25
Premacy 1.9	07/99→03/05	Petrol	FP	1840	4	83.00	85.00	24
Premacy 2.0	11/01→03/05	Petrol	FS7E	1991	4	83.00	92.00	25
Premacy 2.0	11/01→03/05	Petrol	FS7G	1991	4	83.00	92.00	25
Premacy 2.0 TD	07/00→03/05	Diesel	RF4F	1998	4	86.00	86.00	29
Spectron 1.4	10/82→07/88	Petrol	UC17	1415	4	77.00	76.00	12
Spectron 2.0	08/86→10/95	Petrol	FEKN	1998	4	86.00	86.00	28
Spectron 2.0 D	08/86→10/95	Diesel	RF46	1998	4	86.00	86.00	29
Spectron 2.2 TD	08/86→10/95	Diesel	R2	2184	4	86.00	94.00	31
Xedos 6 1.6 16V	06/94→10/99	Petrol	B6 (DOHC)	1598	4	78.00	83.60	17

		cm3	x 			
--	---	-----	---	---	---	---

4EE1-T	Diesel	1686	4	79.00	86.00	20
4G54	Petrol	2555	4	91.10	98.00	32
B1	Petrol	1139	4	68.00	78.40	1
B3	Petrol	1324	4	71.00	83.60	3
B3 (16V)	Petrol	1324	4	71.00	83.60	4
B3A5	Petrol	1324	4	71.00	83.60	3
B3E	Petrol	1324	4	71.00	83.60	3
B5	Petrol	1498	4	78.00	78.40	15
B5C4	Petrol	1498	4	78.00	78.40	15
B5C5	Petrol	1498	4	78.00	78.40	15
B6	Petrol	1598	4	78.00	83.60	17
B6 (DOHC)	Petrol	1598	4	78.00	83.60	17
B6 (SOHC)	Petrol	1598	4	78.00	83.60	17
B6E	Petrol	1598	4	78.00	83.60	17
B6EW	Petrol	1598	4	78.00	83.60	17
B6T	Petrol	1598	4	78.00	83.60	18
B53	Petrol	1498	4	78.00	78.40	15
B61V	Petrol	1597	4	78.00	83.60	17
B67J	Petrol	1597	4	78.00	83.60	17
B67K	Petrol	1597	4	78.00	83.60	17
B67L	Petrol	1597	4	78.00	83.60	17
B116	Petrol	1139	4	68.00	78.40	1
B315	Petrol	1324	4	71.00	83.60	3
B335	Petrol	1324	4	71.00	83.60	3
B518	Petrol	1498	4	78.00	78.40	15
B572	Petrol	1498	4	78.00	78.40	15
B573	Petrol	1498	4	78.00	78.40	15
BJ-E	Petrol	1290	4	78.00	67.50	14
BP (DOHC)	Petrol	1840	4	83.00	85.00	23
BP	Petrol	1840	4	83.00	85.00	23
BP4W	Petrol	1840	4	83.00	85.00	23
BP6J	Petrol	1839	4	83.00	85.00	23
BP52	Petrol	1840	4	83.00	85.00	23
BPF1	Petrol	1840	4	83.00	85.00	23
BP Turbo	Petrol	1840	4	83.00	85.00	23
BP-ZE	Petrol	1840	4	83.00	85.00	23
D5	Petrol	1490	4	77.00	80.00	13
DHF	Petrol	1242	4	71.90	76.50	5
DHG	Petrol	1242	4	71.90	76.50	5
E1	Petrol	1071	4	70.00	69.60	2
E3	Petrol	1296	4	77.00	69.60	11
E5	Petrol	1490	4	77.00	80.00	13
E5E2	Petrol	1490	4	77.00	80.00	13
E5E3	Petrol	1490	4	77.00	80.00	13
F2	Petrol	2184	4	86.00	94.00	30
F2-C	Petrol	2184	4	86.00	94.00	30
F2E	Petrol	2184	4	86.00	94.00	30
F2-EGI	Petrol	2184	4	86.00	94.00	30
F2G	Petrol	2184	4	86.00	94.00	30
F2IB	Petrol	2184	4	86.00	94.00	30
F2L1	Petrol	2184	4	86.00	94.00	30
F2L5	Petrol	2184	4	86.00	94.00	30
F2L8	Petrol	2184	4	86.00	94.00	30
F6	Petrol	1587	4	81.00	77.00	21
F6JA	Diesel	1399	4	73.70	82.00	7
F6JB	Diesel	1399	4	73.70	82.00	7
F8 (12V)	Petrol	1789	4	86.00	77.00	27
F8 (8V)	Petrol	1789	4	86.00	77.00	27
F21	Petrol	2184	4	86.00	94.00	30
F603	Petrol	1587	4	81.00	77.00	21
F658	Petrol	1587	4	81.00	77.00	21
F659	Petrol	1597	4	81.00	77.00	21
FE (8V)	Petrol	1998	4	86.00	86.00	28
FE (16V)	Petrol	1998	4	86.00	86.00	28
FE4J	Petrol	1998	4	86.00	86.00	28
FE4K	Petrol	1998	4	86.00	86.00	28
FECM	Petrol	1998	4	86.00	86.00	28
FEFL	Petrol	1998	4	86.00	86.00	28
FEKN	Petrol	1998	4	86.00	86.00	28

			cm3	x 			
FP	Petrol		1840	4	83.00	85.00	24
FP9A	Petrol		1840	4	83.00	85.00	24
FP55	Petrol		1840	4	83.00	85.00	24
FPY3	Petrol		1840	4	83.00	85.00	24
FS	Petrol		1991	4	83.00	92.00	25
FS2C	Petrol		1991	4	83.00	92.00	25
FS7E	Petrol		1991	4	83.00	92.00	25
FS7G	Petrol		1991	4	83.00	92.00	25
FUJA	Petrol		1242	4	71.90	76.50	5
FXJA	Petrol		1388	4	76.00	76.50	10
FYJA	Petrol		1596	4	79.00	81.40	19
G54B	Petrol		2555	4	91.10	98.00	32
H629	Petrol		1587	4	78.00	83.00	16
HA	Diesel		2977	4	95.00	105.00	33
J4R	Petrol		1299	4	74.00	75.50	8
J4T	Petrol		1299	4	74.00	75.50	8
JJA	Petrol		1299	4	74.00	75.50	9
JJK	Petrol		1299	4	74.00	75.50	9
JJM	Petrol		1299	4	74.00	75.50	9
MR18DE	Petrol		1798	4	84.00	81.10	26
R2	Diesel		2184	4	86.00	94.00	31
RF4F	Diesel		1998	4	86.00	86.00	29
RF46	Diesel		1998	4	86.00	86.00	29
RF-CX	Diesel		1998	4	86.00	86.00	29
RFH7	Diesel		1998	4	86.00	86.00	29
RF-N	Diesel		1998	4	86.00	86.00	29
RF OHC	Diesel		1998	4	86.00	86.00	29
RTJ	Diesel		1753	4	82.50	82.00	22
RTK	Diesel		1753	4	82.50	82.00	22
SL	Diesel		3455	4	100.00	110.00	34
TC	Petrol		1272	4	73.00	76.00	6
UC	Petrol		1415	4	77.00	76.00	12
UC17	Petrol		1415	4	77.00	76.00	12



1										68.00 x 78.40									
B1		4 Cyl.		1139cc		38-42kW (52-57PS)		Petrol										TD1911	
B116		4 Cyl.		1139cc		38-42kW (52-57PS)		Petrol										TD1913	
BE/PL	8	39,940		43,020	17,130	1,510		AL-LF	64-313-1									01-4343/4 STD	
MB/HL 1-5	5	49,940		54,020	17,500	2,010		AL	63-317-1									H1192/5 STD	
MB/HL 1-5	5	49,940		54,020	17,500	2,010		AL	63-317-2										
03/89 →																			

2										70.00 x 69.60									
E1		4 Cyl.		1071cc		40kW (54PS)		Petrol										TD4640	
BE/PL	8	39,940		43,020	17,130	1,510		AL-LF	64-313-1									01-4343/4 STD	

3										71.00 x 83.60									
B3		4 Cyl.		1324cc		40-44kW (54-60PS)		Petrol										TD4634	
B3E		4 Cyl.		1324cc		49kW (67PS)		Petrol										TD1916	
B3A5		4 Cyl.		1324cc		48kW (65PS)		Petrol										TD31518	
B315		4 Cyl.		1324cc		50kW (68PS)		Petrol										TD31290	
B335		4 Cyl.		1324cc		50kW (68PS)		Petrol										TD31575	
BE/PL	8	39,940		43,020	17,130	1,510		AL-LF	64-313-1									01-4343/4 STD	
MB/HL 1-5	5	49,940		54,020	17,500	2,010		AL	63-317-1									H1192/5 STD	
MB/HL 1-5	5	49,940		54,020	17,500	2,010		AL	63-317-2										
03/89 →																			

4										71.00 x 83.60									
B3 (16V)		4 Cyl.		1324cc		39-54kW (53-73PS)		Petrol										TD1918	
BE/PL	8	39,940		43,020	17,130	1,510		AL-LF	64-313-1									01-4343/4 STD	
MB/HL 1-5	5	49,940		54,020	17,500	2,010		AL	63-317-1									H1192/5 STD	
MB/HL 1-5	5	49,940		54,020	17,500	2,010		AL	63-317-2										

5										71.90 x 76.50									
DHF		4 Cyl.		1242cc		55kW (75PS)		Petrol										TD18699	
DHG		4 Cyl.		1242cc		55kW (75PS)		Petrol										TD18700	
FUJA		4 Cyl.		1242cc		55kW (75PS)		Petrol										TD18694	
BE/PL	4	39,980/40,000		43,025/43,045	15,000	1,506	0,020/0,052	AL	4415RA									01-4162/4 STD 0.25	
MB/HL 1,2,4,5	4	47,980/48,000		54,020/54,038	16,100	3,013	0,020/0,057	AL-LF	4416RA									H1100/5 STD	
MB/HL 3	1	47,980/48,000		54,020/54,038	23,750	3,013	0,020/0,057	AL-LF	4417RAH										

	4417RAH	STD	24,000/.9449" - 24,050/.9469"
		0.25mm	24,000/.9449" - 24,050/.9469"



6 73.00 x 76.00

TC		4 Cyl.	1272cc	44-49kW (60-67PS)	Petrol				TD2048
BE/PL	8	39,940	43,020	17,130	1,510		AL-LF	64-313-1	01-4343/4 STD

7 73.70 x 82.00

F6JA		4 Cyl.	1399cc	50kW (68PS)	Diesel Turbo				TD18693
F6JB		4 Cyl.	1399cc	50kW (68PS)	Diesel Turbo				TD20951
BE/PL	1	44,975/44,991	48,665/48,671	17,050	1,820	0,029/0,081	SP	71-3986	71-3986 STD 0.30
MB/HL 1-5	5	49,962/49,981	53,655/53,674	19,900	1,833	0,008/0,046	AL	02-4244	H1066/5 STD 0.30 0.50
TW/A	2	55,200/55,480	71,350/71,700		2,460		AL	04-4245	A217/2 STD
SE/PB	1	24,995/25,000	28,000/28,021	19,980			BS	55-3987	55-3987 SEMI

8 74.00 x 75.50

J4R		4 Cyl.	1299cc	44kW (60PS)	Petrol				TD24680
J4T		4 Cyl.	1299cc	44kW (60PS)	Petrol				TD24681
BE/PL	4	40,990/41,010	43,990/44,010	17,950	1,450	0,080/0,145	AL-LF	4165RA	01-4153/4 STD 0.25 0.75
MB/HL	1	56,990/57,000	60,623/60,636	18,690	1,807	0,020/0,057	AL-LF	4166RA	02-4549 STD 0.25
TW/A	2	63,600	78,100		2,850		AL-LF	66526AF	A209/2 STD

9 74.00 x 75.50

JJA		4 Cyl.	1299cc	37kW (50PS)	Petrol				TD25845
JJK		4 Cyl.	1299cc	37kW (50PS)	Petrol				TD24678
JJM		4 Cyl.	1299cc	37kW (50PS)	Petrol				TD24679
BE/PL	4	40,990/41,010	43,990/44,010	17,950	1,450	0,080/0,145	AL-LF	4165RA	01-4153/4 STD 0.25 0.75
MB/HL	1	56,990/57,000	60,623/60,636	18,690	1,807	0,020/0,057	AL-LF	4166RA	02-4549 STD 0.25
TW/A	2	63,600	78,100		2,850		AL-LF	66526AF	A209/2 STD
CB/NWB 2,3	2	39,615/39,635	42,888/42,913	17,270	1,600		BB	GS128S	N182/3 STD
CB/NWB 1	1	39,615/39,635	42,888/42,913	20,320	1,600		BB	GS129S	

10 76.00 x 76.50

FXJA		4 Cyl.	1388cc	59kW (80PS)	Petrol				TD18695
BE/PL	4	39,980/40,000	43,025/43,045	15,000	1,506	0,020/0,052	AL	4415RA	01-4162/4 STD 0.25
MB/HL 1,2,4,5	4	47,980/48,000	54,020/54,038	16,100	3,013	0,020/0,057	AL-LF	4416RA	H1100/5 STD
MB/HL 3	1	47,980/48,000	54,020/54,038	23,750	3,013	0,020/0,057	AL-LF	4417RAH	



4417RAH STD 24,000/.9449" - 24,050/.9469"
0.25mm 24,000/.9449" - 24,050/.9469"

11 77.00 x 69.60

E3		4 Cyl.	1296cc	44-55kW (60-75PS)	Petrol				TD1955
BE/PL	8	39,940	43,020	17,130	1,510		AL-LF	64-313-1	01-4343/4 STD

MAZDA



12 77.00 x 76.00

UC	4 Cyl.	1415cc	50-56kW (68-76PS)	Petrol	TD5110			
UC17	4 Cyl.	1415cc	52kW (71PS)	Petrol	TD31577			
BE/PL	8	39,940	43,020	17,130	1,510	AL-LF	64-313-1	01-4343/4 STD

13 77.00 x 80.00

D5	4 Cyl.	1490cc	50-59kW (69-80PS)	Petrol	TD1954			
E5	4 Cyl.	1490cc	47-65kW (64-88PS)	Petrol	TD1956			
E5E2	4 Cyl.	1490cc	85kW (115PS)	Petrol	TD18217			
E5E3	4 Cyl.	1490cc	70kW (95PS)	Petrol	TD18216			
BE/PL	8	39,940	43,020	17,130	1,510	AL-LF	64-313-1	01-4343/4 STD

14 78.00 x 67.50

BJ-E	4 Cyl.	1290cc				Petrol	FM9677	
BE/PL	8	44,940	48,020	17,000	1,510	AL-LF	64-317-1	01-4359/4 STD
MB/HL 1-5	5	49,940	54,020	17,500	2,010	AL	63-317-1	H1192/5 STD
MB/HL 1-5	5	49,940	54,020	17,500	2,010	AL	63-317-2	

15 78.00 x 78.40

B5	4 Cyl.	1498cc	54-55kW (73-75PS)	Petrol	TD4636			
B5C4	4 Cyl.	1498cc	62kW (84PS)	Petrol	TD31522			
B5C5	4 Cyl.	1498cc	56kW (76PS)	Petrol	TD31520			
B53	4 Cyl.	1498cc	54-55kW (73-75PS)	Petrol	TD1926			
B518	4 Cyl.	1498cc	56kW (76PS)	Petrol	TD31524			
B572	4 Cyl.	1498cc	56kW (76PS)	Petrol	TD31519			
B573	4 Cyl.	1498cc	56kW (76PS)	Petrol	TD31525			
BE/PL	8	39,940	43,020	17,130	1,510	AL-LF	64-313-1	01-4343/4 STD
MB/HL 1-5	5	49,940	54,020	17,500	2,010	AL	63-317-1	H1192/5 STD
MB/HL 1-5	5	49,940	54,020	17,500	2,010	AL	63-317-2	
TW/A	2	68,875	57,125		2,550	AL-LF	65-317-1	A335/2 STD

16 78.00 x 83.00

H629	4 Cyl.	1587cc	58kW (79PS)	Petrol	TD31538				
BE/PL	4	50,934/50,949	53,997/54,018	21,132	1,509	0,030/0,091	BS	3975P	71-4278/4 STD 0.25 0.50

17 78.00 x 83.60

B6	4 Cyl.	1598cc	64-65kW (87-88PS)	Petrol	TD1930
B6 (DOHC)	4 Cyl.	1598cc	79-80kW (107-109PS)	Petrol	TD9427
B6 (SOHC)	4 Cyl.	1598cc	63-77kW (86-105PS)	Petrol	TD9428
B6E	4 Cyl.	1598cc	62-63kW (84-86PS)	Petrol	TD1931
B6EW	4 Cyl.	1598cc	79kW (107PS)	Petrol	TD26749
B61V	4 Cyl.	1597cc	64kW (87PS)	Petrol	TD31289
B67J	4 Cyl.	1597cc	66kW (90PS)	Petrol	TD31531
B67K	4 Cyl.	1597cc	66kW (90PS)	Petrol	TD31569
B67L	4 Cyl.	1597cc	66kW (90PS)	Petrol	TD31530

BE/PL	8	44,940	48,020	17,000	1,510		AL-LF	64-317-1	01-4359/4 STD	
MB/HL 1-5	5	49,940	54,020	17,500	2,010		AL	63-317-1	H1192/5 STD	
MB/HL 1-5	5	49,940	54,020	17,500	2,010		AL	63-317-2		
TW/A	2	68.875	57.125		2.550		AL-LF	65-317-1	A335/2 STD	

18 78.00 x 83.60

B6T		4 Cyl.		1598cc	98-103kW (134-140PS)		Petrol Turbo Intercooler		TD1932	
BE/PL	8	44,940	48,020	17,000	1,510		AL-LF	64-317-1	01-4359/4 STD	
MB/HL 1-5	5	49,940	54,020	17,500	2,010		AL	63-317-1	H1192/5 STD	
MB/HL 1-5	5	49,940	54,020	17,500	2,010		AL	63-317-2		
01/86→										
TW/A	2	68.875	57.125		2.550		AL-LF	65-317-1	A335/2 STD	

19 79.00 x 81.40

FYJA		4 Cyl.		1596cc	74kW (100PS)		Petrol		TD18692
BE/PL	4	43,985/44,000	47,035/47,045	15,270	1,516	0,020/0,050	AL-LF	01-4040	01-4040/4 STD 0.25
MB/HL 1,2,4,5	4	47,980/48,000	54,020/54,038	16,100	3,013	0,020/0,057	AL-LF	4416RA	H1100/5 STD
MB/HL 3	1	47,980/48,000	54,020/54,038	23,750	3,013	0,020/0,057	AL-LF	4417RAH	
	4417RAH		STD	24,000/.9449" - 24,050/.9469"					
			0.25mm	24,000/.9449" - 24,050/.9469"					

20 79.00 x 86.00

4EE1-T		4 Cyl.		1686cc	60-65kW (82-88PS)		Diesel Turbo		TD9465
BE/PL	4	45,936/45,956	48,976/49,000	16,700	1,500	0,020/0,089	BS	4285CP	71-4297/4 STD 0.25 0.50 9
MB/HL 1-5	5	51,920	56,000	15,530	2,006		AL	63-194-1	H1127/5 STD 0.25 0.50
MB/HL 1-5	5	51,920	56,000	15,530	2,006		AL	63-194-2	
TW/A	2	59,000	73,700		2,110		AL	04-4496	A261/2 STD
SE/PB	1	26,000	29,520	26,350			BS	68144Y	55-4247 SEMI

21 81.00 x 77.00

F6		4 Cyl.		1587cc	59-66kW (80-90PS)		Petrol		TD1967
F603		4 Cyl.		1587cc	55kW (75PS)		Petrol		TD31534
F658		4 Cyl.		1587cc	55kW (75PS)		Petrol		TD31535
F659		4 Cyl.		1597cc	60-82kW (82-112PS)		Petrol		TD31324
BE/PL	4	50,934/50,949	53,997/54,018	21,132	1,509	0,030/0,091	BS	3975P	71-4278/4 STD 0.25 0.50

22 82.50 x 82.00

RTJ		4 Cyl.		1753cc	44kW (60PS)		Diesel		TD18697
RTK		4 Cyl.		1753cc	44kW (60PS)		Diesel		TD18698
BE/PL	4	48,970/48,990	52,000/52,020	21,590	1,495	0,020/0,085	AL-LF	4160RA	01-4152/4 STD 0.25 0.50

MAZDA

MB/HL 1	1	53,970/53,990	57,683/57,696	22,150	1,830	0,033/0,091	AL-LF	4163RA	H1105/5 STD 0.25	
MB/HL 2-5	4	53,970/53,990	57,683/57,696	22,150	1,830	0,033/0,091	AL-LF	4164RAL		
MB/HL 2-5	4	53,970/53,990	57,683/57,696	22,900	1,830	0,033/0,091	AL-LF	4164RAU		
TW/A	2	59,346/59,690	74,498/74,752		2,362		AL-LF	2786BF	A180/2 STD .005	

23

83.00 x 85.00

BP	4 Cyl.	1840cc	76-78kW (103-106PS)	Petrol	TD1947			
BP (DOHC)	4 Cyl.	1840cc	92-96kW (125-130PS)	Petrol	TD1949			
BP Turbo	4 Cyl.	1840cc	120-157kW (163-214PS)	Petrol Turbo Intercooler	TD14748			
BP4W	4 Cyl.	1840cc	113kW (154PS)	Petrol	TD31248			
BP6J	4 Cyl.	1839cc	107kW (146PS)	Petrol	TD31247			
BP52	4 Cyl.	1840cc	76kW (103PS)	Petrol	TD1948			
BPF1	4 Cyl.	1840cc	92-98kW (125-133PS)	Petrol	TD1951			
BP-ZE	4 Cyl.	1840cc	84-107kW (114-146PS)	Petrol	TD11549			
BE/PL	8	44,940	48,020	17,000	1,510	AL-LF	64-317-1	01-4359/4 STD
MB/HL 1-5	5	49,940	54,020	17,500	2,010	AL	63-317-1	H1192/5 STD
MB/HL 1-5	5	49,940	54,020	17,500	2,010	AL	63-317-2	

24

83.00 x 85.00

FP	4 Cyl.	1840cc	74-84kW (100-114PS)	Petrol	TD1996			
FP9A	4 Cyl.	1840cc	74kW (100PS)	Petrol	TD18210			
FP55	4 Cyl.	1840cc	84kW (114PS)	Petrol	TD26760			
FPY3	4 Cyl.	1840cc	66kW (90PS)	Petrol	TD26076			
BE/PL	4	47,940	51,020	17,100	1,510	AL-LF	64-325-1	01-5044/4 STD
MB/HL 1-5	5	49,980	54,020	19,130	1,990	AL-LF	63-135-1	H1358/5 STD
MB/HL 1-5	5	49,980	54,020	19,130	1,990	AL-LF	63-135-2	
TW/A	2				2,550	AL-LF	65-325-1	A336/2 STD

25

83.00 x 92.00

FS	4 Cyl.	1991cc	85-98kW (116-133PS)	Petrol	TD1997			
FS2C	4 Cyl.	1991cc	100kW (136PS)	Petrol	TD18211			
FS7E	4 Cyl.	1991cc	96kW (131PS)	Petrol	TD18214			
FS7G	4 Cyl.	1991cc	96kW (131PS)	Petrol	TD18215			
BE/PL	4	47,940	51,020	17,100	1,510	AL-LF	64-325-1	01-5044/4 STD
MB/HL 1-5	5	49,980	54,020	19,130	1,990	AL-LF	63-135-1	H1358/5 STD
MB/HL 1-5	5	49,980	54,020	19,130	1,990	AL-LF	63-135-2	
TW/A	2				2,550	AL-LF	65-325-1	A336/2 STD

26

84.00 x 81.10

MR18DE	4 Cyl.	1798cc	91kW (124PS)	Petrol	TD30813			
BE/PL	4	44,000	47,010	16,100	1,495	AL-LF	64-1054-1	01-4978/4 STD
BE/PL	4	44,000	47,010	16,100	1,495	AL-LF	64-1054-2	

MB/HL 1-5	10	52,000	56,010	17,100	1,990		AL-LF	63-1054-1	H1340/5 STD	
TW/A	2	59,000	76,500		2,100		AL-LF	65-1054-1	A324/2 STD	

27 86.00 x 77.00

F8 (8V)			4 Cyl.	1789cc	62-67kW (84-91PS)		Petrol		TD1970
F8 (12V)			4 Cyl.	1789cc	58-65kW (79-88PS)		Petrol		TD1969
BE/PL	4	50,934/50,949	53,997/54,018	21,132	1,509	0,030/0,091	BS	3975P	71-4278/4 STD 0.25 0.50

28 86.00 x 86.00

FE (8V)			4 Cyl.	1998cc	60-88kW (82-120PS)		Petrol		TD1976
FE (16V)			4 Cyl.	1998cc	103-109kW (140-148PS)		Petrol		TD1973
FE4J			4 Cyl.	1998cc	74kW (101PS)		Petrol		TD31550
FE4K			4 Cyl.	1998cc	74kW (101PS)		Petrol		TD31549
FECM			4 Cyl.	1998cc	110kW (150PS)		Petrol		TD31323
FEFL			4 Cyl.	1998cc	110kW (150PS)		Petrol		TD31309
FEKN			4 Cyl.	1998cc	71kW (97PS)		Petrol		TD31603
BE/PL	4	50,934/50,949	53,997/54,018	21,132	1,509	0,030/0,091	BS	3975P	71-4278/4 STD 0.25 0.50

29 86.00 x 86.00

RF OHC			4 Cyl.	1998cc	55kW (75PS)		Diesel		TD2042
RF4F			4 Cyl.	1998cc	74kW (101PS)		Diesel		TD18213
RF46			4 Cyl.	1998cc	46-53kW (63-72PS)		Diesel		TD2043
RF-CX			4 Cyl.	1998cc	55kW (75PS)		Diesel		TD4649
RFH7			4 Cyl.	1998cc	55kW (61PS)		Diesel		TD2047
RF-N			4 Cyl.	1998cc	44kW (60PS)		Diesel		TD4650
BE/PL	4	50,934/50,949	53,997/54,018	21,132	1,509	0,030/0,091	BS	3975P	71-4278/4 STD 0.25 0.50
MB/HL 1,2,4,5	4	59,938/59,964	63,997/64,018	19,126	2,007	0,020/0,092	AL	3976RA	H1161/5 STD 0.25
MB/HL 3	1	59,938/59,964	63,997/64,018	21,132	2,007	0,020/0,092	AL	3977RA	

30 86.00 x 94.00

F2			4 Cyl.	2184cc	85kW (115PS)		Petrol		TD1960
F2-C			4 Cyl.	2184cc	94kW (128PS)		Petrol		TD14868
F2E			4 Cyl.	2184cc	85kW (116PS)		Petrol		TD4642
F2-EGI			4 Cyl.	2184cc	100kW (136PS)		Petrol		TD4641
F2G			4 Cyl.	2184cc	85kW (115PS)		Petrol		TD1965
F2IB			4 Cyl.	2184cc	64kW (87PS)		Petrol		TD31547
F2L1			4 Cyl.	2184cc	85kW (115PS)		Petrol		TD1966
F2L5			4 Cyl.	2184cc	68kW (92PS)		Petrol		TD31543
F2L8			4 Cyl.	2184cc	68kW (92PS)		Petrol		TD16444
F21			4 Cyl.	2184cc	85kW (115PS)		Petrol		TD1962
BE/PL	4	50,934/50,949	53,997/54,018	21,132	1,509	0,030/0,091	BS	3975P	71-4278/4 STD 0.25 0.50

31 86.00 x 94.00

R2			4 Cyl.	2184cc	47-52kW (64-71PS)		Diesel		TD2030
BE/PL	4	50,934/50,949	53,997/54,018	21,132	1,509	0,030/0,091	BS	3975P	71-4278/4 STD 0.25 0.50

MAZDA

MB/HL 1,2,4,5	4	59,938/59,964	63,997/64,018	19,126	2,007	0,020/0,092	AL	3976RA	H1161/5 STD 0.25
MB/HL 3	1	59,938/59,964	63,997/64,018	21,132	2,007	0,020/0,092	AL	3977RA	
SE/PB	1	24,990	28,030	26,500			BS	67-316-1S	55-4270 SEMI

32 91.10 x 98.00

4G54			4 Cyl.	2555cc	73kW (99PS)		Petrol		TD25291
G54B			4 Cyl.	2555cc	92kW (125PS)		Petrol		TD31546
BE/PL	8	52,980		56,020	25,130	1,493	AL	64-113-1	71-4194/4 STD 0.25 0.50 0.75
CB/NWB 1,2	2	42,980		46,050	20,250	1,480	AL-LF	68-113-1	N156/2 STD

33 95.00 x 105.00

HA			4 Cyl.	2977cc	50-66kW (68-90PS)		Diesel		TD7868	
MB/HL 1-5	5	75,808/75,824		80,071/80,091	28,600	2,103	0,041/0,102	BS	2061CP	H1191/5 STD

34 100.00 x 110.00

SL			4 Cyl.	3455cc	66-77kW (90-105PS)		Diesel		TD7869	
MB/HL 1-5	5	75,808/75,824		80,071/80,091	28,600	2,103	0,041/0,102	BS	2061CP	H1191/5 STD

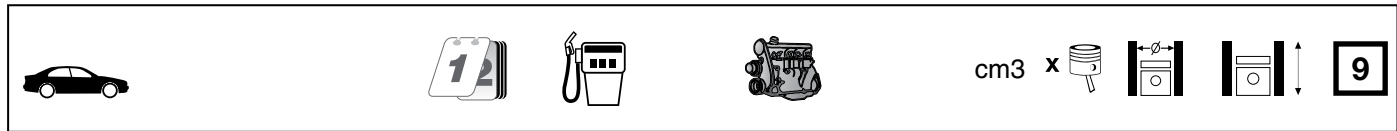

/8 200	01/68→01/77	Petrol	M 115.923	1988	4	87.00	83.60	25
/8 200	01/68→01/77	Petrol	M 115.926	1988	4	87.00	83.60	25
/8 200 D	01/68→01/77	Diesel	OM 615.913	1988	4	87.00	83.60	26
/8 220	01/68→07/73	Petrol	M 115.920	2197	4	87.00	92.40	39
/8 220	01/68→07/73	Petrol	M 115.924	2197	4	87.00	92.40	39
/8 220 D	01/68→01/77	Diesel	OM 615.912	2197	4	87.00	92.40	41
/8 230.4	08/73→12/76	Petrol	M 115.951	2307	4	93.75	83.60	93
/8 240 D	08/73→01/77	Diesel	OM 616.916	2404	4	91.00	92.40	82
/8 240 D 3.0	08/74→11/76	Diesel	OM 617.910	2998	5	90.90	92.40	76
/8 250	01/68→08/72	Petrol	M 114.920	2496	6	82.00	78.80	6
/8 250 2.8	06/72→11/76	Petrol	M 130.923	2778	6	86.50	78.80	24
/8 250 C	04/69→06/72	Petrol	M 114.920	2496	6	82.00	78.80	6
/8 250 C 2.8	06/72→11/76	Petrol	M 130.923	2778	6	86.50	78.80	24
/8 250 CE	04/69→04/72	Petrol	M 114.980	2496	6	82.00	78.80	6
/8 280	06/72→11/76	Petrol	M 110.921	2746	6	86.00	78.80	21
/8 280 C	06/72→02/77	Petrol	M 110.921	2746	6	86.00	78.80	21
/8 280 CE	06/72→01/77	Petrol	M 110.981	2746	6	86.00	78.80	21
/8 280 E	06/72→11/76	Petrol	M 110.981	2746	6	86.00	78.80	21
100 2.0 D	04/88→08/93	Diesel	OM 615.963	1988	4	87.00	83.60	28
100 2.0 D	04/88→04/96	Diesel	OM 615.970	1988	4	87.00	83.60	28
100 2.4 D	01/93→01/96	Diesel	OM 616.963	2399	4	91.00	92.40	81
100 D	02/88→02/96	Diesel	OM 616.963	2399	4	91.00	92.40	81
190 2.0	10/82→10/84	Petrol	M 102.921	1996	4	89.00	80.25	54
190 2.0	09/84→05/90	Petrol	M 102.924	1996	4	89.00	80.25	55
190 2.3	09/87→09/88	Petrol	M 102.985	2298	4	95.50	80.30	94
190 2.3 E	10/82→09/88	Petrol	M 102.985	2298	4	95.50	80.30	94
190 2.6	10/82→09/88	Petrol	M 103.942	2597	6	82.90	80.30	8
190 190 D	09/84→12/85	Diesel	OM 601.921	2197	4	87.00	92.40	40
190 D 2.0	08/83→08/93	Diesel	OM 601.911	1997	4	87.00	84.00	29
190 D 2.5	04/85→08/93	Diesel	OM 602.911	2497	5	87.00	84.00	31
190 E 1.8	04/90→08/93	Petrol	M 102.910	1797	4	89.00	72.20	52
190 E 2.0	10/82→06/93	Petrol	M 102.961	1996	4	89.00	80.25	56
190 E 2.0	10/82→08/93	Petrol	M 102.962	1996	4	89.00	80.25	56
190 E 2.3	09/86→08/93	Petrol	M 102.985	2298	4	95.50	80.30	94
190 E 2.3-16	04/84→08/88	Petrol	M 102.983	2298	4	95.50	80.30	97
190 E 2.5-16	09/88→08/93	Petrol	M 102.990	2498	4	95.50	87.20	98
190 E 2.5-16	03/89→08/93	Petrol	M 102.991	2498	4	95.50	87.20	98
190 E 2.6	09/86→08/93	Petrol	M 103.942	2597	6	82.90	80.30	8
190 E Evolution II 2.5	05/90→08/93	Petrol	M 102.992	2498	4	95.50	87.20	98
190 Turbo-D 2.5	02/88→08/93	Diesel	OM 602.961	2497	5	87.00	84.00	32
A-Class A 140	07/97→08/04	Petrol	M 166.940	1397	4	80.00	69.50	2
A-Class A 140	01/01→08/04	Petrol	M 166.960	1598	4	80.00	79.50	3
A-Class A 150	09/04→06/12	Petrol	M 266.920	1498	4	83.00	69.20	9
A-Class A 160	04/09→06/12	Petrol	M 266.920	1498	4	83.00	69.20	9
A-Class A 160	07/97→08/04	Petrol	M 166.960	1598	4	80.00	79.50	3
A-Class A 160 CDI	02/01→08/04	Diesel	OM 668.940	1689	4	80.00	84.00	5
A-Class A 160 CDI	07/98→02/01	Diesel	OM 668.941	1689	4	80.00	84.00	5
A-Class A 160 CDI	09/04→06/12	Diesel	OM 640.942	1991	4	83.00	92.00	12
A-Class A 170	09/04→06/12	Petrol	M 266.940	1699	4	83.00	78.50	10
A-Class A 170 CDI	07/98→02/01	Diesel	OM 668.940	1689	4	80.00	84.00	5
A-Class A 170 CDI	02/01→08/04	Diesel	OM 668.942	1689	4	80.00	84.00	5
A-Class A 180	04/09→06/12	Petrol	M 266.940	1699	4	83.00	78.50	10
A-Class A 180 CDI	09/04→06/12	Diesel	OM 640.940	1991	4	83.00	92.00	12
A-Class A 190	03/99→08/04	Petrol	M 166.990	1898	4	84.00	85.60	17
A-Class A 200	04/04→	Petrol	M 266.960	2034	4	83.00	94.00	14
A-Class A 200 CDI	09/04→06/12	Diesel	OM 640.941	1991	4	83.00	92.00	12
A-Class A 200 CDI / d	02/14→	Diesel	OM 651.930	2143	4	83.00	99.00	15
A-Class A 200 CDI / d 4-matic	02/14→	Diesel	OM 651.930	2143	4	83.00	99.00	15
A-Class A 200 TURBO	09/05→06/12	Petrol	M 266.980	2034	4	83.00	94.00	14
A-Class A 210	03/02→08/04	Petrol	M 166.995	2084	4	84.00	94.00	18
A-Class A 220 CDI	09/12→	Diesel	OM 651.930	2143	4	83.00	99.00	15
A-Class A 220 CDI 4-matic	09/12→	Diesel	OM 651.930	2143	4	83.00	99.00	15
A-Class A 220 d	07/15→	Diesel	OM 651.930	2143	4	83.00	99.00	15
A-Class A 220 d 4-matic	07/15→	Diesel	OM 651.930	2143	4	83.00	99.00	15
B-Class B 150	03/05→11/11	Petrol	M 266.920	1498	4	83.00	69.20	9
B-Class B 160	04/09→11/11	Petrol	M 266.920	1498	4	83.00	69.20	9
B-Class B 170	03/05→11/11	Petrol	M 266.940	1699	4	83.00	78.50	10
B-Class B 170 NGT	04/08→11/11	Petrol	M 266.960	2034	4	83.00	94.00	14
B-Class B 180	04/09→11/11	Petrol	M 266.940	1699	4	83.00	78.50	10



cm3 x



9

B-Class B 180 CDI	03/05→11/11	Diesel	OM 640.940	1991	4	83.00	92.00	12
B-Class B 180 CDI	07/14→	Diesel	OM 651.930	2143	4	83.00	99.00	15
B-Class B 180 NGT	04/08→11/11	Petrol	M 266.960	2034	4	83.00	94.00	14
B-Class B 200	03/05→11/11	Petrol	M 266.960	2034	4	83.00	94.00	14
B-Class B 200 CDI	03/05→11/11	Diesel	OM 640.941	1991	4	83.00	92.00	12
B-Class B 200 CDI / d	08/14→	Diesel	OM 651.930	2143	4	83.00	99.00	15
B-Class B 200 CDI / d 4-matic	08/14→	Diesel	OM 651.930	2143	4	83.00	99.00	15
B-Class B 200 TURBO	03/05→11/11	Petrol	M 266.980	2034	4	83.00	94.00	14
B-Class B 220 CDI	11/11→	Diesel	OM 651.930	2143	4	83.00	99.00	15
B-Class B 220 CDI / d	06/13→	Diesel	OM 651.930	2143	4	83.00	99.00	15
B-Class B 220 CDI / d 4-matic	09/14→	Diesel	OM 651.930	2143	4	83.00	99.00	15
Cabriolet 280 SE 3.5	01/69→12/71	Petrol	M 116.980	3500	V8	92.00	65.80	83
Cabriolet 300 CE-24	04/92→06/93	Petrol	M 104.980	2960	6	88.50	80.20	50
C-Class 3.5	01/05→02/07	Petrol	M 272.960	3498	V6	92.90	86.00	91
C-Class C 160 Kompressor	05/02→05/08	Petrol	M 271.921	1796	4	82.00	85.00	7
C-Class C 180	06/11→	Petrol	M 271.820	1796	4	82.00	85.00	7
C-Class C 180	03/93→05/00	Petrol	M 111.920	1799	4	85.30	78.70	19
C-Class C 180	03/93→05/00	Petrol	M 111.921	1799	4	85.30	78.70	19
C-Class C 180	10/00→05/02	Petrol	M 111.951	1998	4	89.90	78.70	70
C-Class C 180 CDI	01/11→08/14	Diesel	OM 651.913	2143	4	83.00	99.00	15
C-Class C 180 CGI	01/07→08/14	Petrol	M 271.820	1796	4	82.00	85.00	7
C-Class C 180 Kompressor	01/08→08/14	Petrol	M 271.910	1597	4	80.00	79.50	4
C-Class C 180 Kompressor	05/02→05/08	Petrol	M 271.946	1796	4	82.00	85.00	7
C-Class C 180 Kompressor	01/07→08/14	Petrol	M 271.952	1796	4	82.00	85.00	7
C-Class C 180 T	06/96→09/00	Petrol	M 111.920	1799	4	85.30	78.70	19
C-Class C 180 T	06/96→09/00	Petrol	M 111.921	1799	4	85.30	78.70	19
C-Class C 180 T	09/00→03/01	Petrol	M 111.952	1998	4	89.90	78.70	70
C-Class C 200	05/11→01/14	Petrol	M 271.820	1796	4	82.00	85.00	7
C-Class C 200	01/94→05/00	Petrol	M 111.941	1998	4	89.90	78.70	70
C-Class C 200	01/94→05/00	Petrol	M 111.945	1998	4	89.90	78.70	70
C-Class C 200 CDI	08/10→08/14	Diesel	OM 651.913	2143	4	83.00	99.00	15
C-Class C 200 CDI	09/00→08/07	Diesel	OM 611.962	2148	4	88.00	88.30	47
C-Class C 200 CDI	01/07→12/11	Diesel	OM 646.811	2148	4	88.00	88.30	47
C-Class C 200 CDI	01/07→12/10	Diesel	OM 646.812	2148	4	88.00	88.30	47
C-Class C 200 CDI	02/01→05/08	Diesel	OM 646.962	2148	4	88.00	88.30	47
C-Class C 200 CDI	03/98→05/00	Diesel	OM 611.960	2151	4	88.00	88.30	47
C-Class C 200 CGI	01/07→	Petrol	M 271.820	1796	4	82.00	85.00	7
C-Class C 200 CGI	08/07→08/14	Petrol	M 271.860	1796	4	82.00	85.00	7
C-Class C 200 CGI Kompressor	03/03→05/08	Petrol	M 271.942	1796	4	82.00	85.00	7
C-Class C 200 D	03/93→05/00	Diesel	OM 601.913	1997	4	87.00	84.00	29
C-Class C 200 D	10/96→05/00	Diesel	OM 604.915	1997	4	87.00	84.00	30
C-Class C 200 d	10/15→	Diesel	OM 651.921	2143	4	83.00	99.00	15
C-Class C 200 Kompressor	05/02→05/08	Petrol	M 271.940	1796	4	82.00	85.00	7
C-Class C 200 Kompressor	01/07→08/14	Petrol	M 271.950	1796	4	82.00	85.00	7
C-Class C 200 Kompressor	10/95→05/00	Petrol	M 111.944	1998	4	89.90	78.70	70
C-Class C 200 Kompressor	05/00→06/02	Petrol	M 111.955	1998	4	89.90	78.70	70
C-Class C 200 T	06/96→03/01	Petrol	M 111.941	1998	4	89.90	78.70	70
C-Class C 200 T	06/96→03/01	Petrol	M 111.945	1998	4	89.90	78.70	70
C-Class C 200 T CDI	03/98→03/01	Diesel	OM 611.960	2151	4	88.00	88.30	47
C-Class C 200 T D	10/96→03/01	Diesel	OM 604.915	1997	4	87.00	84.00	30
C-Class C 200 T Kompressor	11/96→03/01	Petrol	M 111.944	1998	4	89.90	78.70	70
C-Class C 200 T Kompressor	09/00→03/01	Petrol	M 111.956	1998	4	89.90	78.70	70
C-Class C 220	05/02→05/08	Petrol	M 271.940	1796	4	82.00	85.00	7
C-Class C 220	03/93→05/00	Petrol	M 111.961	2199	4	89.90	86.60	74
C-Class C 220 BlueTEC / d	12/13→	Diesel	OM 651.921	2143	4	83.00	99.00	15
C-Class C 220 CDI	10/08→	Diesel	OM 651.911	2143	4	83.00	99.00	15
C-Class C 220 CDI	05/00→08/07	Diesel	OM 611.962	2148	4	88.00	88.30	47
C-Class C 220 CDI	01/07→11/08	Diesel	OM 646.811	2148	4	88.00	88.30	47
C-Class C 220 CDI	02/03→05/08	Diesel	OM 646.963	2148	4	88.00	88.30	47
C-Class C 220 CDI	09/97→05/00	Diesel	OM 611.960	2151	4	88.00	88.30	47
C-Class C 220 CDI 4-matic	02/13→08/14	Diesel	OM 651.912	2143	4	83.00	99.00	15
C-Class C 220 d	10/15→	Diesel	OM 651.921	2143	4	83.00	99.00	15
C-Class C 220 D	08/93→05/00	Diesel	OM 604.910	2155	4	89.00	86.60	58
C-Class C 220 d 4-matic	04/15→	Diesel	OM 651.921	2143	4	83.00	99.00	15
C-Class C 220 T CDI	09/97→03/01	Diesel	OM 611.960	2151	4	88.00	88.30	47
C-Class C 220 T D	06/96→03/01	Diesel	OM 604.910	2155	4	89.00	86.60	58
C-Class C 230	06/96→06/97	Petrol	M 111.974	2295	4	90.90	88.40	75
C-Class C 230	09/98→05/00	Petrol	M 111.975	2295	4	90.90	88.40	75
C-Class C 230	01/05→05/08	Petrol	M 272.920	2496	V6	88.00	68.40	44



C-Class C 230	01/07→08/14	Petrol	M 272.921	2496	V6	88.00	68.40	44
C-Class C 230 4-matic	07/07→01/14	Petrol	M 272.911	2496	V6	88.00	68.40	44
C-Class C 230 Kompressor	05/02→05/08	Petrol	M 271.948	1796	4	82.00	85.00	7
C-Class C 230 Kompressor	10/95→05/00	Petrol	M 111.975	2295	4	90.90	88.40	75
C-Class C 230 Kompressor	03/01→12/02	Petrol	M 111.981	2295	4	90.90	88.40	75
C-Class C 230 T	06/96→06/98	Petrol	M 111.974	2295	4	90.90	88.40	75
C-Class C 230 T Kompressor	06/97→09/00	Petrol	M 111.975	2295	4	90.90	88.40	75
C-Class C 240	06/97→05/00	Petrol	M 112.910	2398	V6	83.20	73.50	16
C-Class C 240	05/00→08/07	Petrol	M 112.912	2597	V6	89.90	68.20	67
C-Class C 240 4-matic	07/02→08/07	Petrol	M 112.916	2597	V6	89.90	68.20	67
C-Class C 240 T	06/97→09/00	Petrol	M 112.910	2398	V6	83.20	73.50	16
C-Class C 240 T	09/00→03/01	Petrol	M 112.915	2597	V6	89.90	68.20	67
C-Class C 250	06/11→	Petrol	M 271.860	1796	4	82.00	85.00	7
C-Class C 250 BlueTEC / d	02/14→	Diesel	OM 651.921	2143	4	83.00	99.00	15
C-Class C 250 BlueTEC / d 4-matic	02/14→	Diesel	OM 651.921	2143	4	83.00	99.00	15
C-Class C 250 CDI	08/08→	Diesel	OM 651.911	2143	4	83.00	99.00	15
C-Class C 250 CDI 4-matic	04/10→08/14	Diesel	OM 651.912	2143	4	83.00	99.00	15
C-Class C 250 CGI	07/09→08/14	Petrol	M 271.860	1796	4	82.00	85.00	7
C-Class C 250 d	10/15→	Diesel	OM 651.921	2143	4	83.00	99.00	15
C-Class C 250 D	05/93→05/00	Diesel	OM 605.910	2497	5	87.00	84.00	33
C-Class C 250 Turbo-D	06/96→03/01	Diesel	OM 605.960	2497	5	87.00	84.00	34
C-Class C 250 Turbo-D	10/95→05/00	Diesel	OM 605.960	2497	5	87.00	84.00	34
C-Class C 270 CDI	12/00→08/07	Diesel	OM 612.962	2685	5	88.00	88.30	48
C-Class C 280	05/93→05/00	Petrol	M 104.941	2799	6	89.90	73.50	68
C-Class C 280	06/97→05/00	Petrol	M 112.920	2799	V6	89.90	73.50	69
C-Class C 280	01/05→08/07	Petrol	M 272.940	2996	V6	88.00	82.10	46
C-Class C 280	01/07→08/14	Petrol	M 272.947	2996	V6	88.00	82.10	46
C-Class C 280 4-matic	01/05→08/07	Petrol	M 272.941	2996	V6	88.00	82.10	46
C-Class C 280 4-matic	07/07→01/14	Petrol	M 272.948	2996	V6	88.00	82.10	46
C-Class C 280 T	06/97→03/01	Petrol	M 112.920	2799	V6	89.90	73.50	69
C-Class C 300	08/07→08/14	Petrol	M 272.947	2996	V6	88.00	82.10	46
C-Class C 300	02/11→01/14	Petrol	M 276.957	3498	V6	92.90	86.00	91
C-Class C 300 4-matic	07/07→01/14	Petrol	M 272.948	2996	V6	88.00	82.10	46
C-Class C 300 4-matic	02/11→12/14	Petrol	M 276.957	3498	V6	92.90	86.00	91
C-Class C 300 BlueTEC Hybrid / h	05/14→	Diesel	OM 651.921	2143	4	83.00	99.00	15
C-Class C 320	05/00→05/08	Petrol	M 112.946	3199	V6	89.90	84.00	72
C-Class C 320 4-matic	07/02→08/07	Petrol	M 112.953	3199	V6	89.90	84.00	72
C-Class C 320 CDI	01/05→08/07	Diesel	OM 642.910	2987	6	83.00	92.00	13
C-Class C 320 CDI	01/07→08/14	Diesel	OM 642.960	2987	V6	83.00	92.00	13
C-Class C 320 CDI 4-matic	07/07→08/14	Diesel	OM 642.961	2987	V6	83.00	92.00	13
C-Class C 350	01/05→05/08	Petrol	M 272.960	3498	V6	92.90	86.00	91
C-Class C 350	01/07→08/14	Petrol	M 272.961	3498	V6	92.90	86.00	91
C-Class C 350	01/11→	Petrol	M 276.957	3498	V6	92.90	86.00	91
C-Class C 350 4-matic	01/05→02/07	Petrol	M 272.960	3498	V6	92.90	86.00	91
C-Class C 350 4-matic	01/05→08/07	Petrol	M 272.970	3498	V6	92.90	86.00	91
C-Class C 350 4-matic	07/07→01/14	Petrol	M 272.971	3498	V6	92.90	86.00	91
C-Class C 350 4-matic	01/11→	Petrol	M 276.957	3498	V6	92.90	86.00	91
C-Class C 350 CDI	06/11→08/14	Diesel	OM 642.834	2987	V6	83.00	92.00	13
C-Class C 350 CDI	07/09→01/14	Diesel	OM 642.960	2987	V6	83.00	92.00	13
C-Class C 350 CDI 4-matic	07/09→01/14	Diesel	OM 642.961	2987	V6	83.00	92.00	13
C-Class C 350 CGI	09/08→01/14	Petrol	M 272.982	3498	V6	92.90	86.00	91
C-Class C 350 CGI	06/11→08/14	Petrol	M 276.957	3498	V6	92.90	86.00	91
CLA 200 CDI / d	07/14→	Diesel	OM 651.930	2143	4	83.00	99.00	15
CLA 200 CDI / d 4-matic	07/14→	Diesel	OM 651.930	2143	4	83.00	99.00	15
CLA 220 CDI	01/13→	Diesel	OM 651.930	2143	4	83.00	99.00	15
CLA 220 CDI 4-matic	07/14→	Diesel	OM 651.930	2143	4	83.00	99.00	15
CLA 220 CDI / d	01/13→	Diesel	OM 651.930	2143	4	83.00	99.00	15
CLA 220 CDI / d 4-matic	08/14→	Diesel	OM 651.930	2143	4	83.00	99.00	15
CLC-Class CLC 160	02/09→06/11	Petrol	M 271.911	1597	4	80.00	79.50	4
CLC-Class CLC 180 Kompressor	05/08→06/11	Petrol	M 271.946	1796	4	82.00	85.00	7
CLC-Class CLC 200 CDI	05/08→06/11	Diesel	OM 646.962	2148	4	88.00	88.30	47
CLC-Class CLC 200 Kompressor	05/08→06/11	Petrol	M 271.957	1796	4	82.00	85.00	7
CLC-Class CLC 220 CDI	05/08→06/11	Diesel	OM 646.963	2148	4	88.00	88.30	47
CLC-Class CLC 230	05/08→06/11	Petrol	M 272.920	2496	V6	88.00	68.40	44
CLC-Class CLC 250	06/09→06/11	Petrol	M 272.920	2496	V6	88.00	68.40	44
CLC-Class CLC 350	05/08→06/11	Petrol	M 272.960	3498	V6	92.90	86.00	91
CLK 200	03/98→03/02	Petrol	M 111.941	1998	4	89.90	78.70	70
CLK 200	06/97→06/02	Petrol	M 111.945	1998	4	89.90	78.70	70
CLK 200 CGI	07/03→05/09	Petrol	M 271.942	1796	4	82.00	85.00	7



cm3 x



9

CLK 200 Kompressor	09/02→05/09	Petrol	M 271.940	1796	4	82.00	85.00	7
CLK 200 Kompressor	10/06→05/09	Petrol	M 271.955	1796	4	82.00	85.00	7
CLK 200 Kompressor	06/97→06/00	Petrol	M 111.944	1998	4	89.90	78.70	70
CLK 200 Kompressor	06/00→06/02	Petrol	M 111.956	1998	4	89.90	78.70	70
CLK 220 CDI	01/05→05/09	Diesel	OM 646.966	2148	4	88.00	88.30	47
CLK 230 Kompressor	06/97→06/00	Petrol	M 111.973	2295	4	90.90	88.40	75
CLK 230 Kompressor	06/97→06/00	Petrol	M 111.975	2295	4	90.90	88.40	75
CLK 230 Kompressor	06/00→06/02	Petrol	M 111.982	2295	4	90.90	88.40	75
CLK 240	06/02→05/09	Petrol	M 112.912	2597	V6	89.90	68.20	67
CLK 270 CDI	10/02→05/09	Diesel	OM 612.962	2685	5	88.00	88.30	48
CLK 270 CDI	10/02→05/09	Diesel	OM 612.967	2685	5	88.00	88.30	48
CLK 280	01/05→05/09	Petrol	M 272.940	2996	V6	88.00	82.10	46
CLK 320	06/97→06/02	Petrol	M 112.940	3199	V6	89.90	84.00	72
CLK 320	06/02→05/09	Petrol	M 112.955	3199	V6	89.90	84.00	72
CLK 320 CDI	01/05→05/09	Diesel	OM 642.910	2987	6	83.00	92.00	13
CLK 350	01/05→05/09	Petrol	M 272.960	3498	V6	92.90	86.00	91
CLK CLK 200 CGI	07/03→03/10	Petrol	M 271.942	1796	4	82.00	85.00	7
CLK CLK 200 Kompressor	02/03→03/10	Petrol	M 271.940	1796	4	82.00	85.00	7
CLK CLK 200 Kompressor	10/06→03/10	Petrol	M 271.955	1796	4	82.00	85.00	7
CLK CLK 240	02/03→03/10	Petrol	M 112.912	2597	V6	89.90	68.20	67
CLK CLK 280	01/05→03/10	Petrol	M 272.940	2996	V6	88.00	82.10	46
CLK CLK 320	02/03→03/10	Petrol	M 112.955	3199	V6	89.90	84.00	72
CLK CLK 320 CDI	03/05→03/10	Diesel	OM 642.910	2987	6	83.00	92.00	13
CLK CLK 350	01/05→03/10	Petrol	M 272.960	3498	V6	92.90	86.00	91
CLS CLS 220 BlueTEC	05/14→	Diesel	OM 651.924	2143	4	83.00	99.00	15
CLS CLS 220 BlueTEC / d	05/14→	Diesel	OM 651.924	2143	4	83.00	99.00	15
CLS CLS 250 BlueTEC / d 4-matic	05/14→	Diesel	OM 651.924	2143	4	83.00	99.00	15
CLS CLS 250 CDI / BlueTEC / d	04/11→	Diesel	OM 651.924	2143	4	83.00	99.00	15
CLS CLS 280	07/08→12/10	Petrol	M 272.943	2996	V6	88.00	82.10	46
CLS CLS 300	04/09→12/10	Petrol	M 272.943	2996	V6	88.00	82.10	46
CLS CLS 300 CGI	10/11→	Petrol	M 276.952	3498	V6	92.90	86.00	91
CLS CLS 320 CDI	01/05→12/10	Diesel	OM 642.920	2987	V6	83.00	92.00	13
CLS CLS 350	10/04→12/10	Petrol	M 272.964	3498	V6	92.90	86.00	91
CLS CLS 350	04/06→12/10	Petrol	M 272.985	3498	V6	92.90	86.00	91
CLS CLS 350	01/11→	Petrol	M 276.952	3498	V6	92.90	86.00	91
CLS CLS 350 BlueTEC / d	05/14→	Diesel	OM 642.853	2987	V6	83.00	92.00	13
CLS CLS 350 CDI	01/11→	Diesel	OM 642.853	2987	V6	83.00	92.00	13
CLS CLS 350 CDI	04/09→12/10	Diesel	OM 642.920	2987	V6	83.00	92.00	13
CLS CLS 350 CDI 4-matic	09/11→	Diesel	OM 642.854	2987	V6	83.00	92.00	13
CLS CLS 350 CGI	04/09→12/10	Petrol	M 272.985	3498	V6	92.90	86.00	91
CLS CLS 350 d 4-matic	04/15→	Diesel	OM 642.854	2987	V6	83.00	92.00	13
Coupe 220 CE	10/92→05/93	Petrol	M 111.960	2199	4	89.90	86.60	74
Coupe 230 C	05/77→04/80	Petrol	M 115.954	2307	4	93.75	83.60	93
Coupe 230 CE	03/87→12/92	Petrol	M 102.982	2298	4	95.50	80.30	97
Coupe 230 CE	04/80→12/85	Petrol	M 102.980	2299	4	95.50	80.30	96
Coupe 280 C	03/77→03/80	Petrol	M 110.923	2746	6	86.00	78.80	21
Coupe 280 CE	03/77→11/85	Petrol	M 110.988	2746	6	86.00	78.80	21
Coupe 280 SE	01/67→12/71	Petrol	M 130.984	2778	6	86.50	78.80	23
Coupe 280 SE	01/67→12/71	Petrol	M 130.980	2780	6	86.50	78.80	23
Coupe 280 SE 3.5	01/69→12/71	Petrol	M 116.980	3500	V8	92.00	65.80	83
Coupe 300 CE	03/87→05/93	Petrol	M 103.983	2960	6	88.50	80.25	51
Coupe 300 CE-24	09/89→12/92	Petrol	M 104.980	2960	6	88.50	80.20	50
Coupe 300 C Turbo-D	09/81→07/85	Diesel	OM 617.952	2998	5	90.90	92.40	79
Coupe 320 CE	10/92→05/93	Petrol	M 104.992	3199	6	89.90	84.00	71
E-Class 3.5 4-matic	08/04→08/06	Petrol	M 272.972	3498	V6	92.90	86.00	91
E-Class 350 CGI	05/06→07/09	Petrol	M 272.985	3498	V6	92.90	86.00	91
E-Class E 200	06/93→03/98	Petrol	M 111.940	1998	4	89.90	78.70	70
E-Class E 200	06/95→08/00	Petrol	M 111.942	1998	4	89.90	78.70	70
E-Class E 200 CDI	06/98→03/02	Diesel	OM 611.961	2148	4	88.00	88.30	47
E-Class E 200 CDI	04/06→12/08	Diesel	OM 646.820	2148	4	88.00	88.30	47
E-Class E 200 CDI	04/06→07/09	Diesel	OM 646.821	2148	4	88.00	88.30	47
E-Class E 200 CDI	07/02→12/08	Diesel	OM 646.951	2148	4	88.00	88.30	47
E-Class E 200 CDI / BlueTEC	01/09→	Diesel	OM 651.925	2143	4	83.00	99.00	15
E-Class E 200 CGI	08/09→	Petrol	M 271.820	1796	4	82.00	85.00	7
E-Class E 200 CGI	08/09→	Petrol	M 271.860	1796	4	82.00	85.00	7
E-Class E 200 D	06/93→06/95	Diesel	OM 601.912	1997	4	87.00	84.00	29
E-Class E 200 D	01/96→03/02	Diesel	OM 604.917	1997	4	87.00	84.00	30
E-Class E 200 Kompressor	11/02→12/08	Petrol	M 271.941	1796	4	82.00	85.00	7
E-Class E 200 Kompressor	04/06→07/09	Petrol	M 271.956	1796	4	82.00	85.00	7

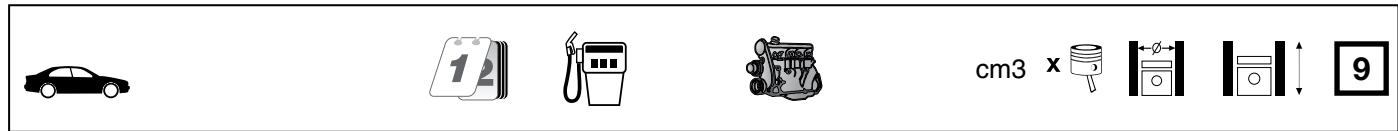

E-Class E 200 Kompressor	06/97→03/02	Petrol	M 111.947	1998	4	89.90	78.70	70
E-Class E 200 Kompressor	08/00→03/02	Petrol	M 111.957	1998	4	89.90	78.70	70
E-Class E 200 NGT	03/04→12/08	Petrol	M 271.941	1796	4	82.00	85.00	7
E-Class E 200 NGT	03/11→	Petrol	M 271.958	1796	4	82.00	85.00	7
E-Class E 200 T	06/93→06/96	Petrol	M 111.940	1998	4	89.90	78.70	70
E-Class E 200 T	06/96→08/00	Petrol	M 111.942	1998	4	89.90	78.70	70
E-Class E 200 T Kompressor	03/03→07/09	Petrol	M 271.941	1796	4	82.00	85.00	7
E-Class E 200 T Kompressor	06/97→03/03	Petrol	M 111.947	1998	4	89.90	78.70	70
E-Class E 200 T Kompressor	08/00→03/03	Petrol	M 111.957	1998	4	89.90	78.70	70
E-Class E 220	06/93→03/98	Petrol	M 111.960	2199	4	89.90	86.60	74
E-Class E 220 BlueTEC	05/14→	Diesel	OM 651.911	2143	4	83.00	99.00	15
E-Class E 220 BlueTEC	05/14→	Diesel	OM 651.924	2143	4	83.00	99.00	15
E-Class E 220 BlueTEC 4-matic	12/14→	Diesel	OM 651.924	2143	4	83.00	99.00	15
E-Class E 220 CDI	02/10→	Diesel	OM 651.911	2143	4	83.00	99.00	15
E-Class E 220 CDI	01/09→	Diesel	OM 651.924	2143	4	83.00	99.00	15
E-Class E 220 CDI	06/98→03/02	Diesel	OM 611.961	2148	4	88.00	88.30	47
E-Class E 220 CDI	03/03→12/08	Diesel	OM 646.821	2148	4	88.00	88.30	47
E-Class E 220 CDI	03/02→07/09	Diesel	OM 646.961	2148	4	88.00	88.30	47
E-Class E 220 CDI / BlueTEC	01/09→	Diesel	OM 651.924	2143	4	83.00	99.00	15
E-Class E 220 CDI / BlueTEC / d	01/10→	Diesel	OM 651.911	2143	4	83.00	99.00	15
E-Class E 220 CDI / d	01/10→	Diesel	OM 651.911	2143	4	83.00	99.00	15
E-Class E 220 D	06/95→03/02	Diesel	OM 604.912	2155	4	89.00	86.60	58
E-Class E 220 T	06/93→06/96	Petrol	M 111.960	2199	4	89.90	86.60	74
E-Class E 220 T CDI	06/98→03/03	Diesel	OM 611.961	2148	4	88.00	88.30	47
E-Class E 220 T CDI	03/03→07/09	Diesel	OM 646.821	2148	4	88.00	88.30	47
E-Class E 220 T CDI	03/03→07/09	Diesel	OM 646.961	2148	4	88.00	88.30	47
E-Class E 230	06/95→06/97	Petrol	M 111.970	2295	4	90.90	88.40	75
E-Class E 230	09/07→12/08	Petrol	M 272.922	2496	V6	88.00	68.40	44
E-Class E 230 T	06/96→06/97	Petrol	M 111.970	2295	4	90.90	88.40	75
E-Class E 230 T	05/07→07/09	Petrol	M 272.922	2496	V6	88.00	68.40	44
E-Class E 240	06/97→08/00	Petrol	M 112.911	2398	V6	83.20	73.50	16
E-Class E 240	03/02→12/08	Petrol	M 112.913	2597	V6	89.90	68.20	67
E-Class E 240	08/00→03/02	Petrol	M 112.914	2597	V6	89.90	68.20	67
E-Class E 240	03/02→12/08	Petrol	M 112.917	2597	V6	89.90	68.20	67
E-Class E 240 4-matic	03/03→12/08	Petrol	M 112.917	2597	V6	89.90	68.20	67
E-Class E 240 T	06/97→03/03	Petrol	M 112.911	2398	V6	83.20	73.50	16
E-Class E 240 T	03/03→07/09	Petrol	M 112.913	2597	V6	89.90	68.20	67
E-Class E 240 T	08/00→03/03	Petrol	M 112.914	2597	V6	89.90	68.20	67
E-Class E 240 T 4-matic	07/03→07/09	Petrol	M 112.917	2597	V6	89.90	68.20	67
E-Class E 250 CDI / BlueTEC	01/09→	Diesel	OM 651.924	2143	4	83.00	99.00	15
E-Class E 250 CDI / BlueTEC 4-matic	01/09→	Diesel	OM 651.924	2143	4	83.00	99.00	15
E-Class E 250 CDI / BlueTEC / d	01/10→	Diesel	OM 651.911	2143	4	83.00	99.00	15
E-Class E 250 CDI / d	01/09→	Diesel	OM 651.911	2143	4	83.00	99.00	15
E-Class E 250 CGI	01/09→	Petrol	M 271.860	1796	4	82.00	85.00	7
E-Class E 250 D	07/93→06/95	Diesel	OM 605.911	2497	5	87.00	84.00	33
E-Class E 250 D	06/95→07/99	Diesel	OM 605.912	2497	5	87.00	84.00	33
E-Class E 250 TD	06/93→06/96	Diesel	OM 605.911	2497	5	87.00	84.00	33
E-Class E 250 T D	06/96→07/99	Diesel	OM 605.912	2497	5	87.00	84.00	33
E-Class E 250 Turbo-D	06/97→07/99	Diesel	OM 605.962	2497	5	87.00	84.00	34
E-Class E 250 Turbo D	06/93→06/96	Diesel	OM 602.962	2497	5	87.00	84.00	32
E-Class E 250 Turbo-D	06/93→06/95	Diesel	OM 602.962	2497	5	87.00	84.00	32
E-Class E 250 Turbo-D	06/97→07/99	Diesel	OM 605.962	2497	5	87.00	84.00	34
E-Class E 270 CDI	07/99→03/02	Diesel	OM 612.961	2685	5	88.00	88.30	48
E-Class E 270 CDI	03/02→12/08	Diesel	OM 647.961	2685	5	88.00	88.30	48
E-Class E 270 T CDI	07/99→03/03	Diesel	OM 612.961	2685	5	88.00	88.30	48
E-Class E 270 T CDI	03/03→07/09	Diesel	OM 647.961	2685	5	88.00	88.30	48
E-Class E 280	06/93→06/95	Petrol	M 104.942	2799	6	89.90	73.50	68
E-Class E 280	01/96→06/97	Petrol	M 104.945	2799	6	89.90	73.50	68
E-Class E 280	12/96→03/02	Petrol	M 112.921	2799	V6	89.90	73.50	69
E-Class E 280	03/05→12/08	Petrol	M 272.943	2996	V6	88.00	82.10	46
E-Class E 280 4-matic	12/96→03/02	Petrol	M 112.921	2799	V6	89.90	73.50	69
E-Class E 280 4-matic	01/06→12/08	Petrol	M 272.943	2996	V6	88.00	82.10	46
E-Class E 280 CDI	03/05→12/08	Diesel	OM 642.920	2987	V6	83.00	92.00	13
E-Class E 280 CDI	05/04→12/08	Diesel	OM 648.961	3222	6	88.00	88.30	49
E-Class E 280 CDI 4-matic	03/05→12/08	Diesel	OM 642.921	2987	V6	83.00	92.00	13
E-Class E 280 T	06/93→06/96	Petrol	M 104.942	2799	6	89.90	73.50	68
E-Class E 280 T	12/96→03/03	Petrol	M 112.921	2799	V6	89.90	73.50	69
E-Class E 280 T	03/05→07/09	Petrol	M 272.943	2996	V6	88.00	82.10	46
E-Class E 280 T 4-matic	12/96→03/03	Petrol	M 112.921	2799	V6	89.90	73.50	69



cm3



E-Class E 280 T 4-matic	03/05→07/09	Petrol	M 272.943	2996	V6	88.00	82.10	46
E-Class E 280 T CDI	03/05→07/09	Diesel	OM 642.920	2987	V6	83.00	92.00	13
E-Class E 280 T CDI	05/04→07/09	Diesel	OM 648.961	3222	6	88.00	88.30	49
E-Class E 280 T CDI 4-matic	03/05→07/09	Diesel	OM 642.921	2987	V6	83.00	92.00	13
E-Class E 290 T Turbo-D	06/96→07/99	Diesel	OM 602.982	2874	5	89.00	92.40	64
E-Class E 290 Turbo-D	03/96→07/99	Diesel	OM 602.982	2874	5	89.00	92.40	64
E-Class E 300	01/09→	Petrol	M 272.952	2996	V6	88.00	82.10	46
E-Class E 300	07/11→	Petrol	M 276.952	3498	V6	92.90	86.00	91
E-Class E 300	04/11→	Petrol	M 276.957	3498	V6	92.90	86.00	91
E-Class E 300 4-matic	06/93→06/95	Petrol	M 103.985	2960	6	88.50	80.25	51
E-Class E 300 4-matic	07/11→	Petrol	M 276.952	3498	V6	92.90	86.00	91
E-Class E 300 BlueTEC	09/07→12/08	Diesel	OM 642.920	2987	V6	83.00	92.00	13
E-Class E 300 D	07/93→06/95	Diesel	OM 606.910	2996	6	87.00	84.00	37
E-Class E 300 D	06/95→06/97	Diesel	OM 606.912	2996	6	87.00	84.00	37
E-Class E 300 Hybrid / BlueTEC Hybrid	12/11→	Diesel	OM 651.924	2143	4	83.00	99.00	15
E-Class E 300 T 4-matic	06/93→06/96	Petrol	M 103.985	2960	6	88.50	80.25	51
E-Class E 300 TD	06/93→06/96	Diesel	OM 603.912	2996	6	87.00	84.00	35
E-Class E 300 TD	06/93→06/96	Diesel	OM 606.910	2996	6	87.00	84.00	37
E-Class E 300 TE-24 AMG	06/93→06/96	Petrol	M 104.980	2960	6	88.50	80.20	50
E-Class E 300 T Turbo-D	06/93→06/96	Diesel	OM 603.960	2996	6	87.00	84.00	36
E-Class E 300 T Turbo-D	12/96→07/99	Diesel	OM 606.962	2996	6	87.00	84.00	38
E-Class E 300 T Turbo-D 4-matic	06/93→06/96	Diesel	OM 603.963	2996	6	87.00	84.00	36
E-Class E 300 Turbo-D	06/93→06/95	Diesel	OM 603.960	2996	6	87.00	84.00	36
E-Class E 300 Turbo-D	12/96→07/99	Diesel	OM 606.962	2996	6	87.00	84.00	38
E-Class E 300 Turbo-D 4-matic	06/93→06/95	Diesel	OM 603.963	2996	6	87.00	84.00	36
E-Class E 320	06/93→03/98	Petrol	M 104.992	3199	6	89.90	84.00	71
E-Class E 320	06/93→03/98	Petrol	M 104.995	3199	6	89.90	84.00	71
E-Class E 320	06/97→03/02	Petrol	M 112.941	3199	V6	89.90	84.00	72
E-Class E 320	03/02→12/08	Petrol	M 112.949	3199	V6	89.90	84.00	72
E-Class E 320 4-matic	06/97→03/02	Petrol	M 112.941	3199	V6	89.90	84.00	72
E-Class E 320 4-matic	03/03→12/08	Petrol	M 112.954	3199	V6	89.90	84.00	72
E-Class E 320 BlueTEC	09/08→03/09	Diesel	OM 642.920	2987	V6	83.00	92.00	13
E-Class E 320 CDI	03/05→12/08	Diesel	OM 642.920	2987	V6	83.00	92.00	13
E-Class E320 CDI	09/06→12/08	Diesel	OM 642.920	2987	V6	83.00	92.00	13
E-Class E 320 CDI	11/02→12/08	Diesel	OM 648.961	3222	6	88.00	88.30	49
E-Class E 320 CDI	07/99→03/02	Diesel	OM 613.961	3226	6	88.00	88.30	49
E-Class E 320 CDI 4-matic	03/05→12/08	Diesel	OM 642.910	2987	6	83.00	92.00	13
E-Class E 320 T	06/93→06/96	Petrol	M 104.992	3199	6	89.90	84.00	71
E-Class E 320 T	12/96→03/03	Petrol	M 112.941	3199	V6	89.90	84.00	72
E-Class E 320 T	03/03→07/09	Petrol	M 112.949	3199	V6	89.90	84.00	72
E-Class E 320 T 4-matic	12/96→03/03	Petrol	M 112.941	3199	V6	89.90	84.00	72
E-Class E 320 T 4-matic	07/03→07/09	Petrol	M 112.954	3199	V6	89.90	84.00	72
E-Class E 320 T CDI	03/05→07/09	Diesel	OM 642.920	2987	V6	83.00	92.00	13
E-Class E 320 T CDI	03/03→07/09	Diesel	OM 648.961	3222	6	88.00	88.30	49
E-Class E 320 T CDI	07/99→03/03	Diesel	OM 613.961	3226	6	88.00	88.30	49
E-Class E 320 T CDI 4-matic	03/05→07/09	Diesel	OM 642.920	2987	V6	83.00	92.00	13
E-Class E 350	03/05→12/08	Petrol	M 272.964	3498	V6	92.90	86.00	91
E-Class E 350	01/09→	Petrol	M 272.980	3498	V6	92.90	86.00	91
E-Class E 350	05/11→	Petrol	M 272.988	3498	V6	92.90	86.00	91
E-Class E 350	09/11→	Petrol	M 276.952	3498	V6	92.90	86.00	91
E-Class E 350	04/11→	Petrol	M 276.957	3498	V6	92.90	86.00	91
E-Class E 350 4-matic	08/04→12/08	Petrol	M 272.972	3498	V6	92.90	86.00	91
E-Class E 350 4-matic	01/09→	Petrol	M 272.977	3498	V6	92.90	86.00	91
E-Class E 350 4-matic	09/11→	Petrol	M 276.952	3498	V6	92.90	86.00	91
E-Class E 350 4-matic	02/13→	Petrol	M 276.957	3498	V6	92.90	86.00	91
E-Class E 350 BlueTEC	03/13→	Diesel	OM 642.838	2987	V6	83.00	92.00	13
E-Class E 350 BlueTEC / d	05/14→	Diesel	OM 642.838	2987	V6	83.00	92.00	13
E-Class E 350 BlueTEC/ d	05/14→	Diesel	OM 642.838	2987	V6	83.00	92.00	13
E-Class E 350 CDI	01/09→	Diesel	OM 642.836	2987	V6	83.00	92.00	13
E-Class E 350 CDI	04/11→	Diesel	OM 642.838	2987	V6	83.00	92.00	13
E-Class E 350 CGI	01/09→	Petrol	M 272.982	3498	V6	92.90	86.00	91
E-Class E 350 CGI	01/09→	Petrol	M 272.983	3498	V6	92.90	86.00	91
E-Class E 350 CGI	01/09→	Petrol	M 272.984	3498	V6	92.90	86.00	91
E-Class E 350 CGI	09/07→12/08	Petrol	M 272.985	3498	V6	92.90	86.00	91
E-Class E 350 T	03/05→07/09	Petrol	M 272.964	3498	V6	92.90	86.00	91
E-Class E 350 T 4-matic	03/05→07/09	Petrol	M 272.972	3498	V6	92.90	86.00	91
E-Class E 400 Hybrid	05/15→	Petrol	M 276.952	3498	V6	92.90	86.00	91
G-Class 200 GE	01/90→07/93	Petrol	M 102.965	1996	4	89.00	80.25	57
G-Class 230 G	03/79→07/93	Petrol	M 115.973	2307	4	93.75	83.60	93

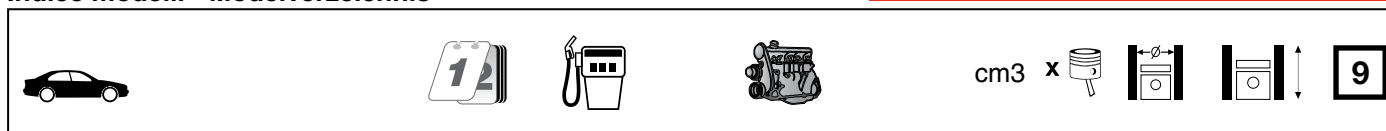

G-Class 230 GE	04/82→06/93	Petrol	M 102.989	2298	4	95.50	80.30	94
G-Class 230 GE	06/93→	Petrol	M 102.996	2298	4	95.50	80.30	95
G-Class 230 GE	05/87→	Petrol	M 102.979	2299	4	95.50	80.30	95
G-Class 230 GE	04/82→08/92	Petrol	M 102.981	2299	4	95.50	80.30	94
G-Class 230 GE	04/82→08/92	Petrol	M 102.987	2299	4	95.50	80.30	94
G-Class 230 GE	06/93→	Petrol	M 102.997	2299	4	95.50	80.30	95
G-Class 240 GD	03/79→08/87	Diesel	OM 616.936	2399	4	91.00	92.40	81
G-Class 250 GD	10/87→12/92	Diesel	OM 602.930	2497	5	87.00	84.00	31
G-Class 250 GD	06/90→	Diesel	OM 602.931	2497	5	87.00	84.00	31
G-Class 250 GD	02/90→	Diesel	OM 602.939	2497	5	87.00	84.00	31
G-Class 280 GE	11/79→08/89	Petrol	M 110.994	2746	6	86.00	78.80	22
G-Class 290 GD/G 290 D	04/92→	Diesel	OM 602.942	2874	5	89.00	92.40	63
G-Class 300 GD	03/79→07/93	Diesel	OM 603.912	2996	6	87.00	84.00	35
G-Class 300 GD	09/89→	Diesel	OM 603.931	2996	6	87.00	84.00	35
G-Class 300 GD	12/79→12/91	Diesel	OM 617.931	2998	5	90.90	92.40	78
G-Class 300 GE	06/90→	Petrol	M 103.987	2960	6	88.50	80.25	51
G-Class 350 Turbo GD	09/91→	Diesel	OM 603.972	3449	6	89.00	92.40	66
G-Class G 270 CDI	10/01→	Diesel	OM 612.965	2685	5	88.00	88.30	48
G-Class G 270 CDI	01/03→	Diesel	OM 612.966	2685	5	88.00	88.30	48
G-Class G 280 CDI	04/09→	Diesel	OM 642.884	2987	V6	83.00	92.00	13
G-Class G 290 TD	07/97→	Diesel	OM 602.983	2874	5	89.00	92.40	64
G-Class G 300 CDI	04/10→	Diesel	OM 642.884	2987	V6	83.00	92.00	13
G-Class G 300 TD	08/96→	Diesel	OM 606.964	2996	6	87.00	84.00	38
G-Class G 320	09/94→12/97	Petrol	M 104.996	3199	6	89.90	84.00	71
G-Class G 320	07/97→	Petrol	M 112.945	3199	V6	89.90	84.00	72
G-Class G 320 CDI	09/06→	Diesel	OM 642.970	2987	V6	83.00	92.00	13
G-Class G 350 CDI	07/11→	Diesel	OM 642.886	2987	V6	83.00	92.00	13
G-Class Cabrio 200 GE	01/90→07/93	Petrol	M 102.965	1996	4	89.00	80.25	57
G-Class Cabrio 230 GE	06/90→02/93	Petrol	M 102.989	2298	4	95.50	80.30	94
G-Class Cabrio 300 GD	12/90→09/97	Diesel	OM 603.931	2996	6	87.00	84.00	35
G-Class Cabrio 300 GE	09/89→09/97	Petrol	M 103.987	2960	6	88.50	80.25	51
G-Class Cabrio 320 GE	09/94→11/97	Petrol	M 104.996	3199	6	89.90	84.00	71
G-Class Cabrio 350 G Turbo-D	09/91→09/97	Diesel	OM 603.972	3449	6	89.00	92.40	66
G-Class Cabrio G 300 TD	09/96→	Diesel	OM 606.964	2996	6	87.00	84.00	38
G-Class Cabrio G 320	11/97→	Petrol	M 112.945	3199	V6	89.90	84.00	72
G-Class Cabrio G 320 CDI	09/06→	Diesel	OM 642.970	2987	V6	83.00	92.00	13
G-Class Cabrio G 350 CDI	07/11→	Diesel	OM 642.886	2987	V6	83.00	92.00	13
GLA-Class GLA 200 CDI 4-matic	12/13→	Diesel	OM 651.930	2143	4	83.00	99.00	15
GLA-Class GLA 200 CDI / d	12/13→	Diesel	OM 651.930	2143	4	83.00	99.00	15
GLA-Class GLA 220 CDI	12/13→	Diesel	OM 651.930	2143	4	83.00	99.00	15
GLA-Class GLA 220 CDI 4-matic	12/13→	Diesel	OM 651.930	2143	4	83.00	99.00	15
GLA-Class GLA 220 CDI / d	12/13→	Diesel	OM 651.930	2143	4	83.00	99.00	15
GLA-Class GLA 220 CDI / d 4-matic	12/13→	Diesel	OM 651.930	2143	4	83.00	99.00	15
GLA-Class GLA 220 d	07/15→	Diesel	OM 651.930	2143	4	83.00	99.00	15
GLA-Class GLA 220 d 4-matic	07/15→	Diesel	OM 651.930	2143	4	83.00	99.00	15
GLC 220 d 4-matic	06/15→	Diesel	OM 651.921	2143	4	83.00	99.00	15
GLC 250 d 4-matic	06/15→	Diesel	OM 651.921	2143	4	83.00	99.00	15
GL-Class GL 320 CDI 4-matic	09/06→12/09	Diesel	OM 642.940	2987	V6	83.00	92.00	13
GL-Class GL 350 CDI 4-matic	10/10→	Diesel	OM 642.822	2987	V6	83.00	92.00	13
GL-Class GL 350 CDI 4-matic	05/09→	Diesel	OM 642.940	2987	V6	83.00	92.00	13
GL-Class GL 350 CDI / BlueTec 4-matic	07/12→	Diesel	OM 642.826	2987	V6	83.00	92.00	13
GLE 250 d	04/15→	Diesel	OM 651.960	2143	4	83.00	99.00	15
GLE 250 d 4-matic	04/15→	Diesel	OM 651.960	2143	4	83.00	99.00	15
GLE 350	11/15→	Petrol	M 276.955	3498	V6	92.90	86.00	91
GLE 350 4-matic	11/15→	Petrol	M 276.955	3498	V6	92.90	86.00	91
GLE 350 d 4-matic	03/15→	Diesel	OM 642.826	2987	V6	83.00	92.00	13
GLK-Class 200 CDI	07/10→	Diesel	OM 651.913	2143	4	83.00	99.00	15
GLK-Class 200 CDI	07/10→	Diesel	OM 651.916	2143	4	83.00	99.00	15
GLK-Class 220 CDI	12/08→	Diesel	OM 651.916	2143	4	83.00	99.00	15
GLK-Class 220 CDI 4-matic	12/08→	Diesel	OM 651.912	2143	4	83.00	99.00	15
GLK-Class 250 CDI 4-matic	09/09→	Diesel	OM 651.912	2143	4	83.00	99.00	15
GLK-Class 280 4-matic	06/08→06/09	Petrol	M 272.948	2996	V6	88.00	82.10	46
GLK-Class 300 4-matic	07/09→04/11	Petrol	M 272.948	2996	V6	88.00	82.10	46
GLK-Class 300 4-matic	09/09→	Petrol	M 276.957	3498	V6	92.90	86.00	91
GLK-Class 320 CDI 4-matic	06/08→	Diesel	OM 642.961	2987	V6	83.00	92.00	13
GLK-Class 350	04/09→	Petrol	M 272.991	3498	V6	92.90	86.00	91
GLK-Class 350 4-matic	06/08→04/11	Petrol	M 272.971	3498	V6	92.90	86.00	91
GLK-Class 350 4-matic	06/08→	Petrol	M 276.957	3498	V6	92.90	86.00	91
GLK-Class 350 CDI 4-matic	07/12→	Diesel	OM 642.835	2987	V6	83.00	92.00	13



cm3 x



9

GLK-Class 350 CGI	09/12→	Petrol	M 276.957	3498	V6	92.90	86.00	91
GLS 350 d 4-matic	11/15→	Diesel	OM 642.826	2987	V6	83.00	92.00	13
Heckflosse 200	07/65→02/68	Petrol	M 115.926	1988	4	87.00	83.60	25
Henschel 2-t 206 D 2.2	02/73→12/77	Diesel	OM 615.917	2197	4	87.00	92.40	41
Henschel 2-t 206 D 2.2	02/73→12/77	Diesel	OM 615.937	2197	4	87.00	92.40	41
Henschel 2-t 206 D 2.2	02/73→12/77	Diesel	OM 615.939	2197	4	87.00	92.40	41
Kombi 200 E	11/92→05/93	Petrol	M 102.922	1996	4	89.00	80.25	55
Kombi 200 T	09/85→05/90	Petrol	M 102.922	1996	4	89.00	80.25	55
Kombi 200 T	11/80→11/85	Petrol	M 102.920	1997	4	89.00	80.25	54
Kombi 200 T	11/80→11/85	Petrol	M 102.939	1997	4	89.00	80.25	54
Kombi 200 T D	09/85→08/91	Diesel	OM 601.912	1997	4	87.00	84.00	29
Kombi 200 TE	09/88→12/89	Petrol	M 102.962	1996	4	89.00	80.25	56
Kombi 200 TE	09/88→08/92	Petrol	M 102.963	1996	4	89.00	80.25	57
Kombi 200 TE	05/86→06/93	Petrol	M 111.940	1998	4	89.90	78.70	70
Kombi 220 TE	10/92→05/93	Petrol	M 111.960	2199	4	89.90	86.60	74
Kombi 230 T	09/77→03/80	Petrol	M 115.954	2307	4	93.75	83.60	93
Kombi 230 TE	09/85→08/92	Petrol	M 102.982	2298	4	95.50	80.30	97
Kombi 230 TE	04/80→11/85	Petrol	M 102.980	2299	4	95.50	80.30	96
Kombi 240 T D	09/77→12/85	Diesel	OM 616.912	2399	4	91.00	92.40	80
Kombi 250 T	05/78→08/82	Petrol	M 123.921	2525	6	86.00	72.50	20
Kombi 250 T D	09/85→06/93	Diesel	OM 602.912	2497	5	87.00	84.00	31
Kombi 250 TD Turbo	03/88→07/93	Diesel	OM 602.962	2497	5	87.00	84.00	32
Kombi 260 TE FGST.	09/85→08/92	Petrol	M 103.940	2597	6	82.90	80.30	8
Kombi 280 TE	09/77→11/85	Petrol	M 110.988	2746	6	86.00	78.80	21
Kombi 280 TE	10/92→06/93	Petrol	M 104.942	2799	6	89.90	73.50	68
Kombi 300 T D	09/86→06/93	Diesel	OM 603.912	2996	6	87.00	84.00	35
Kombi 300 T D	09/77→11/85	Diesel	OM 617.912	2998	5	90.90	92.40	77
Kombi 300 TD T	06/92→05/93	Diesel	OM 603.960	2996	6	87.00	84.00	36
Kombi 300 TE	01/86→08/92	Petrol	M 103.983	2960	6	88.50	80.25	51
Kombi 300 TE 4-matic	09/86→12/89	Petrol	M 103.983	2960	6	88.50	80.25	51
Kombi 300 TE 4-matic	09/86→06/93	Petrol	M 103.985	2960	6	88.50	80.25	51
Kombi 300 TE-24	09/89→08/92	Petrol	M 104.980	2960	6	88.50	80.20	50
Kombi 300 T Turbo-D	09/86→06/93	Diesel	OM 603.960	2996	6	87.00	84.00	36
Kombi 300 T Turbo-D	09/86→01/89	Diesel	OM 603.963	2996	6	87.00	84.00	36
Kombi 300 T Turbo-D	10/80→11/85	Diesel	OM 617.952	2998	5	90.90	92.40	79
Kombi 300 T Turbo-D 4-matic	01/89→06/93	Diesel	OM 603.960	2996	6	87.00	84.00	36
Kombi 300 T Turbo-D 4-matic	09/86→01/89	Diesel	OM 603.963	2996	6	87.00	84.00	36
Kombi 320 TE	10/92→06/93	Petrol	M 104.992	3199	6	89.90	84.00	71
MB100 2.3 D	11/99→01/03	Diesel	OM 661.911	2299	4	89.00	92.40	60
MB100 2.9 D	10/01→05/05	Diesel	OM 662.911	2874	5	89.00	92.40	62
MB140 2.9 D	10/01→05/05	Diesel	OM 662.911	2874	5	89.00	92.40	62
M-Class ML 230	02/98→06/05	Petrol	M 111.977	2295	4	90.90	88.40	75
M-Class ML 250 CDI / BlueTEC 4-matic	06/11→	Diesel	OM 651.960	2143	4	83.00	99.00	15
M-Class ML 270 CDI	12/99→06/05	Diesel	OM 612.963	2685	5	88.00	88.30	48
M-Class ML 280 CDI 4-matic	07/05→07/09	Diesel	OM 642.940	2987	V6	83.00	92.00	13
M-Class ML 300 4-matic	04/14→	Petrol	M 276.955	3498	V6	92.90	86.00	91
M-Class ML 300 CDI 4-matic	07/09→	Diesel	OM 642.940	2987	V6	83.00	92.00	13
M-Class ML 320	02/98→08/02	Petrol	M 112.942	3199	V6	89.90	84.00	72
M-Class ML 320 CDI 4-matic	07/05→07/09	Diesel	OM 642.940	2987	V6	83.00	92.00	13
M-Class ML 350	09/11→	Petrol	M 276.955	3498	V6	92.90	86.00	91
M-Class ML 350	08/02→06/05	Petrol	M 112.970	3724	V6	97.00	84.00	105
M-Class ML 350 4-matic	07/05→	Petrol	M 272.967	3498	V6	92.90	86.00	91
M-Class ML 350 4-matic	06/11→	Petrol	M 276.955	3498	V6	92.90	86.00	91
M-Class ML 350 4-matic	02/03→06/05	Petrol	M 112.970	3724	V6	97.00	84.00	105
M-Class ML 350 BlueTEC 4-matic	06/11→	Diesel	OM 642.826	2987	V6	83.00	92.00	13
M-Class ML 350 CDI 4-matic	09/10→12/11	Diesel	OM 642.822	2987	V6	83.00	92.00	13
M-Class ML 350 CDI 4-matic	07/09→	Diesel	OM 642.940	2987	V6	83.00	92.00	13
Pagode 280 SL	01/68→03/71	Petrol	M 130.983	2778	6	86.50	78.80	23
R-Class R 280	01/07→	Petrol	M 272.945	2996	V6	88.00	82.10	46
R-Class R 280 4-matic	05/07→	Petrol	M 272.945	2996	V6	88.00	82.10	46
R-Class R 280 CDI	05/06→	Diesel	OM 642.950	2987	V6	83.00	92.00	13
R-Class R 280 CDI 4-matic	05/06→	Diesel	OM 642.950	2987	V6	83.00	92.00	13
R-Class R 300	07/09→	Petrol	M 272.945	2996	V6	88.00	82.10	46
R-Class R 300 CDI	07/09→	Diesel	OM 642.950	2987	V6	83.00	92.00	13
R-Class R 300 CDI 4-matic	07/09→	Diesel	OM 642.950	2987	V6	83.00	92.00	13
R-Class R 320 CDI 4-matic	01/06→	Diesel	OM 642.950	2987	V6	83.00	92.00	13
R-Class R 350	01/07→	Petrol	M 272.967	3498	V6	92.90	86.00	91
R-Class R 350 4-matic	01/06→	Petrol	M 272.967	3498	V6	92.90	86.00	91
R-Class R 350 CDI 4-matic	01/06→	Diesel	OM 642.950	2987	V6	83.00	92.00	13

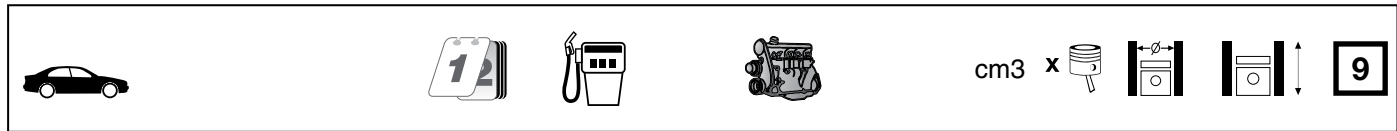

R-Class R 350 CGI 4-matic	01/06→	Petrol	M 276.958	3498	V6	92.90	86.00	91
Saloon 200	02/76→08/80	Petrol	M 115.938	1988	4	87.00	83.60	25
Saloon 200	02/76→08/80	Petrol	M 115.939	1988	4	87.00	83.60	25
Saloon 200	12/85→05/90	Petrol	M 102.922	1996	4	89.00	80.25	55
Saloon 200	06/80→11/85	Petrol	M 102.920	1997	4	89.00	80.25	54
Saloon 200	06/80→11/85	Petrol	M 102.939	1997	4	89.00	80.25	54
Saloon 200 D	07/76→11/85	Diesel	OM 615.940	1988	4	87.00	83.60	27
Saloon 200 D	12/84→06/93	Diesel	OM 601.912	1997	4	87.00	84.00	29
Saloon 200 E	11/92→05/93	Petrol	M 102.922	1996	4	89.00	80.25	55
Saloon 200 E	09/88→08/92	Petrol	M 102.963	1996	4	89.00	80.25	57
Saloon 200 E	10/92→06/93	Petrol	M 111.940	1998	4	89.90	78.70	70
Saloon 220 D	01/76→03/79	Diesel	OM 615.941	2197	4	87.00	92.40	43
Saloon 220 E	10/92→06/93	Petrol	M 111.960	2199	4	89.90	86.60	74
Saloon 230	02/76→03/81	Petrol	M 115.954	2307	4	93.75	83.60	93
Saloon 230 E	12/84→06/93	Petrol	M 102.982	2298	4	95.50	80.30	97
Saloon 230 E	04/80→12/85	Petrol	M 102.980	2299	4	95.50	80.30	96
Saloon 240 D	02/76→11/85	Diesel	OM 616.912	2399	4	91.00	92.40	80
Saloon 250	02/76→07/85	Petrol	M 123.921	2525	6	86.00	72.50	20
Saloon 250 D	04/85→06/93	Diesel	OM 602.912	2497	5	87.00	84.00	31
Saloon 250 Turbo-D	09/88→06/93	Diesel	OM 602.962	2497	5	87.00	84.00	32
Saloon 260 E	09/85→08/92	Petrol	M 103.940	2597	6	82.90	80.30	8
Saloon 260 E 4-matic	12/86→12/89	Petrol	M 103.940	2597	6	82.90	80.30	8
Saloon 260 E 4-matic	09/86→08/92	Petrol	M 103.943	2597	6	82.90	80.30	8
Saloon 280	02/76→08/81	Petrol	M 110.923	2746	6	86.00	78.80	21
Saloon 280 E	02/76→11/85	Petrol	M 110.984	2746	6	86.00	78.80	21
Saloon 280 E	02/76→11/85	Petrol	M 110.988	2746	6	86.00	78.80	21
Saloon 280 E	10/92→06/93	Petrol	M 104.942	2799	6	89.90	73.50	68
Saloon 300 D	12/84→06/93	Diesel	OM 603.912	2996	6	87.00	84.00	35
Saloon 300 D	02/76→11/85	Diesel	OM 617.912	2998	5	90.90	92.40	77
Saloon 300 D 4-matic	09/86→06/93	Diesel	OM 603.913	2996	6	87.00	84.00	35
Saloon 300 E	01/85→12/85	Petrol	M 103.980	2960	6	88.50	80.25	51
Saloon 300 E	06/85→08/92	Petrol	M 103.983	2960	6	88.50	80.25	51
Saloon 300 E 4-matic	09/86→02/92	Petrol	M 103.983	2960	6	88.50	80.25	51
Saloon 300 E 4-matic	09/86→06/93	Petrol	M 103.985	2960	6	88.50	80.25	51
Saloon 300 E-24	09/88→08/92	Petrol	M 104.980	2960	6	88.50	80.20	50
Saloon 300 TD SD	06/91→05/93	Diesel	OM 603.971	3449	6	89.00	92.40	66
Saloon 300 Turbo-D	09/86→06/93	Diesel	OM 603.960	2996	6	87.00	84.00	36
Saloon 300 Turbo-D	09/86→09/88	Diesel	OM 603.963	2996	6	87.00	84.00	36
Saloon 300 Turbo-D	08/81→07/85	Diesel	OM 617.952	2998	5	90.90	92.40	79
Saloon 300 Turbo-D 4-matic	09/86→09/88	Diesel	OM 603.960	2996	6	87.00	84.00	36
Saloon 300 Turbo-D 4-matic	09/86→06/93	Diesel	OM 603.963	2996	6	87.00	84.00	36
Saloon 320 E	10/92→06/93	Petrol	M 104.992	3199	6	89.90	84.00	71
S-Class 260 SE	09/85→06/91	Petrol	M 103.941	2597	6	82.90	80.30	8
S-Class 280 S	08/72→07/80	Petrol	M 110.922	2746	6	86.00	78.80	21
S-Class 280 S	12/79→07/85	Petrol	M 110.924	2746	6	86.00	78.80	22
S-Class 280 S	12/79→07/85	Petrol	M 110.926	2746	6	86.00	78.80	22
S-Class 280 S	10/67→07/72	Petrol	M 130.920	2780	6	86.50	78.80	23
S-Class 280 SE,SEL	08/72→07/80	Petrol	M 110.983	2746	6	86.00	78.80	21
S-Class 280 SE,SEL	08/72→07/80	Petrol	M 110.985	2746	6	86.00	78.80	21
S-Class 280 SE,SEL	10/79→07/85	Petrol	M 110.987	2746	6	86.00	78.80	22
S-Class 280 SE,SEL	10/79→07/85	Petrol	M 110.989	2746	6	86.00	78.80	22
S-Class 280 SE,SEL	01/68→08/72	Petrol	M 130.980	2780	6	86.50	78.80	23
S-Class 280 SE,SEL 3.5	03/71→08/72	Petrol	M 116.980	3500	V8	92.00	65.80	83
S-Class 300 SD	09/80→12/85	Diesel	OM 617.951	2998	5	90.90	92.40	79
S-Class 300 SDL	09/85→12/87	Diesel	OM 603.961	2996	6	87.00	84.00	36
S-Class 300 SE 2.8	01/93→10/98	Petrol	M 104.944	2799	6	89.90	73.50	68
S-Class 300 SEL	01/68→08/72	Petrol	M 130.981	2778	6	86.50	78.80	23
S-Class 300 SEL 3.5	01/70→07/72	Petrol	M 116.981	3500	V8	92.00	65.80	83
S-Class 300 SE,SEL	09/85→06/91	Petrol	M 103.981	2960	6	88.50	80.25	51
S-Class 300 SE,SEL/S320	03/91→10/98	Petrol	M 104.990	3199	6	89.90	84.00	71
S-Class 300 SE,SEL/S320	03/91→10/98	Petrol	M 104.994	3199	6	89.90	84.00	71
S-Class 350 SE,SEL	08/72→02/76	Petrol	M 116.983	3499	V8	92.00	65.80	83
S-Class 350 SE,SEL	03/76→03/80	Petrol	M 116.985	3499	V8	92.00	65.80	83
S-Class S 250 CDI	01/11→12/13	Diesel	OM 651.961	2143	4	83.00	99.00	15
S-Class S 280	02/93→10/98	Petrol	M 104.944	2799	6	89.90	73.50	68
S-Class S 280	10/98→08/05	Petrol	M 112.922	2799	V6	89.90	73.50	69
S-Class S 280	08/06→12/13	Petrol	M 272.946	2996	V6	88.00	82.10	46
S-Class S 300	08/06→12/13	Petrol	M 272.946	2996	V6	88.00	82.10	46
S-Class S 300 BlueTEC Hybrid / h	02/14→	Diesel	OM 651.921	2143	4	83.00	99.00	15



cm3 x



9

S-Class S 300 Turbo-D	05/96→10/98	Diesel	OM 606.961	2996	6	87.00	84.00	38
S-Class S320	10/95→08/98	Petrol	M 104.990	3199	6	89.90	84.00	71
S-Class S 320	10/98→08/05	Petrol	M 112.944	3199	V6	89.90	84.00	72
S-Class S 320 CDI	10/05→12/13	Diesel	OM 642.930	2987	V6	83.00	92.00	13
S-Class S 320 CDI	08/99→09/02	Diesel	OM 613.960	3222	6	88.00	88.30	49
S-Class S 320 CDI	09/02→08/05	Diesel	OM 648.960	3222	6	88.00	88.30	49
S-Class S 350	10/05→12/13	Petrol	M 272.965	3498	V6	92.90	86.00	91
S-Class S 350	09/02→08/05	Petrol	M 112.972	3724	V6	97.00	84.00	105
S-Class S 350 4-matic	02/08→12/13	Petrol	M 272.975	3498	V6	92.90	86.00	91
S-Class S 350 4-matic	06/03→08/05	Petrol	M 112.975	3724	V6	97.00	84.00	105
S-Class S 350 BlueTec	04/11→12/13	Diesel	OM 642.862	2987	V6	83.00	92.00	13
S-Class S 350 BlueTEC / d	05/13→	Diesel	OM 642.861	2987	V6	83.00	92.00	13
S-Class S 350 CDI	06/09→12/13	Diesel	OM 642.930	2987	V6	83.00	92.00	13
S-Class S 350 CGI	04/11→12/13	Petrol	M 276.950	3498	V6	92.90	86.00	91
S-Class S 350 CGI 4-matic	04/11→12/13	Petrol	M 276.950	3498	V6	92.90	86.00	91
S-Class S 350 Turbo-D	01/93→10/98	Diesel	OM 603.971	3449	6	89.00	92.40	66
S-Class S 400 Hybrid	01/09→12/13	Petrol	M 272.974	3498	V6	92.90	86.00	91
SL 280	08/93→10/01	Petrol	M 104.943	2799	6	89.90	73.50	68
SL 280	05/98→10/01	Petrol	M 112.923	2799	V6	89.90	73.50	69
SL 280	03/08→01/12	Petrol	M 272.949	2996	V6	88.00	82.10	46
SL 280	08/74→07/85	Petrol	M 110.982	2746	6	86.00	78.80	21
SL 280	08/74→07/85	Petrol	M 110.986	2746	6	86.00	78.80	21
SL 280	08/74→07/85	Petrol	M 110.990	2746	6	86.00	78.80	21
SL 280 SLC	08/74→09/81	Petrol	M 110.982	2746	6	86.00	78.80	21
SL 280 SLC	08/74→09/81	Petrol	M 110.986	2746	6	86.00	78.80	21
SL 280 SLC	08/74→09/81	Petrol	M 110.990	2746	6	86.00	78.80	21
SL 300	04/09→01/12	Petrol	M 272.949	2996	V6	88.00	82.10	46
SL 300	09/85→08/89	Petrol	M 103.982	2960	6	88.50	80.25	51
SL 300	03/89→08/93	Petrol	M 103.984	2960	6	88.50	80.25	51
SL 300 SL-24	03/89→07/93	Petrol	M 104.981	2960	6	88.50	80.20	50
SL 320	09/93→10/01	Petrol	M 104.991	3199	6	89.90	84.00	71
SL 320	05/98→10/01	Petrol	M 112.943	3199	V6	89.90	84.00	72
SL 350	03/06→01/12	Petrol	M 272.966	3498	V6	92.90	86.00	91
SL 350	04/08→01/12	Petrol	M 272.968	3498	V6	92.90	86.00	91
SL 350	03/03→01/12	Petrol	M 112.973	3724	V6	97.00	84.00	105
SL 350	05/71→02/80	Petrol	M 116.982	3499	V8	92.00	65.80	83
SL 350	05/71→02/80	Petrol	M 116.984	3499	V8	92.00	65.80	83
SL 350 SLC	01/72→02/80	Petrol	M 116.982	3499	V8	92.00	65.80	83
SL 350 SLC	01/72→02/80	Petrol	M 116.984	3499	V8	92.00	65.80	83
SL 320	09/94→12/97	Petrol	M 104.991	3199	6	89.90	84.00	71
SLC 250 d	01/16→	Diesel	OM 651.980	2143	4	83.00	99.00	15
SLK 200	02/11→	Petrol	M 271.860	1796	4	82.00	85.00	7
SLK 200	02/11→	Petrol	M 271.861	1796	4	82.00	85.00	7
SLK 200	09/96→03/00	Petrol	M 111.946	1998	4	89.90	78.70	70
SLK 200 Kompressor	03/04→02/11	Petrol	M 271.944	1795	4	82.00	85.00	7
SLK 200 Kompressor	01/08→02/11	Petrol	M 271.954	1796	4	82.00	85.00	7
SLK 200 Kompressor	10/96→03/00	Petrol	M 111.943	1998	4	89.90	78.70	70
SLK 200 Kompressor	03/00→04/04	Petrol	M 111.958	1998	4	89.90	78.70	70
SLK 230	09/00→04/04	Petrol	M 111.983	2295	4	90.90	88.40	75
SLK 230 Kompressor	09/96→12/00	Petrol	M 111.973	2295	4	90.90	88.40	75
SLK 230 Kompressor	03/00→04/04	Petrol	M 111.983	2295	4	90.90	88.40	75
SLK 250	02/11→	Petrol	M 271.860	1796	4	82.00	85.00	7
SLK 250	02/11→	Petrol	M 271.861	1796	4	82.00	85.00	7
SLK 250 CDI / d	01/12→	Diesel	OM 651.980	2143	4	83.00	99.00	15
SLK 280	01/05→02/11	Petrol	M 272.942	2996	V6	88.00	82.10	46
SLK 300	04/09→02/11	Petrol	M 272.942	2996	V6	88.00	82.10	46
SLK 320	03/00→04/04	Petrol	M 112.947	3199	V6	89.90	84.00	72
SLK 350	06/04→02/11	Petrol	M 272.963	3498	V6	92.90	86.00	91
SLK 350	01/08→02/11	Petrol	M 272.969	3498	V6	92.90	86.00	91
SLK 350	02/11→	Petrol	M 276.956	3498	V6	92.90	86.00	91
Sprinter 616 CDI	04/01→	Diesel	OM 612.981	2685	5	88.00	88.30	48
Sprinter 2-t 208 CDI	04/00→05/06	Diesel	OM 611.987	2148	4	88.00	88.30	47
Sprinter 2-t 208 D	01/95→04/00	Diesel	OM 601.943	2299	4	89.00	92.40	61
Sprinter 2-t 210 D	01/97→04/00	Diesel	OM 602.980	2874	5	89.00	92.40	64
Sprinter 2-t 211 CDI	04/00→05/06	Diesel	OM 611.981	2148	4	88.00	88.30	47
Sprinter 2-t 212 D	02/95→04/00	Diesel	OM 602.980	2874	5	89.00	92.40	64
Sprinter 2-t 213 CDI	04/00→05/06	Diesel	OM 611.981	2148	4	88.00	88.30	47
Sprinter 2-t 214	02/95→05/06	Petrol	M 111.979	2295	4	90.90	88.40	75
Sprinter 2-t 214	02/95→05/06	Petrol	M 111.984	2295	4	90.90	88.40	75

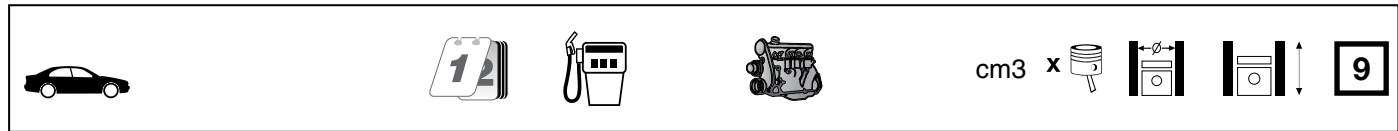

Sprinter 2-t 214 NGT	04/00→05/06	Petrol	M 111.984	2295	4	90.90	88.40	75
Sprinter 2-t 216 CDI	04/00→05/06	Diesel	OM 612.981	2685	5	88.00	88.30	48
Sprinter 3,5-t 309 CDI	06/06→	Diesel	OM 646.984	2148	4	88.00	88.30	47
Sprinter 3,5-t 310 CDI	03/09→	Diesel	OM 651.955	2143	4	83.00	99.00	15
Sprinter 3,5-t 310 CDI	03/09→	Diesel	OM 651.956	2143	4	83.00	99.00	15
Sprinter 3,5-t 311 CDI	06/06→	Diesel	OM 646.985	2148	4	88.00	88.30	47
Sprinter 3,5-t 311 CDI 4x4	02/08→	Diesel	OM 646.985	2148	4	88.00	88.30	47
Sprinter 3,5-t 313 CDI	06/06→	Diesel	OM 651.955	2143	4	83.00	99.00	15
Sprinter 3,5-t 313 CDI	06/06→	Diesel	OM 651.956	2143	4	83.00	99.00	15
Sprinter 3,5-t 313 CDI	06/06→	Diesel	OM 646.986	2148	4	88.00	88.30	47
Sprinter 3,5-t 313 CDI 4x4	06/06→	Diesel	OM 651.955	2143	4	83.00	99.00	15
Sprinter 3,5-t 313 CDI 4x4	06/06→	Diesel	OM 651.956	2143	4	83.00	99.00	15
Sprinter 3,5-t 315 CDI	06/06→	Diesel	OM 646.989	2148	4	88.00	88.30	47
Sprinter 3,5-t 315 CDI	06/06→	Diesel	OM 646.990	2148	4	88.00	88.30	47
Sprinter 3,5-t 315 CDI 4x4	02/08→	Diesel	OM 646.989	2148	4	88.00	88.30	47
Sprinter 3,5-t 315 CDI 4x4	02/08→	Diesel	OM 646.990	2148	4	88.00	88.30	47
Sprinter 3,5-t 316	09/08→	Petrol	M 271.951	1796	4	82.00	85.00	7
Sprinter 3,5-t 316 CDI	03/09→	Diesel	OM 651.955	2143	4	83.00	99.00	15
Sprinter 3,5-t 316 CDI	03/09→	Diesel	OM 651.957	2143	4	83.00	99.00	15
Sprinter 3,5-t 316 CDI 4x4	03/09→	Diesel	OM 651.955	2143	4	83.00	99.00	15
Sprinter 3,5-t 316 CDI 4x4	03/09→	Diesel	OM 651.957	2143	4	83.00	99.00	15
Sprinter 3,5-t 316 LGT	09/08→	Petrol	M 271.951	1796	4	82.00	85.00	7
Sprinter 3,5-t 316 NGT	09/08→	Petrol	M 271.951	1796	4	82.00	85.00	7
Sprinter 3,5-t 318 CDI	06/06→	Diesel	OM 642.896	2987	V6	83.00	92.00	13
Sprinter 3,5-t 318 CDI	06/06→	Diesel	OM 642.992	2987	V6	83.00	92.00	13
Sprinter 3,5-t 318 CDI	06/06→	Diesel	OM 642.993	2987	V6	83.00	92.00	13
Sprinter 3,5-t 318 CDI 4x4	02/08→	Diesel	OM 642.896	2987	V6	83.00	92.00	13
Sprinter 3,5-t 318 CDI 4x4	02/08→	Diesel	OM 642.992	2987	V6	83.00	92.00	13
Sprinter 3,5-t 318 CDI 4x4	02/08→	Diesel	OM 642.993	2987	V6	83.00	92.00	13
Sprinter 3,5-t 319 CDI / BlueTEC	03/09→	Diesel	OM 642.896	2987	V6	83.00	92.00	13
Sprinter 3,5-t 319 CDI / BlueTEC	03/09→	Diesel	OM 642.898	2987	V6	83.00	92.00	13
Sprinter 3,5-t 319 CDI / BlueTEC	03/09→	Diesel	OM 642.992	2987	V6	83.00	92.00	13
Sprinter 3,5-t 319 CDI / BlueTEC 4x4	03/09→	Diesel	OM 642.896	2987	V6	83.00	92.00	13
Sprinter 3,5-t 319 CDI / BlueTEC 4x4	03/09→	Diesel	OM 642.898	2987	V6	83.00	92.00	13
Sprinter 3,5-t 319 CDI / BlueTEC 4x4	03/09→	Diesel	OM 642.992	2987	V6	83.00	92.00	13
Sprinter 3,5-t 324	06/06→	Petrol	M 272.979	3498	V6	92.90	86.00	91
Sprinter 3-t 2.3 D 4x4	06/97→12/99	Diesel	OM 601.943	2299	4	89.00	92.40	61
Sprinter 3-t 209 CDI	06/06→	Diesel	OM 646.984	2148	4	88.00	88.30	47
Sprinter 3-t 210 CDI	03/09→	Diesel	OM 651.955	2143	4	83.00	99.00	15
Sprinter 3-t 211 CDI	06/06→	Diesel	OM 646.985	2148	4	88.00	88.30	47
Sprinter 3-t 213 CDI	06/06→	Diesel	OM 651.955	2143	4	83.00	99.00	15
Sprinter 3-t 213 CDI	06/06→	Diesel	OM 651.956	2143	4	83.00	99.00	15
Sprinter 3-t 213 CDI	06/06→	Diesel	OM 646.986	2148	4	88.00	88.30	47
Sprinter 3-t 215 CDI	06/06→	Diesel	OM 646.986	2148	4	88.00	88.30	47
Sprinter 3-t 215 CDI	06/06→	Diesel	OM 646.989	2148	4	88.00	88.30	47
Sprinter 3-t 215 CDI	06/06→	Diesel	OM 646.990	2148	4	88.00	88.30	47
Sprinter 3-t 216	09/08→	Petrol	M 271.951	1796	4	82.00	85.00	7
Sprinter 3-t 216 CDI	06/06→	Diesel	OM 651.955	2143	4	83.00	99.00	15
Sprinter 3-t 216 CDI	06/06→	Diesel	OM 651.957	2143	4	83.00	99.00	15
Sprinter 3-t 218 CDI	06/06→	Diesel	OM 642.896	2987	V6	83.00	92.00	13
Sprinter 3-t 218 CDI	06/06→	Diesel	OM 642.992	2987	V6	83.00	92.00	13
Sprinter 3-t 218 CDI	06/06→	Diesel	OM 642.993	2987	V6	83.00	92.00	13
Sprinter 3-t 219 CDI / BlueTEC	03/09→	Diesel	OM 642.896	2987	V6	83.00	92.00	13
Sprinter 3-t 219 CDI / BlueTEC	03/09→	Diesel	OM 642.992	2987	V6	83.00	92.00	13
Sprinter 3-t 224	06/06→	Petrol	M 272.979	3498	V6	92.90	86.00	91
Sprinter 3-t 308 CDI	04/00→05/06	Diesel	OM 611.987	2148	4	88.00	88.30	47
Sprinter 3-t 308 D	02/95→04/00	Diesel	OM 601.943	2299	4	89.00	92.40	61
Sprinter 3-t 308 D 2.3	02/95→04/00	Diesel	OM 601.943	2299	4	89.00	92.40	61
Sprinter 3-t 310 D	01/97→12/99	Diesel	OM 602.980	2874	5	89.00	92.40	64
Sprinter 3-t 310 D 2.9	02/95→04/00	Diesel	OM 602.980	2874	5	89.00	92.40	64
Sprinter 3-t 310 D 2.9 4x4	06/97→04/00	Diesel	OM 602.980	2874	5	89.00	92.40	64
Sprinter 3-t 310 D 4x4	05/97→08/02	Diesel	OM 602.980	2874	5	89.00	92.40	64
Sprinter 3-t 311 CDI	04/00→05/06	Diesel	OM 611.981	2148	4	88.00	88.30	47
Sprinter 3-t 311 CDI 4x4	08/02→05/06	Diesel	OM 611.981	2148	4	88.00	88.30	47
Sprinter 3-t 312 D 2.9	02/95→09/01	Diesel	OM 602.980	2874	5	89.00	92.40	64
Sprinter 3-t 312 D 2.9 4x4	05/97→08/02	Diesel	OM 602.980	2874	5	89.00	92.40	64
Sprinter 3-t 313 CDI	04/00→05/06	Diesel	OM 611.981	2148	4	88.00	88.30	47
Sprinter 3-t 313 CDI 4x4	08/02→05/06	Diesel	OM 611.981	2148	4	88.00	88.30	47
Sprinter 3-t 314	02/95→05/06	Petrol	M 111.979	2295	4	90.90	88.40	75



cm3



9

Sprinter 3-t 314	02/95→05/06	Petrol	M 111.984	2295	4	90.90	88.40	75
Sprinter 3-t 314 4x4	08/02→05/06	Petrol	M 111.984	2295	4	90.90	88.40	75
Sprinter 3-t 314 NGT	04/00→05/06	Petrol	M 111.984	2295	4	90.90	88.40	75
Sprinter 3-t 316 CDI	04/00→05/06	Diesel	OM 612.981	2685	5	88.00	88.30	48
Sprinter 3-t 316 CDI 4x4	08/02→05/06	Diesel	OM 612.981	2685	5	88.00	88.30	48
Sprinter 4,6-t 411 CDI	06/09→	Diesel	OM 646.985	2148	4	88.00	88.30	47
Sprinter 4,6-t 413 CDI	06/06→	Diesel	OM 651.955	2143	4	83.00	99.00	15
Sprinter 4,6-t 413 CDI	06/06→	Diesel	OM 651.956	2143	4	83.00	99.00	15
Sprinter 4,6-t 413 CDI	06/06→	Diesel	OM 646.986	2148	4	88.00	88.30	47
Sprinter 4,6-t 415 CDI	06/06→	Diesel	OM 651.957	2143	4	83.00	99.00	15
Sprinter 4,6-t 415 CDI	06/06→	Diesel	OM 646.989	2148	4	88.00	88.30	47
Sprinter 4,6-t 415 CDI	06/06→	Diesel	OM 646.990	2148	4	88.00	88.30	47
Sprinter 4,6-t 416 CDI	03/09→	Diesel	OM 651.957	2143	4	83.00	99.00	15
Sprinter 4,6-t 418 CDI	06/06→	Diesel	OM 642.896	2987	V6	83.00	92.00	13
Sprinter 4,6-t 418 CDI	06/06→	Diesel	OM 642.992	2987	V6	83.00	92.00	13
Sprinter 4,6-t 418 CDI	06/06→	Diesel	OM 642.993	2987	V6	83.00	92.00	13
Sprinter 4,6-t 419 CDI	03/09→	Diesel	OM 642.896	2987	V6	83.00	92.00	13
Sprinter 4,6-t 419 CDI	03/09→	Diesel	OM 642.898	2987	V6	83.00	92.00	13
Sprinter 4,6-t 419 CDI	03/09→	Diesel	OM 642.992	2987	V6	83.00	92.00	13
Sprinter 4,6-t 424	06/06→	Petrol	M 272.979	3498	V6	92.90	86.00	91
Sprinter 4-t 2.3 D 4x4	06/97→12/99	Diesel	OM 601.943	2299	4	89.00	92.40	61
Sprinter 4-t 408 CDI	04/00→05/06	Diesel	OM 611.987	2148	4	88.00	88.30	47
Sprinter 4-t 408 D	02/96→05/06	Diesel	OM 601.943	2299	4	89.00	92.40	61
Sprinter 4-t 410 D	02/96→05/06	Diesel	OM 602.980	2874	5	89.00	92.40	64
Sprinter 4-t 410 D 4x4	05/97→05/06	Diesel	OM 602.980	2874	5	89.00	92.40	64
Sprinter 4-t 411 CDI	04/00→05/06	Diesel	OM 611.981	2148	4	88.00	88.30	47
Sprinter 4-t 411 CDI 4x4	04/00→05/06	Diesel	OM 611.981	2148	4	88.00	88.30	47
Sprinter 4-t 412 D	02/96→05/06	Diesel	OM 602.980	2874	5	89.00	92.40	64
Sprinter 4-t 412 D 4x4	05/97→05/06	Diesel	OM 602.980	2874	5	89.00	92.40	64
Sprinter 4-t 413 CDI	04/00→05/06	Diesel	OM 611.981	2148	4	88.00	88.30	47
Sprinter 4-t 413 CDI 4x4	04/00→05/06	Diesel	OM 611.981	2148	4	88.00	88.30	47
Sprinter 4-t 414	02/96→05/06	Petrol	M 111.979	2295	4	90.90	88.40	75
Sprinter 4-t 414 4x4	05/97→05/06	Petrol	M 111.979	2295	4	90.90	88.40	75
Sprinter 4-t 414 D 4x4	05/97→05/06	Diesel	OM 602.980	2874	5	89.00	92.40	64
Sprinter 4-t 416 CDI	04/00→05/06	Diesel	OM 612.981	2685	5	88.00	88.30	48
Sprinter 4-t 416 CDI 4x4	04/00→05/06	Diesel	OM 612.981	2685	5	88.00	88.30	48
Sprinter 5-t 509 CDI	06/06→	Diesel	OM 646.984	2148	4	88.00	88.30	47
Sprinter 5-t 510 CDI	03/09→	Diesel	OM 651.955	2143	4	83.00	99.00	15
Sprinter 5-t 511 CDI	06/06→	Diesel	OM 646.985	2148	4	88.00	88.30	47
Sprinter 5-t 511 CDI 4x4	06/06→	Diesel	OM 646.985	2148	4	88.00	88.30	47
Sprinter 5-t 513 CDI	06/06→	Diesel	OM 651.955	2143	4	83.00	99.00	15
Sprinter 5-t 513 CDI	06/06→	Diesel	OM 651.956	2143	4	83.00	99.00	15
Sprinter 5-t 513 CDI	06/06→	Diesel	OM 646.986	2148	4	88.00	88.30	47
Sprinter 5-t 513 CDI 4x4	05/11→	Diesel	OM 651.955	2143	4	83.00	99.00	15
Sprinter 5-t 513 CDI 4x4	06/06→	Diesel	OM 651.956	2143	4	83.00	99.00	15
Sprinter 5-t 515 CDI	06/06→	Diesel	OM 651.957	2143	4	83.00	99.00	15
Sprinter 5-t 515 CDI	06/06→	Diesel	OM 646.986	2148	4	88.00	88.30	47
Sprinter 5-t 515 CDI	06/06→	Diesel	OM 646.989	2148	4	88.00	88.30	47
Sprinter 5-t 515 CDI	06/06→	Diesel	OM 646.990	2148	4	88.00	88.30	47
Sprinter 5-t 515 CDI	06/06→	Diesel	OM 646.990	2148	4	88.00	88.30	47
Sprinter 5-t 516	09/08→	Petrol	M 271.951	1796	4	82.00	85.00	7
Sprinter 5-t 516 CDI	03/09→	Diesel	OM 651.955	2143	4	83.00	99.00	15
Sprinter 5-t 516 CDI	03/09→	Diesel	OM 651.957	2143	4	83.00	99.00	15
Sprinter 5-t 516 CDI 4x4	06/06→	Diesel	OM 651.955	2143	4	83.00	99.00	15
Sprinter 5-t 516 CDI 4x4	06/06→	Diesel	OM 651.957	2143	4	83.00	99.00	15
Sprinter 5-t 516 NGT	09/08→	Petrol	M 271.951	1796	4	82.00	85.00	7
Sprinter 5-t 518 CDI	06/06→	Diesel	OM 642.896	2987	V6	83.00	92.00	13
Sprinter 5-t 518 CDI	06/06→	Diesel	OM 642.992	2987	V6	83.00	92.00	13
Sprinter 5-t 518 CDI	06/06→	Diesel	OM 642.993	2987	V6	83.00	92.00	13
Sprinter 5-t 518 CDI 4x4	06/06→	Diesel	OM 642.896	2987	V6	83.00	92.00	13
Sprinter 5-t 518 CDI 4x4	06/06→	Diesel	OM 642.992	2987	V6	83.00	92.00	13
Sprinter 5-t 518 CDI 4x4	06/06→	Diesel	OM 642.993	2987	V6	83.00	92.00	13
Sprinter 5-t 519 CDI / BlueTEC	03/09→	Diesel	OM 642.896	2987	V6	83.00	92.00	13
Sprinter 5-t 519 CDI / BlueTEC	03/09→	Diesel	OM 642.898	2987	V6	83.00	92.00	13
Sprinter 5-t 519 CDI / BlueTEC	03/09→	Diesel	OM 642.992	2987	V6	83.00	92.00	13
Sprinter 5-t 519 CDI / BlueTEC 4x4	03/09→	Diesel	OM 642.896	2987	V6	83.00	92.00	13
Sprinter 5-t 519 CDI / BlueTEC 4x4	03/09→	Diesel	OM 642.898	2987	V6	83.00	92.00	13
Sprinter 5-t 519 CDI / BlueTEC 4x4	03/09→	Diesel	OM 642.992	2987	V6	83.00	92.00	13



Sprinter 5-t 524	06/06→	Petrol	M 272.979	3498	V6	92.90	86.00	91
Sprinter 5-t 616 CDI	04/01→05/06	Diesel	OM 612.981	2685	5	88.00	88.30	48
T1 207 D 2.4	05/77→12/82	Diesel	OM 616.934	2399	4	91.00	92.40	80
T1 207 D 2.4	12/77→01/90	Diesel	OM 616.937	2399	4	91.00	92.40	80
T1 207 D 2.4	06/82→01/90	Diesel	OM 616.939	2399	4	91.00	92.40	81
T1 207 D 2.4	04/77→12/82	Diesel	OM 616.917	2404	4	91.00	92.40	80
T1 208 2.3	05/77→12/82	Petrol	M 115.955	2307	4	93.75	83.60	93
T1 208 2.3	05/77→12/82	Petrol	M 115.972	2307	4	93.75	83.60	93
T1 208 D 2.3	10/88→02/96	Diesel	OM 601.940	2299	4	89.00	92.40	61
T1 209 D 2.9	12/82→01/90	Diesel	OM 617.913	2998	5	90.90	92.40	78
T1 210 2.3	04/77→02/96	Petrol	M 102.942	2298	4	95.50	80.30	94
T1 210 2.3	05/89→02/96	Petrol	M 102.945	2298	4	95.50	80.30	94
T1 210 2.3	07/82→02/96	Petrol	M 102.946	2298	4	95.50	80.30	94
T1 210 2.3	04/77→10/89	Petrol	M 115.955	2307	4	93.75	83.60	93
T1 210 D 2.8	10/88→02/96	Diesel	OM 602.940	2874	5	89.00	92.40	63
T1 210 D 2.9	11/88→02/96	Diesel	OM 602.940	2874	5	89.00	92.40	63
T1 307 D 2.4	04/77→01/90	Diesel	OM 616.937	2399	4	91.00	92.40	80
T1 307 D 2.4	06/82→01/90	Diesel	OM 616.939	2399	4	91.00	92.40	81
T1 307 D 2.4	01/77→12/90	Diesel	OM 616.917	2404	4	91.00	92.40	80
T1 308 D 2.3	11/88→02/96	Diesel	OM 601.940	2299	4	89.00	92.40	61
T1 309 D 3.0	10/82→01/90	Diesel	OM 617.913	2998	5	90.90	92.40	78
T1 310 2.3	01/82→02/96	Petrol	M 102.942	2298	4	95.50	80.30	94
T1 310 2.3	01/89→12/95	Petrol	M 102.945	2298	4	95.50	80.30	94
T1 310 D 2.9	06/89→02/96	Diesel	OM 602.940	2874	5	89.00	92.40	63
T1/TN 407 D	07/81→01/89	Diesel	OM 616.913	2398	4	91.00	92.40	81
T1/TN 407 D	07/81→01/89	Diesel	OM 616.939	2399	4	91.00	92.40	81
T1/TN 408 D	11/88→06/95	Diesel	OM 601.940	2299	4	89.00	92.40	61
T1/TN 409 D	04/82→01/89	Diesel	OM 617.913	2998	5	90.90	92.40	78
T1/TN 410	08/82→06/95	Petrol	M 102.942	2298	4	95.50	80.30	94
T1/TN 410	08/82→06/95	Petrol	M 102.945	2298	4	95.50	80.30	94
T1/TN 410 D	11/88→06/95	Diesel	OM 602.940	2874	5	89.00	92.40	63
T2/L L 406 DG	01/68→12/74	Diesel	OM 615.910	2197	4	87.00	92.40	41
T2/L L 407 D	01/75→12/88	Diesel	OM 616.910	2400	4	91.00	92.40	80
T2/L L 407 D	01/75→12/88	Diesel	OM 616.917	2404	4	91.00	92.40	80
T2/L L 408 G	08/72→12/74	Petrol	M 115.921	2197	4	87.00	92.40	39
T2/L L 408 G	08/72→12/74	Petrol	M 115.928	2197	4	87.00	92.40	39
T2/L L 409	01/75→08/82	Petrol	M 115.952	2307	4	93.75	83.60	93
T2/L L 410	08/82→12/88	Petrol	M 102.943	2299	4	95.50	80.30	94
T2/L LK 408 G	01/68→12/74	Petrol	M 115.921	2197	4	87.00	92.40	39
T2/L LK 408 G, LK 409	08/82→09/83	Petrol	M 102.943	2299	4	95.50	80.30	94
T2/L LK 408 G, LK 409	01/75→08/82	Petrol	M 115.952	2307	4	93.75	83.60	93
T2/L Municipal Vehicle LF 408 G	08/72→12/74	Petrol	M 115.927	2197	4	87.00	92.40	39
T2/L Municipal Vehicle LF 408 G	08/72→12/74	Petrol	M 115.929	2197	4	87.00	92.40	39
T2/L Municipal Vehicle LF 409 G	01/75→08/82	Petrol	M 115.952	2307	4	93.75	83.60	93
T2/L Municipal Vehicle LF 409 G	01/75→08/82	Petrol	M 115.970	2307	4	93.75	83.60	93
T2/L Municipal Vehicle LF 409 G	01/75→08/82	Petrol	M 115.971	2307	4	93.75	83.60	93
T2/LN1 507 D	04/86→04/89	Diesel	OM 616.914	2399	4	91.00	92.40	81
T2/LN1 507 DK	04/86→04/89	Diesel	OM 616.914	2399	4	91.00	92.40	81
T2/LN1 508 D	03/89→12/94	Diesel	OM 601.941	2299	4	89.00	92.40	61
T2/LN1 510	04/86→12/94	Petrol	M 102.946	2298	4	95.50	80.30	94
Vaneo 1.4	06/02→07/05	Petrol	M 166.940	1397	4	80.00	69.50	2
Vaneo 1.6	02/02→07/05	Petrol	M 166.961	1598	4	80.00	79.50	3
Vaneo 1.7 CDI	02/02→07/05	Diesel	OM 668.914	1689	4	80.00	84.00	5
Vaneo 1.9	02/02→07/05	Petrol	M 166.991	1898	4	84.00	85.60	17
Vario 512 D	09/96→	Diesel	OM 602.984	2874	5	89.00	92.40	64
Vario 612 D	09/96→	Diesel	OM 602.984	2874	5	89.00	92.40	64
Vario 612 D	09/96→	Diesel	OM 602.985	2874	5	89.00	92.40	64
Vario 812 D	09/96→	Diesel	OM 602.984	2874	5	89.00	92.40	64
Vario 812 D	09/96→	Diesel	OM 602.985	2874	5	89.00	92.40	64
Vario O 812	09/96→	Diesel	OM 602.984	2874	5	89.00	92.40	64
Vario O 812	09/96→	Diesel	OM 602.985	2874	5	89.00	92.40	64
V-Class V 200	02/97→07/03	Petrol	M 111.948	1998	4	89.90	78.70	70
V-Class V 200	02/97→07/03	Petrol	M 111.950	1998	4	89.90	78.70	70
V-Class V 200 CDI	03/99→07/03	Diesel	OM 611.980	2151	4	88.00	88.30	47
V-Class V 200 CDI / d	03/14→	Diesel	OM 651.950	2143	4	83.00	99.00	15
V-Class V 200 CDI / d 4-matic	04/15→	Diesel	OM 651.950	2143	4	83.00	99.00	15
V-Class V 220 CDI	03/99→07/03	Diesel	OM 611.980	2151	4	88.00	88.30	47
V-Class V 220 CDI / d	03/14→	Diesel	OM 651.950	2143	4	83.00	99.00	15
V-Class V 220 CDI / d 4-matic	04/15→	Diesel	OM 651.950	2143	4	83.00	99.00	15



cm3

x













9





V-Class V 230	10/96→07/03	Petrol	M 111.978	2295	4	90.90	88.40	75
V-Class V 230 TD	09/96→07/03	Diesel	OM 601.970	2299	4	89.00	92.40	59
V-Class V 250 BlueTEC / d	03/14→	Diesel	OM 651.950	2143	4	83.00	99.00	15
V-Class V 250 BlueTEC / d 4-matic	12/14→	Diesel	OM 651.950	2143	4	83.00	99.00	15
Viano 3,0	09/03→	Petrol	M 112.951	3199	V6	89.90	84.00	72
Viano 3.2	09/03→	Petrol	M 112.951	3199	V6	89.90	84.00	72
Viano 3.5	09/07→	Petrol	M 272.978	3498	V6	92.90	86.00	91
Viano 3.7	06/04→	Petrol	M 112.976	3724	V6	97.00	84.00	105
Viano CDI 2.0	07/10→	Diesel	OM 651.940	2143	4	83.00	99.00	15
Viano CDI 2.0	09/03→	Diesel	OM 646.982	2148	4	88.00	88.30	47
Viano CDI 2.0 4-matic	07/10→	Diesel	OM 651.940	2143	4	83.00	99.00	15
Viano CDI 2.0 4-matic	07/05→	Diesel	OM 646.982	2148	4	88.00	88.30	47
Viano CDI 2.2	07/10→	Diesel	OM 651.940	2143	4	83.00	99.00	15
Viano CDI 2.2	09/03→	Diesel	OM 646.980	2148	4	88.00	88.30	47
Viano CDI 2.2	09/03→	Diesel	OM 646.982	2148	4	88.00	88.30	47
Viano CDI 2.2 4-matic	07/10→	Diesel	OM 651.940	2143	4	83.00	99.00	15
Viano CDI 2.2 4-matic	07/05→	Diesel	OM 646.982	2148	4	88.00	88.30	47
Viano CDI 3.0	03/06→	Diesel	OM 642.990	2987	V6	83.00	92.00	13
Vito 108 CDI 2.2	03/99→07/03	Diesel	OM 611A (60 KW CDI)	2151	4	88.00	88.30	47
Vito 108 D 2.3	02/96→07/03	Diesel	OM 601.942	2299	4	89.00	92.40	59
Vito 109 CDI	09/06→	Diesel	OM 646.980	2148	4	88.00	88.30	47
Vito 109 CDI	09/03→	Diesel	OM 646.983	2148	4	88.00	88.30	47
Vito 109 CDI 4x4	09/07→	Diesel	OM 646.981	2148	4	88.00	88.30	47
Vito 110 CDI	09/10→	Diesel	OM 651.940	2143	4	83.00	99.00	15
Vito 110 CDI 2.2	03/99→07/03	Diesel	OM 611LA (75 KW CDI)	2151	4	88.00	88.30	47
Vito 110 D 2.3	03/97→07/03	Diesel	OM 601.970	2299	4	89.00	92.40	59
Vito 110 TD 2.3	02/96→07/03	Diesel	OM 601.970	2299	4	89.00	92.40	59
Vito 111 CDI	09/07→	Diesel	OM 646.980	2148	4	88.00	88.30	47
Vito 111 CDI	09/03→	Diesel	OM 646.982	2148	4	88.00	88.30	47
Vito 111 CDI 4x4	09/07→	Diesel	OM 646.982	2148	4	88.00	88.30	47
Vito 112 CDI 2.2	03/99→07/03	Diesel	OM 611.980	2151	4	88.00	88.30	47
Vito 113 2.0	02/96→07/03	Petrol	M 111.948	1998	4	89.90	78.70	70
Vito 113 2.0	02/96→07/03	Petrol	M 111.950	1998	4	89.90	78.70	70
Vito 113 CDI	09/10→	Diesel	OM 651.940	2143	4	83.00	99.00	15
Vito 113 CDI 4x4	09/10→	Diesel	OM 651.940	2143	4	83.00	99.00	15
Vito 114 2.3	12/96→07/03	Petrol	M 111.978	2295	4	90.90	88.40	75
Vito 114 BlueTEC 4x4	07/15→	Diesel	OM 651.950	2143	4	83.00	99.00	15
Vito 114 CDI	10/14→	Diesel	OM 651.950	2143	4	83.00	99.00	15
Vito 114 CDI 4x4	07/15→	Diesel	OM 651.950	2143	4	83.00	99.00	15
Vito 114 CDI / 114 BlueTEC	10/14→	Diesel	OM 651.950	2143	4	83.00	99.00	15
Vito 115 CDI	09/03→	Diesel	OM 646.982	2148	4	88.00	88.30	47
Vito 115 CDI 4x4	09/07→	Diesel	OM 646.982	2148	4	88.00	88.30	47
Vito 116 BlueTEC 4x4	07/15→	Diesel	OM 651.950	2143	4	83.00	99.00	15
Vito 116 CDI	09/10→	Diesel	OM 651.940	2143	4	83.00	99.00	15
Vito 116 CDI	10/14→	Diesel	OM 651.950	2143	4	83.00	99.00	15
Vito 116 CDI 4x4	09/10→	Diesel	OM 651.940	2143	4	83.00	99.00	15
Vito 116 CDI 4x4	07/15→	Diesel	OM 651.950	2143	4	83.00	99.00	15
Vito 116 CDI / 116 BlueTEC	10/14→	Diesel	OM 651.950	2143	4	83.00	99.00	15
Vito 119	09/03→	Petrol	M 112.951	3199	V6	89.90	84.00	72
Vito 119 BlueTEC	10/14→	Diesel	OM 651.950	2143	4	83.00	99.00	15
Vito 119 BlueTEC 4x4	12/14→	Diesel	OM 651.950	2143	4	83.00	99.00	15
Vito 120 CDI	07/06→	Diesel	OM 642.990	2987	V6	83.00	92.00	13
Vito 122	09/03→	Petrol	M 112.951	3199	V6	89.90	84.00	72
Vito 122 CDI	09/10→	Diesel	OM 642.890	2987	V6	83.00	92.00	13
Vito 123	06/04→	Petrol	M 112.976	3724	V6	97.00	84.00	105
Vito 126	09/07→	Petrol	M 272.978	3498	V6	92.90	86.00	91
Vito / Mixto 109 CDI	08/06→	Diesel	OM 646.980	2148	4	88.00	88.30	47
Vito / Mixto 109 CDI	08/06→	Diesel	OM 646.981	2148	4	88.00	88.30	47
Vito / Mixto 109 CDI	09/03→	Diesel	OM 646.983	2148	4	88.00	88.30	47
Vito / Mixto 110 CDI	09/10→	Diesel	OM 651.940	2143	4	83.00	99.00	15
Vito / Mixto 111 CDI	09/07→	Diesel	OM 646.980	2148	4	88.00	88.30	47
Vito / Mixto 111 CDI	09/03→	Diesel	OM 646.982	2148	4	88.00	88.30	47
Vito / Mixto 111 CDI 4x4	09/07→	Diesel	OM 646.982	2148	4	88.00	88.30	47
Vito / Mixto 113 CDI	09/10→	Diesel	OM 651.940	2143	4	83.00	99.00	15
Vito / Mixto 113 CDI 4x4	09/10→	Diesel	OM 651.940	2143	4	83.00	99.00	15
Vito / Mixto 115 CDI	09/03→	Diesel	OM 646.980	2148	4	88.00	88.30	47
Vito / Mixto 115 CDI	09/03→	Diesel	OM 646.982	2148	4	88.00	88.30	47
Vito / Mixto 115 CDI 4x4	07/06→	Diesel	OM 646.982	2148	4	88.00	88.30	47
Vito / Mixto 116 CDI	09/10→	Diesel	OM 651.940	2143	4	83.00	99.00	15







				cm ³ x 			
---	---	---	---	---	---	---	---







Vito / Mixto 116 CDI 4x4	09/10→	Diesel	OM 651.940	2143	4	83.00	99.00	15
Vito / Mixto 119	09/03→	Petrol	M 112.951	3199	V6	89.90	84.00	72
Vito / Mixto 120 CDI	07/06→	Diesel	OM 642.990	2987	V6	83.00	92.00	13
Vito / Mixto 122	09/03→	Petrol	M 112.951	3199	V6	89.90	84.00	72
Vito / Mixto 122 CDI	09/10→	Diesel	OM 642.890	2987	V6	83.00	92.00	13
Vito / Mixto 123	06/04→07/08	Petrol	M 112.976	3724	V6	97.00	84.00	105
Vito / Mixto 126	09/07→	Petrol	M 272.978	3498	V6	92.90	86.00	91







			cm3	x 			9
M 102.910	Petrol		1797	4	89.00	72.20	52
M 102.919	Petrol		1797	4	89.00	72.20	53
M 102.920	Petrol		1997	4	89.00	80.25	54
M 102.921	Petrol		1996	4	89.00	80.25	54
M 102.922	Petrol		1996	4	89.00	80.25	55
M 102.924	Petrol		1996	4	89.00	80.25	55
M 102.938	Petrol		1997	4	89.00	80.25	56
M 102.939	Petrol		1997	4	89.00	80.25	54
M 102.942	Petrol		2298	4	95.50	80.30	94
M 102.943	Petrol		2299	4	95.50	80.30	94
M 102.945	Petrol		2298	4	95.50	80.30	94
M 102.946	Petrol		2298	4	95.50	80.30	94
M 102.958	Petrol		2299	4	95.50	80.30	94
M 102.959	Petrol		2299	4	95.50	80.30	94
M 102.961	Petrol		1996	4	89.00	80.25	56
M 102.962	Petrol		1996	4	89.00	80.25	56
M 102.963	Petrol		1996	4	89.00	80.25	57
M 102.964	Petrol		1997	4	89.00	80.25	56
M 102.965	Petrol		1996	4	89.00	80.25	57
M 102.979	Petrol		2299	4	95.50	80.30	95
M 102.980	Petrol		2299	4	95.50	80.30	96
M 102.981	Petrol		2299	4	95.50	80.30	94
M 102.982	Petrol		2298	4	95.50	80.30	97
M 102.983	Petrol		2298	4	95.50	80.30	97
M 102.985	Petrol		2298	4	95.50	80.30	94
M 102.987	Petrol		2299	4	95.50	80.30	94
M 102.989	Petrol		2298	4	95.50	80.30	94
M 102.990	Petrol		2498	4	95.50	87.20	98
M 102.991	Petrol		2498	4	95.50	87.20	98
M 102.992	Petrol		2498	4	95.50	87.20	98
M 102.996	Petrol		2298	4	95.50	80.30	95
M 102.997	Petrol		2299	4	95.50	80.30	95
M 102.998	Petrol		2299	4	95.50	80.30	94
M 103.940	Petrol		2597	6	82.90	80.30	8
M 103.941	Petrol		2597	6	82.90	80.30	8
M 103.942	Petrol		2597	6	82.90	80.30	8
M 103.943	Petrol		2597	6	82.90	80.30	8
M 103.980	Petrol		2960	6	88.50	80.25	51
M 103.981	Petrol		2960	6	88.50	80.25	51
M 103.982	Petrol		2960	6	88.50	80.25	51
M 103.983	Petrol		2960	6	88.50	80.25	51
M 103.984	Petrol		2960	6	88.50	80.25	51
M 103.985	Petrol		2960	6	88.50	80.25	51
M 103.987	Petrol		2960	6	88.50	80.25	51
M 104.941	Petrol		2799	6	89.90	73.50	68
M 104.942	Petrol		2799	6	89.90	73.50	68
M 104.943	Petrol		2799	6	89.90	73.50	68
M 104.944	Petrol		2799	6	89.90	73.50	68
M 104.945	Petrol		2799	6	89.90	73.50	68
M 104.980	Petrol		2960	6	88.50	80.20	50
M 104.981	Petrol		2960	6	88.50	80.20	50
M 104.990	Petrol		3199	6	89.90	84.00	71
M 104.991	Petrol		3199	6	89.90	84.00	71
M 104.992	Petrol		3199	6	89.90	84.00	71
M 104.992	Petrol		3199	6	89.90	84.00	71
M 104.994	Petrol		3199	6	89.90	84.00	71
M 104.995	Petrol		3199	6	89.90	84.00	71
M 104.995	Petrol		3199	6	89.90	84.00	71
M 104.996	Petrol		3199	6	89.90	84.00	71
M 110.921	Petrol		2746	6	86.00	78.80	21
M 110.922	Petrol		2746	6	86.00	78.80	21
M 110.923	Petrol		2746	6	86.00	78.80	21
M 110.924	Petrol		2746	6	86.00	78.80	22
M 110.926	Petrol		2746	6	86.00	78.80	22
M 110.931	Petrol		2746	6	86.00	78.80	21
M 110.932	Petrol		2746	6	86.00	78.80	21
M 110.981	Petrol		2746	6	86.00	78.80	21
M 110.982	Petrol		2746	6	86.00	78.80	21
M 110.983	Petrol		2746	6	86.00	78.80	21







			cm3	x 			
M 110.984	Petrol	2746	6	86.00	78.80	21	
M 110.985	Petrol	2746	6	86.00	78.80	21	
M 110.986	Petrol	2746	6	86.00	78.80	21	
M 110.987	Petrol	2746	6	86.00	78.80	22	
M 110.988	Petrol	2746	6	86.00	78.80	21	
M 110.989	Petrol	2746	6	86.00	78.80	22	
M 110.990	Petrol	2746	6	86.00	78.80	21	
M 110.991	Petrol	2746	6	86.00	78.80	21	
M 110.992	Petrol	2746	6	86.00	78.80	21	
M 110.993	Petrol	2746	6	86.00	78.80	21	
M 110.994	Petrol	2746	6	86.00	78.80	22	
M 111.920	Petrol	1799	4	85.30	78.70	19	
M 111.921	Petrol	1799	4	85.30	78.70	19	
M 111.940	Petrol	1998	4	89.90	78.70	70	
M 111.941	Petrol	1998	4	89.90	78.70	70	
M 111.942	Petrol	1998	4	89.90	78.70	70	
M 111.943	Petrol	1998	4	89.90	78.70	70	
M 111.944	Petrol	1998	4	89.90	78.70	70	
M 111.945	Petrol	1998	4	89.90	78.70	70	
M 111.946	Petrol	1998	4	89.90	78.70	70	
M 111.947	Petrol	1998	4	89.90	78.70	70	
M 111.948	Petrol	1998	4	89.90	78.70	70	
M 111.950	Petrol	1998	4	89.90	78.70	70	
M 111.951	Petrol	1998	4	89.90	78.70	70	
M 111.952	Petrol	1998	4	89.90	78.70	70	
M 111.955	Petrol	1998	4	89.90	78.70	70	
M 111.956	Petrol	1998	4	89.90	78.70	70	
M 111.957	Petrol	1998	4	89.90	78.70	70	
M 111.958	Petrol	1998	4	89.90	78.70	70	
M 111.960	Petrol	2199	4	89.90	86.60	74	
M 111.961	Petrol	2199	4	89.90	86.60	74	
M 111.970	Petrol	2295	4	90.90	88.40	75	
M 111.970	Petrol	2295	4	90.90	88.40	75	
M 111.973	Petrol	2295	4	90.90	88.40	75	
M 111.974	Petrol	2295	4	90.90	88.40	75	
M 111.975	Petrol	2295	4	90.90	88.40	75	
M 111.977	Petrol	2295	4	90.90	88.40	75	
M 111.978	Petrol	2295	4	90.90	88.40	75	
M 111.979	Petrol	2295	4	90.90	88.40	75	
M 111.980	Petrol	2295	4	90.90	88.40	75	
M 111.981	Petrol	2295	4	90.90	88.40	75	
M 111.982	Petrol	2295	4	90.90	88.40	75	
M 111.983	Petrol	2295	4	90.90	88.40	75	
M 111.984	Petrol	2295	4	90.90	88.40	75	
M 112.910	Petrol	2398	V6	83.20	73.50	16	
M 112.911	Petrol	2398	V6	83.20	73.50	16	
M 112.912	Petrol	2597	V6	89.90	68.20	67	
M 112.913	Petrol	2597	V6	89.90	68.20	67	
M 112.914	Petrol	2597	V6	89.90	68.20	67	
M 112.915	Petrol	2597	V6	89.90	68.20	67	
M 112.916	Petrol	2597	V6	89.90	68.20	67	
M 112.917	Petrol	2597	V6	89.90	68.20	67	
M 112.920	Petrol	2799	V6	89.90	73.50	69	
M 112.921	Petrol	2799	V6	89.90	73.50	69	
M 112.922	Petrol	2799	V6	89.90	73.50	69	
M 112.923	Petrol	2799	V6	89.90	73.50	69	
M 112.925	Petrol	2799	V6	89.90	73.50	69	
M 112.940	Petrol	3199	V6	89.90	84.00	72	
M 112.941	Petrol	3199	V6	89.90	84.00	72	
M 112.942	Petrol	3199	V6	89.90	84.00	72	
M 112.943	Petrol	3199	V6	89.90	84.00	72	
M 112.944	Petrol	3199	V6	89.90	84.00	72	
M 112.945	Petrol	3199	V6	89.90	84.00	72	
M 112.946	Petrol	3199	V6	89.90	84.00	72	
M 112.947	Petrol	3199	V6	89.90	84.00	72	
M 112.949	Petrol	3199	V6	89.90	84.00	72	
M 112.951	Petrol	3199	V6	89.90	84.00	72	
M 112.953	Petrol	3199	V6	89.90	84.00	72	
M 112.954	Petrol	3199	V6	89.90	84.00	72	







			cm ³	x 			9
M 112.955	Petrol	3199	V6	89.90	84.00	72	
M 112.970	Petrol	3724	V6	97.00	84.00	105	
M 112.972	Petrol	3724	V6	97.00	84.00	105	
M 112.973	Petrol	3724	V6	97.00	84.00	105	
M 112.975	Petrol	3724	V6	97.00	84.00	105	
M 112.976	Petrol	3724	V6	97.00	84.00	105	
M 113.940	Petrol	4266	V8	89.90	84.00	73	
M 113.941	Petrol	4266	V8	89.90	84.00	73	
M 113.942	Petrol	4266	V8	89.90	84.00	73	
M 113.943	Petrol	4266	V8	89.90	84.00	73	
M 113.944	Petrol	4266	V8	89.90	84.00	73	
M 113.948	Petrol	4266	V8	89.90	84.00	73	
M 113.960	Petrol	4966	V8	97.00	84.00	106	
M 113.961	Petrol	4966	V8	97.00	84.00	106	
M 113.962	Petrol	4966	V8	97.00	84.00	106	
M 113.963	Petrol	4966	V8	97.00	84.00	106	
M 113.964	Petrol	4966	V8	97.00	84.00	106	
M 113.965	Petrol	4966	V8	97.00	84.00	106	
M 113.966	Petrol	4966	V8	97.00	84.00	106	
M 113.967	Petrol	4966	V8	97.00	84.00	106	
M 113.968	Petrol	4966	V8	97.00	84.00	106	
M 113.969	Petrol	4966	V8	97.00	84.00	106	
M 113.971	Petrol	4966	V8	97.00	84.00	106	
M 113.980	Petrol	5439	V8	97.00	92.00	107	
M 113.981	Petrol	5439	V8	97.00	92.00	107	
M 113.982	Petrol	5439	V8	97.00	92.00	107	
M 113.984	Petrol	5439	V8	97.00	92.00	107	
M 113.986	Petrol	5439	V8	97.00	92.00	107	
M 113.988	Petrol	5439	V8	97.00	92.00	107	
M 113.989	Petrol	5439	V8	97.00	92.00	107	
M 114.920	Petrol	2496	6	82.00	78.80	6	
M 114.923	Petrol	2496	6	82.00	78.80	6	
M 114.980	Petrol	2496	6	82.00	78.80	6	
M 114.981	Petrol	2496	6	82.00	78.80	6	
M 115.900	Petrol	2197	4	87.00	92.40	39	
M 115.920	Petrol	2197	4	87.00	92.40	39	
M 115.921	Petrol	2197	4	87.00	92.40	39	
M 115.922	Petrol	2197	4	87.00	92.40	39	
M 115.923	Petrol	1988	4	87.00	83.60	25	
M 115.924	Petrol	2197	4	87.00	92.40	39	
M 115.926	Petrol	1988	4	87.00	83.60	25	
M 115.927	Petrol	2197	4	87.00	92.40	39	
M 115.928	Petrol	2197	4	87.00	92.40	39	
M 115.929	Petrol	2197	4	87.00	92.40	39	
M 115.932	Petrol	2197	4	87.00	92.40	39	
M 115.933	Petrol	2197	4	87.00	92.40	39	
M 115.934	Petrol	2197	4	87.00	92.40	39	
M 115.935	Petrol	2197	4	87.00	92.40	39	
M 115.938	Petrol	1988	4	87.00	83.60	25	
M 115.939	Petrol	1988	4	87.00	83.60	25	
M 115.951	Petrol	2307	4	93.75	83.60	93	
M 115.952	Petrol	2307	4	93.75	83.60	93	
M 115.954	Petrol	2307	4	93.75	83.60	93	
M 115.955	Petrol	2307	4	93.75	83.60	93	
M 115.970	Petrol	2307	4	93.75	83.60	93	
M 115.971	Petrol	2307	4	93.75	83.60	93	
M 115.972	Petrol	2307	4	93.75	83.60	93	
M 115.973	Petrol	2307	4	93.75	83.60	93	
M 115.974	Petrol	2307	4	93.75	83.60	93	
M 116.960	Petrol	3818	V8	92.00	71.80	85	
M 116.961	Petrol	3839	V8	88.00	78.90	45	
M 116.962	Petrol	3839	V8	88.00	78.90	45	
M 116.963	Petrol	3839	V8	88.00	78.90	45	
M 116.964	Petrol	4196	V8	92.00	78.90	86	
M 116.965	Petrol	4196	V8	92.00	78.90	86	
M 116.980	Petrol	3500	V8	92.00	65.80	83	
M 116.981	Petrol	3500	V8	92.00	65.80	83	
M 116.982	Petrol	3499	V8	92.00	65.80	83	
M 116.983	Petrol	3499	V8	92.00	65.80	83	







			cm3	x 			
M 116.984	Petrol	3499	V8	92.00	65.80	83	
M 116.985	Petrol	3499	V8	92.00	65.80	83	
M 116.990	Petrol	3499	V8	92.00	65.80	84	
M 116.991	Petrol	3499	V8	92.00	65.80	84	
M 116.992	Petrol	3499	V8	92.00	65.80	84	
M 116.993	Petrol	3499	V8	92.00	65.80	84	
M 117.960	Petrol	4973	V8	96.50	85.00	99	
M 117.961	Petrol	4973	V8	96.50	85.00	99	
M 117.962	Petrol	4973	V8	96.50	85.00	99	
M 117.963	Petrol	4973	V8	96.50	85.00	99	
M 117.964	Petrol	4973	V8	96.50	85.00	100	
M 117.965	Petrol	4973	V8	96.50	85.00	100	
M 117.967	Petrol	5547	V8	96.50	94.80	103	
M 117.968	Petrol	5547	V8	96.50	94.80	104	
M 117.981	Petrol	4520	V8	92.00	85.00	88	
M 117.982	Petrol	4520	V8	92.00	85.00	89	
M 117.983	Petrol	4520	V8	92.00	85.00	89	
M 117.984	Petrol	4520	V8	92.00	85.00	89	
M 117.985	Petrol	4520	V8	92.00	85.00	89	
M 117.986	Petrol	4520	V8	92.00	85.00	89	
M 117.992	Petrol	4520	V8	92.00	85.00	88	
M 117.993	Petrol	4520	V8	92.00	85.00	88	
M 119.960	Petrol	4973	V8	96.50	85.00	101	
M 119.972	Petrol	4973	V8	96.50	85.00	102	
M 119.981	Petrol	4196	V8	92.00	78.90	87	
M 123.920	Petrol	2525	6	86.00	72.50	20	
M 123.921	Petrol	2525	6	86.00	72.50	20	
M 130.920	Petrol	2780	6	86.50	78.80	23	
M 130.921	Petrol	2778	6	86.50	78.80	23	
M 130.922	Petrol	2778	6	86.50	78.80	23	
M 130.923	Petrol	2778	6	86.50	78.80	24	
M 130.924	Petrol	2778	6	86.50	78.80	23	
M 130.925	Petrol	2778	6	86.50	78.80	23	
M 130.933	Petrol	2778	6	86.50	78.80	23	
M 130.980	Petrol	2780	6	86.50	78.80	23	
M 130.981	Petrol	2778	6	86.50	78.80	23	
M 130.983	Petrol	2778	6	86.50	78.80	23	
M 130.984	Petrol	2778	6	86.50	78.80	23	
M 160 E6AL B03	Petrol	599	3	63.50	63.00	1	
M 160 E6AL B04	Petrol	599	3	63.50	63.00	1	
M 160 E6AL B05	Petrol	599	3	63.50	63.00	1	
M 161.971	Petrol	2295	4	90.90	88.40	75	
M 161.974	Petrol	2295	4	90.90	88.40	75	
M 166.940	Petrol	1397	4	80.00	69.50	2	
M 166.960	Petrol	1598	4	80.00	79.50	3	
M 166.961	Petrol	1598	4	80.00	79.50	3	
M 166.990	Petrol	1898	4	84.00	85.60	17	
M 166.991	Petrol	1898	4	84.00	85.60	17	
M 166.995	Petrol	2084	4	84.00	94.00	18	
M 266.920	Petrol	1498	4	83.00	69.20	9	
M 266.940	Petrol	1699	4	83.00	78.50	10	
M 266.960	Petrol	2034	4	83.00	94.00	14	
M 266.980	Petrol	2034	4	83.00	94.00	14	
M 271.820	Petrol	1796	4	82.00	85.00	7	
M 271.860	Petrol	1796	4	82.00	85.00	7	
M 271.861	Petrol	1796	4	82.00	85.00	7	
M 271.910	Petrol	1597	4	80.00	79.50	4	
M 271.911	Petrol	1597	4	80.00	79.50	4	
M 271.921	Petrol	1796	4	82.00	85.00	7	
M 271.940	Petrol	1796	4	82.00	85.00	7	
M 271.941	Petrol	1796	4	82.00	85.00	7	
M 271.942	Petrol	1796	4	82.00	85.00	7	
M 271.944	Petrol	1795	4	82.00	85.00	7	
M 271.946	Petrol	1796	4	82.00	85.00	7	
M 271.948	Petrol	1796	4	82.00	85.00	7	
M 271.950	Petrol	1796	4	82.00	85.00	7	
M 271.951	Petrol	1796	4	82.00	85.00	7	
M 271.952	Petrol	1796	4	82.00	85.00	7	
M 271.954	Petrol	1796	4	82.00	85.00	7	







			cm ³	x 			
M 271.955	Petrol	1796	4	82.00	85.00	7	
M 271.956	Petrol	1796	4	82.00	85.00	7	
M 271.957	Petrol	1796	4	82.00	85.00	7	
M 271.958	Petrol	1796	4	82.00	85.00	7	
M 272.911	Petrol	2496	V6	88.00	68.40	44	
M 272.920	Petrol	2496	V6	88.00	68.40	44	
M 272.921	Petrol	2496	V6	88.00	68.40	44	
M 272.922	Petrol	2496	V6	88.00	68.40	44	
M 272.940	Petrol	2996	V6	88.00	82.10	46	
M 272.941	Petrol	2996	V6	88.00	82.10	46	
M 272.942	Petrol	2996	V6	88.00	82.10	46	
M 272.943	Petrol	2996	V6	88.00	82.10	46	
M 272.944	Petrol	2996	V6	88.00	82.10	46	
M 272.945	Petrol	2996	V6	88.00	82.10	46	
M 272.946	Petrol	2996	V6	88.00	82.10	46	
M 272.947	Petrol	2996	V6	88.00	82.10	46	
M 272.948	Petrol	2996	V6	88.00	82.10	46	
M 272.949	Petrol	2996	V6	88.00	82.10	46	
M 272.952	Petrol	2996	V6	88.00	82.10	46	
M 272.960	Petrol	3498	V6	92.90	86.00	91	
M 272.961	Petrol	3498	V6	92.90	86.00	91	
M 272.962	Petrol	3498	V6	92.90	86.00	91	
M 272.963	Petrol	3498	V6	92.90	86.00	91	
M 272.964	Petrol	3498	V6	92.90	86.00	91	
M 272.965	Petrol	3498	V6	92.90	86.00	91	
M 272.966	Petrol	3498	V6	92.90	86.00	91	
M 272.967	Petrol	3498	V6	92.90	86.00	91	
M 272.968	Petrol	3498	V6	92.90	86.00	91	
M 272.969	Petrol	3498	V6	92.90	86.00	91	
M 272.970	Petrol	3498	V6	92.90	86.00	91	
M 272.971	Petrol	3498	V6	92.90	86.00	91	
M 272.972	Petrol	3498	V6	92.90	86.00	91	
M 272.974	Petrol	3498	V6	92.90	86.00	91	
M 272.975	Petrol	3498	V6	92.90	86.00	91	
M 272.977	Petrol	3498	V6	92.90	86.00	91	
M 272.978	Petrol	3498	V6	92.90	86.00	91	
M 272.979	Petrol	3498	V6	92.90	86.00	91	
M 272.980	Petrol	3498	V6	92.90	86.00	91	
M 272.982	Petrol	3498	V6	92.90	86.00	91	
M 272.983	Petrol	3498	V6	92.90	86.00	91	
M 272.984	Petrol	3498	V6	92.90	86.00	91	
M 272.985	Petrol	3498	V6	92.90	86.00	91	
M 272.988	Petrol	3498	V6	92.90	86.00	91	
M 272.991	Petrol	3498	V6	92.90	86.00	91	
M 273.922	Petrol	4663	V8	92.90	86.00	92	
M 273.923	Petrol	4663	V8	92.90	86.00	92	
M 273.924	Petrol	4663	V8	92.90	86.00	92	
M 273.960	Petrol	5461	V8	98.00	90.50	119	
M 273.961	Petrol	5461	V8	98.00	90.50	119	
M 273.962	Petrol	5461	V8	98.00	90.50	119	
M 273.963	Petrol	5461	V8	98.00	90.50	119	
M 273.965	Petrol	5461	V8	98.00	90.50	119	
M 273.966	Petrol	5461	V8	98.00	90.50	119	
M 273.967	Petrol	5461	V8	98.00	90.50	119	
M 273.968	Petrol	5461	V8	98.00	90.50	119	
M 273.970	Petrol	5461	V8	98.00	90.50	119	
M 273.971	Petrol	5461	V8	98.00	90.50	119	
M 276.950	Petrol	3498	V6	92.90	86.00	91	
M 276.952	Petrol	3498	V6	92.90	86.00	91	
M 276.955	Petrol	3498	V6	92.90	86.00	91	
M 276.956	Petrol	3498	V6	92.90	86.00	91	
M 276.957	Petrol	3498	V6	92.90	86.00	91	
M 276.958	Petrol	3498	V6	92.90	86.00	91	
M 476.920	Gas	11967	6	128.00	155.00	159	
M 476.921	Gas	11967	6	128.00	155.00	159	
M 476.925	Gas	11967	6	128.00	155.00	159	
M 476.926	Gas	11967	6	128.00	155.00	159	
M 476.927	Gas	11967	6	128.00	155.00	159	
M 906.900 Euro 5 EEV	Natural Gas	6884	6	106.00	130.00	124	







		cm3	x 			
M 906.901 Euro 5 EEV	Natural Gas	6884	6	106.00	130.00	124
M 906.903 Euro 5 EEV	Natural Gas	6884	6	106.00	130.00	124
MB OM 601	Diesel	2299	4	89.00	92.40	59
MB-OM 661	Diesel	2299	4	89.00	92.40	60
MB-OM 662	Diesel	2874	5	89.00	92.40	62
OM 314.900	Diesel	3780	4	97.00	128.00	108
OM 314.910	Diesel	3780	4	97.00	128.00	109
OM 314.914	Diesel	3782	4	97.00	128.00	110
OM 314.915	Diesel	3780	4	97.00	128.00	110
OM 314.916	Diesel	3780	4	97.00	128.00	110
OM 314.917	Diesel	3780	4	97.00	128.00	110
OM 314.918	Diesel	3782	4	97.00	128.00	110
OM 314.919	Diesel	3782	4	97.00	128.00	110
OM 314.940	Diesel	3782	4	97.00	128.00	110
OM 314.941	Diesel	3782	4	97.00	128.00	110
OM 314.942	Diesel	3782	4	97.00	128.00	110
OM 314.943	Diesel	3782	4	97.00	128.00	110
OM 314.944	Diesel	3780	4	97.00	128.00	110
OM 314.945	Diesel	3782	4	97.00	128.00	110
OM 314.946	Diesel	3780	4	97.00	128.00	110
OM 314.947	Diesel	3782	4	97.00	128.00	110
OM 314.948	Diesel	3780	4	97.00	128.00	110
OM 314.949	Diesel	3782	4	97.00	128.00	110
OM 314.950	Diesel	3782	4	97.00	128.00	110
OM 314.951	Diesel	3782	4	97.00	128.00	110
OM 314.953	Diesel	3780	4	97.00	128.00	110
OM 314.954	Diesel	3782	4	97.00	128.00	110
OM 314.956	Diesel	3782	4	97.00	128.00	110
OM 314.957	Diesel	3782	4	97.00	128.00	110
OM 314.958	Diesel	3782	4	97.00	128.00	110
OM 314.959	Diesel	3780	4	97.00	128.00	110
OM 314.960	Diesel	3782	4	97.00	128.00	110
OM 314.961	Diesel	3780	4	97.00	128.00	110
OM 314.962	Diesel	3780	4	97.00	128.00	110
OM 314.963	Diesel	3780	4	97.00	128.00	110
OM 314.964	Diesel	3780	4	97.00	128.00	110
OM 314.965	Diesel	3780	4	97.00	128.00	110
OM 314.967	Diesel	3780	4	97.00	128.00	110
OM 314.970	Diesel	3782	4	97.00	128.00	111
OM 344.913	Diesel	5675	6	97.00	128.00	112
OM 344.934	Diesel	5675	6	97.00	128.00	112
OM 344.937	Diesel	5675	6	97.00	128.00	112
OM 344.938	Diesel	5675	6	97.00	128.00	112
OM 344.939	Diesel	5675	6	97.00	128.00	112
OM 344.940	Diesel	5675	6	97.00	128.00	112
OM 344.948	Diesel	5675	6	97.00	128.00	112
OM 344.949	Diesel	5675	6	97.00	128.00	113
OM 344.951	Diesel	5675	6	97.00	128.00	112
OM 344.952	Diesel	5675	6	97.00	128.00	112
OM 346.910	Diesel	10809	6	128.00	140.00	139
OM 346.911	Diesel	10809	6	128.00	140.00	139
OM 346.912	Diesel	10809	6	128.00	140.00	139
OM 346.913	Diesel	10809	6	128.00	140.00	139
OM 346.914	Diesel	10809	6	128.00	140.00	139
OM 346.915	Diesel	10809	6	128.00	140.00	139
OM 346.916	Diesel	10809	6	128.00	140.00	139
OM 346.917	Diesel	10809	6	128.00	140.00	139
OM 346.918	Diesel	10809	6	128.00	140.00	139
OM 346.941	Diesel	10809	6	128.00	140.00	139
OM 346.942	Diesel	10809	6	128.00	140.00	139
OM 346.943	Diesel	10809	6	128.00	140.00	139
OM 346.944	Diesel	10809	6	128.00	140.00	139
OM 346.945	Diesel	10809	6	128.00	140.00	139
OM 346.946	Diesel	10809	6	128.00	140.00	139
OM 346.952	Diesel	10809	6	128.00	140.00	139
OM 346.953	Diesel	10809	6	128.00	140.00	139
OM 352.901	Diesel	5675	6	97.00	128.00	114
OM 352.902	Diesel	5670	6	97.00	128.00	114
OM 352.903	Diesel	5675	6	97.00	128.00	114







		cm ³	x 			
OM 352.904	Diesel	5675	6	97.00	128.00	114
OM 352.905	Diesel	5680	6	97.00	128.00	114
OM 352.906	Diesel	5675	6	97.00	128.00	114
OM 352.907	Diesel	5700	6	97.00	128.00	115
OM 352.908	Diesel	5675	6	97.00	128.00	114
OM 352.909	Diesel	5675	6	97.00	128.00	114
OM 352.910	Diesel	5675	6	97.00	128.00	114
OM 352.911	Diesel	5675	6	97.00	128.00	114
OM 352.912	Diesel	5675	6	97.00	128.00	114
OM 352.913	Diesel	5675	6	97.00	128.00	112
OM 352.914	Diesel	5675	6	97.00	128.00	114
OM 352.915	Diesel	5675	6	97.00	128.00	114
OM 352.916	Diesel	5675	6	97.00	128.00	112
OM 352.917	Diesel	5675	6	97.00	128.00	114
OM 352.918	Diesel	5675	6	97.00	128.00	112
OM 352.919	Diesel	5675	6	97.00	128.00	114
OM 352.930	Diesel	5675	6	97.00	128.00	114
OM 352.931	Diesel	5675	6	97.00	128.00	114
OM 352.932	Diesel	5675	6	97.00	128.00	114
OM 352.933	Diesel	5675	6	97.00	128.00	114
OM 352.934	Diesel	5675	6	97.00	128.00	114
OM 352.935	Diesel	5675	6	97.00	128.00	114
OM 352.936	Diesel	5675	6	97.00	128.00	114
OM 352.937	Diesel	5675	6	97.00	128.00	112
OM 352.938	Diesel	5675	6	97.00	128.00	114
OM 352.939	Diesel	5675	6	97.00	128.00	114
OM 352.942	Diesel	5675	6	97.00	128.00	114
OM 352.943	Diesel	5675	6	97.00	128.00	114
OM 352.944	Diesel	5675	6	97.00	128.00	114
OM 352.945	Diesel	5675	6	97.00	128.00	114
OM 352.946	Diesel	5675	6	97.00	128.00	112
OM 352.948	Diesel	5675	6	97.00	128.00	114
OM 352.949	Diesel	5675	6	97.00	128.00	112
OM 352.950	Diesel	5675	6	97.00	128.00	112
OM 352.953	Diesel	5675	6	97.00	128.00	114
OM 352.954	Diesel	5675	6	97.00	128.00	114
OM 352.955	Diesel	5675	6	97.00	128.00	114
OM 352.959	Diesel	5675	6	97.00	128.00	114
OM 352.963	Diesel	5675	6	97.00	128.00	114
OM 352.964	Diesel	5675	6	97.00	128.00	114
OM 352.965	Diesel	5675	6	97.00	128.00	114
OM 352.966	Diesel	5675	6	97.00	128.00	114
OM 352.967	Diesel	5675	6	97.00	128.00	114
OM 352.968	Diesel	5675	6	97.00	128.00	112
OM 352.969	Diesel	5675	6	97.00	128.00	114
OM 352.970	Diesel	5675	6	97.00	128.00	114
OM 352.971	Diesel	5675	6	97.00	128.00	114
OM 352.972	Diesel	5675	6	97.00	128.00	114
OM 352.973	Diesel	5675	6	97.00	128.00	114
OM 352.974	Diesel	5675	6	97.00	128.00	114
OM 352.975	Diesel	5675	6	97.00	128.00	114
OM 352.976	Diesel	5675	6	97.00	128.00	114
OM 352.978	Diesel	5675	6	97.00	128.00	114
OM 352.979	Diesel	5675	6	97.00	128.00	114
OM 352.980	Diesel	5675	6	97.00	128.00	115
OM 352.981	Diesel	5675	6	97.00	128.00	114
OM 352.982	Diesel	5675	6	97.00	128.00	114
OM 352.983	Diesel	5675	6	97.00	128.00	114
OM 352.984	Diesel	5675	6	97.00	128.00	114
OM 352.985	Diesel	5675	6	97.00	128.00	114
OM 352.986	Diesel	5700	6	97.00	128.00	115
OM 352.987	Diesel	5675	6	97.00	128.00	114
OM 352.988	Diesel	5675	6	97.00	128.00	112
OM 352.989	Diesel	5675	6	97.00	128.00	114
OM 352.990	Diesel	5675	6	97.00	128.00	114
OM 352.991	Diesel	5675	6	97.00	128.00	114
OM 352.992	Diesel	5675	6	97.00	128.00	114
OM 352.993	Diesel	5675	6	97.00	128.00	115
OM 352.994	Diesel	5675	6	97.00	128.00	112







		cm3	x 			
OM 352.996	Diesel	5675	6	97.00	128.00	114
OM 352.997	Diesel	5675	6	97.00	128.00	116
OM 352.998	Diesel	5675	6	97.00	128.00	116
OM 352.999	Diesel	5675	6	97.00	128.00	114
OM 353.900	Diesel	5675	6	97.00	128.00	114
OM 353.901	Diesel	5675	6	97.00	128.00	114
OM 353.902	Diesel	5675	6	97.00	128.00	114
OM 353.903	Diesel	5675	6	97.00	128.00	115
OM 353.904	Diesel	5675	6	97.00	128.00	114
OM 353.905	Diesel	5680	6	97.00	128.00	114
OM 353.906	Diesel	5680	6	97.00	128.00	114
OM 353.907	Diesel	5675	6	97.00	128.00	114
OM 353.909	Diesel	5675	6	97.00	128.00	112
OM 353.910	Diesel	5675	6	97.00	128.00	112
OM 353.911	Diesel	5675	6	97.00	128.00	112
OM 353.912	Diesel	5675	6	97.00	128.00	112
OM 353.913	Diesel	5675	6	97.00	128.00	112
OM 353.914	Diesel	5675	6	97.00	128.00	112
OM 353.915	Diesel	5675	6	97.00	128.00	115
OM 353.916	Diesel	5675	6	97.00	128.00	114
OM 353.917	Diesel	5675	6	97.00	128.00	114
OM 353.920	Diesel	5675	6	97.00	128.00	112
OM 353.921	Diesel	5675	6	97.00	128.00	112
OM 353.922	Diesel	5675	6	97.00	128.00	114
OM 353.923	Diesel	5675	6	97.00	128.00	114
OM 353.930	Diesel	5675	6	97.00	128.00	114
OM 353.931	Diesel	5675	6	97.00	128.00	114
OM 353.932	Diesel	5675	6	97.00	128.00	114
OM 353.933	Diesel	5675	6	97.00	128.00	114
OM 353.934	Diesel	5675	6	97.00	128.00	114
OM 353.935	Diesel	5675	6	97.00	128.00	114
OM 353.936	Diesel	5675	6	97.00	128.00	114
OM 353.937	Diesel	5675	6	97.00	128.00	112
OM 353.938	Diesel	5675	6	97.00	128.00	114
OM 353.939	Diesel	5675	6	97.00	128.00	112
OM 353.940	Diesel	5675	6	97.00	128.00	114
OM 353.941	Diesel	5675	6	97.00	128.00	114
OM 353.942	Diesel	5700	6	97.00	128.00	114
OM 353.943	Diesel	5700	6	97.00	128.00	114
OM 353.944	Diesel	5700	6	97.00	128.00	114
OM 353.945	Diesel	5700	6	97.00	128.00	114
OM 353.946	Diesel	5700	6	97.00	128.00	114
OM 353.949	Diesel	5675	6	97.00	128.00	116
OM 353.950	Diesel	5700	6	97.00	128.00	112
OM 353.951	Diesel	5700	6	97.00	128.00	112
OM 353.952	Diesel	5700	6	97.00	128.00	112
OM 353.953	Diesel	5700	6	97.00	128.00	112
OM 353.954	Diesel	5700	6	97.00	128.00	112
OM 353.957	Diesel	5675	6	97.00	128.00	112
OM 353.958	Diesel	5675	6	97.00	128.00	112
OM 353.959	Diesel	5675	6	97.00	128.00	112
OM 353.960	Diesel	5675	6	97.00	128.00	114
OM 353.961	Diesel	5675	6	97.00	128.00	114
OM 353.962	Diesel	5675	6	97.00	128.00	114
OM 353.963	Diesel	5675	6	97.00	128.00	114
OM 353.964	Diesel	5700	6	97.00	128.00	114
OM 353.965	Diesel	5675	6	97.00	128.00	114
OM 353.966	Diesel	5675	6	97.00	128.00	114
OM 353.967	Diesel	5675	6	97.00	128.00	114
OM 353.968	Diesel	5675	6	97.00	128.00	114
OM 353.969	Diesel	5675	6	97.00	128.00	114
OM 353.970	Diesel	5700	6	97.00	128.00	112
OM 353.971	Diesel	5700	6	97.00	128.00	112
OM 353.972	Diesel	5675	6	97.00	128.00	112
OM 353.973	Diesel	5675	6	97.00	128.00	112
OM 353.974	Diesel	5675	6	97.00	128.00	112
OM 353.975	Diesel	5700	6	97.00	128.00	112
OM 353.976	Diesel	5675	6	97.00	128.00	113
OM 353.977	Diesel	5675	6	97.00	128.00	112







			cm ³	x 			
OM 353.978	Diesel		5675	6	97.00	128.00	112
OM 353.980	Diesel		5675	6	97.00	128.00	114
OM 353.981	Diesel		5675	6	97.00	128.00	114
OM 353.982	Diesel		5675	6	97.00	128.00	114
OM 353.983	Diesel		5675	6	97.00	128.00	114
OM 353.984	Diesel		5675	6	97.00	128.00	114
OM 353.985	Diesel		5675	6	97.00	128.00	116
OM 353.988	Diesel		5675	6	97.00	128.00	114
OM 353.989	Diesel		5675	6	97.00	128.00	114
OM 353.991	Diesel		5675	6	97.00	128.00	112
OM 353.995	Diesel		5675	6	97.00	128.00	112
OM 353.997	Diesel		5675	6	97.00	128.00	112
OM 353.998	Diesel		5675	6	97.00	128.00	114
OM 353.999	Diesel		5675	6	97.00	128.00	114
OM 354.900 Euro 2	Diesel		3972	4	97.50	133.00	117
OM 354.901 Euro 2	Diesel		3972	4	97.50	133.00	117
OM 354.902 Euro 2	Diesel		3972	4	97.50	133.00	117
OM 354.903 Euro 2	Diesel		3972	4	97.50	133.00	117
OM 354.920 Euro 2	Diesel		3972	4	97.50	133.00	117
OM 354.921 Euro 2	Diesel		3972	4	97.50	133.00	117
OM 354.922 Euro 2	Diesel		3972	4	97.50	133.00	117
OM 354.923 Euro 2	Diesel		3972	4	97.50	133.00	117
OM 354.924 Euro 2	Diesel		3972	4	97.50	133.00	117
OM 354.925 Euro 2	Diesel		3972	4	97.50	133.00	117
OM 354.926 Euro 2	Diesel		3972	4	97.50	133.00	117
OM 355.910	Diesel		11581	6	128.00	150.00	155
OM 355.911	Diesel		11581	6	128.00	150.00	155
OM 355.912	Diesel		11581	6	128.00	150.00	155
OM 355.913	Diesel		11581	6	128.00	150.00	155
OM 355.914	Diesel		11581	6	128.00	150.00	155
OM 355.915	Diesel		11581	6	128.00	150.00	155
OM 355.916	Diesel		11581	6	128.00	150.00	155
OM 355.918	Diesel		11581	6	128.00	150.00	155
OM 355.960	Diesel		11581	6	128.00	150.00	155
OM 355.961	Diesel		11581	6	128.00	150.00	155
OM 355.962	Diesel		11581	6	128.00	150.00	155
OM 355.963	Diesel		11581	6	128.00	150.00	155
OM 355.964	Diesel		11581	6	128.00	150.00	155
OM 355.966	Diesel		11581	6	128.00	150.00	155
OM 355.967	Diesel		11581	6	128.00	150.00	155
OM 355.968	Diesel		11581	6	128.00	150.00	155
OM 355.969	Diesel		11581	6	128.00	150.00	155
OM 355.970	Diesel		11581	6	128.00	150.00	155
OM 355.972	Diesel		11581	6	128.00	150.00	155
OM 355.973	Diesel		11581	6	128.00	150.00	155
OM 355.974	Diesel		11581	6	128.00	150.00	155
OM 355.975	Diesel		11581	6	128.00	150.00	155
OM 355.976	Diesel		11581	6	128.00	150.00	155
OM 355.977	Diesel		11581	6	128.00	150.00	155
OM 355.978	Diesel		11581	6	128.00	150.00	155
OM 355.979	Diesel		11581	6	128.00	150.00	155
OM 355.980	Diesel		11581	6	128.00	150.00	155
OM 355.981	Diesel		11581	6	128.00	150.00	155
OM 355.982	Diesel		11581	6	128.00	150.00	155
OM 355.983	Diesel		11581	6	128.00	150.00	155
OM 355.984	Diesel		11581	6	128.00	150.00	155
OM 356.901 Euro 1	Diesel		5958	6	97.50	133.00	118
OM 356.902 Euro 1	Diesel		5958	6	97.50	133.00	118
OM 356.903 Euro 1	Diesel		5958	6	97.50	133.00	118
OM 356.904 Euro 1	Diesel		5958	6	97.50	133.00	118
OM 356.905 Euro 1	Diesel		5958	6	97.50	133.00	118
OM 356.906 Euro 1	Diesel		5958	6	97.50	133.00	118
OM 356.907 Euro 1	Diesel		5958	6	97.50	133.00	118
OM 356.908 Euro 1	Diesel		5958	6	97.50	133.00	118
OM 356.909 Euro 1	Diesel		5958	6	97.50	133.00	118
OM 356.910 Euro 1	Diesel		5958	6	97.50	133.00	118
OM 356.911 Euro 1	Diesel		5958	6	97.50	133.00	118
OM 356.912 Euro 1	Diesel		5958	6	97.50	133.00	118
OM 356.913 Euro 1	Diesel		5958	6	97.50	133.00	118







		cm3	x 			
OM 356.914 Euro 1	Diesel	5958	6	97.50	133.00	118
OM 356.915 Euro 1	Diesel	5958	6	97.50	133.00	118
OM 356.916 Euro 1	Diesel	5958	6	97.50	133.00	118
OM 356.940 Euro 1	Diesel	5958	6	97.50	133.00	118
OM 356.941 Euro 1	Diesel	5958	6	97.50	133.00	118
OM 356.943 Euro 1	Diesel	5958	6	97.50	133.00	118
OM 356.944 Euro 1	Diesel	5958	6	97.50	133.00	118
OM 356.945 Euro 1	Diesel	5958	6	97.50	133.00	118
OM 356.946 Euro 1	Diesel	5958	6	97.50	133.00	118
OM 356.947 Euro 1	Diesel	5958	6	97.50	133.00	118
OM 356.948 Euro 1	Diesel	5958	6	97.50	133.00	118
OM 356.949 Euro 1	Diesel	5958	6	97.50	133.00	118
OM 356.950 Euro 1	Diesel	5958	6	97.50	133.00	118
OM 356.951 Euro 1	Diesel	5958	6	97.50	133.00	118
OM 356.952 Euro 1	Diesel	5958	6	97.50	133.00	118
OM 356.953 Euro 1	Diesel	5958	6	97.50	133.00	118
OM 356.954 Euro 1	Diesel	5958	6	97.50	133.00	118
OM 356.955 Euro 1	Diesel	5958	6	97.50	133.00	118
OM 356.956 Euro 1	Diesel	5958	6	97.50	133.00	118
OM 356.957 Euro 1	Diesel	5958	6	97.50	133.00	118
OM 356.958 Euro 1	Diesel	5958	6	97.50	133.00	118
OM 356.959 Euro 1	Diesel	5958	6	97.50	133.00	118
OM 356.977 Euro 1	Diesel	5958	6	97.50	133.00	118
OM 356.978 Euro 1	Diesel	5958	6	97.50	133.00	118
OM 356.979	Diesel	5958	6	97.50	133.00	118
OM 356.980	Diesel	5958	6	97.50	133.00	118
OM 356.981	Diesel	5958	6	97.50	133.00	118
OM 356.983 Euro 1	Diesel	5958	6	97.50	133.00	118
OM 356.984	Diesel	5958	6	97.50	133.00	118
OM 356.985	Diesel	5958	6	97.50	133.00	118
OM 356.986	Diesel	5958	6	97.50	133.00	118
OM 356.987 Euro 1	Diesel	5958	6	97.50	133.00	118
OM 356.988 Euro 1	Diesel	5958	6	97.50	133.00	118
OM 356.989	Diesel	5958	6	97.50	133.00	118
OM 356.990	Diesel	5958	6	97.50	133.00	118
OM 356.991	Diesel	5958	6	97.50	133.00	118
OM 356.992	Diesel	5958	6	97.50	133.00	118
OM 356.993	Diesel	5958	6	97.50	133.00	118
OM 356.994	Diesel	5958	6	97.50	133.00	118
OM 356.995	Diesel	5958	6	97.50	133.00	118
OM 356.996	Diesel	5958	6	97.50	133.00	118
OM 356.997	Diesel	5958	6	97.50	133.00	118
OM 356.998	Diesel	5958	6	97.50	133.00	118
OM 356.999	Diesel	5958	6	97.50	133.00	118
OM 357.900	Diesel	5958	6	97.50	133.00	118
OM 357.901	Diesel	5958	6	97.50	133.00	118
OM 357.902	Diesel	5958	6	97.50	133.00	118
OM 357.903	Diesel	5958	6	97.50	133.00	118
OM 357.904	Diesel	5958	6	97.50	133.00	118
OM 357.906	Diesel	5958	6	97.50	133.00	118
OM 357.907	Diesel	5958	6	97.50	133.00	118
OM 357.908	Diesel	5958	6	97.50	133.00	118
OM 357.909	Diesel	5958	6	97.50	133.00	118
OM 357.910	Diesel	5958	6	97.50	133.00	118
OM 357.912 Euro 2	Diesel	5958	6	97.50	133.00	118
OM 357.913 Euro 2	Diesel	5958	6	97.50	133.00	118
OM 357.915	Diesel	5958	6	97.50	133.00	118
OM 357.916	Diesel	5958	6	97.50	133.00	118
OM 357.917	Diesel	5958	6	97.50	133.00	118
OM 357.918	Diesel	5958	6	97.50	133.00	118
OM 357.919	Diesel	5958	6	97.50	133.00	118
OM 357.920	Diesel	5958	6	97.50	133.00	118
OM 357.921	Diesel	5958	6	97.50	133.00	118
OM 357.922	Diesel	5958	6	97.50	133.00	118
OM 357.924 Euro 2	Diesel	5958	6	97.50	133.00	118
OM 357.925	Diesel	5958	6	97.50	133.00	118
OM 357.926	Diesel	5958	6	97.50	133.00	118
OM 357.927	Diesel	5958	6	97.50	133.00	118
OM 357.929	Diesel	5958	6	97.50	133.00	118







			cm ³	x 			
OM 357.930	Diesel		5958	6	97.50	133.00	118
OM 357.931 Euro 2	Diesel		5958	6	97.50	133.00	118
OM 357.932	Diesel		5958	6	97.50	133.00	118
OM 357.933	Diesel		5958	6	97.50	133.00	118
OM 357.936 Euro 2	Diesel		5958	6	97.50	133.00	118
OM 357.937 Euro 2	Diesel		5958	6	97.50	133.00	118
OM 357.938 Euro 2	Diesel		5958	6	97.50	133.00	118
OM 357.940	Diesel		5958	6	97.50	133.00	118
OM 357.941	Diesel		5958	6	97.50	133.00	118
OM 357.942	Diesel		5958	6	97.50	133.00	118
OM 357.943	Diesel		5958	6	97.50	133.00	118
OM 357.944	Diesel		5958	6	97.50	133.00	118
OM 357.945 Euro 2	Diesel		5958	6	97.50	133.00	118
OM 357.946	Diesel		5958	6	97.50	133.00	118
OM 357.947	Diesel		5958	6	97.50	133.00	118
OM 357.948	Diesel		5958	6	97.50	133.00	118
OM 357.949 Euro 2	Diesel		5958	6	97.50	133.00	118
OM 357.961	Diesel		5958	6	97.50	133.00	118
OM 357.962	Diesel		5958	6	97.50	133.00	118
OM 357.963	Diesel		5958	6	97.50	133.00	118
OM 360.910	Diesel		8720	6	115.00	140.00	127
OM 360.911	Diesel		8720	6	115.00	140.00	127
OM 360.912	Diesel		8720	6	115.00	140.00	128
OM 360.914	Diesel		8720	6	115.00	140.00	127
OM 360.915	Diesel		8720	6	115.00	140.00	127
OM 360.916	Diesel		8720	6	115.00	140.00	127
OM 360.917	Diesel		8720	6	115.00	140.00	127
OM 360.918	Diesel		8720	6	115.00	140.00	127
OM 360.931	Diesel		8720	6	115.00	140.00	127
OM 360.933	Diesel		8720	6	115.00	140.00	127
OM 360.934	Diesel		8720	6	115.00	140.00	128
OM 360.935	Diesel		8725	6	115.00	140.00	127
OM 360.936	Diesel		8725	6	115.00	140.00	127
OM 360.937	Diesel		8725	6	115.00	140.00	127
OM 360.938	Diesel		8725	6	115.00	140.00	127
OM 360.939	Diesel		8720	6	115.00	140.00	127
OM 360.940	Diesel		8725	6	115.00	140.00	127
OM 360.941	Diesel		8725	6	115.00	140.00	127
OM 360.942	Diesel		8725	6	115.00	140.00	127
OM 360.943	Diesel		8725	6	115.00	140.00	127
OM 360.944	Diesel		8725	6	115.00	140.00	127
OM 360.946	Diesel		8725	6	115.00	140.00	127
OM 360.947	Diesel		8725	6	115.00	140.00	128
OM 360.948	Diesel		8725	6	115.00	140.00	127
OM 360.949	Diesel		8725	6	115.00	140.00	127
OM 360.950	Diesel		8725	6	115.00	140.00	127
OM 360.951	Diesel		8725	6	115.00	140.00	127
OM 360.952	Diesel		8725	6	115.00	140.00	127
OM 360.954	Diesel		8725	6	115.00	140.00	128
OM 360.955	Diesel		8725	6	115.00	140.00	128
OM 360.956	Diesel		8725	6	115.00	140.00	128
OM 360.959	Diesel		8725	6	115.00	140.00	128
OM 360.960	Diesel		8725	6	115.00	140.00	127
OM 360.961	Diesel		8725	6	115.00	140.00	127
OM 360.962	Diesel		8725	6	115.00	140.00	127
OM 360.963	Diesel		8725	6	115.00	140.00	127
OM 360.964	Diesel		8725	6	115.00	140.00	127
OM 360.965	Diesel		8725	6	115.00	140.00	127
OM 360.966	Diesel		8725	6	115.00	140.00	127
OM 360.967	Diesel		8725	6	115.00	140.00	127
OM 360.968	Diesel		8725	6	115.00	140.00	127
OM 360.969	Diesel		8725	6	115.00	140.00	127
OM 360.970	Diesel		8725	6	115.00	140.00	127
OM 360.971	Diesel		8725	6	115.00	140.00	127
OM 360.972	Diesel		8725	6	115.00	140.00	127
OM 360.973	Diesel		8725	6	115.00	140.00	127
OM 360.974	Diesel		8725	6	115.00	140.00	128
OM 360.975	Diesel		8725	6	115.00	140.00	127
OM 360.976	Diesel		8725	6	115.00	140.00	128







		cm3	x 			
OM 360.978	Diesel	8725	6	115.00	140.00	128
OM 360.979	Diesel	8720	6	115.00	140.00	127
OM 360.980	Diesel	8720	6	115.00	140.00	127
OM 360.981	Diesel	8720	6	115.00	140.00	127
OM 360.982	Diesel	8725	6	115.00	140.00	127
OM 360.983	Diesel	8725	6	115.00	140.00	127
OM 360.984	Diesel	8720	6	115.00	140.00	127
OM 360.985	Diesel	8720	6	115.00	140.00	127
OM 360.986	Diesel	8720	6	115.00	140.00	127
OM 362.906	Diesel	5700	6	97.00	128.00	112
OM 362.909	Diesel	5700	6	97.00	128.00	112
OM 362.910	Diesel	5675	6	97.00	128.00	112
OM 364.901	Diesel	3972	4	97.50	133.00	117
OM 364.906	Diesel	3972	4	97.50	133.00	117
OM 364.907	Diesel	3970	4	97.50	133.00	117
OM 364.908	Diesel	3972	4	97.50	133.00	117
OM 364.909	Diesel	3972	4	97.50	133.00	117
OM 364.911	Diesel	3972	4	97.50	133.00	117
OM 364.912	Diesel	3972	4	97.50	133.00	117
OM 364.913	Diesel	3972	4	97.50	133.00	117
OM 364.916 Euro 1	Diesel	3972	4	97.50	133.00	117
OM 364.917 Euro 1	Diesel	3972	4	97.50	133.00	117
OM 364.918	Diesel	3970	4	97.50	133.00	117
OM 364.919	Diesel	3972	4	97.50	133.00	117
OM 364.920	Diesel	3972	4	97.50	133.00	117
OM 364.921 Euro 1	Diesel	3972	4	97.50	133.00	117
OM 364.950	Diesel	3972	4	97.50	133.00	117
OM 364.951	Diesel	3972	4	97.50	133.00	117
OM 364.952	Diesel	3972	4	97.50	133.00	117
OM 364.953	Diesel	3972	4	97.50	133.00	117
OM 364.954	Diesel	3972	4	97.50	133.00	117
OM 364.955	Diesel	3973	4	97.50	133.00	117
OM 364.956 Euro 1	Diesel	3973	4	97.50	133.00	117
OM 364.957	Diesel	3972	4	97.50	133.00	117
OM 364.958	Diesel	3972	4	97.50	133.00	117
OM 364.959 Euro 1	Diesel	3972	4	97.50	133.00	117
OM 364.980	Diesel	3972	4	97.50	133.00	117
OM 364.981	Diesel	3972	4	97.50	133.00	117
OM 364.982	Diesel	3972	4	97.50	133.00	117
OM 364.983 Euro 1	Diesel	3972	4	97.50	133.00	117
OM 364.984	Diesel	3972	4	97.50	133.00	117
OM 364.985	Diesel	3972	4	97.50	133.00	117
OM 364.986	Diesel	3972	4	97.50	133.00	117
OM 364.987	Diesel	3972	4	97.50	133.00	117
OM 364.989 Euro 1	Diesel	3972	4	97.50	133.00	117
OM 366.905	Diesel	5958	6	97.50	133.00	118
OM 366.906	Diesel	5960	6	97.50	133.00	118
OM 366.907	Diesel	5958	6	97.50	133.00	118
OM 366.908	Diesel	5958	6	97.50	133.00	118
OM 366.909	Diesel	5960	6	97.50	133.00	118
OM 366.910	Diesel	5958	6	97.50	133.00	118
OM 366.911 Euro 1	Diesel	5958	6	97.50	133.00	118
OM 366.912	Diesel	5958	6	97.50	133.00	118
OM 366.913	Diesel	5958	6	97.50	133.00	118
OM 366.914	Diesel	5958	6	97.50	133.00	118
OM 366.915	Diesel	5958	6	97.50	133.00	118
OM 366.917	Diesel	5958	6	97.50	133.00	118
OM 366.918	Diesel	5960	6	97.50	133.00	118
OM 366.919	Diesel	5958	6	97.50	133.00	118
OM 366.930	Diesel	5958	6	97.50	133.00	118
OM 366.931	Diesel	5958	6	97.50	133.00	118
OM 366.932	Diesel	5958	6	97.50	133.00	118
OM 366.933	Diesel	5958	6	97.50	133.00	118
OM 366.935	Diesel	5958	6	97.50	133.00	118
OM 366.936	Diesel	5960	6	97.50	133.00	118
OM 366.937	Diesel	5960	6	97.50	133.00	118
OM 366.938	Diesel	5958	6	97.50	133.00	118
OM 366.939	Diesel	5958	6	97.50	133.00	118
OM 366.940	Diesel	5958	6	97.50	133.00	118







			cm ³	x 			
OM 366.941 Euro 1	Diesel		5958	6	97.50	133.00	118
OM 366.942 Euro 1	Diesel		5958	6	97.50	133.00	118
OM 366.943 Euro 1	Diesel		5958	6	97.50	133.00	118
OM 366.944	Diesel		5958	6	97.50	133.00	118
OM 366.945	Diesel		5958	6	97.50	133.00	118
OM 366.946	Diesel		5960	6	97.50	133.00	118
OM 366.947	Diesel		5958	6	97.50	133.00	118
OM 366.948	Diesel		5958	6	97.50	133.00	118
OM 366.949	Diesel		5958	6	97.50	133.00	118
OM 366.951	Diesel		5960	6	97.50	133.00	118
OM 366.952	Diesel		5958	6	97.50	133.00	118
OM 366.953	Diesel		5958	6	97.50	133.00	118
OM 366.954	Diesel		5958	6	97.50	133.00	118
OM 366.955	Diesel		5958	6	97.50	133.00	118
OM 366.956	Diesel		5958	6	97.50	133.00	118
OM 366.957	Diesel		5958	6	97.50	133.00	118
OM 366.958	Diesel		5958	6	97.50	133.00	118
OM 366.960	Diesel		5960	6	97.50	133.00	118
OM 366.962	Diesel		5960	6	97.50	133.00	118
OM 366.963	Diesel		5958	6	97.50	133.00	118
OM 366.965	Diesel		5958	6	97.50	133.00	118
OM 366.966	Diesel		5958	6	97.50	133.00	118
OM 366.967	Diesel		5958	6	97.50	133.00	118
OM 366.968	Diesel		5958	6	97.50	133.00	118
OM 366.969	Diesel		5958	6	97.50	133.00	118
OM 366.970	Diesel		5958	6	97.50	133.00	118
OM 366.971	Diesel		5958	6	97.50	133.00	118
OM 366.973	Diesel		5958	6	97.50	133.00	118
OM 366.974	Diesel		5958	6	97.50	133.00	118
OM 366.975	Diesel		5958	6	97.50	133.00	118
OM 366.976	Diesel		5958	6	97.50	133.00	118
OM 366.977	Diesel		5958	6	97.50	133.00	118
OM 366.978	Diesel		5958	6	97.50	133.00	118
OM 366.979	Diesel		5958	6	97.50	133.00	118
OM 366.980	Diesel		5960	6	97.50	133.00	118
OM 366.981	Diesel		5958	6	97.50	133.00	118
OM 366.983	Diesel		5958	6	97.50	133.00	118
OM 366.984	Diesel		5958	6	97.50	133.00	118
OM 366.988	Diesel		5960	6	97.50	133.00	118
OM 366.990	Diesel		5958	6	97.50	133.00	118
OM 366.992	Diesel		5958	6	97.50	133.00	118
OM 366.993	Diesel		5958	6	97.50	133.00	118
OM 366.994	Diesel		5958	6	97.50	133.00	118
OM 366.995	Diesel		5958	6	97.50	133.00	118
OM 366.996	Diesel		5958	6	97.50	133.00	118
OM 366.997 Euro 1	Diesel		5960	6	97.50	133.00	118
OM 366.999 Euro 1	Diesel		5958	6	97.50	133.00	118
OM 372.906	Diesel		5958	6	97.50	133.00	118
OM 372.907	Diesel		5958	6	97.50	133.00	118
OM 372.930	Diesel		5958	6	97.50	133.00	118
OM 374.905	Diesel		3972	4	97.50	133.00	117
OM 374.907	Diesel		3972	4	97.50	133.00	117
OM 374.908	Diesel		3972	4	97.50	133.00	117
OM 374.992	Diesel		3972	4	97.50	133.00	117
OM 382.912	Diesel		5958	6	97.50	133.00	118
OM 382.913	Diesel		5958	6	97.50	133.00	118
OM 382.916	Diesel		5958	6	97.50	133.00	118
OM 382.917	Diesel		5958	6	97.50	133.00	118
OM 382.919	Diesel		5958	6	97.50	133.00	118
OM 382.950	Diesel		5958	6	97.50	133.00	118
OM 382.970	Diesel		5958	6	97.50	133.00	118
OM 382.971	Diesel		5958	6	97.50	133.00	118
OM 384.907	Diesel		3972	4	97.50	133.00	117
OM 384.908 Euro 1	Diesel		3972	4	97.50	133.00	117
OM 386.906	Diesel		5958	6	97.50	133.00	118
OM 386.950	Diesel		5958	6	97.50	133.00	118
OM 386.951	Diesel		5958	6	97.50	133.00	118
OM 386.952	Diesel		5958	6	97.50	133.00	118
OM 386.980	Diesel		5958	6	97.50	133.00	118







		cm3	x 			
OM 386.981	Diesel	5958	6	97.50	133.00	118
OM 386.983	Diesel	5958	6	97.50	133.00	118
OM 401.905	Diesel	9570	V6	125.00	130.00	129
OM 401.906	Diesel	9570	V6	125.00	130.00	129
OM 401.907	Diesel	9572	V6	125.00	130.00	129
OM 401.908	Diesel	9572	V6	125.00	130.00	129
OM 401.909	Diesel	9570	V6	125.00	130.00	129
OM 401.912	Diesel	9572	V6	125.00	130.00	129
OM 401.913	Diesel	9570	V6	125.00	130.00	129
OM 401.914	Diesel	9570	V6	125.00	130.00	129
OM 401.915	Diesel	9570	V6	125.00	130.00	129
OM 401.916	Diesel	9570	V6	125.00	130.00	129
OM 401.917	Diesel	9570	V6	125.00	130.00	129
OM 401.918	Diesel	9570	V6	125.00	130.00	129
OM 401.919	Diesel	9570	V6	125.00	130.00	129
OM 401.921	Diesel	9570	V6	125.00	130.00	129
OM 401.922	Diesel	9570	V6	125.00	130.00	129
OM 401.923	Diesel	9570	V6	125.00	130.00	129
OM 401.924	Diesel	10456	V6	125.00	142.00	134
OM 401.925	Diesel	9570	V6	125.00	130.00	129
OM 401.926	Diesel	9570	V6	125.00	130.00	129
OM 401.927	Diesel	9570	V6	125.00	130.00	129
OM 401.928	Diesel	9570	V6	125.00	130.00	129
OM 401.970	Diesel	9600	V6	125.00	130.00	130
OM 401.972	Diesel	9572	V6	125.00	130.00	130
OM 401.973	Diesel	9572	V6	125.00	130.00	130
OM 401.974 Euro 1	Diesel	9572	V6	125.00	130.00	130
OM 401.975 Euro 1	Diesel	9572	V6	125.00	130.00	130
OM 401.976 Euro 1	Diesel	9572	V6	125.00	130.00	130
OM 401.977 Euro 1	Diesel	9572	V6	125.00	130.00	130
OM 401.978 Euro 1	Diesel	9572	V6	125.00	130.00	130
OM 401.979 Euro 1	Diesel	9572	V6	125.00	130.00	130
OM 401.980 Euro 1	Diesel	9572	V6	125.00	130.00	130
OM 401.981 Euro 1	Diesel	9572	V6	125.00	130.00	130
OM 401.982 Euro 1	Diesel	9572	V6	125.00	130.00	130
OM 401.983	Diesel	9572	V6	125.00	130.00	130
OM 401.984	Diesel	9572	V6	125.00	130.00	130
OM 401.985	Diesel	9600	V6	125.00	130.00	130
OM 401.986	Diesel	9572	V6	125.00	130.00	130
OM 401.987	Diesel	9572	V6	125.00	130.00	130
OM 401.989	Diesel	9572	V6	125.00	130.00	130
OM 401.990	Diesel	9572	V6	125.00	130.00	130
OM 401.991	Diesel	9600	V6	125.00	130.00	130
OM 401.992	Diesel	9572	V6	125.00	130.00	130
OM 401.993	Diesel	9572	V6	125.00	130.00	130
OM 401.994	Diesel	9600	V6	125.00	130.00	130
OM 402.905	Diesel	12800	V8	125.00	130.00	131
OM 402.906	Diesel	12800	V8	125.00	130.00	131
OM 402.907	Diesel	12800	V8	125.00	130.00	131
OM 402.910	Diesel	12800	V8	125.00	130.00	131
OM 402.911	Diesel	12800	V8	125.00	130.00	131
OM 402.912	Diesel	12800	V8	125.00	130.00	131
OM 402.913	Diesel	12760	V8	125.00	130.00	131
OM 402.914	Diesel	12800	V8	125.00	130.00	131
OM 402.916	Diesel	12800	V8	125.00	130.00	131
OM 402.917	Diesel	12760	V8	125.00	130.00	131
OM 402.919	Diesel	12800	V8	125.00	130.00	131
OM 402.921	Diesel	12760	V8	125.00	130.00	131
OM 402.923	Diesel	12800	V8	125.00	130.00	131
OM 402.924	Diesel	12800	V8	125.00	130.00	131
OM 402.925	Diesel	12760	V8	125.00	130.00	131
OM 402.926	Diesel	12800	V8	125.00	130.00	131
OM 402.927	Diesel	12800	V8	125.00	130.00	131
OM 402.928	Diesel	12800	V8	125.00	130.00	131
OM 402.970 Euro 1	Diesel	12763	V8	125.00	130.00	132
OM 402.971 Euro 1	Diesel	12763	V8	125.00	130.00	132
OM 402.972 Euro 1	Diesel	12763	V8	125.00	130.00	132
OM 402.973 Euro 1	Diesel	12763	V8	125.00	130.00	132
OM 402.974 Euro 1	Diesel	12763	V8	125.00	130.00	132

			cm ³	x 			
OM 402.975 Euro 1	Diesel		12763	V8	125.00	130.00	132
OM 402.977 Euro 1	Diesel		12763	V8	125.00	130.00	132
OM 402.978 Euro 1	Diesel		12763	V8	125.00	130.00	132
OM 402.982 Euro 1	Diesel		12763	V8	125.00	130.00	132
OM 402.983 Euro 1	Diesel		12763	V8	125.00	130.00	132
OM 402.984	Diesel		12763	V8	125.00	130.00	132
OM 402.985 Euro 1	Diesel		12763	V8	125.00	130.00	132
OM 402.986 Euro 1	Diesel		12763	V8	125.00	130.00	132
OM 402.987 Euro 1	Diesel		12763	V8	125.00	130.00	132
OM 402.989 Euro 1	Diesel		12763	V8	125.00	130.00	132
OM 402.990 Euro 1	Diesel		12763	V8	125.00	130.00	132
OM 402.995	Diesel		12763	V8	125.00	130.00	132
OM 402.996 Euro 1	Diesel		12763	V8	125.00	130.00	132
OM 403.905	Diesel		15950	V10	125.00	130.00	133
OM 403.906	Diesel		15950	V10	125.00	130.00	133
OM 403.915	Diesel		15900	V10	125.00	130.00	133
OM 403.916	Diesel		15900	V10	125.00	130.00	133
OM 403.917	Diesel		15950	V10	125.00	130.00	133
OM 403.918	Diesel		15900	V10	125.00	130.00	133
OM 403.919	Diesel		15950	V10	125.00	130.00	133
OM 403.930	Diesel		15950	V10	125.00	130.00	133
OM 403.931	Diesel		15900	V10	125.00	130.00	133
OM 403.932	Diesel		15900	V10	125.00	130.00	133
OM 403.933	Diesel		15950	V10	125.00	130.00	133
OM 403.934	Diesel		15950	V10	125.00	130.00	133
OM 403.935	Diesel		15900	V10	125.00	130.00	133
OM 404	Diesel		20911	V12	125.00	142.00	135
OM 404 A	Diesel		20910	V12	125.00	142.00	135
OM 407.905	Diesel		11000	6	125.00	150.00	137
OM 407.907	Diesel		11045	6	125.00	150.00	137
OM 407.908	Diesel		11000	6	125.00	150.00	137
OM 407.909	Diesel		11000	6	125.00	150.00	137
OM 407.910	Diesel		11000	6	125.00	150.00	137
OM 407.911	Diesel		11000	6	125.00	150.00	137
OM 407.913	Diesel		11413	6	125.00	155.00	138
OM 407.914	Diesel		11413	6	125.00	155.00	138
OM 407.915	Diesel		11413	6	125.00	155.00	138
OM 407.916	Diesel		11413	6	125.00	155.00	138
OM 407.917	Diesel		11413	6	125.00	155.00	138
OM 407.918	Diesel		11413	6	125.00	155.00	138
OM 407.919	Diesel		11413	6	125.00	155.00	138
OM 407.920	Diesel		11412	6	125.00	155.00	138
OM 407.951	Diesel		11413	6	125.00	155.00	138
OM 407.955	Diesel		11413	6	125.00	155.00	138
OM 409.906	Diesel		9204	5	125.00	150.00	136
OM 409.907	Diesel		9204	5	125.00	150.00	136
OM 409.908	Diesel		9204	5	125.00	150.00	136
OM 421.905	Diesel		10964	V6	128.00	142.00	140
OM 421.906	Diesel		10964	V6	128.00	142.00	140
OM 421.907	Diesel		10964	V6	128.00	142.00	140
OM 421.908	Diesel		10964	V6	128.00	142.00	140
OM 421.909	Diesel		10964	V6	128.00	142.00	140
OM 421.910	Diesel		10964	V6	128.00	142.00	140
OM 421.951	Diesel		10964	V6	128.00	142.00	141
OM 422.901	Diesel		14618	V8	128.00	142.00	147
OM 422.905	Diesel		14618	V8	128.00	142.00	148
OM 422.906	Diesel		14618	V8	128.00	142.00	148
OM 422.907	Diesel		14618	V8	128.00	142.00	148
OM 422.908	Diesel		14618	V8	128.00	142.00	148
OM 422.909	Diesel		14618	V8	128.00	142.00	148
OM 422.910	Diesel		14618	V8	128.00	142.00	148
OM 422.911	Diesel		14618	V8	128.00	142.00	148
OM 422.912	Diesel		14618	V8	128.00	142.00	148
OM 422.913	Diesel		14618	V8	128.00	142.00	148
OM 422.914	Diesel		14600	V8	128.00	142.00	148
OM 422.915	Diesel		14618	V8	128.00	142.00	148
OM 422.916	Diesel		14618	V8	128.00	142.00	148
OM 422.917	Diesel		14618	V8	128.00	142.00	148
OM 422.918	Diesel		14618	V8	128.00	142.00	148







		cm3	x 			
OM 422.919	Diesel	14618	V8	128.00	142.00	148
OM 422.920	Diesel	14618	V8	128.00	142.00	148
OM 422.921	Diesel	14618	V8	128.00	142.00	148
OM 422.922	Diesel	14618	V8	128.00	142.00	148
OM 422.923	Diesel	14618	V8	128.00	142.00	148
OM 422.951	Diesel	14600	V8	128.00	142.00	147
OM 422.952	Diesel	14600	V8	128.00	142.00	147
OM 422.953	Diesel	14618	V8	128.00	142.00	147
OM 422.954	Diesel	14618	V8	128.00	142.00	147
OM 422.955	Diesel	14618	V8	128.00	142.00	147
OM 422.956	Diesel	14600	V8	128.00	142.00	147
OM 422.957	Diesel	14620	V8	128.00	142.00	147
OM 422.958	Diesel	14620	V8	128.00	142.00	147
OM 422.959	Diesel	14618	V8	128.00	142.00	147
OM 422.963	Diesel	14618	V8	128.00	142.00	147
OM 423.905	Diesel	18300	V10	128.00	142.00	151
OM 423.906	Diesel	18273	V10	128.00	142.00	151
OM 423.907	Diesel	18273	V10	128.00	142.00	151
OM 423.908	Diesel	18300	V10	128.00	142.00	151
OM 423.909	Diesel	18273	V10	128.00	142.00	151
OM 423.950	Diesel	18273	V10	128.00	142.00	151
OM 423.951	Diesel	18273	V10	128.00	142.00	151
OM 424.900	Diesel	21930	V12	128.00	142.00	152
OM 424.901	Diesel	21930	V12	128.00	142.00	153
OM 424.901-510	Diesel	21930	V12	128.00	142.00	153
OM 427.905	Diesel	11967	6	128.00	155.00	156
OM 427.910	Diesel	11967	6	128.00	155.00	156
OM 427.911	Diesel	11967	6	128.00	155.00	156
OM 427.950	Diesel	11967	6	128.00	155.00	157
OM 427.951	Diesel	11967	6	128.00	155.00	157
OM 427.952	Diesel	11967	6	128.00	155.00	157
OM 429.951	Diesel	9970	5	128.00	155.00	158
OM 429.952	Diesel	9970	5	128.00	155.00	158
OM 429.953	Diesel	9970	5	128.00	155.00	158
OM 429.955	Diesel	9970	5	128.00	155.00	158
OM 440.907 Euro 1	Diesel	15080	V8	130.00	142.00	168
OM 440.909	Diesel	15080	V8	130.00	142.00	168
OM 440.910 Euro 1	Diesel	15080	V8	130.00	142.00	168
OM 440.911 Euro 1	Diesel	15080	V8	130.00	142.00	168
OM 440.940	Diesel	14618	V8	128.00	142.00	147
OM 440.941	Diesel	14618	V8	128.00	142.00	147
OM 440.942	Diesel	14618	V8	128.00	142.00	147
OM 440.943	Diesel	14618	V8	128.00	142.00	147
OM 440.945 Euro 1	Diesel	14618	V8	128.00	142.00	147
OM 440.948	Diesel	14618	V8	128.00	142.00	147
OM 440.970	Diesel	14618	V8	128.00	142.00	149
OM 440.971	Diesel	14618	V8	128.00	142.00	149
OM 440.972 Euro 1	Diesel	14618	V8	128.00	142.00	149
OM 440.973	Diesel	14618	V8	128.00	142.00	149
OM 440.974	Diesel	14618	V8	128.00	142.00	149
OM 440.975	Diesel	14618	V8	128.00	142.00	149
OM 440.976	Diesel	14618	V8	128.00	142.00	149
OM 440.978	Diesel	14618	V8	128.00	142.00	149
OM 440.979	Diesel	14618	V8	128.00	142.00	149
OM 440.980	Diesel	14618	V8	128.00	142.00	149
OM 440.981	Diesel	14618	V8	128.00	142.00	149
OM 440.982	Diesel	14618	V8	128.00	142.00	149
OM 440.983	Diesel	14618	V8	128.00	142.00	149
OM 440.984	Diesel	14618	V8	128.00	142.00	149
OM 440.985	Diesel	14618	V8	128.00	142.00	149
OM 440.986 Euro 1	Diesel	14618	V8	128.00	142.00	149
OM 440.987 Euro 1	Diesel	14618	V8	128.00	142.00	149
OM 440.988 Euro 1	Diesel	14618	V8	128.00	142.00	149
OM 440.989 Euro 1	Diesel	14618	V8	128.00	142.00	149
OM 440.990	Diesel	14618	V8	128.00	142.00	149
OM 440.991	Diesel	14618	V8	128.00	142.00	149
OM 441.905	Diesel	10964	V6	130.00	138.00	165
OM 441.906	Diesel	10964	V6	130.00	138.00	165
OM 441.907	Diesel	10964	V6	130.00	138.00	165







			cm ³	x 			
OM 441.908	Diesel	10964	V6	130.00	138.00	165	
OM 441.909	Diesel	10964	V6	130.00	138.00	165	
OM 441.911	Diesel	10964	V6	130.00	138.00	165	
OM 441.912	Diesel	11309	V6	130.00	142.00	167	
OM 441.913	Diesel	10964	V6	130.00	138.00	165	
OM 441.914	Diesel	11309	V6	130.00	142.00	167	
OM 441.915	Diesel	10964	V6	130.00	138.00	165	
OM 441.916	Diesel	11309	V6	130.00	142.00	167	
OM 441.917	Diesel	10964	V6	130.00	138.00	165	
OM 441.918	Diesel	11309	V6	130.00	142.00	167	
OM 441.919	Diesel	11309	V6	130.00	142.00	167	
OM 441.920	Diesel	11309	V6	130.00	142.00	167	
OM 441.921	Diesel	11300	V6	130.00	142.00	167	
OM 441.922	Diesel	11300	V6	130.00	142.00	167	
OM 441.923	Diesel	10964	V6	130.00	138.00	165	
OM 441.924	Diesel	11309	V6	130.00	142.00	167	
OM 441.925	Diesel	10964	V6	130.00	138.00	165	
OM 441.926	Diesel	10964	V6	130.00	138.00	165	
OM 441.927	Diesel	10964	V6	130.00	138.00	165	
OM 441.932	Diesel	11309	V6	130.00	142.00	167	
OM 441.933	Diesel	11309	V6	130.00	142.00	167	
OM 441.950	Diesel	10964	V6	130.00	138.00	166	
OM 441.951	Diesel	10964	V6	128.00	142.00	142	
OM 441.953	Diesel	10964	V6	128.00	142.00	143	
OM 441.960	Diesel	10964	V6	128.00	142.00	142	
OM 441.961	Diesel	10964	V6	128.00	142.00	142	
OM 441.962	Diesel	10964	V6	128.00	142.00	142	
OM 441.980	Diesel	10964	V6	128.00	142.00	144	
OM 441.981	Diesel	10964	V6	128.00	142.00	142	
OM 441.982	Diesel	10964	V6	128.00	142.00	145	
OM 441.983	Diesel	10964	V6	128.00	142.00	142	
OM 441.985	Diesel	10964	V6	128.00	142.00	145	
OM 441.986	Diesel	10964	V6	128.00	142.00	142	
OM 441.987	Diesel	10964	V6	128.00	142.00	142	
OM 441.988	Diesel	10964	V6	128.00	142.00	144	
OM 441.989	Diesel	10964	V6	128.00	142.00	142	
OM 441.990	Diesel	10964	V6	128.00	142.00	144	
OM 441.991	Diesel	10964	V6	128.00	142.00	142	
OM 441.992	Diesel	10964	V6	128.00	142.00	144	
OM 441.993	Diesel	10964	V6	128.00	142.00	144	
OM 441.994 Euro 1	Diesel	10964	V6	128.00	142.00	144	
OM 441.995 Euro 1	Diesel	10964	V6	128.00	142.00	144	
OM 441.996	Diesel	10964	V6	128.00	142.00	142	
OM 441.997 Euro 1	Diesel	10964	V6	128.00	142.00	142	
OM 441.998	Diesel	10964	V6	128.00	142.00	142	
OM 441.999 Euro 1	Diesel	10964	V6	128.00	142.00	142	
OM 442.905	Diesel	15080	V8	130.00	142.00	169	
OM 442.906	Diesel	15080	V8	130.00	142.00	169	
OM 442.907	Diesel	15080	V8	130.00	142.00	169	
OM 442.908	Diesel	15080	V8	130.00	142.00	169	
OM 442.909	Diesel	15080	V8	130.00	142.00	169	
OM 442.910	Diesel	15080	V8	130.00	142.00	169	
OM 442.911	Diesel	15080	V8	130.00	142.00	169	
OM 442.913	Diesel	15080	V8	130.00	142.00	169	
OM 442.914	Diesel	15080	V8	130.00	142.00	169	
OM 442.915	Diesel	15078	V8	130.00	142.00	169	
OM 442.916	Diesel	15078	V8	130.00	142.00	169	
OM 442.917	Diesel	15080	V8	130.00	142.00	169	
OM 442.918	Diesel	15080	V8	130.00	142.00	169	
OM 442.919	Diesel	15080	V8	130.00	142.00	169	
OM 442.920	Diesel	15080	V8	130.00	142.00	169	
OM 442.921	Diesel	15080	V8	130.00	142.00	169	
OM 442.922	Diesel	15080	V8	130.00	142.00	169	
OM 442.923	Diesel	15080	V8	130.00	142.00	169	
OM 442.924	Diesel	15080	V8	130.00	142.00	169	
OM 442.925	Diesel	15080	V8	130.00	142.00	169	
OM 442.926	Diesel	15080	V8	130.00	142.00	169	
OM 442.927	Diesel	15078	V8	130.00	142.00	169	
OM 442.928	Diesel	15078	V8	130.00	142.00	169	

		cm3	x 			
OM 442.929	Diesel	15080	V8	130.00	142.00	169
OM 442.930	Diesel	15100	V8	130.00	142.00	169
OM 442.931	Diesel	15080	V8	130.00	142.00	169
OM 442.932	Diesel	15080	V8	130.00	142.00	169
OM 442.933	Diesel	15080	V8	130.00	142.00	169
OM 442.934	Diesel	15080	V8	130.00	142.00	169
OM 442.935	Diesel	15080	V8	130.00	142.00	169
OM 442.939	Diesel	15080	V8	130.00	142.00	169
OM 442.941	Diesel	14618	V8	128.00	142.00	150
OM 442.942	Diesel	14618	V8	128.00	142.00	150
OM 442.943	Diesel	14620	V8	128.00	142.00	150
OM 442.944	Diesel	14618	V8	128.00	142.00	150
OM 442.945	Diesel	14618	V8	128.00	142.00	150
OM 442.946	Diesel	14618	V8	128.00	142.00	150
OM 442.950	Diesel	14618	V8	128.00	142.00	150
OM 442.951	Diesel	14618	V8	128.00	142.00	150
OM 442.952	Diesel	14618	V8	128.00	142.00	150
OM 442.953	Diesel	14618	V8	128.00	142.00	150
OM 442.954	Diesel	14618	V8	128.00	142.00	150
OM 442.955	Diesel	14618	V8	128.00	142.00	150
OM 442.957	Diesel	14618	V8	128.00	142.00	150
OM 442.958	Diesel	14618	V8	128.00	142.00	150
OM 442.959	Diesel	14618	V8	128.00	142.00	150
OM 442.960	Diesel	14618	V8	128.00	142.00	150
OM 442.961	Diesel	14618	V8	128.00	142.00	150
OM 442.962	Diesel	14618	V8	128.00	142.00	150
OM 442.963	Diesel	14618	V8	128.00	142.00	150
OM 442.964	Diesel	14618	V8	128.00	142.00	150
OM 442.965	Diesel	14618	V8	128.00	142.00	150
OM 442.966	Diesel	14618	V8	128.00	142.00	150
OM 442.967	Diesel	14618	V8	128.00	142.00	150
OM 442.968	Diesel	14618	V8	128.00	142.00	150
OM 442.971	Diesel	14620	V8	128.00	142.00	150
OM 442.972	Diesel	14620	V8	128.00	142.00	150
OM 442.976	Diesel	14618	V8	128.00	142.00	150
OM 442.977	Diesel	14618	V8	128.00	142.00	150
OM 442.978	Diesel	14620	V8	128.00	142.00	150
OM 442.979	Diesel	14618	V8	128.00	142.00	150
OM 442.980	Diesel	14618	V8	128.00	142.00	150
OM 442.982	Diesel	14618	V8	128.00	142.00	150
OM 442.983	Diesel	14618	V8	128.00	142.00	150
OM 442.985	Diesel	14618	V8	128.00	142.00	150
OM 442.989	Diesel	14618	V8	128.00	142.00	150
OM 442.992	Diesel	14618	V8	128.00	142.00	150
OM 442.993	Diesel	14618	V8	128.00	142.00	150
OM 442.994	Diesel	14618	V8	128.00	142.00	150
OM 442.995 Euro 1	Diesel	14618	V8	128.00	142.00	150
OM 442.996 Euro 1	Diesel	14618	V8	128.00	142.00	150
OM 442.997	Diesel	14618	V8	128.00	142.00	150
OM 442.998	Diesel	14618	V8	128.00	142.00	150
OM 442.999	Diesel	14618	V8	128.00	142.00	150
OM 443.905	Diesel	18848	V10	130.00	142.00	170
OM 443.906	Diesel	18848	V10	130.00	142.00	170
OM 443.908	Diesel	18848	V10	130.00	142.00	170
OM 443.909	Diesel	18848	V10	130.00	142.00	170
OM 443.940	Diesel	18270	V10	128.00	142.00	151
OM 443.980	Diesel	18270	V10	128.00	142.00	151
OM 444 LA	Diesel	21927	12	128.00	142.00	154
OM 445.920	Diesel	10964	V6	128.00	142.00	142
OM 445.921	Diesel	10964	V6	128.00	142.00	142
OM 445.922	Diesel	10964	V6	128.00	142.00	142
OM 445.923	Diesel	10964	V6	128.00	142.00	144
OM 445.924	Diesel	10960	V6	128.00	142.00	142
OM 445.925	Diesel	10964	V6	128.00	142.00	146
OM 445.926	Diesel	10964	V6	128.00	142.00	142
OM 445.927	Diesel	10964	V6	128.00	142.00	146
OM 445.929	Diesel	10964	V6	128.00	142.00	142
OM 445.930	Diesel	10964	V6	128.00	142.00	142
OM 445.931	Diesel	10964	V6	128.00	142.00	144







		cm ³	x 			
--	---	-----------------	---	---	---	---







OM 445.933	Diesel	10964	V6	128.00	142.00	144
OM 445.934 Euro 2	Diesel	10964	V6	128.00	142.00	144
OM 445.935 Euro 2	Diesel	10964	V6	128.00	142.00	144
OM 445.936	Diesel	10964	V6	128.00	142.00	142
OM 445.937	Diesel	10964	V6	128.00	142.00	142
OM 445.938	Diesel	10960	V6	128.00	142.00	142
OM 445.939	Diesel	10964	V6	128.00	142.00	142
OM 445.940	Diesel	10964	V6	128.00	142.00	146
OM 445.941	Diesel	10960	V6	128.00	142.00	142
OM 446.920	Diesel	14618	V8	128.00	142.00	150
OM 446.922	Diesel	14618	V8	128.00	142.00	150
OM 446.923	Diesel	14618	V8	128.00	142.00	150
OM 446.924	Diesel	14618	V8	128.00	142.00	150
OM 446.925	Diesel	14618	V8	128.00	142.00	150
OM 446.926	Diesel	14618	V8	128.00	142.00	150
OM 446.927	Diesel	14618	V8	128.00	142.00	150
OM 446.928	Diesel	14618	V8	128.00	142.00	150
OM 446.929	Diesel	14618	V8	128.00	142.00	150
OM 446.930	Diesel	14618	V8	128.00	142.00	150
OM 446.931	Diesel	14618	V8	128.00	142.00	150
OM 446.932	Diesel	14618	V8	128.00	142.00	150
OM 446.933	Diesel	14618	V8	128.00	142.00	150
OM 446.934 Euro 2	Diesel	14618	V8	128.00	142.00	150
OM 446.935 Euro 2	Diesel	14618	V8	128.00	142.00	150
OM 446.936	Diesel	14618	V8	128.00	142.00	150
OM 446.938 Euro 2	Diesel	14618	V8	128.00	142.00	150
OM 446.939	Diesel	14618	V8	128.00	142.00	150
OM 446.940	Diesel	14618	V8	128.00	142.00	150
OM 446.941 Euro 2	Diesel	14618	V8	128.00	142.00	150
OM 446.942	Diesel	14618	V8	128.00	142.00	150
OM 446.943	Diesel	14618	V8	128.00	142.00	150
OM 446.945	Diesel	14618	V8	128.00	142.00	150
OM 446.946	Diesel	14618	V8	128.00	142.00	150
OM 446.948	Diesel	14618	V8	128.00	142.00	150
OM 447.905	Diesel	11967	6	128.00	155.00	160
OM 447.906	Diesel	11967	6	128.00	155.00	160
OM 447.907	Diesel	11967	6	128.00	155.00	160
OM 447.908	Diesel	11967	6	128.00	155.00	160
OM 447.910	Diesel	11967	6	128.00	155.00	160
OM 447.911	Diesel	11967	6	128.00	155.00	160
OM 447.912	Diesel	11967	6	128.00	155.00	160
OM 447.913 Euro 1	Diesel	11967	6	128.00	155.00	160
OM 447.914 Euro 1	Diesel	11967	6	128.00	155.00	160
OM 447.915	Alcohol	11967	6	128.00	155.00	159
OM 447.916	Methyl Alcohol	11967	6	128.00	155.00	159
OM 447.947 Euro 1	Diesel	11967	6	128.00	155.00	159
OM 447.948 Euro 2	Diesel	11967	6	128.00	155.00	159
OM 447.949 Euro 2	Diesel	11967	6	128.00	155.00	159
OM 447.950	Diesel	11967	6	128.00	155.00	159
OM 447.951	Diesel	11967	6	128.00	155.00	159
OM 447.952 Euro 1	Diesel	11967	6	128.00	155.00	159
OM 447.953 Euro 1	Diesel	11967	6	128.00	155.00	159
OM 447.954 Euro 1	Diesel	11967	6	128.00	155.00	159
OM 447.955 Euro 1	Diesel	11967	6	128.00	155.00	159
OM 447.956	Diesel	11967	6	128.00	155.00	159
OM 447.957	Diesel	11967	6	128.00	155.00	159
OM 447.958	Diesel	11967	6	128.00	155.00	159
OM 447.959	Diesel	11967	6	128.00	155.00	159
OM 447.960 Euro 1	Diesel	11967	6	128.00	155.00	159
OM 447.968 Euro 2	Diesel	11967	6	128.00	155.00	159
OM 447.969	Diesel	11967	6	128.00	155.00	159
OM 447.970 Euro 2	Diesel	11967	6	128.00	155.00	159
OM 447.971 Euro 2	Diesel	11967	6	128.00	155.00	159
OM 447.972 Euro 2	Diesel	11967	6	128.00	155.00	159
OM 447.973 Euro 2	Diesel	11967	6	128.00	155.00	159
OM 447.974 Euro 2	Diesel	11967	6	128.00	155.00	159
OM 447.975 Euro 1	Diesel	11967	6	128.00	155.00	159
OM 447.976 Euro 2	Diesel	11967	6	128.00	155.00	159
OM 447.977 Euro 2	Diesel	11967	6	128.00	155.00	159

		cm3	x 			
OM 447.978	Diesel	11967	6	128.00	155.00	159
OM 447.979 Euro 2	Diesel	11967	6	128.00	155.00	159
OM 447.980 Euro 1	Diesel	11967	6	128.00	155.00	159
OM 447.981	Diesel	11967	6	128.00	155.00	159
OM 447.982	Diesel	11967	6	128.00	155.00	159
OM 447.983	Diesel	11967	6	128.00	155.00	159
OM 447.984	Diesel	11967	6	128.00	155.00	159
OM 447.985 Euro 1	Diesel	11967	6	128.00	155.00	159
OM 447.986	Diesel	11967	6	128.00	155.00	159
OM 447.987	Diesel	11967	6	128.00	155.00	159
OM 447.988 Euro 2	Diesel	11967	6	128.00	155.00	159
OM 447.990 Euro 2	Diesel	11967	6	128.00	155.00	159
OM 447.991 Euro 2	Diesel	11967	6	128.00	155.00	159
OM 447.992 Euro 2	Diesel	11967	6	128.00	155.00	159
OM 447.993 Euro 2	Diesel	11967	6	128.00	155.00	159
OM 447.994 Euro 2	Diesel	11967	6	128.00	155.00	159
OM 447.995	Diesel	11967	6	128.00	155.00	159
OM 447.996 Euro 2	Diesel	11967	6	128.00	155.00	159
OM 447.998 Euro 2	Diesel	11967	6	128.00	155.00	159
OM 457.914 Euro 3	Diesel	11967	6	128.00	155.00	161
OM 457.915 Euro 3	Diesel	11967	6	128.00	155.00	161
OM 457.916 Euro 3	Diesel	11967	6	128.00	155.00	161
OM 457.917 Euro 2/3	Diesel	11967	6	128.00	155.00	161
OM 457.918 Euro 3	Diesel	11967	6	128.00	155.00	161
OM 457.919 Euro 3	Diesel	11967	6	128.00	155.00	161
OM 457.920 Euro 3	Diesel	11967	6	128.00	155.00	161
OM 457.922 Euro 3	Diesel	11967	6	128.00	155.00	161
OM 457.923 Euro 3	Diesel	11967	6	128.00	155.00	161
OM 457.924 Euro 3	Diesel	11967	6	128.00	155.00	161
OM 457.925 Euro 3	Diesel	11967	6	128.00	155.00	161
OM 457.926 Euro 3	Diesel	11967	6	128.00	155.00	161
OM 457.927 Euro 3	Diesel	11967	6	128.00	155.00	161
OM 457.928 Euro 3	Diesel	11967	6	128.00	155.00	161
OM 457.929 Euro 3	Diesel	11967	6	128.00	155.00	161
OM 457.931 Euro 3	Diesel	11967	6	128.00	155.00	161
OM 457.932 Euro 3	Diesel	11967	6	128.00	155.00	161
OM 457.933 Euro 2/3	Diesel	11967	6	128.00	155.00	161
OM 457.934 Euro 2/3	Diesel	11967	6	128.00	155.00	161
OM 457.935 Euro 2/3	Diesel	11967	6	128.00	155.00	161
OM 457.936 Euro 2	Diesel	11967	6	128.00	155.00	161
OM 457.937 Euro 2/3	Diesel	11967	6	128.00	155.00	161
OM 457.938 Euro 2	Diesel	11967	6	128.00	155.00	161
OM 457.939 Euro 2	Diesel	11967	6	128.00	155.00	161
OM 457.940 Euro 2/3	Diesel	11967	6	128.00	155.00	161
OM 457.941 Euro 2/3	Diesel	11967	6	128.00	155.00	161
OM 457.942 Euro 2/3	Diesel	11967	6	128.00	155.00	161
OM 457.943 Euro 2/3	Diesel	11967	6	128.00	155.00	161
OM 457.944 Euro 2/3	Diesel	11967	6	128.00	155.00	161
OM 457.945 Euro 2	Diesel	11967	6	128.00	155.00	161
OM 457.946 Euro 2	Diesel	11967	6	128.00	155.00	161
OM 457.947 Euro 2	Diesel	11967	6	128.00	155.00	161
OM 457.948 Euro 3	Diesel	11967	6	128.00	155.00	162
OM 457.949 Euro 2	Diesel	11967	6	128.00	155.00	161
OM 457.950 Euro 4	Diesel	11967	6	128.00	155.00	162
OM 457.951 Euro 4	Diesel	11967	6	128.00	155.00	162
OM 457.952 Euro 4	Diesel	11967	6	128.00	155.00	162
OM 457.953 Euro 4	Diesel	11967	6	128.00	155.00	162
OM 457.954 Euro 4	Diesel	11967	6	128.00	155.00	162
OM 457.955 Euro 3	Diesel	11967	6	128.00	155.00	161
OM 457.956 Euro 3	Diesel	11967	6	128.00	155.00	161
OM 457.957 Euro 3	Diesel	11967	6	128.00	155.00	162
OM 457.958 Euro 2/3	Diesel	11967	6	128.00	155.00	161
OM 457.959 Euro 4	Diesel	11967	6	128.00	155.00	162
OM 457.960 Euro 2	Diesel	11967	6	128.00	155.00	161
OM 457.961 Euro 3	Diesel	11967	6	128.00	155.00	162
OM 457.962 Euro 3	Diesel	11967	6	128.00	155.00	161
OM 457.964 Euro 4	Diesel	11967	6	128.00	155.00	162
OM 457.965 Euro 4	Diesel	11967	6	128.00	155.00	162
OM 457.966 Euro 4	Diesel	11967	6	128.00	155.00	162







		cm3	x 			
--	---	-----	---	---	---	---







OM 457.967 Euro 4	Diesel	11967	6	128.00	155.00	162
OM 457.968 Euro 4	Diesel	11967	6	128.00	155.00	162
OM 457.969 Euro 4	Diesel	11967	6	128.00	155.00	162
OM 457.973 Euro 4	Diesel	11967	6	128.00	155.00	162
OM 457.980 Euro 2	Diesel	11967	6	128.00	155.00	161
OM 457.981 Euro 3	Diesel	11967	6	128.00	155.00	161
OM 460.900 Euro 3	Diesel	12816	6	128.00	166.00	163
OM 460.901 Euro 3	Diesel	12816	6	128.00	166.00	163
OM 460.902 Euro 3	Diesel	12816	6	128.00	166.00	163
OM 460.903 Euro 3	Diesel	12816	6	128.00	166.00	163
OM 460.904 Euro 3	Diesel	12816	6	128.00	166.00	163
OM 460.905 Euro 3	Diesel	12816	6	128.00	166.00	163
OM 460.906 Euro 3	Diesel	12816	6	128.00	166.00	163
OM 460.907 Euro 3	Diesel	12816	6	128.00	166.00	163
OM 460.908 Euro 3	Diesel	12816	6	128.00	166.00	163
OM 460.909 Euro 3	Diesel	12816	6	128.00	166.00	163
OM 460.910 Euro 3	Diesel	12816	6	128.00	166.00	163
OM 460.911 Euro 3	Diesel	12816	6	128.00	166.00	163
OM 460.912 Euro 3	Diesel	12816	6	128.00	166.00	163
OM 460.913 Euro 3	Diesel	12816	6	128.00	166.00	163
OM 460.914 Euro 3	Diesel	12816	6	128.00	166.00	163
OM 460.915 Euro 3	Diesel	12816	6	128.00	166.00	163
OM 460.916 Euro 3	Diesel	12816	6	128.00	166.00	163
OM 460.917 Euro 3	Diesel	12816	6	128.00	166.00	163
OM 460.918 Euro 3	Diesel	12816	6	128.00	166.00	163
OM 460.919 Euro 3	Diesel	12816	6	128.00	166.00	163
OM 460.920 Euro 3	Diesel	12816	6	128.00	166.00	163
OM 460.921 Euro 3	Diesel	12816	6	128.00	166.00	163
OM 460.922 Euro 3	Diesel	12816	6	128.00	166.00	163
OM 460.923 Euro 3	Diesel	12816	6	128.00	166.00	163
OM 460.925 Euro 3	Diesel	12816	6	128.00	166.00	163
OM 460.926	Diesel	12816	6	128.00	166.00	163
OM 460.927	Diesel	12816	6	128.00	166.00	163
OM 460.929 Euro 3	Diesel	12816	6	128.00	166.00	163
OM 460.931 Euro 3	Diesel	12816	6	128.00	166.00	163
OM 460.932	Diesel	12816	6	128.00	166.00	163
OM 460.933	Diesel	12816	6	128.00	166.00	163
OM 460.934	Diesel	12816	6	128.00	166.00	163
OM 460.935	Diesel	12816	6	128.00	166.00	163
OM 460.936	Diesel	12816	6	128.00	166.00	163
OM 460.937	Diesel	12816	6	128.00	166.00	163
OM 460.938	Diesel	12816	6	128.00	166.00	163
OM 460.939	Diesel	12816	6	128.00	166.00	163
OM 460.940	Diesel	12816	6	128.00	166.00	163
OM 460.941	Diesel	12816	6	128.00	166.00	163
OM 460.942	Diesel	12816	6	128.00	166.00	163
OM 460.943	Diesel	12816	6	128.00	166.00	163
OM 460.944	Diesel	12816	6	128.00	166.00	163
OM 460.945	Diesel	12816	6	128.00	166.00	163
OM 460.946	Diesel	12816	6	128.00	166.00	163
OM 460.947	Diesel	12816	6	128.00	166.00	163
OM 460.948	Diesel	12816	6	128.00	166.00	163
OM 460.949	Diesel	12816	6	128.00	166.00	163
OM 460.950 Euro 3	Diesel	12816	6	128.00	166.00	164
OM 460.951 Euro 3	Diesel	12816	6	128.00	166.00	164
OM 460.960 Euro 3	Diesel	12816	6	128.00	166.00	164
OM 460.961 Euro 3	Diesel	12816	6	128.00	166.00	163
OM 460.970 Euro 3	Diesel	12816	6	128.00	166.00	163
OM 460.971 Euro 3	Diesel	12816	6	128.00	166.00	163
OM 460.975 Euro 3	Diesel	12816	6	128.00	166.00	163
OM 460.976 Euro 3	Diesel	12816	6	128.00	166.00	163
OM 460.977 Euro 3	Diesel	12816	6	128.00	166.00	163
OM 460.978 Euro 3	Diesel	12816	6	128.00	166.00	163
OM 460.979 Euro 3	Diesel	12816	6	128.00	166.00	163
OM 460.980 Euro 3	Diesel	12816	6	128.00	166.00	163
OM 460.981 Euro 3	Diesel	12816	6	128.00	166.00	163
OM 521.940 Euro 2	Diesel	11946	V6	130.00	150.00	171
OM 521.950 Euro 2	Diesel	11946	V6	130.00	150.00	171
OM 522.940 Euro 2	Diesel	15928	V8	130.00	150.00	173







		cm3	x 			
OM 522.941 Euro 2	Diesel	15928	V8	130.00	150.00	173
OM 522.942 Euro 2	Diesel	15928	V8	130.00	150.00	173
OM 522.943 Euro 2	Diesel	15928	V8	130.00	150.00	173
OM 522.950 Euro 2	Diesel	15928	V8	130.00	150.00	173
OM 541.920 Euro 2	Diesel	11946	V6	130.00	150.00	171
OM 541.921 Euro 2	Diesel	11946	V6	130.00	150.00	171
OM 541.922 Euro 2	Diesel	11946	V6	130.00	150.00	171
OM 541.923 Euro 2	Diesel	11946	V6	130.00	150.00	171
OM 541.924 Euro 2	Diesel	11946	V6	130.00	150.00	171
OM 541.925 Euro 2	Diesel	11946	V6	130.00	150.00	171
OM 541.926 Euro 2	Diesel	11946	V6	130.00	150.00	171
OM 541.927 Euro 2	Diesel	11946	V6	130.00	150.00	171
OM 541.928 Euro 2	Diesel	11946	V6	130.00	150.00	171
OM 541.940 Euro 2/3	Diesel	11946	V6	130.00	150.00	171
OM 541.941 Euro 2/3	Diesel	11946	V6	130.00	150.00	171
OM 541.942 Euro 3	Diesel	11946	V6	130.00	150.00	171
OM 541.943 Euro 3	Diesel	11946	V6	130.00	150.00	171
OM 541.944 Euro 3	Diesel	11946	V6	130.00	150.00	171
OM 541.945 Euro 3	Diesel	11946	V6	130.00	150.00	171
OM 541.946 Euro 3	Diesel	11946	V6	130.00	150.00	171
OM 541.947 Euro 3	Diesel	11946	V6	130.00	150.00	171
OM 541.948 Euro 3	Diesel	11946	V6	130.00	150.00	171
OM 541.949 Euro 3	Diesel	11946	V6	130.00	150.00	171
OM 541.950 Euro 3	Diesel	11946	V6	130.00	150.00	171
OM 541.951 Euro 2/3	Diesel	11946	V6	130.00	150.00	171
OM 541.952 Euro 2/3	Diesel	11946	V6	130.00	150.00	171
OM 541.953 Euro 4/5	Diesel	11946	V6	130.00	150.00	172
OM 541.959 Euro 4/5	Diesel	11946	V6	130.00	150.00	172
OM 541.960 Euro 2	Diesel	11946	V6	130.00	150.00	171
OM 541.970 Euro 4	Diesel	11946	V6	130.00	150.00	172
OM 541.971 Euro 4/5	Diesel	11946	V6	130.00	150.00	172
OM 541.972 Euro 4	Diesel	11946	V6	130.00	150.00	172
OM 541.973 Euro 4	Diesel	11946	V6	130.00	150.00	172
OM 541.974 Euro 4	Diesel	11946	V6	130.00	150.00	172
OM 541.975 Euro 4	Diesel	11946	V6	130.00	150.00	172
OM 541.976 Euro 4	Diesel	11946	V6	130.00	150.00	172
OM 541.977 Euro 4	Diesel	11946	V6	130.00	150.00	172
OM 541.978 Euro 3	Diesel	11946	V6	130.00	150.00	172
OM 541.979 Euro 4/5	Diesel	11946	V6	130.00	150.00	172
OM 541.980 Euro 3	Diesel	11946	V6	130.00	150.00	172
OM 541.981 Euro 3	Diesel	11946	V6	130.00	150.00	172
OM 541.990 Euro 5	Diesel	11946	V6	130.00	150.00	172
OM 541.991	Diesel	11946	V6	130.00	150.00	172
OM 541.992 Euro 5	Diesel	11946	V6	130.00	150.00	172
OM 541.993	Diesel	11946	V6	130.00	150.00	172
OM 541.994 Euro 5	Diesel	11946	V6	130.00	150.00	172
OM 541.995	Diesel	11946	V6	130.00	150.00	172
OM 541.996 Euro 5	Diesel	11946	V6	130.00	150.00	172
OM 541.997	Diesel	11946	V6	130.00	150.00	172
OM 541.998 Euro 5	Diesel	11946	V6	130.00	150.00	172
OM 541.999	Diesel	11946	V6	130.00	150.00	172
OM 542.920	Diesel	15928	V8	130.00	150.00	173
OM 542.921	Diesel	15928	V8	130.00	150.00	173
OM 542.922	Diesel	15928	V8	130.00	150.00	173
OM 542.923	Diesel	15928	V8	130.00	150.00	173
OM 542.924	Diesel	15928	V8	130.00	150.00	173
OM 542.925 Euro 2	Diesel	15928	V8	130.00	150.00	173
OM 542.926	Diesel	15928	V8	130.00	150.00	173
OM 542.940 Euro 3	Diesel	15928	V8	130.00	150.00	173
OM 542.941 Euro 3	Diesel	15928	V8	130.00	150.00	173
OM 542.942 Euro 3	Diesel	15928	V8	130.00	150.00	173
OM 542.943 Euro 3	Diesel	15928	V8	130.00	150.00	173
OM 542.944 Euro 3	Diesel	15928	V8	130.00	150.00	173
OM 542.945 Euro 3	Diesel	15928	V8	130.00	150.00	173
OM 542.947	Diesel	15928	V8	130.00	150.00	173
OM 542.948 Euro 3	Diesel	15928	V8	130.00	150.00	173
OM 542.956 Euro 3	Diesel	15928	V8	130.00	150.00	173
OM 542.957 Euro 3	Diesel	15928	V8	130.00	150.00	173
OM 542.958 Euro 3	Diesel	15928	V8	130.00	150.00	173







		cm ³	x 			
--	---	-----------------	---	---	---	---







OM 542.960 Euro 5	Diesel	15928	V8	130.00	150.00	174
OM 542.961 Euro 5	Diesel	15928	V8	130.00	150.00	174
OM 542.962 Euro 5	Diesel	15928	V8	130.00	150.00	174
OM 542.963 Euro 5	Diesel	15928	V8	130.00	150.00	174
OM 542.964 Euro 5	Diesel	15928	V8	130.00	150.00	174
OM 542.965 Euro 5	Diesel	15928	V8	130.00	150.00	174
OM 542.966 Euro 5	Diesel	15928	V8	130.00	150.00	174
OM 542.968 Euro 5	Diesel	15928	V8	130.00	150.00	174
OM 542.969 Euro 5	Diesel	15928	V8	130.00	150.00	174
OM 542.970 Euro 5	Diesel	15928	V8	130.00	150.00	174
OM 601.900	Diesel	2300	4	89.00	92.40	61
OM 601.911	Diesel	1997	4	87.00	84.00	29
OM 601.912	Diesel	1997	4	87.00	84.00	29
OM 601.913	Diesel	1997	4	87.00	84.00	29
OM 601.915	Diesel	1997	4	87.00	84.00	29
OM 601.921	Diesel	2197	4	87.00	92.40	40
OM 601.940	Diesel	2299	4	89.00	92.40	61
OM 601.941	Diesel	2299	4	89.00	92.40	61
OM 601.942	Diesel	2299	4	89.00	92.40	61
OM 601.943	Diesel	2299	4	89.00	92.40	61
OM 601.970	Diesel	2299	4	89.00	92.40	59
OM 602.911	Diesel	2497	5	87.00	84.00	31
OM 602.912	Diesel	2497	5	87.00	84.00	31
OM 602.930	Diesel	2497	5	87.00	84.00	31
OM 602.931	Diesel	2497	5	87.00	84.00	31
OM 602.938	Diesel	2497	5	87.00	84.00	31
OM 602.939	Diesel	2497	5	87.00	84.00	31
OM 602.940	Diesel	2874	5	89.00	92.40	63
OM 602.941	Diesel	2874	5	89.00	92.40	63
OM 602.942	Diesel	2874	5	89.00	92.40	63
OM 602.946	Diesel	2874	5	89.00	92.40	63
OM 602.947	Diesel	2874	5	89.00	92.40	63
OM 602.948	Diesel	2874	5	89.00	92.40	63
OM 602.961	Diesel	2497	5	87.00	84.00	32
OM 602.962	Diesel	2497	5	87.00	84.00	32
OM 602.980	Diesel	2874	5	89.00	92.40	64
OM 602.981	Diesel	2874	5	89.00	92.40	64
OM 602.982	Diesel	2874	5	89.00	92.40	64
OM 602.983	Diesel	2874	5	89.00	92.40	64
OM 602.984	Diesel	2874	5	89.00	92.40	64
OM 602.985	Diesel	2874	5	89.00	92.40	64
OM 602.986	Diesel	2874	5	89.00	92.40	64
OM 602.989	Diesel	2874	5	89.00	92.40	64
OM 602.990	Diesel	2497	5	87.00	84.00	31
OM 602.991	Diesel	2874	5	89.00	92.40	63
OM 602.993	Diesel	2497	5	87.00	84.00	32
OM 602.994	Diesel	2874	5	89.00	92.40	63
OM 602.995	Diesel	2874	5	89.00	92.40	63
OM 603.912	Diesel	2996	6	87.00	84.00	35
OM 603.913	Diesel	2996	6	87.00	84.00	35
OM 603.931	Diesel	2996	6	87.00	84.00	35
OM 603.950	Diesel	2996	6	87.00	84.00	36
OM 603.960	Diesel	2996	6	87.00	84.00	36
OM 603.961	Diesel	2996	6	87.00	84.00	36
OM 603.962	Diesel	2996	6	87.00	84.00	36
OM 603.963	Diesel	2996	6	87.00	84.00	36
OM 603.970	Diesel	3449	6	89.00	92.40	66
OM 603.971	Diesel	3449	6	89.00	92.40	66
OM 603.972	Diesel	3449	6	89.00	92.40	66
OM 604.910	Diesel	2155	4	89.00	86.60	58
OM 604.912	Diesel	2155	4	89.00	86.60	58
OM 604.915	Diesel	1997	4	87.00	84.00	30
OM 604.917	Diesel	1997	4	87.00	84.00	30
OM 605.910	Diesel	2497	5	87.00	84.00	33
OM 605.911	Diesel	2497	5	87.00	84.00	33
OM 605.912	Diesel	2497	5	87.00	84.00	33
OM 605.960	Diesel	2497	5	87.00	84.00	34
OM 605.962	Diesel	2497	5	87.00	84.00	34
OM 606.910	Diesel	2996	6	87.00	84.00	37

		cm3	x 			
OM 606.912	Diesel	2996	6	87.00	84.00	37
OM 606.961	Diesel	2996	6	87.00	84.00	38
OM 606.962	Diesel	2996	6	87.00	84.00	38
OM 606.964	Diesel	2996	6	87.00	84.00	38
OM 611.960	Diesel	2151	4	88.00	88.30	47
OM 611.961	Diesel	2148	4	88.00	88.30	47
OM 611.962	Diesel	2148	4	88.00	88.30	47
OM 611.980	Diesel	2151	4	88.00	88.30	47
OM 611.981	Diesel	2148	4	88.00	88.30	47
OM 611.987	Diesel	2148	4	88.00	88.30	47
OM 611A (60 KW CDI)	Diesel	2151	4	88.00	88.30	47
OM 611LA (75 KW CDI)	Diesel	2151	4	88.00	88.30	47
OM 612.961	Diesel	2685	5	88.00	88.30	48
OM 612.962	Diesel	2685	5	88.00	88.30	48
OM 612.963	Diesel	2685	5	88.00	88.30	48
OM 612.965	Diesel	2685	5	88.00	88.30	48
OM 612.966	Diesel	2685	5	88.00	88.30	48
OM 612.967	Diesel	2685	5	88.00	88.30	48
OM 612.981	Diesel	2685	5	88.00	88.30	48
OM 612.983	Diesel	2685	5	88.00	88.30	48
OM 613.960	Diesel	3222	6	88.00	88.30	49
OM 613.961	Diesel	3226	6	88.00	88.30	49
OM 615.910	Diesel	2197	4	87.00	92.40	41
OM 615.911	Diesel	2197	4	87.00	92.40	41
OM 615.912	Diesel	2197	4	87.00	92.40	41
OM 615.913	Diesel	1988	4	87.00	83.60	26
OM 615.914	Diesel	2197	4	87.00	92.40	42
OM 615.915	Diesel	1988	4	87.00	83.60	26
OM 615.916	Diesel	2197	4	87.00	92.40	42
OM 615.917	Diesel	2197	4	87.00	92.40	41
OM 615.918	Diesel	2197	4	87.00	92.40	42
OM 615.930	Diesel	2197	4	87.00	92.40	42
OM 615.932	Diesel	2197	4	87.00	92.40	42
OM 615.936	Diesel	2197	4	87.00	92.40	42
OM 615.937	Diesel	2197	4	87.00	92.40	41
OM 615.938	Diesel	2197	4	87.00	92.40	42
OM 615.939	Diesel	2197	4	87.00	92.40	41
OM 615.940	Diesel	1988	4	87.00	83.60	27
OM 615.941	Diesel	2197	4	87.00	92.40	43
OM 615.942	Diesel	1988	4	87.00	83.60	27
OM 615.943	Diesel	1988	4	87.00	83.60	27
OM 615.944	Diesel	1988	4	87.00	83.60	27
OM 615.960	Diesel	1988	4	87.00	83.60	27
OM 615.961	Diesel	1988	4	87.00	83.60	27
OM 615.963	Diesel	1988	4	87.00	83.60	28
OM 615.964	Diesel	1988	4	87.00	83.60	27
OM 615.965	Diesel	1988	4	87.00	83.60	27
OM 615.966	Diesel	1988	4	87.00	83.60	27
OM 615.967	Diesel	1988	4	87.00	83.60	27
OM 615.968	Diesel	1988	4	87.00	83.60	27
OM 615.969	Diesel	1988	4	87.00	83.60	27
OM 615.970	Diesel	1988	4	87.00	83.60	28
OM 616.910	Diesel	2400	4	91.00	92.40	80
OM 616.911	Diesel	2404	4	91.00	92.40	80
OM 616.912	Diesel	2399	4	91.00	92.40	80
OM 616.913	Diesel	2398	4	91.00	92.40	81
OM 616.914	Diesel	2399	4	91.00	92.40	81
OM 616.915	Diesel	2448	4	92.00	92.40	90
OM 616.916	Diesel	2404	4	91.00	92.40	82
OM 616.917	Diesel	2404	4	91.00	92.40	80
OM 616.930	Diesel	2448	4	92.00	92.40	90
OM 616.931	Diesel	2448	4	92.00	92.40	90
OM 616.932	Diesel	2404	4	91.00	92.40	80
OM 616.933	Diesel	2404	4	91.00	92.40	80
OM 616.934	Diesel	2399	4	91.00	92.40	80
OM 616.936	Diesel	2399	4	91.00	92.40	81
OM 616.937	Diesel	2399	4	91.00	92.40	80
OM 616.938	Diesel	2399	4	91.00	92.40	80
OM 616.939	Diesel	2399	4	91.00	92.40	81







			cm ³	x 			
OM 616.940	Diesel		2399	4	91.00	92.40	80
OM 616.942	Diesel		2399	4	91.00	92.40	81
OM 616.943	Diesel		2399	4	91.00	92.40	81
OM 616.944	Diesel		2404	4	91.00	92.40	80
OM 616.960	Diesel		2399	4	91.00	92.40	80
OM 616.961	Diesel		2399	4	91.00	92.40	80
OM 616.963	Diesel		2399	4	91.00	92.40	81
OM 617.910	Diesel		2998	5	90.90	92.40	76
OM 617.912	Diesel		2998	5	90.90	92.40	77
OM 617.913	Diesel		2998	5	90.90	92.40	78
OM 617.931	Diesel		2998	5	90.90	92.40	78
OM 617.932	Diesel		2998	5	90.90	92.40	77
OM 617.933	Diesel		2998	5	90.90	92.40	78
OM 617.950	Diesel		2998	5	90.90	92.40	79
OM 617.951	Diesel		2998	5	90.90	92.40	79
OM 617.952	Diesel		2998	5	90.90	92.40	79
OM 639.939	Diesel		1493	3	83.00	92.00	11
OM 640.940	Diesel		1991	4	83.00	92.00	12
OM 640.941	Diesel		1991	4	83.00	92.00	12
OM 640.942	Diesel		1991	4	83.00	92.00	12
OM 642.822	Diesel		2987	V6	83.00	92.00	13
OM 642.826	Diesel		2987	V6	83.00	92.00	13
OM 642.834	Diesel		2987	V6	83.00	92.00	13
OM 642.835	Diesel		2987	V6	83.00	92.00	13
OM 642.836	Diesel		2987	V6	83.00	92.00	13
OM 642.838	Diesel		2987	V6	83.00	92.00	13
OM 642.853	Diesel		2987	V6	83.00	92.00	13
OM 642.854	Diesel		2987	V6	83.00	92.00	13
OM 642.861	Diesel		2987	V6	83.00	92.00	13
OM 642.862	Diesel		2987	V6	83.00	92.00	13
OM 642.884	Diesel		2987	V6	83.00	92.00	13
OM 642.886	Diesel		2987	V6	83.00	92.00	13
OM 642.890	Diesel		2987	V6	83.00	92.00	13
OM 642.896	Diesel		2987	V6	83.00	92.00	13
OM 642.898	Diesel		2987	V6	83.00	92.00	13
OM 642.910	Diesel		2987	6	83.00	92.00	13
OM 642.920	Diesel		2987	V6	83.00	92.00	13
OM 642.921	Diesel		2987	V6	83.00	92.00	13
OM 642.930	Diesel		2987	V6	83.00	92.00	13
OM 642.940	Diesel		2987	V6	83.00	92.00	13
OM 642.950	Diesel		2987	V6	83.00	92.00	13
OM 642.960	Diesel		2987	V6	83.00	92.00	13
OM 642.961	Diesel		2987	V6	83.00	92.00	13
OM 642.970	Diesel		2987	V6	83.00	92.00	13
OM 642.990	Diesel		2987	V6	83.00	92.00	13
OM 642.992	Diesel		2987	V6	83.00	92.00	13
OM 642.993	Diesel		2987	V6	83.00	92.00	13
OM 646.811	Diesel		2148	4	88.00	88.30	47
OM 646.812	Diesel		2148	4	88.00	88.30	47
OM 646.820	Diesel		2148	4	88.00	88.30	47
OM 646.821	Diesel		2148	4	88.00	88.30	47
OM 646.951	Diesel		2148	4	88.00	88.30	47
OM 646.961	Diesel		2148	4	88.00	88.30	47
OM 646.962	Diesel		2148	4	88.00	88.30	47
OM 646.963	Diesel		2148	4	88.00	88.30	47
OM 646.966	Diesel		2148	4	88.00	88.30	47
OM 646.980	Diesel		2148	4	88.00	88.30	47
OM 646.981	Diesel		2148	4	88.00	88.30	47
OM 646.982	Diesel		2148	4	88.00	88.30	47
OM 646.983	Diesel		2148	4	88.00	88.30	47
OM 646.984	Diesel		2148	4	88.00	88.30	47
OM 646.985	Diesel		2148	4	88.00	88.30	47
OM 646.986	Diesel		2148	4	88.00	88.30	47
OM 646.989	Diesel		2148	4	88.00	88.30	47
OM 646.990	Diesel		2148	4	88.00	88.30	47
OM 647.961	Diesel		2685	5	88.00	88.30	48
OM 647.981	Diesel		2685	5	88.00	88.30	48
OM 648.960	Diesel		3222	6	88.00	88.30	49
OM 648.961	Diesel		3222	6	88.00	88.30	49

		cm3	x 			
OM 651.911	Diesel	2143	4	83.00	99.00	15
OM 651.912	Diesel	2143	4	83.00	99.00	15
OM 651.913	Diesel	2143	4	83.00	99.00	15
OM 651.916	Diesel	2143	4	83.00	99.00	15
OM 651.921	Diesel	2143	4	83.00	99.00	15
OM 651.924	Diesel	2143	4	83.00	99.00	15
OM 651.925	Diesel	2143	4	83.00	99.00	15
OM 651.930	Diesel	2143	4	83.00	99.00	15
OM 651.940	Diesel	2143	4	83.00	99.00	15
OM 651.950	Diesel	2143	4	83.00	99.00	15
OM 651.955	Diesel	2143	4	83.00	99.00	15
OM 651.956	Diesel	2143	4	83.00	99.00	15
OM 651.957	Diesel	2143	4	83.00	99.00	15
OM 651.960	Diesel	2143	4	83.00	99.00	15
OM 651.961	Diesel	2143	4	83.00	99.00	15
OM 651.980	Diesel	2143	4	83.00	99.00	15
OM 661.911	Diesel	2299	4	89.00	92.40	60
OM 661.940	Diesel	2299	4	89.00	92.40	60
OM 662.911	Diesel	2874	5	89.00	92.40	62
OM 662.940	Diesel	2874	5	89.00	92.40	65
OM 668.914	Diesel	1689	4	80.00	84.00	5
OM 668.940	Diesel	1689	4	80.00	84.00	5
OM 668.941	Diesel	1689	4	80.00	84.00	5
OM 668.942	Diesel	1689	4	80.00	84.00	5
OM 900.910	Diesel	4249	4	102.00	130.00	120
OM 900.911 Euro 4	Diesel	4249	4	102.00	130.00	121
OM 900.912 Euro 4	Diesel	4249	4	102.00	130.00	121
OM 900.913 Euro 4	Diesel	4249	4	102.00	130.00	121
OM 900.915 Euro 4	Diesel	4249	4	102.00	130.00	121
OM 900.916 Euro 4	Diesel	4249	4	102.00	130.00	121
OM 900.917 Euro 4	Diesel	4249	4	102.00	130.00	121
OM 900.918 Euro 4	Diesel	4249	4	102.00	130.00	121
OM 900.919 Euro 4	Diesel	4249	4	102.00	130.00	121
OM 900.920 Euro 4	Diesel	4249	4	102.00	130.00	121
OM 900.921 Euro 4	Diesel	4249	4	102.00	130.00	121
OM 900.922 Euro 4	Diesel	4249	4	102.00	130.00	121
OM 902.910 Euro 4	Diesel	6374	6	102.00	130.00	122
OM 902.911 Euro 4	Diesel	6374	6	102.00	130.00	122
OM 902.912 Euro 4	Diesel	6374	6	102.00	130.00	122
OM 902.913 Euro 4	Diesel	6374	6	102.00	130.00	122
OM 902.914 Euro 4	Diesel	6374	6	102.00	130.00	122
OM 902.915 Euro 4	Diesel	6374	6	102.00	130.00	122
OM 902.916 Euro 4	Diesel	6374	6	102.00	130.00	122
OM 902.917 Euro 4	Diesel	6374	6	102.00	130.00	122
OM 902.918 Euro 4	Diesel	6374	6	102.00	130.00	122
OM 902.919 Euro 4	Diesel	6374	6	102.00	130.00	122
OM 902.920 Euro 4	Diesel	6374	6	102.00	130.00	122
OM 902.921 Euro 4	Diesel	6374	6	102.00	130.00	122
OM 902.922 Euro 4	Diesel	6374	6	102.00	130.00	122
OM 902.923 Euro 4	Diesel	6374	6	102.00	130.00	122
OM 902.924 Euro 4	Diesel	6374	6	102.00	130.00	122
OM 902.925 Euro 4	Diesel	6374	6	102.00	130.00	122
OM 902.926 Euro 4	Diesel	6374	6	102.00	130.00	122
OM 902.927 Euro 4	Diesel	6374	6	102.00	130.00	122
OM 902.930 Euro 4	Diesel	6374	6	102.00	130.00	122
OM 902.931 Euro 4	Diesel	6374	6	102.00	130.00	122
OM 902.932 Euro 4	Diesel	6374	6	102.00	130.00	122
OM 902.933 Euro 4	Diesel	6374	6	102.00	130.00	122
OM 902.934 Euro 4	Diesel	6374	6	102.00	130.00	122
OM 902.936 Euro 4	Diesel	6374	6	102.00	130.00	122
OM 904.904 Euro 2	Diesel	4250	4	102.00	130.00	120
OM 904.905 Euro 2	Diesel	4249	4	102.00	130.00	120
OM 904.906 Euro 2	Diesel	4249	4	102.00	130.00	120
OM 904.907 Euro 2	Diesel	4249	4	102.00	130.00	120
OM 904.908 Euro 2	Diesel	4250	4	102.00	130.00	120
OM 904.909 Euro 2	Diesel	4249	4	102.00	130.00	120
OM 904.910 Euro 2	Diesel	4249	4	102.00	130.00	120
OM 904.911 Euro 2	Diesel	4249	4	102.00	130.00	120
OM 904.912 Euro 2	Diesel	4249	4	102.00	130.00	120

		cm3	x 			
OM 906.923 Euro 2	Diesel	6374	6	102.00	130.00	123
OM 906.924 Euro 2	Diesel	6374	6	102.00	130.00	123
OM 906.925 Euro 3	Diesel	6374	6	102.00	130.00	123
OM 906.926 Euro 3	Diesel	6374	6	102.00	130.00	123
OM 906.927 Euro 3	Diesel	6374	6	102.00	130.00	123
OM 906.928 Euro 3	Diesel	6374	6	102.00	130.00	123
OM 906.929 Euro 2	Diesel	6374	6	102.00	130.00	123
OM 906.930 Euro 2	Diesel	6374	6	102.00	130.00	123
OM 906.931 Euro 2	Diesel	6374	6	102.00	130.00	123
OM 906.932 Euro 2	Diesel	6374	6	102.00	130.00	123
OM 906.933 Euro 2	Diesel	6374	6	102.00	130.00	123
OM 906.934 Euro 2	Diesel	6374	6	102.00	130.00	123
OM 906.935 Euro 3	Diesel	6374	6	102.00	130.00	123
OM 906.936 Euro 2	Diesel	6374	6	102.00	130.00	123
OM 906.937 Euro 2	Diesel	6374	6	102.00	130.00	123
OM 906.938 Euro 3	Diesel	6374	6	102.00	130.00	123
OM 906.939 Euro 3	Diesel	6374	6	102.00	130.00	123
OM 906.940 Euro 2	Diesel	6374	6	102.00	130.00	123
OM 906.941 Euro 2	Diesel	6374	6	102.00	130.00	123
OM 906.944 Euro 2	Diesel	6374	6	102.00	130.00	123
OM 906.945 Euro 2	Diesel	6374	6	102.00	130.00	123
OM 906.946 Euro 2	Diesel	6374	6	102.00	130.00	123
OM 906.947 Euro 2	Diesel	6374	6	102.00	130.00	123
OM 906.948 Euro 2	Diesel	6374	6	102.00	130.00	123
OM 906.949 Euro 3	Diesel	6374	6	102.00	130.00	123
OM 906.950 Euro 3	Diesel	6374	6	102.00	130.00	123
OM 906.951	Diesel	6374	6	102.00	130.00	123
OM 906.952 Euro 3	Diesel	6374	6	102.00	130.00	123
OM 906.953 Euro 3	Diesel	6374	6	102.00	130.00	123
OM 906.954 Euro 2	Diesel	6374	6	102.00	130.00	123
OM 906.955 Euro 3	Diesel	6374	6	102.00	130.00	123
OM 906.956 Euro 2	Diesel	6374	6	102.00	130.00	123
OM 906.957 Euro 2	Diesel	6374	6	102.00	130.00	123
OM 906.958 Euro 2	Diesel	6374	6	102.00	130.00	123
OM 906.959 Euro 2	Diesel	6374	6	102.00	130.00	123
OM 906.960 Euro 3	Diesel	6374	6	102.00	130.00	123
OM 906.961 Euro 3	Diesel	6374	6	102.00	130.00	123
OM 906.962 Euro 3	Diesel	6374	6	102.00	130.00	123
OM 906.963 Euro 3	Diesel	6374	6	102.00	130.00	123
OM 906.964	Diesel	6374	6	102.00	130.00	123
OM 906.965	Diesel	6374	6	102.00	130.00	123
OM 906.966 Euro 2	Diesel	6374	6	102.00	130.00	123
OM 906.967 Euro 2	Diesel	6374	6	102.00	130.00	123
OM 906.968	Diesel	6374	6	102.00	130.00	123
OM 906.970 Euro 2	Diesel	6374	6	102.00	130.00	123
OM 906.971	Diesel	6374	6	102.00	130.00	123
OM 906.974 Euro 2	Diesel	6374	6	102.00	130.00	123
OM 906.975 Euro 2	Diesel	6374	6	102.00	130.00	123
OM 906.976 Euro 2	Diesel	6374	6	102.00	130.00	123
OM 906.977 Euro 2	Diesel	6374	6	102.00	130.00	123
OM 906.978 Euro 2	Diesel	6374	6	102.00	130.00	123
OM 906.979 Euro 2	Diesel	6374	6	102.00	130.00	123
OM 906.980 Euro 2	Diesel	6374	6	102.00	130.00	123
OM 906.981 Euro 2	Diesel	6374	6	102.00	130.00	123
OM 906.982	Diesel	6374	6	102.00	130.00	123
OM 906.983 Euro 3	Diesel	6374	6	102.00	130.00	123
OM 906.985 Euro 3	Diesel	6374	6	102.00	130.00	123
OM 906.986 Euro 3	Diesel	6374	6	102.00	130.00	123
OM 906.988 Euro 3	Diesel	6374	6	102.00	130.00	123
OM 906.995 Euro 3	Diesel	6374	6	102.00	130.00	123
OM 907.910 Euro 2	Diesel	4250	4	102.00	130.00	120
OM 907.920 Euro 2	Diesel	4250	4	102.00	130.00	120
OM 907.930 Euro 2	Diesel	4249	4	102.00	130.00	120
OM 907.940 Euro 2	Diesel	4250	4	102.00	130.00	120
OM 907.941 Euro 2	Diesel	4249	4	102.00	130.00	120
OM 907.960 Euro 2	Diesel	4250	4	102.00	130.00	120
OM 907.970 Euro 2	Diesel	4250	4	102.00	130.00	120
OM 907.980 Euro 2	Diesel	4249	4	102.00	130.00	120
OM 907.990 Euro 2	Diesel	4250	4	102.00	130.00	120

		cm ³	x 			
--	---	-----------------	---	---	---	---

OM 909.900	Diesel	6374	6	102.00	130.00	123
OM 909.901	Diesel	6374	6	102.00	130.00	123
OM 909.910	Diesel	6374	6	102.00	130.00	123
OM 909.911	Diesel	6374	6	102.00	130.00	123
OM 909.920	Diesel	6374	6	102.00	130.00	123
OM 909.921	Diesel	6374	6	102.00	130.00	123
OM 909.960	Diesel	6374	6	102.00	130.00	123
OM 909.970	Diesel	6374	6	102.00	130.00	123
OM 909.971	Diesel	6374	6	102.00	130.00	123
OM 924.910 Euro 3	Diesel	4801	4	106.00	136.00	125
OM 924.911 Euro 2	Diesel	4801	4	106.00	136.00	125
OM 924.912 Euro 3	Diesel	4801	4	106.00	136.00	125
OM 924.913 Euro 3	Diesel	4801	4	106.00	136.00	125
OM 924.914 Euro 3	Diesel	4801	4	106.00	136.00	125
OM 924.915 Euro 3	Diesel	4801	4	106.00	136.00	125
OM 924.916 Euro 3	Diesel	4801	4	106.00	136.00	125
OM 924.917 Euro 3	Diesel	4801	4	106.00	136.00	125
OM 924.919 Euro 3	Diesel	4801	4	106.00	136.00	125
OM 924.920 Euro 3	Diesel	4801	4	106.00	136.00	125
OM 924.922 Euro 4	Diesel	4801	4	106.00	136.00	125
OM 924.923 Euro 4	Diesel	4801	4	106.00	136.00	125
OM 924.924 Euro 3	Diesel	4801	4	106.00	136.00	125
OM 924.930 Euro 5	Diesel	4801	4	106.00	136.00	125
OM 924.935 Euro 5 EEV	Diesel	4801	4	106.00	136.00	125
OM 924.988 Euro 5 EEV	Diesel	4801	4	106.00	136.00	125
OM 924.989 Euro 5 EEV	Diesel	4801	4	106.00	136.00	125
OM 926.910 Euro 3	Diesel	7201	6	106.00	136.00	126
OM 926.911 Euro 2	Diesel	7201	6	106.00	136.00	126
OM 926.912 Euro 2	Diesel	7201	6	106.00	136.00	126
OM 926.913 Euro 3	Diesel	7201	6	106.00	136.00	126
OM 926.914 Euro 2	Diesel	7201	6	106.00	136.00	126
OM 926.915 Euro 3	Diesel	7201	6	106.00	136.00	126
OM 926.916 Euro 3	Diesel	7201	6	106.00	136.00	126
OM 926.917 Euro 3	Diesel	7201	6	106.00	136.00	126
OM 926.918 Euro 3	Diesel	7201	6	106.00	136.00	126
OM 926.919 Euro 4	Diesel	7201	6	106.00	136.00	126
OM 926.920 Euro 3	Diesel	7201	6	106.00	136.00	126
OM 926.921 Euro 3	Diesel	7201	6	106.00	136.00	126
OM 926.924 Euro 3	Diesel	7201	6	106.00	136.00	126
OM 926.925 Euro 3	Diesel	7201	6	106.00	136.00	126
OM 926.926 Euro 3	Diesel	7201	6	106.00	136.00	126
OM 926.927 Euro 3	Diesel	7201	6	106.00	136.00	126
OM 926.928 Euro 3	Diesel	7201	6	106.00	136.00	126
OM 926.929 Euro 3	Diesel	7201	6	106.00	136.00	126
OM 926.930 Euro 3	Diesel	7201	6	106.00	136.00	126
OM 926.932 Euro 3	Diesel	7201	6	106.00	136.00	126
OM 926.934 Euro 4	Diesel	7201	6	106.00	136.00	126
OM 926.935 Euro 3	Diesel	7201	6	106.00	136.00	126
OM 926.936	Diesel	7201	6	106.00	136.00	126
OM 926.937 Euro 4	Diesel	7201	6	106.00	136.00	126
OM 926.938 Euro 3	Diesel	7201	6	106.00	136.00	126
OM 926.939 Euro 4	Diesel	7201	6	106.00	136.00	126
OM 926.941 Euro 4	Diesel	7201	6	106.00	136.00	126
OM 926.945 Euro 5 EEV	Diesel	7201	6	106.00	136.00	126
OM 926.947 Euro 4/5	Diesel	7201	6	106.00	136.00	126
OM 926.990 Euro 5	Diesel	7201	6	106.00	136.00	126
OM 926.996 Euro 5	Diesel	7201	6	106.00	136.00	126
OM 941.910 Euro 2	Diesel	11946	V6	130.00	150.00	171
OM 941.920 Euro 2	Diesel	11946	V6	130.00	150.00	171
OM 941.921 Euro 2	Diesel	11946	V6	130.00	150.00	171
OM 941.929 Euro 2	Diesel	11946	V6	130.00	150.00	171
OM 941.930 Euro 2	Diesel	11946	V6	130.00	150.00	171
OM 941.940 Euro 2	Diesel	11946	V6	130.00	150.00	171
OM 941.960 Euro 2	Diesel	11946	V6	130.00	150.00	171
OM 941.970 Euro 2	Diesel	11946	V6	130.00	150.00	172
OM 941.980 Euro 2	Diesel	11946	V6	130.00	150.00	172
OM 941.981 Euro 2	Diesel	11946	V6	130.00	150.00	172
OM 941.990 Euro 2	Diesel	11946	V6	130.00	150.00	172
OM 941.991	Diesel	11946	V6	130.00	150.00	172

		cm3	x 			
OM 942.900 Euro 2	Diesel	15928	V8	130.00	150.00	173
OM 942.910 Euro 2	Diesel	15928	V8	130.00	150.00	173
OM 942.911 Euro 2	Diesel	15928	V8	130.00	150.00	173
OM 942.912 Euro 2	Diesel	15928	V8	130.00	150.00	173
OM 942.925 Euro 2	Diesel	15928	V8	130.00	150.00	173
OM 942.930 Euro 2	Diesel	15928	V8	130.00	150.00	173
OM 942.960 Euro 2	Diesel	15928	V8	130.00	150.00	173
OM 942.967 Euro 2	Diesel	15928	V8	130.00	150.00	173
OM 942.970 Euro 2	Diesel	15928	V8	130.00	150.00	173
OM 942.980 Euro 2	Diesel	15928	V8	130.00	150.00	173
OM 942.990 Euro 2	Diesel	15928	V8	130.00	150.00	173

MERCEDES-BENZ



1										63.50 x 63.00									
M 160 E6AL B03		3 Cyl.		599cc		40kW (55PS)		Petrol Turbo		TD9520									
M 160 E6AL B04		3 Cyl.		599cc		33kW (45PS)		Petrol		TD16490									
M 160 E6AL B05		3 Cyl.		599cc		45kW (61PS)		Petrol		TD16491									
BE/PL	3	37,940/37,965	41,600/41,616	17,000	1,813	0,020/0,075	EC	71-3882	71-3882/3 STD 0.25										
MB/HL 1-4	4	44,950/44,965	51,000/51,019	16,000	3,030	0,025/0,034	AL-LF	02-3883	H072/4 STD 0.25										
TW/A	2	52,500/52,750	68,250/68,500		3,200		AL-LF	04-3884	A154/2 STD										
2										80.00 x 69.50									
M 166.940		4 Cyl.		1397cc		60kW (82PS)		Petrol		TD9445									
MB/HL 1-5	5	54,940/54,965	59,000/59,019	17,000	2,012	0,020/0,080	AL-LF	02-3843	H065/5 STD										
TW/A	2	61,250	76,750		2,200		AL-LF	04-4004	A163/4 STD										
TW/A	2	61,250	76,750		2,200		AL-LF	04-4005											
3										80.00 x 79.50									
M 166.960		4 Cyl.		1598cc		60-75kW (82-102PS)		Petrol		TD9446									
M 166.961		4 Cyl.		1598cc		60-75kW (82-102PS)		Petrol		TD18174									
MB/HL 1-5	5	54,940/54,965	59,000/59,019	17,000	2,012	0,020/0,080	AL-LF	02-3843	H065/5 STD										
TW/A	2	61,250	76,750		2,200		AL-LF	04-4004	A163/4 STD										
TW/A	2	61,250	76,750		2,200		AL-LF	04-4005											
4										80.00 x 79.50									
M 271.910		4 Cyl.		1597cc		105-115kW (143-156PS)		Petrol Compressor		TD23992									
M 271.911		4 Cyl.		1597cc		95kW (129PS)		Petrol		TD23993									
BE/PL	4	47,941/47,965	51,600/51,619	20,000	1,815	0,020/0,072	EC	71-4002	71-4002/4 STD										
MB/HL 1-5	5	54,940/54,965	59,000/59,019	20,000	2,019	0,019/0,085	AL-LF	02-4003	H1002/5 STD 0.25										
TW/A	2	61,250	76,750		2,200		AL-LF	04-4004	A163/4 STD										
TW/A	2	61,250	76,750		2,200		AL-LF	04-4005											
SE/PB	1	20,000	22,500/22,521	19,900			BC	55-4006	55-4006 SEMI										
5										80.00 x 84.00									
OM 668.914		4 Cyl.		1689cc		55-67kW (75-91PS)		Diesel Turbo		TD18173									
OM 668.940		4 Cyl.		1689cc		55-66kW (75-90PS)		Diesel Turbo Intercooler		TD10647									
OM 668.941		4 Cyl.		1689cc		44kW (60PS)		Diesel Turbo		TD10648									
OM 668.942		4 Cyl.		1689cc		70kW (95PS)		Diesel Turbo Intercooler		TD17001									
BE/PL	4	45,940/45,965	49,600/49,616	18,900	1,813	0,020/0,075	SP	71-3861	71-3861/4 STD 1										
MB/HL 1-5	5	54,940/54,965	59,000/59,019	17,000	2,012	0,020/0,080	AL-LF	02-3843	H065/5 STD										
SE/PB	1	28,000	30,500/30,525	18,900			BC-LF	55-3865	55-3865 SEMI 6										

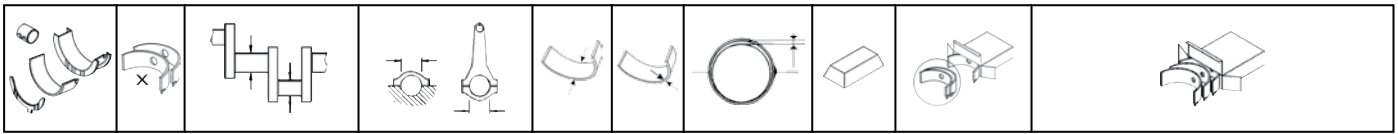

6										82.00 x 78.80		
M 114.920			6 Cyl.	2496cc	85-96kW (116-130PS)	Petrol				TD2136		
M 114.923			6 Cyl.	2496cc	85kW (116PS)	Petrol				TD22704		
M 114.980			6 Cyl.	2496cc	110kW (150PS)	Petrol				TD2137		
M 114.981			6 Cyl.	2496cc	105-110kW (143-150PS)	Petrol				TD2138		
BE/PL	6	47,955/47,965	51,600/51,619	22,000	1,810	0,015/0,064	EC	71-2974	71-2974/6 0.75			
01/70→												
MB/HL 1,2, 5-7	5	59,955/59,965	67,000/67,019	22,500	3,505	0,025/0,079	EC	72-2753	H859/7 0.25			
MB/HL 3	1	59,955/59,965	67,000/67,019	28,900	3,505	0,025/0,079	EC	72-2754H				
MB/HL 4	1	59,955/59,965	67,000/67,019	22,500	3,505	0,025/0,079	EC	72-3015				
01/71→												
			72-2754H	STD	29,000/1.1417" - 29,021/1.1426"							
				0.25mm	29,200/1.1496" - 29,221/1.1504"							
				0.50mm	29,200/1.1496" - 29,221/1.1504"							
SE/PB	1	25,000	28,000	27,600			BC	55-2784	55-2784 SEMI			

7										82.00 x 85.00		
M 271.820			4 Cyl.	1796cc	115-137kW (156-186PS)	Petrol Turbo				TD23776		
M 271.860			4 Cyl.	1796cc	135-150kW (184-204PS)	Petrol Turbo				TD23724		
M 271.861			4 Cyl.	1796cc	135-150kW (184-204PS)	Petrol Turbo Intercooler				TD25100		
M 271.921			4 Cyl.	1796cc	90-95kW (122-129PS)	Petrol Compressor				TD18424		
M 271.940			4 Cyl.	1796cc	120kW (163PS)	Petrol Compressor				TD16883		
M 271.941			4 Cyl.	1796cc	120kW (163PS)	Petrol Compressor				TD17329		
M 271.942			4 Cyl.	1796cc	125kW (170PS)	Petrol Compressor				TD16392		
M 271.944			4 Cyl.	1795cc	120kW (163PS)	Petrol Compressor				TD17432		
M 271.946			4 Cyl.	1796cc	105-125kW (143-170PS)	Petrol Compressor				TD17433		
M 271.948			4 Cyl.	1796cc	141kW (192PS)	Petrol Compressor				TD17434		
M 271.950			4 Cyl.	1796cc	120-135kW (163-184PS)	Petrol Compressor				TD20359		
M 271.951			4 Cyl.	1796cc	115kW (156PS)	Petrol				TD23995		
M 271.952			4 Cyl.	1796cc	115kW (156PS)	Petrol Compressor				TD20358		
M 271.954			4 Cyl.	1796cc	135kW (184PS)	Petrol Compressor				TD21027		
M 271.955			4 Cyl.	1796cc	135kW (184PS)	Petrol Compressor				TD20858		
M 271.956			4 Cyl.	1796cc	135kW (184PS)	Petrol Compressor				TD22141		
M 271.957			4 Cyl.	1796cc	120-135kW (163-184PS)	Petrol Compressor				TD23994		
M 271.958			4 Cyl.	1796cc	120-135kW (163-184PS)	Petrol Compressor				TD25260		
BE/PL	4	47,941/47,965	51,600/51,619	20,000	1,815	0,020/0,072	EC	71-4002	71-4002/4 STD 0.25			
MB/HL 1-5	5	54,940/54,965	59,000/59,019	20,000	2,019	0,019/0,085	AL-LF	02-4003	H1002/5 STD 0.25			
TW/A	2	61,250	76,750		2,200		AL-LF	04-4004	A163/4 STD			
TW/A	2	61,250	76,750		2,200		AL-LF	04-4005				
SE/PB	1	20,000	22,500/22,521	19,900			BC	55-4006	55-4006 SEMI			

8										82.90 x 80.30		
M 103.940			6 Cyl.	2597cc	118-122kW (160-166PS)	Petrol				TD9435		
M 103.941			6 Cyl.	2597cc	118-122kW (160-166PS)	Petrol				TD2096		
M 103.942			6 Cyl.	2597cc	118-122kW (160-166PS)	Petrol				TD2097		

MERCEDES-BENZ



M 103.943		6 Cyl.		2597cc	118kW (160PS)		Petrol		TD2098
BE/PL	6	47,950/47,965	51,600/51,619	21,800	1,814	0,020/0,064	EC	71-3817	71-3817/6 STD 0.25 0.50
MB/HL 1-7	7	57,950/57,965	62,500/62,519	17,500	2,261	0,020/0,072	AL-LF	02-3585	H997/7 STD 0.25 0.50
TW/A	2	65,800	81,000		2,200		AL-LF	04-3586	A129/4 STD 0.10
TW/A	2	65,800	81,000		2,200		AL-LF	04-3587	
SE/PB	1	21,995/22,000	24,500/24,521	21,900			BC	55-3603	55-3603 SEMI

9 83.00 x 69.20

M 266.920		4 Cyl.		1498cc	70kW (95PS)		Petrol		TD18148
BE/PL	4	45,940/45,965	49,600/49,614	19,900	1,813	0,019/0,082	EC	71-3998	71-3998/4 STD
MB/HL 1-5	5	54,950/54,975	59,000/59,019	20,000	2,004	0,023/0,087	AL-LF	02-3999	H1001/5 STD
TW/A	2	61,250	76,750		2,200		AL-LF	04-4004	A163/4 STD
TW/A	2	61,250	76,750		2,200		AL-LF	04-4005	
SE/PB	1	19,000	21,500/21,521	19,900			BC	55-4000	55-4000 SEMI

10 83.00 x 78.50

M 266.940		4 Cyl.		1699cc	85kW (116PS)		Petrol		TD18149
BE/PL	4	45,940/45,965	49,600/49,614	19,900	1,813	0,019/0,082	EC	71-3998	71-3998/4 STD
MB/HL 1-5	5	54,950/54,975	59,000/59,019	20,000	2,004	0,023/0,087	AL-LF	02-3999	H1001/5 STD
TW/A	2	61,250	76,750		2,200		AL-LF	04-4004	A163/4 STD
TW/A	2	61,250	76,750		2,200		AL-LF	04-4005	
SE/PB	1	19,000	21,500/21,521	19,900			BC	55-4000	55-4000 SEMI

11 83.00 x 92.00

OM 639.939 Euro 4		3 Cyl.		1493cc	50-70kW (58-95PS)		Diesel		TD23799
BE/PL	1	49,940/49,965	53,600/53,614	20,400	1,813	0,020/0,072	SP	71-4013	71-4013 STD [1]
MB/HL	1	54,940/54,965	59,000/59,019	18,000	2,018	0,020/0,077	SP	72-4014	72-4014 STD [2]
TW/A	2	61,250	76,750		2,200		AL-LF	04-4004	A163/4 STD
TW/A	2	61,250	76,750		2,200		AL-LF	04-4005	

12 83.00 x 92.00

OM 640.940		4 Cyl.		1991cc	80kW (109PS)		Diesel Turbo		TD18151
OM 640.941		4 Cyl.		1991cc	100-103kW (136-140PS)		Diesel Turbo Intercooler		TD18152
OM 640.942		4 Cyl.		1991cc	60kW (82PS)		Diesel Turbo		TD18153
BE/PL	1	49,940/49,965	53,600/53,614	20,400	1,813	0,020/0,072	SP	71-4013	71-4013 STD [1]
MB/HL	1	54,940/54,965	59,000/59,019	18,000	2,018	0,020/0,077	SP	72-4014	72-4014 STD [2]
TW/A	2	61,250	76,750		2,200		AL-LF	04-4004	A163/4 STD
TW/A	2	61,250	76,750		2,200		AL-LF	04-4005	

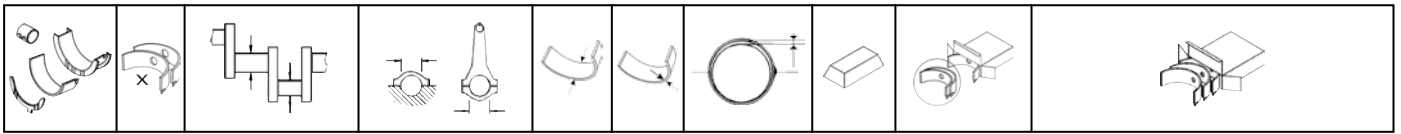

13 83.00 x 92.00

OM 642.822	V6 Cyl.	2987cc	165-195kW (224-265PS)	Diesel Turbo Intercooler	TD19207
OM 642.826	V6 Cyl.	2987cc	179-190kW (243-258PS)	Diesel Turbo Intercooler	TD26600
OM 642.834	V6 Cyl.	2987cc	195kW (265PS)	Diesel Turbo Intercooler	TD26036
OM 642.835	V6 Cyl.	2987cc	195kW (265PS)	Diesel Turbo Intercooler	TD26840
OM 642.836	V6 Cyl.	2987cc	170kW (231PS)	Diesel Turbo	TD23723
OM 642.838	V6 Cyl.	2987cc	185-195kW (252-265PS)	Diesel Turbo	TD26599
OM 642.853	V6 Cyl.	2987cc	190-195kW (258-265PS)	Diesel Turbo	TD26065
OM 642.854	V6 Cyl.	2987cc	190-195kW (258-265PS)	Diesel Turbo	TD26045
OM 642.861	V6 Cyl.	2987cc	190kW (258PS)	Diesel Turbo	TD27896
OM 642.862	V6 Cyl.	2987cc	190kW (258PS)	Diesel Turbo	TD26082
OM 642.884	V6 Cyl.	2987cc	135kW (184PS)	Diesel Turbo Intercooler	TD25842
OM 642.886	V6 Cyl.	2987cc	155kW (211PS)	Diesel Turbo Intercooler	TD28072
OM 642.890	V6 Cyl.	2987cc	165kW (224PS)	Diesel Turbo Intercooler	TD27268
OM 642.896	V6 Cyl.	2987cc	135-140kW (184-190PS)	Diesel Turbo Intercooler	TD25841
OM 642.898	V6 Cyl.	2987cc	140-155kW (190-211PS)	Diesel Turbo Intercooler	TD25843
OM 642.910	6 Cyl.	2987cc	165kW (224PS)	Diesel Turbo Intercooler	TD18416
OM 642.920	V6 Cyl.	2987cc	140-165kW (190-224PS)	Diesel Turbo Intercooler	TD18431
OM 642.921	V6 Cyl.	2987cc	140kW (190PS)	Diesel Turbo Intercooler	TD18428
OM 642.930	V6 Cyl.	2987cc	155-173kW (211-235PS)	Diesel Turbo Intercooler	TD19213
OM 642.940	V6 Cyl.	2987cc	140-170kW (190-231PS)	Diesel Turbo Intercooler	TD18197
OM 642.950	V6 Cyl.	2987cc	140-165kW (190-224PS)	Diesel Turbo Intercooler	TD19206
OM 642.960	V6 Cyl.	2987cc	165kW (224PS)	Diesel Turbo Intercooler	TD20361
OM 642.961	V6 Cyl.	2987cc	165kW (224PS)	Diesel Turbo Intercooler	TD20986
OM 642.970	V6 Cyl.	2987cc	165kW (224PS)	Diesel Turbo Intercooler	TD20729
OM 642.990	V6 Cyl.	2987cc	150-165kW (204-224PS)	Diesel Turbo Intercooler	TD22148
OM 642.992	V6 Cyl.	2987cc	135-140kW (184-190PS)	Diesel Turbo Intercooler	TD22149
OM 642.993	V6 Cyl.	2987cc	135kW (184PS)	Diesel Turbo Intercooler	TD25661

BE/PL	1	63,940/63,965	67,600/67,614	16,800	1,812	0,030/0,102	SP-LF	71-4809	71-4809 STD	①
MB/HL	1	75,940/75,965	80,500/80,522	23,000	2,256	0,027/0,098	SP-LF	72-4810	72-4810 STD	②

14 83.00 x 94.00

M 266.960	4 Cyl.	2034cc	85-100kW (116-136PS)	Petrol	TD18150
M 266.980	4 Cyl.	2034cc	142kW (193PS)	Petrol Turbo	TD18415

BE/PL	4	45,940/45,965	49,600/49,614	19,900	1,813	0,019/0,082	EC	71-3998	71-3998/4 STD
MB/HL 1-5	5	54,950/54,975	59,000/59,019	20,000	2,004	0,023/0,087	AL-LF	02-3999	H1001/5 STD
TW/A	2	61,250	76,750		2,200		AL-LF	04-4004	A163/4 STD
TW/A	2	61,250	76,750		2,200		AL-LF	04-4005	
SE/PB	1	20,000	22,500/22,521	19,900			BC	55-4001	55-4001 SEMI

15 83.00 x 99.00

OM 651.911	4 Cyl.	2143cc	120-150kW (163-204PS)	Diesel Turbo	TD23727
OM 651.912	4 Cyl.	2143cc	120-150kW (163-204PS)	Diesel Turbo	TD23754
OM 651.913	4 Cyl.	2143cc	88-105kW (120-143PS)	Diesel Turbo Intercooler	TD24407
OM 651.916	4 Cyl.	2143cc	100-125kW (136-170PS)	Diesel Turbo	TD23755
OM 651.921	4 Cyl.	2143cc	120-150kW (163-204PS)	Diesel Turbo	TD28575
OM 651.924	4 Cyl.	2143cc	120-150kW (163-204PS)	Diesel Turbo	TD23782

MERCEDES-BENZ



OM 651.925	4 Cyl.	2143cc	100kW (136PS)	Diesel Turbo	TD23783
OM 651.930	4 Cyl.	2143cc	100-130kW (136-177PS)	Diesel Turbo Intercooler	TD26817
OM 651.940	4 Cyl.	2143cc	70-120kW (95-163PS)	Diesel Turbo	TD25280
OM 651.950	4 Cyl.	2143cc	100-140kW (136-190PS)	Diesel Turbo	TD29251
OM 651.955	4 Cyl.	2143cc	70-120kW (95-163PS)	Diesel Turbo	TD24545
OM 651.956	4 Cyl.	2143cc	70-95kW (95-129PS)	Diesel Turbo Intercooler	TD25279
OM 651.957	4 Cyl.	2143cc	120kW (163PS)	Diesel Turbo Intercooler	TD24544
OM 651.960	4 Cyl.	2143cc	150kW (204PS)	Diesel Turbo	TD26549
OM 651.961	4 Cyl.	2143cc	150kW (204PS)	Diesel Turbo	TD25277
OM 651.980	4 Cyl.	2143cc	150kW (204PS)	Diesel Turbo	TD26369

BE/PL	1	51,940/51,965	55,600/55,614	20,500	1,809	0,027/0,091	SP-LF	71-4724	71-4724 STD	[1]
MB/HL	1	59,940/59,965	64,000/64,019	20,500	2,008	0,028/0,096	SP-LF	72-4725	72-4725 STD	[2]
MB/HL	1	59,940/59,965	64,000/64,019	26,240	2,008	0,028/0,096	SP-LF	72-4726H	72-4726H STD	[2]



72-4726H STD 26,500/1.0433" - 26,540/1.0449"
0.25mm 26,500/1.0433" - 26,540/1.0449"

16 83.20 x 73.50

M 112.910	V6 Cyl.	2398cc	125kW (170PS)	Petrol	TD9420				
M 112.911	V6 Cyl.	2398cc	125kW (170PS)	Petrol	TD9887				
BE/PL	6	51,940/51,965	55,600/55,614	19,600	1,814	0,020/0,071	EC	71-3857	71-3857/6 STD
MB/HL 1-4	4	63,940/63,965	68,500/68,519	19,000	2,263	0,020/0,078	AL-LF	02-3858	H069/4 STD

17 84.00 x 85.60

M 166.990	4 Cyl.	1898cc	92kW (125PS)	Petrol	TD15448				
M 166.991	4 Cyl.	1898cc	92kW (125PS)	Petrol	TD18176				
MB/HL 1-5	5	54,940/54,965	59,000/59,019	17,000	2,012	0,020/0,080	AL-LF	02-3843	H065/5 STD
TW/A	2	61,250	76,750		2,200		AL-LF	04-4004	A163/4 STD
TW/A	2	61,250	76,750		2,200		AL-LF	04-4005	

18 84.00 x 94.00

M 166.995	4 Cyl.	2084cc	103kW (140PS)	Petrol	TD16882				
MB/HL 1-5	5	54,940/54,965	59,000/59,019	17,000	2,012	0,020/0,080	AL-LF	02-3843	H065/5 STD
TW/A	2	61,250	76,750		2,200		AL-LF	04-4004	A163/4 STD
TW/A	2	61,250	76,750		2,200		AL-LF	04-4005	

19 85.30 x 78.70

M 111.920	4 Cyl.	1799cc	90kW (122PS)	Petrol	TD2131				
M 111.921	4 Cyl.	1799cc	89-90kW (121-122PS)	Petrol	TD5235				
BE/PL	4	47,950/47,965	51,600/51,619	21,800	1,814	0,020/0,064	EC	71-3817	71-3817/4 STD 0.25 0.50
MB/HL 1-5	5	57,950/57,965	62,500/62,519	17,500	2,261	0,020/0,072	AL-LF	02-3585	H997/5 STD 0.25 0.50
TW/A	2	65,800	81,000		2,200		AL-LF	04-3586	A129/4 STD 0.10
TW/A	2	65,800	81,000		2,200		AL-LF	04-3587	

SE/PB	1	21,995/22,000	24,500/24,521	21,900				BC	55-3603	55-3603 SEMI

20	86.00 x 72.50									
M 123.920			6 Cyl.	2525cc	95-103kW (129-140PS)		Petrol			TD18724
M 123.921			6 Cyl.	2525cc	95-103kW (129-140PS)		Petrol			TD2194
BE/PL	6	47,955/47,965		51,600/51,619	22,000	1,814	0,020/0,062	EC	71-2995	71-2995/6 STD 0.25 0.50 0.75 1.00
SE/PB	1	23,000		26,000/26,021	27,600			BC	55-2996	55-2996 SEMI

21	86.00 x 78.80									
M 110.921			6 Cyl.	2746cc	118kW (160PS)		Petrol			TD2115
M 110.922			6 Cyl.	2746cc	115-118kW (156-160PS)		Petrol			TD2116
M 110.923			6 Cyl.	2746cc	115kW (156PS)		Petrol			TD2117
M 110.931			6 Cyl.	2746cc	107kW (145PS)		Petrol			TD17796
M 110.932			6 Cyl.	2746cc	105kW (143PS)		Petrol			TD17726
M 110.981			6 Cyl.	2746cc	136kW (185PS)		Petrol			TD2120
M 110.982			6 Cyl.	2746cc	130-136kW (177-185PS)		Petrol			TD2121
M 110.983			6 Cyl.	2746cc	130-136kW (177-185PS)		Petrol			TD2122
M 110.984			6 Cyl.	2746cc	136kW (185PS)		Petrol			TD4659
M 110.985			6 Cyl.	2746cc	101-136kW (137-185PS)		Petrol			TD2124
M 110.986			6 Cyl.	2746cc	130-136kW (177-185PS)		Petrol			TD2125
M 110.988			6 Cyl.	2746cc	130-136kW (177-185PS)		Petrol			TD2127
M 110.990			6 Cyl.	2746cc	130-136kW (177-185PS)		Petrol			TD2129
M 110.991			6 Cyl.	2746cc	125kW (170PS)		Petrol			TD17797
M 110.992			6 Cyl.	2746cc	125kW (170PS)		Petrol			TD17798
M 110.993			6 Cyl.	2746cc	90-125kW (122-170PS)		Petrol			TD23183
BE/PL	6	47,955/47,965		51,600/51,619	22,000	1,814	0,020/0,062	EC	71-2995	71-2995/6 STD 0.25 0.50 0.75 1.00
MB/HL 1,2, 5-7	5	59,955/59,965		67,000/67,019	22,500	3,505	0,025/0,079	EC	72-2753	H859/7 0.25
MB/HL 3	1	59,955/59,965		67,000/67,019	28,900	3,505	0,025/0,079	EC	72-2754H	
MB/HL 4	1	59,955/59,965		67,000/67,019	22,500	3,505	0,025/0,079	EC	72-3015	

→12/76

	72-2754H	STD	29,000/1.1417" - 29,021/1.1426"
		0.25mm	29,200/1.1496" - 29,221/1.1504"
		0.50mm	29,200/1.1496" - 29,221/1.1504"

MB/HL 4	1	59,955/59,965		67,000/67,019	22,500	3,505	0,025/0,079	EC	72-3015	H956/7 STD
MB/HL 1,2, 5-7	5	59,955/59,965		67,000/67,019	22,500	3,505	0,025/0,079	EC	72-3322	
MB/HL 3	1	59,955/59,965		67,000/67,019	28,900	3,505	0,025/0,079	EC	72-3323H	

01/77→

	72-3323H	STD	29,000/1.1417" - 29,021/1.1426"
		0.25mm	29,200/1.1496" - 29,221/1.1504"



72-2753

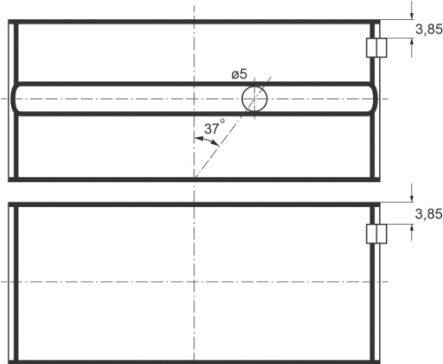

72-2754H

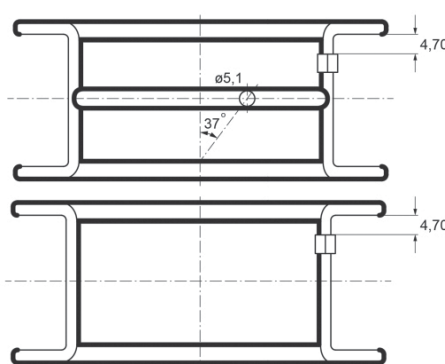

72-3015

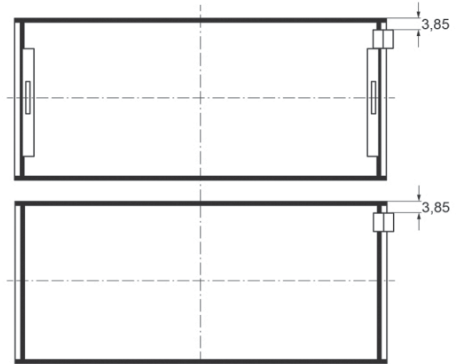

72-3322

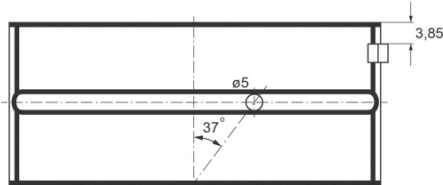

72-3323H

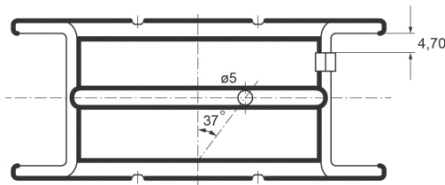

SE/PB	1	23,000	26,000/26,021	27,600			BC	55-2996	55-2996 SEMI
-------	---	--------	---------------	--------	--	--	----	---------	--------------

22

86.00 x 78.80

M 110.924	6 Cyl.	2746cc	115kW (156PS)	Petrol	TD2118				
M 110.926	6 Cyl.	2746cc	115kW (156PS)	Petrol	TD2119				
M 110.987	6 Cyl.	2746cc	136kW (185PS)	Petrol	TD2126				
M 110.989	6 Cyl.	2746cc	136kW (185PS)	Petrol	TD2128				
M 110.994	6 Cyl.	2746cc	110-115kW (150-156PS)	Petrol	TD2130				
BE/PL	6	47,955/47,965	51,600/51,619	22,000	1,814	0,020/0,062	EC	71-2995	71-2995/6 STD 0.25 0.50 0.75 1.00
MB/HL 4	1	59,955/59,965	67,000/67,019	22,500	3,505	0,025/0,079	EC	72-3015	H956/7 STD
MB/HL 1,2, 5-7	5	59,955/59,965	67,000/67,019	22,500	3,505	0,025/0,079	EC	72-3322	
MB/HL 3	1	59,955/59,965	67,000/67,019	28,900	3,505	0,025/0,079	EC	72-3323H	



72-3323H

STD	29,000/1.1417" - 29,021/1.1426"
0.25mm	29,200/1.1496" - 29,221/1.1504"

SE/PB	1	23,000	26,000/26,021	27,600			BC	55-2996	55-2996 SEMI
-------	---	--------	---------------	--------	--	--	----	---------	--------------

23

86.50 x 78.80

M 130.920	6 Cyl.	2780cc	103kW (140PS)	Petrol	TD2195
M 130.921	6 Cyl.	2778cc	92kW (125PS)	Petrol	TD17792
M 130.922	6 Cyl.	2778cc	125kW (170PS)	Petrol	TD22714
M 130.924	6 Cyl.	2778cc	89kW (121PS)	Petrol	TD17793
M 130.925	6 Cyl.	2778cc	81kW (110PS)	Petrol	TD16996
M 130.933	6 Cyl.	2778cc	87kW (118PS)	Petrol	TD17794
M 130.980	6 Cyl.	2780cc	118kW (160PS)	Petrol	TD2197
M 130.981	6 Cyl.	2778cc	118kW (160PS)	Petrol	TD4673
M 130.983	6 Cyl.	2778cc	125kW (170PS)	Petrol	TD2200
M 130.984	6 Cyl.	2778cc	118kW (160PS)	Petrol	TD9989

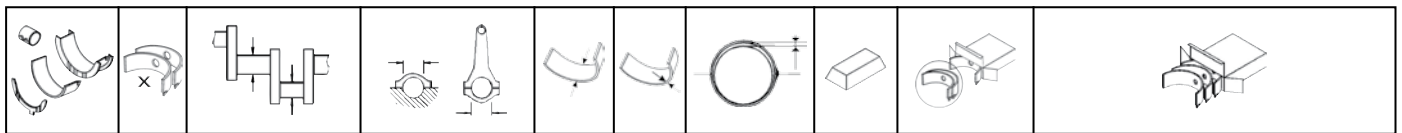

BE/PL	6	47,955/47,965	51,600/51,619	22,000	1,810	0,015/0,064	EC	71-2974	71-2974/6 0.75
-------	---	---------------	---------------	--------	-------	-------------	----	---------	--------------------------

01/70 →

MB/HL 1,2, 5-7	5	59,955/59,965	67,000/67,019	22,500	3,505	0,025/0,079	EC	72-2753	H859/7 0.25
MB/HL 3	1	59,955/59,965	67,000/67,019	28,900	3,505	0,025/0,079	EC	72-2754H	
MB/HL 4	1	59,955/59,965	67,000/67,019	22,500	3,505	0,025/0,079	EC	72-3015	

01/71 →



72-2754H	STD	29,000/1.1417" - 29,021/1.1426"
	0.25mm	29,200/1.1496" - 29,221/1.1504"
	0.50mm	29,200/1.1496" - 29,221/1.1504"

SE/PB	1	25,000	28,000	27,600			BC	55-2784	55-2784 SEMI
-------	---	--------	--------	--------	--	--	----	---------	------------------------

24

86.50 x 78.80

M 130.923	6 Cyl.	2778cc	96kW (130PS)					Petrol	TD2196
------------------	--------	---------------	---------------------	--	--	--	--	---------------	---------------

BE/PL	6	47,955/47,965	51,600/51,619	22,000	1,810	0,015/0,064	EC	71-2974	71-2974/6 0.75
MB/HL 1,2, 5-7	5	59,955/59,965	67,000/67,019	22,500	3,505	0,025/0,079	EC	72-2753	H859/7 0.25
MB/HL 3	1	59,955/59,965	67,000/67,019	28,900	3,505	0,025/0,079	EC	72-2754H	
MB/HL 4	1	59,955/59,965	67,000/67,019	22,500	3,505	0,025/0,079	EC	72-3015	



72-2754H	STD	29,000/1.1417" - 29,021/1.1426"
	0.25mm	29,200/1.1496" - 29,221/1.1504"
	0.50mm	29,200/1.1496" - 29,221/1.1504"

SE/PB	1	25,000	28,000	27,600			BC	55-2784	55-2784 SEMI
-------	---	--------	--------	--------	--	--	----	---------	------------------------

25

87.00 x 83.60

M 115.923	4 Cyl.	1988cc	62-70kW (85-95PS)					Petrol	TD2141
------------------	--------	---------------	--------------------------	--	--	--	--	---------------	---------------

M 115.926	4 Cyl.	1988cc	62-70kW (85-95PS)					Petrol	TD2143
------------------	--------	---------------	--------------------------	--	--	--	--	---------------	---------------

M 115.938	4 Cyl.	1988cc	62-70kW (84-95PS)					Petrol	TD2147
------------------	--------	---------------	--------------------------	--	--	--	--	---------------	---------------

M 115.939	4 Cyl.	1988cc	62-70kW (84-95PS)					Petrol	TD2148
------------------	--------	---------------	--------------------------	--	--	--	--	---------------	---------------

BE/PL	4	51,955/51,965	55,600/55,619	26,000	1,805	0,025/0,079	EC	71-2773	71-2773/4 0.25 0.50 0.75
MB/HL 1,2,4,5	4	69,955/69,965	74,500/74,519	27,000	2,255	0,025/0,079	EC	72-1460	H796/5 STD 0.25 0.50 0.75
MB/HL 3	1	69,955/69,965	74,500/74,519	33,900	2,255	0,025/0,079	EC	72-2774H	



72-2774H	STD	34,000/1.3386" - 34,025/1.3396"
	0.25mm	34,200/1.3465" - 34,225/1.3474"
	0.50mm	34,200/1.3465" - 34,225/1.3474"

MB/HL 1,2,4,5	4	69,955/69,965	74,500/74,519	27,000	2,255	0,025/0,079	AL-LF	02-1460	H914/5 STD 0.25 0.50 0.75 1.00
MB/HL 3	1	69,955/69,965	74,500/74,519	33,900	2,255	0,025/0,079	AL-LF	02-2774H	



02-2774H	STD	34,000/1.3386" - 34,025/1.3396"
-----------------	-----	---------------------------------

SE/PB	1	26,000	29,000/29,021	31,800			BC	55-2532	55-2532 SEMI
-------	---	--------	---------------	--------	--	--	----	---------	------------------------

MERCEDES-BENZ

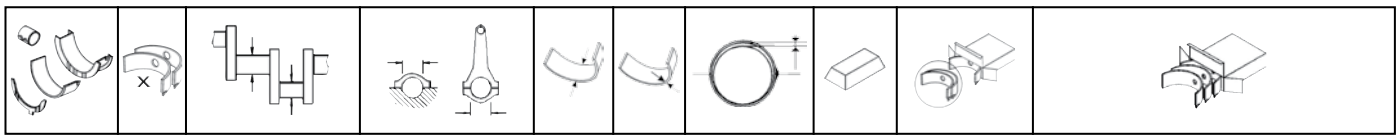

26 87.00 x 83.60

OM 615.913	4 Cyl.	1988cc	40kW (55PS)	Diesel	TD2234				
OM 615.915	4 Cyl.	1988cc	40-44kW (54-60PS)	Diesel	TD17732				
BE/PL	4	51,955/51,965	55,600/55,619	26,000	1,805	0,025/0,079	AL-LF	01-3040	01-3040/4 STD 0.25 0.50 0.75 1.00
01/74 →									
BE/PL	4	51,955/51,965	55,600/55,619	26,000	1,805	0,025/0,079	EC	71-2773	71-2773/4 0.25 0.50 0.75
→12/73									

01-3040

71-2773

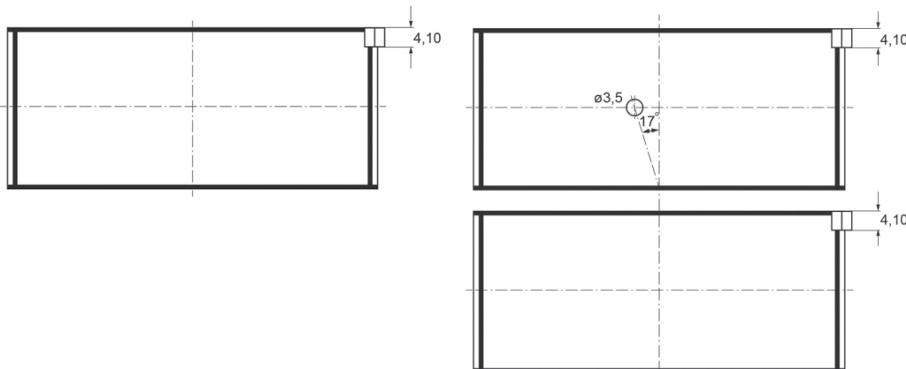

MB/HL 1,2,4,5	4	69,955/69,965	74,500/74,519	27,000	2,255	0,025/0,079	AL-LF	02-1460	H914/5 STD 0.25 0.50 0.75 1.00
MB/HL 3	1	69,955/69,965	74,500/74,519	33,900	2,255	0,025/0,079	AL-LF	02-2774H	

01/72 →

	02-2774H	STD	34,000/1.3386" - 34,025/1.3396"
--	----------	-----	---------------------------------

SE/PB	1	26,000	29,000/29,021	31,800			BC	55-2532	55-2532 SEMI
BU	1	30,000	36,000/36,025	18,000	3,000		BC	57-3049	57-3049 STD

27 87.00 x 83.60

OM 615.940	4 Cyl.	1988cc	40-44kW (55-60PS)	Diesel	TD2238				
OM 615.942	4 Cyl.	1988cc	40kW (54PS)	Diesel	TD22827				
OM 615.943	4 Cyl.	1988cc	40kW (55PS)	Diesel	TD2240				
OM 615.944	4 Cyl.	1988cc	40kW (55PS)	Diesel	TD2241				
OM 615.960	4 Cyl.	1988cc	44kW (60PS)	Diesel	TD22828				
OM 615.961	4 Cyl.	1988cc	44kW (60PS)	Diesel	TD22829				
OM 615.964	4 Cyl.	1988cc	40kW (54PS)	Diesel	TD22830				
OM 615.965	4 Cyl.	1988cc	40kW (54PS)	Diesel	TD22831				
OM 615.966	4 Cyl.	1988cc	40kW (54PS)	Diesel	TD22832				
OM 615.967	4 Cyl.	1988cc	40kW (54PS)	Diesel	TD22833				
OM 615.968	4 Cyl.	1988cc	40kW (54PS)	Diesel	TD22834				
OM 615.969	4 Cyl.	1988cc	40kW (54PS)	Diesel	TD22835				
BE/PL	4	51,955/51,965	55,600/55,619	26,000	1,805	0,025/0,079	AL-LF	01-3040	01-3040/4 STD 0.25 0.50 0.75 1.00

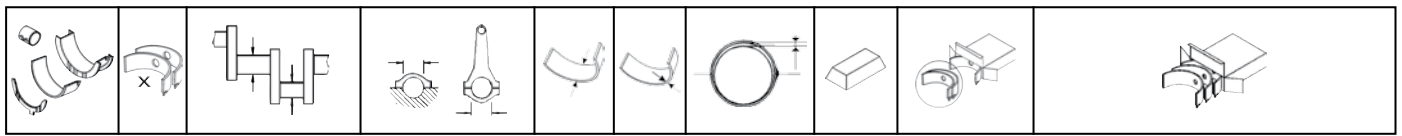

MB/HL 1,2,4,5	4	69,955/69,965	74,500/74,519	27,000	2,255	0,025/0,079	AL-LF	02-1460	H914/5 STD 0.25 0.50 0.75 1.00
MB/HL 3	1	69,955/69,965	74,500/74,519	33,900	2,255	0,025/0,079	AL-LF	02-2774H	

→12/78

	02-2774H	STD	34,000/1.3386" - 34,025/1.3396"
--	-----------------	-----	---------------------------------

MB/HL 1,2,4,5	4	69,955/69,965	74,500/74,519	27,000	2,255	0,025/0,079	AL-LF	02-1460	H951/5 STD 0.25 0.50
MB/HL 3	1	69,955/69,965	74,500/74,519	27,000	2,255	0,025/0,079	AL-LF	02-3435	

01/79→

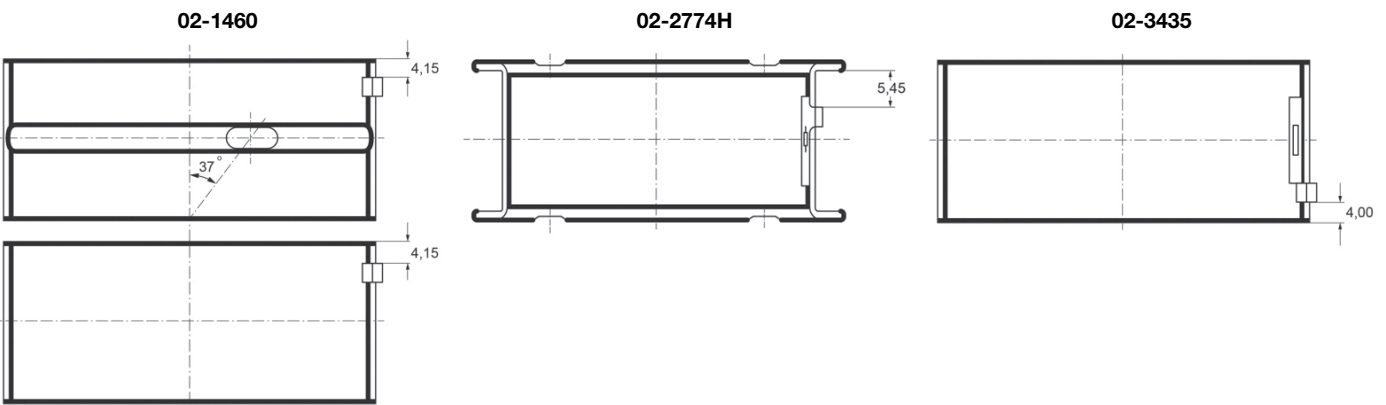

TW/A	2	78,025	91,500		2,200		AL-LF	04-3436	A113/4 STD 0.10
TW/A	2	78,025	91,500		2,200		AL-LF	04-3437	

01/79→

SE/PB	1	26,000	29,000/29,021	31,800			BC	55-2532	55-2532 SEMI
BU	1	30,000	36,000/36,025	18,000	3,000		BC	57-3049	57-3049 STD

28 87.00 x 83.60

OM 615.963	4 Cyl.	1988cc	43kW (58PS)	Diesel	TD2242				
OM 615.970	4 Cyl.	1988cc	43-46kW (58-62PS)	Diesel	TD2243				
BE/PL	4	51,955/51,965	55,600/55,619	26,000	1,805	0,025/0,079	AL-LF	01-3040	01-3040/4 STD 0.25 0.50 0.75 1.00
MB/HL 1,2,4,5	4	69,955/69,965	74,500/74,519	27,000	2,255	0,025/0,079	AL-LF	02-1460	H951/5 STD 0.25 0.50
MB/HL 3	1	69,955/69,965	74,500/74,519	27,000	2,255	0,025/0,079	AL-LF	02-3435	
TW/A	2	78,025	91,500		2,200		AL-LF	04-3436	A113/4 STD 0.10
TW/A	2	78,025	91,500		2,200		AL-LF	04-3437	
SE/PB	1	26,000	29,000/29,021	31,800			BC	55-2532	55-2532 SEMI
BU	1	30,000	36,000/36,025	18,000	3,000		BC	57-3049	57-3049 STD

29 87.00 x 84.00

OM 601.911	4 Cyl.	1997cc	53-55kW (72-75PS)	Diesel	TD2206
OM 601.912	4 Cyl.	1997cc	53-55kW (72-75PS)	Diesel	TD2207
OM 601.913	4 Cyl.	1997cc	55kW (75PS)	Diesel	TD2208

MERCEDES-BENZ



OM 601.915		4 Cyl.		1997cc	55kW (75PS)	Diesel			TD5237
BE/PL	1	47,950/47,965	51,600/51,619	21,800	1,812	0,020/0,070	AL-LF	01-3584	01-3584 STD 0.25 0.50
MB/HL 1-5	5	57,950/57,965	62,500/62,519	17,500	2,261	0,020/0,072	AL-LF	02-3585	H997/5 STD 0.25 0.50
TW/A	2	65,800	81,000		2,200		AL-LF	04-3586	A129/4 STD 0.10
TW/A	2	65,800	81,000		2,200		AL-LF	04-3587	
SE/PB	1	26,995/27,000	29,500/29,521	24,000			BC	55-3588	55-3588 SEMI
SE/PB	1	25,995/26,000	28,500/28,521	21,900			BC	55-3625	55-3625 SEMI

30 87.00 x 84.00

OM 604.915		4 Cyl.		1997cc	65-85kW (88-116PS)	Diesel			TD4677
OM 604.917		4 Cyl.		1997cc	65kW (88PS)	Diesel			TD9424
BE/PL	1	47,950/47,965	51,600/51,619	21,800	1,812	0,020/0,070	AL-LF	01-3771	01-3771 STD 0.25 0.50
MB/HL 1-5	5	57,950/57,965	62,500/62,519	17,500	2,261	0,020/0,072	AL-LF	02-3585	H997/5 STD 0.25 0.50
TW/A	2	65,800	81,000		2,200		AL-LF	04-3586	A129/4 STD 0.10
TW/A	2	65,800	81,000		2,200		AL-LF	04-3587	
SE/PB	1		30,500/30,521	21,900			BC-LF	55-3830	55-3830 SEMI [6]
SE/PB	1		28,500/28,521	21,900			BC-LF	55-3831	55-3831 SEMI [6]

55-3830

55-3831

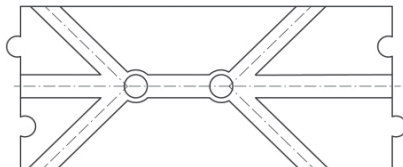
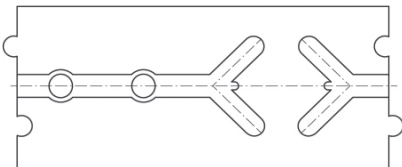

31 87.00 x 84.00

OM 602.911		5 Cyl.		2497cc	66-69kW (90-94PS)	Diesel			TD2211
OM 602.912		5 Cyl.		2497cc	66-69kW (90-94PS)	Diesel			TD2212
OM 602.930		5 Cyl.		2497cc	62-69kW (84-94PS)	Diesel			TD2213
OM 602.931		5 Cyl.		2497cc	69kW (94PS)	Diesel			TD2214
OM 602.938		5 Cyl.		2497cc	68kW (92PS)	Diesel			TD17816
OM 602.939		5 Cyl.		2497cc	68kW (92PS)	Diesel			TD9422
OM 602.990		5 Cyl.		2497cc	63kW (86PS)	Diesel			TD17819
BE/PL	1	47,950/47,965	51,600/51,619	21,800	1,812	0,020/0,070	AL-LF	01-3584	01-3584 STD 0.25 0.50
MB/HL 1-6	6	57,950/57,965	62,500/62,519	17,500	2,261	0,020/0,072	AL-LF	02-3585	H997/6 STD 0.25 0.50
TW/A	2	65,800	81,000		2,200		AL-LF	04-3586	A129/4 STD 0.10
TW/A	2	65,800	81,000		2,200		AL-LF	04-3587	
SE/PB	1	25,995/26,000	28,500/28,521	21,900			BC	55-3625	55-3625 SEMI
SE/PB	1	27,995/28,000	30,500/30,525	21,900			BC	55-3635	55-3635 SEMI
SE/PB	1		30,500/30,521	21,900			BC-LF	55-3830	55-3830 SEMI [6]

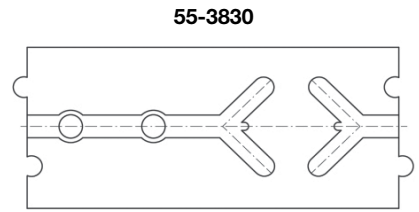
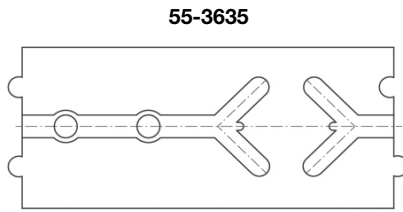
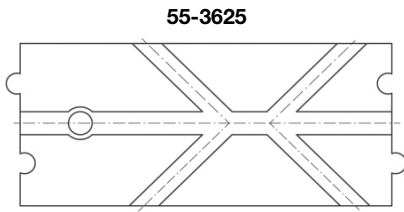
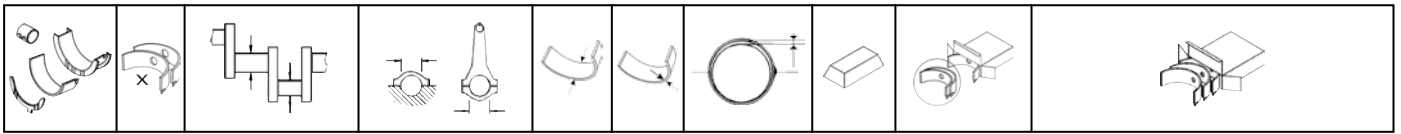

32 87.00 x 84.00

OM 602.961		5 Cyl.	2497cc	90-93kW (122-126PS)	Diesel Turbo		TD2216			
OM 602.962		5 Cyl.	2497cc	93kW (126PS)	Diesel Turbo		TD2217			
OM 602.993		5 Cyl.	2497cc	93kW (126PS)	Diesel Turbo		TD17821			
BE/PL	1	47,950/47,965	51,600/51,619	21,800	1,812	0,020/0,070	SP	71-3645	71-3645 STD 0.25 0.50	[1]
MB/HL 1-6	6	57,950/57,965	62,500/62,519	17,500	2,261	0,020/0,072	AL-LF	02-3585	H997/6 STD 0.25 0.50	
TW/A	2	65,800	81,000		2,200		AL-LF	04-3586	A129/4 STD 0.10	
TW/A	2	65,800	81,000		2,200		AL-LF	04-3587		
SE/PB	1	25,995/26,000	28,500/28,521	21,900			BC	55-3625	55-3625 SEMI	
SE/PB	1	27,995/28,000	30,500/30,525	21,900			BC	55-3635	55-3635 SEMI	
SE/PB	1		30,500/30,521	21,900			BC-LF	55-3830	55-3830 SEMI	[6]

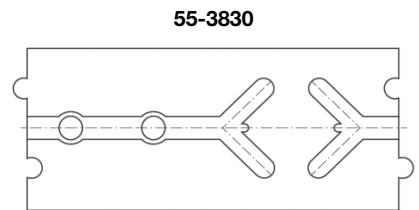
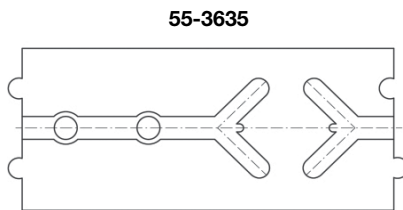
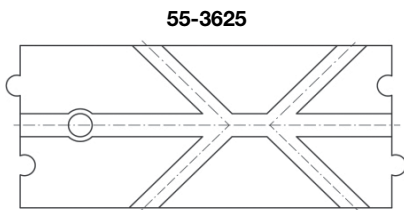

33 87.00 x 84.00

OM 605.910		5 Cyl.	2497cc	83kW (113PS)	Diesel		TD2228			
OM 605.911		5 Cyl.	2497cc	83kW (113PS)	Diesel		TD2229			
OM 605.912		5 Cyl.	2497cc	83kW (113PS)	Diesel		TD4678			
BE/PL	1	47,950/47,965	51,600/51,619	21,800	1,812	0,020/0,070	AL-LF	01-3771	01-3771 STD 0.25 0.50	
MB/HL 1-6	6	57,950/57,965	62,500/62,519	17,500	2,261	0,020/0,072	AL-LF	02-3585	H997/6 STD 0.25 0.50	
TW/A	2	65,800	81,000		2,200		AL-LF	04-3586	A129/4 STD 0.10	
TW/A	2	65,800	81,000		2,200		AL-LF	04-3587		
SE/PB	1		30,500/30,521	21,900			BC-LF	55-3830	55-3830 SEMI	[6]
SE/PB	1		28,500/28,521	21,900			BC-LF	55-3831	55-3831 SEMI	[6]

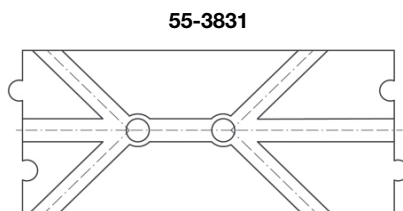
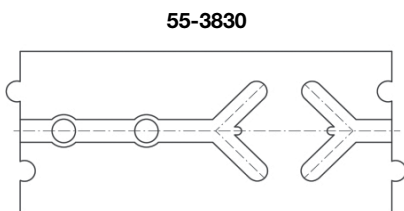

MERCEDES-BENZ

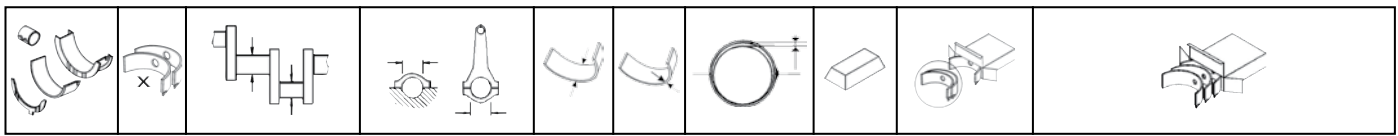

34 87.00 x 84.00

OM 605.960		5 Cyl.	2497cc	110kW (150PS)	Diesel Turbo Intercooler			TD4679
OM 605.962		5 Cyl.	2497cc	110kW (150PS)	Diesel Turbo Intercooler			TD9892
BE/PL	1	47,950/47,965	51,600/51,619	21,800	1,812	0,020/0,070	SP 71-3645	71-3645 STD 0.25 0.50 [1]
MB/HL 1-6	6	57,950/57,965	62,500/62,519	17,500	2,261	0,020/0,072	AL-LF 02-3585	H997/6 STD 0.25 0.50
TW/A	2	65,800	81,000		2,200		AL-LF 04-3586	A129/4 STD 0.10
TW/A	2	65,800	81,000		2,200		AL-LF 04-3587	
SE/PB	1		30,500/30,521	21,900			BC-LF 55-3830	55-3830 SEMI [6]
SE/PB	1		28,500/28,521	21,900			BC-LF 55-3831	55-3831 SEMI [6]

55-3830

55-3831

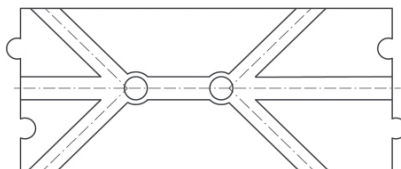
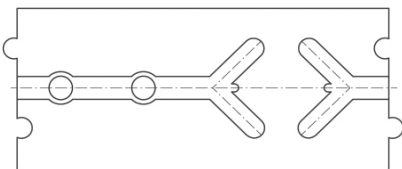

35 87.00 x 84.00

OM 603.912		6 Cyl.	2996cc	80-83kW (109-113PS)	Diesel			TD2218
OM 603.913		6 Cyl.	2996cc	80-83kW (109-113PS)	Diesel			TD2219
OM 603.931		6 Cyl.	2996cc	83kW (113PS)	Diesel			TD2220
BE/PL	1	47,950/47,965	51,600/51,619	21,800	1,812	0,020/0,070	AL-LF 01-3584	01-3584 STD 0.25 0.50
MB/HL 1-7	7	57,950/57,965	62,500/62,519	17,500	2,261	0,020/0,072	AL-LF 02-3585	H997/7 STD 0.25 0.50
TW/A	2	65,800	81,000		2,200		AL-LF 04-3586	A129/4 STD 0.10
TW/A	2	65,800	81,000		2,200		AL-LF 04-3587	
SE/PB	1	25,995/26,000	28,500/28,521	21,900			BC 55-3625	55-3625 SEMI
SE/PB	1	27,995/28,000	30,500/30,525	21,900			BC 55-3635	55-3635 SEMI
SE/PB	1		30,500/30,521	21,900			BC-LF 55-3830	55-3830 SEMI [6]

55-3625

55-3635

55-3830

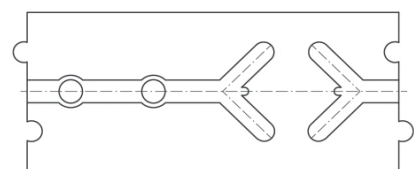
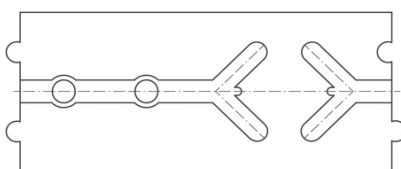
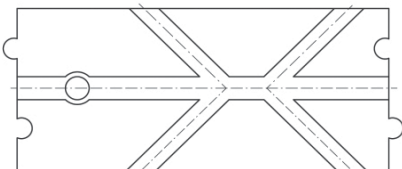

36 87.00 x 84.00

OM 603.950		6 Cyl.	2996cc	100-105kW (136-143PS)	Diesel Turbo			TD21143
OM 603.960		6 Cyl.	2996cc	100-108kW (136-147PS)	Diesel Turbo			TD2221
OM 603.961		6 Cyl.	2996cc	107-110kW (143-148PS)	Diesel Turbo			TD2222
OM 603.962		6 Cyl.	2996cc	105kW (143PS)	Diesel Turbo			TD21144
OM 603.963		6 Cyl.	2996cc	105-108kW (143-147PS)	Diesel Turbo			TD2223
BE/PL	1	47,950/47,965	51,600/51,619	21,800	1,812	0,020/0,070	SP 71-3645	71-3645 STD 0.25 0.50 [1]

MB/HL 1-7	7	57,950/57,965	62,500/62,519	17,500	2,261	0,020/0,072	AL-LF	02-3585	H997/7 STD 0.25 0.50	
TW/A	2	65,800	81,000		2,200		AL-LF	04-3586	A129/4 STD 0.10	
TW/A	2	65,800	81,000		2,200		AL-LF	04-3587		
SE/PB	1	25,995/26,000	28,500/28,521	21,900			BC	55-3625	55-3625 SEMI	
SE/PB	1	27,995/28,000	30,500/30,525	21,900			BC	55-3635	55-3635 SEMI	
SE/PB	1		30,500/30,521	21,900			BC-LF	55-3830	55-3830 SEMI	

6

55-3625

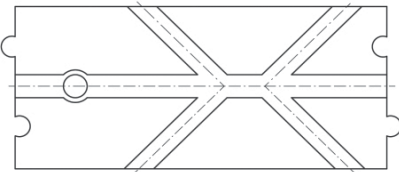

55-3635

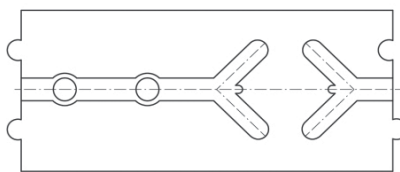

55-3830

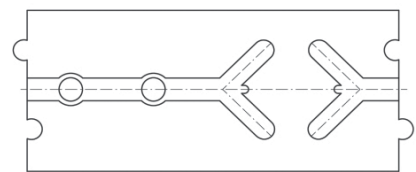

37 87.00 x 84.00

OM 606.910			6 Cyl.	2996cc	100kW (136PS)		Diesel		TD2230
OM 606.912			6 Cyl.	2996cc	100kW (136PS)		Diesel		TD4680
BE/PL	1	47,950/47,965	51,600/51,619	21,800	1,812	0,020/0,070	AL-LF	01-3771	01-3771 STD 0.25 0.50
MB/HL 1-7	7	57,950/57,965	62,500/62,519	17,500	2,261	0,020/0,072	AL-LF	02-3585	H997/7 STD 0.25 0.50
TW/A	2	65,800	81,000		2,200		AL-LF	04-3586	A129/4 STD 0.10
TW/A	2	65,800	81,000		2,200		AL-LF	04-3587	
SE/PB	1		30,500/30,521	21,900			BC-LF	55-3830	55-3830 SEMI
SE/PB	1		28,500/28,521	21,900			BC-LF	55-3831	55-3831 SEMI

6

6

55-3830

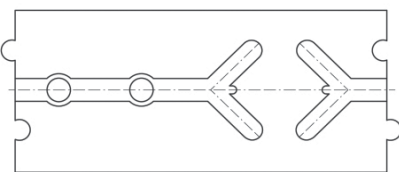

55-3831

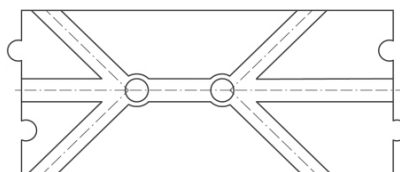

38 87.00 x 84.00

OM 606.961			6 Cyl.	2996cc	130kW (177PS)		Diesel Turbo Intercooler		TD5238
OM 606.962			6 Cyl.	2996cc	130kW (177PS)		Diesel Turbo		TD9416
OM 606.964			6 Cyl.	2996cc	130kW (177PS)		Diesel Turbo		TD9425
BE/PL	1	47,950/47,965	51,600/51,619	21,800	1,812	0,020/0,070	SP	71-3645	71-3645 STD 0.25 0.50
MB/HL 1-7	7	57,950/57,965	62,500/62,519	17,500	2,261	0,020/0,072	AL-LF	02-3585	H997/7 STD 0.25 0.50
TW/A	2	65,800	81,000		2,200		AL-LF	04-3586	A129/4 STD 0.10
TW/A	2	65,800	81,000		2,200		AL-LF	04-3587	
SE/PB	1		30,500/30,521	21,900			BC-LF	55-3830	55-3830 SEMI
SE/PB	1		28,500/28,521	21,900			BC-LF	55-3831	55-3831 SEMI

1

6



6

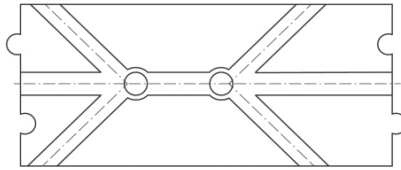
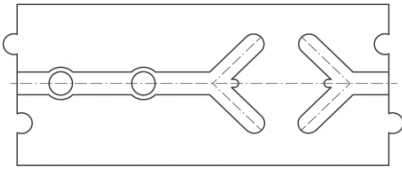

55-3830

55-3831



39		87.00 x 92.40								
M 115.900	4 Cyl.	2197cc	40kW (54PS)	Petrol	TD22705					
M 115.920	4 Cyl.	2197cc	77kW (105PS)	Petrol	TD2139					
M 115.921	4 Cyl.	2197cc	63kW (86PS)	Petrol	TD2140					
M 115.922	4 Cyl.	2197cc	62kW (85PS)	Petrol	TD17799					
M 115.924	4 Cyl.	2197cc	66kW (90PS)	Petrol	TD2142					
M 115.927	4 Cyl.	2197cc	63kW (85PS)	Petrol	TD2144					
M 115.928	4 Cyl.	2197cc	55kW (75PS)	Petrol	TD2145					
M 115.929	4 Cyl.	2197cc	55kW (75PS)	Petrol	TD2146					
M 115.932	4 Cyl.	2197cc	48kW (65PS)	Petrol	TD17785					
M 115.933	4 Cyl.	2197cc	62kW (85PS)	Petrol	TD17800					
M 115.934	4 Cyl.	2197cc	55kW (75PS)	Petrol	TD17801					
M 115.935	4 Cyl.	2197cc	55kW (75PS)	Petrol	TD17802					
BE/PL	4	51,955/51,965	55,600/55,619	26,000	1,805	0,025/0,079	EC	71-2773	71-2773/4 0.25 0.50 0.75	
MB/HL 1,2,4,5	4	69,955/69,965	74,500/74,519	27,000	2,255	0,025/0,079	EC	72-1460	H796/5 STD 0.25 0.50 0.75	
MB/HL 3	1	69,955/69,965	74,500/74,519	33,900	2,255	0,025/0,079	EC	72-2774H		
			72-2774H	STD	34,000/1.3386" - 34,025/1.3396"					
					0.25mm 34,200/1.3465" - 34,225/1.3474"					
					0.50mm 34,200/1.3465" - 34,225/1.3474"					
MB/HL 1,2,4,5	4	69,955/69,965	74,500/74,519	27,000	2,255	0,025/0,079	AL-LF	02-1460	H914/5 STD 0.25 0.50 0.75 1.00	
MB/HL 3	1	69,955/69,965	74,500/74,519	33,900	2,255	0,025/0,079	AL-LF	02-2774H		
			02-2774H	STD	34,000/1.3386" - 34,025/1.3396"					

72-1460

72-2774H

02-1460

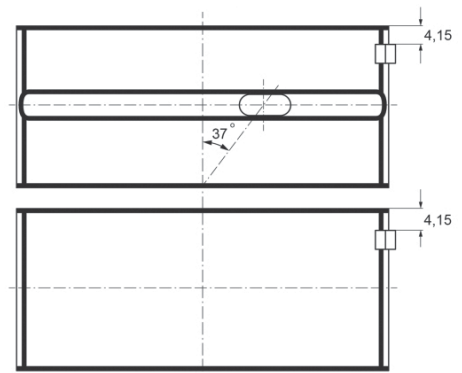
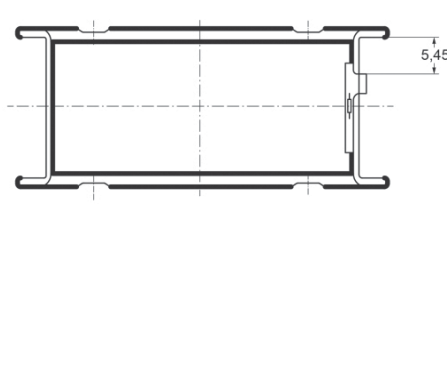
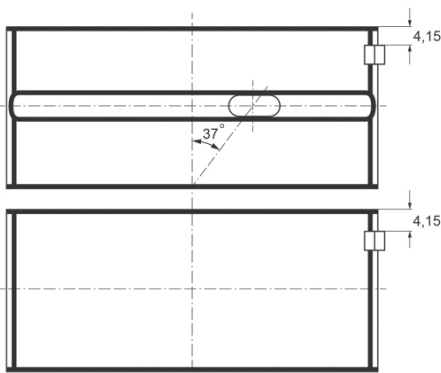



02-2774H

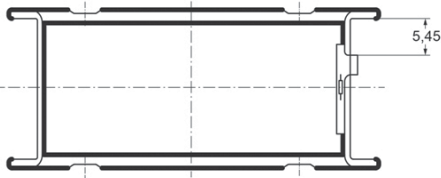

SE/PB	1	26,000	29,000/29,021	31,800			BC	55-2532	55-2532 SEMI
-------	---	--------	---------------	--------	--	--	----	---------	------------------------

40 87.00 x 92.40

OM 601.921		4 Cyl.		2197cc	54kW (72PS)	Diesel			TD2209
BE/PL	1	47,950/47,965	51,600/51,619	21,800	1,812	0,020/0,070	AL-LF	01-3584	01-3584 STD 0.25 0.50
MB/HL 1-5	5	57,950/57,965	62,500/62,519	17,500	2,261	0,020/0,072	AL-LF	02-3585	H997/5 STD 0.25 0.50
TW/A	2	65,800	81,000		2,200		AL-LF	04-3586	A129/4 STD 0.10
TW/A	2	65,800	81,000		2,200		AL-LF	04-3587	
SE/PB	1	26,995/27,000	29,500/29,521	24,000			BC	55-3588	55-3588 SEMI
SE/PB	1	25,995/26,000	28,500/28,521	21,900			BC	55-3625	55-3625 SEMI

41 87.00 x 92.40

OM 615.910		4 Cyl.		2197cc	44kW (60PS)	Diesel			TD2232
OM 615.911		4 Cyl.		2197cc	33kW (45PS)	Diesel			TD7970
OM 615.912		4 Cyl.		2197cc	44kW (60PS)	Diesel			TD2233
OM 615.917		4 Cyl.		2197cc	44kW (60PS)	Diesel			TD5683
OM 615.937		4 Cyl.		2197cc	44kW (60PS)	Diesel			TD2236
OM 615.939		4 Cyl.		2197cc	44kW (60PS)	Diesel			TD2237
BE/PL	4	51,955/51,965	55,600/55,619	26,000	1,805	0,025/0,079	AL-LF	01-3040	01-3040/4 STD 0.25 0.50 0.75 1.00
01/74 →									
BE/PL	4	51,955/51,965	55,600/55,619	26,000	1,805	0,025/0,079	EC	71-2773	71-2773/4 0.25 0.50 0.75
→12/73									

01-3040



71-2773

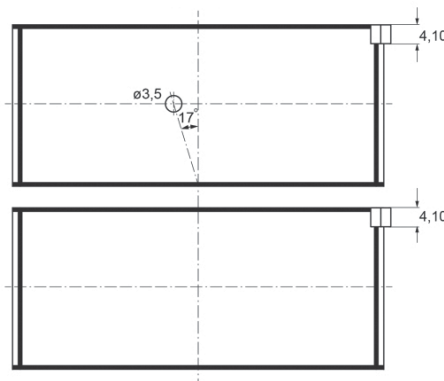

MERCEDES-BENZ

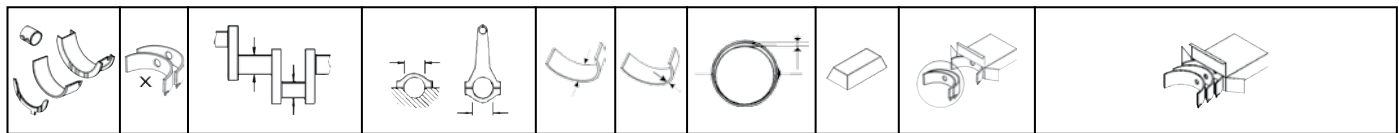

MB/HL 1,2,4,5	4	69,955/69,965	74,500/74,519	27,000	2,255	0,025/0,079	AL-LF	02-1460	H914/5 STD 0.25 0.50 0.75 1.00
MB/HL 3	1	69,955/69,965	74,500/74,519	33,900	2,255	0,025/0,079	AL-LF	02-2774H	

	02-2774H	STD	34,000/1.3386" - 34,025/1.3396"	
--	-----------------	-----	---------------------------------	--

SE/PB	1	26,000	29,000/29,021	31,800			BC	55-2532	55-2532 SEMI
BU	1	12,000	14,000	19,800			BC	56-2782	56-2782 SEMI
BU	1	30,000	36,000/36,025	18,000	3,000		BC	57-3049	57-3049 STD

42 87.00 x 92.40

OM 615.914	4 Cyl.	2197cc	40kW (55PS)	Diesel	TD7972
OM 615.916	4 Cyl.	2197cc	40kW (55PS)	Diesel	TD22823
OM 615.918	4 Cyl.	2197cc	40kW (55PS)	Diesel	TD22824
OM 615.930	4 Cyl.	2197cc	38kW (52PS)	Diesel	TD22825
OM 615.932	4 Cyl.	2197cc	44kW (60PS)	Diesel	TD7989
OM 615.936	4 Cyl.	2197cc	37kW (50PS)	Diesel	TD20151
OM 615.938	4 Cyl.	2197cc	44kW (60PS)	Diesel	TD22826

BE/PL	4	51,955/51,965	55,600/55,619	26,000	1,805	0,025/0,079	AL-LF	01-3040	01-3040/4 STD 0.25 0.50 0.75 1.00
-------	---	---------------	---------------	--------	-------	-------------	-------	---------	---

01/74 →

BE/PL	4	51,955/51,965	55,600/55,619	26,000	1,805	0,025/0,079	EC	71-2773	71-2773/4 0.25 0.50 0.75
-------	---	---------------	---------------	--------	-------	-------------	----	---------	------------------------------------

→12/73

01-3040

71-2773

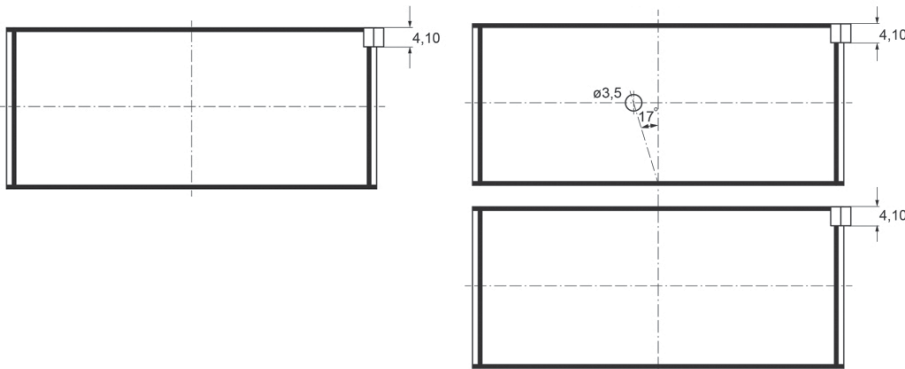

MB/HL 1,2,4,5	4	69,955/69,965	74,500/74,519	27,000	2,255	0,025/0,079	AL-LF	02-1460	H914/5 STD 0.25 0.50 0.75 1.00
MB/HL 3	1	69,955/69,965	74,500/74,519	33,900	2,255	0,025/0,079	AL-LF	02-2774H	

→12/78

	02-2774H	STD	34,000/1.3386" - 34,025/1.3396"	
--	-----------------	-----	---------------------------------	--

MB/HL 1,2,4,5	4	69,955/69,965	74,500/74,519	27,000	2,255	0,025/0,079	AL-LF	02-1460	H951/5 STD 0.25 0.50
MB/HL 3	1	69,955/69,965	74,500/74,519	27,000	2,255	0,025/0,079	AL-LF	02-3435	

01/79 →



02-1460

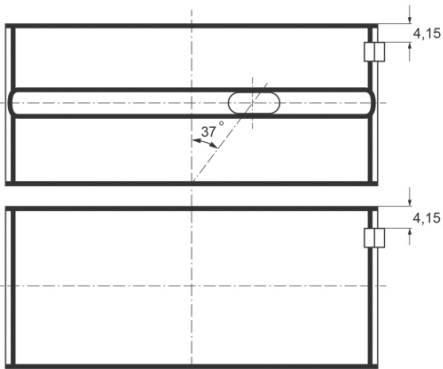

02-2774H

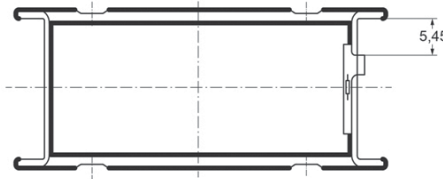

02-3435

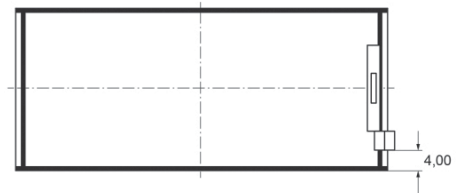

TW/A	2	78,025	91,500		2,200	AL-LF	04-3436	A113/4
TW/A	2	78,025	91,500		2,200	AL-LF	04-3437	STD 0.10

01/79 →

SE/PB	1	26,000	29,000/29,021	31,800		BC	55-2532	55-2532
BU	1	12,000	14,000	19,800		BC	56-2782	56-2782
BU	1	30,000	36,000/36,025	18,000	3,000	BC	57-3049	57-3049
								STD

43

87.00 x 92.40

OM 615.941		4 Cyl.		2197cc	44-49kW (60-67PS)		Diesel		TD2239
BE/PL	4	51,955/51,965	55,600/55,619	26,000	1,805	0,025/0,079	AL-LF	01-3040	01-3040/4
MB/HL 1,2,4,5	4	69,955/69,965	74,500/74,519	27,000	2,255	0,025/0,079	AL-LF	02-1460	H914/5
MB/HL 3	1	69,955/69,965	74,500/74,519	33,900	2,255	0,025/0,079	AL-LF	02-2774H	STD 0.25 0.50 0.75 1.00

→12/78

	02-2774H	STD	34,000/1.3386" - 34,025/1.3396"
---	-----------------	-----	---------------------------------

MB/HL 1,2,4,5	4	69,955/69,965	74,500/74,519	27,000	2,255	0,025/0,079	AL-LF	02-1460	H951/5
MB/HL 3	1	69,955/69,965	74,500/74,519	27,000	2,255	0,025/0,079	AL-LF	02-3435	STD 0.25 0.50

01/79 →

02-1460

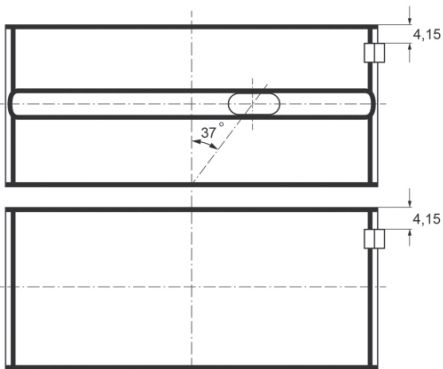

02-2774H

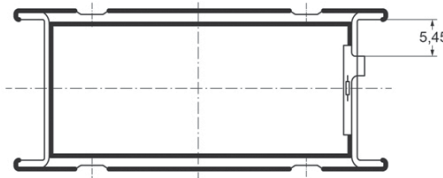

02-3435

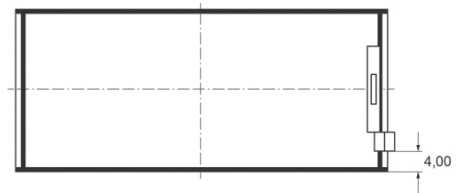

MERCEDES-BENZ

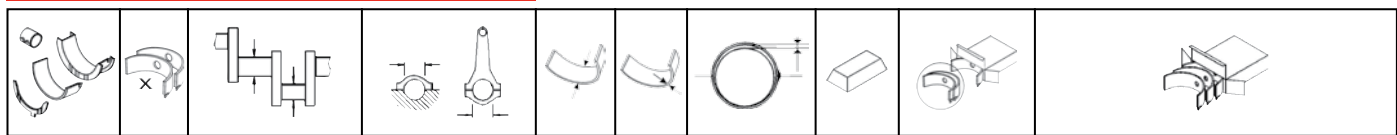

TW/A	2	78,025	91,500		2,200		AL-LF	04-3436	A113/4 STD 0.10
TW/A	2	78,025	91,500		2,200		AL-LF	04-3437	
01/79 →									
SE/PB	1	26,000	29,000/29,021	31,800			BC	55-2532	55-2532 SEMI
BU	1	12,000	14,000	19,800			BC	56-2782	56-2782 SEMI
BU	1	30,000	36,000/36,025	18,000	3,000		BC	57-3049	57-3049 STD

44 88.00 x 68.40

M 272.911	V6 Cyl.		2496cc	150kW (204PS)			Petrol		TD22142
M 272.920	V6 Cyl.		2496cc	150kW (204PS)			Petrol		TD18425
M 272.921	V6 Cyl.		2496cc	150kW (204PS)			Petrol		TD20357
M 272.922	V6 Cyl.		2496cc	150kW (204PS)			Petrol		TD22143
BE/PL	6	51,945/51,965	55,600/55,614	19,600	1,813	0,020/0,067	EC	71-4007	71-4007/6 STD
MB/HL	3	63,945/63,965	68,500/68,519	20,600	2,267	0,020/0,064	AL-LF	02-4008	H1003/4 STD
MB/HL	1	63,945/63,965	68,500/68,519	24,000	2,267	0,020/0,064	AL-LF	02-4009	
TW/A	2	72,250	84,000		1,900		AL-LF	04-4010	A164/4 STD
TW/A	2	72,250	84,000		1,900		AL-LF	04-4011	
SE/PB	1	22,000	24,500/24,521	19,900			BC	55-4012	55-4012 SEMI

45 88.00 x 78.90

M 116.961	V8 Cyl.		3839cc	120-160kW (163-218PS)			Petrol		TD2159
M 116.962	V8 Cyl.		3839cc	150kW (204PS)			Petrol		TD2160
M 116.963	V8 Cyl.		3839cc	150kW (204PS)			Petrol		TD4669
BE/PL	8	51,945/51,965	55,600/55,619	22,000	1,810	0,020/0,079	EC	71-3476	71-3476/8 STD
→12/80									
BE/PL	8	47,945/47,965	51,600/51,619	22,000	1,810	0,020/0,079	EC	71-3477	71-3477/8 STD
01/81 →									
MB/HL	4	63,955/63,965	68,500/68,519	21,000	2,254	0,027/0,081	EC	72-2787	H801/5 STD
MB/HL	1	63,955/63,965	68,500/68,519	26,900	2,254	0,027/0,081	EC	72-2788H	
			72-2788H	STD	27,000/1.0630" - 27,021/1.0638"				
				0.25mm	27,200/1.0709" - 27,221/1.0717"				
				0.50mm	27,200/1.0709" - 27,221/1.0717"				
SE/PB	1	23,000	26,000	27,600			BC	55-3525	55-3525 SEMI

46 88.00 x 82.10

M 272.940	V6 Cyl.		2996cc	170kW (231PS)			Petrol		TD18420
M 272.941	V6 Cyl.		2996cc	170kW (231PS)			Petrol		TD18423
M 272.942	V6 Cyl.		2996cc	170kW (231PS)			Petrol		TD18427
M 272.943	V6 Cyl.		2996cc	170kW (231PS)			Petrol		TD18430
M 272.944	V6 Cyl.		2996cc	170kW (231PS)			Petrol		TD23758
M 272.945	V6 Cyl.		2996cc	170kW (231PS)			Petrol		TD20570

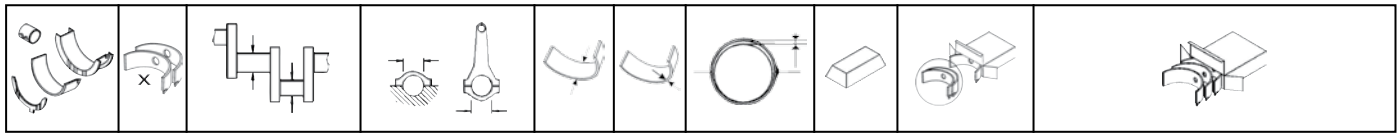

M 272.946			V6 Cyl.	2996cc	170kW (231PS)		Petrol		TD26966
M 272.947			V6 Cyl.	2996cc	170kW (231PS)		Petrol		TD20356
M 272.948			V6 Cyl.	2996cc	170kW (231PS)		Petrol		TD22968
M 272.949			V6 Cyl.	2996cc	170kW (231PS)		Petrol		TD20863
M 272.952			V6 Cyl.	2996cc	170kW (231PS)		Petrol		TD25212

BE/PL	6	51,945/51,965	55,600/55,614	19,600	1,813	0,020/0,067	EC	71-4007	71-4007/6 STD
MB/HL	3	63,945/63,965	68,500/68,519	20,600	2,267	0,020/0,064	AL-LF	02-4008	H1003/4 STD
MB/HL	1	63,945/63,965	68,500/68,519	24,000	2,267	0,020/0,064	AL-LF	02-4009	
TW/A	2	72,250	84,000		1,900		AL-LF	04-4010	A164/4 STD
TW/A	2	72,250	84,000		1,900		AL-LF	04-4011	
SE/PB	1	22,000	24,500/24,521	19,900			BC	55-4012	55-4012 SEMI

47

88.00 x 88.30

OM 611.960			4 Cyl.	2151cc	75-92kW (102-125PS)		Diesel Turbo Intercooler		TD9529
OM 611.961			4 Cyl.	2148cc	75-105kW (102-143PS)		Diesel Turbo Intercooler		TD17005
OM 611.962			4 Cyl.	2148cc	75-105kW (102-143PS)		Diesel Turbo Intercooler		TD15449
OM 611.980			4 Cyl.	2151cc	60-90kW (82-122PS)		Diesel Turbo Intercooler		TD14350
OM 611.981			4 Cyl.	2148cc	80-95kW (109-129PS)		Diesel Turbo		TD17729
OM 611.987			4 Cyl.	2148cc	60kW (82PS)		Diesel Turbo		TD17730
OM 611A (60 KW CDI)			4 Cyl.	2151cc	60kW (82PS)		Diesel		TD14348
OM 611LA (75 KW CDI)			4 Cyl.	2151cc	75kW (102PS)		Diesel		TD14349
OM 646.811			4 Cyl.	2148cc	100-125kW (136-170PS)		Diesel Turbo Intercooler		TD20360
OM 646.812			4 Cyl.	2148cc	100kW (136PS)		Diesel Turbo Intercooler		TD22694
OM 646.820			4 Cyl.	2148cc	100kW (136PS)		Diesel Turbo Intercooler		TD20362
OM 646.821			4 Cyl.	2148cc	100-125kW (136-170PS)		Diesel Turbo Intercooler		TD20334
OM 646.951			4 Cyl.	2148cc	75-90kW (102-122PS)		Diesel		TD18129
OM 646.961			4 Cyl.	2148cc	100-110kW (136-150PS)		Diesel Turbo Intercooler		TD17007
OM 646.962			4 Cyl.	2148cc	75-110kW (102-150PS)		Diesel Turbo Intercooler		TD17542
OM 646.963			4 Cyl.	2148cc	100-110kW (136-150PS)		Diesel Turbo Intercooler		TD17543
OM 646.966			4 Cyl.	2148cc	100-110kW (136-150PS)		Diesel Turbo Intercooler		TD22844
OM 646.980			4 Cyl.	2148cc	70-110kW (95-150PS)		Diesel Turbo Intercooler		TD24573
OM 646.981			4 Cyl.	2148cc	70kW (95PS)		Diesel Turbo Intercooler		TD20984
OM 646.982 Euro 4			4 Cyl.	2148cc	80-110kW (109-150PS)		Diesel Turbo Intercooler		TD18289
OM 646.983			4 Cyl.	2148cc	65-80kW (88-109PS)		Diesel Turbo Intercooler		TD20921
OM 646.984			4 Cyl.	2148cc	65kW (88PS)		Diesel Turbo Intercooler		TD22140
OM 646.985			4 Cyl.	2148cc	80kW (109PS)		Diesel Turbo Intercooler		TD20730
OM 646.986 Euro 4			4 Cyl.	2148cc	95-110kW (129-150PS)		Diesel Turbo Intercooler		TD23620
OM 646.989			4 Cyl.	2148cc	110kW (150PS)		Diesel Turbo Intercooler		TD26257
OM 646.990			4 Cyl.	2148cc	110kW (150PS)		Diesel Turbo Intercooler		TD23618

BE/PL	1	47,950/47,965	51,600/51,619	21,800	1,812	0,020/0,070	SP	71-3876	71-3876 STD 0.25 0.50 0.75	①
MB/HL	1	57,940/57,965	62,500/62,519	17,500	2,265	0,020/0,074	SP	72-3856	72-3856 STD 0.25	②
TW/A	2	65,800	81,000		2,200		AL-LF	04-3586	A129/4 STD 0.10	
TW/A	2	65,800	81,000		2,200		AL-LF	04-3587		
SE/PB	1		32,500/32,521	21,900			BC-LF	55-3898	55-3898 SEMI	⑥

MERCEDES-BENZ



48		88.00 x 88.30									
OM 612.961		5 Cyl.	2685cc	120-125kW (163-170PS)	Diesel Turbo Intercooler	TD15455					
OM 612.962		5 Cyl.	2685cc	125kW (170PS)	Diesel Turbo Intercooler	TD15451					
OM 612.963		5 Cyl.	2685cc	120kW (163PS)	Diesel Turbo Intercooler	TD17009					
OM 612.965		5 Cyl.	2685cc	115-120kW (156-163PS)	Diesel Turbo Intercooler	TD21145					
OM 612.966		5 Cyl.	2685cc	115kW (156PS)	Diesel Turbo Intercooler	TD16895					
OM 612.967		5 Cyl.	2685cc	120-125kW (163-170PS)	Diesel Turbo Intercooler	TD17323					
OM 612.981		5 Cyl.	2685cc	110-115kW (150-156PS)	Diesel Turbo	TD17731					
OM 612.983 Euro 3		5 Cyl.	2685cc	115kW (156PS)	Diesel Turbo	TD25649					
OM 647.961		5 Cyl.	2685cc	120-130kW (163-177PS)	Diesel Turbo Intercooler	TD17008					
OM 647.981		5 Cyl.	2685cc	60-130kW (82-177PS)	Diesel Turbo Intercooler	TD21142					
BE/PL	1	47,950/47,965	51,600/51,619	21,800	1,812	0,020/0,070	SP	71-3876	71-3876 STD 0.25 0.50 0.75	1	
MB/HL	1	57,940/57,965	62,500/62,519	17,500	2,265	0,020/0,074	SP	72-3856	72-3856 STD 0.25	2	
TW/A	2	65,800	81,000		2,200		AL-LF	04-3586	A129/4 STD 0.10		
TW/A	2	65,800	81,000		2,200		AL-LF	04-3587			
SE/PB	1		32,500/32,521	21,900			BC-LF	55-3898	55-3898 SEMI	6	

49		88.00 x 88.30									
OM 613.960		6 Cyl.	3222cc	145kW (197PS)	Diesel Turbo Intercooler	TD15461					
OM 613.961		6 Cyl.	3226cc	145kW (197PS)	Diesel Turbo Intercooler	TD15454					
OM 648.960		6 Cyl.	3222cc	150kW (204PS)	Diesel Turbo Intercooler	TD17187					
OM 648.961		6 Cyl.	3222cc	130-150kW (177-204PS)	Diesel Turbo Intercooler	TD17328					
BE/PL	1	47,950/47,965	51,600/51,619	21,800	1,812	0,020/0,070	SP	71-3876	71-3876 STD 0.25 0.50 0.75	1	
MB/HL	1	57,940/57,965	62,500/62,519	17,500	2,265	0,020/0,074	SP	72-3856	72-3856 STD 0.25	2	
TW/A	2	65,800	81,000		2,200		AL-LF	04-3586	A129/4 STD 0.10		
TW/A	2	65,800	81,000		2,200		AL-LF	04-3587			
SE/PB	1		32,500/32,521	21,900			BC-LF	55-3898	55-3898 SEMI	6	

50		88.50 x 80.20									
M 104.980		6 Cyl.	2960cc	162-170kW (220-231PS)	Petrol	TD2110					
M 104.981		6 Cyl.	2960cc	170kW (231PS)	Petrol	TD2111					
BE/PL	6	47,950/47,965	51,600/51,619	21,800	1,814	0,020/0,064	EC	71-3817	71-3817/6 STD 0.25 0.50		
MB/HL 1-7	7	57,950/57,965	62,500/62,519	17,500	2,261	0,020/0,072	AL-LF	02-3585	H997/7 STD 0.25 0.50		
TW/A	2	65,800	81,000		2,200		AL-LF	04-3586	A129/4 STD 0.10		
TW/A	2	65,800	81,000		2,200		AL-LF	04-3587			
SE/PB	1	21,995/22,000	24,500/24,521	21,900			BC	55-3603	55-3603 SEMI		

51		88.50 x 80.25									
M 103.980		6 Cyl.	2960cc	138kW (188PS)	Petrol	TD2099					
M 103.981		6 Cyl.	2960cc	132-138kW (180-188PS)	Petrol	TD9436					
M 103.982		6 Cyl.	2960cc	132-138kW (180-188PS)	Petrol	TD9444					
M 103.983		6 Cyl.	2960cc	132-138kW (179-188PS)	Petrol	TD9437					

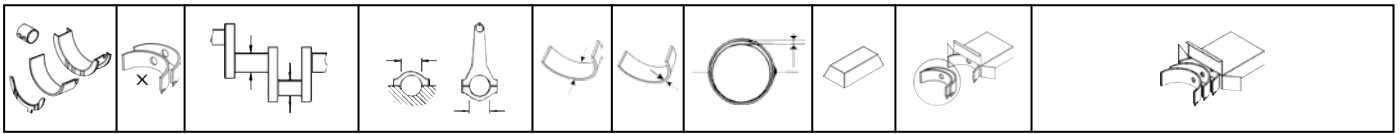

M 103.984			6 Cyl.	2960cc	140kW (190PS)		Petrol		TD2103
M 103.985			6 Cyl.	2960cc	132kW (180PS)		Petrol		TD2104
M 103.987			6 Cyl.	2960cc	125-128kW (170-174PS)		Petrol		TD2105
BE/PL	6	47,950/47,965	51,600/51,619	21,800	1,814	0,020/0,064	EC	71-3817	71-3817/6 STD 0.25 0.50
MB/HL 1-7	7	57,950/57,965	62,500/62,519	17,500	2,261	0,020/0,072	AL-LF	02-3585	H997/7 STD 0.25 0.50
TW/A	2	65,800	81,000		2,200		AL-LF	04-3586	A129/4 STD 0.10
TW/A	2	65,800	81,000		2,200		AL-LF	04-3587	
SE/PB	1	21,995/22,000	24,500/24,521	21,900			BC	55-3603	55-3603 SEMI

52 89.00 x 72.20

M 102.910			4 Cyl.	1797cc	80kW (109PS)		Petrol		TD2061
BE/PL	4	47,950/47,965	51,600/51,619	21,800	1,814	0,020/0,064	EC	71-3817	71-3817/4 STD 0.25 0.50
MB/HL 1-5	5	57,950/57,965	62,500/62,519	17,500	2,261	0,020/0,072	AL-LF	02-3585	H997/5 STD 0.25 0.50
TW/A	2	65,800	81,000		2,200		AL-LF	04-3586	A129/4 STD 0.10
TW/A	2	65,800	81,000		2,200		AL-LF	04-3587	
TW/A	2	65,800	81,000		4,200		AL-LF	04-3642	A132/4 STD
TW/A	2	65,800	81,000		4,200		AL-LF	04-3643	
SE/PB	1	21,995/22,000	24,500/24,521	21,900			BC	55-3603	55-3603 SEMI

53 89.00 x 72.20

M 102.919			4 Cyl.	1797cc	77kW (105PS)		Petrol		TD2062
BE/PL	4	47,955/47,965	51,600/51,619	22,000	1,814	0,020/0,062	EC	71-2995	71-2995/4 STD 0.25 0.50
→12/83									
BE/PL	4	47,950/47,965	51,600/51,619	21,800	1,814	0,020/0,064	EC	71-3817	71-3817/4 STD 0.25 0.50
01/84→									

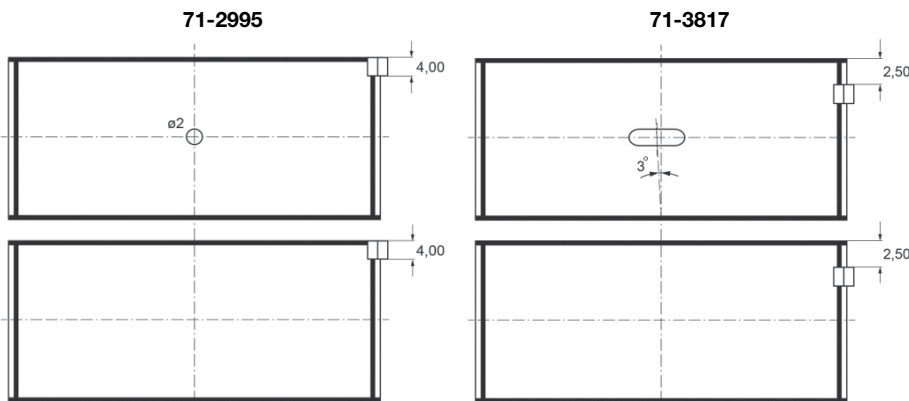

MB/HL 1-5	5	57,950/57,965	62,500/62,519	21,400	2,261	0,020/0,072	AL-LF	02-3513	H977/5 STD 0.25 0.50 0.75
→12/85									
MB/HL 1-5	5	57,950/57,965	62,500/62,519	17,500	2,261	0,020/0,072	AL-LF	02-3585	H997/5 STD 0.25 0.50
01/86→									

MERCEDES-BENZ

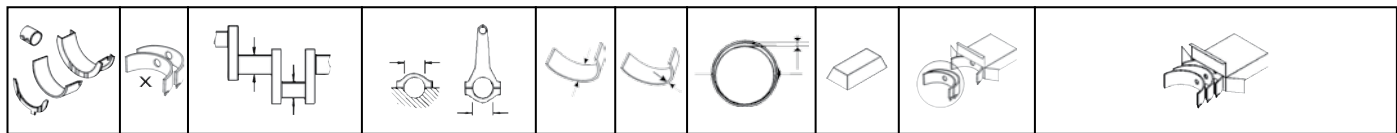

TW/A	2	65,800	81,000		2,200		AL-LF	04-3586	A129/4 STD 0.10
TW/A	2	65,800	81,000		2,200		AL-LF	04-3587	
TW/A	2	65,800	81,000		4,200		AL-LF	04-3642	A132/4 STD
TW/A	2	65,800	81,000		4,200		AL-LF	04-3643	
SE/PB	1	24,000	27,000/27,021	27,600			BC	55-3516	55-3516 SEMI

→12/82

SE/PB	1	21,995/22,000	24,500/24,521	21,900			BC	55-3603	55-3603 SEMI
-------	---	---------------	---------------	--------	--	--	----	---------	------------------------

01/83→

54

89.00 x 80.25

M 102.920	4 Cyl.	1997cc	74-80kW (100-109PS)	Petrol	TD2063
M 102.921	4 Cyl.	1996cc	63-77kW (86-105PS)	Petrol	TD2064
M 102.939	4 Cyl.	1997cc	74-80kW (100-109PS)	Petrol	TD2069

BE/PL	4	47,955/47,965	51,600/51,619	22,000	1,814	0,020/0,062	EC	71-2995	71-2995/4 STD 0.25 0.50
-------	---	---------------	---------------	--------	-------	-------------	----	---------	-----------------------------------

→12/83

BE/PL	4	47,950/47,965	51,600/51,619	21,800	1,814	0,020/0,064	EC	71-3817	71-3817/4 STD 0.25 0.50
-------	---	---------------	---------------	--------	-------	-------------	----	---------	-----------------------------------

01/84→

71-2995

71-3817

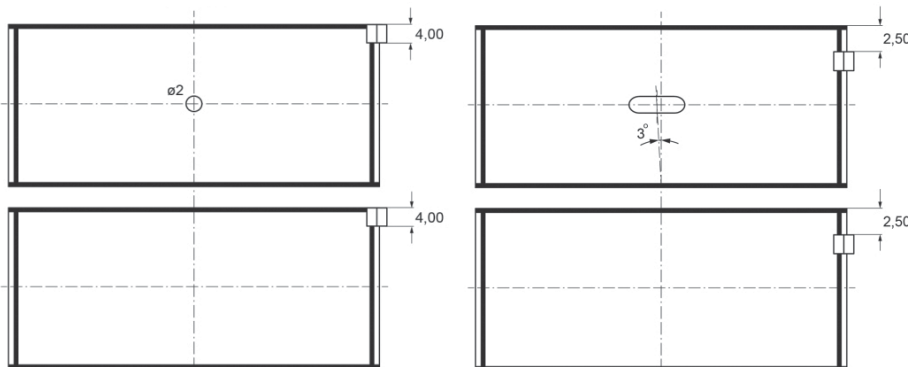

MB/HL 1-5	5	57,950/57,965	62,500/62,519	21,400	2,261	0,020/0,072	AL-LF	02-3513	H977/5 STD 0.25 0.50 0.75
TW/A	2	65,800	81,000		2,200		AL-LF	04-3586	A129/4 STD 0.10
TW/A	2	65,800	81,000		2,200		AL-LF	04-3587	
TW/A	2	65,800	81,000		4,200		AL-LF	04-3642	A132/4 STD
TW/A	2	65,800	81,000		4,200		AL-LF	04-3643	
SE/PB	1	24,000	27,000/27,021	27,600			BC	55-3516	55-3516 SEMI

→12/82

SE/PB	1	21,995/22,000	24,500/24,521	21,900			BC	55-3603	55-3603 SEMI
-------	---	---------------	---------------	--------	--	--	----	---------	------------------------

01/83→

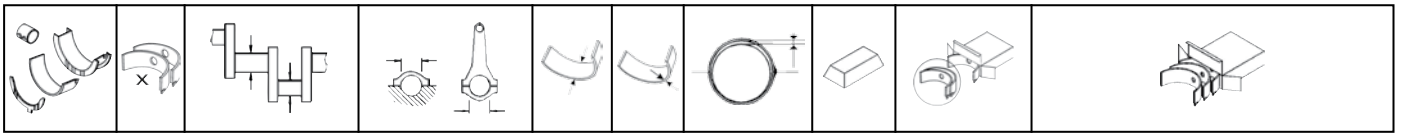

55

89.00 x 80.25

M 102.922			4 Cyl.	1996cc	75-80kW (102-109PS)			Petrol		TD2065
M 102.924			4 Cyl.	1996cc	75-77kW (102-105PS)			Petrol		TD4653
BE/PL	4	47,950/47,965	51,600/51,619	21,800	1,814	0,020/0,064	EC	71-3817	71-3817/4 STD 0.25 0.50	
MB/HL 1-5	5	57,950/57,965	62,500/62,519	21,400	2,261	0,020/0,072	AL-LF	02-3513	H977/5 STD 0.25 0.50 0.75	
→12/85										
MB/HL 1-5	5	57,950/57,965	62,500/62,519	17,500	2,261	0,020/0,072	AL-LF	02-3585	H997/5 STD 0.25 0.50	
01/86→										
TW/A	2	65,800	81,000		2,200		AL-LF	04-3586	A129/4 STD 0.10	
TW/A	2	65,800	81,000		2,200		AL-LF	04-3587		
TW/A	2	65,800	81,000		4,200		AL-LF	04-3642	A132/4 STD	
TW/A	2	65,800	81,000		4,200		AL-LF	04-3643		
SE/PB	1	21,995/22,000	24,500/24,521	21,900			BC	55-3603	55-3603 SEMI	

56

89.00 x 80.25

M 102.938			4 Cyl.	1997cc	63kW (86PS)			Petrol		TD22701
M 102.961			4 Cyl.	1996cc	83-93kW (113-126PS)			Petrol		TD5050
M 102.962			4 Cyl.	1996cc	83-90kW (115-122PS)			Petrol		TD4655
M 102.964			4 Cyl.	1997cc	80kW (109PS)			Petrol		TD17723
BE/PL	4	47,955/47,965	51,600/51,619	22,000	1,814	0,020/0,062	EC	71-2995	71-2995/4 STD 0.25 0.50	
→12/83										
BE/PL	4	47,950/47,965	51,600/51,619	21,800	1,814	0,020/0,064	EC	71-3817	71-3817/4 STD 0.25 0.50	
01/84→										

71-2995

71-3817

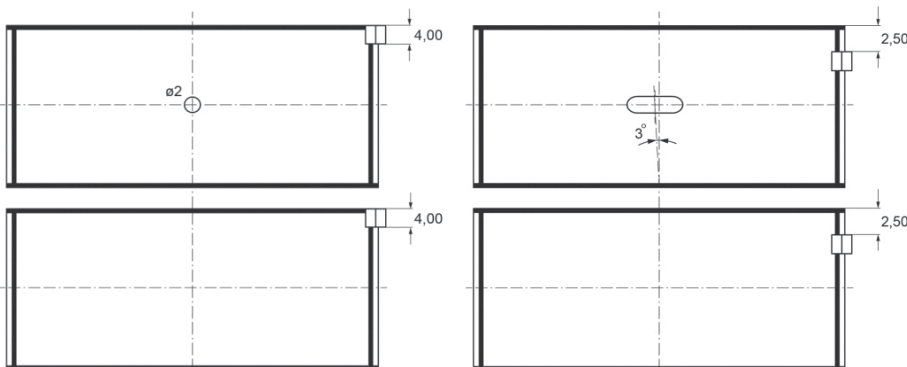

MB/HL 1-5	5	57,950/57,965	62,500/62,519	21,400	2,261	0,020/0,072	AL-LF	02-3513	H977/5 STD 0.25 0.50 0.75	
→12/85										
MB/HL 1-5	5	57,950/57,965	62,500/62,519	17,500	2,261	0,020/0,072	AL-LF	02-3585	H997/5 STD 0.25 0.50	
01/86→										
TW/A	2	65,800	81,000		2,200		AL-LF	04-3586	A129/4 STD 0.10	
TW/A	2	65,800	81,000		2,200		AL-LF	04-3587		

MERCEDES-BENZ

TW/A	2	65,800	81,000		4,200		AL-LF	04-3642	A132/4 STD
TW/A	2	65,800	81,000		4,200		AL-LF	04-3643	
SE/PB	1	24,000	27,000/27,021	27,600			BC	55-3516	55-3516 SEMI
→12/82									
SE/PB	1	21,995/22,000	24,500/24,521	21,900			BC	55-3603	55-3603 SEMI
01/83→									

57	89.00 x 80.25								
M 102.963	4 Cyl.		1996cc	87-90kW (118-122PS)			Petrol		TD2078
M 102.965	4 Cyl.		1996cc	80-85kW (109-116PS)			Petrol		TD2080
BE/PL	4	47,950/47,965	51,600/51,619	21,800	1,814	0,020/0,064	EC	71-3817	71-3817/4 STD 0.25 0.50
MB/HL 1-5	5	57,950/57,965	62,500/62,519	17,500	2,261	0,020/0,072	AL-LF	02-3585	H997/5 STD 0.25 0.50
TW/A	2	65,800	81,000		2,200		AL-LF	04-3586	A129/4 STD 0.10
TW/A	2	65,800	81,000		2,200		AL-LF	04-3587	
TW/A	2	65,800	81,000		4,200		AL-LF	04-3642	A132/4 STD
TW/A	2	65,800	81,000		4,200		AL-LF	04-3643	
SE/PB	1	21,995/22,000	24,500/24,521	21,900			BC	55-3603	55-3603 SEMI

58	89.00 x 86.60								
OM 604.910	4 Cyl.		2155cc	55-70kW (75-95PS)			Diesel		TD2227
OM 604.912	4 Cyl.		2155cc	55-70kW (75-95PS)			Diesel		TD4676
BE/PL	1	47,950/47,965	51,600/51,619	21,800	1,812	0,020/0,070	AL-LF	01-3771	01-3771 STD 0.25 0.50
MB/HL 1-5	5	57,950/57,965	62,500/62,519	17,500	2,261	0,020/0,072	AL-LF	02-3585	H997/5 STD 0.25 0.50
TW/A	2	65,800	81,000		2,200		AL-LF	04-3586	A129/4 STD 0.10
TW/A	2	65,800	81,000		2,200		AL-LF	04-3587	
SE/PB	1		30,500/30,521	21,900			BC-LF	55-3830	55-3830 SEMI [6]
SE/PB	1		28,500/28,521	21,900			BC-LF	55-3831	55-3831 SEMI [6]

55-3830

55-3831

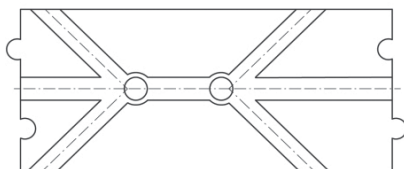
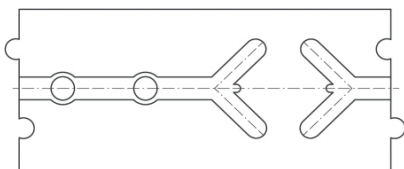

59	89.00 x 92.40								
MB OM 601	4 Cyl.		2299cc	74kW (101PS)			Diesel Turbo		TD13312
OM 601.970	4 Cyl.		2299cc	72kW (98PS)			Diesel Turbo Intercooler		TD4674
BE/PL	1	47,950/47,965	51,600/51,619	21,800	1,812	0,020/0,070	SP	71-3645	71-3645 STD 0.25 0.50 [1]
MB/HL 1-5	5	57,950/57,965	62,500/62,519	17,500	2,261	0,020/0,072	AL-LF	02-3585	H997/5 STD 0.25 0.50

TW/A	2	65,800	81,000		2,200		AL-LF	04-3586	A129/4 STD 0.10	
TW/A	2	65,800	81,000		2,200		AL-LF	04-3587		
SE/PB	1	26,995/27,000	29,500/29,521	24,000			BC	55-3588	55-3588 SEMI	
SE/PB	1	25,995/26,000	28,500/28,521	21,900			BC	55-3625	55-3625 SEMI	

60									
89.00 x 92.40									
MB-OM 661			4 Cyl.		2299cc	59kW (80PS)	Diesel		TD9356
OM 661.911			4 Cyl.		2299cc	57-58kW (77-79PS)	Diesel		TD8942
OM 661.940			4 Cyl.		2299cc	58kW (79PS)	Diesel		TD21373
BE/PL	1	47,950/47,965	51,600/51,619	21,800	1,812	0,020/0,070	AL-LF	01-3771	01-3771 STD 0.25 0.50
MB/HL 1-5	5	57,950/57,965	62,500/62,519	17,500	2,261	0,020/0,072	AL-LF	02-3585	H997/5 STD 0.25 0.50
TW/A	2	65,800	81,000		2,200		AL-LF	04-3586	A129/4 STD 0.10
TW/A	2	65,800	81,000		2,200		AL-LF	04-3587	
SE/PB	1		30,500/30,521	21,900			BC-LF	55-3830	55-3830 SEMI [6]

61									
89.00 x 92.40									
OM 601.900 Euro 2			4 Cyl.		2300cc	62kW (85PS)	Diesel		TD16185
OM 601.940			4 Cyl.		2299cc	58-60kW (79-82PS)	Diesel		TD2210
OM 601.941			4 Cyl.		2299cc	58-60kW (79-82PS)	Diesel		TD8041
OM 601.942			4 Cyl.		2299cc	58kW (79PS)	Diesel		TD5398
OM 601.943			4 Cyl.		2299cc	58-60kW (79-82PS)	Diesel		TD5400
BE/PL	1	47,950/47,965	51,600/51,619	21,800	1,812	0,020/0,070	AL-LF	01-3771	01-3771 STD 0.25 0.50
MB/HL 1-5	5	57,950/57,965	62,500/62,519	17,500	2,261	0,020/0,072	AL-LF	02-3585	H997/5 STD 0.25 0.50
TW/A	2	65,800	81,000		2,200		AL-LF	04-3586	A129/4 STD 0.10
TW/A	2	65,800	81,000		2,200		AL-LF	04-3587	
SE/PB	1	26,995/27,000	29,500/29,521	24,000			BC	55-3588	55-3588 SEMI
SE/PB	1	25,995/26,000	28,500/28,521	21,900			BC	55-3625	55-3625 SEMI

62									
89.00 x 92.40									
MB-OM 662			5 Cyl.		2874cc	72-73kW (98-99PS)	Diesel		TD9355
OM 662.911			5 Cyl.		2874cc	70kW (95PS)	Diesel		TD22700
BE/PL	1	47,950/47,965	51,600/51,619	21,800	1,812	0,020/0,070	AL-LF	01-3771	01-3771 STD 0.25 0.50
MB/HL 1-6	6	57,950/57,965	62,500/62,519	17,500	2,261	0,020/0,072	AL-LF	02-3585	H997/6 STD 0.25 0.50
TW/A	2	65,800	81,000		2,200		AL-LF	04-3586	A129/4 STD 0.10
TW/A	2	65,800	81,000		2,200		AL-LF	04-3587	
SE/PB	1		30,500/30,521	21,900			BC-LF	55-3830	55-3830 SEMI [6]

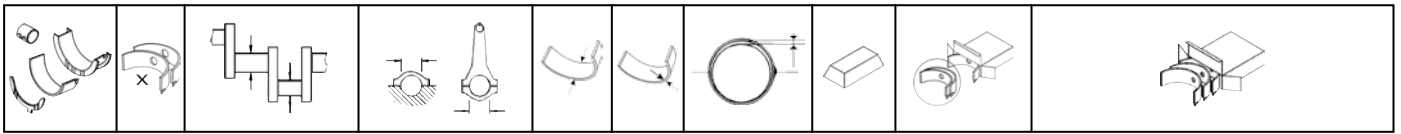

55-3625

55-3635

55-3830

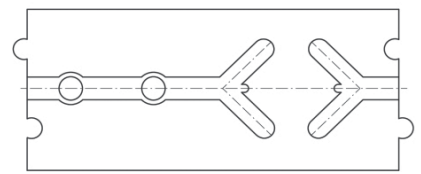
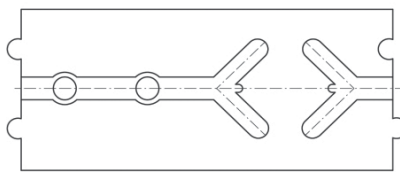
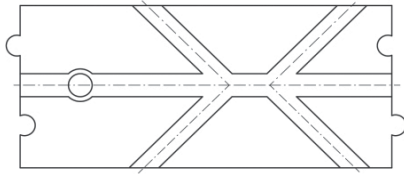

65

89.00 x 92.40

OM 662.940		5 Cyl.		2874cc	70kW (95PS)	Diesel Turbo Intercooler			TD21372	
BE/PL	1	47,950/47,965	51,600/51,619	21,800	1,812	0,020/0,070	SP	71-3645	71-3645 STD 0.25 0.50	①
MB/HL 1-6	6	57,950/57,965	62,500/62,519	17,500	2,261	0,020/0,072	AL-LF	02-3585	H997/6 STD 0.25 0.50	
TW/A	2	65,800	81,000		2,200		AL-LF	04-3586	A129/4 STD 0.10	
TW/A	2	65,800	81,000		2,200		AL-LF	04-3587		
SE/PB	1		30,500/30,521	21,900			BC-LF	55-3830	55-3830 SEMI	⑥

66

89.00 x 92.40

OM 603.970		6 Cyl.		3449cc	100kW (136PS)	Diesel Turbo			TD2224	
OM 603.971		6 Cyl.		3449cc	100-110kW (136-150PS)	Diesel Turbo			TD2225	
OM 603.972		6 Cyl.		3449cc	100kW (136PS)	Diesel Turbo			TD2226	
BE/PL	1	47,950/47,965	51,600/51,619	21,800	1,812	0,020/0,070	SP	71-3645	71-3645 STD 0.25 0.50	①
MB/HL 1-7	7	57,950/57,965	62,500/62,519	17,500	2,261	0,020/0,072	AL-LF	02-3585	H997/7 STD 0.25 0.50	
TW/A	2	65,800	81,000		2,200		AL-LF	04-3586	A129/4 STD 0.10	
TW/A	2	65,800	81,000		2,200		AL-LF	04-3587		
SE/PB	1	25,995/26,000	28,500/28,521	21,900			BC	55-3625	55-3625 SEMI	
SE/PB	1	27,995/28,000	30,500/30,525	21,900			BC	55-3635	55-3635 SEMI	
SE/PB	1		30,500/30,521	21,900			BC-LF	55-3830	55-3830 SEMI	⑥

55-3625

55-3635

55-3830

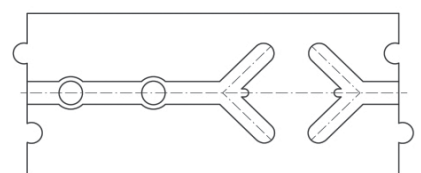
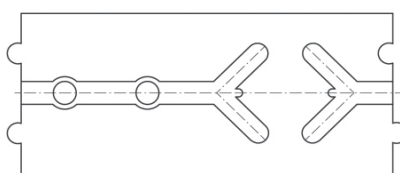
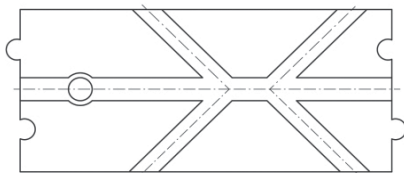

67

89.90 x 68.20

M 112.912		V6 Cyl.		2597cc	120-125kW (163-170PS)	Petrol			TD15450	
M 112.913		V6 Cyl.		2597cc	130kW (177PS)	Petrol			TD17155	
M 112.914		V6 Cyl.		2597cc	125kW (170PS)	Petrol			TD15458	
M 112.915		V6 Cyl.		2597cc	125kW (170PS)	Petrol			TD17004	
M 112.916		V6 Cyl.		2597cc	125kW (170PS)	Petrol			TD17533	
M 112.917		V6 Cyl.		2597cc	130kW (177PS)	Petrol			TD16893	
BE/PL	6	51,940/51,965	55,600/55,614	19,600	1,814	0,020/0,071	EC	71-3857	71-3857/6 STD	
MB/HL 1-4	4	63,940/63,965	68,500/68,519	19,000	2,263	0,020/0,078	AL-LF	02-3858	H069/4 STD	

MERCEDES-BENZ



68		89.90 x 73.50								
M 104.941			6 Cyl.	2799cc	142kW	(193PS)	Petrol			TD2106
M 104.942			6 Cyl.	2799cc	142-145kW	(193-197PS)	Petrol			TD2107
M 104.943			6 Cyl.	2799cc	142-150kW	(193-204PS)	Petrol			TD2108
M 104.944			6 Cyl.	2799cc	142-145kW	(193-197PS)	Petrol			TD2109
M 104.945			6 Cyl.	2799cc	142kW	(193PS)	Petrol			TD9423
BE/PL	6	47,950/47,965	51,600/51,619	21,800	1,814	0,020/0,064	EC	71-3817	71-3817/6 STD 0.25 0.50	
MB/HL 1-7	7	57,950/57,965	62,500/62,519	17,500	2,261	0,020/0,072	AL-LF	02-3585	H997/7 STD 0.25 0.50	
TW/A	2	65,800	81,000		2,200		AL-LF	04-3586	A129/4 STD 0.10	
TW/A	2	65,800	81,000		2,200		AL-LF	04-3587		
SE/PB	1	21,995/22,000	24,500/24,521	21,900			BC	55-3603	55-3603 SEMI	

69		89.90 x 73.50								
M 112.920			V6 Cyl.	2799cc	145-150kW	(197-204PS)	Petrol			TD9421
M 112.921			V6 Cyl.	2799cc	150kW	(204PS)	Petrol			TD9417
M 112.922			V6 Cyl.	2799cc	150kW	(204PS)	Petrol			TD11490
M 112.923			V6 Cyl.	2799cc	150kW	(204PS)	Petrol			TD10888
M 112.925			V6 Cyl.	2799cc	150kW	(204PS)	Petrol			TD15463
BE/PL	6	51,940/51,965	55,600/55,614	19,600	1,814	0,020/0,071	EC	71-3857	71-3857/6 STD	
MB/HL 1-4	4	63,940/63,965	68,500/68,519	19,000	2,263	0,020/0,078	AL-LF	02-3858	H069/4 STD	

70		89.90 x 78.70								
M 111.940			4 Cyl.	1998cc	100kW	(136PS)	Petrol			TD2132
M 111.941			4 Cyl.	1998cc	100kW	(136PS)	Petrol			TD2133
M 111.942			4 Cyl.	1998cc	100kW	(136PS)	Petrol			TD4660
M 111.943			4 Cyl.	1998cc	132-141kW	(180-192PS)	Petrol			TD4661
M 111.944			4 Cyl.	1998cc	132-141kW	(180-192PS)	Petrol	Compressor		TD4662
M 111.945			4 Cyl.	1998cc	100kW	(136PS)	Petrol			TD5236
M 111.946			4 Cyl.	1998cc	100kW	(136PS)	Petrol			TD4663
M 111.947			4 Cyl.	1998cc	137kW	(186PS)	Petrol	Compressor		TD9419
M 111.948			4 Cyl.	1998cc	95kW	(129PS)	Petrol			TD5399
M 111.950			4 Cyl.	1998cc	95kW	(129PS)	Petrol			TD22702
M 111.951			4 Cyl.	1998cc	95kW	(129PS)	Petrol			TD17002
M 111.952			4 Cyl.	1998cc	95kW	(129PS)	Petrol			TD17003
M 111.955			4 Cyl.	1998cc	120kW	(163PS)	Petrol	Compressor		TD14751
M 111.956			4 Cyl.	1998cc	120kW	(163PS)	Petrol	Compressor		TD16488
M 111.957			4 Cyl.	1998cc	120kW	(163PS)	Petrol			TD15456
M 111.958			4 Cyl.	1998cc	120kW	(163PS)	Petrol	Compressor		TD14749
BE/PL	4	47,950/47,965	51,600/51,619	21,800	1,814	0,020/0,064	EC	71-3817	71-3817/4 STD 0.25 0.50	
MB/HL 1-5	5	57,950/57,965	62,500/62,519	17,500	2,261	0,020/0,072	AL-LF	02-3585	H997/5 STD 0.25 0.50	
TW/A	2	65,800	81,000		2,200		AL-LF	04-3586	A129/4 STD 0.10	
TW/A	2	65,800	81,000		2,200		AL-LF	04-3587		
SE/PB	1	21,995/22,000	24,500/24,521	21,900			BC	55-3603	55-3603 SEMI	

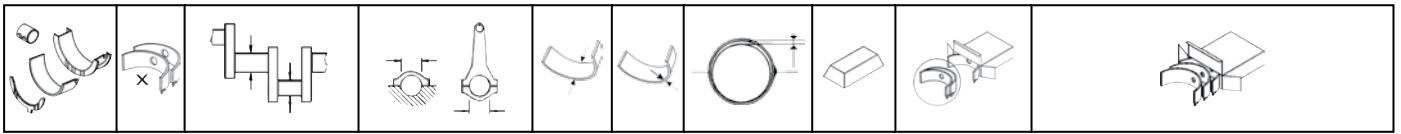

71											89.90 x 84.00		
M 104.990			6 Cyl.	3199cc	162-170kW (220-231PS)	Petrol					TD2112		
M 104.991			6 Cyl.	3199cc	170kW (231PS)	Petrol					TD2113		
M 104.992			6 Cyl.	3199cc	162kW (220PS)	Petrol					TD22988		
M 104.992			6 Cyl.	3199cc	162kW (220PS)	Petrol					TD2114		
M 104.994			6 Cyl.	3199cc	170kW (231PS)	Petrol					TD11250		
M 104.995			6 Cyl.	3199cc	162kW (220PS)	Petrol					TD4658		
M 104.995			6 Cyl.	3199cc	154-156kW (209-212PS)	Petrol					TD22990		
M 104.996			6 Cyl.	3199cc	155kW (211PS)	Petrol					TD11251		
BE/PL	6	47,950/47,965	51,600/51,619	21,800	1,814	0,020/0,064	EC	71-3817		71-3817/6 STD 0.25 0.50			
MB/HL 1-7	7	57,950/57,965	62,500/62,519	17,500	2,261	0,020/0,072	AL-LF	02-3585		H997/7 STD 0.25 0.50			
TW/A	2	65,800	81,000		2,200		AL-LF	04-3586		A129/4 STD 0.10			
TW/A	2	65,800	81,000		2,200		AL-LF	04-3587					
SE/PB	1	21,995/22,000	24,500/24,521	21,900			BC	55-3603		55-3603 SEMI			

72											89.90 x 84.00		
M 112.940			V6 Cyl.	3199cc	160-162kW (218-220PS)	Petrol					TD9407		
M 112.941			V6 Cyl.	3199cc	160-165kW (218-224PS)	Petrol					TD9418		
M 112.942			V6 Cyl.	3199cc	160kW (218PS)	Petrol					TD9898		
M 112.943			V6 Cyl.	3199cc	165kW (224PS)	Petrol					TD11494		
M 112.944			V6 Cyl.	3199cc	165kW (224PS)	Petrol					TD11491		
M 112.945			V6 Cyl.	3199cc	158kW (215PS)	Petrol					TD9888		
M 112.946			V6 Cyl.	3199cc	160kW (218PS)	Petrol					TD15452		
M 112.947			V6 Cyl.	3199cc	160kW (218PS)	Petrol					TD14773		
M 112.949			V6 Cyl.	3199cc	165kW (224PS)	Petrol					TD16894		
M 112.951			V6 Cyl.	3199cc	140-160kW (190-218PS)	Petrol					TD18435		
M 112.953			V6 Cyl.	3199cc	160kW (218PS)	Petrol					TD17535		
M 112.954			V6 Cyl.	3199cc	165kW (224PS)	Petrol					TD17331		
M 112.955			V6 Cyl.	3199cc	160kW (218PS)	Petrol					TD16885		
BE/PL	6	51,940/51,965	55,600/55,614	19,600	1,814	0,020/0,071	EC	71-3857		71-3857/6 STD			
MB/HL 1-4	4	63,940/63,965	68,500/68,519	19,000	2,263	0,020/0,078	AL-LF	02-3858		H069/4 STD			

73											89.90 x 84.00		
M 113.940			V8 Cyl.	4266cc	205kW (279PS)	Petrol					TD9889		
M 113.941			V8 Cyl.	4266cc	205kW (279PS)	Petrol					TD11492		
M 113.942			V8 Cyl.	4266cc	199kW (271PS)	Petrol					TD10949		
M 113.943			V8 Cyl.	4266cc	205kW (279PS)	Petrol					TD10947		
M 113.944			V8 Cyl.	4266cc	205-225kW (279-306PS)	Petrol					TD11489		
M 113.948			V8 Cyl.	4266cc	205kW (279PS)	Petrol					TD17188		
BE/PL	8	51,940/51,965	55,600/55,614	19,600	1,814	0,020/0,071	EC	71-3857		71-3857/8 STD			
MB/HL 1-5	5	63,940/63,965	68,500/68,519	19,000	2,263	0,020/0,078	AL-LF	02-3858		H069/5 STD			

MERCEDES-BENZ



74										89.90 x 86.60									
M 111.960										4 Cyl. 2199cc 110kW (150PS) Petrol TD2134									
M 111.961										4 Cyl. 2199cc 110kW (150PS) Petrol TD2135									
BE/PL	4	47,950/47,965	51,600/51,619	21,800	1,814	0,020/0,064	EC	71-3817	71-3817/4 STD 0.25 0.50										
MB/HL 1-5	5	57,950/57,965	62,500/62,519	17,500	2,261	0,020/0,072	AL-LF	02-3585	H997/5 STD 0.25 0.50										
TW/A	2	65,800	81,000		2,200		AL-LF	04-3586	A129/4 STD 0.10										
TW/A	2	65,800	81,000		2,200		AL-LF	04-3587											
SE/PB	1	21,995/22,000	24,500/24,521	21,900			BC	55-3603	55-3603 SEMI										

75										90.90 x 88.40									
M 111.970										4 Cyl. 2295cc 110kW (150PS) Petrol TD4664									
M 111.970										4 Cyl. 2295cc 103-110kW (140-150PS) Petrol TD22989									
M 111.973										4 Cyl. 2295cc 138-142kW (188-193PS) Petrol Compressor TD4665									
M 111.974										4 Cyl. 2295cc 110kW (150PS) Petrol TD4666									
M 111.975										4 Cyl. 2295cc 138-142kW (188-193PS) Petrol Compressor TD4667									
M 111.977										4 Cyl. 2295cc 110kW (150PS) Petrol TD10948									
M 111.978										4 Cyl. 2295cc 105kW (143PS) Petrol TD4668									
M 111.979										4 Cyl. 2295cc 105kW (143PS) Petrol TD5241									
M 111.980										4 Cyl. 2295cc 105kW (143PS) Petrol TD22703									
M 111.981										4 Cyl. 2295cc 143-145kW (194-197PS) Petrol TD17177									
M 111.982										4 Cyl. 2295cc 145kW (197PS) Petrol Compressor TD16884									
M 111.983										4 Cyl. 2295cc 143-145kW (194-197PS) Petrol Compressor TD14750									
M 111.984										4 Cyl. 2295cc 92-105kW (125-143PS) Petrol TD17850									
M 161.971										4 Cyl. 2295cc 105-110kW (143-150PS) Petrol TD23184									
M 161.974										4 Cyl. 2295cc 110kW (150PS) Petrol TD26679									
BE/PL	4	47,950/47,965	51,600/51,619	21,800	1,814	0,020/0,064	EC	71-3817	71-3817/4 STD 0.25 0.50										
MB/HL 1-5	5	57,950/57,965	62,500/62,519	17,500	2,261	0,020/0,072	AL-LF	02-3585	H997/5 STD 0.25 0.50										
TW/A	2	65,800	81,000		2,200		AL-LF	04-3586	A129/4 STD 0.10										
TW/A	2	65,800	81,000		2,200		AL-LF	04-3587											
SE/PB	1	21,995/22,000	24,500/24,521	21,900			BC	55-3603	55-3603 SEMI										

76										90.90 x 92.40									
OM 617.910										5 Cyl. 2998cc 59kW (80PS) Diesel TD2259									
BE/PL	5	51,955/51,965	55,600/55,619	26,000	1,805	0,025/0,079	AL-LF	01-3040	01-3040/5 STD 0.25 0.50 0.75										
MB/HL 1,2, 4-6	5	69,955/69,965	74,500/74,519	27,000	2,255	0,025/0,079	AL-LF	02-1460	H914/6 STD 0.25										
MB/HL 3	1	69,955/69,965	74,500/74,519	33,900	2,255	0,025/0,079	AL-LF	02-2774H											
				02-2774H	STD	34,000/1.3386" - 34,025/1.3396"													
SE/PB	1	26,000	29,000/29,021	31,800			BC	55-2532	55-2532 SEMI										
BU	1	30,000	36,000/36,025	18,000	3,000		BC	57-3049	57-3049 STD										

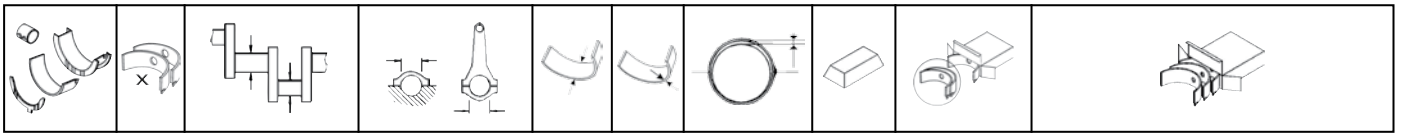

77 90.90 x 92.40

OM 617.912 5 Cyl. **2998cc** **59-65kW** (80-88PS) **Diesel** **TD2260**

OM 617.932 5 Cyl. **2998cc** **65kW** (88PS) **Diesel** **TD17743**

BE/PL	5	51,955/51,965	55,600/55,619	26,000	1,805	0,025/0,079	AL-LF	01-3040	01-3040/5 STD 0.25 0.50 0.75
MB/HL 1,2, 4-6	5	69,955/69,965	74,500/74,519	27,000	2,255	0,025/0,079	AL-LF	02-1460	H914/6 STD 0.25
MB/HL 3	1	69,955/69,965	74,500/74,519	33,900	2,255	0,025/0,079	AL-LF	02-2774H	

→12/78

	02-2774H	STD	34,000/1.3386" - 34,025/1.3396"						
---	-----------------	-----	---------------------------------	--	--	--	--	--	--

MB/HL 1,2, 4-6	5	69,955/69,965	74,500/74,519	27,000	2,255	0,025/0,079	AL-LF	02-1460	H951/6 STD
MB/HL 3	1	69,955/69,965	74,500/74,519	27,000	2,255	0,025/0,079	AL-LF	02-3435	

01/79→

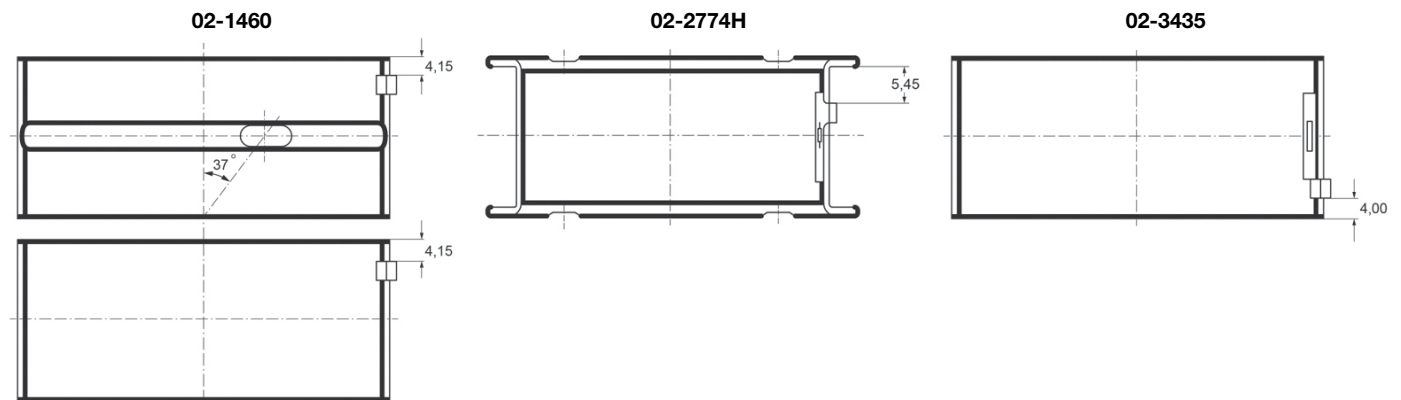

TW/A	2	78,025	91,500		2,200		AL-LF	04-3436	A113/4 STD 0.10
TW/A	2	78,025	91,500		2,200		AL-LF	04-3437	

01/79→

SE/PB	1	26,000	29,000/29,021	31,800			BC	55-2532	55-2532 SEMI
BU	1	30,000	36,000/36,025	18,000	3,000		BC	57-3049	57-3049 STD

78 90.90 x 92.40

OM 617.913 5 Cyl. **2998cc** **65kW** (88PS) **Diesel** **TD2261**

OM 617.931 5 Cyl. **2998cc** **65kW** (88PS) **Diesel** **TD2262**

OM 617.933 5 Cyl. **2998cc** **65kW** (88PS) **Diesel** **TD26550**

BE/PL	5	51,955/51,965	55,600/55,619	26,000	1,805	0,025/0,079	AL-LF	01-3040	01-3040/5 STD 0.25 0.50 0.75
MB/HL 1,2, 4-6	5	69,955/69,965	74,500/74,519	27,000	2,255	0,025/0,079	AL-LF	02-1460	H951/6 STD
MB/HL 3	1	69,955/69,965	74,500/74,519	27,000	2,255	0,025/0,079	AL-LF	02-3435	
TW/A	2	78,025	91,500		2,200		AL-LF	04-3436	A113/4 STD 0.10
TW/A	2	78,025	91,500		2,200		AL-LF	04-3437	
SE/PB	1	26,000	29,000/29,021	31,800			BC	55-2532	55-2532 SEMI

MERCEDES-BENZ

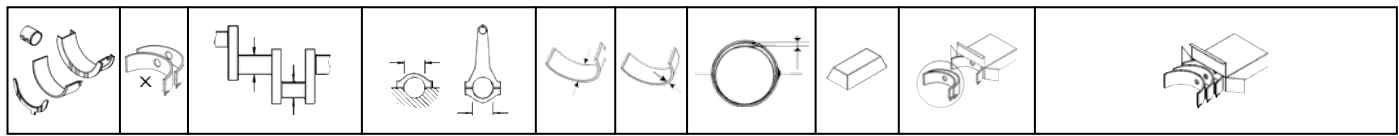

BU	1	30,000	36,000/36,025	18,000	3,000		BC	57-3049	57-3049 STD
----	---	--------	---------------	--------	-------	--	----	---------	-----------------------

79 90.90 x 92.40

OM 617.950			5 Cyl.	2998cc	85-92kW (116-125PS)	Diesel Turbo			TD2263
OM 617.951			5 Cyl.	2998cc	92kW (125PS)	Diesel Turbo			TD2264
OM 617.952			5 Cyl.	2998cc	92kW (125PS)	Diesel Turbo			TD2265
BE/PL	5	51,955/51,965	55,600/55,619	26,000	1,805	0,025/0,079	EC	71-3227	71-3227/5 STD
MB/HL 1,2, 4-6	5	69,955/69,965	74,500/74,519	27,000	2,255	0,025/0,079	AL-LF	02-1460	H951/6 STD
MB/HL 3	1	69,955/69,965	74,500/74,519	27,000	2,255	0,025/0,079	AL-LF	02-3435	
TW/A	2	78,025	91,500		2,200		AL-LF	04-3436	A113/4 STD 0.10
TW/A	2	78,025	91,500		2,200		AL-LF	04-3437	
SE/PB	1	28,000	31,000/31,025	27,900			BC	55-3523	55-3523 SEMI
BU	1	30,000	36,000/36,025	18,000	3,000		BC	57-3049	57-3049 STD

80 91.00 x 92.40

OM 616.910			4 Cyl.	2400cc	48-53kW (65-72PS)	Diesel			TD2245
OM 616.911			4 Cyl.	2404cc	38kW (52PS)	Diesel			TD5675
OM 616.912			4 Cyl.	2399cc	46-53kW (63-72PS)	Diesel			TD9432
OM 616.917			4 Cyl.	2404cc	48kW (65PS)	Diesel			TD2249
OM 616.932			4 Cyl.	2404cc	44kW (60PS)	Diesel			TD6015
OM 616.933			4 Cyl.	2404cc	44kW (60PS)	Diesel			TD16998
OM 616.934			4 Cyl.	2399cc	48kW (65PS)	Diesel			TD2250
OM 616.937			4 Cyl.	2399cc	48-53kW (65-72PS)	Diesel			TD2252
OM 616.938			4 Cyl.	2399cc	53kW (72PS)	Diesel			TD17733
OM 616.940			4 Cyl.	2399cc	53kW (72PS)	Diesel			TD22836
OM 616.944			4 Cyl.	2404cc	44kW (60PS)	Diesel			TD16937
OM 616.960			4 Cyl.	2399cc	53kW (72PS)	Diesel			TD2255
OM 616.961			4 Cyl.	2399cc	53kW (72PS)	Diesel			TD2256

BE/PL	4	51,955/51,965	55,600/55,619	26,000	1,805	0,025/0,079	AL-LF	01-3040	01-3040/4 STD 0.25 0.50 0.75 1.00
MB/HL 1,2,4,5	4	69,955/69,965	74,500/74,519	27,000	2,255	0,025/0,079	AL-LF	02-1460	H914/5 STD 0.25 0.50 0.75 1.00
MB/HL 3	1	69,955/69,965	74,500/74,519	33,900	2,255	0,025/0,079	AL-LF	02-2774H	

→12/78

	02-2774H	STD	34,000/1.3386" - 34,025/1.3396"	
---	-----------------	-----	---------------------------------	--

MB/HL 1,2,4,5	4	69,955/69,965	74,500/74,519	27,000	2,255	0,025/0,079	AL-LF	02-1460	H951/5 STD 0.25 0.50
MB/HL 3	1	69,955/69,965	74,500/74,519	27,000	2,255	0,025/0,079	AL-LF	02-3435	

01/79→

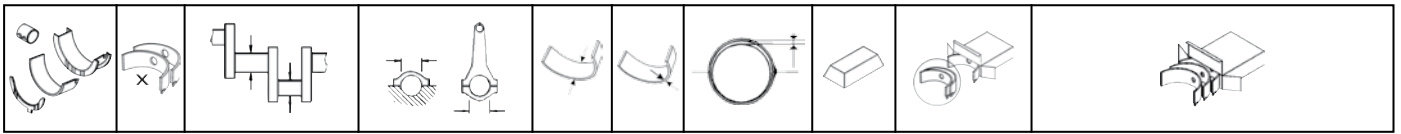

02-1460

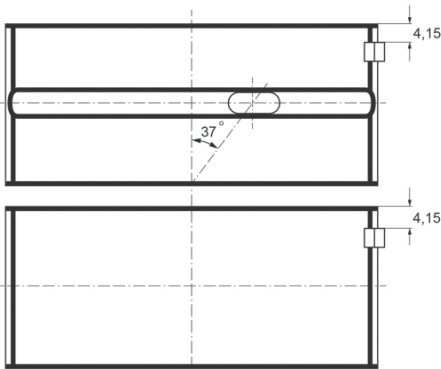

02-2774H

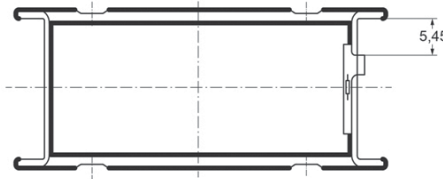

02-3435

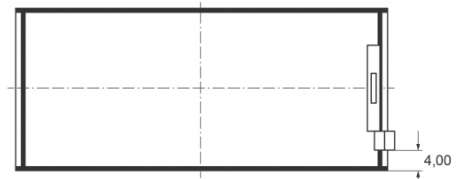

TW/A	2	78,025	91,500		2,200		AL-LF	04-3436	A113/4 STD 0.10
TW/A	2	78,025	91,500		2,200		AL-LF	04-3437	

01/79 →

SE/PB	1	26,000	29,000/29,021	31,800			BC	55-2532	55-2532 SEMI
BU	1	30,000	36,000/36,025	18,000	3,000		BC	57-3049	57-3049 STD

81

91.00 x 92.40

OM 616.913		4 Cyl.		2398cc	53kW (72PS)		Diesel		TD2247
OM 616.914		4 Cyl.		2399cc	53kW (72PS)		Diesel		TD8040
OM 616.936		4 Cyl.		2399cc	53kW (72PS)		Diesel		TD2251
OM 616.939		4 Cyl.		2399cc	53kW (72PS)		Diesel		TD2253
OM 616.942		4 Cyl.		2399cc	38kW (52PS)		Diesel		TD7991
OM 616.943		4 Cyl.		2399cc	44kW (60PS)		Diesel		TD7992
OM 616.963		4 Cyl.		2399cc	53-56kW (72-76PS)		Diesel		TD2257
BE/PL	4	51,955/51,965	55,600/55,619	26,000	1,805	0,025/0,079	AL-LF	01-3040	01-3040/4 STD 0.25 0.50 0.75 1.00
MB/HL 1,2,4,5	4	69,955/69,965	74,500/74,519	27,000	2,255	0,025/0,079	AL-LF	02-1460	H951/5 STD 0.25 0.50
MB/HL 3	1	69,955/69,965	74,500/74,519	27,000	2,255	0,025/0,079	AL-LF	02-3435	
TW/A	2	78,025	91,500		2,200		AL-LF	04-3436	A113/4 STD 0.10
TW/A	2	78,025	91,500		2,200		AL-LF	04-3437	
SE/PB	1	26,000	29,000/29,021	31,800			BC	55-2532	55-2532 SEMI
BU	1	30,000	36,000/36,025	18,000	3,000		BC	57-3049	57-3049 STD

82

91.00 x 92.40

OM 616.916		4 Cyl.		2404cc	48kW (65PS)		Diesel		TD2248
BE/PL	4	51,955/51,965	55,600/55,619	26,000	1,805	0,025/0,079	AL-LF	01-3040	01-3040/4 STD 0.25 0.50 0.75 1.00
MB/HL 1,2,4,5	4	69,955/69,965	74,500/74,519	27,000	2,255	0,025/0,079	AL-LF	02-1460	H914/5 STD 0.25 0.50 0.75 1.00
MB/HL 3	1	69,955/69,965	74,500/74,519	33,900	2,255	0,025/0,079	AL-LF	02-2774H	



02-2774H STD 34,000/1.3386" - 34,025/1.3396"

MERCEDES-BENZ

SE/PB	1	26,000	29,000/29,021	31,800			BC	55-2532	55-2532 SEMI
BU	1	30,000	36,000/36,025	18,000	3,000		BC	57-3049	57-3049 STD

83																		
92.00 x 65.80																		
M 116.980			V8 Cyl.	3500cc	147kW (200PS)			Petrol	TD2164									
M 116.981			V8 Cyl.	3500cc	147kW (200PS)			Petrol	TD2165									
M 116.982			V8 Cyl.	3499cc	143-147kW (194-200PS)			Petrol	TD2166									
M 116.983			V8 Cyl.	3499cc	147kW (200PS)			Petrol	TD2167									
M 116.984			V8 Cyl.	3499cc	143-147kW (194-200PS)			Petrol	TD2168									
M 116.985			V8 Cyl.	3499cc	143-152kW (195-205PS)			Petrol	TD2169									
BE/PL	8	51,945/51,965	55,600/55,619	22,000	1,810	0,020/0,079	EC	71-3476	71-3476/8 STD									
MB/HL	4	63,955/63,965	68,500/68,519	21,000	2,254	0,027/0,081	EC	72-2787	H801/5 STD									
MB/HL	1	63,955/63,965	68,500/68,519	26,900	2,254	0,027/0,081	EC	72-2788H										
<table border="1"> <tr> <td>72-2788H</td> <td>STD</td> <td>27,000/1.0630" - 27,021/1.0638"</td> </tr> <tr> <td></td> <td>0.25mm</td> <td>27,200/1.0709" - 27,221/1.0717"</td> </tr> <tr> <td></td> <td>0.50mm</td> <td>27,200/1.0709" - 27,221/1.0717"</td> </tr> </table>										72-2788H	STD	27,000/1.0630" - 27,021/1.0638"		0.25mm	27,200/1.0709" - 27,221/1.0717"		0.50mm	27,200/1.0709" - 27,221/1.0717"
72-2788H	STD	27,000/1.0630" - 27,021/1.0638"																
	0.25mm	27,200/1.0709" - 27,221/1.0717"																
	0.50mm	27,200/1.0709" - 27,221/1.0717"																
SE/PB	1	23,000	26,000	27,600			BC	55-3525	55-3525 SEMI									

84																		
92.00 x 65.80																		
M 116.990			V8 Cyl.	3499cc	132kW (180PS)			Petrol	TD22706									
M 116.991			V8 Cyl.	3499cc	147kW (200PS)			Petrol	TD22707									
M 116.992			V8 Cyl.	3499cc	132kW (180PS)			Petrol	TD22708									
M 116.993			V8 Cyl.	3499cc	132kW (180PS)			Petrol	TD22709									
BE/PL	8	51,945/51,965	55,600/55,619	22,000	1,810	0,020/0,079	EC	71-3476	71-3476/8 STD									
→12/80																		
BE/PL	8	47,945/47,965	51,600/51,619	22,000	1,810	0,020/0,079	EC	71-3477	71-3477/8 STD									
01/81→																		
MB/HL	4	63,955/63,965	68,500/68,519	21,000	2,254	0,027/0,081	EC	72-2787	H801/5 STD									
MB/HL	1	63,955/63,965	68,500/68,519	26,900	2,254	0,027/0,081	EC	72-2788H										
<table border="1"> <tr> <td>72-2788H</td> <td>STD</td> <td>27,000/1.0630" - 27,021/1.0638"</td> </tr> <tr> <td></td> <td>0.25mm</td> <td>27,200/1.0709" - 27,221/1.0717"</td> </tr> <tr> <td></td> <td>0.50mm</td> <td>27,200/1.0709" - 27,221/1.0717"</td> </tr> </table>										72-2788H	STD	27,000/1.0630" - 27,021/1.0638"		0.25mm	27,200/1.0709" - 27,221/1.0717"		0.50mm	27,200/1.0709" - 27,221/1.0717"
72-2788H	STD	27,000/1.0630" - 27,021/1.0638"																
	0.25mm	27,200/1.0709" - 27,221/1.0717"																
	0.50mm	27,200/1.0709" - 27,221/1.0717"																
SE/PB	1	23,000	26,000	27,600			BC	55-3525	55-3525 SEMI									

85									
92.00 x 71.80									
M 116.960			V8 Cyl.	3818cc	160kW (218PS)			Petrol	TD2158
BE/PL	8	51,945/51,965	55,600/55,619	22,000	1,810	0,020/0,079	EC	71-3476	71-3476/8 STD
→12/80									
BE/PL	8	47,945/47,965	51,600/51,619	22,000	1,810	0,020/0,079	EC	71-3477	71-3477/8 STD
01/81→									

MB/HL	4	63,955/63,965	68,500/68,519	21,000	2,254	0,027/0,081	EC	72-2787	H801/5 STD	
MB/HL	1	63,955/63,965	68,500/68,519	26,900	2,254	0,027/0,081	EC	72-2788H		
			72-2788H	STD	27,000/1.0630" - 27,021/1.0638"					
				0.25mm	27,200/1.0709" - 27,221/1.0717"					
				0.50mm	27,200/1.0709" - 27,221/1.0717"					
SE/PB	1	23,000	26,000	27,600			BC	55-3525	55-3525 SEMI	

86		92.00 x 78.90									
M 116.964			V8 Cyl.	4196cc	150-160kW (204-218PS)		Petrol				TD2162
M 116.965			V8 Cyl.	4196cc	150-170kW (204-231PS)		Petrol				TD2163
BE/PL	8	47,945/47,965	51,600/51,619	22,000	1,810	0,020/0,079	EC	71-3477	71-3477/8 STD		
MB/HL	4	63,955/63,965	68,500/68,519	21,000	2,254	0,027/0,081	EC	72-2787	H801/5 STD		
MB/HL	1	63,955/63,965	68,500/68,519	26,900	2,254	0,027/0,081	EC	72-2788H			
			72-2788H	STD	27,000/1.0630" - 27,021/1.0638"						
				0.25mm	27,200/1.0709" - 27,221/1.0717"						
				0.50mm	27,200/1.0709" - 27,221/1.0717"						
SE/PB	1	23,000	26,000	27,600			BC	55-3525	55-3525 SEMI		

87		92.00 x 78.90									
M 119.981			V8 Cyl.	4196cc	205kW (279PS)		Petrol				TD19046
BE/PL	8	47,950/47,965	51,600/51,619	21,800	1,814	0,020/0,064	EC	71-3817	71-3817/8 STD 0.50		

88		92.00 x 85.00									
M 117.981			V8 Cyl.	4520cc	143kW (195PS)		Petrol				TD2180
M 117.992			V8 Cyl.	4520cc	140kW (190PS)		Petrol				TD22710
M 117.993			V8 Cyl.	4520cc	140kW (190PS)		Petrol				TD22711
BE/PL	8	51,945/51,965	55,600/55,619	22,000	1,810	0,020/0,079	EC	71-3476	71-3476/8 STD		
		→12/80									
BE/PL	8	47,945/47,965	51,600/51,619	22,000	1,810	0,020/0,079	EC	71-3477	71-3477/8 STD		
		01/81→									
MB/HL	4	63,955/63,965	68,500/68,519	21,000	2,254	0,027/0,081	EC	72-2787	H801/5 STD		
MB/HL	1	63,955/63,965	68,500/68,519	26,900	2,254	0,027/0,081	EC	72-2788H			
			72-2788H	STD	27,000/1.0630" - 27,021/1.0638"						
				0.25mm	27,200/1.0709" - 27,221/1.0717"						
				0.50mm	27,200/1.0709" - 27,221/1.0717"						
SE/PB	1	23,000	26,000	27,600			BC	55-3525	55-3525 SEMI		

89		92.00 x 85.00									
M 117.982			V8 Cyl.	4520cc	160-165kW (218-225PS)		Petrol				TD4671
M 117.983			V8 Cyl.	4520cc	143-165kW (194-224PS)		Petrol				TD2182
M 117.984			V8 Cyl.	4520cc	142-144kW (193-196PS)		Petrol				TD2183
M 117.985			V8 Cyl.	4520cc	160-165kW (218-225PS)		Petrol				TD5051
M 117.986			V8 Cyl.	4520cc	160-165kW (218-224PS)		Petrol				TD2185

MERCEDES-BENZ

BE/PL	8	51,945/51,965	55,600/55,619	22,000	1,810	0,020/0,079	EC	71-3476	71-3476/8 STD
MB/HL	4	63,955/63,965	68,500/68,519	21,000	2,254	0,027/0,081	EC	72-2787	H801/5 STD
MB/HL	1	63,955/63,965	68,500/68,519	26,900	2,254	0,027/0,081	EC	72-2788H	
			72-2788H	STD	27,000/1.0630" - 27,021/1.0638"				
				0.25mm	27,200/1.0709" - 27,221/1.0717"				
				0.50mm	27,200/1.0709" - 27,221/1.0717"				
SE/PB	1	23,000	26,000	27,600			BC	55-3525	55-3525 SEMI

90 92.00 x 92.40

OM 616.915	4 Cyl.	2448cc	38kW (52PS)	Diesel	TD6014
OM 616.930	4 Cyl.	2448cc	44kW (60PS)	Diesel	TD5677
OM 616.931	4 Cyl.	2448cc	44kW (60PS)	Diesel	TD5676

BE/PL	4	51,955/51,965	55,600/55,619	26,000	1,805	0,025/0,079	AL-LF	01-3040	01-3040/4 STD 0.25 0.50 0.75 1.00
MB/HL 1,2,4,5	4	69,955/69,965	74,500/74,519	27,000	2,255	0,025/0,079	AL-LF	02-1460	H914/5 STD 0.25 0.50 0.75 1.00
MB/HL 3	1	69,955/69,965	74,500/74,519	33,900	2,255	0,025/0,079	AL-LF	02-2774H	

→12/78

	02-2774H	STD	34,000/1.3386" - 34,025/1.3396"	
--	-----------------	-----	---------------------------------	--

MB/HL 1,2,4,5	4	69,955/69,965	74,500/74,519	27,000	2,255	0,025/0,079	AL-LF	02-1460	H951/5 STD 0.25 0.50
MB/HL 3	1	69,955/69,965	74,500/74,519	27,000	2,255	0,025/0,079	AL-LF	02-3435	

01/79→

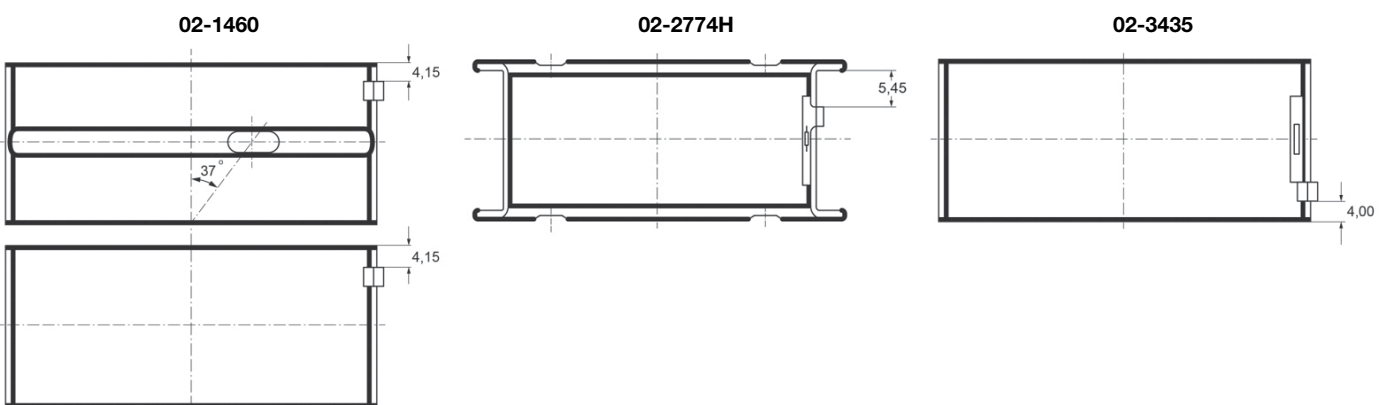

TW/A	2	78,025	91,500		2,200		AL-LF	04-3436	A113/4 STD 0.10
TW/A	2	78,025	91,500		2,200		AL-LF	04-3437	

01/79→

SE/PB	1	26,000	29,000/29,021	31,800			BC	55-2532	55-2532 SEMI
BU	1	30,000	36,000/36,025	18,000	3,000		BC	57-3049	57-3049 STD

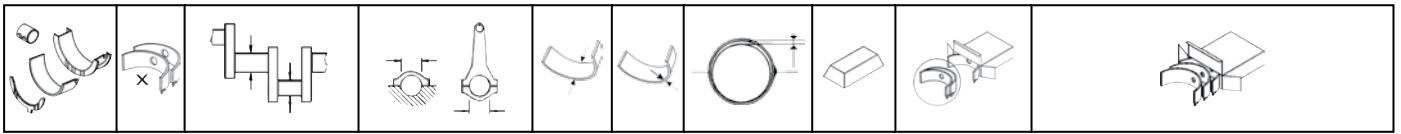

91 92.90 x 86.00

M 272.960	V6 Cyl.	3498cc	200kW (272PS)	Petrol	TD18417
M 272.961	V6 Cyl.	3498cc	200kW (272PS)	Petrol	TD22144
M 272.962	V6 Cyl.	3498cc	200kW (272PS)	Petrol	TD18195
M 272.963	V6 Cyl.	3498cc	200kW (272PS)	Petrol	TD18434
M 272.964	V6 Cyl.	3498cc	200kW (272PS)	Petrol	TD18429
M 272.965	V6 Cyl.	3498cc	200kW (272PS)	Petrol	TD19146
M 272.966	V6 Cyl.	3498cc	200kW (272PS)	Petrol	TD20926
M 272.967	V6 Cyl.	3498cc	200kW (272PS)	Petrol	TD19148
M 272.968	V6 Cyl.	3498cc	232kW (316PS)	Petrol	TD20861
M 272.969	V6 Cyl.	3498cc	224kW (305PS)	Petrol	TD21028
M 272.970	V6 Cyl.	3498cc	200kW (272PS)	Petrol	TD18418
M 272.971	V6 Cyl.	3498cc	200kW (272PS)	Petrol	TD22145
M 272.972	V6 Cyl.	3498cc	200-205kW (272-279PS)	Petrol	TD19145
M 272.974	V6 Cyl.	3498cc	200-205kW (272-279PS)	Petrol	TD24808
M 272.975	V6 Cyl.	3498cc	200kW (272PS)	Petrol	TD23759
M 272.977	V6 Cyl.	3498cc	200kW (272PS)	Petrol	TD23775
M 272.978	V6 Cyl.	3498cc	190kW (258PS)	Petrol	TD20983
M 272.979	V6 Cyl.	3498cc	190kW (258PS)	Petrol	TD23619
M 272.980	V6 Cyl.	3498cc	200kW (272PS)	Petrol	TD25144
M 272.982	V6 Cyl.	3498cc	215kW (292PS)	Petrol	TD23777
M 272.983	V6 Cyl.	3498cc	215kW (292PS)	Petrol	TD23778
M 272.984	V6 Cyl.	3498cc	215kW (292PS)	Petrol	TD23726
M 272.985	V6 Cyl.	3498cc	215kW (292PS)	Petrol	TD19889
M 272.988	V6 Cyl.	3498cc	200-215kW (272-292PS)	Petrol	TD25593
M 272.991	V6 Cyl.	3498cc	200kW (272PS)	Petrol	TD25531
M 276.950	V6 Cyl.	3498cc	225kW (306PS)	Petrol	TD26370
M 276.952	V6 Cyl.	3498cc	185-225kW (252-306PS)	Petrol	TD26060
M 276.955	V6 Cyl.	3498cc	185-225kW (252-306PS)	Petrol	TD26601
M 276.956	V6 Cyl.	3498cc	225kW (306PS)	Petrol	TD26081
M 276.957	V6 Cyl.	3498cc	185-225kW (252-306PS)	Petrol	TD25532
M 276.958	V6 Cyl.	3498cc	225kW (306PS)	Petrol	TD26365

BE/PL	6	51,945/51,965	55,600/55,614	19,600	1,813	0,020/0,067	EC	71-4007	71-4007/6 STD
MB/HL	3	63,945/63,965	68,500/68,519	20,600	2,267	0,020/0,064	AL-LF	02-4008	H1003/4 STD
MB/HL	1	63,945/63,965	68,500/68,519	24,000	2,267	0,020/0,064	AL-LF	02-4009	
TW/A	2	72,250	84,000		1,900		AL-LF	04-4010	A164/4 STD
TW/A	2	72,250	84,000		1,900		AL-LF	04-4011	
SE/PB	1	22,000	24,500/24,521	19,900			BC	55-4012	55-4012 SEMI

92 92.90 x 86.00

M 273.922	V8 Cyl.	4663cc	250kW (340PS)	Petrol	TD22146
M 273.923	V8 Cyl.	4663cc	250kW (340PS)	Petrol	TD19210
M 273.924	V8 Cyl.	4663cc	250kW (340PS)	Petrol	TD23760

BE/PL	8	51,945/51,965	55,600/55,614	19,600	1,813	0,020/0,067	EC	71-4007	71-4007/8 STD
MB/HL	4	63,945/63,965	68,500/68,519	20,600	2,267	0,020/0,064	AL-LF	02-4008	H1003/5 STD
MB/HL	1	63,945/63,965	68,500/68,519	24,000	2,267	0,020/0,064	AL-LF	02-4009	

MERCEDES-BENZ

TW/A	2	72,250	84,000		1,900		AL-LF	04-4010	A164/4 STD
TW/A	2	72,250	84,000		1,900		AL-LF	04-4011	
SE/PB	1	22,000	24,500/24,521	19,900			BC	55-4012	55-4012 SEMI

93

93.75 x 83.60

M 115.951			4 Cyl.	2307cc	81kW (110PS)		Petrol		TD2149
M 115.952			4 Cyl.	2307cc	66kW (90PS)		Petrol		TD2150
M 115.954			4 Cyl.	2307cc	80kW (109PS)		Petrol		TD2151
M 115.955			4 Cyl.	2307cc	62-63kW (84-86PS)		Petrol		TD2152
M 115.970			4 Cyl.	2307cc	66kW (90PS)		Petrol		TD2153
M 115.971			4 Cyl.	2307cc	66kW (90PS)		Petrol		TD17786
M 115.972			4 Cyl.	2307cc	62-63kW (84-86PS)		Petrol		TD2154
M 115.973			4 Cyl.	2307cc	66-75kW (90-102PS)		Petrol		TD2155
M 115.974			4 Cyl.	2307cc	66kW (90PS)		Petrol		TD17727

BE/PL	4	51,955/51,965	55,600/55,619	26,000	1,805	0,025/0,079	EC	71-2773	71-2773/4 0.25 0.50 0.75
MB/HL 1,2,4,5	4	69,955/69,965	74,500/74,519	27,000	2,255	0,025/0,079	EC	72-1460	H796/5 STD 0.25 0.50 0.75
MB/HL 3	1	69,955/69,965	74,500/74,519	33,900	2,255	0,025/0,079	EC	72-2774H	



72-2774H	STD	34,000/1.3386" - 34,025/1.3396"
	0.25mm	34,200/1.3465" - 34,225/1.3474"
	0.50mm	34,200/1.3465" - 34,225/1.3474"

MB/HL 1,2,4,5	4	69,955/69,965	74,500/74,519	27,000	2,255	0,025/0,079	AL-LF	02-1460	H914/5 STD 0.25 0.50 0.75 1.00
MB/HL 3	1	69,955/69,965	74,500/74,519	33,900	2,255	0,025/0,079	AL-LF	02-2774H	



02-2774H	STD	34,000/1.3386" - 34,025/1.3396"
-----------------	-----	---------------------------------

72-1460

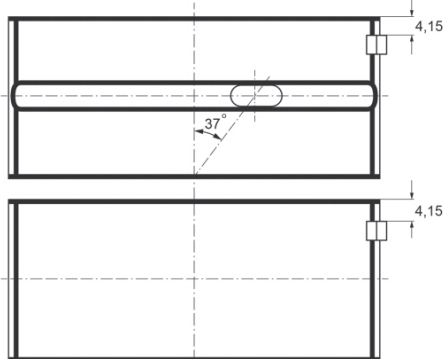

72-2774H

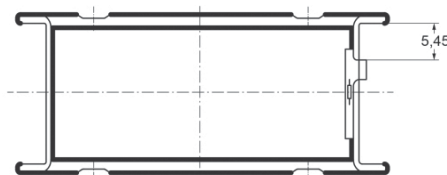

02-1460

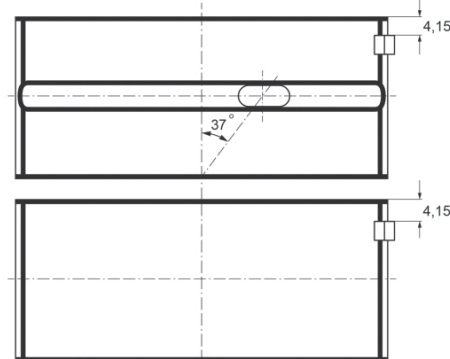

02-2774H

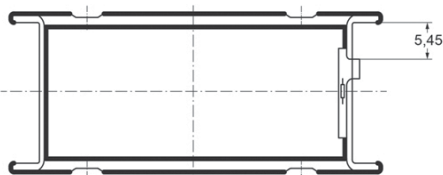

SE/PB	1	26,000	29,000/29,021	31,800			BC	55-2532	55-2532 SEMI
-------	---	--------	---------------	--------	--	--	----	---------	------------------------

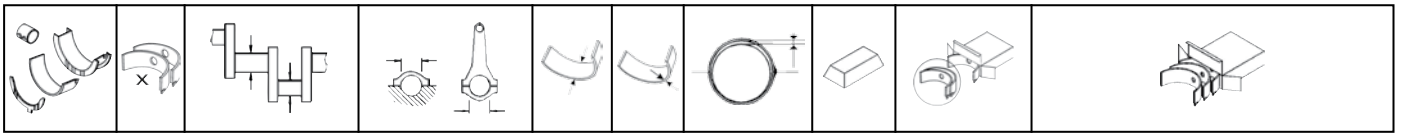

94		95.50 x 80.30								
M 102.942		4 Cyl.	2298cc	70kW (95PS)		Petrol				TD2070
M 102.943		4 Cyl.	2299cc	70kW (95PS)		Petrol				TD2071
M 102.945		4 Cyl.	2298cc	77kW (105PS)		Petrol				TD2072
M 102.946		4 Cyl.	2298cc	70-77kW (95-105PS)		Petrol				TD5397
M 102.958		4 Cyl.	2299cc	79kW (107PS)		Petrol				TD17756
M 102.959		4 Cyl.	2299cc	70kW (95PS)		Petrol				TD17795
M 102.981		4 Cyl.	2299cc	92kW (125PS)		Petrol				TD2083
M 102.985		4 Cyl.	2298cc	97-100kW (132-136PS)		Petrol				TD4657
M 102.987		4 Cyl.	2299cc	90-92kW (122-125PS)		Petrol				TD2089
M 102.989		4 Cyl.	2298cc	93kW (126PS)		Petrol				TD2091
M 102.998		4 Cyl.	2299cc	92kW (125PS)		Petrol				TD17725

BE/PL	4	47,955/47,965	51,600/51,619	22,000	1,814	0,020/0,062	EC	71-2995	71-2995/4 STD 0.25 0.50
-------	---	---------------	---------------	--------	-------	-------------	----	---------	-----------------------------------

→12/83

BE/PL	4	47,950/47,965	51,600/51,619	21,800	1,814	0,020/0,064	EC	71-3817	71-3817/4 STD 0.25 0.50
-------	---	---------------	---------------	--------	-------	-------------	----	---------	-----------------------------------

01/84→

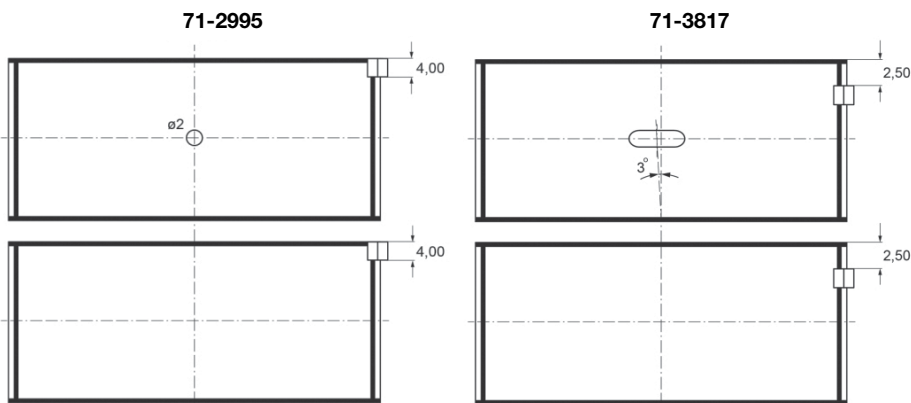

MB/HL 1-5	5	57,950/57,965	62,500/62,519	21,400	2,261	0,020/0,072	AL-LF	02-3513	H977/5 STD 0.25 0.50 0.75
--------------	---	---------------	---------------	--------	-------	-------------	-------	---------	-------------------------------------

→12/85

MB/HL 1-5	5	57,950/57,965	62,500/62,519	17,500	2,261	0,020/0,072	AL-LF	02-3585	H997/5 STD 0.25 0.50
--------------	---	---------------	---------------	--------	-------	-------------	-------	---------	--------------------------------

01/86→

TW/A	2	65,800	81,000		2,200		AL-LF	04-3586	A129/4 STD 0.10
TW/A	2	65,800	81,000		2,200		AL-LF	04-3587	
TW/A	2	65,800	81,000		4,200		AL-LF	04-3642	A132/4 STD
TW/A	2	65,800	81,000		4,200		AL-LF	04-3643	
SE/PB	1	24,000	27,000/27,021	27,600			BC	55-3516	55-3516 SEMI

→12/82

SE/PB	1	21,995/22,000	24,500/24,521	21,900			BC	55-3603	55-3603 SEMI
-------	---	---------------	---------------	--------	--	--	----	---------	------------------------

01/83→

MERCEDES-BENZ

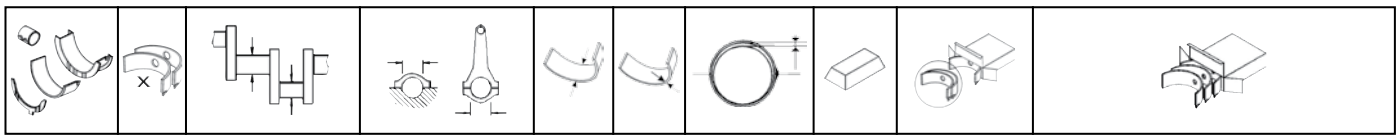

95		95.50 x 80.30							
M 102.979		4 Cyl.	2299cc	90kW (122PS)			Petrol		TD2081
M 102.996		4 Cyl.	2298cc	92kW (125PS)			Petrol		TD11249
M 102.997		4 Cyl.	2299cc	92kW (125PS)			Petrol		TD17724
BE/PL	4	47,950/47,965	51,600/51,619	21,800	1,814	0,020/0,064	EC	71-3817	71-3817/4 STD 0.25 0.50
MB/HL 1-5	5	57,950/57,965	62,500/62,519	17,500	2,261	0,020/0,072	AL-LF	02-3585	H997/5 STD 0.25 0.50
TW/A	2	65,800	81,000		2,200		AL-LF	04-3586	A129/4 STD 0.10
TW/A	2	65,800	81,000		2,200		AL-LF	04-3587	
TW/A	2	65,800	81,000		4,200		AL-LF	04-3642	A132/4 STD
TW/A	2	65,800	81,000		4,200		AL-LF	04-3643	
SE/PB	1	21,995/22,000	24,500/24,521	21,900			BC	55-3603	55-3603 SEMI

96		95.50 x 80.30							
M 102.980		4 Cyl.	2299cc	100kW (136PS)			Petrol		TD2082
BE/PL	4	47,955/47,965	51,600/51,619	22,000	1,814	0,020/0,062	EC	71-2995	71-2995/4 STD 0.25 0.50
→12/83									
BE/PL	4	47,950/47,965	51,600/51,619	21,800	1,814	0,020/0,064	EC	71-3817	71-3817/4 STD 0.25 0.50
01/84→									

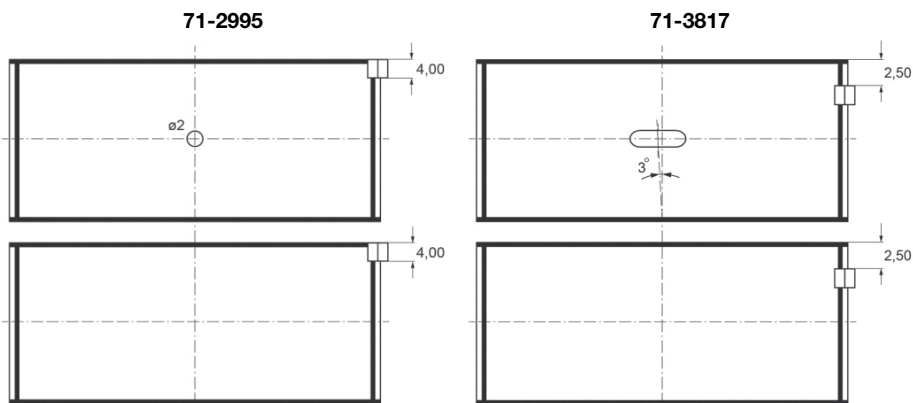

MB/HL 1-5	5	57,950/57,965	62,500/62,519	21,400	2,261	0,020/0,072	AL-LF	02-3513	H977/5 STD 0.25 0.50 0.75
TW/A	2	65,800	81,000		2,200		AL-LF	04-3586	A129/4 STD 0.10
TW/A	2	65,800	81,000		2,200		AL-LF	04-3587	
TW/A	2	65,800	81,000		4,200		AL-LF	04-3642	A132/4 STD
TW/A	2	65,800	81,000		4,200		AL-LF	04-3643	
SE/PB	1	24,000	27,000/27,021	27,600			BC	55-3516	55-3516 SEMI
→12/82									
SE/PB	1	21,995/22,000	24,500/24,521	21,900			BC	55-3603	55-3603 SEMI
01/83→									

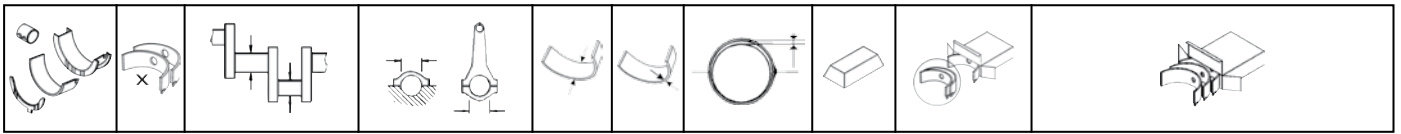

97 95.50 x 80.30									
M 102.982		4 Cyl.		2298cc	97-100kW (132-136PS)		Petrol		TD4656
M 102.983		4 Cyl.		2298cc	125-136kW (170-185PS)		Petrol		TD2086
BE/PL	4	47,950/47,965	51,600/51,619	21,800	1,814	0,020/0,064	EC	71-3817	71-3817/4 STD 0.25 0.50
MB/HL 1-5	5	57,950/57,965	62,500/62,519	21,400	2,261	0,020/0,072	AL-LF	02-3513	H977/5 STD 0.25 0.50 0.75
→12/85									
MB/HL 1-5	5	57,950/57,965	62,500/62,519	17,500	2,261	0,020/0,072	AL-LF	02-3585	H997/5 STD 0.25 0.50
01/86→									
TW/A	2	65,800	81,000		2,200		AL-LF	04-3586	A129/4 STD 0.10
TW/A	2	65,800	81,000		2,200		AL-LF	04-3587	
TW/A	2	65,800	81,000		4,200		AL-LF	04-3642	A132/4 STD
TW/A	2	65,800	81,000		4,200		AL-LF	04-3643	
SE/PB	1	21,995/22,000	24,500/24,521	21,900			BC	55-3603	55-3603 SEMI

98 95.50 x 87.20									
M 102.990		4 Cyl.		2498cc	143-150kW (195-204PS)		Petrol		TD2092
M 102.991		4 Cyl.		2498cc	143kW (195PS)		Petrol		TD2093
M 102.992		4 Cyl.		2498cc	173kW (235PS)		Petrol		TD2094
BE/PL	4	47,950/47,965	51,600/51,619	21,800	1,814	0,020/0,064	EC	71-3817	71-3817/4 STD 0.25 0.50
MB/HL 1-5	5	57,950/57,965	62,500/62,519	17,500	2,261	0,020/0,072	AL-LF	02-3585	H997/5 STD 0.25 0.50
TW/A	2	65,800	81,000		2,200		AL-LF	04-3586	A129/4 STD 0.10
TW/A	2	65,800	81,000		2,200		AL-LF	04-3587	
TW/A	2	65,800	81,000		4,200		AL-LF	04-3642	A132/4 STD
TW/A	2	65,800	81,000		4,200		AL-LF	04-3643	
SE/PB	1	21,995/22,000	24,500/24,521	21,900			BC	55-3603	55-3603 SEMI

99 96.50 x 85.00									
M 117.960		V8 Cyl.		4973cc	170-180kW (231-245PS)		Petrol		TD2170
M 117.961		V8 Cyl.		4973cc	170-177kW (231-240PS)		Petrol		TD2172
M 117.962		V8 Cyl.		4973cc	170kW (231PS)		Petrol		TD17728
M 117.963		V8 Cyl.		4973cc	170-177kW (231-240PS)		Petrol		TD2174
BE/PL	8	51,945/51,965	55,600/55,619	22,000	1,810	0,020/0,079	EC	71-3476	71-3476/8 STD
→12/80									
BE/PL	8	47,945/47,965	51,600/51,619	22,000	1,810	0,020/0,079	EC	71-3477	71-3477/8 STD
01/81→									
MB/HL	4	63,955/63,965	68,500/68,519	21,000	2,254	0,027/0,081	EC	72-2787	H801/5 STD

MERCEDES-BENZ

MB/HL	1	63,955/63,965	68,500/68,519	26,900	2,254	0,027/0,081	EC	72-2788H	
		72-2788H	STD	27,000/1.0630" - 27,021/1.0638"					
			0.25mm	27,200/1.0709" - 27,221/1.0717"					
			0.50mm	27,200/1.0709" - 27,221/1.0717"					
SE/PB	1	23,000	26,000	27,600			BC	55-3525	55-3525 SEMI

100 96.50 x 85.00

M 117.964		V8 Cyl.		4973cc	164-180kW (223-245PS)		Petrol	TD2175	
M 117.965		V8 Cyl.		4973cc	164-195kW (223-265PS)		Petrol	TD4670	
BE/PL	8	47,945/47,965	51,600/51,619	22,000	1,810	0,020/0,079	EC	71-3477	71-3477/8 STD
MB/HL	4	63,955/63,965	68,500/68,519	21,000	2,254	0,027/0,081	EC	72-2787	H801/5 STD
MB/HL	1	63,955/63,965	68,500/68,519	26,900	2,254	0,027/0,081	EC	72-2788H	
		72-2788H	STD	27,000/1.0630" - 27,021/1.0638"					
			0.25mm	27,200/1.0709" - 27,221/1.0717"					
			0.50mm	27,200/1.0709" - 27,221/1.0717"					
SE/PB	1	23,000	26,000	27,600			BC	55-3525	55-3525 SEMI

101 96.50 x 85.00

M 119.960		V8 Cyl.		4973cc	235-240kW (320-326PS)		Petrol	TD2186	
BE/PL	8	47,945/47,965	51,600/51,619	22,000	1,810	0,020/0,079	EC	71-3477	71-3477/8 STD
MB/HL	4	63,955/63,965	68,500/68,519	21,000	2,254	0,027/0,081	EC	72-2787	H801/5 STD
MB/HL	1	63,955/63,965	68,500/68,519	26,900	2,254	0,027/0,081	EC	72-2788H	
		72-2788H	STD	27,000/1.0630" - 27,021/1.0638"					
			0.25mm	27,200/1.0709" - 27,221/1.0717"					
			0.50mm	27,200/1.0709" - 27,221/1.0717"					

102 96.50 x 85.00

M 119.972		V8 Cyl.		4973cc	235-240kW (320-326PS)		Petrol	TD2189	
BE/PL	8	47,950/47,965	51,600/51,619	21,800	1,814	0,020/0,064	EC	71-3817	71-3817/8 STD 0.50

103 96.50 x 94.80

M 117.967		V8 Cyl.		5547cc	178kW (242PS)		Petrol	TD2177	
BE/PL	8	51,945/51,965	55,600/55,619	22,000	1,810	0,020/0,079	EC	71-3476	71-3476/8 STD
→12/80									
BE/PL	8	47,945/47,965	51,600/51,619	22,000	1,810	0,020/0,079	EC	71-3477	71-3477/8 STD
01/81→									
MB/HL	4	63,955/63,965	68,500/68,519	21,000	2,254	0,027/0,081	EC	72-2787	H801/5 STD
MB/HL	1	63,955/63,965	68,500/68,519	26,900	2,254	0,027/0,081	EC	72-2788H	
		72-2788H	STD	27,000/1.0630" - 27,021/1.0638"					
			0.25mm	27,200/1.0709" - 27,221/1.0717"					
			0.50mm	27,200/1.0709" - 27,221/1.0717"					
SE/PB	1	23,000	26,000	27,600			BC	55-3525	55-3525 SEMI

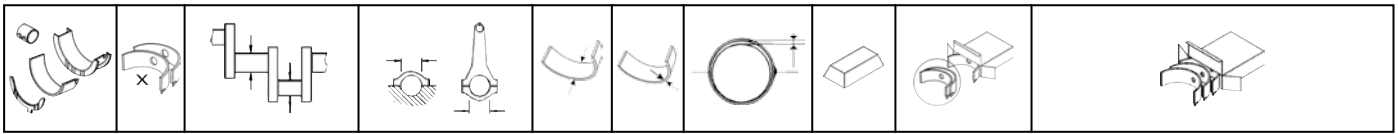

104		96.50 x 94.80									
M 117.968		V8 Cyl.		5547cc	178-220kW (242-300PS)			Petrol	TD2178		
BE/PL	8	47,945/47,965	51,600/51,619	22,000	1,810	0,020/0,079	EC	71-3477	71-3477/8 STD		
MB/HL	4	63,955/63,965	68,500/68,519	21,000	2,254	0,027/0,081	EC	72-2787	H801/5 STD		
MB/HL	1	63,955/63,965	68,500/68,519	26,900	2,254	0,027/0,081	EC	72-2788H			
			72-2788H	STD	27,000/1.0630" - 27,021/1.0638"						
				0.25mm	27,200/1.0709" - 27,221/1.0717"						
				0.50mm	27,200/1.0709" - 27,221/1.0717"						
SE/PB	1	23,000	26,000	27,600			BC	55-3525	55-3525 SEMI		

105		97.00 x 84.00								
M 112.970		V6 Cyl.		3724cc	173-180kW (235-245PS)			Petrol	TD17532	
M 112.972		V6 Cyl.		3724cc	180kW (245PS)			Petrol	TD17189	
M 112.973		V6 Cyl.		3724cc	180kW (245PS)			Petrol	TD17537	
M 112.975		V6 Cyl.		3724cc	180kW (245PS)			Petrol	TD17190	
M 112.976		V6 Cyl.		3724cc	165-170kW (224-231PS)			Petrol	TD18426	
BE/PL	6	51,940/51,965	55,600/55,614	19,600	1,814	0,020/0,071	EC	71-3857	71-3857/6 STD	
MB/HL	4	63,940/63,965	68,500/68,519	19,000	2,263	0,020/0,078	AL-LF	02-3858	H069/4 STD	
	1-4									

106		97.00 x 84.00								
M 113.960		V8 Cyl.		4966cc	215-225kW (292-306PS)			Petrol	TD11493	
M 113.961		V8 Cyl.		4966cc	225kW (306PS)			Petrol	TD11495	
M 113.962		V8 Cyl.		4966cc	215-218kW (292-296PS)			Petrol	TD12027	
M 113.963		V8 Cyl.		4966cc	215-225kW (292-306PS)			Petrol	TD16886	
M 113.964		V8 Cyl.		4966cc	215-225kW (292-306PS)			Petrol	TD17011	
M 113.965		V8 Cyl.		4966cc	215kW (292PS)			Petrol	TD17308	
M 113.966		V8 Cyl.		4966cc	225kW (306PS)			Petrol	TD17191	
M 113.967		V8 Cyl.		4966cc	215-225kW (292-306PS)			Petrol	TD17006	
M 113.968		V8 Cyl.		4966cc	215-225kW (292-306PS)			Petrol	TD16887	
M 113.969		V8 Cyl.		4966cc	225kW (306PS)			Petrol	TD17332	
M 113.971		V8 Cyl.		4966cc	218-225kW (296-306PS)			Petrol	TD18972	
BE/PL	8	51,940/51,965	55,600/55,614	19,600	1,814	0,020/0,071	EC	71-3857	71-3857/8 STD	
MB/HL	5	63,940/63,965	68,500/68,519	19,000	2,263	0,020/0,078	AL-LF	02-3858	H069/5 STD	
	1-5									

107		97.00 x 92.00								
M 113.980		V8 Cyl.		5439cc	255-260kW (347-354PS)			Petrol	TD9890	
M 113.981		V8 Cyl.		5439cc	255kW (347PS)			Petrol	TD14889	
M 113.982		V8 Cyl.		5439cc	260kW (354PS)			Petrol	TD16896	
M 113.984		V8 Cyl.		5439cc	255-260kW (347-354PS)			Petrol	TD15457	
M 113.986		V8 Cyl.		5439cc	265kW (360PS)			Petrol	TD16891	
M 113.988		V8 Cyl.		5439cc	260-270kW (354-367PS)			Petrol	TD17931	
M 113.989		V8 Cyl.		5439cc	260-294kW (354-400PS)			Petrol	TD18433	
BE/PL	8	51,940/51,965	55,600/55,614	19,600	1,814	0,020/0,071	EC	71-3857	71-3857/8 STD	
MB/HL	5	63,940/63,965	68,500/68,519	19,000	2,263	0,020/0,078	AL-LF	02-3858	H069/5 STD	
	1-5									

MERCEDES-BENZ



108 97.00 x 128.00									
OM 314.900			4 Cyl.	3780cc	46-63kW (63-86PS)		Diesel		TD22733
BE/PL	1	31,984/32,000	35,000/35,016	21,000	1,487	0,026/0,083	AL-LF	01-3438	01-3438 STD 10
BE/PL	1	31,984/32,000	35,000/35,016	21,000	1,487	0,026/0,083	BB	11-3438	11-3438 0.25 0.50 10
SE/PB	1	36,000	39,000/39,025	34,500			BS	55-2535	55-2535 SEMI
CB/NWB 1	1	55,941/55,960	60,000/60,030	26,000			BB	13-1864	N122/3L SEMI
CB/NWB 2	1	55,441/55,460	60,000/60,030	26,000			BB	13-1866	
CB/NWB 3	1	55,191/55,210	60,000/60,030	26,000			BB	13-1867	

109 97.00 x 128.00									
OM 314.910			4 Cyl.	3780cc	63kW (85PS)		Diesel		TD5691
BE/PL	1	31,984/32,000	35,000/35,016	21,000	1,487	0,026/0,083	AL-LF	01-3438	01-3438 STD 10
BE/PL	1	31,984/32,000	35,000/35,016	21,000	1,487	0,026/0,083	BB	11-3438	11-3438 0.25 0.50 10
BE/PL	4	59,990/60,015	65,000/65,019	29,400	2,472	0,041/0,110	EC	71-3572	71-3572/4 STD 0.25 0.50 1.00
Mot.314-910-10-004890 →									
MB/HL 1, 3-5	4	87,990/88,010	93,000/93,022	24,100	2,477	0,036/0,103	EC	72-2444	H712/5 STD 0.25 0.50
MB/HL 2	1	87,990/88,010	93,000/93,022	31,810	2,477	0,036/0,103	EC	72-2445H	
Mot.314-910-10-004890 →									
			72-2445H	STD	32,000/1.2598" - 32,062/1.2623"				
				0.25mm	32,100/1.2638" - 32,162/1.2662"				
				0.50mm	32,150/1.2657" - 32,212/1.2682"				
				0.75mm	32,150/1.2657" - 32,212/1.2682"				
				1.00mm	32,500/1.2795" - 32,562/1.2820"				
SE/PB	1	36,000	39,000/39,025	34,500			BS	55-2535	55-2535 SEMI
CB/NWB 1	1	55,941/55,960	60,000/60,030	26,000			BB	13-1864	N122/3L SEMI
CB/NWB 2	1	55,441/55,460	60,000/60,030	26,000			BB	13-1866	
CB/NWB 3	1	55,191/55,210	60,000/60,030	26,000			BB	13-1867	

110 97.00 x 128.00									
OM 314.914			4 Cyl.	3782cc	35-62kW (48-84PS)		Diesel		TD22546
OM 314.915			4 Cyl.	3780cc	63kW (85PS)		Diesel		TD16557
OM 314.916			4 Cyl.	3780cc	40kW (54PS)		Diesel		TD7971
OM 314.917			4 Cyl.	3780cc	48-55kW (66-75PS)		Diesel		TD7973
OM 314.918			4 Cyl.	3782cc	53kW (72PS)		Diesel		TD22545
OM 314.919			4 Cyl.	3782cc	53kW (72PS)		Diesel		TD22547
OM 314.940			4 Cyl.	3782cc	35-62kW (48-84PS)		Diesel		TD22548
OM 314.941			4 Cyl.	3782cc	35-62kW (48-84PS)		Diesel		TD22549
OM 314.942			4 Cyl.	3782cc	35-62kW (48-84PS)		Diesel		TD22550
OM 314.943			4 Cyl.	3782cc	35-62kW (48-84PS)		Diesel		TD22551
OM 314.944			4 Cyl.	3780cc	63kW (85PS)		Diesel		TD6028
OM 314.945			4 Cyl.	3782cc	35-62kW (48-84PS)		Diesel		TD22552
OM 314.946			4 Cyl.	3780cc	63kW (85PS)		Diesel		TD2202

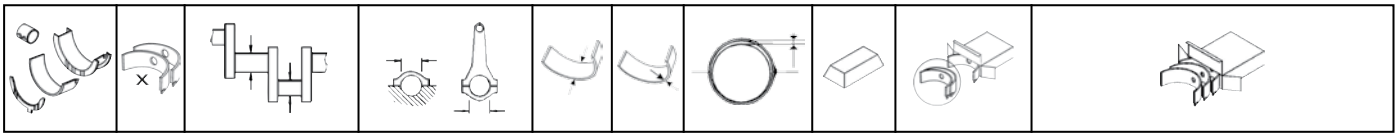

OM 314.947			4 Cyl.	3782cc	35-62kW (48-84PS)		Diesel		TD22553
OM 314.948			4 Cyl.	3780cc	63kW (85PS)		Diesel		TD2203
OM 314.949			4 Cyl.	3782cc	35-62kW (48-84PS)		Diesel		TD22554
OM 314.950			4 Cyl.	3782cc	35-62kW (48-84PS)		Diesel		TD22555
OM 314.951			4 Cyl.	3782cc	35-66kW (48-90PS)		Diesel		TD22556
OM 314.953			4 Cyl.	3780cc	59kW (80PS)		Diesel		TD7975
OM 314.954			4 Cyl.	3782cc	35-62kW (48-84PS)		Diesel		TD22557
OM 314.956			4 Cyl.	3782cc	48kW (65PS)		Diesel		TD16999
OM 314.957			4 Cyl.	3782cc	53kW (72PS)		Diesel		TD17000
OM 314.958			4 Cyl.	3782cc	35-62kW (48-84PS)		Diesel		TD22558
OM 314.959			4 Cyl.	3780cc	63kW (85PS)		Diesel		TD2204
OM 314.960			4 Cyl.	3782cc	35-62kW (48-84PS)		Diesel		TD22559
OM 314.961			4 Cyl.	3780cc	63kW (85PS)		Diesel		TD16552
OM 314.962			4 Cyl.	3780cc	63kW (85PS)		Diesel		TD16553
OM 314.963			4 Cyl.	3780cc	63kW (85PS)		Diesel		TD16554
OM 314.964			4 Cyl.	3780cc	63kW (85PS)		Diesel		TD16555
OM 314.965			4 Cyl.	3780cc	63kW (85PS)		Diesel		TD16556
OM 314.967			4 Cyl.	3780cc	63kW (85PS)		Diesel		TD6026

BE/PL	1	31,984/32,000	35,000/35,016	21,000	1,487	0,026/0,083	AL-LF	01-3438	01-3438 STD	10
BE/PL	1	31,984/32,000	35,000/35,016	21,000	1,487	0,026/0,083	BB	11-3438	11-3438 0.25 0.50	10
BE/PL	4	59,990/60,015	65,000/65,019	29,400	2,472	0,041/0,110	EC	71-3572	71-3572/4 STD 0.25 0.50 1.00	
MB/HL 1, 3-5	4	87,990/88,010	93,000/93,022	24,100	2,477	0,036/0,103	EC	72-2444	H712/5 STD 0.25 0.50	
MB/HL 2	1	87,990/88,010	93,000/93,022	31,810	2,477	0,036/0,103	EC	72-2445H		



72-2445H	STD	32,000/1.2598" - 32,062/1.2623"
	0.25mm	32,100/1.2638" - 32,162/1.2662"
	0.50mm	32,150/1.2657" - 32,212/1.2682"
	0.75mm	32,150/1.2657" - 32,212/1.2682"
	1.00mm	32,500/1.2795" - 32,562/1.2820"

SE/PB	1	36,000	39,000/39,025	34,500			BS	55-2535	55-2535 SEMI	
CB/NWB 1	1	55,941/55,960	60,000/60,030	26,000			BB	13-1864	N122/3L SEMI	
CB/NWB 2	1	55,441/55,460	60,000/60,030	26,000			BB	13-1866		
CB/NWB 3	1	55,191/55,210	60,000/60,030	26,000			BB	13-1867		

111









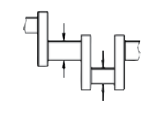
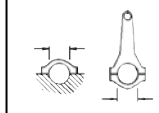
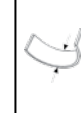

97.00 x 128.00

OM 314.970			4 Cyl.	3782cc	63kW (85PS)		Diesel Turbo		TD17852	
BE/PL	1	31,984/32,000	35,000/35,016	21,000	1,487	0,026/0,083	AL-LF	01-3438	01-3438 STD	10
BE/PL	1	31,984/32,000	35,000/35,016	21,000	1,487	0,026/0,083	BB	11-3438	11-3438 0.25 0.50	10
BE/PL	4	59,990/60,015	65,000/65,019	29,400	2,472	0,041/0,110	EC	71-3572	71-3572/4 STD 0.25 0.50 1.00	
SE/PB	1	36,000	39,000/39,025	34,500			BS	55-2535	55-2535 SEMI	
CB/NWB 1	1	55,941/55,960	60,000/60,030	26,000			BB	13-1864	N122/3L SEMI	
CB/NWB 2	1	55,441/55,460	60,000/60,030	26,000			BB	13-1866		
CB/NWB 3	1	55,191/55,210	60,000/60,030	26,000			BB	13-1867		



MERCEDES-BENZ



112	97.00 x 128.00						
OM 344.913	6 Cyl.	5675cc	115kW (156PS)	Diesel Turbo			TD23170
OM 344.934	6 Cyl.	5675cc	115kW (156PS)	Diesel Turbo			TD7926
OM 344.937	6 Cyl.	5675cc	115kW (156PS)	Diesel Turbo			TD23171
OM 344.938	6 Cyl.	5675cc	115kW (156PS)	Diesel Turbo			TD23172
OM 344.939	6 Cyl.	5675cc	115kW (156PS)	Diesel Turbo			TD23173
OM 344.940	6 Cyl.	5675cc	96kW (131PS)	Diesel Turbo			TD23174
OM 344.948	6 Cyl.	5675cc	115kW (156PS)	Diesel Turbo			TD22734
OM 344.951	6 Cyl.	5675cc	115kW (156PS)	Diesel Turbo			TD23176
OM 344.952	6 Cyl.	5675cc	124kW (169PS)	Diesel Turbo			TD22736
OM 352.913	6 Cyl.	5675cc	115kW (156PS)	Diesel Turbo			TD16643
OM 352.916	6 Cyl.	5675cc	110kW (150PS)	Diesel Turbo			TD7923
OM 352.918	6 Cyl.	5675cc	110kW (150PS)	Diesel Turbo			TD16641
OM 352.937	6 Cyl.	5675cc	110kW (150PS)	Diesel Turbo			TD16644
OM 352.946	6 Cyl.	5675cc	110kW (150PS)	Diesel Turbo			TD16645
OM 352.949	6 Cyl.	5675cc	115kW (156PS)	Diesel Turbo			TD16646
OM 352.950	6 Cyl.	5675cc	110kW (150PS)	Diesel Turbo			TD16647
OM 352.968	6 Cyl.	5675cc	115kW (156PS)	Diesel Turbo			TD16648
OM 352.988	6 Cyl.	5675cc	96kW (130PS)	Diesel Turbo			TD16649
OM 352.994	6 Cyl.	5675cc	110kW (150PS)	Diesel Turbo			TD16650
OM 353.909	6 Cyl.	5675cc	124kW (168PS)	Diesel Turbo			TD8091
OM 353.910	6 Cyl.	5675cc	124kW (168PS)	Diesel Turbo			TD8162
OM 353.911	6 Cyl.	5675cc	124kW (168PS)	Diesel Turbo			TD8090
OM 353.912	6 Cyl.	5675cc	124kW (168PS)	Diesel Turbo			TD8159
OM 353.913	6 Cyl.	5675cc	124kW (168PS)	Diesel Turbo			TD8097
OM 353.914	6 Cyl.	5675cc	124kW (168PS)	Diesel Turbo			TD16662
OM 353.920	6 Cyl.	5675cc	124kW (169PS)	Diesel Turbo			TD26350
OM 353.921	6 Cyl.	5675cc	110kW (150PS)	Diesel Turbo			TD26351
OM 353.937	6 Cyl.	5675cc	92kW (125PS)	Diesel Turbo			TD26361
OM 353.939	6 Cyl.	5675cc	124kW (169PS)	Diesel Turbo			TD26363
OM 353.950	6 Cyl.	5700cc	124kW (168PS)	Diesel Turbo			TD5711
OM 353.951	6 Cyl.	5700cc	124kW (168PS)	Diesel Turbo			TD5747
OM 353.952	6 Cyl.	5700cc	124kW (168PS)	Diesel Turbo			TD6045
OM 353.953	6 Cyl.	5700cc	124kW (168PS)	Diesel Turbo			TD6092
OM 353.954	6 Cyl.	5700cc	124kW (168PS)	Diesel Turbo			TD8096
OM 353.957	6 Cyl.	5675cc	92kW (125PS)	Diesel Turbo			TD16995
OM 353.958	6 Cyl.	5675cc	110kW (150PS)	Diesel Turbo			TD7990
OM 353.959	6 Cyl.	5675cc	124kW (168PS)	Diesel Turbo			TD8009
OM 353.970	6 Cyl.	5700cc	124kW (168PS)	Diesel Turbo			TD5712
OM 353.971	6 Cyl.	5700cc	124kW (168PS)	Diesel Turbo			TD6060
OM 353.972	6 Cyl.	5675cc	124kW (168PS)	Diesel Turbo			TD16660
OM 353.973	6 Cyl.	5675cc	92kW (125PS)	Diesel Turbo			TD7981
OM 353.974	6 Cyl.	5675cc	127kW (172PS)	Diesel Turbo			TD16661
OM 353.975	6 Cyl.	5700cc	124kW (168PS)	Diesel Turbo			TD6321
OM 353.977	6 Cyl.	5675cc	124kW (169PS)	Diesel Turbo			TD22744
OM 353.978	6 Cyl.	5675cc	127kW (172PS)	Diesel Turbo			TD16664
OM 353.991	6 Cyl.	5675cc	124kW (168PS)	Diesel Turbo			TD16665
OM 353.995	6 Cyl.	5675cc	92kW (125PS)	Diesel Turbo			TD7999
OM 353.997	6 Cyl.	5675cc	124kW (168PS)	Diesel Turbo			TD16666
OM 362.906	6 Cyl.	5700cc	141kW (192PS)	Diesel Turbo Intercooler			TD5750
OM 362.909	6 Cyl.	5700cc	141kW (192PS)	Diesel Turbo Intercooler			TD6080
OM 362.910	6 Cyl.	5675cc	141kW (192PS)	Diesel Turbo Intercooler			TD16699

										
BE/PL	1	31,984/32,000	35,000/35,016	21,000	1,487	0,026/0,083	AL-LF	01-3438	01-3438 STD	
BE/PL	1	31,984/32,000	35,000/35,016	21,000	1,487	0,026/0,083	BB	11-3438	11-3438 0.25 0.50	
BE/PL	6	59,990/60,015	65,000/65,019	29,400	2,472	0,041/0,110	EC	71-3572	71-3572/6 STD 0.25 0.50 0.75 1.00	
SE/PB	1	36,000	39,000/39,025	34,500			BS	55-2535	55-2535 SEMI	
CB/NWB 1	1	55,941/55,960	60,000/60,030	26,000			BB	13-1864	N049/4L STD SEMI	
CB/NWB 2	1	55,691/55,710	60,000/60,030	26,000			BB	13-1865		
CB/NWB 3	1	55,441/55,460	60,000/60,030	26,000			BB	13-1866		
CB/NWB 4	1	55,191/55,210	60,000/60,030	26,000			BB	13-1867		
→12/78										
CB/NWB	1	55,691/55,710	60,000/60,030	26,000			AL-LF	03-1865	N128/4 STD	
CB/NWB	1	55,441/55,460	60,000/60,030	26,000			AL-LF	03-1866		
CB/NWB	1	55,191/55,210	60,000/60,030	26,000			AL-LF	03-1867		
CB/NWB	1	55,941/55,960	60,000/60,030	26,000			BC	53-1864		
01/79→										

113 97.00 x 128.00

OM 344.949		6 Cyl.	5675cc	96kW (131PS)	Diesel Turbo				TD22735	
OM 353.976		6 Cyl.	5675cc	110kW (150PS)	Diesel Turbo				TD17860	
BE/PL	1	31,984/32,000	35,000/35,016	21,000	1,487	0,026/0,083	AL-LF	01-3438	01-3438 STD	
BE/PL	1	31,984/32,000	35,000/35,016	21,000	1,487	0,026/0,083	BB	11-3438	11-3438 0.25 0.50	
BE/PL	6	59,990/60,015	65,000/65,019	29,400	2,472	0,041/0,110	EC	71-3572	71-3572/6 STD 0.25 0.50 0.75 1.00	
SE/PB	1	36,000	39,000/39,025	34,500			BS	55-2535	55-2535 SEMI	
CB/NWB	1	55,691/55,710	60,000/60,030	26,000			AL-LF	03-1865	N128/4 STD	
CB/NWB	1	55,441/55,460	60,000/60,030	26,000			AL-LF	03-1866		
CB/NWB	1	55,191/55,210	60,000/60,030	26,000			AL-LF	03-1867		
CB/NWB	1	55,941/55,960	60,000/60,030	26,000			BC	53-1864		

114 97.00 x 128.00

OM 352.901	6 Cyl.	5675cc	96kW (130PS)	Diesel	TD16626
OM 352.902	6 Cyl.	5670cc	52kW (70PS)	Diesel	TD7974
OM 352.903	6 Cyl.	5675cc	66kW (90PS)	Diesel	TD7977
OM 352.904	6 Cyl.	5675cc	93kW (126PS)	Diesel	TD16627
OM 352.905	6 Cyl.	5680cc	96kW (126PS)	Diesel	TD7966
OM 352.906	6 Cyl.	5675cc	81kW (110PS)	Diesel	TD5700
OM 352.908	6 Cyl.	5675cc	81-96kW (110-131PS)	Diesel	TD5701
OM 352.909	6 Cyl.	5675cc	81kW (110PS)	Diesel	TD16606
OM 352.910	6 Cyl.	5675cc	74kW (100PS)	Diesel	TD16615
OM 352.911	6 Cyl.	5675cc	81kW (110PS)	Diesel	TD16607
OM 352.912	6 Cyl.	5675cc	96kW (130PS)	Diesel	TD16628

MERCEDES-BENZ



OM 352.914	6 Cyl.	5675cc	81kW (110PS)	Diesel	TD7921
OM 352.915	6 Cyl.	5675cc	93kW (126PS)	Diesel	TD7922
OM 352.917	6 Cyl.	5675cc	93kW (126PS)	Diesel	TD16629
OM 352.919	6 Cyl.	5675cc	48kW (65PS)	Diesel	TD7984
OM 352.930	6 Cyl.	5675cc	96kW (130PS)	Diesel	TD16630
OM 352.931	6 Cyl.	5675cc	96kW (130PS)	Diesel	TD16631
OM 352.932	6 Cyl.	5675cc	81kW (110PS)	Diesel	TD16608
OM 352.933	6 Cyl.	5675cc	81kW (110PS)	Diesel	TD16609
OM 352.934	6 Cyl.	5675cc	96kW (130PS)	Diesel	TD16632
OM 352.935	6 Cyl.	5675cc	96kW (130PS)	Diesel	TD16633
OM 352.936	6 Cyl.	5675cc	96kW (130PS)	Diesel	TD8158
OM 352.938	6 Cyl.	5675cc	96kW (130PS)	Diesel	TD5738
OM 352.939	6 Cyl.	5675cc	96kW (130PS)	Diesel	TD16634
OM 352.942	6 Cyl.	5675cc	74kW (100PS)	Diesel	TD16616
OM 352.943	6 Cyl.	5675cc	81kW (110PS)	Diesel	TD16610
OM 352.944	6 Cyl.	5675cc	93kW (126PS)	Diesel	TD16635
OM 352.945	6 Cyl.	5675cc	96kW (130PS)	Diesel	TD16637
OM 352.948	6 Cyl.	5675cc	93kW (126PS)	Diesel	TD16638
OM 352.953	6 Cyl.	5675cc	93kW (126PS)	Diesel	TD16639
OM 352.954	6 Cyl.	5675cc	93kW (126PS)	Diesel	TD16640
OM 352.955	6 Cyl.	5675cc	93kW (126PS)	Diesel	TD17012
OM 352.959	6 Cyl.	5675cc	96kW (130PS)	Diesel	TD22737
OM 352.963	6 Cyl.	5675cc	96kW (130PS)	Diesel	TD6071
OM 352.964	6 Cyl.	5675cc	96kW (130PS)	Diesel	TD5714
OM 352.965	6 Cyl.	5675cc	69kW (94PS)	Diesel	TD22738
OM 352.966	6 Cyl.	5675cc	79kW (107PS)	Diesel	TD22739
OM 352.967	6 Cyl.	5675cc	74kW (101PS)	Diesel	TD22740
OM 352.969	6 Cyl.	5675cc	96kW (130PS)	Diesel	TD8089
OM 352.970	6 Cyl.	5675cc	81kW (110PS)	Diesel	TD16611
OM 352.971	6 Cyl.	5675cc	74kW (100PS)	Diesel	TD16617
OM 352.972	6 Cyl.	5675cc	74kW (100PS)	Diesel	TD16618
OM 352.973	6 Cyl.	5675cc	74kW (100PS)	Diesel	TD16619
OM 352.974	6 Cyl.	5675cc	74kW (100PS)	Diesel	TD16620
OM 352.975	6 Cyl.	5675cc	74kW (100PS)	Diesel	TD16621
OM 352.976	6 Cyl.	5675cc	81kW (110PS)	Diesel	TD16612
OM 352.978	6 Cyl.	5675cc	96kW (131PS)	Diesel	TD22741
OM 352.979	6 Cyl.	5675cc	81kW (110PS)	Diesel	TD16613
OM 352.981	6 Cyl.	5675cc	81kW (110PS)	Diesel	TD16622
OM 352.982	6 Cyl.	5675cc	81kW (110PS)	Diesel	TD16614
OM 352.983	6 Cyl.	5675cc	81kW (110PS)	Diesel	TD16623
OM 352.984	6 Cyl.	5675cc	59kW (80PS)	Diesel	TD7976
OM 352.985	6 Cyl.	5675cc	81kW (110PS)	Diesel	TD16624
OM 352.987	6 Cyl.	5675cc	93kW (126PS)	Diesel	TD17013
OM 352.989	6 Cyl.	5675cc	81kW (110PS)	Diesel	TD16625
OM 352.990	6 Cyl.	5675cc	81kW (110PS)	Diesel	TD6036
OM 352.991	6 Cyl.	5675cc	93kW (126PS)	Diesel	TD17014
OM 352.992	6 Cyl.	5675cc	93kW (126PS)	Diesel	TD22742
OM 352.996	6 Cyl.	5675cc	96kW (130PS)	Diesel	TD6281
OM 352.999	6 Cyl.	5675cc	79kW (107PS)	Diesel	TD22743
OM 353.900	6 Cyl.	5675cc	96kW (130PS)	Diesel	TD16651
OM 353.901	6 Cyl.	5675cc	74kW (100PS)	Diesel	TD7979
OM 353.902	6 Cyl.	5675cc	62kW (84PS)	Diesel	TD5678
OM 353.904	6 Cyl.	5675cc	96kW (130PS)	Diesel	TD5697

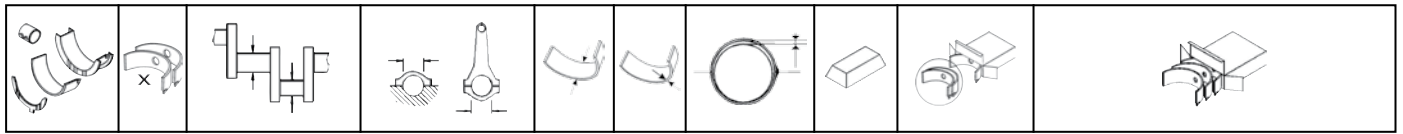

OM 353.905	6 Cyl.	5680cc	74kW (100PS)	Diesel	TD7988
OM 353.906	6 Cyl.	5680cc	130kW (177PS)	Diesel	TD26551
OM 353.907	6 Cyl.	5675cc	92kW (125PS)	Diesel	TD7982
OM 353.916	6 Cyl.	5675cc	81kW (110PS)	Diesel	TD16654
OM 353.917	6 Cyl.	5675cc	96kW (130PS)	Diesel	TD16655
OM 353.922	6 Cyl.	5675cc	88kW (120PS)	Diesel	TD26352
OM 353.923	6 Cyl.	5675cc	81kW (110PS)	Diesel	TD26353
OM 353.930	6 Cyl.	5675cc	62kW (84PS)	Diesel	TD26354
OM 353.931	6 Cyl.	5675cc	81kW (110PS)	Diesel	TD26356
OM 353.932	6 Cyl.	5675cc	88kW (120PS)	Diesel	TD26355
OM 353.933	6 Cyl.	5675cc	88kW (120PS)	Diesel	TD26357
OM 353.934	6 Cyl.	5675cc	88kW (120PS)	Diesel	TD26358
OM 353.935	6 Cyl.	5675cc	88kW (120PS)	Diesel	TD26359
OM 353.936	6 Cyl.	5675cc	81kW (110PS)	Diesel	TD26360
OM 353.938	6 Cyl.	5675cc	88kW (120PS)	Diesel	TD26362
OM 353.940	6 Cyl.	5675cc	81kW (110PS)	Diesel	TD6016
OM 353.941	6 Cyl.	5675cc	96kW (130PS)	Diesel	TD16656
OM 353.942	6 Cyl.	5700cc	96kW (130PS)	Diesel	TD5709
OM 353.943	6 Cyl.	5700cc	96kW (130PS)	Diesel	TD5727
OM 353.944	6 Cyl.	5700cc	96kW (130PS)	Diesel	TD5728
OM 353.945	6 Cyl.	5700cc	96kW (130PS)	Diesel	TD5710
OM 353.946	6 Cyl.	5700cc	96kW (130PS)	Diesel	TD6044
OM 353.960	6 Cyl.	5675cc	88kW (120PS)	Diesel	TD7980
OM 353.961	6 Cyl.	5675cc	96kW (130PS)	Diesel	TD7998
OM 353.962	6 Cyl.	5675cc	70kW (95PS)	Diesel	TD7978
OM 353.963	6 Cyl.	5675cc	96kW (130PS)	Diesel	TD5690
OM 353.964	6 Cyl.	5700cc	96kW (130PS)	Diesel	TD6284
OM 353.965	6 Cyl.	5675cc	96kW (130PS)	Diesel	TD5715
OM 353.966	6 Cyl.	5675cc	96kW (130PS)	Diesel	TD6027
OM 353.967	6 Cyl.	5675cc	74kW (101PS)	Diesel	TD16657
OM 353.968	6 Cyl.	5675cc	96kW (130PS)	Diesel	TD16658
OM 353.969	6 Cyl.	5675cc	96kW (130PS)	Diesel	TD16659
OM 353.980	6 Cyl.	5675cc	81kW (110PS)	Diesel	TD7996
OM 353.981	6 Cyl.	5675cc	96kW (130PS)	Diesel	TD6034
OM 353.982	6 Cyl.	5675cc	96kW (130PS)	Diesel	TD6048
OM 353.983	6 Cyl.	5675cc	96kW (130PS)	Diesel	TD17016
OM 353.984	6 Cyl.	5675cc	96kW (130PS)	Diesel	TD17017
OM 353.988	6 Cyl.	5675cc	96kW (130PS)	Diesel	TD17178
OM 353.989	6 Cyl.	5675cc	96kW (130PS)	Diesel	TD16663
OM 353.998	6 Cyl.	5675cc	81kW (110PS)	Diesel	TD16938
OM 353.999	6 Cyl.	5675cc	81kW (110PS)	Diesel	TD16939

BE/PL	1	31,984/32,000	35,000/35,016	21,000	1,487	0,026/0,083	AL-LF	01-3438	01-3438 STD	10
BE/PL	1	31,984/32,000	35,000/35,016	21,000	1,487	0,026/0,083	BB	11-3438	11-3438 0.25 0.50	10
BE/PL	6	59,990/60,015	65,000/65,019	29,400	2,472	0,041/0,110	EC	71-3572	71-3572/6 STD 0.25 0.50 0.75 1.00	

MERCEDES-BENZ

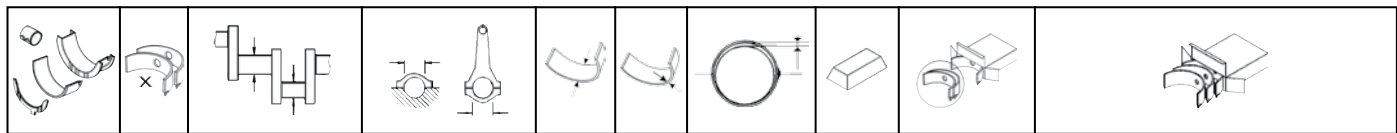

MB/HL 1-3, 5-7	6	87,990/88,010	93,000/93,022	24,100	2,477	0,036/0,103	EC	72-2444	H712/7 STD 0.25 0.50 0.75 1.00
MB/HL 4	1	87,990/88,010	93,000/93,022	31,810	2,477	0,036/0,103	EC	72-2445H	



72-2445H	STD	32,000/1.2598" - 32,062/1.2623"
	0.25mm	32,100/1.2638" - 32,162/1.2662"
	0.50mm	32,150/1.2657" - 32,212/1.2682"
	0.75mm	32,150/1.2657" - 32,212/1.2682"
	1.00mm	32,500/1.2795" - 32,562/1.2820"

SE/PB	1	36,000	39,000/39,025	34,500			BS	55-2535	55-2535 SEMI
CB/NWB 1	1	55,941/55,960	60,000/60,030	26,000			BB	13-1864	N049/4L STD SEMI
CB/NWB 2	1	55,691/55,710	60,000/60,030	26,000			BB	13-1865	
CB/NWB 3	1	55,441/55,460	60,000/60,030	26,000			BB	13-1866	
CB/NWB 4	1	55,191/55,210	60,000/60,030	26,000			BB	13-1867	

→12/78

CB/NWB	1	55,691/55,710	60,000/60,030	26,000			AL-LF	03-1865	N128/4 STD
CB/NWB	1	55,441/55,460	60,000/60,030	26,000			AL-LF	03-1866	
CB/NWB	1	55,191/55,210	60,000/60,030	26,000			AL-LF	03-1867	
CB/NWB	1	55,941/55,960	60,000/60,030	26,000			BC	53-1864	

01/79→

115 97.00 x 128.00

OM 352.907	6 Cyl.	5700cc	81kW (110PS)	Diesel	TD5702
OM 352.980	6 Cyl.	5675cc	96kW (130PS)	Diesel	TD17015
OM 352.986	6 Cyl.	5700cc	81kW (110PS)	Diesel	TD6037
OM 352.993	6 Cyl.	5675cc	96kW (130PS)	Diesel	TD7891
OM 353.903	6 Cyl.	5675cc	81kW (110PS)	Diesel	TD16652
OM 353.915	6 Cyl.	5675cc	81kW (110PS)	Diesel	TD16653

BE/PL	1	31,984/32,000	35,000/35,016	21,000	1,487	0,026/0,083	AL-LF	01-3438	01-3438 STD 10
BE/PL	1	31,984/32,000	35,000/35,016	21,000	1,487	0,026/0,083	BB	11-3438	11-3438 0.25 0.50 10
BE/PL	6	59,990/60,015	65,000/65,019	29,400	2,472	0,041/0,110	EC	71-3572	71-3572/6 STD 0.25 0.50 0.75 1.00
MB/HL 1-3, 5-7	6	87,990/88,010	93,000/93,022	24,100	2,477	0,036/0,103	EC	72-2444	H712/7 STD 0.25 0.50 0.75 1.00
MB/HL 4	1	87,990/88,010	93,000/93,022	31,810	2,477	0,036/0,103	EC	72-2445H	



72-2445H	STD	32,000/1.2598" - 32,062/1.2623"
	0.25mm	32,100/1.2638" - 32,162/1.2662"
	0.50mm	32,150/1.2657" - 32,212/1.2682"
	0.75mm	32,150/1.2657" - 32,212/1.2682"
	1.00mm	32,500/1.2795" - 32,562/1.2820"

SE/PB	1	36,000	39,000/39,025	34,500			BS	55-2535	55-2535 SEMI
-------	---	--------	---------------	--------	--	--	----	---------	------------------------

CB/NWB 1	1	55,941/55,960	60,000/60,030	26,000				BB	13-1864	N049/4L STD SEMI
CB/NWB 2	1	55,691/55,710	60,000/60,030	26,000				BB	13-1865	
CB/NWB 3	1	55,441/55,460	60,000/60,030	26,000				BB	13-1866	
CB/NWB 4	1	55,191/55,210	60,000/60,030	26,000				BB	13-1867	

116 97.00 x 128.00

OM 352.997	6 Cyl.	5675cc	96kW (130PS)	Diesel	TD5713
OM 352.998	6 Cyl.	5675cc	96kW (130PS)	Diesel	TD6047
OM 353.949	6 Cyl.	5675cc	81kW (110PS)	Diesel	TD16994
OM 353.985	6 Cyl.	5675cc	70kW (95PS)	Diesel	TD17856

BE/PL	1	31,984/32,000	35,000/35,016	21,000	1,487	0,026/0,083	AL-LF	01-3438	01-3438 STD	
BE/PL	1	31,984/32,000	35,000/35,016	21,000	1,487	0,026/0,083	BB	11-3438	11-3438 0.25 0.50	
BE/PL	6	59,990/60,015	65,000/65,019	29,400	2,472	0,041/0,110	EC	71-3572	71-3572/6 STD 0.25 0.50 0.75 1.00	
MB/HL 1-3, 5-7	6	87,990/88,010	93,000/93,022	24,100	2,477	0,036/0,103	EC	72-2444	H712/7 STD 0.25 0.50 0.75 1.00	
MB/HL 4	1	87,990/88,010	93,000/93,022	31,810	2,477	0,036/0,103	EC	72-2445H		

	72-2445H	STD	32,000/1.2598" - 32,062/1.2623"
		0.25mm	32,100/1.2638" - 32,162/1.2662"
		0.50mm	32,150/1.2657" - 32,212/1.2682"
		0.75mm	32,150/1.2657" - 32,212/1.2682"
		1.00mm	32,500/1.2795" - 32,562/1.2820"

SE/PB	1	36,000	39,000/39,025	34,500			BS	55-2535	55-2535 SEMI
CB/NWB	1	55,691/55,710	60,000/60,030	26,000			AL-LF	03-1865	N128/4 STD
CB/NWB	1	55,441/55,460	60,000/60,030	26,000			AL-LF	03-1866	
CB/NWB	1	55,191/55,210	60,000/60,030	26,000			AL-LF	03-1867	
CB/NWB	1	55,941/55,960	60,000/60,030	26,000			BC	53-1864	

117 97.50 x 133.00

OM 354.900 Euro 2	4 Cyl.	3972cc	77kW (105PS)	Diesel Turbo Intercooler	TD8054
OM 354.901 Euro 2	4 Cyl.	3972cc	77kW (105PS)	Diesel Turbo Intercooler	TD8084
OM 354.902 Euro 2	4 Cyl.	3972cc	77kW (105PS)	Diesel Turbo Intercooler	TD5695
OM 354.903 Euro 2	4 Cyl.	3972cc	77kW (105PS)	Diesel Turbo Intercooler	TD8083
OM 354.920 Euro 2	4 Cyl.	3972cc	103kW (140PS)	Diesel Turbo Intercooler	TD8059
OM 354.921 Euro 2	4 Cyl.	3972cc	103kW (140PS)	Diesel Turbo Intercooler	TD8066
OM 354.922 Euro 2	4 Cyl.	3972cc	103kW (140PS)	Diesel Turbo Intercooler	TD8061
OM 354.923 Euro 2	4 Cyl.	3972cc	103kW (140PS)	Diesel Turbo Intercooler	TD8057
OM 354.924 Euro 2	4 Cyl.	3972cc	103kW (140PS)	Diesel Turbo Intercooler	TD8085
OM 354.925 Euro 2	4 Cyl.	3972cc	103kW (140PS)	Diesel Turbo Intercooler	TD8087
OM 354.926 Euro 2	4 Cyl.	3972cc	103kW (140PS)	Diesel Turbo Intercooler	TD22745
OM 364.901	4 Cyl.	3972cc	83kW (113PS)	Diesel Turbo	TD21464
OM 364.906	4 Cyl.	3972cc	66kW (90PS)	Diesel	TD8048
OM 364.907	4 Cyl.	3970cc	66kW (90PS)	Diesel	TD8052
OM 364.908	4 Cyl.	3972cc	50kW (68PS)	Diesel	TD17853
OM 364.909	4 Cyl.	3972cc	50kW (68PS)	Diesel	TD17854
OM 364.911	4 Cyl.	3972cc	63-66kW (86-90PS)	Diesel	TD8081

MERCEDES-BENZ



OM 364.912	4 Cyl.	3972cc	66kW (90PS)	Diesel	TD16804
OM 364.913	4 Cyl.	3972cc	66kW (90PS)	Diesel	TD8044
OM 364.916 Euro 1	4 Cyl.	3972cc	58kW (79PS)	Diesel	TD22770
OM 364.917 Euro 1	4 Cyl.	3972cc	60kW (82PS)	Diesel	TD22771
OM 364.918	4 Cyl.	3970cc	63kW (86PS)	Diesel	TD8053
OM 364.919	4 Cyl.	3972cc	63kW (86PS)	Diesel	TD5692
OM 364.920	4 Cyl.	3972cc	63kW (86PS)	Diesel	TD8082
OM 364.921 Euro 1	4 Cyl.	3972cc	63kW (86PS)	Diesel	TD6029
OM 364.950	4 Cyl.	3972cc	85kW (115PS)	Diesel Turbo	TD5696
OM 364.951	4 Cyl.	3972cc	66kW (90PS)	Diesel Turbo	TD17855
OM 364.952	4 Cyl.	3972cc	85kW (115PS)	Diesel Turbo	TD6033
OM 364.953	4 Cyl.	3972cc	66kW (90PS)	Diesel Turbo	TD16806
OM 364.954	4 Cyl.	3972cc	85kW (115PS)	Diesel	TD8045
OM 364.955	4 Cyl.	3973cc	75kW (102PS)	Diesel Turbo	TD8015
OM 364.956 Euro 1	4 Cyl.	3973cc	77kW (105PS)	Diesel Turbo Intercooler	TD22772
OM 364.957	4 Cyl.	3972cc	77kW (105PS)	Diesel Turbo	TD5693
OM 364.958	4 Cyl.	3972cc	77kW (105PS)	Diesel Turbo	TD6030
OM 364.959 Euro 1	4 Cyl.	3972cc	77kW (105PS)	Diesel Turbo	TD22773
OM 364.980	4 Cyl.	3972cc	100kW (136PS)	Diesel Turbo Intercooler	TD8047
OM 364.981	4 Cyl.	3972cc	100kW (136PS)	Diesel Turbo Intercooler	TD8086
OM 364.982	4 Cyl.	3972cc	98kW (133PS)	Diesel Turbo Intercooler	TD8016
OM 364.983 Euro 1	4 Cyl.	3972cc	102kW (139PS)	Diesel Turbo Intercooler	TD20150
OM 364.984	4 Cyl.	3972cc	100kW (136PS)	Diesel Turbo Intercooler	TD8088
OM 364.985	4 Cyl.	3972cc	100-103kW (136-140PS)	Diesel Turbo Intercooler	TD8017
OM 364.986	4 Cyl.	3972cc	100kW (136PS)	Diesel Turbo Intercooler	TD5694
OM 364.987	4 Cyl.	3972cc	100kW (136PS)	Diesel Turbo Intercooler	TD6031
OM 364.989 Euro 1	4 Cyl.	3972cc	100kW (136PS)	Diesel Turbo Intercooler	TD22774
OM 374.905	4 Cyl.	3972cc	66kW (90PS)	Diesel	TD23197
OM 374.907	4 Cyl.	3972cc	66kW (90PS)	Diesel	TD8058
OM 374.908	4 Cyl.	3972cc	66kW (90PS)	Diesel	TD23198
OM 374.992	4 Cyl.	3972cc	80kW (109PS)	Diesel	TD25648
OM 384.907	4 Cyl.	3972cc	85kW (116PS)	Diesel Turbo	TD22788
OM 384.908 Euro 1	4 Cyl.	3972cc	79kW (107PS)	Diesel Turbo	TD22789

BE/PL	1	31,984/32,000	35,000/35,016	21,000	1,487	0,026/0,083	AL-LF	01-3438	01-3438 STD	<input type="checkbox"/>
BE/PL	1	31,984/32,000	35,000/35,016	21,000	1,487	0,026/0,083	BB	11-3438	11-3438 0.25 0.50	<input type="checkbox"/>
BE/PL	4	59,990/60,015	65,000/65,019	29,400	2,472	0,041/0,110	EC	71-3572	71-3572/4 STD 0.25 0.50 1.00	
MB/HL 5	1	87,990/88,010	93,000/93,022	31,810	2,473	0,044/0,111	EC	72-3602H	H048/5 STD 0.25	
MB/HL 1-4	4	87,990/88,010	93,000/93,022	24,100	2,477	0,036/0,103	EC	72-3768		



72-3602H	STD	32,000/1.2598" - 32,062/1.2623"
	0.25mm	32,100/1.2638" - 32,162/1.2662"
	0.50mm	32,150/1.2657" - 32,212/1.2682"
	0.75mm	32,150/1.2657" - 32,212/1.2682"
	1.00mm	32,500/1.2795" - 32,562/1.2820"

SE/PB	1	36,000	39,000/39,025	34,500			BS	55-2535	55-2535 SEMI
-------	---	--------	---------------	--------	--	--	----	---------	-----------------

118 97.50 x 133.00

OM 356.901 Euro 1	6 Cyl.	5958cc	95kW (129PS)	Diesel	TD5704
OM 356.902 Euro 1	6 Cyl.	5958cc	95kW (129PS)	Diesel	TD8064
OM 356.903 Euro 1	6 Cyl.	5958cc	95kW (129PS)	Diesel	TD8093

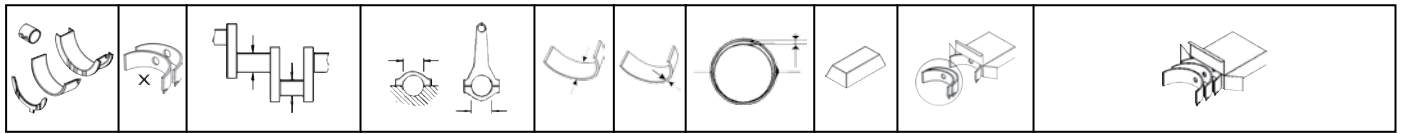





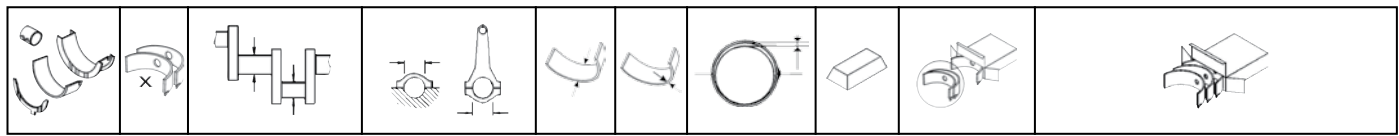

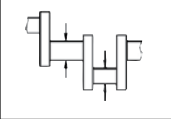
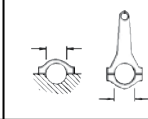

OM 356.904 Euro 1	6 Cyl.	5958cc	95kW (129PS)	Diesel	TD8098
OM 356.905 Euro 1	6 Cyl.	5958cc	95kW (129PS)	Diesel	TD8062
OM 356.906 Euro 1	6 Cyl.	5958cc	95kW (129PS)	Diesel	TD8067
OM 356.907 Euro 1	6 Cyl.	5958cc	95kW (129PS)	Diesel	TD8099
OM 356.908 Euro 1	6 Cyl.	5958cc	95kW (129PS)	Diesel	TD8134
OM 356.909 Euro 1	6 Cyl.	5958cc	95kW (129PS)	Diesel	TD8133
OM 356.910 Euro 1	6 Cyl.	5958cc	95kW (129PS)	Diesel	TD8132
OM 356.911 Euro 1	6 Cyl.	5958cc	95kW (129PS)	Diesel	TD6039
OM 356.912 Euro 1	6 Cyl.	5958cc	81kW (110PS)	Diesel	TD16992
OM 356.913 Euro 1	6 Cyl.	5958cc	100kW (136PS)	Diesel	TD16810
OM 356.914 Euro 1	6 Cyl.	5958cc	75kW (102PS)	Diesel	TD7994
OM 356.915 Euro 1	6 Cyl.	5958cc	97kW (132PS)	Diesel	TD16811
OM 356.916 Euro 1	6 Cyl.	5958cc	97kW (132PS)	Diesel	TD17096
OM 356.940 Euro 1	6 Cyl.	5958cc	129kW (175PS)	Diesel Turbo	TD6098
OM 356.941 Euro 1	6 Cyl.	5958cc	116kW (158PS)	Diesel Turbo	TD5705
OM 356.943 Euro 1	6 Cyl.	5958cc	121kW (165PS)	Diesel Turbo	TD8146
OM 356.944 Euro 1	6 Cyl.	5958cc	116kW (158PS)	Diesel Turbo	TD8136
OM 356.945 Euro 1	6 Cyl.	5958cc	116kW (158PS)	Diesel Turbo	TD8137
OM 356.946 Euro 1	6 Cyl.	5958cc	116kW (158PS)	Diesel Turbo	TD5756
OM 356.947 Euro 1	6 Cyl.	5958cc	116kW (158PS)	Diesel Turbo	TD8103
OM 356.948 Euro 1	6 Cyl.	5958cc	116kW (158PS)	Diesel Turbo	TD8078
OM 356.949 Euro 1	6 Cyl.	5958cc	116kW (158PS)	Diesel Turbo	TD8105
OM 356.950 Euro 1	6 Cyl.	5958cc	92kW (125PS)	Diesel Turbo	TD8000
OM 356.951 Euro 1	6 Cyl.	5958cc	116kW (158PS)	Diesel Turbo	TD8073
OM 356.952 Euro 1	6 Cyl.	5958cc	116kW (158PS)	Diesel Turbo	TD16941
OM 356.953 Euro 1	6 Cyl.	5958cc	116kW (158PS)	Diesel Turbo	TD6089
OM 356.954 Euro 1	6 Cyl.	5958cc	92kW (125PS)	Diesel Turbo	TD8001
OM 356.955 Euro 1	6 Cyl.	5958cc	114kW (155PS)	Diesel Turbo	TD5680
OM 356.956 Euro 1	6 Cyl.	5958cc	114-115kW (155-156PS)	Diesel Turbo	TD6018
OM 356.957 Euro 1	6 Cyl.	5958cc	122kW (166PS)	Diesel Turbo	TD8010
OM 356.958 Euro 1	6 Cyl.	5958cc	116kW (158PS)	Diesel Turbo	TD16812
OM 356.959 Euro 1	6 Cyl.	5958cc	121kW (165PS)	Diesel Turbo	TD16813
OM 356.977 Euro 1	6 Cyl.	5958cc	177kW (240PS)	Diesel Turbo Intercooler	TD16814
OM 356.978 Euro 1	6 Cyl.	5958cc	155kW (211PS)	Diesel Turbo Intercooler	TD16815
OM 356.979	6 Cyl.	5958cc	177kW (240PS)	Diesel Turbo Intercooler	TD5726
OM 356.980	6 Cyl.	5958cc	177kW (240PS)	Diesel Turbo Intercooler	TD8005
OM 356.981	6 Cyl.	5958cc	127kW (170PS)	Diesel Turbo Intercooler	TD8011
OM 356.983 Euro 1	6 Cyl.	5958cc	177kW (240PS)	Diesel Turbo Intercooler	TD5724
OM 356.984	6 Cyl.	5958cc	155kW (211PS)	Diesel Turbo Intercooler	TD8148
OM 356.985	6 Cyl.	5958cc	150kW (204PS)	Diesel Turbo Intercooler	TD8189
OM 356.986	6 Cyl.	5958cc	155kW (211PS)	Diesel Turbo Intercooler	TD8108
OM 356.987 Euro 1	6 Cyl.	5958cc	155kW (211PS)	Diesel Turbo Intercooler	TD8149
OM 356.988 Euro 1	6 Cyl.	5958cc	177kW (241PS)	Diesel Turbo Intercooler	TD22747
OM 356.989	6 Cyl.	5958cc	177kW (240PS)	Diesel Turbo Intercooler	TD6057
OM 356.990	6 Cyl.	5958cc	155kW (211PS)	Diesel Turbo Intercooler	TD8165
OM 356.991	6 Cyl.	5958cc	177kW (240PS)	Diesel Turbo Intercooler	TD6282
OM 356.992	6 Cyl.	5958cc	155kW (211PS)	Diesel Turbo Intercooler	TD8140
OM 356.993	6 Cyl.	5958cc	155kW (211PS)	Diesel Turbo Intercooler	TD8112
OM 356.994	6 Cyl.	5958cc	155kW (211PS)	Diesel Turbo Intercooler	TD5721
OM 356.995	6 Cyl.	5958cc	155kW (211PS)	Diesel Turbo Intercooler	TD6054
OM 356.996	6 Cyl.	5958cc	155kW (211PS)	Diesel Turbo Intercooler	TD8110
OM 356.997	6 Cyl.	5958cc	157kW (214PS)	Diesel Turbo Intercooler	TD5681
OM 356.998	6 Cyl.	5958cc	132kW (180PS)	Diesel Turbo Intercooler	TD6019

MERCEDES-BENZ

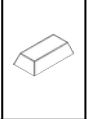

OM 356.999	6 Cyl.	5958cc	177kW (240PS)	Diesel Turbo Intercooler	TD8124
OM 357.900	6 Cyl.	5958cc	125kW (170PS)	Diesel Turbo Intercooler	TD8069
OM 357.901	6 Cyl.	5958cc	125kW (170PS)	Diesel Turbo Intercooler	TD5708
OM 357.902	6 Cyl.	5958cc	125kW (170PS)	Diesel Turbo Intercooler	TD5740
OM 357.903	6 Cyl.	5958cc	125kW (170PS)	Diesel Turbo Intercooler	TD5742
OM 357.904	6 Cyl.	5958cc	125kW (170PS)	Diesel Turbo Intercooler	TD16528
OM 357.906	6 Cyl.	5958cc	125kW (170PS)	Diesel Turbo Intercooler	TD8095
OM 357.907	6 Cyl.	5958cc	125kW (170PS)	Diesel Turbo Intercooler	TD8138
OM 357.908	6 Cyl.	5958cc	125kW (170PS)	Diesel Turbo Intercooler	TD8074
OM 357.909	6 Cyl.	5958cc	125kW (170PS)	Diesel Turbo Intercooler	TD5706
OM 357.910	6 Cyl.	5958cc	125kW (170PS)	Diesel Turbo Intercooler	TD6041
OM 357.912 Euro 2	6 Cyl.	5958cc	100kW (136PS)	Diesel Turbo Intercooler	TD14689
OM 357.913 Euro 2	6 Cyl.	5958cc	120kW (163PS)	Diesel Turbo Intercooler	TD16993
OM 357.915	6 Cyl.	5958cc	125kW (170PS)	Diesel Turbo Intercooler	TD8147
OM 357.916	6 Cyl.	5958cc	125kW (170PS)	Diesel Turbo Intercooler	TD8075
OM 357.917	6 Cyl.	5958cc	125kW (170PS)	Diesel Turbo Intercooler	TD8079
OM 357.918	6 Cyl.	5958cc	125kW (170PS)	Diesel Turbo Intercooler	TD6043
OM 357.919	6 Cyl.	5958cc	125kW (170PS)	Diesel Turbo Intercooler	TD8106
OM 357.920	6 Cyl.	5958cc	155kW (211PS)	Diesel Turbo Intercooler	TD5720
OM 357.921	6 Cyl.	5958cc	155kW (211PS)	Diesel Turbo Intercooler	TD5743
OM 357.922	6 Cyl.	5958cc	155kW (211PS)	Diesel Turbo Intercooler	TD8166
OM 357.924 Euro 2	6 Cyl.	5958cc	155kW (211PS)	Diesel Turbo Intercooler	TD14688
OM 357.925	6 Cyl.	5958cc	155kW (211PS)	Diesel Turbo Intercooler	TD8196
OM 357.926	6 Cyl.	5958cc	155kW (211PS)	Diesel Turbo Intercooler	TD16931
OM 357.927	6 Cyl.	5958cc	155kW (211PS)	Diesel Turbo Intercooler	TD5723
OM 357.929	6 Cyl.	5958cc	155kW (211PS)	Diesel Turbo Intercooler	TD8113
OM 357.930	6 Cyl.	5958cc	155kW (211PS)	Diesel Turbo Intercooler	TD8168
OM 357.931 Euro 2	6 Cyl.	5958cc	155kW (211PS)	Diesel Turbo Intercooler	TD16820
OM 357.932	6 Cyl.	5958cc	155kW (211PS)	Diesel Turbo Intercooler	TD6056
OM 357.933	6 Cyl.	5958cc	155kW (211PS)	Diesel Turbo Intercooler	TD8115
OM 357.936 Euro 2	6 Cyl.	5958cc	155kW (211PS)	Diesel Turbo Intercooler	TD16821
OM 357.937 Euro 2	6 Cyl.	5958cc	155kW (211PS)	Diesel Turbo Intercooler	TD16822
OM 357.938 Euro 2	6 Cyl.	5958cc	155kW (211PS)	Diesel Turbo Intercooler	TD22748
OM 357.940	6 Cyl.	5958cc	177kW (240PS)	Diesel Turbo Intercooler	TD5746
OM 357.941	6 Cyl.	5958cc	177kW (240PS)	Diesel Turbo Intercooler	TD8169
OM 357.942	6 Cyl.	5958cc	177kW (240PS)	Diesel Turbo Intercooler	TD8116
OM 357.943	6 Cyl.	5958cc	177kW (240PS)	Diesel Turbo Intercooler	TD5725
OM 357.944	6 Cyl.	5958cc	177kW (240PS)	Diesel Turbo Intercooler	TD6058
OM 357.945 Euro 2	6 Cyl.	5958cc	177kW (241PS)	Diesel Turbo Intercooler	TD14690
OM 357.946	6 Cyl.	5958cc	177kW (240PS)	Diesel Turbo Intercooler	TD8125
OM 357.947	6 Cyl.	5958cc	177kW (240PS)	Diesel Turbo Intercooler	TD8170
OM 357.948	6 Cyl.	5958cc	177kW (240PS)	Diesel Turbo Intercooler	TD6077
OM 357.949 Euro 2	6 Cyl.	5958cc	177kW (240PS)	Diesel Turbo Intercooler	TD16823
OM 357.961	6 Cyl.	5958cc	125kW (170PS)	Diesel Turbo Intercooler	TD6073
OM 357.962	6 Cyl.	5958cc	125kW (170PS)	Diesel Turbo Intercooler	TD6074
OM 357.963	6 Cyl.	5958cc	125kW (170PS)	Diesel Turbo Intercooler	TD6090
OM 366.905	6 Cyl.	5958cc	100kW (136PS)	Diesel Turbo Intercooler	TD5698
OM 366.906	6 Cyl.	5960cc	100kW (136PS)	Diesel	TD5748
OM 366.907	6 Cyl.	5958cc	100kW (136PS)	Diesel	TD5716
OM 366.908	6 Cyl.	5958cc	81kW (110PS)	Diesel	TD17858
OM 366.909	6 Cyl.	5960cc	100kW (136PS)	Diesel	TD6078
OM 366.910	6 Cyl.	5958cc	100kW (136PS)	Diesel	TD8065
OM 366.911 Euro 1	6 Cyl.	5958cc	96kW (131PS)	Diesel	TD22775

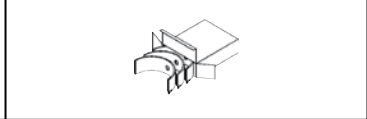
									
OM 366.912	6 Cyl.	5958cc	74kW (100PS)	Diesel					TD17857
OM 366.913	6 Cyl.	5958cc	100kW (136PS)	Diesel					TD17100
OM 366.914	6 Cyl.	5958cc	100kW (136PS)	Diesel					TD6049
OM 366.915	6 Cyl.	5958cc	75kW (102PS)	Diesel					TD7995
OM 366.917	6 Cyl.	5958cc	100kW (136PS)	Diesel					TD7887
OM 366.918	6 Cyl.	5960cc	100kW (136PS)	Diesel					TD5739
OM 366.919	6 Cyl.	5958cc	100kW (136PS)	Diesel					TD16808
OM 366.930	6 Cyl.	5958cc	100kW (136PS)	Diesel					TD8094
OM 366.931	6 Cyl.	5958cc	100kW (136PS)	Diesel					TD5717
OM 366.932	6 Cyl.	5958cc	100kW (136PS)	Diesel					TD8068
OM 366.933	6 Cyl.	5958cc	100kW (136PS)	Diesel					TD8100
OM 366.935	6 Cyl.	5958cc	100kW (136PS)	Diesel					TD6050
OM 366.936	6 Cyl.	5960cc	100kW (136PS)	Diesel					TD8135
OM 366.937	6 Cyl.	5960cc	100kW (136PS)	Diesel					TD6072
OM 366.938	6 Cyl.	5958cc	100kW (136PS)	Diesel					TD16809
OM 366.939	6 Cyl.	5958cc	81kW (110PS)	Diesel					TD7993
OM 366.940	6 Cyl.	5958cc	100kW (136PS)	Diesel					TD6040
OM 366.941 Euro 1	6 Cyl.	5958cc	116kW (158PS)	Diesel Turbo					TD8102
OM 366.942 Euro 1	6 Cyl.	5958cc	121kW (165PS)	Diesel Turbo					TD8076
OM 366.943 Euro 1	6 Cyl.	5958cc	116kW (158PS)	Diesel Turbo					TD8070
OM 366.944	6 Cyl.	5958cc	125kW (170PS)	Diesel Turbo					TD5703
OM 366.945	6 Cyl.	5958cc	125kW (170PS)	Diesel Turbo					TD5757
OM 366.946	6 Cyl.	5960cc	125kW (170PS)	Diesel					TD5741
OM 366.947	6 Cyl.	5958cc	100kW (136PS)	Diesel Turbo					TD5679
OM 366.948	6 Cyl.	5958cc	100-115kW (136-156PS)	Diesel Turbo					TD6017
OM 366.949	6 Cyl.	5958cc	92-115kW (125-156PS)	Diesel Turbo					TD6277
OM 366.951	6 Cyl.	5960cc	125kW (170PS)	Diesel Turbo					TD5749
OM 366.952	6 Cyl.	5958cc	116-129kW (158-175PS)	Diesel Turbo					TD5766
OM 366.953	6 Cyl.	5958cc	125kW (170PS)	Diesel Turbo					TD5718
OM 366.954	6 Cyl.	5958cc	115-132kW (156-180PS)	Diesel Turbo					TD17862
OM 366.955	6 Cyl.	5958cc	100kW (136PS)	Diesel Turbo					TD6276
OM 366.956	6 Cyl.	5958cc	100kW (136PS)	Diesel Turbo					TD6320
OM 366.957	6 Cyl.	5958cc	125kW (170PS)	Diesel Turbo					TD16816
OM 366.958	6 Cyl.	5958cc	100kW (136PS)	Diesel Turbo					TD17861
OM 366.960	6 Cyl.	5960cc	125kW (170PS)	Diesel Turbo					TD17101
OM 366.962	6 Cyl.	5960cc	125kW (170PS)	Diesel Turbo					TD5745
OM 366.963	6 Cyl.	5958cc	125kW (170PS)	Diesel Turbo					TD8006
OM 366.965	6 Cyl.	5958cc	125kW (170PS)	Diesel Turbo					TD7888
OM 366.966	6 Cyl.	5958cc	125kW (170PS)	Diesel Turbo					TD5707
OM 366.967	6 Cyl.	5958cc	125kW (170PS)	Diesel Turbo					TD5699
OM 366.968	6 Cyl.	5958cc	125kW (170PS)	Diesel Turbo					TD8077
OM 366.969	6 Cyl.	5958cc	125kW (170PS)	Diesel Turbo					TD8080
OM 366.970	6 Cyl.	5958cc	125kW (170PS)	Diesel Turbo					TD8104
OM 366.971	6 Cyl.	5958cc	125kW (170PS)	Diesel Turbo					TD8107
OM 366.973	6 Cyl.	5958cc	125kW (170PS)	Diesel Turbo					TD6035
OM 366.974	6 Cyl.	5958cc	125kW (170PS)	Diesel Turbo					TD6042
OM 366.975	6 Cyl.	5958cc	125kW (170PS)	Diesel Turbo					TD5719
OM 366.976	6 Cyl.	5958cc	125kW (170PS)	Diesel Turbo					TD6052
OM 366.977	6 Cyl.	5958cc	92kW (125PS)	Diesel Turbo					TD17859
OM 366.978	6 Cyl.	5958cc	125kW (170PS)	Diesel Turbo					TD6279
OM 366.979	6 Cyl.	5958cc	125kW (170PS)	Diesel Turbo					TD6091
OM 366.980	6 Cyl.	5960cc	148kW (201PS)	Diesel Turbo Intercooler					TD8141
OM 366.981	6 Cyl.	5958cc	148kW (201PS)	Diesel Turbo Intercooler					TD16817

MERCEDES-BENZ



OM 366.983	6 Cyl.	5958cc	150kW (204PS)	Diesel Turbo Intercooler	TD8150
OM 366.984	6 Cyl.	5958cc	150-157kW (204-214PS)	Diesel Turbo Intercooler	TD8007
OM 366.988	6 Cyl.	5960cc	148-150kW (201-204PS)	Diesel Turbo Intercooler	TD5744
OM 366.990	6 Cyl.	5958cc	150kW (204PS)	Diesel Turbo Intercooler	TD16818
OM 366.992	6 Cyl.	5958cc	150kW (204PS)	Diesel Turbo Intercooler	TD5722
OM 366.993	6 Cyl.	5958cc	150kW (204PS)	Diesel Turbo Intercooler	TD8114
OM 366.994	6 Cyl.	5958cc	150kW (204PS)	Diesel Turbo Intercooler	TD6055
OM 366.995	6 Cyl.	5958cc	150kW (204PS)	Diesel Turbo Intercooler	TD8167
OM 366.996	6 Cyl.	5958cc	150kW (204PS)	Diesel Turbo Intercooler	TD16819
OM 366.997 Euro 1	6 Cyl.	5960cc	148-150kW (201-204PS)	Diesel Turbo Intercooler	TD6075
OM 366.999 Euro 1	6 Cyl.	5958cc	170kW (231PS)	Diesel Turbo Intercooler	TD8126
OM 372.906	6 Cyl.	5958cc	100kW (136PS)	Diesel	TD23200
OM 372.907	6 Cyl.	5958cc	100kW (136PS)	Diesel	TD23201
OM 372.930	6 Cyl.	5958cc	100kW (136PS)	Diesel	TD23202
OM 382.912	6 Cyl.	5958cc	100kW (136PS)	Diesel	TD22783
OM 382.913	6 Cyl.	5958cc	125kW (170PS)	Diesel Turbo	TD22784
OM 382.916	6 Cyl.	5958cc	96kW (130PS)	Diesel	TD17174
OM 382.917	6 Cyl.	5958cc	110kW (150PS)	Diesel Turbo	TD17176
OM 382.919	6 Cyl.	5958cc	150kW (204PS)	Diesel Turbo	TD22785
OM 382.950	6 Cyl.	5958cc	125kW (170PS)	Diesel Turbo	TD17175
OM 382.970	6 Cyl.	5958cc	177kW (241PS)	Diesel Turbo Intercooler	TD22786
OM 382.971	6 Cyl.	5958cc	150kW (204PS)	Diesel Turbo	TD22787
OM 386.906	6 Cyl.	5958cc	100kW (136PS)	Diesel Turbo	TD22793
OM 386.950	6 Cyl.	5958cc	125kW (170PS)	Diesel Turbo	TD22794
OM 386.951	6 Cyl.	5958cc	125kW (170PS)	Diesel Turbo	TD22795
OM 386.952	6 Cyl.	5958cc	125kW (170PS)	Diesel Turbo	TD22796
OM 386.980	6 Cyl.	5958cc	150kW (204PS)	Diesel Turbo Intercooler	TD22797
OM 386.981	6 Cyl.	5958cc	150kW (204PS)	Diesel Turbo Intercooler	TD22798
OM 386.983	6 Cyl.	5958cc	150kW (204PS)	Diesel Turbo Intercooler	TD22799

BE/PL	1	31,984/32,000	35,000/35,016	21,000	1,487	0,026/0,083	AL-LF	01-3438	01-3438 STD	10
BE/PL	1	31,984/32,000	35,000/35,016	21,000	1,487	0,026/0,083	BB	11-3438	11-3438 0.25 0.50	10
BE/PL	6	59,990/60,015	65,000/65,019	29,400	2,472	0,041/0,110	EC	71-3572	71-3572/6 STD 0.25 0.50 0.75 1.00	
MB/HL 7	1	87,990/88,010	93,000/93,022	31,810	2,473	0,044/0,111	EC	72-3602H	H048/7 STD 0.25 0.50 0.75 1.00	
MB/HL 1-6	6	87,990/88,010	93,000/93,022	24,100	2,477	0,036/0,103	EC	72-3768		



72-3602H	
STD	32,000/1.2598" - 32,062/1.2623"
0.25mm	32,100/1.2638" - 32,162/1.2662"
0.50mm	32,150/1.2657" - 32,212/1.2682"
0.75mm	32,150/1.2657" - 32,212/1.2682"
1.00mm	32,500/1.2795" - 32,562/1.2820"

SE/PB	1	36,000	39,000/39,025	34,500			BS	55-2535	55-2535 SEMI	
CB/NWB	1	55,691/55,710	60,000/60,030	26,000			AL-LF	03-1865	N128/4 STD	
CB/NWB	1	55,441/55,460	60,000/60,030	26,000			AL-LF	03-1866		
CB/NWB	1	55,191/55,210	60,000/60,030	26,000			AL-LF	03-1867		
CB/NWB	1	55,941/55,960	60,000/60,030	26,000			BC	53-1864		

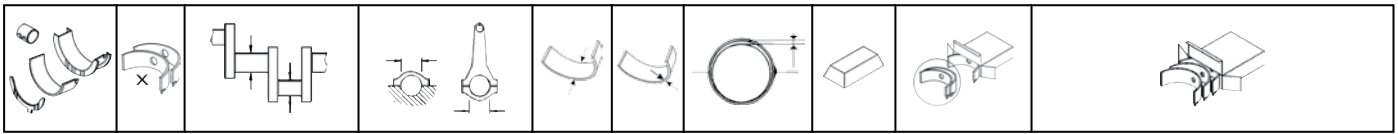

119		98.00 x 90.50								
M 273.960			V8 Cyl.	5461cc	285kW (388PS)		Petrol			TD20737
M 273.961			V8 Cyl.	5461cc	271-285kW (369-388PS)		Petrol			TD19147
M 273.962			V8 Cyl.	5461cc	285kW (388PS)		Petrol			TD20990
M 273.963			V8 Cyl.	5461cc	285kW (388PS)		Petrol			TD19209
M 273.965			V8 Cyl.	5461cc	285kW (388PS)		Petrol			TD19212
M 273.966			V8 Cyl.	5461cc	285kW (388PS)		Petrol			TD23725
M 273.967			V8 Cyl.	5461cc	285kW (388PS)		Petrol			TD21180
M 273.968			V8 Cyl.	5461cc	285kW (388PS)		Petrol			TD20908
M 273.970			V8 Cyl.	5461cc	285kW (388PS)		Petrol			TD23779
M 273.971			V8 Cyl.	5461cc	285kW (388PS)		Petrol			TD23780
BE/PL	8	51,945/51,965	55,600/55,614	19,600	1,813	0,020/0,067	EC	71-4007	71-4007/8 STD	
MB/HL	4	63,945/63,965	68,500/68,519	20,600	2,267	0,020/0,064	AL-LF	02-4008	H1003/5 STD	
MB/HL	1	63,945/63,965	68,500/68,519	24,000	2,267	0,020/0,064	AL-LF	02-4009		
TW/A	2	72,250	84,000		1,900		AL-LF	04-4010	A164/4 STD	
TW/A	2	72,250	84,000		1,900		AL-LF	04-4011		
SE/PB	1	22,000	24,500/24,521	19,900			BC	55-4012	55-4012 SEMI	

120		102.00 x 130.00								
OM 900.910			4 Cyl.	4249cc	128kW (174PS)		Diesel Turbo Intercooler			TD22699
OM 904.904 Euro 2			4 Cyl.	4250cc	75kW (102PS)		Diesel Turbo Intercooler			TD16441
OM 904.905 Euro 2			4 Cyl.	4249cc	90kW (122PS)		Diesel Turbo Intercooler			TD8055
OM 904.906 Euro 2			4 Cyl.	4249cc	100kW (136PS)		Diesel Turbo Intercooler			TD8060
OM 904.907 Euro 2			4 Cyl.	4249cc	125-130kW (170-177PS)		Diesel Turbo Intercooler			TD8072
OM 904.908 Euro 2			4 Cyl.	4250cc	95-100kW (129-136PS)		Diesel Turbo Intercooler			TD8024
OM 904.909 Euro 2			4 Cyl.	4249cc	90kW (122PS)		Diesel Turbo Intercooler			TD12528
OM 904.910 Euro 2			4 Cyl.	4249cc	100kW (136PS)		Diesel Turbo Intercooler			TD12529
OM 904.911 Euro 2			4 Cyl.	4249cc	125kW (170PS)		Diesel Turbo Intercooler			TD12530
OM 904.912 Euro 2			4 Cyl.	4249cc	134kW (182PS)		Diesel Turbo Intercooler			TD17711
OM 904.914 Euro 2			4 Cyl.	4249cc	100kW (136PS)		Diesel Turbo Intercooler			TD16833
OM 904.915 Euro 2			4 Cyl.	4249cc	90kW (122PS)		Diesel Turbo Intercooler			TD16834
OM 904.916 Euro 2			4 Cyl.	4249cc	100kW (136PS)		Diesel Turbo Intercooler			TD16835
OM 904.917 Euro 2			4 Cyl.	4249cc	95-125kW (129-170PS)		Diesel Turbo Intercooler			TD16836
OM 904.918 Euro 2			4 Cyl.	4249cc	90kW (122PS)		Diesel Turbo Intercooler			TD17752
OM 904.919 Euro 2			4 Cyl.	4249cc	100kW (136PS)		Diesel Turbo Intercooler			TD17705
OM 904.920 Euro 2			4 Cyl.	4249cc	125kW (170PS)		Diesel Turbo Intercooler			TD17706
OM 904.921 Euro 2			4 Cyl.	4249cc	112kW (152PS)		Diesel Turbo Intercooler			TD16837
OM 904.922 Euro 2			4 Cyl.	4249cc	112kW (152PS)		Diesel Turbo			TD12531
OM 904.923 Euro 2			4 Cyl.	4250cc	112-115kW (152-156PS)		Diesel Turbo Intercooler			TD16438
OM 904.924 Euro 2			4 Cyl.	4249cc	100kW (136PS)		Diesel Turbo Intercooler			TD17707
OM 904.925 Euro 2			4 Cyl.	4249cc	112kW (152PS)		Diesel Turbo Intercooler			TD17708
OM 904.926 Euro 2			4 Cyl.	4249cc	113kW (154PS)		Diesel Turbo Intercooler			TD17709
OM 904.927 Euro 3			4 Cyl.	4249cc	110kW (150PS)		Diesel Turbo Intercooler			TD17324
OM 904.928 Euro 3			4 Cyl.	4249cc	130kW (177PS)		Diesel Turbo Intercooler			TD17325
OM 904.929 Euro 2			4 Cyl.	4249cc	125kW (170PS)		Diesel Turbo Intercooler			TD17710
OM 904.930 Euro 2			4 Cyl.	4249cc	100kW (136PS)		Diesel Turbo Intercooler			TD16838
OM 904.931 Euro 2			4 Cyl.	4249cc	135kW (180PS)		Diesel Turbo Intercooler			TD16839
OM 904.932 Euro 2			4 Cyl.	4249cc	142kW (193PS)		Diesel Turbo Intercooler			TD17712

MERCEDES-BENZ



OM 904.933 Euro 2	4 Cyl.	4249cc	128kW (174PS)	Diesel Turbo Intercooler	TD17713
OM 904.934 Euro 2	4 Cyl.	4249cc	134kW (174PS)	Diesel Turbo Intercooler	TD17714
OM 904.935 Euro 2	4 Cyl.	4249cc	134kW (174PS)	Diesel Turbo Intercooler	TD17715
OM 904.936 Euro 3	4 Cyl.	4250cc	110kW (150PS)	Diesel Turbo Intercooler	TD16916
OM 904.937 Euro 2	4 Cyl.	4249cc	142kW (193PS)	Diesel Turbo Intercooler	TD17716
OM 904.938 Euro 2	4 Cyl.	4249cc	125kW (170PS)	Diesel Turbo Intercooler	TD17717
OM 904.939 Euro 2	4 Cyl.	4249cc	128kW (174PS)	Diesel Turbo Intercooler	TD17718
OM 904.940 Euro 2	4 Cyl.	4249cc	113kW (154PS)	Diesel Turbo Intercooler	TD17719
OM 904.941 Euro 2	4 Cyl.	4249cc	112kW (152PS)	Diesel Turbo Intercooler	TD17720
OM 904.942 Euro 3	4 Cyl.	4249cc	130kW (177PS)	Diesel Turbo Intercooler	TD17721
OM 904.943 Euro 2	4 Cyl.	4249cc	112kW (152PS)	Diesel Turbo Intercooler	TD17722
OM 904.944 Euro 2	4 Cyl.	4249cc	90kW (122PS)	Diesel Turbo Intercooler	TD17734
OM 904.945 Euro 2	4 Cyl.	4249cc	125kW (170PS)	Diesel Turbo Intercooler	TD17735
OM 904.946 Euro 2	4 Cyl.	4249cc	90-110kW (122-150PS)	Diesel Turbo Intercooler	TD17736
OM 904.947 Euro 3	4 Cyl.	4249cc	130kW (177PS)	Diesel Turbo Intercooler	TD17737
OM 904.948 Euro 2	4 Cyl.	4249cc	113kW (154PS)	Diesel Turbo Intercooler	TD17738
OM 904.949 Euro 2	4 Cyl.	4249cc	128-130kW (174-177PS)	Diesel Turbo Intercooler	TD17739
OM 904.950 Euro 2	4 Cyl.	4249cc	90-110kW (122-150PS)	Diesel Turbo Intercooler	TD17740
OM 904.951 Euro 3	4 Cyl.	4249cc	130kW (177PS)	Diesel Turbo Intercooler	TD17741
OM 904.952 Euro 3	4 Cyl.	4249cc	130kW (177PS)	Diesel Turbo Intercooler	TD17183
OM 904.953 Euro 3	4 Cyl.	4249cc	110kW (150PS)	Diesel Turbo Intercooler	TD17184
OM 904.954 Euro 2	4 Cyl.	4249cc	128kW (174PS)	Diesel Turbo Intercooler	TD17742
OM 904.955 Euro 3	4 Cyl.	4250cc	110kW (150PS)	Diesel Turbo Intercooler	TD16915
OM 904.956 Euro 2	4 Cyl.	4249cc	142kW (193PS)	Diesel Turbo Intercooler	TD17744
OM 904.957 Euro 3	4 Cyl.	4249cc	110kW (150PS)	Diesel Turbo Intercooler	TD17745
OM 904.959 Euro 2	4 Cyl.	4249cc	128kW (174PS)	Diesel Turbo Intercooler	TD17746
OM 904.961 Euro 3	4 Cyl.	4250cc	90kW (122PS)	Diesel Turbo Intercooler	TD16918
OM 904.962 Euro 3	4 Cyl.	4249cc	130kW (177PS)	Diesel Turbo Intercooler	TD17747
OM 904.964 Euro 3	4 Cyl.	4249cc	130kW (177PS)	Diesel Turbo Intercooler	TD16919
OM 904.965 Euro 3	4 Cyl.	4249cc	110kW (150PS)	Diesel Turbo Intercooler	TD17748
OM 904.966 Euro 3	4 Cyl.	4249cc	110kW (150PS)	Diesel Turbo Intercooler	TD17749
OM 904.967 Euro 3	4 Cyl.	4249cc	130kW (177PS)	Diesel Turbo Intercooler	TD17750
OM 904.968 Euro 3	4 Cyl.	4249cc	130kW (177PS)	Diesel Turbo Intercooler	TD17751
OM 904.970 Euro 3	4 Cyl.	4249cc	110kW (150PS)	Diesel Turbo Intercooler	TD24856
OM 904.972 Euro 3	4 Cyl.	4249cc	130kW (177PS)	Diesel Turbo Intercooler	TD24857
OM 904.973 Euro 3	4 Cyl.	4249cc	130kW (177PS)	Diesel Turbo Intercooler	TD24858
OM 904.976 Euro 3	4 Cyl.	4249cc	130kW (177PS)	Diesel Turbo Intercooler	TD24859
OM 907.910 Euro 2	4 Cyl.	4250cc	75kW (102PS)	Diesel Turbo Intercooler	TD16840
OM 907.920 Euro 2	4 Cyl.	4250cc	90kW (122PS)	Diesel Turbo Intercooler	TD16841
OM 907.930 Euro 2	4 Cyl.	4249cc	100kW (136PS)	Diesel Turbo Intercooler	TD17754
OM 907.940 Euro 2	4 Cyl.	4250cc	125kW (170PS)	Diesel Turbo Intercooler	TD16842
OM 907.941 Euro 2	4 Cyl.	4249cc	125kW (170PS)	Diesel Turbo Intercooler	TD17753
OM 907.960 Euro 2	4 Cyl.	4250cc	75kW (102PS)	Diesel Turbo Intercooler	TD16843
OM 907.970 Euro 2	4 Cyl.	4250cc	90kW (122PS)	Diesel Turbo Intercooler	TD16844
OM 907.980 Euro 2	4 Cyl.	4249cc	100kW (136PS)	Diesel Turbo Intercooler	TD17755
OM 907.990 Euro 2	4 Cyl.	4250cc	125kW (170PS)	Diesel Turbo Intercooler	TD16845

BE/PL	1	69,995/70,015	75,000/75,019	28,300	2,478	0,029/0,093	SP	71-3850	71-3850 STD 0.25 0.50	□
MB/HL	1	85,990/86,010	91,000/91,022	23,300	2,475	0,040/0,107	BS	72-3851	72-3851 STD 0.25 0.50	
TW/A	2	93,650/94,000	117,500/117,850		3,310		AL-LF	04-4862	A302/2 STD	
SE/PB	1	39,995/40,000	44,000	33,700			BC	55-3854	55-3854 SEMI	

CB/NWB	1	67,911/67,930	72,000/72,030	29,300				BC	53-4761	53-4761 SEMI
CB/NWB	1	67,911/67,930	72,000/72,030	19,800				BC	53-4762	53-4762 SEMI
BU	1		25,000	23,700				BC	56-3855	56-3855 SEMI

121 102.00 x 130.00

OM 900.911 Euro 4			4 Cyl.	4249cc	95kW (129PS)				Diesel Turbo Intercooler	TD18918
OM 900.912 Euro 4			4 Cyl.	4249cc	115kW (156PS)				Diesel Turbo Intercooler	TD18919
OM 900.913 Euro 4			4 Cyl.	4249cc	130kW (177PS)				Diesel Turbo Intercooler	TD18920
OM 900.915 Euro 4			4 Cyl.	4249cc	110-115kW (150-156PS)				Diesel Turbo Intercooler	TD23299
OM 900.916 Euro 4			4 Cyl.	4249cc	110-115kW (150-156PS)				Diesel Turbo Intercooler	TD23300
OM 900.917 Euro 4			4 Cyl.	4249cc	95kW (129PS)				Diesel Turbo Intercooler	TD18921
OM 900.918 Euro 4			4 Cyl.	4249cc	115kW (156PS)				Diesel Turbo Intercooler	TD18922
OM 900.919 Euro 4			4 Cyl.	4249cc	130kW (177PS)				Diesel Turbo Intercooler	TD18923
OM 900.920 Euro 4			4 Cyl.	4249cc	115kW (156PS)				Diesel Turbo Intercooler	TD22696
OM 900.921 Euro 4			4 Cyl.	4249cc	130kW (177PS)				Diesel Turbo Intercooler	TD22697
OM 900.922 Euro 4			4 Cyl.	4249cc	95kW (129PS)				Diesel Turbo Intercooler	TD22698
BE/PL	1	69,995/70,015	75,000/75,019	26,300	2,478	0,090/0,093	EC	71-4065	71-4065 STD 0.25	[4]
MB/HL	1	85,990/86,010	91,000/91,022	23,300	2,475	0,040/0,102	EC	72-4760	72-4760 STD 0.25 0.50	[4]
TW/A	2	93,650/94,000	117,500/117,850		3,310		AL-LF	04-4862	A302/2 STD	
CB/NWB	1	67,911/67,930	72,000/72,030	29,300			BC	53-4761	53-4761 SEMI	
CB/NWB	1	67,911/67,930	72,000/72,030	19,800			BC	53-4762	53-4762 SEMI	

122 102.00 x 130.00

OM 902.910 Euro 4			6 Cyl.	6374cc	187kW (250PS)				Diesel Turbo Intercooler	TD20244
OM 902.911 Euro 4			6 Cyl.	6374cc	172kW (230PS)				Diesel Turbo Intercooler	TD20247
OM 902.912 Euro 4			6 Cyl.	6374cc	194kW (264PS)				Diesel Turbo Intercooler	TD20249
OM 902.913 Euro 4			6 Cyl.	6374cc	175kW (238PS)				Diesel Turbo Intercooler	TD20250
OM 902.914 Euro 4			6 Cyl.	6374cc	188kW (256PS)				Diesel Turbo Intercooler	TD20251
OM 902.915 Euro 4			6 Cyl.	6374cc	210kW (286PS)				Diesel Turbo Intercooler	TD20252
OM 902.916 Euro 4			6 Cyl.	6374cc	175kW (238PS)				Diesel Turbo Intercooler	TD18924
OM 902.917 Euro 4			6 Cyl.	6374cc	188kW (256PS)				Diesel Turbo Intercooler	TD18930
OM 902.918 Euro 4			6 Cyl.	6374cc	210kW (286PS)				Diesel Turbo Intercooler	TD18931
OM 902.919 Euro 4			6 Cyl.	6374cc	157-172kW (213-234PS)				Diesel Turbo Intercooler	TD20253
OM 902.920 Euro 4			6 Cyl.	6374cc	172kW (230PS)				Diesel Turbo Intercooler	TD20254
OM 902.921 Euro 4			6 Cyl.	6374cc	194kW (264PS)				Diesel Turbo Intercooler	TD20255
OM 902.922 Euro 4			6 Cyl.	6374cc	142kW (190PS)				Diesel Turbo Intercooler	TD20256
OM 902.923 Euro 4			6 Cyl.	6374cc	175kW (238PS)				Diesel Turbo Intercooler	TD23293
OM 902.924 Euro 4			6 Cyl.	6374cc	210kW (286PS)				Diesel Turbo Intercooler	TD23294
OM 902.925 Euro 4			6 Cyl.	6374cc	210kW (286PS)				Diesel Turbo Intercooler	TD23295
OM 902.926 Euro 4			6 Cyl.	6374cc	210kW (286PS)				Diesel Turbo Intercooler	TD23296
OM 902.927 Euro 4			6 Cyl.	6374cc	210kW (286PS)				Diesel Turbo Intercooler	TD20257
OM 902.930 Euro 4			6 Cyl.	6374cc	175kW (238PS)				Diesel Turbo Intercooler	TD20258
OM 902.931 Euro 4			6 Cyl.	6374cc	188kW (256PS)				Diesel Turbo Intercooler	TD20259
OM 902.932 Euro 4			6 Cyl.	6374cc	210kW (286PS)				Diesel Turbo Intercooler	TD20260
OM 902.933 Euro 4			6 Cyl.	6374cc	175kW (238PS)				Diesel Turbo Intercooler	TD20261
OM 902.934 Euro 4			6 Cyl.	6374cc	210kW (286PS)				Diesel Turbo Intercooler	TD23297
OM 902.936 Euro 4			6 Cyl.	6374cc	210kW (286PS)				Diesel Turbo Intercooler	TD23298

MERCEDES-BENZ

BE/PL	1	69,995/70,015	75,000/75,019	28,300	2,478	0,029/0,093	SP	71-3850	71-3850 STD 0.25 0.50	
MB/HL	1	85,990/86,010	91,000/91,022	23,300	2,475	0,040/0,107	BS	72-3851	72-3851 STD 0.25 0.50	
TW/A	2	93,650/94,000	117,500/117,850		3,310		AL-LF	04-4862	A302/2 STD	
CB/NWB	1	67,911/67,930	72,000/72,030	29,300			BC	53-4761	53-4761 SEMI	
CB/NWB	1	67,911/67,930	72,000/72,030	19,800			BC	53-4762	53-4762 SEMI	

123

102.00 x 130.00

OM 906.910 Euro 2	6 Cyl.	6374cc	170kW (231PS)	Diesel Turbo	TD11309
OM 906.911 Euro 2	6 Cyl.	6374cc	205kW (279PS)	Diesel Turbo Intercooler	TD11310
OM 906.912 Euro 2	6 Cyl.	6374cc	194kW (264PS)	Diesel Turbo	TD17757
OM 906.913 Euro 2	6 Cyl.	6374cc	170kW (231PS)	Diesel Turbo Intercooler	TD17758
OM 906.914 Euro 2	6 Cyl.	6374cc	157kW (231PS)	Diesel Turbo Intercooler	TD17759
OM 906.915 Euro 2	6 Cyl.	6374cc	170kW (231PS)	Diesel Turbo	TD11311
OM 906.916 Euro 2	6 Cyl.	6374cc	205kW (279PS)	Diesel Turbo	TD11312
OM 906.917 Euro 2	6 Cyl.	6374cc	170kW (231PS)	Diesel Turbo Intercooler	TD17760
OM 906.918 Euro 2	6 Cyl.	6374cc	180kW (245PS)	Diesel Turbo	TD17761
OM 906.919 Euro 2	6 Cyl.	6374cc	180kW (245PS)	Diesel Turbo	TD11313
OM 906.920 Euro 2	6 Cyl.	6374cc	170-172kW (231-234PS)	Diesel Turbo	TD11314
OM 906.921 Euro 2	6 Cyl.	6374cc	205kW (279PS)	Diesel Turbo	TD11315
OM 906.922 Euro 2	6 Cyl.	6374cc	170kW (231PS)	Diesel Turbo	TD11316
OM 906.923 Euro 2	6 Cyl.	6374cc	205kW (279PS)	Diesel Turbo	TD11317
OM 906.924 Euro 2	6 Cyl.	6374cc	170kW (231PS)	Diesel Turbo Intercooler	TD17762
OM 906.925 Euro 3	6 Cyl.	6374cc	170kW (231PS)	Diesel Turbo Intercooler	TD16920
OM 906.926 Euro 3	6 Cyl.	6374cc	205kW (279PS)	Diesel Turbo Intercooler	TD16923
OM 906.927 Euro 3	6 Cyl.	6374cc	170kW (231PS)	Diesel Turbo Intercooler	TD16921
OM 906.928 Euro 3	6 Cyl.	6374cc	205kW (279PS)	Diesel Turbo Intercooler	TD16924
OM 906.929 Euro 2	6 Cyl.	6374cc	172kW (234PS)	Diesel Turbo Intercooler	TD17763
OM 906.930 Euro 2	6 Cyl.	6374cc	205kW (279PS)	Diesel Turbo	TD11318
OM 906.931 Euro 2	6 Cyl.	6374cc	170kW (231PS)	Diesel Turbo	TD11319
OM 906.932 Euro 2	6 Cyl.	6374cc	172kW (234PS)	Diesel Turbo Intercooler	TD17764
OM 906.933 Euro 2	6 Cyl.	6374cc	209kW (284PS)	Diesel Turbo Intercooler	TD17765
OM 906.934 Euro 2	6 Cyl.	6374cc	209kW (284PS)	Diesel Turbo Intercooler	TD17766
OM 906.935 Euro 3	6 Cyl.	6374cc	170kW (231PS)	Diesel Turbo Intercooler	TD17326
OM 906.936 Euro 2	6 Cyl.	6374cc	172kW (234PS)	Diesel Turbo Intercooler	TD17767
OM 906.937 Euro 2	6 Cyl.	6374cc	170kW (231PS)	Diesel Turbo Intercooler	TD17768
OM 906.938 Euro 3	6 Cyl.	6374cc	205kW (279PS)	Diesel Turbo Intercooler	TD17769
OM 906.939 Euro 3	6 Cyl.	6374cc	180kW (245PS)	Diesel Turbo Intercooler	TD16926
OM 906.940 Euro 2	6 Cyl.	6374cc	170kW (231PS)	Diesel Turbo	TD11320
OM 906.941 Euro 2	6 Cyl.	6374cc	205kW (279PS)	Diesel Turbo	TD11321
OM 906.944 Euro 2	6 Cyl.	6374cc	142kW (193PS)	Diesel Turbo Intercooler	TD17770
OM 906.945 Euro 2	6 Cyl.	6374cc	157kW (214PS)	Diesel Turbo Intercooler	TD17771
OM 906.946 Euro 2	6 Cyl.	6374cc	187kW (254PS)	Diesel Turbo Intercooler	TD17772
OM 906.947 Euro 2	6 Cyl.	6374cc	194kW (264PS)	Diesel Turbo Intercooler	TD17774
OM 906.948 Euro 2	6 Cyl.	6374cc	224kW (305PS)	Diesel Turbo Intercooler	TD17775
OM 906.949 Euro 3	6 Cyl.	6374cc	180kW (245PS)	Diesel Turbo Intercooler	TD17776
OM 906.950 Euro 3	6 Cyl.	6374cc	205kW (279PS)	Diesel Turbo Intercooler	TD17777
OM 906.951	6 Cyl.	6374cc	170kW (231PS)	Diesel Turbo	TD17778
OM 906.952 Euro 3	6 Cyl.	6374cc	205kW (279PS)	Diesel Turbo Intercooler	TD16925
OM 906.953 Euro 3	6 Cyl.	6374cc	205kW (279PS)	Diesel Turbo Intercooler	TD17779
OM 906.954 Euro 2	6 Cyl.	6374cc	172kW (234PS)	Diesel Turbo Intercooler	TD17780

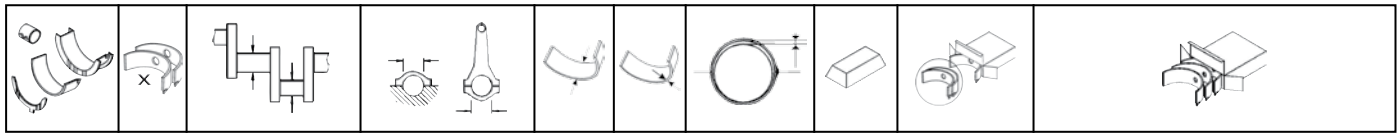

OM 906.955 Euro 3	6 Cyl.	6374cc	205kW (279PS)	Diesel Turbo Intercooler	TD17327
OM 906.956 Euro 2	6 Cyl.	6374cc	209kW (284PS)	Diesel Turbo Intercooler	TD17781
OM 906.957 Euro 2	6 Cyl.	6374cc	142kW (193PS)	Diesel Turbo Intercooler	TD17782
OM 906.958 Euro 2	6 Cyl.	6374cc	157kW (214PS)	Diesel Turbo Intercooler	TD17783
OM 906.959 Euro 2	6 Cyl.	6374cc	157kW (214PS)	Diesel Turbo Intercooler	TD17784
OM 906.960 Euro 3	6 Cyl.	6374cc	205kW (279PS)	Diesel Turbo Intercooler	TD17447
OM 906.961 Euro 3	6 Cyl.	6374cc	205kW (279PS)	Diesel Turbo Intercooler	TD17459
OM 906.962 Euro 3	6 Cyl.	6374cc	180kW (245PS)	Diesel Turbo Intercooler	TD17460
OM 906.963 Euro 3	6 Cyl.	6374cc	180kW (245PS)	Diesel Turbo Intercooler	TD17449
OM 906.964	6 Cyl.	6374cc	170-180kW (231-245PS)	Diesel Turbo Intercooler	TD17823
OM 906.965	6 Cyl.	6374cc	205kW (279PS)	Diesel Turbo Intercooler	TD17824
OM 906.966 Euro 2	6 Cyl.	6374cc	172kW (230PS)	Diesel Turbo Intercooler	TD17825
OM 906.967 Euro 2	6 Cyl.	6374cc	209kW (284PS)	Diesel Turbo Intercooler	TD17826
OM 906.968	6 Cyl.	6374cc	172-187kW (230-254PS)	Diesel Turbo Intercooler	TD17827
OM 906.970 Euro 2	6 Cyl.	6374cc	194-209kW (194-284PS)	Diesel Turbo Intercooler	TD17828
OM 906.971	6 Cyl.	6374cc	170-180kW (231-245PS)	Diesel Turbo Intercooler	TD17829
OM 906.974 Euro 2	6 Cyl.	6374cc	209kW (280PS)	Diesel Turbo Intercooler	TD17830
OM 906.975 Euro 2	6 Cyl.	6374cc	180kW (245PS)	Diesel Turbo Intercooler	TD17831
OM 906.976 Euro 2	6 Cyl.	6374cc	209kW (284PS)	Diesel Turbo Intercooler	TD17773
OM 906.977 Euro 2	6 Cyl.	6374cc	209kW (280PS)	Diesel Turbo Intercooler	TD17833
OM 906.978 Euro 2	6 Cyl.	6374cc	142-157kW (193-214PS)	Diesel Turbo Intercooler	TD17834
OM 906.979 Euro 2	6 Cyl.	6374cc	172-187kW (193-254PS)	Diesel Turbo Intercooler	TD17835
OM 906.980 Euro 2	6 Cyl.	6374cc	194-209kW (264-284PS)	Diesel Turbo Intercooler	TD17836
OM 906.981 Euro 2	6 Cyl.	6374cc	224kW (300PS)	Diesel Turbo Intercooler	TD17837
OM 906.982	6 Cyl.	6374cc	170kW (231PS)	Diesel Turbo Intercooler	TD17838
OM 906.983 Euro 3	6 Cyl.	6374cc	180kW (245PS)	Diesel Turbo Intercooler	TD17839
OM 906.985 Euro 3	6 Cyl.	6374cc	180kW (245PS)	Diesel Turbo Intercooler	TD17840
OM 906.986 Euro 3	6 Cyl.	6374cc	205kW (279PS)	Diesel Turbo Intercooler	TD25471
OM 906.988 Euro 3	6 Cyl.	6374cc	180kW (245PS)	Diesel Turbo Intercooler	TD17841
OM 906.995 Euro 3	6 Cyl.	6374cc	206kW (279PS)	Diesel Turbo Intercooler	TD25657
OM 909.900	6 Cyl.	6374cc	170kW (231PS)	Diesel Turbo Intercooler	TD17443
OM 909.901	6 Cyl.	6374cc	205kW (279PS)	Diesel Turbo Intercooler	TD17445
OM 909.910	6 Cyl.	6374cc	170kW (231PS)	Diesel Turbo Intercooler	TD16846
OM 909.911	6 Cyl.	6374cc	170kW (231PS)	Diesel Turbo Intercooler	TD17444
OM 909.920	6 Cyl.	6374cc	205kW (279PS)	Diesel Turbo Intercooler	TD16847
OM 909.921	6 Cyl.	6374cc	205kW (279PS)	Diesel Turbo Intercooler	TD17446
OM 909.960	6 Cyl.	6374cc	170kW (231PS)	Diesel Turbo Intercooler	TD16848
OM 909.970	6 Cyl.	6374cc	205kW (279PS)	Diesel Turbo Intercooler	TD16849
OM 909.971	6 Cyl.	6374cc	205kW (279PS)	Diesel Turbo Intercooler	TD16850

BE/PL	1	69,995/70,015	75,000/75,019	28,300	2,478	0,029/0,093	SP	71-3850	71-3850 STD 0.25 0.50	1
MB/HL	1	85,990/86,010	91,000/91,022	23,300	2,475	0,040/0,107	BS	72-3851	72-3851 STD 0.25 0.50	
TW/A	2	93,650/94,000	117,500/117,850		3,310		AL-LF	04-4862	A302/2 STD	
SE/PB	1	39,995/40,000	44,000	33,700			BC	55-3854	55-3854 SEMI	
CB/NWB	1	67,911/67,930	72,000/72,030	29,300			BC	53-4761	53-4761 SEMI	
CB/NWB	1	67,911/67,930	72,000/72,030	19,800			BC	53-4762	53-4762 SEMI	
BU	1		25,000	23,700			BC	56-3855	56-3855 SEMI	

MERCEDES-BENZ



124 106.00 x 130.00

M 906.900 Euro 5 EEV		6 Cyl.	6884cc	205kW (279PS)	Natural Gas Turbo Intercooler	TD17842				
M 906.901 Euro 5 EEV		6 Cyl.	6884cc	170kW (231PS)	Natural Gas Turbo Intercooler	TD17844				
M 906.903 Euro 5 EEV		6 Cyl.	6884cc	205kW (279PS)	Natural Gas Turbo Intercooler	TD17843				
BE/PL	1	69,995/70,015	75,000/75,019	28,300	2,478	0,029/0,093	SP	71-3850	71-3850 STD 0.25 0.50	1
MB/HL	1	85,990/86,010	91,000/91,022	23,300	2,475	0,040/0,107	BS	72-3851	72-3851 STD 0.25 0.50	
TW/A	2	93,650/94,000	117,500/117,850		3,310		AL-LF	04-4862	A302/2 STD	
SE/PB	1	39,995/40,000	44,000	33,700			BC	55-3854	55-3854 SEMI	
CB/NWB	1	67,911/67,930	72,000/72,030	29,300			BC	53-4761	53-4761 SEMI	
CB/NWB	1	67,911/67,930	72,000/72,030	19,800			BC	53-4762	53-4762 SEMI	
BU	1		25,000	23,700			BC	56-3855	56-3855 SEMI	

125 106.00 x 136.00

OM 924.910 Euro 3		4 Cyl.	4801cc	160kW (218PS)	Diesel Turbo Intercooler	TD19181				
OM 924.911 Euro 2		4 Cyl.	4801cc	160kW (218PS)	Diesel Turbo Intercooler	TD19182				
OM 924.912 Euro 3		4 Cyl.	4801cc	160kW (218PS)	Diesel Turbo Intercooler	TD19183				
OM 924.913 Euro 3		4 Cyl.	4801cc	160kW (218PS)	Diesel Turbo Intercooler	TD25040				
OM 924.914 Euro 3		4 Cyl.	4801cc	160kW (218PS)	Diesel Turbo Intercooler	TD19184				
OM 924.915 Euro 3		4 Cyl.	4801cc	142-160kW (193-218PS)	Diesel Turbo Intercooler	TD19185				
OM 924.916 Euro 3		4 Cyl.	4801cc	160kW (218PS)	Diesel Turbo Intercooler	TD17185				
OM 924.917 Euro 3		4 Cyl.	4801cc	142kW (193PS)	Diesel Turbo Intercooler	TD19186				
OM 924.919 Euro 3		4 Cyl.	4801cc	160kW (218PS)	Diesel Turbo Intercooler	TD19187				
OM 924.920 Euro 3		4 Cyl.	4801cc	160kW (218PS)	Diesel Turbo Intercooler	TD18917				
OM 924.922 Euro 4		4 Cyl.	4801cc	160kW (218PS)	Diesel Turbo Intercooler	TD19188				
OM 924.923 Euro 4		4 Cyl.	4801cc	160kW (218PS)	Diesel Turbo Intercooler	TD19189				
OM 924.924 Euro 3		4 Cyl.	4801cc	160kW (218PS)	Diesel Turbo Intercooler	TD19191				
OM 924.930 Euro 5		4 Cyl.	4801cc	160kW (218PS)	Diesel Turbo Intercooler	TD25236				
OM 924.935 Euro 5 EEV		4 Cyl.	4801cc	115kW (156PS)	Diesel Turbo Intercooler	TD25237				
OM 924.988 Euro 5 EEV		4 Cyl.	4801cc	142kW (193PS)	Diesel Turbo Intercooler	TD25038				
OM 924.989 Euro 5 EEV		4 Cyl.	4801cc	136kW (185PS)	Diesel Turbo Intercooler	TD25476				
BE/PL	1	69,995/70,015	75,000/75,019	26,300	2,478	0,090/0,093	EC	71-4065	71-4065 STD 0.25	4
MB/HL	1	85,990/86,010	91,000/91,022	23,300	2,475	0,040/0,102	EC	72-4760	72-4760 STD 0.25 0.50	4
TW/A	2	93,650/94,000	117,500/117,850		3,310		AL-LF	04-4862	A302/2 STD	
CB/NWB	1	67,911/67,930	72,000/72,030	29,300			BC	53-4761	53-4761 SEMI	
CB/NWB	1	67,911/67,930	72,000/72,030	19,800			BC	53-4762	53-4762 SEMI	
BU	1		25,000	23,700			BC	56-3855	56-3855 SEMI	

126 106.00 x 136.00

OM 926.910 Euro 3		6 Cyl.	7201cc	240kW (326PS)	Diesel Turbo Intercooler	TD19158
OM 926.911 Euro 2		6 Cyl.	7201cc	240kW (326PS)	Diesel Turbo Intercooler	TD19155
OM 926.912 Euro 2		6 Cyl.	7201cc	240kW (326PS)	Diesel Turbo Intercooler	TD19159
OM 926.913 Euro 3		6 Cyl.	7201cc	240kW (326PS)	Diesel Turbo Intercooler	TD19160
OM 926.914 Euro 2		6 Cyl.	7201cc	240kW (326PS)	Diesel Turbo Intercooler	TD19161

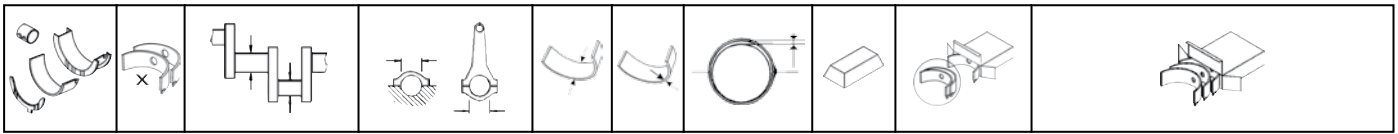

OM 926.915 Euro 3			6 Cyl.	7201cc	240kW (326PS)		Diesel Turbo Intercooler	TD19162
OM 926.916 Euro 3			6 Cyl.	7201cc	240kW (326PS)		Diesel Turbo Intercooler	TD19163
OM 926.917 Euro 3			6 Cyl.	7201cc	240kW (326PS)		Diesel Turbo Intercooler	TD19164
OM 926.918 Euro 3			6 Cyl.	7201cc	215kW (292PS)		Diesel Turbo Intercooler	TD19165
OM 926.919 Euro 4			6 Cyl.	7201cc	240kW (326PS)		Diesel Turbo Intercooler	TD19166
OM 926.920 Euro 3			6 Cyl.	7201cc	209-224kW (284-305PS)		Diesel Turbo Intercooler	TD19167
OM 926.921 Euro 3			6 Cyl.	7201cc	240kW (326PS)		Diesel Turbo Intercooler	TD19168
OM 926.924 Euro 3			6 Cyl.	7201cc	240kW (326PS)		Diesel Turbo Intercooler	TD19169
OM 926.925 Euro 3			6 Cyl.	7201cc	215-220kW (292-299PS)		Diesel Turbo Intercooler	TD19170
OM 926.926 Euro 3			6 Cyl.	7201cc	225kW (306PS)		Diesel Turbo Intercooler	TD19171
OM 926.927 Euro 3			6 Cyl.	7201cc	187kW (254PS)		Diesel Turbo Intercooler	TD19172
OM 926.928 Euro 3			6 Cyl.	7201cc	187-209kW (254-284PS)		Diesel Turbo Intercooler	TD19173
OM 926.929 Euro 3			6 Cyl.	7201cc	220-240kW (299-326PS)		Diesel Turbo Intercooler	TD19174
OM 926.930 Euro 3			6 Cyl.	7201cc	225kW (306PS)		Diesel Turbo Intercooler	TD19175
OM 926.932 Euro 3			6 Cyl.	7201cc	225kW (306PS)		Diesel Turbo Intercooler	TD19176
OM 926.934 Euro 4			6 Cyl.	7201cc	240kW (326PS)		Diesel Turbo Intercooler	TD19177
OM 926.935 Euro 3			6 Cyl.	7201cc	240kW (326PS)		Diesel Turbo Intercooler	TD21087
OM 926.936			6 Cyl.	7201cc	240kW (326PS)		Diesel Turbo Intercooler	TD21088
OM 926.937 Euro 4			6 Cyl.	7201cc	240kW (326PS)		Diesel Turbo Intercooler	TD19178
OM 926.938 Euro 3			6 Cyl.	7201cc	205kW (279PS)		Diesel Turbo Intercooler	TD19179
OM 926.939 Euro 4			6 Cyl.	7201cc	210kW (286PS)		Diesel Turbo Intercooler	TD19180
OM 926.941 Euro 4			6 Cyl.	7201cc	205kW (279PS)		Diesel Turbo Intercooler	TD25472
OM 926.945 Euro 5 EEV			6 Cyl.	7201cc	240kW (326PS)		Diesel Turbo Intercooler	TD25483
OM 926.947 Euro 4/5			6 Cyl.	7201cc	240kW (326PS)		Diesel Turbo Intercooler	TD24829
OM 926.990 Euro 5			6 Cyl.	7201cc	240kW (326PS)		Diesel Turbo Intercooler	TD25470
OM 926.996 Euro 5			6 Cyl.	7201cc	188kW (256PS)		Diesel Turbo Intercooler	TD25045

BE/PL	1	69,995/70,015	75,000/75,019	26,300	2,478	0,090/0,093	EC	71-4065	71-4065 STD 0.25	[4]
MB/HL	1	85,990/86,010	91,000/91,022	23,300	2,475	0,040/0,102	EC	72-4760	72-4760 STD 0.25 0.50	[4]
TW/A	2	93,650/94,000	117,500/117,850		3,310		AL-LF	04-4862	A302/2 STD	
CB/NWB	1	67,911/67,930	72,000/72,030	29,300			BC	53-4761	53-4761 SEMI	
CB/NWB	1	67,911/67,930	72,000/72,030	19,800			BC	53-4762	53-4762 SEMI	
BU	1		25,000	23,700			BC	56-3855	56-3855 SEMI	

127 115.00 x 140.00

OM 360.910			6 Cyl.	8720cc	125-141kW (170-192PS)		Diesel Turbo Intercooler	TD28659
OM 360.911			6 Cyl.	8720cc	125kW (170PS)		Diesel Turbo Intercooler	TD7902
OM 360.914			6 Cyl.	8720cc	141kW (192PS)		Diesel	TD5658
OM 360.915			6 Cyl.	8720cc	141kW (192PS)		Diesel	TD5996
OM 360.916			6 Cyl.	8720cc	125kW (170PS)		Diesel	TD5659
OM 360.917			6 Cyl.	8720cc	125kW (170PS)		Diesel	TD5997
OM 360.918			6 Cyl.	8720cc	125kW (170PS)		Diesel	TD7894
OM 360.931			6 Cyl.	8720cc	141kW (192PS)		Diesel	TD6269
OM 360.933			6 Cyl.	8720cc	125kW (170PS)		Diesel	TD6270
OM 360.935			6 Cyl.	8725cc	125kW (170PS)		Diesel	TD22749
OM 360.936			6 Cyl.	8725cc	125kW (170PS)		Diesel	TD16688
OM 360.937			6 Cyl.	8725cc	127kW (172PS)		Diesel	TD16689
OM 360.938			6 Cyl.	8725cc	127kW (172PS)		Diesel	TD16690
OM 360.939			6 Cyl.	8720cc	125kW (170PS)		Diesel	TD8195
OM 360.940			6 Cyl.	8725cc	127kW (172PS)		Diesel	TD16691

MERCEDES-BENZ

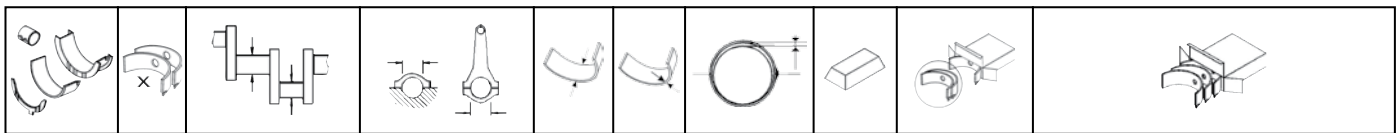

OM 360.941	6 Cyl.	8725cc	141kW (192PS)	Diesel	TD16698
OM 360.942	6 Cyl.	8725cc	127kW (172PS)	Diesel	TD16692
OM 360.943	6 Cyl.	8725cc	127kW (172PS)	Diesel	TD16693
OM 360.944	6 Cyl.	8725cc	127kW (172PS)	Diesel	TD16694
OM 360.946	6 Cyl.	8725cc	127kW (172PS)	Diesel	TD16695
OM 360.948	6 Cyl.	8725cc	125kW (170PS)	Diesel	TD16696
OM 360.949	6 Cyl.	8725cc	125kW (170PS)	Diesel	TD16697
OM 360.950	6 Cyl.	8725cc	125kW (170PS)	Diesel	TD22750
OM 360.951	6 Cyl.	8725cc	125kW (170PS)	Diesel	TD22751
OM 360.952	6 Cyl.	8725cc	125kW (170PS)	Diesel	TD22752
OM 360.960	6 Cyl.	8725cc	141kW (192PS)	Diesel	TD22753
OM 360.961	6 Cyl.	8725cc	141kW (192PS)	Diesel	TD22754
OM 360.962	6 Cyl.	8725cc	127kW (173PS)	Diesel	TD22755
OM 360.963	6 Cyl.	8725cc	141kW (192PS)	Diesel	TD22756
OM 360.964	6 Cyl.	8725cc	141kW (192PS)	Diesel	TD22757
OM 360.965	6 Cyl.	8725cc	141kW (192PS)	Diesel	TD22758
OM 360.966	6 Cyl.	8725cc	141kW (192PS)	Diesel	TD22759
OM 360.967	6 Cyl.	8725cc	127kW (173PS)	Diesel	TD22760
OM 360.968	6 Cyl.	8725cc	93kW (126PS)	Diesel	TD22761
OM 360.969	6 Cyl.	8725cc	93kW (126PS)	Diesel	TD22762
OM 360.970	6 Cyl.	8725cc	93kW (126PS)	Diesel	TD22763
OM 360.971	6 Cyl.	8725cc	141kW (192PS)	Diesel	TD22764
OM 360.972	6 Cyl.	8725cc	141kW (192PS)	Diesel	TD22765
OM 360.973	6 Cyl.	8725cc	81kW (110PS)	Diesel	TD22766
OM 360.975	6 Cyl.	8725cc	141kW (192PS)	Diesel	TD22767
OM 360.979	6 Cyl.	8720cc	125kW (170PS)	Diesel	TD17019
OM 360.980	6 Cyl.	8720cc	141kW (192PS)	Diesel	TD17020
OM 360.981	6 Cyl.	8720cc	141kW (192PS)	Diesel	TD17021
OM 360.982	6 Cyl.	8725cc	154kW (209PS)	Diesel Turbo	TD22768
OM 360.983	6 Cyl.	8725cc	125kW (170PS)	Diesel Turbo	TD22769
OM 360.984	6 Cyl.	8720cc	154kW (210PS)	Diesel Turbo	TD17022
OM 360.985	6 Cyl.	8720cc	141kW (192PS)	Diesel Turbo	TD17024
OM 360.986	6 Cyl.	8720cc	154kW (210PS)	Diesel Turbo	TD17023

BE/PL	6	71,980/72,000	77,000/77,019	35,100	2,476	0,048/0,112	EC	71-2811	71-2811/6 STD 0.25 0.50 0.75
MB/HL 1-6	6	97,980/98,000	104,000/104,022	28,500	2,975	0,050/0,117	EC	72-2413	H809/7 STD 0.50
MB/HL 7	1	97,980/98,000	104,000/104,022	41,810	2,975	0,050/0,117	EC	72-2812H	



72-2812H	STD	42,000/1.6535" - 42,062/1.6560"
	0.25mm	42,100/1.6575" - 42,162/1.6599"
	0.50mm	42,150/1.6594" - 42,212/1.6619"
	0.75mm	42,150/1.6594" - 42,212/1.6619"
	1.00mm	42,500/1.6732" - 42,562/1.6757"

SE/PB	1	42,000	46,000/46,025	41,500			BS	55-2847	55-2847 SEMI
CB/NWB 1	1	57,951/57,970	62,000/62,030	35,000			BB	13-2415	N075/7L SEMI
CB/NWB 2,3,5,6	4	57,851/57,870	62,000/62,030	20,000			BB	13-2416	
CB/NWB 4	1	57,651/57,670	62,000/62,030	48,000			BB	13-2417	
CB/NWB 7	1	57,351/57,370	62,000/62,030	20,000			BB	13-2418	

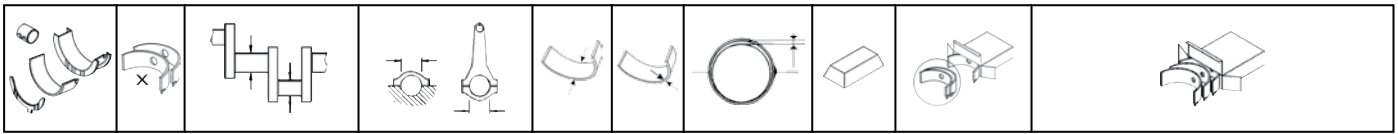

128 115.00 x 140.00

OM 360.912	6 Cyl.	8720cc	125-141kW (170-192PS)	Diesel	TD23186
OM 360.934	6 Cyl.	8720cc	125-141kW (170-192PS)	Diesel	TD23188
OM 360.947	6 Cyl.	8725cc	125-141kW (170-192PS)	Diesel	TD23189
OM 360.954	6 Cyl.	8725cc	125-141kW (170-192PS)	Diesel	TD23190
OM 360.955	6 Cyl.	8725cc	125-141kW (170-192PS)	Diesel	TD23191
OM 360.956	6 Cyl.	8725cc	125-141kW (170-192PS)	Diesel	TD23192
OM 360.959	6 Cyl.	8725cc	125-141kW (170-192PS)	Diesel	TD23193
OM 360.974	6 Cyl.	8725cc	125-141kW (170-192PS)	Diesel	TD23194
OM 360.976	6 Cyl.	8725cc	125-141kW (170-192PS)	Diesel	TD23195
OM 360.978	6 Cyl.	8725cc	125-141kW (170-192PS)	Diesel	TD23196

BE/PL	6	71,980/72,000	77,000/77,019	35,100	2,476	0,048/0,112	EC	71-2811	71-2811/6 STD 0.25 0.50 0.75
MB/HL 1-6	6	97,980/98,000	104,000/104,022	28,500	2,975	0,050/0,117	EC	72-2413	H809/7 STD 0.50
MB/HL 7	1	97,980/98,000	104,000/104,022	41,810	2,975	0,050/0,117	EC	72-2812H	



72-2812H	STD	42,000/1.6535" - 42,062/1.6560"
	0.25mm	42,100/1.6575" - 42,162/1.6599"
	0.50mm	42,150/1.6594" - 42,212/1.6619"
	0.75mm	42,150/1.6594" - 42,212/1.6619"
	1.00mm	42,500/1.6732" - 42,562/1.6757"

129 125.00 x 130.00

OM 401.905	V6 Cyl.	9570cc	141kW (192PS)	Diesel	TD5730
OM 401.906	V6 Cyl.	9570cc	141kW (192PS)	Diesel	TD6062
OM 401.907	V6 Cyl.	9572cc	141kW (192PS)	Diesel	TD16942
OM 401.908	V6 Cyl.	9572cc	141kW (192PS)	Diesel	TD16943
OM 401.909	V6 Cyl.	9570cc	141kW (192PS)	Diesel	TD5767
OM 401.912	V6 Cyl.	9572cc	141kW (192PS)	Diesel	TD7895
OM 401.913	V6 Cyl.	9570cc	141kW (192PS)	Diesel	TD16944
OM 401.914	V6 Cyl.	9570cc	141kW (192PS)	Diesel	TD5729
OM 401.915	V6 Cyl.	9570cc	141kW (192PS)	Diesel	TD6061
OM 401.916	V6 Cyl.	9570cc	141kW (192PS)	Diesel	TD6099
OM 401.917	V6 Cyl.	9570cc	188kW (256PS)	Diesel Turbo	TD16949
OM 401.918	V6 Cyl.	9570cc	141kW (192PS)	Diesel	TD8118
OM 401.919	V6 Cyl.	9570cc	141kW (192PS)	Diesel	TD9596
OM 401.921	V6 Cyl.	9570cc	141kW (192PS)	Diesel	TD16945
OM 401.922	V6 Cyl.	9570cc	141kW (192PS)	Diesel	TD16946
OM 401.923	V6 Cyl.	9570cc	141kW (192PS)	Diesel	TD6081
OM 401.925	V6 Cyl.	9570cc	141kW (192PS)	Diesel	TD8229
OM 401.926	V6 Cyl.	9570cc	141kW (192PS)	Diesel	TD9597
OM 401.927	V6 Cyl.	9570cc	141kW (192PS)	Diesel	TD9598
OM 401.928	V6 Cyl.	9570cc	141kW (192PS)	Diesel	TD16948

BE/PL	1	31,959/31,975	36,000/36,016	19,000	2,011	0,020/0,059	EC	71-2965	71-2965 STD	10
BE/PL	1	89,980/90,000	95,000/95,022	31,000	2,473	0,054/0,121	EC	71-3009	71-3009 STD 0.10 0.25 0.50 0.75 1.00 1.25	
BE/PL	2	31,959/31,975	36,000/36,016	15,000	2,011	0,020/0,060	EC	71-3289	71-3289/2 STD	10

MERCEDES-BENZ

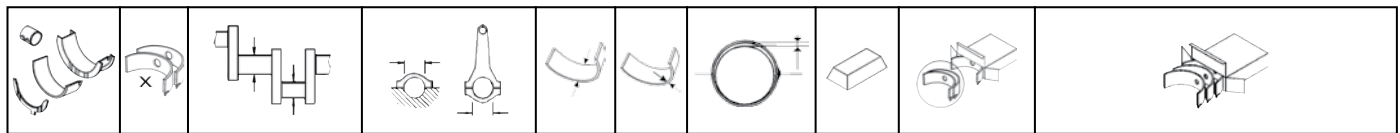

MB/HL	3	103,980/104,000	111,000/111,022	30,500	3,472	0,056/0,123	EC	72-2858	H821/4 STD 0.25 0.50 0.75 1.00	
MB/HL	1	103,980/104,000	111,000/111,022	37,810	3,472	0,056/0,123	EC	72-2859H		
			72-2859H	STD	38,000/1.4961" - 38,062/1.4985"					
				0.25mm	38,500/1.5157" - 38,562/1.5182"					
				0.50mm	38,500/1.5157" - 38,562/1.5182"					
				0.75mm	39,000/1.5354" - 39,062/1.5379"					
				1.00mm	39,000/1.5354" - 39,062/1.5379"					
SE/PB	1	45,595/46,000	50,000/50,025	38,700			BC	55-2862	55-2862 SEMI	
Mot.→070546										
SE/PB	1	45,995/46,000	50,600/50,630	38,700			BC	55-3328	55-3328 SEMI	
Mot.070547→										
CB/NWB	3	69,910/69,940	75,000/75,030	28,000	2,500		BB	13-2861	N110/4L STD SEMI	13
CB/NWB	1	69,910/69,940	76,000/76,030	35,000	3,000		EC	53-3098H		
BU	1	30,000	34,000/34,025	21,000			EC	52-3097	52-3097 SEMI	10
BU	1	25,000	28,000/28,052	17,800			BC	56-3042	56-3042 SEMI	

130 125.00 x 130.00

OM 401.970			V6 Cyl.	9600cc	213kW (290PS)		Diesel Turbo Intercooler	TD7938		
OM 401.972			V6 Cyl.	9572cc	230kW (313PS)		Diesel Turbo Intercooler	TD5777		
OM 401.973			V6 Cyl.	9572cc	200kW (272PS)		Diesel Turbo Intercooler	TD5733		
OM 401.974 Euro 1			V6 Cyl.	9572cc	200kW (272PS)		Diesel Turbo Intercooler	TD7939		
OM 401.975 Euro 1			V6 Cyl.	9572cc	180kW (245PS)		Diesel Turbo Intercooler	TD5751		
OM 401.976 Euro 1			V6 Cyl.	9572cc	180kW (245PS)		Diesel Turbo Intercooler	TD17102		
OM 401.977 Euro 1			V6 Cyl.	9572cc	200kW (272PS)		Diesel Turbo Intercooler	TD5801		
OM 401.978 Euro 1			V6 Cyl.	9572cc	200kW (272PS)		Diesel Turbo Intercooler	TD6065		
OM 401.979 Euro 1			V6 Cyl.	9572cc	230kW (313PS)		Diesel Turbo Intercooler	TD5780		
OM 401.980 Euro 1			V6 Cyl.	9572cc	200kW (272PS)		Diesel Turbo Intercooler	TD6293		
OM 401.981 Euro 1			V6 Cyl.	9572cc	230kW (313PS)		Diesel Turbo Intercooler	TD6162		
OM 401.982 Euro 1			V6 Cyl.	9572cc	230kW (313PS)		Diesel Turbo Intercooler	TD17103		
OM 401.983			V6 Cyl.	9572cc	180kW (245PS)		Diesel Turbo Intercooler	TD17104		
OM 401.984			V6 Cyl.	9572cc	180kW (245PS)		Diesel Turbo Intercooler	TD8127		
OM 401.985			V6 Cyl.	9600cc	200kW (272PS)		Diesel Turbo Intercooler	TD5753		
OM 401.986			V6 Cyl.	9572cc	230kW (313PS)		Diesel Turbo Intercooler	TD8199		
OM 401.987			V6 Cyl.	9572cc	230kW (313PS)		Diesel Turbo Intercooler	TD6163		
OM 401.989			V6 Cyl.	9572cc	200kW (272PS)		Diesel Turbo Intercooler	TD6068		
OM 401.990			V6 Cyl.	9572cc	180kW (245PS)		Diesel Turbo Intercooler	TD16950		
OM 401.991			V6 Cyl.	9600cc	200kW (272PS)		Diesel Turbo Intercooler	TD6086		
OM 401.992			V6 Cyl.	9572cc	200kW (272PS)		Diesel Turbo Intercooler	TD17113		
OM 401.993			V6 Cyl.	9572cc	230kW (313PS)		Diesel Turbo Intercooler	TD6113		
OM 401.994			V6 Cyl.	9600cc	180kW (245PS)		Diesel Turbo Intercooler	TD6084		
BE/PL	1	31,959/31,975	36,000/36,016	19,000	2,011	0,020/0,059	EC	71-2965	71-2965 STD	10
BE/PL	2	31,959/31,975	36,000/36,016	15,000	2,011	0,020/0,060	EC	71-3289	71-3289/2 STD	10
BE/PL	1	89,980/90,000	95,000/95,022	26,700	2,473	0,054/0,121	SP	71-3693	71-3693 STD 0.25 0.50	1
BE/PL	6	89,980/90,000	95,000/95,022	26,700	2,473	0,054/0,121	SP	71-3693	71-3693/6 0.25 0.50 0.75 1.00	1

MB/HL	3	103,980/104,000	111,000/111,022	30,500	3,472	0,056/0,123	EC	72-2858	H821/4 STD 0.25 0.50 0.75 1.00	
MB/HL	1	103,980/104,000	111,000/111,022	37,810	3,472	0,056/0,123	EC	72-2859H		
			72-2859H	STD	38,000/1.4961" - 38,062/1.4985"					
				0.25mm	38,500/1.5157" - 38,562/1.5182"					
				0.50mm	38,500/1.5157" - 38,562/1.5182"					
				0.75mm	39,000/1.5354" - 39,062/1.5379"					
				1.00mm	39,000/1.5354" - 39,062/1.5379"					
SE/PB	1	45,995/46,000	50,600/50,630	38,700			BC	55-3328	55-3328 SEMI	
CB/NWB	3	69,910/69,940	75,000/75,030	28,000	2,500		BB	13-2861	N110/4L STD SEMI [13]	
CB/NWB	1	69,910/69,940	76,000/76,030	35,000	3,000		EC	53-3098H		
BU	1	30,000	34,000/34,025	21,000			EC	52-3097	52-3097 SEMI [10]	
BU	1	25,000	28,000/28,052	17,800			BC	56-3042	56-3042 SEMI	

131 125.00 x 130.00

OM 402.905		V8 Cyl.	12800cc	188kW (256PS)		Diesel	TD8179
OM 402.906		V8 Cyl.	12800cc	188kW (256PS)		Diesel	TD5814
OM 402.907		V8 Cyl.	12800cc	188kW (256PS)		Diesel	TD7896
OM 402.910		V8 Cyl.	12800cc	176kW (240PS)		Diesel	TD5752
OM 402.911		V8 Cyl.	12800cc	176kW (240PS)		Diesel	TD6085
OM 402.912		V8 Cyl.	12800cc	188kW (256PS)		Diesel	TD5758
OM 402.913		V8 Cyl.	12760cc	177kW (240PS)		Diesel	TD17803
OM 402.914		V8 Cyl.	12800cc	176kW (240PS)		Diesel	TD8230
OM 402.916		V8 Cyl.	12800cc	188kW (256PS)		Diesel	TD5798
OM 402.917		V8 Cyl.	12760cc	177kW (240PS)		Diesel	TD17804
OM 402.919		V8 Cyl.	12800cc	176kW (240PS)		Diesel	TD8154
OM 402.921		V8 Cyl.	12760cc	177kW (240PS)		Diesel	TD17805
OM 402.923		V8 Cyl.	12800cc	176kW (240PS)		Diesel	TD8183
OM 402.924		V8 Cyl.	12800cc	188kW (256PS)		Diesel	TD6291
OM 402.925		V8 Cyl.	12760cc	188kW (256PS)		Diesel	TD17806
OM 402.926		V8 Cyl.	12800cc	188kW (256PS)		Diesel	TD6296
OM 402.927		V8 Cyl.	12800cc	176kW (240PS)		Diesel	TD9606
OM 402.928		V8 Cyl.	12800cc	176kW (240PS)		Diesel	TD9607

BE/PL	1	31,959/31,975	36,000/36,016	19,000	2,011	0,020/0,059	EC	71-2965	71-2965 STD [10]
BE/PL	1	89,980/90,000	95,000/95,022	31,000	2,473	0,054/0,121	EC	71-3009	71-3009 STD 0.10 0.25 0.50 0.75 1.00 1.25
BE/PL	2	31,959/31,975	36,000/36,016	15,000	2,011	0,020/0,060	EC	71-3289	71-3289/2 STD [10]
MB/HL	4	103,980/104,000	111,000/111,022	30,500	3,472	0,056/0,123	EC	72-2858	H821/5 STD 0.10 0.25 0.50 0.75 1.00
MB/HL	1	103,980/104,000	111,000/111,022	37,810	3,472	0,056/0,123	EC	72-2859H	

			72-2859H	STD	38,000/1.4961" - 38,062/1.4985"				
				0.25mm	38,500/1.5157" - 38,562/1.5182"				
				0.50mm	38,500/1.5157" - 38,562/1.5182"				
				0.75mm	39,000/1.5354" - 39,062/1.5379"				
				1.00mm	39,000/1.5354" - 39,062/1.5379"				

SE/PB	1	45,595/46,000	50,000/50,025	38,700			BC	55-2862	55-2862 SEMI
-------	---	---------------	---------------	--------	--	--	----	---------	------------------------

Mot. → 070546

MERCEDES-BENZ

									55-3328 SEMI	
Mot.070547 →										
CB/NWB	4	69,910/69,940	75,000/75,030	28,000	2,500		BB	13-2861	N110/5L STD SEMI	
CB/NWB	1	69,910/69,940	76,000/76,030	35,000	3,000		EC	53-3098H		
BU	1	30,000	34,000/34,025	21,000			EC	52-3097	52-3097 SEMI	
BU	1	25,000	28,000/28,052	17,800			BC	56-3042	56-3042 SEMI	

132 125.00 x 130.00

OM 402.970 Euro 1	V8 Cyl.	12763cc	280kW (381PS)	Diesel Turbo Intercooler	TD7940
OM 402.971 Euro 1	V8 Cyl.	12763cc	280kW (381PS)	Diesel Turbo Intercooler	TD5783
OM 402.972 Euro 1	V8 Cyl.	12763cc	280kW (381PS)	Diesel Turbo Intercooler	TD5784
OM 402.973 Euro 1	V8 Cyl.	12763cc	280kW (381PS)	Diesel Turbo Intercooler	TD5832
OM 402.974 Euro 1	V8 Cyl.	12763cc	280-295kW (381-401PS)	Diesel Turbo Intercooler	TD17807
OM 402.975 Euro 1	V8 Cyl.	12763cc	280kW (381PS)	Diesel Turbo Intercooler	TD5818
OM 402.977 Euro 1	V8 Cyl.	12763cc	280kW (381PS)	Diesel Turbo Intercooler	TD5826
OM 402.978 Euro 1	V8 Cyl.	12763cc	280kW (381PS)	Diesel Turbo Intercooler	TD5786
OM 402.982 Euro 1	V8 Cyl.	12763cc	280kW (381PS)	Diesel Turbo Intercooler	TD5830
OM 402.983 Euro 1	V8 Cyl.	12763cc	280kW (381PS)	Diesel Turbo Intercooler	TD6182
OM 402.984	V8 Cyl.	12763cc	280kW (381PS)	Diesel Turbo	TD11268
OM 402.985 Euro 1	V8 Cyl.	12763cc	280kW (381PS)	Diesel Turbo Intercooler	TD5806
OM 402.986 Euro 1	V8 Cyl.	12763cc	280kW (381PS)	Diesel Turbo Intercooler	TD6151
OM 402.987 Euro 1	V8 Cyl.	12763cc	280kW (381PS)	Diesel Turbo Intercooler	TD6178
OM 402.989 Euro 1	V8 Cyl.	12763cc	280kW (381PS)	Diesel Turbo Intercooler	TD5807
OM 402.990 Euro 1	V8 Cyl.	12763cc	280kW (381PS)	Diesel Turbo Intercooler	TD6153
OM 402.995	V8 Cyl.	12763cc	280kW (381PS)	Diesel Turbo	TD11267
OM 402.996 Euro 1	V8 Cyl.	12763cc	280kW (381PS)	Diesel Turbo Intercooler	TD6121

BE/PL	1	31,959/31,975	36,000/36,016	19,000	2,011	0,020/0,059	EC	71-2965	71-2965 STD	
BE/PL	2	31,959/31,975	36,000/36,016	15,000	2,011	0,020/0,060	EC	71-3289	71-3289/2 STD	
BE/PL	1	89,980/90,000	95,000/95,022	31,000	2,473	0,054/0,121	SP	71-3638	71-3638 STD 0.25 0.50	
MB/HL	4	103,980/104,000	111,000/111,022	30,500	3,472	0,056/0,123	EC	72-2858	H821/5 STD 0.10 0.25 0.50 0.75 1.00	
MB/HL	1	103,980/104,000	111,000/111,022	37,810	3,472	0,056/0,123	EC	72-2859H		

	72-2859H	STD	38,000/1.4961" - 38,062/1.4985"
		0.25mm	38,500/1.5157" - 38,562/1.5182"
		0.50mm	38,500/1.5157" - 38,562/1.5182"
		0.75mm	39,000/1.5354" - 39,062/1.5379"
		1.00mm	39,000/1.5354" - 39,062/1.5379"

SE/PB	1	45,995/46,000	50,600/50,630	38,700			BC	55-3328	55-3328 SEMI	
CB/NWB	4	69,910/69,940	75,000/75,030	28,000	2,500		BB	13-2861	N110/5L STD SEMI	
CB/NWB	1	69,910/69,940	76,000/76,030	35,000	3,000		EC	53-3098H		
BU	1	30,000	34,000/34,025	21,000			EC	52-3097	52-3097 SEMI	
BU	1	25,000	28,000/28,052	17,800			BC	56-3042	56-3042 SEMI	

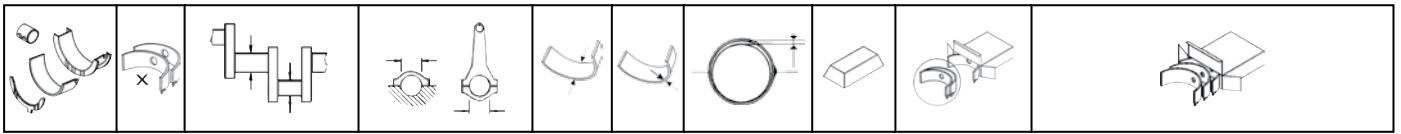

133 125.00 x 130.00

OM 403.905	V10 Cyl.	15950cc	236kW (320PS)	Diesel	TD16951
OM 403.906	V10 Cyl.	15950cc	184kW (250PS)	Diesel	TD16952
OM 403.915	V10 Cyl.	15900cc	236kW (320PS)	Diesel	TD8180
OM 403.916	V10 Cyl.	15900cc	235kW (320PS)	Diesel	TD5816
OM 403.917	V10 Cyl.	15950cc	236kW (320PS)	Diesel	TD16953
OM 403.918	V10 Cyl.	15900cc	235kW (320PS)	Diesel	TD7897
OM 403.919	V10 Cyl.	15950cc	236kW (320PS)	Diesel	TD16954
OM 403.930	V10 Cyl.	15950cc	236kW (320PS)	Diesel	TD16955
OM 403.931	V10 Cyl.	15900cc	235kW (320PS)	Diesel	TD5759
OM 403.932	V10 Cyl.	15900cc	235kW (320PS)	Diesel	TD6133
OM 403.933	V10 Cyl.	15950cc	261kW (355PS)	Diesel	TD16956
OM 403.934	V10 Cyl.	15950cc	236kW (320PS)	Diesel	TD16957
OM 403.935	V10 Cyl.	15900cc	236kW (320PS)	Diesel	TD6299

BE/PL	1	31,959/31,975	36,000/36,016	19,000	2,011	0,020/0,059	EC	71-2965	71-2965 STD 10
BE/PL	1	89,980/90,000	95,000/95,022	31,000	2,473	0,054/0,121	EC	71-3009	71-3009 STD 0.10 0.25 0.50 0.75 1.00 1.25
BE/PL	2	31,959/31,975	36,000/36,016	15,000	2,011	0,020/0,060	EC	71-3289	71-3289/2 STD 10
MB/HL	5	103,980/104,000	111,000/111,022	30,500	3,472	0,056/0,123	EC	72-2858	H821/6 STD 0.25 0.50 0.75 1.00
MB/HL	1	103,980/104,000	111,000/111,022	37,810	3,472	0,056/0,123	EC	72-2859H	



72-2859H	STD	38,000/1.4961" - 38,062/1.4985"
	0.25mm	38,500/1.5157" - 38,562/1.5182"
	0.50mm	38,500/1.5157" - 38,562/1.5182"
	0.75mm	39,000/1.5354" - 39,062/1.5379"
	1.00mm	39,000/1.5354" - 39,062/1.5379"

SE/PB	1	45,595/46,000	50,000/50,025	38,700			BC	55-2862	55-2862 SEMI
Mot.→070546									
SE/PB	1	45,995/46,000	50,600/50,630	38,700			BC	55-3328	55-3328 SEMI

Mot.070547→

CB/NWB	5	69,910/69,940	75,000/75,030	28,000	2,500		BB	13-2861	N110/6L STD SEMI 13
CB/NWB	1	69,910/69,940	76,000/76,030	35,000	3,000		EC	53-3098H	
BU	1	30,000	34,000/34,025	21,000			EC	52-3097	52-3097 SEMI 10
BU	1	25,000	28,000/28,052	17,800			BC	56-3042	56-3042 SEMI

134 125.00 x 142.00

OM 401.924	V6 Cyl.	10456cc	144kW (196PS)	Diesel	TD16947				
BE/PL	1	31,959/31,975	36,000/36,016	19,000	2,011	0,020/0,059	EC	71-2965	71-2965 STD 10
BE/PL	1	89,980/90,000	95,000/95,022	31,000	2,473	0,054/0,121	EC	71-3009	71-3009 STD 0.10 0.25 0.50 0.75 1.00 1.25

MERCEDES-BENZ

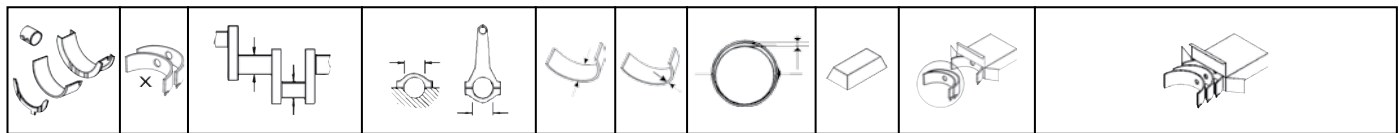



MB/HL	3	103,980/104,000	111,000/111,022	30,500	3,472	0,056/0,123	EC	72-2858	H821/4 STD 0.25 0.50 0.75 1.00	
MB/HL	1	103,980/104,000	111,000/111,022	37,810	3,472	0,056/0,123	EC	72-2859H		
			72-2859H	STD	38,000/1.4961" - 38,062/1.4985"					
				0.25mm	38,500/1.5157" - 38,562/1.5182"					
				0.50mm	38,500/1.5157" - 38,562/1.5182"					
				0.75mm	39,000/1.5354" - 39,062/1.5379"					
				1.00mm	39,000/1.5354" - 39,062/1.5379"					
SE/PB	1	45,595/46,000	50,000/50,025	38,700			BC	55-2862	55-2862 SEMI	
Mot.→070546										
SE/PB	1	45,995/46,000	50,600/50,630	38,700			BC	55-3328	55-3328 SEMI	
Mot.070547→										
CB/NWB	3	69,910/69,940	75,000/75,030	28,000	2,500		BB	13-2861	N110/4L STD SEMI	13
CB/NWB	1	69,910/69,940	76,000/76,030	35,000	3,000		EC	53-3098H		
BU	1	30,000	34,000/34,025	21,000			EC	52-3097	52-3097 SEMI	10
BU	1	25,000	28,000/28,052	17,800			BC	56-3042	56-3042 SEMI	

135 125.00 x 142.00

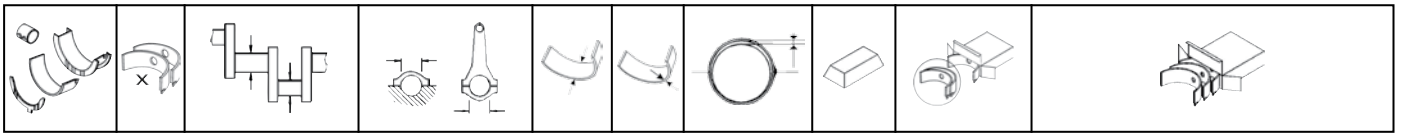
OM 404		V12 Cyl.		20911cc	184-236kW (250-320PS)		Diesel		FM3816	
OM 404 A		V12 Cyl.		20910cc	386kW (525PS)		Diesel Turbo		FM4262	
BE/PL	1	31,959/31,975	36,000/36,016	19,000	2,011	0,020/0,059	EC	71-2965	71-2965 STD	10
BE/PL	1	89,980/90,000	95,000/95,022	31,000	2,473	0,054/0,121	EC	71-3009	71-3009 STD 0.25 0.50 0.75 1.00 1.25 1.50	
BE/PL	2	31,959/31,975	36,000/36,016	15,000	2,011	0,020/0,060	EC	71-3289	71-3289/2 STD	10
MB/HL	6	103,980/104,000	111,000/111,022	30,500	3,472	0,056/0,123	EC	72-2858	H821/7 STD 0.25 0.50	
MB/HL	1	103,980/104,000	111,000/111,022	37,810	3,472	0,056/0,123	EC	72-2859H		
			72-2859H	STD	38,000/1.4961" - 38,062/1.4985"					
				0.25mm	38,500/1.5157" - 38,562/1.5182"					
				0.50mm	38,500/1.5157" - 38,562/1.5182"					
				0.75mm	39,000/1.5354" - 39,062/1.5379"					
				1.00mm	39,000/1.5354" - 39,062/1.5379"					
SE/PB	1	45,595/46,000	50,000/50,025	38,700			BC	55-2862	55-2862 SEMI	
Mot.→000513										
SE/PB	1	45,995/46,000	50,600/50,630	38,700			BC	55-3328	55-3328 SEMI	
Mot.000514→										
CB/NWB	6	69,910/69,940	75,000/75,030	28,000	2,500		BB	13-2861	N110/7 STD	13
CB/NWB	1	69,910/69,940	76,000/76,030	35,000	3,000		EC	53-3098H		
BU	1	30,000	34,000/34,025	21,000			EC	52-3097	52-3097 SEMI	10
BU	1	25,000	28,000/28,052	17,800			BC	56-3042	56-3042 SEMI	



136										125.00 x 150.00	
OM 409.906		5 Cyl.		9204cc	135kW (184PS)		Diesel		TD18812		
OM 409.907		5 Cyl.		9204cc	135kW (184PS)		Diesel		TD18813		
OM 409.908		5 Cyl.		9204cc	135kW (184PS)		Diesel		TD18814		
BE/PL	1	31,959/31,975	36,000/36,016	19,000	2,011	0,020/0,059	EC	71-2965	71-2965 STD	10	
BE/PL	5	89,980/90,000	95,000/95,022	36,200	2,476	0,048/0,115	EC	71-3561	71-3561/5 STD		
MB/HL	5	103,980/104,000	111,000/111,022	36,000	3,478	0,060/0,126	EC	72-3562	H992/6 STD		
MB/HL	1	103,980/104,000	111,000/111,022	45,810	3,478	0,060/0,126	EC	72-3563H			
		72-3563H		STD	46,000/1.8110" - 46,062/1.8135"						
				0.25mm	46,500/1.8307" - 46,562/1.8331"						
				0.50mm	46,500/1.8307" - 46,562/1.8331"						
				0.75mm	47,000/1.8504" - 47,062/1.8528"						
				1.00mm	47,000/1.8504" - 47,062/1.8528"						
SE/PB	1	45,595/46,000	50,000/50,025	38,700			BC	55-2862	55-2862 SEMI		
Mot.→004159											
SE/PB	1	45,995/46,000	50,600/50,630	38,700			BC	55-3328	55-3328 SEMI		
Mot.004160→											
BU	1	30,000	34,000/34,025	21,000			EC	52-3097	52-3097 SEMI	10	
BU	1	25,000	28,000/28,052	17,800			BC	56-3042	56-3042 SEMI		

137										125.00 x 150.00	
OM 407.905		6 Cyl.		11000cc	132kW (180PS)		Diesel		TD5664		
OM 407.907		6 Cyl.		11045cc	155kW (211PS)		Diesel		TD10767		
OM 407.908		6 Cyl.		11000cc	132kW (180PS)		Diesel Turbo Intercooler		TD6002		
OM 407.909		6 Cyl.		11000cc	155kW (210PS)		Diesel		TD5665		
OM 407.910		6 Cyl.		11000cc	155kW (210PS)		Diesel		TD6003		
OM 407.911		6 Cyl.		11000cc	155kW (210PS)		Diesel		TD6273		
BE/PL	1	31,959/31,975	36,000/36,016	19,000	2,011	0,020/0,059	EC	71-2965	71-2965 STD	10	
BE/PL	6	89,980/90,000	95,000/95,022	36,200	2,476	0,048/0,115	EC	71-3561	71-3561/6 STD 0.25 0.50 0.75 1.00		
MB/HL	6	103,980/104,000	111,000/111,022	36,000	3,478	0,060/0,126	EC	72-3562	H992/7 STD 0.25 0.50 0.75		
MB/HL	1	103,980/104,000	111,000/111,022	45,810	3,478	0,060/0,126	EC	72-3563H			
		72-3563H		STD	46,000/1.8110" - 46,062/1.8135"						
				0.25mm	46,500/1.8307" - 46,562/1.8331"						
				0.50mm	46,500/1.8307" - 46,562/1.8331"						
				0.75mm	47,000/1.8504" - 47,062/1.8528"						
				1.00mm	47,000/1.8504" - 47,062/1.8528"						
SE/PB	1	45,595/46,000	50,000/50,025	38,700			BC	55-2862	55-2862 SEMI		
Mot.→004159											
SE/PB	1	45,995/46,000	50,600/50,630	38,700			BC	55-3328	55-3328 SEMI		
Mot.004160→											

MERCEDES-BENZ

CB/NWB	1	69,910/69,940	75,000/75,030	36,000	2,500		BB	13-3102	N109/7L STD SEMI	13
CB/NWB	5	69,910/69,940	75,000/75,030	28,000	2,500		BB	13-3103		
CB/NWB	1	69,910/69,940	76,000/76,030	39,000	3,000		EC	53-3104H		
BU	1	30,000	34,000/34,025	21,000			EC	52-3097	52-3097 SEMI	10
BU	1	25,000	28,000/28,052	17,800			BC	56-3042	56-3042 SEMI	

138 125.00 x 155.00

OM 407.913		6 Cyl.	11413cc	147kW (200PS)		Diesel		TD5666
OM 407.914		6 Cyl.	11413cc	147kW (200PS)		Diesel		TD6004
OM 407.915		6 Cyl.	11413cc	147kW (200PS)		Diesel		TD6274
OM 407.916		6 Cyl.	11413cc	177kW (240PS)		Diesel		TD5667
OM 407.917		6 Cyl.	11413cc	177kW (240PS)		Diesel		TD6005
OM 407.918		6 Cyl.	11413cc	177kW (240PS)		Diesel		TD6275
OM 407.919		6 Cyl.	11413cc	177kW (240PS)		Diesel		TD6006
OM 407.920		6 Cyl.	11412cc	177kW (240PS)		Diesel		TD17808
OM 407.951		6 Cyl.	11413cc	206kW (280PS)		Diesel Turbo		TD5668
OM 407.955		6 Cyl.	11413cc	206kW (280PS)		Diesel Turbo		TD6007

BE/PL	1	31,959/31,975	36,000/36,016	19,000	2,011	0,020/0,059	EC	71-2965	71-2965 STD	10
BE/PL	6	89,980/90,000	95,000/95,022	36,200	2,476	0,048/0,115	EC	71-3561	71-3561/6 STD 0.25 0.50 0.75 1.00	
MB/HL	6	103,980/104,000	111,000/111,022	36,000	3,478	0,060/0,126	EC	72-3562	H992/7 STD 0.25 0.50 0.75	
MB/HL	1	103,980/104,000	111,000/111,022	45,810	3,478	0,060/0,126	EC	72-3563H		



72-3563H

STD	46,000/1.8110" - 46,062/1.8135"
0.25mm	46,500/1.8307" - 46,562/1.8331"
0.50mm	46,500/1.8307" - 46,562/1.8331"
0.75mm	47,000/1.8504" - 47,062/1.8528"
1.00mm	47,000/1.8504" - 47,062/1.8528"

SE/PB	1	45,595/46,000	50,000/50,025	38,700			BC	55-2862	55-2862 SEMI	
-------	---	---------------	---------------	--------	--	--	----	---------	------------------------	--

Mot.→004159

SE/PB	1	45,995/46,000	50,600/50,630	38,700			BC	55-3328	55-3328 SEMI	
-------	---	---------------	---------------	--------	--	--	----	---------	------------------------	--

Mot.004160→

CB/NWB	1	69,910/69,940	75,000/75,030	36,000	2,500		BB	13-3102	N109/7L STD SEMI	13
CB/NWB	5	69,910/69,940	75,000/75,030	28,000	2,500		BB	13-3103		
CB/NWB	1	69,910/69,940	76,000/76,030	39,000	3,000		EC	53-3104H		
BU	1	30,000	34,000/34,025	21,000			EC	52-3097	52-3097 SEMI	10
BU	1	25,000	28,000/28,052	17,800			BC	56-3042	56-3042 SEMI	

139 128.00 x 140.00

OM 346.910		6 Cyl.	10809cc	155kW (210PS)		Diesel		TD16592
OM 346.911		6 Cyl.	10809cc	155kW (210PS)		Diesel		TD7913
OM 346.912		6 Cyl.	10809cc	155kW (210PS)		Diesel		TD8178
OM 346.913		6 Cyl.	10809cc	155kW (210PS)		Diesel		TD16593
OM 346.914		6 Cyl.	10809cc	136kW (185PS)		Diesel		TD16595

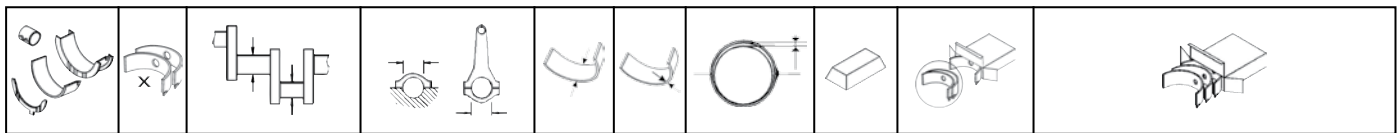

OM 346.915			6 Cyl.	10809cc	136kW (185PS)		Diesel		TD16596
OM 346.916			6 Cyl.	10809cc	136kW (185PS)		Diesel		TD8160
OM 346.917			6 Cyl.	10809cc	155kW (210PS)		Diesel		TD16597
OM 346.918			6 Cyl.	10809cc	132kW (180PS)		Diesel		TD7914
OM 346.941			6 Cyl.	10809cc	155kW (210PS)		Diesel		TD16598
OM 346.942			6 Cyl.	10809cc	155kW (210PS)		Diesel		TD16599
OM 346.943			6 Cyl.	10809cc	136kW (185PS)		Diesel		TD16601
OM 346.944			6 Cyl.	10809cc	136kW (185PS)		Diesel		TD16602
OM 346.945			6 Cyl.	10809cc	136kW (185PS)		Diesel		TD16603
OM 346.946			6 Cyl.	10809cc	136kW (185PS)		Diesel		TD16604
OM 346.952			6 Cyl.	10809cc	141kW (192PS)		Diesel		TD16605
OM 346.953			6 Cyl.	10809cc	136kW (185PS)		Diesel		TD16940
BE/PL	6	73,980/74,000	80,000/80,019	45,100	2,970	0,060/0,124	EC	71-2234	71-2234/6 STD 0.25 0.50

140 128.00 x 142.00

OM 421.905			V6 Cyl.	10964cc	159kW (216PS)		Diesel		TD5799
OM 421.906			V6 Cyl.	10964cc	159kW (216PS)		Diesel		TD8120
OM 421.907			V6 Cyl.	10964cc	159kW (216PS)		Diesel		TD6139
OM 421.908			V6 Cyl.	10964cc	159kW (216PS)		Diesel		TD7898
OM 421.909			V6 Cyl.	10964cc	159kW (216PS)		Diesel		TD17056
OM 421.910			V6 Cyl.	10964cc	159kW (216PS)		Diesel		TD16958

BE/PL	1	31,959/31,975	36,000/36,016	19,000	2,011	0,020/0,059	EC	71-2965	71-2965 STD 10
BE/PL	1	89,980/90,000	95,000/95,022	31,000	2,473	0,054/0,121	EC	71-3009	71-3009 STD 0.10 0.25 0.50 0.75 1.00 1.25
BE/PL	2	31,959/31,975	36,000/36,016	15,000	2,011	0,020/0,060	EC	71-3289	71-3289/2 STD 10
MB/HL	3	103,980/104,000	111,000/111,022	30,500	3,472	0,056/0,123	EC	72-2858	H821/4 STD 0.25 0.50 0.75 1.00
MB/HL	1	103,980/104,000	111,000/111,022	37,810	3,472	0,056/0,123	EC	72-2859H	

	72-2859H	STD	38,000/1.4961" - 38,062/1.4985"
		0.25mm	38,500/1.5157" - 38,562/1.5182"
		0.50mm	38,500/1.5157" - 38,562/1.5182"
		0.75mm	39,000/1.5354" - 39,062/1.5379"
		1.00mm	39,000/1.5354" - 39,062/1.5379"

SE/PB	1	45,995/46,000	50,600/50,630	38,700			BC	55-3328	55-3328 SEMI 10
CB/NWB	3	69,910/69,940	75,000/75,030	28,000	2,500		BB	13-2861	N110/4L STD SEMI 13
CB/NWB	1	69,910/69,940	76,000/76,030	35,000	3,000		EC	53-3098H	
BU	1	30,000	34,000/34,025	21,000			EC	52-3097	52-3097 SEMI 10
BU	1	25,000	28,000/28,052	17,800			BC	56-3042	56-3042 SEMI

141 128.00 x 142.00

OM 421.951			V6 Cyl.	10964cc	184kW (250PS)		Diesel Turbo		TD7899
BE/PL	1	31,959/31,975	36,000/36,016	19,000	2,011	0,020/0,059	EC	71-2965	71-2965 STD 10
BE/PL	2	31,959/31,975	36,000/36,016	15,000	2,011	0,020/0,060	EC	71-3289	71-3289/2 STD 10
BE/PL	1	89,980/90,000	95,000/95,022	31,000	2,473	0,054/0,121	SP	71-3638	71-3638 STD 0.25 0.50 1 3

MERCEDES-BENZ

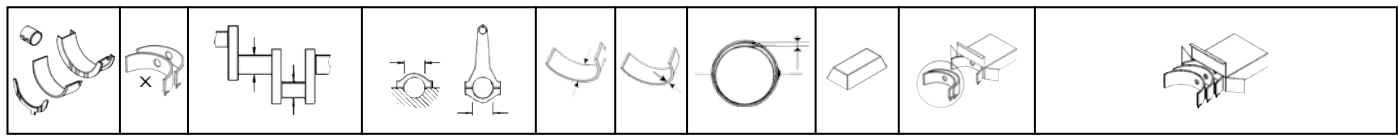

MB/HL	3	103,980/104,000	111,000/111,022	30,500	3,472	0,056/0,123	EC	72-2858	H821/4 STD 0.25 0.50 0.75 1.00	
MB/HL	1	103,980/104,000	111,000/111,022	37,810	3,472	0,056/0,123	EC	72-2859H		
			72-2859H	STD	38,000/1.4961" - 38,062/1.4985"					
				0.25mm	38,500/1.5157" - 38,562/1.5182"					
				0.50mm	38,500/1.5157" - 38,562/1.5182"					
				0.75mm	39,000/1.5354" - 39,062/1.5379"					
				1.00mm	39,000/1.5354" - 39,062/1.5379"					
SE/PB	1	45,995/46,000	50,600/50,630	38,700			BC	55-3328	55-3328 SEMI	
CB/NWB	3	69,910/69,940	75,000/75,030	28,000	2,500		BB	13-2861	N110/4L STD SEMI 13	
CB/NWB	1	69,910/69,940	76,000/76,030	35,000	3,000		EC	53-3098H		
BU	1	30,000	34,000/34,025	21,000			EC	52-3097	52-3097 SEMI 10	
BU	1	25,000	28,000/28,052	17,800			BC	56-3042	56-3042 SEMI	

142 128.00 x 142.00

OM 441.951	V6 Cyl.	10964cc	243kW (330PS)	Diesel Turbo Intercooler	TD8187
OM 441.960	V6 Cyl.	10964cc	243-250kW (330-340PS)	Diesel Turbo Intercooler	TD5772
OM 441.961	V6 Cyl.	10964cc	250kW (340PS)	Diesel Turbo Intercooler	TD16973
OM 441.962	V6 Cyl.	10964cc	243-249kW (330-340PS)	Diesel Turbo Intercooler	TD6104
OM 441.981	V6 Cyl.	10964cc	243-249kW (330-340PS)	Diesel Turbo Intercooler	TD6103
OM 441.983	V6 Cyl.	10964cc	243-249kW (330-340PS)	Diesel Turbo Intercooler	TD6322
OM 441.986	V6 Cyl.	10964cc	250kW (340PS)	Diesel Turbo Intercooler	TD5779
OM 441.987	V6 Cyl.	10964cc	250kW (340PS)	Diesel Turbo Intercooler	TD5782
OM 441.989	V6 Cyl.	10964cc	250kW (340PS)	Diesel Turbo Intercooler	TD5736
OM 441.991	V6 Cyl.	10964cc	250kW (340PS)	Diesel Turbo Intercooler	TD6118
OM 441.996	V6 Cyl.	10964cc	250kW (340PS)	Diesel Turbo Intercooler	TD6116
OM 441.997 Euro 1	V6 Cyl.	10964cc	230kW (313PS)	Diesel Turbo Intercooler	TD16976
OM 441.998	V6 Cyl.	10964cc	230kW (313PS)	Diesel Turbo Intercooler	TD8222
OM 441.999 Euro 1	V6 Cyl.	10964cc	250kW (340PS)	Diesel Turbo Intercooler	TD16977
OM 445.920	V6 Cyl.	10964cc	250kW (340PS)	Diesel Turbo Intercooler	TD5781
OM 445.921	V6 Cyl.	10964cc	250kW (340PS)	Diesel Turbo Intercooler	TD8200
OM 445.922	V6 Cyl.	10964cc	250kW (340PS)	Diesel Turbo Intercooler	TD8252
OM 445.924	V6 Cyl.	10960cc	180kW (245PS)	Diesel Turbo Intercooler	TD5754
OM 445.926	V6 Cyl.	10964cc	200kW (272PS)	Diesel Turbo Intercooler	TD5776
OM 445.929	V6 Cyl.	10964cc	230kW (313PS)	Diesel Turbo Intercooler	TD5778
OM 445.930	V6 Cyl.	10964cc	230kW (313PS)	Diesel Turbo Intercooler	TD6164
OM 445.936	V6 Cyl.	10964cc	200kW (272PS)	Diesel Turbo Intercooler	TD6109
OM 445.937	V6 Cyl.	10964cc	230kW (313PS)	Diesel Turbo Intercooler	TD6112
OM 445.938	V6 Cyl.	10960cc	180kW (245PS)	Diesel Turbo Intercooler	TD6087
OM 445.939	V6 Cyl.	10964cc	250kW (340PS)	Diesel Turbo Intercooler	TD6117
OM 445.941	V6 Cyl.	10960cc	180kW (245PS)	Diesel Turbo Intercooler	TD6288

BE/PL	1	31,959/31,975	36,000/36,016	19,000	2,011	0,020/0,059	EC	71-2965	71-2965 STD 10
BE/PL	2	31,959/31,975	36,000/36,016	15,000	2,011	0,020/0,060	EC	71-3289	71-3289/2 STD 10
BE/PL	1	89,980/90,000	95,000/95,022	26,700	2,473	0,054/0,121	SP	71-3693	71-3693 STD 0.25 0.50 1

08/89 → 12/93, Mot.528573 →

BE/PL	6	89,980/90,000	95,000/95,022	26,700	2,473	0,054/0,121	SP	71-3693	71-3693/6 0.25 0.50 0.75 1.00 1
-------	---	---------------	---------------	--------	-------	-------------	----	---------	--

08/89 → 12/93, Mot.528573 →

BE/PL	6	89,980/90,000	95,000/95,022	24,700	2,473	0,054/0,121	SP	71-3897	71-3897/6 STD	1
01/94 →										
MB/HL	3	103,980/104,000	111,000/111,022	30,500	3,472	0,056/0,123	EC	72-2858	H821/4 STD 0.25 0.50 0.75 1.00	
MB/HL	1	103,980/104,000	111,000/111,022	37,810	3,472	0,056/0,123	EC	72-2859H		
	72-2859H	STD	38,000/1.4961" - 38,062/1.4985"							
		0.25mm	38,500/1.5157" - 38,562/1.5182"							
		0.50mm	38,500/1.5157" - 38,562/1.5182"							
		0.75mm	39,000/1.5354" - 39,062/1.5379"							
		1.00mm	39,000/1.5354" - 39,062/1.5379"							
SE/PB	1	45,995/46,000	50,600/50,630	38,700			BC	55-3328	55-3328 SEMI	
CB/NWB	3	69,910/69,940	75,000/75,030	28,000	2,500		BB	13-2861	N110/4L STD SEMI	13
CB/NWB	1	69,910/69,940	76,000/76,030	35,000	3,000		EC	53-3098H		
BU	1	30,000	34,000/34,025	21,000			EC	52-3097	52-3097 SEMI	10
BU	1	25,000	28,000/28,052	17,800			BC	56-3042	56-3042 SEMI	

143										
128.00 x 142.00										
OM 441.953										
V6 Cyl. 10964cc 191-200kW (260-272PS) Diesel Turbo										
TD5999										
BE/PL	1	31,959/31,975	36,000/36,016	19,000	2,011	0,020/0,059	EC	71-2965	71-2965 STD	10
BE/PL	2	31,959/31,975	36,000/36,016	15,000	2,011	0,020/0,060	EC	71-3289	71-3289/2 STD	10
BE/PL	1	89,980/90,000	95,000/95,022	26,700	2,473	0,054/0,121	SP	71-3693	71-3693 STD 0.25 0.50	1
08/89 →, Mot.528573 →										
BE/PL	6	89,980/90,000	95,000/95,022	26,700	2,473	0,054/0,121	SP	71-3693	71-3693/6 0.25 0.50 0.75 1.00	1
08/89 →, Mot.528573 →										
MB/HL	3	103,980/104,000	111,000/111,022	30,500	3,472	0,056/0,123	EC	72-2858	H821/4 STD 0.25 0.50 0.75 1.00	
MB/HL	1	103,980/104,000	111,000/111,022	37,810	3,472	0,056/0,123	EC	72-2859H		
	72-2859H	STD	38,000/1.4961" - 38,062/1.4985"							
		0.25mm	38,500/1.5157" - 38,562/1.5182"							
		0.50mm	38,500/1.5157" - 38,562/1.5182"							
		0.75mm	39,000/1.5354" - 39,062/1.5379"							
		1.00mm	39,000/1.5354" - 39,062/1.5379"							
SE/PB	1	45,995/46,000	50,600/50,630	38,700			BC	55-3328	55-3328 SEMI	
CB/NWB	3	69,910/69,940	75,000/75,030	28,000	2,500		BB	13-2861	N110/4L STD SEMI	13
CB/NWB	1	69,910/69,940	76,000/76,030	35,000	3,000		EC	53-3098H		
BU	1	30,000	34,000/34,025	21,000			EC	52-3097	52-3097 SEMI	10
BU	1	25,000	28,000/28,052	17,800			BC	56-3042	56-3042 SEMI	

144										
128.00 x 142.00										
OM 441.980										
V6 Cyl. 10964cc 250kW (340PS) Diesel Turbo Intercooler										
TD7943										
OM 441.988										
V6 Cyl. 10964cc 250kW (340PS) Diesel Turbo Intercooler										
TD5825										
OM 441.990										
V6 Cyl. 10964cc 250kW (340PS) Diesel Turbo Intercooler										
TD6177										

MERCEDES-BENZ



OM 441.992	V6 Cyl.	10964cc	250kW (340PS)	Diesel Turbo Intercooler	TD6302
OM 441.993	V6 Cyl.	10964cc	250kW (340PS)	Diesel Turbo Intercooler	TD6069
OM 441.994 Euro 1	V6 Cyl.	10964cc	250kW (340PS)	Diesel Turbo Intercooler	TD16974
OM 441.995 Euro 1	V6 Cyl.	10964cc	250kW (340PS)	Diesel Turbo Intercooler	TD16975
OM 445.923	V6 Cyl.	10964cc	250kW (340PS)	Diesel Turbo Intercooler	TD5737
OM 445.931	V6 Cyl.	10964cc	230kW (313PS)	Diesel Turbo Intercooler	TD6298
OM 445.933	V6 Cyl.	10964cc	200kW (272PS)	Diesel Turbo Intercooler	TD6070
OM 445.934 Euro 2	V6 Cyl.	10964cc	250kW (340PS)	Diesel Turbo	TD10969
OM 445.935 Euro 2	V6 Cyl.	10964cc	213kW (290PS)	Diesel Turbo	TD10970

BE/PL	1	31,959/31,975	36,000/36,016	19,000	2,011	0,020/0,059	EC	71-2965	71-2965 STD	10
BE/PL	2	31,959/31,975	36,000/36,016	15,000	2,011	0,020/0,060	EC	71-3289	71-3289/2 STD	10
BE/PL	1	89,980/90,000	95,000/95,022	26,700	2,473	0,054/0,121	SP	71-3693	71-3693 STD 0.25 0.50	1

→12/93, Mot.528573→

BE/PL	6	89,980/90,000	95,000/95,022	26,700	2,473	0,054/0,121	SP	71-3693	71-3693/6 0.25 0.50 0.75 1.00	1
-------	---	---------------	---------------	--------	-------	-------------	----	---------	---	---

→12/93, Mot.528573→

BE/PL	6	89,980/90,000	95,000/95,022	24,700	2,473	0,054/0,121	SP	71-3897	71-3897/6 STD	1
-------	---	---------------	---------------	--------	-------	-------------	----	---------	-------------------------	---

01/94→

MB/HL	3	103,980/104,000	111,000/111,022	30,500	3,472	0,056/0,123	EC	72-2858	H821/4 STD 0.25 0.50 0.75 1.00	
MB/HL	1	103,980/104,000	111,000/111,022	37,810	3,472	0,056/0,123	EC	72-2859H		



72-2859H	STD	38,000/1.4961" - 38,062/1.4985"
	0.25mm	38,500/1.5157" - 38,562/1.5182"
	0.50mm	38,500/1.5157" - 38,562/1.5182"
	0.75mm	39,000/1.5354" - 39,062/1.5379"
	1.00mm	39,000/1.5354" - 39,062/1.5379"

SE/PB	1	45,995/46,000	50,600/50,630	38,700			BC	55-3328	55-3328 SEMI	
CB/NWB	3	69,910/69,940	75,000/75,030	28,000	2,500		BB	13-2861	N110/4L STD SEMI	13
CB/NWB	1	69,910/69,940	76,000/76,030	35,000	3,000		EC	53-3098H		
BU	1	30,000	34,000/34,025	21,000			EC	52-3097	52-3097 SEMI	10
BU	1	25,000	28,000/28,052	17,800			BC	56-3042	56-3042 SEMI	

145 128.00 x 142.00

OM 441.982	V6 Cyl.	10964cc	250kW (340PS)	Diesel Turbo Intercooler	TD5824
OM 441.985	V6 Cyl.	10964cc	250kW (340PS)	Diesel Turbo Intercooler	TD6176

BE/PL	1	31,959/31,975	36,000/36,016	19,000	2,011	0,020/0,059	EC	71-2965	71-2965 STD	10
BE/PL	2	31,959/31,975	36,000/36,016	15,000	2,011	0,020/0,060	EC	71-3289	71-3289/2 STD	10
BE/PL	1	89,980/90,000	95,000/95,022	26,700	2,473	0,054/0,121	SP	71-3693	71-3693 STD 0.25 0.50	1

Mot.528573→

BE/PL	6	89,980/90,000	95,000/95,022	26,700	2,473	0,054/0,121	SP	71-3693	71-3693/6 0.25 0.50 0.75 1.00	1
-------	---	---------------	---------------	--------	-------	-------------	----	---------	---	---

Mot.528573→

MB/HL	3	103,980/104,000	111,000/111,022	30,500	3,472	0,056/0,123	EC	72-2858	H821/4 STD 0.25 0.50 0.75 1.00	
MB/HL	1	103,980/104,000	111,000/111,022	37,810	3,472	0,056/0,123	EC	72-2859H		
			72-2859H	STD	38,000/1.4961" - 38,062/1.4985"					
				0.25mm	38,500/1.5157" - 38,562/1.5182"					
				0.50mm	38,500/1.5157" - 38,562/1.5182"					
				0.75mm	39,000/1.5354" - 39,062/1.5379"					
				1.00mm	39,000/1.5354" - 39,062/1.5379"					
SE/PB	1	45,995/46,000	50,600/50,630	38,700			BC	55-3328	55-3328 SEMI	
CB/NWB	3	69,910/69,940	75,000/75,030	28,000	2,500		BB	13-2861	N110/4L STD SEMI 13	
CB/NWB	1	69,910/69,940	76,000/76,030	35,000	3,000		EC	53-3098H		
BU	1	30,000	34,000/34,025	21,000			EC	52-3097	52-3097 SEMI 10	
BU	1	25,000	28,000/28,052	17,800			BC	56-3042	56-3042 SEMI	

146 128.00 x 142.00

OM 445.925		V6 Cyl.		10964cc	180kW (245PS)	Diesel Turbo Intercooler		TD8197		
OM 445.927		V6 Cyl.		10964cc	200kW (272PS)	Diesel Turbo Intercooler		TD8235		
OM 445.940		V6 Cyl.		10964cc	200kW (272PS)	Diesel Turbo Intercooler		TD6148		
BE/PL	1	31,959/31,975	36,000/36,016	19,000	2,011	0,020/0,059	EC	71-2965	71-2965 STD 10	
BE/PL	2	31,959/31,975	36,000/36,016	15,000	2,011	0,020/0,060	EC	71-3289	71-3289/2 STD 10	
BE/PL	6	89,980/90,000	95,000/95,022	24,700	2,473	0,054/0,121	SP	71-3897	71-3897/6 STD 1	
MB/HL	3	103,980/104,000	111,000/111,022	30,500	3,472	0,056/0,123	EC	72-2858	H821/4 STD 0.25 0.50 0.75 1.00	
MB/HL	1	103,980/104,000	111,000/111,022	37,810	3,472	0,056/0,123	EC	72-2859H		
			72-2859H	STD	38,000/1.4961" - 38,062/1.4985"					
				0.25mm	38,500/1.5157" - 38,562/1.5182"					
				0.50mm	38,500/1.5157" - 38,562/1.5182"					
				0.75mm	39,000/1.5354" - 39,062/1.5379"					
				1.00mm	39,000/1.5354" - 39,062/1.5379"					
SE/PB	1	45,995/46,000	50,600/50,630	38,700			BC	55-3328	55-3328 SEMI	
CB/NWB	3	69,910/69,940	75,000/75,030	28,000	2,500		BB	13-2861	N110/4L STD SEMI 13	
CB/NWB	1	69,910/69,940	76,000/76,030	35,000	3,000		EC	53-3098H		
BU	1	30,000	34,000/34,025	21,000			EC	52-3097	52-3097 SEMI 10	
BU	1	25,000	28,000/28,052	17,800			BC	56-3042	56-3042 SEMI	

147 128.00 x 142.00

OM 422.901		V8 Cyl.		14618cc	243-276kW (330-375PS)	Diesel Turbo		TD18973		
OM 422.951		V8 Cyl.		14600cc	243kW (330PS)	Diesel Turbo		TD7901		
OM 422.952		V8 Cyl.		14600cc	243kW (330PS)	Diesel Turbo		TD5761		
OM 422.953		V8 Cyl.		14618cc	276kW (375PS)	Diesel Turbo Intercooler		TD5763		
OM 422.954		V8 Cyl.		14618cc	243kW (330PS)	Diesel Turbo		TD6095		
OM 422.955		V8 Cyl.		14618cc	276kW (375PS)	Diesel Turbo Intercooler		TD5800		
OM 422.956		V8 Cyl.		14600cc	243kW (330PS)	Diesel Turbo		TD6134		
OM 422.957		V8 Cyl.		14620cc	243kW (330PS)	Diesel Turbo		TD9613		

MERCEDES-BENZ



OM 422.958	V8 Cyl.	14620cc	243kW (330PS)	Diesel Turbo	TD9614
OM 422.959	V8 Cyl.	14618cc	276kW (375PS)	Diesel Turbo	TD6141
OM 422.963	V8 Cyl.	14618cc	243kW (330PS)	Diesel Turbo	TD11028
OM 440.940	V8 Cyl.	14618cc	250kW (340PS)	Diesel Turbo	TD8194
OM 440.941	V8 Cyl.	14618cc	250kW (340PS)	Diesel Turbo	TD5794
OM 440.942	V8 Cyl.	14618cc	250kW (340PS)	Diesel Turbo	TD6130
OM 440.943	V8 Cyl.	14618cc	250kW (340PS)	Diesel Turbo	TD17122
OM 440.945 Euro 1	V8 Cyl.	14618cc	250kW (340PS)	Diesel Turbo	TD16967
OM 440.948	V8 Cyl.	14618cc	269kW (366PS)	Diesel Turbo	TD17123

BE/PL	1	31,959/31,975	36,000/36,016	19,000	2,011	0,020/0,059	EC	71-2965	71-2965 STD	
BE/PL	2	31,959/31,975	36,000/36,016	15,000	2,011	0,020/0,060	EC	71-3289	71-3289/2 STD	
BE/PL	1	89,980/90,000	95,000/95,022	31,000	2,473	0,054/0,121	SP	71-3638	71-3638 STD 0.25 0.50	
MB/HL	4	103,980/104,000	111,000/111,022	30,500	3,472	0,056/0,123	EC	72-2858	H821/5 STD 0.10 0.25 0.50 0.75 1.00	
MB/HL	1	103,980/104,000	111,000/111,022	37,810	3,472	0,056/0,123	EC	72-2859H		



72-2859H	STD	38,000/1.4961" - 38,062/1.4985"
	0.25mm	38,500/1.5157" - 38,562/1.5182"
	0.50mm	38,500/1.5157" - 38,562/1.5182"
	0.75mm	39,000/1.5354" - 39,062/1.5379"
	1.00mm	39,000/1.5354" - 39,062/1.5379"

SE/PB	1	45,995/46,000	50,600/50,630	38,700			BC	55-3328	55-3328 SEMI	
CB/NWB	4	69,910/69,940	75,000/75,030	28,000	2,500		BB	13-2861	N110/5L STD SEMI	
CB/NWB	1	69,910/69,940	76,000/76,030	35,000	3,000		EC	53-3098H		
BU	1	30,000	34,000/34,025	21,000			EC	52-3097	52-3097 SEMI	
BU	1	25,000	28,000/28,052	17,800			BC	56-3042	56-3042 SEMI	

148 128.00 x 142.00

OM 422.905	V8 Cyl.	14618cc	206kW (280PS)	Diesel	TD5760
OM 422.906	V8 Cyl.	14618cc	206kW (280PS)	Diesel	TD6093
OM 422.907	V8 Cyl.	14618cc	206kW (280PS)	Diesel	TD5805
OM 422.908	V8 Cyl.	14618cc	206kW (280PS)	Diesel	TD7900
OM 422.909	V8 Cyl.	14618cc	184kW (250PS)	Diesel	TD8157
OM 422.910	V8 Cyl.	14618cc	206kW (280PS)	Diesel	TD6132
OM 422.911	V8 Cyl.	14618cc	206kW (280PS)	Diesel	TD6140
OM 422.912	V8 Cyl.	14618cc	184kW (250PS)	Diesel	TD8231
OM 422.913	V8 Cyl.	14618cc	206kW (280PS)	Diesel	TD6149
OM 422.914	V8 Cyl.	14600cc	206kW (280PS)	Diesel	TD5828
OM 422.915	V8 Cyl.	14618cc	184kW (250PS)	Diesel	TD16959
OM 422.916	V8 Cyl.	14618cc	206kW (280PS)	Diesel	TD17111
OM 422.917	V8 Cyl.	14618cc	206kW (280PS)	Diesel	TD11029
OM 422.918	V8 Cyl.	14618cc	206kW (280PS)	Diesel	TD16960
OM 422.919	V8 Cyl.	14618cc	206kW (280PS)	Diesel	TD5821
OM 422.920	V8 Cyl.	14618cc	184kW (250PS)	Diesel	TD8249
OM 422.921	V8 Cyl.	14618cc	206kW (280PS)	Diesel	TD6173
OM 422.922	V8 Cyl.	14618cc	206kW (280PS)	Diesel	TD16961
OM 422.923	V8 Cyl.	14618cc	206kW (280PS)	Diesel	TD16962

BE/PL	1	31,959/31,975	36,000/36,016	19,000	2,011	0,020/0,059	EC	71-2965	71-2965 STD	
-------	---	---------------	---------------	--------	-------	-------------	----	---------	-----------------------	--





BE/PL	1	89,980/90,000	95,000/95,022	31,000	2,473	0,054/0,121	EC	71-3009	71-3009 STD 0.10 0.25 0.50 0.75 1.00 1.25	
BE/PL	2	31,959/31,975	36,000/36,016	15,000	2,011	0,020/0,060	EC	71-3289	71-3289/2 STD 10	
MB/HL	4	103,980/104,000	111,000/111,022	30,500	3,472	0,056/0,123	EC	72-2858	H821/5 STD 0.10 0.25 0.50 0.75 1.00	
MB/HL	1	103,980/104,000	111,000/111,022	37,810	3,472	0,056/0,123	EC	72-2859H		
			72-2859H	STD	38,000/1.4961" - 38,062/1.4985"					
				0.25mm	38,500/1.5157" - 38,562/1.5182"					
				0.50mm	38,500/1.5157" - 38,562/1.5182"					
				0.75mm	39,000/1.5354" - 39,062/1.5379"					
				1.00mm	39,000/1.5354" - 39,062/1.5379"					
SE/PB	1	45,995/46,000	50,600/50,630	38,700			BC	55-3328	55-3328 SEMI	
CB/NWB	4	69,910/69,940	75,000/75,030	28,000	2,500		BB	13-2861	N110/5L STD SEMI 13	
CB/NWB	1	69,910/69,940	76,000/76,030	35,000	3,000		EC	53-3098H		
BU	1	30,000	34,000/34,025	21,000			EC	52-3097	52-3097 SEMI 10	
BU	1	25,000	28,000/28,052	17,800			BC	56-3042	56-3042 SEMI	

149 **128.00 x 142.00**

OM 440.970			V8 Cyl.	14618cc	320kW (435PS)		Diesel Turbo Intercooler	TD5797
OM 440.971			V8 Cyl.	14618cc	370kW (503PS)		Diesel Turbo Intercooler	TD5788
OM 440.972 Euro 1			V8 Cyl.	14618cc	320kW (435PS)		Diesel Turbo Intercooler	TD16968
OM 440.973			V8 Cyl.	14618cc	370kW (503PS)		Diesel Turbo Intercooler	TD6124
OM 440.974			V8 Cyl.	14618cc	320kW (435PS)		Diesel Turbo Intercooler	TD17125
OM 440.975			V8 Cyl.	14618cc	370kW (503PS)		Diesel Turbo Intercooler	TD5833
OM 440.976			V8 Cyl.	14618cc	370kW (503PS)		Diesel Turbo Intercooler	TD8227
OM 440.978			V8 Cyl.	14618cc	320kW (435PS)		Diesel Turbo Intercooler	TD5787
OM 440.979			V8 Cyl.	14618cc	320kW (435PS)		Diesel Turbo Intercooler	TD6138
OM 440.980			V8 Cyl.	14618cc	320kW (435PS)		Diesel Turbo Intercooler	TD6179
OM 440.981			V8 Cyl.	14618cc	370kW (503PS)		Diesel Turbo Intercooler	TD6152
OM 440.982			V8 Cyl.	14618cc	370kW (503PS)		Diesel Turbo Intercooler	TD6185
OM 440.983			V8 Cyl.	14618cc	370kW (503PS)		Diesel Turbo Intercooler	TD6306
OM 440.984			V8 Cyl.	14618cc	320kW (435PS)		Diesel Turbo Intercooler	TD6305
OM 440.985			V8 Cyl.	14618cc	320kW (435PS)		Diesel Turbo Intercooler	TD8256
OM 440.986 Euro 1			V8 Cyl.	14618cc	320kW (435PS)		Diesel Turbo Intercooler	TD16969
OM 440.987 Euro 1			V8 Cyl.	14618cc	280kW (381PS)		Diesel Turbo Intercooler	TD16970
OM 440.988 Euro 1			V8 Cyl.	14618cc	280kW (381PS)		Diesel Turbo Intercooler	TD17126
OM 440.989 Euro 1			V8 Cyl.	14618cc	280kW (381PS)		Diesel Turbo Intercooler	TD16971
OM 440.990			V8 Cyl.	14618cc	280kW (381PS)		Diesel Turbo Intercooler	TD8225
OM 440.991			V8 Cyl.	14618cc	320kW (435PS)		Diesel Turbo Intercooler	TD6122

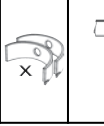
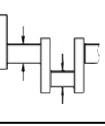
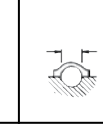
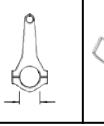
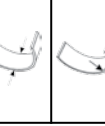
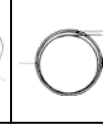
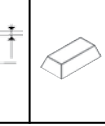
BE/PL	1	31,959/31,975	36,000/36,016	19,000	2,011	0,020/0,059	EC	71-2965	71-2965 STD 10
BE/PL	2	31,959/31,975	36,000/36,016	15,000	2,011	0,020/0,060	EC	71-3289	71-3289/2 STD 10
BE/PL	1	89,980/90,000	95,000/95,022	31,000	2,473	0,054/0,121	SP	71-3638	71-3638 STD 0.25 0.50 1 3
SE/PB	1	45,995/46,000	50,600/50,630	38,700			BC	55-3328	55-3328 SEMI
CB/NWB	4	69,910/69,940	75,000/75,030	28,000	2,500		BB	13-2861	N110/5L STD SEMI 13
CB/NWB	1	69,910/69,940	76,000/76,030	35,000	3,000		EC	53-3098H	

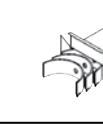
MERCEDES-BENZ

											
BU	1	30,000	34,000/34,025	21,000				EC	52-3097	52-3097 SEMI	10
BU	1	25,000	28,000/28,052	17,800				BC	56-3042	56-3042 SEMI	

150		128.00 x 142.00									
OM 442.941	V8 Cyl.	14618cc	269kW (366PS)	Diesel Turbo	TD16978						
OM 442.942	V8 Cyl.	14618cc	260-269kW (354-366PS)	Diesel Turbo	TD5774						
OM 442.943	V8 Cyl.	14620cc	269kW (366PS)	Diesel Turbo	TD5793						
OM 442.944	V8 Cyl.	14618cc	260-269kW (354-366PS)	Diesel Turbo	TD5773						
OM 442.945	V8 Cyl.	14618cc	269kW (366PS)	Diesel Turbo	TD5829						
OM 442.946	V8 Cyl.	14618cc	266kW (366PS)	Diesel Turbo	TD5831						
OM 442.950	V8 Cyl.	14618cc	260-269kW (354-366PS)	Diesel Turbo	TD5764						
OM 442.951	V8 Cyl.	14618cc	320kW (435PS)	Diesel Turbo Intercooler	TD5765						
OM 442.952	V8 Cyl.	14618cc	260-269kW (354-366PS)	Diesel Turbo	TD6135						
OM 442.953	V8 Cyl.	14618cc	320-329kW (435-447PS)	Diesel Turbo Intercooler	TD5819						
OM 442.954	V8 Cyl.	14618cc	269kW (366PS)	Diesel Turbo	TD10972						
OM 442.955	V8 Cyl.	14618cc	269kW (366PS)	Diesel Turbo	TD10973						
OM 442.957	V8 Cyl.	14618cc	266-269kW (366-366PS)	Diesel Turbo	TD6183						
OM 442.958	V8 Cyl.	14618cc	260-269kW (354-366PS)	Diesel Turbo	TD6290						
OM 442.959	V8 Cyl.	14618cc	269kW (366PS)	Diesel Turbo	TD6161						
OM 442.960	V8 Cyl.	14618cc	260-269kW (354-365PS)	Diesel Turbo	TD5663						
OM 442.961	V8 Cyl.	14618cc	260-269kW (354-365PS)	Diesel Turbo	TD6001						
OM 442.962	V8 Cyl.	14618cc	260-269kW (354-366PS)	Diesel Turbo	TD8215						
OM 442.963	V8 Cyl.	14618cc	260-269kW (354-366PS)	Diesel Turbo	TD5802						
OM 442.964	V8 Cyl.	14618cc	260-269kW (354-366PS)	Diesel Turbo	TD6146						
OM 442.965	V8 Cyl.	14618cc	260-269kW (354-366PS)	Diesel Turbo	TD6292						
OM 442.966	V8 Cyl.	14618cc	260-269kW (354-366PS)	Diesel Turbo	TD6300						
OM 442.967	V8 Cyl.	14618cc	269kW (366PS)	Diesel Turbo	TD17809						
OM 442.968	V8 Cyl.	14618cc	260-269kW (354-366PS)	Diesel Turbo	TD6147						
OM 442.971	V8 Cyl.	14620cc	269kW (366PS)	Diesel Turbo	TD5795						
OM 442.972	V8 Cyl.	14620cc	269kW (366PS)	Diesel Turbo	TD6131						
OM 442.976	V8 Cyl.	14618cc	260-269kW (354-366PS)	Diesel Turbo	TD6323						
OM 442.977	V8 Cyl.	14618cc	250kW (340PS)	Diesel Turbo	TD8219						
OM 442.978	V8 Cyl.	14620cc	250kW (340PS)	Diesel Turbo	TD8216						
OM 442.979	V8 Cyl.	14618cc	250kW (340PS)	Diesel Turbo	TD17136						
OM 442.980	V8 Cyl.	14618cc	320kW (435PS)	Diesel Turbo Intercooler	TD6169						
OM 442.982	V8 Cyl.	14618cc	320-362kW (435-492PS)	Diesel Turbo Intercooler	TD5796						
OM 442.983	V8 Cyl.	14618cc	329kW (447PS)	Diesel Turbo Intercooler	TD8248						
OM 442.985	V8 Cyl.	14618cc	320-362kW (435-492PS)	Diesel Turbo Intercooler	TD5775						
OM 442.989	V8 Cyl.	14618cc	362kW (492PS)	Diesel Turbo Intercooler	TD5817						
OM 442.992	V8 Cyl.	14618cc	320-362kW (435-492PS)	Diesel Turbo Intercooler	TD6301						
OM 442.993	V8 Cyl.	14618cc	362kW (492PS)	Diesel Turbo Intercooler	TD8259						
OM 442.994	V8 Cyl.	14618cc	362kW (492PS)	Diesel Turbo Intercooler	TD6165						
OM 442.995 Euro 1	V8 Cyl.	14618cc	320kW (435PS)	Diesel Turbo Intercooler	TD16979						
OM 442.996 Euro 1	V8 Cyl.	14618cc	370kW (503PS)	Diesel Turbo Intercooler	TD16980						
OM 442.997	V8 Cyl.	14618cc	370kW (503PS)	Diesel Turbo Intercooler	TD5810						
OM 442.998	V8 Cyl.	14618cc	370kW (503PS)	Diesel Turbo Intercooler	TD6157						
OM 442.999	V8 Cyl.	14618cc	370kW (503PS)	Diesel Turbo Intercooler	TD17810						
OM 446.920	V8 Cyl.	14618cc	390kW (530PS)	Diesel Turbo Intercooler	TD5789						
OM 446.922	V8 Cyl.	14618cc	320kW (435PS)	Diesel Turbo Intercooler	TD8207						
OM 446.923	V8 Cyl.	14618cc	320kW (435PS)	Diesel Turbo Intercooler	TD16935						
OM 446.924	V8 Cyl.	14618cc	280kW (381PS)	Diesel Turbo Intercooler	TD5785						
OM 446.925	V8 Cyl.	14618cc	280kW (381PS)	Diesel Turbo Intercooler	TD6120						

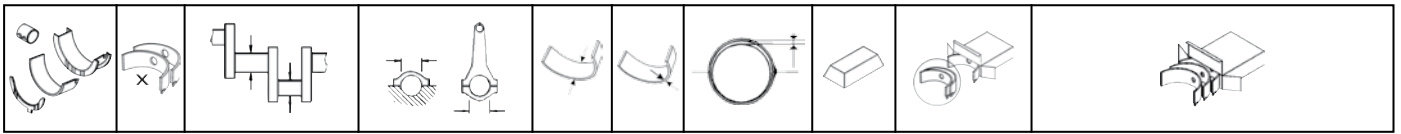

OM 446.926			V8 Cyl.	14618cc	280kW (381PS)		Diesel Turbo Intercooler	TD5834
OM 446.927			V8 Cyl.	14618cc	280kW (381PS)		Diesel Turbo Intercooler	TD8203
OM 446.928			V8 Cyl.	14618cc	280kW (381PS)		Diesel Turbo Intercooler	TD5808
OM 446.929			V8 Cyl.	14618cc	280kW (381PS)		Diesel Turbo Intercooler	TD6155
OM 446.930			V8 Cyl.	14618cc	280kW (381PS)		Diesel Turbo Intercooler	TD6186
OM 446.931			V8 Cyl.	14618cc	280kW (381PS)		Diesel Turbo Intercooler	TD8257
OM 446.932			V8 Cyl.	14618cc	390kW (530PS)		Diesel Turbo Intercooler	TD8260
OM 446.933			V8 Cyl.	14618cc	390kW (530PS)		Diesel Turbo Intercooler	TD5820
OM 446.934 Euro 2			V8 Cyl.	14618cc	280kW (381PS)		Diesel Turbo	TD10974
OM 446.935 Euro 2			V8 Cyl.	14618cc	320kW (435PS)		Diesel Turbo Intercooler	TD16982
OM 446.936			V8 Cyl.	14618cc	320kW (435PS)		Diesel Turbo Intercooler	TD8247
OM 446.938 Euro 2			V8 Cyl.	14618cc	280kW (381PS)		Diesel Turbo	TD10975
OM 446.939			V8 Cyl.	14618cc	320kW (435PS)		Diesel Turbo Intercooler	TD5835
OM 446.940			V8 Cyl.	14618cc	320kW (435PS)		Diesel Turbo Intercooler	TD6187
OM 446.941 Euro 2			V8 Cyl.	14618cc	320kW (435PS)		Diesel Turbo Intercooler	TD16983
OM 446.942			V8 Cyl.	14618cc	320kW (435PS)		Diesel Turbo Intercooler	TD5809
OM 446.943			V8 Cyl.	14618cc	320kW (435PS)		Diesel Turbo Intercooler	TD8204
OM 446.945			V8 Cyl.	14618cc	390kW (530PS)		Diesel Turbo Intercooler	TD6171
OM 446.946			V8 Cyl.	14618cc	390kW (530PS)		Diesel Turbo Intercooler	TD6125
OM 446.948			V8 Cyl.	14618cc	320kW (435PS)		Diesel Turbo Intercooler	TD6156

BE/PL	1	31,959/31,975	36,000/36,016	19,000	2,011	0,020/0,059	EC	71-2965	71-2965 STD	10
BE/PL	2	31,959/31,975	36,000/36,016	15,000	2,011	0,020/0,060	EC	71-3289	71-3289/2 STD	10
BE/PL	1	89,980/90,000	95,000/95,022	31,000	2,473	0,054/0,121	SP	71-3638	71-3638 STD 0.25 0.50	1 3
SE/PB	1	45,995/46,000	50,600/50,630	38,700			BC	55-3328	55-3328 SEMI	
SE/PB	1	45,995/46,000	50,600/50,630	38,700			BC	55-3997	55-3997 SEMI	8

55-3328

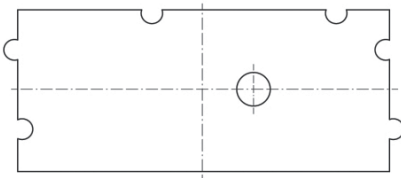

55-3997

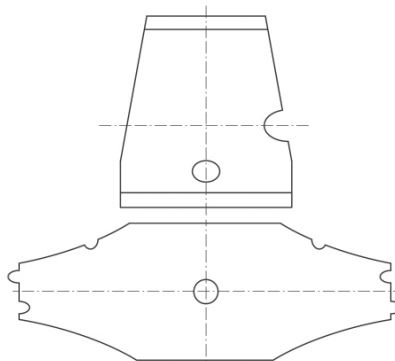

CB/NWB	4	69,910/69,940	75,000/75,030	28,000	2,500		BB	13-2861	N110/5L STD SEMI	13
CB/NWB	1	69,910/69,940	76,000/76,030	35,000	3,000		EC	53-3098H		
BU	1	30,000	34,000/34,025	21,000			EC	52-3097	52-3097 SEMI	10



151 128.00 x 142.00

OM 423.905	V10 Cyl.	18300cc	261kW (355PS)	Diesel	TD5762
OM 423.906	V10 Cyl.	18273cc	261kW (355PS)	Diesel	TD6126
OM 423.907	V10 Cyl.	18273cc	261kW (355PS)	Diesel	TD6289
OM 423.908	V10 Cyl.	18300cc	261kW (355PS)	Diesel	TD6096
OM 423.909	V10 Cyl.	18273cc	261kW (355PS)	Diesel	TD16963
OM 423.950	V10 Cyl.	18273cc	368kW (500PS)	Diesel Turbo Intercooler	TD5827
OM 423.951	V10 Cyl.	18273cc	368kW (500PS)	Diesel Turbo Intercooler	TD6180
OM 443.940	V10 Cyl.	18270cc	340kW (462PS)	Diesel Turbo	TD8214
OM 443.980	V10 Cyl.	18270cc	412kW (560PS)	Diesel Turbo Intercooler	TD8254

BE/PL	1	31,959/31,975	36,000/36,016	19,000	2,011	0,020/0,059	EC	71-2965	71-2965 STD	10
BE/PL	2	31,959/31,975	36,000/36,016	15,000	2,011	0,020/0,060	EC	71-3289	71-3289/2 STD	10
BE/PL	1	89,980/90,000	95,000/95,022	31,000	2,473	0,054/0,121	SP	71-3638	71-3638 STD 0.25 0.50	1 3
MB/HL	5	103,980/104,000	111,000/111,022	30,500	3,472	0,056/0,123	EC	72-2858	H821/6 STD 0.25 0.50 0.75 1.00	
MB/HL	1	103,980/104,000	111,000/111,022	37,810	3,472	0,056/0,123	EC	72-2859H		



72-2859H	STD	38,000/1.4961" - 38,062/1.4985"
	0.25mm	38,500/1.5157" - 38,562/1.5182"
	0.50mm	38,500/1.5157" - 38,562/1.5182"
	0.75mm	39,000/1.5354" - 39,062/1.5379"
	1.00mm	39,000/1.5354" - 39,062/1.5379"

SE/PB	1	45,995/46,000	50,600/50,630	38,700			BC	55-3328	55-3328 SEMI	
CB/NWB	5	69,910/69,940	75,000/75,030	28,000	2,500		BB	13-2861	N110/6L STD SEMI	13
CB/NWB	1	69,910/69,940	76,000/76,030	35,000	3,000		EC	53-3098H		
BU	1	30,000	34,000/34,025	21,000			EC	52-3097	52-3097 SEMI	10
BU	1	25,000	28,000/28,052	17,800			BC	56-3042	56-3042 SEMI	

152 128.00 x 142.00

OM 424.900	V12 Cyl.	21930cc	309kW (420PS)	Diesel	TD18815
-------------------	----------	----------------	----------------------	---------------	----------------









BE/PL	1	31,959/31,975	36,000/36,016	19,000	2,011	0,020/0,059	EC	71-2965	71-2965 STD	10
BE/PL	1	89,980/90,000	95,000/95,022	31,000	2,473	0,054/0,121	EC	71-3009	71-3009 STD 0.10 0.25 0.50 0.75 1.00 1.25	
BE/PL	2	31,959/31,975	36,000/36,016	15,000	2,011	0,020/0,060	EC	71-3289	71-3289/2 STD	10
MB/HL	6	103,980/104,000	111,000/111,022	30,500	3,472	0,056/0,123	EC	72-2858	H821/7 STD 0.25 0.50	
MB/HL	1	103,980/104,000	111,000/111,022	37,810	3,472	0,056/0,123	EC	72-2859H		

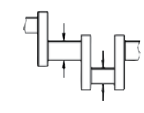
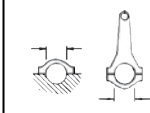

72-2859H	STD	38,000/1.4961" - 38,062/1.4985"
	0.25mm	38,500/1.5157" - 38,562/1.5182"
	0.50mm	38,500/1.5157" - 38,562/1.5182"
	0.75mm	39,000/1.5354" - 39,062/1.5379"
	1.00mm	39,000/1.5354" - 39,062/1.5379"

SE/PB	1	45,595/46,000	50,000/50,025	38,700			BC	55-2862	55-2862 SEMI	
-------	---	---------------	---------------	--------	--	--	----	---------	------------------------	--

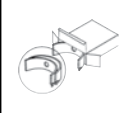
Mot.→000513

											
SE/PB	1	45,995/46,000	50,600/50,630	38,700				BC	55-3328	55-3328 SEMI	
Mot.000514 →											
CB/NWB	6	69,910/69,940	75,000/75,030	28,000	2,500			BB	13-2861	N110/7 STD	13
CB/NWB	1	69,910/69,940	76,000/76,030	35,000	3,000			EC	53-3098H		
BU	1	30,000	34,000/34,025	21,000				EC	52-3097	52-3097 SEMI	10
BU	1	25,000	28,000/28,052	17,800				BC	56-3042	56-3042 SEMI	

153 128.00 x 142.00

OM 424.901 V12 Cyl. **21930cc 441kW (600PS)** Diesel Turbo Intercooler **TD18816**

OM 424.901-510 V12 Cyl. **21930cc 441kW (600PS)** Diesel Turbo Intercooler **TD18817**

BE/PL	1	31,959/31,975	36,000/36,016	19,000	2,011	0,020/0,059	EC	71-2965	71-2965 STD	10
BE/PL	2	31,959/31,975	36,000/36,016	15,000	2,011	0,020/0,060	EC	71-3289	71-3289/2 STD	10
BE/PL	1	89,980/90,000	95,000/95,022	31,000	2,473	0,054/0,121	SP	71-3638	71-3638 STD 0.25 0.50	1 3
MB/HL	6	103,980/104,000	111,000/111,022	30,500	3,472	0,056/0,123	EC	72-2858	H821/7 STD 0.25 0.50	
MB/HL	1	103,980/104,000	111,000/111,022	37,810	3,472	0,056/0,123	EC	72-2859H		

	72-2859H	STD	38,000/1.4961" - 38,062/1.4985"
		0.25mm	38,500/1.5157" - 38,562/1.5182"
		0.50mm	38,500/1.5157" - 38,562/1.5182"
		0.75mm	39,000/1.5354" - 39,062/1.5379"
		1.00mm	39,000/1.5354" - 39,062/1.5379"

SE/PB	1	45,995/46,000	50,600/50,630	38,700				BC	55-3328	55-3328 SEMI	
CB/NWB	6	69,910/69,940	75,000/75,030	28,000	2,500			BB	13-2861	N110/7 STD	13
CB/NWB	1	69,910/69,940	76,000/76,030	35,000	3,000			EC	53-3098H		
BU	1	30,000	34,000/34,025	21,000				EC	52-3097	52-3097 SEMI	10
BU	1	25,000	28,000/28,052	17,800				BC	56-3042	56-3042 SEMI	

154 128.00 x 142.00

OM 444 LA 12 Cyl. **21927cc 478-610kW (530-830PS)** Diesel Turbo Intercooler **FM6642**

BE/PL	1	31,959/31,975	36,000/36,016	19,000	2,011	0,020/0,059	EC	71-2965	71-2965 STD	10	
BE/PL	2	31,959/31,975	36,000/36,016	15,000	2,011	0,020/0,060	EC	71-3289	71-3289/2 STD	10	
BE/PL	1	89,980/90,000	95,000/95,022	31,000	2,473	0,054/0,121	SP	71-3638	71-3638 STD 0.25 0.50	1 3	
SE/PB	1	45,995/46,000	50,600/50,630	38,700				BC	55-3328	55-3328 SEMI	
CB/NWB	6	69,910/69,940	75,000/75,030	28,000	2,500			BB	13-2861	N110/7 STD	13
CB/NWB	1	69,910/69,940	76,000/76,030	35,000	3,000			EC	53-3098H		
BU	1	30,000	34,000/34,025	21,000				EC	52-3097	52-3097 SEMI	10
BU	1	25,000	28,000/28,052	17,800				BC	56-3042	56-3042 SEMI	

MERCEDES-BENZ



155 **128.00 x 150.00**

OM 355.910	6 Cyl.	11581cc	169kW (230PS)	Diesel	TD16668
OM 355.911	6 Cyl.	11581cc	169kW (230PS)	Diesel	TD16669
OM 355.912	6 Cyl.	11581cc	169kW (230PS)	Diesel	TD16670
OM 355.913	6 Cyl.	11581cc	169kW (230PS)	Diesel	TD16671
OM 355.914	6 Cyl.	11581cc	169kW (230PS)	Diesel	TD16672
OM 355.915	6 Cyl.	11581cc	169kW (230PS)	Diesel	TD7892
OM 355.916	6 Cyl.	11581cc	169kW (230PS)	Diesel	TD22746
OM 355.918	6 Cyl.	11581cc	169kW (230PS)	Diesel	TD16673
OM 355.960	6 Cyl.	11581cc	176kW (240PS)	Diesel	TD5813
OM 355.961	6 Cyl.	11581cc	155kW (210PS)	Diesel	TD16675
OM 355.962	6 Cyl.	11581cc	177kW (240PS)	Diesel	TD16676
OM 355.963	6 Cyl.	11581cc	176kW (240PS)	Diesel	TD5812
OM 355.964	6 Cyl.	11581cc	177kW (240PS)	Diesel	TD16677
OM 355.966	6 Cyl.	11581cc	155kW (210PS)	Diesel	TD16678
OM 355.967	6 Cyl.	11581cc	177kW (240PS)	Diesel	TD7893
OM 355.968	6 Cyl.	11581cc	191kW (260PS)	Diesel	TD23185
OM 355.969	6 Cyl.	11581cc	206kW (280PS)	Diesel Turbo	TD8212
OM 355.970	6 Cyl.	11581cc	191kW (260PS)	Diesel	TD16679
OM 355.972	6 Cyl.	11581cc	136kW (185PS)	Diesel	TD16680
OM 355.973	6 Cyl.	11581cc	177kW (240PS)	Diesel	TD16681
OM 355.974	6 Cyl.	11581cc	177kW (240PS)	Diesel	TD16682
OM 355.975	6 Cyl.	11581cc	176kW (240PS)	Diesel	TD6160
OM 355.976	6 Cyl.	11581cc	176kW (240PS)	Diesel	TD6159
OM 355.977	6 Cyl.	11581cc	205kW (275PS)	Diesel Turbo	TD16683
OM 355.978	6 Cyl.	11581cc	177kW (240PS)	Diesel	TD16684
OM 355.979	6 Cyl.	11581cc	177kW (240PS)	Diesel	TD16685
OM 355.980	6 Cyl.	11581cc	177kW (240PS)	Diesel	TD16686
OM 355.981	6 Cyl.	11581cc	184kW (250PS)	Diesel	TD16687
OM 355.982	6 Cyl.	11581cc	184kW (250PS)	Diesel	TD16674
OM 355.983	6 Cyl.	11581cc	177kW (240PS)	Diesel	TD5811
OM 355.984	6 Cyl.	11581cc	177kW (240PS)	Diesel	TD6158

BE/PL	6	77,980/78,000	83,000/83,022	41,750	2,468	0,064/0,131	EC	71-2549	71-2549/6 STD 0.25 0.50 0.75 1.00 1.25 1.50
BE/PL	1	31,989/32,000	34,400/34,416	16,000	1,194	0,022/0,069	EC	71-3004	71-3004 STD 10
MB/HL 1-3, 5,6	5	94,980/95,000	100,000/100,022	35,150	2,470		EC	72-2550	H818/7 STD 0.25 0.50 0.75 1.00 1.25 1.50
MB/HL 7	1	94,980/95,000	100,000/100,022	52,150	2,470		EC	72-2552	
MB/HL 4	1	94,980/95,000	102,000/102,022	64,800	3,470		EC	72-2838H	



72-2838H	STD	65,000/2.5591" - 65,074/2.5620"
	0.25mm	65,500/2.5787" - 65,574/2.5817"
	0.50mm	65,500/2.5787" - 65,574/2.5817"
	0.75mm	65,500/2.5787" - 65,574/2.5817"
	1.00mm	66,000/2.5984" - 66,074/2.6013"

SE/PB	1	47,993/48,000	52,000/52,030	45,000			BS	55-2538	55-2538 SEMI
-------	---	---------------	---------------	--------	--	--	----	---------	-----------------

CB/NWB 1	1	53,851/53,870	58,000/58,030	33,000				AL-LF	03-2553	N082/7 SEMI
CB/NWB 2,4,6	3	53,751/53,770	58,000/58,030	30,000				AL-LF	03-2554	
CB/NWB 3	1	53,651/53,670	58,000/58,030	55,000				AL-LF	03-2555	
CB/NWB 5	1	53,451/53,470	58,000/58,030	30,000				AL-LF	03-2556	
CB/NWB 7	1	53,251/53,270	58,000/58,030	30,000				AL-LF	03-2557	
CB/NWB 1	1	53,851/53,870	58,000/58,030	33,000				BB	13-2553	N082/7L SEMI
CB/NWB 2,4,6	3	53,751/53,770	58,000/58,030	30,000				BB	13-2554	
CB/NWB 3	1	53,651/53,670	58,000/58,030	55,000				BB	13-2555	
CB/NWB 5	1	53,451/53,470	58,000/58,030	30,000				BB	13-2556	
CB/NWB 7	1	53,251/53,270	58,000/58,030	30,000				BB	13-2557	

156 128.00 x 155.00

OM 427.905	6 Cyl.	11967cc	150kW (204PS)	Diesel	TD7951
OM 427.910	6 Cyl.	11967cc	177kW (240PS)	Diesel	TD5671
OM 427.911	6 Cyl.	11967cc	177kW (240PS)	Diesel	TD6010

BE/PL	1	31,959/31,975	36,000/36,016	19,000	2,011	0,020/0,059	EC	71-2965	71-2965 STD	10
MB/HL	6	103,980/104,000	111,000/111,022	36,000	3,478	0,060/0,126	EC	72-3562	H992/7 STD 0.25 0.50 0.75	
MB/HL	1	103,980/104,000	111,000/111,022	45,810	3,478	0,060/0,126	EC	72-3563H		

	72-3563H	STD	46,000/1.8110" - 46,062/1.8135"
		0.25mm	46,500/1.8307" - 46,562/1.8331"
		0.50mm	46,500/1.8307" - 46,562/1.8331"
		0.75mm	47,000/1.8504" - 47,062/1.8528"
		1.00mm	47,000/1.8504" - 47,062/1.8528"

SE/PB	1	45,595/46,000	50,000/50,025	38,700			BC	55-2862	55-2862 SEMI
-------	---	---------------	---------------	--------	--	--	----	---------	------------------------

Mot.→004159

SE/PB	1	45,995/46,000	50,600/50,630	38,700			BC	55-3328	55-3328 SEMI
-------	---	---------------	---------------	--------	--	--	----	---------	------------------------

Mot.004160→







CB/NWB	1	69,910/69,940	75,000/75,030	36,000	2,500		BB	13-3102	N109/7L STD SEMI	13
CB/NWB	5	69,910/69,940	75,000/75,030	28,000	2,500		BB	13-3103		
CB/NWB	1	69,910/69,940	76,000/76,030	39,000	3,000		EC	53-3104H		
BU	1	30,000	34,000/34,025	21,000			EC	52-3097	52-3097 SEMI	10
BU	1	25,000	28,000/28,052	17,800			BC	56-3042	56-3042 SEMI	

157 128.00 x 155.00

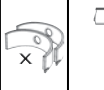
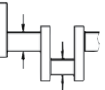
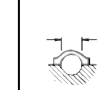
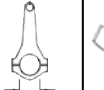
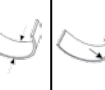
OM 427.950	6 Cyl.	11967cc	206kW (280PS)	Diesel Turbo	TD7946
OM 427.951	6 Cyl.	11967cc	206kW (280PS)	Diesel Turbo	TD16964
OM 427.952	6 Cyl.	11967cc	206kW (280PS)	Diesel Turbo	TD16965

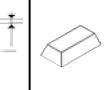
BE/PL	1	31,959/31,975	36,000/36,016	19,000	2,011	0,020/0,059	EC	71-2965	71-2965 STD
-------	---	---------------	---------------	--------	-------	-------------	----	---------	-----------------------

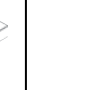
MERCEDES-BENZ

																					
BE/PL	6	89,980/90,000	95,000/95,022	36,200	2,476	0,048/0,115	EC	71-3561	71-3561/6 STD 0.25 0.50 0.75 1.00	10											
MB/HL	6	103,980/104,000	111,000/111,022	36,000	3,478	0,060/0,126	EC	72-3562	H992/7 STD 0.25 0.50 0.75												
MB/HL	1	103,980/104,000	111,000/111,022	45,810	3,478	0,060/0,126	EC	72-3563H													
 72-3563H <table border="0" style="margin-left: 20px;"> <tr> <td>STD</td> <td>46,000/1.8110" - 46,062/1.8135"</td> </tr> <tr> <td>0.25mm</td> <td>46,500/1.8307" - 46,562/1.8331"</td> </tr> <tr> <td>0.50mm</td> <td>46,500/1.8307" - 46,562/1.8331"</td> </tr> <tr> <td>0.75mm</td> <td>47,000/1.8504" - 47,062/1.8528"</td> </tr> <tr> <td>1.00mm</td> <td>47,000/1.8504" - 47,062/1.8528"</td> </tr> </table>												STD	46,000/1.8110" - 46,062/1.8135"	0.25mm	46,500/1.8307" - 46,562/1.8331"	0.50mm	46,500/1.8307" - 46,562/1.8331"	0.75mm	47,000/1.8504" - 47,062/1.8528"	1.00mm	47,000/1.8504" - 47,062/1.8528"
STD	46,000/1.8110" - 46,062/1.8135"																				
0.25mm	46,500/1.8307" - 46,562/1.8331"																				
0.50mm	46,500/1.8307" - 46,562/1.8331"																				
0.75mm	47,000/1.8504" - 47,062/1.8528"																				
1.00mm	47,000/1.8504" - 47,062/1.8528"																				
SE/PB	1	45,595/46,000	50,000/50,025	38,700			BC	55-2862	55-2862 SEMI												
Mot.→004159																					
SE/PB	1	45,995/46,000	50,600/50,630	38,700			BC	55-3328	55-3328 SEMI												
Mot.004160→																					
CB/NWB	1	69,910/69,940	75,000/75,030	36,000	2,500		BB	13-3102	N109/7L STD SEMI	13											
CB/NWB	5	69,910/69,940	75,000/75,030	28,000	2,500		BB	13-3103													
CB/NWB	1	69,910/69,940	76,000/76,030	39,000	3,000		EC	53-3104H													
BU	1	30,000	34,000/34,025	21,000			EC	52-3097	52-3097 SEMI	10											
BU	1	25,000	28,000/28,052	17,800			BC	56-3042	56-3042 SEMI												

158 128.00 x 155.00

OM 429.951	5 Cyl.	9970cc	175kW (235PS)	Diesel Turbo Intercooler	TD8164																
OM 429.952	5 Cyl.	9970cc	175kW (235PS)	Diesel Turbo Intercooler	TD18818																
OM 429.953	5 Cyl.	9970cc	186kW (250PS)	Diesel Turbo	TD5755																
OM 429.955	5 Cyl.	9970cc	186kW (250PS)	Diesel Turbo Intercooler	TD6088																
BE/PL	1	31,959/31,975	36,000/36,016	19,000	2,011	0,020/0,059	EC	71-2965	71-2965 STD	10											
BE/PL	1	89,980/90,000	95,000/95,022	36,200	2,478	0,044/0,111	SP	71-3637	71-3637 STD 0.25	1 3											
MB/HL	5	103,980/104,000	111,000/111,022	36,000	3,478	0,060/0,126	EC	72-3562	H992/6 STD												
MB/HL	1	103,980/104,000	111,000/111,022	45,810	3,478	0,060/0,126	EC	72-3563H													
 72-3563H <table border="0" style="margin-left: 20px;"> <tr> <td>STD</td> <td>46,000/1.8110" - 46,062/1.8135"</td> </tr> <tr> <td>0.25mm</td> <td>46,500/1.8307" - 46,562/1.8331"</td> </tr> <tr> <td>0.50mm</td> <td>46,500/1.8307" - 46,562/1.8331"</td> </tr> <tr> <td>0.75mm</td> <td>47,000/1.8504" - 47,062/1.8528"</td> </tr> <tr> <td>1.00mm</td> <td>47,000/1.8504" - 47,062/1.8528"</td> </tr> </table>												STD	46,000/1.8110" - 46,062/1.8135"	0.25mm	46,500/1.8307" - 46,562/1.8331"	0.50mm	46,500/1.8307" - 46,562/1.8331"	0.75mm	47,000/1.8504" - 47,062/1.8528"	1.00mm	47,000/1.8504" - 47,062/1.8528"
STD	46,000/1.8110" - 46,062/1.8135"																				
0.25mm	46,500/1.8307" - 46,562/1.8331"																				
0.50mm	46,500/1.8307" - 46,562/1.8331"																				
0.75mm	47,000/1.8504" - 47,062/1.8528"																				
1.00mm	47,000/1.8504" - 47,062/1.8528"																				
SE/PB	1	45,995/46,000	50,600/50,630	38,700			BC	55-3328	55-3328 SEMI												

159 128.00 x 155.00

OM 447.947 Euro 1	6 Cyl.	11967cc	220kW (299PS)	Diesel Turbo Intercooler	TD22805
OM 447.948 Euro 2	6 Cyl.	11967cc	220kW (299PS)	Diesel Turbo Intercooler	TD22806
OM 447.949 Euro 2	6 Cyl.	11967cc	157kW (214PS)	Diesel Turbo Intercooler	TD22807
OM 447.950	6 Cyl.	11967cc	206kW (280PS)	Diesel Turbo	TD5673
OM 447.951	6 Cyl.	11967cc	206kW (280PS)	Diesel Turbo	TD6012
OM 447.952 Euro 1	6 Cyl.	11967cc	206kW (280PS)	Diesel Turbo	TD16988
OM 447.953 Euro 1	6 Cyl.	11967cc	206kW (280PS)	Diesel Turbo	TD16989
OM 447.954 Euro 1	6 Cyl.	11967cc	184kW (250PS)	Diesel Turbo	TD10976

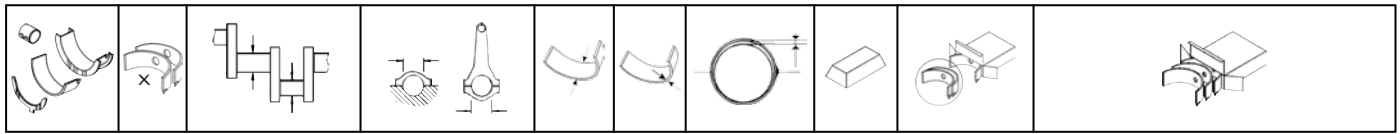

OM 447.955 Euro 1	6 Cyl.	11967cc	184kW (250PS)	Diesel Turbo	TD10977
OM 447.956	6 Cyl.	11967cc	184kW (250PS)	Diesel Turbo	TD7949
OM 447.957	6 Cyl.	11967cc	184kW (250PS)	Diesel Turbo	TD7959
OM 447.958	6 Cyl.	11967cc	184kW (250PS)	Diesel Turbo	TD7962
OM 447.959	6 Cyl.	11967cc	184kW (250PS)	Diesel Turbo	TD7954
OM 447.960 Euro 1	6 Cyl.	11967cc	184kW (250PS)	Diesel Turbo Intercooler	TD22808
OM 447.968 Euro 2	6 Cyl.	11967cc	235kW (320PS)	Diesel Turbo Intercooler	TD22809
OM 447.969	6 Cyl.	11967cc	224-261kW (305-355PS)	Diesel Turbo Intercooler	TD28880
OM 447.970 Euro 2	6 Cyl.	11967cc	157kW (214PS)	Diesel Turbo Intercooler	TD10978
OM 447.971 Euro 2	6 Cyl.	11967cc	184kW (250PS)	Diesel Turbo Intercooler	TD10979
OM 447.972 Euro 2	6 Cyl.	11967cc	220kW (299PS)	Diesel Turbo Intercooler	TD10980
OM 447.973 Euro 2	6 Cyl.	11967cc	157kW (214PS)	Diesel Turbo Intercooler	TD10981
OM 447.974 Euro 2	6 Cyl.	11967cc	184kW (250PS)	Diesel Turbo Intercooler	TD10982
OM 447.975 Euro 1	6 Cyl.	11967cc	220kW (299PS)	Diesel Turbo Intercooler	TD11007
OM 447.976 Euro 2	6 Cyl.	11967cc	184kW (250PS)	Diesel Turbo Intercooler	TD10983
OM 447.977 Euro 2	6 Cyl.	11967cc	220kW (299PS)	Diesel Turbo Intercooler	TD11009
OM 447.978	6 Cyl.	11967cc	184kW (250PS)	Diesel Turbo Intercooler	TD10984
OM 447.979 Euro 2	6 Cyl.	11967cc	220kW (299PS)	Diesel Turbo Intercooler	TD10985
OM 447.980 Euro 1	6 Cyl.	11967cc	220kW (299PS)	Diesel Turbo Intercooler	TD11008
OM 447.981	6 Cyl.	11967cc	220kW (300PS)	Diesel Turbo Intercooler	TD7950
OM 447.982	6 Cyl.	11967cc	220kW (300PS)	Diesel Turbo Intercooler	TD17811
OM 447.983	6 Cyl.	11967cc	220kW (300PS)	Diesel Turbo Intercooler	TD17812
OM 447.984	6 Cyl.	11967cc	220kW (300PS)	Diesel Turbo Intercooler	TD7955
OM 447.985 Euro 1	6 Cyl.	11967cc	220kW (299PS)	Diesel Turbo Intercooler	TD10986
OM 447.986	6 Cyl.	11967cc	220kW (300PS)	Diesel Turbo Intercooler	TD7960
OM 447.987	6 Cyl.	11967cc	220kW (300PS)	Diesel Turbo Intercooler	TD7963
OM 447.988 Euro 2	6 Cyl.	11967cc	220kW (300PS)	Diesel Turbo Intercooler	TD16990
OM 447.990 Euro 2	6 Cyl.	11967cc	184kW (250PS)	Diesel Turbo Intercooler	TD10987
OM 447.991 Euro 2	6 Cyl.	11967cc	220kW (299PS)	Diesel Turbo Intercooler	TD10988
OM 447.992 Euro 2	6 Cyl.	11967cc	184kW (250PS)	Diesel Turbo	TD10989
OM 447.993 Euro 2	6 Cyl.	11967cc	220kW (299PS)	Diesel Turbo Intercooler	TD10990
OM 447.994 Euro 2	6 Cyl.	11967cc	220kW (299PS)	Diesel Turbo Intercooler	TD16991
OM 447.995	6 Cyl.	11967cc	184kW (250PS)	Diesel Turbo	TD17813
OM 447.996 Euro 2	6 Cyl.	11967cc	184kW (250PS)	Diesel Turbo Intercooler	TD22810
OM 447.998 Euro 2	6 Cyl.	11967cc	220kW (299PS)	Diesel Turbo Intercooler	TD11010
M 476.920	6 Cyl.	11967cc	177kW (241PS)	Gas Turbo Intercooler	TD22728
M 476.921	6 Cyl.	11967cc	175kW (238PS)	Gas Turbo Intercooler	TD22729
M 476.925	6 Cyl.	11967cc	177kW (241PS)	Gas Turbo Intercooler	TD22730
M 476.926	6 Cyl.	11967cc	177kW (241PS)	Gas Turbo Intercooler	TD22731
M 476.927	6 Cyl.	11967cc	177kW (241PS)	Gas Turbo Intercooler	TD22732
OM 447.915	6 Cyl.	11967cc	185kW (252PS)	Alcohol	TD16986
OM 447.916	6 Cyl.	11967cc	185kW (252PS)	Methyl Alcohol	TD16987

BE/PL	1	31,959/31,975	36,000/36,016	19,000	2,011	0,020/0,059	EC	71-2965	71-2965 STD	10
BE/PL	1	89,980/90,000	95,000/95,022	36,200	2,478	0,044/0,111	SP	71-3637	71-3637 STD 0.25	1 3
MB/HL	6	103,980/104,000	111,000/111,022	36,000	3,478	0,060/0,126	EC	72-3562	H992/7 STD 0.25 0.50 0.75	
MB/HL	1	103,980/104,000	111,000/111,022	45,810	3,478	0,060/0,126	EC	72-3563H		



72-3563H

STD	46,000/1.8110" - 46,062/1.8135"
0.25mm	46,500/1.8307" - 46,562/1.8331"
0.50mm	46,500/1.8307" - 46,562/1.8331"
0.75mm	47,000/1.8504" - 47,062/1.8528"
1.00mm	47,000/1.8504" - 47,062/1.8528"

SE/PB	1	45,995/46,000	50,600/50,630	38,700			BC	55-3328	55-3328 SEMI
CB/NWB	1	69,910/69,940	75,000/75,030	36,000	2,500		BB	13-3102	N109/7L STD SEMI 13
CB/NWB	5	69,910/69,940	75,000/75,030	28,000	2,500		BB	13-3103	
CB/NWB	1	69,910/69,940	76,000/76,030	39,000	3,000		EC	53-3104H	
BU	1	30,000	34,000/34,025	21,000			EC	52-3097	52-3097 SEMI 10
BU	1	25,000	28,000/28,052	17,800			BC	56-3042	56-3042 SEMI

160 128.00 x 155.00

OM 447.905			6 Cyl.	11967cc	150-177kW (204-241PS)	Diesel			TD7947
OM 447.906			6 Cyl.	11967cc	177-184kW (240-250PS)	Diesel			TD5674
OM 447.907			6 Cyl.	11967cc	177-184kW (240-250PS)	Diesel			TD5672
OM 447.908			6 Cyl.	11967cc	177-184kW (240-250PS)	Diesel			TD6011
OM 447.910			6 Cyl.	11967cc	177-184kW (240-250PS)	Diesel			TD7956
OM 447.911			6 Cyl.	11967cc	150-157kW (204-214PS)	Diesel			TD7957
OM 447.912			6 Cyl.	11967cc	184kW (250PS)	Diesel			TD7961
OM 447.913 Euro 1			6 Cyl.	11967cc	150-157kW (204-214PS)	Diesel			TD7948
OM 447.914 Euro 1			6 Cyl.	11967cc	150-157kW (204-214PS)	Diesel			TD7958
BE/PL	1	31,959/31,975	36,000/36,016	19,000	2,011	0,020/0,059	EC	71-2965	71-2965 STD 10
BE/PL	6	89,980/90,000	95,000/95,022	36,200	2,476	0,048/0,115	EC	71-3561	71-3561/6 STD 0.25 0.50 0.75 1.00
BE/PL	1	89,980/90,000	95,000/95,022	36,200	2,478	0,044/0,111	SP	71-3637	71-3637 STD 0.25 1 3

71-3561

71-3637

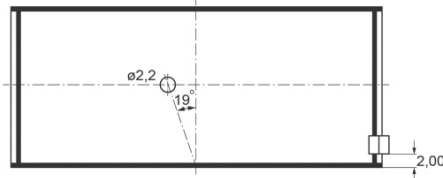
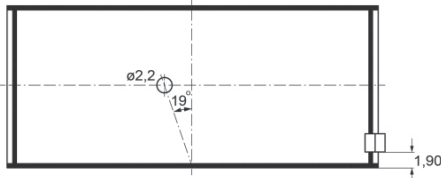

MB/HL	6	103,980/104,000	111,000/111,022	36,000	3,478	0,060/0,126	EC	72-3562	H992/7 STD 0.25 0.50 0.75
MB/HL	1	103,980/104,000	111,000/111,022	45,810	3,478	0,060/0,126	EC	72-3563H	



72-3563H	STD	46,000/1.8110" - 46,062/1.8135"
	0.25mm	46,500/1.8307" - 46,562/1.8331"
	0.50mm	46,500/1.8307" - 46,562/1.8331"
	0.75mm	47,000/1.8504" - 47,062/1.8528"
	1.00mm	47,000/1.8504" - 47,062/1.8528"

SE/PB	1	45,995/46,000	50,600/50,630	38,700			BC	55-3328	55-3328 SEMI
CB/NWB	1	69,910/69,940	75,000/75,030	36,000	2,500		BB	13-3102	N109/7L STD SEMI 13
CB/NWB	5	69,910/69,940	75,000/75,030	28,000	2,500		BB	13-3103	
CB/NWB	1	69,910/69,940	76,000/76,030	39,000	3,000		EC	53-3104H	
BU	1	30,000	34,000/34,025	21,000			EC	52-3097	52-3097 SEMI 10
BU	1	25,000	28,000/28,052	17,800			BC	56-3042	56-3042 SEMI

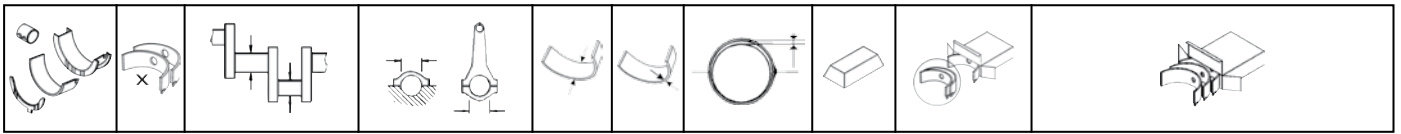

161 128.00 x 155.00

OM 457.914 Euro 3	6 Cyl.	11967cc	250kW (340PS)	Diesel Turbo Intercooler	TD20335
OM 457.915 Euro 3	6 Cyl.	11967cc	265kW (360PS)	Diesel Turbo Intercooler	TD20303
OM 457.916 Euro 3	6 Cyl.	11967cc	265kW (360PS)	Diesel Turbo Intercooler	TD20304
OM 457.917 Euro 2/3	6 Cyl.	11967cc	260-315kW (354-428PS)	Diesel Turbo Intercooler	TD20324
OM 457.918 Euro 3	6 Cyl.	11967cc	260-315kW (354-428PS)	Diesel Turbo Intercooler	TD20305
OM 457.919 Euro 3	6 Cyl.	11967cc	315kW (428PS)	Diesel Turbo Intercooler	TD20306
OM 457.920 Euro 3	6 Cyl.	11967cc	280kW (381PS)	Diesel Turbo Intercooler	TD20307
OM 457.922 Euro 3	6 Cyl.	11967cc	320kW (435PS)	Diesel Turbo Intercooler	TD20308
OM 457.923 Euro 3	6 Cyl.	11967cc	280kW (381PS)	Diesel Turbo Intercooler	TD20309
OM 457.924 Euro 3	6 Cyl.	11967cc	280kW (381PS)	Diesel Turbo Intercooler	TD20310
OM 457.925 Euro 3	6 Cyl.	11967cc	265kW (360PS)	Diesel Turbo Intercooler	TD20311
OM 457.926 Euro 3	6 Cyl.	11967cc	265kW (360PS)	Diesel Turbo Intercooler	TD20312
OM 457.927 Euro 3	6 Cyl.	11967cc	295kW (401PS)	Diesel Turbo Intercooler	TD20336
OM 457.928 Euro 3	6 Cyl.	11967cc	280kW (381PS)	Diesel Turbo Intercooler	TD20313
OM 457.929 Euro 3	6 Cyl.	11967cc	265kW (360PS)	Diesel Turbo Intercooler	TD20314
OM 457.931 Euro 3	6 Cyl.	11967cc	280kW (381PS)	Diesel Turbo Intercooler	TD20315
OM 457.932 Euro 3	6 Cyl.	11967cc	265kW (360PS)	Diesel Turbo Intercooler	TD20316
OM 457.933 Euro 2/3	6 Cyl.	11967cc	260kW (354PS)	Diesel Turbo Intercooler	TD17662
OM 457.934 Euro 2/3	6 Cyl.	11967cc	220kW (299PS)	Diesel Turbo Intercooler	TD17473
OM 457.935 Euro 2/3	6 Cyl.	11967cc	185kW (252PS)	Diesel Turbo Intercooler	TD17502
OM 457.936 Euro 2	6 Cyl.	11967cc	300kW (408PS)	Diesel Turbo Intercooler	TD17653
OM 457.937 Euro 2/3	6 Cyl.	11967cc	260-315kW (354-428PS)	Diesel Turbo Intercooler	TD16489
OM 457.938 Euro 2	6 Cyl.	11967cc	300kW (408PS)	Diesel Turbo Intercooler	TD17645
OM 457.939 Euro 2	6 Cyl.	11967cc	260kW (354PS)	Diesel Turbo Intercooler	TD20317
OM 457.940 Euro 2/3	6 Cyl.	11967cc	260kW (354PS)	Diesel Turbo Intercooler	TD17654
OM 457.941 Euro 2/3	6 Cyl.	11967cc	185-300kW (252-408PS)	Diesel Turbo Intercooler	TD17641
OM 457.942 Euro 2/3	6 Cyl.	11967cc	185-260kW (252-354PS)	Diesel Turbo Intercooler	TD17448
OM 457.943 Euro 2/3	6 Cyl.	11967cc	185-260kW (252-354PS)	Diesel Turbo Intercooler	TD17666
OM 457.944 Euro 2/3	6 Cyl.	11967cc	260-310kW (354-422PS)	Diesel Turbo Intercooler	TD17644
OM 457.945 Euro 2	6 Cyl.	11967cc	260kW (354PS)	Diesel Turbo Intercooler	TD20318
OM 457.946 Euro 2	6 Cyl.	11967cc	220kW (299PS)	Diesel Turbo Intercooler	TD20319
OM 457.947 Euro 2	6 Cyl.	11967cc	260-315kW (354-428PS)	Diesel Turbo Intercooler	TD20320
OM 457.949 Euro 2	6 Cyl.	11967cc	220kW (299PS)	Diesel Turbo Intercooler	TD20321
OM 457.955 Euro 3	6 Cyl.	11967cc	260-315kW (354-428PS)	Diesel Turbo Intercooler	TD20323
OM 457.956 Euro 3	6 Cyl.	11967cc	260-315kW (354-428PS)	Diesel Turbo Intercooler	TD20282
OM 457.958 Euro 2/3	6 Cyl.	11967cc	230-315kW (313-428PS)	Diesel Turbo Intercooler	TD20340
OM 457.960 Euro 2	6 Cyl.	11967cc	260-315kW (354-428PS)	Diesel Turbo Intercooler	TD20322
OM 457.962 Euro 3	6 Cyl.	11967cc	260-315kW (354-428PS)	Diesel Turbo Intercooler	TD23253
OM 457.980 Euro 2	6 Cyl.	11967cc	260-315kW (354-428PS)	Diesel Turbo Intercooler	TD25446
OM 457.981 Euro 3	6 Cyl.	11967cc	260-315kW (354-428PS)	Diesel Turbo Intercooler	TD25447

BE/PL	1	31,959/31,975	36,000/36,016	19,000	2,011	0,020/0,059	EC	71-2965	71-2965 STD	10
BE/PL	6	89,980/90,000	95,000/95,022	36,200	2,478	0,044/0,111	SP	71-3893	71-3893/6 STD	1
MB/HL 1-6	6	103,980/104,000	111,000/111,022	36,000	3,478	0,060/0,126	SP	72-3894	H075/7 STD 0.25	2
MB/HL 7	1	103,980/104,000	111,000/111,022	45,810	3,478	0,060/0,126	SP	72-3895H		
SE/PB	1	45,995/46,000	50,600/50,630	38,700			BC	55-3328	55-3328 SEMI	

MERCEDES-BENZ

CB/NWB	1		87,000				B	23-4900	N205/7 SEMI
CB/NWB	5		87,000	35,000			B	23-4901	
CB/NWB	1		87,000					23-4902H	
BU	1	30,000	34,000/34,025	21,000			EC	52-3097	52-3097 SEMI
BU	1	25,000	28,000/28,052	17,800			BC	56-3042	56-3042 SEMI

162 128.00 x 155.00

OM 457.948 Euro 3	6 Cyl.	11967cc	260-315kW (354-428PS)	Diesel Turbo Intercooler	TD20227
OM 457.950 Euro 4	6 Cyl.	11967cc	220-260kW (299-354PS)	Diesel Turbo Intercooler	TD20337
OM 457.951 Euro 4	6 Cyl.	11967cc	260kW (354PS)	Diesel Turbo Intercooler	TD23250
OM 457.952 Euro 4	6 Cyl.	11967cc	220-300kW (299-408PS)	Diesel Turbo Intercooler	TD20338
OM 457.953 Euro 4	6 Cyl.	11967cc	260-315kW (354-428PS)	Diesel Turbo Intercooler	TD23251
OM 457.954 Euro 4	6 Cyl.	11967cc	220-260kW (299-354PS)	Diesel Turbo Intercooler	TD20339
OM 457.957 Euro 3	6 Cyl.	11967cc	260-315kW (354-428PS)	Diesel Turbo Intercooler	TD20283
OM 457.959 Euro 4	6 Cyl.	11967cc	220-260kW (299-354PS)	Diesel Turbo Intercooler	TD20341
OM 457.961 Euro 3	6 Cyl.	11967cc	260-355kW (354-483PS)	Diesel Turbo Intercooler	TD23252
OM 457.964 Euro 4	6 Cyl.	11967cc	220-260kW (299-408PS)	Diesel Turbo Intercooler	TD23247
OM 457.965 Euro 4	6 Cyl.	11967cc	220-300kW (299-408PS)	Diesel Turbo Intercooler	TD23248
OM 457.966 Euro 4	6 Cyl.	11967cc	220-260kW (299-354PS)	Diesel Turbo Intercooler	TD23249
OM 457.967 Euro 4	6 Cyl.	11967cc	220-260kW (299-354PS)	Diesel Turbo Intercooler	TD28150
OM 457.968 Euro 4	6 Cyl.	11967cc	265-315kW (360-428PS)	Diesel Turbo Intercooler	TD28726
OM 457.969 Euro 4	6 Cyl.	11967cc	265kW (360PS)	Diesel Turbo Intercooler	TD28727
OM 457.973 Euro 4	6 Cyl.	11967cc	220-260kW (299-354PS)	Diesel Turbo Intercooler	TD27003

BE/PL	1	93,980/94,000	99,000/99,022	34,400	2,473	0,081/0,151	SP	71-4784	71-4784 STD 0.25 0.50	1
MB/HL 1-6	6	103,980/104,000	111,000/111,022	36,000	3,478	0,060/0,126	SP	72-3894	H075/7 STD 0.25	2
MB/HL 7	1	103,980/104,000	111,000/111,022	45,810	3,478	0,060/0,126	SP	72-3895H		
CB/NWB	1		87,000				B	23-4900	N205/7 SEMI	
CB/NWB	5		87,000	35,000			B	23-4901		
CB/NWB	1		87,000					23-4902H		

163 128.00 x 166.00

OM 460.900 Euro 3	6 Cyl.	12816cc	324kW (441PS)	Diesel Turbo Intercooler	TD23255
OM 460.901 Euro 3	6 Cyl.	12816cc	261kW (355PS)	Diesel Turbo Intercooler	TD23256
OM 460.902 Euro 3	6 Cyl.	12816cc	276kW (375PS)	Diesel Turbo Intercooler	TD23257
OM 460.903 Euro 3	6 Cyl.	12816cc	276kW (375PS)	Diesel Turbo Intercooler	TD23258
OM 460.904 Euro 3	6 Cyl.	12816cc	306kW (416PS)	Diesel Turbo Intercooler	TD23259
OM 460.905 Euro 3	6 Cyl.	12816cc	306kW (416PS)	Diesel Turbo Intercooler	TD23260
OM 460.906 Euro 3	6 Cyl.	12816cc	261-276kW (355-375PS)	Diesel Turbo Intercooler	TD23261
OM 460.907 Euro 3	6 Cyl.	12816cc	336kW (457PS)	Diesel Turbo Intercooler	TD23262
OM 460.908 Euro 3	6 Cyl.	12816cc	261-336kW (355-457PS)	Diesel Turbo Intercooler	TD23263
OM 460.909 Euro 3	6 Cyl.	12816cc	261-276kW (355-375PS)	Diesel Turbo Intercooler	TD23264
OM 460.910 Euro 3	6 Cyl.	12816cc	261-276kW (355-375PS)	Diesel Turbo Intercooler	TD23265
OM 460.911 Euro 3	6 Cyl.	12816cc	306-336kW (416-457PS)	Diesel Turbo Intercooler	TD23266
OM 460.912 Euro 3	6 Cyl.	12816cc	261-276kW (355-375PS)	Diesel Turbo Intercooler	TD23267
OM 460.913 Euro 3	6 Cyl.	12816cc	306-336kW (416-457PS)	Diesel Turbo Intercooler	TD23268
OM 460.914 Euro 3	6 Cyl.	12816cc	306-336kW (416-457PS)	Diesel Turbo Intercooler	TD23269

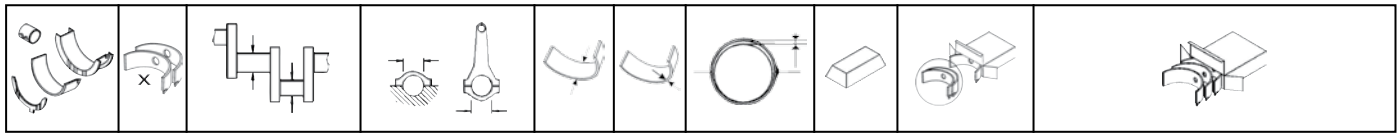

OM 460.915 Euro 3	6 Cyl.	12816cc	261-276kW (355-375PS)	Diesel Turbo Intercooler	TD23270
OM 460.916 Euro 3	6 Cyl.	12816cc	261-276kW (355-375PS)	Diesel Turbo Intercooler	TD23271
OM 460.917 Euro 3	6 Cyl.	12816cc	306-336kW (416-457PS)	Diesel Turbo Intercooler	TD23272
OM 460.918 Euro 3	6 Cyl.	12816cc	261-276kW (355-375PS)	Diesel Turbo Intercooler	TD23273
OM 460.919 Euro 3	6 Cyl.	12816cc	306-336kW (416-457PS)	Diesel Turbo Intercooler	TD23274
OM 460.920 Euro 3	6 Cyl.	12816cc	306-336kW (416-457PS)	Diesel Turbo Intercooler	TD23275
OM 460.921 Euro 3	6 Cyl.	12816cc	306-336kW (416-457PS)	Diesel Turbo Intercooler	TD23276
OM 460.922 Euro 3	6 Cyl.	12816cc	261-276kW (355-375PS)	Diesel Turbo Intercooler	TD23277
OM 460.923 Euro 3	6 Cyl.	12816cc	306-336kW (416-457PS)	Diesel Turbo Intercooler	TD23278
OM 460.925 Euro 3	6 Cyl.	12816cc	306-336kW (416-457PS)	Diesel Turbo Intercooler	TD23279
OM 460.926	6 Cyl.	12816cc	306-336kW (416-457PS)	Diesel Turbo Intercooler	TD28735
OM 460.927	6 Cyl.	12816cc	306-336kW (416-457PS)	Diesel Turbo Intercooler	TD28736
OM 460.929 Euro 3	6 Cyl.	12816cc	306-336kW (416-457PS)	Diesel Turbo Intercooler	TD23280
OM 460.931 Euro 3	6 Cyl.	12816cc	306-336kW (416-457PS)	Diesel Turbo Intercooler	TD23281
OM 460.932	6 Cyl.	12816cc	261-278kW (355-378PS)	Diesel Turbo Intercooler	TD28737
OM 460.933	6 Cyl.	12816cc	306-336kW (416-457PS)	Diesel Turbo Intercooler	TD28738
OM 460.934	6 Cyl.	12816cc	261-278kW (355-378PS)	Diesel Turbo Intercooler	TD28739
OM 460.935	6 Cyl.	12816cc	306-336kW (416-457PS)	Diesel Turbo Intercooler	TD28740
OM 460.936	6 Cyl.	12816cc	261-276kW (355-375PS)	Diesel Turbo Intercooler	TD28741
OM 460.937	6 Cyl.	12816cc	261-276kW (355-375PS)	Diesel Turbo Intercooler	TD28742
OM 460.938	6 Cyl.	12816cc	306-336kW (416-457PS)	Diesel Turbo Intercooler	TD28743
OM 460.939	6 Cyl.	12816cc	261-276kW (355-375PS)	Diesel Turbo Intercooler	TD28744
OM 460.940	6 Cyl.	12816cc	306-336kW (416-457PS)	Diesel Turbo Intercooler	TD28745
OM 460.941	6 Cyl.	12816cc	261-276kW (355-375PS)	Diesel Turbo Intercooler	TD28746
OM 460.942	6 Cyl.	12816cc	306-336kW (416-457PS)	Diesel Turbo Intercooler	TD28747
OM 460.943	6 Cyl.	12816cc	261-276kW (355-375PS)	Diesel Turbo Intercooler	TD28748
OM 460.944	6 Cyl.	12816cc	306-336kW (416-457PS)	Diesel Turbo Intercooler	TD28749
OM 460.945	6 Cyl.	12816cc	261-276kW (355-375PS)	Diesel Turbo Intercooler	TD28750
OM 460.946	6 Cyl.	12816cc	306-336kW (416-457PS)	Diesel Turbo Intercooler	TD28751
OM 460.947	6 Cyl.	12816cc	261-276kW (355-375PS)	Diesel Turbo Intercooler	TD28752
OM 460.948	6 Cyl.	12816cc	306-336kW (416-457PS)	Diesel Turbo Intercooler	TD28753
OM 460.949	6 Cyl.	12816cc	261-276kW (355-375PS)	Diesel Turbo Intercooler	TD28754
OM 460.961 Euro 3	6 Cyl.	12816cc	306-324kW (416-441PS)	Diesel Turbo Intercooler	TD28755
OM 460.970 Euro 3	6 Cyl.	12816cc	261-338kW (355-460PS)	Diesel Turbo Intercooler	TD23282
OM 460.971 Euro 3	6 Cyl.	12816cc	261-338kW (355-460PS)	Diesel Turbo Intercooler	TD23283
OM 460.975 Euro 3	6 Cyl.	12816cc	261-338kW (355-460PS)	Diesel Turbo Intercooler	TD23284
OM 460.976 Euro 3	6 Cyl.	12816cc	261-338kW (355-460PS)	Diesel Turbo Intercooler	TD23285
OM 460.977 Euro 3	6 Cyl.	12816cc	261-338kW (355-460PS)	Diesel Turbo Intercooler	TD23286
OM 460.978 Euro 3	6 Cyl.	12816cc	261-338kW (355-460PS)	Diesel Turbo Intercooler	TD23287
OM 460.979 Euro 3	6 Cyl.	12816cc	261-338kW (355-460PS)	Diesel Turbo Intercooler	TD23288
OM 460.980 Euro 3	6 Cyl.	12816cc	261-338kW (355-460PS)	Diesel Turbo Intercooler	TD23289
OM 460.981 Euro 3	6 Cyl.	12816cc	261-338kW (355-460PS)	Diesel Turbo Intercooler	TD23290

BE/PL	1	93,980/94,000	99,000/99,022	35,000	2,473	0,064/0,126	SP	71-3868	71-3868 STD 0.25 0.50 0.75 1.00	①
MB/HL 1-6	6	103,980/104,000	111,000/111,022	36,000	3,478	0,060/0,126	SP	72-3894	H075/7 STD 0.25	②
MB/HL 7	1	103,980/104,000	111,000/111,022	45,810	3,478	0,060/0,126	SP	72-3895H		
CB/NWB	1		87,000				B	23-4900	N205/7 SEMI	
CB/NWB	5		87,000	35,000			B	23-4901		
CB/NWB	1		87,000					23-4902H		

MERCEDES-BENZ





164 128.00 x 166.00

OM 460.950 Euro 3		6 Cyl.	12816cc	315-350kW (428-476PS)	Diesel Turbo Intercooler	TD22811				
OM 460.951 Euro 3		6 Cyl.	12816cc	315-360kW (428-490PS)	Diesel Turbo Intercooler	TD23254				
OM 460.960 Euro 3		6 Cyl.	12816cc	306kW (416PS)	Diesel Turbo Intercooler	TD22812				
BE/PL	1	93,980/94,000	99,000/99,022	34,400	2,473	0,081/0,151	SP	71-4784	71-4784 STD 0.25 0.50	[1]
MB/HL 1-6	6	103,980/104,000	111,000/111,022	36,000	3,478	0,060/0,126	SP	72-3894	H075/7 STD 0.25	[2]
MB/HL 7	1	103,980/104,000	111,000/111,022	45,810	3,478	0,060/0,126	SP	72-3895H		
CB/NWB	1		87,000				B	23-4900	N205/7 SEMI	
CB/NWB	5		87,000	35,000			B	23-4901		
CB/NWB	1		87,000					23-4902H		

165 130.00 x 138.00

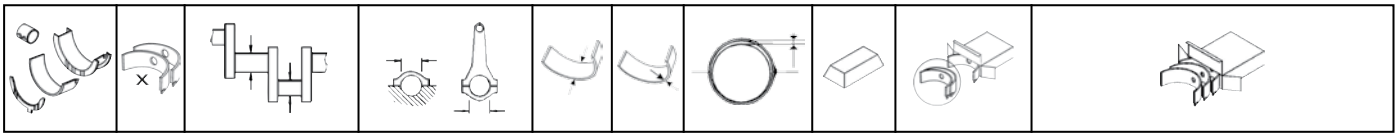
OM 441.905		V6 Cyl.	10964cc	165kW (224PS)	Diesel	TD5731				
OM 441.906		V6 Cyl.	10964cc	150kW (204PS)	Diesel	TD8184				
OM 441.907		V6 Cyl.	10964cc	150kW (204PS)	Diesel	TD8185				
OM 441.908		V6 Cyl.	10964cc	160-165kW (218-224PS)	Diesel	TD5660				
OM 441.909		V6 Cyl.	10964cc	160-165kW (218-224PS)	Diesel	TD5998				
OM 441.911		V6 Cyl.	10964cc	160-165kW (218-224PS)	Diesel	TD6271				
OM 441.913		V6 Cyl.	10964cc	165kW (224PS)	Diesel Turbo Intercooler	TD6063				
OM 441.915		V6 Cyl.	10964cc	165kW (224PS)	Diesel	TD8121				
OM 441.917		V6 Cyl.	10964cc	160kW (218PS)	Diesel	TD8122				
OM 441.923		V6 Cyl.	10964cc	160kW (218PS)	Diesel	TD5732				
OM 441.925		V6 Cyl.	10964cc	160kW (218PS)	Diesel	TD6064				
OM 441.926		V6 Cyl.	10964cc	160kW (218PS)	Diesel	TD8119				
OM 441.927		V6 Cyl.	10964cc	153kW (208PS)	Diesel	TD8123				
BE/PL	1	31,959/31,975	36,000/36,016	19,000	2,011	0,020/0,059	EC	71-2965	71-2965 STD	[10]
BE/PL	1	89,980/90,000	95,000/95,022	31,000	2,473	0,054/0,121	EC	71-3009	71-3009 STD 0.10 0.25 0.50 0.75 1.00 1.25	
BE/PL	2	31,959/31,975	36,000/36,016	15,000	2,011	0,020/0,060	EC	71-3289	71-3289/2 STD	[10]
MB/HL	3	103,980/104,000	111,000/111,022	30,500	3,472	0,056/0,123	EC	72-2858	H821/4 STD 0.25 0.50 0.75 1.00	
MB/HL	1	103,980/104,000	111,000/111,022	37,810	3,472	0,056/0,123	EC	72-2859H		
		72-2859H	STD	38,000/1.4961" - 38,062/1.4985"						
			0.25mm	38,500/1.5157" - 38,562/1.5182"						
			0.50mm	38,500/1.5157" - 38,562/1.5182"						
			0.75mm	39,000/1.5354" - 39,062/1.5379"						
			1.00mm	39,000/1.5354" - 39,062/1.5379"						
SE/PB	1	45,995/46,000	50,600/50,630	38,700			BC	55-3328	55-3328 SEMI	
CB/NWB	3	69,910/69,940	75,000/75,030	28,000	2,500		BB	13-2861	N110/4L STD SEMI	[13]
CB/NWB	1	69,910/69,940	76,000/76,030	35,000	3,000		EC	53-3098H		
BU	1	30,000	34,000/34,025	21,000			EC	52-3097	52-3097 SEMI	[10]
BU	1	25,000	28,000/28,052	17,800			BC	56-3042	56-3042 SEMI	



166		130.00 x 138.00								
OM 441.950		V6 Cyl.			10964cc	191-200kW (260-272PS)		Diesel Turbo		TD5661
BE/PL	1	31,959/31,975	36,000/36,016	19,000	2,011	0,020/0,059	EC	71-2965	71-2965 STD	10
BE/PL	2	31,959/31,975	36,000/36,016	15,000	2,011	0,020/0,060	EC	71-3289	71-3289/2 STD	10
BE/PL	1	89,980/90,000	95,000/95,022	26,700	2,473	0,054/0,121	SP	71-3693	71-3693 STD 0.25 0.50	1
08/89 →, Mot.528573 →										
BE/PL	6	89,980/90,000	95,000/95,022	26,700	2,473	0,054/0,121	SP	71-3693	71-3693/6 0.25 0.50 0.75 1.00	1
08/89 →, Mot.528573 →										
MB/HL	3	103,980/104,000	111,000/111,022	30,500	3,472	0,056/0,123	EC	72-2858	H821/4 STD 0.25 0.50 0.75 1.00	
MB/HL	1	103,980/104,000	111,000/111,022	37,810	3,472	0,056/0,123	EC	72-2859H		
			72-2859H	STD	38,000/1.4961" - 38,062/1.4985"					
				0.25mm	38,500/1.5157" - 38,562/1.5182"					
				0.50mm	38,500/1.5157" - 38,562/1.5182"					
				0.75mm	39,000/1.5354" - 39,062/1.5379"					
				1.00mm	39,000/1.5354" - 39,062/1.5379"					
SE/PB	1	45,995/46,000	50,600/50,630	38,700			BC	55-3328	55-3328 SEMI	
CB/NWB	3	69,910/69,940	75,000/75,030	28,000	2,500		BB	13-2861	N110/4L STD SEMI	13
CB/NWB	1	69,910/69,940	76,000/76,030	35,000	3,000		EC	53-3098H		
BU	1	30,000	34,000/34,025	21,000			EC	52-3097	52-3097 SEMI	10
BU	1	25,000	28,000/28,052	17,800			BC	56-3042	56-3042 SEMI	

167		130.00 x 142.00								
OM 441.912		V6 Cyl.			11309cc	165kW (224PS)		Diesel		TD6142
OM 441.914		V6 Cyl.			11309cc	165kW (224PS)		Diesel		TD6101
OM 441.916		V6 Cyl.			11309cc	153kW (208PS)		Diesel		TD5768
OM 441.918		V6 Cyl.			11309cc	165kW (224PS)		Diesel		TD10968
OM 441.919		V6 Cyl.			11309cc	150-165kW (204-224PS)		Diesel		TD16972
OM 441.920		V6 Cyl.			11309cc	153kW (208PS)		Diesel		TD6100
OM 441.921		V6 Cyl.			11300cc	165kW (224PS)		Diesel		TD7941
OM 441.922		V6 Cyl.			11300cc	151kW (205PS)		Diesel		TD7942
OM 441.924		V6 Cyl.			11309cc	160kW (218PS)		Diesel		TD6143
OM 441.932		V6 Cyl.			11309cc	151kW (205PS)		Diesel		TD8190
OM 441.933		V6 Cyl.			11309cc	151kW (205PS)		Diesel		TD8191
BE/PL	1	31,959/31,975	36,000/36,016	19,000	2,011	0,020/0,059	EC	71-2965	71-2965 STD	10
BE/PL	1	89,980/90,000	95,000/95,022	31,000	2,473	0,054/0,121	EC	71-3009	71-3009 STD 0.10 0.25 0.50 0.75 1.00 1.25	
BE/PL	2	31,959/31,975	36,000/36,016	15,000	2,011	0,020/0,060	EC	71-3289	71-3289/2 STD	10

MERCEDES-BENZ

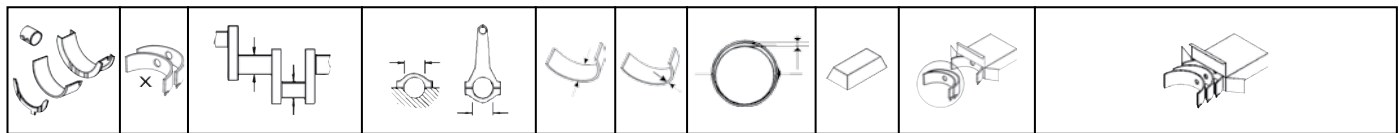

MB/HL	3	103,980/104,000	111,000/111,022	30,500	3,472	0,056/0,123	EC	72-2858	H821/4 STD 0.25 0.50 0.75 1.00	
MB/HL	1	103,980/104,000	111,000/111,022	37,810	3,472	0,056/0,123	EC	72-2859H		
			72-2859H	STD	38,000/1.4961" - 38,062/1.4985"					
				0.25mm	38,500/1.5157" - 38,562/1.5182"					
				0.50mm	38,500/1.5157" - 38,562/1.5182"					
				0.75mm	39,000/1.5354" - 39,062/1.5379"					
				1.00mm	39,000/1.5354" - 39,062/1.5379"					
SE/PB	1	45,995/46,000	50,600/50,630	38,700			BC	55-3328	55-3328 SEMI	
CB/NWB	3	69,910/69,940	75,000/75,030	28,000	2,500		BB	13-2861	N110/4L STD SEMI 13	
CB/NWB	1	69,910/69,940	76,000/76,030	35,000	3,000		EC	53-3098H		
BU	1	30,000	34,000/34,025	21,000			EC	52-3097	52-3097 SEMI 10	
BU	1	25,000	28,000/28,052	17,800			BC	56-3042	56-3042 SEMI	

168 130.00 x 142.00

OM 440.907 Euro 1	V8 Cyl.	15080cc	195kW (265PS)	Diesel	TD16966
OM 440.909	V8 Cyl.	15080cc	195kW (265PS)	Diesel	TD8192
OM 440.910 Euro 1	V8 Cyl.	15080cc	218kW (296PS)	Diesel	TD17119
OM 440.911 Euro 1	V8 Cyl.	15080cc	218kW (296PS)	Diesel	TD17120

BE/PL	1	31,959/31,975	36,000/36,016	19,000	2,011	0,020/0,059	EC	71-2965	71-2965 STD 10
BE/PL	2	31,959/31,975	36,000/36,016	15,000	2,011	0,020/0,060	EC	71-3289	71-3289/2 STD 10
BE/PL	1	89,980/90,000	95,000/95,022	31,000	2,473	0,054/0,121	SP	71-3638	71-3638 STD 0.25 0.50 1 3
MB/HL	4	103,980/104,000	111,000/111,022	30,500	3,472	0,056/0,123	EC	72-2858	H821/5 STD 0.10 0.25 0.50 0.75 1.00
MB/HL	1	103,980/104,000	111,000/111,022	37,810	3,472	0,056/0,123	EC	72-2859H	



72-2859H	STD	38,000/1.4961" - 38,062/1.4985"							
	0.25mm	38,500/1.5157" - 38,562/1.5182"							
	0.50mm	38,500/1.5157" - 38,562/1.5182"							
	0.75mm	39,000/1.5354" - 39,062/1.5379"							
	1.00mm	39,000/1.5354" - 39,062/1.5379"							

SE/PB	1	45,995/46,000	50,600/50,630	38,700			BC	55-3328	55-3328 SEMI
CB/NWB	4	69,910/69,940	75,000/75,030	28,000	2,500		BB	13-2861	N110/5L STD SEMI
CB/NWB	1	69,910/69,940	76,000/76,030	35,000	3,000		EC	53-3098H	
BU	1	30,000	34,000/34,025	21,000			EC	52-3097	52-3097 SEMI 13
BU	1	25,000	28,000/28,052	17,800			BC	56-3042	56-3042 SEMI 10

169 130.00 x 142.00

OM 442.905	V8 Cyl.	15080cc	191kW (260PS)	Diesel	TD8186
OM 442.906	V8 Cyl.	15080cc	218kW (296PS)	Diesel	TD5769
OM 442.907	V8 Cyl.	15080cc	213-218kW (290-296PS)	Diesel	TD5771
OM 442.908	V8 Cyl.	15080cc	210kW (286PS)	Diesel	TD5790
OM 442.909	V8 Cyl.	15080cc	210kW (286PS)	Diesel	TD5791
OM 442.910	V8 Cyl.	15080cc	213-218kW (290-296PS)	Diesel	TD5662
OM 442.911	V8 Cyl.	15080cc	218kW (296PS)	Diesel	TD10971

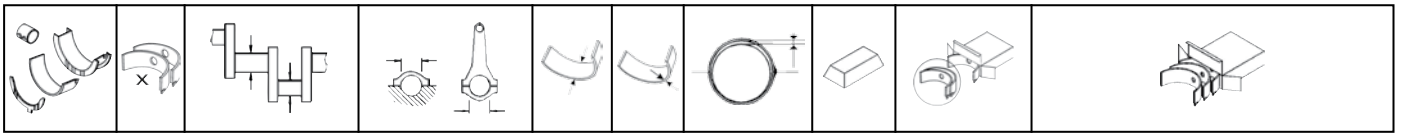

OM 442.913	V8 Cyl.	15080cc	213kW (290PS)	Diesel	TD17130
OM 442.914	V8 Cyl.	15080cc	195kW (265PS)	Diesel	TD5734
OM 442.915	V8 Cyl.	15078cc	218kW (296PS)	Diesel	TD5822
OM 442.916	V8 Cyl.	15078cc	218kW (296PS)	Diesel	TD6174
OM 442.917	V8 Cyl.	15080cc	218kW (296PS)	Diesel	TD6297
OM 442.918	V8 Cyl.	15080cc	213-218kW (290-296PS)	Diesel	TD6000
OM 442.919	V8 Cyl.	15080cc	213-218kW (290-296PS)	Diesel	TD6272
OM 442.920	V8 Cyl.	15080cc	195kW (265PS)	Diesel	TD5735
OM 442.921	V8 Cyl.	15080cc	195kW (265PS)	Diesel	TD6144
OM 442.922	V8 Cyl.	15080cc	195kW (265PS)	Diesel	TD5770
OM 442.923	V8 Cyl.	15080cc	210kW (286PS)	Diesel	TD6127
OM 442.924	V8 Cyl.	15080cc	210kW (286PS)	Diesel	TD6128
OM 442.925	V8 Cyl.	15080cc	213kW (290PS)	Diesel	TD5815
OM 442.926	V8 Cyl.	15080cc	213kW (290PS)	Diesel	TD5792
OM 442.927	V8 Cyl.	15078cc	213kW (290PS)	Diesel	TD5823
OM 442.928	V8 Cyl.	15078cc	213kW (290PS)	Diesel	TD6175
OM 442.929	V8 Cyl.	15080cc	213kW (290PS)	Diesel	TD6129
OM 442.930	V8 Cyl.	15100cc	213kW (290PS)	Diesel	TD7944
OM 442.931	V8 Cyl.	15080cc	195kW (265PS)	Diesel	TD7945
OM 442.932	V8 Cyl.	15080cc	195kW (265PS)	Diesel	TD6066
OM 442.933	V8 Cyl.	15080cc	195kW (265PS)	Diesel	TD6067
OM 442.934	V8 Cyl.	15080cc	195kW (265PS)	Diesel	TD6324
OM 442.935	V8 Cyl.	15080cc	195kW (265PS)	Diesel	TD6102
OM 442.939	V8 Cyl.	15080cc	213-218kW (290-296PS)	Diesel	TD6319

BE/PL	1	31,959/31,975	36,000/36,016	19,000	2,011	0,020/0,059	EC	71-2965	71-2965 STD	[10]
BE/PL	1	89,980/90,000	95,000/95,022	31,000	2,473	0,054/0,121	EC	71-3009	71-3009 STD 0.10 0.25 0.50 0.75 1.00 1.25	
BE/PL	2	31,959/31,975	36,000/36,016	15,000	2,011	0,020/0,060	EC	71-3289	71-3289/2 STD	[10]
MB/HL	4	103,980/104,000	111,000/111,022	30,500	3,472	0,056/0,123	EC	72-2858	H821/5 STD 0.10 0.25 0.50 0.75 1.00	
MB/HL	1	103,980/104,000	111,000/111,022	37,810	3,472	0,056/0,123	EC	72-2859H		

	72-2859H	STD	38,000/1.4961" - 38,062/1.4985"
		0.25mm	38,500/1.5157" - 38,562/1.5182"
		0.50mm	38,500/1.5157" - 38,562/1.5182"
		0.75mm	39,000/1.5354" - 39,062/1.5379"
		1.00mm	39,000/1.5354" - 39,062/1.5379"

SE/PB	1	45,995/46,000	50,600/50,630	38,700			BC	55-3328	55-3328 SEMI	
SE/PB	1	45,995/46,000	50,600/50,630	38,700			BC	55-3997	55-3997 SEMI	[8]

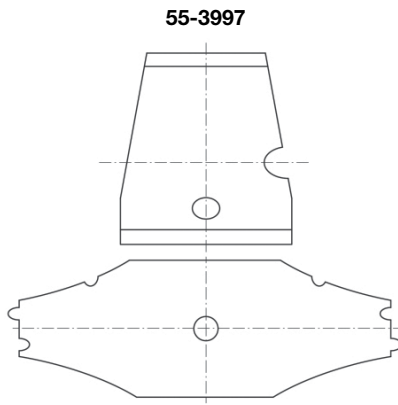
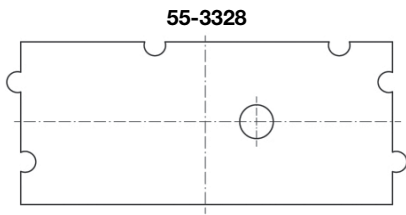

MERCEDES-BENZ

CB/NWB	4	69,910/69,940	75,000/75,030	28,000	2,500		BB	13-2861	N110/5L STD SEMI	13
CB/NWB	1	69,910/69,940	76,000/76,030	35,000	3,000		EC	53-3098H		
BU	1	30,000	34,000/34,025	21,000			EC	52-3097	52-3097 SEMI	10
BU	1	25,000	28,000/28,052	17,800			BC	56-3042	56-3042 SEMI	

170 130.00 x 142.00

OM 443.905	V10 Cyl. 18848cc 271kW (369PS)		Diesel	TD16981						
OM 443.906	V10 Cyl. 18848cc 271kW (369PS)		Diesel	TD17138						
OM 443.908	V10 Cyl. 18848cc 271kW (369PS)		Diesel	TD17139						
OM 443.909	V10 Cyl. 18848cc 271kW (369PS)		Diesel	TD17140						
BE/PL	1	31,959/31,975	36,000/36,016	19,000	2,011	0,020/0,059	EC	71-2965	71-2965 STD	10
BE/PL	2	31,959/31,975	36,000/36,016	15,000	2,011	0,020/0,060	EC	71-3289	71-3289/2 STD	10
BE/PL	1	89,980/90,000	95,000/95,022	31,000	2,473	0,054/0,121	SP	71-3638	71-3638 STD 0.25 0.50	1 3
MB/HL	5	103,980/104,000	111,000/111,022	30,500	3,472	0,056/0,123	EC	72-2858	H821/6 STD 0.25 0.50 0.75 1.00	
MB/HL	1	103,980/104,000	111,000/111,022	37,810	3,472	0,056/0,123	EC	72-2859H		



72-2859H	STD	38,000/1.4961" - 38,062/1.4985"
	0.25mm	38,500/1.5157" - 38,562/1.5182"
	0.50mm	38,500/1.5157" - 38,562/1.5182"
	0.75mm	39,000/1.5354" - 39,062/1.5379"
	1.00mm	39,000/1.5354" - 39,062/1.5379"

SE/PB	1	45,995/46,000	50,600/50,630	38,700			BC	55-3328	55-3328 SEMI	
CB/NWB	5	69,910/69,940	75,000/75,030	28,000	2,500		BB	13-2861	N110/6L STD SEMI	13
CB/NWB	1	69,910/69,940	76,000/76,030	35,000	3,000		EC	53-3098H		
BU	1	30,000	34,000/34,025	21,000			EC	52-3097	52-3097 SEMI	10
BU	1	25,000	28,000/28,052	17,800			BC	56-3042	56-3042 SEMI	

171 130.00 x 150.00

OM 521.940 Euro 2	V6 Cyl. 11946cc 315kW (428PS)	Diesel Turbo Intercooler	TD16791
OM 521.950 Euro 2	V6 Cyl. 11946cc 260kW (354PS)	Diesel Turbo Intercooler	TD17671
OM 541.920 Euro 2	V6 Cyl. 11946cc 230kW (313PS)	Diesel Turbo Intercooler	TD7872
OM 541.921 Euro 2	V6 Cyl. 11946cc 315kW (428PS)	Diesel Turbo Intercooler	TD9673
OM 541.922 Euro 2	V6 Cyl. 11946cc 260kW (354PS)	Diesel Turbo Intercooler	TD7873
OM 541.923 Euro 2	V6 Cyl. 11946cc 290-300kW (394-408PS)	Diesel Turbo Intercooler	TD7874
OM 541.924 Euro 2	V6 Cyl. 11946cc 290kW (394PS)	Diesel Turbo Intercooler	TD7880
OM 541.925 Euro 2	V6 Cyl. 11946cc 315kW (428PS)	Diesel Turbo Intercooler	TD7875
OM 541.926 Euro 2	V6 Cyl. 11946cc 230kW (313PS)	Diesel Turbo Intercooler	TD7879
OM 541.927 Euro 2	V6 Cyl. 11946cc 260kW (354PS)	Diesel Turbo Intercooler	TD9679
OM 541.928 Euro 2	V6 Cyl. 11946cc 315kW (428PS)	Diesel Turbo Intercooler	TD17679
OM 541.940 Euro 2/3	V6 Cyl. 11946cc 230-235kW (313-320PS)	Diesel Turbo Intercooler	TD16897
OM 541.941 Euro 2/3	V6 Cyl. 11946cc 230-235kW (313-320PS)	Diesel Turbo Intercooler	TD16898
OM 541.942 Euro 3	V6 Cyl. 11946cc 260-265kW (354-360PS)	Diesel Turbo Intercooler	TD16899
OM 541.943 Euro 3	V6 Cyl. 11946cc 260-265kW (354-360PS)	Diesel Turbo Intercooler	TD16900
OM 541.944 Euro 3	V6 Cyl. 11946cc 290-300kW (394-408PS)	Diesel Turbo Intercooler	TD16901
OM 541.945 Euro 3	V6 Cyl. 11946cc 290-300kW (394-408PS)	Diesel Turbo Intercooler	TD16902

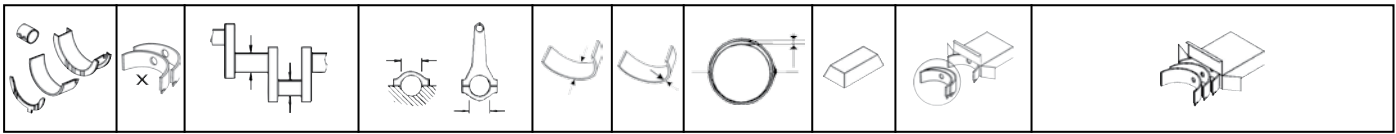

OM 541.946 Euro 3	V6 Cyl.	11946cc	315-320kW (428-435PS)	Diesel Turbo Intercooler	TD16903
OM 541.947 Euro 3	V6 Cyl.	11946cc	315-320kW (428-435PS)	Diesel Turbo Intercooler	TD16904
OM 541.948 Euro 3	V6 Cyl.	11946cc	335-355kW (456-483PS)	Diesel Turbo Intercooler	TD16913
OM 541.949 Euro 3	V6 Cyl.	11946cc	335-355kW (456-483PS)	Diesel Turbo Intercooler	TD16914
OM 541.950 Euro 3	V6 Cyl.	11946cc	260-300kW (354-408PS)	Diesel Turbo Intercooler	TD17682
OM 541.951 Euro 2/3	V6 Cyl.	11946cc	230-235kW (313-320PS)	Diesel Turbo Intercooler	TD17684
OM 541.952 Euro 2/3	V6 Cyl.	11946cc	230-260kW (313-354PS)	Diesel Turbo Intercooler	TD17685
OM 541.960 Euro 2	V6 Cyl.	11946cc	240kW (326PS)	Diesel Turbo Intercooler	TD25520
OM 941.910 Euro 2	V6 Cyl.	11946cc	230kW (313PS)	Diesel Turbo Intercooler	TD17693
OM 941.920 Euro 2	V6 Cyl.	11946cc	260kW (354PS)	Diesel Turbo Intercooler	TD16793
OM 941.921 Euro 2	V6 Cyl.	11946cc	260kW (354PS)	Diesel Turbo Intercooler	TD17694
OM 941.929 Euro 2	V6 Cyl.	11946cc	290kW (394PS)	Diesel Turbo Intercooler	TD16794
OM 941.930 Euro 2	V6 Cyl.	11946cc	300kW (408PS)	Diesel Turbo Intercooler	TD16795
OM 941.940 Euro 2	V6 Cyl.	11946cc	315kW (428PS)	Diesel Turbo Intercooler	TD16796
OM 941.960 Euro 2	V6 Cyl.	11946cc	230kW (313PS)	Diesel Turbo Intercooler	TD16797

BE/PL	1	93,980/94,000	99,000/99,022	28,600	2,473	0,054/0,121	SP	71-3835	71-3835 STD 0.25 0.50 0.75 1.00	①
MB/HL	1	107,980/108,000	115,000/115,022	33,500	3,472	0,066/0,132	SP	72-3837	72-3837 STD 0.25 0.50	②
MB/HL 1-4	4	107,980/108,000	115,000/115,022	33,500	3,472	0,066/0,132	EC	72-3836	H063/4 STD 0.25 0.50 0.75	
TW/A	4	117,300	139,000		5,380		AL-LF	04-3838	A150/4 STD	
CB/NWB	1	91,928/91,893		48,000			B	23-4898H	N204/4 SEMI	
CB/NWB	3	91,928/91,893		23,000			B	23-4899		
BU	1	24,967/24,980	28,000/28,052	17,800			BC	56-3839	56-3839 SEMI	
BU	1	24,967/24,980	28,000/28,052	20,800			BC	56-3840	56-3840 SEMI	

172 **130.00 x 150.00**

OM 541.953 Euro 4/5	V6 Cyl.	11946cc	320kW (435PS)	Diesel Turbo Intercooler	TD28777
OM 541.959 Euro 4/5	V6 Cyl.	11946cc	300kW (408PS)	Diesel Turbo Intercooler	TD28778
OM 541.970 Euro 4	V6 Cyl.	11946cc	235kW (320PS)	Diesel Turbo Intercooler	TD19250
OM 541.971 Euro 4/5	V6 Cyl.	11946cc	235kW (320PS)	Diesel Turbo Intercooler	TD21001
OM 541.972 Euro 4	V6 Cyl.	11946cc	265kW (360PS)	Diesel Turbo Intercooler	TD19251
OM 541.973 Euro 4	V6 Cyl.	11946cc	265kW (360PS)	Diesel Turbo Intercooler	TD21022
OM 541.974 Euro 4	V6 Cyl.	11946cc	300kW (408PS)	Diesel Turbo Intercooler	TD18997
OM 541.975 Euro 4	V6 Cyl.	11946cc	300kW (408PS)	Diesel Turbo Intercooler	TD21023
OM 541.976 Euro 4	V6 Cyl.	11946cc	320kW (435PS)	Diesel Turbo Intercooler	TD19000
OM 541.977 Euro 4	V6 Cyl.	11946cc	320kW (435PS)	Diesel Turbo Intercooler	TD21024
OM 541.978 Euro 3	V6 Cyl.	11946cc	350kW (476PS)	Diesel Turbo Intercooler	TD21007
OM 541.979 Euro 4/5	V6 Cyl.	11946cc	350kW (476PS)	Diesel Turbo Intercooler	TD28783
OM 541.980 Euro 3	V6 Cyl.	11946cc	335kW (456PS)	Diesel Turbo Intercooler	TD21000
OM 541.981 Euro 3	V6 Cyl.	11946cc	335kW (456PS)	Diesel Turbo Intercooler	TD21003
OM 541.990 Euro 5	V6 Cyl.	11946cc	300kW (408PS)	Diesel Turbo Intercooler	TD23767
OM 541.991	V6 Cyl.	11946cc	300kW (408PS)	Diesel Turbo Intercooler	TD25686
OM 541.992 Euro 5	V6 Cyl.	11946cc	320kW (435PS)	Diesel Turbo Intercooler	TD23768
OM 541.993	V6 Cyl.	11946cc	320kW (435PS)	Diesel Turbo Intercooler	TD25687
OM 541.994 Euro 5	V6 Cyl.	11946cc	335kW (456PS)	Diesel Turbo Intercooler	TD23769
OM 541.995	V6 Cyl.	11946cc	335kW (456PS)	Diesel Turbo Intercooler	TD25696
OM 541.996 Euro 5	V6 Cyl.	11946cc	235kW (320PS)	Diesel Turbo Intercooler	TD25486
OM 541.997	V6 Cyl.	11946cc	235kW (320PS)	Diesel Turbo Intercooler	TD25697
OM 541.998 Euro 5	V6 Cyl.	11946cc	265kW (360PS)	Diesel Turbo Intercooler	TD25487

MERCEDES-BENZ



OM 541.999		V6 Cyl.	11946cc	265kW (360PS)	Diesel Turbo Intercooler	TD25698				
OM 941.970 Euro 2		V6 Cyl.	11946cc	260kW (354PS)	Diesel Turbo Intercooler	TD16798				
OM 941.980 Euro 2		V6 Cyl.	11946cc	290kW (394PS)	Diesel Turbo Intercooler	TD17695				
OM 941.981 Euro 2		V6 Cyl.	11946cc	290-315kW (394-428PS)	Diesel Turbo Intercooler	TD17696				
OM 941.990 Euro 2		V6 Cyl.	11946cc	315kW (428PS)	Diesel Turbo Intercooler	TD16799				
OM 941.991		V6 Cyl.	11946cc	260-315kW (354-428PS)	Diesel Turbo Intercooler	TD28855				
BE/PL	1	93,980/94,000	99,000/99,022	28,600	2,470	0,079/0,151	SP	71-4942	71-4942 STD 0.25 0.50	[1]
MB/HL	1	107,980/108,000	115,000/115,022	33,500	3,472	0,066/0,132	SP	72-3837	72-3837 STD 0.25 0.50	[2]
MB/HL 1-4	4	107,980/108,000	115,000/115,022	33,500	3,472	0,066/0,132	EC	72-3836	H063/4 STD 0.25 0.50 0.75	
TW/A	4	117,300	139,000		5,380		AL-LF	04-3838	A150/4 STD	
CB/NWB	1	91,928/91,893		48,000			B	23-4898H	N204/4 SEMI	
CB/NWB	3	91,928/91,893		23,000			B	23-4899		
BU	1	24,967/24,980	28,000/28,052	17,800			BC	56-3839	56-3839 SEMI	
BU	1	24,967/24,980	28,000/28,052	20,800			BC	56-3840	56-3840 SEMI	

173

130.00 x 150.00

OM 522.940 Euro 2		V8 Cyl.	15928cc	420kW (571PS)	Diesel Turbo Intercooler	TD16800
OM 522.941 Euro 2		V8 Cyl.	15928cc	413kW (562PS)	Diesel Turbo Intercooler	TD17672
OM 522.942 Euro 2		V8 Cyl.	15928cc	362kW (496PS)	Diesel Turbo Intercooler	TD17673
OM 522.943 Euro 2		V8 Cyl.	15928cc	362kW (496PS)	Diesel Turbo Intercooler	TD17674
OM 522.950 Euro 2		V8 Cyl.	15928cc	530kW (721PS)	Diesel Turbo Intercooler	TD22822
OM 542.920		V8 Cyl.	15928cc	390kW (530PS)	Diesel Turbo Intercooler	TD7877
OM 542.921		V8 Cyl.	15928cc	350kW (476PS)	Diesel Turbo Intercooler	TD7876
OM 542.922		V8 Cyl.	15928cc	420kW (571PS)	Diesel Turbo Intercooler	TD7878
OM 542.923		V8 Cyl.	15928cc	420kW (571PS)	Diesel Turbo Intercooler	TD16905
OM 542.924		V8 Cyl.	15928cc	420kW (571PS)	Diesel Turbo Intercooler	TD17686
OM 542.925 Euro 2		V8 Cyl.	15928cc	350kW (476PS)	Diesel Turbo Intercooler	TD9683
OM 542.926		V8 Cyl.	15928cc	390kW (530PS)	Diesel Turbo Intercooler	TD17687
OM 542.940 Euro 3		V8 Cyl.	15928cc	350-375kW (476-510PS)	Diesel Turbo Intercooler	TD16909
OM 542.941 Euro 3		V8 Cyl.	15928cc	370kW (503PS)	Diesel Turbo Intercooler	TD16911
OM 542.942 Euro 3		V8 Cyl.	15928cc	390-395kW (530-537PS)	Diesel Turbo Intercooler	TD16906
OM 542.943 Euro 3		V8 Cyl.	15928cc	390-395kW (530-537PS)	Diesel Turbo Intercooler	TD16907
OM 542.944 Euro 3		V8 Cyl.	15928cc	420-425kW (571-578PS)	Diesel Turbo Intercooler	TD16912
OM 542.945 Euro 3		V8 Cyl.	15928cc	420-425kW (571-578PS)	Diesel Turbo Intercooler	TD17689
OM 542.947		V8 Cyl.	15928cc	390-420kW (530-571PS)	Diesel Turbo Intercooler	TD17690
OM 542.948 Euro 3		V8 Cyl.	15928cc	320-370kW (435-503PS)	Diesel Turbo Intercooler	TD17655
OM 542.956 Euro 3		V8 Cyl.	15928cc	448kW (609PS)	Diesel Turbo Intercooler	TD17691
OM 542.957 Euro 3		V8 Cyl.	15928cc	448kW (609PS)	Diesel Turbo Intercooler	TD17692
OM 542.958 Euro 3		V8 Cyl.	15928cc	450kW (612PS)	Diesel Turbo Intercooler	TD24684
OM 942.900 Euro 2		V8 Cyl.	15928cc	350kW (476PS)	Diesel Turbo Intercooler	TD17697
OM 942.910 Euro 2		V8 Cyl.	15928cc	350kW (470PS)	Diesel Turbo Intercooler	TD17698
OM 942.911 Euro 2		V8 Cyl.	15928cc	350kW (476PS)	Diesel Turbo Intercooler	TD16801
OM 942.912 Euro 2		V8 Cyl.	15928cc	350kW (470PS)	Diesel Turbo Intercooler	TD17699
OM 942.925 Euro 2		V8 Cyl.	15928cc	400kW (544PS)	Diesel Turbo Intercooler	TD17700
OM 942.930 Euro 2		V8 Cyl.	15928cc	420kW (570PS)	Diesel Turbo Intercooler	TD16802
OM 942.960 Euro 2		V8 Cyl.	15928cc	350kW (470PS)	Diesel Turbo Intercooler	TD17701
OM 942.967 Euro 2		V8 Cyl.	15928cc	370-380kW (503-517PS)	Diesel Turbo Intercooler	TD17702
OM 942.970 Euro 2		V8 Cyl.	15928cc	390kW (570PS)	Diesel Turbo Intercooler	TD17703

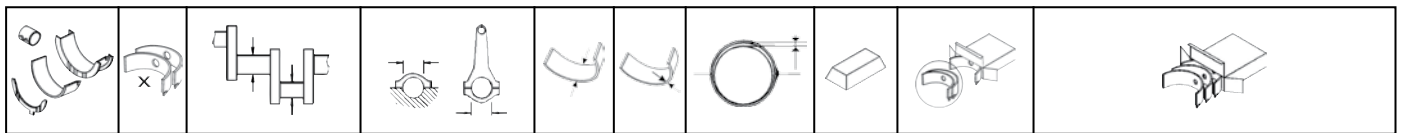

OM 942.980 Euro 2		V8 Cyl.		15928cc	420kW (570PS)	Diesel Turbo Intercooler		TD16803		
OM 942.990 Euro 2		V8 Cyl.		15928cc	330-448kW (570-609PS)	Diesel Turbo Intercooler		TD17704		
BE/PL	1	93,980/94,000	99,000/99,022	35,000	2,473	0,064/0,126	SP	71-3868	71-3868 STD 0.25 0.50 0.75 1.00	①
MB/HL	1	107,980/108,000	115,000/115,022	33,500	3,472	0,066/0,132	SP	72-3837	72-3837 STD 0.25 0.50	②
TW/A	4	117,300	139,000		5,380		AL-LF	04-3838	A150/4 STD	
CB/NWB	1	91,928/91,893		48,000			B	23-4898H	N204/5 SEMI	
CB/NWB	4	91,928/91,893		23,000			B	23-4899		
BU	1	24,967/24,980	28,000/28,052	17,800			BC	56-3839	56-3839 SEMI	
BU	1	24,967/24,980	28,000/28,052	20,800			BC	56-3840	56-3840 SEMI	

174 130.00 x 150.00

OM 542.960 Euro 5		V8 Cyl.		15928cc	375kW (510PS)	Diesel Turbo Intercooler		TD19999		
OM 542.961 Euro 5		V8 Cyl.		15928cc	375kW (510PS)	Diesel Turbo Intercooler		TD21026		
OM 542.962 Euro 5		V8 Cyl.		15928cc	405kW (551PS)	Diesel Turbo Intercooler		TD18840		
OM 542.963 Euro 5		V8 Cyl.		15928cc	405kW (551PS)	Diesel Turbo Intercooler		TD21025		
OM 542.964 Euro 5		V8 Cyl.		15928cc	440kW (598PS)	Diesel Turbo Intercooler		TD20000		
OM 542.965 Euro 5		V8 Cyl.		15928cc	440kW (598PS)	Diesel Turbo Intercooler		TD25688		
OM 542.966 Euro 5		V8 Cyl.		15928cc	350-370kW (476-503PS)	Diesel Turbo Intercooler		TD25103		
OM 542.968 Euro 5		V8 Cyl.		15928cc	480kW (653PS)	Diesel Turbo Intercooler		TD25683		
OM 542.969 Euro 5		V8 Cyl.		15928cc	480kW (653PS)	Diesel Turbo Intercooler		TD25684		
OM 542.970 Euro 5		V8 Cyl.		15928cc	448kW (609PS)	Diesel Turbo Intercooler		TD28779		
BE/PL	1	93,980/94,000	99,000/99,022	34,400	2,473	0,081/0,151	SP	71-4784	71-4784 STD 0.25 0.50	①
MB/HL	1	107,980/108,000	115,000/115,022	33,500	3,472	0,066/0,132	SP	72-3837	72-3837 STD 0.25 0.50	②
TW/A	4	117,300	139,000		5,380		AL-LF	04-3838	A150/4 STD	
CB/NWB	1	91,928/91,893		48,000			B	23-4898H	N204/5 SEMI	
CB/NWB	4	91,928/91,893		23,000			B	23-4899		
BU	1	24,967/24,980	28,000/28,052	17,800			BC	56-3839	56-3839 SEMI	
BU	1	24,967/24,980	28,000/28,052	20,800			BC	56-3840	56-3840 SEMI	



cm3

x



Mini Cooper D	11/06→09/10	Diesel	9HZ (DV6TED4)	1560	4	75.00	88.30	1
Mini Cooper D	02/11→	Diesel	N47 C20 A	1995	4	84.00	90.00	2
Mini Cooper SD	02/11→	Diesel	N47 C20 A	1995	4	84.00	90.00	2
Mini One D	06/09→07/10	Diesel	9HZ (DV6TED4)	1560	4	75.00	88.30	1
Mini Clubman Cooper D	10/07→02/10	Diesel	9HZ (DV6TED4)	1560	4	75.00	88.30	1
Mini Clubman Cooper D	02/11→06/15	Diesel	N47 C20 A	1995	4	84.00	90.00	2
Mini Clubman Cooper SD	02/11→06/15	Diesel	N47 C20 A	1995	4	84.00	90.00	2
Mini Clubvan Cooper D	12/12→	Diesel	N47 C20 A	1995	4	84.00	90.00	2
Mini Countryman Cooper D	02/11→	Diesel	N47 C20 A	1995	4	84.00	90.00	2
Mini Countryman Cooper D ALL4	02/11→	Diesel	N47 C20 A	1995	4	84.00	90.00	2
Mini Countryman Cooper SD	02/11→	Diesel	N47 C20 A	1995	4	84.00	90.00	2
Mini Countryman Cooper SD ALL4	02/11→	Diesel	N47 C20 A	1995	4	84.00	90.00	2
Mini Paceman Cooper D	09/12→	Diesel	N47 C20 A	1995	4	84.00	90.00	2
Mini Paceman Cooper D ALL4	09/12→	Diesel	N47 C20 A	1995	4	84.00	90.00	2
Mini Paceman Cooper SD	10/12→	Diesel	N47 C20 A	1995	4	84.00	90.00	2
Mini Paceman Cooper SD ALL4	10/12→	Diesel	N47 C20 A	1995	4	84.00	90.00	2

		cm ³				
---	---	-----------------	--	---	---	---

9HZ (DV6TED4)	Diesel	1560	4	75.00	88.30	1
N47 C20 A	Diesel	1995	4	84.00	90.00	2











1 75.00 x 88.30

9HZ (DV6TED4)		4 Cyl.		1560cc	66-80kW (90-109PS)			Diesel Turbo Intercooler	TD20982
MB/HL 1-5	5	49,962/49,981	53,655/53,674	19,900	1,833	0,008/0,046	AL	02-4244	H1066/5 STD 0.30 0.50
TW/A	2	55,200/55,480	71,350/71,700		2,460		AL	04-4245	A217/2 STD
SE/PB	1	26,000	29,000/29,021	19,980			BS	55-4102	55-4102 SEMI

2 84.00 x 90.00

N47 C20 A		4 Cyl.		1995cc	82-105kW (112-143PS)			Diesel Turbo Intercooler	TD25060
BE/PL	1	49,975/49,991	53,600/53,619	18,300	1,803	0,026/0,086	SP-LF	71-4805	71-4805 STD □
MB/HL	4	54,971/54,990	60,000/60,019	18,800	2,498	0,023/0,086	EC-LF	72-4803	H1298/5 STD
MB/HL	1	54,971/54,990	60,000/60,019	23,500	2,498	0,023/0,086	EC-LF	72-4804H	

	72-4804H	STD	25,020/.9850" - 25,053/.9863"
		0.25mm	25,220/.9929" - 25,253/.9942"
		0.50mm	25,420/1.0008" - 25,453/1.0021"









				cm ³				
ASX 1.6 DI-D	07/15→	Diesel	9HD	1560	4	75.00	88.30	8
ASX 1.6 DI-D 4WD	07/15→	Diesel	9HD	1560	4	75.00	88.30	8
Canter 2.4	08/01→11/10	Petrol	4G64 (8V)	2351	4	86.50	100.00	30
Canter 2.5 D	09/92→09/96	Diesel	4D56 (8V)	2477	4	91.10	95.00	33
Carisma 1.3 12V	09/00→10/04	Petrol	4G13 (12V)	1299	4	71.00	82.00	2
Carisma 1.3 16V	09/00→10/04	Petrol	4G13 (16V)	1299	4	71.00	82.00	2
Carisma 1.6	07/95→06/06	Petrol	4G92	1597	4	81.00	77.50	19
Carisma 1.8	07/95→09/97	Petrol	4G93	1834	4	81.00	89.00	20
Carisma 1.9 DI-D	09/00→06/06	Diesel	F9Q1	1870	4	80.00	93.00	15
Carisma 1.9 DI-D	09/00→06/06	Diesel	F9Q2	1870	4	80.00	93.00	16
Carisma 1.9 TD	10/96→09/00	Diesel	F8QT	1870	4	80.00	93.00	14
Carisma 2.0 16V GT EVO VI/VII	11/99→06/06	Petrol	4G63 Turbo	1997	4	85.00	88.00	28
Celeste 1.6 ST	01/77→06/81	Petrol	4G32	1597	4	76.90	86.00	10
Celeste 2.0 GSR	10/75→06/81	Petrol	4G52	1995	4	84.00	90.00	26
Colt, Galant 1.5	01/69→12/74	Petrol	4G31	1499	4	74.50	86.00	7
Colt, Galant, Lancer 1.3	01/69→12/71	Petrol	4G30	1289	4	73.00	77.00	4
Colt I 1.2 GL	12/78→01/84	Petrol	4G11	1244	4	69.50	82.00	1
Colt I 1.4 GLX,GT	05/79→01/84	Petrol	4G12	1410	4	74.00	82.00	6
Colt I 1.4 Turbo	09/81→01/84	Petrol	4G12 T	1410	4	74.00	82.00	6
Colt II 1.3 EL,GL	06/86→04/88	Petrol	G13B	1299	4	71.00	82.00	2
Colt II 1.4	10/82→09/86	Petrol	4G33	1439	4	73.00	86.00	5
Colt II 1.5 GLX	09/84→04/88	Petrol	4G15	1468	4	75.50	82.00	9
Colt II 1.5 GLX	09/85→04/88	Petrol	G15B	1468	4	75.50	82.00	9
Colt II 1.6	10/82→09/86	Petrol	4G32	1597	4	76.90	86.00	10
Colt II 1.6 Turbo ECi	02/84→04/88	Petrol	4G32 T/C	1597	4	76.90	86.00	10
Colt II 1.6 Turbo ECi	07/86→04/88	Petrol	G32BT	1597	4	76.90	86.00	10
Colt II 1.8 GL Diesel	02/84→04/88	Diesel	4D65	1796	4	80.60	88.00	18
Colt III 1.3	04/88→05/92	Petrol	4G13 (8V)	1299	4	71.00	82.00	2
Colt III 1.3 12V	04/88→05/92	Petrol	4G13 (12V)	1299	4	71.00	82.00	2
Colt III 1.3 GL	04/88→12/90	Petrol	4G13 (8V)	1299	4	71.00	82.00	2
Colt III 1.4	10/86→06/90	Petrol	4G33	1439	4	73.00	86.00	5
Colt III 1.5	07/90→05/92	Petrol	4G15 (12V)	1468	4	75.50	82.00	9
Colt III 1.5 GLXi	04/88→05/92	Petrol	4G15	1468	4	75.50	82.00	9
Colt III 1.6	10/86→06/90	Petrol	4G32	1597	4	76.90	86.00	10
Colt III 1.6 GTi 16V	04/88→05/90	Petrol	4G61	1596	4	82.30	75.00	23
Colt III 1.8 Diesel GLX	04/88→05/92	Diesel	4D65	1796	4	80.60	88.00	18
Colt IV 1.3 GLi 12V	04/92→04/96	Petrol	4G13 (12V)	1299	4	71.00	82.00	2
Colt IV 1.6	02/94→04/96	Petrol	4G92	1597	4	81.00	77.50	19
Colt IV 1.6 4WD	08/93→08/95	Petrol	4G92	1597	4	81.00	77.50	19
Colt IV 1.6 GLXi 16V	04/92→04/96	Petrol	4G92	1597	4	81.00	77.50	19
Colt V 1.5	09/95→09/03	Petrol	4G15 (16V)	1468	4	75.50	82.00	9
Colt V 1.5 12V	06/96→09/99	Petrol	4G15 (12V)	1468	4	75.50	82.00	9
Colt V 1.5 16V	10/99→09/03	Petrol	4G15 (16V)	1468	4	75.50	82.00	9
Colt V 1.8	11/97→07/01	Petrol	4G93	1834	4	81.00	89.00	20
Colt V 1300	06/00→09/03	Petrol	4G13 (16V)	1299	4	71.00	82.00	2
Colt V 1300 GL,GLX	05/96→06/00	Petrol	4G13 (12V)	1299	4	71.00	82.00	2
Colt V 1600	09/00→09/03	Petrol	4G92	1597	4	81.00	77.50	19
Colt V 1600 GLX	05/96→09/00	Petrol	4G92	1597	4	81.00	77.50	19
Colt VI 1.5	09/04→02/06	Petrol	4G15 (16V)	1468	4	75.50	82.00	9
Colt VI 1.5 DI-D	08/04→06/12	Diesel	OM 639.939	1493	3	83.00	92.00	24
Colt Lancer 1.2	01/78→09/79	Petrol	4G36	1238	4	73.00	74.00	3
Colt Lancer 1.4	01/78→09/79	Petrol	4G33	1439	4	73.00	86.00	5
Colt Lancer 1.6	01/78→09/79	Petrol	4G32 GS	1597	4	76.90	86.00	10
Cordia 1.6 GSL	10/82→12/86	Petrol	4G32	1597	4	76.90	86.00	10
Cordia 1.6 Turbo	10/82→05/85	Petrol	4G32 T	1597	4	76.90	86.00	10
Cordia 1.8	11/84→07/89	Petrol	4G37	1755	4	80.60	86.00	17
Cordia 1.8	10/82→12/83	Petrol	4G62	1795	4	80.60	88.00	18
Cordia 1.8 GSL	10/86→12/86	Petrol	4G37	1755	4	80.60	86.00	17
Cordia 1.8 Turbo	11/84→12/88	Petrol	4G62 T	1795	4	80.60	88.00	18
Cordia 1.8 Turbo	11/84→07/89	Petrol	G62B	1796	4	80.60	88.00	18
Cordia 1.8 Turbo ECi	04/83→07/89	Petrol	4G62 T	1795	4	80.60	88.00	18
Cordia 2.0	11/84→12/88	Petrol	4G63 (SOHC 8V)	1997	4	85.00	88.00	28
Eclipse 1.8	12/89→03/94	Petrol	4G37	1755	4	80.60	86.00	17
Eclipse 1.8	04/94→03/05	Petrol	4G93	1834	4	81.00	89.00	20
Eclipse 2.0	09/95→04/99	Petrol	4G63 T (DOHC 16V)	1997	4	85.00	88.00	28
Eclipse I 1.8	12/89→03/94	Petrol	4G37	1755	4	80.60	86.00	17
Eclipse I 2.0	12/89→12/94	Petrol	4G63 (DOHC 16V)	1997	4	85.00	88.00	28
Eclipse I 2.0	12/89→12/92	Petrol	4G63 T (DOHC 16V)	1997	4	85.00	88.00	28
Eclipse I 2.0 i 16V	04/91→11/95	Petrol	4G63 (DOHC 16V)	1997	4	85.00	88.00	28



cm3 x



Eclipse I 2.0 i 16V 4WD	04/91→11/95	Petrol	4G63 (DOHC 16V)	1997	4	85.00	88.00	28
Eclipse I 2.0 Turbo	12/89→03/94	Petrol	4G63 T (DOHC 16V)	1997	4	85.00	88.00	28
Eclipse I 2.0 Turbo 4WD	12/89→12/94	Petrol	4G63 T (DOHC 16V)	1997	4	85.00	88.00	28
Eclipse II 2.0	09/95→04/99	Petrol	4G63 (DOHC 16V)	1997	4	85.00	88.00	28
Eclipse II 2.0 Turbo	04/94→04/99	Petrol	4G63 T (DOHC 16V)	1997	4	85.00	88.00	28
Eclipse II 2.0 Turbo 4WD	04/94→04/99	Petrol	4G63 T (DOHC 16V)	1997	4	85.00	88.00	28
Eclipse II 2000 GS 16V	12/95→04/99	Petrol	4G63 (DOHC 16V)	1997	4	85.00	88.00	28
Eclipse II 2000 GT 16V	12/95→04/99	Petrol	4G63 T (DOHC 16V)	1997	4	85.00	88.00	28
Expo 1.8	09/91→12/94	Petrol	4G93	1834	4	81.00	89.00	20
Expo 1.8 AWD	09/92→12/93	Petrol	4G93	1834	4	81.00	89.00	20
Expo 2.4	09/91→12/92	Petrol	4G64 (8V)	2351	4	86.50	100.00	30
Freeca 1.8	06/98→04/03	Petrol	4G37	1755	4	80.60	86.00	17
Freeca 2.0	06/98→10/10	Petrol	4G63 (SOHC 16V)	1997	4	85.00	88.00	28
Freeca 2.5 D	06/98→	Diesel	4D56 (8V)	2477	4	91.10	95.00	33
FTO 1.8	09/94→07/01	Petrol	4G93	1834	4	81.00	89.00	20
Galant 1700	01/72→12/77	Petrol	4 G 35	1686	4	79.00	86.00	12
Galant I 1.6	01/77→08/80	Petrol	4G32	1597	4	76.90	86.00	10
Galant I 1.6 GL	01/79→08/80	Petrol	4G32	1597	4	76.90	86.00	10
Galant I 2.0	01/79→08/80	Petrol	4G52	1995	4	84.00	90.00	26
Galant I 2.0 GLX	01/77→08/80	Petrol	4G52	1995	4	84.00	90.00	26
Galant II 1.6 GLX	09/80→05/84	Petrol	4G32	1597	4	76.90	86.00	10
Galant II 2.0 GLS	09/80→05/84	Petrol	4G63 (SOHC 8V)	1997	4	85.00	88.00	28
Galant II 2.0 GLX	09/80→06/83	Petrol	4G63 (SOHC 8V)	1997	4	85.00	88.00	28
Galant II 2.0 Turbo ECi	05/82→05/84	Petrol	4G63 T (ECi)	1997	4	85.00	88.00	28
Galant II 2.3 Turbo-D	09/80→05/84	Diesel	4D55 T	2347	4	91.10	90.00	32
Galant III 1.6 GLX	06/84→04/90	Petrol	4G32	1597	4	76.90	86.00	10
Galant III 1.8 Turbo-D	06/84→04/90	Diesel	4D65 T	1796	4	80.60	88.00	18
Galant III 2.0 GLS	06/84→04/90	Petrol	4G63 (SOHC 8V)	1997	4	85.00	88.00	28
Galant III 2.0 GLS	06/86→04/90	Petrol	G63B	1997	4	85.00	88.00	28
Galant III 2.0 Turbo ECi	06/84→04/90	Petrol	4G63 T (SOHC 8V)	1997	4	85.00	88.00	28
Galant III 2.4	09/84→12/85	Petrol	4G64 (8V)	2351	4	86.50	100.00	30
Galant III 2.4 GLS	06/85→04/90	Petrol	4G64 (8V)	2351	4	86.50	100.00	30
Galant III 2.4 GLS	07/85→04/90	Petrol	4G64B	2351	4	86.50	100.00	30
Galant IV 1.6	01/88→10/92	Petrol	4G32	1597	4	76.90	86.00	10
Galant IV 1.8	11/87→10/92	Petrol	4G37	1755	4	80.60	86.00	17
Galant IV 1.8 D	01/88→10/92	Diesel	4D65	1796	4	80.60	88.00	18
Galant IV 1.8 Turbo-D	12/87→10/92	Diesel	4D65 T	1796	4	80.60	88.00	18
Galant IV 2.0	11/87→03/93	Petrol	4G63 (SOHC 8V)	1997	4	85.00	88.00	28
Galant IV 2.0 4WD	09/88→12/92	Petrol	4G63 (SOHC 8V)	1997	4	85.00	88.00	28
Galant IV 2.0 GTI 16V	11/87→10/92	Petrol	4G63 (DOHC 16V)	1997	4	85.00	88.00	28
Galant IV 2.0 GTI 16V 4x4	07/89→12/92	Petrol	4G63 (DOHC 16V)	1997	4	85.00	88.00	28
Galant IV 2.0 GTi 16V 4WD	06/88→10/92	Petrol	4G63 (DOHC 16V)	1997	4	85.00	88.00	28
Galant IV 2.0 I VR4 Turbo 4WD	10/90→03/93	Petrol	4G63 T (DOHC 16V)	1997	4	85.00	88.00	28
Galant V 1.8	02/94→08/96	Petrol	4G93	1834	4	81.00	89.00	20
Galant V 1.8 GLSI	11/92→08/96	Petrol	4G93	1834	4	81.00	89.00	20
Galant V 2.0	11/92→08/96	Petrol	4G63 (SOHC 16V)	1997	4	85.00	88.00	28
Galant V 2.0 GLSI	11/92→08/96	Petrol	4G63 (SOHC 16V)	1997	4	85.00	88.00	28
Galant V 2.0 GLSI 4WD	11/92→08/96	Petrol	4G63 (SOHC 16V)	1997	4	85.00	88.00	28
Galant VI 2.0	09/96→10/04	Petrol	4G63 (SOHC 16V)	1997	4	85.00	88.00	28
Galant VI 2.4 GDI	02/99→10/04	Petrol	4G64 (GDI)	2351	4	86.50	100.00	30
Galloper 2.5 TD intercooler	09/98→12/03	Diesel	D4BH	2476	4	91.10	95.00	33
Grandis 2.4 GDi GLX	11/97→05/03	Petrol	4G64 (GDI)	2351	4	86.50	100.00	30
Grandis 2.4 GDi GLX 4WD	11/97→05/03	Petrol	4G64 (GDI)	2351	4	86.50	100.00	30
L 200 1.6	03/80→10/96	Petrol	4G32	1597	4	76.90	86.00	10
L 200 2.0	10/81→10/86	Petrol	4G52	1995	4	84.00	90.00	26
L 200 2.0	10/86→08/96	Petrol	4G63 (SOHC 8V)	1997	4	85.00	88.00	28
L 200 2.0	06/96→12/07	Petrol	4G63 (SOHC 16V)	1997	4	85.00	88.00	28
L 200 2.0 4WD	01/81→10/86	Petrol	4G52	1995	4	84.00	90.00	26
L 200 2.0 4WD	01/86→08/96	Petrol	4G63 (SOHC 8V)	1997	4	85.00	88.00	28
L 200 2.3 D	10/82→08/84	Diesel	4D55	2347	4	91.10	90.00	32
L 200 2.3 D	09/82→12/85	Diesel	4D55 T	2347	4	91.10	90.00	32
L 200 2.3 D 4WD	10/82→10/86	Diesel	4D55	2347	4	91.10	90.00	32
L 200 2.3 D 4WD	09/82→12/85	Diesel	4D55 T	2347	4	91.10	90.00	32
L 200 2.4	09/89→10/96	Petrol	4G64 (8V)	2351	4	86.50	100.00	30
L 200 2.4 4WD	11/86→12/94	Petrol	4G64 (8V)	2351	4	86.50	100.00	30
L 200 2.5 D	10/86→12/07	Diesel	4D56 (8V)	2477	4	91.10	95.00	33
L 200 2.5 D 4WD	12/86→12/05	Diesel	4D56 (8V)	2477	4	91.10	95.00	33
L 200 2.5 DiD	11/05→	Diesel	4D56 HP	2477	4	91.10	95.00	33
L 200 2.5 DI-D	11/14→	Diesel	4D56 (16V)	2477	4	91.10	95.00	33

				cm ³	x 			
L 200 2.5 DI-D	08/07→	Diesel	4D56 HP	2477	4	91.10	95.00	33
L 200 2.5 DI-D 4x4	01/04→	Diesel	4D56 T	2477	4	91.10	95.00	34
L 200 2.5 DI-D 4WD	04/07→	Diesel	4D56 (16V)	2477	4	91.10	95.00	33
L 200 2.5 DI-D 4WD	11/05→	Diesel	4D56 HP	2477	4	91.10	95.00	33
L 200 2.5 TD	09/90→11/05	Diesel	4D56 T	2477	4	91.10	95.00	34
L 200 2.5 TD	07/97→01/01	Diesel	4D56 TD	2477	4	91.10	95.00	34
L 200 2.5 TD 4WD	07/97→12/03	Diesel	4D56 (8V)	2477	4	91.10	95.00	33
L 200 2.5 TD 4WD	11/92→12/07	Diesel	4D56 T	2477	4	91.10	95.00	34
L 200 2.5 TD 4WD	06/96→12/07	Diesel	4D56 TD	2477	4	91.10	95.00	34
L 300 1.4	04/90→05/94	Petrol	4G33	1439	4	73.00	86.00	5
L 300 1.6	02/80→	Petrol	4G32	1597	4	76.90	86.00	10
L 300 1.8	03/83→10/86	Petrol	4G62	1795	4	80.60	88.00	18
L 300 1.8 4WD	05/83→02/87	Petrol	4G62	1795	4	80.60	88.00	18
L 300 2.0	11/86→	Petrol	4G63 (SOHC 8V)	1997	4	85.00	88.00	28
L 300 2.0	06/94→02/06	Petrol	4G63 (SOHC 16V)	1997	4	85.00	88.00	28
L 300 2.0	06/82→	Petrol	G63B	1997	4	85.00	88.00	28
L 300 2.0 4WD	06/82→	Petrol	4G63 (SOHC 8V)	1997	4	85.00	88.00	28
L 300 2.0 4WD	06/94→05/03	Petrol	4G63 (SOHC 16V)	1997	4	85.00	88.00	28
L 300 2.0 DL	06/82→08/85	Petrol	4G63 (SOHC 8V)	1997	4	85.00	88.00	28
L 300 2.0 DL	06/82→08/85	Petrol	G63B	1997	4	85.00	88.00	28
L 300 2.0 DL 4WD	08/84→10/86	Petrol	4G63 (SOHC 8V)	1997	4	85.00	88.00	28
L 300 2.0 GLS	06/94→05/96	Petrol	4G63 (SOHC 16V)	1997	4	85.00	88.00	28
L 300 2.0 i	06/94→10/98	Petrol	4G63 (SOHC 16V)	1997	4	85.00	88.00	28
L 300 2.3 D	04/83→10/86	Diesel	4D55	2347	4	91.10	90.00	32
L 300 2.4	11/86→	Petrol	4G64 (8V)	2351	4	86.50	100.00	30
L 300 2.4	11/86→08/97	Petrol	G64B	2351	4	86.50	100.00	30
L 300 2.4 4WD	11/86→	Petrol	4G64 (8V)	2351	4	86.50	100.00	30
L 300 2.4 4WD	11/86→08/97	Petrol	G64B	2351	4	86.50	100.00	30
L 300 2.5 D	11/86→	Diesel	4D56 (8V)	2477	4	91.10	95.00	33
L 300 2.5 TD	02/87→05/03	Diesel	4D56 T	2477	4	91.10	95.00	34
L 300 2.5 TD	09/94→	Diesel	4D56 TD	2477	4	91.10	95.00	34
L 300 2.5 TD 4WD	11/88→	Diesel	4D56 T	2477	4	91.10	95.00	34
L 400 1.6	06/96→10/02	Petrol	4G32	1597	4	76.90	86.00	10
L 400 2.0	12/94→10/02	Petrol	4G63 (SOHC 16V)	1997	4	85.00	88.00	28
L 400 2500 TD	09/96→06/05	Diesel	4D56 T	2477	4	91.10	95.00	34
L 400 2500 TD 4WD	09/96→06/05	Diesel	4D56 T	2477	4	91.10	95.00	34
L 400 / Space Gear 2.0	09/95→10/02	Petrol	4G63 (SOHC 16V)	1997	4	85.00	88.00	28
L 400 / Space Gear 2.0 16V	05/95→05/00	Petrol	4G63 (SOHC 16V)	1997	4	85.00	88.00	28
L 400 / Space Gear 2.5 TD	05/95→05/00	Diesel	4D56 TD	2477	4	91.10	95.00	34
L 400 / Space Gear 2.5 TD 4WD	05/95→05/00	Diesel	4D56 TD	2477	4	91.10	95.00	34
L 400 / Space Gear 2500 TD	05/95→06/05	Diesel	4D56 T	2477	4	91.10	95.00	34
Lancer 1.3	09/03→	Petrol	4G13 (16V)	1299	4	71.00	82.00	2
Lancer 1.5	09/92→	Petrol	4G15 (12V)	1468	4	75.50	82.00	9
Lancer 1.5 16V	07/96→09/04	Petrol	4G15 (16V)	1468	4	75.50	82.00	9
Lancer 1.5 LPG	05/06→	Petrol	4G15 (12V)	1468	4	75.50	82.00	9
Lancer 1.5 LXi	05/04→	Petrol	4G15 (12V)	1468	4	75.50	82.00	9
Lancer 1.6 i	09/92→07/96	Petrol	4G92	1597	4	81.00	77.50	19
Lancer 1.8	09/03→	Petrol	4G93	1834	4	81.00	89.00	20
Lancer 1.8 i	09/92→09/04	Petrol	4G93	1834	4	81.00	89.00	20
Lancer 2.0	09/03→	Petrol	4G63 (DOHC 16V)	1997	4	85.00	88.00	28
Lancer 2.0	01/06→12/09	Petrol	4G63 (SOHC 16V)	1997	4	85.00	88.00	28
Lancer 2.0 4WD	09/02→	Petrol	4G63 Turbo	1997	4	85.00	88.00	28
Lancer 2.0 16V EVO VIII	03/04→	Petrol	4G63 Turbo	1997	4	85.00	88.00	28
Lancer 2.0 16V EVO IX	01/06→	Petrol	4G63 Turbo	1997	4	85.00	88.00	28
Lancer 2.0 DI-D	01/08→	Diesel	BKD	1968	4	81.00	95.50	22
Lancer 2.4 GDI	09/03→	Petrol	4G64 (GDI)	2351	4	86.50	100.00	30
Lancer Cargo 1.8	09/08→	Petrol	MR18DE	1797	4	84.00	81.10	25
Lancer F II 1.2 GLX	03/83→01/84	Petrol	4G11	1244	4	69.50	82.00	1
Lancer F II 1.4	04/84→09/86	Petrol	4G33	1439	4	73.00	86.00	5
Lancer F II 1.4 GLX	03/83→01/84	Petrol	4G12	1410	4	74.00	82.00	6
Lancer F II 1.4 Turbo	03/83→01/84	Petrol	4G12 T	1410	4	74.00	82.00	6
Lancer F II 1.6	04/84→09/86	Petrol	4G32	1597	4	76.90	86.00	10
Lancer I 1.2	01/80→12/81	Petrol	4G11	1244	4	69.50	82.00	1
Lancer I 1.4 GLX	09/79→02/83	Petrol	4G12	1410	4	74.00	82.00	6
Lancer I 1.6	09/79→02/83	Petrol	4G32 GS	1597	4	76.90	86.00	10
Lancer I 2.0 Turbo ECi	03/81→02/83	Petrol	4G63 T (SOHC 8V)	1997	4	85.00	88.00	28
Lancer III 1.3 GL	07/90→08/92	Petrol	4G13 (12V)	1299	4	71.00	82.00	2
Lancer III 1.3 GL	05/88→06/90	Petrol	G13B	1299	4	71.00	82.00	2
Lancer III 1.4	10/86→06/90	Petrol	4G33	1439	4	73.00	86.00	5



cm3 x



9

Lancer III 1.5	09/85→12/90	Petrol	4G15	1468	4	75.50	82.00	9
Lancer III 1.5	09/85→08/89	Petrol	G15B	1468	4	75.50	82.00	9
Lancer III 1.5 12V	09/90→12/91	Petrol	4G15 (12V)	1468	4	75.50	82.00	9
Lancer III 1.5 GLS	08/89→08/92	Petrol	4G15 (12V)	1468	4	75.50	82.00	9
Lancer III 1.5 GLX	11/83→04/88	Petrol	4G15	1468	4	75.50	82.00	9
Lancer III 1.5 GLX	06/85→04/88	Petrol	G15B	1468	4	75.50	82.00	9
Lancer III 1.6	10/86→06/90	Petrol	4G32	1597	4	76.90	86.00	10
Lancer III 1.8 4WD	01/87→06/92	Petrol	4G37	1755	4	80.60	86.00	17
Lancer III 1.8 4WD	01/87→08/89	Petrol	G37B	1755	4	80.60	86.00	17
Lancer III 1.8 D	09/85→06/92	Diesel	4D65	1796	4	80.60	88.00	18
Lancer III 1.8 D 4WD	10/86→10/88	Diesel	4D65	1796	4	80.60	88.00	18
Lancer III 1.8 Diesel	01/84→04/88	Diesel	4D65	1796	4	80.60	88.00	18
Lancer IV 1.3	04/88→05/92	Petrol	4G13 (8V)	1299	4	71.00	82.00	2
Lancer IV 1.3	05/88→05/92	Petrol	G13B	1299	4	71.00	82.00	2
Lancer IV 1.3 12V	07/90→05/94	Petrol	4G13 (12V)	1299	4	71.00	82.00	2
Lancer IV 1.3 GL	05/88→06/90	Petrol	G13B	1299	4	71.00	82.00	2
Lancer IV 1.5	06/88→05/92	Petrol	4G15	1468	4	75.50	82.00	9
Lancer IV 1.5	04/88→09/92	Petrol	4G15 (12V)	1468	4	75.50	82.00	9
Lancer IV 1.5 12V	05/89→05/92	Petrol	4G15 (12V)	1468	4	75.50	82.00	9
Lancer IV 1.5 GLS	08/89→08/92	Petrol	4G15 (12V)	1468	4	75.50	82.00	9
Lancer IV 1.6 4WD	06/92→11/93	Petrol	4G92	1597	4	81.00	77.50	19
Lancer IV 1.6 16V	06/92→05/94	Petrol	4G92	1597	4	81.00	77.50	19
Lancer IV 1.6 GLX	08/89→08/92	Petrol	4G61	1596	4	82.30	75.00	23
Lancer IV 1.6 GTi	05/88→05/90	Petrol	4G61	1596	4	82.30	75.00	23
Lancer IV 1.6 i	09/90→09/92	Petrol	4G61	1596	4	82.30	75.00	23
Lancer IV 1.8 4WD	09/89→06/92	Petrol	4G37	1755	4	80.60	86.00	17
Lancer IV 1.8 D	04/88→05/92	Diesel	4D65	1796	4	80.60	88.00	18
Lancer IV 1.8 GLX Diesel	04/88→05/92	Diesel	4D65	1796	4	80.60	88.00	18
Lancer IV 1.8 GTi	06/92→07/93	Petrol	4G37	1755	4	80.60	86.00	17
Lancer V 1.3	06/92→08/03	Petrol	4G13 (12V)	1299	4	71.00	82.00	2
Lancer V 1.5	09/92→10/03	Petrol	4G15 (12V)	1468	4	75.50	82.00	9
Lancer V 1.6	02/94→12/96	Petrol	4G92	1597	4	81.00	77.50	19
Lancer V 1.6 16V	06/92→10/03	Petrol	4G92	1597	4	81.00	77.50	19
Lancer V 1.6 16V 4WD	06/92→10/03	Petrol	4G92	1597	4	81.00	77.50	19
Lancer V 1.8 4WD	03/95→10/03	Petrol	4G93	1834	4	81.00	89.00	20
Lancer V 1.8 GTi	06/92→07/93	Petrol	4G37	1755	4	80.60	86.00	17
Lancer V 1.8 i	09/92→10/03	Petrol	4G93	1834	4	81.00	89.00	20
Lancer V 2.0 EVO I	10/92→12/93	Petrol	4G63 Turbo	1997	4	85.00	88.00	28
Lancer V 2.0 EVO II	01/94→07/95	Petrol	4G63 Turbo	1997	4	85.00	88.00	28
Lancer V 2.0 EVO III	08/95→07/96	Petrol	4G63 Turbo	1997	4	85.00	88.00	28
Lancer VI 1.3 12V	12/95→08/03	Petrol	4G13 (12V)	1299	4	71.00	82.00	2
Lancer VI 1.5	09/95→08/03	Petrol	4G15 (12V)	1468	4	75.50	82.00	9
Lancer VI 1.5	06/00→08/03	Petrol	4G15 (16V)	1468	4	75.50	82.00	9
Lancer VI 1.5 12V	07/96→09/99	Petrol	4G15 (12V)	1468	4	75.50	82.00	9
Lancer VI 1.5 16V	10/99→08/03	Petrol	4G15 (16V)	1468	4	75.50	82.00	9
Lancer VI 1.6 16V	12/95→08/03	Petrol	4G92	1597	4	81.00	77.50	19
Lancer VI 1.8	09/95→08/03	Petrol	4G93	1834	4	81.00	89.00	20
Lancer VI 1.8 i	09/95→07/96	Petrol	4G93	1834	4	81.00	89.00	20
Lancer VI 2.0 16V EVO	08/98→08/01	Petrol	4G63 Turbo	1997	4	85.00	88.00	28
Lancer VI 2.4 GDI	09/95→08/03	Petrol	4G64 (GDI)	2351	4	86.50	100.00	30
Maven 1.5	09/05→	Petrol	4G15 (12V)	1468	4	75.50	82.00	9
Mirage 1.2	03/79→09/83	Petrol	G11B	1244	4	69.50	82.00	1
Mirage 1.3	12/91→07/03	Petrol	4G13 (12V)	1299	4	71.00	82.00	2
Mirage 1.3	04/86→01/88	Petrol	G13B	1299	4	71.00	82.00	2
Mirage 1.4	03/79→09/83	Petrol	G12B	1410	4	74.00	82.00	6
Mirage 1.5	12/91→12/00	Petrol	4G15 (12V)	1468	4	75.50	82.00	9
Mirage 1.5	09/95→08/99	Petrol	4G15 (16V)	1468	4	75.50	82.00	9
Mirage 1.5	04/86→01/88	Petrol	G31B	1499	4	74.50	86.00	7
Mirage 1.5 GE MVV	12/91→08/95	Petrol	4G15 (12V)	1468	4	75.50	82.00	9
Mirage 1.6	03/79→09/83	Petrol	4G32 GS	1597	4	76.90	86.00	10
Mirage 1.6	12/91→07/03	Petrol	4G92	1597	4	81.00	77.50	19
Mirage 1.6	03/79→09/83	Petrol	G32B	1597	4	76.90	86.00	10
Mirage 1.6 4WD	12/91→08/95	Petrol	4G92	1597	4	81.00	77.50	19
Mirage 1.8	09/92→12/01	Petrol	4G93	1834	4	81.00	89.00	20
Mirage 1.8 GS 4WD	02/86→01/88	Petrol	G37B	1755	4	80.60	86.00	17
Mirage 1.8 Gsi	12/91→08/95	Petrol	4G93	1834	4	81.00	89.00	20
Mirage 1.8 Gti	08/01→07/03	Petrol	4G93	1834	4	81.00	89.00	20
Mirage 1.8 TD	12/91→08/95	Diesel	4D65 T	1796	4	80.60	88.00	18
Mirage 1.8 TD 4WD	12/91→08/95	Diesel	4D65 T	1796	4	80.60	88.00	18

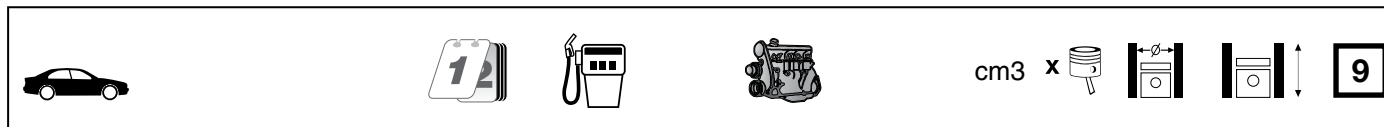







Mirage II 1.3 GL	04/86→01/88	Petrol	G13B	1299	4	71.00	82.00	2
Mirage II 1.5	09/84→12/87	Petrol	4G15	1468	4	75.50	82.00	9
Mirage II 1.5	10/83→01/88	Petrol	G15B	1468	4	75.50	82.00	9
Mirage II 1.5	04/86→01/88	Petrol	G31B	1499	4	74.50	86.00	7
Mirage II 1.6 Turbo	09/84→01/88	Petrol	4G32 T	1597	4	76.90	86.00	10
Mirage II 1.6 Turbo	10/83→01/88	Petrol	G32BT	1597	4	76.90	86.00	10
Mirage II 1.8 D	10/83→01/88	Diesel	4D65	1796	4	80.60	88.00	18
Mirage III 1.3	05/88→11/91	Petrol	4G13 (8V)	1299	4	71.00	82.00	2
Mirage III 1.3	05/88→11/91	Petrol	4G13 (12V)	1299	4	71.00	82.00	2
Mirage III 1.3 12V	07/90→11/91	Petrol	4G13 (12V)	1299	4	71.00	82.00	2
Mirage III 1.3 GS	07/90→11/91	Petrol	4G13 (8V)	1299	4	71.00	82.00	2
Mirage III 1.3 GS	07/90→11/91	Petrol	4G13 (12V)	1299	4	71.00	82.00	2
Mirage III 1.5	07/90→11/91	Petrol	4G15	1468	4	75.50	82.00	9
Mirage III 1.5	05/88→06/90	Petrol	4G15 (12V)	1468	4	75.50	82.00	9
Mirage III 1.5	05/88→11/91	Petrol	G15B	1468	4	75.50	82.00	9
Mirage III 1.5 4WD	05/88→11/91	Petrol	G15B	1468	4	75.50	82.00	9
Mirage III 1.5 12V	05/88→06/90	Petrol	4G15 (12V)	1468	4	75.50	82.00	9
Mirage III 1.5 E	05/88→06/90	Petrol	G15B	1468	4	75.50	82.00	9
Mirage III 1.5 GS	07/90→11/91	Petrol	4G15	1468	4	75.50	82.00	9
Mirage III 1.5 GS - 12V	07/90→11/91	Petrol	4G15 (12V)	1468	4	75.50	82.00	9
Mirage III 1.6	09/90→06/92	Petrol	4G32 T/C	1597	4	76.90	86.00	10
Mirage III 1.6 Gti	06/88→11/91	Petrol	4G61	1596	4	82.30	75.00	23
Mirage III 1.8 D	05/88→11/91	Diesel	4D65	1796	4	80.60	88.00	18
Mirage III 1.8 D 4WD	05/88→11/91	Diesel	4D65	1796	4	80.60	88.00	18
Mirage V 1.3	09/95→08/99	Petrol	4G13 (12V)	1299	4	71.00	82.00	2
Mirage V 1.5	09/96→08/99	Petrol	4G15 (12V)	1468	4	75.50	82.00	9
Mirage V 1.5	09/95→08/99	Petrol	4G15 (16V)	1468	4	75.50	82.00	9
Mirage V 1.8	09/96→08/02	Petrol	4G93	1834	4	81.00	89.00	20
Outlander I 2.0	05/03→10/06	Petrol	4G63 (DOHC 16V)	1997	4	85.00	88.00	28
Outlander I 2.0 4WD	05/03→10/06	Petrol	4G63 (DOHC 16V)	1997	4	85.00	88.00	28
Outlander I 2.0 4WD	01/02→10/06	Petrol	4G63 Turbo	1997	4	85.00	88.00	28
Outlander I 2.0 Turbo 4WD	04/04→10/06	Petrol	4G63 T (DOHC 16V)	1997	4	85.00	88.00	28
Outlander I 2.4 GDI	08/03→10/04	Petrol	4G64 (GDI)	2351	4	86.50	100.00	30
Outlander I 2.4 GDI 4WD	01/05→12/06	Petrol	4G64 (GDI)	2351	4	86.50	100.00	30
Outlander II 2.2 DI-D 4WD	08/07→11/12	Diesel	4HK	2179	4	85.00	96.00	29
Outlander II 2.2 DI-D 4WD	08/07→11/12	Diesel	4HN	2179	4	85.00	96.00	29
Pajero 1.8 4WD	03/01→02/05	Petrol	4G93	1834	4	81.00	89.00	20
Pajero 2.4	09/99→08/06	Petrol	4G64 (12V)	2351	4	86.50	100.00	30
Pajero 2.5 D	04/05→	Diesel	4D56 T	2477	4	91.10	95.00	34
Pajero 2.5 TD	11/98→	Diesel	4D56 T	2477	4	91.10	95.00	34
Pajero 2.5 TD 4WD	11/97→10/98	Diesel	4D56 T	2477	4	91.10	95.00	34
Pajero I 2.0 4WD	01/83→02/91	Petrol	G63B	1997	4	85.00	88.00	28
Pajero I 2.0 Turbo 4WD	10/84→02/91	Petrol	4G63 T (SOHC 8V)	1997	4	85.00	88.00	28
Pajero I 2.3 D	10/84→09/86	Diesel	4D55	2347	4	91.10	90.00	32
Pajero I 2.3 TD	12/82→04/86	Diesel	4D55 T	2347	4	91.10	90.00	32
Pajero I 2.5 TD	05/86→12/91	Diesel	4D56 T	2477	4	91.10	95.00	34
Pajero I 2.5 TD 4WD	10/86→05/91	Diesel	4D56 T	2477	4	91.10	95.00	34
Pajero II 2.4	04/91→01/07	Petrol	4G64 (12V)	2351	4	86.50	100.00	30
Pajero II 2.5 CRTD	09/08→	Diesel	4D56 HP	2477	4	91.10	95.00	33
Pajero II 2.5 CRTD 4WD	09/08→	Diesel	4D56 HP	2477	4	91.10	95.00	33
Pajero II 2.5 DI-D	07/08→	Diesel	4D56 HP	2477	4	91.10	95.00	33
Pajero II 2.5 DI-D 4WD	07/08→	Diesel	4D56 HP	2477	4	91.10	95.00	33
Pajero II 2.5 TD	09/08→	Diesel	4D56 T	2477	4	91.10	95.00	34
Pajero II 2.5 TD 4WD	12/90→04/00	Diesel	4D56 TD	2477	4	91.10	95.00	34
Pajero II 2.5 TDiC	03/91→08/99	Diesel	4D56 T	2477	4	91.10	95.00	34
Pajero III 2.4	10/01→01/07	Petrol	4G64 (12V)	2351	4	86.50	100.00	30
Pajero III 2.5 DI-D	08/15→	Diesel	4D56 HP	2477	4	91.10	95.00	33
Pajero III 2.5 DI-D 4x4	08/15→	Diesel	4D56 HP	2477	4	91.10	95.00	33
Pajero III 2.5 TDi	04/00→12/06	Diesel	4D56 T	2477	4	91.10	95.00	34
Pajero Pinin 1.8	11/01→06/07	Petrol	4G93	1834	4	81.00	89.00	20
Santamo 2.0 16V	05/99→12/04	Petrol	4G63 (DOHC 16V)	1997	4	85.00	88.00	28
Santamo 2.0 16V 4WD	05/99→12/04	Petrol	4G63 (DOHC 16V)	1997	4	85.00	88.00	28
Sapporo I 1.6 SL, GL	04/78→07/80	Petrol	4G32	1597	4	76.90	86.00	10
Sapporo I 2.0	04/78→07/80	Petrol	4G52	1995	4	84.00	90.00	26
Sapporo II 1.6 GLX	08/80→09/84	Petrol	4G32	1597	4	76.90	86.00	10
Sapporo II 2.0 GSL	08/80→08/83	Petrol	4G63 (SOHC 8V)	1997	4	85.00	88.00	28
Sapporo II 2.0 GSR	08/80→09/84	Petrol	4G63 (SOHC 8V)	1997	4	85.00	88.00	28
Sapporo II 2.0 Turbo ECi	08/82→08/83	Petrol	4G63 T (ECi)	1997	4	85.00	88.00	28
Sapporo III 2.4	06/87→08/90	Petrol	4G64 (8V)	2351	4	86.50	100.00	30







cm3 x



Savrin 2.0	01/01→12/04	Petrol	4G63 (DOHC 16V)	1997	4	85.00	88.00	28
Sigma 1.6	10/77→09/85	Petrol	4G32	1597	4	76.90	86.00	10
Sigma 1.9	10/77→05/80	Petrol	4G51	1855	4	81.00	90.00	21
Sigma 2.0	10/77→12/85	Petrol	4G52	1995	4	84.00	90.00	26
Sigma Scorpion 2.0	03/78→06/79	Petrol	4G52	1995	4	84.00	90.00	26
Space 1.8	05/84→12/85	Petrol	4G37	1755	4	80.60	86.00	17
Space 1.8	10/91→08/04	Petrol	4G93	1834	4	81.00	89.00	20
Space 1.8 4WD	10/87→08/88	Petrol	4G37	1755	4	80.60	86.00	17
Space 1.8 4WD	10/91→10/98	Petrol	4G93	1834	4	81.00	89.00	20
Space 1.8 GLX	01/84→12/88	Petrol	4G37	1755	4	80.60	86.00	17
Space 1.8 GLX	09/88→04/91	Petrol	G37B	1755	4	80.60	86.00	17
Space 1.8 TD	06/86→10/98	Diesel	4D65 T	1796	4	80.60	88.00	18
Space 2.0	09/87→10/97	Petrol	4G63 (SOHC 8V)	1997	4	85.00	88.00	28
Space 2.0	10/92→12/04	Petrol	4G63 (SOHC 16V)	1997	4	85.00	88.00	28
Space 2.0 4WD	03/85→04/91	Petrol	4G63 (SOHC 8V)	1997	4	85.00	88.00	28
Space 2.0 4WD	10/92→10/98	Petrol	4G63 (SOHC 16V)	1997	4	85.00	88.00	28
Space 2.0 GLX	06/86→05/88	Petrol	G63B	1997	4	85.00	88.00	28
Space 2.0 GLX 4WD	03/85→08/88	Petrol	4G63 (SOHC 8V)	1997	4	85.00	88.00	28
Space 2.0 GLX 4WD	06/86→05/88	Petrol	G63B	1997	4	85.00	88.00	28
Space 2.0 GLXi	06/88→04/91	Petrol	4G63 (SOHC 8V)	1997	4	85.00	88.00	28
Space 2.0 GLXi 4WD	06/88→04/91	Petrol	4G63 (SOHC 8V)	1997	4	85.00	88.00	28
Space 2.4 GDI	10/98→12/04	Petrol	4G64 (GDI)	2351	4	86.50	100.00	30
Space 2.4 GDI 4WD	10/98→12/04	Petrol	4G64 (GDI)	2351	4	86.50	100.00	30
Space Runner 1.8	10/91→08/99	Petrol	4G93	1834	4	81.00	89.00	20
Space Runner 1.8 4WD	10/91→08/99	Petrol	4G93	1834	4	81.00	89.00	20
Space Runner 2.0	08/99→08/02	Petrol	4G63 (SOHC 16V)	1997	4	85.00	88.00	28
Space Runner 2.0 16V	06/97→08/99	Petrol	4G63 (DOHC 16V)	1997	4	85.00	88.00	28
Space Runner 2.4 GDI	08/99→08/02	Petrol	4G64 (GDI)	2351	4	86.50	100.00	30
Space Star 1.3 16V	06/98→12/04	Petrol	4G13 (16V)	1299	4	71.00	82.00	2
Space Star 1.6	04/01→12/04	Petrol	4G92	1597	4	81.00	77.50	19
Space Star 1.9 DI-D	02/01→12/04	Diesel	F9Q1	1870	4	80.00	93.00	15
Space Star 1.9 DI-D	10/02→12/04	Diesel	F9Q2	1870	4	80.00	93.00	16
Starion 2.0 Turbo ECi	06/82→12/85	Petrol	4G63 T (ECi)	1997	4	85.00	88.00	28
Starion 2.0 Turbo ECi	12/85→12/87	Petrol	4G63 T (SOHC 8V)	1997	4	85.00	88.00	28
Starion 2.0 Turbo ECi	05/85→08/87	Petrol	4G63 T/C	1997	4	85.00	88.00	28
Tredia 1.4 GLX	10/82→08/85	Petrol	4G12	1410	4	74.00	82.00	6
Tredia 1.6 GLS	09/82→10/87	Petrol	4G32	1597	4	76.90	86.00	10
Tredia 1.6 Turbo	09/82→05/85	Petrol	4G32 T	1597	4	76.90	86.00	10
Tredia 1.8	01/83→07/86	Petrol	4G62	1795	4	80.60	88.00	18
Tredia 1.8 GLS	08/84→07/86	Petrol	4G37	1755	4	80.60	86.00	17
Tredia 1.8 GLS 4WD	04/85→07/86	Petrol	4G37	1755	4	80.60	86.00	17
Tredia 1.8 Turbo	08/84→03/88	Petrol	G62B	1796	4	80.60	88.00	18
Tredia 2.0	09/83→03/88	Petrol	G63B	1997	4	85.00	88.00	28
Tredia 2.0 GLXi 4WD	10/86→03/88	Petrol	4G63 (SOHC 8V)	1997	4	85.00	88.00	28
Veryca 1.3	10/11→	Petrol	4G13 (16V)	1299	4	71.00	82.00	2

		cm3	x 			
4D30	Diesel	3297	4	100.00	105.00	38
4D31	Diesel	3298	4	100.00	105.00	39
4D31T	Diesel	3298	4	100.00	105.00	39
4D55	Diesel	2347	4	91.10	90.00	32
4D55 T	Diesel	2347	4	91.10	90.00	32
4D56 (12V) Euro 3	Diesel	2477	4	91.10	95.00	33
4D56 (16V)	Diesel	2477	4	91.10	95.00	33
4D56 (8V)	Diesel	2477	4	91.10	95.00	33
4D56 HP	Diesel	2477	4	91.10	95.00	33
4D56 T	Diesel	2477	4	91.10	95.00	34
4D56 TC	Diesel	2477	4	91.10	95.00	33
4D56 TD	Diesel	2477	4	91.10	95.00	34
4D56 Ti	Diesel	2477	4	91.10	95.00	33
4D65	Diesel	1796	4	80.60	88.00	18
4D65 T	Diesel	1796	4	80.60	88.00	18
4G11	Petrol	1244	4	69.50	82.00	1
4G12	Petrol	1410	4	74.00	82.00	6
4G12 T	Petrol	1410	4	74.00	82.00	6
4G13 (12V)	Petrol	1299	4	71.00	82.00	2
4G13 (16V)	Petrol	1299	4	71.00	82.00	2
4G13 (8V)	Petrol	1299	4	71.00	82.00	2
4G15	Petrol	1468	4	75.50	82.00	9
4G15 (12V)	Petrol	1468	4	75.50	82.00	9
4G15 (16V)	Petrol	1468	4	75.50	82.00	9
4G30	Petrol	1289	4	73.00	77.00	4
4G31	Petrol	1499	4	74.50	86.00	7
4G32	Petrol	1597	4	76.90	86.00	10
4G32 GS	Petrol	1597	4	76.90	86.00	10
4G32 T	Petrol	1597	4	76.90	86.00	10
4G32 T (ECI)	Petrol	1997	4	76.90	86.00	10
4G32 T/C	Petrol	1597	4	76.90	86.00	10
4G33	Petrol	1439	4	73.00	86.00	5
4 G 35	Petrol	1686	4	79.00	86.00	12
4G36	Petrol	1238	4	73.00	74.00	3
4G37	Petrol	1755	4	80.60	86.00	17
4G51	Petrol	1855	4	81.00	90.00	21
4G52	Petrol	1995	4	84.00	90.00	26
4G53	Petrol	2384	4	88.00	98.00	31
4G54	Petrol	2555	4	91.10	98.00	35
4G61	Petrol	1596	4	82.30	75.00	23
4G62	Petrol	1795	4	80.60	88.00	18
4G62 T	Petrol	1795	4	80.60	88.00	18
4G63 (DOHC 16V)	Petrol	1997	4	85.00	88.00	28
4G63 (SOHC 16V)	Petrol	1997	4	85.00	88.00	28
4G63 (SOHC 8V)	Petrol	1997	4	85.00	88.00	28
4G63 T (DOHC 16V)	Petrol	1997	4	85.00	88.00	28
4G63 T (ECI)	Petrol	1997	4	85.00	88.00	28
4G63 T (SOHC 8V)	Petrol	1997	4	85.00	88.00	28
4G63 T/C	Petrol	1997	4	85.00	88.00	28
4G63 Turbo	Petrol	1997	4	85.00	88.00	28
4G64 (12V)	Petrol	2351	4	86.50	100.00	30
4G64 (8V)	Petrol	2351	4	86.50	100.00	30
4G64 (GDI)	Petrol	2351	4	86.50	100.00	30
4G91	Petrol	1499	4	78.40	77.50	11
4G92	Petrol	1597	4	81.00	77.50	19
4G93	Petrol	1834	4	81.00	89.00	20
4HK	Diesel	2179	4	85.00	96.00	29
4HN	Diesel	2179	4	85.00	96.00	29
4M40	Diesel	2835	4	95.00	100.00	36
4M40-A	Diesel	2835	4	95.00	100.00	36
4M40-T	Diesel	2835	4	95.00	100.00	36
4M41 Euro 3	Diesel	3200	4	98.50	105.00	37
9HD	Diesel	1560	4	75.00	88.30	8
BKD	Diesel	1968	4	81.00	95.50	22
BMM	Diesel	1968	4	81.00	95.50	22
D4BH	Diesel	2476	4	91.10	95.00	33
F8Q 784	Diesel	1870	4	80.00	93.00	13
F8QT	Diesel	1870	4	80.00	93.00	14
F9Q1	Diesel	1870	4	80.00	93.00	15

			cm ³	x 			9
F9Q2	Diesel		1870	4	80.00	93.00	16
G11B	Petrol		1244	4	69.50	82.00	1
G12B	Petrol		1410	4	74.00	82.00	6
G13B	Petrol		1299	4	71.00	82.00	2
G15B	Petrol		1468	4	75.50	82.00	9
G31B	Petrol		1499	4	74.50	86.00	7
G32B	Petrol		1597	4	76.90	86.00	10
G32BT	Petrol		1597	4	76.90	86.00	10
G33B	Petrol		1439	4	73.00	86.00	5
G37B	Petrol		1755	4	80.60	86.00	17
G51B	Petrol		1855	4	81.00	90.00	21
G52B	Petrol		1995	4	84.00	90.00	27
G54B	Petrol		2555	4	91.10	98.00	35
G54B T/C	Petrol		2555	4	91.10	98.00	35
G62B	Petrol		1796	4	80.60	88.00	18
G63B	Petrol		1997	4	85.00	88.00	28
G64B	Petrol		2351	4	86.50	100.00	30
MR18DE	Petrol		1797	4	84.00	81.10	25
OM457-T2 Euro 3	Diesel		11967	6	128.00	155.00	40
OM457-T3 Euro 3	Diesel		11967	6	128.00	155.00	40
OM457-T5 Euro 5	Diesel		11967	6	128.00	155.00	40
OM 639.939	Diesel		1493	3	83.00	92.00	24



1 69.50 x 82.00										
4G11			4 Cyl.		1244cc	40kW (55PS)		Petrol		TD2301
G11B			4 Cyl.		1244cc	40-53kW (54-72PS)		Petrol		TD2355
BE/PL	8	41,980		45,020	17,630	1,493		AL-LF	64-119-1	01-4257/4 STD 0.25
2 71.00 x 82.00										
4G13 (12V)			4 Cyl.		1299cc	44-58kW (60-79PS)		Petrol		TD2305
4G13 (16V)			4 Cyl.		1299cc	60-64kW (82-87PS)		Petrol		TD11610
4G13 (8V)			4 Cyl.		1299cc	44-51kW (60-69PS)		Petrol		TD2304
G13B			4 Cyl.		1299cc	44-57kW (60-78PS)		Petrol		TD12952
BE/PL	8	41,980		45,020	17,630	1,493		AL-LF	64-119-1	01-4257/4 STD 0.25
3 73.00 x 74.00										
4G36			4 Cyl.		1238cc	40kW (55PS)		Petrol		TD2315
BE/PL	8	44,980		48,020	23,600	1,493		BS	64-111-1	71-4143/4 STD 0.25 0.50
MB/HL 3	2	56,980		61,020	28,950	1,990		AL	63-111-(2)	H1032/5 STD 0.25 0.50
MB/HL 1,2,4,5	4	56,980		61,020	23,100	1,990		AL	63-111-1	
MB/HL 1,2,4,5	4	56,980		61,020	23,130	1,990		AL	63-111-3	
4 73.00 x 77.00										
4G30			4 Cyl.		1289cc			Petrol		FM1197
BE/PL	8	44,980		48,020	23,600	1,493		BS	64-111-1	71-4143/4 STD 0.25 0.50
MB/HL 3	2	56,980		61,020	28,950	1,990		AL	63-111-(2)	H1032/5 STD 0.25 0.50
MB/HL 1,2,4,5	4	56,980		61,020	23,100	1,990		AL	63-111-1	
MB/HL 1,2,4,5	4	56,980		61,020	23,130	1,990		AL	63-111-3	
5 73.00 x 86.00										
4G33			4 Cyl.		1439cc	50-56kW (68-76PS)		Petrol		TD2313
G33B			4 Cyl.		1439cc	50-68kW (68-92PS)		Petrol		TD2363
BE/PL	8	44,980		48,020	23,600	1,493		BS	64-111-1	71-4143/4 STD 0.25 0.50
MB/HL 3	2	56,980		61,020	28,950	1,990		AL	63-111-(2)	H1032/5 STD 0.25 0.50
MB/HL 1,2,4,5	4	56,980		61,020	23,100	1,990		AL	63-111-1	
MB/HL 1,2,4,5	4	56,980		61,020	23,130	1,990		AL	63-111-3	
6 74.00 x 82.00										
4G12			4 Cyl.		1410cc	50-51kW (68-70PS)		Petrol		TD2302
4G12 T			4 Cyl.		1410cc	77kW (105PS)		Petrol Turbo		TD2303
G12B			4 Cyl.		1410cc	50-60kW (68-82PS)		Petrol		TD2356
BE/PL	8	41,980		45,020	17,630	1,493		AL-LF	64-119-1	01-4257/4 STD 0.25

MITSUBISHI



7 74.50 x 86.00

4G31			4 Cyl.	1499cc				Petrol	FM1195	
G31B			4 Cyl.	1499cc	52kW (71PS)				Petrol	TD22165
BE/PL	8	44,980		48,020	23,600	1,493		BS	64-111-1	71-4143/4 STD 0.25 0.50
MB/HL 3	2	56,980		61,020	28,950	1,990		AL	63-111-(2)	H1032/5 STD 0.25 0.50
MB/HL 1,2,4,5	4	56,980		61,020	23,100	1,990		AL	63-111-1	
MB/HL 1,2,4,5	4	56,980		61,020	23,130	1,990		AL	63-111-3	

8 75.00 x 88.30

9HD			4 Cyl.	1560cc	84kW (114PS)				Diesel Turbo Intercooler	TD31497
MB/HL 1-5	5	49,962/49,981		53,655/53,674	19,900	1,833	0,008/0,046	AL	02-4244	H1066/5 STD 0.30 0.50
TW/A	2	55,200/55,480		71,350/71,700		2,460		AL	04-4245	A217/2 STD
SE/PB	1	26,000		29,000/29,021	19,980			BS	55-4102	55-4102 SEMI

9 75.50 x 82.00

4G15			4 Cyl.	1468cc	55-66kW (75-90PS)					Petrol	TD2308
4G15 (12V)			4 Cyl.	1468cc	56-81kW (76-110PS)					Petrol	TD5327
4G15 (16V)			4 Cyl.	1468cc	69-81kW (94-110PS)					Petrol	TD14208
G15B			4 Cyl.	1468cc	51-64kW (70-87PS)					Petrol	TD2358
BE/PL	8	41,980		45,020	17,630	1,493		AL-LF	64-119-1	01-4257/4 STD 0.25	

10 76.90 x 86.00

4G32			4 Cyl.	1597cc	48-60kW (65-82PS)					Petrol	TD5325
4G32 GS			4 Cyl.	1597cc	60-62kW (82-84PS)					Petrol	TD5314
4G32 T			4 Cyl.	1597cc	84-85kW (114-116PS)					Petrol Turbo	TD2312
4G32 T (ECI)			4 Cyl.	1997cc	125kW (170PS)					Petrol Turbo	TD5310
4G32 T/C			4 Cyl.	1597cc	92kW (125PS)					Petrol Turbo	TD5309
G32B			4 Cyl.	1597cc	48-60kW (65-82PS)					Petrol	TD2362
G32BT			4 Cyl.	1597cc	77kW (105PS)					Petrol Turbo	TD18868
BE/PL	8	44,980		48,020	23,600	1,493		BS	64-111-1	71-4143/4 STD 0.25 0.50	
MB/HL 3	2	56,980		61,020	28,950	1,990		AL	63-111-(2)	H1032/5 STD 0.25 0.50	
MB/HL 1,2,4,5	4	56,980		61,020	23,100	1,990		AL	63-111-1		
MB/HL 1,2,4,5	4	56,980		61,020	23,130	1,990		AL	63-111-3		

11 78.40 x 77.50

4G91			4 Cyl.	1499cc	77-84kW (105-114PS)					Petrol	TD23918
BE/PL	4	44,980		48,020	16,800	1,493		AL-LF	64-135-1	01-5043/4 STD	
MB/HL 1-5	5	49,980		54,020	19,130	1,990		AL-LF	63-135-1	H1357/5 STD	
MB/HL 1-5	5	49,980		54,020	19,130	1,990		AL-LF	63-135-2		
TW/A	2	56,000		75,000		1,975		AL-LF	65-135-1	A334/2 STD	



12 79.00 x 86.00

4 G 35		4 Cyl. 1686cc					Petrol		FM2143
BE/PL	8	44,980	48,020	23,600	1,493		BS	64-111-1	71-4143/4 STD 0.25 0.50
MB/HL	2	56,980	61,020	28,950	1,990		AL	63-111-(2)	H1032/5 STD 0.25 0.50
MB/HL	4	56,980	61,020	23,100	1,990		AL	63-111-1	
MB/HL	4	56,980	61,020	23,130	1,990		AL	63-111-3	

13 80.00 x 93.00

F8Q 784		4 Cyl. 1870cc 66-70kW (90-95PS)					Diesel Turbo		TD22343
BE/PL	4	48,000/48,020	51,587/51,606	20,250	1,776	0,015/0,079	EC	71-3988L	71-3988/4 STD 0.25 0.50
BE/PL	4	48,000/48,020	51,587/51,606	20,500	1,776	0,015/0,079	EC	71-3988U	
01/98 →									
BE/PL	4	48,000/48,020	51,587/51,600	20,500	1,768	0,031/0,089	BS	4060CP	71-4311/4 STD 0.25 0.50
→12/97									

71-3988L

71-3988U

4060CP

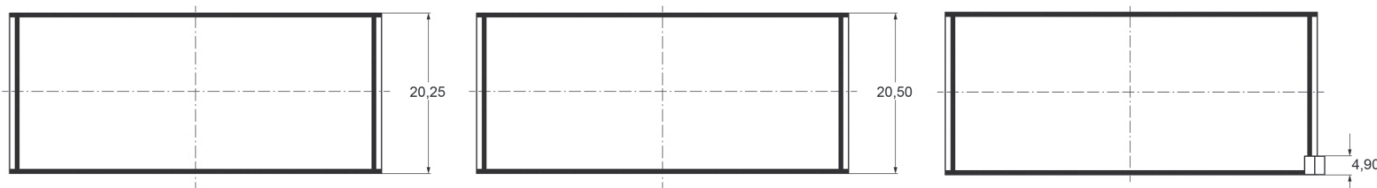

MB/HL	5	54,785/54,805	58,731/58,744	18,500	1,947	0,032/0,090	EC	72-3989	H098/5 STD 0.25 0.50
01/98 →									
MB/HL	5	54,785/54,795	58,731/58,744	18,500	1,945	0,046/0,094	AL-LF	66741RA	H1080/5 STD 0.25 0.50
→12/97									

72-3989

66741RA

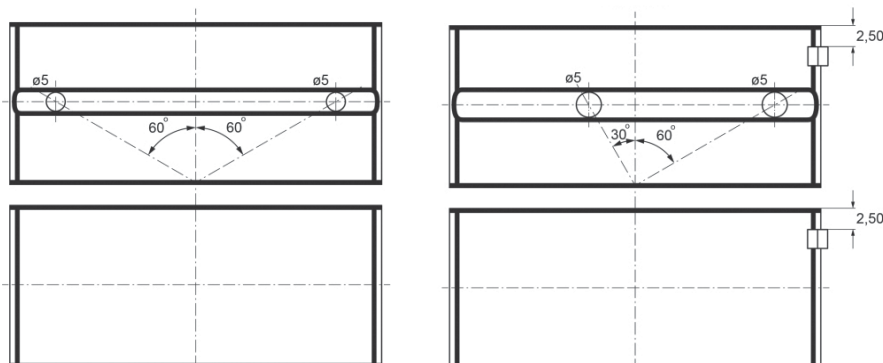

TW/A	2	60,500/60,750	79,750/80,000		2,350		AL-LF	66741AF	A215/2 STD 0.10
SE/PB	1	26,013/26,025	29,000/29,021	22,900			BS	66509Y	55-4394 SEMI



14 80.00 x 93.00

F8QT	4 Cyl.	1870cc	66kW (90PS)	Diesel Turbo Intercooler	TD16271				
BE/PL	4	48,000/48,020	51,587/51,600	20,500	1,768	0,031/0,089	BS	4060CP	71-4311/4 STD 0.25 0.50
MB/HL 1-5	5	54,785/54,795	58,731/58,744	18,500	1,945	0,046/0,094	AL-LF	66741RA	H1080/5 STD 0.25 0.50
MB/HL 1-5	5	54,785/54,795	58,731/58,744	18,500	1,945	0,050/0,090	AL-LF	66741RAB	H1101/5 STD 0.25 0.50

66741RA

66741RAB

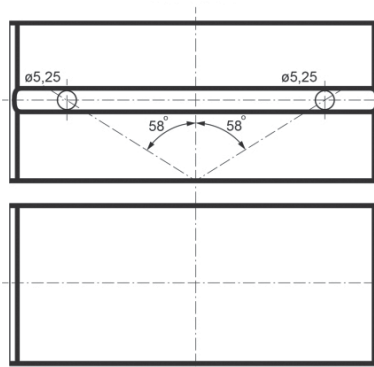
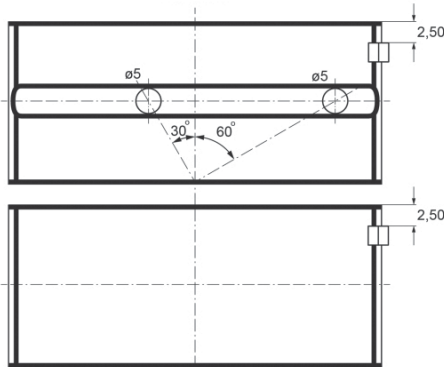

TW/A	2	60,500/60,750	79,750/80,000		2,350		AL-LF	66741AF	A215/2 STD 0.10
SE/PB	1	28,002/28,010	30,000/30,021	25,250			BS	66649RY	55-4294 SEMI
SE/PB	1	26,013/26,025	29,000/29,021	22,900			BS	66509Y	55-4394 SEMI

15 80.00 x 93.00

F9Q1	4 Cyl.	1870cc	75kW (102PS)	Diesel Bi-Turbo Intercooler	TD20725				
BE/PL	4	48,000/48,020	51,587/51,606	20,250	1,776	0,015/0,079	EC	71-3988L	71-3988/4 STD 0.25 0.50
BE/PL	4	48,000/48,020	51,587/51,606	20,500	1,776	0,015/0,079	EC	71-3988U	
MB/HL 1-5	5	54,785/54,805	58,731/58,744	18,500	1,947	0,032/0,090	EC	72-3989	H098/5 STD 0.25 0.50
TW/A	2	60,500/60,750	79,750/80,000		2,350		AL-LF	66741AF	A215/2 STD 0.10
SE/PB	1	28,002/28,010	30,000/30,021	25,250			BS	66649RY	55-4294 SEMI

16 80.00 x 93.00

F9Q2	4 Cyl.	1870cc	85kW (116PS)	Diesel	TD18558				
BE/PL	4	48,000/48,020	51,587/51,606	20,250	1,776	0,015/0,079	EC	71-3988L	71-3988/4 STD 0.25 0.50
BE/PL	4	48,000/48,020	51,587/51,606	20,500	1,776	0,015/0,079	EC	71-3988U	
MB/HL 1-5	5	54,785/54,795	58,731/58,744	18,500	1,945	0,050/0,090	AL-LF	66741RAB	H1101/5 STD 0.25 0.50
TW/A	2	60,500/60,750	79,750/80,000		2,350		AL-LF	66741AF	A215/2 STD 0.10
SE/PB	1	28,002/28,010	30,000/30,021	25,250			BS	66649RY	55-4294 SEMI

17 80.60 x 86.00

4G37	4 Cyl.	1755cc	63-71kW (86-97PS)	Petrol	TD2316
G37B	4 Cyl.	1755cc	61-62kW (83-84PS)	Petrol	TD2365

BE/PL	8	44,980	48,020	23,600	1,493			BS	64-111-1	71-4143/4 STD 0.25 0.50
MB/HL 3	2	56,980	61,020	28,950	1,990			AL	63-111-(2)	H1032/5 STD 0.25 0.50
MB/HL 1,2,4,5	4	56,980	61,020	23,100	1,990			AL	63-111-1	
MB/HL 1,2,4,5	4	56,980	61,020	23,130	1,990			AL	63-111-3	

18
80.60 x 88.00

4G62	4 Cyl.	1795cc	60kW (82PS)	Petrol	TD5326			
4G62 T	4 Cyl.	1795cc	90-110kW (122-150PS)	Petrol Turbo	TD2326			
G62B	4 Cyl.	1796cc	87-100kW (118-136PS)	Petrol Turbo	TD2369			
4D65	4 Cyl.	1796cc	43-48kW (58-65PS)	Diesel	TD2300			
4D65 T	4 Cyl.	1796cc	55-60kW (75-82PS)	Diesel Turbo	TD2296			
BE/PL	8	44,980	48,020	23,600	1,493	BS	64-111-1	71-4143/4 STD 0.25 0.50
MB/HL 3	2	56,980	61,020	28,950	1,990	AL	63-111-(2)	H1032/5 STD 0.25 0.50
MB/HL 1,2,4,5	4	56,980	61,020	23,100	1,990	AL	63-111-1	
MB/HL 1,2,4,5	4	56,980	61,020	23,130	1,990	AL	63-111-3	

19
81.00 x 77.50

4G92	4 Cyl.	1597cc	66-88kW (90-119PS)	Petrol	TD2341			
BE/PL	4	44,980	48,020	16,800	1,493	AL-LF	64-135-1	01-5043/4 STD
MB/HL 1-5	5	49,980	54,020	19,130	1,990	AL-LF	63-135-1	H1357/5 STD
MB/HL 1-5	5	49,980	54,020	19,130	1,990	AL-LF	63-135-2	
TW/A	2	56,000	75,000		1,975	AL-LF	65-135-1	A334/2 STD

20
81.00 x 89.00

4G93	4 Cyl.	1834cc	81-103kW (110-140PS)	Petrol	TD2346			
BE/PL	4	44,980	48,020	16,800	1,493	AL-LF	64-135-1	01-5043/4 STD
MB/HL 1-5	5	49,980	54,020	19,130	1,990	AL-LF	63-135-1	H1357/5 STD
MB/HL 1-5	5	49,980	54,020	19,130	1,990	AL-LF	63-135-2	
TW/A	2	56,000	75,000		1,975	AL-LF	65-135-1	A334/2 STD

21
81.00 x 90.00

4G51	4 Cyl.	1855cc	60-72kW (81-98PS)	Petrol	TD2319			
G51B	4 Cyl.	1855cc	72kW (98PS)	Petrol	TD2366			
BE/PL	8	52,980	56,020	25,130	1,493	AL	64-113-1	71-4194/4 STD 0.25 0.50 0.75
MB/HL 3	2	65,980	70,020	30,950	1,990	AL	63-113-(2)	H1055/5 STD 0.25 0.50
MB/HL 1,2,4,5	4	65,980	70,020	25,130	1,990	AL	63-113-1	
MB/HL 1,2,4,5	4	65,980	70,020	25,130	1,990	AL	63-113-3	



22 81.00 x 95.50										
BKD		4 Cyl.		1968cc	103kW (140PS)			Diesel Turbo Intercooler		TD22162
BMM		4 Cyl.		1968cc	103kW (140PS)			Diesel Turbo Intercooler		TD22164
BE/PL	1	50,858/50,878	53,700/53,712	20,400	1,403	0,020/0,073	SP	71-3930	71-3930 STD 0.25 0.50	①
MB/HL 1-5	5	53,958/53,978	59,000/59,012	18,500	2,501	0,020/0,076	EC	72-3931	H079/5 STD 0.25 0.50	
TW/A	2	59,500	73,200		1,975		AL-LF	04-3527	A123/4 STD	
TW/A	2	59,500	73,200		1,975		AL-LF	04-3528		

23 82.30 x 75.00										
4G61		4 Cyl.		1596cc	90-100kW (122-136PS)			Petrol		TD4685
BE/PL	8	44,980	48,020	23,600	1,493		BS	64-111-1	71-4143/4 STD 0.25 0.50	
MB/HL 3	2	56,980	61,020	28,950	1,990		AL	63-111-(2)	H1032/5 STD 0.25 0.50	
MB/HL 1,2,4,5	4	56,980	61,020	23,100	1,990		AL	63-111-1		
MB/HL 1,2,4,5	4	56,980	61,020	23,130	1,990		AL	63-111-3		

24 83.00 x 92.00										
OM 639.939 Euro 4		3 Cyl.		1493cc	50-70kW (58-95PS)			Diesel		TD27273
BE/PL	1	49,940/49,965	53,600/53,614	20,400	1,813	0,020/0,072	SP	71-4013	71-4013 STD	①
MB/HL	1	54,940/54,965	59,000/59,019	18,000	2,018	0,020/0,077	SP	72-4014	72-4014 STD	②
TW/A	2	61,250	76,750		2,200		AL-LF	04-4004	A163/4 STD	
TW/A	2	61,250	76,750		2,200		AL-LF	04-4005		

25 84.00 x 81.10										
MR18DE		4 Cyl.		1797cc	91kW (124PS)			Petrol		TD27464
BE/PL	4	44,000	47,010	16,100	1,495		AL-LF	64-1054-1	01-4978/4 STD	
BE/PL	4	44,000	47,010	16,100	1,495		AL-LF	64-1054-2		
MB/HL 1-5	10	52,000	56,010	17,100	1,990		AL-LF	63-1054-1	H1340/5 STD	
TW/A	2	59,000	76,500		2,100		AL-LF	65-1054-1	A324/2 STD	

26 84.00 x 90.00										
4G52		4 Cyl.		1995cc	63-79kW (85-107PS)			Petrol		TD5319
BE/PL	8	52,980	56,020	25,130	1,493		AL	64-113-1	71-4194/4 STD 0.25 0.50 0.75	
MB/HL 3	2	65,980	70,020	30,950	1,990		AL	63-113-(2)	H1055/5 STD 0.25 0.50	
MB/HL 1,2,4,5	4	65,980	70,020	25,130	1,990		AL	63-113-1		
MB/HL 1,2,4,5	4	65,980	70,020	25,130	1,990		AL	63-113-3		
→12/77										
CB/NWB 1,2	2	42,980	46,050	20,250	1,480		AL-LF	68-113-1	N156/2 STD	

27 84.00 x 90.00

G52B			4 Cyl.	1995cc	85kW (116PS)		Petrol		TD2367
BE/PL	8	52,980	56,020	25,130	1,493		AL	64-113-1	71-4194/4 STD 0.25 0.50 0.75
MB/HL 3	2	65,980	70,020	30,950	1,990		AL	63-113-(2)	H1055/5 STD 0.25 0.50
MB/HL 1,2,4,5	4	65,980	70,020	25,130	1,990		AL	63-113-1	
MB/HL 1,2,4,5	4	65,980	70,020	25,130	1,990		AL	63-113-3	
CB/NWB 1,2	2	42,980	46,050	20,250	1,480		AL-LF	68-113-1	N156/2 STD

28 85.00 x 88.00

4G63 (DOHC 16V)			4 Cyl.	1997cc	78-110kW (106-150PS)		Petrol		TD2328
4G63 (SOHC 16V)			4 Cyl.	1997cc	82-101kW (112-137PS)		Petrol		TD26410
4G63 (SOHC 8V)			4 Cyl.	1997cc	63-101kW (86-137PS)		Petrol		TD4688
4G63 T (DOHC 16V)			4 Cyl.	1997cc	110-157kW (150-214PS)		Petrol Turbo Intercooler		TD23917
4G63 T (ECI)			4 Cyl.	1997cc	125kW (170PS)		Petrol Turbo		TD5313
4G63 T (SOHC 8V)			4 Cyl.	1997cc	107-148kW (145-201PS)		Petrol Turbo		TD2333
4G63 T/C			4 Cyl.	1997cc	132kW (180PS)		Petrol Turbo		TD5323
4G63 Turbo			4 Cyl.	1997cc	182-217kW (247-295PS)		Petrol Turbo Intercooler		TD14209
G63B			4 Cyl.	1997cc	62-81kW (84-110PS)		Petrol		TD4692
BE/PL	8	44,980	48,020	23,600	1,493		BS	64-111-1	71-4143/4 STD 0.25 0.50
MB/HL 3	2	56,980	61,020	28,950	1,990		AL	63-111-(2)	H1032/5 STD 0.25 0.50
MB/HL 1,2,4,5	4	56,980	61,020	23,100	1,990		AL	63-111-1	
MB/HL 1,2,4,5	4	56,980	61,020	23,130	1,990		AL	63-111-3	

29 85.00 x 96.00

4HK			4 Cyl.	2179cc	115kW (156PS)		Diesel Turbo Intercooler		TD24800
4HN			4 Cyl.	2179cc	115kW (156PS)		Diesel Turbo Intercooler		TD24440
BE/PL	4	49,984/50,000	53,695/53,708	20,000	1,838	0,020/0,070	SP	71-3952	71-3952/4 STD 0.30
MB/HL 1-5	5	59,981/60,000	63,731/63,750	20,290	1,845	0,040/0,100	AL-LF	66726RA	H1057/5 STD 0.30 0.50
TW/A	4	67,050/67,300	83,050/83,300		2,330		BS	66721BF	A214/4 STD 0.10
SE/PB	1	29,995/30,000	33,000/33,025	24,050			BS-LF	55-3984	55-3984 SEMI
CB/NWB	4	27,982/28,000	31,200/31,218	18,150	1,594		AL-LF	03-3981	N151/6 STD
CB/NWB	8	27,982/28,000	31,200/31,218	18,150	1,594		AL-LF	03-3982	

30 86.50 x 100.00

4G64 (GDI)			4 Cyl.	2351cc	84-121kW (114-165PS)		Petrol		TD11611
4G64 (12V)			4 Cyl.	2351cc	82-87kW (112-118PS)		Petrol		TD4689
4G64 (8V)			4 Cyl.	2351cc	82-97kW (111-132PS)		Petrol		TD2335
G64B			4 Cyl.	2351cc	80-82kW (109-112PS)		Petrol		TD4693
BE/PL	8	44,980	48,020	23,600	1,493		BS	64-111-1	71-4143/4 STD 0.25 0.50

MB/HL 3	2	56,980	61,020	28,950	1,990		AL	63-111-(2)	H1032/5 STD 0.25 0.50
MB/HL 1,2,4,5	4	56,980	61,020	23,100	1,990		AL	63-111-1	
MB/HL 1,2,4,5	4	56,980	61,020	23,130	1,990		AL	63-111-3	

31 88.00 x 98.00

4G53		4 Cyl.	2384cc	62kW (84PS)		Petrol		TD8265	
BE/PL	8	52,980	56,020	25,130	1,493	AL	64-113-1	71-4194/4 STD 0.25 0.50 0.75	
MB/HL 3	2	65,980	70,020	30,950	1,990	AL	63-113-(2)	H1055/5 STD 0.25 0.50	
MB/HL 1,2,4,5	4	65,980	70,020	25,130	1,990	AL	63-113-1		
MB/HL 1,2,4,5	4	65,980	70,020	25,130	1,990	AL	63-113-3		
→12/77									
CB/NWB 1,2	2	42,980	46,050	20,250	1,480	AL-LF	68-113-1	N156/2 STD	

32 91.10 x 90.00

4D55		4 Cyl.	2347cc	48-62kW (65-84PS)		Diesel		TD5331
4D55 T		4 Cyl.	2347cc	62-70kW (84-95PS)		Diesel Turbo		TD2292
BE/PL	8	52,980	56,020	25,130	1,493	AL	64-113-1	71-4194/4 STD 0.25 0.50 0.75
MB/HL 3	2	65,980	70,020	30,950	1,990	AL	63-113-(2)	H1055/5 STD 0.25 0.50
MB/HL 1,2,4,5	4	65,980	70,020	25,130	1,990	AL	63-113-1	
MB/HL 1,2,4,5	4	65,980	70,020	25,130	1,990	AL	63-113-3	
SE/PB	1	29,000	32,030	32,000		BS	67-113-1S	55-4208 SEMI
CB/NWB 1,2	2	42,980	46,050	20,250	1,480	AL-LF	68-113-1	N156/2 STD

33 91.10 x 95.00

4D56 (12V) Euro 3		4 Cyl.	2477cc	51-85kW (69-116PS)		Diesel		TD8288
4D56 (16V)		4 Cyl.	2477cc	94-131kW (128-178PS)		Diesel Turbo Intercooler		TD30760
4D56 (8V)		4 Cyl.	2477cc	51-64kW (69-87PS)		Diesel		TD2293
4D56 HP		4 Cyl.	2477cc	94-131kW (128-178PS)		Diesel Turbo Intercooler		TD24055
4D56 TC		4 Cyl.	2477cc	100-123kW (136-167PS)		Diesel Turbo Intercooler		TD25719
4D56 Ti		4 Cyl.	2477cc	85-100kW (116-136PS)		Diesel Turbo Intercooler		TD26177
D4BH		4 Cyl.	2476cc	59-78kW (80-106PS)		Diesel Turbo		TD22925
BE/PL	8	52,980	56,020	25,130	1,493	AL	64-113-1	71-4194/4 STD 0.25 0.50 0.75
MB/HL 3	2	65,980	70,020	30,950	1,990	AL	63-113-(2)	H1055/5 STD 0.25 0.50
MB/HL 1,2,4,5	4	65,980	70,020	25,130	1,990	AL	63-113-1	
MB/HL 1,2,4,5	4	65,980	70,020	25,130	1,990	AL	63-113-3	
SE/PB	1	29,000	32,030	32,000		BS	67-113-1S	55-4208 SEMI
CB/NWB 1,2	2	42,980	46,050	20,250	1,480	AL-LF	68-113-1	N156/2 STD

34 91.10 x 95.00

4D56 T			4 Cyl.	2477cc	62-110kW (84-150PS)			Diesel Turbo Intercooler		TD4682
4D56 TD			4 Cyl.	2477cc	73kW (99PS)			Diesel Turbo Intercooler		TD2294
BE/PL	8	52,980		56,020	25,130	1,493		AL	64-113-1	71-4194/4 STD 0.25 0.50 0.75
MB/HL 1-5	5	65,980		70,020	25,130	1,990		BC	66676RA	H1248/5 STD 0.25 0.50
TW/A	2	72,000		90,000		2,500		AL-LF	65-140-1	A284/2 STD
SE/PB	1	29,000		32,030	32,000			BS	67-113-1S	55-4208 SEMI
CB/NWB 1,2	2	42,980		46,050	20,250	1,480		AL-LF	68-113-1	N156/2 STD

35 91.10 x 98.00

4G54			4 Cyl.	2555cc	73-114kW (99-155PS)			Petrol		TD2322
G54B			4 Cyl.	2555cc	76-114kW (103-155PS)			Petrol		TD2368
G54B T/C			4 Cyl.	2555cc	114kW (155PS)			Petrol Turbo Intercooler		TD5329
BE/PL	8	52,980		56,020	25,130	1,493		AL	64-113-1	71-4194/4 STD 0.25 0.50 0.75
CB/NWB 1,2	2	42,980		46,050	20,250	1,480		AL-LF	68-113-1	N156/2 STD

36 95.00 x 100.00

4M40			4 Cyl.	2835cc	69-71kW (94-97PS)			Diesel Turbo Intercooler		TD2347
4M40-A			4 Cyl.	2835cc	69-71kW (94-97PS)			Diesel		TD16265
4M40-T			4 Cyl.	2835cc	80-92kW (109-125PS)			Diesel Turbo Intercooler		TD19658
BE/PL	4	53,970		58,020	27,630	1,992		BS	64-133-1	71-4567/4 STD 0.25
BE/PL	4	53,970		58,020	27,630	1,992		BS	64-133-2	
MB/HL 1,2,4,5	4	67,980		72,020	22,130	1,992		BS	63-133-1	H1247/5 STD
MB/HL 1,2,4,5	4	67,980		72,020	22,130	1,992		BS	63-133-2	
MB/HL 3	1	68,030		72,020	22,130	1,972		BS	63-133-3	
MB/HL 3	1	68,030		72,020	22,130	1,972		BS	63-133-4	

37 98.50 x 105.00

4M41 Euro 3			4 Cyl.	3200cc	118-147kW (160-200PS)			Diesel Turbo Intercooler		TD18561
BE/PL	4	53,970		58,020	27,630	1,992		BS	64-133-1	71-4567/4 STD 0.25
BE/PL	4	53,970		58,020	27,630	1,992		BS	64-133-2	
MB/HL 1,2,4,5	4	67,980		72,020	22,130	1,992		BS	63-133-1	H1247/5 STD
MB/HL 1,2,4,5	4	67,980		72,020	22,130	1,992		BS	63-133-2	
MB/HL 3	1	68,030		72,020	22,130	1,972		BS	63-133-3	
MB/HL 3	1	68,030		72,020	22,130	1,972		BS	63-133-4	



38 100.00 x 105.00







4D30		4 Cyl.		3297cc	64kW (87PS)	Diesel			TD8268
BE/PL	8	59,950	64,020	33,130	2,000	BS	64-108-1	71-4348/4 STD	
→08/82									
BE/PL	4	59,950	64,020	33,130	2,000	BS	64-108-1	71-4360/4 STD	
BE/PL	4	59,950	64,020	33,130	2,000	BS	64-121-2		
SE/PB	1	33,910	37,030	38,800		BS	67-121-1	55-4268 STD	

39 100.00 x 105.00

4D31		4 Cyl.		3298cc	71kW (96PS)	Diesel			TD8293
4D31T		4 Cyl.		3298cc	86kW (117PS)	Diesel Turbo			TD8269
BE/PL	4	59,950	64,020	33,130	2,000	BS	64-108-1	71-4360/4 STD	
BE/PL	4	59,950	64,020	33,130	2,000	BS	64-121-2		
SE/PB	1	33,910	37,030	38,800		BS	67-121-1	55-4268 STD	

40 128.00 x 155.00

OM457-T2 Euro 3		6 Cyl.		11967cc	265kW (360PS)	Diesel Turbo Intercooler			TD27071	
OM457-T3 Euro 3		6 Cyl.		11967cc	295kW (401PS)	Diesel Turbo Intercooler			TD27068	
OM457-T5 Euro 5		6 Cyl.		11967cc	335kW (455PS)	Diesel Turbo Intercooler			TD27070	
BE/PL	1	93,980/94,000	99,000/99,022	34,400	2,473	0,081/0,151	SP	71-4784	71-4784 STD 0.25 0.50	①
MB/HL 1-6	6	103,980/104,000	111,000/111,022	36,000	3,478	0,060/0,126	SP	72-3894	H075/7 STD 0.25	②
MB/HL 7	1	103,980/104,000	111,000/111,022	45,810	3,478	0,060/0,126	SP	72-3895H		
CB/NWB	1		87,000				B	23-4900	N205/7 SEMI	
CB/NWB	5		87,000	35,000			B	23-4901		
CB/NWB	1		87,000					23-4902H		

		cm3	x 			
D 226 B-2	Diesel	2080	2	105.00	120.00	1
D 226 B-3	Diesel	3120	3	105.00	120.00	2
D 226 B-4	Diesel	4160	4	105.00	120.00	3
D 226 B-6	Diesel	6234	6	105.00	120.00	4
D232-12	Diesel	17634	V12	120.00	130.00	7
D232-6	Diesel	8817	V6	120.00	130.00	5
D232-8	Diesel	11756	V8	120.00	130.00	6
D233-12	Diesel	19134	V12	125.00	130.00	10
D233-6	Diesel	9567	V6	125.00	130.00	8
D233-8	Diesel	12756	V8	125.00	130.00	9
D234-12	Diesel	21607	V12	128.00	143.30	13
D234-6	Diesel	10804	V6	128.00	143.30	11
D234-8	Diesel	14405	V8	128.00	143.30	12
TBD234-6	Diesel	10804	V6	128.00	143.30	11
TBD234-8	Diesel	14405	V8	128.00	143.30	12
TD 226 B-3	Diesel	3120	3	105.00	120.00	2
TD 226 B-4	Diesel	4160	4	105.00	120.00	3
TD 226 B-6	Diesel	6234	6	105.00	120.00	4
TD232-12	Diesel	17634	V12	120.00	130.00	7
TD232-6	Diesel	8817	V6	120.00	130.00	5
TD232-8	Diesel	11756	V8	120.00	130.00	6
TD233-12	Diesel	19134	V12	125.00	130.00	10
TD233-6	Diesel	9567	V6	125.00	130.00	8
TD233-8	Diesel	12756	V8	125.00	130.00	9



1 105.00 x 120.00

D 226 B-2		2 Cyl.		2080cc	32kW (44PS)	Diesel			TD18063
BE/PL	1	62,950/62,970	67,000/67,019	27,100	2,000	0,030/0,113	EC	71-3447	71-3447 STD
MB/HL	1	69,951/69,970	75,000/75,019	28,000	2,490	0,050/0,113	EC	72-3448	72-3448 STD
TW/A	2	79,000	95,200		3,470		AL-LF	04-3449	A116/4 STD
TW/A	2	79,000	95,200		3,470		AL-LF	04-3450	
SE/PB	1	34,995/35,000	38,000/38,016	32,000	1,487		BC	55-3451	55-3451 STD

2 105.00 x 120.00

D 226 B-3		3 Cyl.		3120cc	33-55kW (45-75PS)	Diesel			TD18064
TD 226 B-3		3 Cyl.		3120cc	52-84kW (70-114PS)	Diesel Turbo			TD18067
BE/PL	1	62,950/62,970	67,000/67,019	27,100	2,000	0,030/0,113	EC	71-3447	71-3447 STD
MB/HL	1	69,951/69,970	75,000/75,019	28,000	2,490	0,050/0,113	EC	72-3448	72-3448 STD
TW/A	2	79,000	95,200		3,470		AL-LF	04-3449	A116/4 STD
TW/A	2	79,000	95,200		3,470		AL-LF	04-3450	
SE/PB	1	34,995/35,000	38,000/38,016	32,000	1,487		BC	55-3451	55-3451 STD

3 105.00 x 120.00

D 226 B-4		4 Cyl.		4160cc	52-74kW (70-100PS)	Diesel			TD18065
TD 226 B-4		4 Cyl.		4160cc	60-77kW (82-105PS)	Diesel Turbo			TD18068
BE/PL	1	62,950/62,970	67,000/67,019	27,100	2,000	0,030/0,113	EC	71-3447	71-3447 STD
MB/HL	1	69,951/69,970	75,000/75,019	28,000	2,490	0,050/0,113	EC	72-3448	72-3448 STD
TW/A	2	79,000	95,200		3,470		AL-LF	04-3449	A116/4 STD
TW/A	2	79,000	95,200		3,470		AL-LF	04-3450	
SE/PB	1	34,995/35,000	38,000/38,016	32,000	1,487		BC	55-3451	55-3451 STD

4 105.00 x 120.00

D 226 B-6		6 Cyl.		6234cc	77-88kW (105-120PS)	Diesel			TD18066
TD 226 B-6		6 Cyl.		6234cc	81-136kW (110-185PS)	Diesel Turbo			TD23379
BE/PL	1	62,950/62,970	67,000/67,019	27,100	2,000	0,030/0,113	EC	71-3447	71-3447 STD
MB/HL	1	69,951/69,970	75,000/75,019	28,000	2,490	0,050/0,113	EC	72-3448	72-3448 STD
TW/A	2	79,000	95,200		3,470		AL-LF	04-3449	A116/4 STD
TW/A	2	79,000	95,200		3,470		AL-LF	04-3450	
SE/PB	1	34,995/35,000	38,000/38,016	32,000	1,487		BC	55-3451	55-3451 STD

5 120.00 x 130.00

D232-6		V6 Cyl.		8817cc	53-162kW (72-220PS)	Diesel			FM9016
TD232-6		V6 Cyl.		8817cc	53-162kW (72-220PS)	Diesel			FM999991

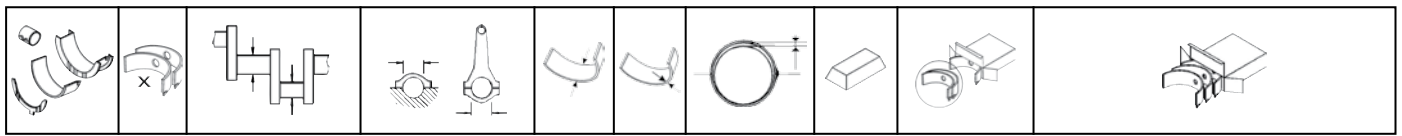

BE/PL	1	89,942/89,964	96,000/96,022	30,900	2,988	0,060/0,129	EC	71-3144	71-3144 0.50
-------	---	---------------	---------------	--------	-------	-------------	----	---------	------------------------

6 120.00 x 130.00

D232-8	V8 Cyl.	11756cc	96-215kW (130-292PS)	Diesel	FM29016
TD232-8	V8 Cyl.	11756cc	96-215kW (130-292PS)	Diesel	FM999994

BE/PL	1	89,942/89,964	96,000/96,022	30,900	2,988	0,060/0,129	EC	71-3144	71-3144 0.50
-------	---	---------------	---------------	--------	-------	-------------	----	---------	------------------------

7 120.00 x 130.00

D232-12	V12 Cyl.	17634cc	144-368kW (196-500PS)	Diesel	FM49016
TD232-12	V12 Cyl.	17634cc	144-368kW (196-500PS)	Diesel	FM999997

BE/PL	1	89,942/89,964	96,000/96,022	30,900	2,988	0,060/0,129	EC	71-3144	71-3144 0.50
-------	---	---------------	---------------	--------	-------	-------------	----	---------	------------------------

8 125.00 x 130.00

D233-6	V6 Cyl.	9567cc	78-186kW (106-253PS)	Diesel	FM19016
TD233-6	V6 Cyl.	9567cc	78-186kW (106-253PS)	Diesel	FM999993

BE/PL	1	89,942/89,964	96,000/96,022	30,900	2,988	0,060/0,129	EC	71-3144	71-3144 0.50
-------	---	---------------	---------------	--------	-------	-------------	----	---------	------------------------

9 125.00 x 130.00

D233-8	V8 Cyl.	12756cc	104-247kW (141-336PS)	Diesel	FM39016
TD233-8	V8 Cyl.	12756cc	104-247kW (141-336PS)	Diesel	FM999995

BE/PL	1	89,942/89,964	96,000/96,022	30,900	2,988	0,060/0,129	EC	71-3144	71-3144 0.50
-------	---	---------------	---------------	--------	-------	-------------	----	---------	------------------------

10 125.00 x 130.00

D233-12	V12 Cyl.	19134cc	157-402kW (213-543PS)	Diesel	FM59016
TD233-12	V12 Cyl.	19134cc	157-402kW (213-543PS)	Diesel	FM999996

BE/PL	1	89,942/89,964	96,000/96,022	30,900	2,988	0,060/0,129	EC	71-3144	71-3144 0.50
-------	---	---------------	---------------	--------	-------	-------------	----	---------	------------------------

11 128.00 x 143.30

D234-6	V6 Cyl.	10804cc		Diesel	FM6017
TBD234-6	V6 Cyl.	10804cc	300kW (408PS)	Diesel Turbo	FM16017

BE/PL	1	91,942/91,964	98,000/98,022	31,000	2,992	0,052/0,121	EC	71-3593	71-3593 STD
SE/PB	1	49,993/50,000	53,985/54,004	44,000	1,980		BC	55-3595	55-3595 STD

12 128.00 x 143.30







D234-8	V8 Cyl.	14405cc		Diesel	FM6018
TBD234-8	V8 Cyl.	14405cc	400kW (544PS)	Diesel Turbo	FM16018

BE/PL	1	91,942/91,964	98,000/98,022	31,000	2,992	0,052/0,121	EC	71-3593	71-3593 STD
SE/PB	1	49,993/50,000	53,985/54,004	44,000	1,980		BC	55-3595	55-3595 STD

13 128.00 x 143.30

D234-12	V12 Cyl.	21607cc	380-720kW (517-979PS)	Diesel	FM6020
----------------	----------	----------------	------------------------------	---------------	---------------

BE/PL	1	91,942/91,964	98,000/98,022	31,000	2,992	0,052/0,121	EC	71-3593	71-3593 STD
SE/PB	1	49,993/50,000	53,985/54,004	44,000	1,980		BC	55-3595	55-3595 STD

		cm ³	x 			
4 BT	Diesel	3922	4	102.00	120.00	8
4 BT 3.9 Euro 2	Diesel	3922	4	102.00	120.00	8
4 BTA 3.9 Euro 2	Diesel	3922	4	102.00	120.00	8
4 BTAA	Diesel	3922	4	102.00	120.00	8
6 B5.9	Diesel	5883	6	102.00	120.00	9
6 BT	Diesel	5880	6	102.00	120.00	9
6 BT5.9	Diesel	5883	6	102.00	120.00	9
6 BTA-180	Diesel	5880	6	102.00	120.00	9
6 BTA-5.9	Diesel	5880	6	102.00	120.00	9
6 C 8.3	Diesel	8270	6	114.00	135.00	23
6 C NA	Diesel	8270	6	114.00	135.00	23
6 CT	Diesel	8270	6	114.00	135.00	23
6 CT 8.3	Diesel	8270	6	114.00	135.00	23
6 CTA 8.3	Diesel	8270	6	114.00	135.00	23
6 CTAA	Diesel	8270	6	114.00	135.00	23
6 CTAA 8.3	Diesel	8270	6	114.00	135.00	23
8025.01	Diesel	1559	2	95.00	110.00	1
8025.02	Diesel	1728	2	100.00	110.00	3
8035.04	Diesel	2748	3	103.00	110.00	10
8035.05	Diesel	2930	3	104.00	115.00	15
8035.06	Diesel	2710	3	100.00	115.00	5
8045.01	Diesel	3119	4	95.00	110.00	2
8045.04	Diesel	3666	4	103.00	110.00	11
8045.05	Diesel	3908	4	104.00	115.00	16
8045.06	Diesel	3613	4	100.00	115.00	6
8045.25	Diesel	3908	4	104.00	115.00	17
8055.04	Diesel	4583	5	103.00	110.00	12
8055.05	Diesel	4885	5	104.00	115.00	18
8065.02	Diesel	5184	6	100.00	110.00	4
8065.04	Diesel	5499	6	103.00	110.00	13
8065.05	Diesel	5862	6	104.00	115.00	19
8065.06	Diesel	5420	6	100.00	115.00	7
8065.24	Diesel	5499	6	103.00	110.00	14
8065.25	Diesel	5868	6	104.00	115.00	20
B 5.9 Euro 2	Diesel	5883	6	102.00	120.00	9
Genesis	Diesel	4400	4	111.78	111.80	21
Genesis GE7450Si15 /.16	Diesel	5000	4	111.78	127.00	22
ISB 160 Euro 1	Diesel	5880	6	102.00	120.00	9
ISB 215 Euro 2	Diesel	5880	6	102.00	120.00	9
ISB 235 Euro 1	Diesel	5880	6	102.00	120.00	9
ISBe 135 Euro 3	Diesel	3922	4	102.00	120.00	8
ISBe 150 Euro 3	Diesel	3922	4	102.00	120.00	8
ISBe 170 Euro 3	Diesel	3922	4	102.00	120.00	8
ISBe 220 Euro 3	Diesel	5883	6	102.00	120.00	9
ISBe 250 Euro 3	Diesel	5883	6	102.00	120.00	9
ISBe 275 Euro 3	Diesel	5883	6	102.00	120.00	9

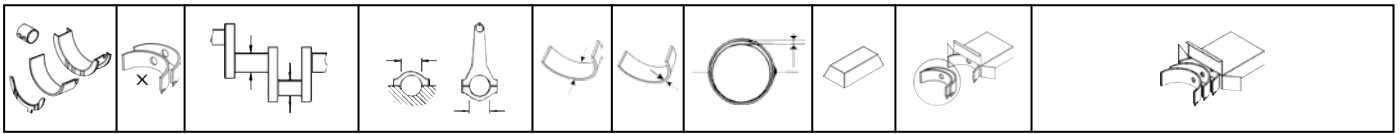

1 95.00 x 110.00

8025.01 2 Cyl. **1559cc** Diesel **FM569**

BE/PL	1	58,730/58,743	62,408/62,420	28,700	1,816	0,033/0,083	BS	66630CP	71-4229 STD 0.25 0.50 0.75 1.00
-------	---	---------------	---------------	--------	-------	-------------	----	---------	---

01/80 →

BE/PL	1	58,730/58,743	62,408/62,420	28,700	1,822	0,021/0,071	BS	60990CP	71-4281 STD 0.25 0.75
-------	---	---------------	---------------	--------	-------	-------------	----	---------	---------------------------------

→ **12/79**

66630CP

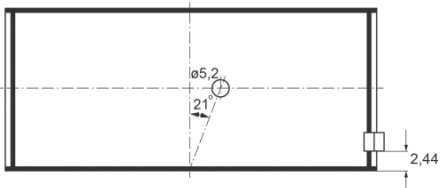

60990CP

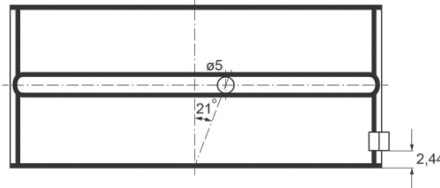

MB/HL	1	76,187/76,200	80,587/80,607	25,000	2,172	0,043/0,101	BS	66631CPA	72-4547 STD 0.25 0.50 0.75 1.00
-------	---	---------------	---------------	--------	-------	-------------	----	----------	---

01/80 →

MB/HL	1	76,187/76,200	80,587/80,607	25,000	2,172	0,043/0,101	BS	60076CP	72-4550 STD 0.25
-------	---	---------------	---------------	--------	-------	-------------	----	---------	----------------------------

→ **12/79**

66631CPA

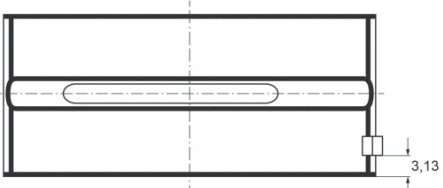

60076CP

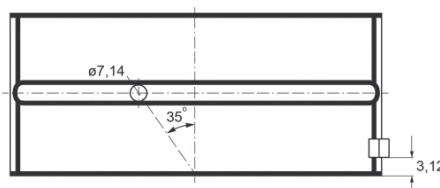

TW/A	4	85,090/85,340	101,600/101,850		3,429		AL-LF	60076AFA	A192/4 STD .005
------	---	---------------	-----------------	--	-------	--	-------	----------	---------------------------

TW/A	4	85,090/85,340	106,550/106,800		3,429		AL-LF	60076AFF	A193/4 STD .005
------	---	---------------	-----------------	--	-------	--	-------	----------	---------------------------

60076AFA

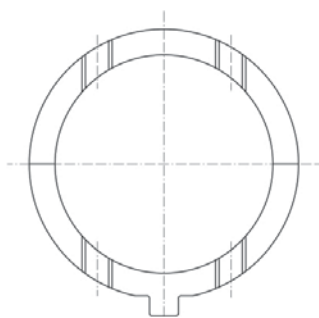

60076AFF

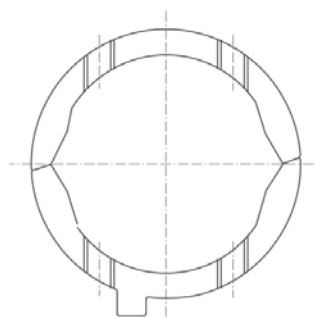

SE/PB	1	32,005/32,012	35,877/35,916	16,690			BS	60079X	55-4211 SEMI
-------	---	---------------	---------------	--------	--	--	----	--------	------------------------

→ **12/77**

NEW HOLLAND

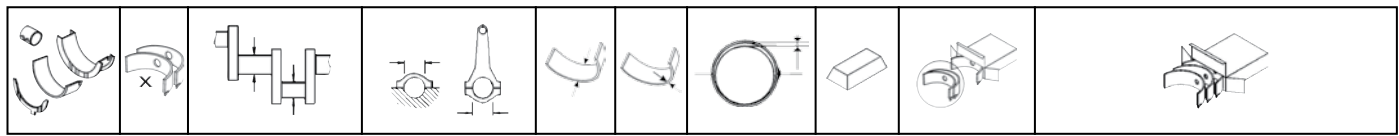

SE/PB	1	34,005/34,012	37,846/37,884	34,800			BS	66634YA	55-4230 SEMI
01/78 →									
SE/PB	1	32,005/32,012	35,877/35,916	34,800			BS	66634YC	55-4231 SEMI
→12/77									
SE/PB	1	34,005/34,012	37,846/37,884	16,690			BS	66634Y	55-4275 SEMI
01/78 →									
CB/NWB 1	1	50,975/51,000	54,780/54,805	28,000	1,875		AL-LF	66231DR	N153/3 STD
CB/NWB 3	1	49,975/50,000	53,780/53,805	24,000	1,875		AL-LF	66232DR	
CB/NWB 2	1	50,475/50,500	54,280/54,305	28,000	1,875		AL-LF	66233DR	

2 95.00 x 110.00

8045.01			4 Cyl.	3119cc			Diesel		FM571
BE/PL	1	58,730/58,743	62,408/62,420	28,700	1,816	0,033/0,083	BS	66630CP	71-4229 STD 0.25 0.50 0.75 1.00
01/80 →									
BE/PL	1	58,730/58,743	62,408/62,420	28,700	1,822	0,021/0,071	BS	60990CP	71-4281 STD 0.25 0.75
→12/79									

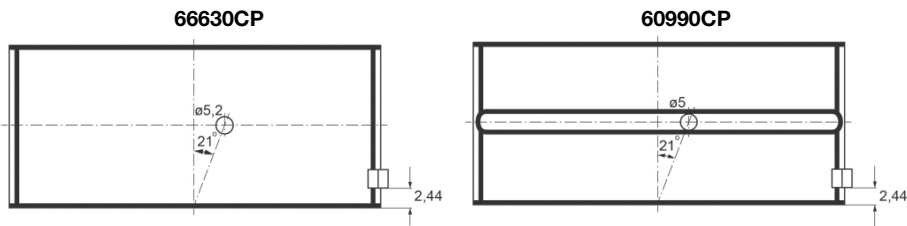

MB/HL	1	76,187/76,200	80,587/80,607	25,000	2,172	0,043/0,101	BS	66631CPA	72-4547 STD 0.25 0.50 0.75 1.00
01/80 →									
MB/HL	1	76,187/76,200	80,587/80,607	25,000	2,172	0,043/0,101	BS	60076CP	72-4550 STD 0.25
→12/79									

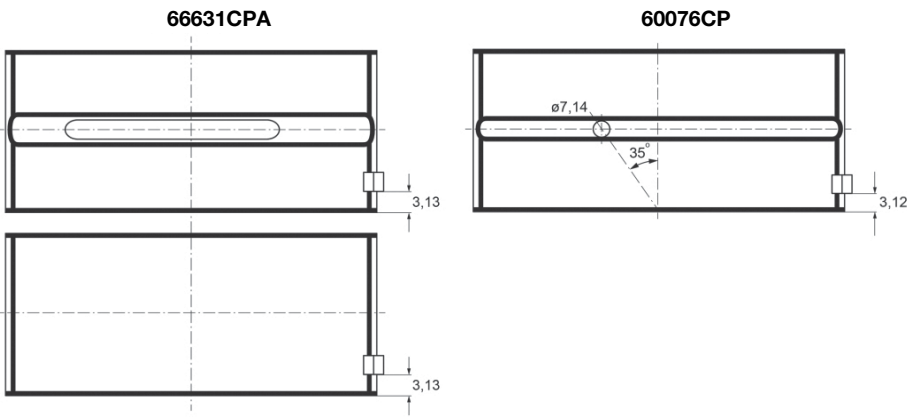

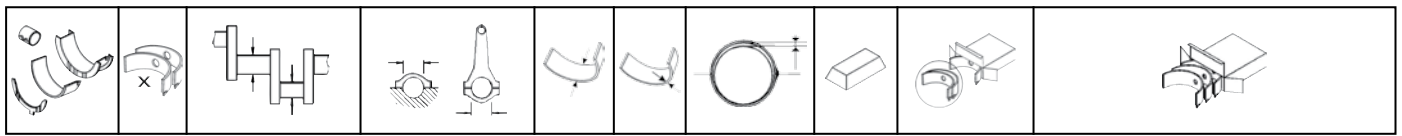

TW/A	4	85,090/85,340	101,600/101,850		3,429		AL-LF	60076AFA	A192/4 STD .005
TW/A	4	85,090/85,340	106,550/106,800		3,429		AL-LF	60076AFF	A193/4 STD .005

60076AFA

60076AFF

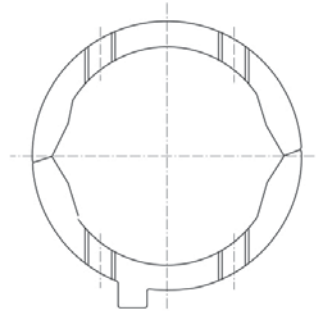
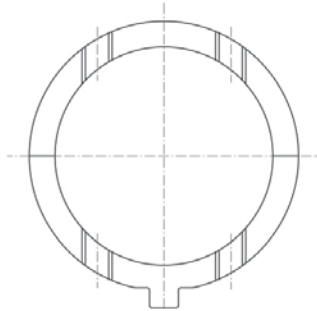

SE/PB	1	32,005/32,012	35,877/35,916	16,690			BS	60079X	55-4211 SEMI
-------	---	---------------	---------------	--------	--	--	----	--------	------------------------

→12/77

SE/PB	1	34,005/34,012	37,846/37,884	34,800			BS	66634YA	55-4230 SEMI
-------	---	---------------	---------------	--------	--	--	----	---------	------------------------

01/78→

SE/PB	1	32,005/32,012	35,877/35,916	34,800			BS	66634YC	55-4231 SEMI
-------	---	---------------	---------------	--------	--	--	----	---------	------------------------

→12/77

SE/PB	1	34,005/34,012	37,846/37,884	16,690			BS	66634Y	55-4275 SEMI
-------	---	---------------	---------------	--------	--	--	----	--------	------------------------

01/78→

3 100.00 x 110.00

8025.02 2 Cyl. 1728cc Diesel FM573

BE/PL	1	58,730/58,743	62,408/62,420	28,700	1,816	0,033/0,083	BS	66630CP	71-4229 STD 0.25 0.50 0.75 1.00
-------	---	---------------	---------------	--------	-------	-------------	----	---------	---

01/80→

BE/PL	1	58,730/58,743	62,408/62,420	28,700	1,822	0,021/0,071	BS	60990CP	71-4281 STD 0.25 0.75
-------	---	---------------	---------------	--------	-------	-------------	----	---------	---------------------------------

→12/79

66630CP

60990CP

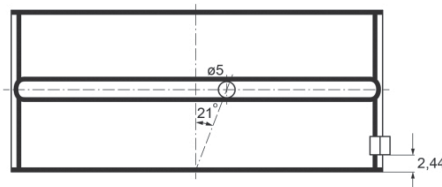
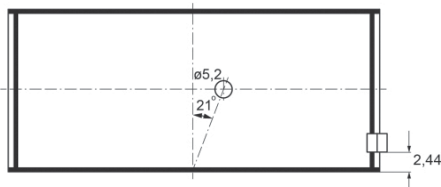

MB/HL	1	76,187/76,200	80,587/80,607	25,000	2,172	0,043/0,101	BS	66631CPA	72-4547 STD 0.25 0.50 0.75 1.00
-------	---	---------------	---------------	--------	-------	-------------	----	----------	---

01/80→

MB/HL	1	76,187/76,200	80,587/80,607	25,000	2,172	0,043/0,101	BS	60076CP	72-4550 STD 0.25
-------	---	---------------	---------------	--------	-------	-------------	----	---------	----------------------------

→12/79



66631CPA

60076CP

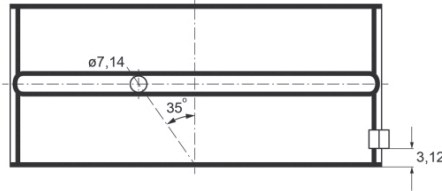
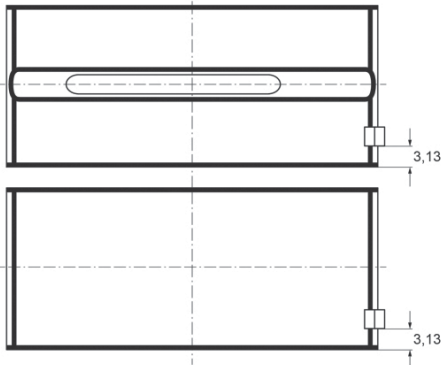

TW/A	4	85,090/85,340	101,600/101,850	3,429	AL-LF	60076AFA	A192/4 STD .005
TW/A	4	85,090/85,340	106,550/106,800	3,429	AL-LF	60076AFF	A193/4 STD .005

60076AFA

60076AFF

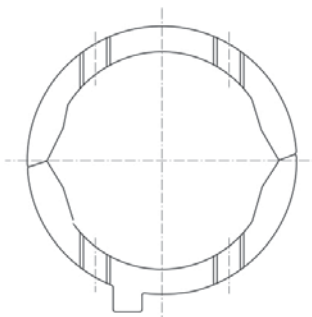
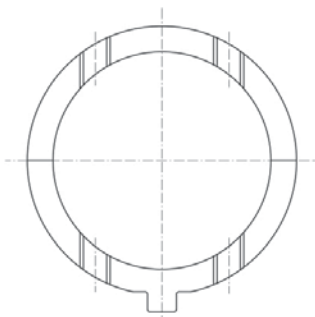

SE/PB	1	32,005/32,012	35,877/35,916	16,690	BS	60079X	55-4211 SEMI
-------	---	---------------	---------------	--------	----	--------	------------------------

→12/77

SE/PB	1	34,005/34,012	37,846/37,884	34,800	BS	66634YA	55-4230 SEMI
-------	---	---------------	---------------	--------	----	---------	------------------------

01/78→

SE/PB	1	32,005/32,012	35,877/35,916	34,800	BS	66634YC	55-4231 SEMI
-------	---	---------------	---------------	--------	----	---------	------------------------

→12/77

SE/PB	1	34,005/34,012	37,846/37,884	16,690	BS	66634Y	55-4275 SEMI
-------	---	---------------	---------------	--------	----	--------	------------------------

01/78→

CB/NWB 1	1	50,975/51,000	54,780/54,805	28,000	1,875	AL-LF	66231DR	N153/3 STD
CB/NWB 3	1	49,975/50,000	53,780/53,805	24,000	1,875	AL-LF	66232DR	
CB/NWB 2	1	50,475/50,500	54,280/54,305	28,000	1,875	AL-LF	66233DR	

4 100.00 x 110.00

8065.02 6 Cyl. **5184cc** Diesel **FM3477**

BE/PL	1	58,730/58,743	62,408/62,420	28,700	1,816	0,033/0,083	BS	66630CP	71-4229 STD 0.25 0.50 0.75 1.00
-------	---	---------------	---------------	--------	-------	-------------	----	---------	---

01/80→

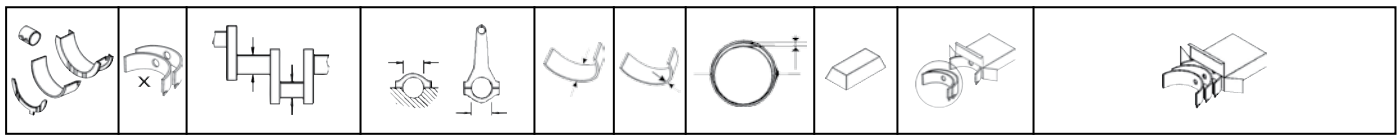

BE/PL	1	58,730/58,743	62,408/62,420	28,700	1,822	0,021/0,071	BS	60990CP	71-4281 STD 0.25 0.75
-------	---	---------------	---------------	--------	-------	-------------	----	---------	---------------------------------

→12/79

66630CP

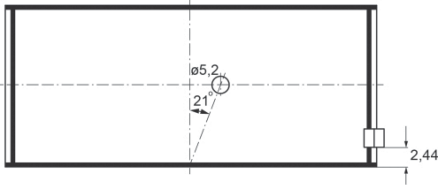

60990CP

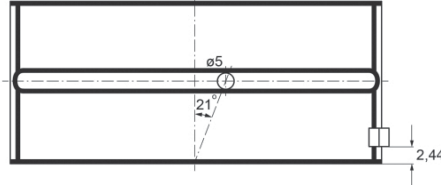

MB/HL	1	76,187/76,200	80,587/80,607	25,000	2,172	0,043/0,101	BS	66631CPA	72-4547 STD 0.25 0.50 0.75 1.00
-------	---	---------------	---------------	--------	-------	-------------	----	----------	---

01/80→

MB/HL	1	76,187/76,200	80,587/80,607	25,000	2,172	0,043/0,101	BS	60076CP	72-4550 STD 0.25
-------	---	---------------	---------------	--------	-------	-------------	----	---------	----------------------------

→12/79

66631CPA

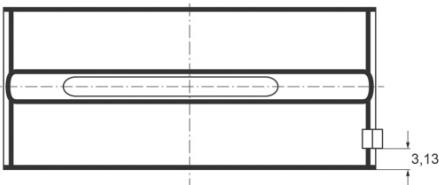

60076CP

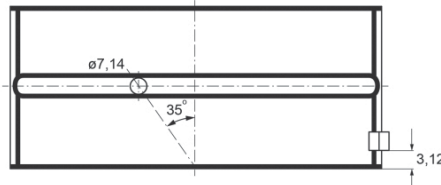

TW/A	4	85,090/85,340	101,600/101,850	3,429			AL-LF	60076AFA	A192/4 STD .005
TW/A	4	85,090/85,340	106,550/106,800	3,429			AL-LF	60076AFF	A193/4 STD .005

60076AFA

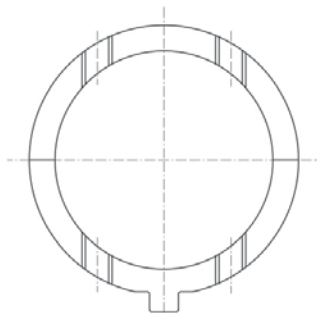

60076AFF

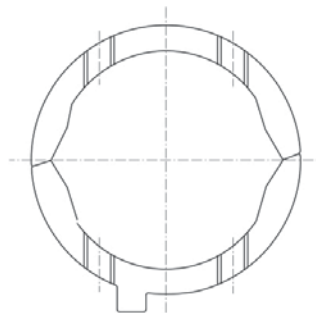

SE/PB	1	32,005/32,012	35,877/35,916	16,690			BS	60079X	55-4211 SEMI
-------	---	---------------	---------------	--------	--	--	----	--------	------------------------

→12/77

SE/PB	1	34,005/34,012	37,846/37,884	34,800			BS	66634YA	55-4230 SEMI
-------	---	---------------	---------------	--------	--	--	----	---------	------------------------

01/78→

SE/PB	1	32,005/32,012	35,877/35,916	34,800			BS	66634YC	55-4231 SEMI
-------	---	---------------	---------------	--------	--	--	----	---------	------------------------

→12/77

NEW HOLLAND



SE/PB	1	34,005/34,012	37,846/37,884	16,690			BS	66634Y	55-4275 SEMI
-------	---	---------------	---------------	--------	--	--	----	--------	------------------------

01/78 →

5 100.00 x 115.00

8035.06		3 Cyl.		2710cc		Diesel		FM4008	
BE/PL	1	63,725/63,744	67,407/67,422	28,700	1,815	0,033/0,092	BS	1010CP	71-4104 STD 0.25 0.50 0.75
MB/HL	1	79,791/79,810	84,200/84,230	25,000	2,179	0,032/0,106	BS	1011CP	72-4546 STD 0.25 0.50 0.75
TW/A	4	87,779/88,033	111,510/111,764		3,429		BS	1011BF	A169/4 STD .005
SE/PB	1	38,004/38,014	41,846/41,884	34,800			BS	1014Y	55-4105 SEMI
SE/PB	1	38,005/38,012	41,846/41,884	34,800			BS	1014YA	55-4106 SEMI

1014Y

1014YA

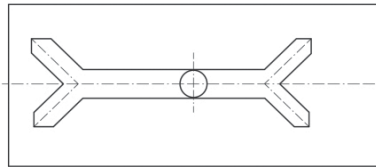
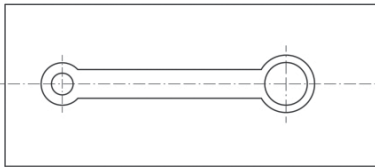

CB/NWB 2	1	50,975/51,000	54,780/54,805	28,000	1,875		AL-LF	66231DR	N154/4 STD
CB/NWB 4	1	49,975/50,000	53,780/53,805	24,000	1,875		AL-LF	66232DR	
CB/NWB 3	1	50,475/50,500	54,280/54,305	28,000	1,875		AL-LF	66233DR	
CB/NWB 1	1	51,475/51,500	55,280/55,305	28,000	1,875		AL-LF	66234DR	

6 100.00 x 115.00

8045.06		4 Cyl.		3613cc		Diesel		FM4013	
BE/PL	1	63,725/63,744	67,407/67,422	28,700	1,815	0,033/0,092	BS	1010CP	71-4104 STD 0.25 0.50 0.75
MB/HL	1	79,791/79,810	84,200/84,230	25,000	2,179	0,032/0,106	BS	1011CP	72-4546 STD 0.25 0.50 0.75
TW/A	4	87,779/88,033	111,510/111,764		3,429		BS	1011BF	A169/4 STD .005
SE/PB	1	38,004/38,014	41,846/41,884	34,800			BS	1014Y	55-4105 SEMI
SE/PB	1	38,005/38,012	41,846/41,884	34,800			BS	1014YA	55-4106 SEMI

1014Y

1014YA

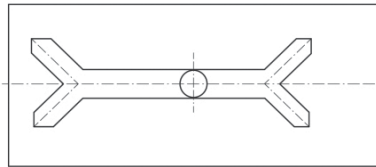
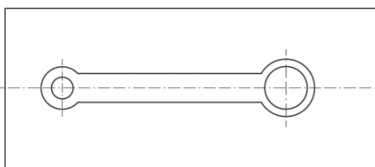

7 100.00 x 115.00

8065.06		6 Cyl.		5420cc		Diesel		FM4017	
BE/PL	1	63,725/63,744	67,407/67,422	28,700	1,815	0,033/0,092	BS	1010CP	71-4104 STD 0.25 0.50 0.75
MB/HL	1	79,791/79,810	84,200/84,230	25,000	2,179	0,032/0,106	BS	1011CP	72-4546 STD 0.25 0.50 0.75

TW/A	4	87,779/88,033	111,510/111,764		3,429			BS	1011BF	A169/4 STD .005
SE/PB	1	38,004/38,014	41,846/41,884	34,800				BS	1014Y	55-4105 SEMI
SE/PB	1	38,005/38,012	41,846/41,884	34,800				BS	1014YA	55-4106 SEMI

1014Y

1014YA

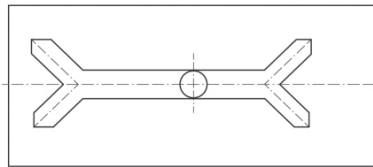
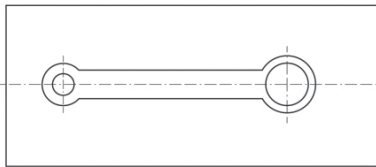

8		102.00 x 120.00								
4 BT			4 Cyl.	3922cc	81kW (110PS)		Diesel Turbo		TD6991	
4 BT 3.9 Euro 2			4 Cyl.	3922cc	57-87kW (78-118PS)		Diesel Turbo		TD21441	
4 BTA 3.9 Euro 2			4 Cyl.	3922cc	57-97kW (78-132PS)		Diesel Turbo Intercooler		TD21442	
4 BTAA			4 Cyl.	3922cc	103-110kW (140-150PS)		Diesel Turbo Intercooler		TD6965	
ISBe 135 Euro 3			4 Cyl.	3922cc	99kW (135PS)		Diesel Turbo Intercooler		TD18969	
ISBe 150 Euro 3			4 Cyl.	3922cc	110kW (150PS)		Diesel		TD18970	
ISBe 170 Euro 3			4 Cyl.	3922cc	123-125kW (167-170PS)		Diesel		TD18971	

BE/PL	1	68,987/69,013	72,987/73,013	31,130	1,968	0,038/0,114	EC	71-4573	71-4573 STD 0.25 0.50
BE/PL	1	68,987/69,013	72,987/73,013	31,130	1,968	0,038/0,114	EC	71-4573	71-4708 STD 0.25 0.50
BE/PL	1	68,987/69,013	72,987/73,013	31,130	1,968	0,038/0,114	EC	71-4708	

71-4573

71-4708

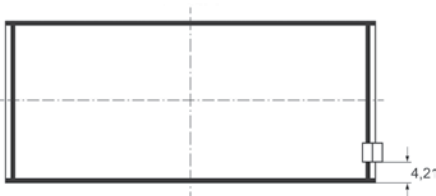

MB/HL	1	82,993/83,013	87,977/88,013	37,348	2,464	0,036/0,116	AL-LF	02-4574H	02-4574H STD 0.25 0.50
MB/HL	1	82,993/83,013	87,982/88,008	29,030	2,464	0,041/0,111	AL-LF	02-4576	
MB/HL	1	82,993/83,013	87,982/88,008	29,030	2,464	0,041/0,111	AL-LF	02-4576	02-4576 STD 0.25 0.50
SE/PB	1	40,000	42,987/43,013	38,100			BS	55-4706	55-4706 SEMI
CB/NWB	1		59,228/59,248	25,400			BS	53-4707	53-4707 SEMI

9		102.00 x 120.00								
6 B5.9			6 Cyl.	5883cc	85kW (115PS)		Diesel Turbo Intercooler		TD6612	
6 BT			6 Cyl.	5880cc	118kW (160PS)		Diesel Turbo		TD6966	
6 BT5.9			6 Cyl.	5883cc	100-117kW (136-159PS)		Diesel Turbo		TD6613	
6 BTA-180			6 Cyl.	5880cc	125kW (168PS)		Diesel Turbo Intercooler		TD23955	
6 BTA-5.9			6 Cyl.	5880cc	118kW (160PS)		Diesel Turbo Intercooler		TD7047	
B 5.9 Euro 2			6 Cyl.	5883cc	131-158kW (178-215PS)		Diesel Turbo		TD24478	
ISB 160 Euro 1			6 Cyl.	5880cc	119kW (162PS)		Diesel Turbo Intercooler		TD24050	
ISB 215 Euro 2			6 Cyl.	5880cc	158kW (215PS)		Diesel Turbo Intercooler		TD24027	
ISB 235 Euro 1			6 Cyl.	5880cc	172kW (235PS)		Diesel Turbo Intercooler		TD24046	

NEW HOLLAND



ISBe 220 Euro 3		6 Cyl.		5883cc	162kW (220PS)		Diesel Turbo Intercooler		TD24028
ISBe 250 Euro 3		6 Cyl.		5883cc	184kW (250PS)		Diesel Turbo Intercooler		TD20459
ISBe 275 Euro 3		6 Cyl.		5883cc	202kW (275PS)		Diesel Turbo Intercooler		TD20462
BE/PL	1	68,987/69,013	72,987/73,013	31,130	1,968	0,038/0,114	EC	71-4573	71-4573 STD 0.25 0.50
BE/PL	1	68,987/69,013	72,987/73,013	31,130	1,968	0,038/0,114	EC	71-4573	71-4708 STD 0.25 0.50
BE/PL	1	68,987/69,013	72,987/73,013	31,130	1,968	0,038/0,114	EC	71-4708	

71-4573

71-4708

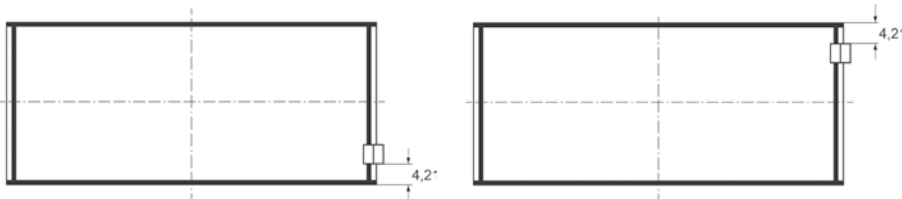

MB/HL	1	82,993/83,013	87,977/88,013	37,348	2,464	0,036/0,116	AL-LF	02-4574H	02-4574H STD 0.25 0.50
MB/HL	1	82,993/83,013	87,982/88,008	29,030	2,464	0,041/0,111	AL-LF	02-4576	
MB/HL	1	82,993/83,013	87,982/88,008	29,030	2,464	0,041/0,111	AL-LF	02-4576	02-4576 STD 0.25 0.50
SE/PB	1	40,000	42,987/43,013	38,100			BS	55-4706	55-4706 SEMI
CB/NWB	1		59,228/59,248	25,400			BS	53-4707	53-4707 SEMI

10

103.00 x 110.00

8035.04		3 Cyl.		2748cc	Diesel		FM4007		
BE/PL	1	58,730/58,743	62,408/62,420	28,700	1,816	0,033/0,083	BS	66630CP	71-4229 STD 0.25 0.50 0.75 1.00
01/80 →									
BE/PL	1	58,730/58,743	62,408/62,420	28,700	1,822	0,021/0,071	BS	60990CP	71-4281 STD 0.25 0.75
→ 12/79									

66630CP

60990CP

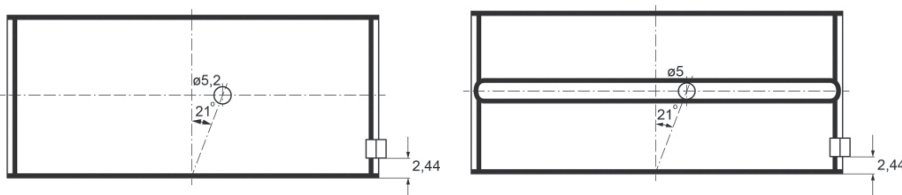

MB/HL	1	76,187/76,200	80,587/80,607	25,000	2,172	0,043/0,101	BS	66631CPA	72-4547 STD 0.25 0.50 0.75 1.00
01/80 →									
MB/HL	1	76,187/76,200	80,587/80,607	25,000	2,172	0,043/0,101	BS	60076CP	72-4550 STD 0.25
→ 12/79									

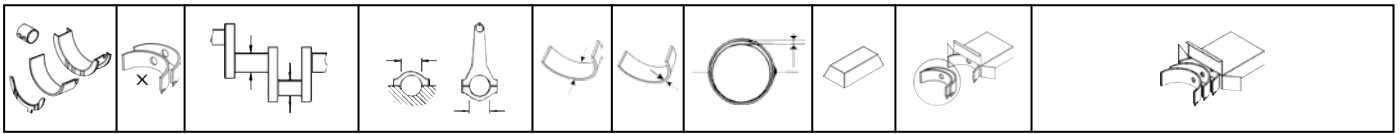

66631CPA

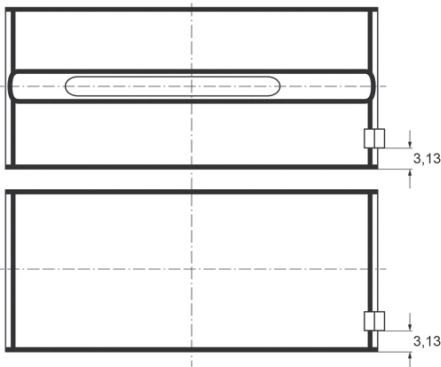

60076CP

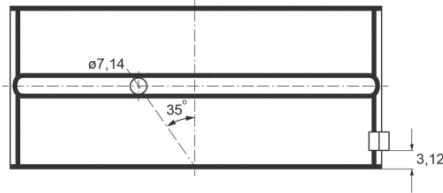

TW/A	4	85,090/85,340	101,600/101,850	3,429	AL-LF	60076AFA	A192/4 STD .005
TW/A	4	85,090/85,340	106,550/106,800	3,429	AL-LF	60076AFF	A193/4 STD .005

60076AFA

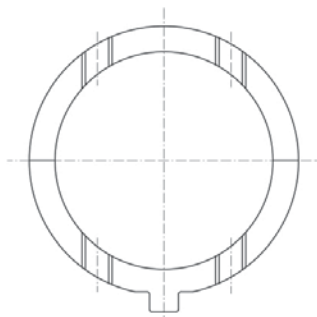

60076AFF

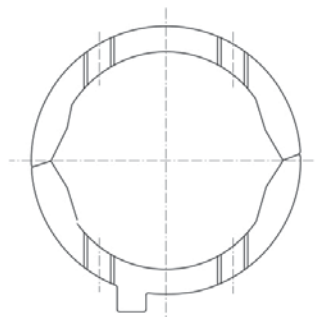

SE/PB	1	34,005/34,012	37,846/37,884	34,800		BS	66634YA	55-4230 SEMI
SE/PB	1	34,005/34,012	37,846/37,884	16,690		BS	66634Y	55-4275 SEMI
CB/NWB 2	1	50,975/51,000	54,780/54,805	28,000	1,875	AL-LF	66231DR	N154/4 STD
CB/NWB 4	1	49,975/50,000	53,780/53,805	24,000	1,875	AL-LF	66232DR	
CB/NWB 3	1	50,475/50,500	54,280/54,305	28,000	1,875	AL-LF	66233DR	
CB/NWB 1	1	51,475/51,500	55,280/55,305	28,000	1,875	AL-LF	66234DR	

11 103.00 x 110.00

8045.04 4 Cyl. **3666cc** Diesel **FM3483**

BE/PL	1	58,730/58,743	62,408/62,420	28,700	1,816	0,033/0,083	BS	66630CP	71-4229 STD 0.25 0.50 0.75 1.00
-------	---	---------------	---------------	--------	-------	-------------	----	---------	---

01/80 →

BE/PL	1	58,730/58,743	62,408/62,420	28,700	1,822	0,021/0,071	BS	60990CP	71-4281 STD 0.25 0.75
-------	---	---------------	---------------	--------	-------	-------------	----	---------	---------------------------------

→ **12/79**

66630CP

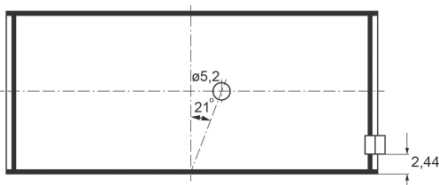

60990CP

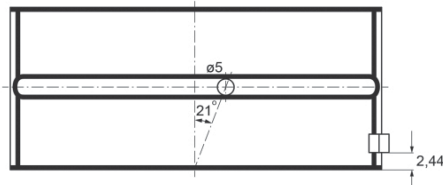

NEW HOLLAND

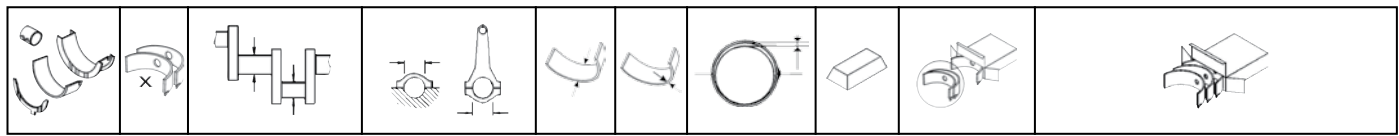

MB/HL	1	76,187/76,200	80,587/80,607	25,000	2,172	0,043/0,101	BS	66631CPA	72-4547 STD 0.25 0.50 0.75 1.00
-------	---	---------------	---------------	--------	-------	-------------	----	----------	---

01/80 →

MB/HL	1	76,187/76,200	80,587/80,607	25,000	2,172	0,043/0,101	BS	60076CP	72-4550 STD 0.25
-------	---	---------------	---------------	--------	-------	-------------	----	---------	----------------------------

→12/79

66631CPA

60076CP

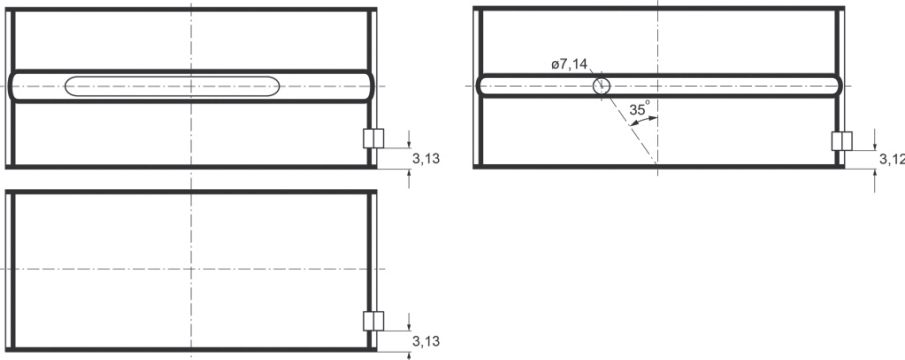

TW/A	4	85,090/85,340	101,600/101,850	3,429	AL-LF	60076AFA	A192/4 STD .005
TW/A	4	85,090/85,340	106,550/106,800	3,429	AL-LF	60076AFF	A193/4 STD .005

60076AFA

60076AFF

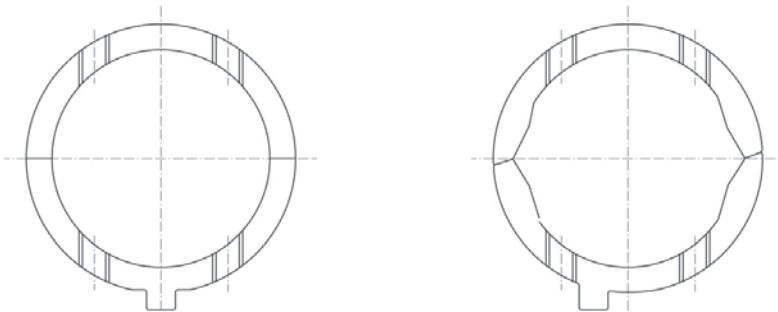

SE/PB	1	32,005/32,012	35,877/35,916	16,690	BS	60079X	55-4211 SEMI
-------	---	---------------	---------------	--------	----	--------	------------------------

→12/77

SE/PB	1	34,005/34,012	37,846/37,884	34,800	BS	66634YA	55-4230 SEMI
-------	---	---------------	---------------	--------	----	---------	------------------------

01/78 →

SE/PB	1	32,005/32,012	35,877/35,916	34,800	BS	66634YC	55-4231 SEMI
-------	---	---------------	---------------	--------	----	---------	------------------------

→12/77

SE/PB	1	34,005/34,012	37,846/37,884	16,690	BS	66634Y	55-4275 SEMI
-------	---	---------------	---------------	--------	----	--------	------------------------

01/78 →

12 103.00 x 110.00

8055.04 5 Cyl. 4583cc Diesel FM3484

BE/PL	1	58,730/58,743	62,408/62,420	28,700	1,816	0,033/0,083	BS	66630CP	71-4229 STD 0.25 0.50 0.75 1.00
MB/HL	1	76,187/76,200	80,587/80,607	25,000	2,172	0,043/0,101	BS	66631CPA	72-4547 STD 0.25 0.50 0.75 1.00
TW/A	4	85,090/85,340	101,600/101,850	3,429	AL-LF	60076AFA	A192/4 STD .005		

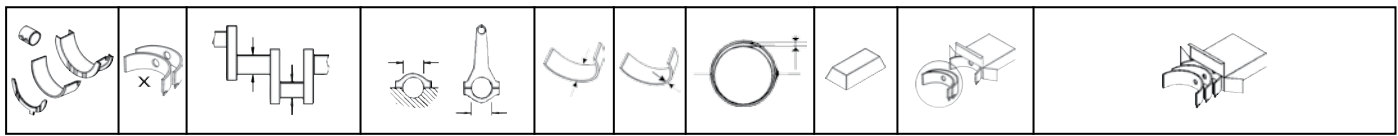

TW/A	4	85,090/85,340	106,550/106,800	3,429	AL-LF	60076AFF	A193/4 STD .005
------	---	---------------	-----------------	-------	-------	----------	---------------------------

60076AFA

60076AFF

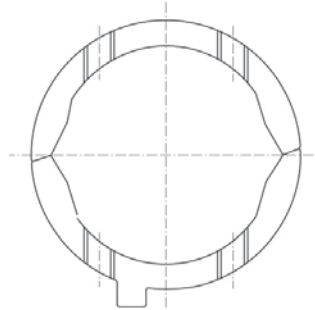
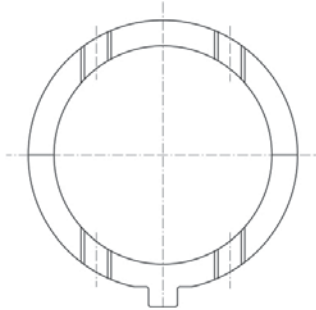

SE/PB	1	34,005/34,012	37,846/37,884	34,800	BS	66634YA	55-4230 SEMI
SE/PB	1	34,005/34,012	37,846/37,884	16,690	BS	66634Y	55-4275 SEMI

13 103.00 x 110.00

8065.04 6 Cyl. **5499cc** Diesel **FM3486**

BE/PL	1	58,730/58,743	62,408/62,420	28,700	1,816	0,033/0,083	BS	66630CP	71-4229 STD 0.25 0.50 0.75 1.00
-------	---	---------------	---------------	--------	-------	-------------	----	---------	---

01/80→

BE/PL	1	58,730/58,743	62,408/62,420	28,700	1,822	0,021/0,071	BS	60990CP	71-4281 STD 0.25 0.75
-------	---	---------------	---------------	--------	-------	-------------	----	---------	---------------------------------

→**12/79**

66630CP

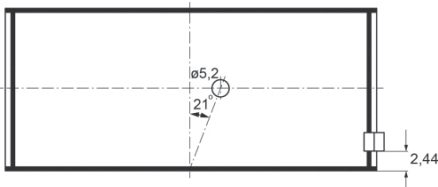

60990CP

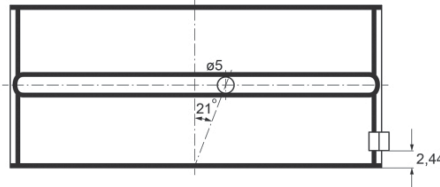

MB/HL	1	76,187/76,200	80,587/80,607	25,000	2,172	0,043/0,101	BS	66631CPA	72-4547 STD 0.25 0.50 0.75 1.00
-------	---	---------------	---------------	--------	-------	-------------	----	----------	---

01/80→

MB/HL	1	76,187/76,200	80,587/80,607	25,000	2,172	0,043/0,101	BS	60076CP	72-4550 STD 0.25
-------	---	---------------	---------------	--------	-------	-------------	----	---------	----------------------------

→**12/79**

66631CPA

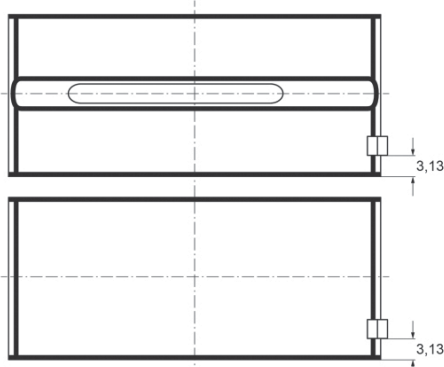

60076CP

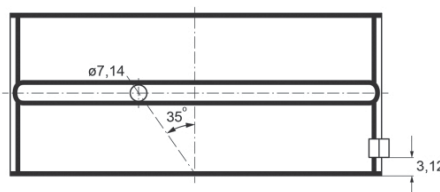

TW/A	4	85,090/85,340	101,600/101,850	3,429	AL-LF	60076AFA	A192/4 STD .005
------	---	---------------	-----------------	-------	-------	----------	---------------------------

NEW HOLLAND

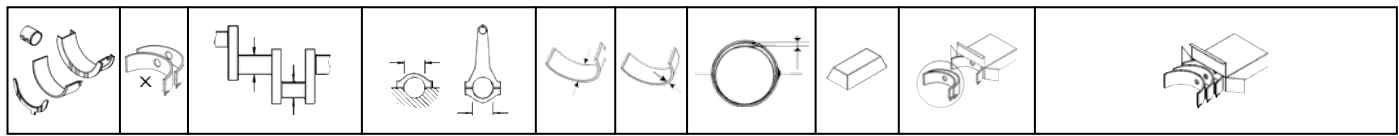

TW/A	4	85,090/85,340	106,550/106,800		3,429		AL-LF	60076AFF	A193/4 STD .005
------	---	---------------	-----------------	--	-------	--	-------	----------	---------------------------

60076AFA

60076AFF

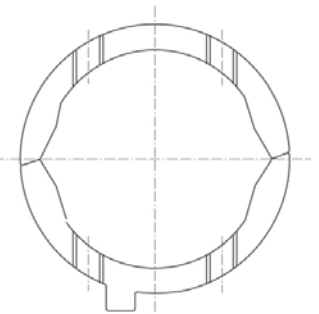
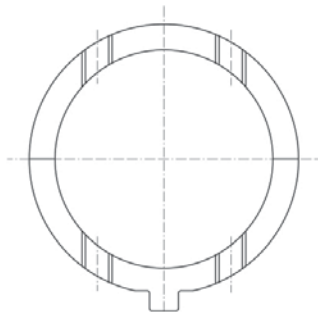

SE/PB	1	34,005/34,012	37,846/37,884	34,800			BS	66634YA	55-4230 SEMI
SE/PB	1	34,005/34,012	37,846/37,884	16,690			BS	66634Y	55-4275 SEMI

14 103.00 x 110.00

8065.24		6 Cyl.	5499cc				Diesel Turbo		FM3487
----------------	--	---------------	---------------	--	--	--	---------------------	--	---------------

BE/PL	1	58,730/58,743	62,408/62,420	28,700	1,816	0,033/0,083	BS	66630CP	71-4229 STD 0.25 0.50 0.75 1.00
MB/HL	1	76,187/76,200	80,587/80,607	25,000	2,172	0,043/0,101	BS	66631CPA	72-4547 STD 0.25 0.50 0.75 1.00
TW/A	4	85,090/85,340	101,600/101,850		3,429		AL-LF	60076AFA	A192/4 STD .005
TW/A	4	85,090/85,340	106,550/106,800		3,429		AL-LF	60076AFF	A193/4 STD .005

60076AFA

60076AFF

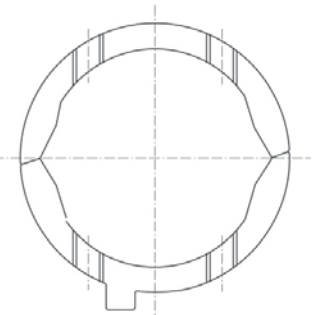
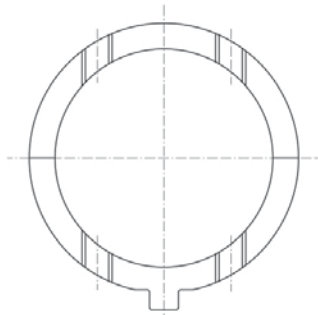

SE/PB	1	34,005/34,012	37,846/37,884	34,800			BS	66634YA	55-4230 SEMI
SE/PB	1	34,005/34,012	37,846/37,884	16,690			BS	66634Y	55-4275 SEMI

15 104.00 x 115.00

8035.05		3 Cyl.	2930cc				Diesel		FM4032
----------------	--	---------------	---------------	--	--	--	---------------	--	---------------

BE/PL	1	63,725/63,744	67,407/67,422	28,700	1,815	0,033/0,092	BS	1010CP	71-4104 STD 0.25 0.50 0.75
MB/HL	1	79,791/79,810	84,200/84,230	25,000	2,179	0,032/0,106	BS	1011CP	72-4546 STD 0.25 0.50 0.75
TW/A	4	87,779/88,033	111,510/111,764		3,429		BS	1011BF	A169/4 STD .005
SE/PB	1	38,004/38,014	41,846/41,884	34,800			BS	1014Y	55-4105 SEMI
SE/PB	1	38,005/38,012	41,846/41,884	34,800			BS	1014YA	55-4106 SEMI



1014Y

1014YA

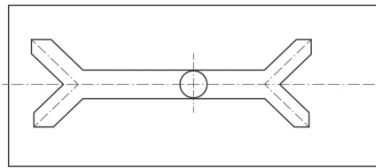
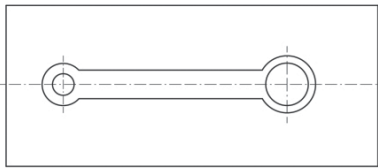

CB/NWB 2	1	50,975/51,000	54,780/54,805	28,000	1,875		AL-LF	66231DR	N154/4 STD
CB/NWB 4	1	49,975/50,000	53,780/53,805	24,000	1,875		AL-LF	66232DR	
CB/NWB 3	1	50,475/50,500	54,280/54,305	28,000	1,875		AL-LF	66233DR	
CB/NWB 1	1	51,475/51,500	55,280/55,305	28,000	1,875		AL-LF	66234DR	

16 104.00 x 115.00

8045.05		4 Cyl.		3908cc		Diesel			FM4012
BE/PL	1	63,725/63,744	67,407/67,422	28,700	1,815	0,033/0,092	BS	1010CP	71-4104 STD 0.25 0.50 0.75
MB/HL	1	79,791/79,810	84,200/84,230	25,000	2,179	0,032/0,106	BS	1011CP	72-4546 STD 0.25 0.50 0.75
TW/A	4	87,779/88,033	111,510/111,764		3,429		BS	1011BF	A169/4 STD .005
SE/PB	1	38,004/38,014	41,846/41,884	34,800			BS	1014Y	55-4105 SEMI
SE/PB	1	38,005/38,012	41,846/41,884	34,800			BS	1014YA	55-4106 SEMI

1014Y

1014YA

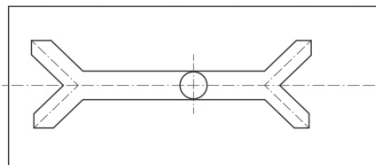
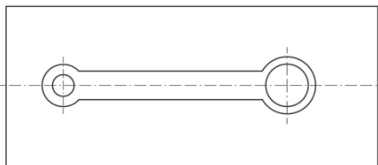

17 104.00 x 115.00

8045.25		4 Cyl.		3908cc		Diesel Turbo			FM9242
BE/PL	1	63,725/63,744	67,407/67,422	28,700	1,815	0,033/0,092	BS	1010CPA	71-4389 STD 0.25 0.50
MB/HL	1	79,791/79,810	84,200/84,230	25,000	2,179	0,032/0,106	BS	1011CP	72-4546 STD 0.25 0.50 0.75
TW/A	4	87,779/88,033	111,510/111,764		3,429		BS	1011BF	A169/4 STD .005
SE/PB	1	38,004/38,014	41,846/41,884	34,800			BS	1014Y	55-4105 SEMI

18 104.00 x 115.00

8055.05		5 Cyl.		4885cc		Diesel			FM4014
BE/PL	1	63,725/63,744	67,407/67,422	28,700	1,815	0,033/0,092	BS	1010CP	71-4104 STD 0.25 0.50 0.75
MB/HL	1	79,791/79,810	84,200/84,230	25,000	2,179	0,032/0,106	BS	1011CP	72-4546 STD 0.25 0.50 0.75
TW/A	4	87,779/88,033	111,510/111,764		3,429		BS	1011BF	A169/4 STD .005
SE/PB	1	38,004/38,014	41,846/41,884	34,800			BS	1014Y	55-4105 SEMI
SE/PB	1	38,005/38,012	41,846/41,884	34,800			BS	1014YA	55-4106 SEMI



1014Y

1014YA

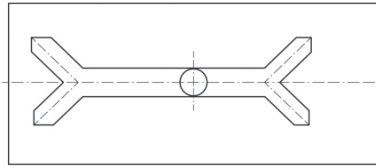
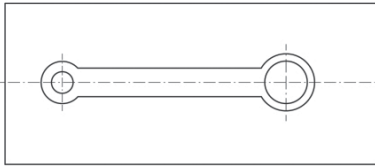

19 104.00 x 115.00

8065.05		6 Cyl.		5862cc		Diesel			FM4016
BE/PL	1	63,725/63,744	67,407/67,422	28,700	1,815	0,033/0,092	BS	1010CP	71-4104 STD 0.25 0.50 0.75
MB/HL	1	79,791/79,810	84,200/84,230	25,000	2,179	0,032/0,106	BS	1011CP	72-4546 STD 0.25 0.50 0.75
TW/A	4	87,779/88,033	111,510/111,764		3,429		BS	1011BF	A169/4 STD .005
SE/PB	1	38,004/38,014	41,846/41,884	34,800			BS	1014Y	55-4105 SEMI
SE/PB	1	38,005/38,012	41,846/41,884	34,800			BS	1014YA	55-4106 SEMI

1014Y

1014YA

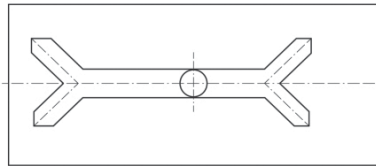
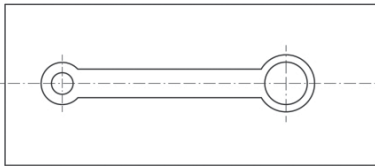

20 104.00 x 115.00

8065.25		6 Cyl.		5868cc		94-110kW (128-150PS)		Diesel Turbo		FM4018
BE/PL	1	63,725/63,744	67,407/67,422	28,700	1,815	0,033/0,092	BS	1010CPA	71-4389 STD 0.25 0.50	
MB/HL	1	79,791/79,810	84,200/84,230	25,000	2,179	0,032/0,106	BS	1011CP	72-4546 STD 0.25 0.50 0.75	
TW/A	4	87,779/88,033	111,510/111,764		3,429		BS	1011BF	A169/4 STD .005	
SE/PB	1	38,004/38,014	41,846/41,884	34,800			BS	1014Y	55-4105 SEMI	

21 111.78 x 111.80

Genesis		4 Cyl.		4400cc		Diesel			FM6763
BE/PL	1	69,840/69,860	74,706/74,727	31,750	2,400	0,046/0,087	AL-LF	GS70431LC	71-4375 STD 0.25 0.50 0.75 1.00
MB/HL 1,2,4,5	4	85,633/85,654	92,055/92,075	28,190	3,177	0,047/0,113	BS	3106RA	H1033/5 STD 0.25 0.50 0.75 1.00
MB/HL 3	1	85,633/85,654	92,055/92,075	36,910	3,177	0,047/0,113	BS	3107RAH	

22 111.78 x 127.00

GENESIS GE7450Si15 /.16		4 Cyl.		5000cc		Diesel Turbo			FM6767
BE/PL	1	69,840/69,860	74,706/74,727	31,750	2,400	0,046/0,087	AL-LF	GS70431LC	71-4375 STD 0.25 0.50 0.75 1.00
MB/HL 1,2,4,5	4	85,633/85,654	92,055/92,075	28,190	3,177	0,047/0,113	BS	3106RA	H1033/5 STD 0.25 0.50 0.75 1.00
MB/HL 3	1	85,633/85,654	92,055/92,075	36,910	3,177	0,047/0,113	BS	3107RAH	

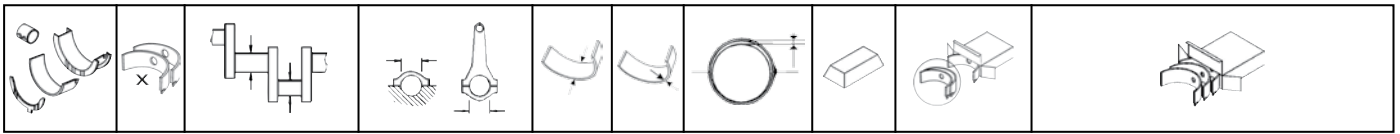

23 **114.00 x 135.00**

6 C 8.3	6 Cyl.	8270cc	121kW (165PS)	Diesel	TD9350
6 C NA	6 Cyl.	8270cc	122kW (166PS)	Diesel	TD6968
6 CT	6 Cyl.	8270cc	158kW (215PS)	Diesel Turbo	TD6967
6 CT 8.3	6 Cyl.	8270cc	160kW (218PS)	Diesel Turbo	TD7558
6 CTA 8.3	6 Cyl.	8270cc	179kW (243PS)	Diesel Turbo Intercooler	TD7559
6 CTAA	6 Cyl.	8270cc	158-177kW (215-241PS)	Diesel Turbo Intercooler	TD6969
6 CTAA 8.3	6 Cyl.	8270cc	213-223kW (290-303PS)	Diesel Turbo Intercooler	TD9351

BE/PL	1	75,961/76,012	80,988/81,013	38,125	2,533	0,033/0,117	BS	71-4986	71-4986/6 STD
MB/HL	6	97,963/98,013	104,99/105,02	34,112	3,454	0,061/0,140	BS	02-4987	H1344/7 STD
MB/HL	7	97,963/98,013	104,99/105,02	34,112	3,454	0,061/0,140	BS	02-4988	
MB/HL	1	97,963/98,013	104,99/105,02	42,788	3,454	0,061/0,140	BS	02-4989H	



cm3



9

100 NX 2.0	10/90→10/94	Petrol	SR20DE	1998	4	86.00	86.00	45
100 NX 2.0 GTI	03/91→10/94	Petrol	SR20DE	1998	4	86.00	86.00	45
180 SX 1.8	09/88→06/92	Petrol	CA18DE	1809	4	83.00	83.60	30
180 SX 1.8 Turbo	09/88→06/92	Petrol	CA18DT	1809	4	83.00	83.60	30
180 SX 1.8 Turbo II	04/89→06/92	Petrol	CA18DET	1809	4	83.00	83.60	30
180 SX 2.0	04/91→03/94	Petrol	SR20DE	1998	4	86.00	86.00	45
200 SX 1.8	09/88→03/94	Petrol	CA18DE	1809	4	83.00	83.60	30
200 SX 1.8 Turbo	07/88→11/93	Petrol	CA18DET	1809	4	83.00	83.60	30
200 SX 1.8 Turbo	01/92→09/94	Petrol	CA18DT	1809	4	83.00	83.60	30
200SX 2.0	09/76→12/79	Petrol	L20B	1952	4	85.00	86.00	43
200 SX 2.0	01/79→06/81	Petrol	Z20E	1952	4	85.00	86.00	43
200SX 2.0	09/79→12/81	Petrol	Z20E	1952	4	85.00	86.00	43
200 SX 2.0	09/95→12/99	Petrol	SR20DE	1998	4	86.00	86.00	45
200 SX 2.0 i 16V	07/88→12/99	Petrol	SR20DE	1998	4	86.00	86.00	45
210 1.4	09/78→12/80	Petrol	A14	1397	4	76.00	77.00	11
210 1.5	09/79→12/82	Petrol	A15	1488	4	76.00	82.00	13
240 SX 2.4	08/88→05/93	Petrol	Z24i	2389	4	89.00	96.00	53
310 1.4	09/78→12/80	Petrol	A14	1397	4	76.00	77.00	11
310 1.5	09/80→12/82	Petrol	A15	1488	4	76.00	82.00	13
510 2.0	09/77→12/81	Petrol	L20B	1952	4	85.00	86.00	43
610 2.0	09/73→12/76	Petrol	L20B	1952	4	85.00	86.00	43
620 2.0	09/74→12/79	Petrol	L20B	1952	4	85.00	86.00	43
710 2.0	09/74→12/77	Petrol	L20B	1952	4	85.00	86.00	43
720 2.0	09/79→12/86	Petrol	L20B	1952	4	85.00	86.00	43
720 2.0 4WD	09/79→12/80	Petrol	L20B	1952	4	85.00	86.00	43
720 2.2	09/80→12/83	Petrol	Z22	2188	4	87.00	92.00	47
720 2.2 4WD	09/80→12/83	Petrol	Z22	2188	4	87.00	92.00	47
720 2.2 D	09/80→12/83	Diesel	SD22	2164	4	83.00	100.00	32
720 2.2 D 4WD	09/80→12/83	Diesel	SD22	2164	4	83.00	100.00	32
720 2.4	09/82→12/86	Petrol	Z24	2388	4	89.00	96.00	53
720 2.4	09/82→12/86	Petrol	Z24i	2389	4	89.00	96.00	53
720 2.4 4WD	09/83→12/86	Petrol	Z24	2388	4	89.00	96.00	53
720 2.4 4WD	09/83→12/86	Petrol	Z24i	2389	4	89.00	96.00	53
720 2.5 D	09/83→12/86	Diesel	SD25	2488	4	89.00	100.00	56
720 2.5 D 4WD	09/83→12/86	Diesel	SD25	2488	4	89.00	100.00	56
1400 1.4	08/81→09/08	Petrol	A14	1397	4	76.00	77.00	11
AD 1.3	10/81→08/88	Petrol	E13S	1269	4	76.00	70.00	9
AD 1.5	10/81→08/88	Petrol	E15S	1488	4	76.00	82.00	14
AD 1.5	12/06→	Petrol	HR15DE	1498	4	78.00	78.40	17
AD 1.6	06/87→04/90	Petrol	E16S	1597	4	76.00	88.00	15
AD 1.6 4WD	12/08→	Petrol	HR16DE	1598	4	78.00	83.60	19
AD 1.7 D	10/84→12/08	Diesel	CD17	1681	4	80.00	83.60	22
AD 1.8	12/06→	Petrol	MR18DE	1798	4	84.00	81.10	35
AD 2.0	10/94→08/01	Petrol	SR20DE	1998	4	86.00	86.00	45
AD 2.0 D	10/94→04/99	Diesel	CD20	1974	4	84.50	88.00	40
Almera 1.5 i	08/12→	Petrol	HR15DE	1498	4	78.00	78.40	17
Almera I 2.0 D	11/95→07/00	Diesel	CD20	1974	4	84.50	88.00	40
Almera I 2.0 GTi	07/96→03/00	Petrol	SR20DE	1998	4	86.00	86.00	45
Almera II 1.5 dCi	01/03→	Diesel	K9K 722	1461	4	76.00	80.50	12
Almera II 1.6	08/12→	Petrol	HR16DE	1598	4	78.00	83.60	19
Almera II 2.0	08/02→	Petrol	SR20DE	1998	4	86.00	86.00	45
Almera II 2.2 dCi	09/03→	Diesel	YD22DDT	2184	4	86.00	94.00	46
Almera II 2.2 dCi	09/03→	Diesel	YD22DDTi	2184	4	86.00	94.00	46
Almera II 2.2 Di	03/00→	Diesel	YD22DDT	2184	4	86.00	94.00	46
Almera Tino 2.0	08/00→	Petrol	SR20DE	1998	4	86.00	86.00	45
Almera Tino 2.2 dCi	09/03→	Diesel	YD22DDT	2184	4	86.00	94.00	46
Almera Tino 2.2 dCi	09/03→	Diesel	YD22DDTi	2184	4	86.00	94.00	46
Almera Tino 2.2 Di	08/00→	Diesel	YD22DDTi	2184	4	86.00	94.00	46
Altima 2.5	08/01→	Petrol	QR25DE	2488	4	89.00	100.00	55
Altima 2.5 Hybrid	10/06→	Petrol	QR25DE	2488	4	89.00	100.00	55
Aprio 1.6	07/08→12/10	Petrol	K4M	1598	4	79.50	80.50	20
Atlas 2.0	10/93→10/97	Petrol	Z20S	1952	4	85.00	86.00	43
Atlas 2.5 D	10/93→10/97	Diesel	TD25	2494	4	92.90	92.00	58
Atlas 2.7 TDiC	07/96→10/04	Diesel	TD27TI	2664	4	96.00	92.00	62
Auster 1.8 Turbo	04/87→10/89	Petrol	CA18T	1809	4	83.60	83.00	34
Auster 2.0	06/86→10/89	Petrol	CA20S	1974	4	84.50	88.00	39
Avenir 2.0	10/89→10/97	Petrol	CA20E	1974	4	84.50	88.00	39
Avenir 2.0	06/86→10/90	Petrol	CA20S	1974	4	84.50	88.00	39
Avenir 2.0	09/01→	Petrol	QR20DE	1998	4	89.00	80.30	50

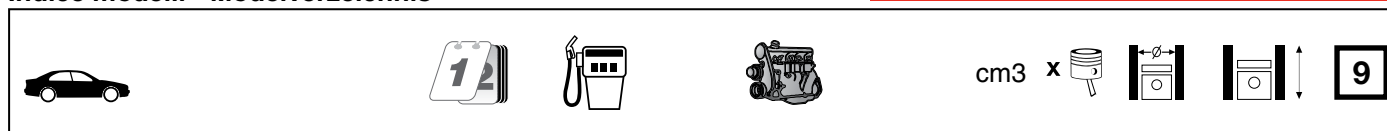

Avenir 2.0	11/97→08/01	Petrol	SR20DE	1998	4	86.00	86.00	45
Avenir 2.0 4x4	09/01→	Petrol	QR20DE	1998	4	89.00	80.30	50
Avenir 2.0 4x4	11/97→12/05	Petrol	SR20DE	1998	4	86.00	86.00	45
Avenir 2.0 TD	10/87→10/92	Diesel	LD20T	1952	4	85.00	86.00	43
Avenir 2.0 TD	11/92→09/99	Diesel	CD20T	1974	4	84.50	88.00	40
B210	01/73→	Petrol	A13 (Early)	1270	4	76.00	76.00	10
B210 1.4	09/74→12/78	Petrol	A14	1397	4	76.00	77.00	11
Bassara 2.5	06/02→08/03	Petrol	QR25DE	2488	4	89.00	100.00	55
Bassara 2.5 DCi	11/99→08/03	Diesel	YD25DDTi	2488	4	89.00	100.00	57
Bluebird 1.6	04/72→11/83	Petrol	L16	1595	4	83.00	73.70	29
Bluebird 1.6	12/85→06/91	Petrol	CA16S	1598	4	78.00	83.60	18
Bluebird 1.6 DX	11/83→02/88	Petrol	CA16S	1598	4	78.00	83.60	18
Bluebird 1.8	04/72→11/79	Petrol	L18	1770	4	85.00	78.00	41
Bluebird 1.8	01/80→05/84	Petrol	L18S	1770	4	85.00	78.00	41
Bluebird 1.8	01/80→05/84	Petrol	L18T	1770	4	85.00	78.00	41
Bluebird 1.8	05/86→11/92	Petrol	CA18N	1809	4	83.00	83.60	30
Bluebird 1.8	11/83→04/90	Petrol	CA18S	1809	4	83.00	83.60	30
Bluebird 1.8	11/91→03/97	Petrol	SR18DE	1838	4	82.50	86.00	26
Bluebird 1.8 i 16V	02/89→12/90	Petrol	CA18D	1809	4	83.00	83.60	30
Bluebird 1.8 Turbo	09/84→04/90	Petrol	CA18ET	1809	4	83.00	83.60	30
Bluebird 1.8 Turbo	04/84→11/92	Petrol	CA18T	1809	4	83.60	83.00	34
Bluebird 1.9 i	01/82→05/84	Petrol	Z20E	1952	4	85.00	86.00	43
Bluebird 2.0	09/74→03/85	Petrol	L20B	1952	4	85.00	86.00	43
Bluebird 2.0	12/85→01/88	Petrol	CA20E	1974	4	84.50	88.00	39
Bluebird 2.0	04/85→09/90	Petrol	CA20S	1974	4	84.50	88.00	39
Bluebird 2.0	11/91→03/97	Petrol	SR20DE	1998	4	86.00	86.00	45
Bluebird 2.0 D	01/80→03/97	Diesel	LD20	1952	4	85.00	86.00	43
Bluebird 2.0 i	05/81→03/85	Petrol	L20B	1952	4	85.00	86.00	43
Bluebird 2.0 i	01/82→12/83	Petrol	Z20E	1952	4	85.00	86.00	43
Bluebird 2.0 i	04/84→12/90	Petrol	CA20E	1974	4	84.50	88.00	39
Bluebird 2.0 LX	12/85→02/90	Petrol	CA20S	1974	4	84.50	88.00	39
Bluebird 2.0 TD	01/83→12/85	Diesel	LD20T	1952	4	85.00	86.00	43
Bluebird Sylphy I 2.0	09/02→08/05	Petrol	QR20DD	1998	4	89.00	80.30	50
Bluebird Sylphy I 2.0	08/00→08/02	Petrol	SR20DE	1998	4	86.00	86.00	45
Bluebird Sylphy II 1.5	09/05→08/12	Petrol	HR15DE	1498	4	78.00	78.40	17
Bluebird Sylphy II 1.5 4x4	09/05→08/12	Petrol	HR15DE	1498	4	78.00	78.40	17
Bluebird Sylphy II 1.6	12/12→	Petrol	K4M	1598	4	79.50	80.50	20
Bluebird Sylphy II 2.0	09/05→08/12	Petrol	MR20DE	1997	4	84.00	90.10	37
Bobby 1.5	11/87→11/94	Petrol	A15S	1488	4	76.00	82.00	13
Bobby 2.0 DLX	11/87→11/94	Diesel	LD20	1952	4	85.00	86.00	43
Bobby 2.0 DX	11/87→11/94	Diesel	LD20	1952	4	85.00	86.00	43
Cabstar 2.0	01/82→05/94	Petrol	Z20S	1952	4	85.00	86.00	43
Cabstar 2.3 D	01/87→12/89	Diesel	TD23	2289	4	89.00	92.00	52
Cabstar 2.4	09/85→09/93	Petrol	Z24	2388	4	89.00	96.00	53
Cabstar 2.5 D	01/89→12/00	Diesel	TD25	2494	4	92.90	92.00	58
Cabstar 2.5 dCi	10/06→09/11	Diesel	YD25DDTi	2488	4	89.00	100.00	57
Cabstar 2.5 TD	01/92→09/93	Diesel	TD25	2494	4	92.90	92.00	58
Cabstar 2.7 D	10/00→04/04	Diesel	TD27	2663	4	96.00	92.00	60
Cabstar 3.0 TD	10/00→04/04	Diesel	BD-30Ti	2953	4	96.00	102.00	63
Cabstar 3.2 TDiC	01/03→06/10	Diesel	QD32	3153	4	99.20	102.00	65
Cabstar 35 DI 3.0	01/04→12/06	Diesel	BD-30Ti	2953	4	96.00	102.00	63
Cabstar E 2.5 D	09/07→12/08	Diesel	YD25DDTi	2488	4	89.00	100.00	57
Cedric 2.0	05/84→08/87	Petrol	CA20S	1974	4	84.50	88.00	39
Cedric 2.3 D	05/84→08/87	Diesel	SD23	2289	4	89.00	92.00	51
Cedric 2.8 D	06/91→04/99	Diesel	RD28T	2826	6	85.00	83.00	42
Cedric 2.8 TD	06/91→10/95	Diesel	RD28	2826	6	85.00	83.00	42
Cefiro 2.4	06/88→09/94	Petrol	Z24i	2389	4	89.00	96.00	53
Cherry 1.0	09/70→09/78	Petrol	A10	988	4	73.00	59.00	3
Cherry II 1.0	08/78→07/81	Petrol	A10	988	4	73.00	59.00	3
Cherry II 1.0	08/78→07/81	Petrol	A10S	988	4	73.00	59.00	3
Cherry II 1.0	08/81→05/82	Petrol	E10	988	4	73.00	59.00	4
Cherry II 1.2	08/78→07/81	Petrol	A12	1171	4	73.00	70.00	5
Cherry II 1.3	08/81→12/83	Petrol	E13	1269	4	76.00	70.00	9
Cherry II 1.4	08/78→07/81	Petrol	A14	1397	4	76.00	77.00	11
Cherry II 1.4	08/80→07/81	Petrol	A14S	1397	4	76.00	77.00	11
Cherry II 1.4 i.e.	08/80→07/81	Petrol	A14S	1397	4	76.00	77.00	11
Cherry II 1.5	08/81→12/82	Petrol	E15	1488	4	76.00	82.00	14
Cherry III 1.0	05/82→05/86	Petrol	E10	988	4	73.00	59.00	4
Cherry III 1.3	05/82→10/86	Petrol	E13	1269	4	76.00	70.00	9











cm3











9

Cherry III 1.5	11/83→06/86	Petrol	E15	1488	4	76.00	82.00	14
Cherry III 1.5	11/83→10/86	Petrol	E15S	1488	4	76.00	82.00	14
Cherry III 1.5 ET Turbo	01/83→12/85	Petrol	E15ET	1488	4	76.00	82.00	14
Cherry III 1.6	05/84→09/87	Petrol	E16	1597	4	76.00	88.00	15
Cherry III 1.7 D	10/82→12/86	Diesel	CD17	1681	4	80.00	83.60	22
Cima 2.0	07/96→02/01	Petrol	SR20DE	1998	4	86.00	86.00	45
Crew 2.8 D	04/86→08/03	Diesel	RD28	2826	6	85.00	83.00	42
Cube 1.5	01/03→09/05	Petrol	HR15DE	1498	4	78.00	78.40	17
Cube 1.5 4x4	01/03→09/05	Petrol	HR15DE	1498	4	78.00	78.40	17
Cube 1.5 16V	11/08→	Petrol	HR15DE	1498	4	78.00	78.40	17
Cube 1.5 dCi	03/10→	Diesel	K9K	1461	4	76.00	80.50	12
Cube 1.6 16V	03/10→	Petrol	HR16DE	1598	4	78.00	83.60	19
Cube 1.8	09/08→	Petrol	MR18DE	1798	4	84.00	81.10	35
Datsun 1.4	02/79→06/83	Petrol	A14	1397	4	76.00	77.00	11
Datsun F-II 1.0	12/75→08/80	Petrol	A10	988	4	73.00	59.00	3
Datsun 100 A 1.0	12/74→06/78	Petrol	A10	988	4	73.00	59.00	3
Datsun 100 A F-II 1.0	12/75→08/80	Petrol	A10	988	4	73.00	59.00	3
Datsun 120 A F-II 1.2	12/75→07/80	Petrol	A12	1171	4	73.00	70.00	5
Datsun 120 Y 1.2	09/74→07/80	Petrol	A12	1171	4	73.00	70.00	5
Datsun 120 Y 1.2	04/62→07/80	Petrol	A12	1171	4	73.00	70.00	5
Datsun 120 Y A F-II 1.2	12/75→08/80	Petrol	A12	1171	4	73.00	70.00	5
Datsun 140 J 1.4	01/73→05/77	Petrol	L14	1428	4	83.00	66.00	28
Datsun 160 J 1.6	01/73→01/78	Petrol	L16S	1595	4	83.00	73.70	29
Datsun 160 J 1.6	01/73→02/82	Petrol	L16T	1595	4	83.00	73.70	29
Datsun 160 J 1.6 i.e.	01/78→02/82	Petrol	L16	1595	4	83.00	73.70	29
Datsun 180 B 1.8	05/77→01/81	Petrol	L18	1770	4	85.00	78.00	41
Datsun 180 B 1.8	05/77→01/81	Petrol	L18S	1770	4	85.00	78.00	41
Datsun 180 B 1.8	05/77→01/81	Petrol	L18T	1770	4	85.00	78.00	41
Elgrand 2.5	11/10→	Petrol	QR25DE	2488	4	89.00	100.00	55
Elgrand 2.5 AWD	11/10→	Petrol	QR25DE	2488	4	89.00	100.00	55
Elgrand 3.0 D	04/03→12/10	Diesel	ZD30	2953	4	96.00	102.00	64
Elgrand 3.0 D AWD	08/99→08/00	Diesel	ZD30DDTi	2953	4	96.00	102.00	64
EXA 1.5 I Turbo	04/83→07/87	Petrol	E15ET	1488	4	76.00	82.00	14
Exa Targa 1.6 i	02/87→12/87	Petrol	CA16DE	1598	4	80.00	79.50	21
Exa Targa 1.8 i	07/87→10/91	Petrol	CA18DE	1809	4	83.00	83.60	30
Expert I 2.0	10/95→04/00	Petrol	SR20DE	1998	4	86.00	86.00	45
Expert II 2.2 D	10/98→04/04	Diesel	YD22D	2184	4	86.00	94.00	46
F10 1.4	09/75→12/78	Petrol	A14	1397	4	76.00	77.00	11
Gloria 2.8 TD	06/91→10/95	Diesel	RD28	2826	6	85.00	83.00	42
Gloria VII 2.0	05/84→08/87	Petrol	CA20S	1974	4	84.50	88.00	39
Homy 2.0	08/82→04/92	Petrol	Z20S	1952	4	85.00	86.00	43
Homy 2.5 TD	05/92→10/95	Diesel	TD25	2494	4	92.90	92.00	58
Homy 2.7 TD	10/93→10/95	Diesel	TD27Ti	2664	4	96.00	92.00	62
Homy 3.2 D	10/93→10/97	Diesel	SD33	3246	6	83.00	100.00	33
Ichi 2.0 D	09/90→05/01	Diesel	LD20	1952	4	85.00	86.00	43
Interstar dCi 80	07/02→	Diesel	F9Q 772	1870	4	80.00	93.00	24
Interstar dCi 90	07/02→	Diesel	G9T 722	2188	4	87.00	92.00	48
Interstar dCi 100	11/03→	Diesel	G9U 720	2463	4	89.00	99.00	54
Interstar dCi 120	07/02→	Diesel	G9U 720	2463	4	89.00	99.00	54
Interstar dCi 140	11/03→	Diesel	ZD30	2953	4	96.00	102.00	64
Interstar dCi 150	08/06→	Diesel	G9U 632	2464	4	89.00	99.00	54
Juke 1.5	10/13→	Petrol	HR15DE	1498	4	78.00	78.40	17
Juke 1.5 dCi	06/10→	Diesel	K9K 636	1461	4	76.00	80.50	12
Juke 1.5 dCi	06/10→	Diesel	K9K 896	1461	4	76.00	80.50	12
Juke 1.6	06/10→	Petrol	HR16DE	1598	4	78.00	83.60	19
Kubistar 1.2	08/03→	Petrol	D7F 764	1149	4	69.00	76.80	2
Kubistar 1.2 16V	04/06→	Petrol	D4F 712	1149	4	69.00	76.80	1
Kubistar 1.4	08/03→10/09	Petrol	K7J 700	1390	4	75.80	77.00	7
Kubistar 1.5 dCi	08/03→	Diesel	K9K 704	1461	4	76.00	80.50	12
Kubistar 1.5 dCi	08/03→	Diesel	K9K 710	1461	4	76.00	80.50	12
Kubistar 1.5 dCi	08/03→	Diesel	K9K 714	1461	4	76.00	80.50	12
Kubistar 1.5 dCi	08/03→	Diesel	K9K 722	1461	4	76.00	80.50	12
Kubistar 1.5 dCi 70	04/06→10/09	Diesel	K9K 700	1461	4	76.00	80.50	12
Kubistar 1.5 dCi 70	04/06→03/10	Diesel	K9K 716	1461	4	76.00	80.50	12
Kubistar 1.5 dCi 85	04/06→10/09	Diesel	K9K 276	1461	4	76.00	80.50	12
Kubistar 1.6 16V	08/03→	Petrol	K4M 752	1598	4	79.50	80.50	20
Lafesta 2.0 CVTC	07/05→	Petrol	MR20DE	1997	4	84.00	90.10	37
Latio 1.5	11/04→	Petrol	HR15DE	1498	4	78.00	78.40	17
Latio 1.5 4x4	11/04→	Petrol	HR15DE	1498	4	78.00	78.40	17

				cm ³	x 			
Latio 1.6	03/07→	Petrol	HR16DE	1598	4	78.00	83.60	19
Laurel 2.0 D	04/81→10/84	Diesel	LD20	1952	4	85.00	86.00	43
Laurel 2.0 GL	11/84→12/85	Petrol	CA20S	1974	4	84.50	88.00	39
Laurel 2.8 D	01/85→12/89	Diesel	RD28	2826	6	85.00	83.00	42
Leopard 1.8	10/80→03/86	Petrol	Z18	1770	4	85.00	78.00	41
Leopard I 1.8	10/80→03/86	Petrol	Z18	1770	4	85.00	78.00	41
Livina / Grand Livina 1.5	03/09→	Petrol	HR15DE	1498	4	78.00	78.40	17
Livina / Grand Livina 1.6	02/07→	Petrol	HR16DE	1598	4	78.00	83.60	19
Livina / Grand Livina 1.6 Flex	03/09→	Petrol	HR16DE	1598	4	78.00	83.60	19
Livina / Grand Livina 1.8	03/09→	Petrol	MR18DE	1798	4	84.00	81.10	35
Livina / Grand Livina 1.8 Flex	03/09→	Petrol	MR18DE	1798	4	84.00	81.10	35
Lucino 1.8 Turbo	11/95→01/00	Petrol	SR18DE	1838	4	82.50	86.00	26
Lucino 2.0	10/91→01/00	Petrol	SR20DE	1998	4	86.00	86.00	45
Lucino 2.0 D	11/97→01/00	Diesel	CD20	1974	4	84.50	88.00	40
Lucino 2.0 GTi	11/95→01/00	Petrol	SR20DE	1998	4	86.00	86.00	45
Micra C+C 1.6 160 SR	08/05→	Petrol	HR16DE	1598	4	78.00	83.60	19
Micra III 1.5 dCi	06/05→06/10	Diesel	K9K 276	1461	4	76.00	80.50	12
Micra III 1.5 dCi	01/03→06/10	Diesel	K9K 704	1461	4	76.00	80.50	12
Micra III 1.5 dCi	06/05→06/10	Diesel	K9K 708	1461	4	76.00	80.50	12
Micra III 1.5 dCi	09/03→06/10	Diesel	K9K 722	1461	4	76.00	80.50	12
Micra III 160 SR	05/05→06/10	Petrol	HR16DE	1598	4	78.00	83.60	19
Micra IV 1.5	11/10→	Petrol	HR15DE	1498	4	78.00	78.40	17
Micra IV 1.5 D	01/11→	Diesel	K9K	1461	4	76.00	80.50	12
Micra IV 1.5 D	11/10→	Diesel	K9K 700	1461	4	76.00	80.50	12
Micra IV 1.5 D	11/10→	Diesel	K9K 704	1461	4	76.00	80.50	12
Micra IV 1.5 NISMO S	06/13→	Petrol	HR15DE	1498	4	78.00	78.40	17
Micra IV 1.6	09/11→	Petrol	HR16DE	1598	4	78.00	83.60	19
Micra IV 1.6 Flex	10/11→	Petrol	HR16DE	1598	4	78.00	83.60	19
Murano 2.5	11/04→10/07	Petrol	QR25DE	2488	4	89.00	100.00	55
Murano 2.5 dCi 4x4	01/10→	Diesel	YD25DDTi	2488	4	89.00	100.00	57
Murano III 2.5 dCi ALL MODE 4x4-i	10/14→	Diesel	YD25DDTi	2488	4	89.00	100.00	57
Navara 2.0	01/86→10/95	Petrol	Z20	1952	4	85.00	86.00	43
Navara 2.0	01/97→08/01	Petrol	SR20DE	1998	4	86.00	86.00	45
Navara 2.4	09/85→03/08	Petrol	Z24	2388	4	89.00	96.00	53
Navara 2.4	09/85→02/97	Petrol	Z24i	2389	4	89.00	96.00	53
Navara 2.4	01/97→12/02	Petrol	Z24S	2389	4	89.00	96.00	53
Navara 2.4 4x4	01/86→12/96	Petrol	Z24	2388	4	89.00	96.00	53
Navara 2.4 4x4	09/85→12/97	Petrol	Z24i	2389	4	89.00	96.00	53
Navara 2.4 4x4	01/97→12/02	Petrol	Z24S	2389	4	89.00	96.00	53
Navara 2.4 4WD	09/85→12/87	Petrol	Z24	2388	4	89.00	96.00	53
Navara 2.5	10/04→	Petrol	QR25DE	2488	4	89.00	100.00	55
Navara 2.5 4x4	01/08→	Petrol	QR25DE	2488	4	89.00	100.00	55
Navara 2.5 4WD	10/04→	Petrol	QR25DE	2488	4	89.00	100.00	55
Navara 2.5 D	01/08→	Diesel	YD25DDTi	2488	4	89.00	100.00	57
Navara 2.5 D	01/86→03/08	Diesel	TD25	2494	4	92.90	92.00	58
Navara 2.5 D 4x4	11/01→	Diesel	YD25DDTi	2488	4	89.00	100.00	57
Navara 2.5 D 4x4	01/86→03/08	Diesel	TD25	2494	4	92.90	92.00	58
Navara 2.5 D 4WD	09/08→	Diesel	YD25DDTi	2488	4	89.00	100.00	57
Navara 2.5 dCi	07/05→	Diesel	YD25DDTi	2488	4	89.00	100.00	57
Navara 2.5 dCi 4WD	07/05→	Diesel	YD25DDTi	2488	4	89.00	100.00	57
Navara 2.5 DDTi	01/15→	Diesel	YD25DDTi	2488	4	89.00	100.00	57
Navara 2.5 Di	02/02→	Diesel	YD25DDTi	2488	4	89.00	100.00	57
Navara 2.5 Di 4WD	02/02→	Diesel	YD25DDTi	2488	4	89.00	100.00	57
Navara 2.5 TD	02/98→10/01	Diesel	TD25	2494	4	92.90	92.00	58
Navara 2.5 TD 4x4	02/98→10/01	Diesel	TD25	2494	4	92.90	92.00	58
Navara 2.5 TDiC 4x4	05/98→10/01	Diesel	TD25TI	2494	4	92.90	92.00	59
Navara 2.7 D	09/87→12/96	Diesel	TD27	2663	4	96.00	92.00	60
Navara 2.7 D 4x4	09/87→08/98	Diesel	TD27	2663	4	96.00	92.00	60
Navara 2.7 TD	01/97→10/01	Diesel	TD27	2663	4	96.00	92.00	60
Navara 2.7 TD	03/97→12/01	Diesel	TD27T	2664	4	96.00	92.00	60
Navara 2.7 TD 4x4	01/97→10/01	Diesel	TD27	2663	4	96.00	92.00	60
Navara 3.0 TD	11/01→04/05	Diesel	ZD30DDT	2953	4	96.00	102.00	64
Navara 3.0 TD 4x4	11/01→04/05	Diesel	ZD30DDT	2953	4	96.00	102.00	64
Navara 3.0 TD 4WD	12/01→01/08	Diesel	ZD30	2953	4	96.00	102.00	64
Navara 3.2 D	01/97→03/02	Diesel	QD32	3153	4	99.20	102.00	65
Navara 3.2 D 4x4	01/98→10/01	Diesel	QD32	3153	4	99.20	102.00	65
Navara 3.2 D 4WD	04/98→12/01	Diesel	QD32	3153	4	99.20	102.00	65
Note 1.5 dCi	03/06→	Diesel	K9K 276	1461	4	76.00	80.50	12
Note 1.5 dCi	07/08→	Diesel	K9K 292	1461	4	76.00	80.50	12



Note 1.5 dCi	03/06→	Diesel	K9K 700	1461	4	76.00	80.50	12
Note 1.5 dCi	06/13→	Diesel	K9K 892	1461	4	76.00	80.50	12
Note 1.6	03/06→	Petrol	HR16DE	1598	4	78.00	83.60	19
Note 1.6 NISMO S	06/13→	Petrol	HR16DE	1598	4	78.00	83.60	19
NP200 1.5 dCi	10/08→	Diesel	K9K 276	1461	4	76.00	80.50	12
NP200 1.6	10/08→	Petrol	HR16DE	1598	4	78.00	83.60	19
NP300 2.5 dCi	09/13→	Diesel	YD25ETi	2488	4	89.00	100.00	57
NP300 2.5 dCi 4x4	09/13→	Diesel	YD25ETi	2488	4	89.00	100.00	57
NP300 III 2.5	05/15→	Petrol	QR25DE	2488	4	89.00	100.00	55
NP300 III 2.5 dCi	04/08→	Diesel	YD25DDTi	2488	4	89.00	100.00	57
NP300 III 2.5 dCi 4x4	04/08→	Diesel	YD25DDTi	2488	4	89.00	100.00	57
NP300 Navara 2.5	07/14→	Petrol	QR25DE	2488	4	89.00	100.00	55
NP300 Navara 2.5 dCi	07/14→	Diesel	YD25DDTi	2488	4	89.00	100.00	57
NP300 Navara 2.5 dCi 4x4	07/14→	Diesel	YD25DDTi	2488	4	89.00	100.00	57
NV200 1.5 dci	02/10→	Diesel	K9K 400	1461	4	76.00	80.50	12
NV200 1.5 dci	02/10→	Diesel	K9K 608	1461	4	76.00	80.50	12
NV200 1.5 dci	02/10→	Diesel	K9K 628	1461	4	76.00	80.50	12
NV200 1.5 dci	04/11→	Diesel	K9K 636	1461	4	76.00	80.50	12
NV200 1.5 dci	04/11→	Diesel	K9K 646	1461	4	76.00	80.50	12
NV200 1.5 dci	04/11→	Diesel	K9K 892	1461	4	76.00	80.50	12
NV200 1.6 16V	02/10→	Petrol	HR16DE	1598	4	78.00	83.60	19
NV200 2.0	09/13→	Petrol	MR20DE	1997	4	84.00	90.10	37
NV200 / Evalia 1.5	01/12→	Petrol	HR15DE	1498	4	78.00	78.40	17
NV200 / Evalia 1.5 dci	07/10→	Diesel	K9K 400	1461	4	76.00	80.50	12
NV200 / Evalia 1.5 dci	07/10→	Diesel	K9K 608	1461	4	76.00	80.50	12
NV200 / Evalia 1.5 dci	07/10→	Diesel	K9K 628	1461	4	76.00	80.50	12
NV200 / Evalia 1.5 dci	04/11→	Diesel	K9K 636	1461	4	76.00	80.50	12
NV200 / Evalia 1.5 dci	04/11→	Diesel	K9K 646	1461	4	76.00	80.50	12
NV200 / Evalia 1.5 dci	04/11→	Diesel	K9K 892	1461	4	76.00	80.50	12
NV200 / Evalia 1.6 16V	07/10→	Petrol	HR16DE	1598	4	78.00	83.60	19
NV200 / Evalia 2.0	09/13→	Petrol	MR20DE	1997	4	84.00	90.10	37
NV350 2.0	05/12→	Petrol	QR20DE	1998	4	89.00	80.30	50
NV350 2.5	05/12→	Petrol	QR25DE	2488	4	89.00	100.00	55
NV350 2.5 CNG	05/12→	Petrol	QR25DE	2488	4	89.00	100.00	55
NV350 2.5 D	05/12→	Diesel	YD25DDTi	2488	4	89.00	100.00	57
NV350 2.5 D 4WD	05/12→	Diesel	YD25DDTi	2488	4	89.00	100.00	57
NV350 2.5 DDTi	03/13→	Diesel	YD25DDTi	2488	4	89.00	100.00	57
NV400 2.3 dCi	11/11→	Diesel	M9T 670	2298	4	85.00	101.30	44
NV400 2.3 dCi	11/11→	Diesel	M9T 672	2298	4	85.00	101.30	44
NV400 2.3 dCi	11/11→	Diesel	M9T 676	2298	4	85.00	101.30	44
NV400 2.3 dCi	11/11→	Diesel	M9T 678	2298	4	85.00	101.30	44
NV400 2.3 dCi	11/11→	Diesel	M9T 680	2298	4	85.00	101.30	44
NV400 2.3 dCi	06/14→	Diesel	M9T 696	2298	4	85.00	101.30	44
NV400 2.3 dCi	06/14→	Diesel	M9T 698	2298	4	85.00	101.30	44
NV400 2.3 dCi	06/14→	Diesel	M9T	2299	4	85.00	101.30	44
NV400 2.3 dCi	06/14→	Diesel	M9T 870	2299	4	85.00	101.30	44
NV400 2.3 dCi	02/14→	Diesel	M9T 880	2299	4	85.00	101.30	44
NV400 2.3 dCi [RWD]	11/11→	Diesel	M9T 686	2298	4	85.00	101.30	44
NV400 2.3 dCi [RWD]	11/11→	Diesel	M9T 690	2298	4	85.00	101.30	44
NV400 2.3 dCi [RWD]	11/11→	Diesel	M9T 692	2298	4	85.00	101.30	44
NV400 2.3 dCi [RWD]	11/11→	Diesel	M9T 694	2298	4	85.00	101.30	44
NV400 2.3 dCi [RWD]	11/11→	Diesel	M9T 696	2298	4	85.00	101.30	44
NV400 2.3 dCi [RWD]	11/11→	Diesel	M9T 698	2298	4	85.00	101.30	44
NV400 2.3 dCi [RWD]	06/14→	Diesel	M9T	2299	4	85.00	101.30	44
NV400 2.3 dCi [RWD]	11/11→	Diesel	M9T 870	2299	4	85.00	101.30	44
NV400 2.3 dCi [RWD]	02/14→	Diesel	M9T 880	2299	4	85.00	101.30	44
NV 3500 2.5	09/13→	Petrol	QR25DE	2488	4	89.00	100.00	55
Pathfinder I 2.4	07/86→08/89	Petrol	Z24i	2389	4	89.00	96.00	53
Pathfinder I 2.4 4WD	07/86→10/95	Petrol	Z24i	2389	4	89.00	96.00	53
Pathfinder I 2.4 E 4WD	09/86→12/88	Petrol	Z24i	2389	4	89.00	96.00	53
Pathfinder II 2.7 TD 4WD	09/97→12/04	Diesel	TD27ETi	2664	4	96.00	92.00	61
Pathfinder II 3.0 DDTi 4WD	09/99→12/04	Diesel	ZD30DDTi	2953	4	96.00	102.00	64
Pathfinder III 2.5 dCi	01/05→	Diesel	YD25DDTi	2488	4	89.00	100.00	57
Pathfinder III 2.5 dCi 4WD	01/05→	Diesel	YD25DDTi	2488	4	89.00	100.00	57
Pathfinder IV 2.5 dCi 4WD	09/12→	Diesel	YD25DDTi	2488	4	89.00	100.00	57
Pathfinder IV 2.5 Hybrid	09/13→	Petrol	QR25DER	2488	4	89.00	100.00	55
Pathfinder IV 2.5 Hybrid 4WD	09/13→	Petrol	QR25DER	2488	4	89.00	100.00	55
Patrol GR IV 2.8 TD	09/88→02/98	Diesel	RD28T	2826	6	85.00	83.00	42
Patrol GR V 2.7 TD	05/98→06/01	Diesel	TD27T	2664	4	96.00	92.00	60

					cm3				
Patrol GR V 2.8 TD		06/97→05/00	Diesel	RD28Ti	2826	6	85.00	83.00	42
Patrol GR V 2.8 TDiC		10/97→02/00	Diesel	RD28Ti	2826	6	85.00	83.00	42
Patrol GR V 3.0 DTi		05/00→	Diesel	ZD30DDTi	2953	4	96.00	102.00	64
Patrol GR V 3.2 D		05/98→06/01	Diesel	SD33	3246	6	83.00	100.00	33
Patrol III/1 3.2 D		11/79→08/88	Diesel	SD33	3246	6	83.00	100.00	33
Patrol III/1 3.2 TD		07/83→08/88	Diesel	SD33T	3246	6	83.00	100.00	33
Patrol III/1 3.3 D 4x4		06/80→12/87	Diesel	SD33	3246	6	83.00	100.00	33
Patrol III/1 3.3 TD 4x4		01/84→12/87	Diesel	SD33T	3246	6	83.00	100.00	33
Patrol III/2 2.8 D		03/89→03/96	Diesel	RD28	2826	6	85.00	83.00	42
Patrol III/2 2.8 D 4x4		03/89→03/96	Diesel	RD28	2826	6	85.00	83.00	42
Patrol III/2 2.8 TD		05/86→11/95	Diesel	RD28T	2826	6	85.00	83.00	42
Patrol III/2 2.8 TD 4x4		03/92→06/93	Diesel	RD28T	2826	6	85.00	83.00	42
Patrol III/2 3.2 D		08/88→06/90	Diesel	SD33T	3246	6	83.00	100.00	33
Patrol IV 2.8 TD 4x4		01/94→12/97	Diesel	RD28T	2826	6	85.00	83.00	42
Patrol V 3.0 D 4x4		09/07→	Diesel	ZD30DDTi	2953	4	96.00	102.00	64
Pick Up I 1.8		01/83→03/86	Petrol	L18	1770	4	85.00	78.00	41
Pick Up I 1.8 4WD		01/80→03/86	Petrol	L18	1770	4	85.00	78.00	41
Pick Up I 2.2		04/83→03/86	Petrol	Z22	2188	4	87.00	92.00	47
Pick Up I 2.2 4WD		04/83→03/86	Petrol	Z22	2188	4	87.00	92.00	47
Pick Up I 2.2 D		01/82→01/84	Diesel	SD22	2164	4	83.00	100.00	32
Pick Up I 2.2 D 4WD		01/82→09/84	Diesel	SD22	2164	4	83.00	100.00	32
Pick Up I 2.3 D		04/83→03/86	Diesel	SD23	2289	4	89.00	92.00	51
Pick Up I 2.3 D 4WD		04/83→03/86	Diesel	SD23	2289	4	89.00	92.00	51
Pick Up I 2.5 D 4WD		04/83→03/86	Diesel	SD25	2488	4	89.00	100.00	56
Pick Up II 2.0		09/85→08/91	Petrol	Z20	1952	4	85.00	86.00	43
Pick Up II 2.0 4WD		03/92→08/95	Petrol	Z20	1952	4	85.00	86.00	43
Pick Up II 2.3 D		09/85→08/88	Diesel	SD23	2289	4	89.00	92.00	51
Pick Up II 2.3 D 4WD		09/85→08/87	Diesel	SD23	2289	4	89.00	92.00	51
Pick Up II 2.4		09/85→12/96	Petrol	Z24	2388	4	89.00	96.00	53
Pick Up II 2.4		09/85→12/96	Petrol	Z24i	2389	4	89.00	96.00	53
Pick Up II 2.4 4x4		09/85→05/94	Petrol	Z24	2388	4	89.00	96.00	53
Pick Up II 2.4 4WD		01/92→12/96	Petrol	Z24	2388	4	89.00	96.00	53
Pick Up II 2.4 4WD		01/92→12/97	Petrol	Z24i	2389	4	89.00	96.00	53
Pick Up II 2.4 i 4WD		03/86→04/92	Petrol	Z24i	2389	4	89.00	96.00	53
Pick Up II 2.5 D		01/86→02/98	Diesel	SD25	2488	4	89.00	100.00	56
Pick Up II 2.5 D		09/87→02/98	Diesel	TD25	2494	4	92.90	92.00	58
Pick Up II 2.5 D 4WD		09/85→08/91	Diesel	SD25	2488	4	89.00	100.00	56
Pick Up II 2.5 D 4WD		08/87→02/98	Diesel	TD25	2494	4	92.90	92.00	58
Pick Up II 2.7 D 4WD		08/87→02/98	Diesel	TD27	2663	4	96.00	92.00	60
Pick Up II 2.7 TD		09/87→12/96	Diesel	TD27T	2664	4	96.00	92.00	60
Pick Up II 2.7 TD 4WD		09/87→12/96	Diesel	TD27T	2664	4	96.00	92.00	60
Pick Up III 2.0		01/97→08/01	Petrol	SR20DE	1998	4	86.00	86.00	45
Pick Up III 2.4		01/97→	Petrol	Z24	2388	4	89.00	96.00	53
Pick Up III 2.4		01/97→12/02	Petrol	Z24S	2389	4	89.00	96.00	53
Pick Up III 2.4 4WD		01/97→	Petrol	Z24	2388	4	89.00	96.00	53
Pick Up III 2.4 4WD		01/97→12/02	Petrol	Z24S	2389	4	89.00	96.00	53
Pick Up III 2.5 D		02/98→	Diesel	TD25	2494	4	92.90	92.00	58
Pick Up III 2.5 D 4WD		02/98→	Diesel	TD25	2494	4	92.90	92.00	58
Pick Up III 2.5 Di		03/02→	Diesel	YD25DDTi	2488	4	89.00	100.00	57
Pick Up III 2.5 Di 4WD		03/02→	Diesel	YD25DDTi	2488	4	89.00	100.00	57
Pick Up III 2.5 TD 4WD		05/98→	Diesel	TD25Ti	2494	4	92.90	92.00	59
Pick Up III 2.5 Tdi		05/98→10/01	Diesel	TD25Ti	2494	4	92.90	92.00	59
Pick Up III 2.7 D		02/98→	Diesel	TD27	2663	4	96.00	92.00	60
Pick Up III 2.7 TD		01/97→10/01	Diesel	TD27T	2664	4	96.00	92.00	60
Pick Up III 2.7 TD 4WD		01/97→10/01	Diesel	TD27T	2664	4	96.00	92.00	60
Pick Up III 3.0 TD		11/01→	Diesel	ZD30	2953	4	96.00	102.00	64
Pick Up III 3.0 TD 4WD		11/01→	Diesel	ZD30	2953	4	96.00	102.00	64
Pick Up III 3.2 D 4WD		12/98→	Diesel	QD32	3153	4	99.20	102.00	65
Pick Up III 3.2 TD		01/97→10/01	Diesel	QD32	3153	4	99.20	102.00	65
Pintara 2.0 i		06/86→10/92	Petrol	CA20E	1974	4	84.50	88.00	39
Platina 1.6		06/01→12/10	Petrol	K4M	1598	4	79.50	80.50	20
Prairie 1.5 S		01/84→12/87	Petrol	E15S	1488	4	76.00	82.00	14
Prairie 1.8 SGL		07/83→10/87	Petrol	CA18S	1809	4	83.00	83.60	30
Prairie 2.0		01/86→09/88	Petrol	CA20E	1974	4	84.50	88.00	39
Prairie 2.0		01/86→09/88	Petrol	CA20S	1974	4	84.50	88.00	39
Prairie 2.0 4x4		01/86→09/88	Petrol	CA20E	1974	4	84.50	88.00	39
Prairie 2.0 4x4		01/86→09/88	Petrol	CA20S	1974	4	84.50	88.00	39
Prairie Pro 2.0		03/89→03/92	Petrol	CA20E	1974	4	84.50	88.00	39
Prairie Pro 2.0		10/89→03/92	Petrol	CA20S	1974	4	84.50	88.00	39











cm3



9

Prairie Pro 2.0 4x4	03/89→03/92	Petrol	CA20E	1974	4	84.50	88.00	39
Prairie Pro 2.0 4x4	10/89→03/92	Petrol	CA20S	1974	4	84.50	88.00	39
Prairie Pro 2.0 i	10/88→04/92	Petrol	CA20E	1974	4	84.50	88.00	39
Prairie Pro 2.0 i 4x4	10/88→12/92	Petrol	CA20E	1974	4	84.50	88.00	39
Presage 2.5	08/01→06/03	Petrol	QR25DE	2488	4	89.00	100.00	55
Presea 1.8	08/97→08/00	Petrol	SR18DE	1838	4	82.50	86.00	26
Presea 2.0	08/97→08/00	Petrol	SR20DE	1998	4	86.00	86.00	45
Primastar 1.9 dCi	07/02→08/06	Diesel	F9Q 760	1870	4	80.00	93.00	24
Primastar 2.0	03/01→	Petrol	F4R 720	1998	4	82.70	93.00	27
Primastar 2.0	03/01→	Petrol	F4R 722	1998	4	82.70	93.00	27
Primastar dCi 80	03/01→	Diesel	F9Q 762	1870	4	80.00	93.00	24
Primastar dCi 90	09/06→	Diesel	M9R 782	1995	4	84.00	90.00	36
Primastar dCi 100	03/01→	Diesel	F9Q 760	1870	4	80.00	93.00	24
Primastar dCi 115	09/08→	Diesel	G9U 720	2463	4	89.00	99.00	54
Primastar dCi 120	09/06→	Diesel	M9R 780	1995	4	84.00	90.00	36
Primastar dCi 140	07/03→	Diesel	G9U 730	2463	4	89.00	99.00	54
Primastar dCi 150	09/06→	Diesel	G9U 632	2464	4	89.00	99.00	54
Primera 1.9 dCi	08/02→	Diesel	F9Q	1870	4	80.00	93.00	24
Primera 2.0	03/02→	Petrol	QR20DE	1998	4	89.00	80.30	50
Primera 2.0	06/90→01/98	Petrol	SR20DE	1998	4	86.00	86.00	45
Primera 2.0	06/96→05/99	Petrol	SR20VE	1998	4	86.00	86.00	45
Primera 2.0 4x4	03/91→04/93	Petrol	SR20DE	1998	4	86.00	86.00	45
Primera 2.0 16V	09/97→08/99	Petrol	QR20DE	1998	4	89.00	80.30	50
Primera 2.0 16V	06/96→07/02	Petrol	SR20De	1998	4	86.00	86.00	45
Primera 2.0 16V	09/96→07/02	Petrol	SR20DE	1998	4	86.00	86.00	45
Primera 2.0 16V	06/90→01/96	Petrol	SR20DI	1998	4	86.00	86.00	45
Primera 2.0 16V	06/96→05/99	Petrol	SR20VE	1998	4	86.00	86.00	45
Primera 2.0 16V 4x4	04/91→06/96	Petrol	SR20DI	1998	4	86.00	86.00	45
Primera 2.0 D	07/90→01/96	Diesel	CD20	1974	4	84.50	88.00	40
Primera 2.0 GT	06/90→01/96	Petrol	SR20DE	1998	4	86.00	86.00	45
Primera 2.0 GT 4x4	03/91→04/93	Petrol	SR20DE	1998	4	86.00	86.00	45
Primera 2.0 i	01/95→06/96	Petrol	SR20DE	1998	4	86.00	86.00	45
Primera 2.0 i	07/90→03/98	Petrol	SR20DI	1998	4	86.00	86.00	45
Primera 2.0 TD	09/96→07/02	Diesel	CD20T	1974	4	84.50	88.00	40
Primera 2.2 dCi	04/03→	Diesel	YD22DDT	2184	4	86.00	94.00	46
Primera 2.2 Di	03/02→	Diesel	YD22DDT	2184	4	86.00	94.00	46
Primera 2.5	01/02→	Petrol	QR25DE	2488	4	89.00	100.00	55
Pulsar 1.3	06/83→12/87	Petrol	E13	1269	4	76.00	70.00	9
Pulsar 1.4	09/78→06/82	Petrol	A14	1397	4	76.00	77.00	11
Pulsar 1.4	09/81→06/82	Petrol	A14S	1397	4	76.00	77.00	11
Pulsar 1.5	11/78→12/82	Petrol	A15	1488	4	76.00	82.00	13
Pulsar 1.5	01/83→12/87	Petrol	E15	1488	4	76.00	82.00	14
Pulsar 1.5	01/84→12/87	Petrol	E15ET	1488	4	76.00	82.00	14
Pulsar 1.5	01/82→07/86	Petrol	E15S	1488	4	76.00	82.00	14
Pulsar 1.5 dCi	10/14→	Diesel	K9K	1461	4	76.00	80.50	12
Pulsar 1.6	01/83→12/83	Petrol	E16	1597	4	76.00	88.00	15
Pulsar 1.6	09/83→03/86	Petrol	E16I	1597	4	76.00	88.00	15
Pulsar I 2.0	07/95→07/00	Petrol	SR20DE	1998	4	86.00	86.00	45
Pulsar NX 1.5 Turbo	09/82→12/84	Petrol	E15T	1488	4	76.00	82.00	14
Pulsar NX 1.6	09/82→12/87	Petrol	E16	1597	4	76.00	88.00	15
Pulsar NX 1.6	09/86→12/87	Petrol	CA16DE	1598	4	80.00	79.50	21
Pulsar NX 1.8	09/87→12/89	Petrol	CA18DE	1809	4	83.00	83.60	30
Qashqai 1.5 dCi	11/13→	Diesel	K9K 636	1461	4	76.00	80.50	12
Qashqai 2.0	06/14→	Petrol	MR20DE	1997	4	84.00	90.10	37
Qashqai / Qashqai +2 1.5 dCi	07/08→	Diesel	K9K 410	1461	4	76.00	80.50	12
Qashqai / Qashqai +2 1.5 dCi	11/10→	Diesel	K9K 430	1461	4	76.00	80.50	12
Qashqai / Qashqai +2 1.5 dCi	02/07→	Diesel	K9K 732	1461	4	76.00	80.50	12
Qashqai / Qashqai +2 1.5 dCi	02/07→	Diesel	K9K 764	1461	4	76.00	80.50	12
Qashqai / Qashqai +2 1.6	02/07→	Petrol	HR16DE	1598	4	78.00	83.60	19
Qashqai / Qashqai +2 2.0	02/07→	Petrol	MR20DE	1997	4	84.00	90.10	37
Qashqai / Qashqai +2 2.0 dCi	02/07→	Diesel	M9R	1995	4	84.00	90.10	38
Rogue 2.5	01/07→12/13	Petrol	QR25DE	2488	4	89.00	100.00	55
Rogue 2.5 AWD	01/07→12/13	Petrol	QR25DE	2488	4	89.00	100.00	55
Sani 2.4	07/86→10/95	Petrol	Z24i	2389	4	89.00	96.00	53
Sani 2.4 4x4	08/92→10/95	Petrol	Z24i	2389	4	89.00	96.00	53
Sani 2.4 4WD	07/86→08/89	Petrol	Z24i	2389	4	89.00	96.00	53
Sani 2.5 dCi	01/05→	Diesel	YD25DDTi	2488	4	89.00	100.00	57
Sani 2.5 dCi 4x4	01/05→	Diesel	YD25DDTi	2488	4	89.00	100.00	57
Sani 2.7 TD 4x4	01/96→12/99	Diesel	TD27	2663	4	96.00	92.00	60

				cm3	x 			
S-Cargo 1.5	01/89→03/94	Petrol	E15S	1488	4	76.00	82.00	14
Sentra 1.5	09/81→12/83	Petrol	E15S	1488	4	76.00	82.00	14
Sentra 1.7 D	09/84→12/86	Diesel	CD17	1681	4	80.00	83.60	22
Sentra III 2.0	02/92→12/94	Petrol	SR20DE	1998	4	86.00	86.00	45
Sentra V 2.0	01/00→12/06	Petrol	SR20DE	1998	4	86.00	86.00	45
Sentra V 2.5	06/02→12/06	Petrol	QR25DE	2488	4	89.00	100.00	55
Sentra VI 2.0	10/06→12/12	Petrol	MR20DE	1997	4	84.00	90.10	37
Sentra VI 2.0 Flex	08/09→12/12	Petrol	MR20DE	1997	4	84.00	90.10	37
Sentra VI 2.5	09/06→12/12	Petrol	QR25DE	2488	4	89.00	100.00	55
Sentra VII 1.6	08/14→	Petrol	HR16DE	1598	4	78.00	83.60	19
Sentra VII 2.0 CVTCS	01/14→	Petrol	MR20DE	1997	4	84.00	90.10	37
Serena 2.0	04/05→11/10	Petrol	MR20DE	1997	4	84.00	90.10	37
Serena 2.0 4x4	04/05→11/10	Petrol	MR20DE	1997	4	84.00	90.10	37
Serena 2.0 16V	11/92→09/01	Petrol	SR20DE	1998	4	86.00	86.00	45
Serena 2.0 D	11/92→09/01	Diesel	LD20	1952	4	85.00	86.00	43
Serena 2.0 SGX	09/00→09/05	Petrol	SR20DE	1998	4	86.00	86.00	45
Serena 2.0 SGX 4x4	09/00→09/05	Petrol	SR20DE	1998	4	86.00	86.00	45
Serena 2.5	02/06→11/10	Petrol	QR25DE	2488	4	89.00	100.00	55
Serena 2.5 4x4	02/06→11/10	Petrol	QR25DE	2488	4	89.00	100.00	55
Serena 2.5 DCi SGX	06/99→09/05	Diesel	YD25DDTi	2488	4	89.00	100.00	57
Serena 2.5 DCi SGX 4x4	06/99→09/05	Diesel	YD25DDTi	2488	4	89.00	100.00	57
Silvia 1.8	01/79→05/83	Petrol	L18E	1770	4	85.00	78.00	41
Silvia 1.8	06/84→12/88	Petrol	CA18ET	1809	4	83.00	83.60	30
Silvia 1.8 Turbo	08/88→03/94	Petrol	CA18DT	1809	4	83.00	83.60	30
Silvia 2.0	01/79→06/81	Petrol	Z20E	1952	4	85.00	86.00	43
Silvia 2.0	09/84→12/88	Petrol	CA20E	1974	4	84.50	88.00	39
Silvia 2.0 GP	01/84→12/88	Petrol	CA20E	1974	4	84.50	88.00	39
Silvia 2.0 GP	04/84→09/88	Petrol	FJ20E	1991	4	89.00	80.00	49
Skyline 1.8	08/81→07/84	Petrol	L18S	1770	4	85.00	78.00	41
Skyline 1.8	03/89→06/93	Petrol	CA18i	1809	4	83.00	83.60	30
Skyline 1.8	07/86→03/89	Petrol	CA18S	1809	4	83.00	83.60	30
Skyline 2.0	01/82→06/86	Petrol	L20B	1952	4	85.00	86.00	43
Skyline 2.0	08/81→07/84	Petrol	Z20E	1952	4	85.00	86.00	43
Skyline 2.0 D	08/81→07/84	Diesel	LD20	1952	4	85.00	86.00	43
Stanza 1.6	08/81→12/85	Petrol	CA16S	1598	4	78.00	83.60	18
Stanza 1.8	08/81→12/85	Petrol	CA18	1809	4	83.00	83.60	30
Stanza 1.8	08/81→12/85	Petrol	CA18S	1809	4	83.00	83.60	30
Stanza 1.8 SGL	03/83→12/85	Petrol	CA18S	1809	4	83.00	83.60	30
Stanza 2.0	01/86→06/89	Petrol	CA20DE	1973	4	84.50	88.00	39
Stanza 2.0	04/83→12/89	Petrol	CA20E	1974	4	84.50	88.00	39
Stanza 2.0	08/81→12/83	Petrol	CA20S	1974	4	84.50	88.00	39
Stanza 2.0 4WD	09/86→12/88	Petrol	CA20E	1974	4	84.50	88.00	39
Sunny 1.2	07/73→02/82	Petrol	A12	1171	4	73.00	70.00	5
Sunny 1.4	01/70→02/82	Petrol	A14	1397	4	76.00	77.00	11
Sunny 1.5	06/79→02/82	Petrol	A15	1488	4	76.00	82.00	13
Sunny 1.5	01/11→	Petrol	HR15DE	1498	4	78.00	78.40	17
Sunny 1.5 dCi	01/11→	Diesel	K9K 772	1461	4	76.00	80.50	12
Sunny I 1.3	03/82→08/90	Petrol	E13	1269	4	76.00	70.00	9
Sunny I 1.5	03/82→05/86	Petrol	E15	1488	4	76.00	82.00	14
Sunny I 1.5	03/82→10/86	Petrol	E15S	1488	4	76.00	82.00	14
Sunny I 1.6	05/84→08/90	Petrol	E16	1597	4	76.00	88.00	15
Sunny I 1.6	03/82→12/88	Petrol	E16i	1597	4	76.00	88.00	15
Sunny I 1.6	05/84→07/86	Petrol	E16S	1597	4	76.00	88.00	15
Sunny I 1.6 4x4	07/86→10/88	Petrol	E16i	1597	4	76.00	88.00	15
Sunny I 1.6 4WD	09/86→12/88	Petrol	E16i	1597	4	76.00	88.00	15
Sunny I 1.6 SLX 4x4	07/86→10/88	Petrol	E16S	1597	4	76.00	88.00	15
Sunny I 1.7 D	03/82→12/87	Diesel	CD17	1681	4	80.00	83.60	22
Sunny II 1.0	07/86→09/90	Petrol	E10S	988	4	73.00	59.00	4
Sunny II 1.3	06/86→10/91	Petrol	E13S	1269	4	76.00	70.00	9
Sunny II 1.5	06/86→10/88	Petrol	E15S	1488	4	76.00	82.00	14
Sunny II 1.6	06/86→10/91	Petrol	E16	1597	4	76.00	88.00	15
Sunny II 1.6	06/86→12/88	Petrol	E16i	1597	4	76.00	88.00	15
Sunny II 1.6	06/86→10/88	Petrol	E16S	1597	4	76.00	88.00	15
Sunny II 1.6 4x4	07/86→10/88	Petrol	E16i	1597	4	76.00	88.00	15
Sunny II 1.6 4WD	06/86→12/88	Petrol	E16i	1597	4	76.00	88.00	15
Sunny II 1.6 GTI 16V	02/87→05/89	Petrol	CA16D	1598	4	78.00	83.60	18
Sunny II 1.6 i	06/86→10/90	Petrol	E16i	1597	4	76.00	88.00	15
Sunny II 1.6 i 4x4	06/86→10/90	Petrol	E16i	1597	4	76.00	88.00	15
Sunny II 1.6 Turbo	09/87→12/90	Petrol	E16E	1597	4	76.00	88.00	16

















cm3















9

Sunny II 1.7 D	01/86→06/91	Diesel	CD17	1681	4	80.00	83.60	22
Sunny II 1.8 GTI 16V	01/89→06/91	Petrol	CA18D	1809	4	83.00	83.60	30
Sunny III 1.6	01/92→12/92	Petrol	E16S	1597	4	76.00	88.00	15
Sunny III 1.7 D	11/90→03/00	Diesel	CD17	1681	4	80.00	83.60	22
Sunny III 1.8	05/90→12/92	Petrol	CA18DE	1809	4	83.00	83.60	30
Sunny III 2.0	08/90→12/96	Petrol	SR20DE	1998	4	86.00	86.00	45
Sunny III 2.0 D	10/90→03/00	Diesel	CD20	1974	4	84.50	88.00	40
Sunny III 2.0 GTI 16V	10/90→05/95	Petrol	SR20DE	1998	4	86.00	86.00	45
Sunny III 2.0 i 16V	10/90→05/95	Petrol	SR20DE	1998	4	86.00	86.00	45
Sunny IV 2.0	09/97→05/02	Petrol	SR20DE	1998	4	86.00	86.00	45
Sylphy III 1.6	08/12→	Petrol	HR16DE	1598	4	78.00	83.60	19
Teana I 2.0	10/03→06/08	Petrol	QR20DE	1998	4	89.00	80.30	50
Teana II 2.0	02/13→09/13	Petrol	MR20DE	1997	4	84.00	90.10	37
Teana III 2.0	09/13→	Petrol	MR20DE	1997	4	84.00	90.10	37
Teana III 2.5	09/13→	Petrol	QR25DE	2488	4	89.00	100.00	55
Terrano 1.5 dCi	10/13→	Diesel	K9K	1461	4	76.00	80.50	12
Terrano 1.6	10/13→	Petrol	K4M	1598	4	79.50	80.50	20
Terrano I 2.4	07/86→10/95	Petrol	Z24i	2389	4	89.00	96.00	53
Terrano I 2.4 i 4WD	10/87→02/93	Petrol	Z24i	2389	4	89.00	96.00	53
Terrano I 2.7 TD 4WD	02/89→02/96	Diesel	TD27T	2664	4	96.00	92.00	60
Terrano II 2.7 TD 4WD	02/93→01/02	Diesel	TD27T	2664	4	96.00	92.00	60
Terrano II 2.7 TDi 4WD	05/96→09/07	Diesel	TD27Ti	2664	4	96.00	92.00	62
Terrano II 3.0 Di 4WD	05/02→09/07	Diesel	ZD30	2953	4	96.00	102.00	64
Terrano II 3.0 Di 4WD	04/03→09/07	Diesel	ZD30Ti	2953	4	96.00	102.00	64
Terrano II 3.0 DiTD 4WD	10/97→12/04	Diesel	ZD30DDTi	2953	4	96.00	102.00	64
Tiida 1.5	05/04→02/07	Petrol	HR15DE	1498	4	78.00	78.40	17
Tiida 1.5 4x4	05/04→02/07	Petrol	HR15DE	1498	4	78.00	78.40	17
Tiida 1.5 dCi	09/07→	Diesel	K9K	1461	4	76.00	80.50	12
Tiida 1.5 dCi	09/07→	Diesel	K9K 728	1461	4	76.00	80.50	12
Tiida 1.5 dCi	01/07→	Diesel	K9K 772	1461	4	76.00	80.50	12
Tiida 1.6	05/04→	Petrol	HR16DE	1598	4	78.00	83.60	19
Tiida 1.6 4x4	05/04→02/07	Petrol	HR16DE	1598	4	78.00	83.60	19
Tiida 1.8	05/04→	Petrol	MR18DE	1798	4	84.00	81.10	35
Tiida 1.8 4x4	08/06→06/11	Petrol	MR18DE	1798	4	84.00	81.10	35
Tiida 1.8 Flex	05/09→	Petrol	MR18DE	1798	4	84.00	81.10	35
Tiida 1.8 Flex 4x4	05/09→06/11	Petrol	MR18DE	1798	4	84.00	81.10	35
Trade 2.0 D	11/86→10/98	Diesel	LD20	1952	4	85.00	86.00	43
Trade 2.7 TD	11/98→09/04	Diesel	TD27T	2664	4	96.00	92.00	60
Trade 3.0 D	04/93→12/98	Diesel	BD30II	2953	4	96.00	102.00	63
Trade 3.0 D	01/96→12/98	Diesel	BD-30Ti	2953	4	96.00	102.00	63
Trade 3.0 TD	11/98→09/04	Diesel	BD-30Ti	2953	4	96.00	102.00	63
Trade 3.0 TDiC	06/96→10/01	Diesel	BD-30Ti	2953	4	96.00	102.00	63
Trade 100	01/96→12/98	Diesel	BD-30Ti	2953	4	96.00	102.00	63
Tsuru 1.6	10/91→12/07	Petrol	E16E	1597	4	76.00	88.00	16
Tsuru 1.6	10/91→03/00	Petrol	E16S	1597	4	76.00	88.00	15
Tsuru 2.0	10/91→12/07	Petrol	SR20DE	1998	4	86.00	86.00	45
Urvan 2.0	12/82→11/98	Petrol	Z20	1952	4	85.00	86.00	43
Urvan 2.0	06/86→09/94	Petrol	Z20S	1952	4	85.00	86.00	43
Urvan 2.0 D	02/92→09/94	Diesel	LD20	1952	4	85.00	86.00	43
Urvan 2.2 D	11/80→07/83	Diesel	SD22	2164	4	83.00	100.00	32
Urvan 2.3 D	11/82→11/88	Diesel	SD23	2289	4	89.00	92.00	51
Urvan 2.3 D	01/88→05/97	Diesel	TD23	2289	4	89.00	92.00	52
Urvan 2.4	09/86→05/97	Petrol	Z24i	2389	4	89.00	96.00	53
Urvan 2.4 i	05/89→09/93	Petrol	Z24i	2389	4	89.00	96.00	53
Urvan 2.5	07/01→11/10	Petrol	QR25DE	2488	4	89.00	100.00	55
Urvan 2.5 D	12/88→05/97	Diesel	TD25	2494	4	92.90	92.00	58
Urvan 2.7 D	03/87→09/93	Diesel	TD27	2663	4	96.00	92.00	60
Urvan 2.7 TD	10/94→04/97	Diesel	TD27	2663	4	96.00	92.00	60
Urvan 2.7 TD	10/95→08/00	Diesel	TD27ETi	2664	4	96.00	92.00	61
Urvan 2.7 TD	10/95→08/00	Diesel	TD27Ti	2664	4	96.00	92.00	62
Urvan 3.0 TDi	07/01→11/10	Diesel	ZD30DDTi	2953	4	96.00	102.00	64
Urvan 3.2 D	10/95→08/00	Diesel	QD32	3153	4	99.20	102.00	65
Urvan 3.2 D	02/92→04/97	Diesel	SD33	3246	6	83.00	100.00	33
Urvan 3.2 TD	02/92→04/97	Diesel	SD33T	3246	6	83.00	100.00	33
Urvan / Caravan 3.0 Di	05/02→	Diesel	ZD30DDTi	2953	4	96.00	102.00	64
Vanette 1.2	07/82→12/84	Petrol	A12	1171	4	73.00	70.00	5
Vanette 1.5	07/82→12/87	Petrol	A15	1488	4	76.00	82.00	13
Vanette 1.5	06/81→12/95	Petrol	A15S	1488	4	76.00	82.00	13
Vanette 2.0	09/82→08/94	Petrol	Z20S	1952	4	85.00	86.00	43

				cm ³	x 			
Vanette 2.0 D	11/82→12/95	Diesel	LD20	1952	4	85.00	86.00	43
Vanette 2.0 D	07/91→01/95	Diesel	LD20II	1952	4	85.00	86.00	43
Vanette 2.4 i	10/86→12/95	Petrol	Z24i	2389	4	89.00	96.00	53
Vanette Cargo 2.0 D	01/96→	Diesel	LD20	1952	4	85.00	86.00	43
Versa 1.5	08/11→	Petrol	HR15DE	1498	4	78.00	78.40	17
Versa 1.5 dCi	08/11→	Diesel	K9K	1461	4	76.00	80.50	12
Versa 1.5 dCi	01/07→	Diesel	K9K 772	1461	4	76.00	80.50	12
Versa 1.6	09/08→	Petrol	HR16DE	1598	4	78.00	83.60	19
Versa 1.6 Flex	01/11→	Petrol	HR16DE	1598	4	78.00	83.60	19
Versa 1.8	08/06→	Petrol	MR18DE	1798	4	84.00	81.10	35
Versa 1.8 Flex	07/10→	Petrol	MR18DE	1798	4	84.00	81.10	35
Wingroad 2.0	10/03→11/05	Petrol	QR20DE	1998	4	89.00	80.30	50
X-Trail 2.0	06/07→11/13	Petrol	MR20DE	1997	4	84.00	90.10	37
X-Trail 2.0	07/01→01/13	Petrol	QR20DE	1998	4	89.00	80.30	50
X-Trail 2.0 4x4	07/01→01/13	Petrol	QR20DE	1998	4	89.00	80.30	50
X-Trail 2.0 4x4	06/01→01/13	Petrol	SR20VET	1998	4	86.00	86.00	45
X-Trail 2.0 dCi	06/07→11/13	Diesel	M9R	1995	4	84.00	90.10	38
X-Trail 2.0 dCi	06/07→11/13	Diesel	M9R 760	1995	4	84.00	90.00	36
X-Trail 2.0 dCi 4x4	10/09→11/13	Diesel	M9R 760	1995	4	84.00	90.00	36
X-Trail 2.0 dCi FWD	06/07→11/13	Diesel	M9R	1995	4	84.00	90.10	38
X-Trail 2.0 FWD	03/07→11/13	Petrol	MR20DE	1997	4	84.00	90.10	37
X-Trail 2.2 dCi	12/03→01/13	Diesel	YD22DDTi	2184	4	86.00	94.00	46
X-Trail 2.2 dCi 4x4	12/03→01/13	Diesel	YD22DDTi	2184	4	86.00	94.00	46
X-Trail 2.2 DCi FWD	06/01→09/03	Diesel	YD22DDTi	2184	4	86.00	94.00	46
X-Trail 2.2 Di 4x4	07/01→10/05	Diesel	YD22ETi	2184	4	86.00	94.00	46
X-Trail 2.5	09/11→	Petrol	QR25DE	2488	4	89.00	100.00	55
X-Trail 2.5 4x4	09/01→	Petrol	QR25DE	2488	4	89.00	100.00	55
X-Trail 2.5 FWD	06/01→12/07	Petrol	QR25DE	2488	4	89.00	100.00	55

			cm ³	x 			
A10	Petrol		988	4	73.00	59.00	3
A10S	Petrol		988	4	73.00	59.00	3
A12	Petrol		1171	4	73.00	70.00	5
A12S	Petrol		1237	4	75.00	70.00	6
A13 (Early)	Petrol		1270	4	76.00	76.00	10
A13S	Petrol		1270	4	76.00	70.00	8
A14	Petrol		1397	4	76.00	77.00	11
A14S	Petrol		1397	4	76.00	77.00	11
A15	Petrol		1488	4	76.00	82.00	13
A15E	Petrol		1488	4	76.00	82.00	13
A15S	Petrol		1488	4	76.00	82.00	13
BD30	Diesel		2953	4	96.00	102.00	63
BD30II	Diesel		2953	4	96.00	102.00	63
BD-30Ti	Diesel		2953	4	96.00	102.00	63
CA16D	Petrol		1598	4	78.00	83.60	18
CA16DE	Petrol		1598	4	80.00	79.50	21
CA16S	Petrol		1598	4	78.00	83.60	18
CA18	Petrol		1809	4	83.00	83.60	30
CA18D	Petrol		1809	4	83.00	83.60	30
CA18DE	Petrol		1809	4	83.00	83.60	30
CA18DET	Petrol		1809	4	83.00	83.60	30
CA18DT	Petrol		1809	4	83.00	83.60	30
CA18ET	Petrol		1809	4	83.00	83.60	30
CA18ET	Petrol		1809	4	83.00	83.60	30
CA18i	Petrol		1809	4	83.00	83.60	30
CA18N	Petrol		1809	4	83.00	83.60	30
CA18S	Petrol		1809	4	83.00	83.60	30
CA18T	Petrol		1809	4	83.60	83.00	34
CA20DE	Petrol		1973	4	84.50	88.00	39
CA20E	Petrol		1974	4	84.50	88.00	39
CA20S	Petrol		1974	4	84.50	88.00	39
CD17	Diesel		1681	4	80.00	83.60	22
CD17T	Diesel		1680	4	80.00	83.60	23
CD20	Diesel		1974	4	84.50	88.00	40
CD20T	Diesel		1974	4	84.50	88.00	40
D4F 712	Petrol		1149	4	69.00	76.80	1
D7F 764	Petrol		1149	4	69.00	76.80	2
E10	Petrol		988	4	73.00	59.00	4
E10S	Petrol		988	4	73.00	59.00	4
E13	Petrol		1269	4	76.00	70.00	9
E13S	Petrol		1269	4	76.00	70.00	9
E15	Petrol		1488	4	76.00	82.00	14
E15ET	Petrol		1488	4	76.00	82.00	14
E15S	Petrol		1488	4	76.00	82.00	14
E15T	Petrol		1488	4	76.00	82.00	14
E16	Petrol		1597	4	76.00	88.00	15
E16E	Petrol		1597	4	76.00	88.00	16
E16I	Petrol		1597	4	76.00	88.00	15
E16i	Petrol		1597	4	76.00	88.00	15
E16S	Petrol		1597	4	76.00	88.00	15
F4R 720	Petrol		1998	4	82.70	93.00	27
F4R 722	Petrol		1998	4	82.70	93.00	27
F9Q	Diesel		1870	4	80.00	93.00	24
F9Q 760	Diesel		1870	4	80.00	93.00	24
F9Q 762	Diesel		1870	4	80.00	93.00	24
F9Q 772	Diesel		1870	4	80.00	93.00	24
F9Q 774	Diesel		1870	4	80.00	93.00	24
FJ20E	Petrol		1991	4	89.00	80.00	49
G9T 722	Diesel		2188	4	87.00	92.00	48
G9T 750	Diesel		2188	4	87.00	92.00	48
G9U 630	Diesel		2464	4	89.00	99.00	54
G9U 632	Diesel		2464	4	89.00	99.00	54
G9U 720	Diesel		2463	4	89.00	99.00	54
G9U 730	Diesel		2463	4	89.00	99.00	54
HR15DE	Petrol		1498	4	78.00	78.40	17
HR16DE	Petrol		1598	4	78.00	83.60	19
JN	Petrol		1781	4	81.00	86.40	25
K4M	Petrol		1598	4	79.50	80.50	20
K4M 752	Petrol		1598	4	79.50	80.50	20

		cm3	x 			
K7J 700	Petrol	1390	4	75.80	77.00	7
K9K	Diesel	1461	4	76.00	80.50	12
K9K 276	Diesel	1461	4	76.00	80.50	12
K9K 292	Diesel	1461	4	76.00	80.50	12
K9K 400	Diesel	1461	4	76.00	80.50	12
K9K 410	Diesel	1461	4	76.00	80.50	12
K9K 430	Diesel	1461	4	76.00	80.50	12
K9K 608	Diesel	1461	4	76.00	80.50	12
K9K 628	Diesel	1461	4	76.00	80.50	12
K9K 636	Diesel	1461	4	76.00	80.50	12
K9K 646	Diesel	1461	4	76.00	80.50	12
K9K 700	Diesel	1461	4	76.00	80.50	12
K9K 702	Diesel	1461	4	76.00	80.50	12
K9K 704	Diesel	1461	4	76.00	80.50	12
K9K 708	Diesel	1461	4	76.00	80.50	12
K9K 710	Diesel	1461	4	76.00	80.50	12
K9K 714	Diesel	1461	4	76.00	80.50	12
K9K 716	Diesel	1461	4	76.00	80.50	12
K9K 722	Diesel	1461	4	76.00	80.50	12
K9K 728	Diesel	1461	4	76.00	80.50	12
K9K 732	Diesel	1461	4	76.00	80.50	12
K9K 764	Diesel	1461	4	76.00	80.50	12
K9K 772	Diesel	1461	4	76.00	80.50	12
K9K 892	Diesel	1461	4	76.00	80.50	12
K9K 896	Diesel	1461	4	76.00	80.50	12
L14	Petrol	1428	4	83.00	66.00	28
L16	Petrol	1595	4	83.00	73.70	29
L16S	Petrol	1595	4	83.00	73.70	29
L16T	Petrol	1595	4	83.00	73.70	29
L18	Petrol	1770	4	85.00	78.00	41
L18E	Petrol	1770	4	85.00	78.00	41
L18S	Petrol	1770	4	85.00	78.00	41
L18T	Petrol	1770	4	85.00	78.00	41
L20B	Petrol	1952	4	85.00	86.00	43
LD20	Diesel	1952	4	85.00	86.00	43
LD20E	Diesel	1952	4	85.00	86.00	43
LD20II	Diesel	1952	4	85.00	86.00	43
LD20IIE	Diesel	1952	4	85.00	86.00	43
LD20IIL	Diesel	1952	4	85.00	86.00	43
LD20T	Diesel	1952	4	85.00	86.00	43
M9R	Diesel	1995	4	84.00	90.10	38
M9R 630	Diesel	1995	4	84.00	90.00	36
M9R 760	Diesel	1995	4	84.00	90.00	36
M9R 780	Diesel	1995	4	84.00	90.00	36
M9R 782	Diesel	1995	4	84.00	90.00	36
M9T	Diesel	2299	4	85.00	101.30	44
M9T 670	Diesel	2298	4	85.00	101.30	44
M9T 672	Diesel	2298	4	85.00	101.30	44
M9T 676	Diesel	2298	4	85.00	101.30	44
M9T 678	Diesel	2298	4	85.00	101.30	44
M9T 680	Diesel	2298	4	85.00	101.30	44
M9T 686	Diesel	2298	4	85.00	101.30	44
M9T 690	Diesel	2298	4	85.00	101.30	44
M9T 692	Diesel	2298	4	85.00	101.30	44
M9T 694	Diesel	2298	4	85.00	101.30	44
M9T 696	Diesel	2298	4	85.00	101.30	44
M9T 698	Diesel	2298	4	85.00	101.30	44
M9T 870	Diesel	2299	4	85.00	101.30	44
M9T 880	Diesel	2299	4	85.00	101.30	44
MR18DE	Petrol	1798	4	84.00	81.10	35
MR20DE	Petrol	1997	4	84.00	90.10	37
QD32	Diesel	3153	4	99.20	102.00	65
QR20DD	Petrol	1998	4	89.00	80.30	50
QR20DE	Petrol	1998	4	89.00	80.30	50
QR25DD	Petrol	2488	4	89.00	100.00	55
QR25DE	Petrol	2488	4	89.00	100.00	55
QR25DER	Petrol	2488	4	89.00	100.00	55
RD28	Diesel	2826	6	85.00	83.00	42
RD28T	Diesel	2826	6	85.00	83.00	42

		cm ³	x 			
RD28Ti	Diesel	2826	6	85.00	83.00	42
SD20	Diesel	1991	4	83.00	92.00	31
SD22	Diesel	2164	4	83.00	100.00	32
SD23	Diesel	2289	4	89.00	92.00	51
SD25	Diesel	2488	4	89.00	100.00	56
SD33	Diesel	3246	6	83.00	100.00	33
SD33T	Diesel	3246	6	83.00	100.00	33
SR18DE	Petrol	1838	4	82.50	86.00	26
SR20De	Petrol	1998	4	86.00	86.00	45
SR20DE	Petrol	1998	4	86.00	86.00	45
SR20DI	Petrol	1998	4	86.00	86.00	45
SR20VE	Petrol	1998	4	86.00	86.00	45
SR20VET	Petrol	1998	4	86.00	86.00	45
TD23	Diesel	2289	4	89.00	92.00	52
TD25	Diesel	2494	4	92.90	92.00	58
TD25Ti	Diesel	2494	4	92.90	92.00	59
TD27	Diesel	2663	4	96.00	92.00	60
TD27ETi	Diesel	2664	4	96.00	92.00	61
TD27T	Diesel	2664	4	96.00	92.00	60
TD27Ti	Diesel	2664	4	96.00	92.00	62
YD22D	Diesel	2184	4	86.00	94.00	46
YD22DDT	Diesel	2184	4	86.00	94.00	46
YD22DDTi	Diesel	2184	4	86.00	94.00	46
YD22ETi	Diesel	2184	4	86.00	94.00	46
YD25DDTi	Diesel	2488	4	89.00	100.00	57
YD25ETi	Diesel	2488	4	89.00	100.00	57
YD25K3LD-5LO	Diesel	2488	4	89.00	100.00	57
YD25K3LD-5MI	Diesel	2488	4	89.00	100.00	57
Z16	Petrol	1595	4	83.00	73.70	29
Z18	Petrol	1770	4	85.00	78.00	41
Z20	Petrol	1952	4	85.00	86.00	43
Z20E	Petrol	1952	4	85.00	86.00	43
Z20S	Petrol	1952	4	85.00	86.00	43
Z22	Petrol	2188	4	87.00	92.00	47
Z24	Petrol	2388	4	89.00	96.00	53
Z24i	Petrol	2389	4	89.00	96.00	53
Z24S	Petrol	2389	4	89.00	96.00	53
ZD30	Diesel	2953	4	96.00	102.00	64
ZD30DDT	Diesel	2953	4	96.00	102.00	64
ZD30DDTi	Diesel	2953	4	96.00	102.00	64
ZD30H HD-5	Diesel	2953	4	96.00	102.00	64
ZD30Ti	Diesel	2953	4	96.00	102.00	64



1 69.00 x 76.80

D4F 712 4 Cyl. **1149cc** **55kW (75PS)** **Petrol** **TD18984**

BE/PL	4	39,984/40,000	43,639/43,650	16,250	1,810	0,020/0,065	AL-LF	01-3977	01-3977/4 STD 0.25 0.50
MB/HL 1,2,4,5	4	43,990/44,010	47,612/47,625	18,800	1,795	0,006/0,064	AL-LF	02-3978	H097/5 STD
MB/HL 3	1	43,990/44,010	47,612/47,625	23,900	1,795	0,006/0,064	AL-LF	02-3979H	



02-3979H STD 24,000/.9449" - 24,045/.9467"

2 69.00 x 76.80

D7F 764 4 Cyl. **1149cc** **44kW (60PS)** **Petrol** **TD22375**

BE/PL	4	39,984/40,000	43,639/43,650	16,250	1,810	0,020/0,065	AL-LF	01-3977	01-3977/4 STD 0.25 0.50
BE/PL	4	39,984/40,000	43,639/43,650	16,250	1,813	0,070/0,065	AL-LF	4405RA	01-4161/4 STD

01-3977

4405RA



MB/HL 1,2,4,5	4	43,990/44,010	47,612/47,625	18,800	1,795	0,006/0,064	AL-LF	02-3978	H097/5 STD
MB/HL 3	1	43,990/44,010	47,612/47,625	23,900	1,795	0,006/0,064	AL-LF	02-3979H	



02-3979H STD 24,000/.9449" - 24,045/.9467"

MB/HL 3	1	43,990/44,010	47,612/47,625	23,900	1,795	0,006/0,064	AL-LF	02-3979H	H1099/5 STD
MB/HL 1,2,4,5	4	43,990/44,010	47,612/47,625	18,800	1,798	0,020/0,064	AL-LF	4406RA	

02-3978

02-3979H

4406RA

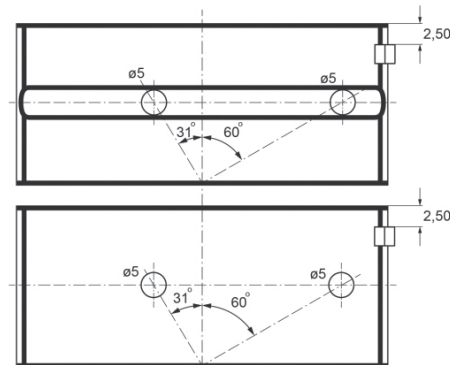
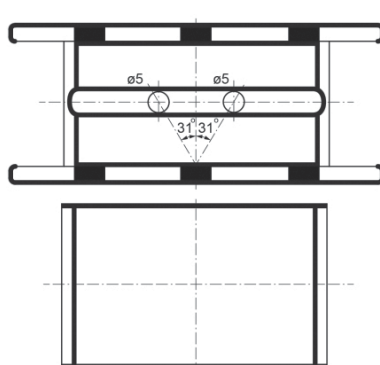
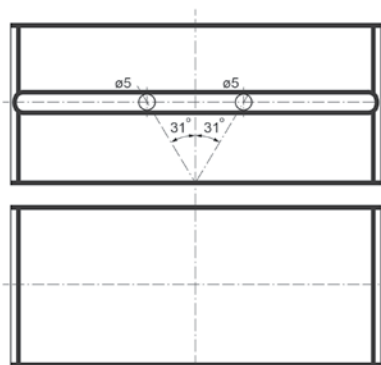



3 73.00 x 59.00

A10 4 Cyl. **988cc** **33kW** (45PS) **Petrol** **TD11047**

A10S 4 Cyl. **988cc** **32kW** (44PS) **Petrol** **TD2382**

BE/PL	8	44,960	48,020	19,600	1,503		BS	64-060-1	01-4333/4 STD 0.25
CB/NWB 1	1	43,730	47,030	23,500	1,580		BB	62-060-1	N158/5 STD
CB/NWB 2	1	43,280	46,520	14,000	1,580		BB	62-060-2	
CB/NWB 3	1	42,790	46,020	14,000	1,580		BB	62-060-3	
CB/NWB 4	1	42,290	45,520	14,000	1,580		BB	62-060-4	
CB/NWB 5	1	41,220	44,460	14,000	1,580		BB	62-060-5	

4 73.00 x 59.00

E10 4 Cyl. **988cc** **37kW** (50PS) **Petrol** **TD2424**

E10S 4 Cyl. **988cc** **37kW** (50PS) **Petrol** **TD2425**

BE/PL	8	39,950	43,010	17,000	1,500		BS	64-068-1	71-4204/4 STD 0.25
-------	---	--------	--------	--------	-------	--	----	----------	------------------------------

5 73.00 x 70.00

A12 4 Cyl. **1171cc** **38-43kW** (52-58PS) **Petrol** **TD2383**

BE/PL	8	44,960	48,020	19,600	1,503		BS	64-060-1	01-4333/4 STD 0.25
MB/HL 3	1	49,950	53,670	26,950	1,835		BS	63-060-(4)	H1147/5 STD
MB/HL 3	1	49,950	53,670	26,950	1,835		BS	63-060-(5)	
MB/HL 1,5	2	49,950	53,670	22,100	1,835		BS	63-060-1	
MB/HL 1,5	2	49,950	53,670	22,100	1,835		BS	63-060-2	
MB/HL 2,4	4	49,950	53,670	18,100	1,835		BS	63-060-3	
CB/NWB 1	1	43,730	47,030	23,500	1,580		BB	62-060-1	N158/5 STD
CB/NWB 2	1	43,280	46,520	14,000	1,580		BB	62-060-2	
CB/NWB 3	1	42,790	46,020	14,000	1,580		BB	62-060-3	
CB/NWB 4	1	42,290	45,520	14,000	1,580		BB	62-060-4	
CB/NWB 5	1	41,220	44,460	14,000	1,580		BB	62-060-5	

6 75.00 x 70.00

A12S 4 Cyl. **1237cc** **52kW** (71PS) **Petrol** **TD2384**

BE/PL	8	44,960	48,020	19,600	1,503		BS	64-060-1	01-4333/4 STD 0.25
-------	---	--------	--------	--------	-------	--	----	----------	------------------------------

MB/HL 3	1	49,950	53,670	26,950	1,835		BS	63-060-(4)	H1147/5 STD	
MB/HL 3	1	49,950	53,670	26,950	1,835		BS	63-060-(5)		
MB/HL 1,5	2	49,950	53,670	22,100	1,835		BS	63-060-1		
MB/HL 1,5	2	49,950	53,670	22,100	1,835		BS	63-060-2		
MB/HL 2,4	4	49,950	53,670	18,100	1,835		BS	63-060-3		
CB/NWB 1	1	43,730	47,030	23,500	1,580		BB	62-060-1	N158/5 STD	
CB/NWB 2	1	43,280	46,520	14,000	1,580		BB	62-060-2		
CB/NWB 3	1	42,790	46,020	14,000	1,580		BB	62-060-3		
CB/NWB 4	1	42,290	45,520	14,000	1,580		BB	62-060-4		
CB/NWB 5	1	41,220	44,460	14,000	1,580		BB	62-060-5		

7 75.80 x 77.00

K7J 700		4 Cyl.	1390cc	55kW (75PS)			Petrol		TD31236
BE/PL	4	43,964/43,980	47,614/47,625	17,750	1,806	0,020/0,074	AL-LF	2950RAA	01-4138/4 STD 0.25 0.50 0.75
TW/A	2	60,500/60,750	79,750/80,000		2,850		AL-LF	60476BF	A195/2 STD 0.10

8 76.00 x 70.00

A13S		4 Cyl.	1270cc	55kW (75PS)			Petrol		TD2385
BE/PL	8	44,960	48,020	19,600	1,503		BS	64-060-1	01-4333/4 STD 0.25
MB/HL 3	1	49,950	53,670	26,950	1,835		BS	63-060-(4)	H1147/5 STD
MB/HL 3	1	49,950	53,670	26,950	1,835		BS	63-060-(5)	
MB/HL 1,5	2	49,950	53,670	22,100	1,835		BS	63-060-1	
MB/HL 1,5	2	49,950	53,670	22,100	1,835		BS	63-060-2	
MB/HL 2,4	4	49,950	53,670	18,100	1,835		BS	63-060-3	
CB/NWB 1	1	43,730	47,030	23,500	1,580		BB	62-060-1	N158/5 STD
CB/NWB 2	1	43,280	46,520	14,000	1,580		BB	62-060-2	
CB/NWB 3	1	42,790	46,020	14,000	1,580		BB	62-060-3	
CB/NWB 4	1	42,290	45,520	14,000	1,580		BB	62-060-4	
CB/NWB 5	1	41,220	44,460	14,000	1,580		BB	62-060-5	

9 76.00 x 70.00

E13		4 Cyl.	1269cc	44kW (60PS)			Petrol		TD2426
E13S		4 Cyl.	1269cc	44kW (60PS)			Petrol		TD2427
BE/PL	8	39,950	43,010	17,000	1,500		BS	64-068-1	71-4204/4 STD 0.25



10		76.00 x 76.00								
A13 (Early)		4 Cyl.			1270cc			Petrol		FM398
BE/PL	8	44,960	48,020	19,600	1,503		BS	64-060-1	01-4333/4 STD 0.25	
MB/HL 3	1	49,950	53,670	26,950	1,835		BS	63-060-(4)	H1147/5 STD	
MB/HL 3	1	49,950	53,670	26,950	1,835		BS	63-060-(5)		
MB/HL 1,5	2	49,950	53,670	22,100	1,835		BS	63-060-1		
MB/HL 1,5	2	49,950	53,670	22,100	1,835		BS	63-060-2		
MB/HL 2,4	4	49,950	53,670	18,100	1,835		BS	63-060-3		
CB/NWB 1	1	43,730	47,030	23,500	1,580		BB	62-060-1	N158/5 STD	
CB/NWB 2	1	43,280	46,520	14,000	1,580		BB	62-060-2		
CB/NWB 3	1	42,790	46,020	14,000	1,580		BB	62-060-3		
CB/NWB 4	1	42,290	45,520	14,000	1,580		BB	62-060-4		
CB/NWB 5	1	41,220	44,460	14,000	1,580		BB	62-060-5		

11		76.00 x 77.00									
A14		4 Cyl.			1397cc			46-52kW (63-71PS)		Petrol	TD4694
A14S		4 Cyl.			1397cc			59kW (80PS)		Petrol	TD2387
BE/PL	8	44,960	48,020	19,600	1,503		BS	64-060-1	01-4333/4 STD 0.25		
MB/HL 3	1	49,950	53,670	26,950	1,835		BS	63-060-(4)	H1147/5 STD		
MB/HL 3	1	49,950	53,670	26,950	1,835		BS	63-060-(5)			
MB/HL 1,5	2	49,950	53,670	22,100	1,835		BS	63-060-1			
MB/HL 1,5	2	49,950	53,670	22,100	1,835		BS	63-060-2			
MB/HL 2,4	4	49,950	53,670	18,100	1,835		BS	63-060-3			
CB/NWB 1	1	43,730	47,030	23,500	1,580		BB	62-060-1	N158/5 STD		
CB/NWB 2	1	43,280	46,520	14,000	1,580		BB	62-060-2			
CB/NWB 3	1	42,790	46,020	14,000	1,580		BB	62-060-3			
CB/NWB 4	1	42,290	45,520	14,000	1,580		BB	62-060-4			
CB/NWB 5	1	41,220	44,460	14,000	1,580		BB	62-060-5			

12		76.00 x 80.50									
K9K		4 Cyl.			1461cc			48-81kW (65-110PS)		Diesel Turbo	TD31672
K9K 276		4 Cyl.			1461cc			62-66kW (84-90PS)		Diesel Turbo Intercooler	TD23877
K9K 292		4 Cyl.			1461cc			76kW (103PS)		Diesel Turbo Intercooler	TD24675
K9K 400 Euro 4		4 Cyl.			1461cc			63kW (86PS)		Diesel Turbo	TD31619
K9K 410		4 Cyl.			1461cc			76-81kW (103-110PS)		Diesel Turbo Intercooler	TD29686
K9K 430		4 Cyl.			1461cc			81kW (110PS)		Diesel Turbo Intercooler	TD29685
K9K 608		4 Cyl.			1461cc			66kW (90PS)		Diesel	TD29422



K9K 628 Euro 6	4 Cyl.	1461cc	63kW (86PS)	Diesel Turbo	TD31622
K9K 636 Euro 5	4 Cyl.	1461cc	81kW (110PS)	Diesel Turbo	TD29420
K9K 646 Euro 6	4 Cyl.	1461cc	81kW (110PS)	Diesel Turbo	TD31623
K9K 700	4 Cyl.	1461cc	48-50kW (65-68PS)	Diesel	TD21368
K9K 702	4 Cyl.	1461cc	60kW (82PS)	Diesel	TD23878
K9K 704	4 Cyl.	1461cc	48kW (65PS)	Diesel Turbo	TD17660
K9K 708	4 Cyl.	1461cc	48-50kW (65-68PS)	Diesel Turbo Intercooler	TD26291
K9K 710	4 Cyl.	1461cc	42-45kW (57-61PS)	Diesel Turbo Intercooler	TD26066
K9K 714	4 Cyl.	1461cc	42-45kW (57-61PS)	Diesel Turbo Intercooler	TD26067
K9K 716	4 Cyl.	1461cc	50kW (68PS)	Diesel Turbo	TD29537
K9K 722	4 Cyl.	1461cc	60kW (82PS)	Diesel Turbo	TD20971
K9K 728	4 Cyl.	1461cc	74-78kW (101-106PS)	Diesel Turbo Intercooler	TD24669
K9K 732	4 Cyl.	1461cc	78kW (106PS)	Diesel Turbo Intercooler	TD29682
K9K 764	4 Cyl.	1461cc	78kW (106PS)	Diesel Turbo Intercooler	TD29684
K9K 772	4 Cyl.	1461cc	63-76kW (86-103PS)	Diesel Turbo	TD28006
K9K 892 Euro 4	4 Cyl.	1461cc	66kW (90PS)	Diesel Turbo	TD31620
K9K 896 Euro 5	4 Cyl.	1461cc	81kW (110PS)	Diesel Turbo	TD31123

BE/PL	4	43,964/43,980	47,614/47,625	17,750	1,807	0,020/0,047	BS	71-4243L	71-4243/4 STD 0.25 0.50
BE/PL	4	43,964/43,980	47,614/47,625	20,750	1,807	0,020/0,047	BS	71-4243U	
MB/HL 1-5	5	47,990/48,010	51,936/51,949	19,500	1,950	0,026/0,059	AL-LF	02-4241	H1065/5 STD 0.25 0.50
TW/A	2	53,000/53,250	73,670/73,920		2,850		AL-LF	04-4048	A168/2 STD
SE/PB	1	25,995/26,000	28,500/28,521	22,500			BC-LF	55-4856	55-4856 SEMI

13
76.00 x 82.00

A15	4 Cyl.	1488cc	49-51kW (67-69PS)	Petrol	TD4695
A15E	4 Cyl.	1488cc	68kW (92PS)	Petrol	TD2390
A15S	4 Cyl.	1488cc	49-60kW (67-82PS)	Petrol	TD2391

BE/PL	8	44,960	48,020	19,600	1,503		BS	64-060-1	01-4333/4 STD 0.25
MB/HL 3	1	49,950	53,670	26,950	1,835		BS	63-060-(4)	H1147/5 STD
MB/HL 3	1	49,950	53,670	26,950	1,835		BS	63-060-(5)	
MB/HL 1,5	2	49,950	53,670	22,100	1,835		BS	63-060-1	
MB/HL 1,5	2	49,950	53,670	22,100	1,835		BS	63-060-2	
MB/HL 2,4	4	49,950	53,670	18,100	1,835		BS	63-060-3	
CB/NWB 1	1	43,730	47,030	23,500	1,580		BB	62-060-1	N158/5 STD
CB/NWB 2	1	43,280	46,520	14,000	1,580		BB	62-060-2	
CB/NWB 3	1	42,790	46,020	14,000	1,580		BB	62-060-3	
CB/NWB 4	1	42,290	45,520	14,000	1,580		BB	62-060-4	
CB/NWB 5	1	41,220	44,460	14,000	1,580		BB	62-060-5	



14	76.00 x 82.00									
E15			4 Cyl.	1488cc	51-55kW (69-75PS)		Petrol		TD2428	
E15ET			4 Cyl.	1488cc	77kW (105PS)		Petrol Turbo		TD5360	
E15S			4 Cyl.	1488cc	50-55kW (68-75PS)		Petrol		TD2429	
E15T			4 Cyl.	1488cc	75-85kW (102-116PS)		Petrol Turbo		TD2430	
BE/PL	8	39,950		43,010	17,000	1,500		BS	64-068-1	71-4204/4 STD 0.25

15	76.00 x 88.00									
E16			4 Cyl.	1597cc	50-62kW (68-84PS)		Petrol		TD2432	
E16i			4 Cyl.	1597cc	51-54kW (69-73PS)		Petrol		TD4701	
E16l			4 Cyl.	1597cc	62-66kW (84-90PS)		Petrol		TD2433	
E16S			4 Cyl.	1597cc	62kW (84PS)		Petrol		TD2435	
BE/PL	8	39,950		43,010	17,000	1,500		BS	64-068-1	71-4204/4 STD 0.25

16	76.00 x 88.00									
E16E			4 Cyl.	1597cc	67kW (91PS)		Petrol		TD28064	
BE/PL	8	39,990		43,020	17,100	1,491		AL-LF	64-043-1	01-4117/4 STD 0.25
BE/PL	4	42,971/42,987		46,000/46,012	16,600	1,497	0,020/0,072	EC	71-3639	71-3639/4 STD 0.25 0.50
MB/HL 1,2,4,5	4	54,972/54,985		59,000/59,013	19,500	2,001	0,020/0,064	EC	72-3505	H975/5 STD 0.25 0.50
MB/HL 3	1	54,972/54,985		59,000/59,013	25,900	2,001	0,020/0,064	EC	72-3506H	
			72-3506H	STD	25,950/1.0217" - 26,002/1.0237"					
				0.25mm	26,150/1.0295" - 26,202/1.0316"					
				0.50mm	26,350/1.0374" - 26,402/1.0394"					

17	78.00 x 78.40									
HR15DE			4 Cyl.	1498cc	73-85kW (99-116PS)		Petrol		TD19289	
BE/PL	4	39,960		43,010	15,000	1,510		AL-LF	64-1056-1	01-5049/4 STD
BE/PL	4	39,960		43,010	15,000	1,510		AL-LF	64-1056-2	
MB/HL 1-5	5	47,970		52,010	16,100	2,005		AL-LF	63-1056-1	H1359/5 STD
TW/A	2					1,950		AL-LF	65-1056-1	A338/2 STD

18	78.00 x 83.60									
CA16D			4 Cyl.	1598cc	79-81kW (107-110PS)		Petrol		TD2401	
CA16S			4 Cyl.	1598cc	60-66kW (82-90PS)		Petrol		TD2402	
BE/PL	8	44,960		48,010	18,600	1,500		BS	64-083-1	71-4122/4 STD 0.25 0.50
MB/HL 3	1	52,950		56,680	27,940	1,829		BS	63-083-(3)	H1070/5 STD 0.25
MB/HL 3	1	52,950		56,680	27,940	1,829		BS	63-083-(4)	
MB/HL 1,2,4,5	4	52,950		56,680	22,100	1,829		BS	63-083-1	
MB/HL 1,2,4,5	4	52,950		56,680	22,100	1,829		BS	63-083-2	



19 78.00 x 83.60

HR16DE		4 Cyl.		1598cc	69-103kW (94-140PS)			Petrol		TD18677
BE/PL	4	39,960	43,010	15,000	1,510		AL-LF	64-1056-1	01-5049/4 STD	
BE/PL	4	39,960	43,010	15,000	1,510		AL-LF	64-1056-2		
MB/HL 1-5	5	47.970	52.010	16.100	2.005		AL-LF	63-1056-1	H1359/5 STD	
TW/A	2				1.950		AL-LF	65-1056-1	A338/2 STD	

20 79.50 x 80.50

K4M		4 Cyl.		1598cc	75kW (102PS)			Petrol		TD31398
K4M 752		4 Cyl.		1598cc	70kW (95PS)			Petrol		TD21398
BE/PL	4	43,964/43,980	47,614/47,625	17,750	1,806	0,020/0,074	AL-LF	2950RAA	01-4138/4 STD 0.25 0.50 0.75	
MB/HL 1-5	5	47,990/48,010	51,936/51,949	19,500	1,950	0,026/0,059	AL-LF	02-4241	H1065/5 STD 0.25 0.50	
TW/A	2	53,000/53,250	73,670/73,920		2,850		AL-LF	04-4048	A168/2 STD	

21 80.00 x 79.50

CA16DE		4 Cyl.		1598cc	85-91kW (116-124PS)			Petrol		TD24807
BE/PL	8	44,960	48,010	18,600	1,500		BS	64-083-1	71-4122/4 STD 0.25 0.50	
MB/HL 3	1	52,950	56,680	27,940	1,829		BS	63-083-(3)	H1070/5 STD 0.25	
MB/HL 3	1	52,950	56,680	27,940	1,829		BS	63-083-(4)		
MB/HL 1,2,4,5	4	52,950	56,680	22,100	1,829		BS	63-083-1		
MB/HL 1,2,4,5	4	52,950	56,680	22,100	1,829		BS	63-083-2		

22 80.00 x 83.60

CD17		4 Cyl.		1681cc	40-41kW (54-56PS)			Diesel		TD2419
BE/PL	8	44,960	48,010	18,600	1,500		BS	64-083-1	71-4122/4 STD 0.25 0.50	
MB/HL 3	1	52,950	56,680	27,940	1,829		BS	63-083-(3)	H1070/5 STD 0.25	
MB/HL 3	1	52,950	56,680	27,940	1,829		BS	63-083-(4)		
MB/HL 1,2,4,5	4	52,950	56,680	22,100	1,829		BS	63-083-1		
MB/HL 1,2,4,5	4	52,950	56,680	22,100	1,829		BS	63-083-2		

→07/83

23 80.00 x 83.60

CD17T		4 Cyl.		1680cc	41-53kW (56-72PS)			Diesel Turbo		TD2420
BE/PL	8	44,960	48,010	18,600	1,500		BS	64-083-1	71-4122/4 STD 0.25 0.50	

MB/HL 3	1	52,950	56,680	27,940	1,829		BS	63-083-(3)	H1070/5 STD 0.25	
MB/HL 3	1	52,950	56,680	27,940	1,829		BS	63-083-(4)		
MB/HL 1,2,4,5	4	52,950	56,680	22,100	1,829		BS	63-083-1		
MB/HL 1,2,4,5	4	52,950	56,680	22,100	1,829		BS	63-083-2		

24 80.00 x 93.00

F9Q	4 Cyl.	1870cc	74-88kW (101-120PS)	Diesel Turbo	TD31671				
F9Q 760	4 Cyl.	1870cc	74kW (101PS)	Diesel Turbo	TD20980				
F9Q 762	4 Cyl.	1870cc	60kW (82PS)	Diesel Turbo	TD20991				
F9Q 772	4 Cyl.	1870cc	60kW (82PS)	Diesel Turbo	TD19378				
F9Q 774	4 Cyl.	1870cc	60kW (82PS)	Diesel Turbo	TD26548				
BE/PL	4	48,000/48,020	51,587/51,606	20,250	1,776	0,015/0,079	EC	71-3988L	71-3988/4 STD 0.25 0.50
BE/PL	4	48,000/48,020	51,587/51,606	20,500	1,776	0,015/0,079	EC	71-3988U	
MB/HL 1-5	5	54,785/54,805	58,731/58,744	18,500	1,947	0,032/0,090	EC	72-3989	H098/5 STD 0.25 0.50
TW/A	2	60,500/60,750	79,750/80,000		2,350		AL-LF	66741AF	A215/2 STD 0.10
SE/PB	1	27,996/28,000	30,240/30,260	24,650			BS-LF	55-4299	55-4299 SEMI

25 81.00 x 86.40

JN	4 Cyl.	1781cc	67kW (91PS)	Petrol	TD2457				
BE/PL	4	47,758/47,778	50,600/50,619	19,000	1,406	0,020/0,074	EC	71-3566	71-3566/4 STD 0.25
→12/85									
BE/PL	4	47,758/47,778	50,600/50,612	19,000	1,406	0,020/0,067	EC	71-3694	71-3694/4 STD 0.25 0.50
01/86→									

71-3566

71-3694

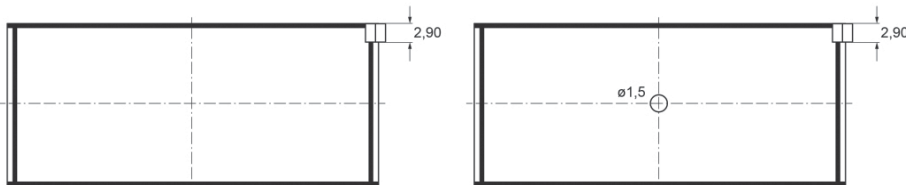

MB/HL	3	53,958/53,978	59,000/59,019	18,500	2,502	0,020/0,082	AL-LF	02-3085L	H025/5 STD 0.25 0.50
MB/HL	5	53,958/53,978	59,000/59,019	18,500	2,502	0,020/0,082	AL-LF	02-3085U	
MB/HL	1	53,958/53,978	59,000/59,019	24,930	2,502	0,020/0,082	AL-LF	02-3086HL	
MB/HL	1	53,958/53,978	59,000/59,019	24,930	2,502	0,020/0,082	AL-LF	02-3086HU	



02-3086HL	STD	25,000/.9843" - 25,040/.9858"
	0.25mm	25,100/.9882" - 25,140/.9898"
	0.50mm	25,100/.9882" - 25,140/.9898"
	0.75mm	25,100/.9882" - 25,140/.9898"

02-3086HU	STD	25,000/.9843" - 25,040/.9858"
	0.25mm	25,100/.9882" - 25,140/.9898"
	0.50mm	25,100/.9882" - 25,140/.9898"
	0.75mm	25,100/.9882" - 25,140/.9898"

MB/HL	4	53,958/53,978	59,000/59,019	18,500	2,502	0,020/0,082	AL-LF	02-3085L	H027/5 STD 0.25 0.50	
MB/HL	6	53,958/53,978	59,000/59,019	18,500	2,502	0,020/0,082	AL-LF	02-3085U		

02-3085L

02-3085U

02-3086HL

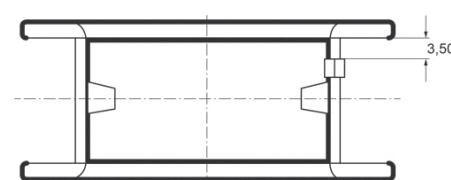
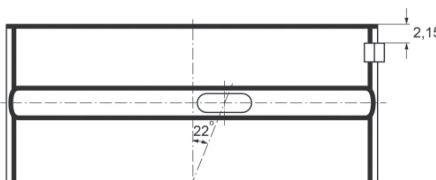

02-3086HU

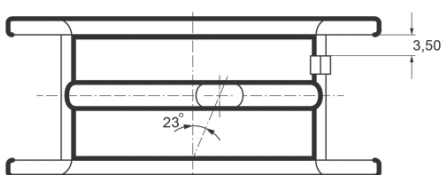

TW/A	2	59,500	73,200		1,975		AL-LF	04-3527	A123/4 STD		
TW/A	2	59,500	73,200		1,975		AL-LF	04-3528			
SE/PB	1	20,000	23,000/23,052	25,000			BC	55-3567	55-3567 SEMI		
CB/NWB 1-5	5	25,939/25,960	28,250/28,271	17,000	1,138		AL-LF	03-3317	N118/5 STD		[12]
BU	1	42,959/42,975	46,055/46,095	15,000			AL-LF	07-3088	07-3088 STD SEMI		[13]

Front, For intermediary shaft

BU	1	41,959/41,975	45,000/45,025	15,000			AL-LF	07-3089	07-3089 STD SEMI		[13]
----	---	---------------	---------------	--------	--	--	-------	---------	----------------------------	--	------

Rear, For intermediary shaft

26 82.50 x 86.00

SR18DE	4 Cyl.		1838cc	92-104kW (125-141PS)		Petrol			TD2517
MB/HL 1-5	5	70,899/70,914	74,980/75,001	26,009	2,009	0,048/0,107	BS	67262CP	H1157/5 STD 0.25

27 82.70 x 93.00

F4R 720	4 Cyl.		1998cc	88kW (120PS)		Petrol			TD19376		
F4R 722	4 Cyl.		1998cc	88kW (120PS)		Petrol			TD19377		
BE/PL	4	48,000/48,020	51,587/51,606	20,250	1,776	0,015/0,079	EC	71-3988L	71-3988/4 STD 0.25 0.50		[4]
BE/PL	4	48,000/48,020	51,587/51,606	20,500	1,776	0,015/0,079	EC	71-3988U			
MB/HL 1-5	5	54,785/54,805	58,731/58,744	18,500	1,947	0,032/0,090	EC	72-3989	H098/5 STD 0.25 0.50		
TW/A	2	60,500/60,750	79,750/80,000		2,350		AL-LF	66741AF	A215/2 STD 0.10		
SE/PB	1	21,000/21,015	23,000/23,021	24,750			BS	4064Y	55-4264 SEMI		

28 83.00 x 66.00

L14	4 Cyl.		1428cc	48kW (65PS)		Petrol			TD2463	
BE/PL	8	49,960	53,010	22,130	1,500		BS	64-054-1	71-4205/4 STD	



29										83.00 x 73.70									
L16										4 Cyl. 1595cc 60-65kW (82-88PS) Petrol TD2464									
L16S										4 Cyl. 1595cc 53kW (72PS) Petrol TD2465									
L16T										4 Cyl. 1595cc 61kW (83PS) Petrol TD11107									
Z16										4 Cyl. 1595cc 62kW (84PS) Petrol TD2555									
BE/PL	8	49,960	53,010	22,130	1,500		BS	64-054-1	71-4205/4 STD										

30										83.00 x 83.60									
CA18										4 Cyl. 1809cc 65kW (88PS) Petrol TD11048									
CA18D										4 Cyl. 1809cc 92-95kW (125-129PS) Petrol TD2405									
CA18DE										4 Cyl. 1809cc 93-99kW (126-135PS) Petrol TD2406									
CA18DET Euro 1										4 Cyl. 1809cc 124-148kW (169-201PS) Petrol Turbo TD2408									
CA18DT										4 Cyl. 1809cc 122-129kW (166-175PS) Petrol Turbo TD23873									
CA18ET										4 Cyl. 1809cc 90-100kW (122-136PS) Petrol Turbo TD2410									
CA18ET										4 Cyl. 1809cc 99kW (135PS) Petrol TD21667									
CA18i										4 Cyl. 1809cc 67kW (91PS) Petrol TD2411									
CA18N										4 Cyl. 1809cc 61-65kW (83-88PS) Petrol TD2412									
CA18S										4 Cyl. 1809cc 65-74kW (88-101PS) Petrol TD4696									
BE/PL	8	44,960	48,010	18,600	1,500		BS	64-083-1	71-4122/4 STD 0.25 0.50										
MB/HL 3	1	52,950	56,680	27,940	1,829		BS	63-083-(3)	H1070/5 STD 0.25										
MB/HL 3	1	52,950	56,680	27,940	1,829		BS	63-083-(4)											
MB/HL 1,2,4,5	4	52,950	56,680	22,100	1,829		BS	63-083-1											
MB/HL 1,2,4,5	4	52,950	56,680	22,100	1,829		BS	63-083-2											

31										83.00 x 92.00									
SD20										4 Cyl. 1991cc 44kW (60PS) Diesel TD29614									
BE/PL	1	52,910/52,926	55,986/55,999	26,009	1,499	0,063/0,117	BS	67260CP	71-4206 STD										
MB/HL 1-3	3	70,906/70,919	74,980/75,001	32,004	2,007	0,048/0,107	BS	67261CP	H1122/3 STD 0.25										
→07/80																			
MB/HL 1-5	5	70,899/70,914	74,980/75,001	26,009	2,009	0,048/0,107	BS	67262CP	H1157/5 STD 0.25										
08/80→																			
TW/A	2	78,700	93,700		2,325		BS	65-080-1	A220/4 STD										
TW/A	2	78,700	93,700		2,325		BS	65-080-2											
CB/NWB 1	1	45,430	48,660	23,750	1,575		BB	62-052-1	N159/3 STD										
CB/NWB 2	1	43,900	47,140	21,750	1,575		BB	62-052-2											
CB/NWB 3	1	41,220	44,550	23,750	1,575		BB	62-052-3											

32										83.00 x 100.00									
SD22										4 Cyl. 2164cc 46-47kW (63-64PS) Diesel TD2512									
BE/PL	1	52,910/52,926	55,986/55,999	26,009	1,499	0,063/0,117	BS	67260CP	71-4206 STD										
MB/HL 1-5	5	70,899/70,914	74,980/75,001	26,009	2,009	0,048/0,107	BS	67262CP	H1157/5 STD 0.25										

TW/A	2	78,700	93,700		2,325		BS	65-080-1	A220/4 STD
TW/A	2	78,700	93,700		2,325		BS	65-080-2	
SE/PB	1	26,000	29,000	32,000	1,562		BS	67-085-1	55-4267 STD
CB/NWB 1	1	45,430	48,660	23,750	1,575		BB	62-052-1	N159/3 STD
CB/NWB 2	1	43,900	47,140	21,750	1,575		BB	62-052-2	
CB/NWB 3	1	41,220	44,550	23,750	1,575		BB	62-052-3	

33 83.00 x 100.00

SD33	6 Cyl.		3246cc	70kW (95PS)		Diesel		TD2515	
SD33T	6 Cyl.		3246cc	81-88kW (110-120PS)		Diesel Turbo		TD2516	
BE/PL	1	52,910/52,926	55,986/55,999	26,009	1,499	0,063/0,117	BS	67260CP	71-4206 STD
TW/A	2	78,700	93,700		2,325		BS	65-080-1	A220/4 STD
TW/A	2	78,700	93,700		2,325		BS	65-080-2	

34 83.60 x 83.00

CA18T	4 Cyl.		1809cc	99kW (135PS)		Petrol Turbo		TD2414	
BE/PL	8	44,960	48,010	18,600	1,500		BS	64-083-1	71-4122/4 STD 0.25 0.50
MB/HL 3	1	52,950	56,680	27,940	1,829		BS	63-083-(3)	H1070/5 STD 0.25
MB/HL 3	1	52,950	56,680	27,940	1,829		BS	63-083-(4)	
MB/HL 1,2,4,5	4	52,950	56,680	22,100	1,829		BS	63-083-1	
MB/HL 1,2,4,5	4	52,950	56,680	22,100	1,829		BS	63-083-2	

35 84.00 x 81.10

MR18DE	4 Cyl.		1798cc	78-97kW (106-132PS)		Petrol		TD19304	
BE/PL	4	44,000	47,010	16,100	1,495		AL-LF	64-1054-1	01-4978/4 STD
BE/PL	4	44,000	47,010	16,100	1,495		AL-LF	64-1054-2	
MB/HL 1-5	10	52,000	56,010	17,100	1,990		AL-LF	63-1054-1	H1340/5 STD
TW/A	2	59,000	76,500		2,100		AL-LF	65-1054-1	A324/2 STD

36 84.00 x 90.00

M9R 630	4 Cyl.		1995cc	66-84kW (90-114PS)		Diesel Turbo Intercooler		TD26730	
M9R 760	4 Cyl.		1995cc	127-130kW (173-177PS)		Diesel Turbo Intercooler		TD20981	
M9R 780	4 Cyl.		1995cc	66-84kW (90-114PS)		Diesel Turbo Intercooler		TD20890	
M9R 782	4 Cyl.		1995cc	66kW (90PS)		Diesel Turbo Intercooler		TD24668	
MB/HL	5	55,985/56,005	59,998/60,011	19,500	1,984	0,035/0,088	AL-LF	02-4560L	H1243/5 STD
MB/HL	5	55,985/56,005	59,998/60,011	17,200	1,984	0,035/0,088	AL-LF	02-4560U	
TW/A	2	65,600/65,850	84,000/84,250		2,700		AL-LF	04-4822	A297/2 STD
SE/PB	1	31,994/32,000	34,985/35,010	23,700			BS-LF	55-4562	55-4562 SEMI



37		84.00 x 90.10								
MR20DE		4 Cyl.			1997cc	98-108kW (133-147PS)		Petrol		TD19288
BE/PL	4	44,000	47,010	16,100	1,495		AL-LF	64-1054-1	01-4978/4 STD	
BE/PL	4	44,000	47,010	16,100	1,495		AL-LF	64-1054-2		
MB/HL 1-5	10	52,000	56,010	17,100	1,990		AL-LF	63-1054-1	H1340/5 STD	
TW/A	2	59,000	76,500		2,100		AL-LF	65-1054-1	A324/2 STD	

38		84.00 x 90.10								
M9R		4 Cyl.			1995cc	110kW (150PS)		Diesel		TD22892
MB/HL	5	55,985/56,005	59,998/60,011	19,500	1,984	0,035/0,088	AL-LF	02-4560L	H1243/5 STD	
MB/HL	5	55,985/56,005	59,998/60,011	17,200	1,984	0,035/0,088	AL-LF	02-4560U		
TW/A	2	65,600/65,850	84,000/84,250		2,700		AL-LF	04-4822	A297/2 STD	
SE/PB	1	31,994/32,000	34,985/35,010	23,700			BS-LF	55-4562	55-4562 SEMI	

39		84.50 x 88.00								
CA20DE		4 Cyl.			1973cc	77kW (105PS)		Petrol		TD20607
CA20E		4 Cyl.			1974cc	72-85kW (98-116PS)		Petrol		TD2416
CA20S		4 Cyl.			1974cc	66-81kW (90-110PS)		Petrol		TD4697
BE/PL	8	44,960	48,010	18,600	1,500		BS	64-083-1	71-4122/4 STD 0.25 0.50	
MB/HL 3	1	52,950	56,680	27,940	1,829		BS	63-083-(3)		
MB/HL 3	1	52,950	56,680	27,940	1,829		BS	63-083-(4)	H1070/5 STD 0.25	
MB/HL 1,2,4,5	4	52,950	56,680	22,100	1,829		BS	63-083-1		
MB/HL 1,2,4,5	4	52,950	56,680	22,100	1,829		BS	63-083-2		

40		84.50 x 88.00								
CD20		4 Cyl.			1974cc	55kW (75PS)		Diesel		TD4698
CD20T		4 Cyl.			1974cc	66kW (90PS)		Diesel Turbo		TD5509
BE/PL	8	49,950	53,010	20,100	1,498		AL-LF	64-095-1	01-4896/4 STD	

41		85.00 x 78.00								
L18		4 Cyl.			1770cc	59-65kW (80-88PS)		Petrol		TD2466
L18E		4 Cyl.			1770cc	68kW (92PS)		Petrol		TD18870
L18S		4 Cyl.			1770cc	65kW (88PS)		Petrol		TD2467
L18T		4 Cyl.			1770cc	66kW (90PS)		Petrol		TD2468
Z18		4 Cyl.			1770cc	77kW (105PS)		Petrol		TD2556
BE/PL	8	49,960	53,010	22,130	1,500		BS	64-054-1	71-4205/4 STD	

42		85.00 x 83.00								
RD28		6 Cyl.			2826cc	66-69kW (90-94PS)		Diesel		TD4711
RD28T		6 Cyl.			2826cc	74-86kW (101-117PS)		Diesel Turbo		TD2511
RD28Ti		6 Cyl.			2826cc	95kW (129PS)		Diesel Turbo		TD13751

BE/PL	12	49,950	53,010	20,100	1,498		AL-LF	64-095-1	01-4374/6 STD	
MB/HL 4	1	54,980	58,670	26,960	1,830		AL	63-097-(3)	H1233/7 STD 0.25	
MB/HL 4	1	54,980	58,670	26,960	1,830		AL	63-097-(4)		
MB/HL 1-3, 5-7	6	54,980	58,670	19,900	1,830		AL	63-097-1		
MB/HL 1-3, 5-7	6	54,980	58,670	19,900	1,830		AL	63-097-2		

43 85.00 x 86.00

L20B	4 Cyl.	1952cc	69-82kW (94-112PS)	Petrol	TD2471				
Z20	4 Cyl.	1952cc	64-66kW (87-90PS)	Petrol	TD2557				
Z20E	4 Cyl.	1952cc	75-88kW (102-120PS)	Petrol	TD2559				
Z20S	4 Cyl.	1952cc	62-66kW (84-90PS)	Petrol	TD2560				
LD20	4 Cyl.	1952cc	43-49kW (58-67PS)	Diesel	TD2482				
LD20E	4 Cyl.	1952cc	41-44kW (56-60PS)	Diesel	TD2484				
LD20II	4 Cyl.	1952cc	44-49kW (60-67PS)	Diesel	TD2485				
LD20IIE	4 Cyl.	1952cc	46kW (63PS)	Diesel	TD2487				
LD20IIL	4 Cyl.	1952cc	47-49kW (64-67PS)	Diesel	TD2488				
LD20T	4 Cyl.	1952cc	57-62kW (78-84PS)	Diesel Turbo	TD2489				
BE/PL	8	49,960	53,010	22,130	1,500	BS	64-054-1	71-4205/4 STD	

44 85.00 x 101.30

M9T	4 Cyl.	2299cc	74-120kW (100-163PS)	Diesel Turbo Intercooler	TD31669					
M9T 670 Euro 5	4 Cyl.	2298cc	74-92kW (101-125PS)	Diesel Turbo	TD26543					
M9T 672 Euro 5	4 Cyl.	2298cc	74-92kW (101-125PS)	Diesel Turbo	TD26768					
M9T 676 Euro 4	4 Cyl.	2298cc	74-92kW (101-125PS)	Diesel Turbo	TD26769					
M9T 678	4 Cyl.	2298cc	107kW (146PS)	Diesel Turbo	TD26770					
M9T 680	4 Cyl.	2298cc	107kW (146PS)	Diesel Turbo	TD26771					
M9T 686 Euro 5	4 Cyl.	2298cc	92kW (125PS)	Diesel Turbo	TD26772					
M9T 690 Euro 5	4 Cyl.	2298cc	74-92kW (101-125PS)	Diesel Turbo	TD26544					
M9T 692 Euro 4	4 Cyl.	2298cc	92kW (125PS)	Diesel Turbo	TD26773					
M9T 694 Euro 4	4 Cyl.	2298cc	107kW (146PS)	Diesel Turbo	TD26774					
M9T 696 Euro 4	4 Cyl.	2298cc	92-107kW (125-146PS)	Diesel Turbo	TD26775					
M9T 698 Euro 5	4 Cyl.	2298cc	92-107kW (125-146PS)	Diesel Turbo	TD26776					
M9T 870 Euro 5	4 Cyl.	2299cc	74-92kW (100-125PS)	Diesel Turbo	TD31670					
M9T 880 Euro 5	4 Cyl.	2299cc	110kW (150PS)	Diesel Turbo	TD30783					
BE/PL	1	53,000/53,020	56,587/56,606	19,000	1,781	0,046/0,069	SP-LF	71-4940	71-4940 STD ①	
MB/HL	5	59,985/60,005	63,998/64,011	19,500	1,986	0,029/0,082	AL-LF	02-4939L	H1327/5 STD	
MB/HL	5	59,985/60,005	63,998/64,011	17,200	1,986	0,029/0,082	AL-LF	02-4939U		
TW/A	2	65,600/65,850	84,000/84,250		2,700		AL-LF	04-4822	A297/2 STD	
SE/PB	1	31,994/32,000	34,985/35,010	23,700			BS-LF	55-4562	55-4562 SEMI	

45 86.00 x 86.00

SR20DE	4 Cyl.	1998cc	92-119kW (125-162PS)	Petrol	TD2521
SR20De	4 Cyl.	1998cc	85kW (115PS)	Petrol	TD19324
SR20DI	4 Cyl.	1998cc	85kW (115PS)	Petrol	TD2525
SR20VE	4 Cyl.	1998cc	139-150kW (189-204PS)	Petrol	TD19703
SR20VET	4 Cyl.	1998cc	206kW (280PS)	Petrol Turbo	TD31680

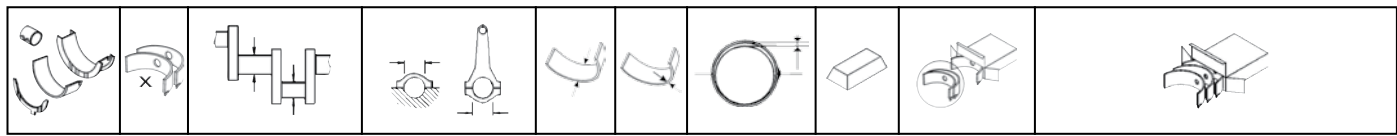

MB/HL 1-5	5	70,899/70,914	74,980/75,001	26,009	2,009	0,048/0,107	BS	67262CP	H1157/5 STD 0.25
--------------	---	---------------	---------------	--------	-------	-------------	----	---------	---------------------

46 86.00 x 94.00

YD22D	4 Cyl.	2184cc	84kW (114PS)	Diesel	TD31633
YD22DDT	4 Cyl.	2184cc	81-102kW (110-139PS)	Diesel	TD16314
YD22DDTi	4 Cyl.	2184cc	84-100kW (114-136PS)	Diesel Turbo Intercooler	TD16229
YD22ETI	4 Cyl.	2184cc	84kW (114PS)	Diesel Turbo Intercooler	TD16320

BE/PL	8	51,980	55,010	23,000	1,498		AL-LF	64-1050-1	71-4580/4 STD
MB/HL 1-5	5	62,980	66,680	20,000	1,826		AL-LF	63-1050-1	H1249/5 STD
MB/HL 1-5	5	62,980	66,680	20,000	1,826		AL-LF	63-1050-2	
TW/A	2	69,750	88,250		1,950		AL-LF	65-1050-1	A308/2 STD

47 87.00 x 92.00

Z22	4 Cyl.	2188cc	71-73kW (97-99PS)	Petrol	TD2562				
BE/PL	8	49,960	53,010	22,130	1,500		BS	64-054-1	71-4205/4 STD

48 87.00 x 92.00

G9T 722	4 Cyl.	2188cc	66kW (90PS)	Diesel Turbo Intercooler	TD19379				
G9T 750	4 Cyl.	2188cc	66kW (90PS)	Diesel Turbo Intercooler	TD23886				
BE/PL	4	52,971/52,990	56,587/56,606	20,650	1,782	0,015/0,069	EC	71-4744	71-4744/4 STD 0.25
MB/HL	5	57,980/58,000	61,668/61,681	20,990	1,810		AL-LF	02-4042	H1013/5 STD 0.25
TW/A	2	63,250/63,500	78,550/78,800		2,350		AL-LF	04-4745	A289/2 STD
SE/PB	1	31,013/31,020	33,500/33,525	25,800			BC	55-4050	55-4050 SEMI

49 89.00 x 80.00

FJ20E	4 Cyl.	1991cc	107kW (146PS)	Petrol	TD4702				
BE/PL	8	49,960	53,010	22,130	1,500		BS	64-054-1	71-4205/4 STD

50 89.00 x 80.30

QR20DD	4 Cyl.	1998cc	110kW (150PS)	Petrol	TD31608				
QR20DE	4 Cyl.	1998cc	96-110kW (131-150PS)	Petrol	TD16319				
BE/PL	8	44,960	48,020	19,000	1,511		AL-LF	64-1052-1	01-4979/4 STD
MB/HL	4	54,960	58,970	20,000	1,980		AL-LF	63-1052-1	H1341/5 STD
MB/HL	1	54,960	58,970	23,400	1,980		AL-LF	63-1052-2	
MB/HL	5	54,960	58,970	20,000	1,980		AL-LF	63-1052-3	

51 89.00 x 92.00

SD23	4 Cyl.	2289cc	50-51kW (68-69PS)	Diesel	TD2513				
BE/PL	1	52,910/52,926	55,986/55,999	26,009	1,499	0,063/0,117	BS	67260CP	71-4206 STD
MB/HL 1-5	5	70,899/70,914	74,980/75,001	26,009	2,009	0,048/0,107	BS	67262CP	H1157/5 STD 0.25

TW/A	2	78,700	93,700	2,325			BS	65-080-1	A220/4 STD
TW/A	2	78,700	93,700	2,325			BS	65-080-2	
CB/NWB 1	1	45,430	48,660	23,750	1,575		BB	62-052-1	N159/3 STD
CB/NWB 2	1	43,900	47,140	21,750	1,575		BB	62-052-2	
CB/NWB 3	1	41,220	44,550	23,750	1,575		BB	62-052-3	

52 89.00 x 92.00

TD23			4 Cyl.	2289cc	51-56kW (69-76PS)		Diesel		TD2528
BE/PL	1	52,910/52,926	55,986/55,999	26,009	1,499	0,063/0,117	BS	67260CP	71-4206 STD
MB/HL 1-5	5	70,900	75,000	26,000	2,013		BS	63-087-1	H1093/5 STD 0.25
MB/HL 1-5	5	70,900	75,000	26,000	2,013		BS	63-087-2	
TW/A	2	78,700	93,700	2,325			BS	65-080-1	A220/4 STD
TW/A	2	78,700	93,700	2,325			BS	65-080-2	

53 89.00 x 96.00

Z24			4 Cyl.	2388cc	74-79kW (101-107PS)		Petrol		TD2563
Z24i			4 Cyl.	2389cc	72-91kW (98-124PS)		Petrol		TD4716
Z24S			4 Cyl.	2389cc	74-79kW (101-107PS)		Petrol		TD2566
BE/PL	8	49,960	53,010	22,130	1,500		BS	64-054-1	71-4205/4 STD

54 89.00 x 99.00

G9U 630 Euro 4			4 Cyl.	2464cc	84-107kW (114-146PS)		Diesel		TD24664
G9U 632 Euro 4			4 Cyl.	2464cc	88-107kW (120-146PS)		Diesel Turbo Intercooler		TD24665
G9U 720			4 Cyl.	2463cc	73-84kW (99-114PS)		Diesel Turbo Intercooler		TD21010
G9U 730			4 Cyl.	2463cc	99kW (135PS)		Diesel Turbo Intercooler		TD18702
BE/PL	4	52,971/52,990	56,587/56,606	20,650	1,782	0,015/0,069	EC	71-4744	71-4744/4 STD 0.25
MB/HL	5	57,980/58,000	61,668/61,681	20,990	1,810		AL-LF	02-4042	H1013/5 STD 0.25
TW/A	2	63,250/63,500	78,550/78,800	2,350			AL-LF	04-4745	A289/2 STD
SE/PB	1	31,013/31,020	33,500/33,525	25,800			BC	55-4050	55-4050 SEMI

55 89.00 x 100.00

QR25DD			4 Cyl.	2488cc	121-125kW (165-170PS)		Petrol		TD31612
QR25DE			4 Cyl.	2488cc	104-136kW (141-185PS)		Petrol		TD17652
QR25DER			4 Cyl.	2488cc	169-188kW (230-256PS)		Petrol Compressor		TD31668
BE/PL	8	44,960	48,020	19,000	1,511		AL-LF	64-1052-1	01-4979/4 STD
MB/HL	4	54,960	58,970	20,000	1,980		AL-LF	63-1052-1	H1341/5 STD
MB/HL	1	54,960	58,970	23,400	1,980		AL-LF	63-1052-2	
MB/HL	5	54,960	58,970	20,000	1,980		AL-LF	63-1052-3	



56		89.00 x 100.00							
SD25		4 Cyl.		2488cc	52-55kW (71-75PS)		Diesel		TD2514
BE/PL	1	52,910/52,926	55,986/55,999	26,009	1,499	0,063/0,117	BS	67260CP	71-4206 STD
MB/HL 1-5	5	70,899/70,914	74,980/75,001	26,009	2,009	0,048/0,107	BS	67262CP	H1157/5 STD 0.25
TW/A	2	78,700	93,700		2,325		BS	65-080-1	A220/4 STD
TW/A	2	78,700	93,700		2,325		BS	65-080-2	
CB/NWB 1	1	45,430	48,660	23,750	1,575		BB	62-052-1	N159/3 STD
CB/NWB 2	1	43,900	47,140	21,750	1,575		BB	62-052-2	
CB/NWB 3	1	41,220	44,550	23,750	1,575		BB	62-052-3	

57		89.00 x 100.00							
YD25DDTi		4 Cyl.		2488cc	95-140kW (129-190PS)		Diesel Turbo Intercooler		TD17650
YD25ETI		4 Cyl.		2488cc	96-98kW (131-133PS)		Diesel Turbo Intercooler		TD26328
YD25K3LD-5LO		4 Cyl.		2488cc	90-107kW (121-145PS)		Diesel Turbo Intercooler		TD26698
YD25K3LD-5MI		4 Cyl.		2488cc	100kW (136PS)		Diesel Turbo Intercooler		TD26699
BE/PL	8	51,980	55,010	23,000	1,498		AL-LF	64-1050-1	71-4580/4 STD
MB/HL 1-5	5	62,980	66,680	20,000	1,826		AL-LF	63-1050-1	H1249/5 STD
MB/HL 1-5	5	62,980	66,680	20,000	1,826		AL-LF	63-1050-2	
TW/A	2	69,750	88,250		1,950		AL-LF	65-1050-1	A308/2 STD

58		92.90 x 92.00							
TD25		4 Cyl.		2494cc	55-62kW (75-84PS)		Diesel		TD4714
BE/PL	8	56,910	60,010	26,100	1,513		BS	64-089-1	71-4156/4 STD
MB/HL 1-5	5	70,900	75,000	26,000	2,013		BS	63-087-1	H1093/5 STD 0.25
MB/HL 1-5	5	70,900	75,000	26,000	2,013		BS	63-087-2	
TW/A	2	78,700	93,700		2,325		BS	65-080-1	A220/4 STD
TW/A	2	78,700	93,700		2,325		BS	65-080-2	

59		92.90 x 92.00							
TD25TI		4 Cyl.		2494cc	76kW (103PS)		Diesel Turbo		TD10589
MB/HL 1-5	5	70,900	75,000	26,000	2,013		BS	63-087-1	H1093/5 STD 0.25
MB/HL 1-5	5	70,900	75,000	26,000	2,013		BS	63-087-2	

60		96.00 x 92.00							
TD27		4 Cyl.		2663cc	58-73kW (79-99PS)		Diesel		TD2532
TD27T		4 Cyl.		2664cc	66-74kW (90-101PS)		Diesel Turbo		TD2533
BE/PL	8	56,910	60,010	26,100	1,513		BS	64-089-1	71-4156/4 STD

MB/HL 1-5	5	70,900	75,000	26,000	2,013		BS	63-087-1	H1093/5 STD 0.25
MB/HL 1-5	5	70,900	75,000	26,000	2,013		BS	63-087-2	
TW/A	2	78,700	93,700		2,325		BS	65-080-1	A220/4 STD
TW/A	2	78,700	93,700		2,325		BS	65-080-2	

61 96.00 x 92.00

TD27ETi			4 Cyl.	2664cc	96kW (131PS)		Diesel Turbo Intercooler		TD9896
MB/HL 1-5	5	70,900	75,000	26,000	2,013		BS	63-087-1	H1093/5 STD 0.25
MB/HL 1-5	5	70,900	75,000	26,000	2,013		BS	63-087-2	

62 96.00 x 92.00

TD27Ti			4 Cyl.	2664cc	92kW (125PS)		Diesel Turbo Intercooler		TD9478
BE/PL	8	56,910	60,010	26,100	1,513		BS	64-089-1	71-4156/4 STD
MB/HL 1-5	5	70,900	75,000	26,000	2,013		BS	63-087-1	H1093/5 STD 0.25
MB/HL 1-5	5	70,900	75,000	26,000	2,013		BS	63-087-2	

63 96.00 x 102.00

BD30			4 Cyl.	2953cc	63-74kW (86-100PS)		Diesel		TD2398
BD30II			4 Cyl.	2953cc	63kW (86PS)		Diesel		TD2399
BD-30Ti			4 Cyl.	2953cc	78-92kW (106-125PS)		Diesel Turbo Intercooler		TD8327
MB/HL 1-5	5	70,900	75,000	26,000	2,013		BS	63-087-1	H1093/5 STD 0.25
MB/HL 1-5	5	70,900	75,000	26,000	2,013		BS	63-087-2	

64 96.00 x 102.00









ZD30			4 Cyl.	2953cc	100-113kW (136-154PS)		Diesel Turbo		TD19371
ZD30DDT			4 Cyl.	2953cc	110kW (150PS)		Diesel Turbo		TD20345
ZD30DDTi			4 Cyl.	2953cc	96-125kW (131-170PS)		Diesel Turbo Intercooler		TD14288
ZD30H HD-5			4 Cyl.	2953cc	110kW (150PS)		Diesel Turbo Intercooler		TD26700
ZD30Ti			4 Cyl.	2953cc	113kW (154PS)		Diesel Turbo Intercooler		TD17659
BE/PL	8	56,900	60,000	26,100	1,508		AL-LF	64-1051-1	01-4977/4 STD
MB/HL 1-5	5	70,900	75,000	25,000	2,010		AL-LF	63-1051-1	H1342/5 STD
MB/HL 1-5	5	70,900	75,000	25,000	2,010		AL-LF	63-1051-2	
TW/A	2	78,750	93,500		2,300		AL-LF	65-1051-1	A323/2 STD

65 99.20 x 102.00

QD32			4 Cyl.	3153cc	70-76kW (95-103PS)		Diesel		TD16476
MB/HL 1-5	5	70,900	75,000	26,000	2,013		BS	63-087-1	H1093/5 STD 0.25
MB/HL 1-5	5	70,900	75,000	26,000	2,013		BS	63-087-2	



Admiral A 2.8 S	10/65→03/69	Petrol	28 S	2784	6	92.00	69.80	55
Admiral B 2.8	03/69→07/76	Petrol	28 H	2784	6	92.00	69.80	55
Admiral B 2.8 E	03/69→01/78	Petrol	28 E	2784	6	92.00	69.80	55
Admiral B 2.8 S	03/69→01/78	Petrol	28 S	2784	6	92.00	69.80	55
Agila 1.0	08/03→12/07	Petrol	Z 10 XEP	998	3	73.40	78.60	7
Agila 1.0 12V	09/00→12/07	Petrol	Z 10 XE	973	3	72.50	78.60	5
Agila 1.2 16V	09/00→12/07	Petrol	Z 12 XE	1199	4	72.50	72.60	4
Agila 1.2 16V Twinport	07/04→12/07	Petrol	Z 12 XEP	1229	4	73.40	72.60	6
Agila 1.3 CDTI	08/03→12/07	Diesel	Z 13 DT	1248	4	69.60	82.00	1
Agila 1.3 CDTI	04/08→	Diesel	Z 13 DTJ	1248	4	69.60	82.00	1
Arena 1.9 D	03/98→08/01	Diesel	F8Q 600	1870	4	80.00	93.00	23
Arena 1.9 D	03/98→08/01	Diesel	F8Q 606	1870	4	80.00	93.00	23
Arena 2.5 D	03/98→08/01	Diesel	S8U 758	2499	4	93.00	92.00	60
Arena 2.5 D	03/98→08/01	Diesel	S8U 780	2499	4	93.00	92.00	60
Arena 2.5 D	03/98→08/01	Diesel	S8U 782	2499	4	93.00	92.00	60
Ascona A 1.2 S	04/72→08/75	Petrol	12 S	1196	4	79.00	61.00	16
Ascona A 1.6 N	10/70→08/75	Petrol	16 N	1584	4	85.00	69.80	38
Ascona A 1.6 S	10/70→08/75	Petrol	16 S	1584	4	85.00	69.80	38
Ascona A 1.9	09/74→08/75	Petrol	19 N	1897	4	93.00	69.80	57
Ascona A 1.9 SR	03/71→08/75	Petrol	19 S	1897	4	93.00	69.80	57
Ascona A Voyage 1.6 N	10/70→08/75	Petrol	16 N	1584	4	85.00	69.80	38
Ascona A Voyage 1.6 S	10/70→08/75	Petrol	16 S	1584	4	85.00	69.80	38
Ascona A Voyage 1.9 SR	10/70→08/75	Petrol	19 S	1897	4	93.00	69.80	57
Ascona B 1.2	08/76→02/79	Petrol	12 N	1196	4	79.00	61.00	16
Ascona B 1.2 S	09/75→02/79	Petrol	12 S	1196	4	79.00	61.00	16
Ascona B 1.3 N	03/79→08/81	Petrol	13 N	1297	4	75.00	73.40	10
Ascona B 1.3 S	08/79→08/81	Petrol	13 S	1297	4	75.00	73.40	10
Ascona B 1.6 N	09/75→08/81	Petrol	16 N	1584	4	85.00	69.80	38
Ascona B 1.6 S	09/75→08/81	Petrol	16 S	1584	4	85.00	69.80	38
Ascona B 1.9 N	08/76→08/81	Petrol	19 N	1897	4	93.00	69.80	57
Ascona B 1.9 S	09/75→08/81	Petrol	19 S	1897	4	93.00	69.80	57
Ascona B 2.0 D	08/78→08/81	Diesel	20 D	1998	4	86.50	85.00	45
Ascona B 2.0 E	08/79→08/81	Petrol	20 E	1979	4	95.00	69.80	62
Ascona B 2.0 N	08/77→08/81	Petrol	20 N	1979	4	95.00	69.80	62
Ascona B 2.0 S	08/77→08/81	Petrol	20 S	1979	4	95.00	69.80	62
Ascona C 1.3 N	09/81→08/86	Petrol	13 N	1297	4	75.00	73.40	10
Ascona C 1.3 S	09/81→08/88	Petrol	13 S	1297	4	75.00	73.40	10
Ascona C 1.6	09/81→08/88	Petrol	16 N	1598	4	80.00	79.50	21
Ascona C 1.6	09/86→08/88	Petrol	16 SV	1598	4	79.00	81.50	17
Ascona C 1.6 D	03/82→08/88	Diesel	16 D	1598	4	80.00	79.50	21
Ascona C 1.6 D	03/82→08/88	Diesel	16 DA	1598	4	80.00	79.50	21
Ascona C 1.6 i	09/87→08/88	Petrol	E 16 LZ	1598	4	79.00	81.50	17
Ascona C 1.6 i	09/87→08/88	Petrol	E 16 NZ	1598	4	79.00	81.50	17
Ascona C 1.6 i CAT	09/86→08/88	Petrol	C 16 LZ	1598	4	80.00	79.50	20
Ascona C 1.6 i CAT	09/86→08/88	Petrol	C 16 NZ	1598	4	79.00	81.50	17
Ascona C 1.6 S	09/81→08/86	Petrol	16 SH	1598	4	80.00	79.50	21
Ascona C 1.8	09/87→08/88	Petrol	E 18 NV	1796	4	84.80	79.50	37
Ascona C 1.8 E	01/85→08/86	Petrol	C 18 NE	1796	4	84.80	79.50	36
Ascona C 1.8 E	01/85→08/86	Petrol	S 18 NV	1796	4	84.80	79.50	36
Ascona C 1.8 i	09/82→08/86	Petrol	18 E	1796	4	84.80	79.50	36
Ascona C 2.0 i	09/86→08/88	Petrol	20 NE	1998	4	86.00	86.00	40
Ascona C 2.0 i CAT	09/86→08/88	Petrol	C 20 NE	1998	4	86.00	86.00	40
Ascona C 2.0 i GT	03/87→08/88	Petrol	20 SEH	1998	4	86.00	86.00	40
Astra F 1.4	09/91→09/93	Petrol	14 NV	1389	4	77.60	73.40	14
Astra F 1.4	09/92→09/98	Petrol	14 SE	1389	4	77.60	73.40	14
Astra F 1.4 Comfort	09/03→01/05	Petrol	Z 14 XEP	1364	4	73.40	80.60	8
Astra F 1.4 i	09/91→01/99	Petrol	C 14 NZ	1389	4	77.60	73.40	14
Astra F 1.4 i	09/91→01/05	Petrol	X 14 NZ	1389	4	77.60	73.40	14
Astra F 1.4 i 16V	01/96→03/01	Petrol	X 14 XE	1389	4	77.60	73.40	14
Astra F 1.4 Si	03/92→03/01	Petrol	C 14 SE	1389	4	77.60	73.40	14
Astra F 1.6	09/95→09/98	Petrol	16 LZ2	1598	4	79.00	81.50	17
Astra F 1.6	09/95→09/98	Petrol	16 NZR	1598	4	79.00	81.50	17
Astra F 1.6 i	09/91→09/98	Petrol	C 16 NZ	1598	4	79.00	81.50	17
Astra F 1.6 i	02/93→08/96	Petrol	X 16 SZ	1598	4	79.00	81.50	17
Astra F 1.6 i	09/91→01/05	Petrol	X 16 SZR	1598	4	79.00	81.50	17
Astra F 1.6 i 16V	08/94→01/05	Petrol	X 16 XEL	1598	4	79.00	81.50	17
Astra F 1.6 Si	03/92→12/94	Petrol	C 16 SE	1598	4	79.00	81.50	17
Astra F 1.7 D	12/91→09/92	Diesel	17 D	1700	4	82.50	79.50	29
Astra F 1.7 D	07/92→01/99	Diesel	17 DR	1700	4	82.50	79.50	29

				cm3	x 			
Astra F 1.7 TD	03/95→02/98	Diesel	X 17 DT (TC4EE1)	1686	4	79.00	86.00	19
Astra F 1.7 TD	08/94→01/99	Diesel	X 17 DTL	1700	4	82.50	79.50	30
Astra F 1.7 TDS	12/91→09/98	Diesel	17 DT (TC4EE1)	1686	4	79.00	86.00	19
Astra F 1.7 TDS	12/91→09/98	Diesel	X 17 DT (TC4EE1)	1686	4	79.00	86.00	19
Astra F 1.8	11/91→07/93	Petrol	18 SE	1796	4	84.80	79.50	36
Astra F 1.8 i	09/91→09/98	Petrol	C 18 NZ	1796	4	84.80	79.50	36
Astra F 1.8 i 16V	09/95→09/96	Petrol	18 SE	1796	4	84.80	79.50	36
Astra F 1.8 i 16V	09/95→08/97	Petrol	C 18 SEL	1796	4	84.80	79.50	37
Astra F 1.8 i 16V	06/93→01/98	Petrol	C 18 XE	1799	4	81.60	86.00	26
Astra F 1.8 i 16V	07/94→03/01	Petrol	C 18 XEL	1799	4	81.60	86.00	26
Astra F 1.8 i 16V	07/94→03/01	Petrol	X 18 XE	1799	4	81.60	86.00	26
Astra F 2.0 GSI 16V	09/91→01/98	Petrol	C 20 XE	1998	4	86.00	86.00	41
Astra F 2.0 i	09/91→09/98	Petrol	C 20 NE	1998	4	86.00	86.00	40
Astra F 2.0 i 16V	03/93→01/98	Petrol	C 20 XE	1998	4	86.00	86.00	41
Astra F 2.0 i 16V	02/95→09/98	Petrol	X 20 XEV	1998	4	86.00	86.00	40
Astra G 1.2 16V	02/98→09/00	Petrol	X 12 XE	1199	4	72.50	72.60	4
Astra G 1.2 16V	09/00→01/05	Petrol	Z 12 XE	1199	4	72.50	72.60	4
Astra G 1.4	10/04→12/09	Petrol	Z 14 XEP	1364	4	73.40	80.60	8
Astra G 1.4 16V	02/98→01/05	Petrol	X 14 XE	1389	4	77.60	73.40	14
Astra G 1.4 16V	02/98→01/05	Petrol	Z 14 XE	1389	4	77.60	73.40	14
Astra G 1.6	02/98→09/00	Petrol	X 16 SZR	1598	4	79.00	81.50	17
Astra G 1.6	09/00→04/05	Petrol	Z 16 SE	1598	4	79.00	81.50	17
Astra G 1.6	12/02→12/09	Petrol	Z 16 XEP	1598	4	79.00	81.50	17
Astra G 1.6 16V	02/98→01/05	Petrol	C 16 SEL	1598	4	79.00	81.50	17
Astra G 1.6 16V	02/98→01/05	Petrol	X 16 XEL	1598	4	79.00	81.50	17
Astra G 1.6 16V	02/98→10/05	Petrol	Z 16 XE	1598	4	79.00	81.50	17
Astra G 1.6 16V	03/00→05/05	Petrol	Z 16 XEP	1598	4	79.00	81.50	17
Astra G 1.6 CNG	03/03→07/04	Petrol	Z 16 YNG	1598	4	79.00	81.50	17
Astra G 1.6 LPG	06/02→01/05	Petrol	Z 16 XE	1598	4	79.00	81.50	17
Astra G 1.7 CDTI	04/03→12/09	Diesel	Z 17 DTL	1686	4	79.00	86.00	19
Astra G 1.7 DTI 16V	02/00→04/05	Diesel	Y 17 DT	1686	4	79.00	86.00	19
Astra G 1.7 TD	02/98→04/05	Diesel	X 17 DTL	1700	4	82.50	79.50	30
Astra G 1.8	02/03→01/05	Petrol	Z 18 XEL	1796	4	80.50	88.20	25
Astra G 1.8 16V	02/98→10/00	Petrol	X 18 XE1	1796	4	80.50	88.20	25
Astra G 1.8 16V	06/00→10/05	Petrol	Z 18 XE	1796	4	80.50	88.20	25
Astra G 2.0 16V	02/98→01/05	Petrol	X 20 XEV	1998	4	86.00	86.00	40
Astra G 2.0 DI	02/98→04/05	Diesel	X 20 DTL	1995	4	84.00	90.00	34
Astra G 2.0 DI	02/98→01/05	Diesel	Y 20 DTL	1995	4	84.00	90.00	34
Astra G 2.0 DTI 16V	08/99→01/05	Diesel	X 20 DTH	1995	4	84.00	90.00	34
Astra G 2.0 DTI 16V	08/99→01/05	Diesel	Y 20 DTH	1995	4	84.00	90.00	34
Astra G 2.2 16V	06/00→10/05	Petrol	Z 22 SE	2198	4	86.00	94.60	44
Astra G 2.2 DTI	09/02→10/05	Diesel	Y 22 DTR	2172	4	84.00	98.00	35
Astra H 1.2	08/05→	Petrol	Z 12 XEP	1229	4	73.40	72.60	6
Astra H 1.3 CDTI	08/05→	Diesel	Z 13 DTH	1248	4	69.60	82.00	1
Astra H 1.4	04/04→	Petrol	Z 14 XEL	1364	4	73.40	80.60	8
Astra H 1.4	03/04→	Petrol	Z 14 XEP	1364	4	73.40	80.60	8
Astra H 1.4 LPG	08/09→	Petrol	Z 14 XEP	1364	4	73.40	80.60	8
Astra H 1.6	02/04→	Petrol	Z 16 XEP	1598	4	79.00	81.50	17
Astra H 1.6	12/06→	Petrol	Z 16 XER	1598	4	79.00	81.50	17
Astra H 1.6 CNG	11/05→	Petrol	Z 16 YNG	1598	4	79.00	81.50	17
Astra H 1.6 LPG	08/09→	Petrol	Z 16 XER	1598	4	79.00	81.50	17
Astra H 1.7 CDTI	03/04→	Diesel	Z 17 DTH	1686	4	79.00	86.00	19
Astra H 1.7 CDTI	03/04→	Diesel	Z 17 DTL	1686	4	79.00	86.00	19
Astra H 1.8	03/04→	Petrol	Z 18 XE	1796	4	80.50	88.20	25
Astra H 1.8	08/05→	Petrol	Z 18 XER	1796	4	80.50	88.20	25
Astra H 1.9 CDTI	06/04→	Diesel	Z 19 DT	1910	4	82.00	90.40	27
Astra H 1.9 CDTI	09/04→	Diesel	Z 19 DTH	1910	4	82.00	90.40	27
Astra H 1.9 CDTI 16V	04/04→	Diesel	Z 19 DTJ	1910	4	82.00	90.40	27
Astra H GTC 1.2	08/05→	Petrol	Z 12 XEP	1229	4	73.40	72.60	6
Astra H GTC 1.3 CDTI	04/05→	Diesel	Z 13 DTH	1248	4	69.60	82.00	1
Astra H GTC 1.4	03/05→	Petrol	Z 14 XEL	1364	4	73.40	80.60	8
Astra H GTC 1.4	03/05→	Petrol	Z 14 XEP	1364	4	73.40	80.60	8
Astra H GTC 1.6	03/05→	Petrol	Z 16 XEP	1598	4	79.00	81.50	17
Astra H GTC 1.6	12/06→	Petrol	Z 16 XER	1598	4	79.00	81.50	17
Astra H GTC 1.6 CNG	11/05→	Petrol	Z 16 YNG	1598	4	79.00	81.50	17
Astra H GTC 1.7 CDTI	03/05→	Diesel	Z 17 DTH	1686	4	79.00	86.00	19
Astra H GTC 1.7 CDTI	03/05→	Diesel	Z 17 DTL	1686	4	79.00	86.00	19
Astra H GTC 1.8	03/05→	Petrol	Z 18 XE	1796	4	80.50	88.20	25
Astra H GTC 1.8	01/06→	Petrol	Z 18 XER	1796	4	80.50	88.20	25



cm3



9

Astra H GTC 1.9 CDTI	09/05→	Diesel	Z 19 DT	1910	4	82.00	90.40	27
Astra H GTC 1.9 CDTI	03/05→	Diesel	Z 19 DTH	1910	4	82.00	90.40	27
Astra H GTC 1.9 CDTI 16V	03/05→	Diesel	Z 19 DTJ	1910	4	82.00	90.40	27
Astra J 1.3 CDTI	12/09→	Diesel	A 13 DTE	1248	4	69.60	82.00	1
Calibra A 2.0 i	06/90→07/97	Petrol	C 20 NE	1998	4	86.00	86.00	40
Calibra A 2.0 i 4x4	06/90→07/97	Petrol	C 20 NE	1998	4	86.00	86.00	40
Calibra A 2.0 i 16V	06/90→02/94	Petrol	C 20 XE	1998	4	86.00	86.00	41
Calibra A 2.0 i 16V	02/94→07/97	Petrol	X 20 XEV	1998	4	86.00	86.00	40
Calibra A 2.0 i 16V 4x4	06/90→02/94	Petrol	C 20 XE	1998	4	86.00	86.00	41
Calibra A 2.0 i 16V 4x4	02/94→07/97	Petrol	X 20 XEV	1998	4	86.00	86.00	40
Calibra A 2.0 i Turbo 4x4	03/92→07/97	Petrol	C 20 LET	1998	4	86.00	86.00	42
Campo 2.2 D	08/87→09/96	Diesel	C223	2238	4	88.00	92.00	51
Campo 2.2 D 4x4	08/87→09/96	Diesel	C223	2238	4	88.00	92.00	51
Campo 2.3	08/91→09/96	Petrol	4 ZD1	2255	4	89.50	90.00	54
Campo 2.3 4x4	08/91→09/96	Petrol	4 ZD1	2255	4	89.50	90.00	54
Campo 2.5 D	08/91→06/94	Diesel	4 JA1	2499	4	93.00	92.00	58
Campo 2.5 D 4x4	08/91→06/94	Diesel	4 JA1	2499	4	93.00	92.00	58
Campo 2.5 DTI	12/01→	Diesel	4 JA1	2499	4	93.00	92.00	58
Campo 2.5 DTI 4x4	12/01→	Diesel	4 JA1	2499	4	93.00	92.00	58
Campo 2.5 TD	07/94→	Diesel	4 JA1T	2499	4	93.00	92.00	59
Campo 2.5 TD 4x4	07/94→	Diesel	4 JA1T	2499	4	93.00	92.00	59
Campo 3.1 TD	12/92→	Diesel	4 JG2T	3059	4	95.40	107.00	66
Campo 3.1 TD 4x4	12/92→	Diesel	4 JG2T	3059	4	95.40	107.00	66
Combo 1.2	07/94→10/01	Petrol	X 12 SZ	1195	4	72.00	73.40	3
Combo 1.2	07/94→10/01	Petrol	C 12 NZ	1196	4	72.00	73.40	3
Combo 1.3 CDTI 16V	10/04→	Diesel	Y 13 DT	1248	4	69.60	82.00	1
Combo 1.3 CDTI 16V	10/04→	Diesel	Z 13 DT	1248	4	69.60	82.00	1
Combo 1.3 CDTI 16V	10/05→	Diesel	Z 13 DTJ	1248	4	69.60	82.00	1
Combo 1.4	10/04→	Petrol	Z 14 XEP	1364	4	73.40	80.60	8
Combo 1.4	07/94→10/01	Petrol	C 14 NZ	1389	4	77.60	73.40	14
Combo 1.4	07/94→10/01	Petrol	C 14 SE	1389	4	77.60	73.40	14
Combo 1.4	07/94→10/01	Petrol	X 14 SZ	1389	4	77.60	73.40	14
Combo 1.4 16V	08/05→	Petrol	Z 14 XEP	1364	4	73.40	80.60	8
Combo 1.4 16V	08/99→10/01	Petrol	X 14 XE	1389	4	77.60	73.40	14
Combo 1.6	10/01→	Petrol	Z 16 SE	1598	4	79.00	81.50	17
Combo 1.6 CNG	04/05→	Petrol	Z 16 YNG	1598	4	79.00	81.50	17
Combo 1.6 CNG 16V	04/05→	Petrol	Z 16 YNG	1598	4	79.00	81.50	17
Combo 1.7 CDTI 16V	12/04→	Diesel	Z 17 DTH	1686	4	79.00	86.00	19
Combo 1.7 D	07/94→10/01	Diesel	17 D (4EE1)	1686	4	79.00	86.00	18
Combo 1.7 D	07/94→10/01	Diesel	X 17 D (4EE1)	1686	4	79.00	86.00	18
Combo 1.7 DI 16V	10/01→	Diesel	Y 17 DTL	1686	4	79.00	86.00	19
Combo 1.7 DTI 16V	10/01→	Diesel	Y 17 DT	1686	4	79.00	86.00	19
Commodore A 2.5	08/67→08/69	Petrol	25 S	2490	6	87.00	69.80	46
Commodore A 2.5 GS	08/67→01/72	Petrol	25 H	2490	6	87.00	69.80	46
Commodore A 2.5 GS/E	08/69→01/72	Petrol	25 E	2490	6	87.00	69.80	46
Commodore B 2.5	01/72→07/78	Petrol	25 S	2490	6	87.00	69.80	46
Commodore B 2.5 GS	01/72→08/75	Petrol	25 H	2490	6	87.00	69.80	46
Commodore B 2.8 GS	01/72→07/78	Petrol	28 HC	2784	6	92.00	69.80	55
Commodore B 2.8 GS/E	07/72→02/75	Petrol	28 E	2784	6	92.00	69.80	55
Commodore B 2.8 GS/E	07/72→02/75	Petrol	28 EC	2784	6	92.00	69.80	55
Commodore B 2.8 GS/E	03/75→07/78	Petrol	28 HC	2784	6	92.00	69.80	55
Commodore C 2.5 E	12/80→12/82	Petrol	25 E	2490	6	87.00	69.80	46
Commodore C 2.5 S	08/78→12/82	Petrol	25 S	2490	6	87.00	69.80	46
Corsa 1.3	01/97→12/02	Petrol	13 NB	1297	4	75.00	73.40	10
Corsa 1.4	07/00→12/03	Petrol	Z 14 XEP	1364	4	73.40	80.60	8
Corsa 1.4	08/94→07/02	Petrol	C 14 NZ	1389	4	77.60	73.40	14
Corsa 1.4	07/00→05/01	Petrol	Z 14 XE	1389	4	77.60	73.40	14
Corsa 1.6	01/00→12/03	Petrol	C 16 SEL	1598	4	79.00	81.50	17
Corsa 1.8	01/02→12/05	Petrol	Z 18 XEL	1796	4	80.50	88.20	25
Corsa A 1.0	09/82→03/93	Petrol	10 S	993	4	72.00	61.00	2
Corsa A 1.2	09/82→08/90	Petrol	12 NC	1196	4	79.00	61.00	16
Corsa A 1.2	09/82→08/90	Petrol	12 S	1196	4	79.00	61.00	16
Corsa A 1.2	02/86→04/89	Petrol	12 ST	1196	4	77.80	62.90	15
Corsa A 1.2	09/82→08/90	Petrol	E 12 GV	1196	4	79.00	61.00	16
Corsa A 1.2 i	09/89→03/93	Petrol	C 12 NZ	1196	4	72.00	73.40	3
Corsa A 1.2 N	01/90→03/93	Petrol	12 NV	1196	4	77.80	62.90	15
Corsa A 1.2 S	09/82→02/90	Petrol	12 ST	1196	4	77.80	62.90	15
Corsa A 1.3	09/85→10/89	Petrol	13 NB	1297	4	75.00	73.40	10
Corsa A 1.3	02/86→04/89	Petrol	13 SB	1297	4	75.00	73.40	10

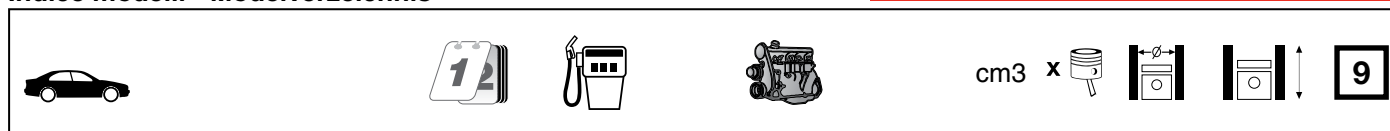









Corsa A 1.3 GL	09/82→03/93	Petrol	13 S	1297	4	75.00	73.40	10
Corsa A 1.3 i	09/86→09/90	Petrol	C 13 N	1297	4	75.00	73.40	10
Corsa A 1.3 S	09/82→10/89	Petrol	13 SB	1297	4	75.00	73.40	10
Corsa A 1.4 i	01/85→03/93	Petrol	C 14 NZ	1389	4	77.60	73.40	14
Corsa A 1.4 S	01/90→03/93	Petrol	14 NV	1389	4	77.60	73.40	14
Corsa A 1.4 Si	09/91→03/93	Petrol	C 14 SE	1389	4	77.60	73.40	14
Corsa A 1.5 D	06/87→03/93	Diesel	15 D (4EC1)	1488	4	76.00	82.00	12
Corsa A 1.5 TD	03/88→03/93	Diesel	15 DT (T4EC1)	1488	4	76.00	82.00	13
Corsa A 1.6 GSI	08/88→09/92	Petrol	C 16 NZ	1598	4	79.00	81.50	17
Corsa A 1.6 GSI	09/89→03/93	Petrol	C 16 SEI	1598	4	79.00	81.50	17
Corsa A 1.6 GSI	05/88→03/92	Petrol	E 16 SE	1598	4	79.00	81.50	17
Corsa A 1.6 GSI CAT	02/92→03/93	Petrol	C 16 SE	1598	4	79.00	81.50	17
Corsa A TR 1.0	09/82→09/92	Petrol	10 S	993	4	72.00	61.00	2
Corsa A TR 1.2 i	09/89→03/93	Petrol	C 12 NZ	1196	4	72.00	73.40	3
Corsa A TR 1.2 N	01/85→10/87	Petrol	12 NC	1196	4	79.00	61.00	16
Corsa A TR 1.2 N	01/85→10/87	Petrol	E 12 GV	1196	4	79.00	61.00	16
Corsa A TR 1.2 S	09/82→10/87	Petrol	12 S	1196	4	79.00	61.00	16
Corsa A TR 1.2 S	09/82→03/93	Petrol	12 ST	1196	4	77.80	62.90	15
Corsa A TR 1.3	09/85→10/87	Petrol	13 NB	1297	4	75.00	73.40	10
Corsa A TR 1.3	09/85→10/87	Petrol	C 13 N	1297	4	75.00	73.40	10
Corsa A TR 1.3 GL	09/82→03/93	Petrol	13 S	1297	4	75.00	73.40	10
Corsa A TR 1.3 S	09/82→10/87	Petrol	13 SB	1297	4	75.00	73.40	10
Corsa A TR 1.4 i	10/89→03/93	Petrol	C 14 NZ	1389	4	77.60	73.40	14
Corsa A TR 1.4 S	09/89→03/93	Petrol	14 NV	1389	4	77.60	73.40	14
Corsa A TR 1.5 D	10/87→11/92	Diesel	15 D (4EC1)	1488	4	76.00	82.00	12
Corsa A TR 1.5 TD	10/87→03/93	Diesel	15 DT (T4EC1)	1488	4	76.00	82.00	13
Corsa B 1.0 i 12V	11/96→09/00	Petrol	X 10 XE	973	3	72.50	78.60	5
Corsa B 1.2 i	03/93→09/00	Petrol	12 NZ	1195	4	72.00	73.40	3
Corsa B 1.2 i	03/93→09/00	Petrol	X 12 SZ	1195	4	72.00	73.40	3
Corsa B 1.2 i	03/93→09/00	Petrol	C 12 NZ	1196	4	72.00	73.40	3
Corsa B 1.2 i 16V	03/98→09/00	Petrol	X 12 XE	1199	4	72.50	72.60	4
Corsa B 1.3	01/96→12/02	Petrol	13 NB	1297	4	75.00	73.40	10
Corsa B 1.4	04/93→08/94	Petrol	C 14 SE	1389	4	77.60	73.40	14
Corsa B 1.4 i	03/93→09/00	Petrol	C 14 NZ	1389	4	77.60	73.40	14
Corsa B 1.4 i	03/93→09/00	Petrol	X 14 SZ	1389	4	77.60	73.40	14
Corsa B 1.4 i 16V	08/97→09/00	Petrol	C 14 SEL	1389	4	77.60	73.40	14
Corsa B 1.4 i 16V	09/94→	Petrol	X 14 XE	1389	4	77.60	73.40	14
Corsa B 1.4 Si	03/93→09/00	Petrol	C 14 SE	1389	4	77.60	73.40	14
Corsa B 1.5 D	03/93→09/00	Diesel	15 D (4EC1)	1488	4	76.00	82.00	12
Corsa B 1.5 TD	03/93→09/00	Diesel	15 DT (T4EC1)	1488	4	76.00	82.00	13
Corsa B 1.5 TD	03/93→09/00	Diesel	X 15 DT (T4EC1)	1488	4	76.00	82.00	13
Corsa B 1.6 GSI 16V	03/93→09/00	Petrol	C 16 XE	1598	4	79.00	81.50	17
Corsa B 1.6 i 16V	08/97→09/00	Petrol	C 16 SEL	1598	4	79.00	81.50	17
Corsa B 1.6 i 16V	09/94→09/00	Petrol	X 16 XE	1598	4	79.00	81.50	17
Corsa B 1.7 D	02/96→09/00	Diesel	17 D (4EE1)	1686	4	79.00	86.00	18
Corsa B 1.7 D	02/96→	Diesel	X 17 D (4EE1)	1686	4	79.00	86.00	18
Corsa C 1.0	09/00→06/03	Petrol	Z 10 XE	973	3	72.50	78.60	5
Corsa C 1.0	06/03→12/09	Petrol	Z 10 XEP	998	3	73.40	78.60	7
Corsa C 1.2	09/00→12/09	Petrol	Z 12 XE	1199	4	72.50	72.60	4
Corsa C 1.2	07/05→	Petrol	Z 12 XEP	1229	4	73.40	72.60	6
Corsa C 1.2 16V	09/00→	Petrol	Z 12 XE	1199	4	72.50	72.60	4
Corsa C 1.2 Twinport	07/04→12/09	Petrol	Z 12 XEP	1229	4	73.40	72.60	6
Corsa C 1.3 CDTI	06/03→12/09	Diesel	Z 13 DT	1248	4	69.60	82.00	1
Corsa C 1.3 CDTI 16V	08/05→	Diesel	Z 13 DT	1248	4	69.60	82.00	1
Corsa C 1.4	08/03→	Petrol	Z 14 XEP	1364	4	73.40	80.60	8
Corsa C 1.4	01/02→12/09	Petrol	14 SE	1389	4	77.60	73.40	14
Corsa C 1.4	09/00→12/09	Petrol	Z 14 XE	1389	4	77.60	73.40	14
Corsa C 1.4 Twinport	06/03→12/09	Petrol	Z 14 XEP	1364	4	73.40	80.60	8
Corsa C 1.6	09/00→12/09	Petrol	Z 16 SE	1598	4	79.00	81.50	17
Corsa C 1.6	05/03→	Petrol	Z 16 YNG	1598	4	79.00	81.50	17
Corsa C 1.7 CDTI	06/03→	Diesel	Z 17 DTH	1686	4	79.00	86.00	19
Corsa C 1.7 DI	09/00→12/09	Diesel	Y 17 DTL	1686	4	79.00	86.00	19
Corsa C 1.7 DI 16V	09/00→	Diesel	Y 17 DTL	1686	4	79.00	86.00	19
Corsa C 1.7 DTI	09/00→12/09	Diesel	Y 17 DT	1686	4	79.00	86.00	19
Corsa C 1.7 DTI 16V	09/00→	Diesel	Y 17 DT	1686	4	79.00	86.00	19
Corsa C 1.8	09/00→12/09	Petrol	Z 18 XE	1796	4	80.50	88.20	25
Corsa C 1.8	01/02→12/09	Petrol	Z 18 XEL	1796	4	80.50	88.20	25
Corsa D 1.0	07/06→	Petrol	Z 10 XEP	998	3	73.40	78.60	7
Corsa D 1.2	07/06→	Petrol	Z 12 XEP	1229	4	73.40	72.60	6



cm3



Corsa D 1.2 LPG	09/09→	Petrol	Z 12 XEP	1229	4	73.40	72.60	6
Corsa D 1.3 CDTI	07/06→	Diesel	A 13 DTC	1248	4	69.60	82.00	1
Corsa D 1.3 CDTI	06/10→	Diesel	A 13 DTE	1248	4	69.60	82.00	1
Corsa D 1.3 CDTI	06/10→	Diesel	Z 13 DTE	1248	4	69.60	82.00	1
Corsa D 1.3 CDTI	07/06→	Diesel	Z 13 DTH	1248	4	69.60	82.00	1
Corsa D 1.3 CDTI	07/06→	Diesel	Z 13 DTJ	1248	4	69.60	82.00	1
Corsa D 1.4	07/06→	Petrol	Z 14 XEP	1364	4	73.40	80.60	8
Corsa D 1.4 LPG	07/06→	Petrol	Z 14 XEP	1364	4	73.40	80.60	8
Corsa D 1.6 Turbo	02/07→	Petrol	A 16 LEL	1598	4	79.00	81.50	17
Corsa D 1.6 Turbo	02/07→	Petrol	A 16 LER	1598	4	79.00	81.50	17
Corsa D 1.6 Turbo	02/07→	Petrol	Z 16 LEL	1598	4	79.00	81.50	17
Corsa D 1.6 Turbo	02/07→	Petrol	Z 16 LER	1598	4	79.00	81.50	17
Corsa Utility 1.3	01/96→12/02	Petrol	13 NB	1297	4	75.00	73.40	10
Corsa Utility 1.4	07/00→12/10	Petrol	Z 14 XE	1389	4	77.60	73.40	14
Corsa Utility 1.7 D	01/03→12/06	Diesel	X 17 D (4EE1)	1686	4	79.00	86.00	18
Corsa Utility 1.7 Di	11/01→06/04	Diesel	Y 17 DTL	1686	4	79.00	86.00	19
Corsa Utility 1.7 DTi	08/01→12/10	Diesel	Y 17 DT	1686	4	79.00	86.00	19
Corsa Utility 1.8	01/03→12/10	Petrol	Z 18 XEL	1796	4	80.50	88.20	25
Diplomat B 2.8	09/72→08/78	Petrol	28 HC	2784	6	92.00	69.80	55
Diplomat B 2.8 E	03/69→02/75	Petrol	28 E	2784	6	92.00	69.80	55
Frontera A 2.0 i	03/92→10/98	Petrol	C 20 NE	1998	4	86.00	86.00	40
Frontera A 2.0 i	03/92→10/98	Petrol	X 20 SE	1998	4	86.00	86.00	40
Frontera A 2.2 i	03/95→10/98	Petrol	X 22 XE	2198	4	86.00	94.60	43
Frontera A 2.3 TD	03/92→10/98	Diesel	23 DTR	2260	4	92.00	85.00	56
Frontera A 2.4 i	03/92→10/98	Petrol	C 24 NE	2410	4	95.00	85.00	65
Frontera B 2.2 DTI	10/98→09/02	Diesel	X 22 DTH	2171	4	84.00	98.00	35
Frontera B 2.2 DTI	10/98→	Diesel	Y 22 DTH	2171	4	84.00	98.00	35
Frontera B 2.2 i	10/98→	Petrol	X 22 SE	2198	4	86.00	94.60	43
Frontera B 2.2 i	10/98→	Petrol	Y 22 SE	2198	4	86.00	94.60	43
GT 1.1	09/68→12/70	Petrol	11 SR	1078	4	75.00	61.00	9
GT 1.9	09/68→08/73	Petrol	19 S	1897	4	93.00	69.80	57
Kadett 1.6	03/95→05/00	Petrol	X 16 SZR	1598	4	79.00	81.50	17
Kadett 1.8 i	09/90→08/91	Petrol	C 18 NZ	1796	4	84.80	79.50	36
Kadett 2.0 i	09/94→05/00	Petrol	C 20 NE	1998	4	86.00	86.00	40
Kadett A 1.0	09/62→08/65	Petrol	10 N	993	4	72.00	61.00	2
Kadett A 1.0 N	03/63→08/65	Petrol	10 N	993	4	72.00	61.00	2
Kadett A 1.0 S	09/62→08/65	Petrol	10 S	993	4	72.00	61.00	2
Kadett B 1.1	09/65→08/73	Petrol	11 N	1078	4	75.00	61.00	9
Kadett B 1.1	09/65→07/71	Petrol	11 S	1078	4	75.00	61.00	9
Kadett B 1.1	11/66→07/71	Petrol	11 SR	1078	4	75.00	61.00	9
Kadett B 1.1 S	09/65→07/71	Petrol	11 S	1078	4	75.00	61.00	9
Kadett B 1.1 SR	11/66→07/71	Petrol	11 SR	1078	4	75.00	61.00	9
Kadett B 1.2	08/71→08/73	Petrol	12 S	1196	4	79.00	61.00	16
Kadett B 1.2 S	08/71→08/73	Petrol	12 S	1196	4	79.00	61.00	16
Kadett B 1.7	08/67→08/71	Petrol	17 S	1698	4	88.00	69.80	48
Kadett B 1.9	08/67→08/73	Petrol	19 S	1897	4	93.00	69.80	57
Kadett C 1.0	01/74→07/79	Petrol	10 N	993	4	72.00	61.00	2
Kadett C 1.2	08/73→07/79	Petrol	12 N	1196	4	79.00	61.00	16
Kadett C 1.2 S	08/73→07/79	Petrol	12 S	1196	4	79.00	61.00	16
Kadett C 1.6 S	05/77→07/79	Petrol	16 S	1584	4	85.00	69.80	38
Kadett C 1.9 GT/E	09/75→07/77	Petrol	19 E	1897	4	93.00	69.80	57
Kadett C 2.0 E Rallye	08/77→07/79	Petrol	20 E	1979	4	95.00	69.80	62
Kadett C 2.0 GT/E	08/77→07/79	Petrol	20 EH	1979	4	95.00	69.80	62
Kadett D 1.0	09/79→08/82	Petrol	10 N	993	4	72.00	61.00	2
Kadett D 1.0	08/79→08/84	Petrol	10 S	993	4	72.00	61.00	2
Kadett D 1.2	08/79→07/82	Petrol	12 N	1196	4	79.00	61.00	16
Kadett D 1.2	08/82→08/84	Petrol	12 ST	1196	4	77.80	62.90	15
Kadett D 1.2 S	08/79→08/84	Petrol	12 S	1196	4	79.00	61.00	16
Kadett D 1.3 N	08/79→08/84	Petrol	13 N	1297	4	75.00	73.40	10
Kadett D 1.3 N	08/79→08/84	Petrol	C 13 N	1297	4	75.00	73.40	10
Kadett D 1.3 S	08/79→08/84	Petrol	13 S	1297	4	75.00	73.40	10
Kadett D 1.6 D	03/82→08/84	Diesel	16 D	1598	4	80.00	79.50	21
Kadett D 1.6 S	09/81→08/84	Petrol	16 SH	1598	4	80.00	79.50	21
Kadett D 1.8 GT/E	02/83→08/84	Petrol	18 E	1796	4	84.80	79.50	36
Kadett E 1.2	09/84→07/86	Petrol	12 SC	1196	4	79.00	61.00	16
Kadett E 1.3	01/85→12/87	Petrol	13 S	1297	4	75.00	73.40	10
Kadett E 1.3 i CAT	09/85→08/91	Petrol	C 13 N	1297	4	75.00	73.40	10
Kadett E 1.3 N	09/84→08/91	Petrol	13 N	1297	4	75.00	73.40	10
Kadett E 1.3 N	09/84→08/91	Petrol	13 NB	1297	4	75.00	73.40	10

				cm3				
Kadett E 1.3 S	09/84→02/93	Petrol	13 S	1297	4	75.00	73.40	10
Kadett E 1.4 i	01/90→07/94	Petrol	C 14 NZ	1389	4	77.60	73.40	14
Kadett E 1.4 S	07/89→02/93	Petrol	14 NV	1389	4	77.60	73.40	14
Kadett E 1.4 S	09/89→08/91	Petrol	C 14 SE	1389	4	77.60	73.40	14
Kadett E 1.5 TD	07/88→08/91	Diesel	15 DT (T4EC1)	1488	4	76.00	82.00	13
Kadett E 1.6	09/86→06/93	Petrol	16 SH	1598	4	80.00	79.50	21
Kadett E 1.6	09/86→12/91	Petrol	16 SV	1598	4	79.00	81.50	17
Kadett E 1.6	09/87→08/91	Petrol	E 16 SE	1598	4	79.00	81.50	17
Kadett E 1.6 D	08/84→01/89	Diesel	16 D	1598	4	80.00	79.50	21
Kadett E 1.6 D	08/84→12/89	Diesel	16 DA	1598	4	80.00	79.50	21
Kadett E 1.6 i	07/89→02/93	Petrol	16 SV	1598	4	79.00	81.50	17
Kadett E 1.6 i	08/89→07/94	Petrol	C 16 NZ	1598	4	79.00	81.50	17
Kadett E 1.6 i	09/86→02/93	Petrol	E 16 NZ	1598	4	79.00	81.50	17
Kadett E 1.6 i CAT	09/86→02/93	Petrol	C 16 LZ	1598	4	80.00	79.50	20
Kadett E 1.6 i CAT	09/86→02/93	Petrol	C 16 NZ	1598	4	79.00	81.50	17
Kadett E 1.6 S	09/84→08/86	Petrol	16 SH	1598	4	80.00	79.50	21
Kadett E 1.6 S	09/86→08/91	Petrol	16 SV	1598	4	79.00	81.50	17
Kadett E 1.7 D	08/88→07/94	Diesel	17 D	1700	4	82.50	79.50	29
Kadett E 1.7 D	07/92→07/94	Diesel	17 DR	1700	4	82.50	79.50	29
Kadett E 1.8	09/87→08/90	Petrol	18 E	1796	4	84.80	79.50	36
Kadett E 1.8	01/86→08/91	Petrol	18 SE	1796	4	84.80	79.50	36
Kadett E 1.8 E	10/85→08/86	Petrol	C 18 NE	1796	4	84.80	79.50	36
Kadett E 1.8 GSI	09/84→08/86	Petrol	18 E	1796	4	84.80	79.50	36
Kadett E 1.8 i	09/84→08/86	Petrol	18 E	1796	4	84.80	79.50	36
Kadett E 1.8 i	09/84→08/86	Petrol	18 SE	1796	4	84.80	79.50	36
Kadett E 1.8 i	09/90→08/91	Petrol	18 SV	1796	4	84.80	79.50	37
Kadett E 1.8 i	10/85→08/86	Petrol	C 18 NE	1796	4	84.80	79.50	36
Kadett E 1.8 i	08/84→09/92	Petrol	C 18 NT	1796	4	84.80	79.50	36
Kadett E 1.8 i	06/85→08/91	Petrol	C 18 NZ	1796	4	84.80	79.50	36
Kadett E 1.8 i	06/85→08/91	Petrol	S 18 NV	1796	4	84.80	79.50	36
Kadett E 1.8 S	09/87→08/91	Petrol	E 18 NV	1796	4	84.80	79.50	37
Kadett E 1.8 S	09/87→08/91	Petrol	S 18 NV	1796	4	84.80	79.50	36
Kadett E 2.0	01/86→12/93	Petrol	20 NE	1998	4	86.00	86.00	40
Kadett E 2.0	09/90→05/92	Petrol	C 20 XE	1998	4	86.00	86.00	41
Kadett E 2.0 GSI	09/86→08/91	Petrol	20 NE	1998	4	86.00	86.00	40
Kadett E 2.0 GSI	09/86→08/91	Petrol	20 SEH	1998	4	86.00	86.00	40
Kadett E 2.0 GSi	09/90→05/92	Petrol	20 SER	1998	4	86.00	86.00	40
Kadett E 2.0 GSI 16V	12/87→08/91	Petrol	20 XE	1998	4	86.00	86.00	41
Kadett E 2.0 GSI 16V CAT	03/88→08/91	Petrol	C 20 XE	1998	4	86.00	86.00	41
Kadett E 2.0 GSI CAT	09/86→08/91	Petrol	C 20 NE	1998	4	86.00	86.00	40
Kadett E 2.0 i	10/86→02/93	Petrol	20 NE	1998	4	86.00	86.00	40
Kadett E 2.0 i	03/87→08/91	Petrol	20 SE	1998	4	86.00	86.00	40
Kadett E 2.0 i CAT	10/86→02/93	Petrol	C 20 NE	1998	4	86.00	86.00	40
Kapitän A 2.8 S	03/64→12/68	Petrol	28 S	2784	6	92.00	69.80	55
Manta A 1.2	04/72→08/75	Petrol	12 S	1196	4	79.00	61.00	16
Manta A 1.6	09/70→08/75	Petrol	16 N	1584	4	85.00	69.80	38
Manta A 1.6	02/75→08/75	Petrol	16 S	1584	4	85.00	69.80	38
Manta A 1.6 S	09/70→08/75	Petrol	16 S	1584	4	85.00	69.80	38
Manta A 1.9	09/74→08/75	Petrol	19 N	1897	4	93.00	69.80	57
Manta A 1.9 GT/E	02/74→08/75	Petrol	19 E	1897	4	93.00	69.80	57
Manta A 1.9 S	09/70→08/75	Petrol	19 S	1897	4	93.00	69.80	57
Manta B 1.2 N	08/76→07/83	Petrol	12 N	1196	4	79.00	61.00	16
Manta B 1.2 S	09/75→02/79	Petrol	12 S	1196	4	79.00	61.00	16
Manta B 1.3 N	03/79→12/80	Petrol	13 N	1297	4	75.00	73.40	10
Manta B 1.3 S	08/79→08/86	Petrol	13 S	1297	4	75.00	73.40	10
Manta B 1.6	09/75→08/81	Petrol	16 S	1584	4	85.00	69.80	38
Manta B 1.6 N	09/75→12/80	Petrol	16 N	1584	4	85.00	69.80	38
Manta B 1.6 S	09/75→12/81	Petrol	16 S	1584	4	85.00	69.80	38
Manta B 1.8 S	07/82→08/87	Petrol	18 S	1796	4	84.80	79.50	36
Manta B 1.9 E	09/75→08/77	Petrol	19 E	1897	4	93.00	69.80	57
Manta B 1.9 N	08/76→12/81	Petrol	19 N	1897	4	93.00	69.80	57
Manta B 1.9 S	09/75→12/80	Petrol	19 S	1897	4	93.00	69.80	57
Manta B 2.0	08/81→07/88	Petrol	20 ER	1979	4	95.00	69.80	62
Manta B 2.0	08/77→12/80	Petrol	20 N	1979	4	95.00	69.80	62
Manta B 2.0 E	08/77→08/88	Petrol	20 E	1979	4	95.00	69.80	62
Manta B 2.0 S	08/77→08/84	Petrol	20 S	1979	4	95.00	69.80	62
Meriva 1.3 CDTI	04/05→05/10	Diesel	Y 13 DT	1248	4	69.60	82.00	1
Meriva 1.3 CDTI	04/05→05/10	Diesel	Z 13 DT	1248	4	69.60	82.00	1
Meriva 1.3 CDTI	09/03→05/10	Diesel	Z 13 DTJ	1248	4	69.60	82.00	1











cm3

x



9

Meriva 1.4 16V Twinport	07/04→05/10	Petrol	Z 14 XEP	1364	4	73.40	80.60	8
Meriva 1.4 16V Twinport LPG	07/04→05/10	Petrol	Z 14 XEP	1364	4	73.40	80.60	8
Meriva 1.6	05/03→05/10	Petrol	Z 16 SE	1598	4	79.00	81.50	17
Meriva 1.6	01/06→05/10	Petrol	Z 16 XEP	1598	4	79.00	81.50	17
Meriva 1.6 16V	05/03→01/06	Petrol	Z 16 XE	1598	4	79.00	81.50	17
Meriva 1.7 CDTI	09/03→05/10	Diesel	Z 17 DT	1686	4	79.00	86.00	19
Meriva 1.7 CDTI	09/03→05/10	Diesel	Z 17 DTH	1686	4	79.00	86.00	19
Meriva 1.7 DTI	09/03→05/10	Diesel	Y 17 DT	1686	4	79.00	86.00	19
Meriva 1.8	05/03→05/10	Petrol	Z 18 XE	1796	4	80.50	88.20	25
Meriva B 1.3 CDTI	06/10→	Diesel	A 13 DTC	1248	4	69.60	82.00	1
Meriva B 1.3 CDTI	06/10→	Diesel	A 13 DTE	1248	4	69.60	82.00	1
Monterey A 3.1 TD	09/91→07/98	Diesel	4 JG2TC	3059	4	95.40	107.00	66
Monza A 2.0 E	03/83→10/84	Petrol	H 20 E	1979	4	95.00	69.80	62
Monza A 2.2 E	11/84→08/86	Petrol	22 E	2197	4	95.00	77.50	64
Monza A 2.5 E	06/84→08/86	Petrol	25 E	2490	6	87.00	69.80	46
Monza A 2.8	02/78→04/81	Petrol	28 H	2784	6	92.00	69.80	55
Monza A 3.0	04/78→07/82	Petrol	30 H	2969	6	95.00	69.80	63
Monza A 3.0 GSE	02/78→08/86	Petrol	30 E	2969	6	95.00	69.80	63
Monza A 3.0 GSE	09/85→08/86	Petrol	C 30 LE	2969	6	95.00	69.80	63
Movano 1.9 DTI	09/00→10/01	Diesel	F9Q 770	1870	4	80.00	93.00	24
Movano 1.9 DTI	10/01→	Diesel	F9Q 772	1870	4	80.00	93.00	24
Movano 1.9 DTI	10/01→	Diesel	F9Q 774	1870	4	80.00	93.00	24
Movano 2.2 DTI	09/00→	Diesel	G9T 720	2188	4	87.00	92.00	47
Movano 2.2 DTI	09/00→	Diesel	G9T 722	2188	4	87.00	92.00	47
Movano 2.2 DTI	09/00→	Diesel	G9T 750	2188	4	87.00	92.00	47
Movano 2.5 CDTI	10/03→12/06	Diesel	G9U 754	2463	4	89.00	99.00	53
Movano 2.5 CDTI	10/03→	Diesel	G9U 632	2464	4	89.00	99.00	53
Movano 2.5 CDTI	10/03→	Diesel	G9U 650	2464	4	89.00	99.00	53
Movano 2.5 D	07/98→09/00	Diesel	S8U 770	2499	4	93.00	92.00	60
Movano 2.5 D	07/98→09/00	Diesel	S8U 772	2499	4	93.00	92.00	60
Movano 2.5 DTI	10/01→	Diesel	G9U 720	2463	4	89.00	99.00	53
Movano 2.5 DTI	10/01→	Diesel	G9U 724	2463	4	89.00	99.00	53
Movano 2.5 DTI	10/01→	Diesel	G9U 750	2463	4	89.00	99.00	53
Movano 2.5 DTI	10/01→	Diesel	G9U 754	2463	4	89.00	99.00	53
Movano B 2.3 CDTI	12/10→	Diesel	M9T 670	2298	4	85.00	101.30	39
Movano B 2.3 CDTI	12/10→	Diesel	M9T 672	2298	4	85.00	101.30	39
Movano B 2.3 CDTI	12/10→	Diesel	M9T 676	2298	4	85.00	101.30	39
Movano B 2.3 CDTI	12/10→	Diesel	M9T 678	2298	4	85.00	101.30	39
Movano B 2.3 CDTI	12/10→	Diesel	M9T 680	2298	4	85.00	101.30	39
Movano B 2.3 CDTI	01/13→	Diesel	M9T 880	2298	4	85.00	101.30	39
Movano B 2.3 CDTI	05/14→	Diesel	M9T 702	2299	4	85.00	101.30	39
Movano B 2.3 CDTI	05/14→	Diesel	M9T 870	2299	4	85.00	101.30	39
Movano B 2.3 CDTI	12/10→	Diesel	M9T 876	2299	4	85.00	101.30	39
Movano B 2.3 CDTI [RWD]	05/10→	Diesel	M9T 686	2298	4	85.00	101.30	39
Movano B 2.3 CDTI [RWD]	05/10→	Diesel	M9T 690	2298	4	85.00	101.30	39
Movano B 2.3 CDTI [RWD]	05/10→	Diesel	M9T 692	2298	4	85.00	101.30	39
Movano B 2.3 CDTI [RWD]	05/10→	Diesel	M9T 694	2298	4	85.00	101.30	39
Movano B 2.3 CDTI [RWD]	05/10→	Diesel	M9T 696	2298	4	85.00	101.30	39
Movano B 2.3 CDTI [RWD]	05/10→	Diesel	M9T 698	2298	4	85.00	101.30	39
Movano B 2.3 CDTI [RWD]	05/14→	Diesel	M9T 700	2299	4	85.00	101.30	39
Movano B 2.3 CDTI [RWD]	05/10→	Diesel	M9T 876	2299	4	85.00	101.30	39
Movano B 2.3 CDTI FWD	05/10→	Diesel	M9T 670	2298	4	85.00	101.30	39
Movano B 2.3 CDTI FWD	05/10→	Diesel	M9T 672	2298	4	85.00	101.30	39
Movano B 2.3 CDTI FWD	05/10→	Diesel	M9T 676	2298	4	85.00	101.30	39
Movano B 2.3 CDTI FWD	05/10→	Diesel	M9T 678	2298	4	85.00	101.30	39
Movano B 2.3 CDTI FWD	05/10→	Diesel	M9T 680	2298	4	85.00	101.30	39
Movano B 2.3 CDTI FWD	01/13→	Diesel	M9T 880	2298	4	85.00	101.30	39
Movano B 2.3 CDTI FWD	05/14→	Diesel	M9T 702	2299	4	85.00	101.30	39
Movano B 2.3 CDTI FWD	02/12→	Diesel	M9T 870	2299	4	85.00	101.30	39
Movano B 2.3 CDTI FWD	05/10→	Diesel	M9T 876	2299	4	85.00	101.30	39
Olympia A 1.0	08/67→08/71	Petrol	11 SR	1078	4	75.00	61.00	9
Olympia A 1.7	08/67→08/71	Petrol	17 S	1698	4	88.00	69.80	48
Olympia A 1.9	08/67→08/71	Petrol	19 S	1897	4	93.00	69.80	57
Omega A 1.8	09/86→03/94	Petrol	18 SEH	1796	4	84.80	79.50	37
Omega A 1.8	09/87→03/94	Petrol	E 18 NVR	1796	4	84.80	79.50	37
Omega A 1.8 N	09/86→08/87	Petrol	18 NV	1796	4	84.80	79.50	37
Omega A 1.8 N	11/86→09/88	Petrol	18 SV	1796	4	84.80	79.50	37
Omega A 1.8 S	09/86→03/94	Petrol	18 SV	1796	4	84.80	79.50	37
Omega A 2.0	09/86→03/94	Petrol	20 SE	1998	4	86.00	86.00	40









				cm3	x 			
Omega A 2.0	09/87→04/94	Petrol	C 20 NE	1998	4	86.00	86.00	40
Omega A 2.0 i	09/86→03/94	Petrol	C 20 NE	1998	4	86.00	86.00	40
Omega A 2.3 D	09/86→03/94	Diesel	23 YD	2260	4	92.00	85.00	56
Omega A 2.3 TD	09/86→08/88	Diesel	23 YDT	2260	4	92.00	85.00	56
Omega A 2.3 TD Interc.	08/88→03/94	Diesel	23 DTR	2260	4	92.00	85.00	56
Omega A 2.4 i	09/88→03/94	Petrol	C 24 NE	2410	4	95.00	85.00	65
Omega A 2.6 i	09/90→03/94	Petrol	C 26 NE	2594	6	88.80	69.80	52
Omega A 3.0	03/87→09/90	Petrol	30 NE	2969	6	95.00	69.80	63
Omega A 3.0	03/87→03/94	Petrol	C 30 LE	2969	6	95.00	69.80	63
Omega A 3.0	03/88→03/94	Petrol	C 30 NE	2969	6	95.00	69.80	63
Omega A 3.0 24V	09/89→03/94	Petrol	C 30 SE	2969	6	95.00	69.80	63
Omega A 3.0 24V	09/89→03/94	Petrol	C 30 SEJ	2969	6	95.00	69.80	63
Omega A 3.0 24V Omega 3000	09/88→04/94	Petrol	C 30 SE	2969	6	95.00	69.80	63
Omega A 3.0 CAT	03/87→03/94	Petrol	C 30 NE	2969	6	95.00	69.80	63
Omega B 2.0	03/94→12/00	Petrol	20 SE	1998	4	86.00	86.00	40
Omega B 2.0	03/94→09/99	Petrol	X 20 SE	1998	4	86.00	86.00	40
Omega B 2.0 16V	03/94→09/99	Petrol	X 20 XEV	1998	4	86.00	86.00	40
Omega B 2.0 DTI 16V	09/97→09/00	Diesel	X 20 DTH	1995	4	84.00	90.00	34
Omega B 2.2 DTI 16V	09/00→07/03	Diesel	Y 22 DTH	2171	4	84.00	98.00	35
Omega B 2.2 DTI 16V	01/01→	Diesel	Y 22 DTR	2172	4	84.00	98.00	35
Omega B 2.5 D	05/94→05/99	Diesel	X 25 TD	2498	6	80.00	82.80	22
Omega B 2.5 DTI	09/01→07/03	Diesel	Y 25 DT	2497	6	80.00	82.80	22
Omega B 2.5 TD	04/94→07/03	Diesel	25 DT	2497	6	80.00	82.80	22
Omega B 2.5 TD	04/94→07/03	Diesel	X 25 DT	2497	6	80.00	82.80	22
Omega B 2.5 TD	04/94→07/03	Diesel	X 25 TD	2498	6	80.00	82.80	22
Rekord 1.9	01/67→12/72	Petrol	19 H	1897	4	93.00	69.80	57
Rekord A 1.7	03/63→08/65	Petrol	17 N	1698	4	88.00	69.80	48
Rekord A 1.7	04/64→08/65	Petrol	17 S	1698	4	88.00	69.80	48
Rekord B 1.7	08/65→12/66	Petrol	17 N	1698	4	88.00	69.80	48
Rekord B 1.7	08/65→12/66	Petrol	17 S	1698	4	88.00	69.80	48
Rekord B 1.9	09/65→08/66	Petrol	19 N	1897	4	93.00	69.80	57
Rekord B 1.9	08/65→02/67	Petrol	19 S	1897	4	93.00	69.80	57
Rekord C 1.7	08/66→12/71	Petrol	17 N	1698	4	88.00	69.80	48
Rekord C 1.7 S	08/66→12/71	Petrol	17 S	1698	4	88.00	69.80	48
Rekord C 1.9	08/66→12/71	Petrol	19 S	1897	4	93.00	69.80	57
Rekord C 1.9 Sprint	08/67→12/71	Petrol	19 SH	1897	4	93.00	69.80	57
Rekord D 1.7	01/72→08/77	Petrol	17 N	1698	4	88.00	69.80	48
Rekord D 1.7 S	01/72→02/75	Petrol	17 S	1698	4	88.00	69.80	48
Rekord D 1.9	03/75→08/77	Petrol	19 N	1897	4	93.00	69.80	57
Rekord D 1.9	03/75→08/77	Petrol	19 SH	1897	4	93.00	69.80	57
Rekord D 1.9 S	01/72→02/75	Petrol	19 SH	1897	4	93.00	69.80	57
Rekord D 2.0	09/75→08/77	Petrol	20 S	1979	4	95.00	69.80	62
Rekord D 2.0 D	08/74→08/77	Diesel	20 D	1998	4	86.50	85.00	45
Rekord D 2.0 S	09/75→08/77	Petrol	20 S	1979	4	95.00	69.80	62
Rekord D 2.1 D	09/72→08/77	Diesel	21 D	2068	4	88.00	85.00	50
Rekord E 1.7	09/77→10/82	Petrol	17 N	1698	4	88.00	69.80	48
Rekord E 1.8	11/82→08/86	Petrol	18 N	1796	4	84.80	79.50	36
Rekord E 1.8 E	05/85→08/86	Petrol	C 18 NV	1796	4	84.80	79.50	36
Rekord E 1.8 S	11/82→08/86	Petrol	18 S	1796	4	84.80	79.50	36
Rekord E 1.9	09/77→10/82	Petrol	19 N	1897	4	93.00	69.80	57
Rekord E 2.0	09/77→10/82	Petrol	20 N	1979	4	95.00	69.80	62
Rekord E 2.0	12/83→12/91	Petrol	20 NE	1998	4	86.00	86.00	40
Rekord E 2.0	12/83→12/91	Petrol	20 SE	1998	4	86.00	86.00	40
Rekord E 2.0	01/88→12/90	Petrol	20 SEH	1998	4	86.00	86.00	40
Rekord E 2.0 D	09/77→10/82	Diesel	20 D	1998	4	86.50	85.00	45
Rekord E 2.0 E	09/77→10/84	Petrol	20 E	1979	4	95.00	69.80	62
Rekord E 2.0 S	08/77→08/86	Petrol	20 S	1979	4	95.00	69.80	62
Rekord E 2.1 D	09/77→07/78	Diesel	21 D	2068	4	88.00	85.00	50
Rekord E 2.2 D	08/78→08/86	Diesel	23 D	2260	4	92.00	85.00	56
Rekord E 2.2 E	11/84→08/86	Petrol	22 E	2197	4	95.00	77.50	64
Rekord E 2.2 TD	06/84→08/86	Diesel	23 TD	2260	4	92.00	85.00	56
Rekord E 2.3 D	11/82→08/86	Diesel	23 D	2260	4	92.00	85.00	56
Rekord P1 1700	07/57→07/60	Petrol	17 L	1698	4	88.00	69.80	48
Rekord Sprint 1.9	01/67→12/72	Petrol	19 H	1897	4	93.00	69.80	57
Senator A 2.0 E	03/83→10/84	Petrol	H 20 E	1979	4	95.00	69.80	62
Senator A 2.2 E	11/84→08/87	Petrol	22 E	2197	4	95.00	77.50	64
Senator A 2.2 TD	11/84→08/87	Diesel	23 TD	2260	4	92.00	85.00	56
Senator A 2.5	05/78→12/80	Petrol	25 S	2490	6	87.00	69.80	46
Senator A 2.5 E	09/84→08/87	Petrol	25 E	2490	6	87.00	69.80	46











cm3















Senator A 2.8	02/78→04/81	Petrol	28 H	2784	6	92.00	69.80	55
Senator A 3.0	04/78→07/82	Petrol	30 H	2969	6	95.00	69.80	63
Senator A 3.0	09/85→08/87	Petrol	C 30 LE	2969	6	95.00	69.80	63
Senator A 3.0 E	02/78→12/86	Petrol	30 E	2969	6	95.00	69.80	63
Senator B 2.5 i	09/90→09/93	Petrol	25 NE	2490	6	87.00	69.80	46
Senator B 2.6 i	09/90→09/93	Petrol	C 26 NE	2594	6	88.80	69.80	52
Senator B 3.0	01/88→09/90	Petrol	30 NE	2969	6	95.00	69.80	63
Senator B 3.0	09/87→09/93	Petrol	C 30 LE	2969	6	95.00	69.80	63
Senator B 3.0 24V	09/89→09/93	Petrol	C 30 SE	2969	6	95.00	69.80	63
Senator B 3.0 i CAT	01/88→09/93	Petrol	C 30 NE	2969	6	95.00	69.80	63
Signum 1.8	05/03→	Petrol	Z 18 XE	1796	4	80.50	88.20	25
Signum 1.8	09/05→	Petrol	Z 18 XER	1796	4	80.50	88.20	25
Signum 1.9 CDTI	04/04→	Diesel	Z 19 DT	1910	4	82.00	90.40	27
Signum 1.9 CDTI	04/04→	Diesel	Z 19 DTH	1910	4	82.00	90.40	27
Signum 2.0 DTI	05/03→	Diesel	Y 20 DTH	1995	4	84.00	90.00	34
Signum 2.2 direct	05/03→	Petrol	Z 22 YH	2198	4	86.00	94.60	44
Signum 2.2 DTI	05/03→	Diesel	Y 22 DTR	2172	4	84.00	98.00	35
Signum 2.2 DTI 16V	05/03→06/08	Diesel	Y 22 DTR	2172	4	84.00	98.00	35
Sintra 2.2 DTI	07/97→04/99	Diesel	X 22 DTH	2171	4	84.00	98.00	35
Sintra 2.2 i 16V	11/96→04/99	Petrol	X 22 XE	2198	4	86.00	94.60	43
Speedster 2.2	09/00→	Petrol	Z 22 SE	2198	4	86.00	94.60	44
Tigra 1.3 CDTI	06/04→	Diesel	Z 13 DT	1248	4	69.60	82.00	1
Tigra 1.4	06/04→	Petrol	Z 14 XEP	1364	4	73.40	80.60	8
Tigra 1.4 16V	07/94→12/00	Petrol	X 14 XE	1389	4	77.60	73.40	14
Tigra 1.6 16V	08/97→08/98	Petrol	C 16 SEL	1598	4	79.00	81.50	17
Tigra 1.6 16V	07/94→08/98	Petrol	X 16 XE	1598	4	79.00	81.50	17
Tigra 1.8	06/04→	Petrol	Z 18 XE	1796	4	80.50	88.20	25
Vectra A 1.4 S	04/88→06/92	Petrol	14 NV	1389	4	77.60	73.40	14
Vectra A 1.6	09/88→05/93	Petrol	16 SV	1598	4	79.00	81.50	17
Vectra A 1.6	08/92→07/93	Petrol	C 16 LZ2	1598	4	79.00	81.50	17
Vectra A 1.6	08/88→06/94	Petrol	E 16 NZ	1598	4	79.00	81.50	17
Vectra A 1.6 i	09/93→11/95	Petrol	16 LZ2	1598	4	79.00	81.50	17
Vectra A 1.6 i	09/93→11/95	Petrol	C 16 LZ2	1598	4	79.00	81.50	17
Vectra A 1.6 i	09/88→11/95	Petrol	C 16 NZ	1598	4	79.00	81.50	17
Vectra A 1.6 i	09/88→11/95	Petrol	C 16 NZ2	1598	4	79.00	81.50	17
Vectra A 1.6 i	09/88→11/95	Petrol	E 16 NZ	1598	4	79.00	81.50	17
Vectra A 1.6 i	09/93→11/95	Petrol	X 16 SZ	1598	4	79.00	81.50	17
Vectra A 1.6 i CAT	09/88→11/95	Petrol	C 16 NZ	1598	4	79.00	81.50	17
Vectra A 1.6 i CAT	09/88→11/95	Petrol	C 16 NZ2	1598	4	79.00	81.50	17
Vectra A 1.6 S	09/88→05/93	Petrol	16 SV	1598	4	79.00	81.50	17
Vectra A 1.7 D	09/88→09/92	Diesel	17 D	1700	4	82.50	79.50	29
Vectra A 1.7 D	07/92→11/95	Diesel	17 DR	1700	4	82.50	79.50	29
Vectra A 1.7 TD	03/90→11/95	Diesel	17 DT (TC4EE1)	1686	4	79.00	86.00	19
Vectra A 1.7 TD	03/90→11/95	Diesel	X 17 DT (TC4EE1)	1686	4	79.00	86.00	19
Vectra A 1.8 i	09/88→10/90	Petrol	18 SV	1796	4	84.80	79.50	37
Vectra A 1.8 i CAT	03/90→11/95	Petrol	C 18 NZ	1796	4	84.80	79.50	36
Vectra A 1.8 S	09/89→10/90	Petrol	18 SV	1796	4	84.80	79.50	37
Vectra A 1.8 S	09/88→07/89	Petrol	E 18 NVR	1796	4	84.80	79.50	37
Vectra A 1.8 S 4x4	01/89→07/89	Petrol	E 18 NVR	1796	4	84.80	79.50	37
Vectra A 2.0 All-wheel Drive	08/89→08/95	Petrol	C 20 XE	1998	4	86.00	86.00	41
Vectra A 2.0 i	09/88→10/90	Petrol	20 NE	1998	4	86.00	86.00	40
Vectra A 2.0 i	09/88→09/92	Petrol	20 SEH	1998	4	86.00	86.00	40
Vectra A 2.0 i 4x4	01/89→10/90	Petrol	20 NE	1998	4	86.00	86.00	40
Vectra A 2.0 i 4x4	01/89→09/92	Petrol	20 SEH	1998	4	86.00	86.00	40
Vectra A 2.0 i 4x4 CAT	01/89→11/95	Petrol	C 20 NE	1998	4	86.00	86.00	40
Vectra A 2.0 i 16V	06/94→11/95	Petrol	X 20 XEV	1998	4	86.00	86.00	40
Vectra A 2.0 i 16V 4x4	06/94→11/95	Petrol	X 20 XEV	1998	4	86.00	86.00	40
Vectra A 2.0 i 16V CAT	02/90→11/95	Petrol	C 20 XE	1998	4	86.00	86.00	41
Vectra A 2.0 i CAT	09/88→11/95	Petrol	C 20 NE	1998	4	86.00	86.00	40
Vectra A 2.0 i GT	09/88→11/95	Petrol	20 SEH	1998	4	86.00	86.00	40
Vectra A 2.0 i Turbo 4x4	06/94→11/95	Petrol	C 20 LET	1998	4	86.00	86.00	42
Vectra A 2000/GT 16V 4x4 CAT	02/90→11/95	Petrol	C 20 XE	1998	4	86.00	86.00	41
Vectra A 2000/GT 16V CAT	02/90→11/95	Petrol	C 20 XE	1998	4	86.00	86.00	41
Vectra B 1.6 GL	09/95→08/96	Petrol	16 SV	1598	4	79.00	81.50	17
Vectra B 1.6 i	10/95→07/03	Petrol	16 LZ2	1598	4	79.00	81.50	17
Vectra B 1.6 i	10/95→07/03	Petrol	X 16 SZR	1598	4	79.00	81.50	17
Vectra B 1.6 i 16V	10/95→07/02	Petrol	X 16 XEL	1598	4	79.00	81.50	17
Vectra B 1.6 i 16V	10/95→07/02	Petrol	Y 16 XE	1598	4	79.00	81.50	17
Vectra B 1.6 i 16V	10/95→07/02	Petrol	Z 16 XE	1598	4	79.00	81.50	17

				cm3	x 			
Vectra B 1.7 TD	10/95→12/98	Diesel	X 17 DT (TC4EE1)	1686	4	79.00	86.00	19
Vectra B 1.8 i 16V	10/95→09/00	Petrol	X 18 XE1	1796	4	80.50	88.20	25
Vectra B 1.8 i 16V	09/00→07/03	Petrol	Z 18 XE	1796	4	80.50	88.20	25
Vectra B 1.8 i 16V	10/95→09/00	Petrol	Z 18 XEL	1796	4	80.50	88.20	25
Vectra B 1.8 i 16V	10/95→09/00	Petrol	X 18 XE	1799	4	81.60	86.00	26
Vectra B 2.0 DI 16V	11/96→04/02	Diesel	X 20 DTL	1995	4	84.00	90.00	34
Vectra B 2.0 DTI 16V	06/97→07/03	Diesel	X 20 DTH	1995	4	84.00	90.00	34
Vectra B 2.0 DTI 16V	06/97→07/03	Diesel	Y 20 DTH	1995	4	84.00	90.00	34
Vectra B 2.0 i	10/95→04/02	Petrol	20 NEJ	1998	4	86.00	86.00	40
Vectra B 2.0 i	10/95→04/02	Petrol	C 20 NE	1998	4	86.00	86.00	40
Vectra B 2.0 i 16V	10/95→09/00	Petrol	X 20 XEV	1998	4	86.00	86.00	40
Vectra B 2.2 DTI 16V	09/00→07/03	Diesel	Y 22 DTR	2172	4	84.00	98.00	35
Vectra B 2.2 i 16V	09/00→07/03	Petrol	Z 22 SE	2198	4	86.00	94.60	44
Vectra C 1.6	01/06→	Petrol	Z 16 XEP	1598	4	79.00	81.50	17
Vectra C 1.6 16V	06/04→	Petrol	Z 16 XE	1598	4	79.00	81.50	17
Vectra C 1.8	10/03→	Petrol	Z 18 XE	1796	4	80.50	88.20	25
Vectra C 1.8	04/02→	Petrol	Z 18 XEL	1796	4	80.50	88.20	25
Vectra C 1.8	01/06→	Petrol	Z 18 XER	1796	4	80.50	88.20	25
Vectra C 1.8 16V	04/02→	Petrol	Z 18 XE	1796	4	80.50	88.20	25
Vectra C 1.9 CDTI	04/04→	Diesel	Z 19 DT	1910	4	82.00	90.40	27
Vectra C 1.9 CDTI	04/04→	Diesel	Z 19 DTH	1910	4	82.00	90.40	27
Vectra C 2.0 DTI	10/03→	Diesel	Y 20 DTH	1995	4	84.00	90.00	34
Vectra C 2.0 DTI 16V	04/02→	Diesel	Y 20 DTH	1995	4	84.00	90.00	34
Vectra C 2.2 16V	04/02→	Petrol	Z 22 SE	2198	4	86.00	94.60	44
Vectra C 2.2 direct	10/03→	Petrol	Z 22 YH	2198	4	86.00	94.60	44
Vectra C 2.2 DTI	10/03→	Diesel	Y 22 DTR	2172	4	84.00	98.00	35
Vectra C 2.2 DTI 16V	04/02→	Diesel	Y 22 DTR	2172	4	84.00	98.00	35
Vectra C GTS 1.6	08/05→	Petrol	Z 16 XE	1598	4	79.00	81.50	17
Vectra C GTS 1.6	01/06→	Petrol	Z 16 XEP	1598	4	79.00	81.50	17
Vectra C GTS 1.8	01/06→	Petrol	Z 18 XER	1796	4	80.50	88.20	25
Vectra C GTS 1.8 16V	08/02→	Petrol	Z 18 XE	1796	4	80.50	88.20	25
Vectra C GTS 1.8 16V	08/02→12/06	Petrol	Z 18 XEL	1796	4	80.50	88.20	25
Vectra C GTS 1.9 CDTI	04/04→	Diesel	Z 19 DT	1910	4	82.00	90.40	27
Vectra C GTS 1.9 CDTI	04/04→	Diesel	Z 19 DTH	1910	4	82.00	90.40	27
Vectra C GTS 2.0 DTI 16V	08/02→	Diesel	Y 20 DTH	1995	4	84.00	90.00	34
Vectra C GTS 2.2 16V	08/02→	Petrol	Z 22 SE	2198	4	86.00	94.60	44
Vectra C GTS 2.2 direct	10/03→	Petrol	Z 22 YH	2198	4	86.00	94.60	44
Vectra C GTS 2.2 DTI 16V	08/02→	Diesel	Y 22 DTR	2172	4	84.00	98.00	35
Vivaro 1.9 DI	08/01→	Diesel	F9Q 762	1870	4	80.00	93.00	24
Vivaro 1.9 DI	08/01→	Diesel	F9Q 774	1870	4	80.00	93.00	24
Vivaro 1.9 DTI	08/01→	Diesel	F9Q 760	1870	4	80.00	93.00	24
Vivaro 2.0 16V	08/01→	Petrol	F4R 720	1998	4	82.70	93.00	31
Vivaro 2.0 CDTI	01/06→	Diesel	M9R 630	1995	4	84.00	90.00	33
Vivaro 2.0 CDTI	08/06→	Diesel	M9R 692	1995	4	84.00	90.00	33
Vivaro 2.0 CDTI	01/06→	Diesel	M9R 780	1995	4	84.00	90.00	33
Vivaro 2.0 CDTI	01/06→	Diesel	M9R 782	1995	4	84.00	90.00	33
Vivaro 2.0 CDTI	08/06→	Diesel	M9R 784	1995	4	84.00	90.00	33
Vivaro 2.0 CDTI	01/06→	Diesel	M9R 786	1995	4	84.00	90.00	33
Vivaro 2.0 CDTI	08/06→	Diesel	M9R 788	1995	4	84.00	90.00	33
Vivaro 2.0 ECOTEC	08/06→	Petrol	F4R 820	1998	4	82.70	93.00	31
Vivaro 2.5 CDTI	08/06→	Diesel	G9MB6	2463	4	89.00	99.00	53
Vivaro 2.5 CDTI	08/06→	Diesel	G9U 630	2464	4	89.00	99.00	53
Vivaro 2.5 DTI	05/03→	Diesel	G9U 730	2463	4	89.00	99.00	53
Zafira A 1.6	10/03→06/05	Petrol	Z 16 XEP	1598	4	79.00	81.50	17
Zafira A 1.6	09/02→06/05	Petrol	Z 16 YNG	1598	4	79.00	81.50	17
Zafira A 1.6 16V	04/99→06/05	Petrol	X 16 XEL	1598	4	79.00	81.50	17
Zafira A 1.6 16V	04/99→06/05	Petrol	Z 16 XE	1598	4	79.00	81.50	17
Zafira A 1.6 CNG	09/01→06/05	Petrol	Z 16 YNG	1598	4	79.00	81.50	17
Zafira A 1.8	02/03→06/05	Petrol	Z 18 XEL	1796	4	80.50	88.20	25
Zafira A 1.8 16V	04/99→09/00	Petrol	X 18 XE1	1796	4	80.50	88.20	25
Zafira A 1.8 16V	09/00→06/05	Petrol	Z 18 XE	1796	4	80.50	88.20	25
Zafira A 2.0 DI	07/99→06/00	Diesel	X 20 DTL	1995	4	84.00	90.00	34
Zafira A 2.0 DI 16V	07/99→06/05	Diesel	X 20 DTL	1995	4	84.00	90.00	34
Zafira A 2.0 DTI 16V	09/00→06/05	Diesel	Y 20 DTH	1995	4	84.00	90.00	34
Zafira A 2.2 16V	09/00→06/05	Petrol	Z 22 SE	2198	4	86.00	94.60	44
Zafira A 2.2 DTI 16V	01/02→06/05	Diesel	Y 22 DTR	2172	4	84.00	98.00	35
Zafira B 1.6	01/06→	Petrol	Z 16 SE	1598	4	79.00	81.50	17
Zafira B 1.6	07/05→	Petrol	Z 16 XEP	1598	4	79.00	81.50	17
Zafira B 1.6	01/08→	Petrol	Z 16 XER	1598	4	79.00	81.50	17







				cm ³ x 				
--	---	---	---	---	---	---	---	---







Zafira B 1.6 CNG	01/06→	Petrol	Z 16 YNG	1598	4	79.00	81.50	17
Zafira B 1.8	07/05→	Petrol	Z 18 XER	1796	4	80.50	88.20	25
Zafira B 1.9 CDTI	07/05→	Diesel	Z 19 DT	1910	4	82.00	90.40	27
Zafira B 1.9 CDTI	07/05→	Diesel	Z 19 DTH	1910	4	82.00	90.40	27
Zafira B 2.2	07/05→	Petrol	Z 22 YH	2198	4	86.00	94.60	44

		cm3	x 			
4 JA1	Diesel	2499	4	93.00	92.00	58
4 JA1	Diesel	2499	4	93.00	92.00	58
4 JA1T	Diesel	2499	4	93.00	92.00	59
4 JA1T	Diesel	2499	4	93.00	92.00	59
4 JG2 T	Diesel	3059	4	95.40	107.00	66
4 JG2T	Diesel	3059	4	95.40	107.00	66
4 JG2TC	Diesel	3059	4	95.40	107.00	66
4 JG2TC	Diesel	3059	4	95.40	107.00	66
4ZB1	Petrol	1817	4	84.00	82.00	32
4ZC1	Petrol	1994	4	88.00	82.00	49
4 ZD1	Petrol	2255	4	89.50	90.00	54
4 ZD1	Petrol	2255	V4	89.50	90.00	54
10 N	Petrol	993	4	72.00	61.00	2
10 S	Petrol	993	4	72.00	61.00	2
10 S	Petrol	993	4	72.00	61.00	2
11 N	Petrol	1078	4	75.00	61.00	9
11 S	Petrol	1078	4	75.00	61.00	9
11 SR	Petrol	1078	4	75.00	61.00	9
12 N	Petrol	1196	4	79.00	61.00	16
12 N	Petrol	1196	4	79.00	61.00	16
12 NC	Petrol	1196	4	79.00	61.00	16
12 NC	Petrol	1196	4	79.00	61.00	16
12 NV	Petrol	1196	4	77.80	62.90	15
12 NV	Petrol	1196	4	77.80	62.90	15
12 NZ	Petrol	1195	4	72.00	73.40	3
12 S	Petrol	1196	4	79.00	61.00	16
12 S	Petrol	1196	4	79.00	61.00	16
12 SC	Petrol	1196	4	79.00	61.00	16
12 SC	Petrol	1196	4	79.00	61.00	16
12 ST	Petrol	1196	4	77.80	62.90	15
12 ST	Petrol	1196	4	77.80	62.90	15
13 N	Petrol	1297	4	75.00	73.40	10
13 N	Petrol	1297	4	75.00	73.40	10
13 NB	Petrol	1297	4	75.00	73.40	10
13 NB	Petrol	1297	4	75.00	73.40	10
13 S	Petrol	1297	4	75.00	73.40	10
13 S	Petrol	1297	4	75.00	73.40	10
13 SB	Petrol	1297	4	75.00	73.40	10
13 SB	Petrol	1297	4	75.00	73.40	10
14 NV	Petrol	1389	4	77.60	73.40	14
14 NV	Petrol	1389	4	77.60	73.40	14
14 SE	Petrol	1389	4	77.60	73.40	14
15 ...	Petrol	1492	4	82.50	69.80	28
15 D	Diesel	1488	4	76.00	82.00	12
15 D (4EC1)	Diesel	1488	4	76.00	82.00	12
15 DT	Diesel	1488	4	76.00	82.00	13
15 DT (T4EC1)	Diesel	1488	4	76.00	82.00	13
15 DT (T4EC1)	Diesel	1488	4	76.00	82.00	13
16 D	Diesel	1598	4	80.00	79.50	21
16 D	Diesel	1598	4	80.00	79.50	21
16 DA	Diesel	1598	4	80.00	79.50	21
16 DA	Diesel	1598	4	80.00	79.50	21
16 LZ2	Petrol	1598	4	79.00	81.50	17
16 N	Petrol	1584	4	85.00	69.80	38
16 N	Petrol	1598	4	80.00	79.50	21
16 N	Petrol	1598	4	80.00	79.50	21
16 N (CIH)	Petrol	1584	4	85.00	69.80	38
16 NZR	Petrol	1598	4	79.00	81.50	17
16 S	Petrol	1584	4	85.00	69.80	38
16 S	Petrol	1598	4	85.00	69.80	38
16 SH	Petrol	1598	4	80.00	79.50	21
16 SH	Petrol	1598	4	80.00	79.50	21
16 SV	Petrol	1598	4	79.00	81.50	17
16 SV	Petrol	1598	4	79.00	81.50	17
17 D	Diesel	1699	4	82.50	79.50	29
17 D	Diesel	1700	4	82.50	79.50	29
17 D (4EE1)	Diesel	1686	4	79.00	86.00	18
17 D (4EE1)	Diesel	1686	4	79.00	86.00	18
17 DR	Diesel	1699	4	82.50	79.50	29







		cm3	x 			
--	---	-----	---	---	---	---







17 DR	Diesel	1700	4	82.50	79.50	29
17 DT (TC4EE1)	Diesel	1686	4	79.00	86.00	19
17 DT (TC4EE1)	Diesel	1686	4	79.00	86.00	19
17 L	Petrol	1698	4	88.00	69.80	48
17 N	Petrol	1698	4	88.00	69.80	48
17 S	Petrol	1698	4	88.00	69.80	48
18 E	Petrol	1796	4	84.80	79.50	36
18 E	Petrol	1796	4	84.80	79.50	36
18 N	Petrol	1796	4	84.80	79.50	36
18 NV	Petrol	1796	4	84.80	79.50	37
18 NV	Petrol	1796	4	84.80	79.50	37
18 S	Petrol	1796	4	84.80	79.50	36
18 S	Petrol	1796	4	84.80	79.50	36
18 SE	Petrol	1796	4	84.80	79.50	36
18 SE	Petrol	1796	4	84.80	79.50	36
18 SEH	Petrol	1796	4	84.80	79.50	37
18 SEH	Petrol	1796	4	84.80	79.50	37
18 SV	Petrol	1796	4	84.80	79.50	37
18 SV	Petrol	1796	4	84.80	79.50	37
19 E	Petrol	1897	4	93.00	69.80	57
19 H	Petrol	1897	4	93.00	69.80	57
19 N	Petrol	1897	4	93.00	69.80	57
19 S	Petrol	1897	4	93.00	69.80	57
19 S	Petrol	1897	4	93.00	69.80	57
19 SH	Petrol	1897	4	93.00	69.80	57
20 D	Diesel	1998	4	86.50	85.00	45
20 E	Petrol	1979	4	95.00	69.80	62
20 E	Petrol	1979	4	95.00	69.80	62
20 EH	Petrol	1979	4	95.00	69.80	62
20 ER	Petrol	1979	4	95.00	69.80	62
20 N	Petrol	1979	4	95.00	69.80	62
20 NE	Petrol	1998	4	86.00	86.00	40
20 NE	Petrol	1998	4	86.00	86.00	40
20 NEJ	Petrol	1998	4	86.00	86.00	40
20 NEJ	Petrol	1998	4	86.00	86.00	40
20 S	Petrol	1979	4	95.00	69.80	62
20 S	Petrol	1979	4	95.00	69.80	62
20 SE	Petrol	1998	4	86.00	86.00	40
20 SE	Petrol	1998	4	86.00	86.00	40
20 SEH	Petrol	1998	4	86.00	86.00	40
20 SEH	Petrol	1998	4	86.00	86.00	40
20 SER	Petrol	1998	4	86.00	86.00	40
20 XE	Petrol	1998	4	86.00	86.00	41
20 XE	Petrol	1998	4	86.00	86.00	41
21 D	Diesel	2068	4	88.00	85.00	50
22 E	Petrol	2197	4	95.00	77.50	64
22 E	Petrol	2197	4	95.00	77.50	64
23 D	Diesel	2260	4	92.00	85.00	56
23 D	Diesel	2260	4	92.00	85.00	56
23 DTR	Diesel	2260	4	92.00	85.00	56
23 DTR	Diesel	2260	4	92.00	85.00	56
23 TD	Diesel	2260	4	92.00	85.00	56
23 TD	Diesel	2260	4	92.00	85.00	56
23 YD	Diesel	2260	4	92.00	85.00	56
23 YD	Diesel	2260	4	92.00	85.00	56
23 YDT	Diesel	2260	4	92.00	85.00	56
23 YDT	Diesel	2260	4	92.00	85.00	56
25 DT	Diesel	2497	6	80.00	82.80	22
25 DT	Diesel	2497	6	80.00	82.80	22
25 E	Petrol	2490	6	87.00	69.80	46
25 E	Petrol	2490	6	87.00	69.80	46
25 H	Petrol	2490	6	87.00	69.80	46
25 NE	Petrol	2490	6	87.00	69.80	46
25 S	Petrol	2490	6	87.00	69.80	46
25 S	Petrol	2490	6	87.00	69.80	46
28 E	Petrol	2784	6	92.00	69.80	55
28 EC	Petrol	2784	6	92.00	69.80	55
28 H	Petrol	2784	6	92.00	69.80	55
28 H	Petrol	2784	6	92.00	69.80	55

		cm3	x 			
28 HC	Petrol	2784	6	92.00	69.80	55
28 S	Petrol	2784	6	92.00	69.80	55
30 E	Petrol	2969	6	95.00	69.80	63
30 E	Petrol	2969	6	95.00	69.80	63
30 H	Petrol	2969	6	95.00	69.80	63
30 H	Petrol	2969	6	95.00	69.80	63
30 NE	Petrol	2969	6	95.00	69.80	63
30 NE	Petrol	2969	6	95.00	69.80	63
30 S	Petrol	2968	6	95.00	69.80	63
A 13 DTC	Diesel	1248	4	69.60	82.00	1
A 13 DTC	Diesel	1248	4	69.60	82.00	1
A 13 DTE	Diesel	1248	4	69.60	82.00	1
A 13 DTE	Diesel	1248	4	69.60	82.00	1
A 16 LEL	Petrol	1598	4	79.00	81.50	17
A 16 LEL	Petrol	1598	4	79.00	81.50	17
A 16 LER	Petrol	1598	4	79.00	81.50	17
A 16 LER	Petrol	1598	4	79.00	81.50	17
A 17 DT	Diesel	1686	4	79.00	86.00	19
C 12 NZ	Petrol	1196	4	72.00	73.40	3
C 12 NZ	Petrol	1196	4	72.00	73.40	3
C 13 N	Petrol	1297	4	75.00	73.40	10
C 13 N	Petrol	1297	4	75.00	73.40	10
C 14 NZ	Petrol	1389	4	77.60	73.40	14
C 14 NZ	Petrol	1389	4	77.60	73.40	14
C 14 SE	Petrol	1389	4	77.60	73.40	14
C 14 SE	Petrol	1389	4	77.60	73.40	14
C 14 SEL	Petrol	1389	4	77.60	73.40	14
C 14 SEL	Petrol	1389	4	77.60	73.40	14
C 16 LZ	Petrol	1598	4	80.00	79.50	20
C 16 LZ	Petrol	1598	4	80.00	79.50	20
C 16 LZ2	Petrol	1598	4	79.00	81.50	17
C 16 NZ	Petrol	1598	4	79.00	81.50	17
C 16 NZ	Petrol	1598	4	79.00	81.50	17
C 16 NZ2	Petrol	1598	4	79.00	81.50	17
C 16 SE	Petrol	1598	4	79.00	81.50	17
C 16 SE	Petrol	1598	4	79.00	81.50	17
C 16 SEI	Petrol	1598	4	79.00	81.50	17
C 16 SEI	Petrol	1598	4	79.00	81.50	17
C 16 SEL	Petrol	1598	4	79.00	81.50	17
C 16 SEL	Petrol	1598	4	79.00	81.50	17
C 16 XE	Petrol	1598	4	79.00	81.50	17
C 16 XE	Petrol	1598	4	79.00	81.50	17
C 18 NE	Petrol	1796	4	84.80	79.50	36
C 18 NE	Petrol	1796	4	84.80	79.50	36
C 18 NT	Petrol	1796	4	84.80	79.50	36
C 18 NV	Petrol	1796	4	84.80	79.50	36
C 18 NZ	Petrol	1796	4	84.80	79.50	37
C 18 NZ	Petrol	1796	4	84.80	79.50	36
C 18 SEL	Petrol	1796	4	84.80	79.50	37
C 18 XE	Petrol	1799	4	81.60	86.00	26
C 18 XE	Petrol	1799	4	81.60	86.00	26
C 18 XEL	Petrol	1799	4	81.60	86.00	26
C 18 XEL	Petrol	1799	4	81.60	86.00	26
C 20 LET	Petrol	1998	4	86.00	86.00	42
C 20 LET	Petrol	1998	4	86.00	86.00	42
C 20 NE	Petrol	1998	4	86.00	86.00	40
C 20 NE	Petrol	1998	4	86.00	86.00	40
C 20 NE	Petrol	1998	4	86.00	86.00	40
C 20 XE	Petrol	1998	4	86.00	86.00	41
C 20 XE	Petrol	1998	4	86.00	86.00	41
C 24 NE	Petrol	2410	4	95.00	85.00	65
C 24 NE	Petrol	2410	4	95.00	85.00	65
C 26 NE	Petrol	2594	6	88.80	69.80	52
C 26 NE	Petrol	2594	6	88.80	69.80	52
C 30 LE	Petrol	2969	6	95.00	69.80	63
C 30 LE	Petrol	2969	6	95.00	69.80	63
C 30 NE	Petrol	2969	6	95.00	69.80	63
C 30 NE	Petrol	2969	6	95.00	69.80	63
C 30 NE	Petrol	2969	6	95.00	69.80	63







		cm3	x 			
--	---	-----	---	---	---	---

C 30 SE	Petrol	2969	6	95.00	69.80	63
C 30 SE	Petrol	2969	6	95.00	69.80	63
C 30 SEJ	Petrol	2969	6	95.00	69.80	63
C 30 SEJ	Petrol	2969	6	95.00	69.80	63
C223	Diesel	2238	4	88.00	92.00	51
C223	Diesel	2238	4	88.00	92.00	51
CB	Petrol	993	3	76.00	73.00	11
E 12 GV	Petrol	1196	4	79.00	61.00	16
E 12 GV	Petrol	1196	4	79.00	61.00	16
E 16 LZ	Petrol	1598	4	79.00	81.50	17
E 16 NZ	Petrol	1598	4	79.00	81.50	17
E 16 NZ	Petrol	1598	4	79.00	81.50	17
E 16 SE	Petrol	1598	4	79.00	81.50	17
E 16 SE	Petrol	1598	4	79.00	81.50	17
E 18 NV	Petrol	1796	4	84.80	79.50	37
E 18 NV	Petrol	1796	4	84.80	79.50	37
E 18 NVR	Petrol	1796	4	84.80	79.50	37
E 18 NVR	Petrol	1796	4	84.80	79.50	37
F4R 720	Petrol	1998	4	82.70	93.00	31
F4R 720	Petrol	1998	4	82.70	93.00	31
F4R 820	Petrol	1998	4	82.70	93.00	31
F4R 820	Petrol	1998	4	82.70	93.00	31
F8Q 600	Diesel	1870	4	80.00	93.00	23
F8Q 600	Diesel	1870	4	80.00	93.00	23
F8Q 606	Diesel	1870	4	80.00	93.00	23
F8Q 606	Diesel	1870	4	80.00	93.00	23
F9Q 760	Diesel	1870	4	80.00	93.00	24
F9Q 760	Diesel	1870	4	80.00	93.00	24
F9Q 762	Diesel	1870	4	80.00	93.00	24
F9Q 762	Diesel	1870	4	80.00	93.00	24
F9Q 770	Diesel	1870	4	80.00	93.00	24
F9Q 770	Diesel	1870	4	80.00	93.00	24
F9Q 772	Diesel	1870	4	80.00	93.00	24
F9Q 772	Diesel	1870	4	80.00	93.00	24
F9Q 774	Diesel	1870	4	80.00	93.00	24
F9Q 774	Diesel	1870	4	80.00	93.00	24
G9MB6	Diesel	2463	4	89.00	99.00	53
G9T 720	Diesel	2188	4	87.00	92.00	47
G9T 720	Diesel	2188	4	87.00	92.00	47
G9T 722	Diesel	2188	4	87.00	92.00	47
G9T 722	Diesel	2188	4	87.00	92.00	47
G9T 750	Diesel	2188	4	87.00	92.00	47
G9T 750	Diesel	2188	4	87.00	92.00	47
G9U 630	Diesel	2464	4	89.00	99.00	53
G9U 630	Diesel	2464	4	89.00	99.00	53
G9U 632	Diesel	2464	4	89.00	99.00	53
G9U 650	Diesel	2464	4	89.00	99.00	53
G9U 720	Diesel	2463	4	89.00	99.00	53
G9U 720	Diesel	2463	4	89.00	99.00	53
G9U 724	Diesel	2463	4	89.00	99.00	53
G9U 724	Diesel	2463	4	89.00	99.00	53
G9U 730	Diesel	2463	4	89.00	99.00	53
G9U 730	Diesel	2463	4	89.00	99.00	53
G9U 750	Diesel	2463	4	89.00	99.00	53
G9U 750	Diesel	2463	4	89.00	99.00	53
G9U 754	Diesel	2463	4	89.00	99.00	53
G9U 754	Diesel	2463	4	89.00	99.00	53
H 20 E	Petrol	1979	4	95.00	69.80	62
H 20 E	Petrol	1979	4	95.00	69.80	62
M9R 630	Diesel	1995	4	84.00	90.00	33
M9R 630	Diesel	1995	4	84.00	90.00	33
M9R 692	Diesel	1995	4	84.00	90.00	33
M9R 780	Diesel	1995	4	84.00	90.00	33
M9R 780	Diesel	1995	4	84.00	90.00	33
M9R 782	Diesel	1995	4	84.00	90.00	33
M9R 782	Diesel	1995	4	84.00	90.00	33
M9R 784	Diesel	1995	4	84.00	90.00	33
M9R 784	Diesel	1995	4	84.00	90.00	33
M9R 786	Diesel	1995	4	84.00	90.00	33

		cm3	x 			
M9R 786	Diesel	1995	4	84.00	90.00	33
M9R 788	Diesel	1995	4	84.00	90.00	33
M9R 788	Diesel	1995	4	84.00	90.00	33
M9T 670	Diesel	2298	4	85.00	101.30	39
M9T 670	Diesel	2298	4	85.00	101.30	39
M9T 672	Diesel	2298	4	85.00	101.30	39
M9T 672	Diesel	2298	4	85.00	101.30	39
M9T 676	Diesel	2298	4	85.00	101.30	39
M9T 676	Diesel	2298	4	85.00	101.30	39
M9T 678	Diesel	2298	4	85.00	101.30	39
M9T 678	Diesel	2298	4	85.00	101.30	39
M9T 680	Diesel	2298	4	85.00	101.30	39
M9T 680	Diesel	2298	4	85.00	101.30	39
M9T 686	Diesel	2298	4	85.00	101.30	39
M9T 686	Diesel	2298	4	85.00	101.30	39
M9T 690	Diesel	2298	4	85.00	101.30	39
M9T 690	Diesel	2298	4	85.00	101.30	39
M9T 692	Diesel	2298	4	85.00	101.30	39
M9T 692	Diesel	2298	4	85.00	101.30	39
M9T 694	Diesel	2298	4	85.00	101.30	39
M9T 694	Diesel	2298	4	85.00	101.30	39
M9T 696	Diesel	2298	4	85.00	101.30	39
M9T 696	Diesel	2298	4	85.00	101.30	39
M9T 698	Diesel	2298	4	85.00	101.30	39
M9T 698	Diesel	2298	4	85.00	101.30	39
M9T 700	Diesel	2298	4	85.00	101.30	39
M9T 700	Diesel	2299	4	85.00	101.30	39
M9T 702	Diesel	2298	4	85.00	101.30	39
M9T 702	Diesel	2299	4	85.00	101.30	39
M9T 870	Diesel	2298	4	85.00	101.30	39
M9T 870	Diesel	2299	4	85.00	101.30	39
M9T 876	Diesel	2299	4	85.00	101.30	39
M9T 876	Diesel	2299	4	85.00	101.30	39
M9T 880	Diesel	2298	4	85.00	101.30	39
M9T 880	Diesel	2298	4	85.00	101.30	39
S8U 758	Diesel	2499	4	93.00	92.00	60
S8U 758	Diesel	2499	4	93.00	92.00	60
S8U 770	Diesel	2499	4	93.00	92.00	60
S8U 770	Diesel	2499	4	93.00	92.00	60
S8U 772	Diesel	2499	4	93.00	92.00	60
S8U 772	Diesel	2499	4	93.00	92.00	61
S8U 780	Diesel	2499	4	93.00	92.00	60
S8U 780	Diesel	2499	4	93.00	92.00	60
S8U 782	Diesel	2499	4	93.00	92.00	60
S8U 782	Diesel	2499	4	93.00	92.00	60
S 18 NV	Petrol	1796	4	84.80	79.50	36
S 18 NV	Petrol	1796	4	84.80	79.50	36
S 18 NV	Petrol	1796	4	84.80	79.50	36
X 10 XE	Petrol	973	3	72.50	78.60	5
X 10 XE	Petrol	973	3	72.50	78.60	5
X 12 SZ	Petrol	1195	4	72.00	73.40	3
X 12 SZ	Petrol	1195	4	72.00	73.40	3
X 12 XE	Petrol	1199	4	72.50	72.60	4
X 12 XE	Petrol	1199	4	72.50	72.60	4
X 14 NZ	Petrol	1389	4	77.60	73.40	14
X 14 SZ	Petrol	1389	4	77.60	73.40	14
X 14 SZ	Petrol	1389	4	77.60	73.40	14
X 14 XE	Petrol	1389	4	77.60	73.40	14
X 14 XE	Petrol	1389	4	77.60	73.40	14
X 15 DT (T4EC1)	Diesel	1488	4	76.00	82.00	13
X 15 DT (T4EC1)	Diesel	1488	4	76.00	82.00	13
X 16 SZ	Petrol	1598	4	79.00	81.50	17
X 16 SZ	Petrol	1598	4	79.00	81.50	17
X 16 SZR	Petrol	1598	4	79.00	81.50	17
X 16 SZR	Petrol	1598	4	79.00	81.50	17
X 16 XE	Petrol	1598	4	79.00	81.50	17
X 16 XE	Petrol	1598	4	79.00	81.50	17
X 16 XEL	Petrol	1598	4	79.00	81.50	17
X 16 XEL	Petrol	1598	4	79.00	81.50	17

		cm3	x 			
--	---	-----	---	---	---	---

X 17 D (4EE1)	Diesel	1686	4	79.00	86.00	18
X 17 D (4EE1)	Diesel	1686	4	79.00	86.00	18
X 17 DT (TC4EE1)	Diesel	1686	4	79.00	86.00	19
X 17 DT (TC4EE1)	Diesel	1686	4	79.00	86.00	19
X 17 DTL	Diesel	1699	4	82.50	79.50	30
X 17 DTL	Diesel	1700	4	82.50	79.50	30
X 18 XE	Petrol	1799	4	81.60	86.00	26
X 18 XE	Petrol	1799	4	81.60	86.00	26
X 18 XE1	Petrol	1796	4	80.50	88.20	25
X 18 XE1	Petrol	1796	4	80.50	88.20	25
X 20 DTH	Diesel	1995	4	84.00	90.00	34
X 20 DTH	Diesel	1995	4	84.00	90.00	34
X 20 DTL	Diesel	1995	4	84.00	90.00	34
X 20 DTL	Diesel	1995	4	84.00	90.00	34
X 20 SE	Petrol	1998	4	86.00	86.00	40
X 20 SE	Petrol	1998	4	86.00	86.00	40
X 20 XEV	Petrol	1998	4	86.00	86.00	40
X 20 XEV	Petrol	1998	4	86.00	86.00	40
X 20 XEV	Petrol	1998	4	86.00	86.00	40
X 20 XEV	Petrol	1998	4	86.00	86.00	40
X 22 DTH	Diesel	2171	4	84.00	98.00	35
X 22 DTH	Diesel	2171	4	84.00	98.00	35
X 22 SE	Petrol	2198	4	86.00	94.60	43
X 22 SE	Petrol	2198	4	86.00	94.60	43
X 22 SE	Petrol	2198	4	86.00	94.60	43
X 22 XE	Petrol	2198	4	86.00	94.60	43
X 22 XE	Petrol	2198	4	86.00	94.60	43
X 22 XE	Petrol	2198	4	86.00	94.60	43
X 25 DT	Diesel	2497	6	80.00	82.80	22
X 25 DT	Diesel	2497	6	80.00	82.80	22
X 25 TD	Diesel	2498	6	80.00	82.80	22
X 25 TD	Diesel	2498	6	80.00	82.80	22
Y 13 DT	Diesel	1248	4	69.60	82.00	1
Y 13 DT	Diesel	1248	4	69.60	82.00	1
Y 16 XE	Petrol	1598	4	79.00	81.50	17
Y 16 XE	Petrol	1598	4	79.00	81.50	17
Y 17 DT	Diesel	1686	4	79.00	86.00	19
Y 17 DT	Diesel	1686	4	79.00	86.00	19
Y 17 DTL	Diesel	1686	4	79.00	86.00	19
Y 17 DTL	Diesel	1686	4	79.00	86.00	19
Y 20 DTH	Diesel	1995	4	84.00	90.00	34
Y 20 DTH	Diesel	1995	4	84.00	90.00	34
Y 20 DTL	Diesel	1995	4	84.00	90.00	34
Y 20 DTL	Diesel	1995	4	84.00	90.00	34
Y 22 DTH	Diesel	2171	4	84.00	98.00	35
Y 22 DTH	Diesel	2171	4	84.00	98.00	35
Y 22 DTR	Diesel	2172	4	84.00	98.00	35
Y 22 DTR	Diesel	2172	4	84.00	98.00	35
Y 22 SE	Petrol	2198	4	86.00	94.60	43
Y 22 SE	Petrol	2198	4	86.00	94.60	43
Y 25 DT	Diesel	2497	6	80.00	82.80	22
Z 10 XE	Petrol	973	3	72.50	78.60	5
Z 10 XE	Petrol	973	3	72.50	78.60	5
Z 10 XEP	Petrol	998	3	73.40	78.60	7
Z 10 XEP	Petrol	998	3	73.40	78.60	7
Z 12 XE	Petrol	1199	4	72.50	72.60	4
Z 12 XE	Petrol	1199	4	72.50	72.60	4
Z 12 XEP	Petrol	1229	4	73.40	72.60	6
Z 12 XEP	Petrol	1229	4	73.40	72.60	6
Z 13 DT	Diesel	1248	4	69.60	82.00	1
Z 13 DT	Diesel	1248	4	69.60	82.00	1
Z 13 DTE	Diesel	1248	4	69.60	82.00	1
Z 13 DTE	Diesel	1248	4	69.60	82.00	1
Z 13 DTH	Diesel	1248	4	69.60	82.00	1
Z 13 DTH	Diesel	1248	4	69.60	82.00	1
Z 13 DTJ	Diesel	1248	4	69.60	82.00	1
Z 13 DTJ	Diesel	1248	4	69.60	82.00	1
Z 13 DTR	Diesel	1248	4	69.60	82.00	1
Z 13 DTR	Diesel	1248	4	69.60	82.00	1
Z 14 XE	Petrol	1389	4	77.60	73.40	14

			cm3	x 			
Z 14 XE	Petrol	1389	4	77.60	73.40	14	
Z 14 XEL	Petrol	1364	4	73.40	80.60	8	
Z 14 XEL	Petrol	1364	4	73.40	80.60	8	
Z 14 XEP	Petrol	1364	4	73.40	80.60	8	
Z 14 XEP	Petrol	1364	4	73.40	80.60	8	
Z 16 LEL	Petrol	1598	4	79.00	81.50	17	
Z 16 LEL	Petrol	1598	4	79.00	81.50	17	
Z 16 LER	Petrol	1598	4	79.00	81.50	17	
Z 16 LER	Petrol	1598	4	79.00	81.50	17	
Z 16 SE	Petrol	1598	4	79.00	81.50	17	
Z 16 SE	Petrol	1598	4	79.00	81.50	17	
Z 16 XE	Petrol	1598	4	79.00	81.50	17	
Z 16 XE	Petrol	1598	4	79.00	81.50	17	
Z 16 XE1	Petrol	1598	4	79.00	81.50	17	
Z 16 XEP	Petrol	1598	4	79.00	81.50	17	
Z 16 XEP	Petrol	1598	4	79.00	81.50	17	
Z 16 XER	Petrol	1598	4	79.00	81.50	17	
Z 16 XER	Petrol	1598	4	79.00	81.50	17	
Z 16 YNG	Petrol	1598	4	79.00	81.50	17	
Z 16 YNG	Petrol	1598	4	79.00	81.50	17	
Z 17 DT	Diesel	1686	4	79.00	86.00	19	
Z 17 DTH	Diesel	1686	4	79.00	86.00	19	
Z 17 DTH	Diesel	1686	4	79.00	86.00	19	
Z 17 DTL	Diesel	1686	4	79.00	86.00	19	
Z 17 DTL	Diesel	1686	4	79.00	86.00	19	
Z 18 XE	Petrol	1796	4	80.50	88.20	25	
Z 18 XE	Petrol	1796	4	80.50	88.20	25	
Z 18 XEL	Petrol	1796	4	80.50	88.20	25	
Z 18 XEL	Petrol	1796	4	80.50	88.20	25	
Z 18 XER	Petrol	1796	4	80.50	88.20	25	
Z 18 XER	Petrol	1796	4	80.50	88.20	25	
Z 19 DT	Diesel	1910	4	82.00	90.40	27	
Z 19 DT	Diesel	1910	4	82.00	90.40	27	
Z 19 DTH	Diesel	1910	4	82.00	90.40	27	
Z 19 DTH	Diesel	1910	4	82.00	90.40	27	
Z 19 DTJ	Diesel	1910	4	82.00	90.40	27	
Z 19 DTJ	Diesel	1910	4	82.00	90.40	27	
Z 22 SE	Petrol	2198	4	86.00	94.60	44	
Z 22 SE	Petrol	2198	4	86.00	94.60	44	
Z 22 YH	Petrol	2198	4	86.00	94.60	44	
Z 22 YH	Petrol	2198	4	86.00	94.60	44	



1 69.60 x 82.00

A 13 DTC Euro 5	4 Cyl.	1248cc	55kW (75PS)	Diesel Turbo	TD24745
A 13 DTC Euro 5	4 Cyl.	1248cc	55kW (75PS)	Diesel Turbo	TD24265
A 13 DTE	4 Cyl.	1248cc	70kW (95PS)	Diesel Turbo	TD23881
A 13 DTE	4 Cyl.	1248cc	70kW (95PS)	Diesel Turbo	TD24232
Y 13 DT	4 Cyl.	1248cc	51kW (70PS)	Diesel Turbo Intercooler	TD23798
Y 13 DT Euro 3/4	4 Cyl.	1248cc	51kW (70PS)	Diesel Turbo Intercooler	TD20084
Z 13 DT Euro 4	4 Cyl.	1248cc	51kW (70PS)	Diesel Turbo Intercooler	TD17477
Z 13 DT Euro 4 (D4)	4 Cyl.	1248cc	51-52kW (70-71PS)	Diesel Turbo Intercooler	TD18361
Z 13 DTE Euro 4	4 Cyl.	1248cc	70kW (95PS)	Diesel Turbo	TD24376
Z 13 DTE Euro 4 (D4)	4 Cyl.	1248cc	70kW (95PS)	Diesel Turbo	TD24377
Z 13 DTH	4 Cyl.	1248cc	66-74kW (90-101PS)	Diesel Turbo Intercooler	TD18654
Z 13 DTH Euro 4	4 Cyl.	1248cc	66-74kW (90-101PS)	Diesel Turbo Intercooler	TD18653
Z 13 DTJ	4 Cyl.	1248cc	51-55kW (69-75PS)	Diesel Turbo Intercooler	TD19348
Z 13 DTJ Euro 4	4 Cyl.	1248cc	55kW (75PS)	Diesel Turbo	TD18989
Z 13 DTR Euro 4 (D4)	4 Cyl.	1248cc	70kW (95PS)	Diesel Turbo	TD25258
Z 13 DTR Euro 4	4 Cyl.	1248cc	70kW (95PS)	Diesel Turbo	TD23708

BE/PL	4	42,582/42,600	45,734/45,744	20,000	1,552	0,030/0,062	BS	71-4033	71-4033/4 STD .010
MB/HL 1,2,4,5	4	50,982/51,000	54,710/54,722	19,000	1,840	0,026/0,050	AL-LF	02-4034	H1011/5 STD 0.25
MB/HL 3	1	50,982/51,000	54,710/54,722	23,950	1,840	0,026/0,050	AL-LF	02-4035H	
SE/PB	1	23,000	25,747/25,772	25,000			BS-LF	55-4077	55-4077 SEMI

2 72.00 x 61.00

10 N	4 Cyl.	993cc	29kW (40PS)	Petrol	TD2576
10 S	4 Cyl.	993cc	33-37kW (45-50PS)	Petrol	TD2578
10 S	4 Cyl.	993cc	29-37kW (39-50PS)	Petrol	TD17551

BE/PL	4	44,971/44,987	48,000/48,012	19,200	1,499	0,020/0,068	EC	71-2195	71-2195/4 STD 0.25
MB/HL 1	1	53,997/54,010	58,000/58,013	25,000	1,982	0,026/0,066	AL-LF	02-2196	H934/3 STD 0.25
MB/HL 2	1	54,007/54,020	58,000/58,013	28,900	1,982	0,016/0,056	AL-LF	02-2197H	
MB/HL 3	1	54,007/54,020	58,000/58,013	22,500	1,982	0,016/0,066	AL-LF	02-2198	

3 72.00 x 73.40

12 NZ	4 Cyl.	1195cc	33kW (45PS)	Petrol	TD4719
C 12 NZ	4 Cyl.	1196cc	33kW (45PS)	Petrol	TD4780
C 12 NZ	4 Cyl.	1196cc	33kW (45PS)	Petrol	TD17553
X 12 SZ	4 Cyl.	1195cc	33kW (45PS)	Petrol	TD2732
X 12 SZ	4 Cyl.	1195cc	33kW (45PS)	Petrol	TD17552

BE/PL	4	42,971/42,987	46,000/46,012	16,600	1,497	0,020/0,072	EC	71-3639	71-3639/4 STD 0.25 0.50
MB/HL 1,2,4,5	4	54,972/54,985	59,000/59,013	19,500	2,001	0,020/0,064	EC	72-3505	H975/5 STD 0.25 0.50
MB/HL 3	1	54,972/54,985	59,000/59,013	25,900	2,001	0,020/0,064	EC	72-3506H	

	72-3506H	STD	25,950/1.0217" - 26,002/1.0237"
		0.25mm	26,150/1.0295" - 26,202/1.0316"
		0.50mm	26,350/1.0374" - 26,402/1.0394"

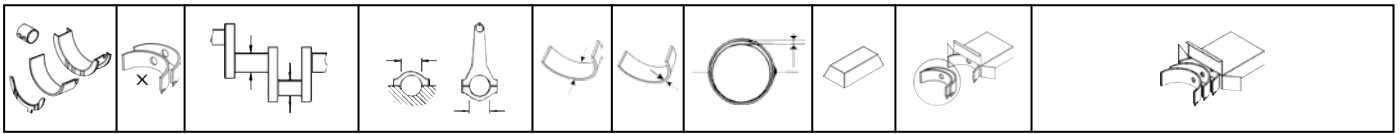

4 72.50 x 72.60									
X 12 XE			4 Cyl.	1199cc	48kW (65PS)		Petrol		TD9508
X 12 XE			4 Cyl.	1199cc	48kW (65PS)		Petrol		TD17620
Z 12 XE			4 Cyl.	1199cc	55kW (75PS)		Petrol		TD17935
Z 12 XE			4 Cyl.	1199cc	55kW (75PS)		Petrol		TD14009
BE/PL	4	42,971/42,987	46,000/46,012	13,200	1,501	0,021/0,069	AL-LF	01-4872	01-4872/4 STD
MB/HL	4	49,984/49,997	54,000/54,013	17,100	1,995	0,022/0,070	AL-LF	02-4797	H1295/5 STD
MB/HL	1	49,984/49,997	54,000/54,013	22,900	1,995	0,022/0,070	AL-LF	02-4798H	

5 72.50 x 78.60									
X 10 XE			3 Cyl.	973cc	40kW (54PS)		Petrol		TD5512
X 10 XE			3 Cyl.	973cc	40kW (54PS)		Petrol		TD17619
Z 10 XE			3 Cyl.	973cc	43kW (58PS)		Petrol		TD17630
Z 10 XE			3 Cyl.	973cc	43kW (58PS)		Petrol		TD14008
BE/PL	3	42,971/42,987	46,000/46,012	13,200	1,501	0,021/0,069	AL-LF	01-4872	01-4872/3 STD
MB/HL	3	49,984/49,997	54,000/54,013	17,100	1,995	0,022/0,070	AL-LF	02-4797	H1295/4 STD
MB/HL	1	49,984/49,997	54,000/54,013	22,900	1,995	0,022/0,070	AL-LF	02-4798H	

6 73.40 x 72.60									
Z 12 XEP			4 Cyl.	1229cc	59kW (80PS)		Petrol		TD19350
Z 12 XEP			4 Cyl.	1229cc	59kW (80PS)		Petrol		TD18012
BE/PL	4	42,971/42,987	46,000/46,012	13,200	1,501	0,021/0,069	AL-LF	01-4872	01-4872/4 STD
MB/HL	4	49,984/49,997	54,000/54,013	17,100	1,995	0,022/0,070	AL-LF	02-4797	H1295/5 STD
MB/HL	1	49,984/49,997	54,000/54,013	22,900	1,995	0,022/0,070	AL-LF	02-4798H	

7 73.40 x 78.60									
Z 10 XEP			3 Cyl.	998cc	44kW (60PS)		Petrol		TD19349
Z 10 XEP			3 Cyl.	998cc	44kW (60PS)		Petrol		TD17475
BE/PL	3	42,971/42,987	46,000/46,012	13,200	1,501	0,021/0,069	AL-LF	01-4872	01-4872/3 STD
MB/HL	3	49,984/49,997	54,000/54,013	17,100	1,995	0,022/0,070	AL-LF	02-4797	H1295/4 STD
MB/HL	1	49,984/49,997	54,000/54,013	22,900	1,995	0,022/0,070	AL-LF	02-4798H	

8 73.40 x 80.60									
Z 14 XEL			4 Cyl.	1364cc	55-59kW (75-80PS)		Petrol		TD25529
Z 14 XEL			4 Cyl.	1364cc	55-59kW (75-80PS)		Petrol		TD18552
Z 14 XEP			4 Cyl.	1364cc	66kW (90PS)		Petrol		TD18228
Z 14 XEP			4 Cyl.	1364cc	66kW (90PS)		Petrol		TD17476
BE/PL	4	42,971/42,987	46,000/46,012	13,200	1,501	0,021/0,069	AL-LF	01-4872	01-4872/4 STD
MB/HL	4	49,984/49,997	54,000/54,013	17,100	1,995	0,022/0,070	AL-LF	02-4797	H1295/5 STD
MB/HL	1	49,984/49,997	54,000/54,013	22,900	1,995	0,022/0,070	AL-LF	02-4798H	



9											75.00 x 61.00	
11 N		4 Cyl.	1078cc	33-37kW (45-50PS)				Petrol			TD2580	
11 S		4 Cyl.	1078cc	40kW (55PS)				Petrol			TD2581	
11 SR		4 Cyl.	1078cc	44kW (60PS)				Petrol			TD2582	
BE/PL	4	44,971/44,987	48,000/48,012	19,200	1,499	0,020/0,068	EC	71-2195	71-2195/4 STD 0.25			
MB/HL 1	1	53,997/54,010	58,000/58,013	25,000	1,982	0,026/0,066	AL-LF	02-2196	H934/3 STD 0.25			
MB/HL 2	1	54,007/54,020	58,000/58,013	28,900	1,982	0,016/0,056	AL-LF	02-2197H				
MB/HL 3	1	54,007/54,020	58,000/58,013	22,500	1,982	0,016/0,066	AL-LF	02-2198				

10											75.00 x 73.40	
13 N		4 Cyl.	1297cc	39-44kW (53-60PS)				Petrol			TD4723	
13 N		4 Cyl.	1297cc	39-44kW (53-60PS)				Petrol			TD17558	
13 NB		4 Cyl.	1297cc	44kW (60PS)				Petrol			TD4724	
13 NB		4 Cyl.	1297cc	44kW (60PS)				Petrol			TD17560	
13 S		4 Cyl.	1297cc	42-55kW (57-75PS)				Petrol			TD4725	
13 S		4 Cyl.	1297cc	42-55kW (57-75PS)				Petrol			TD17561	
13 SB		4 Cyl.	1297cc	51kW (70PS)				Petrol			TD4726	
13 SB		4 Cyl.	1297cc	51kW (69PS)				Petrol			TD17600	
C 13 N		4 Cyl.	1297cc	44kW (60PS)				Petrol			TD4781	
C 13 N		4 Cyl.	1297cc	44kW (60PS)				Petrol			TD18673	
BE/PL	4	42,971/42,987	46,000/46,012	16,600	1,497	0,020/0,072	EC	71-3639	71-3639/4 STD 0.25 0.50			
MB/HL 1,2,4,5	4	54,972/54,985	59,000/59,013	19,500	2,001	0,020/0,064	EC	72-3505	H975/5 STD 0.25 0.50			
MB/HL 3	1	54,972/54,985	59,000/59,013	25,900	2,001	0,020/0,064	EC	72-3506H				
		72-3506H	STD	25,950/1.0217" - 26,002/1.0237"								
			0.25mm	26,150/1.0295" - 26,202/1.0316"								
			0.50mm	26,350/1.0374" - 26,402/1.0394"								

11											76.00 x 73.00	
CB		3 Cyl.	993cc	34kW (46PS)				Petrol			TD26956	
BE/PL	6	39,980	43,020	18,000	1,490		AL	64-255-1	71-4309/3 STD			
MB/HL 1-4	8	41,980	46,020	19,500	1,990		AL	63-255-1	H1141/4 STD 0.25			

12											76.00 x 82.00	
15 D		4 Cyl.	1488cc	37kW (50PS)				Diesel			TD21906	
15 D (4EC1)		4 Cyl.	1488cc	37kW (50PS)				Diesel			TD4732	
BE/PL	4	45,936/45,972	48,976/49,000	16,700	1,500	0,020/0,089	AL-LF	4280RA	01-4361/4 STD			

13											76.00 x 82.00	
15 DT		4 Cyl.	1488cc	53kW (73PS)				Diesel Turbo			TD17578	
15 DT (T4EC1)		4 Cyl.	1488cc	49-53kW (67-72PS)				Diesel Turbo			TD4733	
15 DT (T4EC1)		4 Cyl.	1488cc	49-53kW (67-72PS)				Diesel Turbo			TD18227	
X 15 DT (T4EC1)		4 Cyl.	1488cc	49kW (67PS)				Diesel Turbo			TD5301	
X 15 DT (T4EC1)		4 Cyl.	1488cc	49kW (67PS)				Diesel Turbo			TD22871	
BE/PL	4	45,936/45,956	48,976/49,000	16,700	1,500	0,020/0,089	BS	4285CP	71-4297/4 STD 0.25 0.50			

MB/HL 1-5	5	51,920	56,000	15,530	2,006		AL	63-194-1	H1127/5 STD 0.25 0.50
MB/HL 1-5	5	51,920	56,000	15,530	2,006		AL	63-194-2	
TW/A	2	59,000	69,950		2,210		BS	4251AF	A226/2 STD
SE/PB	1	25,000	28,000	23,800			BS	4253Y	55-4501 STD

14 77.60 x 73.40

14 NV	4 Cyl.	1389cc	53-55kW (72-75PS)	Petrol	TD4728
14 NV	4 Cyl.	1389cc	53-55kW (72-75PS)	Petrol	TD17562
14 SE	4 Cyl.	1389cc	60kW (82PS)	Petrol	TD4730
C 14 NZ	4 Cyl.	1389cc	40-44kW (54-60PS)	Petrol	TD4782
C 14 NZ	4 Cyl.	1389cc	44kW (60PS)	Petrol	TD17581
C 14 SE	4 Cyl.	1389cc	54-60kW (73-82PS)	Petrol	TD4783
C 14 SE	4 Cyl.	1389cc	60kW (82PS)	Petrol	TD17582
C 14 SEL	4 Cyl.	1389cc	63kW (86PS)	Petrol	TD16393
C 14 SEL	4 Cyl.	1389cc	63kW (86PS)	Petrol	TD21363
X 14 NZ	4 Cyl.	1389cc	44kW (60PS)	Petrol	TD14828
X 14 SZ	4 Cyl.	1389cc	40-44kW (54-60PS)	Petrol	TD17621
X 14 SZ	4 Cyl.	1389cc	40-44kW (54-60PS)	Petrol	TD8405
X 14 XE	4 Cyl.	1389cc	66kW (90PS)	Petrol	TD17589
X 14 XE	4 Cyl.	1389cc	63-69kW (86-94PS)	Petrol	TD2733
Z 14 XE	4 Cyl.	1389cc	66kW (90PS)	Petrol	TD14920
Z 14 XE	4 Cyl.	1389cc	66kW (90PS)	Petrol	TD17631

BE/PL	4	42,971/42,987	46,000/46,012	16,600	1,497	0,020/0,072	EC	71-3639	71-3639/4 STD 0.25 0.50
MB/HL 1,2,4,5	4	54,972/54,985	59,000/59,013	19,500	2,001	0,020/0,064	EC	72-3505	H975/5 STD 0.25 0.50
MB/HL 3	1	54,972/54,985	59,000/59,013	25,900	2,001	0,020/0,064	EC	72-3506H	

72-3506H	STD	25,950/1.0217" - 26,002/1.0237"
	0.25mm	26,150/1.0295" - 26,202/1.0316"
	0.50mm	26,350/1.0374" - 26,402/1.0394"

15 77.80 x 62.90

12 NV	4 Cyl.	1196cc	38kW (52PS)	Petrol	TD4718
12 NV	4 Cyl.	1196cc	38kW (52PS)	Petrol	TD22840
12 ST	4 Cyl.	1196cc	40-43kW (55-58PS)	Petrol	TD4722
12 ST	4 Cyl.	1196cc	40-43kW (54-58PS)	Petrol	TD17599

BE/PL	4	42,971/42,987	46,000/46,012	16,600	1,497	0,020/0,072	EC	71-3639	71-3639/4 STD 0.25 0.50
MB/HL 1,2,4,5	4	54,972/54,985	59,000/59,013	19,500	2,001	0,020/0,064	EC	72-3505	H975/5 STD 0.25 0.50
MB/HL 3	1	54,972/54,985	59,000/59,013	25,900	2,001	0,020/0,064	EC	72-3506H	

72-3506H	STD	25,950/1.0217" - 26,002/1.0237"
	0.25mm	26,150/1.0295" - 26,202/1.0316"
	0.50mm	26,350/1.0374" - 26,402/1.0394"

16 79.00 x 61.00

12 N	4 Cyl.	1196cc	38-40kW (52-55PS)	Petrol	TD2583
12 N	4 Cyl.	1196cc	38-40kW (52-55PS)	Petrol	TD17554
12 NC	4 Cyl.	1196cc	33kW (45PS)	Petrol	TD4717
12 NC	4 Cyl.	1196cc	33kW (52PS)	Petrol	TD17555
12 S	4 Cyl.	1196cc	40-44kW (54-60PS)	Petrol	TD4720



12 S	4 Cyl.	1196cc	40-44kW (54-60PS)	Petrol	TD17556
12 SC	4 Cyl.	1196cc	40kW (55PS)	Petrol	TD4721
12 SC	4 Cyl.	1196cc	40kW (54PS)	Petrol	TD17598
E 12 GV	4 Cyl.	1196cc	33kW (45PS)	Petrol	TD4809
E 12 GV	4 Cyl.	1196cc	33kW (45PS)	Petrol	TD22847

BE/PL	4	44,971/44,987	48,000/48,012	19,200	1,499	0,020/0,068	EC	71-2195	71-2195/4 STD 0.25
MB/HL 1	1	53,997/54,010	58,000/58,013	25,000	1,982	0,026/0,066	AL-LF	02-2196	H934/3 STD 0.25
MB/HL 2	1	54,007/54,020	58,000/58,013	28,900	1,982	0,016/0,056	AL-LF	02-2197H	
MB/HL 3	1	54,007/54,020	58,000/58,013	22,500	1,982	0,016/0,066	AL-LF	02-2198	

17 79.00 x 81.50

16 LZ2	4 Cyl.	1598cc	55kW (75PS)	Petrol	TD4736
16 NZR	4 Cyl.	1598cc	55kW (75PS)	Petrol	TD16169
16 SV	4 Cyl.	1598cc	60kW (82PS)	Petrol	TD17565
16 SV	4 Cyl.	1598cc	60kW (82PS)	Petrol	TD4740
A 16 LEL Euro 5	4 Cyl.	1598cc	110kW (150PS)	Petrol Turbo	TD24374
A 16 LEL Euro 5	4 Cyl.	1598cc	110kW (150PS)	Petrol Turbo	TD24756
A 16 LER Euro 5	4 Cyl.	1598cc	141kW (192PS)	Petrol Turbo	TD25059
A 16 LER Euro 5	4 Cyl.	1598cc	141kW (192PS)	Petrol Turbo	TD24375
C 16 LZ2	4 Cyl.	1598cc	51-55kW (69-75PS)	Petrol	TD21179
C 16 NZ	4 Cyl.	1598cc	55-60kW (75-82PS)	Petrol	TD4785
C 16 NZ	4 Cyl.	1598cc	55kW (75PS)	Petrol	TD17583
C 16 NZ2	4 Cyl.	1598cc	55kW (75PS)	Petrol	TD5308
C 16 SE	4 Cyl.	1598cc	74kW (100PS)	Petrol	TD4787
C 16 SE	4 Cyl.	1598cc	74kW (101PS)	Petrol	TD17608
C 16 SEI	4 Cyl.	1598cc	72kW (98PS)	Petrol	TD4788
C 16 SEI	4 Cyl.	1598cc	72kW (98PS)	Petrol	TD22864
C 16 SEL	4 Cyl.	1598cc	74kW (100PS)	Petrol	TD16394
C 16 SEL	4 Cyl.	1598cc	74kW (100PS)	Petrol	TD25534
C 16 XE	4 Cyl.	1598cc	78-80kW (106-109PS)	Petrol	TD17609
C 16 XE	4 Cyl.	1598cc	80kW (109PS)	Petrol	TD4789
E 16 LZ	4 Cyl.	1598cc	55kW (75PS)	Petrol	TD25784
E 16 NZ	4 Cyl.	1598cc	55-65kW (75-88PS)	Petrol	TD4810
E 16 NZ	4 Cyl.	1598cc	55kW (75PS)	Petrol	TD17618
E 16 SE	4 Cyl.	1598cc	60-74kW (81-101PS)	Petrol	TD17586
E 16 SE	4 Cyl.	1598cc	74-75kW (100-102PS)	Petrol	TD4811
X 16 SZ	4 Cyl.	1598cc	52kW (71PS)	Petrol	TD2734
X 16 SZ	4 Cyl.	1598cc	52kW (71PS)	Petrol	TD17622
X 16 SZR	4 Cyl.	1598cc	55kW (75PS)	Petrol	TD17623
X 16 SZR	4 Cyl.	1598cc	55kW (75PS)	Petrol	TD4819
X 16 XE	4 Cyl.	1598cc	78-80kW (106-109PS)	Petrol	TD17624
X 16 XE	4 Cyl.	1598cc	78kW (106PS)	Petrol	TD2735
X 16 XEL	4 Cyl.	1598cc	74kW (101PS)	Petrol	TD17590
X 16 XEL	4 Cyl.	1598cc	74kW (100PS)	Petrol	TD4820
Y 16 XE	4 Cyl.	1598cc	74kW (101PS)	Petrol	TD13688
Y 16 XE	4 Cyl.	1598cc	74kW (101PS)	Petrol	TD22874
Z 16 LEL	4 Cyl.	1598cc	110kW (150PS)	Petrol Turbo	TD20857
Z 16 LEL	4 Cyl.	1598cc	110kW (150PS)	Petrol Turbo	TD24910
Z 16 LER	4 Cyl.	1598cc	141kW (192PS)	Petrol Turbo	TD20059
Z 16 LER	4 Cyl.	1598cc	141-150kW (192-204PS)	Petrol Turbo	TD20164

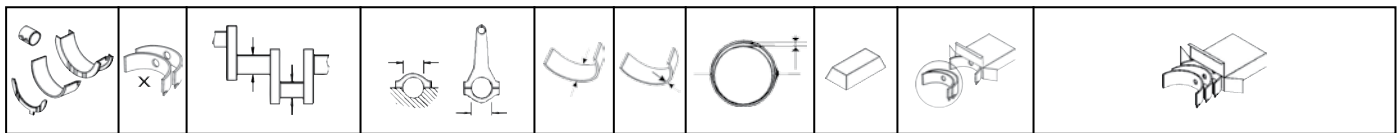

Z 16 SE	4 Cyl.	1598cc	62-64kW (84-87PS)	Petrol	TD17632
Z 16 SE	4 Cyl.	1598cc	62-64kW (84-87PS)	Petrol	TD15089
Z 16 XE	4 Cyl.	1598cc	63-74kW (85-101PS)	Petrol	TD17937
Z 16 XE	4 Cyl.	1598cc	74kW (101PS)	Petrol	TD14923
Z 16 XE1	4 Cyl.	1598cc	77kW (105PS)	Petrol	TD21875
Z 16 XEP	4 Cyl.	1598cc	74-77kW (101-105PS)	Petrol	TD17892
Z 16 XEP	4 Cyl.	1598cc	74-77kW (101-105PS)	Petrol	TD17939
Z 16 XER	4 Cyl.	1598cc	85kW (116PS)	Petrol	TD20060
Z 16 XER	4 Cyl.	1598cc	85kW (116PS)	Petrol	TD21873
Z 16 YNG	4 Cyl.	1598cc	69-74kW (94-101PS)	Petrol	TD17893
Z 16 YNG	4 Cyl.	1598cc	69-74kW (94-101PS)	Petrol	TD24742

BE/PL	4	42,971/42,987	46,000/46,012	16,600	1,497	0,020/0,072	EC	71-3639	71-3639/4 STD 0.25 0.50
MB/HL 1,2,4,5	4	54,972/54,985	59,000/59,013	19,500	2,001	0,020/0,064	EC	72-3505	H975/5 STD 0.25 0.50
MB/HL 3	1	54,972/54,985	59,000/59,013	25,900	2,001	0,020/0,064	EC	72-3506H	



72-3506H	STD	25,950/1.0217" - 26,002/1.0237"
	0.25mm	26,150/1.0295" - 26,202/1.0316"
	0.50mm	26,350/1.0374" - 26,402/1.0394"

18

79.00 x 86.00

17 D (4EE1)	4 Cyl.	1686cc	44kW (60PS)	Diesel	TD5284
17 D (4EE1)	4 Cyl.	1686cc	44kW (60PS)	Diesel	TD22845
X 17 D (4EE1)	4 Cyl.	1686cc	42-44kW (57-60PS)	Diesel	TD5298
X 17 D (4EE1)	4 Cyl.	1686cc	44kW (60PS)	Diesel	TD22872

BE/PL	4	45,936/45,972	48,976/49,000	16,700	1,500	0,020/0,089	AL-LF	4280RA	01-4361/4 STD
MB/HL 1-5	5	51,920	56,000	15,530	2,006		AL	63-194-1	H1127/5 STD 0.25 0.50
MB/HL 1-5	5	51,920	56,000	15,530	2,006		AL	63-194-2	
TW/A	2	59,000	73,700		2,110		AL	04-4496	A261/2 STD
SE/PB	1	26,000	29,520	26,350			BS	68144Y	55-4247 SEMI

19

79.00 x 86.00

17 DT (TC4EE1)	4 Cyl.	1686cc	60kW (82PS)	Diesel Turbo	TD4747
17 DT (TC4EE1)	4 Cyl.	1686cc	60kW (82PS)	Diesel Turbo	TD22846
A 17 DT Euro 5	4 Cyl.	1686cc	74kW (101PS)	Diesel Turbo	TD24746
X 17 DT (TC4EE1)	4 Cyl.	1686cc	60kW (82PS)	Diesel Turbo Intercooler	TD4822
X 17 DT (TC4EE1)	4 Cyl.	1686cc	60kW (82PS)	Diesel Turbo Intercooler	TD22873
Y 17 DT	4 Cyl.	1686cc	55kW (75PS)	Diesel Turbo	TD18380
Y 17 DT	4 Cyl.	1686cc	55kW (75PS)	Diesel Turbo	TD13689
Y 17 DTL	4 Cyl.	1686cc	48kW (65PS)	Diesel	TD18381
Y 17 DTL	4 Cyl.	1686cc	48kW (65PS)	Diesel	TD14921
Z 17 DT	4 Cyl.	1686cc	74kW (101PS)	Diesel Turbo Intercooler	TD25865
Z 17 DTH	4 Cyl.	1686cc	74kW (100PS)	Diesel Turbo Intercooler	TD17941
Z 17 DTH	4 Cyl.	1686cc	74kW (100PS)	Diesel Turbo Intercooler	TD17478
Z 17 DTL	4 Cyl.	1686cc	59kW (80PS)	Diesel Turbo Intercooler	TD17947
Z 17 DTL	4 Cyl.	1686cc	59kW (80PS)	Diesel Turbo Intercooler	TD17945

BE/PL	4	45,936/45,956	48,976/49,000	16,700	1,500	0,020/0,089	BS	4285CP	71-4297/4 STD 0.25 0.50
-------	---	---------------	---------------	--------	-------	-------------	----	--------	-----------------------------------

[9]

MB/HL 1-5	5	51,920	56,000	15,530	2,006		AL	63-194-1	H1127/5 STD 0.25 0.50	
MB/HL 1-5	5	51,920	56,000	15,530	2,006		AL	63-194-2		
TW/A	2	59,000	73,700		2,110		AL	04-4496	A261/2 STD	

20 80.00 x 79.50

C 16 LZ		4 Cyl.	1598cc	55kW (75PS)			Petrol		TD4784
C 16 LZ		4 Cyl.	1598cc	55kW (75PS)			Petrol		TD21362
BE/PL	4	42,971/42,987	46,000/46,012	16,600	1,497	0,020/0,072	EC	71-3639	71-3639/4 STD 0.25 0.50
MB/HL 1,2,4,5	4	54,972/54,985	59,000/59,013	19,500	2,001	0,020/0,064	EC	72-3505	H975/5 STD 0.25 0.50
MB/HL 3	1	54,972/54,985	59,000/59,013	25,900	2,001	0,020/0,064	EC	72-3506H	

	72-3506H	STD	25,950/1.0217" - 26,002/1.0237"
		0.25mm	26,150/1.0295" - 26,202/1.0316"
		0.50mm	26,350/1.0374" - 26,402/1.0394"

21 80.00 x 79.50

16 N		4 Cyl.	1598cc	51-55kW (69-75PS)			Petrol		TD5281
16 N		4 Cyl.	1598cc	51-55kW (69-75PS)			Petrol		TD17602
16 SH		4 Cyl.	1598cc	66kW (90PS)			Petrol		TD4739
16 SH		4 Cyl.	1598cc	66kW (90PS)			Petrol		TD17564
16 D		4 Cyl.	1598cc	40kW (54PS)			Diesel		TD4734
16 D		4 Cyl.	1598cc	40kW (54PS)			Diesel		TD17563
16 DA		4 Cyl.	1598cc	40kW (54PS)			Diesel		TD4735
16 DA		4 Cyl.	1598cc	40kW (54PS)			Diesel		TD17601

BE/PL	4	48,971/48,987	52,000/52,012	19,300	1,500	0,020/0,066	EC	71-3531	71-3531/4 STD
→08/85									
BE/PL	4	48,971/48,987	52,000/52,012	19,300	1,500	0,020/0,066	EC	71-3626	71-3626/4 STD 0.25 0.50
09/85→									

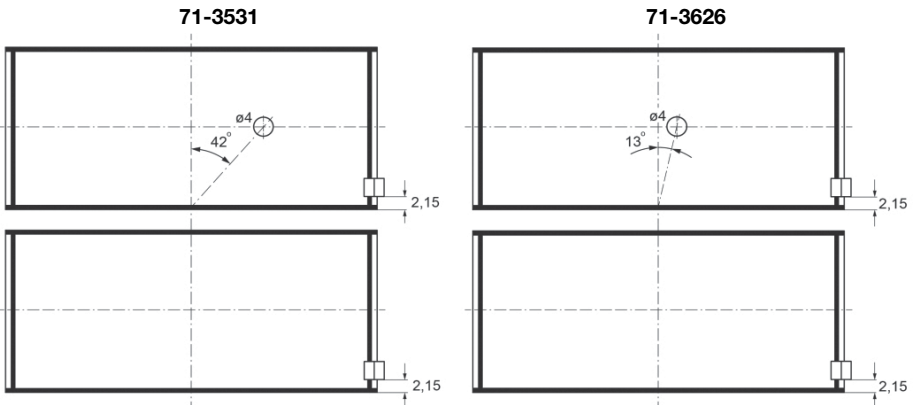

MB/HL 1,2,4,5	4	57,982/57,995	62,000/62,013	19,500	1,995	0,020/0,066	AL-LF	02-3532	H982/5 STD 0.25 0.50
MB/HL 3	1	57,982/57,995	62,000/62,013	25,900	1,995	0,020/0,066	AL-LF	02-3533H	

	02-3533H	STD	25,950/1.0217" - 26,002/1.0237"
		0.25mm	26,150/1.0295" - 26,202/1.0316"
		0.50mm	26,350/1.0374" - 26,402/1.0394"

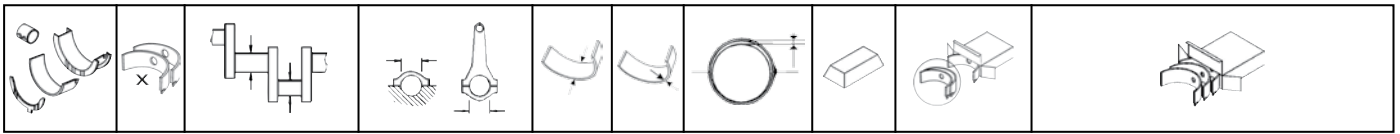

22		80.00 x 82.80								
25 DT		6 Cyl.	2497cc	96kW (130PS)				Diesel Turbo		TD4817
25 DT		6 Cyl.	2497cc	96kW (130PS)				Diesel Turbo		TD22848
X 25 DT		6 Cyl.	2497cc	96kW (130PS)				Diesel Turbo Intercooler		TD4828
X 25 DT		6 Cyl.	2497cc	96kW (131PS)				Diesel Turbo Intercooler		TD17595
X 25 TD		6 Cyl.	2498cc	96kW (131PS)				Diesel Turbo Intercooler		TD17920
X 25 TD		6 Cyl.	2498cc	96kW (131PS)				Diesel Turbo Intercooler		TD17322
Y 25 DT		6 Cyl.	2497cc	110kW (150PS)				Diesel Turbo Intercooler		TD16301
MB/HL 1-5, 7	6	59,971/59,990	65,000/65,019	20,000	2,498	0,020/0,063	AL-LF	02-3646	H023/7 STD 0.25 0.50	
MB/HL 6	1	59,971/59,990	65,000/65,019	24,940	2,498	0,020/0,082	AL-LF	02-3647H		
			02-3647H	STD	25,020/.9853" - 25,053/.9863"					
				0.25mm	25,220/.9929" - 25,253/.9942"					
				0.50mm	25,420/1.0008" - 25,453/1.0021"					

23		80.00 x 93.00								
F8Q 600		4 Cyl.	1870cc	44kW (60PS)				Diesel		TD21361
F8Q 600		4 Cyl.	1870cc	44kW (60PS)				Diesel		TD21360
F8Q 606		4 Cyl.	1870cc	44kW (60PS)				Diesel		TD21359
F8Q 606		4 Cyl.	1870cc	44kW (60PS)				Diesel		TD21358
BE/PL	4	48,000/48,020	51,587/51,606	20,250	1,776	0,015/0,079	EC	71-3988L	71-3988/4 STD 0.25 0.50	[4]
BE/PL	4	48,000/48,020	51,587/51,606	20,500	1,776	0,015/0,079	EC	71-3988U		
MB/HL 1-5	5	54,785/54,805	58,731/58,744	18,500	1,947	0,032/0,090	EC	72-3989	H098/5 STD 0.25 0.50	
TW/A	2	60,500/60,750	79,750/80,000		2,350		AL-LF	66741AF	A215/2 STD 0.10	
SE/PB	1	24,005/24,012	26,000/26,021	24,750			BC	55-3875	55-3875 SEMI	

24		80.00 x 93.00								
F9Q 760		4 Cyl.	1870cc	74kW (101PS)				Diesel Turbo Intercooler		TD19375
F9Q 760		4 Cyl.	1870cc	74kW (101PS)				Diesel Turbo		TD18872
F9Q 762		4 Cyl.	1870cc	59-60kW (80-82PS)				Diesel Turbo		TD21148
F9Q 762		4 Cyl.	1870cc	59-60kW (80-82PS)				Diesel Turbo		TD18494
F9Q 770		4 Cyl.	1870cc	59kW (80PS)				Diesel Turbo		TD19374
F9Q 770		4 Cyl.	1870cc	59kW (80PS)				Diesel Turbo		TD19351
F9Q 772		4 Cyl.	1870cc	60kW (82PS)				Diesel Turbo		TD23125
F9Q 772		4 Cyl.	1870cc	60kW (82PS)				Diesel Turbo		TD19363
F9Q 774		4 Cyl.	1870cc	60kW (82PS)				Diesel Turbo		TD19352
F9Q 774		4 Cyl.	1870cc	60kW (82PS)				Diesel Turbo		TD18252
BE/PL	4	48,000/48,020	51,587/51,606	20,250	1,776	0,015/0,079	EC	71-3988L	71-3988/4 STD 0.25 0.50	[4]
BE/PL	4	48,000/48,020	51,587/51,606	20,500	1,776	0,015/0,079	EC	71-3988U		
MB/HL 1-5	5	54,785/54,805	58,731/58,744	18,500	1,947	0,032/0,090	EC	72-3989	H098/5 STD 0.25 0.50	
TW/A	2	60,500/60,750	79,750/80,000		2,350		AL-LF	66741AF	A215/2 STD 0.10	
SE/PB	1	27,996/28,000	30,240/30,260	24,650			BS-LF	55-4299	55-4299 SEMI	

25		80.50 x 88.20								
X 18 XE1		4 Cyl.	1796cc	85kW (115PS)				Petrol		TD9509



X 18 XE1	4 Cyl.	1796cc	85kW (116PS)	Petrol	TD17626
Z 18 XE	4 Cyl.	1796cc	87-92kW (118-125PS)	Petrol	TD17633
Z 18 XE	4 Cyl.	1796cc	90-92kW (122-125PS)	Petrol	TD14922
Z 18 XEL	4 Cyl.	1796cc	81-85kW (110-116PS)	Petrol	TD17987
Z 18 XEL	4 Cyl.	1796cc	79-85kW (107-116PS)	Petrol	TD17894
Z 18 XER	4 Cyl.	1796cc	103kW (140PS)	Petrol	TD18838
Z 18 XER	4 Cyl.	1796cc	103kW (140PS)	Petrol	TD18730

BE/PL	4	42,971/42,987	46,000/46,012	16,600	1,497	0,020/0,072	EC	71-3639	71-3639/4 STD 0.25 0.50
MB/HL 1,2,4,5	4	54,972/54,985	59,000/59,013	19,500	2,001	0,020/0,064	EC	72-3505	H975/5 STD 0.25 0.50
MB/HL 3	1	54,972/54,985	59,000/59,013	25,900	2,001	0,020/0,064	EC	72-3506H	

	72-3506H	STD	25,950/1.0217" - 26,002/1.0237"
		0.25mm	26,150/1.0295" - 26,202/1.0316"
		0.50mm	26,350/1.0374" - 26,402/1.0394"

26 81.60 x 86.00

C 18 XE	4 Cyl.	1799cc	92kW (125PS)	Petrol	TD4795
C 18 XE	4 Cyl.	1799cc	92kW (125PS)	Petrol	TD17611
C 18 XEL	4 Cyl.	1799cc	85kW (116PS)	Petrol	TD4796
C 18 XEL	4 Cyl.	1799cc	85kW (116PS)	Petrol	TD17636
X 18 XE	4 Cyl.	1799cc	85kW (115PS)	Petrol	TD4823
X 18 XE	4 Cyl.	1799cc	85kW (116PS)	Petrol	TD17625

BE/PL	4	48,971/48,987	52,000/52,012	19,300	1,500	0,020/0,066	EC	71-3626	71-3626/4 STD 0.25 0.50
MB/HL 1,2,4,5	4	57,982/57,995	62,000/62,013	19,500	1,995	0,020/0,066	AL-LF	02-3532	H982/5 STD 0.25 0.50
MB/HL 3	1	57,982/57,995	62,000/62,013	25,900	1,995	0,020/0,066	AL-LF	02-3533H	

	02-3533H	STD	25,950/1.0217" - 26,002/1.0237"
		0.25mm	26,150/1.0295" - 26,202/1.0316"
		0.50mm	26,350/1.0374" - 26,402/1.0394"

27 82.00 x 90.40

Z 19 DT	4 Cyl.	1910cc	88kW (120PS)	Diesel Turbo Intercooler	TD18659
Z 19 DT	4 Cyl.	1910cc	88kW (120PS)	Diesel Turbo Intercooler	TD18046
Z 19 DTH Euro 4 (D4)	4 Cyl.	1910cc	110kW (150PS)	Diesel Turbo Intercooler	TD18016
Z 19 DTH Euro 4	4 Cyl.	1910cc	110kW (150PS)	Diesel Turbo Intercooler	TD18014
Z 19 DTJ	4 Cyl.	1910cc	88kW (120PS)	Diesel Turbo Intercooler	TD18017
Z 19 DTJ	4 Cyl.	1910cc	88kW (120PS)	Diesel Turbo Intercooler	TD18011

BE/PL	1	50,787/50,805	53,901/53,913	19,500	1,534	0,030/0,080	EC	71-3994	71-3994 STD 0.25 4
MB/HL	1	59,986/60,000	63,705/63,718	20,750	1,844	0,031/0,080	EC	72-3995	72-3995 STD 0.25 0.50
TW/A	2	67,785/68,040	82,425/82,677		2,485		AL-LF	4356AF	A191/2 STD
SE/PB	1		28,939/28,972	21,700			BS	4369Y	55-4159 SEMI

28 82.50 x 69.80

15 ...	4 Cyl.	1492cc	43-49kW (58-67PS)	Petrol	TD4731				
BE/PL	1	51,971/51,987	55,000/55,012	19,610	1,449	0,015/0,063	BS	71-3560	71-3560 STD 0.25 0.50
BE/PL	4	51,971/51,987	55,000/55,012	19,610	1,449	0,015/0,063	BS	71-3560	71-3560/4 STD

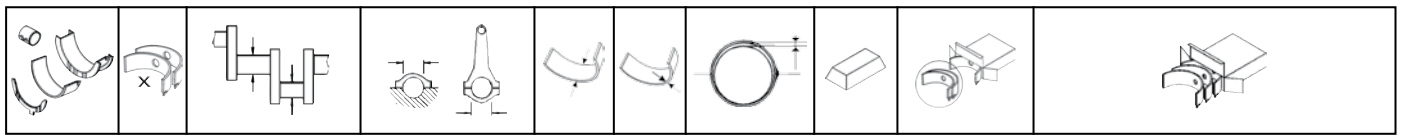

MB/HL 1-4	4	57,987/58,000	62,000/62,013	22,430	1,989	0,019/0,064	AL-LF	02-2421	H901/5 STD 0.25 0.50
MB/HL 5	1	57,987/58,000	62,000/62,013	27,400	1,989	0,019/0,064	AL-LF	02-2422H	
		02-2422H	STD	27,450/1.0807" - 27,510/1.0831"					
			0.25mm	27,660/1.0890" - 27,720/1.0913"					
			0.50mm	27,860/1.0969" - 27,920/1.0992"					
			1.00mm	28,260/1.1126" - 28,320/1.1150"					

29 82.50 x 79.50

17 D	4 Cyl.		1700cc	42kW (57PS)			Diesel	TD4742	
17 D	4 Cyl.		1699cc	42kW (57PS)			Diesel	TD17566	
17 DR	4 Cyl.		1700cc	42-44kW (57-60PS)			Diesel	TD4744	
17 DR	4 Cyl.		1699cc	42-44kW (57-60PS)			Diesel	TD17567	
BE/PL	4	48,971/48,987	52,000/52,012	19,300	1,500	0,020/0,066	EC	71-3626	71-3626/4 STD 0.25 0.50
MB/HL 1,2,4,5	4	57,982/57,995	62,000/62,013	19,500	1,995	0,020/0,066	AL-LF	02-3532	H982/5 STD 0.25 0.50
MB/HL 3	1	57,982/57,995	62,000/62,013	25,900	1,995	0,020/0,066	AL-LF	02-3533H	
		02-3533H	STD	25,950/1.0217" - 26,002/1.0237"					
			0.25mm	26,150/1.0295" - 26,202/1.0316"					
			0.50mm	26,350/1.0374" - 26,402/1.0394"					

30 82.50 x 79.50

X 17 DTL	4 Cyl.		1700cc	50kW (68PS)			Diesel Turbo	TD4821	
X 17 DTL	4 Cyl.		1699cc	50kW (68PS)			Diesel Turbo	TD17591	
BE/PL	4	48,971/48,987	52,000/52,012	19,300	1,510	0,020/0,046	SP	71-3821	71-3821/4 STD 1
MB/HL 1,2,4,5	4	57,974/57,995	62,000/62,013	19,500	2,001	0,020/0,062	AL-LF	02-3822	H059/5 STD
MB/HL 3	1	57,974/57,995	62,000/62,013	25,900	2,001	0,020/0,062	AL-LF	02-3823H	
		02-3823H	STD	25,950/1.0217" - 26,002/1.0237"					
			0.25mm	26,150/1.0295" - 26,202/1.0316"					
MB/HL 1,2,4,5	4	57,982/57,995	62,000/62,013	19,500	1,995	0,020/0,066	AL-LF	02-3532	H982/5 STD 0.25 0.50
MB/HL 3	1	57,982/57,995	62,000/62,013	25,900	1,995	0,020/0,066	AL-LF	02-3533H	
		02-3533H	STD	25,950/1.0217" - 26,002/1.0237"					
			0.25mm	26,150/1.0295" - 26,202/1.0316"					
			0.50mm	26,350/1.0374" - 26,402/1.0394"					

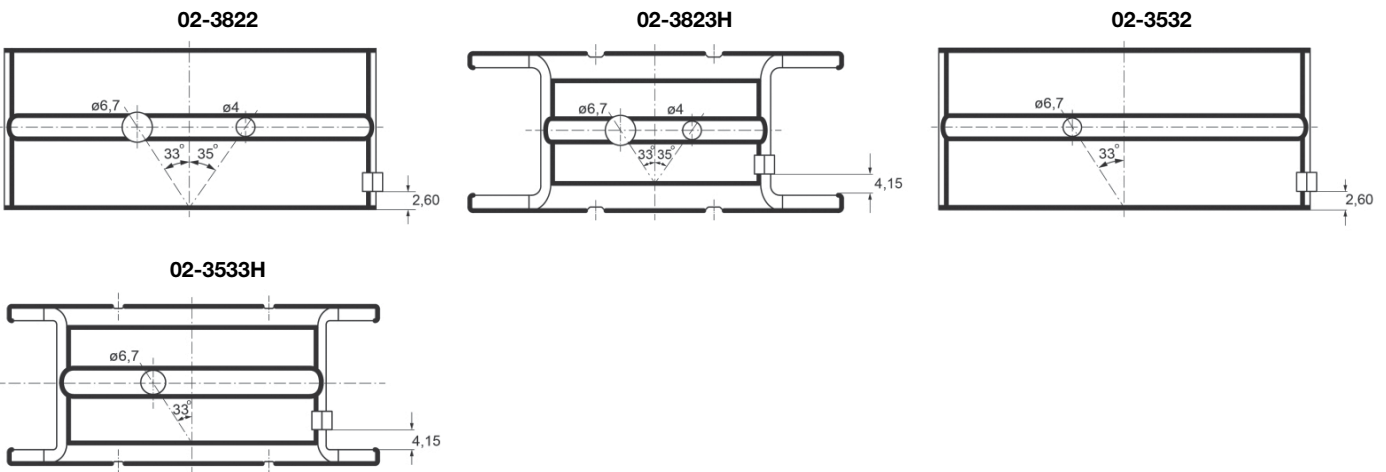



31 82.70 x 93.00

F4R 720			4 Cyl.	1998cc	88kW (120PS)		Petrol		TD19216		
F4R 720			4 Cyl.	1998cc	88kW (120PS)		Petrol		TD18194		
F4R 820			4 Cyl.	1998cc	86kW (117PS)		Petrol		TD21905		
F4R 820			4 Cyl.	1998cc	86kW (117PS)		Petrol		TD21037		
BE/PL	4	48,000/48,020		51,587/51,606	20,250	1,776	0,015/0,079	EC	71-3988L	71-3988/4 STD 0.25 0.50	4
BE/PL	4	48,000/48,020		51,587/51,606	20,500	1,776	0,015/0,079	EC	71-3988U		
MB/HL 1-5	5	54,785/54,805		58,731/58,744	18,500	1,947	0,032/0,090	EC	72-3989	H098/5 STD 0.25 0.50	
TW/A	2	60,500/60,750		79,750/80,000		2,350		AL-LF	66741AF	A215/2 STD 0.10	
SE/PB	1	21,000/21,015		23,000/23,021	24,750			BS	4064Y	55-4264 SEMI	

32 84.00 x 82.00

4ZB1			4 Cyl.	1817cc	55-63kW (75-86PS)		Petrol		TD26951	
MB/HL 1-5	5	55,920/55,930		59,979/59,999	21,869	2,009	0,030/0,086	AL	3961RA	H1225/5 STD

33 84.00 x 90.00

M9R 630			4 Cyl.	1995cc	66-84kW (90-114PS)		Diesel Turbo Intercooler		TD25646	
M9R 630			4 Cyl.	1995cc	66-84kW (90-114PS)		Diesel Turbo Intercooler		TD25645	
M9R 692 Euro 5			4 Cyl.	1995cc	84kW (114PS)		Diesel Turbo		TD28089	
M9R 780			4 Cyl.	1995cc	66-84kW (90-114PS)		Diesel Turbo Intercooler		TD20889	
M9R 780			4 Cyl.	1995cc	66-84kW (90-114PS)		Diesel Turbo Intercooler		TD20888	
M9R 782			4 Cyl.	1995cc	66-84kW (90-114PS)		Diesel Turbo Intercooler		TD24726	
M9R 782			4 Cyl.	1995cc	66-84kW (90-114PS)		Diesel Turbo Intercooler		TD21889	
M9R 784			4 Cyl.	1995cc	84kW (114PS)		Diesel Turbo Intercooler		TD25140	
M9R 784			4 Cyl.	1995cc	84kW (114PS)		Diesel Turbo Intercooler		TD21904	
M9R 786 Euro 4 (D4)			4 Cyl.	1995cc	66-84kW (90-114PS)		Diesel Turbo Intercooler		TD25647	
M9R 786 Euro 4			4 Cyl.	1995cc	66-84kW (90-114PS)		Diesel Turbo Intercooler		TD25139	
M9R 788			4 Cyl.	1995cc	84kW (114PS)		Diesel Turbo Intercooler		TD25644	
M9R 788			4 Cyl.	1995cc	84kW (114PS)		Diesel Turbo Intercooler		TD25143	
MB/HL	5	55,985/56,005		59,998/60,011	19,500	1,984	0,035/0,088	AL-LF	02-4560L	H1243/5 STD
MB/HL	5	55,985/56,005		59,998/60,011	17,200	1,984	0,035/0,088	AL-LF	02-4560U	
TW/A	2	65,600/65,850		84,000/84,250		2,700		AL-LF	04-4822	A297/2 STD
SE/PB	1	31,994/32,000		34,985/35,010	23,700			BS-LF	55-4562	55-4562 SEMI

34 84.00 x 90.00

X 20 DTH			4 Cyl.	1995cc	74kW (101PS)		Diesel Turbo		TD9729	
X 20 DTH			4 Cyl.	1995cc	74kW (101PS)		Diesel Turbo		TD17592	
X 20 DTL			4 Cyl.	1995cc	60-63kW (82-86PS)		Diesel Turbo		TD4824	
X 20 DTL			4 Cyl.	1995cc	60kW (82PS)		Diesel Turbo		TD17627	
Y 20 DTH			4 Cyl.	1995cc	74kW (101PS)		Diesel Turbo Intercooler		TD17924	
Y 20 DTH			4 Cyl.	1995cc	74kW (101PS)		Diesel Turbo		TD13752	
Y 20 DTL			4 Cyl.	1995cc	60kW (82PS)		Diesel Turbo		TD17926	
Y 20 DTL			4 Cyl.	1995cc	60-63kW (82-86PS)		Diesel Turbo		TD15848	
BE/PL	4	48,971/48,990		52,000/52,012	20,300	1,500	0,020/0,066	BS	71-3869	71-3869/4 STD

MB/HL 1,2,4,5	4	67,980/67,996	72,000/72,013	19,500	1,995	0,020/0,068	AL-LF	02-3909	H077/5 STD
MB/HL 3	1	67,980/67,996	72,000/72,013	25,900	1,995	0,020/0,068	AL-LF	02-3910H	
			02-3910H	STD	25,950/1.0217" - 26,002/1.0237"				
SE/PB	1	28,995/29,000	32,000/32,051	26,800			BC	55-3873	55-3873 SEMI

35

84.00 x 98.00

X 22 DTH	4 Cyl.	2171cc	85kW (116PS)					Diesel Turbo	TD9510
X 22 DTH	4 Cyl.	2171cc	85kW (116PS)					Diesel Turbo Intercooler	TD17916
Y 22 DTH	4 Cyl.	2171cc	85-88kW (116-120PS)					Diesel Turbo	TD17928
Y 22 DTH	4 Cyl.	2171cc	81-88kW (110-120PS)					Diesel	TD15091
Y 22 DTR	4 Cyl.	2172cc	92kW (125PS)					Diesel Turbo Intercooler	TD17629
Y 22 DTR	4 Cyl.	2172cc	86-92kW (117-125PS)					Diesel	TD14924
BE/PL	4	48,971/48,990	52,000/52,012	20,300	1,500	0,020/0,066	SP	71-3870	71-3870/4 STD ①
MB/HL 1,2,4,5	4	67,980/67,996	72,000/72,013	19,500	1,995	0,020/0,068	AL-LF	02-3909	H077/5 STD
MB/HL 3	1	67,980/67,996	72,000/72,013	25,900	1,995	0,020/0,068	AL-LF	02-3910H	
			02-3910H	STD	25,950/1.0217" - 26,002/1.0237"				
SE/PB	1	28,995/29,000	32,000/32,051	26,800			BC	55-3873	55-3873 SEMI

36

84.80 x 79.50

18 E	4 Cyl.	1796cc	82-85kW (112-115PS)					Petrol	TD4749
18 E	4 Cyl.	1796cc	82-85kW (112-116PS)					Petrol	TD17568
18 N	4 Cyl.	1796cc	55kW (75PS)					Petrol	TD4750
C 18 NE	4 Cyl.	1796cc	74kW (100PS)					Petrol	TD22865
18 S	4 Cyl.	1796cc	65-66kW (88-90PS)					Petrol	TD4752
18 S	4 Cyl.	1796cc	66kW (90PS)					Petrol	TD17603
18 SE	4 Cyl.	1796cc	82-85kW (112-116PS)					Petrol	TD4753
18 SE	4 Cyl.	1796cc	82-85kW (112-116PS)					Petrol	TD17604
C 18 NE	4 Cyl.	1796cc	74kW (100PS)					Petrol	TD4790
C 18 NT	4 Cyl.	1796cc	66kW (90PS)					Petrol	TD4791
C 18 NV	4 Cyl.	1796cc	74kW (100PS)					Petrol	TD4792
C 18 NZ	4 Cyl.	1796cc	66kW (90PS)					Petrol	TD4793
S 18 NV	4 Cyl.	1796cc	62-74kW (84-101PS)					Petrol	TD21884
S 18 NV	4 Cyl.	1796cc	62-74kW (84-101PS)					Petrol	TD19851
S 18 NV	4 Cyl.	1796cc	62-74kW (84-101PS)					Petrol	TD17891
BE/PL	4	48,971/48,987	52,000/52,012	19,300	1,500	0,020/0,066	EC	71-3531	71-3531/4 STD
→08/85									
BE/PL	4	48,971/48,987	52,000/52,012	19,300	1,500	0,020/0,066	EC	71-3626	71-3626/4 STD 0.25 0.50
09/85→									



71-3531

71-3626

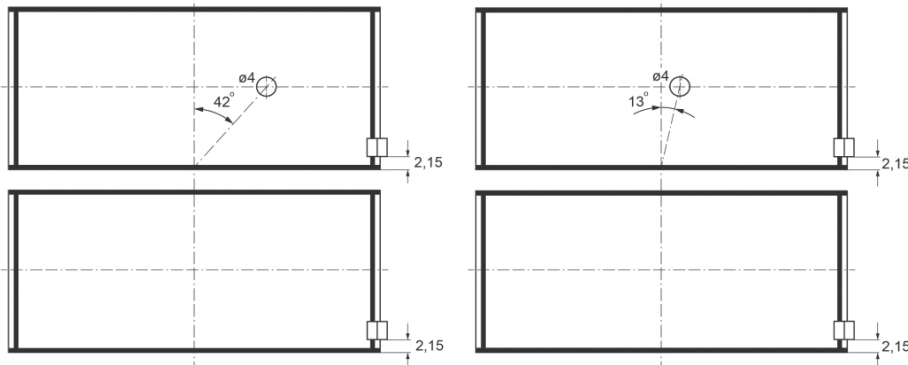

MB/HL 1,2,4,5	4	57,982/57,995	62,000/62,013	19,500	1,995	0,020/0,066	AL-LF	02-3532	H982/5 STD 0.25 0.50
MB/HL 3	1	57,982/57,995	62,000/62,013	25,900	1,995	0,020/0,066	AL-LF	02-3533H	

	02-3533H	STD	25,950/1.0217" - 26,002/1.0237"
		0.25mm	26,150/1.0295" - 26,202/1.0316"
		0.50mm	26,350/1.0374" - 26,402/1.0394"

37

84.80 x 79.50

18 NV	4 Cyl.	1796cc	60kW (82PS)	Petrol	TD4751
18 NV	4 Cyl.	1796cc	60kW (82PS)	Petrol	TD17569
18 SEH	4 Cyl.	1796cc	85kW (115PS)	Petrol	TD4754
18 SEH	4 Cyl.	1796cc	85kW (115PS)	Petrol	TD17570
18 SV	4 Cyl.	1796cc	63-66kW (86-90PS)	Petrol	TD4755
18 SV	4 Cyl.	1796cc	66kW (90PS)	Petrol	TD17571
C 18 NZ	4 Cyl.	1796cc	66kW (90PS)	Petrol	TD17610
C 18 SEL	4 Cyl.	1796cc	85kW (115PS)	Petrol	TD25435
E 18 NV	4 Cyl.	1796cc	62kW (84PS)	Petrol	TD4812
E 18 NV	4 Cyl.	1796cc	62kW (84PS)	Petrol	TD17587
E 18 NVR	4 Cyl.	1796cc	65kW (88PS)	Petrol	TD4813
E 18 NVR	4 Cyl.	1796cc	65kW (88PS)	Petrol	TD17588

BE/PL	4	48,971/48,987	52,000/52,012	19,300	1,500	0,020/0,066	EC	71-3626	71-3626/4 STD 0.25 0.50
MB/HL 1,2,4,5	4	57,982/57,995	62,000/62,013	19,500	1,995	0,020/0,066	AL-LF	02-3532	H982/5 STD 0.25 0.50
MB/HL 3	1	57,982/57,995	62,000/62,013	25,900	1,995	0,020/0,066	AL-LF	02-3533H	

	02-3533H	STD	25,950/1.0217" - 26,002/1.0237"
		0.25mm	26,150/1.0295" - 26,202/1.0316"
		0.50mm	26,350/1.0374" - 26,402/1.0394"

38

85.00 x 69.80

16 N	4 Cyl.	1584cc	44-50kW (60-68PS)	Petrol	TD2609
16 N (CIH)	4 Cyl.	1584cc	44kW (60PS)	Petrol	TD22841
16 S	4 Cyl.	1584cc	55-59kW (75-80PS)	Petrol	TD4737
16 S	4 Cyl.	1598cc	55-66kW (75-90PS)	Petrol	TD22382

BE/PL	1	51,971/51,987	55,000/55,012	19,610	1,449	0,015/0,063	BS	71-3560	71-3560 STD 0.25 0.50
-------	---	---------------	---------------	--------	-------	-------------	----	---------	---------------------------------

MB/HL 1-4	4	57,987/58,000	62,000/62,013	22,430	1,989	0,019/0,064	AL-LF	02-2421	H901/5 STD 0.25 0.50	
MB/HL 5	1	57,987/58,000	62,000/62,013	27,400	1,989	0,019/0,064	AL-LF	02-2422H		
		02-2422H	STD	27,450/1.0807" - 27,510/1.0831"						
			0.25mm	27,660/1.0890" - 27,720/1.0913"						
			0.50mm	27,860/1.0969" - 27,920/1.0992"						
			1.00mm	28,260/1.1126" - 28,320/1.1150"						

39 85.00 x 101.30

M9T 670 Euro 5	4 Cyl.	2298cc	74-92kW (101-125PS)	Diesel Turbo	TD24749
M9T 670 Euro 5	4 Cyl.	2298cc	74-92kW (101-125PS)	Diesel Turbo	TD25055
M9T 672 Euro 5	4 Cyl.	2298cc	74-92kW (101-125PS)	Diesel Turbo	TD25155
M9T 672 Euro 5	4 Cyl.	2298cc	74-92kW (101-125PS)	Diesel Turbo	TD25226
M9T 676 Euro 4	4 Cyl.	2298cc	74-92kW (101-125PS)	Diesel Turbo	TD25056
M9T 676 Euro 4 (D4)	4 Cyl.	2298cc	74-92kW (101-125PS)	Diesel Turbo	TD24748
M9T 678	4 Cyl.	2298cc	107kW (146PS)	Diesel Turbo	TD25157
M9T 678	4 Cyl.	2298cc	107kW (146PS)	Diesel Turbo	TD25156
M9T 680	4 Cyl.	2298cc	92-107kW (125-146PS)	Diesel Turbo	TD25138
M9T 680	4 Cyl.	2298cc	92-107kW (125-146PS)	Diesel Turbo	TD25137
M9T 686 Euro 5	4 Cyl.	2298cc	92kW (125PS)	Diesel Turbo	TD25152
M9T 686 Euro 5	4 Cyl.	2298cc	92kW (125PS)	Diesel Turbo	TD25231
M9T 690 Euro 5	4 Cyl.	2298cc	74-92kW (101-125PS)	Diesel Turbo	TD25230
M9T 690 Euro 5	4 Cyl.	2298cc	74-92kW (101-125PS)	Diesel Turbo	TD25105
M9T 692 Euro 4 (D4)	4 Cyl.	2298cc	74-92kW (101-125PS)	Diesel Turbo	TD25106
M9T 692 Euro 4	4 Cyl.	2298cc	74-92kW (101-125PS)	Diesel Turbo	TD25224
M9T 694 Euro 4 (D4)	4 Cyl.	2298cc	107-110kW (146-150PS)	Diesel Turbo	TD24750
M9T 694 Euro 4	4 Cyl.	2298cc	107-110kW (146-150PS)	Diesel Turbo	TD25058
M9T 696 Euro 4	4 Cyl.	2298cc	92-110kW (125-150PS)	Diesel Turbo	TD25225
M9T 696 Euro 4 (D4)	4 Cyl.	2298cc	92-107kW (125-146PS)	Diesel Turbo	TD25149
M9T 698 Euro 5	4 Cyl.	2298cc	92-107kW (125-146PS)	Diesel Turbo	TD24751
M9T 698 Euro 5	4 Cyl.	2298cc	92-110kW (125-150PS)	Diesel Turbo	TD25057
M9T 700	4 Cyl.	2299cc	100-120kW (136-163PS)	Diesel Bi-Turbo Intercooler	TD29659
M9T 700	4 Cyl.	2298cc	100-120kW (136-163PS)	Diesel Bi-Turbo Intercooler	TD29896
M9T 702	4 Cyl.	2298cc	100-120kW (136-163PS)	Diesel Bi-Turbo Intercooler	TD29895
M9T 702	4 Cyl.	2299cc	100-120kW (136-163PS)	Diesel Bi-Turbo Intercooler	TD29658
M9T 870	4 Cyl.	2298cc	74-81kW (100-110PS)	Diesel Turbo	TD29897
M9T 870	4 Cyl.	2299cc	81kW (110PS)	Diesel Turbo	TD29657
M9T 876	4 Cyl.	2299cc	92kW (125PS)	Diesel Turbo	TD31130
M9T 876	4 Cyl.	2299cc	92kW (125PS)	Diesel Turbo	TD31131
M9T 880	4 Cyl.	2298cc	110kW (150PS)	Diesel Turbo	TD31642
M9T 880	4 Cyl.	2298cc	110kW (150PS)	Diesel Turbo	TD28582

BE/PL	1	53,000/53,020	56,587/56,606	19,000	1,781	0,046/0,069	SP-LF	71-4940	71-4940 STD	1
MB/HL	5	59,985/60,005	63,998/64,011	19,500	1,986	0,029/0,082	AL-LF	02-4939L	H1327/5 STD	
MB/HL	5	59,985/60,005	63,998/64,011	17,200	1,986	0,029/0,082	AL-LF	02-4939U		
TW/A	2	65,600/65,850	84,000/84,250		2,700		AL-LF	04-4822	A297/2 STD	
SE/PB	1	31,994/32,000	34,985/35,010	23,700			BS-LF	55-4562	55-4562 SEMI	

40 86.00 x 86.00

20 NE	4 Cyl.	1998cc	85kW (116PS)	Petrol	TD17637
20 NE	4 Cyl.	1998cc	85-95kW (115-129PS)	Petrol	TD4759



20 NEJ	4 Cyl.	1998cc	82kW (112PS)	Petrol	TD25533
20 NEJ	4 Cyl.	1998cc	82kW (112PS)	Petrol	TD4761
20 SE	4 Cyl.	1998cc	85-90kW (116-122PS)	Petrol	TD17573
20 SE	4 Cyl.	1998cc	85-90kW (115-122PS)	Petrol	TD2651
20 SEH	4 Cyl.	1998cc	95kW (129PS)	Petrol	TD4763
20 SEH	4 Cyl.	1998cc	95kW (129PS)	Petrol	TD17574
20 SER	4 Cyl.	1998cc	90-115kW (122-156PS)	Petrol	TD18871
C 20 NE	4 Cyl.	1998cc	85kW (115PS)	Petrol	TD4799
C 20 NE	4 Cyl.	1998cc	85kW (115PS)	Petrol	TD17584
C 20 NE	4 Cyl.	1998cc	85kW (115PS)	Petrol	TD21445
X 20 SE	4 Cyl.	1998cc	85kW (115PS)	Petrol	TD2736
X 20 SE	4 Cyl.	1998cc	85kW (116PS)	Petrol	TD17593
X 20 XEV	4 Cyl.	1998cc	100kW (136PS)	Petrol	TD26693
X 20 XEV	4 Cyl.	1998cc	100kW (136PS)	Petrol	TD2737
X 20 XEV	4 Cyl.	1998cc	100kW (136PS)	Petrol	TD17594

BE/PL	4	48,971/48,987	52,000/52,012	19,300	1,500	0,020/0,066	EC	71-3626	71-3626/4 STD 0.25 0.50
MB/HL 1,2,4,5	4	57,982/57,995	62,000/62,013	19,500	1,995	0,020/0,066	AL-LF	02-3532	H982/5 STD 0.25 0.50
MB/HL 3	1	57,982/57,995	62,000/62,013	25,900	1,995	0,020/0,066	AL-LF	02-3533H	

	02-3533H	STD	25,950/1.0217" - 26,002/1.0237"
		0.25mm	26,150/1.0295" - 26,202/1.0316"
		0.50mm	26,350/1.0374" - 26,402/1.0394"

41 86.00 x 86.00

20 XE	4 Cyl.	1998cc	115kW (156PS)	Petrol	TD4765
20 XE	4 Cyl.	1998cc	115kW (156PS)	Petrol	TD17605
C 20 XE	4 Cyl.	1998cc	110kW (150PS)	Petrol	TD4801
C 20 XE	4 Cyl.	1998cc	110kW (150PS)	Petrol	TD17585

BE/PL	4	48,971/48,987	52,000/52,012	19,300	1,500	0,020/0,066	EC	71-3626	71-3626/4 STD 0.25 0.50
BE/PL	4	48,971/48,987	52,000/52,012	20,300	1,500	0,020/0,070	EC	71-3764	71-3764/4 STD 0.25

71-3626

71-3764

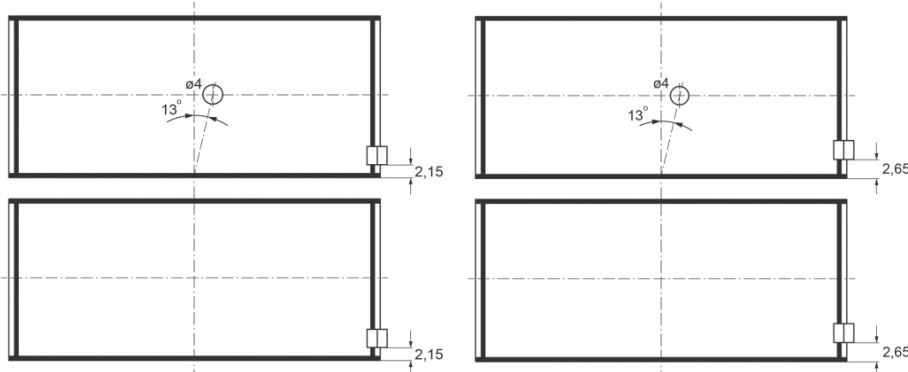

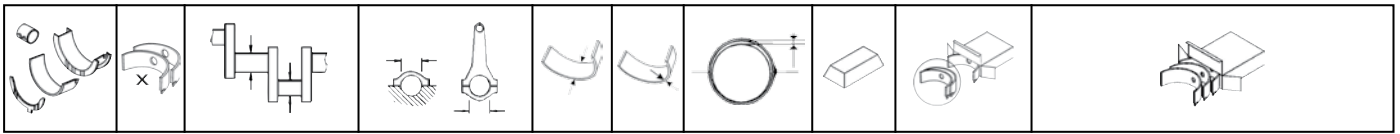

MB/HL 1,2,4,5	4	57,982/57,995	62,000/62,013	19,500	1,995	0,020/0,066	AL-LF	02-3532	H982/5 STD 0.25 0.50
MB/HL 3	1	57,982/57,995	62,000/62,013	25,900	1,995	0,020/0,066	AL-LF	02-3533H	

	02-3533H	STD	25,950/1.0217" - 26,002/1.0237"
		0.25mm	26,150/1.0295" - 26,202/1.0316"
		0.50mm	26,350/1.0374" - 26,402/1.0394"



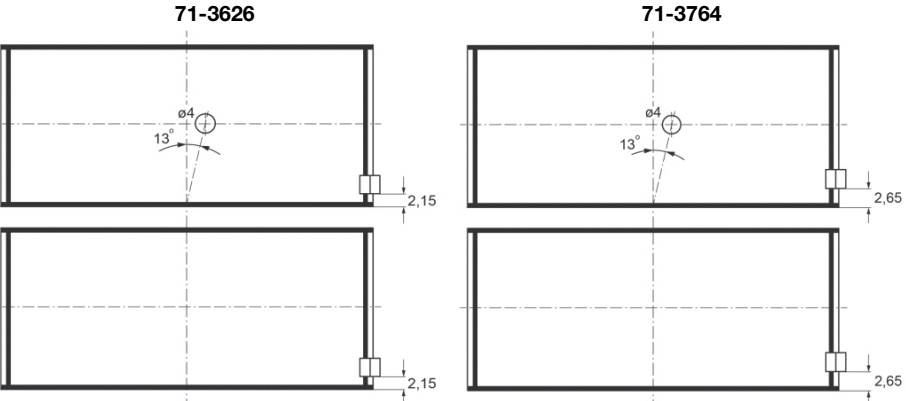

42										86.00 x 86.00										
C 20 LET					4 Cyl.		1998cc		150kW (204PS)		Petrol Turbo Intercooler					TD4798				
C 20 LET					4 Cyl.		1998cc		150kW (204PS)		Petrol Turbo					TD17612				
BE/PL	4	48,971/48,987	52,000/52,012	20,300	1,500	0,020/0,070	EC	71-3764	71-3764/4 STD 0.25											
MB/HL 1,2,4,5	4	57,982/57,995	62,000/62,013	19,500	1,995	0,020/0,066	AL-LF	02-3532	H982/5 STD 0.25 0.50											
MB/HL 3	1	57,982/57,995	62,000/62,013	25,900	1,995	0,020/0,066	AL-LF	02-3533H												
				02-3533H		STD		25,950/1.0217" - 26,002/1.0237"												
						0.25mm		26,150/1.0295" - 26,202/1.0316"												
						0.50mm		26,350/1.0374" - 26,402/1.0394"												

43										86.00 x 94.60										
X 22 SE					4 Cyl.		2198cc		98-104kW (133-141PS)		Petrol					TD21443				
X 22 SE					4 Cyl.		2198cc		100-104kW (136-141PS)		Petrol					TD17918				
X 22 SE					4 Cyl.		2198cc		100-104kW (136-141PS)		Petrol					TD15849				
X 22 XE					4 Cyl.		2198cc		100-104kW (136-141PS)		Petrol					TD4827				
X 22 XE					4 Cyl.		2198cc		100kW (136PS)		Petrol					TD22506				
X 22 XE					4 Cyl.		2198cc		100-104kW (136-141PS)		Petrol					TD17628				
Y 22 SE					4 Cyl.		2198cc		100kW (136PS)		Petrol					TD17930				
Y 22 SE					4 Cyl.		2198cc		100kW (136PS)		Petrol					TD15093				
BE/PL	4	48,971/48,987	52,000/52,012	19,300	1,500	0,020/0,066	EC	71-3626	71-3626/4 STD 0.25 0.50											
BE/PL	4	48,971/48,987	52,000/52,012	20,300	1,500	0,020/0,070	EC	71-3764	71-3764/4 STD 0.25											
				71-3626		STD		25,950/1.0217" - 26,002/1.0237"												
						0.25mm		26,150/1.0295" - 26,202/1.0316"												
						0.50mm		26,350/1.0374" - 26,402/1.0394"												
																				
MB/HL 1,2,4,5	4	57,982/57,995	62,000/62,013	19,500	1,995	0,020/0,066	AL-LF	02-3532	H982/5 STD 0.25 0.50											
MB/HL 3	1	57,982/57,995	62,000/62,013	25,900	1,995	0,020/0,066	AL-LF	02-3533H												
				02-3533H		STD		25,950/1.0217" - 26,002/1.0237"												
						0.25mm		26,150/1.0295" - 26,202/1.0316"												
						0.50mm		26,350/1.0374" - 26,402/1.0394"												

44										86.00 x 94.60										
Z 22 SE					4 Cyl.		2198cc		106-108kW (144-147PS)		Petrol					TD17683				
Z 22 SE					4 Cyl.		2198cc		108kW (147PS)		Petrol					TD14668				
Z 22 YH					4 Cyl.		2198cc		100-114kW (136-155PS)		Petrol					TD18021				
Z 22 YH					4 Cyl.		2198cc		110-114kW (150-155PS)		Petrol					TD18020				
BE/PL	4	49,000/49,014	52,118/52,134	20,300	1,542	0,020/0,066	AL-LF	01-4729	01-4729/4 STD											



45		86.50 x 85.00							
20 D		4 Cyl.		1998cc	40-43kW (54-58PS)		Diesel		TD4757
BE/PL	4	53,971/53,987	57,000/57,012	25,500	1,485	0,043/0,096	EC	71-3174	71-3174/4 STD 0.25 0.50
MB/HL 1-4	4	57,987/58,000	62,000/62,013	24,500	1,987	0,026/0,077	EC	72-3175	H893/5 STD 0.25
MB/HL 5	1	57,987/58,000	62,000/62,013	29,420	1,987	0,026/0,077	EC	72-3176H	
		72-3176H	STD	29,450/1.1594" - 29,490/1.1610"					
			0.25mm	29,700/1.1693" - 29,740/1.1610"					
			0.50mm	29,950/1.1791" - 29,990/1.1807"					

46		87.00 x 69.80							
25 E		6 Cyl.		2490cc	96-110kW (130-150PS)		Petrol		TD2668
25 E		6 Cyl.		2490cc	96-103kW (130-140PS)		Petrol		TD17681
25 H		6 Cyl.		2490cc	96kW (130PS)		Petrol		TD2669
25 NE		6 Cyl.		2490cc	103kW (140PS)		Petrol		TD11147
25 S		6 Cyl.		2490cc	85kW (115PS)		Petrol		TD2671
25 S		6 Cyl.		2490cc	85kW (115PS)		Petrol		TD22849
BE/PL	1	51,971/51,987	55,000/55,012	19,610	1,449	0,015/0,063	BS	71-3560	71-3560 STD 0.25 0.50
BE/PL	6	51,971/51,987	55,000/55,012	19,610	1,449	0,015/0,063	BS	71-3560	71-3560/6 STD 0.50
MB/HL	6	57,987/58,000	62,000/62,013	22,430	1,989	0,019/0,064	AL-LF	02-2421	H901/7 STD
MB/HL	1	57,987/58,000	62,000/62,013	27,400	1,989	0,019/0,064	AL-LF	02-2422H	
		02-2422H	STD	27,450/1.0807" - 27,510/1.0831"					
			0.25mm	27,660/1.0890" - 27,720/1.0913"					
			0.50mm	27,860/1.0969" - 27,920/1.0992"					
			1.00mm	28,260/1.1126" - 28,320/1.1150"					

47		87.00 x 92.00							
G9T 720		4 Cyl.		2188cc	66kW (90PS)		Diesel Turbo		TD19353
G9T 720		4 Cyl.		2188cc	66kW (90PS)		Diesel Turbo		TD18875
G9T 722		4 Cyl.		2188cc	66kW (90PS)		Diesel Turbo Intercooler		TD21397
G9T 722		4 Cyl.		2188cc	66kW (90PS)		Diesel Turbo Intercooler		TD19356
G9T 750		4 Cyl.		2188cc	66kW (90PS)		Diesel Turbo Intercooler		TD23885
G9T 750		4 Cyl.		2188cc	66kW (90PS)		Diesel Turbo Intercooler		TD19355
BE/PL	4	52,971/52,990	56,587/56,606	20,650	1,782	0,015/0,069	EC	71-4744	71-4744/4 STD 0.25 4
MB/HL	5	57,980/58,000	61,668/61,681	20,990	1,810		AL-LF	02-4042	H1013/5 STD 0.25
TW/A	2	63,250/63,500	78,550/78,800		2,350		AL-LF	04-4745	A289/2 STD
SE/PB	1	31,013/31,020	33,500/33,525	25,800			BC	55-4050	55-4050 SEMI

48		88.00 x 69.80							
17 L		4 Cyl.		1698cc	55-61kW (75-83PS)		Petrol		TD26222
17 N		4 Cyl.		1698cc	44-55kW (60-75PS)		Petrol		TD2623
17 S		4 Cyl.		1698cc	55-61kW (75-83PS)		Petrol		TD2625
BE/PL	1	51,971/51,987	55,000/55,012	19,610	1,449	0,015/0,063	BS	71-3560	71-3560 STD 0.25 0.50
BE/PL	4	51,971/51,987	55,000/55,012	19,610	1,449	0,015/0,063	BS	71-3560	71-3560/4 STD

MB/HL 1-4	4	57,987/58,000	62,000/62,013	22,430	1,989	0,019/0,064	AL-LF	02-2421	H901/5 STD 0.25 0.50	
MB/HL 5	1	57,987/58,000	62,000/62,013	27,400	1,989	0,019/0,064	AL-LF	02-2422H		
		02-2422H	STD	27,450/1.0807" - 27,510/1.0831"						
			0.25mm	27,660/1.0890" - 27,720/1.0913"						
			0.50mm	27,860/1.0969" - 27,920/1.0992"						
			1.00mm	28,260/1.1126" - 28,320/1.1150"						

49 88.00 x 82.00

4ZC1	4 Cyl.		1994cc	62kW (84PS)	Petrol		TD27098		
MB/HL 1-5	5	55,920/55,930	59,979/59,999	21,869	2,009	0,030/0,086	AL	3961RA	H1225/5 STD

50 88.00 x 85.00

21 D	4 Cyl.		2068cc	44kW (60PS)	Diesel		TD2658			
BE/PL	4	53,971/53,987	57,000/57,012	25,500	1,485	0,043/0,096	EC	71-3174	71-3174/4 STD 0.25 0.50	
MB/HL 1-4	4	57,987/58,000	62,000/62,013	24,500	1,987	0,026/0,077	EC	72-3175	H893/5 STD 0.25	
MB/HL 5	1	57,987/58,000	62,000/62,013	29,420	1,987	0,026/0,077	EC	72-3176H		
		72-3176H	STD	29,450/1.1594" - 29,490/1.1610"						
			0.25mm	29,700/1.1693" - 29,740/1.1610"						
			0.50mm	29,950/1.1791" - 29,990/1.1807"						

51 88.00 x 92.00

C223	4 Cyl.		2238cc	39-54kW (53-73PS)	Diesel		TD22879		
C223	4 Cyl.		2238cc	39-54kW (53-73PS)	Diesel		TD22878		
BE/PL	8	52,920	56,000	22,530	1,510		BS	64-160-1	71-4258/4 STD
TW/A	2	72,700	86,950		2,480		BS	65-157-1	A219/2 STD

52 88.80 x 69.80

C 26 NE	6 Cyl.		2594cc	110kW (150PS)	Petrol		TD4805			
C 26 NE	6 Cyl.		2594cc	110kW (150PS)	Petrol		TD17614			
BE/PL	1	51,971/51,987	55,000/55,012	19,610	1,449	0,015/0,063	BS	71-3560	71-3560 STD 0.25 0.50	
BE/PL	6	51,971/51,987	55,000/55,012	19,610	1,449	0,015/0,063	BS	71-3560	71-3560/6 STD 0.50	
MB/HL	6	57,987/58,000	62,000/62,013	22,430	1,989	0,019/0,064	AL-LF	02-2421	H901/7 STD	
MB/HL	1	57,987/58,000	62,000/62,013	27,400	1,989	0,019/0,064	AL-LF	02-2422H		
		02-2422H	STD	27,450/1.0807" - 27,510/1.0831"						
			0.25mm	27,660/1.0890" - 27,720/1.0913"						
			0.50mm	27,860/1.0969" - 27,920/1.0992"						
			1.00mm	28,260/1.1126" - 28,320/1.1150"						

53 89.00 x 99.00

G9MB6	4 Cyl.		2463cc	107kW (146PS)	Diesel		TD20330	
G9U 630 Euro 4 (D4)	4 Cyl.		2464cc	84-107kW (114-146PS)	Diesel Turbo Intercooler		TD21903	
G9U 630 Euro 4	4 Cyl.		2464cc	84-107kW (114-146PS)	Diesel Turbo Intercooler		TD20987	
G9U 632 Euro 4	4 Cyl.		2464cc	88-107kW (120-146PS)	Diesel		TD21014	
G9U 650 Euro 4	4 Cyl.		2464cc	74-107kW (101-146PS)	Diesel Turbo Intercooler		TD21012	
G9U 720	4 Cyl.		2463cc	84-85kW (115-116PS)	Diesel Turbo Intercooler		TD19358	
G9U 720	4 Cyl.		2463cc	84-85kW (114-116PS)	Diesel Turbo Intercooler		TD18874	



G9U 724	4 Cyl.	2463cc	84kW (115PS)	Diesel Turbo Intercooler	TD19368
G9U 724	4 Cyl.	2463cc	84kW (115PS)	Diesel Turbo Intercooler	TD19367
G9U 730	4 Cyl.	2463cc	99-107kW (135-146PS)	Diesel Turbo Intercooler	TD18701
G9U 730	4 Cyl.	2463cc	99kW (135PS)	Diesel Turbo	TD18497
G9U 750	4 Cyl.	2463cc	84kW (115PS)	Diesel Turbo Intercooler	TD23887
G9U 750	4 Cyl.	2463cc	84kW (115PS)	Diesel Turbo Intercooler	TD19365
G9U 754	4 Cyl.	2463cc	73-84kW (99-115PS)	Diesel Turbo Intercooler	TD19817
G9U 754	4 Cyl.	2463cc	73-84kW (99-115PS)	Diesel Turbo Intercooler	TD19369

BE/PL	4	52,971/52,990	56,587/56,606	20,650	1,782	0,015/0,069	EC	71-4744	71-4744/4 STD 0.25	4
MB/HL	5	57,980/58,000	61,668/61,681	20,990	1,810		AL-LF	02-4042	H1013/5 STD 0.25	
TW/A	2	63,250/63,500	78,550/78,800		2,350		AL-LF	04-4745	A289/2 STD	
SE/PB	1	31,013/31,020	33,500/33,525	25,800			BC	55-4050	55-4050 SEMI	

54 89.50 x 90.00

4 ZD1	4 Cyl.	2255cc	69-72kW (94-98PS)	Petrol	TD5446					
4 ZD1	V4 Cyl.	2255cc	69-72kW (94-98PS)	Petrol	TD22858					
MB/HL 1-5	5	55,920/55,930	59,979/59,999	21,869	2,009	0,030/0,086	AL	3961RA	H1225/5 STD	

55 92.00 x 69.80

28 E	6 Cyl.	2784cc	118-121kW (160-165PS)	Petrol	TD2675
28 EC	6 Cyl.	2784cc	118kW (160PS)	Petrol	TD2676
28 H	6 Cyl.	2784cc	103-107kW (140-146PS)	Petrol	TD2677
28 H	6 Cyl.	2784cc	103-107kW (140-146PS)	Petrol	TD17607
28 HC	6 Cyl.	2784cc	103-114kW (140-155PS)	Petrol	TD2678
28 S	6 Cyl.	2784cc	92-97kW (125-132PS)	Petrol	TD2679

BE/PL	1	51,971/51,987	55,000/55,012	19,610	1,449	0,015/0,063	BS	71-3560	71-3560 STD 0.25 0.50
BE/PL	6	51,971/51,987	55,000/55,012	19,610	1,449	0,015/0,063	BS	71-3560	71-3560/6 STD 0.50
MB/HL	6	57,987/58,000	62,000/62,013	22,430	1,989	0,019/0,064	AL-LF	02-2421	H901/7 STD
MB/HL	1	57,987/58,000	62,000/62,013	27,400	1,989	0,019/0,064	AL-LF	02-2422H	





02-2422H	STD	27,450/1.0807" - 27,510/1.0831"
	0.25mm	27,660/1.0890" - 27,720/1.0913"
	0.50mm	27,860/1.0969" - 27,920/1.0992"
	1.00mm	28,260/1.1126" - 28,320/1.1150"

56 92.00 x 85.00

23 D	4 Cyl.	2260cc	46-63kW (63-86PS)	Diesel	TD2663
23 D	4 Cyl.	2260cc	48-52kW (65-71PS)	Diesel	TD17575
23 DTR	4 Cyl.	2260cc	74kW (100PS)	Diesel Turbo Intercooler	TD4767
23 DTR	4 Cyl.	2260cc	74kW (100PS)	Diesel Turbo Intercooler	TD17576
23 TD	4 Cyl.	2260cc	63kW (86PS)	Diesel Turbo	TD2665
23 TD	4 Cyl.	2260cc	63kW (86PS)	Diesel Turbo	TD17577
23 YD	4 Cyl.	2260cc	54kW (73PS)	Diesel	TD4768
23 YD	4 Cyl.	2260cc	54kW (73PS)	Diesel	TD17914
23 YDT	4 Cyl.	2260cc	66kW (90PS)	Diesel Turbo	TD4769
23 YDT	4 Cyl.	2260cc	66kW (90PS)	Diesel Turbo	TD17579

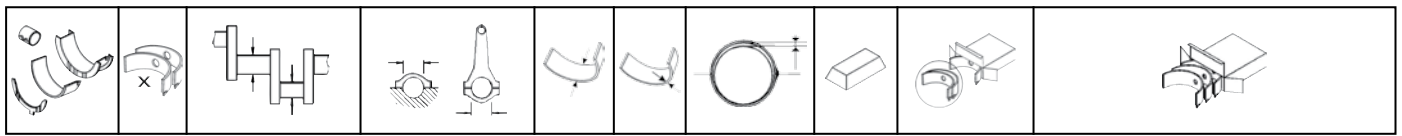
BE/PL	4	53,971/53,987	57,000/57,012	25,500	1,485	0,043/0,096	EC	71-3174	71-3174/4 STD 0.25 0.50
-------	---	---------------	---------------	--------	-------	-------------	----	---------	-----------------------------------



MB/HL 1-4	4	57,987/58,000	62,000/62,013	24,500	1,987	0,026/0,077	EC	72-3175	H893/5 STD 0.25
MB/HL 5	1	57,987/58,000	62,000/62,013	29,420	1,987	0,026/0,077	EC	72-3176H	
		 72-3176H	STD	29,450/1.1594" - 29,490/1.1610"					
			0.25mm	29,700/1.1693 - 29,740/1.1610"					
			0.50mm	29,950/1.1791" - 29,990/1.1807"					

57 93.00 x 69.80

19 E	4 Cyl.	1897cc	77kW (105PS)	Petrol	TD2635
19 H	4 Cyl.	1897cc		Petrol	FM5343
19 N	4 Cyl.	1897cc	55kW (75PS)	Petrol	TD2636
19 S	4 Cyl.	1897cc	65-66kW (88-90PS)	Petrol	TD4756
19 S	4 Cyl.	1897cc	65-66kW (88-90PS)	Petrol	TD19717
19 SH	4 Cyl.	1897cc	66-78kW (90-107PS)	Petrol	TD2640

BE/PL	1	51,971/51,987	55,000/55,012	19,610	1,449	0,015/0,063	BS	71-3560	71-3560 STD 0.25 0.50
BE/PL	4	51,971/51,987	55,000/55,012	19,610	1,449	0,015/0,063	BS	71-3560	71-3560/4 STD
MB/HL 1-4	4	57,987/58,000	62,000/62,013	22,430	1,989	0,019/0,064	AL-LF	02-2421	H901/5 STD 0.25 0.50
MB/HL 5	1	57,987/58,000	62,000/62,013	27,400	1,989	0,019/0,064	AL-LF	02-2422H	
		 02-2422H	STD	27,450/1.0807" - 27,510/1.0831"					
			0.25mm	27,660/1.0890" - 27,720/1.0913"					
			0.50mm	27,860/1.0969" - 27,920/1.0992"					
			1.00mm	28,260/1.1126" - 28,320/1.1150"					

58 93.00 x 92.00

4 JA1	4 Cyl.	2499cc	56-74kW (76-101PS)	Diesel	TD18377
4 JA1	4 Cyl.	2499cc	56-74kW (76-101PS)	Diesel	TD15868

BE/PL	8	52,920	56,000	25,800	1,513		AL-LF	64-184-1	01-4131/4 STD 0.25 0.50
MB/HL 1-5	5	59,920/59,932	63,987/64,000	23,030	2,004	0,035/0,080	BS	GS70221LC/B	H1160/5 STD 0.25
MB/HL 1-5	5	59,920/59,932	63,987/64,000	23,030	2,004	0,035/0,080	BS	GS70221LC/T	
CB/NWB	1	49,950	54,040	25,000	2,010		AL-LF	62-184-1	N178/3 STD
CB/NWB	2	49,950	54,040	22,000	2,010		AL-LF	62-184-2	

59 93.00 x 92.00

4 JA1T	4 Cyl.	2499cc	56kW (76PS)	Diesel Turbo Intercooler	TD5447
4 JA1T	4 Cyl.	2499cc	56kW (76PS)	Diesel Turbo Intercooler	TD22853

BE/PL	8	52,920	56,000	25,800	1,513		AL-LF	64-184-1	01-4131/4 STD 0.25 0.50
MB/HL 1-5	5	59,920/59,932	63,987/64,000	23,030	2,004	0,035/0,080	BS	GS70221LC/B	H1160/5 STD 0.25
MB/HL 1-5	5	59,920/59,932	63,987/64,000	23,030	2,004	0,035/0,080	BS	GS70221LC/T	
TW/A	2	72,700	86,950		2,480		BS	65-157-1	A219/2 STD
CB/NWB	1	49,950	54,040	25,000	2,010		AL-LF	62-184-1	N178/3 STD
CB/NWB	2	49,950	54,040	22,000	2,010		AL-LF	62-184-2	



60 93.00 x 92.00

S8U 758	4 Cyl.	2499cc	55-58kW (75-79PS)	Diesel	TD22883
S8U 758	4 Cyl.	2499cc	55-58kW (75-79PS)	Diesel	TD22880
S8U 770	4 Cyl.	2499cc	59kW (80PS)	Diesel Turbo	TD22881
S8U 770	4 Cyl.	2499cc	59kW (80PS)	Diesel Turbo	TD19357
S8U 772	4 Cyl.	2499cc	59kW (80PS)	Diesel	TD23888
S8U 780	4 Cyl.	2499cc	55kW (75PS)	Diesel	TD22884
S8U 780	4 Cyl.	2499cc	55kW (75PS)	Diesel	TD22882
S8U 782	4 Cyl.	2499cc	55kW (75PS)	Diesel	TD24143
S8U 782	4 Cyl.	2499cc	55kW (75PS)	Diesel	TD22885

BE/PL	4	56,520/56,535	60,333/60,345	24,700	1,870	0,020/0,072	BS	1870CP	71-4130/4 STD 0.25 0.50 0.75
MB/HL 5	1	86,182/86,208	90,588/90,614	30,950	2,164	0,052/0,129	BS	4691CPH	H1104/5 STD 0.25 0.50
MB/HL 1-4	4	80,182/80,208	84,588/84,614	23,800	2,164	0,052/0,129	BS	4692CP	
SE/PB	1	31,990/31,996	34,895/34,920	30,700			BS	66579YA	55-4186 SEMI

Mot.344183→

61 93.00 x 92.00

S8U 772	4 Cyl.	2499cc	59kW (80PS)	Diesel	TD19364
----------------	--------	---------------	--------------------	---------------	----------------

BE/PL	4	56,520/56,535	60,333/60,345	24,700	1,870	0,020/0,072	BS	1870CP	71-4130/4 STD 0.25 0.50 0.75
-------	---	---------------	---------------	--------	-------	-------------	----	--------	--

10/82→

BE/PL	4	56,520/56,535	60,333/60,345	24,700	1,870	0,020/0,070	BS	66575CP	71-4185/4 STD 0.25 0.50 0.75
-------	---	---------------	---------------	--------	-------	-------------	----	---------	--

→09/82

1870CP

66575CP

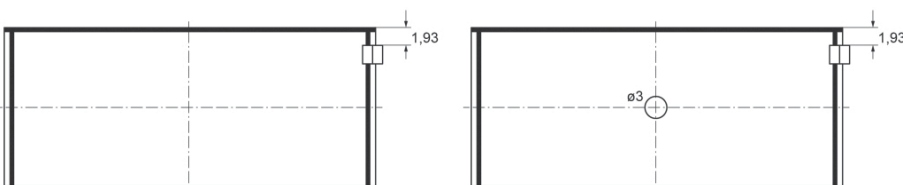

MB/HL 1-4	4	76,187/76,200	80,586/80,607	24,990	2,172	0,042/0,100	BS	66571CP	H1049/5 STD 0.25 0.50 0.75
MB/HL 5	1	76,187/76,200	80,586/80,607	31,950	2,172	0,042/0,100	BS	66572CPH	

→12/92

MB/HL 1-4	4	76,187/76,200	80,586/80,607	24,990	2,172	0,038/0,097	BS	66573CP	H1094/5 STD 0.25
MB/HL 5	1	76,187/76,200	80,586/80,607	31,950	2,172	0,038/0,097	BS	66574CPH	

01/93→08/95

MB/HL 5	1	86,182/86,208	90,588/90,614	30,950	2,164	0,052/0,129	BS	4691CPH	H1104/5 STD 0.25 0.50
MB/HL 1-4	4	80,182/80,208	84,588/84,614	23,800	2,164	0,052/0,129	BS	4692CP	

09/95→

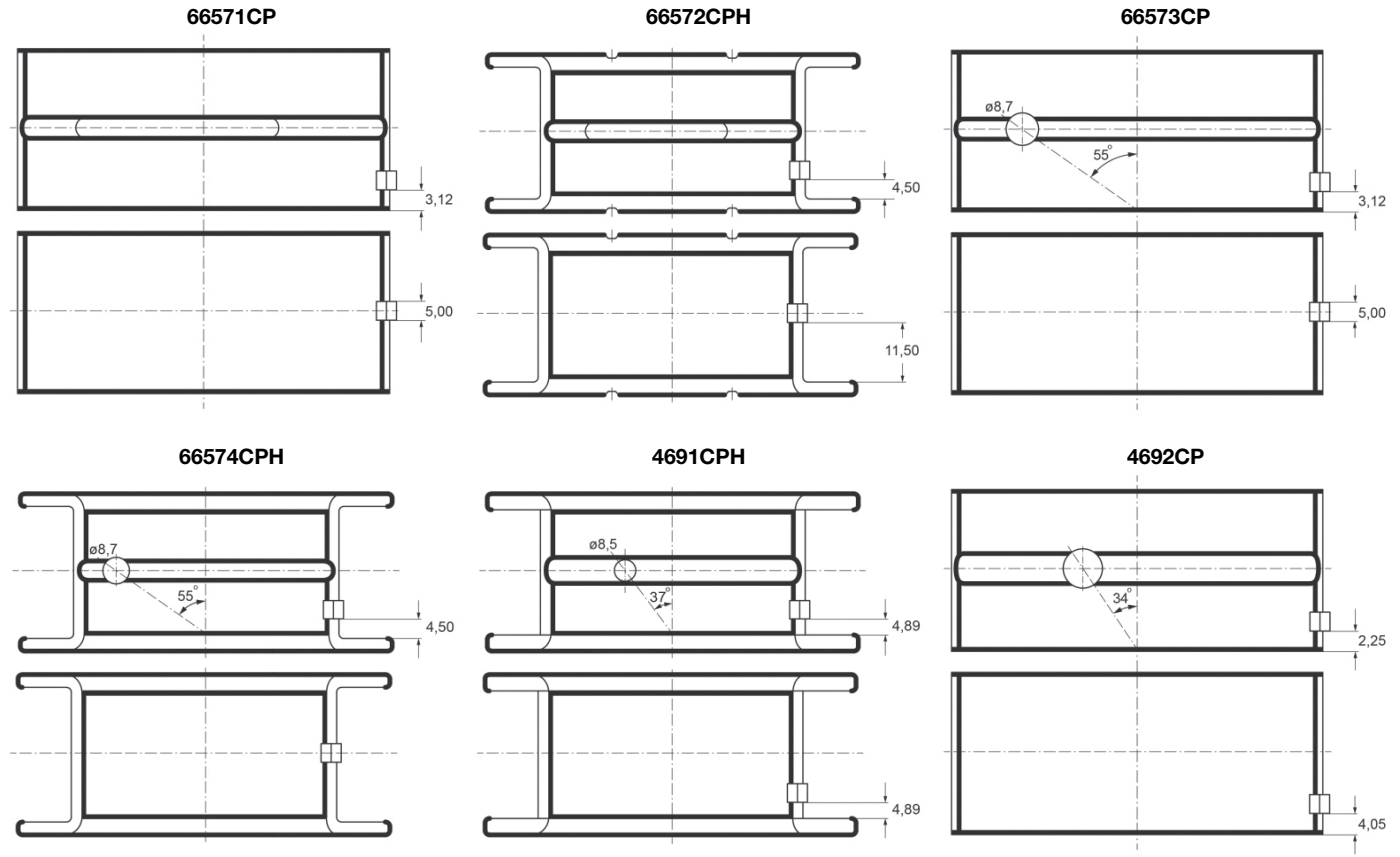
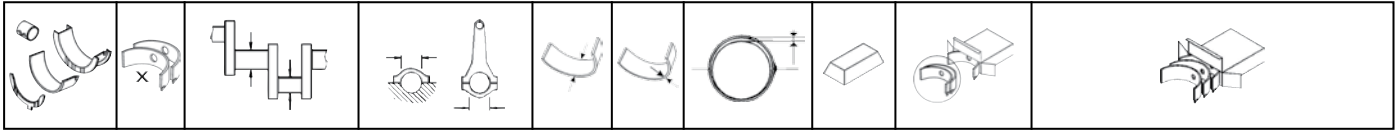

SE/PB	1	31,990/31,996	34,895/34,920	30,700			BS	66579YA	55-4186 SEMI
-------	---	---------------	---------------	--------	--	--	----	---------	-----------------

Mot.344183 →

62	95.00 x 69.80								
20 E			4 Cyl.	1979cc	81kW (110PS)		Petrol		TD2642
20 E			4 Cyl.	1979cc	81kW (110PS)		Petrol		TD18375
20 EH			4 Cyl.	1979cc	85kW (115PS)		Petrol		TD2645
20 ER			4 Cyl.	1979cc	92kW (125PS)		Petrol		TD26220
20 N			4 Cyl.	1979cc	56-66kW (76-90PS)		Petrol		TD4758
20 S			4 Cyl.	1979cc	74kW (100PS)		Petrol		TD4762
20 S			4 Cyl.	1979cc	74-81kW (100-110PS)		Petrol		TD17572
H 20 E			4 Cyl.	1979cc	85kW (115PS)		Petrol		TD5306
H 20 E			4 Cyl.	1979cc	85kW (115PS)		Petrol		TD22869

BE/PL	1	51,971/51,987	55,000/55,012	19,610	1,449	0,015/0,063	BS	71-3560	71-3560 STD 0.25 0.50
MB/HL 1-4	4	57,987/58,000	62,000/62,013	22,430	1,989	0,019/0,064	AL-LF	02-2421	H901/5 STD 0.25 0.50
MB/HL 5	1	57,987/58,000	62,000/62,013	27,400	1,989	0,019/0,064	AL-LF	02-2422H	

	02-2422H	STD	27,450/1.0807" - 27,510/1.0831"
		0.25mm	27,660/1.0890" - 27,720/1.0913"
		0.50mm	27,860/1.0969" - 27,920/1.0992"
		1.00mm	28,260/1.1126" - 28,320/1.1150"

63	95.00 x 69.80								
30 E			6 Cyl.	2969cc	132kW (180PS)		Petrol		TD4775
30 E			6 Cyl.	2969cc	132kW (180PS)		Petrol		TD17580
30 H			6 Cyl.	2969cc	110kW (150PS)		Petrol		TD5307



30 H	6 Cyl.	2969cc	110kW (150PS)	Petrol	TD22852
30 NE	6 Cyl.	2969cc	130kW (177PS)	Petrol	TD4776
30 NE	6 Cyl.	2969cc	130-135kW (177-184PS)	Petrol	TD18376
30 S	6 Cyl.	2968cc	110kW (150PS)	Petrol	TD4777
C 30 LE	6 Cyl.	2969cc	115kW (156PS)	Petrol	TD4806
C 30 LE	6 Cyl.	2969cc	115kW (156PS)	Petrol	TD17615
C 30 NE	6 Cyl.	2969cc	130kW (177PS)	Petrol	TD2709
C 30 NE	6 Cyl.	2969cc	116-130kW (158-177PS)	Petrol	TD19855
C 30 NE	6 Cyl.	2969cc	130kW (177PS)	Petrol	TD17616
C 30 SE	6 Cyl.	2969cc	150kW (204PS)	Petrol	TD4807
C 30 SE	6 Cyl.	2969cc	150kW (204PS)	Petrol	TD17617
C 30 SEJ	6 Cyl.	2969cc	147kW (200PS)	Petrol	TD4808
C 30 SEJ	6 Cyl.	2969cc	147kW (200PS)	Petrol	TD18889

BE/PL	1	51,971/51,987	55,000/55,012	19,610	1,449	0,015/0,063	BS	71-3560	71-3560 STD 0.25 0.50
BE/PL	6	51,971/51,987	55,000/55,012	19,610	1,449	0,015/0,063	BS	71-3560	71-3560/6 STD 0.50
MB/HL	6	57,987/58,000	62,000/62,013	22,430	1,989	0,019/0,064	AL-LF	02-2421	H901/7 STD
MB/HL	1	57,987/58,000	62,000/62,013	27,400	1,989	0,019/0,064	AL-LF	02-2422H	

	02-2422H	STD	27,450/1.0807" - 27,510/1.0831"
		0.25mm	27,660/1.0890" - 27,720/1.0913"
		0.50mm	27,860/1.0969" - 27,920/1.0992"
		1.00mm	28,260/1.1126" - 28,320/1.1150"

64 95.00 x 77.50

22 E	4 Cyl.	2197cc	85kW (115PS)	Petrol	TD2659
22 E	4 Cyl.	2197cc	85kW (116PS)	Petrol	TD17606

BE/PL	1	51,971/51,987	55,000/55,012	19,610	1,449	0,015/0,063	BS	71-3560	71-3560 STD 0.25 0.50
BE/PL	4	51,971/51,987	55,000/55,012	19,610	1,449	0,015/0,063	BS	71-3560	71-3560/4 STD
MB/HL 1-4	4	57,987/58,000	62,000/62,013	22,430	1,989	0,019/0,064	AL-LF	02-2421	H901/5 STD 0.25 0.50
MB/HL 5	1	57,987/58,000	62,000/62,013	27,400	1,989	0,019/0,064	AL-LF	02-2422H	

	02-2422H	STD	27,450/1.0807" - 27,510/1.0831"
		0.25mm	27,660/1.0890" - 27,720/1.0913"
		0.50mm	27,860/1.0969" - 27,920/1.0992"
		1.00mm	28,260/1.1126" - 28,320/1.1150"

65 95.00 x 85.00

C 24 NE	4 Cyl.	2410cc	92kW (125PS)	Petrol	TD4803
C 24 NE	4 Cyl.	2410cc	92kW (125PS)	Petrol	TD17613

BE/PL	4	51,971/51,987	55,000/55,012	19,610	1,499	0,015/0,063	EC	71-3753	71-3753/4 STD 0.25
MB/HL 1-4	4	57,987/58,000	62,000/62,013	22,430	1,989	0,019/0,064	AL-LF	02-2421	H901/5 STD 0.25 0.50
MB/HL 5	1	57,987/58,000	62,000/62,013	27,400	1,989	0,019/0,064	AL-LF	02-2422H	



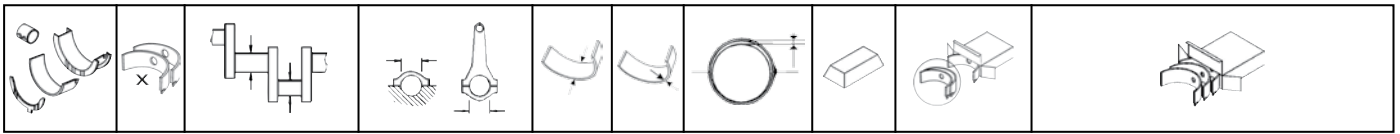



	02-2422H	STD	27,450/1.0807" - 27,510/1.0831"
		0.25mm	27,660/1.0890" - 27,720/1.0913"
		0.50mm	27,860/1.0969" - 27,920/1.0992"
		1.00mm	28,260/1.1126" - 28,320/1.1150"



66 95.40 x 107.00

4 JG2 T	4 Cyl.	3059cc	80-85kW (109-116PS)	Diesel Turbo Intercooler	TD26117
4 JG2T	4 Cyl.	3059cc	80kW (109PS)	Diesel Turbo	TD5448
4 JG2TC	4 Cyl.	3059cc	84kW (114PS)	Diesel Turbo Intercooler	TD2715
4 JG2TC	4 Cyl.	3059cc	84kW (114PS)	Diesel Turbo Intercooler	TD22854

BE/PL	8	52,920	56,000	25,800	1,513	AL-LF	64-184-1	01-4131/4 STD 0.25 0.50
MB/HL 1-5	5	69,920	74,000	23,030	2,006	AL	63-185-1	H1078/5 STD 0.25
MB/HL 1-5	5	69,920	74,000	23,030	2,006	AL	63-185-2	
TW/A	2	77,800	92,950		2,480	AL-LF	65-185-1	A225/2 STD
CB/NWB	1	49,950	54,040	25,000	2,010	AL-LF	62-184-1	N178/3 STD
CB/NWB	2	49,950	54,040	22,000	2,010	AL-LF	62-184-2	

		cm ³	x 			
--	---	-----------------	---	---	---	---

3.144	Diesel	2365	3	88.93	126.90	7
3.152	Diesel	2490	3	91.48	126.30	8
3.1524	Diesel	2490	3	91.48	126.30	8
4.107	Diesel	1760	4	79.38	88.90	2
4.108	Diesel	1760	4	79.38	88.90	2
4.154	Diesel	2523	4	88.90	101.60	4
4.192	Diesel	3150	4	88.93	126.80	5
4.203	Diesel	3335	4	91.48	126.90	9
4.2032	Diesel	3335	4	91.48	126.90	9
4.212	Diesel	3475	4	98.48	114.00	14
4.236	Diesel	3864	4	98.50	126.80	15
4.236 V	Diesel	3864	4	98.50	126.80	15
4.248	Diesel	4064	4	101.00	127.00	23
4.2482	Diesel	4064	4	101.00	127.00	23
4.288D	Diesel	4714	4	108.75	127.00	26
4.318	Diesel	5215	4	114.30	127.00	27
4.99	Diesel	1624	4	76.20	88.90	1
6.288	Diesel	4730	6	88.93	126.80	6
6.305	Diesel	5000	6	91.50	126.90	11
6.354	Diesel	5794	6	98.50	126.80	16
6.354.2	Diesel	5794	6	98.50	126.80	16
6.354.3	Diesel	5794	6	98.50	126.80	17
6.354.4	Diesel	5794	6	98.47	127.00	13
6.372	Diesel	6100	6	101.05	126.80	24
6.372.4	Diesel	6100	6	101.05	126.80	25
1004-40	Diesel	3990	4	100.00	127.00	19
1004-40T	Diesel	3990	4	100.00	127.00	20
1006-6	Diesel	5984	6	100.00	127.00	21
1006-60	Diesel	5984	6	100.00	127.00	21
1006-60T	Diesel	5984	6	100.00	127.00	22
1006-60TW	Diesel	5984	6	100.00	127.00	22
1106C-E60TA	Diesel	5985	6	100.00	127.00	22
D 6.354	Diesel	5800	6	98.50	126.80	16
D6.3544	Diesel	5806	6	98.50	126.80	17
Phaser 6.145T	Diesel	5985	6	100.00	127.00	22
Phaser 6.160T	Diesel	5985	6	100.00	127.00	22
Phaser 6.180Ti	Diesel	5985	6	100.00	127.00	22
Phaser 110 T	Diesel	3990	4	100.00	127.00	20
Phaser 110 TI	Diesel	3990	4	100.00	127.00	20
Phaser 160T	Diesel	5985	6	100.00	127.00	22
Phaser 180Ti Euro 2	Diesel	5985	6	100.00	127.00	22
Phaser 210Ti Euro 2	Diesel	5985	6	100.00	127.00	22
Prima 65	Diesel	1993	4	84.40	88.90	3
T3.152.4	Diesel	2500	3	91.49	127.00	10
T4.236	Diesel	3864	4	98.40	127.00	12
T 6.354	Diesel	5794	6	98.50	126.80	18
T6.354.3 CC	Diesel	5800	6	98.50	126.80	18
T6.3544	Diesel	5794	6	98.50	126.80	18



1 76.20 x 88.90

4.99		4 Cyl.		1624cc	37kW (50PS)	Diesel			TD6580
BE/PL	4	50,787/50,800	54,508/54,521	22,350	1,835	0,038/0,089	AL-LF	2580RA	01-4314/4 STD 0.25 0.50
MB/HL 1-3	3	57,099/57,112	60,833/60,846	31,880	1,836	0,049/0,100	AL-LF	2581RAA	H1138/3 STD 0.25

2 79.38 x 88.90

4.107		4 Cyl.		1760cc	30kW (41PS)	Diesel			TD6333
4.108		4 Cyl.		1760cc	36-42kW (49-57PS)	Diesel			TD6334
BE/PL	4	50,787/50,800	54,508/54,521	22,350	1,835	0,038/0,089	AL-LF	2580RA	01-4314/4 STD 0.25 0.50
MB/HL 1-3	3	57,099/57,112	60,833/60,846	31,880	1,836	0,049/0,100	AL-LF	2581RAA	H1138/3 STD 0.25

3 84.40 x 88.90

Prima 65		4 Cyl.		1993cc	46kW (62PS)	Diesel			TD7539
BE/PL	4	53,990/54,010	57,683/57,696	20,310	1,825	0,023/0,081	BS	1640CP	71-4353/4 STD 0.30
TW/A	4	63,600/63,850	80,250/80,500		2,310		AL-LF	1644AF	A173/4 STD

4 88.90 x 101.60

4.154		4 Cyl.		2523cc	30-46kW (41-63PS)	Diesel			TD6458
BE/PL	1	57,111/57,124	60,833/60,845	30,230	1,822	0,065/0,115	AL-LF	2015RAA	01-4110 STD 0.25 0.50 0.75 1.00
BE/PL	1	53,980/54,000	56,820/56,840	16,480	1,407	0,020/0,071	EC	71-2185	71-2185 STD

5 88.93 x 126.80

4.192		4 Cyl.		3150cc	29-37kW (39-50PS)	Diesel			TD6396
BE/PL	1	57,111/57,124	60,833/60,845	30,230	1,822	0,065/0,115	AL-LF	2015RAA	01-4110 STD 0.25 0.50 0.75 1.00
MB/HL 1	1	69,812/69,825	74,079/74,105	33,150	2,089	0,076/0,140	AL-LF	2781RA	H1027/5 STD 0.25 0.50 0.75 1.00
MB/HL 2,4	2	69,825/69,840	74,070/74,091	25,400	2,089	0,052/0,113	AL-LF	2782RA	
MB/HL 3,5	2	69,812/69,825	74,079/74,105	40,767	2,089	0,076/0,140	AL-LF	2783RA	
TW/A	4	77,343/77,597	90,221/90,475		3,120		AL-LF	2783AFA	A179/4 STD .005 0.25
SE/PB	1	31,743/31,750	34,919/34,955	26,850			BS	2019Y	55-4111 SEMI

6 88.93 x 126.80

6.288		6 Cyl.		4730cc	45kW (61PS)	Diesel			TD6498
BE/PL	1	57,111/57,124	60,833/60,845	30,230	1,822	0,065/0,115	AL-LF	2015RAA	01-4110 STD 0.25 0.50 0.75 1.00
TW/A	4	77,343/77,597	90,221/90,475		3,120		AL-LF	2783AFA	A179/4 STD .005 0.25
SE/PB	1	31,743/31,750	34,919/34,955	26,850			BS	2019Y	55-4111 SEMI

7 88.93 x 126.90

3.144		3 Cyl.		2365cc	22-28kW (30-38PS)	Diesel			TD6787
BE/PL	1	57,111/57,124	60,833/60,845	30,230	1,822	0,065/0,115	AL-LF	2015RAA	01-4110 STD 0.25 0.50 0.75 1.00

MB/HL 1	1	69,812/69,825	74,079/74,105	33,150	2,089	0,076/0,140	AL-LF	2781RA	H1026/4 STD 0.25 0.50 0.75 1.00	
MB/HL 2,3	2	69,825/69,840	74,070/74,091	25,400	2,089	0,052/0,113	AL-LF	2782RA		
MB/HL 4	1	69,812/69,825	74,079/74,105	40,767	2,089	0,076/0,140	AL-LF	2783RA		
TW/A	4	77,343/77,597	90,221/90,475		3,120		AL-LF	2783AFA	A179/4 STD .005 0.25	
SE/PB	1	31,743/31,750	34,919/34,955	26,850			BS	2019Y	55-4111 SEMI	

8 91.48 x 126.30

3.152	3 Cyl.		2490cc	22-33kW (30-45PS)		Diesel		TD6788	
3.1524	3 Cyl.		2490cc	27-30kW (37-41PS)		Diesel		TD29145	
BE/PL	1	57,111/57,124	60,833/60,845	30,230	1,822	0,065/0,115	AL-LF	2015RAA	01-4110 STD 0.25 0.50 0.75 1.00
MB/HL 1	1	69,812/69,825	74,079/74,105	33,150	2,089	0,076/0,140	AL-LF	2781RA	H1026/4 STD 0.25 0.50 0.75 1.00
MB/HL 2,3	2	69,825/69,840	74,070/74,091	25,400	2,089	0,052/0,113	AL-LF	2782RA	
MB/HL 4	1	69,812/69,825	74,079/74,105	40,767	2,089	0,076/0,140	AL-LF	2783RA	
TW/A	4	77,343/77,597	90,221/90,475		3,120		AL-LF	2783AFA	A179/4 STD .005 0.25
SE/PB	1	31,743/31,750	34,919/34,955	26,850			BS	2019Y	55-4111 SEMI

9 91.48 x 126.90

4.203	4 Cyl.		3335cc	44kW (60PS)		Diesel		TD7381	
4.2032	4 Cyl.		3335cc	42kW (57PS)		Diesel		TD29146	
BE/PL	1	57,111/57,124	60,833/60,845	30,230	1,822	0,065/0,115	AL-LF	2015RAA	01-4110 STD 0.25 0.50 0.75 1.00
MB/HL 1	1	69,812/69,825	74,079/74,105	33,150	2,089	0,076/0,140	AL-LF	2781RA	H1027/5 STD 0.25 0.50 0.75 1.00
MB/HL 2,4	2	69,825/69,840	74,070/74,091	25,400	2,089	0,052/0,113	AL-LF	2782RA	
MB/HL 3,5	2	69,812/69,825	74,079/74,105	40,767	2,089	0,076/0,140	AL-LF	2783RA	
TW/A	4	77,343/77,597	90,221/90,475		3,120		AL-LF	2783AFA	A179/4 STD .005 0.25
SE/PB	1	31,743/31,750	34,919/34,955	26,850			BS	2019Y	55-4111 SEMI

10 91.49 x 127.00

T3.152.4	3 Cyl.		2500cc	Diesel Turbo		FM6824			
BE/PL	1	57,111/57,124	60,833/60,845	30,230	1,822	0,065/0,115	AL-LF	2015RAA	01-4110 STD 0.25 0.50 0.75 1.00
MB/HL 1	1	69,812/69,825	74,079/74,105	33,150	2,089	0,076/0,140	AL-LF	2781RA	H1026/4 STD 0.25 0.50 0.75 1.00
MB/HL 2,3	2	69,825/69,840	74,070/74,091	25,400	2,089	0,052/0,113	AL-LF	2782RA	
MB/HL 4	1	69,812/69,825	74,079/74,105	40,767	2,089	0,076/0,140	AL-LF	2783RA	
TW/A	4	77,343/77,597	90,221/90,475		3,120		AL-LF	2783AFA	A179/4 STD .005 0.25
SE/PB	1	31,743/31,750	34,919/34,955	26,850			BS	2019Y	55-4111 SEMI



11 91.50 x 126.90

6.305		6 Cyl.		5000cc	73kW (100PS)		Diesel		TD6399
BE/PL	1	57,111/57,124	60,833/60,845	30,230	1,822	0,065/0,115	AL-LF	2015RAA	01-4110 STD 0.25 0.50 0.75 1.00
SE/PB	1	31,743/31,750	34,919/34,955	26,850			BS	2019Y	55-4111 SEMI

12 98.40 x 127.00

T4.236		4 Cyl.		3864cc	66-76kW (90-103PS)		Diesel Turbo		TD6746
BE/PL	1	63,475/63,487	67,208/67,221	31,880	1,841	0,040/0,080	EC	GS2791LC	71-4115 STD 0.25 0.50
MB/HL 1,2,4,5	4	76,162/76,175	80,416/80,441	31,880	2,090	0,061/0,124	AL-LF	3136RA	H1037/5 STD 0.25 0.50 0.75 1.00
MB/HL 3	1	76,162/76,175	80,416/80,441	36,700	2,090	0,061/0,124	AL-LF	3137RA	
TW/A	4	86,870/87,120	103,850/104,100		2,310		AL-LF	3137BFA	A184/4 STD .0075
Mot.4203049 →									
SE/PB	1	38,095/38,100	42,068/42,094	33,930		0,050/0,051	BS	3138Y	55-4524 SEMI

13 98.47 x 127.00

6.354.4		6 Cyl.		5794cc	94kW (128PS)		Diesel		TD6546
BE/PL	1	63,475/63,487	67,208/67,221	31,880	1,841	0,038/0,089	AL-LF	3135RA	01-4115 STD 0.25 0.50 0.75 1.00
MB/HL 1-3, 5-7	6	76,159/76,179	80,416/80,442	31,120	2,080	0,076/0,147	AL-LF	3138RA	H1124/7 STD 0.25 0.50
MB/HL 4	1	76,159/76,179	80,416/80,442	36,580	2,080	0,076/0,147	AL-LF	3139RA	
TW/A	4	86,870/87,120	103,850/104,100		2,310		AL-LF	3137BFA	A184/4 STD .0075
SE/PB	1	34,920/34,925	38,895/38,920	33,930			AL-LF	3139Y15	05-4521 STD

14 98.48 x 114.00

4.212		4 Cyl.		3475cc	44-47kW (60-64PS)		Diesel		TD29147
BE/PL	1	63,475/63,487	67,208/67,221	31,880	1,841	0,038/0,089	AL-LF	3135RA	01-4115 STD 0.25 0.50 0.75 1.00
BE/PL	4	63,475/63,487	67,208/67,221	31,880	1,841	0,038/0,089	AL-LF	3135RA	01-4115/4 STD 0.25
MB/HL 1,2,4,5	4	76,162/76,175	80,416/80,441	31,880	2,090	0,061/0,124	AL-LF	3136RA	H1037/5 STD 0.25 0.50 0.75 1.00
MB/HL 3	1	76,162/76,175	80,416/80,441	36,700	2,090	0,061/0,124	AL-LF	3137RA	
TW/A	4	86,870/87,120	103,850/104,100		2,310		AL-LF	3137BFA	A184/4 STD .0075
Mot.4203049 →									
SE/PB	1	34,920/34,925	38,895/38,920	33,930			AL-LF	3139Y15	05-4521 STD

15 98.50 x 126.80

4.236		4 Cyl.		3864cc	55-65kW (75-88PS)		Diesel		TD6398
4.236 V		4 Cyl.		3864cc	57kW (77PS)		Diesel		TD6531
BE/PL	1	63,475/63,487	67,208/67,221	31,880	1,841	0,038/0,089	AL-LF	3135RA	01-4115 STD 0.25 0.50 0.75 1.00
BE/PL	4	63,475/63,487	67,208/67,221	31,880	1,841	0,038/0,089	AL-LF	3135RA	01-4115/4 STD 0.25

MB/HL 1,2,4,5	4	76,162/76,175	80,416/80,441	31,880	2,090	0,061/0,124	AL-LF	3136RA	H1037/5 STD 0.25 0.50 0.75 1.00	
MB/HL 3	1	76,162/76,175	80,416/80,441	36,700	2,090	0,061/0,124	AL-LF	3137RA		
TW/A	4	86,870/87,120	103,850/104,100		2,310		AL-LF	3137BFA	A184/4 STD .0075	
Mot.4203049 →										
SE/PB	1	34,920/34,925	38,895/38,920	33,930			AL-LF	3139Y15	05-4521 STD	

16 98.50 x 126.80

6.354			6 Cyl.	5794cc	71-82kW (97-112PS)		Diesel		TD6713
6.354.2			6 Cyl.	5794cc	84-87kW (114-118PS)		Diesel		TD6548
D 6.354			6 Cyl.	5800cc	80kW (109PS)		Diesel		TD6701
BE/PL	1	63,475/63,487	67,208/67,221	31,880	1,841	0,038/0,089	AL-LF	3135RA	01-4115 STD 0.25 0.50 0.75 1.00
MB/HL 1-3, 5-7	6	76,162/76,175	80,416/80,441	31,880	2,090	0,061/0,124	AL-LF	3136RA	H1037/7 STD 0.25
MB/HL 4	1	76,162/76,175	80,416/80,441	36,700	2,090	0,061/0,124	AL-LF	3137RA	
TW/A	4	86,870/87,120	103,850/104,100		2,310		AL-LF	3137BFA	A184/4 STD .0075
Mot.8504189 →									
SE/PB	1	34,920/34,925	38,895/38,920	33,930			AL-LF	3139Y15	05-4521 STD

17 98.50 x 126.80

6.354.3			6 Cyl.	5794cc	86kW (118PS)		Diesel		TD6400
D6.3544			6 Cyl.	5806cc	75kW (102PS)		Diesel		TD8702
BE/PL	1	63,475/63,487	67,208/67,221	31,880	1,841	0,038/0,089	AL-LF	3135RA	01-4115 STD 0.25 0.50 0.75 1.00
MB/HL 1-3, 5-7	6	76,159/76,179	80,416/80,442	31,120	2,080	0,076/0,147	AL-LF	3138RA	H1124/7 STD 0.25 0.50
MB/HL 4	1	76,159/76,179	80,416/80,442	36,580	2,080	0,076/0,147	AL-LF	3139RA	
TW/A	4	86,870/87,120	103,850/104,100		2,310		AL-LF	3137BFA	A184/4 STD .0075
SE/PB	1	34,920/34,925	38,895/38,920	33,930			AL-LF	3139Y15	05-4521 STD

18 98.50 x 126.80

T 6.354			6 Cyl.	5794cc	119kW (162PS)		Diesel Turbo		TD6712
T6.354.3 CC			6 Cyl.	5800cc	110-111kW (148-151PS)		Diesel		TD6747
T6.3544			6 Cyl.	5794cc	110-119kW (150-162PS)		Diesel Turbo		TD8703
BE/PL	1	63,475/63,487	67,208/67,221	31,880	1,841	0,040/0,080	EC	GS2791LC	71-4115 STD 0.25 0.50
BE/PL	6	63,475/63,487	67,208/67,221	31,880	1,841	0,040/0,080	EC	GS2791LC	71-4115/6 STD
MB/HL 1-3, 5-7	6	76,159/76,179	80,416/80,442	31,120	2,080	0,076/0,147	AL-LF	3138RA	H1124/7 STD 0.25 0.50
MB/HL 4	1	76,159/76,179	80,416/80,442	36,580	2,080	0,076/0,147	AL-LF	3139RA	
TW/A	4	86,870/87,120	103,850/104,100		2,310		AL-LF	3137BFA	A184/4 STD .0075
SE/PB	1	38,095/38,100	42,068/42,094	33,930		0,050/0,051	BS	3138Y	55-4524 SEMI



19 100.00 x 127.00

1004-40		4 Cyl.		3990cc	48-52kW (65-71PS)			Diesel		TD20891
BE/PL	4	63,475/63,487	67,208/67,221	31,880	1,841	0,038/0,089	AL-LF	3135RA	01-4115/4 STD 0.25	
MB/HL 1,2,4,5	4	76,162/76,175	80,416/80,441	31,880	2,090	0,061/0,124	AL-LF	3136RA	H1037/5 STD 0.25 0.50 0.75 1.00	
MB/HL 3	1	76,162/76,175	80,416/80,441	36,700	2,090	0,061/0,124	AL-LF	3137RA		
TW/A	4	86,870/87,120	103,850/104,100		2,310		AL-LF	3137BFA	A184/4 STD .0075	
SE/PB	1	34,920/34,925	38,895/38,920	33,930			AL-LF	3139Y15	05-4521 STD	

20 100.00 x 127.00

1004-40T		4 Cyl.		3990cc	67-75kW (91-102PS)			Diesel Turbo		TD29133
Phaser 110 T		4 Cyl.		3990cc	82kW (111PS)			Diesel Turbo		TD8659
Phaser 110 TI		4 Cyl.		3990cc	102kW (139PS)			Diesel Turbo Intercooler		TD8662
BE/PL	1	63,475/63,487	67,208/67,221	31,880	1,841	0,040/0,080	EC	GS2791LC	71-4115 STD 0.25 0.50	
MB/HL 1,2,4,5	4	76,162/76,175	80,416/80,441	31,880	2,090	0,061/0,124	AL-LF	3136RA	H1037/5 STD 0.25 0.50 0.75 1.00	
MB/HL 3	1	76,162/76,175	80,416/80,441	36,700	2,090	0,061/0,124	AL-LF	3137RA		
TW/A	4	86,870/87,120	103,850/104,100		2,310		AL-LF	3137BFA	A184/4 STD .0075	
SE/PB	1	38,095/38,100	42,068/42,094	33,930		0,050/0,051	BS	3138Y	55-4524 SEMI	

21 100.00 x 127.00

1006-6		6 Cyl.		5984cc	96kW (131PS)			Diesel		TD29135
1006-60		6 Cyl.		5984cc	79kW (107PS)			Diesel		TD29136
BE/PL	1	63,475/63,487	67,208/67,221	31,880	1,841	0,040/0,080	EC	GS2791LC	71-4115 STD 0.25 0.50	
BE/PL	6	63,475/63,487	67,208/67,221	31,880	1,841	0,040/0,080	EC	GS2791LC	71-4115/6 STD	
MB/HL 4	1	76,159/76,179	80,416/80,442	36,580	2,080	0,076/0,147	AL-LF	3139RA		
MB/HL	6	76,160/76,180	80,416/80,442	31,700	2,086	0,046/0,107	BS	GS378LC	H1201/7 STD 0.25	
MB/HL	1	76,160/76,180	80,416/80,442	36,500	2,080	0,046/0,107	BS	GS379LC		
TW/A	4	86,870/87,120	103,850/104,100		2,310		AL-LF	3137BFA	A184/4 STD .0075	

22 100.00 x 127.00

1006-60T		6 Cyl.		5984cc	112kW (152PS)			Diesel Turbo		TD29137
1006-60TW		6 Cyl.		5984cc	120-134kW (163-182PS)			Diesel Turbo Intercooler		TD29138
1106C-E60TA		6 Cyl.		5985cc	74-130kW (101-177PS)			Diesel Turbo Intercooler		TD17283
Phaser 6.145T		6 Cyl.		5985cc	107kW (143PS)			Diesel Turbo		TD6411
Phaser 6.160T		6 Cyl.		5985cc	119kW (160PS)			Diesel		TD6412
Phaser 6.180Ti		6 Cyl.		5985cc	134kW (180PS)			Diesel Turbo		TD6404
Phaser 160T		6 Cyl.		5985cc	119kW (160PS)			Diesel Turbo		TD6547
Phaser 180Ti Euro 2		6 Cyl.		5985cc	131-134kW (177-182PS)			Diesel Turbo Intercooler		TD8922
Phaser 210Ti Euro 2		6 Cyl.		5985cc	154-155kW (209-210PS)			Diesel Turbo Intercooler		TD27509
BE/PL	1	63,475/63,487	67,208/67,221	31,880	1,841	0,040/0,080	EC	GS2791LC	71-4115 STD 0.25 0.50	
BE/PL	6	63,475/63,487	67,208/67,221	31,880	1,841	0,040/0,080	EC	GS2791LC	71-4115/6 STD	

MB/HL	6	76,160/76,180	80,416/80,442	31,700	2,086	0,046/0,107	BS	GS378LC	H1201/7 STD 0.25
MB/HL	1	76,160/76,180	80,416/80,442	36,500	2,080	0,046/0,107	BS	GS379LC	
TW/A	4	86,870/87,120	103,850/104,100		2,310		AL-LF	3137BFA	A184/4 STD .0075
SE/PB	1	38,095/38,100	42,068/42,094	33,930		0,050/0,051	BS	3138Y	55-4524 SEMI

23

101.00 x 127.00

4.248	4 Cyl.		4064cc	53kW (72PS)				Diesel	TD29149
4.2482	4 Cyl.		4064cc	60kW (82PS)				Diesel	TD29150
BE/PL	1	63,475/63,487	67,208/67,221	31,880	1,841	0,038/0,089	AL-LF	3135RA	01-4115 STD 0.25 0.50 0.75 1.00
BE/PL	4	63,475/63,487	67,208/67,221	31,880	1,841	0,038/0,089	AL-LF	3135RA	01-4115/4 STD 0.25
MB/HL 1,2,4,5	4	76,162/76,175	80,416/80,441	31,880	2,090	0,061/0,124	AL-LF	3136RA	H1037/5 STD 0.25 0.50 0.75 1.00
MB/HL 3	1	76,162/76,175	80,416/80,441	36,700	2,090	0,061/0,124	AL-LF	3137RA	
TW/A	4	86,870/87,120	103,850/104,100		2,310		AL-LF	3137BFA	A184/4 STD .0075
Mot.4203049 →									
SE/PB	1	34,920/34,925	38,895/38,920	33,930			AL-LF	3139Y15	05-4521 STD

24

101.05 x 126.80

6.372	6 Cyl.		6100cc	87kW (118PS)				Diesel	TD20102
BE/PL	1	63,475/63,487	67,208/67,221	31,880	1,841	0,038/0,089	AL-LF	3135RA	01-4115 STD 0.25 0.50 0.75 1.00
MB/HL 1-3, 5-7	6	76,162/76,175	80,416/80,441	31,880	2,090	0,061/0,124	AL-LF	3136RA	H1037/7 STD 0.25
MB/HL 4	1	76,162/76,175	80,416/80,441	36,700	2,090	0,061/0,124	AL-LF	3137RA	
TW/A	4	86,870/87,120	103,850/104,100		2,310		AL-LF	3137BFA	A184/4 STD .0075
Mot.8504190 →									
SE/PB	1	34,920/34,925	38,895/38,920	33,930			AL-LF	3139Y15	05-4521 STD

25

101.05 x 126.80

6.372.4	6 Cyl.		6100cc	82-87kW (112-118PS)				Diesel	TD20103
BE/PL	1	63,475/63,487	67,208/67,221	31,880	1,841	0,038/0,089	AL-LF	3135RA	01-4115 STD 0.25 0.50 0.75 1.00
MB/HL 1-3, 5-7	6	76,159/76,179	80,416/80,442	31,120	2,080	0,076/0,147	AL-LF	3138RA	H1124/7 STD 0.25 0.50
MB/HL 4	1	76,159/76,179	80,416/80,442	36,580	2,080	0,076/0,147	AL-LF	3139RA	
TW/A	4	86,870/87,120	103,850/104,100		2,310		AL-LF	3137BFA	A184/4 STD .0075
SE/PB	1	34,920/34,925	38,895/38,920	33,930			AL-LF	3139Y15	05-4521 STD

26

108.75 x 127.00

4.288D	4 Cyl.		4714cc				Diesel	FM2526	
BE/PL	1	57,111/57,124	60,833/60,845	30,230	1,822	0,065/0,115	AL-LF	2015RAA	01-4110 STD 0.25 0.50 0.75 1.00

MB/HL 1	1	69,812/69,825	74,079/74,105	33,150	2,089	0,076/0,140	AL-LF	2781RA	H1027/5 STD 0.25 0.50 0.75 1.00	
MB/HL 2,4	2	69,825/69,840	74,070/74,091	25,400	2,089	0,052/0,113	AL-LF	2782RA		
MB/HL 3,5	2	69,812/69,825	74,079/74,105	40,767	2,089	0,076/0,140	AL-LF	2783RA		
TW/A	4	77,343/77,597	90,221/90,475		3,120		AL-LF	2783AFA		
SE/PB	1	31,743/31,750	34,919/34,955	26,850			BS	2019Y		

27

114.30 x 127.00

4.318		4 Cyl.		5215cc	72kW (98PS)	Diesel			TD29151
BE/PL	1	63,475/63,487	67,208/67,221	31,880	1,841	0,038/0,089	AL-LF	3135RA	01-4115 STD 0.25 0.50 0.75 1.00
BE/PL	4	63,475/63,487	67,208/67,221	31,880	1,841	0,038/0,089	AL-LF	3135RA	01-4115/4 STD 0.25
MB/HL 1,2,4,5	4	76,162/76,175	80,416/80,441	31,880	2,090	0,061/0,124	AL-LF	3136RA	H1037/5 STD 0.25 0.50 0.75 1.00
MB/HL 3	1	76,162/76,175	80,416/80,441	36,700	2,090	0,061/0,124	AL-LF	3137RA	
TW/A	4	86,870/87,120	103,850/104,100		2,310		AL-LF	3137BFA	A184/4 STD .0075
SE/PB	1	34,920/34,925	38,895/38,920	33,930			AL-LF	3139Y15	05-4521 STD



cm3 x



9

104 0.9	10/72→10/83	Petrol	108 (XV3)	954	4	70.00	62.00	3
104 0.9	09/73→10/83	Petrol	108 (XV5)	954	4	70.00	62.00	3
104 1.0	09/83→06/88	Petrol	108C (XV8)	954	4	70.00	62.00	4
104 1.1	07/76→06/83	Petrol	109 (XW3)	1124	4	72.00	69.00	8
104 1.1	08/79→06/88	Petrol	109F (XW7)	1124	4	72.00	69.00	9
104 1.1	08/75→06/80	Petrol	121 (XW3S)	1124	4	72.00	69.00	11
104 1.1	09/73→09/79	Petrol	XW3S	1124	4	72.00	69.00	11
104 1.2	08/79→06/83	Petrol	129 (XZ5)	1219	4	75.00	69.00	19
104 1.4	08/79→06/84	Petrol	150 (XY6B)	1360	4	75.00	77.00	21
106 1.0	09/91→03/01	Petrol	CDY (TU9M)	954	4	70.00	62.00	5
106 1.0	09/91→03/01	Petrol	TU9	954	4	70.00	62.00	5
106 1.5 D	10/00→03/01	Diesel	VJX (TUD5)	1527	4	77.00	82.00	31
106 1.5 D	05/96→03/01	Diesel	VJY (TUD5)	1527	4	77.00	82.00	31
106 I 1.0	09/91→04/96	Petrol	CDY (TU9M)	954	4	70.00	62.00	5
106 I 1.0	09/91→04/96	Petrol	CDZ (TU9M)	954	4	70.00	62.00	5
106 I 1.0	09/91→04/96	Petrol	TU9	954	4	70.00	62.00	5
106 I 1.1	09/91→04/96	Petrol	HDZ (TU1M)	1124	4	72.00	69.00	12
106 I 1.3	10/93→04/96	Petrol	TU2J2	1294	4	75.00	73.20	20
106 I 1.4	08/91→03/96	Petrol	K5A (TU3)	1360	4	75.00	77.00	22
106 I 1.4	09/91→04/96	Petrol	KDX (TU3MC)	1361	4	75.00	77.00	22
106 I 1.4	09/91→04/96	Petrol	KDY (TU3M)	1361	4	75.00	77.00	22
106 I 1.4	09/91→04/96	Petrol	KFZ (TU3J2/Z)	1361	4	75.00	77.00	22
106 I 1.4 D	09/92→04/96	Diesel	K9Y (TUD3Y)	1361	4	75.00	77.00	26
106 I 1.5 D	06/94→04/96	Diesel	VJY (TUD5)	1527	4	77.00	82.00	31
106 I 1.6	01/94→04/96	Petrol	NFY (TU5J2)	1587	4	78.50	82.00	35
106 I 1.6	06/93→04/96	Petrol	NFZ (TU5JP)	1587	4	78.50	82.00	35
106 II 1.0 i	05/96→	Petrol	CDY (TU9M)	954	4	70.00	62.00	5
106 II 1.0 i	01/97→	Petrol	CDZ (TU9M)	954	4	70.00	62.00	5
106 II 1.1 i	01/97→	Petrol	HDY (TU1M)	1124	4	72.00	69.00	12
106 II 1.1 i	05/96→	Petrol	HDZ (TU1M)	1124	4	72.00	69.00	12
106 II 1.1 i	05/96→	Petrol	HFX (TU1JP)	1124	4	72.00	69.00	13
106 II 1.4 i	05/96→	Petrol	KFW (TU3JP)	1360	4	75.00	77.00	24
106 II 1.4 i	05/96→	Petrol	KFX (TU3JP)	1361	4	75.00	77.00	24
106 II 1.5 D	04/98→	Diesel	VJX (TUD5)	1527	4	77.00	82.00	31
106 II 1.5 D	05/96→	Diesel	VJY (TUD5)	1527	4	77.00	82.00	31
106 II 1.6 i	05/96→	Petrol	NFW (TU5J2)	1587	4	78.50	82.00	35
106 II 1.6 i	05/96→	Petrol	NFY (TU5J2)	1587	4	78.50	82.00	35
106 II 1.6 i	05/96→	Petrol	NFZ (TU5JP)	1587	4	78.50	82.00	35
106 II 1.6 S16	05/96→	Petrol	NFX (TU5J4)	1587	4	78.50	82.00	35
107 1.0	06/05→	Petrol	1KR (384 F)	998	3	71.00	84.00	7
107 1.4 HDi	06/05→	Diesel	8HT (DV4TD)	1398	4	73.70	82.00	16
204 1.1	09/75→07/77	Petrol	XK5	1127	4	78.00	59.00	32
205 1.1	08/87→07/90	Petrol	H1B (TU1)	1124	4	72.00	69.00	12
205 1.7 Diesel	03/94→	Diesel	161A (XUD7)	1769	4	80.00	88.00	39
205 1.8 D	02/83→07/90	Diesel	A9A (XUD7)	1769	4	80.00	88.00	41
205 I 1.0	02/83→10/87	Petrol	108C (XV8)	954	4	70.00	62.00	4
205 I 1.1	02/83→10/87	Petrol	109F (XW7)	1124	4	72.00	69.00	9
205 I 1.1	02/83→10/87	Petrol	109N (XW7)	1124	4	72.00	69.00	10
205 I 1.1	08/87→12/94	Petrol	H1B (TU1)	1124	4	72.00	69.00	12
205 I 1.1 CJ	10/89→12/94	Petrol	HDZ (TU1M)	1124	4	72.00	69.00	12
205 I 1.3	02/84→10/87	Petrol	G1A	1294	4	76.70	70.00	29
205 I 1.4	02/83→10/87	Petrol	150 (XY6B)	1360	4	75.00	77.00	21
205 I 1.4	02/83→10/87	Petrol	150B (XY8)	1360	4	75.00	77.00	22
205 I 1.4	02/83→10/87	Petrol	150D (XY7)	1360	4	75.00	77.00	22
205 I 1.4	02/83→10/87	Petrol	150G (XY7)	1360	4	75.00	77.00	22
205 I 1.4	10/85→10/87	Petrol	150H (XY8)	1360	4	75.00	77.00	22
205 I 1.4	08/87→06/94	Petrol	K2B (TU3S)	1360	4	75.00	77.00	22
205 I 1.4 CJ	03/88→05/89	Petrol	150D (XY7)	1360	4	75.00	77.00	22
205 I 1.4 CJ	03/88→05/89	Petrol	150G (XY7)	1360	4	75.00	77.00	22
205 I 1.4 CJ	03/89→12/94	Petrol	K1D (TU3A)	1361	4	75.00	77.00	22
205 I 1.4 CJ	05/91→12/94	Petrol	KDY (TU3M)	1361	4	75.00	77.00	22
205 I 1.4 CJ	05/91→12/94	Petrol	KDZ (TU3M)	1361	4	75.00	77.00	22
205 I 1.4 CJ CAT	01/89→09/93	Petrol	KAY (TU3CP)	1361	4	75.00	77.00	22
205 I 1.4 CT	04/86→12/88	Petrol	150B (XY8)	1360	4	75.00	77.00	22
205 I 1.4 CT	04/86→12/88	Petrol	150H (XY8)	1360	4	75.00	77.00	22
205 I 1.6	08/86→10/87	Petrol	B1A (XU51C)	1580	4	83.00	73.00	44
205 I 1.6	03/87→10/87	Petrol	B1E (XU51C)	1580	4	83.00	73.00	44
205 I 1.6	08/86→10/87	Petrol	BAZ (XU5CP)	1580	4	83.00	73.00	44
205 I 1.6 CJ	08/92→12/94	Petrol	BDY (XU5M3Z)	1580	4	83.00	73.00	46

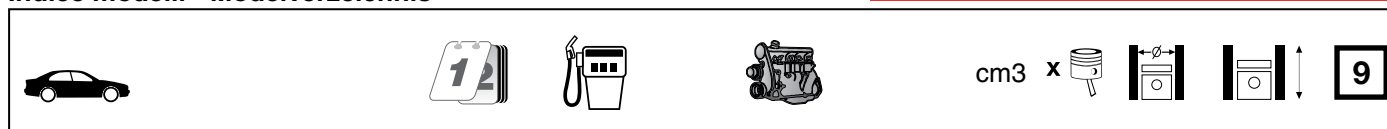

205 I 1.6 CTI	04/86→10/90	Petrol	180A (XU5J)	1580	4	83.00	73.00	45
205 I 1.6 CTI	04/86→10/90	Petrol	180Z (XU5J)	1580	4	83.00	73.00	45
205 I 1.6 GTI	12/84→10/87	Petrol	180A (XU5J)	1580	4	83.00	73.00	45
205 I 1.7 Diesel	08/83→10/87	Diesel	161A (XUD7)	1769	4	80.00	88.00	39
205 I 1.9	05/86→07/87	Petrol	DFZ (XU9J1)	1905	4	83.00	88.00	52
205 I 1.9 CTI	08/87→12/94	Petrol	DFZ (XU9J1)	1905	4	83.00	88.00	52
205 I 1.9 CTi	08/90→07/92	Petrol	DKZ (XU9JAZ)	1905	4	83.00	88.00	51
205 I 1.9 GTI	10/86→10/87	Petrol	D6B (XU9JA)	1905	4	83.00	88.00	52
205 I 1.9 GTI	03/87→10/87	Petrol	DFZ (XU9J1)	1905	4	83.00	88.00	52
205 II 1.0	08/92→05/97	Petrol	CDZ (TU9M)	954	4	70.00	62.00	5
205 II 1.0	10/87→09/98	Petrol	TU9	954	4	70.00	62.00	5
205 II 1.1	10/87→10/90	Petrol	109N (XW7)	1124	4	72.00	69.00	10
205 II 1.1	10/87→10/90	Petrol	H1B (TU1)	1124	4	72.00	69.00	12
205 II 1.1	07/89→09/98	Petrol	HDZ (TU1M)	1124	4	72.00	69.00	12
205 II 1.1 XA	07/87→10/88	Petrol	E1	1118	4	74.00	65.00	17
205 II 1.2	01/87→12/90	Petrol	F1	1204	4	74.00	70.00	18
205 II 1.3	08/90→07/92	Petrol	G1A	1294	4	76.70	70.00	29
205 II 1.3 Rallye	10/87→10/90	Petrol	TU24	1294	4	75.00	73.20	20
205 II 1.4	01/87→07/88	Petrol	150 (XY6B)	1360	4	75.00	77.00	21
205 II 1.4	07/88→05/89	Petrol	150B (XY8)	1360	4	75.00	77.00	22
205 II 1.4	10/87→05/89	Petrol	150D (XY7)	1360	4	75.00	77.00	22
205 II 1.4	10/87→05/89	Petrol	150G (XY7)	1360	4	75.00	77.00	22
205 II 1.4	07/88→05/89	Petrol	150H (XY8)	1360	4	75.00	77.00	22
205 II 1.4	06/87→12/89	Petrol	K2B (TU3S)	1360	4	75.00	77.00	22
205 II 1.4	10/87→10/90	Petrol	K1D (TU3A)	1361	4	75.00	77.00	22
205 II 1.4	08/90→07/98	Petrol	KDX (TU3MC)	1361	4	75.00	77.00	22
205 II 1.4	07/88→09/98	Petrol	KDY (TU3M)	1361	4	75.00	77.00	22
205 II 1.4	07/88→09/98	Petrol	KDZ (TU3M)	1361	4	75.00	77.00	22
205 II 1.4	07/88→09/98	Petrol	KFX (TU3JP)	1361	4	75.00	77.00	24
205 II 1.4	08/90→07/98	Petrol	TU32	1361	4	75.00	77.00	25
205 II 1.4 CAT	08/87→09/93	Petrol	KAY (TU3CP)	1361	4	75.00	77.00	22
205 II 1.6	08/90→07/92	Petrol	171 (XU5S)	1580	4	83.00	73.00	44
205 II 1.6	10/87→09/98	Petrol	B1A (XU51C)	1580	4	83.00	73.00	44
205 II 1.6	10/87→09/98	Petrol	B1E (XU51C)	1580	4	83.00	73.00	44
205 II 1.6	10/87→09/98	Petrol	BAZ (XU5CP)	1580	4	83.00	73.00	44
205 II 1.6 Aut.	05/90→09/98	Petrol	BDY (XU5M2Z)	1580	4	83.00	73.00	46
205 II 1.6 Aut.	05/90→09/98	Petrol	BDY (XU5M3Z)	1580	4	83.00	73.00	46
205 II 1.6 GTI	10/87→12/89	Petrol	180A (XU5J)	1580	4	83.00	73.00	45
205 II 1.6 GTI	10/87→12/89	Petrol	180Z (XU5J)	1580	4	83.00	73.00	45
205 II 1.7 Diesel	07/87→09/98	Diesel	161A (XUD7)	1769	4	80.00	88.00	39
205 II 1.8 TD	01/90→09/98	Diesel	A8B (XUD7TE)	1769	4	80.00	88.00	40
205 II 1.8 XDT	08/90→05/97	Diesel	XUD7T	1769	4	80.00	88.00	40
205 II 1.9	08/92→05/97	Petrol	DFZ (XU9J1)	1905	4	83.00	88.00	52
205 II 1.9	08/90→05/97	Petrol	DKZ (XU9JAZ)	1905	4	83.00	88.00	51
205 II 1.9 Diesel	10/87→09/98	Diesel	DJZ (XUD9Y)	1905	4	83.00	88.00	56
205 II 1.9 Diesel	08/87→06/94	Diesel	XUD9	1905	4	83.00	88.00	56
205 II 1.9 GTI	10/87→05/89	Petrol	D2A (XU92C)	1905	4	83.00	88.00	50
205 II 1.9 GTI	10/87→09/98	Petrol	D6B (XU9JA)	1905	4	83.00	88.00	52
205 II 1.9 GTI	10/87→10/94	Petrol	DKZ (XU9JAZ)	1905	4	83.00	88.00	51
205 II 1.9 GTI CAT	10/87→07/94	Petrol	DFZ (XU9J1)	1905	4	83.00	88.00	52
206 1.1 i	09/98→	Petrol	HFX (TU1JP)	1124	4	72.00	69.00	13
206 1.1 i	09/98→	Petrol	HFZ (TU1JP)	1124	4	72.00	69.00	14
206 1.4	03/07→	Petrol	KFV (TU3A)	1360	4	75.00	77.00	23
206 1.4	03/07→	Petrol	KFW (TU3JP)	1360	4	75.00	77.00	24
206 1.4 16V	10/03→	Petrol	KFU (ET3J4)	1360	4	75.00	77.00	23
206 1.4 CNG	05/06→09/07	Petrol	KFW (TU3A)	1360	4	75.00	77.00	22
206 1.4 Flex	01/06→11/09	Petrol	KFV (TU3A)	1360	4	75.00	77.00	23
206 1.4 HDi	09/01→03/09	Diesel	8HX (DV4TD)	1398	4	73.70	82.00	16
206 1.4 HDi	09/01→03/09	Diesel	8HZ (DV4TD)	1398	4	73.70	82.00	16
206 1.4 HDi eco 70	09/01→	Diesel	8HX (DV4TD)	1398	4	73.70	82.00	16
206 1.4 HDi eco 70	09/01→	Diesel	8HZ (DV4TD)	1398	4	73.70	82.00	16
206 1.4 i	09/98→	Petrol	KFW (TU3JP)	1360	4	75.00	77.00	24
206 1.4 i	09/98→	Petrol	KFX (TU3JP)	1361	4	75.00	77.00	24
206 1.4 LPG	05/06→09/07	Petrol	KFV (TU3JP)	1360	4	75.00	77.00	23
206 1.6	09/01→12/08	Petrol	NFU (TU5JP4)	1587	4	78.50	82.00	35
206 1.6 16V	09/00→	Petrol	NFU (TU5JP4)	1587	4	78.50	82.00	35
206 1.6 Flex	05/05→07/08	Petrol	NFU (TU5JP4)	1587	4	78.50	82.00	35
206 1.6 HDi 110	05/04→	Diesel	9HY (DV6TED4)	1560	4	75.00	88.30	27
206 1.6 HDi 110	05/04→	Diesel	9HZ (DV6TED4)	1560	4	75.00	88.30	27



cm3



206 1.6 i	09/98→12/00	Petrol	NFZ (TU5JP)	1587	4	78.50	82.00	35
206 1.9 D	09/98→11/01	Diesel	WJY (DW8B)	1868	4	82.20	88.00	42
206 1.9 D	09/98→05/07	Diesel	WJZ (DW8)	1868	4	82.20	88.00	42
206 2.0 HDI 90	12/99→	Diesel	RHY (DW10TD)	1997	4	85.00	88.00	66
206 2.0 RC	07/03→	Petrol	RFK (EW10J4S)	1997	4	85.00	88.00	65
206 2.0 S16	06/99→	Petrol	RFN (EW10J4)	1997	4	85.00	88.00	65
206 2.0 S16	04/99→10/00	Petrol	RFR (DEW10J4)	1997	4	85.00	88.00	65
206+ 1.1	01/09→	Petrol	HFX (TU1A)	1124	4	72.00	69.00	12
206+ 1.1	01/09→	Petrol	HFX (TU1JP)	1124	4	72.00	69.00	13
206+ 1.1	01/09→	Petrol	TU1AE5	1124	4	72.00	69.00	12
206+ 1.4 HDi eco 70	01/09→	Diesel	8HX (DV4TD)	1398	4	73.70	82.00	16
206+ 1.4 HDi eco 70	01/09→	Diesel	8HZ (DV4TD)	1398	4	73.70	82.00	16
206+ 1.4 i	09/10→	Petrol	KFT (TU3A)	1360	4	75.00	77.00	22
206+ 1.4 i	01/09→	Petrol	KFV (TU3A)	1360	4	75.00	77.00	23
206+ 1.4 i	01/09→	Petrol	KFW (TU3A)	1360	4	75.00	77.00	22
206+ 1.6 16V	07/10→	Petrol	NFU (TU5JP4)	1587	4	78.50	82.00	35
206 SW 1.1	07/02→	Petrol	HFX (TU1JP)	1124	4	72.00	69.00	13
206 SW 1.4	07/02→	Petrol	KFV (TU3A)	1360	4	75.00	77.00	23
206 SW 1.4	07/02→	Petrol	KFW (TU3JP)	1360	4	75.00	77.00	24
206 SW 1.4 16V	10/03→	Petrol	KFU (ET3J4)	1360	4	75.00	77.00	23
206 SW 1.4 Flex	01/06→07/08	Petrol	KFV (TU3A)	1360	4	75.00	77.00	23
206 SW 1.4 HDi	07/02→	Diesel	8HX (DV4TD)	1398	4	73.70	82.00	16
206 SW 1.4 LPG	07/02→	Petrol	KFW (TU3JP)	1360	4	75.00	77.00	24
206 SW 1.6	05/05→07/08	Petrol	NFU (TU5JP4)	1587	4	78.50	82.00	35
206 SW 1.6 16V	07/02→	Petrol	NFU (TU5JP4)	1587	4	78.50	82.00	35
206 SW 1.6 Flex	05/05→07/08	Petrol	NFU (TU5JP4)	1587	4	78.50	82.00	35
206 SW 1.6 HDi 110	05/04→	Diesel	9HZ (DV6TED4)	1560	4	75.00	88.30	27
206 SW 1.6 LPG	07/02→	Petrol	NFU (TU5JP4)	1587	4	78.50	82.00	35
206 SW 2.0 16V	07/02→	Petrol	RFN (EW10J4)	1997	4	85.00	88.00	65
206 SW 2.0 HDi	07/02→	Diesel	RHY (DW10TD)	1997	4	85.00	88.00	66
207 1.4	12/07→	Petrol	KFT (TU3A)	1360	4	75.00	77.00	22
207 1.4	02/06→	Petrol	KFV (TU3A)	1360	4	75.00	77.00	23
207 1.4	08/08→	Petrol	KFW (TU3A)	1360	4	75.00	77.00	22
207 1.4	01/11→	Petrol	KFW (TU3JP)	1360	4	75.00	77.00	24
207 1.4 16V	02/06→	Petrol	KFU (ET3J4)	1360	4	75.00	77.00	23
207 1.4 Bioflex	08/08→	Petrol	KFW (TU3JP)	1360	4	75.00	77.00	24
207 1.4 Flex	11/08→	Petrol	KFW (TU3A)	1360	4	75.00	77.00	22
207 1.4 HDi	02/06→	Diesel	8HR (DV4C)	1398	4	73.70	82.00	16
207 1.4 HDi	02/06→	Diesel	8HZ (DV4TD)	1398	4	73.70	82.00	16
207 1.6	08/08→	Petrol	N6A (TU5JP4)	1587	4	78.50	82.00	35
207 1.6 16V	02/06→	Petrol	NFU (TU5JP4)	1587	4	78.50	82.00	35
207 1.6 Bioflex	01/08→	Petrol	N6A (TU5JP4)	1587	4	78.50	82.00	35
207 1.6 Flex	08/08→	Petrol	N6A (TU5JP4)	1587	4	78.50	82.00	35
207 1.6 HDi	11/09→	Diesel	9HP (DV6DTEd)	1560	4	75.00	88.30	27
207 1.6 HDi	08/09→	Diesel	9HR (DV6C)	1560	4	75.00	88.30	27
207 1.6 HDi	02/06→	Diesel	9HV (DV6TED4)	1560	4	75.00	88.30	27
207 1.6 HDi	02/06→	Diesel	9HX (DV6ATED4)	1560	4	75.00	88.30	27
207 1.6 HDi	02/06→	Diesel	9HY (DV6TED4)	1560	4	75.00	88.30	27
207 1.6 HDi	02/06→	Diesel	9HZ (DV6TED4)	1560	4	75.00	88.30	27
207 1.6 HDi 110	08/09→	Diesel	9HR (DV6C)	1560	4	75.00	88.30	27
207 1.9 D	10/08→	Diesel	WJZ (DW8)	1868	4	82.20	88.00	42
207 1.9 XSD	12/07→	Diesel	WJY (DW8B)	1868	4	82.20	88.00	42
207 1.9 XSD	12/07→	Diesel	WJZ (DW8)	1868	4	82.20	88.00	42
207 2.0 HDi	12/07→	Diesel	RHY (DW10TD)	1997	4	85.00	88.00	66
207 SW 1.4	06/07→	Petrol	KFV (TU3A)	1360	4	75.00	77.00	23
207 SW 1.4 Flex	08/08→	Petrol	KFW (TU3JP)	1360	4	75.00	77.00	24
207 SW 1.6	08/08→	Petrol	N6A (TU5JP4)	1587	4	78.50	82.00	35
207 SW 1.6	08/08→	Petrol	NFU (TU5JP4)	1587	4	78.50	82.00	35
207 SW 1.6 Flex	08/08→	Petrol	N6A (TU5JP4)	1587	4	78.50	82.00	35
207 SW 1.6 HDi	11/09→	Diesel	9HP (DV6DTEd)	1560	4	75.00	88.30	27
207 SW 1.6 HDi	08/09→	Diesel	9HR (DV6C)	1560	4	75.00	88.30	27
207 SW 1.6 HDi	06/07→	Diesel	9HX (DV6ATED4)	1560	4	75.00	88.30	27
207 SW 1.6 HDi	06/07→	Diesel	9HZ (DV6TED4)	1560	4	75.00	88.30	27
207 SW 2.0 HDi	10/08→	Diesel	RHY (DW10TD)	1997	4	85.00	88.00	66
208 1.2 THP	01/13→	Petrol	HNZ (EB2DT)	1199	3	75.00	90.50	28
208 1.4 HDi	03/12→	Diesel	8HP (DV4C)	1398	4	73.70	82.00	16
208 1.4 HDi	03/12→	Diesel	8HR (DV4C)	1398	4	73.70	82.00	16
208 1.6 BlueHdi 75	04/15→	Diesel	BHW (DV6FE)	1560	4	75.00	88.30	27
208 1.6 BlueHdi 100	01/15→	Diesel	BHY (DV6FD)	1560	4	75.00	88.30	27

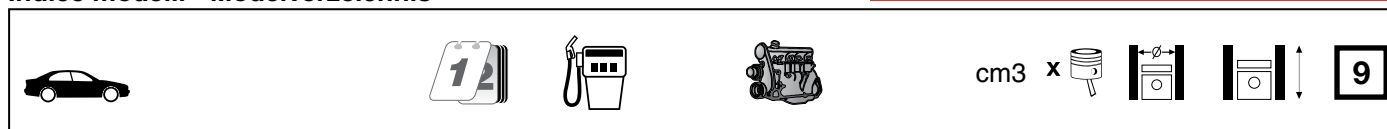

208 1.6 BlueHDi 120	11/13→	Diesel	BHZ (DV6FC)	1560	4	75.00	88.30	27
208 1.6 Flex	01/13→	Petrol	NFU (TU5JP4)	1587	4	78.50	82.00	35
208 1.6 HDi	03/12→	Diesel	9HD (DV6CTED)	1560	4	75.00	88.30	27
208 1.6 HDi	03/12→	Diesel	9HP (DV6DTED)	1560	4	75.00	88.30	27
208 1.6 HDi	04/14→	Diesel	BHX (DV6FC)	1560	4	75.00	88.30	27
208 1.6 HDi / BlueHDi 75	01/13→	Diesel	9HK (DV6ETEDM)	1560	4	75.00	88.30	27
208 1.6 HDi / BlueHDi 75	01/13→	Diesel	BHW (DV6FE)	1560	4	75.00	88.30	27
301 1.6 HDi 90	11/12→	Diesel	9HF (DV6DTED)	1560	4	75.00	88.30	27
304 1.3	08/72→09/75	Petrol	XL5S	1290	4	78.00	67.50	33
304 1.3 GL	09/72→10/79	Petrol	XL5	1290	4	78.00	67.50	33
304 1.5 Diesel	10/69→10/79	Diesel	149 (XID)	1548	4	80.00	77.00	37
304 Break 1.1	10/76→10/80	Petrol	XK5	1127	4	78.00	59.00	32
304 Break 1.3	09/70→10/80	Petrol	XL5	1290	4	78.00	67.50	33
305 I 1.3	11/77→09/82	Petrol	118 (XL5)	1290	4	78.00	67.50	33
305 I 1.3	11/77→09/82	Petrol	XL5	1290	4	78.00	67.50	33
305 I 1.5	05/80→09/82	Petrol	117 (XR5S)	1472	4	78.00	77.00	34
305 I 1.5	11/79→09/82	Petrol	142 (XR5)	1472	4	78.00	77.00	34
305 I 1.5 Diesel	11/77→09/82	Diesel	149 (XID)	1548	4	80.00	77.00	37
305 I Break 1.3	08/80→09/82	Petrol	118 (XL5)	1290	4	78.00	67.50	33
305 I Break 1.5	08/80→09/82	Petrol	142 (XR5)	1472	4	78.00	77.00	34
305 I Break 1.5 Diesel	08/80→09/82	Diesel	149 (XID)	1548	4	80.00	77.00	37
305 II 1.1	11/82→12/88	Petrol	XK5	1127	4	78.00	59.00	32
305 II 1.3	10/82→08/85	Petrol	118 (XL5)	1290	4	78.00	67.50	33
305 II 1.5	10/82→08/85	Petrol	142 (XR5)	1472	4	78.00	77.00	34
305 II 1.5	09/85→07/90	Petrol	142 (XR5A)	1472	4	78.00	77.00	34
305 II 1.6	10/82→06/88	Petrol	171 (XU5S)	1580	4	83.00	73.00	44
305 II 1.6	10/82→12/88	Petrol	B1A (XU51C)	1580	4	83.00	73.00	44
305 II 1.6	11/86→12/88	Petrol	BAZ (XU5CP)	1580	4	83.00	73.00	44
305 II 1.8 D	11/82→12/88	Diesel	161A (XUD7)	1769	4	80.00	88.00	39
305 II 1.9	10/82→08/85	Petrol	159 (XU9S)	1905	4	83.00	88.00	49
305 II 1.9	11/86→12/88	Petrol	DFZ (XU9J1)	1905	4	83.00	88.00	52
305 II 1.9 D	10/82→07/88	Diesel	162 (XUD9)	1905	4	83.00	88.00	53
305 II 1.9 D	10/82→07/88	Diesel	D9A (XUD9)	1905	4	83.00	88.00	53
305 II Break 1.3	10/82→08/86	Petrol	118 (XL5)	1290	4	78.00	67.50	33
305 II Break 1.5	10/82→08/86	Petrol	142 (XR5)	1472	4	78.00	77.00	34
305 II Break 1.5	09/85→10/86	Petrol	142 (XR5A)	1472	4	78.00	77.00	34
305 II Break 1.6	09/83→12/87	Petrol	171 (XU5S)	1580	4	83.00	73.00	44
305 II Break 1.6	11/82→12/88	Petrol	B1A (XU51C)	1580	4	83.00	73.00	44
305 II Break 1.6	11/86→12/88	Petrol	BAZ (XU5CP)	1580	4	83.00	73.00	44
305 II Break 1.8 D	11/82→12/88	Diesel	161A (XUD7)	1769	4	80.00	88.00	39
305 II Break 1.9	09/84→10/87	Petrol	159 (XU9S)	1905	4	83.00	88.00	49
305 II Break 1.9	11/86→12/88	Petrol	DFZ (XU9J1)	1905	4	83.00	88.00	52
305 II Break 1.9 Diesel	10/82→12/88	Diesel	162 (XUD9)	1905	4	83.00	88.00	53
305 II Break 1.9 Diesel	10/82→12/88	Diesel	D9A (XUD9)	1905	4	83.00	88.00	53
306 1.1	05/93→05/01	Petrol	HDZ (TU1M)	1124	4	72.00	69.00	12
306 1.4	03/96→07/01	Petrol	KFW (TU3A)	1360	4	75.00	77.00	22
306 1.4	05/93→05/01	Petrol	KFW (TU3JP)	1360	4	75.00	77.00	24
306 1.4	05/93→05/01	Petrol	KDX (TU3MC)	1361	4	75.00	77.00	22
306 1.4	05/93→05/01	Petrol	KFX (TU3JP)	1361	4	75.00	77.00	24
306 1.4 SL	06/94→05/01	Petrol	KFW (TU3JP)	1360	4	75.00	77.00	24
306 1.4 SL	06/94→05/01	Petrol	KDX (TU3MC)	1361	4	75.00	77.00	22
306 1.4 SL	06/94→05/01	Petrol	KFX (TU3JP)	1361	4	75.00	77.00	24
306 1.6	05/93→05/01	Petrol	NFZ (TU5JP)	1587	4	78.50	82.00	35
306 1.6 SR	06/94→10/00	Petrol	NFZ (TU5JP)	1587	4	78.50	82.00	35
306 1.8	05/93→04/02	Petrol	LFZ (XU7JP)	1762	4	83.00	81.40	48
306 1.8 16V	03/97→10/03	Petrol	LFY (XU7JP4)	1761	4	83.00	81.40	48
306 1.8 D	04/93→05/01	Diesel	A9A (XUD7)	1769	4	80.00	88.00	41
306 1.8 ST	06/94→05/01	Petrol	LFZ (XU7JP)	1762	4	83.00	81.40	48
306 1.9 D	09/98→08/02	Diesel	WJY (DW8B)	1868	4	82.20	88.00	42
306 1.9 D	09/98→08/02	Diesel	WJZ (DW8)	1868	4	82.20	88.00	42
306 1.9 D	03/98→05/01	Diesel	DHV (XUD9BSD)	1905	4	83.00	88.00	54
306 1.9 D	04/93→04/97	Diesel	DHY (XUD9TE)	1905	4	83.00	88.00	54
306 1.9 D	06/94→05/01	Diesel	DJY (XUD9A)	1905	4	83.00	88.00	56
306 1.9 D	05/93→05/01	Diesel	DJZ (XUD9Y)	1905	4	83.00	88.00	56
306 1.9 D	04/93→05/99	Diesel	XUD9	1905	4	83.00	88.00	56
306 1.9 D	04/93→04/99	Diesel	XUD9TE	1905	4	83.00	88.00	54
306 1.9 DT	05/93→05/01	Diesel	DHY (XUD9TE)	1905	4	83.00	88.00	54
306 1.9 SLD	06/94→05/01	Diesel	DJY (XUD9A)	1905	4	83.00	88.00	56
306 1.9 SLD	06/94→05/01	Diesel	DJZ (XUD9Y)	1905	4	83.00	88.00	56



cm3



9

306 1.9 SRDT	06/94→05/01	Diesel	DHY (XUD9TE)	1905	4	83.00	88.00	54
306 1.9 STD	02/94→10/95	Diesel	XUD9	1905	4	83.00	88.00	56
306 2.0	03/97→05/01	Petrol	RFV (XU10J4R)	1998	4	86.00	86.00	71
306 2.0	03/94→04/02	Petrol	RFX (XU10J2)	1998	4	86.00	86.00	70
306 2.0 16V	03/97→04/02	Petrol	RFV (XU10J4R)	1998	4	86.00	86.00	71
306 2.0 HDi	08/98→06/00	Diesel	RHY (DW10TD)	1997	4	85.00	88.00	66
306 2.0 HDI 90	06/99→05/01	Diesel	RHY (DW10TD)	1997	4	85.00	88.00	66
306 2.0 S16	03/96→05/01	Petrol	RFS (XU10J4RS)	1998	4	86.00	86.00	71
306 2.0 S16	06/94→05/01	Petrol	RFT (XU10J4)	1998	4	86.00	86.00	71
306 2.0 S16	05/93→05/01	Petrol	RFY (XU10J4Z)	1998	4	86.00	86.00	70
306 2.0 ST	07/94→05/01	Petrol	RFX (XU10J2)	1998	4	86.00	86.00	70
306 2.0 XSi	05/93→05/01	Petrol	RFX (XU10J2)	1998	4	86.00	86.00	70
306 Break 1.4	03/97→04/02	Petrol	KFW (TU3JP)	1360	4	75.00	77.00	24
306 Break 1.4	03/97→04/02	Petrol	KFX (TU3JP)	1361	4	75.00	77.00	24
306 Break 1.6	03/97→10/00	Petrol	NFZ (TU5JP)	1587	4	78.50	82.00	35
306 Break 1.8	03/97→04/02	Petrol	LFZ (XU7JP)	1762	4	83.00	81.40	48
306 Break 1.8 16V	03/97→04/02	Petrol	LFY (XU7JP4)	1761	4	83.00	81.40	48
306 Break 1.8 D	05/97→06/00	Diesel	161 (XUD7)	1769	4	80.00	88.00	38
306 Break 1.9 D	09/98→04/02	Diesel	WJY (DW8B)	1868	4	82.20	88.00	42
306 Break 1.9 D	09/98→04/02	Diesel	WJZ (DW8)	1868	4	82.20	88.00	42
306 Break 1.9 D	03/98→04/02	Diesel	DHV (XUD9BSD)	1905	4	83.00	88.00	54
306 Break 1.9 D	03/97→04/02	Diesel	DJY (XUD9A)	1905	4	83.00	88.00	56
306 Break 1.9 TD	02/97→04/02	Diesel	DHY (XUD9TE)	1905	4	83.00	88.00	54
306 Break 2.0	03/97→04/02	Petrol	RFV (XU10J4R)	1998	4	86.00	86.00	71
306 Break 2.0 HDI 90	06/99→04/02	Diesel	RHY (DW10TD)	1997	4	85.00	88.00	66
307 1.4	08/00→	Petrol	KFW (TU3JP)	1360	4	75.00	77.00	24
307 1.4 16V	11/03→	Petrol	KFU (ET3J4)	1360	4	75.00	77.00	23
307 1.4 HDi	10/01→	Diesel	8HX (DV4TD)	1398	4	73.70	82.00	16
307 1.4 HDi	10/01→	Diesel	8HZ (DV4TD)	1398	4	73.70	82.00	16
307 1.6	07/06→	Petrol	NFU (TU5JP4)	1587	4	78.50	82.00	35
307 1.6 16V	08/00→	Petrol	NFU (TU5JP4)	1587	4	78.50	82.00	35
307 1.6 BioFlex	09/07→	Petrol	NFU (TU5JP4)	1587	4	78.50	82.00	35
307 1.6 Flex	07/06→	Petrol	N6A (TU5JP4)	1587	4	78.50	82.00	35
307 1.6 Flex	08/06→	Petrol	NFU (TU5JP4)	1587	4	78.50	82.00	35
307 1.6 HDi	04/05→	Diesel	9HV (DV6ATED4)	1560	4	75.00	88.30	27
307 1.6 HDi	04/05→	Diesel	9HV (DV6TED4)	1560	4	75.00	88.30	27
307 1.6 HDi	04/05→	Diesel	9HX (DV6ATED4)	1560	4	75.00	88.30	27
307 1.6 HDi 110	02/04→	Diesel	9HY (DV6TED4)	1560	4	75.00	88.30	27
307 1.6 HDi 110	02/04→	Diesel	9HZ (DV6TED4)	1560	4	75.00	88.30	27
307 2.0	08/08→	Petrol	RFN (EW10J4)	1997	4	85.00	88.00	65
307 2.0 16V	03/05→	Petrol	RFJ (EW10A)	1997	4	85.00	88.00	65
307 2.0 16V	10/03→	Petrol	RFK (EW10J4S)	1997	4	85.00	88.00	65
307 2.0 16V	08/00→	Petrol	RFN (EW10J4)	1997	4	85.00	88.00	65
307 2.0 Flex	01/05→	Petrol	RFJ (EW10A)	1997	4	85.00	88.00	65
307 2.0 Flex	08/08→	Petrol	RFN (EW10J4)	1997	4	85.00	88.00	65
307 2.0 HDi	03/04→	Diesel	RHY (DW10TD)	1997	4	85.00	88.00	66
307 2.0 HDi	08/08→	Diesel	RHZ (DW10ATED)	1997	4	85.00	88.00	67
307 2.0 HDi 90	08/00→	Diesel	RHY (DW10TD)	1997	4	85.00	88.00	66
307 2.0 HDi 110	08/00→	Diesel	RHS (DW10ATED)	1997	4	85.00	88.00	66
307 2.0 HDi 135	10/03→	Diesel	RHR (DW10BTED4)	1997	4	85.00	88.00	67
307 Break 1.4	04/02→09/03	Petrol	KFW (TU3JP)	1360	4	75.00	77.00	24
307 Break 1.4 16V	11/03→	Petrol	KFU (ET3J4)	1360	4	75.00	77.00	23
307 Break 1.4 HDi	03/02→	Diesel	8HZ (DV4TD)	1398	4	73.70	82.00	16
307 Break 1.6 16V	03/02→	Petrol	NFU (TU5JP4)	1587	4	78.50	82.00	35
307 Break 1.6 BioFlex	09/07→	Petrol	NFU (TU5JP4)	1587	4	78.50	82.00	35
307 Break 1.6 HDi	04/05→	Diesel	9HV (DV6ATED4)	1560	4	75.00	88.30	27
307 Break 1.6 HDi 110	02/04→	Diesel	9HY (DV6TED4)	1560	4	75.00	88.30	27
307 Break 1.6 HDi 110	02/04→	Diesel	9HZ (DV6TED4)	1560	4	75.00	88.30	27
307 Break 2.0	03/02→	Petrol	RFN (EW10J4)	1997	4	85.00	88.00	65
307 Break 2.0 16V	03/05→	Petrol	RFJ (EW10A)	1997	4	85.00	88.00	65
307 Break 2.0 16V	06/05→	Petrol	RFK (EW10J4S)	1997	4	85.00	88.00	65
307 Break 2.0 HDi 90	03/02→	Diesel	RHY (DW10TD)	1997	4	85.00	88.00	66
307 Break 2.0 HDi 110	03/02→	Diesel	RHS (DW10ATED)	1997	4	85.00	88.00	66
307 Break 2.0 HDi 135	02/04→	Diesel	RHR (DW10BTED4)	1997	4	85.00	88.00	67
307 SW 1.4	04/02→09/03	Petrol	KFW (TU3JP)	1360	4	75.00	77.00	24
307 SW 1.4 16V	11/03→	Petrol	KFU (ET3J4)	1360	4	75.00	77.00	23
307 SW 1.4 HDi	04/02→06/05	Diesel	8HZ (DV4TD)	1398	4	73.70	82.00	16
307 SW 1.4 HDi 70	03/02→01/05	Diesel	8HZ (DV4TD)	1398	4	73.70	82.00	16
307 SW 1.6 16V	03/02→	Petrol	NFU (TU5JP4)	1587	4	78.50	82.00	35

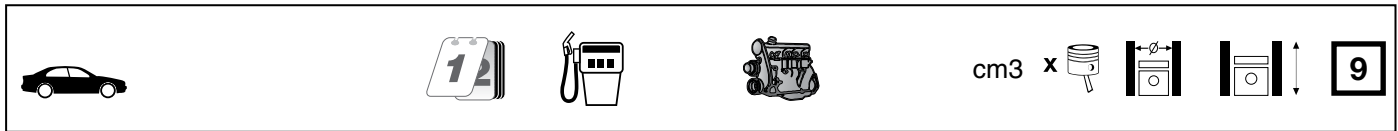

307 SW 1.6 BioFlex	09/07→	Petrol	NFU (TU5JP4)	1587	4	78.50	82.00	35
307 SW 1.6 HDI 90	12/06→	Diesel	9HV (DV6ATED4)	1560	4	75.00	88.30	27
307 SW 1.6 HDI 90	12/06→	Diesel	9HX (DV6ATED4)	1560	4	75.00	88.30	27
307 SW 1.6 HDI 110	02/04→	Diesel	9HY (DV6TED4)	1560	4	75.00	88.30	27
307 SW 1.6 HDI 110	02/04→	Diesel	9HZ (DV6TED4)	1560	4	75.00	88.30	27
307 SW 2.0 16V	03/05→	Petrol	RFJ (EW10A)	1997	4	85.00	88.00	65
307 SW 2.0 16V	03/02→	Petrol	RFN (EW10J4)	1997	4	85.00	88.00	65
307 SW 2.0 Flex	07/04→04/08	Petrol	RFJ (EW10A)	1997	4	85.00	88.00	65
307 SW 2.0 HDI 90	03/02→	Diesel	RHY (DW10TD)	1997	4	85.00	88.00	66
307 SW 2.0 HDI 110	03/02→	Diesel	RHS (DW10ATED)	1997	4	85.00	88.00	66
307 SW 2.0 HDi 135	02/04→	Diesel	RHR (DW10BTED4)	1997	4	85.00	88.00	67
308 1.2 THP 110	03/14→	Petrol	HNZ (EB2DT)	1199	3	75.00	90.50	28
308 1.2 THP 130	03/14→	Petrol	HNY (EB2DTS)	1199	3	75.00	90.50	28
308 1.6 BioFlex	04/08→	Petrol	NFU (TU5JP4)	1587	4	78.50	82.00	35
308 1.6 BlueHDI 100	04/14→	Diesel	BHY (DV6FD)	1560	4	75.00	88.30	27
308 1.6 BlueHDI 120	03/14→	Diesel	BHZ (DV6FC)	1560	4	75.00	88.30	27
308 1.6 HDi	11/09→	Diesel	9HP (DV6DTED)	1560	4	75.00	88.30	27
308 1.6 HDi	06/09→	Diesel	9HR (DV6C)	1560	4	75.00	88.30	27
308 1.6 HDi	09/07→	Diesel	9HZ (DV6TED4)	1560	4	75.00	88.30	27
308 1.6 HDi / BlueHDI 115	03/14→	Diesel	BHZ (DV6FC)	1560	4	75.00	88.30	27
308 2.0	12/11→	Petrol	RFJ (EW10A)	1997	4	85.00	88.00	65
308 2.0 Bioflex	01/08→	Petrol	RFJ (EW10A)	1997	4	85.00	88.00	65
308 2.0 CVVT	07/09→11/14	Petrol	RFJ (EW10A)	1997	4	85.00	88.00	65
308 2.0 HDi	10/11→	Diesel	RHE (DW10CTED4)	1997	4	85.00	88.00	66
308 2.0 HDi	04/09→	Diesel	RHF (DW10BTED4)	1997	4	85.00	88.00	66
308 2.0 HDi	06/09→	Diesel	RHH (DW10CTED4)	1997	4	85.00	88.00	66
308 2.0 HDi	09/07→	Diesel	RHR (DW10BTED4)	1997	4	85.00	88.00	67
308 II 1.2 THP 110	11/13→	Petrol	HNZ (EB2DT)	1199	3	75.00	90.50	28
308 II 1.2 THP 130	11/13→	Petrol	HNY (EB2DTS)	1199	3	75.00	90.50	28
308 II 1.6 BlueHDI 120	11/13→	Diesel	BHZ (DV6FC)	1560	4	75.00	88.30	27
308 II 1.6 HDi 100	04/14→	Diesel	BHY (DV6FD)	1560	4	75.00	88.30	27
308 II 1.6 HDi / BlueHDI 115	09/13→	Diesel	BHZ (DV6FC)	1560	4	75.00	88.30	27
308 SW 1.6 Bioflex	03/09→	Petrol	NFU (TU5JP4)	1587	4	78.50	82.00	35
308 SW 1.6 HDi	11/09→	Diesel	9HP (DV6DTED)	1560	4	75.00	88.30	27
308 SW 1.6 HDi	12/09→	Diesel	9HR (DV6C)	1560	4	75.00	88.30	27
308 SW 1.6 HDi	09/07→	Diesel	9HV (DV6ATED4)	1560	4	75.00	88.30	27
308 SW 1.6 HDi	09/07→	Diesel	9HX (DV6ATED4)	1560	4	75.00	88.30	27
308 SW 1.6 HDi	09/07→	Diesel	9HZ (DV6TED4)	1560	4	75.00	88.30	27
308 SW 2.0 Bioflex	01/08→	Petrol	RFJ (EW10A)	1997	4	85.00	88.00	65
308 SW 2.0 HDi	04/11→	Diesel	RHE (DW10CTED4)	1997	4	85.00	88.00	66
308 SW 2.0 HDi	06/09→	Diesel	RHH (DW10CTED4)	1997	4	85.00	88.00	66
308 SW 2.0 HDi	09/07→	Diesel	RHR (DW10BTED4)	1997	4	85.00	88.00	67
309 I 1.1	10/85→07/89	Petrol	E1	1118	4	74.00	65.00	17
309 I 1.3	10/85→07/89	Petrol	G1A	1294	4	76.70	70.00	29
309 I 1.4	03/89→07/89	Petrol	K2B (TU3S)	1360	4	75.00	77.00	22
309 I 1.4	03/89→07/89	Petrol	K1D (TU3A)	1361	4	75.00	77.00	22
309 I 1.4	03/89→07/89	Petrol	KDY (TU3M)	1361	4	75.00	77.00	22
309 I 1.4	03/89→07/89	Petrol	KDZ (TU3M)	1361	4	75.00	77.00	22
309 I 1.6	11/85→09/88	Petrol	180Z (XU5J)	1580	4	83.00	73.00	45
309 I 1.6	10/85→07/89	Petrol	B1A (XU51C)	1580	4	83.00	73.00	44
309 I 1.6	10/85→07/89	Petrol	B1D (XU51C)	1580	4	83.00	73.00	44
309 I 1.6	08/87→07/89	Petrol	B1E (XU51C)	1580	4	83.00	73.00	44
309 I 1.6	11/85→09/88	Petrol	B6B (XU5J)	1580	4	83.00	73.00	45
309 I 1.6 CAT	09/86→12/89	Petrol	BAZ (XU5CP)	1580	4	83.00	73.00	44
309 I 1.9	10/85→07/89	Petrol	D2B (XU9S)	1905	4	83.00	88.00	49
309 I 1.9	07/88→07/89	Petrol	DDZ (XU9M)	1905	4	83.00	88.00	50
309 I 1.9	03/86→07/89	Petrol	DFZ (XU9J1)	1905	4	83.00	88.00	52
309 I 1.9 D	06/86→07/89	Diesel	162 (XUD9)	1905	4	83.00	88.00	53
309 I 1.9 D	06/86→07/89	Diesel	D9A (XUD9)	1905	4	83.00	88.00	53
309 I 1.9 GTI	10/86→07/89	Petrol	D6B (XU9JA)	1905	4	83.00	88.00	52
309 I 1.9 GTI	07/88→07/89	Petrol	DKZ (XU9JAZ)	1905	4	83.00	88.00	51
309 II 1.1	09/89→10/93	Petrol	H1B (TU1)	1124	4	72.00	69.00	12
309 II 1.1	08/90→12/93	Petrol	HDZ (TU1M)	1124	4	72.00	69.00	12
309 II 1.4	07/90→12/93	Petrol	K1D (TU3A)	1361	4	75.00	77.00	22
309 II 1.4	07/89→12/93	Petrol	KDY (TU3M)	1361	4	75.00	77.00	22
309 II 1.4	07/89→12/93	Petrol	KDZ (TU3M)	1361	4	75.00	77.00	22
309 II 1.6	07/89→12/93	Petrol	B2A (XU52C/K)	1580	4	83.00	73.00	44
309 II 1.6	07/89→12/93	Petrol	BDY (XU5M2Z)	1580	4	83.00	73.00	46
309 II 1.6	07/89→12/93	Petrol	BDY (XU5M3Z)	1580	4	83.00	73.00	46



cm3



9

309 II 1.6	07/89→12/93	Petrol	BDZ (XU5M)	1580	4	83.00	73.00	46
309 II 1.8 Diesel	07/89→12/93	Diesel	161A (XUD7)	1769	4	80.00	88.00	39
309 II 1.8 TD	08/89→12/93	Diesel	A8B (XUD7TE)	1769	4	80.00	88.00	40
309 II 1.9	10/90→12/93	Petrol	DDZ (XU9M)	1905	4	83.00	88.00	50
309 II 1.9	08/89→12/93	Petrol	DFZ (XU9J1)	1905	4	83.00	88.00	52
309 II 1.9 Diesel	07/89→12/93	Diesel	162 (XUD9)	1905	4	83.00	88.00	53
309 II 1.9 Diesel	07/89→12/93	Diesel	D9A (XUD9)	1905	4	83.00	88.00	53
309 II 1.9 Diesel	07/89→12/93	Diesel	DJZ (XUD9Y)	1905	4	83.00	88.00	56
309 II 1.9 GTI	09/89→10/93	Petrol	D6B (XU9JA)	1905	4	83.00	88.00	52
309 II 1.9 GTI	07/89→12/93	Petrol	DKZ (XU9JAZ)	1905	4	83.00	88.00	51
309 II 1.9 GTI 16V	08/89→07/90	Petrol	D6C (XU9J4)	1905	4	83.00	88.00	51
309 II 1.9 GTI 16V	10/90→12/93	Petrol	DFW (XU9J4Z)	1905	4	83.00	88.00	51
404 1.6	04/63→12/71	Petrol	XC6	1618	4	84.00	73.00	57
404 1.6 GT	07/71→12/71	Petrol	XC6	1618	4	84.00	73.00	57
405 I 1.4	01/87→07/92	Petrol	K5A (TU3)	1360	4	75.00	77.00	22
405 I 1.6	07/87→12/92	Petrol	B1E (XU51C)	1580	4	83.00	73.00	44
405 I 1.6	01/87→12/92	Petrol	B2A (XU52C/K)	1580	4	83.00	73.00	44
405 I 1.6	07/87→06/88	Petrol	BAZ (XU5CP)	1580	4	83.00	73.00	44
405 I 1.6	07/87→12/92	Petrol	BDY (XU5M2Z)	1580	4	83.00	73.00	46
405 I 1.6	07/87→12/92	Petrol	BDZ (XU5M)	1580	4	83.00	73.00	46
405 I 1.6 4x4	04/88→07/92	Petrol	BDZ (XU5M)	1580	4	83.00	73.00	46
405 I 1.8 D 4x4	10/87→07/92	Diesel	A8A (XUD7TE)	1769	4	80.00	88.00	40
405 I 1.8 Turbo Diesel	03/88→12/92	Diesel	A8A (XUD7TE)	1769	4	80.00	88.00	40
405 I 1.8 Turbo Diesel	03/88→12/92	Diesel	AJZ (XUD7TEY)	1769	4	80.00	88.00	40
405 I 1.9	07/87→12/92	Petrol	D2C (XU92C)	1905	4	83.00	88.00	50
405 I 1.9	07/87→12/93	Petrol	D6A (XU9J2)	1905	4	83.00	88.00	51
405 I 1.9	07/88→12/92	Petrol	DDZ (XU9M)	1905	4	83.00	88.00	50
405 I 1.9	07/88→12/92	Petrol	DKZ (XU9JAZ)	1905	4	83.00	88.00	51
405 I 1.9 4x4	06/87→07/92	Petrol	D6C (XU9J4)	1905	4	83.00	88.00	51
405 I 1.9 4x4	07/88→12/92	Petrol	DDZ (XU9M)	1905	4	83.00	88.00	50
405 I 1.9 4x4	06/87→07/92	Petrol	DKZ (XU9JAZ)	1905	4	83.00	88.00	51
405 I 1.9 Diesel	03/88→12/92	Diesel	D9B (XUD9A)	1905	4	83.00	88.00	56
405 I 1.9 Diesel	07/88→09/92	Diesel	DJZ (XUD9Y)	1905	4	83.00	88.00	56
405 I 1.9 Injection	07/87→12/92	Petrol	DFZ (XU9J1)	1905	4	83.00	88.00	52
405 I 1.9 MI-16	07/87→11/91	Petrol	D6C (XU9J4)	1905	4	83.00	88.00	51
405 I 1.9 MI-16	04/88→12/92	Petrol	DFW (XU9J4Z)	1905	4	83.00	88.00	51
405 I 1.9 MI-16 4x4	04/88→12/92	Petrol	DFW (XU9J4Z)	1905	4	83.00	88.00	51
405 I Break 1.4	05/88→07/92	Petrol	K5A (TU3)	1360	4	75.00	77.00	22
405 I Break 1.6	10/88→08/92	Petrol	B1E (XU51C)	1580	4	83.00	73.00	44
405 I Break 1.6	05/88→07/92	Petrol	B2A (XU52C/K)	1580	4	83.00	73.00	44
405 I Break 1.6	10/88→08/92	Petrol	BAZ (XU5CP)	1580	4	83.00	73.00	44
405 I Break 1.6	10/88→08/92	Petrol	BDY (XU5M2Z)	1580	4	83.00	73.00	46
405 I Break 1.6	10/88→08/92	Petrol	BDY (XU5M3Z)	1580	4	83.00	73.00	46
405 I Break 1.6	10/88→08/92	Petrol	BDZ (XU5M)	1580	4	83.00	73.00	46
405 I Break 1.6 SRi 4x4	04/88→07/92	Petrol	BDZ (XU5M)	1580	4	83.00	73.00	46
405 I Break 1.8 DT 4x4	05/90→07/92	Diesel	A8A (XUD7TE)	1769	4	80.00	88.00	40
405 I Break 1.8 TD	10/88→08/92	Diesel	A8A (XUD7TE)	1769	4	80.00	88.00	40
405 I Break 1.8 TD	10/88→08/92	Diesel	AJZ (XUD7TEY)	1769	4	80.00	88.00	40
405 I Break 1.9	10/88→08/92	Petrol	D2C (XU92C)	1905	4	83.00	88.00	50
405 I Break 1.9	06/87→07/92	Petrol	D6C (XU9J4)	1905	4	83.00	88.00	51
405 I Break 1.9	10/88→08/92	Petrol	DDZ (XU9M)	1905	4	83.00	88.00	50
405 I Break 1.9	05/88→08/92	Petrol	DFZ (XU9J1)	1905	4	83.00	88.00	52
405 I Break 1.9	10/88→08/92	Petrol	DKZ (XU9JAZ)	1905	4	83.00	88.00	51
405 I Break 1.9 4x4	10/88→08/92	Petrol	DDZ (XU9M)	1905	4	83.00	88.00	50
405 I Break 1.9 4x4	07/90→07/92	Petrol	DKZ (XU9JAZ)	1905	4	83.00	88.00	51
405 I Break 1.9 All-wheel Drive	06/87→07/92	Petrol	D6C (XU9J4)	1905	4	83.00	88.00	51
405 I Break 1.9 All-wheel Drive	09/88→07/92	Petrol	DFZ (XU9J1)	1905	4	83.00	88.00	52
405 I Break 1.9 D	10/88→08/92	Diesel	D9B (XUD9A)	1905	4	83.00	88.00	56
405 I Break 1.9 D	10/88→08/92	Diesel	DJY (XUD9A)	1905	4	83.00	88.00	56
405 I Break 1.9 D	10/88→08/92	Diesel	DJZ (XUD9Y)	1905	4	83.00	88.00	56
405 II 1.4	08/92→10/95	Petrol	KDX (TU3MC)	1361	4	75.00	77.00	22
405 II 1.6	08/92→05/97	Petrol	B2A (XU52C/K)	1580	4	83.00	73.00	44
405 II 1.6	08/92→10/95	Petrol	BDY (XU5M2Z)	1580	4	83.00	73.00	46
405 II 1.6	08/92→10/95	Petrol	BDY (XU5M3Z)	1580	4	83.00	73.00	46
405 II 1.6	08/92→10/95	Petrol	BDZ (XU5M)	1580	4	83.00	73.00	46
405 II 1.6	08/92→05/97	Petrol	BFZ (XU5JP)	1580	4	83.00	73.00	47
405 II 1.6	08/92→05/97	Petrol	NFU (TU5JP4)	1587	4	78.50	82.00	35
405 II 1.8	08/92→11/99	Petrol	LFZ (XU7JP)	1762	4	83.00	81.40	48
405 II 1.9 D	08/97→11/99	Diesel	D9B (XUD9A)	1905	4	83.00	88.00	56

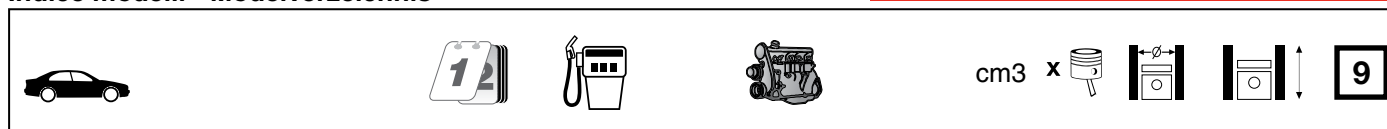

405 II 1.9 D	08/92→10/95	Diesel	DJY (XUD9A)	1905	4	83.00	88.00	56
405 II 1.9 D	08/92→10/95	Diesel	DJZ (XUD9Y)	1905	4	83.00	88.00	56
405 II 1.9 TD	08/92→10/95	Diesel	DHY (XUD9TE)	1905	4	83.00	88.00	54
405 II 1.9 TD	08/92→05/97	Diesel	XUD9TE	1905	4	83.00	88.00	54
405 II 2.0	08/92→10/95	Petrol	RFX (XU10J2)	1998	4	86.00	86.00	70
405 II 2.0 16V	06/94→10/95	Petrol	RFT (XU10J4)	1998	4	86.00	86.00	71
405 II 2.0 X4	08/92→10/95	Petrol	RFX (XU10J2)	1998	4	86.00	86.00	70
405 II 2.0 MI-16	08/92→10/95	Petrol	RFY (XU10J4Z)	1998	4	86.00	86.00	70
405 II 2.0 T 16 X4	08/92→10/95	Petrol	RGZ (XU10J4TE/Z)	1998	4	86.00	86.00	73
405 II Break 1.4	08/92→10/96	Petrol	KDX (TU3MC)	1361	4	75.00	77.00	22
405 II Break 1.6	08/92→10/96	Petrol	BDY (XU5M2Z)	1580	4	83.00	73.00	46
405 II Break 1.6	08/92→10/96	Petrol	BDY (XU5M3Z)	1580	4	83.00	73.00	46
405 II Break 1.6	08/92→10/96	Petrol	BDZ (XU5M)	1580	4	83.00	73.00	46
405 II Break 1.6	08/92→10/96	Petrol	BFZ (XU5JP)	1580	4	83.00	73.00	47
405 II Break 1.6	08/92→10/96	Petrol	NFU (TU5JP4)	1587	4	78.50	82.00	35
405 II Break 1.8	08/92→10/96	Petrol	LFZ (XU7JP)	1762	4	83.00	81.40	48
405 II Break 1.9 D	06/94→10/96	Diesel	DJY (XUD9A)	1905	4	83.00	88.00	56
405 II Break 1.9 D	08/92→10/96	Diesel	DJZ (XUD9Y)	1905	4	83.00	88.00	56
405 II Break 1.9 D	09/93→12/95	Diesel	XUD9	1905	4	83.00	88.00	56
405 II Break 1.9 TD	08/92→10/96	Diesel	DHY (XUD9TE)	1905	4	83.00	88.00	54
405 II Break 2.0	08/92→10/96	Petrol	RFX (XU10J2)	1998	4	86.00	86.00	70
405 II Break 2.0 4x4	08/92→10/96	Petrol	RFX (XU10J2)	1998	4	86.00	86.00	70
405 II Break 2.0 4x4	08/92→12/95	Petrol	RGZ (XU10J4TE/Z)	1998	4	86.00	86.00	73
406 1.6	11/95→05/04	Petrol	BFZ (XU5JP)	1580	4	83.00	73.00	47
406 1.8	05/97→05/04	Petrol	LFX (XU7JB)	1761	4	83.00	81.40	48
406 1.8	10/96→03/99	Petrol	LFZ (XU7JP)	1762	4	83.00	81.40	48
406 1.8 16V	10/00→05/04	Petrol	6FZ (EW7J4)	1749	4	82.70	81.40	43
406 1.8 16V	11/95→10/00	Petrol	LFY (XU7JP4)	1761	4	83.00	81.40	48
406 1.8 Bifuel	04/99→05/03	Petrol	LFY (XU7JP4)	1761	4	83.00	81.40	48
406 1.9 D	10/96→05/04	Diesel	DHW (XUD9SD)	1905	4	83.00	88.00	54
406 1.9 SL	09/97→03/99	Diesel	XUD9	1905	4	83.00	88.00	56
406 1.9 TD	10/95→10/97	Diesel	D8B (XUD9TE)	1905	4	83.00	88.00	54
406 1.9 TD	01/96→05/04	Diesel	DHX (XUD9TE)	1905	4	83.00	88.00	54
406 1.9 TD	01/96→05/04	Diesel	DHY (XUD9TE)	1905	4	83.00	88.00	54
406 2.0	11/96→03/99	Petrol	RGY (XU10J2TE)	1998	4	86.00	86.00	72
406 2.0 16V	08/00→12/04	Petrol	RFN (EW10J4)	1997	4	85.00	88.00	65
406 2.0 16V	01/99→10/00	Petrol	RFR (DEW10J4)	1997	4	85.00	88.00	65
406 2.0 16V	11/95→12/04	Petrol	RFV (XU10J4R)	1998	4	86.00	86.00	71
406 2.0 16V HPI	05/01→05/04	Petrol	RLZ (EW10D)	1997	4	85.00	88.00	65
406 2.0 HDI 90	02/99→05/04	Diesel	RHY (DW10TD)	1997	4	85.00	88.00	66
406 2.0 HDI 110	08/01→05/04	Diesel	RHS (DW10ATED)	1997	4	85.00	88.00	66
406 2.0 HDI 110	06/98→05/04	Diesel	RHZ (DW10ATED)	1997	4	85.00	88.00	67
406 2.0 Turbo	04/96→05/04	Petrol	RGX (XU10J2TE)	1998	4	86.00	86.00	72
406 2.1 TD 12V	01/96→05/04	Diesel	P8C (XUD11BTE)	2088	4	85.00	92.00	68
406 2.2 HDi	03/00→12/04	Diesel	4HX (DW12TED4/FAP)	2179	4	85.00	96.00	69
406 Break 1.8	05/97→10/04	Petrol	LFX (XU7JB)	1761	4	83.00	81.40	48
406 Break 1.8	10/96→03/99	Petrol	LFZ (XU7JP)	1762	4	83.00	81.40	48
406 Break 1.8 16V	10/00→10/04	Petrol	6FZ (EW7J4)	1749	4	82.70	81.40	43
406 Break 1.8 16V	10/96→10/00	Petrol	LFY (XU7JP4)	1761	4	83.00	81.40	48
406 Break 1.9 D	10/96→10/04	Diesel	DHW (XUD9SD)	1905	4	83.00	88.00	54
406 Break 1.9 TD	10/96→10/04	Diesel	DHX (XUD9TE)	1905	4	83.00	88.00	54
406 Break 2.0	11/96→03/99	Petrol	RGY (XU10J2TE)	1998	4	86.00	86.00	72
406 Break 2.0 16V	10/00→10/04	Petrol	RFN (EW10J4)	1997	4	85.00	88.00	65
406 Break 2.0 16V	01/99→10/00	Petrol	RFR (DEW10J4)	1997	4	85.00	88.00	65
406 Break 2.0 16V	10/96→10/04	Petrol	RFV (XU10J4R)	1998	4	86.00	86.00	71
406 Break 2.0 16V HPI	05/01→10/04	Petrol	RLZ (EW10D)	1997	4	85.00	88.00	65
406 Break 2.0 HDI 90	02/99→10/04	Diesel	RHY (DW10TD)	1997	4	85.00	88.00	66
406 Break 2.0 HDi 110	08/01→10/04	Diesel	RHS (DW10ATED)	1997	4	85.00	88.00	66
406 Break 2.0 HDi 110	02/99→10/04	Diesel	RHZ (DW10ATED)	1997	4	85.00	88.00	67
406 Break 2.0 Turbo	10/96→10/04	Petrol	RGX (XU10J2TE)	1998	4	86.00	86.00	72
406 Break 2.1 TD 12V	10/96→10/04	Diesel	P8C (XUD11BTE)	2088	4	85.00	92.00	68
406 Break 2.2 HDi	03/00→10/04	Diesel	4HX (DW12TED4/FAP)	2179	4	85.00	96.00	69
407 1.6 HDi 110	05/04→	Diesel	9HZ (DV6TED4)	1560	4	75.00	88.30	27
407 1.8	05/04→	Petrol	6FZ (EW7J4)	1749	4	82.70	81.40	43
407 1.8 16V	09/05→	Petrol	6FY (EW7A)	1749	4	82.70	81.40	43
407 2.0	05/04→	Petrol	RFN (EW10J4)	1997	4	85.00	88.00	65
407 2.0 16V	09/05→	Petrol	RFJ (EW10A)	1997	4	85.00	88.00	65
407 2.0 Bioflex	09/07→	Petrol	RFJ (EW10A)	1997	4	85.00	88.00	65
407 2.0 HDi	02/10→	Diesel	RHE (DW10CTED4)	1997	4	85.00	88.00	66



cm3



407 2.0 HDi	08/08→	Diesel	RHF (DW10BTED4)	1997	4	85.00	88.00	66
407 2.0 HDi	06/09→	Diesel	RHH (DW10CTED4)	1997	4	85.00	88.00	66
407 2.0 HDi	10/05→	Diesel	RHR (DW10BTED4)	1997	4	85.00	88.00	67
407 2.0 HDi 135	05/04→	Diesel	RHR (DW10BTED4)	1997	4	85.00	88.00	67
407 2.2 HDi	06/08→	Diesel	4HP (DW12BTED4)	2179	4	85.00	96.00	69
407 2.2 HDi 170	05/06→	Diesel	4HT (DW12BTED4)	2179	4	85.00	96.00	69
407 SW 1.6 HDi 110	05/04→	Diesel	9HZ (DV6TED4)	1560	4	75.00	88.30	27
407 SW 1.8	05/04→	Petrol	6FZ (EW7J4)	1749	4	82.70	81.40	43
407 SW 1.8 16V	09/05→	Petrol	6FY (EW7A)	1749	4	82.70	81.40	43
407 SW 2.0	05/04→	Petrol	RFN (EW10J4)	1997	4	85.00	88.00	65
407 SW 2.0 16V	09/05→	Petrol	RFJ (EW10A)	1997	4	85.00	88.00	65
407 SW 2.0 Bioflex	01/08→	Petrol	RFJ (EW10A)	1997	4	85.00	88.00	65
407 SW 2.0 HDi	02/10→	Diesel	RHE (DW10CTED4)	1997	4	85.00	88.00	66
407 SW 2.0 HDi	07/09→	Diesel	RHH (DW10CTED4)	1997	4	85.00	88.00	66
407 SW 2.0 HDi	08/08→	Diesel	RHR (DW10BTED4)	1997	4	85.00	88.00	67
407 SW 2.0 HDi 135	05/04→	Diesel	RHR (DW10BTED4)	1997	4	85.00	88.00	67
407 SW 2.2 HDi	06/08→	Diesel	4HP (DW12BTED4)	2179	4	85.00	96.00	69
407 SW 2.2 HDi 170	05/06→	Diesel	4HT (DW12BTED4)	2179	4	85.00	96.00	69
408 1.6 HDi	11/10→	Diesel	9HL (DV6C)	1560	4	75.00	88.30	27
408 2.0	03/11→	Petrol	RFJ (EW10A)	1997	4	85.00	88.00	65
504 1.6	01/80→06/87	Petrol	XC7P	1618	4	84.00	73.00	58
504 1.8	07/68→02/71	Petrol	XM	1796	4	84.00	81.00	61
504 1.8	01/71→10/99	Petrol	XM7	1796	4	84.00	81.00	62
504 1.8 Injection	07/68→02/71	Petrol	KF5	1796	4	84.00	81.00	61
504 1.8 Injection	07/68→02/71	Petrol	KF6	1796	4	84.00	81.00	61
504 1.9 D	03/73→12/89	Diesel	XD4x88	1948	4	88.00	80.00	78
504 2.0	03/71→06/86	Petrol	106 (XN1)	1971	4	88.00	81.00	79
504 2.0	10/74→08/84	Petrol	107 (XN2)	1971	4	88.00	81.00	79
504 2.0	09/79→	Petrol	XN1	1971	4	88.00	81.00	79
504 2.0 TI	01/71→06/83	Petrol	107 (XN2)	1971	4	88.00	81.00	79
504 2.1 D	02/71→07/86	Diesel	XD4x90	2112	4	90.00	83.00	83
504 2.1 D	09/79→08/82	Diesel	XD90	2112	4	90.00	83.00	83
504 2.3 D	07/75→12/89	Diesel	134 (XD2)	2304	4	94.00	83.00	90
504 2.5 D	08/90→10/99	Diesel	XD3P	2497	4	94.00	90.00	93
504 2.7	10/77→08/84	Petrol	140 (ZMJ)	2664	V6	88.00	73.00	77
504 Break 1.8	04/71→07/86	Petrol	XM7	1796	4	84.00	81.00	62
504 Break 2.0	04/71→07/86	Petrol	XN1	1971	4	88.00	81.00	79
504 Break 2.1 D	04/71→07/86	Diesel	XD4x90	2112	4	90.00	83.00	83
504 Break 2.3 D	07/75→07/86	Diesel	134 (XD2)	2304	4	94.00	83.00	90
505 1.8	06/81→10/85	Petrol	105 (XM7)	1796	4	84.00	81.00	59
505 1.8	09/85→10/86	Petrol	105C (XM7A)	1796	4	84.00	81.00	60
505 2.0	11/80→12/85	Petrol	106 (XN1)	1971	4	88.00	81.00	79
505 2.0	09/85→09/95	Petrol	106E (XN1A)	1971	4	88.00	81.00	80
505 2.0	09/80→09/85	Petrol	XN1	1971	4	88.00	81.00	79
505 2.2	05/81→10/84	Petrol	851 (ZDJ)	2165	4	88.00	89.00	82
505 2.2	03/86→12/93	Petrol	851X (ZDJL)	2165	4	88.00	89.00	82
505 2.2 GTI	08/83→12/93	Petrol	851B (ZDJL)	2165	4	88.00	89.00	82
505 2.3 D	05/79→09/84	Diesel	XD2	2304	4	94.00	83.00	90
505 2.3 Turbo Diesel	09/80→06/86	Diesel	147 (XD2S)	2304	4	94.00	83.00	90
505 2.5 Diesel	06/81→12/93	Diesel	155 (XD3)	2498	4	94.00	90.00	93
505 2.5 Turbo Diesel	10/83→12/90	Diesel	XD3T	2497	4	94.00	90.00	93
505 2.5 Turbo Diesel	10/83→12/93	Diesel	152A (XD3T)	2498	4	94.00	90.00	93
505 2.5 Turbo Diesel	10/86→12/93	Diesel	152B (XD3TE)	2498	4	94.00	90.00	93
505 2.8 GTI V6	06/86→12/93	Petrol	154X (ZN3J)	2849	V6	91.00	73.00	84
505 Break 1.8	10/85→09/89	Petrol	105C (XM7A)	1796	4	84.00	81.00	60
505 Break 1.8	04/82→09/85	Petrol	XM7	1796	4	84.00	81.00	62
505 Break 2.0	08/83→12/85	Petrol	106 (XN1)	1971	4	88.00	81.00	79
505 Break 2.0	09/85→11/87	Petrol	106E (XN1A)	1971	4	88.00	81.00	80
505 Break 2.2	01/86→12/93	Petrol	851X (ZDJL)	2165	4	88.00	89.00	82
505 Break 2.2 GTI	09/85→12/86	Petrol	851B (ZDJL)	2165	4	88.00	89.00	82
505 Break 2.3 D	06/82→09/84	Diesel	XD2	2304	4	94.00	83.00	90
505 Break 2.3 Diesel	04/82→06/86	Diesel	147 (XD2S)	2304	4	94.00	83.00	90
505 Break 2.5 D	10/85→08/91	Diesel	XD3T	2497	4	94.00	90.00	93
505 Break 2.5 Diesel	08/83→12/93	Diesel	155 (XD3)	2498	4	94.00	90.00	93
505 Break 2.5 Turbo Diesel	10/85→11/87	Diesel	152A (XD3T)	2498	4	94.00	90.00	93
505 Break 2.5 Turbo Diesel	10/86→12/93	Diesel	152B (XD3TE)	2498	4	94.00	90.00	93
508 1.6 BlueHDi 120	03/14→	Diesel	BHZ (DV6FC)	1560	4	75.00	88.30	27
508 1.6 HDi	02/12→	Diesel	9HD (DV6CTED)	1560	4	75.00	88.30	27
508 1.6 HDi	11/10→	Diesel	9HR (DV6C)	1560	4	75.00	88.30	27

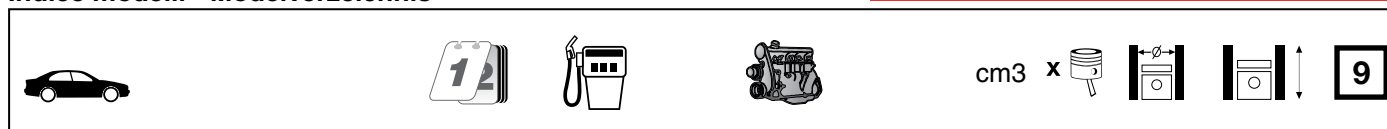

508 1.6 HDi	09/14→	Diesel	BHX (DV6FC)	1560	4	75.00	88.30	27
508 2.0 BlueHDi 150	04/14→	Diesel	AHX (DW10FD)	1997	4	85.00	88.00	66
508 2.0 BlueHDi 180	04/14→	Diesel	AHW (DW10FC)	1997	4	85.00	88.00	66
508 2.0 HDi	11/10→	Diesel	RHF (DW10BTED4)	1997	4	85.00	88.00	66
508 2.0 HDi	11/10→	Diesel	RHH (DW10CTED4)	1997	4	85.00	88.00	66
508 2.0 HDi	11/10→	Diesel	RHR (DW10BTED4)	1997	4	85.00	88.00	67
508 2.0 HDi Hybrid4 AWC	11/10→	Diesel	RHC (DW10CTED4)	1997	4	85.00	88.00	66
508 2.2 HDi	11/10→	Diesel	4HL (DW12C)	2179	4	85.00	96.00	69
508 SW 1.6 BlueHDi 120	03/14→	Diesel	BHZ (DV6FC)	1560	4	75.00	88.30	27
508 SW 1.6 HDi	02/12→	Diesel	9HD (DV6CTED)	1560	4	75.00	88.30	27
508 SW 1.6 HDi	11/10→	Diesel	9HR (DV6C)	1560	4	75.00	88.30	27
508 SW 1.6 HDi	09/14→	Diesel	BHX (DV6FC)	1560	4	75.00	88.30	27
508 SW 2.0 BlueHDi 150	04/14→	Diesel	AHX (DW10FD)	1997	4	85.00	88.00	66
508 SW 2.0 BlueHDi 180	04/14→	Diesel	AHW (DW10FC)	1997	4	85.00	88.00	66
508 SW 2.0 HDi	11/10→	Diesel	RHF (DW10BTED4)	1997	4	85.00	88.00	66
508 SW 2.0 HDi	11/10→	Diesel	RHH (DW10CTED4)	1997	4	85.00	88.00	66
508 SW 2.0 HDi	11/10→	Diesel	RHR (DW10BTED4)	1997	4	85.00	88.00	67
508 SW 2.0 HDi RXH Hybrid4	11/10→	Diesel	RHC (DW10CTED4)	1997	4	85.00	88.00	66
508 SW 2.2 HDi	11/10→	Diesel	4HL (DW12C)	2179	4	85.00	96.00	69
604 2.3 TD	09/79→05/83	Diesel	147 (XD2S)	2304	4	94.00	83.00	90
604 2.5 TD	08/83→12/86	Diesel	152A (XD3T)	2498	4	94.00	90.00	93
604 2.7 SL	08/77→05/83	Petrol	112 (ZM)	2664	V6	88.00	73.00	77
604 2.7 TI,STI	08/77→05/83	Petrol	140 (ZMJ)	2664	V6	88.00	73.00	77
604 2.8 GTI	09/83→07/87	Petrol	154A (ZMJK)	2849	V6	91.00	73.00	84
605 2.0	06/89→09/99	Petrol	R5A (XU102C)	1998	4	86.00	86.00	70
605 2.0	06/89→09/99	Petrol	RFZ (XU10J2Z)	1998	4	86.00	86.00	70
605 2.0 16V	07/94→09/99	Petrol	RFV (XU10J4R)	1998	4	86.00	86.00	71
605 2.0 Turbo	07/91→09/99	Petrol	RGX (XU10J2TE)	1998	4	86.00	86.00	72
605 2.0 Turbo	07/92→09/99	Petrol	RGY (XU10J2TE)	1998	4	86.00	86.00	72
605 2.1 D	06/89→07/95	Diesel	P9A (XUD11A)	2138	4	86.00	92.00	74
605 2.1 TD 12V	08/94→09/99	Diesel	P8C (XUD11BTE)	2088	4	85.00	92.00	68
605 2.1 Turbo Diesel	06/89→09/99	Diesel	PHZ (XUD11ATE)	2088	4	85.00	92.00	68
605 2.5 Turbo Diesel	07/94→09/99	Diesel	THY (DK5ATE)	2446	4	92.00	92.00	85
605 3.0	08/89→09/99	Petrol	UFZ (ZPJ)	2963	V6	93.00	72.70	87
605 3.0	08/89→06/94	Petrol	UKZ (ZPJ4/Z)	2963	V6	93.00	72.70	87
605 3.0 SV 24	08/89→09/99	Petrol	UKZ (ZPJ4/Z)	2963	V6	93.00	72.70	87
607 2.0	02/00→	Petrol	RFN (EW10J4)	1997	4	85.00	88.00	65
607 2.0 HDi	09/05→	Diesel	RHR (DW10BTED4)	1997	4	85.00	88.00	67
607 2.0 HDi	03/01→07/04	Diesel	RHS (DW10ATED)	1997	4	85.00	88.00	66
607 2.0 HDi	05/00→	Diesel	RHZ (DW10ATED)	1997	4	85.00	88.00	67
607 2.2 HDi	05/06→	Diesel	4HT (DW12BTED4)	2179	4	85.00	96.00	69
607 2.2 HDi	02/00→	Diesel	4HX (DW12TED4/FAP)	2179	4	85.00	96.00	69
806 1.8	07/95→08/02	Petrol	LFW (XU7JP)	1761	4	83.00	81.40	48
806 1.9 TD	07/95→08/02	Diesel	DHX (XUD9TE)	1905	4	83.00	88.00	54
806 1.9 TD	05/97→08/02	Diesel	DHY (XUD9TE)	1905	4	83.00	88.00	54
806 2.0	06/94→08/02	Petrol	RFU (XU10J2)	1998	4	86.00	86.00	71
806 2.0 16V	09/00→08/02	Petrol	RFN (EW10J4)	1997	4	85.00	88.00	65
806 2.0 16V	05/98→09/00	Petrol	RFV (XU10J4R)	1998	4	86.00	86.00	71
806 2.0 HDi	08/99→08/02	Diesel	RHZ (DW10ATED)	1997	4	85.00	88.00	67
806 2.0 HDi 16V	08/99→08/02	Diesel	RHW (DW10ATED4)	1997	4	85.00	88.00	67
806 2.0 Turbo	06/94→08/02	Petrol	RGX (XU10J2TE)	1998	4	86.00	86.00	72
806 2.1 td 12V	06/96→08/99	Diesel	P8C (XUD11BTE)	2088	4	85.00	92.00	68
807 2.0	06/02→	Petrol	RFN (EW10J4)	1997	4	85.00	88.00	65
807 2.0 16V	09/05→	Petrol	RFJ (EW10A)	1997	4	85.00	88.00	65
807 2.0 HDi	06/09→	Diesel	RHH (DW10CTED4)	1997	4	85.00	88.00	66
807 2.0 HDi	02/06→	Diesel	RHK (DW10UTED4)	1997	4	85.00	88.00	67
807 2.0 HDi	06/02→	Diesel	RHM (DW10ATED4)	1997	4	85.00	88.00	67
807 2.0 HDi	06/06→	Diesel	RHR (DW10BTED4)	1997	4	85.00	88.00	67
807 2.0 HDi	06/02→	Diesel	RHT (DW10ATED4)	1997	4	85.00	88.00	66
807 2.0 HDi	06/02→	Diesel	RHW (DW10ATED4)	1997	4	85.00	88.00	67
807 2.2 HDi	06/06→	Diesel	4HT (DW12BTED4)	2179	4	85.00	96.00	69
807 2.2 HDi	06/02→	Diesel	4HW (DW12BTED4)	2179	4	85.00	96.00	69
807 2.2 HDi	06/02→	Diesel	4HX (DW12TED4/FAP)	2179	4	85.00	96.00	69
807 2.2 HDi	04/04→	Diesel	4HZ (DW12TED4)	2179	4	85.00	96.00	69
1007 1.4	04/05→	Petrol	KFV (TU3JP)	1360	4	75.00	77.00	23
1007 1.4 16V	10/05→	Petrol	KFU (ET3J4)	1360	4	75.00	77.00	23
1007 1.4 HDi	04/05→	Diesel	8HX (DV4TD)	1398	4	73.70	82.00	16
1007 1.4 HDi	04/05→	Diesel	8HZ (DV4TD)	1398	4	73.70	82.00	16
1007 1.6 16V	04/05→	Petrol	NFU (TU5JP4)	1587	4	78.50	82.00	35



cm3





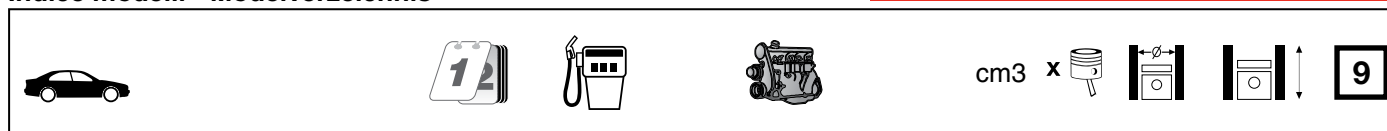

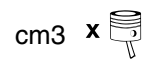

1007 1.6 HDi	06/07→	Diesel	9HZ (DV6TED4)	1560	4	75.00	88.30	27
2008 1.2 THP 110	01/15→	Petrol	HNZ (EB2DT)	1199	3	75.00	90.50	28
2008 1.2 THP 130	01/15→	Petrol	HNY (EB2DTS)	1199	3	75.00	90.50	28
2008 1.4 HDi	06/13→	Diesel	8HR (DV4C)	1398	4	73.70	82.00	16
2008 1.6 BlueHDi 75	01/15→	Diesel	BHW (DV6FE)	1560	4	75.00	88.30	27
2008 1.6 BlueHDi 100	01/15→	Diesel	BHY (DV6FD)	1560	4	75.00	88.30	27
2008 1.6 BlueHDi 120	07/14→	Diesel	BHZ (DV6FC)	1560	4	75.00	88.30	27
2008 1.6 HDi	03/13→	Diesel	9HD (DV6CTED)	1560	4	75.00	88.30	27
2008 1.6 HDi	03/13→	Diesel	9HP (DV6DTE)	1560	4	75.00	88.30	27
2008 1.6 HDi	07/14→	Diesel	BHX (DV6FC)	1560	4	75.00	88.30	27
3008 1.2	01/15→	Petrol	HNY (EB2DTS)	1199	3	75.00	90.50	28
3008 1.6 BlueHDi 120	05/14→	Diesel	BHZ (DV6FC)	1560	4	75.00	88.30	27
3008 1.6 HDi	03/13→	Diesel	9HD (DV6CTED)	1560	4	75.00	88.30	27
3008 1.6 HDi	08/10→	Diesel	9HR (DV6C)	1560	4	75.00	88.30	27
3008 1.6 HDi	06/09→	Diesel	9HZ (DV6TED4)	1560	4	75.00	88.30	27
3008 2.0 HDi	06/09→	Diesel	RHH (DW10CTED4)	1997	4	85.00	88.00	66
3008 2.0 HDi 150 / BlueHDi 150	06/09→	Diesel	AHX (DW10FD)	1997	4	85.00	88.00	66
3008 2.0 HDi 150 / BlueHDi 150	06/09→	Diesel	RHE (DW10CTED4)	1997	4	85.00	88.00	66
3008 2.0 HDi Hybrid4	02/11→	Diesel	RHC (DW10CTED4)	1997	4	85.00	88.00	66
4007 2.2 HDi	02/07→	Diesel	4HK (DW12MTED4)	2179	4	85.00	96.00	69
4007 2.2 HDi	02/07→	Diesel	4HN (DW12MTED4)	2179	4	85.00	96.00	69
5008 1.2	01/15→	Petrol	HNY (EB2DTS)	1199	3	75.00	90.50	28
5008 1.6 BlueHDi 120	05/14→	Diesel	BHZ (DV6FC)	1560	4	75.00	88.30	27
5008 1.6 HDi	03/13→	Diesel	9HD (DV6CTED)	1560	4	75.00	88.30	27
5008 1.6 HDi	08/10→	Diesel	9HR (DV6C)	1560	4	75.00	88.30	27
5008 1.6 HDi	09/09→	Diesel	9HZ (DV6TED4)	1560	4	75.00	88.30	27
5008 2.0 HDi	09/09→	Diesel	RHH (DW10CTED4)	1997	4	85.00	88.00	66
5008 2.0 HDi 136 / BlueHDi 136	02/12→	Diesel	AHV (DW10FD)	1997	4	85.00	88.00	66
5008 2.0 HDi 136 / BlueHDi 136	02/12→	Diesel	RHD (DW10CTED4)	1997	4	85.00	88.00	66
5008 2.0 HDi 150 / BlueHDi 150	06/09→	Diesel	AHX (DW10FD)	1997	4	85.00	88.00	66
5008 2.0 HDi 150 / BlueHDi 150	06/09→	Diesel	RHE (DW10CTED4)	1997	4	85.00	88.00	66
Bipper 1.3 HDi 75	10/10→	Diesel	199 A9.000	1248	4	69.60	82.00	2
Bipper 1.4	02/08→	Petrol	KFV (TU3A)	1360	4	75.00	77.00	23
Bipper 1.4 HDi	02/08→	Diesel	8HS (DV4TED)	1398	4	73.70	82.00	16
Boxer 1.9 D	03/94→04/02	Diesel	D8C (XUD9AU)	1905	4	83.00	88.00	53
Boxer 1.9 D	03/94→04/02	Diesel	D9B (XUD9AU)	1905	4	83.00	88.00	56
Boxer 1.9 D	03/94→04/02	Diesel	DJY (XUD9A)	1905	4	83.00	88.00	56
Boxer 1.9 DT 4x4	03/96→09/98	Diesel	XUD9TE	1905	4	83.00	88.00	54
Boxer 1.9 TD	03/94→04/02	Diesel	D8C (XUD9UTF)	1905	4	83.00	88.00	55
Boxer 1.9 TD	06/94→04/02	Diesel	DHY (XUD9TE)	1905	4	83.00	88.00	54
Boxer 1.9 TD	06/94→04/02	Diesel	XUD9TE	1905	4	83.00	88.00	54
Boxer 1.9 TD 4x4	07/96→04/02	Diesel	D8C (XUD9UTF)	1905	4	83.00	88.00	55
Boxer 2.0	12/01→	Petrol	RFL (XU10J2U)	1998	4	86.00	86.00	71
Boxer 2.0 HDi	04/02→	Diesel	RHV (DW10TD)	1997	4	85.00	88.00	66
Boxer 2.0 HDi	08/01→	Diesel	RHV (DW10UTD)	1997	4	85.00	88.00	66
Boxer 2.0 i	03/94→04/02	Petrol	RFW (XU10J2)	1998	4	86.00	86.00	71
Boxer 2.0 i 4x4	08/96→04/02	Petrol	RFW (XU10J2)	1998	4	86.00	86.00	71
Boxer 2.2 HDi	04/02→	Diesel	4HY (DW12UTED)	2179	4	85.00	96.00	69
Boxer 2.2 HDi 100	04/06→	Diesel	4HV (P22DTE)	2198	4	86.00	94.60	75
Boxer 2.2 HDi 120	04/06→	Diesel	4HU (P22DTE)	2198	4	86.00	94.60	75
Boxer 2.5 D	03/94→04/02	Diesel	T9A (DJ5)	2446	4	92.00	92.00	86
Boxer 2.5 D 4x4	07/96→04/02	Diesel	T9A (DJ5)	2446	4	92.00	92.00	86
Boxer 2.5 TD	03/94→04/02	Diesel	T8A (DJ5T)	2446	4	92.00	92.00	85
Boxer 2.5 TD 4x4	07/96→04/02	Diesel	T8A (DJ5T)	2446	4	92.00	92.00	85
Boxer 2.5 TDI	01/97→04/02	Diesel	THX (DJ5TED)	2446	4	92.00	92.00	85
Boxer 2.5 TDI 4x4	01/97→04/02	Diesel	THX (DJ5TED)	2446	4	92.00	92.00	85
Boxer 2.8 D	01/99→02/02	Diesel	8140.63 (F28D)	2798	4	94.40	100.00	95
Boxer 2.8 DTiC	10/97→09/00	Diesel	8140.43 (F28DT)	2798	4	94.40	100.00	95
Boxer 2.8 HDi	04/04→	Diesel	8140.43N	2798	4	94.40	100.00	95
Boxer 2.8 HDi	10/00→	Diesel	8140.43S (F28DTCR)	2798	4	94.40	100.00	95
Boxer 2.8 HDi 4x4	10/00→	Diesel	8140.43S (F28DTCR)	2798	4	94.40	100.00	95
Boxer 2.8 HDi All-wheel Drive	10/00→11/01	Diesel	8140.43S (F28DTCR)	2798	4	94.40	100.00	95
Boxer 2.8 TD	12/01→03/05	Diesel	8140.43 (F28DT)	2798	4	94.40	100.00	95
Expert 1.6 HDi 90	01/07→	Diesel	9HU (DV6UTED4)	1560	4	75.00	88.30	27
Expert 1.6 HDi 90 8V	01/07→	Diesel	9HH (DV6DUM)	1560	4	75.00	88.30	27
Expert 1.6 HDi 90 8V	01/07→	Diesel	9HM (DV6UC)	1560	4	75.00	88.30	27
Expert 1.6 HDi 90 16V	01/07→	Diesel	9HU (DV6UTED4)	1560	4	75.00	88.30	27
Expert 1.8	10/96→09/00	Petrol	LFZ (XU7JP)	1762	4	83.00	81.40	48
Expert 1.9 D	06/98→	Diesel	WJY (DW8B)	1868	4	82.20	88.00	42









Expert 1.9 D	06/98→	Diesel	WJZ (DW8)	1868	4	82.20	88.00	42
Expert 1.9 D	02/96→	Diesel	D9B (XUD9AU)	1905	4	83.00	88.00	56
Expert 1.9 D	10/95→05/98	Diesel	XUD9TE	1905	4	83.00	88.00	54
Expert 1.9 D 70	12/98→	Diesel	WJY (DW8B)	1868	4	82.20	88.00	42
Expert 1.9 D 70	12/98→	Diesel	WJZ (DW8)	1868	4	82.20	88.00	42
Expert 1.9 TD	02/96→	Diesel	D8B (XUD9TE)	1905	4	83.00	88.00	54
Expert 1.9 TD	02/96→	Diesel	DHX (XUD9TE)	1905	4	83.00	88.00	54
Expert 2.0	07/00→	Petrol	RFN (EW10J4)	1997	4	85.00	88.00	65
Expert 2.0 16V	01/07→	Petrol	RFH (EW10A)	1997	4	85.00	88.00	65
Expert 2.0 16V	01/07→	Petrol	RFJ (EW10A)	1997	4	85.00	88.00	65
Expert 2.0 HDi	07/00→	Diesel	RHW (DW10ATED4)	1997	4	85.00	88.00	67
Expert 2.0 HDi	07/00→	Diesel	RHX (DW10BTED)	1997	4	85.00	88.00	67
Expert 2.0 HDi	07/00→	Diesel	RHZ (DW10ATED)	1997	4	85.00	88.00	67
Expert 2.0 HDi	07/00→	Diesel	RHZ (DW10BTED)	1997	4	85.00	88.00	66
Expert 2.0 HDi	07/00→	Diesel	RHZ (DW10CTED)	1997	4	85.00	88.00	66
Expert 2.0 HDi 16V	07/00→	Diesel	RHW (DW10ATED4)	1997	4	85.00	88.00	67
Expert 2.0 HDi 120	01/07→	Diesel	RHK (DW10UTED4)	1997	4	85.00	88.00	67
Expert 2.0 HDi 120 4x4	01/07→	Diesel	RHK (DW10UTED4)	1997	4	85.00	88.00	67
Expert 2.0 HDi 130	03/11→	Diesel	AHZ (DW10CD)	1997	4	85.00	88.00	66
Expert 2.0 HDi 130 4x4	03/11→	Diesel	AHZ (DW10CD)	1997	4	85.00	88.00	66
Expert 2.0 HDi 140	01/07→	Diesel	RHR (DW10BTED4)	1997	4	85.00	88.00	67
Expert 2.0 HDi 165	09/09→	Diesel	RHH (DW10CTED4)	1997	4	85.00	88.00	66
Hoggar 1.4	05/10→	Petrol	KFV (TU3A)	1360	4	75.00	77.00	23
Hoggar 1.4 Flex	05/10→	Petrol	KFV (TU3A)	1360	4	75.00	77.00	23
Hoggar 1.6	05/10→	Petrol	NFU (TU5JP4)	1587	4	78.50	82.00	35
Hoggar 1.6 Flex	05/10→	Petrol	NFU (TU5JP4)	1587	4	78.50	82.00	35
J5 1.8	01/83→01/94	Petrol	169B (XM7T)	1796	4	84.00	81.00	60
J5 1.9 D	09/87→03/94	Diesel	D9B (XUD9A)	1905	4	83.00	88.00	56
J5 1.9 D	09/87→08/90	Diesel	XUD9	1905	4	83.00	88.00	56
J5 2.0	01/83→09/90	Petrol	170 (XN1T)	1971	4	88.00	81.00	80
J5 2.0	09/81→09/90	Petrol	170B (XN1T)	1971	4	88.00	81.00	81
J5 2.0	09/90→02/94	Petrol	170D (XN1TACP)	1971	4	88.00	81.00	80
J5 2.0	09/81→08/90	Petrol	XN1P	1971	4	88.00	81.00	81
J5 2.0	09/87→08/90	Petrol	XN1T	1971	4	88.00	81.00	80
J5 2.0	09/90→01/94	Petrol	XN1TA	1971	4	88.00	81.00	80
J5 2.0 Super 4x4	09/81→08/90	Petrol	XN1P	1971	4	88.00	81.00	81
J5 2.5 D	09/81→01/94	Diesel	CRD93	2498	4	93.00	92.00	88
J5 2.5 D	09/81→02/94	Diesel	CRD93 (U25/661)	2498	4	93.00	92.00	88
J5 2.5 D 4x4	09/81→08/90	Diesel	CRD93	2498	4	93.00	92.00	88
J5 2.5 D 4x4	10/90→03/94	Diesel	CRD93 (U25/661)	2498	4	93.00	92.00	88
J5 2.5 D All-wheel Drive	09/81→08/90	Diesel	CRD93	2498	4	93.00	92.00	88
J5 2.5 DT	09/81→01/94	Diesel	CRD93L	2498	4	94.00	90.00	94
J5 2.5 DT	09/81→08/90	Diesel	CRD93LS (U25/673)	2498	4	93.00	92.00	89
J5 2.5 DT 4x4	09/81→08/90	Diesel	CRD93L	2498	4	94.00	90.00	94
J5 2.5 DT All-wheel Drive	09/81→08/90	Diesel	CRD93L	2498	4	94.00	90.00	94
J5 2.5 TD	10/90→02/94	Diesel	CRD93LS (U25/673)	2498	4	93.00	92.00	89
J5 2.5 TD 4x4	10/90→03/94	Diesel	CRD93LS (U25/673)	2498	4	93.00	92.00	89
J7 1.5	08/68→07/70	Petrol	XB5P	1468	4	80.00	73.00	36
J7 1.6	08/68→03/80	Petrol	XC5P	1618	4	84.00	73.00	57
J7 1.6	08/68→03/80	Petrol	XC7P	1618	4	84.00	73.00	58
J7 1.8	07/70→03/80	Petrol	XM7P	1796	4	84.00	81.00	63
J7 1.9 D	08/68→07/78	Diesel	XDP88	1948	4	88.00	80.00	78
J7 2.1 D	08/68→07/77	Diesel	XDP90	2112	4	90.00	83.00	83
J7 2.3 D	07/77→03/80	Diesel	XD2P94	2304	4	94.00	83.00	91
J9 1.6	03/80→06/87	Petrol	XC7P	1618	4	84.00	73.00	58
J9 2.0	03/80→06/87	Petrol	XN1P	1971	4	88.00	81.00	81
J9 2.1 D	03/80→06/87	Diesel	XDPX90	2112	4	90.00	83.00	83
J9 2.3 D	03/80→07/82	Diesel	XD2PX94	2304	4	94.00	83.00	90
J9 2.5 D	07/82→06/87	Diesel	XD3P	2497	4	94.00	90.00	93
Partner 1.1	06/96→	Petrol	HDZ (TU1M)	1124	4	72.00	69.00	12
Partner 1.1	06/96→	Petrol	HFX (TU1JP)	1124	4	72.00	69.00	13
Partner 1.2 THP	02/16→	Petrol	HNZ (EB2DT)	1199	3	75.00	90.50	28
Partner 1.4	11/02→10/06	Petrol	KFV (TU3A)	1360	4	75.00	77.00	23
Partner 1.4	10/05→	Petrol	KFV (TU3JP)	1360	4	75.00	77.00	23
Partner 1.4	06/96→	Petrol	KFV (TU3JP)	1360	4	75.00	77.00	24
Partner 1.4	06/96→	Petrol	KFX (TU3JP)	1361	4	75.00	77.00	24
Partner 1.4	06/96→	Petrol	TU32	1361	4	75.00	77.00	25
Partner 1.4 BiFuel	04/03→	Petrol	KFV (TU3JP)	1360	4	75.00	77.00	24
Partner 1.6	04/08→	Petrol	NFR (TU5JP4B)	1587	4	78.50	82.00	35









Partner 1.6	09/00→	Petrol	NFU (TU5JP4)	1587	4	78.50	82.00	35
Partner 1.6 16V	07/01→	Petrol	NFU (TU5JP4)	1587	4	78.50	82.00	35
Partner 1.6 Bioflex	09/00→10/02	Petrol	NFU (TU5JP4)	1587	4	78.50	82.00	35
Partner 1.6 BlueHDi 75	01/15→	Diesel	BHW (DV6FE)	1560	4	75.00	88.30	27
Partner 1.6 BlueHDi 100	12/14→	Diesel	BHY (DV6FD)	1560	4	75.00	88.30	27
Partner 1.6 BlueHDi 120	12/14→	Diesel	BHZ (DV6FC)	1560	4	75.00	88.30	27
Partner 1.6 Flex	09/08→	Petrol	NFU (TU5JP4)	1587	4	78.50	82.00	35
Partner 1.6 Flexfuel	09/00→	Petrol	NFU (TU5JP4)	1587	4	78.50	82.00	35
Partner 1.6 HDi	03/13→	Diesel	9HF (DV6DTEd)	1560	4	75.00	88.30	27
Partner 1.6 HDi	08/10→	Diesel	9HL (DV6C)	1560	4	75.00	88.30	27
Partner 1.6 HDi	04/08→	Diesel	9HN (DV6ETED4)	1560	4	75.00	88.30	27
Partner 1.6 HDi	04/08→	Diesel	9HT (DV6BTED4)	1560	4	75.00	88.30	27
Partner 1.6 HDi	04/08→	Diesel	9HW (DV6BTED4)	1560	4	75.00	88.30	27
Partner 1.6 HDi	04/08→	Diesel	9HZ (DV6TED4)	1560	4	75.00	88.30	27
Partner 1.6 HDi 16V	04/08→	Diesel	9HS (DV6TED4BU)	1560	4	75.00	88.30	27
Partner 1.6 HDi 16V	04/08→	Diesel	9HV (DV6TED4)	1560	4	75.00	88.30	27
Partner 1.6 HDi 16V	04/08→	Diesel	9HX (DV6ATED4)	1560	4	75.00	88.30	27
Partner 1.6 HDi 16V 4x4	04/12→	Diesel	9HS (DV6TED4BU)	1560	4	75.00	88.30	27
Partner 1.6 HDi 16V 4x4	04/12→	Diesel	9HX (DV6ATED4)	1560	4	75.00	88.30	27
Partner 1.6 HDi 75	02/06→	Diesel	9HW (DV6BTED4)	1560	4	75.00	88.30	27
Partner 1.6 HDi 90	04/10→	Diesel	9HP (DV6DTEd)	1560	4	75.00	88.30	27
Partner 1.6 HDi 90	10/05→	Diesel	9HX (DV6ATED4)	1560	4	75.00	88.30	27
Partner 1.8	03/97→	Petrol	LFX (XU7JB)	1761	4	83.00	81.40	48
Partner 1.8 D	06/96→	Diesel	A9A (XUD7)	1769	4	80.00	88.00	41
Partner 1.9 D	06/96→	Diesel	WJY (DW8B)	1868	4	82.20	88.00	42
Partner 1.9 D	06/96→	Diesel	WJZ (DW8)	1868	4	82.20	88.00	42
Partner 1.9 D	05/96→	Diesel	DJY (XUD9A)	1905	4	83.00	88.00	56
Partner 1.9 D	05/96→12/98	Diesel	XUD9	1905	4	83.00	88.00	56
Partner 1.9 D 4x4	04/04→	Diesel	WJY (DW8B)	1868	4	82.20	88.00	42
Partner 2.0 HDi	02/00→	Diesel	RHY (DW10TD)	1997	4	85.00	88.00	66
Partner 2.0 HDi 4x4	04/04→	Diesel	RHY (DW10TD)	1997	4	85.00	88.00	66
RCZ 2.0 HDi	03/10→	Diesel	RHH (DW10CTED4)	1997	4	85.00	88.00	66
Talbot Horizon 1.1 LS	01/79→12/86	Petrol	2E1	1118	4	74.00	65.00	17

		cm3	x 			
1D1	Petrol	944	4	68.00	65.00	1
1G1	Petrol	1294	4	76.70	70.00	29
1KR (384 F)	Petrol	998	3	71.00	84.00	7
2E1	Petrol	1118	4	74.00	65.00	17
2G1-BTC	Petrol	1294	4	76.70	70.00	29
2Y1	Petrol	1442	4	76.70	78.00	30
2Y1B	Petrol	1424	4	76.70	78.00	30
2Y2	Petrol	1424	4	76.70	78.00	30
3E1	Petrol	1118	4	74.00	65.00	17
3E1A	Petrol	1118	4	74.00	65.00	17
3G4	Petrol	1294	4	76.70	70.00	29
4HK (DW12MTED4)	Diesel	2179	4	85.00	96.00	69
4HL (DW12C)	Diesel	2179	4	85.00	96.00	69
4HN (DW12MTED4)	Diesel	2179	4	85.00	96.00	69
4HP (DW12BTED4)	Diesel	2179	4	85.00	96.00	69
4HR (DW12BTED4)	Diesel	2179	4	85.00	96.00	69
4HS (DW12BTED4)	Diesel	2179	4	85.00	96.00	69
4HT (DW12BTED4)	Diesel	2179	4	85.00	96.00	69
4HU (P22DTE)	Diesel	2198	4	86.00	94.60	75
4HV (P22DTE)	Diesel	2198	4	86.00	94.60	75
4HW (DW12BTED4)	Diesel	2179	4	85.00	96.00	69
4HX (DW12TED4/FAP)	Diesel	2179	4	85.00	96.00	69
4HY (DW12UTED)	Diesel	2179	4	85.00	96.00	69
4HZ (DW12TED4)	Diesel	2179	4	85.00	96.00	69
6FY (EW7A)	Petrol	1749	4	82.70	81.40	43
6FZ (EW7J4)	Petrol	1749	4	82.70	81.40	43
6G1D	Petrol	1294	4	76.70	70.00	29
6G1D/VP	Petrol	1294	4	76.70	70.00	29
6Y1	Petrol	1442	4	76.70	78.00	30
6Y2	Petrol	1424	4	76.70	78.00	30
6Y2-BTC	Petrol	1442	4	76.70	78.00	30
6Y4	Petrol	1442	4	76.70	78.00	30
8HP (DV4C)	Diesel	1398	4	73.70	82.00	16
8HR (DV4C)	Diesel	1398	4	73.70	82.00	16
8HS (DV4TED)	Diesel	1398	4	73.70	82.00	16
8HT (DV4TD)	Diesel	1398	4	73.70	82.00	16
8HX (DV4TD)	Diesel	1398	4	73.70	82.00	16
8HZ (DV4TD)	Diesel	1398	4	73.70	82.00	16
9HD (DV6CTED)	Diesel	1560	4	75.00	88.30	27
9HF (DV6DTED)	Diesel	1560	4	75.00	88.30	27
9HH (DV6DUM)	Diesel	1560	4	75.00	88.30	27
9HJ (DV6DTEDM)	Diesel	1560	4	75.00	88.30	27
9HK (DV6ETEDM)	Diesel	1560	4	75.00	88.30	27
9HL (DV6C)	Diesel	1560	4	75.00	88.30	27
9HM (DV6UC)	Diesel	1560	4	75.00	88.30	27
9HN (DV6ETED4)	Diesel	1560	4	75.00	88.30	27
9HP (DV6DTED)	Diesel	1560	4	75.00	88.30	27
9HR (DV6C)	Diesel	1560	4	75.00	88.30	27
9HS (DV6TED4BU)	Diesel	1560	4	75.00	88.30	27
9HT (DV6BTED4)	Diesel	1560	4	75.00	88.30	27
9HU (DV6UTED4)	Diesel	1560	4	75.00	88.30	27
9HV (DV6ATED4)	Diesel	1560	4	75.00	88.30	27
9HV (DV6TED4)	Diesel	1560	4	75.00	88.30	27
9HW (DV6BTED4)	Diesel	1560	4	75.00	88.30	27
9HX (DV6ATED4)	Diesel	1560	4	75.00	88.30	27
9HY (DV6TED4)	Diesel	1560	4	75.00	88.30	27
9HZ (DV6TED4)	Diesel	1560	4	75.00	88.30	27
105 (XM7)	Petrol	1796	4	84.00	81.00	59
105C (XM7A)	Petrol	1796	4	84.00	81.00	60
106 (XN1)	Petrol	1971	4	88.00	81.00	79
106E (XN1A)	Petrol	1971	4	88.00	81.00	80
107 (XN2)	Petrol	1971	4	88.00	81.00	79
108 (XV3)	Petrol	954	4	70.00	62.00	3
108 (XV5)	Petrol	954	4	70.00	62.00	3
108C (XV8)	Petrol	954	4	70.00	62.00	4
109 (XW3)	Petrol	1124	4	72.00	69.00	8
109F (XW7)	Petrol	1124	4	72.00	69.00	9
109N (XW7)	Petrol	1124	4	72.00	69.00	10
112 (ZM)	Petrol	2664	V6	88.00	73.00	77





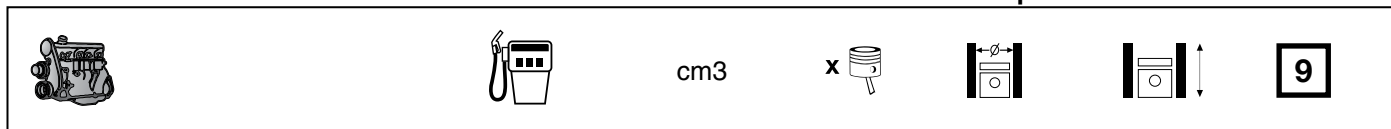

		cm3	x 			
--	---	-----	---	---	---	---

117 (XR5S)	Petrol	1472	4	78.00	77.00	34
118 (XL5)	Petrol	1290	4	78.00	67.50	33
121 (XW3S)	Petrol	1124	4	72.00	69.00	11
129 (XZ5)	Petrol	1219	4	75.00	69.00	19
134 (XD2)	Diesel	2304	4	94.00	83.00	90
140 (ZMJ)	Petrol	2664	V6	88.00	73.00	77
142 (XR5)	Petrol	1472	4	78.00	77.00	34
142 (XR5A)	Petrol	1472	4	78.00	77.00	34
147 (XD2S)	Diesel	2304	4	94.00	83.00	90
149 (XID)	Diesel	1548	4	80.00	77.00	37
150 (XY6B)	Petrol	1360	4	75.00	77.00	21
150B (XY8)	Petrol	1360	4	75.00	77.00	22
150 D	Petrol	1351	4	75.00	77.00	22
150D (XY7)	Petrol	1360	4	75.00	77.00	22
150G (XY7)	Petrol	1360	4	75.00	77.00	22
150H (XY8)	Petrol	1360	4	75.00	77.00	22
152A (XD3T)	Diesel	2498	4	94.00	90.00	93
152B (XD3TE)	Diesel	2498	4	94.00	90.00	93
154A (ZMJK)	Petrol	2849	V6	91.00	73.00	84
154X (ZN3J)	Petrol	2849	V6	91.00	73.00	84
155 (XD3)	Diesel	2498	4	94.00	90.00	93
159 (XU9S)	Petrol	1905	4	83.00	88.00	49
161 (XUD7)	Diesel	1769	4	80.00	88.00	38
161A (XUD7)	Diesel	1769	4	80.00	88.00	39
162 (XUD9)	Diesel	1905	4	83.00	88.00	53
169B (XM7T)	Petrol	1796	4	84.00	81.00	60
170 (XN1T)	Petrol	1971	4	88.00	81.00	80
170B (XN1T)	Petrol	1971	4	88.00	81.00	81
170C (XN1TA)	Petrol	1971	4	88.00	81.00	79
170D (XN1TACP)	Petrol	1971	4	88.00	81.00	80
171 (XU5S)	Petrol	1580	4	83.00	73.00	44
180A (XU5J)	Petrol	1580	4	83.00	73.00	45
180Z (XU5J)	Petrol	1580	4	83.00	73.00	45
199 A9.000	Diesel	1248	4	69.60	82.00	2
851 (ZDJ)	Petrol	2165	4	88.00	89.00	82
851B (ZDJL)	Petrol	2165	4	88.00	89.00	82
851X (ZDJL)	Petrol	2165	4	88.00	89.00	82
1580 SPI	Petrol	1581	4	86.40	67.40	76
8140.23 (F28DTSE)	Diesel	2798	4	94.40	100.00	95
8140.43 (F28DT)	Diesel	2798	4	94.40	100.00	95
8140.43N	Diesel	2798	4	94.40	100.00	95
8140.43S (F28DTCR)	Diesel	2798	4	94.40	100.00	95
8140.63 (F28D)	Diesel	2798	4	94.40	100.00	95
A8A (XUD7TE)	Diesel	1769	4	80.00	88.00	40
A8B (XUD7TE)	Diesel	1769	4	80.00	88.00	40
A9A (XUD7)	Diesel	1769	4	80.00	88.00	41
AHV (DW10FD)	Diesel	1997	4	85.00	88.00	66
AHW (DW10FC)	Diesel	1997	4	85.00	88.00	66
AHX (DW10FD)	Diesel	1997	4	85.00	88.00	66
AHZ (DW10CD)	Diesel	1997	4	85.00	88.00	66
AJZ (XUD7TEY)	Diesel	1769	4	80.00	88.00	40
B1A (XU51C)	Petrol	1580	4	83.00	73.00	44
B1D (XU51C)	Petrol	1580	4	83.00	73.00	44
B1E (XU51C)	Petrol	1580	4	83.00	73.00	44
B2A (XU52C)	Petrol	1580	4	83.00	73.00	44
B2A (XU52C/K)	Petrol	1580	4	83.00	73.00	44
B6B (XU5J)	Petrol	1580	4	83.00	73.00	45
BAZ (XU5CP)	Petrol	1580	4	83.00	73.00	44
BDY (XU5M2Z)	Petrol	1580	4	83.00	73.00	46
BDY (XU5M3Z)	Petrol	1580	4	83.00	73.00	46
BDZ (XU5M)	Petrol	1580	4	83.00	73.00	46
BFZ (XU5JP)	Petrol	1580	4	83.00	73.00	47
BHW (DV6FE)	Diesel	1560	4	75.00	88.30	27
BHX (DV6FC)	Diesel	1560	4	75.00	88.30	27
BHY (DV6FD)	Diesel	1560	4	75.00	88.30	27
BHZ (DV6FC)	Diesel	1560	4	75.00	88.30	27
CDY (TU9M)	Petrol	954	4	70.00	62.00	5
CDZ (TU9M)	Petrol	954	4	70.00	62.00	5
CRD93	Diesel	2498	4	93.00	92.00	88

		cm3	x 			
CRD93	Diesel	2498	4	93.00	92.00	88
CRD93 (U25/661)	Diesel	2498	4	93.00	92.00	88
CRD93L	Diesel	2498	4	94.00	90.00	94
CRD93LS	Diesel	2498	4	93.00	92.00	89
CRD93LS (U25/673)	Diesel	2498	4	93.00	92.00	89
D2A (XU92C)	Petrol	1905	4	83.00	88.00	50
D2B (XU9S)	Petrol	1905	4	83.00	88.00	49
D2C (XU92C)	Petrol	1905	4	83.00	88.00	50
D6A (XU9J2)	Petrol	1905	4	83.00	88.00	51
D6B (XU9JA)	Petrol	1905	4	83.00	88.00	52
D6C (XU9J4)	Petrol	1905	4	83.00	88.00	51
D8B (XUD9TE)	Diesel	1905	4	83.00	88.00	54
D8C (XUD9AU)	Diesel	1905	4	83.00	88.00	53
D8C (XUD9UTF)	Diesel	1905	4	83.00	88.00	55
D9A (XUD9)	Diesel	1905	4	83.00	88.00	53
D9B (XUD9A)	Diesel	1905	4	83.00	88.00	56
D9B (XUD9AU)	Diesel	1905	4	83.00	88.00	56
DDZ (XU9M)	Petrol	1905	4	83.00	88.00	50
DFW (XU9J4Z)	Petrol	1905	4	83.00	88.00	51
DFZ (XU9J1)	Petrol	1905	4	83.00	88.00	52
DHV (XUD9BSD)	Diesel	1905	4	83.00	88.00	54
DHW (XUD9SD)	Diesel	1905	4	83.00	88.00	54
DHX (XUD9TE)	Diesel	1905	4	83.00	88.00	54
DHY (XUD9TE)	Diesel	1905	4	83.00	88.00	54
DJY (XUD9A)	Diesel	1905	4	83.00	88.00	56
DJZ (XUD9Y)	Diesel	1905	4	83.00	88.00	56
DKZ (XU9JAZ)	Petrol	1905	4	83.00	88.00	51
E1	Petrol	1118	4	74.00	65.00	17
E1/BTC	Petrol	1118	4	74.00	65.00	17
E1B	Petrol	1118	4	74.00	65.00	17
EN 55	Diesel	2498	4	94.00	90.00	93
ET 70	Diesel	2496	4	94.00	90.00	93
F1	Petrol	1204	4	74.00	70.00	18
G1A	Petrol	1294	4	76.70	70.00	29
H1B (TU1)	Petrol	1124	4	72.00	69.00	12
HDY (TU1M)	Petrol	1124	4	72.00	69.00	12
HDZ (TU1M)	Petrol	1124	4	72.00	69.00	12
HDZ (TU1M+)	Petrol	1124	4	72.00	69.00	12
HFX (TU1A)	Petrol	1124	4	72.00	69.00	12
HFX (TU1JP)	Petrol	1124	4	72.00	69.00	13
HFZ (TU1JP)	Petrol	1124	4	72.00	69.00	14
HNY (EB2DTS)	Petrol	1199	3	75.00	90.50	28
HNZ (EB2DT)	Petrol	1199	3	75.00	90.50	28
K1D (TU3A)	Petrol	1361	4	75.00	77.00	22
K2B (TU3S)	Petrol	1360	4	75.00	77.00	22
K5A (TU3)	Petrol	1360	4	75.00	77.00	22
K6D (TU3A)	Petrol	1360	4	75.00	77.00	22
K6E (TU3A)	Petrol	1360	4	75.00	77.00	22
K6F (TU3A)	Petrol	1360	4	75.00	77.00	22
K9Y (TUD3Y)	Diesel	1361	4	75.00	77.00	26
KAY (TU3CP)	Petrol	1361	4	75.00	77.00	22
KDX (TU3MC)	Petrol	1361	4	75.00	77.00	22
KDY (TU3M)	Petrol	1361	4	75.00	77.00	22
KDZ (TU3M)	Petrol	1361	4	75.00	77.00	22
KF5	Petrol	1796	4	84.00	81.00	61
KF6	Petrol	1796	4	84.00	81.00	61
KFT (TU3A)	Petrol	1360	4	75.00	77.00	22
KFU (ET3J4)	Petrol	1360	4	75.00	77.00	23
KFV (TU3A)	Petrol	1360	4	75.00	77.00	23
KFV (TU3JP)	Petrol	1360	4	75.00	77.00	23
KFW (TU3A)	Petrol	1360	4	75.00	77.00	22
KFW (TU3JP)	Petrol	1360	4	75.00	77.00	24
KFX (TU3JP)	Petrol	1361	4	75.00	77.00	24
KFZ (TU3J2/Z)	Petrol	1361	4	75.00	77.00	22
LFW (XU7JP)	Petrol	1761	4	83.00	81.40	48
LFX (XU7JB)	Petrol	1761	4	83.00	81.40	48
LFY (XU7JP4)	Petrol	1761	4	83.00	81.40	48
LFZ (XU7JP)	Petrol	1762	4	83.00	81.40	48
N6A (TU5JP4)	Petrol	1587	4	78.50	82.00	35



NFR (TU5JP4B)	Petrol	1587	4	78.50	82.00	35
NFT	Petrol	1587	4	78.50	82.00	35
NFU (DW10TD)	Diesel	1997	4	85.00	88.00	66
NFU (TU5JP4)	Petrol	1587	4	78.50	82.00	35
NFW (TU5J2)	Petrol	1587	4	78.50	82.00	35
NFX (TU5J4)	Petrol	1587	4	78.50	82.00	35
NFY (TU5J2)	Petrol	1587	4	78.50	82.00	35
NFZ (TU5JP)	Petrol	1587	4	78.50	82.00	35
P8C (XUD11BTE)	Diesel	2088	4	85.00	92.00	68
P9A (XUD11A)	Diesel	2138	4	86.00	92.00	74
PHZ (XUD11ATE)	Diesel	2088	4	85.00	92.00	68
R5A (XU102C)	Petrol	1998	4	86.00	86.00	70
RFH (EW10A)	Petrol	1997	4	85.00	88.00	65
RFJ (EW10A)	Petrol	1997	4	85.00	88.00	65
RFK (EW10J4S)	Petrol	1997	4	85.00	88.00	65
RFL (XU10J2U)	Petrol	1998	4	86.00	86.00	71
RFN (EW10J4)	Petrol	1997	4	85.00	88.00	65
RFR (DEW10J4)	Petrol	1997	4	85.00	88.00	65
RFS (XU10J4RS)	Petrol	1998	4	86.00	86.00	71
RFT (XU10J4)	Petrol	1998	4	86.00	86.00	71
RFU (XU10J2)	Petrol	1998	4	86.00	86.00	71
RFV (XU10J4R)	Petrol	1998	4	86.00	86.00	71
RFW (XU10J2)	Petrol	1998	4	86.00	86.00	71
RFX (XU10J2)	Petrol	1998	4	86.00	86.00	70
RFY (XU10J4Z)	Petrol	1998	4	86.00	86.00	70
RFZ (XU10J2Z)	Petrol	1998	4	86.00	86.00	70
RGX (XU10J2CTE)	Petrol	1998	4	86.00	86.00	72
RGX (XU10J2TE)	Petrol	1998	4	86.00	86.00	72
RGY (XU10J2TE)	Petrol	1998	4	86.00	86.00	72
RGZ (XU10J4TE/Z)	Petrol	1998	4	86.00	86.00	73
RHC (DW10CTED4)	Diesel	1997	4	85.00	88.00	66
RHD (DW10CTED4)	Diesel	1997	4	85.00	88.00	66
RHE (DW10CTED4)	Diesel	1997	4	85.00	88.00	66
RHF (DW10BTED4)	Diesel	1997	4	85.00	88.00	66
RHH (DW10CTED4)	Diesel	1997	4	85.00	88.00	66
RHK (DW10UTED4)	Diesel	1997	4	85.00	88.00	67
RHM (DW10ATED4)	Diesel	1997	4	85.00	88.00	67
RHO (DW10DTE4)	Diesel	1997	4	85.00	88.00	66
RHR (DW10BTED4)	Diesel	1997	4	85.00	88.00	67
RHS (DW10ATED)	Diesel	1997	4	85.00	88.00	66
RHT (DW10ATED4)	Diesel	1997	4	85.00	88.00	66
RHV (DW10TD)	Diesel	1997	4	85.00	88.00	66
RHV (DW10UTD)	Diesel	1997	4	85.00	88.00	66
RHW (DW10ATED4)	Diesel	1997	4	85.00	88.00	67
RHX (DW10BTED)	Diesel	1997	4	85.00	88.00	67
RHY (DW10TD)	Diesel	1997	4	85.00	88.00	66
RHZ (DW10ATED)	Diesel	1997	4	85.00	88.00	67
RHZ (DW10BTED)	Diesel	1997	4	85.00	88.00	66
RHZ (DW10CTED)	Diesel	1997	4	85.00	88.00	66
RLZ (EW10D)	Petrol	1997	4	85.00	88.00	65
T8A (DJ5T)	Diesel	2446	4	92.00	92.00	85
T9A (DJ5)	Diesel	2446	4	92.00	92.00	86
THX (DJ5TED)	Diesel	2446	4	92.00	92.00	85
THY (DK5ATE)	Diesel	2446	4	92.00	92.00	85
TU1AE5	Petrol	1124	4	72.00	69.00	12
TU2J2	Petrol	1294	4	75.00	73.20	20
TU9	Petrol	954	4	70.00	62.00	5
TU24	Petrol	1294	4	75.00	73.20	20
TU32	Petrol	1361	4	75.00	77.00	25
UFZ (ZPJ)	Petrol	2963	V6	93.00	72.70	87
UKZ (ZPJ4/Z)	Petrol	2963	V6	93.00	72.70	87
VJX (TUD5)	Diesel	1527	4	77.00	82.00	31
VJY (TUD5)	Diesel	1527	4	77.00	82.00	31
WJY (DW8B)	Diesel	1868	4	82.20	88.00	42
WJZ (DW8)	Diesel	1868	4	82.20	88.00	42
XB5	Petrol	1468	4	80.00	73.00	36
XB5P	Petrol	1468	4	80.00	73.00	36
XC5P	Petrol	1618	4	84.00	73.00	57
XC6	Petrol	1618	4	84.00	73.00	57

		cm ³				
XC7	Petrol	1618	4	84.00	73.00	58
XC7P	Petrol	1618	4	84.00	73.00	58
XD2	Diesel	2304	4	94.00	83.00	90
XD2	Diesel	2304	4	94.00	83.00	90
XD2P94	Diesel	2304	4	94.00	83.00	91
XD2PX94	Diesel	2304	4	94.00	83.00	90
XD2S	Diesel	2288	4	94.00	83.00	92
XD2S	Diesel	2304	4	94.00	83.00	90
XD3P	Diesel	2497	4	94.00	90.00	93
XD3P	Diesel	2498	4	94.00	90.00	93
XD3T	Diesel	2497	4	94.00	90.00	93
XD3TE	Diesel	2498	4	94.00	90.00	93
XD4x88	Diesel	1948	4	88.00	80.00	78
XD4x90	Diesel	2112	4	90.00	83.00	83
XD 88	Diesel	1948	4	88.00	80.00	78
XD90	Diesel	2112	4	90.00	83.00	83
XD P 4.88	Diesel	1948	4	88.00	80.00	78
XD P 4.90	Diesel	2112	4	90.00	83.00	83
XD P 85	Diesel	1816	4	85.00	80.00	64
XD P 88	Diesel	1948	4	88.00	80.00	78
XD P 90	Diesel	2112	4	90.00	83.00	83
XD P X 90	Diesel	2112	4	90.00	83.00	83
XK5	Petrol	1127	4	78.00	59.00	32
XL5	Petrol	1290	4	78.00	67.50	33
XL5S	Petrol	1290	4	78.00	67.50	33
XM	Petrol	1796	4	84.00	81.00	61
XM7	Petrol	1796	4	84.00	81.00	62
XM7P	Petrol	1796	4	84.00	81.00	63
XM7T	Petrol	1796	4	84.00	81.00	62
XN1	Petrol	1971	4	88.00	81.00	79
XN1P	Petrol	1971	4	88.00	81.00	81
XN1T	Petrol	1971	4	88.00	81.00	80
XN1TA	Petrol	1971	4	88.00	81.00	80
XN1TA	Petrol	1971	4	88.00	81.00	80
XUD7T	Diesel	1769	4	80.00	88.00	40
XUD9	Diesel	1905	4	83.00	88.00	53
XUD9	Diesel	1905	4	83.00	88.00	56
XUD9A	Diesel	1905	4	83.00	88.00	56
XUD9TE	Diesel	1905	4	83.00	88.00	54
XV 5	Petrol	954	4	70.00	62.00	3
XV 8	Petrol	954	4	70.00	62.00	6
XW3	Petrol	1124	4	72.00	69.00	15
XW3S	Petrol	1124	4	72.00	69.00	11
XW7	Petrol	1124	4	72.00	69.00	8
XY7	Petrol	1361	4	75.00	77.00	22
XZ7R	Petrol	1219	4	75.00	69.00	19
Y2	Petrol	1424	4	76.70	78.00	30

PEUGEOT



1 68.00 x 65.00									
1D1		4 Cyl.		944cc	29kW (39PS)		Petrol		TD5290
BE/PL	4	40,959/40,967	44,005/44,013	19,240	1,509	0,020/0,061	AL-LF	61820RA	01-4172/4 STD 0.20
MB/HL	2	51,966/51,976	55,882/55,892	18,680	1,924	0,058/0,103	AL-LF	61821RA	H1031/5 STD
MB/HL	6	51,966/51,976	55,882/55,892	18,680	1,924	0,058/0,103	AL-LF	61822RA	
MB/HL	1	51,966/51,976	55,882/55,892	24,680	1,924	0,058/0,103	AL-LF	61823RA	

2 69.60 x 82.00									
199 A9.000 Euro 5		4 Cyl.		1248cc	55kW (75PS)		Diesel Turbo Intercooler		TD26979
BE/PL	4	42,582/42,600	45,734/45,744	20,000	1,552	0,030/0,062	BS	71-4033	71-4033/4 STD .010
MB/HL 1,2,4,5	4	50,982/51,000	54,710/54,722	19,000	1,840	0,026/0,050	AL-LF	02-4034	H1011/5 STD 0.25
MB/HL 3	1	50,982/51,000	54,710/54,722	23,950	1,840	0,026/0,050	AL-LF	02-4035H	
SE/PB	1	23,000	25,747/25,772	25,000			BS-LF	55-4077	55-4077 SEMI

3 70.00 x 62.00									
108 (XV3)		4 Cyl.		954cc	33-34kW (45-46PS)		Petrol		TD2892
108 (XV5)		4 Cyl.		954cc	33-34kW (45-46PS)		Petrol		TD2893
XV 5		4 Cyl.		954cc	31-34kW (42-46PS)		Petrol		TD17982
BE/PL	4	44,975/44,991	48,655/48,671	19,750	1,820	0,024/0,081	AL-LF	62045RA	01-4173/4 STD 0.30 0.50
MB/HL 2,4	2	49,965/49,981	53,655/53,674	17,290	1,832	0,020/0,070	AL-LF	62046RA	H996/5 STD 0.30 0.50
MB/HL 1,3,5	3	49,965/49,981	53,655/53,674	17,290	1,832	0,020/0,070	AL-LF	62047RA	
TW/A	2	55,250/55,500	71,450/71,700		2,350		BS	62047BF	A202/2 STD 0.15
→03/81									
TW/A	2	55,250/55,500	71,450/71,700		2,450		BS	62047BFA	A203/2 STD 0.10
04/81 →									

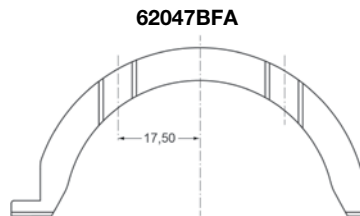
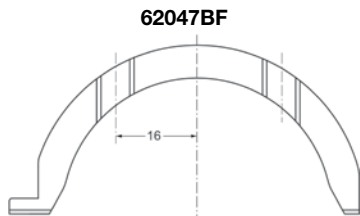

4 70.00 x 62.00									
108C (XV8)		4 Cyl.		954cc	32-33kW (44-45PS)		Petrol		TD2894
BE/PL	4	44,975/44,991	48,655/48,671	19,750	1,820	0,024/0,081	AL-LF	62045RA	01-4173/4 STD 0.30 0.50
MB/HL 2,4	2	49,965/49,981	53,655/53,674	17,290	1,832	0,020/0,070	AL-LF	62046RA	H996/5 STD 0.30 0.50
MB/HL 1,3,5	3	49,965/49,981	53,655/53,674	17,290	1,832	0,020/0,070	AL-LF	62047RA	
TW/A	2	55,250/55,500	71,450/71,700		2,450		BS	62047BFA	A203/2 STD 0.10



5 70.00 x 62.00

CDY (TU9M)		4 Cyl.		954cc	33kW (45PS)	Petrol		TD4841
CDZ (TU9M)		4 Cyl.		954cc	37kW (50PS)	Petrol		TD9405
TU9		4 Cyl.		954cc	33kW (45PS)	Petrol		TD2783
BE/PL	4	37,992/38,008	41,128/41,144	16,300	1,548	0,024/0,081	AL-LF 1260RAA	O1-4123/4 STD 0.30
MB/HL 2-4	3	49,965/49,981	53,655/53,674	17,290	1,832	0,020/0,070	AL-LF 1261RA	H1071/5 STD 0.30 0.50
MB/HL 1,5	2	49,965/49,981	53,655/53,674	17,290	1,832	0,020/0,070	AL-LF 1262RA	
TW/A	2	55,250/55,500	71,450/71,700		2,450		BS 62047BFA	A203/2 STD 0.10

6 70.00 x 62.00

XV 8		4 Cyl.		954cc	33kW (45PS)	Petrol		TD17983
BE/PL	4	44,975/44,991	48,655/48,671	19,750	1,820	0,024/0,081	AL-LF 62045RA	O1-4173/4 STD 0.30 0.50
MB/HL 2-4	3	49,965/49,981	53,655/53,674	17,290	1,832	0,020/0,070	AL-LF 1261RA	H1071/5 STD 0.30 0.50
MB/HL 1,5	2	49,965/49,981	53,655/53,674	17,290	1,832	0,020/0,070	AL-LF 1262RA	
TW/A	2	55,250/55,500	71,450/71,700		2,450		BS 62047BFA	A203/2 STD 0.10

7 71.00 x 84.00

1KR (384 F)		3 Cyl.		998cc	50kW (68PS)	Petrol		TD20286
BE/PL	6	40,000	43,020	13,600	1,495		AL-LF 64-735-1	O1-4980/3 STD
MB/HL 1-4	4	43,990	48,020	14,900	1,997		AL-LF 63-735-1	H1338/4 STD
MB/HL 1-4	4	43,990	48,020	14,900	1,997		AL-LF 63-735-2	
TW/A	2	52,000	63,000		1,990		AL-LF 65-735-1	A322/2 STD

8 72.00 x 69.00

109 (XW3)		4 Cyl.		1124cc	42kW (57PS)	Petrol		TD2895
XW7		4 Cyl.		1124cc	37kW (50PS)	Petrol		TD4927
BE/PL	4	44,975/44,991	48,655/48,671	19,750	1,820	0,024/0,081	AL-LF 62045RA	O1-4173/4 STD 0.30 0.50
MB/HL 2,4	2	49,965/49,981	53,655/53,674	17,290	1,832	0,020/0,070	AL-LF 62046RA	H996/5 STD 0.30 0.50
MB/HL 1,3,5	3	49,965/49,981	53,655/53,674	17,290	1,832	0,020/0,070	AL-LF 62047RA	
TW/A	2	55,250/55,500	71,450/71,700		2,350		BS 62047BF	A202/2 STD 0.15
→03/81								
TW/A	2	55,250/55,500	71,450/71,700		2,450		BS 62047BFA	A203/2 STD 0.10
04/81→								

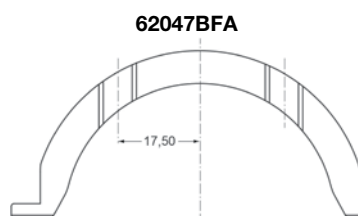
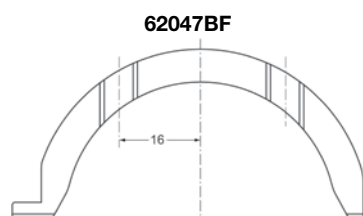



9 **72.00 x 69.00**

109F (XW7) 4 Cyl. **1124cc** **37kW (50PS)** **Petrol** **TD2899**

BE/PL	4	44,975/44,991	48,655/48,671	19,750	1,820	0,024/0,081	AL-LF	62045RA	01-4173/4 STD 0.30 0.50
MB/HL 2-4	3	49,965/49,981	53,655/53,674	17,290	1,832	0,020/0,070	AL-LF	1261RA	H1071/5 STD 0.30 0.50
MB/HL 1,5	2	49,965/49,981	53,655/53,674	17,290	1,832	0,020/0,070	AL-LF	1262RA	

01/85 →

MB/HL 2,4	2	49,965/49,981	53,655/53,674	17,290	1,832	0,020/0,070	AL-LF	62046RA	H996/5 STD 0.30 0.50
MB/HL 1,3,5	3	49,965/49,981	53,655/53,674	17,290	1,832	0,020/0,070	AL-LF	62047RA	

07/82 → 12/84

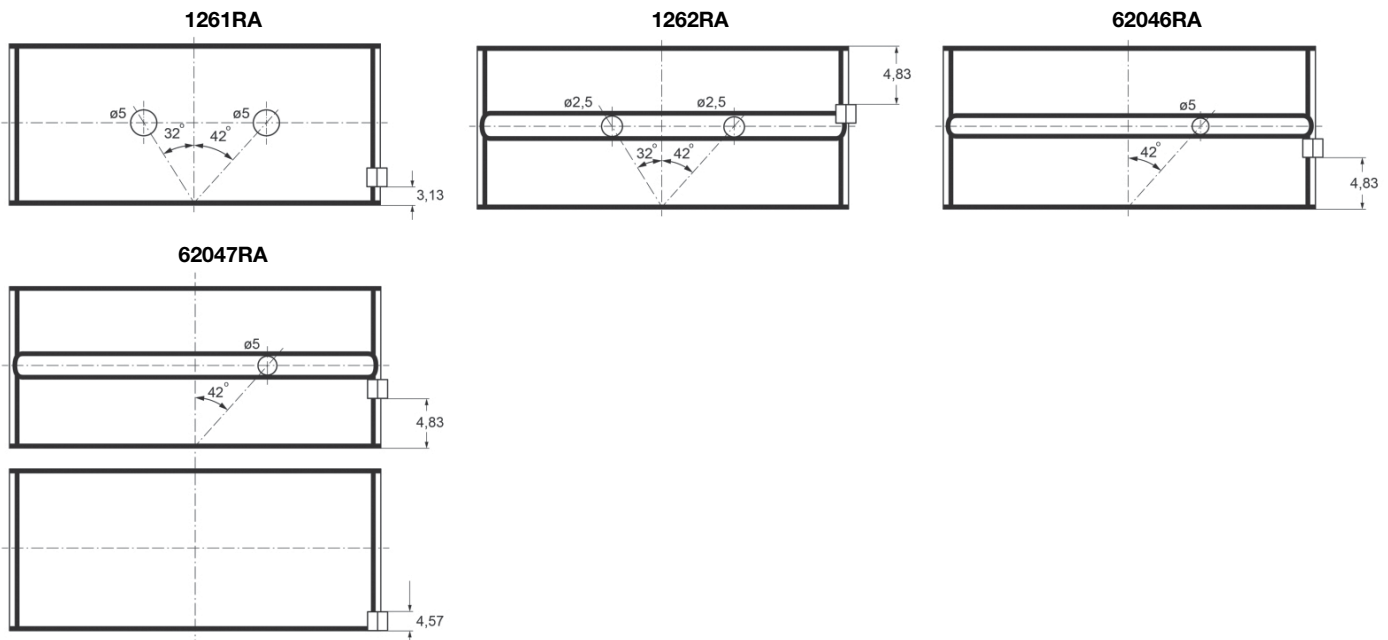

TW/A	2	55,250/55,500	71,450/71,700		2,350		BS	62047BF	A202/2 STD 0.15
------	---	---------------	---------------	--	-------	--	----	---------	---------------------------

→03/81

TW/A	2	55,250/55,500	71,450/71,700		2,450		BS	62047BFA	A203/2 STD 0.10
------	---	---------------	---------------	--	-------	--	----	----------	---------------------------

04/81 →

10 **72.00 x 69.00**

109N (XW7) 4 Cyl. **1124cc** **36kW (50PS)** **Petrol** **TD2900**

BE/PL	4	44,975/44,991	48,655/48,671	19,750	1,820	0,024/0,081	AL-LF	62045RA	01-4173/4 STD 0.30 0.50
MB/HL 2-4	3	49,965/49,981	53,655/53,674	17,290	1,832	0,020/0,070	AL-LF	1261RA	H1071/5 STD 0.30 0.50
MB/HL 1,5	2	49,965/49,981	53,655/53,674	17,290	1,832	0,020/0,070	AL-LF	1262RA	

01/85 →

MB/HL 2,4	2	49,965/49,981	53,655/53,674	17,290	1,832	0,020/0,070	AL-LF	62046RA	H996/5 STD 0.30 0.50
MB/HL 1,3,5	3	49,965/49,981	53,655/53,674	17,290	1,832	0,020/0,070	AL-LF	62047RA	

→12/84

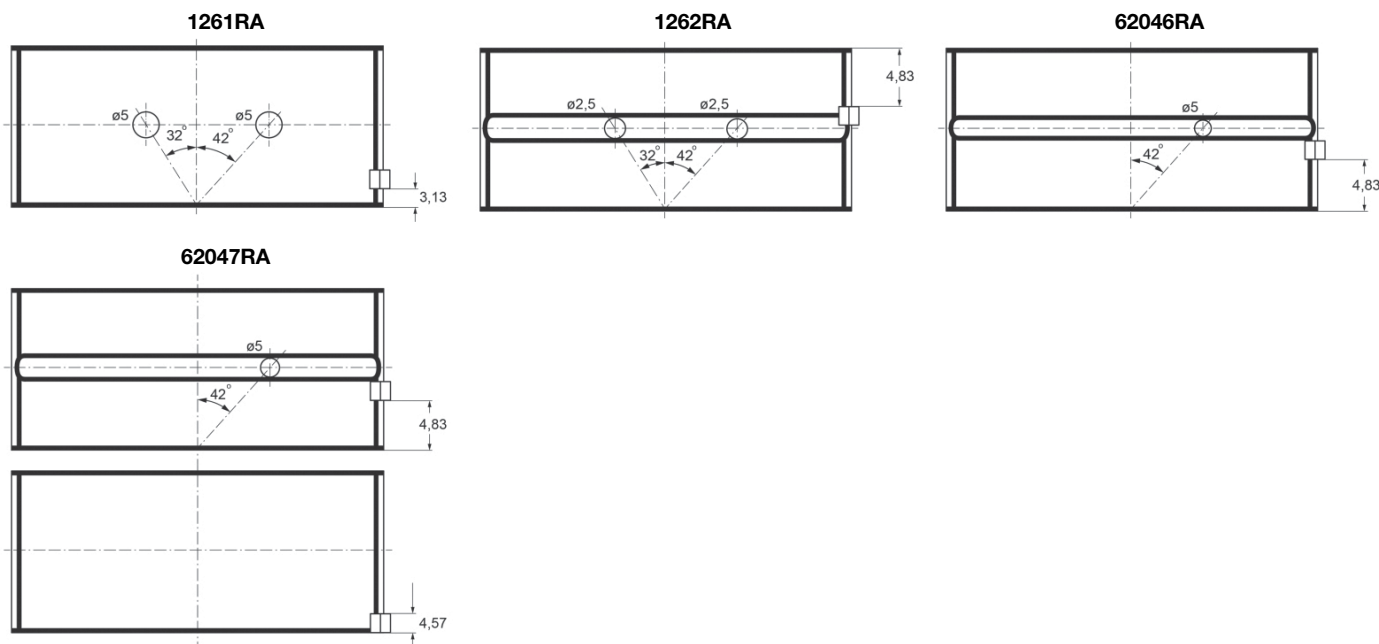

TW/A	2	55,250/55,500	71,450/71,700	2,450	BS	62047BFA	A203/2 STD 0.10
------	---	---------------	---------------	-------	----	----------	---------------------------

11 72.00 x 69.00

121 (XW3S)			4 Cyl.	1124cc	49kW (67PS)		Petrol		TD2896
XW3S			4 Cyl.	1124cc	48kW (66PS)		Petrol		TD12688
BE/PL	4	44,975/44,991	48,655/48,671	19,750	1,820	0,024/0,081	AL-LF	62045RA	01-4173/4 STD 0.30 0.50
MB/HL 2,4	2	49,965/49,981	53,655/53,674	17,290	1,832	0,020/0,070	AL-LF	62046RA	H996/5 STD 0.30 0.50
MB/HL 1,3,5	3	49,965/49,981	53,655/53,674	17,290	1,832	0,020/0,070	AL-LF	62047RA	
TW/A	2	55,250/55,500	71,450/71,700		2,350		BS	62047BF	A202/2 STD 0.15

12 72.00 x 69.00

H1B (TU1)			4 Cyl.	1124cc	40kW (54PS)		Petrol		TD2758
HDY (TU1M)			4 Cyl.	1124cc	40kW (54PS)		Petrol		TD9404
HDZ (TU1M)			4 Cyl.	1124cc	44kW (60PS)		Petrol		TD4834
HDZ (TU1M+)			4 Cyl.	1124cc	44kW (60PS)		Petrol		TD26413
HFX (TU1A)			4 Cyl.	1124cc	44kW (60PS)		Petrol		TD25640
TU1AE5			4 Cyl.	1124cc	44kW (60PS)		Petrol		TD25641
BE/PL	4	44,975/44,991	48,655/48,671	19,750	1,820	0,024/0,081	AL-LF	62045RA	01-4173/4 STD 0.30 0.50
MB/HL 2-4	3	49,965/49,981	53,655/53,674	17,290	1,832	0,020/0,070	AL-LF	1261RA	H1071/5 STD 0.30 0.50
MB/HL 1,5	2	49,965/49,981	53,655/53,674	17,290	1,832	0,020/0,070	AL-LF	1262RA	
TW/A	2	55,250/55,500	71,450/71,700		2,450		BS	62047BFA	A203/2 STD 0.10

13 72.00 x 69.00

HFX (TU1JP)			4 Cyl.	1124cc	44kW (60PS)		Petrol		TD14728
BE/PL	4	44,975/44,991	48,655/48,671	19,750	1,820	0,020/0,080	AL-LF	4650RA	01-4163/4 STD

10/97→

PEUGEOT



BE/PL	4	44,975/44,991	48,655/48,671	19,750	1,820	0,024/0,081	AL-LF	62045RA	01-4173/4 STD 0.30 0.50
-------	---	---------------	---------------	--------	-------	-------------	-------	---------	-----------------------------------

→09/97

4650RA

62045RA

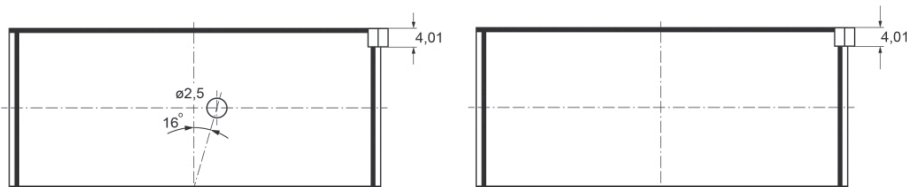

MB/HL 2-4	3	49,965/49,981	53,655/53,674	17,290	1,832	0,020/0,070	AL-LF	1261RA	H1071/5 STD 0.30 0.50
MB/HL 1,5	2	49,965/49,981	53,655/53,674	17,290	1,832	0,020/0,070	AL-LF	1262RA	
TW/A	2	55,250/55,500	71,450/71,700		2,450		BS	62047BFA	A203/2 STD 0.10

14

72.00 x 69.00

HFZ (TU1JP)		4 Cyl.		1124cc	44kW (60PS)	Petrol			TD9848
BE/PL	4	44,975/44,991	48,655/48,671	19,750	1,820	0,020/0,080	AL-LF	4650RA	01-4163/4 STD
MB/HL 2-4	3	49,965/49,981	53,655/53,674	17,290	1,832	0,020/0,070	AL-LF	1261RA	H1071/5 STD 0.30 0.50
MB/HL 1,5	2	49,965/49,981	53,655/53,674	17,290	1,832	0,020/0,070	AL-LF	1262RA	
TW/A	2	55,250/55,500	71,450/71,700		2,450		BS	62047BFA	A203/2 STD 0.10

15

72.00 x 69.00

XW3		4 Cyl.		1124cc	42kW (57PS)	Petrol			TD21366
BE/PL	4	44,975/44,991	48,655/48,671	19,750	1,820	0,024/0,081	AL-LF	62045RA	01-4173/4 STD 0.30 0.50
MB/HL 2,4	2	49,965/49,981	53,655/53,674	17,290	1,832	0,020/0,070	AL-LF	62046RA	H996/5 STD 0.30 0.50
MB/HL 1,3,5	3	49,965/49,981	53,655/53,674	17,290	1,832	0,020/0,070	AL-LF	62047RA	
TW/A	2	55,250/55,500	71,450/71,700		2,350		BS	62047BF	A202/2 STD 0.15

→03/81

TW/A	2	55,250/55,500	71,450/71,700		2,450		BS	62047BFA	A203/2 STD 0.10
------	---	---------------	---------------	--	-------	--	----	----------	---------------------------

04/81→

62047BF

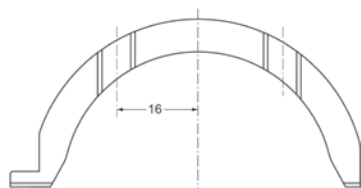

62047BFA

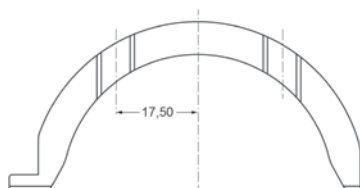

16

73.70 x 82.00

8HP (DV4C)	4 Cyl.	1398cc	50kW (68PS)	Diesel Turbo	TD28225
8HR (DV4C)	4 Cyl.	1398cc	50kW (68PS)	Diesel Turbo	TD28125
8HS (DV4TED) Euro 4	4 Cyl.	1398cc	50kW (68PS)	Diesel Turbo Intercooler	TD29164
8HT (DV4TD)	4 Cyl.	1398cc	40kW (54PS)	Diesel Turbo	TD24924
8HX (DV4TD) Euro 3/4	4 Cyl.	1398cc	50-51kW (68-69PS)	Diesel Turbo	TD16368



8HZ (DV4TD)		4 Cyl.		1398cc	50-51kW (68-69PS)		Diesel Turbo		TD17509
BE/PL	1	44,975/44,991	48,665/48,671	17,050	1,820	0,029/0,081	SP	71-3986	71-3986 STD 0.30
MB/HL 1-5	5	49,962/49,981	53,655/53,674	19,900	1,833	0,008/0,046	AL	02-4244	H1066/5 STD 0.30 0.50
TW/A	2	55,200/55,480	71,350/71,700		2,460		AL	04-4245	A217/2 STD
SE/PB	1	24,995/25,000	28,000/28,021	19,980			BS	55-3987	55-3987 SEMI

17 74.00 x 65.00

2E1		4 Cyl.		1118cc			Petrol		FM4599
3E1		4 Cyl.		1118cc	37-41kW (50-56PS)		Petrol		TD3675
3E1A		4 Cyl.		1118cc	43-44kW (58-60PS)		Petrol		TD5300
E1		4 Cyl.		1118cc	40kW (54PS)		Petrol		TD4832
E1/BTC		4 Cyl.		1118cc	36-41kW (49-56PS)		Petrol		TD3684
E1B		4 Cyl.		1118cc	40kW (54PS)		Petrol		TD3685
BE/PL	4	40,959/40,967	44,005/44,013	19,240	1,509	0,020/0,061	AL-LF	61820RA	01-4172/4 STD 0.20
MB/HL	2	51,966/51,976	55,882/55,892	18,680	1,924	0,058/0,103	AL-LF	61821RA	H1031/5 STD
MB/HL	6	51,966/51,976	55,882/55,892	18,680	1,924	0,058/0,103	AL-LF	61822RA	
MB/HL	1	51,966/51,976	55,882/55,892	24,680	1,924	0,058/0,103	AL-LF	61823RA	

18 74.00 x 70.00

F1		4 Cyl.		1204cc	47kW (64PS)		Petrol		TD2750
BE/PL	4	40,959/40,967	44,005/44,013	19,240	1,509	0,020/0,061	AL-LF	61820RA	01-4172/4 STD 0.20
MB/HL	2	51,966/51,976	55,882/55,892	18,680	1,924	0,058/0,103	AL-LF	61821RA	H1031/5 STD
MB/HL	6	51,966/51,976	55,882/55,892	18,680	1,924	0,058/0,103	AL-LF	61822RA	
MB/HL	1	51,966/51,976	55,882/55,892	24,680	1,924	0,058/0,103	AL-LF	61823RA	

19 75.00 x 69.00

129 (XZ5)		4 Cyl.		1219cc	42kW (57PS)		Petrol		TD2906
XZ7R		4 Cyl.		1219cc	65-66kW (88-90PS)		Petrol		TD3696
BE/PL	4	44,975/44,991	48,655/48,671	19,750	1,820	0,024/0,081	AL-LF	62045RA	01-4173/4 STD 0.30 0.50
MB/HL 2,4	2	49,965/49,981	53,655/53,674	17,290	1,832	0,020/0,070	AL-LF	62046RA	H996/5 STD 0.30 0.50
MB/HL 1,3,5	3	49,965/49,981	53,655/53,674	17,290	1,832	0,020/0,070	AL-LF	62047RA	
TW/A	2	55,250/55,500	71,450/71,700		2,350		BS	62047BF	A202/2 STD 0.15
→03/81									
TW/A	2	55,250/55,500	71,450/71,700		2,450		BS	62047BFA	A203/2 STD 0.10
04/81→									



62047BF

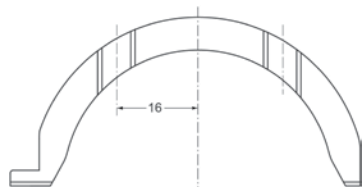

62047BFA

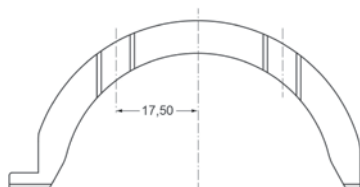

20 75.00 x 73.20

TU2J2	4 Cyl.	1294cc	72-74kW (98-101PS)	Petrol	TD2763				
TU24	4 Cyl.	1294cc	74-76kW (101-103PS)	Petrol	TD12689				
BE/PL	4	44,975/44,991	48,655/48,671	19,750	1,820	0,024/0,081	AL-LF	62045RA	01-4173/4 STD 0.30 0.50
MB/HL 2-4	3	49,965/49,981	53,655/53,674	17,290	1,832	0,020/0,070	AL-LF	1261RA	H1071/5 STD 0.30 0.50
MB/HL 1,5	2	49,965/49,981	53,655/53,674	17,290	1,832	0,020/0,070	AL-LF	1262RA	
TW/A	2	55,250/55,500	71,450/71,700		2,450		BS	62047BFA	A203/2 STD 0.10

21 75.00 x 77.00

150 (XY6B)	4 Cyl.	1360cc	53kW (72PS)	Petrol	TD2901				
BE/PL	4	44,975/44,991	48,655/48,671	19,750	1,820	0,024/0,081	AL-LF	62045RA	01-4173/4 STD 0.30 0.50
MB/HL 2,4	2	49,965/49,981	53,655/53,674	17,290	1,832	0,020/0,070	AL-LF	62046RA	H996/5 STD 0.30 0.50
MB/HL 1,3,5	3	49,965/49,981	53,655/53,674	17,290	1,832	0,020/0,070	AL-LF	62047RA	
TW/A	2	55,250/55,500	71,450/71,700		2,350		BS	62047BF	A202/2 STD 0.15
→03/81									
TW/A	2	55,250/55,500	71,450/71,700		2,450		BS	62047BFA	A203/2 STD 0.10

04/81 →

62047BF

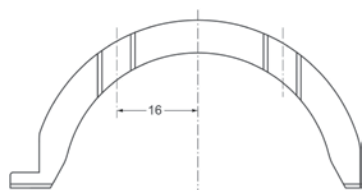

62047BFA

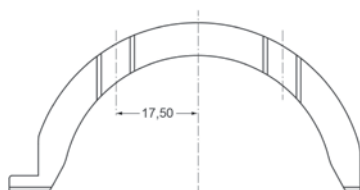

22 75.00 x 77.00

150 D	4 Cyl.	1351cc	44kW (60PS)	Petrol	TD5291
150B (XY8)	4 Cyl.	1360cc	58-59kW (79-80PS)	Petrol	TD2905
150D (XY7)	4 Cyl.	1360cc	44kW (60PS)	Petrol	TD2902
150G (XY7)	4 Cyl.	1360cc	44kW (60PS)	Petrol	TD2903
150H (XY8)	4 Cyl.	1360cc	58kW (79PS)	Petrol	TD2904
K1D (TU3A)	4 Cyl.	1361cc	49kW (67PS)	Petrol	TD2766
K2B (TU3S)	4 Cyl.	1360cc	62kW (85PS)	Petrol	TD2779
K5A (TU3)	4 Cyl.	1360cc	47-51kW (64-69PS)	Petrol	TD26412
K6D (TU3A)	4 Cyl.	1360cc	53kW (72PS)	Petrol	TD24928
K6E (TU3A)	4 Cyl.	1360cc	53kW (72PS)	Petrol	TD24930
K6F (TU3A)	4 Cyl.	1360cc	53kW (72PS)	Petrol	TD24929
KAY (TU3CP)	4 Cyl.	1361cc	44kW (60PS)	Petrol	TD2767
KDX (TU3MC)	4 Cyl.	1361cc	55-58kW (75-79PS)	Petrol	TD2777



KDY (TU3M)	4 Cyl.	1361cc	55-58kW (75-79PS)	Petrol	TD4836
KDZ (TU3M)	4 Cyl.	1361cc	55kW (75PS)	Petrol	TD2775
KFT (TU3A)	4 Cyl.	1360cc	54kW (73PS)	Petrol	TD24931
KFW (TU3A)	4 Cyl.	1360cc	55-60kW (75-82PS)	Petrol	TD24927
KFZ (TU3J2/Z)	4 Cyl.	1361cc	69kW (94PS)	Petrol	TD2770
XY7	4 Cyl.	1361cc	53kW (72PS)	Petrol	TD4928

BE/PL	4	44,975/44,991	48,655/48,671	19,750	1,820	0,024/0,081	AL-LF	62045RA	01-4173/4 STD 0.30 0.50
MB/HL 2,4	2	49,965/49,981	53,655/53,674	17,290	1,832	0,020/0,070	AL-LF	62046RA	H996/5 STD 0.30 0.50
MB/HL 1,3,5	3	49,965/49,981	53,655/53,674	17,290	1,832	0,020/0,070	AL-LF	62047RA	
TW/A	2	55,250/55,500	71,450/71,700		2,450		BS	62047BFA	A203/2 STD 0.10

23 75.00 x 77.00

KFU (ET3J4)	4 Cyl.	1360cc	65kW (88PS)	Petrol	TD17550
KFV (TU3A)	4 Cyl.	1360cc	54-60kW (73-82PS)	Petrol	TD21111
KFV (TU3JP)	4 Cyl.	1360cc	48-55kW (65-75PS)	Petrol	TD18518

BE/PL	4	44,975/44,991	48,655/48,671	19,750	1,820	0,020/0,080	AL-LF	4650RA	01-4163/4 STD
MB/HL 2,4	2	49,965/49,981	53,655/53,674	17,290	1,832	0,020/0,070	AL-LF	62046RA	H996/5 STD 0.30 0.50
MB/HL 1,3,5	3	49,965/49,981	53,655/53,674	17,290	1,832	0,020/0,070	AL-LF	62047RA	
TW/A	2	55,250/55,500	71,450/71,700		2,450		BS	62047BFA	A203/2 STD 0.10

24 75.00 x 77.00

KFW (TU3JP)	4 Cyl.	1360cc	47-60kW (64-82PS)	Petrol	TD14729
KFX (TU3JP)	4 Cyl.	1361cc	49-55kW (67-75PS)	Petrol	TD5396

BE/PL	4	44,975/44,991	48,655/48,671	19,750	1,820	0,020/0,080	AL-LF	4650RA	01-4163/4 STD
10/97→									
BE/PL	4	44,975/44,991	48,655/48,671	19,750	1,820	0,024/0,081	AL-LF	62045RA	01-4173/4 STD 0.30 0.50
→09/97									

4650RA

62045RA

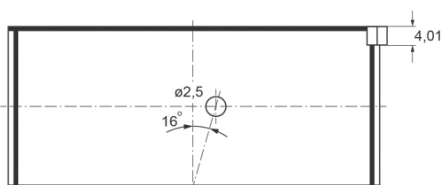

MB/HL 2,4	2	49,965/49,981	53,655/53,674	17,290	1,832	0,020/0,070	AL-LF	62046RA	H996/5 STD 0.30 0.50
MB/HL 1,3,5	3	49,965/49,981	53,655/53,674	17,290	1,832	0,020/0,070	AL-LF	62047RA	
TW/A	2	55,250/55,500	71,450/71,700		2,450		BS	62047BFA	A203/2 STD 0.10

25 75.00 x 77.00

TU32	4 Cyl.	1361cc	51-55kW (70-75PS)	Petrol	TD8507				
BE/PL	4	44,975/44,991	48,655/48,671	19,750	1,820	0,024/0,081	AL-LF	62045RA	01-4173/4 STD 0.30 0.50

PEUGEOT

MB/HL 2,4	2	49,965/49,981	53,655/53,674	17,290	1,832	0,020/0,070	AL-LF	62046RA	H996/5 STD 0.30 0.50	
MB/HL 1,3,5	3	49,965/49,981	53,655/53,674	17,290	1,832	0,020/0,070	AL-LF	62047RA		
TW/A	2	55,250/55,500	71,450/71,700		2,450		BS	62047BFA	A203/2 STD 0.10	

26

75.00 x 77.00

K9Y (TUD3Y)			4 Cyl.	1361cc	37kW (50PS)		Diesel		TD2786
BE/PL	4	44,975/44,991	48,655/48,671	19,650	1,820	0,020/0,080	AL-LF	4665RA	01-4165/4 STD
MB/HL 2-4	3	49,965/49,981	53,655/53,674	17,290	1,832	0,020/0,070	AL-LF	1261RA	H1071/5 STD 0.30 0.50
MB/HL 1,5	2	49,965/49,981	53,655/53,674	17,290	1,832	0,020/0,070	AL-LF	1262RA	
TW/A	2	55,250/55,500	71,450/71,700		2,450		BS	62047BFA	A203/2 STD 0.10

27

75.00 x 88.30

9HD (DV6CTED)			4 Cyl.	1560cc	84kW (115PS)		Diesel		TD26896
9HF (DV6DTED) Euro 4			4 Cyl.	1560cc	66-68kW (90-92PS)		Diesel Turbo Intercooler		TD26710
9HH (DV6DUM)			4 Cyl.	1560cc	66kW (90PS)		Diesel Turbo Intercooler		TD29700
9HJ (DV6DTEDM) Euro 4			4 Cyl.	1560cc	68kW (92PS)		Diesel Turbo Intercooler		TD27967
9HK (DV6ETEDM) Euro 4			4 Cyl.	1560cc	55kW (75PS)		Diesel Turbo Intercooler		TD27968
9HL (DV6C)			4 Cyl.	1560cc	82-85kW (112-116PS)		Diesel Turbo		TD26986
9HM (DV6UC)			4 Cyl.	1560cc	66kW (90PS)		Diesel Turbo Intercooler		TD29699
9HN (DV6ETED4) Euro 4			4 Cyl.	1560cc	55kW (75PS)		Diesel Turbo Intercooler		TD31330
9HP (DV6DTED) Euro 4			4 Cyl.	1560cc	68kW (92PS)		Diesel Turbo Intercooler		TD27064
9HR (DV6C)			4 Cyl.	1560cc	82kW (112PS)		Diesel Turbo		TD26421
9HS (DV6TED4BU) Euro 4			4 Cyl.	1560cc	66kW (90PS)		Diesel Turbo Intercooler		TD29162
9HT (DV6BTED4) Euro 4			4 Cyl.	1560cc	55kW (75PS)		Diesel Turbo Intercooler		TD23537
9HU (DV6UTED4)			4 Cyl.	1560cc	66kW (90PS)		Diesel Turbo Intercooler		TD24693
9HV (DV6ATED4)			4 Cyl.	1560cc	66kW (90PS)		Diesel Turbo Intercooler		TD24730
9HV (DV6TED4)			4 Cyl.	1560cc	66kW (90PS)		Diesel Turbo Intercooler		TD28634
9HW (DV6BTED4) Euro 4			4 Cyl.	1560cc	55kW (75PS)		Diesel Turbo Intercooler		TD24701
9HX (DV6ATED4) Euro 4			4 Cyl.	1560cc	66-68kW (90-92PS)		Diesel Turbo		TD20147
9HY (DV6TED4)			4 Cyl.	1560cc	80kW (109PS)		Diesel Turbo Intercooler		TD17506
9HZ (DV6TED4)			4 Cyl.	1560cc	80-82kW (109-112PS)		Diesel Turbo Intercooler		TD18520
BHW (DV6FE)			4 Cyl.	1560cc	55kW (75PS)		Diesel Turbo Intercooler		TD31071
BHX (DV6FC)			4 Cyl.	1560cc	85kW (116PS)		Diesel Turbo Intercooler		TD29557
BHY (DV6FD)			4 Cyl.	1560cc	73kW (99PS)		Diesel Turbo Intercooler		TD31070
BHZ (DV6FC)			4 Cyl.	1560cc	88kW (120PS)		Diesel Turbo Intercooler		TD28620

BE/PL	4	46,975/46,991	50,655/50,674	17,000	1,818	0,028/0,063	BS	71-4246	71-4246/4 STD 0.30 0.50
-------	---	---------------	---------------	--------	-------	-------------	----	---------	-----------------------------------

USE ONLY UP TO 92HP

MB/HL 1-5	5	49,962/49,981	53,655/53,674	19,900	1,833	0,008/0,046	AL	02-4244	H1066/5 STD 0.30 0.50
TW/A	2	55,200/55,480	71,350/71,700		2,460		AL	04-4245	A217/2 STD
SE/PB	1	26,000	29,000/29,021	19,980			BS	55-4102	55-4102 SEMI

28

75.00 x 90.50

HNY (EB2DTS) Euro 6			3 Cyl.	1199cc	96kW (131PS)		Petrol Turbo		TD28613
HNZ (EB2DT) Euro 6			3 Cyl.	1199cc	81kW (110PS)		Petrol Turbo		TD29556
BE/PL	3	41,984/42,000	45,000/45,016	16,000	1,492	0,023/0,071	AL-LF	01-4990	01-4990/3 STD

MB/HL	4	41,984/42,000	45,600/45,619	16,190	1,795	0,019/0,070	AL-LF	02-4991	H1345/4 STD	
MB/HL	2	41,984/42,000	45,600/45,619	16,190	1,795	0,019/0,070	AL-LF	02-4992		
MB/HL	2	41,984/42,000	45,600/45,619	16,190	1,795	0,019/0,070	AL-LF	02-4993		

29		76.70 x 70.00								
1G1			4 Cyl.	1294cc	44kW (60PS)		Petrol			TD5289
2G1-BTC			4 Cyl.	1294cc	40-50kW (54-68PS)		Petrol			TD3672
3G4			4 Cyl.	1294cc	60-62kW (82-84PS)		Petrol			TD5299
6G1D			4 Cyl.	1294cc	40kW (54PS)		Petrol			TD3677
6G1D/VP			4 Cyl.	1294cc	40kW (54PS)		Petrol			TD3686
G1A			4 Cyl.	1294cc	47-48kW (64-65PS)		Petrol			TD4833
BE/PL	4	40,959/40,967	44,005/44,013	19,240	1,509	0,020/0,061	AL-LF	61820RA	01-4172/4 STD 0.20	
MB/HL	2	51,966/51,976	55,882/55,892	18,680	1,924	0,058/0,103	AL-LF	61821RA	H1031/5 STD	
MB/HL	6	51,966/51,976	55,882/55,892	18,680	1,924	0,058/0,103	AL-LF	61822RA		
MB/HL	1	51,966/51,976	55,882/55,892	24,680	1,924	0,058/0,103	AL-LF	61823RA		

30		76.70 x 78.00								
2Y1			4 Cyl.	1442cc	51kW (70PS)		Petrol			TD3697
2Y1B			4 Cyl.	1424cc	48kW (65PS)		Petrol			TD5295
2Y2			4 Cyl.	1424cc	61kW (83PS)		Petrol			TD4918
6Y1			4 Cyl.	1442cc	51kW (69PS)		Petrol			TD3681
6Y2			4 Cyl.	1424cc	55-63kW (75-86PS)		Petrol			TD4920
6Y2-BTC			4 Cyl.	1442cc	55kW (75PS)		Petrol			TD3682
6Y4			4 Cyl.	1442cc	62-66kW (84-90PS)		Petrol			TD27242
Y2			4 Cyl.	1424cc	61-63kW (83-86PS)		Petrol			TD4930
BE/PL	4	40,959/40,967	44,005/44,013	19,240	1,509	0,020/0,061	AL-LF	61820RA	01-4172/4 STD 0.20	
MB/HL	2	51,966/51,976	55,882/55,892	18,680	1,924	0,058/0,103	AL-LF	61821RA	H1031/5 STD	
MB/HL	6	51,966/51,976	55,882/55,892	18,680	1,924	0,058/0,103	AL-LF	61822RA		
MB/HL	1	51,966/51,976	55,882/55,892	24,680	1,924	0,058/0,103	AL-LF	61823RA		

31		77.00 x 82.00								
VJX (TUD5)			4 Cyl.	1527cc	42kW (57PS)		Diesel			TD16193
VJY (TUD5)			4 Cyl.	1527cc	40-43kW (54-58PS)		Diesel			TD4842
BE/PL	4	44,975/44,991	48,655/48,671	17,400	1,820	0,024/0,081	AL-LF	4630RA	01-4362/4 STD	
MB/HL 2-4	3	49,965/49,981	53,712/53,731	17,290	1,854	0,023/0,086	AL-LF	4151RA	H1087/5 STD 0.30	
MB/HL 1,5	2	49,965/49,981	53,712/53,731	17,290	1,854	0,023/0,086	AL-LF	4152RA		
TW/A	2	55,250/55,500	71,450/71,700		2,450		BS	62047BFA	A203/2 STD 0.10	
SE/PB	1	23,000/23,012	25,200/25,221	19,900			BS	4154Y	55-4150 SEMI	



32 78.00 x 59.00

XK5			4 Cyl.	1127cc	43kW (58PS)		Petrol		TD2815
BE/PL	4	44,975/44,991	48,655/48,671	19,750	1,820	0,024/0,081	AL-LF	62045RA	01-4173/4 STD 0.30 0.50
TW/A	2	61,150/61,400	76,050/76,300		2,330		BS	66411BF	A228/2 0.10 0.15

33 78.00 x 67.50

118 (XL5)			4 Cyl.	1290cc	44kW (60PS)		Petrol		TD2822
XL5			4 Cyl.	1290cc	44-48kW (60-65PS)		Petrol		TD4844
XL5S			4 Cyl.	1290cc	55kW (75PS)		Petrol		TD2821
BE/PL	4	44,975/44,991	48,655/48,671	19,750	1,820	0,024/0,081	AL-LF	62045RA	01-4173/4 STD 0.30 0.50
MB/HL 1-5	5	53,036/53,046	56,822/56,832	19,290	1,880	0,020/0,061	AL-LF	66412RA	H1046/5 STD 0.30 0.50
TW/A	2	61,150/61,400	76,050/76,300		2,330		BS	66411BF	A228/2 0.10 0.15

34 78.00 x 77.00

117 (XR5S)			4 Cyl.	1472cc	65kW (88PS)		Petrol		TD2844
142 (XR5)			4 Cyl.	1472cc	54kW (73PS)		Petrol		TD2749
142 (XR5A)			4 Cyl.	1472cc	50kW (68PS)		Petrol		TD2842
BE/PL	4	44,975/44,991	48,655/48,671	19,750	1,820	0,024/0,081	AL-LF	62045RA	01-4173/4 STD 0.30 0.50
MB/HL 1-5	5	53,036/53,046	56,822/56,832	19,290	1,880	0,020/0,061	AL-LF	66412RA	H1046/5 STD 0.30 0.50
TW/A	2	61,150/61,400	76,050/76,300		2,330		BS	66411BF	A228/2 0.10 0.15

35 78.50 x 82.00

N6A (TU5JP4)			4 Cyl.	1587cc	78-83kW (106-113PS)		Petrol		TD21503
NFR (TU5JP4B)			4 Cyl.	1587cc	66kW (90PS)		Petrol		TD24700
NFT			4 Cyl.	1587cc	72kW (98PS)		Petrol		TD15189
NFU (TU5JP4)			4 Cyl.	1587cc	78-90kW (106-122PS)		Petrol		TD15668
NFW (TU5J2)			4 Cyl.	1587cc	74kW (101PS)		Petrol		TD4837
NFX (TU5J4)			4 Cyl.	1587cc	87kW (118PS)		Petrol		TD4839
NFY (TU5J2)			4 Cyl.	1587cc	74-76kW (101-104PS)		Petrol		TD4838
NFZ (TU5JP)			4 Cyl.	1587cc	65kW (88PS)		Petrol		TD4840
BE/PL	4	44,975/44,991	48,655/48,671	19,750	1,820	0,024/0,081	AL-LF	62045RA	01-4173/4 STD 0.30 0.50
MB/HL 2-4	3	49,965/49,981	53,712/53,731	17,290	1,854	0,023/0,086	AL-LF	4151RA	H1087/5 STD 0.30
MB/HL 1,5	2	49,965/49,981	53,712/53,731	17,290	1,854	0,023/0,086	AL-LF	4152RA	
TW/A	2	55,250/55,500	71,450/71,700		2,450		BS	62047BFA	A203/2 STD 0.10

36 80.00 x 73.00

XB5			4 Cyl.	1468cc	39-44kW (53-60PS)		Petrol		TD18878
XB5P			4 Cyl.	1468cc	61kW (83PS)		Petrol		TD8494
BE/PL	4	49,975/49,991	53,655/53,674	23,400	1,818	0,030/0,080	AL-LF	2865RA	01-4558/4 STD 0.30 0.50 0.80

37 80.00 x 77.00

149 (XID)			4 Cyl.	1548cc	36kW (49PS)		Diesel		TD2812
BE/PL	4	44,975/44,991	48,655/48,671	19,750	1,820	0,024/0,081	AL-LF	66410RA	01-4179/4 STD 0.30

MB/HL 1-5	5	53,036/53,046	56,822/56,832	19,290	1,880	0,020/0,061	AL-LF	66412RA	H1046/5 STD 0.30 0.50
TW/A	2	61,150/61,400	76,050/76,300		2,330		BS	66411BF	A228/2 0.10 0.15
SE/PB	1	23,007/23,020	25,000/25,021	23,850			BS	66414Y	55-4265 SEMI

38 80.00 x 88.00

161 (XUD7)		4 Cyl.		1769cc	44kW (60PS)	Diesel		TD21268	
BE/PL	4	49,984/50,000	53,695/53,708	20,050	1,830	0,040/0,090	AL-LF	66725RA	01-4200/4 STD 0.30 0.50
MB/HL 1-5	5	59,981/60,000	63,731/63,750	20,290	1,845	0,040/0,100	AL-LF	66726RA	H1057/5 STD 0.30 0.50
TW/A	4	67,050/67,300	83,050/83,300		2,330		BS	66721BF	A214/4 STD 0.10
SE/PB	1	25,007/25,020	27,200/27,221	24,050			BS	66729YA	55-4201 SEMI
12/84 →									
SE/PB	1	25,007/25,020	27,000/27,021	24,150			BS	66729Y	55-4266 STD
→11/84									

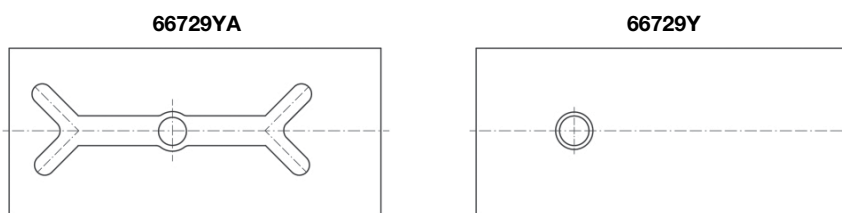

39 80.00 x 88.00

161A (XUD7)		4 Cyl.		1769cc	44kW (60PS)	Diesel		TD2882	
BE/PL	4	49,984/50,000	53,695/53,708	20,050	1,830	0,040/0,090	AL-LF	66725RA	01-4200/4 STD 0.30 0.50
MB/HL 1-5	5	59,981/60,000	63,731/63,750	20,290	1,845	0,040/0,100	AL-LF	66726RA	H1057/5 STD 0.30 0.50
TW/A	4	67,050/67,300	83,050/83,300		2,330		BS	66721BF	A214/4 STD 0.10
SE/PB	1	25,007/25,020	27,200/27,221	24,050			BS	66729YA	55-4201 SEMI
→12/84									
SE/PB	1	25,007/25,020	27,000/27,021	24,150			BS	66729Y	55-4266 STD
→11/84									

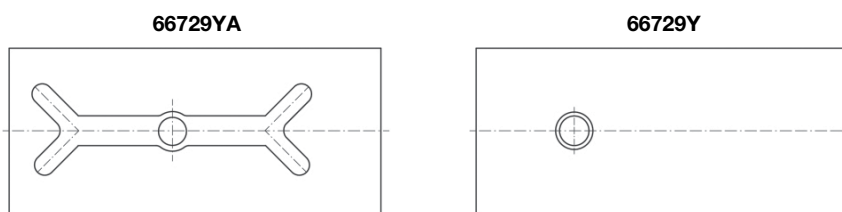

40 80.00 x 88.00

A8A (XUD7TE)	4 Cyl.	1769cc	66kW (90PS)	Diesel Turbo Intercooler		TD2884
A8B (XUD7TE)	4 Cyl.	1769cc	57kW (78PS)	Diesel Turbo		TD10789
AJZ (XUD7TEY)	4 Cyl.	1769cc	66kW (90PS)	Diesel Turbo Intercooler		TD2885
XUD7T	4 Cyl.	1769cc	58kW (79PS)	Diesel Turbo		TD18394

PEUGEOT

BE/PL	4	49,984/50,000	53,695/53,708	20,000	1,838	0,039/0,073	EC	71-3730	71-3730/4 STD 0.30
MB/HL 1-5	5	59,981/60,000	63,731/63,750	20,290	1,845	0,040/0,100	AL-LF	66726RA	H1057/5 STD 0.30 0.50
TW/A	4	67,050/67,300	83,050/83,300		1,880		AL-LF	4141AF	A188/4 STD
SE/PB	1	28,007/28,020	30,200/30,221	23,100			BS	41450.500	55-4499 SEMI

41 80.00 x 88.00

A9A (XUD7)		4 Cyl.	1769cc	43-44kW (58-60PS)		Diesel		TD12351	
BE/PL	4	49,984/50,000	53,695/53,708	20,050	1,830	0,040/0,090	AL-LF	66725RA	01-4200/4 STD 0.30 0.50
MB/HL 1-5	5	59,981/60,000	63,731/63,750	20,290	1,845	0,040/0,100	AL-LF	66726RA	H1057/5 STD 0.30 0.50
TW/A	4	67,050/67,300	83,050/83,300		2,330		BS	66721BF	A214/4 STD 0.10
SE/PB	1	25,007/25,020	27,000/27,021	24,150			BS	66729Y	55-4266 STD

→11/84

42 82.20 x 88.00

WJY (DW8B)		4 Cyl.	1868cc	51kW (69PS)		Diesel		TD13788	
WJZ (DW8)		4 Cyl.	1868cc	51kW (69PS)		Diesel		TD9868	
BE/PL	4	49,984/50,000	53,695/53,708	20,050	1,830	0,040/0,090	AL-LF	66725RA	01-4200/4 STD 0.30 0.50
MB/HL 1-5	5	59,981/60,000	63,731/63,750	20,290	1,845	0,040/0,100	AL-LF	66726RA	H1057/5 STD 0.30 0.50
TW/A	2	67,050/67,300	83,050/83,300		2,330		BS	54-3954	A160/4 STD
TW/A	2	67,050/67,300	83,050/83,300		2,330		BS	54-3955	
SE/PB	1	25,007/25,020	27,200/27,221	24,050			BS	66729YA	55-4201 SEMI

43 82.70 x 81.40

6FY (EW7A)		4 Cyl.	1749cc	92kW (125PS)		Petrol		TD20026	
6FZ (EW7J4)		4 Cyl.	1749cc	85kW (116PS)		Petrol		TD15190	
BE/PL	4	44,975/44,991	48,655/48,671	22,500	1,825	0,020/0,070	AL	4300RA	01-4155/4 STD 0.30
MB/HL 1-5	5	59,981/60,000	63,708/63,727	21,000	1,862	0,020/0,083	AL-LF	02-3957	H086/5 STD
TW/A	2	67,050/67,300	83,050/83,300		2,330		AL	04-3980	A161/2 STD
CB/NWB	4	27,982/28,000	31,200/31,218	18,150	1,594		AL-LF	03-3981	N151/6 STD
CB/NWB	8	27,982/28,000	31,200/31,218	18,150	1,594		AL-LF	03-3982	

44 83.00 x 73.00

171 (XU5S)		4 Cyl.	1580cc	66-71kW (90-97PS)		Petrol		TD2865	
B1A (XU51C)		4 Cyl.	1580cc	55-58kW (75-79PS)		Petrol		TD2857	
B1D (XU51C)		4 Cyl.	1580cc	55kW (75PS)		Petrol		TD2762	
B1E (XU51C)		4 Cyl.	1580cc	53-55kW (72-75PS)		Petrol		TD2856	
B2A (XU52C)		4 Cyl.	1580cc	65-85kW (88-116PS)		Petrol		TD29160	
B2A (XU52C/K)		4 Cyl.	1580cc	66-68kW (90-92PS)		Petrol		TD12430	
BAZ (XU5CP)		4 Cyl.	1580cc	54-55kW (74-75PS)		Petrol		TD2859	
BE/PL	4	44,975/44,991	48,655/48,671	20,250	1,820	0,024/0,081	AL-LF	66720RA	01-4199/4 STD 0.30



MB/HL 1-5	5	59,990/60,000	63,718/63,727	20,290	1,845	0,028/0,072	AL-LF	66721RA	H1074/5 STD 0.30
MB/HL 1-5	5	59,990/60,000	63,718/63,727	20,290	1,845	0,028/0,072	AL-LF	66722RA	

06/87→

MB/HL	4	59,990/60,000	63,718/63,727	20,290	1,845	0,028/0,072	AL-LF	66721RA	H1113/5 STD 0.30
MB/HL	6	59,990/60,000	63,718/63,727	20,290	1,845	0,028/0,072	AL-LF	66722RA	

11/83→05/87

66721RA

66722RA

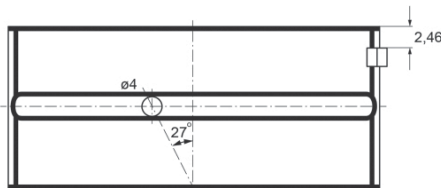
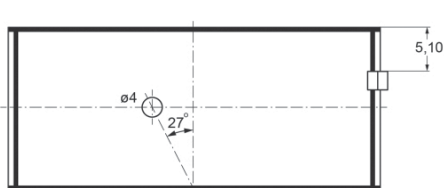

TW/A	4	67,050/67,300	83,050/83,300		2,330		BS	66721BF	A214/4 STD 0.10
------	---	---------------	---------------	--	-------	--	----	---------	---------------------------

45

83.00 x 73.00

180A (XU5J)	4 Cyl.	1580cc	76kW (104PS)	Petrol	TD2861
180Z (XU5J)	4 Cyl.	1580cc	76kW (103PS)	Petrol	TD2862
B6B (XU5J)	4 Cyl.	1580cc	76kW (103PS)	Petrol	TD2858

BE/PL	4	44,975/44,991	48,655/48,671	20,250	1,822	0,020/0,077	EC	71-3627	71-3627/4 STD H1074/5 STD 0.30
MB/HL 1-5	5	59,990/60,000	63,718/63,727	20,290	1,845	0,028/0,072	AL-LF	66721RA	
MB/HL 1-5	5	59,990/60,000	63,718/63,727	20,290	1,845	0,028/0,072	AL-LF	66722RA	

06/87→

MB/HL	4	59,990/60,000	63,718/63,727	20,290	1,845	0,028/0,072	AL-LF	66721RA	H1113/5 STD 0.30
MB/HL	6	59,990/60,000	63,718/63,727	20,290	1,845	0,028/0,072	AL-LF	66722RA	

→05/87

66721RA

66722RA

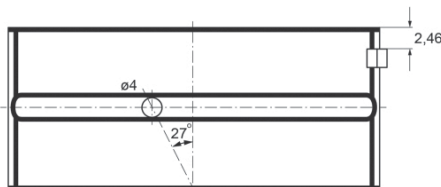
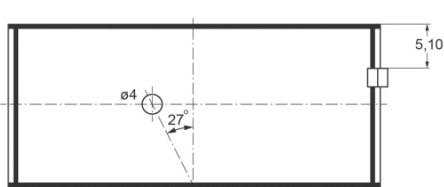

TW/A	4	67,050/67,300	83,050/83,300		2,330		BS	66721BF	A214/4 STD 0.10
------	---	---------------	---------------	--	-------	--	----	---------	---------------------------

46

83.00 x 73.00

BDY (XU5M2Z)	4 Cyl.	1580cc	65-71kW (88-97PS)	Petrol	TD4846
BDY (XU5M3Z)	4 Cyl.	1580cc	65-66kW (88-90PS)	Petrol	TD2864
BDZ (XU5M)	4 Cyl.	1580cc	65-66kW (88-90PS)	Petrol	TD2839

BE/PL	4	44,975/44,991	48,655/48,671	20,250	1,820	0,024/0,081	AL-LF	66720RA	01-4199/4 STD 0.30 H1074/5 STD 0.30
MB/HL 1-5	5	59,990/60,000	63,718/63,727	20,290	1,845	0,028/0,072	AL-LF	66721RA	
MB/HL 1-5	5	59,990/60,000	63,718/63,727	20,290	1,845	0,028/0,072	AL-LF	66722RA	



TW/A	4	67,050/67,300	83,050/83,300		2,330		BS	66721BF	A214/4 STD 0.10
------	---	---------------	---------------	--	-------	--	----	---------	---------------------------

47 83.00 x 73.00

BFZ (XU5JP)		4 Cyl.	1580cc	65-66kW (88-90PS)		Petrol		TD2863	
BE/PL	4	44,975/44,991	48,655/48,671	20,250	1,822	0,020/0,077	EC	71-3627	71-3627/4 STD
MB/HL 1-5	5	59,990/60,000	63,718/63,727	20,290	1,845	0,028/0,072	AL-LF	66721RA	H1074/5 STD 0.30
MB/HL 1-5	5	59,990/60,000	63,718/63,727	20,290	1,845	0,028/0,072	AL-LF	66722RA	
TW/A	4	67,050/67,300	83,050/83,300		2,330		BS	66721BF	A214/4 STD 0.10

48 83.00 x 81.40

LFW (XU7JP)		4 Cyl.	1761cc	73kW (99PS)		Petrol		TD2867	
LFX (XU7JB)		4 Cyl.	1761cc	66kW (90PS)		Petrol		TD12708	
LFY (XU7JP4)		4 Cyl.	1761cc	81-86kW (110-117PS)		Petrol		TD4849	
LFZ (XU7JP)		4 Cyl.	1762cc	74-76kW (101-103PS)		Petrol		TD2866	
BE/PL	4	44,975/44,991	48,655/48,671	22,500	1,825	0,020/0,070	AL	4300RA	01-4155/4 STD 0.30
MB/HL 1-5	5	59,990/60,000	63,718/63,727	20,290	1,845	0,028/0,072	AL-LF	66721RA	H1074/5 STD 0.30
MB/HL 1-5	5	59,990/60,000	63,718/63,727	20,290	1,845	0,028/0,072	AL-LF	66722RA	
TW/A	4	67,050/67,300	83,050/83,300		2,330		BS	66721BF	A214/4 STD 0.10

49 83.00 x 88.00

159 (XU9S)		4 Cyl.	1905cc	75kW (102PS)		Petrol		TD2879	
D2B (XU9S)		4 Cyl.	1905cc	75kW (102PS)		Petrol		TD2772	
BE/PL	4	49,984/50,000	53,695/53,708	20,250	1,836	0,023/0,077	AL-LF	1305RA	01-4125/4 STD 0.30
MB/HL 1-5	5	59,990/60,000	63,718/63,727	20,290	1,845	0,028/0,072	AL-LF	66721RA	H1074/5 STD 0.30
MB/HL 1-5	5	59,990/60,000	63,718/63,727	20,290	1,845	0,028/0,072	AL-LF	66722RA	
06/87 →									
MB/HL	4	59,990/60,000	63,718/63,727	20,290	1,845	0,028/0,072	AL-LF	66721RA	H1113/5 STD 0.30
MB/HL	6	59,990/60,000	63,718/63,727	20,290	1,845	0,028/0,072	AL-LF	66722RA	
→05/87									

66721RA

66722RA

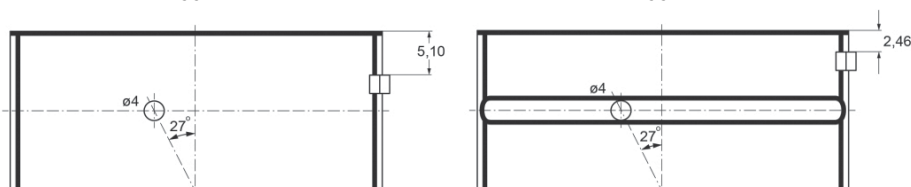

TW/A	4	67,050/67,300	83,050/83,300		2,330		BS	66721BF	A214/4 STD 0.10
------	---	---------------	---------------	--	-------	--	----	---------	---------------------------

50 83.00 x 88.00

D2A (XU92C)		4 Cyl.	1905cc	75kW (102PS)		Petrol		TD2869
D2C (XU92C)		4 Cyl.	1905cc	70kW (95PS)		Petrol		TD2871
DDZ (XU9M)		4 Cyl.	1905cc	80kW (109PS)		Petrol		TD2878

BE/PL	4	49,984/50,000	53,695/53,708	20,250	1,836	0,023/0,077	AL-LF	1305RA	01-4125/4 STD 0.30	
MB/HL 1-5	5	59,990/60,000	63,718/63,727	20,290	1,845	0,028/0,072	AL-LF	66721RA	H1074/5 STD 0.30	
MB/HL 1-5	5	59,990/60,000	63,718/63,727	20,290	1,845	0,028/0,072	AL-LF	66722RA		
TW/A	4	67,050/67,300	83,050/83,300		2,330		BS	66721BF	A214/4 STD 0.10	

51 83.00 x 88.00

D6A (XU9J2)	4 Cyl.	1905cc	90-93kW (122-126PS)	Petrol	TD22159				
D6C (XU9J4)	4 Cyl.	1905cc	116-118kW (158-160PS)	Petrol	TD2873				
DFW (XU9J4Z)	4 Cyl.	1905cc	108kW (147PS)	Petrol	TD2875				
DKZ (XU9JAZ)	4 Cyl.	1905cc	88-90kW (120-122PS)	Petrol	TD2877				
BE/PL	4	49,984/50,000	53,695/53,708	20,250	1,842	0,020/0,065	EC	71-3628	71-3628/4 STD 0.30
MB/HL 1-5	5	59,990/60,000	63,718/63,727	20,290	1,845	0,028/0,072	AL-LF	66721RA	H1074/5 STD 0.30
MB/HL 1-5	5	59,990/60,000	63,718/63,727	20,290	1,845	0,028/0,072	AL-LF	66722RA	
TW/A	4	67,050/67,300	83,050/83,300		2,330		BS	66721BF	A214/4 STD 0.10

52 83.00 x 88.00

D6B (XU9JA)	4 Cyl.	1905cc	94-96kW (128-131PS)	Petrol	TD2872				
DFZ (XU9J1)	4 Cyl.	1905cc	72-77kW (98-105PS)	Petrol	TD2870				
BE/PL	4	49,984/50,000	53,695/53,708	20,250	1,842	0,020/0,065	EC	71-3628	71-3628/4 STD 0.30
MB/HL 1-5	5	59,990/60,000	63,718/63,727	20,290	1,845	0,028/0,072	AL-LF	66721RA	H1074/5 STD 0.30
MB/HL 1-5	5	59,990/60,000	63,718/63,727	20,290	1,845	0,028/0,072	AL-LF	66722RA	
06/87 →									
MB/HL	4	59,990/60,000	63,718/63,727	20,290	1,845	0,028/0,072	AL-LF	66721RA	H1113/5 STD 0.30
MB/HL	6	59,990/60,000	63,718/63,727	20,290	1,845	0,028/0,072	AL-LF	66722RA	
→05/87									

66721RA

66722RA

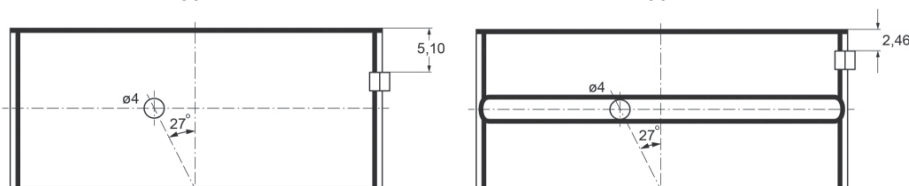

TW/A	4	67,050/67,300	83,050/83,300		2,330		BS	66721BF	A214/4 STD 0.10
------	---	---------------	---------------	--	-------	--	----	---------	---------------------------

53 83.00 x 88.00

162 (XUD9)	4 Cyl.	1905cc	47-48kW (64-65PS)	Diesel	TD2886				
D8C (XUD9AU)	4 Cyl.	1905cc	51kW (69PS)	Diesel	TD10827				
D9A (XUD9)	4 Cyl.	1905cc	47kW (64PS)	Diesel	TD2754				
XUD9	4 Cyl.	1905cc	47-48kW (64-65PS)	Diesel	TD4924				
BE/PL	4	49,984/50,000	53,695/53,708	20,050	1,830	0,040/0,090	AL-LF	66725RA	01-4200/4 STD 0.30 0.50
MB/HL 1-5	5	59,981/60,000	63,731/63,750	20,290	1,845	0,040/0,100	AL-LF	66726RA	H1057/5 STD 0.30 0.50

PEUGEOT



TW/A	4	67,050/67,300	83,050/83,300		2,330		BS	66721BF	A214/4 STD 0.10
SE/PB	1	25,007/25,020	27,200/27,221	24,050			BS	66729YA	55-4201 SEMI

12/84 →

SE/PB	1	25,007/25,020	27,000/27,021	24,150			BS	66729Y	55-4266 STD
-------	---	---------------	---------------	--------	--	--	----	--------	-----------------------

→11/84

66729YA

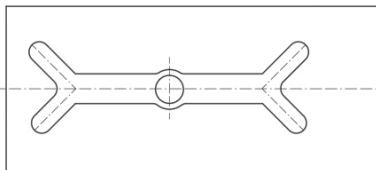

66729Y

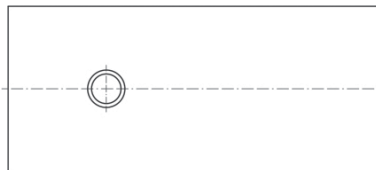

54

83.00 x 88.00

D8B (XUD9TE)	4 Cyl.	1905cc	68-69kW (92-94PS)	Diesel Turbo Intercooler	TD2751				
DHV (XUD9BSD)	4 Cyl.	1905cc	55kW (75PS)	Diesel	TD9867				
DHW (XUD9SD)	4 Cyl.	1905cc	55kW (75PS)	Diesel	TD9365				
DHX (XUD9TE)	4 Cyl.	1905cc	66kW (90PS)	Diesel Turbo	TD2889				
DHY (XUD9TE)	4 Cyl.	1905cc	66-69kW (90-93PS)	Diesel Turbo	TD2888				
XUD9TE	4 Cyl.	1905cc	66-69kW (90-94PS)	Diesel Turbo	TD18953				
BE/PL	4	49,984/50,000	53,695/53,708	20,000	1,838	0,039/0,073	EC	71-3730	71-3730/4 STD 0.30
MB/HL 1-5	5	59,981/60,000	63,731/63,750	20,290	1,845	0,040/0,100	AL-LF	66726RA	H1057/5 STD 0.30 0.50
TW/A	4	67,050/67,300	83,050/83,300		1,880		AL-LF	4141AF	A188/4 STD
SE/PB	1	28,007/28,020	30,200/30,221	23,100			BS	41450.500	55-4499 SEMI

55

83.00 x 88.00

D8C (XUD9UTF)	4 Cyl.	1905cc	68kW (92PS)	Diesel Turbo	TD2890				
BE/PL	4	49,984/50,000	53,695/53,708	20,000	1,838	0,020/0,073	EC	71-3899	71-3899/4 STD 0.30
MB/HL 1-5	5	59,981/60,000	63,731/63,750	20,290	1,845	0,040/0,100	AL-LF	66726RA	H1057/5 STD 0.30 0.50
TW/A	4	67,050/67,300	83,050/83,300		1,880		AL-LF	4141AF	A188/4 STD
SE/PB	1	28,007/28,020	30,200/30,221	23,100			BS	41450.500	55-4499 SEMI

56

83.00 x 88.00

D9B (XUD9A)	4 Cyl.	1905cc	51-52kW (69-71PS)	Diesel	TD2834				
D9B (XUD9AU)	4 Cyl.	1905cc	51kW (70PS)	Diesel	TD2880				
DJY (XUD9A)	4 Cyl.	1905cc	50-51kW (68-69PS)	Diesel	TD2887				
DJZ (XUD9Y)	4 Cyl.	1905cc	47kW (64PS)	Diesel	TD2891				
XUD9	4 Cyl.	1905cc	47-52kW (64-71PS)	Diesel	TD8478				
XUD9A	4 Cyl.	1905cc	51kW (69PS)	Diesel	TD9014				
BE/PL	4	49,984/50,000	53,695/53,708	20,050	1,830	0,040/0,090	AL-LF	66725RA	01-4200/4 STD 0.30 0.50
MB/HL 1-5	5	59,981/60,000	63,731/63,750	20,290	1,845	0,040/0,100	AL-LF	66726RA	H1057/5 STD 0.30 0.50
TW/A	4	67,050/67,300	83,050/83,300		2,330		BS	66721BF	A214/4 STD 0.10
SE/PB	1	25,007/25,020	27,200/27,221	24,050			BS	66729YA	55-4201 SEMI



57									
84.00 x 73.00									
XC5P		4 Cyl.		1618cc	50kW (68PS)		Petrol		TD8495
XC6		4 Cyl.		1618cc	48-60kW (65-82PS)		Petrol		TD2793
BE/PL	4	49,975/49,991	53,655/53,674	23,400	1,818	0,030/0,080	AL-LF	2865RA	01-4558/4 STD 0.30 0.50 0.80
MB/HL 1	1	59,401/59,416	63,227/63,246	29,500	1,888	0,040/0,080	AL-LF	2866RA	H1240/5 STD 0.30 0.50 0.80
MB/HL 2	1	58,548/58,573	62,384/62,403	21,500	1,888	0,040/0,080	AL-LF	61902RA	
MB/HL 3	1	57,174/57,189	61,000/61,019	29,500	1,888	0,040/0,080	AL-LF	61903RA	
MB/HL 4	1	56,140/56,165	59,976/59,995	21,500	1,888	0,040/0,080	AL-LF	61903RAA	
MB/HL 5	1	54,905/54,920	58,731/58,750	29,350	1,888	0,040/0,080	AL-LF	61904RA	
08/71→									
TW/A	4	61,400/61,650	72,550/72,800		2,330		AL-LF	61904BF	A199/4 STD 0.10 0.15 0.20

58									
84.00 x 73.00									
XC7		4 Cyl.		1618cc	54kW (73PS)		Petrol		TD22472
XC7P		4 Cyl.		1618cc	44-46kW (60-63PS)		Petrol		TD8496
BE/PL	4	49,975/49,991	53,655/53,674	23,400	1,818	0,030/0,080	AL-LF	2865RA	01-4558/4 STD 0.30 0.50 0.80
MB/HL 1	1	59,401/59,416	63,227/63,246	29,500	1,888	0,040/0,080	AL-LF	2866RA	H1240/5 STD 0.30 0.50 0.80
MB/HL 2	1	58,548/58,573	62,384/62,403	21,500	1,888	0,040/0,080	AL-LF	61902RA	
MB/HL 3	1	57,174/57,189	61,000/61,019	29,500	1,888	0,040/0,080	AL-LF	61903RA	
MB/HL 4	1	56,140/56,165	59,976/59,995	21,500	1,888	0,040/0,080	AL-LF	61903RAA	
MB/HL 5	1	54,905/54,920	58,731/58,750	29,350	1,888	0,040/0,080	AL-LF	61904RA	
→10/81									
MB/HL 5	1	54,905/54,920	58,731/58,750	29,350	1,900	0,040/0,080	AL-LF	66696RA	H1241/5 STD 0.30 0.50 0.80
MB/HL 4	1	56,140/56,165	59,976/59,995	21,500	1,900	0,040/0,080	AL-LF	66697RA	
MB/HL 3	1	57,174/57,189	61,000/61,019	29,500	1,900	0,040/0,080	AL-LF	66698RA	
MB/HL 2	1	58,548/58,573	62,384/62,403	21,500	1,900	0,040/0,080	AL-LF	66699RA	
MB/HL 1	1	59,401/59,416	63,227/63,246	29,500	1,900	0,040/0,080	AL-LF	66699RAA	
11/81→									
TW/A	4	61,400/61,650	72,550/72,800		2,330		AL-LF	61904BF	A199/4 STD 0.10 0.15 0.20

59									
84.00 x 81.00									
105 (XM7)		4 Cyl.		1796cc	55-60kW (75-82PS)		Petrol		TD2826
BE/PL	4	49,975/49,991	53,655/53,674	23,400	1,818	0,030/0,080	AL-LF	2865RA	01-4558/4 STD 0.30 0.50 0.80

PEUGEOT



MB/HL 1	1	59,401/59,416	63,227/63,246	29,500	1,888	0,040/0,080	AL-LF	2866RA	H1240/5 STD 0.30 0.50 0.80
MB/HL 2	1	58,548/58,573	62,384/62,403	21,500	1,888	0,040/0,080	AL-LF	61902RA	
MB/HL 3	1	57,174/57,189	61,000/61,019	29,500	1,888	0,040/0,080	AL-LF	61903RA	
MB/HL 4	1	56,140/56,165	59,976/59,995	21,500	1,888	0,040/0,080	AL-LF	61903RAA	
MB/HL 5	1	54,905/54,920	58,731/58,750	29,350	1,888	0,040/0,080	AL-LF	61904RA	

→10/81

MB/HL 5	1	54,905/54,920	58,731/58,750	29,350	1,900	0,040/0,080	AL-LF	66696RA	H1241/5 STD 0.30 0.50 0.80
MB/HL 4	1	56,140/56,165	59,976/59,995	21,500	1,900	0,040/0,080	AL-LF	66697RA	
MB/HL 3	1	57,174/57,189	61,000/61,019	29,500	1,900	0,040/0,080	AL-LF	66698RA	
MB/HL 2	1	58,548/58,573	62,384/62,403	21,500	1,900	0,040/0,080	AL-LF	66699RA	
MB/HL 1	1	59,401/59,416	63,227/63,246	29,500	1,900	0,040/0,080	AL-LF	66699RAA	

11/81→

TW/A	4	61,400/61,650	72,550/72,800		2,330		AL-LF	61904BF	A199/4 STD 0.10 0.15 0.20
------	---	---------------	---------------	--	-------	--	-------	---------	-------------------------------------

60

84.00 x 81.00

105C (XM7A)		4 Cyl.	1796cc	62-66kW (84-90PS)		Petrol		TD2827	
169B (XM7T)		4 Cyl.	1796cc	49-51kW (67-69PS)		Petrol		TD6793	
BE/PL	4	49,975/49,991	53,655/53,674	23,400	1,818	0,030/0,080	AL-LF	2865RA	01-4558/4 STD 0.30 0.50 0.80
MB/HL 5	1	54,905/54,920	58,731/58,750	29,350	1,900	0,040/0,080	AL-LF	66696RA	
MB/HL 4	1	56,140/56,165	59,976/59,995	21,500	1,900	0,040/0,080	AL-LF	66697RA	
MB/HL 3	1	57,174/57,189	61,000/61,019	29,500	1,900	0,040/0,080	AL-LF	66698RA	
MB/HL 2	1	58,548/58,573	62,384/62,403	21,500	1,900	0,040/0,080	AL-LF	66699RA	
MB/HL 1	1	59,401/59,416	63,227/63,246	29,500	1,900	0,040/0,080	AL-LF	66699RAA	
TW/A	4	61,400/61,650	72,550/72,800		2,330		AL-LF	61904BF	A199/4 STD 0.10 0.15 0.20

61







84.00 x 81.00

KF5		4 Cyl.	1796cc	71kW (97PS)		Petrol		TD2883	
KF6		4 Cyl.	1796cc	71kW (97PS)		Petrol		TD2755	
XM		4 Cyl.	1796cc	60kW (82PS)		Petrol		TD2824	
BE/PL	4	49,975/49,991	53,655/53,674	23,400	1,818	0,030/0,080	AL-LF	2865RA	01-4558/4 STD 0.30 0.50 0.80

62

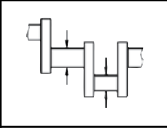
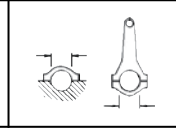
84.00 x 81.00

XM7		4 Cyl.	1796cc	53-58kW (72-79PS)		Petrol		TD2825	
XM7T		4 Cyl.	1796cc	50-51kW (68-69PS)		Petrol		TD9013	
BE/PL	4	49,975/49,991	53,655/53,674	23,400	1,818	0,030/0,080	AL-LF	2865RA	01-4558/4 STD 0.30 0.50 0.80

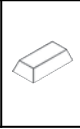
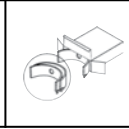
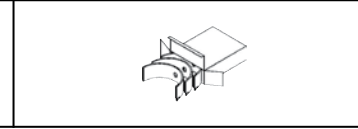
									
MB/HL 1	1	59,401/59,416	63,227/63,246	29,500	1,888	0,040/0,080	AL-LF	2866RA	H1240/5 STD 0.30 0.50 0.80
MB/HL 2	1	58,548/58,573	62,384/62,403	21,500	1,888	0,040/0,080	AL-LF	61902RA	
MB/HL 3	1	57,174/57,189	61,000/61,019	29,500	1,888	0,040/0,080	AL-LF	61903RA	
MB/HL 4	1	56,140/56,165	59,976/59,995	21,500	1,888	0,040/0,080	AL-LF	61903RAA	
MB/HL 5	1	54,905/54,920	58,731/58,750	29,350	1,888	0,040/0,080	AL-LF	61904RA	
08/71→10/81									
MB/HL 5	1	54,905/54,920	58,731/58,750	29,350	1,900	0,040/0,080	AL-LF	66696RA	H1241/5 STD 0.30 0.50 0.80
MB/HL 4	1	56,140/56,165	59,976/59,995	21,500	1,900	0,040/0,080	AL-LF	66697RA	
MB/HL 3	1	57,174/57,189	61,000/61,019	29,500	1,900	0,040/0,080	AL-LF	66698RA	
MB/HL 2	1	58,548/58,573	62,384/62,403	21,500	1,900	0,040/0,080	AL-LF	66699RA	
MB/HL 1	1	59,401/59,416	63,227/63,246	29,500	1,900	0,040/0,080	AL-LF	66699RAA	
11/81→									
TW/A	4	61,400/61,650	72,550/72,800		2,330		AL-LF	61904BF	A199/4 STD 0.10 0.15 0.20

63 84.00 x 81.00

XM7P		4 Cyl.		1796cc	48-50kW (65-68PS)		Petrol		TD8497
BE/PL	4	49,975/49,991	53,655/53,674	23,400	1,818	0,030/0,080	AL-LF	2865RA	01-4558/4 STD 0.30 0.50 0.80
MB/HL 1	1	59,401/59,416	63,227/63,246	29,500	1,888	0,040/0,080	AL-LF	2866RA	H1240/5 STD 0.30 0.50 0.80
MB/HL 2	1	58,548/58,573	62,384/62,403	21,500	1,888	0,040/0,080	AL-LF	61902RA	
MB/HL 3	1	57,174/57,189	61,000/61,019	29,500	1,888	0,040/0,080	AL-LF	61903RA	
MB/HL 4	1	56,140/56,165	59,976/59,995	21,500	1,888	0,040/0,080	AL-LF	61903RAA	
MB/HL 5	1	54,905/54,920	58,731/58,750	29,350	1,888	0,040/0,080	AL-LF	61904RA	
08/71→									
TW/A	4	61,400/61,650	72,550/72,800		2,330		AL-LF	61904BF	A199/4 STD 0.10 0.15 0.20

64 85.00 x 80.00

XDP85		4 Cyl.		1816cc	35-44kW (48-60PS)		Diesel		TD8498
BE/PL	4	49,984/50,000	53,695/53,708	29,000	1,822	0,051/0,105	AL-LF	2870RA	01-4135/4 STD 0.30 0.50 0.80 1.00
TW/A	4	61,976/62,204	79,730/79,784		2,336		BS	2873BF	A181/4 STD 0.10 0.15 0.20
SE/PB	1	27,994/28,000	30,950/30,975	29,700			AL-LF	2874Y	05-4136 SEMI 15

65 85.00 x 88.00

RFH (EW10A) Euro 4	4 Cyl.	1997cc	103kW (140PS)	Petrol	TD23210
RFJ (EW10A) Euro 4	4 Cyl.	1997cc	103-111kW (140-151PS)	Petrol	TD18690
RFK (EW10J4S)	4 Cyl.	1997cc	130kW (177PS)	Petrol	TD17846
RFN (EW10J4)	4 Cyl.	1997cc	100-105kW (136-143PS)	Petrol	TD15188
RFR (DEW10J4)	4 Cyl.	1997cc	99kW (135PS)	Petrol	TD12568
RLZ (EW10D)	4 Cyl.	1997cc	103kW (140PS)	Petrol	TD16234

BE/PL	4	44,975/44,991	48,655/48,671	22,500	1,825	0,020/0,070	AL	4300RA	01-4155/4 STD 0.30	
MB/HL 1-5	5	59,981/60,000	63,708/63,727	21,000	1,862	0,020/0,083	AL-LF	02-3957	H086/5 STD	
TW/A	2	67,050/67,300	83,050/83,300		2,330		AL	04-3980	A161/2 STD	
CB/NWB	4	27,982/28,000	31,200/31,218	18,150	1,594		AL-LF	03-3981	N151/6 STD	
CB/NWB	8	27,982/28,000	31,200/31,218	18,150	1,594		AL-LF	03-3982		

66

85.00 x 88.00

AHV (DW10FD)			4 Cyl.	1997cc	100kW (136PS)		Diesel Turbo Intercooler		TD31484
AHW (DW10FC)			4 Cyl.	1997cc	133kW (180PS)		Diesel Turbo Intercooler		TD30806
AHX (DW10FD) Euro 5			4 Cyl.	1997cc	110kW (150PS)		Diesel Turbo Intercooler		TD28614
AHZ (DW10CD) Euro 5			4 Cyl.	1997cc	94kW (128PS)		Diesel Turbo Intercooler		TD28621
NFU (DW10TD)			4 Cyl.	1997cc	66kW (90PS)		Diesel Turbo Intercooler		TD28060
RHC (DW10CTED4) Euro 5			4 Cyl.	1997cc	120kW (163PS)		Diesel Turbo Intercooler		TD28710
RHD (DW10CTED4)			4 Cyl.	1997cc	100kW (136PS)		Diesel Turbo Intercooler		TD31482
RHE (DW10CTED4) Euro 5			4 Cyl.	1997cc	110kW (150PS)		Diesel Turbo Intercooler		TD25633
RHF (DW10BTED4)			4 Cyl.	1997cc	103kW (140PS)		Diesel Turbo Intercooler		TD26794
RHH (DW10CTED4) Euro 5			4 Cyl.	1997cc	120kW (163PS)		Diesel Turbo Intercooler		TD23536
RHO (DW10DTE4) Euro 5			4 Cyl.	1997cc	110kW (150PS)		Diesel Turbo Intercooler		TD23969
RHS (DW10ATED)			4 Cyl.	1997cc	79kW (107PS)		Diesel Turbo Intercooler		TD20417
RHT (DW10ATED4)			4 Cyl.	1997cc	79kW (107PS)		Diesel Turbo Intercooler		TD20789
RHV (DW10TD)			4 Cyl.	1997cc	62kW (84PS)		Diesel Turbo Intercooler		TD24911
RHV (DW10UTD)			4 Cyl.	1997cc	62kW (84PS)		Diesel Turbo Intercooler		TD17512
RHY (DW10TD)			4 Cyl.	1997cc	66kW (90PS)		Diesel Turbo Intercooler		TD12569
RHZ (DW10BTED)			4 Cyl.	1997cc	80kW (109PS)		Diesel Turbo Intercooler		TD29311
RHZ (DW10CTED)			4 Cyl.	1997cc	80kW (109PS)		Diesel Turbo Intercooler		TD30833
BE/PL	4	49,984/50,000	53,695/53,708	20,000	1,838	0,020/0,070	SP	71-3952	71-3952/4 STD 0.30 1
MB/HL 1-5	5	59,981/60,000	63,731/63,750	20,290	1,845	0,040/0,100	AL-LF	66726RA	H1057/5 STD 0.30 0.50
TW/A	4	67,050/67,300	83,050/83,300		2,330		BS	66721BF	A214/4 STD 0.10
SE/PB	1	27,997/28,000	30,200/30,225	24,050			BS-LF	55-3985	55-3985 SEMI

67

85.00 x 88.00

RHK (DW10UTED4) Euro 4			4 Cyl.	1997cc	79-88kW (107-120PS)		Diesel Turbo		TD19814
RHM (DW10ATED4)			4 Cyl.	1997cc	79kW (107PS)		Diesel Turbo Intercooler		TD20790
RHR (DW10BTED4)			4 Cyl.	1997cc	100-103kW (136-140PS)		Diesel Turbo Intercooler		TD17507
RHW (DW10ATED4)			4 Cyl.	1997cc	79-80kW (107-109PS)		Diesel Turbo Intercooler		TD17510
RHX (DW10BTED)			4 Cyl.	1997cc	69kW (94PS)		Diesel Turbo Intercooler		TD17515
RHZ (DW10ATED)			4 Cyl.	1997cc	79-80kW (107-109PS)		Diesel Turbo Intercooler		TD10727
BE/PL	4	49,984/50,000	53,695/53,708	20,000	1,838	0,020/0,070	SP	71-3952	71-3952/4 STD 0.30 1
MB/HL 1-5	5	59,981/60,000	63,731/63,750	20,290	1,845	0,040/0,100	AL-LF	66726RA	H1057/5 STD 0.30 0.50
TW/A	4	67,050/67,300	83,050/83,300		2,330		BS	66721BF	A214/4 STD 0.10
SE/PB	1	27,997/28,000	30,200/30,225	24,050			BS-LF	55-3985	55-3985 SEMI



68 85.00 x 92.00

P8C (XUD11BTE)		4 Cyl.	2088cc	80kW (109PS)	Diesel Turbo Intercooler				TD4850
PHZ (XUD11ATE)		4 Cyl.	2088cc	80kW (109PS)	Diesel Turbo				TD2881
BE/PL	4	49,984/50,000	53,695/53,708	21,950	1,843	0,020/0,064	BS	4255CP	71-4279/4 STD 0.30
MB/HL 1-5	5	59,981/60,000	63,731/63,750	20,290	1,845	0,040/0,100	AL-LF	66726RA	H1057/5 STD 0.30 0.50
TW/A	4	67,050/67,300	83,050/83,300		1,880		AL-LF	4141AF	A188/4 STD

69 85.00 x 96.00

4HK (DW12MTED4)		4 Cyl.	2179cc	115kW (156PS)	Diesel Turbo Intercooler				TD24916
4HL (DW12C) Euro 5		4 Cyl.	2179cc	147-150kW (200-204PS)	Diesel Turbo Intercooler				TD24921
4HN (DW12MTED4)		4 Cyl.	2179cc	115kW (156PS)	Diesel Turbo Intercooler				TD24727
4HP (DW12BTED4)		4 Cyl.	2179cc	120kW (163PS)	Diesel				TD24729
4HR (DW12BTED4)		4 Cyl.	2179cc	120kW (163PS)	Diesel Turbo Intercooler				TD24914
4HS (DW12BTED4) Euro 4		4 Cyl.	2179cc	125kW (170PS)	Diesel Turbo Intercooler				TD24915
4HT (DW12BTED4) Euro 4		4 Cyl.	2179cc	120-125kW (163-170PS)	Diesel Bi-Turbo Intercooler				TD20028
4HW (DW12BTED4)		4 Cyl.	2179cc	94kW (128PS)	Diesel Turbo Intercooler				TD24913
4HX (DW12TED4/FAP)		4 Cyl.	2179cc	94-98kW (128-133PS)	Diesel				TD16128
4HY (DW12UTED)		4 Cyl.	2179cc	74kW (101PS)	Diesel				TD17513
4HZ (DW12TED4)		4 Cyl.	2179cc	100kW (136PS)	Diesel				TD24912
BE/PL	4	49,984/50,000	53,695/53,708	20,000	1,838	0,020/0,070	SP	71-3952	71-3952/4 STD 0.30
MB/HL 1-5	5	59,981/60,000	63,731/63,750	20,290	1,845	0,040/0,100	AL-LF	66726RA	H1057/5 STD 0.30 0.50
TW/A	4	67,050/67,300	83,050/83,300		2,330		BS	66721BF	A214/4 STD 0.10
SE/PB	1	29,995/30,000	33,000/33,025	24,050			BS-LF	55-3984	55-3984 SEMI
CB/NWB	4	27,982/28,000	31,200/31,218	18,150	1,594		AL-LF	03-3981	N151/6 STD
CB/NWB	8	27,982/28,000	31,200/31,218	18,150	1,594		AL-LF	03-3982	

70 86.00 x 86.00

R5A (XU102C)		4 Cyl.	1998cc	84kW (114PS)	Petrol				TD8480
RFX (XU10J2)		4 Cyl.	1998cc	89-96kW (121-131PS)	Petrol				TD2846
RFY (XU10J4Z)		4 Cyl.	1998cc	112kW (152PS)	Petrol				TD2855
RFZ (XU10J2Z)		4 Cyl.	1998cc	89-90kW (121-123PS)	Petrol				TD2851

BE/PL	4	49,984/50,000	53,695/53,708	21,950	1,834	0,027/0,081	AL-LF	4150RA	01-4149/4 STD 0.30
-------	---	---------------	---------------	--------	-------	-------------	-------	--------	------------------------------

→08/92

BE/PL	4	49,984/50,000	53,695/53,708	20,250	1,837	0,021/0,075	AL	4305RA	01-4298/4 STD 0.30
-------	---	---------------	---------------	--------	-------	-------------	----	--------	------------------------------

09/92→

4150RA

4305RA



MB/HL 1-5	5	59,981/60,000	63,731/63,750	20,290	1,845	0,040/0,100	AL-LF	66726RA	H1057/5 STD 0.30 0.50
--------------	---	---------------	---------------	--------	-------	-------------	-------	---------	---------------------------------

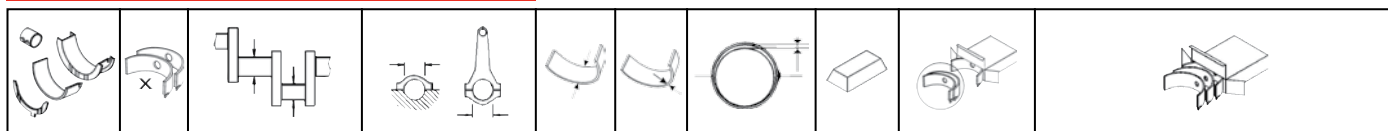

TW/A	4	67,050/67,300	83,050/83,300		1,880		AL-LF	4141AF	A188/4 STD
------	---	---------------	---------------	--	-------	--	-------	--------	----------------------

71 86.00 x 86.00

RFL (XU10J2U)	4 Cyl.	1998cc	81kW (110PS)	Petrol	TD17511
RFS (XU10J4RS)	4 Cyl.	1998cc	120-123kW (163-167PS)	Petrol	TD4848
RFT (XU10J4)	4 Cyl.	1998cc	110-112kW (150-152PS)	Petrol	TD2852
RFU (XU10J2)	4 Cyl.	1998cc	89-90kW (121-123PS)	Petrol	TD2848
RFV (XU10J4R)	4 Cyl.	1998cc	97-99kW (132-135PS)	Petrol	TD2853
RFW (XU10J2)	4 Cyl.	1998cc	80kW (109PS)	Petrol	TD2847

BE/PL	4	49,984/50,000	53,695/53,708	20,250	1,837	0,021/0,075	AL	4305RA	01-4298/4 STD 0.30
MB/HL 1-5	5	59,981/60,000	63,731/63,750	20,290	1,845	0,040/0,100	AL-LF	66726RA	H1057/5 STD 0.30 0.50
TW/A	4	67,050/67,300	83,050/83,300		1,880		AL-LF	4141AF	A188/4 STD

72 86.00 x 86.00

RGX (XU10J2CTE)	4 Cyl.	1998cc	108kW (147PS)	Petrol Turbo Intercooler	TD29171
RGX (XU10J2TE)	4 Cyl.	1998cc	108kW (147PS)	Petrol Turbo	TD4847
RGY (XU10J2TE)	4 Cyl.	1998cc	104kW (141PS)	Petrol Turbo Intercooler	TD2850

BE/PL	4	49,984/50,000	53,695/53,708	20,250	1,837	0,021/0,075	AL	4305RA	01-4298/4 STD 0.30
BE/PL	4	49,984/50,000	53,695/53,708	21,950	1,843	0,020/0,064	BS	4255CP	71-4279/4 STD 0.30
MB/HL 1-5	5	59,981/60,000	63,731/63,750	20,290	1,845	0,040/0,100	AL-LF	66726RA	H1057/5 STD 0.30 0.50
TW/A	4	67,050/67,300	83,050/83,300		1,880		AL-LF	4141AF	A188/4 STD

73 86.00 x 86.00

RGZ (XU10J4TE/Z)	4 Cyl.	1998cc	144kW (196PS)	Petrol Turbo	TD2854
-------------------------	--------	---------------	----------------------	---------------------	---------------

BE/PL	4	49,984/50,000	53,695/53,708	21,950	1,843	0,020/0,064	BS	4255CP	71-4279/4 STD 0.30
MB/HL 1-5	5	59,981/60,000	63,731/63,750	20,290	1,845	0,040/0,100	AL-LF	66726RA	H1057/5 STD 0.30 0.50
TW/A	4	67,050/67,300	83,050/83,300		1,880		AL-LF	4141AF	A188/4 STD

74 86.00 x 92.00

P9A (XUD11A)	4 Cyl.	2138cc	60kW (82PS)	Diesel	TD11187
---------------------	--------	---------------	--------------------	---------------	----------------

MB/HL 1-5	5	59,981/60,000	63,731/63,750	20,290	1,845	0,040/0,100	AL-LF	66726RA	H1057/5 STD 0.30 0.50
TW/A	4	67,050/67,300	83,050/83,300		1,880		AL-LF	4141AF	A188/4 STD

75 86.00 x 94.60

4HU (P22DTE) Euro 4	4 Cyl.	2198cc	88kW (120PS)	Diesel Turbo Intercooler	TD24470
----------------------------	--------	---------------	---------------------	---------------------------------	----------------

4HV (P22DTE) Euro 4	4 Cyl.	2198cc	74kW (101PS)	Diesel Turbo Intercooler	TD24469
----------------------------	--------	---------------	---------------------	---------------------------------	----------------

BE/PL	4	52,980/53,000	55,996/56,016	24,450	1,487	0,026/0,084	BS	71-4066	71-4066/4 STD 0.25 0.50
MB/HL	4	64,940	69,520	23,280	2,250		AL-LF	02-4067	H1018/5 STD 0.25 0.50
MB/HL	3	64,940	69,520	24,080	2,250		AL-LF	02-4068	
MB/HL	2	69,940	74,520	19,580	2,250		AL-LF	02-4069	
MB/HL	1	64,940	69,520	30,150	2,250		AL-LF	02-4070H	



76 86.40 x 67.40

1580 SPI		4 Cyl.		1581cc	58kW (80PS)	Petrol			TD8484
BE/PL	4	45,508/45,528	48,629/48,646	19,200	1,547	0,020/0,069	AL-LF	1645RA	01-4127/4 STD 0.25 0.50
MB/HL 1,2,4,5	4	50,780/50,800	54,507/54,520	20,250	1,849	0,020/0,067	AL-LF	1646RA	H1075/5 STD 0.25 0.50
MB/HL 3	1	50,780/50,800	54,507/54,520	22,750	1,849	0,020/0,067	AL-LF	1647RA	
TW/A	2	56,610/56,864	69,596/69,850		2,362		AL-LF	60987AFA	A198/2 STD .005
SE/PB	1	21,539/21,641	23,939/23,972	25,100			BS	62039Y	55-4288 SEMI

77 88.00 x 73.00

112 (ZM)		V6 Cyl.		2664cc	100kW (136PS)	Petrol			TD2912
140 (ZMJ)		V6 Cyl.		2664cc	106kW (144PS)	Petrol Turbo			TD2914
BE/PL	6	59,971/59,990	63,704/63,723	17,720	1,846	0,022/0,085	EC	71-3733	71-3733/6 STD
MB/HL 1-4	4	70,043/70,062	74,000/74,019	23,470	1,967	0,020/0,067	AL-LF	66311RA	H1041/4 STD

78 88.00 x 80.00

XD 88		4 Cyl.		1948cc	44kW (60PS)	Diesel			TD23802
XD4x88		4 Cyl.		1948cc	40kW (54PS)	Diesel			TD2807
XDP 4.88		4 Cyl.		1948cc	36-46kW (49-63PS)	Diesel			TD22477
XDP88		4 Cyl.		1948cc	40kW (55PS)	Diesel			TD8499
BE/PL	4	49,984/50,000	53,695/53,708	29,000	1,822	0,051/0,105	AL-LF	2870RA	01-4135/4 STD 0.30 0.50 0.80 1.00
MB/HL 1,3,5	3	54,994/55,009	58,731/58,750	30,000	1,835	0,052/0,111	AL-LF	2871RAA	H1029/5 STD 0.30 0.50 0.80
MB/HL 2,4	2	54,994/55,009	58,731/58,750	22,000	1,835	0,052/0,111	AL-LF	2873RAA	
TW/A	4	61,976/62,204	79,730/79,784		2,336		BS	2873BF	A181/4 STD 0.10 0.15 0.20
SE/PB	1	27,994/28,000	30,950/30,975	29,700			AL-LF	2874Y	05-4136 SEMI 15

79 88.00 x 81.00

106 (XN1)		4 Cyl.		1971cc	68-71kW (93-97PS)	Petrol			TD2830
107 (XN2)		4 Cyl.		1971cc	78kW (107PS)	Petrol			TD2831
170C (XN1TA)		4 Cyl.		1971cc	62kW (85PS)	Petrol			TD6804
XN1		4 Cyl.		1971cc	64-79kW (87-107PS)	Petrol			TD2833
BE/PL	4	49,975/49,991	53,655/53,674	23,400	1,818	0,030/0,080	AL-LF	2865RA	01-4558/4 STD 0.30 0.50 0.80
MB/HL 1	1	59,401/59,416	63,227/63,246	29,500	1,888	0,040/0,080	AL-LF	2866RA	H1240/5 STD 0.30 0.50 0.80
MB/HL 2	1	58,548/58,573	62,384/62,403	21,500	1,888	0,040/0,080	AL-LF	61902RA	
MB/HL 3	1	57,174/57,189	61,000/61,019	29,500	1,888	0,040/0,080	AL-LF	61903RA	
MB/HL 4	1	56,140/56,165	59,976/59,995	21,500	1,888	0,040/0,080	AL-LF	61903RAA	
MB/HL 5	1	54,905/54,920	58,731/58,750	29,350	1,888	0,040/0,080	AL-LF	61904RA	

08/71→10/81

PEUGEOT



MB/HL 5	1	54,905/54,920	58,731/58,750	29,350	1,900	0,040/0,080	AL-LF	66696RA	H1241/5 STD 0.30 0.50 0.80
MB/HL 4	1	56,140/56,165	59,976/59,995	21,500	1,900	0,040/0,080	AL-LF	66697RA	
MB/HL 3	1	57,174/57,189	61,000/61,019	29,500	1,900	0,040/0,080	AL-LF	66698RA	
MB/HL 2	1	58,548/58,573	62,384/62,403	21,500	1,900	0,040/0,080	AL-LF	66699RA	
MB/HL 1	1	59,401/59,416	63,227/63,246	29,500	1,900	0,040/0,080	AL-LF	66699RAA	

11/81 →

TW/A	4	61,400/61,650	72,550/72,800		2,330		AL-LF	61904BF	A199/4 STD 0.10 0.15 0.20
------	---	---------------	---------------	--	-------	--	-------	---------	-------------------------------------

80 88.00 x 81.00

106E (XN1A)	4 Cyl.	1971cc	72kW (98PS)				Petrol		TD4845
170 (XN1T)	4 Cyl.	1971cc	58kW (79PS)				Petrol		TD2837
170D (XN1TACP)	4 Cyl.	1971cc	62kW (84PS)				Petrol		TD5194
XN1T	4 Cyl.	1971cc	55-63kW (75-86PS)				Petrol		TD22486
XN1TA	4 Cyl.	1971cc	55-69kW (75-94PS)				Petrol		TD9015
XN1TA	4 Cyl.	1971cc	62-72kW (84-98PS)				Petrol		TD8490

BE/PL	4	49,975/49,991	53,655/53,674	23,400	1,818	0,030/0,080	AL-LF	2865RA	01-4558/4 STD 0.30 0.50 0.80
MB/HL 5	1	54,905/54,920	58,731/58,750	29,350	1,900	0,040/0,080	AL-LF	66696RA	H1241/5 STD 0.30 0.50 0.80
MB/HL 4	1	56,140/56,165	59,976/59,995	21,500	1,900	0,040/0,080	AL-LF	66697RA	
MB/HL 3	1	57,174/57,189	61,000/61,019	29,500	1,900	0,040/0,080	AL-LF	66698RA	
MB/HL 2	1	58,548/58,573	62,384/62,403	21,500	1,900	0,040/0,080	AL-LF	66699RA	
MB/HL 1	1	59,401/59,416	63,227/63,246	29,500	1,900	0,040/0,080	AL-LF	66699RAA	
TW/A	4	61,400/61,650	72,550/72,800		2,330		AL-LF	61904BF	A199/4 STD 0.10 0.15 0.20

81 88.00 x 81.00

170B (XN1T)	4 Cyl.	1971cc	55kW (75PS)				Petrol		TD2836
XN1P	4 Cyl.	1971cc	57kW (78PS)				Petrol		TD8502

BE/PL	4	49,975/49,991	53,655/53,674	23,400	1,818	0,030/0,080	AL-LF	2865RA	01-4558/4 STD 0.30 0.50 0.80
MB/HL 1	1	59,401/59,416	63,227/63,246	29,500	1,888	0,040/0,080	AL-LF	2866RA	H1240/5 STD 0.30 0.50 0.80
MB/HL 2	1	58,548/58,573	62,384/62,403	21,500	1,888	0,040/0,080	AL-LF	61902RA	
MB/HL 3	1	57,174/57,189	61,000/61,019	29,500	1,888	0,040/0,080	AL-LF	61903RA	
MB/HL 4	1	56,140/56,165	59,976/59,995	21,500	1,888	0,040/0,080	AL-LF	61903RAA	
MB/HL 5	1	54,905/54,920	58,731/58,750	29,350	1,888	0,040/0,080	AL-LF	61904RA	

→10/81

MB/HL 5	1	54,905/54,920	58,731/58,750	29,350	1,900	0,040/0,080	AL-LF	66696RA	H1241/5 STD 0.30 0.50 0.80	
MB/HL 4	1	56,140/56,165	59,976/59,995	21,500	1,900	0,040/0,080	AL-LF	66697RA		
MB/HL 3	1	57,174/57,189	61,000/61,019	29,500	1,900	0,040/0,080	AL-LF	66698RA		
MB/HL 2	1	58,548/58,573	62,384/62,403	21,500	1,900	0,040/0,080	AL-LF	66699RA		
MB/HL 1	1	59,401/59,416	63,227/63,246	29,500	1,900	0,040/0,080	AL-LF	66699RAA		
11/81 →										
TW/A	4	61,400/61,650	72,550/72,800		2,330		AL-LF	61904BF	A199/4 STD 0.10 0.15 0.20	

82 88.00 x 89.00

851 (ZDJ)	4 Cyl.	2165cc	85kW (115PS)	Petrol	TD2908
851B (ZDJL)	4 Cyl.	2165cc	90kW (122PS)	Petrol	TD2909
851X (ZDJL)	4 Cyl.	2165cc	84kW (114PS)	Petrol	TD2910

BE/PL	4	56,267/56,286	60,005/60,019	20,750	1,842	0,035/0,093	AL-LF	66635RA	01-4189/4 STD 0.25	
BE/PL	4	56,267/56,286	60,005/60,019	20,750	1,842	0,035/0,093	AL-LF	66645RA		01-4191/4 STD 0.25
BE/PL	4	56,267/56,286	60,005/60,019	20,750	1,842	0,035/0,093	AL-LF	66645RAA		01-4192/4 STD

66635RA

66645RA

66645RAA

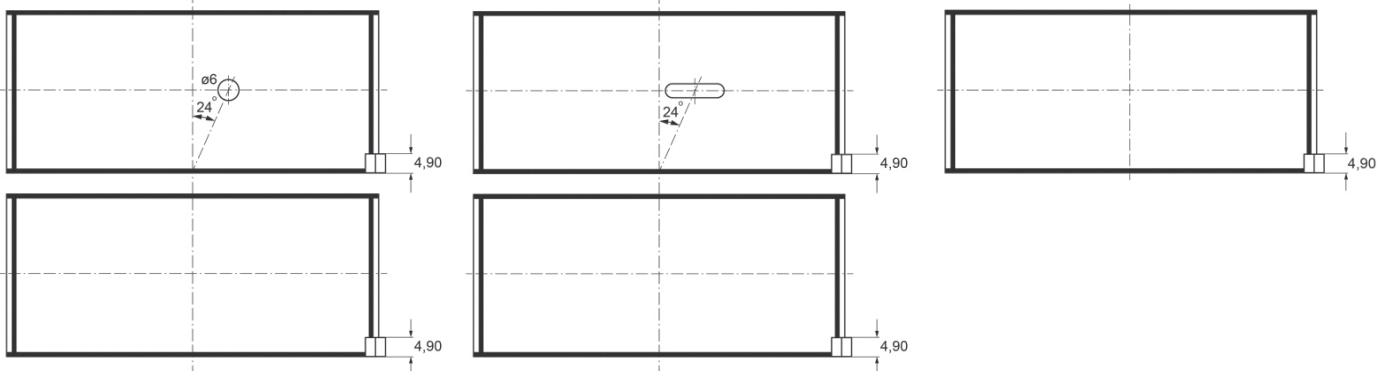

MB/HL 1-5	5	62,873/62,892	66,668/66,687	23,500	1,884	0,020/0,071	AL-LF	66507RA	H1052/5 STD 0.25
MB/HL 1-5	5	62,861/62,880	66,668/66,687	23,250	1,884	0,030/0,093	AL-LF	66646RA	

66507RA

66646RA

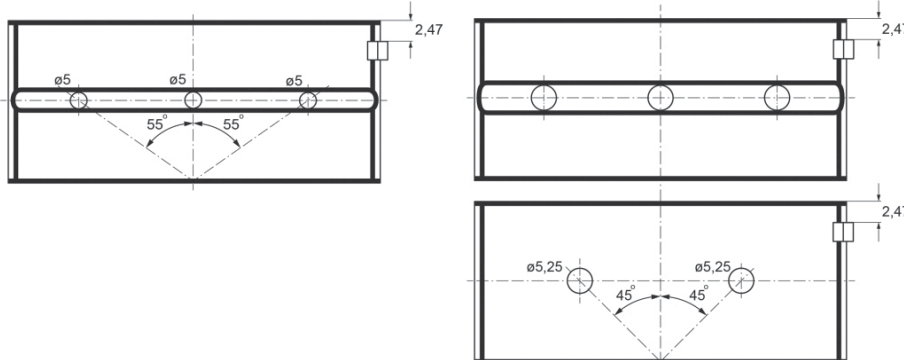

TW/A	2	71,450	88,090		2,850		BS	66506BF	A208/2 STD
TW/A	2	71,450	88,090		2,850		BS	66646BF	



66506BF

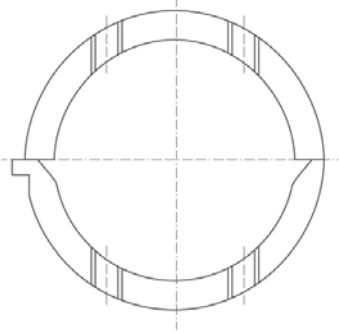

66646BF

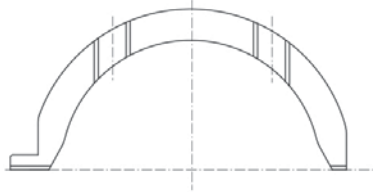

83		90.00 x 83.00								
XD4x90		4 Cyl.		2112cc	48kW (65PS)	Diesel			TD2808	
XD90		4 Cyl.		2112cc	43kW (58PS)	Diesel			TD24572	
XDP 4.90		4 Cyl.		2112cc	43-55kW (58-75PS)	Diesel			TD21440	
XDP90		4 Cyl.		2112cc	42kW (57PS)	Diesel			TD8500	
XDPX90		4 Cyl.		2112cc	41kW (56PS)	Diesel			TD8503	
BE/PL	4	49,984/50,000	53,695/53,708	29,000	1,822	0,051/0,105	AL-LF	2870RA	01-4135/4 STD 0.30 0.50 0.80 1.00	
MB/HL 1,3,5	3	54,994/55,009	58,731/58,750	30,000	1,835	0,052/0,111	AL-LF	2871RAA	H1029/5 STD 0.30 0.50 0.80	
MB/HL 2,4	2	54,994/55,009	58,731/58,750	22,000	1,835	0,052/0,111	AL-LF	2873RAA		
TW/A	4	61,976/62,204	79,730/79,784		2,336		BS	2873BF	A181/4 STD 0.10 0.15 0.20	
SE/PB	1	27,994/28,000	30,950/30,975	29,700			AL-LF	2874Y	05-4136 SEMI 15	

84		91.00 x 73.00								
154A (ZMJK)		V6 Cyl.		2849cc	110kW (150PS)	Petrol			TD2913	
154X (ZN3J)		V6 Cyl.		2849cc	105kW (143PS)	Petrol			TD2917	
BE/PL	6	59,971/59,990	63,704/63,723	17,720	1,846	0,022/0,085	EC	71-3733	71-3733/6 STD	
MB/HL 1-4	4	70,043/70,062	74,000/74,019	23,470	1,967	0,020/0,067	AL-LF	66311RA	H1041/4 STD	

85		92.00 x 92.00								
T8A (DJ5T)		4 Cyl.		2446cc	76kW (103PS)	Diesel Turbo			TD4831	
THX (DJ5TED)		4 Cyl.		2446cc	79kW (107PS)	Diesel Turbo			TD11067	
THY (DK5ATE)		4 Cyl.		2446cc	95kW (129PS)	Diesel Turbo Intercooler			TD2748	
BE/PL	4	53,981/54,000	57,675/57,695	22,700	1,823	0,030/0,090	SP	71-3951	71-3951/4 STD 11	

86		92.00 x 92.00								
T9A (DJ5)		4 Cyl.		2446cc	63kW (86PS)	Diesel			TD4830	
BE/PL	4	53,981/54,000	57,675/57,695	22,650	1,823	0,030/0,090	EC	71-3781	71-3781/4 STD 0.30	

87		93.00 x 72.70								
UFZ (ZPJ)		V6 Cyl.		2963cc	123kW (167PS)	Petrol			TD2920	
UKZ (ZPJ4/Z)		V6 Cyl.		2963cc	147kW (200PS)	Petrol			TD2921	
BE/PL	6	59,971/59,990	63,704/63,723	17,720	1,846	0,022/0,085	EC	71-3733	71-3733/6 STD	
MB/HL 1-4	4	70,043/70,062	74,000/74,019	23,470	1,967	0,020/0,067	AL-LF	66311RA	H1041/4 STD	



88											93.00 x 92.00										
CRD93			4 Cyl.			2498cc		54-55kW (73-75PS)			Diesel			TD9017							
CRD93			4 Cyl.			2498cc		54kW (73PS)			Diesel			TD21168							
CRD93 (U25/661)			4 Cyl.			2498cc		54kW (73PS)			Diesel			TD2747							
BE/PL	4	53,990/54,005	57,675/57,685	24,500	1,826	0,020/0,069	AL-LF	66440RAA	01-4181/4			STD 0.25 0.50									
MB/HL 1-5	5	67,035/67,050	71,695/71,705	28,700	2,317	0,020/0,061	AL-LF	66716RAA	H1089/5			STD 0.25 0.50									
01/83 →																					
TW/A	4	75,500/75,750	89,000/89,100		3,140			BS	66716BF	A213/4			STD								
01/83 →																					
SE/PB	1	30,008/30,014	33,000/33,033	31,900				BS	66444X	55-4393			SEMI								

89											93.00 x 92.00										
CRD93LS			4 Cyl.			2498cc		70kW (95PS)			Diesel Turbo			TD9018							
CRD93LS (U25/673)			4 Cyl.			2498cc		70kW (95PS)			Diesel Turbo			TD4829							
BE/PL	4	53,975/53,990	57,685/57,695	22,500	1,826	0,043/0,093	BS	66715CPA	71-4198/4			STD									
MB/HL 1-5	5	67,035/67,050	71,695/71,705	28,700	2,317	0,020/0,061	AL-LF	66716RAA	H1089/5			STD 0.25 0.50									
TW/A	4	75,500/75,750	89,000/89,100		3,140			BS	66716BF	A213/4			STD								

90											94.00 x 83.00										
134 (XD2)			4 Cyl.			2304cc		51kW (69PS)			Diesel			TD2800							
147 (XD2S)			4 Cyl.			2304cc		59kW (80PS)			Diesel Turbo			TD2802							
XD2			4 Cyl.			2304cc		44-53kW (60-72PS)			Diesel			TD22473							
XD2			4 Cyl.			2304cc		44-53kW (60-72PS)			Diesel			TD21365							
XD2PX94			4 Cyl.			2304cc		49kW (67PS)			Diesel			TD8504							
XD2S			4 Cyl.			2304cc		54-59kW (73-80PS)			Diesel Turbo			TD22474							
BE/PL	4	54,994/55,021	58,737/58,750	29,000	1,838	0,040/0,105	AL-LF	66690RA	01-4195/4			STD 0.30 0.50 0.80									
MB/HL 1,3,5	3	59,994/60,021	63,737/63,750	30,000	1,837	0,042/0,107	AL-LF	66691RA	H1056/5			STD 0.30 0.50									
MB/HL 2,4	2	59,994/60,021	63,737/63,750	24,000	1,837	0,042/0,107	AL-LF	66692RA													
TW/A	4	67,000/67,250	84,750/85,000		2,330			BS	66691BF	A211/4			STD 0.20								
SE/PB	1	30,007/30,020	33,000/33,025	29,700				BS	66694Y	55-4196			SEMI								

91											94.00 x 83.00										
XD2P94			4 Cyl.			2304cc		49kW (67PS)			Diesel			TD8501							
BE/PL	4	54,994/55,021	58,737/58,750	29,000	1,838	0,040/0,105	AL-LF	66690RA	01-4195/4			STD 0.30 0.50 0.80									
MB/HL 1,3,5	3	59,994/60,021	63,737/63,750	30,000	1,837	0,042/0,107	AL-LF	66691RA	H1056/5			STD 0.30 0.50									
MB/HL 2,4	2	59,994/60,021	63,737/63,750	24,000	1,837	0,042/0,107	AL-LF	66692RA													
TW/A	4	67,000/67,250	84,750/85,000		2,330			BS	66691BF	A211/4			STD 0.20								
SE/PB	1	30,007/30,020	33,000/33,025	29,700				BS	66694Y	55-4196			SEMI								
09/79 →																					

PEUGEOT



92 94.00 x 83.00

XD2S		4 Cyl.		2288cc	54-59kW (73-80PS)			Diesel Turbo		TD5288
BE/PL	4	54,994/55,021	58,737/58,750	29,000	1,838	0,040/0,105	AL-LF	66690RA	01-4195/4 STD 0.30 0.50 0.80	
MB/HL 1,3,5	3	59,994/60,021	63,737/63,750	30,000	1,837	0,042/0,107	AL-LF	66691RA	H1056/5 STD 0.30 0.50	
MB/HL 2,4	2	59,994/60,021	63,737/63,750	24,000	1,837	0,042/0,107	AL-LF	66692RA		
TW/A	4	67,000/67,250	84,750/85,000		2,330		BS	66691BF	A211/4 STD 0.20	
SE/PB	1	30,007/30,020	33,000/33,025	29,700			BS	66694Y	55-4196 SEMI	

93 94.00 x 90.00









152A (XD3T)		4 Cyl.		2498cc	66kW (90PS)			Diesel Turbo		TD2805
152B (XD3TE)		4 Cyl.		2498cc	77kW (105PS)			Diesel Turbo		TD2806
155 (XD3)		4 Cyl.		2498cc	51-55kW (70-75PS)			Diesel		TD2803
EN 55		4 Cyl.		2498cc	53-56kW (72-76PS)			Diesel		TD6685
ET 70		4 Cyl.		2496cc	71kW (96PS)			Diesel Turbo		TD6686
XD3P		4 Cyl.		2497cc	53-58kW (72-79PS)			Diesel		TD8505
XD3P		4 Cyl.		2498cc	52-55kW (71-75PS)			Diesel		TD202
XD3T		4 Cyl.		2497cc	66-70kW (90-95PS)			Diesel Turbo Intercooler		TD22475
XD3TE		4 Cyl.		2498cc	54-77kW (73-105PS)			Diesel Turbo Intercooler		TD22476
BE/PL	4	54,994/55,021	58,737/58,750	29,000	1,838	0,040/0,105	AL-LF	66690RA	01-4195/4 STD 0.30 0.50 0.80	
MB/HL 1,3,5	3	59,994/60,021	63,737/63,750	30,000	1,837	0,042/0,107	AL-LF	66691RA	H1056/5 STD 0.30 0.50	
MB/HL 2,4	2	59,994/60,021	63,737/63,750	24,000	1,837	0,042/0,107	AL-LF	66692RA		
TW/A	4	67,000/67,250	84,750/85,000		2,330		BS	66691BF	A211/4 STD 0.20	
SE/PB	1	32,009/32,025	35,000/35,025	29,700			BS	66694YA	55-4197 SEMI	

94 94.00 x 90.00

CRD93L		4 Cyl.		2498cc	70kW (95PS)			Diesel		TD18876
BE/PL	4	53,990/54,005	57,675/57,685	24,500	1,826	0,020/0,069	AL-LF	66440RAA	01-4181/4 STD 0.25 0.50	
MB/HL 1-5	5	67,035/67,050	71,695/71,705	28,700	2,317	0,020/0,061	AL-LF	66716RAA	H1089/5 STD 0.25 0.50	
TW/A	4	75,500/75,750	89,000/89,100		3,140		BS	66716BF	A213/4 STD	
SE/PB	1	30,008/30,014	33,000/33,033	31,900			BS	66444X	55-4393 SEMI	

95 94.40 x 100.00

8140.23 (F28DTSE)		4 Cyl.		2798cc	76kW (103PS)			Diesel Turbo Intercooler		TD24918
8140.43 (F28DT)		4 Cyl.		2798cc	90kW (122PS)			Diesel Turbo Intercooler		TD21169
8140.43N Euro 3		4 Cyl.		2798cc	107kW (146PS)			Diesel Turbo Intercooler		TD24923
8140.43S (F28DTCR)		4 Cyl.		2798cc	92-125kW (125-170PS)			Diesel Turbo Intercooler		TD17514
8140.63 (F28D)		4 Cyl.		2798cc	64kW (87PS)			Diesel		TD24917
BE/PL	4	56,520/56,535	60,333/60,345	24,700	1,870	0,020/0,072	BS	1870CP	71-4130/4 STD 0.25 0.50 0.75	
MB/HL 5	1	86,182/86,208	90,588/90,614	30,950	2,164	0,052/0,129	BS	4691CPH	H1104/5 STD 0.25 0.50	
MB/HL 1-4	4	80,182/80,208	84,588/84,614	23,800	2,164	0,052/0,129	BS	4692CP		
SE/PB	1	31,990/31,996	34,895/34,920	30,700			BS	66579YA	55-4186 SEMI	

				cm3	x 			
356	01/54→12/57	Petrol	Boxer	1286	4	80.00	64.00	1
356 1.3, 356 A (32kW/44Hp)	01/54→12/57	Petrol	Boxer	1286	4	80.00	64.00	1
356 A 1600 S	01/55→12/59	Petrol	616.15	1582	4	82.50	74.00	3
356 A 1600 Super	01/55→12/59	Petrol	616.15	1582	4	82.50	74.00	3
356 B 1600 Super 75	01/59→12/63	Petrol	616.15	1582	4	82.50	74.00	3
356 C 1600	01/63→12/65	Petrol	616.15	1582	4	82.50	74.00	3
911 2.0 E	09/68→12/69	Petrol	901.09	1991	6	80.00	66.00	2
911 2.0 E	09/68→12/69	Petrol	901.11	1991	6	80.00	66.00	2
911 2.0 L	01/63→08/67	Petrol	901.01	1991	6	80.00	66.00	2
911 2.0 L	01/63→08/67	Petrol	901.05	1991	6	80.00	66.00	2
911 2.0 L	01/63→08/67	Petrol	901.06	1991	6	80.00	66.00	2
911 2.0 L	01/63→08/67	Petrol	901.07	1991	6	80.00	66.00	2
911 2.0 L	01/63→08/67	Petrol	901.14	1991	6	80.00	66.00	2
911 2.0 L	01/63→08/67	Petrol	901.17	1991	6	80.00	66.00	2
911 2.0 S	07/66→11/68	Petrol	901.02	1991	6	80.00	66.00	2
911 2.0 S	07/66→11/68	Petrol	901.08	1991	6	80.00	66.00	2
911 2.0 S	09/68→12/69	Petrol	901.10	1991	6	80.00	66.00	2
911 2.0 T	08/68→02/72	Petrol	901.03	1991	6	80.00	66.00	2
911 2.0 T	08/68→02/72	Petrol	901.13	1991	6	80.00	66.00	2
911 2.2 E	09/69→12/71	Petrol	911.01	2195	6	84.00	66.00	4
911 2.2 E	09/69→12/71	Petrol	911.04	2195	6	84.00	66.00	4
911 2.2 S	09/69→12/71	Petrol	911.02	2195	6	84.00	66.00	4
911 2.2 T	01/70→12/72	Petrol	911.03	2195	6	84.00	66.00	4
911 2.2 T	01/70→12/72	Petrol	911.06	2195	6	84.00	66.00	4
911 2.2 T	01/70→12/72	Petrol	911.07	2195	6	84.00	66.00	4
911 2.2 T	01/70→12/72	Petrol	911.08	2195	6	84.00	66.00	4
911 2.3 E	08/71→12/73	Petrol	911.52	2341	6	84.00	70.40	5
911 2.3 S	08/71→01/76	Petrol	911.53	2341	6	84.00	70.40	6
911 2.7	09/73→08/75	Petrol	911.41	2687	6	90.00	70.40	8
911 2.7	09/75→06/77	Petrol	911.43	2687	6	90.00	70.40	8
911 2.7	09/73→08/75	Petrol	911.46	2687	6	90.00	70.40	8
911 2.7	09/75→06/77	Petrol	911.48	2687	6	90.00	70.40	8
911 2.7	09/75→06/77	Petrol	911.81	2687	6	90.00	70.40	9
911 2.7	09/75→06/77	Petrol	911.82	2687	6	90.00	70.40	9
911 2.7	09/75→06/77	Petrol	911.84	2687	6	90.00	70.40	9
911 2.7	09/75→06/77	Petrol	911.85	2687	6	90.00	70.40	9
911 2.7	09/75→06/77	Petrol	911.86	2687	6	90.00	70.40	9
911 2.7	09/75→06/77	Petrol	911.89	2687	6	90.00	70.40	9
911 2.7	09/75→06/77	Petrol	911.90	2687	6	90.00	70.40	9
911 2.7	09/73→08/75	Petrol	911.92	2687	6	90.00	70.40	8
911 2.7	09/75→06/77	Petrol	911.94	2687	6	90.00	70.40	9
911 2.7	09/73→08/75	Petrol	911.97	2687	6	90.00	70.40	8
911 2.7	09/75→06/77	Petrol	911.99	2687	6	90.00	70.40	9
911 2.7 S Carrera	08/73→01/76	Petrol	911.42	2687	6	90.00	70.40	8
911 2.7 S Carrera	08/73→01/76	Petrol	911.47	2687	6	90.00	70.40	8
911 2.7 S Carrera	08/73→01/76	Petrol	911.93	2687	6	90.00	70.40	8
911 2.7 S Carrera	08/73→01/76	Petrol	911.98	2687	6	90.00	70.40	8
911 2.7 SC Carrera RS	08/72→01/79	Petrol	911.83	2687	6	90.00	70.40	8
911 3.0 SC	08/80→07/83	Petrol	930.10	2993	6	95.00	70.40	11
911 3.0 SC Carrera	09/75→06/77	Petrol	930.02	2993	6	95.00	70.40	10
911 3.0 SC Carrera	07/77→06/80	Petrol	930.03	2993	6	95.00	70.40	11
911 3.0 SC Carrera	09/79→06/80	Petrol	930.09	2993	6	95.00	70.40	11
911 3.0 SC Carrera	09/75→06/77	Petrol	930.12	2993	6	95.00	70.40	10
911 3.0 SC Carrera	07/77→06/80	Petrol	930.13	2993	6	95.00	70.40	11
911 3.0 SC Carrera	09/79→06/80	Petrol	930.19	2993	6	95.00	70.40	11
911 3.0 Turbo	01/75→12/77	Petrol	930.50	2993	6	95.00	70.40	10
911 3.0 Turbo	01/75→12/77	Petrol	930.52	2993	6	95.00	70.40	10
911 3.2	08/86→08/89	Petrol	930.25	3164	6	95.00	74.40	12
911 3.2 Carrera Speedster	08/86→08/89	Petrol	930.20	3164	6	95.00	74.40	12
911 3.2 Carrera Speedster	08/86→08/89	Petrol	930.25	3164	6	95.00	74.40	12
911 3.2 SC Carrera	08/83→08/89	Petrol	930.20	3164	6	95.00	74.40	12
911 3.2 SC Carrera	02/84→08/89	Petrol	930.21	3164	6	95.00	74.40	12
911 3.2 SC Carrera	08/83→08/89	Petrol	930.26	3164	6	95.00	74.40	12
911 3.3 SC Turbo	09/77→06/87	Petrol	930.60	3299	6	97.00	74.40	14
911 3.3 SC Turbo	09/77→06/87	Petrol	930.66	3299	6	97.00	74.40	14
911 3.3 Turbo	09/86→11/90	Petrol	930.60	3299	6	97.00	74.40	14
911 3.3 Turbo	06/86→08/89	Petrol	930.66	3299	6	97.00	74.40	14
911 3.3 Turbo	08/90→09/93	Petrol	M 30.69	3299	6	97.00	74.40	14
911 3.3 Turbo S	06/91→12/92	Petrol	M 30.69S	3299	6	97.00	74.40	14











cm3









9

911 3.6 Carrera	07/89→06/94	Petrol	M 64.01	3600	6	100.00	76.40	16
911 3.6 Carrera	07/89→06/94	Petrol	M 64.02	3600	6	100.00	76.40	16
911 3.6 Carrera	10/93→08/95	Petrol	M 64.05	3600	6	100.00	76.40	17
911 3.6 Carrera	10/93→08/95	Petrol	M 64.06	3600	6	100.00	76.40	17
911 3.6 Carrera	10/93→08/95	Petrol	M 64.07	3600	6	100.00	76.40	17
911 3.6 Carrera	10/93→08/95	Petrol	M 64.08	3600	6	100.00	76.40	17
911 3.6 Carrera	08/95→09/97	Petrol	M 64.21	3600	6	100.00	76.40	17
911 3.6 Carrera	08/95→09/97	Petrol	M 64.22	3600	6	100.00	76.40	17
911 3.6 Carrera	08/95→09/97	Petrol	M 64.23	3600	6	100.00	76.40	17
911 3.6 Carrera	08/95→09/97	Petrol	M 64.24	3600	6	100.00	76.40	17
911 3.6 Carrera 4	12/88→05/94	Petrol	M 64.01	3600	6	100.00	76.40	16
911 3.6 Carrera 4	07/94→08/95	Petrol	M 64.05	3600	6	100.00	76.40	17
911 3.6 Carrera 4	07/94→08/95	Petrol	M 64.07	3600	6	100.00	76.40	17
911 3.6 Carrera 4	08/95→09/97	Petrol	M 64.21	3600	6	100.00	76.40	17
911 3.6 Carrera 4	08/95→09/97	Petrol	M 64.23	3600	6	100.00	76.40	17
911 3.6 GT3	03/99→08/05	Petrol	M 96.76	3598	6	100.00	76.40	18
911 3.6 Turbo	01/93→09/93	Petrol	M 64.50	3600	6	100.00	76.40	16
911 3.6 Turbo 4	03/95→09/97	Petrol	M 64.60	3600	6	100.00	76.40	17
911 3.6 Turbo GT2	03/95→09/97	Petrol	M 64.60R	3600	6	100.00	76.40	17
911 3.6 Turbo GT2 4	08/95→09/97	Petrol	M 64.60R	3600	6	100.00	76.40	17
911 3.8 Carrera	06/95→09/97	Petrol	M 64.05S	3600	6	100.00	76.40	17
911 3.8 Carrera	06/95→09/97	Petrol	M 64.06S	3600	6	100.00	76.40	17
911 3.8 Carrera	08/95→09/97	Petrol	M 64.21S	3800	6	102.00	76.40	22
911 3.8 Carrera 4	06/95→09/97	Petrol	M 64.05S	3600	6	100.00	76.40	17
911 3.8 Carrera 4	06/95→09/97	Petrol	M 64.06S	3600	6	100.00	76.40	17
911 3.8 Carrera 4	08/95→09/97	Petrol	M 64.21S	3800	6	102.00	76.40	22
911 3.8 Carrera RS	06/95→09/97	Petrol	M 64.20	3800	6	102.00	76.40	22
911 Targa 2.0 E	09/68→02/72	Petrol	901.09	1991	6	80.00	66.00	2
911 Targa 2.0 E	09/68→02/72	Petrol	901.11	1991	6	80.00	66.00	2
911 Targa 2.0 L	11/64→11/68	Petrol	901.01	1991	6	80.00	66.00	2
911 Targa 2.0 L	11/64→11/68	Petrol	901.05	1991	6	80.00	66.00	2
911 Targa 2.0 S	07/66→11/68	Petrol	901.02	1991	6	80.00	66.00	2
911 Targa 2.0 S	07/66→11/68	Petrol	901.08	1991	6	80.00	66.00	2
911 Targa 2.0 S	07/66→02/72	Petrol	901.10	1991	6	80.00	66.00	2
911 Targa 2.0 T	06/67→02/72	Petrol	901.03	1991	6	80.00	66.00	2
911 Targa 2.0 T	06/67→02/72	Petrol	901.13	1991	6	80.00	66.00	2
911 Targa 2.2 E	09/69→02/72	Petrol	911.01	2195	6	84.00	66.00	4
911 Targa 2.2 E	09/69→02/72	Petrol	911.04	2195	6	84.00	66.00	4
911 Targa 2.2 S	09/69→02/72	Petrol	911.02	2195	6	84.00	66.00	4
911 Targa 2.2 T	01/70→12/72	Petrol	911.06	2195	6	84.00	66.00	4
911 Targa 2.3 E	08/71→12/73	Petrol	911.52	2341	6	84.00	70.40	5
911 Targa 2.3 S	09/71→08/73	Petrol	911.53	2341	6	84.00	70.40	6
911 Targa 2.7	09/73→08/75	Petrol	911.41	2687	6	90.00	70.40	8
911 Targa 2.7	09/75→06/77	Petrol	911.43	2687	6	90.00	70.40	8
911 Targa 2.7	09/73→08/75	Petrol	911.46	2687	6	90.00	70.40	8
911 Targa 2.7	09/75→06/77	Petrol	911.48	2687	6	90.00	70.40	8
911 Targa 2.7	09/75→06/77	Petrol	911.81	2687	6	90.00	70.40	9
911 Targa 2.7	09/75→06/77	Petrol	911.82	2687	6	90.00	70.40	9
911 Targa 2.7	09/75→06/77	Petrol	911.84	2687	6	90.00	70.40	9
911 Targa 2.7	09/75→06/77	Petrol	911.85	2687	6	90.00	70.40	9
911 Targa 2.7	09/75→06/77	Petrol	911.86	2687	6	90.00	70.40	9
911 Targa 2.7	09/75→06/77	Petrol	911.89	2687	6	90.00	70.40	9
911 Targa 2.7	09/75→06/77	Petrol	911.90	2687	6	90.00	70.40	9
911 Targa 2.7	09/73→08/75	Petrol	911.92	2687	6	90.00	70.40	8
911 Targa 2.7	09/75→06/77	Petrol	911.94	2687	6	90.00	70.40	9
911 Targa 2.7	09/73→08/75	Petrol	911.97	2687	6	90.00	70.40	8
911 Targa 2.7	09/75→06/77	Petrol	911.99	2687	6	90.00	70.40	9
911 Targa 2.7 S	08/73→01/76	Petrol	911.42	2687	6	90.00	70.40	8
911 Targa 2.7 S	08/73→01/76	Petrol	911.47	2687	6	90.00	70.40	8
911 Targa 2.7 S	08/73→01/76	Petrol	911.93	2687	6	90.00	70.40	8
911 Targa 2.7 S	08/73→01/76	Petrol	911.98	2687	6	90.00	70.40	8
911 Targa 2.7 SC Carrera RS	08/72→01/79	Petrol	911.83	2687	6	90.00	70.40	8
911 Targa 3.0 SC Carrera	09/75→06/77	Petrol	930.02	2993	6	95.00	70.40	10
911 Targa 3.0 SC Carrera	07/77→06/80	Petrol	930.03	2993	6	95.00	70.40	11
911 Targa 3.0 SC Carrera	09/79→06/80	Petrol	930.09	2993	6	95.00	70.40	11
911 Targa 3.0 SC Carrera	09/75→06/77	Petrol	930.12	2993	6	95.00	70.40	10
911 Targa 3.0 SC Carrera	07/77→06/80	Petrol	930.13	2993	6	95.00	70.40	11
911 Targa 3.0 SC Carrera	09/79→06/80	Petrol	930.19	2993	6	95.00	70.40	11
911 Targa 3.2 Carrera	01/84→12/87	Petrol	930.21	3164	6	95.00	74.40	12
911 Targa 3.2 Carrera	08/86→08/89	Petrol	930.25	3164	6	95.00	74.40	12

				cm3	x				
911 Targa 3.3 Turbo	09/86→11/90	Petrol	930.66	3299	6	97.00	74.40	14	
911 Targa 3.6 Carrera	12/88→09/93	Petrol	M 64.01	3600	6	100.00	76.40	16	
911 Targa 3.6 Carrera	12/88→09/93	Petrol	M 64.02	3600	6	100.00	76.40	16	
911 Targa 3.6 Carrera	08/95→09/97	Petrol	M 64.21	3600	6	100.00	76.40	17	
911 Targa 3.6 Carrera	08/95→09/97	Petrol	M 64.22	3600	6	100.00	76.40	17	
911 Targa 3.6 Carrera	08/95→09/97	Petrol	M 64.23	3600	6	100.00	76.40	17	
911 Targa 3.6 Carrera	08/95→09/97	Petrol	M 64.24	3600	6	100.00	76.40	17	
911 Targa 3.6 Carrera 4	12/88→09/93	Petrol	M 64.01	3600	6	100.00	76.40	16	
911 Targa 3.8 Carrera	05/96→09/97	Petrol	M 64.21S	3800	6	102.00	76.40	22	
912 1.6	01/65→12/69	Petrol	616.36	1582	4	82.50	74.00	3	
912 Targa 1.6	03/65→02/70	Petrol	616.36	1582	4	82.50	74.00	3	
914 /6 2.0	11/69→12/73	Petrol	901.36	1991	6	80.00	66.00	2	
914 /6 2.0	11/69→12/73	Petrol	901.37	1991	6	80.00	66.00	2	
924 2.5 S	10/81→12/84	Petrol	M 44.01	2479	4	100.00	78.90	19	
924 2.5 S	10/81→12/84	Petrol	M 44.03	2479	4	100.00	78.90	19	
924 2.5 S	09/85→07/87	Petrol	M 44.07	2479	4	100.00	78.90	19	
924 2.5 S	09/85→07/87	Petrol	M 44.08	2479	4	100.00	78.90	19	
924 2.5 S	08/87→07/88	Petrol	M 44.09	2479	4	100.00	78.90	19	
924 2.5 S	08/87→07/88	Petrol	M 44.10	2479	4	100.00	78.90	19	
928	01/91→	Petrol	V8	5359	V8	104.00	78.90	24	
928 32V	01/91→	Petrol	V8	5359	V8	104.00	78.90	24	
928 4.5	09/77→08/82	Petrol	M 28.01	4474	V8	95.00	78.90	13	
928 4.5	09/77→08/82	Petrol	M 28.02	4474	V8	95.00	78.90	13	
928 4.5	09/77→12/79	Petrol	M 28.03	4474	V8	95.00	78.90	13	
928 4.5	09/77→12/79	Petrol	M 28.04	4474	V8	95.00	78.90	13	
928 4.5	09/77→08/82	Petrol	M 28.09	4474	V8	95.00	78.90	13	
928 4.5	09/77→08/82	Petrol	M 28.10	4474	V8	95.00	78.90	13	
928 4.5	09/79→12/82	Petrol	M 28.13	4474	V8	95.00	78.90	13	
928 4.5	09/79→12/82	Petrol	M 28.14	4474	V8	95.00	78.90	13	
928 4.5	09/79→12/82	Petrol	M 28.17	4474	V8	95.00	78.90	13	
928 4.5	09/79→12/82	Petrol	M 28.18	4474	V8	95.00	78.90	13	
928 4.7 S	09/79→07/83	Petrol	M 28.11	4664	V8	97.00	78.90	15	
928 4.7 S	09/79→07/83	Petrol	M 28.12	4664	V8	97.00	78.90	15	
928 4.7 S	09/82→12/84	Petrol	M 28.20	4664	V8	97.00	78.90	15	
928 4.7 S	08/83→07/86	Petrol	M 28.21	4664	V8	97.00	78.90	15	
928 4.7 S	08/83→07/86	Petrol	M 28.22	4664	V8	97.00	78.90	15	
928 5.0 GT	01/89→07/91	Petrol	M 28.47	4957	V8	100.00	78.90	20	
928 5.0 S	09/84→12/85	Petrol	M 28.43	4957	V8	100.00	78.90	20	
928 5.0 S	09/84→12/86	Petrol	M 28.44	4957	V8	100.00	78.90	20	
928 5.0 S	09/85→12/86	Petrol	M 28.45	4957	V8	100.00	78.90	20	
928 5.0 S	09/85→12/86	Petrol	M 28.46	4957	V8	100.00	78.90	20	
928 5.0 S4	08/86→07/91	Petrol	M 28.41	4957	V8	100.00	78.90	20	
928 5.0 S4	08/86→07/91	Petrol	M 28.42	4957	V8	100.00	78.90	20	
928 5.0 S4 CAT	08/86→07/91	Petrol	M 28.41	4957	V8	100.00	78.90	20	
928 5.0 S4 CAT	08/86→07/91	Petrol	M 28.42	4957	V8	100.00	78.90	20	
928 5.0 S,S4	08/86→07/91	Petrol	M 28.41	4957	V8	100.00	78.90	20	
928 5.0 S,S4	08/86→07/91	Petrol	M 28.42	4957	V8	100.00	78.90	20	
928 5.4 GTS	08/91→11/95	Petrol	M 28.49	5397	V8	100.00	85.90	21	
928 5.4 GTS	08/91→11/95	Petrol	M 28.50	5397	V8	100.00	85.90	21	
944 2.5	06/81→07/87	Petrol	M 44.01	2479	4	100.00	78.90	19	
944 2.5	01/85→07/87	Petrol	M 44.02	2479	4	100.00	78.90	19	
944 2.5	06/81→07/87	Petrol	M 44.03	2479	4	100.00	78.90	19	
944 2.5	01/85→07/87	Petrol	M 44.04	2479	4	100.00	78.90	19	
944 2.5	06/81→12/90	Petrol	M 44.05	2479	4	100.00	78.90	19	
944 2.5	06/81→07/87	Petrol	M 44.06	2479	4	100.00	78.90	19	
944 2.5	01/85→07/87	Petrol	M 44.07	2479	4	100.00	78.90	19	
944 2.5	01/85→07/87	Petrol	M 44.08	2479	4	100.00	78.90	19	
944 2.5	08/87→12/90	Petrol	M 44.09	2479	4	100.00	78.90	19	
944 2.5	08/87→12/90	Petrol	M 44.10	2479	4	100.00	78.90	19	
944 2.5 S	08/86→07/88	Petrol	M 44.40	2479	4	100.00	78.90	19	
944 2.5 Turbo	08/85→07/88	Petrol	M 44.50	2479	4	100.00	78.90	19	
944 2.5 Turbo	08/85→07/88	Petrol	M 44.51	2479	4	100.00	78.90	19	
944 2.5 Turbo	09/87→07/91	Petrol	M 44.52	2479	4	100.00	78.90	19	
944 2.7	11/88→08/89	Petrol	M 44.11	2681	4	104.00	78.90	23	
944 2.7	11/88→08/89	Petrol	M 44.12	2681	4	104.00	78.90	23	
944 3.0 S2	12/88→07/91	Petrol	M 44.41	2990	4	104.00	88.00	25	
968 3.0	06/91→11/95	Petrol	M 44.43	2990	4	104.00	88.00	25	
968 3.0	06/91→11/95	Petrol	M 44.44	2990	4	104.00	88.00	25	
Cayenne 3.2	08/03→09/07	Petrol	M02.2Y	3189	V6	84.00	95.90	7	

		cm ³	x 			
--	---	-----------------	---	---	---	---

616.15	Petrol	1582	4	82.50	74.00	3
616.16	Petrol	1582	4	82.50	74.00	3
616.36	Petrol	1582	4	82.50	74.00	3
901.01	Petrol	1991	6	80.00	66.00	2
901.02	Petrol	1991	6	80.00	66.00	2
901.03	Petrol	1991	6	80.00	66.00	2
901.05	Petrol	1991	6	80.00	66.00	2
901.06	Petrol	1991	6	80.00	66.00	2
901.07	Petrol	1991	6	80.00	66.00	2
901.08	Petrol	1991	6	80.00	66.00	2
901.09	Petrol	1991	6	80.00	66.00	2
901.10	Petrol	1991	6	80.00	66.00	2
901.11	Petrol	1991	6	80.00	66.00	2
901.13	Petrol	1991	6	80.00	66.00	2
901.14	Petrol	1991	6	80.00	66.00	2
901.17	Petrol	1991	6	80.00	66.00	2
901.36	Petrol	1991	6	80.00	66.00	2
901.37	Petrol	1991	6	80.00	66.00	2
911.01	Petrol	2195	6	84.00	66.00	4
911.02	Petrol	2195	6	84.00	66.00	4
911.03	Petrol	2195	6	84.00	66.00	4
911.04	Petrol	2195	6	84.00	66.00	4
911.06	Petrol	2195	6	84.00	66.00	4
911.07	Petrol	2195	6	84.00	66.00	4
911.08	Petrol	2195	6	84.00	66.00	4
911.41	Petrol	2687	6	90.00	70.40	8
911.42	Petrol	2687	6	90.00	70.40	8
911.43	Petrol	2687	6	90.00	70.40	8
911.46	Petrol	2687	6	90.00	70.40	8
911.47	Petrol	2687	6	90.00	70.40	8
911.48	Petrol	2687	6	90.00	70.40	8
911.52	Petrol	2341	6	84.00	70.40	5
911.53	Petrol	2341	6	84.00	70.40	6
911.81	Petrol	2687	6	90.00	70.40	9
911.82	Petrol	2687	6	90.00	70.40	9
911.83	Petrol	2687	6	90.00	70.40	8
911.84	Petrol	2687	6	90.00	70.40	9
911.85	Petrol	2687	6	90.00	70.40	9
911.86	Petrol	2687	6	90.00	70.40	9
911.89	Petrol	2687	6	90.00	70.40	9
911.90	Petrol	2687	6	90.00	70.40	9
911.92	Petrol	2687	6	90.00	70.40	8
911.93	Petrol	2687	6	90.00	70.40	8
911.94	Petrol	2687	6	90.00	70.40	9
911.97	Petrol	2687	6	90.00	70.40	8
911.98	Petrol	2687	6	90.00	70.40	8
911.99	Petrol	2687	6	90.00	70.40	9
930.02	Petrol	2993	6	95.00	70.40	10
930.03	Petrol	2993	6	95.00	70.40	11
930.09	Petrol	2993	6	95.00	70.40	11
930.10	Petrol	2993	6	95.00	70.40	11
930.12	Petrol	2993	6	95.00	70.40	10
930.13	Petrol	2993	6	95.00	70.40	11
930.19	Petrol	2993	6	95.00	70.40	11
930.20	Petrol	3164	6	95.00	74.40	12
930.21	Petrol	3164	6	95.00	74.40	12
930.25	Petrol	3164	6	95.00	74.40	12
930.26	Petrol	3164	6	95.00	74.40	12
930.50	Petrol	2993	6	95.00	70.40	10
930.51	Petrol	2993	6	95.00	70.40	10
930.52	Petrol	2993	6	95.00	70.40	10
930.60	Petrol	3299	6	97.00	74.40	14
930.66	Petrol	3299	6	97.00	74.40	14
930.68	Petrol	3299	6	97.00	74.40	14
Boxer	Petrol	1286	4	80.00	64.00	1
M02.2Y	Petrol	3189	V6	84.00	95.90	7
M 28.01	Petrol	4474	V8	95.00	78.90	13
M 28.02	Petrol	4474	V8	95.00	78.90	13
M 28.03	Petrol	4474	V8	95.00	78.90	13

			cm3	x 			
M 28.04	Petrol		4474	V8	95.00	78.90	13
M 28.09	Petrol		4474	V8	95.00	78.90	13
M 28.10	Petrol		4474	V8	95.00	78.90	13
M 28.11	Petrol		4664	V8	97.00	78.90	15
M 28.12	Petrol		4664	V8	97.00	78.90	15
M 28.13	Petrol		4474	V8	95.00	78.90	13
M 28.14	Petrol		4474	V8	95.00	78.90	13
M 28.15	Petrol		4474	V8	95.00	78.90	13
M 28.16	Petrol		4474	V8	95.00	78.90	13
M 28.17	Petrol		4474	V8	95.00	78.90	13
M 28.18	Petrol		4474	V8	95.00	78.90	13
M 28.19	Petrol		4664	V8	97.00	78.90	15
M 28.20	Petrol		4664	V8	97.00	78.90	15
M 28.21	Petrol		4664	V8	97.00	78.90	15
M 28.22	Petrol		4664	V8	97.00	78.90	15
M 28.41	Petrol		4957	V8	100.00	78.90	20
M 28.42	Petrol		4957	V8	100.00	78.90	20
M 28.43	Petrol		4957	V8	100.00	78.90	20
M 28.44	Petrol		4957	V8	100.00	78.90	20
M 28.45	Petrol		4957	V8	100.00	78.90	20
M 28.46	Petrol		4957	V8	100.00	78.90	20
M 28.47	Petrol		4957	V8	100.00	78.90	20
M 28.49	Petrol		5397	V8	100.00	85.90	21
M 28.50	Petrol		5397	V8	100.00	85.90	21
M 30.69	Petrol		3299	6	97.00	74.40	14
M 30.69S	Petrol		3299	6	97.00	74.40	14
M 44.01	Petrol		2479	4	100.00	78.90	19
M 44.02	Petrol		2479	4	100.00	78.90	19
M 44.03	Petrol		2479	4	100.00	78.90	19
M 44.04	Petrol		2479	4	100.00	78.90	19
M 44.05	Petrol		2479	4	100.00	78.90	19
M 44.06	Petrol		2479	4	100.00	78.90	19
M 44.07	Petrol		2479	4	100.00	78.90	19
M 44.08	Petrol		2479	4	100.00	78.90	19
M 44.09	Petrol		2479	4	100.00	78.90	19
M 44.10	Petrol		2479	4	100.00	78.90	19
M 44.11	Petrol		2681	4	104.00	78.90	23
M 44.12	Petrol		2681	4	104.00	78.90	23
M 44.40	Petrol		2479	4	100.00	78.90	19
M 44.41	Petrol		2990	4	104.00	88.00	25
M 44.43	Petrol		2990	4	104.00	88.00	25
M 44.44	Petrol		2990	4	104.00	88.00	25
M 44.50	Petrol		2479	4	100.00	78.90	19
M 44.51	Petrol		2479	4	100.00	78.90	19
M 44.52	Petrol		2479	4	100.00	78.90	19
M 48.10	Petrol		3189	V6	84.00	95.90	7
M 64.01	Petrol		3600	6	100.00	76.40	16
M 64.02	Petrol		3600	6	100.00	76.40	16
M 64.05	Petrol		3600	6	100.00	76.40	17
M 64.05S	Petrol		3600	6	100.00	76.40	17
M 64.06	Petrol		3600	6	100.00	76.40	17
M 64.06S	Petrol		3600	6	100.00	76.40	17
M 64.07	Petrol		3600	6	100.00	76.40	17
M 64.08	Petrol		3600	6	100.00	76.40	17
M 64.20	Petrol		3800	6	102.00	76.40	22
M 64.21	Petrol		3600	6	100.00	76.40	17
M 64.21S	Petrol		3800	6	102.00	76.40	22
M 64.22	Petrol		3600	6	100.00	76.40	17
M 64.23	Petrol		3600	6	100.00	76.40	17
M 64.24	Petrol		3600	6	100.00	76.40	17
M 64.50	Petrol		3600	6	100.00	76.40	16
M 64.60	Petrol		3600	6	100.00	76.40	17
M 64.60R	Petrol		3600	6	100.00	76.40	17
M 96.76	Petrol		3598	6	100.00	76.40	18
V8	Petrol		5359	V8	104.00	78.90	24



1 80.00 x 64.00

Boxer			4 Cyl.	1286cc	32kW (44PS)		Petrol		FM6048
BE/PL	4	52,987/53,000	56,980/56,999	16,000	1,975	0,030/0,087	EC	71-1971	71-1971/4 STD

2 80.00 x 66.00

901.01			6 Cyl.	1991cc	96kW (131PS)		Petrol		TD10287
901.02			6 Cyl.	1991cc	118kW (160PS)		Petrol		TD10289
901.03			6 Cyl.	1991cc	81kW (110PS)		Petrol		TD5409
901.05			6 Cyl.	1991cc	96kW (131PS)		Petrol		TD10288
901.06			6 Cyl.	1991cc	96kW (131PS)		Petrol		TD27874
901.07			6 Cyl.	1991cc	96kW (131PS)		Petrol		TD27892
901.08			6 Cyl.	1991cc	118kW (160PS)		Petrol		TD27891
901.09			6 Cyl.	1991cc	103kW (140PS)		Petrol		TD5407
901.10			6 Cyl.	1991cc	125kW (170PS)		Petrol		TD10290
901.11			6 Cyl.	1991cc	103kW (140PS)		Petrol		TD5408
901.13			6 Cyl.	1991cc	81kW (110PS)		Petrol		TD5410
901.14			6 Cyl.	1991cc	96kW (131PS)		Petrol		TD27893
901.17			6 Cyl.	1991cc	96kW (131PS)		Petrol		TD27894
901.36			6 Cyl.	1991cc	81kW (110PS)		Petrol		TD5403
901.37			6 Cyl.	1991cc	81kW (110PS)		Petrol		TD5404

BE/PL	6	56,971/56,990	61,000/61,019	17,800	1,990	0,030/0,093	EC	71-2349	71-2349/6 STD
MB/HL	1	56,971/56,990	62,000/62,019	27,890	2,500	0,020/0,073	EC	72-2350H	H688/7 STD
MB/HL	6	56,971/56,990	62,000/62,019	18,000	2,500	0,020/0,073	EC	72-2351	



SE/PB	1	22,000	25,000/25,021	25,000			BC	55-3280	55-3280 SEMI
BU	1	17,989/18,000	20,000/20,013	25,500			BC	56-2698	56-2698 SEMI

3 82.50 x 74.00

616.15			4 Cyl.	1582cc	55kW (75PS)		Petrol		TD20989
616.16			4 Cyl.	1582cc	66kW (90PS)		Petrol		TD20955
616.36			4 Cyl.	1582cc	66kW (90PS)		Petrol		TD20956
BE/PL	4	52,987/53,000	56,980/56,999	16,000	1,975	0,030/0,087	EC	71-1971	71-1971/4 STD

4 84.00 x 66.00

911.01			6 Cyl.	2195cc	114kW (155PS)		Petrol		TD5411
911.02			6 Cyl.	2195cc	132kW (180PS)		Petrol		TD5413
911.03			6 Cyl.	2195cc	92kW (125PS)		Petrol		TD29179
911.04			6 Cyl.	2195cc	114kW (155PS)		Petrol		TD5412
911.06			6 Cyl.	2195cc	92kW (125PS)		Petrol		TD20957
911.07			6 Cyl.	2195cc	92kW (125PS)		Petrol		TD20958
911.08			6 Cyl.	2195cc	92kW (125PS)		Petrol		TD20959

BE/PL	6	56,971/56,990	61,000/61,019	17,800	1,990	0,030/0,093	EC	71-2349	71-2349/6 STD
-------	---	---------------	---------------	--------	-------	-------------	----	---------	-------------------------

MB/HL	1	56,971/56,990	62,000/62,019	27,890	2,500	0,020/0,073	EC	72-2350H	H688/7 STD
MB/HL	6	56,971/56,990	62,000/62,019	18,000	2,500	0,020/0,073	EC	72-2351	
			72-2350H	STD	28,000/1.1024" - 28,052/1.1044"				
SE/PB	1	22,000	25,000/25,021	25,000			BC	55-3280	55-3280 SEMI
BU	1	17,989/18,000	20,000/20,013	25,500			BC	56-2698	56-2698 SEMI

5 84.00 x 70.40

911.52			6 Cyl.	2341cc	121kW (165PS)			Petrol	TD5416
BE/PL	6	51,971/51,990	56,000/56,019	19,800	1,990	0,030/0,093	EC	71-3014	71-3014/6 STD 0.25 0.50
MB/HL	1	56,971/56,990	62,000/62,019	27,890	2,500	0,020/0,073	EC	72-2350H	H688/7 STD
MB/HL	6	56,971/56,990	62,000/62,019	18,000	2,500	0,020/0,073	EC	72-2351	
			72-2350H	STD	28,000/1.1024" - 28,052/1.1044"				
SE/PB	1	22,000	25,000/25,021	25,000			BC	55-3280	55-3280 SEMI
BU	1	17,989/18,000	20,000/20,013	25,500			BC	56-2698	56-2698 SEMI

6 84.00 x 70.40

911.53			6 Cyl.	2341cc	140kW (190PS)			Petrol	TD5414
BE/PL	6	51,971/51,990	56,000/56,019	19,800	1,990	0,030/0,093	EC	71-3014	71-3014/6 STD 0.25 0.50
MB/HL	1	56,971/56,990	62,000/62,019	27,890	2,500	0,020/0,073	EC	72-2350H	H688/7 STD
MB/HL	6	56,971/56,990	62,000/62,019	18,000	2,500	0,020/0,073	EC	72-2351	
		→12/73							
			72-2350H	STD	28,000/1.1024" - 28,052/1.1044"				
MB/HL	1	56,971/56,990	62,000/62,019	27,890	2,500	0,020/0,073	EC	72-2350H	H928/7 STD
MB/HL	6	56,971/56,990	62,000/62,019	18,000	2,500	0,020/0,073	EC	72-3303	
		01/74→							
			72-2350H	STD	28,000/1.1024" - 28,052/1.1044"				

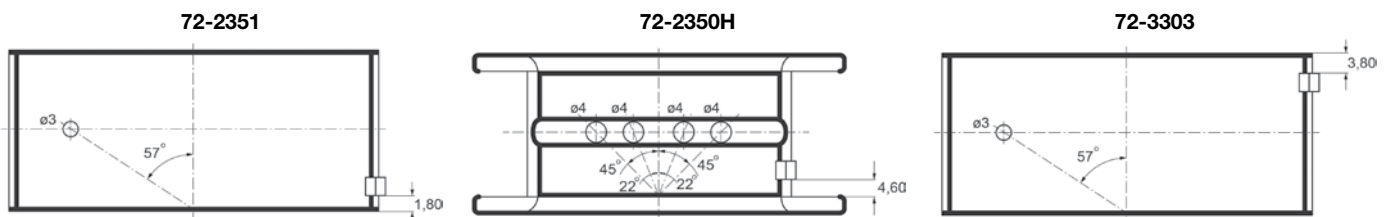

SE/PB	1	22,000	25,000/25,021	25,000			BC	55-3280	55-3280 SEMI
BU	1	17,989/18,000	20,000/20,013	25,500			BC	56-2698	56-2698 SEMI



7										84.00 x 95.90									
M 48.10		V6 Cyl.		3189cc	184kW (250PS)		Petrol		TD18467										
M02.2Y		V6 Cyl.		3189cc	177-184kW (241-250PS)		Petrol		TD23319										
BE/PL	6	53,958/53,978	56,800/56,819	17,000	1,406	0,020/0,074	AL-LF	01-3841	01-3841/6 STD 0.25										
MB/HL 1-7	7	59,958/59,978	65,000/65,010	17,000	2,501	0,020/0,075	AL-LF	02-3716	H035/7 STD 0.25										
TW/A	2	65,450	80,000		1,723		AL-LF	04-3717	A139/4 STD										
TW/A	2	65,450	80,000		1,723		AL-LF	04-3718											
BU	1	42,959/42,975	46,055/46,095	15,000			AL-LF	07-3088	07-3088 STD SEMI										
Front, For intermediary shaft																			
BU	1	14,473/14,484	17,500/17,518	20,000			BB	17-3720	17-3720 SEMI										
Rear, For intermediary shaft																			

8										90.00 x 70.40									
911.41		6 Cyl.		2687cc	110kW (150PS)		Petrol		TD27881										
911.42		6 Cyl.		2687cc	129kW (175PS)		Petrol		TD5421										
911.43		6 Cyl.		2687cc	121kW (165PS)		Petrol		TD27883										
911.46		6 Cyl.		2687cc	110kW (150PS)		Petrol		TD27882										
911.47		6 Cyl.		2687cc	129kW (175PS)		Petrol		TD5422										
911.48		6 Cyl.		2687cc	121kW (165PS)		Petrol		TD27884										
911.83		6 Cyl.		2687cc	154kW (210PS)		Petrol		TD5418										
911.92		6 Cyl.		2687cc	110kW (150PS)		Petrol		TD27879										
911.93		6 Cyl.		2687cc	129kW (175PS)		Petrol		TD5419										
911.97		6 Cyl.		2687cc	110kW (150PS)		Petrol		TD27880										
911.98		6 Cyl.		2687cc	129kW (175PS)		Petrol		TD5420										
BE/PL	6	51,971/51,990	56,000/56,019	19,800	1,990	0,030/0,093	EC	71-3014	71-3014/6 STD 0.25 0.50										
MB/HL	1	56,971/56,990	62,000/62,019	27,890	2,500	0,020/0,073	EC	72-2350H	H688/7 STD										
MB/HL	6	56,971/56,990	62,000/62,019	18,000	2,500	0,020/0,073	EC	72-2351											
→12/73																			
		72-2350H	STD	28,000/1.1024" - 28,052/1.1044"															
MB/HL	1	56,971/56,990	62,000/62,019	27,890	2,500	0,020/0,073	EC	72-2350H	H928/7 STD										
MB/HL	6	56,971/56,990	62,000/62,019	18,000	2,500	0,020/0,073	EC	72-3303											
01/74→																			
		72-2350H	STD	28,000/1.1024" - 28,052/1.1044"															

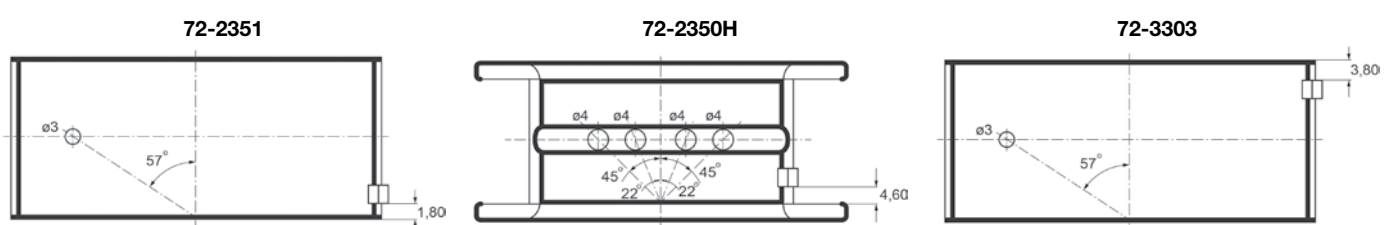

SE/PB	1	22,000	25,000/25,021	25,000			BC	55-3280	55-3280 SEMI	
BU	1	17,989/18,000	20,000/20,013	25,500			BC	56-2698	56-2698 SEMI	

9 90.00 x 70.40

911.81			6 Cyl.	2687cc	121kW (165PS)		Petrol		TD27898
911.82			6 Cyl.	2687cc	121kW (165PS)		Petrol		TD27899
911.84			6 Cyl.	2687cc	121kW (165PS)		Petrol		TD27900
911.85			6 Cyl.	2687cc	121kW (165PS)		Petrol		TD27901
911.86			6 Cyl.	2687cc	121kW (165PS)		Petrol		TD27902
911.89			6 Cyl.	2687cc	121kW (165PS)		Petrol		TD27903
911.90			6 Cyl.	2687cc	121kW (165PS)		Petrol		TD27904
911.94			6 Cyl.	2687cc	121kW (165PS)		Petrol		TD27905
911.99			6 Cyl.	2687cc	121kW (165PS)		Petrol		TD27906

BE/PL	6	51,971/51,990	56,000/56,019	19,800	1,990	0,030/0,093	EC	71-3014	71-3014/6 STD 0.25 0.50
MB/HL	1	56,971/56,990	62,000/62,019	27,890	2,500	0,020/0,073	EC	72-2350H	H928/7 STD
MB/HL	6	56,971/56,990	62,000/62,019	18,000	2,500	0,020/0,073	EC	72-3303	

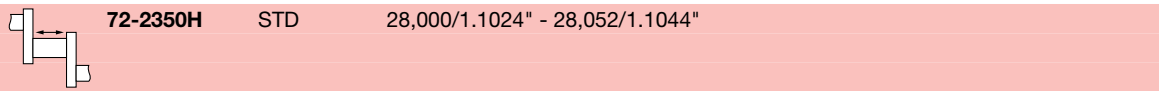

SE/PB	1	22,000	25,000/25,021	25,000			BC	55-3280	55-3280 SEMI
BU	1	17,989/18,000	20,000/20,013	25,500			BC	56-2698	56-2698 SEMI

10 95.00 x 70.40

930.02			6 Cyl.	2993cc	147kW (200PS)		Petrol		TD21393
930.12			6 Cyl.	2993cc	147kW (200PS)		Petrol		TD27910
930.50			6 Cyl.	2993cc	184-191kW (250-260PS)		Petrol Turbo		TD10048
930.51			6 Cyl.	2993cc	180kW (245PS)		Petrol Turbo		TD29176
930.52			6 Cyl.	2993cc	191kW (260PS)		Petrol Turbo		TD21395

BE/PL	6	51,971/51,990	56,000/56,019	19,800	1,990	0,030/0,093	EC	71-3014	71-3014/6 STD 0.25 0.50
MB/HL	1	56,971/56,990	62,000/62,019	27,890	2,500	0,020/0,073	EC	72-2350H	H928/7 STD
MB/HL	6	56,971/56,990	62,000/62,019	18,000	2,500	0,020/0,073	EC	72-3303	

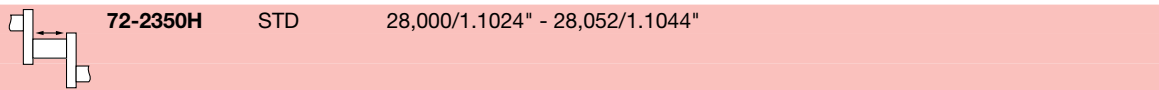

SE/PB	1	22,000	25,000/25,021	25,000			BC	55-3280	55-3280 SEMI
BU	1	17,989/18,000	20,000/20,013	25,500			BC	56-2698	56-2698 SEMI

11 95.00 x 70.40

930.03			6 Cyl.	2993cc	132kW (180PS)		Petrol		TD28033
930.09			6 Cyl.	2993cc	138kW (188PS)		Petrol		TD21394
930.10			6 Cyl.	2993cc	150kW (204PS)		Petrol		TD27912
930.13			6 Cyl.	2993cc	132kW (180PS)		Petrol		TD28034
930.19			6 Cyl.	2993cc	138kW (188PS)		Petrol		TD27913

BE/PL	6	52,971/52,990	56,000/56,019	17,800	1,490	0,030/0,093	EC	71-3426	71-3426/6 STD
-------	---	---------------	---------------	--------	-------	-------------	----	---------	-------------------------

PORSCHE

MB/HL	1	59,971/59,990	65,000/65,019	27,890	2,500	0,020/0,073	EC	72-3428H	H949/7 STD
MB/HL	6	59,971/59,990	65,000/65,019	17,000	2,500	0,020/0,073	EC	72-3429	
			72-3428H	STD	28,000/1.1024" - 28,052/1.1044"				
				0.25mm	28,000/1.1024" - 28,052/1.1044"				
SE/PB	1	22,000	25,000/25,021	25,000			BC	55-3280	55-3280 SEMI
BU	1	17,989/18,000	20,000/20,013	25,500			BC	56-2698	56-2698 SEMI

12 95.00 x 74.40

930.20			6 Cyl.	3164cc	170kW (231PS)		Petrol		TD2944
930.21			6 Cyl.	3164cc	152kW (207PS)		Petrol		TD2945
930.25			6 Cyl.	3164cc	160kW (218PS)		Petrol		TD2946
930.26			6 Cyl.	3164cc	170kW (231PS)		Petrol		TD2947
BE/PL	6	54,971/54,990	58,000/58,019	17,800	1,497	0,020/0,079	EC	71-3427	71-3427/6 STD
MB/HL	1	59,971/59,990	65,000/65,019	27,890	2,500	0,020/0,073	EC	72-3428H	H949/7 STD
MB/HL	6	59,971/59,990	65,000/65,019	17,000	2,500	0,020/0,073	EC	72-3429	
			72-3428H	STD	28,000/1.1024" - 28,052/1.1044"				
				0.25mm	28,000/1.1024" - 28,052/1.1044"				
SE/PB	1	22,000	25,000/25,021	25,000			BC	55-3280	55-3280 SEMI
BU	1	17,989/18,000	20,000/20,013	25,500			BC	56-2698	56-2698 SEMI

13 95.00 x 78.90

M 28.01			V8 Cyl.	4474cc	177kW (241PS)		Petrol		TD27764
M 28.02			V8 Cyl.	4474cc	177kW (241PS)		Petrol		TD27765
M 28.03			V8 Cyl.	4474cc	169kW (230PS)		Petrol		TD2952
M 28.04			V8 Cyl.	4474cc	169kW (230PS)		Petrol		TD2953
M 28.09			V8 Cyl.	4474cc	177kW (241PS)		Petrol		TD27766
M 28.10			V8 Cyl.	4474cc	177kW (241PS)		Petrol		TD18880
M 28.13			V8 Cyl.	4474cc	170kW (231PS)		Petrol		TD2956
M 28.14			V8 Cyl.	4474cc	170kW (231PS)		Petrol		TD2957
M 28.15			V8 Cyl.	4474cc	170kW (231PS)		Petrol		TD27767
M 28.16			V8 Cyl.	4474cc	170kW (231PS)		Petrol		TD27768
M 28.17			V8 Cyl.	4474cc	170kW (231PS)		Petrol		TD27769
M 28.18			V8 Cyl.	4474cc	170kW (231PS)		Petrol		TD27770
BE/PL	8	51,971/51,990	55,000/55,019	24,000	1,497	0,020/0,079	EC	71-3431	71-3431/8 STD

14 97.00 x 74.40

930.60			6 Cyl.	3299cc	221-243kW (300-330PS)		Petrol Turbo Intercooler		TD2948
930.66			6 Cyl.	3299cc	221kW (301PS)		Petrol Turbo Intercooler		TD2949
930.68			6 Cyl.	3299cc	221kW (301PS)		Petrol Turbo		TD2950
M 30.69			6 Cyl.	3299cc	235kW (320PS)		Petrol Turbo Intercooler		TD2934
M 30.69S			6 Cyl.	3299cc	261kW (355PS)		Petrol Turbo		TD5406
BE/PL	6	54,971/54,990	58,000/58,019	17,800	1,497	0,020/0,079	EC	71-3427	71-3427/6 STD

MB/HL	1	59,971/59,990	65,000/65,019	27,890	2,500	0,020/0,073	EC	72-3428H	H949/7 STD	
MB/HL	6	59,971/59,990	65,000/65,019	17,000	2,500	0,020/0,073	EC	72-3429		
			72-3428H	STD	28,000/1.1024" - 28,052/1.1044"					
				0.25mm	28,000/1.1024" - 28,052/1.1044"					
SE/PB	1	23,000	26,000/26,021	25,000			BC	55-3430	55-3430 SEMI	
BU	1	17,989/18,000	20,000/20,013	25,500			BC	56-2698	56-2698 SEMI	

15	97.00 x 78.90									
M 28.11			V8 Cyl.	4664cc	221kW (301PS)			Petrol	TD2954	
M 28.12			V8 Cyl.	4664cc	221kW (301PS)			Petrol	TD2955	
M 28.19			V8 Cyl.	4664cc	178-200kW (242-272PS)			Petrol	TD2958	
M 28.20			V8 Cyl.	4664cc	178-200kW (242-272PS)			Petrol	TD2959	
M 28.21			V8 Cyl.	4664cc	228kW (310PS)			Petrol	TD2960	
M 28.22			V8 Cyl.	4664cc	228kW (310PS)			Petrol	TD2961	
BE/PL	8	51,971/51,990	55,000/55,019	24,000	1,497	0,020/0,079	EC	71-3431	71-3431/8 STD	

16	100.00 x 76.40									
M 64.01			6 Cyl.	3600cc	184kW (250PS)			Petrol	TD2935	
M 64.02			6 Cyl.	3600cc	184kW (250PS)			Petrol	TD2936	
M 64.50			6 Cyl.	3600cc	265kW (360PS)			Petrol Turbo Intercooler	TD5477	
BE/PL	6	54,971/54,990	58,000/58,019	17,800	1,497	0,020/0,079	EC	71-3427	71-3427/6 STD	
MB/HL	1	59,971/59,990	65,000/65,019	27,890	2,500	0,020/0,073	EC	72-3428H	H949/7 STD	
MB/HL	6	59,971/59,990	65,000/65,019	17,000	2,500	0,020/0,073	EC	72-3429		
			72-3428H	STD	28,000/1.1024" - 28,052/1.1044"					
				0.25mm	28,000/1.1024" - 28,052/1.1044"					
SE/PB	1	23,000	26,000/26,021	25,000			BC	55-3430	55-3430 SEMI	
BU	1	17,989/18,000	20,000/20,013	25,500			BC	56-2698	56-2698 SEMI	

17	100.00 x 76.40									
M 64.05			6 Cyl.	3600cc	200kW (272PS)			Petrol	TD2938	
M 64.05S			6 Cyl.	3600cc	210kW (285PS)			Petrol	TD5453	
M 64.06			6 Cyl.	3600cc	200kW (272PS)			Petrol	TD2939	
M 64.06S			6 Cyl.	3600cc	210kW (285PS)			Petrol	TD5454	
M 64.07			6 Cyl.	3600cc	200kW (272PS)			Petrol	TD16161	
M 64.08			6 Cyl.	3600cc	200kW (272PS)			Petrol	TD16162	
M 64.21			6 Cyl.	3600cc	210kW (285PS)			Petrol	TD5451	
M 64.22			6 Cyl.	3600cc	210kW (285PS)			Petrol	TD5452	
M 64.23			6 Cyl.	3600cc	210kW (286PS)			Petrol	TD16159	
M 64.24			6 Cyl.	3600cc	210kW (286PS)			Petrol	TD16160	
M 64.60			6 Cyl.	3600cc	298-300kW (405-408PS)			Petrol Turbo	TD5456	
M 64.60R			6 Cyl.	3600cc	316kW (430PS)			Petrol Bi-Turbo Intercooler	TD5457	
BE/PL	6	54,971/54,990	58,000/58,019	14,800	1,499	0,020/0,075	EC	71-3775	71-3775/6 STD	
MB/HL	1	59,971/59,990	65,000/65,019	27,890	2,500	0,020/0,073	EC	72-3428H	H949/7 STD	

PORSCHE

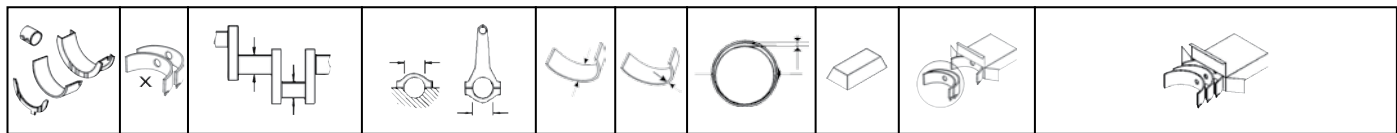

MB/HL	6	59,971/59,990	65,000/65,019	17,000	2,500	0,020/0,073	EC	72-3429	
-------	---	---------------	---------------	--------	-------	-------------	----	---------	--



72-3428H	STD	28,000/1.1024" - 28,052/1.1044"
	0.25mm	28,000/1.1024" - 28,052/1.1044"

BU	1	17,989/18,000	20,000/20,013	25,500			BC	56-2698	56-2698 SEMI
----	---	---------------	---------------	--------	--	--	----	---------	------------------------

18 100.00 x 76.40

M 96.76			6 Cyl.	3598cc	265kW (360PS)		Petrol		TD13628
----------------	--	--	--------	---------------	----------------------	--	---------------	--	----------------

BE/PL	6	52,971/52,990	56,000/56,019	17,800	1,492	0,026/0,089	EC	71-3913	71-3913/6 STD
-------	---	---------------	---------------	--------	-------	-------------	----	---------	-------------------------

19 100.00 x 78.90

M 44.01			4 Cyl.	2479cc	120kW (163PS)		Petrol		TD2975
----------------	--	--	--------	---------------	----------------------	--	---------------	--	---------------

M 44.02			4 Cyl.	2479cc	110kW (150PS)		Petrol		TD2976
----------------	--	--	--------	---------------	----------------------	--	---------------	--	---------------

M 44.03			4 Cyl.	2479cc	120kW (163PS)		Petrol		TD2977
----------------	--	--	--------	---------------	----------------------	--	---------------	--	---------------

M 44.04			4 Cyl.	2479cc	110kW (150PS)		Petrol		TD2978
----------------	--	--	--------	---------------	----------------------	--	---------------	--	---------------

M 44.05			4 Cyl.	2479cc	118-120kW (160-163PS)		Petrol		TD2979
----------------	--	--	--------	---------------	------------------------------	--	---------------	--	---------------

M 44.06			4 Cyl.	2479cc	120kW (163PS)		Petrol		TD2980
----------------	--	--	--------	---------------	----------------------	--	---------------	--	---------------

M 44.07			4 Cyl.	2479cc	110kW (150PS)		Petrol		TD2981
----------------	--	--	--------	---------------	----------------------	--	---------------	--	---------------

M 44.08			4 Cyl.	2479cc	110kW (150PS)		Petrol		TD2982
----------------	--	--	--------	---------------	----------------------	--	---------------	--	---------------

M 44.09			4 Cyl.	2479cc	118kW (160PS)		Petrol		TD2983
----------------	--	--	--------	---------------	----------------------	--	---------------	--	---------------

M 44.10			4 Cyl.	2479cc	118kW (160PS)		Petrol		TD2984
----------------	--	--	--------	---------------	----------------------	--	---------------	--	---------------

M 44.40			4 Cyl.	2479cc	135-140kW (184-190PS)		Petrol		TD2987
----------------	--	--	--------	---------------	------------------------------	--	---------------	--	---------------

M 44.50			4 Cyl.	2479cc	162kW (220PS)		Petrol Turbo Intercooler		TD2991
----------------	--	--	--------	---------------	----------------------	--	---------------------------------	--	---------------

M 44.51			4 Cyl.	2479cc	162kW (220PS)		Petrol Turbo Intercooler		TD2992
----------------	--	--	--------	---------------	----------------------	--	---------------------------------	--	---------------

M 44.52			4 Cyl.	2479cc	184kW (250PS)		Petrol Turbo		TD2993
----------------	--	--	--------	---------------	----------------------	--	---------------------	--	---------------

BE/PL	4	51,971/51,990	55,000/55,019	24,000	1,497	0,020/0,079	EC	71-3431	71-3431/4 STD
-------	---	---------------	---------------	--------	-------	-------------	----	---------	-------------------------

MB/HL 3	1	69,971/69,990	75,000/75,019	29,890	2,498	0,020/0,077	EC	72-3433H	H006/5 STD
------------	---	---------------	---------------	--------	-------	-------------	----	----------	----------------------

MB/HL 1	1	69,971/69,990	75,000/75,019	25,000	2,500	0,010/0,073	EC	72-3534	
------------	---	---------------	---------------	--------	-------	-------------	----	---------	--

MB/HL 2,4,5	3	69,971/69,990	75,000/75,019	25,000	2,498	0,014/0,077	EC	72-3607	
----------------	---	---------------	---------------	--------	-------	-------------	----	---------	--



72-3433H	STD	30,000/1.1811" - 30,052/1.1831"
-----------------	-----	---------------------------------

20 100.00 x 78.90

M 28.41			V8 Cyl.	4957cc	221-235kW (300-320PS)		Petrol		TD2963
----------------	--	--	---------	---------------	------------------------------	--	---------------	--	---------------

M 28.42			V8 Cyl.	4957cc	221-235kW (300-320PS)		Petrol		TD2964
----------------	--	--	---------	---------------	------------------------------	--	---------------	--	---------------

M 28.43			V8 Cyl.	4957cc	200-215kW (272-292PS)		Petrol		TD2965
----------------	--	--	---------	---------------	------------------------------	--	---------------	--	---------------

M 28.44			V8 Cyl.	4957cc	200-215kW (272-292PS)		Petrol		TD2966
----------------	--	--	---------	---------------	------------------------------	--	---------------	--	---------------

M 28.45			V8 Cyl.	4957cc	212kW (288PS)		Petrol		TD2967
----------------	--	--	---------	---------------	----------------------	--	---------------	--	---------------

M 28.46			V8 Cyl.	4957cc	212kW (288PS)		Petrol		TD2968
----------------	--	--	---------	---------------	----------------------	--	---------------	--	---------------

M 28.47			V8 Cyl.	4957cc	243kW (330PS)		Petrol		TD2969
----------------	--	--	---------	---------------	----------------------	--	---------------	--	---------------

BE/PL	8	51,971/51,990	55,000/55,019	24,000	1,497	0,020/0,079	EC	71-3431	71-3431/8 STD
-------	---	---------------	---------------	--------	-------	-------------	----	---------	-------------------------

21 100.00 x 85.90

M 28.49			V8 Cyl.	5397cc	250-257kW (340-350PS)		Petrol		TD2970
----------------	--	--	---------	---------------	------------------------------	--	---------------	--	---------------

M 28.50			V8 Cyl.	5397cc	250-257kW (340-350PS)		Petrol		TD2971
----------------	--	--	---------	---------------	------------------------------	--	---------------	--	---------------

BE/PL	8	51,971/51,990	55,000/55,019	24,000	1,497	0,020/0,079	EC	71-3431	71-3431/8 STD
-------	---	---------------	---------------	--------	-------	-------------	----	---------	-------------------------



22											102.00 x 76.40										
M 64.20			6 Cyl.			3800cc		221kW (300PS)		Petrol			TD4851								
M 64.21S			6 Cyl.			3800cc		221kW (300PS)		Petrol			TD5455								
BE/PL	6	54,971/54,990	58,000/58,019	14,800	1,499	0,020/0,075	EC	71-3775	71-3775/6			STD									
MB/HL	1	59,971/59,990	65,000/65,019	27,890	2,500	0,020/0,073	EC	72-3428H	H949/7			STD									
MB/HL	6	59,971/59,990	65,000/65,019	17,000	2,500	0,020/0,073	EC	72-3429													
				72-3428H		STD		28,000/1.1024" - 28,052/1.1044"					0.25mm 28,000/1.1024" - 28,052/1.1044"								
BU	1	17,989/18,000	20,000/20,013	25,500			BC	56-2698	56-2698			SEMI									

23											104.00 x 78.90										
M 44.11			4 Cyl.			2681cc		121kW (165PS)		Petrol			TD2985								
M 44.12			4 Cyl.			2681cc		121kW (165PS)		Petrol			TD2986								
BE/PL	4	51,971/51,990	55,000/55,019	24,000	1,497	0,020/0,079	EC	71-3431	71-3431/4			STD									
MB/HL	3	69,971/69,990	75,000/75,019	29,890	2,498	0,020/0,077	EC	72-3433H	H006/5			STD									
MB/HL	1	69,971/69,990	75,000/75,019	25,000	2,500	0,010/0,073	EC	72-3534													
MB/HL	3	69,971/69,990	75,000/75,019	25,000	2,498	0,014/0,077	EC	72-3607													
				72-3433H		STD		30,000/1.1811" - 30,052/1.1831"													

24											104.00 x 78.90										
V8			V8 Cyl.			5359cc		250kW (340PS)		Petrol			FM6064								
BE/PL	8	51,971/51,990	55,000/55,019	24,000	1,497	0,020/0,079	EC	71-3431	71-3431/8			STD									

25											104.00 x 88.00										
M 44.41			4 Cyl.			2990cc		155kW (211PS)		Petrol			TD2988								
M 44.43			4 Cyl.			2990cc		176kW (239PS)		Petrol			TD2989								
M 44.44			4 Cyl.			2990cc		176kW (239PS)		Petrol			TD2990								
BE/PL	4	51,971/51,990	55,000/55,019	24,000	1,497	0,020/0,079	EC	71-3431	71-3431/4			STD									
MB/HL	3	69,971/69,990	75,000/75,019	29,890	2,498	0,020/0,077	EC	72-3433H	H006/5			STD									
MB/HL	1	69,971/69,990	75,000/75,019	25,000	2,500	0,010/0,073	EC	72-3534													
MB/HL	3	69,971/69,990	75,000/75,019	25,000	2,498	0,014/0,077	EC	72-3607													
				72-3433H		STD		30,000/1.1811" - 30,052/1.1831"													



cm3 x



4 0.7	04/62→04/71	Petrol	680.702	746	4	54.50	80.00	2
4 0.8	09/71→09/82	Petrol	839 706	782	4	55.80	80.00	3
4 0.8	10/62→09/83	Petrol	800	845	4	58.00	80.00	4
4 0.8	09/66→12/88	Petrol	800 01	845	4	58.00	80.00	4
4 0.8	10/62→07/89	Petrol	800 705	845	4	58.00	80.00	4
4 0.8	04/83→07/89	Petrol	B1B 707	845	4	58.00	80.00	4
4 1.0	12/85→06/93	Petrol	689 710	956	4	65.00	72.00	6
4 1.0	06/87→12/93	Petrol	C1C 708	956	4	65.00	72.00	6
4 1.1	10/76→07/89	Petrol	688 711	1108	4	70.00	72.00	10
4 1.1	10/76→06/90	Petrol	688 712	1108	4	70.00	72.00	10
4 1.1	10/76→06/90	Petrol	C1E 714	1108	4	70.00	72.00	12
4 1.1	10/76→07/89	Petrol	C1E 718	1108	4	70.00	72.00	12
4 1.1	10/76→06/90	Petrol	C1E 719	1108	4	70.00	72.00	12
5 0.8	10/72→12/84	Petrol	800 710	845	4	58.00	80.00	4
5 1.0	01/72→12/85	Petrol	689 710	956	4	65.00	72.00	6
5 1.1	09/80→12/85	Petrol	688 713	1108	4	70.00	72.00	10
5 1.1	09/80→12/85	Petrol	C1E 726	1108	4	70.00	72.00	12
5 1.1	09/80→12/85	Petrol	C1E 750	1108	4	70.00	72.00	12
5 1.1	09/80→12/85	Petrol	C1E 752	1108	4	70.00	72.00	12
5 1.1	09/80→12/85	Petrol	C1E 754	1108	4	70.00	72.00	12
5 1.3	06/79→09/84	Petrol	810 719	1289	4	73.00	77.00	14
5 1.3	09/75→09/84	Petrol	810 725	1289	4	73.00	77.00	14
5 1.3	03/76→08/82	Petrol	810 726	1289	4	73.00	77.00	14
5 1.3 Automatic	06/79→09/84	Petrol	810 729	1289	4	73.00	77.00	14
5 1.4	09/80→03/85	Petrol	840 730	1397	4	76.00	77.00	24
5 1.4	01/82→12/85	Petrol	847 725	1397	4	76.00	77.00	24
5 1.4	01/82→12/85	Petrol	C2J 713	1397	4	76.00	77.00	24
5 1.4	06/84→01/85	Petrol	C6J 750	1397	4	76.00	77.00	24
5 1.4 Alpine A5	09/77→09/81	Petrol	840 725	1397	4	76.00	77.00	24
5 1.4 Alpine Turbo	10/81→01/85	Petrol	840 726	1397	4	76.00	77.00	24
5 1.4 Alpine Turbo	10/81→01/85	Petrol	C6J 750	1397	4	76.00	77.00	24
5 1.4 Automatic	06/82→09/84	Petrol	847 712	1397	4	76.00	77.00	24
5 1.4 Turbo	06/80→01/85	Petrol	840 730	1397	4	76.00	77.00	24
6 0.8	10/69→04/80	Petrol	800.02	845	4	58.00	80.00	4
6 1.1	08/70→04/87	Petrol	688.10	1108	4	70.00	72.00	11
8 1.1	11/62→10/72	Petrol	688.01	1108	4	70.00	72.00	10
9 1.1	09/81→05/87	Petrol	C1E 715	1108	4	70.00	72.00	12
9 1.1	09/81→05/87	Petrol	C1E 720	1108	4	70.00	72.00	12
9 1.2	09/85→12/88	Petrol	C1G 700	1237	4	71.50	77.00	13
9 1.2	09/85→12/88	Petrol	C1G 710	1237	4	71.50	77.00	13
9 1.4	12/81→12/88	Petrol	C1J 715	1397	4	76.00	77.00	24
9 1.4	12/81→12/88	Petrol	C1J 792	1397	4	76.00	77.00	24
9 1.4	12/81→12/88	Petrol	C1J 796	1397	4	76.00	77.00	24
9 1.4	09/81→12/85	Petrol	C2J 717	1397	4	76.00	77.00	24
9 1.4	09/85→12/88	Petrol	C2J 720	1397	4	76.00	77.00	24
9 1.4	12/81→12/88	Petrol	C2J 730	1397	4	76.00	77.00	24
9 1.4	09/81→12/85	Petrol	C2J 755	1397	4	76.00	77.00	24
9 1.4	09/85→12/88	Petrol	C2J 766	1397	4	76.00	77.00	24
9 1.4	09/85→12/88	Petrol	C2J 767	1397	4	76.00	77.00	24
9 1.4	09/85→12/88	Petrol	C2J 768	1397	4	76.00	77.00	24
9 1.4 Automatic	09/81→12/85	Petrol	C2J 718	1397	4	76.00	77.00	24
9 1.4 Automatic	09/81→12/85	Petrol	C2J 757	1397	4	76.00	77.00	24
9 1.4 Turbo	04/84→12/89	Petrol	C1J 760	1397	4	76.00	77.00	24
9 1.4 Turbo	04/84→12/89	Petrol	C1J 764	1397	4	76.00	77.00	24
9 1.6 D	10/82→12/88	Diesel	F8M 700	1596	4	78.00	83.50	29
9 1.6 D	10/82→12/88	Diesel	F8M 720	1596	4	78.00	83.50	29
9 1.6 D	10/82→12/88	Diesel	F8M 730	1596	4	78.00	83.50	29
9 1.7	09/84→12/89	Petrol	F2N 700	1721	4	81.00	83.50	41
9 1.7	09/84→12/89	Petrol	F2N 704	1721	4	81.00	83.50	41
9 1.7	10/86→12/88	Petrol	F2N 708	1721	4	81.00	83.50	41
9 1.7	10/86→12/88	Petrol	F2N 710	1721	4	81.00	83.50	41
9 1.7	10/86→12/88	Petrol	F2N 730	1721	4	81.00	83.50	41
9 1.7	10/86→12/88	Petrol	F2N 798	1721	4	81.00	83.50	41
9 1.7	06/87→12/88	Petrol	F3N 708	1721	4	81.00	83.50	42
9 1.7	10/86→12/88	Petrol	F3N 718	1721	4	81.00	83.50	42
10 1.1	05/66→10/72	Petrol	688.01	1108	4	70.00	72.00	10
10 1.3	07/69→10/72	Petrol	810.03	1289	4	73.00	77.00	16
11 1.1	03/83→06/86	Petrol	C1E 715	1108	4	70.00	72.00	12
11 1.1	03/83→06/86	Petrol	C1E 720	1108	4	70.00	72.00	12

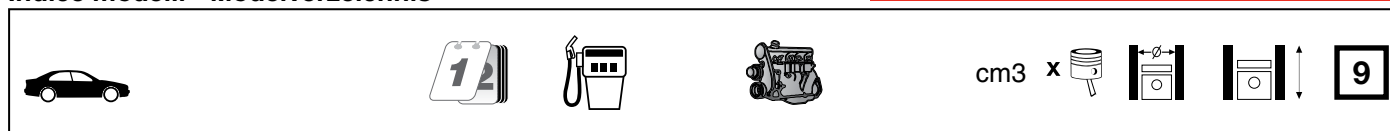

11 1.2	10/84→12/88	Petrol	C1G 700	1237	4	71.50	77.00	13
11 1.2	10/84→12/88	Petrol	C1G 710	1237	4	71.50	77.00	13
11 1.4	03/83→12/88	Petrol	C1J 715	1397	4	76.00	77.00	24
11 1.4	05/83→12/85	Petrol	C2J 717	1397	4	76.00	77.00	24
11 1.4	03/83→12/85	Petrol	C2J 718	1397	4	76.00	77.00	24
11 1.4	03/83→12/88	Petrol	C2J 720	1397	4	76.00	77.00	24
11 1.4	03/83→12/88	Petrol	C2J 730	1397	4	76.00	77.00	24
11 1.4	05/83→12/85	Petrol	C2J 755	1397	4	76.00	77.00	24
11 1.4	03/83→12/85	Petrol	C2J 757	1397	4	76.00	77.00	24
11 1.4	03/83→12/88	Petrol	C2J 766	1397	4	76.00	77.00	24
11 1.4	03/83→12/88	Petrol	C2J 767	1397	4	76.00	77.00	24
11 1.4	03/83→12/88	Petrol	C2J 768	1397	4	76.00	77.00	24
11 1.4 Turbo	04/84→12/86	Petrol	C1J 760	1397	4	76.00	77.00	24
11 1.4 Turbo	02/84→12/86	Petrol	C1J 764	1397	4	76.00	77.00	24
11 1.4 Turbo	10/86→12/88	Petrol	C1J 770	1397	4	76.00	77.00	24
11 1.4 Turbo	10/86→12/88	Petrol	C1J 782	1397	4	76.00	77.00	24
11 1.6 D	08/83→12/88	Diesel	F8M 700	1596	4	78.00	83.50	29
11 1.6 D	08/83→12/88	Diesel	F8M 720	1596	4	78.00	83.50	29
11 1.6 D	08/83→12/88	Diesel	F8M 730	1596	4	78.00	83.50	29
11 1.7	10/83→12/87	Petrol	F2N 700	1721	4	81.00	83.50	41
11 1.7	10/83→12/87	Petrol	F2N 704	1721	4	81.00	83.50	41
11 1.7	10/86→12/88	Petrol	F2N 708	1721	4	81.00	83.50	41
11 1.7	10/86→12/88	Petrol	F2N 710	1721	4	81.00	83.50	41
11 1.7	10/86→12/88	Petrol	F2N 730	1721	4	81.00	83.50	41
11 1.7	06/87→12/88	Petrol	F2N 732	1721	4	81.00	83.50	41
11 1.7	06/87→12/88	Petrol	F2N 742	1721	4	81.00	83.50	41
11 1.7	10/86→12/88	Petrol	F2N 798	1721	4	81.00	83.50	41
11 1.7	06/87→12/88	Petrol	F3N 708	1721	4	81.00	83.50	42
11 1.7	10/84→12/88	Petrol	F3N 718	1721	4	81.00	83.50	42
12 1.3	10/69→08/80	Petrol	810-02/97	1289	4	73.00	77.00	15
12 1.3	07/75→04/80	Petrol	810.02	1289	4	73.00	77.00	14
12 1.3	08/73→08/80	Petrol	810.05	1289	4	73.00	77.00	15
12 1.3	08/73→08/80	Petrol	810.06	1289	4	73.00	77.00	15
12 1.3 TS	08/72→08/80	Petrol	810.05	1289	4	73.00	77.00	15
12 1.3 TS	08/72→08/80	Petrol	810.06	1289	4	73.00	77.00	15
12 1.4	08/76→08/80	Petrol	C1J 791	1397	4	76.00	77.00	24
12 1.6	09/70→12/72	Petrol	821	1565	4	77.00	84.00	27
12 1.6	08/70→08/76	Petrol	821.10	1565	4	77.00	84.00	27
12 1.6	08/70→08/76	Petrol	821.11	1565	4	77.00	84.00	27
12 1.6	08/70→07/75	Petrol	821.20	1565	4	77.00	84.00	27
12 1.6 Gordini	08/70→12/74	Petrol	807.20	1565	4	77.00	84.00	27
12 1.6 Gordini	08/70→12/74	Petrol	821.20	1565	4	77.00	84.00	27
14 1.2	05/76→12/83	Petrol	129	1218	4	75.00	69.00	19
14 1.4	09/79→06/83	Petrol	150	1360	4	75.00	77.00	20
14 1.4	12/81→12/83	Petrol	X5J	1360	4	75.00	77.00	21
15 1.3	03/72→10/80	Petrol	810.05	1289	4	73.00	77.00	15
15 1.6	03/72→10/80	Petrol	807.10	1565	4	77.00	84.00	27
15 1.6	09/71→12/72	Petrol	821	1565	4	77.00	84.00	27
16 1.5	09/65→10/75	Petrol	697.01	1469	4	76.00	81.00	26
16 1.6	09/67→12/72	Petrol	821	1565	4	77.00	84.00	27
16 1.6 TL	01/71→08/80	Petrol	821	1565	4	77.00	84.00	27
16 1.6 TL	01/71→08/80	Petrol	821.03	1565	4	77.00	84.00	27
16 1.6 TL	01/71→08/80	Petrol	821.04	1565	4	77.00	84.00	27
16 1.6 TS	09/68→08/80	Petrol	807	1565	4	77.00	84.00	27
16 1.6 TS	09/68→08/80	Petrol	807.04	1565	4	77.00	84.00	27
16 1.6 TS	09/68→08/80	Petrol	807.05	1565	4	77.00	84.00	27
16 1.6 TX	06/74→08/80	Petrol	843	1647	4	79.00	84.00	31
16 1.6 TX	06/74→08/80	Petrol	843.01	1647	4	79.00	84.00	31
17 1.6	03/72→12/74	Petrol	807	1565	4	77.00	84.00	27
17 1.6	03/72→10/80	Petrol	807.10	1565	4	77.00	84.00	27
17 1.6	06/74→08/79	Petrol	843.05	1647	4	79.00	84.00	31
17 1.6 Gordini	03/74→10/80	Petrol	844.12	1605	4	78.00	84.00	30
18 1.4	04/78→07/86	Petrol	847 720	1397	4	76.00	77.00	24
18 1.4	04/78→07/86	Petrol	847 722	1397	4	76.00	77.00	24
18 1.6	01/82→07/86	Petrol	841 717	1647	4	79.00	84.00	31
18 1.6	04/78→09/82	Petrol	841 725	1647	4	79.00	84.00	31
18 1.6	04/78→09/82	Petrol	841 726	1647	4	79.00	84.00	31
18 1.6	01/82→11/93	Petrol	A2M 723	1647	4	79.00	84.00	31
18 1.6 4x4	01/83→07/86	Petrol	841 717	1647	4	79.00	84.00	31



cm3 x



9

18 1.6 4x4	02/79→06/81	Petrol	841 725	1647	4	79.00	84.00	31
18 1.6 4x4	01/83→07/86	Petrol	A2M 723	1647	4	79.00	84.00	31
18 1.6 TS	05/82→07/86	Petrol	A6M 725	1647	4	79.00	84.00	31
18 1.6 TS	05/82→07/86	Petrol	A6M 726	1647	4	79.00	84.00	31
18 1.6 Turbo	10/80→07/86	Petrol	807 727	1565	4	77.00	84.00	27
18 1.6 Turbo	10/82→07/86	Petrol	A5L 717	1565	4	77.00	84.00	27
18 1.6 Turbo	10/82→07/86	Petrol	A5L 718	1565	4	77.00	84.00	27
18 2.0	10/81→07/86	Petrol	J6R 716	1995	4	88.00	82.00	65
18 2.0 4x4	05/83→12/86	Petrol	J6R 714	1995	4	88.00	82.00	66
18 2.0 4x4	05/83→12/86	Petrol	J6R 716	1995	4	88.00	82.00	65
18 2.1 Diesel	11/80→07/86	Diesel	852 710	2068	4	86.00	89.00	59
18 2.1 Diesel	05/79→07/86	Diesel	J8S 711	2068	4	86.00	89.00	59
18 2.1 TD	11/81→07/86	Diesel	J8S 712	2068	4	86.00	89.00	59
18 2.2 i	06/84→07/86	Petrol	J7T 718	2165	4	88.00	89.00	68
19 I 1.1 TR	07/88→04/92	Petrol	C1E 700	1108	4	70.00	72.00	12
19 I 1.2	01/88→12/92	Petrol	C1G 730	1237	4	71.50	77.00	13
19 I 1.4	01/88→12/92	Petrol	E6J 700	1390	4	75.80	77.00	23
19 I 1.4	01/88→12/92	Petrol	E6J 701	1390	4	75.80	77.00	23
19 I 1.4	09/90→04/92	Petrol	E7J 700	1390	4	75.80	77.00	23
19 I 1.4	07/88→04/92	Petrol	C2J 772	1397	4	76.00	77.00	24
19 I 1.4	07/88→04/92	Petrol	C3J 710	1397	4	76.00	77.00	24
19 I 1.7	09/88→12/92	Petrol	F2N 720	1721	4	81.00	83.50	41
19 I 1.7	07/88→12/92	Petrol	F2N 721	1721	4	81.00	83.50	41
19 I 1.7	07/88→04/92	Petrol	F2N 722	1721	4	81.00	83.50	41
19 I 1.7	07/91→04/92	Petrol	F2N 724	1721	4	81.00	83.50	41
19 I 1.7	09/88→04/92	Petrol	F3N 740	1721	4	81.00	83.50	42
19 I 1.7	09/88→04/92	Petrol	F3N 741	1721	4	81.00	83.50	42
19 I 1.7	07/88→04/92	Petrol	F3N 742	1721	4	81.00	83.50	42
19 I 1.7	07/88→04/92	Petrol	F3N 743	1721	4	81.00	83.50	42
19 I 1.7	08/88→12/92	Petrol	F3N 746	1721	4	81.00	83.50	42
19 I 1.8	05/92→09/94	Petrol	F3P 765	1794	4	82.70	83.50	48
19 I 1.8 16V	06/89→04/92	Petrol	F7P 700	1764	4	82.00	83.50	43
19 I 1.8 16V	06/89→04/92	Petrol	F7P 704	1764	4	82.00	83.50	43
19 I 1.9 D	01/88→12/92	Diesel	F8Q 706	1870	4	80.00	93.00	38
19 I 1.9 D	01/88→12/92	Diesel	F8Q 742	1870	4	80.00	93.00	38
19 I 1.9 DT	09/90→04/92	Diesel	F8Q 610	1870	4	80.00	93.00	36
19 I 1.9 DT	09/90→04/92	Diesel	F8Q 740	1870	4	80.00	93.00	36
19 I 1.9 TD	09/90→04/92	Diesel	F8Q 740	1870	4	80.00	93.00	36
19 II 1.2	05/92→09/94	Petrol	E7F 730	1171	4	75.80	64.90	22
19 II 1.2	03/92→12/95	Petrol	C1G 730	1237	4	71.50	77.00	13
19 II 1.4	01/92→12/95	Petrol	E6J 700	1390	4	75.80	77.00	23
19 II 1.4	10/96→06/01	Petrol	E6J 706	1390	4	75.80	77.00	23
19 II 1.4	01/92→12/95	Petrol	E7J 706	1390	4	75.80	77.00	23
19 II 1.4	01/92→12/95	Petrol	E7J 742	1390	4	75.80	77.00	23
19 II 1.4	10/98→06/01	Petrol	K4J 715	1390	4	79.50	70.00	32
19 II 1.4	10/98→06/01	Petrol	K4J 718	1390	4	79.50	70.00	32
19 II 1.4	05/92→09/94	Petrol	C1J 742	1397	4	76.00	77.00	24
19 II 1.4	10/96→06/01	Petrol	C1J 748	1397	4	76.00	77.00	24
19 II 1.4	05/92→09/94	Petrol	C2J 772	1397	4	76.00	77.00	24
19 II 1.4	04/92→12/95	Petrol	C3J 710	1397	4	76.00	77.00	24
19 II 1.6	10/97→06/99	Petrol	K4M 734	1598	4	79.50	80.50	33
19 II 1.6	10/96→06/01	Petrol	K4M 744	1598	4	79.50	80.50	33
19 II 1.6	10/96→06/01	Petrol	K7M 703	1598	4	79.50	80.50	34
19 II 1.7	01/93→08/95	Petrol	F2N 720	1721	4	81.00	83.50	41
19 II 1.7	01/93→08/95	Petrol	F2N 721	1721	4	81.00	83.50	41
19 II 1.7	04/92→12/95	Petrol	F3N 740	1721	4	81.00	83.50	42
19 II 1.7	04/92→12/95	Petrol	F3N 741	1721	4	81.00	83.50	42
19 II 1.7	04/92→12/95	Petrol	F3N 742	1721	4	81.00	83.50	42
19 II 1.7	04/92→12/95	Petrol	F3N 743	1721	4	81.00	83.50	42
19 II 1.7	05/92→09/94	Petrol	F3N 746	1721	4	81.00	83.50	42
19 II 1.7	10/96→06/01	Petrol	F3N 747	1721	4	81.00	83.50	42
19 II 1.8	05/94→06/96	Petrol	F3P 682	1783	4	82.70	83.00	45
19 II 1.8	07/94→06/96	Petrol	F3P 764	1783	4	82.70	83.00	45
19 II 1.8	04/92→11/95	Petrol	F3P 700	1794	4	82.70	83.50	48
19 II 1.8	04/92→06/96	Petrol	F3P 704	1794	4	82.70	83.50	48
19 II 1.8	04/92→06/96	Petrol	F3P 705	1794	4	82.70	83.50	48
19 II 1.8	04/92→06/96	Petrol	F3P 706	1794	4	82.70	83.50	48
19 II 1.8	04/92→06/96	Petrol	F3P 707	1794	4	82.70	83.50	48
19 II 1.8	04/92→06/96	Petrol	F3P 708	1794	4	82.70	83.50	48

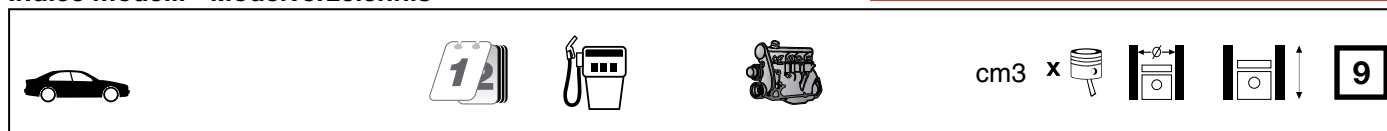

19 II 1.8	04/92→06/96	Petrol	F3P 760	1794	4	82.70	83.50	48
19 II 1.8	05/92→06/96	Petrol	F3P 765	1794	4	82.70	83.50	48
19 II 1.8 16V	10/96→06/01	Petrol	F7P 702	1764	4	82.00	83.50	43
19 II 1.8 16V	04/92→06/96	Petrol	F7P 704	1764	4	82.00	83.50	43
19 II 1.9 D	03/92→12/95	Diesel	F8Q 706	1870	4	80.00	93.00	38
19 II 1.9 D	05/92→11/95	Diesel	F8Q 740	1870	4	80.00	93.00	36
19 II 1.9 D	03/92→12/95	Diesel	F8Q 742	1870	4	80.00	93.00	38
19 II 1.9 D	05/92→11/95	Diesel	F8Q 744	1870	4	80.00	93.00	36
19 II 1.9 D	10/96→06/01	Diesel	F8Q 748	1870	4	80.00	93.00	39
19 II 1.9 D	10/96→06/01	Diesel	F8Q 754	1870	4	80.00	93.00	39
19 II 1.9 dT	03/92→12/95	Diesel	F8Q 740	1870	4	80.00	93.00	36
19 II 1.9 dT	04/92→12/95	Diesel	F8Q 744	1870	4	80.00	93.00	36
20 1.6	10/75→05/77	Petrol	843	1647	4	79.00	84.00	31
20 1.6	05/77→12/83	Petrol	843 720	1647	4	79.00	84.00	31
20 1.6	05/77→12/83	Petrol	843 721	1647	4	79.00	84.00	31
20 2.0	10/77→10/80	Petrol	829 700	1995	4	88.00	82.00	64
20 2.0	10/77→10/80	Petrol	829 701	1995	4	88.00	82.00	64
20 2.0	10/80→12/83	Petrol	829 702	1995	4	88.00	82.00	65
20 2.0	10/80→12/83	Petrol	829 703	1995	4	88.00	82.00	65
20 2.0	10/77→10/80	Petrol	829.01	1995	4	88.00	82.00	64
20 2.1 Diesel	10/80→12/83	Diesel	852	2068	4	86.00	89.00	59
20 2.1 TD	01/82→12/83	Diesel	J8S 702	2068	4	86.00	89.00	59
20 2.2	10/80→12/83	Petrol	851 700	2165	4	88.00	89.00	68
21 1.4	06/88→10/93	Petrol	C2J 770	1397	4	76.00	77.00	24
21 1.7	03/86→04/95	Petrol	F2N 710	1721	4	81.00	83.50	41
21 1.7	07/89→05/93	Petrol	F2N 711	1721	4	81.00	83.50	41
21 1.7	03/86→05/93	Petrol	F2N 712	1721	4	81.00	83.50	41
21 1.7	06/86→02/94	Petrol	F2N 750	1721	4	81.00	83.50	41
21 1.7	06/87→04/89	Petrol	F2N 752	1721	4	81.00	83.50	41
21 1.7	07/89→05/93	Petrol	F2N 754	1721	4	81.00	83.50	41
21 1.7	03/86→06/94	Petrol	F3N 722	1721	4	81.00	83.50	42
21 1.7	03/86→06/94	Petrol	F3N 723	1721	4	81.00	83.50	42
21 1.7	07/86→02/94	Petrol	F3N 726	1721	4	81.00	83.50	42
21 1.9 D	03/86→08/94	Diesel	F8Q 710	1870	4	80.00	93.00	38
21 2.0	03/86→10/93	Petrol	J6R 758	1995	4	88.00	82.00	66
21 2.0	03/86→10/93	Petrol	J6R 759	1995	4	88.00	82.00	66
21 2.0	03/86→10/93	Petrol	J6R 792	1995	4	88.00	82.00	66
21 2.0	03/86→10/93	Petrol	J6R 793	1995	4	88.00	82.00	66
21 2.0	02/90→06/94	Petrol	J7R 740	1995	4	88.00	82.00	66
21 2.0	03/86→12/93	Petrol	J7R 746	1995	4	88.00	82.00	66
21 2.0	03/86→12/93	Petrol	J7R 747	1995	4	88.00	82.00	66
21 2.0	03/86→06/92	Petrol	J7R 750	1995	4	88.00	82.00	66
21 2.0	03/86→06/92	Petrol	J7R 751	1995	4	88.00	82.00	66
21 2.0 4x4	12/89→02/94	Petrol	J7R 740	1995	4	88.00	82.00	66
21 2.0 4x4	03/89→12/93	Petrol	J7R 746	1995	4	88.00	82.00	66
21 2.0 4x4	03/89→12/93	Petrol	J7R 747	1995	4	88.00	82.00	66
21 2.0 Turbo	04/87→03/90	Petrol	J7R 752	1995	4	88.00	82.00	66
21 2.0 Turbo	02/90→10/92	Petrol	J7R 756	1995	4	88.00	82.00	66
21 2.0 Turbo 4x4	08/89→10/93	Petrol	J7R 752	1995	4	88.00	82.00	66
21 2.0 Turbo 4x4	02/90→10/92	Petrol	J7R 756	1995	4	88.00	82.00	66
21 2.0 TXi	07/89→05/93	Petrol	J7R 740	1995	4	88.00	82.00	66
21 2.0 TXi	07/89→05/93	Petrol	J7R 754	1995	4	88.00	82.00	66
21 2.0 TXi 4x4	08/89→08/94	Petrol	J7R 754	1995	4	88.00	82.00	66
21 2.1 D	05/89→06/94	Diesel	J8S 600	2068	4	86.00	89.00	59
21 2.1 D	03/86→08/94	Diesel	J8S 704	2068	4	86.00	89.00	59
21 2.1 D	05/89→06/94	Diesel	J8S 740	2068	4	86.00	89.00	59
21 2.1 D	07/89→09/95	Diesel	J8S 784	2068	4	86.00	89.00	59
21 2.1 D 4x4	10/88→05/92	Diesel	J8S 704	2068	4	86.00	89.00	59
21 2.1 TD	04/86→06/89	Diesel	J8S 704	2068	4	86.00	89.00	59
21 2.1 Turbo-D	03/86→06/94	Diesel	J8S 714	2068	4	86.00	89.00	59
21 2.1 Turbo-D	03/86→06/94	Diesel	J8S 786	2068	4	86.00	89.00	59
21 2.1 Turbo-D	03/86→06/94	Diesel	J8S 788	2068	4	86.00	89.00	59
21 2.2	06/86→06/94	Petrol	J7T 754	2165	4	88.00	89.00	68
21 2.2	04/86→06/94	Petrol	J7T 755	2165	4	88.00	89.00	68
21 2.2 4x4	06/86→06/94	Petrol	J7T 754	2165	4	88.00	89.00	68
21 2.2 4x4	06/86→06/94	Petrol	J7T 755	2165	4	88.00	89.00	68
25 2.0	04/84→12/92	Petrol	J6R 706	1995	4	88.00	82.00	66
25 2.0	04/84→12/92	Petrol	J6R 707	1995	4	88.00	82.00	66
25 2.0	04/84→12/92	Petrol	J6R 760	1995	4	88.00	82.00	66



cm3



25 2.0	04/84→12/92	Petrol	J6R 762	1995	4	88.00	82.00	66
25 2.0	04/84→12/92	Petrol	J6R 763	1995	4	88.00	82.00	66
25 2.0	03/87→12/93	Petrol	J7R 722	1995	4	88.00	82.00	66
25 2.0	03/87→12/93	Petrol	J7R 723	1995	4	88.00	82.00	66
25 2.0 12V	06/88→12/93	Petrol	J7R 720	1995	4	88.00	82.00	66
25 2.0 12V	06/88→12/93	Petrol	J7R 721	1995	4	88.00	82.00	66
25 2.0 12V	06/89→12/92	Petrol	J7R 726	1995	4	88.00	82.00	66
25 2.1 Diesel	04/84→05/89	Diesel	J8S 706	2068	4	86.00	89.00	59
25 2.1 Diesel	06/89→12/92	Diesel	J8S 736	2068	4	86.00	89.00	59
25 2.1 Turbo-D FWD	04/84→12/92	Diesel	J8S 708	2068	4	86.00	89.00	59
25 2.1 Turbo-D FWD	04/84→12/92	Diesel	J8S 738	2068	4	86.00	89.00	59
25 2.2	04/84→12/89	Petrol	J7T 706	2165	4	88.00	89.00	68
25 2.2	04/84→12/89	Petrol	J7T 707	2165	4	88.00	89.00	68
25 2.2	11/85→12/92	Petrol	J7T 708	2165	4	88.00	89.00	68
25 2.2	04/84→12/89	Petrol	J7T 714	2165	4	88.00	89.00	68
25 2.2	04/84→12/89	Petrol	J7T 715	2165	4	88.00	89.00	68
25 2.2	04/84→12/89	Petrol	J7T 730	2165	4	88.00	89.00	68
25 2.2	04/84→12/89	Petrol	J7T 731	2165	4	88.00	89.00	68
25 2.2	11/85→12/92	Petrol	J7T 732	2165	4	88.00	89.00	68
25 2.2	09/86→12/92	Petrol	J7T 733	2165	4	88.00	89.00	68
25 2.7 V6 Injection	04/84→08/89	Petrol	Z7V 708	2664	V6	88.00	73.00	63
25 2.7 V6 Injection	04/84→08/89	Petrol	Z7V 709	2664	V6	88.00	73.00	63
25 2.7 V6 Injection	04/84→08/89	Petrol	Z7V 711	2664	V6	88.00	73.00	63
25 2.8 V6	06/87→02/90	Petrol	Z7W 700	2849	V6	91.00	73.00	71
25 2.8 V6 Injection	06/86→02/88	Petrol	Z7W 702	2849	V6	91.00	73.00	71
25 2.8 V6 Injection	06/87→12/92	Petrol	Z7W 706	2849	V6	91.00	73.00	71
25 2.8 V6 Injection	06/87→12/92	Petrol	Z7W 707	2849	V6	91.00	73.00	71
25 2.8 V6 Injection	06/87→12/92	Petrol	Z7W 709	2849	V6	91.00	73.00	71
30 2.1 Turbo-D	02/82→03/86	Diesel	J8S 702	2068	4	86.00	89.00	59
30 2.6	02/75→08/78	Petrol	112	2664	V6	88.00	73.00	63
30 2.6 TS	07/78→01/84	Petrol	144	2664	V6	88.00	73.00	63
30 2.6 TX	10/78→12/83	Petrol	140	2664	V6	88.00	73.00	63
Avantime 2.0 16V Turbo	11/01→05/03	Petrol	F4R 760	1998	4	82.70	93.00	52
Avantime 2.0 16V Turbo	11/01→05/03	Petrol	F4R 761	1998	4	82.70	93.00	52
Avantime 2.2 dCi	05/02→05/03	Diesel	G9T 712	2188	4	87.00	92.00	62
Captur 1.5 dCi 90	06/13→	Diesel	K9K 608	1461	4	76.00	80.50	25
Clio Grandtour 1.2 16V	02/08→	Petrol	D4F 740	1149	4	69.00	76.80	8
Clio Grandtour 1.2 16V	02/08→	Petrol	D4F 764	1149	4	69.00	76.80	8
Clio Grandtour 1.2 16V	09/10→	Petrol	D4F 786	1149	4	69.00	76.80	8
Clio Grandtour 1.2 16V Hi-Flex	07/08→	Petrol	D4F 740	1149	4	69.00	76.80	8
Clio Grandtour 1.4 16V	02/10→	Petrol	K4J 780	1390	4	79.50	70.00	32
Clio Grandtour 1.5 dCi	02/08→	Diesel	K9K 714	1461	4	76.00	80.50	25
Clio Grandtour 1.5 dCi	02/10→	Diesel	K9K 752	1461	4	76.00	80.50	25
Clio Grandtour 1.5 dCi	02/08→	Diesel	K9K 764	1461	4	76.00	80.50	25
Clio Grandtour 1.5 dCi	02/08→	Diesel	K9K 766	1461	4	76.00	80.50	25
Clio Grandtour 1.5 dCi	02/08→	Diesel	K9K 768	1461	4	76.00	80.50	25
Clio Grandtour 1.5 dCi	08/10→	Diesel	K9K 770	1461	4	76.00	80.50	25
Clio Grandtour 1.5 dCi	02/08→	Diesel	K9K 772	1461	4	76.00	80.50	25
Clio Grandtour 1.5 dCi	02/08→	Diesel	K9K 774	1461	4	76.00	80.50	25
Clio Grandtour 1.6 16V	02/08→	Petrol	K4M 800	1598	4	79.50	80.50	33
Clio Grandtour 1.6 16V	02/08→	Petrol	K4M 801	1598	4	79.50	80.50	33
Clio Grandtour 1.6 16V	11/08→	Petrol	K4M 862	1598	4	79.50	80.50	33
Clio Grandtour IV 1.2 16V	01/13→	Petrol	D4F 740	1149	4	69.00	76.80	8
Clio Grandtour IV 1.5 dCi 75	01/13→	Diesel	K9K 612	1461	4	76.00	80.50	25
Clio Grandtour IV 1.5 dCi 90	01/13→	Diesel	K9K 608	1461	4	76.00	80.50	25
Clio I 1.1	01/91→09/98	Petrol	C1E 700	1108	4	70.00	72.00	12
Clio I 1.2	01/96→09/98	Petrol	D7F 730	1149	4	69.00	76.80	9
Clio I 1.2	05/90→03/96	Petrol	E5F 710	1171	4	75.80	64.90	22
Clio I 1.2	05/90→09/98	Petrol	E7F 700	1171	4	75.80	64.90	22
Clio I 1.2	01/91→09/98	Petrol	E7F 706	1171	4	75.80	64.90	22
Clio I 1.2	05/90→09/98	Petrol	E7F 708	1171	4	75.80	64.90	22
Clio I 1.2	05/90→09/98	Petrol	E7F 750	1171	4	75.80	64.90	22
Clio I 1.2	06/94→02/98	Petrol	C3G 720	1239	4	74.00	72.00	17
Clio I 1.4	05/90→02/98	Petrol	E6J 712	1390	4	75.80	77.00	23
Clio I 1.4	05/90→02/98	Petrol	E6J 713	1390	4	75.80	77.00	23
Clio I 1.4	05/90→02/98	Petrol	E6J 760	1390	4	75.80	77.00	23
Clio I 1.4	01/91→09/98	Petrol	E7J 601	1390	4	75.80	77.00	23
Clio I 1.4	01/91→09/98	Petrol	E7J 710	1390	4	75.80	77.00	23
Clio I 1.4	01/91→09/98	Petrol	E7J 711	1390	4	75.80	77.00	23

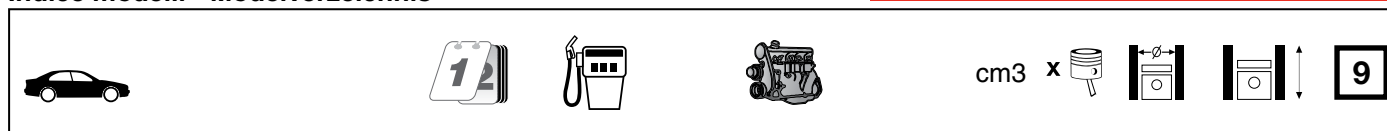

Clio I 1.4	01/91→09/98	Petrol	E7J 718	1390	4	75.80	77.00	23
Clio I 1.4	01/91→09/98	Petrol	E7J 719	1390	4	75.80	77.00	23
Clio I 1.4	01/91→09/98	Petrol	E7J 754	1390	4	75.80	77.00	23
Clio I 1.4	01/91→09/98	Petrol	E7J 756	1390	4	75.80	77.00	23
Clio I 1.4	01/91→09/98	Petrol	E7J 757	1390	4	75.80	77.00	23
Clio I 1.7	01/91→12/93	Petrol	F2N 770	1721	4	81.00	83.50	41
Clio I 1.8	08/90→09/98	Petrol	F3P 755	1783	4	82.70	83.00	44
Clio I 1.8	01/91→09/98	Petrol	F3P 710	1794	4	82.70	83.50	47
Clio I 1.8	01/91→09/98	Petrol	F3P 714	1794	4	82.70	83.50	47
Clio I 1.8	08/94→09/98	Petrol	F3P 754	1794	4	82.70	83.50	47
Clio I 1.8 16V	01/91→03/96	Petrol	F7P 722	1764	4	82.00	83.50	43
Clio I 1.8 Rsi	08/95→09/98	Petrol	F3P 758	1783	4	82.70	83.00	44
Clio I 1.8 Rsi	01/93→08/95	Petrol	F3P 712	1794	4	82.70	83.50	48
Clio I 1.9 D	05/96→02/98	Diesel	F8Q 632	1870	4	80.00	93.00	35
Clio I 1.9 D	05/96→02/98	Diesel	F8Q 676	1870	4	80.00	93.00	35
Clio I 1.9 D	01/97→09/98	Diesel	F8Q 678	1870	4	80.00	93.00	35
Clio I 1.9 D	05/96→02/98	Diesel	F8Q 696	1870	4	80.00	93.00	35
Clio I 1.9 D	05/96→02/98	Diesel	F8Q 714	1870	4	80.00	93.00	35
Clio I 1.9 D	01/91→09/98	Diesel	F8Q 730	1870	4	80.00	93.00	35
Clio I 1.9 D	01/91→09/98	Diesel	F8Q 732	1870	4	80.00	93.00	35
Clio I 1.9 RND	04/96→02/98	Diesel	F8Q 678	1870	4	80.00	93.00	35
Clio I Williams	01/94→09/98	Petrol	F7R 700	1998	4	82.70	93.00	53
Clio II 1.0	02/00→05/01	Petrol	D7D 760	999	4	69.00	66.80	7
Clio II 1.1	09/98→	Petrol	D7F 720	1149	4	69.00	76.80	9
Clio II 1.1	09/98→	Petrol	D7F 726	1149	4	69.00	76.80	9
Clio II 1.1	09/98→	Petrol	D7F 746	1149	4	69.00	76.80	9
Clio II 1.2	09/98→	Petrol	D7F 720	1149	4	69.00	76.80	9
Clio II 1.2	03/99→10/03	Petrol	D7F 722	1149	4	69.00	76.80	9
Clio II 1.2	09/98→	Petrol	D7F 726	1149	4	69.00	76.80	9
Clio II 1.2	09/98→	Petrol	D7F 746	1149	4	69.00	76.80	9
Clio II 1.2	09/98→	Petrol	D7F 764	1149	4	69.00	76.80	9
Clio II 1.2	09/98→	Petrol	D7F 766	1149	4	69.00	76.80	9
Clio II 1.2 16V	06/01→	Petrol	D4F 706	1149	4	69.00	76.80	8
Clio II 1.2 16V	06/01→	Petrol	D4F 712	1149	4	69.00	76.80	8
Clio II 1.2 16V	06/01→	Petrol	D4F 714	1149	4	69.00	76.80	8
Clio II 1.2 16V	06/01→	Petrol	D4F 722	1149	4	69.00	76.80	8
Clio II 1.2 16V	06/01→	Petrol	D4F 728	1149	4	69.00	76.80	8
Clio II 1.2 LPG	09/98→06/09	Petrol	D7F 764	1149	4	69.00	76.80	9
Clio II 1.2 LPG	09/98→06/09	Petrol	D7F 766	1149	4	69.00	76.80	9
Clio II 1.4	09/98→05/05	Petrol	E7J 634	1390	4	75.80	77.00	23
Clio II 1.4	09/98→05/05	Petrol	E7J 780	1390	4	75.80	77.00	23
Clio II 1.4	09/98→05/05	Petrol	K7J 700	1390	4	75.80	77.00	23
Clio II 1.4 16V	08/00→	Petrol	K4J 710	1390	4	79.50	70.00	32
Clio II 1.4 16V	08/00→	Petrol	K4J 711	1390	4	79.50	70.00	32
Clio II 1.4 16V	10/99→	Petrol	K4J 712	1390	4	79.50	70.00	32
Clio II 1.4 16V	10/99→	Petrol	K4J 713	1390	4	79.50	70.00	32
Clio II 1.5 dCi	06/01→	Diesel	K9K 700	1461	4	76.00	80.50	25
Clio II 1.5 dCi	06/01→	Diesel	K9K 702	1461	4	76.00	80.50	25
Clio II 1.5 dCi	06/01→	Diesel	K9K 704	1461	4	76.00	80.50	25
Clio II 1.5 dCi	11/03→	Diesel	K9K 710	1461	4	76.00	80.50	25
Clio II 1.5 dCi	01/04→	Diesel	K9K 712	1461	4	76.00	80.50	25
Clio II 1.5 dCi	04/04→	Diesel	K9K 714	1461	4	76.00	80.50	25
Clio II 1.5 dCi	11/03→	Diesel	K9K 716	1461	4	76.00	80.50	25
Clio II 1.5 dCi	02/07→	Diesel	K9K 718	1461	4	76.00	80.50	25
Clio II 1.5 dCi	06/05→	Diesel	K9K 740	1461	4	76.00	80.50	25
Clio II 1.6	11/04→02/09	Petrol	K4M 740	1598	4	79.50	80.50	33
Clio II 1.6	11/03→	Petrol	K4M 746	1598	4	79.50	80.50	33
Clio II 1.6	11/04→02/09	Petrol	K4M 748	1598	4	79.50	80.50	33
Clio II 1.6	09/98→05/05	Petrol	K7M 744	1598	4	79.50	80.50	34
Clio II 1.6	09/98→05/05	Petrol	K7M 745	1598	4	79.50	80.50	34
Clio II 1.6 16V	09/98→	Petrol	K4M 708	1598	4	79.50	80.50	33
Clio II 1.6 16V	09/98→	Petrol	K4M 740	1598	4	79.50	80.50	33
Clio II 1.6 16V	09/98→	Petrol	K4M 742	1598	4	79.50	80.50	33
Clio II 1.6 16V	09/98→	Petrol	K4M 743	1598	4	79.50	80.50	33
Clio II 1.6 16V	09/98→	Petrol	K4M 744	1598	4	79.50	80.50	33
Clio II 1.6 16V	09/98→	Petrol	K4M 745	1598	4	79.50	80.50	33
Clio II 1.6 16V	09/98→	Petrol	K4M 748	1598	4	79.50	80.50	33
Clio II 1.6 Flex	05/00→12/06	Petrol	K4M 740	1598	4	79.50	80.50	33
Clio II 1.6 Flex	05/00→12/06	Petrol	K4M 748	1598	4	79.50	80.50	33



cm3



9

Clio II 1.6 Hi-Flex	01/05→02/10	Petrol	K4M 748	1598	4	79.50	80.50	33
Clio II 1.9 D	09/98→	Diesel	F8Q 630	1870	4	80.00	93.00	35
Clio II 1.9 D	02/00→05/01	Diesel	F8Q 632	1870	4	80.00	93.00	35
Clio II 1.9 D	03/99→01/00	Diesel	F8Q 662	1870	4	80.00	93.00	35
Clio II 1.9 dTi	12/99→05/05	Diesel	F9Q 780	1870	4	80.00	93.00	40
Clio II 2.0	09/01→12/05	Petrol	F4R	1998	4	82.70	93.00	52
Clio II 2.0 16V	02/00→	Petrol	F4R 730	1998	4	82.70	93.00	52
Clio II 2.0 16V	02/00→	Petrol	F4R 736	1998	4	82.70	93.00	52
Clio II 2.0 16	01/04→	Petrol	F4R 738	1998	4	82.70	93.00	52
Clio III 1.2	10/05→	Petrol	D4F 764	1149	4	69.00	76.80	8
Clio III 1.2	05/05→06/09	Petrol	D7F 766	1149	4	69.00	76.80	9
Clio III 1.2 16V	06/05→	Petrol	D4F 706	1149	4	69.00	76.80	8
Clio III 1.2 16V	06/05→	Petrol	D4F 740	1149	4	69.00	76.80	8
Clio III 1.2 16V	06/05→	Petrol	D4F 764	1149	4	69.00	76.80	8
Clio III 1.2 16V	09/10→	Petrol	D4F 786	1149	4	69.00	76.80	8
Clio III 1.2 16V Hi-Flex	07/08→	Petrol	D4F 740	1149	4	69.00	76.80	8
Clio III 1.2 16V Hi-Flex	07/08→	Petrol	D4F 742	1149	4	69.00	76.80	8
Clio III 1.4 16V	06/05→	Petrol	K4J 780	1390	4	79.50	70.00	32
Clio III 1.5 dCi	06/05→	Diesel	K9K 714	1461	4	76.00	80.50	25
Clio III 1.5 dCi	11/07→	Diesel	K9K 750	1461	4	76.00	80.50	25
Clio III 1.5 dCi	05/05→	Diesel	K9K 752	1461	4	76.00	80.50	25
Clio III 1.5 dCi	06/05→	Diesel	K9K 764	1461	4	76.00	80.50	25
Clio III 1.5 dCi	06/05→	Diesel	K9K 766	1461	4	76.00	80.50	25
Clio III 1.5 dCi	06/05→	Diesel	K9K 768	1461	4	76.00	80.50	25
Clio III 1.5 dCi	08/10→	Diesel	K9K 770	1461	4	76.00	80.50	25
Clio III 1.5 dCi	06/05→	Diesel	K9K 772	1461	4	76.00	80.50	25
Clio III 1.5 dCi	06/05→	Diesel	K9K 774	1461	4	76.00	80.50	25
Clio III 1.6	01/05→02/10	Petrol	K4M 748	1598	4	79.50	80.50	33
Clio III 1.6 16V	06/05→	Petrol	K4M 800	1598	4	79.50	80.50	33
Clio III 1.6 16V	06/05→	Petrol	K4M 801	1598	4	79.50	80.50	33
Clio III 1.6 16V	06/05→	Petrol	K4M 804	1598	4	79.50	80.50	33
Clio III 1.6 16V GT	06/09→	Petrol	K4M 862	1598	4	79.50	80.50	33
Clio III 1.6 Hi-Flex	05/05→02/10	Petrol	K4M 748	1598	4	79.50	80.50	33
Clio IV 1.2 16V	11/12→	Petrol	D4F 728	1149	4	69.00	76.80	8
Clio IV 1.2 16V	11/12→	Petrol	D4F 740	1149	4	69.00	76.80	8
Clio IV 1.5 dCi 75	11/12→	Diesel	K9K 612	1461	4	76.00	80.50	25
Clio IV 1.5 dCi 90	11/12→	Diesel	K9K 608	1461	4	76.00	80.50	25
Duster 1.5 dCi	06/11→	Diesel	K9K 884	1461	4	76.00	80.50	25
Duster 1.6 16V	02/12→	Petrol	K4M 616	1598	4	79.50	80.50	33
Duster 1.6 16V	01/11→	Petrol	K4M 690	1598	4	79.50	80.50	33
Duster 1.6 16V	02/12→	Petrol	K4M 718	1598	4	79.50	80.50	33
Duster 1.6 Flex	10/11→	Petrol	K4M 690	1598	4	79.50	80.50	33
Duster 2.0	01/11→	Petrol	F4R 402	1998	4	82.70	93.00	52
Duster 2.0 4x4	02/12→	Petrol	F4R	1998	4	82.70	93.00	52
Duster 2.0 4x4	10/11→	Petrol	F4R 402	1998	4	82.70	93.00	52
Duster 2.0 All-wheel Drive	01/11→	Petrol	F4R 402	1998	4	82.70	93.00	52
Duster 2.0 Flex	10/11→	Petrol	F4R 402	1998	4	82.70	93.00	52
Duster 2.0 Flex 4x4	10/11→	Petrol	F4R 402	1998	4	82.70	93.00	52
Duster 2.0 Hi-Flex	01/11→	Petrol	F4R 402	1998	4	82.70	93.00	52
Duster 2.0 Hi-Flex 4x4	01/11→	Petrol	F4R 402	1998	4	82.70	93.00	52
Espace I 2.0	07/84→12/90	Petrol	J6R 234	1995	4	88.00	82.00	66
Espace I 2.0	07/84→12/90	Petrol	J6R 236	1995	4	88.00	82.00	66
Espace I 2.0	01/88→12/90	Petrol	J6R 734	1995	4	88.00	82.00	66
Espace I 2.0 i	01/89→12/90	Petrol	J7R 760	1995	4	88.00	82.00	66
Espace I 2.0 i Quadra	03/88→12/92	Petrol	J7R 760	1995	4	88.00	82.00	66
Espace I 2.1 TD	10/84→12/90	Diesel	J8S 240	2068	4	86.00	89.00	59
Espace I 2.1 TD	10/84→12/90	Diesel	J8S 774	2068	4	86.00	89.00	59
Espace I 2.1 TD	10/84→12/90	Diesel	J8S 776	2068	4	86.00	89.00	59
Espace I 2.2	07/86→12/90	Petrol	J7T 770	2165	4	88.00	89.00	68
Espace I 2.2 Quadra	06/87→12/90	Petrol	J7T 770	2165	4	88.00	89.00	68
Espace II 2.0	01/91→10/96	Petrol	J7R 768	1995	4	88.00	82.00	66
Espace II 2.1 RTDT Quadra	01/91→05/92	Diesel	J8S 772	2068	4	86.00	89.00	59
Espace II 2.1 TD	01/91→10/96	Diesel	J8S 610	2068	4	86.00	89.00	59
Espace II 2.1 TD	11/94→10/96	Diesel	J8S 612	2068	4	86.00	89.00	59
Espace II 2.1 TD	01/91→10/96	Diesel	J8S 772	2068	4	86.00	89.00	59
Espace II 2.1 TD	01/91→10/96	Diesel	J8S 776	2068	4	86.00	89.00	59
Espace II 2.1 TD	01/91→10/96	Diesel	J8S 778	2068	4	86.00	89.00	59
Espace II 2.2	01/91→10/96	Petrol	J7T 772	2165	4	88.00	89.00	68
Espace II 2.2	01/91→10/96	Petrol	J7T 773	2165	4	88.00	89.00	68

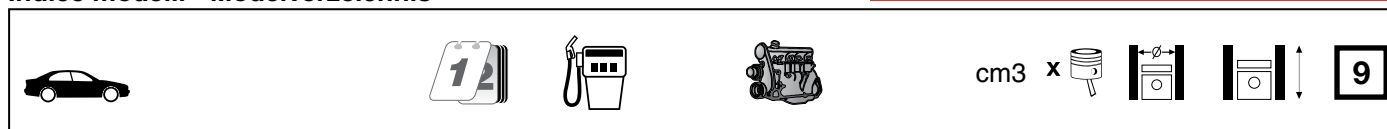

Espace II 2.2	01/91→10/96	Petrol	J7T 776	2165	4	88.00	89.00	68
Espace II 2.2 4x4	03/91→12/96	Petrol	J7T 772	2165	4	88.00	89.00	68
Espace II 2.2 4x4	03/91→12/96	Petrol	J7T 773	2165	4	88.00	89.00	68
Espace II 2.8 V6	01/91→10/96	Petrol	Z7W 712	2849	V6	91.00	73.00	71
Espace II 2.8 V6	01/91→10/96	Petrol	Z7W 713	2849	V6	91.00	73.00	71
Espace II 2.8 V6	01/91→10/96	Petrol	Z7W 717	2849	V6	91.00	73.00	71
Espace III 1.9 dTi	02/99→10/02	Diesel	F9Q 722	1870	4	80.00	93.00	40
Espace III 2.0	11/96→10/00	Petrol	F3R 728	1998	4	82.70	93.00	49
Espace III 2.0	11/96→10/00	Petrol	F3R 729	1998	4	82.70	93.00	49
Espace III 2.0	11/96→10/00	Petrol	F3R 742	1998	4	82.70	93.00	49
Espace III 2.0	11/96→10/00	Petrol	F3R 768	1998	4	82.70	93.00	49
Espace III 2.0	11/96→10/00	Petrol	F3R 769	1998	4	82.70	93.00	49
Espace III 2.0	09/01→10/02	Petrol	F4R 700	1998	4	82.70	93.00	52
Espace III 2.0	09/01→10/02	Petrol	F4R 701	1998	4	82.70	93.00	52
Espace III 2.0 16V	10/98→10/02	Petrol	F4R 700	1998	4	82.70	93.00	52
Espace III 2.0 16V	10/98→10/02	Petrol	F4R 701	1998	4	82.70	93.00	52
Espace III 2.2 12V TD	11/96→10/00	Diesel	G8T 714	2188	4	87.00	92.00	61
Espace III 2.2 12V TD	11/96→10/00	Diesel	G8T 716	2188	4	87.00	92.00	61
Espace III 2.2 12V TD	11/96→10/00	Diesel	G8T 760	2188	4	87.00	92.00	61
Espace III 2.2 D	11/97→01/00	Diesel	G8T 716	2188	4	87.00	92.00	61
Espace III 2.2 dCi	10/00→10/02	Diesel	G9T 642	2188	4	87.00	92.00	62
Espace III 2.2 dCi	07/00→10/02	Diesel	G9T 710	2188	4	87.00	92.00	62
Espace III 3.0	11/96→10/98	Petrol	Z7X 775	2963	V6	93.00	72.70	72
Espace IV 1.9 dCi	11/02→	Diesel	F9Q 680	1870	4	80.00	93.00	40
Espace IV 1.9 dCi	11/02→	Diesel	F9Q 820	1870	4	80.00	93.00	40
Espace IV 1.9 dCi	11/02→	Diesel	F9Q 826	1870	4	80.00	93.00	40
Espace IV 2.0	11/02→02/05	Petrol	F4R 790	1998	4	82.70	93.00	52
Espace IV 2.0	11/02→	Petrol	F4R 792	1998	4	82.70	93.00	52
Espace IV 2.0	04/05→	Petrol	F4R 797	1998	4	82.70	93.00	52
Espace IV 2.0 dCi	01/06→	Diesel	M9R 740	1995	4	84.00	90.00	56
Espace IV 2.0 dCi	01/06→	Diesel	M9R 750	1995	4	84.00	90.00	56
Espace IV 2.0 dCi	01/06→	Diesel	M9R 760	1995	4	84.00	90.00	56
Espace IV 2.0 dCi	01/06→	Diesel	M9R 761	1995	4	84.00	90.00	56
Espace IV 2.0 dCi	01/06→	Diesel	M9R 762	1995	4	84.00	90.00	56
Espace IV 2.0 dCi	01/06→	Diesel	M9R 763	1995	4	84.00	90.00	56
Espace IV 2.0 dCi	01/06→	Diesel	M9R 815	1995	4	84.00	90.00	56
Espace IV 2.0 Turbo	11/02→	Petrol	F4R 794	1998	4	82.70	93.00	52
Espace IV 2.0 Turbo	11/02→	Petrol	F4R 795	1998	4	82.70	93.00	52
Espace IV 2.0 Turbo	11/02→	Petrol	F4R 797	1998	4	82.70	93.00	52
Espace IV 2.2 dCi	02/06→	Diesel	G9T 645	2188	4	87.00	92.00	62
Espace IV 2.2 dCi	11/02→	Diesel	G9T 742	2188	4	87.00	92.00	62
Espace IV 2.2 dCi	11/02→	Diesel	G9T 743	2188	4	87.00	92.00	62
Estafette 1.1	02/62→12/81	Petrol	688.01	1108	4	70.00	72.00	10
Estafette 1.3	08/69→12/81	Petrol	810.01	1289	4	73.00	77.00	15
Express 1.2	07/95→10/99	Petrol	C3G 710	1239	4	74.00	72.00	17
Express 1.9 D	07/95→10/97	Diesel	F8Q 640	1870	4	80.00	93.00	35
Express 1.9 D	07/95→10/99	Diesel	F8Q 724	1870	4	80.00	93.00	35
Express 1.9 D	07/95→10/99	Diesel	F8Q 776	1870	4	80.00	93.00	35
Fluence 1.5 dCi	07/14→	Diesel	K9K 826	1461	4	76.00	80.50	25
Fluence 1.5 dCi	02/10→	Diesel	K9K 830	1461	4	76.00	80.50	25
Fluence 1.5 dCi	02/10→	Diesel	K9K 832	1461	4	76.00	80.50	25
Fluence 1.5 dCi	02/10→	Diesel	K9K 834	1461	4	76.00	80.50	25
Fluence 1.5 dCi	02/10→	Diesel	K9K 836	1461	4	76.00	80.50	25
Fluence 1.5 dCi	02/10→	Diesel	K9K 837	1461	4	76.00	80.50	25
Fluence 1.6 16V	02/10→	Petrol	K4M 838	1598	4	79.50	80.50	33
Fluence 1.6 16V	02/10→	Petrol	K4M 839	1598	4	79.50	80.50	33
Fluence 2.0	02/11→	Petrol	F4R 872	1998	4	82.70	93.00	52
Fuego 1.4 TL/GTL	02/80→10/85	Petrol	847 720	1397	4	76.00	77.00	24
Fuego 1.6	04/83→10/85	Petrol	A2M 723	1647	4	79.00	84.00	31
Fuego 1.6 TS/GTS	10/80→10/85	Petrol	843 723	1647	4	79.00	84.00	31
Fuego 1.6 TS/GTS	10/80→10/85	Petrol	843 724	1647	4	79.00	84.00	31
Fuego 1.6 TS/GTS	10/80→10/85	Petrol	A6M 725	1647	4	79.00	84.00	31
Fuego 1.6 TS/GTS	10/80→10/85	Petrol	A6M 726	1647	4	79.00	84.00	31
Fuego 1.6 Turbo	08/83→10/85	Petrol	A5L 750	1565	4	77.00	84.00	27
Fuego 2.0 TX/GTX	10/80→10/85	Petrol	829 710	1995	4	88.00	82.00	65
Fuego 2.0 TX/GTX	10/80→10/85	Petrol	J6R 710	1995	4	88.00	82.00	65
Fuego 2.0 TX/GTX	10/80→10/85	Petrol	J6R 712	1995	4	88.00	82.00	65
Fuego 2.0 TX/GTX	10/80→10/85	Petrol	J6R 713	1995	4	88.00	82.00	65
Fuego 2.0 TX/GTX	10/80→10/85	Petrol	J6R 715	1995	4	88.00	82.00	65



cm3



Fuego 2.0 TX/GTX	10/80→10/85	Petrol	J6R 726	1995	4	88.00	82.00	65
Fuego 2.1 TD	08/82→10/85	Diesel	J8S 712	2068	4	86.00	89.00	59
Fuego 2.2	10/86→06/88	Petrol	J7T 718	2165	4	88.00	89.00	68
GBK 6, GBK 6 4WD, GBK 75		Diesel	M420 MDX	6328	4	120.00	140.00	97
GLC 6 M, GLC 6 M 2, GLC M 3, RM 3		Diesel	M420 MDX	6328	4	120.00	140.00	97
Grand Scenic II 1.5 dCi	04/04→	Diesel	K9K 722	1461	4	76.00	80.50	25
Grand Scenic II 1.5 dCi	04/04→	Diesel	K9K 728	1461	4	76.00	80.50	25
Grand Scenic II 1.5 dCi	06/06→11/08	Diesel	K9K 734	1461	4	76.00	80.50	25
Grand Scenic II 1.5 dCi	05/05→	Diesel	K9K P 732	1461	4	76.00	80.50	25
Grand Scenic II 1.6	04/04→	Petrol	K4M 761	1598	4	79.50	80.50	33
Grand Scenic II 1.6	04/04→	Petrol	K4M 782	1598	4	79.50	80.50	33
Grand Scenic II 1.6	06/06→	Petrol	K4M 788	1598	4	79.50	80.50	33
Grand Scenic II 1.6	06/06→11/08	Petrol	K4M 812	1598	4	79.50	80.50	33
Grand Scenic II 1.6 Flex	06/06→11/08	Petrol	K4M 766	1598	4	79.50	80.50	33
Grand Scenic II 1.9 dCi	05/05→01/09	Diesel	F9Q 803	1870	4	80.00	93.00	40
Grand Scenic II 1.9 dCi	05/05→01/09	Diesel	F9Q 804	1870	4	80.00	93.00	40
Grand Scenic II 1.9 dCi	04/04→	Diesel	F9Q 812	1870	4	80.00	93.00	40
Grand Scenic II 1.9 dCi	05/05→	Diesel	F9Q 816	1870	4	80.00	93.00	40
Grand Scenic II 1.9 dCi	05/05→	Diesel	F9Q 818	1870	4	80.00	93.00	40
Grand Scenic II 1.9 dCi	05/05→	Diesel	F9Q E 804	1870	4	80.00	93.00	40
Grand Scenic II 1.9 dCi	05/05→	Diesel	F9Q EE 804	1870	4	80.00	93.00	40
Grand Scenic II 1.9 dCi	05/05→	Diesel	F9Q J 803	1870	4	80.00	93.00	40
Grand Scenic II 2.0	04/04→	Petrol	F4R 770	1998	4	82.70	93.00	52
Grand Scenic II 2.0	04/04→	Petrol	F4R 771	1998	4	82.70	93.00	52
Grand Scenic II 2.0 dCi	09/05→	Diesel	M9R 700	1995	4	84.00	90.00	56
Grand Scenic II 2.0 dCi	09/05→	Diesel	M9R 721	1995	4	84.00	90.00	56
Grand Scenic II 2.0 dCi	09/05→	Diesel	M9R 722	1995	4	84.00	90.00	56
Grand Scenic III 1.5 dCi	04/09→	Diesel	K9K 636	1461	4	76.00	80.50	25
Grand Scenic III 1.5 dCi	04/09→	Diesel	K9K 830	1461	4	76.00	80.50	25
Grand Scenic III 1.5 dCi	02/09→	Diesel	K9K 832	1461	4	76.00	80.50	25
Grand Scenic III 1.5 dCi	04/09→	Diesel	K9K 836	1461	4	76.00	80.50	25
Grand Scenic III 1.5 dCi	04/09→	Diesel	K9K 837	1461	4	76.00	80.50	25
Grand Scenic III 1.5 dCi	11/10→	Diesel	K9K 846	1461	4	76.00	80.50	25
Grand Scenic III 1.6 16V	02/09→	Petrol	K4M 858	1598	4	79.50	80.50	33
Grand Scenic III 1.6 16V Bifuel	02/09→	Petrol	K4M 866	1598	4	79.50	80.50	33
Grand Scenic III 1.9 dCi	02/09→	Diesel	F9Q 870	1870	4	80.00	93.00	40
Grand Scenic III 1.9 dCi	02/09→	Diesel	F9Q 872	1870	4	80.00	93.00	40
Grand Scenic III 2.0 dCi	04/09→	Diesel	M9R 610	1995	4	84.00	90.00	56
Grand Scenic III 2.0 dCi	02/09→	Diesel	M9R 615	1995	4	84.00	90.00	56
Kangoo 1.0	01/02→01/07	Petrol	D4D 700	999	4	69.00	66.80	7
Kangoo 1.0	01/02→01/07	Petrol	D4D 720	999	4	69.00	66.80	7
Kangoo 1.2	08/97→	Petrol	D7F 710	1149	4	69.00	76.80	9
Kangoo 1.2	08/97→	Petrol	D7F 720	1149	4	69.00	76.80	9
Kangoo 1.2	08/97→	Petrol	D7F 722	1149	4	69.00	76.80	9
Kangoo 1.2	08/97→	Petrol	D7F 726	1149	4	69.00	76.80	9
Kangoo 1.2	08/97→	Petrol	D7F 744	1149	4	69.00	76.80	9
Kangoo 1.2	08/97→	Petrol	D7F 746	1149	4	69.00	76.80	9
Kangoo 1.2 16V	06/01→	Petrol	D4F 712	1149	4	69.00	76.80	8
Kangoo 1.2 16V	06/01→	Petrol	D4F 714	1149	4	69.00	76.80	8
Kangoo 1.2 16V	06/01→	Petrol	D4F 716	1149	4	69.00	76.80	8
Kangoo 1.2 16V	06/01→	Petrol	D4F 730	1149	4	69.00	76.80	8
Kangoo 1.4	08/97→	Petrol	E7J 634	1390	4	75.80	77.00	23
Kangoo 1.4	08/97→	Petrol	E7J 635	1390	4	75.80	77.00	23
Kangoo 1.4	08/97→	Petrol	E7J 780	1390	4	75.80	77.00	23
Kangoo 1.4	08/97→	Petrol	K7J 700	1390	4	75.80	77.00	23
Kangoo 1.4	08/97→	Petrol	K7J 701	1390	4	75.80	77.00	23
Kangoo 1.5 dCi	12/01→	Diesel	K9K 700	1461	4	76.00	80.50	25
Kangoo 1.5 dCi	07/02→	Diesel	K9K 702	1461	4	76.00	80.50	25
Kangoo 1.5 dCi	12/01→	Diesel	K9K 704	1461	4	76.00	80.50	25
Kangoo 1.5 dCi	07/02→	Diesel	K9K 710	1461	4	76.00	80.50	25
Kangoo 1.5 dCi	06/05→	Diesel	K9K 714	1461	4	76.00	80.50	25
Kangoo 1.5 dCi	06/05→	Diesel	K9K 718	1461	4	76.00	80.50	25
Kangoo 1.6	09/06→12/09	Petrol	K4M 706	1598	4	79.50	80.50	33
Kangoo 1.6	09/99→06/01	Petrol	K7M 746	1598	4	79.50	80.50	34
Kangoo 1.6 16V	06/01→	Petrol	K4M 706	1598	4	79.50	80.50	33
Kangoo 1.6 16V	06/01→	Petrol	K4M 750	1598	4	79.50	80.50	33
Kangoo 1.6 16V	06/01→	Petrol	K4M 752	1598	4	79.50	80.50	33
Kangoo 1.6 16V	06/01→	Petrol	K4M 753	1598	4	79.50	80.50	33
Kangoo 1.6 16V 4x4	10/01→	Petrol	K4M 750	1598	4	79.50	80.50	33

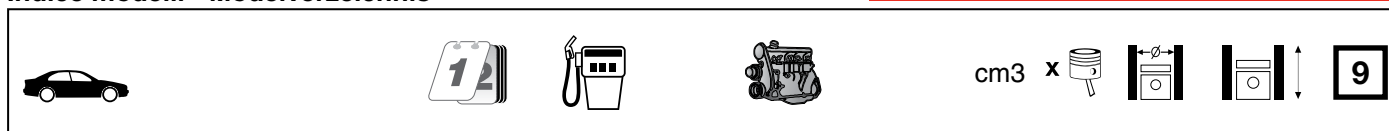

Kangoo 1.6 16V 4x4	10/01→	Petrol	K4M 752	1598	4	79.50	80.50	33
Kangoo 1.6 16V 4x4	10/01→	Petrol	K4M 753	1598	4	79.50	80.50	33
Kangoo 1.6 16V bivalent	06/05→	Petrol	K4M 850	1598	4	79.50	80.50	33
Kangoo 1.6 Flex	01/07→	Petrol	K4M 730	1598	4	79.50	80.50	33
Kangoo 1.9 dCi 4x4	10/01→	Diesel	F9Q 782	1870	4	80.00	93.00	40
Kangoo 1.9 dCi 4x4	10/01→	Diesel	F9Q 790	1870	4	80.00	93.00	40
Kangoo 1.9 dTi	02/00→	Diesel	F9Q 780	1870	4	80.00	93.00	40
Kangoo 1.9 RXED	09/99→06/01	Diesel	F8Q 630	1870	4	80.00	93.00	35
Kangoo 1.9 RXED	09/99→06/01	Diesel	F8Q 632	1870	4	80.00	93.00	35
Kangoo D 55 1.9	08/97→	Diesel	F8Q 662	1870	4	80.00	93.00	35
Kangoo D 65 1.9	08/97→	Diesel	F8Q 630	1870	4	80.00	93.00	35
Kangoo D 65 1.9	08/97→	Diesel	F8Q 632	1870	4	80.00	93.00	35
Kangoo Be Bop 1.5 dCi	06/09→	Diesel	K9K 804	1461	4	76.00	80.50	25
Kangoo Be Bop 1.5 dCi	02/09→	Diesel	K9K 806	1461	4	76.00	80.50	25
Kangoo Be Bop 1.5 dCi	06/09→	Diesel	K9K 808	1461	4	76.00	80.50	25
Kangoo Be Bop 1.5 dCi 75	09/10→	Diesel	K9K 802	1461	4	76.00	80.50	25
Kangoo Be Bop 1.6	02/09→	Petrol	K4M 830	1598	4	79.50	80.50	33
Kangoo Express 1.0	01/02→01/07	Petrol	D4D 700	999	4	69.00	66.80	7
Kangoo Express 1.0	01/02→01/07	Petrol	D4D 720	999	4	69.00	66.80	7
Kangoo Express 1.0	01/02→	Petrol	D7D 700	999	4	69.00	66.80	7
Kangoo Express 1.2	08/97→	Petrol	D7F 710	1149	4	69.00	76.80	9
Kangoo Express 1.2	08/97→	Petrol	D7F 720	1149	4	69.00	76.80	9
Kangoo Express 1.2	08/97→	Petrol	D7F 722	1149	4	69.00	76.80	9
Kangoo Express 1.2	08/97→	Petrol	D7F 726	1149	4	69.00	76.80	9
Kangoo Express 1.2	08/97→	Petrol	D7F 744	1149	4	69.00	76.80	9
Kangoo Express 1.2	08/97→	Petrol	D7F 746	1149	4	69.00	76.80	9
Kangoo Express 1.2	07/98→07/01	Petrol	D7F 764	1149	4	69.00	76.80	9
Kangoo Express 1.2	07/98→07/01	Petrol	D7F 766	1149	4	69.00	76.80	9
Kangoo Express 1.2 16V	10/01→	Petrol	D4F 712	1149	4	69.00	76.80	8
Kangoo Express 1.2 16V	10/01→	Petrol	D4F 714	1149	4	69.00	76.80	8
Kangoo Express 1.2 16V	10/01→	Petrol	D4F 730	1149	4	69.00	76.80	8
Kangoo Express 1.2 BiFuel	07/98→07/01	Petrol	D7F 710	1149	4	69.00	76.80	9
Kangoo Express 1.2 BiFuel	07/98→07/01	Petrol	D7F 744	1149	4	69.00	76.80	9
Kangoo Express 1.4	08/97→	Petrol	E7J 634	1390	4	75.80	77.00	23
Kangoo Express 1.4	08/97→	Petrol	E7J 635	1390	4	75.80	77.00	23
Kangoo Express 1.4	08/97→	Petrol	E7J 780	1390	4	75.80	77.00	23
Kangoo Express 1.4	08/97→	Petrol	K7J 701	1390	4	75.80	77.00	23
Kangoo Express 1.5 dCi	12/01→	Diesel	K9K 700	1461	4	76.00	80.50	25
Kangoo Express 1.5 dCi	12/01→	Diesel	K9K 702	1461	4	76.00	80.50	25
Kangoo Express 1.5 dCi	12/01→	Diesel	K9K 704	1461	4	76.00	80.50	25
Kangoo Express 1.5 dCi	04/03→	Diesel	K9K 710	1461	4	76.00	80.50	25
Kangoo Express 1.5 dCi	06/05→	Diesel	K9K 714	1461	4	76.00	80.50	25
Kangoo Express 1.5 dCi	10/05→	Diesel	K9K 716	1461	4	76.00	80.50	25
Kangoo Express 1.5 dCi	06/05→	Diesel	K9K 718	1461	4	76.00	80.50	25
Kangoo Express 1.5 dCi	02/08→	Diesel	K9K 800	1461	4	76.00	80.50	25
Kangoo Express 1.5 dCi	02/08→	Diesel	K9K 806	1461	4	76.00	80.50	25
Kangoo Express 1.5 dCi 75	09/10→	Diesel	K9K 608	1461	4	76.00	80.50	25
Kangoo Express 1.5 dCi 75	09/10→	Diesel	K9K 808	1461	4	76.00	80.50	25
Kangoo Express 1.5 dCi 85	02/08→	Diesel	K9K 800	1461	4	76.00	80.50	25
Kangoo Express 1.5 dCi 85	02/08→	Diesel	K9K 802	1461	4	76.00	80.50	25
Kangoo Express 1.5 dCi 90	06/09→	Diesel	K9K 608	1461	4	76.00	80.50	25
Kangoo Express 1.5 dCi 90	06/09→	Diesel	K9K 808	1461	4	76.00	80.50	25
Kangoo Express 1.5 dCi 110	09/13→	Diesel	K9K 636	1461	4	76.00	80.50	25
Kangoo Express 1.5 dCi 110	09/10→	Diesel	K9K 804	1461	4	76.00	80.50	25
Kangoo Express 1.6	02/08→12/09	Petrol	K4M 706	1598	4	79.50	80.50	33
Kangoo Express 1.6	02/08→12/09	Petrol	K4M 730	1598	4	79.50	80.50	33
Kangoo Express 1.6	09/99→06/01	Petrol	K7M 746	1598	4	79.50	80.50	34
Kangoo Express 1.6	02/08→	Petrol	K7M 750	1598	4	79.50	80.50	34
Kangoo Express 1.6 16V	10/01→	Petrol	K4M 706	1598	4	79.50	80.50	33
Kangoo Express 1.6 16V	10/01→	Petrol	K4M 752	1598	4	79.50	80.50	33
Kangoo Express 1.6 16V	02/08→	Petrol	K4M 830	1598	4	79.50	80.50	33
Kangoo Express 1.6 16V 4x4	10/01→	Petrol	K4M 750	1598	4	79.50	80.50	33
Kangoo Express 1.6 16V 4x4	10/01→	Petrol	K4M 752	1598	4	79.50	80.50	33
Kangoo Express 1.6 16V 4x4	10/01→	Petrol	K4M 753	1598	4	79.50	80.50	33
Kangoo Express 1.6 16V bivalent	06/05→	Petrol	K4M 850	1598	4	79.50	80.50	33
Kangoo Express 1.6 16V LPG	02/08→	Gas	K4M 834	1598	4	79.50	80.50	33
Kangoo Express 1.6 Flex	03/07→	Petrol	K4M 850	1598	4	79.50	80.50	33
Kangoo Express 1.9 D	09/99→06/03	Diesel	F8Q 632	1870	4	80.00	93.00	35
Kangoo Express 1.9 dCi	07/03→	Diesel	F9Q 782	1870	4	80.00	93.00	40



cm3



9

Kangoo Express 1.9 dCi	07/03→	Diesel	F9Q 790	1870	4	80.00	93.00	40
Kangoo Express 1.9 dCi 4x4	10/01→	Diesel	F9Q 782	1870	4	80.00	93.00	40
Kangoo Express 1.9 dCi 4x4	10/01→	Diesel	F9Q 790	1870	4	80.00	93.00	40
Kangoo Express 1.9 dTi	02/00→	Diesel	F9Q 780	1870	4	80.00	93.00	40
Kangoo Express D 55 1.9	08/97→	Diesel	F8Q 662	1870	4	80.00	93.00	35
Kangoo Express D 65 1.9	08/97→	Diesel	F8Q 630	1870	4	80.00	93.00	35
Kangoo Express D 65 1.9	08/97→	Diesel	F8Q 632	1870	4	80.00	93.00	35
Kangoo / Grand Kangoo 1.5 dCi	11/12→	Diesel	K9K 608	1461	4	76.00	80.50	25
Kangoo / Grand Kangoo 1.5 dCi	01/09→	Diesel	K9K 700	1461	4	76.00	80.50	25
Kangoo / Grand Kangoo 1.5 dCi	02/08→	Diesel	K9K 714	1461	4	76.00	80.50	25
Kangoo / Grand Kangoo 1.5 dCi	02/08→	Diesel	K9K 800	1461	4	76.00	80.50	25
Kangoo / Grand Kangoo 1.5 dCi	02/08→	Diesel	K9K 802	1461	4	76.00	80.50	25
Kangoo / Grand Kangoo 1.5 dCi	02/08→	Diesel	K9K 804	1461	4	76.00	80.50	25
Kangoo / Grand Kangoo 1.5 dCi	02/08→	Diesel	K9K 806	1461	4	76.00	80.50	25
Kangoo / Grand Kangoo 1.5 dCi	11/12→	Diesel	K9K 808	1461	4	76.00	80.50	25
Kangoo / Grand Kangoo 1.5 dCi	02/08→	Diesel	K9K 840	1461	4	76.00	80.50	25
Kangoo / Grand Kangoo 1.5 dCi 110	03/13→	Diesel	K9K 636	1461	4	76.00	80.50	25
Kangoo / Grand Kangoo 1.5 dCi 110	09/10→	Diesel	K9K 804	1461	4	76.00	80.50	25
Kangoo / Grand Kangoo 1.6	01/10→	Petrol	K4M 730	1598	4	79.50	80.50	33
Kangoo / Grand Kangoo 1.6	01/10→	Petrol	K4M 830	1598	4	79.50	80.50	33
Kangoo / Grand Kangoo 1.6	02/08→	Petrol	K7M 750	1598	4	79.50	80.50	34
Kangoo / Grand Kangoo 1.6 16V	02/08→	Petrol	K4M 830	1598	4	79.50	80.50	33
Kangoo / Grand Kangoo 1.6 16V	02/08→	Petrol	K4M 831	1598	4	79.50	80.50	33
Kangoo / Grand Kangoo 1.6 16V Hi-Flex	02/08→	Gas	K4M 834	1598	4	79.50	80.50	33
Kangoo / Grand Kangoo 1.6 16V Hi-Flex	02/08→	Petrol	K4M 850	1598	4	79.50	80.50	33
Koleos 2.0 dCi	09/08→	Diesel	M9R 855	1995	4	84.00	90.00	56
Koleos 2.0 dCi	09/08→	Diesel	M9R 856	1995	4	84.00	90.00	56
Koleos 2.0 dCi	09/08→	Diesel	M9R 862	1995	4	84.00	90.00	56
Koleos 2.0 dCi	09/08→	Diesel	M9R 865	1995	4	84.00	90.00	56
Koleos 2.0 dCi	09/08→	Diesel	M9R 866	1995	4	84.00	90.00	56
Koleos 2.0 dCi 4x4	09/08→	Diesel	M9R 830	1995	4	84.00	90.00	56
Koleos 2.0 dCi 4x4	09/08→	Diesel	M9R 832	1995	4	84.00	90.00	56
Koleos 2.0 dCi 4x4	09/08→	Diesel	M9R 855	1995	4	84.00	90.00	56
Koleos 2.0 dCi 4x4	09/08→	Diesel	M9R 856	1995	4	84.00	90.00	56
Koleos 2.0 dCi 4x4	09/08→	Diesel	M9R 862	1995	4	84.00	90.00	56
Koleos 2.0 dCi 4x4	09/08→	Diesel	M9R 865	1995	4	84.00	90.00	56
Koleos 2.0 dCi 4x4	09/08→	Diesel	M9R 866	1995	4	84.00	90.00	56
L 62 M 3, L 64, 6 M 3		Diesel	M420 MDX	6328	4	120.00	140.00	97
Laguna 1.5 dCi	03/12→	Diesel	K9K 846	1461	4	76.00	80.50	25
Laguna 2.0 dCi	09/08→	Diesel	M9R 800	1995	4	84.00	90.00	56
Laguna 2.0 dCi	09/08→	Diesel	M9R 802	1995	4	84.00	90.00	56
Laguna 2.0 dCi	09/08→	Diesel	M9R 805	1995	4	84.00	90.00	56
Laguna 2.0 dCi	09/08→	Diesel	M9R 809	1995	4	84.00	90.00	56
Laguna 2.0 dCi	09/08→	Diesel	M9R 814	1995	4	84.00	90.00	56
Laguna 2.0 dCi	09/08→	Diesel	M9R 815	1995	4	84.00	90.00	56
Laguna 2.0 dCi GT	09/08→	Diesel	M9R 816	1995	4	84.00	90.00	56
Laguna 2.0 dCi GT	09/08→	Diesel	M9R 820	1995	4	84.00	90.00	56
Laguna I 1.6 16V	11/97→03/01	Petrol	K4M 720	1598	4	79.50	80.50	33
Laguna I 1.6 16V	11/97→03/01	Petrol	K4M 724	1598	4	79.50	80.50	33
Laguna I 1.8	08/95→03/01	Petrol	F3P 670	1783	4	82.70	83.00	44
Laguna I 1.8	06/95→02/01	Petrol	F3P 674	1783	4	82.70	83.00	44
Laguna I 1.8	06/95→03/01	Petrol	F3P 678	1783	4	82.70	83.00	44
Laguna I 1.8	06/95→06/98	Petrol	F3P 676	1794	4	82.70	83.50	47
Laguna I 1.8	11/93→03/01	Petrol	F3P 720	1794	4	82.70	83.50	47
Laguna I 1.8	11/93→03/01	Petrol	F3P 724	1794	4	82.70	83.50	47
Laguna I 1.8 16V	04/98→03/01	Petrol	F4P 760	1783	4	82.70	83.00	46
Laguna I 1.8 16V	04/98→03/01	Petrol	F4P 770	1783	4	82.70	83.00	46
Laguna I 1.9 dCi	09/99→03/01	Diesel	F9Q 718	1870	4	80.00	93.00	40
Laguna I 1.9 dTi	10/97→03/01	Diesel	F9Q 710	1870	4	80.00	93.00	40
Laguna I 1.9 dTi	10/97→03/01	Diesel	F9Q 716	1870	4	80.00	93.00	40
Laguna I 1.9 dTi	10/97→03/01	Diesel	F9Q 717	1870	4	80.00	93.00	40
Laguna I 2.0	06/95→02/01	Petrol	N7Q 700	1948	4	83.00	90.00	54
Laguna I 2.0	06/95→02/01	Petrol	N7Q 704	1948	4	83.00	90.00	54
Laguna I 2.0	03/99→03/01	Petrol	F3R 611	1998	4	82.70	93.00	50
Laguna I 2.0	11/93→03/01	Petrol	F3R 722	1998	4	82.70	93.00	49
Laguna I 2.0	11/93→03/01	Petrol	F3R 723	1998	4	82.70	93.00	49
Laguna I 2.0	06/95→02/01	Petrol	F3R 768	1998	4	82.70	93.00	49
Laguna I 2.0	09/99→02/01	Petrol	F4R 780	1998	4	82.70	93.00	52
Laguna I 2.0 16V	06/95→03/01	Petrol	N7Q 700	1948	4	83.00	90.00	54

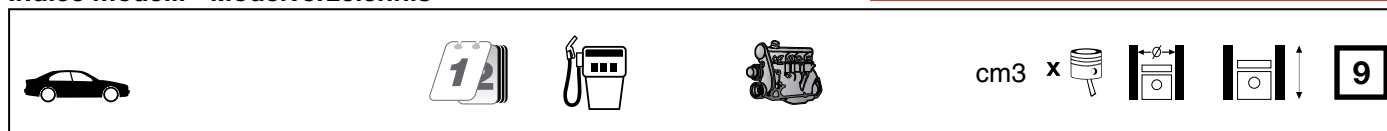

Laguna I 2.0 16V	06/95→03/01	Petrol	N7Q 704	1948	4	83.00	90.00	54
Laguna I 2.0 16V	09/99→03/01	Petrol	F4R 780	1998	4	82.70	93.00	52
Laguna I 2.2 D	11/93→03/01	Diesel	G8T 706	2188	4	87.00	92.00	60
Laguna I 2.2 D	11/93→03/01	Diesel	G8T 752	2188	4	87.00	92.00	60
Laguna I 2.2 D	11/93→03/01	Diesel	G8T 790	2188	4	87.00	92.00	60
Laguna I 2.2 D	11/93→03/01	Diesel	G8T 794	2188	4	87.00	92.00	60
Laguna I 2.2 dT	03/96→03/01	Diesel	G8T 760	2188	4	87.00	92.00	61
Laguna I 3.0	11/93→03/01	Petrol	Z7X 760	2963	V6	93.00	72.70	72
Laguna I 3.0	11/93→03/01	Petrol	Z7X 765	2963	V6	93.00	72.70	72
Laguna I Grandtour 1.6 16V	11/97→03/01	Petrol	K4M 720	1598	4	79.50	80.50	33
Laguna I Grandtour 1.6 16V	11/97→03/01	Petrol	K4M 724	1598	4	79.50	80.50	33
Laguna I Grandtour 1.8	09/95→03/01	Petrol	F3P 670	1783	4	82.70	83.00	44
Laguna I Grandtour 1.8	09/95→03/01	Petrol	F3P 678	1783	4	82.70	83.00	44
Laguna I Grandtour 1.8	09/95→03/01	Petrol	F3P 720	1794	4	82.70	83.50	47
Laguna I Grandtour 1.8	09/95→03/01	Petrol	F3P 724	1794	4	82.70	83.50	47
Laguna I Grandtour 1.8 16V	04/98→03/01	Petrol	F4P 760	1783	4	82.70	83.00	46
Laguna I Grandtour 1.9 dCi	09/99→03/01	Diesel	F9Q 718	1870	4	80.00	93.00	40
Laguna I Grandtour 1.9 dTi	10/97→03/01	Diesel	F9Q 710	1870	4	80.00	93.00	40
Laguna I Grandtour 1.9 dTi	10/97→03/01	Diesel	F9Q 716	1870	4	80.00	93.00	40
Laguna I Grandtour 1.9 dTi	10/97→03/01	Diesel	F9Q 717	1870	4	80.00	93.00	40
Laguna I Grandtour 2.0	09/95→03/01	Petrol	F3R 722	1998	4	82.70	93.00	49
Laguna I Grandtour 2.0	09/95→03/01	Petrol	F3R 723	1998	4	82.70	93.00	49
Laguna I Grandtour 2.0	10/98→01/01	Petrol	F3R 728	1998	4	82.70	93.00	49
Laguna I Grandtour 2.0	10/98→01/01	Petrol	F3R 768	1998	4	82.70	93.00	49
Laguna I Grandtour 2.0 16V	09/95→03/01	Petrol	N7Q 700	1948	4	83.00	90.00	54
Laguna I Grandtour 2.0 16V	09/95→03/01	Petrol	N7Q 704	1948	4	83.00	90.00	54
Laguna I Grandtour 2.0 16V	09/99→03/01	Petrol	F4R 780	1998	4	82.70	93.00	52
Laguna I Grandtour 2.2 D	09/95→03/01	Diesel	G8T 706	2188	4	87.00	92.00	60
Laguna I Grandtour 2.2 D	09/95→03/01	Diesel	G8T 752	2188	4	87.00	92.00	60
Laguna I Grandtour 2.2 D	09/95→03/01	Diesel	G8T 790	2188	4	87.00	92.00	60
Laguna I Grandtour 2.2 D	09/95→03/01	Diesel	G8T 794	2188	4	87.00	92.00	60
Laguna I Grandtour 2.2 dT	03/96→03/01	Diesel	G8T 760	2188	4	87.00	92.00	61
Laguna I Grandtour 3.0	02/96→03/01	Petrol	Z7X 765	2963	V6	93.00	72.70	72
Laguna II 1.6	03/01→05/05	Petrol	K4M 710	1598	4	79.50	80.50	33
Laguna II 1.6 16V	03/01→	Petrol	K4M 710	1598	4	79.50	80.50	33
Laguna II 1.6 16V	03/01→	Petrol	K4M 714	1598	4	79.50	80.50	33
Laguna II 1.6 16V	02/05→	Petrol	K4M 716	1598	4	79.50	80.50	33
Laguna II 1.6 LPG	03/01→05/05	Petrol	K4M 714	1598	4	79.50	80.50	33
Laguna II 1.6 LPG	03/01→05/05	Petrol	K4M 718	1598	4	79.50	80.50	33
Laguna II 1.8 16V	03/01→	Petrol	F4P 770	1783	4	82.70	83.00	46
Laguna II 1.8 16V	03/01→	Petrol	F4P 771	1783	4	82.70	83.00	46
Laguna II 1.8 16V	03/01→	Petrol	F4P 772	1783	4	82.70	83.00	46
Laguna II 1.8 16V	03/01→	Petrol	F4P 773	1783	4	82.70	83.00	46
Laguna II 1.8 16V	03/01→	Petrol	F4P 774	1783	4	82.70	83.00	46
Laguna II 1.8 16V	03/01→	Petrol	F4P 775	1783	4	82.70	83.00	46
Laguna II 1.9 dCi	03/01→	Diesel	F9Q 650	1870	4	80.00	93.00	40
Laguna II 1.9 dCi	03/04→	Diesel	F9Q 664	1870	4	80.00	93.00	40
Laguna II 1.9 dCi	03/01→	Diesel	F9Q 670	1870	4	80.00	93.00	40
Laguna II 1.9 dCi	03/01→	Diesel	F9Q 674	1870	4	80.00	93.00	40
Laguna II 1.9 dCi	03/01→	Diesel	F9Q 718	1870	4	80.00	93.00	40
Laguna II 1.9 dCi	03/01→	Diesel	F9Q 750	1870	4	80.00	93.00	40
Laguna II 1.9 dCi	06/01→	Diesel	F9Q 752	1870	4	80.00	93.00	40
Laguna II 1.9 dCi	03/01→	Diesel	F9Q 754	1870	4	80.00	93.00	40
Laguna II 1.9 dCi	01/05→	Diesel	F9Q 758	1870	4	80.00	93.00	40
Laguna II 1.9 dCi	05/05→	Diesel	F9Q 759	1870	4	80.00	93.00	40
Laguna II 2.0 16V	08/02→	Petrol	F4R 712	1998	4	82.70	93.00	52
Laguna II 2.0 16V	08/02→	Petrol	F4R 713	1998	4	82.70	93.00	52
Laguna II 2.0 16V	08/02→	Petrol	F4R 714	1998	4	82.70	93.00	52
Laguna II 2.0 16V	08/02→	Petrol	F4R 715	1998	4	82.70	93.00	52
Laguna II 2.0 16V	01/05→	Petrol	F4R 786	1998	4	82.70	93.00	52
Laguna II 2.0 16V	01/05→	Petrol	F4R 787	1998	4	82.70	93.00	52
Laguna II 2.0 16V IDE	04/01→	Petrol	F5R 700	1998	4	86.00	86.00	58
Laguna II 2.0 16V IDE	04/01→	Petrol	F5R 701	1998	4	86.00	86.00	58
Laguna II 2.0 16V Turbo	01/03→	Petrol	F4R 764	1998	4	82.70	93.00	52
Laguna II 2.0 16V Turbo	01/03→	Petrol	F4R 765	1998	4	82.70	93.00	52
Laguna II 2.0 16V Turbo	01/03→	Petrol	F4R 786	1998	4	82.70	93.00	52
Laguna II 2.0 16V Turbo	01/03→	Petrol	F4R 787	1998	4	82.70	93.00	52
Laguna II 2.0 dCi	08/05→	Diesel	M9R 740	1995	4	84.00	90.00	56
Laguna II 2.0 dCi	01/06→	Diesel	M9R 760	1995	4	84.00	90.00	56



cm3 x



Laguna II 2.2 dCi	04/04→	Diesel	G9T 600	2188	4	87.00	92.00	62
Laguna II 2.2 dCi	05/05→	Diesel	G9T 605	2188	4	87.00	92.00	62
Laguna II 2.2 dCi	10/01→	Diesel	G9T 700	2188	4	87.00	92.00	62
Laguna II 2.2 dCi	10/01→	Diesel	G9T 702	2188	4	87.00	92.00	62
Laguna II 2.2 dCi	05/05→	Diesel	G9T 706	2188	4	87.00	92.00	62
Laguna II 2.2 dCi	05/05→	Diesel	G9T 707	2188	4	87.00	92.00	62
Laguna II Grandtour 1.6	03/01→10/05	Petrol	K4M 710	1598	4	79.50	80.50	33
Laguna II Grandtour 1.6 16V	03/01→	Petrol	K4M 710	1598	4	79.50	80.50	33
Laguna II Grandtour 1.6 16V	03/01→	Petrol	K4M 714	1598	4	79.50	80.50	33
Laguna II Grandtour 1.6 16V	02/05→	Petrol	K4M 716	1598	4	79.50	80.50	33
Laguna II Grandtour 1.6 Bifuel	06/05→12/07	Petrol	K4M 714	1598	4	79.50	80.50	33
Laguna II Grandtour 1.6 FlexFuel	06/01→10/03	Petrol	K4M 718	1598	4	79.50	80.50	33
Laguna II Grandtour 1.8 16V	03/01→	Petrol	F4P 770	1783	4	82.70	83.00	46
Laguna II Grandtour 1.8 16V	03/01→	Petrol	F4P 771	1783	4	82.70	83.00	46
Laguna II Grandtour 1.8 16V	03/01→	Petrol	F4P 773	1783	4	82.70	83.00	46
Laguna II Grandtour 1.8 16V	03/01→	Petrol	F4P 774	1783	4	82.70	83.00	46
Laguna II Grandtour 1.8 16V	03/01→	Petrol	F4P 775	1783	4	82.70	83.00	46
Laguna II Grandtour 1.9 dCi	08/03→	Diesel	F9Q 664	1870	4	80.00	93.00	40
Laguna II Grandtour 1.9 dCi	03/01→	Diesel	F9Q 670	1870	4	80.00	93.00	40
Laguna II Grandtour 1.9 dCi	03/01→	Diesel	F9Q 674	1870	4	80.00	93.00	40
Laguna II Grandtour 1.9 dCi	03/01→	Diesel	F9Q 718	1870	4	80.00	93.00	40
Laguna II Grandtour 1.9 dCi	03/01→	Diesel	F9Q 750	1870	4	80.00	93.00	40
Laguna II Grandtour 1.9 dCi	06/01→	Diesel	F9Q 752	1870	4	80.00	93.00	40
Laguna II Grandtour 1.9 dCi	03/01→	Diesel	F9Q 754	1870	4	80.00	93.00	40
Laguna II Grandtour 1.9 dCi	01/05→	Diesel	F9Q 758	1870	4	80.00	93.00	40
Laguna II Grandtour 1.9 dCi	05/05→	Diesel	F9Q 759	1870	4	80.00	93.00	40
Laguna II Grandtour 2.0	09/02→05/05	Petrol	F4R 713	1998	4	82.70	93.00	52
Laguna II Grandtour 2.0 16V	08/02→	Petrol	F4R 712	1998	4	82.70	93.00	52
Laguna II Grandtour 2.0 16V	08/02→	Petrol	F4R 713	1998	4	82.70	93.00	52
Laguna II Grandtour 2.0 16V	08/02→	Petrol	F4R 714	1998	4	82.70	93.00	52
Laguna II Grandtour 2.0 16V	08/02→	Petrol	F4R 715	1998	4	82.70	93.00	52
Laguna II Grandtour 2.0 16V	01/05→	Petrol	F4R 786	1998	4	82.70	93.00	52
Laguna II Grandtour 2.0 16V	01/05→	Petrol	F4R 787	1998	4	82.70	93.00	52
Laguna II Grandtour 2.0 16V IDE	04/01→	Petrol	F5R 700	1998	4	86.00	86.00	58
Laguna II Grandtour 2.0 16V IDE	04/01→	Petrol	F5R 701	1998	4	86.00	86.00	58
Laguna II Grandtour 2.0 16V Turbo	01/03→	Petrol	F4R 764	1998	4	82.70	93.00	52
Laguna II Grandtour 2.0 16V Turbo	01/03→	Petrol	F4R 765	1998	4	82.70	93.00	52
Laguna II Grandtour 2.0 16V Turbo	01/03→	Petrol	F4R 786	1998	4	82.70	93.00	52
Laguna II Grandtour 2.0 16V Turbo	01/03→	Petrol	F4R 787	1998	4	82.70	93.00	52
Laguna II Grandtour 2.0 dCi	08/05→	Diesel	M9R 740	1995	4	84.00	90.00	56
Laguna II Grandtour 2.0 dCi	01/06→	Diesel	M9R 760	1995	4	84.00	90.00	56
Laguna II Grandtour 2.2 dCi	04/04→	Diesel	G9T 600	2188	4	87.00	92.00	62
Laguna II Grandtour 2.2 dCi	10/01→	Diesel	G9T 702	2188	4	87.00	92.00	62
Laguna II Grandtour 2.2 dCi	05/05→	Diesel	G9T 706	2188	4	87.00	92.00	62
Laguna II Grandtour 2.2 dCi	05/05→	Diesel	G9T 707	2188	4	87.00	92.00	62
Laguna III 1.5 dCi	10/07→	Diesel	K9K 780	1461	4	76.00	80.50	25
Laguna III 1.6 16V	10/07→	Petrol	K4M 824	1598	4	79.50	80.50	33
Laguna III 2.0 dCi	10/07→	Diesel	M9R 742	1995	4	84.00	90.00	56
Laguna III 2.0 dCi	10/07→	Diesel	M9R 744	1995	4	84.00	90.00	56
Laguna III 2.0 dCi	01/08→	Diesel	M9R 800	1995	4	84.00	90.00	56
Laguna III 2.0 dCi	10/07→	Diesel	M9R 802	1995	4	84.00	90.00	56
Laguna III 2.0 dCi	10/07→	Diesel	M9R 805	1995	4	84.00	90.00	56
Laguna III 2.0 dCi	01/08→	Diesel	M9R 809	1995	4	84.00	90.00	56
Laguna III 2.0 dCi	10/07→	Diesel	M9R 814	1995	4	84.00	90.00	56
Laguna III 2.0 dCi	01/08→	Diesel	M9R 815	1995	4	84.00	90.00	56
Laguna III 2.0 dCi GT	03/08→	Diesel	M9R 816	1995	4	84.00	90.00	56
Laguna III Grandtour 1.5 dCi	10/07→	Diesel	K9K 780	1461	4	76.00	80.50	25
Laguna III Grandtour 1.6 16V	10/07→	Petrol	K4M 824	1598	4	79.50	80.50	33
Laguna III Grandtour 2.0 dCi	10/07→	Diesel	M9R 742	1995	4	84.00	90.00	56
Laguna III Grandtour 2.0 dCi	10/07→	Diesel	M9R 744	1995	4	84.00	90.00	56
Laguna III Grandtour 2.0 dCi	01/08→	Diesel	M9R 800	1995	4	84.00	90.00	56
Laguna III Grandtour 2.0 dCi	10/07→	Diesel	M9R 802	1995	4	84.00	90.00	56
Laguna III Grandtour 2.0 dCi	10/07→	Diesel	M9R 805	1995	4	84.00	90.00	56
Laguna III Grandtour 2.0 dCi	01/08→	Diesel	M9R 809	1995	4	84.00	90.00	56
Laguna III Grandtour 2.0 dCi	10/07→	Diesel	M9R 814	1995	4	84.00	90.00	56
Laguna III Grandtour 2.0 dCi	01/08→	Diesel	M9R 815	1995	4	84.00	90.00	56
Laguna III Grandtour 2.0 dCi GT	03/08→	Diesel	M9R 816	1995	4	84.00	90.00	56
Laguna III Grandtour 2.0 dCi GT	03/08→	Diesel	M9R 820	1995	4	84.00	90.00	56
Latitude 1.5 dCi	07/10→	Diesel	K9K 782	1461	4	76.00	80.50	25

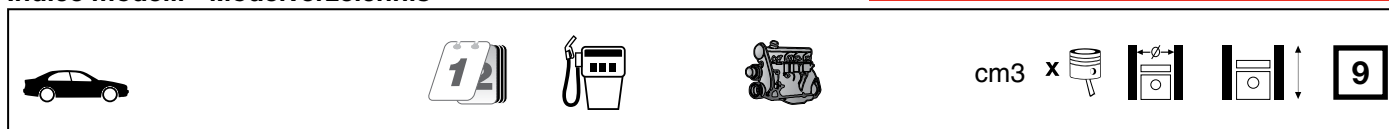

Latitude 2.0 dCi 150	02/11→	Diesel	M9R 824	1995	4	84.00	90.00	56
Latitude 2.0 dCi 150	02/11→	Diesel	M9R 846	1995	4	84.00	90.00	56
Latitude 2.0 dCi 175	05/11→	Diesel	M9R 804	1995	4	84.00	90.00	56
Latitude 2.0 dCi 175	05/11→	Diesel	M9R 817	1995	4	84.00	90.00	56
Latitude 2.0 dCi 175	05/11→	Diesel	M9R 844	1995	4	84.00	90.00	56
Lodgy 1.5 dCi	01/15→	Diesel	K9K 830	1461	4	76.00	80.50	25
Lodgy 1.5 dCi	01/15→	Diesel	K9K 846	1461	4	76.00	80.50	25
Logan Express 1.5 dCi	04/07→	Diesel	K9K 792	1461	4	76.00	80.50	25
Logan Express 1.6	04/07→	Petrol	K7M 710	1598	4	79.50	80.50	34
Logan I 1.4	09/04→	Petrol	K7J 710	1390	4	79.50	70.00	32
Logan I 1.5 dCi	06/11→	Diesel	K9K 700	1461	4	76.00	80.50	25
Logan I 1.5 dCi	06/11→	Diesel	K9K 790	1461	4	76.00	80.50	25
Logan I 1.5 dCi	04/07→	Diesel	K9K 792	1461	4	76.00	80.50	25
Logan I 1.5 dCi	06/11→	Diesel	K9K 794	1461	4	76.00	80.50	25
Logan I 1.5 dCi	02/08→	Diesel	K9K 796	1461	4	76.00	80.50	25
Logan I 1.6	04/07→	Petrol	K4M 690	1598	4	79.50	80.50	33
Logan I 1.6	04/07→	Petrol	K4M 697	1598	4	79.50	80.50	33
Logan I 1.6	02/07→	Petrol	K4M 706	1598	4	79.50	80.50	33
Logan I 1.6	09/04→	Petrol	K7M 710	1598	4	79.50	80.50	34
Logan I 1.6	05/08→	Petrol	K7M 718	1598	4	79.50	80.50	34
Logan I 1.6 Flex	07/07→	Petrol	K4M 698	1598	4	79.50	80.50	33
Logan II 1.2	11/13→	Petrol	D4F 732	1149	4	69.00	76.80	8
Logan II 1.2 16V	12/13→	Petrol	D4F 732	1149	4	69.00	76.80	8
Logan II 1.2 16V LPG	12/13→	Petrol	D4F 732	1149	4	69.00	76.80	8
Master I 2.0	06/85→10/89	Petrol	829 730	1995	4	88.00	82.00	66
Master I 2.0	07/80→06/85	Petrol	829 731	1995	4	88.00	82.00	65
Master I 2.0	11/89→12/95	Petrol	J5R 716	1995	4	88.00	82.00	66
Master I 2.0	11/89→07/93	Petrol	J5R 718	1995	4	88.00	82.00	66
Master I 2.0	06/85→12/95	Petrol	J5R 728	1995	4	88.00	82.00	66
Master I 2.1 D	11/89→04/95	Diesel	J8S 330	2068	4	86.00	89.00	59
Master I 2.2	08/93→02/98	Petrol	J7T 788	2165	4	88.00	89.00	68
Master I 2.4 D	07/83→02/98	Diesel	S8U 730	2445	4	93.00	90.00	75
Master I 2.4 D	07/80→10/89	Diesel	S8U 731	2445	4	93.00	90.00	74
Master I 2.5 D	07/80→10/89	Diesel	S8U 742	2499	4	93.00	92.00	77
Master I 2.5 DT	11/89→10/93	Diesel	S9U 702	2499	4	93.00	92.00	76
Master I 2.5 DT	08/93→02/98	Diesel	S9U 740	2499	4	93.00	92.00	76
Master I 28-35 2.0	10/82→09/86	Petrol	829 730	1995	4	88.00	82.00	66
Master I 28-35 2.0	08/80→10/86	Petrol	829 731	1995	4	88.00	82.00	65
Master I 28-35 2.0	10/86→07/98	Petrol	J5R 718	1995	4	88.00	82.00	66
Master I 28-35 2.0	10/86→07/98	Petrol	J5R 728	1995	4	88.00	82.00	66
Master I 28-35 2,5 D	08/89→07/98	Diesel	8140.67.2510	2499	4	93.00	92.00	76
Master I 28-35 2,5 D	08/89→07/98	Diesel	S8U 742	2499	4	93.00	92.00	77
Master I 28-35 2,5 TD	08/89→07/98	Diesel	8140.27.2580	2499	4	93.00	92.00	76
Master I 28-35 2,5 TD	08/89→07/98	Diesel	S9U 702	2499	4	93.00	92.00	76
Master I 28-35 2.1 D	08/80→07/98	Diesel	J8S 330	2068	4	86.00	89.00	59
Master I 28-35 2.4 D	08/80→08/89	Diesel	8140.61.2300	2445	4	93.00	90.00	74
Master I 28-35 2.4 D	08/80→08/89	Diesel	S8U 731	2445	4	93.00	90.00	74
Master I 28-35 2.5 D	09/80→07/98	Diesel	8140.61.2300	2445	4	93.00	90.00	74
Master I 28-35 2.5 D	09/80→07/98	Diesel	S8U 731	2445	4	93.00	90.00	74
Master I 28-35 2.5 D	08/89→07/98	Diesel	8140.67.2510	2499	4	93.00	92.00	76
Master I 28-35 2.5 D	08/89→07/98	Diesel	S8U 742	2499	4	93.00	92.00	77
Master I 30 2,2	08/80→07/98	Petrol	J7T 782	2165	4	88.00	89.00	68
Master I 30 2,2	08/80→07/98	Petrol	J7T 788	2165	4	88.00	89.00	68
Master I 35 2,5 TD	08/89→07/98	Diesel	8140.27.2500	2499	4	93.00	92.00	78
Master I 35 2,5 TD	08/89→07/98	Diesel	8140.27.2510	2499	4	93.00	92.00	76
Master I 35 2,5 TD	08/89→07/98	Diesel	S9U 714	2499	4	93.00	92.00	76
Master I 35 2,5 TD	08/89→07/98	Diesel	S9U 740	2499	4	93.00	92.00	76
Master II 1.9 dCi 80	11/01→	Diesel	F9Q 772	1870	4	80.00	93.00	40
Master II 1.9 dCi 80	11/01→	Diesel	F9Q 774	1870	4	80.00	93.00	40
Master II 1.9 dTi	09/00→	Diesel	F9Q 770	1870	4	80.00	93.00	40
Master II 2.2 dCi 90	09/00→	Diesel	G9T 720	2188	4	87.00	92.00	62
Master II 2.2 dCi 90	09/00→	Diesel	G9T 722	2188	4	87.00	92.00	62
Master II 2.2 dCi 90	09/00→	Diesel	G9T 750	2188	4	87.00	92.00	62
Master II 2.5 D	07/98→01/01	Diesel	S8U 770	2499	4	93.00	92.00	81
Master II 2.5 dCi	01/04→	Diesel	G9U 750	2463	4	89.00	99.00	70
Master II 2.5 dCi	08/06→	Diesel	G9U 754	2463	4	89.00	99.00	70
Master II 2.5 dCi	08/06→	Diesel	G9U 632	2464	4	89.00	99.00	70
Master II 2.5 dCi	08/06→	Diesel	G9U 650	2464	4	89.00	99.00	70
Master II 2.5 dCi 4x4	10/04→02/12	Diesel	G9U 724	2463	4	89.00	99.00	70



cm3 x



9

Master II 2.5 dCi 100	10/03→	Diesel	G9U 754	2463	4	89.00	99.00	70
Master II 2.5 dCi 120	10/01→	Diesel	G9U 720	2463	4	89.00	99.00	70
Master II 2.5 dCi 120	10/01→	Diesel	G9U 724	2463	4	89.00	99.00	70
Master II 2.5 dCi 120	10/01→	Diesel	G9U 750	2463	4	89.00	99.00	70
Master II 2.5 dCi 120	10/01→	Diesel	G9U 754	2463	4	89.00	99.00	70
Master III 2.3 dCi	09/14→	Diesel	M9T 870	2298	4	85.00	101.30	57
Master III 2.3 dCi	09/14→	Diesel	M9T 890	2298	4	85.00	101.30	57
Master III 2.3 dCi [RWD]	02/10→	Diesel	M9T 670	2298	4	85.00	101.30	57
Master III 2.3 dCi [RWD]	02/10→	Diesel	M9T 686	2298	4	85.00	101.30	57
Master III 2.3 dCi [RWD]	02/10→	Diesel	M9T 690	2298	4	85.00	101.30	57
Master III 2.3 dCi [RWD]	02/10→	Diesel	M9T 692	2298	4	85.00	101.30	57
Master III 2.3 dCi [RWD]	02/10→	Diesel	M9T 694	2298	4	85.00	101.30	57
Master III 2.3 dCi [RWD]	02/10→	Diesel	M9T 696	2298	4	85.00	101.30	57
Master III 2.3 dCi [RWD]	02/10→	Diesel	M9T 698	2298	4	85.00	101.30	57
Master III 2.3 dCi [RWD]	02/10→	Diesel	M9T 870	2298	4	85.00	101.30	57
Master III 2.3 dCi [RWD]	03/13→	Diesel	M9T 880	2298	4	85.00	101.30	57
Master III 2.3 dCi [RWD]	02/10→	Diesel	M9T 890	2298	4	85.00	101.30	57
Master III 2.3 dCi [RWD]	02/10→	Diesel	M9T 896	2298	4	85.00	101.30	57
Master III 2.3 dCi [RWD]	03/13→	Diesel	M9T 898	2298	4	85.00	101.30	57
Master III 2.3 dCi 100 FWD	02/11→	Diesel	M9T 670	2298	4	85.00	101.30	57
Master III 2.3 dCi 100 FWD	02/11→	Diesel	M9T 672	2298	4	85.00	101.30	57
Master III 2.3 dCi 100 FWD	02/11→	Diesel	M9T 676	2298	4	85.00	101.30	57
Master III 2.3 dCi 100 FWD	02/11→	Diesel	M9T 870	2298	4	85.00	101.30	57
Master III 2.3 dCi 125 FWD	02/11→	Diesel	M9T 670	2298	4	85.00	101.30	57
Master III 2.3 dCi 125 FWD	02/11→	Diesel	M9T 672	2298	4	85.00	101.30	57
Master III 2.3 dCi 125 FWD	02/11→	Diesel	M9T 676	2298	4	85.00	101.30	57
Master III 2.3 dCi 125 FWD	02/11→	Diesel	M9T 870	2298	4	85.00	101.30	57
Master III 2.3 dCi 150	10/12→	Diesel	M9T 880	2298	4	85.00	101.30	57
Master III 2.3 dCi FWD	02/10→	Diesel	M9T 670	2298	4	85.00	101.30	57
Master III 2.3 dCi FWD	02/10→	Diesel	M9T 672	2298	4	85.00	101.30	57
Master III 2.3 dCi FWD	02/10→	Diesel	M9T 676	2298	4	85.00	101.30	57
Master III 2.3 dCi FWD	02/10→	Diesel	M9T 678	2298	4	85.00	101.30	57
Master III 2.3 dCi FWD	02/10→	Diesel	M9T 680	2298	4	85.00	101.30	57
Master III 2.3 dCi FWD	02/10→	Diesel	M9T 694	2298	4	85.00	101.30	57
Master III 2.3 dCi FWD	02/10→	Diesel	M9T 696	2298	4	85.00	101.30	57
Master III 2.3 dCi FWD	02/10→	Diesel	M9T 698	2298	4	85.00	101.30	57
Master III 2.3 dCi FWD	02/10→	Diesel	M9T 870	2298	4	85.00	101.30	57
Master III 2.3 dCi FWD	03/13→	Diesel	M9T 880	2298	4	85.00	101.30	57
Master III 2.3 dCi FWD	02/10→	Diesel	M9T 890	2298	4	85.00	101.30	57
Master III 2.3 dCi FWD	02/10→	Diesel	M9T 896	2298	4	85.00	101.30	57
Master III 2.3 dCi FWD	03/13→	Diesel	M9T 898	2298	4	85.00	101.30	57
Megane 1.5 dCi	06/10→	Diesel	K9K 837	1461	4	76.00	80.50	25
Megane 1.6 16V	06/10→	Petrol	K4M 858	1598	4	79.50	80.50	33
Megane 1.9 dCi	06/10→	Diesel	F9Q 870	1870	4	80.00	93.00	40
Megane 2.0 dCi	06/10→	Diesel	M9R 610	1995	4	84.00	90.00	56
Megane 2.0 TCe	06/10→	Petrol	F4R 872	1998	4	82.70	93.00	52
Megane I 1.4	09/96→08/03	Petrol	E7J 626	1390	4	75.80	77.00	23
Megane I 1.4	09/96→08/03	Petrol	E7J 764	1390	4	75.80	77.00	23
Megane I 1.4 16V	03/99→08/03	Petrol	K4J 714	1390	4	79.50	70.00	32
Megane I 1.4 16V	03/99→08/03	Petrol	K4J 750	1390	4	79.50	70.00	32
Megane I 1.4 e	01/96→08/03	Petrol	E7J 626	1390	4	75.80	77.00	23
Megane I 1.4 e	01/96→08/03	Petrol	E7J 764	1390	4	75.80	77.00	23
Megane I 1.4 Eco	01/96→03/99	Petrol	E7J 624	1390	4	75.80	77.00	23
Megane I 1.6	02/00→09/00	Petrol	K7M 704	1598	4	79.50	80.50	34
Megane I 1.6 16V	03/99→08/03	Petrol	K4M 700	1598	4	79.50	80.50	33
Megane I 1.6 16V	03/99→08/03	Petrol	K4M 701	1598	4	79.50	80.50	33
Megane I 1.6 16V	03/99→08/03	Petrol	K4M 704	1598	4	79.50	80.50	33
Megane I 1.6 16V	03/99→08/03	Petrol	K4M 708	1598	4	79.50	80.50	33
Megane I 1.6 e	01/96→03/99	Petrol	K7M 702	1598	4	79.50	80.50	34
Megane I 1.6 e	01/96→03/99	Petrol	K7M 703	1598	4	79.50	80.50	34
Megane I 1.6 e	01/96→03/99	Petrol	K7M 790	1598	4	79.50	80.50	34
Megane I 1.6 i	01/96→03/99	Petrol	K7M 720	1598	4	79.50	80.50	34
Megane I 1.6 LPG	10/00→08/02	Petrol	K4M 704	1598	4	79.50	80.50	33
Megane I 1.6 LPG	08/95→03/99	Petrol	K7M 702	1598	4	79.50	80.50	34
Megane I 1.8 16V	01/01→08/03	Petrol	F4P 720	1783	4	82.70	83.00	46
Megane I 1.8 16V	01/01→08/03	Petrol	F4P 722	1783	4	82.70	83.00	46
Megane I 1.9 D	09/96→08/03	Diesel	F8Q 620	1870	4	80.00	93.00	35
Megane I 1.9 D	09/96→08/03	Diesel	F8Q 624	1870	4	80.00	93.00	35
Megane I 1.9 D	04/96→02/01	Diesel	F8Q 784	1870	4	80.00	93.00	39

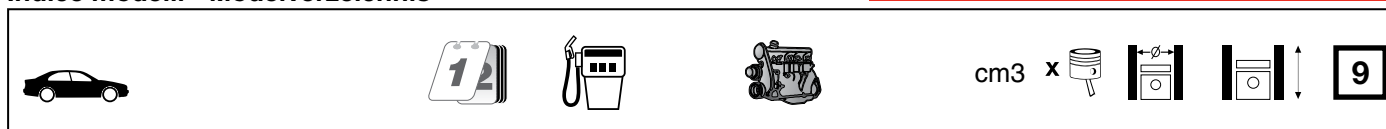

Megane I 1.9 DCi	03/99→08/03	Diesel	F9Q 732	1870	4	80.00	93.00	40
Megane I 1.9 dCi	03/99→08/03	Diesel	F9Q 733	1870	4	80.00	93.00	40
Megane I 1.9 DCi	03/99→08/03	Diesel	F9Q 738	1870	4	80.00	93.00	40
Megane I 1.9 D Eco	01/96→08/03	Diesel	F8Q 620	1870	4	80.00	93.00	35
Megane I 1.9 D Eco	01/96→08/03	Diesel	F8Q 624	1870	4	80.00	93.00	35
Megane I 1.9 dT	01/96→08/03	Diesel	F8Q 784	1870	4	80.00	93.00	39
Megane I 1.9 dT	01/96→08/03	Diesel	F8Q 786	1870	4	80.00	93.00	39
Megane I 1.9 dTi	03/97→02/01	Diesel	F9Q 730	1870	4	80.00	93.00	40
Megane I 1.9 dTi	03/97→02/01	Diesel	F9Q 731	1870	4	80.00	93.00	40
Megane I 1.9 dTi	03/97→02/01	Diesel	F9Q 734	1870	4	80.00	93.00	40
Megane I 1.9 dTi	03/97→02/01	Diesel	F9Q 736	1870	4	80.00	93.00	40
Megane I 1.9 dTi	02/01→08/03	Diesel	F9Q 744	1870	4	80.00	93.00	40
Megane I 1.9 TDI	09/96→08/03	Diesel	F8Q 784	1870	4	80.00	93.00	39
Megane I 2.0	04/97→08/03	Petrol	F3R 750	1998	4	82.70	93.00	49
Megane I 2.0	05/98→05/01	Petrol	F3R 751	1998	4	82.70	93.00	49
Megane I 2.0	05/98→05/01	Petrol	F3R 752	1998	4	82.70	93.00	49
Megane I 2.0	05/98→05/01	Petrol	F3R 791	1998	4	82.70	93.00	49
Megane I 2.0	05/98→05/01	Petrol	F3R 796	1998	4	82.70	93.00	49
Megane I 2.0	05/98→05/01	Petrol	F3R 797	1998	4	82.70	93.00	49
Megane I 2.0	04/97→08/03	Petrol	F3R 798	1998	4	82.70	93.00	51
Megane I 2.0 16V	01/02→08/03	Petrol	F4R 746	1998	4	82.70	93.00	52
Megane I 2.0 16V	01/02→08/03	Petrol	F4R 770	1998	4	82.70	93.00	52
Megane I 2.0 16V	07/96→08/03	Petrol	F7R 710	1998	4	82.70	93.00	53
Megane I 2.0 16V	07/96→08/03	Petrol	F7R 714	1998	4	82.70	93.00	53
Megane I 2.0 16V IDE	11/99→08/03	Petrol	F4R 746	1998	4	82.70	93.00	52
Megane I 2.0 16V IDE	11/99→08/03	Petrol	F5R 740	1998	4	82.70	93.00	52
Megane I 2.0 i	01/96→08/03	Petrol	F3R 750	1998	4	82.70	93.00	49
Megane I 2.0 i	01/96→08/03	Petrol	F3R 751	1998	4	82.70	93.00	49
Megane I 2.0 i	09/96→08/03	Petrol	F3R 752	1998	4	82.70	93.00	49
Megane I 2.0 i	09/96→08/03	Petrol	F3R 791	1998	4	82.70	93.00	49
Megane I 2.0 i	09/96→08/03	Petrol	F3R 796	1998	4	82.70	93.00	49
Megane I 2.0 i	09/96→08/03	Petrol	F3R 797	1998	4	82.70	93.00	49
Megane I 2.0 i	09/96→08/03	Petrol	F3R 798	1998	4	82.70	93.00	51
Megane I 2.0 RT	03/01→08/03	Petrol	F4R 747	1998	4	82.70	93.00	52
Megane I 2.0 RT	03/01→08/03	Petrol	F5R 740	1998	4	82.70	93.00	52
Megane I Coach 1.4 16V	03/99→08/03	Petrol	K4J 714	1390	4	79.50	70.00	32
Megane I Coach 1.4 16V	03/99→08/03	Petrol	K4J 750	1390	4	79.50	70.00	32
Megane I Coach 1.6 16V	03/99→08/03	Petrol	K4M 700	1598	4	79.50	80.50	33
Megane I Coach 1.6 16V	03/99→08/03	Petrol	K4M 701	1598	4	79.50	80.50	33
Megane I Coach 1.6 16V	03/99→08/03	Petrol	K4M 708	1598	4	79.50	80.50	33
Megane I Coach 1.6 e	03/96→03/99	Petrol	K7M 702	1598	4	79.50	80.50	34
Megane I Coach 1.6 e	03/96→03/99	Petrol	K7M 703	1598	4	79.50	80.50	34
Megane I Coach 1.9 DCi	03/99→08/03	Diesel	F9Q 732	1870	4	80.00	93.00	40
Megane I Coach 1.9 dCi	02/01→08/03	Diesel	F9Q 733	1870	4	80.00	93.00	40
Megane I Coach 1.9 DCi	03/99→09/00	Diesel	F9Q 738	1870	4	80.00	93.00	40
Megane I Coach 1.9 dTi	03/97→02/01	Diesel	F9Q 731	1870	4	80.00	93.00	40
Megane I Coach 1.9 dTi	03/97→02/01	Diesel	F9Q 734	1870	4	80.00	93.00	40
Megane I Coach 1.9 dTi	03/97→02/01	Diesel	F9Q 736	1870	4	80.00	93.00	40
Megane I Coach 2.0 16V	01/02→08/03	Petrol	F4R 746	1998	4	82.70	93.00	52
Megane I Coach 2.0 16V	03/96→11/99	Petrol	F7R 710	1998	4	82.70	93.00	53
Megane I Coach 2.0 16V	03/96→11/99	Petrol	F7R 714	1998	4	82.70	93.00	53
Megane I Coach 2.0 16V IDE	11/99→08/03	Petrol	F5R 740	1998	4	82.70	93.00	52
Megane I Coach 2.0 i	03/96→08/03	Petrol	F3R 750	1998	4	82.70	93.00	49
Megane I Coach 2.0 i	03/96→08/03	Petrol	F3R 751	1998	4	82.70	93.00	49
Megane I Coach 2.0 i	03/99→08/03	Petrol	F3R 791	1998	4	82.70	93.00	49
Megane I Coach 2.0 i	03/99→08/03	Petrol	F3R 796	1998	4	82.70	93.00	49
Megane I Coach 2.0 i	03/96→08/03	Petrol	F3R 798	1998	4	82.70	93.00	51
Megane I Grandtour 1.4 16V	03/99→08/03	Petrol	K4J 714	1390	4	79.50	70.00	32
Megane I Grandtour 1.4 16V	03/99→08/03	Petrol	K4J 750	1390	4	79.50	70.00	32
Megane I Grandtour 1.4 e	03/99→08/03	Petrol	E7J 626	1390	4	75.80	77.00	23
Megane I Grandtour 1.6 16V	03/99→08/03	Petrol	K4M 700	1598	4	79.50	80.50	33
Megane I Grandtour 1.6 16V	03/99→08/03	Petrol	K4M 701	1598	4	79.50	80.50	33
Megane I Grandtour 1.6 16V	03/99→08/03	Petrol	K4M 704	1598	4	79.50	80.50	33
Megane I Grandtour 1.6 16V	03/99→08/03	Petrol	K4M 708	1598	4	79.50	80.50	33
Megane I Grandtour 1.6 Bifuel	03/99→09/00	Petrol	K4M 704	1598	4	79.50	80.50	33
Megane I Grandtour 1.6 e	03/99→08/03	Petrol	K7M 702	1598	4	79.50	80.50	34
Megane I Grandtour 1.6 e	03/99→08/03	Petrol	K7M 703	1598	4	79.50	80.50	34
Megane I Grandtour 1.8 16V	01/01→08/03	Petrol	F4P 720	1783	4	82.70	83.00	46
Megane I Grandtour 1.8 16V	01/01→08/03	Petrol	F4P 722	1783	4	82.70	83.00	46



cm3



Megane I Grandtour 1.9 D	04/99→08/03	Diesel	F8Q 622	1870	4	80.00	93.00	37
Megane I Grandtour 1.9 D	04/99→08/03	Diesel	F8Q 790	1870	4	80.00	93.00	35
Megane I Grandtour 1.9 dCi	03/99→08/03	Diesel	F9Q 732	1870	4	80.00	93.00	40
Megane I Grandtour 1.9 dCi	02/01→08/03	Diesel	F9Q 733	1870	4	80.00	93.00	40
Megane I Grandtour 1.9 dCi	02/01→08/03	Diesel	F9Q 738	1870	4	80.00	93.00	40
Megane I Grandtour 1.9 dTi	03/99→02/01	Diesel	F9Q 731	1870	4	80.00	93.00	40
Megane I Grandtour 1.9 dTi	03/99→02/01	Diesel	F9Q 736	1870	4	80.00	93.00	40
Megane I Grandtour 1.9 dTi	02/01→08/03	Diesel	F9Q 744	1870	4	80.00	93.00	40
Megane II 1.4	08/03→	Petrol	K4J 730	1390	4	79.50	70.00	32
Megane II 1.4	09/03→	Petrol	K4J 732	1390	4	79.50	70.00	32
Megane II 1.4	08/03→	Petrol	K4J 740	1390	4	79.50	70.00	32
Megane II 1.4 16V	11/02→02/08	Petrol	K4J 730	1390	4	79.50	70.00	32
Megane II 1.4 16V	10/03→02/08	Petrol	K4J 732	1390	4	79.50	70.00	32
Megane II 1.4 16V	11/02→02/08	Petrol	K4J 740	1390	4	79.50	70.00	32
Megane II 1.5 dCi	11/02→	Diesel	K9K 722	1461	4	76.00	80.50	25
Megane II 1.5 dCi	05/05→	Diesel	K9K 724	1461	4	76.00	80.50	25
Megane II 1.5 dCi	10/03→	Diesel	K9K 728	1461	4	76.00	80.50	25
Megane II 1.5 dCi	10/03→	Diesel	K9K 729	1461	4	76.00	80.50	25
Megane II 1.5 dCi	05/05→	Diesel	K9K 732	1461	4	76.00	80.50	25
Megane II 1.5 dCi	05/05→	Diesel	K9K 734	1461	4	76.00	80.50	25
Megane II 1.6	08/03→	Petrol	K4M 760	1598	4	79.50	80.50	33
Megane II 1.6	08/03→	Petrol	K4M 761	1598	4	79.50	80.50	33
Megane II 1.6	05/05→	Petrol	K4M 762	1598	4	79.50	80.50	33
Megane II 1.6	09/03→	Petrol	K4M 768	1598	4	79.50	80.50	33
Megane II 1.6	06/05→03/09	Petrol	K4M 788	1598	4	79.50	80.50	33
Megane II 1.6	09/07→12/10	Petrol	K4M 812	1598	4	79.50	80.50	33
Megane II 1.6 16V	05/06→01/11	Petrol	K4M 700	1598	4	79.50	80.50	33
Megane II 1.6 16V	11/02→08/09	Petrol	K4M 760	1598	4	79.50	80.50	33
Megane II 1.6 16V	01/06→08/09	Petrol	K4M 761	1598	4	79.50	80.50	33
Megane II 1.6 16V	05/05→07/09	Petrol	K4M 762	1598	4	79.50	80.50	33
Megane II 1.6 16V	05/05→07/09	Petrol	K4M 768	1598	4	79.50	80.50	33
Megane II 1.6 16V	01/06→	Petrol	K4M 812	1598	4	79.50	80.50	33
Megane II 1.6 16V	01/06→	Petrol	K4M 813	1598	4	79.50	80.50	33
Megane II 1.6 16V Hi-Flex	02/08→07/09	Petrol	K4M 856	1598	4	79.50	80.50	33
Megane II 1.6 Bifuel	06/05→02/08	Petrol	K4M 788	1598	4	79.50	80.50	33
Megane II 1.6 Flex-Fuel	01/07→02/08	Petrol	K4M 788	1598	4	79.50	80.50	33
Megane II 1.6 Hi-Flex	03/06→	Petrol	K4M 766	1598	4	79.50	80.50	33
Megane II 1.9 dCi	11/02→	Diesel	F9Q 800	1870	4	80.00	93.00	40
Megane II 1.9 dCi	05/05→	Diesel	F9Q 803	1870	4	80.00	93.00	40
Megane II 1.9 dCi	11/02→	Diesel	F9Q 804	1870	4	80.00	93.00	40
Megane II 1.9 dCi	11/02→	Diesel	F9Q 808	1870	4	80.00	93.00	40
Megane II 1.9 dCi	11/02→	Diesel	F9Q 816	1870	4	80.00	93.00	40
Megane II 1.9 dCi	11/02→	Diesel	F9Q 818	1870	4	80.00	93.00	40
Megane II 2.0	09/03→12/07	Petrol	F4R	1998	4	82.70	93.00	52
Megane II 2.0	08/03→	Petrol	F4R 770	1998	4	82.70	93.00	52
Megane II 2.0	08/03→	Petrol	F4R 771	1998	4	82.70	93.00	52
Megane II 2.0	09/03→12/06	Petrol	F5R 740	1998	4	82.70	93.00	52
Megane II 2.0 16V	11/02→02/08	Petrol	F4R 770	1998	4	82.70	93.00	52
Megane II 2.0 dCi	09/05→	Diesel	M9R 700	1995	4	84.00	90.00	56
Megane II 2.0 dCi	09/05→	Diesel	M9R 722	1995	4	84.00	90.00	56
Megane II 2.0 dCi	01/07→02/08	Diesel	M9R 724	1995	4	84.00	90.00	56
Megane III 1.5 dCi	02/09→	Diesel	K9K 636	1461	4	76.00	80.50	25
Megane III 1.5 dCi	11/08→	Diesel	K9K 830	1461	4	76.00	80.50	25
Megane III 1.5 dCi	02/09→	Diesel	K9K 832	1461	4	76.00	80.50	25
Megane III 1.5 dCi	02/09→	Diesel	K9K 836	1461	4	76.00	80.50	25
Megane III 1.5 dCi	02/09→	Diesel	K9K 837	1461	4	76.00	80.50	25
Megane III 1.5 dCi	02/09→	Diesel	K9K 846	1461	4	76.00	80.50	25
Megane III 1.5 dCi	02/09→	Diesel	K9K G 832	1461	4	76.00	80.50	25
Megane III 1.5 dCi	11/08→	Diesel	K9K H 834	1461	4	76.00	80.50	25
Megane III 1.5 dCi	02/09→	Diesel	K9K J 836	1461	4	76.00	80.50	25
Megane III 1.6 16V	11/08→	Petrol	K4M 848	1598	4	79.50	80.50	33
Megane III 1.6 16V	11/08→	Petrol	K4M 858	1598	4	79.50	80.50	33
Megane III 1.6 16V	11/08→	Petrol	K4M 866	1598	4	79.50	80.50	33
Megane III 1.6 16V Bifuel	11/08→	Petrol	K4M 866	1598	4	79.50	80.50	33
Megane III 1.9 dCi	11/08→	Diesel	F9Q 870	1870	4	80.00	93.00	40
Megane III 1.9 dCi	11/08→	Diesel	F9Q 872	1870	4	80.00	93.00	40
Megane III 2.0 dCi	04/09→	Diesel	M9R 610	1995	4	84.00	90.00	56
Megane III 2.0 dCi	04/09→	Diesel	M9R 615	1995	4	84.00	90.00	56
Megane III 2.0 Tce	06/12→	Petrol	F4R 872	1998	4	82.70	93.00	52

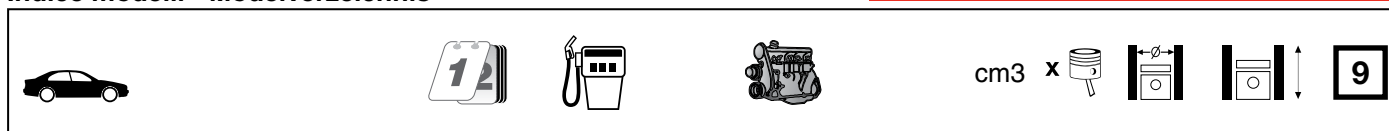

Megane III Grandtour 1.5 dCi	02/09→	Diesel	K9K 636	1461	4	76.00	80.50	25
Megane III Grandtour 1.5 dCi	03/09→	Diesel	K9K 830	1461	4	76.00	80.50	25
Megane III Grandtour 1.5 dCi	05/09→	Diesel	K9K 834	1461	4	76.00	80.50	25
Megane III Grandtour 1.5 dCi	02/09→	Diesel	K9K 836	1461	4	76.00	80.50	25
Megane III Grandtour 1.5 dCi	02/09→	Diesel	K9K 837	1461	4	76.00	80.50	25
Megane III Grandtour 1.5 dCi	02/09→	Diesel	K9K 846	1461	4	76.00	80.50	25
Megane III Grandtour 1.6 16V	05/09→	Petrol	K4M 848	1598	4	79.50	80.50	33
Megane III Grandtour 1.6 16V	05/09→	Petrol	K4M 858	1598	4	79.50	80.50	33
Megane III Grandtour 1.6 16V Bifuel	11/08→	Petrol	K4M 866	1598	4	79.50	80.50	33
Megane III Grandtour 1.9 dCi	05/09→	Diesel	F9Q 870	1870	4	80.00	93.00	40
Megane III Grandtour 1.9 dCi	05/09→	Diesel	F9Q 872	1870	4	80.00	93.00	40
Megane III Grandtour 2.0 dCi	04/09→	Diesel	M9R 610	1995	4	84.00	90.00	56
Megane III Grandtour 2.0 dCi	10/10→	Diesel	M9R 615	1995	4	84.00	90.00	56
Megane III Grandtour 2.0 TCe	11/08→	Petrol	F4R 872	1998	4	82.70	93.00	52
Megane Scenic 1.4 i	01/97→09/99	Petrol	E7J 764	1390	4	75.80	77.00	23
Megane Scenic 1.6 16V	04/98→10/99	Petrol	K4M 700	1598	4	79.50	80.50	33
Megane Scenic 1.6 16V	04/98→10/99	Petrol	K4M 701	1598	4	79.50	80.50	33
Megane Scenic 1.6 16V	04/98→10/99	Petrol	K4M 704	1598	4	79.50	80.50	33
Megane Scenic 1.6 16V	04/98→10/99	Petrol	K4M 708	1598	4	79.50	80.50	33
Megane Scenic 1.6 e	10/96→10/99	Petrol	K7M 702	1598	4	79.50	80.50	34
Megane Scenic 1.6 e	10/96→10/99	Petrol	K7M 703	1598	4	79.50	80.50	34
Megane Scenic 1.6 i	01/97→09/99	Petrol	K7M 720	1598	4	79.50	80.50	34
Megane Scenic 1.9 D	03/97→09/99	Diesel	F8Q 790	1870	4	80.00	93.00	35
Megane Scenic 1.9 dT	01/97→09/99	Diesel	F8Q 784	1870	4	80.00	93.00	39
Megane Scenic 1.9 dT	01/97→09/99	Diesel	F8Q 786	1870	4	80.00	93.00	39
Megane Scenic 1.9 dTi	04/97→09/99	Diesel	F9Q 730	1870	4	80.00	93.00	40
Megane Scenic 1.9 dTi	04/97→09/99	Diesel	F9Q 734	1870	4	80.00	93.00	40
Megane Scenic 2.0	01/99→12/01	Petrol	F3R 798	1998	4	82.70	93.00	51
Megane Scenic 2.0 i	01/97→09/99	Petrol	F3R 750	1998	4	82.70	93.00	49
Megane Scenic 2.0 i	01/97→09/99	Petrol	F3R 751	1998	4	82.70	93.00	49
Megane Scenic 2.0 i	01/99→09/99	Petrol	F3R 796	1998	4	82.70	93.00	49
Megane Scenic 2.0 RXE 4x4	05/97→10/99	Petrol	F3R 750	1998	4	82.70	93.00	49
Modus / Grand Modus 1.2	12/04→	Petrol	D4F 740	1149	4	69.00	76.80	8
Modus / Grand Modus 1.2	12/04→	Petrol	D4F 764	1149	4	69.00	76.80	8
Modus / Grand Modus 1.2	04/11→	Petrol	D4F 786	1149	4	69.00	76.80	8
Modus / Grand Modus 1.2 16V Hi-Flex	10/08→	Petrol	D4F 740	1149	4	69.00	76.80	8
Modus / Grand Modus 1.4	12/04→	Petrol	K4J 770	1390	4	79.50	70.00	32
Modus / Grand Modus 1.4	12/04→	Petrol	K4J 780	1390	4	79.50	70.00	32
Modus / Grand Modus 1.5 dCi	09/04→	Diesel	K9K 750	1461	4	76.00	80.50	25
Modus / Grand Modus 1.5 dCi	12/04→	Diesel	K9K 752	1461	4	76.00	80.50	25
Modus / Grand Modus 1.5 dCi	12/04→	Diesel	K9K 760	1461	4	76.00	80.50	25
Modus / Grand Modus 1.5 dCi	12/04→	Diesel	K9K 762	1461	4	76.00	80.50	25
Modus / Grand Modus 1.5 dCi	05/05→	Diesel	K9K 764	1461	4	76.00	80.50	25
Modus / Grand Modus 1.5 dCi	12/04→	Diesel	K9K 766	1461	4	76.00	80.50	25
Modus / Grand Modus 1.5 dCi	12/04→	Diesel	K9K 768	1461	4	76.00	80.50	25
Modus / Grand Modus 1.5 dCi	05/07→	Diesel	K9K 772	1461	4	76.00	80.50	25
Modus / Grand Modus 1.5 dCi 75	10/10→	Diesel	K9K 770	1461	4	76.00	80.50	25
Modus / Grand Modus 1.5 dCi 90	10/10→	Diesel	K9K 750	1461	4	76.00	80.50	25
Modus / Grand Modus 1.6	12/04→	Petrol	K4M 790	1598	4	79.50	80.50	33
Modus / Grand Modus 1.6	12/04→	Petrol	K4M 791	1598	4	79.50	80.50	33
Modus / Grand Modus 1.6	12/04→	Petrol	K4M 794	1598	4	79.50	80.50	33
Modus / Grand Modus 1.6	12/04→	Petrol	K4M 800	1598	4	79.50	80.50	33
Modus / Grand Modus 1.6	12/04→	Petrol	K4M 801	1598	4	79.50	80.50	33
Pulse 1.5 DCI	01/12→	Diesel	K9K 740	1461	4	76.00	80.50	25
R3	01/45→12/66	Petrol	690	603	4	49.00	80.00	1
R8 1.3 "Gordini" (R1135)	01/68→12/70	Petrol	812	1255	4	74.50	72.00	18
Rapid 1.0	09/85→05/92	Petrol	C1C 706	949	4	65.00	72.00	6
Rapid 1.1	07/85→04/95	Petrol	C1E 750	1108	4	70.00	72.00	12
Rapid 1.1	07/85→04/95	Petrol	C1E 752	1108	4	70.00	72.00	12
Rapid 1.1	07/85→04/95	Petrol	C1E 754	1108	4	70.00	72.00	12
Rapid 1.1	06/87→09/91	Petrol	C1E 756	1108	4	70.00	72.00	12
Rapid 1.1	07/85→04/95	Petrol	C1E 760	1108	4	70.00	72.00	12
Rapid 1.1	07/85→04/95	Petrol	C1E 762	1108	4	70.00	72.00	12
Rapid 1.1	07/85→04/95	Petrol	C1E 792	1108	4	70.00	72.00	12
Rapid 1.2	05/95→11/98	Petrol	E7F 708	1171	4	75.80	64.90	22
Rapid 1.2	09/91→08/93	Petrol	C1G 726	1237	4	71.50	77.00	13
Rapid 1.2	09/91→03/98	Petrol	C3G 710	1239	4	74.00	72.00	17
Rapid 1.2	09/91→03/98	Petrol	C3G 712	1239	4	74.00	72.00	17
Rapid 1.4	09/91→03/98	Petrol	E7J 720	1390	4	75.80	77.00	23



cm3



9

Rapid 1.4	09/91→03/98	Petrol	E7J 724	1390	4	75.80	77.00	23
Rapid 1.4	09/91→03/98	Petrol	E7J 726	1390	4	75.80	77.00	23
Rapid 1.4	01/94→03/98	Petrol	E7J 728	1390	4	75.80	77.00	23
Rapid 1.4	09/91→03/98	Petrol	E7J 773	1390	4	75.80	77.00	23
Rapid 1.4	07/85→08/91	Petrol	C1J 768	1397	4	76.00	77.00	24
Rapid 1.4	07/85→08/91	Petrol	C1J 780	1397	4	76.00	77.00	24
Rapid 1.4	03/86→08/91	Petrol	C2J 784	1397	4	76.00	77.00	24
Rapid 1.4	08/88→03/98	Petrol	C3J 700	1397	4	76.00	77.00	24
Rapid 1.4	08/88→03/98	Petrol	C3J 702	1397	4	76.00	77.00	24
Rapid 1.4	08/88→03/98	Petrol	C3J 760	1397	4	76.00	77.00	24
Rapid 1.4	08/88→03/98	Petrol	C3J 762	1397	4	76.00	77.00	24
Rapid 1.4 RN	09/91→08/93	Petrol	E6J 734	1390	4	75.80	77.00	23
Rapid 1.6 D	03/86→08/98	Diesel	F8M 720	1596	4	78.00	83.50	29
Rapid 1.6 D	03/86→08/98	Diesel	F8M 730	1596	4	78.00	83.50	29
Rapid 1.6 D	03/86→08/98	Diesel	F8M 736	1596	4	78.00	83.50	29
Rapid 1.6 D	03/86→08/98	Diesel	F8M 760	1596	4	78.00	83.50	29
Rapid 1.9 D	09/94→03/98	Diesel	F8Q 640	1870	4	80.00	93.00	35
Rapid 1.9 D	09/91→03/98	Diesel	F8Q 646	1870	4	80.00	93.00	35
Rapid 1.9 D	09/94→03/98	Diesel	F8Q 682	1870	4	80.00	93.00	35
Rapid 1.9 D	09/91→03/98	Diesel	F8Q 722	1870	4	80.00	93.00	35
Rapid 1.9 D	09/91→03/98	Diesel	F8Q 724	1870	4	80.00	93.00	35
Rapid 1.9 D	09/91→03/98	Diesel	F8Q 774	1870	4	80.00	93.00	35
Rapid 1.9 D	09/91→03/98	Diesel	F8Q 776	1870	4	80.00	93.00	35
Rodeo 4 0.8	08/71→11/81	Petrol	800 01	845	4	58.00	80.00	4
Rodeo 5 1.1	11/81→12/87	Petrol	688 712	1108	4	70.00	72.00	10
Rodeo 6 0.8	05/70→08/73	Petrol	800.02	845	4	58.00	80.00	4
Rodeo 6 1.1	08/73→11/81	Petrol	688.10	1108	4	70.00	72.00	11
Safrane I 2.0	11/92→07/96	Petrol	J7R 732	1995	4	88.00	82.00	66
Safrane I 2.0	11/92→07/96	Petrol	J7R 733	1995	4	88.00	82.00	66
Safrane I 2.0 12V	04/92→07/96	Petrol	J7R 734	1995	4	88.00	82.00	66
Safrane I 2.0 12V	04/92→07/96	Petrol	J7R 735	1995	4	88.00	82.00	66
Safrane I 2.1 dT	11/93→07/96	Diesel	J8S 760	2068	4	86.00	89.00	59
Safrane I 2.2	04/92→07/96	Petrol	J7T 760	2165	4	88.00	89.00	68
Safrane I 2.2	04/92→07/96	Petrol	J7T 761	2165	4	88.00	89.00	68
Safrane I 2.2	04/92→07/96	Petrol	J7T 762	2165	4	88.00	89.00	68
Safrane I 2.5 dT	12/92→07/96	Diesel	S8U 762	2500	4	93.00	92.00	76
Safrane I 2.5 dT	12/92→07/96	Diesel	S8U 763	2500	4	93.00	92.00	76
Safrane I 3.0	03/93→10/96	Petrol	Z7X 721	2963	V6	93.00	72.70	72
Safrane I 3.0	02/93→06/96	Petrol	Z7X 723	2963	V6	93.00	72.70	72
Safrane I 3.0 V6	12/92→07/96	Petrol	Z7X 721	2963	V6	93.00	72.70	72
Safrane I 3.0 V6	12/92→07/96	Petrol	Z7X 722	2963	V6	93.00	72.70	72
Safrane I 3.0 V6	12/92→07/96	Petrol	Z7X 723	2963	V6	93.00	72.70	72
Safrane I 3.0 V6	12/92→07/96	Petrol	Z7X 753	2963	V6	93.00	72.70	72
Safrane I 3.0 V6 4x4	12/92→07/96	Petrol	Z7X 721	2963	V6	93.00	72.70	72
Safrane I 3.0 V6 4x4	12/92→07/96	Petrol	Z7X 722	2963	V6	93.00	72.70	72
Safrane I 3.0 V6 4x4	12/92→07/96	Petrol	Z7X 723	2963	V6	93.00	72.70	72
Safrane II 2.0 16V	07/96→12/00	Petrol	N7Q 710	1948	4	83.00	90.00	54
Safrane II 2.0 16V	07/96→12/00	Petrol	N7Q 711	1948	4	83.00	90.00	54
Safrane II 2.2 dT	07/96→12/00	Diesel	G8T 740	2188	4	87.00	92.00	61
Safrane II 2.5 20V	07/96→12/00	Petrol	N7U 700	2435	5	83.00	90.00	55
Safrane II 2.5 20V	07/96→12/00	Petrol	N7U 701	2435	5	83.00	90.00	55
Safrane II 3.0 V6	07/96→12/00	Petrol	Z7X 755	2963	V6	93.00	72.70	72
Sandero/Stepway I 1.4	02/09→	Petrol	K7J 710	1390	4	79.50	70.00	32
Sandero/Stepway I 1.5 dCi	02/08→	Diesel	K9K 700	1461	4	76.00	80.50	25
Sandero/Stepway I 1.5 dCi	02/08→	Diesel	K9K 740	1461	4	76.00	80.50	25
Sandero/Stepway I 1.6	12/07→	Petrol	K4M 690	1598	4	79.50	80.50	33
Sandero/Stepway I 1.6	02/08→	Petrol	K4M 706	1598	4	79.50	80.50	33
Sandero/Stepway I 1.6	12/07→	Petrol	K7M 710	1598	4	79.50	80.50	34
Sandero/Stepway I 1.6	11/10→	Petrol	K7M 718	1598	4	79.50	80.50	34
Sandero/Stepway I 1.6 Flex	08/08→	Petrol	K4M 766	1598	4	79.50	80.50	33
Sandero/Stepway II 1.2 16V	12/13→	Petrol	D4F 732	1149	4	69.00	76.80	8
Sandero/Stepway II 1.5 dCi	12/13→	Diesel	K9K 830	1461	4	76.00	80.50	25
Scala 1.5 dCi	01/12→	Diesel	K9K 766	1461	4	76.00	80.50	25
Scenic I 1.4 16V	09/99→08/03	Petrol	K4J 714	1390	4	79.50	70.00	32
Scenic I 1.4 16V	09/99→08/03	Petrol	K4J 750	1390	4	79.50	70.00	32
Scenic I 1.6	09/99→09/03	Petrol	K4M 700	1598	4	79.50	80.50	33
Scenic I 1.6	06/01→09/03	Petrol	K4M 701	1598	4	79.50	80.50	33
Scenic I 1.6	09/99→09/03	Petrol	K4M 706	1598	4	79.50	80.50	33
Scenic I 1.6	03/01→09/03	Petrol	K4M 708	1598	4	79.50	80.50	33

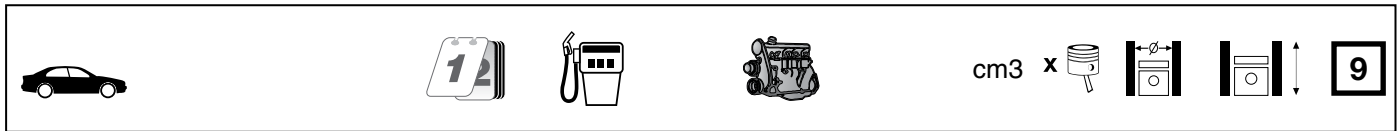

Scenic I 1.6	03/01→08/03	Petrol	K4M 709	1598	4	79.50	80.50	33
Scenic I 1.6 BiFuel	09/99→04/01	Petrol	K4M 704	1598	4	79.50	80.50	33
Scenic I 1.8 4x4	07/00→04/01	Petrol	F4P 722	1783	4	82.70	83.00	46
Scenic I 1.8 16V	01/01→08/03	Petrol	F4P 720	1783	4	82.70	83.00	46
Scenic I 1.8 16V	01/01→08/03	Petrol	F4P 722	1783	4	82.70	83.00	46
Scenic I 1.9 D	09/99→03/01	Diesel	F8Q 790	1870	4	80.00	93.00	35
Scenic I 1.9 dCi	09/99→08/03	Diesel	F9Q 732	1870	4	80.00	93.00	40
Scenic I 1.9 dCi	09/99→08/03	Diesel	F9Q 733	1870	4	80.00	93.00	40
Scenic I 1.9 dCi RX4	12/02→08/03	Diesel	F9Q 732	1870	4	80.00	93.00	40
Scenic I 1.9 dCi RX4	11/00→08/03	Diesel	F9Q 740	1870	4	80.00	93.00	40
Scenic I 1.9 dCi RX4	12/02→08/03	Diesel	F9Q 748	1870	4	80.00	93.00	40
Scenic I 1.9 dCi RX4	12/02→08/03	Diesel	F9Q 796	1870	4	80.00	93.00	40
Scenic I 1.9 dTi	09/99→08/03	Diesel	F9Q 731	1870	4	80.00	93.00	40
PBK 6, PBH 6, TBK 6		Diesel	M420 MDX	6328	4	120.00	140.00	97
PLB 6 M, PLB 6, PL 6 M		Diesel	M420 MDX	6328	4	120.00	140.00	97
Scenic I 1.9 dTi	09/99→08/03	Diesel	F9Q 734	1870	4	80.00	93.00	40
Scenic I 1.9 dTi	09/99→08/03	Diesel	F9Q 736	1870	4	80.00	93.00	40
Scenic I 1.9 dTi	02/01→08/03	Diesel	F9Q 744	1870	4	80.00	93.00	40
Scenic I 2.0 16V	09/99→08/03	Petrol	F4R 740	1998	4	82.70	93.00	52
Scenic I 2.0 16V	09/99→08/03	Petrol	F4R 741	1998	4	82.70	93.00	52
Scenic I 2.0 16V	09/99→08/03	Petrol	F4R 744	1998	4	82.70	93.00	52
Scenic I 2.0 16V	07/00→08/03	Petrol	F4R 746	1998	4	82.70	93.00	52
Scenic I 2.0 16V	09/99→08/03	Petrol	F4R 747	1998	4	82.70	93.00	52
Scenic I 2.0 16V RX4	06/00→08/03	Petrol	F4R 744	1998	4	82.70	93.00	52
Scenic I 2.0 16V RX4	06/00→08/03	Petrol	F4R 746	1998	4	82.70	93.00	52
Scenic II 1.4	06/03→	Petrol	K4J 730	1390	4	79.50	70.00	32
Scenic II 1.4	06/03→	Petrol	K4J 740	1390	4	79.50	70.00	32
Scenic II 1.4	06/03→	Petrol	K4J 770	1390	4	79.50	70.00	32
Scenic II 1.5 dCi	06/03→	Diesel	K9K 722	1461	4	76.00	80.50	25
Scenic II 1.5 dCi	05/05→	Diesel	K9K 724	1461	4	76.00	80.50	25
Scenic II 1.5 dCi	11/03→	Diesel	K9K 728	1461	4	76.00	80.50	25
Scenic II 1.5 dCi	11/03→	Diesel	K9K 729	1461	4	76.00	80.50	25
Scenic II 1.5 dCi	05/05→	Diesel	K9K 732	1461	4	76.00	80.50	25
Scenic II 1.5 dCi	01/07→	Diesel	K9K 734	1461	4	76.00	80.50	25
Scenic II 1.6	06/03→	Petrol	K4M 761	1598	4	79.50	80.50	33
Scenic II 1.6	06/03→	Petrol	K4M 782	1598	4	79.50	80.50	33
Scenic II 1.6	06/06→	Petrol	K4M 788	1598	4	79.50	80.50	33
Scenic II 1.6 16V	10/05→	Petrol	K4M 706	1598	4	79.50	80.50	33
Scenic II 1.6 16V	10/05→	Petrol	K4M 766	1598	4	79.50	80.50	33
Scenic II 1.6 16V	10/05→	Petrol	K4M 812	1598	4	79.50	80.50	33
Scenic II 1.6 16V	10/05→	Petrol	K4M 813	1598	4	79.50	80.50	33
Scenic II 1.6 BiFuel	08/03→05/06	Petrol	K4M 764	1598	4	79.50	80.50	33
Scenic II 1.6 Hi-Flex	03/05→07/10	Petrol	K4M 766	1598	4	79.50	80.50	33
Scenic II 1.9 D	06/06→	Diesel	F9Q 812	1870	4	80.00	93.00	40
Scenic II 1.9 D	06/06→	Diesel	F9Q J 803	1870	4	80.00	93.00	40
Scenic II 1.9 dCi	04/04→10/08	Diesel	F9Q 803	1870	4	80.00	93.00	40
Scenic II 1.9 dCi	06/03→	Diesel	F9Q 804	1870	4	80.00	93.00	40
Scenic II 1.9 dCi	06/03→	Diesel	F9Q 812	1870	4	80.00	93.00	40
Scenic II 1.9 dCi	05/05→	Diesel	F9Q 816	1870	4	80.00	93.00	40
Scenic II 1.9 dCi	05/05→	Diesel	F9Q 818	1870	4	80.00	93.00	40
Scenic II 1.9 dCi	05/05→	Diesel	F9Q J 803	1870	4	80.00	93.00	40
Scenic II 2.0	06/03→	Petrol	F4R 770	1998	4	82.70	93.00	52
Scenic II 2.0	06/03→	Petrol	F4R 771	1998	4	82.70	93.00	52
Scenic II 2.0 dCi	09/05→	Diesel	M9R 700	1995	4	84.00	90.00	56
Scenic II 2.0 dCi	09/05→	Diesel	M9R 721	1995	4	84.00	90.00	56
Scenic II 2.0 dCi	09/05→	Diesel	M9R 722	1995	4	84.00	90.00	56
Scenic III 1.5 dCi	04/09→	Diesel	K9K 636	1461	4	76.00	80.50	25
Scenic III 1.5 dCi	04/09→	Diesel	K9K 830	1461	4	76.00	80.50	25
Scenic III 1.5 dCi	02/09→	Diesel	K9K 832	1461	4	76.00	80.50	25
Scenic III 1.5 dCi	04/09→	Diesel	K9K 836	1461	4	76.00	80.50	25
Scenic III 1.5 dCi	04/09→	Diesel	K9K 837	1461	4	76.00	80.50	25
Scenic III 1.5 dCi	11/10→	Diesel	K9K 846	1461	4	76.00	80.50	25
Scenic III 1.6 16V	02/09→	Petrol	K4M 858	1598	4	79.50	80.50	33
Scenic III 1.6 E85	02/09→	Petrol	K4M 866	1598	4	79.50	80.50	33
Scenic III 1.9 dCi	02/09→	Diesel	F9Q 870	1870	4	80.00	93.00	40
Scenic III 1.9 dCi	02/09→	Diesel	F9Q 872	1870	4	80.00	93.00	40
Scenic III 2.0 dCi	04/09→	Diesel	M9R 610	1995	4	84.00	90.00	56
Scenic III 2.0 dCi	02/09→	Diesel	M9R 615	1995	4	84.00	90.00	56
Sport 2.0	12/95→08/96	Petrol	F7R 710	1998	4	82.70	93.00	53



cm3



Sport 2.0 16V	03/95→10/99	Petrol	F7R 710	1998	4	82.70	93.00	53
Super 5 1.0	10/84→10/88	Petrol	C1C 700	956	4	65.00	72.00	6
Super 5 1.1	10/84→12/96	Petrol	C1E 750	1108	4	70.00	72.00	12
Super 5 1.1	10/84→12/96	Petrol	C1E 752	1108	4	70.00	72.00	12
Super 5 1.1	10/84→12/96	Petrol	C1E 754	1108	4	70.00	72.00	12
Super 5 1.1	01/86→03/95	Petrol	C1E 756	1108	4	70.00	72.00	12
Super 5 1.1	01/86→03/95	Petrol	C1E 760	1108	4	70.00	72.00	12
Super 5 1.2	01/87→12/96	Petrol	C1G 702	1237	4	71.50	77.00	13
Super 5 1.2	01/87→08/90	Petrol	C1G 720	1237	4	71.50	77.00	13
Super 5 1.2	01/87→08/90	Petrol	C1G 722	1237	4	71.50	77.00	13
Super 5 1.4	10/84→06/88	Petrol	C1J 768	1397	4	76.00	77.00	24
Super 5 1.4	10/84→06/88	Petrol	C1J 780	1397	4	76.00	77.00	24
Super 5 1.4	04/85→10/87	Petrol	C1J 788	1397	4	76.00	77.00	24
Super 5 1.4	10/84→07/89	Petrol	C2J 700	1397	4	76.00	77.00	24
Super 5 1.4	10/84→07/89	Petrol	C2J 780	1397	4	76.00	77.00	24
Super 5 1.4	10/84→07/89	Petrol	C2J 781	1397	4	76.00	77.00	24
Super 5 1.4	06/87→07/89	Petrol	C2J 782	1397	4	76.00	77.00	24
Super 5 1.4	06/87→08/90	Petrol	C2J 784	1397	4	76.00	77.00	24
Super 5 1.4	10/84→07/89	Petrol	C2J 788	1397	4	76.00	77.00	24
Super 5 1.4	10/84→07/89	Petrol	C2J 789	1397	4	76.00	77.00	24
Super 5 1.4	10/84→07/89	Petrol	C2J 798	1397	4	76.00	77.00	24
Super 5 1.4	09/85→12/96	Petrol	C3J 700	1397	4	76.00	77.00	24
Super 5 1.4	10/85→12/96	Petrol	C3J 702	1397	4	76.00	77.00	24
Super 5 1.4	10/85→12/96	Petrol	C3J 760	1397	4	76.00	77.00	24
Super 5 1.4 Turbo	04/85→08/90	Petrol	C1J 782	1397	4	76.00	77.00	24
Super 5 1.4 Turbo	04/85→08/90	Petrol	C1J 784	1397	4	76.00	77.00	24
Super 5 1.4 Turbo	04/85→08/90	Petrol	C1J 788	1397	4	76.00	77.00	24
Super 5 1.4 Turbo GT	01/85→05/91	Petrol	840 730	1397	4	76.00	77.00	24
Super 5 1.6 D	10/84→12/96	Diesel	F8M 720	1596	4	78.00	83.50	29
Super 5 1.6 D	04/85→12/96	Diesel	F8M 730	1596	4	78.00	83.50	29
Super 5 1.7	06/87→03/95	Petrol	F2N 740	1721	4	81.00	83.50	41
Super 5 1.7	06/87→03/95	Petrol	F2N 742	1721	4	81.00	83.50	41
Super 5 1.7	10/86→03/95	Petrol	F3N 716	1721	4	81.00	83.50	42
Super 5 1.7	10/86→03/95	Petrol	F3N 717	1721	4	81.00	83.50	42
Super 5 1.7 i	10/86→08/91	Petrol	F3N 702	1721	4	81.00	83.50	42
Super 5 1.7 i	10/86→08/91	Petrol	F3N 722	1721	4	81.00	83.50	42
Thalia I 1.2	02/98→10/03	Petrol	D7F 744	1149	4	69.00	76.80	9
Thalia I 1.2	02/98→10/03	Petrol	D7F 746	1149	4	69.00	76.80	9
Thalia I 1.2 16V	04/02→	Petrol	D4F 706	1149	4	69.00	76.80	8
Thalia I 1.2 16V	04/02→	Petrol	D4F 712	1149	4	69.00	76.80	8
Thalia I 1.4	08/00→	Petrol	K7J 700	1390	4	75.80	77.00	23
Thalia I 1.4 16V	08/00→	Petrol	K4J 712	1390	4	79.50	70.00	32
Thalia I 1.5 dCi	04/02→	Diesel	K9K 700	1461	4	76.00	80.50	25
Thalia I 1.5 dCi	06/01→	Diesel	K9K 702	1461	4	76.00	80.50	25
Thalia I 1.5 dCi	04/04→11/09	Diesel	K9K 706	1461	4	76.00	80.50	25
Thalia I 1.5 dCi	02/03→	Diesel	K9K 714	1461	4	76.00	80.50	25
Thalia I 1.5 dCi	06/05→	Diesel	K9K 740	1461	4	76.00	80.50	25
Thalia I 1.6	01/04→12/08	Petrol	K4M 736	1598	4	79.50	80.50	33
Thalia I 1.6	03/98→	Petrol	K7M 746	1598	4	79.50	80.50	34
Thalia I 1.6 16V	04/02→	Petrol	K4M 740	1598	4	79.50	80.50	33
Thalia I 1.6 Flex	11/04→02/09	Petrol	K4M 740	1598	4	79.50	80.50	33
Thalia I 1.6 Flex	11/04→02/09	Petrol	K4M 743	1598	4	79.50	80.50	33
Thalia I 1.9 D	02/98→05/01	Diesel	F8Q 630	1870	4	80.00	93.00	35
Thalia I 2.0	09/01→	Petrol	F4R 738	1998	4	82.70	93.00	52
Thalia II 1.2 16V	09/08→	Petrol	D4F 728	1149	4	69.00	76.80	8
Thalia II 1.2 LPG	01/10→12/13	Petrol	D4F 728	1149	4	69.00	76.80	8
Thalia II 1.4	09/08→06/14	Petrol	K7J 700	1390	4	75.80	77.00	23
Thalia II 1.5 dCi	11/12→06/14	Diesel	K9K 612	1461	4	76.00	80.50	25
Thalia II 1.5 dCi	01/09→	Diesel	K9K 700	1461	4	76.00	80.50	25
Thalia II 1.5 dCi	09/08→	Diesel	K9K 718	1461	4	76.00	80.50	25
Thalia II 1.5 dCi	09/08→	Diesel	K9K 740	1461	4	76.00	80.50	25
Thalia II 1.5 dCi	01/09→	Diesel	K9K 834	1461	4	76.00	80.50	25
Thalia II 1.6 16V	09/08→	Petrol	K4M 743	1598	4	79.50	80.50	33
Thalia II 1.6 16V	01/09→	Petrol	K4M 744	1598	4	79.50	80.50	33
Thalia II 1.6 16V	01/09→	Petrol	K4M 745	1598	4	79.50	80.50	33
Thalia III 1.2 16V	12/13→	Petrol	D4F 732	1149	4	69.00	76.80	8
Thalia III 1.5 dCi	12/13→	Diesel	K9K 612	1461	4	76.00	80.50	25
Trafic 1.4	03/80→04/89	Petrol	847 700	1397	4	76.00	77.00	24
Trafic 1.4	03/80→04/89	Petrol	847 701	1397	4	76.00	77.00	24

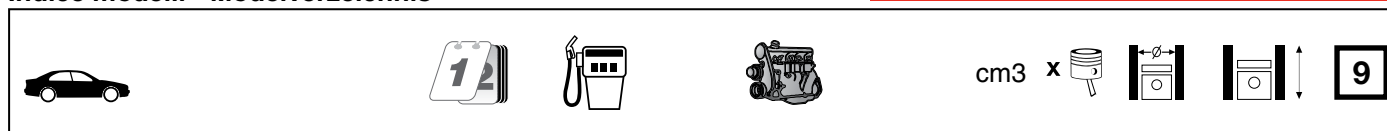







Trafic 1.4	03/80→06/91	Petrol	C1J 700	1397	4	76.00	77.00	24
Trafic 1.6	03/80→06/86	Petrol	841 705	1647	4	79.00	84.00	31
Trafic 1.6	03/80→06/86	Petrol	A1M 705	1647	4	79.00	84.00	31
Trafic 1.6	01/83→06/86	Petrol	A1M 707	1647	4	79.00	84.00	31
Trafic 1.6	01/83→06/86	Petrol	A1M 708	1647	4	79.00	84.00	31
Trafic 1.6 4x4	03/80→08/86	Petrol	A1M 707	1647	4	79.00	84.00	31
Trafic 1.7	08/92→08/94	Petrol	F1N 720	1721	4	81.00	83.50	41
Trafic 1.7	06/86→08/94	Petrol	F1N 722	1721	4	81.00	83.50	41
Trafic 1.7	06/86→08/94	Petrol	F1N 724	1721	4	81.00	83.50	41
Trafic 1.9 D	06/97→03/01	Diesel	F8Q 606	1870	4	80.00	93.00	35
Trafic 2.0	03/80→12/86	Petrol	829 720	1995	4	88.00	82.00	65
Trafic 2.0	03/80→12/86	Petrol	829 721	1995	4	88.00	82.00	65
Trafic 2.0	05/85→08/90	Petrol	J5R 716	1995	4	88.00	82.00	66
Trafic 2.0	06/86→04/89	Petrol	J5R 722	1995	4	88.00	82.00	66
Trafic 2.0	03/80→12/91	Petrol	J5R 726	1995	4	88.00	82.00	65
Trafic 2.0 [RWD]	05/89→10/97	Petrol	J5R 726	1995	4	88.00	82.00	65
Trafic 2.0 4x4	05/85→04/89	Petrol	J5R 716	1995	4	88.00	82.00	66
Trafic 2.0 4x4	06/86→04/89	Petrol	J5R 722	1995	4	88.00	82.00	66
Trafic 2.0 4x4	06/86→04/89	Petrol	J5R 726	1995	4	88.00	82.00	65
Trafic 2.1 D	03/80→06/94	Diesel	852 720	2068	4	86.00	89.00	59
Trafic 2.1 D	03/80→06/94	Diesel	852 750	2068	4	86.00	89.00	59
Trafic 2.1 D	06/94→04/98	Diesel	J8S 620	2068	4	86.00	89.00	59
Trafic 2.1 D	05/85→02/89	Diesel	J8S 750	2068	4	86.00	89.00	59
Trafic 2.1 D	06/94→10/97	Diesel	J8S 758	2068	4	86.00	89.00	59
Trafic 2.1 D [RWD]	05/89→06/94	Diesel	852 720	2068	4	86.00	89.00	59
Trafic 2.1 D [RWD]	06/94→10/97	Diesel	J8S 620	2068	4	86.00	89.00	59
Trafic 2.1 D [RWD]	06/94→10/97	Diesel	J8S 758	2068	4	86.00	89.00	59
Trafic 2.1 D 4x4	05/85→04/89	Diesel	852 750	2068	4	86.00	89.00	59
Trafic 2.2	06/94→04/98	Petrol	J7T 600	2165	4	88.00	89.00	68
Trafic 2.2	05/89→06/94	Petrol	J7T 780	2165	4	88.00	89.00	68
Trafic 2.2 4x4	06/94→04/98	Petrol	J7T 600	2165	4	88.00	89.00	68
Trafic 2.2 4x4	05/89→06/94	Petrol	J7T 780	2165	4	88.00	89.00	68
Trafic 2.5 D	03/80→03/01	Diesel	8140.61.240	2445	4	93.00	90.00	74
Trafic 2.5 D	03/80→03/01	Diesel	S8U 720	2445	4	93.00	90.00	74
Trafic 2.5 D	03/80→03/01	Diesel	S8U 722	2445	4	93.00	90.00	74
Trafic 2.5 D	05/89→03/01	Diesel	8140.67.2500	2499	4	93.00	92.00	76
Trafic 2.5 D	05/89→03/01	Diesel	8140.67.2550	2499	4	93.00	92.00	76
Trafic 2.5 D	05/89→03/01	Diesel	8140.67.2580	2499	4	93.00	92.00	76
Trafic 2.5 D	03/89→03/01	Diesel	S8U 750	2499	4	93.00	92.00	76
Trafic 2.5 D	05/89→03/01	Diesel	S8U 752	2499	4	93.00	92.00	76
Trafic 2.5 D	05/89→03/01	Diesel	S8U 758	2499	4	93.00	92.00	76
Trafic 2.5 D	05/98→03/01	Diesel	S8U 780	2499	4	93.00	92.00	81
Trafic 2.5 D 4x4	05/89→03/01	Diesel	8140.67.2500	2499	4	93.00	92.00	76
Trafic 2.5 D 4x4	08/89→03/01	Diesel	8140.67.2550	2499	4	93.00	92.00	76
Trafic 2.5 D 4x4	05/89→03/01	Diesel	8140.67.2580	2499	4	93.00	92.00	76
Trafic 2.5 D 4x4	03/89→03/01	Diesel	S8U 750	2499	4	93.00	92.00	76
Trafic 2.5 D 4x4	05/89→03/01	Diesel	S8U 752	2499	4	93.00	92.00	76
Trafic 2.5 D 4x4	08/89→03/01	Diesel	S8U 758	2499	4	93.00	92.00	76
Trafic II 1.9 dCi	03/01→	Diesel	F9Q 760	1870	4	80.00	93.00	40
Trafic II 1.9 dCi	04/01→07/03	Diesel	F9Q 762	1870	4	80.00	93.00	40
Trafic II 1.9 dCi 80	03/01→	Diesel	F9Q 760	1870	4	80.00	93.00	40
Trafic II 1.9 dCi 80	03/01→	Diesel	F9Q 762	1870	4	80.00	93.00	40
Trafic II 1.9 dCi 100	03/01→	Diesel	F9Q 760	1870	4	80.00	93.00	40
Trafic II 2.0	03/01→	Petrol	F4R 720	1998	4	82.70	93.00	52
Trafic II 2.0	03/01→	Petrol	F4R 722	1998	4	82.70	93.00	52
Trafic II 2.0 16V	08/06→	Petrol	F4R 820	1998	4	82.70	93.00	52
Trafic II 2.0 dCi 90	08/06→	Diesel	M9R 630	1995	4	84.00	90.00	56
Trafic II 2.0 dCi 90	08/06→	Diesel	M9R 780	1995	4	84.00	90.00	56
Trafic II 2.0 dCi 90	08/06→	Diesel	M9R 782	1995	4	84.00	90.00	56
Trafic II 2.0 dCi 115	08/06→	Diesel	M9R 630	1995	4	84.00	90.00	56
Trafic II 2.0 dCi 115	08/06→	Diesel	M9R 692	1995	4	84.00	90.00	56
Trafic II 2.0 dCi 115	08/06→	Diesel	M9R 780	1995	4	84.00	90.00	56
Trafic II 2.0 dCi 115	08/06→	Diesel	M9R 782	1995	4	84.00	90.00	56
Trafic II 2.0 dCi 115	08/06→	Diesel	M9R 786	1995	4	84.00	90.00	56
Trafic II 2.5 dCi	08/07→	Diesel	G9U 630	2464	4	89.00	99.00	70
Trafic II 2.5 dCi 115	02/08→	Diesel	G9U 630	2464	4	89.00	99.00	70
Trafic II 2.5 dCi 135	03/01→	Diesel	G9U 730	2464	4	89.00	99.00	70
Trafic II 2.5 dCi 145	08/06→	Diesel	G9U 630	2464	4	89.00	99.00	70
Trafic II 2.5 DTi	03/03→07/03	Diesel	G9U 730	2464	4	89.00	99.00	70













cm3





Twingo I 1.0	03/01→05/07	Petrol	D4F 712	1149	4	69.00	76.80	8
Twingo I 1.2	05/96→	Petrol	D7F 700	1149	4	69.00	76.80	9
Twingo I 1.2	05/96→	Petrol	D7F 701	1149	4	69.00	76.80	9
Twingo I 1.2	05/96→	Petrol	D7F 702	1149	4	69.00	76.80	9
Twingo I 1.2	05/96→	Petrol	D7F 703	1149	4	69.00	76.80	9
Twingo I 1.2	05/96→	Petrol	D7F 704	1149	4	69.00	76.80	9
Twingo I 1.2	05/96→	Petrol	D7F 706	1149	4	69.00	76.80	9
Twingo I 1.2	03/93→10/96	Petrol	C3G 700	1239	4	74.00	72.00	17
Twingo I 1.2	03/93→10/96	Petrol	C3G 702	1239	4	74.00	72.00	17
Twingo I 1.2 16V	01/01→	Petrol	D4F 702	1149	4	69.00	76.80	8
Twingo I 1.2 16V	08/04→06/07	Petrol	D4F 708	1149	4	69.00	76.80	8
Twingo I 1.2 LPG	10/03→	Petrol	D7F 702	1149	4	69.00	76.80	9
Twingo I 1.2 LPG	10/03→	Petrol	D7F 708	1149	4	69.00	76.80	9
Twingo II 1.2	03/07→	Petrol	D7F 800	1149	4	69.00	76.80	9
Twingo II 1.2 16V	03/07→	Petrol	D4F 764	1149	4	69.00	76.80	8
Twingo II 1.2 16V	03/07→	Petrol	D4F 770	1149	4	69.00	76.80	8
Twingo II 1.2 16V	03/07→	Petrol	D4F 772	1149	4	69.00	76.80	8
Twingo II 1.5 dCi	04/08→	Diesel	K9K 718	1461	4	76.00	80.50	25
Twingo II 1.5 dCi	03/07→	Diesel	K9K 740	1461	4	76.00	80.50	25
Twingo II 1.5 dCi 75	10/10→	Diesel	K9K 820	1461	4	76.00	80.50	25
Twingo II 1.5 dCi 90	10/10→	Diesel	K9K 820	1461	4	76.00	80.50	25
Twingo II 1.6 RS	05/08→	Petrol	K4M 854	1598	4	79.50	80.50	33
Vel Satis 2.0 16V Turbo	06/02→	Petrol	F4R 762	1998	4	82.70	93.00	52
Vel Satis 2.0 16V Turbo	06/02→	Petrol	F4R 763	1998	4	82.70	93.00	52
Vel Satis 2.0 16 V Turbo	04/04→	Petrol	F4R 766	1998	4	82.70	93.00	52
Vel Satis 2.0 dCi	08/05→	Diesel	M9R 760	1995	4	84.00	90.00	56
Vel Satis 2.0 dCi	01/06→	Diesel	M9R 762	1995	4	84.00	90.00	56
Vel Satis 2.0 dCi	01/06→	Diesel	M9R 763	1995	4	84.00	90.00	56
Vel Satis 2.0 Turbo	04/05→	Petrol	F4R 867	1998	4	82.70	93.00	52
Vel Satis 2.2 dCi	04/04→	Diesel	G9T 600	2188	4	87.00	92.00	62
Vel Satis 2.2 dCi	09/04→	Diesel	G9T 606	2188	4	87.00	92.00	62
Vel Satis 2.2 dCi	09/04→	Diesel	G9T 607	2188	4	87.00	92.00	62
Vel Satis 2.2 dCi	09/04→	Diesel	G9T 700	2188	4	87.00	92.00	62
Vel Satis 2.2 dCi	06/02→	Diesel	G9T 702	2188	4	87.00	92.00	62
Vel Satis 2.2 dCi	06/02→	Diesel	G9T 703	2188	4	87.00	92.00	62
Wind 1.6	07/10→	Petrol	K4M 854	1598	4	79.50	80.50	33







			cm3	x 			
112	Petrol		2664	V6	88.00	73.00	63
129	Petrol		1218	4	75.00	69.00	19
140	Petrol		2664	V6	88.00	73.00	63
144	Petrol		2664	V6	88.00	73.00	63
144.01	Petrol		2664	V6	88.00	73.00	63
150	Petrol		1360	4	75.00	77.00	20
597.02	Diesel		5278	6	100.00	112.00	85
597.02	Diesel		5278	6	100.00	112.00	85
597.03	Diesel		5278	6	100.00	112.00	85
597.04	Diesel		5278	6	100.00	112.00	85
670.800	Petrol		845	4	58.00	80.00	4
680.702	Petrol		746	4	54.50	80.00	2
688.01	Petrol		1108	4	70.00	72.00	10
688.03	Petrol		1108	4	70.00	72.00	10
688.06	Petrol		1108	4	70.00	72.00	11
688.09	Petrol		1108	4	70.00	72.00	11
688.10	Petrol		1108	4	70.00	72.00	11
688.11	Petrol		1108	4	70.00	72.00	11
688.12	Petrol		1108	4	70.00	72.00	11
689.01	Petrol		956	4	65.00	72.00	6
689.10	Petrol		956	4	65.00	72.00	6
690	Petrol		603	4	49.00	80.00	1
697.01	Petrol		1469	4	76.00	81.00	26
712	Diesel		3320	4	98.00	110.00	84
712.01	Diesel		3320	4	98.00	110.00	84
712.01	Diesel		3320	4	98.00	110.00	84
712.02	Diesel		3320	4	98.00	110.00	84
712.03	Diesel		3320	4	98.00	110.00	84
712.03	Diesel		3320	4	98.00	110.00	84
712.04	Diesel		3320	4	98.00	110.00	84
712.04	Diesel		3320	4	98.00	110.00	84
712.07	Diesel		3320	4	98.00	110.00	84
712.11	Diesel		3596	4	102.00	110.00	87
712.13	Diesel		3596	4	102.00	110.00	87
712-01-01	Diesel		3320	4	98.00	110.00	84
712-01-03	Diesel		3320	4	98.00	110.00	84
712-01-03	Diesel		3320	4	98.00	110.00	84
712-01-04	Diesel		3320	4	98.00	110.00	84
712-01-04	Diesel		3320	4	98.00	110.00	84
713	Diesel		2989	4	93.00	110.00	82
720	Diesel		3590	4	102.00	110.00	87
720	Diesel		3596	4	102.00	110.00	87
720.01	Diesel		3596	4	102.00	110.00	87
720.02	Diesel		3596	4	102.00	110.00	87
720.03	Diesel		3596	4	102.00	110.00	87
720.05	Diesel		3596	4	102.00	110.00	87
720.08	Diesel		3596	4	102.00	110.00	87
720.12	Diesel		3590	4	102.00	110.00	87
720-12	Diesel		3595	4	102.00	110.00	87
797-20	Diesel		5490	6	102.00	112.00	88
797-21	Diesel		5453	6	102.00	112.00	88
797-26	Diesel		5490	6	102.00	112.00	88
798-10	Diesel		5490	6	102.00	112.00	89
798-10	Diesel		5490	6	102.00	112.00	89
798-11	Diesel		5490	6	102.00	112.00	89
798-13	Diesel		5490	6	102.00	112.00	89
798-13	Diesel		5490	6	102.00	112.00	89
798-20	Diesel		5490	6	102.00	112.00	89
798-40	Diesel		5490	6	102.00	112.00	89
800	Petrol		845	4	58.00	80.00	4
800.02	Petrol		845	4	58.00	80.00	4
807	Petrol		1565	4	77.00	84.00	27
807.03	Petrol		1565	4	77.00	84.00	27
807.04	Petrol		1565	4	77.00	84.00	27
807.05	Petrol		1565	4	77.00	84.00	27
807.10	Petrol		1565	4	77.00	84.00	27
807.20	Petrol		1565	4	77.00	84.00	27
810.01	Petrol		1289	4	73.00	77.00	15
810.02	Petrol		1289	4	73.00	77.00	14

			cm ³	x 			9
810.03	Petrol		1289	4	73.00	77.00	16
810.05	Petrol		1289	4	73.00	77.00	15
810.06	Petrol		1289	4	73.00	77.00	15
810.10	Petrol		1289	4	73.00	77.00	15
810.19	Petrol		1289	4	73.00	77.00	15
810.25	Petrol		1289	4	73.00	77.00	15
810.26	Petrol		1289	4	73.00	77.00	15
810.29	Petrol		1289	4	73.00	77.00	15
810.96	Petrol		1289	4	73.00	77.00	15
810.97	Petrol		1289	4	73.00	77.00	15
810.99	Petrol		1289	4	73.00	77.00	15
810-02	Petrol		1289	4	73.00	77.00	15
810-02/97	Petrol		1289	4	73.00	77.00	15
812	Petrol		1255	4	74.50	72.00	18
813.02	Petrol		852	4	61.40	72.00	5
821	Petrol		1565	4	77.00	84.00	27
821.01	Petrol		1565	4	77.00	84.00	27
821.02	Petrol		1565	4	77.00	84.00	27
821.03	Petrol		1565	4	77.00	84.00	27
821.04	Petrol		1565	4	77.00	84.00	27
821.10	Petrol		1565	4	77.00	84.00	27
821.11	Petrol		1565	4	77.00	84.00	27
821.20	Petrol		1565	4	77.00	84.00	27
829.00	Petrol		1995	4	88.00	82.00	67
829.01	Petrol		1995	4	88.00	82.00	64
839.06	Petrol		782	4	55.80	80.00	3
839.07	Petrol		782	4	55.80	80.00	3
843	Petrol		1647	4	79.00	84.00	31
843.01	Petrol		1647	4	79.00	84.00	31
843.05	Petrol		1647	4	79.00	84.00	31
843.20	Petrol		1647	4	79.00	84.00	31
843.21	Petrol		1647	4	79.00	84.00	31
843.719	Petrol		1647	4	79.00	84.00	31
844.12	Petrol		1605	4	78.00	84.00	30
844.30	Petrol		1605	4	78.00	84.00	30
844.31	Petrol		1605	4	78.00	84.00	30
844.34	Petrol		1605	4	78.00	84.00	30
847.99	Petrol		1397	4	76.00	77.00	24
852	Diesel		2068	4	86.00	89.00	59
852 J8S	Diesel		2068	4	86.00	89.00	59
8140.07.2530 ID	Diesel		2500	4	93.00	92.00	76
8140.07.2585	Diesel		2500	4	93.00	92.00	76
8140.07.2700	Diesel		2499	4	93.00	92.00	77
8140.07.3700	Diesel		2499	4	93.00	92.00	77
8140.21.235 IDS	Diesel		2445	4	93.00	90.00	73
8140.23.2565	Diesel		2800	4	94.40	100.00	83
8140.23.2585 Euro 2	Diesel		2800	4	94.40	100.00	83
8140.27.2500	Diesel		2499	4	93.00	92.00	78
8140.27.2510	Diesel		2499	4	93.00	92.00	76
8140.27.2512	Diesel		2499	4	93.00	92.00	77
8140.27.2530 IDS	Diesel		2499	4	93.00	92.00	79
8140.27.2560	Diesel		2499	4	93.00	92.00	77
8140.27.2565 IDS	Diesel		2500	4	93.00	92.00	77
8140.27.2580	Diesel		2499	4	93.00	92.00	76
8140.27.2582	Diesel		2499	4	93.00	92.00	77
8140.27.2585	Diesel		2500	4	93.00	92.00	77
8140.27.2700	Diesel		2500	4	93.00	92.00	77
8140.43.2585 Euro 2	Diesel		2800	4	94.40	100.00	83
8140.43.3700 Euro 2	Diesel		2798	4	94.40	100.00	83
8140.43.B.3586 Euro 3	Diesel		2800	4	94.40	100.00	83
8140.43.B.3588 Euro 3	Diesel		2800	4	94.40	100.00	83
8140.43.C.2586	Diesel		2800	4	94.40	100.00	83
8140.43.S.2585 Euro 2	Diesel		2800	4	94.40	100.00	83
8140.43.S.3585 Euro 3	Diesel		2800	4	94.40	100.00	83
8140.43N.3585 Euro 3	Diesel		2798	4	94.40	100.00	83
8140.47.2530 IDR	Diesel		2499	4	93.00	92.00	76
8140.47.2535	Diesel		2499	4	93.00	92.00	77
8140.47.2580	Diesel		2500	4	93.00	92.00	77
8140.47.2585	Diesel		2500	4	93.00	92.00	80

		cm3	x 			
8140.47.2590	Diesel	2499	4	93.00	92.00	76
8140.47.2700	Diesel	2499	4	93.00	92.00	77
8140.47.2721	Diesel	2499	4	93.00	92.00	77
8140.47.2785	Diesel	2499	4	93.00	92.00	77
8140.61.2300	Diesel	2445	4	93.00	90.00	74
8140.61.235	Diesel	2445	4	93.00	90.00	73
8140.61.240	Diesel	2445	4	93.00	90.00	74
8140.63.2585 Euro 2	Diesel	2800	4	94.40	100.00	83
8140.67.2500	Diesel	2499	4	93.00	92.00	76
8140.67.2510	Diesel	2499	4	93.00	92.00	76
8140.67.2550	Diesel	2499	4	93.00	92.00	76
8140.67.2580	Diesel	2499	4	93.00	92.00	76
8140.67.2585	Diesel	2500	4	93.00	92.00	76
8140-07	Diesel	2500	4	93.00	92.00	77
8140-27	Diesel	2500	4	93.00	92.00	77
8140-27 IDS	Diesel	2500	4	93.00	92.00	77
8140-43 k Euro 3	Diesel	2800	4	94.40	100.00	83
8140-47	Diesel	2499	4	93.00	92.00	77
688 02	Petrol	1108	4	70.00	72.00	10
688 13	Petrol	1108	4	70.00	72.00	11
689 71	Petrol	956	4	65.00	72.00	6
800 01	Petrol	845	4	58.00	80.00	4
800 05	Petrol	845	4	58.00	80.00	4
680 701	Petrol	746	4	54.50	80.00	2
688 711	Petrol	1108	4	70.00	72.00	10
688 712	Petrol	1108	4	70.00	72.00	10
688 713	Petrol	1108	4	70.00	72.00	10
689 710	Petrol	956	4	65.00	72.00	6
800 705	Petrol	845	4	58.00	80.00	4
800 710	Petrol	845	4	58.00	80.00	4
807 727	Petrol	1565	4	77.00	84.00	27
810 719	Petrol	1289	4	73.00	77.00	14
810 725	Petrol	1289	4	73.00	77.00	14
810 726	Petrol	1289	4	73.00	77.00	14
810 729	Petrol	1289	4	73.00	77.00	14
829 700	Petrol	1995	4	88.00	82.00	64
829 701	Petrol	1995	4	88.00	82.00	64
829 702	Petrol	1995	4	88.00	82.00	65
829 703	Petrol	1995	4	88.00	82.00	65
829 710	Petrol	1995	4	88.00	82.00	65
829 720	Petrol	1995	4	88.00	82.00	65
829 721	Petrol	1995	4	88.00	82.00	65
829 730	Petrol	1995	4	88.00	82.00	66
829 731	Petrol	1995	4	88.00	82.00	65
839 701	Petrol	782	4	55.80	80.00	3
839 706	Petrol	782	4	55.80	80.00	3
839 707	Petrol	782	4	55.80	80.00	3
840 725	Petrol	1397	4	76.00	77.00	24
840 726	Petrol	1397	4	76.00	77.00	24
840 730	Petrol	1397	4	76.00	77.00	24
841 705	Petrol	1647	4	79.00	84.00	31
841 717	Petrol	1647	4	79.00	84.00	31
841 725	Petrol	1647	4	79.00	84.00	31
841 726	Petrol	1647	4	79.00	84.00	31
843 718	Petrol	1647	4	79.00	84.00	31
843 720	Petrol	1647	4	79.00	84.00	31
843 721	Petrol	1647	4	79.00	84.00	31
843 723	Petrol	1647	4	79.00	84.00	31
843 724	Petrol	1647	4	79.00	84.00	31
847 700	Petrol	1397	4	76.00	77.00	24
847 701	Petrol	1397	4	76.00	77.00	24
847 712	Petrol	1397	4	76.00	77.00	24
847 720	Petrol	1397	4	76.00	77.00	24
847 722	Petrol	1397	4	76.00	77.00	24
847 725	Petrol	1397	4	76.00	77.00	24
851 700	Petrol	2165	4	88.00	89.00	68
852 700	Diesel	2068	4	86.00	89.00	59
852 710	Diesel	2068	4	86.00	89.00	59
852 720	Diesel	2068	4	86.00	89.00	59

		cm3	x 			
--	---	-----	---	---	---	---

852 750	Diesel	2068	4	86.00	89.00	59
A1M 705	Petrol	1647	4	79.00	84.00	31
A1M 707	Petrol	1647	4	79.00	84.00	31
A1M 708	Petrol	1647	4	79.00	84.00	31
A2M 723	Petrol	1647	4	79.00	84.00	31
A2M 725	Petrol	1647	4	79.00	84.00	31
A2M 726	Petrol	1647	4	79.00	84.00	31
A5L 717	Petrol	1565	4	77.00	84.00	27
A5L 718	Petrol	1565	4	77.00	84.00	27
A5L 750	Petrol	1565	4	77.00	84.00	27
A6M 725	Petrol	1647	4	79.00	84.00	31
A6M 726	Petrol	1647	4	79.00	84.00	31
A7L 723	Petrol	1565	4	77.00	84.00	27
B1B 707	Petrol	845	4	58.00	80.00	4
C1C 700	Petrol	956	4	65.00	72.00	6
C1C 706	Petrol	949	4	65.00	72.00	6
C1C 708	Petrol	956	4	65.00	72.00	6
C1C 754	Petrol	956	4	65.00	72.00	6
C1E 688	Petrol	1108	4	70.00	72.00	12
C1E 700	Petrol	1108	4	70.00	72.00	12
C1E 714	Petrol	1108	4	70.00	72.00	12
C1E 715	Petrol	1108	4	70.00	72.00	12
C1E 718	Petrol	1108	4	70.00	72.00	12
C1E 719	Petrol	1108	4	70.00	72.00	12
C1E 720	Petrol	1108	4	70.00	72.00	12
C1E 726	Petrol	1108	4	70.00	72.00	12
C1E 750	Petrol	1108	4	70.00	72.00	12
C1E 752	Petrol	1108	4	70.00	72.00	12
C1E 754	Petrol	1108	4	70.00	72.00	12
C1E 756	Petrol	1108	4	70.00	72.00	12
C1E 760	Petrol	1108	4	70.00	72.00	12
C1E 762	Petrol	1108	4	70.00	72.00	12
C1E 764	Petrol	1108	4	70.00	72.00	12
C1E 792	Petrol	1108	4	70.00	72.00	12
C1G 700	Petrol	1237	4	71.50	77.00	13
C1G 702	Petrol	1237	4	71.50	77.00	13
C1G 710	Petrol	1237	4	71.50	77.00	13
C1G 720	Petrol	1237	4	71.50	77.00	13
C1G 722	Petrol	1237	4	71.50	77.00	13
C1G 726	Petrol	1237	4	71.50	77.00	13
C1G 730	Petrol	1237	4	71.50	77.00	13
C1J 700	Petrol	1397	4	76.00	77.00	24
C1J 715	Petrol	1397	4	76.00	77.00	24
C1J 742	Petrol	1397	4	76.00	77.00	24
C1J 748	Petrol	1397	4	76.00	77.00	24
C1J 760	Petrol	1397	4	76.00	77.00	24
C1J 764	Petrol	1397	4	76.00	77.00	24
C1J 768	Petrol	1397	4	76.00	77.00	24
C1J 770	Petrol	1397	4	76.00	77.00	24
C1J 780	Petrol	1397	4	76.00	77.00	24
C1J 782	Petrol	1397	4	76.00	77.00	24
C1J 784	Petrol	1397	4	76.00	77.00	24
C1J 788	Petrol	1397	4	76.00	77.00	24
C1J 791	Petrol	1397	4	76.00	77.00	24
C1J 792	Petrol	1397	4	76.00	77.00	24
C1J 793	Petrol	1397	4	76.00	77.00	24
C1J 796	Petrol	1397	4	76.00	77.00	24
C2J 700	Petrol	1397	4	76.00	77.00	24
C2J 713	Petrol	1397	4	76.00	77.00	24
C2J 717	Petrol	1397	4	76.00	77.00	24
C2J 718	Petrol	1397	4	76.00	77.00	24
C2J 720	Petrol	1397	4	76.00	77.00	24
C2J 730	Petrol	1397	4	76.00	77.00	24
C2J 755	Petrol	1397	4	76.00	77.00	24
C2J 756	Petrol	1397	4	76.00	77.00	24
C2J 757	Petrol	1397	4	76.00	77.00	24
C2J 760	Petrol	1397	4	76.00	77.00	24
C2J 766	Petrol	1397	4	76.00	77.00	24
C2J 767	Petrol	1397	4	76.00	77.00	24







		cm3	x 			
C2J 768	Petrol	1397	4	76.00	77.00	24
C2J 770	Petrol	1397	4	76.00	77.00	24
C2J 772	Petrol	1397	4	76.00	77.00	24
C2J 776	Petrol	1397	4	76.00	77.00	24
C2J 780	Petrol	1397	4	76.00	77.00	24
C2J 781	Petrol	1397	4	76.00	77.00	24
C2J 782	Petrol	1397	4	76.00	77.00	24
C2J 784	Petrol	1397	4	76.00	77.00	24
C2J 788	Petrol	1397	4	76.00	77.00	24
C2J 789	Petrol	1397	4	76.00	77.00	24
C2J 792	Petrol	1397	4	76.00	77.00	24
C2J 794	Petrol	1397	4	76.00	77.00	24
C2J 796	Petrol	1397	4	76.00	77.00	24
C2J 797	Petrol	1397	4	76.00	77.00	24
C2J 798	Petrol	1397	4	76.00	77.00	24
C2L 714	Petrol	1565	4	77.00	84.00	28
C2L 717	Petrol	1397	4	77.00	84.00	28
C3G 700	Petrol	1239	4	74.00	72.00	17
C3G 702	Petrol	1239	4	74.00	72.00	17
C3G 702	Petrol	1239	4	74.00	72.00	17
C3G 710	Petrol	1239	4	74.00	72.00	17
C3G 712	Petrol	1239	4	74.00	72.00	17
C3G 720	Petrol	1239	4	74.00	72.00	17
C3G 750	Petrol	1239	4	74.00	72.00	17
C3J 700	Petrol	1397	4	76.00	77.00	24
C3J 702	Petrol	1397	4	76.00	77.00	24
C3J 710	Petrol	1397	4	76.00	77.00	24
C3J 756	Petrol	1397	4	76.00	77.00	24
C3J 760	Petrol	1397	4	76.00	77.00	24
C3J 762	Petrol	1397	4	76.00	77.00	24
C6J 750	Petrol	1397	4	76.00	77.00	24
D4D 700	Petrol	999	4	69.00	66.80	7
D4D 720	Petrol	999	4	69.00	66.80	7
D4F 702	Petrol	1149	4	69.00	76.80	8
D4F 704	Petrol	1149	4	69.00	76.80	8
D4F 706	Petrol	1149	4	69.00	76.80	8
D4F 708	Petrol	1149	4	69.00	76.80	8
D4F 712	Petrol	1149	4	69.00	76.80	8
D4F 714	Petrol	1149	4	69.00	76.80	8
D4F 716	Petrol	1149	4	69.00	76.80	8
D4F 722	Petrol	1149	4	69.00	76.80	8
D4F 728	Petrol	1149	4	69.00	76.80	8
D4F 730	Petrol	1149	4	69.00	76.80	8
D4F 732	Petrol	1149	4	69.00	76.80	8
D4F 740	Petrol	1149	4	69.00	76.80	8
D4F 742	Petrol	1149	4	69.00	76.80	8
D4F 764	Petrol	1149	4	69.00	76.80	8
D4F 770	Petrol	1149	4	69.00	76.80	8
D4F 772	Petrol	1149	4	69.00	76.80	8
D4F 786	Petrol	1149	4	69.00	76.80	8
D4F 790	Petrol	1149	4	69.00	76.80	8
D7D 700	Petrol	999	4	69.00	66.80	7
D7D 760	Petrol	999	4	69.00	66.80	7
D7F 700	Petrol	1149	4	69.00	76.80	9
D7F 701	Petrol	1149	4	69.00	76.80	9
D7F 702	Petrol	1149	4	69.00	76.80	9
D7F 703	Petrol	1149	4	69.00	76.80	9
D7F 704	Petrol	1149	4	69.00	76.80	9
D7F 706	Petrol	1149	4	69.00	76.80	9
D7F 708	Petrol	1149	4	69.00	76.80	9
D7F 710	Petrol	1149	4	69.00	76.80	9
D7F 720	Petrol	1149	4	69.00	76.80	9
D7F 722	Petrol	1149	4	69.00	76.80	9
D7F 726	Petrol	1149	4	69.00	76.80	9
D7F 730	Petrol	1149	4	69.00	76.80	9
D7F 744	Petrol	1149	4	69.00	76.80	9
D7F 746	Petrol	1149	4	69.00	76.80	9
D7F 764	Petrol	1149	4	69.00	76.80	9
D7F 766	Petrol	1149	4	69.00	76.80	9















cm3















Engine Model	Fuel Type	Capacity (cm3)	Cylinders	Stroke (cm)	Stroke (cm)	Index
D7F 800	Petrol	1149	4	69.00	76.80	9
dCi 4B Euro 3	Diesel	4120	4	102.00	126.00	91
dCi 4C Euro 3	Diesel	4120	4	102.00	126.00	91
dci 6A Euro 3	Diesel	6177	6	102.00	126.00	92
dci 6W Euro 3	Diesel	6177	6	102.00	126.00	92
dCi 11-270 Euro 3	Diesel	11100	6	123.00	156.00	105
dCi 11 B/43 Euro 2	Diesel	11100	6	123.00	156.00	105
dCi 11C Euro 3	Diesel	11100	6	123.00	156.00	105
dCi 11E Euro 3	Diesel	11100	6	123.00	156.00	105
dCi 11G Euro 3	Diesel	11100	6	123.00	156.00	105
DXi 5	Diesel	4764	4	108.00	130.00	93
DXi 7	Diesel	7200	6	108.00	130.00	94
DXi 11 Euro 3/4	Diesel	10800	6	123.00	152.00	104
DXi 12 Euro 3	Diesel	12130	6	131.00	150.00	107
DXi 13 Euro 4/5	Diesel	12800	6	131.00	158.00	108
DXi 13 440 Euro 4/5	Diesel	12800	6	131.00	158.00	108
DXi 13 460 Euro 4/5	Diesel	12800	6	131.00	158.00	108
DXi 13 480 Euro 4/5	Diesel	12800	6	131.00	158.00	108
DXi 13 500 Euro 4/5	Diesel	12800	6	131.00	158.00	108
DXi 13 520 Euro 4/5	Diesel	12800	6	131.00	158.00	108
E5F 710	Petrol	1171	4	75.80	64.90	22
E5F 716	Petrol	1171	4	75.80	64.90	22
E6J 700	Petrol	1390	4	75.80	77.00	23
E6J 701	Petrol	1390	4	75.80	77.00	23
E6J 706	Petrol	1390	4	75.80	77.00	23
E6J 712	Petrol	1390	4	75.80	77.00	23
E6J 713	Petrol	1390	4	75.80	77.00	23
E6J 718	Petrol	1390	4	75.80	77.00	23
E6J 734	Petrol	1390	4	75.80	77.00	23
E6J 738	Petrol	1390	4	75.80	77.00	23
E6J 760	Petrol	1390	4	75.80	77.00	23
E7F 700	Petrol	1171	4	75.80	64.90	22
E7F 704	Petrol	1171	4	75.80	64.90	22
E7F 706	Petrol	1171	4	75.80	64.90	22
E7F 708	Petrol	1171	4	75.80	64.90	22
E7F 730	Petrol	1171	4	75.80	64.90	22
E7F 750	Petrol	1171	4	75.80	64.90	22
E7J 601	Petrol	1390	4	75.80	77.00	23
E7J 624	Petrol	1390	4	75.80	77.00	23
E7J 626	Petrol	1390	4	75.80	77.00	23
E7J 634	Petrol	1390	4	75.80	77.00	23
E7J 635	Petrol	1390	4	75.80	77.00	23
E7J 700	Petrol	1390	4	75.80	77.00	23
E7J 706	Petrol	1390	4	75.80	77.00	23
E7J 707	Petrol	1390	4	75.80	77.00	23
E7J 710	Petrol	1390	4	75.80	77.00	23
E7J 711	Petrol	1390	4	75.80	77.00	23
E7J 718	Petrol	1390	4	75.80	77.00	23
E7J 719	Petrol	1390	4	75.80	77.00	23
E7J 720	Petrol	1390	4	75.80	77.00	23
E7J 724	Petrol	1390	4	75.80	77.00	23
E7J 726	Petrol	1390	4	75.80	77.00	23
E7J 728	Petrol	1390	4	75.80	77.00	23
E7J 742	Petrol	1390	4	75.80	77.00	23
E7J 745	Petrol	1390	4	75.80	77.00	23
E7J 754	Petrol	1390	4	75.80	77.00	23
E7J 756	Petrol	1390	4	75.80	77.00	23
E7J 757	Petrol	1390	4	75.80	77.00	23
E7J 764	Petrol	1390	4	75.80	77.00	23
E7J 770	Petrol	1390	4	75.80	77.00	23
E7J 771	Petrol	1390	4	75.80	77.00	23
E7J 773	Petrol	1390	4	75.80	77.00	23
E7J 780	Petrol	1390	4	75.80	77.00	23
F1N 720	Petrol	1721	4	81.00	83.50	41
F1N 722	Petrol	1721	4	81.00	83.50	41
F1N 724	Petrol	1721	4	81.00	83.50	41
F2N 700	Petrol	1721	4	81.00	83.50	41
F2N 704	Petrol	1721	4	81.00	83.50	41
F2N 708	Petrol	1721	4	81.00	83.50	41







		cm3	x 			
F2N 710	Petrol	1721	4	81.00	83.50	41
F2N 711	Petrol	1721	4	81.00	83.50	41
F2N 712	Petrol	1721	4	81.00	83.50	41
F2N 716	Petrol	1721	4	81.00	83.50	41
F2N 720	Petrol	1721	4	81.00	83.50	41
F2N 721	Petrol	1721	4	81.00	83.50	41
F2N 722	Petrol	1721	4	81.00	83.50	41
F2N 724	Petrol	1721	4	81.00	83.50	41
F2N 726	Petrol	1721	4	81.00	83.50	41
F2N 727	Petrol	1721	4	81.00	83.50	41
F2N 728	Petrol	1721	4	81.00	83.50	41
F2N 730	Petrol	1721	4	81.00	83.50	41
F2N 732	Petrol	1721	4	81.00	83.50	41
F2N 740	Petrol	1721	4	81.00	83.50	41
F2N 742	Petrol	1721	4	81.00	83.50	41
F2N 750	Petrol	1721	4	81.00	83.50	41
F2N 752	Petrol	1721	4	81.00	83.50	41
F2N 753	Petrol	1721	4	81.00	83.50	41
F2N 754	Petrol	1721	4	81.00	83.50	41
F2N 758	Petrol	1721	4	81.00	83.50	41
F2N 770	Petrol	1721	4	81.00	83.50	41
F2N 783	Petrol	1721	4	81.00	83.50	41
F2N 786	Petrol	1721	4	81.00	83.50	41
F2N 796	Petrol	1721	4	81.00	83.50	41
F2N 797	Petrol	1721	4	81.00	83.50	41
F2N 798	Petrol	1721	4	81.00	83.50	41
F2R 702	Petrol	1721	4	81.00	83.50	41
F3N 702	Petrol	1721	4	81.00	83.50	42
F3N 708	Petrol	1721	4	81.00	83.50	42
F3N 716	Petrol	1721	4	81.00	83.50	42
F3N 717	Petrol	1721	4	81.00	83.50	42
F3N 718	Petrol	1721	4	81.00	83.50	42
F3N 722	Petrol	1721	4	81.00	83.50	42
F3N 723	Petrol	1721	4	81.00	83.50	42
F3N 726	Petrol	1721	4	81.00	83.50	42
F3N 740	Petrol	1721	4	81.00	83.50	42
F3N 741	Petrol	1721	4	81.00	83.50	42
F3N 742	Petrol	1721	4	81.00	83.50	42
F3N 743	Petrol	1721	4	81.00	83.50	42
F3N 746	Petrol	1721	4	81.00	83.50	42
F3N 747	Petrol	1721	4	81.00	83.50	42
F3P 670	Petrol	1783	4	82.70	83.00	44
F3P 674	Petrol	1783	4	82.70	83.00	44
F3P 676	Petrol	1794	4	82.70	83.50	47
F3P 678	Petrol	1783	4	82.70	83.00	44
F3P 682	Petrol	1783	4	82.70	83.00	45
F3P 700	Petrol	1794	4	82.70	83.50	48
F3P 704	Petrol	1794	4	82.70	83.50	48
F3P 705	Petrol	1794	4	82.70	83.50	48
F3P 706	Petrol	1794	4	82.70	83.50	48
F3P 707	Petrol	1794	4	82.70	83.50	48
F3P 708	Petrol	1794	4	82.70	83.50	48
F3P 710	Petrol	1794	4	82.70	83.50	47
F3P 712	Petrol	1794	4	82.70	83.50	48
F3P 714	Petrol	1794	4	82.70	83.50	47
F3P 720	Petrol	1794	4	82.70	83.50	47
F3P 724	Petrol	1794	4	82.70	83.50	47
F3P 754	Petrol	1794	4	82.70	83.50	47
F3P 755	Petrol	1783	4	82.70	83.00	44
F3P 758	Petrol	1783	4	82.70	83.00	44
F3P 760	Petrol	1794	4	82.70	83.50	48
F3P 764	Petrol	1783	4	82.70	83.00	45
F3P 765	Petrol	1794	4	82.70	83.50	48
F3R 200	Petrol	1998	4	82.70	93.00	49
F3R 611	Petrol	1998	4	82.70	93.00	50
F3R 722	Petrol	1998	4	82.70	93.00	49
F3R 723	Petrol	1998	4	82.70	93.00	49
F3R 728	Petrol	1998	4	82.70	93.00	49
F3R 729	Petrol	1998	4	82.70	93.00	49

			cm ³	x 			
F3R 742	Petrol		1998	4	82.70	93.00	49
F3R 750	Petrol		1998	4	82.70	93.00	49
F3R 751	Petrol		1998	4	82.70	93.00	49
F3R 752	Petrol		1998	4	82.70	93.00	49
F3R 768	Petrol		1998	4	82.70	93.00	49
F3R 769	Petrol		1998	4	82.70	93.00	49
F3R 791	Petrol		1998	4	82.70	93.00	49
F3R 796	Petrol		1998	4	82.70	93.00	49
F3R 797	Petrol		1998	4	82.70	93.00	49
F3R 798	Petrol		1998	4	82.70	93.00	51
F3R J7	Petrol		1998	4	82.70	93.00	49
F4P 720	Petrol		1783	4	82.70	83.00	46
F4P 722	Petrol		1783	4	82.70	83.00	46
F4P 760	Petrol		1783	4	82.70	83.00	46
F4P 770	Petrol		1783	4	82.70	83.00	46
F4P 771	Petrol		1783	4	82.70	83.00	46
F4P 772	Petrol		1783	4	82.70	83.00	46
F4P 773	Petrol		1783	4	82.70	83.00	46
F4P 774	Petrol		1783	4	82.70	83.00	46
F4P 775	Petrol		1783	4	82.70	83.00	46
F4R	Petrol		1998	4	82.70	93.00	52
F4R 402	Petrol		1998	4	82.70	93.00	52
F4R 700	Petrol		1998	4	82.70	93.00	52
F4R 701	Petrol		1998	4	82.70	93.00	52
F4R 712	Petrol		1998	4	82.70	93.00	52
F4R 713	Petrol		1998	4	82.70	93.00	52
F4R 714	Petrol		1998	4	82.70	93.00	52
F4R 715	Petrol		1998	4	82.70	93.00	52
F4R 720	Petrol		1998	4	82.70	93.00	52
F4R 722	Petrol		1998	4	82.70	93.00	52
F4R 730	Petrol		1998	4	82.70	93.00	52
F4R 732	Petrol		1998	4	82.70	93.00	52
F4R 736	Petrol		1998	4	82.70	93.00	52
F4R 738	Petrol		1998	4	82.70	93.00	52
F4R 740	Petrol		1998	4	82.70	93.00	52
F4R 741	Petrol		1998	4	82.70	93.00	52
F4R 744	Petrol		1998	4	82.70	93.00	52
F4R 746	Petrol		1998	4	82.70	93.00	52
F4R 747	Petrol		1998	4	82.70	93.00	52
F4R 760	Petrol		1998	4	82.70	93.00	52
F4R 761	Petrol		1998	4	82.70	93.00	52
F4R 762	Petrol		1998	4	82.70	93.00	52
F4R 763	Petrol		1998	4	82.70	93.00	52
F4R 764	Petrol		1998	4	82.70	93.00	52
F4R 765	Petrol		1998	4	82.70	93.00	52
F4R 766	Petrol		1998	4	82.70	93.00	52
F4R 770	Petrol		1998	4	82.70	93.00	52
F4R 771	Petrol		1998	4	82.70	93.00	52
F4R 780	Petrol		1998	4	82.70	93.00	52
F4R 786	Petrol		1998	4	82.70	93.00	52
F4R 787	Petrol		1998	4	82.70	93.00	52
F4R 790	Petrol		1998	4	82.70	93.00	52
F4R 791	Petrol		1998	4	82.70	93.00	52
F4R 792	Petrol		1998	4	82.70	93.00	52
F4R 794	Petrol		1998	4	82.70	93.00	52
F4R 795	Petrol		1998	4	82.70	93.00	52
F4R 797	Petrol		1998	4	82.70	93.00	52
F4R 820	Petrol		1998	4	82.70	93.00	52
F4R 867	Petrol		1998	4	82.70	93.00	52
F4R 872	Petrol		1998	4	82.70	93.00	52
F4R Z 770	Petrol		1998	4	82.70	93.00	52
F5R 700	Petrol		1998	4	86.00	86.00	58
F5R 701	Petrol		1998	4	86.00	86.00	58
F5R 740	Petrol		1998	4	82.70	93.00	52
F7P 700	Petrol		1764	4	82.00	83.50	43
F7P 702	Petrol		1764	4	82.00	83.50	43
F7P 704	Petrol		1764	4	82.00	83.50	43
F7P 720	Petrol		1764	4	82.00	83.50	43
F7P 722	Petrol		1764	4	82.00	83.50	43







		cm3	x 			
F7R 700	Petrol	1998	4	82.70	93.00	53
F7R 710	Petrol	1998	4	82.70	93.00	53
F7R 714	Petrol	1998	4	82.70	93.00	53
F8M 700	Diesel	1596	4	78.00	83.50	29
F8M 700	Diesel	1596	4	78.00	83.50	29
F8M 720	Diesel	1596	4	78.00	83.50	29
F8M 730	Diesel	1596	4	78.00	83.50	29
F8M 736	Diesel	1596	4	78.00	83.50	29
F8M 760	Diesel	1596	4	78.00	83.50	29
F8Q 600	Diesel	1870	4	80.00	93.00	35
F8Q 606	Diesel	1870	4	80.00	93.00	35
F8Q 610	Diesel	1870	4	80.00	93.00	36
F8Q 620	Diesel	1870	4	80.00	93.00	35
F8Q 622	Diesel	1870	4	80.00	93.00	37
F8Q 624	Diesel	1870	4	80.00	93.00	35
F8Q 630	Diesel	1870	4	80.00	93.00	35
F8Q 632	Diesel	1870	4	80.00	93.00	35
F8Q 636	Diesel	1870	4	80.00	93.00	35
F8Q 640	Diesel	1870	4	80.00	93.00	35
F8Q 644	Diesel	1870	4	80.00	93.00	35
F8Q 646	Diesel	1870	4	80.00	93.00	35
F8Q 648	Diesel	1870	4	80.00	93.00	35
F8Q 662	Diesel	1870	4	80.00	93.00	35
F8Q 676	Diesel	1870	4	80.00	93.00	35
F8Q 678	Diesel	1870	4	80.00	93.00	35
F8Q 680	Diesel	1870	4	80.00	93.00	35
F8Q 682	Diesel	1870	4	80.00	93.00	35
F8Q 684	Diesel	1870	4	80.00	93.00	35
F8Q 696	Diesel	1870	4	80.00	93.00	35
F8Q 706	Diesel	1870	4	80.00	93.00	38
F8Q 710	Diesel	1870	4	80.00	93.00	38
F8Q 714	Diesel	1870	4	80.00	93.00	35
F8Q 722	Diesel	1870	4	80.00	93.00	35
F8Q 724	Diesel	1870	4	80.00	93.00	35
F8Q 730	Diesel	1870	4	80.00	93.00	35
F8Q 732	Diesel	1870	4	80.00	93.00	35
F8Q 740	Diesel	1870	4	80.00	93.00	36
F8Q 742	Diesel	1870	4	80.00	93.00	38
F8Q 744	Diesel	1870	4	80.00	93.00	36
F8Q 748	Diesel	1870	4	80.00	93.00	39
F8Q 754	Diesel	1870	4	80.00	93.00	39
F8Q 764	Diesel	1870	4	80.00	93.00	35
F8Q 768	Diesel	1870	4	80.00	93.00	39
F8Q 774	Diesel	1870	4	80.00	93.00	35
F8Q 776	Diesel	1870	4	80.00	93.00	35
F8Q 784	Diesel	1870	4	80.00	93.00	39
F8Q 785	Diesel	1870	4	80.00	93.00	39
F8Q 786	Diesel	1870	4	80.00	93.00	39
F8Q 788	Diesel	1870	4	80.00	93.00	39
F8Q 790	Diesel	1870	4	80.00	93.00	35
F8QA6	Diesel	1870	4	80.00	93.00	35
F8QT	Diesel	1870	4	80.00	93.00	39
F9Q 650	Diesel	1870	4	80.00	93.00	40
F9Q 664	Diesel	1870	4	80.00	93.00	40
F9Q 670	Diesel	1870	4	80.00	93.00	40
F9Q 674	Diesel	1870	4	80.00	93.00	40
F9Q 680	Diesel	1870	4	80.00	93.00	40
F9Q 710	Diesel	1870	4	80.00	93.00	40
F9Q 716	Diesel	1870	4	80.00	93.00	40
F9Q 717	Diesel	1870	4	80.00	93.00	40
F9Q 718	Diesel	1870	4	80.00	93.00	40
F9Q 722	Diesel	1870	4	80.00	93.00	40
F9Q 730	Diesel	1870	4	80.00	93.00	40
F9Q 731	Diesel	1870	4	80.00	93.00	40
F9Q 732	Diesel	1870	4	80.00	93.00	40
F9Q 733	Diesel	1870	4	80.00	93.00	40
F9Q 734	Diesel	1870	4	80.00	93.00	40
F9Q 736	Diesel	1870	4	80.00	93.00	40
F9Q 738	Diesel	1870	4	80.00	93.00	40



		cm ³	x 			
F9Q 740	Diesel	1870	4	80.00	93.00	40
F9Q 744	Diesel	1870	4	80.00	93.00	40
F9Q 746	Diesel	1870	4	80.00	93.00	40
F9Q 748	Diesel	1870	4	80.00	93.00	40
F9Q 750	Diesel	1870	4	80.00	93.00	40
F9Q 751	Diesel	1870	4	80.00	93.00	40
F9Q 752	Diesel	1870	4	80.00	93.00	40
F9Q 754	Diesel	1870	4	80.00	93.00	40
F9Q 756	Diesel	1870	4	80.00	93.00	40
F9Q 758	Diesel	1870	4	80.00	93.00	40
F9Q 759	Diesel	1870	4	80.00	93.00	40
F9Q 760	Diesel	1870	4	80.00	93.00	40
F9Q 762	Diesel	1870	4	80.00	93.00	40
F9Q 770	Diesel	1870	4	80.00	93.00	40
F9Q 772	Diesel	1870	4	80.00	93.00	40
F9Q 774	Diesel	1870	4	80.00	93.00	40
F9Q 780	Diesel	1870	4	80.00	93.00	40
F9Q 782	Diesel	1870	4	80.00	93.00	40
F9Q 790	Diesel	1870	4	80.00	93.00	40
F9Q 796	Diesel	1870	4	80.00	93.00	40
F9Q 800	Diesel	1870	4	80.00	93.00	40
F9Q 803	Diesel	1870	4	80.00	93.00	40
F9Q 804	Diesel	1870	4	80.00	93.00	40
F9Q 808	Diesel	1870	4	80.00	93.00	40
F9Q 812	Diesel	1870	4	80.00	93.00	40
F9Q 816	Diesel	1870	4	80.00	93.00	40
F9Q 818	Diesel	1870	4	80.00	93.00	40
F9Q 820	Diesel	1870	4	80.00	93.00	40
F9Q 826	Diesel	1870	4	80.00	93.00	40
F9Q 870	Diesel	1870	4	80.00	93.00	40
F9Q 872	Diesel	1870	4	80.00	93.00	40
F9Q E 804	Diesel	1870	4	80.00	93.00	40
F9Q EE 804	Diesel	1870	4	80.00	93.00	40
F9Q J 803	Diesel	1870	4	80.00	93.00	40
F9Q J 804	Diesel	1870	4	80.00	93.00	40
F9Q N 870	Diesel	1870	4	80.00	93.00	40
F9Q P 872	Diesel	1870	4	80.00	93.00	40
G8T 706	Diesel	2188	4	87.00	92.00	60
G8T 714	Diesel	2188	4	87.00	92.00	61
G8T 716	Diesel	2188	4	87.00	92.00	61
G8T 740	Diesel	2188	4	87.00	92.00	61
G8T 752	Diesel	2188	4	87.00	92.00	60
G8T 760	Diesel	2188	4	87.00	92.00	61
G8T 790	Diesel	2188	4	87.00	92.00	60
G8T 792	Diesel	2188	4	87.00	92.00	60
G8T 794	Diesel	2188	4	87.00	92.00	60
G9T 600	Diesel	2188	4	87.00	92.00	62
G9T 605	Diesel	2188	4	87.00	92.00	62
G9T 606	Diesel	2188	4	87.00	92.00	62
G9T 607	Diesel	2188	4	87.00	92.00	62
G9T 642	Diesel	2188	4	87.00	92.00	62
G9T 645	Diesel	2188	4	87.00	92.00	62
G9T 700	Diesel	2188	4	87.00	92.00	62
G9T 702	Diesel	2188	4	87.00	92.00	62
G9T 703	Diesel	2188	4	87.00	92.00	62
G9T 704	Diesel	2188	4	87.00	92.00	62
G9T 706	Diesel	2188	4	87.00	92.00	62
G9T 707	Diesel	2188	4	87.00	92.00	62
G9T 710	Diesel	2188	4	87.00	92.00	62
G9T 712	Diesel	2188	4	87.00	92.00	62
G9T 720	Diesel	2188	4	87.00	92.00	62
G9T 722	Diesel	2188	4	87.00	92.00	62
G9T 742	Diesel	2188	4	87.00	92.00	62
G9T 743	Diesel	2188	4	87.00	92.00	62
G9T 750	Diesel	2188	4	87.00	92.00	62
G9U 630	Diesel	2464	4	89.00	99.00	70
G9U 632	Diesel	2464	4	89.00	99.00	70
G9U 650	Diesel	2464	4	89.00	99.00	70
G9U 720	Diesel	2463	4	89.00	99.00	70

		cm3	x 			
G9U 724	Diesel	2463	4	89.00	99.00	70
G9U 730	Diesel	2464	4	89.00	99.00	70
G9U 750	Diesel	2463	4	89.00	99.00	70
G9U 754	Diesel	2463	4	89.00	99.00	70
J5R 716	Petrol	1995	4	88.00	82.00	66
J5R 718	Petrol	1995	4	88.00	82.00	66
J5R 722	Petrol	1995	4	88.00	82.00	66
J5R 726	Petrol	1995	4	88.00	82.00	65
J5R 728	Petrol	1995	4	88.00	82.00	66
J5R 800	Petrol	1995	4	88.00	82.00	65
J6R 234	Petrol	1995	4	88.00	82.00	66
J6R 236	Petrol	1995	4	88.00	82.00	66
J6R 706	Petrol	1995	4	88.00	82.00	66
J6R 707	Petrol	1995	4	88.00	82.00	66
J6R 710	Petrol	1995	4	88.00	82.00	65
J6R 711	Petrol	1995	4	88.00	82.00	65
J6R 712	Petrol	1995	4	88.00	82.00	65
J6R 713	Petrol	1995	4	88.00	82.00	65
J6R 714	Petrol	1995	4	88.00	82.00	66
J6R 715	Petrol	1995	4	88.00	82.00	65
J6R 716	Petrol	1995	4	88.00	82.00	65
J6R 726	Petrol	1995	4	88.00	82.00	65
J6R 734	Petrol	1995	4	88.00	82.00	66
J6R 758	Petrol	1995	4	88.00	82.00	66
J6R 759	Petrol	1995	4	88.00	82.00	66
J6R 760	Petrol	1995	4	88.00	82.00	66
J6R 762	Petrol	1995	4	88.00	82.00	66
J6R 763	Petrol	1995	4	88.00	82.00	66
J6R 792	Petrol	1995	4	88.00	82.00	66
J6R 793	Petrol	1995	4	88.00	82.00	66
J6T 790	Petrol	2165	4	88.00	89.00	69
J6T 791	Petrol	2165	4	88.00	89.00	69
J7R 720	Petrol	1995	4	88.00	82.00	66
J7R 721	Petrol	1995	4	88.00	82.00	66
J7R 722	Petrol	1995	4	88.00	82.00	66
J7R 723	Petrol	1995	4	88.00	82.00	66
J7R 726	Petrol	1995	4	88.00	82.00	66
J7R 732	Petrol	1995	4	88.00	82.00	66
J7R 733	Petrol	1995	4	88.00	82.00	66
J7R 734	Petrol	1995	4	88.00	82.00	66
J7R 735	Petrol	1995	4	88.00	82.00	66
J7R 738	Petrol	1995	4	88.00	82.00	66
J7R 739	Petrol	1995	4	88.00	82.00	66
J7R 740	Petrol	1995	4	88.00	82.00	66
J7R 746	Petrol	1995	4	88.00	82.00	66
J7R 747	Petrol	1995	4	88.00	82.00	66
J7R 750	Petrol	1995	4	88.00	82.00	66
J7R 751	Petrol	1995	4	88.00	82.00	66
J7R 752	Petrol	1995	4	88.00	82.00	66
J7R 754	Petrol	1995	4	88.00	82.00	66
J7R 756	Petrol	1995	4	88.00	82.00	66
J7R 760	Petrol	1995	4	88.00	82.00	66
J7R 768	Petrol	1995	4	88.00	82.00	66
J7T 284	Petrol	2165	4	88.00	89.00	68
J7T 600	Petrol	2165	4	88.00	89.00	68
J7T 706	Petrol	2165	4	88.00	89.00	68
J7T 707	Petrol	2165	4	88.00	89.00	68
J7T 708	Petrol	2165	4	88.00	89.00	68
J7T 714	Petrol	2165	4	88.00	89.00	68
J7T 715	Petrol	2165	4	88.00	89.00	68
J7T 718	Petrol	2165	4	88.00	89.00	68
J7T 719	Petrol	2165	4	88.00	89.00	68
J7T 730	Petrol	2165	4	88.00	89.00	68
J7T 731	Petrol	2165	4	88.00	89.00	68
J7T 732	Petrol	2165	4	88.00	89.00	68
J7T 733	Petrol	2165	4	88.00	89.00	68
J7T 734	Petrol	2165	4	88.00	89.00	68
J7T 736	Petrol	2165	4	88.00	89.00	68
J7T 754	Petrol	2165	4	88.00	89.00	68







		cm ³	x 			
--	---	-----------------	---	---	---	---







J7T 755	Petrol	2165	4	88.00	89.00	68
J7T 756	Petrol	2165	4	88.00	89.00	68
J7T 760	Petrol	2165	4	88.00	89.00	68
J7T 761	Petrol	2165	4	88.00	89.00	68
J7T 762	Petrol	2165	4	88.00	89.00	68
J7T 763	Petrol	2165	4	88.00	89.00	68
J7T 770	Petrol	2165	4	88.00	89.00	68
J7T 772	Petrol	2165	4	88.00	89.00	68
J7T 773	Petrol	2165	4	88.00	89.00	68
J7T 776	Petrol	2165	4	88.00	89.00	68
J7T 780	Petrol	2165	4	88.00	89.00	68
J7T 782	Petrol	2165	4	88.00	89.00	68
J7T 788	Petrol	2165	4	88.00	89.00	68
J8S 120	Diesel	2068	4	86.00	89.00	59
J8S 174	Diesel	2068	4	86.00	89.00	59
J8S 232 (852.232)	Diesel	2068	4	86.00	89.00	59
J8S 234	Diesel	2068	4	86.00	89.00	59
J8S 240	Diesel	2068	4	86.00	89.00	59
J8S 330	Diesel	2068	4	86.00	89.00	59
J8S 600	Diesel	2068	4	86.00	89.00	59
J8S 604	Diesel	2068	4	86.00	89.00	59
J8S 610	Diesel	2068	4	86.00	89.00	59
J8S 612	Diesel	2068	4	86.00	89.00	59
J8S 620	Diesel	2068	4	86.00	89.00	59
J8S 622	Diesel	2068	4	86.00	89.00	59
J8S 702	Diesel	2068	4	86.00	89.00	59
J8S 704	Diesel	2068	4	86.00	89.00	59
J8S 706	Diesel	2068	4	86.00	89.00	59
J8S 708	Diesel	2068	4	86.00	89.00	59
J8S 711	Diesel	2068	4	86.00	89.00	59
J8S 712	Diesel	2068	4	86.00	89.00	59
J8S 714	Diesel	2068	4	86.00	89.00	59
J8S 736	Diesel	2068	4	86.00	89.00	59
J8S 738	Diesel	2068	4	86.00	89.00	59
J8S 740	Diesel	2068	4	86.00	89.00	59
J8S 742	Diesel	2068	4	86.00	89.00	59
J8S 746	Diesel	2068	4	86.00	89.00	59
J8S 750	Diesel	2068	4	86.00	89.00	59
J8S 758	Diesel	2068	4	86.00	89.00	59
J8S 760	Diesel	2068	4	86.00	89.00	59
J8S 772	Diesel	2068	4	86.00	89.00	59
J8S 774	Diesel	2068	4	86.00	89.00	59
J8S 776	Diesel	2068	4	86.00	89.00	59
J8S 778	Diesel	2068	4	86.00	89.00	59
J8S 784	Diesel	2068	4	86.00	89.00	59
J8S 786	Diesel	2068	4	86.00	89.00	59
J8S 788	Diesel	2068	4	86.00	89.00	59
J8S 800	Diesel	2068	4	86.00	89.00	59
J8S 814	Diesel	2068	4	86.00	89.00	59
J8S 890	Diesel	2068	4	86.00	89.00	59
K4J 700	Petrol	1390	4	79.50	70.00	32
K4J 710	Petrol	1390	4	79.50	70.00	32
K4J 711	Petrol	1390	4	79.50	70.00	32
K4J 712	Petrol	1390	4	79.50	70.00	32
K4J 713	Petrol	1390	4	79.50	70.00	32
K4J 714	Petrol	1390	4	79.50	70.00	32
K4J 715	Petrol	1390	4	79.50	70.00	32
K4J 718	Petrol	1390	4	79.50	70.00	32
K4J 730	Petrol	1390	4	79.50	70.00	32
K4J 732	Petrol	1390	4	79.50	70.00	32
K4J 740	Petrol	1390	4	79.50	70.00	32
K4J 750	Petrol	1390	4	79.50	70.00	32
K4J 770	Petrol	1390	4	79.50	70.00	32
K4J 780	Petrol	1390	4	79.50	70.00	32
K4J D 729	Petrol	1390	4	79.50	70.00	32
K4J D 740	Petrol	1390	4	79.50	70.00	32
K4M 616	Petrol	1598	4	79.50	80.50	33
K4M 690	Petrol	1598	4	79.50	80.50	33
K4M 697	Petrol	1598	4	79.50	80.50	33







		cm3	x 			
K4M 698	Petrol	1598	4	79.50	80.50	33
K4M 700	Petrol	1598	4	79.50	80.50	33
K4M 701	Petrol	1598	4	79.50	80.50	33
K4M 704	Petrol	1598	4	79.50	80.50	33
K4M 706	Petrol	1598	4	79.50	80.50	33
K4M 707	Petrol	1598	4	79.50	80.50	33
K4M 708	Petrol	1598	4	79.50	80.50	33
K4M 709	Petrol	1598	4	79.50	80.50	33
K4M 710	Petrol	1598	4	79.50	80.50	33
K4M 711	Petrol	1598	4	79.50	80.50	33
K4M 712	Petrol	1598	4	79.50	80.50	33
K4M 714	Petrol	1598	4	79.50	80.50	33
K4M 716	Petrol	1598	4	79.50	80.50	33
K4M 718	Petrol	1598	4	79.50	80.50	33
K4M 720	Petrol	1598	4	79.50	80.50	33
K4M 724	Petrol	1598	4	79.50	80.50	33
K4M 730	Petrol	1598	4	79.50	80.50	33
K4M 732	Petrol	1598	4	79.50	80.50	33
K4M 734	Petrol	1598	4	79.50	80.50	33
K4M 736	Petrol	1598	4	79.50	80.50	33
K4M 740	Petrol	1598	4	79.50	80.50	33
K4M 742	Petrol	1598	4	79.50	80.50	33
K4M 743	Petrol	1598	4	79.50	80.50	33
K4M 744	Petrol	1598	4	79.50	80.50	33
K4M 745	Petrol	1598	4	79.50	80.50	33
K4M 746	Petrol	1598	4	79.50	80.50	33
K4M 748	Petrol	1598	4	79.50	80.50	33
K4M 750	Petrol	1598	4	79.50	80.50	33
K4M 752	Petrol	1598	4	79.50	80.50	33
K4M 753	Petrol	1598	4	79.50	80.50	33
K4M 754	Petrol	1598	4	79.50	80.50	33
K4M 760	Petrol	1598	4	79.50	80.50	33
K4M 761	Petrol	1598	4	79.50	80.50	33
K4M 762	Petrol	1598	4	79.50	80.50	33
K4M 764	Petrol	1598	4	79.50	80.50	33
K4M 766	Petrol	1598	4	79.50	80.50	33
K4M 768	Petrol	1598	4	79.50	80.50	33
K4M 776	Petrol	1598	4	79.50	80.50	33
K4M 782	Petrol	1598	4	79.50	80.50	33
K4M 788	Petrol	1598	4	79.50	80.50	33
K4M 790	Petrol	1598	4	79.50	80.50	33
K4M 791	Petrol	1598	4	79.50	80.50	33
K4M 792	Petrol	1598	4	79.50	80.50	33
K4M 794	Petrol	1598	4	79.50	80.50	33
K4M 800	Petrol	1598	4	79.50	80.50	33
K4M 801	Petrol	1598	4	79.50	80.50	33
K4M 804	Petrol	1598	4	79.50	80.50	33
K4M 812	Petrol	1598	4	79.50	80.50	33
K4M 813	Petrol	1598	4	79.50	80.50	33
K4M 824	Petrol	1598	4	79.50	80.50	33
K4M 830	Petrol	1598	4	79.50	80.50	33
K4M 831	Petrol	1598	4	79.50	80.50	33
K4M 834	Gas	1598	4	79.50	80.50	33
K4M 838	Petrol	1598	4	79.50	80.50	33
K4M 839	Petrol	1598	4	79.50	80.50	33
K4M 848	Petrol	1598	4	79.50	80.50	33
K4M 850	Petrol	1598	4	79.50	80.50	33
K4M 854	Petrol	1598	4	79.50	80.50	33
K4M 856	Petrol	1598	4	79.50	80.50	33
K4M 858	Petrol	1598	4	79.50	80.50	33
K4M 862	Petrol	1598	4	79.50	80.50	33
K4M 866	Petrol	1598	4	79.50	80.50	33
K4M 8 788	Petrol	1598	4	79.50	80.50	33
K4M 9 766	Petrol	1598	4	79.50	80.50	33
K4M C 812	Petrol	1598	4	79.50	80.50	33
K4M C 813	Petrol	1598	4	79.50	80.50	33
K4M D 812	Petrol	1598	4	79.50	80.50	33
K4M D 813	Petrol	1598	4	79.50	80.50	33
K4M P 848	Petrol	1598	4	79.50	80.50	33







		cm ³	x 			9
--	---	-----------------	---	---	---	----------

K4M R 858	Petrol	1598	4	79.50	80.50	33
K4M T 782	Petrol	1598	4	79.50	80.50	33
K4M T 866	Petrol	1598	4	79.50	80.50	33
K4M W 761	Petrol	1598	4	79.50	80.50	33
K7J 700	Petrol	1390	4	75.80	77.00	23
K7J 701	Petrol	1390	4	75.80	77.00	23
K7J 710	Petrol	1390	4	79.50	70.00	32
K7J 714	Petrol	1390	4	79.50	70.00	32
K7M 690	Petrol	1598	4	79.50	80.50	34
K7M 702	Petrol	1598	4	79.50	80.50	34
K7M 703	Petrol	1598	4	79.50	80.50	34
K7M 704	Petrol	1598	4	79.50	80.50	34
K7M 710	Petrol	1598	4	79.50	80.50	34
K7M 718	Petrol	1598	4	79.50	80.50	34
K7M 720	Petrol	1598	4	79.50	80.50	34
K7M 732	Petrol	1598	4	79.50	80.50	34
K7M 734	Petrol	1598	4	79.50	80.50	34
K7M 744	Petrol	1598	4	79.50	80.50	34
K7M 745	Petrol	1598	4	79.50	80.50	34
K7M 746	Petrol	1598	4	79.50	80.50	34
K7M 750	Petrol	1598	4	79.50	80.50	34
K7M 790	Petrol	1598	4	79.50	80.50	34
K9K 276	Diesel	1461	4	76.00	80.50	25
K9K 608	Diesel	1461	4	76.00	80.50	25
K9K 612	Diesel	1461	4	76.00	80.50	25
K9K 636	Diesel	1461	4	76.00	80.50	25
K9K 700	Diesel	1461	4	76.00	80.50	25
K9K 702	Diesel	1461	4	76.00	80.50	25
K9K 704	Diesel	1461	4	76.00	80.50	25
K9K 706	Diesel	1461	4	76.00	80.50	25
K9K 708	Diesel	1461	4	76.00	80.50	25
K9K 710	Diesel	1461	4	76.00	80.50	25
K9K 712	Diesel	1461	4	76.00	80.50	25
K9K 714	Diesel	1461	4	76.00	80.50	25
K9K 716	Diesel	1461	4	76.00	80.50	25
K9K 718	Diesel	1461	4	76.00	80.50	25
K9K 722	Diesel	1461	4	76.00	80.50	25
K9K 724	Diesel	1461	4	76.00	80.50	25
K9K 728	Diesel	1461	4	76.00	80.50	25
K9K 729	Diesel	1461	4	76.00	80.50	25
K9K 732	Diesel	1461	4	76.00	80.50	25
K9K 734	Diesel	1461	4	76.00	80.50	25
K9K 740	Diesel	1461	4	76.00	80.50	25
K9K 750	Diesel	1461	4	76.00	80.50	25
K9K 752	Diesel	1461	4	76.00	80.50	25
K9K 760	Diesel	1461	4	76.00	80.50	25
K9K 762	Diesel	1461	4	76.00	80.50	25
K9K 764	Diesel	1461	4	76.00	80.50	25
K9K 766	Diesel	1461	4	76.00	80.50	25
K9K 768	Diesel	1461	4	76.00	80.50	25
K9K 770	Diesel	1461	4	76.00	80.50	25
K9K 772	Diesel	1461	4	76.00	80.50	25
K9K 774	Diesel	1461	4	76.00	80.50	25
K9K 780	Diesel	1461	4	76.00	80.50	25
K9K 782	Diesel	1461	4	76.00	80.50	25
K9K 790	Diesel	1461	4	76.00	80.50	25
K9K 792	Diesel	1461	4	76.00	80.50	25
K9K 794	Diesel	1461	4	76.00	80.50	25
K9K 796	Diesel	1461	4	76.00	80.50	25
K9K 800	Diesel	1461	4	76.00	80.50	25
K9K 802	Diesel	1461	4	76.00	80.50	25
K9K 804	Diesel	1461	4	76.00	80.50	25
K9K 806	Diesel	1461	4	76.00	80.50	25
K9K 808	Diesel	1461	4	76.00	80.50	25
K9K 812	Diesel	1461	4	76.00	80.50	25
K9K 820	Diesel	1461	4	76.00	80.50	25
K9K 826	Diesel	1461	4	76.00	80.50	25
K9K 830	Diesel	1461	4	76.00	80.50	25
K9K 832	Diesel	1461	4	76.00	80.50	25

		cm3	x 			
K9K 834	Diesel	1461	4	76.00	80.50	25
K9K 836	Diesel	1461	4	76.00	80.50	25
K9K 837	Diesel	1461	4	76.00	80.50	25
K9K 840	Diesel	1461	4	76.00	80.50	25
K9K 846	Diesel	1461	4	76.00	80.50	25
K9K 884	Diesel	1461	4	76.00	80.50	25
K9K F 830	Diesel	1461	4	76.00	80.50	25
K9K G 724	Diesel	1461	4	76.00	80.50	25
K9K G 832	Diesel	1461	4	76.00	80.50	25
K9K H 834	Diesel	1461	4	76.00	80.50	25
K9K J 836	Diesel	1461	4	76.00	80.50	25
K9K N 837	Diesel	1461	4	76.00	80.50	25
K9K P 732	Diesel	1461	4	76.00	80.50	25
M9R 610	Diesel	1995	4	84.00	90.00	56
M9R 615	Diesel	1995	4	84.00	90.00	56
M9R 630	Diesel	1995	4	84.00	90.00	56
M9R 692	Diesel	1995	4	84.00	90.00	56
M9R 700	Diesel	1995	4	84.00	90.00	56
M9R 721	Diesel	1995	4	84.00	90.00	56
M9R 722	Diesel	1995	4	84.00	90.00	56
M9R 724	Diesel	1995	4	84.00	90.00	56
M9R 740	Diesel	1995	4	84.00	90.00	56
M9R 742	Diesel	1995	4	84.00	90.00	56
M9R 744	Diesel	1995	4	84.00	90.00	56
M9R 746	Diesel	1995	4	84.00	90.00	56
M9R 748	Diesel	1995	4	84.00	90.00	56
M9R 750	Diesel	1995	4	84.00	90.00	56
M9R 760	Diesel	1995	4	84.00	90.00	56
M9R 761	Diesel	1995	4	84.00	90.00	56
M9R 762	Diesel	1995	4	84.00	90.00	56
M9R 763	Diesel	1995	4	84.00	90.00	56
M9R 780	Diesel	1995	4	84.00	90.00	56
M9R 782	Diesel	1995	4	84.00	90.00	56
M9R 784	Diesel	1995	4	84.00	90.00	56
M9R 786	Diesel	1995	4	84.00	90.00	56
M9R 788	Diesel	1995	4	84.00	90.00	56
M9R 800	Diesel	1995	4	84.00	90.00	56
M9R 802	Diesel	1995	4	84.00	90.00	56
M9R 804	Diesel	1995	4	84.00	90.00	56
M9R 805	Diesel	1995	4	84.00	90.00	56
M9R 809	Diesel	1995	4	84.00	90.00	56
M9R 814	Diesel	1995	4	84.00	90.00	56
M9R 815	Diesel	1995	4	84.00	90.00	56
M9R 816	Diesel	1995	4	84.00	90.00	56
M9R 817	Diesel	1995	4	84.00	90.00	56
M9R 820	Diesel	1995	4	84.00	90.00	56
M9R 824	Diesel	1995	4	84.00	90.00	56
M9R 828	Diesel	1995	4	84.00	90.00	56
M9R 830	Diesel	1995	4	84.00	90.00	56
M9R 832	Diesel	1995	4	84.00	90.00	56
M9R 833	Diesel	1995	4	84.00	90.00	56
M9R 844	Diesel	1995	4	84.00	90.00	56
M9R 845	Diesel	1995	4	84.00	90.00	56
M9R 846	Diesel	1995	4	84.00	90.00	56
M9R 849	Diesel	1995	4	84.00	90.00	56
M9R 854	Diesel	1995	4	84.00	90.00	56
M9R 855	Diesel	1995	4	84.00	90.00	56
M9R 856	Diesel	1995	4	84.00	90.00	56
M9R 857	Diesel	1995	4	84.00	90.00	56
M9R 858	Diesel	1995	4	84.00	90.00	56
M9R 859	Diesel	1995	4	84.00	90.00	56
M9R 862	Diesel	1995	4	84.00	90.00	56
M9R 864	Diesel	1995	4	84.00	90.00	56
M9R 865	Diesel	1995	4	84.00	90.00	56
M9R 866	Diesel	1995	4	84.00	90.00	56
M9R A 700	Diesel	1995	4	84.00	90.00	56
M9Ra 742	Diesel	1995	4	84.00	90.00	56
M9R B 610	Diesel	1995	4	84.00	90.00	56
M9R B 721	Diesel	1995	4	84.00	90.00	56

		cm ³	x 			
M9R C 613	Diesel	1995	4	84.00	90.00	56
M9R C 615	Diesel	1995	4	84.00	90.00	56
M9R C 830	Diesel	1995	4	84.00	90.00	56
M9R D 833	Diesel	1995	4	84.00	90.00	56
M9R G 832	Diesel	1995	4	84.00	90.00	56
M9Rk 800	Diesel	1995	4	84.00	90.00	56
M9Rk 802	Diesel	1995	4	84.00	90.00	56
M9Rk 805	Diesel	1995	4	84.00	90.00	56
M9Rk 806	Diesel	1995	4	84.00	90.00	56
M9Rk 816	Diesel	1995	4	84.00	90.00	56
M9T 670	Diesel	2298	4	85.00	101.30	57
M9T 672	Diesel	2298	4	85.00	101.30	57
M9T 676	Diesel	2298	4	85.00	101.30	57
M9T 678	Diesel	2298	4	85.00	101.30	57
M9T 680	Diesel	2298	4	85.00	101.30	57
M9T 686	Diesel	2298	4	85.00	101.30	57
M9T 690	Diesel	2298	4	85.00	101.30	57
M9T 692	Diesel	2298	4	85.00	101.30	57
M9T 694	Diesel	2298	4	85.00	101.30	57
M9T 696	Diesel	2298	4	85.00	101.30	57
M9T 698	Diesel	2298	4	85.00	101.30	57
M9T 870	Diesel	2298	4	85.00	101.30	57
M9T 880	Diesel	2298	4	85.00	101.30	57
M9T 890	Diesel	2298	4	85.00	101.30	57
M9T 896	Diesel	2298	4	85.00	101.30	57
M9T 898	Diesel	2298	4	85.00	101.30	57
M420 MDX	Diesel	6328	4	120.00	140.00	97
M 520	Diesel	7917	5	120.00	140.00	98
M 620 Z 3	Diesel	9500	6	120.00	140.00	99
MDS 06.35.40	Diesel	12024	6	135.00	140.00	109
MDS 06.35.40	Diesel	12024	6	135.00	140.00	109
MDS 06.35.40 A	Diesel	12024	6	135.00	140.00	109
MDS 06.35.40 A	Diesel	12024	6	135.00	140.00	109
MDS 06.35.40 H	Diesel	12024	6	135.00	140.00	109
MDS 06.35.40 I	Diesel	12024	6	135.00	140.00	109
MID 06.20.30	Diesel	8820	6	120.00	130.00	95
MID 06.20.30 C	Diesel	8820	6	120.00	130.00	95
MID 06.20.30 D	Diesel	8820	6	120.00	130.00	95
MID 06.20.30 G	Diesel	8820	6	120.00	130.00	95
MID 06.20.30 H	Diesel	8820	6	120.00	130.00	95
MID 06.20.45	Diesel	9840	6	120.00	145.00	100
MIDR 04.02.26 A/41 Euro 2	Diesel	4100	4	102.00	126.00	91
MIDR 04.02.26 A/4 Euro 2	Diesel	4120	4	102.00	126.00	91
MIDR 04.02.26 B/41 Euro 2	Diesel	4100	4	102.00	126.00	91
MIDR 04.02.26 B/4 Euro 2	Diesel	4120	4	102.00	126.00	91
MIDR 06.02.12	Diesel	5491	6	102.00	112.00	90
MIDR 06.02.12 B	Diesel	5490	6	102.00	112.00	90
MIDR 06.02.12 C	Diesel	5490	6	102.00	112.00	90
MIDR 06.02.12 D	Diesel	5490	6	102.00	112.00	90
MIDR 06.02.12 D3	Diesel	5490	6	102.00	112.00	90
MIDR 06.02.12 L	Diesel	5490	6	102.00	112.00	90
MIDR 06.02.26	Diesel	6180	6	102.00	126.00	92
MIDR 06.02.26 D	Diesel	6180	6	102.00	126.00	92
MIDR 06.02.26 H	Diesel	6180	6	102.00	126.00	92
MIDR 06.02.26 I	Diesel	6180	6	102.00	126.00	92
MIDR 06.02.26 K	Diesel	6180	6	102.00	126.00	92
MIDR 06.02.26 L	Diesel	6180	6	102.00	126.00	92
MIDR 06.02.26 L2	Diesel	6180	6	102.00	126.00	92
MIDR 06.02.26 M	Diesel	6180	6	102.00	126.00	92
MIDR 06.02.26 M2	Diesel	6180	6	102.00	126.00	92
MIDR 06.02.26 Q	Diesel	6180	6	102.00	126.00	92
MIDR 06.02.26 S	Diesel	6174	6	102.00	126.00	92
MIDR 06.02.26 U/4 Euro 2	Diesel	6180	6	102.00	126.00	92
MIDR 06.02.26 U Euro 1	Diesel	6174	6	102.00	126.00	92
MIDR 06.02.26 V/41 Euro 2	Diesel	6180	6	102.00	126.00	92
MIDR 06.02.26 V/4 Euro 2	Diesel	6177	6	102.00	126.00	92
MIDR 06.02.26 V Euro 1	Diesel	6174	6	102.00	126.00	92
MIDR 06.02.26 W/41 Euro 2	Diesel	6180	6	102.00	126.00	92
MIDR 06.02.26 W/4 Euro 2	Diesel	6177	6	102.00	126.00	92

		cm3	x 			
MIDR 06.02.26 W Euro 1	Diesel	6174-6180	6	102.00	126.00	92
MIDR 06.02.26 X Euro 1	Diesel	6180	6	102.00	126.00	92
MIDR 06.02.26 Y/41 Euro 2	Diesel	6177-6180	6	102.00	126.00	92
MIDR 06.20.30 A	Diesel	8820	6	120.00	130.00	95
MIDR 06.20.30 B	Diesel	8820	6	120.00	130.00	95
MIDR 06.20.30 C	Diesel	8820	6	120.00	130.00	95
MIDR 06.20.45	Diesel	9771	6	120.00	145.00	101
MIDR 06.20.45 A	Diesel	9839	6	120.00	145.00	100
MIDR 06.20.45 A2	Diesel	9840	6	120.00	145.00	100
MIDR 06.20.45 B3	Diesel	9839	6	120.00	145.00	102
MIDR 06.20.45 C	Diesel	9840	6	120.00	145.00	100
MIDR 06.20.45 C/4 Euro 2	Diesel	9839	6	120.00	145.00	103
MIDR 06.20.45 D	Diesel	9839	6	120.00	145.00	100
MIDR 06.20.45 D/41 Euro 2	Diesel	9839	6	120.00	145.00	103
MIDR 06.20.45 D3 Euro 1	Diesel	9839	6	120.00	145.00	100
MIDR 06.20.45 E	Diesel	9839	6	120.00	145.00	100
MIDR 06.20.45 E/41 Euro 2	Diesel	9839	6	120.00	145.00	100
MIDR 06.20.45 E2	Diesel	9839	6	120.00	145.00	102
MIDR 06.20.45 E3 Euro 1	Diesel	9839	6	120.00	145.00	100
MIDR 06.20.45 F3	Diesel	9840	6	120.00	145.00	100
MIDR 06.20.45 H	Diesel	9839	6	120.00	145.00	102
MIDR 06.20.45 I3	Diesel	9840	6	120.00	145.00	100
MIDR 06.20.45 I41 Euro 2	Diesel	9840	6	120.00	145.00	103
MIDR 06.20.45 J3	Diesel	9839	6	120.00	145.00	100
MIDR 06.20.45 K	Diesel	9840	6	120.00	145.00	100
MIDR 06.20.45 L	Diesel	9840	6	120.00	145.00	100
MIDR 06.20.45 M	Diesel	9840	6	120.00	145.00	100
MIDR 06.20.45 M3	Diesel	9840	6	120.00	145.00	100
MIDR 06.20.45 M41 Euro 2	Diesel	9839	6	120.00	145.00	100
MIDR 06.20.45 R41 Euro 2	Diesel	9839	6	120.00	145.00	100
MIDR 06.23.56 A/3 Euro 2	Diesel	11100	6	123.00	156.00	106
MIDR 06.23.56 A/41 Euro 2	Diesel	11100	6	123.00	156.00	106
MIDR 06.23.56 B/41 Euro 2	Diesel	11100	6	123.00	156.00	106
MIDR 06.35.40	Diesel	12024	6	135.00	140.00	109
MIDR 06.35.40 C	Diesel	11941	6	135.00	140.00	109
MIDR 06.35.40 G	Diesel	12024	6	135.00	140.00	109
MIDR 06.35.40 H	Diesel	12024	6	135.00	140.00	109
MIDR 06.35.40 J/3 Euro 1	Diesel	12024	6	135.00	140.00	109
MIDR 06.35.40 J1 Euro 1	Diesel	12024	6	135.00	140.00	109
MIDR 06.35.40 L1	Diesel	12024	6	135.00	140.00	109
MIDR 06.35.40 M3 Euro 1	Diesel	12024	6	135.00	140.00	109
MIDR 06.35.40 N/3 Euro 1	Diesel	12024	6	135.00	140.00	109
MIDR 06.35.40 P/41 Euro 2	Diesel	12024	6	135.00	140.00	109
MIDS 06.02.12	Diesel	5490	6	102.00	112.00	90
MIDS 06.02.12 B	Diesel	5453-5490	6	102.00	112.00	90
MIDS 06.02.12 C	Diesel	5490	6	102.00	112.00	90
MIDS 06.02.12 D	Diesel	5490	6	102.00	112.00	90
MIDS 06.02.12 D/3	Diesel	5490	6	102.00	112.00	90
MIDS 06.20.30	Diesel	8820	6	120.00	130.00	95
MIDS 06.20.30	Diesel	8821	6	120.00	130.00	95
MIDS 06.20.30 B	Diesel	8820	6	120.00	130.00	95
MIDS 06.20.30 D	Diesel	8820	6	120.00	130.00	95
MIDS 06.20.30 D	Diesel	8820	6	120.00	130.00	95
MIDS 06.20.30 E	Diesel	8820	6	120.00	130.00	95
MIDS 06.20.30 K	Diesel	8820	6	120.00	130.00	95
MIDS 06.20.30 N	Diesel	8820	6	120.00	130.00	96
MIDS 06.20.30 N1	Diesel	8820	6	120.00	130.00	96
MIDS 06.20.30 P	Diesel	8821	6	120.00	130.00	96
MIDS 06.20.45	Diesel	9839	6	120.00	145.00	101
MIDS 06.20.45 B	Diesel	9839	6	120.00	145.00	100
MIDS 06.20.45 D	Diesel	9840	6	120.00	145.00	100
MIDS 06.20.45 F	Diesel	9840	6	120.00	145.00	100
MIDS 06.20.45 J	Diesel	9840	6	120.00	145.00	102
MIDS 06.20.45 J3	Diesel	9840	6	120.00	145.00	102
MIDS 06.35.40	Diesel	12024	6	135.00	140.00	109
MIDS 06.35.40 B	Diesel	12024	6	135.00	140.00	109
MIDS 06.35.40 D	Diesel	12024	6	135.00	140.00	109
MIDS 06.35.40 E	Diesel	12024	6	135.00	140.00	109
MIHR 06.20.45 A41 Euro 2	Diesel	9839	6	120.00	145.00	100

		cm3	x 			
MIPR 06.20.45	Diesel	9840	6	120.00	145.00	100
MIPR 06.20.45 A	Diesel	9840	6	120.00	145.00	100
MIPR 06.20.45 A3	Diesel	9840	6	120.00	145.00	101
MIPR 06.20.45 B3	Diesel	9840	6	120.00	145.00	100
MIPR 06.20.45 C3	Diesel	9840	6	120.00	145.00	100
MIPS 06.20.30	Diesel	8820	6	120.00	130.00	95
MIPS 06.20.45	Diesel	9840	6	120.00	145.00	100
MIPS 06.20.45 A	Diesel	9840	6	120.00	145.00	100
MIPS 06.20.45 B	Diesel	9840	6	120.00	145.00	101
N7Q 700	Petrol	1948	4	83.00	90.00	54
N7Q 704	Petrol	1948	4	83.00	90.00	54
N7Q 710	Petrol	1948	4	83.00	90.00	54
N7Q 711	Petrol	1948	4	83.00	90.00	54
N7U 700	Petrol	2435	5	83.00	90.00	55
N7U 701	Petrol	2435	5	83.00	90.00	55
S8U 720	Diesel	2445	4	93.00	90.00	74
S8U 722	Diesel	2445	4	93.00	90.00	74
S8U 730	Diesel	2445	4	93.00	90.00	75
S8U 731	Diesel	2445	4	93.00	90.00	74
S8U 742	Diesel	2499	4	93.00	92.00	77
S8U 748	Diesel	2445	4	93.00	90.00	74
S8U 750	Diesel	2499	4	93.00	92.00	76
S8U 752	Diesel	2499	4	93.00	92.00	76
S8U 758	Diesel	2499	4	93.00	92.00	76
S8U 762	Diesel	2500	4	93.00	92.00	76
S8U 763	Diesel	2500	4	93.00	92.00	76
S8U 770	Diesel	2499	4	93.00	92.00	81
S8U 772	Diesel	2499	4	93.00	92.00	77
S8U 780	Diesel	2499	4	93.00	92.00	81
S8U 782	Diesel	2499	4	93.00	92.00	77
S9U 700	Diesel	2499	4	93.00	92.00	77
S9U 702	Diesel	2499	4	93.00	92.00	76
S9U 704	Diesel	2499	4	93.00	92.00	77
S9U 714	Diesel	2499	4	93.00	92.00	76
S9U 740	Diesel	2499	4	93.00	92.00	76
T 4.40	Diesel	3869	4	100.00	127.00	86
X5J	Petrol	1360	4	75.00	77.00	21
Z6W 700	Petrol	2850	V6	91.00	73.00	71
Z6W 702	Petrol	2850	V6	91.00	73.00	71
Z7V 708	Petrol	2664	V6	88.00	73.00	63
Z7V 709	Petrol	2664	V6	88.00	73.00	63
Z7V 711	Petrol	2664	V6	88.00	73.00	63
Z7W 700	Petrol	2849	V6	91.00	73.00	71
Z7W 701	Petrol	2849	V6	91.00	73.00	71
Z7W 702	Petrol	2849	V6	91.00	73.00	71
Z7W 706	Petrol	2849	V6	91.00	73.00	71
Z7W 707	Petrol	2849	V6	91.00	73.00	71
Z7W 709	Petrol	2849	V6	91.00	73.00	71
Z7W 712	Petrol	2849	V6	91.00	73.00	71
Z7W 713	Petrol	2849	V6	91.00	73.00	71
Z7W 717	Petrol	2849	V6	91.00	73.00	71
Z7X 27	Petrol	2963	V6	93.00	72.70	72
Z7X 721	Petrol	2963	V6	93.00	72.70	72
Z7X 722	Petrol	2963	V6	93.00	72.70	72
Z7X 723	Petrol	2963	V6	93.00	72.70	72
Z7X 753	Petrol	2963	V6	93.00	72.70	72
Z7X 755	Petrol	2963	V6	93.00	72.70	72
Z7X 760	Petrol	2963	V6	93.00	72.70	72
Z7X 765	Petrol	2963	V6	93.00	72.70	72
Z7X 767	Petrol	2963	V6	93.00	72.70	72
Z7X 775	Petrol	2963	V6	93.00	72.70	72

1 49.00 x 80.00

690		4 Cyl.		603cc		Petrol		FM3293	
BE/PL	4	37,959/37,975	41,128/41,139	21,180	1,569	0,020/0,067	AL-LF	2390RA	01-4133/4 STD 0.25 0.50 0.75
MB/HL 2	1	39,975/39,991	44,000/44,013	30,120	1,990	0,029/0,083	AL-LF	2392RAA	H1038/3 STD 0.25 0.50
MB/HL 3	1	39,975/39,991	44,000/44,013	32,870	1,990	0,029/0,083	AL-LF	2393RAA	
MB/HL 1	1	39,975/39,991	44,000/44,013	27,130	1,990	0,029/0,083	AL-LF	2394RA	
TW/A	2	44,400/44,650	55,650/55,900		1,975		BS	2392BFF	A177/2 STD

2 54.50 x 80.00

680 701		4 Cyl.		746cc		17-20kW (23-27PS)		Petrol		TD3009	
680.702		4 Cyl.		746cc		15-20kW (20-27PS)		Petrol		TD3010	
BE/PL	4	37,959/37,975	41,128/41,139	21,180	1,569	0,020/0,067	AL-LF	2390RA	01-4133/4 STD 0.25 0.50 0.75		
MB/HL 2	1	39,975/39,991	44,000/44,013	30,120	1,990	0,029/0,083	AL-LF	2392RAA	H1038/3 STD 0.25 0.50		
MB/HL 3	1	39,975/39,991	44,000/44,013	32,870	1,990	0,029/0,083	AL-LF	2393RAA			
MB/HL 1	1	39,975/39,991	44,000/44,013	27,130	1,990	0,029/0,083	AL-LF	2394RA			
TW/A	2	44,400/44,650	55,650/55,900		1,975		BS	2392BFF	A177/2 STD		

3 55.80 x 80.00

839 701		4 Cyl.		782cc		25kW (34PS)		Petrol		TD3049	
839 706		4 Cyl.		782cc		19-20kW (27-27PS)		Petrol		TD3050	
839 707		4 Cyl.		782cc		20kW (27PS)		Petrol		TD3051	
839.06		4 Cyl.		782cc		20kW (27PS)		Petrol		TD3047	
839.07		4 Cyl.		782cc		20kW (27PS)		Petrol		TD3048	
BE/PL	4	37,959/37,975	41,128/41,139	21,180	1,569	0,020/0,067	AL-LF	2390RA	01-4133/4 STD 0.25 0.50 0.75		
MB/HL 2	1	39,975/39,991	44,000/44,013	30,120	1,990	0,029/0,083	AL-LF	2392RAA	H1038/3 STD 0.25 0.50		
MB/HL 3	1	39,975/39,991	44,000/44,013	32,870	1,990	0,029/0,083	AL-LF	2393RAA			
MB/HL 1	1	39,975/39,991	44,000/44,013	27,130	1,990	0,029/0,083	AL-LF	2394RA			
TW/A	2	44,400/44,650	55,650/55,900		1,975		BS	2392BFF	A177/2 STD		

4 58.00 x 80.00

670.800		4 Cyl.		845cc		19-26kW (26-35PS)		Petrol		TD22489	
800		4 Cyl.		845cc		19kW (26PS)		Petrol		TD3023	
800 01		4 Cyl.		845cc		25kW (34PS)		Petrol		TD3024	
800 05		4 Cyl.		845cc		22-25kW (30-34PS)		Petrol		TD3025	
800 705		4 Cyl.		845cc		19-26kW (26-35PS)		Petrol		TD4852	
800 710		4 Cyl.		845cc		26-27kW (36-37PS)		Petrol		TD3028	
800.02		4 Cyl.		845cc		21-26kW (29-35PS)		Petrol		TD21383	
B1B 707		4 Cyl.		845cc		21kW (29PS)		Petrol		TD4855	
BE/PL	4	37,959/37,975	41,128/41,139	21,180	1,569	0,020/0,067	AL-LF	2390RA	01-4133/4 STD 0.25 0.50 0.75		

RENAULT

MB/HL 2	1	39,975/39,991	44,000/44,013	30,120	1,990	0,029/0,083	AL-LF	2392RAA	H1038/3 STD 0.25 0.50
MB/HL 3	1	39,975/39,991	44,000/44,013	32,870	1,990	0,029/0,083	AL-LF	2393RAA	
MB/HL 1	1	39,975/39,991	44,000/44,013	27,130	1,990	0,029/0,083	AL-LF	2394RA	
TW/A	2	44,400/44,650	55,650/55,900		1,975		BS	2392BFF	A177/2 STD

5 61.40 x 72.00

813.02			4 Cyl.	852cc	21kW (29PS)		Petrol		TD22393
BE/PL	4	43,964/43,980	47,614/47,625	20,750	1,810	0,022/0,074	AL-LF	2950RA	01-4137/4 STD 0.25 0.50 0.75
MB/HL 1,3	2	45,990/46,000	49,874/49,890	24,500	1,932	0,020/0,061	AL-LF	62011RA	H1107/5 STD 0.25 0.50 0.75
MB/HL 2,4,5	3	45,990/46,000	49,874/49,890	19,500	1,932	0,020/0,061	AL-LF	62012RA	

6 65.00 x 72.00

689 71			4 Cyl.	956cc	32-33kW (44-45PS)		Petrol		TD3016
689 710			4 Cyl.	956cc	32kW (44PS)		Petrol		TD3017
689.01			4 Cyl.	956cc	29kW (39PS)		Petrol		TD21063
689.10			4 Cyl.	956cc	31-33kW (42-45PS)		Petrol		TD29127
C1C 700			4 Cyl.	956cc	30kW (41PS)		Petrol		TD3097
C1C 706			4 Cyl.	949cc	27-31kW (37-42PS)		Petrol		TD3098
C1C 708			4 Cyl.	956cc	25kW (34PS)		Petrol		TD3099
C1C 754			4 Cyl.	956cc	24kW (33PS)		Petrol		TD22353
BE/PL	4	43,964/43,980	47,614/47,625	20,750	1,810	0,022/0,074	AL-LF	2950RA	01-4137/4 STD 0.25 0.50 0.75
MB/HL 1,3	2	45,990/46,000	49,874/49,890	24,500	1,932	0,020/0,061	AL-LF	62011RA	H1107/5 STD 0.25 0.50 0.75
MB/HL 2,4,5	3	45,990/46,000	49,874/49,890	19,500	1,932	0,020/0,061	AL-LF	62012RA	

7 69.00 x 66.80

D4D 700			4 Cyl.	999cc	44kW (60PS)		Petrol		TD17268
D4D 720			4 Cyl.	999cc	44kW (60PS)		Petrol		TD17269
D7D 700			4 Cyl.	999cc	40kW (54PS)		Petrol		TD28713
D7D 760			4 Cyl.	999cc	40-43kW (54-58PS)		Petrol		TD20901
BE/PL	4	39,984/40,000	43,639/43,650	16,250	1,810	0,020/0,065	AL-LF	01-3977	01-3977/4 STD 0.25 0.50
MB/HL 1,2,4,5	4	43,990/44,010	47,612/47,625	18,800	1,795	0,006/0,064	AL-LF	02-3978	H097/5 STD
MB/HL 3	1	43,990/44,010	47,612/47,625	23,900	1,795	0,006/0,064	AL-LF	02-3979H	



02-3979H STD 24,000/.9449" - 24,045/.9467"

8 69.00 x 76.80

D4F 702			4 Cyl.	1149cc	55kW (75PS)		Petrol		TD16272
D4F 704			4 Cyl.	1149cc	55kW (75PS)		Petrol		TD16273
D4F 706			4 Cyl.	1149cc	55kW (75PS)		Petrol		TD21205
D4F 708 Euro 3			4 Cyl.	1149cc	44kW (60PS)		Petrol		TD19014
D4F 712			4 Cyl.	1149cc	55kW (75PS)		Petrol		TD16186
D4F 714			4 Cyl.	1149cc	55kW (75PS)		Petrol		TD16187
D4F 716			4 Cyl.	1149cc	55kW (75PS)		Petrol		TD17270



D4F 722	4 Cyl.	1149cc	55kW (75PS)	Petrol	TD19671
D4F 728	4 Cyl.	1149cc	55kW (75PS)	Petrol	TD21206
D4F 730	4 Cyl.	1149cc	55kW (75PS)	Petrol	TD21207
D4F 732	4 Cyl.	1149cc	55kW (75PS)	Petrol	TD23528
D4F 740	4 Cyl.	1149cc	48-55kW (65-75PS)	Petrol	TD18421
D4F 742	4 Cyl.	1149cc	55kW (75PS)	Petrol	TD24895
D4F 764	4 Cyl.	1149cc	43-58kW (58-79PS)	Petrol	TD18530
D4F 770	4 Cyl.	1149cc	55kW (75PS)	Petrol	TD30659
D4F 772	4 Cyl.	1149cc	55-56kW (75-76PS)	Petrol	TD20444
D4F 786	4 Cyl.	1149cc	76kW (103PS)	Petrol	TD27696
D4F 790	4 Cyl.	1149cc	55kW (75PS)	Petrol	TD29123

BE/PL	4	39,984/40,000	43,639/43,650	16,250	1,810	0,020/0,065	AL-LF	01-3977	01-3977/4 STD 0.25 0.50
MB/HL 1,2,4,5	4	43,990/44,010	47,612/47,625	18,800	1,795	0,006/0,064	AL-LF	02-3978	H097/5 STD
MB/HL 3	1	43,990/44,010	47,612/47,625	23,900	1,795	0,006/0,064	AL-LF	02-3979H	



02-3979H STD 24,000/.9449" - 24,045/.9467"

9

69.00 x 76.80

D7F 700	4 Cyl.	1149cc	40-43kW (54-58PS)	Petrol	TD5520
D7F 701	4 Cyl.	1149cc	40-43kW (54-58PS)	Petrol	TD5521
D7F 702	4 Cyl.	1149cc	43-44kW (58-60PS)	Petrol	TD16274
D7F 703	4 Cyl.	1149cc	43kW (58PS)	Petrol	TD16275
D7F 704	4 Cyl.	1149cc	43-44kW (58-60PS)	Petrol	TD16276
D7F 706	4 Cyl.	1149cc	43kW (58PS)	Petrol	TD18178
D7F 708	4 Cyl.	1149cc	43-44kW (58-60PS)	Petrol	TD26522
D7F 710	4 Cyl.	1149cc	43kW (58PS)	Petrol	TD9624
D7F 720	4 Cyl.	1149cc	43kW (58PS)	Petrol	TD14328
D7F 722	4 Cyl.	1149cc	43-44kW (58-60PS)	Petrol	TD16326
D7F 726	4 Cyl.	1149cc	43kW (58PS)	Petrol	TD14329
D7F 730	4 Cyl.	1149cc	40-43kW (54-58PS)	Petrol	TD5522
D7F 744	4 Cyl.	1149cc	43kW (58PS)	Petrol	TD17266
D7F 746	4 Cyl.	1149cc	43kW (58PS)	Petrol	TD17267
D7F 764	4 Cyl.	1149cc	43kW (58PS)	Petrol	TD20903
D7F 766 Euro 4	4 Cyl.	1149cc	43kW (58PS)	Petrol	TD19670
D7F 800	4 Cyl.	1149cc	43kW (58PS)	Petrol	TD20443

BE/PL	4	39,984/40,000	43,639/43,650	16,250	1,810	0,020/0,065	AL-LF	01-3977	01-3977/4 STD 0.25 0.50
BE/PL	4	39,984/40,000	43,639/43,650	16,250	1,813	0,070/0,065	AL-LF	4405RA	01-4161/4 STD

01-3977

4405RA



RENAULT

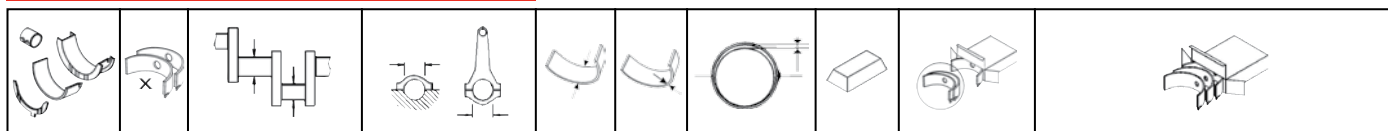

MB/HL 1,2,4,5	4	43,990/44,010	47,612/47,625	18,800	1,795	0,006/0,064	AL-LF	02-3978	H097/5 STD
MB/HL 3	1	43,990/44,010	47,612/47,625	23,900	1,795	0,006/0,064	AL-LF	02-3979H	



MB/HL	1	43,990/44,010	47,612/47,625	23,930	1,798	0,020/0,064	AL-LF	02-3979H	H1099/5 STD
MB/HL 1,2,4,5	4	43,990/44,010	47,612/47,625	18,800	1,798	0,020/0,064	AL-LF	4406RA	

02-3978

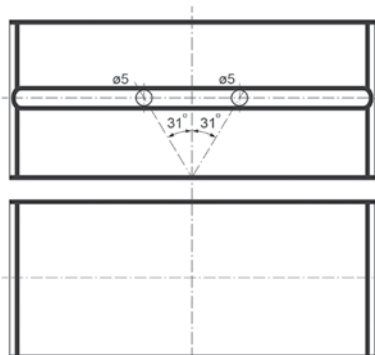

02-3979H

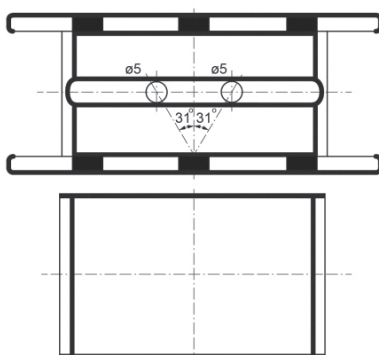

10 70.00 x 72.00

688 02	4 Cyl.	1108cc	41kW (56PS)	Petrol	TD3012
688 711	4 Cyl.	1108cc	25kW (34PS)	Petrol	TD3014
688 712	4 Cyl.	1108cc	25-35kW (34-48PS)	Petrol	TD3015
688 713	4 Cyl.	1108cc	33kW (45PS)	Petrol	TD3013
688.01	4 Cyl.	1108cc	25-39kW (34-53PS)	Petrol	TD22490
688.03	4 Cyl.	1108cc	25-39kW (34-53PS)	Petrol	TD22492

BE/PL	4	43,964/43,980	47,614/47,625	20,750	1,810	0,022/0,074	AL-LF	2950RA	01-4137/4 STD 0.25 0.50 0.75
MB/HL 1-5	5	54,785/54,805	58,731/58,750	19,500	1,950	0,026/0,090	AL-LF	62013RA	H1042/5 STD 0.25 0.50 0.75
MB/HL 1,3	2	45,990/46,000	49,874/49,890	24,500	1,932	0,020/0,061	AL-LF	62011RA	H1107/5 STD 0.25 0.50 0.75
MB/HL 2,4,5	3	45,990/46,000	49,874/49,890	19,500	1,932	0,020/0,061	AL-LF	62012RA	
TW/A	2	60,500/60,750	79,750/80,000		2,850		AL-LF	60476BF	A195/2 STD 0.10

11 70.00 x 72.00

688 13	4 Cyl.	1108cc	33kW (45PS)	Petrol	TD23801
688.06	4 Cyl.	1108cc	26kW (35PS)	Petrol	TD29124
688.09	4 Cyl.	1108cc	26kW (35PS)	Petrol	TD29125
688.10	4 Cyl.	1108cc	25-39kW (34-53PS)	Petrol	TD21382
688.11	4 Cyl.	1108cc	25-39kW (34-53PS)	Petrol	TD28180
688.12	4 Cyl.	1108cc	25kW (34PS)	Petrol	TD29126

BE/PL	4	43,964/43,980	47,614/47,625	20,750	1,810	0,022/0,074	AL-LF	2950RA	01-4137/4 STD 0.25 0.50 0.75
MB/HL 1-5	5	54,785/54,805	58,731/58,750	19,500	1,950	0,026/0,090	AL-LF	62013RA	H1042/5 STD 0.25 0.50 0.75
MB/HL 1,3	2	45,990/46,000	49,874/49,890	24,500	1,932	0,020/0,061	AL-LF	62011RA	H1107/5 STD 0.25 0.50 0.75
MB/HL 2,4,5	3	45,990/46,000	49,874/49,890	19,500	1,932	0,020/0,061	AL-LF	62012RA	



TW/A	2	60,500/60,750	79,750/80,000		2,850		AL-LF	60476BF	A195/2 STD 0.10
------	---	---------------	---------------	--	-------	--	-------	---------	---------------------------

12	70.00 x 72.00
-----------	----------------------

C1E 688			4 Cyl.	1108cc	25kW (34PS)		Petrol		TD24999
C1E 700			4 Cyl.	1108cc	35-36kW (48-49PS)		Petrol		TD3100
C1E 714			4 Cyl.	1108cc	25-32kW (34-44PS)		Petrol		TD3101
C1E 715			4 Cyl.	1108cc	35kW (48PS)		Petrol		TD3102
C1E 718			4 Cyl.	1108cc	25-26kW (34-35PS)		Petrol		TD3103
C1E 719			4 Cyl.	1108cc	25-26kW (34-35PS)		Petrol		TD3104
C1E 720			4 Cyl.	1108cc	35kW (48PS)		Petrol		TD3105
C1E 726			4 Cyl.	1108cc	33kW (45PS)		Petrol		TD3011
C1E 750			4 Cyl.	1108cc	33-35kW (45-48PS)		Petrol		TD3106
C1E 752			4 Cyl.	1108cc	33-34kW (45-46PS)		Petrol		TD3107
C1E 754			4 Cyl.	1108cc	33-34kW (45-46PS)		Petrol		TD3108
C1E 756			4 Cyl.	1108cc	33kW (45PS)		Petrol		TD3109
C1E 760			4 Cyl.	1108cc	33kW (45PS)		Petrol		TD3110
C1E 762			4 Cyl.	1108cc	33-36kW (45-49PS)		Petrol		TD3111
C1E 764			4 Cyl.	1108cc	36kW (49PS)		Petrol		TD3112
C1E 792			4 Cyl.	1108cc	33kW (45PS)		Petrol		TD3113

BE/PL	4	43,964/43,980	47,614/47,625	20,750	1,810	0,022/0,074	AL-LF	2950RA	01-4137/4 STD 0.25 0.50 0.75
MB/HL 1-5	5	54,785/54,805	58,731/58,750	19,500	1,950	0,026/0,090	AL-LF	62013RA	H1042/5 STD 0.25 0.50 0.75
TW/A	2	60,500/60,750	79,750/80,000		2,850		AL-LF	60476BF	A195/2 STD 0.10

13	71.50 x 77.00
-----------	----------------------

C1G 700			4 Cyl.	1237cc	40kW (54PS)		Petrol		TD3114
C1G 702			4 Cyl.	1237cc	40-44kW (54-60PS)		Petrol		TD3115
C1G 710			4 Cyl.	1237cc	40kW (55PS)		Petrol		TD3116
C1G 720			4 Cyl.	1237cc	40kW (54PS)		Petrol		TD3117
C1G 722			4 Cyl.	1237cc	40kW (54PS)		Petrol		TD3118
C1G 726			4 Cyl.	1237cc	40kW (54PS)		Petrol		TD3119
C1G 730			4 Cyl.	1237cc	40kW (54PS)		Petrol		TD3120

BE/PL	4	43,964/43,980	47,614/47,625	17,750	1,806	0,020/0,074	AL-LF	2950RAA	01-4138/4 STD 0.25 0.50 0.75
MB/HL 1-5	5	54,785/54,805	58,731/58,750	19,500	1,950	0,026/0,090	AL-LF	62013RA	H1042/5 STD 0.25 0.50 0.75
TW/A	2	60,500/60,750	79,750/80,000		2,850		AL-LF	60476BF	A195/2 STD 0.10

14	73.00 x 77.00
-----------	----------------------

810 719			4 Cyl.	1289cc	33kW (45PS)		Petrol		TD3035
810 725			4 Cyl.	1289cc	47kW (64PS)		Petrol		TD3036
810 726			4 Cyl.	1289cc	31-43kW (42-58PS)		Petrol		TD3037
810 729			4 Cyl.	1289cc	40kW (54PS)		Petrol		TD3038
810.02			4 Cyl.	1289cc	37kW (50PS)		Petrol		TD3033

BE/PL	4	43,964/43,980	47,614/47,625	17,750	1,806	0,020/0,074	AL-LF	2950RAA	01-4138/4 STD 0.25 0.50 0.75
MB/HL 1-5	5	54,785/54,805	58,731/58,750	19,500	1,950	0,026/0,090	AL-LF	62013RA	H1042/5 STD 0.25 0.50 0.75
TW/A	2	60,500/60,750	79,750/80,000		2,850		AL-LF	60476BF	A195/2 STD 0.10



15 73.00 x 77.00

810.01	4 Cyl.	1289cc	26-32kW (37-44PS)	Petrol	TD8555
810.05	4 Cyl.	1289cc	31-45kW (42-61PS)	Petrol	TD21386
810.06	4 Cyl.	1289cc	44kW (60PS)	Petrol	TD3034
810.10	4 Cyl.	1289cc	44kW (60PS)	Petrol	TD21387
810.19	4 Cyl.	1289cc	33kW (45PS)	Petrol	TD29129
810.25	4 Cyl.	1289cc	31-50kW (42-68PS)	Petrol	TD22391
810.26	4 Cyl.	1289cc	31-50kW (42-68PS)	Petrol	TD22392
810.29	4 Cyl.	1289cc	40kW (54PS)	Petrol	TD29130
810.96	4 Cyl.	1289cc	49kW (68PS)	Petrol	TD3039
810.97	4 Cyl.	1289cc	41kW (57PS)	Petrol	TD3040
810.99	4 Cyl.	1289cc	36-44kW (49-60PS)	Petrol	TD29131
810-02	4 Cyl.	1289cc	37-40kW (50-54PS)	Petrol	TD24105
810-02/97	4 Cyl.	1289cc	40kW (54PS)	Petrol	TD3032

BE/PL	4	43,964/43,980	47,614/47,625	17,750	1,806	0,020/0,074	AL-LF	2950RAA	01-4138/4 STD 0.25 0.50 0.75
MB/HL 1-5	5	54,785/54,805	58,731/58,750	19,500	1,950	0,026/0,090	AL-LF	62013RA	H1042/5 STD 0.25 0.50 0.75

01/75→

MB/HL 1,3	2	45,990/46,000	49,874/49,890	24,500	1,932	0,020/0,061	AL-LF	62011RA	H1107/5 STD 0.25 0.50 0.75
MB/HL 2,4,5	3	45,990/46,000	49,874/49,890	19,500	1,932	0,020/0,061	AL-LF	62012RA	

→12/74

TW/A	2	60,500/60,750	79,750/80,000		2,850		AL-LF	60476BF	A195/2 STD 0.10
------	---	---------------	---------------	--	-------	--	-------	---------	--------------------

01/75→

16 73.00 x 77.00

810.03	4 Cyl.	1289cc	35kW (48PS)	Petrol	TD23613				
BE/PL	4	43,964/43,980	47,614/47,625	17,750	1,806	0,020/0,074	AL-LF	2950RAA	01-4138/4 STD 0.25 0.50 0.75
MB/HL 1,3	2	45,990/46,000	49,874/49,890	24,500	1,932	0,020/0,061	AL-LF	62011RA	H1107/5 STD 0.25 0.50 0.75
MB/HL 2,4,5	3	45,990/46,000	49,874/49,890	19,500	1,932	0,020/0,061	AL-LF	62012RA	

17 74.00 x 72.00

C3G 700	4 Cyl.	1239cc	40kW (55PS)	Petrol	TD3172
C3G 702	4 Cyl.	1239cc	40kW (55PS)	Petrol	TD5515
C3G 702	4 Cyl.	1239cc	40kW (54PS)	Petrol	TD12390
C3G 710	4 Cyl.	1239cc	40kW (55PS)	Petrol	TD3173
C3G 712	4 Cyl.	1239cc	40kW (55PS)	Petrol	TD16545
C3G 720	4 Cyl.	1239cc	40kW (54PS)	Petrol	TD14314
C3G 750	4 Cyl.	1239cc	40kW (54PS)	Petrol	TD22356

BE/PL	4	43,964/43,980	47,614/47,625	20,750	1,810	0,022/0,074	AL-LF	2950RA	01-4137/4 STD 0.25 0.50 0.75
MB/HL 1-5	5	54,785/54,805	58,731/58,750	19,500	1,950	0,026/0,090	AL-LF	62013RA	H1042/5 STD 0.25 0.50 0.75
TW/A	2	60,500/60,750	79,750/80,000		2,850		AL-LF	60476BF	A195/2 STD 0.10

18 74.50 x 72.00

812		4 Cyl.		1255cc	Petrol				FM3130
BE/PL	4	43,964/43,980	47,614/47,625	20,750	1,810	0,022/0,074	AL-LF	2950RA	01-4137/4 STD 0.25 0.50 0.75

19 75.00 x 69.00

129		4 Cyl.		1218cc	42-43kW (57-58PS)		Petrol		TD3007
BE/PL	4	44,975/44,991	48,655/48,671	19,750	1,820	0,024/0,081	AL-LF	62045RA	01-4173/4 STD 0.30 0.50
MB/HL 2,4	2	49,965/49,981	53,655/53,674	17,290	1,832	0,020/0,070	AL-LF	62046RA	H996/5 STD 0.30 0.50
MB/HL 1,3,5	3	49,965/49,981	53,655/53,674	17,290	1,832	0,020/0,070	AL-LF	62047RA	
TW/A	2	55,250/55,500	71,450/71,700		2,350		BS	62047BF	A202/2 STD 0.15
→03/81									
TW/A	2	55,250/55,500	71,450/71,700		2,450		BS	62047BFA	A203/2 STD 0.10

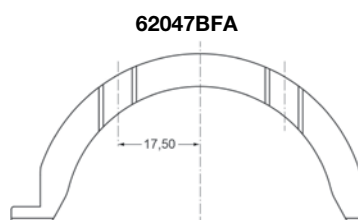
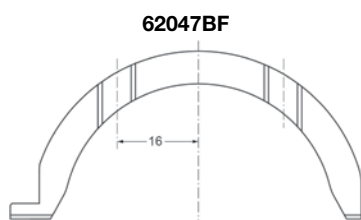
04/81→

20 75.00 x 77.00

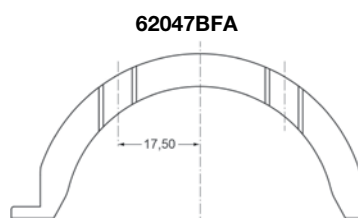
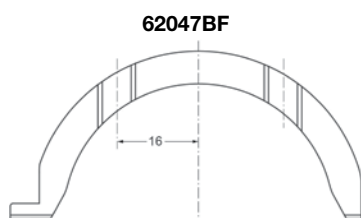
150		4 Cyl.		1360cc	51-52kW (70-71PS)		Petrol		TD3008
BE/PL	4	44,975/44,991	48,655/48,671	19,750	1,820	0,024/0,081	AL-LF	62045RA	01-4173/4 STD 0.30 0.50
MB/HL 2,4	2	49,965/49,981	53,655/53,674	17,290	1,832	0,020/0,070	AL-LF	62046RA	H996/5 STD 0.30 0.50
MB/HL 1,3,5	3	49,965/49,981	53,655/53,674	17,290	1,832	0,020/0,070	AL-LF	62047RA	
TW/A	2	55,250/55,500	71,450/71,700		2,350		BS	62047BF	A202/2 STD 0.15
→03/81									
TW/A	2	55,250/55,500	71,450/71,700		2,450		BS	62047BFA	A203/2 STD 0.10

04/81→

21 75.00 x 77.00

X5J		4 Cyl.		1360cc	44kW (60PS)		Petrol		TD3434
BE/PL	4	44,975/44,991	48,655/48,671	19,750	1,820	0,024/0,081	AL-LF	62045RA	01-4173/4 STD 0.30 0.50

RENAULT

MB/HL 2,4	2	49,965/49,981	53,655/53,674	17,290	1,832	0,020/0,070	AL-LF	62046RA	H996/5 STD 0.30 0.50
MB/HL 1,3,5	3	49,965/49,981	53,655/53,674	17,290	1,832	0,020/0,070	AL-LF	62047RA	
TW/A	2	55,250/55,500	71,450/71,700		2,450		BS	62047BFA	A203/2 STD 0.10

22	75.80 x 64.90								
E5F 710			4 Cyl.	1171cc	40-44kW (55-60PS)		Petrol		TD3181
E5F 716			4 Cyl.	1171cc	40-44kW (55-60PS)		Petrol		TD3182
E7F 700			4 Cyl.	1171cc	43-44kW (58-60PS)		Petrol		TD3192
E7F 704			4 Cyl.	1171cc	44kW (60PS)		Petrol		TD3193
E7F 706			4 Cyl.	1171cc	40-43kW (54-58PS)		Petrol		TD3194
E7F 708			4 Cyl.	1171cc	43-48kW (58-65PS)		Petrol		TD3195
E7F 730			4 Cyl.	1171cc	44-46kW (60-63PS)		Petrol		TD3196
E7F 750			4 Cyl.	1171cc	43-44kW (58-60PS)		Petrol		TD3197
BE/PL	4	43,964/43,980	47,614/47,625	17,750	1,806	0,020/0,074	AL-LF	2950RAA	01-4138/4 STD 0.25 0.50 0.75
TW/A	2	60,500/60,750	79,750/80,000		2,850		AL-LF	60476BF	A195/2 STD 0.10

23	75.80 x 77.00								
E6J 700			4 Cyl.	1390cc	57-59kW (78-80PS)		Petrol		TD3183
E6J 701			4 Cyl.	1390cc	57-59kW (78-80PS)		Petrol		TD3184
E6J 706			4 Cyl.	1390cc	58-60kW (79-82PS)		Petrol		TD3185
E6J 712			4 Cyl.	1390cc	55-57kW (75-80PS)		Petrol		TD3186
E6J 713			4 Cyl.	1390cc	55-57kW (75-80PS)		Petrol		TD3187
E6J 718			4 Cyl.	1390cc	55-57kW (75-78PS)		Petrol		TD3188
E6J 734			4 Cyl.	1390cc	43-44kW (60-60PS)		Petrol		TD3189
E6J 738			4 Cyl.	1390cc	43kW (60PS)		Petrol		TD3190
E6J 760			4 Cyl.	1390cc	55-57kW (75-78PS)		Petrol		TD3191
E7J 601			4 Cyl.	1390cc	58-59kW (80-80PS)		Petrol		TD3198
E7J 624			4 Cyl.	1390cc	52kW (71PS)		Petrol		TD5526
E7J 626			4 Cyl.	1390cc	55kW (75PS)		Petrol		TD16362
E7J 634			4 Cyl.	1390cc	55kW (75PS)		Petrol		TD17271
E7J 635			4 Cyl.	1390cc	55kW (75PS)		Petrol		TD17272
E7J 700			4 Cyl.	1390cc	55-59kW (75-80PS)		Petrol		TD3199
E7J 706			4 Cyl.	1390cc	55-59kW (75-80PS)		Petrol		TD3200
E7J 707			4 Cyl.	1390cc	55-59kW (75-80PS)		Petrol		TD3201
E7J 710			4 Cyl.	1390cc	58-59kW (80-80PS)		Petrol		TD3203
E7J 711			4 Cyl.	1390cc	58-59kW (80-80PS)		Petrol		TD3204
E7J 718			4 Cyl.	1390cc	58kW (79PS)		Petrol		TD3205
E7J 719			4 Cyl.	1390cc	58kW (79PS)		Petrol		TD3206
E7J 720			4 Cyl.	1390cc	43-59kW (58-80PS)		Petrol		TD3207
E7J 724			4 Cyl.	1390cc	54-59kW (73-80PS)		Petrol		TD3208
E7J 726			4 Cyl.	1390cc	55-59kW (75-80PS)		Petrol		TD5508
E7J 728			4 Cyl.	1390cc	58-59kW (79-80PS)		Petrol		TD3209
E7J 742			4 Cyl.	1390cc	55kW (75PS)		Petrol		TD3212
E7J 745			4 Cyl.	1390cc	55-59kW (75-80PS)		Petrol		TD3210
E7J 754			4 Cyl.	1390cc	55-59kW (75-80PS)		Petrol		TD3211
E7J 756			4 Cyl.	1390cc	55kW (75PS)		Petrol		TD17279
E7J 757			4 Cyl.	1390cc	55kW (75PS)		Petrol		TD17282
E7J 764			4 Cyl.	1390cc	55kW (75PS)		Petrol		TD4858
E7J 770			4 Cyl.	1390cc	55-59kW (75-80PS)		Petrol		TD20896
E7J 771			4 Cyl.	1390cc	55-59kW (75-80PS)		Petrol		TD20897



E7J 773			4 Cyl.	1390cc	55-59kW (75-80PS)	Petrol		TD3213	
E7J 780			4 Cyl.	1390cc	55kW (75PS)	Petrol		TD9623	
K7J 700			4 Cyl.	1390cc	55kW (75PS)	Petrol		TD17470	
K7J 701			4 Cyl.	1390cc	55kW (75PS)	Petrol		TD17851	
BE/PL	4	43,964/43,980	47,614/47,625	17,750	1,806	0,020/0,074	AL-LF	2950RAA	01-4138/4 STD 0.25 0.50 0.75
TW/A	2	60,500/60,750	79,750/80,000		2,850		AL-LF	60476BF	A195/2 STD 0.10

24

76.00 x 77.00

840 725			4 Cyl.	1397cc	68kW (93PS)	Petrol		TD3052
840 726			4 Cyl.	1397cc	79-81kW (108-110PS)	Petrol Turbo		TD3053
840 730			4 Cyl.	1397cc	118kW (160PS)	Petrol Turbo		TD3054
847 700			4 Cyl.	1397cc	35kW (48PS)	Petrol		TD3067
847 701			4 Cyl.	1397cc	35kW (48PS)	Petrol		TD3072
847 712			4 Cyl.	1397cc	42-43kW (58-59PS)	Petrol		TD3068
847 720			4 Cyl.	1397cc	47kW (64PS)	Petrol		TD5054
847 722			4 Cyl.	1397cc	47kW (64PS)	Petrol		TD4853
847 725			4 Cyl.	1397cc	43-46kW (59-63PS)	Petrol		TD3070
847.99			4 Cyl.	1397cc	51kW (70PS)	Petrol		TD3071
C1J 700			4 Cyl.	1397cc	35-36kW (48-50PS)	Petrol		TD3122
C1J 715			4 Cyl.	1397cc	44kW (60PS)	Petrol		TD3123
C1J 742			4 Cyl.	1397cc	43-44kW (58-60PS)	Petrol		TD3125
C1J 748			4 Cyl.	1397cc	48kW (65PS)	Petrol		TD27328
C1J 760			4 Cyl.	1397cc	77kW (105PS)	Petrol Turbo		TD3126
C1J 764			4 Cyl.	1397cc	77-87kW (105-118PS)	Petrol Turbo		TD3127
C1J 768			4 Cyl.	1397cc	43-44kW (58-60PS)	Petrol		TD3128
C1J 770			4 Cyl.	1397cc	85kW (115PS)	Petrol Turbo Intercooler		TD3129
C1J 780			4 Cyl.	1397cc	43kW (58PS)	Petrol		TD3130
C1J 782			4 Cyl.	1397cc	85-88kW (115-120PS)	Petrol Turbo Intercooler		TD3131
C1J 784			4 Cyl.	1397cc	85-88kW (115-120PS)	Petrol Turbo Intercooler		TD3133
C1J 788			4 Cyl.	1397cc	85-88kW (115-120PS)	Petrol Turbo Intercooler		TD3134
C1J 791			4 Cyl.	1397cc	49kW (67PS)	Petrol		TD23611
C1J 792			4 Cyl.	1397cc	44kW (60PS)	Petrol		TD3135
C1J 793			4 Cyl.	1397cc	44kW (60PS)	Petrol		TD29259
C1J 796			4 Cyl.	1397cc	44kW (60PS)	Petrol		TD3136
C2J 700			4 Cyl.	1397cc	52-53kW (71-72PS)	Petrol		TD3137
C2J 713			4 Cyl.	1397cc	46kW (63PS)	Petrol		TD3138
C2J 717			4 Cyl.	1397cc	53kW (72PS)	Petrol		TD3141
C2J 718			4 Cyl.	1397cc	49-50kW (67-68PS)	Petrol		TD3143
C2J 720			4 Cyl.	1397cc	43-49kW (58-67PS)	Petrol		TD3144
C2J 730			4 Cyl.	1397cc	44kW (60PS)	Petrol		TD3145
C2J 755			4 Cyl.	1397cc	53kW (72PS)	Petrol		TD5445
C2J 756			4 Cyl.	1397cc	49kW (67PS)	Petrol		TD3146
C2J 757			4 Cyl.	1397cc	49-50kW (67-68PS)	Petrol		TD3147
C2J 760			4 Cyl.	1397cc	51kW (70PS)	Petrol		TD3148
C2J 766			4 Cyl.	1397cc	49kW (67PS)	Petrol		TD3149
C2J 767			4 Cyl.	1397cc	49kW (67PS)	Petrol		TD3151
C2J 768			4 Cyl.	1397cc	49-50kW (67-68PS)	Petrol		TD3152
C2J 770			4 Cyl.	1397cc	51kW (69PS)	Petrol		TD3153
C2J 772			4 Cyl.	1397cc	43-44kW (58-60PS)	Petrol		TD3154
C2J 776			4 Cyl.	1397cc	50kW (68PS)	Petrol		TD3155
C2J 780			4 Cyl.	1397cc	52-53kW (71-72PS)	Petrol		TD3156
C2J 781			4 Cyl.	1397cc	52-53kW (71-72PS)	Petrol		TD3157

RENAULT

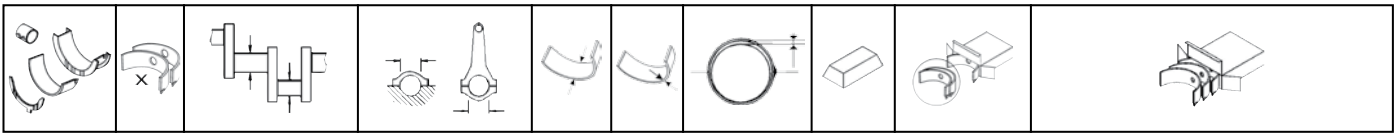

C2J 782			4 Cyl.	1397cc	49kW (67PS)		Petrol		TD3158
C2J 784			4 Cyl.	1397cc	44kW (60PS)		Petrol		TD3161
C2J 788			4 Cyl.	1397cc	52-53kW (71-72PS)		Petrol		TD3162
C2J 789			4 Cyl.	1397cc	52-53kW (71-72PS)		Petrol		TD3163
C2J 792			4 Cyl.	1397cc	53kW (72PS)		Petrol		TD3164
C2J 794			4 Cyl.	1397cc	46-49kW (63-67PS)		Petrol		TD3165
C2J 796			4 Cyl.	1397cc	53kW (72PS)		Petrol		TD3166
C2J 797			4 Cyl.	1397cc	53kW (72PS)		Petrol		TD3167
C2J 798			4 Cyl.	1397cc	52-53kW (71-72PS)		Petrol		TD3168
C3J 700			4 Cyl.	1397cc	43-44kW (58-60PS)		Petrol		TD4856
C3J 702			4 Cyl.	1397cc	43-44kW (58-60PS)		Petrol		TD3175
C3J 710			4 Cyl.	1397cc	43-44kW (58-60PS)		Petrol		TD3176
C3J 756			4 Cyl.	1397cc	43kW (58PS)		Petrol		TD3177
C3J 760			4 Cyl.	1397cc	43-44kW (58-60PS)		Petrol		TD3179
C3J 762			4 Cyl.	1397cc	43-44kW (58-60PS)		Petrol		TD3180
C6J 750			4 Cyl.	1397cc	79-81kW (108-110PS)		Petrol Turbo		TD9392
BE/PL	4	43,964/43,980	47,614/47,625	17,750	1,806	0,020/0,074	AL-LF	2950RAA	01-4138/4 STD 0.25 0.50 0.75
MB/HL 1-5	5	54,785/54,805	58,731/58,750	19,500	1,950	0,026/0,090	AL-LF	62013RA	H1042/5 STD 0.25 0.50 0.75
TW/A	2	60,500/60,750	79,750/80,000		2,850		AL-LF	60476BF	A195/2 STD 0.10

25

76.00 x 80.50

K9K 276			4 Cyl.	1461cc	62kW (84PS)		Diesel Turbo Intercooler		TD23876
K9K 608			4 Cyl.	1461cc	55-66kW (75-90PS)		Diesel		TD27682
K9K 612			4 Cyl.	1461cc	55kW (75PS)		Diesel		TD27683
K9K 636 Euro 5			4 Cyl.	1461cc	81kW (110PS)		Diesel Turbo		TD28220
K9K 700			4 Cyl.	1461cc	48-50kW (65-68PS)		Diesel		TD16219
K9K 702			4 Cyl.	1461cc	48-60kW (65-82PS)		Diesel		TD16344
K9K 704			4 Cyl.	1461cc	42-48kW (57-65PS)		Diesel Turbo Intercooler		TD16343
K9K 706			4 Cyl.	1461cc	48-58kW (65-79PS)		Diesel Turbo Intercooler		TD20974
K9K 708			4 Cyl.	1461cc	48-50kW (65-68PS)		Diesel Turbo Intercooler		TD26047
K9K 710			4 Cyl.	1461cc	60kW (82PS)		Diesel Turbo Intercooler		TD17488
K9K 712 Euro 3			4 Cyl.	1461cc	74kW (100PS)		Diesel Turbo		TD18419
K9K 714			4 Cyl.	1461cc	50kW (68PS)		Diesel Turbo		TD21173
K9K 716			4 Cyl.	1461cc	45-60kW (61-82PS)		Diesel Turbo		TD22179
K9K 718			4 Cyl.	1461cc	62kW (84PS)		Diesel Turbo		TD21171
K9K 722			4 Cyl.	1461cc	60-63kW (82-86PS)		Diesel Turbo		TD16534
K9K 724			4 Cyl.	1461cc	63kW (86PS)		Diesel Turbo Intercooler		TD20988
K9K 728			4 Cyl.	1461cc	74-78kW (101-106PS)		Diesel Turbo Intercooler		TD20706
K9K 729			4 Cyl.	1461cc	74kW (101PS)		Diesel Turbo Intercooler		TD20707
K9K 732			4 Cyl.	1461cc	78kW (106PS)		Diesel Turbo Intercooler		TD20829
K9K 734			4 Cyl.	1461cc	74-78kW (103-106PS)		Diesel Turbo Intercooler		TD22192
K9K 740			4 Cyl.	1461cc	47kW (64PS)		Diesel Turbo Intercooler		TD20446
K9K 750			4 Cyl.	1461cc	57-65kW (78-88PS)		Diesel Turbo Intercooler		TD21133
K9K 752			4 Cyl.	1461cc	47-50kW (64-68PS)		Diesel Turbo Intercooler		TD21134
K9K 760			4 Cyl.	1461cc	50-63kW (68-86PS)		Diesel Turbo		TD21135
K9K 762			4 Cyl.	1461cc	50kW (68PS)		Diesel Turbo		TD20922
K9K 764			4 Cyl.	1461cc	78kW (106PS)		Diesel Turbo Intercooler		TD18538
K9K 766			4 Cyl.	1461cc	63kW (86PS)		Diesel Turbo Intercooler		TD18537
K9K 768			4 Cyl.	1461cc	50kW (68PS)		Diesel Turbo		TD18536
K9K 770			4 Cyl.	1461cc	55-65kW (75-88PS)		Diesel Turbo		TD25691
K9K 772			4 Cyl.	1461cc	63-76kW (86-103PS)		Diesel Turbo		TD23549



K9K 774 Euro 4	4 Cyl.	1461cc	78kW (106PS)	Diesel Turbo Intercooler	TD31279
K9K 780 Euro 4	4 Cyl.	1461cc	76-81kW (103-110PS)	Diesel Turbo Intercooler	TD20817
K9K 782	4 Cyl.	1461cc	81kW (110PS)	Diesel Turbo Intercooler	TD27990
K9K 790	4 Cyl.	1461cc	48kW (65PS)	Diesel Turbo Intercooler	TD21438
K9K 792	4 Cyl.	1461cc	50kW (68PS)	Diesel Turbo Intercooler	TD21439
K9K 794	4 Cyl.	1461cc	48-50kW (65-68PS)	Diesel Turbo Intercooler	TD23795
K9K 796	4 Cyl.	1461cc	63kW (86PS)	Diesel Turbo Intercooler	TD26080
K9K 800	4 Cyl.	1461cc	50-63kW (75-86PS)	Diesel Turbo Intercooler	TD22193
K9K 802 Euro 4	4 Cyl.	1461cc	55-63kW (75-86PS)	Diesel Turbo Intercooler	TD20830
K9K 804 Euro 4	4 Cyl.	1461cc	76-80kW (103-110PS)	Diesel Turbo Intercooler	TD20831
K9K 806 Euro 4	4 Cyl.	1461cc	76kW (103PS)	Diesel Turbo Intercooler	TD20832
K9K 808	4 Cyl.	1461cc	55-66kW (75-90PS)	Diesel Turbo Intercooler	TD26258
K9K 812	4 Cyl.	1461cc	60kW (82PS)	Diesel Turbo Intercooler	TD24967
K9K 820	4 Cyl.	1461cc	55-63kW (75-86PS)	Diesel Turbo	TD25692
K9K 826 Euro 5	4 Cyl.	1461cc	70kW (95PS)	Diesel Turbo	TD29780
K9K 830	4 Cyl.	1461cc	63kW (86PS)	Diesel Turbo	TD25693
K9K 832 Euro 4	4 Cyl.	1461cc	78kW (106PS)	Diesel Turbo	TD23521
K9K 834	4 Cyl.	1461cc	66kW (90PS)	Diesel Turbo	TD23742
K9K 836	4 Cyl.	1461cc	78-81kW (106-110PS)	Diesel Turbo	TD23743
K9K 837 Euro 5	4 Cyl.	1461cc	81kW (110PS)	Diesel Turbo	TD26246
K9K 840	4 Cyl.	1461cc	50kW (68PS)	Diesel Turbo	TD22194
K9K 846 Euro 5	4 Cyl.	1461cc	70-81kW (95-110PS)	Diesel Turbo	TD24579
K9K 884 Euro 5	4 Cyl.	1461cc	66kW (90PS)	Diesel Turbo	TD27697
K9K F 830	4 Cyl.	1461cc	63kW (86PS)	Diesel Turbo	TD23566
K9K G 724	4 Cyl.	1461cc	63kW (86PS)	Diesel Turbo Intercooler	TD19692
K9K G 832	4 Cyl.	1461cc	78kW (106PS)	Diesel Turbo	TD23522
K9K H 834	4 Cyl.	1461cc	66kW (90PS)	Diesel Turbo	TD23569
K9K J 836	4 Cyl.	1461cc	81kW (110PS)	Diesel Turbo	TD23567
K9K N 837	4 Cyl.	1461cc	81kW (110PS)	Diesel Turbo	TD24968
K9K P 732	4 Cyl.	1461cc	78kW (106PS)	Diesel Turbo Intercooler	TD19693

BE/PL	4	43,964/43,980	47,614/47,625	17,750	1,807	0,020/0,047	BS	71-4243L	71-4243/4 STD 0.25 0.50
BE/PL	4	43,964/43,980	47,614/47,625	20,750	1,807	0,020/0,047	BS	71-4243U	
MB/HL 1-5	5	47,990/48,010	51,936/51,949	19,500	1,950	0,026/0,059	AL-LF	02-4241	H1065/5 STD 0.25 0.50
TW/A	2	53,000/53,250	73,670/73,920		2,850		AL-LF	04-4048	A168/2 STD
SE/PB	1	25,995/26,000	28,500/28,521	22,500			BC-LF	55-4856	55-4856 SEMI

26 76.00 x 81.00

697.01	4 Cyl.	1469cc	40-46kW (54-63PS)	Petrol	TD29128				
BE/PL	4	48,002/48,018	51,587/51,600	21,750	1,768	0,033/0,087	AL-LF	60475RA	01-4169/4 STD 0.25
MB/HL 1-5	5	54,803/54,813	58,731/58,750	20,500	1,950	0,020/0,072	AL-LF	60476RA	H1034/5 STD 0.25 0.50
TW/A	2	60,500/60,750	79,750/80,000		2,850		AL-LF	60476BF	A195/2 STD 0.10

27 77.00 x 84.00

807	4 Cyl.	1565cc	49-61kW (67-83PS)	Petrol	TD3029
807 727	4 Cyl.	1565cc	80-81kW (109-110PS)	Petrol Turbo	TD3030
807.03	4 Cyl.	1565cc	61kW (83PS)	Petrol	TD18884
807.04	4 Cyl.	1565cc	61kW (83PS)	Petrol	TD21384
807.05	4 Cyl.	1565cc	61kW (83PS)	Petrol	TD21385



807.10			4 Cyl.	1565cc	66kW (90PS)		Petrol		TD22182
807.20			4 Cyl.	1565cc	83kW (113PS)		Petrol		TD19214
821			4 Cyl.	1565cc	40-52kW (54-71PS)		Petrol		TD3042
821.01			4 Cyl.	1565cc	48kW (65PS)		Petrol		TD29263
821.02			4 Cyl.	1565cc	48kW (65PS)		Petrol		TD29262
821.03			4 Cyl.	1565cc	40-48kW (54-65PS)		Petrol		TD21388
821.04			4 Cyl.	1565cc	40-48kW (54-65PS)		Petrol		TD21389
821.10			4 Cyl.	1565cc	50kW (68PS)		Petrol		TD14890
821.11			4 Cyl.	1565cc	50kW (68PS)		Petrol		TD22247
821.20			4 Cyl.	1565cc	83kW (113PS)		Petrol		TD12308
A5L 717			4 Cyl.	1565cc	92kW (126PS)		Petrol Turbo		TD3088
A5L 718			4 Cyl.	1565cc	92kW (125PS)		Petrol Turbo		TD5430
A5L 750			4 Cyl.	1565cc	97kW (132PS)		Petrol Turbo		TD3089
A7L 723			4 Cyl.	1565cc	81kW (110PS)		Petrol Turbo		TD3092

BE/PL	4	48,002/48,018	51,587/51,600	21,750	1,768	0,033/0,087	AL-LF	60475RA	01-4169/4 STD 0.25
MB/HL 1-5	5	54,803/54,813	58,731/58,750	20,500	1,950	0,020/0,072	AL-LF	60476RA	H1034/5 STD 0.25 0.50
TW/A	2	60,500/60,750	79,750/80,000		2,850		AL-LF	60476BF	A195/2 STD 0.10

28 77.00 x 84.00

C2L 714			4 Cyl.	1565cc	51kW (70PS)		Petrol		TD3170
C2L 717			4 Cyl.	1397cc	50kW (68PS)		Petrol		TD3171

BE/PL	4	43,964/43,980	47,614/47,625	17,750	1,806	0,020/0,074	AL-LF	2950RAA	01-4138/4 STD 0.25 0.50 0.75
MB/HL 1-5	5	54,785/54,805	58,731/58,750	19,500	1,950	0,026/0,090	AL-LF	62013RA	H1042/5 STD 0.25 0.50 0.75
TW/A	2	60,500/60,750	79,750/80,000		2,850		AL-LF	60476BF	A195/2 STD 0.10

29 78.00 x 83.50

F8M 700			4 Cyl.	1596cc	40kW (55PS)		Diesel		TD3282
F8M 700			4 Cyl.	1596cc	40kW (55PS)		Diesel		TD21933
F8M 720			4 Cyl.	1596cc	40kW (55PS)		Diesel		TD3283
F8M 730			4 Cyl.	1596cc	40kW (55PS)		Diesel		TD3284
F8M 736			4 Cyl.	1596cc	40kW (55PS)		Diesel		TD3285
F8M 760			4 Cyl.	1596cc	40kW (55PS)		Diesel		TD3286

BE/PL	4	48,000/48,020	51,587/51,600	20,500	1,768	0,031/0,089	BS	4060CP	71-4311/4 STD 0.25 0.50
MB/HL 1-5	5	54,785/54,795	58,731/58,744	18,500	1,945	0,046/0,094	AL-LF	66741RA	H1080/5 STD 0.25 0.50
TW/A	2	60,500/60,750	79,750/80,000		2,350		AL-LF	66741AF	A215/2 STD 0.10
SE/PB	1	26,013/26,025	29,000/29,021	22,900			BS	66509Y	55-4394 SEMI

30 78.00 x 84.00

844.12			4 Cyl.	1605cc	76-79kW (103-108PS)		Petrol		TD23615
844.30			4 Cyl.	1605cc	93kW (126PS)		Petrol		TD3064
844.31			4 Cyl.	1605cc	93kW (126PS)		Petrol		TD3065
844.34			4 Cyl.	1605cc	93kW (126PS)		Petrol		TD3066

BE/PL	4	48,002/48,018	51,587/51,600	21,750	1,768	0,033/0,087	AL-LF	60475RA	01-4169/4 STD 0.25
MB/HL 1-5	5	54,803/54,813	58,731/58,750	20,500	1,950	0,020/0,072	AL-LF	60476RA	H1034/5 STD 0.25 0.50



TW/A	2	60,500/60,750	79,750/80,000		2,850		AL-LF	60476BF	A195/2 STD 0.10
------	---	---------------	---------------	--	-------	--	-------	---------	---------------------------

31	79.00 x 84.00
-----------	----------------------

841 705	4 Cyl.	1647cc	48-49kW (65-67PS)	Petrol	TD3057
841 717	4 Cyl.	1647cc	54kW (73PS)	Petrol	TD4854
841 725	4 Cyl.	1647cc	58kW (79PS)	Petrol	TD3056
841 726	4 Cyl.	1647cc	58kW (79PS)	Petrol	TD3055
843	4 Cyl.	1647cc	66-68kW (89-92PS)	Petrol	TD3058
843 718	4 Cyl.	1647cc	61kW (83PS)	Petrol	TD3060
843 720	4 Cyl.	1647cc	71kW (97PS)	Petrol	TD3059
843 721	4 Cyl.	1647cc	71kW (97PS)	Petrol	TD5429
843 723	4 Cyl.	1647cc	69-71kW (96-97PS)	Petrol	TD3061
843 724	4 Cyl.	1647cc	69-71kW (96-97PS)	Petrol	TD3062
843.01	4 Cyl.	1647cc	66-68kW (90-92PS)	Petrol	TD21391
843.05	4 Cyl.	1647cc	53-72kW (72-98PS)	Petrol	TD21381
843.20	4 Cyl.	1647cc	66-71kW (90-97PS)	Petrol	TD22346
843.21	4 Cyl.	1647cc	66-71kW (89-97PS)	Petrol	TD5381
843.719	4 Cyl.	1647cc	61kW (83PS)	Petrol	TD3063
A1M 705	4 Cyl.	1647cc	48kW (65PS)	Petrol	TD12868
A1M 707	4 Cyl.	1647cc	48-49kW (65-67PS)	Petrol	TD3082
A1M 708	4 Cyl.	1647cc	48-49kW (65-67PS)	Petrol	TD3083
A2M 723	4 Cyl.	1647cc	52-54kW (71-73PS)	Petrol	TD5055
A2M 725	4 Cyl.	1647cc	71kW (97PS)	Petrol	TD3086
A2M 726	4 Cyl.	1647cc	71kW (97PS)	Petrol	TD3087
A6M 725	4 Cyl.	1647cc	71kW (96PS)	Petrol	TD3090
A6M 726	4 Cyl.	1647cc	71kW (96PS)	Petrol	TD3091









BE/PL	4	48,002/48,018	51,587/51,600	21,750	1,768	0,033/0,087	AL-LF	60475RA	01-4169/4 STD 0.25
MB/HL 1-5	5	54,803/54,813	58,731/58,750	20,500	1,950	0,020/0,072	AL-LF	60476RA	H1034/5 STD 0.25 0.50
TW/A	2	60,500/60,750	79,750/80,000		2,850		AL-LF	60476BF	A195/2 STD 0.10

32	79.50 x 70.00
-----------	----------------------

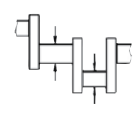
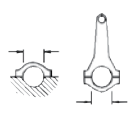
K4J 700	4 Cyl.	1390cc	72kW (98PS)	Petrol	TD16342
K4J 710 Euro 4	4 Cyl.	1390cc	72kW (98PS)	Petrol	TD19673
K4J 711 Euro 4	4 Cyl.	1390cc	72kW (98PS)	Petrol	TD19672
K4J 712	4 Cyl.	1390cc	70-72kW (95-98PS)	Petrol	TD14330
K4J 713	4 Cyl.	1390cc	70-72kW (95-98PS)	Petrol	TD14331
K4J 714	4 Cyl.	1390cc	70kW (95PS)	Petrol	TD16349
K4J 715	4 Cyl.	1390cc	70-72kW (95-98PS)	Petrol	TD20907
K4J 718	4 Cyl.	1390cc	70kW (95PS)	Petrol	TD27308
K4J 730	4 Cyl.	1390cc	72kW (98PS)	Petrol	TD16531
K4J 732	4 Cyl.	1390cc	60kW (82PS)	Petrol	TD20910
K4J 740	4 Cyl.	1390cc	72kW (98PS)	Petrol	TD21208
K4J 750	4 Cyl.	1390cc	70kW (95PS)	Petrol	TD13310
K4J 770	4 Cyl.	1390cc	72kW (98PS)	Petrol	TD18422
K4J 780	4 Cyl.	1390cc	72kW (98PS)	Petrol	TD18533
K4J D 729	4 Cyl.	1390cc	72kW (98PS)	Petrol	TD20822
K4J D 740	4 Cyl.	1390cc	72kW (98PS)	Petrol	TD19686
K7J 710	4 Cyl.	1390cc	55kW (75PS)	Petrol	TD18138
K7J 714	4 Cyl.	1390cc	53kW (72PS)	Petrol	TD23530

BE/PL	4	43,964/43,980	47,614/47,625	17,750	1,806	0,020/0,074	AL-LF	2950RAA	01-4138/4 STD 0.25 0.50 0.75
-------	---	---------------	---------------	--------	-------	-------------	-------	---------	--

RENAULT

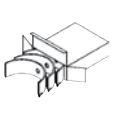
									
MB/HL 1-5	5	47,990/48,010	51,936/51,949	19,500	1,950	0,026/0,059	AL-LF	02-4241	H1065/5 STD 0.25 0.50
TW/A	2	53,000/53,250	73,670/73,920		2,850		AL-LF	04-4048	A168/2 STD

33		79.50 x 80.50							
K4M 616	4 Cyl.	1598cc	75kW (102PS)	Petrol	TD27695				
K4M 690	4 Cyl.	1598cc	77-85kW (105-116PS)	Petrol	TD22187				
K4M 697	4 Cyl.	1598cc	77-82kW (105-112PS)	Petrol	TD23897				
K4M 698	4 Cyl.	1598cc	77kW (105PS)	Petrol	TD23898				
K4M 700	4 Cyl.	1598cc	79kW (107PS)	Petrol	TD13308				
K4M 701	4 Cyl.	1598cc	79-81kW (107-110PS)	Petrol	TD13309				
K4M 704	4 Cyl.	1598cc	79-80kW (107-109PS)	Petrol	TD16346				
K4M 706	4 Cyl.	1598cc	71-80kW (97-109PS)	Petrol	TD21193				
K4M 707	4 Cyl.	1598cc	79-80kW (107-109PS)	Petrol	TD26523				
K4M 708	4 Cyl.	1598cc	75-79kW (102-107PS)	Petrol	TD16345				
K4M 709	4 Cyl.	1598cc	75-79kW (102-107PS)	Petrol	TD21194				
K4M 710	4 Cyl.	1598cc	76-79kW (103-107PS)	Petrol	TD16214				
K4M 711	4 Cyl.	1598cc	79kW (107PS)	Petrol	TD16215				
K4M 712	4 Cyl.	1598cc	79kW (107PS)	Petrol	TD21163				
K4M 714	4 Cyl.	1598cc	79kW (107PS)	Petrol	TD21164				
K4M 716	4 Cyl.	1598cc	82kW (112PS)	Petrol	TD21200				
K4M 718	4 Cyl.	1598cc	76kW (103PS)	Petrol	TD21162				
K4M 720	4 Cyl.	1598cc	79kW (107PS)	Petrol	TD16269				
K4M 724	4 Cyl.	1598cc	79kW (107PS)	Petrol	TD16270				
K4M 730	4 Cyl.	1598cc	70kW (95PS)	Petrol	TD21195				
K4M 732	4 Cyl.	1598cc	66-70kW (90-95PS)	Petrol	TD20911				
K4M 734	4 Cyl.	1598cc	58-66kW (79-90PS)	Petrol	TD20912				
K4M 736	4 Cyl.	1598cc	79-82kW (107-112PS)	Petrol	TD21201				
K4M 740	4 Cyl.	1598cc	79kW (107PS)	Petrol	TD18445				
K4M 742	4 Cyl.	1598cc	66-79kW (90-107PS)	Petrol	TD20913				
K4M 743	4 Cyl.	1598cc	66-81kW (90-110PS)	Petrol	TD20914				
K4M 744 Euro 4	4 Cyl.	1598cc	55-79kW (75-107PS)	Petrol	TD19674				
K4M 745 Euro 4	4 Cyl.	1598cc	79kW (107PS)	Petrol	TD19675				
K4M 746	4 Cyl.	1598cc	79kW (107PS)	Petrol	TD20915				
K4M 748	4 Cyl.	1598cc	79-86kW (107-117PS)	Petrol	TD11567				
K4M 750	4 Cyl.	1598cc	70kW (95PS)	Petrol	TD17489				
K4M 752	4 Cyl.	1598cc	70kW (95PS)	Petrol	TD16370				
K4M 753	4 Cyl.	1598cc	70kW (95PS)	Petrol	TD17494				
K4M 754	4 Cyl.	1598cc	98kW (133PS)	Petrol	TD21176				
K4M 760	4 Cyl.	1598cc	81-83kW (110-113PS)	Petrol	TD16532				
K4M 761	4 Cyl.	1598cc	81-83kW (110-113PS)	Petrol	TD18302				
K4M 762	4 Cyl.	1598cc	77kW (105PS)	Petrol	TD21202				
K4M 764	4 Cyl.	1598cc	82-85kW (112-116PS)	Petrol	TD20916				
K4M 766	4 Cyl.	1598cc	82kW (112PS)	Petrol	TD26524				
K4M 768	4 Cyl.	1598cc	75kW (102PS)	Petrol	TD21203				
K4M 776	4 Cyl.	1598cc	79kW (107PS)	Petrol	TD26525				
K4M 782	4 Cyl.	1598cc	83kW (113PS)	Petrol	TD18303				
K4M 788	4 Cyl.	1598cc	77kW (105PS)	Petrol	TD21204				
K4M 790	4 Cyl.	1598cc	82kW (112PS)	Petrol	TD18898				
K4M 791	4 Cyl.	1598cc	82kW (112PS)	Petrol	TD18899				
K4M 792	4 Cyl.	1598cc	65kW (88PS)	Petrol	TD20894				
K4M 794	4 Cyl.	1598cc	65kW (88PS)	Petrol	TD20895				
K4M 8 788	4 Cyl.	1598cc	75-78kW (102-106PS)	Petrol	TD19690				



K4M 800	4 Cyl.	1598cc	82kW (112PS)	Petrol	TD18534
K4M 801	4 Cyl.	1598cc	82kW (112PS)	Petrol	TD18535
K4M 804	4 Cyl.	1598cc	65kW (88PS)	Petrol	TD18532
K4M 812	4 Cyl.	1598cc	82kW (112PS)	Petrol	TD21294
K4M 813	4 Cyl.	1598cc	82kW (112PS)	Petrol	TD26333
K4M 824 Euro 4	4 Cyl.	1598cc	81kW (110PS)	Petrol	TD20814
K4M 830 Euro 4	4 Cyl.	1598cc	70-78kW (95-106PS)	Petrol	TD23581
K4M 831 Euro 4	4 Cyl.	1598cc	78-79kW (105-107PS)	Petrol	TD26526
K4M 838	4 Cyl.	1598cc	81-82kW (110-112PS)	Petrol	TD26123
K4M 839	4 Cyl.	1598cc	81kW (110PS)	Petrol	TD26124
K4M 848 Euro 4	4 Cyl.	1598cc	74kW (101PS)	Petrol	TD26527
K4M 850	4 Cyl.	1598cc	60-78kW (82-106PS)	Petrol	TD26565
K4M 854 Euro 4/5	4 Cyl.	1598cc	98kW (133PS)	Petrol	TD21229
K4M 856 Euro 4	4 Cyl.	1598cc	77kW (105PS)	Petrol	TD26528
K4M 858 Euro 4	4 Cyl.	1598cc	81kW (110PS)	Petrol	TD23580
K4M 862 Euro 4	4 Cyl.	1598cc	94-98kW (128-133PS)	Petrol	TD23548
K4M 866	4 Cyl.	1598cc	81kW (110PS)	Petrol	TD23553
K4M 9 766	4 Cyl.	1598cc	81-82kW (109-112PS)	Petrol	TD19687
K4M C 812	4 Cyl.	1598cc	82kW (112PS)	Petrol	TD21104
K4M C 813	4 Cyl.	1598cc	82kW (112PS)	Petrol	TD19689
K4M D 812	4 Cyl.	1598cc	80-82kW (109-112PS)	Petrol	TD21107
K4M D 813	4 Cyl.	1598cc	82kW (112PS)	Petrol	TD21105
K4M P 848	4 Cyl.	1598cc	74kW (101PS)	Petrol	TD24253
K4M R 858	4 Cyl.	1598cc	81kW (110PS)	Petrol	TD24969
K4M T 782	4 Cyl.	1598cc	83kW (113PS)	Petrol	TD20824
K4M T 866	4 Cyl.	1598cc	81kW (110PS)	Petrol	TD23552
K4M W 761	4 Cyl.	1598cc	83kW (113PS)	Petrol	TD20827
K4M 834 Euro 4	4 Cyl.	1598cc	72-78kW (98-106PS)	Gas	TD26128

BE/PL	4	43,964/43,980	47,614/47,625	17,750	1,806	0,020/0,074	AL-LF	2950RAA	01-4138/4 STD 0.25 0.50 0.75
MB/HL 1-5	5	47,990/48,010	51,936/51,949	19,500	1,950	0,026/0,059	AL-LF	02-4241	H1065/5 STD 0.25 0.50
TW/A	2	53,000/53,250	73,670/73,920		2,850		AL-LF	04-4048	A168/2 STD

34
79.50 x 80.50

K7M 690	4 Cyl.	1598cc	77kW (105PS)	Petrol	TD22190
K7M 702	4 Cyl.	1598cc	66kW (90PS)	Petrol	TD4876
K7M 703	4 Cyl.	1598cc	66kW (90PS)	Petrol	TD4877
K7M 704	4 Cyl.	1598cc	64-66kW (87-90PS)	Petrol	TD20917
K7M 710	4 Cyl.	1598cc	64-75kW (87-102PS)	Petrol	TD18139
K7M 718 Euro 4	4 Cyl.	1598cc	62kW (84PS)	Petrol	TD23534
K7M 720	4 Cyl.	1598cc	55kW (75PS)	Petrol	TD4878
K7M 732 Euro 4	4 Cyl.	1598cc	64kW (87PS)	Petrol	TD23532
K7M 734	4 Cyl.	1598cc	68kW (92PS)	Petrol	TD27699
K7M 744	4 Cyl.	1598cc	66kW (90PS)	Petrol	TD14332
K7M 745	4 Cyl.	1598cc	66kW (90PS)	Petrol	TD14333
K7M 746	4 Cyl.	1598cc	66kW (90PS)	Petrol	TD20918
K7M 750	4 Cyl.	1598cc	64kW (87PS)	Petrol	TD22191
K7M 790	4 Cyl.	1598cc	66kW (90PS)	Petrol	TD4879

BE/PL	4	43,964/43,980	47,614/47,625	17,750	1,806	0,020/0,074	AL-LF	2950RAA	01-4138/4 STD 0.25 0.50 0.75
-------	---	---------------	---------------	--------	-------	-------------	-------	---------	--

RENAULT

MB/HL	3	47,990/48,010	51,936/51,949	19,500	1,950	0,026/0,059	AL-LF	02-4241L	H1014/5 STD 0.25	
MB/HL	7	47,990/48,010	51,936/51,949	19,500	1,950	0,026/0,059	AL-LF	02-4241U		
TW/A	2	53,000/53,250	73,670/73,920		2,850		AL-LF	04-4048	A168/2 STD	

35 80.00 x 93.00

F8Q 600	4 Cyl.	1870cc	44kW (60PS)	Diesel	TD16330
F8Q 606	4 Cyl.	1870cc	44kW (60PS)	Diesel	TD9690
F8Q 620	4 Cyl.	1870cc	47kW (64PS)	Diesel	TD4867
F8Q 624	4 Cyl.	1870cc	47kW (64PS)	Diesel	TD16348
F8Q 630	4 Cyl.	1870cc	47kW (64PS)	Diesel	TD9626
F8Q 632	4 Cyl.	1870cc	47-48kW (64-65PS)	Diesel	TD17431
F8Q 636	4 Cyl.	1870cc	45kW (61PS)	Diesel	TD21227
F8Q 640	4 Cyl.	1870cc	40kW (54PS)	Diesel	TD5510
F8Q 644	4 Cyl.	1870cc	40-66kW (54-90PS)	Diesel	TD21146
F8Q 646	4 Cyl.	1870cc	47-66kW (64-90PS)	Diesel	TD21252
F8Q 648	4 Cyl.	1870cc	66kW (90PS)	Diesel	TD21251
F8Q 662	4 Cyl.	1870cc	40-48kW (54-65PS)	Diesel	TD9625
F8Q 676	4 Cyl.	1870cc	48kW (65PS)	Diesel	TD23895
F8Q 678	4 Cyl.	1870cc	40-48kW (54-65PS)	Diesel	TD20390
F8Q 680	4 Cyl.	1870cc	40-66kW (54-90PS)	Diesel	TD21253
F8Q 682	4 Cyl.	1870cc	40kW (54PS)	Diesel	TD16544
F8Q 684	4 Cyl.	1870cc	40-48kW (54-65PS)	Diesel	TD21254
F8Q 696	4 Cyl.	1870cc	40-48kW (54-65PS)	Diesel	TD21255
F8Q 714	4 Cyl.	1870cc	47-48kW (64-65PS)	Diesel	TD3289
F8Q 722	4 Cyl.	1870cc	47-48kW (64-67PS)	Diesel	TD3290
F8Q 724	4 Cyl.	1870cc	47-48kW (64-67PS)	Diesel	TD3291
F8Q 730	4 Cyl.	1870cc	47-48kW (64-65PS)	Diesel	TD4868
F8Q 732	4 Cyl.	1870cc	47-48kW (64-65PS)	Diesel	TD4869
F8Q 764	4 Cyl.	1870cc	47kW (64PS)	Diesel	TD3297
F8Q 774	4 Cyl.	1870cc	47-48kW (64-67PS)	Diesel	TD3298
F8Q 776	4 Cyl.	1870cc	47-48kW (64-67PS)	Diesel	TD3299
F8Q 790	4 Cyl.	1870cc	47kW (64PS)	Diesel	TD18290
F8QA6	4 Cyl.	1870cc	48kW (65PS)	Diesel	TD26765

BE/PL	4	48,000/48,020	51,587/51,606	20,250	1,776	0,015/0,079	EC	71-3988L	71-3988/4 STD 0.25 0.50	4
BE/PL	4	48,000/48,020	51,587/51,606	20,500	1,776	0,015/0,079	EC	71-3988U		

01/98→

BE/PL	4	48,000/48,020	51,587/51,600	20,500	1,768	0,031/0,089	BS	4060CP	71-4311/4 STD 0.25 0.50
-------	---	---------------	---------------	--------	-------	-------------	----	--------	-----------------------------------

→12/97

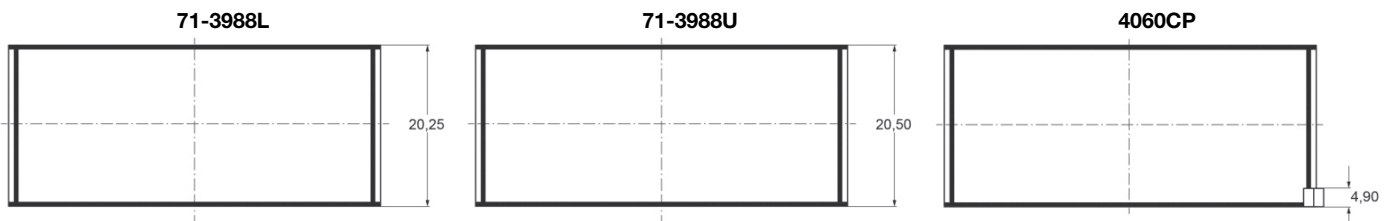

MB/HL 1-5	5	54,785/54,805	58,731/58,744	18,500	1,947	0,032/0,090	EC	72-3989	H098/5 STD 0.25 0.50
--------------	---	---------------	---------------	--------	-------	-------------	----	---------	--------------------------------

01/98→



MB/HL 1-5	5	54,785/54,795	58,731/58,744	18,500	1,945	0,046/0,094	AL-LF	66741RA	H1080/5 STD 0.25 0.50
--------------	---	---------------	---------------	--------	-------	-------------	-------	---------	---------------------------------

→12/97

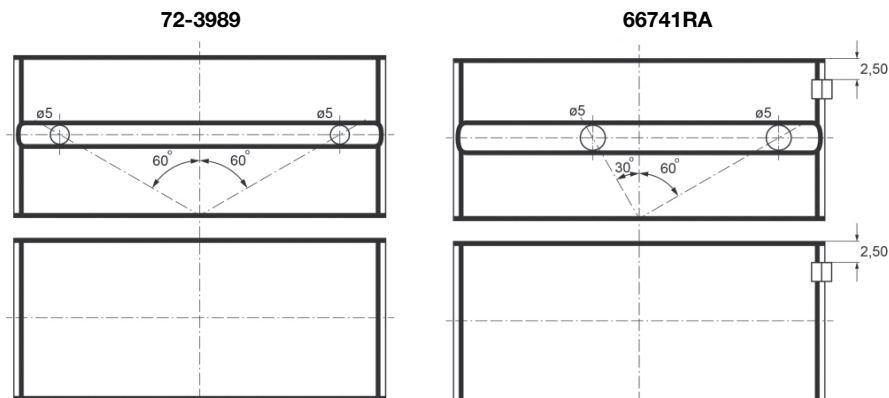

TW/A	2	60,500/60,750	79,750/80,000		2,350		AL-LF	66741AF	A215/2 STD 0.10
SE/PB	1	24,005/24,012	26,000/26,021	24,750			BC	55-3875	55-3875 SEMI

36 80.00 x 93.00

F8Q 610	4 Cyl.	1870cc	66-69kW (90-94PS)	Diesel Turbo	TD19666
F8Q 740	4 Cyl.	1870cc	66-68kW (90-93PS)	Diesel Turbo	TD3294
F8Q 744	4 Cyl.	1870cc	66-68kW (90-92PS)	Diesel Turbo	TD3296

BE/PL	4	48,000/48,020	51,587/51,600	20,500	1,768	0,031/0,089	BS	4060CP	71-4311/4 STD 0.25 0.50
MB/HL 1-5	5	54,785/54,795	58,731/58,744	18,500	1,945	0,046/0,094	AL-LF	66741RA	H1080/5 STD 0.25 0.50
TW/A	2	60,500/60,750	79,750/80,000		2,350		AL-LF	66741AF	A215/2 STD 0.10
SE/PB	1	26,013/26,025	29,000/29,021	22,900			BS	66509Y	55-4394 SEMI

37 80.00 x 93.00

F8Q 622	4 Cyl.	1870cc	47kW (64PS)	Diesel	TD18295
----------------	--------	---------------	--------------------	---------------	----------------

BE/PL	4	48,000/48,020	51,587/51,606	20,250	1,776	0,015/0,079	EC	71-3988L	71-3988/4 STD 0.25 0.50	[4]
BE/PL	4	48,000/48,020	51,587/51,606	20,500	1,776	0,015/0,079	EC	71-3988U		
MB/HL 1-5	5	54,785/54,805	58,731/58,744	18,500	1,947	0,032/0,090	EC	72-3989	H098/5 STD 0.25 0.50	
TW/A	2	60,500/60,750	79,750/80,000		2,350		AL-LF	66741AF	A215/2 STD 0.10	
SE/PB	1	24,005/24,012	26,000/26,021	24,750			BC	55-3875	55-3875 SEMI	

38 80.00 x 93.00

F8Q 706	4 Cyl.	1870cc	47-48kW (64-65PS)	Diesel	TD3287
F8Q 710	4 Cyl.	1870cc	47kW (64PS)	Diesel	TD3288
F8Q 742	4 Cyl.	1870cc	47-48kW (64-65PS)	Diesel	TD3295

BE/PL	4	48,000/48,020	51,587/51,600	20,500	1,768	0,031/0,089	BS	4060CP	71-4311/4 STD 0.25 0.50
MB/HL 1-5	5	54,785/54,795	58,731/58,744	18,500	1,945	0,046/0,094	AL-LF	66741RA	H1080/5 STD 0.25 0.50
TW/A	2	60,500/60,750	79,750/80,000		2,350		AL-LF	66741AF	A215/2 STD 0.10

RENAULT

SE/PB	1	24,005/24,012	26,000/26,021	24,750		BC	55-3875	55-3875 SEMI

39 80.00 x 93.00

F8Q 748	4 Cyl.	1870cc	52kW (71PS)	Diesel Turbo	TD27320
F8Q 754	4 Cyl.	1870cc	71kW (97PS)	Diesel Turbo	TD27327
F8Q 768	4 Cyl.	1870cc	66-69kW (90-94PS)	Diesel Turbo	TD19234
F8Q 784	4 Cyl.	1870cc	66-69kW (90-94PS)	Diesel Turbo	TD4870
F8Q 785	4 Cyl.	1870cc	68-70kW (92-95PS)	Diesel Turbo	TD22363
F8Q 786	4 Cyl.	1870cc	66kW (90PS)	Diesel Turbo	TD16352
F8Q 788	4 Cyl.	1870cc	66kW (90PS)	Diesel Turbo	TD21256
F8QT	4 Cyl.	1870cc	66-69kW (90-94PS)	Diesel Turbo Intercooler	TD24107

BE/PL	4	48,000/48,020	51,587/51,606	20,250	1,776	0,015/0,079	EC	71-3988L	71-3988/4 STD 0.25 0.50	4
BE/PL	4	48,000/48,020	51,587/51,606	20,500	1,776	0,015/0,079	EC	71-3988U		

01/98 →

BE/PL	4	48,000/48,020	51,587/51,600	20,500	1,768	0,031/0,089	BS	4060CP	71-4311/4 STD 0.25 0.50
-------	---	---------------	---------------	--------	-------	-------------	----	--------	----------------------------

→12/97

71-3988L

71-3988U

4060CP

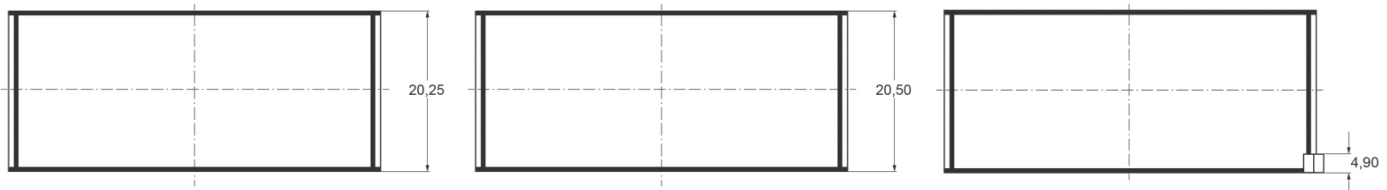

MB/HL 1-5	5	54,785/54,805	58,731/58,744	18,500	1,947	0,032/0,090	EC	72-3989	H098/5 STD 0.25 0.50
--------------	---	---------------	---------------	--------	-------	-------------	----	---------	-------------------------

01/98 →

MB/HL 1-5	5	54,785/54,795	58,731/58,744	18,500	1,945	0,046/0,094	AL-LF	66741RA	H1080/5 STD 0.25 0.50
--------------	---	---------------	---------------	--------	-------	-------------	-------	---------	--------------------------

→12/97

72-3989



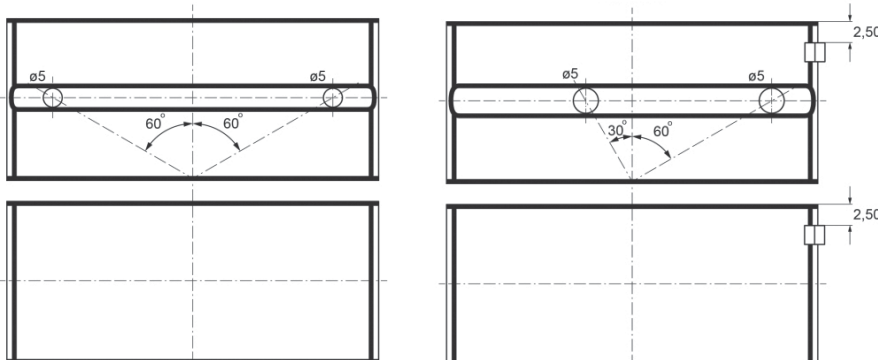

66741RA



TW/A	2	60,500/60,750	79,750/80,000	2,350		AL-LF	66741AF	A215/2 STD 0.10
SE/PB	1	26,013/26,025	29,000/29,021	22,900		BS	66509Y	55-4394 SEMI

40 80.00 x 93.00

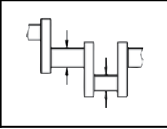
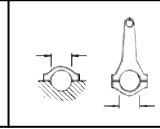
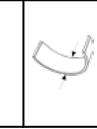
F9Q 650	4 Cyl.	1870cc	88kW (120PS)	Diesel Turbo	TD21223
F9Q 664	4 Cyl.	1870cc	68kW (92PS)	Diesel	TD19677

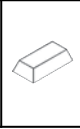
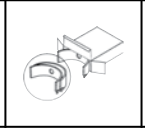
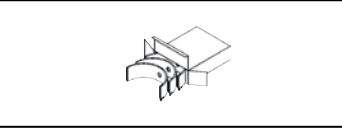
									
F9Q 670	4 Cyl.	1870cc	88kW (120PS)	Diesel Turbo	TD21224				
F9Q 674	4 Cyl.	1870cc	81-88kW (110-120PS)	Diesel Turbo	TD21225				
F9Q 680	4 Cyl.	1870cc	88kW (120PS)	Diesel Turbo Intercooler	TD18286				
F9Q 710	4 Cyl.	1870cc	72kW (98PS)	Diesel Turbo	TD16190				
F9Q 716	4 Cyl.	1870cc	72-75kW (98-102PS)	Diesel Turbo	TD16191				
F9Q 717	4 Cyl.	1870cc	72-75kW (98-102PS)	Diesel Turbo	TD21136				
F9Q 718	4 Cyl.	1870cc	79kW (107PS)	Diesel Turbo	TD16192				
F9Q 722	4 Cyl.	1870cc	72kW (98PS)	Diesel Turbo	TD16305				
F9Q 730	4 Cyl.	1870cc	72kW (98PS)	Diesel Turbo	TD11427				
F9Q 731	4 Cyl.	1870cc	72kW (98PS)	Diesel Turbo	TD16353				
F9Q 732	4 Cyl.	1870cc	74-77kW (101-105PS)	Diesel Turbo	TD16347				
F9Q 733	4 Cyl.	1870cc	75-77kW (102-105PS)	Diesel Turbo	TD16363				
F9Q 734	4 Cyl.	1870cc	72kW (98PS)	Diesel Turbo	TD11428				
F9Q 736	4 Cyl.	1870cc	72kW (98PS)	Diesel Turbo	TD16354				
F9Q 738	4 Cyl.	1870cc	74-79kW (101-107PS)	Diesel Turbo	TD21137				
F9Q 740	4 Cyl.	1870cc	75kW (102PS)	Diesel Turbo	TD16341				
F9Q 744	4 Cyl.	1870cc	59kW (80PS)	Diesel Turbo	TD16361				
F9Q 746	4 Cyl.	1870cc	75-79kW (102-107PS)	Diesel Turbo	TD24971				
F9Q 748	4 Cyl.	1870cc	74-79kW (101-107PS)	Diesel Turbo	TD21138				
F9Q 750	4 Cyl.	1870cc	88kW (120PS)	Diesel Turbo	TD17028				
F9Q 751	4 Cyl.	1870cc	88kW (120PS)	Diesel Turbo	TD21226				
F9Q 752	4 Cyl.	1870cc	74-77kW (101-105PS)	Diesel Turbo	TD21139				
F9Q 754	4 Cyl.	1870cc	74-79kW (101-107PS)	Diesel Turbo	TD20841				
F9Q 756	4 Cyl.	1870cc	88kW (120PS)	Diesel Turbo	TD17064				
F9Q 758	4 Cyl.	1870cc	81-96kW (110-130PS)	Diesel Turbo	TD19678				
F9Q 759	4 Cyl.	1870cc	85-96kW (116-130PS)	Diesel Turbo	TD19679				
F9Q 760	4 Cyl.	1870cc	60-75kW (82-102PS)	Diesel Turbo	TD16529				
F9Q 762	4 Cyl.	1870cc	60kW (82PS)	Diesel Turbo	TD18691				
F9Q 770	4 Cyl.	1870cc	59kW (80PS)	Diesel Turbo	TD15688				
F9Q 772	4 Cyl.	1870cc	60kW (82PS)	Diesel Turbo	TD16304				
F9Q 774	4 Cyl.	1870cc	60kW (82PS)	Diesel Turbo	TD19370				
F9Q 780	4 Cyl.	1870cc	59kW (80PS)	Diesel Turbo	TD16339				
F9Q 782	4 Cyl.	1870cc	59-62kW (80-84PS)	Diesel	TD17498				
F9Q 790	4 Cyl.	1870cc	59-62kW (80-84PS)	Diesel Turbo	TD16358				
F9Q 796	4 Cyl.	1870cc	75kW (102PS)	Diesel Turbo	TD24972				
F9Q 800	4 Cyl.	1870cc	88kW (120PS)	Diesel Turbo	TD16535				
F9Q 803	4 Cyl.	1870cc	72-96kW (98-131PS)	Diesel Turbo Intercooler	TD20973				
F9Q 804	4 Cyl.	1870cc	81-96kW (110-131PS)	Diesel Turbo	TD20391				
F9Q 808	4 Cyl.	1870cc	66-75kW (90-102PS)	Diesel Turbo	TD21147				
F9Q 812	4 Cyl.	1870cc	85-88kW (116-120PS)	Diesel Turbo Intercooler	TD20392				
F9Q 816	4 Cyl.	1870cc	81-96kW (110-131PS)	Diesel Turbo Intercooler	TD22184				
F9Q 818	4 Cyl.	1870cc	81-96kW (110-131PS)	Diesel Turbo Intercooler	TD22185				
F9Q 820	4 Cyl.	1870cc	85-88kW (115-120PS)	Diesel Turbo Intercooler	TD18287				
F9Q 826	4 Cyl.	1870cc	88kW (120PS)	Diesel Turbo	TD18288				
F9Q 870	4 Cyl.	1870cc	96kW (131PS)	Diesel Turbo	TD23617				
F9Q 872	4 Cyl.	1870cc	96kW (131PS)	Diesel Turbo	TD23555				
F9Q E 804 Euro 4	4 Cyl.	1870cc	81-96kW (110-131PS)	Diesel Turbo	TD19683				
F9Q EE 804 Euro 4	4 Cyl.	1870cc	81-96kW (110-131PS)	Diesel Turbo	TD19696				
F9Q J 803	4 Cyl.	1870cc	85-96kW (116-131PS)	Diesel Turbo	TD19694				
F9Q J 804	4 Cyl.	1870cc	85-96kW (116-131PS)	Diesel Turbo	TD21106				
F9Q N 870	4 Cyl.	1870cc	96kW (131PS)	Diesel Turbo	TD23568				
F9Q P 872	4 Cyl.	1870cc	96kW (131PS)	Diesel Turbo	TD23554				

RENAULT

BE/PL	4	48,000/48,020	51,587/51,606	20,250	1,776	0,015/0,079	EC	71-3988L	71-3988/4 STD 0.25 0.50	4	
BE/PL	4	48,000/48,020	51,587/51,606	20,500	1,776	0,015/0,079	EC	71-3988U			
MB/HL 1-5	5	54,785/54,805	58,731/58,744	18,500	1,947	0,032/0,090	EC	72-3989	H098/5 STD 0.25 0.50		
TW/A	2	60,500/60,750	79,750/80,000		2,350		AL-LF	66741AF	A215/2 STD 0.10		
SE/PB	1	27,996/28,000	30,240/30,260	24,650			BS-LF	55-4299	55-4299 SEMI		

41

81.00 x 83.50

F1N 720	4 Cyl.	1721cc	50kW (68PS)	Petrol	TD3216				
F1N 722	4 Cyl.	1721cc	50kW (68PS)	Petrol	TD3217				
F1N 724	4 Cyl.	1721cc	50-51kW (68-69PS)	Petrol	TD3218				
F2N 700	4 Cyl.	1721cc	59kW (80PS)	Petrol	TD3219				
F2N 704	4 Cyl.	1721cc	59kW (80PS)	Petrol	TD3220				
F2N 708	4 Cyl.	1721cc	65kW (88PS)	Petrol	TD3221				
F2N 710	4 Cyl.	1721cc	65kW (88PS)	Petrol	TD3222				
F2N 711	4 Cyl.	1721cc	65kW (88PS)	Petrol	TD3223				
F2N 712	4 Cyl.	1721cc	55kW (75PS)	Petrol	TD3224				
F2N 716	4 Cyl.	1721cc	56kW (76PS)	Petrol	TD3226				
F2N 720	4 Cyl.	1721cc	65-68kW (88-92PS)	Petrol	TD4862				
F2N 721	4 Cyl.	1721cc	68-69kW (92-94PS)	Petrol	TD3228				
F2N 722	4 Cyl.	1721cc	66-69kW (90-94PS)	Petrol	TD3229				
F2N 724	4 Cyl.	1721cc	55-56kW (75-76PS)	Petrol	TD3230				
F2N 726	4 Cyl.	1721cc	68kW (92PS)	Petrol	TD3231				
F2N 727	4 Cyl.	1721cc	68kW (92PS)	Petrol	TD3232				
F2N 728	4 Cyl.	1721cc	55kW (75PS)	Petrol	TD3233				
F2N 730	4 Cyl.	1721cc	54-55kW (73-75PS)	Petrol	TD3234				
F2N 732	4 Cyl.	1721cc	64kW (87PS)	Petrol	TD3235				
F2N 740	4 Cyl.	1721cc	64-66kW (87-90PS)	Petrol	TD3236				
F2N 742	4 Cyl.	1721cc	64-66kW (87-90PS)	Petrol	TD4861				
F2N 750	4 Cyl.	1721cc	54kW (73PS)	Petrol	TD3238				
F2N 752	4 Cyl.	1721cc	64kW (87PS)	Petrol	TD3239				
F2N 753	4 Cyl.	1721cc	60-66kW (82-90PS)	Petrol	TD22362				
F2N 754	4 Cyl.	1721cc	65kW (88PS)	Petrol	TD3240				
F2N 758	4 Cyl.	1721cc	56-66kW (76-90PS)	Petrol	TD3241				
F2N 770	4 Cyl.	1721cc	66-68kW (90-92PS)	Petrol	TD3242				
F2N 783	4 Cyl.	1721cc	65kW (88PS)	Petrol	TD3243				
F2N 786	4 Cyl.	1721cc	59kW (80PS)	Petrol	TD3244				
F2N 796	4 Cyl.	1721cc	59kW (80PS)	Petrol	TD3245				
F2N 797	4 Cyl.	1721cc	59kW (80PS)	Petrol	TD3246				
F2N 798	4 Cyl.	1721cc	65kW (88PS)	Petrol	TD3247				
F2R 702	4 Cyl.	1721cc	66kW (90PS)	Petrol	TD3248				
BE/PL	4	48,000/48,020	51,587/51,600	20,500	1,768	0,031/0,089	BS	4060CP	71-4311/4 STD 0.25 0.50
MB/HL 1-5	5	54,785/54,795	58,731/58,744	18,500	1,945	0,046/0,094	AL-LF	66741RA	H1080/5 STD 0.25 0.50
TW/A	2	60,500/60,750	79,750/80,000		2,350		AL-LF	66741AF	A215/2 STD 0.10

42

81.00 x 83.50

F3N 702	4 Cyl.	1721cc	68-69kW (92-94PS)	Petrol	TD3249
F3N 708	4 Cyl.	1721cc	69kW (94PS)	Petrol	TD3250
F3N 716	4 Cyl.	1721cc	54-55kW (73-75PS)	Petrol	TD3251



F3N 717	4 Cyl.	1721cc	54-55kW (73-75PS)	Petrol	TD3252
F3N 718	4 Cyl.	1721cc	54-55kW (73-75PS)	Petrol	TD4863
F3N 722	4 Cyl.	1721cc	66-70kW (90-95PS)	Petrol	TD3254
F3N 723	4 Cyl.	1721cc	66-70kW (90-95PS)	Petrol	TD3255
F3N 726	4 Cyl.	1721cc	54kW (73PS)	Petrol	TD3256
F3N 740	4 Cyl.	1721cc	54-55kW (73-75PS)	Petrol	TD3257
F3N 741	4 Cyl.	1721cc	54-55kW (73-75PS)	Petrol	TD3258
F3N 742	4 Cyl.	1721cc	66-70kW (90-95PS)	Petrol	TD3259
F3N 743	4 Cyl.	1721cc	66kW (90PS)	Petrol	TD3260
F3N 746	4 Cyl.	1721cc	66-80kW (90-109PS)	Petrol	TD3261
F3N 747	4 Cyl.	1721cc	69kW (94PS)	Petrol	TD27329

BE/PL	4	48,000/48,020	51,587/51,600	20,500	1,768	0,031/0,089	BS	4060CP	71-4311/4 STD 0.25 0.50
MB/HL 1-5	5	54,785/54,795	58,731/58,744	18,500	1,945	0,046/0,094	AL-LF	66741RA	H1080/5 STD 0.25 0.50
TW/A	2	60,500/60,750	79,750/80,000		2,350		AL-LF	66741AF	A215/2 STD 0.10
SE/PB	1	21,000/21,015	23,000/23,021	24,750			BS	4064Y	55-4264 SEMI

43

82.00 x 83.50

F7P 700	4 Cyl.	1764cc	101-103kW (137-140PS)	Petrol	TD3277
F7P 702	4 Cyl.	1764cc	104kW (141PS)	Petrol	TD27307
F7P 704	4 Cyl.	1764cc	99-101kW (135-137PS)	Petrol	TD3278
F7P 720	4 Cyl.	1764cc	101-103kW (137-140PS)	Petrol	TD3279
F7P 722	4 Cyl.	1764cc	99kW (135PS)	Petrol	TD3280

BE/PL	4	48,000/48,020	51,587/51,600	20,500	1,768	0,031/0,089	BS	4060CP	71-4311/4 STD 0.25 0.50
MB/HL 1-5	5	54,785/54,795	58,731/58,744	18,500	1,945	0,046/0,094	AL-LF	66741RA	H1080/5 STD 0.25 0.50
TW/A	2	60,500/60,750	79,750/80,000		2,350		AL-LF	66741AF	A215/2 STD 0.10
SE/PB	1	21,000/21,015	23,000/23,021	24,750			BS	4064Y	55-4264 SEMI

44

82.70 x 83.00

F3P 670	4 Cyl.	1783cc	66kW (90PS)	Petrol	TD5541
F3P 674	4 Cyl.	1783cc	69kW (94PS)	Petrol	TD18885
F3P 678	4 Cyl.	1783cc	66kW (90PS)	Petrol	TD5542
F3P 755	4 Cyl.	1783cc	66kW (90PS)	Petrol	TD3272
F3P 758	4 Cyl.	1783cc	79-80kW (107-109PS)	Petrol	TD3273

BE/PL	4	48,000/48,020	51,587/51,606	20,250	1,776	0,015/0,079	EC	71-3988L	71-3988/4 STD 0.25 0.50	[4]
BE/PL	4	48,000/48,020	51,587/51,606	20,500	1,776	0,015/0,079	EC	71-3988U		

01/98 →

BE/PL	4	48,000/48,020	51,587/51,600	20,500	1,768	0,031/0,089	BS	4060CP	71-4311/4 STD 0.25 0.50
-------	---	---------------	---------------	--------	-------	-------------	----	--------	-----------------------------------

→12/97

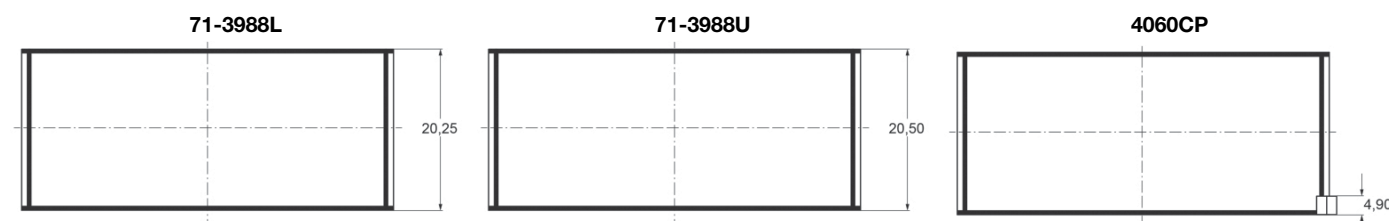

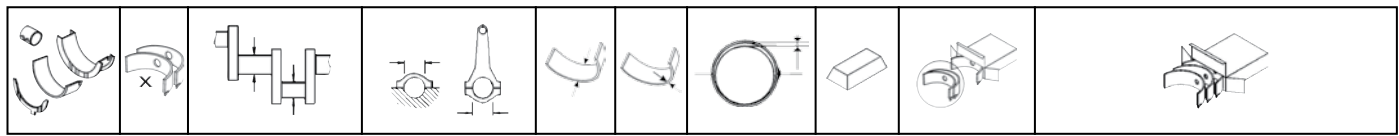

MB/HL 1-5	5	54,785/54,805	58,731/58,744	18,500	1,947	0,032/0,090	EC	72-3989	H098/5 STD 0.25 0.50
--------------	---	---------------	---------------	--------	-------	-------------	----	---------	--------------------------------

01/98 →

MB/HL 1-5	5	54,785/54,795	58,731/58,744	18,500	1,945	0,046/0,094	AL-LF	66741RA	H1080/5 STD 0.25 0.50
--------------	---	---------------	---------------	--------	-------	-------------	-------	---------	---------------------------------

→12/97

72-3989

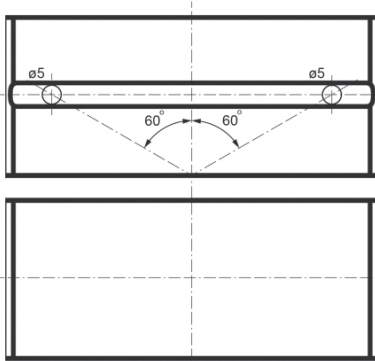

66741RA

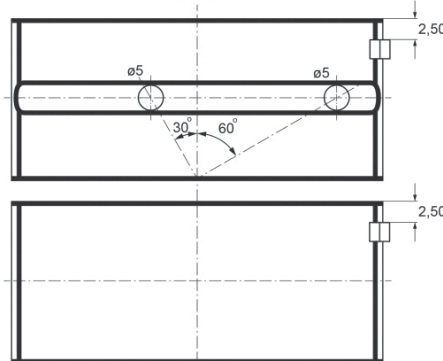

TW/A	2	60,500/60,750	79,750/80,000	2,350	AL-LF	66741AF	A215/2 STD 0.10
------	---	---------------	---------------	-------	-------	---------	---------------------------

45 82.70 x 83.00

F3P 682	4 Cyl.	1783cc	79kW (107PS)	Petrol	TD5483				
F3P 764	4 Cyl.	1783cc	79kW (107PS)	Petrol	TD9554				
BE/PL	4	48,000/48,020	51,587/51,600	20,500	1,768	0,031/0,089	BS	4060CP	71-4311/4 STD 0.25 0.50
MB/HL 1-5	5	54,785/54,795	58,731/58,744	18,500	1,945	0,046/0,094	AL-LF	66741RA	H1080/5 STD 0.25 0.50
TW/A	2	60,500/60,750	79,750/80,000	2,350	AL-LF	66741AF	A215/2 STD 0.10		

46 82.70 x 83.00

F4P 720	4 Cyl.	1783cc	85kW (115PS)	Petrol	TD16220				
F4P 722	4 Cyl.	1783cc	85kW (115PS)	Petrol	TD16221				
F4P 760	4 Cyl.	1783cc	88kW (120PS)	Petrol	TD16189				
F4P 770	4 Cyl.	1783cc	85-89kW (116-121PS)	Petrol	TD16216				
F4P 771	4 Cyl.	1783cc	85-89kW (116-121PS)	Petrol	TD18272				
F4P 772	4 Cyl.	1783cc	89kW (121PS)	Petrol	TD21211				
F4P 773	4 Cyl.	1783cc	85-89kW (116-121PS)	Petrol	TD16217				
F4P 774	4 Cyl.	1783cc	85-89kW (116-121PS)	Petrol	TD18273				
F4P 775	4 Cyl.	1783cc	85-89kW (116-121PS)	Petrol	TD18274				
MB/HL 1-5	5	54,785/54,795	58,731/58,744	18,500	1,945	0,050/0,090	AL-LF	66741RAB	H1101/5 STD 0.25 0.50
TW/A	2	60,500/60,750	79,750/80,000	2,350	AL-LF	66741AF	A215/2 STD 0.10		
SE/PB	1	21,000/21,015	23,000/23,021	24,750	BS	4064Y	55-4264 SEMI		

47 82.70 x 83.50

F3P 676	4 Cyl.	1794cc	69-70kW (94-95PS)	Petrol	TD20049
F3P 710	4 Cyl.	1794cc	65-70kW (88-95PS)	Petrol	TD3267
F3P 714	4 Cyl.	1794cc	65-70kW (88-95PS)	Petrol	TD3269
F3P 720	4 Cyl.	1794cc	66-69kW (90-94PS)	Petrol	TD3270
F3P 724	4 Cyl.	1794cc	66-69kW (90-94PS)	Petrol	TD3271
F3P 754	4 Cyl.	1794cc	66kW (90PS)	Petrol	TD5523



BE/PL	4	48,000/48,020	51,587/51,606	20,250	1,776	0,015/0,079	EC	71-3988L	71-3988/4 STD 0.25 0.50	4
BE/PL	4	48,000/48,020	51,587/51,606	20,500	1,776	0,015/0,079	EC	71-3988U		

01/98 →

BE/PL	4	48,000/48,020	51,587/51,600	20,500	1,768	0,031/0,089	BS	4060CP	71-4311/4 STD 0.25 0.50	
-------	---	---------------	---------------	--------	-------	-------------	----	--------	-----------------------------------	--

→12/97

71-3988L



71-3988U



4060CP

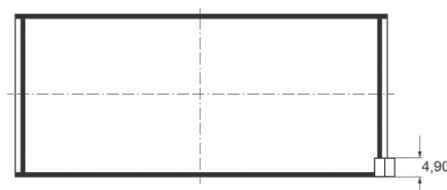

MB/HL 1-5	5	54,785/54,805	58,731/58,744	18,500	1,947	0,032/0,090	EC	72-3989	H098/5 STD 0.25 0.50	
--------------	---	---------------	---------------	--------	-------	-------------	----	---------	--------------------------------	--

01/98 →

MB/HL 1-5	5	54,785/54,795	58,731/58,744	18,500	1,945	0,046/0,094	AL-LF	66741RA	H1080/5 STD 0.25 0.50	
--------------	---	---------------	---------------	--------	-------	-------------	-------	---------	---------------------------------	--

→12/97

72-3989

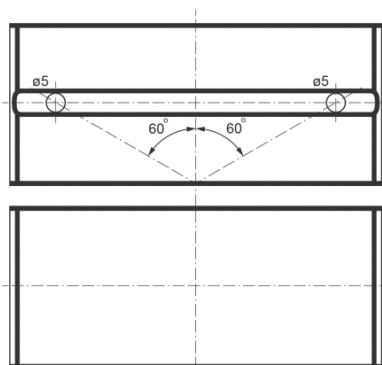

66741RA

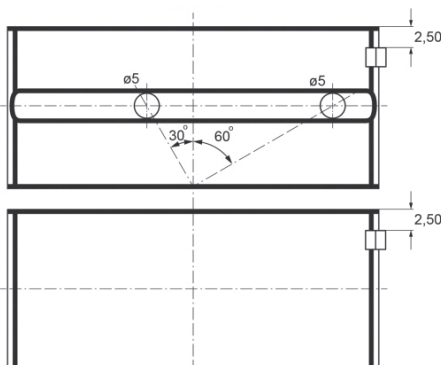

TW/A	2	60,500/60,750	79,750/80,000		2,350		AL-LF	66741AF	A215/2 STD 0.10	
------	---	---------------	---------------	--	-------	--	-------	---------	---------------------------	--

48

82.70 x 83.50

F3P 700	4 Cyl.	1794cc	79-81kW (107-110PS)	Petrol	TD3262
F3P 704	4 Cyl.	1794cc	65-66kW (88-90PS)	Petrol	TD5488
F3P 705	4 Cyl.	1794cc	65-66kW (88-90PS)	Petrol	TD3263
F3P 706	4 Cyl.	1794cc	65-79kW (88-107PS)	Petrol	TD3264
F3P 707	4 Cyl.	1794cc	65-66kW (88-90PS)	Petrol	TD3265
F3P 708	4 Cyl.	1794cc	65-66kW (88-90PS)	Petrol	TD3266
F3P 712	4 Cyl.	1794cc	66-80kW (90-109PS)	Petrol	TD3268
F3P 760	4 Cyl.	1794cc	65-66kW (88-90PS)	Petrol	TD3274
F3P 765	4 Cyl.	1794cc	67-79kW (91-107PS)	Petrol	TD5494

BE/PL	4	48,000/48,020	51,587/51,600	20,500	1,768	0,031/0,089	BS	4060CP	71-4311/4 STD 0.25 0.50	
MB/HL 1-5	5	54,785/54,795	58,731/58,744	18,500	1,945	0,046/0,094	AL-LF	66741RA	H1080/5 STD 0.25 0.50	
TW/A	2	60,500/60,750	79,750/80,000		2,350		AL-LF	66741AF	A215/2 STD 0.10	

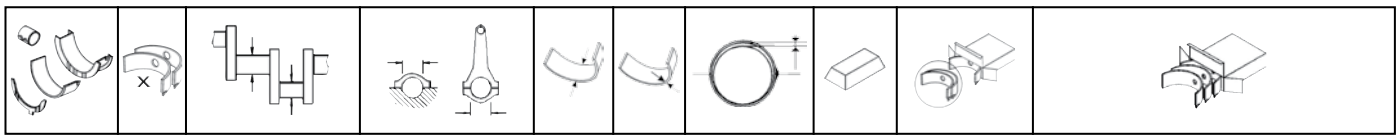

49 **82.70 x 93.00**

F3R 200	4 Cyl.	1998cc	84kW (114PS)	Petrol	TD21210
F3R 722	4 Cyl.	1998cc	83-84kW (113-114PS)	Petrol	TD3275
F3R 723	4 Cyl.	1998cc	83-84kW (113-114PS)	Petrol	TD3276
F3R 728	4 Cyl.	1998cc	84kW (114PS)	Petrol	TD16177
F3R 729	4 Cyl.	1998cc	84kW (114PS)	Petrol	TD16178
F3R 742	4 Cyl.	1998cc	84kW (114PS)	Petrol	TD16372
F3R 750	4 Cyl.	1998cc	80-84kW (109-114PS)	Petrol	TD4865
F3R 751	4 Cyl.	1998cc	80-84kW (109-114PS)	Petrol	TD16357
F3R 752	4 Cyl.	1998cc	80-84kW (109-114PS)	Petrol	TD20052
F3R 768	4 Cyl.	1998cc	84kW (114PS)	Petrol	TD16373
F3R 769	4 Cyl.	1998cc	84kW (114PS)	Petrol	TD16374
F3R 791	4 Cyl.	1998cc	80-84kW (109-114PS)	Petrol	TD16350
F3R 796	4 Cyl.	1998cc	80-84kW (109-114PS)	Petrol	TD16351
F3R 797	4 Cyl.	1998cc	80-84kW (109-114PS)	Petrol	TD20050
F3R J7	4 Cyl.	1998cc	84kW (114PS)	Petrol	TD5504

BE/PL	4	48,000/48,020	51,587/51,606	20,250	1,776	0,015/0,079	EC	71-3988L	71-3988/4 STD 0.25 0.50	4
BE/PL	4	48,000/48,020	51,587/51,606	20,500	1,776	0,015/0,079	EC	71-3988U		

01/98 →

BE/PL	4	48,000/48,020	51,587/51,600	20,500	1,768	0,031/0,089	BS	4060CP	71-4311/4 STD 0.25 0.50
-------	---	---------------	---------------	--------	-------	-------------	----	--------	-----------------------------------

→12/97

71-3988L



71-3988U



4060CP



MB/HL 1-5	5	54,785/54,795	58,731/58,744	18,500	1,945	0,046/0,094	AL-LF	66741RA	H1080/5 STD 0.25 0.50
--------------	---	---------------	---------------	--------	-------	-------------	-------	---------	---------------------------------

→12/97

MB/HL 1-5	5	54,785/54,795	58,731/58,744	18,500	1,945	0,050/0,090	AL-LF	66741RAB	H1101/5 STD 0.25 0.50
--------------	---	---------------	---------------	--------	-------	-------------	-------	----------	---------------------------------

01/98 →

66741RA

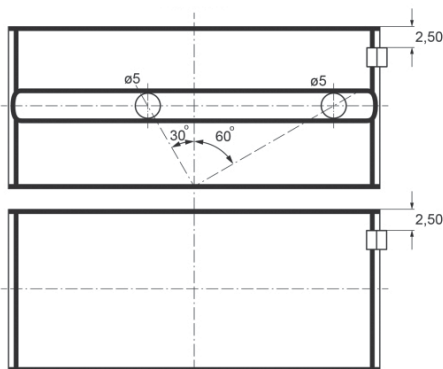

66741RAB

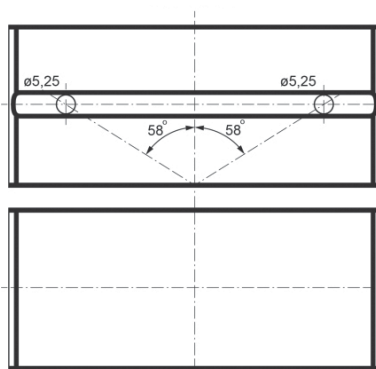

TW/A	2	60,500/60,750	79,750/80,000	2,350			AL-LF	66741AF	A215/2 STD 0.10
------	---	---------------	---------------	-------	--	--	-------	---------	---------------------------



50 82.70 x 93.00

F3R 611		4 Cyl.		1998cc	80-85kW (109-116PS)			Petrol	TD20904	
BE/PL	4	48,000/48,020	51,587/51,606	20,250	1,776	0,015/0,079	EC	71-3988L	71-3988/4 STD 0.25 0.50	[4]
BE/PL	4	48,000/48,020	51,587/51,606	20,500	1,776	0,015/0,079	EC	71-3988U		
MB/HL 1-5	5	54,785/54,795	58,731/58,744	18,500	1,945	0,050/0,090	AL-LF	66741RAB	H1101/5 STD 0.25 0.50	
TW/A	2	60,500/60,750	79,750/80,000		2,350		AL-LF	66741AF	A215/2 STD 0.10	

51 82.70 x 93.00

F3R 798		4 Cyl.		1998cc	80-84kW (109-114PS)			Petrol	TD20051	
BE/PL	4	48,000/48,020	51,587/51,606	20,250	1,776	0,015/0,079	EC	71-3988L	71-3988/4 STD 0.25 0.50	[4]
BE/PL	4	48,000/48,020	51,587/51,606	20,500	1,776	0,015/0,079	EC	71-3988U		
01/98 →										
BE/PL	4	48,000/48,020	51,587/51,600	20,500	1,768	0,031/0,089	BS	4060CP	71-4311/4 STD 0.25 0.50	
→12/97										

71-3988L

71-3988U

4060CP

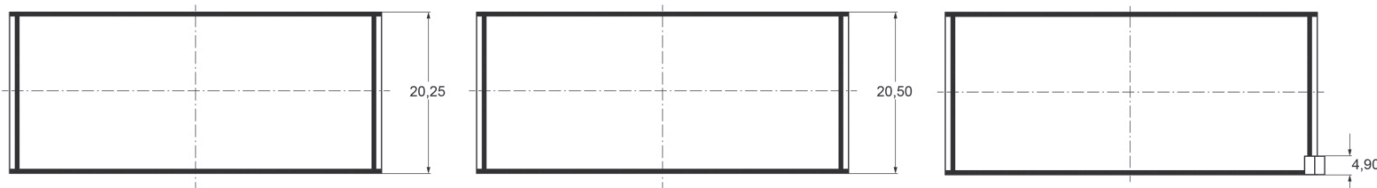

MB/HL 1-5	5	54,785/54,795	58,731/58,744	18,500	1,945	0,046/0,094	AL-LF	66741RA	H1080/5 STD 0.25 0.50	
→12/97										
MB/HL 1-5	5	54,785/54,795	58,731/58,744	18,500	1,945	0,050/0,090	AL-LF	66741RAB	H1101/5 STD 0.25 0.50	
01/98 →										

66741RA

66741RAB

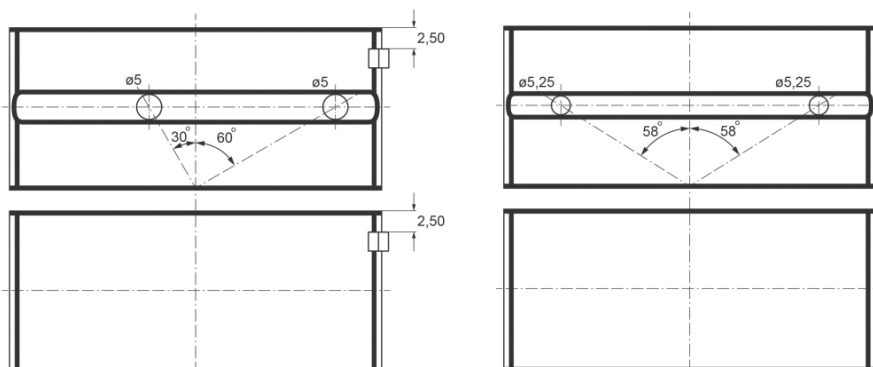

TW/A	2	60,500/60,750	79,750/80,000		2,350		AL-LF	66741AF	A215/2 STD 0.10	
------	---	---------------	---------------	--	-------	--	-------	---------	---------------------------	--

52 82.70 x 93.00

F4R	4 Cyl.	1998cc	99-110kW (135-150PS)			Petrol	TD29449
F4R 402	4 Cyl.	1998cc	99-104kW (135-141PS)			Petrol	TD29258
F4R 700	4 Cyl.	1998cc	103kW (140PS)			Petrol	TD16306
F4R 701	4 Cyl.	1998cc	103kW (140PS)			Petrol	TD16307

RENAULT



F4R 712	4 Cyl.	1998cc	99kW (135PS)	Petrol	TD18276
F4R 713	4 Cyl.	1998cc	95-99kW (129-135PS)	Petrol	TD18278
F4R 714	4 Cyl.	1998cc	98-99kW (133-135PS)	Petrol	TD18279
F4R 715	4 Cyl.	1998cc	99kW (135PS)	Petrol	TD18280
F4R 720	4 Cyl.	1998cc	88kW (120PS)	Petrol	TD16359
F4R 722	4 Cyl.	1998cc	88kW (120PS)	Petrol	TD16360
F4R 730	4 Cyl.	1998cc	124kW (169PS)	Petrol	TD14334
F4R 732	4 Cyl.	1998cc	124kW (169PS)	Petrol	TD21212
F4R 736	4 Cyl.	1998cc	124kW (169PS)	Petrol	TD21213
F4R 738 Euro 3	4 Cyl.	1998cc	124-132kW (168-180PS)	Petrol	TD19676
F4R 740	4 Cyl.	1998cc	99-103kW (135-140PS)	Petrol	TD16355
F4R 741	4 Cyl.	1998cc	99-103kW (135-140PS)	Petrol	TD16356
F4R 744	4 Cyl.	1998cc	99-103kW (135-140PS)	Petrol	TD16340
F4R 746	4 Cyl.	1998cc	102-103kW (139-140PS)	Petrol	TD21214
F4R 747	4 Cyl.	1998cc	103kW (140PS)	Petrol	TD21215
F4R 760	4 Cyl.	1998cc	120kW (163PS)	Petrol Turbo	TD16478
F4R 761	4 Cyl.	1998cc	120kW (163PS)	Petrol Turbo	TD16480
F4R 762	4 Cyl.	1998cc	120kW (163PS)	Petrol Turbo	TD16286
F4R 763	4 Cyl.	1998cc	120kW (163PS)	Petrol Turbo	TD16376
F4R 764	4 Cyl.	1998cc	120kW (163PS)	Petrol Turbo	TD18281
F4R 765	4 Cyl.	1998cc	120kW (163PS)	Petrol Turbo	TD18282
F4R 766 Euro 4	4 Cyl.	1998cc	125kW (170PS)	Petrol Turbo	TD19668
F4R 770	4 Cyl.	1998cc	99-103kW (135-140PS)	Petrol	TD16533
F4R 771	4 Cyl.	1998cc	99kW (135PS)	Petrol	TD18301
F4R 780	4 Cyl.	1998cc	103kW (140PS)	Petrol	TD16475
F4R 786	4 Cyl.	1998cc	120-125kW (163-170PS)	Petrol Turbo Intercooler	TD18283
F4R 787	4 Cyl.	1998cc	120-125kW (163-170PS)	Petrol Turbo	TD18284
F4R 790	4 Cyl.	1998cc	98-100kW (133-136PS)	Petrol	TD17057
F4R 791	4 Cyl.	1998cc	100kW (136PS)	Petrol	TD17058
F4R 792	4 Cyl.	1998cc	100kW (136PS)	Petrol	TD21197
F4R 794	4 Cyl.	1998cc	120kW (163PS)	Petrol Turbo Intercooler	TD17059
F4R 795	4 Cyl.	1998cc	120kW (163PS)	Petrol Turbo Intercooler	TD17060
F4R 797	4 Cyl.	1998cc	120-125kW (163-170PS)	Petrol Turbo Intercooler	TD17061
F4R 820	4 Cyl.	1998cc	86kW (117PS)	Petrol	TD19712
F4R 867	4 Cyl.	1998cc	108kW (147PS)	Petrol	TD21217
F4R 872	4 Cyl.	1998cc	132kW (180PS)	Petrol Turbo Intercooler	TD26242
F4R Z 770	4 Cyl.	1998cc	99kW (135PS)	Petrol	TD19691
F5R 740	4 Cyl.	1998cc	103kW (140PS)	Petrol	TD13311

BE/PL	4	48,000/48,020	51,587/51,606	20,250	1,776	0,015/0,079	EC	71-3988L	71-3988/4 STD 0.25 0.50	4
BE/PL	4	48,000/48,020	51,587/51,606	20,500	1,776	0,015/0,079	EC	71-3988U		
MB/HL 1-5	5	54,785/54,805	58,731/58,744	18,500	1,947	0,032/0,090	EC	72-3989	H098/5 STD 0.25 0.50	
TW/A	2	60,500/60,750	79,750/80,000		2,350		AL-LF	66741AF	A215/2 STD 0.10	
SE/PB	1	21,000/21,015	23,000/23,021	24,750			BS	4064Y	55-4264 SEMI	

53

82.70 x 93.00

F7R 700	4 Cyl.	1998cc	108-110kW (147-150PS)	Petrol	TD3281
F7R 710	4 Cyl.	1998cc	108-110kW (147-150PS)	Petrol	TD4866
F7R 714	4 Cyl.	1998cc	108kW (147PS)	Petrol	TD16278



BE/PL	4	48,000/48,020	51,587/51,606	20,250	1,776	0,015/0,079	EC	71-3988L	71-3988/4 STD 0.25 0.50	4
BE/PL	4	48,000/48,020	51,587/51,606	20,500	1,776	0,015/0,079	EC	71-3988U		

01/98 →

BE/PL	4	48,000/48,020	51,587/51,600	20,500	1,768	0,031/0,089	BS	4060CP	71-4311/4 STD 0.25 0.50	
-------	---	---------------	---------------	--------	-------	-------------	----	--------	-----------------------------------	--

→12/97

71-3988L



71-3988U

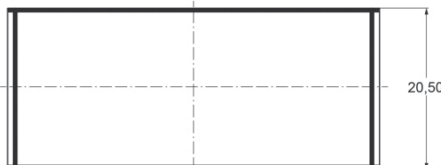

4060CP



MB/HL 1-5	5	54,785/54,805	58,731/58,744	18,500	1,947	0,032/0,090	EC	72-3989	H098/5 STD 0.25 0.50	
--------------	---	---------------	---------------	--------	-------	-------------	----	---------	--------------------------------	--

01/98 →

MB/HL 1-5	5	54,785/54,795	58,731/58,744	18,500	1,945	0,046/0,094	AL-LF	66741RA	H1080/5 STD 0.25 0.50	
--------------	---	---------------	---------------	--------	-------	-------------	-------	---------	---------------------------------	--

→12/97

72-3989

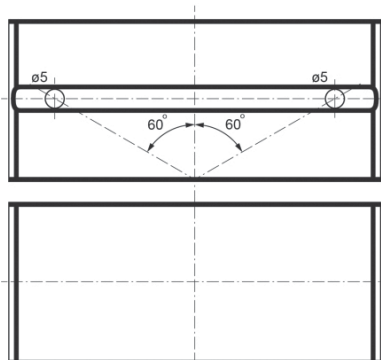

66741RA

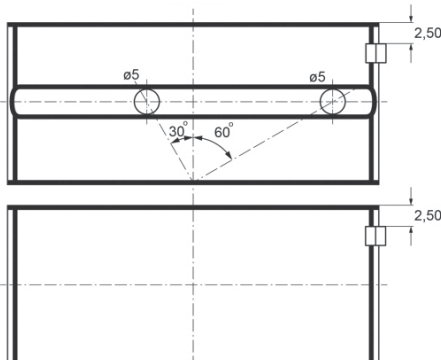

TW/A	2	60,500/60,750	79,750/80,000		2,350		AL-LF	66741AF	A215/2 STD 0.10	
SE/PB	1	21,000/21,015	23,000/23,021	24,750			BS	4064Y	55-4264 SEMI	

54

83.00 x 90.00

N7Q 700	4 Cyl.	1948cc	102kW (139PS)				Petrol		TD5529
N7Q 704	4 Cyl.	1948cc	102kW (139PS)				Petrol		TD5530
N7Q 710	4 Cyl.	1948cc	100kW (136PS)				Petrol		TD5547
N7Q 711	4 Cyl.	1948cc	100kW (136PS)				Petrol		TD5548

BE/PL	4	49,984/50,000	53,000/53,013	19,500	1,496	0,020/0,064	EC	71-3754	71-3754/4 STD 0.25	
MB/HL 1,2,4,5	4	64,987/65,000	69,000/69,014	19,600	1,994	0,020/0,064	AL-LF	02-3755	H046/5 STD 0.25	
MB/HL 3	1	64,987/65,000	69,000/69,014	25,880	1,998	0,020/0,056	AL-LF	02-3756H		



02-3756H

STD 25,960/1.0221" - 26,000/1.0237"
0.25mm 25,960/1.0221" - 26,000/1.0237"

SE/PB	1	23,000	26,000/26,025	25,200			BC	55-3783	55-3783 SEMI	
-------	---	--------	---------------	--------	--	--	----	---------	------------------------	--



55		83.00 x 90.00							
N7U 700		5 Cyl.	2435cc	121kW (165PS)	Petrol				TD5551
N7U 701		5 Cyl.	2435cc	121kW (165PS)	Petrol				TD5552
BE/PL	5	49,984/50,000	53,000/53,013	19,500	1,496	0,020/0,064	EC	71-3754	71-3754/5 STD 0.25 0.50
MB/HL 1-3, 5, 6	5	64,987/65,000	69,000/69,014	19,600	1,994	0,020/0,064	AL-LF	02-3755	H046/6 STD 0.25
MB/HL 4	1	64,987/65,000	69,000/69,014	25,880	1,998	0,020/0,056	AL-LF	02-3756H	
		02-3756H	STD 0.25mm	25,960/1.0221" - 26,000/1.0237"					
SE/PB	1	23,000	26,000/26,025	25,200			BC	55-3783	55-3783 SEMI

56		84.00 x 90.00							
M9R 610	4 Cyl.	1995cc	118-120kW (160-163PS)	Diesel Turbo Intercooler	TD23557				
M9R 615	4 Cyl.	1995cc	110kW (150PS)	Diesel Turbo Intercooler	TD23559				
M9R 630	4 Cyl.	1995cc	66-84kW (90-114PS)	Diesel Turbo Intercooler	TD26729				
M9R 692 Euro 5	4 Cyl.	1995cc	84kW (114PS)	Diesel Turbo	TD26569				
M9R 700	4 Cyl.	1995cc	110kW (150PS)	Diesel Turbo Intercooler	TD20708				
M9R 721	4 Cyl.	1995cc	110kW (150PS)	Diesel Turbo Intercooler	TD23502				
M9R 722	4 Cyl.	1995cc	110kW (150PS)	Diesel Turbo Intercooler	TD23503				
M9R 724	4 Cyl.	1995cc	127kW (173PS)	Diesel Turbo Intercooler	TD22195				
M9R 740	4 Cyl.	1995cc	96-110kW (131-150PS)	Diesel Turbo Intercooler	TD19680				
M9R 742	4 Cyl.	1995cc	96-110kW (131-150PS)	Diesel Turbo Intercooler	TD23504				
M9R 744	4 Cyl.	1995cc	96-110kW (131-150PS)	Diesel Turbo Intercooler	TD23505				
M9R 746	4 Cyl.	1995cc	110kW (150PS)	Diesel Turbo Intercooler	TD23506				
M9R 748	4 Cyl.	1995cc	110kW (150PS)	Diesel Turbo Intercooler	TD23507				
M9R 750	4 Cyl.	1995cc	96-110kW (131-150PS)	Diesel Turbo Intercooler	TD23508				
M9R 760	4 Cyl.	1995cc	96-127kW (131-173PS)	Diesel Turbo Intercooler	TD19681				
M9R 761	4 Cyl.	1995cc	96-127kW (131-173PS)	Diesel Turbo Intercooler	TD23899				
M9R 762	4 Cyl.	1995cc	96-127kW (131-173PS)	Diesel Turbo Intercooler	TD23900				
M9R 763	4 Cyl.	1995cc	96-127kW (131-173PS)	Diesel Turbo Intercooler	TD23901				
M9R 780 Euro 4	4 Cyl.	1995cc	66-84kW (90-114PS)	Diesel Turbo Intercooler	TD19714				
M9R 782	4 Cyl.	1995cc	66-84kW (90-114PS)	Diesel Turbo Intercooler	TD23109				
M9R 784	4 Cyl.	1995cc	84kW (114PS)	Diesel Turbo Intercooler	TD25141				
M9R 786 Euro 4	4 Cyl.	1995cc	66-84kW (90-114PS)	Diesel Turbo Intercooler	TD24966				
M9R 788	4 Cyl.	1995cc	84kW (114PS)	Diesel Turbo Intercooler	TD25142				
M9R 800	4 Cyl.	1995cc	127kW (173PS)	Diesel Turbo Intercooler	TD22196				
M9R 802	4 Cyl.	1995cc	96-110kW (131-150PS)	Diesel Turbo Intercooler	TD22197				
M9R 804	4 Cyl.	1995cc	127kW (173PS)	Diesel Turbo Intercooler	TD26134				
M9R 805 Euro 4	4 Cyl.	1995cc	110kW (150PS)	Diesel Turbo Intercooler	TD26244				
M9R 809	4 Cyl.	1995cc	127kW (173PS)	Diesel Turbo Intercooler	TD22198				
M9R 814	4 Cyl.	1995cc	110kW (150PS)	Diesel Turbo Intercooler	TD26247				
M9R 815	4 Cyl.	1995cc	110-127kW (150-173PS)	Diesel Turbo Intercooler	TD26531				
M9R 816	4 Cyl.	1995cc	127-132kW (173-180PS)	Diesel Turbo Intercooler	TD22199				
M9R 817	4 Cyl.	1995cc	127kW (173PS)	Diesel Turbo Intercooler	TD26135				
M9R 820	4 Cyl.	1995cc	131kW (178PS)	Diesel Turbo Intercooler	TD26532				
M9R 824	4 Cyl.	1995cc	110kW (150PS)	Diesel Turbo Intercooler	TD26073				
M9R 828	4 Cyl.	1995cc	131kW (178PS)	Diesel Turbo Intercooler	TD31477				
M9R 830	4 Cyl.	1995cc	127-130kW (173-177PS)	Diesel Turbo Intercooler	TD22206				
M9R 832	4 Cyl.	1995cc	110kW (150PS)	Diesel Turbo Intercooler	TD22207				
M9R 833	4 Cyl.	1995cc	110kW (150PS)	Diesel Turbo Intercooler	TD26252				



M9R 844	4 Cyl.	1995cc	127kW (173PS)	Diesel Turbo Intercooler	TD26533
M9R 845	4 Cyl.	1995cc	110kW (150PS)	Diesel Turbo Intercooler	TD26254
M9R 846	4 Cyl.	1995cc	110kW (150PS)	Diesel Turbo Intercooler	TD26534
M9R 849	4 Cyl.	1995cc	110kW (150PS)	Diesel Turbo Intercooler	TD26253
M9R 854	4 Cyl.	1995cc	96-110kW (131-150PS)	Diesel Turbo Intercooler	TD31478
M9R 855	4 Cyl.	1995cc	110kW (150PS)	Diesel Turbo Intercooler	TD26248
M9R 856	4 Cyl.	1995cc	110kW (150PS)	Diesel Turbo Intercooler	TD26249
M9R 857	4 Cyl.	1995cc	127kW (173PS)	Diesel Turbo Intercooler	TD31479
M9R 858	4 Cyl.	1995cc	110-127kW (150-173PS)	Diesel Turbo Intercooler	TD31480
M9R 859	4 Cyl.	1995cc	127kW (173PS)	Diesel Turbo Intercooler	TD31481
M9R 862	4 Cyl.	1995cc	110kW (150PS)	Diesel Turbo Intercooler	TD26255
M9R 864	4 Cyl.	1995cc	127kW (173PS)	Diesel Turbo Intercooler	TD26256
M9R 865	4 Cyl.	1995cc	110kW (150PS)	Diesel Turbo Intercooler	TD26250
M9R 866	4 Cyl.	1995cc	110kW (150PS)	Diesel Turbo Intercooler	TD26251
M9R A 700 Euro 4	4 Cyl.	1995cc	110kW (150PS)	Diesel Turbo	TD19684
M9R B 610	4 Cyl.	1995cc	118kW (160PS)	Diesel Turbo Intercooler	TD23556
M9R B 721 Euro 4	4 Cyl.	1995cc	110kW (150PS)	Diesel Turbo	TD19685
M9R C 613	4 Cyl.	1995cc	110kW (150PS)	Diesel Turbo Intercooler	TD23570
M9R C 615	4 Cyl.	1995cc	110kW (150PS)	Diesel Turbo Intercooler	TD23558
M9R C 830	4 Cyl.	1995cc	110kW (150PS)	Diesel Turbo Intercooler	TD20968
M9R D 833	4 Cyl.	1995cc	110kW (150PS)	Diesel Turbo Intercooler	TD20967
M9R G 832	4 Cyl.	1995cc	110kW (150PS)	Diesel Turbo Intercooler	TD20966
M9Ra 742 Euro 4	4 Cyl.	1995cc	96-110kW (131-150PS)	Diesel	TD20818
M9Rk 800 Euro 4	4 Cyl.	1995cc	127kW (173PS)	Diesel	TD20821
M9Rk 802 Euro 4	4 Cyl.	1995cc	96-110kW (131-150PS)	Diesel	TD20819
M9Rk 805 Euro 4	4 Cyl.	1995cc	110kW (150PS)	Diesel	TD20820
M9Rk 806 Euro 4	4 Cyl.	1995cc	127kW (173PS)	Diesel Turbo	TD23055
M9Rk 816 Euro 4	4 Cyl.	1995cc	131kW (178PS)	Diesel Turbo	TD23056

MB/HL 1-5	5	55,985/56,005	59,998/60,011	19,500	1,984	0,035/0,088	AL-LF	02-4560L	H1243/5 STD
MB/HL 1-5	5	55,985/56,005	59,998/60,011	17,200	1,984	0,035/0,088	AL-LF	02-4560U	
TW/A	2	65,600/65,850	84,000/84,250		2,700		AL-LF	04-4822	A297/2 STD
SE/PB	1	31,994/32,000	34,985/35,010	23,700			BS-LF	55-4562	55-4562 SEMI

57
85.00 x 101.30

M9T 670 Euro 5	4 Cyl.	2298cc	74-92kW (101-125PS)	Diesel Turbo	TD24269
M9T 672 Euro 5	4 Cyl.	2298cc	74-92kW (101-125PS)	Diesel Turbo	TD25154
M9T 676 Euro 4	4 Cyl.	2298cc	74-92kW (101-125PS)	Diesel Turbo	TD24268
M9T 678	4 Cyl.	2298cc	107kW (146PS)	Diesel Turbo	TD25158
M9T 680	4 Cyl.	2298cc	107kW (146PS)	Diesel Turbo	TD24295
M9T 686 Euro 5	4 Cyl.	2298cc	92kW (125PS)	Diesel Turbo	TD25151
M9T 690 Euro 5	4 Cyl.	2298cc	74-92kW (101-125PS)	Diesel Turbo	TD24270
M9T 692 Euro 4	4 Cyl.	2298cc	74-92kW (101-125PS)	Diesel Turbo	TD24271
M9T 694 Euro 4	4 Cyl.	2298cc	107kW (146PS)	Diesel Turbo	TD24272
M9T 696 Euro 4	4 Cyl.	2298cc	92-107kW (125-146PS)	Diesel Turbo	TD25150
M9T 698 Euro 5	4 Cyl.	2298cc	92-107kW (125-146PS)	Diesel Turbo	TD24273
M9T 870 Euro 5	4 Cyl.	2298cc	74-92kW (100-125PS)	Diesel Turbo	TD29755
M9T 880 Euro 5	4 Cyl.	2298cc	110kW (150PS)	Diesel Turbo	TD29756
M9T 890 Euro 5	4 Cyl.	2298cc	74-92kW (100-125PS)	Diesel Turbo	TD29758
M9T 896 Euro 4	4 Cyl.	2298cc	92-107kW (125-146PS)	Diesel Turbo	TD29759
M9T 898 Euro 5	4 Cyl.	2298cc	110kW (150PS)	Diesel Turbo	TD29757

RENAULT

BE/PL	1	53,000/53,020	56,587/56,606	19,000	1,781	0,046/0,069	SP-LF	71-4940	71-4940 STD	1
MB/HL 1-5	5	59,985/60,005	63,998/64,011	19,500	1,986	0,029/0,082	AL-LF	02-4939L	H1327/5 STD	
MB/HL 1-5	5	59,985/60,005	63,998/64,011	17,200	1,986	0,029/0,082	AL-LF	02-4939U		
TW/A	2	65,600/65,850	84,000/84,250		2,700		AL-LF	04-4822	A297/2 STD	
SE/PB	1	31,994/32,000	34,985/35,010	23,700			BS-LF	55-4562	55-4562 SEMI	

58

86.00 x 86.00

F5R 700			4 Cyl.	1998cc	103kW (140PS)		Petrol			TD16369
F5R 701			4 Cyl.	1998cc	103kW (140PS)		Petrol			TD21228
BE/PL	4	48,000/48,020	51,587/51,606	20,250	1,776	0,015/0,079	EC	71-3988L	71-3988/4 STD 0.25 0.50	4
BE/PL	4	48,000/48,020	51,587/51,606	20,500	1,776	0,015/0,079	EC	71-3988U		
MB/HL 1-5	5	54,785/54,805	58,731/58,744	18,500	1,947	0,032/0,090	EC	72-3989	H098/5 STD 0.25 0.50	
TW/A	2	60,500/60,750	79,750/80,000		2,350		AL-LF	66741AF	A215/2 STD 0.10	
SE/PB	1	21,000/21,015	23,000/23,021	24,750			BS	4064Y	55-4264 SEMI	

59

86.00 x 89.00

852			4 Cyl.	2068cc	47kW (64PS)		Diesel			TD3077
852 700			4 Cyl.	2068cc	46-49kW (63-67PS)		Diesel			TD29260
852 710			4 Cyl.	2068cc	49kW (67PS)		Diesel			TD3078
852 720			4 Cyl.	2068cc	43-44kW (58-60PS)		Diesel			TD3079
852 750			4 Cyl.	2068cc	43-44kW (58-60PS)		Diesel			TD3080
852 J8S			4 Cyl.	2068cc	63kW (85PS)		Diesel			TD3081
J8S 120			4 Cyl.	2068cc	65-66kW (88-90PS)		Diesel			TD3383
J8S 174			4 Cyl.	2068cc	65kW (88PS)		Diesel Turbo			TD29122
J8S 232 (852.232)			4 Cyl.	2068cc	43kW (60PS)		Diesel			TD3384
J8S 234			4 Cyl.	2068cc	57kW (78PS)		Diesel			TD3385
J8S 240			4 Cyl.	2068cc	65kW (88PS)		Diesel Turbo			TD3386
J8S 330			4 Cyl.	2068cc	44-46kW (60-63PS)		Diesel			TD3387
J8S 600			4 Cyl.	2068cc	53kW (72PS)		Diesel			TD3388
J8S 604			4 Cyl.	2068cc	65kW (88PS)		Diesel Turbo			TD3389
J8S 610			4 Cyl.	2068cc	65kW (88PS)		Diesel Turbo Intercooler			TD3390
J8S 612			4 Cyl.	2068cc	66kW (90PS)		Diesel Turbo Intercooler			TD5525
J8S 620			4 Cyl.	2068cc	47kW (64PS)		Diesel			TD5564
J8S 622			4 Cyl.	2068cc	47kW (64PS)		Diesel			TD23794
J8S 702			4 Cyl.	2068cc	63kW (86PS)		Diesel Turbo			TD3382
J8S 704			4 Cyl.	2068cc	48-50kW (65-68PS)		Diesel			TD3391
J8S 706			4 Cyl.	2068cc	46kW (63PS)		Diesel			TD3392
J8S 708			4 Cyl.	2068cc	63kW (86PS)		Diesel Turbo Intercooler			TD3393
J8S 711			4 Cyl.	2068cc	49-53kW (67-72PS)		Diesel			TD5431
J8S 712			4 Cyl.	2068cc	65kW (88PS)		Diesel Turbo			TD3394
J8S 714			4 Cyl.	2068cc	65kW (88PS)		Diesel Turbo			TD3395
J8S 736			4 Cyl.	2068cc	51kW (69PS)		Diesel			TD3396
J8S 738			4 Cyl.	2068cc	63kW (86PS)		Diesel Turbo Intercooler			TD3397
J8S 740			4 Cyl.	2068cc	53kW (72PS)		Diesel			TD3398
J8S 742			4 Cyl.	2068cc	65kW (88PS)		Diesel Turbo			TD3399
J8S 746			4 Cyl.	2068cc	65kW (88PS)		Diesel Turbo			TD3400



J8S 750			4 Cyl.	2068cc	44kW (60PS)		Diesel		TD22186
J8S 758			4 Cyl.	2068cc	47kW (64PS)		Diesel		TD5565
J8S 760			4 Cyl.	2068cc	65-66kW (88-90PS)		Diesel Turbo		TD3401
J8S 772			4 Cyl.	2068cc	65kW (88PS)		Diesel Turbo Intercooler		TD3402
J8S 774			4 Cyl.	2068cc	65kW (88PS)		Diesel Turbo		TD3403
J8S 776			4 Cyl.	2068cc	65kW (88PS)		Diesel Turbo		TD3404
J8S 778			4 Cyl.	2068cc	65kW (88PS)		Diesel Turbo		TD3405
J8S 784			4 Cyl.	2068cc	51kW (69PS)		Diesel		TD3406
J8S 786			4 Cyl.	2068cc	65kW (88PS)		Diesel Turbo		TD3407
J8S 788			4 Cyl.	2068cc	65kW (88PS)		Diesel Turbo		TD3408
J8S 800			4 Cyl.	2068cc	44kW (60PS)		Diesel		TD26568
J8S 814			4 Cyl.	2068cc	65kW (88PS)		Diesel Turbo Intercooler		TD21257
J8S 890			4 Cyl.	2068cc	65kW (88PS)		Diesel Turbo		TD21258

BE/PL	4	56,267/56,286	60,005/60,019	20,750	1,842	0,035/0,093	AL-LF	66635RA	01-4189/4 STD 0.25
BE/PL	4	56,267/56,286	60,005/60,019	20,750	1,842	0,035/0,093	AL-LF	66645RA	01-4191/4 STD 0.25
BE/PL	4	56,267/56,286	60,005/60,019	20,750	1,842	0,035/0,093	AL-LF	66645RAA	01-4192/4 STD

66635RA

66645RA

66645RAA

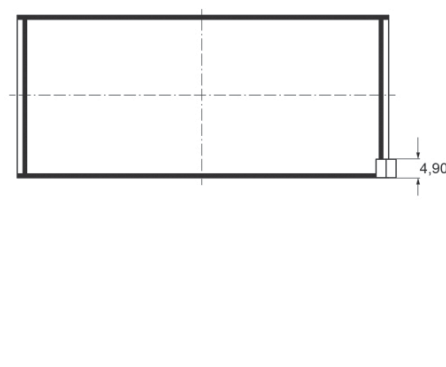
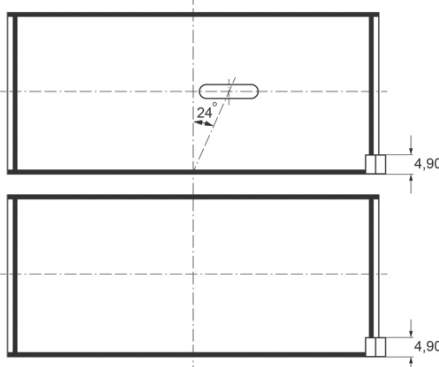
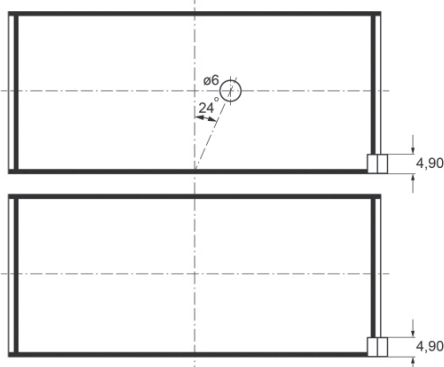

MB/HL 1-5	5	62,873/62,892	66,668/66,687	23,500	1,884	0,020/0,071	AL-LF	66507RA	H1052/5 STD 0.25
MB/HL 1-5	5	62,861/62,880	66,668/66,687	23,250	1,884	0,030/0,093	AL-LF	66646RA	H1058/5 STD 0.25

66507RA

66646RA

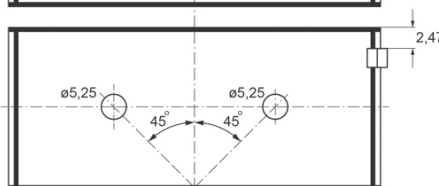
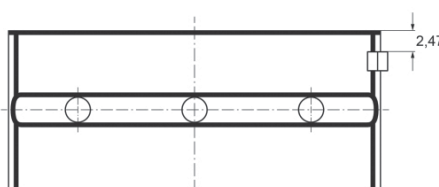
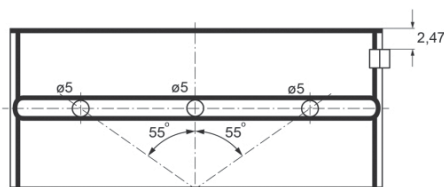

TW/A	2	71,450	88,090		2,850		BS	66506BF	A208/2 STD
TW/A	2	71,450	88,090		2,850		BS	66646BF	A210/2 STD



66506BF

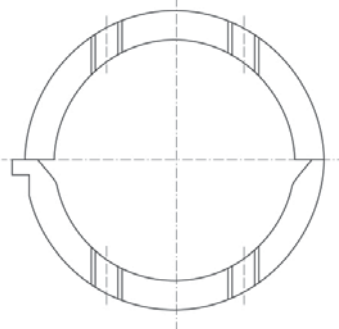

66646BF

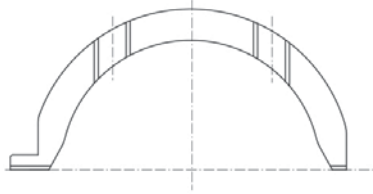

SE/PB	1	28,002/28,010	30,000/30,021	25,250			BS	66649RY	55-4294 SEMI
-------	---	---------------	---------------	--------	--	--	----	---------	-----------------

60		87.00 x 92.00								
G8T 706			4 Cyl.	2188cc	61kW (83PS)			Diesel		TD3301
G8T 752			4 Cyl.	2188cc	61kW (83PS)			Diesel		TD4872
G8T 790			4 Cyl.	2188cc	61kW (83PS)			Diesel		TD4873
G8T 792			4 Cyl.	2188cc	61kW (83PS)			Diesel		TD18886
G8T 794			4 Cyl.	2188cc	61kW (83PS)			Diesel		TD4874
MB/HL 1-5	5	57,980/58,000	61,668/61,681	20,990	1,810		AL-LF	02-4042	H1013/5 STD 0.25	
TW/A	2	60,500/60,750	79,750/80,000		2,350		AL-LF	66741AF	A215/2 STD 0.10	

61		87.00 x 92.00								
G8T 714			4 Cyl.	2188cc	83kW (113PS)			Diesel Turbo Intercooler		TD16308
G8T 716			4 Cyl.	2188cc	83kW (113PS)			Diesel Turbo		TD16309
G8T 740			4 Cyl.	2188cc	83kW (113PS)			Diesel Turbo Intercooler		TD3300
G8T 760			4 Cyl.	2188cc	83kW (113PS)			Diesel Turbo Intercooler		TD4871
BE/PL	4	47,975/47,991	51,612/51,625	20,650	1,803	0,025/0,074	BS	71-4041	71-4041/4 STD	
MB/HL 1-5	5	57,980/58,000	61,668/61,681	20,990	1,810		AL-LF	02-4042	H1013/5 STD 0.25	
TW/A	2	60,500/60,750	79,750/80,000		2,350		AL-LF	66741AF	A215/2 STD 0.10	
SE/PB	1	31,013/31,020	33,500/33,525	25,800			BC	55-4050	55-4050 SEMI	

62		87.00 x 92.00								
G9T 600 Euro 4			4 Cyl.	2188cc	85-102kW (116-139PS)			Diesel Turbo		TD19667
G9T 605 Euro 4			4 Cyl.	2188cc	102kW (139PS)			Diesel Turbo		TD19682
G9T 606 Euro 4			4 Cyl.	2188cc	102kW (139PS)			Diesel Turbo		TD21209
G9T 607			4 Cyl.	2188cc	102-110kW (139-150PS)			Diesel Turbo Intercooler		TD23896
G9T 642			4 Cyl.	2188cc	95-110kW (129-150PS)			Diesel Turbo Intercooler		TD23177
G9T 645 Euro 4			4 Cyl.	2188cc	102kW (139PS)			Diesel Turbo		TD21198
G9T 700			4 Cyl.	2188cc	102-110kW (139-150PS)			Diesel Turbo Intercooler		TD20978
G9T 702 Euro 3			4 Cyl.	2188cc	102-110kW (140-150PS)			Diesel Turbo		TD16288
G9T 703			4 Cyl.	2188cc	110kW (150PS)			Diesel Turbo Intercooler		TD16377
G9T 704			4 Cyl.	2188cc	110kW (150PS)			Diesel Turbo Intercooler		TD20975
G9T 706			4 Cyl.	2188cc	102-110kW (139-150PS)			Diesel Turbo Intercooler		TD20976
G9T 707			4 Cyl.	2188cc	102-110kW (139-150PS)			Diesel Turbo Intercooler		TD20977
G9T 710			4 Cyl.	2188cc	85-95kW (115-130PS)			Diesel Turbo Intercooler		TD16310
G9T 712			4 Cyl.	2188cc	110kW (150PS)			Diesel Turbo Intercooler		TD18298
G9T 720			4 Cyl.	2188cc	66kW (90PS)			Diesel Turbo		TD14928



G9T 722	4 Cyl.	2188cc	66kW (90PS)	Diesel Turbo Intercooler	TD16302
G9T 742 Euro 3	4 Cyl.	2188cc	110kW (150PS)	Diesel Turbo Intercooler	TD17062
G9T 743 Euro 3	4 Cyl.	2188cc	110kW (150PS)	Diesel Turbo Intercooler	TD17063
G9T 750	4 Cyl.	2188cc	66kW (90PS)	Diesel Turbo Intercooler	TD19088

BE/PL	4	52,971/52,990	56,587/56,606	20,650	1,782	0,015/0,069	EC	71-4744	71-4744/4 STD 0.25	4
MB/HL 1-5	5	57,980/58,000	61,668/61,681	20,990	1,810		AL-LF	02-4042	H1013/5 STD 0.25	
TW/A	2	63,250/63,500	78,550/78,800		2,350		AL-LF	04-4745	A289/2 STD	
SE/PB	1	31,013/31,020	33,500/33,525	25,800			BC	55-4050	55-4050 SEMI	

63 88.00 x 73.00

112	V6 Cyl.	2664cc	92-96kW (125-131PS)	Petrol	TD3410
140	V6 Cyl.	2664cc	105kW (143PS)	Petrol	TD3411
144	V6 Cyl.	2664cc	94kW (128PS)	Petrol	TD3412
144.01	V6 Cyl.	2664cc	85-96kW (116-131PS)	Petrol	TD22488
Z7V 708	V6 Cyl.	2664cc	104kW (141PS)	Petrol	TD3441
Z7V 709	V6 Cyl.	2664cc	104kW (141PS)	Petrol	TD3442
Z7V 711	V6 Cyl.	2664cc	104kW (141PS)	Petrol	TD3443

BE/PL	6	59,971/59,990	63,704/63,723	17,720	1,846	0,022/0,085	EC	71-3733	71-3733/6 STD
MB/HL 1-4	4	70,043/70,062	74,000/74,019	23,470	1,967	0,020/0,067	AL-LF	66311RA	H1041/4 STD

64 88.00 x 82.00

829 700	4 Cyl.	1995cc	80kW (109PS)	Petrol	TD3043
829 701	4 Cyl.	1995cc	80kW (109PS)	Petrol	TD5428
829.01	4 Cyl.	1995cc	76-80kW (103-109PS)	Petrol	TD21390

BE/PL	4	52,267/52,286	56,000/56,019	18,750	1,852	0,020/0,073	AL-LF	66600RA	01-4187/4 STD
-------	---	---------------	---------------	--------	-------	-------------	-------	---------	-------------------------

01/78→

MB/HL 1-5	5	62,873/62,892	66,668/66,687	23,500	1,884	0,020/0,071	AL-LF	66507RA	H1052/5 STD 0.25
TW/A	2	71,450	88,090		2,850		BS	66506BF	A208/2 STD

65 88.00 x 82.00

829 702	4 Cyl.	1995cc	76kW (103PS)	Petrol	TD3307
829 703	4 Cyl.	1995cc	76kW (103PS)	Petrol	TD5427
829 710	4 Cyl.	1995cc	81kW (110PS)	Petrol	TD3044
829 720	4 Cyl.	1995cc	58-63kW (79-86PS)	Petrol	TD5561
829 721	4 Cyl.	1995cc	63kW (86PS)	Petrol	TD5562
829 731	4 Cyl.	1995cc	57-59kW (78-82PS)	Petrol	TD3046
J5R 726	4 Cyl.	1995cc	59kW (80PS)	Petrol	TD3305
J5R 800	4 Cyl.	1995cc	61-63kW (85-86PS)	Petrol	TD21103
J6R 710	4 Cyl.	1995cc	81kW (110PS)	Petrol	TD3312
J6R 711	4 Cyl.	1995cc	77-79kW (105-107PS)	Petrol	TD5063
J6R 712	4 Cyl.	1995cc	81kW (110PS)	Petrol	TD3314
J6R 713	4 Cyl.	1995cc	81kW (110PS)	Petrol	TD3315
J6R 715	4 Cyl.	1995cc	81kW (110PS)	Petrol	TD3319
J6R 716	4 Cyl.	1995cc	77kW (105PS)	Petrol	TD5064
J6R 726	4 Cyl.	1995cc	81kW (110PS)	Petrol	TD3322

BE/PL	4	52,267/52,286	56,000/56,019	18,750	1,852	0,020/0,073	AL-LF	66600RA	01-4187/4 STD
-------	---	---------------	---------------	--------	-------	-------------	-------	---------	-------------------------

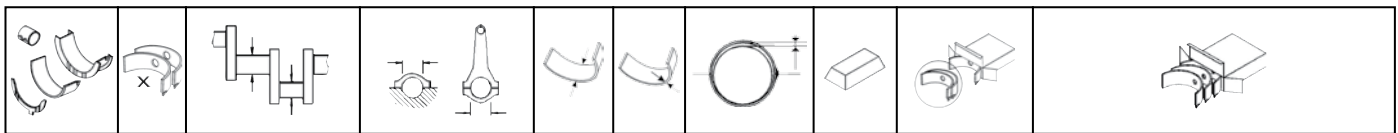

MB/HL 1-5	5	62,873/62,892	66,668/66,687	23,500	1,884	0,020/0,071	AL-LF	66507RA	H1052/5 STD 0.25
--------------	---	---------------	---------------	--------	-------	-------------	-------	---------	----------------------------

→06/82

MB/HL 1-5	5	62,861/62,880	66,668/66,687	23,250	1,884	0,030/0,093	AL-LF	66646RA	H1058/5 STD 0.25
--------------	---	---------------	---------------	--------	-------	-------------	-------	---------	----------------------------

07/82→

66507RA

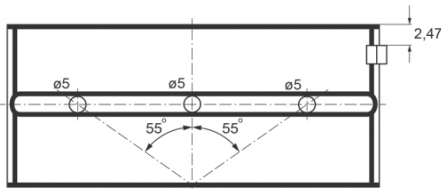

66646RA

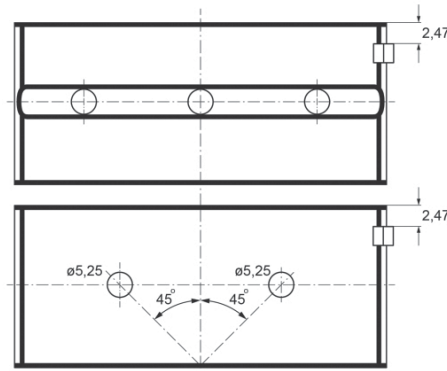

TW/A	2	71,450	88,090		2,850	BS	66506BF	A208/2 STD
------	---	--------	--------	--	-------	----	---------	----------------------

→06/82

TW/A	2	71,450	88,090		2,850	BS	66646BF	A210/2 STD
------	---	--------	--------	--	-------	----	---------	----------------------

07/82→

66506BF

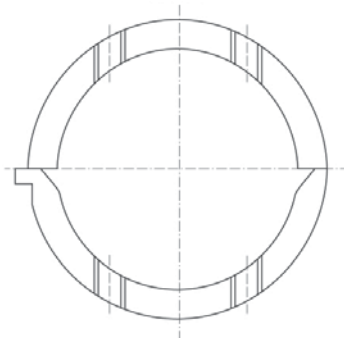

66646BF

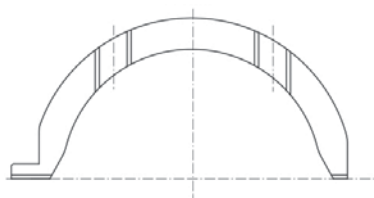

66	88.00 x 82.00							
829 730	4 Cyl.	1995cc	59kW (80PS)	Petrol	TD3045			
J5R 716	4 Cyl.	1995cc	59-62kW (80-84PS)	Petrol	TD3302			
J5R 718	4 Cyl.	1995cc	57-60kW (78-82PS)	Petrol	TD3303			
J5R 722	4 Cyl.	1995cc	59kW (80PS)	Petrol	TD3304			
J5R 728	4 Cyl.	1995cc	58-60kW (79-82PS)	Petrol	TD3306			
J6R 234	4 Cyl.	1995cc	79-81kW (107-110PS)	Petrol	TD3308			
J6R 236	4 Cyl.	1995cc	80kW (108PS)	Petrol	TD3309			
J6R 706	4 Cyl.	1995cc	74kW (101PS)	Petrol	TD3310			
J6R 707	4 Cyl.	1995cc	74kW (101PS)	Petrol	TD3311			
J6R 714	4 Cyl.	1995cc	77kW (105PS)	Petrol	TD5062			
J6R 734	4 Cyl.	1995cc	74kW (101PS)	Petrol	TD3323			
J6R 758	4 Cyl.	1995cc	75-78kW (102-106PS)	Petrol	TD3324			
J6R 759	4 Cyl.	1995cc	75kW (102PS)	Petrol	TD3325			
J6R 760	4 Cyl.	1995cc	74kW (101PS)	Petrol	TD3326			
J6R 762	4 Cyl.	1995cc	74kW (101PS)	Petrol	TD3327			
J6R 763	4 Cyl.	1995cc	74kW (101PS)	Petrol	TD3328			



J6R 792	4 Cyl.	1995cc	75kW (102PS)	Petrol	TD3329
J6R 793	4 Cyl.	1995cc	75kW (102PS)	Petrol	TD3330
J7R 720	4 Cyl.	1995cc	103kW (140PS)	Petrol	TD3333
J7R 721	4 Cyl.	1995cc	103kW (140PS)	Petrol	TD3334
J7R 722	4 Cyl.	1995cc	88kW (120PS)	Petrol	TD3335
J7R 723	4 Cyl.	1995cc	88kW (120PS)	Petrol	TD3336
J7R 726	4 Cyl.	1995cc	99-100kW (135-136PS)	Petrol	TD3337
J7R 732	4 Cyl.	1995cc	77kW (105PS)	Petrol	TD3338
J7R 733	4 Cyl.	1995cc	77kW (105PS)	Petrol	TD3339
J7R 734	4 Cyl.	1995cc	97-99kW (132-135PS)	Petrol	TD3340
J7R 735	4 Cyl.	1995cc	97-99kW (132-135PS)	Petrol	TD3341
J7R 738	4 Cyl.	1995cc	97-99kW (135-135PS)	Petrol	TD3342
J7R 739	4 Cyl.	1995cc	97-99kW (135-135PS)	Petrol	TD3343
J7R 740	4 Cyl.	1995cc	99-100kW (134-136PS)	Petrol	TD3344
J7R 746	4 Cyl.	1995cc	88kW (120PS)	Petrol	TD3345
J7R 747	4 Cyl.	1995cc	88kW (120PS)	Petrol	TD3346
J7R 750	4 Cyl.	1995cc	85-86kW (116-117PS)	Petrol	TD3347
J7R 751	4 Cyl.	1995cc	85-86kW (116-117PS)	Petrol	TD3348
J7R 752	4 Cyl.	1995cc	129kW (175PS)	Petrol Turbo	TD3349
J7R 754	4 Cyl.	1995cc	98-100kW (133-136PS)	Petrol	TD3350
J7R 756	4 Cyl.	1995cc	119kW (162PS)	Petrol Turbo	TD3351
J7R 760	4 Cyl.	1995cc	87-88kW (118-120PS)	Petrol	TD3352
J7R 768	4 Cyl.	1995cc	76kW (103PS)	Petrol	TD3353

BE/PL	4	52,267/52,286	56,000/56,019	18,750	1,852	0,020/0,073	AL-LF	66600RA	01-4187/4 STD
MB/HL 1-5	5	62,861/62,880	66,668/66,687	23,250	1,884	0,030/0,093	AL-LF	66646RA	H1058/5 STD 0.25
TW/A	2	71,450	88,090		2,850		BS	66646BF	A210/2 STD

67 88.00 x 82.00

829.00	4 Cyl.	1995cc	76-80kW (103-109PS)	Petrol	TD29261
---------------	--------	---------------	----------------------------	---------------	----------------

BE/PL	4	52,267/52,286	56,000/56,019	18,750	1,852	0,020/0,073	AL-LF	66600RA	01-4187/4 STD
-------	---	---------------	---------------	--------	-------	-------------	-------	---------	-------------------------

01/78 →

MB/HL 1-5	5	62,873/62,892	66,668/66,687	23,500	1,884	0,020/0,071	AL-LF	66507RA	H1052/5 STD 0.25
--------------	---	---------------	---------------	--------	-------	-------------	-------	---------	----------------------------

→06/82

MB/HL 1-5	5	62,861/62,880	66,668/66,687	23,250	1,884	0,030/0,093	AL-LF	66646RA	H1058/5 STD 0.25
--------------	---	---------------	---------------	--------	-------	-------------	-------	---------	----------------------------

07/82 →

66507RA

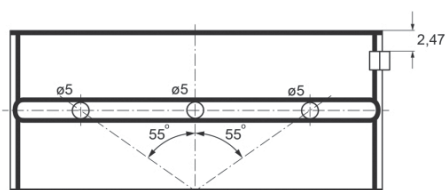

66646RA

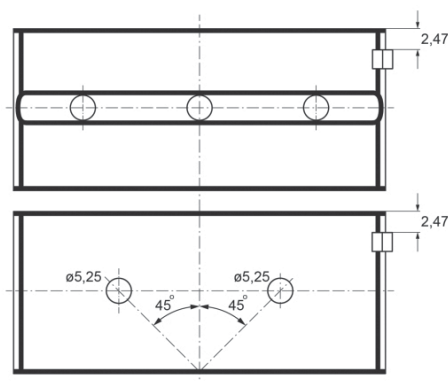

RENAULT

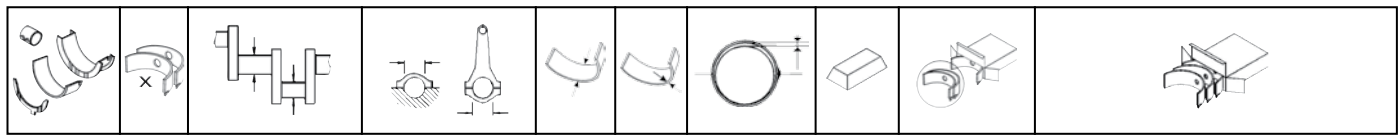

TW/A	2	71,450	88,090		2,850		BS	66506BF	A208/2 STD
------	---	--------	--------	--	-------	--	----	---------	---------------

→06/82

TW/A	2	71,450	88,090		2,850		BS	66646BF	A210/2 STD
------	---	--------	--------	--	-------	--	----	---------	---------------

07/82→

66506BF

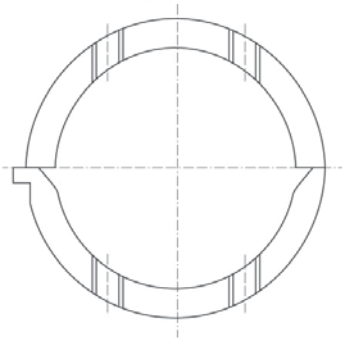

66646BF

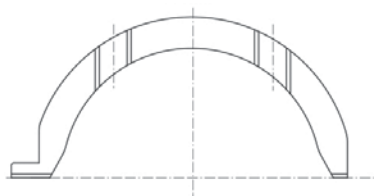

68

88.00 x 89.00

851 700	4 Cyl.	2165cc	85kW (116PS)	Petrol	TD3076
J7T 284	4 Cyl.	2165cc	74kW (101PS)	Petrol	TD3354
J7T 600	4 Cyl.	2165cc	74kW (101PS)	Petrol	TD5563
J7T 706	4 Cyl.	2165cc	89kW (121PS)	Petrol	TD3355
J7T 707	4 Cyl.	2165cc	89kW (121PS)	Petrol	TD3356
J7T 708	4 Cyl.	2165cc	79kW (107PS)	Petrol	TD3357
J7T 714	4 Cyl.	2165cc	89-91kW (121-124PS)	Petrol	TD3358
J7T 715	4 Cyl.	2165cc	89-91kW (121-124PS)	Petrol	TD3359
J7T 718	4 Cyl.	2165cc	76-77kW (103-105PS)	Petrol	TD3360
J7T 719	4 Cyl.	2165cc	77kW (105PS)	Petrol	TD3362
J7T 730	4 Cyl.	2165cc	91kW (124PS)	Petrol	TD3364
J7T 731	4 Cyl.	2165cc	91kW (124PS)	Petrol	TD3365
J7T 732	4 Cyl.	2165cc	79kW (107PS)	Petrol	TD3366
J7T 733	4 Cyl.	2165cc	79kW (107PS)	Petrol	TD3367
J7T 734	4 Cyl.	2165cc	75-80kW (102-109PS)	Petrol	TD3368
J7T 736	4 Cyl.	2165cc	79kW (107PS)	Petrol	TD3369
J7T 754	4 Cyl.	2165cc	79kW (107PS)	Petrol	TD3370
J7T 755	4 Cyl.	2165cc	79-81kW (107-110PS)	Petrol	TD3371
J7T 756	4 Cyl.	2165cc	79-81kW (107-110PS)	Petrol	TD3372
J7T 760	4 Cyl.	2165cc	101kW (137PS)	Petrol	TD3373
J7T 761	4 Cyl.	2165cc	101kW (137PS)	Petrol	TD3374
J7T 762	4 Cyl.	2165cc	79-81kW (107-110PS)	Petrol	TD3375
J7T 763	4 Cyl.	2165cc	79-81kW (107-110PS)	Petrol	TD3376
J7T 770	4 Cyl.	2165cc	79-81kW (107-110PS)	Petrol	TD3377
J7T 772	4 Cyl.	2165cc	79-81kW (107-110PS)	Petrol	TD3378
J7T 773	4 Cyl.	2165cc	79-81kW (108-110PS)	Petrol	TD5524
J7T 776	4 Cyl.	2165cc	79-81kW (107-110PS)	Petrol	TD3379
J7T 780	4 Cyl.	2165cc	70kW (95PS)	Petrol	TD3380
J7T 782	4 Cyl.	2165cc	67-69kW (91-94PS)	Petrol	TD3381
J7T 788	4 Cyl.	2165cc	67-71kW (91-97PS)	Petrol	TD12736

BE/PL	4	56,267/56,286	60,005/60,019	20,750	1,842	0,035/0,093	AL-LF	66635RA	01-4189/4 STD 0.25
BE/PL	4	56,267/56,286	60,005/60,019	20,750	1,842	0,035/0,093	AL-LF	66645RA	01-4191/4 STD 0.25



BE/PL	4	56,267/56,286	60,005/60,019	20,750	1,842	0,035/0,093	AL-LF	66645RAA	01-4192/4 STD
-------	---	---------------	---------------	--------	-------	-------------	-------	----------	-------------------------

66635RA

66645RA

66645RAA

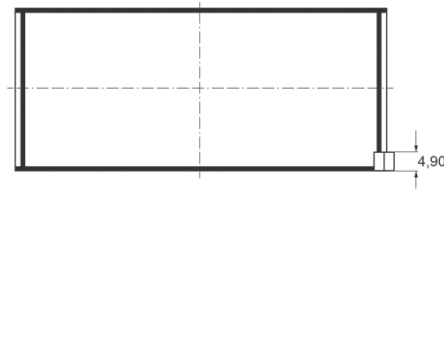
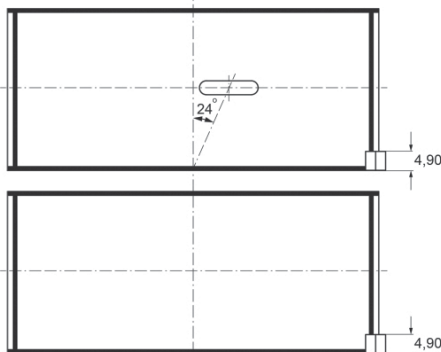
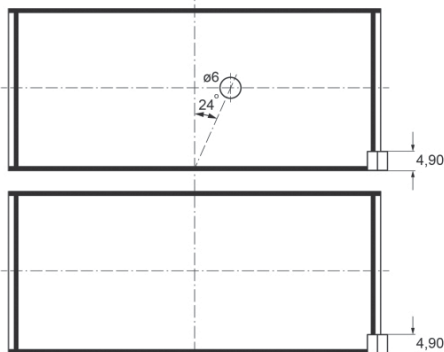

MB/HL 1-5	5	62,873/62,892	66,668/66,687	23,500	1,884	0,020/0,071	AL-LF	66507RA	H1052/5 STD 0.25
MB/HL 1-5	5	62,861/62,880	66,668/66,687	23,250	1,884	0,030/0,093	AL-LF	66646RA	

66507RA

66646RA

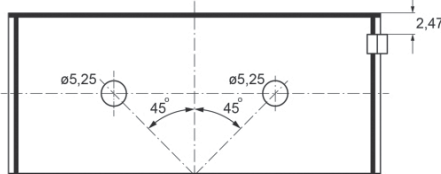
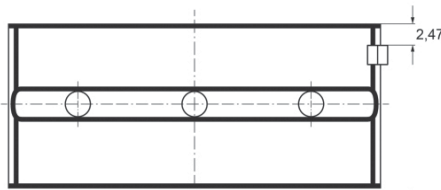
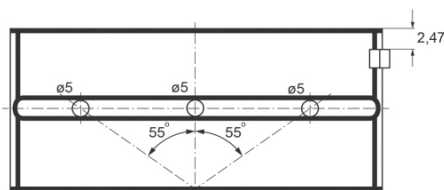

TW/A	2	71,450	88,090	2,850	BS	66506BF	A208/2 STD
TW/A	2	71,450	88,090	2,850	BS	66646BF	A210/2 STD

66506BF

66646BF

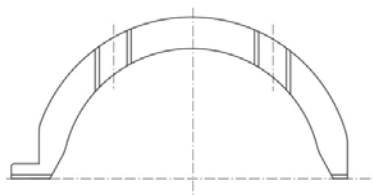
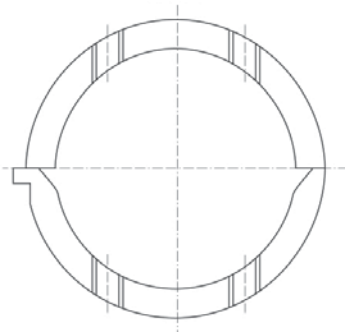

69

88.00 x 89.00

J6T 790	4 Cyl.	2165cc	85kW (116PS)	Petrol	TD3331
J6T 791	4 Cyl.	2165cc	85kW (116PS)	Petrol	TD3332

BE/PL	4	56,267/56,286	60,005/60,019	20,750	1,842	0,035/0,093	AL-LF	66645RA	01-4191/4 STD 0.25
MB/HL 1-5	5	62,873/62,892	66,668/66,687	23,500	1,884	0,020/0,071	AL-LF	66507RA	H1052/5 STD 0.25
TW/A	2	71,450	88,090	2,850	BS	66506BF	A208/2 STD		



70		89.00 x 99.00								
G9U 630 Euro 4		4 Cyl.	2464cc	84-107kW (114-146PS)	Diesel Turbo Intercooler					TD19713
G9U 632 Euro 4		4 Cyl.	2464cc	88-107kW (120-146PS)	Diesel Turbo Intercooler					TD21013
G9U 650 Euro 4		4 Cyl.	2464cc	74-88kW (101-120PS)	Diesel Turbo Intercooler					TD21011
G9U 720		4 Cyl.	2463cc	84kW (115PS)	Diesel Turbo Intercooler					TD16303
G9U 724		4 Cyl.	2463cc	84-85kW (115-116PS)	Diesel Turbo Intercooler					TD19366
G9U 730		4 Cyl.	2464cc	99kW (135PS)	Diesel Turbo Intercooler					TD18275
G9U 750		4 Cyl.	2463cc	84kW (115PS)	Diesel Turbo Intercooler					TD19359
G9U 754		4 Cyl.	2463cc	73-85kW (99-115PS)	Diesel Turbo Intercooler					TD19085
BE/PL	4	52,971/52,990	56,587/56,606	20,650	1,782	0,015/0,069	EC	71-4744	71-4744/4 STD 0.25	4
MB/HL 1-5	5	57,980/58,000	61,668/61,681	20,990	1,810		AL-LF	02-4042	H1013/5 STD 0.25	
TW/A	2	63,250/63,500	78,550/78,800		2,350		AL-LF	04-4745	A289/2 STD	
SE/PB	1	31,013/31,020	33,500/33,525	25,800			BC	55-4050	55-4050 SEMI	

71		91.00 x 73.00								
Z6W 700		V6 Cyl.	2850cc	116kW (158PS)	Petrol					TD3435
Z6W 702		V6 Cyl.	2850cc	116kW (158PS)	Petrol					TD3436
Z7W 700		V6 Cyl.	2849cc	115kW (156PS)	Petrol					TD3444
Z7W 701		V6 Cyl.	2849cc	115kW (156PS)	Petrol					TD3445
Z7W 702		V6 Cyl.	2849cc	100kW (136PS)	Petrol					TD3446
Z7W 706		V6 Cyl.	2849cc	110-112kW (150-153PS)	Petrol					TD3447
Z7W 707		V6 Cyl.	2849cc	110-112kW (150-153PS)	Petrol					TD3448
Z7W 709		V6 Cyl.	2849cc	110kW (150PS)	Petrol					TD3449
Z7W 712		V6 Cyl.	2849cc	110kW (150PS)	Petrol					TD3450
Z7W 713		V6 Cyl.	2849cc	110kW (150PS)	Petrol					TD3451
Z7W 717		V6 Cyl.	2849cc	110kW (150PS)	Petrol					TD17866
BE/PL	6	59,971/59,990	63,704/63,723	17,720	1,846	0,022/0,085	EC	71-3733	71-3733/6 STD	
MB/HL 1-4	4	70,043/70,062	74,000/74,019	23,470	1,967	0,020/0,067	AL-LF	66311RA	H1041/4 STD	

72		93.00 x 72.70								
Z7X 27		V6 Cyl.	2963cc	123kW (167PS)	Petrol					TD5505
Z7X 721		V6 Cyl.	2963cc	123-125kW (167-170PS)	Petrol					TD3452
Z7X 722		V6 Cyl.	2963cc	123kW (167PS)	Petrol					TD3453
Z7X 723		V6 Cyl.	2963cc	123kW (167PS)	Petrol					TD3454
Z7X 753		V6 Cyl.	2963cc	123-125kW (170-170PS)	Petrol					TD3457
Z7X 755		V6 Cyl.	2963cc	123-125kW (170-170PS)	Petrol					TD23902
Z7X 760		V6 Cyl.	2963cc	123kW (167PS)	Petrol					TD3458
Z7X 765		V6 Cyl.	2963cc	123kW (167PS)	Petrol					TD3459
Z7X 767		V6 Cyl.	2963cc	123-125kW (170-170PS)	Petrol					TD23903
Z7X 775		V6 Cyl.	2963cc	123kW (167PS)	Petrol					TD12228
BE/PL	6	59,971/59,990	63,704/63,723	17,720	1,846	0,022/0,085	EC	71-3733	71-3733/6 STD	
MB/HL 1-4	4	70,043/70,062	74,000/74,019	23,470	1,967	0,020/0,067	AL-LF	66311RA	H1041/4 STD	



73 93.00 x 90.00

8140.21.235 IDS		4 Cyl.	2445cc	68-71kW (92-96PS)			Diesel Turbo	TD3418
8140.61.235		4 Cyl.	2445cc	53kW (72PS)			Diesel	TD3430
BE/PL	4	56,520/56,535	60,333/60,345	24,700	1,870	0,020/0,072	BS 1870CP	71-4130/4 STD 0.25 0.50 0.75
MB/HL 1-4	4	76,187/76,200	80,586/80,607	24,990	2,172	0,042/0,100	BS 66571CP	H1049/5 STD 0.25 0.50 0.75
MB/HL 5	1	76,187/76,200	80,586/80,607	31,950	2,172	0,042/0,100	BS 66572CPH	
SE/PB	1	31,990/31,996	34,895/34,920	30,700			BS 66579YA	55-4186 SEMI

Mot.344183 →

74 93.00 x 90.00

8140.61.2300		4 Cyl.	2445cc	52kW (71PS)			Diesel	TD3429
8140.61.240		4 Cyl.	2445cc	51kW (69PS)			Diesel Turbo	TD12871
S8U 720		4 Cyl.	2445cc	51kW (69PS)			Diesel	TD3413
S8U 722		4 Cyl.	2445cc	51kW (69PS)			Diesel	TD3414
S8U 731		4 Cyl.	2445cc	50-53kW (68-72PS)			Diesel	TD12730
S8U 748		4 Cyl.	2445cc	55kW (75PS)			Diesel	TD12735

BE/PL	4	56,520/56,535	60,333/60,345	24,700	1,870	0,020/0,072	BS 1870CP	71-4130/4 STD 0.25 0.50 0.75
-------	---	---------------	---------------	--------	-------	-------------	-----------	--

10/82 →

BE/PL	4	56,520/56,535	60,333/60,345	24,700	1,870	0,020/0,070	BS 66575CP	71-4185/4 STD 0.25 0.50 0.75
-------	---	---------------	---------------	--------	-------	-------------	------------	--

→09/82

1870CP

66575CP

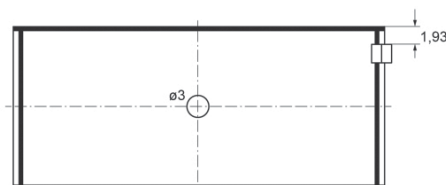

MB/HL 1-4	4	76,187/76,200	80,586/80,607	24,990	2,172	0,042/0,100	BS 66571CP	H1049/5 STD 0.25 0.50 0.75
MB/HL 5	1	76,187/76,200	80,586/80,607	31,950	2,172	0,042/0,100	BS 66572CPH	

→12/92

MB/HL 1-4	4	76,187/76,200	80,586/80,607	24,990	2,172	0,038/0,097	BS 66573CP	H1094/5 STD 0.25
MB/HL 5	1	76,187/76,200	80,586/80,607	31,950	2,172	0,038/0,097	BS 66574CPH	

01/93 → 08/95

MB/HL 5	1	86,182/86,208	90,588/90,614	30,950	2,164	0,052/0,129	BS 4691CPH	H1104/5 STD 0.25 0.50
MB/HL 1-4	4	80,182/80,208	84,588/84,614	23,800	2,164	0,052/0,129	BS 4692CP	

09/95 →



66571CP

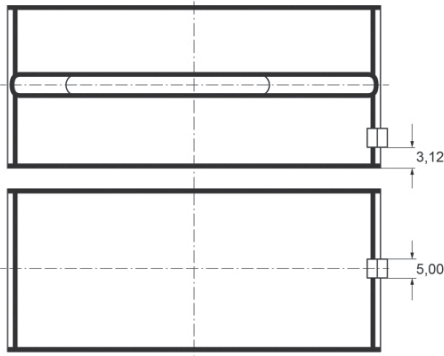

66572CPH

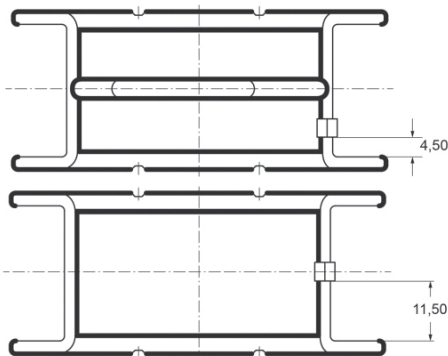

66573CP

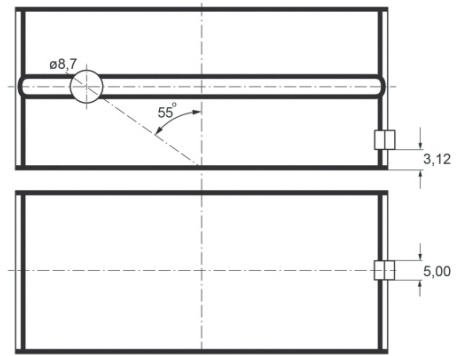

66574CPH

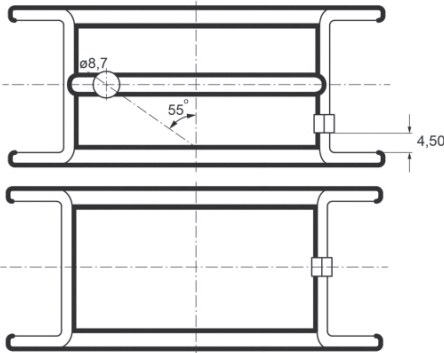

4691CPH

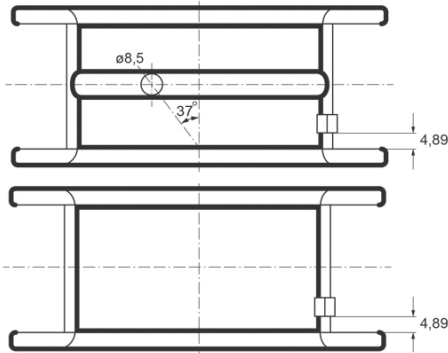

4692CP

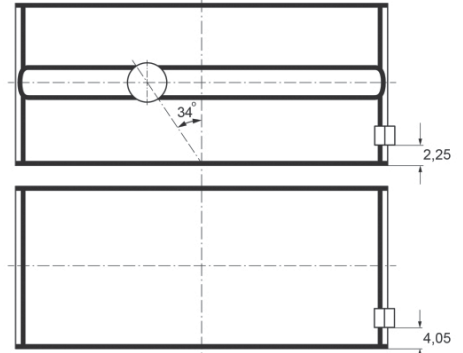

SE/PB	1	31,990/31,996	34,895/34,920	30,700		BS	66579YA	55-4186 SEMI
-------	---	---------------	---------------	--------	--	----	---------	-----------------

Mot.344183 →

75

93.00 x 90.00

S8U 730	4 Cyl.	2445cc	52kW (71PS)	Diesel	TD12873				
BE/PL	4	56,520/56,535	60,333/60,345	24,700	1,870	0,020/0,072	BS	1870CP	71-4130/4 STD 0.25 0.50 0.75
MB/HL 1-4	4	76,187/76,200	80,586/80,607	24,990	2,172	0,042/0,100	BS	66571CP	H1049/5 STD 0.25 0.50 0.75
MB/HL 5	1	76,187/76,200	80,586/80,607	31,950	2,172	0,042/0,100	BS	66572CPH	

→12/92

MB/HL 1-4	4	76,187/76,200	80,586/80,607	24,990	2,172	0,038/0,097	BS	66573CP	H1094/5 STD 0.25
MB/HL 5	1	76,187/76,200	80,586/80,607	31,950	2,172	0,038/0,097	BS	66574CPH	

01/93 → 08/95

MB/HL 5	1	86,182/86,208	90,588/90,614	30,950	2,164	0,052/0,129	BS	4691CPH	H1104/5 STD 0.25 0.50
MB/HL 1-4	4	80,182/80,208	84,588/84,614	23,800	2,164	0,052/0,129	BS	4692CP	

09/95 →



66571CP

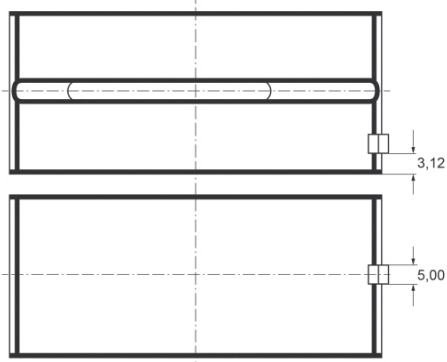

66572CPH

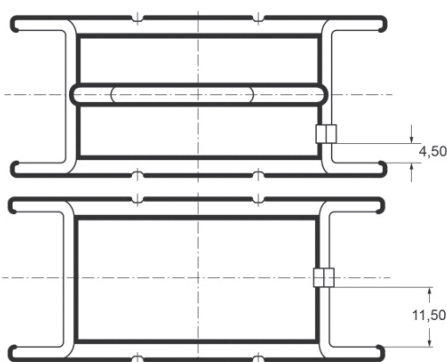

66573CP

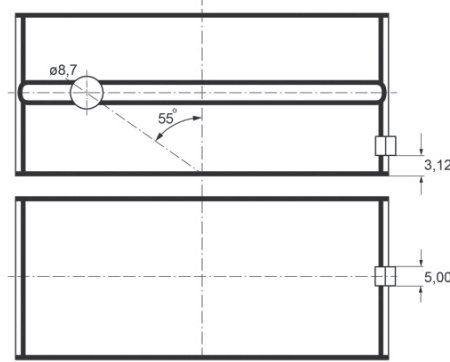

66574CPH

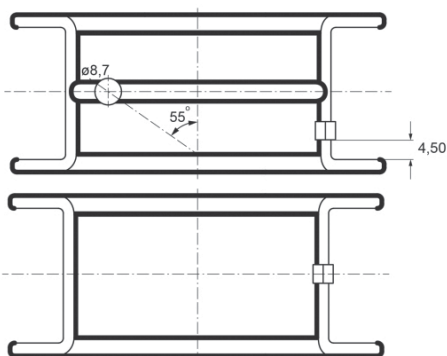

4691CPH

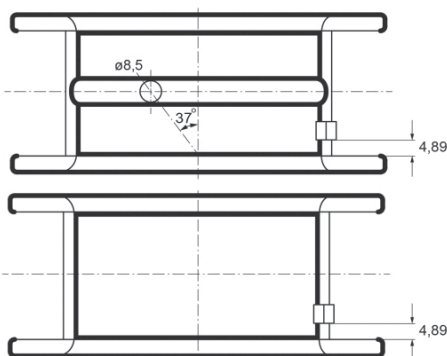

4692CP

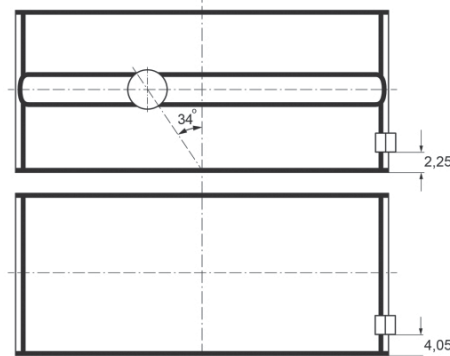

SE/PB | 1 | 31,990/31,996 | 34,895/34,920 | 30,700 | | BS | 66579YA | 55-4186 SEMI

Mot.344183 →

76

93.00 x 92.00

8140.07.2530 ID	4 Cyl.	2500cc	56kW (76PS)	Diesel	TD3417
8140.07.2585 Euro 1	4 Cyl.	2500cc	55kW (75PS)	Diesel	TD12192
8140.27.2510	4 Cyl.	2499cc	69kW (94PS)	Diesel Turbo	TD3420
8140.27.2580	4 Cyl.	2499cc	72kW (98PS)	Diesel Turbo	TD3423
8140.47.2530 IDR	4 Cyl.	2499cc	85kW (116PS)	Diesel Turbo	TD3425
8140.47.2590 Euro 1	4 Cyl.	2499cc	85kW (116PS)	Diesel Turbo Intercooler	TD12199
8140.67.2500	4 Cyl.	2499cc	55kW (75PS)	Diesel	TD3431
8140.67.2510	4 Cyl.	2499cc	55kW (75PS)	Diesel	TD3432
8140.67.2550	4 Cyl.	2499cc	55kW (75PS)	Diesel	TD12872
8140.67.2580	4 Cyl.	2499cc	55kW (75PS)	Diesel	TD3433
8140.67.2585 Euro 2	4 Cyl.	2500cc	55kW (75PS)	Diesel Turbo Intercooler	TD12193
S8U 750	4 Cyl.	2499cc	55kW (75PS)	Diesel	TD5566
S8U 752	4 Cyl.	2499cc	55kW (75PS)	Diesel	TD5567
S8U 758	4 Cyl.	2499cc	55-58kW (75-79PS)	Diesel	TD9689
S8U 762	4 Cyl.	2500cc	83kW (113PS)	Diesel Turbo Intercooler	TD3415
S8U 763	4 Cyl.	2500cc	83kW (113PS)	Diesel Turbo Intercooler	TD3416
S9U 702	4 Cyl.	2499cc	69-72kW (94-98PS)	Diesel Turbo	TD12731
S9U 714	4 Cyl.	2499cc	69kW (94PS)	Diesel Turbo	TD12732
S9U 740	4 Cyl.	2499cc	69kW (94PS)	Diesel Turbo	TD12728

BE/PL | 4 | 56,520/56,535 | 60,333/60,345 | 24,700 | 1,870 | 0,020/0,072 | BS | 1870CP | 71-4130/4 STD 0.25 0.50 0.75

RENAULT

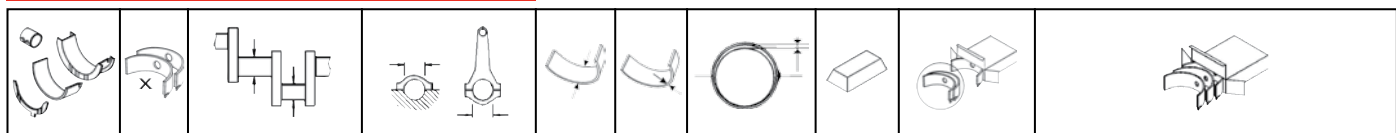

MB/HL 1-4	4	76,187/76,200	80,586/80,607	24,990	2,172	0,042/0,100	BS	66571CP	H1049/5 STD 0.25 0.50 0.75
MB/HL 5	1	76,187/76,200	80,586/80,607	31,950	2,172	0,042/0,100	BS	66572CPH	

→12/92

MB/HL 1-4	4	76,187/76,200	80,586/80,607	24,990	2,172	0,038/0,097	BS	66573CP	H1094/5 STD 0.25
MB/HL 5	1	76,187/76,200	80,586/80,607	31,950	2,172	0,038/0,097	BS	66574CPH	

01/93→08/95

MB/HL 5	1	86,182/86,208	90,588/90,614	30,950	2,164	0,052/0,129	BS	4691CPH	H1104/5 STD 0.25 0.50
MB/HL 1-4	4	80,182/80,208	84,588/84,614	23,800	2,164	0,052/0,129	BS	4692CP	

09/95→

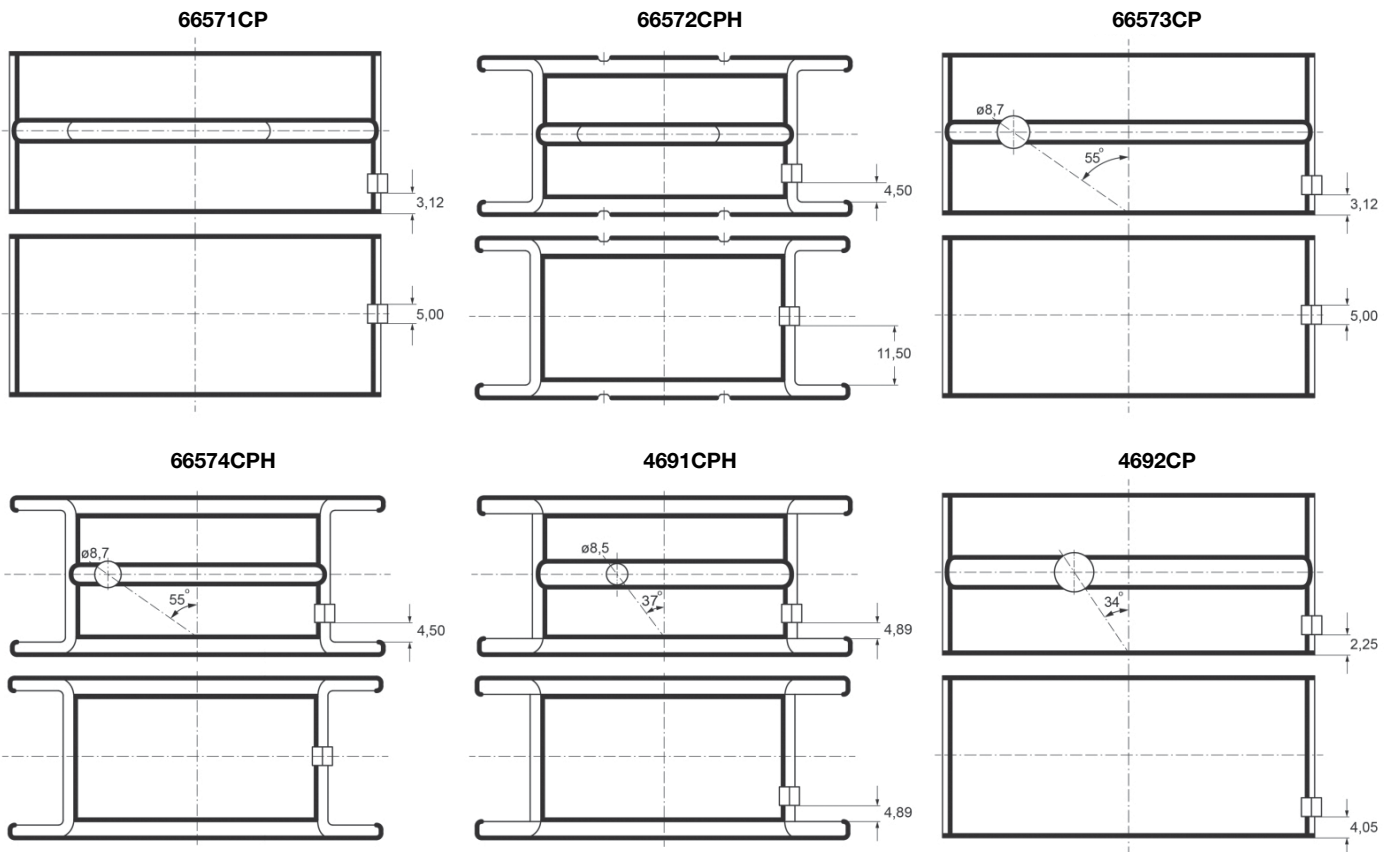

SE/PB	1	31,990/31,996	34,895/34,920	30,700			BS	66579YA	55-4186 SEMI
-------	---	---------------	---------------	--------	--	--	----	---------	------------------------

Mot.344183→

77	93.00 x 92.00								
8140.07.2700	4 Cyl.	2499cc	55kW (75PS)	Diesel					TD22385
8140.07.3700 Euro 1	4 Cyl.	2499cc	55kW (75PS)	Diesel	Turbo	Intercooler			TD22386
8140.27.2512	4 Cyl.	2499cc	69kW (94PS)	Diesel	Turbo				TD3421
8140.27.2560	4 Cyl.	2499cc	69kW (94PS)	Diesel					TD8623
8140.27.2565 IDS	4 Cyl.	2500cc	78kW (106PS)	Diesel					TD12197
8140.27.2582	4 Cyl.	2499cc	92kW (125PS)	Diesel	Turbo				TD3424
8140.27.2700	4 Cyl.	2500cc	68-76kW (92-103PS)	Diesel	Turbo				TD21392
8140.47.2535	4 Cyl.	2499cc	85kW (116PS)	Diesel	Turbo	Intercooler			TD3426
8140.47.2580	4 Cyl.	2500cc	76kW (103PS)	Diesel	Turbo	Intercooler			TD3427



8140.27.2585			4 Cyl.	2500cc	78kW (106PS)		Diesel Turbo	TD12195
8140.47.2700 Euro 1			4 Cyl.	2499cc	85kW (116PS)		Diesel Turbo Intercooler	TD22395
8140.47.2721 Euro 1			4 Cyl.	2499cc	85kW (116PS)		Diesel Turbo Intercooler	TD22396
8140.47.2785 Euro 1			4 Cyl.	2499cc	85kW (116PS)		Diesel Turbo Intercooler	TD22397
8140-07			4 Cyl.	2500cc	55kW (75PS)		Diesel	TD8524
8140-27			4 Cyl.	2500cc	78kW (106PS)		Diesel Turbo	TD8529
8140-27 IDS			4 Cyl.	2500cc	78kW (106PS)		Diesel Turbo	TD8530
8140-47			4 Cyl.	2499cc	85kW (116PS)		Diesel Turbo Intercooler	TD8533
S8U 742			4 Cyl.	2499cc	55kW (75PS)		Diesel	TD5442
S8U 772			4 Cyl.	2499cc	59kW (80PS)		Diesel	TD23889
S8U 782			4 Cyl.	2499cc	55kW (75PS)		Diesel	TD16329
S9U 700			4 Cyl.	2499cc	69kW (94PS)		Diesel Turbo	TD12734
S9U 704			4 Cyl.	2499cc	69kW (94PS)		Diesel Turbo	TD12733

BE/PL	4	56,520/56,535	60,333/60,345	24,700	1,870	0,020/0,072	BS	1870CP	71-4130/4 STD 0.25 0.50 0.75
-------	---	---------------	---------------	--------	-------	-------------	----	--------	--

10/82 →

BE/PL	4	56,520/56,535	60,333/60,345	24,700	1,870	0,020/0,070	BS	66575CP	71-4185/4 STD 0.25 0.50 0.75
-------	---	---------------	---------------	--------	-------	-------------	----	---------	--

→09/82

1870CP

66575CP

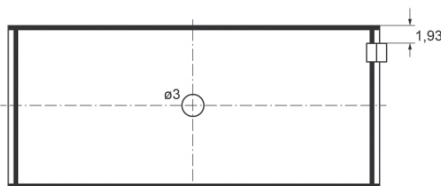

MB/HL 1-4	4	76,187/76,200	80,586/80,607	24,990	2,172	0,042/0,100	BS	66571CP	H1049/5 STD 0.25 0.50 0.75
MB/HL 5	1	76,187/76,200	80,586/80,607	31,950	2,172	0,042/0,100	BS	66572CPH	

→12/92

MB/HL 1-4	4	76,187/76,200	80,586/80,607	24,990	2,172	0,038/0,097	BS	66573CP	H1094/5 STD 0.25
MB/HL 5	1	76,187/76,200	80,586/80,607	31,950	2,172	0,038/0,097	BS	66574CPH	

01/93 → 08/95

MB/HL 5	1	86,182/86,208	90,588/90,614	30,950	2,164	0,052/0,129	BS	4691CPH	H1104/5 STD 0.25 0.50
MB/HL 1-4	4	80,182/80,208	84,588/84,614	23,800	2,164	0,052/0,129	BS	4692CP	

09/95 →

66571CP

66572CPH

66573CP

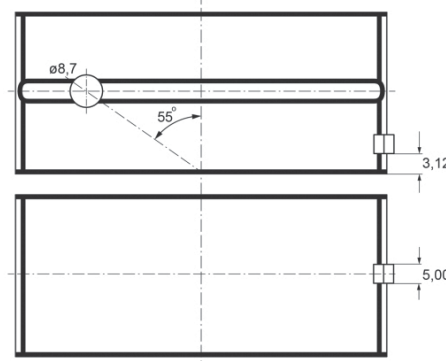
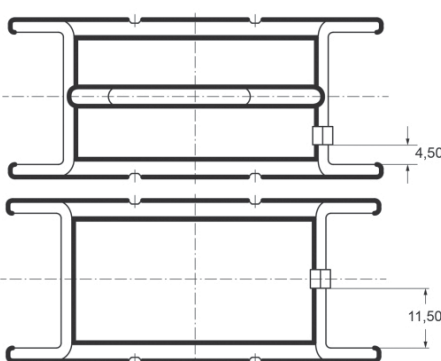
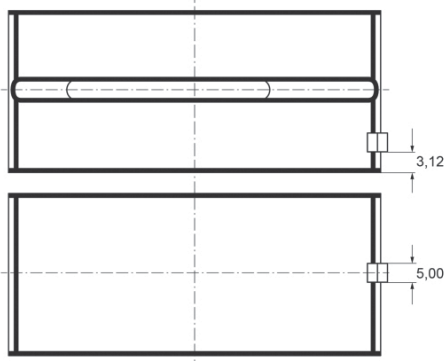



66574CPH

4691CPH

4692CP

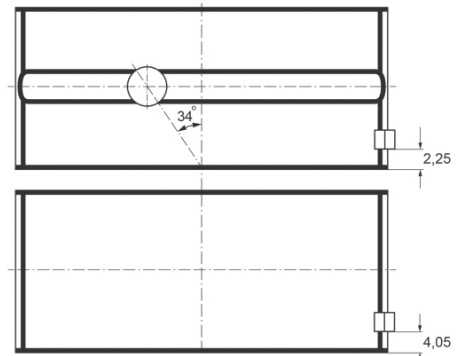
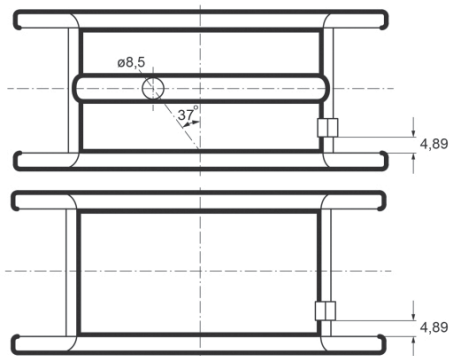
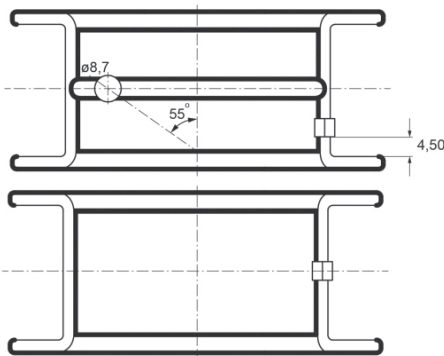

SE/PB	1	31,990/31,996	34,895/34,920	30,700	BS	66579YA	55-4186 SEMI
-------	---	---------------	---------------	--------	----	---------	-----------------

Mot.344183 →

78

93.00 x 92.00

8140.27.2500		4 Cyl.		2499cc	69kW (94PS)	Diesel Turbo		TD3419	
BE/PL	4	56,520/56,535	60,333/60,345	24,700	1,870	0,020/0,072	BS	1870CP	71-4130/4 STD 0.25 0.50 0.75
MB/HL 1-4	4	76,187/76,200	80,586/80,607	24,990	2,172	0,042/0,100	BS	66571CP	H1049/5 STD 0.25 0.50 0.75
MB/HL 5	1	76,187/76,200	80,586/80,607	31,950	2,172	0,042/0,100	BS	66572CPH	
→12/92									
MB/HL 1-4	4	76,187/76,200	80,586/80,607	24,990	2,172	0,038/0,097	BS	66573CP	H1094/5 STD 0.25
MB/HL 5	1	76,187/76,200	80,586/80,607	31,950	2,172	0,038/0,097	BS	66574CPH	
01/93 → 08/95									
MB/HL 5	1	86,182/86,208	90,588/90,614	30,950	2,164	0,052/0,129	BS	4691CPH	H1104/5 STD 0.25 0.50
MB/HL 1-4	4	80,182/80,208	84,588/84,614	23,800	2,164	0,052/0,129	BS	4692CP	
09/95 →									

66571CP

66572CPH

66573CP

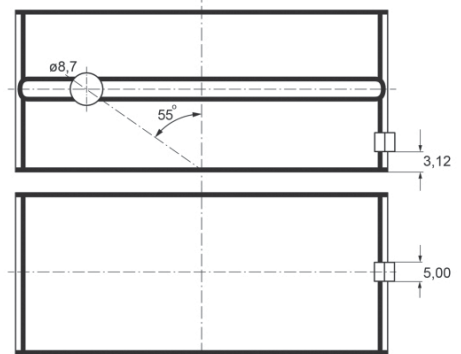
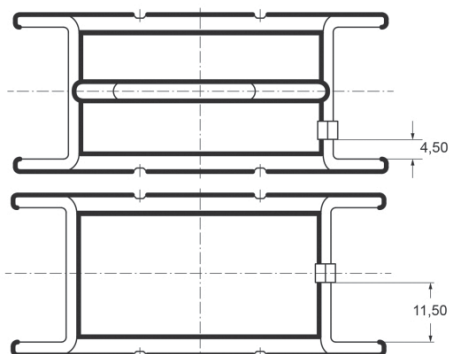
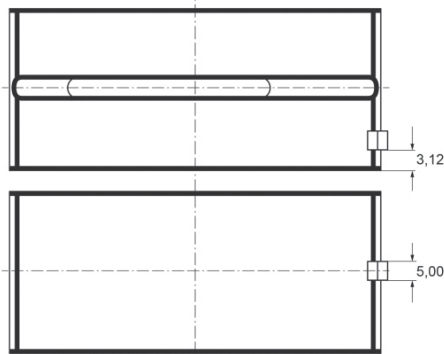

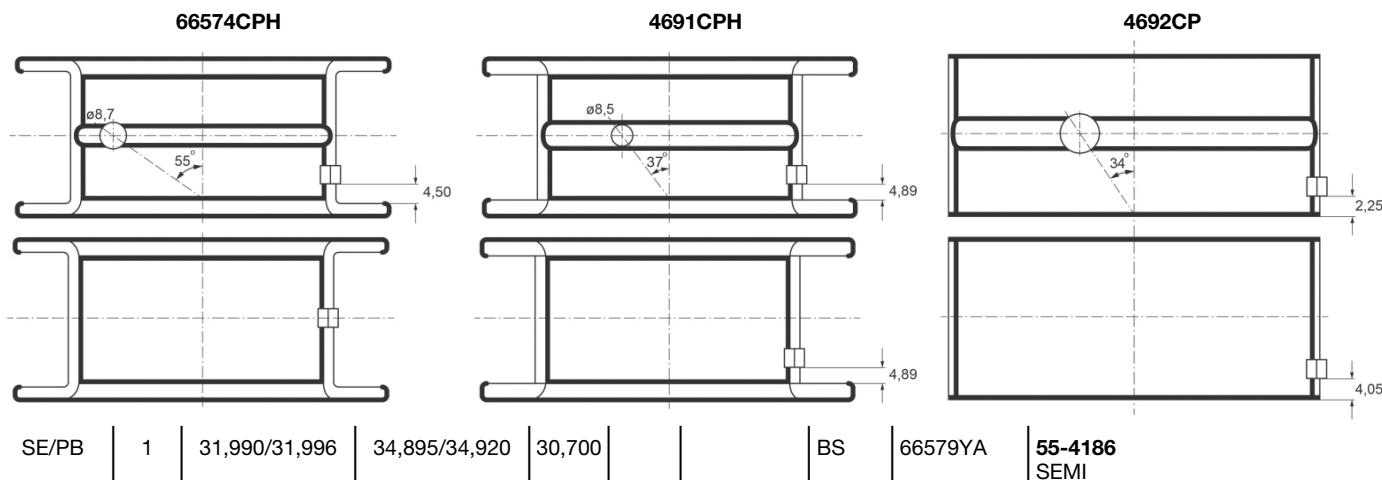

Mot.344183 →

79 93.00 x 92.00

8140.27.2530 IDS		4 Cyl.		2499cc	71-78kW (96-106PS)		Diesel Turbo		TD3422
BE/PL	4	56,520/56,535	60,333/60,345	24,700	1,870	0,020/0,072	BS	1870CP	71-4130/4 STD 0.25 0.50 0.75
MB/HL 1-4	4	76,187/76,200	80,586/80,607	24,990	2,172	0,042/0,100	BS	66571CP	H1049/5 STD 0.25 0.50 0.75
MB/HL 5	1	76,187/76,200	80,586/80,607	31,950	2,172	0,042/0,100	BS	66572CPH	
SE/PB	1	31,990/31,996	34,895/34,920	30,700			BS	66579YA	55-4186 SEMI

Mot.344183 →

80 93.00 x 92.00

8140.47.2585 Euro 1		4 Cyl.		2500cc	85kW (116PS)		Diesel Turbo Intercooler		TD3428
BE/PL	4	56,520/56,535	60,333/60,345	24,700	1,870	0,020/0,072	BS	1870CP	71-4130/4 STD 0.25 0.50 0.75
MB/HL 1-4	4	76,187/76,200	80,586/80,607	24,990	2,172	0,038/0,097	BS	66573CP	H1094/5 STD 0.25
MB/HL 5	1	76,187/76,200	80,586/80,607	31,950	2,172	0,038/0,097	BS	66574CPH	

→08/95

MB/HL 5	1	86,182/86,208	90,588/90,614	30,950	2,164	0,052/0,129	BS	4691CPH	H1104/5 STD 0.25 0.50
MB/HL 1-4	4	80,182/80,208	84,588/84,614	23,800	2,164	0,052/0,129	BS	4692CP	

09/95 →

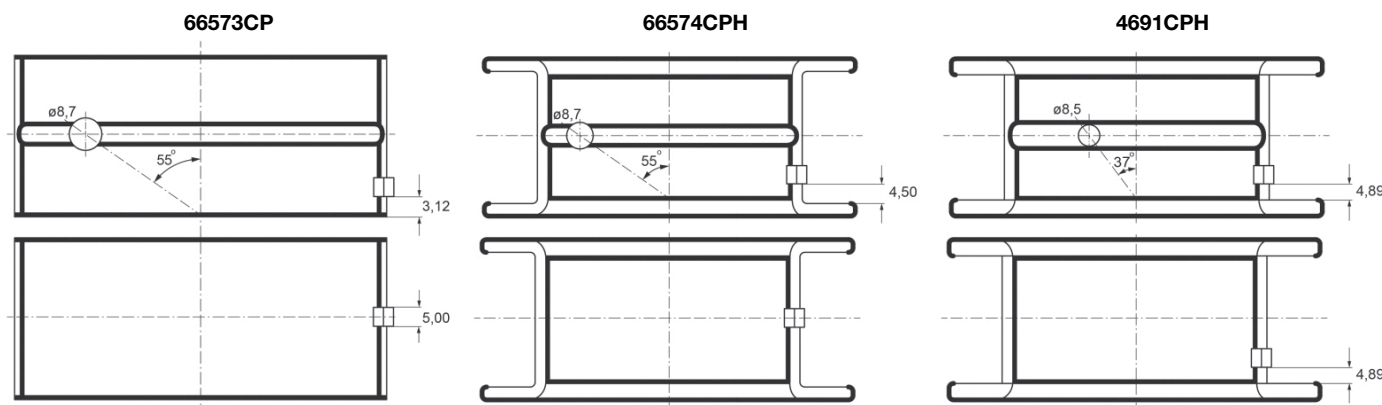

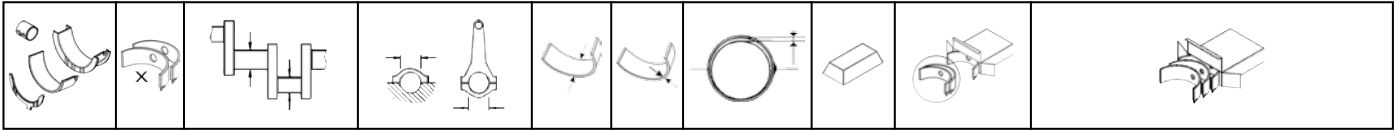

4692CP

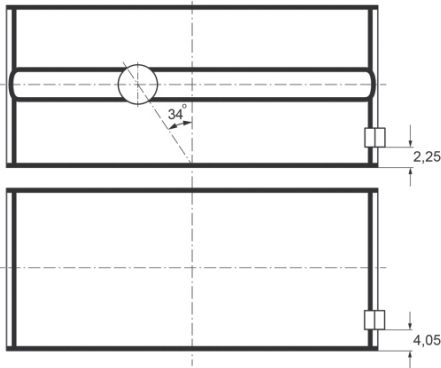

SE/PB	1	31,990/31,996	34,895/34,920	30,700			BS	66579YA	55-4186 SEMI
-------	---	---------------	---------------	--------	--	--	----	---------	-----------------

Mot.344183 →

81

93.00 x 92.00

S8U 770		4 Cyl.		2499cc	59kW (80PS)	Diesel Turbo			TD13409
S8U 780		4 Cyl.		2499cc	55kW (75PS)	Diesel			TD16328
BE/PL	4	56,520/56,535	60,333/60,345	24,700	1,870	0,020/0,072	BS	1870CP	71-4130/4 STD 0.25 0.50 0.75
MB/HL 5	1	86,182/86,208	90,588/90,614	30,950	2,164	0,052/0,129	BS	4691CPH	H1104/5 STD 0.25 0.50
MB/HL 1-4	4	80,182/80,208	84,588/84,614	23,800	2,164	0,052/0,129	BS	4692CP	
SE/PB	1	31,990/31,996	34,895/34,920	30,700			BS	66579YA	55-4186 SEMI

Mot.344183 →

82

93.00 x 110.00

713		4 Cyl.		2989cc	Diesel			FM6072	
BE/PL	4	60,261/60,274	63,995/64,008	30,380	1,835	0,051/0,102	BS	60965CP	71-4170/4 STD 0.25 0.50
MB/HL 1,3,5	3	73,962/73,975	78,691/78,710	35,340	2,335	0,046/0,103	BS	61886CP	H1035/5 STD 0.25
MB/HL 2,4	2	73,962/73,975	78,691/78,710	26,300	2,335	0,046/0,103	BS	61887CP	
TW/A	4	83,500/83,750	99,670/99,920		3,150		AL-LF	61887BF	A272/4 STD
SE/PB	1	35,984/35,990	38,967/38,992	33,700			BS	3069Y	55-4140 SEMI
CB/NWB	1	49,950/49,975	54,000/54,030	33,000			BS	3066DR	N152/5 STD
CB/NWB	2	49,950/49,975	54,000/54,030	26,000			BS	3067DR	
CB/NWB	1	49,950/49,975	54,000/54,030	20,000			BS	3068DR	
CB/NWB	1	49,950/49,975	54,000/54,030	21,000			BS	3069DR	

83

94.40 x 100.00

8140.23.2565	4 Cyl.	2800cc	78kW (106PS)	Diesel Turbo Intercooler			TD17285
8140.23.2585 Euro 2	4 Cyl.	2800cc	78kW (106PS)	Diesel			TD12194
8140.43.2585 Euro 2	4 Cyl.	2800cc	90kW (122PS)	Diesel Turbo Intercooler			TD12198
8140.43.3700 Euro 2	4 Cyl.	2798cc	85kW (116PS)	Diesel Turbo Intercooler			TD22394
8140.43.B.3586 Euro 3	4 Cyl.	2800cc	78kW (106PS)	Diesel Turbo Intercooler			TD17194



8140.43.B.3588 Euro 3	4 Cyl.	2800cc	78kW (106PS)	Diesel Turbo Intercooler	TD17195
8140.43.C.2586	4 Cyl.	2800cc	78kW (106PS)	Diesel Turbo Intercooler	TD14090
8140.43.S.2585 Euro 2	4 Cyl.	2800cc	92kW (125PS)	Diesel Turbo Intercooler	TD14091
8140.43.S.3585 Euro 3	4 Cyl.	2800cc	92kW (125PS)	Diesel Turbo Intercooler	TD17196
8140.43N.3585 Euro 3	4 Cyl.	2798cc	107kW (146PS)	Diesel Turbo Intercooler	TD17197
8140.63.2585 Euro 2	4 Cyl.	2800cc	63kW (86PS)	Diesel Turbo Intercooler	TD14089
8140-43 k Euro 3	4 Cyl.	2800cc	103kW (140PS)	Diesel Turbo Intercooler	TD16211

BE/PL	4	56,520/56,535	60,333/60,345	24,700	1,870	0,020/0,072	BS	1870CP	71-4130/4 STD 0.25 0.50 0.75
MB/HL 5	1	86,182/86,208	90,588/90,614	30,950	2,164	0,052/0,129	BS	4691CPH	H1104/5 STD 0.25 0.50
MB/HL 1-4	4	80,182/80,208	84,588/84,614	23,800	2,164	0,052/0,129	BS	4692CP	
SE/PB	1	31,990/31,996	35,570/35,595	30,400			BS	55-4099	55-4099 SEMI
SE/PB	1	31,990/31,996	34,895/34,920	30,700			BS	66579YA	55-4186 SEMI

55-4099

66579YA

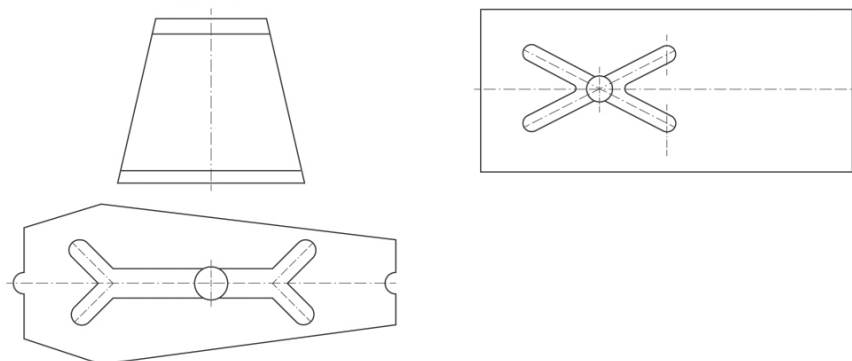

84

98.00 x 110.00

712	4 Cyl.	3320cc	56kW (76PS)	Diesel	TD8669
712.01	4 Cyl.	3320cc	63-65kW (86-88PS)	Diesel	TD7136
712.01	4 Cyl.	3320cc	63-65kW (86-88PS)	Diesel	TD29080
712.02	4 Cyl.	3320cc	65kW (88PS)	Diesel	TD29084
712.03	4 Cyl.	3320cc	51kW (70PS)	Diesel	TD7634
712.03	4 Cyl.	3320cc	51-65kW (70-88PS)	Diesel	TD29081
712.04	4 Cyl.	3320cc	51-58kW (70-79PS)	Diesel	TD7635
712.04	4 Cyl.	3320cc	51-65kW (70-88PS)	Diesel	TD29082
712.07	4 Cyl.	3320cc	56kW (76PS)	Diesel	TD29083
712-01-01	4 Cyl.	3320cc	68kW (92PS)	Diesel	TD3546
712-01-03	4 Cyl.	3320cc	54kW (73PS)	Diesel	TD8769
712-01-03	4 Cyl.	3320cc	53kW (72PS)	Diesel	TD3019
712-01-04	4 Cyl.	3320cc	54kW (73PS)	Diesel	TD8765
712-01-04	4 Cyl.	3320cc	54kW (73PS)	Diesel	TD3020

BE/PL	4	60,261/60,274	63,995/64,008	30,380	1,835	0,051/0,102	BS	60965CP	71-4170/4 STD 0.25 0.50
MB/HL 1,3,5	3	73,962/73,975	78,691/78,710	35,340	2,335	0,046/0,103	BS	61886CP	H1035/5 STD 0.25 0.50
MB/HL 2,4	2	73,962/73,975	78,691/78,710	26,300	2,335	0,046/0,103	BS	61887CP	
TW/A	4	83,500/83,750	99,670/99,920		3,150		AL-LF	61887BF	A272/4 STD
SE/PB	1	35,984/35,990	38,967/38,992	33,700			BS	3069Y	55-4140 SEMI

RENAULT

CB/NWB	1	49,950/49,975	54,000/54,030	33,000			BS	3066DR	N152/5 STD
CB/NWB	2	49,950/49,975	54,000/54,030	26,000			BS	3067DR	
CB/NWB	1	49,950/49,975	54,000/54,030	20,000			BS	3068DR	
CB/NWB	1	49,950/49,975	54,000/54,030	21,000			BS	3069DR	

85	100.00 x 112.00								
597.02			6 Cyl.	5278cc	93kW (126PS)		Diesel		TD8777
597.02			6 Cyl.	5278cc	93kW (126PS)		Diesel		TD29121
597.03			6 Cyl.	5278cc	93kW (126PS)		Diesel		TD7643
597.04			6 Cyl.	5278cc	93kW (126PS)		Diesel		TD7673
BE/PL	1	64,981/65,000	68,701/68,720	30,380	1,830	0,041/0,104	BS	61890CP	71-4286 STD 0.25 0.50
MB/HL 1-7	7	70,002/70,021	74,000/74,018	29,000	1,960	0,059/0,096	BS	61891CP	H1036/7 STD 0.25
SE/PB	1	35,984/35,990	38,967/38,992	37,700			BS	61899Y	55-4287 SEMI

86	100.00 x 127.00								
T 4.40			4 Cyl.	3869cc	82kW (112PS)		Diesel Turbo		TD13968
BE/PL	1	63,475/63,487	67,208/67,221	31,880	1,841	0,040/0,080	EC	GS2791LC	71-4115 STD 0.25 0.50
MB/HL 1,2,4,5	4	76,162/76,175	80,416/80,441	31,880	2,090	0,061/0,124	AL-LF	3136RA	H1037/5 STD 0.25 0.50 0.75 1.00
MB/HL 3	1	76,162/76,175	80,416/80,441	36,700	2,090	0,061/0,124	AL-LF	3137RA	
TW/A	4	86,870/87,120	103,850/104,100		2,310		AL-LF	3137BFA	A184/4 STD .0075
SE/PB	1	38,095/38,100	42,068/42,094	33,930		0,050/0,051	BS	3138Y	55-4524 SEMI

87	102.00 x 110.00								
712.11			4 Cyl.	3596cc	83kW (113PS)		Diesel		TD29085
712.13			4 Cyl.	3596cc	83kW (113PS)		Diesel		TD29086
720			4 Cyl.	3596cc	66kW (90PS)		Diesel		TD7638
720			4 Cyl.	3590cc	67-72kW (91-98PS)		Diesel		TD3022
720.01			4 Cyl.	3596cc	67-73kW (90-99PS)		Diesel		TD29087
720.02			4 Cyl.	3596cc	67-73kW (90-99PS)		Diesel		TD29088
720.03			4 Cyl.	3596cc	67-73kW (90-99PS)		Diesel		TD29089
720.05			4 Cyl.	3596cc	67-73kW (90-99PS)		Diesel		TD29090
720.08			4 Cyl.	3596cc	67-73kW (90-99PS)		Diesel		TD29091
720.12			4 Cyl.	3590cc	67-72kW (90-98PS)		Diesel		TD8609
720-12			4 Cyl.	3595cc	65kW (88PS)		Diesel		TD6217
BE/PL	4	60,261/60,274	63,995/64,008	30,380	1,835	0,051/0,102	BS	60965CP	71-4170/4 STD 0.25 0.50
MB/HL 1,3,5	3	73,962/73,975	78,691/78,710	35,340	2,335	0,046/0,103	BS	61886CP	H1035/5 STD 0.25 0.50
MB/HL 2,4	2	73,962/73,975	78,691/78,710	26,300	2,335	0,046/0,103	BS	61887CP	
TW/A	4	83,500/83,750	99,670/99,920		3,150		AL-LF	61887BF	A272/4 STD
SE/PB	1	35,984/35,990	38,967/38,992	33,700			BS	3069Y	55-4140 SEMI

CB/NWB	1	49,950/49,975	54,000/54,030	33,000				BS	3066DR	N152/5 STD
CB/NWB	2	49,950/49,975	54,000/54,030	26,000				BS	3067DR	
CB/NWB	1	49,950/49,975	54,000/54,030	20,000				BS	3068DR	
CB/NWB	1	49,950/49,975	54,000/54,030	21,000				BS	3069DR	

88
102.00 x 112.00

797-20			6 Cyl.	5490cc	96-98kW (130-133PS)			Diesel Turbo		TD8607
797-21			6 Cyl.	5453cc	76kW (103PS)			Diesel		TD8658
797-26			6 Cyl.	5490cc	98kW (133PS)			Diesel Turbo		TD8593
BE/PL	1	64,981/65,000	68,701/68,720	30,380	1,830	0,041/0,104	BS	61890CP	71-4286 STD 0.25 0.50	
MB/HL 1-7	7	70,002/70,021	74,000/74,018	29,000	1,960	0,059/0,096	BS	61891CP	H1036/7 STD 0.25	
SE/PB	1	35,984/35,990	38,967/38,992	37,700			BS	61899Y	55-4287 SEMI	

89
102.00 x 112.00

798-10			6 Cyl.	5490cc	111kW (151PS)			Diesel Turbo		TD6218
798-10			6 Cyl.	5490cc	113kW (154PS)			Diesel Turbo		TD6210
798-11			6 Cyl.	5490cc	125kW (170PS)			Diesel Turbo		TD8778
798-13			6 Cyl.	5490cc	111kW (151PS)			Diesel Turbo		TD5870
798-13			6 Cyl.	5490cc	111-112kW (151-152PS)			Diesel Turbo		TD5861
798-20			6 Cyl.	5490cc	113kW (154PS)			Diesel Turbo		TD8606
798-40			6 Cyl.	5490cc	107kW (145PS)			Diesel Turbo		TD8744
BE/PL	1	64,981/65,000	68,701/68,720	30,380	1,830	0,041/0,104	BS	61890CP	71-4286 STD 0.25 0.50	
MB/HL 1-7	7	70,002/70,021	74,000/74,018	29,000	1,960	0,059/0,096	BS	61891CP	H1036/7 STD 0.25	

90
102.00 x 112.00

MIDR 06.02.12			6 Cyl.	5491cc	128-134kW (173-182PS)			Diesel Turbo Intercooler		TD8547
MIDR 06.02.12 B			6 Cyl.	5490cc	117kW (159PS)			Diesel Turbo Intercooler		TD8644
MIDR 06.02.12 C			6 Cyl.	5490cc	121-133kW (170-181PS)			Diesel Turbo Intercooler		TD5985
MIDR 06.02.12 D			6 Cyl.	5490cc	127-134kW (172-182PS)			Diesel Turbo Intercooler		TD8583
MIDR 06.02.12 D3			6 Cyl.	5490cc	110kW (150PS)			Diesel Turbo Intercooler		TD8663
MIDR 06.02.12 L			6 Cyl.	5490cc	121-133kW (170-181PS)			Diesel Turbo Intercooler		TD6318
MIDS 06.02.12			6 Cyl.	5490cc	107kW (145PS)			Diesel Turbo		TD8545
MIDS 06.02.12 B			6 Cyl.	5453-5490cc	113-117kW (154-159PS)			Diesel Turbo		TD8608
MIDS 06.02.12 C			6 Cyl.	5490cc	97-103kW (132-140PS)			Diesel Turbo		TD8615
MIDS 06.02.12 D			6 Cyl.	5490cc	110kW (150PS)			Diesel		TD29111
MIDS 06.02.12 D/3			6 Cyl.	5490cc	110kW (150PS)			Diesel Turbo		TD14068
BE/PL	1	64,981/65,000	68,701/68,720	31,150	1,836	0,029/0,092	BS	4240CP	71-4289 STD 0.25	
MB/HL 1-7	7	70,002/70,021	74,000/74,018	29,000	1,960	0,059/0,096	BS	61891CP	H1036/7 STD 0.25	
MB/HL 1-7	7	76,002/76,021	80,000/80,019	28,000	1,969	0,041/0,104	BS	4241CP	H1090/7 STD 0.25 0.50	

91
102.00 x 126.00

dCi 4B Euro 3			4 Cyl.	4120cc	112kW (152PS)			Diesel		TD17333
dCi 4C Euro 3			4 Cyl.	4120cc	128kW (174PS)			Diesel Turbo Intercooler		TD17335
MIDR 04.02.26 A/4 Euro 2			4 Cyl.	4120cc	100kW (136PS)			Diesel Turbo Intercooler		TD14509
MIDR 04.02.26 A/41 Euro 2			4 Cyl.	4100cc	100kW (136PS)			Diesel Turbo Intercooler		TD12269



MIDR 04.02.26 B/4 Euro 2		4 Cyl.		4120cc	110kW (150PS)	Diesel Turbo Intercooler			TD14510
MIDR 04.02.26 B/41 Euro 2		4 Cyl.		4100cc	110kW (150PS)	Diesel Turbo Intercooler			TD12268
BE/PL	1	64,981/65,000	68,701/68,720	31,150	1,836	0,029/0,092	BS	4240CP	71-4289 STD 0.25
MB/HL 1-7	7	76,002/76,021	80,000/80,019	28,000	1,969	0,041/0,104	BS	4241CP	H1090/7 STD 0.25 0.50
TW/A	4	85,100/85,350	107,600/107,850		3,150		BS	4241BF	A189/4 STD
SE/PB	1	42,000/42,016	46,000/46,025	34,600			BS	61909Y	55-4291 SEMI

92

102.00 x 126.00

dci 6A Euro 3		6 Cyl.		6177cc	195kW (265PS)	Diesel Turbo Intercooler			TD17339
dci 6W Euro 3		6 Cyl.		6177cc	158kW (215PS)	Diesel Turbo Intercooler			TD17338
MIDR 06.02.26		6 Cyl.		6180cc	159kW (216PS)	Diesel Turbo Intercooler			TD14049
MIDR 06.02.26 D		6 Cyl.		6180cc	166kW (226PS)	Diesel Turbo Intercooler			TD5862
MIDR 06.02.26 H		6 Cyl.		6180cc	133-144kW (181-196PS)	Diesel Turbo Intercooler			TD5645
MIDR 06.02.26 I		6 Cyl.		6180cc	133kW (181PS)	Diesel Turbo Intercooler			TD5986
MIDR 06.02.26 K		6 Cyl.		6180cc	155kW (211PS)	Diesel Turbo Intercooler			TD7554
MIDR 06.02.26 L		6 Cyl.		6180cc	132kW (180PS)	Diesel Turbo Intercooler			TD7552
MIDR 06.02.26 L2		6 Cyl.		6180cc	132kW (180PS)	Diesel Turbo Intercooler			TD7553
MIDR 06.02.26 M		6 Cyl.		6180cc	155kW (211PS)	Diesel Turbo Intercooler			TD7556
MIDR 06.02.26 M2		6 Cyl.		6180cc	155kW (211PS)	Diesel Turbo Intercooler			TD7555
MIDR 06.02.26 Q		6 Cyl.		6180cc	137-140kW (186-190PS)	Diesel Turbo			TD8584
MIDR 06.02.26 S		6 Cyl.		6174cc	166kW (226PS)	Diesel Turbo Intercooler			TD6211
MIDR 06.02.26 U Euro 1		6 Cyl.		6174cc	110kW (150PS)	Diesel Turbo Intercooler			TD8616
MIDR 06.02.26 U/4 Euro 2		6 Cyl.		6180cc	110kW (150PS)	Diesel Turbo Intercooler			TD12208
MIDR 06.02.26 V Euro 1		6 Cyl.		6174cc	129-132kW (175-180PS)	Diesel Turbo Intercooler			TD8618
MIDR 06.02.26 V/4 Euro 2		6 Cyl.		6177cc	132kW (180PS)	Diesel Turbo Intercooler			TD14508
MIDR 06.02.26 V/41 Euro 2		6 Cyl.		6180cc	132kW (180PS)	Diesel Turbo Intercooler			TD12248
MIDR 06.02.26 W Euro 1		6 Cyl.		6174-6180cc	151kW (205PS)	Diesel Turbo Intercooler			TD8587
MIDR 06.02.26 W/4 Euro 2		6 Cyl.		6177cc	154kW (209PS)	Diesel Turbo Intercooler			TD14511
MIDR 06.02.26 W/41 Euro 2		6 Cyl.		6180cc	154kW (210PS)	Diesel Turbo Intercooler			TD8638
MIDR 06.02.26 X Euro 1		6 Cyl.		6180cc	166kW (226PS)	Diesel Turbo Intercooler			TD8536
MIDR 06.02.26 Y/41 Euro 2		6 Cyl.		6177-6180cc	184kW (250PS)	Diesel Turbo Intercooler			TD8639
BE/PL	1	64,981/65,000	68,701/68,720	31,150	1,836	0,029/0,092	BS	4240CP	71-4289 STD 0.25
MB/HL 1-7	7	76,002/76,021	80,000/80,019	28,000	1,969	0,041/0,104	BS	4241CP	H1090/7 STD 0.25 0.50
TW/A	4	85,100/85,350	107,600/107,850		3,150		BS	4241BF	A189/4 STD
SE/PB	1	42,000/42,016	46,000/46,025	34,600			BS	61909Y	55-4291 SEMI

93

108.00 x 130.00

DXi 5		4 Cyl.		4764cc	118-162kW (160-220PS)	Diesel Turbo Intercooler			TD19015
BE/PL	1	74,980/75,000	80,000/80,020	29,200	2,482	0,036/0,100	SP	71-4716	71-4716 STD [1]
MB/HL	1	84,980/85,000	90,500/90,520	26,500	2,735	0,030/0,094	EC	72-4717	72-4717 STD [4]
TW/A	2	91,400	114,000		2,950		AL-LF	04-4718	A285/4 STD
TW/A	2	91,400	114,000		2,950		AL-LF	04-4719	
SE/PB	1	44,994/45,000	48,000/48,020	36,700			BC-LF	55-4720	55-4720 SEMI [6]

CB/NWB 1	1	72,930/72,950	77,000/77,019	27,000			BC	53-4721	N192/5 STD
CB/NWB 2-5	4	72,930/72,950	77,000/77,019	22,000			BC	53-4722	

94
108.00 x 130.00

DXi 7			6 Cyl.	7200cc	177-247kW (240-340PS)		Diesel Turbo Intercooler		TD19016
BE/PL	1	74,980/75,000	80,000/80,020	29,200	2,482	0,036/0,100	SP	71-4716	71-4716 STD [1]
MB/HL	1	84,980/85,000	90,500/90,520	26,500	2,735	0,030/0,094	EC	72-4717	72-4717 STD [4]
TW/A	2	91,400	114,000		2,950		AL-LF	04-4718	A285/4 STD
TW/A	2	91,400	114,000		2,950		AL-LF	04-4719	
SE/PB	1	44,994/45,000	48,000/48,020	36,700			BC-LF	55-4720	55-4720 SEMI [6]
CB/NWB 1	1	72,930/72,950	77,000/77,019	27,000			BC	53-4721	N192/7 STD
CB/NWB 2-7	6	72,930/72,950	77,000/77,019	22,000			BC	53-4722	

95
120.00 x 130.00

MID 06.20.30			6 Cyl.	8820cc	104kW (141PS)		Diesel		TD26707
MID 06.20.30 C			6 Cyl.	8820cc	135-141kW (184-192PS)		Diesel		TD12249
MID 06.20.30 D			6 Cyl.	8820cc	135-141kW (184-192PS)		Diesel		TD12250
MID 06.20.30 G			6 Cyl.	8820cc	141kW (192PS)		Diesel		TD8598
MID 06.20.30 H			6 Cyl.	8820cc	141kW (192PS)		Diesel		TD12255
MIDR 06.20.30 A			6 Cyl.	8820cc	194kW (264PS)		Diesel Turbo Intercooler		TD8603
MIDR 06.20.30 B			6 Cyl.	8820cc	146-158kW (199-215PS)		Diesel Turbo Intercooler		TD5646
MIDR 06.20.30 C			6 Cyl.	8820cc	146-158kW (199-215PS)		Diesel Turbo Intercooler		TD5987
MIDS 06.20.30			6 Cyl.	8821cc	159-169kW (216-230PS)		Diesel Turbo		TD8595
MIDS 06.20.30			6 Cyl.	8820cc	162kW (220PS)		Diesel Turbo		TD6503
MIDS 06.20.30 B			6 Cyl.	8820cc	159kW (216PS)		Diesel Turbo		TD8599
MIDS 06.20.30 D			6 Cyl.	8820cc	169kW (230PS)		Diesel Turbo		TD8604
MIDS 06.20.30 D			6 Cyl.	8820cc	165kW (225PS)		Diesel Turbo		TD6509
MIDS 06.20.30 E			6 Cyl.	8820cc	159kW (216PS)		Diesel Turbo		TD12256
MIDS 06.20.30 K			6 Cyl.	8820cc	158kW (215PS)		Diesel Turbo		TD7557
MIPS 06.20.30			6 Cyl.	8820cc	166kW (225PS)		Diesel Turbo		TD8626
BE/PL	1	71,960/71,980	76,000/76,020	39,300	1,987	0,046/0,111	BS	66475CP	71-4222 STD 0.50
MB/HL 1-7	7	95,966/95,988	102,000/102,022	34,000	2,976	0,060/0,129	BS	66476CP	H1050/7 STD 0.50
→11/96, Locating lug height (mm): 8,5mm									
MB/HL 1-7	7	95,966/95,989	102,000/102,022	34,000	2,980	0,091/0,134	BS	72-4318	H1129/7 STD 0.25 0.50
12/96→, Locating lug height (mm): 7mm									

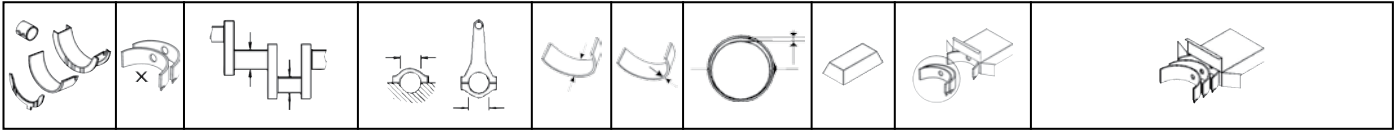

66476CP

72-4318

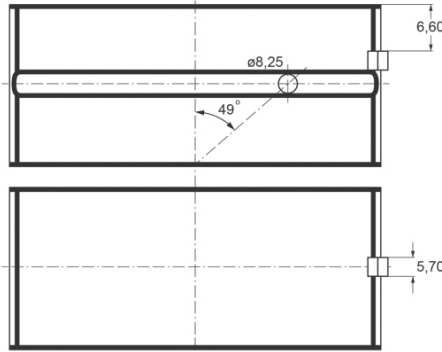
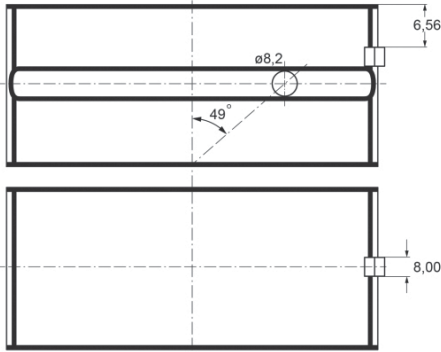

TW/A	4	108,000/108,250	131,750/132,000		4,450		BS	66476BF	A207/4 STD
SE/PB	1	49,969/49,975	54,000/54,030	46,600			BS	66479YA	55-4292 SEMI

96 120.00 x 130.00

MIDS 06.20.30 N	6 Cyl.	8820cc	153kW (208PS)					Diesel Turbo	TD8535
MIDS 06.20.30 N1	6 Cyl.	8820cc	162kW (220PS)					Diesel Turbo	TD8586
MIDS 06.20.30 P	6 Cyl.	8821cc	169-177kW (230-240PS)					Diesel Turbo	TD8590
BE/PL	1	71,960/71,980	76,000/76,020	39,300	1,987	0,046/0,111	BS	66475CP	71-4222 STD 0.50
MB/HL 1-7	7	95,966/95,988	102,000/102,022	34,000	2,976	0,060/0,129	BS	66476CP	H1050/7 STD 0.50

Locating lug height (mm): 8,5mm

TW/A	4	108,000/108,250	131,750/132,000		4,450		BS	66476BF	A207/4 STD
SE/PB	1	49,969/49,975	54,000/54,030	46,600			BS	66479YA	55-4292 SEMI

97 120.00 x 140.00

M420 MDX	4 Cyl.	6328cc						Diesel	FM4363
BE/PL	1	83,960/83,980	90,000/90,020	45,000	2,975	0,070/0,135	BS	2975CP	71-4113 STD 0.25 0.50 0.75 1.00
TW/A	4	100,500	122,000		2,940		BS	2977BF	A239/4 STD
SE/PB	1	44,984/45,000	49,989/50,014	39,500			BS	60654X	55-4283 SEMI

98 120.00 x 140.00

M 520	5 Cyl.	7917cc	108-110kW (147-150PS)					Diesel	TD8614
BE/PL	1	83,960/83,980	90,000/90,020	45,000	2,975	0,070/0,135	BS	2975CP	71-4113 STD 0.25 0.50 0.75 1.00
TW/A	4	100,500	122,000		2,940		BS	2977BF	A239/4 STD
SE/PB	1	44,984/45,000	49,989/50,014	39,500			BS	60654X	55-4283 SEMI

99 120.00 x 140.00

M 620 Z 3	6 Cyl.	9500cc	132kW (180PS)					Diesel	TD8600
BE/PL	1	83,960/83,980	90,000/90,020	45,000	2,975	0,070/0,135	BS	2975CP	71-4113 STD 0.25 0.50 0.75 1.00
MB/HL 2,3,5,6	4	89,940/89,960	96,000/96,027	40,250	2,975	0,090/0,162	BS	2977CP	H1054/7 STD 0.25 0.50
MB/HL 1,4,7	3	89,940/89,960	96,000/96,027	63,620	2,975	0,090/0,162	BS	66731CP	

TW/A	4	100,500	122,000		2,940		BS	2977BF	A239/4 STD
SE/PB	1	44,984/45,000	49,989/50,014	39,500			BS	60654X	55-4283 SEMI

100 **120.00 x 145.00**

MID 06.20.45	6 Cyl.	9840cc	152kW (207PS)	Diesel		TD8534
MIDR 06.20.45 A	6 Cyl.	9839cc	192kW (260PS)	Diesel Turbo Intercooler		TD8591
MIDR 06.20.45 A2	6 Cyl.	9840cc	202kW (275PS)	Diesel Turbo Intercooler		TD8579
MIDR 06.20.45 C	6 Cyl.	9840cc	206-210kW (280-285PS)	Diesel Turbo Intercooler		TD8580
MIDR 06.20.45 D	6 Cyl.	9839cc	210-222kW (286-302PS)	Diesel Turbo Intercooler		TD8538
MIDR 06.20.45 D3 Euro 1	6 Cyl.	9839cc	222kW (302PS)	Diesel Turbo Intercooler		TD8539
MIDR 06.20.45 E	6 Cyl.	9839cc	240-249kW (326-339PS)	Diesel Turbo Intercooler		TD5860
MIDR 06.20.45 E/41 Euro 2	6 Cyl.	9839cc	249kW (338PS)	Diesel Turbo Intercooler		TD8642
MIDR 06.20.45 E3 Euro 1	6 Cyl.	9839cc	249kW (339PS)	Diesel Turbo Intercooler		TD8541
MIDR 06.20.45 F3	6 Cyl.	9840cc	144kW (196PS)	Diesel Turbo Intercooler		TD8646
MIDR 06.20.45 I3	6 Cyl.	9840cc	191kW (260PS)	Diesel Turbo Intercooler		TD12190
MIDR 06.20.45 J3	6 Cyl.	9839cc	222kW (302PS)	Diesel Turbo Intercooler		TD12204
MIDR 06.20.45 K	6 Cyl.	9840cc	177kW (241PS)	Diesel Turbo Intercooler		TD7550
MIDR 06.20.45 L	6 Cyl.	9840cc	177-187kW (241-254PS)	Diesel		TD7551
MIDR 06.20.45 M	6 Cyl.	9840cc	236kW (320PS)	Diesel Turbo Intercooler		TD8581
MIDR 06.20.45 M3	6 Cyl.	9840cc	250kW (340PS)	Diesel Turbo Intercooler		TD8582
MIDR 06.20.45 M41 Euro 2	6 Cyl.	9839cc	250kW (340PS)	Diesel Turbo Intercooler		TD21231
MIDR 06.20.45 R41 Euro 2	6 Cyl.	9839cc	222kW (302PS)	Diesel Turbo Intercooler		TD21230
MIDS 06.20.45 B	6 Cyl.	9839cc	192-202kW (260-275PS)	Diesel Turbo		TD8537
MIDS 06.20.45 D	6 Cyl.	9840cc	129kW (175PS)	Diesel Turbo		TD8647
MIDS 06.20.45 F	6 Cyl.	9840cc	144kW (196PS)	Diesel Turbo		TD8648
MIHR 06.20.45 A41 Euro 2	6 Cyl.	9839cc	185kW (252PS)	Diesel Turbo Intercooler		TD21269
MIPR 06.20.45	6 Cyl.	9840cc	195-265kW (265-360PS)	Diesel Turbo Intercooler		TD29114
MIPR 06.20.45 A	6 Cyl.	9840cc	210kW (286PS)	Diesel Turbo Intercooler		TD8634
MIPR 06.20.45 B3	6 Cyl.	9840cc	186kW (253PS)	Diesel		TD8628
MIPR 06.20.45 C3	6 Cyl.	9840cc	152kW (206PS)	Diesel		TD8629
MIPS 06.20.45	6 Cyl.	9840cc	137-186kW (186-253PS)	Diesel Turbo Intercooler		TD8630
MIPS 06.20.45 A	6 Cyl.	9840cc	129kW (175PS)	Diesel Turbo Intercooler		TD8631

BE/PL	1	76,960/76,980	82,000/82,022	40,900	2,485	0,050/0,112	BS	4370CP	71-4290 STD 0.25
-------	---	---------------	---------------	--------	-------	-------------	----	--------	---------------------

07/94 →

BE/PL	1	76,960/76,980	82,000/82,022	40,900	2,485	0,050/0,112	BS	66735CP	71-4295 STD 0.25 0.50
-------	---	---------------	---------------	--------	-------	-------------	----	---------	--------------------------

→06/94

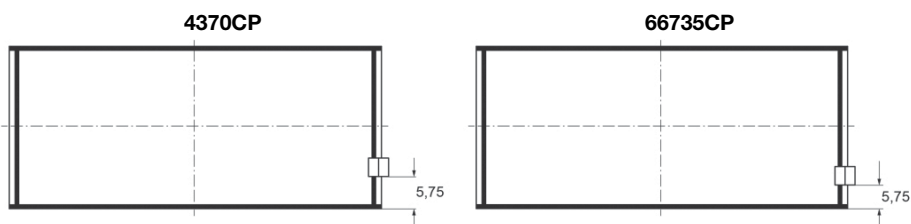

MB/HL 1-7	7	95,966/95,988	102,000/102,022	34,000	2,976	0,060/0,129	BS	66476CP	H1050/7 STD 0.50
-----------	---	---------------	-----------------	--------	-------	-------------	----	---------	---------------------

→11/96, Locating lug height (mm): 8,5mm

MB/HL 1-7	7	95,966/95,989	102,000/102,022	34,000	2,980	0,091/0,134	BS	72-4318	H1129/7 STD 0.25 0.50
-----------	---	---------------	-----------------	--------	-------	-------------	----	---------	--------------------------

12/96 →, Locating lug height (mm): 7mm



66476CP

72-4318

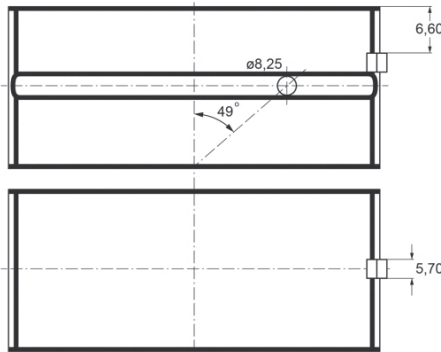
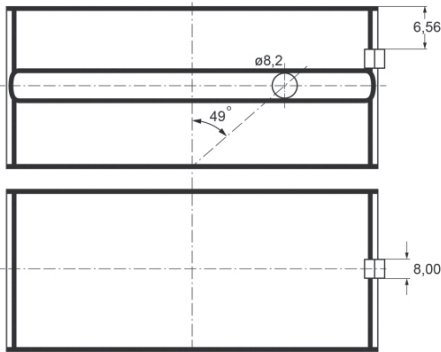

TW/A	4	108,000/108,250	131,750/132,000		4,450		BS	66476BF	A207/4 STD
SE/PB	1	50,000/50,016	54,000/54,030	40,000			BS	66739Y	55-4296 SEMI

101 120.00 x 145.00

MIDR 06.20.45	6 Cyl.	9771cc	214-222kW (291-302PS)	Diesel Turbo Intercooler	TD8414				
MIDS 06.20.45	6 Cyl.	9839cc	192-202kW (261-275PS)	Diesel Turbo	TD8633				
MIPR 06.20.45 A3	6 Cyl.	9840cc	222kW (302PS)	Diesel Turbo Intercooler	TD8635				
MIPS 06.20.45 B	6 Cyl.	9840cc	176-186kW (240-253PS)	Diesel Turbo Intercooler	TD8636				
BE/PL	1	76,960/76,980	82,000/82,022	40,900	2,485	0,050/0,117	BS	66735CP	71-4295 STD 0.25 0.50
MB/HL 1-7	7	95,966/95,988	102,000/102,022	34,000	2,976	0,060/0,129	BS	66476CP	H1050/7 STD 0.50

Locating lug height (mm): 8,5mm

TW/A	4	108,000/108,250	131,750/132,000		4,450		BS	66476BF	A207/4 STD
SE/PB	1	50,000/50,016	54,000/54,030	40,000			BS	66739Y	55-4296 SEMI

102 120.00 x 145.00

MIDR 06.20.45 B3	6 Cyl.	9839cc	195kW (265PS)	Diesel Turbo Intercooler	TD8592				
MIDR 06.20.45 E2	6 Cyl.	9839cc	249kW (339PS)	Diesel Turbo Intercooler	TD8540				
MIDR 06.20.45 H	6 Cyl.	9839cc	227-240kW (310-326PS)	Diesel Turbo Intercooler	TD6209				
MIDS 06.20.45 J	6 Cyl.	9840cc	161kW (219PS)	Diesel Turbo	TD8588				
MIDS 06.20.45 J3	6 Cyl.	9840cc	168kW (228PS)	Diesel Turbo	TD8589				
BE/PL	1	76,960/76,980	82,000/82,022	40,900	2,485	0,050/0,112	BS	4370CP	71-4290 STD 0.25

07/94 →

BE/PL	1	76,960/76,980	82,000/82,022	40,900	2,485	0,050/0,117	BS	66735CP	71-4295 STD 0.25 0.50
-------	---	---------------	---------------	--------	-------	-------------	----	---------	--------------------------

→06/94

4370CP

66735CP

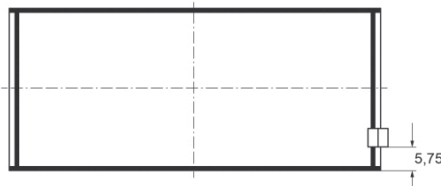
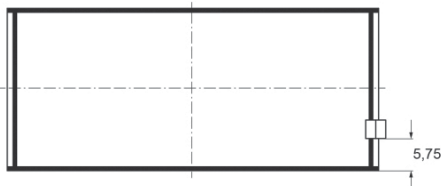

MB/HL 1-7	7	95,966/95,988	102,000/102,022	34,000	2,976	0,060/0,129	BS	66476CP	H1050/7 STD 0.50
--------------	---	---------------	-----------------	--------	-------	-------------	----	---------	---------------------

Locating lug height (mm): 8,5mm

TW/A	4	108,000/108,250	131,750/132,000		4,450		BS	66476BF	A207/4 STD
SE/PB	1	50,000/50,016	54,000/54,030	40,000			BS	66739Y	55-4296 SEMI

103 120.00 x 145.00

MIDR 06.20.45 C/4 Euro 2		6 Cyl.	9839cc	188kW (256PS)			Diesel Turbo Intercooler	TD17421	
MIDR 06.20.45 D/41 Euro 2		6 Cyl.	9839cc	219kW (298PS)			Diesel Turbo Intercooler	TD8641	
MIDR 06.20.45 I41 Euro 2		6 Cyl.	9840cc	188kW (256PS)			Diesel Turbo Intercooler	TD12191	
BE/PL	1	76,960/76,980	82,000/82,022	40,900	2,485	0,050/0,112	BS	4370CP	71-4290 STD 0.25
MB/HL 1-7	7	95,966/95,988	102,000/102,022	34,000	2,976	0,060/0,129	BS	66476CP	H1050/7 STD 0.50
→11/96, Locating lug height (mm): 8,5mm									
MB/HL 1-7	7	95,966/95,989	102,000/102,022	34,000	2,980	0,091/0,134	BS	72-4318	H1129/7 STD 0.25 0.50
12/96→, Locating lug height (mm): 7mm									

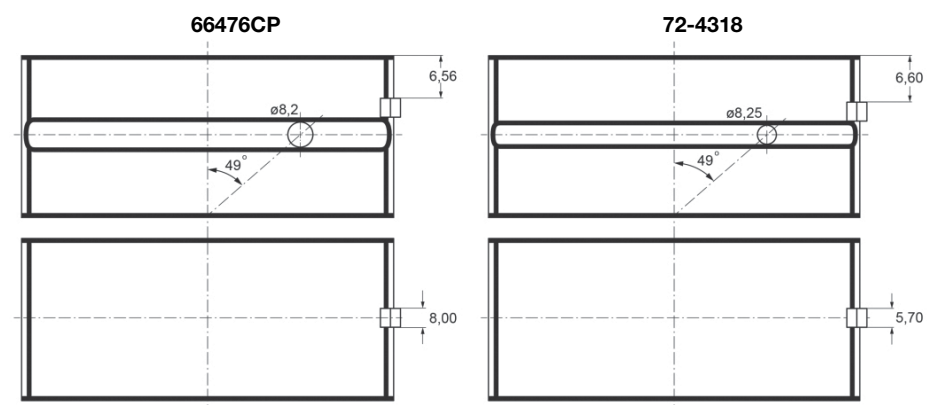

TW/A	4	108,000/108,250	131,750/132,000		4,450		BS	66476BF	A207/4 STD
SE/PB	1	50,000/50,016	54,000/54,030	40,000			BS	66739Y	55-4296 SEMI

104 123.00 x 152.00

DXi 11 Euro 3/4		6 Cyl.	10800cc	243-339kW (330-460PS)			Diesel	TD19017	
BE/PL	6	85,978/86,000	90,830/90,845	45,100	2,390	0,046/0,096	EC	71-4060	71-4060/6 STD 0.25
MB/HL 1-7	7	107,978/108,000	113,040/113,065	32,200	2,497	0,046/0,113	EC	72-4024	H1008/7 STD
SE/PB	1	53,992/54,000	59,100/59,146	40,250			BS-LF	55-4059	55-4059 SEMI

105 123.00 x 156.00

dCi 11 B/43 Euro 2		6 Cyl.	11100cc	303kW (412PS)			Diesel Turbo Intercooler	TD14848	
dCi 11-270 Euro 3		6 Cyl.	11100cc	195kW (265PS)			Diesel Turbo Intercooler	TD16876	
dCi 11C Euro 3		6 Cyl.	11100cc	303kW (412PS)			Diesel Turbo Intercooler	TD16880	
dCi 11E Euro 3		6 Cyl.	11100cc	266kW (362PS)			Diesel Turbo Intercooler	TD16879	
dCi 11G Euro 3		6 Cyl.	11100cc	230kW (313PS)			Diesel Turbo Intercooler	TD16878	
BE/PL	6	76,960/76,980	82,000/82,022	40,900	2,485	0,059/0,127	BS	71-4904	71-4904/6 STD 0.25 0.50
MB/HL 1-7	7	101,966/101,998	108,000/108,022	33,000	2,982	0,048/0,112	BS	72-4903	H1324/7 STD 0.25 0.50
TW/A	2	114,000/114,250	137,750/138,000		3,160		BS	54-4905	A309/4 STD
TW/A	2	114,000/114,250	137,750/138,000		3,160		BS	54-4906	

RENAULT



SE/PB	1		54,000/54,030				BS	55-4908	55-4908 SEMI
CB/NWB 1-7	7		63,488/63,518	25,250			BS	53-4907	N206/7 SEMI

106 123.00 x 156.00

MIDR 06.23.56 A/41 Euro 2	6 Cyl.	11100cc	280kW (381PS)				Diesel Turbo Intercooler	TD8643
MIDR 06.23.56 A/3 Euro 2	6 Cyl.	11100cc	255kW (347PS)				Diesel Turbo Intercooler	TD17528
MIDR 06.23.56 B/41 Euro 2	6 Cyl.	11100cc	288kW (392PS)				Diesel Turbo Intercooler	TD12207

BE/PL	1	76,960/76,980	82,000/82,022	40,900	2,485	0,050/0,112	BS	4370CP	71-4290 STD 0.25
MB/HL 1-7	7	95,966/95,988	102,000/102,022	34,000	2,976	0,060/0,129	BS	66476CP	H1050/7 STD 0.50

Locating lug height (mm): 8,5mm

MB/HL 1-7	7	95,966/95,988	102,000/102,022	34,000	2,971	0,070/0,139	BS	4371CP	H1097/7 STD 0.25
MB/HL 1-7	7	95,966/95,989	102,000/102,022	34,000	2,980	0,091/0,134	BS	72-4318	H1129/7 STD 0.25 0.50

Locating lug height (mm): 7mm

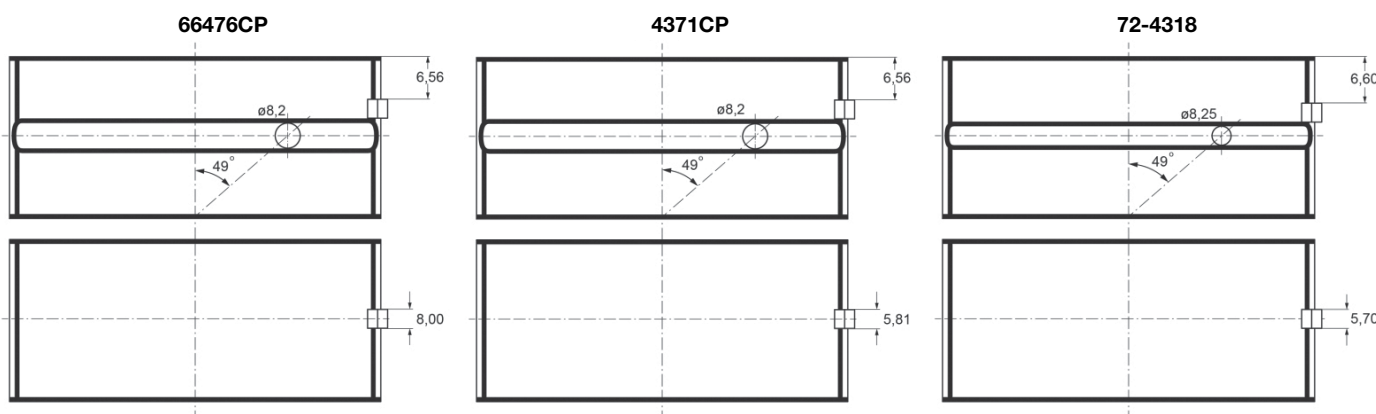

TW/A	4	108,000/108,250	131,750/132,000		4,450		BS	66476BF	A207/4 STD
------	---	-----------------	-----------------	--	-------	--	----	---------	----------------------

107 131.00 x 150.00

DXi 12 Euro 3	6 Cyl.	12130cc	324-353kW (441-480PS)				Diesel Turbo Intercooler	TD19083
----------------------	--------	----------------	------------------------------	--	--	--	---------------------------------	----------------

BE/PL	6	91,978/92,000	96,835/96,850	49,100	2,395	0,050/0,110	EC	71-3923	71-3923/6 STD
MB/HL 1-7	7	107,978/108,000	113,040/113,065	37,800	2,497	0,046/0,096	EC	72-4053	H1015/7 STD 0.25 0.50
TW/A	4	116,660/117,094	139,929/139,680		3,213		EC	54-3622	A131/4 STD
SE/PB	1	54,992/55,000	60,300/60,346	46,750			BC	55-3925	55-3925 SEMI
BU	1	43,975/44,000	48,600/48,639	38,500		0,030/0,080	BC	57-4994	57-4994 SEMI

108 131.00 x 158.00

DXi 13 440 Euro 4/5	6 Cyl.	12800cc	323kW (440PS)				Diesel Turbo Intercooler	TD29092
DXi 13 460 Euro 4/5	6 Cyl.	12800cc	338kW (460PS)				Diesel Turbo Intercooler	TD29093
DXi 13 480 Euro 4/5	6 Cyl.	12800cc	353kW (480PS)				Diesel Turbo Intercooler	TD29094
DXi 13 500 Euro 4/5	6 Cyl.	12800cc	368kW (500PS)				Diesel Turbo Intercooler	TD29095
DXi 13 520 Euro 4/5	6 Cyl.	12800cc	382kW (520PS)				Diesel Turbo Intercooler	TD29096
DXi 13 Euro 4/5	6 Cyl.	12800cc	323-382kW (440-520PS)				Diesel Turbo Intercooler	TD19084

BE/PL	6	98,978/99,000	103,835/103,850	48,850	2,395	0,045/0,106	EC	71-4052	71-4052/6 STD 0.25 0.50
-------	---	---------------	-----------------	--------	-------	-------------	----	---------	-----------------------------------

BE/PL	6	98,978/99,000	103,84/103,85	48,850	2,395	0,045/0,106	AL-LF	01-4949	71-4949/6 STD	
BE/PL	6	98,978/99,000	103,835/103,850	48,850	2,395	0,045/0,106	EC	71-4052		

71-4052

01-4949



MB/HL 1-7	7	107,978/108,000	113,040/113,065	37,800	2,497	0,046/0,096	EC	72-4053	H1015/7 STD 0.25 0.50
TW/A	4	116,660/117,094	139,929/139,680		3,213		EC	54-3622	A131/4 STD
SE/PB	1	57,992/58,000	63,300/63,346	47,500			BS-LF	55-4054	55-4054 SEMI
BU	1	43,975/44,000	48,600/48,639	38,500		0,030/0,080	BC	57-4994	57-4994 SEMI

109 135.00 x 140.00

MDS 06.35.40	6 Cyl.	12024cc	177-208kW (241-283PS)	Diesel Turbo Intercooler	TD8668
MDS 06.35.40	6 Cyl.	12024cc	188-224kW (256-305PS)	Diesel Turbo Intercooler	TD6500
MDS 06.35.40 A	6 Cyl.	12024cc	206kW (280PS)	Diesel Turbo Intercooler	TD26708
MDS 06.35.40 A	6 Cyl.	12024cc	191kW (260PS)	Diesel Turbo	TD6501
MDS 06.35.40 H	6 Cyl.	12024cc	178kW (242PS)	Diesel Turbo Intercooler	TD8596
MDS 06.35.40 I	6 Cyl.	12024cc	196kW (266PS)	Diesel Turbo Intercooler	TD8601
MIDR 06.35.40	6 Cyl.	12024cc	206-226kW (280-307PS)	Diesel Turbo Intercooler	TD19965
MIDR 06.35.40 C	6 Cyl.	11941cc	224-228kW (305-310PS)	Diesel Turbo Intercooler	TD8645
MIDR 06.35.40 G	6 Cyl.	12024cc	243-259kW (330-352PS)	Diesel Turbo Intercooler	TD12202
MIDR 06.35.40 H	6 Cyl.	12024cc	264-279kW (359-380PS)	Diesel Turbo Intercooler	TD8516
MIDR 06.35.40 J/3 Euro 1	6 Cyl.	12024cc	305kW (415PS)	Diesel Turbo Intercooler	TD8519
MIDR 06.35.40 J1 Euro 1	6 Cyl.	12024cc	314kW (427PS)	Diesel Turbo Intercooler	TD8653
MIDR 06.35.40 L1	6 Cyl.	12024cc	283kW (385PS)	Diesel Turbo Intercooler	TD8517
MIDR 06.35.40 M3 Euro 1	6 Cyl.	12024cc	236kW (321PS)	Diesel Turbo Intercooler	TD8543
MIDR 06.35.40 N/3 Euro 1	6 Cyl.	12024cc	283kW (385PS)	Diesel Turbo Intercooler	TD8518
MIDR 06.35.40 P/41 Euro 2	6 Cyl.	12024cc	305kW (415PS)	Diesel Turbo Intercooler	TD12187
MIDS 06.35.40	6 Cyl.	12024cc	206kW (280PS)	Diesel Turbo	TD29112
MIDS 06.35.40 B	6 Cyl.	12024cc	225kW (306PS)	Diesel Turbo	TD29113
MIDS 06.35.40 D	6 Cyl.	12024cc	208kW (283PS)	Diesel Turbo	TD8542
MIDS 06.35.40 E	6 Cyl.	12024cc	195kW (265PS)	Diesel Turbo	TD8597

BE/PL	1	83,960/83,980	90,000/90,020	45,000	2,975	0,070/0,135	BS	2975CP	71-4113 STD 0.25 0.50 0.75 1.00
BE/PL	1	83,960/83,980	90,000/90,020	45,000	2,975	0,070/0,135	BS	66730CP	71-4239 STD 0.25 0.50
BE/PL	1	83,960/83,980	90,000/90,020	40,000	2,973	0,074/0,139	BS	66200CP	71-4306 STD







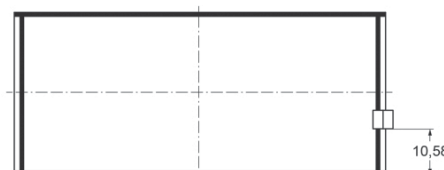
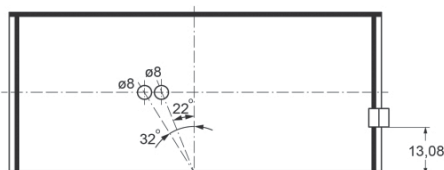

2975CP



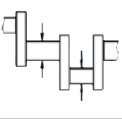
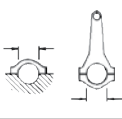



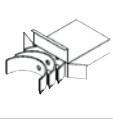

66730CP

66200CP



RENAULT

									
MB/HL 2,3,5,6	4	89,940/89,960	96,000/96,027	40,250	2,975	0,090/0,162	BS	2977CP	H1054/7 STD 0.25 0.50
MB/HL 1,4,7	3	89,940/89,960	96,000/96,027	63,620	2,975	0,090/0,162	BS	66731CP	
TW/A	2	100,500	122,000		2,940		BS	54-4534	A264/4 STD 0.25
TW/A	2	100,500	122,000		2,940		BS	54-4535	
SE/PB	1	55,000/55,019	60,000/60,030	46,000			BS	4126X	55-4124 STD







				cm3	x 			
25 1.1	09/99→06/01	Petrol	11 K4F	1119	4	75.00	63.30	5
25 1.1 16V	01/04→05/05	Petrol	11 K4F	1119	4	75.00	63.30	5
25 1.4 16V	10/99→05/05	Petrol	14 K4F	1396	4	75.00	79.00	7
25 1.4 16V	10/99→05/05	Petrol	14 K4M	1396	4	75.00	79.00	7
25 1.6 16V	10/99→05/05	Petrol	16 K4F	1588	4	80.00	79.00	12
25 1.8 16V	10/99→05/05	Petrol	18 K4F	1796	4	80.00	89.30	15
25 1.8 16V	02/00→05/05	Petrol	18 K4K	1796	4	80.00	89.30	15
25 2.0 iDT	10/99→05/05	Diesel	20 T2N	1994	4	84.45	89.00	20
45 1.4	02/00→05/05	Petrol	14 K4F	1396	4	75.00	79.00	7
45 1.6	02/00→05/05	Petrol	16 K4F	1588	4	80.00	79.00	12
45 1.8	02/00→05/05	Petrol	18 K4F	1796	4	80.00	89.30	15
45 2.0 iDT	02/00→05/05	Diesel	20 T2N	1994	4	84.45	89.00	20
75 1.8	02/99→05/05	Petrol	K 1.8	1796	4	80.00	89.30	15
75 1.8 Turbo	05/03→05/05	Petrol	18 K4G	1795	4	80.00	89.30	15
75 2.0 CDT	02/99→05/05	Diesel	M 47 R	1950	4	84.00	88.00	17
75 2.0 CDTi	02/03→05/05	Diesel	204D2	1951	4	84.00	88.00	16
80 2.3	01/61→12/62	Petrol	2250	2250	4	76.20	82.55	10
100 111	04/94→10/97	Petrol	11 K2D	1119	4	75.00	63.30	5
100 114	04/94→10/97	Petrol	14 K2A	1396	4	75.00	79.00	7
100 114	04/94→10/97	Petrol	14 K2D	1396	4	75.00	79.00	7
100 114	03/97→10/98	Petrol	14 K4F	1396	4	75.00	79.00	7
100 / Metro 111 C/L/S	03/90→12/98	Petrol	11 K2A	1119	4	75.00	63.30	5
100 / Metro 111 C/L/S	03/90→12/98	Petrol	11 K2D	1119	4	75.00	63.30	5
100 / Metro 114 D	10/92→12/94	Diesel	TUD 3	1361	4	75.00	77.00	6
100 / Metro 114 GSi	10/94→10/95	Petrol	14 K4F	1396	4	75.00	79.00	7
100 / Metro 114 GTI 16V	03/90→08/91	Petrol	14 K4C	1396	4	75.00	79.00	7
100 / Metro 114 GTI 16V	03/90→08/91	Petrol	14 K4D	1396	4	75.00	79.00	7
100 / Metro 114 GTI 16V	08/91→12/98	Petrol	14 K4F	1396	4	75.00	79.00	7
100 / Metro 114 GTI/GT 16V CAT	03/90→12/98	Petrol	14 K4C	1396	4	75.00	79.00	7
100 / Metro 114 GTI/GT 16V CAT	03/90→12/98	Petrol	14 K4D	1396	4	75.00	79.00	7
100 / Metro 114 S/L/GTA	03/90→12/98	Petrol	14 K2A	1396	4	75.00	79.00	7
100 / Metro 114 S/L/GTA	03/90→12/98	Petrol	14 K2D	1396	4	75.00	79.00	7
100 / Metro 115 D	12/94→12/98	Diesel	TUD 5	1527	4	77.00	82.00	11
200 1.4	01/96→12/97	Petrol	14 K4D	1396	4	75.00	79.00	7
200 211	01/98→03/00	Petrol	11 K2D	1119	4	75.00	63.30	5
200 214	09/93→10/95	Petrol	14 K2A	1396	4	75.00	79.00	7
200 214	09/93→10/95	Petrol	14 K2D	1396	4	75.00	79.00	7
200 214 GSi/Si	01/90→10/95	Petrol	14 K4C	1396	4	75.00	79.00	7
200 214 GSi/Si	12/92→10/95	Petrol	14 K4F	1396	4	75.00	79.00	7
200 214 i	11/95→03/00	Petrol	14 K2F	1396	4	75.00	79.00	7
200 214 Si	11/95→03/00	Petrol	14 K4F	1396	4	75.00	79.00	7
200 214 Si/Gsi	10/89→10/95	Petrol	14 K4C	1396	4	75.00	79.00	7
200 214 Si/Gsi	10/89→10/95	Petrol	14 K4D	1396	4	75.00	79.00	7
200 216	01/96→12/97	Petrol	16 K4F	1588	4	80.00	79.00	12
200 216	10/92→06/99	Petrol	D 16 A8	1590	4	75.00	90.00	8
200 216 GSi	10/89→10/95	Petrol	D 16 A7	1590	4	75.00	90.00	9
200 216 GSi	10/89→10/95	Petrol	D 16 Z2	1590	4	75.00	90.00	9
200 216 GTi	09/90→10/95	Petrol	D 16 A8	1590	4	75.00	90.00	8
200 216 GTi	09/90→10/95	Petrol	D 16 A9	1590	4	75.00	90.00	9
200 216 Si	11/95→03/00	Petrol	16 K4F	1588	4	80.00	79.00	12
200 218 K Vi	11/95→03/00	Petrol	18 K4K	1796	4	80.00	89.30	15
200 218 Si	08/99→03/00	Petrol	18 K4F	1796	4	80.00	89.30	15
200 218 TD	09/91→10/95	Diesel	XUD 7TE	1769	4	80.00	88.00	14
200 220 D/SD	11/95→03/00	Diesel	20 T2R	1994	4	84.45	88.90	18
200 220 GSi	05/94→06/99	Petrol	20 T4H	1994	4	84.50	89.00	21
200 220 GTi	09/91→10/95	Petrol	20 M4F	1994	4	84.50	89.00	21
200 220 GTi	01/93→10/95	Petrol	20 T4H	1994	4	84.50	89.00	21
200 220 SDi	11/95→03/00	Diesel	20 T2N	1994	4	84.45	89.00	20
200 220 Turbo	10/92→06/99	Petrol	20 T4G	1994	4	84.50	89.00	21
400 1.6 i	05/94→11/98	Petrol	D 16 A8	1590	4	75.00	90.00	8
400 1.6 i	05/94→11/98	Petrol	D 16 Z2	1590	4	75.00	90.00	9
400 1.8 i	06/96→11/98	Petrol	18 K4K	1796	4	80.00	89.30	15
400 1.8 TD	09/93→11/98	Diesel	XUD 7TE	1769	4	80.00	88.00	14
400 2.0 i	05/94→11/98	Petrol	20 T4H	1994	4	84.50	89.00	21
400 414	03/96→12/99	Petrol	14 K2F	1396	4	75.00	79.00	7
400 414	01/93→04/95	Petrol	14 K4C	1396	4	75.00	79.00	7
400 414 GSi/Si	04/90→04/95	Petrol	14 K4C	1396	4	75.00	79.00	7
400 414 GSi/Si	04/90→04/95	Petrol	14 K4D	1396	4	75.00	79.00	7
400 414 GSi/Si CAT	01/93→04/95	Petrol	14 K4F	1396	4	75.00	79.00	7







cm3



400 414 Si	05/95→03/00	Petrol	14 K4F	1396	4	75.00	79.00	7
400 416 GSI	04/90→04/95	Petrol	D 16 Z2	1590	4	75.00	90.00	9
400 416 GSI/GSE	04/90→04/95	Petrol	D 16 A7	1590	4	75.00	90.00	9
400 416 GTI	04/90→04/95	Petrol	D 16 A8	1590	4	75.00	90.00	8
400 416 GTI/GTE	04/90→04/95	Petrol	D 16 A9	1590	4	75.00	90.00	9
400 416 Si	05/95→03/00	Petrol	16 K4F	1588	4	80.00	79.00	12
400 416 Si	05/95→03/00	Petrol	D16B2	1590	4	75.00	90.00	8
400 416 Si	05/95→03/00	Petrol	D 16 Y2	1590	4	75.00	90.00	9
400 418 TD	09/91→04/95	Diesel	XUD 7TE	1769	4	80.00	88.00	14
400 420 D	11/95→03/00	Diesel	20 T2R	1994	4	84.45	88.90	18
400 420 Di	05/95→03/00	Diesel	20 T2N	1994	4	84.45	89.00	20
400 420 GSI/SLI/GTI/Vite	01/93→04/95	Petrol	20 T4H	1994	4	84.50	89.00	21
400 420 GTI/GSI/Vitesse	02/92→04/95	Petrol	20 M4F	1994	4	84.50	89.00	21
400 420 Si Lux	12/95→03/00	Petrol	20 T4H	1994	4	84.50	89.00	21
400 420 Turbo	01/93→04/95	Petrol	20 T4G	1994	4	84.50	89.00	21
416i 1.6	05/86→12/89	Petrol	D 16 A3	1590	4	75.00	90.00	8
600 620 Sdi	12/94→02/99	Diesel	20 T2N	1994	4	84.45	89.00	20
600 620 Ti Vitesse	07/94→02/99	Petrol	20 T4G	1994	4	84.50	89.00	21
800 2.0	08/87→09/88	Petrol	20 T4H	1994	4	84.50	89.00	21
800 820	12/96→02/99	Petrol	20 T4G	1994	4	84.50	89.00	21
800 820 16 V I/SI	10/86→10/88	Petrol	20 HD	1994	4	84.50	89.00	21
800 820 16V Turbo	01/92→02/99	Petrol	T 16	1994	4	84.50	89.00	21
800 820e	10/86→10/91	Petrol	20 HS	1994	4	84.50	89.00	21
800 820 i/Si	10/88→12/91	Petrol	20 HD	1994	4	84.50	89.00	21
800 820 I/SI	01/92→02/99	Petrol	20 T4H	1994	4	84.50	89.00	21
800 820 SE/SI	10/86→12/91	Petrol	20 HS	1994	4	84.50	89.00	21
800 820 SI	10/88→12/91	Petrol	20 HD M 16	1994	4	84.50	89.00	21
800 820	04/94→03/96	Petrol	20 T4G	1994	4	84.50	89.00	21
800 825 D/SD	01/90→02/99	Diesel	425 SL1RR	2500	4	92.00	94.00	27
800 825 D/SD	01/90→02/99	Diesel	492 4 SHIRG	2500	4	92.00	94.00	27
800 825 SD	09/93→02/99	Diesel	425 SL1RR	2500	4	92.00	94.00	27
800 825 SD	09/93→02/99	Diesel	492 4 SHIRG	2500	4	92.00	94.00	27
2000-3500 2400 TD	05/82→10/86	Diesel	HR 492 HT	2393	4	92.00	90.00	26
2000-3500 3500	06/76→10/86	Petrol	38 A	3528	V8	88.86	71.10	24
2000-3500 3500	06/76→10/86	Petrol	39 A	3528	V8	88.86	71.10	24
2000-3500 3500 Vitesse	10/82→10/86	Petrol	30 A	3528	V8	88.86	71.10	24
2000-3500 3500 Vitesse	10/82→10/86	Petrol	31 A	3528	V8	88.86	71.10	24
Cabriolet 1.6	04/90→02/96	Petrol	D 16 Z2	1590	4	75.00	90.00	9
Cabriolet 214 1.4	04/90→11/99	Petrol	14 K4C	1396	4	75.00	79.00	7
Cabriolet 214 1.4	01/92→11/99	Petrol	14 K4D	1396	4	75.00	79.00	7
Cabriolet 214 1.4i 16V	01/93→11/99	Petrol	14 K4F	1396	4	75.00	79.00	7
Cabriolet 216 1.6i	01/92→11/99	Petrol	D 16 A8	1590	4	75.00	90.00	8
Cabriolet 216 1.6i 16V	01/96→11/99	Petrol	16 K4F	1588	4	80.00	79.00	12
Coupe 1.6 16 V	03/96→11/99	Petrol	16 K4F	1588	4	80.00	79.00	12
Coupe 1.8 16 V	03/96→11/99	Petrol	18 K4K	1796	4	80.00	89.30	15
Maestro 1.3	09/90→01/95	Petrol	12 HE	1275	4	70.60	81.30	4
Maestro 2.0 TD	09/90→01/95	Diesel	BB	1996	4	84.50	90.00	22
Mini 1.3 S	02/98→05/01	Petrol	12 A2L	1275	4	70.60	81.30	2
Mini 1000	01/92→06/93	Petrol	99 HD 81	999	4	64.60	76.20	1
Mini 1300	01/91→12/91	Petrol	12 A2A	1273	4	70.60	81.30	2
Mini 1300	04/92→11/00	Petrol	12 A2B	1273	4	70.60	81.30	2
Mini 1300	01/92→04/95	Petrol	12 A2D	1273	4	70.60	81.30	2
Mini 1300	01/92→11/00	Petrol	12 A2E	1273	4	70.60	81.30	2
Mini 1300	01/92→11/00	Petrol	12 A2L	1275	4	70.60	81.30	2
Mini 1300 / Cooper	06/91→02/94	Petrol	12 A2A	1273	4	70.60	81.30	2
Mini-Moke 1.0	09/86→	Petrol	99 H	998	4	64.60	76.20	1
Montego 1.3	10/84→10/88	Petrol	12 HL	1275	4	70.60	81.30	3
Montego 2.0 D Turbo	10/88→10/95	Diesel	BB	1996	4	84.50	90.00	22
Montego 2.0 GTi	10/88→10/91	Petrol	20 H	1994	4	84.50	89.00	21
Montego 2.0 GTI/LXI	12/90→12/93	Petrol	20 H	1994	4	84.50	89.00	21
Montego 2.0 i CAT	12/90→10/94	Petrol	20 H	1994	4	84.50	89.00	21
Montego 2.0 Turbo-D	01/93→12/93	Diesel	BB	1996	4	84.50	90.00	22
Streetwise 1.4	08/03→05/05	Petrol	14 K4F	1396	4	75.00	79.00	7
Streetwise 1.4	08/03→05/05	Petrol	14 K4M	1396	4	75.00	79.00	7
Streetwise 1.6	01/04→05/05	Petrol	16 K4F	1588	4	80.00	79.00	12
Streetwise 1.8	08/03→05/05	Petrol	18 K4F	1796	4	80.00	89.30	15
Streetwise 2.0 TD	08/03→05/05	Diesel	20 T2N	1994	4	84.45	89.00	20

		cm3	x 			
11 D	Petrol	3528	V8	88.86	71.10	24
11 K2A	Petrol	1119	4	75.00	63.30	5
11 K2D	Petrol	1119	4	75.00	63.30	5
11 K4F	Petrol	1119	4	75.00	63.30	5
12 A2A	Petrol	1273	4	70.60	81.30	2
12 A2B	Petrol	1273	4	70.60	81.30	2
12 A2D	Petrol	1273	4	70.60	81.30	2
12 A2E	Petrol	1273	4	70.60	81.30	2
12 A2L	Petrol	1275	4	70.60	81.30	2
12 H	Petrol	1275	4	70.60	81.30	3
12 HE	Petrol	1275	4	70.60	81.30	4
12 HL	Petrol	1275	4	70.60	81.30	3
12 L	Diesel	2496	4	90.50	97.00	25
14 K2A	Petrol	1396	4	75.00	79.00	7
14 K2D	Petrol	1396	4	75.00	79.00	7
14 K2F	Petrol	1396	4	75.00	79.00	7
14 K4C	Petrol	1396	4	75.00	79.00	7
14 K4D	Petrol	1396	4	75.00	79.00	7
14 K4F	Petrol	1396	4	75.00	79.00	7
14 K4M	Petrol	1396	4	75.00	79.00	7
14 L	Diesel	2496	4	90.50	97.00	25
16 K4F	Petrol	1588	4	80.00	79.00	12
18 K4F	Petrol	1796	4	80.00	89.30	15
18 K4G	Petrol	1795	4	80.00	89.30	15
18 K4K	Petrol	1796	4	80.00	89.30	15
19 L	Diesel	2496	4	90.50	97.00	25
20 H	Petrol	1994	4	84.50	89.00	21
20 HD	Petrol	1994	4	84.50	89.00	21
20 HD M 16	Petrol	1994	4	84.50	89.00	21
20 HS	Petrol	1994	4	84.50	89.00	21
20 M4F	Petrol	1994	4	84.50	89.00	21
20 T2N	Diesel	1994	4	84.45	89.00	20
20 T2R	Diesel	1994	4	84.45	88.90	18
20 T4G	Petrol	1994	4	84.50	89.00	21
20 T4H	Petrol	1994	4	84.50	89.00	21
20 T4H	Petrol	1994	4	84.50	89.00	21
21 L	Diesel	2495	4	90.50	97.00	25
22 D	Petrol	3531	V8	88.86	71.10	24
23 L	Diesel	2495	4	90.50	97.00	25
24 D	Petrol	3528	V8	88.86	71.10	24
25 D	Petrol	3528	V8	88.86	71.10	24
30 A	Petrol	3528	V8	88.86	71.10	24
31 A	Petrol	3528	V8	88.86	71.10	24
31 D	Petrol	3528	V8	88.86	71.10	24
35 D	Petrol	3950	V8	94.00	71.10	28
36 D	Petrol	3950	V8	94.00	71.10	28
37 D	Petrol	3950	V8	94.00	71.10	28
38 A	Petrol	3528	V8	88.86	71.10	24
38 D	Petrol	3950	V8	94.00	71.10	28
39 A	Petrol	3528	V8	88.86	71.10	24
40 D	Petrol	4275	V8	94.00	77.00	30
42 D	Petrol	3947	V8	94.00	71.10	29
46 D	Petrol	4553	8	94.00	82.00	31
46 D	Petrol	4553	V8	94.00	82.00	31
99 H	Petrol	998	4	64.60	76.20	1
99 HD 81	Petrol	999	4	64.60	76.20	1
204D2	Diesel	1951	4	84.00	88.00	16
25 6T (BMW)	Diesel	2497	6	80.00	82.80	13
425 SL1RR	Diesel	2500	4	92.00	94.00	27
2250	Petrol	2250	4	76.20	82.55	10
492 4 SHIRG	Diesel	2500	4	92.00	94.00	27
BB	Diesel	1996	4	84.50	90.00	22
D 16 A3	Petrol	1590	4	75.00	90.00	8
D 16 A7	Petrol	1590	4	75.00	90.00	9
D 16 A8	Petrol	1590	4	75.00	90.00	8
D 16 A9	Petrol	1590	4	75.00	90.00	9
D16B2	Petrol	1590	4	75.00	90.00	8
D 16 Y2	Petrol	1590	4	75.00	90.00	9
D 16 Z2	Petrol	1590	4	75.00	90.00	9

			cm ³	x 			9
F 20 A4	Petrol	1997	4	85.00	88.00	23	
HR 492 HI	Diesel	2393	4	92.00	90.00	26	
HR 492 HT	Diesel	2393	4	92.00	90.00	26	
K 1.8	Petrol	1796	4	80.00	89.30	15	
M16i	Petrol	1996	4	84.50	89.00	21	
M 47 R	Diesel	1950	4	84.00	88.00	17	
T 16	Petrol	1994	4	84.50	89.00	21	
TD5	Diesel	2496	5	84.45	88.90	19	
TUD 3	Diesel	1361	4	75.00	77.00	6	
TUD 5	Diesel	1527	4	77.00	82.00	11	
VM-HR 492.4	Diesel	2393	4	92.00	90.00	26	
XUD 7TE	Diesel	1769	4	80.00	88.00	14	

1 64.60 x 76.20

99 H	4 Cyl.	998cc	26-33kW (35-45PS)	Petrol	TD27689				
99 HD 81	4 Cyl.	999cc	30kW (41PS)	Petrol	TD3483				
BE/PL	4	41,285/41,298	44,970/44,983	22,350	1,825	0,022/0,073	AL-LF	2965RA	01-4313/4 STD 0.25 0.50 0.75
BE/PL	8	41,285/41,298	44,970/44,983	22,350	1,825	0,024/0,073	BS	71-4869	71-4869/4 STD 0.25

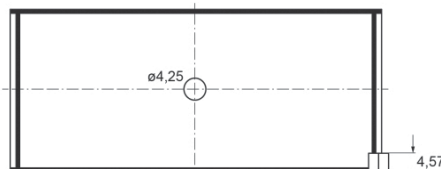
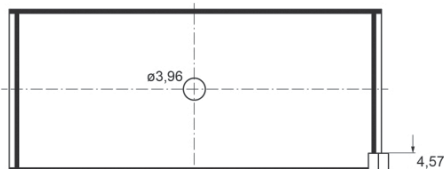
2965RA
71-4869

MB/HL 1-3	3	44,463/44,475	48,158/48,171	27,100	1,830		BS	GS705LC	H1311/3 STD 0.25
MB/HL 1-3	3	44,463/44,475	48,158/48,171	27,100	1,830		BS	GS705LCB	
TW/A	2	49,910/50,160	71,750/72,000		2,360		EC	54-2304	A005/4 STD
TW/A	2	49,910/50,160	71,750/72,000		2,360		EC	54-3337	
CB/NWB 1	1	42,279/42,991	45,606/45,631	28,700			BB	2064DR	N162/3 STD
CB/NWB 2	1	41,217/41,229	44,539/44,552	19,180			BB	2066DRI	
CB/NWB 3	1	34,867/34,879	38,189/38,209	13,600			BB	2067DRI	

2 70.60 x 81.30

12 A2A	4 Cyl.	1273cc	45kW (61PS)	Petrol	TD9490
12 A2B	4 Cyl.	1273cc	37kW (50PS)	Petrol	TD4880
12 A2D	4 Cyl.	1273cc	39kW (53PS)	Petrol	TD3473
12 A2E	4 Cyl.	1273cc	46kW (63PS)	Petrol	TD3487
12 A2L	4 Cyl.	1275cc	37-46kW (50-63PS)	Petrol	TD9489

BE/PL	4	44,460/44,473	48,146/48,158	21,590	1,830	0,020/0,063	AL-LF	65905RA	01-4331/4 STD 0.25 0.50 0.75
BE/PL	8	44,460/44,473	48,146/48,158	21,590	1,826	0,020/0,071	BS	71-4870	71-4870/4 0.25
MB/HL 1-3	6	50,813/50,825	54,509/54,521	25,020	1,830	0,025/0,063	BS	AE4691	H1312/3 STD 0.25 0.50 0.75
TW/A	2	56,260/56,510	76,073/76,327		2,340		EC	54-2848L	A006/4 STD
TW/A	2	56,260/56,510	76,073/76,327		2,340		EC	54-2848U	
CB/NWB 1	1	42,341/42,392	45,605/45,631	28,830	1,630		BB	1096DR	N181/3 STD
CB/NWB 2	1	41,262/41,300	44,526/44,551	19,300	1,630		BB	1097DR	
CB/NWB 3	1	34,912/34,963	38,176/38,202	19,690	1,630		BB	1098DR	

3 70.60 x 81.30

12 H	4 Cyl.	1275cc	47kW (64PS)	Petrol	TD22364				
12 HL	4 Cyl.	1275cc	46-50kW (63-68PS)	Petrol	TD22905				
BE/PL	4	44,460/44,473	48,146/48,158	21,590	1,830	0,020/0,063	AL-LF	65905RA	01-4331/4 STD 0.25 0.50 0.75

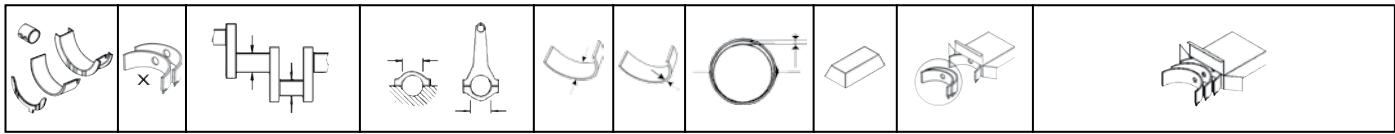

MB/HL 1-3	6	50,813/50,825	54,509/54,521	25,020	1,830	0,025/0,063	BS	AE4691	H1312/3 STD 0.25 0.50 0.75
--------------	---	---------------	---------------	--------	-------	-------------	----	--------	--------------------------------------

→12/82

MB/HL 1-3	3	50,813/50,825	54,509/54,521	25,020	1,830	0,025/0,063	BS	AE4691	H1313/3 STD 0.25 0.50
MB/HL 1-3	3	50,830/50,840	54,510/54,520	25,020			BS	AE6568	

01/83→

AE4691

AE6568

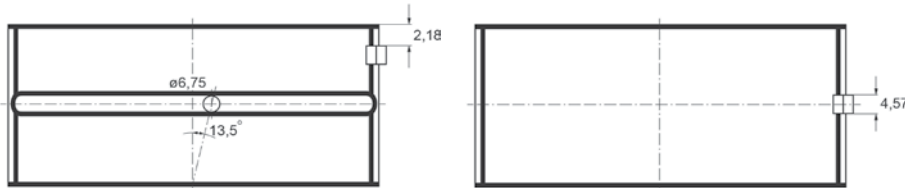

TW/A	2	56,260/56,510	76,073/76,327		2,340		EC	54-2848L	A006/4 STD
TW/A	2	56,260/56,510	76,073/76,327		2,340		EC	54-2848U	
CB/NWB 1	1	42,341/42,392	45,605/45,631	28,830	1,630		BB	1096DR	N181/3 STD
CB/NWB 2	1	41,262/41,300	44,526/44,551	19,300	1,630		BB	1097DR	
CB/NWB 3	1	34,912/34,963	38,176/38,202	19,690	1,630		BB	1098DR	

4 70.60 x 81.30

12 HE			4 Cyl.	1275cc	49-51kW (67-69PS)		Petrol		TD26936
BE/PL	4	44,460/44,473	48,146/48,158	21,590	1,830	0,020/0,063	AL-LF	65905RA	01-4331/4 STD 0.25 0.50 0.75
MB/HL 1-3	3	50,813/50,825	54,509/54,521	25,020	1,830	0,025/0,063	BS	AE4691	H1313/3 STD 0.25 0.50
MB/HL 1-3	3	50,830/50,840	54,510/54,520	25,020			BS	AE6568	
TW/A	2	56,260/56,510	76,073/76,327		2,340		EC	54-2848L	A006/4 STD
TW/A	2	56,260/56,510	76,073/76,327		2,340		EC	54-2848U	
CB/NWB 1	1	42,341/42,392	45,605/45,631	28,830	1,630		BB	1096DR	N181/3 STD
CB/NWB 2	1	41,262/41,300	44,526/44,551	19,300	1,630		BB	1097DR	
CB/NWB 3	1	34,912/34,963	38,176/38,202	19,690	1,630		BB	1098DR	

5 75.00 x 63.30

11 K2A			4 Cyl.	1119cc	44kW (60PS)		Petrol		TD9488
11 K2D			4 Cyl.	1119cc	44kW (60PS)		Petrol		TD4884
11 K4F			4 Cyl.	1119cc	55kW (75PS)		Petrol		TD18365
BE/PL	4	43,000/43,007	46,666/46,687	21,610	1,824	0,020/0,064	AL-LF	4130RA	01-4147/4 STD 0.25
MB/HL 1,3,5	3	47,993/48,000	51,579/51,600	17,450	1,789	0,020/0,054	AL-LF	4131RA	H1085/5 STD 0.25
MB/HL 2,4	2	47,993/48,000	51,579/51,600	17,450	1,789	0,020/0,054	AL-LF	4132RA	
TW/A	2	56,800/57,050	73,300/73,550		2,400		AL-LF	4131AF	A241/2 STD

6
75.00 x 77.00

TUD 3		4 Cyl.		1361cc	38kW (52PS)		Diesel		TD12127
BE/PL	4	44,975/44,991	48,655/48,671	19,650	1,820	0,020/0,080	AL-LF	4665RA	01-4165/4 STD
MB/HL 2-4	3	49,965/49,981	53,655/53,674	17,290	1,832	0,020/0,070	AL-LF	1261RA	H1071/5 STD 0.30 0.50
MB/HL 1,5	2	49,965/49,981	53,655/53,674	17,290	1,832	0,020/0,070	AL-LF	1262RA	
TW/A	2	55,250/55,500	71,450/71,700		2,450		BS	62047BFA	A203/2 STD 0.10

7
75.00 x 79.00

14 K2A		4 Cyl.		1396cc	55kW (75PS)		Petrol		TD3477
14 K2D		4 Cyl.		1396cc	55kW (75PS)		Petrol		TD3478
14 K2F		4 Cyl.		1396cc	55kW (75PS)		Petrol		TD9499
14 K4C		4 Cyl.		1396cc	66-70kW (90-95PS)		Petrol		TD3480
14 K4D		4 Cyl.		1396cc	66kW (90PS)		Petrol		TD3488
14 K4F		4 Cyl.		1396cc	76kW (103PS)		Petrol		TD3481
14 K4M		4 Cyl.		1396cc	62kW (84PS)		Petrol		TD18231
BE/PL	4	43,000/43,007	46,666/46,687	21,610	1,824	0,020/0,064	AL-LF	4130RA	01-4147/4 STD 0.25
MB/HL 1,3,5	3	47,993/48,000	51,579/51,600	17,450	1,789	0,020/0,054	AL-LF	4131RA	H1085/5 STD 0.25
MB/HL 2,4	2	47,993/48,000	51,579/51,600	17,450	1,789	0,020/0,054	AL-LF	4132RA	
TW/A	2	56,800/57,050	73,300/73,550		2,400		AL-LF	4131AF	A241/2 STD

8
75.00 x 90.00

D 16 A3		4 Cyl.		1590cc	88kW (120PS)		Petrol		TD25478
D 16 A8		4 Cyl.		1590cc	90kW (122PS)		Petrol		TD4881
D16B2		4 Cyl.		1590cc	85kW (116PS)		Petrol		TD27728
BE/PL	4	44,980/45,000	48,021/48,042	18,500	1,500		BS	XGS10474LC	71-4358/4 STD 0.25

9
75.00 x 90.00

D 16 A7		4 Cyl.		1590cc	85kW (116PS)		Petrol		TD18331
D 16 A9		4 Cyl.		1590cc	96kW (131PS)		Petrol		TD18330
D 16 Y2		4 Cyl.		1590cc	83kW (113PS)		Petrol		TD9498
D 16 Z2		4 Cyl.		1590cc	82kW (112PS)		Petrol		TD3467
BE/PL	4	44,980/45,000	48,021/48,042	18,500	1,500		BS	XGS10474LC	71-4358/4 STD 0.25

10
76.20 x 82.55

2250		4 Cyl.		2250cc			Petrol		FM1525
BE/PL	4	58,725/58,744	62,433/62,446	25,070	1,830	0,029/0,086	AL-LF	GS9763SA	01-4174/4 STD 0.25 0.50 0.75
MB/HL 1,2	2	63,475/63,487	67,704/67,716	25,580	2,080	0,057/0,106	BS	65191CP	H1136/3 STD 0.25
MB/HL 3	1	63,475/63,487	67,704/67,716	39,880	2,080	0,057/0,106	BS	65192CP	
TW/A	2	70,739/70,993	85,598/85,852		2,340		BS	65192BF	A204/2 STD .005
SE/PB	1	25,000	28,600	32,250			BS	8064Y	55-4248 SEMI

ROVER



CB/NWB 1	1	46,500	50,000	24,500	1,594		BS	8061DR	N165/4 STD
CB/NWB 2-4	3	46,500	50,000	19,000	1,594		BS	8062DR	

11 77.00 x 82.00

TUD 5		4 Cyl.		1527cc	42kW (57PS)		Diesel		TD3490
BE/PL	4	44,975/44,991	48,655/48,671	17,400	1,820	0,024/0,081	AL-LF	4630RA	01-4362/4 STD
MB/HL 2-4	3	49,965/49,981	53,712/53,731	17,290	1,854	0,023/0,086	AL-LF	4151RA	H1087/5 STD 0.30
MB/HL 1,5	2	49,965/49,981	53,712/53,731	17,290	1,854	0,023/0,086	AL-LF	4152RA	
TW/A	2	55,250/55,500	71,450/71,700		2,450		BS	62047BFA	A203/2 STD 0.10
SE/PB	1	23,000/23,012	25,200/25,221	19,900			BS	4154Y	55-4150 SEMI

12 80.00 x 79.00

16 K4F		4 Cyl.		1588cc	80-86kW (109-117PS)		Petrol		TD9358
BE/PL	4	43,000/43,007	46,666/46,687	21,610	1,824	0,020/0,064	AL-LF	4130RA	01-4147/4 STD 0.25
MB/HL 1,3,5	3	47,993/48,000	51,579/51,600	17,450	1,789	0,020/0,054	AL-LF	4131RA	H1085/5 STD 0.25
MB/HL 2,4	2	47,993/48,000	51,579/51,600	17,450	1,789	0,020/0,054	AL-LF	4132RA	
TW/A	2	56,800/57,050	73,300/73,550		2,400		AL-LF	4131AF	A241/2 STD

13 80.00 x 82.80

25 6T (BMW)		6 Cyl.		2497cc	100kW (136PS)		Diesel		TD9485
BE/PL	6	44,975/44,991	48,000/48,016	18,000	1,497	0,020/0,072	SP	71-3704	71-3704/6 STD 1
MB/HL 1-5, 7	6	59,971/59,990	65,000/65,019	20,000	2,498	0,020/0,063	AL-LF	02-3646	H023/7 STD 0.25 0.50
MB/HL 6	1	59,971/59,990	65,000/65,019	24,940	2,498	0,020/0,082	AL-LF	02-3647H	
			02-3647H	STD	25,020/.9853" - 25,053/.9863"				
				0.25mm	25,220/.9929" - 25,253/.9942"				
				0.50mm	25,420/1.0008" - 25,453/1.0021"				
SE/PB	1	29,995/30,000	31,995/32,025	22,200			BC	55-3937	55-3937 SEMI

14 80.00 x 88.00

XUD 7TE		4 Cyl.		1769cc	65kW (88PS)		Diesel Turbo		TD3504
BE/PL	4	49,984/50,000	53,695/53,708	20,000	1,838	0,039/0,073	EC	71-3730	71-3730/4 STD 0.30
MB/HL 1-5	5	59,981/60,000	63,731/63,750	20,290	1,845	0,040/0,100	AL-LF	66726RA	H1057/5 STD 0.30 0.50
TW/A	4	67,050/67,300	83,050/83,300		1,880		AL-LF	4141AF	A188/4 STD
SE/PB	1	28,007/28,020	30,200/30,221	23,100			BS	41450.500	55-4499 SEMI

15 80.00 x 89.30

18 K4F	4 Cyl.	1796cc	85-88kW (116-120PS)		Petrol	TD9483
18 K4G	4 Cyl.	1795cc	110kW (150PS)		Petrol Turbo	TD26623
18 K4K	4 Cyl.	1796cc	107-110kW (146-150PS)		Petrol	TD3500
K 1.8	4 Cyl.	1796cc	88kW (120PS)		Petrol	TD11607

BE/PL	4	47,992/48,007	51,666/51,687	18,420	1,826	0,020/0,055	AL-LF	01-4039	01-4039/4 STD 0.25	
MB/HL 1,3,5	3	47,993/48,000	51,579/51,600	17,450	1,789	0,020/0,054	AL-LF	4131RA	H1085/5 STD 0.25	
MB/HL 2,4	2	47,993/48,000	51,579/51,600	17,450	1,789	0,020/0,054	AL-LF	4132RA		
TW/A	2	56,800/57,050	73,300/73,550		2,400		AL-LF	4131AF	A241/2 STD	

16
84.00 x 88.00

204D2	4 Cyl.			1951cc	85-96kW (116-131PS)		Diesel		TD18240
BE/PL	4	44,975/44,991	48,000/48,016	18,000	1,497	0,020/0,072	SP	71-3704	71-3704/4 STD 0.25 ①
MB/HL 1,2,4,5	4	59,971/59,990	65,000/65,019	20,000	2,498	0,020/0,063	AL-LF	02-3646	H023/5 STD 0.25
MB/HL 3	1	59,971/59,990	65,000/65,019	24,940	2,498	0,020/0,082	AL-LF	02-3647H	
	02-3647H	STD	25,020/.9853" - 25,053/.9863"						
		0.25mm	25,220/.9929" - 25,253/.9942"						
		0.50mm	25,420/1.0008" - 25,453/1.0021"						

17
84.00 x 88.00

M 47 R	4 Cyl.			1950cc	85kW (116PS)		Diesel Turbo Intercooler		TD11609
BE/PL	4	44,975/44,991	48,000/48,016	18,000	1,497	0,020/0,072	SP	71-3704	71-3704/4 STD 0.25 ①
MB/HL 1,2,4,5	4	59,971/59,990	65,000/65,019	20,000	2,498	0,020/0,063	AL-LF	02-3646	H023/5 STD 0.25
MB/HL 3	1	59,971/59,990	65,000/65,019	24,940	2,498	0,020/0,082	AL-LF	02-3647H	
	02-3647H	STD	25,020/.9853" - 25,053/.9863"						
		0.25mm	25,220/.9929" - 25,253/.9942"						
		0.50mm	25,420/1.0008" - 25,453/1.0021"						
SE/PB	1	29,995/30,000	31,995/32,025	22,200			BC	55-3937	55-3937 SEMI

18
84.45 x 88.90

20 T2R	4 Cyl.			1994cc	63kW (86PS)		Diesel Turbo		TD9497
BE/PL	4	53,990/54,010	57,683/57,696	21,800	1,825	0,023/0,081	BS	4660CP	71-4164/4 STD
MB/HL 1-5	5	56,990/57,010	60,703/60,719	22,600	1,835	0,023/0,084	AL-LF	4392RA	H1098/5 STD
TW/A	4	63,600/63,850	80,250/80,500		2,310		AL-LF	1644AF	A173/4 STD

19
84.45 x 88.90

TD5	5 Cyl.			2496cc	90kW (122PS)		Diesel Turbo Intercooler		TD22117
BE/PL	5	53,990/54,010	57,683/57,696	20,800	1,825	0,023/0,081	EC	71-3902	71-3902/5 STD ④
TW/A	4	63,600/63,850	80,250/80,500		2,310		AL-LF	1644AF	A173/4 STD

20
84.45 x 89.00

20 T2N	4 Cyl.			1994cc	74-83kW (101-113PS)		Diesel Turbo		TD9496
BE/PL	4	53,990/54,010	57,683/57,696	21,800	1,825	0,023/0,081	BS	4660CP	71-4164/4 STD
MB/HL 1-5	5	56,990/57,010	60,703/60,719	22,600	1,835	0,023/0,084	AL-LF	4392RA	H1098/5 STD
TW/A	4	63,600/63,850	80,250/80,500		2,310		AL-LF	1644AF	A173/4 STD

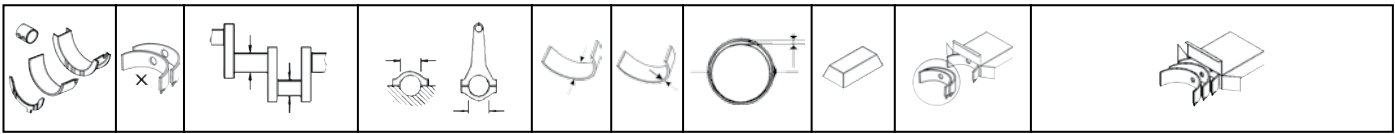

21											84.50 x 89.00	
20 H		4 Cyl.		1994cc	75-86kW (102-117PS)			Petrol		TD3482		
20 HD		4 Cyl.		1994cc	103kW (140PS)			Petrol		TD3484		
20 HD M 16		4 Cyl.		1994cc	98kW (133PS)			Petrol		TD3485		
20 HS		4 Cyl.		1994cc	88kW (120PS)			Petrol		TD18411		
20 M4F		4 Cyl.		1994cc	103kW (140PS)			Petrol		TD9502		
20 T4G		4 Cyl.		1994cc	145-147kW (197-200PS)			Petrol Turbo Intercooler		TD4885		
20 T4H		4 Cyl.		1994cc	100kW (136PS)			Petrol Turbo		TD3479		
20 T4H		4 Cyl.		1994cc	99kW (135PS)			Petrol		TD22419		
M16i		4 Cyl.		1996cc	98-103kW (133-140PS)			Petrol		TD2377		
T 16		4 Cyl.		1994cc	100-147kW (136-200PS)			Petrol Turbo Intercooler		TD4886		
BE/PL	4	47,648/47,660	51,330/51,349	19,840	1,830	0,010/0,066	AL-LF	GS315SA	01-4340/4 STD 0.25			
MB/HL 1,3,5	3	54,013/54,025	57,683/57,696	28,700	1,816	0,025/0,063	AL-LF	GS316SA	H1150/5 STD			
MB/HL 2,4	2	54,013/54,025	57,683/57,696	19,560	1,816	0,025/0,063	AL-LF	GS317SA				
TW/A	4	59,436/59,960	74,498/74,752		2,340		AL-LF	65077BF	A233/4 STD			

22											84.50 x 90.00	
BB		4 Cyl.		1996cc	60kW (82PS)			Diesel Turbo		TD3486		
BE/PL	4	53,990/54,010	57,683/57,696	20,310	1,825	0,023/0,081	BS	1640CP	71-4353/4 STD 0.30			
TW/A	4	63,600/63,850	80,250/80,500		2,310		AL-LF	1644AF	A173/4 STD			

23											85.00 x 88.00	
F 20 A4		4 Cyl.		1997cc	98kW (133PS)			Petrol		TD21379		
BE/PL	8	44,980	48,020	19,400	1,498		BS	64-454-1	71-4253/4 STD			

24											88.86 x 71.10	
11 D		V8 Cyl.		3528cc	93kW (126PS)			Petrol		TD3494		
22 D		V8 Cyl.		3531cc	113kW (154PS)			Petrol		TD3498		
24 D		V8 Cyl.		3528cc	120kW (163PS)			Petrol		TD3496		
25 D		V8 Cyl.		3528cc	120kW (163PS)			Petrol		TD3495		
30 A		V8 Cyl.		3528cc	142kW (193PS)			Petrol		TD3476		
31 A		V8 Cyl.		3528cc	142kW (193PS)			Petrol		TD3475		
31 D		V8 Cyl.		3528cc	107kW (146PS)			Petrol		TD9484		
38 A		V8 Cyl.		3528cc	115kW (156PS)			Petrol		TD9501		
39 A		V8 Cyl.		3528cc	115kW (156PS)			Petrol		TD9500		
BE/PL	8	50,787/50,813	53,967/53,980	18,850	1,575	0,020/0,068	BS	2500RAA	01-4377/8 STD 0.25			
MB/HL 1,2,4,5	4	58,377/58,402	63,261/63,287	20,500	2,421	0,020/0,093	AL-LF	GS9955SA	H1189/5 STD 0.25 0.50			
MB/HL 3	1	58,387/58,412	63,261/63,287	26,870	2,421	0,020/0,083	AL-LF	GS9956SA				

CB/NWB 3	1	43,815/43,840	47,130/47,181	19,050	1,641		BS	2103DR	N170/5 STD
CB/NWB 4	1	43,053/43,079	46,368/46,419	19,050	1,641		BS	2103DRI	
CB/NWB 5	1	42,291/42,316	45,606/45,657	19,050	1,641		BS	2104DR	
CB/NWB 2	1	44,577/44,602	47,892/47,943	19,050	1,641		BS	2502DR	
CB/NWB 1	1	45,339/45,364	48,654/48,705	19,300	1,638		BS	3321DRI	

25
90.50 x 97.00

12 L			4 Cyl.	2496cc	83kW (113PS)			Diesel Turbo Intercooler	TD3461
14 L			4 Cyl.	2496cc	83kW (113PS)			Diesel Turbo	TD3491
19 L			4 Cyl.	2496cc	83-90kW (113-122PS)			Diesel Turbo	TD9482
21 L			4 Cyl.	2495cc	83kW (113PS)			Diesel Turbo Intercooler	TD15168
23 L			4 Cyl.	2495cc	83kW (113PS)			Diesel Turbo	TD9481
BE/PL	4	58,725/58,744	62,433/62,446	25,070	1,830	0,020/0,086	BS	4170CP	71-4396/4 STD 0.25 0.50
MB/HL 1-4	4	63,487/63,500	67,703/67,716	24,390	2,080	0,020/0,056	BS	GS604LC	H1279/5 STD 0.25 0.50
MB/HL 1-4	4	63,487/63,500	67,703/67,716	24,390	2,080	0,018/0,061	BS	GS604LCB	
MB/HL 5	1	63,487/63,500	67,703/67,716	35,130	2,080	0,020/0,056	BS	GS605LC	
MB/HL 5	1	63,487/63,500	67,703/67,716	35,130	2,080	0,026/0,076	BS	GS605LCB	
TW/A	2	70,739/70,993	85,598/85,852		2,340		BS	65192BF	A204/2 STD .005
SE/PB	1	30,166/30,176	34,130/34,155	32,530			BS	8059Y	55-4545 SEMI
CB/NWB 1	1	46,500	50,000	24,500	1,594		BS	8061DR	N165/4 STD
CB/NWB 2-4	3	46,500	50,000	19,000	1,594		BS	8062DR	

26
92.00 x 90.00

HR 492 HI			4 Cyl.	2393cc	81-84kW (110-114PS)			Diesel Turbo Intercooler	TD22365
HR 492 HT			4 Cyl.	2393cc	67kW (91PS)			Diesel Turbo	TD22366
VM-HR 492.4			4 Cyl.	2393cc	89kW (121PS)			Diesel Turbo	TD3503
BE/PL	1	53,940/53,955	57,563/57,582	23,250	1,798	0,020/0,071	BS	66655CP	71-4234 STD 0.25 0.50 0.75
TW/A	2	74,250/74,500	88,000/88,100		2,362		AL-LF	61588AF	A227/2 STD
SE/PB	1	29,990/29,996	34,000/34,025	30,120			BS	66659XA	55-4235 SEMI

27
92.00 x 94.00

425 SL1RR			4 Cyl.	2500cc	87kW (118PS)			Diesel	TD4888
492 4 SHIRG			4 Cyl.	2500cc	87kW (118PS)			Diesel	TD3502
BE/PL	1	53,940/53,955	57,563/57,582	23,250	1,798	0,020/0,071	BS	66655CP	71-4234 STD 0.25 0.50 0.75
TW/A	2	74,250/74,500	88,000/88,100		2,362		AL-LF	61588AF	A227/2 STD
SE/PB	1	29,990/29,996	34,000/34,025	30,120			BS	66659XA	55-4235 SEMI











28											94.00 x 71.10										
35 D			V8 Cyl.		3950cc	134kW (182PS)		Petrol			TD3499										
36 D			V8 Cyl.		3950cc	134kW (182PS)		Petrol			TD3468										
37 D			V8 Cyl.		3950cc	127kW (173PS)		Petrol			TD3497										
38 D			V8 Cyl.		3950cc	127kW (173PS)		Petrol			TD3493										
BE/PL	8	50,787/50,813	53,967/53,980	18,850	1,575	0,020/0,068	BS	2500RAA	01-4377/8 STD 0.25												
MB/HL 1,2,4,5	4	58,377/58,402	63,261/63,287	20,500	2,421	0,020/0,093	AL-LF	GS9955SA	H1189/5 STD 0.25 0.50												
MB/HL 3	1	58,387/58,412	63,261/63,287	26,870	2,421	0,020/0,083	AL-LF	GS9956SA													
CB/NWB 3	1	43,815/43,840	47,130/47,181	19,050	1,641		BS	2103DR	N170/5 STD												
CB/NWB 4	1	43,053/43,079	46,368/46,419	19,050	1,641		BS	2103DRI													
CB/NWB 5	1	42,291/42,316	45,606/45,657	19,050	1,641		BS	2104DR													
CB/NWB 2	1	44,577/44,602	47,892/47,943	19,050	1,641		BS	2502DR													
CB/NWB 1	1	45,339/45,364	48,654/48,705	19,300	1,638		BS	3321DRI													

29											94.00 x 71.10										
42 D			V8 Cyl.		3947cc	140kW (190PS)		Petrol			TD9486										
BE/PL	8	55,500/55,513	58,750/58,768	17,600	1,580	0,015/0,055	BS	GS70710LC	71-4378/8 STD 0.25 0.50												
MB/HL	4	63,487/63,500	67,704/67,716	20,350	2,080	0,010/0,048	AL-LF	GS70711SA/B	H1142/5 STD 0.25												
MB/HL	5	63,487/63,500	67,704/67,716	20,350	2,080	0,010/0,048	AL-LF	GS70711SA/T													
MB/HL	1	63,487/63,500	67,704/67,716	26,800	2,080	0,010/0,048	AL-LF	GS70712SA													

30											94.00 x 77.00										
40 D			V8 Cyl.		4275cc	149kW (203PS)		Petrol			TD3492										
BE/PL	8	50,787/50,813	53,967/53,980	18,850	1,575	0,020/0,068	BS	2500RAA	01-4377/8 STD 0.25												
MB/HL 1,2,4,5	4	58,377/58,402	63,261/63,287	20,500	2,421	0,020/0,093	AL-LF	GS9955SA	H1189/5 STD 0.25 0.50												
MB/HL 3	1	58,387/58,412	63,261/63,287	26,870	2,421	0,020/0,083	AL-LF	GS9956SA													

31											94.00 x 82.00										
46 D			8 Cyl.		4553cc	143-164kW (194-223PS)		Petrol			TD26932										
46 D			V8 Cyl.		4553cc	165-168kW (224-228PS)		Petrol			TD9487										
BE/PL	8	55,500/55,513	58,750/58,768	17,600	1,580	0,015/0,055	BS	GS70710LC	71-4378/8 STD 0.25 0.50												
MB/HL	4	63,487/63,500	67,704/67,716	20,350	2,080	0,010/0,048	AL-LF	GS70711SA/B	H1142/5 STD 0.25												
MB/HL	5	63,487/63,500	67,704/67,716	20,350	2,080	0,010/0,048	AL-LF	GS70711SA/T													
MB/HL	1	63,487/63,500	67,704/67,716	26,800	2,080	0,010/0,048	AL-LF	GS70712SA													







				cm3	x 			
9-3 1.8 i	01/04→	Petrol	Z 18 XE	1796	4	80.50	88.20	1
9-3 1.9 TiD	09/04→	Diesel	Z 19 DT	1910	4	82.00	90.40	2
9-3 1.9 TiD	09/04→	Diesel	Z 19 DTH	1910	4	82.00	90.40	2
9-3 2.0 i	02/98→08/03	Petrol	B204I	1985	4	90.00	78.00	8
9-3 2.0 SE Turbo	02/98→08/03	Petrol	B204R	1985	4	90.00	78.00	8
9-3 2.0 Turbo	10/98→08/03	Petrol	B204E	1985	4	90.00	78.00	8
9-3 2.0 Turbo	02/98→08/03	Petrol	B204L	1985	4	90.00	78.00	8
9-3 2.0 Turbo	02/98→08/03	Petrol	B205L	1985	4	90.00	78.00	8
9-3 2.2 TiD	02/98→	Diesel	D223L	2171	4	84.00	98.00	3
9-3 2.2 TiD	02/98→11/00	Diesel	X 22 DTH	2171	4	84.00	98.00	3
9-3 2.3	09/99→01/02	Petrol	B235R	2290	4	90.00	90.00	9
9-3 2.3 i	02/98→08/03	Petrol	B234I	2290	4	90.00	90.00	9
9-3 2.3 Turbo	10/98→08/03	Petrol	B235R	2290	4	90.00	90.00	9
9-5 1.9 TiD	01/06→12/09	Diesel	Z 19 DTH	1910	4	82.00	90.40	2
9-5 2.0 t	10/98→12/09	Petrol	B204R	1985	4	90.00	78.00	8
9-5 2.0 t	07/00→12/09	Petrol	B205L	1985	4	90.00	78.00	8
9-5 2.2 TiD	03/02→12/09	Diesel	D223L	2171	4	84.00	98.00	3
9-5 2.3	09/99→12/09	Petrol	B235R	2290	4	90.00	90.00	9
9-5 2.3 t	09/97→12/09	Petrol	B235E	2290	4	90.00	90.00	10
9-5 2.3 t BioPower	01/07→12/09	Petrol	B235E	2290	4	90.00	90.00	10
9-5 2.3 t BioPower	11/06→12/09	Petrol	B235R	2290	4	90.00	90.00	9
9-5 2.3 Turbo	04/08→12/09	Petrol	B235E	2290	4	90.00	90.00	10
9-5 2.3 Turbo	10/99→12/09	Petrol	B235R	2290	4	90.00	90.00	9
90 2.0	08/84→08/87	Petrol	B 20 I	1985	4	90.00	78.00	7
95 1.5 V4	10/65→12/78	Petrol	Ford V4	1498	V4	90.00	58.90	6
96 1.5 V4	10/65→08/80	Petrol	Ford V4	1498	V4	90.00	58.90	6
99 2.0	09/71→01/84	Petrol	B 20	1985	4	90.00	78.00	7
99 2.0	10/72→08/74	Petrol	B 20 P	1985	4	90.00	78.00	7
99 2.0	03/76→05/78	Petrol	B20T	1985	4	90.00	78.00	7
99 2.0 EMS	09/74→12/78	Petrol	B 20 I	1985	4	90.00	78.00	7
99 2.0 EMS	04/72→08/74	Petrol	B20I	1985	4	90.00	78.00	7
99 2.0 GL	09/74→12/84	Petrol	B 20 C	1985	4	90.00	78.00	7
99 2.0 GL	09/74→12/84	Petrol	B 20 I	1985	4	90.00	78.00	7
99 2.0 i	01/81→12/84	Petrol	BI 20	1985	4	90.00	78.00	7
99 2.0 Turbo	10/77→06/80	Petrol	BSI 20	1985	4	90.00	78.00	7
600 1.3	01/80→12/86	Petrol	831 A2.000	1301	4	86.40	55.50	4
600 1.5	01/80→12/86	Petrol	831 A1.000	1498	4	86.40	63.90	5
900	01/86→	Petrol	B234	2290	4	90.00	90.00	9
900 I 2.0	06/78→10/91	Petrol	B20I	1985	4	90.00	78.00	7
900 I 2.0	10/87→10/91	Petrol	B202I	1985	4	90.00	78.00	8
900 I 2.0	05/91→10/93	Petrol	B202S	1985	4	90.00	78.00	8
900 I 2.0	10/89→10/93	Petrol	B202XL	1985	4	90.00	78.00	8
900 I 2.0 8V Turbo	01/88→12/90	Petrol	B201L	1985	4	90.00	78.00	7
900 I 2.0 -16	01/89→06/94	Petrol	B202I	1985	4	90.00	78.00	8
900 I 2.0 -16	01/86→12/88	Petrol	B202XI	1985	4	90.00	78.00	8
900 I 2.0 -16	05/91→10/93	Petrol	B202S	1985	4	90.00	78.00	8
900 I 2.0 16v	04/90→12/90	Petrol	B202I	1985	4	90.00	78.00	8
900 I 2.0 c	09/79→12/88	Petrol	B 20	1985	4	90.00	78.00	7
900 I 2.0 c	09/78→08/84	Petrol	B20T	1985	4	90.00	78.00	7
900 I 2.0 c	09/78→08/84	Petrol	BT 20	1985	4	90.00	78.00	7
900 I 2.0 EMS	09/78→12/80	Petrol	BI 20	1985	4	90.00	78.00	7
900 I 2.0 i	09/85→08/90	Petrol	B20I	1985	4	90.00	78.00	7
900 I 2.0 i	11/80→08/90	Petrol	B201XI	1985	4	90.00	78.00	7
900 I 2.0 i	11/80→08/90	Petrol	BI 20	1985	4	90.00	78.00	7
900 I 2.0 S Turbo-16	07/91→06/94	Petrol	B202S	1985	4	90.00	78.00	8
900 I 2.0 T8	10/86→09/89	Petrol	B201L	1985	4	90.00	78.00	7
900 I 2.0 Turbo	09/78→07/85	Petrol	B201S	1985	4	90.00	78.00	7
900 I 2.0 Turbo	01/86→12/91	Petrol	B201XL	1985	4	90.00	78.00	7
900 I 2.0 Turbo	09/78→07/85	Petrol	BSI 20	1985	4	90.00	78.00	7
900 I 2.0 Turbo-16	01/93→06/94	Petrol	B202L	1985	4	90.00	78.00	8
900 I 2.0 Turbo-16	11/85→06/94	Petrol	B202XL	1985	4	90.00	78.00	8
900 I 2.0 Turbo-16 S	01/84→06/94	Petrol	B202XL	1985	4	90.00	78.00	8
900 I 2.0 Turbo-16 S CAT	01/89→12/93	Petrol	B202XL	1985	4	90.00	78.00	8
900 I 2.1	09/90→06/94	Petrol	B212I	2119	4	93.00	78.00	11
900 I 2.1 -16	08/90→06/94	Petrol	B212I	2119	4	93.00	78.00	11
900 I 2.1 16 S	10/89→07/92	Petrol	B212I	2119	4	93.00	78.00	11
900 II 2.0 -16 Turbo	07/93→02/98	Petrol	B204L	1985	4	90.00	78.00	8
900 II 2.0 i	12/93→02/98	Petrol	B204I	1985	4	90.00	78.00	8
900 II 2.0 i	07/93→07/94	Petrol	B206I	1985	4	90.00	78.00	8





cm3

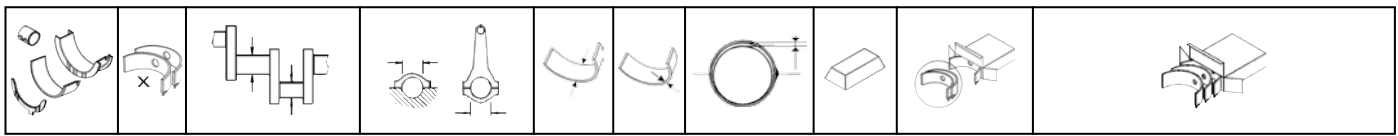

900 II 2.1	09/93→12/94	Petrol	B212I	2119	4	93.00	78.00	11
900 II 2.3	09/93→02/98	Petrol	B234I	2290	4	90.00	90.00	9
900 II 2.3 -16	07/93→02/98	Petrol	B234I	2290	4	90.00	90.00	9
9000	01/91→	Petrol	B234	2290	4	90.00	90.00	9
9000 2.0	10/88→08/90	Petrol	B202I	1985	4	90.00	78.00	8
9000 2.0 -16	01/89→01/93	Petrol	B202I	1985	4	90.00	78.00	8
9000 2.0 -16	12/85→12/88	Petrol	B202XI	1985	4	90.00	78.00	8
9000 2.0 -16 CD	09/93→12/98	Petrol	B202I	1985	4	90.00	78.00	8
9000 2.0 -16 CD	09/93→12/98	Petrol	B202S	1985	4	90.00	78.00	8
9000 2.0 -16 CD	09/93→12/98	Petrol	B204E	1985	4	90.00	78.00	8
9000 2.0 -16 CD	09/93→12/98	Petrol	B204I	1985	4	90.00	78.00	8
9000 2.0 -16 CD	09/93→12/98	Petrol	B204S	1985	4	90.00	78.00	8
9000 2.0 -16 CS	01/89→12/98	Petrol	B202I	1985	4	90.00	78.00	8
9000 2.0 -16 CS	09/93→12/98	Petrol	B204I	1985	4	90.00	78.00	8
9000 2.0 16v	09/89→01/90	Petrol	B202L	1985	4	90.00	78.00	8
9000 2.0 -16 ND Turbo	09/93→12/98	Petrol	B202S	1985	4	90.00	78.00	8
9000 2.0 -16 ND Turbo	09/93→12/98	Petrol	B204E	1985	4	90.00	78.00	8
9000 2.0 -16 ND Turbo	09/93→12/98	Petrol	B204S	1985	4	90.00	78.00	8
9000 2.0 -16 Turbo	06/89→09/93	Petrol	B202	1985	4	90.00	78.00	8
9000 2.0 -16 Turbo	09/84→12/91	Petrol	B202L	1985	4	90.00	78.00	8
9000 2.0 -16 Turbo	09/84→08/93	Petrol	B202XL	1985	4	90.00	78.00	8
9000 2.0 -16 Turbo CD	09/89→12/98	Petrol	B202L	1985	4	90.00	78.00	8
9000 2.0 -16 Turbo CD	09/92→12/98	Petrol	B202S	1985	4	90.00	78.00	8
9000 2.0 -16 Turbo CD	09/88→08/93	Petrol	B202XL	1985	4	90.00	78.00	8
9000 2.0 -16 Turbo CD	09/92→12/98	Petrol	B204E	1985	4	90.00	78.00	8
9000 2.0 -16 Turbo CS	09/88→12/98	Petrol	B202L	1985	4	90.00	78.00	8
9000 2.0 Carlsson	09/89→08/90	Petrol	B204L	1985	4	90.00	78.00	8
9000 2.0 T16	06/89→10/90	Petrol	B202L	1985	4	90.00	78.00	8
9000 2.3	10/89→12/93	Petrol	B234I	2290	4	90.00	90.00	9
9000 2.3	09/97→12/98	Petrol	B234L	2290	4	90.00	90.00	9
9000 2.3	09/90→12/98	Petrol	B234R	2290	4	90.00	90.00	9
9000 2.3 -16 Aero CS	02/93→12/98	Petrol	B234R	2290	4	90.00	90.00	9
9000 2.3 -16 CD	08/89→12/98	Petrol	B234I	2290	4	90.00	90.00	9
9000 2.3 -16 CDE	09/93→12/98	Petrol	B234I	2290	4	90.00	90.00	9
9000 2.3 -16 CDE Eco-Power	09/93→12/98	Petrol	B234E	2290	4	90.00	90.00	9
9000 2.3 -16 CD Turbo	07/90→12/98	Petrol	B234L	2290	4	90.00	90.00	9
9000 2.3 -16 CS	09/89→12/98	Petrol	B234I	2290	4	90.00	90.00	9
9000 2.3 -16 CSE	09/93→12/98	Petrol	B234I	2290	4	90.00	90.00	9
9000 2.3 -16 CSE Eco Power	09/93→12/98	Petrol	B234E	2290	4	90.00	90.00	9
9000 2.3 -16 Turbo	09/90→12/98	Petrol	B234L	2290	4	90.00	90.00	9
9000 2.3 -16 Turbo CSE	09/93→12/98	Petrol	B234L	2290	4	90.00	90.00	9
9000 S, CS, SE 2.3-16 Turbo	01/91→	Petrol	B234	2290	4	90.00	90.00	9
CD	01/91→	Petrol	B234	2290	4	90.00	90.00	9
CD Turbo 16v	01/91→	Petrol	B234	2290	4	90.00	90.00	9

			cm3	x 			
831 A1.000	Petrol		1498	4	86.40	63.90	5
831 A2.000	Petrol		1301	4	86.40	55.50	4
B 20	Petrol		1985	4	90.00	78.00	7
B 20 C	Petrol		1985	4	90.00	78.00	7
B 20 I	Petrol		1985	4	90.00	78.00	7
B 20 P	Petrol		1985	4	90.00	78.00	7
B20T	Petrol		1985	4	90.00	78.00	7
B201	Petrol		1985	4	90.00	78.00	7
B201I	Petrol		1985	4	90.00	78.00	7
B201L	Petrol		1985	4	90.00	78.00	7
B201S	Petrol		1985	4	90.00	78.00	7
B201XI	Petrol		1985	4	90.00	78.00	7
B201XL	Petrol		1985	4	90.00	78.00	7
B202	Petrol		1985	4	90.00	78.00	8
B202I	Petrol		1985	4	90.00	78.00	8
B202L	Petrol		1985	4	90.00	78.00	8
B202S	Petrol		1985	4	90.00	78.00	8
B202XI	Petrol		1985	4	90.00	78.00	8
B202XL	Petrol		1985	4	90.00	78.00	8
B204E	Petrol		1985	4	90.00	78.00	8
B204I	Petrol		1985	4	90.00	78.00	8
B204L	Petrol		1985	4	90.00	78.00	8
B204R	Petrol		1985	4	90.00	78.00	8
B204S	Petrol		1985	4	90.00	78.00	8
B205F	Petrol		1985	4	90.00	78.00	8
B205L	Petrol		1985	4	90.00	78.00	8
B206I	Petrol		1985	4	90.00	78.00	8
B212I	Petrol		2119	4	93.00	78.00	11
B234	Petrol		2290	4	90.00	90.00	9
B234E	Petrol		2290	4	90.00	90.00	9
B234I	Petrol		2290	4	90.00	90.00	9
B234L	Petrol		2290	4	90.00	90.00	9
B234R	Petrol		2290	4	90.00	90.00	9
B235E	Petrol		2290	4	90.00	90.00	10
B235R	Petrol		2290	4	90.00	90.00	9
BI 20	Petrol		1985	4	90.00	78.00	7
BSI 20	Petrol		1985	4	90.00	78.00	7
BT 20	Petrol		1985	4	90.00	78.00	7
D223L	Diesel		2171	4	84.00	98.00	3
Ford V4	Petrol		1498	V4	90.00	58.90	6
X 22 DTH	Diesel		2171	4	84.00	98.00	3
Y 22 DTH	Diesel		2171	4	84.00	98.00	3
Z 18 XE	Petrol		1796	4	80.50	88.20	1
Z 19 DT	Diesel		1910	4	82.00	90.40	2
Z 19 DTH	Diesel		1910	4	82.00	90.40	2
Z 19 DTJ	Diesel		1910	4	82.00	90.40	2



1										
80.50 x 88.20										
Z 18 XE		4 Cyl.		1796cc	90kW (122PS)		Petrol		TD18079	
BE/PL	4	42,971/42,987	46,000/46,012	16,600	1,497	0,020/0,072	EC	71-3639	71-3639/4 STD 0.25 0.50	
MB/HL 1,2,4,5	4	54,972/54,985	59,000/59,013	19,500	2,001	0,020/0,064	EC	72-3505	H975/5 STD 0.25 0.50	
MB/HL 3	1	54,972/54,985	59,000/59,013	25,900	2,001	0,020/0,064	EC	72-3506H		
		72-3506H	STD	25,950/1.0217" - 26,002/1.0237"						
			0.25mm	26,150/1.0295" - 26,202/1.0316"						
			0.50mm	26,350/1.0374" - 26,402/1.0394"						

2										
82.00 x 90.40										
Z 19 DT		4 Cyl.		1910cc	88kW (120PS)		Diesel Turbo Intercooler		TD18086	
Z 19 DTH		4 Cyl.		1910cc	110kW (150PS)		Diesel Turbo Intercooler		TD18084	
Z 19 DTJ		4 Cyl.		1910cc	88kW (120PS)		Diesel Turbo Intercooler		TD24819	
BE/PL	1	50,787/50,805	53,901/53,913	19,500	1,534	0,030/0,080	EC	71-3994	71-3994 STD 0.25 [4]	
MB/HL	1	59,986/60,000	63,705/63,718	20,750	1,844	0,031/0,080	EC	72-3995	72-3995 STD 0.25 0.50	
TW/A	2	67,785/68,040	82,425/82,677		2,485		AL-LF	4356AF	A191/2 STD	
SE/PB	1		28,939/28,972	21,700			BS	4369Y	55-4159 SEMI	

3										
84.00 x 98.00										
D223L		4 Cyl.		2171cc	85-92kW (115-125PS)		Diesel Turbo Intercooler		TD18087	
X 22 DTH		4 Cyl.		2171cc	85kW (115PS)		Diesel Turbo Intercooler		TD9750	
Y 22 DTH		4 Cyl.		2171cc	85-88kW (116-120PS)		Diesel Turbo Intercooler		TD19130	
BE/PL	4	48,971/48,990	52,000/52,012	20,300	1,500	0,020/0,066	SP	71-3870	71-3870/4 STD [1]	
MB/HL 1,2,4,5	4	67,980/67,996	72,000/72,013	19,500	1,995	0,020/0,068	AL-LF	02-3909	H077/5 STD	
MB/HL 3	1	67,980/67,996	72,000/72,013	25,900	1,995	0,020/0,068	AL-LF	02-3910H		
		02-3910H	STD	25,950/1.0217" - 26,002/1.0237"						
SE/PB	1	28,995/29,000	32,000/32,051	26,800			BC	55-3873	55-3873 SEMI	

4										
86.40 x 55.50										
831 A2.000		4 Cyl.		1301cc	55-58kW (75-79PS)		Petrol		TD31803	
BE/PL	4	45,508/45,528	48,629/48,646	19,200	1,547	0,020/0,069	AL-LF	1645RA	01-4127/4 STD 0.25 0.50	
BE/PL	4	45,508/45,528	48,629/48,646	19,200	1,538	0,025/0,087	AL-LF	60985RA	01-4171/4 STD	

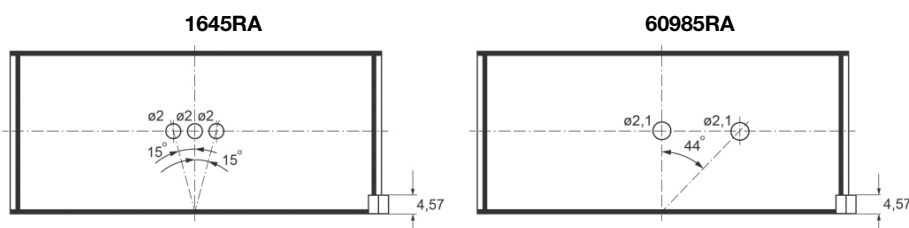

MB/HL 1,2,4,5	4	50,785/50,805	54,507/54,520	20,250	1,831	0,040/0,098	AL-LF	60986RA	H1028/5 STD 0.25	
MB/HL 3	1	50,785/50,805	54,507/54,520	22,750	1,831	0,040/0,098	AL-LF	60987RA		
TW/A	2	56,610/56,864	69,596/69,850		2,362		AL-LF	60987AFA	A198/2 STD .005	
SE/PB	1	21,539/21,641	23,939/23,972	25,100			BS	62039Y	55-4288 SEMI	

5 86.40 x 63.90

831 A1.000		4 Cyl.		1498cc	63kW (86PS)	Petrol				TD31804
BE/PL	4	45,508/45,528	48,629/48,646	19,200	1,547	0,020/0,069	AL-LF	1645RA	01-4127/4 STD 0.25 0.50	
MB/HL 1,2,4,5	4	50,780/50,800	54,507/54,520	20,250	1,849	0,020/0,067	AL-LF	1646RA	H1075/5 STD 0.25 0.50	
MB/HL 3	1	50,780/50,800	54,507/54,520	22,750	1,849	0,020/0,067	AL-LF	1647RA		
TW/A	2	56,610/56,864	69,596/69,850		2,362		AL-LF	60987AFA	A198/2 STD .005	
SE/PB	1	21,539/21,641	23,939/23,972	25,100			BS	62039Y	55-4288 SEMI	

6 90.00 x 58.90

Ford V4		V4 Cyl.		1498cc	46-50kW (63-68PS)	Petrol				TD3535
BE/PL	1	53,980/54,000	56,820/56,840	16,480	1,407	0,020/0,071	EC	71-2185	71-2185 STD	

7 90.00 x 78.00

B 20			4 Cyl.	1985cc	64-74kW (86-101PS)	Petrol				TD3505
B 20 C			4 Cyl.	1985cc	74kW (100PS)	Petrol				TD3506
B 20 I			4 Cyl.	1985cc	74-87kW (100-118PS)	Petrol				TD3507
B 20 P			4 Cyl.	1985cc	70kW (95PS)	Petrol				TD5380
B20T			4 Cyl.	1985cc	79kW (108PS)	Petrol				TD3513
B201			4 Cyl.	1985cc	81kW (110PS)	Petrol				TD3510
B201I			4 Cyl.	1985cc	85kW (116PS)	Petrol				TD25597
B201L			4 Cyl.	1985cc	114kW (155PS)	Petrol Turbo				TD26115
B201S			4 Cyl.	1985cc	107kW (145PS)	Petrol Turbo				TD3512
B201XI			4 Cyl.	1985cc	85-87kW (115-118PS)	Petrol				TD3509
B201XL			4 Cyl.	1985cc	103-114kW (140-155PS)	Petrol Turbo Intercooler				TD5367
BI 20			4 Cyl.	1985cc	85-87kW (115-118PS)	Petrol				TD3528
BSI 20			4 Cyl.	1985cc	107kW (145PS)	Petrol Turbo				TD3530
BT 20			4 Cyl.	1985cc	79kW (108PS)	Petrol				TD3531
BE/PL	4	51,981/52,000	56,000/56,019	20,250	1,988	0,024/0,087	EC	71-3507	71-3507/4 STD 0.25	
MB/HL 1-5	5	57,981/58,000	62,000/62,019	21,500	1,988	0,024/0,087	EC	72-3508	H976/5 STD 0.25	
SE/PB	1	23,996/24,000	27,000/27,021	25,500			BC	55-3543	55-3543 SEMI	

8 90.00 x 78.00

B202			4 Cyl.	1985cc	127kW (172PS)	Petrol Turbo Intercooler				TD5374
B202I			4 Cyl.	1985cc	93-99kW (126-135PS)	Petrol				TD3515
B202L			4 Cyl.	1985cc	129-150kW (175-204PS)	Petrol Turbo Intercooler				TD3519
B202S			4 Cyl.	1985cc	104-110kW (141-150PS)	Petrol Turbo				TD5365
B202XI			4 Cyl.	1985cc	92-96kW (125-130PS)	Petrol				TD3514
B202XL			4 Cyl.	1985cc	118-132kW (160-180PS)	Petrol Turbo				TD3517
B204E			4 Cyl.	1985cc	108-113kW (147-154PS)	Petrol Turbo				TD5372



B204I	4 Cyl.	1985cc	96kW (131PS)	Petrol	TD3518
B204L	4 Cyl.	1985cc	136-147kW (185-200PS)	Petrol Turbo Intercooler	TD5369
B204R	4 Cyl.	1985cc	141-147kW (192-200PS)	Petrol Turbo Intercooler	TD13388
B204S	4 Cyl.	1985cc	110kW (150PS)	Petrol Turbo	TD25001
B205F	4 Cyl.	1985cc	129kW (175PS)	Petrol Turbo Intercooler	TD25008
B205L	4 Cyl.	1985cc	136kW (185PS)	Petrol Turbo Intercooler	TD20490
B206I	4 Cyl.	1985cc	98kW (133PS)	Petrol	TD3520

BE/PL	4	51,981/52,000	56,000/56,019	20,250	1,988	0,024/0,087	EC	71-3507	71-3507/4 STD 0.25
MB/HL 1-5	5	57,981/58,000	62,000/62,019	21,500	1,990	0,020/0,083	EC	72-3731	H038/5 STD 0.25
TW/A	2	62,025	81,900		1,860		AL-LF	04-3761	A141/2 STD
SE/PB	1	23,996/24,000	27,000/27,021	25,500			BC	55-3543	55-3543 SEMI

9 90.00 x 90.00

B234	4 Cyl.	2290cc	120-143kW (163-194PS)	Petrol Turbo	FM5240
B234E	4 Cyl.	2290cc	125kW (170PS)	Petrol Turbo	TD3522
B234I	4 Cyl.	2290cc	107-112kW (146-152PS)	Petrol	TD3523
B234L	4 Cyl.	2290cc	143-149kW (195-203PS)	Petrol Turbo	TD3525
B234R	4 Cyl.	2290cc	162-168kW (220-228PS)	Petrol Turbo	TD3524
B235R	4 Cyl.	2290cc	152-191kW (207-260PS)	Petrol Turbo Intercooler	TD18089







BE/PL	4	51,981/52,000	56,000/56,019	20,250	1,988	0,024/0,087	EC	71-3507	71-3507/4 STD 0.25
MB/HL 1-5	5	57,981/58,000	62,000/62,019	21,500	1,990	0,020/0,083	EC	72-3731	H038/5 STD 0.25
TW/A	2	62,025	81,900		1,860		AL-LF	04-3761	A141/2 STD
SE/PB	1	23,996/24,000	27,000/27,021	25,500			BC	55-3543	55-3543 SEMI

10 90.00 x 90.00

B235E	4 Cyl.	2290cc	125-136kW (170-185PS)	Petrol Turbo	TD9448				
BE/PL	4	51,981/52,000	56,000/56,019	20,250	1,988	0,024/0,087	EC	71-3507	71-3507/4 STD 0.25
MB/HL 1-5	5	57,981/58,000	62,000/62,019	21,500	1,990	0,020/0,083	EC	72-3731	H038/5 STD 0.25
TW/A	2	62,025	81,900		1,860		AL-LF	04-3761	A141/2 STD

11 93.00 x 78.00

B212I	4 Cyl.	2119cc	100-107kW (136-145PS)	Petrol	TD3521				
BE/PL	4	51,981/52,000	56,000/56,019	20,250	1,988	0,024/0,087	EC	71-3507	71-3507/4 STD 0.25
MB/HL 1-5	5	57,981/58,000	62,000/62,019	21,500	1,990	0,020/0,083	EC	72-3731	H038/5 STD 0.25
TW/A	2	62,025	81,900		1,860		AL-LF	04-3761	A141/2 STD
SE/PB	1	23,996/24,000	27,000/27,021	25,500			BC	55-3543	55-3543 SEMI

		cm3	x 			
982 L	Diesel	1810	2	98.00	120.00	2
983 L	Diesel	2715	3	98.00	120.00	3
984L	Diesel	3620	4	98.00	120.00	4
985 P/041	Diesel	4524	5	98.00	120.00	5
986 L	Diesel	5428	6	98.00	120.00	6
1000.3 W	Diesel	3000	3	105.00	115.50	8
1000.4W	Diesel	4000	4	105.00	115.50	9
1000.4 WT	Diesel	4000	4	105.00	115.50	9
1052L	Diesel	2078	2	105.00	120.00	10
1053L	Diesel	3117	3	105.00	120.00	11
1053 P	Diesel	3117	3	105.00	120.00	11
1054L	Diesel	4155	4	105.00	120.00	12
1054 P	Diesel	4156	4	105.00	120.00	12
1054 PT	Diesel	4156	4	105.00	120.00	12
1055L	Diesel	5195	5	105.00	120.00	13
1055 P	Diesel	5195	5	105.00	120.00	13
1056/L	Diesel	6234	6	98.43	120.00	7
1056 P	Diesel	6234	6	105.00	120.00	14
1056 PT	Diesel	6234	6	105.00	120.00	14
DA953	Diesel	2551	3	95.00	120.00	1



1 95.00 x 120.00

DA953		3 Cyl.		2551cc		Diesel			FM4147
BE/PL	1	67,940/67,950	71,725/71,744	27,000	1,863	0,049/0,103	BS	66510CP	71-4223 STD 0.25 0.50
01/73 →									
MB/HL	1	69,980/70,000	73,970/74,000	32,000	1,962	0,046/0,121	BS	66511CP	72-4552 STD 0.25 0.50 0.75
TW/A	4	77,500/77,690	91,900/92,000		2,360		AL-LF	60856AF	A196/4 STD
SE/PB	1	35,025/35,035	39,000/39,025	35,150			BS	66514Y	55-4225 SEMI

2 98.00 x 120.00

982 L		2 Cyl.		1810cc		Diesel			FM4118
BE/PL	1	67,940/67,950	71,725/71,744	27,000	1,863	0,049/0,103	BS	66510CP	71-4223 STD 0.25 0.50
01/73 →									
MB/HL	1	69,980/70,000	73,970/74,000	32,000	1,962	0,046/0,121	BS	66511CP	72-4552 STD 0.25 0.50 0.75
TW/A	4	77,500/77,690	91,900/92,000		2,360		AL-LF	60856AF	A196/4 STD
SE/PB	1	35,025/35,035	39,000/39,025	35,150			BS	66514Y	55-4225 SEMI

3 98.00 x 120.00

983 L		3 Cyl.		2715cc		Diesel			FM4119
BE/PL	1	67,940/67,950	71,725/71,744	27,000	1,863	0,049/0,103	BS	66510CP	71-4223 STD 0.25 0.50
01/73 →									
MB/HL	1	69,980/70,000	73,970/74,000	32,000	1,962	0,046/0,121	BS	66511CP	72-4552 STD 0.25 0.50 0.75
TW/A	4	77,500/77,690	91,900/92,000		2,360		AL-LF	60856AF	A196/4 STD
SE/PB	1	35,025/35,035	39,000/39,025	35,150			BS	66514Y	55-4225 SEMI

4 98.00 x 120.00

984L		4 Cyl.		3620cc		Diesel			FM4122
BE/PL	1	67,940/67,950	71,725/71,744	27,000	1,863	0,049/0,103	BS	66510CP	71-4223 STD 0.25 0.50
01/73 →									
MB/HL	1	69,980/70,000	73,970/74,000	32,000	1,962	0,046/0,121	BS	66511CP	72-4552 STD 0.25 0.50 0.75
TW/A	4	77,500/77,690	91,900/92,000		2,360		AL-LF	60856AF	A196/4 STD
SE/PB	1	35,025/35,035	39,000/39,025	35,150			BS	66514Y	55-4225 SEMI

5 98.00 x 120.00

985 P/041		5 Cyl.		4524cc		Diesel			FM9142
BE/PL	1	67,940/67,950	71,725/71,744	27,000	1,863	0,049/0,103	BS	66510CP	71-4223 STD 0.25 0.50
01/73 →									
MB/HL	1	69,980/70,000	73,970/74,000	32,000	1,962	0,046/0,121	BS	66511CP	72-4552 STD 0.25 0.50 0.75
TW/A	4	77,500/77,690	91,900/92,000		2,360		AL-LF	60856AF	A196/4 STD



SE/PB	1	35,025/35,035	39,000/39,025	35,150			BS	66514Y	55-4225 SEMI
-------	---	---------------	---------------	--------	--	--	----	--------	------------------------

6 98.00 x 120.00

986 L			6 Cyl.	5428cc			Diesel		FM9143
--------------	--	--	--------	---------------	--	--	---------------	--	---------------

BE/PL	1	67,940/67,950	71,725/71,744	27,000	1,863	0,049/0,103	BS	66510CP	71-4223 STD 0.25 0.50
-------	---	---------------	---------------	--------	-------	-------------	----	---------	---------------------------------

01/73 →

MB/HL	1	69,980/70,000	73,970/74,000	32,000	1,962	0,046/0,121	BS	66511CP	72-4552 STD 0.25 0.50 0.75
-------	---	---------------	---------------	--------	-------	-------------	----	---------	--------------------------------------

TW/A	4	77,500/77,690	91,900/92,000		2,360		AL-LF	60856AF	A196/4 STD
------	---	---------------	---------------	--	-------	--	-------	---------	----------------------

SE/PB	1	35,025/35,035	39,000/39,025	35,150			BS	66514Y	55-4225 SEMI
-------	---	---------------	---------------	--------	--	--	----	--------	------------------------

7 98.43 x 120.00

1056/L			6 Cyl.	6234cc			Diesel		FM9147
---------------	--	--	--------	---------------	--	--	---------------	--	---------------

BE/PL	1	67,940/67,950	71,725/71,744	27,000	1,863	0,049/0,103	BS	66510CP	71-4223 STD 0.25 0.50
-------	---	---------------	---------------	--------	-------	-------------	----	---------	---------------------------------

01/73 →

MB/HL	1	69,980/70,000	73,970/74,000	32,000	1,962	0,046/0,121	BS	66511CP	72-4552 STD 0.25 0.50 0.75
-------	---	---------------	---------------	--------	-------	-------------	----	---------	--------------------------------------

TW/A	4	77,500/77,690	91,900/92,000		2,360		AL-LF	60856AF	A196/4 STD
------	---	---------------	---------------	--	-------	--	-------	---------	----------------------

SE/PB	1	35,025/35,035	39,000/39,025	35,150			BS	66514Y	55-4225 SEMI
-------	---	---------------	---------------	--------	--	--	----	--------	------------------------

8 105.00 x 115.50

1000.3 W			3 Cyl.	3000cc	23-47kW (31-64PS)		Diesel		TD29715
-----------------	--	--	--------	---------------	--------------------------	--	---------------	--	----------------

BE/PL	1	63,480/63,500	67,201/67,221	29,250	1,833	0,035/0,100	BS	1915CP	71-4109 STD 0.25
-------	---	---------------	---------------	--------	-------	-------------	----	--------	----------------------------

9 105.00 x 115.50

1000.4 WT			4 Cyl.	4000cc	37-76kW (50-103PS)		Diesel Turbo		TD29717
------------------	--	--	--------	---------------	---------------------------	--	---------------------	--	----------------

1000.4W			4 Cyl.	4000cc	30-62kW (41-84PS)		Diesel		TD29718
----------------	--	--	--------	---------------	--------------------------	--	---------------	--	----------------

BE/PL	1	63,480/63,500	67,201/67,221	29,250	1,833	0,035/0,100	BS	1915CP	71-4109 STD 0.25
-------	---	---------------	---------------	--------	-------	-------------	----	--------	----------------------------

10 105.00 x 120.00

1052L			2 Cyl.	2078cc			Diesel		FM4148
--------------	--	--	--------	---------------	--	--	---------------	--	---------------

BE/PL	1	67,940/67,950	71,725/71,744	27,000	1,863	0,049/0,103	BS	66510CP	71-4223 STD 0.25 0.50
-------	---	---------------	---------------	--------	-------	-------------	----	---------	---------------------------------

01/73 →

MB/HL	1	69,980/70,000	73,970/74,000	32,000	1,962	0,046/0,121	BS	66511CP	72-4552 STD 0.25 0.50 0.75
-------	---	---------------	---------------	--------	-------	-------------	----	---------	--------------------------------------

TW/A	4	77,500/77,690	91,900/92,000		2,360		AL-LF	60856AF	A196/4 STD
------	---	---------------	---------------	--	-------	--	-------	---------	----------------------

SE/PB	1	35,025/35,035	39,000/39,025	35,150			BS	66514Y	55-4225 SEMI
-------	---	---------------	---------------	--------	--	--	----	--------	------------------------

11 105.00 x 120.00

1053 P			3 Cyl.	3117cc			Diesel		FM4152
---------------	--	--	--------	---------------	--	--	---------------	--	---------------

1053L			3 Cyl.	3117cc			Diesel		FM4121
--------------	--	--	--------	---------------	--	--	---------------	--	---------------

BE/PL	1	67,940/67,950	71,725/71,744	27,000	1,863	0,049/0,103	BS	66510CP	71-4223 STD 0.25 0.50
-------	---	---------------	---------------	--------	-------	-------------	----	---------	---------------------------------

01/73 →

MB/HL	1	69,980/70,000	73,970/74,000	32,000	1,962	0,046/0,121	BS	66511CP	72-4552 STD 0.25 0.50 0.75	
TW/A	4	77,500/77,690	91,900/92,000		2,360		AL-LF	60856AF	A196/4 STD	
SE/PB	1	35,025/35,035	39,000/39,025	35,150			BS	66514Y	55-4225 SEMI	

12 105.00 x 120.00







1054 P			4 Cyl.	4156cc				Diesel		FM9146
1054 PT			4 Cyl.	4156cc				Diesel Turbo		FM9148
1054L			4 Cyl.	4155cc				Diesel		FM4149
BE/PL	1	67,940/67,950	71,725/71,744	27,000	1,863	0,049/0,103	BS	66510CP	71-4223 STD 0.25 0.50	
01/73 →										
MB/HL	1	69,980/70,000	73,970/74,000	32,000	1,962	0,046/0,121	BS	66511CP	72-4552 STD 0.25 0.50 0.75	
TW/A	4	77,500/77,690	91,900/92,000		2,360		AL-LF	60856AF	A196/4 STD	
SE/PB	1	35,025/35,035	39,000/39,025	35,150			BS	66514Y	55-4225 SEMI	







13 105.00 x 120.00







1055 P			5 Cyl.	5195cc				Diesel		FM4124
1055L			5 Cyl.	5195cc				Diesel		FM9150
BE/PL	1	67,940/67,950	71,725/71,744	27,000	1,863	0,049/0,103	BS	66510CP	71-4223 STD 0.25 0.50	
01/73 →										
MB/HL	1	69,980/70,000	73,970/74,000	32,000	1,962	0,046/0,121	BS	66511CP	72-4552 STD 0.25 0.50 0.75	
TW/A	4	77,500/77,690	91,900/92,000		2,360		AL-LF	60856AF	A196/4 STD	
SE/PB	1	35,025/35,035	39,000/39,025	35,150			BS	66514Y	55-4225 SEMI	







14 105.00 x 120.00

1056 P			6 Cyl.	6234cc				Diesel		FM4125
1056 PT			6 Cyl.	6234cc				Diesel Turbo		FM9149
BE/PL	1	67,940/67,950	71,725/71,744	27,000	1,863	0,049/0,103	BS	66510CP	71-4223 STD 0.25 0.50	
01/73 →										
MB/HL	1	69,980/70,000	73,970/74,000	32,000	1,962	0,046/0,121	BS	66511CP	72-4552 STD 0.25 0.50 0.75	
TW/A	4	77,500/77,690	91,900/92,000		2,360		AL-LF	60856AF	A196/4 STD	
SE/PB	1	35,025/35,035	39,000/39,025	35,150			BS	66514Y	55-4225 SEMI	

		cm3	x 			
D 8	Diesel	7800	6	115.00	125.00	1
D 8.01 B09	Diesel	7800	6	115.00	125.00	1
D 8.02 B09	Diesel	7790	6	115.00	125.00	1
D 8 R 01	Diesel	7800	6	115.00	125.00	1
D 10-R 01	Diesel	10260	6	127.00	135.00	6
D 11	Diesel	11022	6	127.00	145.00	10
D 11 R 23	Diesel	11022	6	127.00	145.00	10
D 14	Diesel	14181	V8	127.00	140.00	8
DC 9.01 Euro 3	Diesel	9000	6	115.00	144.00	4
DC 9.02 Euro 3	Diesel	9000	6	115.00	144.00	5
DC 9.03 Euro 3	Diesel	9000	6	115.00	144.00	5
DC 9.04 Euro 3	Diesel	9000	6	115.00	144.00	4
DC 9.05 Euro 3	Diesel	9000	6	115.00	144.00	5
DC 9.06	Diesel	9000	6	115.00	144.00	5
DC 9.11 Euro 3	Diesel	8867	5	127.00	140.00	7
DC 9.12 Euro 3	Diesel	8867	5	127.00	140.00	7
DC 9.13 Euro 3	Diesel	8867	5	127.00	140.00	7
DC 9.16 Euro 4	Diesel	8867	5	127.00	140.00	7
DC 9.17 Euro 4	Diesel	8867	5	127.00	140.00	7
DC 9.18 Euro 4	Diesel	8867	5	127.00	140.00	7
DC 9.20 Euro 3	Diesel	8867	5	127.00	140.00	7
DC 9.22 Euro 5	Diesel	9300	5	130.00	140.00	14
DC 9.24	Diesel	9300	5	130.00	140.00	14
DC 9.29	Diesel	9300	5	130.00	140.00	14
DC 9.30	Diesel	9300	5	130.00	140.00	14
DC 9.32	Diesel	9300	5	130.00	140.00	14
DC 9.35 Euro 5	Diesel	9300	5	130.00	140.00	14
DC 9.36 Euro 5	Diesel	9300	5	130.00	140.00	14
DC 9.37 Euro 5	Diesel	9300	5	130.00	140.00	14
DC 9.38 Euro 5	Diesel	9300	5	130.00	140.00	14
DC 9.39 Euro 5	Diesel	9300	5	130.00	140.00	14
DC 9E.02	Ethanol	8867	5	127.00	140.00	7
DC 12.01 Euro 3	Diesel	11700	6	127.00	154.00	12
DC 12.02 Euro 2	Diesel	11700	6	127.00	154.00	12
DC 12.03 Euro 3	Diesel	11700	6	127.00	154.00	12
DC 12.06 Euro 3	Diesel	11700	6	127.00	154.00	12
DC 12.09 Euro 3	Diesel	11700	6	127.00	154.00	12
DC 12.10 Euro 4	Diesel	11700	6	127.00	154.00	12
DC 12.13 Euro 4	Diesel	11700	6	127.00	154.00	12
DC 12.14 Euro 3	Diesel	11716	6	127.00	154.00	12
DC 12.15	Diesel	11716	6	127.00	154.00	12
DC 12.17 Euro 3	Diesel	11716	6	127.00	154.00	12
DC 12.18 Euro 5	Diesel	11716	6	127.00	154.00	12
DC 12.22 Euro 5	Diesel	11716	6	127.00	154.00	12
DC 12.23 Euro 4	Diesel	11716	6	127.00	154.00	12
DC 12.24 Euro 4	Diesel	11716	6	127.00	154.00	12
DC 12.26 Euro 4	Diesel	11716	6	127.00	154.00	12
DC 13.05 Euro 5	Diesel	12742	6	130.00	160.00	15
DC 13.06 Euro 5	Diesel	12742	6	130.00	160.00	15
DC 13.07 Euro 5	Diesel	12742	6	130.00	160.00	15
DC 13.08	Diesel	12742	6	130.00	160.00	15
DC 13.101 Euro 4 (D4)	Diesel	12742	6	130.00	160.00	15
DC 13.102 Euro 4 (D4)	Diesel	12742	6	130.00	160.00	15
DC 13.103 Euro 4 (D4)	Diesel	12742	6	130.00	160.00	15
DC 13.104 Euro 4 (D4)	Diesel	12742	6	130.00	160.00	15
DC 13.106 Euro 3	Diesel	12742	6	130.00	160.00	15
DC 13.107 Euro 4 (D4)	Diesel	12742	6	130.00	160.00	15
DC 13.108 Euro 4 (D4)	Diesel	12742	6	130.00	160.00	15
DC 13.109 Euro 6	Diesel	12742	6	130.00	160.00	15
DC 13.10 Euro 5	Diesel	12742	6	130.00	160.00	15
DC 13.11	Diesel	12742	6	130.00	160.00	15
DC 13.110 Euro 6	Diesel	12742	6	130.00	160.00	15
DC 13.111 Euro 5/EEV	Diesel	12742	6	130.00	160.00	15
DC 13.112 Euro 5	Diesel	12742	6	130.00	160.00	15
DC 13.113 Euro 5	Diesel	12742	6	130.00	160.00	15
DC 13.114 Euro 5	Diesel	12742	6	130.00	160.00	15
DC 13.115 Euro 6	Diesel	12742	6	130.00	160.00	15
DC 13.116 Euro 6	Diesel	12742	6	130.00	160.00	15
DC 13.119 Euro 6	Diesel	12742	6	130.00	160.00	15

		cm ³	x 			
DC 13.120 EEV	Diesel	12742	6	130.00	160.00	15
DC 13.121 EEV	Diesel	12742	6	130.00	160.00	15
DC 13.124 Euro 6	Diesel	12742	6	130.00	160.00	15
DC 13.125 Euro 6	Diesel	12742	6	130.00	160.00	15
DC 13.147 Euro 6	Diesel	12742	6	130.00	160.00	15
DC 16.01 Euro 3	Diesel	15600	V8	127.00	154.00	13
DC 16.02 Euro 3	Diesel	15600	V8	127.00	154.00	13
DC 16.03 Euro 3	Diesel	15600	V8	127.00	154.00	13
DC 16.04 Euro 3	Diesel	15600	V8	127.00	154.00	13
DC 16.05 Euro 4	Diesel	15600	V8	127.00	154.00	13
DC 16.06 Euro 4	Diesel	15600	V8	127.00	154.00	13
DC 16.08 Euro 4	Diesel	15600	V8	127.00	154.00	13
DC 16.09 Euro 5	Diesel	15600	V8	127.00	154.00	13
DC 16.17 Euro 5	Diesel	15600	V8	127.00	154.00	13
DC 16.18 Euro 5	Diesel	15600	V8	127.00	154.00	13
DC 16.19 Euro 5	Diesel	15600	V8	127.00	154.00	13
DN 8.01	Diesel	7800	6	115.00	125.00	1
DN 9.01	Diesel	8475	6	115.00	136.00	2
DN 11.01	Diesel	11020	6	127.00	145.00	11
DN 11.01 B10	Diesel	11022	6	127.00	145.00	10
DN 11.01 C 09	Diesel	11020	6	127.00	145.00	10
DN 11.04 B10	Diesel	11022	6	127.00	145.00	10
DN 11.04 C 01	Diesel	11022	6	127.00	145.00	10
DN 11.06	Diesel	11020	6	127.00	145.00	10
DN 11.06 B	Diesel	11020	6	127.00	145.00	10
DN 11.06 C	Diesel	11020	6	127.00	145.00	10
DN 11.07	Diesel	11022	6	127.00	145.00	10
DN 11.08	Diesel	11022	6	127.00	145.00	10
DN 11.08 B01	Diesel	11020	6	127.00	145.00	10
DS 8	Diesel	7800	6	115.00	125.00	1
DS 8.01	Diesel	7800	6	115.00	125.00	1
DS 8.01 B10	Diesel	7800	6	115.00	125.00	1
DS 8.01 B11	Diesel	7800	6	115.00	125.00	1
DS 8.01 B12	Diesel	7800	6	115.00	125.00	1
DS 8.05	Diesel	7800	6	115.00	125.00	1
DS 8.05 B	Diesel	7800	6	115.00	125.00	1
DS 8.06	Diesel	7800	6	115.00	125.00	1
DS 9.01	Diesel	8475	6	115.00	136.00	3
DS 9.02	Diesel	8475	6	115.00	136.00	2
DS 9.03 B 01	Diesel	8480	6	115.00	136.00	2
DS 9.03 B 02	Diesel	8480	6	115.00	136.00	2
DS 9.05 B 01	Diesel	8475	6	115.00	136.00	2
DS 9.05 B 02	Diesel	8475	6	115.00	136.00	2
DS 9.05 Euro 1	Diesel	8475	6	115.00	136.00	2
DS 9.06	Diesel	8475	6	115.00	136.00	3
DS 9.08	Diesel	8475	6	115.00	136.00	3
DS 11	Diesel	11022	6	127.00	145.00	10
DS 11.01	Diesel	11022	6	127.00	145.00	10
DS 11.01 B 06	Diesel	11000	6	127.00	145.00	10
DS 11.02	Diesel	11022	6	127.00	145.00	10
DS 11.10	Diesel	11020	6	127.00	145.00	10
DS 11.14	Diesel	11022	6	127.00	145.00	11
DS 11.15	Diesel	11022	6	127.00	145.00	11
DS 11.15 B	Diesel	11022	6	127.00	145.00	10
DS 11.18	Diesel	11022	6	127.00	145.00	10
DS 11.22	Diesel	11022	6	127.00	145.00	10
DS 11.23	Diesel	11022	6	127.00	145.00	10
DS 11.25	Diesel	11022	6	127.00	145.00	10
DS 11.34	Diesel	11020	6	127.00	145.00	11
DS 11.34 B	Diesel	11020	6	127.00	145.00	10
DS 11.34 BO 6	Diesel	11020	6	127.00	145.00	10
DS 11.34 C	Diesel	11020	6	127.00	145.00	10
DS 11.71	Diesel	11020	6	127.00	145.00	10
DS 11.71 C	Diesel	11020	6	127.00	145.00	10
DS 11.72	Diesel	11022	6	127.00	145.00	10
DS 11.73	Diesel	11020	6	127.00	145.00	11
DS 11.73 B	Diesel	11020	6	127.00	145.00	10
DS 11.74	Diesel	11020	6	127.00	145.00	10
DS 11.74 C	Diesel	11020	6	127.00	145.00	10

		cm3	x 			
DS 11.75	Diesel	11020	6	127.00	145.00	11
DS 11.76	Diesel	11020	6	127.00	145.00	10
DS 11.78	Diesel	11020	6	127.00	145.00	10
DS 14	Diesel	14181	V8	127.00	140.00	8
DS 14.01	Diesel	14190	V8	127.00	140.00	8
DS 14.01 L 01	Diesel	14200	V8	127.00	140.00	9
DS 14.02	Diesel	14190	V8	127.00	140.00	8
DS 14.06	Diesel	14190	V8	127.00	140.00	9
DS 14.06 L 01	Diesel	14200	V8	127.00	140.00	8
DS 14.07	Diesel	14190	V8	127.00	140.00	8
DS 14 LB 05	Diesel	14200	V8	127.00	140.00	9
DS 14 LB 08	Diesel	14200	V8	127.00	140.00	8
DSC 9.01	Diesel	8475	6	115.00	136.00	3
DSC 9.02	Diesel	8475	6	115.00	136.00	2
DSC 9.07 Euro 1	Diesel	8475	6	115.00	136.00	2
DSC 9.08 Euro 1	Diesel	8475	6	115.00	136.00	2
DSC 9.09 Euro 2	Diesel	8475	6	115.00	136.00	2
DSC 9.10 Euro 1	Diesel	8475	6	115.00	136.00	2
DSC 9.11	Diesel	9000	6	115.00	144.00	5
DSC 9.12 Euro 2	Diesel	9000	6	115.00	144.00	5
DSC 9.13 Euro 2	Diesel	9000	6	115.00	144.00	5
DSC 9.15 Euro 2	Diesel	9000	6	115.00	144.00	5
DSC 11.01	Diesel	11020	6	127.00	145.00	10
DSC 11.01 B	Diesel	11022	6	127.00	145.00	10
DSC 11.02	Diesel	11022	6	127.00	145.00	10
DSC 11.03	Diesel	11020	6	127.00	145.00	10
DSC 11.04	Diesel	11020	6	127.00	145.00	10
DSC 11.04 C	Diesel	11020	6	127.00	145.00	10
DSC 11.06	Diesel	11020	6	127.00	145.00	11
DSC 11.07	Diesel	11020	6	127.00	145.00	11
DSC 11.08	Diesel	11020	6	127.00	145.00	11
DSC 11.08 B	Diesel	11020	6	127.00	145.00	10
DSC 11.08 C	Diesel	11020	6	127.00	145.00	10
DSC 11.10	Diesel	11020	6	127.00	145.00	10
DSC 11.12	Diesel	11020	6	127.00	145.00	10
DSC 11.13	Diesel	11020	6	127.00	145.00	11
DSC 11.13 B	Diesel	11020	6	127.00	145.00	10
DSC 11.16	Diesel	11020	6	127.00	145.00	11
DSC 11.16 B	Diesel	11020	6	127.00	145.00	10
DSC 11.17	Diesel	11020	6	127.00	145.00	11
DSC 11.17 B	Diesel	11020	6	127.00	145.00	10
DSC 11.18	Diesel	11020	6	127.00	145.00	11
DSC 11.18 B	Diesel	11020	6	127.00	145.00	10
DSC 11.18 BO 1	Diesel	11020	6	127.00	145.00	10
DSC 11.18 L01	Diesel	11020	6	127.00	145.00	10
DSC 11.21 Euro 1	Diesel	11020	6	127.00	145.00	11
DSC 11.22 Euro 1	Diesel	11020	6	127.00	145.00	11
DSC 11.23 Euro 1	Diesel	11020	6	127.00	145.00	11
DSC 11.24 Euro 2	Diesel	11020	6	127.00	145.00	11
DSC 11.27	Diesel	11020	6	127.00	145.00	10
DSC 11.27 C	Diesel	11020	6	127.00	145.00	10
DSC 11.30	Diesel	11020	6	127.00	145.00	11
DSC 11.32	Diesel	11020	6	127.00	145.00	10
DSC 11.33	Diesel	11020	6	127.00	145.00	10
DSC 11.35	Diesel	11020	6	127.00	145.00	10
DSC 11.36	Diesel	11020	6	127.00	145.00	10
DSC 11.39 Euro 1	Diesel	11020	6	127.00	145.00	10
DSC 11.70 Euro 2	Diesel	11020	6	127.00	145.00	11
DSC 11.71	Diesel	11020	6	127.00	145.00	10
DSC 11.74 Euro 1	Diesel	11020	6	127.00	145.00	10
DSC 11.75 Euro 1	Diesel	11020	6	127.00	145.00	10
DSC 11.79	Diesel	11000	6	127.00	145.00	11
DSC 11.81	Diesel	11020	6	127.00	145.00	11
DSC 12.01 Euro 2	Diesel	11700	6	127.00	154.00	12
DSC 12.02 Euro 2	Diesel	11700	6	127.00	154.00	12
DSC 12.03 Euro 2	Diesel	11700	6	127.00	154.00	12
DSC 12.05 Euro 2	Diesel	11700	6	127.00	154.00	12
DSC 12.06 Euro 2	Diesel	11700	6	127.00	154.00	12
DSC 14.01	Diesel	14190	V8	127.00	140.00	9

		cm ³	x 			
DSC 14.02	Diesel	14190	V8	127.00	140.00	9
DSC 14.03	Diesel	14190	V8	127.00	140.00	9
DSC 14.03 L07	Diesel	14188	V8	127.00	140.00	8
DSC 14.04	Diesel	14190	V8	127.00	140.00	9
DSC 14.05	Diesel	14190	V8	127.00	140.00	8
DSC 14.06	Diesel	14190	V8	127.00	140.00	9
DSC 14.07 L 01	Diesel	14200	V8	127.00	140.00	8
DSC 14.08 Euro 1	Diesel	14190	V8	127.00	140.00	9
DSC 14.09 Euro 1	Diesel	14190	V8	127.00	140.00	9
DSC 14.10 Euro 1	Diesel	14190	V8	127.00	140.00	9
DSC 14.13 Euro 2	Diesel	14200	V8	127.00	140.00	9
DSC 14.15 Euro 3	Diesel	14200	V8	127.00	140.00	9
DSC 14.16 Euro 2	Diesel	14190	V8	127.00	140.00	9
DSI 8.01	Diesel	7800	6	115.00	125.00	1
DSI 8.01 B	Diesel	7800	6	115.00	125.00	1
DSI 11 EO 1	Diesel	11020	6	127.00	145.00	10
DSI 14.47	Diesel	14181	V8	127.00	140.00	8
DSI 14.50	Diesel	14181	V8	127.00	140.00	8
DSI 14.60	Diesel	14181	V8	127.00	140.00	8
DSI 14.61	Diesel	14181	V8	127.00	140.00	8
DSI 14.63	Diesel	14181	V8	127.00	140.00	8
DT 12.02 Euro 3	Diesel	11716	6	127.00	154.00	12
DT 12.03 Euro 4	Diesel	11716	6	127.00	154.00	12
DT 12.06 Euro 4	Diesel	11716	6	127.00	154.00	12
DT 12.08	Diesel	11716	6	127.00	154.00	12
DT 12.10 Euro 4	Diesel	11716	6	127.00	154.00	12
DT 12.11 Euro 4	Diesel	11716	6	127.00	154.00	12
DT 12.12 Euro 4	Diesel	11716	6	127.00	154.00	12
DT 12.14	Diesel	11716	6	127.00	154.00	12
DT 12.17 Euro 4	Diesel	11716	6	127.00	154.00	12
DT 12.18 Euro 3	Diesel	11716	6	127.00	154.00	12
DT 16.08 Euro 4	Diesel	15600	V8	127.00	154.00	13
DTC 11.01 Euro 1	Diesel	11020	6	127.00	145.00	11
DTC 11.02 Euro 2	Diesel	11020	6	127.00	145.00	11



1 115.00 x 125.00

D 8	6 Cyl.	7800cc	115-120kW (157-163PS)	Diesel	TD8795
D 8 R 01	6 Cyl.	7800cc	107kW (145PS)	Diesel	TD8834
D 8.01 B09	6 Cyl.	7800cc	114kW (155PS)	Diesel	TD5871
D 8.02 B09	6 Cyl.	7790cc	114kW (155PS)	Diesel Turbo	TD6219
DN 8.01	6 Cyl.	7800cc	123kW (167PS)	Diesel	TD8838
DS 8	6 Cyl.	7800cc	154-160kW (210-218PS)	Diesel Turbo	TD8796
DS 8.01	6 Cyl.	7800cc	154-170kW (209-231PS)	Diesel Turbo	TD8842
DS 8.01 B10	6 Cyl.	7800cc	155kW (211PS)	Diesel Turbo	TD8797
DS 8.01 B11	6 Cyl.	7800cc	155kW (211PS)	Diesel Turbo	TD5873
DS 8.01 B12	6 Cyl.	7800cc	155kW (211PS)	Diesel Turbo	TD6221
DS 8.05	6 Cyl.	7800cc	155kW (211PS)	Diesel Turbo	TD8839
DS 8.05 B	6 Cyl.	7800cc	155kW (211PS)	Diesel Turbo	TD8807
DS 8.06	6 Cyl.	7800cc	140kW (190PS)	Diesel Turbo	TD8840
DSI 8.01	6 Cyl.	7800cc	178kW (242PS)	Diesel Turbo Intercooler	TD8841
DSI 8.01 B	6 Cyl.	7800cc	170kW (231PS)	Diesel Turbo Intercooler	TD8809

BE/PL	6	74,991/75,000	78,702/78,721	42,400	1,833	0,036/0,089	EC	71-3191	71-3191/6 STD
MB/HL 1-7	7	84,978/85,000	89,399/89,422	32,000	2,177	0,045/0,115	EC	72-3549	H987/7 STD

2 115.00 x 136.00

DN 9.01	6 Cyl.	8475cc	128-150kW (174-204PS)	Diesel	TD8843
DS 9.02	6 Cyl.	8475cc	167-185kW (227-252PS)	Diesel Turbo	TD8845
DS 9.03 B 01	6 Cyl.	8480cc	150kW (204PS)	Diesel Turbo	TD5875
DS 9.03 B 02	6 Cyl.	8480cc	150kW (204PS)	Diesel Turbo	TD6223
DS 9.05 B 01	6 Cyl.	8475cc	181kW (246PS)	Diesel Turbo	TD5876
DS 9.05 B 02	6 Cyl.	8475cc	181kW (246PS)	Diesel Turbo	TD6224
DS 9.05 Euro 1	6 Cyl.	8475cc	185kW (252PS)	Diesel Turbo	TD8846
DSC 9.02	6 Cyl.	8475cc	207kW (282PS)	Diesel Turbo Intercooler	TD8849
DSC 9.07 Euro 1	6 Cyl.	8475cc	185kW (252PS)	Diesel Turbo Intercooler	TD8851
DSC 9.08 Euro 1	6 Cyl.	8475cc	208kW (283PS)	Diesel Turbo Intercooler	TD8810
DSC 9.09 Euro 2	6 Cyl.	8475cc	184kW (250PS)	Diesel Turbo Intercooler	TD13068
DSC 9.10 Euro 1	6 Cyl.	8475cc	162kW (220PS)	Diesel Turbo Intercooler	TD8852

BE/PL	6	79,978/80,000	84,230/84,252	42,250	2,090	0,050/0,119	BS	1290CP	71-4214/6 STD 0.25
MB/HL 1-7	7	89,978/90,000	94,200/94,222	35,500	2,070	0,060/0,129	BS	1291CP	H1073/7 STD 0.25

→10/96

MB/HL 1-7	7	94,978/95,000	99,200/99,222	35,500	2,070		BS	1293CP	H1280/7 STD 0.25 0.50
--------------	---	---------------	---------------	--------	-------	--	----	--------	---------------------------------

11/96→

TW/A	4	100,650/101,000	125,100/125,500		3,510		BS	1291BF	A271/4 STD
------	---	-----------------	-----------------	--	-------	--	----	--------	----------------------

→10/96

TW/A	4	130,000/130,350	106,000/106,350		3,430		EC	54-4843	A300/4 STD
------	---	-----------------	-----------------	--	-------	--	----	---------	----------------------

11/96→

CB/NWB	7	66,930/66,950	71,000/71,030	35,000		0,046/0,146	BS	53-4863	N199/7 STD
--------	---	---------------	---------------	--------	--	-------------	----	---------	----------------------



3		115.00 x 136.00								
DS 9.01		6 Cyl.		8475cc	180-185kW (245-252PS)			Diesel Turbo		TD8844
DS 9.06		6 Cyl.		8475cc	167kW (227PS)			Diesel Turbo		TD8847
DS 9.08		6 Cyl.		8475cc	155-185kW (211-252PS)			Diesel Turbo		TD8850
DSC 9.01		6 Cyl.		8475cc	202kW (275PS)			Diesel Turbo Intercooler		TD8848
BE/PL	6	79,978/80,000	84,230/84,252	42,250	2,090	0,050/0,119	BS	1290CP	71-4214/6 STD 0.25	
MB/HL 1-7	7	89,978/90,000	94,200/94,222	35,500	2,070	0,060/0,129	BS	1291CP	H1073/7 STD 0.25	
TW/A	4	100,650/101,000	125,100/125,500		3,510		BS	1291BF	A271/4 STD	
CB/NWB	7	66,930/66,950	71,000/71,030	35,000		0,046/0,146	BS	53-4863	N199/7 STD	

4		115.00 x 144.00								
DC 9.01 Euro 3		6 Cyl.		9000cc	169kW (230PS)			Diesel Turbo Intercooler		TD15408
DC 9.04 Euro 3		6 Cyl.		9000cc	169kW (230PS)			Diesel Turbo Intercooler		TD15410
BE/PL	6	79,978/80,000	84,230/84,252	42,250	2,090	0,050/0,119	BS	1290CP	71-4214/6 STD 0.25	
MB/HL 1-7	7	94,978/95,000	99,200/99,222	35,500	2,070		BS	1293CP	H1280/7 STD 0.25 0.50	
TW/A	4	130,000/130,350	106,000/106,350		3,430		EC	54-4843	A300/4 STD	
CB/NWB	7	66,930/66,950	71,000/71,030	35,000		0,046/0,146	BS	53-4863	N199/7 STD	

5		115.00 x 144.00								
DC 9.02 Euro 3		6 Cyl.		9000cc	191kW (260PS)			Diesel Turbo Intercooler		TD15411
DC 9.03 Euro 3		6 Cyl.		9000cc	221kW (300PS)			Diesel Turbo Intercooler		TD15413
DC 9.05 Euro 3		6 Cyl.		9000cc	191kW (260PS)			Diesel Turbo Intercooler		TD15412
DC 9.06		6 Cyl.		9000cc	221kW (300PS)			Diesel Turbo Intercooler		TD15414
DSC 9.11		6 Cyl.		9000cc	162kW (220PS)			Diesel Turbo Intercooler		TD8854
DSC 9.12 Euro 2		6 Cyl.		9000cc	191kW (260PS)			Diesel Turbo Intercooler		TD8855
DSC 9.13 Euro 2		6 Cyl.		9000cc	228kW (310PS)			Diesel Turbo Intercooler		TD8853
DSC 9.15 Euro 2		6 Cyl.		9000cc	228kW (310PS)			Diesel Turbo Intercooler		TD12608
BE/PL	6	79,978/80,000	84,230/84,252	42,250	2,090	0,050/0,119	BS	1290CP	71-4214/6 STD 0.25	
MB/HL 1-7	7	89,978/90,000	94,200/94,222	35,500	2,070	0,060/0,129	BS	1291CP	H1073/7 STD 0.25	
→10/96										
MB/HL 1-7	7	94,978/95,000	99,200/99,222	35,500	2,070		BS	1293CP	H1280/7 STD 0.25 0.50	
11/96→										
TW/A	4	100,650/101,000	125,100/125,500		3,510		BS	1291BF	A271/4 STD	
→10/96										
TW/A	4	130,000/130,350	106,000/106,350		3,430		EC	54-4843	A300/4 STD	
11/96→										
CB/NWB	7	66,930/66,950	71,000/71,030	35,000		0,046/0,146	BS	53-4863	N199/7 STD	

6		127.00 x 135.00								
D 10-R 01		6 Cyl.		10260cc	121-151kW (165-205PS)			Diesel		TD5877
BE/PL	6	84,233/84,255	88,483/88,505	48,000	2,089	0,050/0,119	BS	66745CP	71-4237/6 STD 0.25 0.50 0.75	

MB/HL 1-3, 5-7	6	101,598/101,620	106,262/106,284	35,950	2,296	0,050/0,119	BS	66746CP	H1059/7 STD 0.25 0.50 0.75
MB/HL 4	1	101,598/101,620	106,262/106,284	44,000	2,296	0,050/0,119	BS	66747CP	
TW/A	4	112,650/113,030	132,500/132,900		3,430		BS	66747BF	A216/4 STD .005 0.25
01/75 →									
SE/PB	1	49,995/50,000	53,800/53,830	48,550			BS	66754Y	55-4240 SEMI
SE/PB	1	49,758	53,949	23,430	2,020		BS	36 40 25	55-4504 SEMI
CB/NWB 1	1	68,136/68,155	71,438/71,488	35,310			BS	53-4838	N197/4 SEMI
CB/NWB 2,3	2		71,438/71,488	30,400			BS	53-4839	
CB/NWB 4	1	59,951/59,970	63,475/63,525	30,400			BS	53-4840	

7 127.00 x 140.00

DC 9.11 Euro 3			5 Cyl.	8867cc	228kW (310PS)		Diesel Turbo Intercooler	TD18048	
DC 9.12 Euro 3			5 Cyl.	8867cc	198kW (270PS)		Diesel Turbo Intercooler	TD18047	
DC 9.13 Euro 3			5 Cyl.	8867cc	169kW (230PS)		Diesel Turbo Intercooler	TD18045	
DC 9.16 Euro 4			5 Cyl.	8867cc	169kW (230PS)		Diesel Turbo Intercooler	TD18641	
DC 9.17 Euro 4			5 Cyl.	8867cc	198kW (270PS)		Diesel Turbo Intercooler	TD18642	
DC 9.18 Euro 4			5 Cyl.	8867cc	228kW (310PS)		Diesel Turbo Intercooler	TD18643	
DC 9.20 Euro 3			5 Cyl.	8867cc	198-199kW (269-271PS)		Diesel Turbo Intercooler	TD21006	
DC 9E.02			5 Cyl.	8867cc	198kW (269PS)		Ethanol Turbo Intercooler	TD23701	
BE/PL	1	86,978/87,000	91,230/91,252	45,200	2,090	0,050/0,118	BS	71-4860	71-4860 STD 0.25 0.50
MB/HL	1	107,978/108,000	112,200/112,222	34,400	2,070	0,060/0,129	BS	72-4072	72-4072 STD 0.25 0.50
TW/A	4	118,650/119,000	143,700/144,100		3,430		BS	4681BF	A232/4 STD
SE/PB	1	53,995/54,000	57,800/57,830	48,250			BS	4689Y	55-4544 SEMI

8 127.00 x 140.00

D 14			V8 Cyl.	14181cc	202kW (275PS)		Diesel	TD8804	
DS 14			V8 Cyl.	14181cc	257kW (350PS)		Diesel Turbo	TD8835	
DS 14 LB 08			V8 Cyl.	14200cc	276kW (375PS)		Diesel Turbo	TD8895	
DS 14.01			V8 Cyl.	14190cc	283-293kW (385-398PS)		Diesel Turbo	TD8902	
DS 14.02			V8 Cyl.	14190cc	309-320kW (420-435PS)		Diesel Turbo	TD22368	
DS 14.06 L 01			V8 Cyl.	14200cc	290kW (394PS)		Diesel Turbo	TD8904	
DS 14.07			V8 Cyl.	14190cc	293kW (398PS)		Diesel Turbo	TD8897	
DSC 14.03 L07			V8 Cyl.	14188cc	331kW (450PS)		Diesel Turbo Intercooler	TD8913	
DSC 14.05			V8 Cyl.	14190cc	318kW (432PS)		Diesel Turbo Intercooler	TD8900	
DSC 14.07 L 01			V8 Cyl.	14200cc	298kW (405PS)		Diesel Turbo Intercooler	TD8905	
DSI 14.47			V8 Cyl.	14181cc	341kW (464PS)		Diesel Turbo Intercooler	TD19149	
DSI 14.50			V8 Cyl.	14181cc	341kW (464PS)		Diesel Turbo Intercooler	TD19150	
DSI 14.60			V8 Cyl.	14181cc	341kW (464PS)		Diesel Turbo Intercooler	TD19151	
DSI 14.61			V8 Cyl.	14181cc	341kW (464PS)		Diesel Turbo Intercooler	TD19152	
DSI 14.63			V8 Cyl.	14181cc	341kW (464PS)		Diesel Turbo Intercooler	TD19153	
BE/PL	8	89,978/90,000	94,000/94,022	41,250	1,976	0,048/0,117	BS	66750CP	71-4249/8 STD 0.25 0.50 0.75 1.00
MB/HL 1-5	5	101,598/101,620	106,262/106,284	40,000	2,296	0,050/0,119	BS	66751CP	H1060/5 STD 0.25 0.50 0.75 1.00

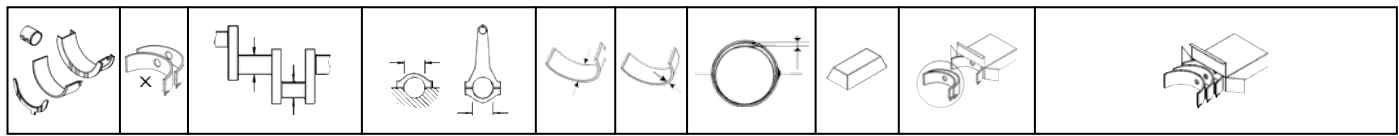

TW/A	4	112,650/113,030	132,500/132,900		3,430		BS	66747BF	A216/4 STD .005 0.25
01/75 →									
SE/PB	1	49,995/50,000	53,800/53,830	48,550			BS	66754Y	55-4240 SEMI
SE/PB	1	49,758	53,949	23,430	2,020		BS	36 40 25	55-4504 SEMI

9 127.00 x 140.00

DS 14 LB 05	V8 Cyl.	14200cc	257kW (350PS)	Diesel Turbo	TD8894
DS 14.01 L 01	V8 Cyl.	14200cc	276kW (375PS)	Diesel Turbo	TD8903
DS 14.06	V8 Cyl.	14190cc	285-291kW (388-396PS)	Diesel Turbo	TD8896
DSC 14.01	V8 Cyl.	14190cc	309kW (420PS)	Diesel Turbo Intercooler	TD8898
DSC 14.02	V8 Cyl.	14190cc	301kW (409PS)	Diesel Turbo Intercooler	TD8899
DSC 14.03	V8 Cyl.	14190cc	331kW (450PS)	Diesel Turbo Intercooler	TD8906
DSC 14.04	V8 Cyl.	14190cc	346kW (470PS)	Diesel Turbo Intercooler	TD8907
DSC 14.06	V8 Cyl.	14190cc	297-309kW (404-420PS)	Diesel Turbo Intercooler	TD8901
DSC 14.08 Euro 1	V8 Cyl.	14190cc	309-331kW (420-450PS)	Diesel Turbo Intercooler	TD8908
DSC 14.09 Euro 1	V8 Cyl.	14190cc	368kW (500PS)	Diesel Turbo Intercooler	TD8909
DSC 14.10 Euro 1	V8 Cyl.	14190cc	333-346kW (453-471PS)	Diesel Turbo Intercooler	TD8910
DSC 14.13 Euro 2	V8 Cyl.	14200cc	390kW (530PS)	Diesel Turbo Intercooler	TD8911
DSC 14.15 Euro 3	V8 Cyl.	14200cc	338kW (460PS)	Diesel Turbo Intercooler	TD8914
DSC 14.16 Euro 2	V8 Cyl.	14190cc	368kW (500PS)	Diesel Turbo Intercooler	TD8912

BE/PL	8	89,978/90,000	94,000/94,022	41,250	1,976	0,048/0,117	BS	66750CP	71-4249/8 STD 0.25 0.50 0.75 1.00
MB/HL 1-5	5	101,598/101,620	106,262/106,284	40,000	2,296	0,050/0,119	BS	66751CP	H1060/5 STD 0.25 0.50 0.75 1.00
TW/A	4	112,650/113,030	132,500/132,900		3,430		BS	66747BF	A216/4 STD .005 0.25
SE/PB	1	49,995/50,000	53,800/53,830	48,550			BS	66754Y	55-4240 SEMI
SE/PB	1	49,758	53,949	23,430	2,020		BS	36 40 25	55-4504 SEMI

10 127.00 x 145.00

D 11	6 Cyl.	11022cc	140-149kW (190-203PS)	Diesel	TD8794
D 11 R 23	6 Cyl.	11022cc	143kW (195PS)	Diesel	TD8805
DN 11.01 B10	6 Cyl.	11022cc	155kW (211PS)	Diesel	TD5872
DN 11.01 C 09	6 Cyl.	11020cc	158kW (215PS)	Diesel	TD8836
DN 11.04 B10	6 Cyl.	11022cc	155kW (211PS)	Diesel	TD6220
DN 11.04 C 01	6 Cyl.	11022cc	158kW (215PS)	Diesel Turbo	TD8837
DN 11.06	6 Cyl.	11020cc	134kW (182PS)	Diesel	TD8875
DN 11.06 B	6 Cyl.	11020cc	143kW (195PS)	Diesel	TD8800
DN 11.06 C	6 Cyl.	11020cc	143-149kW (194-203PS)	Diesel	TD8817
DN 11.07	6 Cyl.	11022cc	139kW (189PS)	Diesel	TD8808
DN 11.08	6 Cyl.	11022cc	150kW (204PS)	Diesel	TD8886
DN 11.08 B01	6 Cyl.	11020cc	149kW (203PS)	Diesel	TD8889
DS 11	6 Cyl.	11022cc	184-202kW (250-275PS)	Diesel Turbo	TD8798
DS 11.01	6 Cyl.	11022cc	184-202kW (250-275PS)	Diesel Turbo	TD5874
DS 11.01 B 06	6 Cyl.	11000cc	202kW (275PS)	Diesel Turbo	TD8799
DS 11.02	6 Cyl.	11022cc	206-245kW (280-333PS)	Diesel Turbo Intercooler	TD8864
DS 11.10	6 Cyl.	11020cc	265kW (360PS)	Diesel Turbo	TD8865
DS 11.15 B	6 Cyl.	11022cc	224kW (305PS)	Diesel Turbo Intercooler	TD8801
DS 11.18	6 Cyl.	11022cc	254kW (345PS)	Diesel Turbo Intercooler	TD8857
DS 11.22	6 Cyl.	11022cc	280kW (381PS)	Diesel Turbo	TD7436



DS 11.23			6 Cyl.	11022cc	266kW (362PS)		Diesel Turbo	TD7180
DS 11.25			6 Cyl.	11022cc	185-189kW (252-260PS)		Diesel Turbo	TD8856
DS 11.34 B			6 Cyl.	11020cc	228kW (310PS)		Diesel Turbo	TD8818
DS 11.34 BO 6			6 Cyl.	11020cc	230kW (313PS)		Diesel Turbo	TD8830
DS 11.34 C			6 Cyl.	11020cc	228kW (310PS)		Diesel Turbo	TD8866
DS 11.71			6 Cyl.	11020cc	189kW (257PS)		Diesel Turbo	TD8873
DS 11.71 C			6 Cyl.	11020cc	189kW (257PS)		Diesel Turbo	TD5878
DS 11.72			6 Cyl.	11022cc	230kW (313PS)		Diesel Turbo	TD8858
DS 11.73 B			6 Cyl.	11020cc	230kW (313PS)		Diesel Turbo	TD8819
DS 11.74			6 Cyl.	11020cc	194kW (257PS)		Diesel Turbo	TD8820
DS 11.74 C			6 Cyl.	11020cc	189kW (257PS)		Diesel Turbo	TD6226
DS 11.76			6 Cyl.	11020cc	190kW (258PS)		Diesel Turbo	TD8890
DS 11.78			6 Cyl.	11020cc	200kW (272PS)		Diesel Turbo Intercooler	TD8822
DSC 11.01			6 Cyl.	11020cc	230kW (313PS)		Diesel Turbo Intercooler	TD8811
DSC 11.01 B			6 Cyl.	11022cc	254kW (345PS)		Diesel Turbo Intercooler	TD8802
DSC 11.02			6 Cyl.	11022cc	267kW (363PS)		Diesel Turbo Intercooler	TD8860
DSC 11.03			6 Cyl.	11020cc	254kW (345PS)		Diesel Turbo Intercooler	TD8862
DSC 11.04			6 Cyl.	11020cc	189-245kW (257-333PS)		Diesel Turbo Intercooler	TD8868
DSC 11.04 C			6 Cyl.	11020cc	189kW (257PS)		Diesel Turbo Intercooler	TD5879
DSC 11.08 B			6 Cyl.	11020cc	228kW (310PS)		Diesel Turbo Intercooler	TD8828
DSC 11.08 C			6 Cyl.	11020cc	228kW (310PS)		Diesel Turbo Intercooler	TD8867
DSC 11.10			6 Cyl.	11020cc	280kW (381PS)		Diesel Turbo Intercooler	TD8877
DSC 11.12			6 Cyl.	11020cc	254kW (345PS)		Diesel Turbo Intercooler	TD8861
DSC 11.13 B			6 Cyl.	11020cc	267kW (363PS)		Diesel Turbo Intercooler	TD8824
DSC 11.16 B			6 Cyl.	11020cc	239kW (325PS)		Diesel Turbo Intercooler	TD8825
DSC 11.17 B			6 Cyl.	11020cc	235kW (320PS)		Diesel Turbo Intercooler	TD8829
DSC 11.18 B			6 Cyl.	11020cc	267kW (363PS)		Diesel Turbo Intercooler	TD8827
DSC 11.18 BO 1			6 Cyl.	11020cc	265kW (360PS)		Diesel Turbo Intercooler	TD8831
DSC 11.18 L01			6 Cyl.	11020cc	267kW (360PS)		Diesel Turbo Intercooler	TD8891
DSC 11.27			6 Cyl.	11020cc	180-200kW (245-272PS)		Diesel Turbo Intercooler	TD8871
DSC 11.27 C			6 Cyl.	11020cc	189kW (257PS)		Diesel Turbo Intercooler	TD6227
DSC 11.32			6 Cyl.	11020cc	235kW (320PS)		Diesel Turbo Intercooler	TD8887
DSC 11.33			6 Cyl.	11020cc	266kW (362PS)		Diesel Turbo Intercooler	TD8888
DSC 11.35			6 Cyl.	11020cc	235-266kW (320-362PS)		Diesel Turbo Intercooler	TD8815
DSC 11.36			6 Cyl.	11020cc	235-266kW (320-362PS)		Diesel Turbo Intercooler	TD8816
DSC 11.39 Euro 1			6 Cyl.	11020cc	258kW (351PS)		Diesel Turbo Intercooler	TD8882
DSC 11.71			6 Cyl.	11020cc	235-266kW (320-362PS)		Diesel Turbo Intercooler	TD8872
DSC 11.74 Euro 1			6 Cyl.	11020cc	235-266kW (320-362PS)		Diesel Turbo Intercooler	TD22369
DSC 11.75 Euro 1			6 Cyl.	11020cc	235-266kW (320-362PS)		Diesel Turbo Intercooler	TD22370
DSI 11 EO 1			6 Cyl.	11020cc	191kW (260PS)		Diesel Turbo	TD8874

BE/PL	6	84,233/84,255	88,483/88,505	48,000	2,089	0,050/0,119	BS	66745CP	71-4237/6 STD 0.25 0.50 0.75
MB/HL 1-3, 5-7	6	101,598/101,620	106,262/106,284	35,950	2,296	0,050/0,119	BS	66746CP	H1059/7 STD 0.25 0.50 0.75
MB/HL 4	1	101,598/101,620	106,262/106,284	44,000	2,296	0,050/0,119	BS	66747CP	
TW/A	4	112,650/113,030	132,500/132,900		3,430		BS	66747BF	A216/4 STD .005 0.25

01/75→

SE/PB	1	49,995/50,000	53,800/53,830	48,550			BS	66754Y	55-4240 SEMI
SE/PB	1	49,758	53,949	23,430	2,020		BS	36 40 25	55-4504 SEMI

CB/NWB 1	1	68,136/68,155	71,438/71,488	35,310			BS	53-4838	N197/4 SEMI
CB/NWB 2,3	2		71,438/71,488	30,400			BS	53-4839	
CB/NWB 4	1	59,951/59,970	63,475/63,525	30,400			BS	53-4840	

11 127.00 x 145.00

DN 11.01			6 Cyl.	11020cc	149-153kW (203-208PS)	Diesel			TD8806
DS 11.14			6 Cyl.	11022cc	206-245kW (280-333PS)	Diesel Turbo Intercooler			TD6222
DS 11.15			6 Cyl.	11022cc	224-245kW (305-333PS)	Diesel Turbo Intercooler			TD8803
DS 11.34			6 Cyl.	11020cc	228kW (310PS)	Diesel Turbo Intercooler			TD8869
DS 11.73			6 Cyl.	11020cc	228-230kW (310-313PS)	Diesel Turbo			TD8859
DS 11.75			6 Cyl.	11020cc	228-230kW (310-313PS)	Diesel Turbo			TD8821
DSC 11.06			6 Cyl.	11020cc	229kW (311PS)	Diesel Turbo Intercooler			TD8863
DSC 11.07			6 Cyl.	11020cc	250kW (340PS)	Diesel Bi-Turbo Intercooler			TD30335
DSC 11.08			6 Cyl.	11020cc	228-280kW (310-381PS)	Diesel Turbo Intercooler			TD8823
DSC 11.13			6 Cyl.	11020cc	267kW (363PS)	Diesel Turbo Intercooler			TD8878
DSC 11.16			6 Cyl.	11020cc	239kW (325PS)	Diesel Turbo Intercooler			TD8879
DSC 11.17			6 Cyl.	11020cc	237kW (322PS)	Diesel Turbo Intercooler			TD8880
DSC 11.18			6 Cyl.	11020cc	267kW (363PS)	Diesel Turbo Intercooler			TD8826
DSC 11.21 Euro 1			6 Cyl.	11020cc	235-266kW (320-362PS)	Diesel Turbo Intercooler			TD8812
DSC 11.22 Euro 1			6 Cyl.	11020cc	280kW (381PS)	Diesel Bi-Turbo Intercooler			TD8813
DSC 11.23 Euro 1			6 Cyl.	11020cc	266kW (362PS)	Diesel Turbo Intercooler			TD8814
DSC 11.24 Euro 2			6 Cyl.	11020cc	191kW (260PS)	Diesel Turbo Intercooler			TD8870
DSC 11.30			6 Cyl.	11020cc	265-280kW (360-381PS)	Diesel Turbo Intercooler			TD8881
DSC 11.70 Euro 2			6 Cyl.	11020cc	280kW (381PS)	Diesel Turbo Intercooler			TD8884
DSC 11.79			6 Cyl.	11000cc	250kW (340PS)	Diesel Bi-Turbo Intercooler			TD12768
DSC 11.81			6 Cyl.	11020cc	305kW (415PS)	Diesel Turbo Intercooler			TD17286
DTC 11.01 Euro 1			6 Cyl.	11020cc	295kW (401PS)	Diesel Turbo Intercooler			TD8883
DTC 11.02 Euro 2			6 Cyl.	11020cc	295kW (401PS)	Diesel Turbo Intercooler			TD8885
BE/PL	6	84,233/84,255	88,483/88,505	48,000	2,089	0,050/0,119	BS	66745CP	71-4237/6 STD 0.25 0.50 0.75
MB/HL 1-3, 5-7	6	101,598/101,620	106,262/106,284	35,950	2,296	0,050/0,119	BS	66746CP	H1059/7 STD 0.25 0.50 0.75
MB/HL 4	1	101,598/101,620	106,262/106,284	44,000	2,296	0,050/0,119	BS	66747CP	
TW/A	4	112,650/113,030	132,500/132,900		3,430		BS	66747BF	A216/4 STD .005 0.25
SE/PB	1	49,995/50,000	53,800/53,830	48,550			BS	66754Y	55-4240 SEMI
SE/PB	1	49,758	53,949	23,430	2,020		BS	36 40 25	55-4504 SEMI
CB/NWB 1	1	68,136/68,155	71,438/71,488	35,310			BS	53-4838	N197/4 SEMI
CB/NWB 2,3	2		71,438/71,488	30,400			BS	53-4839	
CB/NWB 4	1	59,951/59,970	63,475/63,525	30,400			BS	53-4840	

12 127.00 x 154.00

DC 12.01 Euro 3			6 Cyl.	11700cc	309kW (420PS)	Diesel Turbo Intercooler			TD15418
DC 12.02 Euro 2			6 Cyl.	11700cc	265kW (360PS)	Diesel Turbo Intercooler			TD21080
DC 12.03 Euro 3			6 Cyl.	11700cc	308kW (420PS)	Diesel Turbo Intercooler			TD16852
DC 12.06 Euro 3			6 Cyl.	11700cc	309kW (420PS)	Diesel Turbo Intercooler			TD20875
DC 12.09 Euro 3			6 Cyl.	11700cc	309kW (420PS)	Diesel Turbo Intercooler			TD22367
DC 12.10 Euro 4			6 Cyl.	11700cc	250kW (340PS)	Diesel Turbo Intercooler			TD18644



DC 12.13 Euro 4	6 Cyl.	11700cc	280kW (380PS)	Diesel Turbo Intercooler	TD18645
DC 12.14 Euro 3	6 Cyl.	11716cc	309kW (420PS)	Diesel Turbo Intercooler	TD17453
DC 12.15	6 Cyl.	11716cc	309kW (420PS)	Diesel Turbo Intercooler	TD18647
DC 12.17 Euro 3	6 Cyl.	11716cc	279kW (379PS)	Diesel Turbo Intercooler	TD20873
DC 12.18 Euro 5	6 Cyl.	11716cc	279kW (379PS)	Diesel Turbo Intercooler	TD20874
DC 12.22 Euro 5	6 Cyl.	11716cc	309kW (420PS)	Diesel Turbo Intercooler	TD23694
DC 12.23 Euro 4	6 Cyl.	11716cc	309kW (420PS)	Diesel Turbo Intercooler	TD23698
DC 12.24 Euro 4	6 Cyl.	11716cc	280kW (381PS)	Diesel Turbo Intercooler	TD23699
DC 12.26 Euro 4	6 Cyl.	11716cc	250kW (340PS)	Diesel Turbo Intercooler	TD23700
DSC 12.01 Euro 2	6 Cyl.	11700cc	294kW (400PS)	Diesel Turbo Intercooler	TD8892
DSC 12.02 Euro 2	6 Cyl.	11700cc	265kW (360PS)	Diesel Turbo Intercooler	TD8893
DSC 12.03 Euro 2	6 Cyl.	11700cc	265-325kW (360-442PS)	Diesel Turbo Intercooler	TD22371
DSC 12.05 Euro 2	6 Cyl.	11700cc	309kW (420PS)	Diesel Turbo Intercooler	TD12870
DSC 12.06 Euro 2	6 Cyl.	11700cc	309kW (420PS)	Diesel Turbo Intercooler	TD22372
DT 12.02 Euro 3	6 Cyl.	11716cc	345kW (470PS)	Diesel Turbo Intercooler	TD16495
DT 12.03 Euro 4	6 Cyl.	11716cc	345kW (470PS)	Diesel Turbo Intercooler	TD18648
DT 12.06 Euro 4	6 Cyl.	11716cc	345kW (470PS)	Diesel Turbo Intercooler	TD17455
DT 12.08	6 Cyl.	11716cc	324kW (440PS)	Diesel Turbo Intercooler	TD16716
DT 12.10 Euro 4	6 Cyl.	11716cc	324kW (441PS)	Diesel Turbo Intercooler	TD29079
DT 12.11 Euro 4	6 Cyl.	11716cc	309kW (420PS)	Diesel Turbo Intercooler	TD17454
DT 12.12 Euro 4	6 Cyl.	11716cc	309kW (420PS)	Diesel Turbo Intercooler	TD18646
DT 12.14	6 Cyl.	11716cc	309kW (420PS)	Diesel Turbo Intercooler	TD20876
DT 12.17 Euro 4	6 Cyl.	11716cc	353kW (480PS)	Diesel Turbo Intercooler	TD20878
DT 12.18 Euro 3	6 Cyl.	11716cc	324kW (440PS)	Diesel Turbo Intercooler	TD20877

BE/PL	1	86,978/87,000	91,230/91,252	45,200	2,090	0,050/0,118	BS	71-4860	71-4860 STD 0.25 0.50
MB/HL	1	107,978/108,000	112,200/112,222	34,400	2,070	0,060/0,129	BS	72-4072	72-4072 STD 0.25 0.50
MB/HL 1-7	7	107,978/108,000	112,200/112,222	35,500	2,070	0,060/0,130	BS	4681CP	H1103/7 STD

72-4072

4681CP

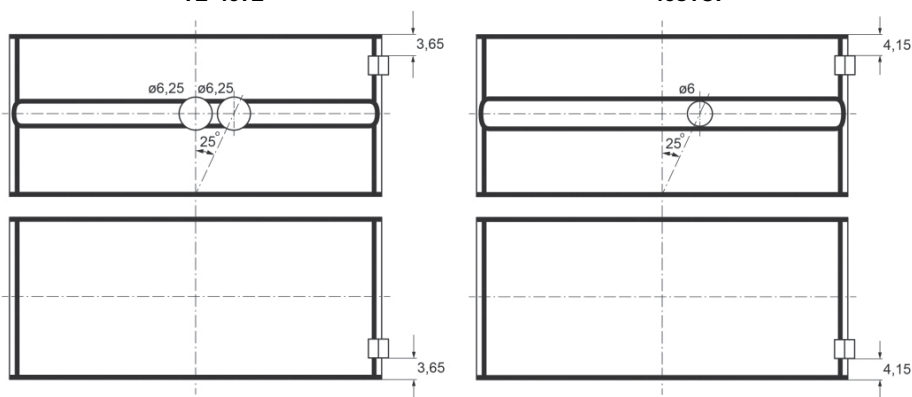

TW/A	4	118,650/119,000	143,700/144,100	3,430	BS	4681BF	A232/4 STD
SE/PB	1	53,995/54,000	57,800/57,830	48,250	BS	4689Y	55-4544 SEMI
CB/NWB 1-7	7	84,942/84,964	89,000/89,022	35,000	BS	4681DR	N173/7 STD

13

127.00 x 154.00

DC 16.01 Euro 3	V8 Cyl.	15600cc	426kW (580PS)	Diesel Turbo Intercooler	TD15429
DC 16.02 Euro 3	V8 Cyl.	15600cc	353kW (480PS)	Diesel Turbo Intercooler	TD15428
DC 16.03 Euro 3	V8 Cyl.	15600cc	426kW (580PS)	Diesel Turbo Intercooler	TD17458
DC 16.04 Euro 3	V8 Cyl.	15600cc	368kW (500PS)	Diesel Turbo Intercooler	TD17457



DC 16.05 Euro 4	V8 Cyl.	15600cc	412kW (560PS)	Diesel Turbo Intercooler	TD18649
DC 16.06 Euro 4	V8 Cyl.	15600cc	368kW (500PS)	Diesel Turbo Intercooler	TD18650
DC 16.08 Euro 4	V8 Cyl.	15600cc	456kW (620PS)	Diesel Turbo Intercooler	TD18652
DC 16.09 Euro 5	V8 Cyl.	15600cc	368kW (500PS)	Diesel Turbo Intercooler	TD18651
DC 16.17 Euro 5	V8 Cyl.	15600cc	456kW (620PS)	Diesel Turbo Intercooler	TD20881
DC 16.18 Euro 5	V8 Cyl.	15600cc	412kW (560PS)	Diesel Turbo Intercooler	TD20880
DC 16.19 Euro 5	V8 Cyl.	15600cc	368kW (500PS)	Diesel Turbo Intercooler	TD20879
DT 16.08 Euro 4	V8 Cyl.	15600cc	456kW (620PS)	Diesel Turbo Intercooler	TD21019

BE/PL	1	92,978/93,000	97,230/97,252	40,350	2,090	0,050/0,118	BS	71-4861	71-4861 STD 0.25 0.50
MB/HL	1	107,978/108,000	112,200/112,222	34,400	2,070	0,060/0,129	BS	72-4072	72-4072 STD 0.25 0.50
TW/A	4	118,650/119,000	143,700/144,100		3,430		BS	4681BF	A232/4 STD
SE/PB	1	53,995/54,000	57,800/57,830	48,250			BS	4689Y	55-4544 SEMI

14

130.00 x 140.00

DC 9.22 Euro 5	5 Cyl.	9300cc	235kW (320PS)	Diesel Turbo Intercooler	TD20871
DC 9.24	5 Cyl.	9300cc	265kW (360PS)	Diesel Turbo Intercooler	TD23693
DC 9.29	5 Cyl.	9300cc	206kW (280PS)	Diesel Turbo Intercooler	TD20870
DC 9.30	5 Cyl.	9300cc	169kW (230PS)	Diesel Turbo Intercooler	TD20847
DC 9.32	5 Cyl.	9300cc	235kW (320PS)	Diesel Turbo Intercooler	TD20872
DC 9.35 Euro 5	5 Cyl.	9300cc	169kW (230PS)	Diesel Turbo Intercooler	TD20848
DC 9.36 Euro 5	5 Cyl.	9300cc	206kW (280PS)	Diesel Turbo Intercooler	TD20869
DC 9.37 Euro 5	5 Cyl.	9300cc	235kW (320PS)	Diesel Turbo Intercooler	TD23697
DC 9.38 Euro 5	5 Cyl.	9300cc	206kW (280PS)	Diesel Turbo Intercooler	TD23696
DC 9.39 Euro 5	5 Cyl.	9300cc	169kW (230PS)	Diesel Turbo Intercooler	TD23695

BE/PL	1	86,978/87,000	91,230/91,252	45,200	2,090	0,050/0,118	BS	71-4860	71-4860 STD 0.25 0.50
MB/HL	1	107,978/108,000	112,200/112,222	34,400	2,070	0,060/0,129	BS	72-4072	72-4072 STD 0.25 0.50
TW/A	4	118,650/119,000	143,700/144,100		3,430		BS	4681BF	A232/4 STD
SE/PB	1	53,995/54,000	57,800/57,830	48,250			BS	4689Y	55-4544 SEMI

15

130.00 x 160.00

DC 13.05 Euro 5	6 Cyl.	12742cc	294kW (400PS)	Diesel Turbo Intercooler	TD20882
DC 13.06 Euro 5	6 Cyl.	12742cc	265kW (360PS)	Diesel Turbo Intercooler	TD20887
DC 13.07 Euro 5	6 Cyl.	12742cc	353kW (480PS)	Diesel Turbo Intercooler	TD20886
DC 13.08	6 Cyl.	12742cc	346kW (471PS)	Diesel Turbo Intercooler	TD20885
DC 13.10 Euro 5	6 Cyl.	12742cc	324kW (441PS)	Diesel Turbo Intercooler	TD20884
DC 13.101 Euro 4 (D4)	6 Cyl.	12742cc	353kW (480PS)	Diesel Turbo Intercooler	TD28144
DC 13.102 Euro 4 (D4)	6 Cyl.	12742cc	324kW (441PS)	Diesel Turbo Intercooler	TD28143
DC 13.103 Euro 4 (D4)	6 Cyl.	12742cc	294kW (400PS)	Diesel Turbo Intercooler	TD28142
DC 13.104 Euro 4 (D4)	6 Cyl.	12742cc	265kW (360PS)	Diesel Turbo Intercooler	TD28141
DC 13.106 Euro 3	6 Cyl.	12742cc	338kW (460PS)	Diesel Turbo Intercooler	TD29021
DC 13.107 Euro 4 (D4)	6 Cyl.	12742cc	301kW (409PS)	Diesel Turbo Intercooler	TD28496
DC 13.108 Euro 4 (D4)	6 Cyl.	12742cc	265kW (360PS)	Diesel Turbo Intercooler	TD28475
DC 13.109 Euro 6	6 Cyl.	12742cc	324kW (441PS)	Diesel Turbo Intercooler	TD28126
DC 13.11	6 Cyl.	12742cc	309kW (420PS)	Diesel Turbo Intercooler	TD20883
DC 13.110 Euro 6	6 Cyl.	12742cc	353kW (480PS)	Diesel Turbo Intercooler	TD28127
DC 13.111 Euro 5/EEV	6 Cyl.	12742cc	353kW (480PS)	Diesel Turbo Intercooler	TD29019
DC 13.112 Euro 5	6 Cyl.	12742cc	324kW (441PS)	Diesel Turbo Intercooler	TD28135
DC 13.113 Euro 5	6 Cyl.	12742cc	294kW (400PS)	Diesel Turbo Intercooler	TD28133



DC 13.114 Euro 5			6 Cyl.	12742cc	265kW (360PS)		Diesel Turbo Intercooler	TD28132
DC 13.115 Euro 6			6 Cyl.	12742cc	301-302kW (409-411PS)		Diesel Turbo Intercooler	TD29007
DC 13.116 Euro 6			6 Cyl.	12742cc	272kW (370PS)		Diesel Turbo Intercooler	TD29006
DC 13.119 Euro 6			6 Cyl.	12742cc	404-405kW (549-551PS)		Diesel Turbo Intercooler	TD30800
DC 13.120 EEV			6 Cyl.	12742cc	294kW (400PS)		Diesel Turbo Intercooler	TD28134
DC 13.121 EEV			6 Cyl.	12742cc	324kW (441PS)		Diesel Turbo Intercooler	TD28136
DC 13.124 Euro 6			6 Cyl.	12742cc	331kW (450PS)		Diesel Turbo Intercooler	TD29008
DC 13.125 Euro 6			6 Cyl.	12742cc	360kW (490PS)		Diesel Turbo Intercooler	TD29009
DC 13.147 Euro 6			6 Cyl.	12742cc	331kW (450PS)		Diesel Turbo Intercooler	TD30799

MB/HL	1	107,978/108,000	112,200/112,222	34,400	2,070	0,060/0,129	BS	72-4072	72-4072 STD 0.25 0.50
TW/A	4	118,650/119,000	143,700/144,100		3,430		BS	4681BF	A232/4 STD



cm3



9

124 1.6	09/76→10/80	Petrol	FC16	1585	4	84.00	71.50	78
124 D1200	01/68→12/76	Petrol	124 A.000	1197	4	73.00	71.50	7
124 LS1200	01/70→12/76	Petrol	124 A.000	1197	4	73.00	71.50	7
124 LS1200	01/68→10/80	Petrol	FA12	1197	4	73.00	71.50	7
127 0.9	04/72→12/82	Petrol	A112 A5.000	903	4	65.00	68.00	4
131 1.6	03/82→01/85	Petrol	132 BB OA O	1592	4	80.00	79.20	50
131 2.0	06/78→12/85	Petrol	131 C4.000	1995	4	84.00	90.00	80
131 2.4 Diesel	06/78→12/86	Diesel	8144.61	2445	4	93.00	90.00	82
132 2.2 D	05/79→12/82	Diesel	OM 615.912	2197	4	87.00	92.40	81
133 0.8	05/74→11/79	Petrol	DG	837	4	65.00	63.60	3
Alhambra 1.4 TSI	06/10→	Petrol	CAVA	1390	4	76.50	75.60	18
Alhambra 1.4 TSI	06/10→	Petrol	CNWB	1390	4	76.50	75.60	18
Alhambra 1.8 T 20V	10/97→03/10	Petrol	AJH	1781	4	81.00	86.40	59
Alhambra 1.8 T 20V	10/97→03/10	Petrol	AWC	1781	4	81.00	86.40	60
Alhambra 1.9 TDI	04/96→03/10	Diesel	1Z	1896	4	79.50	95.50	35
Alhambra 1.9 TDI	08/96→06/00	Diesel	AFN	1896	4	79.50	95.50	37
Alhambra 1.9 TDI	04/96→03/10	Diesel	AHU	1896	4	79.50	95.50	41
Alhambra 1.9 TDI	04/96→03/10	Diesel	ANU	1896	4	79.50	95.50	42
Alhambra 1.9 TDI	11/02→11/08	Diesel	ASZ	1896	4	79.50	95.50	43
Alhambra 1.9 TDI	06/00→03/10	Diesel	AUY	1896	4	79.50	95.50	45
Alhambra 1.9 TDI	08/96→06/00	Diesel	AVG	1896	4	79.50	95.50	37
Alhambra 1.9 TDI	05/05→05/07	Diesel	BTB	1896	4	79.50	95.50	43
Alhambra 1.9 TDI	06/00→03/10	Diesel	BVK	1896	4	79.50	95.50	43
Alhambra 1.9 Tdi 4x4	06/05→11/08	Diesel	ASZ	1896	4	79.50	95.50	43
Alhambra 1.9 TDI 4motion	06/00→03/10	Diesel	AUY	1896	4	79.50	95.50	45
Alhambra 1.9 TDI 4motion	06/00→03/10	Diesel	BVK	1896	4	79.50	95.50	43
Alhambra 2.0 i	04/96→03/10	Petrol	ADY	1984	4	82.50	92.80	71
Alhambra 2.0 i	04/96→03/10	Petrol	ATM	1984	4	82.50	92.80	73
Alhambra 2.0 TDI	11/05→03/10	Diesel	BRT	1968	4	81.00	95.50	69
Alhambra 2.0 TDI	06/10→05/11	Diesel	CFFA	1968	4	81.00	95.50	70
Alhambra 2.0 TDI	06/10→	Diesel	CFFB	1968	4	81.00	95.50	70
Alhambra 2.0 TDI	05/11→	Diesel	CFFE	1968	4	81.00	95.50	70
Alhambra 2.0 TDI	06/10→	Diesel	CFGB	1968	4	81.00	95.50	70
Alhambra 2.0 TDI	11/12→	Diesel	CFGC	1968	4	81.00	95.50	70
Alhambra 2.0 TDI 4Drive	05/11→	Diesel	CFFB	1968	4	81.00	95.50	70
Alhambra 2.8 V6	06/00→03/10	Petrol	AUE	2792	V6	81.00	90.30	67
Alhambra 2.8 V6	06/00→03/10	Petrol	AYL	2792	V6	81.00	90.30	67
Alhambra 2.8 V6 4motion	06/00→03/10	Petrol	AUE	2792	V6	81.00	90.30	67
Alhambra 2.8 V6 4motion	06/00→03/10	Petrol	AYL	2792	V6	81.00	90.30	67
Altea 1.2 TSI	04/10→	Petrol	CBZB	1197	4	71.00	75.60	6
Altea 1.4 16V	05/06→	Petrol	BXW	1390	4	76.50	75.60	18
Altea 1.4 16V	05/06→	Petrol	CGGB	1390	4	76.50	75.60	20
Altea 1.4 TSI	11/07→	Petrol	CAXC	1390	4	76.50	75.60	18
Altea 1.6	03/04→	Petrol	BGU	1595	4	81.00	77.40	54
Altea 1.6	03/04→	Petrol	BSE	1595	4	81.00	77.40	54
Altea 1.6	03/04→	Petrol	BSF	1595	4	81.00	77.40	54
Altea 1.6	03/04→	Petrol	CCSA	1595	4	81.00	77.40	54
Altea 1.6 LPG	09/09→	Petrol	CHGA	1595	4	81.00	77.40	54
Altea 1.6 Multifuel	10/06→	Petrol	CCSA	1595	4	81.00	77.40	54
Altea 1.6 TDI	11/10→	Diesel	CAYB	1598	4	79.50	80.50	30
Altea 1.6 TDI	10/09→	Diesel	CAYC	1598	4	79.50	80.50	30
Altea 1.9 TDI	04/04→	Diesel	BJB	1896	4	79.50	95.50	46
Altea 1.9 TDI	04/04→	Diesel	BKC	1896	4	79.50	95.50	46
Altea 1.9 TDI	04/04→	Diesel	BLS	1896	4	79.50	95.50	46
Altea 1.9 TDI	04/04→	Diesel	BXE	1896	4	79.50	95.50	46
Altea 1.9 TDI	08/09→	Diesel	BXF	1896	4	79.50	95.50	46
Altea 1.9 TDI 4x4	06/09→12/10	Diesel	BLS	1896	4	79.50	95.50	46
Altea 2.0 FSI	05/04→03/09	Petrol	BLR	1984	4	82.50	92.80	74
Altea 2.0 FSI	05/04→03/09	Petrol	BLY	1984	4	82.50	92.80	74
Altea 2.0 FSI	05/04→03/09	Petrol	BVY	1984	4	82.50	92.80	74
Altea 2.0 FSI	05/04→03/09	Petrol	BVZ	1984	4	82.50	92.80	74
Altea 2.0 TDI	03/04→05/09	Diesel	AZV	1968	4	81.00	95.50	68
Altea 2.0 TDI	11/05→	Diesel	BMM	1968	4	81.00	95.50	69
Altea 2.0 TDI	03/06→	Diesel	BMN	1968	4	81.00	95.50	68
Altea 2.0 TDI	03/06→	Diesel	CEGA	1968	4	81.00	95.50	70
Altea 2.0 TDI 4x4	06/07→	Diesel	BMM	1968	4	81.00	95.50	69
Altea 2.0 TDI 4x4	06/07→	Diesel	BMN	1968	4	81.00	95.50	68
Altea 2.0 TDI 4x4	06/07→	Diesel	CEGA	1968	4	81.00	95.50	70
Altea 2.0 TDI 4x4	06/07→	Diesel	CFJA	1968	4	81.00	95.50	70

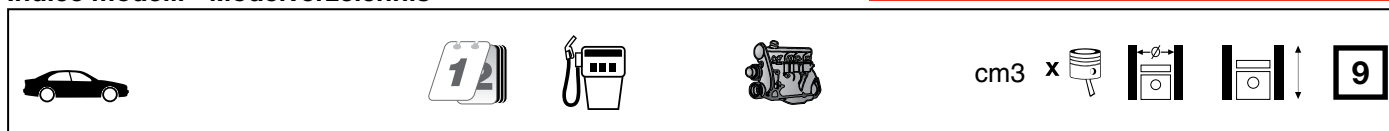

Altea 2.0 TDI 16V	03/04→	Diesel	BKD	1968	4	81.00	95.50	68
Altea 2.0 TDI 16V	03/04→	Diesel	CFHC	1968	4	81.00	95.50	70
Altea 2.0 TDI 16V 4x4	10/10→	Diesel	CFHC	1968	4	81.00	95.50	70
Arosa 1.0	10/98→01/01	Petrol	AHT	997	4	67.10	70.60	5
Arosa 1.0	05/97→06/04	Petrol	AER	999	4	67.10	70.60	5
Arosa 1.0	05/97→06/04	Petrol	ALD	999	4	67.10	70.60	5
Arosa 1.0	05/97→06/04	Petrol	ALL	999	4	67.10	70.60	5
Arosa 1.0	05/97→06/04	Petrol	ANV	999	4	67.10	70.60	5
Arosa 1.0	05/97→06/04	Petrol	AUC	999	4	67.10	70.60	5
Arosa 1.4	05/97→06/04	Petrol	AKK	1390	4	76.50	75.60	15
Arosa 1.4	05/97→06/04	Petrol	ANW	1390	4	76.50	75.60	18
Arosa 1.4	05/97→06/04	Petrol	AUD	1390	4	76.50	75.60	15
Arosa 1.4	05/97→06/04	Petrol	AEX	1391	4	76.50	75.60	13
Arosa 1.4	05/97→06/04	Petrol	AKV	1391	4	76.50	75.60	16
Arosa 1.4	05/97→06/04	Petrol	APQ	1391	4	76.50	75.60	16
Arosa 1.4 16V	01/00→06/04	Petrol	AFK	1390	4	76.50	75.60	15
Arosa 1.4 16V	01/00→06/04	Petrol	AQQ	1390	4	76.50	75.60	15
Arosa 1.4 16V	01/00→06/04	Petrol	AUB	1390	4	76.50	75.60	15
Arosa 1.4 TDI	01/00→06/04	Diesel	AMF	1422	3	79.50	95.50	33
Arosa 1.7 SDI	08/97→06/04	Diesel	AKU	1716	4	79.50	86.40	32
Cordoba 1.0	06/99→10/02	Petrol	ALD	999	4	67.10	70.60	5
Cordoba 1.0	06/99→10/02	Petrol	ANV	999	4	67.10	70.60	5
Cordoba 1.0	06/99→10/02	Petrol	AUC	999	4	67.10	70.60	5
Cordoba 1.0 16V	05/00→10/02	Petrol	AST	999	4	67.10	70.60	5
Cordoba 1.0 16V	05/00→10/02	Petrol	AVZ	999	4	67.10	70.60	5
Cordoba 1.0 CL	02/93→06/96	Petrol	AAU	1043	4	75.00	59.00	8
Cordoba 1.0 i	09/96→06/99	Petrol	AER	999	4	67.10	70.60	5
Cordoba 1.2	10/02→06/06	Petrol	AZQ	1198	3	76.50	86.90	22
Cordoba 1.2	10/02→06/06	Petrol	BME	1198	3	76.50	86.90	22
Cordoba 1.3	02/93→08/94	Petrol	2G	1272	4	75.00	72.00	10
Cordoba 1.3	02/93→08/94	Petrol	AAV	1272	4	75.00	72.00	10
Cordoba 1.4	06/99→12/02	Petrol	AKK	1390	4	76.50	75.60	15
Cordoba 1.4	06/99→12/02	Petrol	ANW	1390	4	76.50	75.60	18
Cordoba 1.4	12/97→04/99	Petrol	ANX	1390	4	76.50	75.60	16
Cordoba 1.4	02/00→12/02	Petrol	AQQ	1390	4	76.50	75.60	15
Cordoba 1.4	02/00→12/02	Petrol	AUB	1390	4	76.50	75.60	15
Cordoba 1.4	06/99→12/02	Petrol	AUD	1390	4	76.50	75.60	15
Cordoba 1.4 16V	06/99→12/02	Petrol	APE	1390	4	76.50	75.60	15
Cordoba 1.4 16V	02/00→10/02	Petrol	AQQ	1390	4	76.50	75.60	15
Cordoba 1.4 16V	06/99→12/02	Petrol	AUA	1390	4	76.50	75.60	15
Cordoba 1.4 16V	02/00→11/09	Petrol	AUB	1390	4	76.50	75.60	15
Cordoba 1.4 16V	09/02→12/07	Petrol	BBY	1390	4	76.50	75.60	15
Cordoba 1.4 16V	10/02→11/09	Petrol	BBZ	1390	4	76.50	75.60	15
Cordoba 1.4 16V	09/02→12/07	Petrol	BKY	1390	4	76.50	75.60	15
Cordoba 1.4 16V	05/06→11/09	Petrol	BXW	1390	4	76.50	75.60	18
Cordoba 1.4 i	06/94→06/99	Petrol	ABD	1390	4	75.00	78.70	11
Cordoba 1.4 i	06/94→06/99	Petrol	AEX	1391	4	76.50	75.60	13
Cordoba 1.4 i	06/94→06/99	Petrol	AKV	1391	4	76.50	75.60	16
Cordoba 1.4 i	06/94→06/99	Petrol	APQ	1391	4	76.50	75.60	16
Cordoba 1.4 i 16V	09/96→06/99	Petrol	AFH	1390	4	76.50	75.60	14
Cordoba 1.4 TDI	10/02→12/05	Diesel	AMF	1422	3	79.50	95.50	33
Cordoba 1.4 TDI	06/05→11/09	Diesel	BMS	1422	3	79.50	95.50	33
Cordoba 1.4 TDI	05/05→11/09	Diesel	BNM	1422	3	79.50	95.50	33
Cordoba 1.4 TDI	06/05→11/09	Diesel	BNV	1422	3	79.50	95.50	33
Cordoba 1.6	06/99→12/02	Petrol	AEH	1595	4	81.00	77.40	52
Cordoba 1.6	06/99→12/02	Petrol	AKL	1595	4	81.00	77.40	52
Cordoba 1.6	06/99→12/02	Petrol	APF	1595	4	81.00	77.40	52
Cordoba 1.6	06/99→12/02	Petrol	AUR	1595	4	81.00	77.40	52
Cordoba 1.6	06/99→12/02	Petrol	ABU	1598	4	76.50	86.90	23
Cordoba 1.6	06/99→12/02	Petrol	ALM	1598	4	76.50	86.90	25
Cordoba 1.6	04/03→11/09	Petrol	BAH	1598	4	76.50	86.90	28
Cordoba 1.6 16V	11/06→11/09	Petrol	BTS	1598	4	76.50	86.90	28
Cordoba 1.6 i	05/94→06/99	Petrol	1F	1595	4	81.00	77.40	51
Cordoba 1.6 i	07/96→10/99	Petrol	AFT	1595	4	81.00	77.40	53
Cordoba 1.6 i	07/96→10/99	Petrol	AKL	1595	4	81.00	77.40	52
Cordoba 1.6 i	02/93→06/99	Petrol	ABU	1598	4	76.50	86.90	23
Cordoba 1.6 i	02/93→06/99	Petrol	AEE	1598	4	76.50	86.90	24
Cordoba 1.6 i	02/93→06/99	Petrol	ALM	1598	4	76.50	86.90	25
Cordoba 1.8 i	02/93→06/99	Petrol	ABS	1781	4	81.00	86.40	57











cm3

x



9

Cordoba 1.8 i	02/93→09/02	Petrol	ACC	1781	4	81.00	86.40	57
Cordoba 1.8 i	02/93→06/99	Petrol	ADZ	1781	4	81.00	86.40	57
Cordoba 1.8 i 16V	10/93→08/96	Petrol	ADL	1781	4	81.00	86.40	57
Cordoba 1.8 T 20V Cupra	07/00→10/02	Petrol	AQX	1781	4	81.00	86.40	59
Cordoba 1.8 T 20V Cupra	07/00→10/02	Petrol	AYP	1781	4	81.00	86.40	59
Cordoba 1.9 D	02/93→08/96	Diesel	1Y	1896	4	79.50	95.50	34
Cordoba 1.9 SDI	08/96→06/99	Diesel	AEY	1896	4	79.50	95.50	36
Cordoba 1.9 SDI	06/99→12/02	Diesel	AGP	1896	4	79.50	95.50	38
Cordoba 1.9 SDI	06/99→12/02	Diesel	AQM	1896	4	79.50	95.50	34
Cordoba 1.9 SDI	09/02→11/09	Diesel	ASY	1896	4	79.50	95.50	34
Cordoba 1.9 TD	02/93→08/96	Diesel	AAZ	1896	4	79.50	95.50	35
Cordoba 1.9 TDI	08/96→06/99	Diesel	1Z	1896	4	79.50	95.50	35
Cordoba 1.9 TDI	03/97→06/99	Diesel	AFN	1896	4	79.50	95.50	37
Cordoba 1.9 TDI	06/99→12/02	Diesel	AGR	1896	4	79.50	95.50	39
Cordoba 1.9 TDI	08/96→10/02	Diesel	AHU	1896	4	79.50	95.50	41
Cordoba 1.9 TDI	06/99→12/02	Diesel	ALH	1896	4	79.50	95.50	35
Cordoba 1.9 TDI	06/99→12/02	Diesel	ASK	1896	4	79.50	95.50	44
Cordoba 1.9 TDI	06/99→12/02	Diesel	ASV	1896	4	79.50	95.50	40
Cordoba 1.9 TDI	10/02→11/09	Diesel	ASZ	1896	4	79.50	95.50	43
Cordoba 1.9 TDI	09/02→11/09	Diesel	ATD	1896	4	79.50	95.50	45
Cordoba 1.9 TDI	09/02→11/09	Diesel	AXR	1896	4	79.50	95.50	46
Cordoba 1.9 TDI	10/02→11/09	Diesel	BLT	1896	4	79.50	95.50	47
Cordoba 1.9 TDI	09/02→11/09	Diesel	BMT	1896	4	79.50	95.50	46
Cordoba 2.0	09/02→11/09	Petrol	AZL	1984	4	82.50	92.80	73
Cordoba 2.0 i	02/93→06/99	Petrol	2E	1984	4	82.50	92.80	71
Cordoba 2.0 i	02/93→06/99	Petrol	AGG	1984	4	82.50	92.80	72
Cordoba 2.0 i 16V	08/96→06/99	Petrol	ABF	1984	4	82.50	92.80	71
Exeo 1.6	03/09→09/10	Petrol	ALZ	1595	4	81.00	77.40	54
Exeo 2.0 TDI	12/08→	Diesel	CAGA	1968	4	81.00	95.50	68
Exeo 2.0 TDI	12/08→	Diesel	CAGC	1968	4	81.00	95.50	68
Exeo 2.0 TDI	02/09→	Diesel	CAHA	1968	4	81.00	95.50	68
Exeo 2.0 TDI	02/09→	Diesel	CGLB	1968	4	81.00	95.50	68
Exeo 2.0 TDI	12/08→	Diesel	CJCA	1968	4	81.00	95.50	68
Exeo 2.0 TDI	12/08→	Diesel	CJCC	1968	4	81.00	95.50	70
Fura 0.9	03/84→12/86	Petrol	09 NCA	903	4	65.00	68.00	4
Fura 0.9	01/82→06/86	Petrol	100 GL 3000	903	4	65.00	68.00	4
Fura 0.9	03/84→12/86	Petrol	100 GL 7000	903	4	65.00	68.00	4
Fura 0.9	01/82→06/86	Petrol	HB 90	903	4	65.00	68.00	4
Ibiza I 0.9	08/90→05/93	Petrol	09 NCA	903	4	65.00	68.00	4
Ibiza I 0.9	08/86→05/93	Petrol	146 A 000	903	4	65.00	68.00	4
Ibiza I 1.2	11/84→12/93	Petrol	021 A 1000	1193	4	75.00	67.50	9
Ibiza I 1.2 i	01/89→05/93	Petrol	021 C.1000	1193	4	75.00	67.50	9
Ibiza I 1.5	11/84→05/93	Petrol	021 A 2000	1461	4	83.00	67.50	75
Ibiza II 1.0	03/93→09/96	Petrol	AAU	1043	4	75.00	59.00	8
Ibiza II 1.0 i	09/96→08/99	Petrol	AER	999	4	67.10	70.60	5
Ibiza II 1.3 i	03/93→08/99	Petrol	2G	1272	4	75.00	72.00	10
Ibiza II 1.3 i	03/93→08/99	Petrol	AAV	1272	4	75.00	72.00	10
Ibiza II 1.4	12/97→04/99	Petrol	ANX	1390	4	76.50	75.60	16
Ibiza II 1.4 i	09/93→08/99	Petrol	ABD	1390	4	75.00	78.70	11
Ibiza II 1.4 i	09/93→08/99	Petrol	AEX	1391	4	76.50	75.60	13
Ibiza II 1.4 i	09/93→08/99	Petrol	AKV	1391	4	76.50	75.60	16
Ibiza II 1.4 i	09/93→08/99	Petrol	APQ	1391	4	76.50	75.60	16
Ibiza II 1.4 i 16V	06/97→08/99	Petrol	AFH	1390	4	76.50	75.60	14
Ibiza II 1.6 i	09/94→06/99	Petrol	1F	1595	4	81.00	77.40	51
Ibiza II 1.6 i	04/96→08/99	Petrol	AFT	1595	4	81.00	77.40	53
Ibiza II 1.6 i	03/93→08/99	Petrol	ABU	1598	4	76.50	86.90	23
Ibiza II 1.6 i	03/93→08/99	Petrol	AEE	1598	4	76.50	86.90	24
Ibiza II 1.6 i	03/93→08/99	Petrol	ALM	1598	4	76.50	86.90	25
Ibiza II 1.8 i	03/93→08/99	Petrol	ABS	1781	4	81.00	86.40	57
Ibiza II 1.8 i	03/93→08/99	Petrol	ACC	1781	4	81.00	86.40	57
Ibiza II 1.8 i	03/93→08/99	Petrol	ADZ	1781	4	81.00	86.40	57
Ibiza II 1.8 i 16V	11/93→08/96	Petrol	ADL	1781	4	81.00	86.40	57
Ibiza II 1.9 D	04/93→08/96	Diesel	1Y	1896	4	79.50	95.50	34
Ibiza II 1.9 D	04/93→08/96	Diesel	AEY	1896	4	79.50	95.50	36
Ibiza II 1.9 SDI	08/96→08/99	Diesel	AEY	1896	4	79.50	95.50	36
Ibiza II 1.9 TD	03/93→08/96	Diesel	AAZ	1896	4	79.50	95.50	35
Ibiza II 1.9 TDI	08/96→08/99	Diesel	1Z	1896	4	79.50	95.50	35
Ibiza II 1.9 TDI	02/97→08/99	Diesel	AFN	1896	4	79.50	95.50	37
Ibiza II 1.9 TDI	08/96→08/99	Diesel	AHU	1896	4	79.50	95.50	41

				cm3	x 			
Ibiza II 2.0 i	03/93→08/99	Petrol	2E	1984	4	82.50	92.80	71
Ibiza II 2.0 i	03/93→08/99	Petrol	AGG	1984	4	82.50	92.80	72
Ibiza II 2.0 i 16V	08/96→08/99	Petrol	ALD	1984	4	82.50	92.80	71
Ibiza III 1.0	08/99→02/02	Petrol	ABF	999	4	67.10	70.60	5
Ibiza III 1.0	08/99→02/02	Petrol	ANV	999	4	67.10	70.60	5
Ibiza III 1.0	08/99→02/02	Petrol	AUC	999	4	67.10	70.60	5
Ibiza III 1.0 16V	10/99→02/02	Petrol	AST	999	4	67.10	70.60	5
Ibiza III 1.0 16V	10/99→02/02	Petrol	AVZ	999	4	67.10	70.60	5
Ibiza III 1.4	08/99→02/02	Petrol	AKK	1390	4	76.50	75.60	15
Ibiza III 1.4	08/99→02/02	Petrol	ANW	1390	4	76.50	75.60	18
Ibiza III 1.4	08/99→02/02	Petrol	AUD	1390	4	76.50	75.60	15
Ibiza III 1.4 16V	05/00→02/02	Petrol	APE	1390	4	76.50	75.60	15
Ibiza III 1.4 16V	08/99→02/02	Petrol	AQQ	1390	4	76.50	75.60	15
Ibiza III 1.4 16V	05/00→02/02	Petrol	AUA	1390	4	76.50	75.60	15
Ibiza III 1.4 16V	08/99→02/02	Petrol	AUB	1390	4	76.50	75.60	15
Ibiza III 1.6	08/99→02/02	Petrol	AEH	1595	4	81.00	77.40	52
Ibiza III 1.6	08/99→02/02	Petrol	AKL	1595	4	81.00	77.40	52
Ibiza III 1.6	08/99→02/02	Petrol	APF	1595	4	81.00	77.40	52
Ibiza III 1.6	08/99→02/02	Petrol	AUR	1595	4	81.00	77.40	52
Ibiza III 1.6	08/99→02/02	Petrol	ALM	1598	4	76.50	86.90	25
Ibiza III 1.8 T 20V Cupra	07/00→02/02	Petrol	AQX	1781	4	81.00	86.40	59
Ibiza III 1.8 T 20V Cupra	07/00→02/02	Petrol	AYP	1781	4	81.00	86.40	59
Ibiza III 1.9 SDI	08/99→02/02	Diesel	AGP	1896	4	79.50	95.50	38
Ibiza III 1.9 SDI	08/99→02/02	Diesel	AQM	1896	4	79.50	95.50	34
Ibiza III 1.9 TDI	08/99→02/02	Diesel	AGR	1896	4	79.50	95.50	39
Ibiza III 1.9 TDI	08/99→02/02	Diesel	ALH	1896	4	79.50	95.50	35
Ibiza III 1.9 TDI	08/99→02/02	Diesel	ASK	1896	4	79.50	95.50	44
Ibiza III 1.9 TDI	08/99→02/02	Diesel	ASV	1896	4	79.50	95.50	40
Ibiza IV 1.2	02/02→06/06	Petrol	AZQ	1198	3	76.50	86.90	22
Ibiza IV 1.2	06/07→05/08	Petrol	BBM	1198	3	76.50	86.90	22
Ibiza IV 1.2	02/02→06/06	Petrol	BME	1198	3	76.50	86.90	22
Ibiza IV 1.4 16V	02/02→11/09	Petrol	AUB	1390	4	76.50	75.60	15
Ibiza IV 1.4 16V	02/02→12/07	Petrol	BBY	1390	4	76.50	75.60	15
Ibiza IV 1.4 16V	02/02→11/09	Petrol	BBZ	1390	4	76.50	75.60	15
Ibiza IV 1.4 16V	02/02→12/07	Petrol	BKY	1390	4	76.50	75.60	15
Ibiza IV 1.4 16V	05/06→11/09	Petrol	BXW	1390	4	76.50	75.60	18
Ibiza IV 1.4 TDI	05/02→12/05	Diesel	AMF	1422	3	79.50	95.50	33
Ibiza IV 1.4 TDI	06/05→11/09	Diesel	BMS	1422	3	79.50	95.50	33
Ibiza IV 1.4 TDI	05/05→11/09	Diesel	BNM	1422	3	79.50	95.50	33
Ibiza IV 1.4 TDI	06/05→11/09	Diesel	BNV	1422	3	79.50	95.50	33
Ibiza IV 1.6	02/03→11/09	Petrol	BAH	1598	4	76.50	86.90	28
Ibiza IV 1.6 16V	11/06→11/09	Petrol	BTS	1598	4	76.50	86.90	28
Ibiza IV 1.8 T Cupra R	01/04→02/08	Petrol	BLZ	1781	4	81.00	86.40	63
Ibiza IV 1.8 T FR	12/03→05/08	Petrol	BKV	1781	4	81.00	86.40	62
Ibiza IV 1.9 SDI	02/02→12/05	Diesel	ASY	1896	4	79.50	95.50	34
Ibiza IV 1.9 TDI	02/02→11/09	Diesel	ASZ	1896	4	79.50	95.50	43
Ibiza IV 1.9 TDI	02/02→11/09	Diesel	ATD	1896	4	79.50	95.50	45
Ibiza IV 1.9 TDI	02/02→11/09	Diesel	AXR	1896	4	79.50	95.50	46
Ibiza IV 1.9 TDI	02/02→11/09	Diesel	BLT	1896	4	79.50	95.50	47
Ibiza IV 1.9 TDI	02/02→11/09	Diesel	BMT	1896	4	79.50	95.50	46
Ibiza IV 2.0	04/02→11/09	Petrol	AZL	1984	4	82.50	92.80	73
Ibiza V 1.2	03/08→	Petrol	BZG	1198	3	76.50	86.90	22
Ibiza V 1.2	03/08→	Petrol	CGPA	1198	3	76.50	86.90	22
Ibiza V 1.2	07/09→	Petrol	CGPB	1198	3	76.50	86.90	22
Ibiza V 1.2 TDI	04/10→	Diesel	CFWA	1199	3	79.50	80.50	29
Ibiza V 1.2 TSI	08/12→	Petrol	CBZA	1197	4	71.00	75.60	6
Ibiza V 1.2 TSI	09/10→	Petrol	CBZB	1197	4	71.00	75.60	6
Ibiza V 1.4	03/08→	Petrol	BXW	1390	4	76.50	75.60	18
Ibiza V 1.4	03/08→	Petrol	CGGB	1390	4	76.50	75.60	20
Ibiza V 1.4 TDI	07/08→06/10	Diesel	BMS	1422	3	79.50	95.50	33
Ibiza V 1.4 TSI	06/09→	Petrol	CAVF	1390	4	76.50	75.60	18
Ibiza V 1.4 TSI	06/09→	Petrol	CNUB	1390	4	76.50	75.60	18
Ibiza V 1.4 TSI	06/09→	Petrol	CTHF	1390	4	76.50	75.60	18
Ibiza V 1.4 TSI	06/09→	Petrol	CTJB	1390	4	76.50	75.60	18
Ibiza V 1.4 TSI Cupra	06/09→	Petrol	CAVE	1390	4	76.50	75.60	18
Ibiza V 1.4 TSI Cupra	06/09→	Petrol	CTHE	1390	4	76.50	75.60	18
Ibiza V 1.4 TSI Cupra	06/09→	Petrol	CTJC	1390	4	76.50	75.60	18
Ibiza V 1.6	09/08→	Petrol	BAH	1598	4	76.50	86.90	28
Ibiza V 1.6	05/08→	Petrol	BTS	1598	4	76.50	86.90	28



cm3



9

Ibiza V 1.6 LPG	05/11→	Petrol	CNKA	1598	4	76.50	86.90	26
Ibiza V 1.6 TDI	05/09→	Diesel	CAYB	1598	4	79.50	80.50	30
Ibiza V 1.6 TDI	05/09→	Diesel	CAYC	1598	4	79.50	80.50	30
Ibiza V 1.6 TDI	05/09→	Diesel	CLNA	1598	4	79.50	80.50	30
Ibiza V 1.9 TDI	03/08→06/10	Diesel	BLS	1896	4	79.50	95.50	46
Ibiza V 1.9 TDI	07/08→06/10	Diesel	BXJ	1896	4	79.50	95.50	46
Ibiza V 2.0	10/08→	Petrol	CEKA	1984	4	82.50	92.80	73
Ibiza V 2.0 TDI	01/10→	Diesel	CFHD	1968	4	81.00	95.50	68
Inca 1.4 16V	04/00→06/03	Petrol	AUA	1390	4	76.50	75.60	15
Inca 1.4 i	11/95→06/03	Petrol	AUD	1390	4	76.50	75.60	15
Inca 1.4 i	11/95→06/03	Petrol	AEX	1391	4	76.50	75.60	13
Inca 1.4 i	11/95→06/03	Petrol	AKV	1391	4	76.50	75.60	16
Inca 1.4 i	11/95→06/03	Petrol	APQ	1391	4	76.50	75.60	16
Inca 1.6 i	11/95→05/98	Petrol	1F	1595	4	81.00	77.40	51
Inca 1.6 i	06/97→09/00	Petrol	AEE	1598	4	76.50	86.90	24
Inca 1.6 i	06/97→09/00	Petrol	ALM	1598	4	76.50	86.90	25
Inca 1.7 D	09/96→06/03	Diesel	AHB	1716	4	79.50	86.40	32
Inca 1.9 D	11/95→06/03	Diesel	1Y	1896	4	79.50	95.50	34
Inca 1.9 SDI	11/95→06/03	Diesel	1Y	1896	4	79.50	95.50	34
Inca 1.9 SDI	11/95→06/03	Diesel	AEY	1896	4	79.50	95.50	36
Inca 1.9 SDI	11/95→06/03	Diesel	AYQ	1896	4	79.50	95.50	34
Inca 1.9 TDI	09/96→06/03	Diesel	ALH	1896	4	79.50	95.50	35
Leon 1.2 TSI	02/10→12/12	Petrol	CBZB	1197	4	71.00	75.60	6
Leon 1.4 16V	11/99→06/06	Petrol	AHW	1390	4	76.50	75.60	15
Leon 1.4 16V	11/99→06/06	Petrol	APE	1390	4	76.50	75.60	15
Leon 1.4 16V	11/99→06/06	Petrol	AUA	1390	4	76.50	75.60	15
Leon 1.4 16V	11/99→06/06	Petrol	AXP	1390	4	76.50	75.60	15
Leon 1.4 16V	11/99→06/06	Petrol	BCA	1390	4	76.50	75.60	19
Leon 1.4 16V	06/06→12/12	Petrol	BXW	1390	4	76.50	75.60	18
Leon 1.4 16V	06/06→12/12	Petrol	CGGB	1390	4	76.50	75.60	20
Leon 1.4 TSI	11/07→12/12	Petrol	CAXC	1390	4	76.50	75.60	18
Leon 1.6	11/99→06/06	Petrol	AEH	1595	4	81.00	77.40	52
Leon 1.6	11/99→06/06	Petrol	AKL	1595	4	81.00	77.40	52
Leon 1.6	11/99→06/06	Petrol	APF	1595	4	81.00	77.40	52
Leon 1.6	10/05→06/06	Petrol	BFQ	1595	4	81.00	77.40	54
Leon 1.6	10/05→06/06	Petrol	BGU	1595	4	81.00	77.40	54
Leon 1.6	07/05→12/12	Petrol	BSE	1595	4	81.00	77.40	54
Leon 1.6	07/05→12/12	Petrol	BSF	1595	4	81.00	77.40	54
Leon 1.6	07/05→12/12	Petrol	CCSA	1595	4	81.00	77.40	54
Leon 1.6 16 V	09/00→06/06	Petrol	ATN	1598	4	76.50	86.90	26
Leon 1.6 16 V	09/00→06/06	Petrol	AUS	1598	4	76.50	86.90	27
Leon 1.6 16 V	09/00→06/06	Petrol	AZD	1598	4	76.50	86.90	27
Leon 1.6 16 V	09/00→06/06	Petrol	BCB	1598	4	76.50	86.90	27
Leon 1.6 LPG	12/09→12/12	Petrol	CHGA	1595	4	81.00	77.40	54
Leon 1.6 MultiFuel	11/10→12/12	Petrol	BSE	1595	4	81.00	77.40	54
Leon 1.6 TDI	11/10→12/12	Diesel	CAYB	1598	4	79.50	80.50	30
Leon 1.6 TDI	02/10→12/12	Diesel	CAYC	1598	4	79.50	80.50	30
Leon 1.6 TDI	11/12→	Diesel	CLHA	1598	4	79.50	80.50	31
Leon 1.6 TDI 4Drive	04/14→	Diesel	CLHA	1598	4	79.50	80.50	31
Leon 1.8 20V	11/99→06/06	Petrol	AGN	1781	4	81.00	86.40	58
Leon 1.8 20V	11/99→06/06	Petrol	APG	1781	4	81.00	86.40	58
Leon 1.8 20V T	11/99→06/06	Petrol	APP	1781	4	81.00	86.40	60
Leon 1.8 20V T	11/99→06/06	Petrol	AUQ	1781	4	81.00	86.40	61
Leon 1.8 20V T 4	11/99→06/06	Petrol	AJQ	1781	4	81.00	86.40	60
Leon 1.8 20V T 4	11/99→06/06	Petrol	ARY	1781	4	81.00	86.40	61
Leon 1.8 T Cupra R	02/02→06/06	Petrol	AMK	1781	4	81.00	86.40	60
Leon 1.8 Turbo 4x4	05/02→05/03	Petrol	AMK	1781	4	81.00	86.40	60
Leon 1.9 SDI	11/99→06/06	Diesel	AQM	1896	4	79.50	95.50	34
Leon 1.9 TDI	11/99→06/06	Diesel	AGR	1896	4	79.50	95.50	39
Leon 1.9 TDI	11/99→06/06	Diesel	AHF	1896	4	79.50	95.50	40
Leon 1.9 TDI	11/99→06/06	Diesel	ALH	1896	4	79.50	95.50	35
Leon 1.9 TDI	09/00→06/06	Diesel	ARL	1896	4	79.50	95.50	43
Leon 1.9 TDI	11/99→12/12	Diesel	ASV	1896	4	79.50	95.50	40
Leon 1.9 TDI	05/03→06/06	Diesel	ASZ	1896	4	79.50	95.50	43
Leon 1.9 TDI	10/05→06/06	Diesel	AXR	1896	4	79.50	95.50	46
Leon 1.9 TDI	07/05→12/10	Diesel	BKC	1896	4	79.50	95.50	46
Leon 1.9 TDI	07/05→12/10	Diesel	BLS	1896	4	79.50	95.50	46
Leon 1.9 TDI	07/05→12/10	Diesel	BXE	1896	4	79.50	95.50	46
Leon 1.9 TDI	06/07→12/10	Diesel	BXF	1896	4	79.50	95.50	46

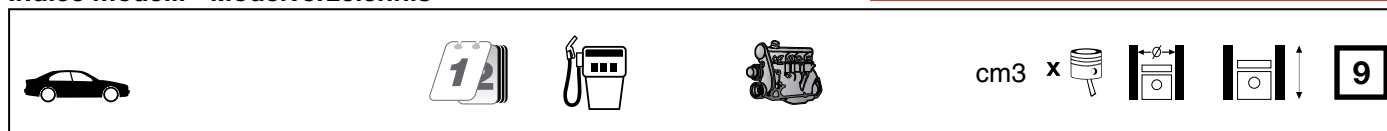

Leon 1.9 TDI Syncro	05/02→06/06	Diesel	ARL	1896	4	79.50	95.50	43
Leon 2.0 FSI	07/05→05/10	Petrol	BLR	1984	4	82.50	92.80	74
Leon 2.0 FSI	07/05→05/10	Petrol	BLY	1984	4	82.50	92.80	74
Leon 2.0 FSI	07/05→05/10	Petrol	BVY	1984	4	82.50	92.80	74
Leon 2.0 FSI	07/05→05/10	Petrol	BVZ	1984	4	82.50	92.80	74
Leon 2.0 TDI	07/05→05/10	Diesel	AZV	1968	4	81.00	95.50	68
Leon 2.0 TDI	10/05→10/10	Diesel	BMM	1968	4	81.00	95.50	69
Leon 2.0 TDI	05/06→12/12	Diesel	BMN	1968	4	81.00	95.50	68
Leon 2.0 TDI	05/06→12/12	Diesel	CEGA	1968	4	81.00	95.50	70
Leon 2.0 TDI	05/06→12/12	Diesel	CFJA	1968	4	81.00	95.50	70
Leon 2.0 TDI	10/13→	Diesel	CRLB	1968	4	81.00	95.50	70
Leon 2.0 TDI	09/12→	Diesel	CUNA	1968	4	81.00	95.50	70
Leon 2.0 TDI	09/12→	Diesel	CUPA	1968	4	81.00	95.50	70
Leon 2.0 TDI 4Drive	04/14→	Diesel	CRLB	1968	4	81.00	95.50	70
Leon 2.0 TDI 4Drive	11/14→	Diesel	CUNA	1968	4	81.00	95.50	70
Leon 2.0 TDI 16V	07/05→12/12	Diesel	BKD	1968	4	81.00	95.50	68
Leon 2.0 TDI 16V	07/05→12/12	Diesel	CFHC	1968	4	81.00	95.50	70
Leon 2.0 TDI 16V	07/05→12/12	Diesel	CLCB	1968	4	81.00	95.50	70
Leon 2.8	05/02→06/04	Petrol	BDE	2792	V6	81.00	90.30	67
Leon 2.8 Cupra 4	02/01→06/06	Petrol	AUE	2792	V6	81.00	90.30	67
Malaga 1.2	11/84→12/93	Petrol	021 A 1000	1193	4	75.00	67.50	9
Malaga 1.2 i	12/89→12/93	Petrol	021 C.1000	1193	4	75.00	67.50	9
Malaga 1.5	05/85→12/93	Petrol	021 A 2000	1461	4	83.00	67.50	75
Malaga 1.5 i CAT	10/86→12/93	Petrol	021 A 2000	1461	4	83.00	67.50	75
Marbella 0.8	08/86→12/93	Petrol	08 NCA	843	4	65.00	63.60	1
Marbella 0.9	07/97→10/98	Petrol	08 NCB	899	4	65.00	68.00	4
Marbella 0.9	01/87→12/93	Petrol	09 NCA	903	4	65.00	68.00	4
Marbella 0.9	01/87→12/93	Petrol	100 GL 7000	903	4	65.00	68.00	4
Marbella 0.9 CAT	11/96→10/98	Petrol	08 NCB	899	4	65.00	68.00	4
Marbella 0.9 CAT	01/87→11/96	Petrol	09 NCB	903	4	65.00	68.00	4
Marbella 0.9 CAT	01/90→11/96	Petrol	100 GL 7000	903	4	65.00	68.00	4
Panda 0.9	10/80→12/86	Petrol	100 GL 3000	903	4	65.00	68.00	4
Ronda 1.2	08/83→12/86	Petrol	021 A 1000	1193	4	75.00	67.50	9
Ronda 1.4	06/82→11/88	Petrol	124 B7.000	1438	4	80.00	71.50	48
Ronda 1.5	09/84→12/86	Petrol	021 A 2000	1461	4	83.00	67.50	75
Ronda 1.6	08/83→09/85	Petrol	022 A 000	1592	4	80.00	79.20	49
Ronda 1.6	08/83→09/85	Petrol	138 AR6.000	1592	4	80.00	79.20	50
Terra 0.9	01/87→12/96	Petrol	09 NCA	903	4	65.00	68.00	4
Terra 0.9 CAT	01/90→12/95	Petrol	09 NCB	903	4	65.00	68.00	4
Terra 1.3 D	03/90→12/94	Diesel	MN	1272	4	75.00	72.00	10
Terra 1.4 D	10/90→12/95	Diesel	1 W	1398	4	75.00	79.10	12
Toledo I 1.6 i	05/91→03/99	Petrol	1F	1595	4	81.00	77.40	51
Toledo I 1.6 i	05/91→03/99	Petrol	ABN	1595	4	81.00	77.40	51
Toledo I 1.6 i	11/96→03/99	Petrol	AFT	1595	4	81.00	77.40	53
Toledo I 1.6 i	05/91→03/99	Petrol	EZ	1595	4	81.00	77.40	55
Toledo I 1.8 16V	05/91→03/99	Petrol	KR	1781	4	81.00	86.40	64
Toledo I 1.8 16V	05/91→03/99	Petrol	PL	1781	4	81.00	86.40	65
Toledo I 1.8 GT	05/91→11/92	Petrol	KR	1781	4	81.00	86.40	64
Toledo I 1.8 i	11/93→12/96	Petrol	ABS	1781	4	81.00	86.40	57
Toledo I 1.8 i	11/93→12/96	Petrol	ACC	1781	4	81.00	86.40	57
Toledo I 1.8 i	11/93→12/96	Petrol	ADZ	1781	4	81.00	86.40	57
Toledo I 1.8 i	05/91→12/96	Petrol	RP	1781	4	81.00	86.40	66
Toledo I 1.9 D	05/91→03/99	Diesel	1Y	1896	4	79.50	95.50	34
Toledo I 1.9 TD	05/91→03/99	Diesel	AAZ	1896	4	79.50	95.50	35
Toledo I 1.9 TDI	08/95→03/99	Diesel	1Z	1896	4	79.50	95.50	35
Toledo I 1.9 TDI	11/96→03/99	Diesel	AFN	1896	4	79.50	95.50	37
Toledo I 1.9 TDI	08/95→03/99	Diesel	AHU	1896	4	79.50	95.50	41
Toledo I 2.0 i	05/91→03/99	Petrol	2E	1984	4	82.50	92.80	71
Toledo I 2.0 i	05/91→03/99	Petrol	AGG	1984	4	82.50	92.80	72
Toledo I 2.0 i 16V	11/93→03/99	Petrol	ABF	1984	4	82.50	92.80	71
Toledo II 1.4 16V	01/00→05/02	Petrol	AHW	1390	4	76.50	75.60	15
Toledo II 1.4 16V	01/00→05/02	Petrol	APE	1390	4	76.50	75.60	15
Toledo II 1.4 16V	01/00→05/02	Petrol	AUA	1390	4	76.50	75.60	15
Toledo II 1.4 16V	01/00→05/02	Petrol	AXP	1390	4	76.50	75.60	15
Toledo II 1.4 16V	01/00→05/02	Petrol	BCA	1390	4	76.50	75.60	19
Toledo II 1.6	10/98→07/04	Petrol	AEH	1595	4	81.00	77.40	52
Toledo II 1.6	10/98→07/04	Petrol	AKL	1595	4	81.00	77.40	52
Toledo II 1.6	10/98→07/04	Petrol	APF	1595	4	81.00	77.40	52
Toledo II 1.6	08/05→05/06	Petrol	BFQ	1595	4	81.00	77.40	54















cm3













9

Toledo II 1.6 16V	06/00→05/06	Petrol	AUS	1598	4	76.50	86.90	27
Toledo II 1.6 16V	06/00→05/06	Petrol	AZD	1598	4	76.50	86.90	27
Toledo II 1.6 16V	06/00→05/06	Petrol	BCB	1598	4	76.50	86.90	27
Toledo II 1.8 20V	10/98→07/04	Petrol	AGN	1781	4	81.00	86.40	58
Toledo II 1.8 20V	10/98→07/04	Petrol	APG	1781	4	81.00	86.40	58
Toledo II 1.8 20VT	09/00→07/04	Petrol	APP	1781	4	81.00	86.40	60
Toledo II 1.8 20VT	09/00→07/04	Petrol	AUQ	1781	4	81.00	86.40	61
Toledo II 1.9 TDI	03/99→07/04	Diesel	AGR	1896	4	79.50	95.50	39
Toledo II 1.9 TDI	10/98→07/04	Diesel	AHF	1896	4	79.50	95.50	40
Toledo II 1.9 TDI	03/99→07/04	Diesel	ALH	1896	4	79.50	95.50	35
Toledo II 1.9 TDI	10/00→07/04	Diesel	ARL	1896	4	79.50	95.50	43
Toledo II 1.9 TDI	10/98→07/04	Diesel	ASV	1896	4	79.50	95.50	40
Toledo II 1.9 TDI	05/03→05/06	Diesel	ASZ	1896	4	79.50	95.50	43
Toledo II 1.9 TDI	08/05→05/06	Diesel	AXR	1896	4	79.50	95.50	46
Toledo II 2.8	10/00→07/01	Petrol	AUE	2792	V6	81.00	90.30	67
Toledo III 1.4 16V	05/06→05/09	Petrol	BXW	1390	4	76.50	75.60	18
Toledo III 1.6	10/04→05/09	Petrol	BGU	1595	4	81.00	77.40	54
Toledo III 1.6	10/04→05/09	Petrol	BSE	1595	4	81.00	77.40	54
Toledo III 1.6	10/04→05/09	Petrol	BSF	1595	4	81.00	77.40	54
Toledo III 1.6	10/04→05/09	Petrol	CCSA	1595	4	81.00	77.40	54
Toledo III 1.9 TDI	10/04→05/09	Diesel	BJB	1896	4	79.50	95.50	46
Toledo III 1.9 TDI	10/04→05/09	Diesel	BKC	1896	4	79.50	95.50	46
Toledo III 1.9 TDI	10/04→05/09	Diesel	BLS	1896	4	79.50	95.50	46
Toledo III 1.9 TDI	10/04→05/09	Diesel	BXE	1896	4	79.50	95.50	46
Toledo III 2.0 FSI	10/04→05/09	Petrol	BLR	1984	4	82.50	92.80	74
Toledo III 2.0 FSI	10/04→05/09	Petrol	BLY	1984	4	82.50	92.80	74
Toledo III 2.0 FSI	10/04→05/09	Petrol	BVY	1984	4	82.50	92.80	74
Toledo III 2.0 FSI	10/04→05/09	Petrol	BVZ	1984	4	82.50	92.80	74
Toledo III 2.0 TDI	09/04→05/09	Diesel	AZV	1968	4	81.00	95.50	68
Toledo III 2.0 TDI	11/05→05/09	Diesel	BMM	1968	4	81.00	95.50	69
Toledo III 2.0 TDI	01/06→05/09	Diesel	BMN	1968	4	81.00	95.50	68
Toledo III 2.0 TDI	01/06→05/09	Diesel	CEGA	1968	4	81.00	95.50	70
Toledo III 2.0 TDI 16V	04/04→05/09	Diesel	BKD	1968	4	81.00	95.50	68
Toledo IV 1.2 TSI	07/12→	Petrol	CBZA	1197	4	71.00	75.60	6
Toledo IV 1.2 TSI	07/12→	Petrol	CBZB	1197	4	71.00	75.60	6
Toledo IV 1.4 TSI	07/12→	Petrol	CAXA	1390	4	76.50	75.60	18
Toledo IV 1.6	07/13→	Petrol	CFNA	1598	4	76.50	86.90	28
Toledo IV 1.6 TDI	06/13→	Diesel	CAYB	1598	4	79.50	80.50	30
Toledo IV 1.6 TDI	07/12→	Diesel	CAYC	1598	4	79.50	80.50	30
Toledo IV 1.6 TDI	07/12→	Diesel	CLNA	1598	4	79.50	80.50	30

		cm3	x 			
1F	Petrol	1595	4	81.00	77.40	51
1 W	Diesel	1398	4	75.00	79.10	12
1Y	Diesel	1896	4	79.50	95.50	34
1Z	Diesel	1896	4	79.50	95.50	35
2E	Petrol	1984	4	82.50	92.80	71
2G	Petrol	1272	4	75.00	72.00	10
08 NCA	Petrol	843	4	65.00	63.60	1
08 NCB	Petrol	899	4	65.00	68.00	4
09 NCA	Petrol	903	4	65.00	68.00	4
09 NCB	Petrol	903	4	65.00	68.00	4
021 A 1000	Petrol	1193	4	75.00	67.50	9
021 A 2000	Petrol	1461	4	83.00	67.50	75
021 C.1000	Petrol	1193	4	75.00	67.50	9
022 A 000	Petrol	1592	4	80.00	79.20	49
100 GL 3000	Petrol	903	4	65.00	68.00	4
100 GL 6000	Petrol	843	4	65.00	63.60	2
100 GL 7000	Petrol	903	4	65.00	68.00	4
124 A.000	Petrol	1197	4	73.00	71.50	7
124 B2.000	Petrol	1438	4	80.00	71.50	48
124 B3.000	Petrol	1585	4	84.00	71.50	77
124 B7.000	Petrol	1438	4	80.00	71.50	48
131 C4.000	Petrol	1995	4	84.00	90.00	80
132 B1.000	Petrol	1756	4	84.00	79.20	79
132 BB OA O	Petrol	1592	4	80.00	79.20	50
138 A5.000	Diesel	1714	4	83.00	79.20	76
138 AR6.000	Petrol	1592	4	80.00	79.20	50
146 A 000	Petrol	903	4	65.00	68.00	4
1000 GL 7000	Petrol	903	4	65.00	68.00	4
8144.61	Diesel	2445	4	93.00	90.00	82
A112 A5.000	Petrol	903	4	65.00	68.00	4
AAU	Petrol	1043	4	75.00	59.00	8
AAV	Petrol	1272	4	75.00	72.00	10
AAZ	Diesel	1896	4	79.50	95.50	35
ABD	Petrol	1390	4	75.00	78.70	11
ABF	Petrol	1984	4	82.50	92.80	71
ABN	Petrol	1595	4	81.00	77.40	51
ABS	Petrol	1781	4	81.00	86.40	57
ABU	Petrol	1598	4	76.50	86.90	23
ACC	Petrol	1781	4	81.00	86.40	57
ADL	Petrol	1781	4	81.00	86.40	57
ADY	Petrol	1984	4	82.50	92.80	71
ADZ	Petrol	1781	4	81.00	86.40	57
AEE	Petrol	1598	4	76.50	86.90	24
AEF	Diesel	1896	4	79.50	95.50	34
AEH	Petrol	1595	4	81.00	77.40	52
AER	Petrol	999	4	67.10	70.60	5
AEX	Petrol	1391	4	76.50	75.60	13
AEY	Diesel	1896	4	79.50	95.50	36
AFH	Petrol	1390	4	76.50	75.60	14
AFK	Petrol	1390	4	76.50	75.60	15
AFN	Diesel	1896	4	79.50	95.50	37
AFT	Petrol	1595	4	81.00	77.40	53
AGG	Petrol	1984	4	82.50	92.80	72
AGN	Petrol	1781	4	81.00	86.40	58
AGP	Diesel	1896	4	79.50	95.50	38
AGR	Diesel	1896	4	79.50	95.50	39
AHB	Diesel	1716	4	79.50	86.40	32
AHF	Diesel	1896	4	79.50	95.50	40
AHT	Petrol	997	4	67.10	70.60	5
AHU	Diesel	1896	4	79.50	95.50	41
AHW	Petrol	1390	4	76.50	75.60	15
AJH	Petrol	1781	4	81.00	86.40	59
AJQ	Petrol	1781	4	81.00	86.40	60
AKK	Petrol	1390	4	76.50	75.60	15
AKL	Petrol	1595	4	81.00	77.40	52
AKU	Diesel	1716	4	79.50	86.40	32
AKV	Petrol	1391	4	76.50	75.60	16
ALD	Petrol	999	4	67.10	70.60	5
ALH	Diesel	1896	4	79.50	95.50	35

			cm ³	x 			
ALL	Petrol		999	4	67.10	70.60	5
ALM	Petrol		1598	4	76.50	86.90	25
ALZ	Petrol		1595	4	81.00	77.40	54
AMF	Diesel		1422	3	79.50	95.50	33
AMK	Petrol		1781	4	81.00	86.40	60
ANM	Petrol		1390	4	76.50	75.60	17
ANU	Diesel		1896	4	79.50	95.50	42
ANV	Petrol		999	4	67.10	70.60	5
ANW	Petrol		1390	4	76.50	75.60	18
ANX	Petrol		1390	4	76.50	75.60	16
APE	Petrol		1390	4	76.50	75.60	15
APF	Petrol		1595	4	81.00	77.40	52
APG	Petrol		1781	4	81.00	86.40	58
APP	Petrol		1781	4	81.00	86.40	60
APQ	Petrol		1391	4	76.50	75.60	16
AQM	Diesel		1896	4	79.50	95.50	34
AQQ	Petrol		1390	4	76.50	75.60	15
AQX	Petrol		1781	4	81.00	86.40	59
ARL	Diesel		1896	4	79.50	95.50	43
ARY	Petrol		1781	4	81.00	86.40	61
ASK	Diesel		1896	4	79.50	95.50	44
AST	Petrol		999	4	67.10	70.60	5
ASV	Diesel		1896	4	79.50	95.50	40
ASY	Diesel		1896	4	79.50	95.50	34
ASZ	Diesel		1896	4	79.50	95.50	43
ATD	Diesel		1896	4	79.50	95.50	45
ATM	Petrol		1984	4	82.50	92.80	73
ATN	Petrol		1598	4	76.50	86.90	26
AUA	Petrol		1390	4	76.50	75.60	15
AUB	Petrol		1390	4	76.50	75.60	15
AUC	Petrol		999	4	67.10	70.60	5
AUD	Petrol		1390	4	76.50	75.60	15
AUE	Petrol		2792	V6	81.00	90.30	67
AUQ	Petrol		1781	4	81.00	86.40	61
AUR	Petrol		1595	4	81.00	77.40	52
AUS	Petrol		1598	4	76.50	86.90	27
AUY	Diesel		1896	4	79.50	95.50	45
AVG	Diesel		1896	4	79.50	95.50	37
AVZ	Petrol		999	4	67.10	70.60	5
AWC	Petrol		1781	4	81.00	86.40	60
AXP	Petrol		1390	4	76.50	75.60	15
AXR	Diesel		1896	4	79.50	95.50	46
AYL	Petrol		2792	V6	81.00	90.30	67
AYP	Petrol		1781	4	81.00	86.40	59
AYQ	Diesel		1896	4	79.50	95.50	34
AZD	Petrol		1598	4	76.50	86.90	27
AZL	Petrol		1984	4	82.50	92.80	73
AZQ	Petrol		1198	3	76.50	86.90	22
AZV	Diesel		1968	4	81.00	95.50	68
BAH	Petrol		1598	4	76.50	86.90	28
BBM	Petrol		1198	3	76.50	86.90	22
BBY	Petrol		1390	4	76.50	75.60	15
BBZ	Petrol		1390	4	76.50	75.60	15
BCA	Petrol		1390	4	76.50	75.60	19
BCB	Petrol		1598	4	76.50	86.90	27
BDE	Petrol		2792	V6	81.00	90.30	67
BFQ	Petrol		1595	4	81.00	77.40	54
BGU	Petrol		1595	4	81.00	77.40	54
BJB	Diesel		1896	4	79.50	95.50	46
BKC	Diesel		1896	4	79.50	95.50	46
BKD	Diesel		1968	4	81.00	95.50	68
BKV	Petrol		1781	4	81.00	86.40	62
BKY	Petrol		1390	4	76.50	75.60	15
BLR	Petrol		1984	4	82.50	92.80	74
BLS	Diesel		1896	4	79.50	95.50	46
BLT	Diesel		1896	4	79.50	95.50	47
BLY	Petrol		1984	4	82.50	92.80	74
BLZ	Petrol		1781	4	81.00	86.40	63
BME	Petrol		1198	3	76.50	86.90	22

		cm3	x 			
BMM	Diesel	1968	4	81.00	95.50	69
BMN	Diesel	1968	4	81.00	95.50	68
BMS	Diesel	1422	3	79.50	95.50	33
BMT	Diesel	1896	4	79.50	95.50	46
BNM	Diesel	1422	3	79.50	95.50	33
BNV	Diesel	1422	3	79.50	95.50	33
BRT	Diesel	1968	4	81.00	95.50	69
BSE	Petrol	1595	4	81.00	77.40	54
BSF	Petrol	1595	4	81.00	77.40	54
BTB	Diesel	1896	4	79.50	95.50	43
BTS	Petrol	1598	4	76.50	86.90	28
BVK	Diesel	1896	4	79.50	95.50	43
BVY	Petrol	1984	4	82.50	92.80	74
BVZ	Petrol	1984	4	82.50	92.80	74
BXE	Diesel	1896	4	79.50	95.50	46
BXF	Diesel	1896	4	79.50	95.50	46
BXJ	Diesel	1896	4	79.50	95.50	46
BXW	Petrol	1390	4	76.50	75.60	18
BZG	Petrol	1198	3	76.50	86.90	22
CAGA	Diesel	1968	4	81.00	95.50	68
CAGC	Diesel	1968	4	81.00	95.50	68
CAHA	Diesel	1968	4	81.00	95.50	68
CAVA	Petrol	1390	4	76.50	75.60	18
CAVE	Petrol	1390	4	76.50	75.60	18
CAVF	Petrol	1390	4	76.50	75.60	18
CAXA	Petrol	1390	4	76.50	75.60	18
CAXC	Petrol	1390	4	76.50	75.60	18
CAYA	Diesel	1598	4	79.50	80.50	30
CAYB	Diesel	1598	4	79.50	80.50	30
CAYC	Diesel	1598	4	79.50	80.50	30
CBDB	Diesel	1968	4	81.00	95.50	70
CBZA	Petrol	1197	4	71.00	75.60	6
CBZB	Petrol	1197	4	71.00	75.60	6
CCSA	Petrol	1595	4	81.00	77.40	54
CEGA	Diesel	1968	4	81.00	95.50	70
CEKA	Petrol	1984	4	82.50	92.80	73
CFFA	Diesel	1968	4	81.00	95.50	70
CFFB	Diesel	1968	4	81.00	95.50	70
CFFE	Diesel	1968	4	81.00	95.50	70
CFGB	Diesel	1968	4	81.00	95.50	70
CFGC	Diesel	1968	4	81.00	95.50	70
CFHC	Diesel	1968	4	81.00	95.50	70
CFHD	Diesel	1968	4	81.00	95.50	68
CFJA	Diesel	1968	4	81.00	95.50	70
CFNA	Petrol	1598	4	76.50	86.90	28
CFWA	Diesel	1199	3	79.50	80.50	29
CGGB	Petrol	1390	4	76.50	75.60	20
CGLB	Diesel	1968	4	81.00	95.50	68
CGPA	Petrol	1198	3	76.50	86.90	22
CGPB	Petrol	1198	3	76.50	86.90	22
CHFA	Petrol	1198	3	76.50	86.90	22
CHGA	Petrol	1595	4	81.00	77.40	54
CJCA	Diesel	1968	4	81.00	95.50	68
CJCC	Diesel	1968	4	81.00	95.50	70
CLCB	Diesel	1968	4	81.00	95.50	70
CLHA	Diesel	1598	4	79.50	80.50	31
CLNA	Diesel	1598	4	79.50	80.50	30
CNKA	Petrol	1598	4	76.50	86.90	26
CNUB	Petrol	1390	4	76.50	75.60	18
CNWB	Petrol	1390	4	76.50	75.60	18
CRLB	Diesel	1968	4	81.00	95.50	70
CTHE	Petrol	1390	4	76.50	75.60	18
CTHF	Petrol	1390	4	76.50	75.60	18
CTJB	Petrol	1390	4	76.50	75.60	18
CTJC	Petrol	1390	4	76.50	75.60	18
CUNA	Diesel	1968	4	81.00	95.50	70
CUPA	Diesel	1968	4	81.00	95.50	70
DG	Petrol	837	4	65.00	63.60	3
DH	Petrol	1915	4	94.00	69.00	83

			cm ³	x 			9
EZ	Petrol	1595	4	81.00	77.40	55	
FA12	Petrol	1197	4	73.00	71.50	7	
FC16	Petrol	1585	4	84.00	71.50	78	
FD	Petrol	1470	4	76.50	80.00	21	
GH	Diesel	1919	4	94.00	69.00	84	
HB 90	Petrol	903	4	65.00	68.00	4	
HM	Petrol	1595	4	81.00	77.40	56	
KR	Petrol	1781	4	81.00	86.40	64	
MN	Diesel	1272	4	75.00	72.00	10	
OM 615.912	Diesel	2197	4	87.00	92.40	81	
PL	Petrol	1781	4	81.00	86.40	65	
RP	Petrol	1781	4	81.00	86.40	66	

**1 65.00 x 63.60**

08 NCA		4 Cyl.		843cc	25kW (34PS)	Petrol			TD3556
BE/PL	4	39,985/40,005	43,657/43,670	16,550	1,813	0,026/0,084	AL-LF	3025RA	01-4139/4 STD 0.25 0.50
MB/HL 1,3	2	50,785/50,805	54,507/54,520	20,620	1,837	0,028/0,086	AL-LF	62006RA	H1039/3 STD 0.25 0.50
MB/HL 2	1	50,790/50,810	54,507/54,520	22,780	1,837	0,028/0,086	AL-LF	62007RA	
TW/A	2	54,610/54,864	69,596/69,850		2,362		AL-LF	2897AFF	A182/2 STD

2 65.00 x 63.60

100 GL 6000		4 Cyl.		843cc	25kW (35PS)	Petrol			TD3559
BE/PL	4	39,985/40,005	43,657/43,670	16,550	1,813	0,026/0,084	AL-LF	3025RA	01-4139/4 STD 0.25 0.50
MB/HL 1,3	2	50,785/50,805	54,507/54,520	20,620	1,837	0,028/0,086	AL-LF	62006RA	H1039/3 STD 0.25 0.50
MB/HL 2	1	50,790/50,810	54,507/54,520	22,780	1,837	0,028/0,086	AL-LF	62007RA	
01/70→									
TW/A	2	54,610/54,864	69,596/69,850		2,362		AL-LF	2897AFF	A182/2 STD

3 65.00 x 63.60

DG		4 Cyl.		837cc	25kW (34PS)	Petrol			TD4898
BE/PL	4	54,971/54,990	57,800/57,819	17,600	1,397	0,020/0,079	EC	71-1950	71-1950/4 STD 0.25 0.50

4 65.00 x 68.00

08 NCB		4 Cyl.		899cc	30-32kW (41-44PS)		Petrol		TD5539
09 NCA		4 Cyl.		903cc	29kW (40PS)		Petrol		TD3557
09 NCB		4 Cyl.		903cc	29kW (40PS)		Petrol		TD5540
100 GL 3000		4 Cyl.		903cc	31-33kW (42-45PS)		Petrol		TD3558
100 GL 7000		4 Cyl.		903cc	29kW (40PS)		Petrol		TD3560
146 A 000		4 Cyl.		903cc	29-32kW (40-43PS)		Petrol		TD9377
1000 GL 7000		4 Cyl.		903cc	29-32kW (39-44PS)		Petrol		TD3561
A112 A5.000		4 Cyl.		903cc	29-33kW (40-45PS)		Petrol		TD20969
HB 90		4 Cyl.		903cc	31kW (43PS)		Petrol		TD3589
BE/PL	4	39,985/40,005	43,657/43,670	16,550	1,813	0,026/0,084	AL-LF	3025RA	01-4139/4 STD 0.25 0.50
MB/HL 1,3	2	50,785/50,805	54,507/54,520	20,620	1,837	0,028/0,086	AL-LF	62006RA	H1039/3 STD 0.25 0.50
MB/HL 2	1	50,790/50,810	54,507/54,520	22,780	1,837	0,028/0,086	AL-LF	62007RA	
TW/A	2	54,610/54,864	69,596/69,850		2,362		AL-LF	2897AFF	A182/2 STD

5 67.10 x 70.60

AER		4 Cyl.		999cc	37kW (50PS)		Petrol		TD5533
AHT		4 Cyl.		997cc	37kW (50PS)		Petrol		TD13889
ALD		4 Cyl.		999cc	37kW (50PS)		Petrol		TD13890
ALL		4 Cyl.		999cc	37kW (50PS)		Petrol		TD13891
ANV		4 Cyl.		999cc	37kW (50PS)		Petrol		TD13888
AST		4 Cyl.		999cc	51kW (69PS)		Petrol		TD16543
AUC		4 Cyl.		999cc	37kW (50PS)		Petrol		TD16138
AVZ		4 Cyl.		999cc	51kW (69PS)		Petrol		TD16542

BE/PL	4	41,965/41,980	45,000/45,012	18,500	1,505	0,020/0,060	AL-LF	01-3874	01-3874/4 STD 0.25
MB/HL 1-5	5	53,963/53,978	59,000/59,019	18,500	2,504	0,020/0,073	AL-LF	02-4929	H1325/5 STD 0.25 0.50
TW/A	2	59,500	73,200		1,975		AL-LF	04-3527	A123/4 STD
TW/A	2	59,500	73,200		1,975		AL-LF	04-3528	

6 71.00 x 75.60

CBZA	4 Cyl.		1197cc	63kW (86PS)	Petrol Turbo		TD23927		
CBZB	4 Cyl.		1197cc	77kW (105PS)	Petrol Turbo		TD23908		
BE/PL	4	41,963/41,978	45,000/45,012	15,200	1,503	0,024/0,062	AL-LF	01-4873	01-4873/4 STD
TW/A	2		64,750/65,000		2,475		AL-LF	04-4930	A314/2 STD
SE/PB	1	19,000	21,000/21,033	17,800			BC-LF	55-4875	55-4875 SEMI

7 73.00 x 71.50

124 A.000	4 Cyl.		1197cc	44-48kW (60-65PS)	Petrol		TD3562		
FA12	4 Cyl.		1197cc	48kW (65PS)	Petrol		TD3582		
BE/PL	4	45,508/45,528	48,629/48,646	19,200	1,547	0,020/0,069	AL-LF	1645RA	01-4127/4 STD 0.25 0.50
BE/PL	4	45,508/45,528	48,629/48,646	19,200	1,538	0,025/0,087	AL-LF	60985RA	01-4171/4 STD

1645RA

60985RA

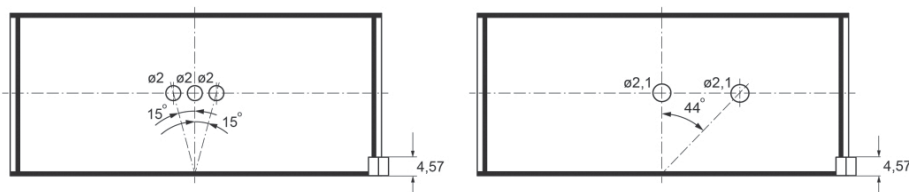

MB/HL 1,2,4,5	4	50,785/50,805	54,507/54,520	20,250	1,831	0,040/0,098	AL-LF	60986RA	H1028/5 STD 0.25
MB/HL 3	1	50,785/50,805	54,507/54,520	22,750	1,831	0,040/0,098	AL-LF	60987RA	
TW/A	2	56,610/56,684	69,596/69,850		2,362		AL-LF	60987AF	A197/2 STD .005
TW/A	2	56,610/56,864	69,596/69,850		2,362		AL-LF	60987AFA	A198/2 STD .005

60987AF

60987AFA

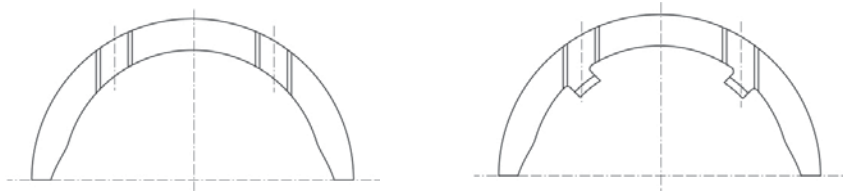

SE/PB	1	21,539/21,641	23,939/23,972	25,100			BS	62039Y	55-4288 SEMI
-------	---	---------------	---------------	--------	--	--	----	--------	------------------------

8 75.00 x 59.00

AAU	4 Cyl.		1043cc	33kW (45PS)	Petrol		TD4892		
BE/PL	4	41,965/41,980	45,000/45,016	18,000	1,505	0,020/0,066	EC	71-3276	71-3276/4 STD 0.25
MB/HL 1-5	10	53,958/53,978	59,000/59,019	18,500	2,502	0,020/0,082	AL-LF	02-3085U	H026/5 STD 0.25 0.50

TW/A	2	59,500	73,200		1,975		AL-LF	04-3527	A123/4 STD	
TW/A	2	59,500	73,200		1,975		AL-LF	04-3528		
SE/PB	1	20,000	23,000/23,025	24,000			BC	55-3277	55-3277 SEMI	
BU	1	42,959/42,975	46,055/46,095	15,000			AL-LF	07-3088	07-3088 STD SEMI	13
Front, For intermediary shaft										
BU	1	41,959/41,975	45,000/45,025	15,000			AL-LF	07-3089	07-3089 STD SEMI	13
Rear, For intermediary shaft										

9	75.00 x 67.50									
021 A 1000			4 Cyl.	1193cc	44-47kW (60-63PS)		Petrol			TD3553
021 C.1000			4 Cyl.	1193cc	52kW (71PS)		Petrol			TD9382
BE/PL	4	39,975/39,991	43,000/43,016	19,000	1,500	0,019/0,071	EC	71-3665	71-3665/4 STD	

10	75.00 x 72.00																					
2G			4 Cyl.	1272cc	40kW (54PS)		Petrol			TD3571												
AAV			4 Cyl.	1272cc	40kW (54PS)		Petrol			TD4893												
MN			4 Cyl.	1272cc	33kW (45PS)		Diesel			TD9401												
BE/PL	4	41,965/41,980	45,000/45,016	18,000	1,505	0,020/0,066	EC	71-3276	71-3276/4 STD 0.25													
MB/HL	8	53,958/53,978	59,000/59,019	18,500	2,502	0,020/0,082	AL-LF	02-3085U	H024/5 STD 0.25													
MB/HL	2	53,958/53,978	59,000/59,019	24,930	2,502	0,020/0,082	AL-LF	02-3086HU														
 <table border="1"> <tr> <td>02-3086HU</td> <td>STD</td> <td>25,000/.9843" - 25,040/.9858"</td> </tr> <tr> <td></td> <td>0.25mm</td> <td>25,100/.9882" - 25,140/.9898"</td> </tr> <tr> <td></td> <td>0.50mm</td> <td>25,100/.9882" - 25,140/.9898"</td> </tr> <tr> <td></td> <td>0.75mm</td> <td>25,100/.9882" - 25,140/.9898"</td> </tr> </table>											02-3086HU	STD	25,000/.9843" - 25,040/.9858"		0.25mm	25,100/.9882" - 25,140/.9898"		0.50mm	25,100/.9882" - 25,140/.9898"		0.75mm	25,100/.9882" - 25,140/.9898"
02-3086HU	STD	25,000/.9843" - 25,040/.9858"																				
	0.25mm	25,100/.9882" - 25,140/.9898"																				
	0.50mm	25,100/.9882" - 25,140/.9898"																				
	0.75mm	25,100/.9882" - 25,140/.9898"																				
MB/HL 1-5	10	53,958/53,978	59,000/59,019	18,500	2,502	0,020/0,082	AL-LF	02-3085U	H026/5 STD 0.25 0.50													

02-3085U

02-3086HU

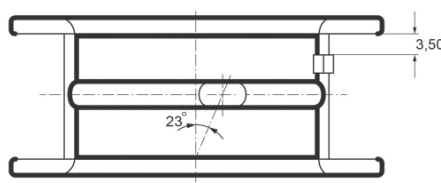
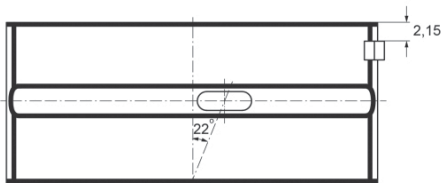

TW/A	2	59,500	73,200		1,975		AL-LF	04-3527	A123/4 STD	
TW/A	2	59,500	73,200		1,975		AL-LF	04-3528		
SE/PB	1	20,000	23,000/23,025	24,000			BC	55-3277	55-3277 SEMI	
BU	1	42,959/42,975	46,055/46,095	15,000			AL-LF	07-3088	07-3088 STD SEMI	13
Front, For intermediary shaft										
BU	1	41,959/41,975	45,000/45,025	15,000			AL-LF	07-3089	07-3089 STD SEMI	13
Rear, For intermediary shaft										



11 75.00 x 78.70

ABD	4 Cyl.		1390cc	44kW (60PS)			Petrol		TD3574
BE/PL	4	41,965/41,980	45,000/45,016	18,000	1,505	0,020/0,066	EC	71-3276	71-3276/4 STD 0.25
MB/HL 1-5	10	53,958/53,978	59,000/59,019	18,500	2,502	0,020/0,082	AL-LF	02-3085U	H026/5 STD 0.25 0.50
TW/A	2	59,500	73,200		1,975		AL-LF	04-3527	A123/4 STD
TW/A	2	59,500	73,200		1,975		AL-LF	04-3528	
SE/PB	1	20,000	23,000/23,025	24,000			BC	55-3277	55-3277 SEMI
BU	1	42,959/42,975	46,055/46,095	15,000			AL-LF	07-3088	07-3088 STD SEMI 13
Front, For intermediary shaft									
BU	1	41,959/41,975	45,000/45,025	15,000			AL-LF	07-3089	07-3089 STD SEMI 13
Rear, For intermediary shaft									

12 75.00 x 79.10

1 W	4 Cyl.		1398cc	35kW (48PS)			Diesel		TD9402
BE/PL	4	41,965/41,980	45,000/45,016	18,000	1,505	0,020/0,066	EC	71-3276	71-3276/4 STD 0.25
MB/HL 1-5	10	53,958/53,978	59,000/59,019	18,500	2,502	0,020/0,082	AL-LF	02-3085U	H026/5 STD 0.25 0.50
TW/A	2	59,500	73,200		1,975		AL-LF	04-3527	A123/4 STD
TW/A	2	59,500	73,200		1,975		AL-LF	04-3528	
SE/PB	1	20,000	23,000/23,025	24,000			BC	55-3277	55-3277 SEMI
BU	1	42,959/42,975	46,055/46,095	15,000			AL-LF	07-3088	07-3088 STD SEMI 13
Front, For intermediary shaft									
BU	1	41,959/41,975	45,000/45,025	15,000			AL-LF	07-3089	07-3089 STD SEMI 13
Rear, For intermediary shaft									

13 76.50 x 75.60

AEX	4 Cyl.		1391cc	44kW (60PS)			Petrol		TD5532
BE/PL	4	47,763/47,778	50,600/50,612	18,500	1,406	0,020/0,062	AL-LF	01-3867	01-3867/4 STD 0.25
MB/HL 1-5	10	53,958/53,978	59,000/59,019	18,500	2,502	0,020/0,082	AL-LF	02-3085U	H026/5 STD 0.25 0.50
TW/A	2	59,500	73,200		1,975		AL-LF	04-3527	A123/4 STD
TW/A	2	59,500	73,200		1,975		AL-LF	04-3528	
BU	1	42,959/42,975	46,055/46,095	15,000			AL-LF	07-3088	07-3088 STD SEMI 13
Front, For intermediary shaft									
BU	1	41,959/41,975	45,000/45,025	15,000			AL-LF	07-3089	07-3089 STD SEMI 13
Rear, For intermediary shaft									



14 **76.50 x 75.60**

AFH		4 Cyl.		1390cc	74kW (101PS)	Petrol		TD5534	
BE/PL	4	47,763/47,778	50,600/50,612	18,500	1,406	0,020/0,062	AL-LF	01-3867	01-3867/4 STD 0.25
BE/PL	4	47,758/47,778	50,600/50,612	20,000	1,406	0,020/0,067	SP	71-3847	71-3847/4 STD 0.25

01-3867

71-3847

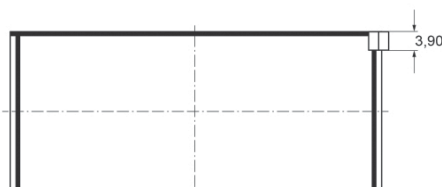
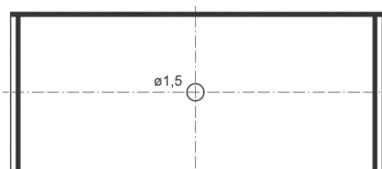

MB/HL 1-5	5	53,958/53,978	59,000/59,019	18,500	2,502	0,020/0,082	AL-LF	02-3085L	H084/5 STD 0.25 0.50
MB/HL 1-5	5	53,958/53,978	59,000/59,019	18,500	2,502	0,020/0,082	AL-LF	02-3085U	

Mot.→AFH030000

MB/HL 1-5	5	53,963/53,978	59,000/59,019	18,500	2,504	0,020/0,073	AL-LF	02-4929	H1325/5 STD 0.25 0.50
-----------	---	---------------	---------------	--------	-------	-------------	-------	---------	---------------------------------

Mot.AFH030001→

02-3085L

02-3085U

02-4929

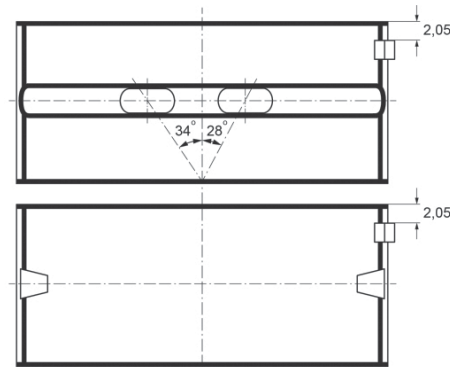
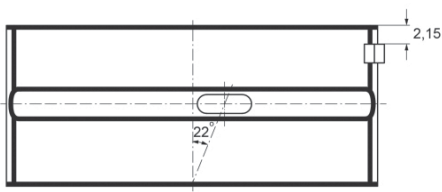
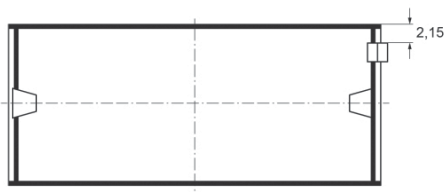

TW/A	2	59,500	73,200		1,975		AL-LF	04-3527	A123/4 STD
TW/A	2	59,500	73,200		1,975		AL-LF	04-3528	

15 **76.50 x 75.60**

AFK			4 Cyl.	1390cc	74kW (101PS)		Petrol		TD13893
AHW			4 Cyl.	1390cc	55kW (75PS)		Petrol		TD15529
AKK			4 Cyl.	1390cc	44kW (60PS)		Petrol		TD13892
APE			4 Cyl.	1390cc	55kW (75PS)		Petrol		TD13268
AQQ			4 Cyl.	1390cc	74kW (100PS)		Petrol		TD15528
AUA			4 Cyl.	1390cc	55kW (75PS)		Petrol		TD16197
AUB			4 Cyl.	1390cc	74kW (100PS)		Petrol		TD16140
AUD			4 Cyl.	1390cc	44kW (60PS)		Petrol		TD16139
AXP			4 Cyl.	1390cc	55kW (75PS)		Petrol		TD16134
BBY			4 Cyl.	1390cc	55kW (75PS)		Petrol		TD16460
BBZ			4 Cyl.	1390cc	74kW (100PS)		Petrol		TD16541
BKY			4 Cyl.	1390cc	55kW (75PS)		Petrol		TD18750

BE/PL	4	47,763/47,778	50,600/50,612	18,500	1,406	0,020/0,062	AL-LF	01-3867	01-3867/4 STD 0.25
-------	---	---------------	---------------	--------	-------	-------------	-------	---------	------------------------------

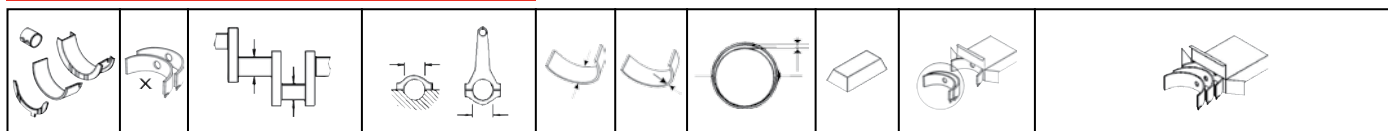

MB/HL 1-5	5	53,963/53,978	59,000/59,019	18,500	2,504	0,020/0,073	AL-LF	02-4929	H1325/5 STD 0.25 0.50
TW/A	2	59,500	73,200		1,975		AL-LF	04-3527	A123/4 STD
TW/A	2	59,500	73,200		1,975		AL-LF	04-3528	
BU	1	42,959/42,975	46,055/46,095	15,000			AL-LF	07-3088	07-3088 STD SEMI

Front, For intermediary shaft

BU	1	41,959/41,975	45,000/45,025	15,000			AL-LF	07-3089	07-3089 STD SEMI
----	---	---------------	---------------	--------	--	--	-------	---------	----------------------------

Rear, For intermediary shaft

16 76.50 x 75.60

AKV	4 Cyl.	1391cc	44kW (60PS)	Petrol	TD12513
ANX	4 Cyl.	1390cc	40kW (54PS)	Petrol	TD12514
APQ	4 Cyl.	1391cc	44kW (60PS)	Petrol	TD12515

BE/PL	4	47,763/47,778	50,600/50,612	18,500	1,406	0,020/0,062	AL-LF	01-3867	01-3867/4 STD 0.25
MB/HL 1-5	10	53,958/53,978	59,000/59,019	18,500	2,502	0,020/0,082	AL-LF	02-3085U	H026/5 STD 0.25 0.50
MB/HL 1-5	5	53,963/53,978	59,000/59,019	18,500	2,504	0,020/0,073	AL-LF	02-4929	H1325/5 STD 0.25 0.50

02-3085U

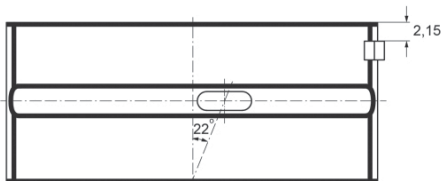

02-4929

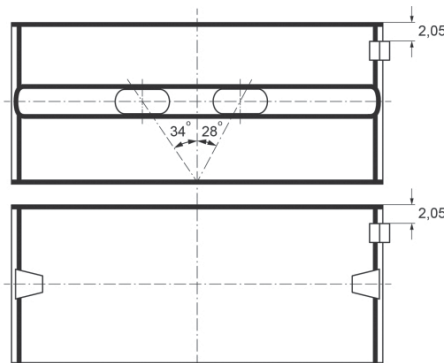

TW/A	2	59,500	73,200		1,975		AL-LF	04-3527	A123/4 STD
TW/A	2	59,500	73,200		1,975		AL-LF	04-3528	
BU	1	42,959/42,975	46,055/46,095	15,000			AL-LF	07-3088	07-3088 STD SEMI

Front, For intermediary shaft

BU	1	41,959/41,975	45,000/45,025	15,000			AL-LF	07-3089	07-3089 STD SEMI
----	---	---------------	---------------	--------	--	--	-------	---------	----------------------------

Rear, For intermediary shaft

17 76.50 x 75.60

ANM	4 Cyl.	1390cc	74kW (101PS)	Petrol	TD13894				
BE/PL	4	47,763/47,778	50,600/50,612	18,500	1,406	0,020/0,062	AL-LF	01-3867	01-3867/4 STD 0.25
BU	1	42,959/42,975	46,055/46,095	15,000			AL-LF	07-3088	07-3088 STD SEMI

Front, For intermediary shaft

BU	1	41,959/41,975	45,000/45,025	15,000			AL-LF	07-3089	07-3089 STD SEMI
----	---	---------------	---------------	--------	--	--	-------	---------	----------------------------

Rear, For intermediary shaft

**18****76.50 x 75.60**

ANW			4 Cyl.	1390cc	44kW (60PS)		Petrol		TD13274
BXW			4 Cyl.	1390cc	63kW (86PS)		Petrol		TD19427
CAVA			4 Cyl.	1390cc	110kW (150PS)		Petrol Turbo		TD24449
CAVE			4 Cyl.	1390cc	132kW (180PS)		Petrol Turbo		TD23095
CAVF			4 Cyl.	1390cc	110kW (150PS)		Petrol Turbo		TD23096
CAXA			4 Cyl.	1390cc	90kW (122PS)		Petrol Turbo		TD27223
CAXC			4 Cyl.	1390cc	92kW (125PS)		Petrol Turbo		TD20488
CNUB			4 Cyl.	1390cc	110kW (150PS)		Petrol Turbo		TD26338
CNWB			4 Cyl.	1390cc	110kW (150PS)		Petrol Turbo		TD25702
CTHE			4 Cyl.	1390cc	132kW (180PS)		Petrol Turbo		TD26916
CTHF			4 Cyl.	1390cc	110kW (150PS)		Petrol Turbo		TD26920
CTJB			4 Cyl.	1390cc	110kW (150PS)		Petrol Turbo		TD26919
CTJC			4 Cyl.	1390cc	132kW (180PS)		Petrol Turbo		TD26918
BE/PL	4	47,763/47,778	50,600/50,612	17,200	1,406	0,023/0,071	AL-LF	01-4100	01-4100/4 STD
MB/HL 1-5	5	53,963/53,978	59,000/59,019	18,500	2,504	0,020/0,073	AL-LF	02-4929	H1325/5 STD 0.25 0.50
TW/A	2	59,500	73,200		1,975		AL-LF	04-3527	A123/4 STD
TW/A	2	59,500	73,200		1,975		AL-LF	04-3528	

19**76.50 x 75.60**

BCA			4 Cyl.	1390cc	55kW (75PS)		Petrol		TD16434
BE/PL	4	47,763/47,778	50,600/50,612	17,200	1,406	0,023/0,071	AL-LF	01-4100	01-4100/4 STD
MB/HL 1-5	5	53,963/53,978	59,000/59,019	18,500	2,504	0,020/0,073	AL-LF	02-4929	H1325/5 STD 0.25 0.50
TW/A	2	59,500	73,200		1,975		AL-LF	04-3527	A123/4 STD
TW/A	2	59,500	73,200		1,975		AL-LF	04-3528	
BU	1	42,959/42,975	46,055/46,095	15,000			AL-LF	07-3088	07-3088 STD SEMI 13
Front, For intermediary shaft									
BU	1	41,959/41,975	45,000/45,025	15,000			AL-LF	07-3089	07-3089 STD SEMI 13
Rear, For intermediary shaft									

20**76.50 x 75.60**

CGGB			4 Cyl.	1390cc	63kW (85PS)		Petrol		TD23136
BE/PL	4	47,763/47,778	50,600/50,612	17,200	1,406	0,023/0,071	AL-LF	01-4100	01-4100/4 STD

21**76.50 x 80.00**

FD			4 Cyl.	1470cc	55-63kW (75-86PS)		Petrol		TD3584
BE/PL	1	45,950/45,970	49,000/49,016	19,000	1,506	0,020/0,078	EC	71-3084	71-3084 STD 0.25



MB/HL	3	53,958/53,978	59,000/59,019	18,500	2,502	0,020/0,082	AL-LF	02-3085L	H025/5 STD 0.25 0.50
MB/HL	5	53,958/53,978	59,000/59,019	18,500	2,502	0,020/0,082	AL-LF	02-3085U	
MB/HL	1	53,958/53,978	59,000/59,019	24,930	2,502	0,020/0,082	AL-LF	02-3086HL	
MB/HL	1	53,958/53,978	59,000/59,019	24,930	2,502	0,020/0,082	AL-LF	02-3086HU	

	02-3086HL	STD	25,000/.9843" - 25,040/.9858"
		0.25mm	25,100/.9882" - 25,140/.9898"
		0.50mm	25,100/.9882" - 25,140/.9898"
		0.75mm	25,100/.9882" - 25,140/.9898"
	02-3086HU	STD	25,000/.9843" - 25,040/.9858"
		0.25mm	25,100/.9882" - 25,140/.9898"
		0.50mm	25,100/.9882" - 25,140/.9898"
		0.75mm	25,100/.9882" - 25,140/.9898"

CB/NWB 1-5	5	25,939/25,960	28,250/28,271	17,000	1,138		AL-LF	03-3317	N118/5 STD	12
BU	1	42,959/42,975	46,055/46,095	15,000			AL-LF	07-3088	07-3088 STD SEMI	13

Front, For intermediary shaft

BU	1	41,959/41,975	45,000/45,025	15,000			AL-LF	07-3089	07-3089 STD SEMI	13
----	---	---------------	---------------	--------	--	--	-------	---------	----------------------------	----

Rear, For intermediary shaft

22		76.50 x 86.90								
AZQ			3 Cyl.	1198cc	47kW (64PS)		Petrol			TD16459
BBM			3 Cyl.	1198cc	44kW (60PS)		Petrol			TD21594
BME			3 Cyl.	1198cc	47kW (64PS)		Petrol			TD20510
BZG			3 Cyl.	1198cc	51kW (70PS)		Petrol			TD20839
CGPA			3 Cyl.	1198cc	51kW (70PS)		Petrol			TD23138
CGPB			3 Cyl.	1198cc	44kW (60PS)		Petrol			TD23097
CHFA			3 Cyl.	1198cc	44kW (60PS)		Petrol			TD23098
MB/HL 1-4	4	47,976/47,997	55,000/55,015	18,500	3,514	0,027/0,057	AL-LF	02-4981	H1343/4 STD 0.25	

23		76.50 x 86.90								
ABU			4 Cyl.	1598cc	55kW (75PS)		Petrol			TD4897
BE/PL	4	47,763/47,778	50,600/50,612	18,500	1,406	0,020/0,062	AL-LF	01-3867	01-3867/4 STD 0.25	
MB/HL 1-5	10	53,958/53,978	59,000/59,019	18,500	2,502	0,020/0,082	AL-LF	02-3085U	H026/5 STD 0.25 0.50	
TW/A	2	59,500	73,200		1,975		AL-LF	04-3527	A123/4 STD	
TW/A	2	59,500	73,200		1,975		AL-LF	04-3528		

24		76.50 x 86.90								
AEE			4 Cyl.	1598cc	55kW (75PS)		Petrol			TD10867
BE/PL	4	47,763/47,778	50,600/50,612	18,500	1,406	0,020/0,062	AL-LF	01-3867	01-3867/4 STD 0.25	
BE/PL	4	47,763/47,778	50,600/50,612	17,200	1,406	0,023/0,071	AL-LF	01-4100	01-4100/4 STD	



01-3867

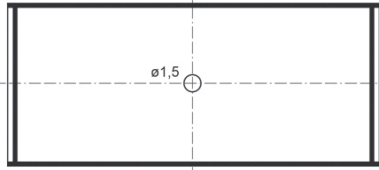

01-4100

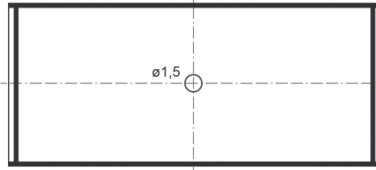

MB/HL 1-5	10	53,958/53,978	59,000/59,019	18,500	2,502	0,020/0,082	AL-LF	02-3085U	H026/5 STD 0.25 0.50
MB/HL 1-5	5	53,958/53,978	59,000/59,019	18,500	2,502	0,020/0,082	AL-LF	02-3085L	H084/5 STD 0.25 0.50
MB/HL 1-5	5	53,958/53,978	59,000/59,019	18,500	2,502	0,020/0,082	AL-LF	02-3085U	

Mot.→629000

MB/HL 1-5	5	53,963/53,978	59,000/59,019	18,500	2,504	0,020/0,073	AL-LF	02-4929	H1325/5 STD 0.25 0.50
--------------	---	---------------	---------------	--------	-------	-------------	-------	---------	---------------------------------

Mot.629001→

02-3085U

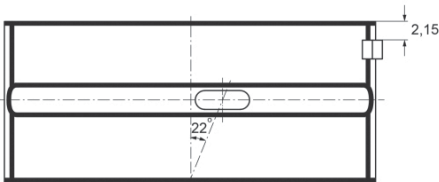

02-3085L

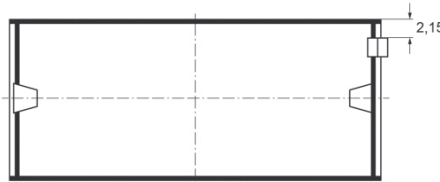

02-4929

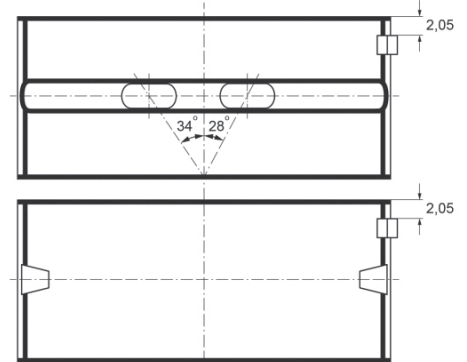

TW/A	2	59,500	73,200		1,975		AL-LF	04-3527	A123/4 STD
TW/A	2	59,500	73,200		1,975		AL-LF	04-3528	
BU	1	42,959/42,975	46,055/46,095	15,000			AL-LF	07-3088	07-3088 STD SEMI

Front, For intermediary shaft

BU	1	41,959/41,975	45,000/45,025	15,000			AL-LF	07-3089	07-3089 STD SEMI
----	---	---------------	---------------	--------	--	--	-------	---------	----------------------------

Rear, For intermediary shaft

25

76.50 x 86.90

ALM	4 Cyl.		1598cc	55kW (75PS)	Petrol		TD12949		
BE/PL	4	47,763/47,778	50,600/50,612	17,200	1,406	0,023/0,071	AL-LF	01-4100	01-4100/4 STD
MB/HL 1-5	5	53,963/53,978	59,000/59,019	18,500	2,504	0,020/0,073	AL-LF	02-4929	H1325/5 STD 0.25 0.50
TW/A	2	59,500	73,200		1,975		AL-LF	04-3527	A123/4 STD
TW/A	2	59,500	73,200		1,975		AL-LF	04-3528	
BU	1	42,959/42,975	46,055/46,095	15,000			AL-LF	07-3088	07-3088 STD SEMI

Front, For intermediary shaft



BU	1	41,959/41,975	45,000/45,025	15,000			AL-LF	07-3089	07-3089 STD SEMI	13
----	---	---------------	---------------	--------	--	--	-------	---------	----------------------------	----

Rear, For intermediary shaft

26 76.50 x 86.90

ATN	4 Cyl.		1598cc	77kW (105PS)	Petrol				TD15531
CNKA	4 Cyl.		1598cc	60kW (81PS)	Petrol				TD25408
MB/HL 1-5	5	53,963/53,978	59,000/59,019	18,500	2,504	0,020/0,073	AL-LF	02-4929	H1325/5 STD 0.25 0.50
TW/A	2	59,500	73,200		1,975		AL-LF	04-3527	A123/4 STD
TW/A	2	59,500	73,200		1,975		AL-LF	04-3528	

27 76.50 x 86.90

AUS	4 Cyl.		1598cc	77kW (105PS)	Petrol				TD15788
AZD	4 Cyl.		1598cc	77kW (105PS)	Petrol				TD16131
BCB	4 Cyl.		1598cc	77kW (105PS)	Petrol				TD16435
BE/PL	4	47,763/47,778	50,600/50,612	18,500	1,406	0,020/0,062	AL-LF	01-3867	01-3867/4 STD 0.25
MB/HL 1-5	5	53,963/53,978	59,000/59,019	18,500	2,504	0,020/0,073	AL-LF	02-4929	H1325/5 STD 0.25 0.50
TW/A	2	59,500	73,200		1,975		AL-LF	04-3527	A123/4 STD
TW/A	2	59,500	73,200		1,975		AL-LF	04-3528	

28 76.50 x 86.90

BAH	4 Cyl.		1598cc	74-75kW (101-102PS)	Petrol				TD17340
BTS	4 Cyl.		1598cc	77kW (105PS)	Petrol				TD19428
CFNA	4 Cyl.		1598cc	77kW (105PS)	Petrol				TD27224
BE/PL	4	47,763/47,778	50,600/50,612	17,200	1,406	0,023/0,071	AL-LF	01-4100	01-4100/4 STD
MB/HL 1-5	5	53,963/53,978	59,000/59,019	18,500	2,504	0,020/0,073	AL-LF	02-4929	H1325/5 STD 0.25 0.50
TW/A	2	59,500	73,200		1,975		AL-LF	04-3527	A123/4 STD
TW/A	2	59,500	73,200		1,975		AL-LF	04-3528	

29 79.50 x 80.50

CFWA	3 Cyl.		1199cc	55kW (75PS)	Diesel Turbo			TD23935		
BE/PL	1	47,758/47,778	50,600/50,612	20,000	1,406	0,020/0,067	SP	71-3904	71-3904 STD 0.25 0.50	1
MB/HL 1-5	5	53,958/53,978	59,000/59,012	18,500	2,501	0,020/0,076	EC	72-3931	H079/5 STD 0.25 0.50	

30 79.50 x 80.50

CAYA	4 Cyl.		1598cc	55kW (75PS)	Diesel Turbo Intercooler			TD25762		
CAYB	4 Cyl.		1598cc	66kW (90PS)	Diesel Turbo Intercooler			TD22670		
CAYC	4 Cyl.		1598cc	77kW (105PS)	Diesel Turbo Intercooler			TD22671		
CLNA	4 Cyl.		1598cc	77kW (105PS)	Diesel Turbo Intercooler			TD23934		
BE/PL	1	47,758/47,778	50,600/50,612	20,000	1,406	0,020/0,067	SP	71-3904	71-3904 STD 0.25 0.50	1
MB/HL 1-5	5	53,958/53,978	59,000/59,012	18,500	2,501	0,020/0,076	EC	72-3931	H079/5 STD 0.25 0.50	

→11/11

MB/HL 2-5	4	53,958/53,978	59,000/59,019	18,500	2,502	0,020/0,082	AL-LF	02-3085L	H1328/5 STD		7
MB/HL 2-5	4	53,958/53,978	59,000/59,019	18,500	2,502	0,020/0,082	AL-LF	02-3085U			
MB/HL 1	1	53,958/53,978	59,000/59,012	18,500	2,506	0,020/0,062		02-4941L			
MB/HL 1	1	53,958/53,978	59,000/59,012	18,500	2,506	0,020/0,062		02-4941U			

12/11→

02-3085L



02-3085U

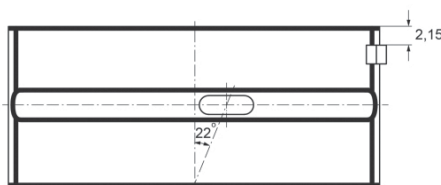

02-4941L



02-4941U

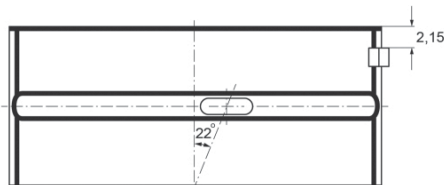

TW/A	2	59,500	73,200		1,975		AL-LF	04-3527	A123/4 STD
TW/A	2	59,500	73,200		1,975		AL-LF	04-3528	

31**79.50 x 80.50**

CLHA			4 Cyl.	1598cc	77kW (105PS)			Diesel Turbo Intercooler	TD27258
MB/HL 1-5	5	53,963/53,978	59,000/59,019	18,500	2,504	0,020/0,073	AL-LF	02-4929	H1325/5 STD 0.25 0.50 A123/4 STD
TW/A	2	59,500	73,200		1,975		AL-LF	04-3527	
TW/A	2	59,500	73,200		1,975		AL-LF	04-3528	

32**79.50 x 86.40**

AHB			4 Cyl.	1716cc	42kW (57PS)			Diesel	TD9403
AKU			4 Cyl.	1716cc	44kW (60PS)			Diesel	TD13896
BE/PL	4	47,758/47,778	50,600/50,619	19,000	1,406	0,020/0,074	EC	71-3442	71-3442/4 STD 0.25 0.50 0.75
MB/HL 1-5	5	53,958/53,978	59,000/59,019	18,500	2,502	0,020/0,082	AL-LF	02-3085L	
MB/HL 1-5	5	53,958/53,978	59,000/59,019	18,500	2,502	0,020/0,082	AL-LF	02-3085U	H084/5 STD 0.25 0.50 A123/4 STD
TW/A	2	59,500	73,200		1,975		AL-LF	04-3527	
TW/A	2	59,500	73,200		1,975		AL-LF	04-3528	



33										79.50 x 95.50										
AMF					3 Cyl.		1422cc		55kW (75PS)		Diesel Turbo					TD13895				
BMS					3 Cyl.		1422cc		59kW (80PS)		Diesel Turbo Intercooler					TD18727				
BNM					3 Cyl.		1422cc		51kW (70PS)		Diesel Turbo Intercooler					TD18726				
BNV					3 Cyl.		1422cc		59kW (80PS)		Diesel Turbo Intercooler					TD18738				
BE/PL	1	47,758/47,778	50,600/50,612	20,000	1,406	0,020/0,067	SP	71-3904	71-3904					STD 0.25 0.50					1	
CB/NWB 1-4	4	28,947/28,960	32,000/32,025	25,000	1,513	0,020/0,068	EC	73-3903	N147/4					STD						
BU	1	31,984/32,000	35,000/35,025	22,000			AL-LF	07-4037	07-4037					SEMI						
BU	1	41,984/42,000	45,000/45,025	22,000			AL-LF	07-4038	07-4038					SEMI						

34										79.50 x 95.50										
1Y					4 Cyl.		1896cc		47-50kW (64-68PS)		Diesel					TD4891				
AEF					4 Cyl.		1896cc		47kW (64PS)		Diesel					TD9373				
AQM					4 Cyl.		1896cc		50kW (68PS)		Diesel					TD13271				
ASY					4 Cyl.		1896cc		47kW (64PS)		Diesel					TD16461				
AYQ					4 Cyl.		1896cc		47kW (64PS)		Diesel					TD16198				
BE/PL	4	47,758/47,778	50,600/50,619	19,000	1,406	0,020/0,074	EC	71-3442	71-3442/4					STD 0.25 0.50 0.75						
MB/HL 1-5	5	53,958/53,978	59,000/59,019	18,500	2,502	0,020/0,082	AL-LF	02-3085L	H084/5					STD 0.25 0.50						
MB/HL 1-5	5	53,958/53,978	59,000/59,019	18,500	2,502	0,020/0,082	AL-LF	02-3085U												
TW/A	2	59,500	73,200		1,975		AL-LF	04-3527	A123/4					STD						
TW/A	2	59,500	73,200		1,975		AL-LF	04-3528												
CB/NWB 1-5	5	28,947/28,960	32,000/32,025	25,000	1,513	0,020/0,068	EC	73-3903	N147/5					STD						

35										79.50 x 95.50										
1Z					4 Cyl.		1896cc		66kW (90PS)		Diesel Turbo Intercooler					TD5527				
AAZ					4 Cyl.		1896cc		55kW (75PS)		Diesel Turbo					TD4894				
ALH					4 Cyl.		1896cc		66kW (90PS)		Diesel Turbo Intercooler					TD13272				
BE/PL	4	47,758/47,778	50,600/50,619	20,000	1,406	0,020/0,074	EC	71-3728	71-3728/4					STD 0.25 0.50						
MB/HL 1-5	5	53,958/53,978	59,000/59,019	18,500	2,502	0,020/0,082	AL-LF	02-3085L	H084/5					STD 0.25 0.50						
MB/HL 1-5	5	53,958/53,978	59,000/59,019	18,500	2,502	0,020/0,082	AL-LF	02-3085U												
TW/A	2	59,500	73,200		1,975		AL-LF	04-3527	A123/4					STD						
TW/A	2	59,500	73,200		1,975		AL-LF	04-3528												
SE/PB	1	26,000	29,000/29,052	25,000			BC	55-3729	55-3729					SEMI						
CB/NWB 1-5	5	28,947/28,960	32,000/32,025	25,000	1,513	0,020/0,068	EC	73-3903	N147/5					STD						
BU	1	42,959/42,975	46,055/46,095	15,000			AL-LF	07-3088	07-3088					STD SEMI					13	

Front, For intermediary shaft

BU	1	41,959/41,975	45,000/45,025	15,000			AL-LF	07-3089	07-3089					STD SEMI					13
----	---	---------------	---------------	--------	--	--	-------	---------	----------------	--	--	--	--	-----------------	--	--	--	--	-----------

Rear, For intermediary shaft



36 79.50 x 95.50

AEY		4 Cyl.		1896cc	47kW (64PS)	Diesel			TD5535
BE/PL	4	47,758/47,778	50,600/50,619	20,000	1,406	0,020/0,074	EC	71-3728	71-3728/4 STD 0.25 0.50
MB/HL 1-5	5	53,958/53,978	59,000/59,019	18,500	2,502	0,020/0,082	AL-LF	02-3085L	H084/5 STD 0.25 0.50
MB/HL 1-5	5	53,958/53,978	59,000/59,019	18,500	2,502	0,020/0,082	AL-LF	02-3085U	
TW/A	2	59,500	73,200		1,975		AL-LF	04-3527	A123/4 STD
TW/A	2	59,500	73,200		1,975		AL-LF	04-3528	
SE/PB	1	26,000	29,000/29,052	25,000			BC	55-3729	55-3729 SEMI
CB/NWB 1-5	5	28,947/28,960	32,000/32,025	25,000	1,513	0,020/0,068	EC	73-3903	N147/5 STD

37 79.50 x 95.50

AFN		4 Cyl.		1896cc	81kW (110PS)	Diesel Turbo Intercooler			TD5531
AVG		4 Cyl.		1896cc	81kW (110PS)	Diesel Turbo			TD23884
BE/PL	4	47,758/47,778	50,600/50,612	20,000	1,406	0,020/0,067	SP	71-3847	71-3847/4 STD 0.25 I
BE/PL	4	47,758/47,778	50,600/50,612	19,000	1,406	0,020/0,067	EC	71-3929	71-3929/4 STD II

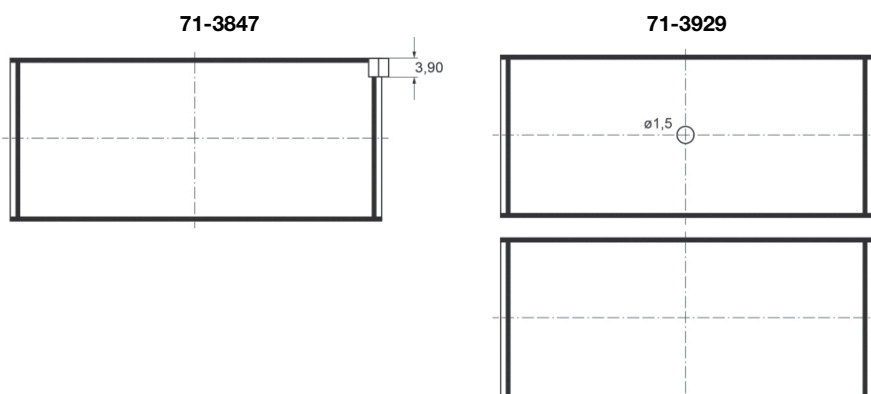

MB/HL 1-5	5	53,958/53,978	59,000/59,019	18,500	2,502	0,020/0,082	AL-LF	02-3085L	H084/5 STD 0.25 0.50
MB/HL 1-5	5	53,958/53,978	59,000/59,019	18,500	2,502	0,020/0,082	AL-LF	02-3085U	
TW/A	2	59,500	73,200		1,975		AL-LF	04-3527	A123/4 STD
TW/A	2	59,500	73,200		1,975		AL-LF	04-3528	
SE/PB	1	26,000	29,000/29,052	25,000			BC	55-3729	55-3729 SEMI
CB/NWB 1-5	5	28,947/28,960	32,000/32,025	25,000	1,513	0,020/0,068	EC	73-3903	N147/5 STD

38 79.50 x 95.50

AGP		4 Cyl.		1896cc	50kW (68PS)	Diesel			TD14808
BE/PL	4	47,758/47,778	50,600/50,619	19,000	1,406	0,020/0,074	EC	71-3442	71-3442/4 STD 0.25 0.50 0.75
Mot. AGP065001 →									
BE/PL	4	47,758/47,778	50,600/50,619	20,000	1,406	0,020/0,074	EC	71-3728	71-3728/4 STD 0.25 0.50
Mot. → AGP065000									

MB/HL 1-5	5	53,958/53,978	59,000/59,019	18,500	2,502	0,020/0,082	AL-LF	02-3085L	H084/5 STD 0.25 0.50	
MB/HL 1-5	5	53,958/53,978	59,000/59,019	18,500	2,502	0,020/0,082	AL-LF	02-3085U		
TW/A	2	59,500	73,200		1,975		AL-LF	04-3527	A123/4 STD	
TW/A	2	59,500	73,200		1,975		AL-LF	04-3528		
SE/PB	1	26,000	29,000/29,052	25,000			BC	55-3729	55-3729 SEMI	
CB/NWB 1-5	5	28,947/28,960	32,000/32,025	25,000	1,513	0,020/0,068	EC	73-3903	N147/5 STD	

39

79.50 x 95.50

AGR			4 Cyl.	1896cc	66kW (90PS)		Diesel Turbo Intercooler		TD13278
BE/PL	4	47,758/47,778	50,600/50,619	20,000	1,406	0,020/0,074	EC	71-3728	71-3728/4 STD 0.25 0.50
MB/HL	4	53,958/53,978	59,000/59,019	18,500	2,502	0,020/0,082	AL-LF	02-3085L	H027/5 STD 0.25 0.50
MB/HL	6	53,958/53,978	59,000/59,019	18,500	2,502	0,020/0,082	AL-LF	02-3085U	
MB/HL 1-5	5	53,958/53,978	59,000/59,019	18,500	2,502	0,020/0,082	AL-LF	02-3085L	H084/5 STD 0.25 0.50
MB/HL 1-5	5	53,958/53,978	59,000/59,019	18,500	2,502	0,020/0,082	AL-LF	02-3085U	

02-3085L

02-3085U

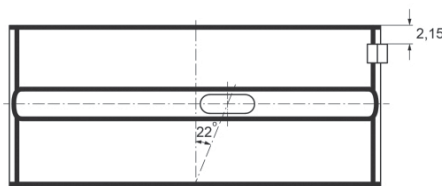

TW/A	2	59,500	73,200		1,975		AL-LF	04-3527	A123/4 STD
TW/A	2	59,500	73,200		1,975		AL-LF	04-3528	
SE/PB	1	26,000	29,000/29,052	25,000			BC	55-3729	55-3729 SEMI
CB/NWB 1-5	5	28,947/28,960	32,000/32,025	25,000	1,513	0,020/0,068	EC	73-3903	N147/5 STD
BU	1	42,959/42,975	46,055/46,095	15,000			AL-LF	07-3088	07-3088 STD SEMI 13

Front, For intermediary shaft

BU	1	41,959/41,975	45,000/45,025	15,000			AL-LF	07-3089	07-3089 STD SEMI 13
----	---	---------------	---------------	--------	--	--	-------	---------	--

Rear, For intermediary shaft

40 79.50 x 95.50

AHF			4 Cyl.	1896cc	81kW (110PS)		Diesel Turbo Intercooler		TD12512
ASV			4 Cyl.	1896cc	81kW (110PS)		Diesel Turbo Intercooler		TD13273
BE/PL	4	47,758/47,778	50,600/50,612	20,000	1,406	0,020/0,067	SP	71-3847	71-3847/4 STD 0.25 1
MB/HL 1-5	5	53,958/53,978	59,000/59,019	18,500	2,502	0,020/0,082	AL-LF	02-3085L	H084/5 STD 0.25 0.50
MB/HL 1-5	5	53,958/53,978	59,000/59,019	18,500	2,502	0,020/0,082	AL-LF	02-3085U	

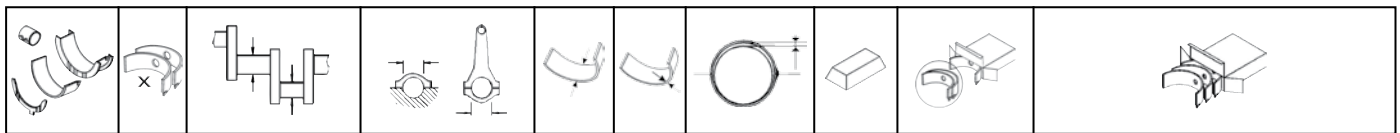

TW/A	2	59,500	73,200		1,975		AL-LF	04-3527	A123/4 STD
TW/A	2	59,500	73,200		1,975		AL-LF	04-3528	
SE/PB	1	26,000	29,000/29,052	25,000			BC	55-3729	55-3729 SEMI
CB/NWB 1-5	5	28,947/28,960	32,000/32,025	25,000	1,513	0,020/0,068	EC	73-3903	N147/5 STD
BU	1	42,959/42,975	46,055/46,095	15,000			AL-LF	07-3088	07-3088 STD SEMI

Front, For intermediary shaft

BU	1	41,959/41,975	45,000/45,025	15,000			AL-LF	07-3089	07-3089 STD SEMI
----	---	---------------	---------------	--------	--	--	-------	---------	----------------------------

Rear, For intermediary shaft

41 79.50 x 95.50

AHU			4 Cyl.	1896cc	66kW (90PS)		Diesel Turbo Intercooler		TD5528
BE/PL	4	47,758/47,778	50,600/50,619	20,000	1,406	0,020/0,074	EC	71-3728	71-3728/4 STD 0.25 0.50
BE/PL	4	47,758/47,778	50,600/50,612	19,000	1,406	0,020/0,067	EC	71-3929	71-3929/4 STD

71-3728

71-3929

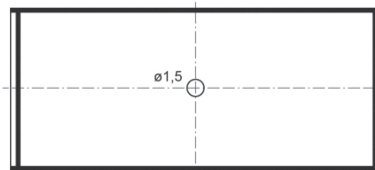

MB/HL 1-5	5	53,958/53,978	59,000/59,019	18,500	2,502	0,020/0,082	AL-LF	02-3085L	H084/5 STD 0.25 0.50
MB/HL 1-5	5	53,958/53,978	59,000/59,019	18,500	2,502	0,020/0,082	AL-LF	02-3085U	
TW/A	2	59,500	73,200		1,975		AL-LF	04-3527	A123/4 STD
TW/A	2	59,500	73,200		1,975		AL-LF	04-3528	
SE/PB	1	26,000	29,000/29,052	25,000			BC	55-3729	55-3729 SEMI
CB/NWB 1-5	5	28,947/28,960	32,000/32,025	25,000	1,513	0,020/0,068	EC	73-3903	N147/5 STD
BU	1	42,959/42,975	46,055/46,095	15,000			AL-LF	07-3088	07-3088 STD SEMI

Front, For intermediary shaft

BU	1	41,959/41,975	45,000/45,025	15,000			AL-LF	07-3089	07-3089 STD SEMI
----	---	---------------	---------------	--------	--	--	-------	---------	----------------------------

Rear, For intermediary shaft

42 79.50 x 95.50

ANU			4 Cyl.	1896cc	66kW (90PS)		Diesel Turbo		TD14911
BE/PL	1	47,758/47,778	50,600/50,612	20,000	1,406	0,020/0,067	SP	71-3904	71-3904 STD 0.25 0.50

MB/HL 1-5	5	53,958/53,978	59,000/59,019	18,500	2,502	0,020/0,082	AL-LF	02-3085L	H084/5 STD 0.25 0.50	
MB/HL 1-5	5	53,958/53,978	59,000/59,019	18,500	2,502	0,020/0,082	AL-LF	02-3085U		
TW/A	2	59,500	73,200		1,975		AL-LF	04-3527	A123/4 STD	
TW/A	2	59,500	73,200		1,975		AL-LF	04-3528		
SE/PB	1	26,000	29,000/29,052	25,000			BC	55-3729	55-3729 SEMI	
CB/NWB 1-5	5	28,947/28,960	32,000/32,025	25,000	1,513	0,020/0,068	EC	73-3903	N147/5 STD	
BU	1	42,959/42,975	46,055/46,095	15,000			AL-LF	07-3088	07-3088 STD SEMI 13	
Front, For intermediary shaft										
BU	1	41,959/41,975	45,000/45,025	15,000			AL-LF	07-3089	07-3089 STD SEMI 13	
Rear, For intermediary shaft										

43 79.50 x 95.50

ARL	4 Cyl.		1896cc	110kW (150PS)	Diesel Turbo		TD15768	
ASZ	4 Cyl.		1896cc	96kW (130PS)	Diesel Turbo		TD16463	
BTB	4 Cyl.		1896cc	110kW (150PS)	Diesel Turbo Intercooler		TD20625	
BVK	4 Cyl.		1896cc	85kW (115PS)	Diesel Turbo Intercooler		TD20515	
BE/PL	1	50,858/50,878	53,700/53,712	20,400	1,403	0,020/0,073	SP 71-3930	71-3930 STD 0.25 0.50 1
MB/HL 1-5	5	53,958/53,978	59,000/59,012	18,500	2,501	0,020/0,076	EC 72-3931	H079/5 STD 0.25 0.50
TW/A	2	59,500	73,200		1,975		AL-LF 04-3527	A123/4 STD
TW/A	2	59,500	73,200		1,975		AL-LF 04-3528	
CB/NWB 1-5	5	28,947/28,960	32,000/32,025	25,000	1,513	0,020/0,068	EC 73-3903	N147/5 STD

44 79.50 x 95.50

ASK	4 Cyl.		1896cc	81kW (110PS)	Diesel Turbo Intercooler		TD13277	
BE/PL	4	47,758/47,778	50,600/50,612	20,000	1,406	0,020/0,067	SP 71-3847	71-3847/4 STD 0.25 1
BE/PL	1	47,758/47,778	50,600/50,612	20,000	1,406	0,020/0,067	SP 71-3904	71-3904 STD 0.25 0.50 1

71-3847

71-3904

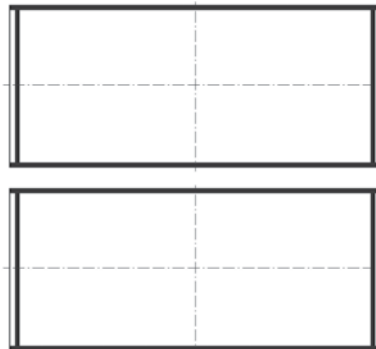
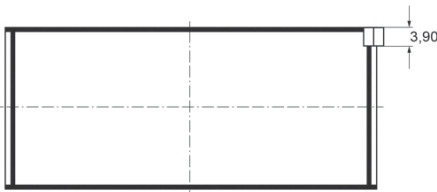

MB/HL	4	53,958/53,978	59,000/59,019	18,500	2,502	0,020/0,082	AL-LF	02-3085L	H027/5 STD 0.25 0.50
MB/HL	6	53,958/53,978	59,000/59,019	18,500	2,502	0,020/0,082	AL-LF	02-3085U	

MB/HL 1-5	5	53,958/53,978	59,000/59,019	18,500	2,502	0,020/0,082	AL-LF	02-3085L	H084/5 STD 0.25 0.50
MB/HL 1-5	5	53,958/53,978	59,000/59,019	18,500	2,502	0,020/0,082	AL-LF	02-3085U	

02-3085L

02-3085U

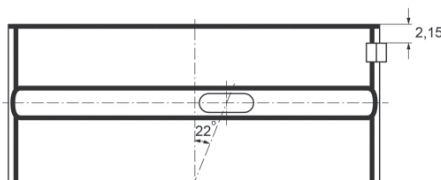

TW/A	2	59,500	73,200		1,975		AL-LF	04-3527	A123/4 STD
TW/A	2	59,500	73,200		1,975		AL-LF	04-3528	
SE/PB	1	26,000	29,000/29,052	25,000			BC	55-3729	55-3729 SEMI
CB/NWB 1-5	5	28,947/28,960	32,000/32,025	25,000	1,513	0,020/0,068	EC	73-3903	N147/5 STD
BU	1	42,959/42,975	46,055/46,095	15,000			AL-LF	07-3088	07-3088 STD SEMI

Front, For intermediary shaft

BU	1	41,959/41,975	45,000/45,025	15,000			AL-LF	07-3089	07-3089 STD SEMI
----	---	---------------	---------------	--------	--	--	-------	---------	----------------------------

Rear, For intermediary shaft

45 79.50 x 95.50

ATD			4 Cyl.	1896cc	74kW (100PS)		Diesel Turbo		TD16462
AUY			4 Cyl.	1896cc	85kW (115PS)		Diesel Turbo Intercooler		TD14912
BE/PL	1	47,758/47,778	50,600/50,612	20,000	1,406	0,020/0,067	SP	71-3904	71-3904 STD 0.25 0.50
MB/HL 1-5	5	53,958/53,978	59,000/59,019	18,500	2,502	0,020/0,082	AL-LF	02-3085L	H084/5 STD 0.25 0.50
MB/HL 1-5	5	53,958/53,978	59,000/59,019	18,500	2,502	0,020/0,082	AL-LF	02-3085U	
TW/A	2	59,500	73,200		1,975		AL-LF	04-3527	A123/4 STD
TW/A	2	59,500	73,200		1,975		AL-LF	04-3528	
CB/NWB 1-5	5	28,947/28,960	32,000/32,025	25,000	1,513	0,020/0,068	EC	73-3903	N147/5 STD

46 79.50 x 95.50

AXR			4 Cyl.	1896cc	74kW (100PS)		Diesel Turbo Intercooler		TD18739
BJB			4 Cyl.	1896cc	77kW (105PS)		Diesel Turbo Intercooler		TD17356
BKC			4 Cyl.	1896cc	77kW (105PS)		Diesel Turbo Intercooler		TD17355
BLS			4 Cyl.	1896cc	77kW (105PS)		Diesel Turbo Intercooler		TD18268
BMT			4 Cyl.	1896cc	74kW (101PS)		Diesel Turbo Intercooler		TD20495
BXE			4 Cyl.	1896cc	77kW (105PS)		Diesel Turbo Intercooler		TD19819
BXF			4 Cyl.	1896cc	66kW (90PS)		Diesel Turbo Intercooler		TD20866
BXJ			4 Cyl.	1896cc	66kW (90PS)		Diesel Turbo Intercooler		TD20840
BE/PL	1	47,758/47,778	50,600/50,612	20,000	1,406	0,020/0,067	SP	71-3904	71-3904 STD 0.25 0.50
MB/HL 1-5	5	53,958/53,978	59,000/59,012	18,500	2,501	0,020/0,076	EC	72-3931	H079/5 STD 0.25 0.50

TW/A	2	59,500	73,200		1,975		AL-LF	04-3527	A123/4 STD
TW/A	2	59,500	73,200		1,975		AL-LF	04-3528	
CB/NWB 1-5	5	28,947/28,960	32,000/32,025	25,000	1,513	0,020/0,068	EC	73-3903	N147/5 STD

47 79.50 x 95.50

BLT		4 Cyl.	1896cc	96kW (131PS)			Diesel Turbo Intercooler		TD20516
BE/PL	1	47,758/47,778	50,600/50,612	20,000	1,406	0,020/0,067	SP	71-3904	71-3904 STD 0.25 0.50 1
BE/PL	1	50,858/50,878	53,700/53,712	20,400	1,403	0,020/0,073	SP	71-3930	71-3930 STD 0.25 0.50 1
MB/HL 1-5	5	53,958/53,978	59,000/59,012	18,500	2,501	0,020/0,076	EC	72-3931	H079/5 STD 0.25 0.50
TW/A	2	59,500	73,200		1,975		AL-LF	04-3527	A123/4 STD
TW/A	2	59,500	73,200		1,975		AL-LF	04-3528	
CB/NWB 1-5	5	28,947/28,960	32,000/32,025	25,000	1,513	0,020/0,068	EC	73-3903	N147/5 STD

48 80.00 x 71.50

124 B2.000		4 Cyl.	1438cc	56kW (77PS)			Petrol		TD3563
124 B7.000		4 Cyl.	1438cc	54kW (73PS)			Petrol		TD3566
BE/PL	4	45,508/45,528	48,629/48,646	19,200	1,547	0,020/0,069	AL-LF	1645RA	01-4127/4 STD 0.25 0.50
BE/PL	4	45,508/45,528	48,629/48,646	19,200	1,538	0,025/0,087	AL-LF	60985RA	01-4171/4 STD

1645RA

60985RA

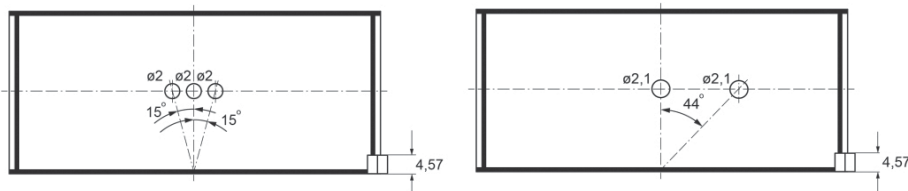

MB/HL 1,2,4,5	4	50,785/50,805	54,507/54,520	20,250	1,831	0,040/0,098	AL-LF	60986RA	H1028/5 STD 0.25
MB/HL 3	1	50,785/50,805	54,507/54,520	22,750	1,831	0,040/0,098	AL-LF	60987RA	
TW/A	2	56,610/56,684	69,596/69,850		2,362		AL-LF	60987AF	A197/2 STD .005
TW/A	2	56,610/56,864	69,596/69,850		2,362		AL-LF	60987AFA	A198/2 STD .005

60987AF

60987AFA

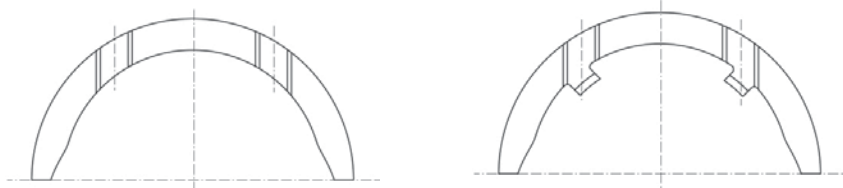

SE/PB	1	21,539/21,641	23,939/23,972	25,100			BS	62039Y	55-4288 SEMI
-------	---	---------------	---------------	--------	--	--	----	--------	------------------------

49 80.00 x 79.20

022 A 000		4 Cyl.	1592cc	68-70kW (93-95PS)			Petrol		TD9376
BE/PL	4	50,782/50,802	53,897/53,913	19,500	1,537	0,021/0,082	AL-LF	66240RA	01-4175/4 STD 0.25 0.50 0.75 1.00

MB/HL 1,2,4,5	4	52,985/53,005	56,717/56,730	20,750	1,841	0,030/0,088	AL-LF	66316RA	H1043/5 STD 0.25 0.50 0.75
MB/HL 3	1	52,985/53,005	56,717/56,730	24,250	1,841	0,030/0,088	AL-LF	66317RA	
TW/A	2	59,000/59,250	73,600/73,850		2,362		BS	62037AF	A201/2 STD .005
SE/PB	1	21,539/21,641	25,000/25,021	25,100			BS	66649Y	55-4193 SEMI
SE/PB	1	21,539/21,641	23,939/23,972	25,100			BS	62039Y	55-4288 SEMI

→12/84

50**80.00 x 79.20**

132 BB OA O			4 Cyl.	1592cc	71-72kW (97-98PS)		Petrol		TD22904
138 AR6.000			4 Cyl.	1592cc	68kW (92PS)		Petrol		TD3568
BE/PL	4	50,782/50,802	53,897/53,913	19,500	1,537	0,021/0,082	AL-LF	66240RA	01-4175/4 STD 0.25 0.50 0.75 1.00
MB/HL 1,2,4,5	4	52,985/53,005	56,717/56,730	20,750	1,841	0,030/0,088	AL-LF	66316RA	H1043/5 STD 0.25 0.50 0.75
MB/HL 3	1	52,985/53,005	56,717/56,730	24,250	1,841	0,030/0,088	AL-LF	66317RA	
TW/A	2	59,000/59,250	73,600/73,850		2,362		BS	62037AF	A201/2 STD .005
SE/PB	1	21,539/21,641	25,000/25,021	25,100			BS	66649Y	55-4193 SEMI
SE/PB	1	21,539/21,641	23,939/23,972	25,100			BS	62039Y	55-4288 SEMI

51**81.00 x 77.40**

1F			4 Cyl.	1595cc	52-55kW (71-75PS)		Petrol		TD4890
ABN			4 Cyl.	1595cc	54-55kW (73-75PS)		Petrol		TD17897
BE/PL	4	47,758/47,778	50,600/50,612	19,000	1,406	0,020/0,067	EC	71-3694	71-3694/4 STD 0.25 0.50
MB/HL	4	53,958/53,978	59,000/59,019	18,500	2,502	0,020/0,082	AL-LF	02-3085L	H027/5 STD 0.25 0.50
MB/HL	6	53,958/53,978	59,000/59,019	18,500	2,502	0,020/0,082	AL-LF	02-3085U	
TW/A	2	59,500	73,200		1,975		AL-LF	04-3527	A123/4 STD
TW/A	2	59,500	73,200		1,975		AL-LF	04-3528	
SE/PB	1	20,000	23,000/23,021	25,000			BC	55-3698	55-3698 SEMI
CB/NWB 1-5	5	25,939/25,960	28,250/28,271	17,000	1,138		AL-LF	03-3317	N118/5 STD 12
BU	1	42,959/42,975	46,055/46,095	15,000			AL-LF	07-3088	07-3088 STD SEMI 13
Front, For intermediary shaft									
BU	1	41,959/41,975	45,000/45,025	15,000			AL-LF	07-3089	07-3089 STD SEMI 13
Rear, For intermediary shaft									

52**81.00 x 77.40**

AEH			4 Cyl.	1595cc	74kW (101PS)		Petrol		TD12488
AKL			4 Cyl.	1595cc	74kW (101PS)		Petrol		TD12509
APF			4 Cyl.	1595cc	74kW (100PS)		Petrol		TD13269
AUR			4 Cyl.	1595cc	74kW (101PS)		Petrol		TD16200
BE/PL	4	47,758/47,778	50,600/50,612	19,000	1,406	0,020/0,067	EC	71-3694	71-3694/4 STD 0.25 0.50



BE/PL	4	47,758/47,778	50,600/50,612	19,000	1,406	0,020/0,067	EC	71-3929	71-3929/4 STD	11
-------	---	---------------	---------------	--------	-------	-------------	----	---------	------------------	----

71-3694

71-3929

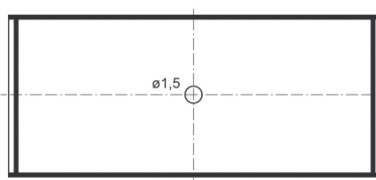
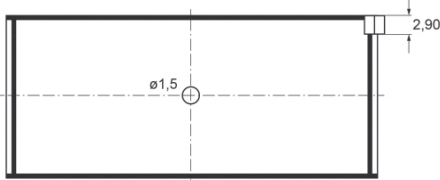

MB/HL 1-5	5	53,958/53,978	59,000/59,019	18,500	2,502	0,020/0,082	AL-LF	02-3085L	H084/5 STD 0.25 0.50	
MB/HL 1-5	5	53,958/53,978	59,000/59,019	18,500	2,502	0,020/0,082	AL-LF	02-3085U		
TW/A	2	59,500	73,200		1,975		AL-LF	04-3527	A123/4 STD	
TW/A	2	59,500	73,200		1,975		AL-LF	04-3528		
SE/PB	1	20,000	23,000/23,021	25,000			BC	55-3698	55-3698 SEMI	
CB/NWB 1-5	5	25,939/25,960	28,250/28,271	17,000	1,138		AL-LF	03-3317	N118/5 STD	12
BU	1	42,959/42,975	46,055/46,095	15,000			AL-LF	07-3088	07-3088 STD SEMI	13

Front, For intermediary shaft

BU	1	41,959/41,975	45,000/45,025	15,000			AL-LF	07-3089	07-3089 STD SEMI	13
----	---	---------------	---------------	--------	--	--	-------	---------	---------------------	----

Rear, For intermediary shaft

53 81.00 x 77.40

AFT			4 Cyl.	1595cc	74kW (101PS)		Petrol		TD5536	
BE/PL	4	47,758/47,778	50,600/50,612	19,000	1,406	0,020/0,067	EC	71-3694	71-3694/4 STD 0.25 0.50	
BE/PL	4	47,758/47,778	50,600/50,612	19,000	1,406	0,020/0,067	EC	71-3929	71-3929/4 STD	11

71-3694

71-3929

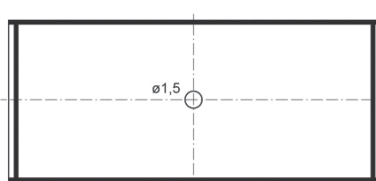
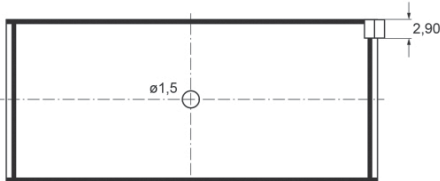



MB/HL	4	53,958/53,978	59,000/59,019	18,500	2,502	0,020/0,082	AL-LF	02-3085L	H027/5 STD 0.25 0.50
MB/HL	6	53,958/53,978	59,000/59,019	18,500	2,502	0,020/0,082	AL-LF	02-3085U	

Mot.→1EY010001

MB/HL 1-5	5	53,958/53,978	59,000/59,019	18,500	2,502	0,020/0,082	AL-LF	02-3085L	H084/5 STD 0.25 0.50
MB/HL 1-5	5	53,958/53,978	59,000/59,019	18,500	2,502	0,020/0,082	AL-LF	02-3085U	

Mot.1EY010001→

02-3085L

02-3085U

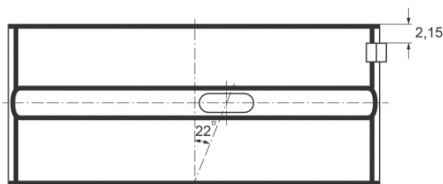

TW/A	2	59,500	73,200		1,975		AL-LF	04-3527	A123/4 STD
TW/A	2	59,500	73,200		1,975		AL-LF	04-3528	
SE/PB	1	20,000	23,000/23,021	25,000			BC	55-3698	55-3698 SEMI
CB/NWB 1-5	5	25,939/25,960	28,250/28,271	17,000	1,138		AL-LF	03-3317	N118/5 STD
BU	1	42,959/42,975	46,055/46,095	15,000			AL-LF	07-3088	07-3088 STD SEMI

12

13

Front, For intermediary shaft

BU	1	41,959/41,975	45,000/45,025	15,000			AL-LF	07-3089	07-3089 STD SEMI
----	---	---------------	---------------	--------	--	--	-------	---------	----------------------------

13

Rear, For intermediary shaft

54	81.00 x 77.40								
ALZ			4 Cyl.	1595cc	75kW (102PS)		Petrol		TD22242
BFQ			4 Cyl.	1595cc	75kW (102PS)		Petrol		TD20621
BGU			4 Cyl.	1595cc	75kW (102PS)		Petrol		TD17352
BSE			4 Cyl.	1595cc	75kW (102PS)		Petrol		TD18245
BSF			4 Cyl.	1595cc	75kW (102PS)		Petrol		TD18246
CCSA			4 Cyl.	1595cc	75kW (102PS)		Petrol		TD20710
CHGA			4 Cyl.	1595cc	75kW (102PS)		Petrol		TD22676
BE/PL	4	41,965/41,980	45,000/45,016	19,000	1,505	0,020/0,070	AL-LF	01-3961	01-3961/4 STD

55	81.00 x 77.40								
EZ			4 Cyl.	1595cc	52-54kW (71-73PS)		Petrol		TD4899
BE/PL	4	47,758/47,778	50,600/50,612	19,000	1,406	0,020/0,067	EC	71-3694	71-3694/4 STD 0.25 0.50

SEAT



MB/HL	3	53,958/53,978	59,000/59,019	18,500	2,502	0,020/0,082	AL-LF	02-3085L	H025/5 STD 0.25 0.50
MB/HL	5	53,958/53,978	59,000/59,019	18,500	2,502	0,020/0,082	AL-LF	02-3085U	
MB/HL	1	53,958/53,978	59,000/59,019	24,930	2,502	0,020/0,082	AL-LF	02-3086HL	
MB/HL	1	53,958/53,978	59,000/59,019	24,930	2,502	0,020/0,082	AL-LF	02-3086HU	



02-3086HL	STD	25,000/.9843" - 25,040/.9858"
	0.25mm	25,100/.9882" - 25,140/.9898"
	0.50mm	25,100/.9882" - 25,140/.9898"
	0.75mm	25,100/.9882" - 25,140/.9898"

02-3086HU	STD	25,000/.9843" - 25,040/.9858"
	0.25mm	25,100/.9882" - 25,140/.9898"
	0.50mm	25,100/.9882" - 25,140/.9898"
	0.75mm	25,100/.9882" - 25,140/.9898"

MB/HL	4	53,958/53,978	59,000/59,019	18,500	2,502	0,020/0,082	AL-LF	02-3085L	H027/5 STD 0.25 0.50
MB/HL	6	53,958/53,978	59,000/59,019	18,500	2,502	0,020/0,082	AL-LF	02-3085U	

02-3085L

02-3085U

02-3086HL

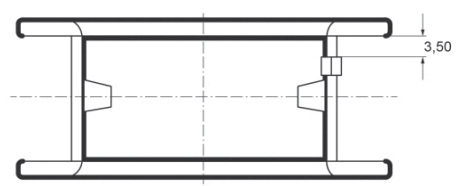
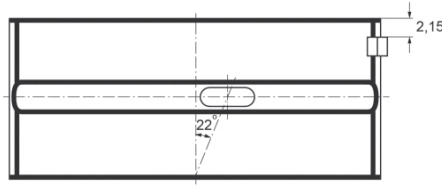
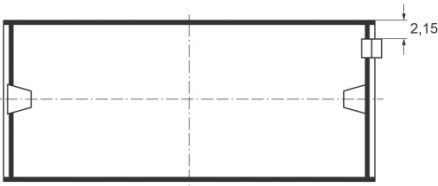

02-3086HU

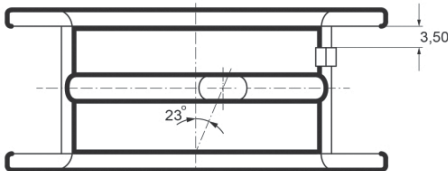

TW/A	2	59,500	73,200		1,975		AL-LF	04-3527	A123/4 STD
TW/A	2	59,500	73,200		1,975		AL-LF	04-3528	
SE/PB	1	20,000	23,000/23,052	25,000			BC	55-3567	55-3567 SEMI

Mot.→53L020000

SE/PB	1	20,000	23,000/23,021	25,000			BC	55-3698	55-3698 SEMI
-------	---	--------	---------------	--------	--	--	----	---------	------------------------

Mot.53M000001→

55-3567

55-3698

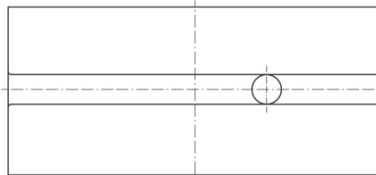
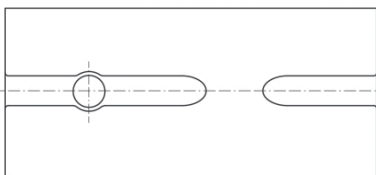

CB/NWB 1-5	5	25,939/25,960	28,250/28,271	17,000	1,138		AL-LF	03-3317	N118/5 STD	12
BU	1	42,959/42,975	46,055/46,095	15,000			AL-LF	07-3088		

Front, For intermediary shaft

BU	1	41,959/41,975	45,000/45,025	15,000				AL-LF	07-3089	07-3089 STD SEMI	

Rear, For intermediary shaft

56

81.00 x 77.40

HM			4 Cyl.	1595cc	38-55kW (52-75PS)			Petrol		TD3590
BE/PL	1	45,950/45,970	49,000/49,016	19,000	1,506	0,020/0,078	EC	71-3084	71-3084 STD 0.25	
→12/83										
BE/PL	4	47,758/47,778	50,600/50,619	19,000	1,406	0,020/0,074	EC	71-3566	71-3566/4 STD 0.25	
01/84 → 12/85										
BE/PL	4	47,758/47,778	50,600/50,612	19,000	1,406	0,020/0,067	EC	71-3694	71-3694/4 STD 0.25 0.50	
01/86 →										

71-3084



71-3566



71-3694

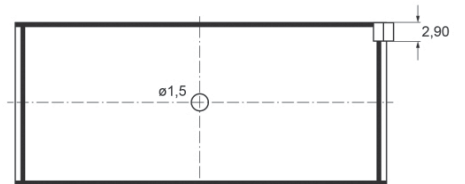

MB/HL	3	53,958/53,978	59,000/59,019	18,500	2,502	0,020/0,082	AL-LF	02-3085L	H025/5 STD 0.25 0.50
MB/HL	5	53,958/53,978	59,000/59,019	18,500	2,502	0,020/0,082	AL-LF	02-3085U	
MB/HL	1	53,958/53,978	59,000/59,019	24,930	2,502	0,020/0,082	AL-LF	02-3086HL	
MB/HL	1	53,958/53,978	59,000/59,019	24,930	2,502	0,020/0,082	AL-LF	02-3086HU	



02-3086HL	STD	25,000/.9843" - 25,040/.9858"
	0.25mm	25,100/.9882" - 25,140/.9898"
	0.50mm	25,100/.9882" - 25,140/.9898"
	0.75mm	25,100/.9882" - 25,140/.9898"

02-3086HU	STD	25,000/.9843" - 25,040/.9858"
	0.25mm	25,100/.9882" - 25,140/.9898"
	0.50mm	25,100/.9882" - 25,140/.9898"
	0.75mm	25,100/.9882" - 25,140/.9898"

MB/HL	4	53,958/53,978	59,000/59,019	18,500	2,502	0,020/0,082	AL-LF	02-3085L	H027/5 STD 0.25 0.50
MB/HL	6	53,958/53,978	59,000/59,019	18,500	2,502	0,020/0,082	AL-LF	02-3085U	

02-3085L



02-3085U

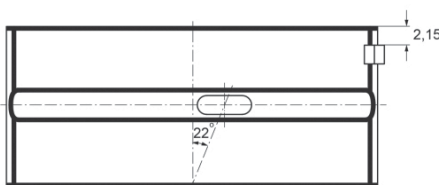

02-3086HL

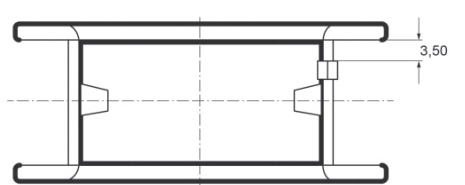



02-3086HU

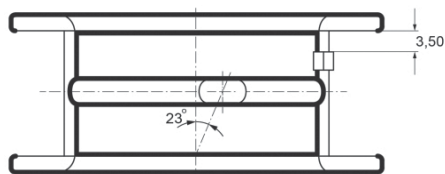

TW/A	2	59,500	73,200		1,975		AL-LF	04-3527	A123/4 STD	
TW/A	2	59,500	73,200		1,975		AL-LF	04-3528		
SE/PB	1	20,000	23,000/23,052	25,000			BC	55-3567	55-3567 SEMI	
CB/NWB 1-5	5	25,939/25,960	28,250/28,271	17,000	1,138		AL-LF	03-3317	N118/5 STD	12
BU	1	42,959/42,975	46,055/46,095	15,000			AL-LF	07-3088	07-3088 STD SEMI	13
Front, For intermediary shaft										
BU	1	41,959/41,975	45,000/45,025	15,000			AL-LF	07-3089	07-3089 STD SEMI	13
Rear, For intermediary shaft										

57

81.00 x 86.40

ABS			4 Cyl.	1781cc	66kW (90PS)		Petrol		TD3576	
ACC			4 Cyl.	1781cc	66kW (90PS)		Petrol		TD18752	
ADL			4 Cyl.	1781cc	95kW (129PS)		Petrol		TD3578	
ADZ			4 Cyl.	1781cc	66kW (90PS)		Petrol		TD9384	
BE/PL	4	47,758/47,778	50,600/50,612	19,000	1,406	0,020/0,067	EC	71-3694	71-3694/4 STD 0.25 0.50	
MB/HL	4	53,958/53,978	59,000/59,019	18,500	2,502	0,020/0,082	AL-LF	02-3085L	H027/5 STD 0.25 0.50	
MB/HL	6	53,958/53,978	59,000/59,019	18,500	2,502	0,020/0,082	AL-LF	02-3085U		
TW/A	2	59,500	73,200		1,975		AL-LF	04-3527	A123/4 STD	
TW/A	2	59,500	73,200		1,975		AL-LF	04-3528		
SE/PB	1	20,000	23,000/23,021	25,000			BC	55-3698	55-3698 SEMI	
BU	1	42,959/42,975	46,055/46,095	15,000			AL-LF	07-3088	07-3088 STD SEMI	
Front, For intermediary shaft										
BU	1	41,959/41,975	45,000/45,025	15,000			AL-LF	07-3089	07-3089 STD SEMI	
Rear, For intermediary shaft										

58

81.00 x 86.40

AGN			4 Cyl.	1781cc	92kW (125PS)		Petrol		TD12510
APG			4 Cyl.	1781cc	92kW (125PS)		Petrol		TD15530
BE/PL	4	47,758/47,778	50,600/50,612	19,000	1,406	0,020/0,067	EC	71-3694	71-3694/4 STD 0.25 0.50
MB/HL 1-5	5	53,958/53,978	59,000/59,019	18,500	2,502	0,020/0,082	AL-LF	02-3085L	H084/5 STD 0.25 0.50
MB/HL 1-5	5	53,958/53,978	59,000/59,019	18,500	2,502	0,020/0,082	AL-LF	02-3085U	

TW/A	2	59,500	73,200		1,975		AL-LF	04-3527	A123/4 STD
TW/A	2	59,500	73,200		1,975		AL-LF	04-3528	
SE/PB	1	20,000	23,000/23,021	25,000			BC	55-3698	55-3698 SEMI

59**81.00 x 86.40**

AJH			4 Cyl.	1781cc	110kW (150PS)		Petrol Turbo Intercooler		TD17899
AQX			4 Cyl.	1781cc	115kW (156PS)		Petrol Turbo		TD13275
AYP			4 Cyl.	1781cc	115kW (156PS)		Petrol Turbo		TD16201
BE/PL	4	47,758/47,778	50,600/50,612	19,000	1,406	0,020/0,067	EC	71-3694	71-3694/4 STD 0.25 0.50
BE/PL	1	47,758/47,778	50,600/50,612	19,000	1,395	0,032/0,089	SP	71-3732	71-3732 STD 1

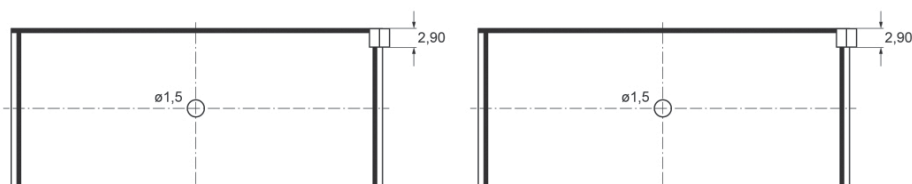
71-3694**71-3732**

MB/HL	4	53,958/53,978	59,000/59,019	18,500	2,502	0,020/0,082	AL-LF	02-3085L	H027/5 STD 0.25 0.50
MB/HL	6	53,958/53,978	59,000/59,019	18,500	2,502	0,020/0,082	AL-LF	02-3085U	
TW/A	2	59,500	73,200		1,975		AL-LF	04-3527	A123/4 STD
TW/A	2	59,500	73,200		1,975		AL-LF	04-3528	
SE/PB	1	20,000	23,000/23,021	25,000			BC	55-3698	55-3698 SEMI

60**81.00 x 86.40**

AJQ			4 Cyl.	1781cc	132kW (180PS)		Petrol Turbo Intercooler		TD16199
AMK			4 Cyl.	1781cc	154kW (209PS)		Petrol Turbo		TD16436
APP			4 Cyl.	1781cc	132kW (180PS)		Petrol Turbo		TD13270
AWC			4 Cyl.	1781cc	110kW (150PS)		Petrol Turbo Intercooler		TD14909
BE/PL	1	47,758/47,778	50,600/50,612	19,000	1,395	0,032/0,089	SP	71-3732	71-3732 STD 1
MB/HL 1-5	5	53,958/53,978	59,000/59,019	18,500	2,502	0,020/0,082	AL-LF	02-3085L	H084/5 STD 0.25 0.50
MB/HL 1-5	5	53,958/53,978	59,000/59,019	18,500	2,502	0,020/0,082	AL-LF	02-3085U	
TW/A	2	59,500	73,200		1,975		AL-LF	04-3527	A123/4 STD
TW/A	2	59,500	73,200		1,975		AL-LF	04-3528	
SE/PB	1	20,000	23,000/23,021	25,000			BC	55-3698	55-3698 SEMI

61**81.00 x 86.40**

ARY			4 Cyl.	1781cc	132kW (180PS)		Petrol Turbo		TD16136
AUQ			4 Cyl.	1781cc	132kW (180PS)		Petrol Turbo		TD16135
BE/PL	4	47,758/47,778	50,600/50,612	19,000	1,406	0,020/0,067	EC	71-3929	71-3929/4 STD 1
MB/HL 1-5	5	53,958/53,978	59,000/59,019	18,500	2,502	0,020/0,082	AL-LF	02-3085L	H084/5 STD 0.25 0.50

MB/HL 1-5	5	53,958/53,978	59,000/59,019	18,500	2,502	0,020/0,082	AL-LF	02-3085U	
TW/A	2	59,500	73,200		1,975		AL-LF	04-3527	A123/4 STD
TW/A	2	59,500	73,200		1,975		AL-LF	04-3528	
SE/PB	1	20,000	23,000/23,021	25,000			BC	55-3698	55-3698 SEMI

62 81.00 x 86.40

BKV	4 Cyl.		1781cc	110kW (150PS)			Petrol Turbo Intercooler		TD17321
BE/PL	4	47,758/47,778	50,600/50,612	19,000	1,406	0,020/0,067	EC	71-3694	71-3694/4 STD 0.25 0.50
MB/HL 1-5	5	53,958/53,978	59,000/59,019	18,500	2,502	0,020/0,082	AL-LF	02-3085L	H084/5 STD 0.25 0.50
MB/HL 1-5	5	53,958/53,978	59,000/59,019	18,500	2,502	0,020/0,082	AL-LF	02-3085U	
TW/A	2	59,500	73,200		1,975		AL-LF	04-3527	A123/4 STD
TW/A	2	59,500	73,200		1,975		AL-LF	04-3528	

63 81.00 x 86.40

BLZ	4 Cyl.		1781cc	132kW (180PS)			Petrol		TD18751
BE/PL	4	47,758/47,778	50,600/50,612	19,000	1,406	0,020/0,067	EC	71-3929	71-3929/4 STD II
MB/HL 1-5	5	53,958/53,978	59,000/59,019	18,500	2,502	0,020/0,082	AL-LF	02-3085L	H084/5 STD 0.25 0.50
MB/HL 1-5	5	53,958/53,978	59,000/59,019	18,500	2,502	0,020/0,082	AL-LF	02-3085U	
TW/A	2	59,500	73,200		1,975		AL-LF	04-3527	A123/4 STD
TW/A	2	59,500	73,200		1,975		AL-LF	04-3528	

64 81.00 x 86.40

KR	4 Cyl.		1781cc	98-102kW (133-139PS)			Petrol		TD3591																																																																																
BE/PL	4	47,758/47,778	50,600/50,612	19,000	1,406	0,020/0,067	EC	71-3694	71-3694/4 STD 0.25 0.50																																																																																
MB/HL	3	53,958/53,978	59,000/59,019	18,500	2,502	0,020/0,082	AL-LF	02-3085L	H025/5 STD 0.25 0.50																																																																																
MB/HL	5	53,958/53,978	59,000/59,019	18,500	2,502	0,020/0,082	AL-LF	02-3085U																																																																																	
MB/HL	1	53,958/53,978	59,000/59,019	24,930	2,502	0,020/0,082	AL-LF	02-3086HL																																																																																	
MB/HL	1	53,958/53,978	59,000/59,019	24,930	2,502	0,020/0,082	AL-LF	02-3086HU																																																																																	
<table border="0" style="width: 100%;"> <tr> <td style="width: 15%;">02-3086HL</td> <td style="width: 15%;">STD</td> <td style="width: 15%;">25,000/.9843" - 25,040/.9858"</td> <td colspan="7"></td> </tr> <tr> <td></td> <td>0.25mm</td> <td>25,100/.9882" - 25,140/.9898"</td> <td colspan="7"></td> </tr> <tr> <td></td> <td>0.50mm</td> <td>25,100/.9882" - 25,140/.9898"</td> <td colspan="7"></td> </tr> <tr> <td></td> <td>0.75mm</td> <td>25,100/.9882" - 25,140/.9898"</td> <td colspan="7"></td> </tr> <tr> <td>02-3086HU</td> <td>STD</td> <td>25,000/.9843" - 25,040/.9858"</td> <td colspan="7"></td> </tr> <tr> <td></td> <td>0.25mm</td> <td>25,100/.9882" - 25,140/.9898"</td> <td colspan="7"></td> </tr> <tr> <td></td> <td>0.50mm</td> <td>25,100/.9882" - 25,140/.9898"</td> <td colspan="7"></td> </tr> <tr> <td></td> <td>0.75mm</td> <td>25,100/.9882" - 25,140/.9898"</td> <td colspan="7"></td> </tr> </table>										02-3086HL	STD	25,000/.9843" - 25,040/.9858"									0.25mm	25,100/.9882" - 25,140/.9898"									0.50mm	25,100/.9882" - 25,140/.9898"									0.75mm	25,100/.9882" - 25,140/.9898"								02-3086HU	STD	25,000/.9843" - 25,040/.9858"									0.25mm	25,100/.9882" - 25,140/.9898"									0.50mm	25,100/.9882" - 25,140/.9898"									0.75mm	25,100/.9882" - 25,140/.9898"							
02-3086HL	STD	25,000/.9843" - 25,040/.9858"																																																																																							
	0.25mm	25,100/.9882" - 25,140/.9898"																																																																																							
	0.50mm	25,100/.9882" - 25,140/.9898"																																																																																							
	0.75mm	25,100/.9882" - 25,140/.9898"																																																																																							
02-3086HU	STD	25,000/.9843" - 25,040/.9858"																																																																																							
	0.25mm	25,100/.9882" - 25,140/.9898"																																																																																							
	0.50mm	25,100/.9882" - 25,140/.9898"																																																																																							
	0.75mm	25,100/.9882" - 25,140/.9898"																																																																																							
MB/HL	4	53,958/53,978	59,000/59,019	18,500	2,502	0,020/0,082	AL-LF	02-3085L	H027/5 STD 0.25 0.50																																																																																
MB/HL	6	53,958/53,978	59,000/59,019	18,500	2,502	0,020/0,082	AL-LF	02-3085U																																																																																	

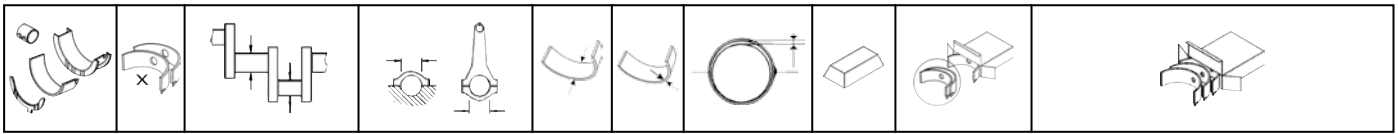

02-3085L



02-3085U

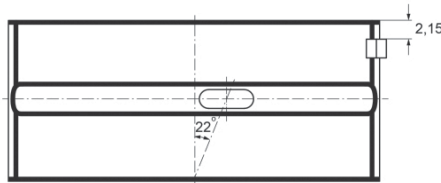

02-3086HL

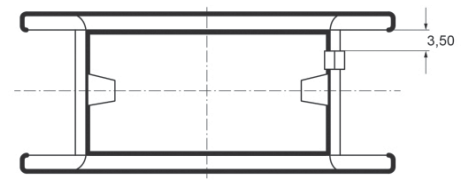

02-3086HU

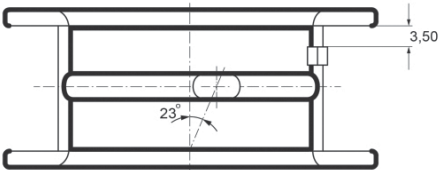

TW/A	2	59,500	73,200		1,975	AL-LF	04-3527	A123/4 STD
TW/A	2	59,500	73,200		1,975	AL-LF	04-3528	
SE/PB	1	20,000	23,000/23,052	25,000		BC	55-3567	55-3567 SEMI
SE/PB	1	20,000	23,000/23,021	25,000		BC	55-3698	55-3698 SEMI

55-3567

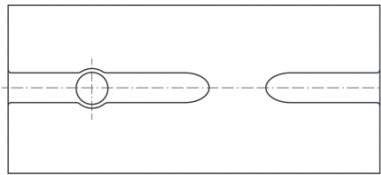

55-3698

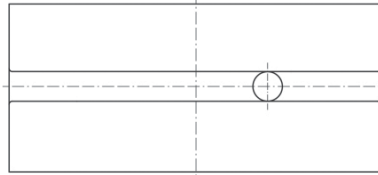

BU	1	42,959/42,975	46,055/46,095	15,000		AL-LF	07-3088	07-3088 STD SEMI	13
Front, For intermediary shaft									
BU	1	41,959/41,975	45,000/45,025	15,000		AL-LF	07-3089	07-3089 STD SEMI	13

Rear, For intermediary shaft

65

81.00 x 86.40

PL		4 Cyl.	1781cc	92kW (125PS)		Petrol		TD3595	
BE/PL	4	47,758/47,778	50,600/50,612	19,000	1,406	0,020/0,067	EC	71-3694	71-3694/4 STD 0.25 0.50
MB/HL	4	53,958/53,978	59,000/59,019	18,500	2,502	0,020/0,082	AL-LF	02-3085L	H027/5 STD 0.25 0.50
MB/HL	6	53,958/53,978	59,000/59,019	18,500	2,502	0,020/0,082	AL-LF	02-3085U	
MB/HL 1-5	5	53,958/53,978	59,000/59,019	18,500	2,502	0,020/0,082	AL-LF	02-3085L	H084/5 STD 0.25 0.50
MB/HL 1-5	5	53,958/53,978	59,000/59,019	18,500	2,502	0,020/0,082	AL-LF	02-3085U	

02-3085L



02-3085U

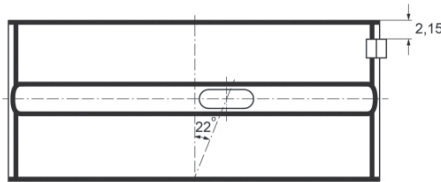



TW/A	2	59,500	73,200		1,975		AL-LF	04-3527	A123/4 STD
TW/A	2	59,500	73,200		1,975		AL-LF	04-3528	
SE/PB	1	20,000	23,000/23,052	25,000			BC	55-3567	55-3567 SEMI
SE/PB	1	20,000	23,000/23,021	25,000			BC	55-3698	55-3698 SEMI

55-3567

55-3698

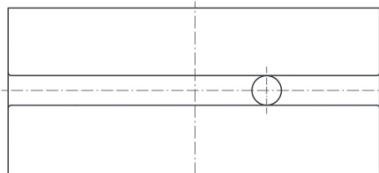
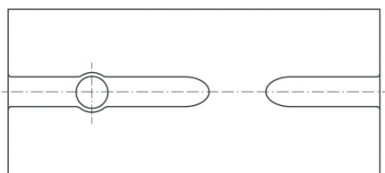

BU	1	42,959/42,975	46,055/46,095	15,000			AL-LF	07-3088	07-3088 STD SEMI	13
----	---	---------------	---------------	--------	--	--	-------	---------	----------------------------	----

Front, For intermediary shaft

BU	1	41,959/41,975	45,000/45,025	15,000			AL-LF	07-3089	07-3089 STD SEMI	13
----	---	---------------	---------------	--------	--	--	-------	---------	----------------------------	----

Rear, For intermediary shaft

66

81.00 x 86.40

RP			4 Cyl.	1781cc	65kW (88PS)		Petrol		TD3596
-----------	--	--	--------	---------------	--------------------	--	---------------	--	---------------

BE/PL	4	47,758/47,778	50,600/50,612	19,000	1,406	0,020/0,067	EC	71-3694	71-3694/4 STD 0.25 0.50
-------	---	---------------	---------------	--------	-------	-------------	----	---------	-----------------------------------

01/86 →

MB/HL	4	53,958/53,978	59,000/59,019	18,500	2,502	0,020/0,082	AL-LF	02-3085L	H027/5 STD 0.25 0.50
MB/HL	6	53,958/53,978	59,000/59,019	18,500	2,502	0,020/0,082	AL-LF	02-3085U	

Mot. → 8DX199999

MB/HL 1-5	5	53,958/53,978	59,000/59,019	18,500	2,502	0,020/0,082	AL-LF	02-3085L	H084/5 STD 0.25 0.50
MB/HL 1-5	5	53,958/53,978	59,000/59,019	18,500	2,502	0,020/0,082	AL-LF	02-3085U	

Mot. 8DX200001 →

02-3085L

02-3085U

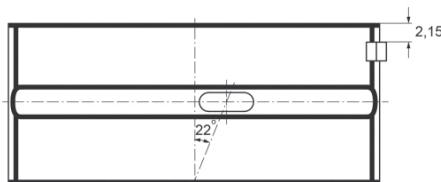

TW/A	2	59,500	73,200		1,975		AL-LF	04-3527	A123/4 STD	
TW/A	2	59,500	73,200		1,975		AL-LF	04-3528		
SE/PB	1	20,000	23,000/23,021	25,000			BC	55-3698	55-3698 SEMI	
CB/NWB 1-5	5	25,939/25,960	28,250/28,271	17,000	1,138		AL-LF	03-3317	N118/5 STD	12
BU	1	42,959/42,975	46,055/46,095	15,000			AL-LF	07-3088	07-3088 STD SEMI	13

Front, For intermediary shaft



BU	1	41,959/41,975	45,000/45,025	15,000			AL-LF	07-3089	07-3089 STD SEMI	13
----	---	---------------	---------------	--------	--	--	-------	---------	----------------------------	----

Rear, For intermediary shaft

67 81.00 x 90.30

AUE	V6 Cyl.		2792cc	150kW (204PS)			Petrol			TD16137
AYL	V6 Cyl.		2792cc	150kW (204PS)			Petrol			TD14910
BDE	V6 Cyl.		2792cc	150kW (204PS)			Petrol			TD18753

BE/PL	6	53,958/53,978	56,800/56,819	17,000	1,406	0,020/0,074	AL-LF	01-3841	01-3841/6 STD 0.25	
MB/HL 1-7	7	59,958/59,978	65,000/65,010	17,000	2,501	0,020/0,075	AL-LF	02-3716	H035/7 STD 0.25	
TW/A	2	65,450	80,000		1,723		AL-LF	04-3717	A139/4 STD	
TW/A	2	65,450	80,000		1,723		AL-LF	04-3718		
BU	1	42,959/42,975	46,055/46,095	15,000			AL-LF	07-3088	07-3088 STD SEMI	13

Front, For intermediary shaft

BU	1	14,473/14,484	17,500/17,518	20,000			BB	17-3720	17-3720 SEMI	13
----	---	---------------	---------------	--------	--	--	----	---------	------------------------	----

Rear, For intermediary shaft

68 81.00 x 95.50

AZV	4 Cyl.		1968cc	100kW (136PS)			Diesel Turbo Intercooler			TD18247
BKD	4 Cyl.		1968cc	103kW (140PS)			Diesel Turbo Intercooler			TD17357
BMN	4 Cyl.		1968cc	125kW (170PS)			Diesel Turbo Intercooler			TD18977
CAGA	4 Cyl.		1968cc	105kW (143PS)			Diesel Turbo Intercooler			TD22243
CAGC	4 Cyl.		1968cc	88kW (120PS)			Diesel Turbo Intercooler			TD22669
CAHA	4 Cyl.		1968cc	125kW (170PS)			Diesel Turbo Intercooler			TD22244
CFHD	4 Cyl.		1968cc	105kW (143PS)			Diesel Turbo Intercooler			TD23582
CGLB	4 Cyl.		1968cc	125kW (170PS)			Diesel Turbo			TD26498
CJCA	4 Cyl.		1968cc	105kW (143PS)			Diesel Turbo			TD26497

BE/PL	1	50,858/50,878	53,700/53,712	20,400	1,403	0,020/0,073	SP	71-3930	71-3930 STD 0.25 0.50	1
MB/HL 1-5	5	53,958/53,978	59,000/59,012	18,500	2,501	0,020/0,076	EC	72-3931	H079/5 STD 0.25 0.50	
TW/A	2	59,500	73,200		1,975		AL-LF	04-3527	A123/4 STD	
TW/A	2	59,500	73,200		1,975		AL-LF	04-3528		

69 81.00 x 95.50

BMM	4 Cyl.		1968cc	103kW (140PS)			Diesel Turbo Intercooler			TD18269
BRT	4 Cyl.		1968cc	103kW (140PS)			Diesel Turbo Intercooler			TD19388

BE/PL	1	50,858/50,878	53,700/53,712	20,400	1,403	0,020/0,073	SP	71-3930	71-3930 STD 0.25 0.50	1
MB/HL 1-5	5	53,958/53,978	59,000/59,012	18,500	2,501	0,020/0,076	EC	72-3931	H079/5 STD 0.25 0.50	
TW/A	2	59,500	73,200		1,975		AL-LF	04-3527	A123/4 STD	
TW/A	2	59,500	73,200		1,975		AL-LF	04-3528		
CB/NWB 1-5	5	28,947/28,960	32,000/32,025	25,000	1,513	0,020/0,068	EC	73-3903	N147/5 STD	

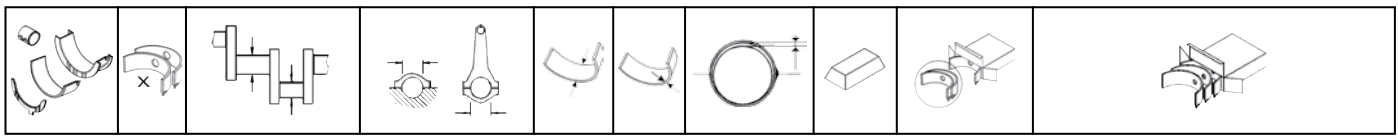

70 81.00 x 95.50

CBDB	4 Cyl.	1968cc	103kW (140PS)	Diesel Turbo Intercooler	TD24327
CEGA	4 Cyl.	1968cc	125kW (170PS)	Diesel Turbo	TD22674
CFFA	4 Cyl.	1968cc	100kW (136PS)	Diesel Turbo Intercooler	TD25404
CFFB	4 Cyl.	1968cc	103kW (140PS)	Diesel Turbo Intercooler	TD24450
CFFE	4 Cyl.	1968cc	85kW (116PS)	Diesel Turbo Intercooler	TD25403
CFGB	4 Cyl.	1968cc	125kW (170PS)	Diesel Turbo Intercooler	TD24451
CFGC	4 Cyl.	1968cc	130kW (177PS)	Diesel Turbo	TD27529
CFHC	4 Cyl.	1968cc	103kW (140PS)	Diesel Turbo Intercooler	TD24326
CFJA	4 Cyl.	1968cc	125kW (170PS)	Diesel Turbo	TD24333
CJCC	4 Cyl.	1968cc	88kW (120PS)	Diesel Turbo Intercooler	TD27013
CLCB	4 Cyl.	1968cc	103kW (140PS)	Diesel Turbo	TD25102
CRLB	4 Cyl.	1968cc	110kW (150PS)	Diesel Turbo Intercooler	TD29192
CUNA	4 Cyl.	1968cc	135kW (184PS)	Diesel Turbo	TD28019
CUPA	4 Cyl.	1968cc	135kW (184PS)	Diesel Turbo	TD27262

BE/PL	1	50,858/50,878	53,700/53,712	20,400	1,403	0,020/0,073	SP	71-3930	71-3930 STD 0.25 0.50	1
MB/HL 1-5	5	53,958/53,978	59,000/59,012	18,500	2,501	0,020/0,076	EC	72-3931	H079/5 STD 0.25 0.50	
MB/HL 2-5	4	53,958/53,978	59,000/59,019	18,500	2,502	0,020/0,082	AL-LF	02-3085L	H1328/5 STD	7
MB/HL 2-5	4	53,958/53,978	59,000/59,019	18,500	2,502	0,020/0,082	AL-LF	02-3085U		
MB/HL 1	1	53,958/53,978	59,000/59,012	18,500	2,506	0,020/0,062		02-4941L		
MB/HL 1	1	53,958/53,978	59,000/59,012	18,500	2,506	0,020/0,062		02-4941U		



12/11 →

02-3085L

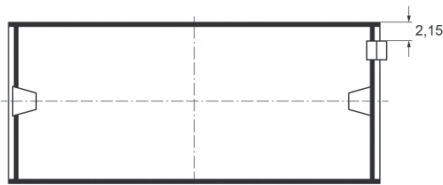

02-3085U

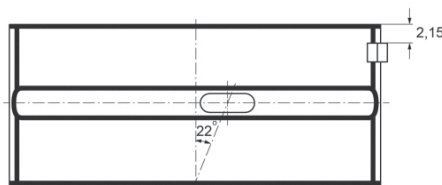

02-4941L



02-4941U

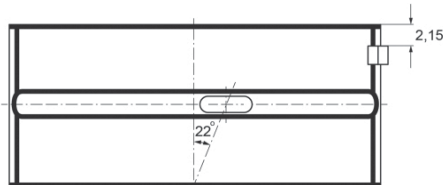

TW/A	2	59,500	73,200		1,975		AL-LF	04-3527	A123/4 STD
TW/A	2	59,500	73,200		1,975		AL-LF	04-3528	

71 82.50 x 92.80

2E	4 Cyl.	1984cc	85kW (115PS)	Petrol	TD3570
ABF	4 Cyl.	1984cc	110kW (150PS)	Petrol	TD4895
ADY	4 Cyl.	1984cc	85kW (115PS)	Petrol	TD9386

BE/PL	4	47,758/47,778	50,600/50,612	19,000	1,406	0,020/0,067	EC	71-3694	71-3694/4 STD 0.25 0.50
-------	---	---------------	---------------	--------	-------	-------------	----	---------	-----------------------------------

MB/HL	4	53,958/53,978	59,000/59,019	18,500	2,502	0,020/0,082	AL-LF	02-3085L	H027/5 STD 0.25 0.50
MB/HL	6	53,958/53,978	59,000/59,019	18,500	2,502	0,020/0,082	AL-LF	02-3085U	
TW/A	2	59,500	73,200		1,975		AL-LF	04-3527	A123/4 STD
TW/A	2	59,500	73,200		1,975		AL-LF	04-3528	
SE/PB	1	20,000	23,000/23,021	25,000			BC	55-3698	55-3698 SEMI

72 82.50 x 92.80

AGG			4 Cyl.	1984cc	85kW (115PS)		Petrol		TD5537
BE/PL	4	47,758/47,778	50,600/50,612	19,000	1,406	0,020/0,067	EC	71-3694	71-3694/4 STD 0.25 0.50
BE/PL	4	47,758/47,778	50,600/50,612	19,000	1,406	0,020/0,067	EC	71-3929	71-3929/4 STD 11

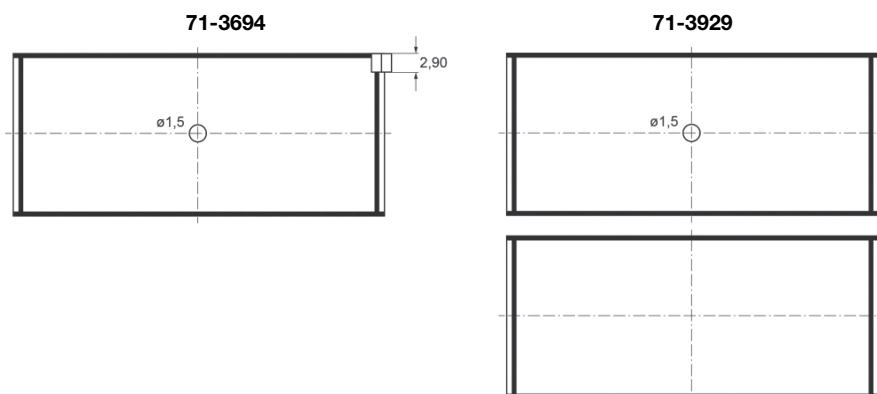

MB/HL 1-5	5	53,958/53,978	59,000/59,019	18,500	2,502	0,020/0,082	AL-LF	02-3085L	H084/5 STD 0.25 0.50
MB/HL 1-5	5	53,958/53,978	59,000/59,019	18,500	2,502	0,020/0,082	AL-LF	02-3085U	
TW/A	2	59,500	73,200		1,975		AL-LF	04-3527	A123/4 STD
TW/A	2	59,500	73,200		1,975		AL-LF	04-3528	
SE/PB	1	20,000	23,000/23,021	25,000			BC	55-3698	55-3698 SEMI
BU	1	42,959/42,975	46,055/46,095	15,000			AL-LF	07-3088	07-3088 STD SEMI 13







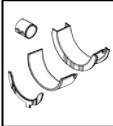

Front, For intermediary shaft

BU	1	41,959/41,975	45,000/45,025	15,000			AL-LF	07-3089	07-3089 STD SEMI 13
----	---	---------------	---------------	--------	--	--	-------	---------	--

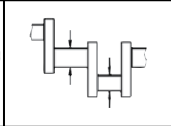
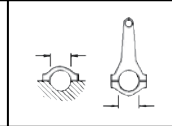
Rear, For intermediary shaft

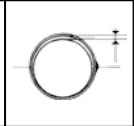
73 82.50 x 92.80

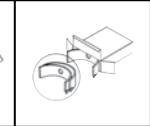
ATM			4 Cyl.	1984cc	85kW (115PS)		Petrol		TD14908
AZL			4 Cyl.	1984cc	85kW (115PS)		Petrol		TD17901
CEKA			4 Cyl.	1984cc	85-86kW (115-117PS)		Petrol		TD22467
BE/PL	4	47,758/47,778	50,600/50,612	19,000	1,406	0,020/0,067	EC	71-3929	71-3929/4 STD 11
MB/HL 1-5	5	53,958/53,978	59,000/59,019	18,500	2,502	0,020/0,082	AL-LF	02-3085L	H084/5 STD 0.25 0.50
MB/HL 1-5	5	53,958/53,978	59,000/59,019	18,500	2,502	0,020/0,082	AL-LF	02-3085U	

									
TW/A	2	59,500	73,200		1,975		AL-LF	04-3527	A123/4 STD
TW/A	2	59,500	73,200		1,975		AL-LF	04-3528	
SE/PB	1	20,000	23,000/23,021	25,000			BC	55-3698	55-3698 SEMI

74 82.50 x 92.80

BLR			4 Cyl.	1984cc	110kW (150PS)		Petrol		TD17353
BLY			4 Cyl.	1984cc	110kW (150PS)		Petrol		TD17354
BVY			4 Cyl.	1984cc	110kW (150PS)		Petrol		TD18266
BVZ			4 Cyl.	1984cc	110kW (150PS)		Petrol		TD18267
BE/PL	4	47,758/47,778	50,600/50,612	19,000	1,406	0,020/0,067	EC	71-3929	71-3929/4 STD II

75 83.00 x 67.50

021 A 2000			4 Cyl.	1461cc	63-66kW (85-90PS)		Petrol		TD3554
BE/PL	4	39,975/39,991	43,000/43,016	19,000	1,500	0,019/0,071	EC	71-3665	71-3665/4 STD

76 83.00 x 79.20

138 A5.000			4 Cyl.	1714cc	40-42kW (55-57PS)		Diesel		TD3585
BE/PL	4	50,782/50,802	53,897/53,913	19,500	1,537	0,021/0,082	AL-LF	66240RA	01-4175/4 STD 0.25 0.50 0.75 1.00
MB/HL 1,2,4,5	4	52,985/53,005	56,717/56,730	20,750	1,841	0,030/0,088	AL-LF	66316RA	H1043/5 STD 0.25 0.50 0.75
MB/HL 3	1	52,985/53,005	56,717/56,730	24,250	1,841	0,030/0,088	AL-LF	66317RA	
TW/A	2	59,000/59,250	73,600/73,850		2,362		BS	62037AF	A201/2 STD .005
SE/PB	1	25,004/25,010	26,939/26,972	25,400			BS	66644Y	55-4190 SEMI

77 84.00 x 71.50

124 B3.000			4 Cyl.	1585cc	55kW (75PS)		Petrol		TD3564
BE/PL	4	50,782/50,802	53,897/53,913	19,500	1,537	0,021/0,082	AL-LF	66240RA	01-4175/4 STD 0.25 0.50 0.75 1.00
Mot.402353 →									
MB/HL 1,2,4,5	4	52,985/53,005	56,717/56,730	20,750	1,841	0,030/0,088	AL-LF	66316RA	H1043/5 STD 0.25 0.50 0.75
MB/HL 3	1	52,985/53,005	56,717/56,730	24,250	1,841	0,030/0,088	AL-LF	66317RA	
TW/A	2	59,000/59,250	73,600/73,850		2,362		BS	62037AF	A201/2 STD .005
SE/PB	1	21,539/21,641	23,939/23,972	25,100			BS	62039Y	55-4288 SEMI

78 84.00 x 71.50

FC16			4 Cyl.	1585cc	70kW (95PS)		Petrol		TD3583
BE/PL	4	50,782/50,802	53,897/53,913	19,500	1,537	0,021/0,082	AL-LF	66240RA	01-4175/4 STD 0.25 0.50 0.75 1.00
MB/HL 1,2,4,5	4	52,985/53,005	56,717/56,730	20,750	1,841	0,030/0,088	AL-LF	66316RA	H1043/5 STD 0.25 0.50 0.75
MB/HL 3	1	52,985/53,005	56,717/56,730	24,250	1,841	0,030/0,088	AL-LF	66317RA	
TW/A	2	59,000/59,250	73,600/73,850		2,362		BS	62037AF	A201/2 STD .005
SE/PB	1	21,539/21,641	23,939/23,972	25,100			BS	62039Y	55-4288 SEMI



79 84.00 x 79.20

132 B1.000		4 Cyl.		1756cc	77-82kW (105-112PS)		Petrol		TD21376
BE/PL	4	50,782/50,802	53,897/53,913	19,500	1,537	0,021/0,082	AL-LF	66240RA	01-4175/4 STD 0.25 0.50 0.75 1.00
MB/HL 1,2,4,5	4	52,985/53,005	56,717/56,730	20,750	1,841	0,030/0,088	AL-LF	66316RA	H1043/5 STD 0.25 0.50 0.75
MB/HL 3	1	52,985/53,005	56,717/56,730	24,250	1,841	0,030/0,088	AL-LF	66317RA	
TW/A	2	59,000/59,250	73,600/73,850		2,362		BS	62037AF	A201/2 STD .005
SE/PB	1	21,539/21,641	23,939/23,972	25,100			BS	62039Y	55-4288 SEMI

80 84.00 x 90.00

131 C4.000		4 Cyl.		1995cc	83-85kW (113-116PS)		Petrol		TD21375
BE/PL	4	50,782/50,802	53,897/53,913	19,500	1,537	0,021/0,082	AL-LF	66240RA	01-4175/4 STD 0.25 0.50 0.75 1.00
MB/HL 1,2,4,5	4	52,985/53,005	56,717/56,730	20,750	1,841	0,030/0,088	AL-LF	66316RA	H1043/5 STD 0.25 0.50 0.75
MB/HL 3	1	52,985/53,005	56,717/56,730	24,250	1,841	0,030/0,088	AL-LF	66317RA	
TW/A	2	59,000/59,250	73,600/73,850		2,362		BS	62037AF	A201/2 STD .005
SE/PB	1	21,539/21,641	25,000/25,021	25,100			BS	66649Y	55-4193 SEMI

01/85 →

SE/PB	1	21,539/21,641	23,939/23,972	25,100			BS	62039Y	55-4288 SEMI
-------	---	---------------	---------------	--------	--	--	----	--------	------------------------

→12/84

81 87.00 x 92.40

OM 615.912		4 Cyl.		2197cc	44kW (60PS)		Diesel		TD21374
BE/PL	4	51,955/51,965	55,600/55,619	26,000	1,805	0,025/0,079	AL-LF	01-3040	01-3040/4 STD 0.25 0.50 0.75 1.00

01/74 →

BE/PL	4	51,955/51,965	55,600/55,619	26,000	1,805	0,025/0,079	EC	71-2773	71-2773/4 0.25 0.50 0.75
-------	---	---------------	---------------	--------	-------	-------------	----	---------	------------------------------------

→12/73

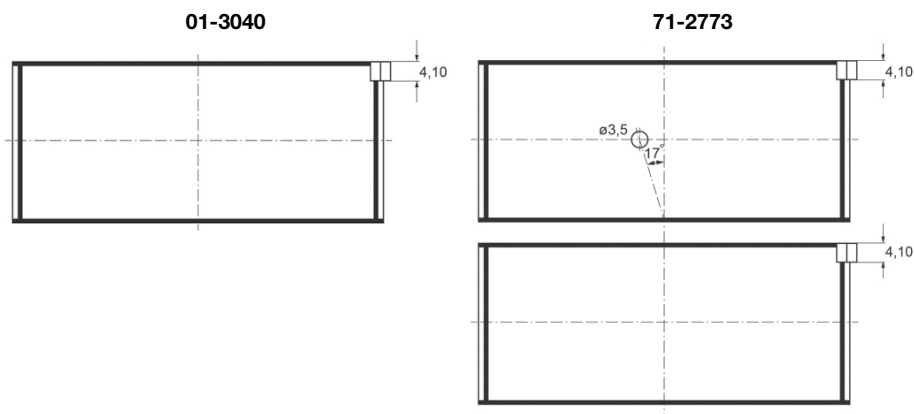

MB/HL 1,2,4,5	4	69,955/69,965	74,500/74,519	27,000	2,255	0,025/0,079	AL-LF	02-1460	H914/5 STD 0.25 0.50 0.75 1.00
MB/HL 3	1	69,955/69,965	74,500/74,519	33,900	2,255	0,025/0,079	AL-LF	02-2774H	
			02-2774H	STD	34,000/1.3386" - 34,025/1.3396"				
SE/PB	1	26,000	29,000/29,021	31,800			BC	55-2532	55-2532 SEMI
BU	1	30,000	36,000/36,025	18,000	3,000		BC	57-3049	57-3049 STD

82 93.00 x 90.00

8144.61		4 Cyl.	2445cc	52-55kW (72-75PS)			Diesel		TD3597
BE/PL	4	56,520/56,535	60,333/60,345	24,700	1,870	0,020/0,072	BS	1870CP	71-4130/4 STD 0.25 0.50 0.75
BE/PL	4	56,520/56,535	60,333/60,345	24,700	1,870	0,020/0,070	BS	66575CP	71-4185/4 STD 0.25 0.50 0.75

1870CP

66575CP

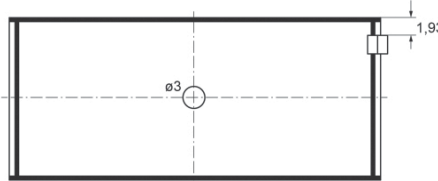

MB/HL 1-4	4	76,187/76,200	80,586/80,607	24,990	2,172	0,042/0,100	BS	66571CP	H1049/5 STD 0.25 0.50 0.75
MB/HL 5	1	76,187/76,200	80,586/80,607	31,950	2,172	0,042/0,100	BS	66572CPH	
MB/HL 1-4	4	76,187/76,200	80,586/80,607	24,990	2,172	0,038/0,097	BS	66573CP	H1094/5 STD 0.25
MB/HL 5	1	76,187/76,200	80,586/80,607	31,950	2,172	0,038/0,097	BS	66574CPH	

66571CP

66572CPH

66573CP

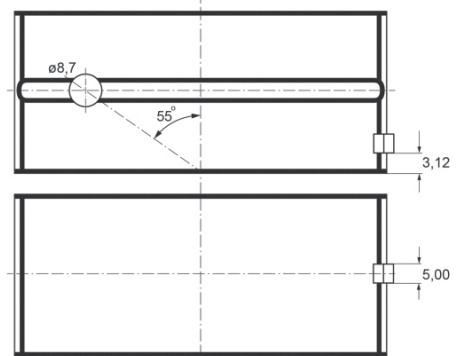
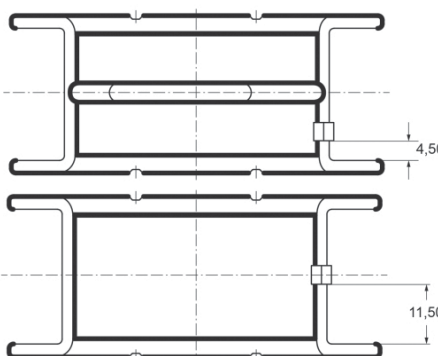
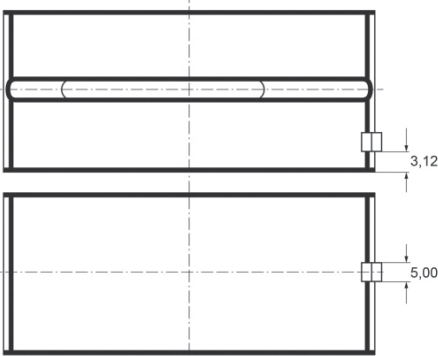

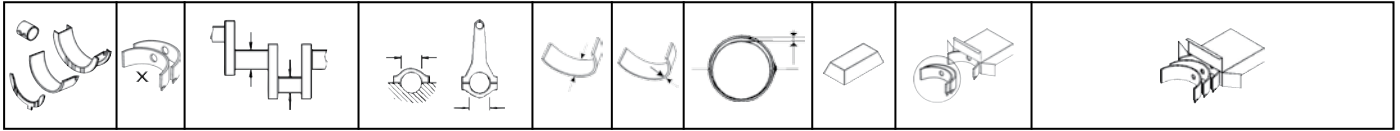

66574CPH

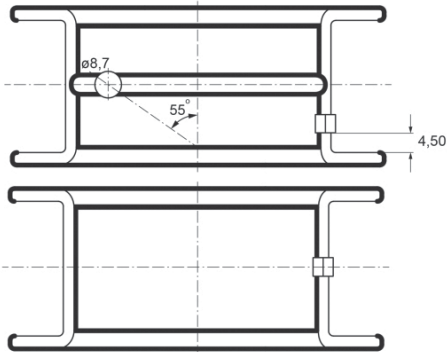

SE/PB	1	31,990/31,996	34,895/34,920	30,700			BS	66579YA	55-4186 SEMI
-------	---	---------------	---------------	--------	--	--	----	---------	------------------------

83 94.00 x 69.00

DH			4 Cyl.	1915cc	60-63kW (82-86PS)		Petrol		TD3580
BE/PL	4	54,971/54,990	57,800/57,819	17,600	1,397	0,020/0,079	EC	71-1950	71-1950/4 STD 0.25 0.50

84 94.00 x 69.00

GH			4 Cyl.	1919cc	82kW (111PS)		Diesel		TD3588
BE/PL	1	45,950/45,970	49,000/49,016	19,000	1,506	0,020/0,078	EC	71-3084	71-3084 STD 0.25
MB/HL	3	53,958/53,978	59,000/59,019	18,500	2,502	0,020/0,082	AL-LF	02-3085L	H025/5 STD 0.25 0.50
MB/HL	5	53,958/53,978	59,000/59,019	18,500	2,502	0,020/0,082	AL-LF	02-3085U	
MB/HL	1	53,958/53,978	59,000/59,019	24,930	2,502	0,020/0,082	AL-LF	02-3086HL	
MB/HL	1	53,958/53,978	59,000/59,019	24,930	2,502	0,020/0,082	AL-LF	02-3086HU	

	02-3086HL	STD	25,000/.9843" - 25,040/.9858"
		0.25mm	25,100/.9882" - 25,140/.9898"
		0.50mm	25,100/.9882" - 25,140/.9898"
		0.75mm	25,100/.9882" - 25,140/.9898"
	02-3086HU	STD	25,000/.9843" - 25,040/.9858"
		0.25mm	25,100/.9882" - 25,140/.9898"
		0.50mm	25,100/.9882" - 25,140/.9898"
		0.75mm	25,100/.9882" - 25,140/.9898"



cm3 x



Fabia 1.0	12/99→08/02	Petrol	AQV	996	4	72.00	61.20	3
Fabia 1.0	12/99→08/02	Petrol	ARV	996	4	72.00	61.20	3
Fabia 1.2	07/01→03/08	Petrol	AWY	1198	3	76.50	86.90	8
Fabia 1.2	01/03→03/08	Petrol	AZQ	1198	3	76.50	86.90	8
Fabia 1.2	12/06→12/14	Petrol	BBM	1198	3	76.50	86.90	8
Fabia 1.2	07/01→03/08	Petrol	BMD	1198	3	76.50	86.90	8
Fabia 1.2	01/03→03/08	Petrol	BME	1198	3	76.50	86.90	8
Fabia 1.2	01/07→12/14	Petrol	BZG	1198	3	76.50	86.90	8
Fabia 1.2	01/07→12/14	Petrol	CGPA	1198	3	76.50	86.90	8
Fabia 1.2	12/06→12/14	Petrol	CHFA	1198	3	76.50	86.90	8
Fabia 1.2 12V	11/11→12/14	Petrol	CGPB	1198	3	76.50	86.90	8
Fabia 1.2 TDI	05/10→12/14	Diesel	CFWA	1199	3	79.50	80.50	12
Fabia 1.2 TSI	03/10→12/14	Petrol	CBZA	1197	4	71.00	75.60	1
Fabia 1.2 TSI	03/10→12/14	Petrol	CBZB	1197	4	71.00	75.60	2
Fabia 1.4	02/06→10/06	Petrol	BUD	1390	4	76.50	75.60	6
Fabia 1.4	01/07→12/14	Petrol	BXW	1390	4	76.50	75.60	7
Fabia 1.4	01/07→12/14	Petrol	CGGB	1390	4	76.50	75.60	7
Fabia 1.4 16V	10/99→03/08	Petrol	AUA	1390	4	76.50	75.60	5
Fabia 1.4 16V	12/99→03/08	Petrol	AUB	1390	4	76.50	75.60	5
Fabia 1.4 16V	10/99→03/08	Petrol	BBY	1390	4	76.50	75.60	5
Fabia 1.4 16V	12/99→03/08	Petrol	BBZ	1390	4	76.50	75.60	5
Fabia 1.4 16V	10/99→03/08	Petrol	BKY	1390	4	76.50	75.60	6
Fabia 1.4 16V	04/06→12/07	Petrol	BUD	1390	4	76.50	75.60	6
Fabia 1.4 TDI	04/03→03/08	Diesel	AMF	1422	3	79.50	95.50	15
Fabia 1.4 TDI	01/07→03/10	Diesel	BMS	1422	3	79.50	95.50	15
Fabia 1.4 TDI	10/05→03/10	Diesel	BNM	1422	3	79.50	95.50	15
Fabia 1.4 TDI	10/05→03/10	Diesel	BNV	1422	3	79.50	95.50	15
Fabia 1.4 TSI RS	05/10→12/14	Petrol	CAVE	1390	4	76.50	75.60	6
Fabia 1.6	04/07→12/14	Petrol	BTS	1598	4	76.50	86.90	10
Fabia 1.6	04/07→12/14	Petrol	CFNA	1598	4	76.50	86.90	10
Fabia 1.6 TDI	04/10→12/14	Diesel	CAYA	1598	4	79.50	80.50	13
Fabia 1.6 TDI	03/10→12/14	Diesel	CAYB	1598	4	79.50	80.50	13
Fabia 1.6 TDI	03/10→12/14	Diesel	CAYC	1598	4	79.50	80.50	13
Fabia 1.9 SDI	11/99→03/08	Diesel	ASY	1896	4	79.50	95.50	16
Fabia 1.9 TDI	01/00→03/08	Diesel	ATD	1896	4	79.50	95.50	23
Fabia 1.9 TDI	01/00→03/08	Diesel	AXR	1896	4	79.50	95.50	26
Fabia 1.9 TDI	04/07→03/10	Diesel	BLS	1896	4	79.50	95.50	26
Fabia 1.9 TDI	04/07→03/10	Diesel	BSW	1896	4	79.50	95.50	23
Fabia 1.9 TDI RS	06/03→03/08	Diesel	ASZ	1896	4	79.50	95.50	22
Fabia 1.9 TDI RS	06/03→03/08	Diesel	BLT	1896	4	79.50	95.50	27
Fabia 2.0	12/99→03/08	Petrol	AZL	1984	4	82.50	92.80	42
Favorit 1.3	12/92→06/97	Petrol	135B	1289	4	75.50	72.00	4
Favorit 1.3	12/91→06/97	Petrol	781.135	1289	4	75.50	72.00	4
Favorit 1.3	09/91→06/95	Petrol	781.135E	1289	4	75.50	72.00	4
Favorit 1.3	08/91→06/95	Petrol	OHC	1289	4	75.50	72.00	4
Favorit 1.3 135	10/90→09/94	Petrol	781.135	1289	4	75.50	72.00	4
Favorit 1.3 135 X,LX,GLX	01/90→09/94	Petrol	781.135E	1289	4	75.50	72.00	4
Favorit 1.3 135L	05/89→09/94	Petrol	781.135	1289	4	75.50	72.00	4
Felicia I 1.3	10/94→04/02	Petrol	135B	1289	4	75.50	72.00	4
Felicia I 1.3	10/94→03/98	Petrol	135 L	1289	4	75.50	72.00	4
Felicia I 1.3	10/94→04/02	Petrol	AMG	1289	4	75.50	72.00	4
Felicia I 1.3	10/94→04/02	Petrol	AMH	1289	4	75.50	72.00	4
Felicia I 1.3	10/94→04/02	Petrol	AMJ	1289	4	75.50	72.00	4
Felicia I 1.3 LX	08/95→03/98	Petrol	135B	1289	4	75.50	72.00	4
Felicia I 1.3 LX	08/95→03/98	Petrol	AMG	1289	4	75.50	72.00	4
Felicia I 1.3 LXI	08/95→03/98	Petrol	AMH	1289	4	75.50	72.00	4
Felicia I 1.6	06/97→04/02	Petrol	AEE	1598	4	76.50	86.90	9
Felicia I 1.6 GLX	08/95→03/98	Petrol	AEE	1598	4	76.50	86.90	9
Felicia I 1.6 LX	08/95→03/98	Petrol	AEE	1598	4	76.50	86.90	9
Felicia I 1.9 D	10/95→04/02	Diesel	AEF	1896	4	79.50	95.50	16
Felicia II 1.3	01/98→06/01	Petrol	AMG	1289	4	75.50	72.00	4
Felicia II 1.3	01/98→06/01	Petrol	AMH	1289	4	75.50	72.00	4
Felicia II 1.3	01/98→06/01	Petrol	AMJ	1289	4	75.50	72.00	4
Felicia II 1.6	01/98→06/01	Petrol	AEE	1598	4	76.50	86.90	9
Felicia II 1.9 D	01/98→06/01	Diesel	AEF	1896	4	79.50	95.50	16
Octavia 1.2 TSI	02/10→06/13	Petrol	CBZB	1197	4	71.00	75.60	2
Octavia 1.4	05/04→05/06	Petrol	BCA	1390	4	76.50	75.60	6
Octavia 1.4	06/04→06/13	Petrol	BUD	1390	4	76.50	75.60	6
Octavia 1.4	06/04→06/13	Petrol	CGGA	1390	4	76.50	75.60	7

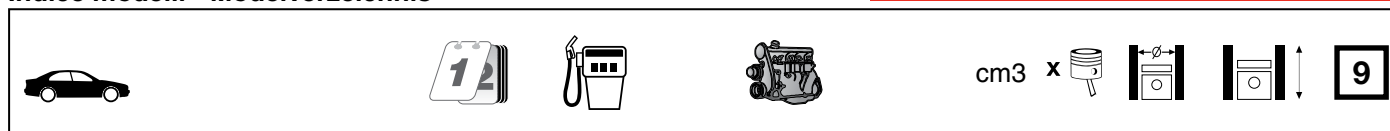

Octavia 1.4 16V	08/00→12/10	Petrol	AXP	1390	4	76.50	75.60	5
Octavia 1.4 16V	08/00→12/10	Petrol	BCA	1390	4	76.50	75.60	6
Octavia 1.4 TSI	11/08→06/13	Petrol	CAXA	1390	4	76.50	75.60	6
Octavia 1.6	02/97→12/07	Petrol	AEH	1595	4	81.00	77.40	29
Octavia 1.6	02/97→12/07	Petrol	AKL	1595	4	81.00	77.40	29
Octavia 1.6	09/00→12/10	Petrol	AVU	1595	4	81.00	77.40	30
Octavia 1.6	09/00→12/10	Petrol	BFQ	1595	4	81.00	77.40	30
Octavia 1.6	06/04→06/13	Petrol	BGU	1595	4	81.00	77.40	30
Octavia 1.6	06/04→06/13	Petrol	BSE	1595	4	81.00	77.40	30
Octavia 1.6	06/04→06/13	Petrol	BSF	1595	4	81.00	77.40	30
Octavia 1.6	06/04→06/13	Petrol	CCSA	1595	4	81.00	77.40	30
Octavia 1.6	06/04→06/13	Petrol	CMXA	1595	4	81.00	77.40	30
Octavia 1.6	09/96→09/04	Petrol	AEE	1598	4	76.50	86.90	9
Octavia 1.6 FSI	02/04→10/08	Petrol	BLF	1598	4	76.50	86.90	10
Octavia 1.6 LPG	08/09→11/12	Petrol	CHGA	1595	4	81.00	77.40	30
Octavia 1.6 MultiFuel	01/08→06/13	Petrol	CCSA	1595	4	81.00	77.40	30
Octavia 1.6 MultiFuel	01/08→06/13	Petrol	CMXA	1595	4	81.00	77.40	30
Octavia 1.6 TDI	06/09→04/13	Diesel	CAYC	1598	4	79.50	80.50	13
Octavia 1.6 TDI	11/12→	Diesel	CLHA	1598	4	79.50	80.50	14
Octavia 1.6 TDI 4x4	06/09→02/13	Diesel	CAYC	1598	4	79.50	80.50	13
Octavia 1.6 TDI 4x4	11/12→	Diesel	CLHA	1598	4	79.50	80.50	14
Octavia 1.8	09/96→07/00	Petrol	AGN	1781	4	81.00	86.40	32
Octavia 1.8 20V	07/98→07/00	Petrol	AGN	1781	4	81.00	86.40	32
Octavia 1.8 T	08/97→12/10	Petrol	AGU	1781	4	81.00	86.40	33
Octavia 1.8 T	08/97→12/10	Petrol	ARX	1781	4	81.00	86.40	34
Octavia 1.8 T	08/97→12/10	Petrol	ARZ	1781	4	81.00	86.40	33
Octavia 1.8 T	08/97→12/10	Petrol	AUM	1781	4	81.00	86.40	34
Octavia 1.8 T 4x4	05/01→05/06	Petrol	ARX	1781	4	81.00	86.40	34
Octavia 1.9 SDI	06/97→12/03	Diesel	AGP	1896	4	79.50	95.50	18
Octavia 1.9 SDI	06/97→12/03	Diesel	AQM	1896	4	79.50	95.50	16
Octavia 1.9 TDI	09/96→03/10	Diesel	AGR	1896	4	79.50	95.50	19
Octavia 1.9 TDI	08/97→01/06	Diesel	AHF	1896	4	79.50	95.50	20
Octavia 1.9 TDI	09/96→03/10	Diesel	ALH	1896	4	79.50	95.50	21
Octavia 1.9 TDI	08/97→01/06	Diesel	ASV	1896	4	79.50	95.50	20
Octavia 1.9 TDI	09/02→09/04	Diesel	ASZ	1896	4	79.50	95.50	22
Octavia 1.9 TDI	08/00→12/10	Diesel	AXR	1896	4	79.50	95.50	26
Octavia 1.9 TDI	06/04→12/10	Diesel	BJB	1896	4	79.50	95.50	26
Octavia 1.9 TDI	06/04→12/10	Diesel	BKC	1896	4	79.50	95.50	26
Octavia 1.9 TDI	06/04→12/10	Diesel	BLS	1896	4	79.50	95.50	26
Octavia 1.9 TDI	06/04→12/10	Diesel	BXE	1896	4	79.50	95.50	26
Octavia 1.9 TDI 4x4	11/99→02/06	Diesel	AGR	1896	4	79.50	95.50	19
Octavia 1.9 TDI 4x4	09/00→01/06	Diesel	ATD	1896	4	79.50	95.50	23
Octavia 1.9 TDI 4x4	11/04→12/10	Diesel	BKC	1896	4	79.50	95.50	26
Octavia 1.9 TDI 4x4	11/04→12/10	Diesel	BLS	1896	4	79.50	95.50	26
Octavia 1.9 TDI 4x4	11/04→12/10	Diesel	BXE	1896	4	79.50	95.50	26
Octavia 2.0	04/99→05/07	Petrol	AEG	1984	4	82.50	92.80	39
Octavia 2.0	04/99→05/07	Petrol	APK	1984	4	82.50	92.80	40
Octavia 2.0	04/99→05/07	Petrol	AQY	1984	4	82.50	92.80	39
Octavia 2.0	04/99→05/07	Petrol	AZH	1984	4	82.50	92.80	41
Octavia 2.0 4x4	08/00→09/04	Petrol	AZH	1984	4	82.50	92.80	41
Octavia 2.0 FSI	11/04→10/08	Petrol	BLR	1984	4	82.50	92.80	43
Octavia 2.0 FSI	11/04→10/08	Petrol	BLY	1984	4	82.50	92.80	43
Octavia 2.0 FSI	11/04→10/08	Petrol	BVY	1984	4	82.50	92.80	43
Octavia 2.0 FSI	11/04→10/08	Petrol	BVZ	1984	4	82.50	92.80	43
Octavia 2.0 FSI 4x4	11/04→10/08	Petrol	BLX	1984	4	82.50	92.80	43
Octavia 2.0 FSI 4x4	11/04→10/08	Petrol	BVX	1984	4	82.50	92.80	43
Octavia 2.0 TDI	02/04→05/10	Diesel	AZV	1968	4	81.00	95.50	35
Octavia 2.0 TDI	11/05→05/10	Diesel	BMM	1968	4	81.00	95.50	36
Octavia 2.0 TDI	03/10→06/13	Diesel	CFHF	1968	4	81.00	95.50	37
Octavia 2.0 TDI	03/10→06/13	Diesel	CLCA	1968	4	81.00	95.50	37
Octavia 2.0 TDI 4x4	07/06→05/10	Diesel	BMM	1968	4	81.00	95.50	36
Octavia 2.0 TDI 4x4	05/11→02/13	Diesel	CFHF	1968	4	81.00	95.50	37
Octavia 2.0 TDI 4x4	09/14→	Diesel	CUNA	1968	4	81.00	95.50	37
Octavia 2.0 TDI 4x4	09/14→	Diesel	CUPA	1968	4	81.00	95.50	37
Octavia 2.0 TDI 16V	02/04→05/10	Diesel	AZV	1968	4	81.00	95.50	35
Octavia 2.0 TDI 16V	02/04→05/13	Diesel	BKD	1968	4	81.00	95.50	35
Octavia 2.0 TDI 16V	02/04→05/13	Diesel	CFHC	1968	4	81.00	95.50	37
Octavia 2.0 TDI 16V	02/04→05/13	Diesel	CLCB	1968	4	81.00	95.50	37
Octavia 2.0 TDI 16V 4x4	05/10→02/13	Diesel	CFHC	1968	4	81.00	95.50	37











cm3









9







Octavia 2.0 TDI RS	04/06→02/13	Diesel	BMN	1968	4	81.00	95.50	35
Octavia 2.0 TDI RS	04/06→02/13	Diesel	CEGA	1968	4	81.00	95.50	37
Octavia 2.0 TDI RS	05/13→	Diesel	CUNA	1968	4	81.00	95.50	37
Octavia 2.0 TDI RS	05/13→	Diesel	CUPA	1968	4	81.00	95.50	37
Octavia RS 1.8 T	05/01→01/06	Petrol	AUQ	1781	4	81.00	86.40	34
Rapid 1.2 TSI	07/12→	Petrol	CBZA	1197	4	71.00	75.60	1
Rapid 1.2 TSI	07/12→	Petrol	CBZB	1197	4	71.00	75.60	2
Rapid 1.4 TSI	07/12→	Petrol	CAXA	1390	4	76.50	75.60	6
Rapid 1.6	07/12→	Petrol	CFNA	1598	4	76.50	86.90	10
Rapid 1.6 TDI	08/13→	Diesel	CAYB	1598	4	79.50	80.50	13
Rapid 1.6 TDI	07/12→	Diesel	CAYC	1598	4	79.50	80.50	13
Rapid 1.6 TDI	10/11→	Diesel	CLNA	1598	4	79.50	80.50	13
Roomster 1.2	05/06→01/07	Petrol	BME	1198	3	76.50	86.90	8
Roomster 1.2	01/07→05/15	Petrol	BZG	1198	3	76.50	86.90	8
Roomster 1.2	01/07→05/15	Petrol	CGPA	1198	3	76.50	86.90	8
Roomster 1.2 TDI	03/10→05/15	Diesel	CFWA	1199	3	79.50	80.50	12
Roomster 1.2 TSI	03/10→05/15	Petrol	CBZA	1197	4	71.00	75.60	1
Roomster 1.2 TSI	03/10→05/15	Petrol	CBZB	1197	4	71.00	75.60	2
Roomster 1.4	09/06→05/15	Petrol	BXW	1390	4	76.50	75.60	7
Roomster 1.4	09/06→05/15	Petrol	CGGB	1390	4	76.50	75.60	7
Roomster 1.4 TDI	09/06→03/10	Diesel	BMS	1422	3	79.50	95.50	15
Roomster 1.4 TDI	07/06→03/10	Diesel	BNM	1422	3	79.50	95.50	15
Roomster 1.4 TDI	09/06→03/10	Diesel	BNV	1422	3	79.50	95.50	15
Roomster 1.6	09/06→05/15	Petrol	BTS	1598	4	76.50	86.90	10
Roomster 1.6	09/06→05/15	Petrol	CFNA	1598	4	76.50	86.90	10
Roomster 1.6 TDI	03/10→05/15	Diesel	CAYB	1598	4	79.50	80.50	13
Roomster 1.6 TDI	03/10→05/15	Diesel	CAYC	1598	4	79.50	80.50	13
Roomster 1.9 TDI	03/06→05/06	Diesel	AXR	1896	4	79.50	95.50	26
Roomster 1.9 TDI	09/06→03/10	Diesel	BLS	1896	4	79.50	95.50	26
Roomster 1.9 TDI	09/06→03/10	Diesel	BSW	1896	4	79.50	95.50	23
Superb 1.4 TSI	07/08→05/15	Petrol	CAXC	1390	4	76.50	75.60	6
Superb 1.6 TDI	09/10→05/15	Diesel	CAYC	1598	4	79.50	80.50	13
Superb 1.8 T	12/01→03/08	Petrol	AWT	1781	4	81.00	86.40	34
Superb 1.9 TDI	08/02→10/05	Diesel	AVB	1896	4	79.50	95.50	24
Superb 1.9 TDI	12/01→03/08	Diesel	AVF	1896	4	79.50	95.50	25
Superb 1.9 TDI	12/01→03/08	Diesel	AWX	1896	4	79.50	95.50	25
Superb 1.9 TDI	03/08→11/10	Diesel	BLS	1896	4	79.50	95.50	26
Superb 1.9 TDI	01/07→03/08	Diesel	BPZ	1896	4	79.50	95.50	28
Superb 1.9 TDI	10/05→05/07	Diesel	BSV	1896	4	79.50	95.50	28
Superb 1.9 TDI	03/08→11/10	Diesel	BXE	1896	4	79.50	95.50	26
Superb 2.0 TDI	03/08→05/10	Diesel	BMP	1968	4	81.00	95.50	35
Superb 2.0 TDI	10/05→03/08	Diesel	BSS	1968	4	81.00	95.50	35
Superb 2.0 TDI	07/08→05/15	Diesel	CBBB	1968	4	81.00	95.50	37
Superb 2.0 TDI	07/08→05/15	Diesel	CFGB	1968	4	81.00	95.50	37
Superb 2.0 TDI	03/15→	Diesel	CRLB	1968	4	81.00	95.50	37
Superb 2.0 TDI	03/15→	Diesel	DDAA	1968	4	81.00	95.50	37
Superb 2.0 TDI	03/15→	Diesel	DFCA	1968	4	81.00	95.50	37
Superb 2.0 TDI	03/15→	Diesel	DFEA	1968	4	81.00	95.50	37
Superb 2.0 TDI 4x4	09/08→05/15	Diesel	CBBB	1968	4	81.00	95.50	37
Superb 2.0 TDI 4x4	09/08→05/15	Diesel	CFGB	1968	4	81.00	95.50	37
Superb 2.0 TDI 4x4	03/15→	Diesel	CRLB	1968	4	81.00	95.50	37
Superb 2.0 TDI 4x4	03/15→	Diesel	DDAA	1968	4	81.00	95.50	37
Superb 2.0 TDI 4x4	03/15→	Diesel	DFCA	1968	4	81.00	95.50	37
Superb 2.0 TDI 4x4	03/15→	Diesel	DFEA	1968	4	81.00	95.50	37
Superb 2.0 TDI 16V	01/09→05/15	Diesel	BKD	1968	4	81.00	95.50	35
Superb 2.0 TDI 16V	01/09→05/15	Diesel	CFFB	1968	4	81.00	95.50	37
Superb 2.0 TDI 16V	01/09→05/15	Diesel	CLJA	1968	4	81.00	95.50	37
Superb 2.0 TDI 16V 4x4	11/10→05/15	Diesel	CFFB	1968	4	81.00	95.50	37
Superb 2.5 TDI	12/01→08/03	Diesel	AYM	2496	V6	78.30	86.40	11
Superb 2.5 TDI	06/03→03/08	Diesel	BDG	2496	V6	78.30	86.40	11
Superb 2.8 V6	12/01→03/08	Petrol	AMX	2771	V6	82.50	86.40	38
Superb 2.8 V6	06/02→03/08	Petrol	BBG	2771	V6	82.50	86.40	38
Yeti 1.2 TSI	09/09→	Petrol	CBZB	1197	4	71.00	75.60	2
Yeti 1.4 TSI	06/10→	Petrol	CAXA	1390	4	76.50	75.60	6
Yeti 1.6 TDI	11/10→	Diesel	CAYC	1598	4	79.50	80.50	13
Yeti 2.0 TDI	11/09→	Diesel	CFHA	1968	4	81.00	95.50	36
Yeti 2.0 TDI	11/11→	Diesel	CFHC	1968	4	81.00	95.50	37
Yeti 2.0 TDI	11/09→	Diesel	CLCA	1968	4	81.00	95.50	37
Yeti 2.0 TDI 4x4	05/09→	Diesel	CBDB	1968	4	81.00	95.50	37

				cm ³ x 			
---	---	---	---	---	---	---	---

Yeti 2.0 TDI 4x4	11/09→	Diesel	CEGA	1968	4	81.00	95.50	37
Yeti 2.0 TDI 4x4	05/09→	Diesel	CFHC	1968	4	81.00	95.50	37
Yeti 2.0 TDI 4x4	11/09→	Diesel	CFHF	1968	4	81.00	95.50	37
Yeti 2.0 TDI 4x4	11/09→	Diesel	CFJA	1968	4	81.00	95.50	37
Yeti 2.0 TDI 4x4	05/09→	Diesel	CLCB	1968	4	81.00	95.50	37

		cm3	x 			
--	---	-----	---	---	---	---

135B	Petrol	1289	4	75.50	72.00	4
135 L	Petrol	1289	4	75.50	72.00	4
781.135	Petrol	1289	4	75.50	72.00	4
781.135E	Petrol	1289	4	75.50	72.00	4
781.136	Petrol	1289	4	75.50	72.00	4
ADR	Petrol	1781	4	81.00	86.40	31
AEE	Petrol	1598	4	76.50	86.90	9
AEF	Diesel	1896	4	79.50	95.50	16
AEG	Petrol	1984	4	82.50	92.80	39
AEH	Petrol	1595	4	81.00	77.40	29
AEY	Diesel	1896	4	79.50	95.50	17
AGN	Petrol	1781	4	81.00	86.40	32
AGP	Diesel	1896	4	79.50	95.50	18
AGR	Diesel	1896	4	79.50	95.50	19
AGU	Petrol	1781	4	81.00	86.40	33
AHF	Diesel	1896	4	79.50	95.50	20
AKL	Petrol	1595	4	81.00	77.40	29
ALH	Diesel	1896	4	79.50	95.50	21
AMF	Diesel	1422	3	79.50	95.50	15
AMG	Petrol	1289	4	75.50	72.00	4
AMH	Petrol	1289	4	75.50	72.00	4
AMJ	Petrol	1289	4	75.50	72.00	4
AMX	Petrol	2771	V6	82.50	86.40	38
APK	Petrol	1984	4	82.50	92.80	40
AQM	Diesel	1896	4	79.50	95.50	16
AQV	Petrol	996	4	72.00	61.20	3
AQY	Petrol	1984	4	82.50	92.80	39
ARV	Petrol	996	4	72.00	61.20	3
ARX	Petrol	1781	4	81.00	86.40	34
ARZ	Petrol	1781	4	81.00	86.40	33
ASV	Diesel	1896	4	79.50	95.50	20
ASY	Diesel	1896	4	79.50	95.50	16
ASZ	Diesel	1896	4	79.50	95.50	22
ATD	Diesel	1896	4	79.50	95.50	23
ATY	Petrol	996	4	72.00	61.20	3
AUA	Petrol	1390	4	76.50	75.60	5
AUB	Petrol	1390	4	76.50	75.60	5
AUM	Petrol	1781	4	81.00	86.40	34
AUQ	Petrol	1781	4	81.00	86.40	34
AVB	Diesel	1896	4	79.50	95.50	24
AVF	Diesel	1896	4	79.50	95.50	25
AVU	Petrol	1595	4	81.00	77.40	30
AWT	Petrol	1781	4	81.00	86.40	34
AWX	Diesel	1896	4	79.50	95.50	25
AWY	Petrol	1198	3	76.50	86.90	8
AXP	Petrol	1390	4	76.50	75.60	5
AXR	Diesel	1896	4	79.50	95.50	26
AYM	Diesel	2496	V6	78.30	86.40	11
AZH	Petrol	1984	4	82.50	92.80	41
AZL	Petrol	1984	4	82.50	92.80	42
AZQ	Petrol	1198	3	76.50	86.90	8
AZV	Diesel	1968	4	81.00	95.50	35
BBG	Petrol	2771	V6	82.50	86.40	38
BBM	Petrol	1198	3	76.50	86.90	8
BBY	Petrol	1390	4	76.50	75.60	5
BBZ	Petrol	1390	4	76.50	75.60	5
BCA	Petrol	1390	4	76.50	75.60	6
BDG	Diesel	2496	V6	78.30	86.40	11
BFQ	Petrol	1595	4	81.00	77.40	30
BGU	Petrol	1595	4	81.00	77.40	30
BJB	Diesel	1896	4	79.50	95.50	26
BKC	Diesel	1896	4	79.50	95.50	26
BKD	Diesel	1968	4	81.00	95.50	35
BKY	Petrol	1390	4	76.50	75.60	6
BLF	Petrol	1598	4	76.50	86.90	10
BLR	Petrol	1984	4	82.50	92.80	43
BLS	Diesel	1896	4	79.50	95.50	26
BLT	Diesel	1896	4	79.50	95.50	27
BLX	Petrol	1984	4	82.50	92.80	43

			cm ³	x 			
BLY	Petrol		1984	4	82.50	92.80	43
BMD	Petrol		1198	3	76.50	86.90	8
BME	Petrol		1198	3	76.50	86.90	8
BMM	Diesel		1968	4	81.00	95.50	36
BMN	Diesel		1968	4	81.00	95.50	35
BMP	Diesel		1968	4	81.00	95.50	35
BMS	Diesel		1422	3	79.50	95.50	15
BNM	Diesel		1422	3	79.50	95.50	15
BNV	Diesel		1422	3	79.50	95.50	15
BPZ	Diesel		1896	4	79.50	95.50	28
BSE	Petrol		1595	4	81.00	77.40	30
BSF	Petrol		1595	4	81.00	77.40	30
BSS	Diesel		1968	4	81.00	95.50	35
BSV	Diesel		1896	4	79.50	95.50	28
BSW	Diesel		1896	4	79.50	95.50	23
BTS	Petrol		1598	4	76.50	86.90	10
BUD	Petrol		1390	4	76.50	75.60	6
BVX	Petrol		1984	4	82.50	92.80	43
BVY	Petrol		1984	4	82.50	92.80	43
BVZ	Petrol		1984	4	82.50	92.80	43
BXE	Diesel		1896	4	79.50	95.50	26
BXW	Petrol		1390	4	76.50	75.60	7
BZG	Petrol		1198	3	76.50	86.90	8
CAVE	Petrol		1390	4	76.50	75.60	6
CAXA	Petrol		1390	4	76.50	75.60	6
CAXC	Petrol		1390	4	76.50	75.60	6
CAYA	Diesel		1598	4	79.50	80.50	13
CAYB	Diesel		1598	4	79.50	80.50	13
CAYC	Diesel		1598	4	79.50	80.50	13
CBBB	Diesel		1968	4	81.00	95.50	37
CBDB	Diesel		1968	4	81.00	95.50	37
CBZA	Petrol		1197	4	71.00	75.60	1
CBZB	Petrol		1197	4	71.00	75.60	2
CCSA	Petrol		1595	4	81.00	77.40	30
CEGA	Diesel		1968	4	81.00	95.50	37
CFFB	Diesel		1968	4	81.00	95.50	37
CFGB	Diesel		1968	4	81.00	95.50	37
CFHA	Diesel		1968	4	81.00	95.50	36
CFHC	Diesel		1968	4	81.00	95.50	37
CFHF	Diesel		1968	4	81.00	95.50	37
CFJA	Diesel		1968	4	81.00	95.50	37
CFNA	Petrol		1598	4	76.50	86.90	10
CFWA	Diesel		1199	3	79.50	80.50	12
CGGA	Petrol		1390	4	76.50	75.60	7
CGGB	Petrol		1390	4	76.50	75.60	7
CGPA	Petrol		1198	3	76.50	86.90	8
CGPB	Petrol		1198	3	76.50	86.90	8
CHFA	Petrol		1198	3	76.50	86.90	8
CHGA	Petrol		1595	4	81.00	77.40	30
CLCA	Diesel		1968	4	81.00	95.50	37
CLCB	Diesel		1968	4	81.00	95.50	37
CLHA	Diesel		1598	4	79.50	80.50	14
CLJA	Diesel		1968	4	81.00	95.50	37
CLNA	Diesel		1598	4	79.50	80.50	13
CMXA	Petrol		1595	4	81.00	77.40	30
CRLB	Diesel		1968	4	81.00	95.50	37
CUNA	Diesel		1968	4	81.00	95.50	37
CUPA	Diesel		1968	4	81.00	95.50	37
DDAA	Diesel		1968	4	81.00	95.50	37
DFCA	Diesel		1968	4	81.00	95.50	37
DFEA	Diesel		1968	4	81.00	95.50	37
OHC	Petrol		1289	4	75.50	72.00	4



1 71.00 x 75.60

CBZA			4 Cyl.	1197cc	63kW (86PS)	Petrol Turbo			TD23928
BE/PL	4	41,963/41,978	45,000/45,012	15,200	1,503	0,024/0,062	AL-LF	01-4873	01-4873/4 STD
TW/A	2		64,750/65,000		2,475		AL-LF	04-4930	A314/2 STD
SE/PB	1	19,000	21,000/21,033	17,800			BC-LF	55-4875	55-4875 SEMI

2 71.00 x 75.60

CBZB			4 Cyl.	1197cc	77kW (105PS)	Petrol Turbo			TD23583
BE/PL	4	41,963/41,978	45,000/45,012	15,200	1,503	0,024/0,062	AL-LF	01-4873	01-4873/4 STD
TW/A	2		64,750/65,000		2,475		AL-LF	04-4930	A314/2 STD
SE/PB	1	19,000	21,000/21,033	17,800			BC-LF	55-4875	55-4875 SEMI

3 72.00 x 61.20

AQV			4 Cyl.	996cc	37kW (50PS)	Petrol			TD16238
-----	--	--	--------	-------	-------------	--------	--	--	---------

ARV			4 Cyl.	996cc	37kW (50PS)	Petrol			TD15368
-----	--	--	--------	-------	-------------	--------	--	--	---------

ATY			4 Cyl.	996cc	37kW (50PS)	Petrol			FM15369
-----	--	--	--------	-------	-------------	--------	--	--	---------

BE/PL	4	41,965/41,980	45,000/45,012	18,500	1,505	0,020/0,060	AL-LF	01-3874	01-3874/4 STD 0.25
MB/HL	8	53,958/53,978	59,000/59,019	18,500	2,502	0,020/0,082	AL-LF	02-3085U	H024/5 STD 0.25
MB/HL	2	53,958/53,978	59,000/59,019	24,930	2,502	0,020/0,082	AL-LF	02-3086HU	



02-3086HU	STD	25,000/.9843" - 25,040/.9858"
	0.25mm	25,100/.9882" - 25,140/.9898"
	0.50mm	25,100/.9882" - 25,140/.9898"
	0.75mm	25,100/.9882" - 25,140/.9898"

MB/HL 1-5	10	53,958/53,978	59,000/59,019	18,500	2,502	0,020/0,082	AL-LF	02-3085U	H026/5 STD 0.25 0.50
--------------	----	---------------	---------------	--------	-------	-------------	-------	----------	-------------------------

02-3085U

02-3086HU

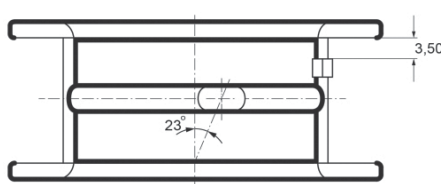
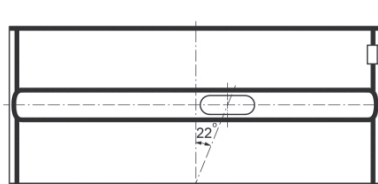

TW/A	2	59,500	73,200		1,975		AL-LF	04-3527	A123/4 STD
TW/A	2	59,500	73,200		1,975		AL-LF	04-3528	
BU	1	42,959/42,975	46,055/46,095	15,000			AL-LF	07-3088	07-3088 STD SEMI

For intermediary shaft, Front, For intermediary shaft

BU	1	41,959/41,975	45,000/45,025	15,000			AL-LF	07-3089	07-3089 STD SEMI
----	---	---------------	---------------	--------	--	--	-------	---------	---------------------

For intermediary shaft, Rear, For intermediary shaft

4 75.50 x 72.00

135 L			4 Cyl.	1289cc	43kW (58PS)	Petrol			TD13848
-------	--	--	--------	--------	-------------	--------	--	--	---------

135B			4 Cyl.	1289cc	40kW (54PS)	Petrol			TD13391
------	--	--	--------	--------	-------------	--------	--	--	---------

781.135			4 Cyl.	1289cc	42-44kW (57-60PS)	Petrol			TD5347
---------	--	--	--------	--------	-------------------	--------	--	--	--------



781.135E			4 Cyl.	1289cc	40kW (54PS)		Petrol		TD13389
781.136			4 Cyl.	1289cc	46kW (63PS)		Petrol		TD28629
AMG			4 Cyl.	1289cc	40kW (54PS)		Petrol		TD13828
AMH			4 Cyl.	1289cc	50kW (68PS)		Petrol		TD13829
AMJ			4 Cyl.	1289cc	43kW (58PS)		Petrol		TD13849
OHC			4 Cyl.	1289cc	40-45kW (55-61PS)		Petrol		TD4902

BE/PL	4	44,975/44,991	48,000/48,011	22,000	1,490	0,029/0,081	AL-LF	4645RA	01-4259/4 STD
-------	---	---------------	---------------	--------	-------	-------------	-------	--------	-------------------------

5
76.50 x 75.60

AUA			4 Cyl.	1390cc	55kW (75PS)		Petrol		TD15374
AUB			4 Cyl.	1390cc	74kW (100PS)		Petrol		TD15375
AXP			4 Cyl.	1390cc	55kW (75PS)		Petrol		TD16050
BBY			4 Cyl.	1390cc	55kW (75PS)		Petrol		TD17471
BBZ			4 Cyl.	1390cc	74kW (100PS)		Petrol		TD17472

BE/PL	4	47,763/47,778	50,600/50,612	18,500	1,406	0,020/0,062	AL-LF	01-3867	01-3867/4 STD 0.25
MB/HL 1-5	5	53,963/53,978	59,000/59,019	18,500	2,504	0,020/0,073	AL-LF	02-4929	H1325/5 STD 0.25 0.50
TW/A	2	59,500	73,200		1,975		AL-LF	04-3528	
BU	1	42,959/42,975	46,055/46,095	15,000			AL-LF	07-3088	07-3088 STD SEMI

Front, For intermediary shaft

BU	1	41,959/41,975	45,000/45,025	15,000			AL-LF	07-3089	07-3089 STD SEMI
----	---	---------------	---------------	--------	--	--	-------	---------	----------------------------

Rear, For intermediary shaft
6
76.50 x 75.60

BCA			4 Cyl.	1390cc	55kW (75PS)		Petrol		TD17495
BKY			4 Cyl.	1390cc	55kW (75PS)		Petrol		TD18696
BUD			4 Cyl.	1390cc	59kW (80PS)		Petrol		TD20190
CAVE			4 Cyl.	1390cc	132kW (180PS)		Petrol Turbo		TD24217
CAXA			4 Cyl.	1390cc	90kW (122PS)		Petrol Turbo		TD21592
CAXC			4 Cyl.	1390cc	92kW (125PS)		Petrol Turbo		TD22677

BE/PL	4	47,763/47,778	50,600/50,612	17,200	1,406	0,023/0,071	AL-LF	01-4100	01-4100/4 STD
MB/HL 1-5	5	53,963/53,978	59,000/59,019	18,500	2,504	0,020/0,073	AL-LF	02-4929	H1325/5 STD 0.25 0.50
TW/A	2	59,500	73,200		1,975		AL-LF	04-3527	A123/4 STD
TW/A	2	59,500	73,200		1,975		AL-LF	04-3528	

7
76.50 x 75.60

BXW			4 Cyl.	1390cc	63kW (86PS)		Petrol		TD19089
CGGA			4 Cyl.	1390cc	59kW (80PS)		Petrol		TD24838
CGGB			4 Cyl.	1390cc	63kW (85PS)		Petrol		TD24980

BE/PL	4	47,763/47,778	50,600/50,612	17,200	1,406	0,023/0,071	AL-LF	01-4100	01-4100/4 STD
-------	---	---------------	---------------	--------	-------	-------------	-------	---------	-------------------------

8
76.50 x 86.90

AWY			3 Cyl.	1198cc	40kW (54PS)		Petrol		TD16524
AZQ			3 Cyl.	1198cc	47kW (64PS)		Petrol		TD17070
BBM			3 Cyl.	1198cc	44kW (60PS)		Petrol		TD20009
BMD			3 Cyl.	1198cc	40kW (54PS)		Petrol		TD18835

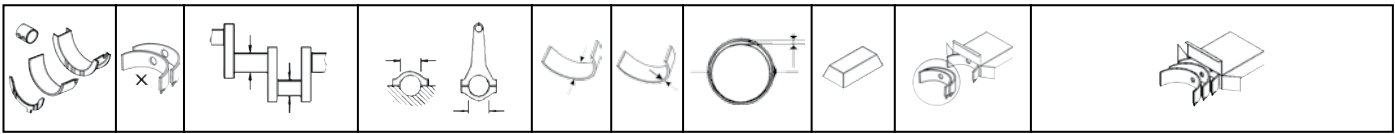

BME	3 Cyl.	1198cc	47kW (64PS)	Petrol	TD18836
BZG	3 Cyl.	1198cc	51kW (70PS)	Petrol	TD20010
CGPA	3 Cyl.	1198cc	51kW (70PS)	Petrol	TD23524
CGPB	3 Cyl.	1198cc	44kW (60PS)	Petrol	TD24978
CHFA	3 Cyl.	1198cc	44kW (60PS)	Petrol	TD23439

MB/HL 1-4	4	47,976/47,997	55,000/55,015	18,500	3,514	0,027/0,057	AL-LF	02-4981	H1343/4 STD 0.25
--------------	---	---------------	---------------	--------	-------	-------------	-------	---------	----------------------------

9 76.50 x 86.90

AEE	4 Cyl.	1598cc	55kW (75PS)	Petrol	TD13394
------------	--------	---------------	--------------------	---------------	----------------

BE/PL	4	47,763/47,778	50,600/50,612	18,500	1,406	0,020/0,062	AL-LF	01-3867	01-3867/4 STD 0.25
BE/PL	4	47,763/47,778	50,600/50,612	17,200	1,406	0,023/0,071	AL-LF	01-4100	01-4100/4 STD

01-3867

01-4100

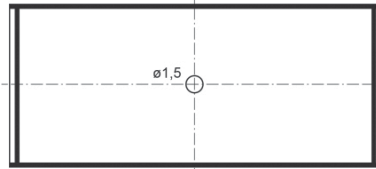
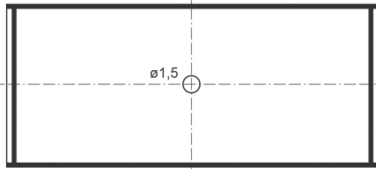

MB/HL 1-5	10	53,958/53,978	59,000/59,019	18,500	2,502	0,020/0,082	AL-LF	02-3085U	H026/5 STD 0.25 0.50
MB/HL 1-5	5	53,958/53,978	59,000/59,019	18,500	2,502	0,020/0,082	AL-LF	02-3085L	H084/5 STD 0.25 0.50
MB/HL 1-5	5	53,958/53,978	59,000/59,019	18,500	2,502	0,020/0,082	AL-LF	02-3085U	

Mot.→629000

MB/HL 1-5	5	53,963/53,978	59,000/59,019	18,500	2,504	0,020/0,073	AL-LF	02-4929	H1325/5 STD 0.25 0.50
--------------	---	---------------	---------------	--------	-------	-------------	-------	---------	---------------------------------

Mot.629001→

02-3085U

02-3085L

02-4929

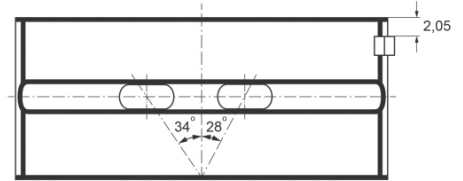
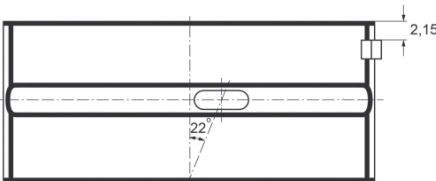

TW/A	2	59,500	73,200		1,975		AL-LF	04-3527	A123/4 STD
TW/A	2	59,500	73,200		1,975		AL-LF	04-3528	
BU	1	42,959/42,975	46,055/46,095	15,000			AL-LF	07-3088	07-3088 STD SEMI

Front, For intermediary shaft

BU	1	41,959/41,975	45,000/45,025	15,000			AL-LF	07-3089	07-3089 STD SEMI
----	---	---------------	---------------	--------	--	--	-------	---------	----------------------------

Rear, For intermediary shaft



10 76.50 x 86.90

BLF			4 Cyl.	1598cc	85kW (115PS)		Petrol		TD17501
BTS			4 Cyl.	1598cc	77kW (105PS)		Petrol		TD19090
CFNA			4 Cyl.	1598cc	77kW (105PS)		Petrol		TD24981
BE/PL	4	47,763/47,778	50,600/50,612	17,200	1,406	0,023/0,071	AL-LF	01-4100	01-4100/4 STD
MB/HL 1-5	5	53,963/53,978	59,000/59,019	18,500	2,504	0,020/0,073	AL-LF	02-4929	H1325/5 STD 0.25 0.50
TW/A	2	59,500	73,200		1,975		AL-LF	04-3527	A123/4 STD
TW/A	2	59,500	73,200		1,975		AL-LF	04-3528	

11 78.30 x 86.40

AYM			V6 Cyl.	2496cc	114kW (155PS)		Diesel Turbo Intercooler		TD16404
BDG			V6 Cyl.	2496cc	120kW (163PS)		Diesel Turbo Intercooler		TD17350
MB/HL 1-4	4	64,959/64,978	70,000/70,019	18,000	2,508	0,020/0,070	EC	72-3712	H034/4 STD 0.25

12 79.50 x 80.50

CFWA			3 Cyl.	1199cc	55kW (75PS)		Diesel Turbo		TD24261
BE/PL	1	47,758/47,778	50,600/50,612	20,000	1,406	0,020/0,067	SP	71-3904	71-3904 STD 0.25 0.50
MB/HL 1-5	5	53,958/53,978	59,000/59,012	18,500	2,501	0,020/0,076	EC	72-3931	H079/5 STD 0.25 0.50

13 79.50 x 80.50

CAYA			4 Cyl.	1598cc	55kW (75PS)		Diesel Turbo Intercooler		TD24216
CAYB			4 Cyl.	1598cc	66kW (90PS)		Diesel Turbo Intercooler		TD23929
CAYC			4 Cyl.	1598cc	77kW (105PS)		Diesel Turbo Intercooler		TD22678
CLNA			4 Cyl.	1598cc	77kW (105PS)		Diesel Turbo Intercooler		TD25764
BE/PL	1	47,758/47,778	50,600/50,612	20,000	1,406	0,020/0,067	SP	71-3904	71-3904 STD 0.25 0.50
MB/HL 1-5	5	53,958/53,978	59,000/59,012	18,500	2,501	0,020/0,076	EC	72-3931	H079/5 STD 0.25 0.50

→11/11

MB/HL 2-5	4	53,958/53,978	59,000/59,019	18,500	2,502	0,020/0,082	AL-LF	02-3085L	H1328/5 STD	
MB/HL 2-5	4	53,958/53,978	59,000/59,019	18,500	2,502	0,020/0,082	AL-LF	02-3085U		
MB/HL 1	1	53,958/53,978	59,000/59,012	18,500	2,506	0,020/0,062		02-4941L		
MB/HL 1	1	53,958/53,978	59,000/59,012	18,500	2,506	0,020/0,062		02-4941U		

12/11→

02-3085L



02-3085U

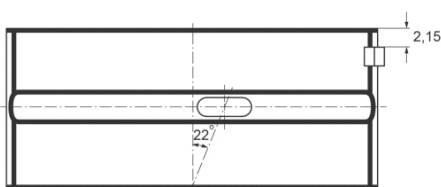

02-4941L





02-4941U



TW/A	2	59,500	73,200	1,975	AL-LF	04-3527	A123/4 STD
TW/A	2	59,500	73,200	1,975	AL-LF	04-3528	

14 79.50 x 80.50

CLHA	4 Cyl.		1598cc	77kW (105PS)	Diesel Turbo Intercooler			TD27810
MB/HL 1-5	5	53,963/53,978	59,000/59,019	18,500	2,504	0,020/0,073	AL-LF 02-4929	H1325/5 STD 0.25 0.50
TW/A	2	59,500	73,200	1,975			AL-LF 04-3527	A123/4 STD
TW/A	2	59,500	73,200	1,975			AL-LF 04-3528	

15 79.50 x 95.50

AMF	3 Cyl.		1422cc	55kW (75PS)	Diesel Turbo			TD17348
BMS	3 Cyl.		1422cc	59kW (80PS)	Diesel Turbo Intercooler			TD19092
BNM	3 Cyl.		1422cc	51kW (70PS)	Diesel Turbo Intercooler			TD18740
BNV	3 Cyl.		1422cc	59kW (80PS)	Diesel Turbo Intercooler			TD18741
BE/PL	1	47,758/47,778	50,600/50,612	20,000	1,406	0,020/0,067	SP 71-3904	71-3904 STD 0.25 0.50 1
CB/NWB 1-4	4	28,947/28,960	32,000/32,025	25,000	1,513	0,020/0,068	EC 73-3903	N147/4 STD
BU	1	31,984/32,000	35,000/35,025	22,000			AL-LF 07-4037	07-4037 SEMI
BU	1	41,984/42,000	45,000/45,025	22,000			AL-LF 07-4038	07-4038 SEMI

16 79.50 x 95.50

AEF	4 Cyl.		1896cc	47kW (64PS)	Diesel			TD13395
AQM	4 Cyl.		1896cc	50kW (68PS)	Diesel			TD16089
ASY	4 Cyl.		1896cc	47kW (64PS)	Diesel			TD15376
BE/PL	4	47,758/47,778	50,600/50,619	19,000	1,406	0,020/0,074	EC 71-3442	71-3442/4 STD 0.25 0.50 0.75
MB/HL 1-5	5	53,958/53,978	59,000/59,019	18,500	2,502	0,020/0,082	AL-LF 02-3085L	H084/5 STD 0.25 0.50
MB/HL 1-5	5	53,958/53,978	59,000/59,019	18,500	2,502	0,020/0,082	AL-LF 02-3085U	
TW/A	2	59,500	73,200	1,975			AL-LF 04-3527	A123/4 STD
TW/A	2	59,500	73,200	1,975			AL-LF 04-3528	
CB/NWB 1-5	5	28,947/28,960	32,000/32,025	25,000	1,513	0,020/0,068	EC 73-3903	N147/5 STD

17 79.50 x 95.50

AEY	4 Cyl.		1896cc	47kW (64PS)	Diesel			TD18729
BE/PL	4	47,758/47,778	50,600/50,619	20,000	1,406	0,020/0,074	EC 71-3728	71-3728/4 STD 0.25 0.50

MB/HL 1-5	5	53,958/53,978	59,000/59,019	18,500	2,502	0,020/0,082	AL-LF	02-3085L	H084/5 STD 0.25 0.50
MB/HL 1-5	5	53,958/53,978	59,000/59,019	18,500	2,502	0,020/0,082	AL-LF	02-3085U	
TW/A	2	59,500	73,200		1,975		AL-LF	04-3527	A123/4 STD
TW/A	2	59,500	73,200		1,975		AL-LF	04-3528	
SE/PB	1	26,000	29,000/29,052	25,000			BC	55-3729	55-3729 SEMI
CB/NWB 1-5	5	28,947/28,960	32,000/32,025	25,000	1,513	0,020/0,068	EC	73-3903	N147/5 STD

18

79.50 x 95.50

AGP			4 Cyl.	1896cc	50kW (68PS)		Diesel		TD16424
BE/PL	4	47,758/47,778	50,600/50,619	19,000	1,406	0,020/0,074	EC	71-3442	71-3442/4 STD 0.25 0.50 0.75
Mot.→AGP065001→									
BE/PL	4	47,758/47,778	50,600/50,619	20,000	1,406	0,020/0,074	EC	71-3728	71-3728/4 STD 0.25 0.50
Mot.→AGP065000									

71-3728

71-3442



MB/HL 1-5	5	53,958/53,978	59,000/59,019	18,500	2,502	0,020/0,082	AL-LF	02-3085L	H084/5 STD 0.25 0.50
MB/HL 1-5	5	53,958/53,978	59,000/59,019	18,500	2,502	0,020/0,082	AL-LF	02-3085U	
TW/A	2	59,500	73,200		1,975		AL-LF	04-3527	A123/4 STD
TW/A	2	59,500	73,200		1,975		AL-LF	04-3528	
SE/PB	1	26,000	29,000/29,052	25,000			BC	55-3729	55-3729 SEMI
CB/NWB 1-5	5	28,947/28,960	32,000/32,025	25,000	1,513	0,020/0,068	EC	73-3903	N147/5 STD

19

79.50 x 95.50

AGR			4 Cyl.	1896cc	66kW (90PS)		Diesel Turbo Intercooler		TD17905
BE/PL	4	47,758/47,778	50,600/50,619	20,000	1,406	0,020/0,074	EC	71-3728	71-3728/4 STD 0.25 0.50
MB/HL	4	53,958/53,978	59,000/59,019	18,500	2,502	0,020/0,082	AL-LF	02-3085L	H027/5 STD 0.25 0.50
MB/HL	6	53,958/53,978	59,000/59,019	18,500	2,502	0,020/0,082	AL-LF	02-3085U	
MB/HL 1-5	5	53,958/53,978	59,000/59,019	18,500	2,502	0,020/0,082	AL-LF	02-3085L	H084/5 STD 0.25 0.50
MB/HL 1-5	5	53,958/53,978	59,000/59,019	18,500	2,502	0,020/0,082	AL-LF	02-3085U	



02-3085L

02-3085U

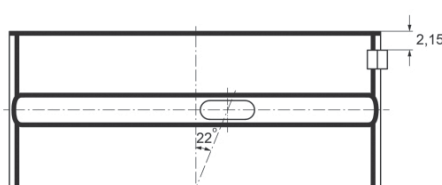

TW/A	2	59,500	73,200		1,975		AL-LF	04-3527	A123/4 STD
TW/A	2	59,500	73,200		1,975		AL-LF	04-3528	
SE/PB	1	26,000	29,000/29,052	25,000			BC	55-3729	55-3729 SEMI
CB/NWB 1-5	5	28,947/28,960	32,000/32,025	25,000	1,513	0,020/0,068	EC	73-3903	N147/5 STD
BU	1	42,959/42,975	46,055/46,095	15,000			AL-LF	07-3088	07-3088 STD SEMI
Front, For intermediary shaft									
BU	1	41,959/41,975	45,000/45,025	15,000			AL-LF	07-3089	07-3089 STD SEMI
Rear, For intermediary shaft									

20

79.50 x 95.50

AHF		4 Cyl.		1896cc	81kW (110PS)	Diesel Turbo Intercooler			TD17910
ASV		4 Cyl.		1896cc	81kW (110PS)	Diesel Turbo Intercooler			TD16091
BE/PL	4	47,758/47,778	50,600/50,612	20,000	1,406	0,020/0,067	SP	71-3847	71-3847/4 STD 0.25
MB/HL 1-5	5	53,958/53,978	59,000/59,019	18,500	2,502	0,020/0,082	AL-LF	02-3085L	H084/5 STD 0.25 0.50
MB/HL 1-5	5	53,958/53,978	59,000/59,019	18,500	2,502	0,020/0,082	AL-LF	02-3085U	
TW/A	2	59,500	73,200		1,975		AL-LF	04-3527	A123/4 STD
TW/A	2	59,500	73,200		1,975		AL-LF	04-3528	
SE/PB	1	26,000	29,000/29,052	25,000			BC	55-3729	55-3729 SEMI
CB/NWB 1-5	5	28,947/28,960	32,000/32,025	25,000	1,513	0,020/0,068	EC	73-3903	N147/5 STD
BU	1	42,959/42,975	46,055/46,095	15,000			AL-LF	07-3088	07-3088 STD SEMI
Front, For intermediary shaft									
BU	1	41,959/41,975	45,000/45,025	15,000			AL-LF	07-3089	07-3089 STD SEMI
Rear, For intermediary shaft									

21

79.50 x 95.50

ALH		4 Cyl.		1896cc	66kW (90PS)	Diesel Turbo Intercooler			TD16090
BE/PL	4	47,758/47,778	50,600/50,619	20,000	1,406	0,020/0,074	EC	71-3728	71-3728/4 STD 0.25 0.50
MB/HL 1-5	5	53,958/53,978	59,000/59,019	18,500	2,502	0,020/0,082	AL-LF	02-3085L	H084/5 STD 0.25 0.50
MB/HL 1-5	5	53,958/53,978	59,000/59,019	18,500	2,502	0,020/0,082	AL-LF	02-3085U	
TW/A	2	59,500	73,200		1,975		AL-LF	04-3527	A123/4 STD
TW/A	2	59,500	73,200		1,975		AL-LF	04-3528	

SE/PB	1	26,000	29,000/29,052	25,000			BC	55-3729	55-3729 SEMI
CB/NWB 1-5	5	28,947/28,960	32,000/32,025	25,000	1,513	0,020/0,068	EC	73-3903	N147/5 STD
BU	1	42,959/42,975	46,055/46,095	15,000			AL-LF	07-3088	07-3088 STD SEMI
Front, For intermediary shaft									
BU	1	41,959/41,975	45,000/45,025	15,000			AL-LF	07-3089	07-3089 STD SEMI
Rear, For intermediary shaft									

22	79.50 x 95.50								
ASZ	4 Cyl.		1896cc	96kW (130PS)		Diesel Turbo Intercooler			TD17036
BE/PL	1	50,858/50,878	53,700/53,712	20,400	1,403	0,020/0,073	SP	71-3930	71-3930 STD 0.25 0.50
MB/HL 1-5	5	53,958/53,978	59,000/59,012	18,500	2,501	0,020/0,076	EC	72-3931	H079/5 STD 0.25 0.50
TW/A	2	59,500	73,200		1,975		AL-LF	04-3527	A123/4 STD
TW/A	2	59,500	73,200		1,975		AL-LF	04-3528	
CB/NWB 1-5	5	28,947/28,960	32,000/32,025	25,000	1,513	0,020/0,068	EC	73-3903	N147/5 STD
BU	1	42,959/42,975	46,055/46,095	15,000			AL-LF	07-3088	07-3088 STD SEMI
Front, For intermediary shaft									
BU	1	41,959/41,975	45,000/45,025	15,000			AL-LF	07-3089	07-3089 STD SEMI
Rear, For intermediary shaft									

23	79.50 x 95.50								
ATD	4 Cyl.		1896cc	74kW (100PS)		Diesel Turbo Intercooler			TD15377
BSW	4 Cyl.		1896cc	77kW (105PS)		Diesel Turbo Intercooler			TD20004
BE/PL	1	47,758/47,778	50,600/50,612	20,000	1,406	0,020/0,067	SP	71-3904	71-3904 STD 0.25 0.50
MB/HL 1-5	5	53,958/53,978	59,000/59,019	18,500	2,502	0,020/0,082	AL-LF	02-3085L	H084/5 STD 0.25 0.50
MB/HL 1-5	5	53,958/53,978	59,000/59,019	18,500	2,502	0,020/0,082	AL-LF	02-3085U	
TW/A	2	59,500	73,200		1,975		AL-LF	04-3527	A123/4 STD
TW/A	2	59,500	73,200		1,975		AL-LF	04-3528	
CB/NWB 1-5	5	28,947/28,960	32,000/32,025	25,000	1,513	0,020/0,068	EC	73-3903	N147/5 STD

24	79.50 x 95.50								
AVB	4 Cyl.		1896cc	74kW (101PS)		Diesel Turbo Intercooler			TD17037
BE/PL	1	47,758/47,778	50,600/50,612	20,000	1,406	0,020/0,067	SP	71-3904	71-3904 STD 0.25 0.50
MB/HL 1-5	5	53,958/53,978	59,000/59,019	18,500	2,502	0,020/0,082	AL-LF	02-3085L	H084/5 STD 0.25 0.50
MB/HL 1-5	5	53,958/53,978	59,000/59,019	18,500	2,502	0,020/0,082	AL-LF	02-3085U	
TW/A	2	59,500	73,200		1,975		AL-LF	04-3527	A123/4 STD
TW/A	2	59,500	73,200		1,975		AL-LF	04-3528	



SE/PB	1	26,000	29,000/29,052	25,000			BC	55-3729	55-3729 SEMI
CB/NWB 1-5	5	28,947/28,960	32,000/32,025	25,000	1,513	0,020/0,068	EC	73-3903	N147/5 STD

25 79.50 x 95.50

AVF	4 Cyl.		1896cc	96kW (130PS)				Diesel Turbo Intercooler	TD18239
AWX	4 Cyl.		1896cc	96kW (130PS)				Diesel Turbo Intercooler	TD16403
BE/PL	1	50,858/50,878	53,700/53,712	20,400	1,403	0,020/0,073	SP	71-3930	71-3930 STD 0.25 0.50 I
MB/HL 1-5	5	53,958/53,978	59,000/59,012	18,500	2,501	0,020/0,076	EC	72-3931	H079/5 STD 0.25 0.50
TW/A	2	59,500	73,200		1,975		AL-LF	04-3527	A123/4 STD
TW/A	2	59,500	73,200		1,975		AL-LF	04-3528	
SE/PB	1	26,000	29,000/29,052	25,000			BC	55-3729	55-3729 SEMI
CB/NWB 1-5	5	28,947/28,960	32,000/32,025	25,000	1,513	0,020/0,068	EC	73-3903	N147/5 STD

26 79.50 x 95.50

AXR	4 Cyl.		1896cc	74kW (100PS)				Diesel Turbo Intercooler	TD20195
BJB	4 Cyl.		1896cc	77kW (105PS)				Diesel Turbo Intercooler	TD17499
BKC	4 Cyl.		1896cc	77kW (105PS)				Diesel Turbo Intercooler	TD17497
BLS	4 Cyl.		1896cc	77kW (105PS)				Diesel Turbo Intercooler	TD19091
BXE	4 Cyl.		1896cc	77kW (105PS)				Diesel Turbo Intercooler	TD20513
BE/PL	1	47,758/47,778	50,600/50,612	20,000	1,406	0,020/0,067	SP	71-3904	71-3904 STD 0.25 0.50 I
MB/HL 1-5	5	53,958/53,978	59,000/59,012	18,500	2,501	0,020/0,076	EC	72-3931	H079/5 STD 0.25 0.50
TW/A	2	59,500	73,200		1,975		AL-LF	04-3527	A123/4 STD
TW/A	2	59,500	73,200		1,975		AL-LF	04-3528	
CB/NWB 1-5	5	28,947/28,960	32,000/32,025	25,000	1,513	0,020/0,068	EC	73-3903	N147/5 STD

27 79.50 x 95.50

BLT	4 Cyl.		1896cc	96kW (130PS)				Diesel Turbo Intercooler	TD20517
BE/PL	1	47,758/47,778	50,600/50,612	20,000	1,406	0,020/0,067	SP	71-3904	71-3904 STD 0.25 0.50 I
BE/PL	1	50,858/50,878	53,700/53,712	20,400	1,403	0,020/0,073	SP	71-3930	71-3930 STD 0.25 0.50 I
MB/HL 1-5	5	53,958/53,978	59,000/59,012	18,500	2,501	0,020/0,076	EC	72-3931	H079/5 STD 0.25 0.50
TW/A	2	59,500	73,200		1,975		AL-LF	04-3527	A123/4 STD
TW/A	2	59,500	73,200		1,975		AL-LF	04-3528	
CB/NWB 1-5	5	28,947/28,960	32,000/32,025	25,000	1,513	0,020/0,068	EC	73-3903	N147/5 STD

28 79.50 x 95.50

BPZ	4 Cyl.		1896cc	85kW (115PS)				Diesel Turbo Intercooler	TD20205
BSV	4 Cyl.		1896cc	77kW (105PS)				Diesel Turbo Intercooler	TD20206
BE/PL	1	50,858/50,878	53,700/53,712	20,400	1,403	0,020/0,073	SP	71-3930	71-3930 STD 0.25 0.50 I
MB/HL 1-5	5	53,958/53,978	59,000/59,012	18,500	2,501	0,020/0,076	EC	72-3931	H079/5 STD 0.25 0.50

TW/A	2	59,500	73,200		1,975		AL-LF	04-3527	A123/4 STD
TW/A	2	59,500	73,200		1,975		AL-LF	04-3528	
CB/NWB 1-5	5	28,947/28,960	32,000/32,025	25,000	1,513	0,020/0,068	EC	73-3903	N147/5 STD

29 81.00 x 77.40

AEH		4 Cyl.	1595cc	74kW (101PS)			Petrol		TD12950
AKL		4 Cyl.	1595cc	74kW (101PS)			Petrol		TD12951
BE/PL	4	47,758/47,778	50,600/50,612	19,000	1,406	0,020/0,067	EC	71-3694	71-3694/4 STD 0.25 0.50
BE/PL	4	47,758/47,778	50,600/50,612	19,000	1,406	0,020/0,067	EC	71-3929	71-3929/4 STD 11

71-3694

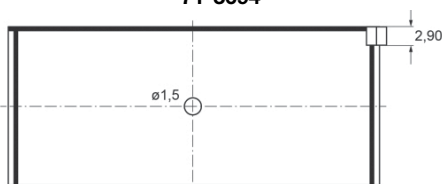

71-3929

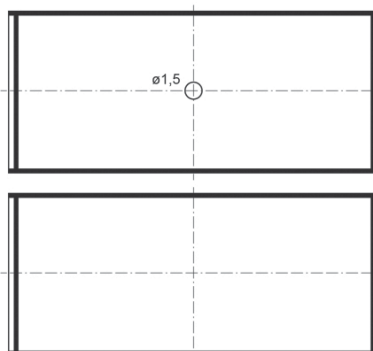

MB/HL 1-5	5	53,958/53,978	59,000/59,019	18,500	2,502	0,020/0,082	AL-LF	02-3085L	H084/5 STD 0.25 0.50
MB/HL 1-5	5	53,958/53,978	59,000/59,019	18,500	2,502	0,020/0,082	AL-LF	02-3085U	
TW/A	2	59,500	73,200		1,975		AL-LF	04-3527	A123/4 STD
TW/A	2	59,500	73,200		1,975		AL-LF	04-3528	
SE/PB	1	20,000	23,000/23,021	25,000			BC	55-3698	55-3698 SEMI
CB/NWB 1-5	5	25,939/25,960	28,250/28,271	17,000	1,138		AL-LF	03-3317	N118/5 STD 12
BU	1	42,959/42,975	46,055/46,095	15,000			AL-LF	07-3088	07-3088 STD SEMI 13

Front, For intermediary shaft

BU	1	41,959/41,975	45,000/45,025	15,000			AL-LF	07-3089	07-3089 STD SEMI 13
----	---	---------------	---------------	--------	--	--	-------	---------	--

Rear, For intermediary shaft

30 81.00 x 77.40

AVU		4 Cyl.	1595cc	75kW (102PS)			Petrol		TD16068
BFQ		4 Cyl.	1595cc	75kW (102PS)			Petrol		TD17912
BGU		4 Cyl.	1595cc	75kW (102PS)			Petrol		TD17496
BSE		4 Cyl.	1595cc	75kW (102PS)			Petrol		TD20898
BSF		4 Cyl.	1595cc	75kW (102PS)			Petrol		TD20899
CCSA		4 Cyl.	1595cc	75kW (102PS)			Petrol		TD20900
CHGA		4 Cyl.	1595cc	75kW (102PS)			Petrol		TD22691
CMXA		4 Cyl.	1595cc	75kW (102PS)			Petrol		TD24599
BE/PL	4	41,965/41,980	45,000/45,016	19,000	1,505	0,020/0,070	AL-LF	01-3961	01-3961/4 STD



31 81.00 x 86.40

ADR 4 Cyl. **1781cc** **92kW** (125PS) **Petrol** **TD20805**

BE/PL	4	47,758/47,778	50,600/50,612	19,000	1,406	0,020/0,067	EC	71-3694	71-3694/4 STD 0.25 0.50
MB/HL	4	53,958/53,978	59,000/59,019	18,500	2,502	0,020/0,082	AL-LF	02-3085L	H027/5 STD 0.25 0.50
MB/HL	6	53,958/53,978	59,000/59,019	18,500	2,502	0,020/0,082	AL-LF	02-3085U	
MB/HL 1-5	5	53,958/53,978	59,000/59,019	18,500	2,502	0,020/0,082	AL-LF	02-3085L	H084/5 STD 0.25 0.50
MB/HL 1-5	5	53,958/53,978	59,000/59,019	18,500	2,502	0,020/0,082	AL-LF	02-3085U	

02-3085L

02-3085U

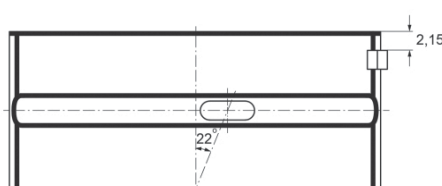

TW/A	2	59,500	73,200		1,975		AL-LF	04-3527	A123/4 STD
TW/A	2	59,500	73,200		1,975		AL-LF	04-3528	
SE/PB	1	20,000	23,000/23,021	25,000			BC	55-3698	55-3698 SEMI

32 81.00 x 86.40

AGN 4 Cyl. **1781cc** **92kW** (125PS) **Petrol** **TD17903**

BE/PL	4	47,758/47,778	50,600/50,612	19,000	1,406	0,020/0,067	EC	71-3694	71-3694/4 STD 0.25 0.50
MB/HL 1-5	5	53,958/53,978	59,000/59,019	18,500	2,502	0,020/0,082	AL-LF	02-3085L	H084/5 STD 0.25 0.50
MB/HL 1-5	5	53,958/53,978	59,000/59,019	18,500	2,502	0,020/0,082	AL-LF	02-3085U	
TW/A	2	59,500	73,200		1,975		AL-LF	04-3527	A123/4 STD
TW/A	2	59,500	73,200		1,975		AL-LF	04-3528	
SE/PB	1	20,000	23,000/23,021	25,000			BC	55-3698	55-3698 SEMI

33 81.00 x 86.40

AGU 4 Cyl. **1781cc** **110kW** (150PS) **Petrol Turbo Intercooler** **TD13396**

ARZ 4 Cyl. **1781cc** **110kW** (150PS) **Petrol Turbo Intercooler** **TD16030**

BE/PL	1	47,758/47,778	50,600/50,612	19,000	1,395	0,032/0,089	SP	71-3732	71-3732 STD I
MB/HL 1-5	5	53,958/53,978	59,000/59,019	18,500	2,502	0,020/0,082	AL-LF	02-3085L	H084/5 STD 0.25 0.50
MB/HL 1-5	5	53,958/53,978	59,000/59,019	18,500	2,502	0,020/0,082	AL-LF	02-3085U	
TW/A	2	59,500	73,200		1,975		AL-LF	04-3527	A123/4 STD
TW/A	2	59,500	73,200		1,975		AL-LF	04-3528	
SE/PB	1	20,000	23,000/23,021	25,000			BC	55-3698	55-3698 SEMI

34 81.00 x 86.40

ARX			4 Cyl.	1781cc	110kW (150PS)		Petrol Turbo Intercooler	TD16069
AUM			4 Cyl.	1781cc	110kW (150PS)		Petrol Turbo Intercooler	TD16070
AUQ			4 Cyl.	1781cc	132kW (180PS)		Petrol Turbo	TD16279
AWT			4 Cyl.	1781cc	110kW (150PS)		Petrol Turbo	TD16365
MB/HL 1-5	5	53,958/53,978	59,000/59,019	18,500	2,502	0,020/0,082	AL-LF 02-3085L	H084/5 STD 0.25 0.50
MB/HL 1-5	5	53,958/53,978	59,000/59,019	18,500	2,502	0,020/0,082	AL-LF 02-3085U	
TW/A	2	59,500	73,200		1,975		AL-LF 04-3527	A123/4 STD
TW/A	2	59,500	73,200		1,975		AL-LF 04-3528	

35 81.00 x 95.50

AZV			4 Cyl.	1968cc	100kW (136PS)		Diesel Turbo Intercooler	TD20909
BKD			4 Cyl.	1968cc	103kW (140PS)		Diesel Turbo Intercooler	TD17500
BMN			4 Cyl.	1968cc	125kW (170PS)		Diesel Turbo Intercooler	TD20735
BMP			4 Cyl.	1968cc	103kW (140PS)		Diesel Turbo Intercooler	TD20945
BSS			4 Cyl.	1968cc	103kW (140PS)		Diesel Turbo Intercooler	TD19317
BE/PL	1	50,858/50,878	53,700/53,712	20,400	1,403	0,020/0,073	SP 71-3930	71-3930 STD 0.25 0.50 ①
MB/HL 1-5	5	53,958/53,978	59,000/59,012	18,500	2,501	0,020/0,076	EC 72-3931	H079/5 STD 0.25 0.50
TW/A	2	59,500	73,200		1,975		AL-LF 04-3527	A123/4 STD
TW/A	2	59,500	73,200		1,975		AL-LF 04-3528	

36 81.00 x 95.50

BMM			4 Cyl.	1968cc	103kW (140PS)		Diesel Turbo Intercooler	TD19315
CFHA			4 Cyl.	1968cc	81kW (110PS)		Diesel Turbo	TD23584
BE/PL	1	50,858/50,878	53,700/53,712	20,400	1,403	0,020/0,073	SP 71-3930	71-3930 STD 0.25 0.50 ①
MB/HL 1-5	5	53,958/53,978	59,000/59,012	18,500	2,501	0,020/0,076	EC 72-3931	H079/5 STD 0.25 0.50
TW/A	2	59,500	73,200		1,975		AL-LF 04-3527	A123/4 STD
TW/A	2	59,500	73,200		1,975		AL-LF 04-3528	
CB/NWB 1-5	5	28,947/28,960	32,000/32,025	25,000	1,513	0,020/0,068	EC 73-3903	N147/5 STD

37 81.00 x 95.50

CBBB			4 Cyl.	1968cc	125kW (170PS)		Diesel Turbo Intercooler	TD20944
CBDB			4 Cyl.	1968cc	103kW (140PS)		Diesel Turbo	TD23586
CEGA			4 Cyl.	1968cc	125kW (170PS)		Diesel Turbo	TD20905
CFFB			4 Cyl.	1968cc	103kW (140PS)		Diesel Turbo Intercooler	TD23589
CFGB			4 Cyl.	1968cc	125kW (170PS)		Diesel Turbo Intercooler	TD23591
CFHC			4 Cyl.	1968cc	103kW (140PS)		Diesel Turbo	TD23587
CFHF			4 Cyl.	1968cc	81kW (110PS)		Diesel Turbo	TD23585
CFJA			4 Cyl.	1968cc	125kW (170PS)		Diesel Turbo	TD23588
CLCA			4 Cyl.	1968cc	81kW (110PS)		Diesel Turbo Intercooler	TD24839
CLCB			4 Cyl.	1968cc	103kW (140PS)		Diesel Turbo	TD24598
CLJA			4 Cyl.	1968cc	103kW (140PS)		Diesel Turbo Intercooler	TD23590
CRLB			4 Cyl.	1968cc	110kW (150PS)		Diesel Turbo Intercooler	TD31653

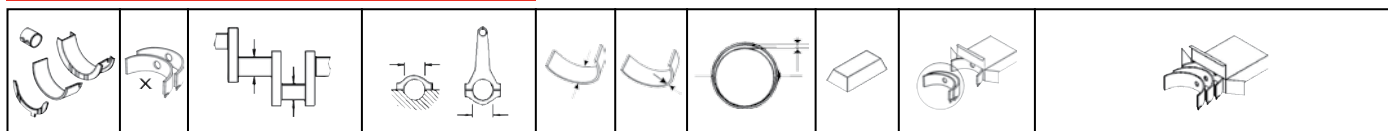

CUNA	4 Cyl.	1968cc	135kW (184PS)	Diesel Turbo	TD29186
CUPA	4 Cyl.	1968cc	135kW (184PS)	Diesel Turbo	TD28040
DDAA	4 Cyl.	1968cc	140kW (190PS)	Diesel Turbo	TD31655
DFCA	4 Cyl.	1968cc	140kW (190PS)	Diesel Turbo	TD31656
DFEA	4 Cyl.	1968cc	110kW (150PS)	Diesel Turbo Intercooler	TD31654

BE/PL	1	50,858/50,878	53,700/53,712	20,400	1,403	0,020/0,073	SP	71-3930	71-3930 STD 0.25 0.50	1
MB/HL 1-5	5	53,958/53,978	59,000/59,012	18,500	2,501	0,020/0,076	EC	72-3931	H079/5 STD 0.25 0.50	
MB/HL 2-5	4	53,958/53,978	59,000/59,019	18,500	2,502	0,020/0,082	AL-LF	02-3085L	H1328/5 STD	7
MB/HL 2-5	4	53,958/53,978	59,000/59,019	18,500	2,502	0,020/0,082	AL-LF	02-3085U		
MB/HL 1	1	53,958/53,978	59,000/59,012	18,500	2,506	0,020/0,062		02-4941L		
MB/HL 1	1	53,958/53,978	59,000/59,012	18,500	2,506	0,020/0,062		02-4941U		



12/11 →

02-3085L



02-3085U

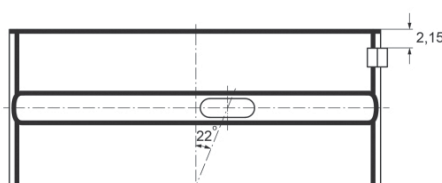

02-4941L



02-4941U

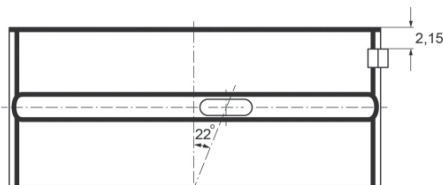

TW/A	2	59,500	73,200		1,975		AL-LF	04-3527	A123/4 STD
TW/A	2	59,500	73,200		1,975		AL-LF	04-3528	

38

82.50 x 86.40

AMX	V6 Cyl.	2771cc	142kW (193PS)	Petrol	TD16367
BBG	V6 Cyl.	2771cc	140kW (190PS)	Petrol	TD18754

BE/PL	6	53,958/53,978	57,600/57,612	17,000	1,806	0,020/0,069	EC	71-3711	71-3711/6 STD
MB/HL 1-4	4	64,959/64,978	70,000/70,019	18,000	2,508	0,020/0,070	EC	72-3712	H034/4 STD 0.25
TW/A	2	70,500	84,900		1,965		AL-LF	04-3713	A138/4 STD
TW/A	2	70,500	84,900		1,965		AL-LF	04-3714	

39

82.50 x 92.80

AEQ	4 Cyl.	1984cc	85kW (116PS)	Petrol	TD16280
AQY	4 Cyl.	1984cc	85kW (116PS)	Petrol	TD13869

BE/PL	4	47,758/47,778	50,600/50,612	19,000	1,406	0,020/0,067	EC	71-3694	71-3694/4 STD 0.25 0.50
-------	---	---------------	---------------	--------	-------	-------------	----	---------	-----------------------------------

TW/A	2	59,500	73,200		1,975		AL-LF	04-3527	A123/4 STD
TW/A	2	59,500	73,200		1,975		AL-LF	04-3528	
SE/PB	1	20,000	23,000/23,021	25,000			BC	55-3698	55-3698 SEMI

40 82.50 x 92.80

APK	4 Cyl. 1984cc 85kW (116PS)						Petrol		TD16031
BE/PL	4	47,758/47,778	50,600/50,612	19,000	1,406	0,020/0,067	EC	71-3694	71-3694/4 STD 0.25 0.50
MB/HL 1-5	5	53,958/53,978	59,000/59,019	18,500	2,502	0,020/0,082	AL-LF	02-3085L	H084/5 STD 0.25 0.50
MB/HL 1-5	5	53,958/53,978	59,000/59,019	18,500	2,502	0,020/0,082	AL-LF	02-3085U	
TW/A	2	59,500	73,200		1,975		AL-LF	04-3527	A123/4 STD
TW/A	2	59,500	73,200		1,975		AL-LF	04-3528	
SE/PB	1	20,000	23,000/23,021	25,000			BC	55-3698	55-3698 SEMI

41 82.50 x 92.80

AZH	4 Cyl. 1984cc 85kW (116PS)						Petrol		TD16092
BE/PL	4	47,758/47,778	50,600/50,612	19,000	1,406	0,020/0,067	EC	71-3929	71-3929/4 STD [1]
MB/HL 1-5	5	53,958/53,978	59,000/59,019	18,500	2,502	0,020/0,082	AL-LF	02-3085L	H084/5 STD 0.25 0.50
MB/HL 1-5	5	53,958/53,978	59,000/59,019	18,500	2,502	0,020/0,082	AL-LF	02-3085U	
TW/A	2	59,500	73,200		1,975		AL-LF	04-3527	A123/4 STD
TW/A	2	59,500	73,200		1,975		AL-LF	04-3528	

42 82.50 x 92.80

AZL	4 Cyl. 1984cc 85kW (116PS)						Petrol		TD16241
BE/PL	4	47,758/47,778	50,600/50,612	19,000	1,406	0,020/0,067	EC	71-3929	71-3929/4 STD [1]
MB/HL 1-5	5	53,958/53,978	59,000/59,019	18,500	2,502	0,020/0,082	AL-LF	02-3085L	H084/5 STD 0.25 0.50
MB/HL 1-5	5	53,958/53,978	59,000/59,019	18,500	2,502	0,020/0,082	AL-LF	02-3085U	
TW/A	2	59,500	73,200		1,975		AL-LF	04-3527	A123/4 STD
TW/A	2	59,500	73,200		1,975		AL-LF	04-3528	
SE/PB	1	20,000	23,000/23,021	25,000			BC	55-3698	55-3698 SEMI

43 82.50 x 92.80

BLR	4 Cyl. 1984cc 110kW (150PS)						Petrol		TD18102
BLX	4 Cyl. 1984cc 110kW (150PS)						Petrol		TD20393
BLY	4 Cyl. 1984cc 110kW (150PS)						Petrol		TD18101
BVX	4 Cyl. 1984cc 110kW (150PS)						Petrol		TD20394
BVY	4 Cyl. 1984cc 110kW (150PS)						Petrol		TD20518
BVZ	4 Cyl. 1984cc 110kW (150PS)						Petrol		TD20519
BE/PL	4	47,758/47,778	50,600/50,612	19,000	1,406	0,020/0,067	EC	71-3929	71-3929/4 STD [1]



cm3

x



Cabrio 0.6	03/00→01/04	Petrol	M 160 E6AL B03	599	3	63.50	63.00	1
Cabrio 0.6	01/01→01/04	Petrol	M 160 E6AL B05	599	3	63.50	63.00	1
City-Coupe 0.6	07/98→01/04	Petrol	M 160 E6AL B03	599	3	63.50	63.00	1
City-Coupe 0.6	07/98→01/04	Petrol	M 160 E6AL B04	599	3	63.50	63.00	1
City-Coupe 0.6	01/01→01/04	Petrol	M 160 E6AL B05	599	3	63.50	63.00	1
Forfour 1.5 CDI	09/04→06/06	Diesel	OM 639.939	1493	3	83.00	92.00	2

		cm ³	x 			
---	---	-----------------	--	---	---	---









M 160 E6AL B03	Petrol	599	3	63.50	63.00	1
M 160 E6AL B04	Petrol	599	3	63.50	63.00	1
M 160 E6AL B05	Petrol	599	3	63.50	63.00	1
OM 639.939	Diesel	1493	3	83.00	92.00	2

SMART









1		63.50 x 63.00							
M 160 E6AL B03		3 Cyl.		599cc	40kW (55PS)		Petrol Turbo		TD22902
M 160 E6AL B04		3 Cyl.		599cc	33kW (45PS)		Petrol		TD22903
M 160 E6AL B05		3 Cyl.		599cc	45kW (61PS)		Petrol		TD22901
BE/PL	3	37,940/37,965	41,600/41,616	17,000	1,813	0,020/0,075	EC	71-3882	71-3882/3 STD 0.25
MB/HL 1-4	4	44,950/44,965	51,000/51,019	16,000	3,030	0,025/0,034	AL-LF	02-3883	H072/4 STD 0.25
TW/A	2	52,500/52,750	68,250/68,500		3,200		AL-LF	04-3884	A154/2 STD

2		83.00 x 92.00							
OM 639.939 Euro 4		3 Cyl.		1493cc	50-70kW (58-95PS)		Diesel		TD23800
BE/PL	1	49,940/49,965	53,600/53,614	20,400	1,813	0,020/0,072	SP	71-4013	71-4013 STD ①
MB/HL	1	54,940/54,965	59,000/59,019	18,000	2,018	0,020/0,077	SP	72-4014	72-4014 STD ②
TW/A	2	61,250	76,750		2,200		AL-LF	04-4004	A163/4 STD
TW/A	2	61,250	76,750		2,200		AL-LF	04-4005	

				cm ³ x 			
---	---	---	---	---	---	---	---

Justy II 1.3 4x4	04/01→11/03	Petrol	G13BB	1298	4	74.00	75.50	2
Justy III 1.3 AWD	09/03→	Petrol	M13A	1328	4	78.00	69.50	3
Justy III 1.5 AWD	09/03→	Petrol	M15A	1490	4	78.00	78.10	4
Justy IV 1.0	01/07→	Petrol	1KR-FE	998	3	71.00	84.00	1

			cm ³	x 			
1KR-FE		Petrol	998	3	71.00	84.00	1
G13B		Petrol	1298	4	74.00	75.50	2
G13BB		Petrol	1298	4	74.00	75.50	2
M13A		Petrol	1328	4	78.00	69.50	3
M15A		Petrol	1490	4	78.00	78.10	4



1 71.00 x 84.00

1KR-FE Euro 4		3 Cyl.		998cc	50-51kW (68-70PS)		Petrol		TD26119
BE/PL	6	40,000	43,020	13,600	1,495		AL-LF	64-735-1	01-4980/3 STD
MB/HL 1-4	4	43,990	48,020	14,900	1,997		AL-LF	63-735-1	H1338/4 STD
MB/HL 1-4	4	43,990	48,020	14,900	1,997		AL-LF	63-735-2	
TW/A	2	52,000	63,000		1,990		AL-LF	65-735-1	A322/2 STD

2 74.00 x 75.50

G13B		4 Cyl.		1298cc	50kW (68PS)		Petrol		TD19194
G13BB		4 Cyl.		1298cc	62-63kW (84-86PS)		Petrol		TD18569
BE/PL	8	41,980	45,020	18,100	1,490		AL	64-655-1	01-4119/4 STD 0.25 0.50
MB/HL 1-5	5	44,980	49,020	18,100	2,000		AL	63-655-1	H1159/5 STD 0.25
MB/HL 1-5	5	44,980	49,020	18,100	2,000		AL	63-655-2	
TW/A	2	52,000	68,000		2,520		AL-LF	65-655-1	A170/2 STD

3 78.00 x 69.50

M13A		4 Cyl.		1328cc	60-69kW (82-94PS)		Petrol		TD24894
BE/PL	8	41,980	45,020	16,000	1,493		AL-LF	64-664-1	01-4946/4 STD
MB/HL 1-5	5	44,980	49,020	18,000	2,000		AL-LF	63-664-1	H1330/5 STD
MB/HL 1-5	5	44,980	49,020	18,000	2,000		AL-LF	63-664-2	
TW/A	2	59,000	75,000		2,520		AL-LF	65-664-1	A316/2 STD

4 78.00 x 78.10

M15A		4 Cyl.		1490cc	73-80kW (99-109PS)		Petrol		TD20972
BE/PL	8	41,980	45,020	18,000	1,490		AL-LF	64-665-1	01-4947/4 STD
MB/HL 1-5	5	51,980	56,020	18,000	2,000		AL-LF	63-665-1	H1331/5 STD
MB/HL 1-5	5	51,980	56,020	18,000	2,000		AL-LF	63-665-2	
TW/A	2	59,000	75,000		2,520		AL-LF	65-664-1	A316/2 STD











cm3



9

Alto 0.5	09/85→05/88	Petrol	F5A	543	3	62.00	60.00	1
Alto 0.8	06/82→06/96	Petrol	F8B	796	3	68.50	72.00	4
Alto 0.8	10/83→08/84	Petrol	F8A	797	4	62.00	66.00	2
Alto 1.3	10/98→09/00	Petrol	G13BB	1298	4	74.00	75.50	9
Alto 1.6	10/98→09/00	Petrol	G16B	1590	4	75.00	90.00	13
APV 1.5	06/05→	Petrol	G15A	1493	4	75.00	84.50	11
APV 1.6 16V	06/05→	Petrol	G16A (16V)	1590	4	75.00	90.00	13
Baleno 1.3	04/96→05/02	Petrol	G13BA	1298	4	74.00	75.50	9
Baleno 1.3 16V	03/97→05/02	Petrol	G13BB	1298	4	74.00	75.50	9
Baleno 1.3 i 16V	07/95→05/02	Petrol	G13BB	1298	4	74.00	75.50	9
Baleno 1.5	03/95→08/98	Petrol	G15A	1493	4	75.00	84.50	11
Baleno 1.6	09/97→12/00	Petrol	G16B	1590	4	75.00	90.00	13
Baleno 1.6 i 16V	07/95→05/02	Petrol	G16B	1590	4	75.00	90.00	13
Baleno 1.6 i 16V 4x4	07/95→05/02	Petrol	G16B	1590	4	75.00	90.00	13
Baleno 1.8	09/99→05/02	Petrol	J18A	1839	4	84.00	83.00	24
Baleno 1.8 GTX	03/96→05/02	Petrol	J18A	1839	4	84.00	83.00	24
Baleno 1.8 i 4x4	03/96→05/02	Petrol	J18A	1839	4	84.00	83.00	24
Baleno 1.8 i 16V	08/96→05/02	Petrol	J18A	1839	4	84.00	83.00	24
Baleno 1.8 i 16V 4x4	08/96→05/02	Petrol	J18A	1839	4	84.00	83.00	24
Baleno 1.9 TD	04/98→05/02	Diesel	DHV (XUD9BSD)	1905	4	83.00	88.00	23
Baleno 1.9 TD	04/98→05/02	Diesel	DHW (XUD9SD)	1905	4	83.00	88.00	23
Carry 0.8	11/80→10/85	Petrol	F8A	797	4	62.00	66.00	2
Carry 1.0	07/85→03/99	Petrol	F10A	970	4	65.50	72.00	3
Carry 1.3	03/99→	Petrol	G13BB	1298	4	74.00	75.50	9
Carry 1.3 4x4	02/99→07/05	Petrol	G13BB	1298	4	74.00	75.50	9
Carry 1.3 16 V	03/00→	Petrol	G13BB	1298	4	74.00	75.50	9
Carry 1.5	03/11→	Petrol	G15A	1493	4	75.00	84.50	11
Equator 2.5	09/08→12/12	Petrol	QR25DE	2488	4	89.00	100.00	30
Farmworker 1.3 4x4	01/11→	Petrol	G13BB	1298	4	74.00	75.50	9
Fun 1.4	02/05→	Petrol	C 14 SE	1389	4	77.60	73.40	16
Grand Vitara I 1.3	03/98→07/03	Petrol	M13A	1328	4	78.00	69.50	17
Grand Vitara I 1.6	09/98→12/02	Petrol	G16B	1590	4	75.00	90.00	13
Grand Vitara I 1.6 4x4	03/98→09/05	Petrol	G16B	1590	4	75.00	90.00	13
Grand Vitara I 2.0	09/98→12/03	Petrol	J20A	1995	4	84.00	90.00	25
Grand Vitara I 2.0 4x4	03/98→08/05	Petrol	J20A	1995	4	84.00	90.00	25
Grand Vitara I 2.0 HDI 110	07/01→09/05	Diesel	RHZ	1997	4	85.00	88.00	27
Grand Vitara I 2.0 HDI 110 16V	07/01→09/05	Diesel	RHW	1997	4	85.00	88.00	27
Grand Vitara I 2.0 TD	03/98→07/03	Diesel	RF	1998	4	86.00	86.00	28
Grand Vitara I 2.0 TD 4x4	10/98→03/03	Diesel	RF	1998	4	86.00	86.00	28
Grand Vitara II 1.3	05/05→07/06	Petrol	G13BB	1298	4	74.00	75.50	9
Grand Vitara II 1.3	08/06→02/15	Petrol	M13A	1328	4	78.00	69.50	17
Grand Vitara II 1.6	10/05→	Petrol	M16A	1586	4	78.00	83.00	19
Grand Vitara II 1.6 All-wheel Drive	04/05→	Petrol	M16A	1586	4	78.00	83.00	19
Grand Vitara II 1.9 DDiS	10/05→02/15	Diesel	F9QB	1870	4	80.00	93.00	20
Grand Vitara II 2.0	10/05→02/15	Petrol	J20A	1995	4	84.00	90.00	25
Grand Vitara II 2.0 All-wheel Drive	10/05→02/15	Petrol	J20A	1995	4	84.00	90.00	25
Grand Vitara II 2.0 HDi All-wheel Drive	01/06→02/15	Diesel	RHW	1997	4	85.00	88.00	27
Hatch 0.5	02/80→12/85	Petrol	F5A	543	3	62.00	60.00	1
Hatch 0.8	11/80→12/85	Petrol	F8B	796	3	68.50	72.00	4
Ignis 1.3	10/00→09/03	Petrol	M13A	1328	4	78.00	69.50	17
Ignis 1.3 4WD	10/00→09/03	Petrol	M13A	1328	4	78.00	69.50	17
Ignis 1.5	08/03→12/05	Petrol	M15A	1490	4	78.00	78.10	18
Ignis II 1.3	09/03→	Petrol	M13A	1328	4	78.00	69.50	17
Ignis II 1.3 4x4	09/03→	Petrol	M13A	1328	4	78.00	69.50	17
Ignis II 1.3 DDiS	09/03→	Diesel	Z13DT	1248	4	69.60	82.00	5
Ignis II 1.5	09/03→	Petrol	M15A	1490	4	78.00	78.10	18
Ignis II 1.5 4x4	09/03→	Petrol	M15A	1490	4	78.00	78.10	18
Ignis II 1.5	12/03→	Petrol	M15A	1490	4	78.00	78.10	18
Jimny 1.3	11/88→03/98	Petrol	G13BA	1298	4	74.00	75.50	9
Jimny 1.3	08/04→	Petrol	M13A	1328	4	78.00	69.50	17
Jimny 1.3 4x4	09/98→08/00	Petrol	G13BB	1298	4	74.00	75.50	9
Jimny 1.3 4x4	09/00→08/02	Petrol	M13A	1328	4	78.00	69.50	17
Jimny 1.3 4WD	05/14→	Petrol	M13A	1328	4	78.00	69.50	17
Jimny 1.3 16V	09/98→	Petrol	G13BB	1298	4	74.00	75.50	9
Jimny 1.3 16V	02/01→	Petrol	M13A	1328	4	78.00	69.50	17
Jimny 1.3 16V 4x4	08/05→	Petrol	M13A	1328	4	78.00	69.50	17
Jimny 1.3 16V 4WD	09/98→	Petrol	G13BB	1298	4	74.00	75.50	9
Jimny 1.3 16V 4WD	02/01→	Petrol	M13A	1328	4	78.00	69.50	17
Jimny 1.5 DDiS 4x4	08/05→	Diesel	K9K 266	1461	4	76.00	80.50	14

				cm3				
Jimny 1.5 DDiS 4WD	12/03→	Diesel	K9K 700	1461	4	76.00	80.50	14
Jimny 1.6 VVT	05/04→	Petrol	M16A	1586	4	78.00	83.00	19
Kei 1.3	09/98→	Petrol	G13BA	1298	4	74.00	75.50	9
Landy 2.0	01/10→	Petrol	MR20	1997	4	84.00	90.10	26
Landy 2.0	01/07→12/09	Petrol	MR20DE	1997	4	84.00	90.10	26
Landy 2.0 4WD	01/07→12/09	Petrol	MR20DE	1997	4	84.00	90.10	26
Liana 1.3	07/01→	Petrol	M13A	1328	4	78.00	69.50	17
Liana 1.4 DDiS	04/04→	Diesel	8HY	1398	4	73.70	82.00	8
Liana 1.5	04/04→11/07	Petrol	M15A	1490	4	78.00	78.10	18
Liana 1.6	07/01→	Petrol	M16A	1586	4	78.00	83.00	19
Liana 1.6 4WD	07/01→	Petrol	M16A	1586	4	78.00	83.00	19
Liana 1.6 i	04/02→	Petrol	M16A	1586	4	78.00	83.00	19
Liana 1.8 i	10/01→	Petrol	M18A	1796	4	83.00	83.00	22
Liana 2.0	10/01→12/03	Petrol	J20A	1995	4	84.00	90.00	25
Liana 2.0 AWD	09/02→12/03	Petrol	J20A	1995	4	84.00	90.00	25
LJ 80 0.8	01/80→01/84	Petrol	F8A	797	4	62.00	66.00	2
LJ 80 4x4	11/77→12/81	Petrol	F8A	797	4	62.00	66.00	2
LJ 81 4x4	11/77→12/81	Petrol	F8A	797	4	62.00	66.00	2
Maruti 800	02/88→12/94	Petrol	F8B	796	3	68.50	72.00	4
Mighty Boy 0.5	07/85→10/88	Petrol	F5A	543	3	62.00	60.00	1
Samurai 1.0 All-wheel Drive	11/88→12/04	Petrol	F10A	970	4	65.50	72.00	3
Samurai 1.3	11/88→03/98	Petrol	G13BA	1298	4	74.00	75.50	9
Samurai 1.3	11/88→12/04	Petrol	G13BB	1298	4	74.00	75.50	9
Samurai 1.3	11/88→12/04	Petrol	G13A	1324	4	74.00	77.00	10
Samurai 1.3 4WD	09/89→12/95	Petrol	G13BA	1298	4	74.00	75.50	9
Samurai 1.3 All-wheel Drive	11/88→12/04	Petrol	G13BA	1298	4	74.00	75.50	9
Samurai 1.3 All-wheel Drive	11/88→12/04	Petrol	G13A	1324	4	74.00	77.00	10
Samurai 1.9 TD	11/98→12/04	Diesel	XUD9	1905	4	83.00	88.00	23
SC100 1.0	03/77→12/82	Petrol	F10A	970	4	65.50	72.00	3
Sierra 1.0 All-wheel Drive	09/81→12/88	Petrol	F10A	970	4	65.50	72.00	3
Sierra 1.3	01/89→07/99	Petrol	G13BA	1298	4	74.00	75.50	9
Sierra 1.3	09/84→03/90	Petrol	G13A	1324	4	74.00	77.00	10
Sierra 1.3 All-wheel Drive	09/84→03/90	Petrol	G13A	1324	4	74.00	77.00	10
Sierra II All-wheel Drive	12/88→02/00	Petrol	F10A	970	4	65.50	72.00	3
SJ 410 1.0	09/81→12/88	Petrol	F10A	970	4	65.50	72.00	3
SJ 410 1.0 4WD	09/79→12/85	Petrol	F10A	970	4	65.50	72.00	3
SJ 410 Cabrio 1.0	09/81→12/88	Petrol	F10A	970	4	65.50	72.00	3
SJ 413 1.3	11/88→08/90	Petrol	G13BA	1298	4	74.00	75.50	9
SJ 413 1.3	11/88→08/90	Petrol	G13BB	1298	4	74.00	75.50	9
SJ 413 1.3	09/84→08/90	Petrol	G13A	1324	4	74.00	77.00	10
SJ 413 1.3 4WD	09/84→12/85	Petrol	G13B	1298	4	74.00	75.50	9
Splash 1.3 CDTI	01/08→	Diesel	Z 13 DTJ	1248	4	69.60	82.00	5
Super Carry 1.0	10/85→03/99	Petrol	F10A	970	4	65.50	72.00	3
Swift 1.3 i	01/92→10/96	Petrol	G13B	1298	4	74.00	75.50	9
Swift 1.3 i	09/91→10/96	Petrol	G13BA	1298	4	74.00	75.50	9
Swift I 1.3	10/84→03/89	Petrol	G13A	1324	4	74.00	77.00	10
Swift I 1.3 GTi/GXi	08/85→03/89	Petrol	G13B	1298	4	74.00	75.50	9
Swift II 1.3	09/97→12/01	Petrol	G13B	1298	4	74.00	75.50	9
Swift II 1.3	03/89→12/97	Petrol	G13BA	1298	4	74.00	75.50	9
Swift II 1.3	06/01→12/03	Petrol	G13BB	1298	4	74.00	75.50	9
Swift II 1.3	03/89→05/01	Petrol	G13A	1324	4	74.00	77.00	10
Swift II 1.3 4WD	03/89→05/01	Petrol	G13A	1324	4	74.00	77.00	10
Swift II 1.3 GTi	03/89→05/01	Petrol	G13B	1298	4	74.00	75.50	9
Swift II 1.6	11/89→12/93	Petrol	G16B	1590	4	75.00	90.00	13
Swift II 1.6 4x4	03/89→10/96	Petrol	G16B	1590	4	75.00	90.00	13
Swift II 1.6 4WD	11/89→12/91	Petrol	G16B	1590	4	75.00	90.00	13
Swift II 1.6 i	01/90→05/01	Petrol	G16B	1590	4	75.00	90.00	13
Swift II 1.6 i 4WD	01/90→05/01	Petrol	G16B	1590	4	75.00	90.00	13
Swift III 1.3	02/05→	Petrol	M13A	1328	4	78.00	69.50	17
Swift III 1.3 4x4	02/05→	Petrol	M13A	1328	4	78.00	69.50	17
Swift III 1.3 DDiS	08/05→	Diesel	Z13DT	1248	4	69.60	82.00	5
Swift III 1.3 DDiS	08/05→	Diesel	Z 13 DTJ	1248	4	69.60	82.00	5
Swift III 1.5	02/05→	Petrol	M15A	1490	4	78.00	78.10	18
Swift III 1.5 4x4	02/05→	Petrol	M15A	1490	4	78.00	78.10	18
Swift III 1.6	05/06→	Petrol	M16A	1586	4	78.00	83.00	19
Swift IV 1.6	01/12→	Petrol	M16A	1586	4	78.00	83.00	19
Sx4 1.5	06/06→	Petrol	M15A	1490	4	78.00	78.10	18
Sx4 1.5 VVT	07/10→	Petrol	M15A	1490	4	78.00	78.10	18
Sx4 1.5 VVT 4x4	07/10→	Petrol	M15A	1490	4	78.00	78.10	18









cm3



9

Sx4 1.6	06/06→	Petrol	M16A	1586	4	78.00	83.00	19
Sx4 1.6 AWD	10/07→	Petrol	M16A	1586	4	78.00	83.00	19
Sx4 1.6 DDiS	04/07→	Diesel	9HX	1560	4	75.00	88.30	12
Sx4 1.6 VVT	06/06→	Petrol	M16A	1586	4	78.00	83.00	19
Sx4 1.6 VVT 4x4	06/06→	Petrol	M16A	1586	4	78.00	83.00	19
Sx4 1.9 DDiS	06/06→	Diesel	D19AA	1910	4	82.00	90.40	21
Sx4 1.9 DDiS 4x4	06/06→	Diesel	D19AA	1910	4	82.00	90.40	21
Sx4 2.0	06/06→	Petrol	J20A	1995	4	84.00	90.00	25
Sx4 2.0 4x4	06/06→	Petrol	J20A	1995	4	84.00	90.00	25
Sx4 2.0 AWD	10/07→12/09	Petrol	J20A	1995	4	84.00	90.00	25
SX4 S-Cross 1.6	08/13→	Petrol	M16A	1586	4	78.00	83.00	19
Vitara 1.3 All-wheel Drive	09/88→12/89	Petrol	G13A	1324	4	74.00	77.00	10
Vitara 1.6	02/15→	Petrol	M16A	1586	4	78.00	83.00	19
Vitara 1.6	07/88→01/95	Petrol	G16A (8V)	1590	4	75.00	90.00	13
Vitara 1.6	02/91→03/98	Petrol	G16B	1590	4	75.00	90.00	13
Vitara 1.6 16V	10/99→10/02	Petrol	G16B	1590	4	75.00	90.00	13
Vitara 1.6 All-wheel Drive	07/88→08/99	Petrol	G16A (8V)	1590	4	75.00	90.00	13
Vitara 1.6 i 16V	07/90→03/99	Petrol	G16B	1590	4	75.00	90.00	13
Vitara 1.6 i 16V All-wheel Drive	07/90→03/98	Petrol	G16B	1590	4	75.00	90.00	13
Vitara 1.8	09/96→12/98	Petrol	J18A	1839	4	84.00	83.00	24
Vitara 1.8 All-wheel Drive	09/95→12/98	Petrol	J18A	1839	4	84.00	83.00	24
Vitara 1.9 D	01/95→03/98	Diesel	XUD9A	1905	4	83.00	88.00	23
Vitara 1.9 D	08/96→03/99	Diesel	XUD9SD	1905	4	83.00	88.00	23
Vitara 1.9 D All-wheel Drive	01/95→03/98	Diesel	XUD9A	1905	4	83.00	88.00	23
Vitara 1.9 D All-wheel Drive	08/96→03/98	Diesel	XUD9SD	1905	4	83.00	88.00	23
Vitara 2.0 16V	12/96→03/99	Petrol	J20A	1995	4	84.00	90.00	25
Vitara 2.0 16V All-wheel Drive	12/96→03/98	Petrol	J20A	1995	4	84.00	90.00	25
Vitara 2.0 HDI	12/03→12/05	Diesel	RHP (DW10TD)	1997	4	85.00	88.00	27
Vitara 2.0 TD All-wheel Drive	12/94→03/98	Diesel	RF	1998	4	86.00	86.00	28
Vitara 2.0 TD Intercooler All-wheel Drive	12/95→03/98	Diesel	RF	1998	4	86.00	86.00	28
Vitara HDI	12/03→12/05	Diesel	RHP (DW10TD)	1997	4	85.00	88.00	27
Wagon R 1.0	06/04→08/05	Petrol	Z 10 XEP	998	3	73.40	78.60	7
Wagon R 1.2	06/04→08/05	Petrol	Z 12 XEP	1229	4	73.40	72.60	6
Wagon R+ 1.3	05/00→12/04	Petrol	G13BB	1298	4	74.00	75.50	9
Wagon R+ 1.3	08/01→	Petrol	M13A	1328	4	78.00	69.50	17
Wagon R+ 1.3 4WD	10/01→	Petrol	G13BB	1298	4	74.00	75.50	9
Wagon R+ 1.3 4WD	09/03→	Petrol	M13A	1328	4	78.00	69.50	17
Wagon R+ 1.3 DDiS	09/03→	Diesel	Z13DT	1248	4	69.60	82.00	5
X-90 1.6 i 16V	09/95→12/97	Petrol	G16B	1590	4	75.00	90.00	13
X-90 1.6 i 16V 4x4	09/95→12/97	Petrol	G16B	1590	4	75.00	90.00	13

		cm3	x 			
8HY	Diesel	1398	4	73.70	82.00	8
9HX	Diesel	1560	4	75.00	88.30	12
C 14 SE	Petrol	1389	4	77.60	73.40	16
D19AA	Diesel	1910	4	82.00	90.40	21
DHV (XUD9BSD)	Diesel	1905	4	83.00	88.00	23
DHW (XUD9SD)	Diesel	1905	4	83.00	88.00	23
F5A	Petrol	543	3	62.00	60.00	1
F5A	Petrol	543	3	62.00	60.00	1
F8A	Petrol	797	4	62.00	66.00	2
F8A	Petrol	797	4	62.00	66.00	2
F8B	Petrol	796	3	68.50	72.00	4
F8B	Petrol	796	3	68.50	72.00	4
F9QB	Diesel	1870	4	80.00	93.00	20
F10A	Petrol	970	4	65.50	72.00	3
F10A	Petrol	970	4	65.50	72.00	3
G13A	Petrol	1324	4	74.00	77.00	10
G13B	Petrol	1298	4	74.00	75.50	9
G13BA	Petrol	1298	4	74.00	75.50	9
G13BB	Petrol	1298	4	74.00	75.50	9
G15A	Petrol	1493	4	75.00	84.50	11
G15MF	Petrol	1498	4	76.50	81.50	15
G16A (16V)	Petrol	1590	4	75.00	90.00	13
G16A (8V)	Petrol	1590	4	75.00	90.00	13
G16B	Petrol	1590	4	75.00	90.00	13
J18A	Petrol	1839	4	84.00	83.00	24
J20A	Petrol	1995	4	84.00	90.00	25
K9K 266	Diesel	1461	4	76.00	80.50	14
K9K 700	Diesel	1461	4	76.00	80.50	14
M13A	Petrol	1328	4	78.00	69.50	17
M15A	Petrol	1490	4	78.00	78.10	18
M16A	Petrol	1586	4	78.00	83.00	19
M18A	Petrol	1796	4	83.00	83.00	22
MR20	Petrol	1997	4	84.00	90.10	26
MR20DE	Petrol	1997	4	84.00	90.10	26
QR25	Petrol	2488	4	89.00	100.00	30
QR25DE	Petrol	2488	4	89.00	100.00	30
RF	Diesel	1998	4	86.00	86.00	28
RFS	Diesel	1998	4	86.00	86.00	29
RHP (DW10TD)	Diesel	1997	4	85.00	88.00	27
RHW	Diesel	1997	4	85.00	88.00	27
RHZ	Diesel	1997	4	85.00	88.00	27
XUD9	Diesel	1905	4	83.00	88.00	23
XUD9A	Diesel	1905	4	83.00	88.00	23
XUD9SD	Diesel	1905	4	83.00	88.00	23
Z 10 EXP	Petrol	998	3	73.40	78.60	7
Z 10 XEP	Petrol	998	3	73.40	78.60	7
Z 12 XEP	Petrol	1229	4	73.40	72.60	6
Z13DT	Diesel	1248	4	69.60	82.00	5
Z 13 DTJ	Diesel	1248	4	69.60	82.00	5



1 62.00 x 60.00

F5A			3 Cyl.	543cc	16-25kW (22-34PS)		Petrol		TD3652
F5A			3 Cyl.	543cc	16-25kW (22-34PS)		Petrol		TD26682
BE/PL	1	37,981/37,991	40,998/41,021	18,011	1,491	0,025/0,083	AL	GS36SA	01-4203 STD 0.25 0.50

2 62.00 x 66.00

F8A			4 Cyl.	797cc	27-29kW (37-39PS)		Petrol		TD4910
F8A			4 Cyl.	797cc	27-29kW (37-39PS)		Petrol		TD26686
BE/PL	1	37,981/37,991	40,998/41,021	18,011	1,491	0,025/0,083	AL	GS36SA	01-4203 STD 0.25 0.50
MB/HL 1-5	10	49,980	54,020	20,100	1,990		AL-LF	63-651-1	H1062/5 STD 0.25
TW/A	2	57,000	73,000		2,520		BS	65-651-1	A218/2 STD

3 65.50 x 72.00

F10A			4 Cyl.	970cc	29-34kW (39-46PS)		Petrol		TD3650
F10A			4 Cyl.	970cc	34kW (46PS)		Petrol		TD29536
BE/PL	1	37,981/37,991	40,998/41,021	18,011	1,491	0,025/0,083	AL	GS36SA	01-4203 STD 0.25 0.50
MB/HL 1-5	10	49,980	54,020	20,100	1,990		AL-LF	63-651-1	H1062/5 STD 0.25
TW/A	2	57,000	73,000		2,520		BS	65-651-1	A218/2 STD

4 68.50 x 72.00

F8B			3 Cyl.	796cc	29kW (39PS)		Petrol		TD3655
F8B			3 Cyl.	796cc	28-35kW (38-48PS)		Petrol		TD18849
BE/PL	1	37,981/37,991	40,998/41,021	18,011	1,491	0,025/0,083	AL	GS36SA	01-4203 STD 0.25 0.50
TW/A	2	57,000	73,000		2,520		BS	65-651-1	A218/2 STD

5 69.60 x 82.00

Z 13 DTJ Euro 4			4 Cyl.	1248cc	55kW (75PS)		Diesel Turbo Intercooler		TD21665
Z13DT			4 Cyl.	1248cc	51kW (69PS)		Diesel Turbo Intercooler		TD18265
BE/PL	4	42,582/42,600	45,734/45,744	20,000	1,552	0,030/0,062	BS	71-4033	71-4033/4 STD .010
MB/HL 1,2,4,5	4	50,982/51,000	54,710/54,722	19,000	1,840	0,026/0,050	AL-LF	02-4034	H1011/5 STD 0.25
MB/HL 3	1	50,982/51,000	54,710/54,722	23,950	1,840	0,026/0,050	AL-LF	02-4035H	
SE/PB	1	23,000	25,747/25,772	25,000			BS-LF	55-4077	55-4077 SEMI

6 73.40 x 72.60

Z 12 XEP			4 Cyl.	1229cc	59kW (80PS)		Petrol		TD19903
BE/PL	4	42,971/42,987	46,000/46,012	13,200	1,501	0,021/0,069	AL-LF	01-4872	01-4872/4 STD
MB/HL	4	49,984/49,997	54,000/54,013	17,100	1,995	0,022/0,070	AL-LF	02-4797	H1295/5 STD
MB/HL	1	49,984/49,997	54,000/54,013	22,900	1,995	0,022/0,070	AL-LF	02-4798H	



7											73.40 x 78.60										
Z 10 EXP			3 Cyl.			998cc		44kW (60PS)			Petrol			TD22440							
Z 10 XEP			3 Cyl.			998cc		44kW (60PS)			Petrol			TD27099							
BE/PL	3	42,971/42,987	46,000/46,012	13,200	1,501	0,021/0,069	AL-LF	01-4872	01-4872/3 STD												
MB/HL	3	49,984/49,997	54,000/54,013	17,100	1,995	0,022/0,070	AL-LF	02-4797	H1295/4 STD												
MB/HL	1	49,984/49,997	54,000/54,013	22,900	1,995	0,022/0,070	AL-LF	02-4798H													

8											73.70 x 82.00										
8HY			4 Cyl.			1398cc		66kW (90PS)			Diesel			TD18220							
BE/PL	1	44,975/44,991	48,665/48,671	17,050	1,820	0,029/0,081	SP	71-3986	71-3986 STD 0.30												
MB/HL 1-5	5	49,962/49,981	53,655/53,674	19,900	1,833	0,008/0,046	AL	02-4244	H1066/5 STD 0.30 0.50												
TW/A	2	55,200/55,480	71,350/71,700		2,460		AL	04-4245	A217/2 STD												
SE/PB	1	24,995/25,000	28,000/28,021	19,980			BS	55-3987	55-3987 SEMI												

9											74.00 x 75.50										
G13B			4 Cyl.			1298cc		44-74kW (60-101PS)			Petrol			TD4915							
G13BA			4 Cyl.			1298cc		49-59kW (67-80PS)			Petrol			TD3666							
G13BB			4 Cyl.			1298cc		56-63kW (76-86PS)			Petrol			TD11288							
BE/PL	8	41,980	45,020	18,100	1,490		AL	64-655-1	01-4119/4 STD 0.25 0.50												
MB/HL 1-5	5	44,980	49,020	18,100	2,000		AL	63-655-1	H1159/5 STD 0.25												
MB/HL 1-5	5	44,980	49,020	18,100	2,000		AL	63-655-2													
TW/A	2	52,000	68,000		2,520		AL-LF	65-655-1	A170/2 STD												

10											74.00 x 77.00										
G13A			4 Cyl.			1324cc		44-54kW (60-73PS)			Petrol			TD3659							
BE/PL	8	41,980	45,020	18,100	1,490		AL	64-655-1	01-4119/4 STD 0.25 0.50												
MB/HL 1-5	5	44,980	49,020	18,100	2,000		AL	63-655-1	H1159/5 STD 0.25												
MB/HL 1-5	5	44,980	49,020	18,100	2,000		AL	63-655-2													
TW/A	2	52,000	68,000		2,520		AL-LF	65-655-1	A170/2 STD												

11											75.00 x 84.50										
G15A			4 Cyl.			1493cc		57-77kW (77-105PS)			Petrol			TD20613							
BE/PL	4	43,980	47,020	18,100	1,490		AL-LF	64-657-1	01-5042/4 STD												
MB/HL 1-5	5	51,980	56,020	18,100	2,000		AL-LF	63-657-1	H1356/5 STD												
MB/HL 1-5	5	51,980	56,020	18,100	2,000		AL-LF	63-657-2													
TW/A	2	59,000	75,000		2,520		AL-LF	65-657-1	A333/2 STD												



12 75.00 x 88.30										
9HX Euro 4		4 Cyl.		1560cc	66kW (90PS)		Diesel Turbo Intercooler			TD21659
BE/PL	4	46,975/46,991	50,655/50,674	17,000	1,818	0,028/0,063	BS	71-4246	71-4246/4 STD 0.30 0.50	
MB/HL 1-5	5	49,962/49,981	53,655/53,674	19,900	1,833	0,008/0,046	AL	02-4244	H1066/5 STD 0.30 0.50	
TW/A	2	55,200/55,480	71,350/71,700		2,460		AL	04-4245	A217/2 STD	
SE/PB	1	26,000	29,000/29,021	19,980			BS	55-4102	55-4102 SEMI	

13 75.00 x 90.00										
G16A (16V)		4 Cyl.		1590cc	68kW (92PS)		Petrol			TD25888
G16A (8V)		4 Cyl.		1590cc	50-60kW (68-82PS)		Petrol			TD3667
G16B		4 Cyl.		1590cc	68-73kW (92-99PS)		Petrol			TD4917
BE/PL	4	43,980	47,020	18,100	1,490		AL-LF	64-657-1	01-5042/4 STD	
MB/HL 1-5	5	51,980	56,020	18,100	2,000		AL-LF	63-657-1	H1356/5 STD	
MB/HL 1-5	5	51,980	56,020	18,100	2,000		AL-LF	63-657-2		
TW/A	2	59,000	75,000		2,520		AL-LF	65-657-1	A333/2 STD	

14 76.00 x 80.50										
K9K 266		4 Cyl.		1461cc	63kW (86PS)		Diesel Turbo			TD24900
K9K 700		4 Cyl.		1461cc	48-50kW (65-68PS)		Diesel			TD21367
BE/PL	4	43,964/43,980	47,614/47,625	17,750	1,807	0,020/0,047	BS	71-4243L	71-4243/4 STD 0.25 0.50	
BE/PL	4	43,964/43,980	47,614/47,625	20,750	1,807	0,020/0,047	BS	71-4243U		
MB/HL 1-5	5	47,990/48,010	51,936/51,949	19,500	1,950	0,026/0,059	AL-LF	02-4241	H1065/5 STD 0.25 0.50	
TW/A	2	53,000/53,250	73,670/73,920		2,850		AL-LF	04-4048	A168/2 STD	
SE/PB	1	25,995/26,000	28,500/28,521	22,500			BC-LF	55-4856	55-4856 SEMI [6]	

15 76.50 x 81.50										
G15MF		4 Cyl.		1498cc	44-59kW (55-80PS)		Petrol			TD5490
BE/PL	4	42,971/42,987	46,000/46,012	16,600	1,497	0,020/0,072	EC	71-3639	71-3639/4 STD 0.25 0.50	
MB/HL 1,2,4,5	4	54,972/54,985	59,000/59,013	19,500	2,001	0,020/0,064	EC	72-3505	H975/5 STD 0.25 0.50	
MB/HL 3	1	54,972/54,985	59,000/59,013	25,900	2,001	0,020/0,064	EC	72-3506H		
			72-3506H	STD	25,950/1.0217" - 26,002/1.0237"					
				0.25mm	26,150/1.0295" - 26,202/1.0316"					
				0.50mm	26,350/1.0374" - 26,402/1.0394"					

16 77.60 x 73.40										
C 14 SE		4 Cyl.		1389cc	60-63kW (82-86PS)		Petrol			TD26169
BE/PL	4	42,971/42,987	46,000/46,012	16,600	1,497	0,020/0,072	EC	71-3639	71-3639/4 STD 0.25 0.50	

MB/HL 1,2,4,5	4	54,972/54,985	59,000/59,013	19,500	2,001	0,020/0,064	EC	72-3505	H975/5 STD 0.25 0.50
MB/HL 3	1	54,972/54,985	59,000/59,013	25,900	2,001	0,020/0,064	EC	72-3506H	
	72-3506H	STD	25,950/1.0217" - 26,002/1.0237"						
		0.25mm	26,150/1.0295" - 26,202/1.0316"						
		0.50mm	26,350/1.0374" - 26,402/1.0394"						

17 78.00 x 69.50

M13A	4 Cyl.		1328cc	60-69kW (82-94PS)		Petrol		TD17430
BE/PL	8	41,980	45,020	16,000	1,493	AL-LF	64-664-1	01-4946/4 STD
MB/HL 1-5	5	44,980	49,020	18,000	2,000	AL-LF	63-664-1	H1330/5 STD
MB/HL 1-5	5	44,980	49,020	18,000	2,000	AL-LF	63-664-2	
TW/A	2	59,000	75,000		2,520	AL-LF	65-664-1	A316/2 STD

18 78.00 x 78.10

M15A	4 Cyl.		1490cc	73-83kW (99-113PS)		Petrol		TD18264
BE/PL	8	41,980	45,020	18,000	1,490	AL-LF	64-665-1	01-4947/4 STD
MB/HL 1-5	5	51,980	56,020	18,000	2,000	AL-LF	63-665-1	H1331/5 STD
MB/HL 1-5	5	51,980	56,020	18,000	2,000	AL-LF	63-665-2	
TW/A	2	59,000	75,000		2,520	AL-LF	65-664-1	A316/2 STD

19 78.00 x 83.00

M16A	4 Cyl.		1586cc	73-100kW (99-136PS)		Petrol		TD18221
BE/PL	8	41,980	45,020	18,000	1,490	AL-LF	64-665-1	01-4947/4 STD
MB/HL 1-5	5	51,980	56,020	18,000	2,000	AL-LF	63-665-1	H1331/5 STD
MB/HL 1-5	5	51,980	56,020	18,000	2,000	AL-LF	63-665-2	
TW/A	2	59,000	75,000		2,520	AL-LF	65-664-1	A316/2 STD

20 80.00 x 93.00

F9QB	4 Cyl.		1870cc	95kW (129PS)		Diesel Turbo Intercooler		TD25639	
BE/PL	4	48,000/48,020	51,587/51,606	20,250	1,776	0,015/0,079	EC	71-3988L	71-3988/4 STD 0.25 0.50 4
BE/PL	4	48,000/48,020	51,587/51,606	20,500	1,776	0,015/0,079	EC	71-3988U	
MB/HL 1-5	5	54,785/54,805	58,731/58,744	18,500	1,947	0,032/0,090	EC	72-3989	H098/5 STD 0.25 0.50

21 82.00 x 90.40

D19AA	4 Cyl.		1910cc	88kW (120PS)		Diesel Turbo Intercooler		TD20931	
BE/PL	1	50,787/50,805	53,901/53,913	19,500	1,534	0,030/0,080	EC	71-3994	71-3994 STD 0.25 4
MB/HL 1-5	5	59,986/60,000	63,705/63,718	20,750	1,844	0,031/0,075	BS	4356CP	H1095/5 STD 0.25 0.50
TW/A	2	67,785/68,040	82,425/82,677		2,485		AL-LF	4356AF	A191/2 STD
SE/PB	1		28,939/28,972	21,700			BS	4369Y	55-4159 SEMI



22		83.00 x 83.00									
M18A		4 Cyl.		1796cc	92kW (125PS)			Petrol		TD20623	
BE/PL	8	41,980	45,020	18,000	1,490		AL-LF	64-665-1	01-4947/4 STD		
MB/HL 1-5	5	51,980	56,020	18,000	2,000		AL-LF	63-665-1	H1331/5 STD		
MB/HL 1-5	5	51,980	56,020	18,000	2,000		AL-LF	63-665-2			
TW/A	2	59,000	75,000		2,520		AL-LF	65-664-1	A316/2 STD		

23		83.00 x 88.00									
DHV (XUD9BSD)		4 Cyl.		1905cc	55kW (75PS)			Diesel		TD30748	
DHW (XUD9SD)		4 Cyl.		1905cc	55kW (75PS)			Diesel		TD30747	
XUD9		4 Cyl.		1905cc	46-50kW (63-68PS)			Diesel Turbo		TD16375	
XUD9A		4 Cyl.		1905cc	50kW (68PS)			Diesel		TD5443	
XUD9SD		4 Cyl.		1905cc	55kW (75PS)			Diesel		TD22439	
BE/PL	4	49,984/50,000	53,695/53,708	20,050	1,830	0,040/0,090	AL-LF	66725RA	01-4200/4 STD 0.30 0.50		
MB/HL 1-5	5	59,981/60,000	63,731/63,750	20,290	1,845	0,040/0,100	AL-LF	66726RA	H1057/5 STD 0.30 0.50		
TW/A	4	67,050/67,300	83,050/83,300		2,330		BS	66721BF	A214/4 STD 0.10		
SE/PB	1	25,007/25,020	27,200/27,221	24,050			BS	66729YA	55-4201 SEMI		

24		84.00 x 83.00									
J18A		4 Cyl.		1839cc	89kW (121PS)			Petrol		TD5353	
BE/PL	8	49,980	53,020	16,100	1,485		AL-LF	64-661-1	71-4732/4 STD		
MB/HL 1-5	5	57,980	62,020	19,100	1,994		AL	63-661-1	H1277/5 STD		
MB/HL 1-5	5	57,980	62,020	19,100	1,994		AL	63-661-2			
TW/A	2	71,000	85,000		2,475		AL-LF	65-661-1	A287/2 STD		

25		84.00 x 90.00									
J20A		4 Cyl.		1995cc	94-107kW (128-146PS)			Petrol		TD18366	
BE/PL	8	49,980	53,020	16,100	1,485		AL-LF	64-661-1	71-4732/4 STD		
MB/HL 1-5	5	57,980	62,020	19,100	1,994		AL	63-661-1	H1277/5 STD		
MB/HL 1-5	5	57,980	62,020	19,100	1,994		AL	63-661-2			
TW/A	2	71,000	85,000		2,475		AL-LF	65-661-1	A287/2 STD		

26		84.00 x 90.10									
MR20		4 Cyl.		1997cc	106-108kW (144-147PS)			Petrol		TD26214	
MR20DE		4 Cyl.		1997cc	96-108kW (131-147PS)			Petrol		TD26212	
BE/PL	4	44,000	47,010	16,100	1,495		AL-LF	64-1054-1	01-4978/4 STD		
BE/PL	4	44,000	47,010	16,100	1,495		AL-LF	64-1054-2			
MB/HL 1-5	10	52,000	56,010	17,100	1,990		AL-LF	63-1054-1	H1340/5 STD		
TW/A	2	59,000	76,500		2,100		AL-LF	65-1054-1	A324/2 STD		



27 85.00 x 88.00

RHP (DW10TD)	4 Cyl.		1997cc	64kW (87PS)	Diesel Turbo Intercooler		TD26490
RHW	4 Cyl.		1997cc	80kW (109PS)	Diesel Turbo Intercooler		TD18270
RHZ	4 Cyl.		1997cc	80kW (109PS)	Diesel Turbo Intercooler		TD19715
BE/PL	4	49,984/50,000	53,695/53,708	20,000	1,838	0,020/0,070	SP 71-3952 71-3952/4 STD 0.30 ①
MB/HL 1-5	5	59,981/60,000	63,731/63,750	20,290	1,845	0,040/0,100	AL-LF 66726RA H1057/5 STD 0.30 0.50
TW/A	4	67,050/67,300	83,050/83,300		2,330		BS 66721BF A214/4 STD 0.10
SE/PB	1	27,997/28,000	30,200/30,225	24,050			BS-LF 55-3985 55-3985 SEMI

28 86.00 x 86.00

RF	4 Cyl.		1998cc	52-68kW (71-92PS)	Diesel Turbo Intercooler		TD5444
BE/PL	4	50,934/50,949	53,997/54,018	21,132	1,509	0,030/0,091	BS 3975P 71-4278/4 STD 0.25 0.50
→06/86							
MB/HL 1,2,4,5	4	59,938/59,964	63,997/64,018	19,126	2,007	0,020/0,092	AL 3976RA H1161/5 STD 0.25
MB/HL 3	1	59,938/59,964	63,997/64,018	21,132	2,007	0,020/0,092	AL 3977RA
SE/PB	1	24,990	28,030	26,500			BS 67-316-1S 55-4270 SEMI

29 86.00 x 86.00

RFS	4 Cyl.		1998cc	52kW (71PS)	Diesel Turbo Intercooler		TD19237
BE/PL	4	49,984/50,000	53,695/53,708	21,950	1,843	0,020/0,064	BS 4255CP 71-4279/4 STD 0.30
MB/HL 1-5	5	59,981/60,000	63,731/63,750	20,290	1,845	0,040/0,100	AL-LF 66726RA H1057/5 STD 0.30 0.50
TW/A	4	67,050/67,300	83,050/83,300		1,880		AL-LF 4141AF A188/4 STD

30 89.00 x 100.00

QR25	4 Cyl.		2488cc	135kW (184PS)	Petrol		TD24867
QR25DE	4 Cyl.		2488cc	104-134kW (141-182PS)	Petrol		TD29477
BE/PL	8	44,960	48,020	19,000	1,511		AL-LF 64-1052-1 01-4979/4 STD
MB/HL	4	54,960	58,970	20,000	1,980		AL-LF 63-1052-1 H1341/5 STD
MB/HL	1	54,960	58,970	23,400	1,980		AL-LF 63-1052-2
MB/HL	5	54,960	58,970	20,000	1,980		AL-LF 63-1052-3











cm3 x



9

4 Runner 1.8 2WD	08/00→11/02	Petrol	7K-E	1781	4	80.50	87.50	24
4 Runner 2.4 D	07/84→05/88	Diesel	2L	2446	4	92.00	92.00	40
4 Runner 2.4 TD	08/89→11/95	Diesel	2L-T	2446	4	92.00	92.00	41
4 Runner 2.7	03/09→	Petrol	2TR-FE	2694	4	95.00	95.00	44
4 Runner 2.7 4WD	09/09→12/10	Petrol	2TR-FE	2694	4	95.00	95.00	44
4 Runner 2.8 D	05/88→03/96	Diesel	3L	2779	4	96.00	96.00	47
4 Runner 3.0 TDi	09/00→07/02	Diesel	1KZ-TE	2982	4	96.00	103.00	48
4 Runner 3.0 Turbo-D	10/93→11/02	Diesel	1KZ-T	2982	4	96.00	103.00	48
1000 1.0	04/69→08/88	Petrol	2K	993	4	72.00	61.00	4
Agya 1.0	12/12→	Petrol	1KR-FE	998	3	71.00	84.00	3
Allion I 1.5	06/01→04/05	Petrol	1NZ-FE	1497	4	75.00	84.70	13
Allion I 1.8	06/01→04/05	Petrol	1ZZ-FE	1794	4	79.00	91.50	21
Allion I 1.8	06/01→06/07	Petrol	2ZR-FE	1798	4	80.50	88.30	25
Allion I 1.8 4WD	06/01→06/07	Petrol	1ZZ-FE	1794	4	79.00	91.50	21
Allion I 1.8 4WD	06/01→06/07	Petrol	2ZR-FE	1798	4	80.50	88.30	25
Allion II 1.5	07/07→	Petrol	1NZ-FE	1497	4	75.00	84.70	13
Allion II 1.8	07/07→	Petrol	2ZR-FAE	1798	4	80.50	88.30	25
Allion II 1.8 4WD	07/07→	Petrol	2ZR-FAE	1798	4	80.50	88.30	25
Aqua 1.5 Hybrid	12/11→	Petrol	1NZ-FXE	1497	4	75.00	84.70	13
Ascent 1.8	06/01→10/03	Petrol	7A-FE	1762	4	81.00	85.50	29
Auris 1.4 VVTi	03/07→09/12	Petrol	4ZZ-FE	1398	4	79.00	71.30	19
Auris 1.5	09/09→	Petrol	1NZ-FE	1497	4	75.00	84.70	13
Auris 1.5 4WD	09/09→	Petrol	1NZ-FE	1497	4	75.00	84.70	13
Auris 1.6	05/09→	Petrol	1ZR-FAE	1598	4	80.50	78.50	23
Auris 1.6 VVTi	03/07→09/12	Petrol	1ZR-FE	1598	4	80.50	78.50	23
Auris 1.8	02/09→	Petrol	2ZR-FAE	1798	4	80.50	88.30	25
Auris 1.8	10/12→	Petrol	2ZR-FE	1798	4	80.50	88.30	25
Auris 1.8 4WD	02/09→09/12	Petrol	2ZR-FAE	1798	4	80.50	88.30	25
Auris 1.8 Hybrid	09/10→	Petrol	2ZR-FXE	1798	4	80.50	88.30	25
Auris 1.8 VVTi	10/06→09/12	Petrol	2ZR-FE	1798	4	80.50	88.30	25
Avensis 1.6	09/97→10/00	Petrol	4A-FE	1587	4	81.00	77.00	27
Avensis 1.6	11/08→	Petrol	1ZR-FAE	1598	4	80.50	78.50	23
Avensis 1.6 VVT-i	10/00→11/08	Petrol	3ZZ-FE	1598	4	79.00	81.50	20
Avensis 1.8	09/97→10/00	Petrol	7A-FE	1762	4	81.00	85.50	29
Avensis 1.8	04/03→11/08	Petrol	1ZZ-FE	1794	4	79.00	91.50	21
Avensis 1.8	11/08→	Petrol	2ZR-FAE	1798	4	80.50	88.30	25
Avensis 1.8 VVT-i	10/00→02/03	Petrol	1ZZ-FE	1794	4	79.00	91.50	21
Avensis 2.0 D	10/97→05/98	Diesel	2C-T	1975	4	86.00	85.00	36
Aygo 1.0	07/05→	Petrol	1KR-FE	998	3	71.00	84.00	3
Aygo 1.0 GPL	07/05→	Petrol	1KR-FE	998	3	71.00	84.00	3
bB I 1.5	03/00→12/05	Petrol	1NZ-FE	1497	4	75.00	84.70	13
Blizzard 2.2 D	03/82→12/83	Diesel	L	2188	4	90.00	86.00	39
Blizzard 2.5 TD	10/86→10/95	Diesel	2L-TII	2446	4	92.00	92.00	41
Caldina 1.6	02/92→09/97	Petrol	4A-FE	1587	4	81.00	77.00	27
Caldina 1.8	02/92→09/01	Petrol	7A-FE	1762	4	81.00	85.50	29
Caldina 2.0 TD	06/94→09/97	Diesel	2C	1975	4	86.00	85.00	36
Camry 1.8	11/86→08/88	Petrol	1S	1832	4	80.50	90.00	26
Camry 1.8	02/83→10/86	Petrol	1S-L	1832	4	80.50	90.00	26
Camry 1.8 i	10/86→08/88	Petrol	1S-L	1832	4	80.50	90.00	26
Camry 1.8 Turbo-D	11/83→01/88	Diesel	1C-TL	1840	4	83.00	85.00	32
Camry 2.0	04/86→01/88	Petrol	2S-E	1995	4	84.00	90.00	33
Camry 2.0	01/83→12/87	Petrol	2S-EL	1995	4	84.00	90.00	33
Camry 2.0	01/83→01/88	Petrol	2S-ELC	1995	4	84.00	90.00	33
Camry 2.0 GLI	03/83→10/86	Petrol	2S-EL	1995	4	84.00	90.00	33
Camry 2.0 TD	09/85→10/86	Diesel	2C-TL	1974	4	86.00	85.00	37
Camry 2.0 TD	08/96→09/99	Diesel	2C-T	1975	4	86.00	85.00	36
Camry 2.0 Turbo-D	11/86→05/91	Diesel	2C-T	1975	4	86.00	85.00	36
Caribe 1.3	10/86→08/94	Petrol	2A	1296	4	76.00	71.40	14
Caribe 1.3	09/94→08/96	Petrol	4E-FE	1332	4	74.00	77.40	8
Caribe 1.5 4WD	05/84→01/88	Petrol	3A	1452	4	77.50	77.00	15
Caribe 1.6	09/94→08/03	Petrol	4A-FE	1587	4	81.00	77.00	27
Caribe 1.8	09/94→08/03	Petrol	7A-FE	1762	4	81.00	85.50	29
Carina 1.6	09/71→09/83	Petrol	2T	1588	4	85.00	70.00	34
Carina 1.6	10/75→03/78	Petrol	2TB	1588	4	85.00	70.00	34
Carina 1.8	01/78→09/83	Petrol	3T	1770	4	85.00	78.00	35
Carina 1.8 D	04/82→09/83	Diesel	1C	1840	4	83.00	85.00	31
Carina 1.8 XE	08/81→09/83	Petrol	3T	1770	4	85.00	78.00	35
Carina E 1.5 SG	04/92→09/97	Petrol	5A-FE	1497	4	78.70	77.00	18
Carina E 1.6	04/92→09/97	Petrol	4A-FE	1587	4	81.00	77.00	27

				cm3	x 			
Carina E 1.6 16V	12/94→09/97	Petrol	4A-FE	1587	4	81.00	77.00	27
Carina E 1.6 GLI	04/92→09/97	Petrol	4A-FE	1587	4	81.00	77.00	27
Carina E 1.6 i	02/95→09/97	Petrol	4A-FE	1587	4	81.00	77.00	27
Carina E 1.8	04/92→09/97	Petrol	7A-FE	1762	4	81.00	85.50	29
Carina E 1.8 GL	10/94→09/97	Petrol	7A-FE	1762	4	81.00	85.50	29
Carina E 1.8 i	02/95→09/97	Petrol	7A-FE	1762	4	81.00	85.50	29
Carina E 1.8 i 16V	01/95→09/97	Petrol	7A-FE	1762	4	81.00	85.50	29
Carina E 2.0 D	04/92→01/96	Diesel	2C	1975	4	86.00	85.00	36
Carina E 2.0 TD	01/96→09/97	Diesel	2C-T	1975	4	86.00	85.00	36
Carina II 1.5	12/87→03/92	Petrol	5A-FE	1497	4	78.70	77.00	18
Carina II 1.5 DX	12/87→03/92	Petrol	5A-FE	1497	4	78.70	77.00	18
Carina II 1.5 GL	12/87→03/92	Petrol	5A-FE	1497	4	78.70	77.00	18
Carina II 1.6	12/87→08/90	Petrol	4A-F	1587	4	81.00	77.00	27
Carina II 1.6	12/87→03/92	Petrol	4A-FE	1587	4	81.00	77.00	27
Carina II 1.6	10/83→11/87	Petrol	4A-LC	1587	4	81.00	77.00	27
Carina II 1.6	10/83→11/87	Petrol	4A-L	1588	4	81.00	77.00	27
Carina II 1.6 4WD	12/87→03/92	Petrol	4A-FE	1587	4	81.00	77.00	27
Carina II 1.6 GX 4WD	12/87→03/92	Petrol	4A-FE	1587	4	81.00	77.00	27
Carina II 1.8 GLI	10/83→11/87	Petrol	1S-EL	1832	4	80.50	90.00	26
Carina II 1.8 GLI	10/83→11/87	Petrol	1S-L	1832	4	80.50	90.00	26
Carina II 2.0 D	03/88→06/92	Diesel	2C	1975	4	86.00	85.00	36
Carina II 2.0 D	02/84→06/92	Diesel	2C-L	1975	4	86.00	85.00	36
Carri 1.4	01/02→07/06	Petrol	4ZZ-FE	1398	4	79.00	71.30	19
Celica 1.6	08/83→12/85	Petrol	4A-GE	1587	4	81.00	77.00	28
Celica 1.6	04/86→08/89	Petrol	4A-L	1588	4	81.00	77.00	27
Celica 1.6 GT	08/87→08/89	Petrol	4A-GELC	1587	4	81.00	77.00	28
Celica 1.6 GT	12/74→07/81	Petrol	2T-G	1588	4	85.00	70.00	34
Celica 1.6 GT 16V	09/85→08/89	Petrol	4A-GEL	1587	4	81.00	77.00	28
Celica 1.6 GTI 16V	01/88→12/89	Petrol	4A-GEL	1587	4	81.00	77.00	28
Celica 1.6 LT	02/76→03/78	Petrol	2T	1588	4	85.00	70.00	34
Celica 1.6 LT	02/79→07/81	Petrol	2TB	1588	4	85.00	70.00	34
Celica 1.6 LT	05/73→03/78	Petrol	2TJ	1588	4	85.00	70.00	34
Celica 1.6 ST	02/79→07/81	Petrol	2T	1588	4	85.00	70.00	34
Celica 1.6 ST	05/73→07/81	Petrol	2TB	1588	4	85.00	70.00	34
Celica 1.6 ST	08/77→07/81	Petrol	4A-L	1588	4	81.00	77.00	27
Celica 1.6 STI	10/89→11/93	Petrol	4A-FE	1587	4	81.00	77.00	27
Celica 1.8	11/93→12/97	Petrol	7A-FE	1762	4	81.00	85.50	29
Celica 1.8	09/99→09/05	Petrol	1ZZ-FE	1794	4	79.00	91.50	21
Celica 1.8	08/87→08/89	Petrol	1S-EL	1832	4	80.50	90.00	26
Celica 1.8 16V VT-i	08/99→07/05	Petrol	1ZZ-FE	1794	4	79.00	91.50	21
Celica 1.8 i 16V	11/93→11/99	Petrol	7A-FE	1762	4	81.00	85.50	29
Celica 2.0	10/83→09/84	Petrol	2S-C	1995	4	84.00	90.00	33
Celica 2.0	09/85→12/86	Petrol	2S-ELC	1995	4	84.00	90.00	33
Celica 2.0 GTS	09/85→12/86	Petrol	2S-ELC	1995	4	84.00	90.00	33
Chaser 1.8	10/93→08/96	Petrol	7A-FE	1762	4	81.00	85.50	29
Chaser 2.4 D	10/92→08/96	Diesel	2L	2446	4	92.00	92.00	40
Chaser 2.4 TD	10/92→08/96	Diesel	2L-TII	2446	4	92.00	92.00	41
Coaster 2.7	08/04→	Petrol	2TR-FE	2694	4	95.00	95.00	44
Coaster 3.2 D	08/77→04/82	Diesel	2B	3197	4	98.00	105.00	49
Coaster 3.7 D	02/93→	Diesel	14B	3661	4	102.00	112.00	54
Conquest 1.3	01/95→12/99	Petrol	2E	1296	4	73.00	77.40	7
Conquest 1.6	01/95→12/95	Petrol	4A-FE	1587	4	81.00	77.00	27
Conquest 1.6	01/96→12/99	Petrol	3ZZ-FE	1598	4	79.00	81.50	20
Corolla 1.2	07/75→01/80	Petrol	3K	1166	4	75.00	66.00	9
Corolla 1.2	10/72→12/80	Petrol	3K-B	1166	4	75.00	66.00	9
Corolla 1.2	10/72→12/80	Petrol	3K-C	1166	4	75.00	66.00	9
Corolla 1.2	10/72→12/80	Petrol	3K-H	1166	4	75.00	66.00	9
Corolla 1.3	09/79→08/87	Petrol	4K	1290	4	75.00	73.00	10
Corolla 1.3	11/78→01/82	Petrol	4K-C	1290	4	75.00	73.00	10
Corolla 1.3	09/85→05/89	Petrol	2A	1296	4	76.00	71.40	14
Corolla 1.3	06/83→10/84	Petrol	2A-L	1296	4	73.00	77.40	6
Corolla 1.3	08/83→10/01	Petrol	2E	1296	4	73.00	77.40	7
Corolla 1.3	10/84→08/87	Petrol	2E-L	1296	4	73.00	77.40	7
Corolla 1.3	10/84→08/87	Petrol	2E-LC	1296	4	73.00	77.40	7
Corolla 1.3	11/01→05/04	Petrol	2NZ-FE	1299	4	75.00	73.50	11
Corolla 1.3 12V	07/92→04/97	Petrol	2E	1296	4	73.00	77.40	7
Corolla 1.3 i	08/87→12/92	Petrol	2E	1296	4	73.00	77.40	7
Corolla 1.3 i	08/87→12/92	Petrol	2E-E	1296	4	73.00	77.40	7
Corolla 1.3 VVT-i	03/08→	Petrol	2NZ-FE	1299	4	75.00	73.50	11



cm3 x



Corolla 1.3 XLI	07/92→04/97	Petrol	4E-FE	1332	4	74.00	77.40	8
Corolla 1.3 XLI 16V	07/92→09/95	Petrol	4E-FE	1332	4	74.00	77.40	8
Corolla 1.4	04/97→02/00	Petrol	4E-FE	1332	4	74.00	77.40	8
Corolla 1.4	02/00→01/02	Petrol	4ZZ-FE	1398	4	79.00	71.30	19
Corolla 1.4 16V	02/00→11/01	Petrol	4ZZ-FE	1398	4	79.00	71.30	19
Corolla 1.4 VVT-i	01/02→	Petrol	4ZZ-FE	1398	4	79.00	71.30	19
Corolla 1.5	09/99→	Petrol	1NZ-FE	1497	4	75.00	84.70	13
Corolla 1.5	11/89→04/92	Petrol	5A-FE	1497	4	78.70	77.00	18
Corolla 1.5 4WD	09/06→	Petrol	1NZ-FE	1497	4	75.00	84.70	13
Corolla 1.5 4WD	08/90→04/92	Petrol	5A-FE	1497	4	78.70	77.00	18
Corolla 1.5 DX	08/87→05/91	Petrol	5A-FE	1497	4	78.70	77.00	18
Corolla 1.5 G 4WD	11/01→05/04	Petrol	1NZ-FE	1497	4	75.00	84.70	13
Corolla 1.5 Hybrid	10/14→	Petrol	1NZ-FXE	1497	4	75.00	84.70	13
Corolla 1.5 L	06/83→07/87	Petrol	3A-U	1452	4	77.50	77.00	15
Corolla 1.6	09/82→12/87	Petrol	4A-C	1587	4	81.00	77.00	27
Corolla 1.6	08/87→12/97	Petrol	4A-F	1587	4	81.00	77.00	27
Corolla 1.6	08/87→02/00	Petrol	4A-FE	1587	4	81.00	77.00	27
Corolla 1.6	05/87→04/94	Petrol	4A-GE	1587	4	81.00	77.00	28
Corolla 1.6	09/84→07/87	Petrol	4A-GEC	1587	4	81.00	77.00	27
Corolla 1.6	05/85→04/87	Petrol	4A-GELC	1587	4	81.00	77.00	28
Corolla 1.6	09/83→06/89	Petrol	4A-LC	1587	4	81.00	77.00	27
Corolla 1.6	01/71→09/83	Petrol	2T	1588	4	85.00	70.00	34
Corolla 1.6	09/76→05/83	Petrol	2TB	1588	4	85.00	70.00	34
Corolla 1.6	06/83→05/88	Petrol	4A-L	1588	4	81.00	77.00	27
Corolla 1.6	01/09→	Petrol	1ZR-FAE	1598	4	80.50	78.50	23
Corolla 1.6	01/09→	Petrol	1ZR-FE	1598	4	80.50	78.50	23
Corolla 1.6	02/00→03/09	Petrol	3ZZ-FE	1598	4	79.00	81.50	20
Corolla 1.6 4WD	08/87→12/93	Petrol	4A-F	1587	4	81.00	77.00	27
Corolla 1.6 4WD	09/89→05/92	Petrol	4A-FE	1587	4	81.00	77.00	27
Corolla 1.6 16V	12/85→04/87	Petrol	4A-GEC	1587	4	81.00	77.00	27
Corolla 1.6 16V	02/00→11/01	Petrol	3ZZ-FE	1598	4	79.00	81.50	20
Corolla 1.6 Aut.	04/97→02/00	Petrol	4A-FE	1587	4	81.00	77.00	27
Corolla 1.6 4WD	12/87→12/92	Petrol	4A-F	1587	4	81.00	77.00	27
Corolla 1.6 BiFuel	06/13→	Petrol	1ZR-FE	1598	4	80.50	78.50	23
Corolla 1.6 CNG	08/07→	Petrol	3ZZ-FE	1598	4	79.00	81.50	20
Corolla 1.6 Dual VVTi	01/07→	Petrol	1ZR-FE	1598	4	80.50	78.50	23
Corolla 1.6 EFi	08/91→09/94	Petrol	4A-GE	1587	4	81.00	77.00	28
Corolla 1.6 GL 4WD	10/87→08/90	Petrol	4A-F	1587	4	81.00	77.00	27
Corolla 1.6 GLI	07/92→04/97	Petrol	4A-FE	1587	4	81.00	77.00	27
Corolla 1.6 GT	05/80→09/83	Petrol	2T-G	1588	4	85.00	70.00	34
Corolla 1.6 GT 16V	08/83→07/87	Petrol	4A-GE	1587	4	81.00	77.00	28
Corolla 1.6 GTi	07/87→06/93	Petrol	4A-GE	1587	4	81.00	77.00	28
Corolla 1.6 GTi Twin Cam	06/83→07/87	Petrol	4A-GE	1587	4	81.00	77.00	28
Corolla 1.6 i	10/81→09/85	Petrol	4A-C	1587	4	81.00	77.00	27
Corolla 1.6 i	08/89→11/99	Petrol	4A-FE	1587	4	81.00	77.00	27
Corolla 1.6 i 4WD	10/87→08/90	Petrol	4A-FE	1587	4	81.00	77.00	27
Corolla 1.6 Si	07/92→04/97	Petrol	4A-FE	1587	4	81.00	77.00	27
Corolla 1.6 SR	08/83→04/85	Petrol	4A-C	1587	4	81.00	77.00	27
Corolla 1.6 SR 16V	05/83→04/87	Petrol	4A-C	1587	4	81.00	77.00	27
Corolla 1.6 VVTi	10/06→	Petrol	1ZR-FE	1598	4	80.50	78.50	23
Corolla 1.6 VVTi	12/07→	Petrol	3ZZ-FE	1598	4	79.00	81.50	20
Corolla 1.6 VVT-i	01/02→	Petrol	3ZZ-FE	1598	4	79.00	81.50	20
Corolla 1.6 XL	09/89→04/92	Petrol	4A-F	1587	4	81.00	77.00	27
Corolla 1.6 XLI	11/89→06/92	Petrol	4A-FE	1587	4	81.00	77.00	27
Corolla 1.6 XLI 4WD	08/88→06/92	Petrol	4A-FE	1587	4	81.00	77.00	27
Corolla 1.8	09/92→06/02	Petrol	7A-FE	1762	4	81.00	85.50	29
Corolla 1.8	08/82→09/83	Petrol	3T	1770	4	85.00	78.00	35
Corolla 1.8	09/97→	Petrol	1ZZ-FE	1794	4	79.00	91.50	21
Corolla 1.8	09/06→	Petrol	2ZR-FAE	1798	4	80.50	88.30	25
Corolla 1.8	08/10→	Petrol	2ZR-FE	1798	4	80.50	88.30	25
Corolla 1.8 4x4	06/07→07/07	Petrol	1ZZ-FE	1794	4	79.00	91.50	21
Corolla 1.8 4WD	05/92→10/01	Petrol	7A-FE	1762	4	81.00	85.50	29
Corolla 1.8 4WD	12/01→02/07	Petrol	1ZZ-FE	1794	4	79.00	91.50	21
Corolla 1.8 4WD	09/06→	Petrol	2ZR-FAE	1798	4	80.50	88.30	25
Corolla 1.8 16V 4WD	09/95→04/97	Petrol	7A-FE	1762	4	81.00	85.50	29
Corolla 1.8 CNG	02/10→06/11	Petrol	1ZZ-FE	1794	4	79.00	91.50	21
Corolla 1.8 D	06/83→06/89	Diesel	1C-L	1839	4	83.00	85.00	32
Corolla 1.8 D	01/83→06/93	Diesel	1C	1840	4	83.00	85.00	31
Corolla 1.8 EFi	10/92→08/94	Petrol	7A-FE	1762	4	81.00	85.50	29

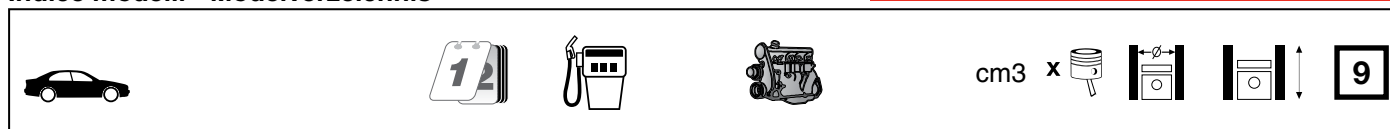

Corolla 1.8 Flex	03/07→	Petrol	1ZZ-FE	1794	4	79.00	91.50	21
Corolla 1.8 Flex	09/06→	Petrol	2ZR-FE	1798	4	80.50	88.30	25
Corolla 1.8 GT	11/92→05/95	Petrol	7A-FE	1762	4	81.00	85.50	29
Corolla 1.8 GTi 4WD	11/92→04/95	Petrol	7A-FE	1762	4	81.00	85.50	29
Corolla 1.8 i	11/92→09/94	Petrol	7A-FE	1762	4	81.00	85.50	29
Corolla 1.8 VVTi	06/04→	Petrol	1ZZ-FE	1794	4	79.00	91.50	21
Corolla 1.8 VVTi	01/08→	Petrol	2ZR-FE	1798	4	80.50	88.30	25
Corolla 1.8 VVT-i	01/02→05/04	Petrol	1ZZ-FE	1794	4	79.00	91.50	21
Corolla 1.8 VVT-i	12/13→	Petrol	2ZR-FE	1798	4	80.50	88.30	25
Corolla 1.8 VVTi 4WD	10/01→02/04	Petrol	1ZZ-FE	1794	4	79.00	91.50	21
Corolla 1.8 VVTL-i	05/07→	Petrol	2ZR-FAE	1798	4	80.50	88.30	25
Corolla 1.8 VVTL-i	05/07→	Petrol	2ZR-FE	1798	4	80.50	88.30	25
Corolla 1.8 XL	09/92→11/93	Petrol	7A-FE	1762	4	81.00	85.50	29
Corolla 1.8 XL 4WD	09/92→11/93	Petrol	7A-FE	1762	4	81.00	85.50	29
Corolla 2.0 D	07/92→04/97	Diesel	2C	1975	4	86.00	85.00	36
Corolla FX 1.3	10/84→04/87	Petrol	2E	1296	4	73.00	77.40	7
Corolla FX 1.3	08/85→08/87	Petrol	2E-L	1296	4	73.00	77.40	7
Corolla FX 1.6	08/84→08/87	Petrol	4A-C	1587	4	81.00	77.00	27
Corolla FX 1.6	05/85→04/87	Petrol	4A-GELC	1587	4	81.00	77.00	28
Corolla FX 1.6	01/87→09/87	Petrol	4A-LC	1587	4	81.00	77.00	27
Corolla FX 1.6 GT 16V	08/85→08/87	Petrol	4A-GEL	1587	4	81.00	77.00	28
Corolla FX 1.8 D	08/85→08/87	Diesel	1C-L	1839	4	83.00	85.00	32
Corolla FX 1.8 D	01/85→05/88	Diesel	1C	1840	4	83.00	85.00	31
Corolla Levin 1.5 S	06/91→08/97	Petrol	5A-FE	1497	4	78.70	77.00	18
Corolla Levin 1.6 GT	06/91→08/97	Petrol	4A-FE	1587	4	81.00	77.00	27
Corolla Levin 1.6 GT-Z	06/91→08/97	Petrol	4A-GZE	1587	4	81.00	77.00	28
Corolla Rumion 1.5	09/07→	Petrol	1NZ-FE	1497	4	75.00	84.70	13
Corolla Rumion 1.8	09/07→	Petrol	2ZR-FAE	1798	4	80.50	88.30	25
Corolla Rumion 1.8 4WD	09/07→	Petrol	2ZR-FAE	1798	4	80.50	88.30	25
Corona 1.5	11/87→08/89	Petrol	5A-FE	1497	4	78.70	77.00	18
Corona 1.6	12/87→12/92	Petrol	4A-F	1587	4	81.00	77.00	27
Corona 1.6	06/89→09/97	Petrol	4A-FE	1587	4	81.00	77.00	27
Corona 1.6	02/72→07/73	Petrol	12R	1587	4	80.50	78.00	22
Corona 1.6	10/83→04/87	Petrol	4A-L	1588	4	81.00	77.00	27
Corona 1.8	02/92→09/97	Petrol	7A-FE	1762	4	81.00	85.50	29
Corona 1.8	06/79→07/81	Petrol	3T	1770	4	85.00	78.00	35
Corona 1.8	11/83→04/87	Petrol	1S-L	1832	4	80.50	90.00	26
Corona 2.0	08/83→04/87	Petrol	2S-C	1995	4	84.00	90.00	33
Corona 2.0 D	01/84→09/03	Diesel	2C	1975	4	86.00	85.00	36
Corona 2.0 D	06/97→02/00	Diesel	2C-T	1975	4	86.00	85.00	36
Corona 2.0 S	08/85→08/88	Petrol	2S	1988	6	75.00	75.00	12
Corona 2.0 TD	07/94→09/97	Diesel	2C-T	1975	4	86.00	85.00	36
Corona 1600 GT	01/67→12/69	Petrol	9R	1599	4	80.50	78.00	22
Corona 1600 S/GT.	01/65→12/68	Petrol	4R	1587	4	80.50	78.00	22
Corona Premio 2.0 TD	01/96→12/97	Diesel	2C-T	1975	4	86.00	85.00	36
Corsa 1.3	10/90→09/99	Petrol	4E-FE	1332	4	74.00	77.40	8
Cressida 1.8	09/80→12/86	Petrol	3T	1770	4	85.00	78.00	35
Cressida 2.2 D	09/80→03/85	Diesel	L	2188	4	90.00	86.00	39
Cressida 2.4 TD	01/85→10/88	Diesel	2L-T	2446	4	92.00	92.00	41
Cressida 2.4 TD	11/84→01/93	Diesel	2L-TII	2446	4	92.00	92.00	41
Cresta 2.4 D	09/88→10/96	Diesel	2L	2446	4	92.00	92.00	40
Crown 2.2 D	04/80→07/83	Diesel	L	2188	4	90.00	86.00	39
Crown 2.4 D	08/94→07/02	Diesel	2L-TE	2446	4	92.00	92.00	41
Curren 1.6	09/89→10/93	Petrol	4A-FE	1587	4	81.00	77.00	27
Curren 1.8	11/93→10/98	Petrol	7A-FE	1762	4	81.00	85.50	29
Deliboy 2.0 D	10/89→10/95	Diesel	2C	1975	4	86.00	85.00	36
Dyna 2.0	09/06→	Petrol	1TR-FE	1998	4	86.00	86.00	38
Dyna 2.0 4WD	09/06→	Petrol	1TR-FE	1998	4	86.00	86.00	38
Dyna 2.4 D	08/77→07/01	Diesel	2L	2446	4	92.00	92.00	40
Dyna 2.5 D4d	08/01→	Diesel	2KD-FTV	2494	4	92.00	93.80	42
Dyna 2.7	09/06→	Petrol	2TR-FE	2694	4	95.00	95.00	44
Dyna 2.8 D	08/88→08/98	Diesel	3L	2779	4	96.00	96.00	47
Dyna 3.0 D	09/98→07/01	Diesel	5L	2986	4	99.50	96.00	50
Dyna 3.0 D	08/88→05/95	Diesel	11B	2986	4	95.00	105.00	45
Dyna 3.0 D4d	08/01→	Diesel	1KD-FTV	2982	4	96.00	103.00	48
Dyna 3.0 D4d	08/01→	Diesel	5L	2986	4	99.50	96.00	50
Dyna 3.0 D4d 4WD	09/06→	Diesel	1KD-FTV	2982	4	96.00	103.00	48
Dyna 3.4 D	08/77→08/87	Diesel	13B	3431	4	102.00	105.00	52
Dyna 3.4 D	09/88→05/99	Diesel	3B	3432	4	102.00	105.00	51



cm3



9

Dyna 3.7 D	08/88→07/01	Diesel	14B	3661	4	102.00	112.00	54
Dyna 3.7 D	06/95→07/01	Diesel	14BT	3661	4	105.40	105.00	57
Echo 1.0 VVTi	04/03→08/05	Petrol	1SZ-FE	998	4	69.00	66.70	1
Echo 1.3 VVTi	04/03→08/05	Petrol	2SZ-FE	1298	4	72.00	79.70	5
Echo 1.3 VVTi	08/99→03/03	Petrol	2NZ-FE	1299	4	75.00	73.50	11
Echo 1.5 VVTi	04/99→08/05	Petrol	1NZ-FE	1497	4	75.00	84.70	13
Esquire 1.8 Hybrid	10/14→	Petrol	2ZR-FXE	1798	4	80.50	88.30	25
Fortuner 2.5 D-4D 4WD	01/09→05/15	Diesel	2KD-FTV	2494	4	92.00	93.80	42
Fortuner 2.7	05/15→	Petrol	2TR-FE	2694	4	95.00	95.00	44
Fortuner 2.7 4WD	05/15→	Petrol	2TR-FE	2694	4	95.00	95.00	44
Fortuner 2.7 Flexfuel	01/12→05/15	Petrol	2TR-FE	2694	4	95.00	95.00	44
Fortuner 2.7 VVTi	06/04→05/15	Petrol	2TR-FE	2694	4	95.00	95.00	44
Fortuner 2.7 VVTi 4WD	06/04→05/15	Petrol	2TR-FE	2694	4	95.00	95.00	44
Fortuner 3.0 D	08/09→05/15	Diesel	1KD-FTV	2982	4	96.00	103.00	48
Fortuner 3.0 D 4WD	06/04→05/15	Diesel	1KD-FTV	2982	4	96.00	103.00	48
Granvia 3.0 TDi	08/95→	Diesel	1KZ-TE	2982	4	96.00	103.00	48
Hiace 1.6	02/77→11/82	Petrol	12R	1587	4	80.50	78.00	22
Hiace 2.2 D	01/79→07/85	Diesel	L	2188	4	90.00	86.00	39
Hiace / Commuter V 2.0	11/08→	Petrol	1TR-FE	1998	4	86.00	86.00	38
Hiace / Commuter V 2.5 D-4D	09/06→	Diesel	2KD-FTV	2494	4	92.00	93.80	42
Hiace / Commuter V 2.5 D-4D 4WD	01/05→	Diesel	2KD-FTV	2494	4	92.00	93.80	42
Hiace / Commuter V 2.7 VVTi	01/05→	Petrol	2TR-FE	2694	4	95.00	95.00	44
Hiace / Commuter V 3.0 D	01/05→	Diesel	1KD-FTV	2982	4	96.00	103.00	48
Hiace / Commuter V 3.0 D	01/05→	Diesel	5L	2986	4	99.50	96.00	50
Hiace I 1.6	02/77→03/83	Petrol	12R	1587	4	80.50	78.00	22
Hiace I 2.2 D	01/79→03/83	Diesel	L	2188	4	90.00	86.00	39
Hiace II 2.2 D	03/83→11/89	Diesel	L	2188	4	90.00	86.00	39
Hiace II 2.4 D	05/84→11/89	Diesel	2L	2446	4	92.00	92.00	40
Hiace II 2.4 D 4WD	04/84→01/88	Diesel	2L	2446	4	92.00	92.00	40
Hiace III 2.4 D	08/89→08/95	Diesel	2L	2446	4	92.00	92.00	40
Hiace III 2.4 D 4WD	08/89→08/95	Diesel	2L	2446	4	92.00	92.00	40
Hiace III 2.5 D-4D 4WD	08/01→08/04	Diesel	2KD-FTV	2494	4	92.00	93.80	42
Hiace III 2.8 D	08/89→08/00	Diesel	3L	2779	4	96.00	96.00	47
Hiace III 3.0 D	08/98→08/04	Diesel	5L	2986	4	99.50	96.00	50
Hiace III 3.0 TD	08/96→06/99	Diesel	1KZ-T	2982	4	96.00	103.00	48
Hiace III 3.0 TD	01/97→12/02	Diesel	1KZ-TE	2982	4	96.00	103.00	48
Hiace IV 2.4 D	08/95→08/06	Diesel	2L	2446	4	92.00	92.00	40
Hiace IV 2.4 TD	08/95→08/06	Diesel	2L-T	2446	4	92.00	92.00	41
Hiace IV 2.4 TD 4WD	08/95→08/06	Diesel	2L-T	2446	4	92.00	92.00	41
Hiace IV 2.5 D-4D	11/01→	Diesel	2KD-FTV	2494	4	92.00	93.80	42
Hiace IV 2.5 D-4D 4WD	11/01→	Diesel	2KD-FTV	2494	4	92.00	93.80	42
Hiace IV 2.7	09/09→	Petrol	2TR-FE	2694	4	95.00	95.00	44
Hiace V 2.0	11/08→	Petrol	1TR-FE	1998	4	86.00	86.00	38
Hiace V 2.5 D-4D	09/06→	Diesel	2KD-FTV	2494	4	92.00	93.80	42
Hiace V 2.7 VVTi	01/05→	Petrol	2TR-FE	2694	4	95.00	95.00	44
Hiace V 3.0 D	01/05→	Diesel	1KD-FTV	2982	4	96.00	103.00	48
Hiace V 3.0 D	01/05→	Diesel	5L	2986	4	99.50	96.00	50
Hilux 1.5	05/68→05/72	Petrol	2R	1490	4	78.00	78.00	17
Hilux 1.6	02/71→05/72	Petrol	12R	1587	4	80.50	78.00	22
Hilux 2.4 TD 4WD	08/88→07/01	Diesel	2L-T	2446	4	92.00	92.00	41
Hilux 2.4 TD 4WD	08/89→11/95	Diesel	2L-TE	2446	4	92.00	92.00	41
Hilux 2.7	05/15→	Petrol	2TR-FE	2694	4	95.00	95.00	44
Hilux 2.7 4WD	05/15→	Petrol	2TR-FE	2694	4	95.00	95.00	44
Hilux 2.8 D	08/95→08/98	Diesel	3L	2779	4	96.00	96.00	47
Hilux 3.0 D	08/02→07/04	Diesel	5L	2986	4	99.50	96.00	50
Hilux 3.0 D 4WD	01/02→02/05	Diesel	5L	2986	4	99.50	96.00	50
Hilux 3.0 TDiC 4WD	08/93→07/97	Diesel	1KZ-T	2982	4	96.00	103.00	48
Hilux I 1.6	05/72→12/78	Petrol	12R	1587	4	80.50	78.00	22
Hilux I 1.6	08/78→07/83	Petrol	12R	1587	4	80.50	78.00	22
Hilux I 2.2 D	05/79→12/83	Diesel	L	2188	4	90.00	86.00	39
Hilux I 2.2 D 4WD	09/80→12/83	Diesel	L	2188	4	90.00	86.00	39
Hilux II 2.2 D	08/83→08/84	Diesel	L	2188	4	90.00	86.00	39
Hilux II 2.2 D 4WD	08/83→08/84	Diesel	L	2188	4	90.00	86.00	39
Hilux II 2.4 D	09/84→07/05	Diesel	2L	2446	4	92.00	92.00	40
Hilux II 2.4 D 4WD	01/84→07/05	Diesel	2L	2446	4	92.00	92.00	40
Hilux II 2.4 D 4WD	08/88→08/97	Diesel	2L-T	2446	4	92.00	92.00	41
Hilux II 2.4 TD	08/98→01/02	Diesel	2L-T	2446	4	92.00	92.00	41
Hilux II 2.4 TD 4WD	08/98→01/02	Diesel	2L-T	2446	4	92.00	92.00	41
Hilux II 2.5 D-4D	11/01→07/05	Diesel	2KD-FTV	2494	4	92.00	93.80	42

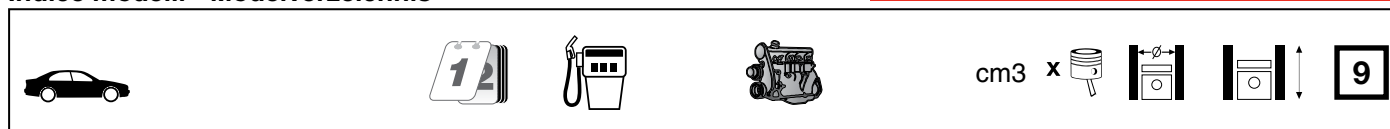









Hilux II 2.5 D-4D 4WD	11/01→07/05	Diesel	2KD-FTV	2494	4	92.00	93.80	42
Hilux II 2.7	09/03→07/05	Petrol	2TR-FE	2694	4	95.00	95.00	44
Hilux II 2.8 D	09/91→06/01	Diesel	3L	2779	4	96.00	96.00	47
Hilux II 2.8 D 4WD	10/88→07/05	Diesel	3L	2779	4	96.00	96.00	47
Hilux II 3.0 D	09/96→06/05	Diesel	1KZ-TE	2982	4	96.00	103.00	48
Hilux II 3.0 D	11/97→04/05	Diesel	5L	2986	4	99.50	96.00	50
Hilux II 3.0 D 4WD	08/97→08/05	Diesel	1KZ-T	2982	4	96.00	103.00	48
Hilux II 3.0 D 4WD	08/93→12/00	Diesel	1KZ-TE	2982	4	96.00	103.00	48
Hilux II 3.0 D 4WD	11/97→07/05	Diesel	5L	2986	4	99.50	96.00	50
Hilux III 2.0	02/05→	Petrol	1TR-FE	1998	4	86.00	86.00	38
Hilux III 2.5 D-4D	07/05→	Diesel	2KD-FTV	2494	4	92.00	93.80	42
Hilux III 2.5 D-4D 4WD	11/04→	Diesel	2KD-FTV	2494	4	92.00	93.80	42
Hilux III 2.5 D 4WD	08/05→	Diesel	2KD-FTV	2494	4	92.00	93.80	42
Hilux III 2.7	02/05→	Petrol	2TR-FE	2694	4	95.00	95.00	44
Hilux III 2.7 4WD	08/05→	Petrol	2TR-FE	2694	4	95.00	95.00	44
Hilux III 2.7 Flex	02/12→	Petrol	2TR-FE	2694	4	95.00	95.00	44
Hilux III 2.7 Flex 4WD	02/12→	Petrol	2TR-FE	2694	4	95.00	95.00	44
Hilux III 3.0 D	02/05→	Diesel	1KD-FTV	2982	4	96.00	103.00	48
Hilux III 3.0 D-4D 4WD	12/07→	Diesel	1KD-FTV	2982	4	96.00	103.00	48
Hilux III 3.0 D 4WD	02/05→	Diesel	1KD-FTV	2982	4	96.00	103.00	48
Mark II 1.8	08/80→10/83	Petrol	13T-U	1770	4	85.00	78.00	35
Mark II 1.8	11/83→03/88	Petrol	1S-L	1832	4	80.50	90.00	26
Mark II 2.0	11/83→03/88	Petrol	2S-EL	1995	4	84.00	90.00	33
Mark II 2.2 DX	08/80→10/83	Diesel	L	2188	4	90.00	86.00	39
Mark II 2.4 D	04/88→09/96	Diesel	2L	2446	4	92.00	92.00	40
Mark II 2.4 D	11/84→03/88	Diesel	2L-TII	2446	4	92.00	92.00	41
Mark II 2.4 TD	11/84→09/96	Diesel	2L-TE	2446	4	92.00	92.00	41
Mark II 2.4 TD	08/81→09/96	Diesel	2L-TII	2446	4	92.00	92.00	41
IQ 1.0	01/09→	Petrol	1KR-FE	998	3	71.00	84.00	3
Isis 1.8 VVTi	07/04→	Petrol	1ZZ-FE	1794	4	79.00	91.50	21
Isis 1.8 VVTi	04/07→	Petrol	2ZR-FAE	1798	4	80.50	88.30	25
Isis 1.8 VVTi 4WD	04/07→	Petrol	2ZR-FAE	1798	4	80.50	88.30	25
IST 1.3 VVTi	05/04→07/07	Petrol	2NZ-FE	1299	4	75.00	73.50	11
IST 1.5 VVTi	05/04→07/07	Petrol	1NZ-FE	1497	4	75.00	84.70	13
Kijang 1.8	08/91→08/00	Petrol	7K	1781	4	80.50	87.50	24
Kijang 1.8	07/99→08/04	Petrol	7K-E	1781	4	80.50	87.50	24
Kijang 2.4 D	08/89→12/00	Diesel	2L	2446	4	92.00	92.00	40
Kijang 2.7 D	09/93→08/00	Diesel	3L	2779	4	96.00	96.00	47
Kijang 3.0 D	07/99→07/01	Diesel	5L	2986	4	99.50	96.00	50
Kijang Innova 2.0	07/03→	Petrol	1TR-FE	1998	4	86.00	86.00	38
Kijang Innova 2.0 CNG	02/09→	Petrol	1TR-FE	1998	4	86.00	86.00	38
Kijang Innova 2.4 D	08/04→	Diesel	2L	2446	4	92.00	92.00	40
Kijang Innova 2.5 D-4D	08/04→	Diesel	2KD-FTV	2494	4	92.00	93.80	42
Kijang Innova 2.7 VVTi	08/04→	Petrol	2TR-FE	2694	4	95.00	95.00	44
Land Cruiser 2.4 D	11/84→10/85	Diesel	2L	2446	4	92.00	92.00	40
Land Cruiser 2.4 TD	10/85→05/96	Diesel	2L-T	2446	4	92.00	92.00	41
Land Cruiser 2.7	11/03→	Petrol	2TR-FE	2694	4	95.00	95.00	44
Land Cruiser 2.7 TD 4x4	01/90→08/01	Diesel	3L	2779	4	96.00	96.00	47
Land Cruiser 3.0 D	02/74→10/84	Diesel	B	2977	4	95.00	105.00	46
Land Cruiser 3.0 D	08/05→07/09	Diesel	1KZ-TE	2982	4	96.00	103.00	48
Land Cruiser 3.0 D-4D	02/00→	Diesel	1KD-FTV	2982	4	96.00	103.00	48
Land Cruiser 3.0 D-4D	09/02→07/09	Diesel	1KZ-TE	2982	4	96.00	103.00	48
Land Cruiser 3.0 TD	01/90→05/96	Diesel	1KZ-T	2982	4	96.00	103.00	48
Land Cruiser 3.0 TD	04/95→	Diesel	1KZ-TE	2982	4	96.00	103.00	48
Land Cruiser 3.0 TDi	01/10→	Diesel	1KD-FTV	2982	4	96.00	103.00	48
Land Cruiser 3.4 D	08/80→12/96	Diesel	3B	3432	4	102.00	105.00	51
Land Cruiser 3.4 Diesel	10/81→08/87	Diesel	3B	3432	4	102.00	105.00	51
Land Cruiser 3.4 TD	10/85→08/86	Diesel	13BT	3431	4	102.00	105.00	53
Land Cruiser 3.7 D 4WD	11/92→11/01	Diesel	14B	3661	4	102.00	112.00	54
Liteace 1.3	10/79→10/86	Petrol	4K	1290	4	75.00	73.00	10
Liteace 1.3	10/79→10/86	Petrol	4K-C	1290	4	75.00	73.00	10
Liteace 1.8	10/97→08/01	Petrol	1ZZ-FE	1794	4	79.00	91.50	21
Liteace 1.8 D	10/82→08/88	Diesel	1C	1840	4	83.00	85.00	31
Liteace 2.0 D	08/88→05/94	Diesel	2C	1975	4	86.00	85.00	36
Master Ace Surf 2.0 D	02/85→10/93	Diesel	2C	1975	4	86.00	85.00	36
Master Ace Surf 2.0 TD	02/85→10/93	Diesel	2C-T	1975	4	86.00	85.00	36
Master Ace Surf 2.0 TD 4WD	02/85→12/96	Diesel	2C-T	1975	4	86.00	85.00	36
Matrix 1.8	09/05→12/07	Petrol	1ZZ-FE	1794	4	79.00	91.50	21
Matrix 1.8	01/08→	Petrol	2ZR-FE	1798	4	80.50	88.30	25



cm3



Matrix 1.8 4WD	09/05→12/07	Petrol	1ZZ-FE	1794	4	79.00	91.50	21
Matrix 1.8 VVTi	09/01→12/05	Petrol	1ZZ-FE	1794	4	79.00	91.50	21
Matrix 1.8 VVTi 4WD	09/01→12/05	Petrol	1ZZ-FE	1794	4	79.00	91.50	21
Modell F 2.0 D	04/85→08/88	Diesel	2C	1975	4	86.00	85.00	36
MR 2 I 1.6	09/84→12/89	Petrol	4A-GELC	1587	4	81.00	77.00	28
MR 2 I 1.6 16V	11/84→06/90	Petrol	4A-GEL	1587	4	81.00	77.00	28
MR 2 I 1.6 16V	11/84→06/90	Petrol	4A-GELC	1587	4	81.00	77.00	28
MR 2 I 1.6 Supercharged	08/86→12/89	Petrol	4A-GZE	1587	4	81.00	77.00	28
MR 2 III 1.8 16V VT-i	10/99→06/07	Petrol	1ZZ-FE	1794	4	79.00	91.50	21
Noah/Voxy 1.8 Hybrid	10/13→	Petrol	2ZR-FXE	1798	4	80.50	88.30	25
Opa 1.8	04/00→08/03	Petrol	1ZZ-FE	1794	4	79.00	91.50	21
Opa 1.8 4WD	04/00→08/03	Petrol	1ZZ-FE	1794	4	79.00	91.50	21
Paseo 1.3	08/95→06/99	Petrol	4E-FE	1332	4	74.00	77.40	8
Passo 1.0	06/05→	Petrol	1KR-FE	998	3	71.00	84.00	3
Passo 1.0 4WD	06/05→	Petrol	1KR-FE	998	3	71.00	84.00	3
Pickup 2.2 D	09/80→12/83	Diesel	L	2188	4	90.00	86.00	39
Pickup 2.2 D 4WD	09/80→12/83	Diesel	L	2188	4	90.00	86.00	39
Platz 1.0 VVTi	04/99→08/05	Petrol	1SZ-FE	998	4	69.00	66.70	1
Platz 1.3 VVTi	09/02→08/05	Petrol	2NZ-FE	1299	4	75.00	73.50	11
Platz 1.3 VVTi 4WD	09/02→08/05	Petrol	2NZ-FE	1299	4	75.00	73.50	11
Platz 1.5 VVTi	04/99→08/05	Petrol	1NZ-FE	1497	4	75.00	84.70	13
Platz 1.5 VVTi 4WD	09/02→08/05	Petrol	1NZ-FE	1497	4	75.00	84.70	13
Porte 1.3 VVTi	07/04→07/12	Petrol	2NZ-FE	1299	4	75.00	73.50	11
Porte 1.5 4WD	07/04→07/12	Petrol	1NZ-FE	1497	4	75.00	84.70	13
Porte 1.5 VVTi	07/04→07/12	Petrol	1NZ-FE	1497	4	75.00	84.70	13
Porte II 1.5	08/12→	Petrol	1NZ-FE	1497	4	75.00	84.70	13
Porte II 1.5 4WD	08/12→	Petrol	1NZ-FE	1497	4	75.00	84.70	13
Premio 1.5	12/01→	Petrol	1NZ-FE	1497	4	75.00	84.70	13
Premio 1.8	12/01→05/07	Petrol	7A-FE	1762	4	81.00	85.50	29
Premio 1.8	07/07→	Petrol	2ZR-FAE	1798	4	80.50	88.30	25
Premio 1.8 4WD	07/07→	Petrol	2ZR-FAE	1798	4	80.50	88.30	25
Prius 1.5	08/03→03/09	Petrol	1NZ-FXE	1497	4	75.00	84.70	13
Prius 1.5 Hybrid	05/00→03/09	Petrol	1NZ-FXE	1497	4	75.00	84.70	13
Prius 1.8 Hybrid	04/09→	Petrol	2ZR-FXE	1798	4	80.50	88.30	25
Prius 1.8 Hybrid E-Four 4WD	09/15→	Petrol	2ZR-FXE	1798	4	80.50	88.30	25
Prius C 1.5 Hybrid	09/11→	Petrol	1NZ-FXE	1497	4	75.00	84.70	13
Prius Plus 1.8 Hybrid	05/11→	Petrol	2ZR-FXE	1798	4	80.50	88.30	25
Pro/Succeed 1.3 VVTi	07/02→	Petrol	2NZ-FE	1299	4	75.00	73.50	11
Pro/Succeed 1.5 VVTi	07/02→	Petrol	1NZ-FE	1497	4	75.00	84.70	13
Pro/Succeed 1.5 VVTi	07/02→	Gas	1NZ-FNE	1497	4	75.00	84.70	13
Pro/Succeed 1.5 VVTi 4WD	07/02→	Petrol	1NZ-FE	1497	4	75.00	84.70	13
Pro/Succeed 1.5 VVTi Hybrid	07/02→	Petrol	1NZ-FXE	1497	4	75.00	84.70	13
Qualis 1.8	01/99→10/04	Petrol	7K	1781	4	80.50	87.50	24
Qualis 2.4 D	01/99→10/04	Diesel	2L	2446	4	92.00	92.00	40
Qualis 3.0 D	07/03→10/04	Diesel	5L	2986	4	99.50	96.00	50
Ractis 1.3	09/05→08/10	Petrol	2SZ-FE	1298	4	72.00	79.70	5
Ractis 1.5 VVTi	09/05→08/10	Petrol	1NZ-FE	1497	4	75.00	84.70	13
Ractis 1.5 VVTi 4WD	09/05→08/10	Petrol	1NZ-FE	1497	4	75.00	84.70	13
Raum MPV 1.5	05/03→	Petrol	1NZ-FE	1497	4	75.00	84.70	13
Raum MPV 1.5 4WD	05/03→	Petrol	1NZ-FE	1497	4	75.00	84.70	13
Rav 4 II 1.8 VVTi	08/00→11/05	Petrol	1ZZ-FE	1794	4	79.00	91.50	21
Regiusace 2.0	08/04→	Petrol	1TR-FE	1998	4	86.00	86.00	38
Regiusace 2.5 D-4D	08/04→	Diesel	2KD-FTV	2494	4	92.00	93.80	42
Regiusace 2.7	08/04→	Petrol	2TR-FE	2694	4	95.00	95.00	44
Regiusace 3.0 D-4D	08/04→	Diesel	1KD-FTV	2982	4	96.00	103.00	48
Regiusace 3.0 D-4D 4WD	08/04→	Diesel	1KD-FTV	2982	4	96.00	103.00	48
Scepter 2.0 TD	11/92→09/96	Diesel	2C-T	1975	4	86.00	85.00	36
Sienta 1.5	05/03→05/15	Petrol	1NZ-FE	1497	4	75.00	84.70	13
Sienta 1.5 4WD	05/03→	Petrol	1NZ-FE	1497	4	75.00	84.70	13
Sienta 1.5 Hybrid	06/15→	Petrol	1NZ-FXE	1497	4	75.00	84.70	13
Soluna 1.5	12/96→06/03	Petrol	5A-FE	1497	4	78.70	77.00	18
Soluna Vios 1.5	07/02→	Petrol	5A-FE	1497	4	78.70	77.00	18
Spade 1.5	08/12→	Petrol	1NZ-FE	1497	4	75.00	84.70	13
Spade 1.5 4WD	08/12→	Petrol	1NZ-FE	1497	4	75.00	84.70	13
Sprinter 1.3	08/87→04/92	Petrol	2E	1296	4	73.00	77.40	7
Sprinter 1.3	08/87→04/92	Petrol	2E-E	1296	4	73.00	77.40	7
Sprinter 1.3	06/83→07/87	Petrol	2E-L	1296	4	73.00	77.40	7
Sprinter 1.3	06/92→11/00	Petrol	4E-FE	1332	4	74.00	77.40	8
Sprinter 1.5	06/83→07/87	Petrol	3A-U	1452	4	77.50	77.00	15







				cm3	x 			
Sprinter 1.5	08/87→11/02	Petrol	5A-FE	1497	4	78.70	77.00	18
Sprinter 1.6	08/87→11/00	Petrol	4A-FE	1587	4	81.00	77.00	27
Sprinter 1.6	10/84→07/87	Petrol	4A-LC	1587	4	81.00	77.00	27
Sprinter 1.6 4WD	10/88→04/92	Petrol	4A-FE	1587	4	81.00	77.00	27
Sprinter 1.6 GTi	06/83→07/87	Petrol	4A-GE	1587	4	81.00	77.00	28
Sprinter 1.6 GTi	10/84→07/87	Petrol	4A-GEC	1587	4	81.00	77.00	27
Sprinter 1.8	11/92→04/97	Petrol	7A-FE	1762	4	81.00	85.50	29
Sprinter 2.0 D	04/95→11/00	Diesel	2C	1975	4	86.00	85.00	36
Sprinter Carib 1.3	06/92→04/97	Petrol	4E-FE	1332	4	74.00	77.40	8
Sprinter Carib 1.5 4WD	05/82→10/87	Petrol	3A-U	1452	4	77.50	77.00	15
Sprinter Carib 1.6	08/95→10/01	Petrol	4A-FE	1587	4	81.00	77.00	27
Sprinter Carib 1.6 4WD	11/87→05/92	Petrol	4A-F	1587	4	81.00	77.00	27
Sprinter Carib 1.6 4WD	11/87→07/95	Petrol	4A-FE	1587	4	81.00	77.00	27
Sprinter Carib 1.8	11/92→10/01	Petrol	7A-FE	1762	4	81.00	85.50	29
Sprinter Carib 1.8 4WD	08/95→10/01	Petrol	7A-FE	1762	4	81.00	85.50	29
Stallion 2.4 D	08/99→05/05	Diesel	2L	2446	4	92.00	92.00	40
Starlet 1.0	11/74→09/84	Petrol	2K	993	4	72.00	61.00	4
Starlet 1.0	12/89→12/92	Petrol	1E	999	4	70.50	64.00	2
Starlet 1.0	10/84→12/89	Petrol	1E-L	999	4	70.50	64.00	2
Starlet 1.2	02/78→09/82	Petrol	3K-H	1166	4	75.00	66.00	9
Starlet 1.2 S	10/78→08/82	Petrol	3K-H	1166	4	75.00	66.00	9
Starlet 1.3	02/78→09/84	Petrol	4K	1290	4	75.00	73.00	10
Starlet 1.3	09/80→12/84	Petrol	4K-C	1290	4	75.00	73.00	10
Starlet 1.3	04/96→07/99	Petrol	2E	1296	4	73.00	77.40	7
Starlet 1.3	10/84→12/89	Petrol	2E-LC	1296	4	73.00	77.40	7
Starlet 1.3	04/96→03/99	Petrol	4E-FE	1332	4	74.00	77.40	8
Starlet 1.3 12V	12/89→12/92	Petrol	2E	1296	4	73.00	77.40	7
Starlet 1.3 12V	12/89→03/96	Petrol	2E-E	1296	4	73.00	77.40	7
Starlet 1.3 S	08/82→09/84	Petrol	4K	1290	4	75.00	73.00	10
Starlet 1.3 XL	12/89→12/91	Petrol	2E	1296	4	73.00	77.40	7
Starlet 1000 1.0	05/76→08/78	Petrol	2K	993	4	72.00	61.00	4
Tacoma 2.7	09/04→	Petrol	2TR-FE	2694	4	95.00	95.00	44
Tacoma 2.7 4WD	09/04→	Petrol	2TR-FE	2694	4	95.00	95.00	44
Tamaraw Fx 2.4 D	01/99→10/04	Diesel	2L	2446	4	92.00	92.00	40
Tazz 1.3	04/96→07/06	Petrol	2E	1296	4	73.00	77.40	7
Tazz 1.6	04/96→07/06	Petrol	4A-FE	1587	4	81.00	77.00	27
Tercel 1.3	03/79→01/88	Petrol	2A	1296	4	76.00	71.40	14
Tercel 1.3	05/92→09/99	Petrol	4E-FE	1332	4	74.00	77.40	8
Tercel 1.45	03/79→05/85	Petrol	3A-C	1452	4	77.50	77.00	16
Tercel 1.5	08/82→10/86	Petrol	3A	1452	4	77.50	77.00	15
Tercel 1.5	10/82→01/88	Petrol	3A-C	1452	4	77.50	77.00	16
Tercel 1.5	05/82→10/87	Petrol	3A-U	1452	4	77.50	77.00	15
Tercel 1.5 4WD	10/82→01/88	Petrol	3A	1452	4	77.50	77.00	15
Tercel 1.5 4WD	10/82→01/88	Petrol	3A-C	1452	4	77.50	77.00	16
Tercel 1.5 4WD	08/82→10/85	Petrol	3A-U	1452	4	77.50	77.00	15
Town Ace 1.8 i	12/98→07/07	Petrol	7K-E	1781	4	80.50	87.50	24
Town Ace 1.8 SBV	02/97→01/99	Petrol	7K	1781	4	80.50	87.50	24
Town Ace 2.0 D	01/92→04/95	Diesel	2C	1975	4	86.00	85.00	36
Town Ace 2.0 TD	04/85→12/91	Diesel	2C-T	1975	4	86.00	85.00	36
Town Ace 2.2 D	04/85→12/91	Diesel	L	2188	4	90.00	86.00	39
Town Ace 2.4 D	04/85→12/91	Diesel	2L	2446	4	92.00	92.00	40
Town Ace 2.8 D	05/95→09/01	Diesel	3L	2779	4	96.00	96.00	47
Town Ace 3.0 D	10/01→07/07	Diesel	5L	2986	4	99.50	96.00	50
TUV 1.8	12/96→12/06	Petrol	7K-E	1781	4	80.50	87.50	24
TUV 2.4 D	12/96→07/07	Diesel	2L	2446	4	92.00	92.00	40
TUV 3.0 D	06/03→02/05	Diesel	5L	2986	4	99.50	96.00	50
Urban Cruiser 1.5 VVTi	07/07→	Petrol	1NZ-FE	1497	4	75.00	84.70	13
Urban Cruiser 1.5 VVTi 4WD	04/09→	Petrol	1NZ-FE	1497	4	75.00	84.70	13
Verso 1.6	04/09→	Petrol	1ZR-FAE	1598	4	80.50	78.50	23
Verso 1.8	04/09→	Petrol	2ZR-FAE	1798	4	80.50	88.30	25
Verso S 1.5	11/10→	Petrol	1NZ-FE	1497	4	75.00	84.70	13
Verso S 1.5 4WD	11/10→	Petrol	1NZ-FE	1497	4	75.00	84.70	13
Vios 1.3	05/03→09/05	Petrol	2NZ-FE	1299	4	75.00	73.50	11
Vios 1.5	07/02→01/08	Petrol	1NZ-FE	1497	4	75.00	84.70	13
Vios 1.5	07/02→01/08	Petrol	5A-FE	1497	4	78.70	77.00	18
Vios 1.5 VVTi	07/02→01/08	Petrol	1NZ-FE	1497	4	75.00	84.70	13
Vios 1.5 VVTi	07/02→01/08	Petrol	5A-FE	1497	4	78.70	77.00	18
Vios/Yaris 1.0	08/07→	Petrol	1KR-FE	998	3	71.00	84.00	3
Vios/Yaris 1.3	08/07→	Petrol	2SZ-FE	1298	4	72.00	79.70	5



cm3



Vios/Yaris 1.3	08/07→	Petrol	2NZ-FE	1299	4	75.00	73.50	11
Vios/Yaris 1.3 4WD	08/07→	Petrol	2NZ-FE	1299	4	75.00	73.50	11
Vios/Yaris 1.5	08/07→	Petrol	1NZ-FE	1497	4	75.00	84.70	13
Vista 1.8	06/98→08/03	Petrol	1ZZ-FE	1794	4	79.00	91.50	21
Vista 1.8	10/86→10/88	Petrol	1S	1832	4	80.50	90.00	26
Vista 1.8	06/82→06/86	Petrol	1S-L	1832	4	80.50	90.00	26
Vista 2.0 D	07/90→05/98	Diesel	2C-T	1975	4	86.00	85.00	36
Vista 2.0 GL	09/83→06/86	Petrol	2S-EL	1995	4	84.00	90.00	33
Vista 2.0 TD	11/88→06/91	Diesel	2C-T	1975	4	86.00	85.00	36
Will Cypha 1.3 VVTi	05/01→07/05	Petrol	2NZ-FE	1299	4	75.00	73.50	11
Will Cypha 1.5 VVTi 4WD	05/01→07/05	Petrol	1NZ-FE	1497	4	75.00	84.70	13
Will Vi 1.3	01/00→12/01	Petrol	2NZ-FE	1299	4	75.00	73.50	11
Will VS 1.5 VVTi 4WD	03/01→04/04	Petrol	1NZ-FE	1497	4	75.00	84.70	13
Will VS 1.8 VVTi	03/01→04/04	Petrol	1ZZ-FE	1794	4	79.00	91.50	21
Will VS 1.8 VVTi 4WD	03/01→04/04	Petrol	1ZZ-FE	1794	4	79.00	91.50	21
Will VS 1.8 VVTi GT	03/01→04/04	Petrol	1ZZ-GE	1794	4	79.00	91.50	21
Wish MPV 1.8	04/09→	Petrol	2ZR-FAE	1798	4	80.50	88.30	25
Wish MPV 1.8 4WD	04/09→	Petrol	2ZR-FAE	1798	4	80.50	88.30	25
Wish MPV 1.8 Hi	04/03→03/09	Petrol	1ZZ-FE	1794	4	79.00	91.50	21
Wish MPV 1.8 Hi 4WD	04/03→03/09	Petrol	1ZZ-FE	1794	4	79.00	91.50	21
Yaris 1.0	09/11→	Petrol	1KR-FE	998	3	71.00	84.00	3
Yaris 1.0 16V	04/99→09/05	Petrol	1SZ-FE	998	4	69.00	66.70	1
Yaris 1.0 GPL	01/06→	Petrol	1KR-FE	998	3	71.00	84.00	3
Yaris 1.0 VVT-i	08/05→	Petrol	1KR-FE	998	3	71.00	84.00	3
Yaris 1.3	04/02→09/05	Petrol	2SZ-FE	1298	4	72.00	79.70	5
Yaris 1.3	08/99→09/05	Petrol	2NZ-FE	1299	4	75.00	73.50	11
Yaris 1.3 4WD	08/07→	Petrol	2SZ-FE	1298	4	72.00	79.70	5
Yaris 1.3 4WD	08/07→	Petrol	2NZ-FE	1299	4	75.00	73.50	11
Yaris 1.3 16V	11/99→09/05	Petrol	2SZ-FE	1298	4	72.00	79.70	5
Yaris 1.3 16V	11/99→09/05	Petrol	2NZ-FE	1299	4	75.00	73.50	11
Yaris 1.3 VVT-i	08/05→	Petrol	2SZ-FE	1298	4	72.00	79.70	5
Yaris 1.3 VVT-i	08/05→	Petrol	2NZ-FE	1299	4	75.00	73.50	11
Yaris 1.5	01/99→	Petrol	1NZ-FE	1497	4	75.00	84.70	13
Yaris 1.5 4WD	03/00→09/05	Petrol	1NZ-FE	1497	4	75.00	84.70	13
Yaris 1.5 Hybrid	03/12→	Petrol	1NZ-FXE	1497	4	75.00	84.70	13
Yaris 1.5 TS	01/03→09/05	Petrol	1NZ-FE	1497	4	75.00	84.70	13
Yaris 1.5 VVT-i TS	04/01→09/05	Petrol	1NZ-FE	1497	4	75.00	84.70	13
Yaris 1.8 VVTi	11/05→	Petrol	1ZZ-FE	1794	4	79.00	91.50	21
Yaris 1.8 VVTi	01/07→	Petrol	2ZR-FE	1798	4	80.50	88.30	25

		cm3	x 			
1C	Diesel	1840	4	83.00	85.00	31
1C-L	Diesel	1839	4	83.00	85.00	32
1C-TL	Diesel	1840	4	83.00	85.00	32
1E	Petrol	999	4	70.50	64.00	2
1E-L	Petrol	999	4	70.50	64.00	2
1HD-FT	Diesel	4164	6	94.00	100.00	43
1HD-T	Diesel	4164	6	94.00	100.00	43
1H-Z	Diesel	4164	6	94.00	100.00	43
1KD-FTV	Diesel	2982	4	96.00	103.00	48
1KR-FE	Petrol	998	3	71.00	84.00	3
1KZ-T	Diesel	2982	4	96.00	103.00	48
1KZ-TE	Diesel	2982	4	96.00	103.00	48
1NZ-FE	Petrol	1497	4	75.00	84.70	13
1NZ-FNE	Gas	1497	4	75.00	84.70	13
1NZ-FXE	Petrol	1497	4	75.00	84.70	13
1S	Petrol	1832	4	80.50	90.00	26
1S-EL	Petrol	1832	4	80.50	90.00	26
1S-L	Petrol	1832	4	80.50	90.00	26
1SZ-FE	Petrol	998	4	69.00	66.70	1
1TR-FE	Petrol	1998	4	86.00	86.00	38
1W	Diesel	4009	4	104.00	118.00	55
1ZR-FAE	Petrol	1598	4	80.50	78.50	23
1ZR-FE	Petrol	1598	4	80.50	78.50	23
1ZZ-FE	Petrol	1794	4	79.00	91.50	21
1ZZ-GE	Petrol	1794	4	79.00	91.50	21
2A	Petrol	1296	4	76.00	71.40	14
2A-L	Petrol	1296	4	73.00	77.40	6
2B	Diesel	3197	4	98.00	105.00	49
2C	Diesel	1975	4	86.00	85.00	36
2C-L	Diesel	1975	4	86.00	85.00	36
2C-T	Diesel	1975	4	86.00	85.00	36
2C-TL	Diesel	1974	4	86.00	85.00	37
2E	Petrol	1296	4	73.00	77.40	7
2E-E	Petrol	1296	4	73.00	77.40	7
2E-L	Petrol	1296	4	73.00	77.40	7
2E-LC	Petrol	1296	4	73.00	77.40	7
2K	Petrol	993	4	72.00	61.00	4
2KD-FTV	Diesel	2494	4	92.00	93.80	42
2L	Diesel	2446	4	92.00	92.00	40
2L-T	Diesel	2446	4	92.00	92.00	41
2L-TE	Diesel	2446	4	92.00	92.00	41
2L-TII	Diesel	2446	4	92.00	92.00	41
2NZ-FE	Petrol	1299	4	75.00	73.50	11
2R	Petrol	1490	4	78.00	78.00	17
2S	Petrol	1988	6	75.00	75.00	12
2S-C	Petrol	1995	4	84.00	90.00	33
2S-E	Petrol	1995	4	84.00	90.00	33
2S-EL	Petrol	1995	4	84.00	90.00	33
2S-ELC	Petrol	1995	4	84.00	90.00	33
2SZ-FE	Petrol	1298	4	72.00	79.70	5
2T	Petrol	1588	4	85.00	70.00	34
2TB	Petrol	1588	4	85.00	70.00	34
2T-G	Petrol	1588	4	85.00	70.00	34
2TJ	Petrol	1588	4	85.00	70.00	34
2TR-FE	Petrol	2694	4	95.00	95.00	44
2ZR-FAE	Petrol	1798	4	80.50	88.30	25
2ZR-FE	Petrol	1798	4	80.50	88.30	25
2ZR-FXE	Petrol	1798	4	80.50	88.30	25
3A	Petrol	1452	4	77.50	77.00	15
3A-C	Petrol	1452	4	77.50	77.00	16
3A-U	Petrol	1452	4	77.50	77.00	15
3B	Diesel	3432	4	102.00	105.00	51
3K	Petrol	1166	4	75.00	66.00	9
3K-B	Petrol	1166	4	75.00	66.00	9
3K-C	Petrol	1166	4	75.00	66.00	9
3K-D	Petrol	1166	4	75.00	66.00	9
3K-H	Petrol	1166	4	75.00	66.00	9
3KJ	Petrol	1166	4	75.00	66.00	9
3L	Diesel	2779	4	96.00	96.00	47



cm³



9

3T	Petrol	1770	4	85.00	78.00	35
3ZZ-FE	Petrol	1598	4	79.00	81.50	20
4A-C	Petrol	1587	4	81.00	77.00	27
4A-F	Petrol	1587	4	81.00	77.00	27
4A-FE	Petrol	1587	4	81.00	77.00	27
4A-G	Petrol	1587	4	81.00	114.30	30
4A-GE	Petrol	1587	4	81.00	77.00	28
4A-GEC	Petrol	1587	4	81.00	77.00	27
4A-GEL	Petrol	1587	4	81.00	77.00	28
4A-GELC	Petrol	1587	4	81.00	77.00	28
4A-GZE	Petrol	1587	4	81.00	77.00	28
4A-L	Petrol	1588	4	81.00	77.00	27
4A-LC	Petrol	1587	4	81.00	77.00	27
4E-FE	Petrol	1332	4	74.00	77.40	8
4K	Petrol	1290	4	75.00	73.00	10
4K-C	Petrol	1290	4	75.00	73.00	10
4KJ	Petrol	1290	4	75.00	73.00	10
4R	Petrol	1587	4	80.50	78.00	22
4ZZ-FE	Petrol	1398	4	79.00	71.30	19
5A-FE	Petrol	1497	4	78.70	77.00	18
5L	Diesel	2986	4	99.50	96.00	50
7A-FE	Petrol	1762	4	81.00	85.50	29
7K	Petrol	1781	4	80.50	87.50	24
7K-E	Petrol	1781	4	80.50	87.50	24
9R	Petrol	1599	4	80.50	78.00	22
11B	Diesel	2986	4	95.00	105.00	45
12R	Petrol	1587	4	80.50	78.00	22
12RJ	Petrol	1587	4	80.50	78.00	22
13B	Diesel	3431	4	102.00	105.00	52
13BT	Diesel	3431	4	102.00	105.00	53
13T-U	Petrol	1770	4	85.00	78.00	35
14B	Diesel	3661	4	102.00	112.00	54
14BT	Diesel	3661	4	105.40	105.00	57
B	Diesel	2977	4	95.00	105.00	46
L	Diesel	2188	4	90.00	86.00	39
N04C-UH	Diesel	4009	4	104.00	118.00	56
N04C-UL	Diesel	4009	4	104.00	118.00	56
N04C-UM	Diesel	4009	4	104.00	118.00	56
N04C-UN	Diesel	4009	4	104.00	118.00	56
N04C-UP	Diesel	4009	4	104.00	118.00	56
N04C-UQ	Diesel	4009	4	104.00	118.00	56
N04C-VF	Diesel	4009	4	104.00	118.00	56
W04D-TP	Diesel	4009	4	104.00	118.00	56
W04D-TR	Diesel	4009	4	104.00	118.00	56



1 69.00 x 66.70

1SZ-FE		4 Cyl.		998cc	48-50kW (65-68PS)		Petrol		TD11808
BE/PL	4	35,000	38,010	13,200	1,492		AL-LF	64-725-1	01-4801/4 STD
MB/HL 1-5	5	45,988/46,000	50,000/50,018	14,900	1,992	0,016/0,066	AL-LF	02-4799	H1296/5 STD
→12/02									
MB/HL 1-5	5	46,000	50,020	14,900	1,992		AL-LF	63-726-1	H1332/5 STD
MB/HL 1-5	5	46,000	50,020	14,900	1,992		AL-LF	63-726-2	
01/03→									
TW/A	2	52,000/52,250	62,750/63,000		1,990		AL-LF	04-4800	A295/2 STD

2 70.50 x 64.00

1E		4 Cyl.		999cc	40kW (54PS)		Petrol		TD3718
1E-L		4 Cyl.		999cc	40kW (54PS)		Petrol		TD3719
BE/PL	8	39,990	43,020	15,100	1,491		AL	64-025-1	01-4128/4 STD 0.25
MB/HL 1-5	5	46,990	51,040	16,100	1,999		AL	63-025-1	H1077/5 STD 0.25
MB/HL 1-5	5	46,990	51,040	16,100	1,999		AL	63-025-2	
TW/A	2	52,500	64,500		2,490		AL-LF	65-025-1	A175/4 STD
TW/A	2	52,500	64,500		2,490		AL-LF	65-025-2	

3 71.00 x 84.00

1KR-FE Euro 4		3 Cyl.		998cc	49-52kW (66-71PS)		Petrol		TD18481
BE/PL	6	40,000	43,020	13,600	1,495		AL-LF	64-735-1	01-4980/3 STD
MB/HL 1-4	4	43,990	48,020	14,900	1,997		AL-LF	63-735-1	H1338/4 STD
MB/HL 1-4	4	43,990	48,020	14,900	1,997		AL-LF	63-735-2	
TW/A	2	52,000	63,000		1,990		AL-LF	65-735-1	A322/2 STD

4 72.00 x 61.00

2K		4 Cyl.		993cc	33kW (45PS)		Petrol		TD3763
BE/PL	8	41,980	45,020	18,900	1,492		AL	64-021-1	71-4261/4 STD
→12/81									
MB/HL 1-5	5	49,974/49,999	54,002/54,028	21,844	1,994	0,020/0,091	BS	67271CP	H1176/5 STD
→08/82									
TW/A	2	55,820	67,820		2,464		BS	67271BFL	A235/4 STD
TW/A	2	55,820	67,820		2,464		BS	67271BFU	

5 72.00 x 79.70

2SZ-FE		4 Cyl.		1298cc	63-64kW (86-87PS)		Petrol		TD17287
BE/PL	8	40,000	43,010	13,200	1,492		AL-LF	64-726-1	01-4892/4 STD

TOYOTA

MB/HL 1-5	5	46,000	50,020	14,900	1,992		AL-LF	63-726-1	H1332/5 STD
MB/HL 1-5	5	46,000	50,020	14,900	1,992		AL-LF	63-726-2	
TW/A	2	52,000/52,250	62,750/63,000		1,990		AL-LF	04-4800	A295/2 STD

6 73.00 x 77.40

2A-L			4 Cyl.	1296cc	51-55kW (69-75PS)		Petrol		TD4934
BE/PL	8	39,990		43,020	17,100	1,491	AL-LF	64-043-1	01-4117/4 STD 0.25
07/83→									
MB/HL 1-5	5	47,980		52,040	19,900	2,005	AL	63-043-1	H1068/5 STD 0.25 0.50
MB/HL 1-5	5	47,980		52,040	19,900	2,005	AL	63-043-2	
TW/A	2	53,500		66,000		2,490	AL-LF	65-022-1	A186/4 STD
TW/A	2	53,500		66,000		2,490	AL-LF	65-022-2	

7 73.00 x 77.40

2E			4 Cyl.	1296cc	48-60kW (65-82PS)		Petrol		TD4935
2E-E			4 Cyl.	1296cc	55kW (75PS)		Petrol		TD4936
2E-L			4 Cyl.	1296cc	55-60kW (75-82PS)		Petrol		TD4937
2E-LC			4 Cyl.	1296cc	52-55kW (71-75PS)		Petrol		TD3756
BE/PL	8	39,990		43,020	15,100	1,491	AL	64-025-1	01-4128/4 STD 0.25
MB/HL 1-5	5	46,990		51,040	16,100	1,999	AL	63-025-1	H1077/5 STD 0.25
MB/HL 1-5	5	46,990		51,040	16,100	1,999	AL	63-025-2	
TW/A	2	52,500		64,500		2,490	AL-LF	65-025-1	A175/4 STD
TW/A	2	52,500		64,500		2,490	AL-LF	65-025-2	

8 74.00 x 77.40

4E-FE			4 Cyl.	1332cc	55-65kW (75-88PS)		Petrol		TD3833
BE/PL	8	39,990		43,020	15,100	1,491	AL	64-025-1	01-4128/4 STD 0.25
MB/HL 1-5	5	46,990		51,040	16,100	1,999	AL	63-025-1	H1077/5 STD 0.25
MB/HL 1-5	5	46,990		51,040	16,100	1,999	AL	63-025-2	
TW/A	2	52,500		64,500		2,490	AL-LF	65-025-1	A175/4 STD
TW/A	2	52,500		64,500		2,490	AL-LF	65-025-2	

9 75.00 x 66.00

3K			4 Cyl.	1166cc	40kW (54PS)		Petrol		TD4943
3K-B			4 Cyl.	1166cc	40-43kW (54-58PS)		Petrol		TD3792
3K-C			4 Cyl.	1166cc	40-43kW (54-58PS)		Petrol		TD3794
3K-D			4 Cyl.	1166cc	48-50kW (65-68PS)		Petrol		TD22380
3K-H			4 Cyl.	1166cc	39-43kW (53-58PS)		Petrol		TD4944
3KJ			4 Cyl.	1166cc	40kW (54PS)		Petrol		TD9071
BE/PL	8	41,980		45,020	18,900	1,492	AL	64-021-1	71-4261/4 STD

MB/HL 1-5	5	49,974/49,999	54,002/54,028	21,844	1,994	0,020/0,091	BS	67271CP	H1176/5 STD
TW/A	2	55,820	67,820		2,464		BS	67271BFL	A235/4 STD
TW/A	2	55,820	67,820		2,464		BS	67271BFU	

10 75.00 x 73.00

4K	4 Cyl.		1290cc	41-48kW (56-65PS)		Petrol			TD4950
4K-C	4 Cyl.		1290cc	42-44kW (57-60PS)		Petrol			TD4951
4KJ	4 Cyl.		1290cc	40-46kW (54-63PS)		Petrol			TD9072
BE/PL	8	41,980	45,020	18,900	1,492		AL	64-021-1	71-4261/4 STD
MB/HL 1-5	5	49,974/49,999	54,002/54,028	21,844	1,994	0,020/0,091	BS	67271CP	H1176/5 STD
→08/82									
TW/A	2	55,820	67,820		2,464		BS	67271BFL	A235/4 STD
TW/A	2	55,820	67,820		2,464		BS	67271BFU	

11 75.00 x 73.50

2NZ-FE	4 Cyl.		1299cc	62-66kW (84-90PS)		Petrol			TD13088
BE/PL	8	39,990	43,020	13,600	1,494		AL-LF	64-723-1-1	01-4577/4 STD
MB/HL 1-5	5			16,100	1,996		AL-LF	02-4300	H1128/5 STD
TW/A	2	53,500	70,000		2,480		AL-LF	65-715-1	A276/2 STD

12 75.00 x 75.00

2S	6 Cyl.		1988cc	96kW (131PS)		Petrol			TD3771
BE/PL	8	47,990	51,020	20,400	1,488		AL	64-024-1	01-4144/4 STD
TW/A	2	63,800	76,000		2,490		AL-LF	65-018-1	A229/4 STD
TW/A	2	63,800	76,000		2,490		AL-LF	65-018-2	

13 75.00 x 84.70

1NZ-FE	4 Cyl.		1497cc	76-110kW (103-150PS)		Petrol			TD15499
1NZ-FXE	4 Cyl.		1497cc	53-74kW (72-101PS)		Petrol			TD15589
1NZ-FNE	4 Cyl.		1497cc	68kW (92PS)		Gas			TD25278
BE/PL	8	39,990	43,020	13,600	1,494		AL-LF	64-723-1-1	01-4577/4 STD
MB/HL 1-5	5			16,100	1,996		AL-LF	02-4300	H1128/5 STD
TW/A	2	53,500	70,000		2,480		AL-LF	65-715-1	A276/2 STD

14 76.00 x 71.40

2A	4 Cyl.		1296cc	48kW (65PS)		Petrol			TD3745
BE/PL	8	39,990	43,020	17,100	1,491		AL-LF	64-043-1	01-4117/4 STD 0.25
07/83→									

TOYOTA

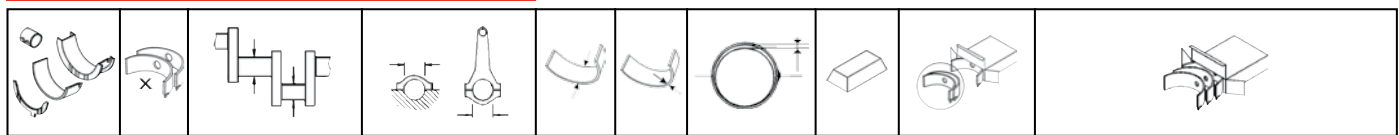

MB/HL 1-5	5	47,980	52,040	19,900	2,005		AL	63-043-1	H1068/5 STD 0.25 0.50
MB/HL 1-5	5	47,980	52,040	19,900	2,005		AL	63-043-2	
01/83 →									
TW/A	2	53,500	66,000		2,490		AL-LF	65-022-1	A186/4 STD
TW/A	2	53,500	66,000		2,490		AL-LF	65-022-2	

15 77.50 x 77.00

3A		4 Cyl.		1452cc	52kW (71PS)		Petrol		TD4942
3A-U		4 Cyl.		1452cc	47-63kW (64-86PS)		Petrol		TD22379
BE/PL	8	39,990	43,020	17,100	1,491		AL-LF	64-043-1	01-4117/4 STD 0.25
07/83 →									
MB/HL 1-5	5	47,980	52,040	19,900	2,005		AL	63-043-1	H1068/5 STD 0.25 0.50
MB/HL 1-5	5	47,980	52,040	19,900	2,005		AL	63-043-2	
01/83 →									
TW/A	2	53,500	66,000		2,490		AL-LF	65-022-1	A186/4 STD
TW/A	2	53,500	66,000		2,490		AL-LF	65-022-2	

16 77.50 x 77.00

3A-C		4 Cyl.		1452cc	46-52kW (63-71PS)		Petrol		TD3788
BE/PL	8	39,990	43,020	17,100	1,491		AL-LF	64-043-1	01-4117/4 STD 0.25
MB/HL 1-5	5	47,980	52,040	19,900	2,005		AL	63-043-1	H1068/5 STD 0.25 0.50
MB/HL 1-5	5	47,980	52,040	19,900	2,005		AL	63-043-2	
TW/A	2	53,500	66,000		2,490		AL-LF	65-022-1	A186/4 STD
TW/A	2	53,500	66,000		2,490		AL-LF	65-022-2	

17 78.00 x 78.00

2R		4 Cyl.		1490cc	51-55kW (70-75PS)		Petrol		TD3769
BE/PL	4	49,985/50,000	53,010/53,030	27,000	1,500	0,020/0,061	AL-LF	GS1971SA	01-4330/4 0.50

18 78.70 x 77.00

5A-FE		4 Cyl.		1497cc	63-105kW (86-143PS)		Petrol		TD20610
BE/PL	8	39,990	43,020	17,100	1,491		AL-LF	64-043-1	01-4117/4 STD 0.25
MB/HL 1-5	5	47,980	52,040	19,900	2,005		AL	63-043-1	H1068/5 STD 0.25 0.50
MB/HL 1-5	5	47,980	52,040	19,900	2,005		AL	63-043-2	
TW/A	2	53,500	66,000		2,490		AL-LF	65-022-1	A186/4 STD
TW/A	2	53,500	66,000		2,490		AL-LF	65-022-2	



19 79.00 x 71.30

4ZZ-FE			4 Cyl.	1398cc	71-74kW (97-101PS)		Petrol		TD14228
BE/PL	4	43,992/44,000	47,000/47,024	15,700	1,494	0,020/0,068	BC	01-3991	01-3991/4 STD
TW/A	2	53,500/53,750	65,750/66,000		2,490		AL	04-3993	A162/2 STD

20 79.00 x 81.50

3ZZ-FE			4 Cyl.	1598cc	80-81kW (109-110PS)		Petrol		TD14229
BE/PL	4	43,992/44,000	47,000/47,024	15,700	1,494	0,020/0,068	BC	01-3991	01-3991/4 STD
TW/A	2	53,500/53,750	65,750/66,000		2,490		AL	04-3993	A162/2 STD

21 79.00 x 91.50

1ZZ-FE			4 Cyl.	1794cc	89-107kW (121-146PS)		Petrol		TD13368
1ZZ-GE			4 Cyl.	1794cc	140kW (190PS)		Petrol		TD22033
BE/PL	8	43,990	47,020	15,700	1,488		AL-LF	64-715-1	01-4894/4 STD
MB/HL 1-5	5	47,990	52,020	17,000	1,997		AL-LF	63-715-1	H1322/5 STD
MB/HL 1-5	5	47,990	52,020	17,000	1,997		AL-LF	63-715-2	
TW/A	2	53,500	70,000		2,480		AL-LF	65-715-1	A276/2 STD

22 80.50 x 78.00

4R			4 Cyl.	1587cc			Petrol		FM1697
9R			4 Cyl.	1599cc			Petrol		FM2137
12R			4 Cyl.	1587cc	49kW (67PS)		Petrol		TD9068
12RJ			4 Cyl.	1587cc	49kW (66PS)		Petrol		TD3705
BE/PL	4	49,985/50,000	53,010/53,030	27,000	1,500	0,020/0,061	AL-LF	GS1971SA	01-4330/4 0.50

23 80.50 x 78.50

1ZR-FAE			4 Cyl.	1598cc	97-132kW (132-180PS)		Petrol		TD21730
1ZR-FE			4 Cyl.	1598cc	90-97kW (122-132PS)		Petrol		TD20925
BE/PL	8	44,010	47,020	14,500	1,493		AL-LF	64-734-1	01-4893/4 STD
MB/HL 1-5	5	47,990	52,020	17,200	1,997		AL-LF	63-734-1	H1321/5 STD
MB/HL 1-5	5	47,990	52,020	17,200	1,997		AL-LF	63-734-2	
TW/A	2	53,500	70,000		2,480		AL-LF	65-715-1	A276/2 STD

24 80.50 x 87.50

7K			4 Cyl.	1781cc	56-61kW (76-83PS)		Petrol		TD24293
7K-E			4 Cyl.	1781cc	56-83kW (76-113PS)		Petrol		TD24294
BE/PL	4	47,990	51,020	17,100	1,490		AL-LF	64-714-1	01-5041/4 STD



25		80.50 x 88.30							
2ZR-FAE		4 Cyl.		1798cc	95-108kW (129-147PS)		Petrol		TD21731
2ZR-FE		4 Cyl.		1798cc	97-111kW (133-151PS)		Petrol		TD19815
2ZR-FXE		4 Cyl.		1798cc	73kW (99PS)		Petrol		TD22621
BE/PL	8	44,010	47,020	14,500	1,493		AL-LF	64-734-1	01-4893/4 STD
MB/HL 1-5	5	47,990	52,020	17,200	1,997		AL-LF	63-734-1	H1321/5 STD
MB/HL 1-5	5	47,990	52,020	17,200	1,997		AL-LF	63-734-2	
TW/A	2	53,500	70,000		2,480		AL-LF	65-715-1	A276/2 STD

26		80.50 x 90.00							
1S		4 Cyl.		1832cc	66kW (90PS)		Petrol		TD15709
1S-EL		4 Cyl.		1832cc	67-74kW (91-101PS)		Petrol		TD3733
1S-L		4 Cyl.		1832cc	66-74kW (90-101PS)		Petrol		TD4932
BE/PL	8	47,990	51,020	20,400	1,488		AL	64-024-1	01-4144/4 STD
TW/A	2	63,800	76,000		2,490		AL-LF	65-018-1	A229/4 STD
TW/A	2	63,800	76,000		2,490		AL-LF	65-018-2	

27		81.00 x 77.00							
4A-C		4 Cyl.		1587cc	52-67kW (71-91PS)		Petrol		TD3814
4A-F		4 Cyl.		1587cc	66-79kW (90-107PS)		Petrol		TD3818
4A-FE		4 Cyl.		1587cc	66-136kW (90-185PS)		Petrol		TD3820
4A-GEC		4 Cyl.		1587cc	84-91kW (113-124PS)		Petrol		TD3826
4A-L		4 Cyl.		1588cc	62-63kW (84-86PS)		Petrol		TD3831
4A-LC		4 Cyl.		1587cc	52-58kW (71-79PS)		Petrol		TD3832
BE/PL	8	39,990	43,020	17,100	1,491		AL-LF	64-043-1	01-4117/4 STD 0.25
MB/HL 1-5	5	47,980	52,040	19,900	2,005		AL	63-043-1	H1068/5 STD 0.25 0.50
MB/HL 1-5	5	47,980	52,040	19,900	2,005		AL	63-043-2	
TW/A	2	53,500	66,000		2,490		AL-LF	65-022-1	A186/4 STD
TW/A	2	53,500	66,000		2,490		AL-LF	65-022-2	

28		81.00 x 77.00							
4A-GE		4 Cyl.		1587cc	85-121kW (116-165PS)		Petrol		TD3824
4A-GEL		4 Cyl.		1587cc	85-92kW (116-125PS)		Petrol		TD3827
4A-GELC		4 Cyl.		1587cc	84-85kW (114-116PS)		Petrol		TD3830
4A-GZE		4 Cyl.		1587cc	96-127kW (131-173PS)		Petrol Compressor		TD19301
MB/HL 1-5	5	47,980	52,040	19,900	2,005		AL	63-043-1	H1068/5 STD 0.25 0.50
MB/HL 1-5	5	47,980	52,040	19,900	2,005		AL	63-043-2	
TW/A	2	53,500	66,000		2,490		AL-LF	65-022-1	A186/4 STD
TW/A	2	53,500	66,000		2,490		AL-LF	65-022-2	



29 81.00 x 85.50

7A-FE		4 Cyl.		1762cc	78-106kW (106-144PS)		Petrol		TD3854
BE/PL	4	47,990	51,020	17,100	1,490		AL-LF	64-714-1	01-5041/4 STD
MB/HL 1-5	5	47,980	52,040	19,900	2,005		AL	63-043-1	H1068/5 STD 0.25 0.50
MB/HL 1-5	5	47,980	52,040	19,900	2,005		AL	63-043-2	
TW/A	2	53,500	66,000		2,490		AL-LF	65-022-1	A186/4 STD
TW/A	2	53,500	66,000		2,490		AL-LF	65-022-2	

30 81.00 x 114.30

4A-G		4 Cyl.		1587cc	86kW (117PS)		Petrol		TD3822
BE/PL	8	39,990	43,020	17,100	1,491		AL-LF	64-043-1	01-4117/4 STD 0.25
MB/HL 1-5	5	47,980	52,040	19,900	2,005		AL	63-043-1	H1068/5 STD 0.25 0.50
MB/HL 1-5	5	47,980	52,040	19,900	2,005		AL	63-043-2	
TW/A	2	53,500	66,000		2,490		AL-LF	65-022-1	A186/4 STD
TW/A	2	53,500	66,000		2,490		AL-LF	65-022-2	

31 83.00 x 85.00

1C		4 Cyl.		1840cc	41-49kW (56-67PS)		Diesel		TD3715
BE/PL	4	50,480/50,495	53,500/53,520	18,897	1,486	0,033/0,093	BS	3935CP	71-4256/4 STD
05/85 → 08/90									

32 83.00 x 85.00

1C-L		4 Cyl.		1839cc	47kW (64PS)		Diesel		TD3716
1C-TL		4 Cyl.		1840cc	54kW (73PS)		Diesel Turbo		TD3717
BE/PL	4	50,480/50,495	53,500/53,520	18,897	1,486	0,033/0,093	BS	3935CP	71-4256/4 STD
05/85 →									

33 84.00 x 90.00

2S-C		4 Cyl.		1995cc	70-73kW (95-99PS)		Petrol		TD3772
2S-E		4 Cyl.		1995cc	73kW (99PS)		Petrol		TD5192
2S-EL		4 Cyl.		1995cc	79kW (107PS)		Petrol		TD4939
2S-ELC		4 Cyl.		1995cc	71-73kW (97-99PS)		Petrol		TD3775
BE/PL	8	47,990	51,020	20,400	1,488		AL	64-024-1	01-4144/4 STD
TW/A	2	63,800	76,000		2,490		AL-LF	65-018-1	A229/4 STD
TW/A	2	63,800	76,000		2,490		AL-LF	65-018-2	



34		85.00 x 70.00									
2T		4 Cyl.		1588cc	54-66kW (73-90PS)			Petrol		TD4940	
2TB		4 Cyl.		1588cc	55-63kW (75-86PS)			Petrol		TD4941	
2T-G		4 Cyl.		1588cc	79-81kW (107-110PS)			Petrol		TD3778	
2TJ		4 Cyl.		1588cc	58-62kW (79-84PS)			Petrol		TD9073	
MB/HL 1-5	10	57,980	62,020	20,930	2,004		BS	63-018-1	H1148/5 STD 0.25		
TW/A	2	63,800	76,000		2,490		AL-LF	65-018-1	A229/4 STD		
TW/A	2	63,800	76,000		2,490		AL-LF	65-018-2			

35		85.00 x 78.00									
3T		4 Cyl.		1770cc	57-63kW (78-86PS)			Petrol		TD4946	
13T-U		4 Cyl.		1770cc	70-71kW (95-97PS)			Petrol		TD9074	
MB/HL 1-5	10	57,980	62,020	20,930	2,004		BS	63-018-1	H1148/5 STD 0.25		
TW/A	2	63,800	76,000		2,490		AL-LF	65-018-1	A229/4 STD		
TW/A	2	63,800	76,000		2,490		AL-LF	65-018-2			

36		86.00 x 85.00									
2C		4 Cyl.		1975cc	49-56kW (67-76PS)			Diesel		TD3747	
2C-L		4 Cyl.		1975cc	50-54kW (68-73PS)			Diesel		TD3748	
2C-T		4 Cyl.		1975cc	61-67kW (83-91PS)			Diesel Turbo		TD3749	
BE/PL	4	50,480/50,495	53,500/53,520	18,897	1,486	0,033/0,093	BS	3935CP	71-4256/4 STD		
05/85 → 08/90											

37		86.00 x 85.00									
2C-TL		4 Cyl.		1974cc	63kW (86PS)			Diesel Turbo		TD3750	
BE/PL	4	50,480/50,495	53,500/53,520	18,897	1,486	0,033/0,093	BS	3935CP	71-4256/4 STD		

38		86.00 x 86.00									
1TR-FE		4 Cyl.		1998cc	98-100kW (133-136PS)			Petrol		TD20611	
BE/PL	4			15,500	1,496		BS	GS6061LC	71-4564/4 STD 0.25 0.50		
MB/HL	5			21,050	1,996		AL-LF	GS6072SA	H1244/5 STD 0.25 0.50		
TW/A	2	65,000	81,000		2,490		AL-LF	65-729-1	A306/4 STD		
TW/A	2	65,000	81,000		2,490		AL-LF	65-729-2			

39		90.00 x 86.00									
L		4 Cyl.		2188cc	46-53kW (63-72PS)			Diesel		TD4955	
BE/PL	4	52,979/52,999	56,004/56,019	26,009	1,486	0,033/0,093	AL	3920RA	01-4345/4 STD 0.25		
→01/82											
BE/PL	8	52,990	56,020	26,000	1,486	0,093	AL	64-037-1	71-4145/4 STD 0.25 0.50		
02/82 →											



MB/HL 1-5	5	61,981/61,998	66,004/66,019	27,609	1,984	0,039/0,096	AL	3922RA	H1061/5 STD 0.25 0.50
04/83 →									
TW/A	2	70,000	81,800		2,480		AL-LF	65-037-1	A185/4 STD
TW/A	2	70,000	81,800		2,480		AL-LF	65-037-2	
SE/PB	1	27,000	30,030	31,000			BS	67-032-1S	55-4269 SEMI

40
92.00 x 92.00

2L			4 Cyl.	2446cc	53-63kW (72-86PS)			Diesel		TD4938
BE/PL	8	52,990		56,020	26,000	1,486	0,093	AL	64-037-1	71-4145/4 STD 0.25 0.50
MB/HL 1-5	5	61,981/61,998	66,004/66,019	27,609	1,984	0,039/0,096	AL	3922RA	H1061/5 STD 0.25 0.50	
TW/A	2	70,000	81,800		2,480		AL-LF	65-037-1	A185/4 STD	
TW/A	2	70,000	81,800		2,480		AL-LF	65-037-2		
SE/PB	1	27,000	30,030	31,000			BS	67-032-1S	55-4269 SEMI	

41
92.00 x 92.00

2L-T			4 Cyl.	2446cc	63-92kW (85-125PS)			Diesel Turbo		TD3767
2L-TE			4 Cyl.	2446cc	66-71kW (90-97PS)			Diesel Turbo		TD24627
2L-TII			4 Cyl.	2446cc	60-71kW (82-97PS)			Diesel Turbo		TD21259
BE/PL	8	54,980		58,020	26,000	1,486		AL	64-039-1	01-4146/4 STD 0.25 0.50 0.75
MB/HL 1-5	5	61,981/61,998	66,004/66,019	27,609	1,984	0,039/0,096	AL	3922RA	H1061/5 STD 0.25 0.50	
TW/A	2	70,000	81,800		2,480		AL-LF	65-037-1	A185/4 STD	
TW/A	2	70,000	81,800		2,480		AL-LF	65-037-2		

42
92.00 x 93.80

2KD-FTV			4 Cyl.	2494cc	65-106kW (88-144PS)			Diesel Turbo Intercooler		TD16332
BE/PL	4	58,985/59,000	62,030	24,590	1,500			BS	GS70860LC	71-4565/4 STD 0.25 0.50
MB/HL	5	69,980/70,000	75,000/75,020	23,750	2,492	0,016/0,068	AL-LF	GS70859SA	H1237/5 STD 0.25 0.50	
TW/A	2	79,950	90,700		2,480		AL-LF	65-720-1	A275/4 STD	
TW/A	2	79,950	90,700		2,480		AL-LF	65-720-2		

43
94.00 x 100.00

1HD-FT			6 Cyl.	4164cc	122-125kW (166-170PS)			Diesel Turbo		TD5193
1HD-T			6 Cyl.	4164cc	118-123kW (160-167PS)			Diesel Turbo		TD3725
1H-Z			6 Cyl.	4164cc	59-123kW (80-167PS)			Diesel		TD3726
BE/PL	12	58,980	62,030	23,600	1,487			AL	64-706-1	71-4376/6 STD

44
95.00 x 95.00

2TR-FE			4 Cyl.	2694cc	106-122kW (144-166PS)			Petrol		TD19298
BE/PL	4			15,500	1,496			BS	GS6061LC	71-4564/4 STD 0.25 0.50

TOYOTA

MB/HL	5			21,050	1,996		AL-LF	GS6072SA	H1244/5 STD 0.25 0.50				
TW/A	2	65,000	81,000		2,490		AL-LF	65-729-1	A306/4 STD				
TW/A	2	65,000	81,000		2,490		AL-LF	65-729-2					

45 95.00 x 105.00

11B			4 Cyl.	2986cc	61-75kW (83-102PS)		Diesel		TD3703				
BE/PL	4	60,980	64,020	30,000	1,490		AL	64-040-1	01-4346/4 STD 0.25				
→08/88													
MB/HL 1-5	5	69,979/69,999	75,003/75,018	26,898	2,489	0,026/0,086	AL	1153RA	H1125/5 STD				
04/84 →													
TW/A	2	76,000	90,700				AL-LF	65-040-1	A172/4 STD				
TW/A	2	76,000	90,700		2,480		AL-LF	65-040-2					
04/84 →													

46 95.00 x 105.00

B			4 Cyl.	2977cc	59-63kW (80-86PS)		Diesel		TD9039				
BE/PL	8	58,980	62,020	30,000	1,490		AL	64-035-1	71-4342/4 STD 0.25				
MB/HL 1-5	5	69,979/69,999	75,003/75,018	26,898	2,489	0,026/0,086	AL	1153RA	H1125/5 STD				
04/84 →													
TW/A	2	76,000	90,700				AL-LF	65-040-1	A172/4 STD				
TW/A	2	76,000	90,700		2,480		AL-LF	65-040-2					
04/84 →													

47 96.00 x 96.00

3L			4 Cyl.	2779cc	58-66kW (79-90PS)		Diesel		TD3796				
BE/PL	8	54,980	58,020	26,000	1,486		AL	64-039-1	01-4146/4 STD 0.25 0.50 0.75				
MB/HL 1-5	5	61,981/61,998	66,004/66,019	27,609	1,984	0,039/0,096	AL	3922RA	H1061/5 STD 0.25 0.50				
TW/A	2	70,000	81,800		2,480		AL-LF	65-037-1	A185/4 STD				
TW/A	2	70,000	81,800		2,480		AL-LF	65-037-2					

48 96.00 x 103.00

1KD-FTV			4 Cyl.	2982cc	75-140kW (102-190PS)		Diesel Turbo Intercooler		TD15208				
1KZ-T			4 Cyl.	2982cc	87-92kW (118-125PS)		Diesel Turbo		TD3728				
1KZ-TE			4 Cyl.	2982cc	85-103kW (116-140PS)		Diesel Turbo		TD9479				
BE/PL	4	58,985/59,000	62,030	24,590	1,500		BS	GS70860LC	71-4565/4 STD 0.25 0.50				
MB/HL 1-5	5	69,980/70,000	75,000/75,020	23,750	2,492	0,016/0,068	AL-LF	GS70859SA	H1237/5 STD 0.25 0.50				
TW/A	2	79,950	90,700		2,480		AL-LF	65-720-1	A275/4 STD				
TW/A	2	79,950	90,700		2,480		AL-LF	65-720-2					



49 98.00 x 105.00

2B	4 Cyl.			3197cc	56-72kW (76-98PS)		Diesel		TD22034
BE/PL	8	58,980	62,020	30,000	1,490		AL	64-035-1	71-4342/4 STD 0.25

50 99.50 x 96.00

5L	4 Cyl.			2986cc	65-67kW (88-91PS)		Diesel		TD18745
BE/PL	8	54,980	58,020	26,000	1,486		AL	64-039-1	01-4146/4 STD 0.25 0.50 0.75
MB/HL 1-5	5	61,981/61,998	66,004/66,019	27,609	1,984	0,039/0,096	AL	3922RA	H1061/5 STD 0.25 0.50
TW/A	2	70,000	81,800		2,480		AL-LF	65-037-1	A185/4 STD
TW/A	2	70,000	81,800		2,480		AL-LF	65-037-2	

51 102.00 x 105.00

3B	4 Cyl.			3432cc	66-72kW (90-98PS)		Diesel		TD3789
BE/PL	4	60,980	64,020	30,000	1,490		AL	64-040-1	01-4346/4 STD 0.25
→08/88									
MB/HL 1-5	5	69,979/69,999	75,003/75,018	26,898	2,489	0,026/0,086	AL	1153RA	H1125/5 STD
09/84→08/88									
MB/HL 1-5	5	69,980/70,000	75,000/75,024	26,900	2,490	0,020/0,090	BS	GS70571SA	H1193/5 0.25
09/88→									
TW/A	2	76,000	90,700				AL-LF	65-040-1	A172/4 STD
TW/A	2	76,000	90,700		2,480		AL-LF	65-040-2	

52 102.00 x 105.00

13B	4 Cyl.			3431cc	66kW (90PS)		Diesel		TD3706
BE/PL	4	60,980	64,020	30,000	1,490		AL	64-040-1	01-4346/4 STD 0.25
MB/HL 1-5	5	69,979/69,999	75,003/75,018	26,898	2,489	0,026/0,086	AL	1153RA	H1125/5 STD
04/84→									
TW/A	2	76,000	90,700				AL-LF	65-040-1	A172/4 STD
TW/A	2	76,000	90,700		2,480		AL-LF	65-040-2	

53 102.00 x 105.00

13BT	4 Cyl.			3431cc	91kW (124PS)		Diesel		TD3707
BE/PL	4	60,980	64,020	30,000	1,490		AL	64-040-1	01-4346/4 STD 0.25
MB/HL 1-5	5	69,979/69,999	75,003/75,018	26,898	2,489	0,026/0,086	AL	1153RA	H1125/5 STD
TW/A	2	76,000	90,700				AL-LF	65-040-1	A172/4 STD
TW/A	2	76,000	90,700		2,480		AL-LF	65-040-2	



54		102.00 x 112.00							
14B		4 Cyl.		3661cc	71-89kW (97-121PS)		Diesel		TD3708
MB/HL 1-5	5	69,980/70,000	75,000/75,024	26,900	2,490	0,020/0,090	BS	GS70571SA	H1193/5 0.25
TW/A	2	76,000	90,700				AL-LF	65-040-1	A172/4 STD
TW/A	2	76,000	90,700		2,480		AL-LF	65-040-2	





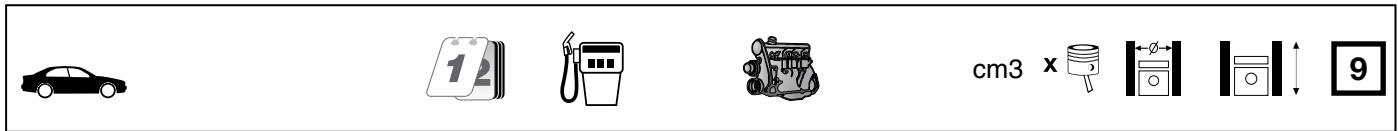

55		104.00 x 118.00							
1W		4 Cyl.		4009cc	85kW (116PS)		Diesel		TD3738
MB/HL 1-5	10	72,940	78,000	25,130	2,493		BS	63-216-1	H1246/5 STD 0.50

56		104.00 x 118.00							
N04C-UH			4 Cyl.	4009cc	110kW (150PS)		Diesel Turbo Intercooler		TD24620
N04C-UL			4 Cyl.	4009cc	110kW (150PS)		Diesel Turbo Intercooler		TD26170
N04C-UM			4 Cyl.	4009cc	85kW (116PS)		Diesel Turbo Intercooler		TD26171
N04C-UN			4 Cyl.	4009cc	100kW (136PS)		Diesel Turbo Intercooler		TD26172
N04C-UP			4 Cyl.	4009cc	110kW (150PS)		Diesel Turbo Intercooler		TD26173
N04C-UQ			4 Cyl.	4009cc	132kW (180PS)		Diesel Turbo Intercooler		TD26174
N04C-VF			4 Cyl.	4009cc	132kW (180PS)		Diesel Turbo Intercooler		TD27475
W04D-TP			4 Cyl.	4009cc	81kW (110PS)		Diesel Turbo Intercooler		TD28306
W04D-TR			4 Cyl.	4009cc	96kW (130PS)		Diesel Turbo Intercooler		TD28305
MB/HL 1-5	10	72,940	78,000	25,130	2,493		BS	63-216-1	H1246/5 STD 0.50
TW/A	2	82,000	98,900		2,500		BS	65-216-1	A303/4 STD
TW/A	2	82,000	98,900		2,500		BS	65-216-2	
SE/PB	1	34,990	39,030	29,800	1,992		BS	67-216-1	55-4886 STD
CB/NWB 1	1	56,950	60,030	27,000			BB	62-216-1	N203/3 STD
CB/NWB 2	1	56,750	59,830	27,000			BB	62-216-2	
CB/NWB 3	1	56,550	59,630	27,000			BB	62-216-3	

57		105.40 x 105.00							
14BT		4 Cyl.		3661cc	75kW (102PS)		Diesel Turbo		TD3709
MB/HL 1-5	5	69,980/70,000	75,000/75,024	26,900	2,490	0,020/0,090	BS	GS70571SA	H1193/5 0.25
TW/A	2	76,000	90,700				AL-LF	65-040-1	A172/4 STD
TW/A	2	76,000	90,700		2,480		AL-LF	65-040-2	



2.5 PI I 2.5	01/68→12/75	Petrol	25PI	2498	6	74.60	95.20	4
1500 1.5	01/72→12/74	Petrol	1EH	1493	4	73.70	87.50	3
1500 1.5	10/70→12/74	Petrol	1EL	1493	4	73.70	87.50	3
1500 1.5 TC	04/75→12/77	Petrol	1E	1493	4	73.70	87.50	3
2000	01/65→12/70	Petrol	KC	1998	6	74.70	76.00	5
2000 II	01/70→12/77	Petrol	KC	1998	6	74.70	76.00	5
2000 II, 2000TC II	10/69→12/77	Petrol	KC	1998	6	74.70	76.00	5
Acclaim 1.3	01/82→12/85	Petrol	EJ	1335	4	72.00	82.00	1
GT6 I	01/66→12/68	Petrol	KE1L	1998	6	74.70	76.00	5
GT6 II	12/68→12/70	Petrol	KE1L	1998	6	74.70	76.00	5
GT6 II	12/68→12/70	Petrol	KE2L	1998	6	74.70	76.00	5
GT6 III	12/71→12/73	Petrol	KE2L	1998	6	74.70	76.00	5
GT6 I, Vitesse I 2.0	01/66→12/68	Petrol	KC	1998	6	74.70	76.00	5
GT6 III	01/66→12/73	Petrol	KC	1998	6	74.70	76.00	5
Spitfire 1.3 MK III	12/67→12/70	Petrol	FM3	1296	4	73.70	76.00	2
Spitfire 1.3 MK IV	01/71→12/72	Petrol	FM3	1296	4	73.70	76.00	2
Spitfire 1500	01/75→01/80	Petrol	FM11	1493	4	73.70	87.50	3
Tea Tractor	01/47→	Diesel	1849CC	1849	4	80.00	92.00	7
TR 2 2.0	01/53→12/55	Petrol	HCL	1991	4	83.00	92.00	8
TR 3 2.0	12/55→12/57	Petrol	HCL	1991	4	83.00	92.00	8
TR 3A 2.2	01/59→12/61	Petrol	HE0H	2138	4	86.00	92.00	9
TR 4A 2.2	12/65→12/67	Petrol	HE0H	2138	4	86.00	92.00	9
TR 6 2.5	01/72→12/76	Petrol	CF1	2498	6	74.70	95.00	6
TR 6 2.5	03/69→01/74	Petrol	CR1H	2498	6	74.70	95.00	6
TR8	01/77→12/81	Petrol	KC	1998	6	74.70	76.00	5
Vitesse 2.0	12/68→12/71	Petrol	HB1HE	1998	6	74.70	76.00	5
Vitesse 2.0	01/67→12/75	Petrol	HB1LE	1998	6	74.70	76.00	5
Vitesse 2.0 II	01/68→12/71	Petrol	KC	1998	6	74.70	76.00	5

		cm ³	x 			
--	---	-----------------	---	---	---	---

1E	Petrol	1493	4	73.70	87.50	3
1EH	Petrol	1493	4	73.70	87.50	3
1EL	Petrol	1493	4	73.70	87.50	3
25PI	Petrol	2498	6	74.60	95.20	4
1849CC	Diesel	1849	4	80.00	92.00	7
CF1	Petrol	2498	6	74.70	95.00	6
CR1H	Petrol	2498	6	74.70	95.00	6
EJ	Petrol	1335	4	72.00	82.00	1
EN4	Petrol	1335	4	72.00	82.00	1
FM3	Petrol	1296	4	73.70	76.00	2
FM11	Petrol	1493	4	73.70	87.50	3
HB1HE	Petrol	1998	6	74.70	76.00	5
HB1LE	Petrol	1998	6	74.70	76.00	5
HCL	Petrol	1991	4	83.00	92.00	8
HE0H	Petrol	2138	4	86.00	92.00	9
KC	Petrol	1998	6	74.70	76.00	5
KE1L	Petrol	1998	6	74.70	76.00	5
KE2L	Petrol	1998	6	74.70	76.00	5

1 72.00 x 82.00

EJ			4 Cyl.	1335cc	51kW (70PS)		Petrol		TD5249
EN4			4 Cyl.	1335cc	52kW (71PS)		Petrol		TD20146
BE/PL	4	39,977/39,999	42,999/43,025	17,500	1,490	0,020/0,071	BS	GS700LC	71-4339/4 0.25 0.50

2 73.70 x 76.00

FM3			4 Cyl.	1296cc	48-55kW (65-76PS)		Petrol		TD18386
BE/PL	1	47,625/47,638	51,333/51,346	17,580	1,830	0,012/0,051	AL-LF	GS2022SA	01-4335 STD 0.25 0.50
01/70→									
MB/HL	1	58,699/58,712	62,408/62,421	21,720	1,830	0,013/0,055	AL-LF	GS2020SA	02-4551 STD 0.25 0.50
01/70→									

3 73.70 x 87.50

1E			4 Cyl.	1493cc	53kW (72PS)		Petrol		TD24557
1EH			4 Cyl.	1493cc	49kW (67PS)		Petrol		TD24560
1EL			4 Cyl.	1493cc	42kW (57PS)		Petrol		TD24559
FM11			4 Cyl.	1493cc	40-52kW (54-71PS)		Petrol		TD18387
BE/PL	1	47,625/47,638	51,333/51,346	17,580	1,830	0,012/0,051	AL-LF	GS2022SA	01-4335 STD 0.25 0.50
MB/HL	1	58,699/58,712	62,408/62,421	21,720	1,830	0,013/0,055	AL-LF	GS2020SA	02-4551 STD 0.25 0.50

4 74.60 x 95.20

25PI			6 Cyl.	2498cc	90-100kW (122-136PS)		Petrol		TD18389
BE/PL	1	47,625/47,638	51,333/51,346	17,580	1,830	0,012/0,051	AL-LF	GS2022SA	01-4335 STD 0.25 0.50
MB/HL	1	58,699/58,712	62,408/62,421	21,720	1,830	0,013/0,055	AL-LF	GS2020SA	02-4551 STD 0.25 0.50

5 74.70 x 76.00

HB1HE			6 Cyl.	1998cc	77kW (105PS)		Petrol		TD24556
HB1LE			6 Cyl.	1998cc	70kW (95PS)		Petrol		TD24555
KC			6 Cyl.	1998cc			Petrol		FM1728
KE1L			6 Cyl.	1998cc	70-77kW (95-105PS)		Petrol		TD24550
KE2L			6 Cyl.	1998cc	71-77kW (97-105PS)		Petrol		TD24551
BE/PL	1	47,625/47,638	51,333/51,346	17,580	1,830	0,012/0,051	AL-LF	GS2022SA	01-4335 STD 0.25 0.50
MB/HL	1	58,699/58,712	62,408/62,421	21,720	1,830	0,013/0,055	AL-LF	GS2020SA	02-4551 STD 0.25 0.50



6 74.70 x 95.00

CF1			6 Cyl.	2498cc	83-90kW (113-122PS)		Petrol		TD18385
CR1H			6 Cyl.	2498cc	121kW (165PS)		Petrol		TD24552
BE/PL	1	47,625/47,638	51,333/51,346	17,580	1,830	0,012/0,051	AL-LF	GS2022SA	01-4335 STD 0.25 0.50
MB/HL	1	58,699/58,712	62,408/62,421	21,720	1,830	0,013/0,055	AL-LF	GS2020SA	02-4551 STD 0.25 0.50

7 80.00 x 92.00

1849CC			4 Cyl.	1849cc			Diesel		FM504
BE/PL	4	52,984/53,000	56,711/56,731	24,770	1,830	0,051/0,087	AL-LF	GS6832SA	01-4315/4 STD 0.25

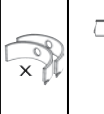
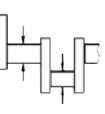
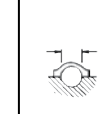
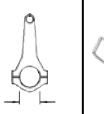
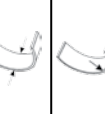
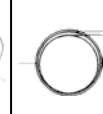
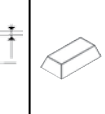
TRIUMPH

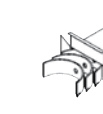
										
TW/A	2	52,500	64,500		2,490		AL-LF	65-025-1	A175/4 STD	
TW/A	2	52,500	64,500		2,490		AL-LF	65-025-2		

8







83.00 x 92.00

HCL			4 Cyl.	1991cc	66-70kW (90-95PS)			Petrol		TD24553
BE/PL	4	52,984/53,000	56,711/56,731	24,770	1,830	0,051/0,087	AL-LF	GS6832SA	01-4315/4 STD 0.25	
MB/HL 1-3	3	62,967/62,979	66,675/66,688	38,230	1,830	0,038/0,063	AL-LF	GS6831SA	H1186/3 STD 0.25	

9

86.00 x 92.00

HE0H			4 Cyl.	2138cc	74-76kW (101-103PS)			Petrol		TD24554
BE/PL	4	52,984/53,000	56,711/56,731	24,770	1,830	0,051/0,087	AL-LF	GS6832SA	01-4315/4 STD 0.25	
MB/HL 1-3	3	62,967/62,979	66,675/66,688	38,230	1,830	0,038/0,063	AL-LF	GS6831SA	H1186/3 STD 0.25	

		cm3	x 			
192A	Diesel	508	1	92.00	90.00	3
292A	Diesel	1196	2	92.00	90.00	4
392 A	Diesel	1794	3	92.00	90.00	5
394 H/HT	Diesel	2082	3	94.00	100.00	12
425 OHV Euro 2	Diesel	2499	4	92.00	94.00	8
492A	Diesel	2392	4	92.00	90.00	6
494 H/HT	Diesel	2776	4	94.00	100.00	13
531 OHV	Diesel	3125	5	92.00	94.00	9
638 OHV	Diesel	3749	6	92.00	94.00	10
692 A	Diesel	3588	6	92.00	90.00	7
HR694	Diesel	4164	6	94.00	100.00	14
R 425 DOHC	Diesel	2499	4	92.00	94.00	8
R 425 OHV	Diesel	2499	4	92.00	94.00	8
R 428 DOHC Euro 4	Diesel	2776	4	94.00	100.00	13
R 531 OHV	Diesel	3125	5	92.00	94.00	9
R 638 OHV Euro 2	Diesel	3749	6	92.00	94.00	10
RA 428 DOHC Euro 4	Diesel	2776	4	94.00	100.00	13
VM 66 A	Diesel	2494	5	88.00	82.00	2
VM 80 A	Diesel	1995	4	88.00	82.00	1
VM 81 A	Diesel	2393	4	92.00	90.00	6
VM 84 A	Diesel	2499	4	92.00	94.00	8
VM-425HLT	Diesel	2500	4	93.00	92.00	11
VM-425 SLIER	Diesel	2500	4	92.00	94.00	8

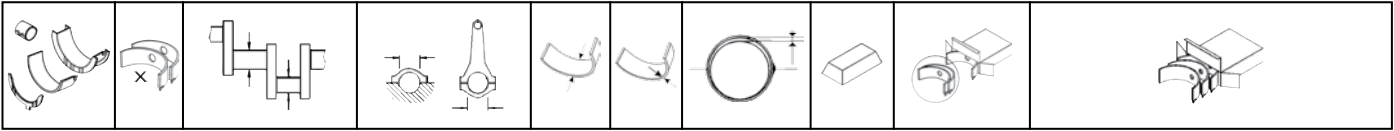

1										88.00 x 82.00									
VM 80 A		4 Cyl.				1995cc		70-78kW (95-106PS)			Diesel Turbo			TD21355					
BE/PL	1	53,940/53,955	57,563/57,582	23,250	1,798	0,020/0,071	BS	66655CP	71-4234 STD 0.25 0.50 0.75										
TW/A	2	74,250/74,500	88,000/88,100		2,362		AL-LF	61588AF	A227/2 STD										
SE/PB	1	29,990/29,996	34,000/34,025	30,120			BS	66659XA	55-4235 SEMI										

2										88.00 x 82.00									
VM 66 A		5 Cyl.				2494cc		105-108kW (143-147PS)			Diesel Turbo			TD23796					
BE/PL	1	53,940/53,955	57,563/57,582	23,250	1,798	0,020/0,071	BS	66655CP	71-4234 STD 0.25 0.50 0.75										
TW/A	2	74,250/74,500	88,000/88,100		2,362		AL-LF	61588AF	A227/2 STD										
SE/PB	1	29,990/29,996	34,000/34,025	30,120			BS	66659XA	55-4235 SEMI										

3										92.00 x 90.00									
192A		1 Cyl.				508cc					Diesel			FM4206					
BE/PL	1	53,940/53,955	57,563/57,582	23,250	1,798	0,020/0,071	BS	66655CP	71-4234 STD 0.25 0.50 0.75										
TW/A	2	74,250/74,500	88,000/88,100		2,362		AL-LF	61588AF	A227/2 STD										
SE/PB	1	29,990/29,996	34,000/34,025	30,120			BS	66659XA	55-4235 SEMI										

4										92.00 x 90.00									
292A		2 Cyl.				1196cc					Diesel			FM4207					
BE/PL	1	53,940/53,955	57,563/57,582	23,250	1,798	0,020/0,071	BS	66655CP	71-4234 STD 0.25 0.50 0.75										
TW/A	2	74,250/74,500	88,000/88,100		2,362		AL-LF	61588AF	A227/2 STD										
SE/PB	1	29,990/29,996	34,000/34,025	30,120			BS	66659XA	55-4235 SEMI										

5										92.00 x 90.00									
392 A		3 Cyl.				1794cc					Diesel			FM4208					
BE/PL	1	53,940/53,955	57,563/57,582	23,250	1,798	0,020/0,071	BS	66655CP	71-4234 STD 0.25 0.50 0.75										
TW/A	2	74,250/74,500	88,000/88,100		2,362		AL-LF	61588AF	A227/2 STD										
SE/PB	1	29,990/29,996	34,000/34,025	30,120			BS	66659XA	55-4235 SEMI										

6										92.00 x 90.00									
492A		4 Cyl.				2392cc		71kW (96PS)			Diesel			FM4210					
VM 81 A		4 Cyl.				2393cc		81kW (110PS)			Diesel Turbo			TD21356					
BE/PL	1	53,940/53,955	57,563/57,582	23,250	1,798	0,020/0,071	BS	66655CP	71-4234 STD 0.25 0.50 0.75										
TW/A	2	74,250/74,500	88,000/88,100		2,362		AL-LF	61588AF	A227/2 STD										
SE/PB	1	29,990/29,996	34,000/34,025	30,120			BS	66659XA	55-4235 SEMI										

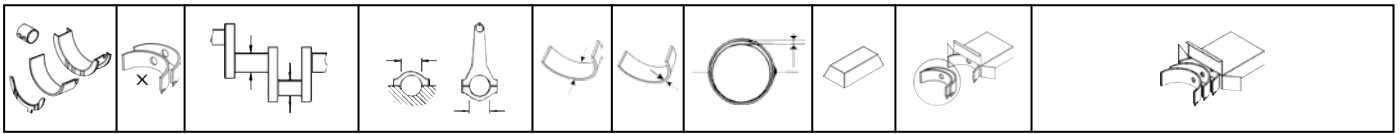

7 92.00 x 90.00										
692 A			6 Cyl.		3588cc		Diesel			FM4212
BE/PL	1	53,940/53,955	57,563/57,582	23,250	1,798	0,020/0,071	BS	66655CP	71-4234 STD 0.25 0.50 0.75	
TW/A	2	74,250/74,500	88,000/88,100		2,362		AL-LF	61588AF	A227/2 STD	
SE/PB	1	29,990/29,996	34,000/34,025	30,120			BS	66659XA	55-4235 SEMI	

8 92.00 x 94.00											
425 OHV Euro 2			4 Cyl.		2499cc		85kW (116PS)		Diesel Turbo Intercooler		TD18624
R 425 DOHC			4 Cyl.		2499cc		105-125kW (143-170PS)		Diesel Turbo Intercooler		TD18633
R 425 OHV			4 Cyl.		2499cc		87kW (118PS)		Diesel Turbo Intercooler		TD18627
VM 84 A			4 Cyl.		2499cc		84-86kW (114-117PS)		Diesel Turbo Intercooler		TD23797
VM-425 SLIER			4 Cyl.		2500cc		87-92kW (118-125PS)		Diesel Turbo Intercooler		TD29206
BE/PL	1	53,940/53,955	57,563/57,582	23,250	1,798	0,020/0,071	BS	66655CP	71-4234 STD 0.25 0.50 0.75		
TW/A	2	74,250/74,500	88,000/88,100		2,362		AL-LF	61588AF	A227/2 STD		
SE/PB	1	29,990/29,996	34,000/34,025	30,120			BS	66659XA	55-4235 SEMI		

9 92.00 x 94.00											
531 OHV			5 Cyl.		3125cc		103kW (140PS)		Diesel Turbo Intercooler		TD18625
R 531 OHV			5 Cyl.		3125cc		110kW (150PS)		Diesel Turbo Intercooler		TD18628
BE/PL	1	53,940/53,955	57,563/57,582	23,250	1,798	0,020/0,071	BS	66655CP	71-4234 STD 0.25 0.50 0.75		
TW/A	2	74,250/74,500	88,000/88,100		2,362		AL-LF	61588AF	A227/2 STD		
SE/PB	1	29,990/29,996	34,000/34,025	30,120			BS	66659XA	55-4235 SEMI		

10 92.00 x 94.00											
638 OHV			6 Cyl.		3749cc		118kW (160PS)		Diesel Turbo Intercooler		TD18626
R 638 OHV Euro 2			6 Cyl.		3749cc		125kW (170PS)		Diesel Turbo Intercooler		TD18629
BE/PL	1	53,940/53,955	57,563/57,582	23,250	1,798	0,020/0,071	BS	66655CP	71-4234 STD 0.25 0.50 0.75		
TW/A	2	74,250/74,500	88,000/88,100		2,362		AL-LF	61588AF	A227/2 STD		
SE/PB	1	29,990/29,996	34,000/34,025	30,120			BS	66659XA	55-4235 SEMI		

11 93.00 x 92.00											
VM-425HLT			4 Cyl.		2500cc		74kW (101PS)		Diesel		TD12388
BE/PL	1	53,940/53,955	57,563/57,582	23,250	1,798	0,020/0,071	BS	66655CP	71-4234 STD 0.25 0.50 0.75		
TW/A	2	74,250/74,500	88,000/88,100		2,362		AL-LF	61588AF	A227/2 STD		
SE/PB	1	29,990/29,996	34,000/34,025	30,120			BS	66659XA	55-4235 SEMI		

12 94.00 x 100.00										
394 H/HT			3 Cyl.		2082cc		Diesel			FM4209
BE/PL	1	53,940/53,955	57,563/57,582	23,250	1,798	0,020/0,071	BS	66655CP	71-4234 STD 0.25 0.50 0.75	
TW/A	2	74,250/74,500	88,000/88,100		2,362		AL-LF	61588AF	A227/2 STD	

SE/PB	1	29,990/29,996	34,000/34,025	30,120			BS	66659XA	55-4235 SEMI

13 94.00 x 100.00

494 H/HT		4 Cyl.		2776cc		Diesel		FM4211		
R 428 DOHC Euro 4		4 Cyl.		2776cc		120kW (163PS)		Diesel Turbo Intercooler		TD18634
RA 428 DOHC Euro 4		4 Cyl.		2776cc		130kW (163PS)		Diesel Turbo Intercooler		TD20176
BE/PL	1	53,940/53,955	57,563/57,582	23,250	1,798	0,020/0,071	BS	66655CP	71-4234 STD 0.25 0.50 0.75	
TW/A	2	74,250/74,500	88,000/88,100		2,362		AL-LF	61588AF	A227/2 STD	
SE/PB	1	29,990/29,996	34,000/34,025	30,120			BS	66659XA	55-4235 SEMI	

14 94.00 x 100.00

HR694		6 Cyl.		4164cc		Diesel Turbo		FM4213	
BE/PL	1	53,940/53,955	57,563/57,582	23,250	1,798	0,020/0,071	BS	66655CP	71-4234 STD 0.25 0.50 0.75
TW/A	2	74,250/74,500	88,000/88,100		2,362		AL-LF	61588AF	A227/2 STD
SE/PB	1	29,990/29,996	34,000/34,025	30,120			BS	66659XA	55-4235 SEMI

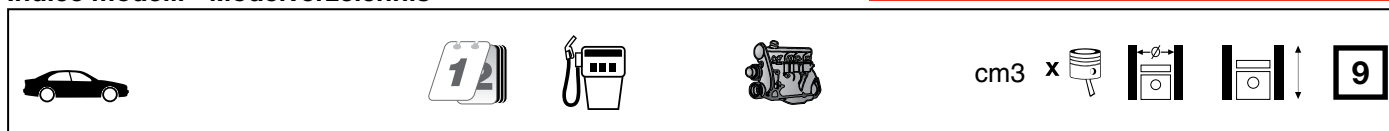

181 1.5	09/69→07/70	Petrol	H	1493	4	83.00	69.00	155
181 1.6	09/72→12/74	Petrol	AH	1584	4	85.50	69.00	160
181 1.6	03/73→02/79	Petrol	AL	1584	4	85.50	69.00	160
181 1.6	03/73→02/79	Petrol	AM	1584	4	85.50	69.00	160
1500,1600 1.6	08/65→07/73	Petrol	U	1584	4	85.50	69.00	160
1500,1600 1.6 L	07/64→07/73	Petrol	P	1584	4	85.50	69.00	161
1500,1600 1.6 L	08/65→07/73	Petrol	U	1584	4	85.50	69.00	160
1500,1600 1.6 TL	08/65→07/73	Petrol	U	1584	4	85.50	69.00	160
Amarok 2.0 BiTDI	09/10→	Diesel	CDCA	1968	4	81.00	95.50	134
Amarok 2.0 BiTDI	11/11→	Diesel	CNEA	1968	4	81.00	95.50	134
Amarok 2.0 BiTDI	11/11→	Diesel	CSHA	1968	4	81.00	95.50	134
Amarok 2.0 BiTDI 4motion	09/10→	Diesel	CDCA	1968	4	81.00	95.50	134
Amarok 2.0 BiTDI 4motion	11/11→	Diesel	CNEA	1968	4	81.00	95.50	134
Amarok 2.0 BiTDI 4motion	11/11→	Diesel	CSHA	1968	4	81.00	95.50	134
Amarok 2.0 TDI	09/10→	Diesel	CDBA	1968	4	81.00	95.50	134
Amarok 2.0 TDI	09/11→	Diesel	CDCA	1968	4	81.00	95.50	134
Amarok 2.0 TDI	09/11→	Diesel	CNEA	1968	4	81.00	95.50	134
Amarok 2.0 TDI	09/10→	Diesel	CNFA	1968	4	81.00	95.50	134
Amarok 2.0 TDI	09/11→	Diesel	CNFB	1968	4	81.00	95.50	134
Amarok 2.0 TDI	09/11→	Diesel	CSHA	1968	4	81.00	95.50	134
Amarok 2.0 TDI 4motion	09/10→	Diesel	CDBA	1968	4	81.00	95.50	134
Amarok 2.0 TDI 4motion	09/11→	Diesel	CDCA	1968	4	81.00	95.50	134
Amarok 2.0 TDI 4motion	09/11→	Diesel	CNEA	1968	4	81.00	95.50	134
Amarok 2.0 TDI 4motion	09/10→	Diesel	CNFA	1968	4	81.00	95.50	134
Amarok 2.0 TDI 4motion	09/11→	Diesel	CNFB	1968	4	81.00	95.50	134
Amarok 2.0 TDI 4motion	09/11→	Diesel	CSHA	1968	4	81.00	95.50	134
Beetle 1.2 TSI	07/11→	Petrol	CBZB	1197	4	71.00	75.60	5
Beetle 1.4 TSI	10/11→	Petrol	CAVD	1390	4	76.50	75.60	23
Beetle 1.4 TSI	10/11→	Petrol	CNWA	1390	4	76.50	75.60	23
Beetle 1.6 TDI	10/11→	Diesel	CAYC	1598	4	79.50	80.50	53
Beetle 2.0 TDI	04/11→	Diesel	CFFB	1968	4	81.00	95.50	134
Beetle 2.0 TDI	04/11→	Diesel	CJAA	1968	4	81.00	95.50	134
Beetle 2.0 TDI	06/14→	Diesel	CUUA	1968	4	81.00	95.50	134
Beetle 2.0 TDI	07/14→	Diesel	CVCA	1968	4	81.00	95.50	134
Beetle 2.0 TDI	09/14→	Diesel	DELA	1968	4	81.00	95.50	134
Bora 1.4 16V	03/00→05/05	Petrol	AHW	1390	4	76.50	75.60	20
Bora 1.4 16V	03/00→05/05	Petrol	AKQ	1390	4	76.50	75.60	20
Bora 1.4 16V	03/00→05/05	Petrol	APE	1390	4	76.50	75.60	20
Bora 1.4 16V	03/00→05/05	Petrol	AXP	1390	4	76.50	75.60	20
Bora 1.4 16V	03/00→05/05	Petrol	BCA	1390	4	76.50	75.60	25
Bora 1.6	10/98→05/05	Petrol	AEH	1595	4	81.00	77.40	82
Bora 1.6	10/98→05/05	Petrol	AKL	1595	4	81.00	77.40	82
Bora 1.6	10/98→05/05	Petrol	APF	1595	4	81.00	77.40	82
Bora 1.6	08/00→05/05	Petrol	AVU	1595	4	81.00	77.40	85
Bora 1.6	08/00→05/05	Petrol	BFQ	1595	4	81.00	77.40	85
Bora 1.6 16V	02/00→05/05	Petrol	ATN	1598	4	76.50	86.90	40
Bora 1.6 16V	02/00→05/05	Petrol	AUS	1598	4	76.50	86.90	43
Bora 1.6 16V	02/00→05/05	Petrol	AZD	1598	4	76.50	86.90	43
Bora 1.6 16V	02/00→05/05	Petrol	BCB	1598	4	76.50	86.90	43
Bora 1.6 FSI	01/02→05/05	Petrol	BAD	1598	4	76.50	86.90	42
Bora 1.8	10/98→05/05	Petrol	AGN	1781	4	81.00	86.40	109
Bora 1.8 4motion	02/99→05/05	Petrol	AGN	1781	4	81.00	86.40	109
Bora 1.8 T	05/00→05/05	Petrol	AGU	1781	4	81.00	86.40	110
Bora 1.8 T	05/00→05/05	Petrol	ARX	1781	4	81.00	86.40	113
Bora 1.8 T 4motion	10/00→05/01	Petrol	ARX	1781	4	81.00	86.40	113
Bora 1.9 SDI	10/98→05/05	Diesel	AGP	1896	4	79.50	95.50	65
Bora 1.9 SDI	10/98→05/05	Diesel	AQM	1896	4	79.50	95.50	61
Bora 1.9 TDI	10/98→05/05	Diesel	AGR	1896	4	79.50	95.50	66
Bora 1.9 TDI	10/98→06/01	Diesel	AHF	1896	4	79.50	95.50	67
Bora 1.9 TDI	12/98→01/02	Diesel	AJM	1896	4	79.50	95.50	69
Bora 1.9 TDI	10/98→05/05	Diesel	ALH	1896	4	79.50	95.50	62
Bora 1.9 TDI	05/00→05/05	Diesel	ARL	1896	4	79.50	95.50	71
Bora 1.9 TDI	10/98→06/01	Diesel	ASV	1896	4	79.50	95.50	67
Bora 1.9 TDI	11/00→05/05	Diesel	ASZ	1896	4	79.50	95.50	71
Bora 1.9 TDI	09/00→05/05	Diesel	ATD	1896	4	79.50	95.50	69
Bora 1.9 TDI	12/98→01/02	Diesel	AUY	1896	4	79.50	95.50	69
Bora 1.9 TDI	09/00→05/05	Diesel	AXR	1896	4	79.50	95.50	74
Bora 1.9 TDI 4motion	11/98→04/02	Diesel	AGR	1896	4	79.50	95.50	66
Bora 1.9 TDI 4motion	02/99→06/01	Diesel	AJM	1896	4	79.50	95.50	69











cm3 x



9

Bora 1.9 TDI 4motion	05/00→05/05	Diesel	ARL	1896	4	79.50	95.50	71
Bora 1.9 TDI 4motion	11/00→05/05	Diesel	ASZ	1896	4	79.50	95.50	71
Bora 1.9 TDI 4motion	09/00→05/05	Diesel	ATD	1896	4	79.50	95.50	69
Bora 1.9 TDI 4motion	02/99→06/01	Diesel	AUY	1896	4	79.50	95.50	69
Bora 2.0	10/98→05/05	Petrol	APK	1984	4	82.50	92.80	150
Bora 2.0	10/98→05/05	Petrol	AQY	1984	4	82.50	92.80	145
Bora 2.0	10/98→05/05	Petrol	AZH	1984	4	82.50	92.80	153
Bora 2.0 4motion	04/00→05/05	Petrol	AZH	1984	4	82.50	92.80	153
Bora 2.8 V6 4motion	03/99→05/05	Petrol	AQP	2792	6	81.00	90.30	129
Bora 2.8 V6 4motion	03/99→05/05	Petrol	AUE	2792	6	81.00	90.30	129
Bora 2.8 V6 4motion	03/99→05/05	Petrol	BDE	2792	V6	81.00	90.30	129
Bora 2.8 VR6	08/02→07/05	Petrol	AAA	2792	6	81.00	90.30	128
Bora 2.8 VR6	03/00→05/00	Petrol	AUE	2792	6	81.00	90.30	129
Caddy Alltrack 2.0 TDI	05/15→	Diesel	CUUD	1968	4	81.00	95.50	134
Caddy Alltrack 2.0 TDI	05/15→	Diesel	CUUF	1968	4	81.00	95.50	134
Caddy Alltrack 2.0 TDI 4motion	05/15→	Diesel	CUUE	1968	4	81.00	95.50	134
Caddy I 1.5	08/82→07/83	Petrol	JB	1457	4	79.50	73.40	48
Caddy I 1.6	10/82→10/83	Petrol	EM	1588	4	79.50	80.00	50
Caddy I 1.6	01/83→07/92	Petrol	EW	1595	4	81.00	77.40	90
Caddy I 1.6 D	08/82→07/92	Diesel	JK	1588	4	76.50	86.40	33
Caddy I 1.6 D	08/82→07/92	Diesel	ME	1588	4	76.50	86.40	31
Caddy I 1.7	09/80→12/83	Petrol	EN	1716	4	79.50	86.40	54
Caddy I 1.8	08/85→07/92	Petrol	JH	1781	4	81.00	86.40	119
Caddy II 1.4	11/95→01/04	Petrol	AEX	1390	4	76.50	75.60	18
Caddy II 1.4	11/95→01/04	Petrol	AKV	1390	4	76.50	75.60	21
Caddy II 1.4	11/95→01/04	Petrol	APQ	1390	4	76.50	75.60	21
Caddy II 1.4	08/00→01/04	Petrol	AUA	1390	4	76.50	75.60	20
Caddy II 1.4	11/95→01/04	Petrol	AUD	1390	4	76.50	75.60	20
Caddy II 1.4 16V	08/00→01/04	Petrol	AUA	1390	4	76.50	75.60	20
Caddy II 1.6	11/95→05/97	Petrol	1F	1595	4	81.00	77.40	80
Caddy II 1.6	06/96→12/00	Petrol	AEE	1598	4	76.50	86.90	38
Caddy II 1.7 SDI	07/96→09/00	Diesel	AHB	1716	4	79.50	86.40	57
Caddy II 1.9 D	11/95→01/04	Diesel	1Y	1896	4	79.50	95.50	61
Caddy II 1.9 D	06/96→12/00	Diesel	AEF	1896	4	79.50	95.50	61
Caddy II 1.9 SDI	11/95→01/04	Diesel	AEY	1896	4	79.50	95.50	63
Caddy II 1.9 SDI	11/95→01/04	Diesel	AYQ	1896	4	79.50	95.50	61
Caddy II 1.9 TDI	09/96→01/04	Diesel	1Z	1896	4	79.50	95.50	62
Caddy II 1.9 TDI	09/96→01/04	Diesel	AHU	1896	4	79.50	95.50	68
Caddy II 1.9 TDI	10/96→01/04	Diesel	ALE	1896	4	79.50	95.50	68
Caddy II 1.9 TDI	09/96→01/04	Diesel	ALH	1896	4	79.50	95.50	62
Caddy II 60 1.4	11/95→01/04	Petrol	AEX	1390	4	76.50	75.60	18
Caddy II 60 1.4	11/95→01/04	Petrol	APQ	1390	4	76.50	75.60	21
Caddy II 60 1.4	11/95→01/04	Petrol	AUD	1390	4	76.50	75.60	20
Caddy II 75 1.6	11/95→05/97	Petrol	1F	1595	4	81.00	77.40	80
Caddy II 75 1.6	11/95→09/00	Petrol	AEE	1598	4	76.50	86.90	38
Caddy III 1.2 TSI	09/10→	Petrol	CBZA	1197	4	71.00	75.60	5
Caddy III 1.2 TSI	09/10→	Petrol	CBZB	1197	4	71.00	75.60	5
Caddy III 1.4	03/04→05/06	Petrol	BCA	1390	4	76.50	75.60	25
Caddy III 1.4	05/06→08/10	Petrol	BUD	1390	4	76.50	75.60	23
Caddy III 1.6	04/04→	Petrol	BGU	1595	4	81.00	77.40	85
Caddy III 1.6	04/04→	Petrol	BSE	1595	4	81.00	77.40	85
Caddy III 1.6	04/04→	Petrol	BSF	1595	4	81.00	77.40	85
Caddy III 1.6 BiFuel	05/11→	Petrol	CHGA	1595	4	81.00	77.40	85
Caddy III 1.6 TDI	08/10→	Diesel	CAYD	1598	4	79.50	80.50	53
Caddy III 1.6 TDI	08/10→	Diesel	CAYE	1598	4	79.50	80.50	53
Caddy III 1.9 D	10/05→06/09	Diesel	1Y	1896	4	79.50	95.50	61
Caddy III 1.9 TDI	04/04→08/10	Diesel	BJB	1896	4	79.50	95.50	74
Caddy III 1.9 TDI	04/04→08/10	Diesel	BLS	1896	4	79.50	95.50	74
Caddy III 1.9 TDI	09/05→08/10	Diesel	BSU	1896	4	79.50	95.50	77
Caddy III 1.9 TDI 4motion	05/08→08/10	Diesel	BLS	1896	4	79.50	95.50	74
Caddy III 2.0 SDI	03/04→08/10	Diesel	BDJ	1968	4	81.00	95.50	132
Caddy III 2.0 SDI	03/04→08/10	Diesel	BST	1968	4	81.00	95.50	132
Caddy III 2.0 TDI	09/07→08/10	Diesel	BMM	1968	4	81.00	95.50	131
Caddy III 2.0 TDI	11/10→	Diesel	CFHE	1968	4	81.00	95.50	134
Caddy III 2.0 TDI	05/12→	Diesel	CFJA	1968	4	81.00	95.50	134
Caddy III 2.0 TDI	08/10→	Diesel	CLCA	1968	4	81.00	95.50	134
Caddy III 2.0 TDI 4motion	12/10→	Diesel	CFHE	1968	4	81.00	95.50	134
Caddy III 2.0 TDI 4motion	08/10→	Diesel	CFHF	1968	4	81.00	95.50	134
Caddy III 2.0 TDI 16V	11/10→	Diesel	CFHC	1968	4	81.00	95.50	134

				cm3				
Caddy III 2.0 TDI 16V	11/10→	Diesel	CLCB	1968	4	81.00	95.50	134
Caddy III 2.0 TDI 16V 4motion	11/10→	Diesel	CFHC	1968	4	81.00	95.50	134
Caddy IV 1.6 TDI	05/15→	Diesel	CAYD	1598	4	79.50	80.50	53
Caddy IV 1.6 TDI	05/15→	Diesel	CAYE	1598	4	79.50	80.50	53
Caddy IV 2.0 TDI	05/15→	Diesel	CFHC	1968	4	81.00	95.50	134
Caddy IV 2.0 TDI	09/15→	Diesel	CLCA	1968	4	81.00	95.50	134
Caddy IV 2.0 TDI	05/15→	Diesel	CLCB	1968	4	81.00	95.50	134
Caddy IV 2.0 TDI	05/15→	Diesel	CUUD	1968	4	81.00	95.50	134
Caddy IV 2.0 TDI	05/15→	Diesel	CUUF	1968	4	81.00	95.50	134
Caddy IV 2.0 TDI 4motion	05/15→	Diesel	CFHC	1968	4	81.00	95.50	134
Caddy IV 2.0 TDI 4motion	05/15→	Diesel	CFHF	1968	4	81.00	95.50	134
Caddy IV 2.0 TDI 4motion	05/15→	Diesel	CUUE	1968	4	81.00	95.50	134
CC 1.4 TSI MultiFuel	11/11→	Flexfuel	CKMA	1390	4	76.50	75.60	23
CC 2.0 TDI	11/11→	Diesel	CFFA	1968	4	81.00	95.50	134
CC 2.0 TDI	11/11→	Diesel	CFFB	1968	4	81.00	95.50	134
CC 2.0 TDI	11/11→	Diesel	CFGB	1968	4	81.00	95.50	134
CC 2.0 TDI	12/12→	Diesel	CFGC	1968	4	81.00	95.50	134
CC 2.0 TDI	11/11→	Diesel	CLLA	1968	4	81.00	95.50	134
CC 2.0 TDI	05/15→	Diesel	CUVC	1968	4	81.00	95.50	134
CC 2.0 TDI	05/15→	Diesel	CUWA	1968	4	81.00	95.50	134
CC 2.0 TDI 4motion	11/11→	Diesel	CFFB	1968	4	81.00	95.50	134
CC 2.0 TDI 4motion	11/11→	Diesel	CFGB	1968	4	81.00	95.50	134
CC 2.0 TDI 4motion	12/12→	Diesel	CFGC	1968	4	81.00	95.50	134
CC 3.6 FSI	11/11→	Petrol	BLV	3597	V6	89.00	96.40	163
CC 3.6 FSI 4motion	11/11→	Petrol	BWS	3597	V6	89.00	96.40	163
Citygolf 1.3	01/81→12/84	Petrol	EP	1297	4	75.00	73.40	12
Citygolf 1.6	06/96→12/99	Petrol	HM	1595	4	81.00	77.40	88
Citygolf 1.8	06/96→12/99	Petrol	AGN	1781	4	81.00	86.40	109
Corrado 1.8 16V	04/89→07/92	Petrol	KR	1781	4	81.00	86.40	119
Corrado 1.8 G60	09/88→09/93	Petrol	PG	1781	4	81.00	86.40	123
Corrado 2.0 i	04/93→12/95	Petrol	2E	1984	4	82.50	92.80	143
Corrado 2.0 i	04/93→12/95	Petrol	ADY	1984	4	82.50	92.80	143
Corrado 2.0 i 16V	08/91→12/95	Petrol	9A	1984	4	82.50	92.80	144
Corrado 2.8 VR6	09/91→12/95	Petrol	AAA	2792	6	81.00	90.30	128
Corrado 2.9 VR6	08/91→12/95	Petrol	ABV	2861	V6	82.00	90.30	140
Crafter 2.0 TDI	05/11→	Diesel	CKTB	1968	4	81.00	95.50	135
Crafter 2.0 TDI	05/11→	Diesel	CKTC	1968	4	81.00	95.50	135
Crafter 2.0 TDI	07/11→	Diesel	CKUB	1968	4	81.00	95.50	135
Crafter 2.0 TDI	10/11→	Diesel	CKUC	1968	4	81.00	95.50	135
Crafter 2.0 TDI	11/13→	Diesel	CSLB	1968	4	81.00	95.50	134
Crafter 2.0 TDI	07/11→	Diesel	CSNA	1968	4	81.00	95.50	134
Crafter 2.0 TDI 4motion	11/11→	Diesel	CKUB	1968	4	81.00	95.50	135
Crafter 2.0 TDI 4motion	11/11→	Diesel	CSNA	1968	4	81.00	95.50	134
Crafter 2.5 TDI	04/06→07/11	Diesel	BJJ	2461	5	81.00	95.50	139
Crafter 2.5 TDI	04/06→	Diesel	BJK	2461	5	81.00	95.50	139
Crafter 2.5 TDI	04/06→	Diesel	BJL	2461	5	81.00	95.50	139
Crafter 2.5 TDI	04/06→07/11	Diesel	BJM	2461	5	81.00	95.50	139
Crafter 2.5 TDI	04/06→07/11	Diesel	CEBA	2461	5	81.00	95.50	139
Crafter 2.5 TDI	04/06→	Diesel	CEBB	2461	5	81.00	95.50	139
Crafter 2.5 TDI	04/06→	Diesel	CECA	2461	5	81.00	95.50	139
Crafter 2.5 TDI	04/06→07/11	Diesel	CECB	2461	5	81.00	95.50	139
Crafter 30-35 2.0 TDI	05/11→	Diesel	CKTB	1968	4	81.00	95.50	135
Crafter 30-35 2.0 TDI	05/11→	Diesel	CKTC	1968	4	81.00	95.50	135
Crafter 30-35 2.0 TDI	07/11→	Diesel	CKUB	1968	4	81.00	95.50	135
Crafter 30-35 2.0 TDI	10/11→	Diesel	CKUC	1968	4	81.00	95.50	135
Crafter 30-35 2.0 TDI	11/13→	Diesel	CSLB	1968	4	81.00	95.50	134
Crafter 30-35 2.0 TDI	07/11→	Diesel	CSNA	1968	4	81.00	95.50	134
Crafter 30-35 2.0 TDI 4motion	11/11→	Diesel	CKUB	1968	4	81.00	95.50	135
Crafter 30-35 2.0 TDI 4motion	11/11→	Diesel	CSNA	1968	4	81.00	95.50	134
Crafter 30-35 2.5 TDI	04/06→07/11	Diesel	BJJ	2461	5	81.00	95.50	139
Crafter 30-35 2.5 TDI	04/06→	Diesel	BJK	2461	5	81.00	95.50	139
Crafter 30-35 2.5 TDI	04/06→	Diesel	BJL	2461	5	81.00	95.50	139
Crafter 30-35 2.5 TDI	04/06→07/11	Diesel	BJM	2461	5	81.00	95.50	139
Crafter 30-35 2.5 TDI	04/06→07/11	Diesel	CEBA	2461	5	81.00	95.50	139
Crafter 30-35 2.5 TDI	04/06→	Diesel	CEBB	2461	5	81.00	95.50	139
Crafter 30-35 2.5 TDI	04/06→	Diesel	CECA	2461	5	81.00	95.50	139
Crafter 30-35 2.5 TDI	04/06→07/11	Diesel	CECB	2461	5	81.00	95.50	139
Crafter 30-50 2.0 TDI	05/11→	Diesel	CKTB	1968	4	81.00	95.50	135
Crafter 30-50 2.0 TDI	05/11→	Diesel	CKTC	1968	4	81.00	95.50	135



cm3 x



9

Crafter 30-50 2.0 TDI	07/11→	Diesel	CKUB	1968	4	81.00	95.50	135
Crafter 30-50 2.0 TDI	10/11→	Diesel	CKUC	1968	4	81.00	95.50	135
Crafter 30-50 2.0 TDI	11/13→	Diesel	CSLB	1968	4	81.00	95.50	134
Crafter 30-50 2.0 TDI	07/11→	Diesel	CSNA	1968	4	81.00	95.50	134
Crafter 30-50 2.0 TDI 4motion	11/11→	Diesel	CKUB	1968	4	81.00	95.50	135
Crafter 30-50 2.0 TDI 4motion	11/11→	Diesel	CSNA	1968	4	81.00	95.50	134
Crafter 30-50 2.5 TDI	04/06→07/11	Diesel	BJJ	2461	5	81.00	95.50	139
Crafter 30-50 2.5 TDI	04/06→	Diesel	BJK	2461	5	81.00	95.50	139
Crafter 30-50 2.5 TDI	04/06→	Diesel	BJL	2461	5	81.00	95.50	139
Crafter 30-50 2.5 TDI	04/06→07/11	Diesel	BJM	2461	5	81.00	95.50	139
Crafter 30-50 2.5 TDI	04/06→07/11	Diesel	CEBA	2461	5	81.00	95.50	139
Crafter 30-50 2.5 TDI	04/06→	Diesel	CEBB	2461	5	81.00	95.50	139
Crafter 30-50 2.5 TDI	04/06→	Diesel	CECA	2461	5	81.00	95.50	139
Crafter 30-50 2.5 TDI	04/06→07/11	Diesel	CECB	2461	5	81.00	95.50	139
Derby 0.9	02/77→09/81	Petrol	HA	895	4	69.50	59.00	3
Derby 1.0	10/81→12/84	Petrol	GL	1043	4	75.00	59.00	9
Derby 1.1	02/77→07/83	Petrol	HB	1093	4	69.50	72.00	4
Derby 1.3	09/82→12/84	Petrol	GK	1272	4	75.00	72.00	10
Derby 1.3	02/77→07/83	Petrol	HH	1272	4	75.00	72.00	10
Derby 1.3	02/77→09/81	Petrol	HJ	1272	4	75.00	72.00	10
Derby 1.3	08/83→12/84	Petrol	HK	1272	4	75.00	72.00	10
Derby 1.3	08/83→12/84	Petrol	HW	1272	4	75.00	72.00	11
Derby 1.8	09/94→12/09	Petrol	ADD	1781	4	81.00	86.40	104
Eos 1.4 TSI	05/08→	Petrol	CAVD	1390	4	76.50	75.60	23
Eos 1.4 TSI	11/07→	Petrol	CAXA	1390	4	76.50	75.60	23
Eos 1.6 FSI	06/06→05/08	Petrol	BLF	1598	4	76.50	86.90	42
Eos 2.0 FSI	03/06→05/08	Petrol	BVY	1984	4	82.50	92.80	149
Eos 2.0 FSI	03/06→05/08	Petrol	BVZ	1984	4	82.50	92.80	149
Eos 2.0 TDI	06/06→05/08	Diesel	BMM	1968	4	81.00	95.50	131
Eos 2.0 TDI	11/10→	Diesel	CFFA	1968	4	81.00	95.50	134
Eos 2.0 TDI 16V	05/08→	Diesel	CBAB	1968	4	81.00	95.50	131
Eos 2.0 TDI 16V	05/08→	Diesel	CFFB	1968	4	81.00	95.50	134
Eos 3.2 V6	06/06→05/09	Petrol	BUB	3189	V6	84.00	95.90	157
Eos 3.2 V6	06/06→05/09	Petrol	CBRA	3189	V6	84.00	95.90	157
Fox 1.2	04/05→	Petrol	BMD	1198	3	76.50	86.90	36
Fox 1.2	09/10→	Petrol	CHFA	1198	3	76.50	86.90	36
Fox 1.2	04/05→	Petrol	CHFB	1198	3	76.50	86.90	36
Fox 1.4	04/05→	Petrol	BKR	1390	4	76.50	75.60	26
Fox 1.4 TDI	04/05→	Diesel	BNM	1422	3	79.50	95.50	60
Fox 1.6	01/87→12/93	Petrol	HM	1595	4	81.00	77.40	88
Fox 1.8	10/90→12/93	Petrol	EV	1781	4	81.00	86.40	118
Fox 1.8	09/86→12/90	Petrol	JN	1781	4	81.00	86.40	115
Fox 1.9 D	12/07→	Diesel	ASY	1896	4	79.50	95.50	61
Golf 2.0 TDI	02/14→	Diesel	CRLB	1968	4	81.00	95.50	134
Golf 2.0 TDI	05/14→	Diesel	CRVA	1968	4	81.00	95.50	134
Golf Alltrack 2.0 TDI 4motion	12/14→	Diesel	CRLB	1968	4	81.00	95.50	134
Golf Alltrack 2.0 TDI 4motion	12/14→	Diesel	CUNA	1968	4	81.00	95.50	134
Golf I 1.1	04/74→07/83	Petrol	FA	1093	4	69.50	72.00	4
Golf I 1.1	08/76→07/80	Petrol	FJ	1093	4	69.50	72.00	4
Golf I 1.1	04/74→07/83	Petrol	GG	1093	4	69.50	72.00	4
Golf I 1.3	08/79→07/83	Petrol	GF	1272	4	75.00	72.00	10
Golf I 1.3	08/82→12/83	Petrol	GS	1272	4	75.00	72.00	11
Golf I 1.3	08/83→07/86	Petrol	HK	1272	4	75.00	72.00	10
Golf I 1.5	08/77→11/83	Petrol	JB	1457	4	79.50	73.40	48
Golf I 1.5	04/74→12/75	Petrol	FH	1471	4	76.50	80.00	28
Golf I 1.5 D	08/76→07/80	Diesel	CK	1471	4	76.50	80.00	28
Golf I 1.6	08/79→07/82	Petrol	EG	1588	4	79.50	80.00	50
Golf I 1.6	08/75→02/84	Petrol	EM	1588	4	79.50	80.00	50
Golf I 1.6	08/75→02/84	Petrol	FN	1588	4	79.50	80.00	50
Golf I 1.6	08/75→02/84	Petrol	FP	1588	4	79.50	80.00	50
Golf I 1.6	08/75→07/77	Petrol	FT	1588	4	79.50	80.00	50
Golf I 1.6	01/83→04/92	Petrol	EW	1595	4	81.00	77.40	90
Golf I 1.6	01/83→04/92	Petrol	HN	1595	4	81.00	77.40	93
Golf I 1.6	04/86→02/90	Petrol	RE	1595	4	81.00	77.40	96
Golf I 1.6 D	08/80→07/83	Diesel	CR	1588	4	76.50	86.40	33
Golf I 1.6 D	08/80→07/83	Diesel	JK	1588	4	76.50	86.40	33
Golf I 1.6 GTI	08/76→07/82	Petrol	EG	1588	4	79.50	80.00	50
Golf I 1.6 TD	03/82→07/83	Diesel	CY	1588	4	76.50	86.40	33
Golf I 1.7	09/80→12/84	Petrol	EN	1716	4	79.50	86.40	54

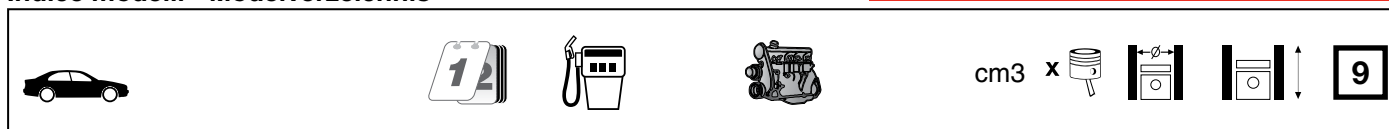

Golf I 1.8	08/82→12/92	Petrol	DX	1781	4	81.00	86.40	116
Golf I 1.8	08/82→12/89	Petrol	EV	1781	4	81.00	86.40	118
Golf I 1.8	08/83→09/92	Petrol	EX	1781	4	81.00	86.40	119
Golf I 1.8	09/82→04/93	Petrol	JH	1781	4	81.00	86.40	119
Golf I 1.8	08/82→12/89	Petrol	PB	1781	4	81.00	86.40	121
Golf I 1.8 GTI	08/82→12/83	Petrol	DX	1781	4	81.00	86.40	116
Golf II 1.0	11/83→08/85	Petrol	GN	1043	4	75.00	59.00	9
Golf II 1.0	08/85→10/91	Petrol	HZ	1043	4	75.00	59.00	8
Golf II 1.3	08/83→10/86	Petrol	GT	1272	4	75.00	72.00	10
Golf II 1.3	08/83→06/87	Petrol	HK	1272	4	75.00	72.00	10
Golf II 1.3	08/83→06/87	Petrol	MH	1272	4	75.00	72.00	11
Golf II 1.3	08/85→12/87	Petrol	NU	1272	4	75.00	72.00	11
Golf II 1.3 CAT	06/86→12/92	Petrol	2G	1272	4	75.00	72.00	10
Golf II 1.3 CAT	06/86→12/92	Petrol	MH	1272	4	75.00	72.00	11
Golf II 1.3 CAT	06/86→12/92	Petrol	NZ	1272	4	75.00	72.00	11
Golf II 1.6	08/83→07/92	Petrol	ABN	1595	4	81.00	77.40	81
Golf II 1.6	08/83→07/92	Petrol	EZ	1595	4	81.00	77.40	91
Golf II 1.6	08/86→07/91	Petrol	EZA	1595	4	81.00	77.40	92
Golf II 1.6	08/83→07/92	Petrol	HM	1595	4	81.00	77.40	88
Golf II 1.6	08/86→12/92	Petrol	PN	1595	4	81.00	77.40	94
Golf II 1.6	02/86→10/91	Petrol	RF	1595	4	81.00	77.40	97
Golf II 1.6 D	08/83→10/91	Diesel	JP	1588	4	76.50	86.40	34
Golf II 1.6 D	08/83→10/91	Diesel	ME	1588	4	76.50	86.40	31
Golf II 1.6 TD	08/83→10/91	Diesel	JR	1588	4	76.50	86.40	31
Golf II 1.6 TD	08/83→10/91	Diesel	MF	1588	4	76.50	86.40	31
Golf II 1.6 TD	04/89→10/91	Diesel	RA	1588	4	76.50	86.40	31
Golf II 1.6 TD	04/89→10/91	Diesel	SB	1588	4	76.50	86.40	31
Golf II 1.6 TD	08/89→10/91	Diesel	1V	1589	4	76.50	86.40	31
Golf II 1.8	08/84→10/91	Petrol	GU	1781	4	81.00	86.40	119
Golf II 1.8	08/84→10/91	Petrol	GX	1781	4	81.00	86.40	118
Golf II 1.8	09/87→12/92	Petrol	PF	1781	4	81.00	86.40	122
Golf II 1.8	08/86→01/90	Petrol	RH	1781	4	81.00	86.40	124
Golf II 1.8	09/87→12/92	Petrol	RV	1781	4	81.00	86.40	125
Golf II 1.8 16V	09/86→12/89	Petrol	PL	1781	4	81.00	86.40	124
Golf II 1.8 GTI	08/83→10/91	Petrol	DX	1781	4	81.00	86.40	116
Golf II 1.8 GTI	08/83→10/91	Petrol	EV	1781	4	81.00	86.40	118
Golf II 1.8 GTI	08/83→10/91	Petrol	PB	1781	4	81.00	86.40	121
Golf II 1.8 GTI	01/85→07/85	Petrol	RV	1781	4	81.00	86.40	125
Golf II 1.8 GTI 16V	02/86→06/90	Petrol	KR	1781	4	81.00	86.40	119
Golf II 1.8 GTI 16V	02/86→10/91	Petrol	PL	1781	4	81.00	86.40	124
Golf II 1.8 GTI CAT	01/87→10/91	Petrol	PF	1781	4	81.00	86.40	122
Golf II 1.8 GTI G60	04/90→07/91	Petrol	PG	1781	4	81.00	86.40	123
Golf II 1.8 GTI G60 Syncro	08/88→12/91	Petrol	1H	1781	4	81.00	86.40	101
Golf II 1.8 GTI G60 Syncro	08/88→12/91	Petrol	PG	1781	4	81.00	86.40	123
Golf II 1.8 i CAT	08/87→10/91	Petrol	GX	1781	4	81.00	86.40	118
Golf II 1.8 i CAT	08/87→10/91	Petrol	RP	1781	4	81.00	86.40	108
Golf II 1.8 i Syncro CAT	08/87→10/91	Petrol	RP	1781	4	81.00	86.40	108
Golf II 1.8 Syncro	08/88→07/91	Petrol	1P	1781	4	81.00	86.40	102
Golf II 1.8 Syncro	02/86→07/91	Petrol	GU	1781	4	81.00	86.40	119
Golf II 1.8 Syncro	02/86→07/91	Petrol	GX	1781	4	81.00	86.40	118
Golf II 1.8 Syncro	08/87→07/88	Petrol	RH	1781	4	81.00	86.40	124
Golf II 2.0 GTI	09/89→12/92	Petrol	9A	1984	4	82.50	92.80	144
Golf III 1.3	08/91→07/92	Petrol	2G	1272	4	75.00	72.00	10
Golf III 1.4	10/91→04/99	Petrol	ABD	1390	4	75.00	78.70	15
Golf III 1.4	10/91→04/99	Petrol	AEX	1390	4	76.50	75.60	18
Golf III 1.4	07/93→04/99	Petrol	APQ	1390	4	76.50	75.60	21
Golf III 1.6	07/94→04/99	Petrol	AEK	1595	4	81.00	77.40	80
Golf III 1.6	07/94→04/99	Petrol	AFT	1595	4	81.00	77.40	83
Golf III 1.6	07/94→04/99	Petrol	AKS	1595	4	81.00	77.40	84
Golf III 1.6	09/92→08/97	Petrol	ABU	1598	4	76.50	86.90	37
Golf III 1.6	09/92→08/97	Petrol	AEA	1598	4	76.50	86.90	37
Golf III 1.6	09/92→08/97	Petrol	AEE	1598	4	76.50	86.90	38
Golf III 1.8	11/91→04/99	Petrol	AAM	1781	4	81.00	86.40	103
Golf III 1.8	11/91→04/99	Petrol	ABS	1781	4	81.00	86.40	104
Golf III 1.8	11/91→08/97	Petrol	ACC	1781	4	81.00	86.40	105
Golf III 1.8	11/91→04/99	Petrol	ADZ	1781	4	81.00	86.40	104
Golf III 1.8	07/93→04/99	Petrol	ANN	1781	4	81.00	86.40	103
Golf III 1.8	07/93→04/99	Petrol	ANP	1781	4	81.00	86.40	103
Golf III 1.8 Syncro	01/93→08/97	Petrol	ABS	1781	4	81.00	86.40	104











cm3 x



9

Golf III 1.8 Syncro	01/93→04/99	Petrol	ADZ	1781	4	81.00	86.40	104
Golf III 1.9 D	11/91→04/99	Diesel	1Y	1896	4	79.50	95.50	61
Golf III 1.9 SDI	07/95→04/99	Diesel	AEY	1896	4	79.50	95.50	63
Golf III 1.9 TD	07/93→04/99	Diesel	AAZ	1896	4	79.50	95.50	62
Golf III 1.9 TD,GTD	11/91→08/97	Diesel	AAZ	1896	4	79.50	95.50	62
Golf III 1.9 TDI	09/93→04/99	Diesel	1Z	1896	4	79.50	95.50	62
Golf III 1.9 TDI	04/96→04/99	Diesel	AFN	1896	4	79.50	95.50	64
Golf III 1.9 TDI	09/93→04/99	Diesel	AHU	1896	4	79.50	95.50	68
Golf III 1.9 TDI	09/93→04/99	Diesel	ALE	1896	4	79.50	95.50	68
Golf III 1.9 TDI Syncro	07/95→04/99	Diesel	1Z	1896	4	79.50	95.50	62
Golf III 1.9 TDI Syncro	07/95→04/99	Diesel	AHU	1896	4	79.50	95.50	68
Golf III 1.9 TDI Syncro	07/95→04/99	Diesel	ALE	1896	4	79.50	95.50	68
Golf III 2.0	11/91→04/99	Petrol	2E	1984	4	82.50	92.80	143
Golf III 2.0	11/91→04/99	Petrol	ADY	1984	4	82.50	92.80	143
Golf III 2.0	08/95→04/96	Petrol	AEP	1984	4	82.50	92.80	146
Golf III 2.0	11/91→04/99	Petrol	AGG	1984	4	82.50	92.80	147
Golf III 2.0	11/91→04/99	Petrol	AKR	1984	4	82.50	92.80	148
Golf III 2.0 GL	08/95→09/97	Petrol	AEP	1984	4	82.50	92.80	146
Golf III 2.0 GTI 16V	08/92→08/97	Petrol	ABF	1984	4	82.50	92.80	143
Golf III 2.0 Syncro	08/95→04/99	Petrol	AGG	1984	4	82.50	92.80	147
Golf III 2.8 VR6	01/92→09/97	Petrol	AAA	2792	6	81.00	90.30	128
Golf III 2.9 VR6 Syncro	10/94→04/99	Petrol	ABV	2861	V6	82.00	90.30	140
Golf IV 1.4 16V	08/97→06/06	Petrol	AHW	1390	4	76.50	75.60	20
Golf IV 1.4 16V	08/97→06/06	Petrol	AKQ	1390	4	76.50	75.60	20
Golf IV 1.4 16V	08/97→06/06	Petrol	APE	1390	4	76.50	75.60	20
Golf IV 1.4 16V	08/97→06/06	Petrol	AXP	1390	4	76.50	75.60	20
Golf IV 1.4 16V	08/97→06/06	Petrol	BCA	1390	4	76.50	75.60	25
Golf IV 1.6	08/97→05/04	Petrol	AEH	1595	4	81.00	77.40	82
Golf IV 1.6	06/98→06/02	Petrol	AFT	1595	4	81.00	77.40	83
Golf IV 1.6	08/97→05/04	Petrol	AKL	1595	4	81.00	77.40	82
Golf IV 1.6	06/98→06/02	Petrol	AKS	1595	4	81.00	77.40	84
Golf IV 1.6	08/97→05/04	Petrol	APF	1595	4	81.00	77.40	82
Golf IV 1.6	08/00→06/06	Petrol	AVU	1595	4	81.00	77.40	85
Golf IV 1.6	08/00→06/06	Petrol	BFQ	1595	4	81.00	77.40	85
Golf IV 1.6 16V	02/00→06/06	Petrol	ATN	1598	4	76.50	86.90	40
Golf IV 1.6 16V	02/00→06/06	Petrol	AUS	1598	4	76.50	86.90	43
Golf IV 1.6 16V	02/00→06/06	Petrol	AZD	1598	4	76.50	86.90	43
Golf IV 1.6 16V	02/00→06/06	Petrol	BCB	1598	4	76.50	86.90	43
Golf IV 1.6 FSI	01/02→06/06	Petrol	BAD	1598	4	76.50	86.90	42
Golf IV 1.6 FSi	10/03→07/04	Petrol	BAG	1598	4	76.50	86.90	42
Golf IV 1.8	06/98→06/02	Petrol	AAM	1781	4	81.00	86.40	103
Golf IV 1.8	10/97→09/99	Petrol	ACC	1781	4	81.00	86.40	105
Golf IV 1.8	06/98→06/02	Petrol	ADZ	1781	4	81.00	86.40	104
Golf IV 1.8	08/97→06/05	Petrol	AGN	1781	4	81.00	86.40	109
Golf IV 1.8	06/98→06/02	Petrol	ANN	1781	4	81.00	86.40	103
Golf IV 1.8	06/98→06/02	Petrol	ANP	1781	4	81.00	86.40	103
Golf IV 1.8 4motion	05/98→06/06	Petrol	AGN	1781	4	81.00	86.40	109
Golf IV 1.8 T	08/97→06/06	Petrol	AGU	1781	4	81.00	86.40	110
Golf IV 1.8 T	08/97→06/06	Petrol	ARZ	1781	4	81.00	86.40	110
Golf IV 1.9 SDI	08/97→06/06	Diesel	AGP	1896	4	79.50	95.50	65
Golf IV 1.9 SDI	08/97→06/06	Diesel	AQM	1896	4	79.50	95.50	61
Golf IV 1.9 TD	10/97→09/99	Diesel	AAZ	1896	4	79.50	95.50	62
Golf IV 1.9 TDI	06/98→06/02	Diesel	AFN	1896	4	79.50	95.50	64
Golf IV 1.9 TDI	10/97→05/06	Diesel	AGR	1896	4	79.50	95.50	66
Golf IV 1.9 TDI	08/97→05/04	Diesel	AHF	1896	4	79.50	95.50	67
Golf IV 1.9 TDI	06/98→06/02	Diesel	AHU	1896	4	79.50	95.50	68
Golf IV 1.9 TDI	12/98→06/01	Diesel	AJM	1896	4	79.50	95.50	69
Golf IV 1.9 TDI	06/98→06/02	Diesel	ALE	1896	4	79.50	95.50	68
Golf IV 1.9 TDI	10/97→05/06	Diesel	ALH	1896	4	79.50	95.50	62
Golf IV 1.9 TDI	05/00→06/06	Diesel	ARL	1896	4	79.50	95.50	71
Golf IV 1.9 TDI	08/97→05/04	Diesel	ASV	1896	4	79.50	95.50	67
Golf IV 1.9 TDI	11/00→06/06	Diesel	ASZ	1896	4	79.50	95.50	71
Golf IV 1.9 TDI	09/00→06/06	Diesel	ATD	1896	4	79.50	95.50	69
Golf IV 1.9 TDI	12/98→06/01	Diesel	AUY	1896	4	79.50	95.50	69
Golf IV 1.9 TDI	06/98→06/02	Diesel	AVG	1896	4	79.50	95.50	64
Golf IV 1.9 TDI	09/00→06/06	Diesel	AXR	1896	4	79.50	95.50	74
Golf IV 1.9 TDI 4motion	07/98→04/02	Diesel	AGR	1896	4	79.50	95.50	66
Golf IV 1.9 TDI 4motion	05/99→06/01	Diesel	AJM	1896	4	79.50	95.50	69
Golf IV 1.9 TDI 4motion	02/00→06/05	Diesel	ARL	1896	4	79.50	95.50	71

				cm3	x 			
Golf IV 1.9 TDI 4motion	11/00→06/06	Diesel	ASZ	1896	4	79.50	95.50	71
Golf IV 1.9 TDI 4motion	09/00→06/06	Diesel	ATD	1896	4	79.50	95.50	69
Golf IV 1.9 TDI 4motion	09/99→06/01	Diesel	AUY	1896	4	79.50	95.50	69
Golf IV 2.0	06/98→06/02	Petrol	AGG	1984	4	82.50	92.80	147
Golf IV 2.0	06/98→06/02	Petrol	AKR	1984	4	82.50	92.80	148
Golf IV 2.0	07/98→06/06	Petrol	APK	1984	4	82.50	92.80	150
Golf IV 2.0	07/98→06/06	Petrol	AQY	1984	4	82.50	92.80	145
Golf IV 2.0	06/98→06/02	Petrol	ATU	1984	4	82.50	92.80	147
Golf IV 2.0	06/98→06/02	Petrol	AWF	1984	4	82.50	92.80	147
Golf IV 2.0	06/98→06/02	Petrol	AWG	1984	4	82.50	92.80	147
Golf IV 2.0 4motion	10/00→06/06	Petrol	AZH	1984	4	82.50	92.80	153
Golf IV 2.8 V6 4motion	03/99→06/06	Petrol	AQP	2792	6	81.00	90.30	129
Golf IV 2.8 V6 4motion	03/99→06/06	Petrol	AUE	2792	6	81.00	90.30	129
Golf IV 2.8 V6 4motion	03/99→06/06	Petrol	BDE	2792	V6	81.00	90.30	129
Golf IV 3.2 R32 4motion	09/02→06/05	Petrol	BFH	3189	V6	84.00	95.90	157
Golf IV 3.2 R32 4motion	09/02→12/03	Petrol	BJS	3189	V6	84.00	95.90	157
Golf IV 3.2 R32 4motion	09/02→06/05	Petrol	BML	3189	V6	84.00	95.90	157
Golf V 1.4	06/07→07/09	Petrol	BUD	1390	4	76.50	75.60	23
Golf V 1.4 16V	10/03→05/06	Petrol	BCA	1390	4	76.50	75.60	25
Golf V 1.4 16V	05/06→11/08	Petrol	BUD	1390	4	76.50	75.60	23
Golf V 1.4 FSI	10/03→07/06	Petrol	BLN	1390	4	76.50	75.60	23
Golf V 1.4 TSI	11/05→07/09	Petrol	BLG	1390	4	76.50	75.60	23
Golf V 1.4 TSI	05/06→07/09	Petrol	BMV	1390	4	76.50	75.60	23
Golf V 1.4 TSI	07/08→07/09	Petrol	CAVD	1390	4	76.50	75.60	23
Golf V 1.4 TSI	05/07→07/09	Petrol	CAXA	1390	4	76.50	75.60	23
Golf V 1.6	01/04→07/09	Petrol	BGU	1595	4	81.00	77.40	85
Golf V 1.6	01/04→07/09	Petrol	BSE	1595	4	81.00	77.40	85
Golf V 1.6	01/04→07/09	Petrol	BSF	1595	4	81.00	77.40	85
Golf V 1.6	06/07→07/09	Petrol	CCSA	1595	4	81.00	77.40	85
Golf V 1.6 FSI	10/03→07/08	Petrol	BAG	1598	4	76.50	86.90	42
Golf V 1.6 FSI	10/03→07/08	Petrol	BLF	1598	4	76.50	86.90	42
Golf V 1.6 FSI	10/03→07/08	Petrol	BLP	1598	4	76.50	86.90	42
Golf V 1.6 MultiFuel	10/07→07/09	Petrol	CCSA	1595	4	81.00	77.40	85
Golf V 1.9 TDI	10/03→11/08	Diesel	BKC	1896	4	79.50	95.50	74
Golf V 1.9 TDI	10/03→07/09	Diesel	BLS	1896	4	79.50	95.50	74
Golf V 1.9 TDI	05/04→11/08	Diesel	BRU	1896	4	79.50	95.50	74
Golf V 1.9 TDI	10/03→07/09	Diesel	BXE	1896	4	79.50	95.50	74
Golf V 1.9 TDI	05/04→11/08	Diesel	BXF	1896	4	79.50	95.50	74
Golf V 1.9 TDI	05/04→11/08	Diesel	BXJ	1896	4	79.50	95.50	74
Golf V 1.9 TDI 4motion	08/04→11/08	Diesel	BKC	1896	4	79.50	95.50	74
Golf V 1.9 TDI 4motion	08/04→07/09	Diesel	BLS	1896	4	79.50	95.50	74
Golf V 1.9 TDI 4motion	08/04→11/08	Diesel	BXE	1896	4	79.50	95.50	74
Golf V 2.0	08/06→11/08	Petrol	BHY	1984	4	82.50	92.80	154
Golf V 2.0 FSI	01/04→11/08	Petrol	AXW	1984	4	82.50	92.80	149
Golf V 2.0 FSI	01/04→11/08	Petrol	BLR	1984	4	82.50	92.80	149
Golf V 2.0 FSI	01/04→11/08	Petrol	BLX	1984	4	82.50	92.80	149
Golf V 2.0 FSI	01/04→11/08	Petrol	BLY	1984	4	82.50	92.80	149
Golf V 2.0 FSI	01/04→11/08	Petrol	BVX	1984	4	82.50	92.80	149
Golf V 2.0 FSI	01/04→11/08	Petrol	BVY	1984	4	82.50	92.80	149
Golf V 2.0 FSI	01/04→11/08	Petrol	BVZ	1984	4	82.50	92.80	149
Golf V 2.0 FSI 4motion	08/04→11/08	Petrol	BLX	1984	4	82.50	92.80	149
Golf V 2.0 FSI 4motion	08/04→11/08	Petrol	BVX	1984	4	82.50	92.80	149
Golf V 2.0 SDI	01/04→11/08	Diesel	BDK	1968	4	81.00	95.50	132
Golf V 2.0 TDI	10/03→07/09	Diesel	AZV	1968	4	81.00	95.50	131
Golf V 2.0 TDI	12/04→07/09	Diesel	BMM	1968	4	81.00	95.50	131
Golf V 2.0 TDI	11/05→11/08	Diesel	BMN	1968	4	81.00	95.50	131
Golf V 2.0 TDI 4motion	06/07→07/09	Diesel	AZV	1968	4	81.00	95.50	131
Golf V 2.0 TDI 4motion	08/04→11/08	Diesel	BMM	1968	4	81.00	95.50	131
Golf V 2.0 TDI 16V	10/03→07/09	Diesel	BKD	1968	4	81.00	95.50	131
Golf V 2.0 TDI 16V	06/07→07/09	Diesel	CBDB	1968	4	81.00	95.50	134
Golf V 2.0 TDI 16V 4motion	08/04→11/08	Diesel	BKD	1968	4	81.00	95.50	131
Golf V 3.2	09/05→11/08	Petrol	BUB	3189	V6	84.00	95.90	157
Golf V 3.2 R32 4motion	01/04→11/08	Petrol	BJS	3189	V6	84.00	95.90	157
Golf V 3.2 R32 4motion	11/05→11/08	Petrol	BUB	3189	V6	84.00	95.90	157
Golf V 3.2 R32 4motion	11/05→11/08	Petrol	CBRA	3189	V6	84.00	95.90	157
Golf VI 1.2 TSI	05/10→07/13	Petrol	CBZA	1197	4	71.00	75.60	5
Golf VI 1.2 TSI	11/08→	Petrol	CBZB	1197	4	71.00	75.60	5
Golf VI 1.4	07/09→07/13	Petrol	BUD	1390	4	76.50	75.60	23
Golf VI 1.4	10/08→07/13	Petrol	CGGA	1390	4	76.50	75.60	27



cm3



9

Golf VI 1.4 TSI	10/08→	Petrol	CAVD	1390	4	76.50	75.60	23
Golf VI 1.4 TSI	10/08→	Petrol	CAXA	1390	4	76.50	75.60	23
Golf VI 1.4 TSI	10/08→	Petrol	CNWA	1390	4	76.50	75.60	23
Golf VI 1.6	10/08→07/13	Petrol	BSE	1595	4	81.00	77.40	85
Golf VI 1.6	10/08→07/13	Petrol	BSF	1595	4	81.00	77.40	85
Golf VI 1.6	10/08→07/13	Petrol	CCSA	1595	4	81.00	77.40	85
Golf VI 1.6	10/08→07/13	Petrol	CMXA	1595	4	81.00	77.40	85
Golf VI 1.6 BiFuel	03/09→11/12	Petrol	CHGA	1595	4	81.00	77.40	85
Golf VI 1.6 MultiFuel	10/08→11/12	Petrol	CCSA	1595	4	81.00	77.40	85
Golf VI 1.6 MultiFuel	10/08→07/13	Petrol	CMXA	1595	4	81.00	77.40	85
Golf VI 1.6 TDI	02/09→07/13	Diesel	CAYB	1598	4	79.50	80.50	53
Golf VI 1.6 TDI	02/09→	Diesel	CAYC	1598	4	79.50	80.50	53
Golf VI 1.6 TDI 4motion	07/09→07/13	Diesel	CAYC	1598	4	79.50	80.50	53
Golf VI 2.0 TDI	10/08→11/12	Diesel	CBAA	1968	4	81.00	95.50	131
Golf VI 2.0 TDI	10/08→05/13	Diesel	CBAB	1968	4	81.00	95.50	131
Golf VI 2.0 TDI	04/09→11/12	Diesel	CBBB	1968	4	81.00	95.50	134
Golf VI 2.0 TDI	07/09→07/13	Diesel	CBDA	1968	4	81.00	95.50	131
Golf VI 2.0 TDI	10/08→11/12	Diesel	CBDC	1968	4	81.00	95.50	131
Golf VI 2.0 TDI	10/08→11/12	Diesel	CFFA	1968	4	81.00	95.50	134
Golf VI 2.0 TDI	10/08→05/13	Diesel	CFFB	1968	4	81.00	95.50	134
Golf VI 2.0 TDI	04/09→11/12	Diesel	CFGB	1968	4	81.00	95.50	134
Golf VI 2.0 TDI	07/09→07/13	Diesel	CFHB	1968	4	81.00	95.50	134
Golf VI 2.0 TDI	11/11→	Diesel	CFHC	1968	4	81.00	95.50	134
Golf VI 2.0 TDI	10/08→05/13	Diesel	CJAA	1968	4	81.00	95.50	134
Golf VI 2.0 TDI	10/08→07/13	Diesel	CLCA	1968	4	81.00	95.50	134
Golf VI 2.0 TDI	11/13→	Diesel	CUUA	1968	4	81.00	95.50	134
Golf VI 2.0 TDI 4motion	05/09→11/12	Diesel	CBAB	1968	4	81.00	95.50	131
Golf VI 2.0 TDI 4motion	05/09→11/12	Diesel	CFFB	1968	4	81.00	95.50	134
Golf VI 2.0 TDI 16V	07/09→07/13	Diesel	CBDB	1968	4	81.00	95.50	134
Golf VI 2.0 TDI 16V	07/09→07/13	Diesel	CFHC	1968	4	81.00	95.50	134
Golf VI 2.0 TDI 16V	07/09→07/13	Diesel	CJAA	1968	4	81.00	95.50	134
Golf VI 2.0 TDI 16V	07/09→07/13	Diesel	CLCB	1968	4	81.00	95.50	134
Golf VII 2.0 GTD	04/13→	Diesel	CUNA	1968	4	81.00	95.50	134
Golf VII 2.0 TDI	07/13→	Diesel	CJAA	1968	4	81.00	95.50	134
Golf VII 2.0 TDI	11/12→	Diesel	CKFC	1968	4	81.00	95.50	134
Golf VII 2.0 TDI	08/12→	Diesel	CRBB	1968	4	81.00	95.50	134
Golf VII 2.0 TDI	11/12→	Diesel	CRLB	1968	4	81.00	95.50	134
Golf VII 2.0 TDI	11/12→	Diesel	CRMB	1968	4	81.00	95.50	134
Golf VII 2.0 TDI	11/12→	Diesel	CRUA	1968	4	81.00	95.50	134
Golf VII 2.0 TDI	11/12→	Diesel	CRVA	1968	4	81.00	95.50	134
Golf VII 2.0 TDI	08/12→	Diesel	CRVC	1968	4	81.00	95.50	134
Golf VII 2.0 TDI 4motion	11/12→	Diesel	CKFC	1968	4	81.00	95.50	134
Golf VII 2.0 TDI 4motion	11/12→	Diesel	CRLB	1968	4	81.00	95.50	134
Golf VII 2.0 TDI 4motion	11/12→	Diesel	CRMB	1968	4	81.00	95.50	134
Golf Plus 1.2 TSI	05/10→12/13	Petrol	CBZA	1197	4	71.00	75.60	5
Golf Plus 1.2 TSI	11/09→12/13	Petrol	CBZB	1197	4	71.00	75.60	5
Golf Plus 1.4 16V	01/05→11/06	Petrol	BCA	1390	4	76.50	75.60	25
Golf Plus 1.4 16V	05/06→12/13	Petrol	BUD	1390	4	76.50	75.60	23
Golf Plus 1.4 16V	05/06→12/13	Petrol	CGGA	1390	4	76.50	75.60	27
Golf Plus 1.4 FSI	07/05→11/06	Petrol	BLN	1390	4	76.50	75.60	23
Golf Plus 1.4 TSI	05/06→06/08	Petrol	BLG	1390	4	76.50	75.60	23
Golf Plus 1.4 TSI	05/06→06/08	Petrol	BMV	1390	4	76.50	75.60	23
Golf Plus 1.4 TSI	06/08→12/13	Petrol	CAVD	1390	4	76.50	75.60	23
Golf Plus 1.4 TSI	06/07→12/13	Petrol	CAXA	1390	4	76.50	75.60	23
Golf Plus 1.4 TSI	06/08→12/13	Petrol	CNWA	1390	4	76.50	75.60	23
Golf Plus 1.6	05/05→12/13	Petrol	BSE	1595	4	81.00	77.40	85
Golf Plus 1.6	05/05→12/13	Petrol	BSF	1595	4	81.00	77.40	85
Golf Plus 1.6	05/05→12/13	Petrol	CCSA	1595	4	81.00	77.40	85
Golf Plus 1.6	05/05→12/13	Petrol	CMXA	1595	4	81.00	77.40	85
Golf Plus 1.6 BiFuel	05/09→12/13	Petrol	CHGA	1595	4	81.00	77.40	85
Golf Plus 1.6 FSI	01/05→05/08	Petrol	BLF	1598	4	76.50	86.90	42
Golf Plus 1.6 MultiFuel	11/07→12/13	Petrol	CCSA	1595	4	81.00	77.40	85
Golf Plus 1.6 MultiFuel	11/07→12/13	Petrol	CMXA	1595	4	81.00	77.40	85
Golf Plus 1.6 TDI	02/09→12/13	Diesel	CAYB	1598	4	79.50	80.50	53
Golf Plus 1.6 TDI	03/09→12/13	Diesel	CAYC	1598	4	79.50	80.50	53
Golf Plus 1.9 TDI	01/05→01/09	Diesel	BKC	1896	4	79.50	95.50	74
Golf Plus 1.9 TDI	01/05→01/09	Diesel	BLS	1896	4	79.50	95.50	74
Golf Plus 1.9 TDI	05/05→12/08	Diesel	BRU	1896	4	79.50	95.50	74
Golf Plus 1.9 TDI	01/05→01/09	Diesel	BXE	1896	4	79.50	95.50	74

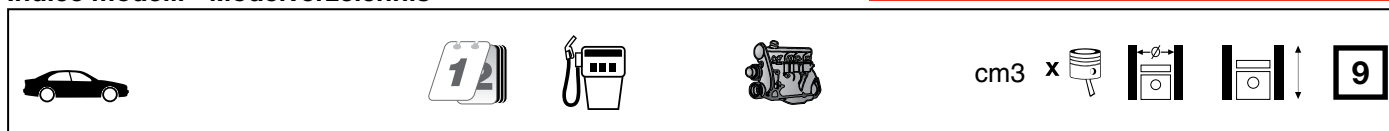

Golf Plus 1.9 TDI	05/05→12/08	Diesel	BXF	1896	4	79.50	95.50	74
Golf Plus 1.9 TDI	05/05→12/08	Diesel	BXJ	1896	4	79.50	95.50	74
Golf Plus 2.0 FSI	05/05→06/08	Petrol	BLR	1984	4	82.50	92.80	149
Golf Plus 2.0 FSI	05/05→06/08	Petrol	BLY	1984	4	82.50	92.80	149
Golf Plus 2.0 FSI	05/05→06/08	Petrol	BVY	1984	4	82.50	92.80	149
Golf Plus 2.0 FSI	05/05→06/08	Petrol	BVZ	1984	4	82.50	92.80	149
Golf Plus 2.0 TDI	05/05→12/13	Diesel	AZV	1968	4	81.00	95.50	131
Golf Plus 2.0 TDI	12/05→05/11	Diesel	BMM	1968	4	81.00	95.50	131
Golf Plus 2.0 TDI	05/05→12/13	Diesel	CBDA	1968	4	81.00	95.50	131
Golf Plus 2.0 TDI	01/09→12/13	Diesel	CBDC	1968	4	81.00	95.50	131
Golf Plus 2.0 TDI	05/05→12/13	Diesel	CFHB	1968	4	81.00	95.50	134
Golf Plus 2.0 TDI	01/09→12/13	Diesel	CLCA	1968	4	81.00	95.50	134
Golf Plus 2.0 TDI 16V	01/05→12/13	Diesel	BKD	1968	4	81.00	95.50	131
Golf Plus 2.0 TDI 16V	01/05→12/13	Diesel	CBDB	1968	4	81.00	95.50	134
Golf Plus 2.0 TDI 16V	01/05→12/13	Diesel	CFHC	1968	4	81.00	95.50	134
Gol I 1.3	05/80→07/82	Petrol	AR	1285	4	77.00	69.00	46
Gol III 1.9 D	06/02→06/05	Diesel	1Y	1896	4	79.50	95.50	61
Gol IV 2.0 TotalFlex	05/07→10/08	Petrol	BHY	1984	4	82.50	92.80	154
Ilitis 1.7	03/79→12/88	Petrol	WL	1714	4	79.50	86.40	56
Jetta I 1.1	08/78→02/84	Petrol	FA	1093	4	69.50	72.00	4
Jetta I 1.1	08/78→02/84	Petrol	GG	1093	4	69.50	72.00	4
Jetta I 1.3	08/79→02/84	Petrol	GF	1272	4	75.00	72.00	10
Jetta I 1.3	08/82→02/84	Petrol	GS	1272	4	75.00	72.00	11
Jetta I 1.5	08/78→02/84	Petrol	JB	1457	4	79.50	73.40	48
Jetta I 1.5 D	08/78→07/80	Diesel	CK	1471	4	76.50	80.00	28
Jetta I 1.6	08/81→07/83	Petrol	EM	1588	4	79.50	80.00	50
Jetta I 1.6	08/78→02/84	Petrol	FR	1588	4	79.50	80.00	50
Jetta I 1.6	08/82→07/83	Petrol	EW	1595	4	81.00	77.40	90
Jetta I 1.6 D	08/80→12/84	Diesel	CR	1588	4	76.50	86.40	33
Jetta I 1.6 D	08/80→12/84	Diesel	JK	1588	4	76.50	86.40	33
Jetta I 1.6 GLI	08/78→07/82	Petrol	EG	1588	4	79.50	80.00	50
Jetta I 1.6 TD	03/82→02/84	Diesel	CY	1588	4	76.50	86.40	33
Jetta I 1.7	09/80→02/84	Petrol	EN	1716	4	79.50	86.40	54
Jetta I 1.8	08/82→02/84	Petrol	DX	1781	4	81.00	86.40	116
Jetta I 1.8	09/83→02/84	Petrol	JH	1781	4	81.00	86.40	119
Jetta II 1.3	01/84→10/86	Petrol	GT	1272	4	75.00	72.00	10
Jetta II 1.3	01/84→06/87	Petrol	HK	1272	4	75.00	72.00	10
Jetta II 1.3	01/84→06/87	Petrol	MH	1272	4	75.00	72.00	11
Jetta II 1.3 CAT	06/87→12/91	Petrol	2G	1272	4	75.00	72.00	10
Jetta II 1.3 CAT	06/87→12/91	Petrol	MH	1272	4	75.00	72.00	11
Jetta II 1.3 CAT	06/87→12/91	Petrol	NZ	1272	4	75.00	72.00	11
Jetta II 1.6	01/84→07/92	Petrol	ABN	1595	4	81.00	77.40	81
Jetta II 1.6	01/84→07/92	Petrol	EZ	1595	4	81.00	77.40	91
Jetta II 1.6	01/84→07/92	Petrol	HM	1595	4	81.00	77.40	88
Jetta II 1.6	10/86→10/91	Petrol	PN	1595	4	81.00	77.40	94
Jetta II 1.6	03/86→10/91	Petrol	RF	1595	4	81.00	77.40	97
Jetta II 1.6 D	01/84→10/91	Diesel	JP	1588	4	76.50	86.40	34
Jetta II 1.6 D	01/84→10/91	Diesel	ME	1588	4	76.50	86.40	31
Jetta II 1.6 TD	01/84→10/91	Diesel	JR	1588	4	76.50	86.40	31
Jetta II 1.6 TD	01/84→10/91	Diesel	MF	1588	4	76.50	86.40	31
Jetta II 1.6 TD	04/89→10/91	Diesel	RA	1588	4	76.50	86.40	31
Jetta II 1.6 TD	04/89→10/91	Diesel	SB	1588	4	76.50	86.40	31
Jetta II 1.6 TD	01/90→10/91	Diesel	1V	1589	4	76.50	86.40	31
Jetta II 1.8	01/84→10/91	Petrol	EV	1781	4	81.00	86.40	118
Jetta II 1.8	08/84→10/91	Petrol	GU	1781	4	81.00	86.40	119
Jetta II 1.8	08/84→10/91	Petrol	GX	1781	4	81.00	86.40	118
Jetta II 1.8	01/84→10/91	Petrol	PB	1781	4	81.00	86.40	121
Jetta II 1.8	09/86→12/92	Petrol	PF	1781	4	81.00	86.40	122
Jetta II 1.8	08/86→01/90	Petrol	RH	1781	4	81.00	86.40	124
Jetta II 1.8	01/85→12/92	Petrol	RV	1781	4	81.00	86.40	125
Jetta II 1.8 16V	06/87→12/89	Petrol	KR	1781	4	81.00	86.40	119
Jetta II 1.8 16V	08/86→10/91	Petrol	PL	1781	4	81.00	86.40	124
Jetta II 1.8 CAT	08/87→10/91	Petrol	GX	1781	4	81.00	86.40	118
Jetta II 1.8 CAT	01/87→10/91	Petrol	PF	1781	4	81.00	86.40	122
Jetta II 1.8 CAT	08/87→10/91	Petrol	RP	1781	4	81.00	86.40	108
Jetta II 1.8 Syncro	08/88→07/91	Petrol	1P	1781	4	81.00	86.40	102
Jetta II 1.8 Syncro	08/87→12/88	Petrol	GU	1781	4	81.00	86.40	119
Jetta II 1.8 Syncro	08/87→07/88	Petrol	RH	1781	4	81.00	86.40	124
Jetta II 1.8 Syncro	08/87→12/88	Petrol	RP	1781	4	81.00	86.40	108











cm3



9

Jetta II 2.0	08/89→07/92	Petrol	9A	1984	4	82.50	92.80	144
Jetta III 1.4 TSI	07/06→10/10	Petrol	BLG	1390	4	76.50	75.60	23
Jetta III 1.4 TSI	07/06→10/10	Petrol	BMV	1390	4	76.50	75.60	23
Jetta III 1.4 TSI	07/08→10/10	Petrol	CAVD	1390	4	76.50	75.60	23
Jetta III 1.4 TSI	05/07→10/10	Petrol	CAXA	1390	4	76.50	75.60	23
Jetta III 1.6	10/05→10/10	Petrol	BGU	1595	4	81.00	77.40	85
Jetta III 1.6	10/05→10/10	Petrol	BSE	1595	4	81.00	77.40	85
Jetta III 1.6	10/05→10/10	Petrol	BFS	1595	4	81.00	77.40	85
Jetta III 1.6	10/05→10/10	Petrol	CCSA	1595	4	81.00	77.40	85
Jetta III 1.6 FSI	09/05→10/10	Petrol	BLF	1598	4	76.50	86.90	42
Jetta III 1.6 MultiFuel	01/08→10/10	Petrol	CCSA	1595	4	81.00	77.40	85
Jetta III 1.6 TDI	12/09→10/10	Diesel	CAYB	1598	4	79.50	80.50	53
Jetta III 1.6 TDI	06/09→10/10	Diesel	CAYC	1598	4	79.50	80.50	53
Jetta III 1.9 TDI	08/05→10/10	Diesel	BKC	1896	4	79.50	95.50	74
Jetta III 1.9 TDI	08/05→10/10	Diesel	BLS	1896	4	79.50	95.50	74
Jetta III 1.9 TDI	08/05→10/10	Diesel	BXE	1896	4	79.50	95.50	74
Jetta III 2.0	08/05→10/10	Petrol	BHY	1984	4	82.50	92.80	154
Jetta III 2.0 FSI	08/05→10/10	Petrol	BLR	1984	4	82.50	92.80	149
Jetta III 2.0 FSI	08/05→10/10	Petrol	BLX	1984	4	82.50	92.80	149
Jetta III 2.0 FSI	08/05→10/10	Petrol	BLY	1984	4	82.50	92.80	149
Jetta III 2.0 FSI	08/05→10/10	Petrol	BVY	1984	4	82.50	92.80	149
Jetta III 2.0 FSI	08/05→10/10	Petrol	BVZ	1984	4	82.50	92.80	149
Jetta III 2.0 TDI	09/05→10/10	Diesel	AZV	1968	4	81.00	95.50	131
Jetta III 2.0 TDI	10/05→10/10	Diesel	BMM	1968	4	81.00	95.50	131
Jetta III 2.0 TDI	10/06→10/10	Diesel	BMN	1968	4	81.00	95.50	131
Jetta III 2.0 TDI	09/05→10/10	Diesel	CBDA	1968	4	81.00	95.50	131
Jetta III 2.0 TDI	10/06→10/10	Diesel	CEGA	1968	4	81.00	95.50	134
Jetta III 2.0 TDI	01/10→10/10	Diesel	CLCA	1968	4	81.00	95.50	134
Jetta III 2.0 TDI 16V	08/05→10/10	Diesel	BKD	1968	4	81.00	95.50	131
Jetta III 2.0 TDI 16V	08/05→10/10	Diesel	CBDB	1968	4	81.00	95.50	134
Jetta III 2.0 TDI 16V	08/05→10/10	Diesel	CBEA	1968	4	81.00	95.50	131
Jetta III 2.0 TDI 16V	08/05→10/10	Diesel	CJAA	1968	4	81.00	95.50	134
Jetta III 2.8 VR6	10/09→10/10	Petrol	AAA	2792	6	81.00	90.30	128
Jetta IV 1.2 TSI	02/11→	Petrol	CBZB	1197	4	71.00	75.60	5
Jetta IV 1.4 TSI	04/11→07/14	Petrol	CAVA	1390	4	76.50	75.60	23
Jetta IV 1.4 TSI	04/11→	Petrol	CAVD	1390	4	76.50	75.60	23
Jetta IV 1.4 TSI	05/11→	Petrol	CAXA	1390	4	76.50	75.60	23
Jetta IV 1.6	12/11→	Petrol	CFNA	1598	4	76.50	86.90	42
Jetta IV 1.6	03/13→	Petrol	CFNB	1598	4	76.50	86.90	44
Jetta IV 1.6 TDI	02/11→	Diesel	CAYC	1598	4	79.50	80.50	53
Jetta IV 2.0 TDI	02/11→	Diesel	CFFB	1968	4	81.00	95.50	134
Jetta IV 2.0 TDI	02/11→	Diesel	CFHC	1968	4	81.00	95.50	134
Jetta IV 2.0 TDI	02/11→	Diesel	CJAA	1968	4	81.00	95.50	134
Jetta IV 2.0 TDI	10/10→	Diesel	CLCA	1968	4	81.00	95.50	134
Jetta IV 2.0 TDI	02/11→	Diesel	CLCB	1968	4	81.00	95.50	134
Kaefer 1.6	09/74→12/80	Petrol	AJ	1584	4	85.50	69.00	160
Kaefer 1200 1.2	01/60→12/85	Petrol	D	1192	4	77.00	64.00	45
Kaefer 1300 1.3	01/70→01/73	Petrol	AB	1285	4	77.00	69.00	46
Kaefer 1300 1.3	08/65→07/70	Petrol	E	1285	4	77.00	69.00	46
Kaefer 1300 1.3	01/65→07/70	Petrol	F	1285	4	77.00	69.00	46
Kaefer 1302 1.2	08/69→08/72	Petrol	D	1192	4	77.00	64.00	45
Kaefer 1302 1.3	08/70→08/72	Petrol	AB	1285	4	77.00	69.00	46
Kaefer 1302 1.3	08/70→07/75	Petrol	AC	1285	4	77.00	69.00	46
Kaefer 1302 1.6	01/70→08/72	Petrol	AD	1584	4	84.00	71.50	156
Kaefer 1302 1.6	07/71→07/74	Petrol	AE	1584	4	85.50	69.00	160
Kaefer 1302 1.6	07/71→07/74	Petrol	AH	1584	4	85.50	69.00	160
Kaefer 1302 1.6	07/71→07/74	Petrol	AK	1584	4	85.50	69.00	160
Kaefer 1302,1303 1.6	07/70→06/79	Petrol	AD	1584	4	84.00	71.50	156
Kaefer 1303 1.2	07/72→12/79	Petrol	D	1192	4	77.00	64.00	45
Kaefer 1303 1.3	07/70→03/81	Petrol	AB	1285	4	77.00	69.00	46
Kaefer 1303 1.3	08/72→07/75	Petrol	AR	1285	4	77.00	69.00	46
Kaefer 1303 1.6	08/72→12/79	Petrol	AD	1584	4	84.00	71.50	156
Kaefer 1303 1.6	08/70→07/74	Petrol	AE	1584	4	85.50	69.00	160
Kaefer 1303 1.6	08/70→07/74	Petrol	AH	1584	4	85.50	69.00	160
Kaefer 1303 1.6	08/70→07/74	Petrol	AK	1584	4	85.50	69.00	160
Kaefer 1303 LS,S 1.6	08/72→12/79	Petrol	AD	1584	4	84.00	71.50	156
Kaefer 1303 LS,S 1.6	08/72→12/79	Petrol	AJ	1584	4	85.50	69.00	160
Kaefer 1303 LS,S 1.6	08/72→12/79	Petrol	AS	1584	4	85.50	69.00	160
Kaefer 1500 1.5	01/66→11/73	Petrol	H	1493	4	83.00	69.00	155

				cm ³	x 			
Kaefer 1500 1.6	07/70→01/73	Petrol	AD	1584	4	84.00	71.50	156
Kaefer 1500 1.6	07/69→07/70	Petrol	B	1584	4	85.50	69.00	160
Kaefer 1600	09/92→08/03	Petrol	ACD	1584	4	85.50	69.00	159
Kaefer 1600 i	10/92→07/03	Petrol	ACD	1584	4	85.50	69.00	159
Kaefer Karmann 1.3	07/64→07/70	Petrol	F	1285	4	77.00	69.00	46
Karmann Ghia 1200	08/55→12/65	Petrol	D	1192	4	77.00	64.00	45
Karmann Ghia 1300	07/70→07/74	Petrol	AB	1285	4	77.00	69.00	46
Karmann Ghia 1500	07/64→07/74	Petrol	F	1285	4	77.00	69.00	46
Karmann Ghia 1500	01/66→12/69	Petrol	H	1493	4	83.00	69.00	155
Karmann Ghia 1600	01/70→07/74	Petrol	AD	1584	4	84.00	71.50	156
Karmann Ghia 1600	07/71→07/74	Petrol	AL	1584	4	85.50	69.00	160
Kombi 1.6	08/92→07/00	Petrol	EZ	1595	4	81.00	77.40	91
LT 28-35 I 2.4	12/82→07/92	Petrol	DL	2383	6	76.50	86.40	35
LT 28-35 I 2.4 D	08/89→06/96	Diesel	1S	2383	6	76.50	86.40	35
LT 28-35 I 2.4 D	08/89→06/96	Diesel	ACT	2383	6	76.50	86.40	35
LT 28-35 I 2.4 D	12/78→07/92	Diesel	CP	2383	6	76.50	86.40	35
LT 28-35 I 2.4 D	12/78→07/92	Diesel	DW	2383	6	76.50	86.40	35
LT 28-35 I 2.4 D Syncro	08/91→07/92	Diesel	1S	2383	6	76.50	86.40	35
LT 28-35 I 2.4 D Syncro	08/91→07/92	Diesel	DW	2383	6	76.50	86.40	35
LT 28-35 I 2.4 i	08/89→06/96	Petrol	1E	2383	6	76.50	86.40	35
LT 28-35 I 2.4 Syncro	08/92→07/94	Petrol	1E	2383	6	76.50	86.40	35
LT 28-35 I 2.4 Syncro	08/91→07/92	Petrol	DL	2383	6	76.50	86.40	35
LT 28-35 I 2.4 TD	08/88→08/92	Diesel	1G	2383	6	76.50	86.40	35
LT 28-35 I 2.4 TD	06/92→06/96	Diesel	ACL	2383	6	76.50	86.40	35
LT 28-35 I 2.4 TD	12/82→09/93	Diesel	DV	2383	6	76.50	86.40	35
LT 28-35 I 2.4 TD Syncro	08/91→07/92	Diesel	1G	2383	6	76.50	86.40	35
LT 28-35 I 2.4 TD Syncro	08/92→04/96	Diesel	ACL	2383	6	76.50	86.40	35
LT 28-35 I 2.4 TD Syncro	08/91→07/92	Diesel	DV	2383	6	76.50	86.40	35
LT 28-35 II 2.5 SDI	07/96→07/06	Diesel	AGX	2461	5	81.00	95.50	137
LT 28-35 II 2.5 TDI	05/96→08/99	Diesel	AHD	2461	5	81.00	95.50	137
LT 28-35 II 2.5 TDI	05/99→07/06	Diesel	ANJ	2461	5	81.00	95.50	137
LT 28-35 II 2.5 TDI	05/99→07/06	Diesel	APA	2461	5	81.00	95.50	137
LT 28-35 II 2.5 TDI	05/99→07/06	Diesel	AVR	2461	5	81.00	95.50	137
LT 28-35 II 2.5 TDI	05/01→07/06	Diesel	BBE	2461	5	81.00	95.50	137
LT 28-35 II 2.5 TDI	05/01→07/06	Diesel	BBF	2461	5	81.00	95.50	137
LT 28-46 II 2.5 SDI	09/96→07/06	Diesel	AGX	2461	5	81.00	95.50	137
LT 28-46 II 2.5 TDI	05/96→08/99	Diesel	AHD	2461	5	81.00	95.50	137
LT 28-46 II 2.5 TDI	05/99→07/06	Diesel	ANJ	2461	5	81.00	95.50	137
LT 28-46 II 2.5 TDI	05/99→07/06	Diesel	APA	2461	5	81.00	95.50	137
LT 28-46 II 2.5 TDI	05/99→07/06	Diesel	AVR	2461	5	81.00	95.50	137
LT 28-46 II 2.5 TDI	05/01→07/06	Diesel	BBE	2461	5	81.00	95.50	137
LT 28-46 II 2.5 TDI	05/01→07/06	Diesel	BBF	2461	5	81.00	95.50	137
LT 40-55 I 2.4	08/88→07/89	Petrol	1E	2383	6	76.50	86.40	35
LT 40-55 I 2.4	12/82→07/92	Petrol	DL	2383	6	76.50	86.40	35
LT 40-55 I 2.4 4WD	12/82→07/92	Petrol	DL	2383	6	76.50	86.40	35
LT 40-55 I 2.4 D	07/90→06/96	Diesel	1S	2383	6	76.50	86.40	35
LT 40-55 I 2.4 D	07/90→06/96	Diesel	ACT	2383	6	76.50	86.40	35
LT 40-55 I 2.4 D	12/78→07/92	Diesel	CP	2383	6	76.50	86.40	35
LT 40-55 I 2.4 D	12/78→07/92	Diesel	DW	2383	6	76.50	86.40	35
LT 40-55 I 2.4 D 4WD	01/79→03/86	Diesel	DW	2383	6	76.50	86.40	35
LT 40-55 I 2.4 i	01/93→06/96	Petrol	1E	2383	6	76.50	86.40	35
LT 40-55 I 2.4 Syncro	12/82→07/89	Petrol	DL	2383	6	76.50	86.40	35
LT 40-55 I 2.4 TD	08/88→08/92	Diesel	1G	2383	6	76.50	86.40	35
LT 40-55 I 2.4 TD	06/92→06/96	Diesel	ACL	2383	6	76.50	86.40	35
LT 40-55 I 2.4 TD	12/82→09/93	Diesel	DV	2383	6	76.50	86.40	35
LT 40-55 I 2.4 TD 4WD	08/78→07/92	Diesel	DV	2383	6	76.50	86.40	35
LT 40-55 I 2.4 TD Syncro	08/91→07/92	Diesel	1G	2383	6	76.50	86.40	35
LT 40-55 I 2.4 TD Syncro	08/92→04/96	Diesel	ACL	2383	6	76.50	86.40	35
LT 40-55 I 2.4 TD Syncro	08/91→07/92	Diesel	DV	2383	6	76.50	86.40	35
Lupo 1.0	10/98→05/00	Petrol	AHT	997	4	72.00	61.20	6
Lupo 1.0	09/98→07/05	Petrol	AER	999	4	67.10	70.60	2
Lupo 1.0	09/98→07/05	Petrol	ALD	999	4	67.10	70.60	2
Lupo 1.0	09/98→07/05	Petrol	ALL	999	4	67.10	70.60	2
Lupo 1.0	09/98→07/05	Petrol	ANV	999	4	67.10	70.60	2
Lupo 1.0	09/98→07/05	Petrol	AUC	999	4	67.10	70.60	2
Lupo 1.2 TDI 3L	07/99→07/05	Diesel	ANY	1191	3	76.50	86.40	30
Lupo 1.2 TDI 3L	07/99→07/05	Diesel	AYZ	1191	3	76.50	86.40	30
Lupo 1.4	10/00→07/05	Petrol	AUD	1390	4	76.50	75.60	20
Lupo 1.4 16V	08/99→07/05	Petrol	AFK	1390	4	76.50	75.60	20











cm3



9

Lupo 1.4 16V	09/98→07/05	Petrol	AHW	1390	4	76.50	75.60	20
Lupo 1.4 16V	09/98→07/05	Petrol	AKQ	1390	4	76.50	75.60	20
Lupo 1.4 16V	09/98→07/05	Petrol	APE	1390	4	76.50	75.60	20
Lupo 1.4 16V	08/99→07/05	Petrol	AQQ	1390	4	76.50	75.60	20
Lupo 1.4 16V	09/98→07/05	Petrol	AUA	1390	4	76.50	75.60	20
Lupo 1.4 16V	08/99→07/05	Petrol	AUB	1390	4	76.50	75.60	20
Lupo 1.4 16V	09/98→07/05	Petrol	BBY	1390	4	76.50	75.60	20
Lupo 1.4 FSI	02/01→07/05	Petrol	ARR	1390	4	76.50	75.60	22
Lupo 1.4 TDI	01/99→07/05	Diesel	AMF	1422	3	79.50	95.50	60
Lupo 1.6 GTI	09/00→07/05	Petrol	AVY	1598	4	76.50	86.90	42
Lupo 1.7 SDI	09/98→07/05	Diesel	AKU	1716	4	79.50	86.40	57
Multivan V 1.9 TDI	04/03→11/09	Diesel	AXB	1896	4	79.50	95.50	71
Multivan V 1.9 TDI	04/03→11/09	Diesel	AXC	1896	4	79.50	95.50	71
Multivan V 1.9 TDI	01/06→11/09	Diesel	BRR	1896	4	79.50	95.50	71
Multivan V 1.9 TDI	06/06→11/09	Diesel	BRS	1896	4	79.50	95.50	71
Multivan V 2.0	11/03→	Petrol	AXA	1984	4	82.50	92.80	152
Multivan V 2.0 BiTDI	09/09→	Diesel	CFCA	1968	4	81.00	95.50	134
Multivan V 2.0 BiTDI 4motion	09/09→	Diesel	CFCA	1968	4	81.00	95.50	134
Multivan V 2.0 TDI	09/09→	Diesel	CAAA	1968	4	81.00	95.50	134
Multivan V 2.0 TDI	09/09→	Diesel	CAAB	1968	4	81.00	95.50	134
Multivan V 2.0 TDI	09/09→	Diesel	CAAC	1968	4	81.00	95.50	134
Multivan V 2.0 TDI	05/11→	Diesel	CAAD	1968	4	81.00	95.50	134
Multivan V 2.0 TDI	05/10→	Diesel	CAAE	1968	4	81.00	95.50	134
Multivan V 2.0 TDI	09/09→	Diesel	CCHA	1968	4	81.00	95.50	134
Multivan V 2.0 TDI	05/10→	Diesel	CCHB	1968	4	81.00	95.50	134
Multivan V 2.0 TDI 4motion	09/09→	Diesel	CAAC	1968	4	81.00	95.50	134
Multivan V 2.0 TDI 4motion	05/10→	Diesel	CAAE	1968	4	81.00	95.50	134
Multivan V 2.0 TDI 4motion	09/09→	Diesel	CCHA	1968	4	81.00	95.50	134
Multivan V 2.0 TDI 4motion	05/10→	Diesel	CCHB	1968	4	81.00	95.50	134
Multivan V 2.5 TDI	04/03→11/09	Diesel	AXD	2461	5	81.00	95.50	138
Multivan V 2.5 TDI	04/03→11/09	Diesel	AXE	2461	5	81.00	95.50	138
Multivan V 2.5 TDI	11/03→11/09	Diesel	BLJ	2461	5	81.00	95.50	138
Multivan V 2.5 TDI	04/03→11/09	Diesel	BNZ	2461	5	81.00	95.50	138
Multivan V 2.5 TDI	04/03→11/09	Diesel	BPC	2461	5	81.00	95.50	138
Multivan V 2.5 TDI 4motion	07/04→11/09	Diesel	AXD	2461	5	81.00	95.50	138
Multivan V 2.5 TDI 4motion	07/04→11/09	Diesel	AXE	2461	5	81.00	95.50	138
Multivan V 2.5 TDI 4motion	07/04→11/09	Diesel	BNZ	2461	5	81.00	95.50	138
Multivan V 2.5 TDI 4motion	07/04→11/09	Diesel	BPC	2461	5	81.00	95.50	138
Multivan V 3.2 4motion	11/03→06/06	Petrol	BDL	3189	V6	84.00	95.90	157
Multivan V 3.2 V6	02/04→06/04	Petrol	BDL	3189	V6	84.00	95.90	157
Multivan V 3.2 V6	02/04→11/09	Petrol	BKK	3189	V6	84.00	95.90	157
Multivan V 3.2 V6	02/04→11/09	Petrol	CFLA	3189	V6	84.00	95.90	157
Multivan V 3.2 V6 4motion	07/04→11/09	Petrol	BKK	3189	V6	84.00	95.90	157
Multivan V 3.2 V6 4motion	07/04→11/09	Petrol	CFLA	3189	V6	84.00	95.90	157
Multivan Vi 2.0 TDI	04/15→	Diesel	CAAB	1968	4	81.00	95.50	134
Multivan Vi 2.0 TDI	04/15→	Diesel	CAAC	1968	4	81.00	95.50	134
Multivan Vi 2.0 TDI	04/15→	Diesel	CFCA	1968	4	81.00	95.50	134
Multivan Vi 2.0 TDI	06/15→	Diesel	CXEB	1968	4	81.00	95.50	134
Multivan Vi 2.0 TDI	04/15→	Diesel	CXFA	1968	4	81.00	95.50	134
Multivan Vi 2.0 TDI	04/15→	Diesel	CXGA	1968	4	81.00	95.50	134
Multivan Vi 2.0 TDI	04/15→	Diesel	CXGB	1968	4	81.00	95.50	134
Multivan Vi 2.0 TDI	04/15→	Diesel	CXHA	1968	4	81.00	95.50	134
Multivan Vi 2.0 TDI 4motion	06/15→	Diesel	CAAC	1968	4	81.00	95.50	134
Multivan Vi 2.0 TDI 4motion	06/15→	Diesel	CFCA	1968	4	81.00	95.50	134
Multivan Vi 2.0 TDI 4motion	06/15→	Diesel	CXEB	1968	4	81.00	95.50	134
Multivan Vi 2.0 TDI 4motion	08/15→	Diesel	CXFA	1968	4	81.00	95.50	134
New Beetle 1.4	11/01→09/10	Petrol	BCA	1390	4	76.50	75.60	25
New Beetle 1.6	10/99→09/00	Petrol	AWH	1595	4	81.00	77.40	82
New Beetle 1.6	06/00→09/10	Petrol	AYD	1595	4	81.00	77.40	85
New Beetle 1.6	06/00→09/10	Petrol	BFS	1595	4	81.00	77.40	87
New Beetle 1.8 T	10/99→09/10	Petrol	AGU	1781	4	81.00	86.40	110
New Beetle 1.8 T	10/99→09/10	Petrol	APH	1781	4	81.00	86.40	112
New Beetle 1.8 T	10/99→09/10	Petrol	AVC	1781	4	81.00	86.40	110
New Beetle 1.8 T	11/01→06/05	Petrol	AWP	1781	4	81.00	86.40	114
New Beetle 1.8 T	10/99→09/10	Petrol	AWU	1781	4	81.00	86.40	114
New Beetle 1.8 T	10/99→09/10	Petrol	AWV	1781	4	81.00	86.40	114
New Beetle 1.9 TDI	01/98→12/04	Diesel	ALH	1896	4	79.50	95.50	62
New Beetle 1.9 TDI	02/01→09/10	Diesel	ATD	1896	4	79.50	95.50	69
New Beetle 1.9 TDI	06/03→09/10	Diesel	AXR	1896	4	79.50	95.50	74

				cm3	x 			
New Beetle 1.9 TDI	02/01→09/10	Diesel	BEW	1896	4	79.50	95.50	74
New Beetle 1.9 TDI	07/05→09/10	Diesel	BSW	1896	4	79.50	95.50	69
New Beetle 2.0	01/98→09/10	Petrol	AEG	1984	4	82.50	92.80	145
New Beetle 2.0	01/98→09/10	Petrol	APK	1984	4	82.50	92.80	150
New Beetle 2.0	01/98→10/10	Petrol	AQY	1984	4	82.50	92.80	145
New Beetle RSI 3.2 4motion	04/00→05/01	Petrol	AXJ	3189	V6	84.00	95.90	157
Parati I 1.6	05/82→12/95	Petrol	FS	1588	4	79.50	80.00	50
Parati I 1.8 Hybrid	08/87→07/94	Petrol	JH	1781	4	81.00	86.40	119
Parati II 2.0	01/97→07/99	Petrol	ADY	1984	4	82.50	92.80	143
Parati III 1.9 D	08/02→	Diesel	1Y	1896	4	79.50	95.50	61
Passat 1.3	05/73→07/83	Petrol	FY	1272	4	75.00	72.00	10
Passat 1.3	01/78→07/86	Petrol	FZ	1272	4	75.00	72.00	10
Passat 1.3	08/80→07/86	Petrol	EP	1297	4	75.00	73.40	12
Passat 1.3	08/80→07/86	Petrol	EU	1297	4	75.00	73.40	13
Passat 1.3	05/73→01/78	Petrol	ZA	1297	4	75.00	73.40	14
Passat 1.3	05/73→01/78	Petrol	ZF	1297	4	75.00	73.40	14
Passat 1.4 TSI	05/07→12/14	Petrol	CAXA	1390	4	76.50	75.60	23
Passat 1.4 TSI EcoFuel	01/09→12/14	Petrol	CDGA	1390	4	76.50	75.60	27
Passat 1.4 TSI MultiFuel	11/10→12/14	Flexfuel	CKMA	1390	4	76.50	75.60	23
Passat 1.5	07/73→12/75	Petrol	YJ	1471	4	76.50	80.00	28
Passat 1.5	07/73→12/75	Petrol	ZB	1471	4	76.50	80.00	28
Passat 1.5	05/73→12/75	Petrol	ZC	1471	4	76.50	80.00	28
Passat 1.5 D	02/77→07/80	Diesel	CK	1471	4	76.50	80.00	28
Passat 1.6	08/75→07/80	Petrol	FS	1588	4	79.50	80.00	50
Passat 1.6	08/80→03/88	Petrol	WV	1588	4	79.50	80.00	50
Passat 1.6	09/79→07/80	Petrol	WY	1588	4	79.50	80.00	50
Passat 1.6	09/79→07/80	Petrol	WZ	1588	4	79.50	80.00	50
Passat 1.6	09/75→07/80	Petrol	YG	1588	4	79.50	80.00	50
Passat 1.6	09/75→12/80	Petrol	YH	1588	4	79.50	80.00	50
Passat 1.6	09/75→12/80	Petrol	YK	1588	4	79.50	80.00	50
Passat 1.6	02/76→03/88	Petrol	YN	1588	4	79.50	80.00	50
Passat 1.6	08/75→02/83	Petrol	YP	1588	4	79.50	80.00	50
Passat 1.6	02/88→09/91	Petrol	1F	1595	4	81.00	77.40	80
Passat 1.6	02/88→12/88	Petrol	ABN	1595	4	81.00	77.40	81
Passat 1.6	10/96→11/00	Petrol	ADP	1595	4	81.00	77.40	80
Passat 1.6	07/94→08/96	Petrol	AEK	1595	4	81.00	77.40	80
Passat 1.6	07/94→08/96	Petrol	AFT	1595	4	81.00	77.40	83
Passat 1.6	10/96→11/00	Petrol	AHL	1595	4	81.00	77.40	82
Passat 1.6	11/00→05/05	Petrol	ALZ	1595	4	81.00	77.40	85
Passat 1.6	10/96→11/00	Petrol	ANA	1595	4	81.00	77.40	85
Passat 1.6	10/96→11/00	Petrol	ARM	1595	4	81.00	77.40	82
Passat 1.6	05/05→11/10	Petrol	BSE	1595	4	81.00	77.40	85
Passat 1.6	05/05→11/10	Petrol	BSF	1595	4	81.00	77.40	85
Passat 1.6	08/80→03/88	Petrol	DT	1595	4	81.00	77.40	88
Passat 1.6	02/88→09/91	Petrol	EZ	1595	4	81.00	77.40	91
Passat 1.6	08/87→03/88	Petrol	PP	1595	4	81.00	77.40	95
Passat 1.6	01/85→03/88	Petrol	RL	1595	4	81.00	77.40	98
Passat 1.6 D	02/79→03/88	Diesel	CR	1588	4	76.50	86.40	33
Passat 1.6 D	08/80→03/88	Diesel	JK	1588	4	76.50	86.40	33
Passat 1.6 FSI	03/05→06/08	Petrol	BLF	1598	4	76.50	86.90	42
Passat 1.6 GLi	08/77→07/80	Petrol	YS	1588	4	79.50	80.00	50
Passat 1.6 i	06/78→07/80	Petrol	YS	1588	4	79.50	80.00	50
Passat 1.6 TD	04/82→03/88	Diesel	CY	1588	4	76.50	86.40	33
Passat 1.6 TD	05/86→09/93	Diesel	RA	1588	4	76.50	86.40	31
Passat 1.6 TD	08/88→09/93	Diesel	SB	1588	4	76.50	86.40	31
Passat 1.6 TDI	08/09→12/14	Diesel	CAYC	1598	4	79.50	80.50	53
Passat 1.8	08/90→05/97	Petrol	AAM	1781	4	81.00	86.40	103
Passat 1.8	02/88→05/97	Petrol	ABS	1781	4	81.00	86.40	104
Passat 1.8	10/96→11/00	Petrol	ADR	1781	4	81.00	86.40	106
Passat 1.8	02/88→05/97	Petrol	ADZ	1781	4	81.00	86.40	104
Passat 1.8	01/00→12/01	Petrol	AEB	1781	4	81.00	86.40	107
Passat 1.8	01/97→03/05	Petrol	AFY	1781	4	81.00	86.40	108
Passat 1.8	10/96→11/00	Petrol	APT	1781	4	81.00	86.40	109
Passat 1.8	10/96→11/00	Petrol	ARG	1781	4	81.00	86.40	109
Passat 1.8	01/83→03/88	Petrol	DS	1781	4	81.00	86.40	115
Passat 1.8	12/83→03/88	Petrol	DZ	1781	4	81.00	86.40	117
Passat 1.8	01/83→03/88	Petrol	JN	1781	4	81.00	86.40	115
Passat 1.8	01/83→03/88	Petrol	JV	1781	4	81.00	86.40	115
Passat 1.8	08/91→09/93	Petrol	KR	1781	4	81.00	86.40	119



cm3 x



9

Passat 1.8	04/88→07/92	Petrol	PB	1781	4	81.00	86.40	121
Passat 1.8	04/88→07/93	Petrol	PF	1781	4	81.00	86.40	122
Passat 1.8	09/92→12/93	Petrol	PG	1781	4	81.00	86.40	123
Passat 1.8	02/88→05/97	Petrol	RP	1781	4	81.00	86.40	108
Passat 1.8 4motion	09/98→12/99	Petrol	AEB	1781	4	81.00	86.40	107
Passat 1.8 16V	04/88→12/89	Petrol	KR	1781	4	81.00	86.40	119
Passat 1.8 G60 Syncro	08/88→05/97	Petrol	PG	1781	4	81.00	86.40	123
Passat 1.8 GL	08/91→09/93	Petrol	KR	1781	4	81.00	86.40	119
Passat 1.8 Syncro	01/86→03/88	Petrol	DS	1781	4	81.00	86.40	115
Passat 1.8 Syncro	01/86→03/88	Petrol	JN	1781	4	81.00	86.40	115
Passat 1.8 Syncro/4motion	10/96→11/00	Petrol	ADR	1781	4	81.00	86.40	106
Passat 1.8 Syncro/4motion	10/96→11/00	Petrol	APT	1781	4	81.00	86.40	109
Passat 1.8 Syncro/4motion	10/96→11/00	Petrol	ARG	1781	4	81.00	86.40	109
Passat 1.8 T	10/96→11/00	Petrol	AEB	1781	4	81.00	86.40	107
Passat 1.8 T	10/96→11/00	Petrol	ANB	1781	4	81.00	86.40	111
Passat 1.8 T	10/96→11/00	Petrol	APU	1781	4	81.00	86.40	111
Passat 1.8 T 20V	11/00→05/05	Petrol	AWL	1781	4	81.00	86.40	114
Passat 1.8 T Syncro	11/96→08/00	Petrol	AEB	1781	4	81.00	86.40	107
Passat 1.9	01/81→07/83	Petrol	WN	1921	5	79.50	77.40	49
Passat 1.9 D	05/89→10/93	Diesel	1Y	1896	4	79.50	95.50	61
Passat 1.9 TD	03/91→05/97	Diesel	AAZ	1896	4	79.50	95.50	62
Passat 1.9 TDI	10/93→05/97	Diesel	1Z	1896	4	79.50	95.50	62
Passat 1.9 TDI	03/96→11/00	Diesel	AFN	1896	4	79.50	95.50	64
Passat 1.9 TDI	10/96→11/00	Diesel	AHH	1896	4	79.50	95.50	62
Passat 1.9 TDI	10/93→11/00	Diesel	AHU	1896	4	79.50	95.50	68
Passat 1.9 TDI	08/98→11/00	Diesel	AJM	1896	4	79.50	95.50	69
Passat 1.9 TDI	08/98→11/00	Diesel	ATJ	1896	4	79.50	95.50	69
Passat 1.9 TDI	02/00→05/05	Diesel	AVB	1896	4	79.50	95.50	72
Passat 1.9 TDI	11/00→05/05	Diesel	AVF	1896	4	79.50	95.50	73
Passat 1.9 TDI	10/96→11/00	Diesel	AVG	1896	4	79.50	95.50	64
Passat 1.9 TDI	11/00→05/05	Diesel	AWX	1896	4	79.50	95.50	73
Passat 1.9 TDI	03/05→11/08	Diesel	BKC	1896	4	79.50	95.50	74
Passat 1.9 TDI	03/05→11/08	Diesel	BLS	1896	4	79.50	95.50	74
Passat 1.9 TDI	03/05→11/08	Diesel	BXE	1896	4	79.50	95.50	74
Passat 1.9 TDI 4motion	08/99→11/00	Diesel	ATJ	1896	4	79.50	95.50	69
Passat 1.9 TDI 4motion	11/00→05/05	Diesel	AVF	1896	4	79.50	95.50	73
Passat 1.9 TDI Syncro/4motion	10/96→11/00	Diesel	AFN	1896	4	79.50	95.50	64
Passat 1.9 TDI Syncro/4motion	10/96→11/00	Diesel	AVG	1896	4	79.50	95.50	64
Passat 2.0	02/90→05/97	Petrol	2E	1984	4	82.50	92.80	143
Passat 2.0	02/90→05/97	Petrol	ADY	1984	4	82.50	92.80	143
Passat 2.0	03/95→08/96	Petrol	AEP	1984	4	82.50	92.80	146
Passat 2.0	02/90→05/97	Petrol	AGG	1984	4	82.50	92.80	147
Passat 2.0	11/01→05/05	Petrol	ALT	1984	4	82.50	92.80	149
Passat 2.0	04/00→11/00	Petrol	AUZ	1984	4	82.50	92.80	147
Passat 2.0	08/83→03/88	Petrol	HP	1994	5	81.00	77.40	99
Passat 2.0	08/83→03/88	Petrol	JS	1994	5	81.00	77.40	100
Passat 2.0 4motion	04/00→11/00	Petrol	AUZ	1984	4	82.50	92.80	147
Passat 2.0 16V	08/88→09/93	Petrol	9A	1984	4	82.50	92.80	144
Passat 2.0 16V	01/94→05/97	Petrol	ABF	1984	4	82.50	92.80	143
Passat 2.0 BlueTDI	01/09→11/10	Diesel	CBAC	1968	4	81.00	95.50	131
Passat 2.0 FSI	03/05→11/10	Petrol	BLR	1984	4	82.50	92.80	149
Passat 2.0 FSI	03/05→11/10	Petrol	BLY	1984	4	82.50	92.80	149
Passat 2.0 FSI	03/05→11/10	Petrol	BVY	1984	4	82.50	92.80	149
Passat 2.0 FSI	03/05→11/10	Petrol	BVZ	1984	4	82.50	92.80	149
Passat 2.0 FSI 4motion	09/05→11/10	Petrol	BLX	1984	4	82.50	92.80	149
Passat 2.0 FSI 4motion	09/05→11/10	Petrol	BLY	1984	4	82.50	92.80	149
Passat 2.0 FSI 4motion	09/05→11/10	Petrol	BVX	1984	4	82.50	92.80	149
Passat 2.0 Syncro	10/90→05/97	Petrol	2E	1984	4	82.50	92.80	143
Passat 2.0 Syncro	10/90→05/97	Petrol	ADY	1984	4	82.50	92.80	143
Passat 2.0 Syncro	10/90→05/97	Petrol	AGG	1984	4	82.50	92.80	147
Passat 2.0 Syncro	05/84→03/88	Petrol	JS	1994	5	81.00	77.40	100
Passat 2.0 TDI	12/03→05/05	Diesel	BGW	1968	4	81.00	95.50	133
Passat 2.0 TDI	12/03→05/05	Diesel	BHW	1968	4	81.00	95.50	133
Passat 2.0 TDI	03/05→11/10	Diesel	BMA	1968	4	81.00	95.50	131
Passat 2.0 TDI	03/05→05/09	Diesel	BMP	1968	4	81.00	95.50	131
Passat 2.0 TDI	08/05→11/10	Diesel	BMR	1968	4	81.00	95.50	131
Passat 2.0 TDI	08/05→05/09	Diesel	BUZ	1968	4	81.00	95.50	131
Passat 2.0 TDI	08/05→07/06	Diesel	BVE	1968	4	81.00	95.50	131
Passat 2.0 TDI	11/05→05/07	Diesel	BWV	1968	4	81.00	95.50	131

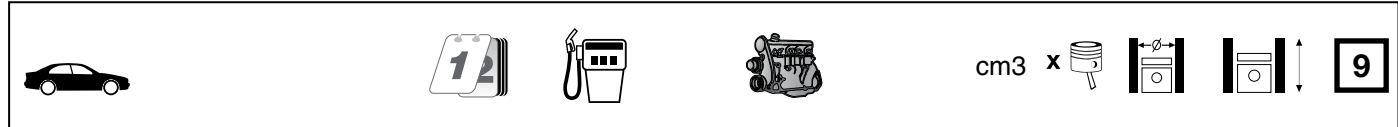

Passat 2.0 TDI	03/05→05/11	Diesel	CBAA	1968	4	81.00	95.50	131
Passat 2.0 TDI	06/08→01/12	Diesel	CBAB	1968	4	81.00	95.50	131
Passat 2.0 TDI	05/08→05/11	Diesel	CBBA	1968	4	81.00	95.50	131
Passat 2.0 TDI	08/05→01/12	Diesel	CBBB	1968	4	81.00	95.50	134
Passat 2.0 TDI	11/08→11/10	Diesel	CBDC	1968	4	81.00	95.50	131
Passat 2.0 TDI	06/08→12/14	Diesel	CFFA	1968	4	81.00	95.50	134
Passat 2.0 TDI	06/08→12/14	Diesel	CFFB	1968	4	81.00	95.50	134
Passat 2.0 TDI	06/08→12/14	Diesel	CFGB	1968	4	81.00	95.50	134
Passat 2.0 TDI	12/12→12/14	Diesel	CFGC	1968	4	81.00	95.50	134
Passat 2.0 TDI	06/08→12/14	Diesel	CLLA	1968	4	81.00	95.50	134
Passat 2.0 TDI	11/14→	Diesel	CRLB	1968	4	81.00	95.50	134
Passat 2.0 TDI	06/14→	Diesel	CVCA	1968	4	81.00	95.50	134
Passat 2.0 TDI	11/14→	Diesel	DDAA	1968	4	81.00	95.50	134
Passat 2.0 TDI	11/14→	Diesel	DFCA	1968	4	81.00	95.50	134
Passat 2.0 TDI 4motion	03/05→05/09	Diesel	BMP	1968	4	81.00	95.50	131
Passat 2.0 TDI 4motion	08/09→01/12	Diesel	CBAB	1968	4	81.00	95.50	131
Passat 2.0 TDI 4motion	05/09→01/12	Diesel	CBBB	1968	4	81.00	95.50	134
Passat 2.0 TDI 4motion	08/09→12/14	Diesel	CFFB	1968	4	81.00	95.50	134
Passat 2.0 TDI 4motion	11/09→01/13	Diesel	CFGB	1968	4	81.00	95.50	134
Passat 2.0 TDI 4motion	01/13→12/14	Diesel	CFGC	1968	4	81.00	95.50	134
Passat 2.0 TDI 4motion	02/15→	Diesel	CRLB	1968	4	81.00	95.50	134
Passat 2.0 TDI 4motion	11/14→	Diesel	DDAA	1968	4	81.00	95.50	134
Passat 2.0 TDI 4motion	11/14→	Diesel	DFCA	1968	4	81.00	95.50	134
Passat 2.0 TDI 4motion	02/15→	Diesel	DFEA	1968	4	81.00	95.50	134
Passat 2.0 TDI 16V	03/05→11/10	Diesel	BKP	1968	4	81.00	95.50	131
Passat 2.0 TDI 16V	03/05→11/10	Diesel	CBAB	1968	4	81.00	95.50	131
Passat 2.0 TDI 16V 4motion	03/05→11/10	Diesel	BKP	1968	4	81.00	95.50	131
Passat 2.0 TDI 16V 4motion	03/05→11/10	Diesel	CBAB	1968	4	81.00	95.50	131
Passat 2.1	01/81→07/83	Petrol	WE	2144	5	79.50	86.40	59
Passat 2.2	09/82→12/84	Petrol	WE	2144	5	79.50	86.40	59
Passat 2.2	01/85→03/88	Petrol	KV	2226	5	81.00	86.40	127
Passat 2.2	08/84→12/88	Petrol	KX	2226	5	81.00	86.40	127
Passat 2.2 Syncro	08/84→07/88	Petrol	HY	2226	5	81.00	86.40	126
Passat 2.2 Syncro	08/85→12/88	Petrol	JT	2226	5	81.00	86.40	127
Passat 2.5 TDI	07/98→05/05	Diesel	AFB	2496	V6	78.30	86.40	47
Passat 2.5 TDI	07/98→05/05	Diesel	AKN	2496	V6	78.30	86.40	47
Passat 2.5 TDI	05/03→05/05	Diesel	BDG	2496	V6	78.30	86.40	47
Passat 2.5 TDI 4motion	11/00→05/05	Diesel	AFB	2496	V6	78.30	86.40	47
Passat 2.5 TDI 4motion	11/00→05/05	Diesel	AKN	2496	V6	78.30	86.40	47
Passat 2.5 TDI 4motion	01/03→05/05	Diesel	BAU	2496	V6	78.30	86.40	47
Passat 2.5 TDI 4motion	01/03→05/05	Diesel	BDH	2496	V6	78.30	86.40	47
Passat 2.5 TDI Syncro/4motion	12/98→11/00	Diesel	AFB	2496	V6	78.30	86.40	47
Passat 2.5 TDI Syncro/4motion	12/98→11/00	Diesel	AKN	2496	V6	78.30	86.40	47
Passat 2.8	05/02→05/03	Petrol	AMX	2771	V6	82.50	86.40	141
Passat 2.8	10/00→08/05	Petrol	ATQ	2771	V6	82.50	86.40	141
Passat 2.8 4motion	11/00→05/05	Petrol	AMX	2771	V6	82.50	86.40	141
Passat 2.8 4motion	11/00→05/05	Petrol	ATQ	2771	V6	82.50	86.40	141
Passat 2.8 V6	08/96→11/00	Petrol	ACK	2771	V6	82.50	86.40	141
Passat 2.8 V6	05/97→09/99	Petrol	AGE	2771	V6	82.50	86.40	142
Passat 2.8 V6	08/96→11/00	Petrol	APR	2771	V6	82.50	86.40	141
Passat 2.8 V6	08/96→11/00	Petrol	AQD	2771	V6	82.50	86.40	142
Passat 2.8 V6	09/99→11/00	Petrol	ATX	2771	V6	82.50	86.40	141
Passat 2.8 V6	09/99→11/00	Petrol	BBG	2771	V6	82.50	86.40	141
Passat 2.8 V6 4motion	09/99→11/00	Petrol	ATX	2771	V6	82.50	86.40	141
Passat 2.8 V6 Syncro/4motion	10/96→11/00	Petrol	ACK	2771	V6	82.50	86.40	141
Passat 2.8 V6 Syncro/4motion	10/96→11/00	Petrol	ALG	2771	V6	82.50	86.40	142
Passat 2.8 V6 Syncro/4motion	10/96→11/00	Petrol	APR	2771	V6	82.50	86.40	141
Passat 2.8 V6 Syncro/4motion	10/96→11/00	Petrol	AQD	2771	V6	82.50	86.40	142
Passat 2.8 Syncro	05/97→09/99	Petrol	AGE	2771	V6	82.50	86.40	142
Passat 2.8 VR6	06/91→05/97	Petrol	AAA	2792	6	81.00	90.30	128
Passat 2.9 VR6 Syncro	01/94→05/97	Petrol	ABV	2861	V6	82.00	90.30	140
Passat 3.2 FSI 4motion	11/05→11/10	Petrol	AXZ	3168	V6	86.00	90.90	162
Passat 3.6 FSI	06/05→01/12	Petrol	BLV	3597	V6	89.00	96.40	163
Passat 3.6 FSI 4motion	09/05→01/12	Petrol	BLV	3597	V6	89.00	96.40	163
Passat 3.6 FSI 4motion	06/08→12/14	Petrol	BWS	3597	V6	89.00	96.40	163
Passat 3.6 R36 4motion	04/07→11/10	Petrol	BWS	3597	V6	89.00	96.40	163
Passat Alltrack 2.0 TDI	01/12→12/14	Diesel	CFFB	1968	4	81.00	95.50	134
Passat Alltrack 2.0 TDI 4motion	01/12→12/14	Diesel	CFGB	1968	4	81.00	95.50	134











cm3 x



9

Passat Alltrack 2.0 TDI 4motion	01/13→12/14	Diesel	CFGC	1968	4	81.00	95.50	134
Passat Alltrack 2.0 TDI 4motion	05/15→	Diesel	CRLB	1968	4	81.00	95.50	134
Passat Alltrack 2.0 TDI 4motion	05/15→	Diesel	DDAA	1968	4	81.00	95.50	134
Passat Alltrack 2.0 TDI 4motion	05/15→	Diesel	DFCA	1968	4	81.00	95.50	134
Passat Alltrack 2.0 TDI 4motion	05/15→	Diesel	DFEA	1968	4	81.00	95.50	134
Phaeton 3.2 V6	04/02→	Petrol	AYT	3189	V6	84.00	95.90	157
Phaeton 3.2 V6	04/02→	Petrol	BKL	3189	V6	84.00	95.90	157
Phaeton 3.2 V6 4motion	02/04→	Petrol	BKL	3189	V6	84.00	95.90	157
Phaeton 3.2 V6 4motion	02/04→	Petrol	BRK	3189	V6	84.00	95.90	157
Polo 0.8	09/75→09/81	Petrol	HE	771	4	64.50	59.00	1
Polo 0.9	09/75→12/81	Petrol	HA	895	4	69.50	59.00	3
Polo 1.0	08/96→12/01	Petrol	AER	999	4	67.10	70.60	2
Polo 1.0	05/99→05/02	Petrol	ALD	999	4	67.10	70.60	2
Polo 1.0	10/99→09/01	Petrol	AUC	999	4	67.10	70.60	2
Polo 1.0	01/85→09/94	Petrol	AAK	1043	4	75.00	59.00	8
Polo 1.0	01/85→09/94	Petrol	AAU	1043	4	75.00	59.00	8
Polo 1.0	10/94→12/99	Petrol	AEV	1043	4	75.00	59.00	8
Polo 1.0	10/81→10/86	Petrol	GL	1043	4	75.00	59.00	9
Polo 1.0	01/85→09/94	Petrol	HZ	1043	4	75.00	59.00	8
Polo 1.0 CAT	08/89→09/94	Petrol	AAK	1043	4	75.00	59.00	8
Polo 1.0 CAT	08/89→09/94	Petrol	AAU	1043	4	75.00	59.00	8
Polo 1.0 CAT	08/89→09/94	Petrol	ACM	1043	4	75.00	59.00	8
Polo 1.1	03/75→09/89	Petrol	HB	1093	4	69.50	72.00	4
Polo 1.1	03/75→09/81	Petrol	HC	1093	4	69.50	72.00	4
Polo 1.2	01/02→05/07	Petrol	AWY	1198	3	76.50	86.90	36
Polo 1.2	05/07→11/09	Petrol	BBM	1198	3	76.50	86.90	36
Polo 1.2	01/02→05/07	Petrol	BMD	1198	3	76.50	86.90	36
Polo 1.2	06/09→	Petrol	CGPA	1198	3	76.50	86.90	36
Polo 1.2	06/09→	Petrol	CGPB	1198	3	76.50	86.90	36
Polo 1.2 12V	10/01→07/07	Petrol	AZQ	1198	3	76.50	86.90	36
Polo 1.2 12V	10/01→07/07	Petrol	BME	1198	3	76.50	86.90	36
Polo 1.2 12V	05/07→11/09	Petrol	BZG	1198	3	76.50	86.90	36
Polo 1.2 TDI	10/09→	Diesel	CFWA	1199	3	79.50	80.50	52
Polo 1.2 TSI	06/09→	Petrol	CBZA	1197	4	71.00	75.60	5
Polo 1.2 TSI	11/09→	Petrol	CBZB	1197	4	71.00	75.60	5
Polo 1.3	10/90→09/94	Petrol	3F	1272	4	75.00	72.00	10
Polo 1.3	08/92→07/94	Petrol	AAV	1272	4	75.00	72.00	10
Polo 1.3	09/82→09/89	Petrol	GK	1272	4	75.00	72.00	10
Polo 1.3	08/82→07/88	Petrol	GT	1272	4	75.00	72.00	10
Polo 1.3	12/76→07/83	Petrol	HH	1272	4	75.00	72.00	10
Polo 1.3	08/82→07/88	Petrol	HJ	1272	4	75.00	72.00	10
Polo 1.3	08/83→07/88	Petrol	HK	1272	4	75.00	72.00	10
Polo 1.3	08/83→07/85	Petrol	HW	1272	4	75.00	72.00	11
Polo 1.3	08/83→07/88	Petrol	MH	1272	4	75.00	72.00	11
Polo 1.3 CAT	07/87→09/94	Petrol	2G	1272	4	75.00	72.00	10
Polo 1.3 CAT	10/89→09/94	Petrol	3F	1272	4	75.00	72.00	10
Polo 1.3 CAT	07/87→09/94	Petrol	AAV	1272	4	75.00	72.00	10
Polo 1.3 CAT	07/87→09/94	Petrol	MH	1272	4	75.00	72.00	11
Polo 1.3 CAT	07/87→09/94	Petrol	NZ	1272	4	75.00	72.00	11
Polo 1.3 D	08/86→08/90	Diesel	MN	1272	4	75.00	72.00	11
Polo 1.3 G40	01/87→09/94	Petrol	PY	1272	4	75.00	72.00	11
Polo 1.4	05/97→09/01	Petrol	AEX	1390	4	76.50	75.60	18
Polo 1.4	05/97→09/01	Petrol	AKK	1390	4	76.50	75.60	20
Polo 1.4	12/98→09/01	Petrol	AKP	1390	4	76.50	75.60	20
Polo 1.4	05/97→09/01	Petrol	AKV	1390	4	76.50	75.60	21
Polo 1.4	05/97→09/01	Petrol	ANW	1390	4	76.50	75.60	23
Polo 1.4	10/99→09/01	Petrol	ANX	1390	4	76.50	75.60	21
Polo 1.4	05/97→09/01	Petrol	APQ	1390	4	76.50	75.60	21
Polo 1.4	05/97→09/01	Petrol	AUD	1390	4	76.50	75.60	20
Polo 1.4	07/03→	Petrol	BBY	1390	4	76.50	75.60	20
Polo 1.4	11/03→	Petrol	BBZ	1390	4	76.50	75.60	20
Polo 1.4	07/03→	Petrol	BKY	1390	4	76.50	75.60	20
Polo 1.4	06/09→	Petrol	CGGB	1390	4	76.50	75.60	27
Polo 1.4 16V	10/99→09/01	Petrol	AFK	1390	4	76.50	75.60	20
Polo 1.4 16V	10/99→09/01	Petrol	AHW	1390	4	76.50	75.60	20
Polo 1.4 16V	10/99→09/01	Petrol	APE	1390	4	76.50	75.60	20
Polo 1.4 16V	10/99→09/01	Petrol	AQQ	1390	4	76.50	75.60	20
Polo 1.4 16V	10/99→05/08	Petrol	AUA	1390	4	76.50	75.60	20
Polo 1.4 16V	10/99→05/08	Petrol	AUB	1390	4	76.50	75.60	20

				cm ³	x 			
Polo 1.4 16V	10/01→05/08	Petrol	BBY	1390	4	76.50	75.60	20
Polo 1.4 16V	10/01→05/08	Petrol	BBZ	1390	4	76.50	75.60	20
Polo 1.4 16V	10/01→05/08	Petrol	BKY	1390	4	76.50	75.60	20
Polo 1.4 16V	05/06→11/09	Petrol	BUD	1390	4	76.50	75.60	23
Polo 1.4 D	08/90→09/94	Diesel	1W	1398	4	75.00	79.10	16
Polo 1.4 FSI	02/02→07/06	Petrol	AXU	1390	4	76.50	75.60	24
Polo 1.4 GTI	05/10→	Petrol	CAVE	1390	4	76.50	75.60	23
Polo 1.4 TDI	10/99→06/05	Diesel	AMF	1422	3	79.50	95.50	60
Polo 1.4 TDi	01/00→10/00	Diesel	ATL	1422	3	79.50	95.50	60
Polo 1.4 TDI	10/01→	Diesel	BAY	1422	3	79.50	95.50	60
Polo 1.4 TDI	04/05→11/09	Diesel	BMS	1422	3	79.50	95.50	60
Polo 1.4 TDI	04/05→11/09	Diesel	BNM	1422	3	79.50	95.50	60
Polo 1.4 TDI	04/05→11/09	Diesel	BNV	1422	3	79.50	95.50	60
Polo 1.4 TDI	04/05→11/09	Diesel	BWB	1422	3	79.50	95.50	60
Polo 1.6	05/97→09/01	Petrol	AEH	1595	4	81.00	77.40	82
Polo 1.6	05/97→09/01	Petrol	AFT	1595	4	81.00	77.40	83
Polo 1.6	05/97→10/04	Petrol	AKL	1595	4	81.00	77.40	82
Polo 1.6	05/97→09/01	Petrol	APF	1595	4	81.00	77.40	82
Polo 1.6	05/97→09/01	Petrol	AUR	1595	4	81.00	77.40	86
Polo 1.6	09/94→12/95	Petrol	AEA	1598	4	76.50	86.90	37
Polo 1.6	05/97→09/01	Petrol	AEE	1598	4	76.50	86.90	38
Polo 1.6	05/97→09/01	Petrol	ALM	1598	4	76.50	86.90	41
Polo 1.6	01/07→12/10	Petrol	BTS	1598	4	76.50	86.90	42
Polo 1.6	01/10→	Petrol	CFNA	1598	4	76.50	86.90	42
Polo 1.6	05/10→	Petrol	CFNB	1598	4	76.50	86.90	44
Polo 1.6 16V	05/06→11/09	Petrol	BTS	1598	4	76.50	86.90	42
Polo 1.6 16V GTI	10/99→09/01	Petrol	ARC	1598	4	76.50	86.90	42
Polo 1.6 16V GTI	10/99→09/01	Petrol	AVY	1598	4	76.50	86.90	42
Polo 1.6 BiFuel	01/11→	Petrol	CNKA	1598	4	76.50	86.90	40
Polo 1.6 TDI	06/09→	Diesel	CAYA	1598	4	79.50	80.50	53
Polo 1.6 TDI	06/09→	Diesel	CAYB	1598	4	79.50	80.50	53
Polo 1.6 TDI	06/09→	Diesel	CAYC	1598	4	79.50	80.50	53
Polo 1.6 TDI	06/09→	Diesel	CLNA	1598	4	79.50	80.50	53
Polo 1.7 SDI	04/97→10/99	Diesel	AHG	1716	4	79.50	86.40	57
Polo 1.7 SDI	08/97→09/01	Diesel	AKU	1716	4	79.50	86.40	57
Polo 1.7 SDI	08/97→09/01	Diesel	AKW	1716	4	79.50	86.40	57
Polo 1.8	10/05→12/08	Petrol	ADD	1781	4	81.00	86.40	104
Polo 1.8	01/95→09/01	Petrol	ADZ	1781	4	81.00	86.40	104
Polo 1.9 D	10/94→09/01	Diesel	AEF	1896	4	79.50	95.50	61
Polo 1.9 SDI	06/96→09/01	Diesel	AEY	1896	4	79.50	95.50	63
Polo 1.9 SDI	07/96→09/01	Diesel	AGD	1896	4	79.50	95.50	63
Polo 1.9 SDI	08/99→09/01	Diesel	AGP	1896	4	79.50	95.50	65
Polo 1.9 SDI	08/99→09/01	Diesel	AQM	1896	4	79.50	95.50	61
Polo 1.9 SDI	10/99→09/01	Diesel	ASX	1896	4	79.50	95.50	63
Polo 1.9 SDI	10/01→	Diesel	ASY	1896	4	79.50	95.50	61
Polo 1.9 TDI	06/98→09/01	Diesel	AFN	1896	4	79.50	95.50	64
Polo 1.9 TDI	05/97→09/01	Diesel	AGR	1896	4	79.50	95.50	66
Polo 1.9 TDI	01/97→09/01	Diesel	AHU	1896	4	79.50	95.50	68
Polo 1.9 TDI	05/97→09/01	Diesel	ALE	1896	4	79.50	95.50	68
Polo 1.9 TDI	05/97→09/01	Diesel	ALH	1896	4	79.50	95.50	62
Polo 1.9 TDI	06/98→09/01	Diesel	ASV	1896	4	79.50	95.50	67
Polo 1.9 TDI	11/03→11/09	Diesel	ASZ	1896	4	79.50	95.50	71
Polo 1.9 TDI	10/01→	Diesel	ATD	1896	4	79.50	95.50	69
Polo 1.9 TDI	10/01→11/09	Diesel	AXR	1896	4	79.50	95.50	74
Polo 1.9 TDI	11/03→11/09	Diesel	BLT	1896	4	79.50	95.50	76
Polo 1.9 TDI	10/01→11/09	Diesel	BMT	1896	4	79.50	95.50	74
Polo 45 1.0	10/94→09/96	Petrol	AEV	1043	4	75.00	59.00	8
Polo 50 1.0	09/96→10/99	Petrol	AER	999	4	67.10	70.60	2
Polo 50 1.0	09/96→10/99	Petrol	ALL	999	4	67.10	70.60	2
Polo 54 1.4	01/98→08/99	Petrol	ANX	1390	4	76.50	75.60	21
Polo 55 1.3	10/94→07/95	Petrol	ADX	1296	4	76.50	70.50	17
Polo 55 1.4	08/95→10/99	Petrol	AEX	1390	4	76.50	75.60	18
Polo 57 1.7 SDI	07/97→09/01	Diesel	AKW	1716	4	79.50	86.40	57
Polo 60 1.4	07/95→09/01	Petrol	AEX	1390	4	76.50	75.60	18
Polo 60 1.4	12/95→09/01	Petrol	AKK	1390	4	76.50	75.60	20
Polo 60 1.4	07/95→09/01	Petrol	AKV	1390	4	76.50	75.60	21
Polo 60 1.4	12/95→09/01	Petrol	ANW	1390	4	76.50	75.60	23
Polo 60 1.4	07/95→09/01	Petrol	APQ	1390	4	76.50	75.60	21
Polo 60 1.4	12/95→09/01	Petrol	AUD	1390	4	76.50	75.60	20

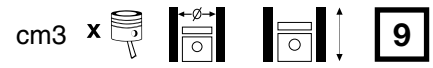

Polo 60 1.7 SDI	08/97→10/99	Diesel	AKU	1716	4	79.50	86.40	57
Polo 64 1.9 D	01/96→10/96	Diesel	1Y	1896	4	79.50	95.50	61
Polo 64 1.9 D	10/94→10/99	Diesel	AEF	1896	4	79.50	95.50	61
Polo 64 1.9 SDI	12/95→08/99	Diesel	AEY	1896	4	79.50	95.50	63
Polo 64 1.9 SDI	07/96→10/99	Diesel	AGD	1896	4	79.50	95.50	63
Polo 68 1.9 SDI	08/99→01/02	Diesel	AGP	1896	4	79.50	95.50	65
Polo 68 1.9 SDI	08/99→01/02	Diesel	AQM	1896	4	79.50	95.50	61
Polo 75 1.4 16V	10/99→09/01	Petrol	APE	1390	4	76.50	75.60	20
Polo 75 1.4 16V	10/99→09/01	Petrol	AUA	1390	4	76.50	75.60	20
Polo 75 1.6	11/95→09/97	Petrol	1F	1595	4	81.00	77.40	80
Polo 75 1.6	10/94→10/99	Petrol	AEA	1598	4	76.50	86.90	37
Polo 75 1.6	10/94→09/01	Petrol	AEE	1598	4	76.50	86.90	38
Polo 75 1.6	10/94→10/99	Petrol	AHS	1598	4	76.50	86.90	39
Polo 75 1.6	11/95→09/01	Petrol	ALM	1598	4	76.50	86.90	41
Polo 90 1.8	01/97→09/01	Petrol	ABS	1781	4	81.00	86.40	104
Polo 90 1.8	01/97→09/01	Petrol	ADD	1781	4	81.00	86.40	104
Polo 90 1.8	01/97→09/01	Petrol	ADZ	1781	4	81.00	86.40	104
Polo 90 1.9 TDI	09/96→09/01	Diesel	AGR	1896	4	79.50	95.50	66
Polo 90 1.9 TDI	09/96→09/01	Diesel	AHU	1896	4	79.50	95.50	68
Polo 90 1.9 TDI	09/96→09/01	Diesel	ALE	1896	4	79.50	95.50	68
Polo 90 1.9 TDI	09/96→09/01	Diesel	ALH	1896	4	79.50	95.50	62
Polo 100 1.4 16V	04/96→10/99	Petrol	AFH	1390	4	76.50	75.60	19
Polo 100 1.6	12/95→09/01	Petrol	AEH	1595	4	81.00	77.40	82
Polo 100 1.6	12/95→09/01	Petrol	AFT	1595	4	81.00	77.40	83
Polo 100 1.6	12/95→09/01	Petrol	AKL	1595	4	81.00	77.40	82
Polo 100 1.6	12/95→09/01	Petrol	APF	1595	4	81.00	77.40	82
Polo 100 1.6	12/95→09/01	Petrol	AUR	1595	4	81.00	77.40	86
Polo 110 1.9 TDI	06/98→01/02	Diesel	AFN	1896	4	79.50	95.50	64
Polo 110 1.9 TDI	06/98→01/02	Diesel	ASV	1896	4	79.50	95.50	67
Polo 120 1.6 16V GTI	09/98→10/99	Petrol	AJV	1598	4	76.50	86.90	40
Quantum 1.8	04/85→07/90	Petrol	JV	1781	4	81.00	86.40	115
Santana 1.3	08/81→07/83	Petrol	FZ	1272	4	75.00	72.00	10
Santana 1.3 CX	08/84→12/85	Petrol	EP	1297	4	75.00	73.40	12
Santana 1.6	08/81→12/84	Petrol	WV	1588	4	79.50	80.00	50
Santana 1.6	08/81→12/82	Petrol	YP	1588	4	79.50	80.00	50
Santana 1.6	08/81→12/84	Petrol	DT	1595	4	81.00	77.40	88
Santana 1.6 D	08/81→12/84	Diesel	CR	1588	4	76.50	86.40	33
Santana 1.6 D	08/81→12/84	Diesel	JK	1588	4	76.50	86.40	33
Santana 1.6 TD	12/81→12/84	Diesel	CY	1588	4	76.50	86.40	33
Santana 1.8	01/83→07/94	Petrol	DS	1781	4	81.00	86.40	115
Santana 1.8	09/83→07/94	Petrol	JN	1781	4	81.00	86.40	115
Santana 1.8	04/85→12/99	Petrol	JV	1781	4	81.00	86.40	115
Santana 1.8 GL	05/91→07/94	Petrol	JN	1781	4	81.00	86.40	115
Santana 1.9	08/81→07/83	Petrol	WN	1921	5	79.50	77.40	49
Santana 2.0	08/83→12/84	Petrol	HP	1994	5	81.00	77.40	99
Santana 2.0	08/83→12/84	Petrol	JS	1994	5	81.00	77.40	100
Santana 2.1	08/82→12/83	Petrol	WE	2144	5	79.50	86.40	59
Santana 2.2	09/82→12/84	Petrol	WE	2144	5	79.50	86.40	59
Santana 2.2	09/84→12/85	Petrol	KX	2226	5	81.00	86.40	127
Saveiro I 1.6	08/90→07/96	Petrol	1F	1595	4	81.00	77.40	80
Saveiro I 1.6	08/90→07/96	Petrol	EW	1595	4	81.00	77.40	90
Saveiro I 1.6 Álcool	04/93→11/96	Petrol	YH	1588	4	79.50	80.00	50
Saveiro I 1.6 Álcool	07/85→10/89	Petrol	HM	1595	4	81.00	77.40	88
Saveiro I 1.6 D	08/91→07/96	Diesel	SB	1588	4	76.50	86.40	31
Saveiro II 1.6	07/97→02/02	Petrol	1F	1595	4	81.00	77.40	80
Saveiro II 1.6	07/97→02/02	Petrol	EW	1595	4	81.00	77.40	90
Saveiro II 1.9 D	02/98→02/02	Diesel	1Y	1896	4	79.50	95.50	61
Scirocco 1.1	04/74→07/79	Petrol	FA	1093	4	69.50	72.00	4
Scirocco 1.3	08/79→12/83	Petrol	GF	1272	4	75.00	72.00	10
Scirocco 1.3	08/83→07/84	Petrol	HK	1272	4	75.00	72.00	10
Scirocco 1.4 TSI	05/08→	Petrol	CAVD	1390	4	76.50	75.60	23
Scirocco 1.4 TSI	08/08→	Petrol	CAXA	1390	4	76.50	75.60	23
Scirocco 1.4 TSI	05/08→	Petrol	CNWA	1390	4	76.50	75.60	23
Scirocco 1.5	09/77→12/78	Petrol	EH	1457	4	79.50	73.40	48
Scirocco 1.5	08/77→12/83	Petrol	JB	1457	4	79.50	73.40	48
Scirocco 1.5	02/74→12/77	Petrol	FD	1471	4	76.50	80.00	28
Scirocco 1.5	02/74→12/75	Petrol	FH	1471	4	76.50	80.00	28
Scirocco 1.5	02/74→08/75	Petrol	YJ	1471	4	76.50	80.00	28
Scirocco 1.5	02/74→08/75	Petrol	ZB	1471	4	76.50	80.00	28



Scirocco 1.6	06/76→07/82	Petrol	EG	1588	4	79.50	80.00	50
Scirocco 1.6	08/78→07/80	Petrol	EJ	1588	4	79.50	80.00	51
Scirocco 1.6	08/82→07/83	Petrol	EM	1588	4	79.50	80.00	50
Scirocco 1.6	08/75→07/79	Petrol	FN	1588	4	79.50	80.00	50
Scirocco 1.6	08/75→07/79	Petrol	FP	1588	4	79.50	80.00	50
Scirocco 1.6	08/75→04/84	Petrol	FR	1588	4	79.50	80.00	50
Scirocco 1.6	08/75→07/77	Petrol	FT	1588	4	79.50	80.00	50
Scirocco 1.6	01/83→12/89	Petrol	EW	1595	4	81.00	77.40	90
Scirocco 1.6	04/86→07/90	Petrol	RE	1595	4	81.00	77.40	96
Scirocco 1.7	09/80→12/83	Petrol	EN	1716	4	79.50	86.40	54
Scirocco 1.8	08/82→12/89	Petrol	DX	1781	4	81.00	86.40	116
Scirocco 1.8	08/82→12/89	Petrol	EV	1781	4	81.00	86.40	118
Scirocco 1.8	08/83→07/92	Petrol	EX	1781	4	81.00	86.40	119
Scirocco 1.8	11/85→07/92	Petrol	JH	1781	4	81.00	86.40	119
Scirocco 1.8	08/82→12/89	Petrol	PB	1781	4	81.00	86.40	121
Scirocco 1.8 16V	10/85→07/89	Petrol	KR	1781	4	81.00	86.40	119
Scirocco 1.8 16V	09/85→07/92	Petrol	PL	1781	4	81.00	86.40	124
Scirocco 2.0 TDI	05/09→	Diesel	CBBB	1968	4	81.00	95.50	134
Scirocco 2.0 TDI	08/08→	Diesel	CBDB	1968	4	81.00	95.50	134
Scirocco 2.0 TDI	05/09→	Diesel	CFGB	1968	4	81.00	95.50	134
Scirocco 2.0 TDI	01/13→	Diesel	CFGC	1968	4	81.00	95.50	134
Scirocco 2.0 TDI	11/10→	Diesel	CFHB	1968	4	81.00	95.50	134
Scirocco 2.0 TDI	08/08→	Diesel	CFHC	1968	4	81.00	95.50	134
Scirocco 2.0 TDI	05/14→	Diesel	CUWA	1968	4	81.00	95.50	134
Sharan 1.4 TSI	05/10→	Petrol	CAVA	1390	4	76.50	75.60	23
Sharan 1.8 T 20V	09/97→03/10	Petrol	AJH	1781	4	81.00	86.40	104
Sharan 1.8 T 20V	09/97→03/10	Petrol	AWC	1781	4	81.00	86.40	110
Sharan 1.9 TDI	09/95→03/10	Diesel	1Z	1896	4	79.50	95.50	62
Sharan 1.9 TDI	09/96→04/00	Diesel	AFN	1896	4	79.50	95.50	64
Sharan 1.9 TDI	09/95→03/10	Diesel	AHU	1896	4	79.50	95.50	68
Sharan 1.9 TDI	09/95→03/10	Diesel	ANU	1896	4	79.50	95.50	70
Sharan 1.9 TDI	11/02→03/10	Diesel	ASZ	1896	4	79.50	95.50	71
Sharan 1.9 TDI	04/00→03/10	Diesel	AUY	1896	4	79.50	95.50	69
Sharan 1.9 TDI	09/96→04/00	Diesel	AVG	1896	4	79.50	95.50	64
Sharan 1.9 TDI	06/05→03/10	Diesel	BTB	1896	4	79.50	95.50	78
Sharan 1.9 TDI	04/00→03/10	Diesel	BVK	1896	4	79.50	95.50	71
Sharan 1.9 TDI 4motion	04/00→03/10	Diesel	AUY	1896	4	79.50	95.50	69
Sharan 1.9 TDI 4motion	04/00→03/10	Diesel	BVK	1896	4	79.50	95.50	71
Sharan 2.0	09/95→03/10	Petrol	ADY	1984	4	82.50	92.80	143
Sharan 2.0	09/95→03/10	Petrol	ATM	1984	4	82.50	92.80	151
Sharan 2.0 LPG	04/06→03/10	Petrol	ATM	1984	4	82.50	92.80	151
Sharan 2.0 TDI	11/05→03/10	Diesel	BRT	1968	4	81.00	95.50	131
Sharan 2.0 TDI	11/05→03/10	Diesel	BVH	1968	4	81.00	95.50	131
Sharan 2.0 TDI	05/10→	Diesel	CFFA	1968	4	81.00	95.50	134
Sharan 2.0 TDI	05/10→	Diesel	CFFB	1968	4	81.00	95.50	134
Sharan 2.0 TDI	05/11→	Diesel	CFFE	1968	4	81.00	95.50	134
Sharan 2.0 TDI	08/10→	Diesel	CFGB	1968	4	81.00	95.50	134
Sharan 2.0 TDI	01/13→	Diesel	CFGC	1968	4	81.00	95.50	134
Sharan 2.0 TDI	05/11→	Diesel	CUVA	1968	4	81.00	95.50	134
Sharan 2.0 TDI	05/15→	Diesel	CUVC	1968	4	81.00	95.50	134
Sharan 2.0 TDI	05/15→	Diesel	CUWA	1968	4	81.00	95.50	134
Sharan 2.0 TDI 4motion	05/11→05/12	Diesel	CFFA	1968	4	81.00	95.50	134
Sharan 2.0 TDI 4motion	05/11→	Diesel	CFFB	1968	4	81.00	95.50	134
Sharan 2.0 TDI 4motion	05/15→	Diesel	CUVC	1968	4	81.00	95.50	134
Sharan 2.8 V6 24V	04/00→03/10	Petrol	AYL	2792	V6	81.00	90.30	129
Sharan 2.8 V6 24V 4motion	04/00→03/10	Petrol	AYL	2792	V6	81.00	90.30	129
Sharan 2.8 VR6	09/95→04/00	Petrol	AAA	2792	6	81.00	90.30	128
Sharan 2.8 VR6	09/95→04/00	Petrol	AMY	2792	6	81.00	90.30	129
Sharan 2.8 VR6 Syncro	11/96→04/00	Petrol	AAA	2792	6	81.00	90.30	128
Sharan 2.8 VR6 Syncro	11/96→04/00	Petrol	AMY	2792	6	81.00	90.30	129
Spacefox / Space Cross 1.9 SDI	09/07→	Diesel	ASY	1896	4	79.50	95.50	61
Tiguan 1.4 TSI	05/08→	Petrol	BWK	1390	4	76.50	75.60	23
Tiguan 1.4 TSI	05/08→	Petrol	CAVA	1390	4	76.50	75.60	23
Tiguan 1.4 TSI	05/11→	Petrol	CAVD	1390	4	76.50	75.60	23
Tiguan 1.4 TSI	08/10→	Petrol	CAXA	1390	4	76.50	75.60	23
Tiguan 1.4 TSI 4motion	09/07→	Petrol	BWK	1390	4	76.50	75.60	23
Tiguan 1.4 TSI 4motion	09/07→	Petrol	CAVA	1390	4	76.50	75.60	23
Tiguan 1.4 TSI 4motion	05/11→	Petrol	CAVD	1390	4	76.50	75.60	23
Tiguan 2.0 TDI	03/08→	Diesel	CBAB	1968	4	81.00	95.50	131











cm3 x



9

Tiguan 2.0 TDI	03/08→	Diesel	CFFB	1968	4	81.00	95.50	134
Tiguan 2.0 TDI	05/10→	Diesel	CFFD	1968	4	81.00	95.50	134
Tiguan 2.0 TDI	05/15→	Diesel	CUVC	1968	4	81.00	95.50	134
Tiguan 2.0 TDI 4motion	11/07→	Diesel	CBAA	1968	4	81.00	95.50	131
Tiguan 2.0 TDI 4motion	09/07→	Diesel	CBAB	1968	4	81.00	95.50	131
Tiguan 2.0 TDI 4motion	02/08→08/09	Diesel	CBBA	1968	4	81.00	95.50	131
Tiguan 2.0 TDI 4motion	09/07→	Diesel	CBBB	1968	4	81.00	95.50	134
Tiguan 2.0 TDI 4motion	11/07→	Diesel	CFFA	1968	4	81.00	95.50	134
Tiguan 2.0 TDI 4motion	09/07→	Diesel	CFFB	1968	4	81.00	95.50	134
Tiguan 2.0 TDI 4motion	09/07→	Diesel	CFGB	1968	4	81.00	95.50	134
Tiguan 2.0 TDI 4motion	11/12→	Diesel	CFGC	1968	4	81.00	95.50	134
Tiguan 2.0 TDI 4motion	09/07→	Diesel	CLJA	1968	4	81.00	95.50	134
Tiguan 2.0 TDI 4motion	05/15→	Diesel	CUVC	1968	4	81.00	95.50	134
Tiguan 2.0 TDI 4motion	05/15→	Diesel	CUWA	1968	4	81.00	95.50	134
Touareg 2.5 R5 TDI	01/03→05/10	Diesel	BAC	2461	5	81.00	95.50	138
Touareg 2.5 R5 TDI	08/03→05/10	Diesel	BLK	2461	5	81.00	95.50	138
Touareg 2.5 R5 TDI	08/03→05/10	Diesel	BPD	2461	5	81.00	95.50	138
Touareg 2.5 R5 TDI	01/03→05/10	Diesel	BPE	2461	5	81.00	95.50	138
Touareg 3.2 V6	10/02→11/06	Petrol	AZZ	3189	V6	84.00	95.90	157
Touareg 3.2 V6	10/02→11/06	Petrol	BAA	3189	V6	84.00	95.90	157
Touareg 3.2 V6	10/02→11/06	Petrol	BKJ	3189	V6	84.00	95.90	157
Touareg 3.2 V6	10/02→11/06	Petrol	BMV	3189	V6	84.00	95.90	157
Touareg 3.2 V6	10/02→11/06	Petrol	BMX	3189	V6	84.00	95.90	157
Touareg 3.2 V6	10/02→11/06	Petrol	BRJ	3189	V6	84.00	95.90	157
Touareg 3.6 V6 FSI	10/05→05/10	Petrol	BHK	3597	V6	89.00	96.40	163
Touareg 3.6 V6 FSI	08/10→	Petrol	CMTA	3597	V6	89.00	96.40	164
Touareg 4.2 V8	12/02→11/06	Petrol	AXQ	4172	V8	84.50	93.00	158
Touran 1.2 TSI	05/10→05/15	Petrol	CBZB	1197	4	71.00	75.60	5
Touran 1.4 FSI	11/06→05/10	Petrol	BLG	1390	4	76.50	75.60	23
Touran 1.4 FSI	11/06→05/10	Petrol	CAVB	1390	4	76.50	75.60	23
Touran 1.4 TSI	02/06→05/10	Petrol	BYM	1390	4	76.50	75.60	23
Touran 1.4 TSI	05/10→05/15	Petrol	CAVB	1390	4	76.50	75.60	23
Touran 1.4 TSI	02/06→05/15	Petrol	CAVC	1390	4	76.50	75.60	23
Touran 1.4 TSI EcoFuel	05/09→05/15	Petrol	CDGA	1390	4	76.50	75.60	27
Touran 1.6	07/03→05/10	Petrol	BGU	1595	4	81.00	77.40	85
Touran 1.6	07/03→05/10	Petrol	BSE	1595	4	81.00	77.40	85
Touran 1.6	07/03→05/10	Petrol	BSF	1595	4	81.00	77.40	85
Touran 1.6 FSI	02/03→01/07	Petrol	BAG	1598	4	76.50	86.90	42
Touran 1.6 FSI	02/03→01/07	Petrol	BLF	1598	4	76.50	86.90	42
Touran 1.6 FSI	02/03→01/07	Petrol	BLP	1598	4	76.50	86.90	42
Touran 1.6 TDI	05/10→05/15	Diesel	CAYB	1598	4	79.50	80.50	53
Touran 1.6 TDI	05/10→05/15	Diesel	CAYC	1598	4	79.50	80.50	53
Touran 1.9 TDI	02/03→05/04	Diesel	AVQ	1896	4	79.50	95.50	74
Touran 1.9 TDI	08/03→05/10	Diesel	BKC	1896	4	79.50	95.50	74
Touran 1.9 TDI	08/03→05/10	Diesel	BLS	1896	4	79.50	95.50	74
Touran 1.9 TDI	11/04→05/10	Diesel	BRU	1896	4	79.50	95.50	74
Touran 1.9 TDI	08/03→05/10	Diesel	BXE	1896	4	79.50	95.50	74
Touran 1.9 TDI	11/04→05/10	Diesel	BXF	1896	4	79.50	95.50	74
Touran 1.9 TDI	11/04→05/10	Diesel	BXJ	1896	4	79.50	95.50	74
Touran 2.0 FSI	10/03→01/07	Petrol	AXW	1984	4	82.50	92.80	149
Touran 2.0 FSI	10/03→01/07	Petrol	BLR	1984	4	82.50	92.80	149
Touran 2.0 FSI	10/03→01/07	Petrol	BLX	1984	4	82.50	92.80	149
Touran 2.0 FSI	10/03→01/07	Petrol	BLY	1984	4	82.50	92.80	149
Touran 2.0 FSI	10/03→01/07	Petrol	BVY	1984	4	82.50	92.80	149
Touran 2.0 FSI	10/03→01/07	Petrol	BVZ	1984	4	82.50	92.80	149
Touran 2.0 TDI	02/03→05/10	Diesel	AZV	1968	4	81.00	95.50	131
Touran 2.0 TDI	12/05→05/10	Diesel	BMM	1968	4	81.00	95.50	131
Touran 2.0 TDI	12/05→05/10	Diesel	BMN	1968	4	81.00	95.50	131
Touran 2.0 TDI	05/10→05/15	Diesel	CFHC	1968	4	81.00	95.50	134
Touran 2.0 TDI	11/10→05/15	Diesel	CFHF	1968	4	81.00	95.50	134
Touran 2.0 TDI	05/10→01/13	Diesel	CFJA	1968	4	81.00	95.50	134
Touran 2.0 TDI	01/13→05/15	Diesel	CFJB	1968	4	81.00	95.50	134
Touran 2.0 TDI	11/10→05/15	Diesel	CLCA	1968	4	81.00	95.50	134
Touran 2.0 TDI	11/15→	Diesel	CRVA	1968	4	81.00	95.50	134
Touran 2.0 TDI	05/15→	Diesel	DFEA	1968	4	81.00	95.50	134
Touran 2.0 TDI 16V	08/03→05/10	Diesel	BKD	1968	4	81.00	95.50	131
Transporter I 1.5	02/62→10/70	Petrol	H	1493	4	83.00	69.00	155
Transporter I 1.6	08/64→12/68	Petrol	B	1584	4	85.50	69.00	160
Transporter II 1.6	08/68→07/79	Petrol	AD	1584	4	84.00	71.50	156







				cm3	x 			
Transporter II 1.6	08/70→04/79	Petrol	AE	1584	4	85.50	69.00	160
Transporter II 1.6	08/70→04/79	Petrol	AH	1584	4	85.50	69.00	160
Transporter II 1.6	08/68→07/79	Petrol	AS	1584	4	85.50	69.00	160
Transporter II 1.6	08/68→07/79	Petrol	B	1584	4	85.50	69.00	160
Transporter III 1.6 D	01/81→07/87	Diesel	CS	1588	4	76.50	86.40	33
Transporter III 1.6 TD	08/84→07/92	Diesel	JX	1589	4	76.50	86.40	31
Transporter III 1.6 TD Syncro	03/86→07/92	Diesel	JX	1589	4	76.50	86.40	31
Transporter III 1.7 D	08/85→07/92	Diesel	KY	1716	4	79.50	86.40	58
Transporter III 1.9	08/82→07/92	Petrol	DF	1913	4	94.00	69.00	165
Transporter III 1.9	08/82→07/92	Petrol	DG	1913	4	94.00	69.00	165
Transporter III 1.9	01/83→02/89	Petrol	DH	1913	4	94.00	69.00	165
Transporter III 1.9	08/83→02/89	Petrol	GW	1913	4	94.00	69.00	165
Transporter III 1.9 Syncro	11/84→07/92	Petrol	DG	1913	4	94.00	69.00	165
Transporter III 2.1	10/86→07/92	Petrol	SR	2109	4	94.00	76.00	166
Transporter III 2.1	08/84→07/92	Petrol	DJ	2110	4	94.00	76.00	166
Transporter III 2.1	08/85→07/92	Petrol	MV	2110	4	94.00	76.00	166
Transporter III 2.1 CAT	06/89→07/92	Petrol	MV	2110	4	94.00	76.00	166
Transporter III 2.1 i	07/89→07/92	Petrol	SS	2110	4	94.00	76.00	166
Transporter III 2.1 Syncro	10/86→07/92	Petrol	SR	2109	4	94.00	76.00	166
Transporter III 2.1 Syncro	01/86→07/92	Petrol	DJ	2110	4	94.00	76.00	166
Transporter III 2.1 Syncro	08/85→07/92	Petrol	MV	2110	4	94.00	76.00	166
Transporter IV 1.9 D	07/90→12/95	Diesel	1X	1896	4	79.50	95.50	61
Transporter IV 1.9 TD	10/92→04/03	Diesel	ABL	1896	4	79.50	95.50	62
Transporter IV 2.0	07/90→04/03	Petrol	AAC	1968	4	81.00	95.50	130
Transporter IV 2.4 D	07/90→04/98	Diesel	AAB	2370	5	79.50	95.50	79
Transporter IV 2.4 D	08/97→04/03	Diesel	AJA	2370	5	79.50	95.50	79
Transporter IV 2.4 D Syncro	10/92→09/98	Diesel	AAB	2370	5	79.50	95.50	79
Transporter IV 2.5	11/90→04/03	Petrol	AAF	2461	5	81.00	95.50	136
Transporter IV 2.5	11/90→04/03	Petrol	ACU	2461	5	81.00	95.50	136
Transporter IV 2.5	11/90→04/03	Petrol	AEN	2461	5	81.00	95.50	136
Transporter IV 2.5	08/96→04/03	Petrol	AET	2461	5	81.00	95.50	136
Transporter IV 2.5	11/90→04/03	Petrol	AEU	2461	5	81.00	95.50	136
Transporter IV 2.5	08/96→04/03	Petrol	APL	2461	5	81.00	95.50	136
Transporter IV 2.5	08/96→04/03	Petrol	AVT	2461	5	81.00	95.50	136
Transporter IV 2.5 Syncro	10/92→04/03	Petrol	AAF	2461	5	81.00	95.50	136
Transporter IV 2.5 Syncro	10/92→04/03	Petrol	ACU	2461	5	81.00	95.50	136
Transporter IV 2.5 Syncro	10/92→04/03	Petrol	AEN	2461	5	81.00	95.50	136
Transporter IV 2.5 Syncro	07/96→04/03	Petrol	AET	2461	5	81.00	95.50	136
Transporter IV 2.5 Syncro	10/92→04/03	Petrol	AEU	2461	5	81.00	95.50	136
Transporter IV 2.5 Syncro	07/96→04/03	Petrol	APL	2461	5	81.00	95.50	136
Transporter IV 2.5 Syncro	07/96→04/03	Petrol	AVT	2461	5	81.00	95.50	136
Transporter IV 2.5 TDI	09/95→04/03	Diesel	ACV	2461	5	81.00	95.50	137
Transporter IV 2.5 TDI	05/98→04/03	Diesel	AHY	2461	5	81.00	95.50	137
Transporter IV 2.5 TDI	05/98→04/03	Diesel	AJT	2461	5	81.00	95.50	137
Transporter IV 2.5 TDI	09/95→04/03	Diesel	AUF	2461	5	81.00	95.50	137
Transporter IV 2.5 TDI	05/98→04/03	Diesel	AXG	2461	5	81.00	95.50	137
Transporter IV 2.5 TDI	09/95→04/03	Diesel	AYC	2461	5	81.00	95.50	137
Transporter IV 2.5 TDI	05/98→04/03	Diesel	AYY	2461	5	81.00	95.50	137
Transporter IV 2.5 TDI Syncro	09/95→04/03	Diesel	ACV	2461	5	81.00	95.50	137
Transporter IV 2.5 TDI Syncro	09/95→04/03	Diesel	AXL	2461	5	81.00	95.50	137
Transporter IV 2.8	05/96→05/00	Petrol	AES	2792	6	81.00	90.30	129
Transporter IV 2.8 VR6	11/95→04/00	Petrol	AES	2792	6	81.00	90.30	129
Transporter IV 2.8 VR6	05/96→05/00	Petrol	AES	2792	6	81.00	90.30	129
Transporter IV 2.8 VR6	04/00→04/03	Petrol	AMV	2792	6	81.00	90.30	129
Transporter IV 2.8 VR6 Syncro	01/96→04/96	Petrol	AES	2792	6	81.00	90.30	129
Transporter V 1.9 TDI	04/03→11/09	Diesel	AXB	1896	4	79.50	95.50	71
Transporter V 1.9 TDI	04/03→11/09	Diesel	AXC	1896	4	79.50	95.50	71
Transporter V 1.9 TDI	01/06→11/09	Diesel	BRR	1896	4	79.50	95.50	71
Transporter V 1.9 TDI	06/06→11/09	Diesel	BRS	1896	4	79.50	95.50	71
Transporter V 2.0	11/03→	Petrol	AXA	1984	4	82.50	92.80	152
Transporter V 2.0 BiTDI	09/09→	Diesel	CFCA	1968	4	81.00	95.50	134
Transporter V 2.0 BiTDI 4motion	09/09→	Diesel	CFCA	1968	4	81.00	95.50	134
Transporter V 2.0 TDI	09/09→	Diesel	CAAA	1968	4	81.00	95.50	134
Transporter V 2.0 TDI	09/09→	Diesel	CAAB	1968	4	81.00	95.50	134
Transporter V 2.0 TDI	09/09→	Diesel	CAAC	1968	4	81.00	95.50	134
Transporter V 2.0 TDI	05/11→	Diesel	CAAD	1968	4	81.00	95.50	134
Transporter V 2.0 TDI	05/10→	Diesel	CAAE	1968	4	81.00	95.50	134
Transporter V 2.0 TDI	09/09→	Diesel	CCHA	1968	4	81.00	95.50	134
Transporter V 2.0 TDI	05/10→	Diesel	CCHB	1968	4	81.00	95.50	134









cm3















Transporter V 2.0 TDI 4motion	09/09→	Diesel	CAAC	1968	4	81.00	95.50	134
Transporter V 2.0 TDI 4motion	05/10→	Diesel	CAAE	1968	4	81.00	95.50	134
Transporter V 2.0 TDI 4motion	09/09→	Diesel	CCHA	1968	4	81.00	95.50	134
Transporter V 2.0 TDI 4motion	05/10→	Diesel	CCHB	1968	4	81.00	95.50	134
Transporter V 2.5 TDI	04/03→11/09	Diesel	AXD	2461	5	81.00	95.50	138
Transporter V 2.5 TDi	11/03→11/09	Diesel	BLJ	2461	5	81.00	95.50	138
Transporter V 2.5 TDI	04/03→11/09	Diesel	BNZ	2461	5	81.00	95.50	138
Transporter V 2.5 TDI	04/03→11/09	Diesel	BPC	2461	5	81.00	95.50	138
Transporter V 2.5 TDI 4motion	07/04→11/09	Diesel	AXD	2461	5	81.00	95.50	138
Transporter V 2.5 TDI 4motion	04/04→11/09	Diesel	AXE	2461	5	81.00	95.50	138
Transporter V 2.5 TDI 4motion	07/04→11/09	Diesel	BNZ	2461	5	81.00	95.50	138
Transporter V 2.5 TDI 4motion	04/04→11/09	Diesel	BPC	2461	5	81.00	95.50	138
Transporter V 3.2 4motion	11/03→11/09	Petrol	BDL	3189	V6	84.00	95.90	157
Transporter V 3.2 4motion	11/03→11/09	Petrol	BKK	3189	V6	84.00	95.90	157
Transporter V 3.2 4motion	11/03→11/09	Petrol	CFLA	3189	V6	84.00	95.90	157
Transporter V 3.2 V6	04/03→11/09	Petrol	BDL	3189	V6	84.00	95.90	157
Transporter V 3.2 V6	08/03→11/09	Petrol	BKK	3189	V6	84.00	95.90	157
Transporter V 3.2 V6	02/04→11/09	Petrol	CFLA	3189	V6	84.00	95.90	157
Transporter V 3.2 V6 4motion	11/03→11/09	Petrol	BKK	3189	V6	84.00	95.90	157
Transporter V 3.2 V6 4motion	11/03→11/09	Petrol	CFLA	3189	V6	84.00	95.90	157
Transporter VI 2.0 TDI	04/15→	Diesel	CAAA	1968	4	81.00	95.50	134
Transporter VI 2.0 TDI	04/15→	Diesel	CAAB	1968	4	81.00	95.50	134
Transporter VI 2.0 TDI	04/15→	Diesel	CAAC	1968	4	81.00	95.50	134
Transporter VI 2.0 TDI	04/15→	Diesel	CFCA	1968	4	81.00	95.50	134
Transporter VI 2.0 TDI	06/15→	Diesel	CXEB	1968	4	81.00	95.50	134
Transporter VI 2.0 TDI	04/15→	Diesel	CXFA	1968	4	81.00	95.50	134
Transporter VI 2.0 TDI	04/15→	Diesel	CXGA	1968	4	81.00	95.50	134
Transporter VI 2.0 TDI	04/15→	Diesel	CXGB	1968	4	81.00	95.50	134
Transporter VI 2.0 TDI	04/15→	Diesel	CXHA	1968	4	81.00	95.50	134
Transporter VI 2.0 TDI 4motion	06/15→	Diesel	CAAC	1968	4	81.00	95.50	134
Transporter VI 2.0 TDI 4motion	06/15→	Diesel	CFCA	1968	4	81.00	95.50	134
Transporter VI 2.0 TDI 4motion	06/15→	Diesel	CXEB	1968	4	81.00	95.50	134
Transporter VI 2.0 TDI 4motion	08/15→	Diesel	CXFA	1968	4	81.00	95.50	134
Transporter VI 2.0 TDI 4motion	08/15→	Diesel	CXHA	1968	4	81.00	95.50	134
Van 1.8	09/07→12/09	Petrol	ADD	1781	4	81.00	86.40	104
Vento 1.2	01/10→	Petrol	CBZB	1197	4	71.00	75.60	5
Vento 1.4	11/91→09/98	Petrol	ABD	1390	4	75.00	78.70	15
Vento 1.4	11/91→09/98	Petrol	AEX	1390	4	76.50	75.60	18
Vento 1.6	10/94→09/98	Petrol	AEK	1595	4	81.00	77.40	80
Vento 1.6	10/94→09/98	Petrol	AFT	1595	4	81.00	77.40	83
Vento 1.6	09/92→09/98	Petrol	ABU	1598	4	76.50	86.90	37
Vento 1.6	09/92→09/98	Petrol	AEA	1598	4	76.50	86.90	37
Vento 1.6	09/92→09/98	Petrol	AEE	1598	4	76.50	86.90	38
Vento 1.6	01/10→12/12	Petrol	CFNA	1598	4	76.50	86.90	42
Vento 1.8	11/91→09/98	Petrol	AAM	1781	4	81.00	86.40	103
Vento 1.8	11/91→09/98	Petrol	ABS	1781	4	81.00	86.40	104
Vento 1.8	11/91→12/95	Petrol	ACC	1781	4	81.00	86.40	105
Vento 1.8	11/91→09/98	Petrol	ADZ	1781	4	81.00	86.40	104
Vento 1.9 D	11/91→09/98	Diesel	1Y	1896	4	79.50	95.50	61
Vento 1.9 SDI	04/97→09/98	Diesel	AEY	1896	4	79.50	95.50	63
Vento 1.9 TD	11/91→09/98	Diesel	AAZ	1896	4	79.50	95.50	62
Vento 1.9 TDI	09/93→09/98	Diesel	1Z	1896	4	79.50	95.50	62
Vento 1.9 TDI	04/96→09/98	Diesel	AFN	1896	4	79.50	95.50	64
Vento 1.9 TDI	09/93→09/98	Diesel	AHU	1896	4	79.50	95.50	68
Vento 1.9 TDI	09/93→09/98	Diesel	ALE	1896	4	79.50	95.50	68
Vento 2.0	11/91→09/98	Petrol	2E	1984	4	82.50	92.80	143
Vento 2.0	11/91→09/98	Petrol	ADY	1984	4	82.50	92.80	143
Vento 2.0	11/91→09/98	Petrol	AGG	1984	4	82.50	92.80	147
Vento 2.0	11/91→09/98	Petrol	AKR	1984	4	82.50	92.80	148
Vento 2.0 GL	11/91→07/98	Petrol	AAC	1968	4	81.00	95.50	130
Vento 2.0 GL	05/96→12/97	Petrol	AEP	1984	4	82.50	92.80	146
Vento 2.8 VR6	01/92→09/98	Petrol	AAA	2792	6	81.00	90.30	128
Voyage 1.0	08/96→12/01	Petrol	AER	999	4	67.10	70.60	2
Voyage 1.9 D	06/96→09/01	Diesel	1Y	1896	4	79.50	95.50	61
Voyage 1.9 TDi	09/99→09/01	Diesel	1Z	1896	4	79.50	95.50	62

			cm3	x 			
1E	Petrol	2383	6	76.50	86.40	35	
1F	Petrol	1595	4	81.00	77.40	80	
1G	Diesel	2383	6	76.50	86.40	35	
1H	Petrol	1781	4	81.00	86.40	101	
1P	Petrol	1781	4	81.00	86.40	102	
1S	Diesel	2383	6	76.50	86.40	35	
1V	Diesel	1589	4	76.50	86.40	31	
1W	Diesel	1398	4	75.00	79.10	16	
1X	Diesel	1896	4	79.50	95.50	61	
1Y	Diesel	1896	4	79.50	95.50	61	
1Z	Diesel	1896	4	79.50	95.50	62	
2E	Petrol	1984	4	82.50	92.80	143	
2G	Petrol	1272	4	75.00	72.00	10	
3F	Petrol	1272	4	75.00	72.00	10	
9A	Petrol	1984	4	82.50	92.80	144	
68A	Diesel	1588	4	76.50	86.40	31	
68C	Diesel	1588	4	76.50	86.40	31	
122	Petrol	1192	4	77.00	64.00	45	
496	Petrol	1588	4	79.50	80.00	50	
682	Diesel	1471	4	76.50	80.00	29	
685	Diesel	1588	4	76.50	86.40	31	
686	Diesel	1588	4	76.50	86.40	31	
AAA	Petrol	2792	6	81.00	90.30	128	
AAB	Diesel	2370	5	79.50	95.50	79	
AAC	Petrol	1968	4	81.00	95.50	130	
AAF	Petrol	2461	5	81.00	95.50	136	
AAK	Petrol	1043	4	75.00	59.00	8	
AAM	Petrol	1781	4	81.00	86.40	103	
AAU	Petrol	1043	4	75.00	59.00	8	
AAV	Petrol	1272	4	75.00	72.00	10	
AAZ	Diesel	1896	4	79.50	95.50	62	
AB	Petrol	1285	4	77.00	69.00	46	
ABD	Petrol	1390	4	75.00	78.70	15	
ABF	Petrol	1984	4	82.50	92.80	143	
ABL	Diesel	1896	4	79.50	95.50	62	
ABN	Petrol	1595	4	81.00	77.40	81	
ABS	Petrol	1781	4	81.00	86.40	104	
ABU	Petrol	1598	4	76.50	86.90	37	
ABV	Petrol	2861	V6	82.00	90.30	140	
AC	Petrol	1285	4	77.00	69.00	46	
ACC	Petrol	1781	4	81.00	86.40	105	
ACD	Petrol	1584	4	85.50	69.00	159	
ACK	Petrol	2771	V6	82.50	86.40	141	
ACL	Diesel	2383	6	76.50	86.40	35	
ACM	Petrol	1043	4	75.00	59.00	8	
ACT	Diesel	2383	6	76.50	86.40	35	
ACU	Petrol	2461	5	81.00	95.50	136	
ACV	Diesel	2461	5	81.00	95.50	137	
AD	Petrol	1584	4	84.00	71.50	156	
ADD	Petrol	1781	4	81.00	86.40	104	
ADE	Diesel	1896	4	79.50	95.50	63	
ADF	Petrol	1781	4	81.00	86.40	104	
ADG	Diesel	1896	4	79.50	95.50	61	
ADK	Diesel	1588	4	76.50	86.40	32	
ADP	Petrol	1595	4	81.00	77.40	80	
ADR	Petrol	1781	4	81.00	86.40	106	
ADX	Petrol	1296	4	76.50	70.50	17	
ADY	Petrol	1984	4	82.50	92.80	143	
ADZ	Petrol	1781	4	81.00	86.40	104	
AE	Petrol	1584	4	85.50	69.00	160	
AEA	Petrol	1598	4	76.50	86.90	37	
AEB	Petrol	1781	4	81.00	86.40	107	
AEE	Petrol	1598	4	76.50	86.90	38	
AEF	Diesel	1896	4	79.50	95.50	61	
AEG	Petrol	1984	4	82.50	92.80	145	
AEH	Petrol	1595	4	81.00	77.40	82	
AEK	Petrol	1595	4	81.00	77.40	80	
AEN	Petrol	2461	5	81.00	95.50	136	
AEP	Petrol	1984	4	82.50	92.80	146	







		cm3	x 			
--	---	-----	---	---	---	---







AER	Petrol	999	4	67.10	70.60	2
AES	Petrol	2792	6	81.00	90.30	129
AET	Petrol	2461	5	81.00	95.50	136
AEU	Petrol	2461	5	81.00	95.50	136
AEV	Petrol	1043	4	75.00	59.00	8
AEX	Petrol	1390	4	76.50	75.60	18
AEY	Diesel	1896	4	79.50	95.50	63
AFB	Diesel	2496	V6	78.30	86.40	47
AFD	Diesel	1896	4	79.50	95.50	63
AFH	Petrol	1390	4	76.50	75.60	19
AFK	Petrol	1390	4	76.50	75.60	20
AFN	Diesel	1896	4	79.50	95.50	64
AFT	Petrol	1595	4	81.00	77.40	83
AFY	Petrol	1781	4	81.00	86.40	108
AGD	Diesel	1896	4	79.50	95.50	63
AGE	Petrol	2771	V6	82.50	86.40	142
AGG	Petrol	1984	4	82.50	92.80	147
AGN	Petrol	1781	4	81.00	86.40	109
AGP	Diesel	1896	4	79.50	95.50	65
AGR	Diesel	1896	4	79.50	95.50	66
AGU	Petrol	1781	4	81.00	86.40	110
AGX	Diesel	2461	5	81.00	95.50	137
AH	Petrol	1584	4	85.50	69.00	160
AHB	Diesel	1716	4	79.50	86.40	57
AHD	Diesel	2461	5	81.00	95.50	137
AHF	Diesel	1896	4	79.50	95.50	67
AHG	Diesel	1716	4	79.50	86.40	57
AHH	Diesel	1896	4	79.50	95.50	62
AHL	Petrol	1595	4	81.00	77.40	82
AHS	Petrol	1598	4	76.50	86.90	39
AHT	Petrol	997	4	72.00	61.20	6
AHU	Diesel	1896	4	79.50	95.50	68
AHW	Petrol	1390	4	76.50	75.60	20
AHY	Diesel	2461	5	81.00	95.50	137
AJ	Petrol	1584	4	85.50	69.00	160
AJA	Diesel	2370	5	79.50	95.50	79
AJH	Petrol	1781	4	81.00	86.40	104
AJM	Diesel	1896	4	79.50	95.50	69
AJT	Diesel	2461	5	81.00	95.50	137
AJV	Petrol	1598	4	76.50	86.90	40
AK	Petrol	1584	4	85.50	69.00	160
AKK	Petrol	1390	4	76.50	75.60	20
AKL	Petrol	1595	4	81.00	77.40	82
AKN	Diesel	2496	V6	78.30	86.40	47
AKP	Petrol	1390	4	76.50	75.60	20
AKQ	Petrol	1390	4	76.50	75.60	20
AKR	Petrol	1984	4	82.50	92.80	148
AKS	Petrol	1595	4	81.00	77.40	84
AKU	Diesel	1716	4	79.50	86.40	57
AKV	Petrol	1390	4	76.50	75.60	21
AKW	Diesel	1716	4	79.50	86.40	57
AL	Petrol	1584	4	85.50	69.00	160
ALD	Petrol	999	4	67.10	70.60	2
ALE	Diesel	1896	4	79.50	95.50	68
ALG	Petrol	2771	V6	82.50	86.40	142
ALH	Diesel	1896	4	79.50	95.50	62
ALL	Petrol	999	4	67.10	70.60	2
ALM	Petrol	1598	4	76.50	86.90	41
ALT	Petrol	1984	4	82.50	92.80	149
ALZ	Petrol	1595	4	81.00	77.40	85
AM	Petrol	1584	4	85.50	69.00	160
AMF	Diesel	1422	3	79.50	95.50	60
AMV	Petrol	2792	6	81.00	90.30	129
AMX	Petrol	2771	V6	82.50	86.40	141
AMY	Petrol	2792	6	81.00	90.30	129
ANA	Petrol	1595	4	81.00	77.40	85
ANB	Petrol	1781	4	81.00	86.40	111
ANC	Diesel	1896	4	79.50	95.50	61
ANF	Diesel	2461	5	81.00	95.50	137

			cm3	x 			
ANG	Diesel		2461	5	81.00	95.50	137
ANH	Diesel		2461	5	81.00	95.50	137
ANJ	Diesel		2461	5	81.00	95.50	137
ANM	Petrol		1390	4	76.50	75.60	22
ANN	Petrol		1781	4	81.00	86.40	103
ANP	Petrol		1781	4	81.00	86.40	103
ANU	Diesel		1896	4	79.50	95.50	70
ANV	Petrol		999	4	67.10	70.60	2
ANW	Petrol		1390	4	76.50	75.60	23
ANX	Petrol		1390	4	76.50	75.60	21
ANY	Diesel		1191	3	76.50	86.40	30
APA	Diesel		2461	5	81.00	95.50	137
APE	Petrol		1390	4	76.50	75.60	20
APF	Petrol		1595	4	81.00	77.40	82
APH	Petrol		1781	4	81.00	86.40	112
APK	Petrol		1984	4	82.50	92.80	150
APL	Petrol		2461	5	81.00	95.50	136
APQ	Petrol		1390	4	76.50	75.60	21
APR	Petrol		2771	V6	82.50	86.40	141
APT	Petrol		1781	4	81.00	86.40	109
APU	Petrol		1781	4	81.00	86.40	111
AQD	Petrol		2771	V6	82.50	86.40	142
AQM	Diesel		1896	4	79.50	95.50	61
AQP	Petrol		2792	6	81.00	90.30	129
AQQ	Petrol		1390	4	76.50	75.60	20
AQY	Petrol		1984	4	82.50	92.80	145
AR	Petrol		1285	4	77.00	69.00	46
ARC	Petrol		1598	4	76.50	86.90	42
ARD	Diesel		1896	4	79.50	95.50	63
ARG	Petrol		1781	4	81.00	86.40	109
ARL	Diesel		1896	4	79.50	95.50	71
ARM	Petrol		1595	4	81.00	77.40	82
ARR	Petrol		1390	4	76.50	75.60	22
ARX	Petrol		1781	4	81.00	86.40	113
ARZ	Petrol		1781	4	81.00	86.40	110
AS	Petrol		1584	4	85.50	69.00	160
ASV	Diesel		1896	4	79.50	95.50	67
ASX	Diesel		1896	4	79.50	95.50	63
ASY	Diesel		1896	4	79.50	95.50	61
ASZ	Diesel		1896	4	79.50	95.50	71
ATD	Diesel		1896	4	79.50	95.50	69
ATE	Petrol		999	4	67.10	70.60	2
ATJ	Diesel		1896	4	79.50	95.50	69
ATL	Diesel		1422	3	79.50	95.50	60
ATM	Petrol		1984	4	82.50	92.80	151
ATN	Petrol		1598	4	76.50	86.90	40
ATQ	Petrol		2771	V6	82.50	86.40	141
ATU	Petrol		1984	4	82.50	92.80	147
ATX	Petrol		2771	V6	82.50	86.40	141
AUA	Petrol		1390	4	76.50	75.60	20
AUB	Petrol		1390	4	76.50	75.60	20
AUC	Petrol		999	4	67.10	70.60	2
AUD	Petrol		1390	4	76.50	75.60	20
AUE	Petrol		2792	6	81.00	90.30	129
AUF	Diesel		2461	5	81.00	95.50	137
AUR	Petrol		1595	4	81.00	77.40	86
AUS	Petrol		1598	4	76.50	86.90	43
AUY	Diesel		1896	4	79.50	95.50	69
AUZ	Petrol		1984	4	82.50	92.80	147
AVB	Diesel		1896	4	79.50	95.50	72
AVC	Petrol		1781	4	81.00	86.40	110
AVF	Diesel		1896	4	79.50	95.50	73
AVG	Diesel		1896	4	79.50	95.50	64
AVM	Diesel		1896	4	79.50	95.50	63
AVQ	Diesel		1896	4	79.50	95.50	74
AVR	Diesel		2461	5	81.00	95.50	137
AVT	Petrol		2461	5	81.00	95.50	136
AVU	Petrol		1595	4	81.00	77.40	85
AVY	Petrol		1598	4	76.50	86.90	42







		cm ³	x 			
--	---	-----------------	---	---	---	---





AWC	Petrol	1781	4	81.00	86.40	110
AWF	Petrol	1984	4	82.50	92.80	147
AWG	Petrol	1984	4	82.50	92.80	147
AWH	Petrol	1595	4	81.00	77.40	82
AWL	Petrol	1781	4	81.00	86.40	114
AWP	Petrol	1781	4	81.00	86.40	114
AWU	Petrol	1781	4	81.00	86.40	114
AWV	Petrol	1781	4	81.00	86.40	114
AWX	Diesel	1896	4	79.50	95.50	73
AWY	Petrol	1198	3	76.50	86.90	36
AXA	Petrol	1984	4	82.50	92.80	152
AXB	Diesel	1896	4	79.50	95.50	71
AXC	Diesel	1896	4	79.50	95.50	71
AXD	Diesel	2461	5	81.00	95.50	138
AXE	Diesel	2461	5	81.00	95.50	138
AXG	Diesel	2461	5	81.00	95.50	137
AXJ	Petrol	3189	V6	84.00	95.90	157
AXL	Diesel	2461	5	81.00	95.50	137
AXP	Petrol	1390	4	76.50	75.60	20
AXQ	Petrol	4172	V8	84.50	93.00	158
AXR	Diesel	1896	4	79.50	95.50	74
AXU	Petrol	1390	4	76.50	75.60	24
AXW	Petrol	1984	4	82.50	92.80	149
AXZ	Petrol	3168	V6	86.00	90.90	162
AYC	Diesel	2461	5	81.00	95.50	137
AYD	Petrol	1595	4	81.00	77.40	85
AYL	Petrol	2792	V6	81.00	90.30	129
AYQ	Diesel	1896	4	79.50	95.50	61
AYT	Petrol	3189	V6	84.00	95.90	157
AYY	Diesel	2461	5	81.00	95.50	137
AYZ	Diesel	1191	3	76.50	86.40	30
AZD	Petrol	1598	4	76.50	86.90	43
AZH	Petrol	1984	4	82.50	92.80	153
AZQ	Petrol	1198	3	76.50	86.90	36
AZV	Diesel	1968	4	81.00	95.50	131
AZZ	Petrol	3189	V6	84.00	95.90	157
B	Petrol	1584	4	85.50	69.00	160
BAA	Petrol	3189	V6	84.00	95.90	157
BAC	Diesel	2461	5	81.00	95.50	138
BAD	Petrol	1598	4	76.50	86.90	42
BAG	Petrol	1598	4	76.50	86.90	42
BAU	Diesel	2496	V6	78.30	86.40	47
BAY	Diesel	1422	3	79.50	95.50	60
BBE	Diesel	2461	5	81.00	95.50	137
BBF	Diesel	2461	5	81.00	95.50	137
BBG	Petrol	2771	V6	82.50	86.40	141
BBM	Petrol	1198	3	76.50	86.90	36
BBR	Diesel	2461	5	81.00	95.50	137
BBY	Petrol	1390	4	76.50	75.60	20
BBZ	Petrol	1390	4	76.50	75.60	20
BCA	Petrol	1390	4	76.50	75.60	25
BCB	Petrol	1598	4	76.50	86.90	43
BCT	Diesel	2461	5	81.00	95.50	137
BCU	Diesel	2461	5	81.00	95.50	137
BCV	Diesel	2461	5	81.00	95.50	137
BDE	Petrol	2792	V6	81.00	90.30	129
BDG	Diesel	2496	V6	78.30	86.40	47
BDH	Diesel	2496	V6	78.30	86.40	47
BDJ	Diesel	1968	4	81.00	95.50	132
BDK	Diesel	1968	4	81.00	95.50	132
BDL	Petrol	3189	V6	84.00	95.90	157
BEQ	Diesel	1896	4	79.50	95.50	63
BEU	Diesel	1896	4	79.50	95.50	63
BEW	Diesel	1896	4	79.50	95.50	74
BFH	Petrol	3189	V6	84.00	95.90	157
BFQ	Petrol	1595	4	81.00	77.40	85
BFS	Petrol	1595	4	81.00	77.40	87
BGL	Diesel	1896	4	79.50	95.50	75
BGM	Diesel	1896	4	79.50	95.50	75







		cm3	x 			
BGU	Petrol	1595	4	81.00	77.40	85
BGW	Diesel	1968	4	81.00	95.50	133
BHK	Petrol	3597	V6	89.00	96.40	163
BHW	Diesel	1968	4	81.00	95.50	133
BHY	Petrol	1984	4	82.50	92.80	154
BJB	Diesel	1896	4	79.50	95.50	74
BJC	Diesel	1896	4	79.50	95.50	63
BJJ	Diesel	2461	5	81.00	95.50	139
BJK	Diesel	2461	5	81.00	95.50	139
BJL	Diesel	2461	5	81.00	95.50	139
BJM	Diesel	2461	5	81.00	95.50	139
BJS	Petrol	3189	V6	84.00	95.90	157
BKC	Diesel	1896	4	79.50	95.50	74
BKD	Diesel	1968	4	81.00	95.50	131
BKJ	Petrol	3189	V6	84.00	95.90	157
BKK	Petrol	3189	V6	84.00	95.90	157
BKL	Petrol	3189	V6	84.00	95.90	157
BKP	Diesel	1968	4	81.00	95.50	131
BKR	Petrol	1390	4	76.50	75.60	26
BKY	Petrol	1390	4	76.50	75.60	20
BLF	Petrol	1598	4	76.50	86.90	42
BLG	Petrol	1390	4	76.50	75.60	23
BLJ	Diesel	2461	5	81.00	95.50	138
BLK	Diesel	2461	5	81.00	95.50	138
BLM	Petrol	1390	4	76.50	75.60	23
BLN	Petrol	1390	4	76.50	75.60	23
BLP	Petrol	1598	4	76.50	86.90	42
BLR	Petrol	1984	4	82.50	92.80	149
BLS	Diesel	1896	4	79.50	95.50	74
BLT	Diesel	1896	4	79.50	95.50	76
BLV	Petrol	3597	V6	89.00	96.40	163
BLX	Petrol	1984	4	82.50	92.80	149
BLY	Petrol	1984	4	82.50	92.80	149
BMA	Diesel	1968	4	81.00	95.50	131
BMD	Petrol	1198	3	76.50	86.90	36
BME	Petrol	1198	3	76.50	86.90	36
BML	Petrol	3189	V6	84.00	95.90	157
BMM	Diesel	1968	4	81.00	95.50	131
BMN	Diesel	1968	4	81.00	95.50	131
BMP	Diesel	1968	4	81.00	95.50	131
BMR	Diesel	1968	4	81.00	95.50	131
BMS	Diesel	1422	3	79.50	95.50	60
BMT	Diesel	1896	4	79.50	95.50	74
BMV	Petrol	3189	V6	84.00	95.90	157
BMX	Petrol	3189	V6	84.00	95.90	157
BYM	Petrol	1390	4	76.50	75.60	23
BNM	Diesel	1422	3	79.50	95.50	60
BNV	Diesel	1422	3	79.50	95.50	60
BNZ	Diesel	2461	5	81.00	95.50	138
BPC	Diesel	2461	5	81.00	95.50	138
BPD	Diesel	2461	5	81.00	95.50	138
BPE	Diesel	2461	5	81.00	95.50	138
BPF	Petrol	3189	V6	84.00	95.90	157
BPZ	Diesel	1896	4	79.50	95.50	71
BRJ	Petrol	3189	V6	84.00	95.90	157
BRK	Petrol	3189	V6	84.00	95.90	157
BRR	Diesel	1896	4	79.50	95.50	71
BRS	Diesel	1896	4	79.50	95.50	71
BRT	Diesel	1968	4	81.00	95.50	131
BRU	Diesel	1896	4	79.50	95.50	74
BSE	Petrol	1595	4	81.00	77.40	85
BSF	Petrol	1595	4	81.00	77.40	85
BST	Diesel	1968	4	81.00	95.50	132
BSU	Diesel	1896	4	79.50	95.50	77
BSW	Diesel	1896	4	79.50	95.50	69
BTB	Diesel	1896	4	79.50	95.50	78
BTS	Petrol	1598	4	76.50	86.90	42
BUB	Petrol	3189	V6	84.00	95.90	157
BUD	Petrol	1390	4	76.50	75.60	23

		cm3	x 			
--	---	-----	---	---	---	---

BUZ	Diesel	1968	4	81.00	95.50	131
BVD	Diesel	1968	4	81.00	95.50	131
BVE	Diesel	1968	4	81.00	95.50	131
BVH	Diesel	1968	4	81.00	95.50	131
BVK	Diesel	1896	4	79.50	95.50	71
BVX	Petrol	1984	4	82.50	92.80	149
BVY	Petrol	1984	4	82.50	92.80	149
BVZ	Petrol	1984	4	82.50	92.80	149
BWB	Diesel	1422	3	79.50	95.50	60
BWK	Petrol	1390	4	76.50	75.60	23
BWS	Petrol	3597	V6	89.00	96.40	163
BWV	Diesel	1968	4	81.00	95.50	131
BXE	Diesel	1896	4	79.50	95.50	74
BXF	Diesel	1896	4	79.50	95.50	74
BXJ	Diesel	1896	4	79.50	95.50	74
BXT	Diesel	1896	4	79.50	95.50	63
BZG	Petrol	1198	3	76.50	86.90	36
CAAA	Diesel	1968	4	81.00	95.50	134
CAAB	Diesel	1968	4	81.00	95.50	134
CAAC	Diesel	1968	4	81.00	95.50	134
CAAD	Diesel	1968	4	81.00	95.50	134
CAAE	Diesel	1968	4	81.00	95.50	134
CAVA	Petrol	1390	4	76.50	75.60	23
CAVB	Petrol	1390	4	76.50	75.60	23
CAVC	Petrol	1390	4	76.50	75.60	23
CAVD	Petrol	1390	4	76.50	75.60	23
CAVE	Petrol	1390	4	76.50	75.60	23
CAXA	Petrol	1390	4	76.50	75.60	23
CAYA	Diesel	1598	4	79.50	80.50	53
CAYB	Diesel	1598	4	79.50	80.50	53
CAYC	Diesel	1598	4	79.50	80.50	53
CAYD	Diesel	1598	4	79.50	80.50	53
CAYE	Diesel	1598	4	79.50	80.50	53
CBAA	Diesel	1968	4	81.00	95.50	131
CBAB	Diesel	1968	4	81.00	95.50	131
CBAC	Diesel	1968	4	81.00	95.50	131
CBBA	Diesel	1968	4	81.00	95.50	131
CBBB	Diesel	1968	4	81.00	95.50	134
CBDA	Diesel	1968	4	81.00	95.50	131
CBDB	Diesel	1968	4	81.00	95.50	134
CBDC	Diesel	1968	4	81.00	95.50	131
CBEA	Diesel	1968	4	81.00	95.50	131
CBHA	Diesel	1968	4	81.00	95.50	131
CBJB	Diesel	1968	4	81.00	95.50	131
CBKA	Diesel	1968	4	81.00	95.50	131
CBR	Petrol	3189	V6	84.00	95.90	157
CBRA	Petrol	3189	V6	84.00	95.90	157
CBZA	Petrol	1197	4	71.00	75.60	5
CBZB	Petrol	1197	4	71.00	75.60	5
CCHA	Diesel	1968	4	81.00	95.50	134
CCHB	Diesel	1968	4	81.00	95.50	134
CCSA	Petrol	1595	4	81.00	77.40	85
CDBA	Diesel	1968	4	81.00	95.50	134
CDCA	Diesel	1968	4	81.00	95.50	134
CDGA	Petrol	1390	4	76.50	75.60	27
CEBA	Diesel	2461	5	81.00	95.50	139
CEBB	Diesel	2461	5	81.00	95.50	139
CECA	Diesel	2461	5	81.00	95.50	139
CECB	Diesel	2461	5	81.00	95.50	139
CEGA	Diesel	1968	4	81.00	95.50	134
CFCA	Diesel	1968	4	81.00	95.50	134
CFFA	Diesel	1968	4	81.00	95.50	134
CFFB	Diesel	1968	4	81.00	95.50	134
CFFD	Diesel	1968	4	81.00	95.50	134
CFFE	Diesel	1968	4	81.00	95.50	134
CFGB	Diesel	1968	4	81.00	95.50	134
CFGC	Diesel	1968	4	81.00	95.50	134
CFHB	Diesel	1968	4	81.00	95.50	134
CFHC	Diesel	1968	4	81.00	95.50	134

		cm3	x 			
CFHE	Diesel	1968	4	81.00	95.50	134
CFHF	Diesel	1968	4	81.00	95.50	134
CFJA	Diesel	1968	4	81.00	95.50	134
CFJB	Diesel	1968	4	81.00	95.50	134
CFLA	Petrol	3189	V6	84.00	95.90	157
CFNA	Petrol	1598	4	76.50	86.90	42
CFNB	Petrol	1598	4	76.50	86.90	44
CFWA	Diesel	1199	3	79.50	80.50	52
CGGA	Petrol	1390	4	76.50	75.60	27
CGGB	Petrol	1390	4	76.50	75.60	27
CGPA	Petrol	1198	3	76.50	86.90	36
CGPB	Petrol	1198	3	76.50	86.90	36
CHFA	Petrol	1198	3	76.50	86.90	36
CHFB	Petrol	1198	3	76.50	86.90	36
CHGA	Petrol	1595	4	81.00	77.40	85
CJAA	Diesel	1968	4	81.00	95.50	134
CK	Diesel	1471	4	76.50	80.00	28
CKFC	Diesel	1968	4	81.00	95.50	134
CKMA	Flexfuel	1390	4	76.50	75.60	23
CKTB	Diesel	1968	4	81.00	95.50	135
CKTC	Diesel	1968	4	81.00	95.50	135
CKUB	Diesel	1968	4	81.00	95.50	135
CKUC	Diesel	1968	4	81.00	95.50	135
CLCA	Diesel	1968	4	81.00	95.50	134
CLCB	Diesel	1968	4	81.00	95.50	134
CLJA	Diesel	1968	4	81.00	95.50	134
CLLA	Diesel	1968	4	81.00	95.50	134
CLNA	Diesel	1598	4	79.50	80.50	53
CMTA	Petrol	3597	V6	89.00	96.40	164
CMXA	Petrol	1595	4	81.00	77.40	85
CNEA	Diesel	1968	4	81.00	95.50	134
CNFA	Diesel	1968	4	81.00	95.50	134
CNFB	Diesel	1968	4	81.00	95.50	134
CNKA	Petrol	1598	4	76.50	86.90	40
CNWA	Petrol	1390	4	76.50	75.60	23
CP	Diesel	2383	6	76.50	86.40	35
CR	Diesel	1588	4	76.50	86.40	33
CRBB	Diesel	1968	4	81.00	95.50	134
CRLB	Diesel	1968	4	81.00	95.50	134
CRMB	Diesel	1968	4	81.00	95.50	134
CRUA	Diesel	1968	4	81.00	95.50	134
CRVA	Diesel	1968	4	81.00	95.50	134
CRVC	Diesel	1968	4	81.00	95.50	134
CS	Diesel	1588	4	76.50	86.40	33
CSHA	Diesel	1968	4	81.00	95.50	134
CSLB	Diesel	1968	4	81.00	95.50	134
CSNA	Diesel	1968	4	81.00	95.50	134
CUNA	Diesel	1968	4	81.00	95.50	134
CUUA	Diesel	1968	4	81.00	95.50	134
CUUD	Diesel	1968	4	81.00	95.50	134
CUUE	Diesel	1968	4	81.00	95.50	134
CUUF	Diesel	1968	4	81.00	95.50	134
CUVA	Diesel	1968	4	81.00	95.50	134
CUVC	Diesel	1968	4	81.00	95.50	134
CUWA	Diesel	1968	4	81.00	95.50	134
CVCA	Diesel	1968	4	81.00	95.50	134
CXEB	Diesel	1968	4	81.00	95.50	134
CXFA	Diesel	1968	4	81.00	95.50	134
CXGA	Diesel	1968	4	81.00	95.50	134
CXGB	Diesel	1968	4	81.00	95.50	134
CXHA	Diesel	1968	4	81.00	95.50	134
CY	Diesel	1588	4	76.50	86.40	33
CZ	Petrol	1584	4	85.50	69.00	161
D	Petrol	1192	4	77.00	64.00	45
DDAA	Diesel	1968	4	81.00	95.50	134
DELA	Diesel	1968	4	81.00	95.50	134
DF	Petrol	1913	4	94.00	69.00	165
DFCA	Diesel	1968	4	81.00	95.50	134
DFEA	Diesel	1968	4	81.00	95.50	134

			cm ³	x 			9
DG	Petrol		1913	4	94.00	69.00	165
DH	Petrol		1913	4	94.00	69.00	165
DJ	Petrol		2110	4	94.00	76.00	166
DL	Petrol		2383	6	76.50	86.40	35
DS	Petrol		1781	4	81.00	86.40	115
DT	Petrol		1595	4	81.00	77.40	88
DTA	Petrol		1595	4	81.00	77.40	89
DV	Diesel		2383	6	76.50	86.40	35
DW	Diesel		2383	6	76.50	86.40	35
DX	Petrol		1781	4	81.00	86.40	116
DZ	Petrol		1781	4	81.00	86.40	117
E	Petrol		1285	4	77.00	69.00	46
EE	Petrol		1588	4	79.50	80.00	51
EF	Petrol		1588	4	79.50	80.00	50
EG	Petrol		1588	4	79.50	80.00	50
EH	Petrol		1457	4	79.50	73.40	48
EJ	Petrol		1588	4	79.50	80.00	51
EM	Petrol		1588	4	79.50	80.00	50
EN	Petrol		1716	4	79.50	86.40	54
EP	Petrol		1297	4	75.00	73.40	12
EU	Petrol		1297	4	75.00	73.40	13
EV	Petrol		1781	4	81.00	86.40	118
EW	Petrol		1595	4	81.00	77.40	90
EX	Petrol		1781	4	81.00	86.40	119
EZ	Petrol		1595	4	81.00	77.40	91
EZA	Petrol		1595	4	81.00	77.40	92
F	Petrol		1285	4	77.00	69.00	46
FA	Petrol		1093	4	69.50	72.00	4
FB	Petrol		1470	4	76.50	80.00	28
FD	Petrol		1471	4	76.50	80.00	28
FF	Petrol		1471	4	76.50	80.00	28
FH	Petrol		1471	4	76.50	80.00	28
FJ	Petrol		1093	4	69.50	72.00	4
FK	Petrol		1471	4	76.50	80.00	28
FN	Petrol		1588	4	79.50	80.00	50
FP	Petrol		1588	4	79.50	80.00	50
FR	Petrol		1588	4	79.50	80.00	50
FS	Petrol		1588	4	79.50	80.00	50
FT	Petrol		1588	4	79.50	80.00	50
FV	Petrol		1588	4	79.50	80.00	50
FY	Petrol		1272	4	75.00	72.00	10
FZ	Petrol		1272	4	75.00	72.00	10
GF	Petrol		1272	4	75.00	72.00	10
GG	Petrol		1093	4	69.50	72.00	4
GH	Petrol		1457	4	79.50	73.40	48
GK	Petrol		1272	4	75.00	72.00	10
GL	Petrol		1043	4	75.00	59.00	9
GN	Petrol		1043	4	75.00	59.00	9
GS	Petrol		1272	4	75.00	72.00	11
GT	Petrol		1272	4	75.00	72.00	10
GU	Petrol		1781	4	81.00	86.40	119
GW	Petrol		1913	4	94.00	69.00	165
GX	Petrol		1781	4	81.00	86.40	118
H	Petrol		1493	4	83.00	69.00	155
HA	Petrol		895	4	69.50	59.00	3
HB	Petrol		1093	4	69.50	72.00	4
HC	Petrol		1093	4	69.50	72.00	4
HD	Petrol		1093	4	69.50	72.00	4
HE	Petrol		771	4	64.50	59.00	1
HH	Petrol		1272	4	75.00	72.00	10
HJ	Petrol		1272	4	75.00	72.00	10
HK	Petrol		1272	4	75.00	72.00	10
HM	Petrol		1595	4	81.00	77.40	88
HN	Petrol		1595	4	81.00	77.40	93
HN	Petrol		1595	4	81.00	77.40	93
HP	Petrol		1994	5	81.00	77.40	99
HS	Petrol		2384	6	76.50	86.40	35
HW	Petrol		1272	4	75.00	72.00	11
HY	Petrol		2226	5	81.00	86.40	126

			cm3	x 			
HZ	Petrol	1043	4	75.00	59.00	8	
JB	Petrol	1457	4	79.50	73.40	48	
JF	Petrol	1715	4	79.50	86.40	55	
JH	Petrol	1781	4	81.00	86.40	119	
JJE	Petrol	1299	4	74.00	75.50	7	
JK	Diesel	1588	4	76.50	86.40	33	
JN	Petrol	1781	4	81.00	86.40	115	
JP	Diesel	1588	4	76.50	86.40	34	
JR	Diesel	1588	4	76.50	86.40	31	
JS	Petrol	1994	5	81.00	77.40	100	
JT	Petrol	2226	5	81.00	86.40	127	
JU	Petrol	1595	4	81.00	77.40	93	
JV	Petrol	1781	4	81.00	86.40	115	
JX	Diesel	1589	4	76.50	86.40	31	
KR	Petrol	1781	4	81.00	86.40	119	
KT	Petrol	1781	4	81.00	86.40	120	
KV	Petrol	2226	5	81.00	86.40	127	
KX	Petrol	2226	5	81.00	86.40	127	
KY	Diesel	1716	4	79.50	86.40	58	
ME	Diesel	1588	4	76.50	86.40	31	
MF	Diesel	1588	4	76.50	86.40	31	
MH	Petrol	1272	4	75.00	72.00	11	
MN	Diesel	1272	4	75.00	72.00	11	
MV	Petrol	2110	4	94.00	76.00	166	
NU	Petrol	1272	4	75.00	72.00	11	
NZ	Petrol	1272	4	75.00	72.00	11	
P	Petrol	1584	4	85.50	69.00	161	
PB	Petrol	1781	4	81.00	86.40	121	
PF	Petrol	1781	4	81.00	86.40	122	
PG	Petrol	1781	4	81.00	86.40	123	
PL	Petrol	1781	4	81.00	86.40	124	
PN	Petrol	1595	4	81.00	77.40	94	
PP	Petrol	1595	4	81.00	77.40	95	
PY	Petrol	1272	4	75.00	72.00	11	
RA	Diesel	1588	4	76.50	86.40	31	
RE	Petrol	1595	4	81.00	77.40	96	
RF	Petrol	1595	4	81.00	77.40	97	
RG	Petrol	1781	4	81.00	86.40	117	
RH	Petrol	1781	4	81.00	86.40	124	
RL	Petrol	1595	4	81.00	77.40	98	
RP	Petrol	1781	4	81.00	86.40	108	
RV	Petrol	1781	4	81.00	86.40	125	
SB	Diesel	1588	4	76.50	86.40	31	
SR	Petrol	2109	4	94.00	76.00	166	
SS	Petrol	2110	4	94.00	76.00	166	
U	Petrol	1584	4	85.50	69.00	160	
WE	Petrol	2144	5	79.50	86.40	59	
WL	Petrol	1714	4	79.50	86.40	56	
WN	Petrol	1921	5	79.50	77.40	49	
WP	Petrol	1588	4	79.50	80.00	50	
WV	Petrol	1588	4	79.50	80.00	50	
WY	Petrol	1588	4	79.50	80.00	50	
WZ	Petrol	1588	4	79.50	80.00	50	
YG	Petrol	1588	4	79.50	80.00	50	
YH	Petrol	1588	4	79.50	80.00	50	
YJ	Petrol	1471	4	76.50	80.00	28	
YK	Petrol	1588	4	79.50	80.00	50	
YN	Petrol	1588	4	79.50	80.00	50	
YP	Petrol	1588	4	79.50	80.00	50	
YS	Petrol	1588	4	79.50	80.00	50	
YU	Petrol	1588	4	79.50	80.00	50	
YY	Petrol	1588	4	79.50	80.00	50	
ZA	Petrol	1297	4	75.00	73.40	14	
ZB	Petrol	1471	4	76.50	80.00	28	
ZC	Petrol	1471	4	76.50	80.00	28	
ZF	Petrol	1297	4	75.00	73.40	14	



1 64.50 x 59.00

HE 4 Cyl. **771cc** **25kW (34PS)** **Petrol** **TD16537**

BE/PL	4	41,965/41,980	45,000/45,016	18,000	1,505	0,020/0,066	EC	71-3276	71-3276/4 STD 0.25
MB/HL	8	53,958/53,978	59,000/59,019	18,500	2,502	0,020/0,082	AL-LF	02-3085U	H024/5 STD 0.25
MB/HL	2	53,958/53,978	59,000/59,019	24,930	2,502	0,020/0,082	AL-LF	02-3086HU	



02-3086HU	STD	25,000/.9843" - 25,040/.9858"
	0.25mm	25,100/.9882" - 25,140/.9898"
	0.50mm	25,100/.9882" - 25,140/.9898"
	0.75mm	25,100/.9882" - 25,140/.9898"

SE/PB	1	20,000	23,000/23,025	24,000			BC	55-3277	55-3277 SEMI
BU	1	42,959/42,975	46,055/46,095	15,000			AL-LF	07-3088	07-3088 STD SEMI 13

Front, For intermediary shaft

BU	1	41,959/41,975	45,000/45,025	15,000			AL-LF	07-3089	07-3089 STD SEMI 13
----	---	---------------	---------------	--------	--	--	-------	---------	--

Rear, For intermediary shaft

2 67.10 x 70.60

AER 4 Cyl. **999cc** **37kW (50PS)** **Petrol** **TD9519**

ALD 4 Cyl. **999cc** **37kW (50PS)** **Petrol** **TD11468**

ALL 4 Cyl. **999cc** **37kW (50PS)** **Petrol** **TD10609**

ANV 4 Cyl. **999cc** **37kW (50PS)** **Petrol** **TD11469**

ATE 4 Cyl. **999cc** **37kW (50PS)** **Petrol** **TD22625**

AUC 4 Cyl. **999cc** **37kW (50PS)** **Petrol** **TD15491**

BE/PL	4	41,965/41,980	45,000/45,012	18,500	1,505	0,020/0,060	AL-LF	01-3874	01-3874/4 STD 0.25
MB/HL 1-5	5	53,963/53,978	59,000/59,019	18,500	2,504	0,020/0,073	AL-LF	02-4929	H1325/5 STD 0.25 0.50
TW/A	2	59,500	73,200		1,975		AL-LF	04-3527	A123/4 STD
TW/A	2	59,500	73,200		1,975		AL-LF	04-3528	

3 69.50 x 59.00

HA 4 Cyl. **895cc** **29kW (40PS)** **Petrol** **TD4104**

BE/PL	4	41,965/41,980	45,000/45,016	18,000	1,505	0,020/0,066	EC	71-3276	71-3276/4 STD 0.25
MB/HL	8	53,958/53,978	59,000/59,019	18,500	2,502	0,020/0,082	AL-LF	02-3085U	H024/5 STD 0.25
MB/HL	2	53,958/53,978	59,000/59,019	24,930	2,502	0,020/0,082	AL-LF	02-3086HU	



02-3086HU	STD	25,000/.9843" - 25,040/.9858"
	0.25mm	25,100/.9882" - 25,140/.9898"
	0.50mm	25,100/.9882" - 25,140/.9898"
	0.75mm	25,100/.9882" - 25,140/.9898"

SE/PB	1	20,000	23,000/23,025	24,000			BC	55-3277	55-3277 SEMI
BU	1	42,959/42,975	46,055/46,095	15,000			AL-LF	07-3088	07-3088 STD SEMI 13

Front, For intermediary shaft

BU	1	41,959/41,975	45,000/45,025	15,000			AL-LF	07-3089	07-3089 STD SEMI 13
----	---	---------------	---------------	--------	--	--	-------	---------	--

Rear, For intermediary shaft



4 69.50 x 72.00

FA	4 Cyl.	1093cc	37kW (50PS)	Petrol	TD5001
FJ	4 Cyl.	1093cc	38kW (52PS)	Petrol	TD4082
GG	4 Cyl.	1093cc	37kW (50PS)	Petrol	TD4093
HB	4 Cyl.	1093cc	37kW (50PS)	Petrol	TD5008
HC	4 Cyl.	1093cc	44kW (60PS)	Petrol	TD5009
HD	4 Cyl.	1093cc	38kW (52PS)	Petrol	TD21345

BE/PL	4	41,965/41,980	45,000/45,016	18,000	1,505	0,020/0,066	EC	71-3276	71-3276/4 STD 0.25
MB/HL	8	53,958/53,978	59,000/59,019	18,500	2,502	0,020/0,082	AL-LF	02-3085U	H024/5 STD 0.25
MB/HL	2	53,958/53,978	59,000/59,019	24,930	2,502	0,020/0,082	AL-LF	02-3086HU	

	02-3086HU	STD	25,000/.9843" - 25,040/.9858"
		0.25mm	25,100/.9882" - 25,140/.9898"
		0.50mm	25,100/.9882" - 25,140/.9898"
		0.75mm	25,100/.9882" - 25,140/.9898"

SE/PB	1	20,000	23,000/23,025	24,000			BC	55-3277	55-3277 SEMI
BU	1	42,959/42,975	46,055/46,095	15,000			AL-LF	07-3088	07-3088 STD SEMI [13]

Front, For intermediary shaft

BU	1	41,959/41,975	45,000/45,025	15,000			AL-LF	07-3089	07-3089 STD SEMI [13]
----	---	---------------	---------------	--------	--	--	-------	---------	--

Rear, For intermediary shaft

5 71.00 x 75.60

CBZA	4 Cyl.	1197cc	63kW (86PS)	Petrol Turbo	TD24312
CBZB	4 Cyl.	1197cc	77kW (105PS)	Petrol Turbo	TD23520

BE/PL	4	41,963/41,978	45,000/45,012	15,200	1,503	0,024/0,062	AL-LF	01-4873	01-4873/4 STD
TW/A	2		64,750/65,000		2,475		AL-LF	04-4930	A314/2 STD
SE/PB	1	19,000	21,000/21,033	17,800			BC-LF	55-4875	55-4875 SEMI [6]

6 72.00 x 61.20

AHT	4 Cyl.	997cc	37kW (50PS)	Petrol	TD11467				
BE/PL	4	41,965/41,980	45,000/45,012	18,500	1,505	0,020/0,060	AL-LF	01-3874	01-3874/4 STD 0.25

7 74.00 x 75.50

JJE	4 Cyl.	1299cc	37kW (50PS)	Petrol	TD24146				
BE/PL	4	40,990/41,010	43,990/44,010	17,950	1,450	0,080/0,145	AL-LF	4165RA	01-4153/4 STD 0.25 0.75
MB/HL	1	56,990/57,000	60,623/60,636	18,690	1,807	0,020/0,057	AL-LF	4166RA	02-4549 STD 0.25
TW/A	2	63,600	78,100		2,850		AL-LF	66526AF	A209/2 STD

8 75.00 x 59.00

AAK	4 Cyl.	1043cc	33kW (45PS)	Petrol	TD4003
AAU	4 Cyl.	1043cc	33kW (45PS)	Petrol	TD4971
ACM	4 Cyl.	1043cc	33kW (45PS)	Petrol	TD4013
AEV	4 Cyl.	1043cc	33kW (45PS)	Petrol	TD4021
HZ	4 Cyl.	1043cc	33-37kW (45-50PS)	Petrol	TD5012

VOLKSWAGEN

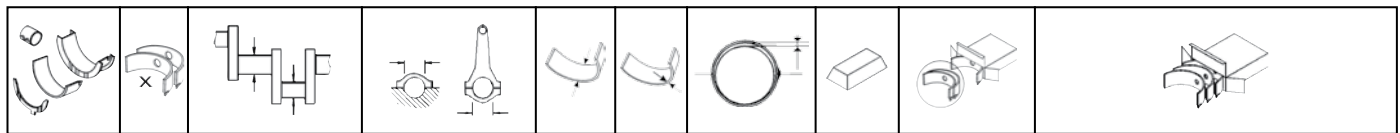

BE/PL	4	41,965/41,980	45,000/45,016	18,000	1,505	0,020/0,066	EC	71-3276	71-3276/4 STD 0.25
MB/HL 1-5	10	53,958/53,978	59,000/59,019	18,500	2,502	0,020/0,082	AL-LF	02-3085U	H026/5 STD 0.25 0.50
TW/A	2	59,500	73,200		1,975		AL-LF	04-3527	A123/4 STD
TW/A	2	59,500	73,200		1,975		AL-LF	04-3528	
SE/PB	1	20,000	23,000/23,025	24,000			BC	55-3277	55-3277 SEMI
BU	1	42,959/42,975	46,055/46,095	15,000			AL-LF	07-3088	07-3088 STD SEMI

Front, For intermediary shaft

BU	1	41,959/41,975	45,000/45,025	15,000			AL-LF	07-3089	07-3089 STD SEMI
----	---	---------------	---------------	--------	--	--	-------	---------	----------------------------

Rear, For intermediary shaft

9 75.00 x 59.00

GL	4 Cyl.	1043cc	29kW (40PS)	Petrol	TD5006
GN	4 Cyl.	1043cc	33-37kW (45-50PS)	Petrol	TD4095

BE/PL	4	41,965/41,980	45,000/45,016	18,000	1,505	0,020/0,066	EC	71-3276	71-3276/4 STD 0.25
MB/HL	8	53,958/53,978	59,000/59,019	18,500	2,502	0,020/0,082	AL-LF	02-3085U	H024/5 STD 0.25
MB/HL	2	53,958/53,978	59,000/59,019	24,930	2,502	0,020/0,082	AL-LF	02-3086HU	
			02-3086HU	STD	25,000/.9843" - 25,040/.9858"				
				0.25mm	25,100/.9882" - 25,140/.9898"				
				0.50mm	25,100/.9882" - 25,140/.9898"				
				0.75mm	25,100/.9882" - 25,140/.9898"				

SE/PB	1	20,000	23,000/23,025	24,000			BC	55-3277	55-3277 SEMI
BU	1	42,959/42,975	46,055/46,095	15,000			AL-LF	07-3088	07-3088 STD SEMI

Front, For intermediary shaft

BU	1	41,959/41,975	45,000/45,025	15,000			AL-LF	07-3089	07-3089 STD SEMI
----	---	---------------	---------------	--------	--	--	-------	---------	----------------------------

Rear, For intermediary shaft

10 75.00 x 72.00

2G	4 Cyl.	1272cc	40kW (54PS)	Petrol	TD4964
3F	4 Cyl.	1272cc	55-57kW (75-78PS)	Petrol	TD4968
AAV	4 Cyl.	1272cc	40kW (55PS)	Petrol	TD5159
FY	4 Cyl.	1272cc	40kW (55PS)	Petrol	TD5002
FZ	4 Cyl.	1272cc	44kW (60PS)	Petrol	TD5003
GF	4 Cyl.	1272cc	44kW (60PS)	Petrol	TD4092
GK	4 Cyl.	1272cc	55kW (75PS)	Petrol	TD4094
GT	4 Cyl.	1272cc	43kW (58PS)	Petrol	TD4097
HH	4 Cyl.	1272cc	44kW (60PS)	Petrol	TD5010
HJ	4 Cyl.	1272cc	43kW (58PS)	Petrol	TD4105
HK	4 Cyl.	1272cc	40kW (55PS)	Petrol	TD5011

BE/PL	4	41,965/41,980	45,000/45,016	18,000	1,505	0,020/0,066	EC	71-3276	71-3276/4 STD 0.25
-------	---	---------------	---------------	--------	-------	-------------	----	---------	------------------------------

MB/HL	8	53,958/53,978	59,000/59,019	18,500	2,502	0,020/0,082	AL-LF	02-3085U	H024/5 STD 0.25
MB/HL	2	53,958/53,978	59,000/59,019	24,930	2,502	0,020/0,082	AL-LF	02-3086HU	
		02-3086HU	STD	25,000/.9843" - 25,040/.9858"					
			0.25mm	25,100/.9882" - 25,140/.9898"					
			0.50mm	25,100/.9882" - 25,140/.9898"					
			0.75mm	25,100/.9882" - 25,140/.9898"					
SE/PB	1	20,000	23,000/23,025	24,000			BC	55-3277	55-3277 SEMI
BU	1	42,959/42,975	46,055/46,095	15,000			AL-LF	07-3088	07-3088 STD SEMI
Front, For intermediary shaft									
BU	1	41,959/41,975	45,000/45,025	15,000			AL-LF	07-3089	07-3089 STD SEMI
Rear, For intermediary shaft									

11

75.00 x 72.00

GS			4 Cyl.	1272cc	43kW (58PS)		Petrol		TD4096
HW			4 Cyl.	1272cc	37kW (50PS)		Petrol		TD4113
MH			4 Cyl.	1272cc	40kW (55PS)		Petrol		TD4131
NU			4 Cyl.	1272cc	37kW (50PS)		Petrol		TD4135
NZ			4 Cyl.	1272cc	40kW (55PS)		Petrol		TD4136
PY			4 Cyl.	1272cc	83-85kW (113-115PS)		Petrol		TD5023
MN			4 Cyl.	1272cc	33kW (44PS)		Diesel		TD4132
BE/PL	4	41,965/41,980	45,000/45,016	18,000	1,505	0,020/0,066	EC	71-3276	71-3276/4 STD 0.25
MB/HL	8	53,958/53,978	59,000/59,019	18,500	2,502	0,020/0,082	AL-LF	02-3085U	H024/5 STD 0.25
MB/HL	2	53,958/53,978	59,000/59,019	24,930	2,502	0,020/0,082	AL-LF	02-3086HU	
		02-3086HU	STD	25,000/.9843" - 25,040/.9858"					
			0.25mm	25,100/.9882" - 25,140/.9898"					
			0.50mm	25,100/.9882" - 25,140/.9898"					
			0.75mm	25,100/.9882" - 25,140/.9898"					
MB/HL 1-5	10	53,958/53,978	59,000/59,019	18,500	2,502	0,020/0,082	AL-LF	02-3085U	H026/5 STD 0.25 0.50

02-3085U

02-3086HU

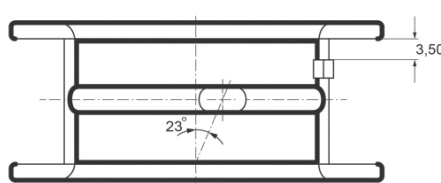
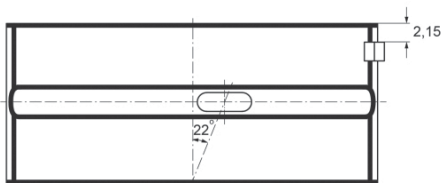

TW/A	2	59,500	73,200		1,975		AL-LF	04-3527	A123/4 STD
TW/A	2	59,500	73,200		1,975		AL-LF	04-3528	
SE/PB	1	20,000	23,000/23,025	24,000			BC	55-3277	55-3277 SEMI
BU	1	42,959/42,975	46,055/46,095	15,000			AL-LF	07-3088	07-3088 STD SEMI
Front, For intermediary shaft									
BU	1	41,959/41,975	45,000/45,025	15,000			AL-LF	07-3089	07-3089 STD SEMI
Rear, For intermediary shaft									

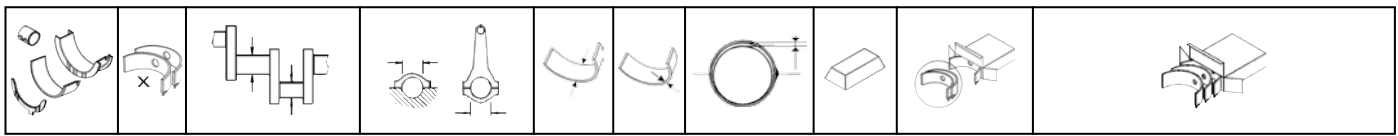

12 **75.00 x 73.40**

EP **4 Cyl.** **1297cc** **44kW (60PS)** **Petrol** **TD5158**

BE/PL	1	45,950/45,970	49,000/49,016	19,000	1,506	0,020/0,078	EC	71-3084	71-3084 STD 0.25
-------	---	---------------	---------------	--------	-------	-------------	----	---------	----------------------------

Mot.→81D250000

BE/PL	4	47,758/47,778	50,600/50,612	19,000	1,406	0,020/0,067	EC	71-3694	71-3694/4 STD 0.25 0.50
-------	---	---------------	---------------	--------	-------	-------------	----	---------	-----------------------------------

Mot.81E000001→

71-3084

71-3694

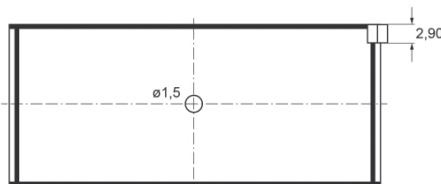

MB/HL	3	53,958/53,978	59,000/59,019	18,500	2,502	0,020/0,082	AL-LF	02-3085L	H025/5 STD 0.25 0.50
MB/HL	5	53,958/53,978	59,000/59,019	18,500	2,502	0,020/0,082	AL-LF	02-3085U	
MB/HL	1	53,958/53,978	59,000/59,019	24,930	2,502	0,020/0,082	AL-LF	02-3086HL	
MB/HL	1	53,958/53,978	59,000/59,019	24,930	2,502	0,020/0,082	AL-LF	02-3086HU	



02-3086HL	STD	25,000/.9843" - 25,040/.9858"
	0.25mm	25,100/.9882" - 25,140/.9898"
	0.50mm	25,100/.9882" - 25,140/.9898"
	0.75mm	25,100/.9882" - 25,140/.9898"

02-3086HU	STD	25,000/.9843" - 25,040/.9858"
	0.25mm	25,100/.9882" - 25,140/.9898"
	0.50mm	25,100/.9882" - 25,140/.9898"
	0.75mm	25,100/.9882" - 25,140/.9898"

MB/HL	4	53,958/53,978	59,000/59,019	18,500	2,502	0,020/0,082	AL-LF	02-3085L	H027/5 STD 0.25 0.50
MB/HL	6	53,958/53,978	59,000/59,019	18,500	2,502	0,020/0,082	AL-LF	02-3085U	

02-3085L

02-3085U

02-3086HL

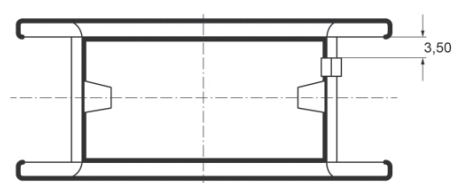
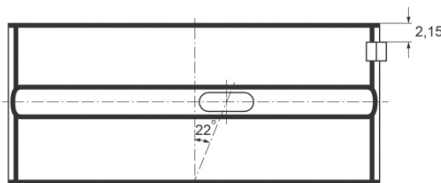

02-3086HU

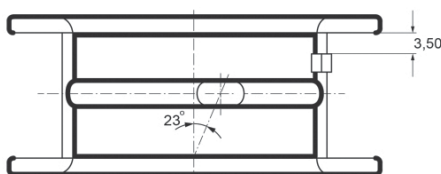

TW/A	2	59,500	73,200		1,975		AL-LF	04-3527	A123/4 STD
TW/A	2	59,500	73,200		1,975		AL-LF	04-3528	
SE/PB	1	20,000	23,000/23,052	25,000			BC	55-3567	55-3567 SEMI
01/83 →									
CB/NWB 1-5	5	25,939/25,960	28,250/28,271	17,000	1,138		AL-LF	03-3317	N118/5 STD
BU	1	42,959/42,975	46,055/46,095	15,000			AL-LF	07-3088	07-3088 STD SEMI
Front, For intermediary shaft									
BU	1	41,959/41,975	45,000/45,025	15,000			AL-LF	07-3089	07-3089 STD SEMI
Rear, For intermediary shaft									

13

75.00 x 73.40

EU	4 Cyl.		1297cc	44kW (60PS)	Petrol				TD16428																																
BE/PL	4	47,758/47,778	50,600/50,612	19,000	1,406	0,020/0,067	EC	71-3694	71-3694/4 STD 0.25 0.50																																
MB/HL	3	53,958/53,978	59,000/59,019	18,500	2,502	0,020/0,082	AL-LF	02-3085L	H025/5 STD 0.25 0.50																																
MB/HL	5	53,958/53,978	59,000/59,019	18,500	2,502	0,020/0,082	AL-LF	02-3085U																																	
MB/HL	1	53,958/53,978	59,000/59,019	24,930	2,502	0,020/0,082	AL-LF	02-3086HL																																	
MB/HL	1	53,958/53,978	59,000/59,019	24,930	2,502	0,020/0,082	AL-LF	02-3086HU																																	
<table border="0"> <tr> <td>02-3086HL</td> <td>STD</td> <td colspan="2">25,000/.9843" - 25,040/.9858"</td> </tr> <tr> <td></td> <td>0.25mm</td> <td colspan="2">25,100/.9882" - 25,140/.9898"</td> </tr> <tr> <td></td> <td>0.50mm</td> <td colspan="2">25,100/.9882" - 25,140/.9898"</td> </tr> <tr> <td></td> <td>0.75mm</td> <td colspan="2">25,100/.9882" - 25,140/.9898"</td> </tr> <tr> <td>02-3086HU</td> <td>STD</td> <td colspan="2">25,000/.9843" - 25,040/.9858"</td> </tr> <tr> <td></td> <td>0.25mm</td> <td colspan="2">25,100/.9882" - 25,140/.9898"</td> </tr> <tr> <td></td> <td>0.50mm</td> <td colspan="2">25,100/.9882" - 25,140/.9898"</td> </tr> <tr> <td></td> <td>0.75mm</td> <td colspan="2">25,100/.9882" - 25,140/.9898"</td> </tr> </table>										02-3086HL	STD	25,000/.9843" - 25,040/.9858"			0.25mm	25,100/.9882" - 25,140/.9898"			0.50mm	25,100/.9882" - 25,140/.9898"			0.75mm	25,100/.9882" - 25,140/.9898"		02-3086HU	STD	25,000/.9843" - 25,040/.9858"			0.25mm	25,100/.9882" - 25,140/.9898"			0.50mm	25,100/.9882" - 25,140/.9898"			0.75mm	25,100/.9882" - 25,140/.9898"	
02-3086HL	STD	25,000/.9843" - 25,040/.9858"																																							
	0.25mm	25,100/.9882" - 25,140/.9898"																																							
	0.50mm	25,100/.9882" - 25,140/.9898"																																							
	0.75mm	25,100/.9882" - 25,140/.9898"																																							
02-3086HU	STD	25,000/.9843" - 25,040/.9858"																																							
	0.25mm	25,100/.9882" - 25,140/.9898"																																							
	0.50mm	25,100/.9882" - 25,140/.9898"																																							
	0.75mm	25,100/.9882" - 25,140/.9898"																																							
SE/PB	1	20,000	23,000/23,052	25,000			BC	55-3567	55-3567 SEMI																																
BU	1	42,959/42,975	46,055/46,095	15,000			AL-LF	07-3088	07-3088 STD SEMI																																
Front, For intermediary shaft																																									
BU	1	41,959/41,975	45,000/45,025	15,000			AL-LF	07-3089	07-3089 STD SEMI																																
Rear, For intermediary shaft																																									

14

75.00 x 73.40

ZA	4 Cyl.		1297cc	40kW (55PS)	Petrol				TD5036
ZF	4 Cyl.		1297cc	44kW (60PS)	Petrol				TD5140
BE/PL	1	45,950/45,970	49,000/49,016	19,000	1,506	0,020/0,078	EC	71-3084	71-3084 STD 0.25

VOLKSWAGEN

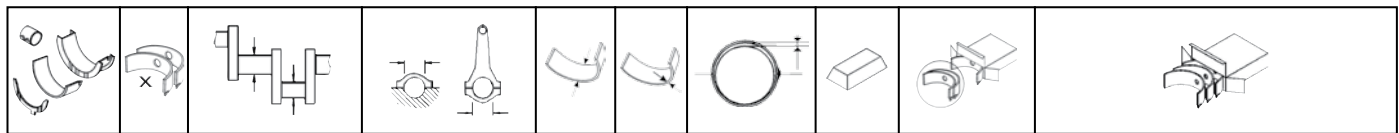

MB/HL	3	53,958/53,978	59,000/59,019	18,500	2,502	0,020/0,082	AL-LF	02-3085L	H025/5 STD 0.25 0.50
MB/HL	5	53,958/53,978	59,000/59,019	18,500	2,502	0,020/0,082	AL-LF	02-3085U	
MB/HL	1	53,958/53,978	59,000/59,019	24,930	2,502	0,020/0,082	AL-LF	02-3086HL	
MB/HL	1	53,958/53,978	59,000/59,019	24,930	2,502	0,020/0,082	AL-LF	02-3086HU	



02-3086HL	STD	25,000/.9843" - 25,040/.9858"
	0.25mm	25,100/.9882" - 25,140/.9898"
	0.50mm	25,100/.9882" - 25,140/.9898"
	0.75mm	25,100/.9882" - 25,140/.9898"

02-3086HU	STD	25,000/.9843" - 25,040/.9858"
	0.25mm	25,100/.9882" - 25,140/.9898"
	0.50mm	25,100/.9882" - 25,140/.9898"
	0.75mm	25,100/.9882" - 25,140/.9898"

CB/NWB 1-5	5	25,939/25,960	28,250/28,271	17,000	1,138		AL-LF	03-3317	N118/5 STD	12
BU	1	42,959/42,975	46,055/46,095	15,000			AL-LF	07-3088	07-3088 STD SEMI	13

Front, For intermediary shaft

BU	1	41,959/41,975	45,000/45,025	15,000			AL-LF	07-3089	07-3089 STD SEMI	13
----	---	---------------	---------------	--------	--	--	-------	---------	----------------------------	----

Rear, For intermediary shaft

15 75.00 x 78.70

ABD			4 Cyl.	1390cc	40-44kW (55-60PS)		Petrol		TD4973
------------	--	--	--------	---------------	--------------------------	--	---------------	--	---------------

BE/PL	4	41,965/41,980	45,000/45,016	18,000	1,505	0,020/0,066	EC	71-3276	71-3276/4 STD 0.25	
MB/HL 1-5	10	53,958/53,978	59,000/59,019	18,500	2,502	0,020/0,082	AL-LF	02-3085U	H026/5 STD 0.25 0.50	
TW/A	2	59,500	73,200		1,975		AL-LF	04-3527	A123/4 STD	
TW/A	2	59,500	73,200		1,975		AL-LF	04-3528		
SE/PB	1	20,000	23,000/23,025	24,000			BC	55-3277	55-3277 SEMI	
BU	1	42,959/42,975	46,055/46,095	15,000			AL-LF	07-3088	07-3088 STD SEMI	13

Front, For intermediary shaft

BU	1	41,959/41,975	45,000/45,025	15,000			AL-LF	07-3089	07-3089 STD SEMI	13
----	---	---------------	---------------	--------	--	--	-------	---------	----------------------------	----

Rear, For intermediary shaft

16 75.00 x 79.10

1W			4 Cyl.	1398cc	35kW (48PS)		Diesel		TD4959
-----------	--	--	--------	---------------	--------------------	--	---------------	--	---------------

BE/PL	4	41,965/41,980	45,000/45,016	18,000	1,505	0,020/0,066	EC	71-3276	71-3276/4 STD 0.25
MB/HL 1-5	10	53,958/53,978	59,000/59,019	18,500	2,502	0,020/0,082	AL-LF	02-3085U	H026/5 STD 0.25 0.50
TW/A	2	59,500	73,200		1,975		AL-LF	04-3527	A123/4 STD
TW/A	2	59,500	73,200		1,975		AL-LF	04-3528	
SE/PB	1	20,000	23,000/23,025	24,000			BC	55-3277	55-3277 SEMI



BU	1	42,959/42,975	46,055/46,095	15,000			AL-LF	07-3088	07-3088 STD SEMI	13
----	---	---------------	---------------	--------	--	--	-------	---------	----------------------------	----

Front, For intermediary shaft

BU	1	41,959/41,975	45,000/45,025	15,000			AL-LF	07-3089	07-3089 STD SEMI	13
----	---	---------------	---------------	--------	--	--	-------	---------	----------------------------	----

Rear, For intermediary shaft

17 76.50 x 70.50

ADX	4 Cyl.			1296cc	40kW (55PS)		Petrol		TD4017
BE/PL	4	47,763/47,778	50,600/50,612	18,500	1,406	0,020/0,062	AL-LF	01-3867	01-3867/4 STD 0.25
MB/HL 1-5	10	53,958/53,978	59,000/59,019	18,500	2,502	0,020/0,082	AL-LF	02-3085U	H026/5 STD 0.25 0.50
TW/A	2	59,500	73,200		1,975		AL-LF	04-3527	A123/4 STD
TW/A	2	59,500	73,200		1,975		AL-LF	04-3528	

18 76.50 x 75.60

AEX	4 Cyl.			1390cc	40-44kW (55-60PS)		Petrol		TD4984	
BE/PL	4	47,763/47,778	50,600/50,612	18,500	1,406	0,020/0,062	AL-LF	01-3867	01-3867/4 STD 0.25	
MB/HL 1-5	10	53,958/53,978	59,000/59,019	18,500	2,502	0,020/0,082	AL-LF	02-3085U	H026/5 STD 0.25 0.50	
TW/A	2	59,500	73,200		1,975		AL-LF	04-3527	A123/4 STD	
TW/A	2	59,500	73,200		1,975		AL-LF	04-3528		
BU	1	42,959/42,975	46,055/46,095	15,000			AL-LF	07-3088	07-3088 STD SEMI	13

Front, For intermediary shaft

BU	1	41,959/41,975	45,000/45,025	15,000			AL-LF	07-3089	07-3089 STD SEMI	13
----	---	---------------	---------------	--------	--	--	-------	---------	----------------------------	----

Rear, For intermediary shaft

19 76.50 x 75.60

AFH	4 Cyl.			1390cc	74kW (100PS)		Petrol		TD4986	
BE/PL	4	47,763/47,778	50,600/50,612	18,500	1,406	0,020/0,062	AL-LF	01-3867	01-3867/4 STD 0.25	
BE/PL	4	47,758/47,778	50,600/50,612	20,000	1,406	0,020/0,067	SP	71-3847	71-3847/4 STD 0.25	1

01-3867

71-3847

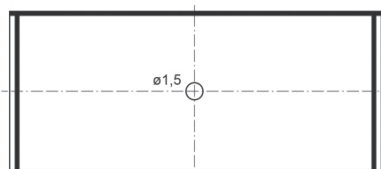

MB/HL 1-5	5	53,958/53,978	59,000/59,019	18,500	2,502	0,020/0,082	AL-LF	02-3085L	H084/5 STD 0.25 0.50
MB/HL 1-5	5	53,958/53,978	59,000/59,019	18,500	2,502	0,020/0,082	AL-LF	02-3085U	

Mot.→AFH030000

MB/HL 1-5	5	53,963/53,978	59,000/59,019	18,500	2,504	0,020/0,073	AL-LF	02-4929	H1325/5 STD 0.25 0.50
--------------	---	---------------	---------------	--------	-------	-------------	-------	---------	---------------------------------

Mot.AFH030001→



02-3085L

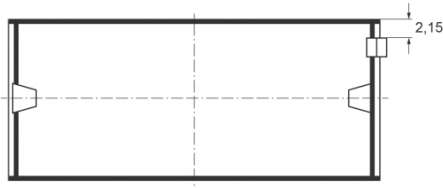

02-3085U

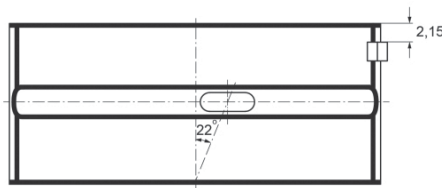

02-4929

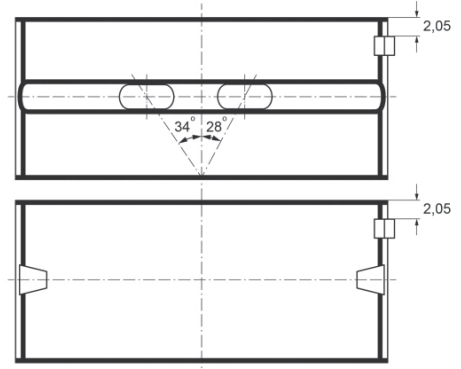

TW/A	2	59,500	73,200		1,975	AL-LF	04-3527	A123/4 STD
TW/A	2	59,500	73,200		1,975	AL-LF	04-3528	

20

76.50 x 75.60

AFK			4 Cyl.	1390cc	74kW (101PS)		Petrol	TD12028
AHW			4 Cyl.	1390cc	55kW (75PS)		Petrol	TD9453
AKK			4 Cyl.	1390cc	44kW (60PS)		Petrol	TD13768
AKP			4 Cyl.	1390cc	40kW (54PS)		Petrol	TD14168
AKQ			4 Cyl.	1390cc	55kW (75PS)		Petrol	TD9454
APE			4 Cyl.	1390cc	55kW (75PS)		Petrol	TD13468
AQQ			4 Cyl.	1390cc	74kW (101PS)		Petrol	TD13469
AUA			4 Cyl.	1390cc	55kW (75PS)		Petrol	TD13771
AUB			4 Cyl.	1390cc	74kW (101PS)		Petrol	TD13772
AUD			4 Cyl.	1390cc	44kW (60PS)		Petrol	TD13770
AXP			4 Cyl.	1390cc	55kW (75PS)		Petrol	TD15474
BBY			4 Cyl.	1390cc	55kW (75PS)		Petrol	TD16335
BBZ			4 Cyl.	1390cc	74kW (101PS)		Petrol	TD16540
BKY			4 Cyl.	1390cc	55kW (75PS)		Petrol	TD18154

BE/PL	4	47,763/47,778	50,600/50,612	18,500	1,406	0,020/0,062	AL-LF	01-3867	01-3867/4 STD 0.25
MB/HL 1-5	5	53,963/53,978	59,000/59,019	18,500	2,504	0,020/0,073	AL-LF	02-4929	H1325/5 STD 0.25 0.50
TW/A	2	59,500	73,200		1,975		AL-LF	04-3527	A123/4 STD
TW/A	2	59,500	73,200		1,975		AL-LF	04-3528	
BU	1	42,959/42,975	46,055/46,095	15,000			AL-LF	07-3088	07-3088 STD SEMI

Front, For intermediary shaft

BU	1	41,959/41,975	45,000/45,025	15,000			AL-LF	07-3089	07-3089 STD SEMI
----	---	---------------	---------------	--------	--	--	-------	---------	---------------------

Rear, For intermediary shaft

21

76.50 x 75.60

AKV			4 Cyl.	1390cc	44kW (60PS)		Petrol	TD9688
ANX			4 Cyl.	1390cc	40kW (54PS)		Petrol	TD15613
APQ			4 Cyl.	1390cc	44kW (60PS)		Petrol	TD15614

BE/PL	4	47,763/47,778	50,600/50,612	18,500	1,406	0,020/0,062	AL-LF	01-3867	01-3867/4 STD 0.25
MB/HL 1-5	10	53,958/53,978	59,000/59,019	18,500	2,502	0,020/0,082	AL-LF	02-3085U	H026/5 STD 0.25 0.50

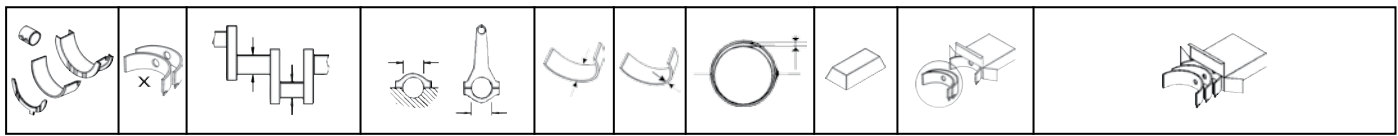

MB/HL 1-5	5	53,963/53,978	59,000/59,019	18,500	2,504	0,020/0,073	AL-LF	02-4929	H1325/5 STD 0.25 0.50
--------------	---	---------------	---------------	--------	-------	-------------	-------	---------	---------------------------------

02-3085U

02-4929

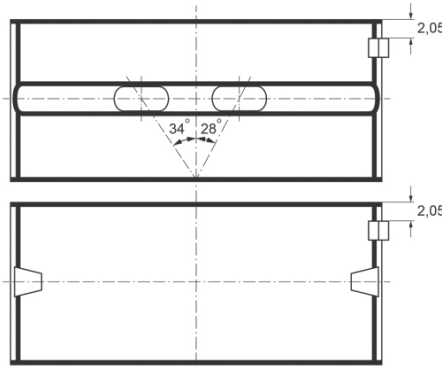
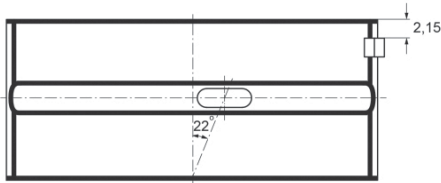

TW/A	2	59,500	73,200		1,975		AL-LF	04-3527	A123/4 STD	
TW/A	2	59,500	73,200		1,975		AL-LF	04-3528		
BU	1	42,959/42,975	46,055/46,095	15,000			AL-LF	07-3088	07-3088 STD SEMI	[13]

Front, For intermediary shaft

BU	1	41,959/41,975	45,000/45,025	15,000			AL-LF	07-3089	07-3089 STD SEMI	[13]
----	---	---------------	---------------	--------	--	--	-------	---------	----------------------------	------

Rear, For intermediary shaft

22 76.50 x 75.60

ANM			4 Cyl.	1390cc	74kW (101PS)		Petrol		TD13470	
ARR			4 Cyl.	1390cc	77kW (105PS)		Petrol		TD15492	
BE/PL	4	47,763/47,778	50,600/50,612	18,500	1,406	0,020/0,062	AL-LF	01-3867	01-3867/4 STD 0.25	
BU	1	42,959/42,975	46,055/46,095	15,000			AL-LF	07-3088	07-3088 STD SEMI	[13]

Front, For intermediary shaft

BU	1	41,959/41,975	45,000/45,025	15,000			AL-LF	07-3089	07-3089 STD SEMI	[13]
----	---	---------------	---------------	--------	--	--	-------	---------	----------------------------	------

Rear, For intermediary shaft

23 76.50 x 75.60

ANW			4 Cyl.	1390cc	44kW (60PS)		Petrol		TD15568
BLG			4 Cyl.	1390cc	125kW (170PS)		Petrol Turbo		TD18470
BLM			4 Cyl.	1390cc	63kW (86PS)		Petrol		TD21076
BLN			4 Cyl.	1390cc	66kW (90PS)		Petrol		TD18911
BMY			4 Cyl.	1390cc	103kW (140PS)		Petrol Turbo		TD18910
BUD			4 Cyl.	1390cc	59kW (80PS)		Petrol		TD18909
BWK			4 Cyl.	1390cc	110kW (150PS)		Petrol Turbo Intercooler		TD20734
CAVA			4 Cyl.	1390cc	110kW (150PS)		Petrol Turbo		TD22452
CAVB			4 Cyl.	1390cc	125kW (170PS)		Petrol Turbo Intercooler		TD22173
CAVC			4 Cyl.	1390cc	103kW (140PS)		Petrol Turbo Intercooler		TD22174
CAVD			4 Cyl.	1390cc	118kW (160PS)		Petrol Turbo		TD20792
CAVE			4 Cyl.	1390cc	132kW (180PS)		Petrol Turbo		TD24000
CAXA			4 Cyl.	1390cc	90kW (122PS)		Petrol Turbo		TD20606
CNWA			4 Cyl.	1390cc	118kW (160PS)		Petrol Turbo		TD24834
CKMA			4 Cyl.	1390cc	118kW (160PS)		Flexfuel Turbo		TD25401

VOLKSWAGEN

BE/PL	4	47,763/47,778	50,600/50,612	17,200	1,406	0,023/0,071	AL-LF	01-4100	01-4100/4 STD	
MB/HL 1-5	5	53,963/53,978	59,000/59,019	18,500	2,504	0,020/0,073	AL-LF	02-4929	H1325/5 STD 0.25 0.50	
TW/A	2	59,500	73,200		1,975		AL-LF	04-3527	A123/4 STD	
TW/A	2	59,500	73,200		1,975		AL-LF	04-3528		

24 76.50 x 75.60

AXU	4 Cyl.		1390cc	63kW (86PS)		Petrol			TD16430
BE/PL	4	47,763/47,778	50,600/50,612	17,200	1,406	0,023/0,071	AL-LF	01-4100	01-4100/4 STD
MB/HL 1-5	10	53,958/53,978	59,000/59,019	18,500	2,502	0,020/0,082	AL-LF	02-3085U	H026/5 STD 0.25 0.50
TW/A	2	59,500	73,200		1,975		AL-LF	04-3527	A123/4 STD
TW/A	2	59,500	73,200		1,975		AL-LF	04-3528	
BU	1	42,959/42,975	46,055/46,095	15,000			AL-LF	07-3088	07-3088 STD SEMI 13
Front, For intermediary shaft									
BU	1	41,959/41,975	45,000/45,025	15,000			AL-LF	07-3089	07-3089 STD SEMI 13
Rear, For intermediary shaft									

25 76.50 x 75.60

BCA	4 Cyl.		1390cc	55kW (75PS)		Petrol			TD16386
BE/PL	4	47,763/47,778	50,600/50,612	17,200	1,406	0,023/0,071	AL-LF	01-4100	01-4100/4 STD
MB/HL 1-5	5	53,963/53,978	59,000/59,019	18,500	2,504	0,020/0,073	AL-LF	02-4929	H1325/5 STD 0.25 0.50
TW/A	2	59,500	73,200		1,975		AL-LF	04-3527	A123/4 STD
TW/A	2	59,500	73,200		1,975		AL-LF	04-3528	
BU	1	42,959/42,975	46,055/46,095	15,000			AL-LF	07-3088	07-3088 STD SEMI 13
Front, For intermediary shaft									
BU	1	41,959/41,975	45,000/45,025	15,000			AL-LF	07-3089	07-3089 STD SEMI 13
Rear, For intermediary shaft									

26 76.50 x 75.60

BKR	4 Cyl.		1390cc	55kW (75PS)		Petrol			TD18271
BE/PL	4	47,763/47,778	50,600/50,612	18,500	1,406	0,020/0,060	EC	71-3765	71-3765/4 STD 0.25
TW/A	2	59,500	73,200		1,975		AL-LF	04-3527	A123/4 STD
TW/A	2	59,500	73,200		1,975		AL-LF	04-3528	

27 76.50 x 75.60

CDGA	4 Cyl.		1390cc	110kW (150PS)		Petrol Turbo			TD22222
CGGA	4 Cyl.		1390cc	59kW (80PS)		Petrol			TD20791
CGGB	4 Cyl.		1390cc	63kW (85PS)		Petrol			TD23103
BE/PL	4	47,763/47,778	50,600/50,612	17,200	1,406	0,023/0,071	AL-LF	01-4100	01-4100/4 STD



28 76.50 x 80.00

FB			4 Cyl.	1470cc	48-55kW (65-75PS)		Petrol		TD4077
FD			4 Cyl.	1471cc	55-63kW (75-86PS)		Petrol		TD21346
FF			4 Cyl.	1471cc	48kW (65PS)		Petrol		TD4078
FH			4 Cyl.	1471cc	51kW (70PS)		Petrol		TD4080
FK			4 Cyl.	1471cc	48-51kW (65-70PS)		Petrol		TD4083
YJ			4 Cyl.	1471cc	55kW (75PS)		Petrol		TD5033
ZB			4 Cyl.	1471cc	55kW (75PS)		Petrol		TD5037
ZC			4 Cyl.	1471cc	63kW (85PS)		Petrol		TD5141
CK			4 Cyl.	1471cc	37kW (50PS)		Diesel		TD4046

BE/PL	1	45,950/45,970	49,000/49,016	19,000	1,506	0,020/0,078	EC	71-3084	71-3084 STD 0.25	
MB/HL	3	53,958/53,978	59,000/59,019	18,500	2,502	0,020/0,082	AL-LF	02-3085L	H025/5 STD 0.25 0.50	
MB/HL	5	53,958/53,978	59,000/59,019	18,500	2,502	0,020/0,082	AL-LF	02-3085U		
MB/HL	1	53,958/53,978	59,000/59,019	24,930	2,502	0,020/0,082	AL-LF	02-3086HL		
MB/HL	1	53,958/53,978	59,000/59,019	24,930	2,502	0,020/0,082	AL-LF	02-3086HU		



02-3086HL	STD	25,000/.9843" - 25,040/.9858"
	0.25mm	25,100/.9882" - 25,140/.9898"
	0.50mm	25,100/.9882" - 25,140/.9898"
	0.75mm	25,100/.9882" - 25,140/.9898"

02-3086HU	STD	25,000/.9843" - 25,040/.9858"
	0.25mm	25,100/.9882" - 25,140/.9898"
	0.50mm	25,100/.9882" - 25,140/.9898"
	0.75mm	25,100/.9882" - 25,140/.9898"

CB/NWB 1-5	5	25,939/25,960	28,250/28,271	17,000	1,138		AL-LF	03-3317	N118/5 STD	
BU	1	42,959/42,975	46,055/46,095	15,000			AL-LF	07-3088	07-3088 STD SEMI	

Front, For intermediary shaft

BU	1	41,959/41,975	45,000/45,025	15,000			AL-LF	07-3089	07-3089 STD SEMI	
----	---	---------------	---------------	--------	--	--	-------	---------	----------------------------	--

Rear, For intermediary shaft

29 76.50 x 80.00

682			4 Cyl.	1471cc	33kW (45PS)		Diesel		TD22612
------------	--	--	--------	---------------	--------------------	--	---------------	--	----------------

MB/HL	3	53,958/53,978	59,000/59,019	18,500	2,502	0,020/0,082	AL-LF	02-3085L	H025/5 STD 0.25 0.50	
MB/HL	5	53,958/53,978	59,000/59,019	18,500	2,502	0,020/0,082	AL-LF	02-3085U		
MB/HL	1	53,958/53,978	59,000/59,019	24,930	2,502	0,020/0,082	AL-LF	02-3086HL		
MB/HL	1	53,958/53,978	59,000/59,019	24,930	2,502	0,020/0,082	AL-LF	02-3086HU		



02-3086HL	STD	25,000/.9843" - 25,040/.9858"
	0.25mm	25,100/.9882" - 25,140/.9898"
	0.50mm	25,100/.9882" - 25,140/.9898"
	0.75mm	25,100/.9882" - 25,140/.9898"

02-3086HU	STD	25,000/.9843" - 25,040/.9858"
	0.25mm	25,100/.9882" - 25,140/.9898"
	0.50mm	25,100/.9882" - 25,140/.9898"
	0.75mm	25,100/.9882" - 25,140/.9898"

VOLKSWAGEN



30										76.50 x 86.40									
ANY		3 Cyl.		1191cc		45kW (61PS)		Diesel Turbo Intercooler		TD12029									
AYZ		3 Cyl.		1191cc		45kW (61PS)		Diesel		TD15494									
BE/PL	1	47,758/47,778	50,600/50,612	20,000	1,406	0,020/0,067	SP	71-3904	71-3904 STD 0.25 0.50			1							
CB/NWB 1-4	4	28,947/28,960	32,000/32,025	25,000	1,513	0,020/0,068	EC	73-3903	N147/4 STD										
BU	1	31,984/32,000	35,000/35,025	22,000			AL-LF	07-4037	07-4037 SEMI										
BU	1	41,984/42,000	45,000/45,025	22,000			AL-LF	07-4038	07-4038 SEMI										

31										76.50 x 86.40									
1V		4 Cyl.		1589cc		44kW (60PS)		Diesel Turbo		TD3996									
68A		4 Cyl.		1588cc		45kW (61PS)		Diesel Turbo		TD22615									
68C		4 Cyl.		1588cc		50kW (68PS)		Diesel Turbo		TD22616									
685		4 Cyl.		1588cc		36kW (49PS)		Diesel		TD22613									
686		4 Cyl.		1588cc		45kW (61PS)		Diesel		TD22614									
JR		4 Cyl.		1588cc		51kW (70PS)		Diesel Turbo		TD4121									
JX		4 Cyl.		1589cc		51kW (69PS)		Diesel Turbo		TD5018									
ME		4 Cyl.		1588cc		40kW (55PS)		Diesel		TD4129									
MF		4 Cyl.		1588cc		51kW (70PS)		Diesel Turbo		TD4130									
RA		4 Cyl.		1588cc		59kW (80PS)		Diesel Turbo Intercooler		TD5024									
SB		4 Cyl.		1588cc		59kW (80PS)		Diesel Turbo Intercooler		TD5028									
BE/PL	4	47,758/47,778	50,600/50,619	19,000	1,406	0,020/0,074	EC	71-3442	71-3442/4 STD 0.25 0.50 0.75										
MB/HL 1-5	5	53,958/53,978	59,000/59,019	18,500	2,502	0,020/0,082	AL-LF	02-3085L	H084/5 STD 0.25 0.50										
MB/HL 1-5	5	53,958/53,978	59,000/59,019	18,500	2,502	0,020/0,082	AL-LF	02-3085U											
TW/A	2	59,500	73,200		1,975		AL-LF	04-3527	A123/4 STD										
TW/A	2	59,500	73,200		1,975		AL-LF	04-3528											
SE/PB	1	24,000/24,012	27,000/27,021	25,000			BC	55-3443	55-3443 SEMI										

32										76.50 x 86.40									
ADK		4 Cyl.		1588cc		40kW (54PS)		Diesel		TD22619									
BE/PL	4	47,758/47,778	50,600/50,619	19,000	1,406	0,020/0,074	EC	71-3442	71-3442/4 STD 0.25 0.50 0.75										
MB/HL 1-5	5	53,958/53,978	59,000/59,019	18,500	2,502	0,020/0,082	AL-LF	02-3085L	H084/5 STD 0.25 0.50										
MB/HL 1-5	5	53,958/53,978	59,000/59,019	18,500	2,502	0,020/0,082	AL-LF	02-3085U											
TW/A	2	59,500	73,200		1,975		AL-LF	04-3527	A123/4 STD										
TW/A	2	59,500	73,200		1,975		AL-LF	04-3528											
SE/PB	1	24,000/24,012	27,000/27,021	25,000			BC	55-3443	55-3443 SEMI										
CB/NWB 1-5	5	25,939/25,960	28,250/28,271	17,000	1,138		AL-LF	03-3317	N118/5 STD			12							



33 76.50 x 86.40

CR	4 Cyl.	1588cc	39-40kW (52-54PS)	Diesel	TD4992
CS	4 Cyl.	1588cc	37kW (50PS)	Diesel	TD4048
CY	4 Cyl.	1588cc	51kW (70PS)	Diesel Turbo	TD4052
JK	4 Cyl.	1588cc	39-40kW (52-54PS)	Diesel	TD5013

BE/PL	4	47,758/47,778	50,600/50,619	19,000	1,406	0,020/0,074	EC	71-3442	71-3442/4 STD 0.25 0.50 0.75 H025/5 STD 0.25 0.50
MB/HL	3	53,958/53,978	59,000/59,019	18,500	2,502	0,020/0,082	AL-LF	02-3085L	
MB/HL	5	53,958/53,978	59,000/59,019	18,500	2,502	0,020/0,082	AL-LF	02-3085U	
MB/HL	1	53,958/53,978	59,000/59,019	24,930	2,502	0,020/0,082	AL-LF	02-3086HL	
MB/HL	1	53,958/53,978	59,000/59,019	24,930	2,502	0,020/0,082	AL-LF	02-3086HU	

	02-3086HL	STD	25,000/.9843" - 25,040/.9858"
		0.25mm	25,100/.9882" - 25,140/.9898"
		0.50mm	25,100/.9882" - 25,140/.9898"
		0.75mm	25,100/.9882" - 25,140/.9898"
	02-3086HU	STD	25,000/.9843" - 25,040/.9858"
		0.25mm	25,100/.9882" - 25,140/.9898"
		0.50mm	25,100/.9882" - 25,140/.9898"
		0.75mm	25,100/.9882" - 25,140/.9898"

SE/PB	1	24,000/24,012	27,000/27,021	25,000			BC	55-3443	55-3443 SEMI
CB/NWB 1-5	5	25,939/25,960	28,250/28,271	17,000	1,138		AL-LF	03-3317	N118/5 STD

12

34 76.50 x 86.40

JP	4 Cyl.	1588cc	40kW (54PS)	Diesel	TD4120
-----------	--------	---------------	--------------------	---------------	---------------

BE/PL	4	47,758/47,778	50,600/50,619	19,000	1,406	0,020/0,074	EC	71-3442	71-3442/4 STD 0.25 0.50 0.75 H025/5 STD 0.25 0.50
MB/HL	3	53,958/53,978	59,000/59,019	18,500	2,502	0,020/0,082	AL-LF	02-3085L	
MB/HL	5	53,958/53,978	59,000/59,019	18,500	2,502	0,020/0,082	AL-LF	02-3085U	
MB/HL	1	53,958/53,978	59,000/59,019	24,930	2,502	0,020/0,082	AL-LF	02-3086HL	
MB/HL	1	53,958/53,978	59,000/59,019	24,930	2,502	0,020/0,082	AL-LF	02-3086HU	

	02-3086HL	STD	25,000/.9843" - 25,040/.9858"
		0.25mm	25,100/.9882" - 25,140/.9898"
		0.50mm	25,100/.9882" - 25,140/.9898"
		0.75mm	25,100/.9882" - 25,140/.9898"
	02-3086HU	STD	25,000/.9843" - 25,040/.9858"
		0.25mm	25,100/.9882" - 25,140/.9898"
		0.50mm	25,100/.9882" - 25,140/.9898"
		0.75mm	25,100/.9882" - 25,140/.9898"

SE/PB	1	24,000/24,012	27,000/27,021	25,000			BC	55-3443	55-3443 SEMI
-------	---	---------------	---------------	--------	--	--	----	---------	------------------------

35 76.50 x 86.40

1E	6 Cyl.	2383cc	69-70kW (94-95PS)	Petrol	TD4956
DL	6 Cyl.	2383cc	66kW (90PS)	Petrol	TD4995
HS	6 Cyl.	2384cc	62kW (82PS)	Petrol	TD4108
1G	6 Cyl.	2383cc	68kW (93PS)	Diesel Turbo	TD3993

VOLKSWAGEN



1S	6 Cyl.	2383cc	51kW (70PS)	Diesel	TD4958
ACL	6 Cyl.	2383cc	70kW (95PS)	Diesel Turbo	TD4012
ACT	6 Cyl.	2383cc	51kW (70PS)	Diesel	TD4014
CP	6 Cyl.	2383cc	55kW (75PS)	Diesel	TD4047
DV	6 Cyl.	2383cc	75-80kW (102-109PS)	Diesel Turbo	TD4061
DW	6 Cyl.	2383cc	55-57kW (75-78PS)	Diesel	TD4062

BE/PL	6	47,758/47,778	50,600/50,619	19,000	1,406	0,020/0,074	EC	71-3442	71-3442/6 STD 0.25 0.50
MB/HL 1,2, 4-7	6	57,958/57,978	63,000/63,019	18,500	2,502	0,020/0,082	EC	72-3400	H941/7 STD 0.25
MB/HL 3	1	57,958/57,978	63,000/63,019	24,930	2,502	0,020/0,082	EC	72-3401H	



72-3401H

STD	25,000/.9843" - 25,040/.9858"
0.25mm	25,100/.9882" - 25,140/.9898"
0.50mm	25,100/.9882" - 25,140/.9898"
0.75mm	25,100/.9882" - 25,140/.9898"

MB/HL 1-7	7	57,958/57,978	63,000/63,019	18,500	2,502	0,020/0,082	EC	72-3400	H981/7 STD 0.25
TW/A	2	63,500/63,750	77,200/77,450		1,975		AL-LF	04-3529	A124/4 STD
TW/A	2	63,500/63,750	77,200/77,450		1,975		AL-LF	04-3530	
TW/A	2	63,500/63,750	76,950/77,200		1,975		AL-LF	04-4782	A292/4 STD
TW/A	2	63,500/63,750	76,950/77,200		1,975		AL-LF	04-4783	

04-3529

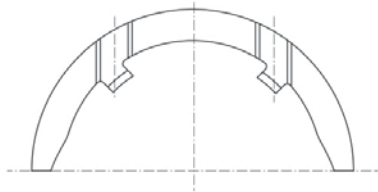

04-3530

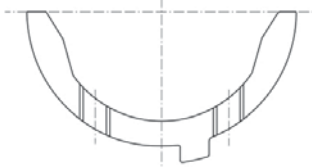

04-4782

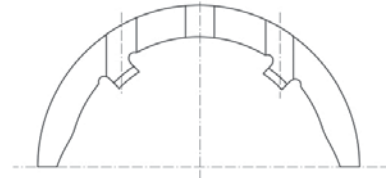

04-4783

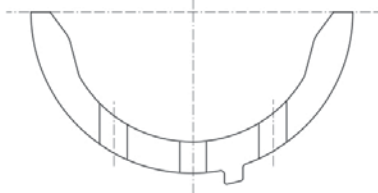

SE/PB	1	24,000/24,012	27,000/27,021	25,000			BC	55-3443	55-3443 SEMI
-------	---	---------------	---------------	--------	--	--	----	---------	------------------------

36

76.50 x 86.90

AWY	3 Cyl.	1198cc	40kW (54PS)	Petrol	TD16334
AZQ	3 Cyl.	1198cc	47kW (64PS)	Petrol	TD16333
BBM	3 Cyl.	1198cc	44kW (60PS)	Petrol	TD20142
BMD	3 Cyl.	1198cc	40kW (54PS)	Petrol	TD18155
BME	3 Cyl.	1198cc	47kW (64PS)	Petrol	TD18156
BZG	3 Cyl.	1198cc	51kW (69PS)	Petrol	TD20141
CGPA	3 Cyl.	1198cc	51kW (70PS)	Petrol	TD23102
CGPB	3 Cyl.	1198cc	44kW (60PS)	Petrol	TD23100
CHFA	3 Cyl.	1198cc	44kW (60PS)	Petrol	TD23101
CHFB Euro 4	3 Cyl.	1198cc	40kW (54PS)	Petrol	TD24054

MB/HL	4	47,976/47,997	55,000/55,015	18,500	3,514	0,027/0,057	AL-LF	02-4981	H1343/4 STD 0.25

37 76.50 x 86.90

ABU	4 Cyl.		1598cc	55kW (75PS)	Petrol				TD4976
AEA	4 Cyl.		1598cc	55kW (75PS)	Petrol				TD4019
BE/PL	4	47,763/47,778	50,600/50,612	18,500	1,406	0,020/0,062	AL-LF	01-3867	01-3867/4 STD 0.25
MB/HL 1-5	10	53,958/53,978	59,000/59,019	18,500	2,502	0,020/0,082	AL-LF	02-3085U	H026/5 STD 0.25 0.50
TW/A	2	59,500	73,200		1,975		AL-LF	04-3527	A123/4 STD
TW/A	2	59,500	73,200		1,975		AL-LF	04-3528	

38 76.50 x 86.90

AEE	4 Cyl.		1598cc	55kW (75PS)	Petrol				TD4981
BE/PL	4	47,763/47,778	50,600/50,612	18,500	1,406	0,020/0,062	AL-LF	01-3867	01-3867/4 STD 0.25
BE/PL	4	47,763/47,778	50,600/50,612	17,200	1,406	0,023/0,071	AL-LF	01-4100	01-4100/4 STD

01-3867

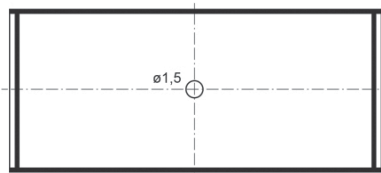

01-4100

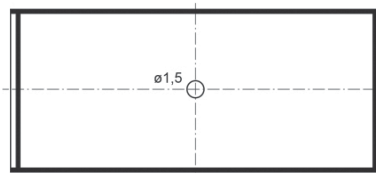

MB/HL 1-5	10	53,958/53,978	59,000/59,019	18,500	2,502	0,020/0,082	AL-LF	02-3085U	H026/5 STD 0.25 0.50
MB/HL 1-5	5	53,958/53,978	59,000/59,019	18,500	2,502	0,020/0,082	AL-LF	02-3085L	H084/5 STD 0.25 0.50
MB/HL 1-5	5	53,958/53,978	59,000/59,019	18,500	2,502	0,020/0,082	AL-LF	02-3085U	

Mot. → 629000

MB/HL 1-5	5	53,963/53,978	59,000/59,019	18,500	2,504	0,020/0,073	AL-LF	02-4929	H1325/5 STD 0.25 0.50
--------------	---	---------------	---------------	--------	-------	-------------	-------	---------	---------------------------------

Mot. 629001 →

02-3085U

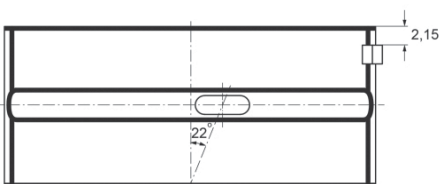

02-3085L



02-4929

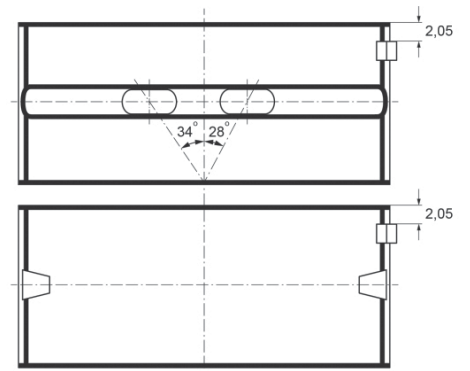

TW/A	2	59,500	73,200		1,975		AL-LF	04-3527	A123/4 STD
TW/A	2	59,500	73,200		1,975		AL-LF	04-3528	

VOLKSWAGEN

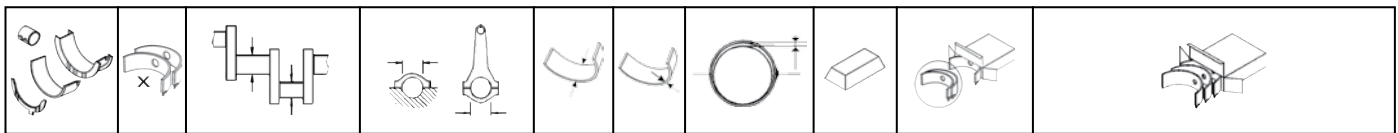

BU	1	42,959/42,975	46,055/46,095	15,000			AL-LF	07-3088	07-3088 STD SEMI	13
----	---	---------------	---------------	--------	--	--	-------	---------	----------------------------	----

Front, For intermediary shaft

BU	1	41,959/41,975	45,000/45,025	15,000			AL-LF	07-3089	07-3089 STD SEMI	13
----	---	---------------	---------------	--------	--	--	-------	---------	----------------------------	----

Rear, For intermediary shaft

39 76.50 x 86.90

AHS			4 Cyl.	1598cc	55kW (75PS)		Petrol			TD12948
------------	--	--	--------	---------------	--------------------	--	---------------	--	--	----------------

BE/PL	4	47,763/47,778	50,600/50,612	18,500	1,406	0,020/0,062	AL-LF	01-3867	01-3867/4 STD 0.25
MB/HL 1-5	5	53,958/53,978	59,000/59,019	18,500	2,502	0,020/0,082	AL-LF	02-3085L	H084/5 STD 0.25 0.50
MB/HL 1-5	5	53,958/53,978	59,000/59,019	18,500	2,502	0,020/0,082	AL-LF	02-3085U	

Mot.→043000

MB/HL 1-5	5	53,963/53,978	59,000/59,019	18,500	2,504	0,020/0,073	AL-LF	02-4929	H1325/5 STD 0.25 0.50
--------------	---	---------------	---------------	--------	-------	-------------	-------	---------	---------------------------------

Mot.043001→

02-3085L



02-3085U

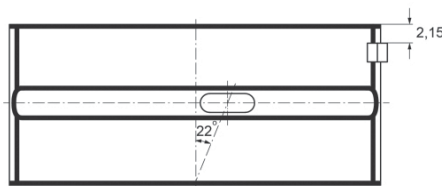

02-4929

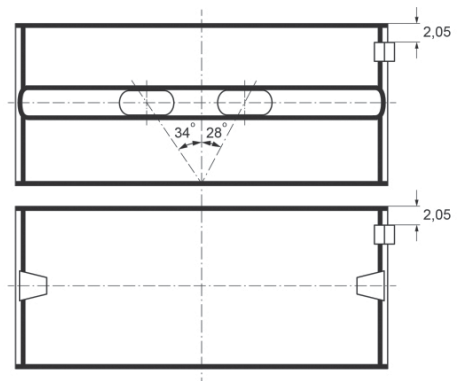

TW/A	2	59,500	73,200		1,975		AL-LF	04-3527	A123/4 STD
TW/A	2	59,500	73,200		1,975		AL-LF	04-3528	

40 76.50 x 86.90

AJV			4 Cyl.	1598cc	88kW (120PS)		Petrol			TD11247
------------	--	--	--------	---------------	---------------------	--	---------------	--	--	----------------

ATN			4 Cyl.	1598cc	77kW (105PS)		Petrol			TD15476
------------	--	--	--------	---------------	---------------------	--	---------------	--	--	----------------

CNKA			4 Cyl.	1598cc	60kW (82PS)		Petrol			TD25189
-------------	--	--	--------	---------------	--------------------	--	---------------	--	--	----------------

MB/HL 1-5	5	53,963/53,978	59,000/59,019	18,500	2,504	0,020/0,073	AL-LF	02-4929	H1325/5 STD 0.25 0.50
TW/A	2	59,500	73,200		1,975		AL-LF	04-3527	A123/4 STD
TW/A	2	59,500	73,200		1,975		AL-LF	04-3528	

41 76.50 x 86.90

ALM			4 Cyl.	1598cc	55kW (75PS)		Petrol			TD15610
------------	--	--	--------	---------------	--------------------	--	---------------	--	--	----------------

BE/PL	4	47,763/47,778	50,600/50,612	17,200	1,406	0,023/0,071	AL-LF	01-4100	01-4100/4 STD
MB/HL 1-5	5	53,963/53,978	59,000/59,019	18,500	2,504	0,020/0,073	AL-LF	02-4929	H1325/5 STD 0.25 0.50

TW/A	2	59,500	73,200		1,975		AL-LF	04-3527	A123/4 STD
TW/A	2	59,500	73,200		1,975		AL-LF	04-3528	
BU	1	42,959/42,975	46,055/46,095	15,000			AL-LF	07-3088	07-3088 STD SEMI
Front, For intermediary shaft									
BU	1	41,959/41,975	45,000/45,025	15,000			AL-LF	07-3089	07-3089 STD SEMI
Rear, For intermediary shaft									

42	76.50 x 86.90									
ARC			4 Cyl.	1598cc	92kW (125PS)		Petrol		TD14169	
AVY			4 Cyl.	1598cc	92kW (125PS)		Petrol		TD15493	
BAD			4 Cyl.	1598cc	81kW (110PS)		Petrol		TD16388	
BAG			4 Cyl.	1598cc	85kW (115PS)		Petrol		TD17048	
BLF			4 Cyl.	1598cc	85kW (115PS)		Petrol		TD18100	
BLP			4 Cyl.	1598cc	85kW (115PS)		Petrol		TD18202	
BTS			4 Cyl.	1598cc	77kW (105PS)		Petrol		TD19093	
CFNA			4 Cyl.	1598cc	77kW (105PS)		Petrol		TD25747	
BE/PL	4	47,763/47,778		50,600/50,612	17,200	1,406	0,023/0,071	AL-LF	01-4100	01-4100/4 STD
MB/HL 1-5	5	53,963/53,978		59,000/59,019	18,500	2,504	0,020/0,073	AL-LF	02-4929	H1325/5 STD 0.25 0.50
TW/A	2	59,500		73,200		1,975		AL-LF	04-3527	A123/4 STD
TW/A	2	59,500		73,200		1,975		AL-LF	04-3528	

43	76.50 x 86.90									
AUS			4 Cyl.	1598cc	77kW (105PS)		Petrol		TD15477	
AZD			4 Cyl.	1598cc	77kW (105PS)		Petrol		TD15478	
BCB			4 Cyl.	1598cc	77kW (105PS)		Petrol		TD16387	
BE/PL	4	47,763/47,778		50,600/50,612	18,500	1,406	0,020/0,062	AL-LF	01-3867	01-3867/4 STD 0.25
MB/HL 1-5	5	53,963/53,978		59,000/59,019	18,500	2,504	0,020/0,073	AL-LF	02-4929	H1325/5 STD 0.25 0.50
TW/A	2	59,500		73,200		1,975		AL-LF	04-3527	A123/4 STD
TW/A	2	59,500		73,200		1,975		AL-LF	04-3528	

44	76.50 x 86.90									
CFNB			4 Cyl.	1598cc	63kW (86PS)		Petrol		TD25748	
BE/PL	1	47,758/47,778		50,600/50,612	20,000	1,406	0,020/0,067	SP	71-3904	71-3904 STD 0.25 0.50
MB/HL 1-5	5	53,963/53,978		59,000/59,019	18,500	2,504	0,020/0,073	AL-LF	02-4929	H1325/5 STD 0.25 0.50
TW/A	2	59,500		73,200		1,975		AL-LF	04-3527	A123/4 STD
TW/A	2	59,500		73,200		1,975		AL-LF	04-3528	

VOLKSWAGEN



45 77.00 x 64.00

		4 Cyl.		1192cc	18-25kW (25-34PS)		Petrol		TD22607
D		4 Cyl.		1192cc	25kW (34PS)		Petrol		TD4054
BE/PL	4	54,971/54,990	57,800/57,819	17,600	1,397	0,020/0,079	EC	71-1950	71-1950/4 STD 0.25 0.50
SE/PB	1	20,000	22,000	24,400			BC	55-2567	55-2567 SEMI
SE/PB	1	22,000	23,970/24,003	23,400			BC	55-2723	55-2723 SEMI
CB/NWB 1	2	24,987/25,000	27,500/27,521	20,000	1,245		BB	13-2368	N072/3 STD
CB/NWB 2	2	24,987/25,000	27,500/27,521	23,000	1,245		BB	13-2369	
CB/NWB 3	1	24,987/25,000	27,500/27,521	28,000	1,245		BB	13-2370HL	
CB/NWB 3	1	24,987/25,000	27,500/27,521	25,000	1,245		BB	13-2370U	
CB/NWB 1	2	24,987/25,000	27,500/27,521	20,000	1,245		BB	13-2368	N139/3 STD
CB/NWB 2	2	24,987/25,000	27,500/27,521	23,000	1,245		BB	13-2369	
CB/NWB 3	2	24,987/25,000	27,500/27,521	28,000	1,245		BB	13-2370HL	

46 77.00 x 69.00

AB		4 Cyl.		1285cc	32kW (44PS)		Petrol		TD4005
AC		4 Cyl.		1285cc	29kW (39PS)		Petrol		TD5135
AR		4 Cyl.		1285cc	31-32kW (42-44PS)		Petrol		TD4029
E		4 Cyl.		1285cc	27kW (37PS)		Petrol		TD5132
F		4 Cyl.		1285cc	29kW (40PS)		Petrol		TD4076
BE/PL	4	54,971/54,990	57,800/57,819	17,600	1,397	0,020/0,079	EC	71-1950	71-1950/4 STD 0.25 0.50
SE/PB	1	20,000	22,000	24,400			BC	55-2567	55-2567 SEMI
SE/PB	1	22,000	23,970/24,003	23,400			BC	55-2723	55-2723 SEMI
CB/NWB 1	2	24,987/25,000	27,500/27,521	20,000	1,245		BB	13-2368	N072/3 STD
CB/NWB 2	2	24,987/25,000	27,500/27,521	23,000	1,245		BB	13-2369	
CB/NWB 3	1	24,987/25,000	27,500/27,521	28,000	1,245		BB	13-2370HL	
CB/NWB 3	1	24,987/25,000	27,500/27,521	25,000	1,245		BB	13-2370U	
CB/NWB 1	2	24,987/25,000	27,500/27,521	20,000	1,245		BB	13-2368	N139/3 STD
CB/NWB 2	2	24,987/25,000	27,500/27,521	23,000	1,245		BB	13-2369	
CB/NWB 3	2	24,987/25,000	27,500/27,521	28,000	1,245		BB	13-2370HL	

47 78.30 x 86.40

AFB		V6 Cyl.		2496cc	110kW (150PS)		Diesel Turbo Intercooler		TD11499
AKN		V6 Cyl.		2496cc	110kW (150PS)		Diesel Turbo Intercooler		TD11498
BAU		V6 Cyl.		2496cc	132kW (180PS)		Diesel Turbo Intercooler		TD17046
BDG		V6 Cyl.		2496cc	120kW (163PS)		Diesel Turbo Intercooler		TD16985
BDH		V6 Cyl.		2496cc	132kW (180PS)		Diesel Turbo Intercooler		TD17047
MB/HL 1-4	4	64,959/64,978	70,000/70,019	18,000	2,508	0,020/0,070	EC	72-3712	H034/4 STD 0.25



48 79.50 x 73.40

EH	4 Cyl.	1457cc	53-57kW (72-78PS)	Petrol	TD21347
GH	4 Cyl.	1457cc	48kW (65PS)	Petrol	TD22653
JB	4 Cyl.	1457cc	51kW (70PS)	Petrol	TD4115

BE/PL	1	45,950/45,970	49,000/49,016	19,000	1,506	0,020/0,078	EC	71-3084	71-3084 STD 0.25
MB/HL	3	53,958/53,978	59,000/59,019	18,500	2,502	0,020/0,082	AL-LF	02-3085L	H025/5 STD 0.25 0.50
MB/HL	5	53,958/53,978	59,000/59,019	18,500	2,502	0,020/0,082	AL-LF	02-3085U	
MB/HL	1	53,958/53,978	59,000/59,019	24,930	2,502	0,020/0,082	AL-LF	02-3086HL	
MB/HL	1	53,958/53,978	59,000/59,019	24,930	2,502	0,020/0,082	AL-LF	02-3086HU	



02-3086HL	STD	25,000/.9843" - 25,040/.9858"
	0.25mm	25,100/.9882" - 25,140/.9898"
	0.50mm	25,100/.9882" - 25,140/.9898"
	0.75mm	25,100/.9882" - 25,140/.9898"

02-3086HU	STD	25,000/.9843" - 25,040/.9858"
	0.25mm	25,100/.9882" - 25,140/.9898"
	0.50mm	25,100/.9882" - 25,140/.9898"
	0.75mm	25,100/.9882" - 25,140/.9898"

CB/NWB 1-5	5	25,939/25,960	28,250/28,271	17,000	1,138		AL-LF	03-3317	N118/5 STD	[12]
BU	1	42,959/42,975	46,055/46,095	15,000			AL-LF	07-3088	07-3088 STD SEMI	[13]

Front, For intermediary shaft

BU	1	41,959/41,975	45,000/45,025	15,000			AL-LF	07-3089	07-3089 STD SEMI	[13]
----	---	---------------	---------------	--------	--	--	-------	---------	----------------------------	------

Rear, For intermediary shaft

49 79.50 x 77.40

WN	5 Cyl.	1921cc	85kW (115PS)	Petrol	TD5031
-----------	--------	---------------	---------------------	---------------	---------------

BE/PL	1	45,950/45,970	49,000/49,016	19,000	1,506	0,020/0,078	EC	71-3084	71-3084 STD 0.25
MB/HL 1-6	6	57,958/57,978	63,000/63,019	18,500	2,502	0,020/0,082	EC	72-3400	H981/6 STD 0.25
TW/A	2	63,500/63,750	77,200/77,450		1,975		AL-LF	04-3529	A124/4 STD
TW/A	2	63,500/63,750	77,200/77,450		1,975		AL-LF	04-3530	
TW/A	2	63,500/63,750	76,950/77,200		1,975		AL-LF	04-4782	A292/4 STD
TW/A	2	63,500/63,750	76,950/77,200		1,975		AL-LF	04-4783	

04-3529

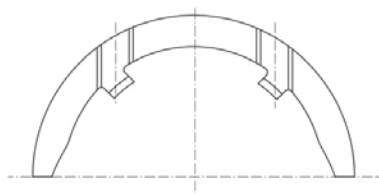

04-3530

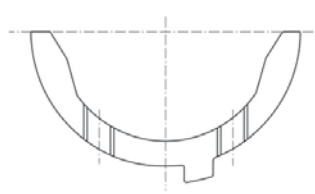

04-4782

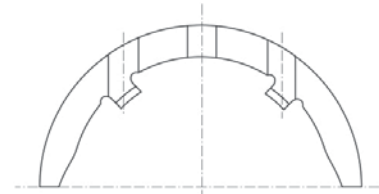

VOLKSWAGEN



04-4783

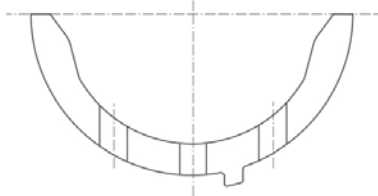

50	79.50 x 80.00								
496			4 Cyl.	1588cc	48kW (65PS)		Petrol		TD22610
EF			4 Cyl.	1588cc	60kW (82PS)		Petrol		TD4066
EG			4 Cyl.	1588cc	81kW (110PS)		Petrol		TD4999
EM			4 Cyl.	1588cc	55kW (75PS)		Petrol		TD4068
FN			4 Cyl.	1588cc	53-57kW (71-78PS)		Petrol		TD4085
FP			4 Cyl.	1588cc	51-55kW (70-75PS)		Petrol		TD4086
FR			4 Cyl.	1588cc	63kW (85PS)		Petrol		TD4088
FS			4 Cyl.	1588cc	53kW (72PS)		Petrol		TD16536
FT			4 Cyl.	1588cc	51kW (70PS)		Petrol		TD4089
FV			4 Cyl.	1588cc	51kW (70PS)		Petrol		TD4090
WP			4 Cyl.	1588cc	48kW (65PS)		Petrol		TD17200
WV			4 Cyl.	1588cc	55kW (75PS)		Petrol		TD5032
WY			4 Cyl.	1588cc	55kW (75PS)		Petrol		TD21343
WZ			4 Cyl.	1588cc	55kW (75PS)		Petrol		TD4171
YG			4 Cyl.	1588cc	61kW (83PS)		Petrol		TD19257
YH			4 Cyl.	1588cc	57-61kW (77-83PS)		Petrol		TD4175
YK			4 Cyl.	1588cc	59-61kW (80-83PS)		Petrol		TD4176
YN			4 Cyl.	1588cc	55kW (75PS)		Petrol		TD5034
YP			4 Cyl.	1588cc	63kW (85PS)		Petrol		TD5035
YS			4 Cyl.	1588cc	81kW (110PS)		Petrol		TD9378
YU			4 Cyl.	1588cc	51kW (70PS)		Petrol		TD4177
YY			4 Cyl.	1588cc	51kW (70PS)		Petrol		TD22655

BE/PL	1	45,950/45,970	49,000/49,016	19,000	1,506	0,020/0,078	EC	71-3084	71-3084 STD 0.25
MB/HL	3	53,958/53,978	59,000/59,019	18,500	2,502	0,020/0,082	AL-LF	02-3085L	H025/5 STD 0.25 0.50
MB/HL	5	53,958/53,978	59,000/59,019	18,500	2,502	0,020/0,082	AL-LF	02-3085U	
MB/HL	1	53,958/53,978	59,000/59,019	24,930	2,502	0,020/0,082	AL-LF	02-3086HL	
MB/HL	1	53,958/53,978	59,000/59,019	24,930	2,502	0,020/0,082	AL-LF	02-3086HU	



02-3086HL	STD	25,000/.9843" - 25,040/.9858"
	0.25mm	25,100/.9882" - 25,140/.9898"
	0.50mm	25,100/.9882" - 25,140/.9898"
	0.75mm	25,100/.9882" - 25,140/.9898"

02-3086HU	STD	25,000/.9843" - 25,040/.9858"
	0.25mm	25,100/.9882" - 25,140/.9898"
	0.50mm	25,100/.9882" - 25,140/.9898"
	0.75mm	25,100/.9882" - 25,140/.9898"

CB/NWB 1-5	5	25,939/25,960	28,250/28,271	17,000	1,138		AL-LF	03-3317	N118/5 STD	[12]
BU	1	42,959/42,975	46,055/46,095	15,000			AL-LF	07-3088	07-3088 STD SEMI	[13]

Front, For intermediary shaft



BU	1	41,959/41,975	45,000/45,025	15,000			AL-LF	07-3089	07-3089 STD SEMI	13
----	---	---------------	---------------	--------	--	--	-------	---------	----------------------------	----

Rear, For intermediary shaft

51 79.50 x 80.00

EE	4 Cyl.			1588cc	60kW (82PS)	Petrol			TD4065
EJ	4 Cyl.			1588cc	61kW (83PS)	Petrol			TD4067

BE/PL	1	45,950/45,970	49,000/49,016	19,000	1,506	0,020/0,078	EC	71-3084	71-3084 STD 0.25
MB/HL	3	53,958/53,978	59,000/59,019	18,500	2,502	0,020/0,082	AL-LF	02-3085L	H025/5 STD 0.25 0.50
MB/HL	5	53,958/53,978	59,000/59,019	18,500	2,502	0,020/0,082	AL-LF	02-3085U	
MB/HL	1	53,958/53,978	59,000/59,019	24,930	2,502	0,020/0,082	AL-LF	02-3086HL	
MB/HL	1	53,958/53,978	59,000/59,019	24,930	2,502	0,020/0,082	AL-LF	02-3086HU	



02-3086HL	STD	25,000/.9843" - 25,040/.9858"
	0.25mm	25,100/.9882" - 25,140/.9898"
	0.50mm	25,100/.9882" - 25,140/.9898"
	0.75mm	25,100/.9882" - 25,140/.9898"

02-3086HU	STD	25,000/.9843" - 25,040/.9858"
	0.25mm	25,100/.9882" - 25,140/.9898"
	0.50mm	25,100/.9882" - 25,140/.9898"
	0.75mm	25,100/.9882" - 25,140/.9898"

52 79.50 x 80.50

CFWA	3 Cyl.			1199cc	55kW (75PS)	Diesel Turbo			TD23610
-------------	--------	--	--	---------------	--------------------	---------------------	--	--	----------------

BE/PL	1	47,758/47,778	50,600/50,612	20,000	1,406	0,020/0,067	SP	71-3904	71-3904 STD 0.25 0.50	1
MB/HL 1-5	5	53,958/53,978	59,000/59,012	18,500	2,501	0,020/0,076	EC	72-3931	H079/5 STD 0.25 0.50	

53 79.50 x 80.50

CAYA	4 Cyl.			1598cc	55kW (75PS)	Diesel Turbo Intercooler			TD23105
CAYB	4 Cyl.			1598cc	66kW (90PS)	Diesel Turbo Intercooler			TD22638
CAYC	4 Cyl.			1598cc	77kW (105PS)	Diesel Turbo Intercooler			TD22639
CAYD	4 Cyl.			1598cc	75kW (102PS)	Diesel Turbo Intercooler			TD24364
CAYE	4 Cyl.			1598cc	55kW (75PS)	Diesel Turbo Intercooler			TD24365
CLNA	4 Cyl.			1598cc	77kW (105PS)	Diesel Turbo Intercooler			TD25704

BE/PL	1	47,758/47,778	50,600/50,612	20,000	1,406	0,020/0,067	SP	71-3904	71-3904 STD 0.25 0.50	1
MB/HL 1-5	5	53,958/53,978	59,000/59,012	18,500	2,501	0,020/0,076	EC	72-3931	H079/5 STD 0.25 0.50	

→11/11

MB/HL 2-5	4	53,958/53,978	59,000/59,019	18,500	2,502	0,020/0,082	AL-LF	02-3085L	H1328/5 STD		7
MB/HL 2-5	4	53,958/53,978	59,000/59,019	18,500	2,502	0,020/0,082	AL-LF	02-3085U			
MB/HL 1	1	53,958/53,978	59,000/59,012	18,500	2,506	0,020/0,062		02-4941L			
MB/HL 1	1	53,958/53,978	59,000/59,012	18,500	2,506	0,020/0,062		02-4941U			

12/11→



02-3085L

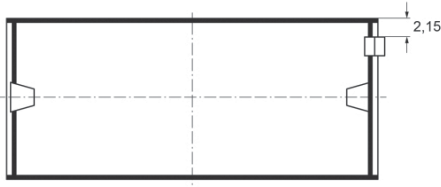

02-3085U

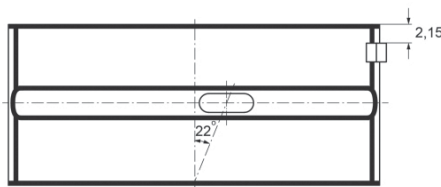

02-4941L

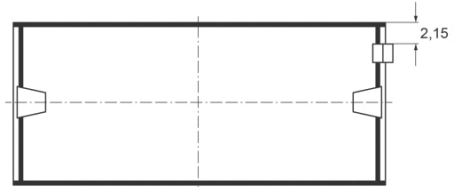

02-4941U



TW/A	2	59,500	73,200		1,975		AL-LF	04-3527	A123/4 STD
TW/A	2	59,500	73,200		1,975		AL-LF	04-3528	

54 79.50 x 86.40

EN	4 Cyl.		1716cc	55-57kW (75-78PS)			Petrol		TD22652
BE/PL	4	47,758/47,778	50,600/50,619	19,000	1,406	0,020/0,074	EC	71-3442	71-3442/4 STD 0.25 0.50 0.75
MB/HL 1-5	5	53,958/53,978	59,000/59,019	18,500	2,502	0,020/0,082	AL-LF	02-3085L	H084/5 STD 0.25 0.50
MB/HL 1-5	5	53,958/53,978	59,000/59,019	18,500	2,502	0,020/0,082	AL-LF	02-3085U	
TW/A	2	59,500	73,200		1,975		AL-LF	04-3527	A123/4 STD
TW/A	2	59,500	73,200		1,975		AL-LF	04-3528	
CB/NWB 1-5	5	25,939/25,960	28,250/28,271	17,000	1,138		AL-LF	03-3317	N118/5 STD 12

55 79.50 x 86.40

JF	4 Cyl.		1715cc	48kW (65PS)			Petrol		TD4116
BE/PL	1	45,950/45,970	49,000/49,016	19,000	1,506	0,020/0,078	EC	71-3084	71-3084 STD 0.25

56 79.50 x 86.40

WL	4 Cyl.		1714cc	55kW (75PS)			Petrol		TD13488
BE/PL	4	47,758/47,778	50,600/50,612	19,000	1,406	0,020/0,067	EC	71-3694	71-3694/4 STD 0.25 0.50

57 79.50 x 86.40

AHB	4 Cyl.		1716cc	42kW (57PS)			Diesel		TD15028
AHG	4 Cyl.		1716cc	42-44kW (57-60PS)			Diesel		TD11207
AKU	4 Cyl.		1716cc	44kW (60PS)			Diesel		TD9513
AKW	4 Cyl.		1716cc	42kW (57PS)			Diesel		TD9687
BE/PL	4	47,758/47,778	50,600/50,619	19,000	1,406	0,020/0,074	EC	71-3442	71-3442/4 STD 0.25 0.50 0.75
MB/HL 1-5	5	53,958/53,978	59,000/59,019	18,500	2,502	0,020/0,082	AL-LF	02-3085L	H084/5 STD 0.25 0.50
MB/HL 1-5	5	53,958/53,978	59,000/59,019	18,500	2,502	0,020/0,082	AL-LF	02-3085U	

TW/A	2	59,500	73,200		1,975		AL-LF	04-3527	A123/4 STD
TW/A	2	59,500	73,200		1,975		AL-LF	04-3528	

58 79.50 x 86.40

KY		4 Cyl.		1716cc	42kW (57PS)		Diesel		TD4126
BE/PL	4	47,758/47,778	50,600/50,619	19,000	1,406	0,020/0,074	EC	71-3442	71-3442/4 STD 0.25 0.50 0.75
MB/HL 1-5	5	53,958/53,978	59,000/59,019	18,500	2,502	0,020/0,082	AL-LF	02-3085L	H084/5 STD 0.25 0.50
MB/HL 1-5	5	53,958/53,978	59,000/59,019	18,500	2,502	0,020/0,082	AL-LF	02-3085U	
TW/A	2	59,500	73,200		1,975		AL-LF	04-3527	A123/4 STD
TW/A	2	59,500	73,200		1,975		AL-LF	04-3528	
SE/PB	1	24,000/24,012	27,000/27,021	25,000			BC	55-3443	55-3443 SEMI

59 79.50 x 86.40

WE		5 Cyl.		2144cc	75-85kW (102-116PS)		Petrol		TD16427
BE/PL	1	45,950/45,970	49,000/49,016	19,000	1,506	0,020/0,078	EC	71-3084	71-3084 STD 0.25
MB/HL 1,2, 4-6	5	57,958/57,978	63,000/63,019	18,500	2,502	0,020/0,082	EC	72-3400	H941/6 STD 0.25
MB/HL 3	1	57,958/57,978	63,000/63,019	24,930	2,502	0,020/0,082	EC	72-3401H	
	72-3401H	STD	25,000/.9843" - 25,040/.9858"						
		0.25mm	25,100/.9882" - 25,140/.9898"						
		0.50mm	25,100/.9882" - 25,140/.9898"						
		0.75mm	25,100/.9882" - 25,140/.9898"						

60 79.50 x 95.50

AMF		3 Cyl.		1422cc	55kW (75PS)		Diesel Turbo		TD12589
ATL		3 Cyl.		1422cc	66kW (90PS)		Diesel Turbo Intercooler		TD21352
BAY		3 Cyl.		1422cc	55kW (75PS)		Diesel Turbo Intercooler		TD16336
BMS		3 Cyl.		1422cc	59kW (80PS)		Diesel Turbo Intercooler		TD18157
BNM		3 Cyl.		1422cc	51kW (70PS)		Diesel Turbo Intercooler		TD18159
BNV		3 Cyl.		1422cc	59kW (80PS)		Diesel Turbo Intercooler		TD18158
BWB		3 Cyl.		1422cc	51kW (70PS)		Diesel Turbo Intercooler		TD20514
BE/PL	1	47,758/47,778	50,600/50,612	20,000	1,406	0,020/0,067	SP	71-3904	71-3904 STD 0.25 0.50 ①
CB/NWB 1-4	4	28,947/28,960	32,000/32,025	25,000	1,513	0,020/0,068	EC	73-3903	N147/4 STD
→05/08									
BU	1	31,984/32,000	35,000/35,025	22,000			AL-LF	07-4037	07-4037 SEMI
BU	1	41,984/42,000	45,000/45,025	22,000			AL-LF	07-4038	07-4038 SEMI

61 79.50 x 95.50

1X		4 Cyl.		1896cc	44-45kW (60-61PS)		Diesel		TD3997
1Y		4 Cyl.		1896cc	47-50kW (64-68PS)		Diesel		TD4960
ADG		4 Cyl.		1896cc	48kW (65PS)		Diesel		TD20098
AEF		4 Cyl.		1896cc	47kW (64PS)		Diesel		TD4020
ANC		4 Cyl.		1896cc	44kW (60PS)		Diesel		TD20491
AQM		4 Cyl.		1896cc	50kW (68PS)		Diesel		TD11351

VOLKSWAGEN



ASY			4 Cyl.	1896cc	47kW (64PS)	Diesel			TD16338
AYQ			4 Cyl.	1896cc	47kW (64PS)	Diesel			TD16863
BE/PL	4	47,758/47,778	50,600/50,619	19,000	1,406	0,020/0,074	EC	71-3442	71-3442/4 STD 0.25 0.50 0.75
MB/HL 1-5	5	53,958/53,978	59,000/59,019	18,500	2,502	0,020/0,082	AL-LF	02-3085L	H084/5 STD 0.25 0.50
MB/HL 1-5	5	53,958/53,978	59,000/59,019	18,500	2,502	0,020/0,082	AL-LF	02-3085U	
TW/A	2	59,500	73,200		1,975		AL-LF	04-3527	A123/4 STD
TW/A	2	59,500	73,200		1,975		AL-LF	04-3528	
CB/NWB 1-5	5	28,947/28,960	32,000/32,025	25,000	1,513	0,020/0,068	EC	73-3903	N147/5 STD

62 79.50 x 95.50

1Z			4 Cyl.	1896cc	66kW (90PS)	Diesel Turbo			TD4961
AAZ			4 Cyl.	1896cc	55kW (75PS)	Diesel Turbo			TD4972
ABL			4 Cyl.	1896cc	50kW (68PS)	Diesel Turbo			TD4009
AHH			4 Cyl.	1896cc	66kW (90PS)	Diesel Turbo			TD10927
ALH			4 Cyl.	1896cc	66-67kW (90-91PS)	Diesel Turbo Intercooler			TD9455
BE/PL	4	47,758/47,778	50,600/50,619	20,000	1,406	0,020/0,074	EC	71-3728	71-3728/4 STD 0.25 0.50
MB/HL 1-5	5	53,958/53,978	59,000/59,019	18,500	2,502	0,020/0,082	AL-LF	02-3085L	H084/5 STD 0.25 0.50
MB/HL 1-5	5	53,958/53,978	59,000/59,019	18,500	2,502	0,020/0,082	AL-LF	02-3085U	
TW/A	2	59,500	73,200		1,975		AL-LF	04-3527	A123/4 STD
TW/A	2	59,500	73,200		1,975		AL-LF	04-3528	
SE/PB	1	26,000	29,000/29,052	25,000			BC	55-3729	55-3729 SEMI
CB/NWB 1-5	5	28,947/28,960	32,000/32,025	25,000	1,513	0,020/0,068	EC	73-3903	N147/5 STD
BU	1	42,959/42,975	46,055/46,095	15,000			AL-LF	07-3088	07-3088 STD SEMI

Front, For intermediary shaft

BU	1	41,959/41,975	45,000/45,025	15,000			AL-LF	07-3089	07-3089 STD SEMI
----	---	---------------	---------------	--------	--	--	-------	---------	----------------------------

Rear, For intermediary shaft

63			79.50 x 95.50						
ADE			4 Cyl.	1896cc	55kW (75PS)	Diesel Turbo			TD20097
AEY			4 Cyl.	1896cc	47-48kW (64-65PS)	Diesel			TD4985
AFD			4 Cyl.	1896cc	58kW (79PS)	Diesel Turbo			TD16184
AGD			4 Cyl.	1896cc	47kW (64PS)	Diesel			TD9372
ARD			4 Cyl.	1896cc	44kW (60PS)	Diesel			TD20099
ASX			4 Cyl.	1896cc	47kW (64PS)	Diesel			TD15495
AVM Euro 3			4 Cyl.	1896cc	63kW (86PS)	Diesel Turbo			TD18705
BEQ			4 Cyl.	1896cc	33kW (45PS)	Diesel			TD20100
BEU			4 Cyl.	1896cc	43kW (58PS)	Diesel Turbo			TD20101
BJC			4 Cyl.	1896cc	53kW (72PS)	Diesel Turbo Intercooler			TD22453
BXT			4 Cyl.	1896cc	30kW (41PS)	Diesel Turbo			TD25869
BE/PL	4	47,758/47,778	50,600/50,619	20,000	1,406	0,020/0,074	EC	71-3728	71-3728/4 STD 0.25 0.50

MB/HL 1-5	5	53,958/53,978	59,000/59,019	18,500	2,502	0,020/0,082	AL-LF	02-3085L	H084/5 STD 0.25 0.50	
MB/HL 1-5	5	53,958/53,978	59,000/59,019	18,500	2,502	0,020/0,082	AL-LF	02-3085U		
TW/A	2	59,500	73,200		1,975		AL-LF	04-3527	A123/4 STD	
TW/A	2	59,500	73,200		1,975		AL-LF	04-3528		
SE/PB	1	26,000	29,000/29,052	25,000			BC	55-3729	55-3729 SEMI	
CB/NWB 1-5	5	28,947/28,960	32,000/32,025	25,000	1,513	0,020/0,068	EC	73-3903	N147/5 STD	

64

79.50 x 95.50

AFN	4 Cyl.		1896cc	81kW (110PS)	Diesel Turbo Intercooler				TD4987
AVG	4 Cyl.		1896cc	81kW (110PS)	Diesel Turbo				TD14988
BE/PL	4	47,758/47,778	50,600/50,612	20,000	1,406	0,020/0,067	SP	71-3847	71-3847/4 STD 0.25 I
BE/PL	4	47,758/47,778	50,600/50,612	19,000	1,406	0,020/0,067	EC	71-3929	71-3929/4 STD II

71-3847

71-3929

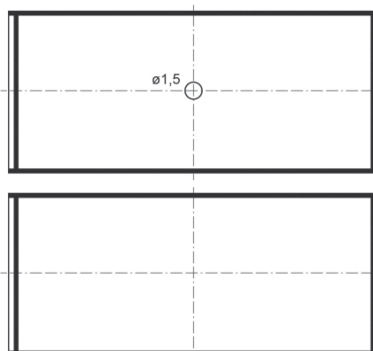

MB/HL 1-5	5	53,958/53,978	59,000/59,019	18,500	2,502	0,020/0,082	AL-LF	02-3085L	H084/5 STD 0.25 0.50
MB/HL 1-5	5	53,958/53,978	59,000/59,019	18,500	2,502	0,020/0,082	AL-LF	02-3085U	
TW/A	2	59,500	73,200		1,975		AL-LF	04-3527	A123/4 STD
TW/A	2	59,500	73,200		1,975		AL-LF	04-3528	
SE/PB	1	26,000	29,000/29,052	25,000			BC	55-3729	55-3729 SEMI
CB/NWB 1-5	5	28,947/28,960	32,000/32,025	25,000	1,513	0,020/0,068	EC	73-3903	N147/5 STD

65

79.50 x 95.50

AGP	4 Cyl.		1896cc	50kW (68PS)	Diesel				TD9452
BE/PL	4	47,758/47,778	50,600/50,619	19,000	1,406	0,020/0,074	EC	71-3442	71-3442/4 STD 0.25 0.50 0.75
Mot.AGP065001 →									
BE/PL	4	47,758/47,778	50,600/50,619	20,000	1,406	0,020/0,074	EC	71-3728	71-3728/4 STD 0.25 0.50
Mot. → AGP065000									



71-3728

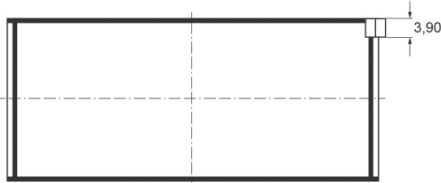

MB/HL 1-5	5	53,958/53,978	59,000/59,019	18,500	2,502	0,020/0,082	AL-LF	02-3085L	H084/5 STD 0.25 0.50
MB/HL 1-5	5	53,958/53,978	59,000/59,019	18,500	2,502	0,020/0,082	AL-LF	02-3085U	
TW/A	2	59,500	73,200		1,975		AL-LF	04-3527	A123/4 STD
TW/A	2	59,500	73,200		1,975		AL-LF	04-3528	
SE/PB	1	26,000	29,000/29,052	25,000			BC	55-3729	55-3729 SEMI
CB/NWB 1-5	5	28,947/28,960	32,000/32,025	25,000	1,513	0,020/0,068	EC	73-3903	N147/5 STD

66

79.50 x 95.50

AGR			4 Cyl.	1896cc	66kW (90PS)		Diesel Turbo Intercooler		TD9364
BE/PL	4	47,758/47,778	50,600/50,619	20,000	1,406	0,020/0,074	EC	71-3728	71-3728/4 STD 0.25 0.50
MB/HL	4	53,958/53,978	59,000/59,019	18,500	2,502	0,020/0,082	AL-LF	02-3085L	H027/5 STD 0.25 0.50
MB/HL	6	53,958/53,978	59,000/59,019	18,500	2,502	0,020/0,082	AL-LF	02-3085U	
MB/HL 1-5	5	53,958/53,978	59,000/59,019	18,500	2,502	0,020/0,082	AL-LF	02-3085L	H084/5 STD 0.25 0.50
MB/HL 1-5	5	53,958/53,978	59,000/59,019	18,500	2,502	0,020/0,082	AL-LF	02-3085U	

02-3085L

02-3085U

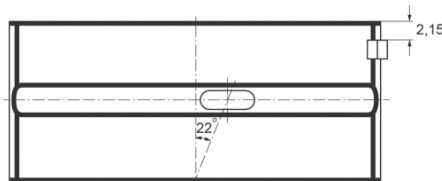

TW/A	2	59,500	73,200		1,975		AL-LF	04-3527	A123/4 STD
TW/A	2	59,500	73,200		1,975		AL-LF	04-3528	
SE/PB	1	26,000	29,000/29,052	25,000			BC	55-3729	55-3729 SEMI
CB/NWB 1-5	5	28,947/28,960	32,000/32,025	25,000	1,513	0,020/0,068	EC	73-3903	N147/5 STD
BU	1	42,959/42,975	46,055/46,095	15,000			AL-LF	07-3088	07-3088 STD SEMI

Front, For intermediary shaft

BU	1	41,959/41,975	45,000/45,025	15,000			AL-LF	07-3089	07-3089 STD SEMI
----	---	---------------	---------------	--------	--	--	-------	---------	----------------------------

Rear, For intermediary shaft

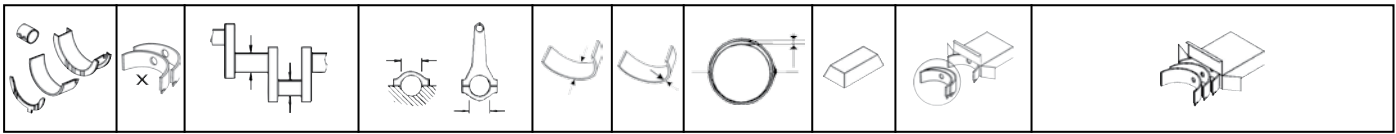

67

79.50 x 95.50

AHF		4 Cyl.		1896cc	81kW (110PS)		Diesel Turbo Intercooler		TD9788
ASV		4 Cyl.		1896cc	81kW (110PS)		Diesel Turbo Intercooler		TD13773
BE/PL	4	47,758/47,778	50,600/50,612	20,000	1,406	0,020/0,067	SP	71-3847	71-3847/4 STD 0.25 [1]
MB/HL 1-5	5	53,958/53,978	59,000/59,019	18,500	2,502	0,020/0,082	AL-LF	02-3085L	H084/5 STD 0.25 0.50
MB/HL 1-5	5	53,958/53,978	59,000/59,019	18,500	2,502	0,020/0,082	AL-LF	02-3085U	
TW/A	2	59,500	73,200		1,975		AL-LF	04-3527	A123/4 STD
TW/A	2	59,500	73,200		1,975		AL-LF	04-3528	
SE/PB	1	26,000	29,000/29,052	25,000			BC	55-3729	55-3729 SEMI
CB/NWB 1-5	5	28,947/28,960	32,000/32,025	25,000	1,513	0,020/0,068	EC	73-3903	N147/5 STD
BU	1	42,959/42,975	46,055/46,095	15,000			AL-LF	07-3088	
Front, For intermediary shaft									
BU	1	41,959/41,975	45,000/45,025	15,000			AL-LF	07-3089	07-3089 STD SEMI [13]
Rear, For intermediary shaft									

68

79.50 x 95.50

AHU		4 Cyl.		1896cc	66-67kW (90-91PS)		Diesel Turbo		TD4990
ALE		4 Cyl.		1896cc	66kW (90PS)		Diesel Turbo Intercooler		TD9512
BE/PL	4	47,758/47,778	50,600/50,619	20,000	1,406	0,020/0,074	EC	71-3728	71-3728/4 STD 0.25 0.50
BE/PL	4	47,758/47,778	50,600/50,612	19,000	1,406	0,020/0,067	EC	71-3929	

71-3728

71-3929

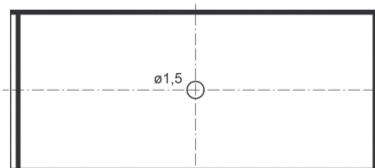

MB/HL 1-5	5	53,958/53,978	59,000/59,019	18,500	2,502	0,020/0,082	AL-LF	02-3085L	H084/5 STD 0.25 0.50
MB/HL 1-5	5	53,958/53,978	59,000/59,019	18,500	2,502	0,020/0,082	AL-LF	02-3085U	
TW/A	2	59,500	73,200		1,975		AL-LF	04-3527	A123/4 STD
TW/A	2	59,500	73,200		1,975		AL-LF	04-3528	
SE/PB	1	26,000	29,000/29,052	25,000			BC	55-3729	55-3729 SEMI
BU	1	42,959/42,975	46,055/46,095	15,000			AL-LF	07-3088	07-3088 STD SEMI [13]

Front, For intermediary shaft

VOLKSWAGEN



BU	1	41,959/41,975	45,000/45,025	15,000			AL-LF	07-3089	07-3089 STD SEMI	13
----	---	---------------	---------------	--------	--	--	-------	---------	----------------------------	----

Rear, For intermediary shaft

69 79.50 x 95.50

AJM			4 Cyl.	1896cc	85kW (115PS)		Diesel Turbo		TD12588	
ATD			4 Cyl.	1896cc	74kW (101PS)		Diesel Turbo		TD15473	
ATJ			4 Cyl.	1896cc	85kW (115PS)		Diesel Turbo Intercooler		TD16258	
AUY			4 Cyl.	1896cc	85kW (115PS)		Diesel Turbo Intercooler		TD14915	
BSW			4 Cyl.	1896cc	77kW (105PS)		Diesel Turbo Intercooler		TD18771	
BE/PL	1	47,758/47,778	50,600/50,612	20,000	1,406	0,020/0,067	SP	71-3904	71-3904 STD 0.25 0.50	1
MB/HL 1-5	5	53,958/53,978	59,000/59,019	18,500	2,502	0,020/0,082	AL-LF	02-3085L	H084/5 STD 0.25 0.50	
MB/HL 1-5	5	53,958/53,978	59,000/59,019	18,500	2,502	0,020/0,082	AL-LF	02-3085U		
TW/A	2	59,500	73,200		1,975		AL-LF	04-3527	A123/4 STD	
TW/A	2	59,500	73,200		1,975		AL-LF	04-3528		
CB/NWB 1-5	5	28,947/28,960	32,000/32,025	25,000	1,513	0,020/0,068	EC	73-3903	N147/5 STD	

70 79.50 x 95.50

ANU			4 Cyl.	1896cc	66kW (90PS)		Diesel Turbo		TD13443	
BE/PL	1	47,758/47,778	50,600/50,612	20,000	1,406	0,020/0,067	SP	71-3904	71-3904 STD 0.25 0.50	1
MB/HL 1-5	5	53,958/53,978	59,000/59,019	18,500	2,502	0,020/0,082	AL-LF	02-3085L	H084/5 STD 0.25 0.50	
MB/HL 1-5	5	53,958/53,978	59,000/59,019	18,500	2,502	0,020/0,082	AL-LF	02-3085U		
TW/A	2	59,500	73,200		1,975		AL-LF	04-3527	A123/4 STD	
TW/A	2	59,500	73,200		1,975		AL-LF	04-3528		
CB/NWB 1-5	5	28,947/28,960	32,000/32,025	25,000	1,513	0,020/0,068	EC	73-3903	N147/5 STD	
BU	1	42,959/42,975	46,055/46,095	15,000			AL-LF	07-3088	07-3088 STD SEMI	13

Front, For intermediary shaft

BU	1	41,959/41,975	45,000/45,025	15,000			AL-LF	07-3089	07-3089 STD SEMI	13
----	---	---------------	---------------	--------	--	--	-------	---------	----------------------------	----

Rear, For intermediary shaft

71 79.50 x 95.50

ARL			4 Cyl.	1896cc	110kW (150PS)		Diesel Turbo Intercooler		TD15484	
ASZ			4 Cyl.	1896cc	96kW (130PS)		Diesel Turbo Intercooler		TD16231	
AXB			4 Cyl.	1896cc	77kW (105PS)		Diesel Turbo Intercooler		TD16867	
AXC			4 Cyl.	1896cc	63kW (85PS)		Diesel Turbo Intercooler		TD16881	
BPZ			4 Cyl.	1896cc	85kW (115PS)		Diesel Turbo Intercooler		TD25766	
BRR			4 Cyl.	1896cc	62kW (84PS)		Diesel Turbo Intercooler		TD20159	
BRS			4 Cyl.	1896cc	75kW (102PS)		Diesel Turbo Intercooler		TD18994	
BVK			4 Cyl.	1896cc	85kW (115PS)		Diesel Turbo Intercooler		TD20489	
BE/PL	1	50,858/50,878	53,700/53,712	20,400	1,403	0,020/0,073	SP	71-3930	71-3930 STD 0.25 0.50	1
MB/HL 1-5	5	53,958/53,978	59,000/59,012	18,500	2,501	0,020/0,076	EC	72-3931	H079/5 STD 0.25 0.50	

TW/A	2	59,500	73,200		1,975		AL-LF	04-3527	A123/4 STD
TW/A	2	59,500	73,200		1,975		AL-LF	04-3528	
CB/NWB 1-5	5	28,947/28,960	32,000/32,025	25,000	1,513	0,020/0,068	EC	73-3903	N147/5 STD

72 79.50 x 95.50

AVB	4 Cyl.		1896cc	74kW (101PS)	Diesel Turbo		TD15152		
BE/PL	1	47,758/47,778	50,600/50,612	20,000	1,406	0,020/0,067	SP	71-3904	71-3904 STD 0.25 0.50 1
MB/HL 1-5	5	53,958/53,978	59,000/59,019	18,500	2,502	0,020/0,082	AL-LF	02-3085L	H084/5 STD 0.25 0.50
MB/HL 1-5	5	53,958/53,978	59,000/59,019	18,500	2,502	0,020/0,082	AL-LF	02-3085U	
TW/A	2	59,500	73,200		1,975		AL-LF	04-3527	A123/4 STD
TW/A	2	59,500	73,200		1,975		AL-LF	04-3528	
SE/PB	1	26,000	29,000/29,052	25,000			BC	55-3729	55-3729 SEMI
CB/NWB 1-5	5	28,947/28,960	32,000/32,025	25,000	1,513	0,020/0,068	EC	73-3903	N147/5 STD

73 79.50 x 95.50

AVF	4 Cyl.		1896cc	96kW (130PS)	Diesel Turbo		TD15153		
AWX	4 Cyl.		1896cc	96kW (130PS)	Diesel Turbo		TD15154		
BE/PL	1	50,858/50,878	53,700/53,712	20,400	1,403	0,020/0,073	SP	71-3930	71-3930 STD 0.25 0.50 1
MB/HL 1-5	5	53,958/53,978	59,000/59,012	18,500	2,501	0,020/0,076	EC	72-3931	H079/5 STD 0.25 0.50
TW/A	2	59,500	73,200		1,975		AL-LF	04-3527	A123/4 STD
TW/A	2	59,500	73,200		1,975		AL-LF	04-3528	
SE/PB	1	26,000	29,000/29,052	25,000			BC	55-3729	55-3729 SEMI
CB/NWB 1-5	5	28,947/28,960	32,000/32,025	25,000	1,513	0,020/0,068	EC	73-3903	N147/5 STD

74 79.50 x 95.50

AVQ	4 Cyl.		1896cc	74kW (100PS)	Diesel Turbo Intercooler		TD16861		
AXR	4 Cyl.		1896cc	74kW (100PS)	Diesel Turbo Intercooler		TD16337		
BEW	4 Cyl.		1896cc	74kW (101PS)	Diesel Turbo Intercooler		TD19255		
BJB	4 Cyl.		1896cc	77kW (105PS)	Diesel Turbo Intercooler		TD17078		
BKC	4 Cyl.		1896cc	77kW (105PS)	Diesel Turbo Intercooler		TD17079		
BLS	4 Cyl.		1896cc	77kW (105PS)	Diesel Turbo Intercooler		TD18224		
BMT	4 Cyl.		1896cc	74kW (101PS)	Diesel Turbo Intercooler		TD20494		
BRU	4 Cyl.		1896cc	66kW (90PS)	Diesel Turbo Intercooler		TD17468		
BXE	4 Cyl.		1896cc	77kW (105PS)	Diesel Turbo Intercooler		TD18908		
BXF	4 Cyl.		1896cc	66kW (90PS)	Diesel Turbo Intercooler		TD18907		
BXJ	4 Cyl.		1896cc	66kW (90PS)	Diesel Turbo Intercooler		TD20493		
BE/PL	1	47,758/47,778	50,600/50,612	20,000	1,406	0,020/0,067	SP	71-3904	71-3904 STD 0.25 0.50 1
MB/HL 1-5	5	53,958/53,978	59,000/59,012	18,500	2,501	0,020/0,076	EC	72-3931	H079/5 STD 0.25 0.50
TW/A	2	59,500	73,200		1,975		AL-LF	04-3527	A123/4 STD
TW/A	2	59,500	73,200		1,975		AL-LF	04-3528	

VOLKSWAGEN



CB/NWB 1-5	5	28,947/28,960	32,000/32,025	25,000	1,513	0,020/0,068	EC	73-3903	N147/5 STD
---------------	---	---------------	---------------	--------	-------	-------------	----	---------	----------------------

75 79.50 x 95.50

BGL		4 Cyl.		1896cc	37kW (50PS)	Diesel			TD25870
BGM		4 Cyl.		1896cc	29kW (39PS)	Diesel			TD25871
BE/PL	4	47,758/47,778	50,600/50,619	19,000	1,406	0,020/0,074	EC	71-3442	71-3442/4 STD 0.25 0.50 0.75
MB/HL 1-5	5	53,958/53,978	59,000/59,019	18,500	2,502	0,020/0,082	AL-LF	02-3085L	H084/5 STD 0.25 0.50
MB/HL 1-5	5	53,958/53,978	59,000/59,019	18,500	2,502	0,020/0,082	AL-LF	02-3085U	
TW/A	2	59,500	73,200		1,975		AL-LF	04-3527	A123/4 STD
TW/A	2	59,500	73,200		1,975		AL-LF	04-3528	
SE/PB	1	26,000	29,000/29,052	25,000			BC	55-3729	55-3729 SEMI
CB/NWB 1-5	5	28,947/28,960	32,000/32,025	25,000	1,513	0,020/0,068	EC	73-3903	N147/5 STD

76 79.50 x 95.50

BLT		4 Cyl.		1896cc	96kW (130PS)	Diesel Turbo Intercooler			TD17467
BE/PL	1	47,758/47,778	50,600/50,612	20,000	1,406	0,020/0,067	SP	71-3904	71-3904 STD 0.25 0.50 I
BE/PL	1	50,858/50,878	53,700/53,712	20,400	1,403	0,020/0,073	SP	71-3930	71-3930 STD 0.25 0.50 I
MB/HL 1-5	5	53,958/53,978	59,000/59,012	18,500	2,501	0,020/0,076	EC	72-3931	H079/5 STD 0.25 0.50
TW/A	2	59,500	73,200		1,975		AL-LF	04-3527	A123/4 STD
TW/A	2	59,500	73,200		1,975		AL-LF	04-3528	
CB/NWB 1-5	5	28,947/28,960	32,000/32,025	25,000	1,513	0,020/0,068	EC	73-3903	N147/5 STD

77 79.50 x 95.50

BSU		4 Cyl.		1896cc	55kW (75PS)	Diesel Turbo			TD18755
BE/PL	1	47,758/47,778	50,600/50,612	20,000	1,406	0,020/0,067	SP	71-3904	71-3904 STD 0.25 0.50 I
MB/HL 1-5	5	53,958/53,978	59,000/59,012	18,500	2,501	0,020/0,076	EC	72-3931	H079/5 STD 0.25 0.50
TW/A	2	59,500	73,200		1,975		AL-LF	04-3527	A123/4 STD
TW/A	2	59,500	73,200		1,975		AL-LF	04-3528	
CB/NWB 1-5	5	28,947/28,960	32,000/32,025	25,000	1,513	0,020/0,068	EC	73-3903	N147/5 STD

→12/08

78 79.50 x 95.50

BTB		4 Cyl.		1896cc	110kW (150PS)	Diesel Turbo Intercooler			TD18232
BE/PL	1	50,858/50,878	53,700/53,712	20,400	1,403	0,020/0,073	SP	71-3930	71-3930 STD 0.25 0.50 I
MB/HL 1-5	5	53,958/53,978	59,000/59,012	18,500	2,501	0,020/0,076	EC	72-3931	H079/5 STD 0.25 0.50
TW/A	2	59,500	73,200		1,975		AL-LF	04-3527	A123/4 STD
TW/A	2	59,500	73,200		1,975		AL-LF	04-3528	



79 79.50 x 95.50

AAB		5 Cyl.		2370cc	57kW (78PS)	Diesel			TD4000
AJA		5 Cyl.		2370cc	55kW (75PS)	Diesel			TD11049
BE/PL	5	47,758/47,778	50,600/50,619	19,000	1,406	0,020/0,074	EC	71-3442	71-3442/5 STD 0.25 0.50
MB/HL 1-6	6	57,958/57,978	63,000/63,019	18,500	2,502	0,020/0,082	EC	72-3400	H981/6 STD 0.25
TW/A	2	63,500/63,750	77,200/77,450		1,975		AL-LF	04-3529	A124/4 STD
TW/A	2	63,500/63,750	77,200/77,450		1,975		AL-LF	04-3530	
TW/A	2	63,500/63,750	76,950/77,200		1,975		AL-LF	04-4782	A292/4 STD
TW/A	2	63,500/63,750	76,950/77,200		1,975		AL-LF	04-4783	

04-3529

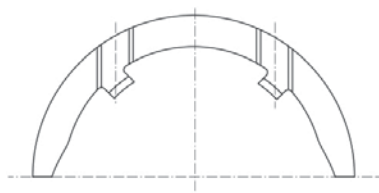

04-3530

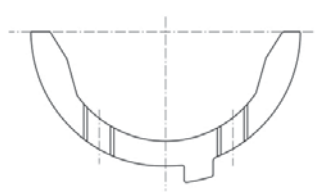

04-4782

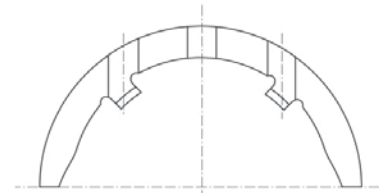

04-4783

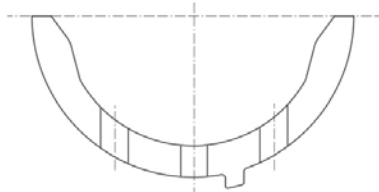

80 81.00 x 77.40

1F		4 Cyl.		1595cc	53-55kW (72-75PS)	Petrol			TD4957
ADP		4 Cyl.		1595cc	74kW (101PS)	Petrol			TD16253
AEK		4 Cyl.		1595cc	74kW (101PS)	Petrol			TD4982
BE/PL	4	47,758/47,778	50,600/50,612	19,000	1,406	0,020/0,067	EC	71-3694	71-3694/4 STD 0.25 0.50
MB/HL	4	53,958/53,978	59,000/59,019	18,500	2,502	0,020/0,082	AL-LF	02-3085L	H027/5 STD 0.25 0.50
MB/HL	6	53,958/53,978	59,000/59,019	18,500	2,502	0,020/0,082	AL-LF	02-3085U	
TW/A	2	59,500	73,200		1,975		AL-LF	04-3527	A123/4 STD
TW/A	2	59,500	73,200		1,975		AL-LF	04-3528	
SE/PB	1	20,000	23,000/23,021	25,000			BC	55-3698	55-3698 SEMI
CB/NWB 1-5	5	25,939/25,960	28,250/28,271	17,000	1,138		AL-LF	03-3317	N118/5 STD 12
BU	1	42,959/42,975	46,055/46,095	15,000			AL-LF	07-3088	07-3088 STD SEMI 13
Front, For intermediary shaft									
BU	1	41,959/41,975	45,000/45,025	15,000			AL-LF	07-3089	07-3089 STD SEMI 13
Rear, For intermediary shaft									

VOLKSWAGEN



81 81.00 x 77.40

ABN 4 Cyl. **1595cc** **54-55kW (73-75PS)** **Petrol** **TD4974**

BE/PL	1	45,950/45,970	49,000/49,016	19,000	1,506	0,020/0,078	EC	71-3084	71-3084 STD 0.25
-------	---	---------------	---------------	--------	-------	-------------	----	---------	----------------------------

→12/83

BE/PL	4	47,758/47,778	50,600/50,619	19,000	1,406	0,020/0,074	EC	71-3566	71-3566/4 STD 0.25
-------	---	---------------	---------------	--------	-------	-------------	----	---------	------------------------------

→12/85

BE/PL	4	47,758/47,778	50,600/50,612	19,000	1,406	0,020/0,067	EC	71-3694	71-3694/4 STD 0.25 0.50
-------	---	---------------	---------------	--------	-------	-------------	----	---------	-----------------------------------

01/86→

71-3084

71-3566

71-3694



MB/HL	4	53,958/53,978	59,000/59,019	18,500	2,502	0,020/0,082	AL-LF	02-3085L	H027/5 STD 0.25 0.50
MB/HL	6	53,958/53,978	59,000/59,019	18,500	2,502	0,020/0,082	AL-LF	02-3085U	
TW/A	2	59,500	73,200		1,975		AL-LF	04-3527	A123/4 STD
TW/A	2	59,500	73,200		1,975		AL-LF	04-3528	
SE/PB	1	20,000	23,000/23,021	25,000			BC	55-3698	55-3698 SEMI
CB/NWB 1-5	5	25,939/25,960	28,250/28,271	17,000	1,138		AL-LF	03-3317	N118/5 STD 12
BU	1	42,959/42,975	46,055/46,095	15,000			AL-LF	07-3088	07-3088 STD SEMI 13

Front, For intermediary shaft

BU	1	41,959/41,975	45,000/45,025	15,000			AL-LF	07-3089	07-3089 STD SEMI 13
----	---	---------------	---------------	--------	--	--	-------	---------	--

Rear, For intermediary shaft

82 81.00 x 77.40

AEH	4 Cyl.	1595cc	74kW (100PS)	Petrol	TD9450
AHL	4 Cyl.	1595cc	74kW (101PS)	Petrol	TD5556
AKL	4 Cyl.	1595cc	74-76kW (100-103PS)	Petrol	TD9451
APF	4 Cyl.	1595cc	74kW (101PS)	Petrol	TD12848
ARM	4 Cyl.	1595cc	74kW (101PS)	Petrol	TD16255
AWH	4 Cyl.	1595cc	74kW (101PS)	Petrol	TD15465

BE/PL	4	47,758/47,778	50,600/50,612	19,000	1,406	0,020/0,067	EC	71-3694	71-3694/4 STD 0.25 0.50
-------	---	---------------	---------------	--------	-------	-------------	----	---------	-----------------------------------

BE/PL	4	47,758/47,778	50,600/50,612	19,000	1,406	0,020/0,067	EC	71-3929	71-3929/4 STD 11
-------	---	---------------	---------------	--------	-------	-------------	----	---------	---



71-3694

71-3929

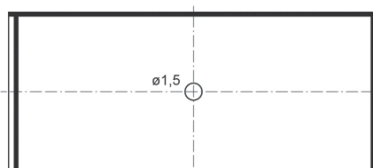
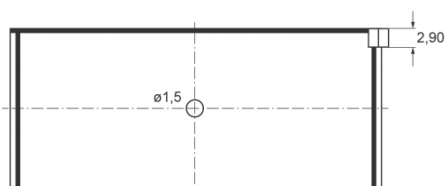

MB/HL 1-5	5	53,958/53,978	59,000/59,019	18,500	2,502	0,020/0,082	AL-LF	02-3085L	H084/5 STD 0.25 0.50	
MB/HL 1-5	5	53,958/53,978	59,000/59,019	18,500	2,502	0,020/0,082	AL-LF	02-3085U		
TW/A	2	59,500	73,200		1,975		AL-LF	04-3527	A123/4 STD	
TW/A	2	59,500	73,200		1,975		AL-LF	04-3528		
SE/PB	1	20,000	23,000/23,021	25,000			BC	55-3698	55-3698 SEMI	
CB/NWB 1-5	5	25,939/25,960	28,250/28,271	17,000	1,138		AL-LF	03-3317	N118/5 STD	[12]
BU	1	42,959/42,975	46,055/46,095	15,000			AL-LF	07-3088	07-3088 STD SEMI	[13]

Front, For intermediary shaft

BU	1	41,959/41,975	45,000/45,025	15,000			AL-LF	07-3089	07-3089 STD SEMI	[13]
----	---	---------------	---------------	--------	--	--	-------	---------	----------------------------	------

Rear, For intermediary shaft

83 81.00 x 77.40

AFT	4 Cyl.			1595cc	74kW (101PS)	Petrol			TD4988	
BE/PL	4	47,758/47,778	50,600/50,612	19,000	1,406	0,020/0,067	EC	71-3694	71-3694/4 STD 0.25 0.50	
BE/PL	4	47,758/47,778	50,600/50,612	19,000	1,406	0,020/0,067	EC	71-3929	71-3929/4 STD	[11]

71-3694

71-3929

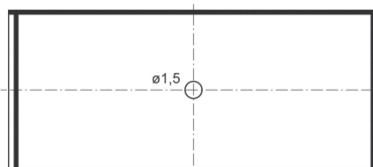
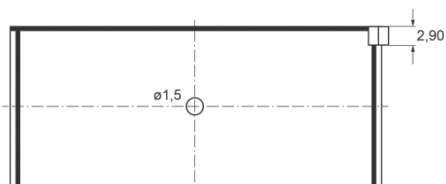

MB/HL	4	53,958/53,978	59,000/59,019	18,500	2,502	0,020/0,082	AL-LF	02-3085L	H027/5 STD 0.25 0.50	
MB/HL	6	53,958/53,978	59,000/59,019	18,500	2,502	0,020/0,082	AL-LF	02-3085U		

Mot. → 1EY010001

VOLKSWAGEN



MB/HL 1-5	5	53,958/53,978	59,000/59,019	18,500	2,502	0,020/0,082	AL-LF	02-3085L	H084/5 STD 0.25 0.50
MB/HL 1-5	5	53,958/53,978	59,000/59,019	18,500	2,502	0,020/0,082	AL-LF	02-3085U	

Mot.1EY010001→

02-3085L

02-3085U

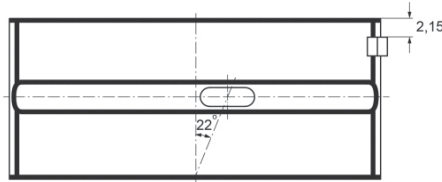
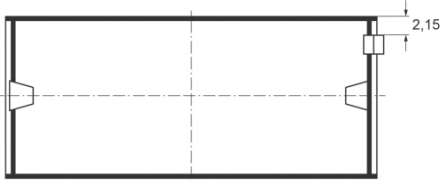

TW/A	2	59,500	73,200		1,975		AL-LF	04-3527	A123/4 STD
TW/A	2	59,500	73,200		1,975		AL-LF	04-3528	
SE/PB	1	20,000	23,000/23,021	25,000			BC	55-3698	55-3698 SEMI
CB/NWB 1-5	5	25,939/25,960	28,250/28,271	17,000	1,138		AL-LF	03-3317	N118/5 STD 12
BU	1	42,959/42,975	46,055/46,095	15,000			AL-LF	07-3088	07-3088 STD SEMI 13

Front, For intermediary shaft

BU	1	41,959/41,975	45,000/45,025	15,000			AL-LF	07-3089	07-3089 STD SEMI 13
----	---	---------------	---------------	--------	--	--	-------	---------	--

Rear, For intermediary shaft

84

81.00 x 77.40

AKS 4 Cyl. 1595cc 74kW (101PS) Petrol TD9991

BE/PL	4	47,758/47,778	50,600/50,612	19,000	1,406	0,020/0,067	EC	71-3694	71-3694/4 STD 0.25 0.50
BE/PL	4	47,758/47,778	50,600/50,612	19,000	1,406	0,020/0,067	EC	71-3929	71-3929/4 STD 11

71-3694

71-3929

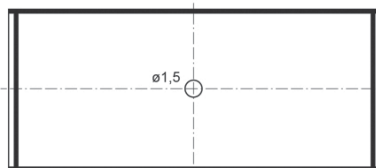
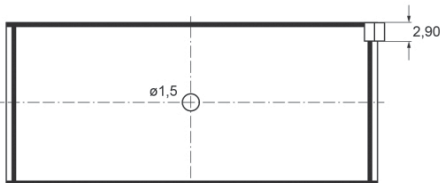

MB/HL	4	53,958/53,978	59,000/59,019	18,500	2,502	0,020/0,082	AL-LF	02-3085L	H027/5 STD 0.25 0.50
MB/HL	6	53,958/53,978	59,000/59,019	18,500	2,502	0,020/0,082	AL-LF	02-3085U	
MB/HL 1-5	5	53,958/53,978	59,000/59,019	18,500	2,502	0,020/0,082	AL-LF	02-3085L	H084/5 STD 0.25 0.50
MB/HL 1-5	5	53,958/53,978	59,000/59,019	18,500	2,502	0,020/0,082	AL-LF	02-3085U	



02-3085L

02-3085U

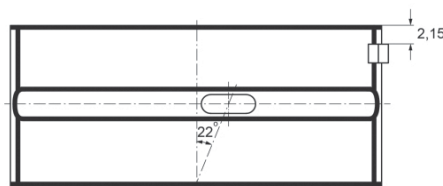

TW/A	2	59,500	73,200		1,975		AL-LF	04-3527	A123/4 STD	
TW/A	2	59,500	73,200		1,975		AL-LF	04-3528		
SE/PB	1	20,000	23,000/23,021	25,000			BC	55-3698	55-3698 SEMI	
CB/NWB 1-5	5	25,939/25,960	28,250/28,271	17,000	1,138		AL-LF	03-3317	N118/5 STD	[12]
BU	1	42,959/42,975	46,055/46,095	15,000			AL-LF	07-3088	07-3088 STD SEMI	[13]
Front, For intermediary shaft										
BU	1	41,959/41,975	45,000/45,025	15,000			AL-LF	07-3089	07-3089 STD SEMI	[13]
Rear, For intermediary shaft										

85

81.00 x 77.40

ALZ			4 Cyl.	1595cc	75kW (102PS)		Petrol		TD15148
ANA			4 Cyl.	1595cc	74kW (101PS)		Petrol		TD16254
AVU			4 Cyl.	1595cc	75kW (102PS)		Petrol		TD15475
AYD			4 Cyl.	1595cc	75kW (102PS)		Petrol		TD15466
BFQ			4 Cyl.	1595cc	75kW (102PS)		Petrol		TD18137
BGU			4 Cyl.	1595cc	75kW (102PS)		Petrol		TD17067
BSE			4 Cyl.	1595cc	75kW (102PS)		Petrol		TD18222
BSF			4 Cyl.	1595cc	75kW (102PS)		Petrol		TD18223
CCSA			4 Cyl.	1595cc	75kW (102PS)		Petrol		TD20780
CHGA			4 Cyl.	1595cc	75kW (102PS)		Petrol		TD22180
CMXA			4 Cyl.	1595cc	75kW (102PS)		Petrol		TD24313
BE/PL	4	41,965/41,980	45,000/45,016	19,000	1,505	0,020/0,070	AL-LF	01-3961	01-3961/4 STD

86

81.00 x 77.40

AUR			4 Cyl.	1595cc	74kW (101PS)		Petrol		TD15611
BE/PL	4	47,758/47,778	50,600/50,612	19,000	1,406	0,020/0,067	EC	71-3694	71-3694/4 STD 0.25 0.50
BE/PL	4	47,758/47,778	50,600/50,612	19,000	1,406	0,020/0,067	EC	71-3929	71-3929/4 STD [11]



71-3694

71-3929

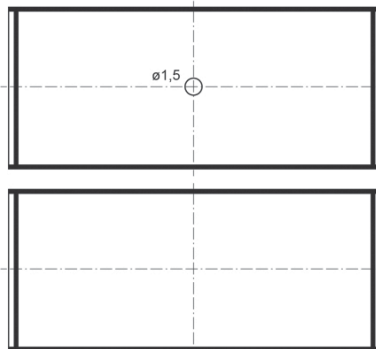
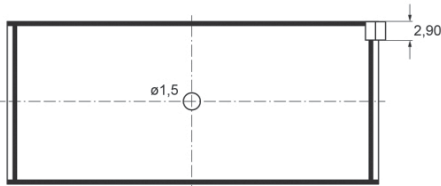

MB/HL 1-5	5	53,958/53,978	59,000/59,019	18,500	2,502	0,020/0,082	AL-LF	02-3085L	H084/5 STD 0.25 0.50
MB/HL 1-5	5	53,958/53,978	59,000/59,019	18,500	2,502	0,020/0,082	AL-LF	02-3085U	
TW/A	2	59,500	73,200		1,975		AL-LF	04-3527	A123/4 STD
TW/A	2	59,500	73,200		1,975		AL-LF	04-3528	
SE/PB	1	20,000	23,000/23,021	25,000			BC	55-3698	55-3698 SEMI
CB/NWB 1-5	5	25,939/25,960	28,250/28,271	17,000	1,138		AL-LF	03-3317	N118/5 STD 12
BU	1	42,959/42,975	46,055/46,095	15,000			AL-LF	07-3088	07-3088 STD SEMI 13

Front, For intermediary shaft

BU	1	41,959/41,975	45,000/45,025	15,000			AL-LF	07-3089	07-3089 STD SEMI 13
----	---	---------------	---------------	--------	--	--	-------	---------	--

Rear, For intermediary shaft

87		81.00 x 77.40							
BFS		4 Cyl.		1595cc	75kW (102PS)		Petrol		TD16743
BE/PL	4	41,965/41,980	45,000/45,016	19,000	1,505	0,020/0,070	AL-LF	01-3961	01-3961/4 STD
CB/NWB 1-5	5	25,939/25,960	28,250/28,271	17,000	1,138		AL-LF	03-3317	N118/5 STD 12

88		81.00 x 77.40							
DT		4 Cyl.		1595cc	55kW (75PS)		Petrol		TD4997
HM		4 Cyl.		1595cc	55-60kW (75-82PS)		Petrol		TD9523
BE/PL	1	45,950/45,970	49,000/49,016	19,000	1,506	0,020/0,078	EC	71-3084	71-3084 STD 0.25

→12/83

BE/PL	4	47,758/47,778	50,600/50,612	19,000	1,406	0,020/0,067	EC	71-3694	71-3694/4 STD 0.25 0.50
-------	---	---------------	---------------	--------	-------	-------------	----	---------	-----------------------------------

71-3084

71-3694

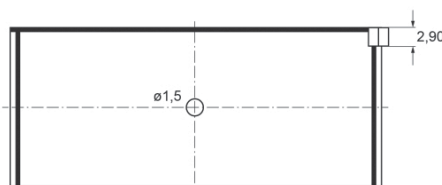

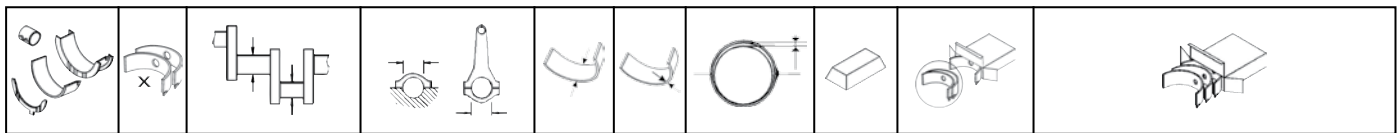

MB/HL	3	53,958/53,978	59,000/59,019	18,500	2,502	0,020/0,082	AL-LF	02-3085L	H025/5 STD 0.25 0.50
MB/HL	5	53,958/53,978	59,000/59,019	18,500	2,502	0,020/0,082	AL-LF	02-3085U	
MB/HL	1	53,958/53,978	59,000/59,019	24,930	2,502	0,020/0,082	AL-LF	02-3086HL	
MB/HL	1	53,958/53,978	59,000/59,019	24,930	2,502	0,020/0,082	AL-LF	02-3086HU	

	02-3086HL	STD	25,000/.9843" - 25,040/.9858"
		0.25mm	25,100/.9882" - 25,140/.9898"
		0.50mm	25,100/.9882" - 25,140/.9898"
		0.75mm	25,100/.9882" - 25,140/.9898"
	02-3086HU	STD	25,000/.9843" - 25,040/.9858"
		0.25mm	25,100/.9882" - 25,140/.9898"
		0.50mm	25,100/.9882" - 25,140/.9898"
		0.75mm	25,100/.9882" - 25,140/.9898"

MB/HL	4	53,958/53,978	59,000/59,019	18,500	2,502	0,020/0,082	AL-LF	02-3085L	H027/5 STD 0.25 0.50
MB/HL	6	53,958/53,978	59,000/59,019	18,500	2,502	0,020/0,082	AL-LF	02-3085U	

02-3085L

02-3085U

02-3086HL

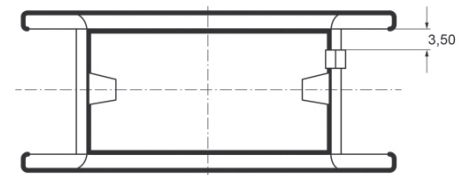
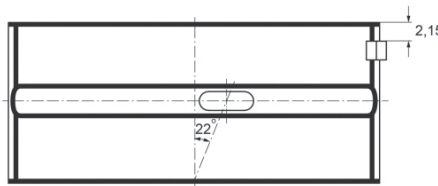

02-3086HU

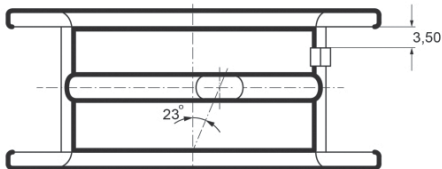

TW/A	2	59,500	73,200		1,975		AL-LF	04-3527	A123/4 STD
TW/A	2	59,500	73,200		1,975		AL-LF	04-3528	
SE/PB	1	20,000	23,000/23,052	25,000			BC	55-3567	55-3567 SEMI
CB/NWB 1-5	5	25,939/25,960	28,250/28,271	17,000	1,138		AL-LF	03-3317	N118/5 STD
BU	1	42,959/42,975	46,055/46,095	15,000			AL-LF	07-3088	

Front, For intermediary shaft

BU	1	41,959/41,975	45,000/45,025	15,000			AL-LF	07-3089	07-3089 STD SEMI
----	---	---------------	---------------	--------	--	--	-------	---------	----------------------------

Rear, For intermediary shaft

89 81.00 x 77.40

DTA			4 Cyl.	1595cc	51-55kW (69-75PS)		Petrol		TD22646
BE/PL	1	45,950/45,970	49,000/49,016	19,000	1,506	0,020/0,078	EC	71-3084	71-3084 STD 0.25

→12/84

VOLKSWAGEN

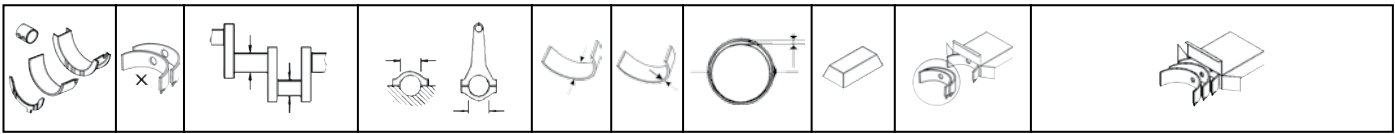

BE/PL	4	47,758/47,778	50,600/50,619	19,000	1,406	0,020/0,074	EC	71-3566	71-3566/4 STD 0.25
-------	---	---------------	---------------	--------	-------	-------------	----	---------	------------------------------

01/84 → 12/85

BE/PL	4	47,758/47,778	50,600/50,612	19,000	1,406	0,020/0,067	EC	71-3694	71-3694/4 STD 0.25 0.50
-------	---	---------------	---------------	--------	-------	-------------	----	---------	-----------------------------------

01/86 →

71-3084

71-3566

71-3694

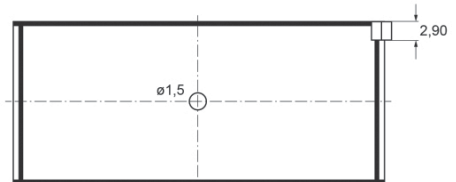

MB/HL	3	53,958/53,978	59,000/59,019	18,500	2,502	0,020/0,082	AL-LF	02-3085L	H025/5 STD 0.25 0.50
MB/HL	5	53,958/53,978	59,000/59,019	18,500	2,502	0,020/0,082	AL-LF	02-3085U	
MB/HL	1	53,958/53,978	59,000/59,019	24,930	2,502	0,020/0,082	AL-LF	02-3086HL	
MB/HL	1	53,958/53,978	59,000/59,019	24,930	2,502	0,020/0,082	AL-LF	02-3086HU	



02-3086HL	STD	25,000/.9843" - 25,040/.9858"
	0.25mm	25,100/.9882" - 25,140/.9898"
	0.50mm	25,100/.9882" - 25,140/.9898"
	0.75mm	25,100/.9882" - 25,140/.9898"

02-3086HU	STD	25,000/.9843" - 25,040/.9858"
	0.25mm	25,100/.9882" - 25,140/.9898"
	0.50mm	25,100/.9882" - 25,140/.9898"
	0.75mm	25,100/.9882" - 25,140/.9898"

MB/HL	4	53,958/53,978	59,000/59,019	18,500	2,502	0,020/0,082	AL-LF	02-3085L	H027/5 STD 0.25 0.50
MB/HL	6	53,958/53,978	59,000/59,019	18,500	2,502	0,020/0,082	AL-LF	02-3085U	

02-3085L

02-3085U

02-3086HL

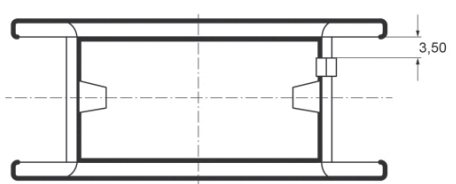
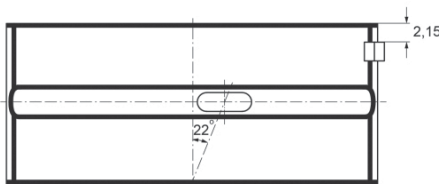

02-3086HU

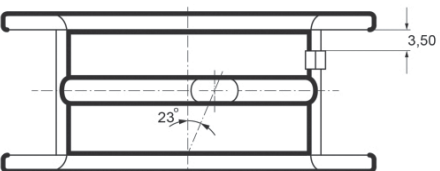

TW/A	2	59,500	73,200		1,975		AL-LF	04-3527	A123/4 STD
TW/A	2	59,500	73,200		1,975		AL-LF	04-3528	
SE/PB	1	20,000	23,000/23,052	25,000			BC	55-3567	55-3567 SEMI
CB/NWB 1-5	5	25,939/25,960	28,250/28,271	17,000	1,138		AL-LF	03-3317	N118/5 STD

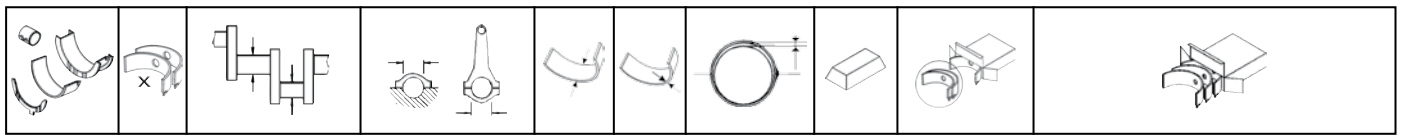

BU	1	42,959/42,975	46,055/46,095	15,000			AL-LF	07-3088	07-3088 STD SEMI	13
----	---	---------------	---------------	--------	--	--	-------	---------	----------------------------	----

Front, For intermediary shaft

BU	1	41,959/41,975	45,000/45,025	15,000			AL-LF	07-3089	07-3089 STD SEMI	13
----	---	---------------	---------------	--------	--	--	-------	---------	----------------------------	----

Rear, For intermediary shaft

90	81.00 x 77.40
-----------	----------------------

EW		4 Cyl.	1595cc	55kW (75PS)		Petrol		TD4070	
BE/PL	4	47,758/47,778	50,600/50,612	19,000	1,406	0,020/0,067	EC	71-3694	71-3694/4 STD 0.25 0.50
MB/HL	3	53,958/53,978	59,000/59,019	18,500	2,502	0,020/0,082	AL-LF	02-3085L	H025/5 STD 0.25 0.50
MB/HL	5	53,958/53,978	59,000/59,019	18,500	2,502	0,020/0,082	AL-LF	02-3085U	
MB/HL	1	53,958/53,978	59,000/59,019	24,930	2,502	0,020/0,082	AL-LF	02-3086HL	
MB/HL	1	53,958/53,978	59,000/59,019	24,930	2,502	0,020/0,082	AL-LF	02-3086HU	



02-3086HL	STD	25,000/.9843" - 25,040/.9858"
	0.25mm	25,100/.9882" - 25,140/.9898"
	0.50mm	25,100/.9882" - 25,140/.9898"
	0.75mm	25,100/.9882" - 25,140/.9898"

02-3086HU	STD	25,000/.9843" - 25,040/.9858"
	0.25mm	25,100/.9882" - 25,140/.9898"
	0.50mm	25,100/.9882" - 25,140/.9898"
	0.75mm	25,100/.9882" - 25,140/.9898"

MB/HL	4	53,958/53,978	59,000/59,019	18,500	2,502	0,020/0,082	AL-LF	02-3085L	H027/5 STD 0.25 0.50
MB/HL	6	53,958/53,978	59,000/59,019	18,500	2,502	0,020/0,082	AL-LF	02-3085U	

02-3085L



02-3085U

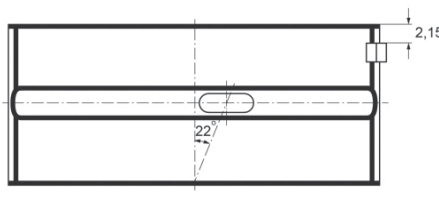

02-3086HL

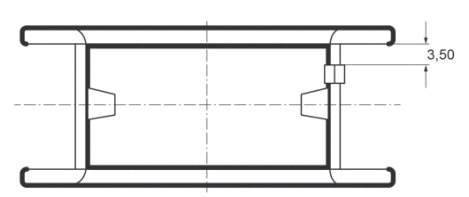

02-3086HU

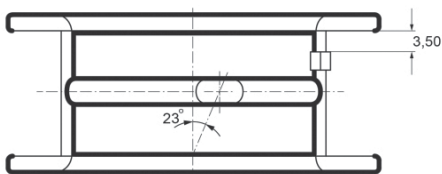

TW/A	2	59,500	73,200		1,975		AL-LF	04-3527	A123/4 STD
TW/A	2	59,500	73,200		1,975		AL-LF	04-3528	
SE/PB	1	20,000	23,000/23,052	25,000			BC	55-3567	55-3567 SEMI
SE/PB	1	20,000	23,000/23,021	25,000			BC	55-3698	55-3698 SEMI



55-3567

55-3698

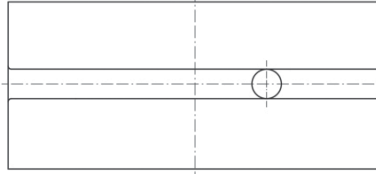
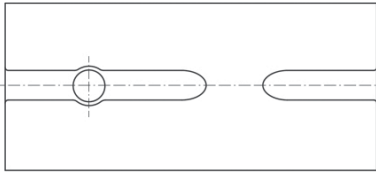

CB/NWB 1-5	5	25,939/25,960	28,250/28,271	17,000	1,138		AL-LF	03-3317	N118/5 STD	12
BU	1	42,959/42,975	46,055/46,095	15,000			AL-LF	07-3088	07-3088 STD SEMI	13

Front, For intermediary shaft

BU	1	41,959/41,975	45,000/45,025	15,000			AL-LF	07-3089	07-3089 STD SEMI	13
----	---	---------------	---------------	--------	--	--	-------	---------	----------------------------	----

Rear, For intermediary shaft

91 81.00 x 77.40

EZ		4 Cyl.	1595cc	53-55kW (72-75PS)		Petrol			TD4074
-----------	--	--------	---------------	--------------------------	--	---------------	--	--	---------------

BE/PL	1	45,950/45,970	49,000/49,016	19,000	1,506	0,020/0,078	EC	71-3084	71-3084 STD 0.25
-------	---	---------------	---------------	--------	-------	-------------	----	---------	----------------------------

→12/83

BE/PL	4	47,758/47,778	50,600/50,612	19,000	1,406	0,020/0,067	EC	71-3694	71-3694/4 STD 0.25 0.50
-------	---	---------------	---------------	--------	-------	-------------	----	---------	-----------------------------------

71-3084

71-3694

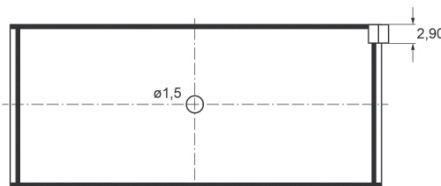

MB/HL	3	53,958/53,978	59,000/59,019	18,500	2,502	0,020/0,082	AL-LF	02-3085L	H025/5 STD 0.25 0.50
MB/HL	5	53,958/53,978	59,000/59,019	18,500	2,502	0,020/0,082	AL-LF	02-3085U	
MB/HL	1	53,958/53,978	59,000/59,019	24,930	2,502	0,020/0,082	AL-LF	02-3086HL	
MB/HL	1	53,958/53,978	59,000/59,019	24,930	2,502	0,020/0,082	AL-LF	02-3086HU	



02-3086HL	STD	25,000/.9843" - 25,040/.9858"
	0.25mm	25,100/.9882" - 25,140/.9898"
	0.50mm	25,100/.9882" - 25,140/.9898"
	0.75mm	25,100/.9882" - 25,140/.9898"

02-3086HU	STD	25,000/.9843" - 25,040/.9858"
	0.25mm	25,100/.9882" - 25,140/.9898"
	0.50mm	25,100/.9882" - 25,140/.9898"
	0.75mm	25,100/.9882" - 25,140/.9898"

MB/HL	4	53,958/53,978	59,000/59,019	18,500	2,502	0,020/0,082	AL-LF	02-3085L	H027/5 STD 0.25 0.50
MB/HL	6	53,958/53,978	59,000/59,019	18,500	2,502	0,020/0,082	AL-LF	02-3085U	



02-3085L

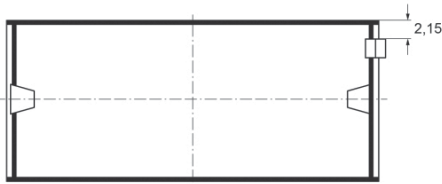

02-3085U

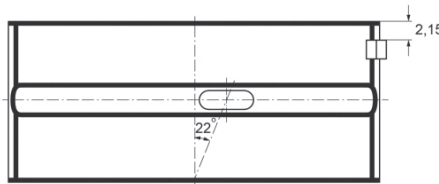

02-3086HL

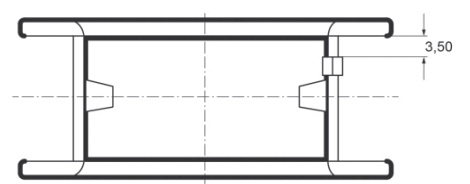

02-3086HU

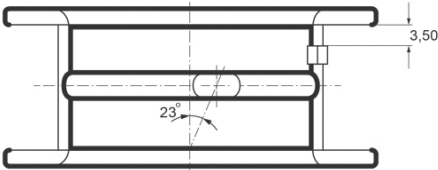

TW/A	2	59,500	73,200		1,975	AL-LF	04-3527	A123/4 STD
TW/A	2	59,500	73,200		1,975	AL-LF	04-3528	
SE/PB	1	20,000	23,000/23,052	25,000		BC	55-3567	55-3567 SEMI

Mot. → 53L020000

SE/PB	1	20,000	23,000/23,021	25,000		BC	55-3698	55-3698 SEMI
-------	---	--------	---------------	--------	--	----	---------	-----------------

Mot. 53M000001 →

55-3567

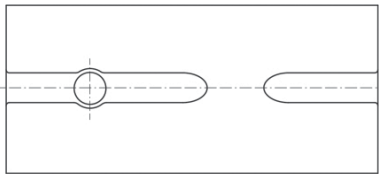

55-3698

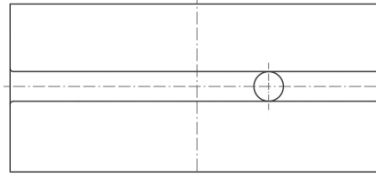

CB/NWB 1-5	5	25,939/25,960	28,250/28,271	17,000	1,138	AL-LF	03-3317	N118/5 STD	12
BU	1	42,959/42,975	46,055/46,095	15,000		AL-LF	07-3088	07-3088 STD SEMI	13

Front, For intermediary shaft

BU	1	41,959/41,975	45,000/45,025	15,000		AL-LF	07-3089	07-3089 STD SEMI	13
----	---	---------------	---------------	--------	--	-------	---------	---------------------	----

Rear, For intermediary shaft

92

81.00 x 77.40

EZA			4 Cyl.	1595cc	51-55kW (70-75PS)	Petrol		TD4075	
BE/PL	1	45,950/45,970	49,000/49,016	19,000	1,506	0,020/0,078	EC	71-3084	71-3084 STD 0.25
BE/PL	4	47,758/47,778	50,600/50,612	19,000	1,406	0,020/0,067	EC	71-3694	71-3694/4 STD 0.25 0.50

71-3084



71-3694

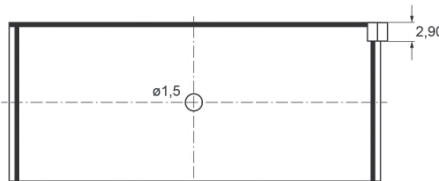

VOLKSWAGEN



MB/HL	3	53,958/53,978	59,000/59,019	18,500	2,502	0,020/0,082	AL-LF	02-3085L	H025/5 STD 0.25 0.50
MB/HL	5	53,958/53,978	59,000/59,019	18,500	2,502	0,020/0,082	AL-LF	02-3085U	
MB/HL	1	53,958/53,978	59,000/59,019	24,930	2,502	0,020/0,082	AL-LF	02-3086HL	
MB/HL	1	53,958/53,978	59,000/59,019	24,930	2,502	0,020/0,082	AL-LF	02-3086HU	



02-3086HL	STD	25,000/.9843" - 25,040/.9858"
	0.25mm	25,100/.9882" - 25,140/.9898"
	0.50mm	25,100/.9882" - 25,140/.9898"
	0.75mm	25,100/.9882" - 25,140/.9898"

02-3086HU	STD	25,000/.9843" - 25,040/.9858"
	0.25mm	25,100/.9882" - 25,140/.9898"
	0.50mm	25,100/.9882" - 25,140/.9898"
	0.75mm	25,100/.9882" - 25,140/.9898"

MB/HL	4	53,958/53,978	59,000/59,019	18,500	2,502	0,020/0,082	AL-LF	02-3085L	H027/5 STD 0.25 0.50
MB/HL	6	53,958/53,978	59,000/59,019	18,500	2,502	0,020/0,082	AL-LF	02-3085U	

02-3085L

02-3085U

02-3086HL

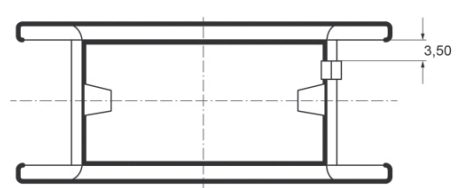
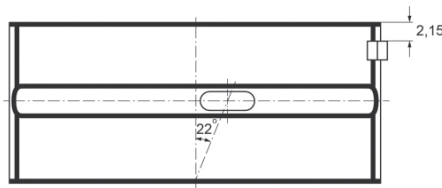
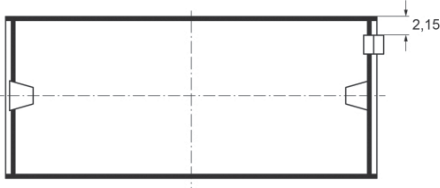

02-3086HU

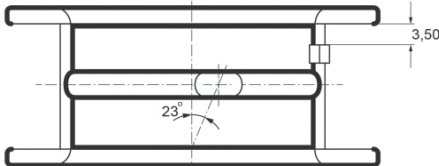

TW/A	2	59,500	73,200		1,975		AL-LF	04-3527	A123/4 STD
TW/A	2	59,500	73,200		1,975		AL-LF	04-3528	
SE/PB	1	20,000	23,000/23,052	25,000			BC	55-3567	55-3567 SEMI
CB/NWB 1-5	5	25,939/25,960	28,250/28,271	17,000	1,138		AL-LF	03-3317	N118/5 STD [12]
BU	1	42,959/42,975	46,055/46,095	15,000			AL-LF	07-3088	07-3088 STD SEMI [13]

Front, For intermediary shaft

BU	1	41,959/41,975	45,000/45,025	15,000			AL-LF	07-3089	07-3089 STD SEMI [13]
----	---	---------------	---------------	--------	--	--	-------	---------	--

Rear, For intermediary shaft

93	81.00 x 77.40								
HN		4 Cyl.	1595cc	53-55kW (72-75PS)		Petrol			TD4107
HN		4 Cyl.	1595cc	53-55kW (72-75PS)		Petrol			TD24106
JU		4 Cyl.	1595cc	55kW (75PS)		Petrol			TD12532
BE/PL	1	45,950/45,970	49,000/49,016	19,000	1,506	0,020/0,078	EC	71-3084	71-3084 STD 0.25

→12/83

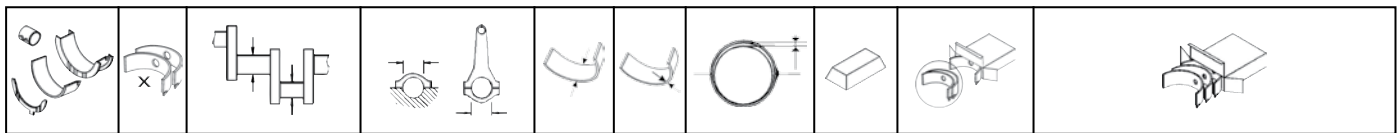

BE/PL	4	47,758/47,778	50,600/50,619	19,000	1,406	0,020/0,074	EC	71-3566	71-3566/4 STD 0.25
-------	---	---------------	---------------	--------	-------	-------------	----	---------	------------------------------

01/84 → 12/85

BE/PL	4	47,758/47,778	50,600/50,612	19,000	1,406	0,020/0,067	EC	71-3694	71-3694/4 STD 0.25 0.50
-------	---	---------------	---------------	--------	-------	-------------	----	---------	-----------------------------------

01/86 →

71-3084



71-3566



71-3694

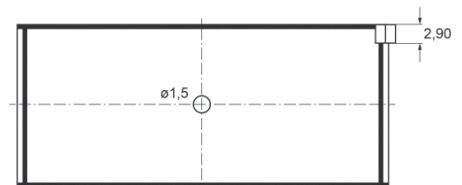

MB/HL	3	53,958/53,978	59,000/59,019	18,500	2,502	0,020/0,082	AL-LF	02-3085L	H025/5 STD 0.25 0.50
MB/HL	5	53,958/53,978	59,000/59,019	18,500	2,502	0,020/0,082	AL-LF	02-3085U	
MB/HL	1	53,958/53,978	59,000/59,019	24,930	2,502	0,020/0,082	AL-LF	02-3086HL	
MB/HL	1	53,958/53,978	59,000/59,019	24,930	2,502	0,020/0,082	AL-LF	02-3086HU	



02-3086HL	STD	25,000/.9843" - 25,040/.9858"
	0.25mm	25,100/.9882" - 25,140/.9898"
	0.50mm	25,100/.9882" - 25,140/.9898"
	0.75mm	25,100/.9882" - 25,140/.9898"

02-3086HU	STD	25,000/.9843" - 25,040/.9858"
	0.25mm	25,100/.9882" - 25,140/.9898"
	0.50mm	25,100/.9882" - 25,140/.9898"
	0.75mm	25,100/.9882" - 25,140/.9898"

MB/HL	4	53,958/53,978	59,000/59,019	18,500	2,502	0,020/0,082	AL-LF	02-3085L	H027/5 STD 0.25 0.50
MB/HL	6	53,958/53,978	59,000/59,019	18,500	2,502	0,020/0,082	AL-LF	02-3085U	

02-3085L



02-3085U

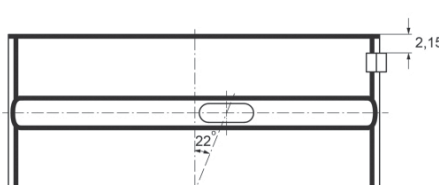

02-3086HL

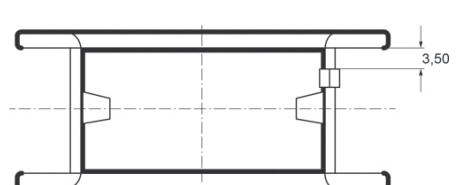

02-3086HU

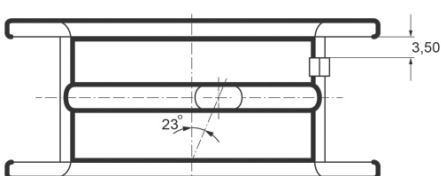

TW/A	2	59,500	73,200		1,975		AL-LF	04-3527	A123/4 STD
TW/A	2	59,500	73,200		1,975		AL-LF	04-3528	
SE/PB	1	20,000	23,000/23,052	25,000			BC	55-3567	55-3567 SEMI
CB/NWB 1-5	5	25,939/25,960	28,250/28,271	17,000	1,138		AL-LF	03-3317	N118/5 STD

VOLKSWAGEN



BU	1	42,959/42,975	46,055/46,095	15,000			AL-LF	07-3088	07-3088 STD SEMI	13
----	---	---------------	---------------	--------	--	--	-------	---------	----------------------------	----

Front, For intermediary shaft

BU	1	41,959/41,975	45,000/45,025	15,000			AL-LF	07-3089	07-3089 STD SEMI	13
----	---	---------------	---------------	--------	--	--	-------	---------	----------------------------	----

Rear, For intermediary shaft

94 81.00 x 77.40

PN		4 Cyl.	1595cc	51kW (70PS)			Petrol		TD4141
BE/PL	4	47,758/47,778	50,600/50,612	19,000	1,406	0,020/0,067	EC	71-3694	71-3694/4 STD 0.25 0.50
MB/HL	4	53,958/53,978	59,000/59,019	18,500	2,502	0,020/0,082	AL-LF	02-3085L	H027/5 STD 0.25 0.50
MB/HL	6	53,958/53,978	59,000/59,019	18,500	2,502	0,020/0,082	AL-LF	02-3085U	
TW/A	2	59,500	73,200		1,975		AL-LF	04-3527	A123/4 STD
TW/A	2	59,500	73,200		1,975		AL-LF	04-3528	
SE/PB	1	20,000	23,000/23,052	25,000			BC	55-3567	55-3567 SEMI
SE/PB	1	20,000	23,000/23,021	25,000			BC	55-3698	55-3698 SEMI

55-3567

55-3698

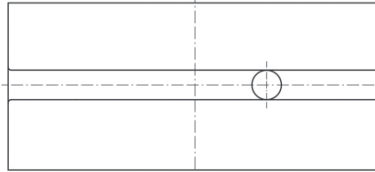
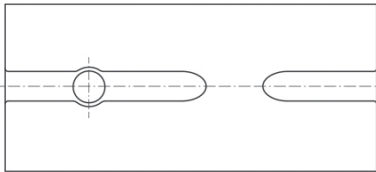

CB/NWB 1-5	5	25,939/25,960	28,250/28,271	17,000	1,138		AL-LF	03-3317	N118/5 STD	12
BU	1	42,959/42,975	46,055/46,095	15,000			AL-LF	07-3088	07-3088 STD SEMI	13

Front, For intermediary shaft

BU	1	41,959/41,975	45,000/45,025	15,000			AL-LF	07-3089	07-3089 STD SEMI	13
----	---	---------------	---------------	--------	--	--	-------	---------	----------------------------	----

Rear, For intermediary shaft

95 81.00 x 77.40

PP		4 Cyl.	1595cc	51kW (70PS)			Petrol		TD5022	
BE/PL	4	47,758/47,778	50,600/50,612	19,000	1,406	0,020/0,067	EC	71-3694	71-3694/4 STD 0.25 0.50	
MB/HL	4	53,958/53,978	59,000/59,019	18,500	2,502	0,020/0,082	AL-LF	02-3085L	H027/5 STD 0.25 0.50	
MB/HL	6	53,958/53,978	59,000/59,019	18,500	2,502	0,020/0,082	AL-LF	02-3085U		
TW/A	2	59,500	73,200		1,975		AL-LF	04-3527	A123/4 STD	
TW/A	2	59,500	73,200		1,975		AL-LF	04-3528		
SE/PB	1	20,000	23,000/23,052	25,000			BC	55-3567	55-3567 SEMI	
CB/NWB 1-5	5	25,939/25,960	28,250/28,271	17,000	1,138		AL-LF	03-3317	N118/5 STD	12
BU	1	42,959/42,975	46,055/46,095	15,000			AL-LF	07-3088	07-3088 STD SEMI	13

Front, For intermediary shaft

BU	1	41,959/41,975	45,000/45,025	15,000				AL-LF	07-3089	07-3089 STD SEMI	13

Rear, For intermediary shaft

96

81.00 x 77.40

RE			4 Cyl.	1595cc	53kW (72PS)		Petrol		TD4145
BE/PL	4	47,758/47,778	50,600/50,612	19,000	1,406	0,020/0,067	EC	71-3694	71-3694/4 STD 0.25 0.50
MB/HL	3	53,958/53,978	59,000/59,019	18,500	2,502	0,020/0,082	AL-LF	02-3085L	H025/5 STD 0.25 0.50
MB/HL	5	53,958/53,978	59,000/59,019	18,500	2,502	0,020/0,082	AL-LF	02-3085U	
MB/HL	1	53,958/53,978	59,000/59,019	24,930	2,502	0,020/0,082	AL-LF	02-3086HL	
MB/HL	1	53,958/53,978	59,000/59,019	24,930	2,502	0,020/0,082	AL-LF	02-3086HU	



02-3086HL	STD	25,000/.9843" - 25,040/.9858"
	0.25mm	25,100/.9882" - 25,140/.9898"
	0.50mm	25,100/.9882" - 25,140/.9898"
	0.75mm	25,100/.9882" - 25,140/.9898"

02-3086HU	STD	25,000/.9843" - 25,040/.9858"
	0.25mm	25,100/.9882" - 25,140/.9898"
	0.50mm	25,100/.9882" - 25,140/.9898"
	0.75mm	25,100/.9882" - 25,140/.9898"

MB/HL	4	53,958/53,978	59,000/59,019	18,500	2,502	0,020/0,082	AL-LF	02-3085L	H027/5 STD 0.25 0.50
MB/HL	6	53,958/53,978	59,000/59,019	18,500	2,502	0,020/0,082	AL-LF	02-3085U	

02-3085L



02-3085U

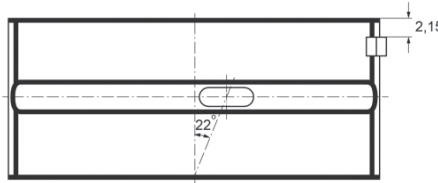

02-3086HL

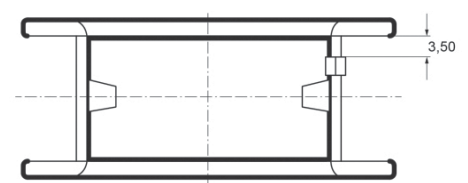

02-3086HU

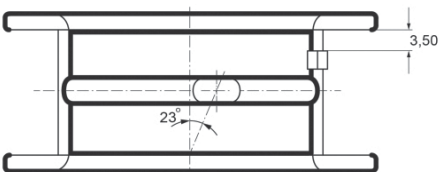

TW/A	2	59,500	73,200		1,975		AL-LF	04-3527	A123/4 STD	
TW/A	2	59,500	73,200		1,975		AL-LF	04-3528		
SE/PB	1	20,000	23,000/23,052	25,000			BC	55-3567	55-3567 SEMI	
CB/NWB 1-5	5	25,939/25,960	28,250/28,271	17,000	1,138		AL-LF	03-3317	N118/5 STD	12
BU	1	42,959/42,975	46,055/46,095	15,000			AL-LF	07-3088	07-3088 STD SEMI	13

Front, For intermediary shaft

BU	1	41,959/41,975	45,000/45,025	15,000			AL-LF	07-3089	07-3089 STD SEMI	13
----	---	---------------	---------------	--------	--	--	-------	---------	----------------------------	----

Rear, For intermediary shaft

VOLKSWAGEN



97 81.00 x 77.40

RF	4 Cyl.		1595cc	53kW (72PS)			Petrol		TD5025
BE/PL	4	47,758/47,778	50,600/50,612	19,000	1,406	0,020/0,067	EC	71-3694	71-3694/4 STD 0.25 0.50
MB/HL	4	53,958/53,978	59,000/59,019	18,500	2,502	0,020/0,082	AL-LF	02-3085L	H027/5 STD 0.25 0.50
MB/HL	6	53,958/53,978	59,000/59,019	18,500	2,502	0,020/0,082	AL-LF	02-3085U	
TW/A	2	59,500	73,200		1,975		AL-LF	04-3527	A123/4 STD
TW/A	2	59,500	73,200		1,975		AL-LF	04-3528	
SE/PB	1	20,000	23,000/23,052	25,000			BC	55-3567	55-3567 SEMI
SE/PB	1	20,000	23,000/23,021	25,000			BC	55-3698	55-3698 SEMI

55-3567

55-3698

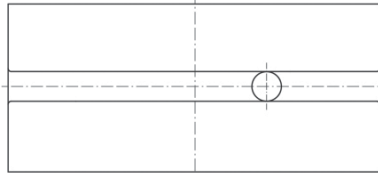
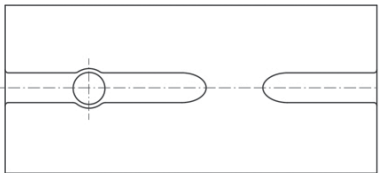

CB/NWB 1-5	5	25,939/25,960	28,250/28,271	17,000	1,138		AL-LF	03-3317	N118/5 STD 12
---------------	---	---------------	---------------	--------	-------	--	-------	---------	--

98 81.00 x 77.40

RL	4 Cyl.		1595cc	53kW (72PS)			Petrol		TD4148
BE/PL	4	47,758/47,778	50,600/50,619	19,000	1,406	0,020/0,074	EC	71-3566	71-3566/4 STD 0.25
→12/85									
BE/PL	4	47,758/47,778	50,600/50,612	19,000	1,406	0,020/0,067	EC	71-3694	71-3694/4 STD 0.25 0.50

01/86→

71-3566

71-3694

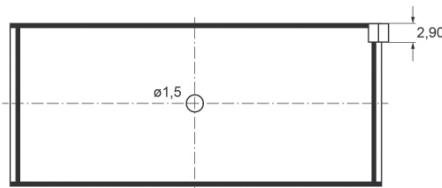
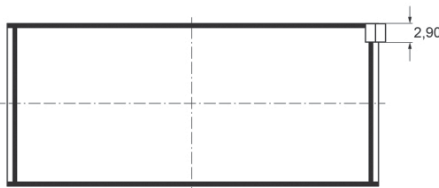



MB/HL	3	53,958/53,978	59,000/59,019	18,500	2,502	0,020/0,082	AL-LF	02-3085L	H025/5 STD 0.25 0.50
MB/HL	5	53,958/53,978	59,000/59,019	18,500	2,502	0,020/0,082	AL-LF	02-3085U	
MB/HL	1	53,958/53,978	59,000/59,019	24,930	2,502	0,020/0,082	AL-LF	02-3086HL	
MB/HL	1	53,958/53,978	59,000/59,019	24,930	2,502	0,020/0,082	AL-LF	02-3086HU	

	02-3086HL	STD	25,000/.9843" - 25,040/.9858"
		0.25mm	25,100/.9882" - 25,140/.9898"
		0.50mm	25,100/.9882" - 25,140/.9898"
		0.75mm	25,100/.9882" - 25,140/.9898"
	02-3086HU	STD	25,000/.9843" - 25,040/.9858"
		0.25mm	25,100/.9882" - 25,140/.9898"
		0.50mm	25,100/.9882" - 25,140/.9898"
		0.75mm	25,100/.9882" - 25,140/.9898"

MB/HL	4	53,958/53,978	59,000/59,019	18,500	2,502	0,020/0,082	AL-LF	02-3085L	H027/5 STD 0.25 0.50
MB/HL	6	53,958/53,978	59,000/59,019	18,500	2,502	0,020/0,082	AL-LF	02-3085U	

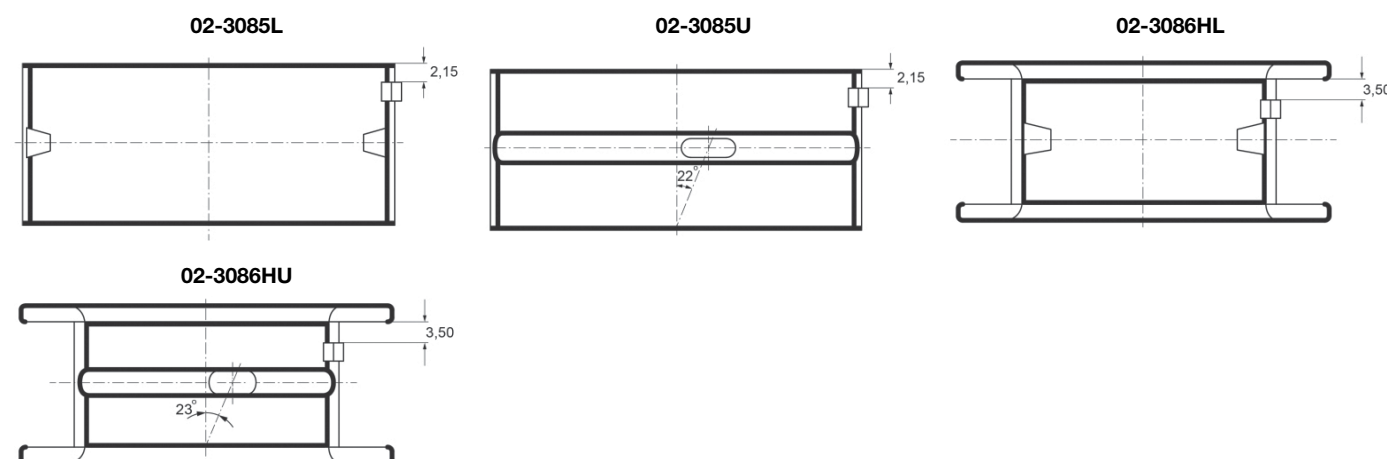

TW/A	2	59,500	73,200		1,975		AL-LF	04-3527	A123/4 STD	
TW/A	2	59,500	73,200		1,975		AL-LF	04-3528		
SE/PB	1	20,000	23,000/23,052	25,000			BC	55-3567	55-3567 SEMI	
CB/NWB 1-5	5	25,939/25,960	28,250/28,271	17,000	1,138		AL-LF	03-3317		N118/5 STD
BU	1	42,959/42,975	46,055/46,095	15,000			AL-LF	07-3088	07-3088 STD SEMI	[13]

Front, For intermediary shaft

BU	1	41,959/41,975	45,000/45,025	15,000			AL-LF	07-3089	07-3089 STD SEMI	[13]
----	---	---------------	---------------	--------	--	--	-------	---------	----------------------------	------

Rear, For intermediary shaft

99	81.00 x 77.40									
HP		5 Cyl.		1994cc	85kW (115PS)		Petrol		TD16429	
BE/PL	1	45,950/45,970	49,000/49,016	19,000	1,506	0,020/0,078	EC	71-3084	71-3084 STD 0.25	

→12/83

VOLKSWAGEN



BE/PL	5	47,758/47,778	50,600/50,619	19,000	1,406	0,020/0,074	EC	71-3566	71-3566/5 STD
-------	---	---------------	---------------	--------	-------	-------------	----	---------	-------------------------

01/84 → 12/85

BE/PL	5	47,758/47,778	50,600/50,612	19,000	1,406	0,020/0,067	EC	71-3694	71-3694/5 STD 0.25
-------	---	---------------	---------------	--------	-------	-------------	----	---------	------------------------------

01/86 →

71-3084

71-3694

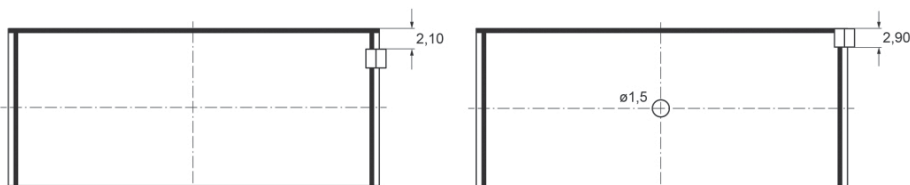

MB/HL 1-6	6	57,958/57,978	63,000/63,019	18,500	2,502	0,020/0,082	EC	72-3400	H981/6 STD 0.25
TW/A	2	63,500/63,750	77,200/77,450		1,975		AL-LF	04-3529	A124/4 STD
TW/A	2	63,500/63,750	77,200/77,450		1,975		AL-LF	04-3530	
TW/A	2	63,500/63,750	76,950/77,200		1,975		AL-LF	04-4782	A292/4 STD
TW/A	2	63,500/63,750	76,950/77,200		1,975		AL-LF	04-4783	

04-3529

04-3530

04-4782

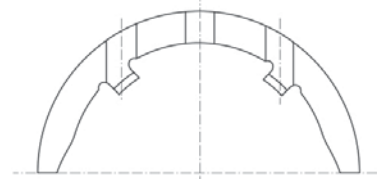
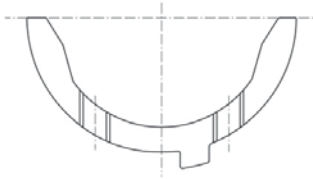
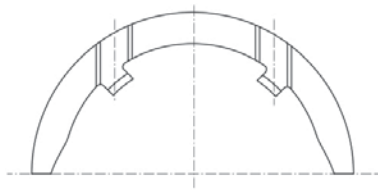

04-4783

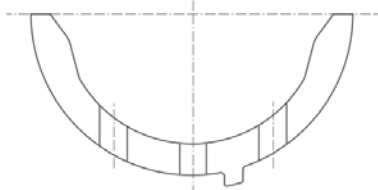

SE/PB	1	20,000	23,000/23,052	25,000			BC	55-3567	55-3567 SEMI
SE/PB	1	20,000	23,000/23,021	25,000			BC	55-3698	55-3698 SEMI

100

81.00 x 77.40

JS 5 Cyl. **1994cc** **85kW** (115PS) **Petrol** **TD5015**

BE/PL	1	45,950/45,970	49,000/49,016	19,000	1,506	0,020/0,078	EC	71-3084	71-3084 STD 0.25
-------	---	---------------	---------------	--------	-------	-------------	----	---------	----------------------------









→12/83

BE/PL	5	47,758/47,778	50,600/50,619	19,000	1,406	0,020/0,074	EC	71-3566	71-3566/5 STD
-------	---	---------------	---------------	--------	-------	-------------	----	---------	-------------------------

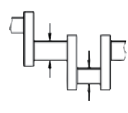
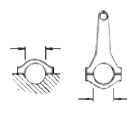
01/84 → 12/85

BE/PL	5	47,758/47,778	50,600/50,612	19,000	1,406	0,020/0,067	EC	71-3694	71-3694/5 STD 0.25
-------	---	---------------	---------------	--------	-------	-------------	----	---------	------------------------------

01/86 →

									
MB/HL 1-6	6	57,958/57,978	63,000/63,019	18,500	2,502	0,020/0,082	EC	72-3400	H981/6 STD 0.25
TW/A	2	63,500/63,750	77,200/77,450		1,975		AL-LF	04-3529	A124/4 STD
TW/A	2	63,500/63,750	77,200/77,450		1,975		AL-LF	04-3530	
TW/A	2	63,500/63,750	76,950/77,200		1,975		AL-LF	04-4782	A292/4 STD
TW/A	2	63,500/63,750	76,950/77,200		1,975		AL-LF	04-4783	

04-3529

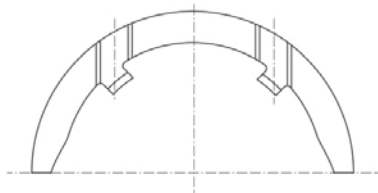

04-3530

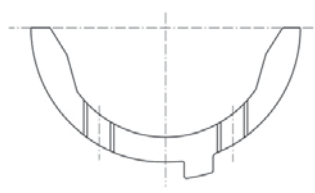

04-4782

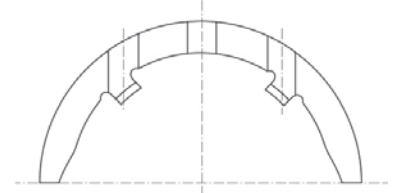

04-4783

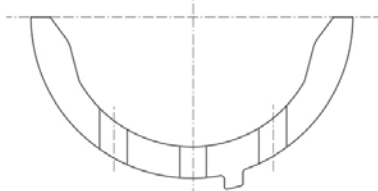

SE/PB	1	20,000	23,000/23,052	25,000		BC	55-3567	55-3567 SEMI
SE/PB	1	20,000	23,000/23,021	25,000		BC	55-3698	55-3698 SEMI

55-3567

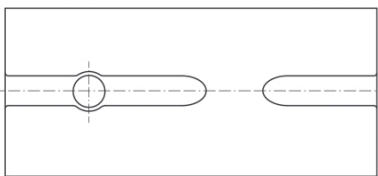

55-3698

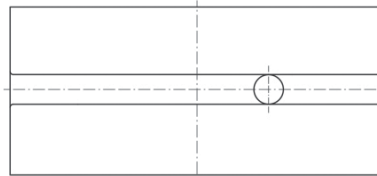

101		81.00 x 86.40							
1H		4 Cyl.		1781cc	118kW (160PS)	Petrol		TD3994	
BE/PL	4	47,758/47,778	50,600/50,612	19,000	1,406	0,020/0,067	EC	71-3694	71-3694/4 STD 0.25 0.50
MB/HL	4	53,958/53,978	59,000/59,019	18,500	2,502	0,020/0,082	AL-LF	02-3085L	H027/5 STD 0.25 0.50
MB/HL	6	53,958/53,978	59,000/59,019	18,500	2,502	0,020/0,082	AL-LF	02-3085U	
TW/A	2	59,500	73,200		1,975		AL-LF	04-3527	A123/4 STD
TW/A	2	59,500	73,200		1,975		AL-LF	04-3528	

102		81.00 x 86.40							
1P		4 Cyl.		1781cc	72kW (98PS)	Petrol		TD3995	
BE/PL	4	47,758/47,778	50,600/50,612	19,000	1,406	0,020/0,067	EC	71-3694	71-3694/4 STD 0.25 0.50
MB/HL	4	53,958/53,978	59,000/59,019	18,500	2,502	0,020/0,082	AL-LF	02-3085L	H027/5 STD 0.25 0.50
MB/HL	6	53,958/53,978	59,000/59,019	18,500	2,502	0,020/0,082	AL-LF	02-3085U	

VOLKSWAGEN

TW/A	2	59,500	73,200		1,975		AL-LF	04-3527	A123/4 STD
TW/A	2	59,500	73,200		1,975		AL-LF	04-3528	
SE/PB	1	20,000	23,000/23,052	25,000			BC	55-3567	55-3567 SEMI

103 81.00 x 86.40

AAM			4 Cyl.	1781cc	55kW (75PS)		Petrol		TD4004
ANN			4 Cyl.	1781cc	55kW (75PS)		Petrol		TD10847
ANP			4 Cyl.	1781cc	66kW (90PS)		Petrol		TD10848
BE/PL	4	47,758/47,778	50,600/50,612	19,000	1,406	0,020/0,067	EC	71-3694	71-3694/4 STD 0.25 0.50
BE/PL	4	47,758/47,778	50,600/50,612	19,000	1,406	0,020/0,067	EC	71-3929	71-3929/4 STD II

71-3694

71-3929

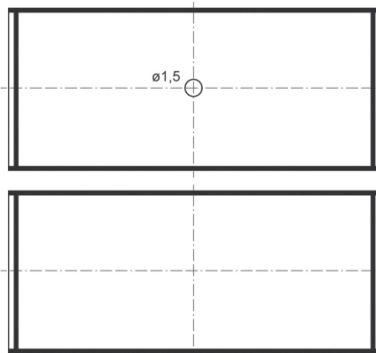
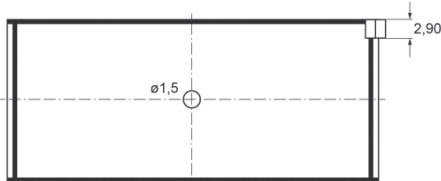

MB/HL	4	53,958/53,978	59,000/59,019	18,500	2,502	0,020/0,082	AL-LF	02-3085L	H027/5 STD 0.25 0.50
MB/HL	6	53,958/53,978	59,000/59,019	18,500	2,502	0,020/0,082	AL-LF	02-3085U	
TW/A	2	59,500	73,200		1,975		AL-LF	04-3527	A123/4 STD
TW/A	2	59,500	73,200		1,975		AL-LF	04-3528	
SE/PB	1	20,000	23,000/23,021	25,000			BC	55-3698	55-3698 SEMI

104 81.00 x 86.40

ABS			4 Cyl.	1781cc	66kW (90PS)		Petrol		TD4975
ADD			4 Cyl.	1781cc	63-75kW (86-102PS)		Petrol		TD15496
ADF			4 Cyl.	1781cc	55kW (75PS)		Petrol		TD21353
ADZ			4 Cyl.	1781cc	66kW (90PS)		Petrol		TD4980
AJH			4 Cyl.	1781cc	110kW (150PS)		Petrol Turbo Intercooler		TD10887
BE/PL	4	47,758/47,778	50,600/50,612	19,000	1,406	0,020/0,067	EC	71-3694	71-3694/4 STD 0.25 0.50
MB/HL	4	53,958/53,978	59,000/59,019	18,500	2,502	0,020/0,082	AL-LF	02-3085L	H027/5 STD 0.25 0.50
MB/HL	6	53,958/53,978	59,000/59,019	18,500	2,502	0,020/0,082	AL-LF	02-3085U	
TW/A	2	59,500	73,200		1,975		AL-LF	04-3527	A123/4 STD
TW/A	2	59,500	73,200		1,975		AL-LF	04-3528	
SE/PB	1	20,000	23,000/23,021	25,000			BC	55-3698	55-3698 SEMI



BU	1	42,959/42,975	46,055/46,095	15,000			AL-LF	07-3088	07-3088 STD SEMI	13
----	---	---------------	---------------	--------	--	--	-------	---------	----------------------------	----

Front, For intermediary shaft

BU	1	41,959/41,975	45,000/45,025	15,000			AL-LF	07-3089	07-3089 STD SEMI	13
----	---	---------------	---------------	--------	--	--	-------	---------	----------------------------	----

Rear, For intermediary shaft

105 81.00 x 86.40

ACC	4 Cyl. 1781cc 66-67kW (90-91PS)			Petrol				TD4011	
BE/PL	4	47,758/47,778	50,600/50,612	19,000	1,406	0,020/0,067	EC	71-3694	71-3694/4 STD 0.25 0.50
MB/HL	4	53,958/53,978	59,000/59,019	18,500	2,502	0,020/0,082	AL-LF	02-3085L	H027/5 STD 0.25 0.50
MB/HL	6	53,958/53,978	59,000/59,019	18,500	2,502	0,020/0,082	AL-LF	02-3085U	
TW/A	2	59,500	73,200		1,975		AL-LF	04-3527	A123/4 STD
TW/A	2	59,500	73,200		1,975		AL-LF	04-3528	
SE/PB	1	20,000	23,000/23,021	25,000			BC	55-3698	55-3698 SEMI

106 81.00 x 86.40

ADR	4 Cyl. 1781cc 92kW (125PS)			Petrol				TD5557	
BE/PL	4	47,758/47,778	50,600/50,612	19,000	1,406	0,020/0,067	EC	71-3694	71-3694/4 STD 0.25 0.50
MB/HL	4	53,958/53,978	59,000/59,019	18,500	2,502	0,020/0,082	AL-LF	02-3085L	H027/5 STD 0.25 0.50
MB/HL	6	53,958/53,978	59,000/59,019	18,500	2,502	0,020/0,082	AL-LF	02-3085U	
MB/HL 1-5	5	53,958/53,978	59,000/59,019	18,500	2,502	0,020/0,082	AL-LF	02-3085L	H084/5 STD 0.25 0.50
MB/HL 1-5	5	53,958/53,978	59,000/59,019	18,500	2,502	0,020/0,082	AL-LF	02-3085U	

02-3085L

02-3085U

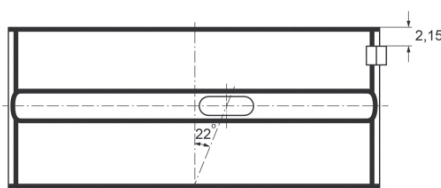

TW/A	2	59,500	73,200		1,975		AL-LF	04-3527	A123/4 STD
TW/A	2	59,500	73,200		1,975		AL-LF	04-3528	
SE/PB	1	20,000	23,000/23,021	25,000			BC	55-3698	55-3698 SEMI

107 81.00 x 86.40

AEB	4 Cyl. 1781cc 110-112kW (150-152PS)			Petrol Turbo				TD5558		
BE/PL	1	47,758/47,778	50,600/50,612	19,000	1,395	0,032/0,089	SP	71-3732	71-3732 STD	1
MB/HL	4	53,958/53,978	59,000/59,019	18,500	2,502	0,020/0,082	AL-LF	02-3085L	H027/5 STD 0.25 0.50	
MB/HL	6	53,958/53,978	59,000/59,019	18,500	2,502	0,020/0,082	AL-LF	02-3085U		

VOLKSWAGEN

TW/A	2	59,500	73,200		1,975		AL-LF	04-3527	A123/4 STD
TW/A	2	59,500	73,200		1,975		AL-LF	04-3528	
SE/PB	1	20,000	23,000/23,021	25,000			BC	55-3698	55-3698 SEMI

108 81.00 x 86.40

AFY	4 Cyl.	1781cc	85kW (115PS)	Petrol	TD16244
RP	4 Cyl.	1781cc	66kW (90PS)	Petrol	TD5027

BE/PL	4	47,758/47,778	50,600/50,612	19,000	1,406	0,020/0,067	EC	71-3694	71-3694/4 STD 0.25 0.50
-------	---	---------------	---------------	--------	-------	-------------	----	---------	-----------------------------------

01/86 →

MB/HL	4	53,958/53,978	59,000/59,019	18,500	2,502	0,020/0,082	AL-LF	02-3085L	H027/5 STD 0.25 0.50
MB/HL	6	53,958/53,978	59,000/59,019	18,500	2,502	0,020/0,082	AL-LF	02-3085U	

Mot. → 8DX199999

MB/HL 1-5	5	53,958/53,978	59,000/59,019	18,500	2,502	0,020/0,082	AL-LF	02-3085L	H084/5 STD 0.25 0.50
MB/HL 1-5	5	53,958/53,978	59,000/59,019	18,500	2,502	0,020/0,082	AL-LF	02-3085U	

Mot. 8DX200001 →

02-3085L

02-3085U

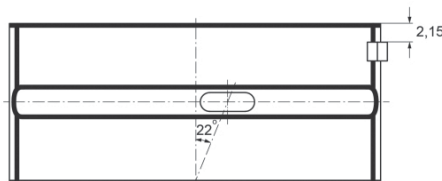

TW/A	2	59,500	73,200		1,975		AL-LF	04-3527	A123/4 STD
TW/A	2	59,500	73,200		1,975		AL-LF	04-3528	
SE/PB	1	20,000	23,000/23,021	25,000			BC	55-3698	55-3698 SEMI
CB/NWB 1-5	5	25,939/25,960	28,250/28,271	17,000	1,138		AL-LF	03-3317	N118/5 STD 12
BU	1	42,959/42,975	46,055/46,095	15,000			AL-LF	07-3088	07-3088 STD SEMI 13

Front, For intermediary shaft

BU	1	41,959/41,975	45,000/45,025	15,000			AL-LF	07-3089	07-3089 STD SEMI 13
----	---	---------------	---------------	--------	--	--	-------	---------	--

Rear, For intermediary shaft

109 81.00 x 86.40

AGN	4 Cyl.	1781cc	92kW (125PS)	Petrol	TD9363
APT	4 Cyl.	1781cc	92kW (125PS)	Petrol	TD11497

ARG	4 Cyl.	1781cc	92kW (125PS)	Petrol	TD16237
------------	--------	---------------	---------------------	---------------	----------------

BE/PL	4	47,758/47,778	50,600/50,612	19,000	1,406	0,020/0,067	EC	71-3694	71-3694/4 STD 0.25 0.50
MB/HL 1-5	5	53,958/53,978	59,000/59,019	18,500	2,502	0,020/0,082	AL-LF	02-3085L	H084/5 STD 0.25 0.50
MB/HL 1-5	5	53,958/53,978	59,000/59,019	18,500	2,502	0,020/0,082	AL-LF	02-3085U	

TW/A	2	59,500	73,200		1,975		AL-LF	04-3527	A123/4 STD
TW/A	2	59,500	73,200		1,975		AL-LF	04-3528	
SE/PB	1	20,000	23,000/23,021	25,000			BC	55-3698	55-3698 SEMI

110 81.00 x 86.40

AGU Euro 2		4 Cyl.	1781cc	110kW (150PS)	Petrol Turbo Intercooler		TD9456		
ARZ		4 Cyl.	1781cc	110kW (150PS)	Petrol Turbo		TD16385		
AVC		4 Cyl.	1781cc	110kW (150PS)	Petrol Turbo		TD15467		
AWC		4 Cyl.	1781cc	110kW (150PS)	Petrol Turbo Intercooler		TD14914		
BE/PL	1	47,758/47,778	50,600/50,612	19,000	1,395	0,032/0,089	SP 71-3732	71-3732 STD	[1]
MB/HL 1-5	5	53,958/53,978	59,000/59,019	18,500	2,502	0,020/0,082	AL-LF 02-3085L	H084/5 STD 0.25 0.50	
MB/HL 1-5	5	53,958/53,978	59,000/59,019	18,500	2,502	0,020/0,082	AL-LF 02-3085U		
TW/A	2	59,500	73,200		1,975		AL-LF 04-3527	A123/4 STD	
TW/A	2	59,500	73,200		1,975		AL-LF 04-3528		
SE/PB	1	20,000	23,000/23,021	25,000			BC 55-3698	55-3698 SEMI	

111 81.00 x 86.40

ANB		4 Cyl.	1781cc	110kW (150PS)	Petrol Turbo		TD16256		
APU		4 Cyl.	1781cc	110kW (150PS)	Petrol Turbo Intercooler		TD16257		
BE/PL	4	47,758/47,778	50,600/50,612	19,000	1,406	0,020/0,067	EC 71-3694	71-3694/4 STD 0.25 0.50	
BE/PL	1	47,758/47,778	50,600/50,612	19,000	1,395	0,032/0,089	SP 71-3732	71-3732 STD	[1]

71-3694

71-3732

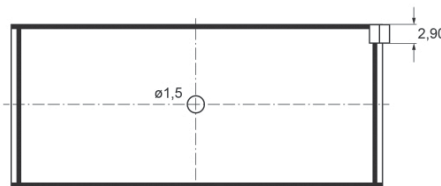
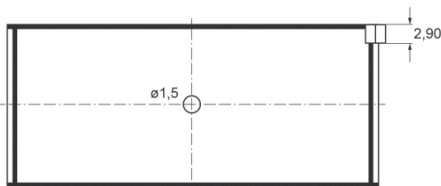

MB/HL 1-5	5	53,958/53,978	59,000/59,019	18,500	2,502	0,020/0,082	AL-LF 02-3085L	H084/5 STD 0.25 0.50	
MB/HL 1-5	5	53,958/53,978	59,000/59,019	18,500	2,502	0,020/0,082	AL-LF 02-3085U		
TW/A	2	59,500	73,200		1,975		AL-LF 04-3527	A123/4 STD	
TW/A	2	59,500	73,200		1,975		AL-LF 04-3528		
SE/PB	1	20,000	23,000/23,021	25,000			BC 55-3698	55-3698 SEMI	

112 81.00 x 86.40

APH		4 Cyl.	1781cc	110kW (150PS)	Petrol Turbo		TD13441		
BE/PL	1	47,758/47,778	50,600/50,612	19,000	1,395	0,032/0,089	SP 71-3732	71-3732 STD	[1]
MB/HL 1-5	5	53,958/53,978	59,000/59,019	18,500	2,502	0,020/0,082	AL-LF 02-3085L	H084/5 STD 0.25 0.50	
MB/HL 1-5	5	53,958/53,978	59,000/59,019	18,500	2,502	0,020/0,082	AL-LF 02-3085U		

VOLKSWAGEN

SE/PB	1	20,000	23,000/23,021	25,000		BC	55-3698	55-3698 SEMI

113	81.00 x 86.40							
ARX		4 Cyl.	1781cc	110kW (150PS)			Petrol Turbo Intercooler	TD15485
MB/HL 1-5	5	53,958/53,978	59,000/59,019	18,500	2,502	0,020/0,082	AL-LF 02-3085L	H084/5 STD 0.25 0.50
MB/HL 1-5	5	53,958/53,978	59,000/59,019	18,500	2,502	0,020/0,082	AL-LF 02-3085U	
TW/A	2	59,500	73,200		1,975		AL-LF 04-3527	A123/4 STD
TW/A	2	59,500	73,200		1,975		AL-LF 04-3528	

114	81.00 x 86.40							
AWL		4 Cyl.	1781cc	110kW (150PS)			Petrol Turbo	TD19134
AWP		4 Cyl.	1781cc	132kW (180PS)			Petrol Turbo	TD19253
AWU		4 Cyl.	1781cc	110kW (150PS)			Petrol Turbo	TD15468
AWV		4 Cyl.	1781cc	110kW (150PS)			Petrol Turbo	TD15469
BE/PL	4	47,758/47,778	50,600/50,612	19,000	1,406	0,020/0,067	EC 71-3929	71-3929/4 STD II
MB/HL 1-5	5	53,958/53,978	59,000/59,019	18,500	2,502	0,020/0,082	AL-LF 02-3085L	H084/5 STD 0.25 0.50
MB/HL 1-5	5	53,958/53,978	59,000/59,019	18,500	2,502	0,020/0,082	AL-LF 02-3085U	
TW/A	2	59,500	73,200		1,975		AL-LF 04-3527	A123/4 STD
TW/A	2	59,500	73,200		1,975		AL-LF 04-3528	

115	81.00 x 86.40							
DS		4 Cyl.	1781cc	66kW (90PS)			Petrol	TD4996
JN		4 Cyl.	1781cc	66-76kW (90-103PS)			Petrol	TD5014
JV		4 Cyl.	1781cc	66kW (90PS)			Petrol	TD5017
BE/PL	4	47,758/47,778	50,600/50,619	19,000	1,406	0,020/0,074	EC 71-3566	71-3566/4 STD 0.25
→12/85								
BE/PL	4	47,758/47,778	50,600/50,612	19,000	1,406	0,020/0,067	EC 71-3694	71-3694/4 STD 0.25 0.50
01/86→								

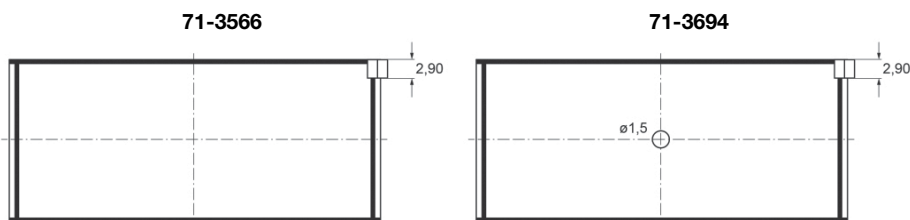

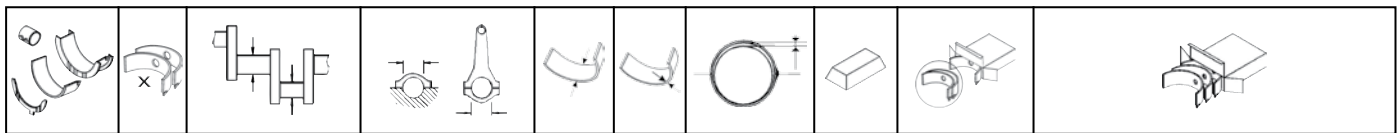

MB/HL	3	53,958/53,978	59,000/59,019	18,500	2,502	0,020/0,082	AL-LF	02-3085L	H025/5 STD 0.25 0.50
MB/HL	5	53,958/53,978	59,000/59,019	18,500	2,502	0,020/0,082	AL-LF	02-3085U	
MB/HL	1	53,958/53,978	59,000/59,019	24,930	2,502	0,020/0,082	AL-LF	02-3086HL	
MB/HL	1	53,958/53,978	59,000/59,019	24,930	2,502	0,020/0,082	AL-LF	02-3086HU	



02-3086HL	STD	25,000/.9843" - 25,040/.9858"
	0.25mm	25,100/.9882" - 25,140/.9898"
	0.50mm	25,100/.9882" - 25,140/.9898"
	0.75mm	25,100/.9882" - 25,140/.9898"

02-3086HU	STD	25,000/.9843" - 25,040/.9858"
	0.25mm	25,100/.9882" - 25,140/.9898"
	0.50mm	25,100/.9882" - 25,140/.9898"
	0.75mm	25,100/.9882" - 25,140/.9898"

MB/HL	4	53,958/53,978	59,000/59,019	18,500	2,502	0,020/0,082	AL-LF	02-3085L	H027/5 STD 0.25 0.50
MB/HL	6	53,958/53,978	59,000/59,019	18,500	2,502	0,020/0,082	AL-LF	02-3085U	

02-3085L



02-3085U

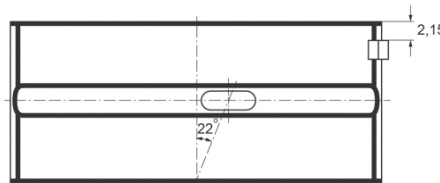

02-3086HL

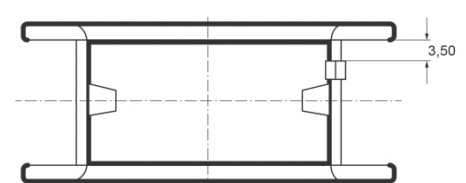

02-3086HU

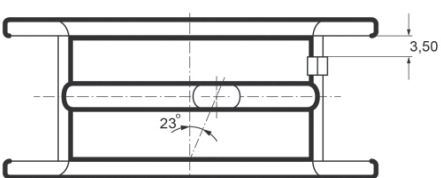

TW/A	2	59,500	73,200		1,975		AL-LF	04-3527	A123/4 STD	
TW/A	2	59,500	73,200		1,975		AL-LF	04-3528		
SE/PB	1	20,000	23,000/23,052	25,000			BC	55-3567	55-3567 SEMI	
CB/NWB 1-5	5	25,939/25,960	28,250/28,271	17,000	1,138		AL-LF	03-3317	N118/5 STD	[12]
BU	1	42,959/42,975	46,055/46,095	15,000			AL-LF	07-3088	07-3088 STD SEMI	[13]

Front, For intermediary shaft

BU	1	41,959/41,975	45,000/45,025	15,000			AL-LF	07-3089	07-3089 STD SEMI	[13]
----	---	---------------	---------------	--------	--	--	-------	---------	----------------------------	------

Rear, For intermediary shaft

116 81.00 x 86.40

DX			4 Cyl.	1781cc	82kW (112PS)		Petrol		TD4063
BE/PL	4	47,758/47,778	50,600/50,619	19,000	1,406	0,020/0,074	EC	71-3566	71-3566/4 STD 0.25

→12/85

VOLKSWAGEN

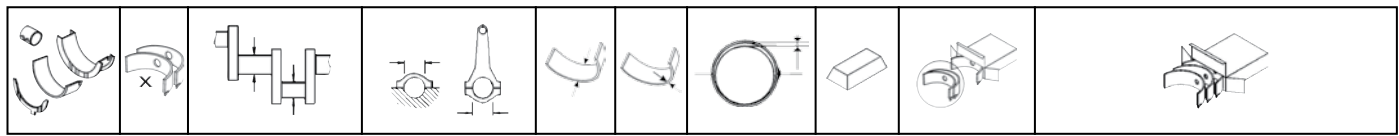

BE/PL	4	47,758/47,778	50,600/50,612	19,000	1,406	0,020/0,067	EC	71-3694	71-3694/4 STD 0.25 0.50
-------	---	---------------	---------------	--------	-------	-------------	----	---------	-----------------------------------

01/86 →

71-3566

71-3694

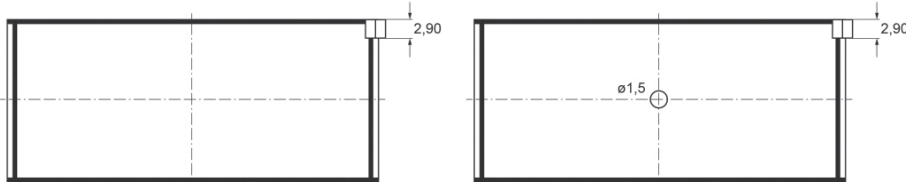

MB/HL	3	53,958/53,978	59,000/59,019	18,500	2,502	0,020/0,082	AL-LF	02-3085L	H025/5 STD 0.25 0.50
MB/HL	5	53,958/53,978	59,000/59,019	18,500	2,502	0,020/0,082	AL-LF	02-3085U	
MB/HL	1	53,958/53,978	59,000/59,019	24,930	2,502	0,020/0,082	AL-LF	02-3086HL	
MB/HL	1	53,958/53,978	59,000/59,019	24,930	2,502	0,020/0,082	AL-LF	02-3086HU	



02-3086HL	STD	25,000/.9843" - 25,040/.9858"
	0.25mm	25,100/.9882" - 25,140/.9898"
	0.50mm	25,100/.9882" - 25,140/.9898"
	0.75mm	25,100/.9882" - 25,140/.9898"

02-3086HU	STD	25,000/.9843" - 25,040/.9858"
	0.25mm	25,100/.9882" - 25,140/.9898"
	0.50mm	25,100/.9882" - 25,140/.9898"
	0.75mm	25,100/.9882" - 25,140/.9898"

MB/HL	4	53,958/53,978	59,000/59,019	18,500	2,502	0,020/0,082	AL-LF	02-3085L	H027/5 STD 0.25 0.50
MB/HL	6	53,958/53,978	59,000/59,019	18,500	2,502	0,020/0,082	AL-LF	02-3085U	

02-3085L

02-3085U

02-3086HL

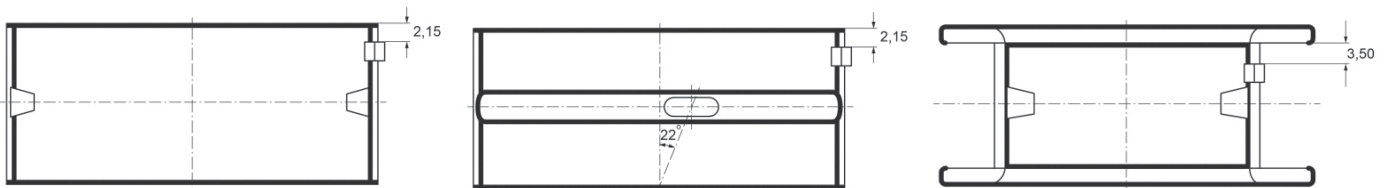

02-3086HU

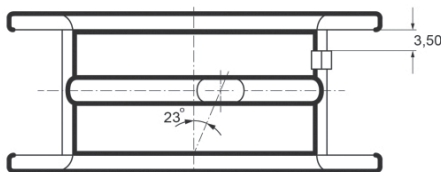

TW/A	2	59,500	73,200		1,975		AL-LF	04-3527	A123/4 STD
TW/A	2	59,500	73,200		1,975		AL-LF	04-3528	
SE/PB	1	20,000	23,000/23,052	25,000			BC	55-3567	55-3567 SEMI
SE/PB	1	20,000	23,000/23,021	25,000			BC	55-3698	55-3698 SEMI



55-3567

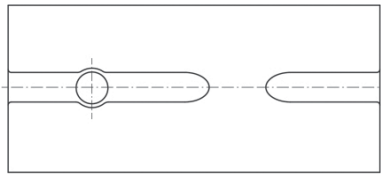

55-3698

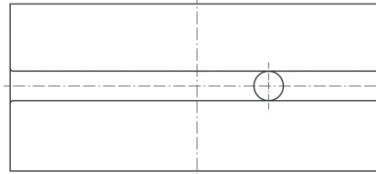

CB/NWB 1-5	5	25,939/25,960	28,250/28,271	17,000	1,138		AL-LF	03-3317	N118/5 STD	12
BU	1	42,959/42,975	46,055/46,095	15,000			AL-LF	07-3088	07-3088 STD SEMI	13

Front, For intermediary shaft

BU	1	41,959/41,975	45,000/45,025	15,000			AL-LF	07-3089	07-3089 STD SEMI	13
----	---	---------------	---------------	--------	--	--	-------	---------	----------------------------	----

Rear, For intermediary shaft

117 81.00 x 86.40

DZ		4 Cyl.	1781cc	82kW (112PS)			Petrol		TD4998
RG		4 Cyl.	1781cc	79kW (105PS)			Petrol		TD4146

BE/PL	4	47,758/47,778	50,600/50,612	19,000	1,406	0,020/0,067	EC	71-3694	71-3694/4 STD 0.25 0.50
MB/HL	3	53,958/53,978	59,000/59,019	18,500	2,502	0,020/0,082	AL-LF	02-3085L	H025/5 STD 0.25 0.50
MB/HL	5	53,958/53,978	59,000/59,019	18,500	2,502	0,020/0,082	AL-LF	02-3085U	
MB/HL	1	53,958/53,978	59,000/59,019	24,930	2,502	0,020/0,082	AL-LF	02-3086HL	
MB/HL	1	53,958/53,978	59,000/59,019	24,930	2,502	0,020/0,082	AL-LF	02-3086HU	



02-3086HL	STD	25,000/.9843" - 25,040/.9858"
	0.25mm	25,100/.9882" - 25,140/.9898"
	0.50mm	25,100/.9882" - 25,140/.9898"
	0.75mm	25,100/.9882" - 25,140/.9898"

02-3086HU	STD	25,000/.9843" - 25,040/.9858"
	0.25mm	25,100/.9882" - 25,140/.9898"
	0.50mm	25,100/.9882" - 25,140/.9898"
	0.75mm	25,100/.9882" - 25,140/.9898"

MB/HL	4	53,958/53,978	59,000/59,019	18,500	2,502	0,020/0,082	AL-LF	02-3085L	H027/5 STD 0.25 0.50
MB/HL	6	53,958/53,978	59,000/59,019	18,500	2,502	0,020/0,082	AL-LF	02-3085U	

02-3085L



02-3085U

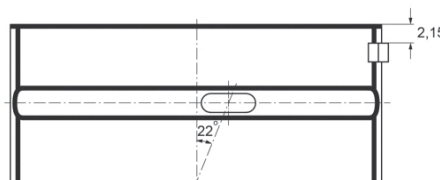

02-3086HL

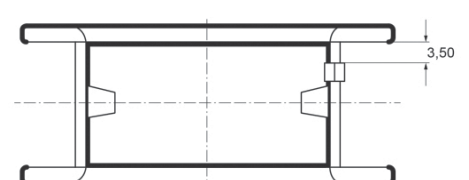

02-3086HU

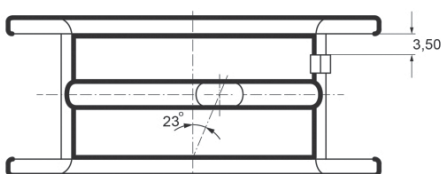

VOLKSWAGEN



TW/A	2	59,500	73,200		1,975		AL-LF	04-3527	A123/4 STD
TW/A	2	59,500	73,200		1,975		AL-LF	04-3528	
SE/PB	1	20,000	23,000/23,052	25,000			BC	55-3567	55-3567 SEMI
BU	1	42,959/42,975	46,055/46,095	15,000			AL-LF	07-3088	07-3088 STD SEMI

Front, For intermediary shaft

BU	1	41,959/41,975	45,000/45,025	15,000			AL-LF	07-3089	07-3089 STD SEMI
----	---	---------------	---------------	--------	--	--	-------	---------	----------------------------

Rear, For intermediary shaft

118 81.00 x 86.40

EV		4 Cyl.	1781cc	82kW (112PS)			Petrol		TD4069
-----------	--	--------	---------------	---------------------	--	--	---------------	--	---------------

GX		4 Cyl.	1781cc	66kW (90PS)			Petrol		TD4100
-----------	--	--------	---------------	--------------------	--	--	---------------	--	---------------

BE/PL	4	47,758/47,778	50,600/50,619	19,000	1,406	0,020/0,074	EC	71-3566	71-3566/4 STD 0.25
-------	---	---------------	---------------	--------	-------	-------------	----	---------	------------------------------

→12/85

BE/PL	4	47,758/47,778	50,600/50,612	19,000	1,406	0,020/0,067	EC	71-3694	71-3694/4 STD 0.25 0.50
-------	---	---------------	---------------	--------	-------	-------------	----	---------	-----------------------------------

01/86→

71-3566

71-3694

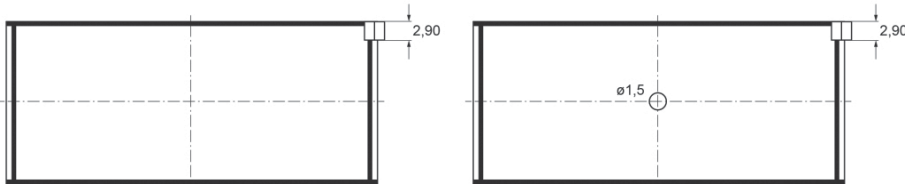

MB/HL	3	53,958/53,978	59,000/59,019	18,500	2,502	0,020/0,082	AL-LF	02-3085L	H025/5 STD 0.25 0.50
MB/HL	5	53,958/53,978	59,000/59,019	18,500	2,502	0,020/0,082	AL-LF	02-3085U	
MB/HL	1	53,958/53,978	59,000/59,019	24,930	2,502	0,020/0,082	AL-LF	02-3086HL	
MB/HL	1	53,958/53,978	59,000/59,019	24,930	2,502	0,020/0,082	AL-LF	02-3086HU	



02-3086HL	STD	25,000/.9843" - 25,040/.9858"
	0.25mm	25,100/.9882" - 25,140/.9898"
	0.50mm	25,100/.9882" - 25,140/.9898"
	0.75mm	25,100/.9882" - 25,140/.9898"

02-3086HU	STD	25,000/.9843" - 25,040/.9858"
	0.25mm	25,100/.9882" - 25,140/.9898"
	0.50mm	25,100/.9882" - 25,140/.9898"
	0.75mm	25,100/.9882" - 25,140/.9898"

MB/HL	4	53,958/53,978	59,000/59,019	18,500	2,502	0,020/0,082	AL-LF	02-3085L	H027/5 STD 0.25 0.50
MB/HL	6	53,958/53,978	59,000/59,019	18,500	2,502	0,020/0,082	AL-LF	02-3085U	

02-3085L

02-3085U

02-3086HL

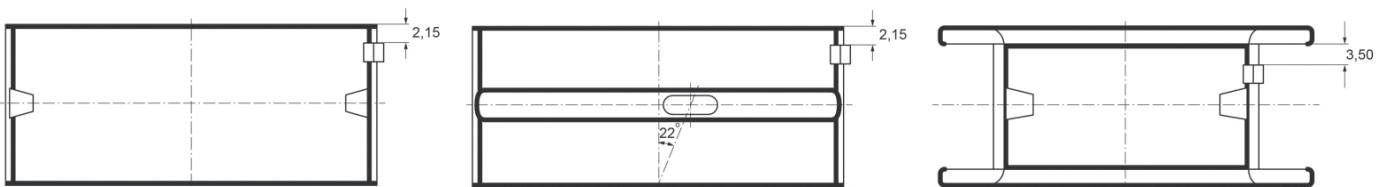



02-3086HU

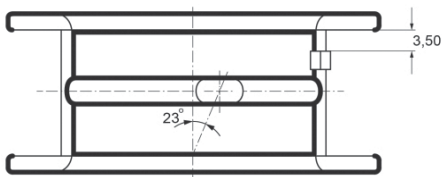

TW/A	2	59,500	73,200		1,975		AL-LF	04-3527	A123/4 STD	
TW/A	2	59,500	73,200		1,975		AL-LF	04-3528		
SE/PB	1	20,000	23,000/23,052	25,000			BC	55-3567	55-3567 SEMI	
BU	1	42,959/42,975	46,055/46,095	15,000			AL-LF	07-3088	07-3088 STD SEMI	[13]

Front, For intermediary shaft

BU	1	41,959/41,975	45,000/45,025	15,000			AL-LF	07-3089	07-3089 STD SEMI	[13]
----	---	---------------	---------------	--------	--	--	-------	---------	----------------------------	------

Rear, For intermediary shaft

119 81.00 x 86.40

EX	4 Cyl.	1781cc	66kW (90PS)	Petrol	TD5000
GU	4 Cyl.	1781cc	66kW (90PS)	Petrol	TD5007
JH	4 Cyl.	1781cc	66-75kW (90-102PS)	Petrol	TD4117
KR	4 Cyl.	1781cc	100-102kW (136-140PS)	Petrol	TD5019

BE/PL	4	47,758/47,778	50,600/50,612	19,000	1,406	0,020/0,067	EC	71-3694	71-3694/4 STD 0.25 0.50	
BE/PL	1	47,758/47,778	50,600/50,612	19,000	1,395	0,032/0,089	SP	71-3732	71-3732 STD	[1]

71-3694

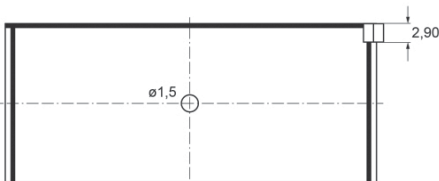

71-3732

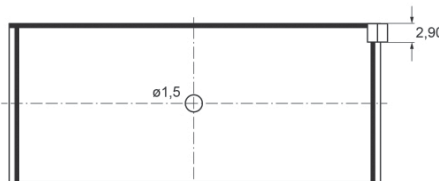

MB/HL	3	53,958/53,978	59,000/59,019	18,500	2,502	0,020/0,082	AL-LF	02-3085L	H025/5 STD 0.25 0.50	
MB/HL	5	53,958/53,978	59,000/59,019	18,500	2,502	0,020/0,082	AL-LF	02-3085U		
MB/HL	1	53,958/53,978	59,000/59,019	24,930	2,502	0,020/0,082	AL-LF	02-3086HL		
MB/HL	1	53,958/53,978	59,000/59,019	24,930	2,502	0,020/0,082	AL-LF	02-3086HU		



02-3086HL	STD	25,000/.9843" - 25,040/.9858"
	0.25mm	25,100/.9882" - 25,140/.9898"
	0.50mm	25,100/.9882" - 25,140/.9898"
	0.75mm	25,100/.9882" - 25,140/.9898"

02-3086HU	STD	25,000/.9843" - 25,040/.9858"
	0.25mm	25,100/.9882" - 25,140/.9898"
	0.50mm	25,100/.9882" - 25,140/.9898"
	0.75mm	25,100/.9882" - 25,140/.9898"

MB/HL	4	53,958/53,978	59,000/59,019	18,500	2,502	0,020/0,082	AL-LF	02-3085L	H027/5 STD 0.25 0.50	
MB/HL	6	53,958/53,978	59,000/59,019	18,500	2,502	0,020/0,082	AL-LF	02-3085U		

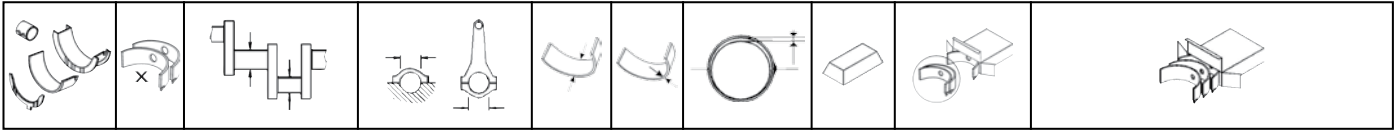

02-3085L

02-3085U

02-3086HL

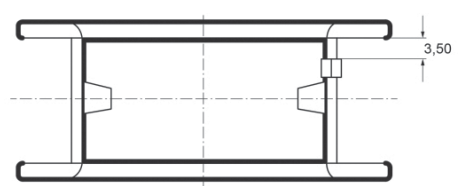
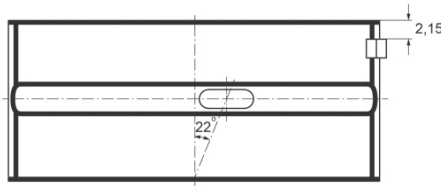

02-3086HU

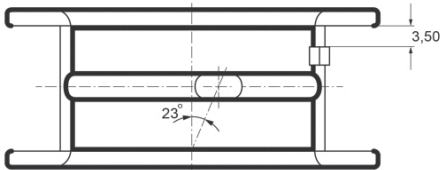

TW/A	2	59,500	73,200		1,975	AL-LF	04-3527	A123/4 STD
TW/A	2	59,500	73,200		1,975	AL-LF	04-3528	
SE/PB	1	20,000	23,000/23,052	25,000		BC	55-3567	55-3567 SEMI
SE/PB	1	20,000	23,000/23,021	25,000		BC	55-3698	55-3698 SEMI

55-3567

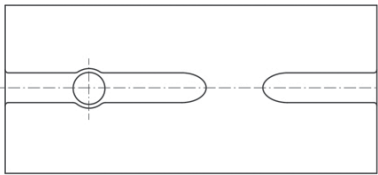

55-3698

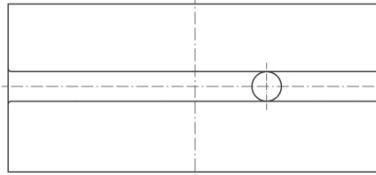

BU	1	42,959/42,975	46,055/46,095	15,000		AL-LF	07-3088	07-3088 STD SEMI	13
----	---	---------------	---------------	--------	--	-------	---------	----------------------------	----

Front, For intermediary shaft

BU	1	41,959/41,975	45,000/45,025	15,000		AL-LF	07-3089	07-3089 STD SEMI	13
----	---	---------------	---------------	--------	--	-------	---------	----------------------------	----

Rear, For intermediary shaft

120 81.00 x 86.40

KT		4 Cyl.	1781cc	82kW (112PS)	Petrol			TD4124		
BE/PL	4	47,758/47,778	50,600/50,619	19,000	1,406	0,020/0,074	EC	71-3566	71-3566/4 STD 0.25	
BE/PL	4	47,758/47,778	50,600/50,612	19,000	1,406	0,020/0,067	EC	71-3694	71-3694/4 STD 0.25 0.50	
BE/PL	1	47,758/47,778	50,600/50,612	19,000	1,395	0,032/0,089	SP	71-3732	71-3732 STD	1

71-3566

71-3694

71-3732

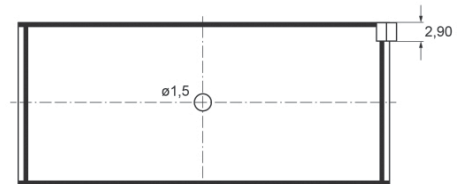
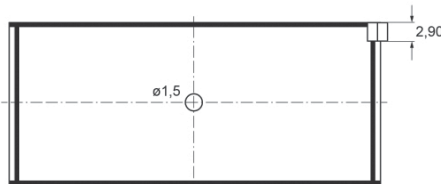

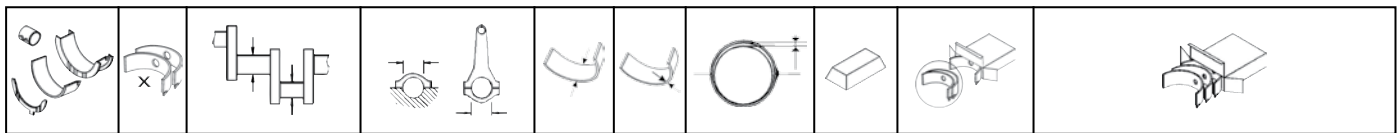

MB/HL	3	53,958/53,978	59,000/59,019	18,500	2,502	0,020/0,082	AL-LF	02-3085L	H025/5 STD 0.25 0.50
MB/HL	5	53,958/53,978	59,000/59,019	18,500	2,502	0,020/0,082	AL-LF	02-3085U	
MB/HL	1	53,958/53,978	59,000/59,019	24,930	2,502	0,020/0,082	AL-LF	02-3086HL	
MB/HL	1	53,958/53,978	59,000/59,019	24,930	2,502	0,020/0,082	AL-LF	02-3086HU	

	02-3086HL	STD	25,000/.9843" - 25,040/.9858"
		0.25mm	25,100/.9882" - 25,140/.9898"
		0.50mm	25,100/.9882" - 25,140/.9898"
		0.75mm	25,100/.9882" - 25,140/.9898"
	02-3086HU	STD	25,000/.9843" - 25,040/.9858"
		0.25mm	25,100/.9882" - 25,140/.9898"
		0.50mm	25,100/.9882" - 25,140/.9898"
		0.75mm	25,100/.9882" - 25,140/.9898"

MB/HL	4	53,958/53,978	59,000/59,019	18,500	2,502	0,020/0,082	AL-LF	02-3085L	H027/5 STD 0.25 0.50
MB/HL	6	53,958/53,978	59,000/59,019	18,500	2,502	0,020/0,082	AL-LF	02-3085U	

02-3085L

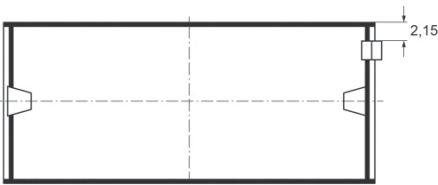

02-3085U

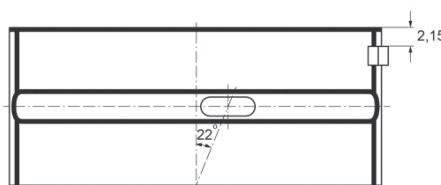

02-3086HL

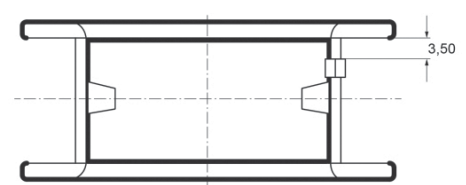

02-3086HU

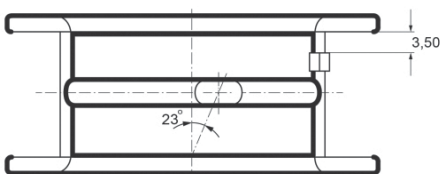

TW/A	2	59,500	73,200		1,975		AL-LF	04-3527	A123/4 STD
TW/A	2	59,500	73,200		1,975		AL-LF	04-3528	
SE/PB	1	20,000	23,000/23,052	25,000			BC	55-3567	55-3567 SEMI
BU	1	42,959/42,975	46,055/46,095	15,000			AL-LF	07-3088	07-3088 STD SEMI

Front, For intermediary shaft

BU	1	41,959/41,975	45,000/45,025	15,000			AL-LF	07-3089	07-3089 STD SEMI
----	---	---------------	---------------	--------	--	--	-------	---------	----------------------------

Rear, For intermediary shaft

121 81.00 x 86.40

PB			4 Cyl.	1781cc	82kW (112PS)		Petrol		TD9367
BE/PL	4	47,758/47,778	50,600/50,619	19,000	1,406	0,020/0,074	EC	71-3566	71-3566/4 STD 0.25
→12/85									
BE/PL	4	47,758/47,778	50,600/50,612	19,000	1,406	0,020/0,067	EC	71-3694	71-3694/4 STD 0.25 0.50
01/86→									



71-3566

71-3694

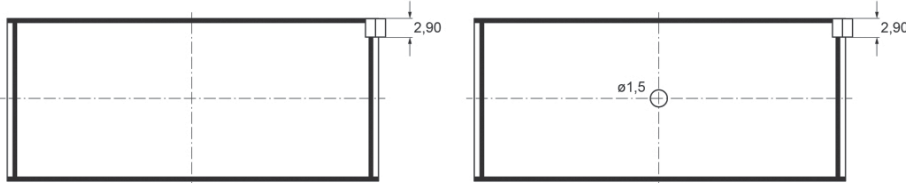

MB/HL	4	53,958/53,978	59,000/59,019	18,500	2,502	0,020/0,082	AL-LF	02-3085L	H027/5 STD 0.25 0.50
MB/HL	6	53,958/53,978	59,000/59,019	18,500	2,502	0,020/0,082	AL-LF	02-3085U	
TW/A	2	59,500	73,200		1,975		AL-LF	04-3527	A123/4 STD
TW/A	2	59,500	73,200		1,975		AL-LF	04-3528	
SE/PB	1	20,000	23,000/23,052	25,000			BC	55-3567	55-3567 SEMI
SE/PB	1	20,000	23,000/23,021	25,000			BC	55-3698	55-3698 SEMI

55-3567

55-3698

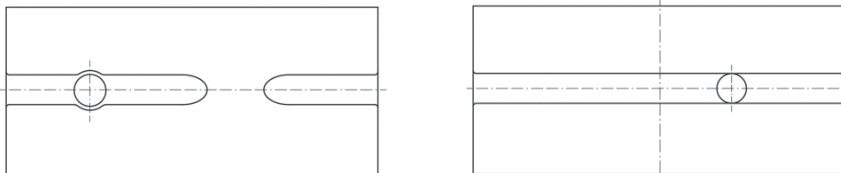

CB/NWB 1-5	5	25,939/25,960	28,250/28,271	17,000	1,138		AL-LF	03-3317	N118/5 STD	12
BU	1	42,959/42,975	46,055/46,095	15,000			AL-LF	07-3088	07-3088 STD SEMI	13

Front, For intermediary shaft

BU	1	41,959/41,975	45,000/45,025	15,000			AL-LF	07-3089	07-3089 STD SEMI	13
----	---	---------------	---------------	--------	--	--	-------	---------	----------------------------	----

Rear, For intermediary shaft

122 81.00 x 86.40

PF	4 Cyl.	1781cc	75-79kW (102-107PS)	Petrol	TD4139				
BE/PL	4	47,758/47,778	50,600/50,612	19,000	1,406	0,020/0,067	EC	71-3694	71-3694/4 STD 0.25 0.50
MB/HL	4	53,958/53,978	59,000/59,019	18,500	2,502	0,020/0,082	AL-LF	02-3085L	H027/5 STD 0.25 0.50
MB/HL	6	53,958/53,978	59,000/59,019	18,500	2,502	0,020/0,082	AL-LF	02-3085U	
TW/A	2	59,500	73,200		1,975		AL-LF	04-3527	A123/4 STD
TW/A	2	59,500	73,200		1,975		AL-LF	04-3528	
SE/PB	1	20,000	23,000/23,052	25,000			BC	55-3567	55-3567 SEMI
SE/PB	1	20,000	23,000/23,021	25,000			BC	55-3698	55-3698 SEMI

55-3567

55-3698

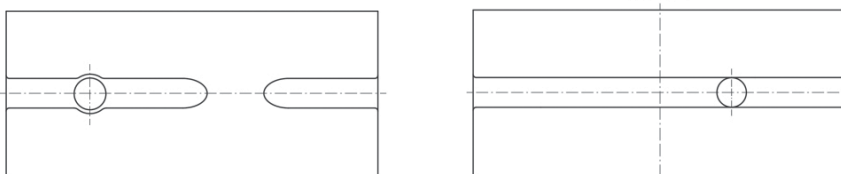

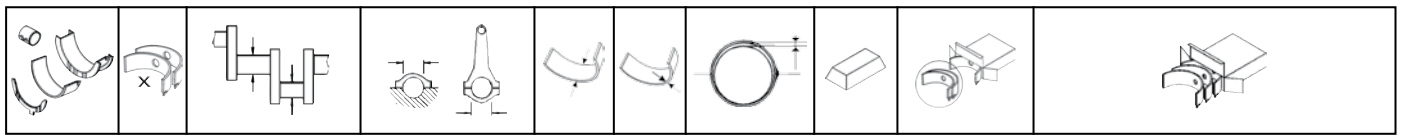

BU	1	42,959/42,975	46,055/46,095	15,000			AL-LF	07-3088	07-3088 STD SEMI	13
----	---	---------------	---------------	--------	--	--	-------	---------	----------------------------	----

Front, For intermediary shaft

BU	1	41,959/41,975	45,000/45,025	15,000			AL-LF	07-3089	07-3089 STD SEMI	13
----	---	---------------	---------------	--------	--	--	-------	---------	----------------------------	----

Rear, For intermediary shaft

123 81.00 x 86.40

PG			4 Cyl.	1781cc	110-118kW (150-160PS)			Petrol		TD4140
-----------	--	--	--------	---------------	------------------------------	--	--	---------------	--	---------------

BE/PL	1	47,758/47,778	50,600/50,612	19,000	1,395	0,032/0,089	SP	71-3732	71-3732 STD	1
-------	---	---------------	---------------	--------	-------	-------------	----	---------	-----------------------	---

71-3732

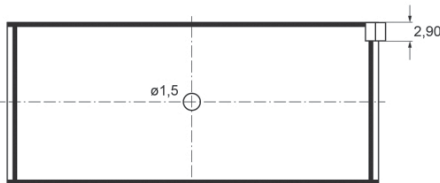

MB/HL	4	53,958/53,978	59,000/59,019	18,500	2,502	0,020/0,082	AL-LF	02-3085L	H027/5 STD 0.25 0.50
-------	---	---------------	---------------	--------	-------	-------------	-------	----------	--------------------------------

MB/HL	6	53,958/53,978	59,000/59,019	18,500	2,502	0,020/0,082	AL-LF	02-3085U	
-------	---	---------------	---------------	--------	-------	-------------	-------	----------	--

TW/A	2	59,500	73,200		1,975		AL-LF	04-3527	A123/4 STD
------	---	--------	--------	--	-------	--	-------	---------	----------------------

TW/A	2	59,500	73,200		1,975		AL-LF	04-3528	
------	---	--------	--------	--	-------	--	-------	---------	--

BU	1	42,959/42,975	46,055/46,095	15,000			AL-LF	07-3088	07-3088 STD SEMI	13
----	---	---------------	---------------	--------	--	--	-------	---------	----------------------------	----

Front, For intermediary shaft

BU	1	41,959/41,975	45,000/45,025	15,000			AL-LF	07-3089	07-3089 STD SEMI	13
----	---	---------------	---------------	--------	--	--	-------	---------	----------------------------	----

Rear, For intermediary shaft

124 81.00 x 86.40

PL			4 Cyl.	1781cc	92-95kW (125-129PS)			Petrol		TD5021
-----------	--	--	--------	---------------	----------------------------	--	--	---------------	--	---------------

RH			4 Cyl.	1781cc	62kW (84PS)			Petrol		TD5026
-----------	--	--	--------	---------------	--------------------	--	--	---------------	--	---------------

BE/PL	4	47,758/47,778	50,600/50,612	19,000	1,406	0,020/0,067	EC	71-3694	71-3694/4 STD 0.25 0.50
-------	---	---------------	---------------	--------	-------	-------------	----	---------	-----------------------------------

MB/HL	4	53,958/53,978	59,000/59,019	18,500	2,502	0,020/0,082	AL-LF	02-3085L	H027/5 STD 0.25 0.50
-------	---	---------------	---------------	--------	-------	-------------	-------	----------	--------------------------------

MB/HL	6	53,958/53,978	59,000/59,019	18,500	2,502	0,020/0,082	AL-LF	02-3085U	
-------	---	---------------	---------------	--------	-------	-------------	-------	----------	--

TW/A	2	59,500	73,200		1,975		AL-LF	04-3527	A123/4 STD
------	---	--------	--------	--	-------	--	-------	---------	----------------------

TW/A	2	59,500	73,200		1,975		AL-LF	04-3528	
------	---	--------	--------	--	-------	--	-------	---------	--

SE/PB	1	20,000	23,000/23,052	25,000			BC	55-3567	55-3567 SEMI
-------	---	--------	---------------	--------	--	--	----	---------	------------------------

BU	1	42,959/42,975	46,055/46,095	15,000			AL-LF	07-3088	07-3088 STD SEMI	13
----	---	---------------	---------------	--------	--	--	-------	---------	----------------------------	----

Front, For intermediary shaft

BU	1	41,959/41,975	45,000/45,025	15,000			AL-LF	07-3089	07-3089 STD SEMI	13
----	---	---------------	---------------	--------	--	--	-------	---------	----------------------------	----

Rear, For intermediary shaft

VOLKSWAGEN

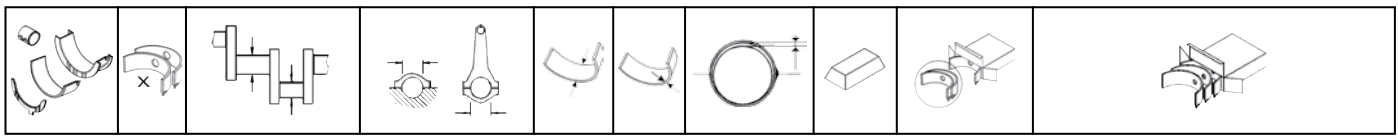

125 **81.00 x 86.40**

RV 4 Cyl. **1781cc** **75-77kW (102-105PS)** **Petrol** **TD4151**

BE/PL	4	47,758/47,778	50,600/50,619	19,000	1,406	0,020/0,074	EC	71-3566	71-3566/4 STD 0.25
-------	---	---------------	---------------	--------	-------	-------------	----	---------	------------------------------

→12/85

BE/PL	4	47,758/47,778	50,600/50,612	19,000	1,406	0,020/0,067	EC	71-3694	71-3694/4 STD 0.25 0.50
-------	---	---------------	---------------	--------	-------	-------------	----	---------	-----------------------------------

01/86→

BE/PL	4	47,758/47,778	50,600/50,612	19,000	1,406	0,020/0,067	EC	71-3929	71-3929/4 STD
-------	---	---------------	---------------	--------	-------	-------------	----	---------	-------------------------

11

71-3566

71-3694

71-3929

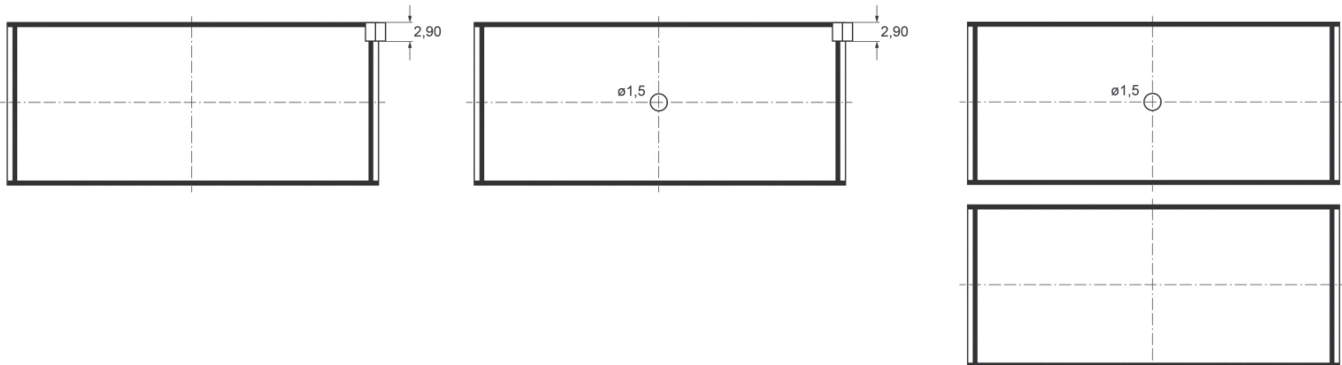

MB/HL	4	53,958/53,978	59,000/59,019	18,500	2,502	0,020/0,082	AL-LF	02-3085L	H027/5 STD 0.25 0.50
MB/HL	6	53,958/53,978	59,000/59,019	18,500	2,502	0,020/0,082	AL-LF	02-3085U	
TW/A	2	59,500	73,200		1,975		AL-LF	04-3527	A123/4 STD
TW/A	2	59,500	73,200		1,975		AL-LF	04-3528	
SE/PB	1	20,000	23,000/23,052	25,000			BC	55-3567	55-3567 SEMI
SE/PB	1	20,000	23,000/23,021	25,000			BC	55-3698	55-3698 SEMI

55-3567

55-3698

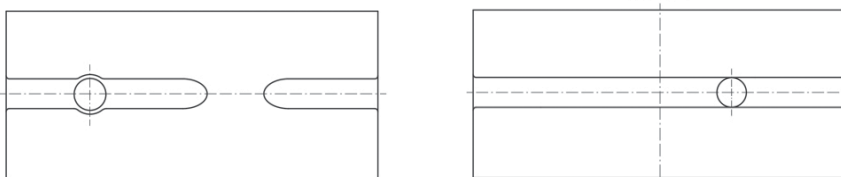

BU	1	42,959/42,975	46,055/46,095	15,000			AL-LF	07-3088	07-3088 STD SEMI
----	---	---------------	---------------	--------	--	--	-------	---------	----------------------------

13

Front, For intermediary shaft

BU	1	41,959/41,975	45,000/45,025	15,000			AL-LF	07-3089	07-3089 STD SEMI
----	---	---------------	---------------	--------	--	--	-------	---------	----------------------------

13

Rear, For intermediary shaft

126 **81.00 x 86.40**

HY 5 Cyl. **2226cc** **100kW (136PS)** **Petrol** **TD21344**

BE/PL	5	47,758/47,778	50,600/50,612	19,000	1,406	0,020/0,067	EC	71-3694	71-3694/5 STD 0.25
-------	---	---------------	---------------	--------	-------	-------------	----	---------	------------------------------

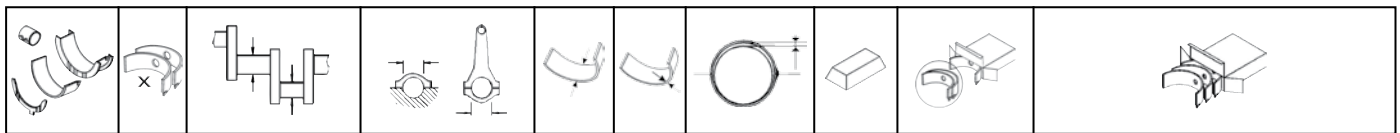

MB/HL 1,2, 4-6	5	57,958/57,978	63,000/63,019	18,500	2,502	0,020/0,082	EC	72-3400	H941/6 STD 0.25
MB/HL 3	1	57,958/57,978	63,000/63,019	24,930	2,502	0,020/0,082	EC	72-3401H	

	72-3401H	STD	25,000/.9843" - 25,040/.9858"
		0.25mm	25,100/.9882" - 25,140/.9898"
		0.50mm	25,100/.9882" - 25,140/.9898"
		0.75mm	25,100/.9882" - 25,140/.9898"

MB/HL 1-6	6	57,958/57,978	63,000/63,019	18,500	2,502	0,020/0,082	EC	72-3400	H981/6 STD 0.25
TW/A	2	63,500/63,750	77,200/77,450		1,975		AL-LF	04-3529	A124/4 STD
TW/A	2	63,500/63,750	77,200/77,450		1,975		AL-LF	04-3530	
TW/A	2	63,500/63,750	76,950/77,200		1,975		AL-LF	04-4782	A292/4 STD
TW/A	2	63,500/63,750	76,950/77,200		1,975		AL-LF	04-4783	

04-3529

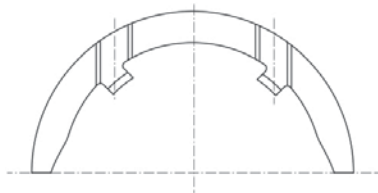

04-3530

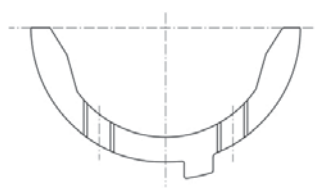

04-4782

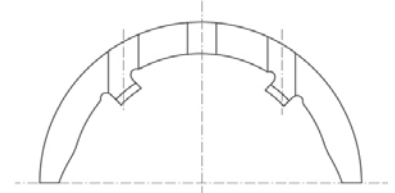

04-4783

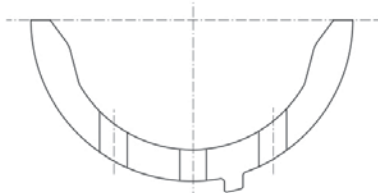

SE/PB	1	20,000	23,000/23,052	25,000			BC	55-3567	55-3567 SEMI
-------	---	--------	---------------	--------	--	--	----	---------	------------------------

127

81.00 x 86.40

JT	5 Cyl.	2226cc	82-88kW (112-120PS)	Petrol	TD5016
KV	5 Cyl.	2226cc	100kW (136PS)	Petrol	TD4125
KX	5 Cyl.	2226cc	82-85kW (112-116PS)	Petrol	TD5020

BE/PL	5	47,758/47,778	50,600/50,619	19,000	1,406	0,020/0,074	EC	71-3566	71-3566/5 STD
-------	---	---------------	---------------	--------	-------	-------------	----	---------	-------------------------

→12/85

BE/PL	5	47,758/47,778	50,600/50,612	19,000	1,406	0,020/0,067	EC	71-3694	71-3694/5 STD 0.25
-------	---	---------------	---------------	--------	-------	-------------	----	---------	------------------------------

01/86→

71-3566



71-3694

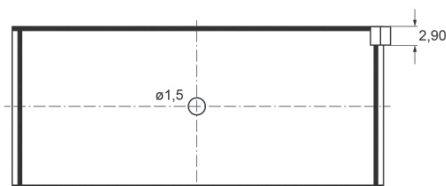

VOLKSWAGEN



MB/HL 1,2, 4-6	5	57,958/57,978	63,000/63,019	18,500	2,502	0,020/0,082	EC	72-3400	H941/6 STD 0.25
MB/HL 3	1	57,958/57,978	63,000/63,019	24,930	2,502	0,020/0,082	EC	72-3401H	

	72-3401H	STD	25,000/.9843" - 25,040/.9858"
		0.25mm	25,100/.9882" - 25,140/.9898"
		0.50mm	25,100/.9882" - 25,140/.9898"
		0.75mm	25,100/.9882" - 25,140/.9898"

MB/HL 1-6	6	57,958/57,978	63,000/63,019	18,500	2,502	0,020/0,082	EC	72-3400	H981/6 STD 0.25
TW/A	2	63,500/63,750	77,200/77,450		1,975		AL-LF	04-3529	A124/4 STD
TW/A	2	63,500/63,750	77,200/77,450		1,975		AL-LF	04-3530	
TW/A	2	63,500/63,750	76,950/77,200		1,975		AL-LF	04-4782	A292/4 STD
TW/A	2	63,500/63,750	76,950/77,200		1,975		AL-LF	04-4783	

04-3529

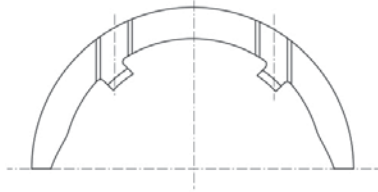

04-3530

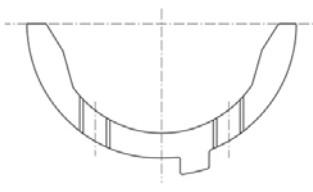

04-4782

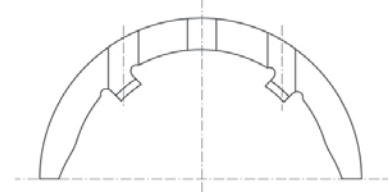

04-4783

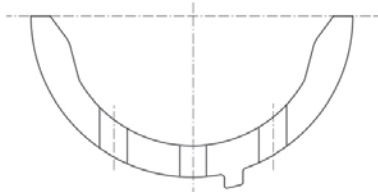

SE/PB	1	20,000	23,000/23,052	25,000			BC	55-3567	55-3567 SEMI
SE/PB	1	20,000	23,000/23,021	25,000			BC	55-3698	55-3698 SEMI

128

81.00 x 90.30

AAA 6 Cyl. **2792cc** **120-128kW** (163-174PS) **Petrol** **TD3999**

BE/PL	6	53,958/53,978	56,800/56,819	17,000	1,406	0,020/0,074	AL-LF	01-3841	01-3841/6 STD 0.25
MB/HL 1-7	7	59,958/59,978	65,000/65,010	17,000	2,501	0,020/0,075	AL-LF	02-3716	H035/7 STD 0.25

04/93 →

TW/A	2	65,450	80,000		1,723		AL-LF	04-3717	A139/4 STD
TW/A	2	65,450	80,000		1,723		AL-LF	04-3718	
BU	1	42,959/42,975	46,055/46,095	15,000			AL-LF	07-3088	07-3088 STD SEMI 13

Front, For intermediary shaft

BU	1	14,473/14,484	17,500/17,518	20,000			BB	17-3720	17-3720 SEMI 13
----	---	---------------	---------------	--------	--	--	----	---------	--

Rear, For intermediary shaft



129 81.00 x 90.30

AES	6 Cyl.	2792cc	103kW (140PS)	Petrol	TD9346
AMV	6 Cyl.	2792cc	150kW (204PS)	Petrol	TD15128
AMY	6 Cyl.	2792cc	128kW (174PS)	Petrol	TD17199
AQP	6 Cyl.	2792cc	150kW (204PS)	Petrol	TD12849
AUE	6 Cyl.	2792cc	150kW (204PS)	Petrol	TD15482
AYL	V6 Cyl.	2792cc	150kW (204PS)	Petrol	TD14916
BDE	V6 Cyl.	2792cc	150kW (204PS)	Petrol	TD16390

BE/PL	6	53,958/53,978	56,800/56,819	17,000	1,406	0,020/0,074	AL-LF	01-3841	01-3841/6 STD 0.25
MB/HL 1-7	7	59,958/59,978	65,000/65,010	17,000	2,501	0,020/0,075	AL-LF	02-3716	H035/7 STD 0.25
TW/A	2	65,450	80,000		1,723		AL-LF	04-3717	A139/4 STD
TW/A	2	65,450	80,000		1,723		AL-LF	04-3718	
BU	1	42,959/42,975	46,055/46,095	15,000			AL-LF	07-3088	07-3088 STD SEMI

Front, For intermediary shaft

BU	1	14,473/14,484	17,500/17,518	20,000			BB	17-3720	17-3720 SEMI
----	---	---------------	---------------	--------	--	--	----	---------	------------------------

Rear, For intermediary shaft

130 81.00 x 95.50

AAC	4 Cyl.	1968cc	62kW (84PS)	Petrol	TD4001				
BE/PL	4	47,758/47,778	50,600/50,612	19,000	1,406	0,020/0,067	EC	71-3694	71-3694/4 STD 0.25 0.50
MB/HL	4	53,958/53,978	59,000/59,019	18,500	2,502	0,020/0,082	AL-LF	02-3085L	H027/5 STD 0.25 0.50
MB/HL	6	53,958/53,978	59,000/59,019	18,500	2,502	0,020/0,082	AL-LF	02-3085U	
TW/A	2	59,500	73,200		1,975		AL-LF	04-3527	A123/4 STD
TW/A	2	59,500	73,200		1,975		AL-LF	04-3528	
SE/PB	1	24,000	27,000/27,021	25,000			BC	55-3696	55-3696

131 81.00 x 95.50

AZV	4 Cyl.	1968cc	100kW (136PS)	Diesel Turbo Intercooler	TD16862
BKD	4 Cyl.	1968cc	103kW (140PS)	Diesel Turbo Intercooler	TD17080
BKP	4 Cyl.	1968cc	103kW (140PS)	Diesel Turbo Intercooler	TD18135
BMA	4 Cyl.	1968cc	100kW (136PS)	Diesel Turbo Intercooler	TD18225
BMM	4 Cyl.	1968cc	103kW (140PS)	Diesel Turbo Intercooler	TD18482
BMN	4 Cyl.	1968cc	125kW (170PS)	Diesel Turbo Intercooler	TD18471
BMP	4 Cyl.	1968cc	103kW (140PS)	Diesel Turbo Intercooler	TD18136
BMR	4 Cyl.	1968cc	125kW (170PS)	Diesel Turbo Intercooler	TD18188
BRT	4 Cyl.	1968cc	103kW (140PS)	Diesel Turbo Intercooler	TD19105
BUZ	4 Cyl.	1968cc	120kW (163PS)	Diesel Turbo Intercooler	TD20499
BVD	4 Cyl.	1968cc	90kW (122PS)	Diesel Turbo Intercooler	TD18542
BVE	4 Cyl.	1968cc	90kW (122PS)	Diesel Turbo Intercooler	TD18543
BVH	4 Cyl.	1968cc	100kW (136PS)	Diesel Turbo Intercooler	TD20520
BWV	4 Cyl.	1968cc	88kW (120PS)	Diesel Turbo Intercooler	TD20498
CBAA	4 Cyl.	1968cc	100kW (136PS)	Diesel Turbo Intercooler	TD20798
CBAB	4 Cyl.	1968cc	103kW (140PS)	Diesel Turbo Intercooler	TD20799

VOLKSWAGEN



CBAC	4 Cyl.	1968cc	105kW (143PS)	Diesel Turbo Intercooler	TD20800
CBBA	4 Cyl.	1968cc	120kW (163PS)	Diesel Turbo Intercooler	TD21661
CBDA	4 Cyl.	1968cc	100kW (136PS)	Diesel Turbo Intercooler	TD22715
CBDC	4 Cyl.	1968cc	81kW (110PS)	Diesel Turbo Intercooler	TD21109
CBEA	4 Cyl.	1968cc	103kW (140PS)	Diesel Turbo Intercooler	TD22176
CBHA	4 Cyl.	1968cc	47kW (64PS)	Diesel Turbo	TD22527
CBJB	4 Cyl.	1968cc	55kW (75PS)	Diesel Turbo	TD22525
CBKA	4 Cyl.	1968cc	74kW (101PS)	Diesel Turbo	TD22528

BE/PL	1	50,858/50,878	53,700/53,712	20,400	1,403	0,020/0,073	SP	71-3930	71-3930 STD 0.25 0.50	ⓘ
MB/HL 1-5	5	53,958/53,978	59,000/59,012	18,500	2,501	0,020/0,076	EC	72-3931	H079/5 STD 0.25 0.50	
TW/A	2	59,500	73,200		1,975		AL-LF	04-3527	A123/4 STD	
TW/A	2	59,500	73,200		1,975		AL-LF	04-3528		

132 81.00 x 95.50

BDJ	4 Cyl.	1968cc	51kW (70PS)	Diesel	TD17358
BDK	4 Cyl.	1968cc	55kW (75PS)	Diesel Turbo Intercooler	TD17359
BST	4 Cyl.	1968cc	51kW (70PS)	Diesel	TD20501

BE/PL	1	47,758/47,778	50,600/50,612	20,000	1,406	0,020/0,067	SP	71-3904	71-3904 STD 0.25 0.50	ⓘ
MB/HL 1-5	5	53,958/53,978	59,000/59,012	18,500	2,501	0,020/0,076	EC	72-3931	H079/5 STD 0.25 0.50	
TW/A	2	59,500	73,200		1,975		AL-LF	04-3527	A123/4 STD	
TW/A	2	59,500	73,200		1,975		AL-LF	04-3528		

133 81.00 x 95.50

BGW	4 Cyl.	1968cc	100kW (136PS)	Diesel Turbo Intercooler	TD18539
BHW	4 Cyl.	1968cc	100kW (136PS)	Diesel	TD22177

BE/PL	1	50,858/50,878	53,700/53,712	20,400	1,403	0,020/0,073	SP	71-3930	71-3930 STD 0.25 0.50	ⓘ
MB/HL 1-5	5	53,958/53,978	59,000/59,012	18,500	2,501	0,020/0,076	EC	72-3931	H079/5 STD 0.25 0.50	
TW/A	2	59,500	73,200		1,975		AL-LF	04-3527	A123/4 STD	
TW/A	2	59,500	73,200		1,975		AL-LF	04-3528		
SE/PB	1	26,000	29,000/29,052	25,000			BC	55-3729	55-3729 SEMI	

134 81.00 x 95.50

CAAA Euro 5	4 Cyl.	1968cc	62kW (84PS)	Diesel Turbo Intercooler	TD23411
CAAB Euro 5	4 Cyl.	1968cc	75kW (102PS)	Diesel Turbo Intercooler	TD23412
CAAC Euro 5	4 Cyl.	1968cc	103kW (140PS)	Diesel Turbo Intercooler	TD23414
CAAD	4 Cyl.	1968cc	84kW (114PS)	Diesel Turbo Intercooler	TD26334
CAAE	4 Cyl.	1968cc	100kW (136PS)	Diesel Turbo	TD24473
CBBB	4 Cyl.	1968cc	125kW (170PS)	Diesel Turbo Intercooler	TD20949
CBDB	4 Cyl.	1968cc	103kW (140PS)	Diesel Turbo Intercooler	TD21070
CCHA	4 Cyl.	1968cc	103kW (140PS)	Diesel Turbo	TD24471
CCHB	4 Cyl.	1968cc	100kW (136PS)	Diesel Turbo	TD24474
CDBA	4 Cyl.	1968cc	90kW (122PS)	Diesel Turbo	TD24402
CDCA	4 Cyl.	1968cc	120kW (163PS)	Diesel Turbo	TD24403
CEGA	4 Cyl.	1968cc	125kW (170PS)	Diesel Turbo	TD24125



CFCA Euro 5	4 Cyl.	1968cc	132kW (180PS)	Diesel Bi-Turbo Intercooler	TD23421
CFFA	4 Cyl.	1968cc	100kW (136PS)	Diesel Turbo Intercooler	TD23312
CFFB	4 Cyl.	1968cc	103kW (140PS)	Diesel Turbo Intercooler	TD23178
CFFD	4 Cyl.	1968cc	81kW (110PS)	Diesel Turbo Intercooler	TD24215
CFFE	4 Cyl.	1968cc	85kW (116PS)	Diesel Turbo Intercooler	TD25739
CFGB	4 Cyl.	1968cc	125kW (170PS)	Diesel Turbo Intercooler	TD23180
CFGC	4 Cyl.	1968cc	130kW (177PS)	Diesel Turbo	TD26990
CFHB	4 Cyl.	1968cc	100kW (136PS)	Diesel Turbo Intercooler	TD24314
CFHC	4 Cyl.	1968cc	103kW (140PS)	Diesel Turbo Intercooler	TD24315
CFHE	4 Cyl.	1968cc	62kW (85PS)	Diesel Turbo Intercooler	TD25438
CFHF	4 Cyl.	1968cc	81kW (110PS)	Diesel Turbo	TD24366
CFJA	4 Cyl.	1968cc	125kW (170PS)	Diesel Turbo	TD24994
CFJB	4 Cyl.	1968cc	130kW (177PS)	Diesel Turbo	TD27973
CJAA	4 Cyl.	1968cc	103-104kW (140-141PS)	Diesel Turbo Intercooler	TD23179
CKFC	4 Cyl.	1968cc	110kW (150PS)	Diesel Turbo	TD27197
CLCA	4 Cyl.	1968cc	81kW (110PS)	Diesel Turbo Intercooler	TD24835
CLCB	4 Cyl.	1968cc	103kW (140PS)	Diesel Turbo	TD24600
CLJA	4 Cyl.	1968cc	103kW (140PS)	Diesel Turbo Intercooler	TD24963
CLLA	4 Cyl.	1968cc	125kW (170PS)	Diesel Turbo Intercooler	TD24441
CNEA	4 Cyl.	1968cc	132kW (180PS)	Diesel Turbo	TD26330
CNFA	4 Cyl.	1968cc	90kW (122PS)	Diesel Turbo	TD26995
CNFB	4 Cyl.	1968cc	103kW (140PS)	Diesel Turbo	TD26996
CRBB	4 Cyl.	1968cc	105kW (143PS)	Diesel Turbo	TD27964
CRLB	4 Cyl.	1968cc	110kW (150PS)	Diesel Turbo Intercooler	TD27196
CRMB	4 Cyl.	1968cc	110kW (150PS)	Diesel Turbo	TD27198
CRUA	4 Cyl.	1968cc	110kW (150PS)	Diesel Turbo Intercooler	TD31407
CRVA	4 Cyl.	1968cc	81kW (110PS)	Diesel Turbo Intercooler	TD27965
CRVC	4 Cyl.	1968cc	105kW (143PS)	Diesel Turbo Intercooler	TD29264
CSHA	4 Cyl.	1968cc	132kW (180PS)	Diesel Turbo	TD26331
CSLB	4 Cyl.	1968cc	84kW (114PS)	Diesel Turbo Intercooler	TD28424
CSNA	4 Cyl.	1968cc	120kW (163PS)	Diesel Bi-Turbo Intercooler	TD30982
CUNA	4 Cyl.	1968cc	135kW (184PS)	Diesel Turbo	TD27978
CUUA	4 Cyl.	1968cc	81kW (110PS)	Diesel Turbo	TD30261
CUUD	4 Cyl.	1968cc	75kW (102PS)	Diesel Turbo	TD31239
CUUE	4 Cyl.	1968cc	90kW (122PS)	Diesel Turbo	TD31241
CUUF	4 Cyl.	1968cc	55kW (75PS)	Diesel Turbo	TD31240
CUVA	4 Cyl.	1968cc	85kW (116PS)	Diesel Turbo Intercooler	TD31371
CUVC	4 Cyl.	1968cc	110kW (150PS)	Diesel Turbo	TD30995
CUWA	4 Cyl.	1968cc	135kW (184PS)	Diesel Turbo	TD30937
CVCA	4 Cyl.	1968cc	110kW (150PS)	Diesel Turbo	TD30260
CXEB	4 Cyl.	1968cc	150kW (204PS)	Diesel Turbo Intercooler	TD31317
CXFA	4 Cyl.	1968cc	110kW (150PS)	Diesel Turbo Intercooler	TD31318
CXGA	4 Cyl.	1968cc	62kW (84PS)	Diesel Turbo Intercooler	TD31319
CXGB	4 Cyl.	1968cc	75kW (102PS)	Diesel Turbo Intercooler	TD31328
CXHA	4 Cyl.	1968cc	110kW (150PS)	Diesel Turbo Intercooler	TD31329
DDAA	4 Cyl.	1968cc	140kW (190PS)	Diesel Turbo	TD29842
DELA	4 Cyl.	1968cc	110kW (150PS)	Diesel Turbo	TD31807
DFCA	4 Cyl.	1968cc	140kW (190PS)	Diesel Turbo	TD31778
DFEA	4 Cyl.	1968cc	110kW (150PS)	Diesel Turbo Intercooler	TD31777

BE/PL	1	50,858/50,878	53,700/53,712	20,400	1,403	0,020/0,073	SP	71-3930	71-3930 STD 0.25 0.50	1
MB/HL 1-5	5	53,958/53,978	59,000/59,012	18,500	2,501	0,020/0,076	EC	72-3931	H079/5 STD 0.25 0.50	

VOLKSWAGEN

MB/HL 2-5	4	53,958/53,978	59,000/59,019	18,500	2,502	0,020/0,082	AL-LF	02-3085L	H1328/5 STD	
MB/HL 2-5	4	53,958/53,978	59,000/59,019	18,500	2,502	0,020/0,082	AL-LF	02-3085U		
MB/HL 1	1	53,958/53,978	59,000/59,012	18,500	2,506	0,020/0,062		02-4941L		
MB/HL 1	1	53,958/53,978	59,000/59,012	18,500	2,506	0,020/0,062		02-4941U		

12/11 →

02-3085L

02-3085U

02-4941L

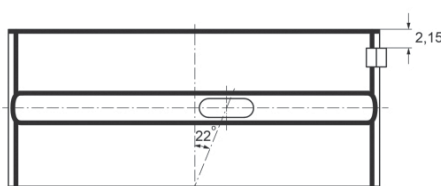
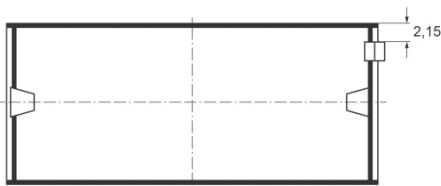

02-4941U

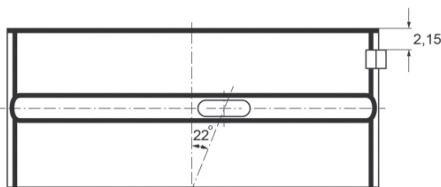

TW/A	2	59,500	73,200		1,975		AL-LF	04-3527	A123/4 STD
TW/A	2	59,500	73,200		1,975		AL-LF	04-3528	

135

81.00 x 95.50

CKTB	4 Cyl.	1968cc	80kW (109PS)	Diesel Turbo Intercooler	TD25415
CKTC	4 Cyl.	1968cc	100kW (136PS)	Diesel Turbo Intercooler	TD25416
CKUB	4 Cyl.	1968cc	120kW (163PS)	Diesel Bi-Turbo Intercooler	TD25417
CKUC	4 Cyl.	1968cc	105kW (142PS)	Diesel Turbo Intercooler	TD25418

MB/HL 1-5	5	53,958/53,978	59,000/59,012	18,500	2,501	0,020/0,076	EC	72-3931	H079/5 STD 0.25 0.50	
MB/HL 2-5	4	53,958/53,978	59,000/59,019	18,500	2,502	0,020/0,082	AL-LF	02-3085L		
MB/HL 2-5	4	53,958/53,978	59,000/59,019	18,500	2,502	0,020/0,082	AL-LF	02-3085U		
MB/HL 1	1	53,958/53,978	59,000/59,012	18,500	2,506	0,020/0,062		02-4941L		
MB/HL 1	1	53,958/53,978	59,000/59,012	18,500	2,506	0,020/0,062		02-4941U		

12/11 →

02-3085L

02-3085U

02-4941L

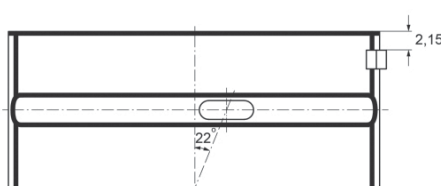

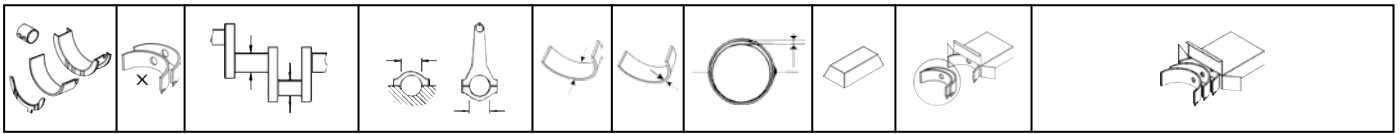

02-4941U

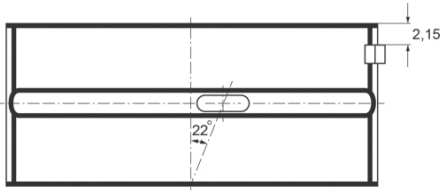

TW/A	2	59,500	73,200		1,975		AL-LF	04-3527	A123/4 STD
TW/A	2	59,500	73,200		1,975		AL-LF	04-3528	

136

81.00 x 95.50

AAF		5 Cyl.	2461cc	80-81kW (108-110PS)	Petrol	TD4002
ACU		5 Cyl.	2461cc	80-81kW (108-110PS)	Petrol	TD4015
AEN		5 Cyl.	2461cc	81kW (110PS)	Petrol	TD9347
AET		5 Cyl.	2461cc	81-85kW (110-115PS)	Petrol	TD4983
AEU		5 Cyl.	2461cc	81kW (110PS)	Petrol	TD9344
APL		5 Cyl.	2461cc	85kW (115PS)	Petrol	TD15288
AVT		5 Cyl.	2461cc	85kW (115PS)	Petrol	TD15370

BE/PL	1	45,950/45,970	49,000/49,016	19,000	1,506	0,020/0,078	EC	71-3084	71-3084 STD 0.25
BE/PL	5	47,758/47,778	50,600/50,612	19,000	1,406	0,020/0,067	EC	71-3694	71-3694/5 STD 0.25

71-3084

71-3694

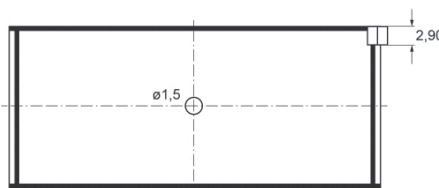

MB/HL 1,2, 4-6	5	57,958/57,978	63,000/63,019	18,500	2,502	0,020/0,082	EC	72-3400	H941/6 STD 0.25
MB/HL 3	1	57,958/57,978	63,000/63,019	24,930	2,502	0,020/0,082	EC	72-3401H	



72-3401H	STD	25,000/.9843" - 25,040/.9858"
	0.25mm	25,100/.9882" - 25,140/.9898"
	0.50mm	25,100/.9882" - 25,140/.9898"
	0.75mm	25,100/.9882" - 25,140/.9898"

MB/HL 1-6	6	57,958/57,978	63,000/63,019	18,500	2,502	0,020/0,082	EC	72-3400	H981/6 STD 0.25
TW/A	2	63,500/63,750	77,200/77,450		1,975		AL-LF	04-3529	A124/4 STD
TW/A	2	63,500/63,750	77,200/77,450		1,975		AL-LF	04-3530	
TW/A	2	63,500/63,750	76,950/77,200		1,975		AL-LF	04-4782	A292/4 STD
TW/A	2	63,500/63,750	76,950/77,200		1,975		AL-LF	04-4783	

04-3529

04-3530

04-4782

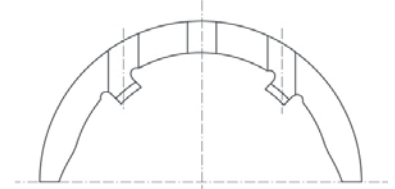
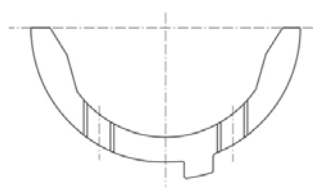
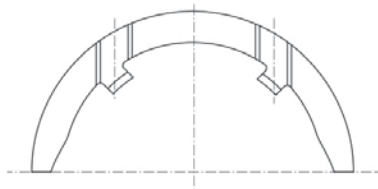

VOLKSWAGEN



04-4783

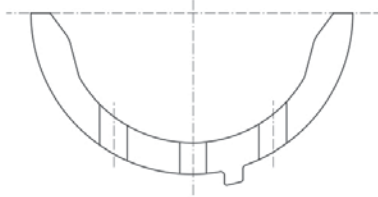

SE/PB	1	20,000	23,000/23,052	25,000			BC	55-3567	55-3567 SEMI
SE/PB	1	20,000	23,000/23,021	25,000			BC	55-3698	55-3698 SEMI

137

81.00 x 95.50

ACV			5 Cyl.	2461cc	75kW (102PS)		Diesel Turbo Intercooler	TD4978
AGX			5 Cyl.	2461cc	55kW (75PS)		Diesel Turbo Intercooler	TD9295
AHD			5 Cyl.	2461cc	75kW (102PS)		Diesel Turbo Intercooler	TD9294
AHY			5 Cyl.	2461cc	111kW (151PS)		Diesel Turbo Intercooler	TD10748
AJT			5 Cyl.	2461cc	65kW (88PS)		Diesel Turbo	TD10747
ANF			5 Cyl.	2461cc	55kW (75PS)		Diesel	TD20502
ANG			5 Cyl.	2461cc	88kW (120PS)		Diesel Turbo	TD20503
ANH			5 Cyl.	2461cc	111kW (151PS)		Diesel Turbo	TD20504
ANJ			5 Cyl.	2461cc	80kW (109PS)		Diesel Turbo	TD13446
APA			5 Cyl.	2461cc	66kW (90PS)		Diesel Turbo Intercooler	TD13445
AUF			5 Cyl.	2461cc	75kW (102PS)		Diesel Turbo	TD16857
AVR			5 Cyl.	2461cc	80kW (109PS)		Diesel Turbo Intercooler	TD15497
AXG			5 Cyl.	2461cc	111kW (151PS)		Diesel Turbo	TD17505
AXL			5 Cyl.	2461cc	75kW (102PS)		Diesel Turbo Intercooler	TD18687
AYC			5 Cyl.	2461cc	75kW (102PS)		Diesel Turbo	TD17504
AYY			5 Cyl.	2461cc	65kW (88PS)		Diesel Turbo	TD17503
BBE			5 Cyl.	2461cc	61kW (83PS)		Diesel	TD16451
BBF			5 Cyl.	2461cc	70kW (95PS)		Diesel	TD16452
BBR			5 Cyl.	2461cc	80kW (109PS)		Diesel Turbo Intercooler	TD22627
BCT			5 Cyl.	2461cc	40kW (54PS)		Diesel	TD22630
BCU			5 Cyl.	2461cc	74kW (101PS)		Diesel Turbo	TD22631
BCV			5 Cyl.	2461cc	108kW (147PS)		Diesel Turbo Intercooler	TD22632

BE/PL	5	47,758/47,778	50,600/50,612	20,000	1,406	0,020/0,067	SP	71-3847	71-3847/5 STD	1
MB/HL 1,2, 4-6	5	57,958/57,978	63,000/63,019	18,500	2,502	0,020/0,082	EC	72-3400	H941/6 STD 0.25	
MB/HL 3	1	57,958/57,978	63,000/63,019	24,930	2,502	0,020/0,082	EC	72-3401H		



72-3401H

STD	25,000/.9843" - 25,040/.9858"
0.25mm	25,100/.9882" - 25,140/.9898"
0.50mm	25,100/.9882" - 25,140/.9898"
0.75mm	25,100/.9882" - 25,140/.9898"

MB/HL 1-6	6	57,958/57,978	63,000/63,019	18,500	2,502	0,020/0,082	EC	72-3400	H981/6 STD 0.25
TW/A	2	63,500/63,750	77,200/77,450		1,975		AL-LF	04-3529	A124/4 STD
TW/A	2	63,500/63,750	77,200/77,450		1,975		AL-LF	04-3530	
TW/A	2	63,500/63,750	76,950/77,200		1,975		AL-LF	04-4782	A292/4 STD
TW/A	2	63,500/63,750	76,950/77,200		1,975		AL-LF	04-4783	



04-3529

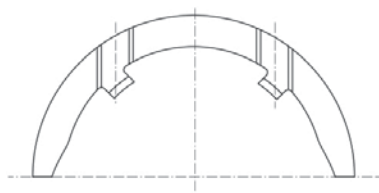

04-3530

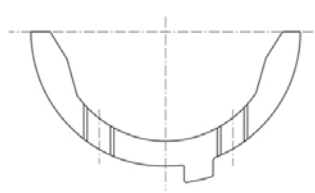

04-4782

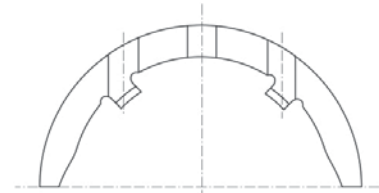

04-4783

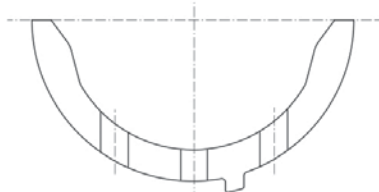

SE/PB	1	26,000	29,000/29,052	25,000			BC	55-3729	55-3729 SEMI
-------	---	--------	---------------	--------	--	--	----	---------	-----------------

138		81.00 x 95.50							
AXD			5 Cyl.	2461cc	96kW (130PS)		Diesel Turbo Intercooler	TD16868	
AXE			5 Cyl.	2461cc	128kW (174PS)		Diesel Turbo Intercooler	TD16869	
BAC			5 Cyl.	2461cc	128kW (174PS)		Diesel Turbo Intercooler	TD16855	
BLJ			5 Cyl.	2461cc	120kW (163PS)		Diesel Turbo Intercooler	TD20505	
BLK			5 Cyl.	2461cc	120kW (163PS)		Diesel Turbo Intercooler	TD20506	
BNZ			5 Cyl.	2461cc	96kW (130PS)		Diesel Turbo Intercooler	TD20398	
BPC			5 Cyl.	2461cc	128kW (174PS)		Diesel Turbo Intercooler	TD20397	
BPD			5 Cyl.	2461cc	120kW (163PS)		Diesel Turbo Intercooler	TD20507	
BPE			5 Cyl.	2461cc	128kW (174PS)		Diesel Turbo Intercooler	TD20508	
BE/PL	1	50,858/50,878	53,700/53,712	20,400	1,403	0,020/0,073	SP 71-3930	71-3930 STD 0.25 0.50	①
MB/HL 1-6	6	57,963/57,978	64,000/64,010	18,500	3,003		AL-LF 02-4781	H1294/6 STD 0.25 0.50	
CB/NWB	1	28,947/28,960	32,000/32,025	18,000	1,513	0,020/0,078	EC-LF 73-4828	73-4828 STD	
CB/NWB 1-5	5	28,947/28,960	32,000/32,025	25,000	1,513	0,020/0,068	EC 73-3903	N147/5 STD	

139		81.00 x 95.50							
BJJ			5 Cyl.	2461cc	65kW (88PS)		Diesel Turbo Intercooler	TD18891	
BJK			5 Cyl.	2461cc	80kW (109PS)		Diesel Turbo Intercooler	TD18892	
BJL			5 Cyl.	2461cc	100kW (136PS)		Diesel Turbo Intercooler	TD18893	
BJM			5 Cyl.	2461cc	120kW (163PS)		Diesel Turbo Intercooler	TD18894	
CEBA			5 Cyl.	2461cc	65kW (88PS)		Diesel Turbo Intercooler	TD24719	
CEBB			5 Cyl.	2461cc	80kW (109PS)		Diesel Turbo Intercooler	TD24720	
CECA			5 Cyl.	2461cc	100kW (136PS)		Diesel Turbo Intercooler	TD24721	
CECB			5 Cyl.	2461cc	120kW (163PS)		Diesel Turbo Intercooler	TD24722	
BE/PL	1	50,858/50,878	53,700/53,712	20,400	1,403	0,020/0,073	SP 71-3930	71-3930 STD 0.25 0.50	①
MB/HL 1-6	6	57,958/57,978	63,000/63,019	18,500	2,502	0,020/0,082	EC 72-3400	H981/6 STD 0.25	
TW/A	2	63,500/63,750	77,200/77,450		1,975		AL-LF 04-3529	A124/4 STD	
TW/A	2	63,500/63,750	77,200/77,450		1,975		AL-LF 04-3530		

VOLKSWAGEN



TW/A	2	63,500/63,750	76,950/77,200		1,975		AL-LF	04-4782	A292/4 STD
TW/A	2	63,500/63,750	76,950/77,200		1,975		AL-LF	04-4783	

04-3529

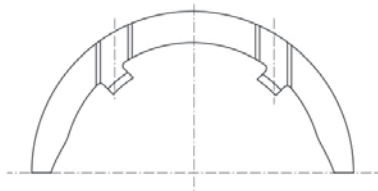

04-3530

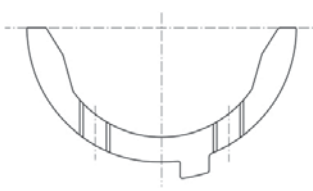

04-4782

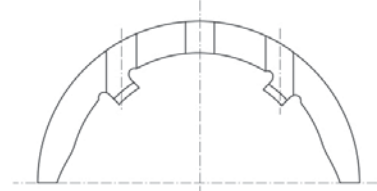

04-4783

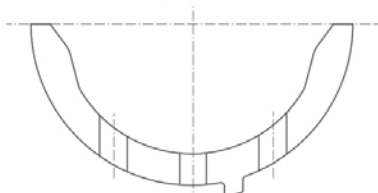

140 82.00 x 90.30

ABV	V6 Cyl.		2861cc	135-140kW (184-190PS)			Petrol	TD4977	
BE/PL	6	53,958/53,978	56,800/56,819	17,000	1,406	0,020/0,074	AL-LF	01-3841	01-3841/6 STD 0.25
MB/HL 1-7	7	59,958/59,978	65,000/65,010	17,000	2,501	0,020/0,075	AL-LF	02-3716	H035/7 STD 0.25
04/93 →									
TW/A	2	65,450	80,000		1,723		AL-LF	04-3717	A139/4 STD
TW/A	2	65,450	80,000		1,723		AL-LF	04-3718	
BU	1	42,959/42,975	46,055/46,095	15,000			AL-LF	07-3088	07-3088 STD SEMI 13
Front, For intermediary shaft									
BU	1	14,473/14,484	17,500/17,518	20,000			BB	17-3720	17-3720 SEMI 13
Rear, For intermediary shaft									

141 82.50 x 86.40

ACK	V6 Cyl.		2771cc	142kW (193PS)			Petrol	TD5560	
AMX	V6 Cyl.		2771cc	142kW (193PS)			Petrol	TD15155	
APR	V6 Cyl.		2771cc	142kW (193PS)			Petrol	TD15808	
ATQ	V6 Cyl.		2771cc	142kW (193PS)			Petrol	TD16422	
ATX	V6 Cyl.		2771cc	140kW (190PS)			Petrol	TD16252	
BBG	V6 Cyl.		2771cc	140kW (190PS)			Petrol	TD17913	
BE/PL	6	53,958/53,978	57,600/57,612	17,000	1,806	0,020/0,069	EC	71-3711	71-3711/6 STD
MB/HL 1-4	4	64,959/64,978	70,000/70,019	18,000	2,508	0,020/0,070	EC	72-3712	H034/4 STD 0.25
TW/A	2	70,500	84,900		1,965		AL-LF	04-3713	A138/4 STD
TW/A	2	70,500	84,900		1,965		AL-LF	04-3714	



142 82.50 x 86.40									
AGE		V6 Cyl.		2771cc	132kW (180PS)	Petrol		TD16251	
ALG		V6 Cyl.		2771cc	142kW (193PS)	Petrol		TD16260	
AQD		V6 Cyl.		2771cc	142kW (193PS)	Petrol		TD16259	
BE/PL	6	53,958/53,978	57,600/57,612	17,000	1,806	0,020/0,069	EC	71-3711	71-3711/6 STD
TW/A	2	70,500	84,900		1,965		AL-LF	04-3713	A138/4 STD
TW/A	2	70,500	84,900		1,965		AL-LF	04-3714	

143 82.50 x 92.80									
2E		4 Cyl.		1984cc	85kW (115PS)	Petrol		TD4963	
ABF		4 Cyl.		1984cc	110kW (150PS)	Petrol		TD4007	
ADY		4 Cyl.		1984cc	85kW (115PS)	Petrol		TD4979	
BE/PL	4	47,758/47,778	50,600/50,612	19,000	1,406	0,020/0,067	EC	71-3694	71-3694/4 STD 0.25 0.50
MB/HL	4	53,958/53,978	59,000/59,019	18,500	2,502	0,020/0,082	AL-LF	02-3085L	H027/5 STD 0.25 0.50
MB/HL	6	53,958/53,978	59,000/59,019	18,500	2,502	0,020/0,082	AL-LF	02-3085U	
TW/A	2	59,500	73,200		1,975		AL-LF	04-3527	A123/4 STD
TW/A	2	59,500	73,200		1,975		AL-LF	04-3528	
BU	1	42,959/42,975	46,055/46,095	15,000			AL-LF	07-3088	07-3088 STD SEMI

Front, For intermediary shaft

BU	1	41,959/41,975	45,000/45,025	15,000			AL-LF	07-3089	07-3089 STD SEMI
----	---	---------------	---------------	--------	--	--	-------	---------	----------------------------

Rear, For intermediary shaft

144 82.50 x 92.80									
9A		4 Cyl.		1984cc	100kW (136PS)	Petrol		TD3998	
BE/PL	4	47,758/47,778	50,600/50,612	19,000	1,406	0,020/0,067	EC	71-3694	71-3694/4 STD 0.25 0.50
MB/HL	4	53,958/53,978	59,000/59,019	18,500	2,502	0,020/0,082	AL-LF	02-3085L	H027/5 STD 0.25 0.50
MB/HL	6	53,958/53,978	59,000/59,019	18,500	2,502	0,020/0,082	AL-LF	02-3085U	
TW/A	2	59,500	73,200		1,975		AL-LF	04-3527	A123/4 STD
TW/A	2	59,500	73,200		1,975		AL-LF	04-3528	
SE/PB	1	20,000	23,000/23,021	25,000			BC	55-3698	55-3698 SEMI
BU	1	42,959/42,975	46,055/46,095	15,000			AL-LF	07-3088	07-3088 STD SEMI

Front, For intermediary shaft

BU	1	41,959/41,975	45,000/45,025	15,000			AL-LF	07-3089	07-3089 STD SEMI
----	---	---------------	---------------	--------	--	--	-------	---------	----------------------------

Rear, For intermediary shaft

VOLKSWAGEN



145 82.50 x 92.80

AEG	4 Cyl.		1984cc	85kW (115PS)	Petrol		TD13442		
AQY	4 Cyl.		1984cc	85kW (115PS)	Petrol		TD10607		
BE/PL	4	47,758/47,778	50,600/50,612	19,000	1,406	0,020/0,067	EC	71-3694	71-3694/4 STD 0.25 0.50
TW/A	2	59,500	73,200		1,975		AL-LF	04-3527	A123/4 STD
TW/A	2	59,500	73,200		1,975		AL-LF	04-3528	
SE/PB	1	20,000	23,000/23,021	25,000			BC	55-3698	55-3698 SEMI

146 82.50 x 92.80

AEP	4 Cyl.		1984cc	79kW (107PS)	Petrol		TD11448		
BE/PL	4	47,758/47,778	50,600/50,612	19,000	1,406	0,020/0,067	EC	71-3694	71-3694/4 STD 0.25 0.50
MB/HL	4	53,958/53,978	59,000/59,019	18,500	2,502	0,020/0,082	AL-LF	02-3085L	H027/5 STD 0.25 0.50
MB/HL	6	53,958/53,978	59,000/59,019	18,500	2,502	0,020/0,082	AL-LF	02-3085U	
TW/A	2	59,500	73,200		1,975		AL-LF	04-3527	A123/4 STD
TW/A	2	59,500	73,200		1,975		AL-LF	04-3528	

147 82.50 x 92.80

AGG	4 Cyl.		1984cc	85kW (115PS)	Petrol		TD4989		
ATU	4 Cyl.		1984cc	85kW (116PS)	Petrol		TD15490		
AUZ	4 Cyl.		1984cc	88kW (120PS)	Petrol		TD16243		
AWF	4 Cyl.		1984cc	85kW (115PS)	Petrol		TD15488		
AWG	4 Cyl.		1984cc	85kW (116PS)	Petrol		TD15489		
BE/PL	4	47,758/47,778	50,600/50,612	19,000	1,406	0,020/0,067	EC	71-3694	71-3694/4 STD 0.25 0.50
BE/PL	4	47,758/47,778	50,600/50,612	19,000	1,406	0,020/0,067	EC	71-3929	71-3929/4 STD II

71-3694

71-3929

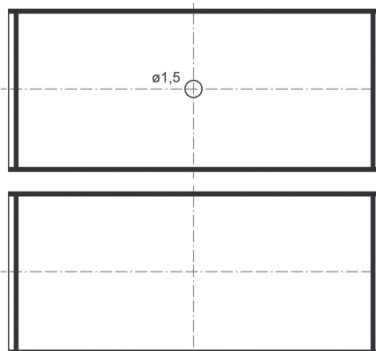
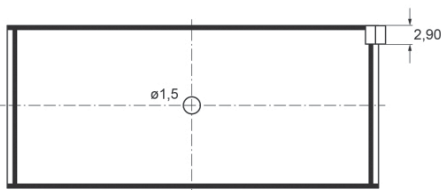

MB/HL 1-5	5	53,958/53,978	59,000/59,019	18,500	2,502	0,020/0,082	AL-LF	02-3085L	H084/5 STD 0.25 0.50
MB/HL 1-5	5	53,958/53,978	59,000/59,019	18,500	2,502	0,020/0,082	AL-LF	02-3085U	
TW/A	2	59,500	73,200		1,975		AL-LF	04-3527	A123/4 STD
TW/A	2	59,500	73,200		1,975		AL-LF	04-3528	
SE/PB	1	20,000	23,000/23,021	25,000			BC	55-3698	55-3698 SEMI

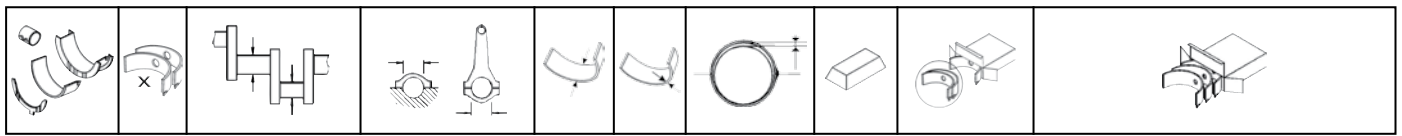

BU	1	42,959/42,975	46,055/46,095	15,000			AL-LF	07-3088	07-3088 STD SEMI	[13]
----	---	---------------	---------------	--------	--	--	-------	---------	----------------------------	------

Front, For intermediary shaft

BU	1	41,959/41,975	45,000/45,025	15,000			AL-LF	07-3089	07-3089 STD SEMI	[13]
----	---	---------------	---------------	--------	--	--	-------	---------	----------------------------	------

Rear, For intermediary shaft

148 82.50 x 92.80

AKR			4 Cyl.	1984cc	85kW (115PS)		Petrol		TD11354	
BE/PL	4	47,758/47,778	50,600/50,612	19,000	1,406	0,020/0,067	EC	71-3694	71-3694/4 STD 0.25 0.50	
BE/PL	4	47,758/47,778	50,600/50,612	19,000	1,406	0,020/0,067	EC	71-3929	71-3929/4 STD	[11]

71-3694

71-3929

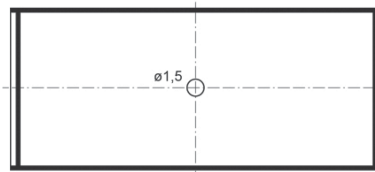
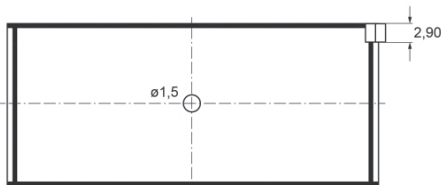

MB/HL 1-5	5	53,958/53,978	59,000/59,019	18,500	2,502	0,020/0,082	AL-LF	02-3085L	H084/5 STD 0.25 0.50
MB/HL 1-5	5	53,958/53,978	59,000/59,019	18,500	2,502	0,020/0,082	AL-LF	02-3085U	
TW/A	2	59,500	73,200		1,975		AL-LF	04-3527	A123/4 STD
TW/A	2	59,500	73,200		1,975		AL-LF	04-3528	

149 82.50 x 92.80

ALT			4 Cyl.	1984cc	96kW (130PS)		Petrol		TD17040	
AXW			4 Cyl.	1984cc	110kW (150PS)		Petrol		TD17081	
BLR			4 Cyl.	1984cc	110kW (150PS)		Petrol		TD18134	
BLX			4 Cyl.	1984cc	110kW (150PS)		Petrol		TD17985	
BLY			4 Cyl.	1984cc	110kW (150PS)		Petrol		TD17986	
BVX			4 Cyl.	1984cc	110kW (150PS)		Petrol		TD18912	
BVY			4 Cyl.	1984cc	110kW (150PS)		Petrol		TD18468	
BVZ			4 Cyl.	1984cc	110kW (150PS)		Petrol		TD18469	
BE/PL	4	47,758/47,778	50,600/50,612	19,000	1,406	0,020/0,067	EC	71-3929	71-3929/4 STD	[11]
MB/HL 1-5	5	53,958/53,978	59,000/59,019	18,500	2,502	0,020/0,082	AL-LF	02-3085L	H084/5 STD 0.25 0.50	
MB/HL 1-5	5	53,958/53,978	59,000/59,019	18,500	2,502	0,020/0,082	AL-LF	02-3085U		

150 82.50 x 92.80

APK			4 Cyl.	1984cc	85kW (116PS)		Petrol		TD11927
BE/PL	4	47,758/47,778	50,600/50,612	19,000	1,406	0,020/0,067	EC	71-3694	71-3694/4 STD 0.25 0.50

VOLKSWAGEN

MB/HL 1-5	5	53,958/53,978	59,000/59,019	18,500	2,502	0,020/0,082	AL-LF	02-3085L	H084/5 STD 0.25 0.50
MB/HL 1-5	5	53,958/53,978	59,000/59,019	18,500	2,502	0,020/0,082	AL-LF	02-3085U	
TW/A	2	59,500	73,200		1,975		AL-LF	04-3527	A123/4 STD
TW/A	2	59,500	73,200		1,975		AL-LF	04-3528	
SE/PB	1	20,000	23,000/23,021	25,000			BC	55-3698	55-3698 SEMI

151 82.50 x 92.80

ATM		4 Cyl.		1984cc	85kW (115PS)	Petrol			TD14913
BE/PL	4	47,758/47,778	50,600/50,612	19,000	1,406	0,020/0,067	EC	71-3929	71-3929/4 STD [11]
MB/HL 1-5	5	53,958/53,978	59,000/59,019	18,500	2,502	0,020/0,082	AL-LF	02-3085L	H084/5 STD 0.25 0.50
MB/HL 1-5	5	53,958/53,978	59,000/59,019	18,500	2,502	0,020/0,082	AL-LF	02-3085U	
TW/A	2	59,500	73,200		1,975		AL-LF	04-3527	A123/4 STD
TW/A	2	59,500	73,200		1,975		AL-LF	04-3528	
SE/PB	1	20,000	23,000/23,021	25,000			BC	55-3698	55-3698 SEMI

152 82.50 x 92.80

AXA		4 Cyl.		1984cc	85kW (115PS)	Petrol			TD16866
BE/PL	4	47,758/47,778	50,600/50,612	19,000	1,406	0,020/0,067	EC	71-3694	71-3694/4 STD 0.25 0.50
Mot. → 7J-5-036000									
BE/PL	4	47,758/47,778	50,600/50,612	19,000	1,406	0,020/0,067	EC	71-3929	71-3929/4 STD [11]
Mot. 7J-5-036001 →									

71-3694

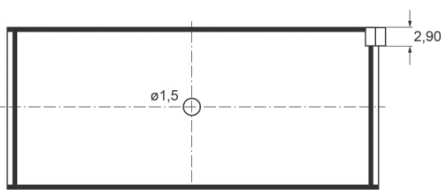

71-3929

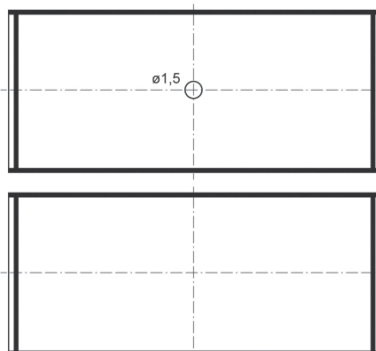

TW/A	2	59,500	73,200		1,975		AL-LF	04-3527	A123/4 STD
TW/A	2	59,500	73,200		1,975		AL-LF	04-3528	
SE/PB	1	20,000	23,000/23,021	25,000			BC	55-3698	55-3698 SEMI
BU	1	42,959/42,975	46,055/46,095	15,000			AL-LF	07-3088	07-3088 STD SEMI [13]

Front, For intermediary shaft

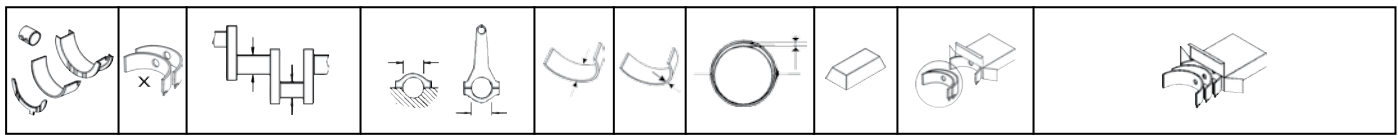

BU	1	41,959/41,975	45,000/45,025	15,000			AL-LF	07-3089	07-3089 STD SEMI	[13]
----	---	---------------	---------------	--------	--	--	-------	---------	----------------------------	------

Rear, For intermediary shaft

153 82.50 x 92.80

AZH		4 Cyl.		1984cc	85kW (115PS)		Petrol		TD15479	
BE/PL	4	47,758/47,778	50,600/50,612	19,000	1,406	0,020/0,067	EC	71-3929	71-3929/4 STD	[11]
MB/HL 1-5	5	53,958/53,978	59,000/59,019	18,500	2,502	0,020/0,082	AL-LF	02-3085L	H084/5 STD 0.25 0.50	
MB/HL 1-5	5	53,958/53,978	59,000/59,019	18,500	2,502	0,020/0,082	AL-LF	02-3085U		
TW/A	2	59,500	73,200		1,975		AL-LF	04-3527	A123/4 STD	
TW/A	2	59,500	73,200		1,975		AL-LF	04-3528		

154 82.50 x 92.80

BHY		4 Cyl.		1984cc	85kW (115PS)		Petrol		TD22634
BE/PL	4	47,758/47,778	50,600/50,612	19,000	1,406	0,020/0,067	EC	71-3694	71-3694/4 STD 0.25 0.50
MB/HL 1-5	5	53,958/53,978	59,000/59,019	18,500	2,502	0,020/0,082	AL-LF	02-3085L	H084/5 STD 0.25 0.50
MB/HL 1-5	5	53,958/53,978	59,000/59,019	18,500	2,502	0,020/0,082	AL-LF	02-3085U	
TW/A	2	59,500	73,200		1,975		AL-LF	04-3527	A123/4 STD
TW/A	2	59,500	73,200		1,975		AL-LF	04-3528	

155 83.00 x 69.00

H		4 Cyl.		1493cc	29-33kW (40-45PS)		Petrol		TD4103
BE/PL	4	54,971/54,990	57,800/57,819	17,600	1,397	0,020/0,079	EC	71-1950	71-1950/4 STD 0.25 0.50
SE/PB	1	20,000	22,000	24,400			BC	55-2567	55-2567 SEMI
SE/PB	1	22,000	23,970/24,003	23,400			BC	55-2723	55-2723 SEMI
CB/NWB 1	2	24,987/25,000	27,500/27,521	20,000	1,245		BB	13-2368	N072/3 STD
CB/NWB 2	2	24,987/25,000	27,500/27,521	23,000	1,245		BB	13-2369	
CB/NWB 3	1	24,987/25,000	27,500/27,521	28,000	1,245		BB	13-2370HL	
CB/NWB 3	1	24,987/25,000	27,500/27,521	25,000	1,245		BB	13-2370U	

156 84.00 x 71.50

AD		4 Cyl.		1584cc	35-37kW (48-50PS)		Petrol		TD4016
BE/PL	4	54,971/54,990	57,800/57,819	17,600	1,397	0,020/0,079	EC	71-1950	71-1950/4 STD 0.25 0.50
SE/PB	1	20,000	22,000	24,400			BC	55-2567	55-2567 SEMI
SE/PB	1	22,000	23,970/24,003	23,400			BC	55-2723	55-2723 SEMI

VOLKSWAGEN

CB/NWB 1	2	24,987/25,000	27,500/27,521	20,000	1,245		BB	13-2368	N072/3 STD
CB/NWB 2	2	24,987/25,000	27,500/27,521	23,000	1,245		BB	13-2369	
CB/NWB 3	1	24,987/25,000	27,500/27,521	28,000	1,245		BB	13-2370HL	
CB/NWB 3	1	24,987/25,000	27,500/27,521	25,000	1,245		BB	13-2370U	

157

84.00 x 95.90

AXJ			V6 Cyl.	3189cc	165kW (224PS)		Petrol		TD15471
AYT			V6 Cyl.	3189cc	177kW (241PS)		Petrol		TD16481
AZZ			V6 Cyl.	3189cc	162kW (220PS)		Petrol		TD17041
BAA			V6 Cyl.	3189cc	162kW (220PS)		Petrol		TD20531
BDL			V6 Cyl.	3189cc	170kW (231PS)		Petrol		TD16870
BFH			V6 Cyl.	3189cc	177kW (241PS)		Petrol		TD16526
BJS			V6 Cyl.	3189cc	177-179kW (241-243PS)		Petrol		TD25200
BKJ			V6 Cyl.	3189cc	162kW (220PS)		Petrol		TD17042
BKK			V6 Cyl.	3189cc	173kW (235PS)		Petrol		TD17186
BKL			V6 Cyl.	3189cc	177kW (241PS)		Petrol		TD18024
BML			V6 Cyl.	3189cc	177kW (241PS)		Petrol		TD20523
BMV			V6 Cyl.	3189cc	162-177kW (220-241PS)		Petrol		TD20525
BMX			V6 Cyl.	3189cc	162kW (220PS)		Petrol		TD19256
BPF			V6 Cyl.	3189cc	184kW (250PS)		Petrol		TD20524
BRJ			V6 Cyl.	3189cc	162kW (220PS)		Petrol		TD20526
BRK			V6 Cyl.	3189cc	177kW (241PS)		Petrol		TD18025
BUB			V6 Cyl.	3189cc	184kW (250PS)		Petrol		TD18472
CBR			V6 Cyl.	3189cc	184kW (250PS)		Petrol		TD20023
CBRA			V6 Cyl.	3189cc	184kW (250PS)		Petrol		TD22178
CFLA			V6 Cyl.	3189cc	173kW (235PS)		Petrol		TD20920
BE/PL	6	53,958/53,978	56,800/56,819	17,000	1,406	0,020/0,074	AL-LF	01-3841	01-3841/6 STD 0.25
TW/A	2	65,450	80,000		1,723		AL-LF	04-3717	A139/4 STD
TW/A	2	65,450	80,000		1,723		AL-LF	04-3718	

158

84.50 x 93.00

AXQ			V8 Cyl.	4172cc	228kW (310PS)		Petrol		TD16853
BE/PL	1	53,958/53,978	57,600/57,619	18,000	1,801	0,020/0,084	EC	71-3932	71-3932 STD
TW/A	2	70,500	84,900		1,965		AL-LF	04-3713	A138/4 STD
TW/A	2	70,500	84,900		1,965		AL-LF	04-3714	

159

85.50 x 69.00

ACD			4 Cyl.	1584cc	34-36kW (46-49PS)		Petrol		TD9471
BE/PL	4	54,971/54,990	57,800/57,819	17,600	1,397	0,020/0,079	EC	71-1950	71-1950/4 STD 0.25 0.50

160

85.50 x 69.00

AE			4 Cyl.	1584cc	35-37kW (48-50PS)		Petrol		TD5133
AH			4 Cyl.	1584cc	35-39kW (48-53PS)		Petrol		TD4018
AJ			4 Cyl.	1584cc	36-37kW (48-50PS)		Petrol		TD4024
AK			4 Cyl.	1584cc	35kW (48PS)		Petrol		TD5134
AL			4 Cyl.	1584cc	35kW (48PS)		Petrol		TD14189



AM	4 Cyl.	1584cc	35kW (48PS)	Petrol	TD14190
AS	4 Cyl.	1584cc	37kW (50PS)	Petrol	TD4030
B	4 Cyl.	1584cc	35kW (48PS)	Petrol	TD5137
U	4 Cyl.	1584cc	40kW (54PS)	Petrol	TD5030

BE/PL	4	54,971/54,990	57,800/57,819	17,600	1,397	0,020/0,079	EC	71-1950	71-1950/4 STD 0.25 0.50
SE/PB	1	20,000	22,000	24,400			BC	55-2567	55-2567 SEMI
SE/PB	1	22,000	23,970/24,003	23,400			BC	55-2723	55-2723 SEMI
CB/NWB 1	2	24,987/25,000	27,500/27,521	20,000	1,245		BB	13-2368	N072/3 STD
CB/NWB 2	2	24,987/25,000	27,500/27,521	23,000	1,245		BB	13-2369	
CB/NWB 3	1	24,987/25,000	27,500/27,521	28,000	1,245		BB	13-2370HL	
CB/NWB 3	1	24,987/25,000	27,500/27,521	25,000	1,245		BB	13-2370U	

161 85.50 x 69.00

CZ	4 Cyl.	1584cc	34kW (46PS)	Petrol	TD4053
P	4 Cyl.	1584cc	37kW (50PS)	Petrol	TD5139

BE/PL	4	54,971/54,990	57,800/57,819	17,600	1,397	0,020/0,079	EC	71-1950	71-1950/4 STD 0.25 0.50
SE/PB	1	20,000	22,000	24,400			BC	55-2567	55-2567 SEMI
SE/PB	1	22,000	23,970/24,003	23,400			BC	55-2723	55-2723 SEMI
CB/NWB 1	2	24,987/25,000	27,500/27,521	20,000	1,245		BB	13-2368	N072/3 STD
CB/NWB 2	2	24,987/25,000	27,500/27,521	23,000	1,245		BB	13-2369	
CB/NWB 3	1	24,987/25,000	27,500/27,521	28,000	1,245		BB	13-2370HL	
CB/NWB 3	1	24,987/25,000	27,500/27,521	25,000	1,245		BB	13-2370U	

01/65 →

162 86.00 x 90.90

AXZ	V6 Cyl.	3168cc	184kW (250PS)	Petrol	TD18187				
BE/PL	6	53,958/53,978	56,800/56,819	17,000	1,406	0,020/0,074	AL-LF	01-3841	01-3841/6 STD 0.25

163 89.00 x 96.40

BHK	V6 Cyl.	3597cc	206kW (280PS)	Petrol	TD18998				
BLV	V6 Cyl.	3597cc	206kW (280PS)	Petrol	TD19259				
BWS	V6 Cyl.	3597cc	220kW (300PS)	Petrol	TD19820				
BE/PL	6	53,958/53,978	56,800/56,819	17,000	1,406	0,020/0,074	AL-LF	01-3841	01-3841/6 STD 0.25

164 89.00 x 96.40

CMTA	V6 Cyl.	3597cc	183kW (249PS)	Petrol	TD24889				
BE/PL	4	48,226/48,244	51,354/51,366	19,100	1,540	0,030/0,056	EC-LF	71-4776	71-4776/4 STD
TW/A	2	59,000/59,260	73,600/73,850		2,485		AL-LF	04-4778	A291/2 STD
SE/PB	1	31,990/31,996	34,895/34,920	30,700			BS	66579YA	55-4186 SEMI









5

VOLKSWAGEN

SE/PB	1	26,000	28,939/28,972	22,100			BS-LF	55-4779	55-4779 SEMI

165	94.00 x 69.00								
DF			4 Cyl.	1913cc	44kW (60PS)		Petrol		TD4058
DG			4 Cyl.	1913cc	57kW (78PS)		Petrol		TD4993
DH			4 Cyl.	1913cc	61-62kW (83-84PS)		Petrol		TD4994
GW			4 Cyl.	1913cc	66kW (90PS)		Petrol		TD4099
BE/PL	4	54,971/54,990	57,800/57,819	17,600	1,397	0,020/0,079	EC	71-1950	71-1950/4 STD 0.25 0.50

166	94.00 x 76.00								
DJ			4 Cyl.	2110cc	82kW (112PS)		Petrol		TD4059
MV			4 Cyl.	2110cc	67-71kW (91-97PS)		Petrol		TD4133
SR			4 Cyl.	2109cc	64kW (87PS)		Petrol		TD4153
SS			4 Cyl.	2110cc	68-70kW (92-95PS)		Petrol		TD4154
BE/PL	4	54,971/54,990	57,800/57,819	17,600	1,397	0,020/0,079	EC	71-1950	71-1950/4 STD 0.25 0.50









				cm3	x 			
66 DL 1.1	08/75→11/79	Petrol	B 11	1108	4	70.00	72.00	2
66 GL 1.3	08/75→11/79	Petrol	B 130	1289	4	73.00	76.50	3
140 1.8	08/66→07/68	Petrol	B 18 A	1780	4	84.14	80.00	39
140 1.8	09/66→12/68	Petrol	B 18 B	1780	4	84.14	80.00	39
140 1.8 S	08/66→07/68	Petrol	B 18 A	1780	4	84.14	80.00	39
140 1.8 S	08/66→01/72	Petrol	B 18 B	1780	4	84.14	80.00	39
140 2.0	08/68→07/74	Petrol	B 20 A	1986	4	88.90	80.00	43
140 2.0	08/71→07/72	Petrol	B 20 D	1986	4	88.90	80.00	43
140 2.0	09/68→04/75	Petrol	B 20 E	1986	4	88.90	80.00	43
140 2.0 S	09/72→08/75	Petrol	B 20 F	1985	4	88.90	80.00	43
140 2.0 S	08/68→07/74	Petrol	B 20 A	1986	4	88.90	80.00	43
140 2.0 S	11/68→07/74	Petrol	B 20 B	1986	4	88.90	80.00	43
140 2.0 S	08/72→07/74	Petrol	B 20 D	1986	4	88.90	80.00	43
140 2.0 S	08/72→07/73	Petrol	B 20 E	1986	4	88.90	80.00	43
240 2.0	08/76→12/84	Petrol	B 19 A	1986	4	88.90	80.00	42
240 2.0	08/84→12/93	Petrol	B 19 E	1986	4	88.90	80.00	42
240 2.0	10/82→08/84	Petrol	B 19 ET	1986	4	88.90	80.00	42
240 2.0	09/78→12/84	Petrol	B 19 K	1986	4	88.90	80.00	42
240 2.0	08/74→07/76	Petrol	B 20 A	1986	4	88.90	80.00	43
240 2.0	08/83→12/93	Petrol	B 200 E	1986	4	88.90	80.00	44
240 2.0	09/88→12/93	Petrol	B 200 F	1986	4	88.90	80.00	44
240 2.0	08/84→07/85	Petrol	B 200 K	1986	4	88.90	80.00	44
240 2.1	08/74→12/84	Petrol	B 21 A	2127	4	92.00	80.00	46
240 2.1	08/74→07/80	Petrol	B 21 E	2127	4	92.00	80.00	46
240 2.1	09/80→12/84	Petrol	B 21 ET	2127	4	92.00	80.00	46
240 2.1	09/79→07/84	Petrol	B 21 F	2127	4	92.00	80.00	46
240 2.1 Turbo	08/80→07/85	Petrol	B 21 ET	2127	4	92.00	80.00	46
240 2.3	08/80→07/84	Petrol	B 23 A	2316	4	96.00	80.00	50
240 2.3	08/78→12/89	Petrol	B 23 E	2316	4	96.00	80.00	50
240 2.3	08/84→07/86	Petrol	B 230 A	2316	4	96.00	80.00	51
240 2.3	08/83→07/85	Petrol	B 230 E	2316	4	96.00	80.00	51
240 2.3	09/81→07/87	Petrol	B 230 F	2316	4	96.00	80.00	51
240 2.3	08/86→12/88	Petrol	B 230 K	2316	4	96.00	80.00	51
240 2.3 CAT	08/91→07/92	Petrol	B 230 F	2316	4	96.00	80.00	51
240 2.3 i CAT	08/86→07/93	Petrol	B 230 F	2316	4	96.00	80.00	51
240 2.4 D	09/81→12/84	Diesel	D 24	2383	6	76.50	86.40	6
240 2.4 Diesel	08/78→08/93	Diesel	D 24	2383	6	76.50	86.40	6
240 2.7 GLT6	08/79→07/80	Petrol	B 27 E	2664	V6	88.00	73.00	41
240 2.8	10/81→09/82	Petrol	B 28 A	2849	V6	91.00	73.00	45
240 2.8	10/80→09/84	Petrol	B 28 E	2849	V6	91.00	73.00	45
260 2.1	09/79→12/80	Petrol	B 21 E	2127	4	92.00	80.00	46
260 2.4 D	09/79→12/81	Diesel	D 24	2383	6	76.50	86.40	6
260 2.7	08/75→07/82	Petrol	B 27 A	2664	V6	88.00	73.00	41
260 2.7	08/74→07/82	Petrol	B 27 E	2664	V6	88.00	73.00	41
260 2.7	08/78→07/82	Petrol	B 27 F	2664	V6	88.00	73.00	41
260 2.8	08/80→07/82	Petrol	B 28 A	2849	V6	91.00	73.00	45
260 2.8	08/80→07/82	Petrol	B 28 E	2849	V6	91.00	73.00	45
260 2.8	09/79→07/82	Petrol	B 28 F	2849	V6	91.00	73.00	45
340-360 1.3	01/89→12/90	Petrol	B 13	1289	4	73.00	76.50	3
340-360 1.4	08/79→12/86	Petrol	B 14.3 E	1397	4	76.00	77.00	5
340-360 1.4	08/75→12/88	Petrol	B 14.4 S	1397	4	76.00	77.00	5
340-360 1.6 Diesel	08/84→07/91	Diesel	D 16	1596	4	78.00	83.60	7
340-360 1.7	08/85→07/91	Petrol	B 17 2 K	1721	4	81.00	83.50	17
340-360 2.0	08/80→07/84	Petrol	B 19 A	1986	4	88.90	80.00	42
340-360 2.0	08/82→07/84	Petrol	B 19 E	1986	4	88.90	80.00	42
340-360 2.0	08/84→07/88	Petrol	B 200 E	1986	4	88.90	80.00	44
340-360 2.0	08/86→07/88	Petrol	B 200 EA	1986	4	88.90	80.00	44
340-360 2.0	08/86→07/89	Petrol	B 200 F	1986	4	88.90	80.00	44
340-360 2.0	08/80→07/90	Petrol	B 200 K	1986	4	88.90	80.00	44
340-360 2.1	08/81→07/82	Petrol	B 21 E	2127	4	92.00	80.00	46
440 K 1.7	09/88→12/96	Petrol	B 18 EP	1721	4	81.00	83.50	17
440 K 1.7	08/88→07/89	Petrol	B 18 F	1721	4	81.00	83.50	17
440 K 1.7	08/89→12/96	Petrol	B 18 FP	1721	4	81.00	83.50	17
440 K 1.7	09/88→08/89	Petrol	B 18 K	1721	4	81.00	83.50	17
440 K 1.7	09/88→08/92	Petrol	B 18 KD	1721	4	81.00	83.50	17
440 K 1.7	09/88→12/96	Petrol	B 18 KP	1721	4	81.00	83.50	17
440 K 1.7 Turbo	08/88→12/96	Petrol	B 18 FT	1721	4	81.00	83.50	17
440 K 1.8	08/91→12/96	Petrol	B 18 U	1794	4	82.70	83.50	28
440 K 1.9 Turbo-Diesel	07/94→12/96	Diesel	D 19 T	1870	4	80.00	93.00	9



cm3



440 K 2.0	08/92→07/96	Petrol	B 20 F	1998	4	82.70	93.00	29
460 L 1.7	08/89→07/92	Petrol	B 18 E	1721	4	81.00	83.50	17
460 L 1.7	08/89→07/92	Petrol	B 18 EP	1721	4	81.00	83.50	17
460 L 1.7	09/89→08/91	Petrol	B 18 KD	1721	4	81.00	83.50	17
460 L 1.7	09/88→07/96	Petrol	B 18 KP	1721	4	81.00	83.50	17
460 L 1.7 Turbo	08/89→07/96	Petrol	B 18 FT	1721	4	81.00	83.50	17
460 L 1.8	08/91→07/96	Petrol	B 18 U	1794	4	82.70	83.50	28
460 L 1.9 Turbo-Diesel	07/94→07/96	Diesel	D 19 T	1870	4	80.00	93.00	9
460 L 2.0	08/92→07/96	Petrol	B 20 F	1998	4	82.70	93.00	29
480 E 1.7	04/86→07/89	Petrol	B 18 E	1721	4	81.00	83.50	17
480 E 1.7	08/89→07/96	Petrol	B 18 EP	1721	4	81.00	83.50	17
480 E 1.7	08/87→07/89	Petrol	B 18 F	1721	4	81.00	83.50	17
480 E 1.7 Turbo	08/87→07/96	Petrol	B 18 FT	1721	4	81.00	83.50	17
480 E 2.0	08/92→09/95	Petrol	B 20 F	1998	4	82.70	93.00	29
740 2.0	12/83→07/84	Petrol	B 19 ET	1986	4	88.90	80.00	42
740 2.0	08/85→07/92	Petrol	B 200 E	1986	4	88.90	80.00	44
740 2.0	01/85→08/90	Petrol	B 200 ET	1986	4	88.90	80.00	44
740 2.0	08/89→08/92	Petrol	B 200 F	1986	4	88.90	80.00	44
740 2.0	08/85→07/92	Petrol	B 200 G	1986	4	88.90	80.00	44
740 2.0	09/88→08/90	Petrol	B 200 K	1986	4	88.90	80.00	44
740 2.0	09/90→08/92	Petrol	B 204 FTE	1986	4	88.90	80.00	44
740 2.0 16V	09/87→08/90	Petrol	B 204 E	1986	4	88.90	80.00	44
740 2.0 GLE	04/83→07/84	Petrol	B 19 E	1986	4	88.90	80.00	42
740 2.0 GLE	09/87→08/90	Petrol	B 204 E	1986	4	88.90	80.00	44
740 2.0 Turbo	05/85→08/90	Petrol	B 200 ET	1986	4	88.90	80.00	44
740 2.0 Turbo	09/90→08/91	Petrol	B 200 FT	1986	4	88.90	80.00	44
740 2.3	08/84→07/90	Petrol	B 23 A	2316	4	96.00	80.00	50
740 2.3	08/83→07/84	Petrol	B 23 E	2316	4	96.00	80.00	50
740 2.3	08/84→07/86	Petrol	B 230 A	2316	4	96.00	80.00	51
740 2.3	08/84→07/88	Petrol	B 230 E	2316	4	96.00	80.00	51
740 2.3	08/84→07/92	Petrol	B 230 F	2316	4	96.00	80.00	51
740 2.3	08/88→07/90	Petrol	B 230 FB	2316	4	96.00	80.00	51
740 2.3	09/85→07/90	Petrol	B 230 K	2316	4	96.00	80.00	51
740 2.3	08/87→08/92	Petrol	B 234 F	2316	4	96.00	80.00	51
740 2.3 GL	08/84→08/87	Petrol	B 230 E	2316	4	96.00	80.00	51
740 2.3 GLE	08/84→08/87	Petrol	B 23 E	2316	4	96.00	80.00	50
740 2.3 Turbo	08/85→12/88	Petrol	B 230 ET	2316	4	96.00	80.00	51
740 2.3 Turbo	08/86→08/91	Petrol	B 230 FT	2316	4	96.00	80.00	51
740 2.3 Turbo	08/89→08/91	Petrol	B 230 GT	2316	4	96.00	80.00	51
740 2.4 Diesel	08/84→07/92	Diesel	D 24	2383	6	76.50	86.40	6
740 2.4 TD	08/84→12/90	Diesel	D 24 T	2383	6	76.50	86.40	6
740 2.4 TD	08/86→10/88	Diesel	D 24 TIC	2383	6	76.50	86.40	6
740 2.4 TD Interc.	08/86→07/88	Diesel	D 24 TIC	2383	6	76.50	86.40	6
740 2.4 Turbo-Diesel	09/85→07/92	Diesel	D 24 T	2383	6	76.50	86.40	6
760 2.3	01/84→03/86	Petrol	B 23 ET	2315	4	96.00	80.00	50
760 2.3	08/84→08/87	Petrol	B 230 ET	2316	4	96.00	80.00	51
760 2.3	09/83→07/92	Petrol	B 230 FT	2316	4	96.00	80.00	51
760 2.3	08/84→08/87	Petrol	B 230 K	2316	4	96.00	80.00	51
760 2.3 Turbo	08/82→07/84	Petrol	B 23 ET	2315	4	96.00	80.00	50
760 2.3 Turbo	08/84→08/90	Petrol	B 230 ET	2316	4	96.00	80.00	51
760 2.3 Turbo	09/87→08/90	Petrol	B 230 FT	2316	4	96.00	80.00	51
760 2.4 D	01/82→07/92	Diesel	D 24	2383	6	76.50	86.40	6
760 2.4 D	09/82→12/85	Diesel	D 24 T	2383	6	76.50	86.40	6
760 2.4 TD Interc.	08/87→07/92	Diesel	D 24 TIC	2383	6	76.50	86.40	6
760 2.4 Turbo Diesel	08/82→07/92	Diesel	D 24 T	2383	6	76.50	86.40	6
760 2.8	01/82→12/87	Petrol	B 28 A	2849	V6	91.00	73.00	45
760 2.8	08/81→08/90	Petrol	B 28 E	2849	V6	91.00	73.00	45
760 2.8	08/81→08/90	Petrol	B 280 E	2849	V6	91.00	73.00	45
760 2.8	09/82→08/91	Petrol	B 280 F	2849	V6	91.00	73.00	45
780 2.3	09/88→07/90	Petrol	B 230 FT	2316	4	96.00	80.00	51
780 2.4 D	04/86→07/90	Diesel	D 24 TIC	2383	6	76.50	86.40	6
780 2.9	08/86→07/87	Petrol	B 280 E	2849	V6	91.00	73.00	45
780 2.9	08/87→07/90	Petrol	B 280 F	2849	V6	91.00	73.00	45
850 2.0	08/94→12/96	Petrol	B 5202 S	1984	5	81.00	77.00	13
850 2.0	06/91→12/96	Petrol	B 5204 F	1984	5	81.00	77.00	13
850 2.0 Turbo	02/93→12/96	Petrol	B 5204 T	1984	5	81.00	77.00	14
850 2.0 Turbo	09/93→10/97	Petrol	B 5204 T2	1984	5	81.00	77.00	14
850 2.3	01/96→10/96	Petrol	B 5234 FS	2319	5	81.00	90.00	21
850 2.3	09/93→12/94	Petrol	B 5234 FT	2319	5	81.00	90.00	20

				cm3	x 			
850 2.3 T5	02/93→12/96	Petrol	B 5234 FT	2319	5	81.00	90.00	20
850 2.3 T5 R	04/96→10/96	Petrol	B 5234 T2	2319	5	81.00	90.00	20
850 2.3 T5-R	08/95→12/96	Petrol	B 5234 T4	2319	5	81.00	90.00	20
850 2.3 Turbo	09/93→12/94	Petrol	B 5234 FT	2319	5	81.00	90.00	20
850 2.3 Turbo R	09/94→10/97	Petrol	B 5234 T5	2319	5	81.00	90.00	20
850 2.4	09/93→12/94	Petrol	B 5252 FS	2435	5	83.00	90.00	34
850 2.4 GLE	09/93→10/97	Petrol	B 5254 T	2435	5	83.00	90.00	35
850 2.5	06/91→07/94	Petrol	B 5252	2435	5	83.00	90.00	34
850 2.5	08/94→12/96	Petrol	B 5252 FS	2435	5	83.00	90.00	34
850 2.5	08/91→12/96	Petrol	B 5254 S	2435	5	83.00	90.00	34
850 2.5 AWD	04/96→12/96	Petrol	B 5254 T	2435	5	83.00	90.00	35
850 2.5 TDI	08/95→12/96	Diesel	D 5252 T	2461	5	81.00	95.50	24
940 2.0	09/90→09/93	Petrol	B 200 E	1986	4	88.90	80.00	44
940 2.0	01/92→07/94	Petrol	B 200 F	1986	4	88.90	80.00	44
940 2.0	09/90→09/93	Petrol	B 200 G	1986	4	88.90	80.00	44
940 2.0	09/90→09/93	Petrol	B 204 FT	1986	4	88.90	80.00	44
940 2.0 GL	09/90→04/92	Petrol	B 204 E	1986	4	88.90	80.00	44
940 2.0 Turbo	08/90→07/95	Petrol	B 200 FT	1986	4	88.90	80.00	44
940 2.3	08/90→12/94	Petrol	B 230 FB	2316	4	96.00	80.00	51
940 2.3	08/92→07/94	Petrol	B 230 FD	2316	4	96.00	80.00	51
940 2.3	09/90→09/93	Petrol	B 230 FT	2316	4	96.00	80.00	51
940 2.3	08/90→12/94	Petrol	B 230 G	2316	4	96.00	80.00	51
940 2.3	08/90→07/91	Petrol	B 234 F	2316	4	96.00	80.00	51
940 2.3	08/90→07/91	Petrol	B 234 G	2316	4	96.00	80.00	51
940 2.3 Turbo	08/90→07/94	Petrol	B 230 FT	2316	4	96.00	80.00	51
940 2.3 Turbo	08/91→07/93	Petrol	B 230 FT+	2316	4	96.00	80.00	51
940 2.4 D	08/90→07/95	Diesel	D 24	2383	6	76.50	86.40	6
940 2.4 TD Intercooler	08/90→12/94	Diesel	D 24 TIC	2383	6	76.50	86.40	6
940 2.4 Turbo Diesel	08/90→12/94	Diesel	D 24 T	2383	6	76.50	86.40	6
940 II 2.0	11/94→12/95	Petrol	B 200 G	1986	4	88.90	80.00	44
940 II 2.0	10/94→05/97	Petrol	B 204 FT	1986	4	88.90	80.00	44
940 II 2.0 Turbo	04/96→10/98	Petrol	B 200 FT	1986	4	88.90	80.00	44
940 II 2.3	08/94→10/98	Petrol	B 230 FB	2316	4	96.00	80.00	51
940 II 2.3	08/94→07/95	Petrol	B 230 FD	2316	4	96.00	80.00	51
940 II 2.3	10/94→05/97	Petrol	B 230 GK	2316	4	96.00	80.00	51
940 II 2.3 ti	01/95→10/98	Petrol	B 230 FK	2316	4	96.00	80.00	51
940 II 2.3 Turbo	08/94→12/98	Petrol	B 230 FT	2316	4	96.00	80.00	51
940 II 2.4 TD Interc.	08/94→10/98	Diesel	D 24 TIC	2383	6	76.50	86.40	6
960 2.0	09/90→09/93	Petrol	B 200 F	1986	4	88.90	80.00	44
960 2.0	09/90→08/93	Petrol	B 204 E	1986	4	88.90	80.00	44
960 2.0	08/90→09/93	Petrol	B 204 FT	1986	4	88.90	80.00	44
960 2.3 Turbo	09/90→08/93	Petrol	B 230 FT	2316	4	96.00	80.00	51
960 2.4 Tdi	09/90→08/93	Diesel	D 24 TIC	2383	6	76.50	86.40	6
960 2.4 TD Interc.	09/91→07/94	Diesel	D 24 TIC	2383	6	76.50	86.40	6
960 2.8	09/90→05/92	Petrol	B 280 F	2849	V6	91.00	73.00	45
960 2.8 GL	09/90→05/92	Petrol	B 280 E	2849	V6	91.00	73.00	45
960 2.8 GL	09/90→05/92	Petrol	B 280 F	2849	V6	91.00	73.00	45
960 2.9	08/90→07/94	Petrol	B 6304 F	2922	6	83.00	90.00	36
960 2.9	08/90→07/94	Petrol	B 6304 G	2922	6	83.00	90.00	36
960 2.9	08/90→07/94	Petrol	B 6304 S	2922	6	83.00	90.00	36
960 II 2.5	07/94→12/96	Petrol	B 6254 S	2473	6	81.00	80.00	16
960 II 2.9	07/94→12/96	Petrol	B 6304 S	2922	6	83.00	90.00	36
960 II 2.9	07/94→12/96	Petrol	B 6304 S2	2922	6	83.00	90.00	36
C30 1.6	10/06→12/12	Petrol	B 4164 S3	1596	4	79.00	81.40	8
C30 1.6 D	10/06→12/12	Diesel	D 4164 T	1560	4	75.00	88.30	4
C30 2.0 D	10/06→12/12	Diesel	D 4204 T	1998	4	85.00	88.00	40
C30 2.4 i	10/06→12/12	Petrol	B 5244 S4	2435	5	83.00	90.00	34
C30 D3	10/10→12/12	Diesel	D 5204 T5	1984	5	81.00	77.00	15
C30 D4	10/10→12/12	Diesel	D 5204 T	1984	5	81.00	77.00	15
C30 D5	10/06→12/12	Diesel	D 5244 T8	2400	5	81.00	93.20	23
C30 D5	10/06→12/12	Diesel	D 5244 T9	2400	5	81.00	93.20	23
C30 D5	10/06→12/12	Diesel	D 5244 T13	2400	5	81.00	93.20	23
C30 T5	10/06→12/12	Petrol	B 5254 T3	2521	5	83.00	93.20	38
C30 T5	03/07→12/12	Petrol	B 5254 T7	2521	5	83.00	93.20	38
C70 I 2.0	03/97→10/05	Petrol	B 5204 T2	1984	5	81.00	77.00	14
C70 I 2.0 T	03/97→10/05	Petrol	B 5204 T3	1984	5	81.00	77.00	14
C70 I 2.0 T	03/00→10/05	Petrol	B 5204 T4	1984	5	81.00	77.00	14
C70 I 2.3	09/02→12/03	Petrol	B 5234 T3	2319	5	81.00	90.00	20
C70 I 2.3 T5	03/98→10/05	Petrol	B 5234 T3	2319	5	81.00	90.00	20











cm3



9

C70 I 2.3 T5	07/02→10/05	Petrol	B 5234 T9	2319	5	81.00	90.00	20
C70 I 2.3 T-5	03/97→09/02	Petrol	B 5234 T3	2319	5	81.00	90.00	20
C70 I 2.4	09/04→10/05	Petrol	B 5244 T5	2400	5	81.00	93.15	22
C70 I 2.4 T	07/02→10/05	Petrol	B 5244 T7	2435	5	83.00	90.00	35
C70 I 2.5	05/99→09/02	Petrol	B 5244 S	2435	5	83.00	90.00	34
C70 I 2.5	06/98→10/05	Petrol	B 5254 S	2435	5	83.00	90.00	34
C70 I 2.5 T	03/97→10/05	Petrol	B 5244 T	2435	5	83.00	90.00	35
C70 I 2.5 T	03/97→10/05	Petrol	B 5254 T	2435	5	83.00	90.00	35
C70 II 2.0 D	01/08→10/09	Diesel	D 4204 T	1998	4	85.00	88.00	40
C70 II 2.4	03/06→10/09	Petrol	B 5244 S5	2435	5	83.00	90.00	34
C70 II 2.4 D	03/07→06/13	Diesel	D 5244 T9	2400	5	81.00	93.20	23
C70 II 2.4 i	03/06→10/09	Petrol	B 5244 S4	2435	5	83.00	90.00	34
C70 II D3	10/10→06/13	Diesel	D 5204 T5	1984	5	81.00	77.00	15
C70 II D4	10/10→06/13	Diesel	D 5204 T	1984	5	81.00	77.00	15
C70 II D5	03/06→06/13	Diesel	D 5244 T8	2400	5	81.00	93.20	23
C70 II D5	03/06→06/13	Diesel	D 5244 T13	2400	5	81.00	93.20	23
C70 II T5	03/06→02/07	Petrol	B 5254 T3	2521	5	83.00	93.20	38
C70 II T5	03/07→10/09	Petrol	B 5254 T7	2521	5	83.00	93.20	38
Duett 1.8	08/61→07/67	Petrol	B 18 A	1780	4	84.14	80.00	39
LV370/375/385		Diesel	D47A/VDE	4704	6	95.25	100.00	48
P 121 1.8	02/67→05/71	Petrol	B 18	1780	4	84.14	80.00	39
P 121 1.8	05/59→09/66	Petrol	B 18 A	1780	4	84.14	80.00	39
P 121 2.0	11/68→05/71	Petrol	B 20 A	1986	4	88.90	80.00	43
P 122 S Amazon 1.8	05/59→05/71	Petrol	B 18	1780	4	84.14	80.00	39
P 122 S Amazon 1.8	02/67→05/71	Petrol	B 18 D	1780	4	84.14	80.00	39
P 122 S Amazon 2.0	11/68→05/71	Petrol	B 20 B	1986	4	88.90	80.00	43
P 544 1.8	08/61→07/67	Petrol	B 18 A	1780	4	84.14	80.00	39
P 544 1.8	08/61→07/67	Petrol	B 18 D	1780	4	84.14	80.00	39
P 1800 1.8	04/62→05/70	Petrol	B 18 A	1780	4	84.14	80.00	39
P 1800 1.8	09/66→12/68	Petrol	B 18 B	1780	4	84.14	80.00	39
P 1800 2.0	09/69→11/73	Petrol	B 20 E	1986	4	88.90	80.00	43
P 1800 2.0 ES	04/72→11/73	Petrol	B 20 E	1986	4	88.90	80.00	43
P 2200 1.8	09/64→08/67	Petrol	B 18 A	1780	4	84.14	80.00	39
P 2200 1.8	09/64→08/67	Petrol	B 18 B	1780	4	84.14	80.00	39
P 2200 1.8	09/64→08/67	Petrol	B 18 D	1780	4	84.14	80.00	39
S40 I 1.6	03/99→12/03	Petrol	B 4164 S2	1587	4	81.00	77.00	12
S40 I 1.6	09/95→08/99	Petrol	B 4164 S	1588	4	81.00	77.00	12
S40 I 1.8	07/95→08/99	Petrol	B 4184 S	1731	4	83.00	80.00	30
S40 I 1.8	07/95→08/99	Petrol	B 4184 S3	1731	4	83.00	80.00	30
S40 I 1.8	03/99→12/03	Petrol	B 4184 S2	1783	4	83.00	82.40	31
S40 I 1.8	03/99→12/03	Petrol	B 4184 S9	1783	4	83.00	82.40	31
S40 I 1.8 i	06/01→12/03	Petrol	B 4184 SJ	1834	4	81.00	89.00	18
S40 I 1.8 i	03/98→12/03	Petrol	B 4184 SM	1834	4	81.00	89.00	18
S40 I 1.9	09/02→12/03	Petrol	B 4204 T4	1948	4	83.00	90.00	33
S40 I 1.9 DI	07/00→12/03	Diesel	D 4192 T3	1870	4	80.00	93.00	10
S40 I 1.9 DI	07/00→12/03	Diesel	D 4192 T4	1870	4	80.00	93.00	10
S40 I 1.9 T4	05/97→07/00	Petrol	B 4194 T	1855	4	81.00	90.00	19
S40 I 1.9 T4	05/97→07/00	Petrol	B 4194 T2	1855	4	81.00	90.00	19
S40 I 1.9 TD	07/95→08/99	Diesel	D 4192 T	1870	4	80.00	93.00	10
S40 I 2.0	07/95→12/03	Petrol	B 4204 S	1948	4	83.00	90.00	32
S40 I 2.0	07/95→12/03	Petrol	B 4204 S2	1948	4	83.00	90.00	32
S40 I 2.0 D	12/02→06/04	Diesel	D 4204 T	1998	4	85.00	88.00	40
S40 I 2.0 T	10/97→12/03	Petrol	B 4204 T	1948	4	83.00	90.00	33
S40 I 2.0 T	07/00→06/01	Petrol	B 4204 T2	1948	4	83.00	90.00	33
S40 I 2.0 T	07/00→12/03	Petrol	B 4204 T3	1948	4	83.00	90.00	33
S40 I 2.0 T4	07/00→12/03	Petrol	B 4204 T5	1948	4	83.00	90.00	33
S40 II 1.6	01/05→	Petrol	B 4164 S3	1596	4	79.00	81.40	8
S40 II 1.6 D	01/05→	Diesel	D 4164 T	1560	4	75.00	88.30	4
S40 II 1.9	01/04→12/04	Petrol	B 4204 T4	1948	4	83.00	90.00	33
S40 II 2.0 D	01/04→	Diesel	D 4204 T	1998	4	85.00	88.00	40
S40 II 2.0 D4	07/05→	Diesel	D 4204 T2	1998	4	85.00	88.00	40
S40 II 2.4	01/04→	Petrol	B 5244 S4	2435	5	83.00	90.00	34
S40 II 2.4	01/04→	Petrol	B 5244 S5	2435	5	83.00	90.00	34
S40 II 2.4 AWD	08/06→	Petrol	B 5244 S4	2435	5	83.00	90.00	34
S40 II 2.4 D5	03/06→	Diesel	D 5244 T8	2400	5	81.00	93.20	23
S40 II 2.4 D5	03/06→	Diesel	D 5244 T13	2400	5	81.00	93.20	23
S40 II D3	10/10→	Diesel	D 5204 T5	1984	5	81.00	77.00	15
S40 II D4	10/10→	Diesel	D 5204 T	1984	5	81.00	77.00	15
S40 II T5	01/04→	Petrol	B 5254 T3	2521	5	83.00	93.20	38

				cm ³	x 			
S40 II T5	03/07→	Petrol	B 5254 T7	2521	5	83.00	93.20	38
S40 II T5 AWD	04/04→	Petrol	B 5254 T3	2521	5	83.00	93.20	38
S40 II T5 AWD	03/07→	Petrol	B 5254 T7	2521	5	83.00	93.20	38
S60 I 2.0 T	07/00→04/10	Petrol	B 5204 T5	1984	5	81.00	77.00	14
S60 I 2.3 T5	09/00→12/04	Petrol	B 5234 T3	2319	5	81.00	90.00	20
S60 I 2.3 T5	07/00→09/02	Petrol	B 5234 T7	2319	5	81.00	90.00	20
S60 I 2.4	11/00→04/10	Petrol	B 5244 S	2435	5	83.00	90.00	34
S60 I 2.4	11/00→04/10	Petrol	B 5244 S2	2435	5	83.00	90.00	34
S60 I 2.4	01/05→10/06	Petrol	B 5244 T4	2435	5	83.00	90.00	35
S60 I 2.4 AWD	02/04→04/10	Petrol	B 5244 T5	2400	5	81.00	93.15	22
S60 I 2.4 Bifuel	06/02→04/10	Petrol	B 5244 SG	2435	5	83.00	90.00	34
S60 I 2.4 Bifuel	06/02→04/10	Petrol	B 5244 SG2	2435	5	83.00	90.00	34
S60 I 2.4 D	12/01→04/10	Diesel	D 5244 T2	2400	5	81.00	93.20	23
S60 I 2.4 D	09/05→01/09	Diesel	D 5244 T5	2400	5	81.00	93.20	23
S60 I 2.4 D	09/05→04/10	Diesel	D 5244 T7	2400	5	81.00	93.20	23
S60 I 2.4 D5	07/01→04/10	Diesel	D 5244 T	2400	5	81.00	93.20	23
S60 I 2.4 D5	09/05→04/10	Diesel	D 5244 T4	2400	5	81.00	93.20	23
S60 I 2.4 T	01/01→04/10	Petrol	B 5244 T	2435	5	83.00	90.00	35
S60 I 2.4 T	11/00→04/10	Petrol	B 5244 T3	2435	5	83.00	90.00	35
S60 I 2.4 T5	04/04→04/10	Petrol	B 5244 T5	2400	5	81.00	93.15	22
S60 I 2.4 T AWD	11/01→04/10	Petrol	B 5244 T3	2435	5	83.00	90.00	35
S60 I 2.5 T	02/04→04/10	Petrol	B 5254 T2	2521	5	83.00	93.20	38
S60 I 2.5 T AWD	04/04→04/10	Petrol	B 5254 T2	2521	5	83.00	93.20	38
S60 I R 2,5 T AWD	03/03→04/10	Petrol	B 5254 T4	2521	5	83.00	93.20	38
S60 II T5	11/00→04/10	Petrol	B 5234 T3	2319	5	81.00	90.00	20
S60 II 2.0 T	12/13→	Petrol	B 5204 T8	1984	5	81.00	77.00	14
S60 II 2.0 T3	03/15→	Petrol	B 4204 T37	1969	4	82.00	93.20	26
S60 II 2.0 T4	05/15→	Petrol	B 4204 T19	1969	4	82.00	93.20	26
S60 II 2.4 D4 AWD	03/15→	Diesel	D 5244 T21	2400	5	81.00	93.20	23
S60 II 2.5 T5	09/11→	Petrol	B 5254 T5	2521	5	83.00	93.20	38
S60 II 2.5 T5 AWD	09/12→	Petrol	B 5254 T5	2521	5	83.00	93.20	38
S60 II D3	04/10→04/12	Diesel	D 5204 T2	1984	5	81.00	77.00	15
S60 II D3	04/10→04/12	Diesel	D 5204 T3	1984	5	81.00	77.00	15
S60 II D3	05/12→	Diesel	D 5204 T7	1984	5	81.00	77.00	15
S60 II D4	05/12→	Diesel	D 5204 T3	1984	5	81.00	77.00	15
S60 II D5	04/10→	Diesel	D 5244 T10	2400	5	81.00	93.20	23
S60 II D5	06/11→	Diesel	D 5244 T11	2400	5	81.00	93.20	23
S60 II D5	06/11→	Diesel	D 5244 T15	2400	5	81.00	93.20	23
S60 II D5	04/14→	Diesel	D 5244 T23	2400	5	81.00	93.20	23
S60 II D5 AWD	04/10→	Diesel	D 5244 T10	2400	5	81.00	93.20	23
S60 II D5 AWD	06/11→	Diesel	D 5244 T15	2400	5	81.00	93.20	23
S60 II D5 AWD	04/14→	Diesel	D 5244 T23	2400	5	81.00	93.20	23
S60 II T5	07/14→	Petrol	B 4204 T9	1969	4	82.00	93.20	25
S60 II T5	09/13→	Petrol	B 4204 T11	1969	4	82.00	93.20	25
S60 II T5	11/13→	Petrol	B 5204 T9	1984	5	81.00	77.00	14
S60 II T5 AWD	07/14→	Petrol	B 4204 T11	1969	4	82.00	93.20	25
S60 II T5 AWD	08/15→	Petrol	B 5254 T12	2497	5	83.00	92.30	37
S60 II T6	09/13→	Petrol	B 4204 T9	1969	4	82.00	93.20	25
S60 II T6 AWD	09/15→	Petrol	B 4204 T9	1969	4	82.00	93.20	25
S70 2.0	01/97→11/00	Petrol	B 5202 FS	1984	5	81.00	77.00	13
S70 2.0	01/97→11/00	Petrol	B 5202 S	1984	5	81.00	77.00	13
S70 2.0	01/97→11/00	Petrol	B 5204 F	1984	5	81.00	77.00	13
S70 2.0	01/97→11/00	Petrol	B 5204 T2	1984	5	81.00	77.00	14
S70 2.0	01/97→11/00	Petrol	B 5204 T4	1984	5	81.00	77.00	14
S70 2.0 Turbo	01/97→11/00	Petrol	B 5204 T	1984	5	81.00	77.00	14
S70 2.0 Turbo	01/97→11/00	Petrol	B 5204 T3	1984	5	81.00	77.00	14
S70 2.3	11/96→11/00	Petrol	B 5234 T3	2319	5	81.00	90.00	20
S70 2.3	04/99→09/00	Petrol	B 5234 T7	2319	5	81.00	90.00	20
S70 2.3 AWD	04/99→09/00	Petrol	B 5234 T7	2319	5	81.00	90.00	20
S70 2.3 T-5	01/97→11/00	Petrol	B 5234 T3	2319	5	81.00	90.00	20
S70 2.3 T5 AWD	11/96→09/98	Petrol	B 5234 T3	2319	5	81.00	90.00	20
S70 2.3 T5 AWD	07/97→09/00	Petrol	B 5234 T4	2319	5	81.00	90.00	20
S70 2.3 T5 R AWD	11/96→09/98	Petrol	B 5234 T2	2319	5	81.00	90.00	20
S70 2.3 Turbo	01/97→11/00	Petrol	B 5234 FT+	2319	5	81.00	90.00	20
S70 2.4	01/97→11/00	Petrol	B 5244 S	2435	5	83.00	90.00	34
S70 2.4	08/99→11/00	Petrol	B 5244 S2	2435	5	83.00	90.00	34
S70 2.4	08/99→11/00	Petrol	B 5244 SG	2435	5	83.00	90.00	34
S70 2.4	01/97→11/00	Petrol	B 5254 S	2435	5	83.00	90.00	34
S70 2.4 AWD	04/99→09/00	Petrol	B 5244 S	2435	5	83.00	90.00	34











cm3



9

S70 2.4 AWD	04/99→09/00	Petrol	B 5244 S2	2435	5	83.00	90.00	34
S70 2.4 AWD	11/96→05/99	Petrol	B 5252 FS	2435	5	83.00	90.00	34
S70 2.4 AWD	10/98→05/99	Petrol	B 5254 S	2435	5	83.00	90.00	34
S70 2.4 Blu-Fuel	07/97→09/00	Petrol	B 5244 S2	2435	5	83.00	90.00	34
S70 2.4 Blu-Fuel	07/97→09/00	Petrol	B 5244 SG	2435	5	83.00	90.00	34
S70 2.4 T5 AWD	11/96→04/99	Petrol	B 5254 T	2435	5	83.00	90.00	35
S70 2.4 Turbo	01/97→11/00	Petrol	B 5244 T	2435	5	83.00	90.00	35
S70 2.4 Turbo	01/97→11/00	Petrol	B 5254 T	2435	5	83.00	90.00	35
S70 2.5	01/97→11/00	Petrol	B 5252 FS	2435	5	83.00	90.00	34
S70 2.5	06/98→11/00	Petrol	B 5254 S	2435	5	83.00	90.00	34
S70 2.5 Bifuel	07/99→11/00	Petrol	B 5244 SG	2435	5	83.00	90.00	34
S70 2.5 TDI	01/97→11/00	Diesel	D 5252 T	2461	5	81.00	95.50	24
S70 2.5 TDi AWD	10/99→09/00	Diesel	D 5252 T	2461	5	81.00	95.50	24
S80 I 2.0	06/98→07/06	Petrol	B 5204 T4	1984	5	81.00	77.00	14
S80 I 2.0 T	06/98→07/06	Petrol	B 5204 T3	1984	5	81.00	77.00	14
S80 I 2.0 T	12/99→07/06	Petrol	B 5204 T5	1984	5	81.00	77.00	14
S80 I 2.3 R	04/00→08/05	Petrol	B 5234 T7	2319	5	81.00	90.00	20
S80 I 2.4	01/99→07/06	Petrol	B 5244 S	2435	5	83.00	90.00	34
S80 I 2.4	01/99→07/06	Petrol	B 5244 S2	2435	5	83.00	90.00	34
S80 I 2.4 Bifuel	09/01→07/06	Petrol	B 5244 SG	2435	5	83.00	90.00	34
S80 I 2.4 Bifuel	09/01→07/06	Petrol	B 5244 SG2	2435	5	83.00	90.00	34
S80 I 2.4 D	10/01→07/06	Diesel	D 5244 T2	2400	5	81.00	93.20	23
S80 I 2.4 D5	08/01→07/06	Diesel	D 5244 T	2400	5	81.00	93.20	23
S80 I 2.4 LTP	06/04→07/06	Petrol	B 5244 T4	2435	5	83.00	90.00	35
S80 I 2.4 T	06/00→07/06	Petrol	B 5244 T3	2435	5	83.00	90.00	35
S80 I 2.4 T5 AWD	04/00→09/03	Petrol	B 5244 T3	2435	5	83.00	90.00	35
S80 I 2.5 T	03/03→07/06	Petrol	B 5254 T2	2521	5	83.00	93.20	38
S80 I 2.5 T AWD	07/03→07/06	Petrol	B 5254 T2	2521	5	83.00	93.20	38
S80 I 2.5 TDI	01/99→07/06	Diesel	D 5252 T	2461	5	81.00	95.50	24
S80 I 2.9	05/98→07/06	Petrol	B 6304 S3	2922	6	83.00	90.00	36
S80 II 1.6 D DRIVE	01/10→	Diesel	D 4164 T	1560	4	75.00	88.30	4
S80 II 2.0 Drive- E	12/14→	Petrol	B 4204 T11	1969	4	82.00	93.20	25
S80 II 2.0 TDi	02/08→	Diesel	D 4204 T	1998	4	85.00	88.00	40
S80 II 2.4 D	03/06→	Diesel	D 5244 T	2400	5	81.00	93.20	23
S80 II 2.4 D	03/06→	Diesel	D 5244 T5	2400	5	81.00	93.20	23
S80 II 2.4 D	01/10→	Diesel	D 5244 T14	2400	5	81.00	93.20	23
S80 II 2.5 T	01/12→	Petrol	B 5254 T12	2497	5	83.00	92.30	37
S80 II 2.5 T	09/12→	Petrol	B 5254 T14	2497	5	83.00	92.30	37
S80 II 2.5 T	03/06→	Petrol	B 5254 T6	2521	5	83.00	93.20	38
S80 II 2.5 T	01/10→	Petrol	B 5254 T10	2521	5	83.00	93.20	38
S80 II 2.5 T AWD	10/06→	Petrol	B 5254 T6	2521	5	83.00	93.20	38
S80 II 2.5 T FlexFuel	05/08→	Flexfuel	B 5254 T8	2521	5	83.00	93.20	38
S80 II 2.5 T FlexFuel	01/10→	Flexfuel	B 5254 T11	2521	5	83.00	93.20	38
S80 II D3	05/12→	Diesel	D 5204 T7	1984	5	81.00	77.00	15
S80 II D3 / D4	01/10→	Diesel	D 5204 T2	1984	5	81.00	77.00	15
S80 II D3 / D4	01/10→	Diesel	D 5204 T3	1984	5	81.00	77.00	15
S80 II D5	03/06→	Diesel	D 5244 T4	2400	5	81.00	93.20	23
S80 II D5	01/10→	Diesel	D 5244 T10	2400	5	81.00	93.20	23
S80 II D5	06/11→	Diesel	D 5244 T11	2400	5	81.00	93.20	23
S80 II D5	06/11→	Diesel	D 5244 T15	2400	5	81.00	93.20	23
S80 II D5 AWD	01/07→	Diesel	D 5244 T4	2400	5	81.00	93.20	23
S80 II D5 AWD	01/10→	Diesel	D 5244 T10	2400	5	81.00	93.20	23
S80 II D5 AWD	06/11→	Diesel	D 5244 T15	2400	5	81.00	93.20	23
S80 II T5	09/13→	Petrol	B 4204 T11	1969	4	82.00	93.20	25
S80 II T6 AWD	01/07→	Petrol	B 6304 T2	2953	6	82.00	93.20	27
S90 2.5	11/96→10/97	Petrol	B 6244 FS	2473	6	81.00	80.00	16
S90 2.5	11/96→10/98	Petrol	B 6254 FS	2473	6	81.00	80.00	16
S90 2.9	01/97→05/98	Petrol	B 6304 G	2922	6	83.00	90.00	36
S90 2.9	11/96→12/98	Petrol	B 6304 S2	2922	6	83.00	90.00	36
V40 1.6	03/99→06/04	Petrol	B 4164 S2	1587	4	81.00	77.00	12
V40 1.6	12/95→08/99	Petrol	B 4164 S	1588	4	81.00	77.00	12
V40 1.8	07/95→08/99	Petrol	B 4184 S	1731	4	83.00	80.00	30
V40 1.8	07/95→08/99	Petrol	B 4184 S3	1731	4	83.00	80.00	30
V40 1.8	03/99→06/04	Petrol	B 4184 S2	1783	4	83.00	82.40	31
V40 1.8	03/99→06/04	Petrol	B 4184 S9	1783	4	83.00	82.40	31
V40 1.8 Bi-Fuel	11/99→08/03	Petrol	B 4184 S9	1783	4	83.00	82.40	31
V40 1.8 Blu-Fuel	06/01→08/03	Petrol	B 4184 S2	1783	4	83.00	82.40	31
V40 1.8 i	06/01→06/04	Petrol	B 4184 SJ	1834	4	81.00	89.00	18
V40 1.8 i	03/98→06/04	Petrol	B 4184 SM	1834	4	81.00	89.00	18









				cm3				
V40 1.9	09/03→06/04	Petrol	B 4204 T4	1948	4	83.00	90.00	33
V40 1.9 DI	07/00→06/04	Diesel	D 4192 T3	1870	4	80.00	93.00	10
V40 1.9 DI	07/00→06/04	Diesel	D 4192 T4	1870	4	80.00	93.00	10
V40 1.9 T4	05/97→07/00	Petrol	B 4194 T	1855	4	81.00	90.00	19
V40 1.9 TD	07/95→08/99	Diesel	D 4192 T	1870	4	80.00	93.00	10
V40 2.0	07/95→06/04	Petrol	B 4204 S	1948	4	83.00	90.00	32
V40 2.0	07/95→06/04	Petrol	B 4204 S2	1948	4	83.00	90.00	32
V40 2.0	09/99→12/00	Petrol	B 4204 T	1948	4	83.00	90.00	33
V40 2.0	09/99→12/00	Petrol	B 4204 T2	1948	4	83.00	90.00	33
V40 2.0 D	12/02→06/04	Diesel	D 4204 T	1998	4	85.00	88.00	40
V40 2.0 T	10/97→07/00	Petrol	B 4204 T	1948	4	83.00	90.00	33
V40 2.0 T	07/99→06/04	Petrol	B 4204 T2	1948	4	83.00	90.00	33
V40 2.0 T	06/01→06/04	Petrol	B 4204 T3	1948	4	83.00	90.00	33
V40 2.0 T4	07/00→06/04	Petrol	B 4204 T5	1948	4	83.00	90.00	33
V40 D3	03/12→03/15	Diesel	D 5204 T6	1984	5	81.00	77.00	15
V40 D4	03/12→	Diesel	D 5204 T4	1984	5	81.00	77.00	15
V40 T2	02/15→	Petrol	B 4204 T38	1969	4	82.00	93.20	26
V40 T3	02/15→	Petrol	B 4204 T37	1969	4	82.00	93.20	26
V40 T4	08/15→	Petrol	B 4204 T19	1969	4	82.00	93.20	26
V40 T4	07/13→	Petrol	B 5204 T8	1984	5	81.00	77.00	14
V40 T4 AWD	05/14→	Petrol	B 4204 T21	1969	4	82.00	93.20	26
V40 T4 AWD	07/13→	Petrol	B 5204 T8	1984	5	81.00	77.00	14
V40 T5	05/14→	Petrol	B 4204 T11	1969	4	82.00	93.20	25
V40 T5	03/13→	Petrol	B 5204 T9	1984	5	81.00	77.00	14
V40 T5	12/12→	Petrol	B 5254 T12	2497	5	83.00	92.30	37
V40 T5	01/14→	Petrol	B 5254 T14	2497	5	83.00	92.30	37
V40 T5 AWD	05/14→	Petrol	B 4204 T11	1969	4	82.00	93.20	25
V40 T5 AWD	03/13→	Petrol	B 5204 T9	1984	5	81.00	77.00	14
V40 T5 AWD	01/13→	Petrol	B 5254 T12	2497	5	83.00	92.30	37
V50 1.6	01/05→	Petrol	B 4164 S3	1596	4	79.00	81.40	8
V50 1.6 D	01/05→	Diesel	D 4164 T	1560	4	75.00	88.30	4
V50 2.0 D	04/04→	Diesel	D 4204 T	1998	4	85.00	88.00	40
V50 2.4	04/04→	Petrol	B 5244 S4	2435	5	83.00	90.00	34
V50 2.4	04/04→	Petrol	B 5244 S5	2435	5	83.00	90.00	34
V50 2.4 AWD	08/06→	Petrol	B 5244 S4	2435	5	83.00	90.00	34
V50 2.4 D5	03/06→	Diesel	D 5244 T8	2400	5	81.00	93.20	23
V50 2.4 D5	03/06→	Diesel	D 5244 T13	2400	5	81.00	93.20	23
V50 2.4 Tdi	05/07→	Diesel	D 5244 T9	2400	5	81.00	93.20	23
V50 D3	10/10→	Diesel	D 5204 T5	1984	5	81.00	77.00	15
V50 D4	10/10→	Diesel	D 5204 T	1984	5	81.00	77.00	15
V50 T5	04/04→	Petrol	B 5254 T3	2521	5	83.00	93.20	38
V50 T5	03/07→	Petrol	B 5254 T7	2521	5	83.00	93.20	38
V50 T5 AWD	04/04→	Petrol	B 5254 T3	2521	5	83.00	93.20	38
V50 T5 AWD	03/07→	Petrol	B 5254 T7	2521	5	83.00	93.20	38
V60 2.0 T4	05/15→	Petrol	B 4204 T19	1969	4	82.00	93.20	26
V60 2.4 D5	06/11→	Diesel	D 5244 T11	2400	5	81.00	93.20	23
V60 2.4 D5	06/11→	Diesel	D 5244 T15	2400	5	81.00	93.20	23
V60 2.4 D5 AWD	06/11→	Diesel	D 5244 T15	2400	5	81.00	93.20	23
V60 2.5 T5	07/14→	Petrol	B 5254 T5	2521	5	83.00	93.20	38
V60 2.5 T5 AWD	07/14→	Petrol	B 5254 T5	2521	5	83.00	93.20	38
V60 D3	12/12→	Diesel	D 5204 T7	1984	5	81.00	77.00	15
V60 D3 / D4	09/10→	Diesel	D 5204 T2	1984	5	81.00	77.00	15
V60 D3 / D4	09/10→	Diesel	D 5204 T3	1984	5	81.00	77.00	15
V60 D4 AWD	10/13→	Diesel	D 5244 T12	2400	5	81.00	93.20	23
V60 D4 AWD	12/12→	Diesel	D 5244 T17	2400	5	81.00	93.20	23
V60 D4 AWD	03/15→	Diesel	D 5244 T21	2400	5	81.00	93.20	23
V60 D5	09/10→	Diesel	D 5244 T10	2400	5	81.00	93.20	23
V60 D5	04/14→	Diesel	D 5244 T23	2400	5	81.00	93.20	23
V60 D5 AWD	09/10→	Diesel	D 5244 T10	2400	5	81.00	93.20	23
V60 D5 AWD	04/14→	Diesel	D 5244 T15	2400	5	81.00	93.20	23
V60 D5 AWD	04/14→	Diesel	D 5244 T23	2400	5	81.00	93.20	23
V60 T3	03/15→	Petrol	B 4204 T37	1969	4	82.00	93.20	26
V60 T5	10/13→	Petrol	B 4204 T11	1969	4	82.00	93.20	25
V60 T5	04/14→	Petrol	B 5204 T9	1984	5	81.00	77.00	14
V60 T5 AWD	07/14→	Petrol	B 4204 T11	1969	4	82.00	93.20	25
V60 T5 AWD	08/15→	Petrol	B 5254 T12	2497	5	83.00	92.30	37
V60 T6	10/13→	Petrol	B 4204 T9	1969	4	82.00	93.20	25
V60 T6 AWD	10/13→	Petrol	B 4204 T9	1969	4	82.00	93.20	25
V70 I 2.0	01/97→03/00	Petrol	B 5202 S	1984	5	81.00	77.00	13



cm3



V70 I 2.0	01/97→03/00	Petrol	B 5204 F	1984	5	81.00	77.00	13
V70 I 2.0	01/97→03/00	Petrol	B 5204 T2	1984	5	81.00	77.00	14
V70 I 2.0	01/97→03/00	Petrol	B 5204 T4	1984	5	81.00	77.00	14
V70 I 2.0 Turbo	01/97→03/00	Petrol	B 5204 T	1984	5	81.00	77.00	14
V70 I 2.0 Turbo	01/97→03/00	Petrol	B 5204 T3	1984	5	81.00	77.00	14
V70 I 2.0 Turbo AWD	01/97→03/00	Petrol	B 5204 T3	1984	5	81.00	77.00	14
V70 I 2.3	11/96→11/00	Petrol	B 5234 T3	2319	5	81.00	90.00	20
V70 I 2.3 AWD	04/97→09/98	Petrol	B 5234 T3	2319	5	81.00	90.00	20
V70 I 2.3 AWD	12/98→02/00	Petrol	B 5234 T7	2319	5	81.00	90.00	20
V70 I 2.3 AWD	12/98→02/00	Petrol	B 5234 T8	2319	5	81.00	90.00	20
V70 I 2.3 T-5	01/97→03/00	Petrol	B 5234 T3	2319	5	81.00	90.00	20
V70 I 2.3 T-5 AWD	01/97→03/00	Petrol	B 5234 T3	2319	5	81.00	90.00	20
V70 I 2.3 T AWD	04/97→03/00	Petrol	B 5234 FT+	2319	5	81.00	90.00	20
V70 I 2.3 T AWD	04/97→03/00	Petrol	B 5234 T4	2319	5	81.00	90.00	20
V70 I 2.3 Turbo	01/97→03/00	Petrol	B 5234 FT+	2319	5	81.00	90.00	20
V70 I 2.4	01/97→05/00	Petrol	B 5244 S	2435	5	83.00	90.00	34
V70 I 2.4	08/99→05/00	Petrol	B 5244 S2	2435	5	83.00	90.00	34
V70 I 2.4	08/99→05/00	Petrol	B 5244 SG2	2435	5	83.00	90.00	34
V70 I 2.4	01/97→05/00	Petrol	B 5254 S	2435	5	83.00	90.00	34
V70 I 2.4 AWD	10/98→05/99	Petrol	B 5254 S	2435	5	83.00	90.00	34
V70 I 2.4 Bifuel	08/99→03/00	Petrol	B 5244 SG	2435	5	83.00	90.00	34
V70 I 2.4 Turbo	01/97→03/00	Petrol	B 5244 T	2435	5	83.00	90.00	35
V70 I 2.4 Turbo	01/97→03/00	Petrol	B 5254 T	2435	5	83.00	90.00	35
V70 I 2.4 Turbo AWD	05/99→02/00	Petrol	B 5244 T2	2435	5	83.00	90.00	35
V70 I 2.5	01/97→03/00	Petrol	B 5252 FS	2435	5	83.00	90.00	34
V70 I 2.5	06/98→03/00	Petrol	B 5254 S	2435	5	83.00	90.00	34
V70 I 2.5 AWD	03/99→03/00	Petrol	B 5244 T2	2435	5	83.00	90.00	35
V70 I 2.5 TDI	01/97→05/00	Diesel	D 5252 T	2461	5	81.00	95.50	24
V70 I 2.5 TDi AWD	11/96→02/00	Diesel	D 5252 T	2461	5	81.00	95.50	24
V70 I 2.5 Turbo AWD	01/97→05/00	Petrol	B 5244 T	2435	5	83.00	90.00	35
V70 I 2.5 Turbo AWD	01/97→05/00	Petrol	B 5254 T	2435	5	83.00	90.00	35
V70 II 2.0 T	07/01→08/07	Petrol	B 5204 T5	1984	5	81.00	77.00	14
V70 II 2.3	03/02→12/04	Petrol	B 5234 T3	2319	5	81.00	90.00	20
V70 II 2.3	10/00→09/04	Petrol	B 5234 T7	2319	5	81.00	90.00	20
V70 II 2.3 AWD	10/00→09/04	Petrol	B 5234 T7	2319	5	81.00	90.00	20
V70 II 2.3 AWD	10/00→09/04	Petrol	B 5234 T8	2319	5	81.00	90.00	20
V70 II 2.3 T5	03/00→08/04	Petrol	B 5234 T3	2319	5	81.00	90.00	20
V70 II 2.4	03/00→08/07	Petrol	B 5244 S	2435	5	83.00	90.00	34
V70 II 2.4	03/00→08/07	Petrol	B 5244 S2	2435	5	83.00	90.00	34
V70 II 2.4	03/00→09/03	Petrol	B 5254 S	2435	5	83.00	90.00	34
V70 II 2.4 AWD	03/00→09/03	Petrol	B 5254 S	2435	5	83.00	90.00	34
V70 II 2.4 Bifuel	09/01→08/07	Petrol	B 5244 SG	2435	5	83.00	90.00	34
V70 II 2.4 Bifuel	09/01→08/07	Petrol	B 5244 SG2	2435	5	83.00	90.00	34
V70 II 2.4 D	12/01→08/07	Diesel	D 5244 T2	2400	5	81.00	93.20	23
V70 II 2.4 D	05/05→08/07	Diesel	D 5244 T7	2400	5	81.00	93.20	23
V70 II 2.4 D5	08/01→08/07	Diesel	D 5244 T	2400	5	81.00	93.20	23
V70 II 2.4 D5	12/05→08/07	Diesel	D 5244 T4	2400	5	81.00	93.20	23
V70 II 2.4 D5	08/01→08/07	Diesel	D 5244 T5	2400	5	81.00	93.20	23
V70 II 2.4 D5 AWD	03/03→08/07	Diesel	D 5244 T	2400	5	81.00	93.20	23
V70 II 2.4 D5 AWD	03/03→08/07	Diesel	D 5244 T2	2400	5	81.00	93.20	23
V70 II 2.4 D5 AWD	12/05→08/07	Diesel	D 5244 T4	2400	5	81.00	93.20	23
V70 II 2.4 D5 AWD	03/03→08/07	Diesel	D 5244 T5	2400	5	81.00	93.20	23
V70 II 2.4 T	03/00→08/03	Petrol	B 5244 T3	2435	5	83.00	90.00	35
V70 II 2.4 T5	04/04→08/07	Petrol	B 5244 T5	2400	5	81.00	93.15	22
V70 II 2.4 T AWD	09/00→12/02	Petrol	B 5244 T	2435	5	83.00	90.00	35
V70 II 2.4 T AWD	09/01→08/02	Petrol	B 5244 T3	2435	5	83.00	90.00	35
V70 II 2.5	09/03→08/07	Petrol	B 5254 T2	2521	5	83.00	93.20	38
V70 II 2.5 AWD	09/02→12/04	Petrol	B 5254 T2	2521	5	83.00	93.20	38
V70 II 2.5 R	12/02→08/07	Petrol	B 5254 T4	2521	5	83.00	93.20	38
V70 II 2.5 T	04/04→08/07	Petrol	B 5254 T2	2521	5	83.00	93.20	38
V70 II 2.5 T AWD	09/02→08/07	Petrol	B 5254 T2	2521	5	83.00	93.20	38
V70 II 2.5 TDI	03/00→08/07	Diesel	D 5252 T	2461	5	81.00	95.50	24
V70 II R 2,5 T AWD	03/03→08/07	Petrol	B 5254 T4	2521	5	83.00	93.20	38
V70 III 1.6 D	01/10→	Diesel	D 4164 T	1560	4	75.00	88.30	4
V70 III 2.0 BiFuel	03/13→	Petrol	B 5204 T9	1984	5	81.00	77.00	14
V70 III 2.0 D	10/07→	Diesel	D 4204 T	1998	4	85.00	88.00	40
V70 III 2.0 GDI	03/13→	Petrol	B 5204 T9	1984	5	81.00	77.00	14
V70 III 2.4 D	08/07→	Diesel	D 5244 T5	2400	5	81.00	93.20	23
V70 III 2.4 D	10/09→	Diesel	D 5244 T14	2400	5	81.00	93.20	23







				cm ³	x 			
V70 III 2.5 T	08/07→	Petrol	B 5254 T6	2521	5	83.00	93.20	38
V70 III 2.5 T	01/10→	Petrol	B 5254 T10	2521	5	83.00	93.20	38
V70 III 2.5 T FlexiFuel	05/08→	Flexfuel	B 5254 T8	2521	5	83.00	93.20	38
V70 III 2.5 T FlexiFuel	10/09→	Flexfuel	B 5254 T11	2521	5	83.00	93.20	38
V70 III D3	03/10→	Diesel	D 5204 T7	1984	5	81.00	77.00	15
V70 III D3 / D4	03/10→	Diesel	D 5204 T2	1984	5	81.00	77.00	15
V70 III D3 / D4	03/10→	Diesel	D 5204 T3	1984	5	81.00	77.00	15
V70 III D4 AWD	10/13→	Diesel	D 5244 T12	2400	5	81.00	93.20	23
V70 III D4 AWD	01/13→	Diesel	D 5244 T17	2400	5	81.00	93.20	23
V70 III D5	08/07→	Diesel	D 5244 T4	2400	5	81.00	93.20	23
V70 III D5	12/09→	Diesel	D 5244 T10	2400	5	81.00	93.20	23
V70 III D5	06/11→	Diesel	D 5244 T11	2400	5	81.00	93.20	23
V70 III D5	06/11→	Diesel	D 5244 T15	2400	5	81.00	93.20	23
V70 III D5 AWD	10/07→	Diesel	D 5244 T4	2400	5	81.00	93.20	23
V70 III D5 AWD	12/09→	Diesel	D 5244 T10	2400	5	81.00	93.20	23
V70 III D5 AWD	06/11→	Diesel	D 5244 T11	2400	5	81.00	93.20	23
V70 III D5 AWD	06/11→	Diesel	D 5244 T15	2400	5	81.00	93.20	23
V70 III T4	03/15→	Petrol	B 4204 T19	1969	4	82.00	93.20	26
V70 III T5	10/13→	Petrol	B 4204 T11	1969	4	82.00	93.20	25
V70 III T6 AWD	08/07→	Petrol	B 6304 T2	2953	6	82.00	93.20	27
V90 2.5	11/96→10/97	Petrol	B 6244 FS	2473	6	81.00	80.00	16
V90 2.5	11/96→10/98	Petrol	B 6254 FS	2473	6	81.00	80.00	16
V90 2.9	01/97→12/98	Petrol	B 6304 G	2922	6	83.00	90.00	36
V90 2.9	01/97→12/98	Petrol	B 6304 S2	2922	6	83.00	90.00	36
XC60 2.4 D	07/09→	Diesel	D 5244 T14	2400	5	81.00	93.20	23
XC60 2.4 D AWD	06/09→12/10	Diesel	D 5244 T14	2400	5	81.00	93.20	23
XC60 2.4 D / D3 / D4 AWD	05/08→	Diesel	D 5244 T5	2400	5	81.00	93.20	23
XC60 2.4 D / D3 / D4 AWD	05/08→	Diesel	D 5244 T16	2400	5	81.00	93.20	23
XC60 2.4 D / D3 / D4 AWD	05/08→	Diesel	D 5244 T17	2400	5	81.00	93.20	23
XC60 D3	04/12→	Diesel	D 5204 T7	1984	5	81.00	77.00	15
XC60 D3 / D4	03/10→	Diesel	D 5204 T2	1984	5	81.00	77.00	15
XC60 D3 / D4	03/10→	Diesel	D 5204 T3	1984	5	81.00	77.00	15
XC60 D4 AWD	10/13→	Diesel	D 5244 T12	2400	5	81.00	93.20	23
XC60 D4 AWD	03/15→	Diesel	D 5244 T21	2400	5	81.00	93.20	23
XC60 D5	06/11→	Diesel	D 5244 T15	2400	5	81.00	93.20	23
XC60 D5 AWD	05/08→	Diesel	D 5244 T4	2400	5	81.00	93.20	23
XC60 D5 AWD	07/09→06/11	Diesel	D 5244 T10	2400	5	81.00	93.20	23
XC60 D5 AWD	06/11→	Diesel	D 5244 T11	2400	5	81.00	93.20	23
XC60 D5 AWD	06/11→	Diesel	D 5244 T15	2400	5	81.00	93.20	23
XC60 D5 AWD	03/15→	Diesel	D 5244 T20	2400	5	81.00	93.20	23
XC60 D5 AWD	03/15→	Diesel	D 5244 T22	2400	5	81.00	93.20	23
XC60 D5 AWD	04/14→	Diesel	D 5244 T23	2400	5	81.00	93.20	23
XC60 T5	10/13→	Petrol	B 4204 T11	1969	4	82.00	93.20	25
XC60 T5 AWD	04/14→	Petrol	B 5254 T12	2497	5	83.00	92.30	37
XC60 T6	10/13→	Petrol	B 4204 T9	1969	4	82.00	93.20	25
XC60 T6 AWD	10/13→	Petrol	B 4204 T9	1969	4	82.00	93.20	25
XC60 T6 AWD	05/08→	Petrol	B 6304 T2	2953	6	82.00	93.20	27
XC70 Cross Country 2.0 T5 AWD	10/97→03/99	Petrol	B 5204 T3	1984	5	81.00	77.00	14
XC70 Cross Country 2.4 D5 AWD	12/05→08/07	Diesel	D 5244 T4	2400	5	81.00	93.20	23
XC70 Cross Country 2.4 D5 XC AWD	09/02→08/07	Diesel	D 5244 T	2400	5	81.00	93.20	23
XC70 Cross Country 2.4 T XC AWD	03/00→09/02	Petrol	B 5244 T3	2435	5	83.00	90.00	35
XC70 Cross Country 2.4 T XC AWD	11/97→09/02	Petrol	B 5254 T	2435	5	83.00	90.00	35
XC70 Cross Country 2.5 T XC AWD	08/02→08/07	Petrol	B 5254 T2	2521	5	83.00	93.20	38
XC70 II 2.4 D	01/10→	Diesel	D 5244 T14	2400	5	81.00	93.20	23
XC70 II 2.4 D / D4 AWD	08/07→	Diesel	D 5244 T5	2400	5	81.00	93.20	23
XC70 II 2.4 D / D4 AWD	08/07→	Diesel	D 5244 T16	2400	5	81.00	93.20	23
XC70 II 2.4 D / D4 AWD	08/07→	Diesel	D 5244 T17	2400	5	81.00	93.20	23
XC70 II D3	08/11→	Diesel	D 5204 T2	1984	5	81.00	77.00	15
XC70 II D3	08/11→	Diesel	D 5204 T3	1984	5	81.00	77.00	15
XC70 II D3 AWD	08/11→	Diesel	D 5204 T2	1984	5	81.00	77.00	15
XC70 II D4 AWD	10/13→	Diesel	D 5244 T12	2400	5	81.00	93.20	23
XC70 II D5 AWD	08/07→	Diesel	D 5244 T4	2400	5	81.00	93.20	23
XC70 II D5 AWD	12/09→	Diesel	D 5244 T10	2400	5	81.00	93.20	23
XC70 II D5 AWD	06/11→	Diesel	D 5244 T11	2400	5	81.00	93.20	23
XC70 II D5 AWD	06/11→	Diesel	D 5244 T15	2400	5	81.00	93.20	23
XC70 II D5 AWD	03/15→	Diesel	D 5244 T20	2400	5	81.00	93.20	23
XC70 II T5	10/13→	Petrol	B 4204 T11	1969	4	82.00	93.20	25
XC70 II T5 AWD	08/15→	Petrol	B 5254 T12	2497	5	83.00	92.30	37
XC70 II T6 AWD	01/08→	Petrol	B 6304 T2	2953	6	82.00	93.20	27















cm3















XC90 I 2.5 T	10/02→	Petrol	B 5254 T2	2521	5	83.00	93.20	38
XC90 I 2.5 T AWD	10/12→	Petrol	B 5254 T9	2497	5	83.00	92.30	37
XC90 I D3 / D5	04/09→	Diesel	D 5244 T5	2400	5	81.00	93.20	23
XC90 I D5	10/02→	Diesel	D 5244 T	2400	5	81.00	93.20	23
XC90 I D5	05/06→	Diesel	D 5244 T4	2400	5	81.00	93.20	23
XC90 I D5	10/02→	Diesel	D 5244 T5	2400	5	81.00	93.20	23
XC90 I D5	01/11→	Diesel	D 5244 T18	2400	5	81.00	93.20	23
XC90 I D5 AWD	10/07→	Diesel	D 5244 T5	2400	5	81.00	93.20	23
XC90 II T5 AWD	06/15→	Petrol	B 4204 T23	1969	4	82.00	93.20	26
XC90 II T6 AWD	09/14→	Petrol	B 4204 T27	1969	4	82.00	93.20	25
XC90 II T8 Hybrid AWD	06/15→	Petrol	B4204T35	1969	4	82.00	93.20	26

		cm3	x 			
B 10 E	Petrol	1108	4	70.00	72.00	1
B 11	Petrol	1108	4	70.00	72.00	2
B 13	Petrol	1289	4	73.00	76.50	3
B 13 E	Petrol	1289	4	73.00	76.50	3
B 14.3 E	Petrol	1397	4	76.00	77.00	5
B 14.4 S	Petrol	1397	4	76.00	77.00	5
B 14 OE	Petrol	1397	4	76.00	77.00	5
B 18	Petrol	1780	4	84.14	80.00	39
B 18 A	Petrol	1780	4	84.14	80.00	39
B 18 B	Petrol	1780	4	84.14	80.00	39
B 18 D	Petrol	1780	4	84.14	80.00	39
B 18 E	Petrol	1721	4	81.00	83.50	17
B 18 ED	Petrol	1721	4	81.00	83.50	17
B 18 EP	Petrol	1721	4	81.00	83.50	17
B 18 F	Petrol	1721	4	81.00	83.50	17
B 18 FP	Petrol	1721	4	81.00	83.50	17
B 18 FT	Petrol	1721	4	81.00	83.50	17
B 18 FTM	Petrol	1721	4	81.00	83.50	17
B 18 K	Petrol	1721	4	81.00	83.50	17
B 18 KD	Petrol	1721	4	81.00	83.50	17
B 18 KP	Petrol	1721	4	81.00	83.50	17
B 18 KPD	Petrol	1721	4	81.00	83.50	17
B 18 U	Petrol	1794	4	82.70	83.50	28
B 19 A	Petrol	1986	4	88.90	80.00	42
B 19 E	Petrol	1986	4	88.90	80.00	42
B 19 ET	Petrol	1986	4	88.90	80.00	42
B 19 K	Petrol	1986	4	88.90	80.00	42
B 20	Petrol	1986	4	88.90	80.00	43
B 20 A	Petrol	1986	4	88.90	80.00	43
B 20 B	Petrol	1986	4	88.90	80.00	43
B 20 D	Petrol	1986	4	88.90	80.00	43
B 20 E	Petrol	1986	4	88.90	80.00	43
B 20 F	Petrol	1985	4	88.90	80.00	43
B 20 F	Petrol	1998	4	82.70	93.00	29
B 21 A	Petrol	2127	4	92.00	80.00	46
B 21 E	Petrol	2127	4	92.00	80.00	46
B 21 ET	Petrol	2127	4	92.00	80.00	46
B 21 F	Petrol	2127	4	92.00	80.00	46
B 23 A	Petrol	2316	4	96.00	80.00	50
B 23 E	Petrol	2316	4	96.00	80.00	50
B 23 ET	Petrol	2315	4	96.00	80.00	50
B 23 F	Petrol	2316	4	96.00	80.00	50
B 23 FT	Petrol	2316	4	96.00	80.00	50
B 27 A	Petrol	2664	V6	88.00	73.00	41
B 27 E	Petrol	2664	V6	88.00	73.00	41
B 27 F	Petrol	2664	V6	88.00	73.00	41
B 28 A	Petrol	2849	V6	91.00	73.00	45
B 28 E	Petrol	2849	V6	91.00	73.00	45
B 28 F	Petrol	2849	V6	91.00	73.00	45
B 130	Petrol	1289	4	73.00	76.50	3
B 17 2 K	Petrol	1721	4	81.00	83.50	17
B 200 E	Petrol	1986	4	88.90	80.00	44
B 200 EA	Petrol	1986	4	88.90	80.00	44
B 200 ET	Petrol	1986	4	88.90	80.00	44
B 200 F	Petrol	1986	4	88.90	80.00	44
B 200 FT	Petrol	1986	4	88.90	80.00	44
B 200 G	Petrol	1986	4	88.90	80.00	44
B 200 K	Petrol	1986	4	88.90	80.00	44
B 200 KE	Petrol	1986	4	88.90	80.00	44
B 204 E	Petrol	1986	4	88.90	80.00	44
B 204 FT	Petrol	1986	4	88.90	80.00	44
B 204 FTE	Petrol	1986	4	88.90	80.00	44
B 204 GT	Petrol	1986	4	88.90	80.00	44
B 230 A	Petrol	2316	4	96.00	80.00	51
B 230 E	Petrol	2316	4	96.00	80.00	51
B 230 ET	Petrol	2316	4	96.00	80.00	51
B 230 F	Petrol	2316	4	96.00	80.00	51
B 230 FB	Petrol	2316	4	96.00	80.00	51
B 230 FD	Petrol	2316	4	96.00	80.00	51

			cm ³	x 			
B 230 FK	Petrol		2316	4	96.00	80.00	51
B 230 FT	Petrol		2316	4	96.00	80.00	51
B 230 FT+	Petrol		2316	4	96.00	80.00	51
B 230 FX	Petrol		2316	4	96.00	80.00	51
B 230 G	Petrol		2316	4	96.00	80.00	51
B 230 GK	Petrol		2316	4	96.00	80.00	51
B 230 GS	Petrol		2316	4	96.00	80.00	51
B 230 GT	Petrol		2316	4	96.00	80.00	51
B 230 K	Petrol		2316	4	96.00	80.00	51
B 234 F	Petrol		2316	4	96.00	80.00	51
B 234 G	Petrol		2316	4	96.00	80.00	51
B 280 E	Petrol		2849	V6	91.00	73.00	45
B 280 F	Petrol		2849	V6	91.00	73.00	45
B 4164 S	Petrol		1588	4	81.00	77.00	12
B 4164 S2	Petrol		1587	4	81.00	77.00	12
B 4164 S3	Petrol		1596	4	79.00	81.40	8
B 4184 S	Petrol		1731	4	83.00	80.00	30
B 4184 S2	Petrol		1783	4	83.00	82.40	31
B 4184 S3	Petrol		1731	4	83.00	80.00	30
B 4184 S9	Petrol		1783	4	83.00	82.40	31
B 4184 SJ	Petrol		1834	4	81.00	89.00	18
B 4184 SM	Petrol		1834	4	81.00	89.00	18
B 4194 T	Petrol		1855	4	81.00	90.00	19
B 4194 T2	Petrol		1855	4	81.00	90.00	19
B 4204 S	Petrol		1948	4	83.00	90.00	32
B 4204 S2	Petrol		1948	4	83.00	90.00	32
B 4204 T	Petrol		1948	4	83.00	90.00	33
B 4204 T11	Petrol		1969	4	82.00	93.20	25
B 4204 T19	Petrol		1969	4	82.00	93.20	26
B 4204 T2	Petrol		1948	4	83.00	90.00	33
B 4204 T21	Petrol		1969	4	82.00	93.20	26
B 4204 T23	Petrol		1969	4	82.00	93.20	26
B 4204 T27	Petrol		1969	4	82.00	93.20	25
B 4204 T3	Petrol		1948	4	83.00	90.00	33
B4204T35	Petrol		1969	4	82.00	93.20	26
B 4204 T37	Petrol		1969	4	82.00	93.20	26
B 4204 T38	Petrol		1969	4	82.00	93.20	26
B 4204 T4	Petrol		1948	4	83.00	90.00	33
B 4204 T5	Petrol		1948	4	83.00	90.00	33
B 4204 T9	Petrol		1969	4	82.00	93.20	25
B 5202 F	Petrol		1984	5	81.00	77.00	13
B 5202 FS	Petrol		1984	5	81.00	77.00	13
B 5202 S	Petrol		1984	5	81.00	77.00	13
B 5204 F	Petrol		1984	5	81.00	77.00	13
B 5204 S	Petrol		1984	5	81.00	77.00	13
B 5204 T	Petrol		1984	5	81.00	77.00	14
B 5204 T2	Petrol		1984	5	81.00	77.00	14
B 5204 T3	Petrol		1984	5	81.00	77.00	14
B 5204 T4	Petrol		1984	5	81.00	77.00	14
B 5204 T5	Petrol		1984	5	81.00	77.00	14
B 5204 T8	Petrol		1984	5	81.00	77.00	14
B 5204 T9	Petrol		1984	5	81.00	77.00	14
B 5234 F	Petrol		2319	5	81.00	90.00	20
B 5234 FS	Petrol		2319	5	81.00	90.00	21
B 5234 FT	Petrol		2319	5	81.00	90.00	20
B 5234 FT+	Petrol		2319	5	81.00	90.00	20
B 5234 T1	Petrol		2319	5	81.00	90.00	20
B 5234 T2	Petrol		2319	5	81.00	90.00	20
B 5234 T3	Petrol		2319	5	81.00	90.00	20
B 5234 T4	Petrol		2319	5	81.00	90.00	20
B 5234 T5	Petrol		2319	5	81.00	90.00	20
B 5234 T6	Petrol		2319	5	81.00	90.00	20
B 5234 T7	Petrol		2319	5	81.00	90.00	20
B 5234 T8	Petrol		2319	5	81.00	90.00	20
B 5234 T9	Petrol		2319	5	81.00	90.00	20
B 5244 S	Petrol		2435	5	83.00	90.00	34
B 5244 S2	Petrol		2435	5	83.00	90.00	34
B 5244 S4	Petrol		2435	5	83.00	90.00	34
B 5244 S5	Petrol		2435	5	83.00	90.00	34

		cm3	x 			
B 5244 SG	Petrol	2435	5	83.00	90.00	34
B 5244 SG2	Petrol	2435	5	83.00	90.00	34
B 5244 T	Petrol	2435	5	83.00	90.00	35
B 5244 T2	Petrol	2435	5	83.00	90.00	35
B 5244 T3	Petrol	2435	5	83.00	90.00	35
B 5244 T4	Petrol	2435	5	83.00	90.00	35
B 5244 T5	Petrol	2400	5	81.00	93.15	22
B 5244 T7	Petrol	2435	5	83.00	90.00	35
B 5252	Petrol	2435	5	83.00	90.00	34
B 5252 F	Petrol	2435	5	83.00	90.00	34
B 5252 FS	Petrol	2435	5	83.00	90.00	34
B 5252 S	Petrol	2435	5	83.00	90.00	34
B 5254 F	Petrol	2435	5	83.00	90.00	34
B 5254 S	Petrol	2435	5	83.00	90.00	34
B 5254 T	Petrol	2435	5	83.00	90.00	35
B 5254 T10	Petrol	2521	5	83.00	93.20	38
B 5254 T11	Flexfuel	2521	5	83.00	93.20	38
B 5254 T12	Petrol	2497	5	83.00	92.30	37
B 5254 T14	Petrol	2497	5	83.00	92.30	37
B 5254 T2	Petrol	2521	5	83.00	93.20	38
B 5254 T3	Petrol	2521	5	83.00	93.20	38
B 5254 T4	Petrol	2521	5	83.00	93.20	38
B 5254 T5	Petrol	2521	5	83.00	93.20	38
B 5254 T6	Petrol	2521	5	83.00	93.20	38
B 5254 T7	Petrol	2521	5	83.00	93.20	38
B 5254 T8	Flexfuel	2521	5	83.00	93.20	38
B 5254 T9	Petrol	2497	5	83.00	92.30	37
B 6244 FS	Petrol	2473	6	81.00	80.00	16
B 6254 FS	Petrol	2473	6	81.00	80.00	16
B 6254 G	Petrol	2473	6	81.00	80.00	16
B 6254 S	Petrol	2473	6	81.00	80.00	16
B 6304 F	Petrol	2922	6	83.00	90.00	36
B 6304 G	Petrol	2922	6	83.00	90.00	36
B 6304 S	Petrol	2922	6	83.00	90.00	36
B 6304 S2	Petrol	2922	6	83.00	90.00	36
B 6304 S3	Petrol	2922	6	83.00	90.00	36
B 6304 T2	Petrol	2953	6	82.00	93.20	27
B 6304 T3 Euro 5	Petrol	2953	6	82.00	93.20	27
B 6304 T4 Euro 5	Petrol	2953	6	82.00	93.20	27
B 6304 T5 Euro 5	Petrol	2953	6	82.00	93.20	27
D6A180	Diesel	5480	6	98.43	120.00	52
D6A210	Diesel	5480	6	98.43	120.00	52
D6A230	Diesel	5480	6	98.43	120.00	52
D6A250	Diesel	5480	6	98.43	120.00	52
D6B Euro 3	Diesel	5480	6	98.43	120.00	52
D7A230	Diesel	6700	6	104.78	130.00	55
D7A260	Diesel	6700	6	104.78	130.00	55
D7A285	Diesel	6700	6	104.78	130.00	55
D7B230	Diesel	6700	6	104.78	130.00	55
D7B260	Diesel	6700	6	104.78	130.00	55
D7C215 Euro 2	Diesel	7300	6	107.00	135.00	60
D7C250 Euro 2	Diesel	7300	6	107.00	135.00	60
D7C275 Euro 2	Diesel	7300	6	107.00	135.00	60
D7C290	Diesel	7300	6	107.00	135.00	60
D7C310 Euro 2	Diesel	7300	6	107.00	135.00	60
D7E240 Euro 4	Diesel	7146	6	108.00	130.00	61
D7E280 Euro 4/5	Diesel	7146	6	108.00	130.00	61
D7E290	Diesel	7146	6	108.00	130.00	61
D7E320 Euro 4/5	Diesel	7146	6	108.00	130.00	61
D7F240 Euro 5	Diesel	7146	6	108.00	130.00	61
D7F260 Euro 5	Diesel	7146	6	108.00	130.00	61
D7F290 Euro 5	Diesel	7146	6	108.00	130.00	61
D7F300 Euro 5	Diesel	7146	6	108.00	130.00	61
D7F340 Euro 5	Diesel	7146	6	108.00	130.00	61
D9A260 Euro 3	Diesel	9364	6	120.00	138.00	62
D9A300 Euro 3	Diesel	9364	6	120.00	138.00	62
D9A340 Euro 3	Diesel	9364	6	120.00	138.00	62
D9A380 Euro 3	Diesel	9364	6	120.00	138.00	62
D9B260	Diesel	9364	6	120.00	138.00	62







		cm ³	x 			
D9B300 Euro 4	Diesel	9364	6	120.00	138.00	62
D9B310	Diesel	9364	6	120.00	138.00	62
D9B340 Euro 4	Diesel	9364	6	120.00	138.00	62
D9B360 Euro 4/5	Diesel	9364	6	120.00	138.00	62
D9B380 Euro 4	Diesel	9364	6	120.00	138.00	62
D10A320	Diesel	9600	6	120.65	140.00	64
D10A360	Diesel	9600	6	120.65	140.00	64
D10B320 Euro 2	Diesel	9600	6	120.65	140.00	64
D10B360 Euro 2	Diesel	9600	6	120.65	140.00	64
D11-325	Diesel	10800	6	123.00	152.00	66
D11-355	Diesel	10800	6	123.00	152.00	66
D11-365	Diesel	10800	6	123.00	152.00	66
D11-385	Diesel	10800	6	123.00	152.00	66
D11-405	Diesel	10800	6	123.00	152.00	66
D11A430 Euro 3	Diesel	10840	6	123.00	152.00	66
D11B390 Euro 4/5	Diesel	10800	6	123.00	152.00	66
D11B430 Euro 4/5	Diesel	10800	6	123.00	152.00	66
D11C330 Euro 5	Diesel	10800	6	123.00	152.00	66
D11C370 Euro 5	Diesel	10840	6	123.00	152.00	66
D11C410 Euro 5	Diesel	10800	6	123.00	152.00	66
D11C450 Euro 5	Diesel	10800	6	123.00	152.00	66
D11K330 Euro 6	Diesel	10840	6	123.00	152.00	66
D11K370 Euro 6	Diesel	10840	6	123.00	152.00	66
D11K410 Euro 6	Diesel	10840	6	123.00	152.00	66
D11K450 Euro 6	Diesel	10840	6	123.00	152.00	66
D12A340	Diesel	12100	6	131.00	150.00	69
D12A380 Euro 2	Diesel	12100	6	131.00	150.00	69
D12A420 Euro 2	Diesel	12100	6	131.00	150.00	69
D12C340 Euro 2	Diesel	12100	6	131.00	150.00	69
D12C380	Diesel	12100	6	131.00	150.00	69
D12C390	Diesel	12100	6	131.00	150.00	69
D12C420	Diesel	12100	6	131.00	150.00	69
D12C460	Diesel	12100	6	131.00	150.00	69
D12D340 Euro 3	Diesel	12100	6	131.00	150.00	69
D12D380 Euro 3	Diesel	12100	6	131.00	150.00	69
D12D390 Euro 3	Diesel	12100	6	131.00	150.00	69
D12D420 Euro 3	Diesel	12100	6	131.00	150.00	69
D12D460 Euro 3	Diesel	12100	6	131.00	150.00	69
D12D500 Euro 3	Diesel	12100	6	131.00	150.00	69
D13A360 Euro 5	Diesel	12800	6	131.00	158.00	70
D13A400 Euro 5	Diesel	12800	6	131.00	158.00	70
D13A440 Euro 5	Diesel	12800	6	131.00	158.00	70
D13A480 Euro 5	Diesel	12800	6	131.00	158.00	70
D13A520 Euro 5	Diesel	12800	6	131.00	158.00	70
D13B360 Euro 4/5	Diesel	12800	6	131.00	158.00	70
D13B400 Euro 4/5	Diesel	12800	6	131.00	158.00	70
D13B440 Euro 4/5	Diesel	12800	6	131.00	158.00	70
D13B500 Euro 4/5	Diesel	12800	6	131.00	158.00	70
D13C380 Euro 5	Diesel	12800	6	131.00	158.00	70
D13C420 Euro 5	Diesel	12800	6	131.00	158.00	70
D13C460 Euro 5	Diesel	12800	6	131.00	158.00	70
D13C500 Euro 5	Diesel	12800	6	131.00	158.00	70
D13C540 Euro 5	Diesel	12800	6	131.00	158.00	70
D 16	Diesel	1596	4	78.00	83.60	7
D 16A	Diesel	16123	6	144.00	165.00	71
D16A470 Euro 2	Diesel	16120	6	144.00	165.00	71
D16A520	Diesel	16120	6	144.00	165.00	71
D16B520	Diesel	16120	6	144.00	165.00	71
D16C550 Euro 3	Diesel	16120	6	144.00	165.00	71
D16C610 Euro 3	Diesel	16120	6	144.00	165.00	71
D16E540 Euro 4	Diesel	16120	6	144.00	165.00	71
D16E580 Euro 4	Diesel	16120	6	144.00	165.00	71
D16E660 Euro 4	Diesel	16120	6	144.00	165.00	71
D 19 T	Diesel	1870	4	80.00	93.00	9
D 24	Diesel	2383	6	76.50	86.40	6
D 24 T	Diesel	2383	6	76.50	86.40	6
D 24 TIC	Diesel	2383	6	76.50	86.40	6
D 39 B	Diesel	3860	4	98.43	127.00	53
D47A/VDE	Diesel	4704	6	95.25	100.00	48







		cm3	x 			
D 50 A	Diesel	5100	6	95.00	120.00	47
D 50 B	Diesel	5100	6	95.00	120.00	47
D 60 A	Diesel	5480	6	98.43	120.00	52
D 70 A	Diesel	6700	6	104.78	130.00	54
D 70 B	Diesel	6700	6	104.78	130.00	54
D 100 A	Diesel	9600	6	120.65	140.00	63
D 100 B	Diesel	9600	6	120.65	140.00	63
D 4164 T	Diesel	1560	4	75.00	88.30	4
D 4192 T	Diesel	1870	4	80.00	93.00	10
D 4192 T3	Diesel	1870	4	80.00	93.00	10
D 4192 T4	Diesel	1870	4	80.00	93.00	10
D 4204 T	Diesel	1998	4	85.00	88.00	40
D 4204 T2	Diesel	1998	4	85.00	88.00	40
D 5204 T	Diesel	1984	5	81.00	77.00	15
D 5204 T2	Diesel	1984	5	81.00	77.00	15
D 5204 T3	Diesel	1984	5	81.00	77.00	15
D 5204 T4	Diesel	1984	5	81.00	77.00	15
D 5204 T5	Diesel	1984	5	81.00	77.00	15
D 5204 T6	Diesel	1984	5	81.00	77.00	15
D 5204 T7	Diesel	1984	5	81.00	77.00	15
D 5244	Diesel	2400	5	81.00	93.20	23
D 5244 T	Diesel	2400	5	81.00	93.20	23
D 5244 T10	Diesel	2400	5	81.00	93.20	23
D 5244 T11	Diesel	2400	5	81.00	93.20	23
D 5244 T12	Diesel	2400	5	81.00	93.20	23
D 5244 T13	Diesel	2400	5	81.00	93.20	23
D 5244 T14	Diesel	2400	5	81.00	93.20	23
D 5244 T15	Diesel	2400	5	81.00	93.20	23
D 5244 T16	Diesel	2400	5	81.00	93.20	23
D 5244 T17	Diesel	2400	5	81.00	93.20	23
D 5244 T18	Diesel	2400	5	81.00	93.20	23
D 5244 T2	Diesel	2400	5	81.00	93.20	23
D 5244 T20	Diesel	2400	5	81.00	93.20	23
D 5244 T21	Diesel	2400	5	81.00	93.20	23
D 5244 T22	Diesel	2400	5	81.00	93.20	23
D 5244 T23	Diesel	2400	5	81.00	93.20	23
D 5244 T4	Diesel	2400	5	81.00	93.20	23
D 5244 T5	Diesel	2400	5	81.00	93.20	23
D 5244 T7	Diesel	2400	5	81.00	93.20	23
D 5244 T8	Diesel	2400	5	81.00	93.20	23
D 5244 T9	Diesel	2400	5	81.00	93.20	23
D 5252 T	Diesel	2461	5	81.00	95.50	24
DH12D340 Euro 3	Diesel	12100	6	131.00	150.00	69
DH12D380 Euro 3	Diesel	12100	6	131.00	150.00	69
DH12D420 Euro 3	Diesel	12100	6	131.00	150.00	69
DH12E340	Diesel	12100	6	131.00	150.00	69
DH12E380 Euro 4	Diesel	12100	6	131.00	150.00	69
DH12E420	Diesel	12100	6	131.00	150.00	69
DH12E460 Euro 4	Diesel	12100	6	131.00	150.00	69
F8Q 768	Diesel	1870	4	80.00	93.00	11
HD 100 A	Diesel	9600	6	120.65	140.00	63
HD 100 D	Diesel	9600	6	120.65	140.00	63
TD 50 A	Diesel	5130	6	95.25	120.00	49
TD 50 B	Diesel	5130	6	95.25	120.00	49
TD 60 A	Diesel	5480	6	98.43	120.00	52
TD 60 B	Diesel	5480	6	98.43	120.00	52
TD 60 C	Diesel	5480	6	98.43	120.00	52
TD 60 D	Diesel	5480	6	98.43	120.00	52
TD 60 DG	Diesel	5480	6	98.43	120.00	52
TD 61 F	Diesel	5480	6	98.43	120.00	52
TD 61 FB	Diesel	5480	6	98.43	120.00	52
TD 61 G	Diesel	5480	6	98.43	120.00	52
TD 61 GA	Diesel	5480	6	98.43	120.00	52
TD 61 GB	Diesel	5480	6	98.43	120.00	52
TD 61 GC	Diesel	5480	6	98.43	120.00	52
TD 61 GE	Diesel	5480	6	98.43	120.00	52
TD 61 GS	Diesel	5480	6	98.43	120.00	52
TD 63 E	Diesel	5480	6	98.43	120.00	52
TD 63 ES	Diesel	5480	6	98.43	120.00	52

cm³

9

TD 70 A	Diesel	6700	6	104.78	130.00	54
TD 70 B	Diesel	6700	6	104.78	130.00	56
TD 70 C	Diesel	6700	6	104.78	130.00	54
TD 70 E	Diesel	6700	6	104.78	130.00	54
TD 70 ES	Diesel	6700	6	104.78	130.00	54
TD 70 F	Diesel	6700	6	104.78	130.00	57
TD 70 FS	Diesel	6700	6	104.78	130.00	54
TD 70 G	Diesel	6700	6	104.78	130.00	54
TD 70 H	Diesel	6700	6	104.78	130.00	54
TD 70 HA	Diesel	6700	6	104.78	130.00	54
TD 71 A	Diesel	6700	6	104.78	130.00	57
TD 71 ACE	Diesel	6700	6	104.78	130.00	57
TD 71 AG	Diesel	6700	6	104.78	130.00	57
TD 71 AGP	Diesel	6700	6	104.78	130.00	57
TD 71 AP	Diesel	6700	6	104.78	130.00	57
TD 71 APB	Diesel	6700	6	104.78	130.00	57
TD 71 AW	Diesel	6700	6	104.78	130.00	57
TD 71 F	Diesel	6700	6	104.78	130.00	58
TD 71 FA	Diesel	6700	6	104.78	130.00	58
TD 71 FC	Diesel	6700	6	104.78	130.00	57
TD 71 FD	Diesel	6700	6	104.78	130.00	57
TD 71 FQ	Diesel	6700	6	104.78	130.00	58
TD 71 FS	Diesel	6700	6	104.78	130.00	57
TD 71 FSQ	Diesel	6700	6	104.78	130.00	57
TD 71 G	Diesel	6700	6	104.78	130.00	57
TD 73 E	Diesel	6700	6	104.78	130.00	57
TD 73 EA	Diesel	6700	6	104.78	130.00	59
TD 73 ES	Diesel	6700	6	104.78	130.00	57
TD 73 KFE	Diesel	6700	6	104.78	130.00	59
TD 100 A	Diesel	9600	6	120.65	140.00	65
TD 100 B	Diesel	9600	6	120.65	140.00	63
TD 100 BG	Diesel	9600	6	120.65	140.00	63
TD 100 C	Diesel	9600	6	120.65	140.00	63
TD 100 CHC	Diesel	9600	6	120.65	140.00	63
TD 100 F	Diesel	9600	6	120.65	140.00	63
TD 100 G	Diesel	9600	6	120.65	140.00	63
TD 100 GA	Diesel	9600	6	120.65	140.00	63
TD 101 F	Diesel	9600	6	120.65	140.00	63
TD 101 FA	Diesel	9600	6	120.65	140.00	64
TD 101 FC	Diesel	9600	6	120.65	140.00	63
TD 101 FD	Diesel	9600	6	120.65	140.00	63
TD 101 G	Diesel	9600	6	120.65	140.00	63
TD 101 GA	Diesel	9600	6	120.65	140.00	63
TD 101 GB	Diesel	9600	6	120.65	140.00	63
TD 101 GE	Diesel	9600	6	120.65	140.00	63
TD 102 F	Diesel	9600	6	120.65	140.00	64
TD 102 FAQ	Diesel	9600	6	120.65	140.00	63
TD 102 FBQ	Diesel	9600	6	120.65	140.00	64
TD 102 FCQ	Diesel	9600	6	120.65	140.00	63
TD 102 FD Euro 1	Diesel	9600	6	120.65	140.00	63
TD 102 FDQ	Diesel	9600	6	120.65	140.00	64
TD 102 FEQ	Diesel	9600	6	120.65	140.00	63
TD 102 FF	Diesel	9600	6	120.65	140.00	64
TD 102 FGQ	Diesel	9600	6	120.65	140.00	63
TD 102 FH	Diesel	9600	6	120.65	140.00	63
TD 102 FL Euro 1	Diesel	9600	6	120.65	140.00	64
TD 102 FM	Diesel	9600	6	120.65	140.00	64
TD 102 FQ	Diesel	9600	6	120.65	140.00	63
TD 102 FS	Diesel	9600	6	120.65	140.00	63
TD 102 FT	Diesel	9600	6	120.65	140.00	63
TD 103 EA Euro 1	Diesel	9600	6	120.65	140.00	63
TD 103 E Euro 1	Diesel	9600	6	120.65	140.00	64
TD 103 ES Euro 1	Diesel	9600	6	120.65	140.00	64
TD 103 KB Euro 1	Diesel	9600	6	120.65	140.00	63
TD 103 KF Euro 1	Diesel	9600	6	120.65	140.00	63
TD 120 A	Diesel	12000	6	130.18	150.00	67
TD 120 C	Diesel	12000	6	130.18	150.00	67
TD 120 D	Diesel	11980	6	130.18	150.00	67
TD 120 E	Diesel	11980	6	130.18	150.00	67

		cm3	x 			
TD 120 F	Diesel	11980	6	130.18	150.00	67
TD 120 FA	Diesel	11980	6	130.18	150.00	67
TD 120 FB	Diesel	11980	6	130.18	150.00	67
TD 120 FC	Diesel	11980	6	130.18	150.00	67
TD 120 FTQ	Diesel	11980	6	130.18	150.00	67
TD 120 G	Diesel	11980	6	130.18	150.00	67
TD 120 GA	Diesel	11980	6	130.18	150.00	67
TD 121 F	Diesel	11980	6	130.18	150.00	68
TD 121 FA	Diesel	11980	6	130.18	150.00	68
TD 121 FB	Diesel	11980	6	130.18	150.00	68
TD 121 FC	Diesel	11980	6	130.18	150.00	68
TD 121 FD	Diesel	11980	6	130.18	150.00	68
TD 121 FE	Diesel	11980	6	130.18	150.00	68
TD 121 FF	Diesel	11980	6	130.18	150.00	68
TD 121 FG	Diesel	11980	6	130.18	150.00	68
TD 121 FH	Diesel	11980	6	130.18	150.00	68
TD 121 FK	Diesel	11980	6	130.18	150.00	68
TD 121 G	Diesel	11980	6	130.18	150.00	68
TD 121 GD	Diesel	11980	6	130.18	150.00	68
TD 122	Diesel	11980	6	130.18	150.00	68
TD 122 ED	Diesel	11980	6	130.18	150.00	68
TD 122 F	Diesel	11980	6	130.18	150.00	68
TD 122 FA	Diesel	11980	6	130.18	150.00	68
TD 122 FAQ	Diesel	11980	6	130.18	150.00	68
TD 122 FBQ	Diesel	11980	6	130.18	150.00	68
TD 122 FCQ	Diesel	11980	6	130.18	150.00	68
TD 122 FH Euro 1	Diesel	11980	6	130.18	150.00	68
TD 122 FK	Diesel	11980	6	130.18	150.00	68
TD 122 FKQ	Diesel	11980	6	130.18	150.00	68
TD 122 FL	Diesel	11980	6	130.18	150.00	68
TD 122 FR	Diesel	11980	6	130.18	150.00	68
TD 122 FS	Diesel	11980	6	130.18	150.00	68
TD 122 FTO	Diesel	11980	6	130.18	150.00	68
TD 122 KBE	Diesel	11980	6	130.18	150.00	68
TD 122 KE	Diesel	11980	6	130.18	150.00	68
TD 122 KHD	Diesel	11980	6	130.18	150.00	68
TD 123 EA	Diesel	11980	6	130.18	150.00	68
TD 123 EB	Diesel	11980	6	130.18	150.00	68
TD 123 EC	Diesel	11980	6	130.18	150.00	68
TD 123 ED	Diesel	11980	6	130.18	150.00	68
TD 123 E Euro 1	Diesel	11980	6	130.18	150.00	68
TD 123 ES Euro 1	Diesel	11980	6	130.18	150.00	68
TD 162 F	Diesel	16123	6	144.00	165.00	72
TD 162 FJ	Diesel	16123	6	144.00	165.00	72
TD 162 FL	Diesel	16120	6	144.00	165.00	72
TD 162 FS	Diesel	16123	6	144.00	165.00	72
TD 163 ES	Diesel	16123	6	144.00	165.00	72
THD 100 A	Diesel	9600	6	120.65	140.00	63
THD 100 D	Diesel	9600	6	120.65	140.00	63
THD 100 DA	Diesel	9600	6	120.65	140.00	63
THD 100 DB	Diesel	9600	6	120.65	140.00	63
THD 100 DC	Diesel	9600	6	120.65	140.00	64
THD 100 DD	Diesel	9600	6	120.65	140.00	63
THD 100 E	Diesel	9600	6	120.65	140.00	63
THD 100 EA	Diesel	9600	6	120.65	140.00	63
THD 100 EB	Diesel	9600	6	120.65	140.00	63
THD 100 EC	Diesel	9600	6	120.65	140.00	63
THD 100 ED	Diesel	9600	6	120.65	140.00	63
THD 100 EE	Diesel	9600	6	120.65	140.00	63
THD 100 EK	Diesel	9600	6	120.65	140.00	63
THD 101 B	Diesel	9600	6	120.65	140.00	63
THD 101 GB	Diesel	9600	6	120.65	140.00	63
THD 101 GC	Diesel	9600	6	120.65	140.00	63
THD 101 GD	Diesel	9600	6	120.65	140.00	63
THD 101 KB	Diesel	9600	6	120.65	140.00	63
THD 101 KC	Diesel	9600	6	120.65	140.00	63
THD 101 KE	Diesel	9600	6	120.65	140.00	63
THD 102 KA	Diesel	9600	6	120.65	140.00	63
THD 102 KB Euro 1	Diesel	9600	6	120.65	140.00	63

		cm3	x 			
--	---	-----	---	---	---	---

THD 102 KD	Diesel	9600	6	120.65	140.00	63
THD 102 KF	Diesel	9600	6	120.65	140.00	63
THD 103 E Euro 2	Diesel	9600	6	120.65	140.00	63
THD 103 ES Euro 2	Diesel	9600	6	120.65	140.00	63
THD 103 KB	Diesel	9600	6	120.65	140.00	63
THD 103 KD	Diesel	9600	6	120.65	140.00	63
THD 103 KF	Diesel	9600	6	120.65	140.00	63



1 70.00 x 72.00

B 10 E		4 Cyl.		1108cc	33-35kW (45-48PS)		Petrol		TD21325
BE/PL	4	43,964/43,980	47,614/47,625	17,750	1,806	0,020/0,074	AL-LF	2950RAA	01-4138/4 STD 0.25 0.50 0.75
BE/PL	4	43,964/43,980	47,614/47,625	17,750	1,806	0,070/0,074	AL-LF	2950RAB	01-4255/4 STD

2950RAA

2950RAB

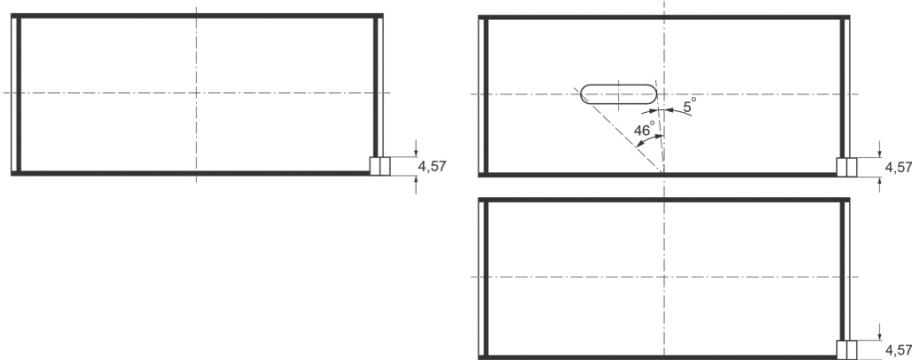

MB/HL 1-5	5	54,785/54,805	58,731/58,750	19,500	1,950	0,026/0,090	AL-LF	62013RA	H1042/5 STD 0.25 0.50 0.75
TW/A	2	60,500/60,750	79,750/80,000		2,850		AL-LF	60476BF	A195/2 STD 0.10

2 70.00 x 72.00

B 11		4 Cyl.		1108cc	33kW (45PS)		Petrol		TD3980
BE/PL	4	43,964/43,980	47,614/47,625	20,750	1,810	0,022/0,074	AL-LF	2950RA	01-4137/4 STD 0.25 0.50 0.75
MB/HL 1-5	5	54,785/54,805	58,731/58,750	19,500	1,950	0,026/0,090	AL-LF	62013RA	H1042/5 STD 0.25 0.50 0.75
MB/HL 1,3	2	45,990/46,000	49,874/49,890	24,500	1,932	0,020/0,061	AL-LF	62011RA	H1107/5 STD 0.25 0.50 0.75
MB/HL 2,4,5	3	45,990/46,000	49,874/49,890	19,500	1,932	0,020/0,061	AL-LF	62012RA	
TW/A	2	60,500/60,750	79,750/80,000		2,850		AL-LF	60476BF	A195/2 STD 0.10

3 73.00 x 76.50

B 13		4 Cyl.		1289cc	49kW (66PS)		Petrol		TD3987
B 13 E		4 Cyl.		1289cc	42kW (57PS)		Petrol		TD21326
B 130		4 Cyl.		1289cc	42kW (57PS)		Petrol		TD3904
BE/PL	4	43,964/43,980	47,614/47,625	17,750	1,806	0,020/0,074	AL-LF	2950RAA	01-4138/4 STD 0.25 0.50 0.75
MB/HL 1,3	2	45,990/46,000	49,874/49,890	24,500	1,932	0,020/0,061	AL-LF	62011RA	H1107/5 STD 0.25 0.50 0.75
MB/HL 2,4,5	3	45,990/46,000	49,874/49,890	19,500	1,932	0,020/0,061	AL-LF	62012RA	

4 75.00 x 88.30

D 4164 T		4 Cyl.		1560cc	80kW (109PS)		Diesel Turbo Intercooler		TD20849
MB/HL 1-5	5	49,962/49,981	53,655/53,674	19,900	1,833	0,008/0,046	AL	02-4244	H1066/5 STD 0.30 0.50
TW/A	2	55,200/55,480	71,350/71,700		2,460		AL	04-4245	A217/2 STD
SE/PB	1	26,000	29,000/29,021	19,980			BS	55-4102	55-4102 SEMI

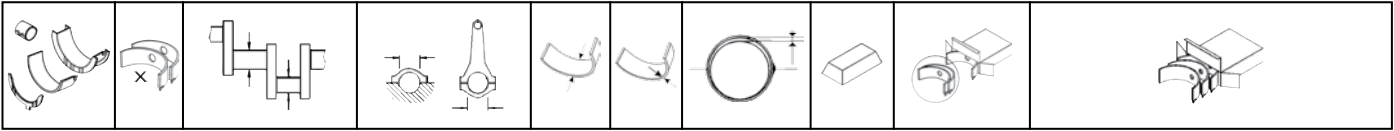

5	76.00 x 77.00								
B 14 OE		4 Cyl.	1397cc	51kW (69PS)			Petrol		TD23445
B 14.3 E		4 Cyl.	1397cc	46-53kW (63-72PS)			Petrol		TD3988
B 14.4 S		4 Cyl.	1397cc	50-53kW (68-72PS)			Petrol		TD5142

BE/PL	4	43,964/43,980	47,614/47,625	17,750	1,806	0,020/0,074	AL-LF	2950RAA	01-4138/4 STD 0.25 0.50 0.75
BE/PL	4	43,964/43,980	47,614/47,625	17,750	1,806	0,070/0,074	AL-LF	2950RAB	01-4255/4 STD

2950RAA

2950RAB

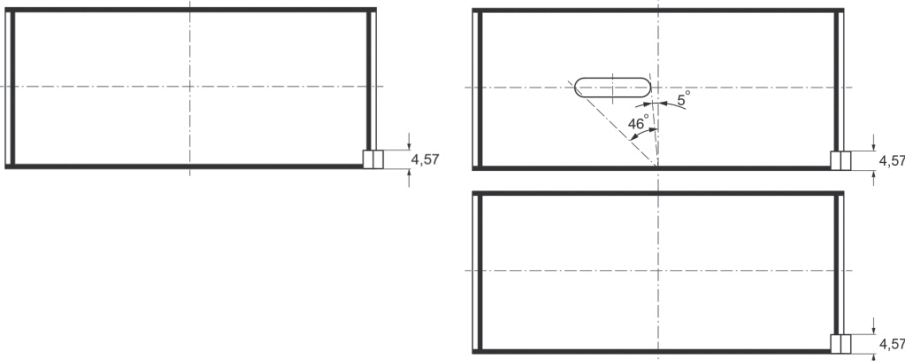

MB/HL 1-5	5	54,785/54,805	58,731/58,750	19,500	1,950	0,026/0,090	AL-LF	62013RA	H1042/5 STD 0.25 0.50 0.75
TW/A	2	60,500/60,750	79,750/80,000		2,850		AL-LF	60476BF	A195/2 STD 0.10

6	76.50 x 86.40								
----------	----------------------	--	--	--	--	--	--	--	--

D 24		6 Cyl.	2383cc	58-61kW (79-83PS)			Diesel		TD3984
D 24 T		6 Cyl.	2383cc	79-83kW (107-113PS)			Diesel Turbo		TD3985
D 24 TIC		6 Cyl.	2383cc	85-95kW (115-129PS)			Diesel Turbo Intercooler		TD3986

BE/PL	6	47,758/47,778	50,600/50,619	19,000	1,406	0,020/0,074	EC	71-3442	71-3442/6 STD 0.25 0.50
MB/HL 1,2, 4-7	6	57,958/57,978	63,000/63,019	18,500	2,502	0,020/0,082	EC	72-3400	H941/7 STD 0.25
MB/HL 3	1	57,958/57,978	63,000/63,019	24,930	2,502	0,020/0,082	EC	72-3401H	

	72-3401H	STD	25,000/.9843" - 25,040/.9858"
		0.25mm	25,100/.9882" - 25,140/.9898"
		0.50mm	25,100/.9882" - 25,140/.9898"
		0.75mm	25,100/.9882" - 25,140/.9898"

MB/HL 1-7	7	57,958/57,978	63,000/63,019	18,500	2,502	0,020/0,082	EC	72-3400	H981/7 STD 0.25
TW/A	2	63,500/63,750	77,200/77,450		1,975		AL-LF	04-3529	A124/4 STD
TW/A	2	63,500/63,750	77,200/77,450		1,975		AL-LF	04-3530	
TW/A	2	63,500/63,750	76,950/77,200		1,975		AL-LF	04-4782	A292/4 STD
TW/A	2	63,500/63,750	76,950/77,200		1,975		AL-LF	04-4783	
SE/PB	1	24,000/24,012	27,000/27,021	25,000			BC	55-3443	55-3443 SEMI

7	78.00 x 83.60								
----------	----------------------	--	--	--	--	--	--	--	--

D 16		4 Cyl.	1596cc	40kW (54PS)			Diesel		TD3981
BE/PL	4	48,000/48,020	51,587/51,600	20,500	1,768	0,030/0,090	AL-LF	66740RAA	01-4202/4 STD 0.25

MB/HL 1-5	5	54,785/54,795	58,731/58,744	18,500	1,945	0,046/0,094	AL-LF	66741RA	H1080/5 STD 0.25 0.50	
TW/A	2	60,500/60,750	79,750/80,000		2,350		AL-LF	66741AF	A215/2 STD 0.10	

8 79.00 x 81.40

B 4164 S3		4 Cyl.		1596cc	74kW (101PS)	Petrol		TD18513	
BE/PL	4	49,984/50,000	53,000/53,013	19,500	1,496	0,020/0,064	EC	71-3754	71-3754/4 STD 0.25
MB/HL 1-3, 5,6	5	64,987/65,000	69,000/69,014	19,600	1,994	0,020/0,064	AL-LF	02-3755	H046/6 STD 0.25
MB/HL 4	1	64,987/65,000	69,000/69,014	25,880	1,998	0,020/0,056	AL-LF	02-3756H	
			02-3756H	STD 25,960/1.0221" - 26,000/1.0237"					
				0.25mm 25,960/1.0221" - 26,000/1.0237"					
SE/PB	1	23,000	26,000/26,025	25,200			BC	55-3783	55-3783 SEMI

9 80.00 x 93.00

D 19 T		4 Cyl.		1870cc	66kW (90PS)	Diesel Turbo		TD5044	
MB/HL 1-5	5	54,785/54,795	58,731/58,744	18,500	1,945	0,046/0,094	AL-LF	66741RA	H1080/5 STD 0.25 0.50
TW/A	2	60,500/60,750	79,750/80,000		2,350		AL-LF	66741AF	A215/2 STD 0.10

10 80.00 x 93.00

D 4192 T		4 Cyl.		1870cc	66kW (90PS)	Diesel Turbo		TD5550	
D 4192 T3		4 Cyl.		1870cc	85kW (116PS)	Diesel Turbo		TD17997	
D 4192 T4		4 Cyl.		1870cc	75kW (102PS)	Diesel Turbo		TD17996	
BE/PL	4	48,000/48,020	51,587/51,600	20,500	1,768	0,031/0,089	BS	4060CP	71-4311/4 STD 0.25 0.50
MB/HL 1-5	5	54,785/54,795	58,731/58,744	18,500	1,945	0,046/0,094	AL-LF	66741RA	H1080/5 STD 0.25 0.50
TW/A	2	60,500/60,750	79,750/80,000		2,350		AL-LF	66741AF	A215/2 STD 0.10

11 80.00 x 93.00

F8Q 768		4 Cyl.		1870cc	66-69kW (90-94PS)	Diesel Turbo		TD19235	
BE/PL	4	48,000/48,020	51,587/51,606	20,250	1,776	0,015/0,079	EC	71-3988L	71-3988/4 STD 0.25 0.50
BE/PL	4	48,000/48,020	51,587/51,606	20,500	1,776	0,015/0,079	EC	71-3988U	
01/98 →									
BE/PL	4	48,000/48,020	51,587/51,600	20,500	1,768	0,031/0,089	BS	4060CP	71-4311/4 STD 0.25 0.50
→12/97									

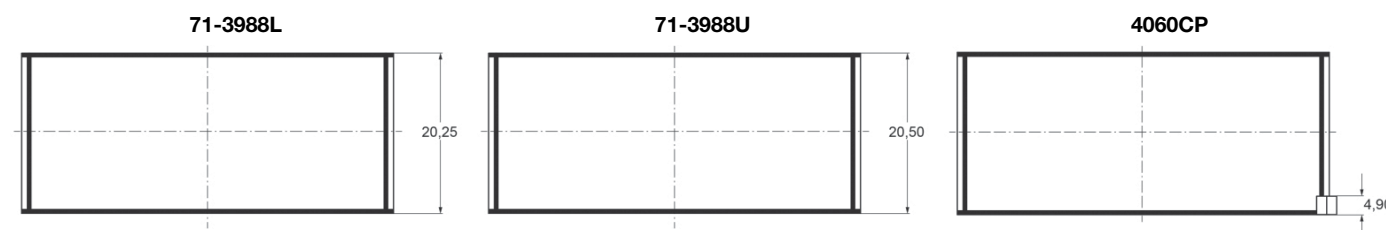

MB/HL 1-5	5	54,785/54,805	58,731/58,744	18,500	1,947	0,032/0,090	EC	72-3989	H098/5 STD 0.25 0.50
-----------	---	---------------	---------------	--------	-------	-------------	----	---------	--------------------------------

01/98 →

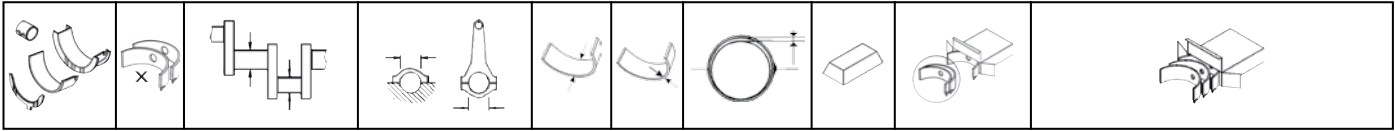

MB/HL 1-5	5	54,785/54,795	58,731/58,744	18,500	1,945	0,046/0,094	AL-LF	66741RA	H1080/5 STD 0.25 0.50
--------------	---	---------------	---------------	--------	-------	-------------	-------	---------	---------------------------------

→12/97

72-3989

66741RA

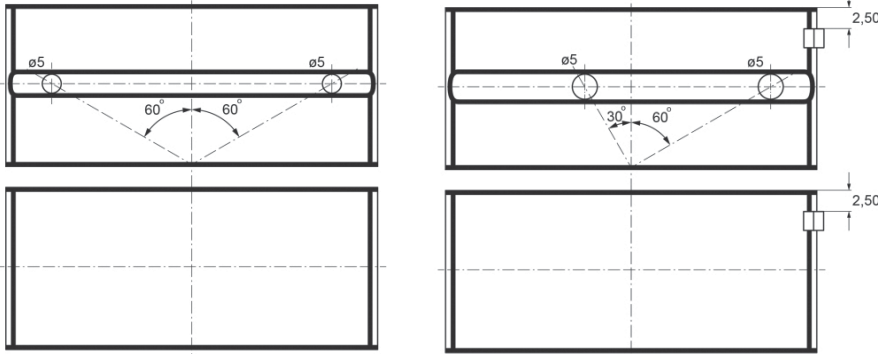

TW/A	2	60,500/60,750	79,750/80,000		2,350		AL-LF	66741AF	A215/2 STD 0.10
SE/PB	1	26,013/26,025	29,000/29,021	22,900			BS	66509Y	55-4394 SEMI

12 81.00 x 77.00

B 4164 S	4 Cyl.	1588cc	77kW (105PS)				Petrol		TD5549
B 4164 S2	4 Cyl.	1587cc	80kW (109PS)				Petrol		TD13708

BE/PL	4	49,984/50,000	53,000/53,013	19,500	1,496	0,020/0,064	EC	71-3754	71-3754/4 STD 0.25
MB/HL 1,2,4,5	4	64,987/65,000	69,000/69,014	19,600	1,994	0,020/0,064	AL-LF	02-3755	H046/5 STD 0.25
MB/HL 3	1	64,987/65,000	69,000/69,014	25,880	1,998	0,020/0,056	AL-LF	02-3756H	



02-3756H	STD	25,960/1.0221" - 26,000/1.0237"
	0.25mm	25,960/1.0221" - 26,000/1.0237"

SE/PB	1	23,000	26,000/26,025	25,200			BC	55-3783	55-3783 SEMI
-------	---	--------	---------------	--------	--	--	----	---------	------------------------

13 81.00 x 77.00

B 5202 F	5 Cyl.	1984cc	93kW (126PS)				Petrol		TD3970
B 5202 FS	5 Cyl.	1984cc	93kW (126PS)				Petrol		TD28773
B 5202 S	5 Cyl.	1984cc	93kW (126PS)				Petrol		TD5143
B 5204 F	5 Cyl.	1984cc	105kW (143PS)				Petrol		TD3971
B 5204 S	5 Cyl.	1984cc	93-105kW (126-143PS)				Petrol		TD23443

BE/PL	5	49,984/50,000	53,000/53,013	19,500	1,496	0,020/0,064	EC	71-3754	71-3754/5 STD 0.25 0.50
MB/HL 1-3, 5,6	5	64,987/65,000	69,000/69,014	19,600	1,994	0,020/0,064	AL-LF	02-3755	H046/6 STD 0.25
MB/HL 4	1	64,987/65,000	69,000/69,014	25,880	1,998	0,020/0,056	AL-LF	02-3756H	



02-3756H	STD	25,960/1.0221" - 26,000/1.0237"
	0.25mm	25,960/1.0221" - 26,000/1.0237"

SE/PB	1	23,000	26,000/26,025	25,200			BC	55-3783	55-3783 SEMI
SE/PB	1	21,000	24,000/24,025	21,350			BC	55-3927	55-3927 SEMI



14 81.00 x 77.00

B 5204 T	5 Cyl.	1984cc	155kW (211PS)	Petrol Turbo	TD9893
B 5204 T2	5 Cyl.	1984cc	132kW (180PS)	Petrol Turbo	TD5554
B 5204 T3	5 Cyl.	1984cc	166kW (226PS)	Petrol Turbo Intercooler	TD5553
B 5204 T4	5 Cyl.	1984cc	120kW (163PS)	Petrol Turbo	TD11553
B 5204 T5	5 Cyl.	1984cc	132kW (180PS)	Petrol Turbo	TD18006
B 5204 T8	5 Cyl.	1984cc	132kW (180PS)	Petrol Turbo	TD26509
B 5204 T9	5 Cyl.	1984cc	154-157kW (210-214PS)	Petrol Turbo	TD26510

BE/PL	1	49,984/50,000	53,000/53,013	19,500	1,496	0,020/0,062	SP	71-3926	71-3926 STD	①
MB/HL 1-3, 5,6	5	64,987/65,000	69,000/69,014	19,600	1,994	0,020/0,064	AL-LF	02-3755	H046/6 STD 0.25	
MB/HL 4	1	64,987/65,000	69,000/69,014	25,880	1,998	0,020/0,056	AL-LF	02-3756H		
			02-3756H	STD	25,960/1.0221" - 26,000/1.0237"					
				0.25mm	25,960/1.0221" - 26,000/1.0237"					
SE/PB	1	23,000	26,000/26,025	25,200			BC	55-3783	55-3783 SEMI	
SE/PB	1	21,000	24,000/24,025	21,350			BC	55-3927	55-3927 SEMI	

15 81.00 x 77.00

D 5204 T	5 Cyl.	1984cc	130kW (177PS)	Diesel Turbo	TD23987
D 5204 T2	5 Cyl.	1984cc	120kW (163PS)	Diesel Turbo	TD23985
D 5204 T3	5 Cyl.	1984cc	120kW (163PS)	Diesel Turbo	TD25778
D 5204 T4	5 Cyl.	1984cc	130kW (177PS)	Diesel Turbo	TD26513
D 5204 T5	5 Cyl.	1984cc	110kW (150PS)	Diesel Turbo	TD23986
D 5204 T6	5 Cyl.	1984cc	110kW (150PS)	Diesel Turbo	TD26512
D 5204 T7	5 Cyl.	1984cc	100kW (136PS)	Diesel Turbo	TD27100

BE/PL	1	49,984/50,000	53,000/53,013	19,500	1,496	0,020/0,062	SP	71-3926	71-3926 STD	①
MB/HL	1	64,987/65,000	69,000/69,014	25,880	1,998	0,020/0,056	AL-LF	02-3756H	H095/6 STD	
MB/HL	5	64,987/65,000	69,000/69,014	19,600	1,998	0,004/0,056	AL-LF	72-3974		
			02-3756H	STD	25,960/1.0221" - 26,000/1.0237"					
				0.25mm	25,960/1.0221" - 26,000/1.0237"					
SE/PB	1	27,995/28,000	31,000/31,025	27,100			BC-LF	55-3975	55-3975 SEMI	⑥

16 81.00 x 80.00

B 6244 FS	6 Cyl.	2473cc	132kW (180PS)	Petrol	TD21828
B 6254 FS	6 Cyl.	2473cc	125kW (170PS)	Petrol	TD21827
B 6254 G	6 Cyl.	2473cc	125kW (170PS)	Petrol	TD23444
B 6254 S	6 Cyl.	2473cc	125kW (170PS)	Petrol	TD5154

BE/PL	6	49,984/50,000	53,000/53,013	19,500	1,496	0,020/0,064	EC	71-3754	71-3754/6 STD 0.25	
MB/HL	6	64,987/65,000	69,000/69,014	19,600	1,994	0,020/0,064	AL-LF	02-3755	H046/7 STD 0.25	
MB/HL	1	64,987/65,000	69,000/69,014	25,880	1,998	0,020/0,056	AL-LF	02-3756H		
			02-3756H	STD	25,960/1.0221" - 26,000/1.0237"					
				0.25mm	25,960/1.0221" - 26,000/1.0237"					

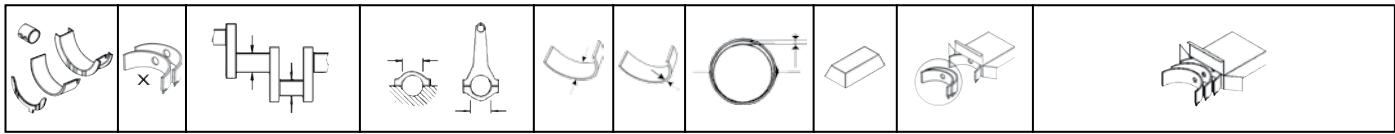

SE/PB	1	23,000	26,000/26,025	25,200			BC	55-3783	55-3783 SEMI
SE/PB	1	21,000	24,000/24,025	21,350			BC	55-3927	55-3927 SEMI

17 81.00 x 83.50

B 17 2 K			4 Cyl.	1721cc	59kW (80PS)		Petrol		TD3991
B 18 E			4 Cyl.	1721cc	78-80kW (106-109PS)		Petrol		TD3907
B 18 ED			4 Cyl.	1721cc	78kW (106PS)		Petrol		TD19336
B 18 EP			4 Cyl.	1721cc	75-78kW (102-106PS)		Petrol		TD3908
B 18 F			4 Cyl.	1721cc	70-75kW (95-102PS)		Petrol		TD3909
B 18 FP			4 Cyl.	1721cc	75kW (102PS)		Petrol		TD3910
B 18 FT			4 Cyl.	1721cc	88-90kW (120-122PS)		Petrol Turbo		TD3911
B 18 FTM			4 Cyl.	1721cc	90kW (122PS)		Petrol Turbo		TD19337
B 18 K			4 Cyl.	1721cc	58-60kW (79-82PS)		Petrol		TD3912
B 18 KD			4 Cyl.	1721cc	58kW (79PS)		Petrol		TD19338
B 18 KP			4 Cyl.	1721cc	60-66kW (82-90PS)		Petrol		TD3913
B 18 KPD			4 Cyl.	1721cc	66kW (90PS)		Petrol		TD17257
BE/PL	4	48,000/48,020	51,587/51,600	20,500	1,768	0,030/0,090	AL-LF	66740RAA	01-4202/4 STD 0.25
MB/HL 1-5	5	54,785/54,795	58,731/58,744	18,500	1,945	0,046/0,094	AL-LF	66741RA	H1080/5 STD 0.25 0.50
TW/A	2	60,500/60,750	79,750/80,000		2,350		AL-LF	66741AF	A215/2 STD 0.10

18 81.00 x 89.00

B 4184 SJ			4 Cyl.	1834cc	90kW (122PS)		Petrol		TD18000
B 4184 SM			4 Cyl.	1834cc	92kW (125PS)		Petrol		TD12329
BE/PL	4	49,984/50,000	53,000/53,013	19,500	1,496	0,020/0,064	EC	71-3754	71-3754/4 STD 0.25
MB/HL 1,2,4,5	4	64,987/65,000	69,000/69,014	19,600	1,994	0,020/0,064	AL-LF	02-3755	H046/5 STD 0.25
MB/HL 3	1	64,987/65,000	69,000/69,014	25,880	1,998	0,020/0,056	AL-LF	02-3756H	
				02-3756H	STD	25,960/1.0221" - 26,000/1.0237"			
					0.25mm	25,960/1.0221" - 26,000/1.0237"			
SE/PB	1	23,000	26,000/26,025	25,200			BC	55-3783	55-3783 SEMI

19 81.00 x 90.00

B 4194 T			4 Cyl.	1855cc	147kW (200PS)		Petrol Turbo		TD18003
B 4194 T2			4 Cyl.	1855cc	147kW (200PS)		Petrol Turbo		TD18004
BE/PL	1	49,984/50,000	53,000/53,013	19,500	1,496	0,020/0,062	SP	71-3926	71-3926 STD [1]
MB/HL 1,2,4,5	4	64,987/65,000	69,000/69,014	19,600	1,994	0,020/0,064	AL-LF	02-3755	H046/5 STD 0.25
MB/HL 3	1	64,987/65,000	69,000/69,014	25,880	1,998	0,020/0,056	AL-LF	02-3756H	
				02-3756H	STD	25,960/1.0221" - 26,000/1.0237"			
					0.25mm	25,960/1.0221" - 26,000/1.0237"			
SE/PB	1	23,000	26,000/26,025	25,200			BC	55-3783	55-3783 SEMI

20 81.00 x 90.00

B 5234 F			5 Cyl.	2319cc	166kW (225PS)		Petrol Turbo		TD19269
-----------------	--	--	--------	---------------	----------------------	--	---------------------	--	----------------



B 5234 FT	5 Cyl.	2319cc	166-170kW (225-231PS)	Petrol Turbo	TD3973
B 5234 FT+	5 Cyl.	2319cc	184kW (250PS)	Petrol Turbo	TD5148
B 5234 T1	5 Cyl.	2319cc	166kW (226PS)	Petrol Turbo	TD19268
B 5234 T2	5 Cyl.	2319cc	176kW (239PS)	Petrol Turbo	TD19341
B 5234 T3	5 Cyl.	2319cc	147-184kW (239-250PS)	Petrol Turbo Intercooler	TD5401
B 5234 T4	5 Cyl.	2319cc	176-184kW (239-250PS)	Petrol Turbo Intercooler	TD17848
B 5234 T5	5 Cyl.	2319cc	177-179kW (241-243PS)	Petrol Turbo	TD19264
B 5234 T6	5 Cyl.	2319cc	184kW (250PS)	Petrol Turbo	TD19265
B 5234 T7	5 Cyl.	2319cc	195kW (265PS)	Petrol Turbo	TD19340
B 5234 T8	5 Cyl.	2319cc	195kW (265PS)	Petrol Turbo	TD19343
B 5234 T9	5 Cyl.	2319cc	180kW (245PS)	Petrol Turbo	TD19284

BE/PL	1	49,984/50,000	53,000/53,013	19,500	1,496	0,020/0,062	SP	71-3926	71-3926 STD	1
MB/HL 1-3, 5,6	5	64,987/65,000	69,000/69,014	19,600	1,994	0,020/0,064	AL-LF	02-3755	H046/6 STD 0.25	
MB/HL 4	1	64,987/65,000	69,000/69,014	25,880	1,998	0,020/0,056	AL-LF	02-3756H		
<p>02-3756H STD 25,960/1.0221" - 26,000/1.0237" 0.25mm 25,960/1.0221" - 26,000/1.0237"</p>										
SE/PB	1	23,000	26,000/26,025	25,200			BC	55-3783	55-3783 SEMI	
SE/PB	1	21,000	24,000/24,025	21,350			BC	55-3927	55-3927 SEMI	

21 81.00 x 90.00

B 5234 FS	5 Cyl.	2319cc	106kW (144PS)	Petrol	TD19339
------------------	--------	---------------	----------------------	---------------	----------------

BE/PL	5	49,984/50,000	53,000/53,013	19,500	1,496	0,020/0,064	EC	71-3754	71-3754/5 STD 0.25 0.50	
MB/HL 1-3, 5,6	5	64,987/65,000	69,000/69,014	19,600	1,994	0,020/0,064	AL-LF	02-3755	H046/6 STD 0.25	
MB/HL 4	1	64,987/65,000	69,000/69,014	25,880	1,998	0,020/0,056	AL-LF	02-3756H		
<p>02-3756H STD 25,960/1.0221" - 26,000/1.0237" 0.25mm 25,960/1.0221" - 26,000/1.0237"</p>										
SE/PB	1	23,000	26,000/26,025	25,200			BC	55-3783	55-3783 SEMI	
SE/PB	1	21,000	24,000/24,025	21,350			BC	55-3927	55-3927 SEMI	

22 81.00 x 93.15

B 5244 T5	5 Cyl.	2400cc	191kW (260PS)	Petrol Turbo Intercooler	TD18547
------------------	--------	---------------	----------------------	---------------------------------	----------------

BE/PL	1	49,984/50,000	53,000/53,013	19,500	1,496	0,020/0,062	SP	71-3926	71-3926 STD	1
MB/HL 1-3, 5,6	5	64,987/65,000	69,000/69,014	19,600	1,994	0,020/0,064	AL-LF	02-3755	H046/6 STD 0.25	
MB/HL 4	1	64,987/65,000	69,000/69,014	25,880	1,998	0,020/0,056	AL-LF	02-3756H		
<p>02-3756H STD 25,960/1.0221" - 26,000/1.0237" 0.25mm 25,960/1.0221" - 26,000/1.0237"</p>										
SE/PB	1	23,000	26,000/26,025	25,200			BC	55-3783	55-3783 SEMI	
SE/PB	1	21,000	24,000/24,025	21,350			BC	55-3927	55-3927 SEMI	

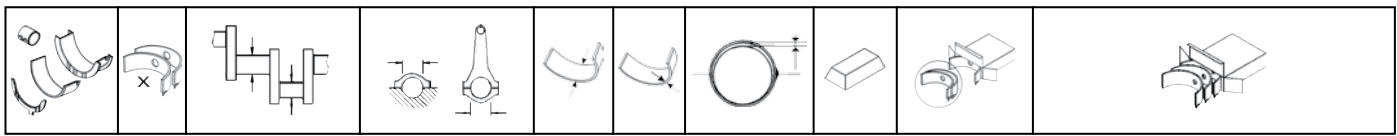

23 81.00 x 93.20

D 5244	5 Cyl.	2400cc	120kW (163PS)	Diesel	TD20835
D 5244 T	5 Cyl.	2400cc	120kW (163PS)	Diesel Turbo	TD16325
D 5244 T10	5 Cyl.	2400cc	151kW (205PS)	Diesel Turbo	TD23621
D 5244 T11	5 Cyl.	2400cc	158kW (215PS)	Diesel Turbo	TD25185
D 5244 T12	5 Cyl.	2400cc	133kW (181PS)	Diesel Turbo Intercooler	TD28501
D 5244 T13	5 Cyl.	2400cc	132kW (180PS)	Diesel Turbo	TD20850
D 5244 T14	5 Cyl.	2400cc	129kW (175PS)	Diesel Turbo	TD23623
D 5244 T15	5 Cyl.	2400cc	158-169kW (215-230PS)	Diesel Turbo	TD25186
D 5244 T16	5 Cyl.	2400cc	120kW (163PS)	Diesel Turbo	TD23624
D 5244 T17 Euro 5	5 Cyl.	2400cc	120kW (163PS)	Diesel Turbo	TD25779
D 5244 T18 Euro 5	5 Cyl.	2400cc	147kW (200PS)	Diesel Turbo	TD25007
D 5244 T2	5 Cyl.	2400cc	96-120kW (131-163PS)	Diesel Turbo	TD17990
D 5244 T20	5 Cyl.	2400cc	162kW (220PS)	Diesel Turbo	TD31057
D 5244 T21	5 Cyl.	2400cc	140kW (190PS)	Diesel Turbo	TD31031
D 5244 T22	5 Cyl.	2400cc	162kW (220PS)	Diesel Turbo	TD31056
D 5244 T23	5 Cyl.	2400cc	169kW (230PS)	Diesel Turbo	TD29584
D 5244 T4	5 Cyl.	2400cc	136kW (185PS)	Diesel Turbo	TD20081
D 5244 T5	5 Cyl.	2400cc	120kW (163PS)	Diesel Turbo	TD20833
D 5244 T7	5 Cyl.	2400cc	92kW (125PS)	Diesel Turbo	TD20834
D 5244 T8	5 Cyl.	2400cc	132kW (180PS)	Diesel Turbo	TD19660
D 5244 T9	5 Cyl.	2400cc	120kW (163PS)	Diesel Turbo	TD20851

BE/PL	1	49,984/50,000	53,000/53,013	19,500	1,496	0,020/0,062	SP	71-3926	71-3926 STD	[1]
MB/HL	1	64,987/65,000	69,000/69,014	25,880	1,998	0,020/0,056	AL-LF	02-3756H	H095/6 STD	
MB/HL	5	64,987/65,000	69,000/69,014	19,600	1,998	0,004/0,056	AL-LF	72-3974		

	02-3756H	STD	25,960/1.0221" - 26,000/1.0237"
		0.25mm	25,960/1.0221" - 26,000/1.0237"

SE/PB	1	27,995/28,000	31,000/31,025	27,100			BC-LF	55-3975	55-3975 SEMI	[6]
-------	---	---------------	---------------	--------	--	--	-------	---------	-----------------	-----

24 81.00 x 95.50

D 5252 T	5 Cyl.	2461cc	103kW (140PS)	Diesel Turbo	TD5145					
BE/PL	1	47,758/47,778	50,600/50,612	19,000	1,395	0,032/0,089	SP	71-3732	71-3732 STD	[1]
MB/HL 1,2, 4-6	5	57,958/57,978	63,000/63,019	18,500	2,502	0,020/0,082	EC	72-3400	H941/6 STD 0.25	
MB/HL 3	1	57,958/57,978	63,000/63,019	24,930	2,502	0,020/0,082	EC	72-3401H		

	72-3401H	STD	25,000/.9843" - 25,040/.9858"
		0.25mm	25,100/.9882" - 25,140/.9898"
		0.50mm	25,100/.9882" - 25,140/.9898"
		0.75mm	25,100/.9882" - 25,140/.9898"

MB/HL 1-6	6	57,958/57,978	63,000/63,019	18,500	2,502	0,020/0,082	EC	72-3400	H981/6 STD 0.25	
TW/A	2	63,500/63,750	77,200/77,450		1,975		AL-LF	04-3529	A124/4 STD	
TW/A	2	63,500/63,750	77,200/77,450		1,975		AL-LF	04-3530		
SE/PB	1	24,000/24,012	27,000/27,021	25,000			BC	55-3443	55-3443 SEMI	



25		82.00 x 93.20								
B 4204 T11		4 Cyl.	1969cc	179-180kW (243-245PS)	Petrol Turbo			TD28541		
B 4204 T27		4 Cyl.	1969cc	236kW (321PS)	Petrol Turbo			TD29612		
B 4204 T9		4 Cyl.	1969cc	225kW (306PS)	Petrol Turbo			TD28542		
BE/PL	1	49,984/50,000	53,000/53,013	19,500	1,496	0,020/0,062	SP	71-3926	71-3926 STD	①
MB/HL 1,2,4,5	4	64,987/65,000	69,000/69,014	19,600	1,994	0,020/0,064	AL-LF	02-3755	H046/5 STD 0.25	
MB/HL 3	1	64,987/65,000	69,000/69,014	25,880	1,998	0,020/0,056	AL-LF	02-3756H		
			02-3756H	STD	25,960/1.0221" - 26,000/1.0237"					
				0.25mm	25,960/1.0221" - 26,000/1.0237"					
SE/PB	1	23,000	26,000/26,025	25,200			BC	55-3783	55-3783 SEMI	

26		82.00 x 93.20								
B 4204 T19		4 Cyl.	1969cc	140kW (190PS)	Petrol Turbo			TD31257		
B 4204 T21		4 Cyl.	1969cc	140kW (190PS)	Petrol Turbo			TD30942		
B 4204 T23		4 Cyl.	1969cc	187kW (254PS)	Petrol Turbo			TD30816		
B 4204 T37		4 Cyl.	1969cc	112kW (152PS)	Petrol Turbo			TD30814		
B 4204 T38		4 Cyl.	1969cc	90kW (122PS)	Petrol Turbo			TD30812		
B4204T35		4 Cyl.	1969cc	235kW (320PS)	Petrol Turbo			TD31418		
BE/PL	1	49,984/50,000	53,000/53,013	19,500	1,496	0,020/0,062	SP	71-3926	71-3926 STD	①
MB/HL 1-3, 5,6	5	64,987/65,000	69,000/69,014	19,600	1,994	0,020/0,064	AL-LF	02-3755	H046/6 STD 0.25	
MB/HL 4	1	64,987/65,000	69,000/69,014	25,880	1,998	0,020/0,056	AL-LF	02-3756H		
			02-3756H	STD	25,960/1.0221" - 26,000/1.0237"					
				0.25mm	25,960/1.0221" - 26,000/1.0237"					
SE/PB	1	23,000	26,000/26,025	25,200			BC	55-3783	55-3783 SEMI	

27		82.00 x 93.20								
B 6304 T2		6 Cyl.	2953cc	210kW (286PS)	Petrol Turbo Intercooler			TD20992		
B 6304 T3 Euro 5		6 Cyl.	2953cc	242kW (329PS)	Petrol Turbo Intercooler			TD29583		
B 6304 T4 Euro 5		6 Cyl.	2953cc	224-242kW (305-329PS)	Petrol Turbo Intercooler			TD23982		
B 6304 T5 Euro 5		6 Cyl.	2953cc	258kW (351PS)	Petrol Turbo Intercooler			TD29314		
BE/PL	1	49,984/50,000	53,000/53,013	19,500	1,496	0,020/0,062	SP	71-3926	71-3926 STD	①
MB/HL	6	64,987/65,000	69,000/69,014	19,600	1,994	0,020/0,064	AL-LF	02-3755	H046/7 STD 0.25	
MB/HL	1	64,987/65,000	69,000/69,014	25,880	1,998	0,020/0,056	AL-LF	02-3756H		
			02-3756H	STD	25,960/1.0221" - 26,000/1.0237"					
				0.25mm	25,960/1.0221" - 26,000/1.0237"					
SE/PB	1	23,000	26,000/26,025	25,200			BC	55-3783	55-3783 SEMI	
SE/PB	1	21,000	24,000/24,025	21,350			BC	55-3927	55-3927 SEMI	

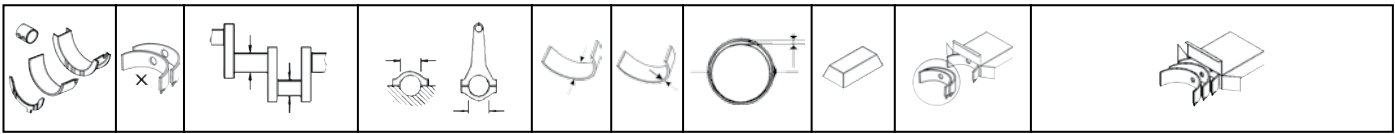

28										82.70 x 83.50									
B 18 U										4 Cyl. 1794cc 66kW (90PS) Petrol TD3914									
BE/PL	4	48,000/48,020	51,587/51,600	20,500	1,768	0,031/0,089	BS	4060CP	71-4311/4	STD 0.25 0.50									
MB/HL 1-5	5	54,785/54,795	58,731/58,744	18,500	1,945	0,046/0,094	AL-LF	66741RA	H1080/5	STD 0.25 0.50									
TW/A	2	60,500/60,750	79,750/80,000		2,350		AL-LF	66741AF	A215/2	STD 0.10									
SE/PB	1	24,005/24,012	26,000/26,021	24,750			BC	55-3875	55-3875	SEMI									

29										82.70 x 93.00									
B 20 F										4 Cyl. 1998cc 80-85kW (108-115PS) Petrol TD3924									
BE/PL	4	48,000/48,020	51,587/51,600	20,500	1,768	0,031/0,089	BS	4060CP	71-4311/4	STD 0.25 0.50									
MB/HL 1-5	5	54,785/54,795	58,731/58,744	18,500	1,945	0,046/0,094	AL-LF	66741RA	H1080/5	STD 0.25 0.50									
TW/A	2	60,500/60,750	79,750/80,000		2,350		AL-LF	66741AF	A215/2	STD 0.10									
SE/PB	1	24,005/24,012	26,000/26,021	24,750			BC	55-3875	55-3875	SEMI									

30										83.00 x 80.00									
B 4184 S										4 Cyl. 1731cc 85kW (115PS) Petrol TD5152									
B 4184 S3										4 Cyl. 1731cc 85kW (116PS) Petrol TD13748									
BE/PL	4	49,984/50,000	53,000/53,013	19,500	1,496	0,020/0,064	EC	71-3754	71-3754/4	STD 0.25									
MB/HL 1,2,4,5	4	64,987/65,000	69,000/69,014	19,600	1,994	0,020/0,064	AL-LF	02-3755	H046/5	STD 0.25									
MB/HL 3	1	64,987/65,000	69,000/69,014	25,880	1,998	0,020/0,056	AL-LF	02-3756H											
		02-3756H		STD	25,960/1.0221" - 26,000/1.0237"														
				0.25mm	25,960/1.0221" - 26,000/1.0237"														
SE/PB	1	23,000	26,000/26,025	25,200			BC	55-3783	55-3783	SEMI									

31										83.00 x 82.40									
B 4184 S2										4 Cyl. 1783cc 85-90kW (116-122PS) Petrol TD13729									
B 4184 S9										4 Cyl. 1783cc 88-90kW (120-122PS) Petrol TD17998									
BE/PL	4	49,984/50,000	53,000/53,013	19,500	1,496	0,020/0,064	EC	71-3754	71-3754/4	STD 0.25									
MB/HL 1,2,4,5	4	64,987/65,000	69,000/69,014	19,600	1,994	0,020/0,064	AL-LF	02-3755	H046/5	STD 0.25									
MB/HL 3	1	64,987/65,000	69,000/69,014	25,880	1,998	0,020/0,056	AL-LF	02-3756H											
		02-3756H		STD	25,960/1.0221" - 26,000/1.0237"														
				0.25mm	25,960/1.0221" - 26,000/1.0237"														
SE/PB	1	23,000	26,000/26,025	25,200			BC	55-3783	55-3783	SEMI									

32										83.00 x 90.00									
B 4204 S										4 Cyl. 1948cc 100-103kW (136-140PS) Petrol TD5153									
B 4204 S2										4 Cyl. 1948cc 100kW (136PS) Petrol TD17999									
BE/PL	4	49,984/50,000	53,000/53,013	19,500	1,496	0,020/0,064	EC	71-3754	71-3754/4	STD 0.25									

MB/HL 1,2,4,5	4	64,987/65,000	69,000/69,014	19,600	1,994	0,020/0,064	AL-LF	02-3755	H046/5 STD 0.25	
MB/HL 3	1	64,987/65,000	69,000/69,014	25,880	1,998	0,020/0,056	AL-LF	02-3756H		
			02-3756H	STD	25,960/1.0221" - 26,000/1.0237"					
				0.25mm	25,960/1.0221" - 26,000/1.0237"					
SE/PB	1	23,000	26,000/26,025	25,200			BC	55-3783	55-3783 SEMI	

33 83.00 x 90.00

B 4204 T	4 Cyl.	1948cc	118-119kW (160-162PS)	Petrol Turbo	TD11287				
B 4204 T2	4 Cyl.	1948cc	118-121kW (160-165PS)	Petrol Turbo	TD18005				
B 4204 T3	4 Cyl.	1948cc	120-121kW (163-165PS)	Petrol Turbo	TD18001				
B 4204 T4	4 Cyl.	1948cc	127kW (173PS)	Petrol Turbo	TD29364				
B 4204 T5	4 Cyl.	1948cc	147kW (200PS)	Petrol Turbo	TD18002				
BE/PL	1	49,984/50,000	53,000/53,013	19,500	1,496	0,020/0,062	SP	71-3926	71-3926 STD 1
MB/HL 1,2,4,5	4	64,987/65,000	69,000/69,014	19,600	1,994	0,020/0,064	AL-LF	02-3755	H046/5 STD 0.25
MB/HL 3	1	64,987/65,000	69,000/69,014	25,880	1,998	0,020/0,056	AL-LF	02-3756H	
			02-3756H	STD	25,960/1.0221" - 26,000/1.0237"				
				0.25mm	25,960/1.0221" - 26,000/1.0237"				
SE/PB	1	23,000	26,000/26,025	25,200			BC	55-3783	55-3783 SEMI

34 83.00 x 90.00

B 5244 S	5 Cyl.	2435cc	125kW (170PS)	Petrol	TD11552				
B 5244 S2	5 Cyl.	2435cc	103kW (140PS)	Petrol	TD9847				
B 5244 S4	5 Cyl.	2435cc	125kW (170PS)	Petrol	TD19285				
B 5244 S5	5 Cyl.	2435cc	103kW (140PS)	Petrol	TD18249				
B 5244 SG	5 Cyl.	2435cc	103kW (140PS)	Petrol	TD12328				
B 5244 SG2	5 Cyl.	2435cc	103kW (140PS)	Petrol	TD17992				
B 5252	5 Cyl.	2435cc	103kW (140PS)	Petrol	TD5144				
B 5252 F	5 Cyl.	2435cc	103-106kW (140-144PS)	Petrol	TD19267				
B 5252 FS	5 Cyl.	2435cc	104-106kW (141-144PS)	Petrol	TD21829				
B 5252 S	5 Cyl.	2435cc	106kW (144PS)	Petrol	TD5146				
B 5254 F	5 Cyl.	2435cc	121-125kW (165-170PS)	Petrol	TD19266				
B 5254 S	5 Cyl.	2435cc	121-125kW (165-170PS)	Petrol	TD5147				
BE/PL	5	49,984/50,000	53,000/53,013	19,500	1,496	0,020/0,064	EC	71-3754	71-3754/5 STD 0.25 0.50
MB/HL 1-3, 5,6	5	64,987/65,000	69,000/69,014	19,600	1,994	0,020/0,064	AL-LF	02-3755	H046/6 STD 0.25
MB/HL 4	1	64,987/65,000	69,000/69,014	25,880	1,998	0,020/0,056	AL-LF	02-3756H	
			02-3756H	STD	25,960/1.0221" - 26,000/1.0237"				
				0.25mm	25,960/1.0221" - 26,000/1.0237"				
SE/PB	1	23,000	26,000/26,025	25,200			BC	55-3783	55-3783 SEMI
SE/PB	1	21,000	24,000/24,025	21,350			BC	55-3927	55-3927 SEMI

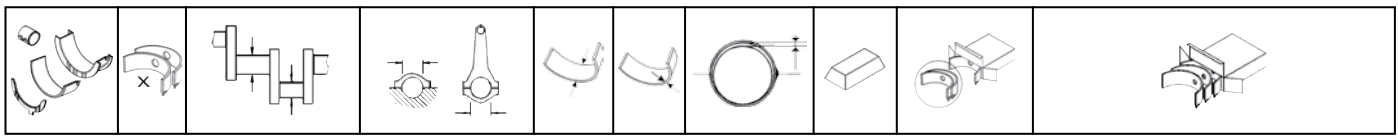



35										83.00 x 90.00									
B 5244 T		5 Cyl.		2435cc	142kW (193PS)		Petrol Turbo			TD17995									
B 5244 T2		5 Cyl.		2435cc	195kW (265PS)		Petrol Turbo			TD19342									
B 5244 T3		5 Cyl.		2435cc	147kW (200PS)		Petrol Turbo			TD15008									
B 5244 T4		5 Cyl.		2435cc	132kW (180PS)		Petrol Turbo Intercooler			TD21830									
B 5244 T7		5 Cyl.		2435cc	147kW (200PS)		Petrol Turbo			TD18251									
B 5254 T		5 Cyl.		2435cc	142kW (193PS)		Petrol Turbo			TD9366									
BE/PL	1	49,984/50,000	53,000/53,013	19,500	1,496	0,020/0,062	SP	71-3926	71-3926 STD	I									
MB/HL 1-3, 5,6	5	64,987/65,000	69,000/69,014	19,600	1,994	0,020/0,064	AL-LF	02-3755	H046/6 STD 0.25										
MB/HL 4	1	64,987/65,000	69,000/69,014	25,880	1,998	0,020/0,056	AL-LF	02-3756H											
		02-3756H	STD	25,960/1.0221" - 26,000/1.0237"															
			0.25mm	25,960/1.0221" - 26,000/1.0237"															
SE/PB	1	23,000	26,000/26,025	25,200			BC	55-3783	55-3783 SEMI										
SE/PB	1	21,000	24,000/24,025	21,350			BC	55-3927	55-3927 SEMI										

36										83.00 x 90.00									
B 6304 F		6 Cyl.		2922cc	150-152kW (204-207PS)		Petrol			TD5042									
B 6304 G		6 Cyl.		2922cc	150kW (204PS)		Petrol			TD5402									
B 6304 S		6 Cyl.		2922cc	150kW (204PS)		Petrol			TD5555									
B 6304 S2		6 Cyl.		2922cc	132-135kW (180-184PS)		Petrol			TD5155									
B 6304 S3		6 Cyl.		2922cc	150kW (204PS)		Petrol			TD9827									
BE/PL	6	49,984/50,000	53,000/53,013	19,500	1,496	0,020/0,064	EC	71-3754	71-3754/6 STD 0.25										
MB/HL	6	64,987/65,000	69,000/69,014	19,600	1,994	0,020/0,064	AL-LF	02-3755	H046/7 STD 0.25										
MB/HL	1	64,987/65,000	69,000/69,014	25,880	1,998	0,020/0,056	AL-LF	02-3756H											
		02-3756H	STD	25,960/1.0221" - 26,000/1.0237"															
			0.25mm	25,960/1.0221" - 26,000/1.0237"															
SE/PB	1	23,000	26,000/26,025	25,200			BC	55-3783	55-3783 SEMI										
SE/PB	1	21,000	24,000/24,025	21,350			BC	55-3927	55-3927 SEMI										

37										83.00 x 92.30									
B 5254 T12		5 Cyl.		2497cc	187kW (254PS)		Petrol Turbo			TD26511									
B 5254 T14		5 Cyl.		2497cc	183kW (249PS)		Petrol Turbo			TD29810									
B 5254 T9		5 Cyl.		2497cc	154kW (210PS)		Petrol Turbo			TD29888									
BE/PL	1	49,984/50,000	53,000/53,013	19,500	1,496	0,020/0,062	SP	71-3926	71-3926 STD	I									
MB/HL 1-3, 5,6	5	64,987/65,000	69,000/69,014	19,600	1,994	0,020/0,064	AL-LF	02-3755	H046/6 STD 0.25										
MB/HL 4	1	64,987/65,000	69,000/69,014	25,880	1,998	0,020/0,056	AL-LF	02-3756H											
		02-3756H	STD	25,960/1.0221" - 26,000/1.0237"															
			0.25mm	25,960/1.0221" - 26,000/1.0237"															
SE/PB	1	23,000	26,000/26,025	25,200			BC	55-3783	55-3783 SEMI										
SE/PB	1	21,000	24,000/24,025	21,350			BC	55-3927	55-3927 SEMI										



38		83.00 x 93.20								
B 5254 T10			5 Cyl.	2521cc	170kW (231PS)		Petrol Turbo			TD24239
B 5254 T2			5 Cyl.	2521cc	154-162kW (209-220PS)		Petrol Turbo			TD17991
B 5254 T3			5 Cyl.	2521cc	162kW (220PS)		Petrol Turbo			TD18250
B 5254 T4			5 Cyl.	2521cc	220-224kW (299-305PS)		Petrol Turbo			TD18248
B 5254 T5			5 Cyl.	2521cc	186kW (253PS)		Petrol Turbo			TD29363
B 5254 T6			5 Cyl.	2521cc	147kW (200PS)		Petrol Turbo Intercooler			TD20985
B 5254 T7			5 Cyl.	2521cc	169kW (230PS)		Petrol Turbo			TD20963
B 5254 T11			5 Cyl.	2521cc	170kW (231PS)		Flexfuel Turbo			TD24235
B 5254 T8			5 Cyl.	2521cc	147kW (200PS)		Flexfuel Turbo Intercooler			TD21270
BE/PL	1	49,984/50,000	53,000/53,013	19,500	1,496	0,020/0,062	SP	71-3926	71-3926 STD	1
MB/HL 1-3, 5,6	5	64,987/65,000	69,000/69,014	19,600	1,994	0,020/0,064	AL-LF	02-3755	H046/6 STD 0.25	
MB/HL 4	1	64,987/65,000	69,000/69,014	25,880	1,998	0,020/0,056	AL-LF	02-3756H		
				 02-3756H	STD	25,960/1.0221" - 26,000/1.0237"				
					0.25mm	25,960/1.0221" - 26,000/1.0237"				
SE/PB	1	23,000	26,000/26,025	25,200			BC	55-3783	55-3783 SEMI	
SE/PB	1	21,000	24,000/24,025	21,350			BC	55-3927	55-3927 SEMI	

39		84.14 x 80.00								
B 18			4 Cyl.	1780cc	55-76kW (75-103PS)		Petrol			TD5127
B 18 A			4 Cyl.	1780cc	49-55kW (66-75PS)		Petrol			TD5126
B 18 B			4 Cyl.	1780cc	74-75kW (101-102PS)		Petrol			TD5136
B 18 D			4 Cyl.	1780cc	59-66kW (80-90PS)		Petrol			TD5128
BE/PL	4	54,089/54,102	57,823/57,835	26,950	1,841	0,038/0,089	EC	71-2724	71-2724/4 STD 0.25	
MB/HL 1-4	4	63,442/63,464	67,462/67,488	28,200	1,985	0,028/0,101	EC	72-2725	H783/5 STD 0.254 0.508	
MB/HL 5	1	63,442/63,454	67,462/67,488	38,913	1,985	0,028/0,101	EC	72-2726H		
				 72-2726H	STD	38,960/1.5339" - 39,000/1.5354"				
					0.254mm	39,061/1.5378" - 39,101/1.5394"				
					0.508mm	39,163/1.5419" - 39,203/1.5434"				
CB/NWB 1	1	46,977/46,990	45,911/45,936	27,100	1,520		BB	13-2756	N088/3 STD	
CB/NWB 2	1	42,977/43,002	45,911/45,936	26,310	1,520		BB	13-2779		
CB/NWB 3	1	36,975/37,000	39,929/39,954	26,890	1,520		BB	13-2780		

40		85.00 x 88.00								
D 4204 T			4 Cyl.	1998cc	100kW (136PS)		Diesel Turbo Intercooler			TD18993
D 4204 T2			4 Cyl.	1998cc	96kW (131PS)		Diesel Turbo Intercooler			TD21826
BE/PL	4	49,984/50,000	53,695/53,708	20,000	1,838	0,020/0,070	SP	71-3952	71-3952/4 STD 0.30	1
MB/HL 1-5	5	59,981/60,000	63,731/63,750	20,290	1,845	0,040/0,100	AL-LF	66726RA	H1057/5 STD 0.30 0.50	
TW/A	4	67,050/67,300	83,050/83,300		2,330		BS	66721BF	A214/4 STD 0.10	
SE/PB	1	27,997/28,000	30,200/30,225	24,050			BS-LF	55-3985	55-3985 SEMI	

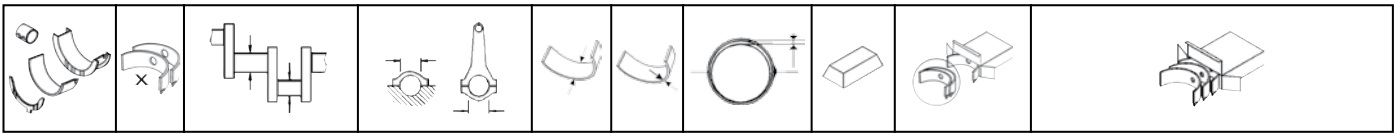

41		88.00 x 73.00							
B 27 A		V6 Cyl.		2664cc	92-93kW (125-126PS)		Petrol	TD3958	
B 27 E		V6 Cyl.		2664cc	103-109kW (140-148PS)		Petrol	TD3959	
B 27 F		V6 Cyl.		2664cc	109kW (148PS)		Petrol	TD3960	
BE/PL	6	59,971/59,990	63,704/63,723	17,720	1,846	0,022/0,085	EC	71-3733	71-3733/6 STD
MB/HL 1-4	4	70,043/70,062	74,000/74,019	23,470	1,967	0,020/0,067	AL-LF	66311RA	H1041/4 STD

42		88.90 x 80.00							
B 19 A		4 Cyl.		1986cc	65-71kW (88-97PS)		Petrol	TD3915	
B 19 E		4 Cyl.		1986cc	74-86kW (101-117PS)		Petrol	TD3916	
B 19 ET		4 Cyl.		1986cc	100-110kW (136-150PS)		Petrol Turbo	TD3917	
B 19 K		4 Cyl.		1986cc	71-74kW (97-101PS)		Petrol	TD19335	
BE/PL	4	53,987/54,000	58,000/58,013	24,000	1,988	0,024/0,075	EC	71-3271	71-3271/4 STD
MB/HL 1-4	4	63,442/63,464	67,462/67,488	28,200	1,985	0,028/0,101	EC	72-2725	H783/5 STD 0.254 0.508
MB/HL 5	1	63,442/63,454	67,462/67,488	38,913	1,985	0,028/0,101	EC	72-2726H	
		72-2726H	STD	38,960/1.5339" - 39,000/1.5354"					
			0.254mm	39,061/1.5378" - 39,101/1.5394"					
			0.508mm	39,163/1.5419" - 39,203/1.5434"					
CB/NWB 1	1	46,977/46,990	45,911/45,936	27,100	1,520		BB	13-2756	N088/3 STD
CB/NWB 2	1	42,977/43,002	45,911/45,936	26,310	1,520		BB	13-2779	
CB/NWB 3	1	36,975/37,000	39,929/39,954	26,890	1,520		BB	13-2780	

43		88.90 x 80.00							
B 20		4 Cyl.		1986cc	71kW (97PS)		Petrol	TD5138	
B 20 A		4 Cyl.		1986cc	60kW (82PS)		Petrol	TD3919	
B 20 B		4 Cyl.		1986cc	73-74kW (100-101PS)		Petrol	TD3920	
B 20 D		4 Cyl.		1986cc	70kW (95PS)		Petrol	TD3921	
B 20 E		4 Cyl.		1986cc	91kW (124PS)		Petrol	TD3922	
B 20 F		4 Cyl.		1985cc	85kW (116PS)		Petrol	TD15068	
BE/PL	4	54,089/54,102	57,823/57,835	26,950	1,841	0,038/0,089	EC	71-2724	71-2724/4 STD 0.25
→12/73									
BE/PL	4	53,987/54,000	58,000/58,013	24,000	1,988	0,024/0,075	EC	71-3271	71-3271/4 STD
01/74→									
MB/HL 1-4	4	63,442/63,464	67,462/67,488	28,200	1,985	0,028/0,101	EC	72-2725	H783/5 STD 0.254 0.508
MB/HL 5	1	63,442/63,454	67,462/67,488	38,913	1,985	0,028/0,101	EC	72-2726H	
		72-2726H	STD	38,960/1.5339" - 39,000/1.5354"					
			0.254mm	39,061/1.5378" - 39,101/1.5394"					
			0.508mm	39,163/1.5419" - 39,203/1.5434"					
CB/NWB 1	1	46,977/46,990	45,911/45,936	27,100	1,520		BB	13-2756	N088/3 STD
CB/NWB 2	1	42,977/43,002	45,911/45,936	26,310	1,520		BB	13-2779	
CB/NWB 3	1	36,975/37,000	39,929/39,954	26,890	1,520		BB	13-2780	



44 88.90 x 80.00

B 200 E	4 Cyl.	1986cc	82-89kW (112-121PS)	Petrol	TD3925
B 200 EA	4 Cyl.	1986cc	81-82kW (110-112PS)	Petrol	TD5150
B 200 ET	4 Cyl.	1986cc	115-120kW (156-163PS)	Petrol Turbo	TD3926
B 200 F	4 Cyl.	1986cc	80-82kW (109-112PS)	Petrol	TD3927
B 200 FT	4 Cyl.	1986cc	105-114kW (143-155PS)	Petrol Turbo	TD3928
B 200 G	4 Cyl.	1986cc	80-89kW (109-121PS)	Petrol	TD3929
B 200 K	4 Cyl.	1986cc	70-77kW (95-105PS)	Petrol	TD3930
B 200 KE	4 Cyl.	1986cc	84-86kW (114-117PS)	Petrol	TD21328
B 204 E	4 Cyl.	1986cc	100-103kW (136-140PS)	Petrol	TD3931
B 204 FT	4 Cyl.	1986cc	102-140kW (139-190PS)	Petrol Turbo Intercooler	TD3932
B 204 FTE	4 Cyl.	1986cc	147kW (200PS)	Petrol	TD21845
B 204 GT	4 Cyl.	1986cc	136kW (185PS)	Petrol	TD3933

BE/PL	4	48,985/49,005	52,000/52,013	24,000	1,492	0,020/0,069	EC	71-3616	71-3616/4 STD 0.25
MB/HL 1-5	5	54,987/55,000	59,000/59,019	21,000	1,993	0,020/0,071	AL-LF	02-3617	H003/5 STD 0.25 0.50
MB/HL	4	62,987/63,000	67,000/67,019	21,000	1,996	0,020/0,065	AL-LF	02-3678	H016/5 STD 0.25
MB/HL	1	62,987/63,000	67,000/67,019	35,380	1,998	0,020/0,061	AL-LF	02-3679H	



02-3679H STD 35,460/1.3961" - 35,500/1.3976"
0.25mm 35,460/1.3961" - 35,500/1.3976"

TW/A	1	61,250	76,000		2,000		AL-LF	04-3618	A130/2 STD
TW/A	1	61,250	76,000		2,000		AL-LF	04-3619	
SE/PB	1	22,996/23,000	26,000/26,025	24,500			BC	55-3620	55-3620 SEMI

45 91.00 x 73.00

B 28 A	V6 Cyl.	2849cc	95-97kW (129-132PS)	Petrol	TD3962
B 28 E	V6 Cyl.	2849cc	114-125kW (155-170PS)	Petrol	TD3963
B 28 F	V6 Cyl.	2849cc	114kW (155PS)	Petrol	TD3964
B 280 E	V6 Cyl.	2849cc	108-125kW (147-170PS)	Petrol	TD3965
B 280 F	V6 Cyl.	2849cc	105-108kW (143-147PS)	Petrol	TD5041

BE/PL	6	59,971/59,990	63,704/63,723	17,720	1,846	0,022/0,085	EC	71-3733	71-3733/6 STD
MB/HL 1-4	4	70,043/70,062	74,000/74,019	23,470	1,967	0,020/0,067	AL-LF	66311RA	H1041/4 STD

46 92.00 x 80.00

B 21 A	4 Cyl.	2127cc	71-80kW (97-108PS)	Petrol	TD3934
B 21 E	4 Cyl.	2127cc	86-91kW (117-124PS)	Petrol	TD3935
B 21 ET	4 Cyl.	2127cc	114-115kW (155-156PS)	Petrol Turbo	TD3936
B 21 F	4 Cyl.	2127cc	80kW (109PS)	Petrol	TD3937

BE/PL	4	53,987/54,000	58,000/58,013	24,000	1,988	0,024/0,075	EC	71-3271	71-3271/4 STD
MB/HL 1-4	4	63,442/63,464	67,462/67,488	28,200	1,985	0,028/0,101	EC	72-2725	H783/5 STD 0.254 0.508
MB/HL 5	1	63,442/63,454	67,462/67,488	38,913	1,985	0,028/0,101	EC	72-2726H	



72-2726H STD 38,960/1.5339" - 39,000/1.5354"
0.254mm 39,061/1.5378" - 39,101/1.5394"
0.508mm 39,163/1.5419" - 39,203/1.5434"

CB/NWB 1	1	46,977/46,990	45,911/45,936	27,100	1,520		BB	13-2756	N088/3 STD
CB/NWB 2	1	42,977/43,002	45,911/45,936	26,310	1,520		BB	13-2779	
CB/NWB 3	1	36,975/37,000	39,929/39,954	26,890	1,520		BB	13-2780	

47 95.00 x 120.00

D 50 A			6 Cyl.	5100cc	79kW (107PS)		Diesel		TD9126
D 50 B			6 Cyl.	5100cc	86kW (117PS)		Diesel		TD9202
BE/PL	6	63,449/63,462	67,323/67,336	34,000	1,902	0,057/0,108	EC	71-3446	71-3446/6 STD 0.254
BE/PL	6	63,449/63,462	67,323/67,336	34,000	1,902	0,057/0,108	EC	71-3695	71-3695/6 STD 0.254

71-3446

71-3695

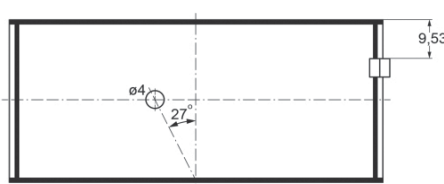
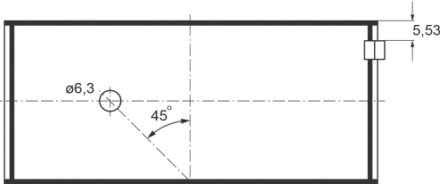

MB/HL 1-7	7	76,149/76,162	81,051/81,076	26,500	2,413	0,063/0,126	EC	72-3489	H969/7 STD 0.254
TW/A	4	85,090/85,340	104,390/104,690		3,123		EC	54-3511	A121/4 STD
SE/PB	1	40,000/40,012	43,043/43,068	31,950			BC	55-3524	55-3524 SEMI
SE/PB	1	40,000/40,004	43,043/43,068	31,700			BC	55-3663	55-3663 SEMI

55-3524

55-3663

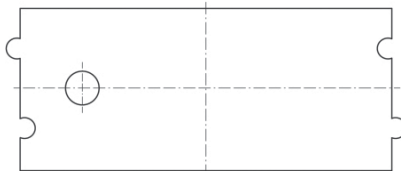
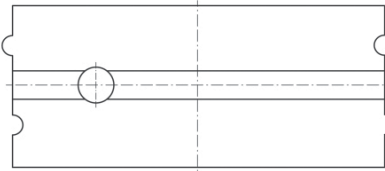

48 95.25 x 100.00

D47A/VDE			6 Cyl.	4704cc			Diesel		FM1823
BE/PL	6	63,449/63,462	67,323/67,336	34,000	1,902	0,057/0,108	EC	71-3446	71-3446/6 STD 0.254

49 95.25 x 120.00

TD 50 A			6 Cyl.	5130cc	108kW (147PS)		Diesel Turbo		TD9127
TD 50 B			6 Cyl.	5130cc	121kW (165PS)		Diesel Turbo		TD9207
BE/PL	6	63,449/63,462	67,323/67,336	34,000	1,902	0,057/0,108	EC	71-3446	71-3446/6 STD 0.254
BE/PL	6	63,449/63,462	67,323/67,336	34,000	1,902	0,057/0,108	EC	71-3695	71-3695/6 STD 0.254

71-3446

71-3695

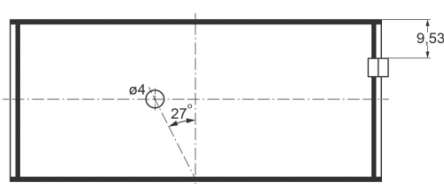
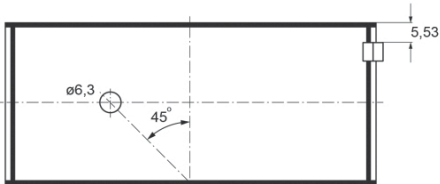

MB/HL 1-7	7	76,149/76,162	81,051/81,076	26,500	2,413	0,063/0,126	EC	72-3489	H969/7 STD 0.254
-----------	---	---------------	---------------	--------	-------	-------------	----	---------	----------------------------



TW/A	4	85,090/85,340	104,390/104,690		3,123		EC	54-3511	A121/4 STD
SE/PB	1	40,000/40,012	43,043/43,068	31,950			BC	55-3524	55-3524 SEMI
SE/PB	1	40,000/40,004	43,043/43,068	31,700			BC	55-3663	55-3663 SEMI

55-3524

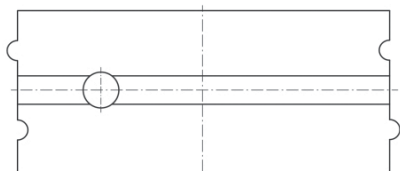

55-3663

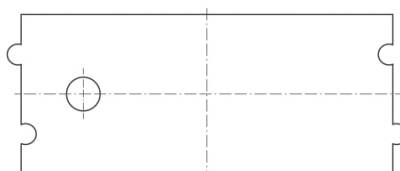

50 96.00 x 80.00

B 23 A			4 Cyl.	2316cc	78-84kW (106-114PS)	Petrol			TD3941
B 23 E			4 Cyl.	2316cc	91-103kW (124-140PS)	Petrol			TD3942
B 23 ET			4 Cyl.	2315cc	127kW (173PS)	Petrol Turbo			TD3943
B 23 F			4 Cyl.	2316cc	83-90kW (113-123PS)	Petrol			TD3944
B 23 FT			4 Cyl.	2316cc	97-119kW (132-162PS)	Petrol Turbo			TD19262

BE/PL	4	53,987/54,000	58,000/58,013	24,000	1,988	0,024/0,075	EC	71-3271	71-3271/4 STD
MB/HL 1-4	4	63,442/63,464	67,462/67,488	28,200	1,985	0,028/0,101	EC	72-2725	H783/5 STD 0.254 0.508
MB/HL 5	1	63,442/63,454	67,462/67,488	38,913	1,985	0,028/0,101	EC	72-2726H	



72-2726H

STD	38,960/1.5339" - 39,000/1.5354"
0.254mm	39,061/1.5378" - 39,101/1.5394"
0.508mm	39,163/1.5419" - 39,203/1.5434"

CB/NWB 1	1	46,977/46,990	45,911/45,936	27,100	1,520		BB	13-2756	N088/3 STD
CB/NWB 2	1	42,977/43,002	45,911/45,936	26,310	1,520		BB	13-2779	
CB/NWB 3	1	36,975/37,000	39,929/39,954	26,890	1,520		BB	13-2780	

51 96.00 x 80.00

B 230 A			4 Cyl.	2316cc	81-86kW (110-117PS)	Petrol			TD3945
B 230 E			4 Cyl.	2316cc	89-98kW (121-133PS)	Petrol			TD5038
B 230 ET			4 Cyl.	2316cc	130-134kW (177-182PS)	Petrol Turbo Intercooler			TD3947
B 230 F			4 Cyl.	2316cc	81-100kW (110-136PS)	Petrol			TD3948
B 230 FB			4 Cyl.	2316cc	96kW (131PS)	Petrol			TD5157
B 230 FD			4 Cyl.	2316cc	85-96kW (116-131PS)	Petrol			TD3949
B 230 FK			4 Cyl.	2316cc	99kW (135PS)	Petrol Turbo			TD5156
B 230 FT			4 Cyl.	2316cc	115-151kW (156-205PS)	Petrol Turbo			TD3950
B 230 FT+			4 Cyl.	2316cc	140kW (190PS)	Petrol Turbo			TD5361
B 230 FX			4 Cyl.	2316cc	100kW (136PS)	Petrol			TD21129
B 230 G			4 Cyl.	2316cc	90-96kW (122-131PS)	Petrol			TD3951
B 230 GK			4 Cyl.	2316cc	104-113kW (141-154PS)	Petrol			TD3952
B 230 GS			4 Cyl.	2316cc	114kW (155PS)	Petrol			TD3953
B 230 GT			4 Cyl.	2316cc	121-125kW (165-170PS)	Petrol Turbo Intercooler			TD5039
B 230 K			4 Cyl.	2316cc	80-86kW (109-117PS)	Petrol			TD3955
B 234 F			4 Cyl.	2316cc	111-117kW (151-159PS)	Petrol			TD3956
B 234 G			4 Cyl.	2316cc	114kW (155PS)	Petrol			TD3957

BE/PL	4	48,985/49,005	52,000/52,013	24,000	1,492	0,020/0,069	EC	71-3616	71-3616/4 STD 0.25
-------	---	---------------	---------------	--------	-------	-------------	----	---------	------------------------------

MB/HL 1-5	5	54,987/55,000	59,000/59,019	21,000	1,993	0,020/0,071	AL-LF	02-3617	H003/5 STD 0.25 0.50	
MB/HL	4	62,987/63,000	67,000/67,019	21,000	1,996	0,020/0,065	AL-LF	02-3678	H016/5 STD 0.25	
MB/HL	1	62,987/63,000	67,000/67,019	35,380	1,998	0,020/0,061	AL-LF	02-3679H		
		02-3679H	STD	35,460/1.3961" - 35,500/1.3976"						
			0.25mm	35,460/1.3961" - 35,500/1.3976"						
TW/A	1	61,250	76,000		2,000		AL-LF	04-3618	A130/2 STD	
TW/A	1	61,250	76,000		2,000		AL-LF	04-3619		
SE/PB	1	22,996/23,000	26,000/26,025	24,500			BC	55-3620	55-3620 SEMI	

52 98.43 x 120.00

D 60 A	6 Cyl.	5480cc	88kW (120PS)				Diesel		TD9146
D6A180	6 Cyl.	5480cc	132kW (180PS)				Diesel Turbo Intercooler		TD9219
D6A210	6 Cyl.	5480cc	154kW (210PS)				Diesel Turbo Intercooler		TD9220
D6A230	6 Cyl.	5480cc	169kW (230PS)				Diesel Turbo Intercooler		TD9227
D6A250	6 Cyl.	5480cc	184kW (250PS)				Diesel Turbo Intercooler		TD9228
D6B Euro 3	6 Cyl.	5480cc	132-184kW (180-250PS)				Diesel Turbo Intercooler		TD17367
TD 60 A	6 Cyl.	5480cc	132kW (180PS)				Diesel Turbo		TD9095
TD 60 B	6 Cyl.	5480cc	128-132kW (174-180PS)				Diesel Turbo		TD9096
TD 60 C	6 Cyl.	5480cc	108-113kW (147-154PS)				Diesel Turbo		TD9147
TD 60 D	6 Cyl.	5480cc	108-113kW (147-154PS)				Diesel Turbo		TD23336
TD 60 DG	6 Cyl.	5480cc	108-113kW (147-154PS)				Diesel Turbo		TD23337
TD 61 F	6 Cyl.	5480cc	150-152kW (204-207PS)				Diesel Turbo Intercooler		TD9225
TD 61 FB	6 Cyl.	5480cc	153kW (206PS)				Diesel Turbo Intercooler		TD9211
TD 61 G	6 Cyl.	5480cc	108-152kW (147-207PS)				Diesel Turbo Intercooler		TD9221
TD 61 GA	6 Cyl.	5480cc	112kW (152PS)				Diesel Turbo		TD9222
TD 61 GB	6 Cyl.	5480cc	131-132kW (179-180PS)				Diesel Turbo		TD6249
TD 61 GC	6 Cyl.	5480cc	132kW (180PS)				Diesel Turbo		TD9226
TD 61 GE	6 Cyl.	5480cc	130kW (175PS)				Diesel Turbo		TD9210
TD 61 GS	6 Cyl.	5480cc	131-132kW (179-180PS)				Diesel Turbo		TD5902
TD 63 E	6 Cyl.	5480cc	132kW (180PS)				Diesel Turbo Intercooler		TD9223
TD 63 ES	6 Cyl.	5480cc	154kW (210PS)				Diesel Turbo Intercooler		TD9224

BE/PL	6	63,449/63,462	67,323/67,336	34,000	1,902	0,057/0,108	EC	71-3446	71-3446/6 STD 0.254
BE/PL	6	63,449/63,462	67,323/67,336	34,000	1,902	0,057/0,108	EC	71-3695	71-3695/6 STD 0.254

71-3446

71-3695

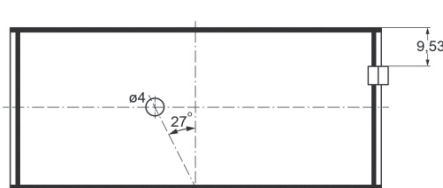
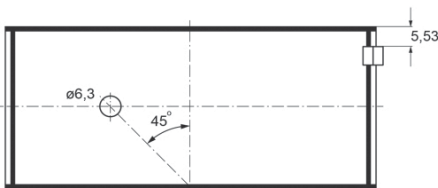

MB/HL 1-7	7	76,149/76,162	81,051/81,076	26,500	2,413	0,063/0,126	EC	72-3489	H969/7 STD 0.254
TW/A	4	85,090/85,340	104,390/104,690		3,123		EC	54-3511	A121/4 STD
SE/PB	1	40,000/40,012	43,043/43,068	31,950			BC	55-3524	55-3524 SEMI
SE/PB	1	40,000/40,004	43,043/43,068	31,700			BC	55-3663	55-3663 SEMI



55-3524

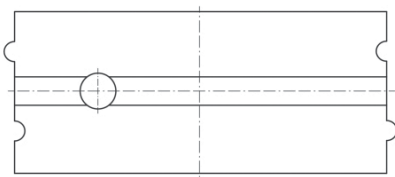

55-3663



53 98.43 x 127.00

D 39 B		4 Cyl.		3860cc	57-59kW (78-80PS)			Diesel		TD9201
BE/PL	1	63,475/63,487	67,208/67,221	31,880	1,841	0,038/0,089	AL-LF	3135RA	01-4115 STD 0.25 0.50 0.75 1.00	
MB/HL 1,2,4,5	4	76,162/76,175	80,416/80,441	31,880	2,090	0,061/0,124	AL-LF	3136RA	H1037/5 STD 0.25 0.50 0.75 1.00	
MB/HL 3	1	76,162/76,175	80,416/80,441	36,700	2,090	0,061/0,124	AL-LF	3137RA		
TW/A	4	86,870/87,120	103,850/104,100		2,310		AL-LF	3137BFA	A184/4 STD .0075	
Mot.4203049 →										
SE/PB	1	34,920/34,925	38,895/38,920	33,930			AL-LF	3139Y15	05-4521 STD	

54 104.78 x 130.00

D 70 A		6 Cyl.		6700cc	106kW (144PS)			Diesel		TD9128
D 70 B		6 Cyl.		6700cc	110kW (150PS)			Diesel		TD9129
TD 70 A		6 Cyl.		6700cc	136kW (185PS)			Diesel Turbo		TD9131
TD 70 C		6 Cyl.		6700cc	149-152kW (202-207PS)			Diesel Turbo		TD9208
TD 70 E		6 Cyl.		6700cc	154kW (210PS)			Diesel Turbo		TD9133
TD 70 ES		6 Cyl.		6700cc	155-166kW (211-226PS)			Diesel Turbo		TD9250
TD 70 FS		6 Cyl.		6700cc	157-180kW (214-245PS)			Diesel Turbo		TD9150
TD 70 G		6 Cyl.		6700cc	147-180kW (200-245PS)			Diesel Turbo		TD9151
TD 70 H		6 Cyl.		6700cc	157kW (213PS)			Diesel Turbo		TD9097
TD 70 HA		6 Cyl.		6700cc	143kW (194PS)			Diesel Turbo		TD9130
BE/PL	6	69,840/69,850	73,740/73,753	37,100	1,912	0,066/0,114	EC	71-3480	71-3480/6 STD 0.254 0.508	
MB/HL 1-7	7	82,535/82,550	88,483/88,508	30,600	2,935	0,063/0,128	EC	72-2953	H841/7 STD 0.254 0.508	
TW/A	4	90,150/90,390	112,570/112,820		2,362		EC	54-3544	A126/4 STD	
SE/PB	1	45,000/45,004	49,887/49,912	37,640			BC	55-3621	55-3621 SEMI	

01/83 →

CB/NWB 1	1		72,225/72,250	33,600			BB	68331DR	N157/7 STD SEMI
CB/NWB 2	1		69,850/69,875	25,650			BB	68332DR	
CB/NWB 3	1		67,426/67,487	25,650			BB	68333DR	
CB/NWB 4	1		66,675/66,700	25,650			BB	68334DR	
CB/NWB 5	1		64,287/64,313	25,650			BB	68336DR	
CB/NWB 6	1		63,500/63,525	25,650			BB	68337DR	
CB/NWB 7	1		59,525/59,550	25,650			BB	68338DR	
BU	1		28,175/28,196	22,500			BC	56-3611	56-3611 SEMI



55 104.78 x 130.00

D7A230	6 Cyl.	6700cc	169kW (230PS)	Diesel Turbo Intercooler	TD29201
D7A260	6 Cyl.	6700cc	191kW (260PS)	Diesel Turbo Intercooler	TD29199
D7A285	6 Cyl.	6700cc	210kW (286PS)	Diesel Turbo Intercooler	TD9229
D7B230	6 Cyl.	6700cc	169kW (230PS)	Diesel Turbo Intercooler	TD9242
D7B260	6 Cyl.	6700cc	191kW (260PS)	Diesel Turbo Intercooler	TD9243

BE/PL	6	69,837/69,850	73,740/73,753	37,100	1,912	0,066/0,117	EC	71-3623	71-3623/6 STD 0.254
-------	---	---------------	---------------	--------	-------	-------------	----	---------	-------------------------------

Mot.→97292

BE/PL	6	73,831/73,850	77,740/77,753	37,100	1,922	0,050/0,100	EC	71-3964	71-3964/6 STD
MB/HL	7	90,528/90,550	96,483/96,508	30,400	2,943	0,047/0,142	EC	72-4835	H1303/7 STD 0.25 0.50
MB/HL 1-7	7	82,535/82,550	88,483/88,508	30,600	2,935	0,063/0,128	EC	72-2953	H841/7 STD 0.254 0.508

Mot.→97292

SE/PB	1	47,000/47,004	52,000/52,046	36,600			BC	55-3965	55-3965 SEMI
-------	---	---------------	---------------	--------	--	--	----	---------	------------------------

8

56 104.78 x 130.00

TD 70 B	6 Cyl.	6700cc	152kW (207PS)	Diesel Turbo	TD9132
----------------	--------	---------------	----------------------	---------------------	---------------

BE/PL	6	69,840/69,850	73,740/73,753	37,100	1,912	0,066/0,114	EC	71-3480	71-3480/6 STD 0.254 0.508
MB/HL 1-7	7	82,535/82,550	88,483/88,508	30,600	2,935	0,063/0,128	EC	72-2953	H841/7 STD 0.254 0.508
TW/A	4	90,150/90,390	112,570/112,820		2,362		EC	54-3544	A126/4 STD
CB/NWB 1	1		72,225/72,250	33,600			BB	68331DR	N157/7 STD SEMI
CB/NWB 2	1		69,850/69,875	25,650			BB	68332DR	
CB/NWB 3	1		67,426/67,487	25,650			BB	68333DR	
CB/NWB 4	1		66,675/66,700	25,650			BB	68334DR	
CB/NWB 5	1		64,287/64,313	25,650			BB	68336DR	
CB/NWB 6	1		63,500/63,525	25,650			BB	68337DR	
CB/NWB 7	1		59,525/59,550	25,650			BB	68338DR	
BU	1		28,175/28,196	22,500			BC	56-3611	56-3611 SEMI

57 104.78 x 130.00

TD 70 F	6 Cyl.	6700cc	157-180kW (214-245PS)	Diesel Turbo	TD9148
TD 71 A	6 Cyl.	6700cc	169kW (220PS)	Diesel Turbo Intercooler	TD23335
TD 71 ACE	6 Cyl.	6700cc	169kW (220PS)	Diesel Turbo Intercooler	TD23334
TD 71 AG	6 Cyl.	6700cc	169kW (220PS)	Diesel Turbo Intercooler	TD23333
TD 71 AGP	6 Cyl.	6700cc	169kW (220PS)	Diesel Turbo Intercooler	TD23332
TD 71 AP	6 Cyl.	6700cc	169kW (220PS)	Diesel Turbo Intercooler	TD23331
TD 71 APB	6 Cyl.	6700cc	169kW (220PS)	Diesel Turbo Intercooler	TD23330
TD 71 AW	6 Cyl.	6700cc	169kW (220PS)	Diesel Turbo Intercooler	TD23329
TD 71 FC	6 Cyl.	6700cc	173kW (236PS)	Diesel Turbo	TD9213
TD 71 FD	6 Cyl.	6700cc	180kW (245PS)	Diesel Turbo Intercooler	TD9232
TD 71 FS	6 Cyl.	6700cc	178-184kW (242-250PS)	Diesel Turbo Intercooler	TD5904
TD 71 FSQ	6 Cyl.	6700cc	169-184kW (230-250PS)	Diesel Turbo Intercooler	TD6251



TD 71 G			6 Cyl.	6700cc	178-184kW (242-250PS)	Diesel Turbo Intercooler	TD26265		
TD 73 E			6 Cyl.	6700cc	169kW (230PS)	Diesel Turbo Intercooler	TD9233		
TD 73 ES			6 Cyl.	6700cc	191kW (260PS)	Diesel Turbo Intercooler	TD9236		
BE/PL	6	69,837/69,850	73,740/73,753	37,100	1,912	0,066/0,117	EC	71-3623	71-3623/6 STD 0.254
MB/HL 1-7	7	82,535/82,550	88,483/88,508	30,600	2,935	0,063/0,128	EC	72-2953	H841/7 STD 0.254 0.508
TW/A	4	90,150/90,390	112,570/112,820		2,362		EC	54-3544	A126/4 STD
SE/PB	1	45,000/45,004	49,887/49,912	37,640			BC	55-3621	55-3621 SEMI

01/83→

CB/NWB 1	1		72,225/72,250	33,600			BB	68331DR	N157/7 STD SEMI
CB/NWB 2	1		69,850/69,875	25,650			BB	68332DR	
CB/NWB 3	1		67,426/67,487	25,650			BB	68333DR	
CB/NWB 4	1		66,675/66,700	25,650			BB	68334DR	
CB/NWB 5	1		64,287/64,313	25,650			BB	68336DR	
CB/NWB 6	1		63,500/63,525	25,650			BB	68337DR	
CB/NWB 7	1		59,525/59,550	25,650			BB	68338DR	
BU	1		28,175/28,196	22,500			BC	56-3611	56-3611 SEMI

58

104.78 x 130.00

TD 71 F			6 Cyl.	6700cc	169-180kW (220-245PS)	Diesel Turbo	TD5903		
TD 71 FA			6 Cyl.	6700cc	173kW (236PS)	Diesel Turbo	TD9212		
TD 71 FQ			6 Cyl.	6700cc	169-173kW (220-235PS)	Diesel Turbo Intercooler	TD6250		
BE/PL	6	69,837/69,850	73,740/73,753	37,100	1,912	0,066/0,117	EC	71-3623	71-3623/6 STD 0.254
MB/HL 1-7	7	82,535/82,550	88,483/88,508	30,600	2,935	0,063/0,128	EC	72-2953	H841/7 STD 0.254 0.508
TW/A	4	90,150/90,390	112,570/112,820		2,362		EC	54-3544	A126/4 STD
SE/PB	1	45,000/45,004	49,887/49,912	37,640			BC	55-3621	55-3621 SEMI
CB/NWB 1	1		72,225/72,250	33,600			BB	68331DR	N157/7 STD SEMI
CB/NWB 2	1		69,850/69,875	25,650			BB	68332DR	
CB/NWB 3	1		67,426/67,487	25,650			BB	68333DR	
CB/NWB 4	1		66,675/66,700	25,650			BB	68334DR	
CB/NWB 5	1		64,287/64,313	25,650			BB	68336DR	
CB/NWB 6	1		63,500/63,525	25,650			BB	68337DR	
CB/NWB 7	1		59,525/59,550	25,650			BB	68338DR	
BU	1		28,175/28,196	22,500			BC	56-3611	56-3611 SEMI



59 104.78 x 130.00

TD 73 EA		6 Cyl.	6700cc	160kW (215PS)	Diesel Turbo Intercooler				TD9234
TD 73 KFE		6 Cyl.	6700cc	170kW (231PS)	Diesel Turbo Intercooler				TD26595
BE/PL	6	69,840/69,850	73,740/73,753	37,100	1,912	0,066/0,114	EC	71-3480	71-3480/6 STD 0.254 0.508
MB/HL 1-7	7	82,535/82,550	88,483/88,508	30,600	2,935	0,063/0,128	EC	72-2953	H841/7 STD 0.254 0.508
TW/A	4	90,150/90,390	112,570/112,820		2,362		EC	54-3544	A126/4 STD
SE/PB	1	45,000/45,004	49,887/49,912	37,640			BC	55-3621	55-3621 SEMI 8
CB/NWB 1	1		72,225/72,250	33,600			BB	68331DR	N157/7 STD SEMI
CB/NWB 2	1		69,850/69,875	25,650			BB	68332DR	
CB/NWB 3	1		67,426/67,487	25,650			BB	68333DR	
CB/NWB 4	1		66,675/66,700	25,650			BB	68334DR	
CB/NWB 5	1		64,287/64,313	25,650			BB	68336DR	
CB/NWB 6	1		63,500/63,525	25,650			BB	68337DR	
CB/NWB 7	1		59,525/59,550	25,650			BB	68338DR	
BU	1		28,175/28,196	22,500			BC	56-3611	56-3611 SEMI

60 107.00 x 135.00

D7C215 Euro 2		6 Cyl.	7300cc	158kW (215PS)	Diesel Turbo Intercooler				TD18725
D7C250 Euro 2		6 Cyl.	7300cc	184kW (250PS)	Diesel Turbo Intercooler				TD11770
D7C275 Euro 2		6 Cyl.	7300cc	202kW (275PS)	Diesel Turbo Intercooler				TD29197
D7C290		6 Cyl.	7300cc	213kW (290PS)	Diesel Turbo Intercooler				TD11771
D7C310 Euro 2		6 Cyl.	7300cc	228kW (310PS)	Diesel Turbo Intercooler				TD16726
BE/PL	6	69,837/69,850	73,740/73,753	37,100	1,912	0,066/0,117	EC	71-3623	71-3623/6 STD 0.254
Mot. → 97292									
BE/PL	6	73,831/73,850	77,740/77,753	37,100	1,922	0,050/0,100	EC	71-3964	71-3964/6 STD
MB/HL	7	90,528/90,550	96,483/96,508	30,400	2,943	0,047/0,142	EC	72-4835	H1303/7 STD 0.25 0.50
MB/HL 1-7	7	82,535/82,550	88,483/88,508	30,600	2,935	0,063/0,128	EC	72-2953	H841/7 STD 0.254 0.508
Mot. → 97292									
SE/PB	1	47,000/47,004	52,000/52,046	36,600			BC	55-3965	55-3965 SEMI 8

61 108.00 x 130.00

D7E240 Euro 4		6 Cyl.	7146cc	177kW (240PS)	Diesel Turbo Intercooler				TD18965
D7E280 Euro 4/5		6 Cyl.	7146cc	206kW (280PS)	Diesel Turbo Intercooler				TD18964
D7E290		6 Cyl.	7146cc	213kW (290PS)	Diesel Turbo Intercooler				TD20460
D7E320 Euro 4/5		6 Cyl.	7146cc	235kW (320PS)	Diesel Turbo Intercooler				TD18963
D7F240 Euro 5		6 Cyl.	7146cc	177kW (241PS)	Diesel Turbo Intercooler				TD21581
D7F260 Euro 5		6 Cyl.	7146cc	191kW (260PS)	Diesel Turbo Intercooler				TD21621
D7F290 Euro 5		6 Cyl.	7146cc	213kW (290PS)	Diesel Turbo Intercooler				TD21623
D7F300 Euro 5		6 Cyl.	7146cc	221kW (301PS)	Diesel Turbo Intercooler				TD21624
D7F340 Euro 5		6 Cyl.	7146cc	250kW (340PS)	Diesel Turbo Intercooler				TD21626

BE/PL	1	74,980/75,000	80,000/80,020	29,200	2,482	0,036/0,100	SP	71-4716	71-4716 STD	1
MB/HL	1	84,980/85,000	90,500/90,520	26,500	2,735	0,030/0,094	EC	72-4717	72-4717 STD	4
TW/A	2	91,400	114,000		2,950		AL-LF	04-4718	A285/4 STD	
TW/A	2	91,400	114,000		2,950		AL-LF	04-4719		
SE/PB	1	44,994/45,000	48,000/48,020	36,700			BC-LF	55-4720	55-4720 SEMI	6
CB/NWB 1	1	72,930/72,950	77,000/77,019	27,000			BC	53-4721	N192/7 STD	
CB/NWB 2-7	6	72,930/72,950	77,000/77,019	22,000			BC	53-4722		

62 120.00 x 138.00

D9A260 Euro 3			6 Cyl.	9364cc	191kW (260PS)		Diesel Turbo Intercooler		TD16780	
D9A300 Euro 3			6 Cyl.	9364cc	221-224kW (300-305PS)		Diesel Turbo Intercooler		TD16781	
D9A340 Euro 3			6 Cyl.	9364cc	250-251kW (340-341PS)		Diesel Turbo Intercooler		TD16782	
D9A380 Euro 3			6 Cyl.	9364cc	279kW (380PS)		Diesel Turbo Intercooler		TD16783	
D9B260			6 Cyl.	9364cc	191kW (260PS)		Diesel Turbo Intercooler		TD21048	
D9B300 Euro 4			6 Cyl.	9364cc	221kW (300PS)		Diesel Turbo Intercooler		TD18978	
D9B310			6 Cyl.	9364cc	228kW (310PS)		Diesel Turbo Intercooler		TD21049	
D9B340 Euro 4			6 Cyl.	9364cc	250kW (340PS)		Diesel Turbo Intercooler		TD18979	
D9B360 Euro 4/5			6 Cyl.	9364cc	265kW (360PS)		Diesel Turbo Intercooler		TD21050	
D9B380 Euro 4			6 Cyl.	9364cc	280kW (380PS)		Diesel Turbo Intercooler		TD18980	
BE/PL	6	87,987/88,000	92,835/92,850	45,100	2,395	0,045/0,102	EC	71-4023	71-4023/6 STD	
MB/HL 1-7	7	107,978/108,000	113,040/113,065	32,200	2,497	0,046/0,113	EC	72-4024	H1008/7 STD	
SE/PB	1	53,992/54,000	59,100/59,146	40,250			BC-LF	55-4025	55-4025 SEMI	6 8

63 120.65 x 140.00

D 100 A			6 Cyl.	9600cc	122-147kW (166-200PS)		Diesel		TD9204
D 100 B			6 Cyl.	9600cc	147kW (200PS)		Diesel		TD9205
HD 100 A			6 Cyl.	9600cc	129kW (175PS)		Diesel		TD9134
HD 100 D			6 Cyl.	9600cc	125-132kW (170-180PS)		Diesel		TD9135
TD 100 B			6 Cyl.	9600cc	206-220kW (280-299PS)		Diesel Turbo		TD9153
TD 100 BG			6 Cyl.	9600cc	207kW (282PS)		Diesel Turbo		TD21337
TD 100 C			6 Cyl.	9600cc	189kW (257PS)		Diesel Turbo		TD9251
TD 100 CHC			6 Cyl.	9600cc	200kW (272PS)		Diesel Turbo		TD21338
TD 100 F			6 Cyl.	9600cc	200kW (272PS)		Diesel Turbo		TD21339
TD 100 G			6 Cyl.	9600cc	192-202kW (261-275PS)		Diesel Turbo		TD9154
TD 100 GA			6 Cyl.	9600cc	200kW (272PS)		Diesel Turbo		TD9155
TD 101 F			6 Cyl.	9600cc	215-220kW (292-299PS)		Diesel Turbo Intercooler		TD9156
TD 101 FC			6 Cyl.	9600cc	221kW (301PS)		Diesel Turbo Intercooler		TD9237
TD 101 FD			6 Cyl.	9600cc	220-222kW (299-302PS)		Diesel Turbo Intercooler		TD9238
TD 101 G			6 Cyl.	9600cc	192-202kW (261-275PS)		Diesel Turbo		TD9158
TD 101 GA			6 Cyl.	9600cc	200kW (272PS)		Diesel Turbo Intercooler		TD9159
TD 101 GB			6 Cyl.	9600cc	185-200kW (252-272PS)		Diesel Turbo Intercooler		TD9252
TD 101 GE			6 Cyl.	9600cc	200kW (272PS)		Diesel Turbo Intercooler		TD21340
TD 102 FAQ			6 Cyl.	9600cc	221kW (301PS)		Diesel Turbo Intercooler		TD9161
TD 102 FCQ			6 Cyl.	9600cc	220kW (299PS)		Diesel Turbo Intercooler		TD9163
TD 102 FD Euro 1			6 Cyl.	9600cc	234kW (318PS)		Diesel Turbo Intercooler		TD21341
TD 102 FEQ			6 Cyl.	9600cc	191kW (260PS)		Diesel Turbo Intercooler		TD9165

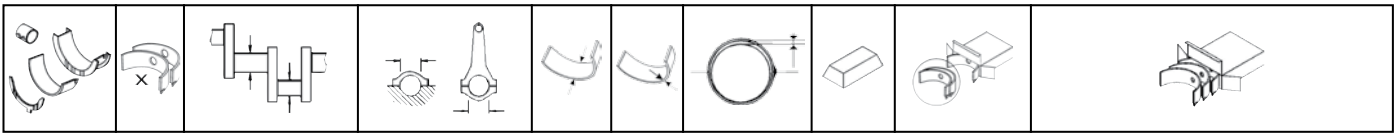

TD 102 FGQ	6 Cyl.	9600cc	205kW (279PS)	Diesel Turbo Intercooler	TD9167
TD 102 FH	6 Cyl.	9600cc	210-234kW (286-318PS)	Diesel Turbo Intercooler	TD9168
TD 102 FQ	6 Cyl.	9600cc	234kW (318PS)	Diesel Turbo Intercooler	TD26264
TD 102 FS	6 Cyl.	9600cc	250kW (340PS)	Diesel Turbo Intercooler	TD9264
TD 102 FT	6 Cyl.	9600cc	228kW (310PS)	Diesel Turbo Intercooler	TD9262
TD 103 EA Euro 1	6 Cyl.	9600cc	235kW (320PS)	Diesel Turbo	TD21342
TD 103 KB Euro 1	6 Cyl.	9600cc	210-235kW (286-320PS)	Diesel Turbo Intercooler	TD19062
TD 103 KF Euro 1	6 Cyl.	9600cc	210-235kW (286-320PS)	Diesel Turbo Intercooler	TD19063
THD 100 A	6 Cyl.	9600cc	139-191kW (200-260PS)	Diesel Turbo	TD9136
THD 100 D	6 Cyl.	9600cc	155-177kW (211-241PS)	Diesel Turbo	TD9119
THD 100 DA	6 Cyl.	9600cc	133kW (181PS)	Diesel Turbo Intercooler	TD9103
THD 100 DB	6 Cyl.	9600cc	160-203kW (218-276PS)	Diesel Turbo Intercooler	TD9120
THD 100 DD	6 Cyl.	9600cc	203kW (276PS)	Diesel Turbo	TD9105
THD 100 E	6 Cyl.	9600cc	160-203kW (218-276PS)	Diesel Turbo Intercooler	TD9137
THD 100 EA	6 Cyl.	9600cc	133-180kW (180-245PS)	Diesel Turbo	TD9106
THD 100 EB	6 Cyl.	9600cc	160-203kW (218-276PS)	Diesel Turbo	TD9107
THD 100 EC	6 Cyl.	9600cc	160-203kW (218-276PS)	Diesel Turbo	TD9108
THD 100 ED	6 Cyl.	9600cc	160-203kW (218-276PS)	Diesel Turbo Intercooler	TD9109
THD 100 EE	6 Cyl.	9600cc	212kW (288PS)	Diesel Turbo	TD9110
THD 100 EK	6 Cyl.	9600cc	179kW (243PS)	Diesel Turbo	TD9111
THD 101 B	6 Cyl.	9600cc	169-191kW (230-260PS)	Diesel Turbo	TD23324
THD 101 GB	6 Cyl.	9600cc	160kW (218PS)	Diesel Turbo	TD9112
THD 101 GC	6 Cyl.	9600cc	180kW (245PS)	Diesel Turbo	TD9113
THD 101 GD	6 Cyl.	9600cc	160-203kW (218-276PS)	Diesel Turbo	TD9114
THD 101 KB	6 Cyl.	9600cc	210kW (286PS)	Diesel Turbo Intercooler	TD9115
THD 101 KC	6 Cyl.	9600cc	228kW (310PS)	Diesel Turbo Intercooler	TD9116
THD 101 KE	6 Cyl.	9600cc	235kW (320PS)	Diesel Bi-Turbo Intercooler	TD9117
THD 102 KA	6 Cyl.	9600cc	210kW (286PS)	Diesel Turbo Intercooler	TD23325
THD 102 KB Euro 1	6 Cyl.	9600cc	210kW (286PS)	Diesel Turbo Intercooler	TD23326
THD 102 KD	6 Cyl.	9600cc	252kW (343PS)	Diesel Turbo Intercooler	TD9118
THD 102 KF	6 Cyl.	9600cc	180-210kW (245-286PS)	Diesel Turbo Intercooler	TD9121
THD 103 E Euro 2	6 Cyl.	9600cc	235kW (320PS)	Diesel Turbo Intercooler	TD23327
THD 103 ES Euro 2	6 Cyl.	9600cc	235kW (320PS)	Diesel Turbo Intercooler	TD23328
THD 103 KB	6 Cyl.	9600cc	210kW (286PS)	Diesel Turbo	TD9098
THD 103 KD	6 Cyl.	9600cc	250kW (340PS)	Diesel Turbo	TD9099
THD 103 KF	6 Cyl.	9600cc	180kW (245PS)	Diesel Turbo	TD9100

BE/PL	6	86,003/86,018	90,925/90,940	45,700	2,418	0,071/0,126	EC	71-1227	71-1227/6 STD 0.254 0.508 0.762
-------	---	---------------	---------------	--------	-------	-------------	----	---------	------------------------------------

→12/82

BE/PL	6	86,003/86,018	90,925/90,940	45,700	2,418	0,071/0,126	EC	71-3601	71-3601/6 STD 0.254 0.508
-------	---	---------------	---------------	--------	-------	-------------	----	---------	------------------------------

01/83→

71-1227

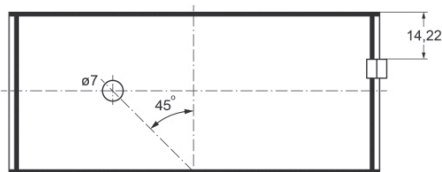

71-3601

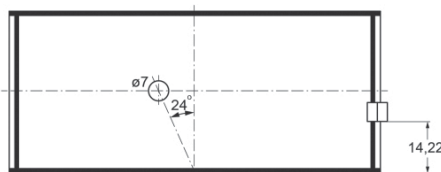

MB/HL 1-7	7	99,978/100,000	104,978/105,003	37,300	2,452	0,074/0,146	EC	72-2962	H842/7 STD 0.254 0.508 0.762
TW/A	4	108,450/108,710	131,920/131,670		2,362		EC	54-3521	A122/4 STD



SE/PB	1	52,000/52,004	57,300/57,346	45,900			BC	55-3509	55-3509 SEMI
-------	---	---------------	---------------	--------	--	--	----	---------	------------------------

→12/82

SE/PB	1	52,000/52,004	57,300/57,346	45,600			BC	55-3610	55-3610 SEMI
-------	---	---------------	---------------	--------	--	--	----	---------	------------------------

01/83→

55-3509

55-3610

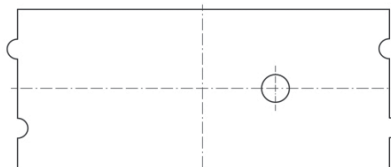
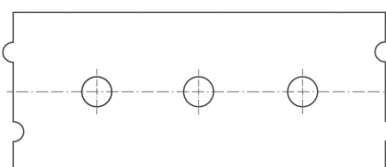

CB/NWB 1	1		72,225/72,250	33,600			BB	68331DR	N157/7 STD SEMI
CB/NWB 2	1		69,850/69,875	25,650			BB	68332DR	
CB/NWB 3	1		67,426/67,487	25,650			BB	68333DR	
CB/NWB 4	1		66,675/66,700	25,650			BB	68334DR	
CB/NWB 5	1		64,287/64,313	25,650			BB	68336DR	
CB/NWB 6	1		63,500/63,525	25,650			BB	68337DR	
CB/NWB 7	1		59,525/59,550	25,650			BB	68338DR	
BU	1		28,175/28,196	22,500			BC	56-3611	56-3611 SEMI

64 120.65 x 140.00

D10A320	6 Cyl.	9600cc	235kW (320PS)	Diesel	TD9263
D10A360	6 Cyl.	9600cc	265kW (360PS)	Diesel	TD12047
D10B320 Euro 2	6 Cyl.	9600cc	235kW (320PS)	Diesel Turbo Intercooler	TD16235
D10B360 Euro 2	6 Cyl.	9600cc	265kW (360PS)	Diesel Turbo Intercooler	TD16236
TD 101 FA	6 Cyl.	9600cc	220kW (299PS)	Diesel Turbo Intercooler	TD9157
TD 102 F	6 Cyl.	9600cc	230-234kW (313-318PS)	Diesel Turbo Intercooler	TD9160
TD 102 FBQ	6 Cyl.	9600cc	228kW (310PS)	Diesel Turbo Intercooler	TD9162
TD 102 FDQ	6 Cyl.	9600cc	232-234kW (316-318PS)	Diesel Turbo Intercooler	TD9164
TD 102 FF	6 Cyl.	9600cc	230-234kW (313-318PS)	Diesel Turbo Intercooler	TD9166
TD 102 FL Euro 1	6 Cyl.	9600cc	234kW (318PS)	Diesel Turbo	TD9169
TD 102 FM	6 Cyl.	9600cc	230-252kW (313-343PS)	Diesel Turbo Intercooler	TD9170
TD 103 E Euro 1	6 Cyl.	9600cc	210-235kW (286-320PS)	Diesel Turbo Intercooler	TD5900
TD 103 ES Euro 1	6 Cyl.	9600cc	210-235kW (286-320PS)	Diesel Turbo	TD6247
THD 100 DC	6 Cyl.	9600cc	160-203kW (218-276PS)	Diesel Turbo Intercooler	TD9104

BE/PL	6	86,003/86,018	90,925/90,940	45,700	2,418	0,071/0,126	EC	71-3601	71-3601/6 STD 0.254 0.508
MB/HL 1-7	7	99,978/100,000	104,978/105,003	37,300	2,452	0,074/0,146	EC	72-2962	H842/7 STD 0.254 0.508 0.762
TW/A	4	108,450/108,710	131,920/131,670		2,362		EC	54-3521	A122/4 STD
SE/PB	1	52,000/52,004	57,300/57,346	45,600			BC	55-3610	55-3610 SEMI

CB/NWB 1	1		72,225/72,250	33,600			BB	68331DR	N157/7 STD SEMI
CB/NWB 2	1		69,850/69,875	25,650			BB	68332DR	
CB/NWB 3	1		67,426/67,487	25,650			BB	68333DR	
CB/NWB 4	1		66,675/66,700	25,650			BB	68334DR	
CB/NWB 5	1		64,287/64,313	25,650			BB	68336DR	
CB/NWB 6	1		63,500/63,525	25,650			BB	68337DR	
CB/NWB 7	1		59,525/59,550	25,650			BB	68338DR	
BU	1		28,175/28,196	22,500			BC	56-3611	56-3611 SEMI

65

120.65 x 140.00

TD 100 A	6 Cyl.	9600cc	176-190kW (239-258PS)	Diesel Turbo	TD9152				
BE/PL	6	86,003/86,018	90,925/90,940	45,700	2,418	0,071/0,126	EC	71-1227	71-1227/6 STD 0.254 0.508 0.762
MB/HL 1-7	7	99,978/100,000	104,978/105,003	37,300	2,452	0,074/0,146	EC	72-2962	H842/7 STD 0.254 0.508 0.762
TW/A	4	108,450/108,710	131,920/131,670		2,362		EC	54-3521	A122/4 STD
SE/PB	1	52,000/52,004	57,300/57,346	45,900			BC	55-3509	55-3509 SEMI
CB/NWB 1	1		72,225/72,250	33,600			BB	68331DR	N157/7 STD SEMI
CB/NWB 2	1		69,850/69,875	25,650			BB	68332DR	
CB/NWB 3	1		67,426/67,487	25,650			BB	68333DR	
CB/NWB 4	1		66,675/66,700	25,650			BB	68334DR	
CB/NWB 5	1		64,287/64,313	25,650			BB	68336DR	
CB/NWB 6	1		63,500/63,525	25,650			BB	68337DR	
CB/NWB 7	1		59,525/59,550	25,650			BB	68338DR	
BU	1		28,175/28,196	22,500			BC	56-3611	56-3611 SEMI

66

123.00 x 152.00

D11-325	6 Cyl.	10800cc	239kW (325PS)	Diesel Turbo Intercooler	TD22576
D11-355	6 Cyl.	10800cc	261kW (355PS)	Diesel Turbo Intercooler	TD22578
D11-365	6 Cyl.	10800cc	268kW (365PS)	Diesel Turbo Intercooler	TD22579
D11-385	6 Cyl.	10800cc	283kW (385PS)	Diesel Turbo Intercooler	TD22580
D11-405	6 Cyl.	10800cc	298kW (405PS)	Diesel Turbo Intercooler	TD22581
D11A430 Euro 3	6 Cyl.	10840cc	316kW (430PS)	Diesel Turbo Intercooler	TD28572
D11B390 Euro 4/5	6 Cyl.	10800cc	287kW (390PS)	Diesel Turbo Intercooler	TD23374
D11B430 Euro 4/5	6 Cyl.	10800cc	316kW (430PS)	Diesel Turbo Intercooler	TD23373
D11C330 Euro 5	6 Cyl.	10800cc	243kW (330PS)	Diesel Turbo Intercooler	TD22373
D11C370 Euro 5	6 Cyl.	10840cc	272kW (370PS)	Diesel Turbo Intercooler	TD22374
D11C410 Euro 5	6 Cyl.	10800cc	302kW (410PS)	Diesel Turbo Intercooler	TD22376
D11C450 Euro 5	6 Cyl.	10800cc	332kW (450PS)	Diesel Turbo Intercooler	TD22377
D11K330 Euro 6	6 Cyl.	10840cc	243kW (330PS)	Diesel Turbo Intercooler	TD28562
D11K370 Euro 6	6 Cyl.	10840cc	272kW (370PS)	Diesel Turbo Intercooler	TD28563



D11K410 Euro 6		6 Cyl.		10840cc	302kW (410PS)	Diesel Turbo Intercooler			TD28564	
D11K450 Euro 6		6 Cyl.		10840cc	332kW (450PS)	Diesel Turbo Intercooler			TD28565	
BE/PL	6	85,978/86,000	90,830/90,845	45,100	2,390	0,046/0,096	EC	71-4060	71-4060/6 STD 0.25	4
MB/HL 1-7	7	107,978/108,000	113,040/113,065	32,200	2,497	0,046/0,113	EC	72-4024	H1008/7 STD	
SE/PB	1	53,992/54,000	59,100/59,146	40,250			BS-LF	55-4059	55-4059 SEMI	

67 130.18 x 150.00

TD 120 A	6 Cyl.		12000cc	243kW (330PS)	Diesel Turbo			TD9206
TD 120 C	6 Cyl.		12000cc	260kW (354PS)	Diesel Turbo			TD9171
TD 120 D	6 Cyl.		11980cc	273kW (371PS)	Diesel Turbo			TD9172
TD 120 E	6 Cyl.		11980cc	225-273kW (306-371PS)	Diesel Turbo			TD9173
TD 120 F	6 Cyl.		11980cc	265kW (360PS)	Diesel Turbo Intercooler			TD9174
TD 120 FA	6 Cyl.		11980cc	213kW (290PS)	Diesel Turbo Intercooler			TD9254
TD 120 FB	6 Cyl.		11980cc	226-265kW (307-360PS)	Diesel Turbo Intercooler			TD9255
TD 120 FC	6 Cyl.		11980cc	265kW (360PS)	Diesel Turbo Intercooler			TD9175
TD 120 FTQ	6 Cyl.		11980cc	220kW (299PS)	Diesel Turbo Intercooler			TD9176
TD 120 G	6 Cyl.		11980cc	226-243kW (307-330PS)	Diesel Turbo			TD9177
TD 120 GA	6 Cyl.		11980cc	227kW (308PS)	Diesel Turbo			TD9178

BE/PL	6	92,028/92,043	96,835/96,850	46,250	2,362	0,068/0,123	BS	1275CP	71-3613/6 STD 0.25 0.50
-------	---	---------------	---------------	--------	-------	-------------	----	--------	-----------------------------------

Mot.80371→

BE/PL	6	92,028/92,043	96,835/96,850	46,250	2,362	0,068/0,123	BS	66615CP	71-4236/6 STD 0.25 0.50
-------	---	---------------	---------------	--------	-------	-------------	----	---------	-----------------------------------

Mot.→80370

1275CP

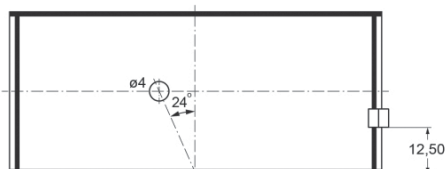

66615CP

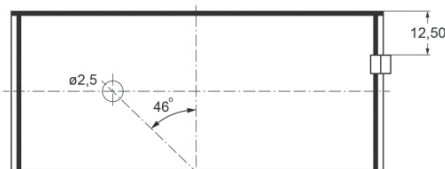

MB/HL 1-7	7	107,915/107,937	113,040/113,065	37,100	2,515	0,073/0,145	BS	66616CP	H1053/7 STD 0.25 0.50 0.75
TW/A	4	116,660/117,094	139,929/139,680		3,213		EC	54-3622	A131/4 STD
SE/PB	1	55,021/55,026	60,300/60,345	48,150			BS	AE6686	55-4509 STD
SE/PB	1	55,000/55,004	60,300/60,346	48,150			BS	66619Y	55-4594 SEMI

AE6686

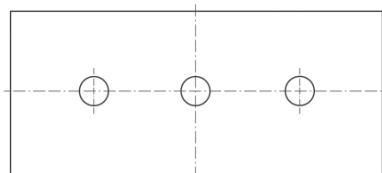

66619Y

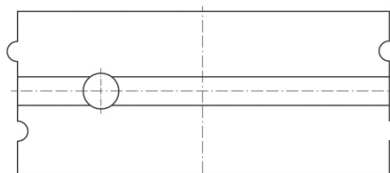

CB/NWB 1	1		72,225/72,250	33,600			BB	68331DR	N1577 STD SEMI
CB/NWB 2	1		69,850/69,875	25,650			BB	68332DR	
CB/NWB 3	1		67,426/67,487	25,650			BB	68333DR	
CB/NWB 4	1		66,675/66,700	25,650			BB	68334DR	
CB/NWB 5	1		64,287/64,313	25,650			BB	68336DR	
CB/NWB 6	1		63,500/63,525	25,650			BB	68337DR	
CB/NWB 7	1		59,525/59,550	25,650			BB	68338DR	
BU	1		28,175/28,196	22,500			BC	56-3611	56-3611 SEMI

68

130.18 x 150.00

TD 121 F	6 Cyl.	11980cc	272-283kW (370-385PS)	Diesel Turbo Intercooler	TD9179				
TD 121 FA	6 Cyl.	11980cc	206kW (280PS)	Diesel Turbo Intercooler	TD9256				
TD 121 FB	6 Cyl.	11980cc	210kW (285PS)	Diesel Turbo Intercooler	TD9257				
TD 121 FC	6 Cyl.	11980cc	232kW (315PS)	Diesel Turbo Intercooler	TD9258				
TD 121 FD	6 Cyl.	11980cc	283kW (385PS)	Diesel Turbo Intercooler	TD9180				
TD 121 FE	6 Cyl.	11980cc	257kW (350PS)	Diesel Turbo Intercooler	TD9259				
TD 121 FF	6 Cyl.	11980cc	272kW (370PS)	Diesel Turbo Intercooler	TD9260				
TD 121 FG	6 Cyl.	11980cc	280kW (380PS)	Diesel Turbo Intercooler	TD9261				
TD 121 FH	6 Cyl.	11980cc	232kW (315PS)	Diesel Turbo Intercooler	TD9181				
TD 121 FK	6 Cyl.	11980cc	280kW (381PS)	Diesel Turbo Intercooler	TD9182				
TD 121 G	6 Cyl.	11980cc	235-243kW (320-330PS)	Diesel Turbo	TD9183				
TD 121 GD	6 Cyl.	11980cc	243kW (330PS)	Diesel Turbo	TD9143				
TD 122	6 Cyl.	11980cc	309kW (420PS)	Diesel Turbo Intercooler	TD9184				
TD 122 ED	6 Cyl.	11980cc	300-310kW (408-422PS)	Diesel Turbo Intercooler	TD9185				
TD 122 F	6 Cyl.	11980cc	257-262kW (350-356PS)	Diesel Turbo	TD9186				
TD 122 FA	6 Cyl.	11980cc	272kW (370PS)	Diesel Turbo	TD9187				
TD 122 FAQ	6 Cyl.	11980cc	287kW (390PS)	Diesel Turbo Intercooler	TD9188				
TD 122 FBQ	6 Cyl.	11980cc	287kW (390PS)	Diesel Turbo Intercooler	TD9189				
TD 122 FCQ	6 Cyl.	11980cc	287kW (390PS)	Diesel Turbo Intercooler	TD9190				
TD 122 FH Euro 1	6 Cyl.	11980cc	262kW (356PS)	Diesel Turbo Intercooler	TD9122				
TD 122 FK	6 Cyl.	11980cc	287-291kW (390-396PS)	Diesel Turbo Intercooler	TD9191				
TD 122 FKQ	6 Cyl.	11980cc	254kW (345PS)	Diesel Turbo Intercooler	TD9192				
TD 122 FL	6 Cyl.	11980cc	291kW (396PS)	Diesel Turbo Intercooler	TD9123				
TD 122 FR	6 Cyl.	11980cc	262-291kW (356-396PS)	Diesel Turbo Intercooler	TD9193				
TD 122 FS	6 Cyl.	11980cc	287-291kW (395-396PS)	Diesel Turbo Intercooler	TD9194				
TD 122 FTO	6 Cyl.	11980cc	221kW (300PS)	Diesel Turbo	TD9195				
TD 122 KBE	6 Cyl.	11980cc	226-265kW (307-360PS)	Diesel Turbo Intercooler	TD23340				
TD 122 KE	6 Cyl.	11980cc	290kW (394PS)	Diesel Turbo Intercooler	TD23339				
TD 122 KHD	6 Cyl.	11980cc	272kW (370PS)	Diesel Turbo Intercooler	TD23338				
TD 123 E Euro 1	6 Cyl.	11980cc	262-265kW (356-360PS)	Diesel Turbo	TD9124				
TD 123 EA	6 Cyl.	11980cc	224kW (305PS)	Diesel Turbo	TD9196				
TD 123 EB	6 Cyl.	11980cc	246kW (335PS)	Diesel Turbo	TD9197				
TD 123 EC	6 Cyl.	11980cc	270kW (367PS)	Diesel Turbo Intercooler	TD9198				
TD 123 ED	6 Cyl.	11980cc	301kW (410PS)	Diesel Turbo Intercooler	TD9199				
TD 123 ES Euro 1	6 Cyl.	11980cc	298kW (405PS)	Diesel Turbo	TD9125				
BE/PL	6	92,028/92,043	96,835/96,850	46,250	2,362	0,068/0,123	BS	1275CP	71-3613/6 STD 0.25 0.50

Mot.80371→



BE/PL	6	92,028/92,043	96,835/96,850	46,250	2,362	0,068/0,123	BS	66615CP	71-4236/6 STD 0.25 0.50
-------	---	---------------	---------------	--------	-------	-------------	----	---------	-----------------------------------

Mot.→80370

1275CP

66615CP

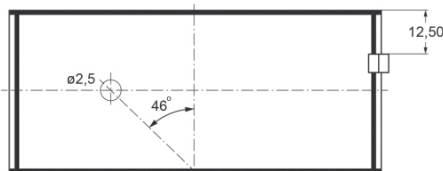
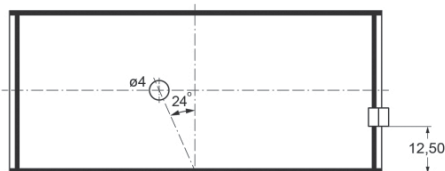

MB/HL 1-7	7	107,915/107,937	113,040/113,065	37,100	2,515	0,073/0,145	BS	66616CP	H1053/7 STD 0.25 0.50 0.75
TW/A	4	116,660/117,094	139,929/139,680		3,213		EC	54-3622	A131/4 STD
SE/PB	1	54,992/55,000	60,300/60,346	46,750			BC	55-3925	55-3925 SEMI
CB/NWB 1	1		72,225/72,250	33,600			BB	68331DR	N157/7 STD SEMI
CB/NWB 2	1		69,850/69,875	25,650			BB	68332DR	
CB/NWB 3	1		67,426/67,487	25,650			BB	68333DR	
CB/NWB 4	1		66,675/66,700	25,650			BB	68334DR	
CB/NWB 5	1		64,287/64,313	25,650			BB	68336DR	
CB/NWB 6	1		63,500/63,525	25,650			BB	68337DR	
CB/NWB 7	1		59,525/59,550	25,650			BB	68338DR	
BU	1		28,175/28,196	22,500			BC	56-3611	56-3611 SEMI

69

131.00 x 150.00

D12A340	6 Cyl.	12100cc	250kW (340PS)	Diesel Turbo Intercooler	TD11727
D12A380 Euro 2	6 Cyl.	12100cc	279kW (380PS)	Diesel Turbo Intercooler	TD9215
D12A420 Euro 2	6 Cyl.	12100cc	309kW (420PS)	Diesel Turbo Intercooler	TD9216
D12C340 Euro 2	6 Cyl.	12100cc	250kW (340PS)	Diesel Turbo Intercooler	TD11731
D12C380	6 Cyl.	12100cc	279kW (380PS)	Diesel Turbo Intercooler	TD11728
D12C390	6 Cyl.	12100cc	289kW (393PS)	Diesel Turbo Intercooler	TD26596
D12C420	6 Cyl.	12100cc	309kW (420PS)	Diesel Turbo Intercooler	TD11729
D12C460	6 Cyl.	12100cc	338kW (460PS)	Diesel Turbo Intercooler	TD11730
D12D340 Euro 3	6 Cyl.	12100cc	250kW (340PS)	Diesel Turbo Intercooler	TD16784
D12D380 Euro 3	6 Cyl.	12100cc	279kW (379PS)	Diesel Turbo Intercooler	TD16785
D12D390 Euro 3	6 Cyl.	12100cc	289kW (393PS)	Diesel Turbo Intercooler	TD26597
D12D420 Euro 3	6 Cyl.	12100cc	309kW (420PS)	Diesel Turbo Intercooler	TD16786
D12D460 Euro 3	6 Cyl.	12100cc	338kW (460PS)	Diesel Turbo Intercooler	TD16787
D12D500 Euro 3	6 Cyl.	12100cc	368kW (500PS)	Diesel Turbo Intercooler	TD16508
DH12D340 Euro 3	6 Cyl.	12100cc	250kW (340PS)	Diesel Turbo Intercooler	TD16511
DH12D380 Euro 3	6 Cyl.	12100cc	280kW (380PS)	Diesel Turbo Intercooler	TD16512
DH12D420 Euro 3	6 Cyl.	12100cc	309kW (420PS)	Diesel Turbo Intercooler	TD16513
DH12E340	6 Cyl.	12100cc	250kW (340PS)	Diesel Turbo Intercooler	TD22155
DH12E380 Euro 4	6 Cyl.	12100cc	280kW (380PS)	Diesel Turbo Intercooler	TD22156
DH12E420	6 Cyl.	12100cc	309kW (420PS)	Diesel Turbo Intercooler	TD22157
DH12E460 Euro 4	6 Cyl.	12100cc	338kW (460PS)	Diesel Turbo Intercooler	TD22158

BE/PL	6	91,978/92,000	96,835/96,850	49,100	2,395	0,050/0,110	EC	71-3923	71-3923/6 STD
-------	---	---------------	---------------	--------	-------	-------------	----	---------	-------------------------

MB/HL 1-7	7	107,978/108,000	113,040/113,065	37,800	2,497	0,046/0,096	EC	72-4053	H1015/7 STD 0.25 0.50	
TW/A	4	116,660/117,094	139,929/139,680		3,213		EC	54-3622	A131/4 STD	
SE/PB	1	54,992/55,000	60,300/60,346	46,750			BC	55-3925	55-3925 SEMI	
CB/NWB	6	69,970/70,000	73,888/73,913	33,000	1,930	0,040/0,115	AL-LF	03-4864	N200/7 STD	
CB/NWB	1	69,970/70,000	73,888/73,913	42,150	1,930	0,040/0,115	AL-LF	03-4865H		
BU	1	43,975/44,000	48,600/48,639	38,500		0,030/0,080	BC	57-4994	57-4994 SEMI	

8

70

131.00 x 158.00

D13A360 Euro 5	6 Cyl.	12800cc	264kW (360PS)	Diesel Turbo Intercooler	TD18826
D13A400 Euro 5	6 Cyl.	12800cc	294kW (400PS)	Diesel Turbo Intercooler	TD18827
D13A440 Euro 5	6 Cyl.	12800cc	324kW (440PS)	Diesel Turbo Intercooler	TD18828
D13A480 Euro 5	6 Cyl.	12800cc	353kW (480PS)	Diesel Turbo Intercooler	TD18829
D13A520 Euro 5	6 Cyl.	12800cc	382kW (520PS)	Diesel Turbo Intercooler	TD18830
D13B360 Euro 4/5	6 Cyl.	12800cc	264kW (360PS)	Diesel Turbo Intercooler	TD20776
D13B400 Euro 4/5	6 Cyl.	12800cc	294kW (400PS)	Diesel Turbo Intercooler	TD20777
D13B440 Euro 4/5	6 Cyl.	12800cc	324kW (440PS)	Diesel Turbo Intercooler	TD20778
D13B500 Euro 4/5	6 Cyl.	12800cc	368kW (500PS)	Diesel Turbo Intercooler	TD20779
D13C380 Euro 5	6 Cyl.	12800cc	280-285kW (380-388PS)	Diesel Turbo Intercooler	TD22378
D13C420 Euro 5	6 Cyl.	12800cc	309kW (420PS)	Diesel Turbo Intercooler	TD22150
D13C460 Euro 5	6 Cyl.	12800cc	338kW (460PS)	Diesel Turbo Intercooler	TD22151
D13C500 Euro 5	6 Cyl.	12800cc	368kW (500PS)	Diesel Turbo Intercooler	TD22152
D13C540 Euro 5	6 Cyl.	12800cc	397kW (540PS)	Diesel Turbo Intercooler	TD22153

BE/PL	6	98,978/99,000	103,835/103,850	48,850	2,395	0,045/0,106	EC	71-4052	71-4052/6 STD 0.25 0.50
BE/PL	6	98,978/99,000	103,84/103,85	48,850	2,395	0,045/0,106	AL-LF	01-4949	71-4949/6 STD
BE/PL	6	98,978/99,000	103,835/103,850	48,850	2,395	0,045/0,106	EC	71-4052	

71-4052

01-4949



MB/HL 1-7	7	107,978/108,000	113,040/113,065	37,800	2,497	0,046/0,096	EC	72-4053	H1015/7 STD 0.25 0.50
TW/A	4	116,660/117,094	139,929/139,680		3,213		EC	54-3622	A131/4 STD
SE/PB	1	57,992/58,000	63,300/63,346	47,500			BS-LF	55-4054	55-4054 SEMI
BU	1	43,975/44,000	48,600/48,639	38,500		0,030/0,080	BC	57-4994	57-4994 SEMI

71

144.00 x 165.00

D 16A	6 Cyl.	16123cc	346-382kW (470-520PS)	Diesel Turbo Intercooler	TD9217
D16A470 Euro 2	6 Cyl.	16120cc	346kW (470PS)	Diesel Turbo Intercooler	TD17534
D16A520	6 Cyl.	16120cc	382kW (520PS)	Diesel Turbo Intercooler	TD11767
D16B520	6 Cyl.	16120cc	382kW (520PS)	Diesel Turbo Intercooler	TD11768
D16C550 Euro 3	6 Cyl.	16120cc	404kW (549PS)	Diesel Turbo Intercooler	TD17170
D16C610 Euro 3	6 Cyl.	16120cc	449kW (610PS)	Diesel Turbo Intercooler	TD17171



D16E540 Euro 4		6 Cyl.		16120cc	396kW (540PS)	Diesel Turbo Intercooler		TD20770	
D16E580 Euro 4		6 Cyl.		16120cc	426kW (580PS)	Diesel Turbo Intercooler		TD18966	
D16E660 Euro 4		6 Cyl.		16120cc	485kW (660PS)	Diesel Turbo Intercooler		TD18967	
BE/PL	6	111,978/112,000	116,79/116,807	50,550	2,358	0,076/0,137	EC	71-4055	71-4055/6 STD
MB/HL	7	117,978/118,000	123,110/123,135	38,600	2,515	0,080/0,150	BS	4101CP	H1083/7 STD 0.25
TW/A	4	129,300/129,800	151,400/151,900		3,210		BS	4101BF	A187/4 STD
SE/PB	1	62,994/63,000	68,300/68,346	41,000			BC-LF	55-4058	55-4058 SEMI

72**144.00 x 165.00**

TD 162 F		6 Cyl.		16123cc	330-357kW (450-485PS)	Diesel Turbo Intercooler		TD5901	
TD 162 FJ		6 Cyl.		16123cc	330-357kW (450-485PS)	Diesel Turbo Intercooler		TD6248	
TD 162 FL		6 Cyl.		16120cc	330-357kW (450-485PS)	Diesel Turbo		TD6313	
TD 162 FS		6 Cyl.		16123cc	330-357kW (450-485PS)	Diesel Turbo Intercooler		TD6327	
TD 163 ES		6 Cyl.		16123cc	368kW (500PS)	Diesel Turbo Intercooler		TD9200	
BE/PL	6	99,988/100,000	104,792/104,807	46,550	2,362	0,070/0,120	BS	4100CP	71-4219/6 STD 0.25 0.50
MB/HL	7	117,978/118,000	123,110/123,135	38,600	2,515	0,080/0,150	BS	4101CP	H1083/7 STD 0.25
TW/A	4	129,300/129,800	151,400/151,900		3,210		BS	4101BF	A187/4 STD
SE/PB	1	59,998/60,004	65,300/65,346	58,500			BS	4104Y	55-4272 SEMI
CB/NWB	1	68,946/68,965	72,000/72,025	23,900	1,480		AL-LF	4101DR	N172/7 STD
CB/NWB	6	64,946/64,965	68,000/68,025	20,900	1,480		AL-LF	4102DR	

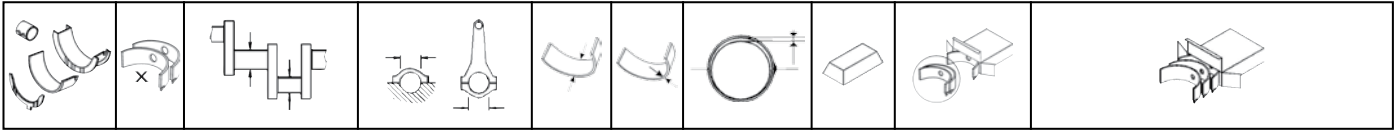









1

COMPRESSOR









Petrol









FM6344

BE/PL	1	34,975/34,991	37,600/37,616	21,000	1,312	0,020/0,045	EC	71-3192	71-3192 STD
-------	---	---------------	---------------	--------	-------	-------------	----	---------	-----------------------









  			  			  		
01-2800	DEUTZ	247		VOLKSWAGEN	1290		PERKINS	943
	DEUTZ	248		VOLKSWAGEN	1291		VOLVO	1401
	DEUTZ	249		VOLKSWAGEN	1297	01-4115/4	CHEVROLET	162
	DEUTZ	250		VOLKSWAGEN	1298		PERKINS	939
	DEUTZ	251		VOLKSWAGEN	1299		PERKINS	941
	IVECO	515	01-3874/4	SEAT	1150		PERKINS	942
	IVECO	516		SKODA	1190		PERKINS	943
01-3040/4	MERCEDES-BENZ	732		VOLKSWAGEN	1282	01-4116/4	FIAT	288
	MERCEDES-BENZ	733		VOLKSWAGEN	1283		FIAT	291
	MERCEDES-BENZ	739	01-3961/4	AUDI	71		FIAT	293
	MERCEDES-BENZ	740		SEAT	1169		LANCIA	581
	MERCEDES-BENZ	741		SKODA	1199	01-4117/4	DAIHATSU	236
	MERCEDES-BENZ	756		VOLKSWAGEN	1317		NISSAN	882
	MERCEDES-BENZ	757		VOLKSWAGEN	1318		TOYOTA	1232
	MERCEDES-BENZ	760	01-3977/4	DACIA	211		TOYOTA	1233
	SEAT	1181		NISSAN	877		TOYOTA	1234
01-3040/5	MERCEDES-BENZ	754		RENAULT	1046		TOYOTA	1236
	MERCEDES-BENZ	755		RENAULT	1047		TOYOTA	1237
01-3438	MERCEDES-BENZ	768	01-3991/4	TOYOTA	1235	01-4119/4	SUBARU	1209
	MERCEDES-BENZ	769	01-4039/4	LAND ROVER	600		SUZUKI	1215
	MERCEDES-BENZ	771		ROVER	1111	01-4123/4	CITROËN	184
	MERCEDES-BENZ	773	01-4040/4	FORD	399		PEUGEOT	963
	MERCEDES-BENZ	774		FORD	413	01-4125/4	CITROËN	195
	MERCEDES-BENZ	775		MAZDA	675		CITROËN	196
	MERCEDES-BENZ	776	01-4079/4	ALFA ROMEO	12		PEUGEOT	976
	MERCEDES-BENZ	780		CHRYSLER	165	01-4127/4	PEUGEOT	977
01-3557/4	FORD	396		FIAT	292		CITROËN	202
	FORD	397		LANCIA	581		FIAT	293
	FORD	402	01-4100/4	AUDI	49		FIAT	297
	FORD	403		AUDI	52		FIAT	298
	FORD	404		SEAT	1155		FIAT	299
01-3584	MERCEDES-BENZ	734		SEAT	1156		FIAT	300
	MERCEDES-BENZ	736		SEAT	1157		FIAT	301
	MERCEDES-BENZ	739		SEAT	1158		FIAT	316
01-3688	DEUTZ	245		SKODA	1191		FIAT	317
	DEUTZ	246		SKODA	1192		FIAT	318
01-3771	MERCEDES-BENZ	734		SKODA	1193		FIAT	319
	MERCEDES-BENZ	735		VOLKSWAGEN	1292		FIAT	320
	MERCEDES-BENZ	737		VOLKSWAGEN	1297		LANCIA	583
	MERCEDES-BENZ	748		VOLKSWAGEN	1298		LANCIA	584
	MERCEDES-BENZ	749		VOLKSWAGEN	1299		LANCIA	594
	MERCEDES-BENZ	750	01-4110	BEDFORD	115		LANCIA	595
01-3814	DEUTZ	258		JOHN DEERE	553		PEUGEOT	985
01-3841/6	AUDI	101		PERKINS	937		SAAB	1118
	FORD	410		PERKINS	938		SAAB	1119
	PORSCHE	998		PERKINS	939		SEAT	1150
	SEAT	1177		PERKINS	942		SEAT	1166
	VOLKSWAGEN	1348	01-4112/2	FIAT	289	01-4128/4	TOYOTA	1231
	VOLKSWAGEN	1349		FIAT	290		TOYOTA	1232
	VOLKSWAGEN	1356		FIAT	293	01-4131/4	CHEVROLET	161
	VOLKSWAGEN	1362		FIAT	296		ISUZU	474
	VOLKSWAGEN	1363		FIAT	298		OPEL	931
01-3841/8	AUDI	92	01-4114	FORD	433		OPEL	935
	AUDI	101		FORD	434	01-4132/4	FORD	405
01-3867/4	AUDI	49		FORD	435	01-4133/4	RENAULT	1045
	SEAT	1152		FORD	436	01-4135/4	PEUGEOT	981
	SEAT	1153	01-4114/4	FORD	428		PEUGEOT	985
	SEAT	1154		FORD	433		PEUGEOT	988
	SEAT	1156		FORD	435	01-4137/4	DAF	217
	SEAT	1158	01-4115	CHEVROLET	161		RENAULT	1046
	SKODA	1191		PERKINS	939		RENAULT	1048
	SKODA	1192		PERKINS	940		RENAULT	1049
	VOLKSWAGEN	1289		PERKINS	942		RENAULT	1050









NUMERICAL PARTS LIST

  			  			  		
	RENAULT	1051		FIAT	315		PEUGEOT	969
	VOLVO	1383		LANCIA	592		PEUGEOT	972
01-4138/4	DACIA	211		PEUGEOT	974		RENAULT	1051
	DACIA	212		PEUGEOT	976	01-4174/4	ROVER	1109
	DAF	217		PEUGEOT	982	01-4175/4	ALFA ROMEO	19
	NISSAN	879	01-4160/4	ALFA ROMEO	16		FIAT	299
	NISSAN	883		FIAT	302		FIAT	300
	RENAULT	1049		LANCIA	585		FIAT	304
	RENAULT	1050	01-4161/4	NISSAN	877		FIAT	305
	RENAULT	1052		RENAULT	1047		FIAT	306
	RENAULT	1053	01-4162/4	FORD	389		FIAT	308
	RENAULT	1054		FORD	390		FIAT	310
	RENAULT	1056		FORD	395		FIAT	312
	RENAULT	1057		FORD	405		FIAT	313
	RENAULT	1059		MAZDA	672		FIAT	315
	VOLVO	1383		MAZDA	673		LANCIA	589
	VOLVO	1384	01-4163/4	CITROËN	187		LANCIA	590
01-4139/4	FIAT	288		CITROËN	189		SEAT	1166
	FIAT	289		CITROËN	190		SEAT	1167
	LANCIA	580		FIAT	292		SEAT	1180
	SEAT	1149		FIAT	294		SEAT	1181
01-4142/4	FORD	394		PEUGEOT	965	01-4176/4	FIAT	295
	FORD	397		PEUGEOT	966		FIAT	296
	FORD	398		PEUGEOT	969		FIAT	299
	FORD	410	01-4165/4	CITROËN	190		FIAT	309
	FORD	411		PEUGEOT	970		FIAT	312
	FORD	420		ROVER	1109		LANCIA	582
	FORD	421	01-4166/4	FORD	416		LANCIA	589
	FORD	424		FORD	420		LANCIA	591
	FORD	425		FORD	422	01-4177/4	LEYLAND	610
	FORD	426	01-4169/4	RENAULT	1055		LEYLAND	611
01-4144/4	TOYOTA	1233		RENAULT	1056	01-4177/6	LEYLAND	610
	TOYOTA	1236		RENAULT	1057		LEYLAND	611
	TOYOTA	1237	01-4171/4	FIAT	293	01-4178/4	ALFA ROMEO	13
01-4146/4	TOYOTA	1239		FIAT	298		ALFA ROMEO	14
	TOYOTA	1240		FIAT	299		ALFA ROMEO	15
	TOYOTA	1241		FIAT	316		ALFA ROMEO	21
01-4147/4	LAND ROVER	603		FIAT	317		ALFA ROMEO	23
	ROVER	1108		LANCIA	584	01-4179/4	PEUGEOT	972
	ROVER	1109		LANCIA	594	01-4180/4	LADA	569
	ROVER	1110		SAAB	1118		LADA	570
01-4148/4	FORD	396		SEAT	1150		LADA	571
	FORD	406		SEAT	1166	01-4181/4	CITROËN	205
	FORD	414	01-4172/4	CHRYSLER	165		CITROËN	206
01-4149/4	CITROËN	201		CITROËN	191		FIAT	324
	FIAT	317		PEUGEOT	962		PEUGEOT	989
	LANCIA	593		PEUGEOT	967		PEUGEOT	990
	PEUGEOT	983		PEUGEOT	971	01-4183/4	FORD	429
01-4152/4	FORD	412	01-4173/4	CITROËN	184		FORD	430
	MAZDA	675		CITROËN	185	01-4184/4	FORD	390
01-4153/4	FORD	389		CITROËN	186		FORD	391
	FORD	391		CITROËN	187		FORD	392
	FORD	393		CITROËN	188		FORD	393
	MAZDA	673		CITROËN	189	01-4187/4	CITROËN	203
	VOLKSWAGEN	1283		CITROËN	190		JOHN DEERE	553
01-4154/4	ALFA ROMEO	12		CITROËN	192		RENAULT	1077
	CHRYSLER	165		PEUGEOT	962		RENAULT	1079
	FIAT	292		PEUGEOT	963	01-4189/4	CHRYSLER	166
	LANCIA	581		PEUGEOT	964		CITROËN	204
01-4155/4	CITROËN	193		PEUGEOT	965		JOHN DEERE	552
	CITROËN	195		PEUGEOT	966		PEUGEOT	987
	CITROËN	199		PEUGEOT	967		RENAULT	1075
	FIAT	307		PEUGEOT	968		RENAULT	1080

  	  	  
01-4191/4 CHRYSLER 166	01-4312 FORD 431	LAND ROVER 605
CITROËN 204	FORD 432	ROVER 1112
JOHN DEERE 552	FORD 433	ROVER 1114
PEUGEOT 987	01-4313/4 AUSTIN 104	01-4448 BEDFORD 117
RENAULT 1075	AUSTIN 105	FORD 432
RENAULT 1080	AUSTIN 106	FORD 434
RENAULT 1081	AUSTIN 108	01-4448/6 FORD 433
01-4192/4 CHRYSLER 166	LEYLAND 608	01-4558/4 CITROËN 198
CITROËN 204	ROVER 1107	CITROËN 199
JOHN DEERE 552	01-4314/4 ALFA ROMEO 14	CITROËN 202
PEUGEOT 987	JOHN DEERE 552	CITROËN 203
RENAULT 1075	PERKINS 937	FIAT 311
RENAULT 1081	01-4315/4 TRIUMPH 1245	FIAT 320
01-4195/4 CITROËN 207	TRIUMPH 1246	PEUGEOT 972
DAF 218	01-4316/4 FORD 406	PEUGEOT 979
FORD 430	FORD 407	PEUGEOT 980
FORD 431	FORD 408	PEUGEOT 981
PEUGEOT 989	FORD 409	PEUGEOT 985
PEUGEOT 990	FORD 410	PEUGEOT 986
01-4199/4 CITROËN 193	01-4330/4 DAIHATSU 236	01-4577/4 TOYOTA 1233
CITROËN 194	TOYOTA 1234	01-4729/4 CHEVROLET 160
CITROËN 195	TOYOTA 1235	OPEL 927
PEUGEOT 974	01-4331/4 AUSTIN 106	01-4801/4 TOYOTA 1231
PEUGEOT 975	AUSTIN 107	01-4818/6 AUDI 70
01-4200/4 CITROËN 192	AUSTIN 108	AUDI 101
CITROËN 193	ROVER 1107	01-4872/3 CHEVROLET 155
CITROËN 197	ROVER 1108	OPEL 913
CITROËN 198	01-4333/4 NISSAN 878	SUZUKI 1215
FIAT 304	NISSAN 879	01-4872/4 CHEVROLET 155
FIAT 307	NISSAN 880	OPEL 913
FIAT 308	NISSAN 881	SUZUKI 1214
HYUNDAI 459	01-4334/4 DAVID BROWN 240	01-4873/4 AUDI 46
LADA 571	01-4335 TRIUMPH 1245	SEAT 1150
PEUGEOT 973	01-4340/4 AUSTIN 109	SKODA 1190
PEUGEOT 974	AUSTIN 110	VOLKSWAGEN 1283
PEUGEOT 977	LEYLAND 610	01-4892/4 TOYOTA 1231
PEUGEOT 978	ROVER 1112	01-4893/4 TOYOTA 1235
SUZUKI 1218	01-4343/4 FORD 389	TOYOTA 1236
01-4202/4 VOLVO 1384	FORD 396	01-4894/4 CHEVROLET 157
VOLVO 1388	KIA 563	TOYOTA 1235
01-4203 BEDFORD 113	KIA 564	01-4896/4 NISSAN 888
CHEVROLET 155	MAZDA 672	01-4937/4 LADA 570
SUZUKI 1214	MAZDA 673	LADA 571
01-4207/4 FIAT 294	MAZDA 674	01-4943/4 HYUNDAI 457
FIAT 295	01-4345/4 TOYOTA 1238	KIA 563
FIAT 296	01-4346/4 DAIHATSU 237	01-4946/4 CHEVROLET 156
FIAT 318	TOYOTA 1240	SUBARU 1209
LANCIA 582	TOYOTA 1241	SUZUKI 1217
01-4255/4 VOLVO 1383	01-4359/4 FORD 397	01-4947/4 CHEVROLET 156
VOLVO 1384	KIA 564	FIAT 297
01-4257/4 HYUNDAI 457	MAZDA 674	SUBARU 1209
MITSUBISHI 835	MAZDA 675	SUZUKI 1217
MITSUBISHI 836	MAZDA 676	SUZUKI 1218
01-4259/4 SKODA 1191	01-4361/4 ISUZU 471	01-4967/2 ALFA ROMEO 16
01-4298/4 CITROËN 201	OPEL 914	CHRYSLER 166
FIAT 317	OPEL 917	FIAT 301
LANCIA 593	01-4362/4 CITROËN 191	LANCIA 584
PEUGEOT 983	PEUGEOT 971	01-4976/4 HONDA 450
PEUGEOT 984	ROVER 1110	01-4977/4 ISUZU 475
01-4301 LISTER 615	01-4364/6 BEDFORD 116	NISSAN 893
LISTER 616	01-4366/6 LEYLAND 612	01-4978/4 MAZDA 676
01-4307/4 ALFA ROMEO 13	01-4374/6 NISSAN 889	MITSUBISHI 840
ALFA ROMEO 15	01-4377/8 LAND ROVER 601	NISSAN 887









NUMERICAL PARTS LIST









  			  			  		
	NISSAN	888		PEUGEOT	985		SKODA	1199
	SUZUKI	1218		PEUGEOT	988		VOLKSWAGEN	1282
01-4979/4	NISSAN	890	05-4521	CHEVROLET	162		VOLKSWAGEN	1283
	NISSAN	891		PERKINS	939		VOLKSWAGEN	1284
	SUZUKI	1219		PERKINS	940		VOLKSWAGEN	1285
01-4980/3	CITROËN	184		PERKINS	941		VOLKSWAGEN	1287
	DAIHATSU	235		PERKINS	942		VOLKSWAGEN	1288
	PEUGEOT	963		PERKINS	943		VOLKSWAGEN	1289
	SUBARU	1209		VOLVO	1401		VOLKSWAGEN	1290
	TOYOTA	1231	07-3088	AUDI	46		VOLKSWAGEN	1291
01-4990/3	CITROËN	191		AUDI	47		VOLKSWAGEN	1292
	PEUGEOT	970		AUDI	48		VOLKSWAGEN	1293
01-4999/4	HYUNDAI	458		AUDI	49		VOLKSWAGEN	1298
	KIA	563		AUDI	50		VOLKSWAGEN	1299
01-5040/4	HONDA	448		AUDI	55		VOLKSWAGEN	1301
01-5041/4	CHEVROLET	158		AUDI	56		VOLKSWAGEN	1302
	TOYOTA	1235		AUDI	64		VOLKSWAGEN	1306
	TOYOTA	1237		AUDI	66		VOLKSWAGEN	1308
01-5042/4	SUZUKI	1215		AUDI	67		VOLKSWAGEN	1309
	SUZUKI	1216		AUDI	70		VOLKSWAGEN	1310
01-5043/4	mitsubishi	836		AUDI	71		VOLKSWAGEN	1313
	mitsubishi	839		AUDI	72		VOLKSWAGEN	1314
01-5044/4	FORD	413		AUDI	73		VOLKSWAGEN	1315
	MAZDA	676		AUDI	78		VOLKSWAGEN	1316
01-5049/4	NISSAN	882		AUDI	80		VOLKSWAGEN	1317
	NISSAN	883		AUDI	84		VOLKSWAGEN	1318
02-2228	DEUTZ	245		AUDI	86		VOLKSWAGEN	1319
	DEUTZ	246		AUDI	87		VOLKSWAGEN	1321
	DEUTZ	247		AUDI	97		VOLKSWAGEN	1322
	DEUTZ	248		AUDI	99		VOLKSWAGEN	1323
	DEUTZ	249		AUDI	100		VOLKSWAGEN	1324
	DEUTZ	250		AUDI	101		VOLKSWAGEN	1326
	DEUTZ	251		FORD	399		VOLKSWAGEN	1327
	IVECO	515		FORD	400		VOLKSWAGEN	1329
	IVECO	516		FORD	401		VOLKSWAGEN	1333
02-3689	DEUTZ	245		FORD	410		VOLKSWAGEN	1334
	DEUTZ	246		NISSAN	885		VOLKSWAGEN	1337
02-4516	JOHN DEERE	556		PORSCHE	998		VOLKSWAGEN	1339
	JOHN DEERE	557		SEAT	1151		VOLKSWAGEN	1340
	JOHN DEERE	558		SEAT	1152		VOLKSWAGEN	1341
02-4549	FORD	389		SEAT	1154		VOLKSWAGEN	1342
	FORD	391		SEAT	1155		VOLKSWAGEN	1343
	FORD	393		SEAT	1156		VOLKSWAGEN	1344
	MAZDA	673		SEAT	1157		VOLKSWAGEN	1345
	VOLKSWAGEN	1283		SEAT	1160		VOLKSWAGEN	1346
02-4551	TRIUMPH	1245		SEAT	1162		VOLKSWAGEN	1348
02-4574H	NEW HOLLAND	855		SEAT	1163		VOLKSWAGEN	1349
	NEW HOLLAND	856		SEAT	1164		VOLKSWAGEN	1356
02-4575H	DAF	219		SEAT	1165		VOLKSWAGEN	1357
	DAF	220		SEAT	1167		VOLKSWAGEN	1359
	IVECO	514		SEAT	1168		VOLKSWAGEN	1360
	IVECO	515		SEAT	1169	07-3089	AUDI	46
02-4576	DAF	219		SEAT	1170		AUDI	47
	DAF	220		SEAT	1172		AUDI	48
	IVECO	514		SEAT	1175		AUDI	49
	IVECO	515		SEAT	1176		AUDI	50
	NEW HOLLAND	855		SEAT	1177		AUDI	55
	NEW HOLLAND	856		SEAT	1179		AUDI	56
03-4727	MAN	640		SKODA	1190		AUDI	64
	MAN	641		SKODA	1191		AUDI	66
	MAN	642		SKODA	1192		AUDI	67
	MAN	650		SKODA	1196		AUDI	70
05-4136	PEUGEOT	981		SKODA	1197		AUDI	71

  	  	  			
AUDI	72	VOLKSWAGEN	1317	MAN	651
AUDI	73	VOLKSWAGEN	1318	MAN	652
AUDI	78	VOLKSWAGEN	1319	MAN	653
AUDI	80	VOLKSWAGEN	1321	MAN	654
AUDI	84	VOLKSWAGEN	1322	MAN	655
AUDI	86	VOLKSWAGEN	1323	MAN	656
AUDI	87	VOLKSWAGEN	1324	MAN	657
AUDI	97	VOLKSWAGEN	1326	MAN	659
AUDI	99	VOLKSWAGEN	1327	MAN	660
AUDI	100	VOLKSWAGEN	1329	MAN	661
FORD	399	VOLKSWAGEN	1333	MAN	662
FORD	401	VOLKSWAGEN	1334	MAN	663
NISSAN	885	VOLKSWAGEN	1337	MERCEDES-BENZ	790
SEAT	1151	VOLKSWAGEN	1339	MERCEDES-BENZ	791
SEAT	1152	VOLKSWAGEN	1340	MERCEDES-BENZ	792
SEAT	1154	VOLKSWAGEN	1341	MERCEDES-BENZ	793
SEAT	1155	VOLKSWAGEN	1342	MERCEDES-BENZ	794
SEAT	1156	VOLKSWAGEN	1343	MERCEDES-BENZ	795
SEAT	1157	VOLKSWAGEN	1344	MERCEDES-BENZ	796
SEAT	1158	VOLKSWAGEN	1345	MERCEDES-BENZ	797
SEAT	1160	VOLKSWAGEN	1346	MERCEDES-BENZ	798
SEAT	1162	VOLKSWAGEN	1357	MERCEDES-BENZ	799
SEAT	1163	VOLKSWAGEN	1359	MERCEDES-BENZ	800
SEAT	1164	VOLKSWAGEN	1361	MERCEDES-BENZ	801
SEAT	1165	07-4037 AUDI	50	MERCEDES-BENZ	802
SEAT	1167	AUDI	64	MERCEDES-BENZ	803
SEAT	1168	SEAT	1160	MERCEDES-BENZ	804
SEAT	1169	SKODA	1194	MERCEDES-BENZ	805
SEAT	1171	VOLKSWAGEN	1294	MERCEDES-BENZ	806
SEAT	1172	VOLKSWAGEN	1305	MERCEDES-BENZ	807
SEAT	1175	07-4038 AUDI	50	MERCEDES-BENZ	809
SEAT	1176	AUDI	64	MERCEDES-BENZ	810
SEAT	1177	SEAT	1160	MERCEDES-BENZ	812
SEAT	1179	SKODA	1194	MERCEDES-BENZ	814
SKODA	1190	VOLKSWAGEN	1294	MERCEDES-BENZ	816
SKODA	1191	VOLKSWAGEN	1305	MERCEDES-BENZ	817
SKODA	1192	07-4997 MAN	640	MERCEDES-BENZ	818
SKODA	1196	MAN	641	MERCEDES-BENZ	820
SKODA	1197	MAN	642	53-2441 IHC	464
SKODA	1199	MAN	650	IHC	465
VOLKSWAGEN	1282	11-3438 MERCEDES-BENZ	768	IHC	466
VOLKSWAGEN	1283	MERCEDES-BENZ	769	IHC	467
VOLKSWAGEN	1284	MERCEDES-BENZ	771	53-2442 IHC	464
VOLKSWAGEN	1285	MERCEDES-BENZ	773	IHC	465
VOLKSWAGEN	1287	MERCEDES-BENZ	774	IHC	466
VOLKSWAGEN	1288	MERCEDES-BENZ	775	IHC	467
VOLKSWAGEN	1289	MERCEDES-BENZ	776	53-3944 MAN	632
VOLKSWAGEN	1290	MERCEDES-BENZ	780	MAN	636
VOLKSWAGEN	1291	17-3720 AUDI	101	53-4707 DAF	219
VOLKSWAGEN	1292	FORD	410	DAF	220
VOLKSWAGEN	1293	PORSCHE	998	IVECO	514
VOLKSWAGEN	1298	SEAT	1177	IVECO	515
VOLKSWAGEN	1299	VOLKSWAGEN	1348	NEW HOLLAND	855
VOLKSWAGEN	1301	VOLKSWAGEN	1349	NEW HOLLAND	856
VOLKSWAGEN	1303	VOLKSWAGEN	1356	53-4753 MAN	632
VOLKSWAGEN	1306	51-1302 IHC	463	MAN	636
VOLKSWAGEN	1308	52-3097 MAN	643	53-4757 DEUTZ	257
VOLKSWAGEN	1309	MAN	644	DEUTZ	258
VOLKSWAGEN	1310	MAN	645	53-4758 DEUTZ	257
VOLKSWAGEN	1313	MAN	646	DEUTZ	258
VOLKSWAGEN	1314	MAN	647	53-4761 MERCEDES-BENZ	783
VOLKSWAGEN	1315	MAN	648	MERCEDES-BENZ	784
VOLKSWAGEN	1316	MAN	649	MERCEDES-BENZ	785









NUMERICAL PARTS LIST









Nummerische Teileliste • Elenco referimento • Liste numérique des references
 Lista de referencias numéricas • Lista numeryczna części
 Список номеров деталей • قائمة الأجزاء الرقمية

  	  	  
MERCEDES-BENZ 786	VOLKSWAGEN 1363	MAN 654
MERCEDES-BENZ 787	55-2784 MERCEDES-BENZ 725	MAN 655
53-4762 MERCEDES-BENZ 783	MERCEDES-BENZ 731	MAN 656
MERCEDES-BENZ 784	55-2847 MERCEDES-BENZ 788	MAN 657
MERCEDES-BENZ 785	55-2862 MAN 643	MAN 659
MERCEDES-BENZ 786	MAN 644	MAN 660
MERCEDES-BENZ 787	MAN 645	MAN 661
55-2528 BMW 133	MAN 646	MAN 662
BMW 134	MAN 647	MERCEDES-BENZ 790
BMW 144	MAN 648	MERCEDES-BENZ 791
BMW 145	MAN 649	MERCEDES-BENZ 792
BMW 146	MAN 651	MERCEDES-BENZ 793
BMW 147	MAN 652	MERCEDES-BENZ 794
BMW 148	MAN 653	MERCEDES-BENZ 795
55-2532 MERCEDES-BENZ 731	MAN 654	MERCEDES-BENZ 796
MERCEDES-BENZ 732	MAN 655	MERCEDES-BENZ 797
MERCEDES-BENZ 733	MAN 656	MERCEDES-BENZ 798
MERCEDES-BENZ 739	MAN 657	MERCEDES-BENZ 799
MERCEDES-BENZ 740	MAN 659	MERCEDES-BENZ 800
MERCEDES-BENZ 741	MAN 660	MERCEDES-BENZ 801
MERCEDES-BENZ 742	MAN 661	MERCEDES-BENZ 802
MERCEDES-BENZ 754	MAN 662	MERCEDES-BENZ 803
MERCEDES-BENZ 755	MERCEDES-BENZ 790	MERCEDES-BENZ 805
MERCEDES-BENZ 757	MERCEDES-BENZ 791	MERCEDES-BENZ 806
MERCEDES-BENZ 758	MERCEDES-BENZ 793	MERCEDES-BENZ 807
MERCEDES-BENZ 760	MERCEDES-BENZ 794	MERCEDES-BENZ 809
MERCEDES-BENZ 762	MERCEDES-BENZ 795	MERCEDES-BENZ 810
SEAT 1182	MERCEDES-BENZ 796	MERCEDES-BENZ 812
55-2535 MERCEDES-BENZ 768	MERCEDES-BENZ 806	MERCEDES-BENZ 813
MERCEDES-BENZ 769	MERCEDES-BENZ 809	MERCEDES-BENZ 816
MERCEDES-BENZ 771	MERCEDES-BENZ 810	MERCEDES-BENZ 817
MERCEDES-BENZ 774	55-2996 MERCEDES-BENZ 729	MERCEDES-BENZ 818
MERCEDES-BENZ 775	MERCEDES-BENZ 730	MERCEDES-BENZ 819
MERCEDES-BENZ 776	55-3170 DEUTZ 251	MERCEDES-BENZ 820
MERCEDES-BENZ 780	IVECO 516	55-3422 BMW 131
55-2538 MERCEDES-BENZ 808	55-3277 AUDI 46	BMW 132
55-2567 VOLKSWAGEN 1300	AUDI 47	BMW 136
VOLKSWAGEN 1361	SEAT 1151	BMW 138
VOLKSWAGEN 1363	SEAT 1152	BMW 139
55-2640 DEUTZ 253	VOLKSWAGEN 1282	55-3430 PORSCHE 1001
DEUTZ 254	VOLKSWAGEN 1283	55-3443 AUDI 51
DEUTZ 255	VOLKSWAGEN 1284	AUDI 52
DEUTZ 256	VOLKSWAGEN 1285	AUDI 69
DEUTZ 257	VOLKSWAGEN 1288	VOLKSWAGEN 1294
IVECO 537	55-3280 PORSCHE 996	VOLKSWAGEN 1295
IVECO 539	PORSCHE 997	VOLKSWAGEN 1296
IVECO 540	PORSCHE 999	VOLKSWAGEN 1305
55-2641 IHC 463	PORSCHE 1000	VOLVO 1384
IHC 464	55-3327 IHC 463	VOLVO 1390
IHC 465	IHC 464	55-3451 MWM 846
IHC 466	IHC 465	55-3486 MAN 630
IHC 467	IHC 466	55-3509 VOLVO 1407
55-2650 DEUTZ 245	IHC 467	VOLVO 1408
DEUTZ 246	55-3328 MAN 643	55-3516 MERCEDES-BENZ 746
DEUTZ 247	MAN 644	MERCEDES-BENZ 748
DEUTZ 248	MAN 645	MERCEDES-BENZ 763
DEUTZ 249	MAN 646	MERCEDES-BENZ 764
DEUTZ 250	MAN 647	55-3523 MERCEDES-BENZ 756
DEUTZ 251	MAN 648	55-3524 VOLVO 1398
DEUTZ 252	MAN 649	VOLVO 1399
IVECO 516	MAN 651	VOLVO 1400
55-2723 VOLKSWAGEN 1300	MAN 652	55-3525 MERCEDES-BENZ 742
VOLKSWAGEN 1361	MAN 653	MERCEDES-BENZ 758









  	  	  			
MERCEDES-BENZ	759	MERCEDES-BENZ	748	AUDI	100
MERCEDES-BENZ	760	MERCEDES-BENZ	752	SEAT	1167
MERCEDES-BENZ	766	MERCEDES-BENZ	753	SEAT	1168
MERCEDES-BENZ	767	MERCEDES-BENZ	754	SEAT	1169
55-3543 SAAB	1119	MERCEDES-BENZ	763	SEAT	1170
55-3567 SAAB	1120	MERCEDES-BENZ	764	SEAT	1172
AUDI	48	MERCEDES-BENZ	765	SEAT	1173
AUDI	72	55-3610 VOLVO	1407	SEAT	1174
AUDI	73	55-3620 VOLVO	1397	SEAT	1175
AUDI	74	VOLVO	1400	SEAT	1176
AUDI	75	55-3621 VOLVO	1401	SEAT	1179
AUDI	76	VOLVO	1403	SEAT	1180
AUDI	78	VOLVO	1404	SKODA	1199
AUDI	83	55-3625 MERCEDES-BENZ	734	SKODA	1200
AUDI	86	MERCEDES-BENZ	735	SKODA	1203
AUDI	87	MERCEDES-BENZ	736	VOLKSWAGEN	1313
AUDI	89	MERCEDES-BENZ	737	VOLKSWAGEN	1314
AUDI	90	MERCEDES-BENZ	739	VOLKSWAGEN	1315
AUDI	96	MERCEDES-BENZ	749	VOLKSWAGEN	1316
AUDI	98	MERCEDES-BENZ	750	VOLKSWAGEN	1317
NISSAN	885	MERCEDES-BENZ	751	VOLKSWAGEN	1318
SEAT	1170	55-3635 MERCEDES-BENZ	734	VOLKSWAGEN	1321
SEAT	1172	MERCEDES-BENZ	735	VOLKSWAGEN	1323
SEAT	1175	MERCEDES-BENZ	736	VOLKSWAGEN	1326
SEAT	1176	MERCEDES-BENZ	737	VOLKSWAGEN	1328
VOLKSWAGEN	1287	MERCEDES-BENZ	750	VOLKSWAGEN	1330
VOLKSWAGEN	1319	MERCEDES-BENZ	751	VOLKSWAGEN	1331
VOLKSWAGEN	1320	55-3648 BMW	131	VOLKSWAGEN	1332
VOLKSWAGEN	1321	BMW	132	VOLKSWAGEN	1333
VOLKSWAGEN	1323	BMW	134	VOLKSWAGEN	1334
VOLKSWAGEN	1324	BMW	136	VOLKSWAGEN	1335
VOLKSWAGEN	1325	BMW	137	VOLKSWAGEN	1336
VOLKSWAGEN	1326	BMW	138	VOLKSWAGEN	1338
VOLKSWAGEN	1327	BMW	139	VOLKSWAGEN	1342
VOLKSWAGEN	1328	BMW	143	VOLKSWAGEN	1344
VOLKSWAGEN	1329	BMW	144	VOLKSWAGEN	1346
VOLKSWAGEN	1330	55-3663 VOLVO	1398	VOLKSWAGEN	1348
VOLKSWAGEN	1331	VOLVO	1399	VOLKSWAGEN	1354
VOLKSWAGEN	1332	VOLVO	1400	VOLKSWAGEN	1357
VOLKSWAGEN	1337	55-3696 VOLKSWAGEN	1349	VOLKSWAGEN	1358
VOLKSWAGEN	1338	55-3698 AUDI	57	VOLKSWAGEN	1360
VOLKSWAGEN	1340	AUDI	58	55-3705 BMW	133
VOLKSWAGEN	1341	AUDI	59	BMW	140
VOLKSWAGEN	1342	AUDI	61	55-3715 AUDI	77
VOLKSWAGEN	1343	AUDI	62	AUDI	92
VOLKSWAGEN	1344	AUDI	63	55-3729 AUDI	64
VOLKSWAGEN	1345	AUDI	70	AUDI	65
VOLKSWAGEN	1346	AUDI	71	AUDI	66
VOLKSWAGEN	1347	AUDI	74	AUDI	67
VOLKSWAGEN	1348	AUDI	75	AUDI	68
VOLKSWAGEN	1354	AUDI	76	AUDI	69
55-3576 BMW	132	AUDI	79	AUDI	81
BMW	133	AUDI	80	FORD	399
55-3588 MERCEDES-BENZ	734	AUDI	81	FORD	400
MERCEDES-BENZ	739	AUDI	82	FORD	401
MERCEDES-BENZ	749	AUDI	83	FORD	402
55-3595 MWM	847	AUDI	88	SEAT	1160
55-3603 MERCEDES-BENZ	726	AUDI	89	SEAT	1161
MERCEDES-BENZ	729	AUDI	90	SEAT	1162
MERCEDES-BENZ	744	AUDI	96	SEAT	1163
MERCEDES-BENZ	745	AUDI	97	SEAT	1164
MERCEDES-BENZ	746	AUDI	98	SEAT	1165
MERCEDES-BENZ	747	AUDI	99	SKODA	1195









NUMERICAL PARTS LIST

  			  			  		
	SKODA	1196	55-3875	DACIA	213		MERCEDES-BENZ	761
	SKODA	1197		OPEL	919		MERCEDES-BENZ	762
	SKODA	1198		RENAULT	1061		MERCEDES-BENZ	781
	VOLKSWAGEN	1306		RENAULT	1062	55-4025	VOLVO	1405
	VOLKSWAGEN	1307		VOLVO	1392	55-4050	NISSAN	890
	VOLKSWAGEN	1308	55-3898	MERCEDES-BENZ	743		NISSAN	891
	VOLKSWAGEN	1309		MERCEDES-BENZ	744		OPEL	928
	VOLKSWAGEN	1311	55-3925	RENAULT	1100		OPEL	930
	VOLKSWAGEN	1312		VOLVO	1411		RENAULT	1076
	VOLKSWAGEN	1350		VOLVO	1412		RENAULT	1077
	VOLKSWAGEN	1355	55-3927	VOLVO	1386		RENAULT	1082
55-3783	RENAULT	1071		VOLVO	1387	55-4054	RENAULT	1101
	RENAULT	1072		VOLVO	1388		VOLVO	1412
	VOLVO	1385		VOLVO	1389	55-4058	VOLVO	1413
	VOLVO	1386		VOLVO	1391	55-4059	RENAULT	1099
	VOLVO	1387		VOLVO	1393		VOLVO	1409
	VOLVO	1388		VOLVO	1394	55-4077	ALFA ROMEO	12
	VOLVO	1389		VOLVO	1395		CHEVROLET	155
	VOLVO	1391	55-3937	BMW	136		CHRYSLER	165
	VOLVO	1392		BMW	139		CITROËN	184
	VOLVO	1393		BMW	140		FIAT	290
	VOLVO	1394		BMW	141		LANCIA	580
	VOLVO	1395		BMW	142		OPEL	912
55-3792	DAF	218		BMW	143		PEUGEOT	962
	DAF	222		LAND ROVER	600		SUZUKI	1214
	DAF	223		LAND ROVER	601	55-4078	ALFA ROMEO	12
	DAF	225		ROVER	1110		CHRYSLER	165
	DAF	226		ROVER	1111		FIAT	292
	DAF	227	55-3946	MAN	633		LANCIA	582
55-3793	DAF	218		MAN	637	55-4090	IVECO	534
	DAF	222		MAN	639	55-4094	IVECO	540
	DAF	223	55-3950	DAF	232	55-4098	IVECO	541
	DAF	225	55-3965	DEUTZ	253	55-4099	RENAULT	1091
	DAF	226		VOLVO	1402	55-4102	CITROËN	191
	DAF	227		VOLVO	1404		FIAT	294
	DAF	228	55-3975	VOLVO	1387		FORD	394
	DAF	229		VOLVO	1390		FORD	395
	DAF	231	55-3984	CITROËN	201		MINI	826
	LEYLAND	613		FIAT	316		MINI	826
55-3800	DAF	221		LANCIA	593		MINI	826
55-3811	DEUTZ	252		LANCIA	593		MINI	826
55-3813	MAN	665		LAND ROVER	601		MINI	826
	MAN	666		MITSUBISHI	841		MINI	826
55-3830	MERCEDES-BENZ	734		PEUGEOT	983		MINI	826
	MERCEDES-BENZ	735	55-3985	CITROËN	200	55-4105	MINI	826
	MERCEDES-BENZ	736		FIAT	315		MINI	826
	MERCEDES-BENZ	737		LANCIA	593		MINI	826
	MERCEDES-BENZ	748		PEUGEOT	982		MINI	826
	MERCEDES-BENZ	749		SUZUKI	1219		MINI	826
	MERCEDES-BENZ	750		VOLVO	1395		MINI	826
	MERCEDES-BENZ	751	55-3987	CITROËN	187		MINI	826
55-3831	MERCEDES-BENZ	734		CITROËN	188		MINI	826
	MERCEDES-BENZ	735		FORD	390		MINI	826
	MERCEDES-BENZ	736		MAZDA	673		MINI	826
	MERCEDES-BENZ	737		PEUGEOT	967		MINI	826
	MERCEDES-BENZ	748		SUZUKI	1215		MINI	826
55-3854	MERCEDES-BENZ	782	55-3997	MERCEDES-BENZ	805		MINI	826
	MERCEDES-BENZ	785		MERCEDES-BENZ	819		MINI	826
	MERCEDES-BENZ	786	55-4000	MERCEDES-BENZ	726		MINI	826
55-3865	MERCEDES-BENZ	724	55-4001	MERCEDES-BENZ	727		MINI	826
55-3873	CHEVROLET	158	55-4006	MERCEDES-BENZ	724		MINI	826
	OPEL	923		MERCEDES-BENZ	725		MINI	826
	SAAB	1118	55-4012	MERCEDES-BENZ	742		MINI	826
				MERCEDES-BENZ	743		MINI	826









  			  			  			
55-4106	FIAT	334		IVECO	502		502	MITSUBISHI	842
	FIAT	335		IVECO	503		503	MITSUBISHI	843
	FIAT	342		IVECO	505	55-4210	505	FIAT	289
	FIAT	344		IVECO	506		506	FIAT	290
	FIAT	346		IVECO	508		508	FIAT	293
	FIAT	348		LANCIA	583		583	FIAT	296
	FIAT	349		LANCIA	596		596	FIAT	299
	IVECO	513		LANCIA	597	55-4211	597	FIAT	326
	IVECO	520		OPEL	932		932	FIAT	328
	IVECO	521		OPEL	933		933	FIAT	329
	IVECO	522		PEUGEOT	990		990	FIAT	330
	IVECO	523		RENAULT	1083		1083	FIAT	331
	IVECO	524		RENAULT	1084		1084	FIAT	332
	IVECO	525		RENAULT	1085		1085	FIAT	333
	IVECO	527		RENAULT	1086		1086	FIAT	337
	IVECO	530		RENAULT	1088		1088	FIAT	338
	NEW HOLLAND	854		RENAULT	1089		1089	FIAT	340
	NEW HOLLAND	855		RENAULT	1090		1090	FIAT	341
	NEW HOLLAND	860		RENAULT	1091		1091	IVECO	508
	NEW HOLLAND	861		SEAT	1183		1183	IVECO	509
	NEW HOLLAND	862		VOLKSWAGEN	1363		1363	IVECO	510
55-4107	FIAT	355	55-4190	ALFA ROMEO	19		19	IVECO	511
	FIAT	356		FIAT	305		305	IVECO	512
	IVECO	542		FIAT	306		306	IVECO	517
	IVECO	544		FIAT	307		307	IVECO	518
55-4111	JOHN DEERE	553		LANCIA	587		587	NEW HOLLAND	849
	PERKINS	937		LANCIA	588		588	NEW HOLLAND	851
	PERKINS	938		SEAT	1180		1180	NEW HOLLAND	852
	PERKINS	939	55-4193	ALFA ROMEO	23		23	NEW HOLLAND	853
	PERKINS	943		FIAT	300		300	NEW HOLLAND	858
55-4124	RENAULT	1102		FIAT	309	55-4217	309	FIAT	353
55-4140	RENAULT	1090		FIAT	310		310	FIAT	355
	RENAULT	1091		FIAT	311		311	FIAT	356
	RENAULT	1092		FIAT	313		313	IVECO	540
55-4150	CITROËN	191		FIAT	314		314	IVECO	542
	PEUGEOT	971		FIAT	315		315	IVECO	544
	ROVER	1110		LANCIA	590	55-4225	590	SAME	1122
55-4159	ALFA ROMEO	17		LANCIA	591		591	SAME	1123
	ALFA ROMEO	18		LANCIA	592		592	SAME	1124
	ALFA ROMEO	20		SEAT	1167	55-4230	1167	FIAT	326
	CHRYSLER	166		SEAT	1181		1181	FIAT	328
	FIAT	302	55-4196	FORD	430		430	FIAT	329
	FIAT	303		PEUGEOT	989		989	FIAT	330
	FIAT	304		PEUGEOT	990		990	FIAT	331
	FIAT	308	55-4197	CITROËN	207		207	FIAT	332
	FIAT	343		DAF	218		218	FIAT	333
	LANCIA	586		FORD	431		431	FIAT	337
	LANCIA	587		PEUGEOT	990	55-4201	990	FIAT	338
	LANCIA	588		CITROËN	192		192	FIAT	339
	LANCIA	589		CITROËN	193		193	FIAT	340
	OPEL	920		CITROËN	197		197	FIAT	341
	SAAB	1118		CITROËN	198		198	IVECO	511
	SUZUKI	1217		FIAT	304		304	IVECO	513
55-4186	ALFA ROMEO	27		FIAT	307		307	IVECO	517
	ALFA ROMEO	28		FIAT	308		308	IVECO	518
	CITROËN	207		HYUNDAI	459		459	NEW HOLLAND	850
	FIAT	323		LADA	571		571	NEW HOLLAND	851
	FIAT	324		PEUGEOT	973		973	NEW HOLLAND	852
	IVECO	495		PEUGEOT	974		974	NEW HOLLAND	853
	IVECO	496		PEUGEOT	978		978	NEW HOLLAND	857
	IVECO	497		SUZUKI	1218		1218	NEW HOLLAND	858
	IVECO	498	55-4208	FORD	427		427	NEW HOLLAND	859
	IVECO	500		HYUNDAI	460		460	NEW HOLLAND	860









NUMERICAL PARTS LIST

  			  			  		
55-4231	FIAT	326	55-4270	FORD	417		FIAT	295
	FIAT	328		KIA	565		FIAT	296
	FIAT	329		MAZDA	678		FIAT	297
	FIAT	331		SUZUKI	1219		FIAT	298
	FIAT	332	55-4271	ISUZU	473		FIAT	299
	FIAT	333	55-4272	VOLVO	1413		FIAT	300
	FIAT	337	55-4275	FIAT	326		FIAT	301
	FIAT	338		FIAT	328		FIAT	309
	FIAT	340		FIAT	329		FIAT	310
	FIAT	341		FIAT	331		FIAT	312
	IVECO	508		FIAT	332		FIAT	313
	IVECO	509		FIAT	333		FIAT	315
	IVECO	511		FIAT	337		FIAT	316
	IVECO	513		FIAT	338		FIAT	318
	IVECO	517		FIAT	339		FIAT	319
	IVECO	518		FIAT	340		FIAT	320
	NEW HOLLAND	850		FIAT	341		LANCIA	582
	NEW HOLLAND	851		IVECO	510		LANCIA	583
	NEW HOLLAND	852		IVECO	511		LANCIA	584
	NEW HOLLAND	853		IVECO	513		LANCIA	589
	NEW HOLLAND	858		IVECO	517		LANCIA	590
55-4232	ALFA ROMEO	19		IVECO	518		LANCIA	591
	FIAT	306		NEW HOLLAND	850		LANCIA	594
	LANCIA	587		NEW HOLLAND	851		LANCIA	595
	LANCIA	588		NEW HOLLAND	852		PEUGEOT	985
55-4233	FIAT	305		NEW HOLLAND	854		SAAB	1119
	FIAT	306		NEW HOLLAND	857		SEAT	1150
	LANCIA	587		NEW HOLLAND	858		SEAT	1166
	LANCIA	588		NEW HOLLAND	859		SEAT	1167
55-4235	ALFA ROMEO	24		NEW HOLLAND	860		SEAT	1180
	ALFA ROMEO	25	55-4280	ALFA ROMEO	13		SEAT	1181
	CHRYSLER	168		ALFA ROMEO	14	55-4291	RENAULT	1094
	FORD	428		ALFA ROMEO	15	55-4292	RENAULT	1096
	JOHN DEERE	554		ALFA ROMEO	16	55-4293	FIAT	350
	ROVER	1113		ALFA ROMEO	21		FIAT	351
	VM	1248		ALFA ROMEO	22		FIAT	352
	VM	1249		ALFA ROMEO	23		IVECO	532
	VM	1250		ALFA ROMEO	24		IVECO	533
55-4240	SCANIA	1131		ALFA ROMEO	25		IVECO	534
	SCANIA	1132		ALFA ROMEO	26		IVECO	535
	SCANIA	1133		ALFA ROMEO	320		IVECO	536
	SCANIA	1134		LANCIA	595		IVECO	537
55-4247	ISUZU	471	55-4282	FIAT	349	55-4294	CHRYSLER	167
	MAZDA	675		FIAT	350		FIAT	311
	OPEL	917		FIAT	351		JOHN DEERE	553
55-4248	LAND ROVER	604		FIAT	352		MINITUBISHI	838
	ROVER	1109		IVECO	531		RENAULT	1076
55-4264	NISSAN	885		IVECO	532	55-4296	RENAULT	1098
	OPEL	922		IVECO	533		RENAULT	1099
	RENAULT	1065		IVECO	534	55-4299	NISSAN	884
	RENAULT	1066		IVECO	535		OPEL	919
	RENAULT	1070		IVECO	536		RENAULT	1064
	RENAULT	1071		IVECO	537	55-4393	CITROËN	205
	RENAULT	1074	55-4283	RENAULT	1096		CITROËN	206
55-4265	PEUGEOT	973		RENAULT	1097		CITROËN	207
55-4266	CITROËN	192	55-4285	FIAT	352		FIAT	324
	CITROËN	197		IVECO	538		PEUGEOT	989
	PEUGEOT	973		IVECO	539		PEUGEOT	990
	PEUGEOT	974	55-4287	RENAULT	1092	55-4394	MINITUBISHI	837
	PEUGEOT	978		RENAULT	1093		MINITUBISHI	838
55-4267	NISSAN	887	55-4288	CITROËN	202		RENAULT	1056
55-4268	MINITUBISHI	844		FIAT	293		RENAULT	1061
55-4269	TOYOTA	1239		FIAT	294		RENAULT	1062









  			  			  		
	VOLVO	1386		RENAULT	1074		LANCIA	585
55-4444	FORD	429	55-4563	MAN	650	56-2651	DEUTZ	245
	FORD	430	55-4572	BMW	136		DEUTZ	246
55-4499	CITROËN	192		BMW	141		DEUTZ	247
	CITROËN	197		BMW	142		DEUTZ	248
	CITROËN	198		BMW	143		DEUTZ	249
	FIAT	307		LAND ROVER	600		DEUTZ	250
	HONDA	450	55-4584	MAN	664		DEUTZ	251
	PEUGEOT	974		MAN	665		DEUTZ	252
	PEUGEOT	978		MAN	666		IVECO	516
	ROVER	1110	55-4594	VOLVO	1409	56-2698	PORSCHE	996
55-4501	ISUZU	471	55-4706	DAF	219		PORSCHE	997
	OPEL	915		DAF	220		PORSCHE	999
55-4502	BEDFORD	116		IVECO	514		PORSCHE	1000
55-4504	SCANIA	1131		IVECO	515		PORSCHE	1001
	SCANIA	1132		NEW HOLLAND	855		PORSCHE	1002
	SCANIA	1133		NEW HOLLAND	856		PORSCHE	1003
	SCANIA	1134	55-4720	DEUTZ	252	56-2782	MERCEDES-BENZ	740
55-4505	ALFA ROMEO	13		RENAULT	1094		MERCEDES-BENZ	741
	ALFA ROMEO	14		RENAULT	1095		MERCEDES-BENZ	742
	ALFA ROMEO	15		VOLVO	1405	56-3042	MAN	643
	ALFA ROMEO	21	55-4747	MAN	660		MAN	644
	ALFA ROMEO	23		MAN	661		MAN	645
	ALFA ROMEO	24		MAN	662		MAN	646
55-4507	FIAT	357	55-4752	MAN	632		MAN	647
	FIAT	358		MAN	636		MAN	648
	IVECO	544	55-4779	ALFA ROMEO	14		MAN	649
	IVECO	545		ALFA ROMEO	19		MAN	651
55-4509	VOLVO	1409		CHRYSLER	166		MAN	652
55-4522	FORD	429		FIAT	298		MAN	653
	FORD	433		FIAT	308		MAN	654
	FORD	435		LANCIA	583		MAN	655
55-4524	PERKINS	939		LANCIA	588		MAN	656
	PERKINS	940		VOLKSWAGEN	1364		MAN	657
	PERKINS	941	55-4790	DAF	232		MAN	659
	PERKINS	942	55-4808	BMW	134		MAN	661
	RENAULT	1092		BMW	135		MAN	662
55-4532	MAN	640		BMW	137		MAN	663
	MAN	641		BMW	140		MERCEDES-BENZ	790
	MAN	642		BMW	141		MERCEDES-BENZ	791
55-4540	ALFA ROMEO	16		BMW	143		MERCEDES-BENZ	792
	ALFA ROMEO	17		BMW	144		MERCEDES-BENZ	793
	ALFA ROMEO	20	55-4832	MAN	665		MERCEDES-BENZ	794
	FIAT	302		MAN	666		MERCEDES-BENZ	795
	LANCIA	585	55-4856	DACIA	212		MERCEDES-BENZ	796
	LANCIA	589		NISSAN	881		MERCEDES-BENZ	797
55-4542	LEYLAND	610		RENAULT	1055		MERCEDES-BENZ	798
	LEYLAND	611		SUZUKI	1216		MERCEDES-BENZ	799
55-4543	JAGUAR	548	55-4875	AUDI	46		MERCEDES-BENZ	800
	JAGUAR	549		SEAT	1150		MERCEDES-BENZ	801
55-4544	SCANIA	1131		SKODA	1190		MERCEDES-BENZ	802
	SCANIA	1135		VOLKSWAGEN	1283		MERCEDES-BENZ	803
	SCANIA	1136	55-4886	HINO	438		MERCEDES-BENZ	804
55-4545	LAND ROVER	602		TOYOTA	1242		MERCEDES-BENZ	806
	LAND ROVER	603	55-4895	ISUZU	475		MERCEDES-BENZ	807
	LAND ROVER	605		ISUZU	476		MERCEDES-BENZ	809
	ROVER	1113	55-4908	RENAULT	1100		MERCEDES-BENZ	810
55-4562	NISSAN	887	55-4932	IVECO	537		MERCEDES-BENZ	812
	NISSAN	888	55-4938	LADA	570		MERCEDES-BENZ	814
	NISSAN	889		LADA	571		MERCEDES-BENZ	816
	OPEL	922	55-4970	ALFA ROMEO	16		MERCEDES-BENZ	817
	OPEL	925		CHRYSLER	166		MERCEDES-BENZ	818
	RENAULT	1073		FIAT	301		MERCEDES-BENZ	820









NUMERICAL PARTS LIST

  			  			  		
56-3611	VOLVO	1401		OPEL	914		MERCEDES-BENZ	806
	VOLVO	1402		OPEL	916		MERCEDES-BENZ	807
	VOLVO	1403	71-2234/6	MERCEDES-BENZ	797		MERCEDES-BENZ	809
	VOLVO	1404	71-2349/6	PORSCHE	996		MERCEDES-BENZ	810
	VOLVO	1407	71-2438	IHC	463		MERCEDES-BENZ	811
	VOLVO	1408		IHC	464		MERCEDES-BENZ	812
	VOLVO	1410		IHC	465		MERCEDES-BENZ	813
	VOLVO	1411		IHC	466		MERCEDES-BENZ	816
56-3839	MERCEDES-BENZ	821	71-2549/6	MERCEDES-BENZ	808		MERCEDES-BENZ	817
	MERCEDES-BENZ	822	71-2724/4	VOLVO	1395		MERCEDES-BENZ	818
	MERCEDES-BENZ	823		VOLVO	1396		MERCEDES-BENZ	819
56-3840	MERCEDES-BENZ	821	71-2773/4	MERCEDES-BENZ	731		MERCEDES-BENZ	820
	MERCEDES-BENZ	822		MERCEDES-BENZ	732	71-2974/6	MERCEDES-BENZ	725
	MERCEDES-BENZ	823		MERCEDES-BENZ	738		MERCEDES-BENZ	731
56-3855	MERCEDES-BENZ	783		MERCEDES-BENZ	739	71-2995/4	MERCEDES-BENZ	745
	MERCEDES-BENZ	785		MERCEDES-BENZ	740		MERCEDES-BENZ	746
	MERCEDES-BENZ	786		MERCEDES-BENZ	762		MERCEDES-BENZ	747
	MERCEDES-BENZ	787		SEAT	1181		MERCEDES-BENZ	763
56-3949	MAN	664	71-2811/6	MERCEDES-BENZ	788		MERCEDES-BENZ	764
	MAN	665		MERCEDES-BENZ	789	71-2995/6	MERCEDES-BENZ	729
	MAN	666	71-2834	DEUTZ	253		MERCEDES-BENZ	730
57-3049	MERCEDES-BENZ	732		DEUTZ	254	71-3004	MAN	643
	MERCEDES-BENZ	733		DEUTZ	255		MERCEDES-BENZ	808
	MERCEDES-BENZ	740		DEUTZ	256	71-3009	MERCEDES-BENZ	789
	MERCEDES-BENZ	741		DEUTZ	257		MERCEDES-BENZ	791
	MERCEDES-BENZ	742		IVECO	537		MERCEDES-BENZ	793
	MERCEDES-BENZ	754		IVECO	539		MERCEDES-BENZ	794
	MERCEDES-BENZ	755		IVECO	540		MERCEDES-BENZ	797
	MERCEDES-BENZ	756	71-2965	MAN	643		MERCEDES-BENZ	803
	MERCEDES-BENZ	757		MAN	644		MERCEDES-BENZ	806
	MERCEDES-BENZ	758		MAN	645		MERCEDES-BENZ	816
	MERCEDES-BENZ	760		MAN	646		MERCEDES-BENZ	817
	SEAT	1182		MAN	647		MERCEDES-BENZ	819
57-4994	RENAULT	1100		MAN	649	71-3014/6	PORSCHE	997
	RENAULT	1101		MAN	650		PORSCHE	998
	VOLVO	1412		MAN	651		PORSCHE	999
71-1227/6	VOLVO	1406		MAN	652	71-3084	AUDI	47
	VOLVO	1408		MAN	653		AUDI	48
71-1739/6	DAF	218		MAN	654		AUDI	50
	DAF	220		MAN	655		AUDI	53
	LEYLAND	611		MAN	656		AUDI	54
71-1950/4	SEAT	1149		MAN	657		AUDI	56
	SEAT	1183		MAN	658		AUDI	57
	VOLKSWAGEN	1300		MAN	660		AUDI	58
	VOLKSWAGEN	1361		MAN	661		AUDI	59
	VOLKSWAGEN	1362		MAN	662		AUDI	60
	VOLKSWAGEN	1363		MAN	663		AUDI	61
	VOLKSWAGEN	1364		MERCEDES-BENZ	789		AUDI	62
71-1971/4	PORSCHE	996		MERCEDES-BENZ	790		AUDI	63
71-2182/4	BMW	133		MERCEDES-BENZ	791		AUDI	71
	BMW	134		MERCEDES-BENZ	792		AUDI	73
	BMW	145		MERCEDES-BENZ	793		AUDI	84
71-2182/6	BMW	144		MERCEDES-BENZ	794		AUDI	91
	BMW	146		MERCEDES-BENZ	795		SEAT	1155
	BMW	147		MERCEDES-BENZ	796		SEAT	1171
71-2185	BEDFORD	115		MERCEDES-BENZ	797		SEAT	1183
	FORD	403		MERCEDES-BENZ	798		VOLKSWAGEN	1286
	FORD	413		MERCEDES-BENZ	799		VOLKSWAGEN	1287
	FORD	423		MERCEDES-BENZ	800		VOLKSWAGEN	1293
	FORD	428		MERCEDES-BENZ	801		VOLKSWAGEN	1301
	PERKINS	937		MERCEDES-BENZ	802		VOLKSWAGEN	1302
	SAAB	1119		MERCEDES-BENZ	803		VOLKSWAGEN	1303
71-2195/4	OPEL	912		MERCEDES-BENZ	805		VOLKSWAGEN	1304









  			  			  		
	VOLKSWAGEN	1305		DAF	223	71-3482/6	MAN	630
	VOLKSWAGEN	1314		DAF	224	71-3507/4	SAAB	1119
	VOLKSWAGEN	1318		DAF	226		SAAB	1120
	VOLKSWAGEN	1319	71-3324	MAN	643	71-3531/4	BEDFORD	114
	VOLKSWAGEN	1322		MAN	644		CHEVROLET	157
	VOLKSWAGEN	1323		MAN	651		CHEVROLET	159
	VOLKSWAGEN	1324		MAN	652		OPEL	918
	VOLKSWAGEN	1329		MAN	653		OPEL	923
	VOLKSWAGEN	1330	71-3419/4	BMW	134	71-3560	BEDFORD	115
	VOLKSWAGEN	1353		BMW	137		CHEVROLET	161
71-3144	MWM	847		BMW	143		OPEL	920
71-3174/4	BEDFORD	115	71-3419/6	BMW	130		OPEL	924
	OPEL	928		BMW	131		OPEL	928
	OPEL	929		BMW	135		OPEL	929
	OPEL	930		BMW	137		OPEL	930
71-3191/6	SCANIA	1129		BMW	138		OPEL	931
71-3192	WABCO	1414	71-3426/6	PORSCHE	999		OPEL	933
71-3227/5	MERCEDES-BENZ	756	71-3427/6	PORSCHE	1000		OPEL	934
71-3251	DEUTZ	259		PORSCHE	1001	71-3560/4	BEDFORD	115
71-3271/4	VOLVO	1396	71-3431/4	PORSCHE	1002		OPEL	920
	VOLVO	1397		PORSCHE	1003		OPEL	928
	VOLVO	1399	71-3431/8	PORSCHE	1000		OPEL	931
71-3276/4	AUDI	46		PORSCHE	1001		OPEL	934
	AUDI	47		PORSCHE	1002	71-3560/6	CHEVROLET	161
	SEAT	1150		PORSCHE	1003		OPEL	928
	SEAT	1151	71-3442/4	AUDI	50		OPEL	929
	SEAT	1152		AUDI	51		OPEL	930
	VOLKSWAGEN	1282		AUDI	64		OPEL	934
	VOLKSWAGEN	1283		SEAT	1159	71-3561/5	MAN	646
	VOLKSWAGEN	1284		SEAT	1160		MAN	647
	VOLKSWAGEN	1285		SEAT	1161		MERCEDES-BENZ	795
	VOLKSWAGEN	1288		SKODA	1194	71-3561/6	MAN	647
71-3289/2	MAN	643		SKODA	1195		MAN	649
	MAN	644		VOLKSWAGEN	1294		MAN	655
	MAN	645		VOLKSWAGEN	1295		MAN	656
	MAN	646		VOLKSWAGEN	1304		MERCEDES-BENZ	795
	MAN	650		VOLKSWAGEN	1305		MERCEDES-BENZ	796
	MAN	651		VOLKSWAGEN	1306		MERCEDES-BENZ	810
	MAN	652		VOLKSWAGEN	1307		MERCEDES-BENZ	812
	MAN	653		VOLKSWAGEN	1312	71-3566/4	AUDI	71
	MAN	654	71-3442/5	AUDI	51		AUDI	74
	MERCEDES-BENZ	789		AUDI	69		AUDI	78
	MERCEDES-BENZ	790		VOLKSWAGEN	1313		AUDI	85
	MERCEDES-BENZ	791	71-3442/6	VOLKSWAGEN	1296		NISSAN	884
	MERCEDES-BENZ	792		VOLVO	1384		SEAT	1171
	MERCEDES-BENZ	793	71-3446/6	VOLVO	1398		VOLKSWAGEN	1314
	MERCEDES-BENZ	794		VOLVO	1400		VOLKSWAGEN	1320
	MERCEDES-BENZ	797	71-3447	MWM	846		VOLKSWAGEN	1325
	MERCEDES-BENZ	798	71-3476/8	MERCEDES-BENZ	742		VOLKSWAGEN	1328
	MERCEDES-BENZ	799		MERCEDES-BENZ	758		VOLKSWAGEN	1336
	MERCEDES-BENZ	800		MERCEDES-BENZ	759		VOLKSWAGEN	1337
	MERCEDES-BENZ	801		MERCEDES-BENZ	760		VOLKSWAGEN	1340
	MERCEDES-BENZ	802		MERCEDES-BENZ	765		VOLKSWAGEN	1342
	MERCEDES-BENZ	803		MERCEDES-BENZ	766		VOLKSWAGEN	1343
	MERCEDES-BENZ	805	71-3477/8	MERCEDES-BENZ	742		VOLKSWAGEN	1346
	MERCEDES-BENZ	806		MERCEDES-BENZ	758	71-3566/5	AUDI	53
	MERCEDES-BENZ	807		MERCEDES-BENZ	759		AUDI	57
	MERCEDES-BENZ	816		MERCEDES-BENZ	765		AUDI	58
	MERCEDES-BENZ	817		MERCEDES-BENZ	766		AUDI	60
	MERCEDES-BENZ	818		MERCEDES-BENZ	767		AUDI	61
	MERCEDES-BENZ	819	71-3480/6	VOLVO	1401		AUDI	74
	MERCEDES-BENZ	820		VOLVO	1402		AUDI	75
71-3291/6P	DAF	222		VOLVO	1404		AUDI	77













NUMERICAL PARTS LIST

  	  	  
AUDI 89	MAN 650	AUDI 87
VOLKSWAGEN 1330	MAN 651	AUDI 96
VOLKSWAGEN 1347	MAN 652	AUDI 99
71-3572/4 MERCEDES-BENZ 768	MAN 653	AUDI 100
MERCEDES-BENZ 769	MAN 654	NISSAN 884
MERCEDES-BENZ 776	MERCEDES-BENZ 792	SEAT 1167
71-3572/6 MERCEDES-BENZ 771	MERCEDES-BENZ 797	SEAT 1168
MERCEDES-BENZ 773	MERCEDES-BENZ 802	SEAT 1169
MERCEDES-BENZ 774	MERCEDES-BENZ 803	SEAT 1171
MERCEDES-BENZ 775	MERCEDES-BENZ 805	SEAT 1172
MERCEDES-BENZ 780	MERCEDES-BENZ 806	SEAT 1173
71-3573/6 BMW 132	MERCEDES-BENZ 807	SEAT 1174
BMW 140	MERCEDES-BENZ 818	SEAT 1175
71-3593 MWM 847	MERCEDES-BENZ 820	SEAT 1176
71-3601/6 VOLVO 1406	71-3639/4 BEDFORD 113	SEAT 1178
VOLVO 1407	CHEVROLET 155	SEAT 1179
71-3613/6 VOLVO 1409	CHEVROLET 156	SKODA 1199
VOLVO 1410	CHEVROLET 157	SKODA 1200
71-3616/4 VOLVO 1397	CHEVROLET 158	SKODA 1202
VOLVO 1399	NISSAN 882	SKODA 1203
71-3623/6 VOLVO 1402	OPEL 912	VOLKSWAGEN 1286
VOLVO 1403	OPEL 914	VOLKSWAGEN 1287
VOLVO 1404	OPEL 915	VOLKSWAGEN 1304
71-3626/4 BEDFORD 114	OPEL 917	VOLKSWAGEN 1313
CHEVROLET 157	OPEL 918	VOLKSWAGEN 1314
CHEVROLET 159	OPEL 920	VOLKSWAGEN 1315
CHEVROLET 160	SAAB 1118	VOLKSWAGEN 1316
ISUZU 472	SUZUKI 1216	VOLKSWAGEN 1317
LADA 571	71-3645 MERCEDES-BENZ 735	VOLKSWAGEN 1318
OPEL 918	MERCEDES-BENZ 736	VOLKSWAGEN 1318
OPEL 920	MERCEDES-BENZ 737	VOLKSWAGEN 1320
OPEL 921	MERCEDES-BENZ 748	VOLKSWAGEN 1321
OPEL 923	MERCEDES-BENZ 750	VOLKSWAGEN 1322
OPEL 924	MERCEDES-BENZ 751	VOLKSWAGEN 1323
OPEL 926	71-3652 BMW 147	VOLKSWAGEN 1325
OPEL 927	71-3660/4 MAN 631	VOLKSWAGEN 1326
71-3627/4 CITROËN 194	71-3660/6 MAN 630	VOLKSWAGEN 1327
PEUGEOT 975	MAN 634	VOLKSWAGEN 1328
PEUGEOT 976	MAN 635	VOLKSWAGEN 1331
71-3628/4 CITROËN 196	71-3665/4 SEAT 1151	VOLKSWAGEN 1332
PEUGEOT 977	SEAT 1180	VOLKSWAGEN 1333
71-3631/6P DAF 224	71-3693 MERCEDES-BENZ 790	VOLKSWAGEN 1334
DAF 225	MERCEDES-BENZ 798	VOLKSWAGEN 1335
DAF 226	MERCEDES-BENZ 799	VOLKSWAGEN 1336
DAF 227	MERCEDES-BENZ 800	VOLKSWAGEN 1338
DAF 229	MERCEDES-BENZ 817	VOLKSWAGEN 1339
DAF 230	71-3693/6 MERCEDES-BENZ 790	VOLKSWAGEN 1340
LEYLAND 612	MERCEDES-BENZ 798	VOLKSWAGEN 1341
71-3637 MAN 655	MERCEDES-BENZ 799	VOLKSWAGEN 1342
MAN 656	MERCEDES-BENZ 800	VOLKSWAGEN 1343
MAN 657	MERCEDES-BENZ 817	VOLKSWAGEN 1344
MAN 658	71-3694/4 AUDI 47	VOLKSWAGEN 1345
MAN 660	AUDI 70	VOLKSWAGEN 1346
MAN 661	AUDI 71	VOLKSWAGEN 1349
MAN 662	AUDI 72	VOLKSWAGEN 1357
MAN 663	AUDI 73	VOLKSWAGEN 1358
MERCEDES-BENZ 810	AUDI 78	VOLKSWAGEN 1359
MERCEDES-BENZ 811	AUDI 79	VOLKSWAGEN 1360
MERCEDES-BENZ 812	AUDI 80	VOLKSWAGEN 1361
71-3638 MAN 643	71-3694/5 AUDI 57	AUDI 57
MAN 644	AUDI 59	AUDI 59
MAN 645	AUDI 74	AUDI 74
MAN 646	AUDI 75	AUDI 75
	AUDI 81	AUDI 76
	AUDI 84	
	AUDI 85	
	AUDI 86	









  		  		  	
AUDI	77	AUDI	88	MERCEDES-BENZ	753
AUDI	87	AUDI	95	71-3817/8 MERCEDES-BENZ	759
AUDI	89	AUDI	96	MERCEDES-BENZ	766
AUDI	90	SEAT	1173	71-3821/4 OPEL	921
AUDI	97	SKODA	1200	71-3835 MERCEDES-BENZ	821
VOLKSWAGEN	1330	VOLKSWAGEN	1333	71-3847/4 AUDI	65
VOLKSWAGEN	1346	VOLKSWAGEN	1335	AUDI	66
VOLKSWAGEN	1347	VOLKSWAGEN	1341	FORD	399
VOLKSWAGEN	1353	VOLKSWAGEN	1342	FORD	401
71-3695/6 VOLVO	1398	VOLKSWAGEN	1345	SEAT	1153
VOLVO	1400	VOLVO	1390	SEAT	1161
71-3704/4 BMW	133	71-3733/6 CITROËN	206	SEAT	1162
BMW	139	PEUGEOT	985	SEAT	1164
BMW	141	PEUGEOT	988	SKODA	1196
LAND ROVER	600	RENAULT	1077	VOLKSWAGEN	1289
ROVER	1111	RENAULT	1082	VOLKSWAGEN	1307
71-3704/6 BMW	132	VOLVO	1396	VOLKSWAGEN	1309
BMW	133	VOLVO	1397	71-3847/5 VOLKSWAGEN	1354
BMW	136	71-3753/4 CHEVROLET	161	71-3850 MERCEDES-BENZ	782
BMW	140	OPEL	934	MERCEDES-BENZ	784
BMW	142	71-3754/4 RENAULT	1071	MERCEDES-BENZ	785
LAND ROVER	600	VOLVO	1385	MERCEDES-BENZ	786
ROVER	1110	VOLVO	1386	71-3857/6 MERCEDES-BENZ	728
71-3706/8 BMW	134	VOLVO	1388	MERCEDES-BENZ	751
BMW	137	VOLVO	1392	MERCEDES-BENZ	752
BMW	146	71-3754/5 RENAULT	1072	MERCEDES-BENZ	753
BMW	147	VOLVO	1386	MERCEDES-BENZ	767
71-3711/6 AUDI	77	VOLVO	1389	71-3857/8 MERCEDES-BENZ	753
AUDI	92	VOLVO	1393	MERCEDES-BENZ	767
AUDI	96	71-3754/6 VOLVO	1387	71-3861/4 MERCEDES-BENZ	724
AUDI	98	VOLVO	1394	71-3866/6 DAF	232
AUDI	100	71-3764/4 CHEVROLET	159	71-3868 MERCEDES-BENZ	815
SKODA	1202	CHEVROLET	160	MERCEDES-BENZ	823
VOLKSWAGEN	1356	ISUZU	472	71-3869/4 CHEVROLET	158
VOLKSWAGEN	1357	LADA	571	OPEL	922
71-3728/4 AUDI	64	OPEL	926	71-3870/4 OPEL	923
AUDI	65	OPEL	927	SAAB	1118
AUDI	66	71-3765/4 VOLKSWAGEN	1292	71-3876 MERCEDES-BENZ	743
FORD	399	71-3775/6 PORSCHE	1001	MERCEDES-BENZ	744
FORD	400	PORSCHE	1003	71-3882/3 MERCEDES-BENZ	724
SEAT	1160	71-3781/4 CITROËN	205	SMART	1206
SEAT	1161	DAF	218	71-3893/6 MERCEDES-BENZ	813
SEAT	1162	PEUGEOT	988	71-3897/6 MERCEDES-BENZ	799
SEAT	1163	DAF	218	MERCEDES-BENZ	800
SKODA	1194	DAF	226	MERCEDES-BENZ	801
SKODA	1195	DAF	227	71-3899/4 CITROËN	197
SKODA	1196	DAF	230	CITROËN	198
VOLKSWAGEN	1306	LEYLAND	612	FIAT	307
VOLKSWAGEN	1307	71-3794/6 DAF	221	PEUGEOT	978
VOLKSWAGEN	1308	71-3817/4 MERCEDES-BENZ	728	71-3902/5 ROVER	1111
VOLKSWAGEN	1309	MERCEDES-BENZ	745	71-3904 AUDI	50
71-3730/4 CITROËN	192	MERCEDES-BENZ	746	AUDI	55
CITROËN	197	MERCEDES-BENZ	747	AUDI	63
CITROËN	198	MERCEDES-BENZ	748	AUDI	67
FIAT	307	MERCEDES-BENZ	752	AUDI	68
HONDA	450	MERCEDES-BENZ	754	AUDI	69
PEUGEOT	974	MERCEDES-BENZ	763	FORD	401
PEUGEOT	978	MERCEDES-BENZ	764	SEAT	1158
ROVER	1110	MERCEDES-BENZ	765	SEAT	1160
71-3732 AUDI	79	71-3817/6 MERCEDES-BENZ	726	SEAT	1163
AUDI	80	MERCEDES-BENZ	744	SEAT	1164
AUDI	81	MERCEDES-BENZ	745	SEAT	1165
AUDI	82	MERCEDES-BENZ	752	SEAT	1166









NUMERICAL PARTS LIST

  	  	  			
SKODA	1193	SEAT	1164	RENAULT	1069
SKODA	1194	SEAT	1166	RENAULT	1070
SKODA	1197	SEAT	1177	RENAULT	1071
SKODA	1198	SEAT	1178	RENAULT	1074
VOLKSWAGEN	1294	SKODA	1197	SUZUKI	1217
VOLKSWAGEN	1299	SKODA	1198	VOLVO	1385
VOLKSWAGEN	1303	SKODA	1201	71-3994 ALFA ROMEO	17
VOLKSWAGEN	1305	SKODA	1202	ALFA ROMEO	18
VOLKSWAGEN	1310	VOLKSWAGEN	1310	ALFA ROMEO	20
VOLKSWAGEN	1311	VOLKSWAGEN	1311	CHRYSLER	166
VOLKSWAGEN	1312	VOLKSWAGEN	1312	FIAT	303
VOLKSWAGEN	1350	VOLKSWAGEN	1350	FIAT	304
71-3913/6 PORSCHE	1002	VOLKSWAGEN	1351	FIAT	308
71-3914/6 DAF	222	VOLKSWAGEN	1355	FIAT	343
71-3919/6 DAF	231	71-3932 VOLKSWAGEN	1362	LANCIA	586
71-3922/6 DEUTZ	252	71-3933/8 AUDI	92	LANCIA	587
71-3923/6 RENAULT	1100	AUDI	101	LANCIA	588
VOLVO	1411	71-3938/6 MAN	637	OPEL	920
71-3926 VOLVO	1387	MAN	638	SAAB	1118
VOLVO	1388	71-3939 MAN	633	SUZUKI	1217
VOLVO	1389	MAN	637	71-3996/4 ALFA ROMEO	16
VOLVO	1390	MAN	638	71-3998/4 MERCEDES-BENZ	726
VOLVO	1391	71-3951/4 CITROËN	205	MERCEDES-BENZ	727
VOLVO	1393	DAF	218	71-4002/4 MERCEDES-BENZ	724
VOLVO	1394	FIAT	322	MERCEDES-BENZ	725
VOLVO	1395	PEUGEOT	988	71-4007/6 MERCEDES-BENZ	742
71-3929/4 AUDI	65	71-3952/4 CITROËN	200	MERCEDES-BENZ	743
AUDI	66	CITROËN	201	MERCEDES-BENZ	761
AUDI	70	FIAT	315	71-4007/8 MERCEDES-BENZ	761
AUDI	81	FIAT	316	MERCEDES-BENZ	781
AUDI	82	FORD	415	71-4013 HYUNDAI	459
AUDI	84	FORD	416	MERCEDES-BENZ	726
AUDI	100	FORD	419	MITSUBISHI	840
FORD	399	LANCIA	593	SMART	1206
FORD	400	LAND ROVER	601	71-4023/6 VOLVO	1405
FORD	401	MITSUBISHI	841	71-4033/4 ALFA ROMEO	12
SEAT	1161	PEUGEOT	982	CHEVROLET	155
SEAT	1163	PEUGEOT	983	CHRYSLER	165
SEAT	1168	SUZUKI	1219	CITROËN	184
SEAT	1173	VOLVO	1395	FIAT	290
SEAT	1174	71-3964/6 DEUTZ	253	LANCIA	580
SEAT	1179	VOLVO	1402	OPEL	912
SEAT	1180	VOLVO	1404	PEUGEOT	962
SKODA	1199	71-3986 CITROËN	187	SUZUKI	1214
SKODA	1203	FORD	390	71-4041/4 RENAULT	1076
VOLKSWAGEN	1307	MAZDA	673	71-4052/6 RENAULT	1100
VOLKSWAGEN	1309	PEUGEOT	967	VOLVO	1412
VOLKSWAGEN	1314	SUZUKI	1215	71-4055/6 VOLVO	1413
VOLKSWAGEN	1315	71-3988/4 DACIA	212	71-4060/6 RENAULT	1099
VOLKSWAGEN	1316	DACIA	213	VOLVO	1409
VOLKSWAGEN	1317	MITSUBISHI	837	71-4065 MERCEDES-BENZ	783
VOLKSWAGEN	1332	MITSUBISHI	838	MERCEDES-BENZ	786
VOLKSWAGEN	1336	NISSAN	884	MERCEDES-BENZ	787
VOLKSWAGEN	1346	NISSAN	885	71-4066/4 CITROËN	202
VOLKSWAGEN	1358	OPEL	919	FIAT	317
VOLKSWAGEN	1359	OPEL	922	FORD	415
VOLKSWAGEN	1360	RENAULT	1060	FORD	417
VOLKSWAGEN	1361	RENAULT	1061	FORD	418
71-3930 AUDI	68	RENAULT	1062	FORD	419
AUDI	93	RENAULT	1064	FORD	422
FORD	401	RENAULT	1065	JAGUAR	548
JOHN DEERE	552	RENAULT	1067	PEUGEOT	984
MITSUBISHI	840	RENAULT	1068	71-4080/4 FIAT	321

   	   	   
IVECO 494	ALFA ROMEO 27	ALFA ROMEO 21
IVECO 510	CITROËN 207	71-4164/4 HONDA 451
71-4082/4 FIAT 327	FIAT 322	LAND ROVER 601
IVECO 510	FIAT 323	ROVER 1111
71-4087/6 IVECO 534	FIAT 324	71-4167/4 FORD 429
71-4091/6 IVECO 539	IVECO 495	71-4168/4 ALFA ROMEO 13
71-4095/6 IVECO 541	IVECO 496	ALFA ROMEO 16
71-4104 FIAT 334	IVECO 499	ALFA ROMEO 21
FIAT 335	IVECO 500	ALFA ROMEO 22
FIAT 342	IVECO 501	ALFA ROMEO 23
FIAT 344	IVECO 502	71-4170/4 RENAULT 1090
FIAT 345	IVECO 503	RENAULT 1091
FIAT 346	IVECO 504	RENAULT 1092
FIAT 348	IVECO 505	71-4185/4 ALFA ROMEO 26
FIAT 349	IVECO 506	ALFA ROMEO 27
IVECO 513	IVECO 508	FIAT 322
IVECO 519	LANCIA 595	FIAT 323
IVECO 520	LANCIA 596	IVECO 494
IVECO 522	OPEL 932	IVECO 495
IVECO 523	PEUGEOT 990	IVECO 496
IVECO 524	RENAULT 1083	IVECO 497
IVECO 525	RENAULT 1084	IVECO 501
IVECO 526	RENAULT 1085	IVECO 505
IVECO 529	RENAULT 1087	LANCIA 595
IVECO 530	RENAULT 1088	LANCIA 596
NEW HOLLAND 854	RENAULT 1089	OPEL 932
NEW HOLLAND 860	RENAULT 1090	RENAULT 1083
NEW HOLLAND 861	RENAULT 1091	RENAULT 1087
NEW HOLLAND 862	SEAT 1182	SEAT 1182
71-4108 FIAT 357	71-4143/4 FORD 414	71-4194/4 FORD 427
FIAT 358	HYUNDAI 457	HYUNDAI 460
IVECO 545	HYUNDAI 458	KIA 565
71-4109 SAME 1123	HYUNDAI 459	MAZDA 678
71-4113 RENAULT 1096	HYUNDAI 460	MITSUBISHI 839
RENAULT 1101	KIA 564	MITSUBISHI 840
71-4114 FORD 435	MITSUBISHI 835	MITSUBISHI 841
FORD 436	MITSUBISHI 836	MITSUBISHI 842
71-4115 PERKINS 939	MITSUBISHI 837	MITSUBISHI 843
PERKINS 940	MITSUBISHI 839	71-4198/4 CITROËN 206
PERKINS 941	MITSUBISHI 840	PEUGEOT 989
RENAULT 1092	MITSUBISHI 841	71-4204/4 NISSAN 878
71-4115/6 PERKINS 940	71-4145/4 TOYOTA 1238	NISSAN 879
PERKINS 941	TOYOTA 1239	NISSAN 882
71-4118/4 ALFA ROMEO 23	71-4151/4 FORD 412	71-4205/4 CHEVROLET 156
FIAT 306	FORD 431	NISSAN 885
FIAT 313	71-4156/4 ISUZU 474	NISSAN 886
FIAT 314	NISSAN 892	NISSAN 888
LANCIA 587	NISSAN 893	NISSAN 889
LANCIA 592	71-4157/4 ALFA ROMEO 17	NISSAN 890
71-4120/4 FIAT 311	ALFA ROMEO 19	NISSAN 891
FIAT 313	ALFA ROMEO 20	71-4206 FORD 431
FIAT 314	ALFA ROMEO 23	NISSAN 886
LANCIA 590	FIAT 302	NISSAN 887
LANCIA 591	FIAT 303	NISSAN 890
71-4121/4 FIAT 297	FIAT 305	NISSAN 891
71-4122/4 NISSAN 882	FIAT 306	NISSAN 892
NISSAN 883	FIAT 311	71-4209/5 FIAT 302
NISSAN 886	FIAT 314	LANCIA 585
NISSAN 887	LANCIA 585	71-4212 FIAT 349
NISSAN 888	LANCIA 591	IVECO 531
71-4126/4 FIAT 297	LANCIA 592	IVECO 532
FIAT 300	71-4157/5 LANCIA 589	71-4214/6 SCANIA 1129
71-4130/4 ALFA ROMEO 26	71-4158/4 ALFA ROMEO 16	SCANIA 1130

NUMERICAL PARTS LIST

  			  			  		
71-4215/6	FIAT	354		VM	1248		FIAT	337
	FIAT	355		VM	1249		IVECO	508
	FIAT	356		VM	1250		IVECO	509
	IVECO	541	71-4236/6	VOLVO	1409		IVECO	512
	IVECO	543		VOLVO	1411		IVECO	516
71-4218/6	ALFA ROMEO	15	71-4237/6	SCANIA	1130		NEW HOLLAND	849
	ALFA ROMEO	24		SCANIA	1133		NEW HOLLAND	850
	ALFA ROMEO	25		SCANIA	1134		NEW HOLLAND	851
	ALFA ROMEO	26	71-4238	FIAT	356		NEW HOLLAND	853
	FIAT	320		FIAT	357		NEW HOLLAND	856
	LANCIA	595		IVECO	544		NEW HOLLAND	857
71-4219/6	VOLVO	1413		IVECO	545		NEW HOLLAND	859
71-4221/6	FIAT	352	71-4239	RENAULT	1101	71-4284	FIAT	352
	IVECO	540	71-4243/4	DACIA	211		IVECO	538
71-4222	RENAULT	1095		NISSAN	881	71-4286	RENAULT	1092
	RENAULT	1096		RENAULT	1055		RENAULT	1093
71-4223	SAME	1122		SUZUKI	1216	71-4289	RENAULT	1093
	SAME	1123	71-4246/4	CITROËN	191		RENAULT	1094
	SAME	1124		FIAT	294	71-4290	RENAULT	1097
71-4227	FIAT	350		FORD	395		RENAULT	1098
	FIAT	351		PEUGEOT	970		RENAULT	1099
	IVECO	532		SUZUKI	1216		RENAULT	1100
	IVECO	533	71-4249/8	SCANIA	1131	71-4295	RENAULT	1097
	IVECO	534		SCANIA	1132		RENAULT	1098
	IVECO	535	71-4250/4	ALFA ROMEO	24	71-4297/4	CHEVROLET	157
	IVECO	536	71-4253/4	HONDA	450		ISUZU	471
71-4229	FIAT	325		HONDA	451		MAZDA	675
	FIAT	326		HONDA	452		OPEL	914
	FIAT	327		ISUZU	472		OPEL	917
	FIAT	328		ROVER	1112	71-4302	LISTER	615
	FIAT	330	71-4256/4	TOYOTA	1237	71-4304	LISTER	616
	FIAT	331		TOYOTA	1238	71-4305	LISTER	615
	FIAT	333	71-4258/4	ISUZU	471	71-4306	RENAULT	1101
	FIAT	334		ISUZU	472	71-4309/3	BEDFORD	113
	FIAT	336		ISUZU	473		DAIHATSU	235
	FIAT	337		OPEL	929		DAIHATSU	236
	FIAT	338	71-4261/4	DAIHATSU	235		KIA	563
	FIAT	339		TOYOTA	1231		OPEL	914
	FIAT	340		TOYOTA	1232	71-4311/4	DACIA	212
	FIAT	341		TOYOTA	1233		DAIHATSU	837
	FIAT	342	71-4277	JOHN DEERE	556		DAIHATSU	838
	FIAT	346		JOHN DEERE	557		RENAULT	1056
	IVECO	510		JOHN DEERE	558		RENAULT	1060
	IVECO	511	71-4278/4	DAIHATSU	237		RENAULT	1061
	IVECO	512		FORD	409		RENAULT	1062
	IVECO	516		FORD	417		RENAULT	1064
	IVECO	518		KIA	565		RENAULT	1065
	IVECO	519		MAZDA	674		RENAULT	1066
	NEW HOLLAND	849		MAZDA	675		RENAULT	1067
	NEW HOLLAND	850		MAZDA	677		RENAULT	1068
	NEW HOLLAND	851		SUZUKI	1219		RENAULT	1069
	NEW HOLLAND	852	71-4279/4	CITROËN	200		RENAULT	1071
	NEW HOLLAND	856		CITROËN	201		VOLVO	1385
	NEW HOLLAND	857		CITROËN	202		VOLVO	1392
	NEW HOLLAND	858		FIAT	316	71-4336/4	AUSTIN	109
	NEW HOLLAND	859		LANCIA	593		LEYLAND	609
	NEW HOLLAND	860		LANCIA	594	71-4339/4	LEYLAND	610
71-4234	ALFA ROMEO	24		PEUGEOT	983		HONDA	448
	ALFA ROMEO	25		PEUGEOT	984	71-4342/4	TRIUMPH	1245
	CHRYSLER	168		SUZUKI	1219		DAIHATSU	237
	FORD	428	71-4281	FIAT	325		TOYOTA	1240
	JOHN DEERE	554		FIAT	328		TOYOTA	1241
	ROVER	1113		FIAT	331	71-4348/4	DAIHATSU	844









  	  	  
71-4353/4 AUSTIN 109	JOHN DEERE 558	FIAT 308
LEYLAND 610	71-4510/12 JAGUAR 549	LANCIA 586
PERKINS 937	71-4529 MAN 640	LANCIA 587
ROVER 1112	MAN 641	LANCIA 588
71-4357/4 HONDA 449	MAN 642	71-4784 MERCEDES-BENZ 814
71-4358/4 HONDA 449	MAN 650	MERCEDES-BENZ 816
HONDA 450	71-4564/4 TOYOTA 1238	MERCEDES-BENZ 823
ROVER 1109	TOYOTA 1239	MITSUBISHI 844
71-4360/4 MITSUBISHI 844	71-4565/4 TOYOTA 1239	71-4785 DAF 232
71-4368/6 LEYLAND 612	TOYOTA 1240	71-4787 DAF 232
71-4371/6 JAGUAR 548	71-4567/4 MITSUBISHI 843	71-4805 BMW 142
JAGUAR 549	71-4573 DAF 219	BMW 143
71-4372/6 BEDFORD 117	DAF 220	MINI 826
71-4375 NEW HOLLAND 862	IVECO 513	71-4806/4 BMW 135
71-4376/6 TOYOTA 1239	IVECO 514	BMW 137
71-4378/8 LAND ROVER 605	IVECO 515	BMW 140
LAND ROVER 606	NEW HOLLAND 855	BMW 141
ROVER 1114	NEW HOLLAND 856	BMW 143
71-4379/4 FORD 406	71-4580/4 NISSAN 890	71-4806/6 BMW 134
FORD 407	NISSAN 892	BMW 144
FORD 408	71-4708 DAF 219	71-4807/2 BMW 133
FORD 409	DAF 220	BMW 140
FORD 410	IVECO 513	BMW 141
71-4382/4 FORD 398	IVECO 514	71-4809 MERCEDES-BENZ 727
FORD 420	NEW HOLLAND 855	71-4823 DEUTZ 257
FORD 424	NEW HOLLAND 856	71-4856/4 ISUZU 475
FORD 425	71-4716 DEUTZ 252	71-4856/6 ISUZU 475
FORD 426	RENAULT 1094	ISUZU 476
71-4383/6 DAF 221	RENAULT 1095	71-4860 SCANIA 1131
71-4385/6 FIAT 354	VOLVO 1405	SCANIA 1135
FIAT 355	71-4723 DEUTZ 250	SCANIA 1136
FIAT 356	71-4724 JOHN DEERE 552	71-4861 SCANIA 1136
IVECO 542	MERCEDES-BENZ 728	71-4869/4 AUSTIN 104
IVECO 543	71-4732/4 CHEVROLET 158	AUSTIN 105
71-4386/6 FIAT 352	SUZUKI 1218	AUSTIN 106
IVECO 539	71-4744/4 NISSAN 890	AUSTIN 108
71-4389 FIAT 342	NISSAN 891	LEYLAND 608
FIAT 344	OPEL 928	ROVER 1107
FIAT 345	OPEL 930	71-4870/4 AUSTIN 107
FIAT 346	RENAULT 1077	ROVER 1107
FIAT 348	RENAULT 1082	71-4888 HINO 440
FIAT 349	71-4746 MAN 640	71-4889 HINO 438
IVECO 519	MAN 641	HINO 439
IVECO 520	MAN 664	71-4890/4 HONDA 452
IVECO 522	MAN 665	71-4891/4 HONDA 452
IVECO 523	MAN 666	71-4904/6 RENAULT 1099
IVECO 526	71-4748 MAN 632	71-4909 KAMAZ 560
IVECO 529	MAN 636	71-4936/6 IVECO 537
NEW HOLLAND 861	71-4755 DEUTZ 257	71-4940 NISSAN 889
NEW HOLLAND 862	DEUTZ 258	OPEL 925
71-4390 FIAT 350	71-4776/4 ALFA ROMEO 14	RENAULT 1074
FIAT 351	ALFA ROMEO 19	71-4942 MERCEDES-BENZ 822
IVECO 532	CHRYSLER 165	71-4948/6 ISUZU 476
IVECO 533	FIAT 298	ISUZU 477
IVECO 534	FIAT 308	71-4949/6 RENAULT 1101
IVECO 535	LANCIA 583	VOLVO 1412
IVECO 536	LANCIA 588	71-4986/6 NEW HOLLAND 863
71-4396/4 LAND ROVER 602	VOLKSWAGEN 1363	71-5002/4 HYUNDAI 458
LAND ROVER 604	71-4780 ALFA ROMEO 18	HYUNDAI 459
ROVER 1113	ALFA ROMEO 19	KIA 564
71-4446/4 FORD 405	ALFA ROMEO 20	71-5006/4 HYUNDAI 459
71-4498/6 JOHN DEERE 556	CHRYSLER 166	KIA 564
JOHN DEERE 557	FIAT 304	71-5007/4 HYUNDAI 460









NUMERICAL PARTS LIST

Nummerische Teileliste • Elenco referimento • Liste numérique des references









Lista de referencias numéricas • Lista numeryczna części









Список номеров деталей • قائمة الأجزاء الرقمية

  			  			  		
	KIA	564		NEW HOLLAND	861		NEW HOLLAND	851
72-2439	IHC	463		NEW HOLLAND	862		NEW HOLLAND	853
	IHC	464	72-4547	FIAT	325		NEW HOLLAND	856
	IHC	465		FIAT	326		NEW HOLLAND	858
	IHC	466		FIAT	327		NEW HOLLAND	859
	IHC	467		FIAT	328	72-4552	SAME	1122
72-2440H	IHC	463		FIAT	330		SAME	1123
	IHC	464		FIAT	331		SAME	1124
	IHC	465		FIAT	332	72-4556	FIAT	342
	IHC	466		FIAT	333		FIAT	344
	IHC	467		FIAT	334		FIAT	345
72-2658	DEUTZ	258		FIAT	335		FIAT	348
72-3448	MWM	846		FIAT	336		IVECO	520
72-3837	MERCEDES-BENZ	821		FIAT	337		IVECO	521
	MERCEDES-BENZ	822		FIAT	338		IVECO	524
	MERCEDES-BENZ	823		FIAT	339		IVECO	527
72-3851	MERCEDES-BENZ	782		FIAT	340		IVECO	529
	MERCEDES-BENZ	784		FIAT	341		IVECO	530
	MERCEDES-BENZ	785		FIAT	342	72-4557	LISTER	616
	MERCEDES-BENZ	786		FIAT	343	72-4717	DEUTZ	252
72-3856	MERCEDES-BENZ	743		FIAT	346		RENAULT	1094
	MERCEDES-BENZ	744		IVECO	510		RENAULT	1095
72-3995	ALFA ROMEO	17		IVECO	511		VOLVO	1405
	ALFA ROMEO	18		IVECO	512	72-4725	JOHN DEERE	552
	ALFA ROMEO	19		IVECO	517		MERCEDES-BENZ	728
	ALFA ROMEO	20		IVECO	518	72-4726H	JOHN DEERE	552
	CHRYSLER	166		IVECO	519		MERCEDES-BENZ	728
	FIAT	304		NEW HOLLAND	849	72-4749	MAN	632
	FIAT	308		NEW HOLLAND	850		MAN	636
	LANCIA	586		NEW HOLLAND	851	72-4756	DEUTZ	257
	LANCIA	587		NEW HOLLAND	853		DEUTZ	258
	LANCIA	588		NEW HOLLAND	856	72-4760	MERCEDES-BENZ	783
	OPEL	920		NEW HOLLAND	858		MERCEDES-BENZ	786
	SAAB	1118		NEW HOLLAND	859		MERCEDES-BENZ	787
72-4014	HYUNDAI	459		NEW HOLLAND	860	72-4788	DAF	232
	MERCEDES-BENZ	726	72-4548	FIAT	356	72-4793	MAN	664
	MITSUBISHI	840		FIAT	357	72-4810	MERCEDES-BENZ	727
	SMART	1206		FIAT	358	72-4826	DEUTZ	257
72-4072	SCANIA	1131		IVECO	544	72-4887	HINO	438
	SCANIA	1135		IVECO	545		HINO	439
	SCANIA	1136	72-4550	FIAT	325		HINO	440
	SCANIA	1137		FIAT	326	72-4910	KAMAZ	560
72-4546	FIAT	334		FIAT	327	73-4828	VOLKSWAGEN	1355
	FIAT	335		FIAT	328	A005/4	AUSTIN	104
	FIAT	342		FIAT	330		AUSTIN	105
	FIAT	343		FIAT	332		AUSTIN	106
	FIAT	344		FIAT	333		LEYLAND	608
	FIAT	345		FIAT	334		ROVER	1107
	FIAT	346		FIAT	335	A006/4	AUSTIN	107
	FIAT	348		FIAT	336		AUSTIN	108
	FIAT	349		FIAT	337		AUSTIN	109
	IVECO	513		FIAT	338		ROVER	1107
	IVECO	520		FIAT	340		ROVER	1108
	IVECO	521		FIAT	341	A022/4	DAF	221
	IVECO	522		FIAT	343	A023/4	DAF	218
	IVECO	523		FIAT	346		DAF	222
	IVECO	524		IVECO	508		DAF	223
	IVECO	525		IVECO	509		DAF	225
	IVECO	527		IVECO	511		DAF	226
	IVECO	529		IVECO	512		DAF	227
	IVECO	530		IVECO	517		DAF	228
	NEW HOLLAND	854		NEW HOLLAND	849		DAF	229
	NEW HOLLAND	860		NEW HOLLAND	850		DAF	231









  			  			  		
	LEYLAND	613	AUDI	94	VOLKSWAGEN	1291		
A031/4	DAVID BROWN	240	AUDI	95	VOLKSWAGEN	1292		
	LISTER	615	AUDI	96	VOLKSWAGEN	1294		
A045/4	FORD	394	AUDI	99	VOLKSWAGEN	1297		
	FORD	397	AUDI	100	VOLKSWAGEN	1298		
	FORD	398	FORD	399	VOLKSWAGEN	1299		
	FORD	410	FORD	400	VOLKSWAGEN	1304		
	FORD	411	FORD	401	VOLKSWAGEN	1305		
	FORD	420	FORD	402	VOLKSWAGEN	1306		
	FORD	421	JOHN DEERE	552	VOLKSWAGEN	1307		
	FORD	422	mitsubishi	840	VOLKSWAGEN	1308		
	FORD	424	NISSAN	885	VOLKSWAGEN	1309		
	FORD	425	SEAT	1150	VOLKSWAGEN	1310		
	FORD	426	SEAT	1151	VOLKSWAGEN	1311		
A087/4	DEUTZ	251	SEAT	1152	VOLKSWAGEN	1312		
	IVECO	516	SEAT	1153	VOLKSWAGEN	1313		
A110/4	DEUTZ	247	SEAT	1154	VOLKSWAGEN	1314		
	DEUTZ	248	SEAT	1155	VOLKSWAGEN	1315		
	DEUTZ	249	SEAT	1156	VOLKSWAGEN	1316		
	DEUTZ	250	SEAT	1157	VOLKSWAGEN	1317		
	DEUTZ	251	SEAT	1158	VOLKSWAGEN	1318		
	DEUTZ	252	SEAT	1159	VOLKSWAGEN	1319		
	IVECO	516	SEAT	1160	VOLKSWAGEN	1320		
A113/4	MERCEDES-BENZ	733	SEAT	1161	VOLKSWAGEN	1321		
	MERCEDES-BENZ	741	SEAT	1162	VOLKSWAGEN	1323		
	MERCEDES-BENZ	742	SEAT	1163	VOLKSWAGEN	1324		
	MERCEDES-BENZ	755	SEAT	1164	VOLKSWAGEN	1325		
	MERCEDES-BENZ	756	SEAT	1165	VOLKSWAGEN	1326		
	MERCEDES-BENZ	757	SEAT	1166	VOLKSWAGEN	1327		
	MERCEDES-BENZ	760	SEAT	1167	VOLKSWAGEN	1328		
A116/4	MWM	846	SEAT	1168	VOLKSWAGEN	1329		
A121/4	VOLVO	1398	SEAT	1169	VOLKSWAGEN	1331		
	VOLVO	1399	SEAT	1170	VOLKSWAGEN	1332		
	VOLVO	1400	SEAT	1172	VOLKSWAGEN	1333		
A122/4	VOLVO	1406	SEAT	1173	VOLKSWAGEN	1334		
	VOLVO	1407	SEAT	1174	VOLKSWAGEN	1335		
	VOLVO	1408	SEAT	1175	VOLKSWAGEN	1336		
A123/4	AUDI	47	SEAT	1176	VOLKSWAGEN	1337		
	AUDI	48	SEAT	1177	VOLKSWAGEN	1338		
	AUDI	49	SEAT	1178	VOLKSWAGEN	1340		
	AUDI	51	SEAT	1179	VOLKSWAGEN	1341		
	AUDI	52	SEAT	1180	VOLKSWAGEN	1342		
	AUDI	56	SKODA	1190	VOLKSWAGEN	1343		
	AUDI	64	SKODA	1191	VOLKSWAGEN	1344		
	AUDI	65	SKODA	1192	VOLKSWAGEN	1345		
	AUDI	66	SKODA	1193	VOLKSWAGEN	1346		
	AUDI	67	SKODA	1194	VOLKSWAGEN	1349		
	AUDI	68	SKODA	1195	VOLKSWAGEN	1350		
	AUDI	69	SKODA	1196	VOLKSWAGEN	1352		
	AUDI	70	SKODA	1197	VOLKSWAGEN	1353		
	AUDI	71	SKODA	1198	VOLKSWAGEN	1357		
	AUDI	72	SKODA	1199	VOLKSWAGEN	1358		
	AUDI	73	SKODA	1200	VOLKSWAGEN	1359		
	AUDI	78	SKODA	1201	VOLKSWAGEN	1360		
	AUDI	79	SKODA	1202	VOLKSWAGEN	1361		
	AUDI	80	SKODA	1203	A124/4 AUDI	51		
	AUDI	82	VOLKSWAGEN	1282	AUDI	53		
	AUDI	83	VOLKSWAGEN	1284	AUDI	57		
	AUDI	84	VOLKSWAGEN	1285	AUDI	58		
	AUDI	85	VOLKSWAGEN	1287	AUDI	59		
	AUDI	86	VOLKSWAGEN	1288	AUDI	60		
	AUDI	87	VOLKSWAGEN	1289	AUDI	61		
	AUDI	93	VOLKSWAGEN	1290	AUDI	62		









NUMERICAL PARTS LIST

  		  		  	
AUDI	63	VOLVO	1409	FIAT	315
AUDI	69	VOLVO	1411	LANCIA	592
AUDI	74	VOLVO	1412	PEUGEOT	974
AUDI	75	A132/4 MERCEDES-BENZ	745	PEUGEOT	982
AUDI	76	MERCEDES-BENZ	746	A162/2 TOYOTA	1235
AUDI	77	MERCEDES-BENZ	747	A163/4 HYUNDAI	459
AUDI	87	MERCEDES-BENZ	748	MERCEDES-BENZ	724
AUDI	88	MERCEDES-BENZ	763	MERCEDES-BENZ	725
AUDI	89	MERCEDES-BENZ	764	MERCEDES-BENZ	726
AUDI	90	MERCEDES-BENZ	765	MERCEDES-BENZ	727
AUDI	91	A138/4 AUDI	77	MERCEDES-BENZ	728
AUDI	95	AUDI	92	DAIA	840
AUDI	97	AUDI	96	SMART	1206
VOLKSWAGEN	1296	AUDI	98	A164/4 MERCEDES-BENZ	742
VOLKSWAGEN	1301	AUDI	100	MERCEDES-BENZ	743
VOLKSWAGEN	1313	AUDI	101	MERCEDES-BENZ	761
VOLKSWAGEN	1330	SKODA	1202	MERCEDES-BENZ	762
VOLKSWAGEN	1331	VOLKSWAGEN	1356	MERCEDES-BENZ	781
VOLKSWAGEN	1347	VOLKSWAGEN	1357	A168/2 DACIA	212
VOLKSWAGEN	1348	VOLKSWAGEN	1362	NISSAN	881
VOLKSWAGEN	1353	A139/4 AUDI	101	NISSAN	883
VOLKSWAGEN	1354	FORD	410	RENAULT	1055
VOLKSWAGEN	1355	PORSCHE	998	RENAULT	1058
VOLVO	1384	SEAT	1177	RENAULT	1059
A126/4 VOLVO	1390	VOLKSWAGEN	1348	RENAULT	1060
VOLVO	1401	VOLKSWAGEN	1349	SUZUKI	1216
VOLVO	1402	VOLKSWAGEN	1356	A169/4 FIAT	334
VOLVO	1403	VOLKSWAGEN	1362	FIAT	335
A127/2 VOLVO	1404	A141/2 SAAB	1120	FIAT	342
FORD	391	A142/4 DAF	218	FIAT	344
FORD	392	DAF	227	FIAT	345
FORD	396	DAF	228	FIAT	346
FORD	397	DAF	229	FIAT	348
FORD	402	DAF	231	FIAT	349
FORD	403	DAF	232	FIAT	350
FORD	404	LEYLAND	613	FIAT	351
FORD	405	A145/4 DAF	221	FIAT	352
A129/4 MERCEDES-BENZ	726	A150/4 MERCEDES-BENZ	821	IVECO	513
MERCEDES-BENZ	728	MERCEDES-BENZ	822	IVECO	520
MERCEDES-BENZ	734	MERCEDES-BENZ	823	IVECO	521
MERCEDES-BENZ	735	A154/2 MERCEDES-BENZ	724	IVECO	522
MERCEDES-BENZ	736	SMART	1206	IVECO	523
MERCEDES-BENZ	737	A158/4 MAN	633	IVECO	524
MERCEDES-BENZ	739	MAN	637	IVECO	525
MERCEDES-BENZ	743	MAN	638	IVECO	527
MERCEDES-BENZ	744	MAN	639	IVECO	530
MERCEDES-BENZ	745	A159/4 MAN	640	IVECO	532
MERCEDES-BENZ	746	MAN	641	IVECO	533
MERCEDES-BENZ	747	MAN	642	IVECO	534
MERCEDES-BENZ	748	MAN	650	IVECO	535
MERCEDES-BENZ	749	MAN	656	IVECO	536
MERCEDES-BENZ	750	MAN	659	IVECO	537
MERCEDES-BENZ	751	MAN	660	NEW HOLLAND	854
MERCEDES-BENZ	752	MAN	662	NEW HOLLAND	855
MERCEDES-BENZ	753	MAN	663	NEW HOLLAND	860
MERCEDES-BENZ	754	MAN	664	NEW HOLLAND	861
MERCEDES-BENZ	763	MAN	665	NEW HOLLAND	862
MERCEDES-BENZ	764	MAN	666	A170/2 SUBARU	1209
MERCEDES-BENZ	765	A160/4 CITROËN	193	SUZUKI	1215
A130/2 VOLVO	1397	FIAT	304	A171/4 FIAT	352
VOLVO	1400	PEUGEOT	974	IVECO	538
A131/4 RENAULT	1100	A161/2 CITROËN	193	IVECO	539
RENAULT	1101	CITROËN	199	A172/4 DAIHATSU	237









  	  	  
	TOYOTA	IVECO
	TOYOTA	IVECO
	A187/4 VOLVO	IVECO
A173/4	A188/4 CITROËN	NEW HOLLAND
AUSTIN	CITROËN	NEW HOLLAND
HONDA	CITROËN	NEW HOLLAND
LAND ROVER	CITROËN	NEW HOLLAND
LEYLAND	CITROËN	NEW HOLLAND
PERKINS	CITROËN	NEW HOLLAND
ROVER	FIAT	NEW HOLLAND
ROVER	FIAT	NEW HOLLAND
A174/4 FORD	FIAT	A193/4 FIAT
FORD	HONDA	FIAT
A175/4 TOYOTA	HYUNDAI	FIAT
TOYOTA	LANCIA	FIAT
TRIUMPH	LANCIA	FIAT
A176/4 FORD	PEUGEOT	FIAT
FORD	PEUGEOT	FIAT
FORD	PEUGEOT	FIAT
FORD	PEUGEOT	FIAT
A177/2 RENAULT	ROVER	FIAT
RENAULT	SUZUKI	FIAT
A178/4 ALFA ROMEO	A189/4 RENAULT	FIAT
ALFA ROMEO	A190/2 ALFA ROMEO	IVECO
ALFA ROMEO	ALFA ROMEO	IVECO
ALFA ROMEO	ALFA ROMEO	IVECO
ALFA ROMEO	ALFA ROMEO	IVECO
ALFA ROMEO	FIAT	IVECO
A179/4 JOHN DEERE	FIAT	IVECO
PERKINS	LANCIA	IVECO
PERKINS	A191/2 ALFA ROMEO	IVECO
PERKINS	ALFA ROMEO	NEW HOLLAND
A180/2 FORD	ALFA ROMEO	NEW HOLLAND
FORD	ALFA ROMEO	NEW HOLLAND
FORD	CHRYSLER	NEW HOLLAND
FORD	FIAT	NEW HOLLAND
FORD	FIAT	NEW HOLLAND
FORD	FIAT	NEW HOLLAND
FORD	FIAT	NEW HOLLAND
FORD	FIAT	NEW HOLLAND
FORD	FIAT	A194/4 FIAT
MAZDA	LANCIA	FIAT
A181/4 PEUGEOT	LANCIA	IVECO
PEUGEOT	LANCIA	IVECO
PEUGEOT	LANCIA	A195/2 DACIA
A182/2 FIAT	LANCIA	DAF
FIAT	OPEL	NISSAN
LANCIA	SAAB	RENAULT
SEAT	SUZUKI	RENAULT
A184/4 CHEVROLET	A192/4 FIAT	RENAULT
PERKINS	FIAT	RENAULT
PERKINS	FIAT	RENAULT
PERKINS	FIAT	RENAULT
PERKINS	FIAT	RENAULT
PERKINS	FIAT	RENAULT
PERKINS	FIAT	RENAULT
RENAULT	FIAT	RENAULT
VOLVO	FIAT	VOLVO
A185/4 TOYOTA	FIAT	VOLVO
TOYOTA	FIAT	A196/4 SAME
TOYOTA	FIAT	SAME
A186/4 CHEVROLET	IVECO	SAME
DAIHATSU	IVECO	A197/2 FIAT
TOYOTA	IVECO	LADA
TOYOTA	IVECO	LADA









NUMERICAL PARTS LIST

  			  			  		
	SEAT	1150		SEAT	1181		RENAULT	1080
	SEAT	1166	A202/2	CITROËN	185	A209/2	RENAULT	1081
A198/2	CITROËN	202		CITROËN	186		FORD	389
	FIAT	293		PEUGEOT	962		FORD	391
	FIAT	297		PEUGEOT	963		FORD	392
	FIAT	298		PEUGEOT	964		FORD	393
	FIAT	299		PEUGEOT	965		FORD	394
	FIAT	300		PEUGEOT	966		MAZDA	673
	FIAT	301		PEUGEOT	967		VOLKSWAGEN	1283
	FIAT	316		PEUGEOT	968	A210/2	CHRYSLER	167
	FIAT	318		RENAULT	1051		CITROËN	204
	FIAT	319	A203/2	CITROËN	184		CITROËN	205
	FIAT	320		CITROËN	185		JOHN DEERE	553
	LADA	569		CITROËN	186		PEUGEOT	987
	LADA	570		CITROËN	187		RENAULT	1075
	LADA	571		CITROËN	188		RENAULT	1078
	LANCIA	583		CITROËN	189		RENAULT	1079
	LANCIA	584		CITROËN	190		RENAULT	1080
	LANCIA	594		CITROËN	191		RENAULT	1081
	LANCIA	595		CITROËN	192	A211/4	CITROËN	207
	PEUGEOT	985		FIAT	292		DAF	218
	SAAB	1119		FIAT	294		FORD	430
	SEAT	1150		PEUGEOT	962		FORD	431
	SEAT	1166		PEUGEOT	963		PEUGEOT	989
A199/4	CITROËN	198		PEUGEOT	964		PEUGEOT	990
	CITROËN	199		PEUGEOT	965	A212/4	FIAT	357
	CITROËN	203		PEUGEOT	966		FIAT	358
	FIAT	311		PEUGEOT	967		IVECO	544
	FIAT	320		PEUGEOT	968		IVECO	545
	PEUGEOT	979		PEUGEOT	969	A213/4	CITROËN	206
	PEUGEOT	980		PEUGEOT	970		CITROËN	207
	PEUGEOT	981		PEUGEOT	971		FIAT	324
	PEUGEOT	986		PEUGEOT	972		PEUGEOT	989
	PEUGEOT	987		RENAULT	1051		PEUGEOT	990
A200/4	FIAT	355		RENAULT	1052	A214/4	CITROËN	192
	FIAT	356		ROVER	1109		CITROËN	194
	IVECO	542		ROVER	1110		CITROËN	195
	IVECO	544	A204/2	LAND ROVER	602		CITROËN	196
A201/2	ALFA ROMEO	19		LAND ROVER	603		CITROËN	197
	ALFA ROMEO	23		LAND ROVER	604		CITROËN	198
	FIAT	295		LAND ROVER	605		CITROËN	200
	FIAT	297		ROVER	1109		CITROËN	201
	FIAT	299		ROVER	1113		FIAT	307
	FIAT	300	A205/2	ALFA ROMEO	13		FIAT	308
	FIAT	305		ALFA ROMEO	14		FIAT	315
	FIAT	306		ALFA ROMEO	15		FIAT	316
	FIAT	307		ALFA ROMEO	21		FORD	415
	FIAT	309		ALFA ROMEO	23		FORD	419
	FIAT	310		ALFA ROMEO	24		LADA	571
	FIAT	311	A206/2	FIAT	290		LANCIA	593
	FIAT	312		LANCIA	580		LAND ROVER	601
	FIAT	313	A207/4	RENAULT	1096		MITSUBISHI	841
	FIAT	314		RENAULT	1098		PEUGEOT	973
	FIAT	315		RENAULT	1099		PEUGEOT	974
	LANCIA	582		RENAULT	1100		PEUGEOT	975
	LANCIA	587	A208/2	CHRYSLER	167		PEUGEOT	976
	LANCIA	588		CITROËN	204		PEUGEOT	977
	LANCIA	589		CITROËN	205		PEUGEOT	978
	LANCIA	590		JOHN DEERE	553		PEUGEOT	982
	LANCIA	591		PEUGEOT	987		PEUGEOT	983
	LANCIA	592		RENAULT	1075		SUZUKI	1218
	SEAT	1167		RENAULT	1077		SUZUKI	1219
	SEAT	1180		RENAULT	1078		VOLVO	1395









  			  			  		
A215/2	DACIA	213		FIAT	319	A270/2	FORD	416
	MITSUBISHI	837		LANCIA	582		FORD	420
	MITSUBISHI	838	A225/2	ISUZU	474		FORD	422
	NISSAN	884		OPEL	935	A271/4	SCANIA	1129
	NISSAN	885	A226/2	ISUZU	471		SCANIA	1130
	OPEL	919		OPEL	915	A272/4	RENAULT	1090
	OPEL	922	A227/2	ALFA ROMEO	24		RENAULT	1091
	RENAULT	1056		ALFA ROMEO	25		RENAULT	1092
	RENAULT	1061		CHRYSLER	168	A275/4	TOYOTA	1239
	RENAULT	1062		FORD	428		TOYOTA	1240
	RENAULT	1064		JOHN DEERE	554	A276/2	CHEVROLET	157
	RENAULT	1065		ROVER	1113		TOYOTA	1233
	RENAULT	1066		VM	1248		TOYOTA	1235
	RENAULT	1067		VM	1249		TOYOTA	1236
	RENAULT	1068		VM	1250	A284/2	FORD	427
	RENAULT	1069	A228/2	PEUGEOT	972		HYUNDAI	460
	RENAULT	1070		PEUGEOT	973		NISSAN	843
	RENAULT	1071	A229/4	DAIHATSU	237	A285/4	DEUTZ	252
	RENAULT	1074		TOYOTA	1233		RENAULT	1094
	RENAULT	1076		TOYOTA	1236		RENAULT	1095
	VOLVO	1385		TOYOTA	1237		VOLVO	1405
	VOLVO	1386		TOYOTA	1238	A287/2	CHEVROLET	158
	VOLVO	1388	A231/4	LEYLAND	609		SUZUKI	1218
	VOLVO	1392	A232/4	SCANIA	1131	A289/2	NISSAN	890
A216/4	SCANIA	1131		SCANIA	1135		NISSAN	891
	SCANIA	1132		SCANIA	1136		OPEL	928
	SCANIA	1133		SCANIA	1137		OPEL	930
	SCANIA	1134	A233/4	AUSTIN	109		RENAULT	1077
A217/2	CITROËN	187		AUSTIN	110		RENAULT	1082
	CITROËN	188		LEYLAND	609	A290/4	MAN	632
	CITROËN	191		LEYLAND	610		MAN	636
	FIAT	294		ROVER	1112	A291/2	ALFA ROMEO	14
	FORD	390	A234/4	LEYLAND	610		ALFA ROMEO	19
	FORD	394		LEYLAND	611		CHRYSLER	166
	FORD	395	A235/4	DAIHATSU	235		FIAT	298
	MAZDA	673		TOYOTA	1231		FIAT	308
	MINI	826		TOYOTA	1233		LANCIA	583
	MITSUBISHI	836	A239/4	RENAULT	1096		LANCIA	588
	PEUGEOT	967		RENAULT	1097		VOLKSWAGEN	1363
	PEUGEOT	970	A240/2	ISUZU	473	A292/4	AUDI	52
	SUZUKI	1215	A241/2	FIAT	317		AUDI	53
	SUZUKI	1216		LANCIA	594		AUDI	54
	VOLVO	1383		LAND ROVER	600		AUDI	57
A218/2	BEDFORD	113		ROVER	1108		AUDI	58
	CHEVROLET	155		ROVER	1109		AUDI	59
	SUZUKI	1214		ROVER	1110		AUDI	60
A219/2	CHEVROLET	161		ROVER	1111		AUDI	61
	ISUZU	472	A244/4	FIAT	353		AUDI	62
	ISUZU	473		IVECO	540		AUDI	63
	ISUZU	474	A253/2	JAGUAR	548		AUDI	69
	OPEL	929		JAGUAR	549		AUDI	74
	OPEL	931	A261/2	CHEVROLET	157		AUDI	75
A220/4	FORD	431		ISUZU	471		AUDI	76
	ISUZU	475		MAZDA	675		AUDI	77
	NISSAN	886		OPEL	917		AUDI	87
	NISSAN	887		OPEL	918		AUDI	88
	NISSAN	891	A264/4	RENAULT	1102		AUDI	89
	NISSAN	892	A265/4	BEDFORD	117		AUDI	90
	NISSAN	893		FORD	433		AUDI	91
A221/2	FIAT	294		FORD	434		AUDI	95
	FIAT	295	A266/4	BEDFORD	116		AUDI	97
	FIAT	296	A268/2	LISTER	615		VOLKSWAGEN	1296
	FIAT	318		LISTER	616		VOLKSWAGEN	1301









NUMERICAL PARTS LIST

  			  			  		
	VOLKSWAGEN	1313		TOYOTA	1231		BMW	131
	VOLKSWAGEN	1330	A323/2	ISUZU	475		BMW	132
	VOLKSWAGEN	1331		NISSAN	893		BMW	133
	VOLKSWAGEN	1347	A324/2	MAZDA	677		BMW	135
	VOLKSWAGEN	1348		MITSUBISHI	840		BMW	136
	VOLKSWAGEN	1353		NISSAN	887		BMW	137
	VOLKSWAGEN	1354		NISSAN	888		BMW	138
	VOLKSWAGEN	1356		SUZUKI	1218		BMW	140
	VOLVO	1384	A326/2	HYUNDAI	458		BMW	141
A293/4	DAF	232		KIA	563		BMW	142
A294/2	MAN	664	A327/2	HYUNDAI	458		BMW	145
A295/2	TOYOTA	1231		HYUNDAI	459		LAND ROVER	600
	TOYOTA	1232		KIA	564		LAND ROVER	601
A297/2	NISSAN	887	A328/2	HYUNDAI	460		OPEL	919
	NISSAN	888		KIA	564		ROVER	1110
	NISSAN	889	A332/2	HONDA	448	H024/5	AUDI	46
	OPEL	922		HONDA	449		AUDI	47
	OPEL	925	A333/2	SUZUKI	1215		SEAT	1151
	RENAULT	1073		SUZUKI	1216		SKODA	1190
	RENAULT	1074	A334/2	MITSUBISHI	836		VOLKSWAGEN	1282
A298/4	DEUTZ	257		MITSUBISHI	839		VOLKSWAGEN	1283
	DEUTZ	258	A335/2	MAZDA	674		VOLKSWAGEN	1284
A299/4	DEUTZ	257		MAZDA	675		VOLKSWAGEN	1285
	DEUTZ	258	A336/2	FORD	413	H025/5	AUDI	48
A300/4	SCANIA	1129		MAZDA	676		AUDI	49
	SCANIA	1130	A338/2	NISSAN	882		AUDI	50
A302/2	MERCEDES-BENZ	782		NISSAN	883		AUDI	51
	MERCEDES-BENZ	783	H003/5	VOLVO	1397		AUDI	55
	MERCEDES-BENZ	784		VOLVO	1400		AUDI	56
	MERCEDES-BENZ	785	H005/7P	DAF	222		AUDI	72
	MERCEDES-BENZ	786		DAF	223		AUDI	73
	MERCEDES-BENZ	787		DAF	224		AUDI	81
A303/4	HINO	438		DAF	225		AUDI	83
	TOYOTA	1242		DAF	226		AUDI	84
A304/4	HINO	438		DAF	228		AUDI	85
	HINO	439		DAF	229		AUDI	86
	HINO	440		DAF	230		NISSAN	884
A305/2	HONDA	452		DAF	231		SEAT	1156
A306/4	TOYOTA	1238		DAF	232		SEAT	1170
	TOYOTA	1240		LEYLAND	612		SEAT	1171
A307/3	ISUZU	475	H006/5	PORSCHE	1002		SEAT	1174
	ISUZU	476		PORSCHE	1003		SEAT	1183
A308/2	NISSAN	890	H007/5	BMW	134		VOLKSWAGEN	1286
	NISSAN	892		BMW	137		VOLKSWAGEN	1287
A309/4	RENAULT	1099		BMW	143		VOLKSWAGEN	1288
A314/2	AUDI	46	H016/5	VOLVO	1397		VOLKSWAGEN	1293
	SEAT	1150		VOLVO	1400		VOLKSWAGEN	1295
	SKODA	1190	H017/7	BMW	144		VOLKSWAGEN	1301
	VOLKSWAGEN	1283	H022/7P	DAF	222		VOLKSWAGEN	1302
A315/4	IVECO	537		DAF	223		VOLKSWAGEN	1303
A316/2	CHEVROLET	156		DAF	224		VOLKSWAGEN	1319
	FIAT	297		DAF	225		VOLKSWAGEN	1320
	SUBARU	1209		DAF	226		VOLKSWAGEN	1321
	SUZUKI	1217		DAF	228		VOLKSWAGEN	1322
	SUZUKI	1218		DAF	229		VOLKSWAGEN	1324
A321/2	ALFA ROMEO	16		DAF	230		VOLKSWAGEN	1325
	CHRYSLER	166		LEYLAND	612		VOLKSWAGEN	1327
	FIAT	301	H023/5	BMW	133		VOLKSWAGEN	1329
	LANCIA	584		BMW	139		VOLKSWAGEN	1337
A322/2	CITROËN	184		BMW	141		VOLKSWAGEN	1338
	DAIHATSU	235		LAND ROVER	600		VOLKSWAGEN	1339
	PEUGEOT	963		ROVER	1111		VOLKSWAGEN	1340
	SUBARU	1209	H023/7	BMW	130		VOLKSWAGEN	1341









  			  			  		
	VOLKSWAGEN	1343		VOLKSWAGEN	1333		MAN	635
H026/5	AUDI	47		VOLKSWAGEN	1334	H054/7	DAF	221
	SEAT	1150		VOLKSWAGEN	1337	H056/7	DEUTZ	252
	SEAT	1151		VOLKSWAGEN	1338	H059/5	OPEL	921
	SEAT	1152		VOLKSWAGEN	1339	H063/4	MERCEDES-BENZ	821
	SEAT	1154		VOLKSWAGEN	1340		MERCEDES-BENZ	822
	SEAT	1156		VOLKSWAGEN	1341	H065/5	MERCEDES-BENZ	724
	SEAT	1157		VOLKSWAGEN	1343		MERCEDES-BENZ	728
	SKODA	1190		VOLKSWAGEN	1344	H066/4	AUDI	77
	SKODA	1192		VOLKSWAGEN	1345	H069/4	MERCEDES-BENZ	728
	VOLKSWAGEN	1284		VOLKSWAGEN	1346		MERCEDES-BENZ	751
	VOLKSWAGEN	1285		VOLKSWAGEN	1349		MERCEDES-BENZ	752
	VOLKSWAGEN	1288		VOLKSWAGEN	1357		MERCEDES-BENZ	753
	VOLKSWAGEN	1289		VOLKSWAGEN	1358		MERCEDES-BENZ	767
	VOLKSWAGEN	1290	H033/5	BMW	134	H069/5	MERCEDES-BENZ	753
	VOLKSWAGEN	1292		BMW	137		MERCEDES-BENZ	767
	VOLKSWAGEN	1297		BMW	146	H072/4	MERCEDES-BENZ	724
H027/5	AUDI	48		BMW	147		SMART	1206
	AUDI	65	H034/4	AUDI	52	H075/7	MERCEDES-BENZ	813
	AUDI	70		AUDI	92		MERCEDES-BENZ	814
	AUDI	72		AUDI	96		MERCEDES-BENZ	815
	AUDI	73		AUDI	98		MERCEDES-BENZ	816
	AUDI	78		AUDI	100		MITSUBISHI	844
	AUDI	79		AUDI	101	H077/5	CHEVROLET	158
	AUDI	83		SKODA	1193		OPEL	923
	AUDI	85		SKODA	1202		SAAB	1118
	AUDI	86		VOLKSWAGEN	1300	H079/5	AUDI	55
	AUDI	87		VOLKSWAGEN	1356		AUDI	68
	AUDI	96	H035/7	FORD	410		AUDI	69
	AUDI	99		PORSCHE	998		AUDI	93
	NISSAN	885		SEAT	1177		AUDI	94
	SEAT	1162		VOLKSWAGEN	1348		AUDI	95
	SEAT	1164		VOLKSWAGEN	1349		FORD	401
	SEAT	1167		VOLKSWAGEN	1356		JOHN DEERE	552
	SEAT	1169	H038/5	SAAB	1120		MITSUBISHI	840
	SEAT	1170	H039/5	FORD	396		SEAT	1158
	SEAT	1171		FORD	397		SEAT	1164
	SEAT	1172		FORD	402		SEAT	1165
	SEAT	1173		FORD	403		SEAT	1166
	SEAT	1174		FORD	404		SEAT	1177
	SEAT	1175	H046/5	RENAULT	1071		SEAT	1178
	SEAT	1176		VOLVO	1386		SKODA	1193
	SEAT	1179		VOLVO	1388		SKODA	1197
	SKODA	1195		VOLVO	1391		SKODA	1198
	SKODA	1200		VOLVO	1392		SKODA	1201
	VOLKSWAGEN	1286		VOLVO	1393		SKODA	1202
	VOLKSWAGEN	1308	H046/6	RENAULT	1072		VOLKSWAGEN	1303
	VOLKSWAGEN	1313		VOLVO	1385		VOLKSWAGEN	1310
	VOLKSWAGEN	1314		VOLVO	1386		VOLKSWAGEN	1311
	VOLKSWAGEN	1315		VOLVO	1387		VOLKSWAGEN	1312
	VOLKSWAGEN	1316		VOLVO	1389		VOLKSWAGEN	1350
	VOLKSWAGEN	1319		VOLVO	1391		VOLKSWAGEN	1351
	VOLKSWAGEN	1320		VOLVO	1393		VOLKSWAGEN	1352
	VOLKSWAGEN	1321		VOLVO	1394	H082/5	MAN	633
	VOLKSWAGEN	1322		VOLVO	1395	H082/7	MAN	637
	VOLKSWAGEN	1324	H046/7	VOLVO	1387		MAN	638
	VOLKSWAGEN	1325		VOLVO	1391		MAN	639
	VOLKSWAGEN	1326		VOLVO	1394	H084/5	AUDI	51
	VOLKSWAGEN	1327	H048/5	MERCEDES-BENZ	776		AUDI	64
	VOLKSWAGEN	1328	H048/7	MERCEDES-BENZ	780		AUDI	65
	VOLKSWAGEN	1329	H049/5	MAN	631		AUDI	66
	VOLKSWAGEN	1331	H049/7	MAN	630		AUDI	67
	VOLKSWAGEN	1332		MAN	634		AUDI	68









NUMERICAL PARTS LIST

  		  		  			
AUDI	71	H085/7	DEUTZ	251	MERCEDES-BENZ	797	
AUDI	79		IVECO	516	MERCEDES-BENZ	798	
AUDI	80	H086/5	CITROËN	193	MERCEDES-BENZ	799	
AUDI	81		CITROËN	199	MERCEDES-BENZ	800	
AUDI	82		FIAT	315	MERCEDES-BENZ	801	
AUDI	83		LANCIA	592	MERCEDES-BENZ	816	
AUDI	84		PEUGEOT	974	MERCEDES-BENZ	817	
AUDI	96		PEUGEOT	982	MERCEDES-BENZ	818	
AUDI	100	H095/6	VOLVO	1387	H821/5	MERCEDES-BENZ	791
FORD	399		VOLVO	1390		MERCEDES-BENZ	792
FORD	400	H097/5	DACIA	211		MERCEDES-BENZ	802
FORD	401		NISSAN	877		MERCEDES-BENZ	803
FORD	402		RENAULT	1046		MERCEDES-BENZ	818
SEAT	1153		RENAULT	1047		MERCEDES-BENZ	819
SEAT	1157		RENAULT	1048	H821/6	MERCEDES-BENZ	793
SEAT	1159	H098/5	DACIA	213		MERCEDES-BENZ	806
SEAT	1160		MITSUBISHI	837		MERCEDES-BENZ	820
SEAT	1161		MITSUBISHI	838	H821/7	MERCEDES-BENZ	794
SEAT	1162		NISSAN	884		MERCEDES-BENZ	806
SEAT	1163		NISSAN	885		MERCEDES-BENZ	807
SEAT	1164		OPEL	919	H841/7	VOLVO	1401
SEAT	1165		OPEL	922		VOLVO	1402
SEAT	1168		RENAULT	1060		VOLVO	1403
SEAT	1169		RENAULT	1061		VOLVO	1404
SEAT	1172		RENAULT	1062	H842/7	VOLVO	1406
SEAT	1173		RENAULT	1064		VOLVO	1407
SEAT	1174		RENAULT	1066		VOLVO	1408
SEAT	1175		RENAULT	1067	H853/5	FORD	394
SEAT	1176		RENAULT	1070		FORD	397
SEAT	1179		RENAULT	1071		FORD	398
SKODA	1192		RENAULT	1074		FORD	411
SKODA	1194		SUZUKI	1217		FORD	420
SKODA	1195		VOLVO	1385		FORD	421
SKODA	1196	H629/5	BMW	133		FORD	424
SKODA	1197		BMW	134		FORD	425
SKODA	1199		BMW	145		FORD	426
SKODA	1200	H688/7	PORSCHE	996	H859/7	MERCEDES-BENZ	725
SKODA	1201		PORSCHE	997		MERCEDES-BENZ	729
SKODA	1203		PORSCHE	998		MERCEDES-BENZ	731
VOLKSWAGEN	1289	H712/5	MERCEDES-BENZ	768	H893/5	BEDFORD	115
VOLKSWAGEN	1294		MERCEDES-BENZ	769		OPEL	928
VOLKSWAGEN	1297	H712/7	MERCEDES-BENZ	774		OPEL	929
VOLKSWAGEN	1298		MERCEDES-BENZ	775		OPEL	931
VOLKSWAGEN	1304	H783/5	VOLVO	1395	H901/5	BEDFORD	116
VOLKSWAGEN	1305		VOLVO	1396		CHEVROLET	161
VOLKSWAGEN	1306		VOLVO	1397		OPEL	921
VOLKSWAGEN	1307		VOLVO	1399		OPEL	925
VOLKSWAGEN	1308	H796/5	MERCEDES-BENZ	731		OPEL	929
VOLKSWAGEN	1309		MERCEDES-BENZ	738		OPEL	931
VOLKSWAGEN	1310		MERCEDES-BENZ	762		OPEL	933
VOLKSWAGEN	1311	H801/5	MERCEDES-BENZ	742		OPEL	934
VOLKSWAGEN	1312		MERCEDES-BENZ	758	H901/7	CHEVROLET	161
VOLKSWAGEN	1315		MERCEDES-BENZ	759		OPEL	928
VOLKSWAGEN	1316		MERCEDES-BENZ	760		OPEL	929
VOLKSWAGEN	1318		MERCEDES-BENZ	765		OPEL	930
VOLKSWAGEN	1333		MERCEDES-BENZ	766		OPEL	934
VOLKSWAGEN	1334		MERCEDES-BENZ	767	H914/5	MERCEDES-BENZ	731
VOLKSWAGEN	1335	H809/7	MERCEDES-BENZ	788		MERCEDES-BENZ	732
VOLKSWAGEN	1336		MERCEDES-BENZ	789		MERCEDES-BENZ	733
VOLKSWAGEN	1358	H818/7	MERCEDES-BENZ	808		MERCEDES-BENZ	738
VOLKSWAGEN	1359	H821/4	MERCEDES-BENZ	790		MERCEDES-BENZ	740
VOLKSWAGEN	1360		MERCEDES-BENZ	791		MERCEDES-BENZ	741
VOLKSWAGEN	1361		MERCEDES-BENZ	794		MERCEDES-BENZ	756









  			  			  		
	MERCEDES-BENZ	757		CHEVROLET	156		OPEL	921
	MERCEDES-BENZ	760		CHEVROLET	158		OPEL	924
	MERCEDES-BENZ	762		NISSAN	882		OPEL	926
	SEAT	1182		OPEL	912		OPEL	927
H914/6	MERCEDES-BENZ	754		OPEL	914	H987/7	SCANIA	1129
	MERCEDES-BENZ	755		OPEL	915	H992/6	MAN	646
H928/7	PORSCHE	997		OPEL	917		MAN	648
	PORSCHE	998		OPEL	918		MAN	655
	PORSCHE	999		OPEL	920		MERCEDES-BENZ	795
H931/5	DEUTZ	255		SAAB	1118		MERCEDES-BENZ	810
	DEUTZ	256		SUZUKI	1216	H992/7	MAN	647
	DEUTZ	257		SUZUKI	1217		MAN	649
	IVECO	539	H976/5	SAAB	1119		MAN	656
	IVECO	540	H977/5	MERCEDES-BENZ	745		MAN	657
H934/3	OPEL	912		MERCEDES-BENZ	746		MAN	659
	OPEL	914		MERCEDES-BENZ	747		MAN	660
	OPEL	916		MERCEDES-BENZ	763		MAN	661
H941/6	AUDI	51		MERCEDES-BENZ	764		MAN	663
	AUDI	58		MERCEDES-BENZ	765		MAN	664
	AUDI	59	H981/6	AUDI	51		MAN	665
	AUDI	60		AUDI	53		MERCEDES-BENZ	795
	AUDI	61		AUDI	57		MERCEDES-BENZ	796
	AUDI	62		AUDI	58		MERCEDES-BENZ	809
	AUDI	87		AUDI	59		MERCEDES-BENZ	810
	AUDI	89		AUDI	60		MERCEDES-BENZ	811
	AUDI	90		AUDI	61		MERCEDES-BENZ	812
	VOLKSWAGEN	1305		AUDI	62	H993/5	MAN	643
	VOLKSWAGEN	1347		AUDI	63		MAN	644
	VOLKSWAGEN	1348		AUDI	69		MAN	650
	VOLKSWAGEN	1353		AUDI	74		MAN	651
	VOLKSWAGEN	1354		AUDI	75	H993/6	MAN	644
	VOLVO	1390		AUDI	76		MAN	645
H941/7	VOLKSWAGEN	1296		AUDI	77		MAN	652
	VOLVO	1384		AUDI	87	H996/5	CITROËN	184
H948/7	BMW	130		AUDI	88		CITROËN	185
	BMW	131		AUDI	89		CITROËN	186
	BMW	135		AUDI	90		CITROËN	188
	BMW	138		AUDI	91		CITROËN	189
	BMW	139		AUDI	95		CITROËN	190
H949/7	PORSCHE	1000		AUDI	97		PEUGEOT	962
	PORSCHE	1001		VOLKSWAGEN	1301		PEUGEOT	963
	PORSCHE	1003		VOLKSWAGEN	1313		PEUGEOT	964
H951/5	MERCEDES-BENZ	733		VOLKSWAGEN	1330		PEUGEOT	965
	MERCEDES-BENZ	740		VOLKSWAGEN	1331		PEUGEOT	966
	MERCEDES-BENZ	741		VOLKSWAGEN	1347		PEUGEOT	967
	MERCEDES-BENZ	756		VOLKSWAGEN	1348		PEUGEOT	968
	MERCEDES-BENZ	757		VOLKSWAGEN	1353		PEUGEOT	969
	MERCEDES-BENZ	760		VOLKSWAGEN	1354		PEUGEOT	970
H951/6	MERCEDES-BENZ	755		VOLKSWAGEN	1355		RENAULT	1051
	MERCEDES-BENZ	756		VOLVO	1390		RENAULT	1052
H956/7	MERCEDES-BENZ	729	H981/7	VOLKSWAGEN	1296	H997/5	MERCEDES-BENZ	728
	MERCEDES-BENZ	730		VOLVO	1384		MERCEDES-BENZ	734
H969/7	VOLVO	1398	H982/5	BEDFORD	114		MERCEDES-BENZ	739
	VOLVO	1400		BEDFORD	115		MERCEDES-BENZ	745
H971/2	BMW MOTORCYCLES	151		CHEVROLET	157		MERCEDES-BENZ	747
H973/7	BMW	144		CHEVROLET	158		MERCEDES-BENZ	748
	BMW	145		CHEVROLET	159		MERCEDES-BENZ	749
	BMW	146		CHEVROLET	160		MERCEDES-BENZ	752
	BMW	147		ISUZU	472		MERCEDES-BENZ	754
	BMW	148		ISUZU	473		MERCEDES-BENZ	763
H975/5	BEDFORD	113		LADA	572		MERCEDES-BENZ	764
	BEDFORD	114		OPEL	918		MERCEDES-BENZ	765
	CHEVROLET	155		OPEL	920	H997/6	MERCEDES-BENZ	734









NUMERICAL PARTS LIST

  	  	  			
MERCEDES-BENZ	735	PERKINS	937	PERKINS	940
MERCEDES-BENZ	736	PERKINS	938	PERKINS	941
MERCEDES-BENZ	749	PERKINS	943	PERKINS	942
MERCEDES-BENZ	750	H1028/5 FIAT	293	PERKINS	943
MERCEDES-BENZ	751	FIAT	298	RENAULT	1092
H997/7 MERCEDES-BENZ	726	FIAT	299	VOLVO	1401
MERCEDES-BENZ	736	FIAT	300	H1037/7 PERKINS	940
MERCEDES-BENZ	737	FIAT	316	PERKINS	942
MERCEDES-BENZ	744	FIAT	318	H1038/3 RENAULT	1045
MERCEDES-BENZ	745	LANCIA	583	RENAULT	1046
MERCEDES-BENZ	751	LANCIA	584	H1039/3 FIAT	288
MERCEDES-BENZ	752	LANCIA	594	FIAT	289
MERCEDES-BENZ	753	SAAB	1119	LANCIA	580
H1001/5 MERCEDES-BENZ	726	SEAT	1150	SEAT	1149
MERCEDES-BENZ	727	SEAT	1166	H1041/4 CITROËN	206
H1002/5 MERCEDES-BENZ	724	H1029/5 PEUGEOT	985	LANCIA	595
MERCEDES-BENZ	725	PEUGEOT	988	PEUGEOT	985
H1003/4 MERCEDES-BENZ	742	H1030/5 ALFA ROMEO	13	PEUGEOT	988
MERCEDES-BENZ	743	ALFA ROMEO	15	RENAULT	1077
MERCEDES-BENZ	761	ALFA ROMEO	16	RENAULT	1082
H1003/5 MERCEDES-BENZ	761	ALFA ROMEO	21	VOLVO	1396
MERCEDES-BENZ	781	ALFA ROMEO	22	VOLVO	1397
H1008/7 RENAULT	1099	ALFA ROMEO	23	H1042/5 DACIA	211
VOLVO	1405	H1031/5 CHRYSLER	165	DAF	217
VOLVO	1409	CITROËN	191	RENAULT	1048
H1011/5 ALFA ROMEO	12	PEUGEOT	962	RENAULT	1049
CHEVROLET	155	PEUGEOT	967	RENAULT	1050
CITROËN	184	PEUGEOT	971	RENAULT	1054
FIAT	290	H1032/5 FORD	414	RENAULT	1056
LANCIA	580	FORD	420	VOLVO	1383
OPEL	912	HYUNDAI	457	VOLVO	1384
PEUGEOT	962	HYUNDAI	458	H1043/5 ALFA ROMEO	19
SUZUKI	1214	HYUNDAI	459	FIAT	295
H1013/5 NISSAN	890	HYUNDAI	460	FIAT	296
NISSAN	891	HYUNDAI	460	FIAT	299
OPEL	928	KIA	564	FIAT	300
OPEL	930	MITSUBISHI	835	FIAT	304
RENAULT	1076	MITSUBISHI	836	FIAT	305
RENAULT	1077	MITSUBISHI	837	FIAT	306
RENAULT	1082	MITSUBISHI	839	FIAT	309
H1014/5 DACIA	212	MITSUBISHI	840	FIAT	310
RENAULT	1060	MITSUBISHI	841	FIAT	310
H1015/7 RENAULT	1100	MITSUBISHI	842	FIAT	311
RENAULT	1101	H1033/4 FORD	433	FIAT	312
VOLVO	1412	FORD	434	FIAT	313
H1018/5 CITROËN	202	FORD	435	FIAT	314
FIAT	317	FORD	436	FIAT	315
FORD	415	H1033/5 FORD	428	LANCIA	582
FORD	417	FORD	433	LANCIA	589
FORD	419	FORD	435	LANCIA	590
FORD	419	FORD	436	LANCIA	591
FORD	422	NEW HOLLAND	862	LANCIA	592
FORD	423	H1033/7 FORD	435	SEAT	1167
JAGUAR	548	FORD	436	SEAT	1180
PEUGEOT	984	H1034/5 RENAULT	1055	SEAT	1181
H1020/5 FIAT	321	RENAULT	1056	H1044/3 ALFA ROMEO	13
IVECO	494	RENAULT	1057	ALFA ROMEO	14
IVECO	510	H1035/5 RENAULT	1090	ALFA ROMEO	15
H1021/7 IVECO	534	RENAULT	1091	ALFA ROMEO	21
H1022/7 IVECO	540	RENAULT	1092	ALFA ROMEO	23
H1023/7 IVECO	541	H1036/7 RENAULT	1092	H1045/5 LADA	569
H1026/4 PERKINS	938	RENAULT	1093	LADA	570
H1027/5 IVECO	538	H1037/5 CHEVROLET	162	H1046/5 PEUGEOT	972
JOHN DEERE	553	PERKINS	939	PEUGEOT	973









  			  			  		
H1047/7	FIAT	355		KIA	565		SUZUKI	1214
	FIAT	356		DAIA	839	H1065/5	DAIA	212
	IVECO	542		MITSUBISHI	840		NISSAN	881
	IVECO	544		MITSUBISHI	841		NISSAN	883
H1048/5	FIAT	350		MITSUBISHI	842		RENAULT	1055
	IVECO	532	H1056/5	CITROËN	207		RENAULT	1058
	IVECO	533		DAF	218		RENAULT	1059
	IVECO	534		FORD	430		SUZUKI	1216
H1048/7	FIAT	350		FORD	431	H1066/5	CITROËN	187
	FIAT	351		PEUGEOT	989		CITROËN	191
	IVECO	532		PEUGEOT	990		FIAT	294
	IVECO	533	H1057/5	CITROËN	192		FORD	390
	IVECO	535		CITROËN	193		FORD	394
	IVECO	536		CITROËN	197		FORD	395
	IVECO	537		CITROËN	198		MAZDA	673
H1049/5	ALFA ROMEO	26		CITROËN	200		MINI	826
	ALFA ROMEO	27		CITROËN	201		MITSUBISHI	836
	FIAT	320		CITROËN	202		PEUGEOT	967
	FIAT	322		FIAT	304		PEUGEOT	970
	FIAT	323		FIAT	307		SUZUKI	1215
	IVECO	494		FIAT	308		SUZUKI	1216
	IVECO	495		FIAT	315		VOLVO	1383
	IVECO	496		FIAT	316	H1067/5	FIAT	288
	IVECO	497		FIAT	317		FIAT	291
	IVECO	499		FORD	415		FIAT	293
	IVECO	500		FORD	416		LANCIA	581
	IVECO	501		FORD	419	H1068/5	CHEVROLET	158
	IVECO	502		HONDA	450		DAIHATSU	236
	IVECO	503		HYUNDAI	459		TOYOTA	1232
	IVECO	504		LADA	571		TOYOTA	1234
	IVECO	505		LANCIA	593		TOYOTA	1236
	LANCIA	595		LANCIA	594		TOYOTA	1237
	LANCIA	596		LAND ROVER	601	H1069/5	FIAT	294
	OPEL	932		MITSUBISHI	841		FIAT	295
	RENAULT	1083		PEUGEOT	973		FIAT	296
	RENAULT	1084		PEUGEOT	974		FIAT	318
	RENAULT	1086		PEUGEOT	977		LANCIA	582
	RENAULT	1087		PEUGEOT	978	H1070/5	NISSAN	882
	RENAULT	1088		PEUGEOT	982		NISSAN	883
	RENAULT	1089		PEUGEOT	983		NISSAN	884
	SEAT	1182		PEUGEOT	984		NISSAN	886
H1050/7	RENAULT	1095		ROVER	1110		NISSAN	887
	RENAULT	1096		SUZUKI	1218		NISSAN	888
	RENAULT	1097		SUZUKI	1219	H1071/5	CITROËN	184
	RENAULT	1098		VOLVO	1395		CITROËN	185
	RENAULT	1099	H1058/5	CHRYSLER	167		CITROËN	186
	RENAULT	1100		CITROËN	203		CITROËN	187
H1052/5	CHRYSLER	167		CITROËN	205		CITROËN	188
	CITROËN	203		JOHN DEERE	553		CITROËN	190
	CITROËN	204		PEUGEOT	987		FIAT	292
	JOHN DEERE	552		RENAULT	1075		FIAT	294
	PEUGEOT	987		RENAULT	1078		PEUGEOT	963
	RENAULT	1075		RENAULT	1079		PEUGEOT	964
	RENAULT	1077		RENAULT	1081		PEUGEOT	965
	RENAULT	1078	H1059/7	SCANIA	1131		PEUGEOT	966
	RENAULT	1079		SCANIA	1133		PEUGEOT	968
	RENAULT	1081		SCANIA	1134		PEUGEOT	970
H1053/7	VOLVO	1409	H1060/5	SCANIA	1131		ROVER	1109
	VOLVO	1411		SCANIA	1132	H1072/7	FIAT	352
H1054/7	RENAULT	1096	H1061/5	TOYOTA	1239		IVECO	538
	RENAULT	1102		TOYOTA	1240	H1073/7	SCANIA	1129
H1055/5	FORD	427		TOYOTA	1241		SCANIA	1130
	HYUNDAI	461	H1062/5	BEDFORD	113	H1074/5	CITROËN	193









NUMERICAL PARTS LIST

  		  		  				
	CITROËN	194		FIAT	314		RENAULT	1087
	CITROËN	195		LANCIA	587		RENAULT	1088
	CITROËN	196		LANCIA	589		RENAULT	1089
	CITROËN	197		LANCIA	591		SEAT	1182
	FIAT	307		LANCIA	592	H1095/5	ALFA ROMEO	17
	PEUGEOT	975	H1085/5	LAND ROVER	600		FIAT	303
	PEUGEOT	976		ROVER	1108		LANCIA	586
	PEUGEOT	977		ROVER	1109		SUZUKI	1217
H1075/5	CITROËN	202		ROVER	1110	H1095/6	ALFA ROMEO	18
	FIAT	297		ROVER	1111		FIAT	302
	FIAT	300	H1086/5	FORD	396		FIAT	304
	FIAT	301		FORD	406		FIAT	343
	FIAT	319		FORD	413		LANCIA	585
	FIAT	320		FORD	414		LANCIA	586
	LANCIA	584		FORD	420		LANCIA	589
	LANCIA	594	H1087/5	CITROËN	189	H1096/5	ALFA ROMEO	16
	LANCIA	595		CITROËN	191		ALFA ROMEO	17
	PEUGEOT	985		CITROËN	192		ALFA ROMEO	20
	SAAB	1119		PEUGEOT	971		ALFA ROMEO	21
H1076/5	FORD	429		PEUGEOT	972		FIAT	302
	FORD	430		ROVER	1110		FIAT	303
H1077/5	TOYOTA	1231	H1089/5	CITROËN	206		FIAT	318
	TOYOTA	1232		CITROËN	207		FIAT	319
H1078/5	ISUZU	474		FIAT	324		LANCIA	585
	OPEL	935		PEUGEOT	989		LANCIA	594
H1079/5	FORD	391		PEUGEOT	990	H1097/7	RENAULT	1100
	FORD	392	H1090/7	RENAULT	1093	H1098/5	HONDA	451
	FORD	397		RENAULT	1094		LAND ROVER	601
	FORD	402	H1091/5	FIAT	288		ROVER	1111
	FORD	403		FIAT	291	H1099/5	NISSAN	877
	FORD	404		FIAT	293		RENAULT	1048
H1080/5	DACIA	213		LANCIA	581	H1100/5	FORD	389
	MITSUBISHI	837	H1092/5	ALFA ROMEO	12		FORD	390
	MITSUBISHI	838		CHRYSLER	165		FORD	395
	RENAULT	1056		FIAT	292		FORD	399
	RENAULT	1061		LANCIA	581		FORD	405
	RENAULT	1062		LANCIA	582		MAZDA	672
	RENAULT	1064	H1093/5	FORD	431		MAZDA	673
	RENAULT	1065		ISUZU	475		MAZDA	675
	RENAULT	1066		NISSAN	891	H1101/5	CHRYSLER	165
	RENAULT	1067		NISSAN	892		MITSUBISHI	838
	RENAULT	1068		NISSAN	893		RENAULT	1066
	RENAULT	1069	H1094/5	ALFA ROMEO	26		RENAULT	1068
	RENAULT	1071		ALFA ROMEO	27		RENAULT	1069
	VOLVO	1385		FIAT	321	H1103/7	SCANIA	1135
	VOLVO	1386		FIAT	322	H1104/5	CITROËN	207
	VOLVO	1388		FIAT	323		FIAT	324
	VOLVO	1392		IVECO	494		IVECO	500
H1081/3	ALFA ROMEO	24		IVECO	495		IVECO	502
H1082/4	ALFA ROMEO	15		IVECO	497		IVECO	503
	ALFA ROMEO	24		IVECO	498		IVECO	506
	ALFA ROMEO	25		IVECO	499		IVECO	508
	ALFA ROMEO	26		IVECO	501		OPEL	932
	FIAT	320		IVECO	503		PEUGEOT	990
	LANCIA	595		IVECO	504		RENAULT	1083
H1083/7	VOLVO	1413		IVECO	505		RENAULT	1084
H1084/5	ALFA ROMEO	19		LANCIA	583		RENAULT	1086
	ALFA ROMEO	23		LANCIA	596		RENAULT	1087
	FIAT	297		LANCIA	597		RENAULT	1088
	FIAT	305		OPEL	932		RENAULT	1089
	FIAT	306		RENAULT	1083		RENAULT	1090
	FIAT	311		RENAULT	1084		RENAULT	1091
	FIAT	313		RENAULT	1086	H1105/5	FORD	412







  	  	  			
FORD	413	FORD	408	MAZDA	672
MAZDA	676	FORD	409	MAZDA	674
H1106/5 LAND ROVER	602	FORD	410	MAZDA	675
LAND ROVER	603	H1144/5 AUSTIN	109	MAZDA	676
LAND ROVER	604	LEYLAND	609	H1193/5 DAIHATSU	237
H1107/5 DACIA	211	LEYLAND	610	TOYOTA	1241
DAF	217	H1146/5 FORD	430	TOYOTA	1242
RENAULT	1046	H1147/5 NISSAN	878	H1196/7 JAGUAR	548
RENAULT	1048	NISSAN	879	JAGUAR	549
RENAULT	1050	NISSAN	880	H1198/7 JAGUAR	549
VOLVO	1383	NISSAN	881	H1199/7 JAGUAR	549
H1111/5 FORD	405	H1148/5 DAIHATSU	236	H1200/5 FORD	407
H1113/5 CITROËN	193	TOYOTA	1238	FORD	408
CITROËN	194	H1149/5 ISUZU	472	FORD	409
CITROËN	195	ISUZU	473	FORD	410
CITROËN	196	H1150/5 AUSTIN	109	H1201/7 PERKINS	941
PEUGEOT	975	AUSTIN	110	PERKINS	942
PEUGEOT	976	LEYLAND	610	H1222/5 FORD	398
PEUGEOT	977	ROVER	1112	FORD	420
H1116/5 FORD	431	H1157/5 NISSAN	885	FORD	424
FORD	432	NISSAN	886	FORD	425
H1119/7 LEYLAND	610	NISSAN	890	H1225/5 BEDFORD	115
LEYLAND	611	NISSAN	892	ISUZU	471
H1120/5 LEYLAND	610	H1159/5 SUBARU	1209	ISUZU	472
LEYLAND	611	SUZUKI	1215	ISUZU	473
H1122/3 NISSAN	886	H1160/5 CHEVROLET	161	OPEL	922
H1124/7 PERKINS	939	ISUZU	474	OPEL	929
PERKINS	940	OPEL	931	OPEL	930
PERKINS	942	H1161/5 FORD	417	H1233/7 NISSAN	889
H1125/5 DAIHATSU	237	KIA	565	H1234/7 JOHN DEERE	556
TOYOTA	1240	MAZDA	677	JOHN DEERE	557
TOYOTA	1241	MAZDA	678	JOHN DEERE	558
H1127/5 CHEVROLET	157	SUZUKI	1219	H1235/5 FORD	398
ISUZU	471	H1163/5 FORD	416	FORD	424
MAZDA	675	FORD	420	FORD	425
OPEL	915	FORD	422	FORD	426
OPEL	917	H1167/7 BEDFORD	116	H1237/5 TOYOTA	1239
OPEL	918	H1169/7 BEDFORD	117	TOYOTA	1240
H1128/5 TOYOTA	1233	FORD	431	H1238/7 BMW	136
H1129/7 RENAULT	1095	FORD	432	BMW	143
RENAULT	1097	FORD	433	H1239/7 MAN	640
RENAULT	1099	FORD	434	MAN	641
RENAULT	1100	H1175/5 FIAT	349	MAN	642
H1132/7 FIAT	352	IVECO	531	MAN	650
IVECO	540	IVECO	532	MAN	655
H1133/3 FORD	391	H1175/7 FIAT	349	MAN	658
FORD	392	H1176/5 DAIHATSU	235	MAN	660
H1136/3 LAND ROVER	603	TOYOTA	1231	MAN	662
ROVER	1109	TOYOTA	1233	MAN	663
H1137/3 DAVID BROWN	240	H1178/3 FIAT	290	MAN	664
H1138/3 ALFA ROMEO	14	LANCIA	580	MAN	665
JOHN DEERE	552	H1186/3 TRIUMPH	1246	MAN	666
PERKINS	937	H1189/5 LAND ROVER	601	H1240/5 CITROËN	199
H1141/4 BEDFORD	113	LAND ROVER	605	CITROËN	203
DAIHATSU	235	LAND ROVER	606	FIAT	311
DAIHATSU	236	ROVER	1112	FIAT	320
KIA	563	ROVER	1114	PEUGEOT	979
OPEL	914	H1191/5 KIA	565	PEUGEOT	980
H1142/5 LAND ROVER	605	MAZDA	678	PEUGEOT	981
LAND ROVER	606	H1192/5 FORD	389	PEUGEOT	985
ROVER	1114	FORD	397	PEUGEOT	986
H1143/5 FORD	406	KIA	563	H1241/5 CITROËN	198
FORD	407	KIA	564	CITROËN	199

NUMERICAL PARTS LIST

  	  	  			
CITROËN	203	LEYLAND	608	FIAT	297
FIAT	311	H1311/3 AUSTIN	104	SUBARU	1209
FIAT	312	AUSTIN	105	SUZUKI	1217
FIAT	320	ROVER	1107	SUZUKI	1218
PEUGEOT	979	H1312/3 AUSTIN	106	H1332/5 TOYOTA	1231
PEUGEOT	980	AUSTIN	107	TOYOTA	1232
PEUGEOT	981	AUSTIN	108	H1333/7 ISUZU	476
PEUGEOT	986	AUSTIN	109	ISUZU	477
PEUGEOT	987	ROVER	1107	H1337/3 ALFA ROMEO	16
H1242/5 FORD	432	ROVER	1108	CHRYSLER	166
FORD	434	H1313/3 AUSTIN	106	FIAT	301
H1243/5 NISSAN	887	AUSTIN	107	LANCIA	584
NISSAN	888	AUSTIN	108	H1338/4 CITROËN	184
OPEL	922	ROVER	1108	DAIHATSU	235
RENAULT	1073	H1320/5 HONDA	452	PEUGEOT	963
H1244/5 TOYOTA	1238	H1321/5 TOYOTA	1235	SUBARU	1209
TOYOTA	1240	TOYOTA	1236	TOYOTA	1231
H1246/5 HINO	438	H1322/5 CHEVROLET	157	H1339/5 HONDA	450
TOYOTA	1242	TOYOTA	1235	H1340/5 MAZDA	677
H1247/5 MITSUBISHI	843	H1324/7 RENAULT	1099	MITSUBISHI	840
H1248/5 FORD	427	H1325/5 AUDI	49	NISSAN	887
HYUNDAI	460	AUDI	52	NISSAN	888
MITSUBISHI	843	AUDI	56	SUZUKI	1218
H1249/5 NISSAN	890	SEAT	1150	H1341/5 NISSAN	890
NISSAN	892	SEAT	1153	NISSAN	891
H1254/7 DAF	221	SEAT	1154	SUZUKI	1219
H1277/5 CHEVROLET	158	SEAT	1155	H1342/5 ISUZU	475
SUZUKI	1218	SEAT	1157	NISSAN	893
H1279/5 LAND ROVER	602	SEAT	1158	H1343/4 SEAT	1156
LAND ROVER	603	SEAT	1159	SKODA	1192
LAND ROVER	604	SKODA	1191	VOLKSWAGEN	1297
LAND ROVER	605	SKODA	1192	H1344/7 NEW HOLLAND	863
ROVER	1113	SKODA	1193	H1345/4 CITROËN	191
H1280/7 SCANIA	1129	SKODA	1194	PEUGEOT	971
SCANIA	1130	VOLKSWAGEN	1282	H1346/5 HYUNDAI	458
H1293/5 ALFA ROMEO	14	VOLKSWAGEN	1289	KIA	563
ALFA ROMEO	19	VOLKSWAGEN	1290	H1347/5 HYUNDAI	458
CHRYSLER	166	VOLKSWAGEN	1291	HYUNDAI	459
FIAT	298	VOLKSWAGEN	1292	KIA	564
FIAT	308	VOLKSWAGEN	1297	H1348/5 HYUNDAI	459
LANCIA	583	VOLKSWAGEN	1298	HYUNDAI	460
LANCIA	588	VOLKSWAGEN	1299	KIA	564
H1294/6 VOLKSWAGEN	1355	H1326/7 IVECO	537	H1350/5 FORD	390
H1295/4 CHEVROLET	155	H1327/5 NISSAN	889	FORD	395
OPEL	913	OPEL	925	FORD	399
SUZUKI	1215	RENAULT	1074	H1355/5 HONDA	448
H1295/5 CHEVROLET	155	H1328/5 AUDI	55	H1356/5 SUZUKI	1215
OPEL	913	AUDI	93	SUZUKI	1216
SUZUKI	1214	AUDI	94	H1357/5 MITSUBISHI	836
H1296/5 TOYOTA	1231	AUDI	95	MITSUBISHI	839
H1298/5 BMW	142	SEAT	1159	H1358/5 FORD	413
MINI	826	SEAT	1178	MAZDA	676
H1298/7 BMW	143	SKODA	1193	H1359/5 NISSAN	882
H1300/4 AUDI	101	SKODA	1202	NISSAN	883
H1303/7 VOLVO	1402	VOLKSWAGEN	1303	N049/4L MERCEDES-BENZ	771
VOLVO	1404	VOLKSWAGEN	1352	MERCEDES-BENZ	774
H1307/5 ISUZU	475	H1329/5 HYUNDAI	457	MERCEDES-BENZ	775
ISUZU	476	HYUNDAI	458	N072/3 VOLKSWAGEN	1300
H1307/7 ISUZU	475	KIA	563	VOLKSWAGEN	1361
ISUZU	476	H1330/5 CHEVROLET	156	VOLKSWAGEN	1362
H1310/3 AUSTIN	104	SUBARU	1209	VOLKSWAGEN	1363
AUSTIN	105	SUZUKI	1217	N075/7L MERCEDES-BENZ	788
AUSTIN	106	H1331/5 CHEVROLET	156	N082/7 MERCEDES-BENZ	809

  			  			  		
N082/7L	MERCEDES-BENZ	809	AUDI	50	N139/3	VOLKSWAGEN	1300	
N088/3	VOLVO	1395	AUDI	51	N145/3	FORD	398	
	VOLVO	1396	AUDI	55		FORD	410	
	VOLVO	1398	AUDI	56		FORD	411	
	VOLVO	1399	AUDI	72		FORD	420	
N095/5	DAF	218	AUDI	73		FORD	421	
	DAF	223	AUDI	78		FORD	422	
	DAF	225	AUDI	80		FORD	424	
	DAF	226	AUDI	81		FORD	425	
	DAF	227	AUDI	84		FORD	426	
	DAF	228	AUDI	86	N147/4	AUDI	50	
	DAF	229	NISSAN	885		AUDI	63	
	DAF	231	SEAT	1156		SEAT	1160	
	LEYLAND	613	SEAT	1167		SKODA	1194	
N109/7L	MAN	647	SEAT	1168		VOLKSWAGEN	1294	
	MAN	649	SEAT	1169		VOLKSWAGEN	1305	
	MAN	656	SEAT	1170	N147/5	AUDI	64	
	MAN	657	SEAT	1172		AUDI	65	
	MAN	659	SEAT	1176		AUDI	66	
	MAN	660	SKODA	1199		AUDI	67	
	MAN	661	VOLKSWAGEN	1287		AUDI	68	
	MAN	662	VOLKSWAGEN	1288		AUDI	69	
	MAN	663	VOLKSWAGEN	1293		FORD	401	
	MAN	664	VOLKSWAGEN	1294		FORD	402	
	MAN	665	VOLKSWAGEN	1295		SEAT	1160	
	MAN	666	VOLKSWAGEN	1301		SEAT	1161	
	MERCEDES-BENZ	796	VOLKSWAGEN	1302		SEAT	1162	
	MERCEDES-BENZ	809	VOLKSWAGEN	1304		SEAT	1163	
	MERCEDES-BENZ	810	VOLKSWAGEN	1313		SEAT	1164	
	MERCEDES-BENZ	812	VOLKSWAGEN	1314		SEAT	1165	
N110/4L	MERCEDES-BENZ	790	VOLKSWAGEN	1315		SEAT	1166	
	MERCEDES-BENZ	791	VOLKSWAGEN	1316		SEAT	1177	
	MERCEDES-BENZ	794	VOLKSWAGEN	1317		SKODA	1194	
	MERCEDES-BENZ	797	VOLKSWAGEN	1318		SKODA	1195	
	MERCEDES-BENZ	798	VOLKSWAGEN	1319		SKODA	1196	
	MERCEDES-BENZ	799	VOLKSWAGEN	1320		SKODA	1197	
	MERCEDES-BENZ	800	VOLKSWAGEN	1322		SKODA	1198	
	MERCEDES-BENZ	801	VOLKSWAGEN	1323		SKODA	1199	
	MERCEDES-BENZ	816	VOLKSWAGEN	1324		SKODA	1201	
	MERCEDES-BENZ	817	VOLKSWAGEN	1325		VOLKSWAGEN	1306	
	MERCEDES-BENZ	818	VOLKSWAGEN	1326		VOLKSWAGEN	1307	
N110/5L	MAN	643	VOLKSWAGEN	1327		VOLKSWAGEN	1308	
	MAN	644	VOLKSWAGEN	1328		VOLKSWAGEN	1309	
	MAN	651	VOLKSWAGEN	1329		VOLKSWAGEN	1310	
	MERCEDES-BENZ	792	VOLKSWAGEN	1334		VOLKSWAGEN	1311	
	MERCEDES-BENZ	802	VOLKSWAGEN	1337		VOLKSWAGEN	1312	
	MERCEDES-BENZ	803	VOLKSWAGEN	1339		VOLKSWAGEN	1355	
	MERCEDES-BENZ	805	VOLKSWAGEN	1344	N150/5	MAN	633	
	MERCEDES-BENZ	818	N120/5	DEUTZ	253	N150/7	MAN	637
	MERCEDES-BENZ	820		DEUTZ	255		MAN	638
N110/6L	MAN	644		DEUTZ	256		MAN	639
	MAN	645		DEUTZ	257	N151/6	CITROËN	193
	MAN	652		IVECO	539		CITROËN	199
	MERCEDES-BENZ	793		IVECO	540		CITROËN	201
	MERCEDES-BENZ	806	N122/3L	MERCEDES-BENZ	768		FIAT	312
	MERCEDES-BENZ	820		MERCEDES-BENZ	769		FIAT	315
N110/7	MAN	646	N125/4	MAN	630		FIAT	316
	MAN	653		MAN	634		LANCIA	592
	MAN	654		MAN	635		LANCIA	593
	MERCEDES-BENZ	794	N128/4	MERCEDES-BENZ	771		LAND ROVER	601
	MERCEDES-BENZ	807		MERCEDES-BENZ	774		LAND ROVER	601
N118/5	AUDI	48		MERCEDES-BENZ	775		LAND ROVER	601
	AUDI	49		MERCEDES-BENZ	780		MITSUBISHI	841
							PEUGEOT	974
							PEUGEOT	982

NUMERICAL PARTS LIST

  			  		
	PEUGEOT	983		ROVER	1113
N152/5	RENAULT	1090	N166/5	FORD	429
	RENAULT	1092		FORD	434
	RENAULT	1093		FORD	435
N153/3	IVECO	513		FORD	436
	IVECO	521	N167/4	BEDFORD	116
	IVECO	523	N170/5	LAND ROVER	601
	IVECO	531		LAND ROVER	605
	NEW HOLLAND	850		ROVER	1113
	NEW HOLLAND	852		ROVER	1114
N154/4	FIAT	326	N171/6	BEDFORD	117
	FIAT	329		FORD	432
	FIAT	335		FORD	433
	IVECO	508		FORD	434
	IVECO	511	N172/7	VOLVO	1413
	IVECO	513	N173/7	SCANIA	1135
	NEW HOLLAND	854	N174/4	FIAT	355
	NEW HOLLAND	857		FIAT	356
	NEW HOLLAND	861		IVECO	542
N156/2	FORD	427		IVECO	544
	HYUNDAI	460	N178/3	CHEVROLET	161
	HYUNDAI	461		ISUZU	474
	KIA	565		OPEL	931
	MAZDA	678		OPEL	935
	mitsubishi	840	N180/8	JAGUAR	548
	mitsubishi	841		JAGUAR	549
	mitsubishi	842	N181/3	AUSTIN	107
	mitsubishi	843		AUSTIN	108
N157/7	VOLVO	1401		AUSTIN	109
	VOLVO	1402		ROVER	1107
	VOLVO	1403		ROVER	1108
	VOLVO	1404	N182/3	FORD	389
	VOLVO	1407		FORD	391
	VOLVO	1408		FORD	392
	VOLVO	1410		FORD	393
	VOLVO	1411		FORD	394
N158/5	NISSAN	878		MAZDA	673
	NISSAN	879	N192/5	DEUTZ	252
	NISSAN	880		RENAULT	1095
	NISSAN	881	N192/7	DEUTZ	253
N159/3	NISSAN	886		RENAULT	1095
	NISSAN	887		VOLVO	1405
	NISSAN	891	N194/4	DAF	232
	NISSAN	892	N195/7	DAF	232
N160/3	AUSTIN	109	N196/5	MAN	664
	LEYLAND	609	N197/4	SCANIA	1131
	LEYLAND	610		SCANIA	1134
N161/3	FORD	406	N199/7	SCANIA	1129
	FORD	407		SCANIA	1130
	FORD	408	N200/7	VOLVO	1412
	FORD	409	N203/3	HINO	438
	FORD	410		TOYOTA	1242
N162/3	AUSTIN	104	N204/4	MERCEDES-BENZ	821
	AUSTIN	105		MERCEDES-BENZ	822
	AUSTIN	106	N204/5	MERCEDES-BENZ	823
	LEYLAND	608	N205/7	MERCEDES-BENZ	814
	LEYLAND	609		MERCEDES-BENZ	815
	ROVER	1107		MERCEDES-BENZ	816
N165/4	LAND ROVER	602		MITSUBISHI	844
	LAND ROVER	603	N206/7	RENAULT	1100
	LAND ROVER	604	N207/7	IVECO	537
	LAND ROVER	605			
	ROVER	1110			

Federal-Mogul Global Aftermarket EMEA bvba

Prins Boudewijnlaan 5 • B-2550 Kontich • Belgium

Central Distribution Centre

Prins Boudewijnlaan 7 • B-2550 Kontich • Belgium

Phone +32 (0) 3450 83 10 • Fax +32 (0) 3450 83 38

Federal-Mogul Italy Srl**Aftermarket Division**

Via Enrico Fermi 8 • 37135 Verona • Italy

Phone +39 045 828 13 11 • Fax +39 045 828 14 00

Federal-Mogul Germany GmbH

Albert-Ruprecht-Strasse 2 • 71636 Ludwigsburg • Germany

Phone +49 (0) 7141-64865-8230 • Fax +49 (0) 7141-64865-8390

Federal-Mogul Aftermarket UK Limited

Greyhound Drive • Bradford BD7 1NQ • England

Phone +44 (0) 1274 723481 • Fax: +44 (0) 1274 848282

Federal-Mogul Ibérica, S.L.**Federal-Mogul Aftermarket España, S.A.**

Calle Alcarria, nº 2 • 28823 Coslada • Madrid • Spain

Phone: + 34 91 746 1900 • Fax: + 34 91 746 18 90

Federal-Mogul Aftermarket France

60-62, rue Danjou • 92517 Boulogne-Billancourt Cedex • France

Phone +33 (0) 1 46 94 27 00 • Fax +33 (0) 1 46 94 27 01

Service Commande de stock :

Phone +33 (0) 810 000 029 • Fax +32 34 50 80 26

Service Commande express :

Phone +33 (0) 810 000 029 • Fax +32 34 50 80 26

Federal-Mogul Aftermarket**Southern Africa (PTY) Ltd**

33 Western Boulevard • City West • Johannesburg • South Africa

Phone +27 11 630 3000 • Fax +27 11 630 3040

Federal-Mogul Aftermarket Turkey

Meclis-i Mebusan Cad. No: 53 Dereli İş Merkezi 34427 • Fındıklı / İstanbul • Türkiye

Phone +90 212 292 6313 • Fax +90 212 292 6260

Federal-Mogul Aftermarket Russia Ltd

Smolnaya street 24D, 13th floor • 125445 Moscow • Russia

Phone +7 495 221 50 60 • Fax +7 495 221 50 64



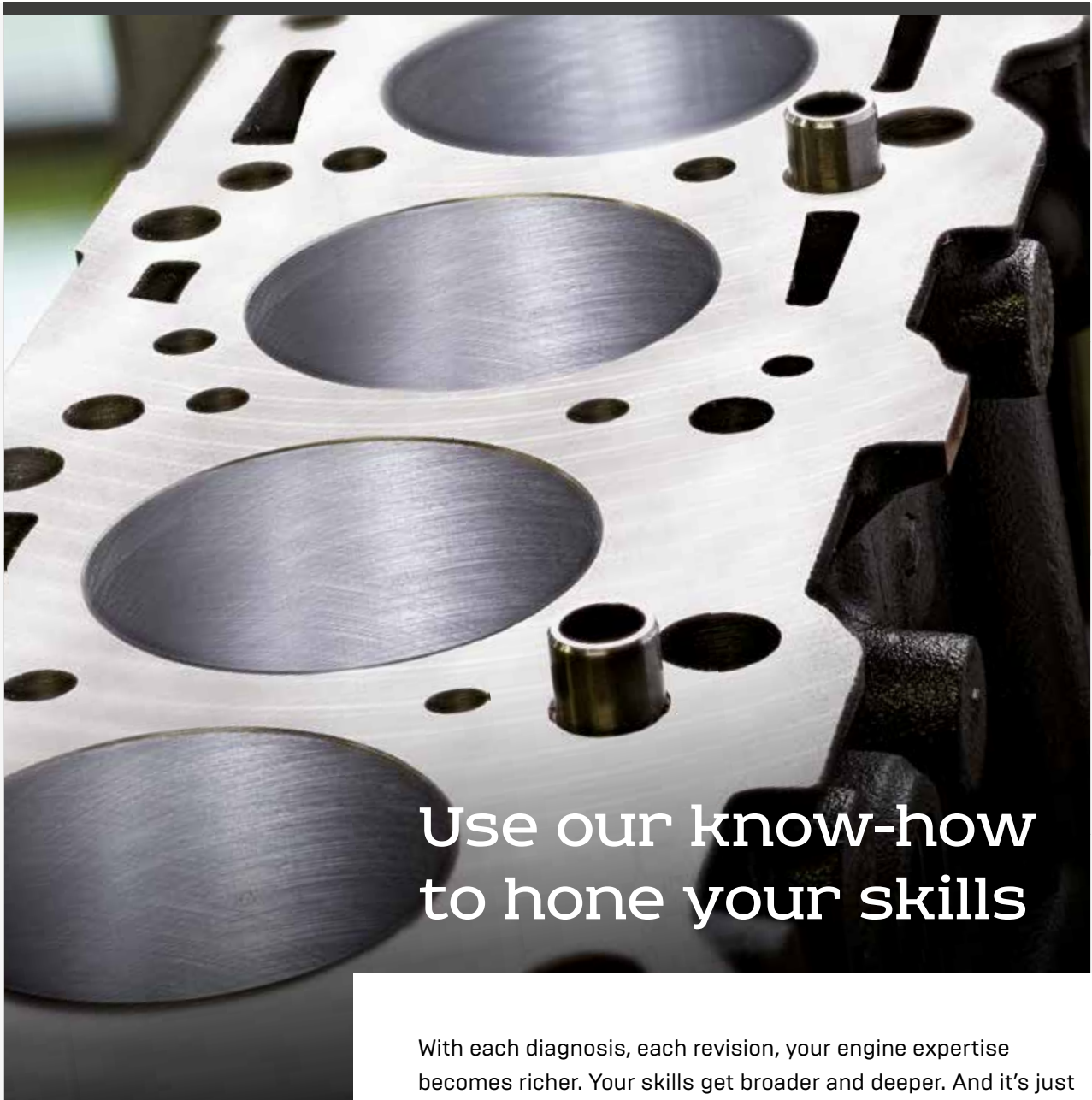

Use our know-how to hone your skills

With each diagnosis, each revision, your engine expertise becomes richer. Your skills get broader and deeper. And it's just the same at Federal-Mogul. That's why people rely on you. For example, your eye for detail and your feel for precise cylinder liner honing guarantee optimum engine performance. Your expertise helps us understand which parts you need, and how we can give you even more support to make it easier for you to achieve perfection with each engine job.

Because our engine expertise... is based on yours.



ENGINE EXPERTISE
BY  **FEDERAL-MOGUL**
MOTORPARTS



 **GLYCO**

 **GOETZE**

Niral

 **Payen**

