

Niiral[®]

FITTED WITH  GOETZE[®] RINGS

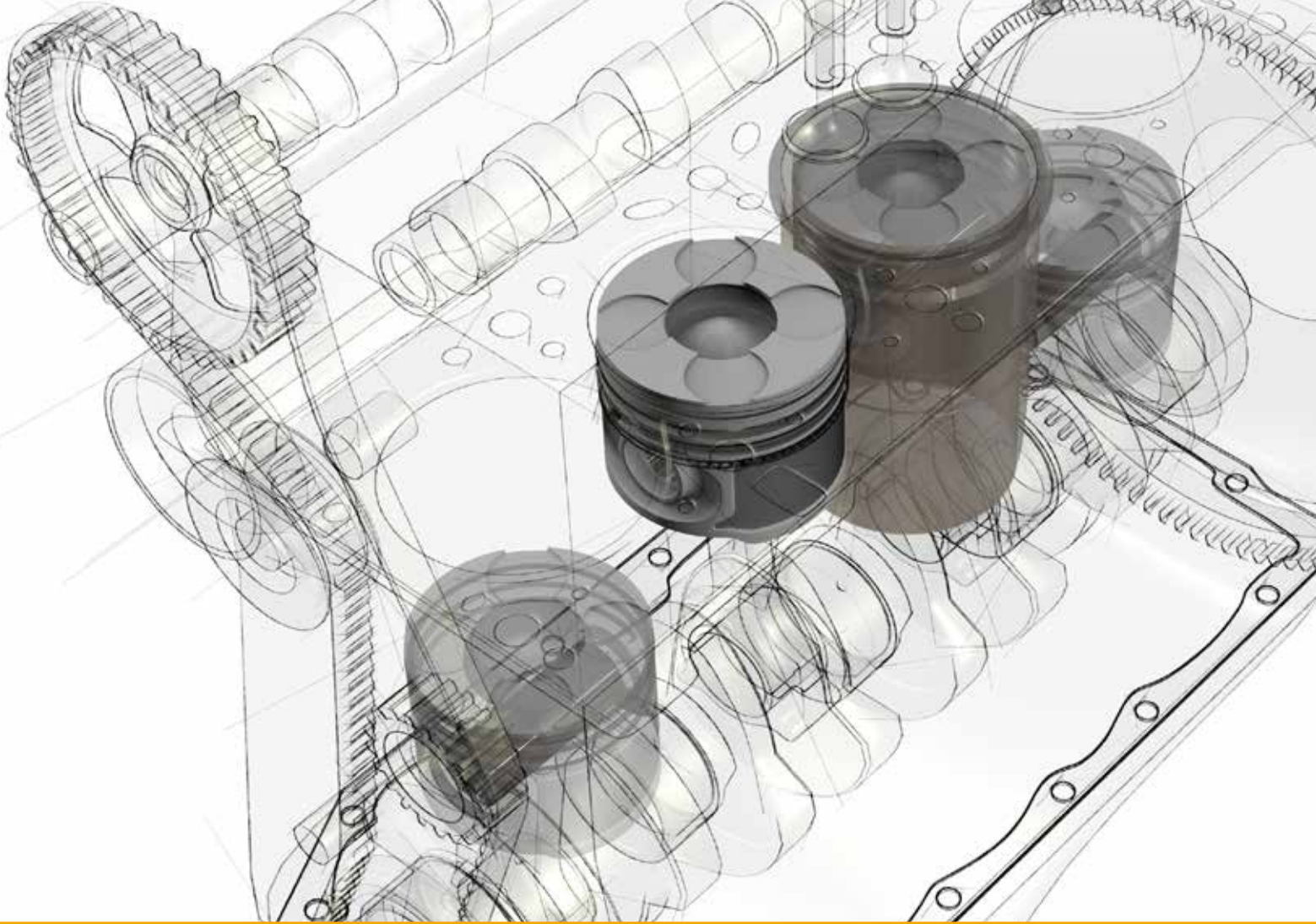

Pistons, Liners and Assemblies
Kolben, Laufbuchsen und Zubehör
Pistoni, Canne e Gruppi Cilindro
Pistons, Chemises et Kits
Pistones, Camisas y Equipos
Tłoki, Tulei i Zespołów Części Cylindrowych
Поршни, Цилиндры и Поршнекомплекты
المكابيس ، القمصان و مجموعات السلندر

CATNU1601



2017-2019

ENGINE EXPERTISE BY  **FEDERAL-MOGUL**
MOTORPARTS



 GLYCO

 GOETZE[®]

Niiral

 Payen



Use our know-how to hone your skills

With each diagnosis, each revision, your engine expertise becomes richer. Your skills get broader and deeper. And it's just the same at Federal-Mogul. That's why people rely on you. For example, your eye for detail and your feel for precise cylinder liner honing guarantee optimum engine performance. Your expertise helps us understand which parts you need, and how we can give you even more support to make it easier for you to achieve perfection with each engine job.

Because our engine expertise... is based on yours.



ENGINE EXPERTISE
BY  **FEDERAL-MOGUL**
MOTORPARTS



 **GLYCO**

 **GOETZE**

Nirral

 **Payen**



GOETZE®



UP TO 50% LESS OIL CONSUMPTION

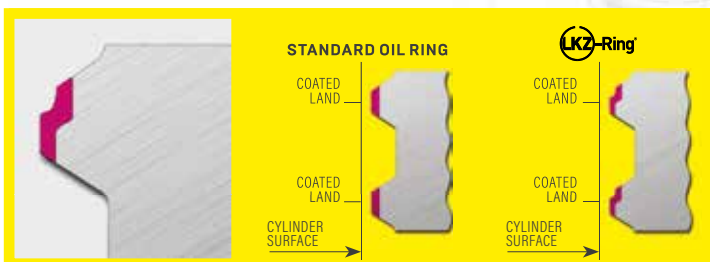

GOETZE® BRINGS ITS INNOVATIVE, OE-PROVEN TECHNOLOGY TO THE AFTERMARKET

- Reduced oil consumption up to -50%* and friction up to -15%*
- Cuts CO₂ and improves fuel consumption
- Variety of surface treatments: CKS, GDC®, PVD
- Winner of the prestigious Automotive News PACE™ award

* Compared to conventional two-piece oil rings



ENGINE EXPERTISE
BY  **FEDERAL-MOGUL**
MOTORPARTS



 **GLYCO**

 **GOETZE®**

Niral®

 **Payen®**

CONTENTS



Contents	II
Manufacturers list	IV
Federal-Mogul anti-counterfeit program	V
Terms of business	VI-VII
How to use this catalogue	VIII-IX
Campus	XXIV
New parts list	XXV
Applications by manufacturer	1
Numerical parts list	1378
Nüral pistons fitted with Goetze rings	1420
Pistons clearance data	1428
Piston protrusion data	1435
Federal-Mogul latest engine & sealing catalogues	1438



Contenuti	II
Elenco costruttori	IV
Programma di anti-contraffazione di Federal-Mogul	V
Condizioni generali	VI-VII
Come si utilizza il catalogo	XII-XIII
Campus	XXIV
Elenco codici nuovi	XXV
Applicazioni del costruttore	1
Elenco riferimenti	1378
Pistoni Nüral con segmenti Goetze	1420
Dati sul gioco dei pistoni	1428
Dati sporgenza pistone	1435
Ultimi cataloghi guarnizioni e motori Federal-Mogul	1438



Inhaltsverzeichnis	II
Herstellerliste	IV
Federal-Mogul Anti-Fälschungsprogramm	V
Geschäftsbedingungen	VI-VII
So benutzen Sie diesen Katalog	X-XI
Campus	XXIV
Neuaufnahmen	XXV
Anwendungen nach Hersteller	1
Numerische Teilleiste	1378
Nüral-Kolben mit Goetze-Kolbenringen	1420
Daten Kolbenspiel	1428
Kolbenüberstands-Daten	1435
Neueste Motoren- und Dichtungskataloge von Federal Mogul	1438



Contenu	II
Liste des constructeurs	IV
Le programme anti-contrefaçon de Federal-Mogul	V
Conditions générales de vente	VI-VII
Comment utiliser ce catalogue	XIV-XV
Campus	XXIV
Liste des nouvelles références	XXV
Applications par constructeur	1
Liste numérique des références	1378
Pistons Nüral équipés de segments Goetze	1420
Jeu de pistons	1428
Données de dépassement de piston	1435
Catalogues de Federal-Mogul de pièces moteur et étanchéité les plus récents	1438



Contenido	III
Lista de fabricantes	IV
Programa antifalsificación de Federal-Mogul	V
Condiciones de venta	VI-VII
Cómo utilizar este catálogo	XVI-XVII
Campus	XXIV
Lista de nuevas referencias	XXV
Aplicaciones por fabricante	1
Lista de referencias numéricas	1378
Pistones Nüral con segmentos Goetze	1420
Datos de holgura de pistones	1428
Altura del pistón en PMS	1435
Últimos catálogos de componentes de sellado y motores de Federal-Mogul	1438



Содержание	III
Список производителей	IV
Программа защиты от подделок Federal-Mogul	V
Условия делового сотрудничества	VI-VII
Как пользоваться каталогом	XX-XXI
Campus	XXIV
Список новой продукции	XXV
Модели автомобилей, сортировка по производителю	1
Список номеров деталей	1378
Поршни Nüral, оснащаемые кольцами Goetze	1420
Спецификация зазора поршня	1428
Параметры выступления поршня	1435
Новейшие каталоги уплотнений и деталей для двигателей Federal-Mogul	1438



Zawartość	III
Lista producentów	IV
Program przeciwdziałania podrabianiu części Federal-Mogul	V
Warunki prowadzenia biznesu	VI-VII
Jak używać tego katalogu	XVIII-XIX
Campus	XXIV
Lista nowych części	XXV
Lista zastosowań wg producentów	1
Numeryczna lista części	1378
Tłoki Nüral wyposażone w pierścienie Goetze	1420
Dane dotyczące luzów tłokowych	1428
Dane dotyczące wysunięcia tłoka	1435
Najnowsze katalogi części silnikowych i uszczelnień Federal-Mogul	1438



المحتويات	III
قائمة جهات التصنيع	IV
برنامج Federal-Mogul لمكافحة إنتاج قطع الغيار المقلدة	V
شروط العمل التجاري	VII-VI
كيفية استخدام هذا الكatalog	XXIII-XXII
Campus	XXIV
قائمة قطع الغيار الجديدة	XXV
التطبيقات حسب جهة التصنيع	1
قائمة الأجزاء الرقمية	1378
يتم تركيب كباسات Nüral باستخدام حلقات Goetze	1420
معلومات خلوص المكبس	1428
معلومات بروز المكبس	1435
أحدث كتالوجات Federal-Mogul للمحركات ومنتجات منع التسرب	1438

MANUFACTURERS LIST



AGCO SISU	1
ALFA ROMEO	2
ARO	29
ASTRA	> IVECO
AUDI	34
AUSTIN MORRIS	85
AUTOBIANCHI	> FIAT/LANCIA
BEDFORD	94
BELARUS	100
BERLIET	> RENAULT TRUCK
BMW	101
CADILLAC	117
CATERHAM	118
CHEVROLET	120
CHRYSLER	129
CITROËN	131
CLAYTON DEWANDRE	173
COMPRESSOR	174
CUMMINS	178
DACIA	179
DAEWOO	188
DAF	192
DAIMLER	> JAGUAR
DAIMLER-BENZ	> MERCEDES-BENZ
DAVID BROWN	205
DEUTZ / KHD	206
EBRO TRACTOR	> FORD TRACTOR
FIAT	230
FIAT ALLIS-HITACHI	> IVECO
FIAT INDUSTRIAL	> IVECO
FORD EUROPE	299
FORD COMMERCIAL	377
FORD TRACTOR	383
FSO	390
HATZ	394
HENSCHEL	396
HINO	397
HONDA	398
HYUNDAI	400
IFA	410
IHC	411
INNOCENTI	> FIAT
ISUZU	413
IVECO	419
JAGUAR	483
JEEP	492
JOHN DEERE	496
KAMAZ	501
KHD	> DEUTZ/KHD
KIA	502
KOMATSU	507
LADA	508
LANCIA	514

LAND ROVER	547
LDV	565
LEYLAND	567
LISTER	576
LOTUS	577
MAN	579
MARELLI	634
MASSEY-FERGUSON	> PERKINS
MAZDA	636
MERCEDES-BENZ	643
MERCEDES-BENZ COMMERCIAL	700
MG	776
MINI	783
MITSUBISHI	785
MORRIS	> AUSTIN/MORRIS
MWM	796
NEW HOLLAND	797
NISSAN	812
OPEL	829
PERKINS	879
PEUGEOT	897
POLSKI FIAT	> FIAT
PUCH	> MERCEDES-BENZ
RABA	944
RENAULT	945
RENAULT TRUCK	1021
ROVER	1042
RVI	> RENAULT TRUCK
SAAB	1057
SAME	1062
SAVIEM	> RENAULT TRUCK
SCANIA	1063
SEAT	1083
SKODA	1130
SMART	1163
SSANGYONG	1167
STEYR	1176
SUBARU	1180
SUZUKI	1181
TALBOT	1188
TOYOTA	1193
TRIUMPH	1204
TRIUMPH MOTORCYCLE	1205
UAZ	1206
UTB	1207
VAUXHALL	1208
VM	1249
VOLKSWAGEN	1250
VOLVO CAR	1331
VOLVO COMMERCIAL	1341
VOLVO PENTA	> VOLVO COMMERCIAL
ZASTAVA	1375



**KEEP IT REAL
KEEP OUT COUNTERFEIT**

The authenticity of all our engine and sealing products is protected by the MAPP Code (Manufacturers Against Product Piracy) and the PrioSpot® Authentication device, featured on a special Anti-Counterfeit label on the packaging. In this way you can be sure of our trusted Federal-Mogul quality!

HOW TO CHECK THE AUTHENTICITY OF YOUR PRODUCTS

1 Check if the packaging is closed and the label is intact

2 Verify the unique alphanumeric code and data matrix code

- Type in the alphanumeric code at www.fmecat.eu
- or
- Read the Data Matrix Code with a 2-D scanner
- or
- Read the Data Matrix Code on your smartphone with a barcode reader app

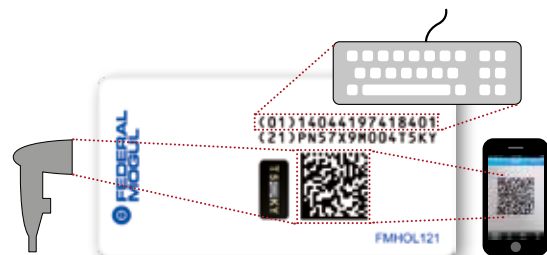

3 Verify the unique security code on the PrioSpot® Label

- Different code on each packaging



- Code contains the last 4 digits of the alphanumeric code
- The code and the Federal-Mogul logo shimmer in rainbow colours only in direct light
- Only in direct light a digit, repeating the last digit of the security code, is visible. This digit will move up and down when you change the angle of the PrioSpot®



ENGINE EXPERTISE
BY **FEDERAL-MOGUL**
MOTORPARTS



GILYCO

GOETZE

Niral

Payen

TERMS OF BUSINESS

IMPORTANT

Reproduction of this catalogue or parts thereof is only allowed with our explicit permission in writing. Pictorial representations and design are copyrighted. Claims for damages, of any form whatsoever, resulting from details made in this catalogue or from incorrect use, application, storage or handling, are explicitly excluded. Contractual rights and any resulting or related claims based thereon, irrespective of form, initially come into being on the basis of a separate written agreement, in particular on the basis of our general terms of sale and delivery.

All former statements lose their validity with the publication of this catalogue.

The catalogue is not an operating manual for the use and installation of pistons, liners and assemblies. It does not contain any advice in a legal sense. The catalogue neither replaces the constantly applicable technical regulations – particularly for tolerances – nor the installation and maintenance stipulations of the individual engine manufacturer.

Also, it is not possible to forego the expertise of those carrying out the installation and application. The individual references made in this catalogue for the installation and the application of pistons, liners and assemblies are instructions solely for the technically qualified specialist and are to be checked and verified by them for their suitability in each case. Federal-Mogul accepts no responsibility for application decisions.

The contents of the catalogue are not intended to create or substitute any contractual agreement which has to be reserved exclusively to a separate agreement between 2 identified parties, whereby seller can be only one of our Federal-Mogul entities as mentioned on the inside back cover.

The right is retained to correct errors and alterations, particularly with regard to amendments in the engine manufacturers' details and stipulations.

ZUR BEACHTUNG

Die Reproduktion dieses Katalogs ist nur mit unserer ausdrücklichen Genehmigung gestattet. Bildliche Darstellungen und der Entwurf sind urheberrechtlich geschützt. Schadenersatzansprüche in jedweder Form unter Berufung auf die Angaben in diesem Katalog oder infolge unsachgemäßen Gebrauchs, unsachgemäßer Anwendung, Lagerung oder Handhabung sind ausdrücklich ausgeschlossen. Vertragliche Rechte und etwaige hieraus folgende oder abgeleitete Ansprüche jedweder Art werden erst durch getrennte schriftliche Vereinbarung, im Besonderen auf der Grundlage unserer allgemeinen Verkaufs- und Lieferbedingungen, begründet.

Mit Erscheinen dieses Katalogs verlieren alle früheren Angaben ihre Gültigkeit.

Der Katalog stellt keine Anleitung für den Gebrauch und den Einbau von Kolben, Laufbuchsen und Zubehör dar. Es werden keine Ratschläge im rechtlichen Sinne abgegeben. Der Katalog ersetzt weder die jeweils geltenden technischen Maßgaben – insbesondere für Toleranzen – noch die Einbau- und Wartungsvorschriften des jeweiligen Motorenherstellers.

Auch ist die Sachkenntnis derer, die den Einbau und die Anwendung vornehmen, eine wesentliche Größe. Die Aussagen in diesem Katalog zum Einbau und Einsatz von Kolben, Laufbuchsen und Baugruppen richten sich ausschließlich an den technisch versierten Fachmann und sind von diesem von Fall zu Fall auf Eignung und Gültigkeit zu überprüfen. Federal-Mogul übernimmt keine Verantwortung für Anwendungsentscheidungen.

Der Inhalt des Katalogs begründet oder ersetzt keine vertragliche Vereinbarung, welche ausschließlich einer getrennten Vereinbarung zwischen zwei bestimmten Parteien vorbehalten sein muss, in der die Verkäuferpartei eine unserer in den Rückdeckel genannten Federal-Mogul Gesellschaften ist. Das Recht auf Berichtigung von Irrtümern und Abänderungen, insbesondere hinsichtlich geänderter Angaben und Bestimmungen der Motorenhersteller, bleibt vorbehalten.

IMPORTANTE

La riproduzione di questo catalogo, anche parziale, è permessa soltanto in seguito ad una autorizzazione scritta. I grafici ed i disegni sono depositati e coperti da copyright. Reclami per difetti, di qualsiasi natura essi siano, relativi al contenuto di questo catalogo, o all'uso improprio, verranno respinti. Le pretese avanzate o i reclami dovranno essere in conformità con le nostre condizioni generali di vendita.

Il presente catalogo annulla e sostituisce tutte le edizioni precedenti.

Il catalogo non è un manuale per l'utilizzo ed il montaggio di pistoni, canne e gruppi cilindro. Non contiene indicazioni in questo senso. Esso non sostituisce le descrizioni tecniche, sempre prioritarie, in particolare per le tolleranze, né le istruzioni relative al montaggio ed alla manutenzione date dai costruttori dei rispettivi motori. Non può in nessun caso essere paragonato alla conoscenza professionale necessaria per il montaggio e l'utilizzo. Le considerazioni sul montaggio di pistoni, canne e gruppi cilindro, fatte su questo catalogo, sono destinate esclusivamente a professionisti con formazione tecnica i quali verificheranno l'esattezza delle informazioni, in ogni caso. Le responsabilità derivanti dall'utilizzo improprio dello stesso non potranno essere addebitate alla Federal-Mogul.

I contenuti del catalogo non sostituiscono in alcun modo gli accordi contrattuali che sono riservati esclusivamente a due contraenti definiti; come venditore si intende una delle società Federal-Mogul menzionate sul retro del catalogo.

Ci riserviamo di apportare correzioni e modifiche, relative in particolare, a dati o istruzioni ricevute dal costruttore del motore.

IMPORTANT

La reproduction de ce catalogue, même partielle, n'est autorisée qu'avec notre accord préalable et par écrit. Les illustrations graphiques et la présentation font l'objet d'un copyright. Nous excluons toutes réclamations ayant pour objet ce catalogue ou pouvant résulter de son incompréhension, portant sur de mauvaises utilisations, manipulations, manutentions ou mauvais stockage. Des droits contractuels et des droits dérivés, de quelque nature qu'ils soient, ne peuvent résulter que d'un accord écrit, sur la base de nos conditions générales de ventes et de livraisons.

Ce catalogue annule et remplace toute édition antérieure.

Le catalogue n'est pas une notice d'utilisation et de montage des pistons, chemises et kits. Il ne contient pas de directives en tant que telles. Le catalogue ne remplace ni les prescriptions techniques, toujours prioritaires, particulièrement pour les tolérances, ni les prescriptions de montage et d'entretien des fabricants des moteurs figurant dans ce catalogue. Il ne peut en aucun cas remplacer les connaissances professionnelles nécessaires pour le montage et l'utilisation des produits. Les remarques données pour le montage et l'utilisation des pistons, chemises et kits sont exclusivement destinées au professionnel averti et de formation technique, à qui il appartiendra de vérifier la conformité des indications pour chaque cas. La responsabilité quant aux décisions d'utilisation ne peut être prise en charge par Federal-Mogul.

Le contenu de ce catalogue ne peut constituer ou remplacer un contrat qui doit faire l'objet d'un document séparé établi entre 2 parties, dont l'une doit être une entité légale de Federal-Mogul (dont la liste figure sur la couverture arrière).

Nous nous réservons le droit d'apporter toutes corrections d'erreurs et modifications, suite notamment à de nouvelles données fournies par les constructeurs.

TERMS OF BUSINESS

IMPORTANTE

Queda totalmente prohibida la reproducción, total o parcial, del contenido de este catálogo, salvo previa autorización nuestra, realizada por escrito. Están, asimismo, reservados todos los derechos sobre el diseño y presentación del catálogo. No se aceptará ningún tipo de reclamación que esté basada en la interpretación de los datos contenidos en este catálogo, así como en el incorrecto uso, manipulación o almacenaje de nuestras piezas. Únicamente se aceptarán reclamaciones que estén basadas en derechos contractuales o en los motivos arriba indicados, siempre que exista un acuerdo especial y por escrito basado en nuestras condiciones generales de venta y suministro.

Con la edición de este catálogo queda anulada toda la información contenida en catálogos anteriores.

El catálogo no es un manual para el uso e instalación de los pistones, camisas y equipos, y no representa una asesoría técnica en el sentido legal. Los datos del catálogo no sustituyen, en ningún caso, a las especificaciones técnicas, tanto en lo que se refiere a tolerancias como a las instrucciones de instalación y mantenimiento, indicadas por los fabricantes de los motores, especificaciones que serán siempre prioritarias. Se entiende que el uso y montaje de estas piezas está encomendado a personal debidamente cualificado. Las indicaciones sobre uso y montaje de los pistones, camisas y equipos, contenidas en este catálogo, están exclusivamente dirigidas a profesionales con la debida capacitación y formación técnica, que deben decidir en cada caso sobre la exactitud de las mismas. La responsabilidad de estas decisiones no puede ser, en ningún caso atribuidas a Federal-Mogul.

La información facilitada en el catálogo no representa o sustituye ningún tipo de acuerdo, quedando a tal efecto, el acuerdo por separado entre dos partes donde sólo entidades de Federal-Mogul, pueden ser identificadas como la parte vendedora como se menciona en la contraportada.

Los datos e instrucciones contenidos en este catálogo podrán ser corregidos o modificados sin previo aviso.

WAŻNE

Reprodukcja tego katalogu lub jego części jest możliwa tylko za wyraźną zgodą na piśmie. Ilustracje i grafika są chronione prawem autorskim. Roszczenia dotyczące szkód, niezależnie od formy, wynikających z przedstawionych w tym katalogu treści lub z nieprawidłowego użycia, zastosowania, przechowywania lub obsługi są w sposób wyraźny wyłączone. Prawa umowne i inne wynikające lub związane z roszczeniami na nimi opartymi, niezależnie od formy, są tworzone na podstawie oddzielnej umowy pisemnej, w szczególności na podstawie naszych ogólnych warunków sprzedaży i dostawy. Wszystkie wcześniejsze oświadczenia tracą ważność wraz z opublikowaniem tego katalogu.

Katalog nie jest instrukcją obsługi i instalacji tłoków, tulei i zespołów części cylindrowych. Nie zawiera porad w sensie prawnym. Katalog nie zastępuje obowiązujących uregulowań technicznych – zwłaszcza w zakresie tolerancji – ani opisów montażu i konserwacji poszczególnych producentów silników. Nie jest również możliwe pominięcie doświadczenia osób dokonujących doboru i przeprowadzających montaż części. Poszczególne odniesienia zawarte w tym katalogu, a dotyczące doboru, montażu i stosowania tłoków, tulei i zespołów części cylindrowych, są instrukcjami wyłącznie dla wykwalifikowanego technicznie specjalisty, który w każdym przypadku musi je sprawdzić i zweryfikować ich przydatność. Federal-Mogul nie przyjmuje odpowiedzialności za decyzje dotyczące zastosowania.

Zawartość tego katalogu nie stanowi ani nie zastępuje umowy, która może być zawarta jedynie jako oddzielny dokument podpisany przez dwie strony, przy czym sprzedawcą może być tylko jedna z jednostek koncernu Federal-Mogul, zgodnie z opisem na wewnętrznej stronie tylnej okładki.

Zachowane zostaje prawo korygowania błędów i wprowadzania zmian, zwłaszcza odnośnie zmian dotyczących parametrów i warunków pracy określonych przez producentów silników

ВАЖНО

Копирование данного каталога или его частей допускается исключительно при получении нашего разрешения в письменной форме. Иллюстрации и дизайн защищены авторским правом. Требования о возмещении ущерба любой формы, исходя из содержания каталога или из-за неправильного использования, хранения или обращения, абсолютно исключены. Договорные права и любые результирующие или связанные с этим требования, независимо от их формы, должны являться частью отдельного письменного соглашения и основываться на наших общих условиях продаж и поставок.

Все прежние утверждения теряют свою юридическую силу с момента публикации данного каталога.

Каталог не является руководством пользователя и инструкцией по установке поршней, гильз цилиндров и др. комплектующих. Он не содержит советов в юридическом понимании этого слова. Каталог не является заменой для издаваемых производителями двигателей технических инструкций по ремонту, в особенности для допусков технических величин, а также инструкций по монтажу и регламентному обслуживанию. Отдельные ссылки для установки и замены поршней, гильз цилиндров и др. комплектующих, приведенные в этом каталоге, являются инструкциями исключительно для технически компетентного специалиста и в каждом случае должны быть проверены им на предмет их пригодности. Federal-Mogul не несет ответственность за ремонтные работы.

Содержимое каталога не предназначено для создания или замены любого контрактного соглашения, которое может быть оформлено только в виде отдельного соглашения между двумя установленными сторонами, где продавцом может являться только одно из юридических лиц Federal-Mogul, как упомянуто на внутренней стороне обложки каталога. Federal-Mogul оставляет за собой право вносить исправления и изменения в частности в отношении поправок по деталям изготовителей двигателей и их условиям.

هام

لا يُسمح بنسخ هذا الدليل أو أي جزء منه إلا بتصريح كتابي صريح. جميع التمثيلات التصويرية والتصميمات محفوظة بموجب حقوق الطبع والنشر، ولا تتحمل الشركة صراحة أي مطالبات بخسائر، أيًا كانت صورتها، تنشأ عن التفاصيل الواردة في هذا الدليل أو نتيجة لسوء الاستخدام أو التطبيق أو التخزين أو النقل. أي حقوق تعاقدية أو أي مطالبات لها علاقة بتلك الحقوق أو تنشأ تأسيسًا عليها، بغض النظر عن صورتها، تنشأ تأسيسًا على اتفاق كتابي منفصل، وبخاصة تأسيسًا على شروط البيع والتسليم الخاصة بنا. تفقد كل البيانات السابقة صلاحيتها بمجرد نشر هذا الدليل.

هذا الدليل ليس دليلًا للتشغيل لتوضيح استخدام وتركيب المكابس أو البطانة أو التجميع. كما لا يحتوي على أي نصيحة بالمعنى القانوني، ولا يحل هذا الدليل محل القواعد الفنية المطبقة باستمرار خاصة فيما يتعلق بالتحميل، كما لا يحل محل شروط التركيب والصيانة الخاصة بمصنعي المحركات الفردية. كذلك لا يمكن الاستغناء عن خبرة الفنيين الذين يقومون بالتركيب أو التطبيق. وجميع الإشارات الواردة في هذا الدليل والتي تتعلق بتركيب وتطبيق المكابس والبطانة وعمليات التجميع هي إرشادات للمتخصصين الفنيين المؤهلين فحسب ويتم مراجعتها والتأكد من ملاءمتها في كل حالة على حدة. ولا تتحمل شركة Federal-Mogul أي مسؤولية تتعلق بقرارات التطبيق.

ليس المقصود بمحتوى هذا الدليل أن يخلق أو يستبدل أي اتفاقات تعاقدية يتم الاحتفاظ بها حصريًا في اتفاقية منفصلة بين طرفين محددتين، والتي يمكن أن يكون بموجبها أحد الكيانات التابعة لشركة Federal-Mogul هو الطرف البائع كما هو موضح في الوجه الداخلي للغلاف الخارجي. وتحفظ الشركة بحقها في تصحيح أي أخطاء وإجراء أي تعديلات وبخاصة فيما يتعلق بتعديل تفاصيل مصنع المحرك والأحكام المنصوص عليها.

© Federal-Mogul Corporation 2015
The contents of this publication are the copyright of Federal-Mogul Corporation.
Unauthorised reproduction in whole or in part is expressly forbidden.

Niral is a trademark of Federal-Mogul Corporation



Niral[®]
FITTED WITH GOETZE RINGS

🇬🇧 HOW TO USE

CITROËN

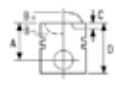

1 **72.00**

1	2						
AX 11 3	09/86→12/97	TU1M (HDZ) 4	4 Cyl.				
Berlingo 1.1 i, Berlingo Box 1.1 i	07/96→						
BX 11	10/88→06/92		1124cc	40kW (54PS)			10
C15 1.1 i	07/88→12/96						TD661
C15 Estate 1.1	08/88→07/96						
Saxo 1.1 X,SX	05/96→09/03						
ZX 1.1	03/91→06/97						

5	6	7	8	9
87-154300-00 STD	08-154300-00 STD 08-154307-00 0.50mm	14-636470-00 WH	B 79.50 C 122.00 D 89.20 E 85.00	88-154300-00
A 40.05 B+ 2.97 D 64.05 20x62	01/87→ 1.50 2.00 3.00	CR P P CR		
11				
12	Steel	Stahl	Acier	Acciaio
				Acero

- 1** Panel No.
- 2** Bore size
- 3** Model (Car and Light Commercial Vehicle only)
- 4** Engine
- 5** Piston reference
 - A = Compression Height
 - B = Bowl Depth / Crown Height
 - BØ = Bowl Diameter
 - C = Valve Pocket Depth
 - D = Length
 - RT Alfin Insert
 - KK Oil Cooling Gallery
 - AK Oil Jet Cut-out
 - HA Hard Anodised Coating on Crown
 - NB Bronze Pin Bush
 - TP = Trapezoidal Conrod
- 6** Ring Set Reference
 - Ring Width
 - Ring Design
 - Ring Surface Treatment and Material
- 7** Liner Reference
 - B = Outer Diameter
 - C = Overall Length
 - D = Flange Diameter
 - E = Flange Width
 - F = Firelip Height
- 8** Liner Type
 - D = Dry
 - WH = Wet Honed
 - DH = Dry Honed
- 9** Assembly reference
- 10** TecDoc / F-M engine number
- 11** Piston Image and Casting Number (if applicable)
- 12** Comment

PART NUMBERING SYSTEM



87 - 114900 - 25	Catalogue reference	<table border="0"> <tr> <td>Size</td> <td>Metric</td> <td>Imperial</td> </tr> <tr> <td>00</td> <td>STD</td> <td></td> </tr> <tr> <td>03</td> <td>0.125MM</td> <td></td> </tr> <tr> <td>04</td> <td>0.20MM</td> <td></td> </tr> <tr> <td>05</td> <td>0.25MM</td> <td>.010</td> </tr> <tr> <td>06</td> <td>0.40MM</td> <td></td> </tr> <tr> <td>07</td> <td>0.50MM</td> <td>.020</td> </tr> <tr> <td>08</td> <td>0.60MM</td> <td></td> </tr> <tr> <td>09</td> <td>0.75MM</td> <td>.030</td> </tr> <tr> <td>10</td> <td>0.80MM</td> <td></td> </tr> <tr> <td>11</td> <td>1.00MM</td> <td>.040</td> </tr> <tr> <td>13</td> <td>1.25MM</td> <td></td> </tr> <tr> <td>14</td> <td>1.50MM</td> <td>.060</td> </tr> <tr> <td>16</td> <td>2.00MM</td> <td></td> </tr> <tr> <td>17</td> <td>2.286MM</td> <td>.090</td> </tr> <tr> <td>20</td> <td>0.70MM</td> <td></td> </tr> <tr> <td>21</td> <td>0.65MM</td> <td></td> </tr> <tr> <td>22</td> <td>0.30MM</td> <td></td> </tr> </table>	Size	Metric	Imperial	00	STD		03	0.125MM		04	0.20MM		05	0.25MM	.010	06	0.40MM		07	0.50MM	.020	08	0.60MM		09	0.75MM	.030	10	0.80MM		11	1.00MM	.040	13	1.25MM		14	1.50MM	.060	16	2.00MM		17	2.286MM	.090	20	0.70MM		21	0.65MM		22	0.30MM	
Size	Metric		Imperial																																																					
00	STD																																																							
03	0.125MM																																																							
04	0.20MM																																																							
05	0.25MM		.010																																																					
06	0.40MM																																																							
07	0.50MM		.020																																																					
08	0.60MM																																																							
09	0.75MM		.030																																																					
10	0.80MM																																																							
11	1.00MM	.040																																																						
13	1.25MM																																																							
14	1.50MM	.060																																																						
16	2.00MM																																																							
17	2.286MM	.090																																																						
20	0.70MM																																																							
21	0.65MM																																																							
22	0.30MM																																																							
87 - 114900 - 25	Piston assembly																																																							
88 - 114900 - 25	Kit-set without seals																																																							
89 - 114900 - 25	Kit-set with seals																																																							
87 - 114900 - 25	Reference																																																							
87 - 114900 - 25	Size* →																																																							
87 - 114900 - 25	Version																																																							

* If imperial in the past, it continues to be imperial

Feature Codes		
RT Alfin Insert	HA Hard Anodized Coating on	
KK Oil Cooling Gallery	Crown	
AK Oil Jet Cut-out	NB Bronze Pin Bush	



PISTON RINGS

08 - 114900 - 00	Catalogue reference
08 - 114900 - 00	Ring set assembly
08 - 114900 - 00	Reference
08 - 114900 - 00	Size* (See Niral pistons table)
08 - 114900 - 00	Version

* If imperial in the past, it continues to be imperial

CYLINDER LINERS

14 - 451160 - 00	Catalogue reference	
14 - 451160 - 00	Cylinder liner	
15 - 451160 - 00	Cylinder liner with seals	01 - 19 = Dry Liner
14 - 451160 - 00	Liner type →	20 - 99 = Wet Liner
14 - 451160 - 00	Serial number	
14 - 451160 - 00	Size →	0 = STD
14 - 451160 - 00	Version	1 = 1st oversize
		2 = 2nd oversize



COATINGS AND TREATMENT CODES

CR Chromed	P Phosphated
MO Molybdenum inlaid	NT Nitrided
MQL Molybdenum coated	PS Plasma spray coated
CK Chromium-Ceramic-Coated	GDC Goetze Diamond Coated®
PVD Chromium Nitride	DLC Diamond Like Carbon

PISTON RING CROSS SECTIONS

Cross Section	Description
	Plain compression ring
	Plain compression ring (inside bevel - top side)
	Plain compression ring (inside bevel - bottom side)
	Plain compression ring (inside step - top side)
	Plain compression ring (inside step - bottom side)
	Tapered Ring
	Tapered Ring (inside bevel - top side)
	Tapered Ring (inside bevel - bottom side)
	Tapered Ring (inside step - top side)
	Tapered Ring (inside step - bottom side)
	Slightly Tapered Ring
	Slightly Tapered Ring (inside bevel - top side)
	Slightly Tapered Ring (inside bevel - bottom side)
	Slightly Tapered Ring (inside step - top side)
	Slightly Tapered Ring (inside step - bottom side)
	Wedge type compression ring
	Wedge type compression ring (inside bevel - top side)
	Wedge type compression ring (inside bevel - bottom side)
	Wedge type compression ring (inside step - top side)
	Wedge type compression ring (inside step - bottom side)
	Keystone type compression ring
	Keystone type compression ring (inside bevel - top side)
	Keystone type compression ring (inside bevel - bottom side)
	Keystone type compression ring (inside step - top side)
	Keystone type compression ring (inside step - bottom side)
	Taper-faced keystone ring
	Taper-faced keystone ring (inside bevel - top side)
	Taper-faced keystone ring (inside bevel - bottom side)
	Taper-faced keystone ring (inside step - top side)
	Taper-faced keystone ring (inside step - bottom side)
	Single hook scraper
	Single hook scraper (inside bevel - top side)
	Single hook scraper (inside bevel - bottom side)
	Single hook scraper (inside step - top side)
	Single hook scraper (inside step - bottom side)
	Tapered single hook scraper
	Tapered single hook scraper (inside bevel - top side)
	Tapered single hook scraper (inside bevel - bottom side)
	Tapered single hook scraper (inside step - top side)
	Tapered single hook scraper (inside step - bottom side)
	Slotted Oil Scraper ring
	Bevel-edged oil control ring
	Double bevel-edged oil control ring
	Slotted Oil Scraper ring with coil spring
	Bevel-edged oil control ring with coil spring
	Double bevel-edged oil control ring with coil spring
	Slotted Oil Scraper with coil spring
	Steel rail oil control ring with VF spring



CITROËN

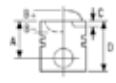

1  **72.00**

1

2

AX 11 3	09/86→12/97	TU1M (HDZ) 4	4 Cyl.		
Berlingo 1.1 i, Berlingo Box 1.1 i	07/96→				
BX 11	10/88→06/92		1124cc	40kW (54PS)	10
C15 1.1 i	07/88→12/96				TD661
C15 Estate 1.1	08/88→07/96				
Saxo 1.1 X,SX	05/96→09/03				
ZX 1.1	03/91→06/97				

5

87-154300-00 STD

A 40.05
B+ 2.97
D 64.05
20x62

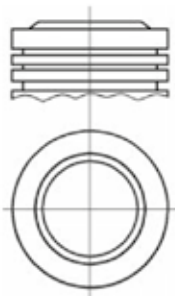

11

12

 Steel

6

08-154300-00 STD
08-154307-00 0.50mm

01/87→

1.50
2.00
3.00



CR P
P
CR 

 Stahl

7

8

14-636470-00 WH B 79.50 C 122.00 D 89.20 E 85.00

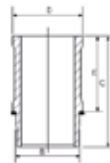

 Acier

9

88-154300-00

 Acero

- 1** Infotafel
- 2** Bohrung
- 3** Modell (nur PKWs oder Transporter)
- 4** Motor
- 5** Artikelnummer Kolben
 - A = Kompressionshöhe
 - B = Muldentiefe / Bodenhöhe
 - BØ = Muldendurchmesser
 - C = Ventiltaschentiefe
 - D = Länge
 - RT = Ringträger
 - KK Ölkühlkanal
 - AK Öldüsenausparung
 - HA Hartanodisierter Kolbenboden
 - NB Bolzenbuchse aus Bronze
 - TP = Trapezpleuel
- 6** Artikelnummer Kolbenringsatz
 - Ringhöhe
 - Ringbauart
 - Ringoberflächenbehandlung und Material
- 7** Artikelnummer Laufbuchse
 - B = Außendurchmesser
 - C = Gesamtlänge
 - D = Bunddurchmesser
 - E = Bundbreite
 - F = Feuersteghöhe
- 8** Laufbuchsentyp
 - D = trocken
 - WH = nass, gehont
 - DH = trocken, gehont
- 9** Artikelnummer Assembly
- 10** TecDoc-Nr. / F-M-Motornummer
- 11** Kolbenabbildung und Kokille (gegebenenfalls)
- 12** Kommentar

TEILENUMMERIERUNGSSYSTEM



87 - 114900 - 25	Artikelnummer	
87 - 114900 - 25	Assembly	
88 - 114900 - 25	Assembly ohne Abdichtungen	
89 - 114900 - 25	Assembly mit Abdichtungen	
87 - 114900 - 25	Artikelnummer	
87 - 114900 - 25	Größe*	→
87 - 114900 - 25	Version	→

Größe	Metrisch	Britische Maßeinheiten
00	STD	
03	0.125MM	
04	0.20MM	
05	0.25MM	.010
06	0.40MM	
07	0.50MM	.020
08	0.60MM	
09	0.75MM	.030
10	0.80MM	
11	1.00MM	.040
13	1.25MM	
14	1.50MM	.060
16	2.00MM	
17	2.286MM	.090
20	0.70MM	
21	0.65MM	
22	0.30MM	

* Falls Maßangaben bisher nach Britischer Norm waren, werden sie weiterhin so angegeben

Kurzzeichen Ausstattung

RT Rinträger	HA Hartanodisierter
KK Ölkühlkanal	Kolbenboden
AK Öldüsenausparung	NB Bolzenbuchse aus Bronze



KOLBENRINGE

08 - 114900 - 00	Artikelnummer im Katalog
08 - 114900 - 00	Kolbenringsatz
08 - 114900 - 00	Referenz
08 - 114900 - 00	Größe* (siehe Niral-Kolbentabelle)
08 - 114900 - 00	Version

* Falls Maßangaben bisher nach Britischer Norm waren, werden sie weiterhin so angegeben

ZYLINDERLAUFBUCHSEN

14 - 451160 - 00	Artikelnummer	
14 - 451160 - 00	Zylinderlaufbuchse	
15 - 451160 - 00	Zylinderlaufbuchse mit Abdichtung	
14 - 451160 - 00	Laufbuchsentyp	→
14 - 451160 - 00	Seriennummer	→
14 - 451160 - 00	Größe	→
14 - 451160 - 00	Version	→

01 - 19 = Trockene Zylinderlaufbuchse
20 - 99 = Nasse Zylinderlaufbuchse

0 = STD
1 = 1. Übergröße
2 = 2. Übergröße



KURZZEICHEN BESCHICHTUNGEN UND BEHANDLUNGEN

CR	Verchromt	P	Phosphatiert
MO	Lauffläche teilweise mit Molybdän beschichtet	NT	Nitriert
MOL	Molybdän beschichtet	PS	Plasmaspritzbeschichtet
CK	Chrom-Keramik beschichtet	GDC	Goetze Diamond Coated®
PVD	Chromnitrid	DLC	Diamantähnlicher Kohlenstoff

KOLBENRINGQUERSCHNITTE

Querschnitt	Beschreibung
	Rechteckring
	Rechteckring (mit Innenfase an der Oberflanke)
	Rechteckring (mit Innenfase an der Unterflanke)
	Rechteckring (mit Innenwinkel an der Oberflanke)
	Rechteckring (mit Innenwinkel an der Unterflanke)
	Minutenring
	Minutenring (mit Innenfase an der Oberflanke)
	Minutenring (mit Innenfase an der Unterflanke)
	Minutenring (mit Innenwinkel an der Oberflanke)
	Minutenring (mit Innenwinkel an der Unterflanke)
	Schwachminutenring
	Schwachminutenring (mit Innenfase an der Oberflanke)
	Schwachminutenring (mit Innenfase an der Unterflanke)
	Schwachminutenring (mit Innenwinkel an der Oberflanke)
	Schwachminutenring (mit Innenwinkel an der Unterflanke)
	Einseitiger Trapezring
	Einseitiger Trapezring (mit Innenfase an der Oberflanke)
	Einseitiger Trapezring (mit Innenfase an der Unterflanke)
	Einseitiger Trapezring (mit Innenwinkel an der Oberflanke)
	Einseitiger Trapezring (mit Innenwinkel an der Unterflanke)
	Doppeltrapezring
	Doppeltrapezring (mit Innenfase an der Oberflanke)
	Doppeltrapezring (mit Innenfase an der Unterflanke)
	Doppeltrapezring (mit Innenwinkel an der Oberflanke)
	Doppeltrapezring (mit Innenwinkel an der Unterflanke)
	Doppeltrapezring mit konischer Lauffläche
	Doppeltrapezring mit konischer Lauffläche (Innenfase an der Oberflanke)
	Doppeltrapezring mit konischer Lauffläche (Innenfase an der Unterflanke)
	Doppeltrapezring mit konischer Lauffläche (Innenwinkel an der Oberflanke)
	Doppeltrapezring mit konischer Lauffläche (Innenwinkel an der Unterflanke)
	Nasenring
	Nasenring (mit Innenfase an der Oberflanke)
	Nasenring (mit Innenfase an der Unterflanke)
	Nasenring (mit Innenwinkel an der Oberflanke)
	Nasenring (mit Innenwinkel an der Unterflanke)
	Nasen-Minutenring
	Nasen-Minutenring (mit Innenfase an der Oberflanke)
	Nasen-Minutenring (mit Innenfase an der Unterflanke)
	Nasen-Minutenring (mit Innenwinkel an der Oberflanke)
	Nasen-Minutenring (mit Innenwinkel an der Unterflanke)
	Ölschlitzring
	Dachfasenring
	Gleichfasenring
	Ölschlitzring
	Ölschlitzring mit Schlauchfeder
	Dachfasenring mit Schlauchfeder
	Gleichfasenring mit Schlauchfeder
	Ölschlitzring mit Schlauchfeder
	Ölabstreif-Stahlbandring mit VF-Feder







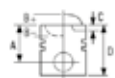

COME SI UTILIZZA IL CATALOGO

CITROËN

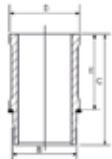
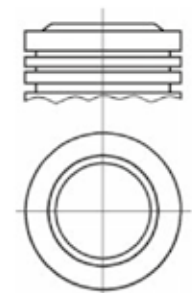

1  **72.00**

1	2					
AX 11 3	09/86→12/97	TU1M (HDZ) 4	4 Cyl.			
Berlingo 1.1 i, Berlingo Box 1.1 i	07/96→					
BX 11	10/88→06/92		1124cc	40kW (54PS)		10
C15 1.1 i	07/88→12/96					TD661
C15 Estate 1.1	08/88→07/96					
Saxo 1.1 X,SX	05/96→09/03					
ZX 1.1	03/91→06/97					

5	6	7	8	9
87-154300-00	08-154300-00 08-154307-00	14-636470-00 WH	B 79.50 C 122.00 D 89.20 E 85.00	88-154300-00
STD	STD 0.50mm			
A 40.05 B+ 2.97 D 64.05 RT 20x62	01/87→ 1.50 2.00 3.00	CR P P CR 		
				
11				
12				
				

- | | |
|---|---|
| <p>1 N. Pannello</p> <p>2 Alesaggio</p> <p>3 Modello (Auto e Veicoli Commerciali Leggeri)</p> <p>4 Motore</p> <p>5 Codice Pistone</p> <p>A = Altezza di compressione</p> <p>B = Profondità Camera di Combustione/Sporgenza testa</p> <p>BØ = Diametro Camera di Combustione</p> <p>C = Profondità Sedi Valvole</p> <p>D = Lunghezza</p> <p>RT Inserto Alfin</p> <p>KK Galleria di raffreddamento dell'olio</p> <p>AK Getto olio</p> <p>HA Rivestimento di Anodizzazione sulla Testa del Pistone</p> <p>NB Boccola Foro Spinotto in Bronzo</p> <p>TP = Biella Trapezoidale</p> | <p>6 Codice Set Segmenti</p> <p>Altezza Segmento</p> <p>Forma Segmento</p> <p>Materiale e Trattamento Superficiale Segmento</p> <p>7 Codice Canna Cilindro</p> <p>B = Diametro Esterno</p> <p>C = Lunghezza Totale</p> <p>D = Diametro Flangia</p> <p>E = Larghezza Flangia</p> <p>F = Altezza Parafiamma</p> <p>8 Tipo Canna Cilindro</p> <p>D = A Secco</p> <p>WH = Riportata in Umido</p> <p>DH = Riportata a Secco</p> <p>9 Codice Gruppo</p> <p>10 TecDoc / F-M numero motore</p> <p>11 Immagine Pistone e Numero di Fusione (se applicabile)</p> <p>12 Note</p> |
|---|---|

SISTEMA DI CATALOGAZIONE DEI RICAMBI



87 - 114900 - 25
87 - 114900 - 25
88 - 114900 - 25
89 - 114900 - 25
87 - 114900 - 25
87 - 114900 - 25
87 - 114900 - 25

Codice catalogo
Gruppo pistone
Kit-set senza guarnizioni
Kit-set con guarnizioni
Codice
Dimensioni*
Versione

Dimensioni	Metriehe	Imperiali
00	STD	
03	0.125MM	
04	0.20MM	
05	0.25MM	.010
06	0.40MM	
07	0.50MM	.020
08	0.60MM	
09	0.75MM	.030
10	0.80MM	
11	1.00MM	.040
13	1.25MM	
14	1.50MM	.060
16	2.00MM	
17	2.286MM	.090
20	0.70MM	
21	0.65MM	
22	0.30MM	

* Se precedentemente indicato in misure imperiali, rimane tale

Codici Caratteristiche

HA	Rivestimento
RT	Inserito Alfin
KK	Galleria di raffreddamento dell'olio
AK	Getto olio
	Anodizzazione su Testa Pistone
NB	Boccola Foro Spinotto in Bronzo



SEGMENTI PISTONE

08 - 114900 - 00
08 - 114900 - 00
08 - 114900 - 00
08 - 114900 - 00
08 - 114900 - 00

Codice catalogo
Assieme set segmenti
Codice
Dimensioni* (Vedi tabella pistoni Niral)
Versione

* Se precedentemente indicato in misure imperiali, rimane tale

CANNE CILINDRO

14 - 451160 - 00
14 - 451160 - 00
15 - 451160 - 00
14 - 451160 - 00
14 - 451160 - 00
14 - 451160 - 00
14 - 451160 - 00

Codice catalogo
Canna cilindro
Canna cilindro con guarnizione
Tipo canna cilindro
Numero di seriale
Dimensioni
Versione

01 - 19	= Canna a secco
20 - 99	= Canna in umido
0	= STD
1	= 1° maggiorazione
2	= 2° maggiorazione



CODICI RIVESTIMENTI E TRATTAMENTI

CR	Cromato	P	Fosfatato
MO	Inserito in molibdeno	NT	Nitrurato
MQL	Rivestimento in molibdeno	PS	Rivestimento a getto di plasma
CK	Nitrato de cromo	GDC	Rivestimento Goetze Diamond Coated®
PVD	Carbonio diamantato	DLC	Carbonio diamantato

SEZIONE SEGMENTI PISTONE

Sezione	Descrizione
	Segmento di compressione rettangolare
	Segmento di compressione rettangolare con smusso interno - lato superiore
	Segmento di compressione rettangolare con smusso interno - lato inferiore
	Segmento di compressione rettangolare con gradino interno - lato superiore
	Segmento di compressione rettangolare con gradino interno - lato inferiore
	Segmento Conico
	Segmento Conico con smusso interno - lato superiore
	Segmento Conico con smusso interno - lato inferiore
	Segmento Conico con gradino interno - lato superiore
	Segmento Conico con gradino interno - lato inferiore
	Segmento Leggermente Conico
	Segmento Leggermente Conico con smusso interno - lato superiore
	Segmento Leggermente Conico con smusso interno - lato inferiore
	Segmento Leggermente Conico con gradino interno - lato superiore
	Segmento Leggermente Conico con gradino interno - lato inferiore
	Segmento di compressione di tipo a cuneo
	Segmento di compressione di tipo a cuneo con smusso interno - lato superiore
	Segmento di compressione di tipo a cuneo con smusso interno - lato inferiore
	Segmento di compressione di tipo a cuneo con gradino interno - lato superiore
	Segmento di compressione di tipo a cuneo con gradino interno - lato inferiore
	Segmento di compressione a sezione trapezoidale
	Segmento di compressione a sezione trapezoidale con smusso interno - lato superiore
	Segmento di compressione a sezione trapezoidale con smusso interno - lato inferiore
	Segmento di compressione a sezione trapezoidale con gradino interno - lato superiore
	Segmento di compressione a sezione trapezoidale con gradino interno - lato inferiore
	Segmento di compressione a sezione trapezoidale con fianchi inclinati
	Segmento di compressione a sezione trapezoidale con fianchi inclinati con smusso interno - lato superiore
	Segmento di compressione a sezione trapezoidale con fianchi inclinati con smusso interno - lato inferiore
	Segmento di compressione a sezione trapezoidale con fianchi inclinati con gradino interno - lato superiore
	Segmento di compressione a sezione trapezoidale con fianchi inclinati con gradino interno - lato inferiore
	Segmento raschiaolio
	Segmento raschiaolio con smusso interno - lato superiore
	Segmento raschiaolio con smusso interno - lato inferiore
	Segmento raschiaolio con gradino interno - lato superiore
	Segmento raschiaolio con gradino interno - lato inferiore
	Segmento raschiaolio conico
	Segmento raschiaolio conico con smusso interno - lato superiore
	Segmento raschiaolio conico con smusso interno - lato inferiore
	Segmento raschiaolio conico con gradino interno - lato superiore
	Segmento raschiaolio conico con gradino interno - lato inferiore
	Segmento raschiaolio con fori
	Segmento raschiaolio con pattini smussati
	Segmento raschiaolio con smussi convergenti
	Segmento raschiaolio con fori
	Segmento raschiaolio con fori e con molla
	Segmento raschiaolio con smussi paralleli e con molla
	Segmento raschiaolio con doppio bordo smussato e con molla
	Segmento raschiaolio con fori e con molla
	Segmento raschiaolio con guida in acciaio e con molla VF

CITROËN

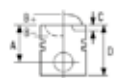

1 **72.00**

1

2

AX 11 3	09/86→12/97	TU1M (HDZ) 4	4 Cyl.		
Berlingo 1.1 i, Berlingo Box 1.1 i	07/96→				
BX 11	10/88→06/92		1124cc	40kW (54PS)	10
C15 1.1 i	07/88→12/96				TD661
C15 Estate 1.1	08/88→07/96				
Saxo 1.1 X,SX	05/96→09/03				
ZX 1.1	03/91→06/97				

5

87-154300-00 STD

A 40.05
B+ 2.97
D 64.05
20x62

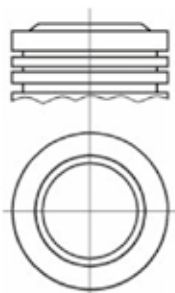

11

12

Steel

6

08-154300-00 STD
08-154307-00 0.50mm

01/87→

1.50 CR P
2.00 P
3.00 CR



Stahl

7

8

14-636470-00 WH B 79.50 C 122.00 D 89.20 E 85.00

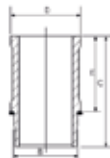

Acier

9

88-154300-00

Acero

- 1 Numéro d'encadré
- 2 Alésage
- 3 Modèle (Uniquement voitures et véhicules utilitaires légers)
- 4 Moteur
- 5 Référence du piston
 - A = Hauteur d'axe
 - B = Profondeur de la chambre / Hauteur du bossage
 - BØ = Diamètre de la chambre du piston
 - C = Passage de la soupape
 - D = Longueur totale
 - RT Piston à porte-segments
 - KK Canal de refroidissement
 - AK Dégagement pour gicleur d'huile de refroidissement
 - HA Tête endurcie par oxydation
 - NB Bague en bronze
 - TP = Bielle trapézoïdale

- 6 Référence du jeu de segments
 - Largeur de segment
 - Schémas des segments
 - Traitement de surface et matériau
- 7 Référence de chemise
 - B = Diamètre extérieur
 - C = Longueur totale
 - D = Diamètre bride
 - E = Largeur de collerette
 - F = Hauteur du parefeu
- 8 Type chemise
 - D = Sèche
 - WH = Chemise humide
 - DH = Chemise sèche
- 9 Référence du kit (piston+chemise)
- 10 Numéro moteur F-M / Numéro TecDoc
- 11 Image piston et numéro coquille (si applicable)
- 12 Commentaires

🇪🇸 CÓMO UTILIZAR ESTE CATÁLOGO

CITROËN

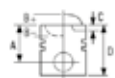

1 **72.00**

1

2

AX 11 3	09/86 → 12/97	TU1M (HDZ) 4	4 Cyl.		
Berlingo 1.1 i, Berlingo Box 1.1 i	07/96 →				
BX 11	10/88 → 06/92		1124cc	40kW (54PS)	10
C15 1.1 i	07/88 → 12/96				TD661
C15 Estate 1.1	08/88 → 07/96				
Saxo 1.1 X, SX	05/96 → 09/03				
ZX 1.1	03/91 → 06/97				

5

87-154300-00 STD

A 40.05
B+ 2.97
D 64.05
RT 20x62

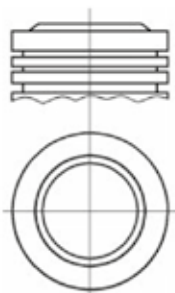

11

12

Steel

6

08-154300-00 STD
08-154307-00 0.50mm

01/87 →

1.50
2.00
3.00



CR P
P
CR

Stahl

7

8

14-636470-00 WH B 79.50 C 122.00 D 89.20 E 85.00

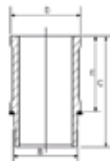

Acier

9

88-154300-00

Acero

- | | |
|--|--|
| <p>1 N.º panel</p> <p>2 Tamaño del diámetro</p> <p>3 Modelo (Turismos y Furgonetas exclusivamente)</p> <p>4 Motor</p> <p>5 Referencia del pistón</p> <p>A = Altura de compresión</p> <p>B = Profundidad de la cabeza / Altura de la corona</p> <p>BØ = Diámetro de la cabeza</p> <p>C = Profundidad bolsa de válvula</p> <p>D = Longitud</p> <p>RT Inserción alfin</p> <p>KK Conductos de refrigeración de aceite</p> <p>AK Corte del inyector de aceite</p> <p>HA Revestimiento duro anodizado en la corona</p> <p>NB Casquillo de bronce</p> <p>TP = Cabeza de biela trapezoidal</p> | <p>6 Referencia del conjunto de segmentos</p> <p>Anchura del segmento</p> <p>Diseño del segmento</p> <p>Material y tratamiento de la superficie del segmento</p> <p>7 Referencia de la camisa</p> <p>B = Diámetro exterior</p> <p>C = Longitud general</p> <p>D = Diámetro de la brida</p> <p>E = Anchura de la brida</p> <p>F = Altura cortafuego</p> <p>8 Tipo de camisa</p> <p>D = Seca</p> <p>WH = Alisada húmeda</p> <p>DH = Alisada seca</p> <p>9 Referencia del conjunto</p> <p>10 Número motor F-M / TecDoc</p> <p>11 Número de moldeado e imagen del pistón (si procede)</p> <p>12 Comentario</p> |
|--|--|

SISTEMA DE NUMERACIÓN DE REFERENCIAS



Referencia del catálogo	Tamaño	Sistema métrico	Imperial
87 - 114900 - 25	00	STD	
87 - 114900 - 25	03	0.125MM	
88 - 114900 - 25	04	0.20MM	
89 - 114900 - 25	05	0.25MM	.010
87 - 114900 - 25	06	0.40MM	
87 - 114900 - 25	07	0.50MM	.020
87 - 114900 - 25	08	0.60MM	
87 - 114900 - 25	09	0.75MM	.030
	10	0.80MM	
	11	1.00MM	.040
	13	1.25MM	
	14	1.50MM	.060
	16	2.00MM	
	17	2.286MM	.090
	20	0.70MM	
	21	0.65MM	
	22	0.30MM	

* Si anteriormente se utilizó el sistema imperial, sigue siendo el sistema imperial

Códigos de característica	Descripción
AK	Corte del inyector de aceite
RT	Inserción alfin
HA	Revestimiento duro
KK	Conductos de refrigeración de aceite
NB	Perno de bronce



SEGMENTOS DE PISTÓN

Referencia del catálogo	Tamaño*
08 - 114900 - 00	01 - 19 = Camisa seca
08 - 114900 - 00	20 - 99 = Camisa húmeda

* Si anteriormente se utilizó el sistema imperial, sigue siendo el sistema imperial

CAMISAS

Referencia del catálogo	Tamaño*
14 - 451160 - 00	0 = Estándar
14 - 451160 - 00	1 = Primera sobredimensión
14 - 451160 - 00	2 = Segunda sobredimensión



CÓDIGOS DE TRATAMIENTO Y REVESTIMIENTO

CR	Cromado	P	Fosfatado
MO	Incrustación de molibdeno	NT	Nitrurado
MOL	Revestimiento de molibdeno	PS	Revestimiento de pulverización de plasma
CK	Revestimiento cerámico de cromo	GDC	Diamond Coated® de Goetze
PVD	Nitruro de cromo	DLC	Carbon adiamantado

SECCIONES TRANSVERSALES DE LOS SEGMENTOS

Sección transversal	Descripción
	Segmento de compresión plano
	Segmento de compresión plano (bisel interior, lado superior)
	Segmento de compresión plano (bisel interior, lado inferior)
	Segmento de compresión plano (paso interior, lado superior)
	Segmento de compresión plano (paso interior, lado inferior)
	Segmento cónico
	Segmento cónico (bisel interior, lado superior)
	Segmento cónico (bisel interior, lado inferior)
	Segmento cónico (paso interior, lado superior)
	Segmento cónico (paso interior, lado inferior)
	Segmento ligeramente cónico
	Segmento ligeramente cónico (bisel interior, lado superior)
	Segmento ligeramente cónico (bisel interior, lado inferior)
	Segmento ligeramente cónico (paso interior, lado superior)
	Segmento ligeramente cónico (paso interior, lado inferior)
	Segmento de compresión tipo cuña
	Segmento de compresión tipo cuña (bisel interior, lado superior)
	Segmento de compresión tipo cuña (bisel interior, lado inferior)
	Segmento de compresión tipo cuña (paso interior, lado superior)
	Segmento de compresión tipo cuña (paso interior, lado inferior)
	Segmento de compresión tipo trapecoidal
	Segmento de compresión tipo trapecoidal (bisel interior, lado superior)
	Segmento de compresión tipo trapecoidal (bisel interior, lado inferior)
	Segmento de compresión tipo trapecoidal (paso interior, lado superior)
	Segmento de compresión tipo trapecoidal (paso interior, lado inferior)
	Segmento trapecoidal con superficie de cuña
	Segmento trapecoidal con superficie de cuña (bisel interior, lado superior)
	Segmento trapecoidal con superficie de cuña (bisel interior, lado inferior)
	Segmento trapecoidal con superficie de cuña (paso interior, lado superior)
	Segmento trapecoidal con superficie de cuña (paso interior, lado inferior)
	Rascador de gancho simple
	Rascador de gancho simple (bisel interior, lado superior)
	Rascador de gancho simple (bisel interior, lado inferior)
	Rascador de gancho simple (paso interior, lado superior)
	Rascador de gancho simple (paso interior, lado inferior)
	Rascador de gancho simple cónico
	Rascador de gancho simple cónico (bisel interior, lado superior)
	Rascador de gancho simple cónico (bisel interior, lado inferior)
	Rascador de gancho simple cónico (paso interior, lado superior)
	Rascador de gancho simple cónico (paso interior, lado inferior)
	Rascador de aceite ranurado
	Segmento de control de aceite con lado en bisel
	Segmento de control de aceite con dos lados en bisel
	Rascador de aceite ranurado
	Rascador de aceite ranurado con muelle en espiral
	Segmento de control de aceite con lado en bisel y muelle en espiral
	Segmento de control de aceite con dos lados en bisel y muelle en espiral
	Rascador de aceite ranurado con muelle en espiral
	Segmento de control de aceite y rail de acero con muelle VF

SYSTEM NUMEROWANIA CZĘŚCI



87 - 114900 - 25	Katalogowy numer referencyjny	Rozmiar	Metryczny	Angielski
87 - 114900 - 25	Zestaw tłoka	00	STD	
88 - 114900 - 25	Zestaw bez uszczelnień	03	0.125MM	
89 - 114900 - 25	Zestaw z uszczelnieniami	04	0.20MM	
87 - 114900 - 25	Numer części	05	0.25MM	.010
87 - 114900 - 25	Wielkość* →	06	0.40MM	
87 - 114900 - 25	Wersja	07	0.50MM	.020
		08	0.60MM	
		09	0.75MM	.030
		10	0.80MM	
		11	1.00MM	.040
		13	1.25MM	
		14	1.50MM	.060
		16	2.00MM	
		17	2.286MM	.090
		20	0.70MM	
		21	0.65MM	
		22	0.30MM	

* Jeśli w przeszłości był system angielski, nadal stosowany jest system angielski

Oznaczenia cech charakterystycznych

RT	Wkładka alfinowa	HA	Warstwa utwardzenia
KK	Olejowa galeria chłodząca		anodowego na koronie
AK	Wycięcie natrysku olejowego	NB	Tuleja sworzni z brzo



PIERŚCIEŃ TŁOKOWE

08 - 114900 - 00	Katalogowy numer referencyjny
08 - 114900 - 00	Zestaw pierścieni
08 - 114900 - 00	Numer części
08 - 114900 - 00	Rozmiar* (Patrz tabela tłoków Niral)
08 - 114900 - 00	Wersja

* Jeśli w przeszłości był system angielski, nadal stosowany jest system angielski

TULEJE CYLINDROWE

14 - 451160 - 00	Katalogowy numer referencyjny	
14 - 451160 - 00	Tuleja cylindrowa	
15 - 451160 - 00	Tuleja cylindrowa z uszczelnieniem	01 - 19 = Tuleja sucha
14 - 451160 - 00	Typ tulei →	20 - 99 = Tuleja mokra
14 - 451160 - 00	Numer seryjny	
14 - 451160 - 00	Rozmiar →	0 = STD (standard)
14 - 451160 - 00	Wersja	1 = pierwszy nadwymiar
		2 = drugi nadwymiar



KODY POKRYĆ I OBRÓBK

CR	Chromowany	P	Fosforanowany
MO	Zawierający cząstki molibdenu	NT	Azotowany
MO-L	Pokryty warstwą molibdenu	PS	Z powłoką napyłaną plazmowo
CK	Z powłoką chromowo-ceramiczną	GDC	Powłoka diamentowa Goetze
PVD	Azotek Chromu	DLC	Diamentopodobne Pokrycie Węgłowe

PRZEKROJE POPRZECZNE PIERŚCIEŃI TŁOKOWYCH

Przekrój poprzeczny	Opis
	Zwykły pierścień kompresyjny
	Zwykły pierścień kompresyjny (wewnętrzna faza - góra)
	Zwykły pierścień kompresyjny (wewnętrzna faza - dół)
	Zwykły pierścień kompresyjny (wewnętrzny stopień - góra)
	Zwykły pierścień kompresyjny (wewnętrzny stopień - dół)
	Pierścień stożkowy
	Pierścień stożkowy (wewnętrzna faza - góra)
	Pierścień stożkowy (wewnętrzna faza - dół)
	Pierścień stożkowy (wewnętrzny stopień - góra)
	Pierścień stożkowy (wewnętrzny stopień - dół)
	Pierścień lekko-stożkowy
	Pierścień lekko-stożkowy (wewnętrzna faza - góra)
	Pierścień lekko-stożkowy (wewnętrzna faza - dół)
	Pierścień lekko-stożkowy (wewnętrzny stopień - góra)
	Pierścień lekko-stożkowy (wewnętrzny stopień - dół)
	Klinowy pierścień kompresyjny
	Klinowy pierścień kompresyjny (wewnętrzna faza - góra)
	Klinowy pierścień kompresyjny (wewnętrzna faza - dół)
	Klinowy pierścień kompresyjny (wewnętrzny stopień - góra)
	Klinowy pierścień kompresyjny (wewnętrzny stopień - dół)
	Pierścień kompresyjny trapezowy dwustronny
	Pierścień kompresyjny trapezowy dwustronny (wewnętrzna faza - góra)
	Pierścień kompresyjny trapezowy dwustronny (wewnętrzna faza - dół)
	Pierścień kompresyjny trapezowy dwustronny (wewnętrzny stopień - góra)
	Pierścień kompresyjny trapezowy dwustronny (wewnętrzny stopień - dół)
	Pierścień trapezowy dwustronny o czole stożkowym
	Pierścień trapezowy dwustronny o czole stożkowym (wewnętrzna faza - góra)
	Pierścień trapezowy dwustronny o czole stożkowym (wewnętrzna faza - dół)
	Pierścień trapezowy dwustronny o czole stożkowym (wewnętrzny stopień - góra)
	Pierścień trapezowy dwustronny o czole stożkowym (wewnętrzny stopień - dół)
	Pierścień zgarniający o przekroju hakowym - pojedynczym
	Pierścień zgarniający o przekroju hakowym - pojedynczym (wewnętrzna faza - góra)
	Pierścień zgarniający o przekroju hakowym - pojedynczym (wewnętrzna faza - dół)
	Pierścień zgarniający o przekroju hakowym - pojedynczym (wewnętrzny stopień - góra)
	Pierścień zgarniający o przekroju hakowym - pojedynczym (wewnętrzny stopień - dół)
	Stożkowy pierścień zgarniający o przekroju hakowym - pojedynczym
	Stożkowy pierścień zgarniający o przekroju hakowym - pojedynczym (wewnętrzna faza - góra)
	Stożkowy pierścień zgarniający o przekroju hakowym - pojedynczym (wewnętrzna faza - dół)
	Stożkowy pierścień zgarniający o przekroju hakowym - pojedynczym (wewnętrzny stopień - góra)
	Stożkowy pierścień zgarniający o przekroju hakowym - pojedynczym (wewnętrzny stopień - dół)
	Szczelinowy olejowy pierścień zgarniający
	Fazowany pierścień olejowy
	Podwójnie fazowany pierścień olejowy
	Szczelinowy olejowy pierścień zgarniający
	Szczelinowy olejowy pierścień zgarniający ze sprężyną spiralną
	Fazowany pierścień olejowy ze sprężyną spiralną
	Podwójnie fazowany pierścień olejowy ze sprężyną spiralną
	Szczelinowy zgarniacz olejowy ze sprężyną spiralną
	Olejowy pierścień z szyną stalową i sprężyną typu VF

CITROËN

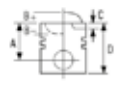

1 **72.00**

1

2

AX 11 3	09/86→12/97	TU1M (HDZ) 4	4 Cyl.		
Berlingo 1.1 i, Berlingo Box 1.1 i	07/96→				
BX 11	10/88→06/92		1124cc	40kW (54PS)	10
C15 1.1 i	07/88→12/96				TD661
C15 Estate 1.1	08/88→07/96				
Saxo 1.1 X,SX	05/96→09/03				
ZX 1.1	03/91→06/97				

5

87-154300-00 STD

A 40.05
B+ 2.97
D 64.05
 20x62

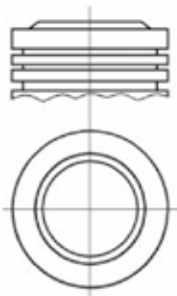

11

12

Steel

6

08-154300-00 STD
08-154307-00 0.50mm

01/87→

1.50
2.00
3.00



CR P
P
CR

Stahl

7

8

14-636470-00 WH B 79.50 C 122.00 D 89.20 E 85.00

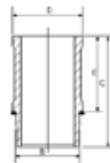

Acier

9

88-154300-00

Acciaio

Acero

- | | |
|--|--|
| <p>1 № секции</p> <p>2 Диаметр цилиндра</p> <p>3 Модель (Только легковые и легкие коммерческие автомобили)</p> <p>4 Двигатель</p> <p>5 Артикул и спецификация поршня
A = высота сжатия
B = глубина выемки / высота головки
B∅ = диаметр выемки
C = глубина выемки под клапан
D = длина
RT с усилителем канавки верхнего поршневого кольца Alfin
KK с каналом масляного охлаждения
AK с пазом/фаской для масляной форсунки
HA с головкой с твердым анодированным покрытием
NB с бронзовой втулкой поршневого пальца
TP = трапециевидный шатун</p> | <p>6 Информация о комплекте колец
Ширина кольца
Конструкция кольца
Обработка поверхности и материал кольца</p> <p>7 Информация о гильзе
B = внешний диаметр
C = общая длина
D = диаметр фланца
E = ширина фланца
F = высота огнезащитного уплотнения</p> <p>8 Тип гильзы
D = "сухая"
WH = "мокрая" с хонинговкой
DH = "сухая" с хонинговкой</p> <p>9 Артикул установочного комплекта</p> <p>10 TecDoc / номер двигателя F-M</p> <p>11 Изображение поршня и номер отливки (если есть)</p> <p>12 Комментарии</p> |
|--|--|

СИСТЕМА НУМЕРАЦИИ ДЕТАЛЕЙ



87 - 114900 - 25 **Номер детали в каталоге**

87 - 114900 - 25 **Поршень в сборе**

88 - 114900 - 25 **Комплект с гильзой без уплотнений**

89 - 114900 - 25 **Комплект с гильзой с уплотнениями**

87 - 114900 - 25 **код**

87 - 114900 - 25 **Размер***

87 - 114900 - 25 **Версия**

* Если ранее использовалась британская система мер, то она продолжает использоваться

Расшифровка кодов

- RT с усилителем канавки верхнего поршневого кольца Alfin
- KK с каналом масляного охлаждения
- AK с пазом/фаской для масляной форсунки
- HA с головкой с твердым анодированным покрытием
- NB с бронзовой втулкой поршневого пальца

Размер	Метрическая система	Британская система мер
00	STD	
03	0.125MM	
04	0.20MM	
05	0.25MM	.010
06	0.40MM	
07	0.50MM	.020
08	0.60MM	
09	0.75MM	.030
10	0.80MM	
11	1.00MM	.040
13	1.25MM	
14	1.50MM	.060
16	2.00MM	
17	2.286MM	.090
20	0.70MM	
21	0.65MM	
22	0.30MM	



ПОРШНЕВЫЕ КОЛЬЦА

08 - 114900 - 00 **Номер детали в каталоге**

08 - 114900 - 00 **Комплект колец в сборе**

08 - 114900 - 00 **код**

08 - 114900 - 00 **Размер* (см. таблицу поршней Niral)**

08 - 114900 - 00 **Версия**

* Если ранее использовалась британская система мер, то она продолжает использоваться

ГИЛЬЗЫ ЦИЛИНДРОВ

14 - 451160 - 00 **Номер детали в каталоге**

14 - 451160 - 00 **Гильза цилиндра**

15 - 451160 - 00 **Гильза цилиндра с уплотнением**

14 - 451160 - 00 **Тип гильзы**

14 - 451160 - 00 **Серийный номер**

14 - 451160 - 00 **Размер**

14 - 451160 - 00 **Версия**

01 - 19 = "Сухая" гильза
20 - 99 = "Мокрая" гильза

0 = стандартный
1 = 1й ремонтный размер
2 = 2й ремонтный размер



КОДЫ ПОКРЫТИЙ И ВИДОВ ОБРАБОТКИ

CR	С хромовым покрытием	NT	С азотированием поверхности
MO	С молибденовым подслоем	PS	С плазменным напылением
MOL	С молибденовым покрытием	GDC	С алмазо-углеродным покрытием Goetze Diamond®
CK	С хромокерамическим покрытием	DLC	С алмазоподобным покрытием
PVD	С покрытием из нитрида хрома		
P	С фосфатированием поверхности		

СЕЧЕНИЯ ПОРШНЕВЫХ КОЛЕЦ

Сечение	Описание
	Цилиндрическое компрессионное кольцо
	Цилиндрическое компрессионное кольцо (с внутренней фаской сверху)
	Цилиндрическое компрессионное кольцо (с внутренней фаской снизу)
	Цилиндрическое компрессионное кольцо (с внутренним уступом сверху)
	Цилиндрическое компрессионное кольцо (с внутренним уступом снизу)
	Конусообразное кольцо
	Конусообразное кольцо (с внутренней фаской сверху)
	Конусообразное кольцо (с внутренней фаской снизу)
	Конусообразное кольцо (с внутренним уступом сверху)
	Конусообразное кольцо (с внутренним уступом снизу)
	Минутное компрессионное конусообразное кольцо
	Минутное компрессионное конусообразное кольцо (с внутренней фаской сверху)
	Минутное компрессионное конусообразное кольцо (с внутренней фаской снизу)
	Минутное компрессионное конусообразное кольцо (с внутренним уступом сверху)
	Минутное компрессионное конусообразное кольцо (с внутренним уступом снизу)
	Клиновидное компрессионное кольцо
	Клиновидное компрессионное кольцо (с внутренней фаской сверху)
	Клиновидное компрессионное кольцо (с внутренней фаской снизу)
	Клиновидное компрессионное кольцо (с внутренним уступом сверху)
	Клиновидное компрессионное кольцо (с внутренним уступом снизу)
	Трапециевидное компрессионное кольцо
	Трапециевидное компрессионное кольцо (с внутренней фаской сверху)
	Трапециевидное компрессионное кольцо (с внутренней фаской снизу)
	Трапециевидное компрессионное кольцо (с внутренним уступом сверху)
	Трапециевидное компрессионное кольцо (с внутренним уступом снизу)
	Трапециевидное конусообразное кольцо
	Трапециевидное конусообразное кольцо (с внутренней фаской сверху)
	Трапециевидное конусообразное кольцо (с внутренней фаской снизу)
	Трапециевидное конусообразное кольцо (с внутренним уступом сверху)
	Трапециевидное конусообразное кольцо (с внутренним уступом снизу)
	Скребок с зубом
	Скребок с зубом (с внутренней фаской сверху)
	Скребок с зубом (с внутренней фаской снизу)
	Скребок с зубом (с внутренним уступом сверху)
	Скребок с зубом (с внутренним уступом снизу)
	Скребок конический с зубом
	Скребок конический с зубом (с внутренней фаской сверху)
	Скребок конический с зубом (с внутренней фаской снизу)
	Скребок конический с зубом (с внутренним уступом сверху)
	Скребок конический с зубом (с внутренним уступом снизу)
	Маслосъемное коромысло с дренажными прорезями
	Маслосъемное коромысло со сходящимися фасками
	Маслосъемное коромысло с параллельными фасками
	Маслосъемное коромысло с дренажными прорезями
	Маслосъемное коромысло с дренажными прорезями с витым пружинным расширителем
	Маслосъемное коромысло со сходящимися фасками с витым пружинным расширителем
	Маслосъемное коромысло с параллельными фасками с витым пружинным расширителем
	Стальное пластинчатое маслосъемное кольцо с пружинным расширителем VF

نظام ترقيم القطع

Niral[®]
FITTED WITH **GOETZE** RINGS

القطعة	الوصف	الحجم	مترى الحجم	إمبريالي
87 - 114900 - 25	مرجع الكتالوج	00	STD	
87 - 114900 - 25	مجموعة الكباس	03	0.125MM	
88 - 114900 - 25	مجموعة طقم بدون سدادات	04	0.20MM	
89 - 114900 - 25	مجموعة طقم ذات سدادات	05	0.25MM	.010
87 - 114900 - 25	المرجع	06	0.40MM	
87 - 114900 - 25	*الحجم	07	0.50MM	.020
87 - 114900 - 25		08	0.60MM	
87 - 114900 - 25	الإصدار	09	0.75MM	.030
		10	0.80MM	
		11	1.00MM	.040
		13	1.25MM	
		14	1.50MM	.060
		16	2.00MM	
		17	2.286MM	.090
		20	0.70MM	
		21	0.65MM	
		22	0.30MM	

* إذا كان المقياس إمبريالي في الماضي، يستمر لكي يكون إمبريالي

أكواد المميزات
RT إدراج ألفين
KK استوديو تبريد الزيت
AK قطع نفث الزيت

بطانة مؤكسدة قوية على HA التاج
NB جلبة بنز برونزي

GOETZE[®]

حلقات الكباس

08 - 114900 - 00	مرجع الكتالوج
08 - 114900 - 00	تجميع مجموعة الحلقة
08 - 114900 - 00	المرجع
08 - 114900 - 00	Niral الحجم* (انظر جدول كباسات)
08 - 114900 - 00	الإصدار

* إذا كان المقياس إمبريالي في الماضي، يستمر لكي يكون إمبريالي

بطانات الأسطوانات

14 - 451160 - 00	مرجع الكتالوج	
14 - 451160 - 00	بطانة الاسطوانة	
15 - 451160 - 00	بطانة الاسطوانة ذات مانع التسريب	19 - 01 = بطانة جافة
14 - 451160 - 00	نوع البطانة	99 - 20 = بطانة رطبة
14 - 451160 - 00	الرقم المسلسل	
14 - 451160 - 00	الحجم	0 = قياسي
14 - 451160 - 00	الإصدار	1 = الحجم الزائد الأول
		2 = الحجم الزائد الثاني

GOETZE[®]

أكواد المعالجة والأغطية

CR	ملون بالكروم	P	مصنوع من الفوسفات
MO	مرصع بالموليبدينوم	NT	بالنيتريد
MOL	مكسو بالموليبدينوم	PS	مغطى برشاش البلازما
CK	مكسو بالسيرايميك - الكروميوم	GDC	Goetze® غطاء ماس
PVD	كروم نيتريد	DLC	للحاس مثل الكروميوم

الأقسام المستعرضة لحلقات الكباس

القسم المستعرض	الوصف
	حلقة ضغط بسيطة
	حلقة ضغط بسيطة (الشفة الداخلية - الجانب العلوي)
	حلقة ضغط بسيطة (الشفة الداخلية - الجانب السفلي)
	حلقة ضغط بسيطة (الدرج الداخلي - الجانب العلوي)
	حلقة ضغط بسيطة (الدرج الداخلي - الجانب السفلي)
	حلقة مستدقة
	حلقة مستدقة (الشفة الداخلية - الجانب العلوي)
	حلقة مستدقة (الشفة الداخلية - الجانب السفلي)
	حلقة مستدقة (الدرج الداخلي - الجانب العلوي)
	حلقة مستدقة (الدرج الداخلي - الجانب السفلي)
	الحلقة المستدقة بشكل طفيف
	الحلقة المستدقة بشكل طفيف (الشفة الداخلية - الجانب العلوي)
	الحلقة المستدقة بشكل طفيف (الشفة الداخلية - الجانب السفلي)
	الحلقة المستدقة بشكل طفيف (الدرج الداخلي - الجانب العلوي)
	الحلقة المستدقة بشكل طفيف (الدرج الداخلي - الجانب السفلي)
	حلقة ضغط من نوع الإسفين
	حلقة ضغط من نوع الإسفين (الشفة الداخلية - الجانب العلوي)
	حلقة ضغط من نوع الإسفين (الشفة الداخلية - الجانب السفلي)
	حلقة ضغط من نوع الإسفين (الدرج الداخلي - الجانب العلوي)
	حلقة ضغط من نوع الإسفين (الدرج الداخلي - الجانب السفلي)
	حلقة ضغط من النوع المرتكز
	حلقة ضغط من النوع المرتكز (الشفة الداخلية - الجانب العلوي)
	حلقة ضغط من النوع المرتكز (الشفة الداخلية - الجانب السفلي)
	حلقة ضغط من النوع المرتكز (الدرج الداخلي - الجانب العلوي)
	حلقة ضغط من النوع المرتكز (الدرج الداخلي - الجانب السفلي)
	حلقة مرتكز ذات وجه مستدق
	حلقة مرتكز ذات وجه مستدق (الشفة الداخلية - الجانب العلوي)
	حلقة مرتكز ذات وجه مستدق (الشفة الداخلية - الجانب السفلي)
	حلقة مرتكز ذات وجه مستدق (الشفة الداخلية - الجانب العلوي)
	حلقة مرتكز ذات وجه مستدق (الشفة الداخلية - الجانب السفلي)
	كاشطة منفردة الخطاف
	كاشطة منفردة الخطاف (الشفة الداخلية - الجانب العلوي)
	كاشطة منفردة الخطاف (الشفة الداخلية - الجانب السفلي)
	كاشطة منفردة الخطاف (الدرج الداخلي - الجانب العلوي)
	كاشطة منفردة الخطاف (الدرج الداخلي - الجانب السفلي)
	كاشطة منفردة الخطاف مستدقة
	كاشطة منفردة الخطاف مستدقة (الشفة الداخلية - الجانب العلوي)
	كاشطة منفردة الخطاف مستدقة (الشفة الداخلية - الجانب السفلي)
	كاشطة منفردة الخطاف مستدقة (الدرج الداخلي - الجانب العلوي)
	كاشطة منفردة الخطاف مستدقة (الدرج الداخلي - الجانب السفلي)
	حلقة كاشطة الزيت المثقوبة
	حلقة تحكم زيت مشطوفة الحافة
	حلقة تحكم زيت مشطوفة الحافة مزدوجة
	حلقة كاشطة الزيت المثقوبة
	حلقة كاشطة الزيت المثقوبة مع باي ملفوف
	حلقة تحكم زيت مشطوفة الحافة مع باي ملفوف
	حلقة تحكم زيت مشطوفة الحافة مزدوجة مع باي ملفوف
	كاشطة الزيت المثقوبة مع باي ملفوف
	حلقة تحكم زيت صلبة مع باي VF

Niral[®]
FITTED WITH **GOETZE** RINGS

CAMPUS

Federal-Mogul Motorparts' Technical Portal



ENHANCE YOUR KNOWLEDGE AND SKILLS

- ▶ Comprehensive interactive training modules
- ▶ 9 languages
- ▶ Accessible online using your PC or tablet and offline via an iPad app
- ▶ Free registration
- ▶ Technical Resource Center: diagnostic & troubleshooting documents
- ▶ Free Registration & Available 24/7
- ▶ Latest Automotive News
- ▶ Personal Training Scoreboard
- ▶ Follow Federal Mogul Events!
- ▶ F-M Campus Newsletter. Sign up & Keep up with the latest trainings & automotive news

For additional information:

 www.fmcampus.eu

 info@fmcampus.eu

 @FMCampus_EMEA

 F-M Campus



Used in more than
120 countries!





CONTENT FOR MY CAMPUS





- ▶ Generic Training
- ▶ Brake Training
- ▶ Chassis Training
- ▶ Engine parts Training
- ▶ Wheel-end Bearing Training
- ▶ Filter Training
- ▶ Installation Guides
- ▶ Technical Tips
- ▶ Diagnostic Aids
- ▶ Sales Arguments
- ▶ Technical Posters





				9
87-101100-00	STD	VOLVO COMMERCIAL	TAD1630G/GE/P, TAD1631G, TWD1630G/P	1374 47
87-101100-10	STD	VOLVO COMMERCIAL	D16A, D16A470 Euro 2, D16A520, D16B520, TD163ES	1373 46
87-101700-10	STD	PERKINS	Phaser 90 (1004-4), Phaser 125 (1006-6)	892 19
87-104107-00	0.50mm	NISSAN	D7F 764	813 2
		RENAULT	D7F 700, D7F 701, D7F 702, D7F 703, D7F 704, D7F 706, D7F 710, D7F 720, D7F 722, D7F 726, D7F 730, D7F 746, D7F 764, D7F 766 Euro 4	957 3
87-104207-40	0.50mm	DACIA	K7J 710, K7J 714	184 8
		RENAULT	K7J 710, K7J 714	982 26
87-114400-65	STD	BMW	M47 N204D4 Euro 4, M47 N204D5TU Euro 4	110 11
87-114708-40	0.60mm	CITROEN	DW10BTE4 (RHF), DW10BTE4 (RHJ) Euro 4, DW10BTE4 (RHR) Euro 4, DW10UTE4 (RHK) Euro 4	158 31
		FIAT	RHK	282 69
		LANCIA	RHK (DW10UTE4) Euro 4	543 37
		PEUGEOT	DW10BTE4 (RHF), DW10BTE4 (RHR), DW10UTE4 (RHK) Euro 4	927 33
87-123400-40	STD	RENAULT	K9K 770 Euro 5, K9K 782 Euro 5, K9K 808 Euro 5, K9K 816 Euro 5, K9K 820, K9K 834, K9K 836 Euro 5, K9K H 834 Euro 5, K9K J 836 Euro 5	970 16
87-123400-50	STD	RENAULT	K9K 742 Euro 5, K9K 814 Euro 5	977 21
87-123407-40	0.50mm	RENAULT	K9K 770 Euro 5, K9K 782 Euro 5, K9K 808 Euro 5, K9K 816 Euro 5, K9K 820, K9K 834, K9K 836 Euro 5, K9K H 834 Euro 5, K9K J 836 Euro 5	970 16
87-123407-50	0.50mm	RENAULT	K9K 742 Euro 5, K9K 814 Euro 5	977 21
87-123900-10	STD	DEUTZ KHD	BF 6M 1015 C Euro 2, BF 8M 1015 C Euro 2	229 35
87-124500-40	STD	MAN	D 2840 LE, D 2840 LE403, D 2842 LE402, D 2842 LE406, D 2842 LE408, D 2848 LE	619 31
87-127907-00	0.50mm	DEUTZ KHD	BF 4M 2012 C Euro 2, BF 4M 2012 Euro 2, BF 6M 2012 C Euro 2	215 12
87-135500-10	STD	RENAULT TRUCKS	dCi 11C Euro 3	1036 22
87-136500-90	STD	MAN	D 0834 LFL60 EEV, D 0834 LFL61 EEV, D 0834 LFL62 EEV, D 0834 LFL63 Euro 5, D 0834 LFL64 Euro 5, D 0834 LFL65 Euro 5, D 0834 LOH61 Euro 5, D 0836 LFL61 EEV, D 0836 LFL62 EEV, D 0836 LFL63 Euro 5, D 0836 LFL64 Euro 5, D 0836 LFL65 Euro 5, D 0836 LFL69 Euro 5, D 0836 LFL70 Euro 5, D 0836 LFL71 Euro 5	604 12
87-136500-91	STD	MAN	D 0834 LFL60 EEV, D 0834 LFL61 EEV, D 0834 LFL62 EEV, D 0834 LFL63 Euro 5, D 0834 LFL64 Euro 5, D 0834 LFL65 Euro 5, D 0834 LOH61 Euro 5, D 0836 LFL61 EEV, D 0836 LFL62 EEV, D 0836 LFL63 Euro 5, D 0836 LFL64 Euro 5, D 0836 LFL65 Euro 5, D 0836 LFL69 Euro 5, D 0836 LFL70 Euro 5, D 0836 LFL71 Euro 5	604 12
87-136507-65	0.50mm	MAN	D 0834 LFL50 Euro 4, D 0834 LFL51 Euro 4, D 0834 LFL52 Euro 4, D 0834 LFL53 Euro 4, D 0834 LFL54 Euro 4, D 0834 LFL55 Euro 4, D 0834 LOH50 Euro 4, D 0834 LOH51 Euro 4, D 0834 LOH52 Euro 4, D 0834 LOH53 Euro 4, D 0836 LFL60 Euro 5, D 0836 LFL61 Euro 5, D 0836 LFL62 Euro 5, D 0836 LFL63 Euro 5, D 0836 LFL64 Euro 5, D 0836 LFL65 Euro 5, D 0836 LFL69 Euro 5, D 0836 LFL70 Euro 5, D 0836 LFL71 Euro 5, D 0836 LOH54 Euro 4, D 0836 LOH55 Euro 4, D 0836 LOH56 Euro 4, D 0836 LOH57 Euro 4, D 0836 LOH58 Euro 4, D 0836 LOH59 Euro 4, D 0836 LOH60 Euro 4, D 0836 LOH61 Euro 4, D 0836 LOH62 Euro 4, D 0836 LOH63 Euro 4, D 0836 LOH64 Euro 5, D 0836 LOH65 Euro 5, D 0836 LOH66 Euro 6	602 11
87-136900-00	STD	DEUTZ KHD	BF 4M 1013 C Euro 1, BF 4M 1013 Euro 1, BF 6M 1013 C Euro 1, BF 6M 1013 Euro 1, BF 6M 1013 CP Euro 1	222 23 224 26
87-136900-10	STD	DEUTZ KHD	BF 4M 1013 E Euro 2, BF 6M 1013 E Euro 2, TCD 2013 L4 2V Euro 2, TCD 2013 L6 2V Euro 2	222 24
			BF 4M 1013 EC Euro 2, BF 4M 1013 FC Euro 2/3, BF 6M 1013 EC Euro 2, BF 6M 1013 ECP Euro 2/3	223 25
		VOLVO COMMERCIAL	D7DEAE2 Euro 2, D7DECE2 Euro 2, D7DEEE2 Euro 2, D7DLAE2 Euro 2, D7DLBE2 Euro 2	1354 17
87-136900-30	STD	DEUTZ KHD	BF 4M 1013 EC Euro 2, BF 4M 1013 FC Euro 2/3, BF 6M 1013 EC Euro 2, BF 6M 1013 ECP Euro 2/3	223 25
			BF 6M 1013 CP Euro 1	224 26
			BF 6M 1013 FC Euro 2/3	225 27
87-137500-30	STD	RENAULT	G9U 630 Euro 4, G9U 632 Euro 4, G9U 650 Euro 4	1012 49
87-137507-30	0.50mm	RENAULT	G9U 630 Euro 4, G9U 632 Euro 4, G9U 650 Euro 4	1012 49
87-140200-00	STD	DAF	PE 228 C Euro 3, PE 265 C Euro 3, PE 310 C Euro 3, PE 360 C Euro 3	198 10
			PE 235 C Euro 3	199 11
87-141200-00	STD	CHEVROLET	Z 18 XE Ecotec	125 10
		OPEL	X 18 XE1 Ecotec, Z 18 XE Ecotec, Z 18 XEL Ecotec	855 31
		SAAB	Z18XE	1058 2
		VAUXHALL	X 18 XE1 Ecotec, Z 18 XE Ecotec, Z 18 XEL Ecotec	1230 32
87-141207-00	0.50mm	CHEVROLET	Z 18 XE Ecotec	125 10
		OPEL	X 18 XE1 Ecotec, Z 18 XE Ecotec, Z 18 XEL Ecotec	855 31
		SAAB	Z18XE	1058 2
		VAUXHALL	X 18 XE1 Ecotec, Z 18 XE Ecotec, Z 18 XEL Ecotec	1230 32
87-141300-10	STD	FORD EUROPE	FYDA Zetec SE, FYDB Zetec SE, FYDC Zetec SE, FYDD Zetec SE, FYDH Zetec SE, FYJA, FYJB	317 13
87-141300-20	STD	FORD EUROPE	HWDA, HWDB, HXDA Duratec, HXDB Duratec, PNBA, SHDA, SHDB, SHDC, SIDA Duratec	318 14
87-141307-10	0.50mm	FORD EUROPE	FYDA Zetec SE, FYDB Zetec SE, FYDC Zetec SE, FYDD Zetec SE, FYDH Zetec SE, FYJA, FYJB	317 13
87-141307-20	0.50mm	FORD EUROPE	HWDA, HWDB, HXDA Duratec, HXDB Duratec, PNBA, SHDA, SHDB, SHDC, SIDA Duratec	318 14
87-143600-40	STD	SCANIA	DC 9.11 Euro 3 DC 9, DC 9.12 Euro 3 DC 9, DC 9.13 Euro 3 DC 9, DC 9.19 Euro 3 DC 9, DC 9.20 Euro 3, DC 9.21, DC 11.02 Euro 3, DC 11.04 Euro 3, DC 11.09 Euro 3	1071 11
87-143600-50	STD	SCANIA	DC 11.01 Euro 3, DC 11.03 Euro 3, DC 11.07 Euro 2, DC 11.08 Euro 3	1072 13

NEW PARTS LIST

Liste der Neuaufnahmen • Elenco nuovi riferimenti
Liste des nouvelles références





		  		 9	
87-144200-00	STD	CHEVROLET	Z 14 XE Ecotec	123	5
		OPEL	Z 14 XE Ecotec	840	13
		VAUXHALL	Z 14 XE Ecotec	1218	14
87-144207-00	0.50mm	CHEVROLET	Z 14 XE Ecotec	123	5
		OPEL	Z 14 XE Ecotec	840	13
		VAUXHALL	Z 14 XE Ecotec	1218	14
87-148100-80	STD	FORD EUROPE	SAFA Duratorq, SAFB Duratorq	362	61
87-148100-85	STD	FORD EUROPE	SAFA Duratorq, SAFB Duratorq	362	61
87-148105-00	0.25mm	FORD EUROPE	DOFA (DT24) Duratorq	359	57
		LAND ROVER	160 A1.046, 836 A4.000	556	14
87-148105-80	0.25mm	FORD EUROPE	SAFA Duratorq, SAFB Duratorq	362	61
87-148107-00	0.50mm	FORD EUROPE	DOFA (DT24) Duratorq	359	57
		LAND ROVER	160 A1.046, 836 A4.000	556	14
87-148107-80	0.50mm	FORD EUROPE	SAFA Duratorq, SAFB Duratorq	362	61
87-148107-85	0.50mm	FORD EUROPE	SAFA Duratorq, SAFB Duratorq	362	61
87-148300-00	STD	AUDI	AHL	67	25
			ALZ, ANA, AVU, BFO, BGU, BSE, BSF	68	26
		SEAT	ALZ, BFO, BGU, BSE, BSF, CHGA	1117	30
		SKODA	AVU, BFO, BGU, BSE, BSF, CHGA	1156	21
		VOLKSWAGEN	ALZ, ANA, AVU, AYD, BFO, BFS, BGU, BSE, BSF, CHGA	1306	37
87-148307-00	0.50mm	AUDI	AHL	67	25
			ALZ, ANA, AVU, BFO, BGU, BSE, BSF	68	26
		SEAT	ALZ, BFO, BGU, BSE, BSF, CHGA	1117	30
		SKODA	AVU, BFO, BGU, BSE, BSF, CHGA	1156	21
		VOLKSWAGEN	ALZ, ANA, AVU, AYD, BFO, BFS, BGU, BSE, BSF, CHGA	1306	37
87-181100-30	STD	JOHN DEERE	6068 D/6068 T	500	6
87-247600-10	STD	ISUZU	C 223	416	5
		OPEL	C 223	874	54
		VAUXHALL	C 223	1245	53
87-252500-30	STD	DEUTZ KHD	F 2M 1011, F 3M 1011 F, F 4M 1011 F	209	3
87-252507-30	0.50mm	DEUTZ KHD	F 2M 1011, F 3M 1011 F, F 4M 1011 F	209	3
87-288000-00	STD	HYUNDAI	4D55	406	8
		MITSUBISHI	4 D 55	789	5
87-288007-00	0.50mm	HYUNDAI	4D55	406	8
		MITSUBISHI	4 D 55	789	5
87-325600-30	STD	PERKINS	C4.40, Phaser 110T (1004-4T), Phaser 160T (1006-6T) 1989>, Phaser 180Ti (1006-6TW), Phaser 180Ti (CC6.60) Euro 2	891	17
87-346500-00	STD	RENAULT TRUCKS	797, 797-20, 797-21, 797-26	1026	8
87-420900-50	STD	MERCEDES-BENZ COMMERCIAL	OM 541.991 OM 501 LA, OM 941.991 OM 501 LA	775	57
87-421007-30	0.50mm	VOLKSWAGEN	BJL, BJM, CECA, CECB	1318	47
87-422000-10	STD	NISSAN		821	12
		OPEL	M9R 630, M9R 692 Euro 5	862	40
		RENAULT	M9R 610, M9R 615, M9R 630, M9R 692 Euro 5, M9R 828, M9R 854, M9R 856, M9R 857, M9R 858, M9R 859, M9R 862, M9R 864, M9R 865, M9R 866	996	37
			M9R 630	1236	40
			M9R 630	821	12
87-422007-10	0.50mm	NISSAN		821	12
		OPEL	M9R 630, M9R 692 Euro 5	862	40
		RENAULT	M9R 610, M9R 615, M9R 630, M9R 692 Euro 5, M9R 828, M9R 854, M9R 856, M9R 857, M9R 858, M9R 859, M9R 862, M9R 864, M9R 865, M9R 866	996	37
			M9R 630	1236	40
			M9R 630	821	12
87-423407-00	0.50mm	FORD EUROPE	AODA, AODB, AODE, CJBA Duratec HE, CJBB Duratec HE, N4JB Duratec ST, SYDA Duratec HE	355	51
		MAZDA	LF17, LF18, LFF7	642	8
		VOLVO CARS	B 4204 S3	1340	15
87-424100-00	STD	TOYOTA	1ND-TV	1195	2
87-424107-00	0.50mm	TOYOTA	1ND-TV	1195	2
87-424200-00	STD	HYUNDAI	G4ED Euro 4	403	4
		KIA	G4ED Euro 4	504	3
87-424207-00	0.50mm	HYUNDAI	G4ED Euro 4	403	4
		KIA	G4ED Euro 4	504	3
87-425300-00	STD	BMW	M54 256S5, M54 B25 (256 S3), M54 B25 (256 S5)	105	6
87-425307-00	0.50mm	BMW	M54 256S5, M54 B25 (256 S3), M54 B25 (256 S5)	105	6
87-425700-00	STD	BMW	M43 194E1, M43 B19 (194E1)	116	16
87-425707-00	0.50mm	BMW	M43 194E1, M43 B19 (194E1)	116	16
87-426100-00	STD	FORD EUROPE	ASDA, ASDB, FXDA Zetec SE, FXDB Zetec SE, FXDC Zetec SE, FXDD Zetec SE, FXJA, FXJB	314	10
		MAZDA	FXJA	639	4





		  		 9	
87-426107-00	0.50mm	FORD EUROPE	ASDA, ASDB, FXDA Zetec SE, FXDB Zetec SE, FXDC Zetec SE, FXDD Zetec SE, FXJA, FXJB	314	10
		MAZDA	FXJA	639	4
87-427700-40	STD	FORD EUROPE	CYRA Duratorq, CYRB Duratorq, SRFA, SRFB, SRFC, SRFD, SRFE, UHFA Duratorq, UHFB Duratorq, UHFC Duratorq	350	46
			PGFA Euro 4, PGFB	353	50
		LAND ROVER	188 A5.000 Euro 3 Fire	553	11
87-427700-50	STD	FORD EUROPE	CVF5 Duratorq, CVRA Duratorq, CVRB Duratorq, CVRC Duratorq, GBVAJPF Duratorq, GBVAJQJ Duratorq, GBVAJQW Duratorq	349	45
87-427707-30	0.50mm	CITROEN	P22DTE (4HV) Euro 4	165	39
		FIAT	4HV Euro 4	284	72
		FORD EUROPE	P8FA, P8FB	352	48
		PEUGEOT	P22DTE (4HV) Euro 4	933	40
87-427707-40	0.50mm	FORD EUROPE	CYRA Duratorq, CYRB Duratorq, SRFA, SRFB, SRFC, SRFD, SRFE, UHFA Duratorq, UHFB Duratorq, UHFC Duratorq	350	46
			PGFA Euro 4, PGFB	353	50
		LAND ROVER	188 A5.000 Euro 3 Fire	553	11
87-427707-50	0.50mm	FORD EUROPE	CVF5 Duratorq, CVRA Duratorq, CVRB Duratorq, CVRC Duratorq, GBVAJPF Duratorq, GBVAJQJ Duratorq, GBVAJQW Duratorq	349	45
87-427800-00	STD	OPEL	Z 16 XEP	847	21
		VAUXHALL	Z 16 XEP	1223	22
87-427807-00	0.50mm	OPEL	Z 16 XEP	847	21
		VAUXHALL	Z 16 XEP	1223	22
87-427900-00		IVECO	F4AE3481A Euro 4/5 Tector E18, F4AE3481B Euro 4/5 Tector E18, F4AE3481C Euro 4/5 Tector E14, F4AE3481D Euro 4/5 Tector E16, F4AE3681A Euro 4/5 Tector E30, F4AE3681B Euro 4/5 Tector E22, F4AE3681C Euro 4/5 Tector E22, F4AE3681D Euro 4/5 Tector E25, F4AE3681E Euro 4/5 Tector E28	447	24
87-428600-10	STD	MAN	D 2066 LUH41 EEV, D 2066 LUH42 EEV, D 2066 LUH43 EEV, D 2066 LUH46 EEV, D 2066 LUH47 EEV, D 2066 LUH48 EEV	611	20
87-428707-00	0.50mm	MERCEDES-BENZ	OM 646.986 Euro 4	675	25
87-429407-00	0.50mm	FORD EUROPE	CGBA Duratec HE, CGBB Duratec HE, CHBA Duratec HE, CHBB Duratec HE, CSDA Duratec HE, CSDB Duratec HE, Q7DA Duratec HE, QQDA Duratec HE, QQDB Duratec HE	343	39
87-429500-10	STD	OPEL	Z 12 XEP	836	7
		SUZUKI	Z 12 XEP	1183	3
		VAUXHALL	Z 12 XEP	1214	8
87-429500-30	STD	CHEVROLET	A 14 XER	122	3
		OPEL	A 14 XER	835	6
		VAUXHALL	A 14 XER	1214	7
87-429507-10	0.50mm	OPEL	Z 12 XEP	836	7
		SUZUKI	Z 12 XEP	1183	3
		VAUXHALL	Z 12 XEP	1214	8
87-429507-30	0.50mm	CHEVROLET	A 14 XER	122	3
		OPEL	A 14 XER	835	6
		VAUXHALL	A 14 XER	1214	7
87-429600-00	STD	RENAULT TRUCKS	MIDR 06.24.65, MIDR 06.24.65 A/42 Euro 2, MIDR 06.24.65 B/42 Euro 2, MIDR 06.24.65 C/42 Euro 2	1038	26
87-429900-00	STD	AUDI	CAXA, CAXC, CMSA, CNVA	40	4
		SEAT	CAXA, CAXC	1095	12
		SKODA	CAXA, CAXC	1138	8
		VOLKSWAGEN	CAXA, CMSB	1267	11
87-429907-00	0.50mm	AUDI	CAXA, CAXC, CMSA, CNVA	40	4
		SEAT	CAXA, CAXC	1095	12
		SKODA	CAXA, CAXC	1138	8
		VOLKSWAGEN	CAXA, CMSB	1267	11
87-432205-00	0.25mm	BMW	N47 D2 A, N47 D20B, N47 D20C, N47 SD20D	115	15
87-432207-00	0.50mm	BMW	N47 D2 A, N47 D20B, N47 D20C, N47 SD20D	115	15
87-432307-00	0.50mm	AUDI	CAGA, CAGB, CAGC, CAHA, CAHB, CBAA, CBAB, CBBB, CMEA	77	33
		SEAT	CAGA, CAGC, CAHA, CBDB, CEGA	1121	34
		SKODA	CBBB, CBDB, CEGA	1159	24
		VOLKSWAGEN	CAAA Euro 5, CAAB Euro 5, CAAC Euro 5, CAAD, CAAE, CBAA, CBAB, CBAC, CBBB, CBDA, CBDB, CBDC, CCHA, CCHB, CDBA, CDCA, CEGA, CFCA Euro 5, CJAA	1320	48
87-432307-10	0.50mm	AUDI	CFFA, CFFB, CFFG, CFGC, CFGB, CFHD, CFHA, CGLB, CGLC, CGLD, CGLE, CJCA, CJC B, CLJA, CLLB, CMGA, CMGB	79	34
		SEAT	CFFA, CFFB, CFFE, CFGB, CFGC, CFHC, CFHD, CFJA, CGLB, CJCA, CLCB	1123	35
		SKODA	CFFB, CFGB, CFHA, CFHC, CFHF, CFJA, CLCA, CLCB, CLJA	1160	25
		VOLKSWAGEN	CFFA, CFFB, CFFD, CFFE, CFGB, CFGC, CFHB, CFHC, CFHE, CFHF, CFJA, CFJB, CKTB, CKTC, CKUB, CKUC, CLCA, CLCB, CLJA, CLLA, CNEA, CNFA, CNFB, CSHA	1323	49
87-432900-00	STD	AUDI	CAYB, CAYC	60	19
		SEAT	CAYA, CAYB, CAYC, CFWA, CLNA	1110	22
		SKODA	CAYA, CAYB, CAYC, CFWA, CLNA	1151	16
		VOLKSWAGEN	CAYA, CAYB, CAYC, CAYD, CAYE, CFWA, CLNA	1294	28

										9		
87-435200-00	STD	NISSAN	M9T, M9T 670 Euro 5, M9T 672 Euro 5, M9T 676 Euro 4, M9T 678, M9T 680, M9T 686 Euro 5, M9T 690 Euro 5,	824	14	OPEL	M9T 692 Euro 4, M9T 694 Euro 4, M9T 696 Euro 4, M9T 698 Euro 5, M9T 870 Euro 5, M9T 880 Euro 5	869	47	M9T 670 Euro 5, M9T 672 Euro 5, M9T 676 Euro 4, M9T 678, M9T 680, M9T 686 Euro 5, M9T 690 Euro 5,	1000	39
			M9T 692 Euro 4, M9T 694 Euro 4, M9T 696 Euro 4, M9T 698 Euro 5, M9T 700, M9T 702, M9T 870, M9T 876, M9T 880, M9T 896, M9T 898									
			M9T 670 Euro 5, M9T 672 Euro 5, M9T 676 Euro 4, M9T 678, M9T 680, M9T 686 Euro 5, M9T 690 Euro 5, M9T 692 Euro 4, M9T 694 Euro 4, M9T 696 Euro 4, M9T 698 Euro 5, M9T 870 Euro 5, M9T 880 Euro 5, M9T 890 Euro 5, M9T 896 Euro 4, M9T 898 Euro 5									
			M9T 670 Euro 5, M9T 672 Euro 5, M9T 676 Euro 4, M9T 678, M9T 680, M9T 686 Euro 5, M9T 690 Euro 5, M9T 692 Euro 4, M9T 694 Euro 4, M9T 696 Euro 4, M9T 698 Euro 5, M9T 700, M9T 702, M9T 870, M9T 876, M9T 880									
			M9T 670 Euro 5, M9T 672 Euro 5, M9T 676 Euro 4, M9T 678, M9T 680, M9T 686 Euro 5, M9T 690 Euro 5, M9T 692 Euro 4, M9T 694 Euro 4, M9T 696 Euro 4, M9T 698 Euro 5, M9T 700, M9T 702, M9T 870, M9T 876, M9T 880									
87-435207-00	0.50mm	NISSAN	M9T, M9T 670 Euro 5, M9T 672 Euro 5, M9T 676 Euro 4, M9T 678, M9T 680, M9T 686 Euro 5, M9T 690 Euro 5,	824	14	OPEL	M9T 692 Euro 4, M9T 694 Euro 4, M9T 696 Euro 4, M9T 698 Euro 5, M9T 870 Euro 5, M9T 880 Euro 5	869	47	M9T 670 Euro 5, M9T 672 Euro 5, M9T 676 Euro 4, M9T 678, M9T 680, M9T 686 Euro 5, M9T 690 Euro 5,	1000	39
			M9T 692 Euro 4, M9T 694 Euro 4, M9T 696 Euro 4, M9T 698 Euro 5, M9T 700, M9T 702, M9T 870, M9T 876, M9T 880, M9T 896, M9T 898									
			M9T 670 Euro 5, M9T 672 Euro 5, M9T 676 Euro 4, M9T 678, M9T 680, M9T 686 Euro 5, M9T 690 Euro 5, M9T 692 Euro 4, M9T 694 Euro 4, M9T 696 Euro 4, M9T 698 Euro 5, M9T 870 Euro 5, M9T 880 Euro 5, M9T 890 Euro 5, M9T 896 Euro 4, M9T 898 Euro 5									
			M9T 670 Euro 5, M9T 672 Euro 5, M9T 676 Euro 4, M9T 678, M9T 680, M9T 686 Euro 5, M9T 690 Euro 5, M9T 692 Euro 4, M9T 694 Euro 4, M9T 696 Euro 4, M9T 698 Euro 5, M9T 700, M9T 702, M9T 870, M9T 876, M9T 880									
			M9T 670 Euro 5, M9T 672 Euro 5, M9T 676 Euro 4, M9T 678, M9T 680, M9T 686 Euro 5, M9T 690 Euro 5, M9T 692 Euro 4, M9T 694 Euro 4, M9T 696 Euro 4, M9T 698 Euro 5, M9T 700, M9T 702, M9T 870, M9T 876, M9T 880									
87-435300-00	STD	OPEL	Z 16 XER	847	22	VAUXHALL	Z 16 XER	1223	23			
			87-435307-00	0.50mm	OPEL		Z 16 XER	847	22	VAUXHALL	Z 16 XER	1223
87-435400-00	STD	HYUNDAI	G4EK	402	3							
87-435407-00	0.50mm	HYUNDAI	G4EK	402	3							
87-435500-00	STD	OPEL	A 16 LET Euro 5	843	16							
		SAAB	A16 LET Euro 5	1058	1							
		VAUXHALL	A 16 LET Euro 5	1220	17							
87-435507-00	0.50mm	OPEL	A 16 LET Euro 5	843	16							
		SAAB	A16 LET Euro 5	1058	1							
		VAUXHALL	A 16 LET Euro 5	1220	17							
87-435700-00	STD	FIAT	199 B1.000 Euro 5, 263 A2.000	241	10							
87-435700-10	STD	FIAT	169 A1.000, 199 A9.000 Euro 5, 199 B2.000 Euro 5, 263 A6.000	238	7							
87-435706-00	0.40mm	FIAT	199 B1.000 Euro 5, 263 A2.000	241	10							
87-435706-10	0.40mm	FIAT	169 A1.000, 199 A9.000 Euro 5, 199 B2.000 Euro 5, 263 A6.000	238	7							
87-436500-00	STD	ALFA ROMEO	198 A5.000, 844 A2.000, 939 B4.000, 939 B5.000, 940 A4.000, 940 A5.000 Euro 5, 940 A7.000 Euro 5, 940 A8.000 Euro 5	20	23							
		CHRYSLER	198 A5.000 Multijet	129	1							
		FIAT	198 A5.000, 844 A2.000, 939 B5.000, 940 A5.000 Euro 5	274	57							
		LANCIA	198 A5.000 Multijet, 844 A2.000	536	30							
		OPEL	A 20 DTC Euro 5, A 20 DT Euro 5, A 20 DTH Euro 5, A 20 DTJ Euro 5, A 20 DTL Euro 5, Z 20 DTJ	861	38							
		SAAB	A20 DTH Euro 5	1061	6							
		VAUXHALL	A 20 DTC Euro 5, A 20 DT Euro 5, A 20 DTH Euro 5, A 20 DTJ Euro 5, A 20 DTL Euro 5, Z 20 DTJ	1235	39							
		87-436506-00	0.40mm	ALFA ROMEO	198 A5.000, 844 A2.000, 939 B4.000, 939 B5.000, 940 A4.000, 940 A5.000 Euro 5, 940 A7.000 Euro 5, 940 A8.000 Euro 5	20	23					
CHRYSLER	198 A5.000 Multijet	129	1									
FIAT	198 A5.000, 844 A2.000, 939 B5.000, 940 A5.000 Euro 5	274	57									
LANCIA	198 A5.000 Multijet, 844 A2.000	536	30									
OPEL	A 20 DTC Euro 5, A 20 DT Euro 5, A 20 DTH Euro 5, A 20 DTJ Euro 5, A 20 DTL Euro 5, Z 20 DTJ	861	38									
SAAB	A20 DTH Euro 5	1061	6									
VAUXHALL	A 20 DTC Euro 5, A 20 DT Euro 5, A 20 DTH Euro 5, A 20 DTJ Euro 5, A 20 DTL Euro 5, Z 20 DTJ	1235	39									
87-436700-00	STD	CITROEN	DW12C (4HL)	162	35							
		FORD EUROPE	KNBA Duratorq, KNBB Duratorq, KNWA Duratorq, KNWB Duratorq	345	41							
		JAGUAR	224DT	485	3							
		LAND ROVER	176 B9.000 Fire	552	9							
		PEUGEOT	DW12C (4HL) Euro 5	930	36							
		87-436700-10	STD	CITROEN	DW12BTEd4 (4HP) Euro 4, DW12BTEd4 (4HR) Euro 4, DW12BTEd4 (4HT) Euro 4, DW12MTEd4 (4HN)	161	34					
FIAT	4HP, 4HR, 4HS Euro 4, 4HT (DW12BTEd4) Euro 4	280	65									
LANCIA	4HP, 4HR, 4HS Euro 4, 4HT Euro 4	541	34									
LAND ROVER	188 A4.000 Euro 3 Fire	553	10									
MITSUBISHI	4HK, 4HN	788	4									
PEUGEOT	DW12BTEd4 (4HP)/DW12BTEd4 (4HP), DW12BTEd4 (4HR), DW12BTEd4 (4HS) Euro 4, DW12BTEd4 (4HT) Euro 4, DW12BTEd4 (4HW), DW12MTEd4 (4HK), DW12MTEd4 (4HN)	929	35									

NEW PARTS LIST





Liste der Neuaufnahmen • Elenco nuovi riferimenti
Liste des nouvelles références



		  		 9	
87-436708-00	0.60mm	CITROEN	DW12C (4HL)	162	35
		FORD EUROPE	KNBA Duratorq, KNBB Duratorq, KNWA Duratorq, KNWB Duratorq	345	41
		JAGUAR	224DT	485	3
		LAND ROVER	176 B9.000 Fire	552	9
		PEUGEOT	DW12C (4HL) Euro 5	930	36
87-436708-10	0.60mm	CITROEN	DW12BTEd4 (4HP) Euro 4, DW12BTEd4 (4HR) Euro 4, DW12BTEd4 (4HT) Euro 4, DW12MTEd4 (4HN)	161	34
		FIAT	4HP, 4HR, 4HS Euro 4, 4HT (DW12BTEd4) Euro 4	280	65
		LANCIA	4HP, 4HR, 4HS Euro 4, 4HT Euro 4	541	34
		LAND ROVER	188 A4.000 Euro 3 Fire	553	10
		mitsubishi	4HK, 4HN	788	4
		PEUGEOT	DW12BTEd4 (4HP)/DW12BTEd4 (4HP), DW12BTEd4 (4HR), DW12BTEd4 (4HS) Euro 4, DW12BTEd4 (4HT) Euro 4, DW12BTEd4 (4HW), DW12MTEd4 (4HK), DW12MTEd4 (4HN)	929	35
87-436800-00	STD	ALFA ROMEO	350 A1.000 Euro 4/5	4	2
		FIAT	350 A1.000 Euro 4/5	248	22
		LANCIA	350 A1.000	523	13
87-436806-00	0.40mm	ALFA ROMEO	350 A1.000 Euro 4/5	4	2
		FIAT	350 A1.000 Euro 4/5	248	22
		LANCIA	350 A1.000	523	13
87-436900-00	STD	SEAT	BKY, BXW, CGGB Euro 5	1093	10
		SKODA	BKY, BUD, BXW, CDDA, CGGA, CGGB, CLPA	1136	6
		VOLKSWAGEN	BKR, BKY, BUD, CDDA, CGGA, CGGB, CLPA	1264	9
87-437000-00	STD	FORD EUROPE	KKDA Euro 4, RWPA Duratorq, RWPC Duratorq, RWPD Duratorq	342	37
87-437000-10	STD	FORD EUROPE	BHPA Endura DI, HCPA Duratorq, HCPB Duratorq, P7PA Duratorq, P7PB Duratorq, P9PA Duratorq, P9PB Duratorq, P9PC Duratorq, P9PD Duratorq, R2PA Duratorq, R3PA Duratorq, RWPE Duratorq, RWPF Duratorq	338	33
		FORD EUROPE	KKDA Euro 4, RWPA Duratorq, RWPC Duratorq, RWPD Duratorq	342	37
87-437007-00	0.50mm	FORD EUROPE	BHPA Endura DI, HCPA Duratorq, HCPB Duratorq, P7PA Duratorq, P7PB Duratorq, P9PA Duratorq, P9PB Duratorq, P9PC Duratorq, P9PD Duratorq, R2PA Duratorq, R3PA Duratorq, RWPE Duratorq, RWPF Duratorq	338	33
87-437400-00	STD	CHEVROLET	A 14 NET Euro 5	121	1
		OPEL	A 14 NET Euro 5	833	3
		VAUXHALL	A 14 NET Euro 5	1212	4
87-437600-00	STD	SCANIA	DC 12.10 Euro 4, DC 12.13 Euro 4, DT 12.03 Euro 4, DT 12.11 Euro 4, DT 12.12 Euro 4, DT 12.17 Euro 4	1074	16
87-438500-00	STD	AUDI	AXX, BWA	82	38
		SEAT	BWA	1126	39
		SKODA	BWA	1162	27
		VOLKSWAGEN	AXX, BWA	1327	53
87-438507-00	0.50mm	AUDI	AXX, BWA	82	38
		SEAT	BWA	1126	39
		SKODA	BWA	1162	27
		VOLKSWAGEN	AXX, BWA	1327	53
87-438800-00	STD	RENAULT TRUCKS	DXI 11 Euro 4/5	1037	24
		VOLVO COMMERCIAL	D11B430 Euro 4/5, D11C330 Euro 5, D11C370 Euro 5, D11C410 Euro 5	1365	33
87-438900-00	STD	VOLVO COMMERCIAL	D9B260 Euro 4/5, D9B300 Euro 4, D9B310 Euro 4/5, D9B340 Euro 4, D9B360 Euro 4/5, D9B380 Euro 4	1355	20
87-440500-00	STD	MERCEDES-BENZ	M 274.920	651	6
87-440600-00	STD	MERCEDES-BENZ COMMERCIAL	OM 471.900 Euro 6 OM 471 LA, OM 471.902 OM 471 LA, OM 471.906 Euro 6 OM 471 LA, OM 471.909 Euro 5 OM 471 LA	775	58
87-440900-00	STD	MERCEDES-BENZ	M 272.911, M 272.920, M 272.921, M 272.922, M 272.940, M 272.941, M 272.942, M 272.943, M 272.944, M 272.945, M 272.946, M 272.947, M 272.949, M 272.952	667	18
87-441100-00	STD	AGCO SISU	84 CTA Euro 3	1	1
87-441300-00	STD	PERKINS	1103A-33, 1103B-33 Euro 2, 1103C-33 Euro 2, 1103D-33, 1104A-44, 1104C-44 Euro 2, 1104C-E44	896	25
87-441900-00	STD	FIAT	312 A4.000, 312 A6.000	276	60
87-442300-00	STD	AUDI	CBZA, CBZB	37	1
		SEAT	CBZA, CBZB	1087	3
		SKODA	CBZA, CBZB	1132	1
		VOLKSWAGEN	CBZA, CBZB, CBZC, CYVD	1257	2
87-442400-00	STD	DEUTZ KHD	BF 6L 914 C	218	17
87-442400-10	STD	DEUTZ KHD	BF 3L 914, BF 4L 914, BF 6L 914	215	13
87-442407-00	0.50mm	DEUTZ KHD	BF 6L 914 C	218	17
87-442407-10	0.50mm	DEUTZ KHD	BF 3L 914, BF 4L 914, BF 6L 914	215	13
87-443100-00	STD	CITROEN	DW10CTED4 (RHC) Euro 5, DW10CTED4 (RHD) Euro 4, DW10CTED4 (RHE), DW10CTED4 (RHH) Euro 5	159	32
		PEUGEOT	DW10CTED4 (RHC) Euro 5, DW10CTED4 (RHE) Euro 5, DW10CTED4 (RHH) Euro 5	928	34
87-443100-10	STD	CITROEN	DW10FC (AHW) Euro 5, DW10FD (AHR) Euro 5, DW10FD (AHX) Euro 5, DW10FDD (AHV) Euro 5	160	33
		PEUGEOT	AHV (DW10FD), AHW (DW10FC), DW10FD (AHX) Euro 5	924	30
87-443108-00	0.60mm	CITROEN	DW10CTED4 (RHC) Euro 5, DW10CTED4 (RHD) Euro 4, DW10CTED4 (RHE), DW10CTED4 (RHH) Euro 5	159	32
		PEUGEOT	DW10CTED4 (RHC) Euro 5, DW10CTED4 (RHE) Euro 5, DW10CTED4 (RHH) Euro 5	928	34

		  			9
87-443108-10	0.60mm	CITROEN	DW10FC (AHW) Euro 5, DW10FD (AHR) Euro 5, DW10FD (AHX) Euro 5, DW10FDD (AHV) Euro 5	160	33
		PEUGEOT	AHV (DW10FD), AHW (DW10FC), DW10FD (AHX) Euro 5	924	30
87-443500-00	STD	MITSUBISHI	4 D 56 HP	792	9
87-443500-10	STD	MITSUBISHI	4 D 56 HP	792	9
87-443507-00	0.50mm	MITSUBISHI	4 D 56 HP	792	9
87-443507-10	0.50mm	MITSUBISHI	4 D 56 HP	792	9
87-443600-00	STD	SEAT	CHYA, CHYB, CPGA	1088	4
		SKODA	CHYA, CHYB, CPGA	1133	2
		VOLKSWAGEN	CHYA, CHYB, CPGA, CWRA	1258	3
87-443700-00	STD	DACIA	K7M 732 Euro 4	186	10
		RENAULT	K7M 732 Euro 4	984	28
87-443707-00	0.50mm	DACIA	K7M 732 Euro 4	186	10
		RENAULT	K7M 732 Euro 4	984	28
87-443800-00	STD	AUDI	CDA A, CDHA, CDHB	83	39
		SEAT	CDA A, CDHA, CDHB	1127	40
		VOLKSWAGEN	CDA A, CDAB	1328	54
87-443807-00	0.50mm	AUDI	CDA A, CDHA, CDHB	83	39
		SEAT	CDA A, CDHA, CDHB	1127	40
		VOLKSWAGEN	CDA A, CDAB	1328	54
87-449000-00	STD	FORD EUROPE	A9A, A9B	306	4
87-449007-00	0.50mm	FORD EUROPE	A9A, A9B	306	4
87-450000-00	STD	DACIA	D4F 732	180	1
		NISSAN	D4F 712	813	1
		RENAULT	D4F 702, D4F 704, D4F 706, D4F 708 Euro 3, D4F 712, D4F 714, D4F 716, D4F 722, D4F 728, D4F 730, D4F 732, D4F 740, D4F 742, D4F 764, D4F 772, D4F 790	956	2
87-450007-00	0.50mm	DACIA	D4F 732	180	1
		NISSAN	D4F 712	813	1
		RENAULT	D4F 702, D4F 704, D4F 706, D4F 708 Euro 3, D4F 712, D4F 714, D4F 716, D4F 722, D4F 728, D4F 730, D4F 732, D4F 740, D4F 742, D4F 764, D4F 772, D4F 790	956	2
87-502900-30	STD	AUDI	AMB, ARX, ARY, ATC, AUM Euro 4, AUQ, AVJ, AWM, AWP, AWT, BEX, BFB, BVP, BVR	69	27
		SEAT	ARY, AUQ, BJX	1118	31
		SKODA	ARX, AUM, AUQ, AWT	1155	20
		VOLKSWAGEN	ARX, AUM, AWM, AWP, AWT, AWU, AWW, BJX, BNU	1307	38
87-502907-30	0.50mm	AUDI	AMB, ARX, ARY, ATC, AUM Euro 4, AUQ, AVJ, AWM, AWP, AWT, BEX, BFB, BVP, BVR	69	27
		SEAT	ARY, AUQ, BJX	1118	31
		SKODA	ARX, AUM, AUQ, AWT	1155	20
		VOLKSWAGEN	ARX, AUM, AWM, AWP, AWT, AWU, AWW, BJX, BNU	1307	38
87-741207-10	0.50mm	COMPRESSOR	Westinghouse MB OM457/904/906, DAF 825/1160	176	3
		MERCEDES-BENZ COMMERCIAL	OM457/904/906 Compressor	716	1
87-849000-00	STD	HYUNDAI	D4FA	401	1
		KIA	D4FA Euro 3	503	1
87-849007-00	0.50mm	HYUNDAI	D4FA	401	1
		KIA	D4FA Euro 3	503	1
87-849200-00	STD	HYUNDAI	G4EE Euro 4	401	2
		KIA	G4EE Euro 4	503	2
87-849207-00	0.50mm	HYUNDAI	G4EE Euro 4	401	2
		KIA	G4EE Euro 4	503	2
87-879200-00	STD	CHEVROLET	Z 20 S, Z 20 S1	126	11
		OPEL	Z 20 S	862	39
87-879207-00	0.50mm	CHEVROLET	Z 20 S, Z 20 S1	126	11
		OPEL	Z 20 S	862	39

NEW PARTS LIST





Liste der Neuaufnahmen • Elenco nuovi riferimenti
Liste des nouvelles références



		  		 9	
88-104000-00	CITROEN	DW8 (WJZ) / DW8B (WJY), DW8B (WJY)	149	20	
	FIAT	WJZ (DW8)	265	46	
	PEUGEOT	DW8 (WJZ), DW8B (WJY)	915	22	
88-123900-10	DEUTZ KHD	BF 6M 1015 C Euro 2, BF 8M 1015 C Euro 2	229	35	
88-124500-30	MAN	D 2842 LE202, D 2842 LE404, D 2842 LE414, D 2842 LE415, D 2842 LE416, D 2842 LE417	620	33	
88-136500-30	MAN	D 0834 LFL40 Euro 3, D 0834 LFL41 Euro 3, D 0834 LFL42 Euro 3, D 0836 LF41 Euro 3, D 0836 LF44 Euro 3, D 0836 LF40 Euro 3	599	10	
		D 0836 LFL40 Euro 3, D 0836 LFL41 Euro 3, D 0836 LFL44 Euro 3, D 0836 LOH40 Euro 3, D 0836 LOH41 Euro 3			
88-136500-65	MAN	D 0834 LFL50 Euro 4, D 0834 LFL51 Euro 4, D 0834 LFL52 Euro 4, D 0834 LFL53 Euro 4, D 0834 LFL54 Euro 4, D 0834 LFL55 Euro 4, D 0834 LOH50 Euro 4, D 0834 LOH51 Euro 4, D 0834 LOH52 Euro 4, D 0834 LOH53 Euro 4, D 0834 LFL55 Euro 4, D 0834 LOH55 Euro 4, D 0836 LFL50 Euro 4, D 0836 LFL51 Euro 4, D 0836 LFL52 Euro 4, D 0836 LFL53 Euro 4, D 0836 LFL54 Euro 4, D 0836 LFL55 Euro 4, D 0836 LOH51 Euro 4, D 0836 LOH52 Euro 4, D 0836 LOH55 Euro 4, D 0836 LOH56 Euro 4, D 0836 LOH60 EEV, D 0836 LOH61 EEV, D 0836 LOH62 Euro 4, D 0836 LOH63 EEV, D 0836 LOH64 Euro 5, D 0836 LOH65 Euro 5, D 0836 LOH66 Euro 6	602	11	
88-136900-00	DEUTZ KHD	BF 4M 1013 C Euro 1, BF 4M 1013 Euro 1, BF 6M 1013 C Euro 1, BF 6M 1013 Euro 1	222	23	
		BF 6M 1013 CP Euro 1	224	26	
88-138900-10	PEUGEOT	TU3JP (KFW), TU3JP (KFX)	906	8	
88-138900-30	CITROEN	TU3JP (KFW), TU3JP (KFX), TU3JP-L4 (KFW)	141	10	
	PEUGEOT	TU3JP (KFW), TU3JP (KFX)	906	8	
		TU3JP-L4	907	9	
88-141900-00	VOLVO COMMERCIAL	D7C215 Euro 2, D7C250 Euro 2, D7C275 Euro 2, D7C290 Euro 2, D7C310 Euro 2	1353	15	
88-167600-00	DEUTZ KHD	F 6L 413, F 8L 413, F 10L 413, F 12L 413	227	31	
88-181100-30	JOHN DEERE	6068 DJ/6068 T	500	6	
88-289300-00	MERCEDES-BENZ COMMERCIAL	OM 904.955 Euro 3 OM 904 LA.III/2, OM 904.956 Euro 2 OM 904 LA, OM 904.957 Euro 3 OM 904 LA, OM 904.959 Euro 2 OM 904 LA, OM 904.962 Euro 3 OM 904 LA, OM 904.965 Euro 3 OM 904 LA.III/2, OM 904.966 Euro 3 OM 904 LA.III/2, OM 904.967 Euro 3 OM 904 LA, OM 904.968 Euro 3 OM 904 LA, OM 904.970 Euro 3 OM 904 LA, OM 904.972 Euro 3 OM 904 LA, OM 904.974 Euro 2 OM 904 LA, OM 907.910 Euro 2 OM 904 LA, OM 907.920 Euro 2 OM 904 LA, OM 907.930 Euro 2 OM 904 LA, OM 907.940 Euro 2 OM 904 LA, OM 907.941 Euro 2 OM 904 LA, OM 907.960 Euro 2 OM 904 LA, OM 907.970 Euro 2 OM 904 LA, OM 907.980 Euro 2 OM 904 LA, OM 907.990 Euro 2 OM 904 LA, OM 909.900 OM 906 HLA, OM 909.901 OM 906 HLA, OM 909.910 OM 906 LA, OM 909.911 OM 906 LA, OM 909.920 OM 906 LA, OM 909.921 OM 906 LA, OM 909.960 OM 906 LA, OM 909.970 OM 906 LA, OM 909.971 OM 906 LA	736	21	
88-423000-00	MAN	D 2066 LFO1 Euro 4 D 20, D 2066 LFO2 Euro 4 D 20, D 2066 LFO3 Euro 4 D 20, D 2066 LFO6 Euro 4 D 20, D 2066 LFO1 Euro 4 D 20, D 2066 LF12 Euro 4 D 20, D 2066 LF13 Euro 4 D 20, D 2066 LF14 Euro 4 D 20, D 2066 LF29 Euro 4 D 20, D 2066 LF30 Euro 4 D 20, D 2066 LF31 Euro 4 D 20, D 2066 LF32 Euro 4 D 20, D 2066 LF33 Euro 4 D 20, D 2066 LF35 Euro 4 D 20, D 2066 LF36 Euro 4 D 20, D 2066 LF37 Euro 4 D 20, D 2066 LF38 Euro 4 D 20, D 2066 LF39 Euro 4 D 20, D 2066 LF69 Euro 4, D 2066 LF70 Euro 4, D 2066 LF71 Euro 4, D 2066 LOH01 Euro 4, D 2066 LOH02 Euro 4, D 2066 LOH03 Euro 4, D 2066 LOH04 Euro 4, D 2066 LOH05 Euro 4, D 2066 LOH06 Euro 4, D 2066 LOH07 Euro 4, D 2066 LOH08 Euro 4, D 2066 LOH01 Euro 4, D 2066 LUH11 Euro 4, D 2066 LUH12 Euro 4, D 2066 LUH13 Euro 4, D 2066 LUH14 Euro 4, D 2066 LUH15 Euro 4, D 2066 LUH21 Euro 4, D 2066 LUH22 Euro 4, D 2066 LUH23 Euro 4, D 2066 LUH24 Euro 4	608	17	
88-423000-10	MAN	D 2066 LFO4 Euro 4 D 20, D 2066 LFO6 Euro 4 D 20, D 2066 LFO7 Euro 3 D 20, D 2066 LF48 Euro 3, D 2066 LF49 Euro 3, D 2066 LF50 Euro 3, D 2066 LF Euro 2/3, D 2066 LF Euro 3, D 2066 LOH10 Euro 3, D 2066 LOH11 Euro 3, D 2066 LOH12 Euro 3, D 2066 LUH07 Euro 3, D 2066 LUH08 Euro 3, D 2066 LUH09 Euro 3	607	16	
88-428600-00	MAN	D 2066 LF17 Euro 5, D 2066 LF18 Euro 5, D 2066 LF19 Euro 5, D 2066 LF20 Euro 5, D 2066 LF21 Euro 5, D 2066 LF22 Euro 5, D 2066 LF23 Euro 5 D 20, D 2066 LF24 Euro 5 D 20, D 2066 LF25 Euro 5 D 20, D 2066 LF26 Euro 5 D 20, D 2066 LF27 Euro 5 D 20, D 2066 LF40 Euro 5 D 20, D 2066 LF41 Euro 5 D 20, D 2066 LF42 Euro 5 D 20, D 2066 LF43 Euro 5, D 2066 LF44 Euro 5, D 2066 LF45 Euro 5, D 2066 LF46 Euro 5, D 2066 LF47 Euro 5, D 2066 LF51 Euro 5 D 20, D 2066 LF52 Euro 5 D 20, D 2066 LF53 Euro 5, D 2066 LOH28 Euro 5, D 2066 LUH32 Euro 5, D 2066 LUH33 Euro 5, D 2066 LUH34 Euro 5	609	18	
88-433300-00	DAF	XE 280 C1 Euro 3, XE 315 C1 Euro 3	204	20	
89-101100-00	VOLVO COMMERCIAL	TAD1630G/GE/P, TAD1631G, TWD1630G/P	1374	47	
89-101100-10	VOLVO COMMERCIAL	D16A, D16A470 Euro 2, D16A520, D16B520, TD163ES	1373	46	
89-124500-40	MAN	D 2840 LE, D 2840 LE403, D 2842 LE402, D 2842 LE406, D 2842 LE408, D 2848 LE	619	31	
89-135500-10	RENAULT TRUCKS	dCi 11C Euro 3	1036	22	
89-136900-10	VOLVO COMMERCIAL	D7DEAE2 Euro 2, D7DECE2 Euro 2, D7DEEE2 Euro 2, D7DLAE2 Euro 2, D7DLBE2 Euro 2	1354	17	
89-142500-10	VOLVO COMMERCIAL	D6A180 Euro 3, D6A210 Euro 3, D6A230 Euro 3, D6A250 Euro 3	1345	2	
89-143600-40	SCANIA	DC 9.11 Euro 3 DC 9, DC 9.12 Euro 3 DC 9, DC 9.13 Euro 3 DC 9, DC 9.19 Euro 3 DC 9, DC 9.20 Euro 3, DC 9.21, DC 11.02 Euro 3, DC 11.04 Euro 3, DC 11.09 Euro 3	1071	11	
89-420900-50	MERCEDES-BENZ COMMERCIAL	OM 541.991 OM 501 LA, OM 941.991 OM 501 LA	775	57	

						9
89-431000-00	MAN	D 2676 LF01 Euro 4, D 2676 LF02 Euro 3, D 2676 LF03 Euro 2, D 2676 LF04 Euro 2, D 2676 LF05 Euro 4, D 2676 LF06 Euro 5, D 2676 LF07 Euro 5, D 2676 LF08 Euro 5, D 2676 LF10 Euro 4, D 2676 LF11 Euro 4, D 2676 LF12 Euro 4, D 2676 LF13 Euro 5, D 2676 LF14 Euro 5, D 2676 LF15 Euro 5, D 2676 LF16 Euro 5, D 2676 LF17 EEV, D 2676 LF18 EEV, D 2676 LF19 Euro 4, D 2676 LF20 Euro 4, D 2676 LF21 Euro 5, D 2676 LF22 Euro 5, D 2676 LF25 Euro 6, D 2676 LF26 Euro 6, D 2676 LF28 Euro 5, D 2676 LF31 Euro 3, D 2676 LF32 Euro 4, D 2676 LF33 Euro 4		616	27	
89-434400-00	VOLVO COMMERCIAL	D13A360 Euro 5, D13A400 Euro 5, D13A440 Euro 5, D13A480 Euro 5		1372	43	
89-434400-10	VOLVO COMMERCIAL	D13C380 Euro 5, D13C420 Euro 5, D13C460 Euro 5, D13C500 Euro 5, D13C540 Euro 5		1372	44	
89-435000-00	RENAULT TRUCKS	dCi 6 W Euro 3		1027	10	
89-435000-10	RENAULT TRUCKS	dCi 6 W Euro 3		1028	10	
89-437600-00	SCANIA	DC 12.10 Euro 4, DC 12.13 Euro 4, DT 12.03 Euro 4, DT 12.11 Euro 4, DT 12.12 Euro 4, DT 12.17 Euro 4		1074	16	
89-438800-00	RENAULT TRUCKS	DXi 11 Euro 4/5		1037	24	
89-438800-10	VOLVO COMMERCIAL	D11B430 Euro 4/5, D11C330 Euro 5, D11C370 Euro 5, D11C410 Euro 5		1365	33	
89-438900-00	VOLVO COMMERCIAL	D9B260 Euro 4/5, D9B300 Euro 4, D9B310 Euro 4/5, D9B340 Euro 4, D9B360 Euro 4/5, D9B380 Euro 4		1355	20	

NEW PARTS LIST

Liste der Neuaufnahmen • Elenco nuovi riferimenti
Liste des nouvelles références

		  		 9		
14-020280-00	NISSAN	F9Q 760, F9Q 762, F9Q 772, F9Q 774	819	9		
	OPEL	F9Q 760, F9Q 762, F9Q 770, F9Q 772, F9Q 774	853	29		
	RENAULT	F9Q 710, F9Q 717, F9Q 718, F9Q 730, F9Q 732, F9Q 733, F9Q 734, F9Q 736, F9Q 738, F9Q 740, F9Q 744, F9Q 748,	991	33		
		F9Q 752, F9Q 754, F9Q 760, F9Q 762, F9Q 770, F9Q 772, F9Q 774, F9Q 780, F9Q 782, F9Q 790, F9Q 796				
		F9Q 731	991	34		
14-020300-00	MERCEDES-BENZ	OM 611.960	668	19		
		OM 611LA (75 KW CDI), OM 611.961, OM 611.980 Euro 3 OM 611LA (90 KW CDI)	669	20		
		OM 611.962, OM 611.987 Euro 3, OM 612.961, OM 612.962, OM 612.963, OM 612.966, OM 612.967, OM 612.981	671	21		
		OM 611.981 Euro 3, OM 613.960, OM 613.961	672	22		
	MERCEDES-BENZ COMMERCIAL	OM 611A (60 KW CDI)	673	23		
		OM 612.966	717	4		
14-020540-00	FORD EUROPE	D2FA Duratorq, D2FB Duratorq, D2FE, F4FA Duratorq	357	55		
		D4FA Duratorq, FXFA Duratorq	358	56		
		DOFA (DT24) Duratorq	359	57		
		H9FA Euro 4	359	58		
		H9FB Euro 4, JXFA Euro 4	360	59		
		PHFA, PHFC Euro 4	361	60		
		SAFA Duratorq, SAFB Duratorq	362	61		
		LAND ROVER	160 A1.046, 836 A4.000	556	14	
	14-021080-00	FIAT	176 A8.000 Fire, 176 B4.000 Fire, 178 B5.000 Euro 3 Fire, 178 E2.000 Fire, 188 A4.000 Euro 3 Fire, 223 A5.000 Euro 3 Fire	245	18	
			178 E8.011, 178 E9.011	246	20	
188 A5.000 Euro 3 Fire			247	21		
LANCIA		188 A4.000 Euro 3 Fire	521	10		
		176 B9.000 Fire	521	9		
		188 A5.000 Euro 3 Fire	522	11		
ZASTAVA		840 A3.000 Fire	522	12		
		188 A4.000	1375	1		
14-022060-00		ALFA ROMEO	199 A3.000	4	1	
		FIAT	188 A8.000, 188 A9.000, 199 A2.000	239	8	
	199 A3.000, 223 A9.000		240	9		
	LANCIA	188 A9.000, 199 A2.000	518	4		
		199 A3.000	519	5		
14-022110-00	FORD EUROPE	CVF5 Duratorq, CVRA Duratorq, CVRB Duratorq, CVRC Duratorq, GBVAJPF Duratorq, GBVAJQJ Duratorq, GBVAJQW Duratorq	349	45		
14-025873-00	PERKINS	3.152	881	4		
		4.203, D3.152	882	5		
		6.305	883	6		
		AD3.152	884	7		
14-450920-00	RENAULT TRUCKS	dCi 11C Euro 3	1036	22		
		dCi 11E Euro 3	1036	23		
		MIDR 06.23.56 A/3 Euro 2, MIDR 06.23.56 A/41 Euro 2, MIDR 06.23.56 B/41 Euro 2	1037	25		
14-450960-00	DEUTZ KHD	BF 6M 1015, BF 6M 1015 CP, BF 8M 1015, BF 8M 1015 CP	229	34		
		BF 6M 1015 C Euro 2, BF 8M 1015 C Euro 2	229	35		
14-451190-00	RENAULT TRUCKS	DXi 13 Euro 4	1039	28		
	VOLVO COMMERCIAL	D13A360 Euro 5, D13A400 Euro 5, D13A440 Euro 5, D13A480 Euro 5	1372	43		
		D13C380 Euro 5, D13C420 Euro 5, D13C460 Euro 5, D13C500 Euro 5, D13C540 Euro 5	1372	44		
14-476000-00	AGCO SISU	84 CTA Euro 3	1	1		
14-480440-00	RENAULT TRUCKS	DXi 11 Euro 4/5	1037	24		
	VOLVO COMMERCIAL	D11B430 Euro 4/5, D11C330 Euro 5, D11C370 Euro 5, D11C410 Euro 5	1365	33		
14-480460-00	VOLVO COMMERCIAL	D9B260 Euro 4/5, D9B300 Euro 4, D9B310 Euro 4/5, D9B340 Euro 4, D9B360 Euro 4/5, D9B380 Euro 4	1355	20		
14-740130-00	RENAULT TRUCKS	MIDR 06.24.65, MIDR 06.24.65 A/42 Euro 2, MIDR 06.24.65 B/42 Euro 2, MIDR 06.24.65 C/42 Euro 2	1038	26		
14-900110-00	DEUTZ KHD	BF 4L 913, BF 4L 913 C, BF 6L 913	216	14		
		BF 4L 913 T, BF 6L 913 T	217	15		
		BF 6L 913 C	217	16		
14-900120-00	DEUTZ KHD	BF 3L 914, BF 4L 914, BF 6L 914	215	13		
		BF 4L 913, BF 4L 913 C, BF 6L 913	216	14		
		BF 4L 913 T, BF 6L 913 T	217	15		
		BF 6L 913 C	217	16		
		BF 6L 914 C	218	17		
		F 3L 914, F 4L 914, F 5L 914, F 6L 914	221	20		

							9	
15-450630-00	MAN	D 2066 LF04 Euro 4 D 20, D 2066 LFD6 Euro 4 D 20, D 2066 LF07 Euro 3 D 20, D 2066 LF48 Euro 3,	607	16				
		D 2066 LF49 Euro 3, D 2066 LF50 Euro 3, D 2066 LF Euro 2/3, D 2066 LF Euro 3, D 2066 LOH10 Euro 3,						
		D 2066 LOH11 Euro 3, D 2066 LOH12 Euro 3, D 2066 LUH07 Euro 3, D 2066 LUH08 Euro 3, D 2066 LUH09 Euro 3						
		D 2066 LF01 Euro 4 D 20, D 2066 LF02 Euro 4 D 20, D 2066 LF03 Euro 4 D 20, D 2066 LF06 Euro 4 D 20,	608	17				
		D 2066 LF11 Euro 4 D 20, D 2066 LF12 Euro 4 D 20, D 2066 LF13 Euro 4 D 20, D 2066 LF14 Euro 4 D 20,						
		D 2066 LF29 Euro 4 D 20, D 2066 LF30 Euro 4 D 20, D 2066 LF31 Euro 4 D 20, D 2066 LF32 Euro 4 D 20,						
		D 2066 LF33 Euro 4 D 20, D 2066 LF35 Euro 4 D 20, D 2066 LF36 Euro 4 D 20, D 2066 LF37 Euro 4 D 20,						
		D 2066 LF38 Euro 4 D 20, D 2066 LF39 Euro 4 D 20, D 2066 LF69 Euro 4, D 2066 LF70 Euro 4, D 2066 LF71 Euro 4,						
		D 2066 LOH01 Euro 4, D 2066 LOH02 Euro 4, D 2066 LOH03 Euro 4, D 2066 LOH04 Euro 4, D 2066 LOH05 Euro 4,						
		D 2066 LOH06 Euro 4, D 2066 LOH07 Euro 4, D 2066 LOH08 Euro 4, D 2066 LUH01 Euro 4, D 2066 LUH11 Euro 4,						
D 2066 LUH12 Euro 4, D 2066 LUH13 Euro 4, D 2066 LUH14 Euro 4, D 2066 LUH15 Euro 4, D 2066 LUH21 Euro 4,								
D 2066 LUH22 Euro 4, D 2066 LUH23 Euro 4, D 2066 LUH24 Euro 4								
D 2066 LF17 Euro 5, D 2066 LF18 Euro 5, D 2066 LF19 Euro 5, D 2066 LF20 Euro 5, D 2066 LF21 Euro 5,	609	18						
D 2066 LF22 Euro 5, D 2066 LF23 Euro 5 D 20, D 2066 LF24 Euro 5 D 20, D 2066 LF25 Euro 5 D 20,								
D 2066 LF26 Euro 5 D 20, D 2066 LF27 Euro 5 D 20, D 2066 LF40 Euro 5 D 20, D 2066 LF41 Euro 5 D 20,								
D 2066 LF42 Euro 5 D 20, D 2066 LF43 Euro 5, D 2066 LF44 Euro 5, D 2066 LF45 Euro 5, D 2066 LF46 Euro 5,								
D 2066 LF47 Euro 5, D 2066 LF51 Euro 5 D 20, D 2066 LF52 Euro 5 D 20, D 2066 LF53 Euro 5, D 2066 LOH28 Euro 5,								
D 2066 LUH32 Euro 5, D 2066 LUH33 Euro 5, D 2066 LUH34 Euro 5								
D 2066 LF28 Euro 4 D 20, D 2066 LF57 EEV, D 2066 LF58 EEV, D 2066 LF59 EEV, D 2066 LF60 EEV,	610	19						
D 2066 LF62 Euro 4, D 2066 LF63 Euro 4, D 2066 LF64 Euro 4, D 2066 LF65 Euro 4, D 2066 LF72 Euro 4,								
D 2066 LOH26 EEV, D 2066 LOH27 EEV								
D 2066 LUH41 EEV, D 2066 LUH42 EEV, D 2066 LUH43 EEV, D 2066 LUH46 EEV, D 2066 LUH47 EEV, D 2066 LUH48 EEV	611	20						
15-450810-00	VOLVO COMMERCIAL	D7C215 Euro 2, D7C250 Euro 2, D7C275 Euro 2, D7C290 Euro 2, D7C310 Euro 2	1353	15				
		TAD 740 GE, TWD 740 GE	1353	16				
15-451030-00	VOLVO COMMERCIAL	D16A, D16A470 Euro 2, D16A520, D16B520, TD163ES	1373	46				
		TAD1630G/GE/P, TAD1631G, TWD1630G/P	1374	47				
15-451070-10	MERCEDES-BENZ COMMERCIAL	OM 457.910 Euro 5 OM 457 LA, OM 458.990 OM 460 LA, OM 458.991 OM 460 LA	762	45				
		OM 457.948 Euro 4 OM 457 LA, OM 457.950 Euro 4 OM 457 HLA, OM 457.951 Euro 4 OM 457 LA,	766	49				
		OM 457.952 Euro 4 OM 457 HLA, OM 457.953 Euro 4 OM 457 LA, OM 457.954 Euro 4 OM 457 HLA,						
		OM 457.957 Euro 4 OM 457 LA, OM 457.959 Euro 4 OM 457 HLA, OM 457.961 Euro 4 OM 457 LA,						
		OM 457.964 Euro 4 OM 457 HLA, OM 457.965 Euro 4 OM 457 HLA, OM 457.966 Euro 4 OM 457 HLA,						
		OM 457.967 Euro 4, OM 457.968 Euro 4 OM 457 LA, OM 457.969 Euro 4 OM 457 LA,						
OM 457.973 Euro 4 OM 457 HLA, OM 457.974 Euro 4 OM 457 HLA, OM 457.976 Euro 3,								
OM 457.977 Euro 4 OM 457 HLA, OM 457.980 Euro 2 OM 457 LA, OM 457.981 Euro 3 OM 457 LA								
15-451220-00	MERCEDES-BENZ COMMERCIAL	OM 541.953 Euro 4/5 OM 501 LA, OM 541.959 Euro 4/5 OM 501 LA, OM 541.970 Euro 4 OM 501 LA,	774	56				
		OM 541.971 Euro 4/5 OM 501 LA, OM 541.972 Euro 4 OM 501 LA, OM 541.973 Euro 4 OM 501 LA,						
		OM 541.974 Euro 4 OM 501 LA, OM 541.975 Euro 4 OM 501 LA, OM 541.976 Euro 4 OM 501 LA,						
		OM 541.977 Euro 4 OM 501 LA, OM 541.978 Euro 4 OM 501 LA, OM 541.979 Euro 4/5 OM 501 LA,						
		OM 541.980 Euro 4 OM 501 LA, OM 541.981 Euro 4 OM 501 LA, OM 541.990 Euro 5 OM 501 LA,						
		OM 541.992 Euro 5 OM 501 LA, OM 541.994 Euro 5 OM 501 LA, OM 541.996 Euro 5 OM 501 LA,						
		OM 541.997 OM 501 LA, OM 541.998 Euro 5 OM 501 LA, OM 541.999 OM 501 LA, OM 542.960 Euro 5,						
		OM 542.961 Euro 5, OM 542.962 Euro 5 OM 502 LA, OM 542.963 Euro 5 OM 502 LA, OM 542.964 Euro 5,						
		OM 542.965, OM 542.966 Euro 5, OM 542.970 Euro 5, OM 542.971 Euro 5, OM 542.972 Euro 5						
		OM 541.991 OM 501 LA, OM 941.991 OM 501 LA	775	57				
15-451230-00	DAF	MX 13 303 Euro 6, MX 13 340 Euro 6, MX 13 375 Euro 6, MX 265 Euro 4/5 Paccar MX, MX 300 Euro 4/5 Paccar MX,	201	15				
		MX 340 Euro 4/5 Paccar MX, MX 375 Euro 4/5 Paccar MX						
15-480040-00	DEUTZ KHD	BF 4M 1013 C Euro 1, BF 4M 1013 Euro 1, BF 6M 1013 C Euro 1, BF 6M 1013 Euro 1	222	23				
		BF 4M 1013 E Euro 2, BF 6M 1013 E Euro 2, TCD 2013 L4 2V Euro 2, TCD 2013 L6 2V Euro 2	222	24				
		BF 4M 1013 EC Euro 2, BF 4M 1013 FC Euro 2/3, BF 6M 1013 EC Euro 2, BF 6M 1013 ECP Euro 2/3	223	25				
		BF 6M 1013 CP Euro 1	224	26				
		BF 6M 1013 FC Euro 2/3	225	27				
15-570050-00	VOLVO COMMERCIAL	D7DEAE2 Euro 2, D7DECE2 Euro 2, D7DEEE2 Euro 2, D7DLAE2 Euro 2, D7DLBE2 Euro 2	1354	17				
15-570060-00	SCANIA	DC 9.11 Euro 3 DC 9, DC 9.12 Euro 3 DC 9, DC 9.13 Euro 3 DC 9, DC 9.19 Euro 3 DC 9, DC 9.20 Euro 3,	1071	11				
		DC 9.21, DC 11.02 Euro 3, DC 11.04 Euro 3, DC 11.09 Euro 3						
		DC 9.16 Euro 4 DC 9, DC 9.17 Euro 4 DC 9, DC 12.14 Euro 3, DC 12.15, DC 12.18 Euro 5, DC 12.22 Euro 5,	1072	12				
		DC 12.23 Euro 4, DC 12.24 Euro 4, DC 12.26 Euro 4, DT 12.06 Euro 4, DT 12.14, DT 12.18 Euro 3						
		DC 11.01 Euro 3, DC 11.03 Euro 3, DC 11.07 Euro 2, DC 11.08 Euro 3	1072	13				
DC 12.10 Euro 4, DC 12.13 Euro 4, DT 12.03 Euro 4, DT 12.11 Euro 4, DT 12.12 Euro 4, DT 12.17 Euro 4	1074	16						
15-570060-00	SCANIA	DC 9.11 Euro 3 DC 9, DC 9.12 Euro 3 DC 9, DC 9.13 Euro 3 DC 9, DC 9.19 Euro 3 DC 9, DC 9.20 Euro 3, DC 9.21,	1071	11				
		DC 11.02 Euro 3, DC 11.04 Euro 3, DC 11.09 Euro 3						
		DC 9.16 Euro 4 DC 9, DC 9.17 Euro 4 DC 9, DC 12.14 Euro 3, DC 12.15, DC 12.18 Euro 5, DC 12.22 Euro 5,	1072	12				
		DC 12.23 Euro 4, DC 12.24 Euro 4, DC 12.26 Euro 4, DT 12.06 Euro 4, DT 12.14, DT 12.18 Euro 3						
		DC 11.01 Euro 3, DC 11.03 Euro 3, DC 11.07 Euro 2, DC 11.08 Euro 3	1072	13				
DC 12.10 Euro 4, DC 12.13 Euro 4, DT 12.03 Euro 4, DT 12.11 Euro 4, DT 12.12 Euro 4, DT 12.17 Euro 4	1074	16						

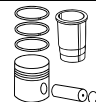
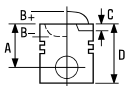

1 111.00

84 CTA Euro 3 6 Cyl. 8420cc 187-305kW (254-415PS) Diesel Turbo Intercooled TD26025

87-441100-00 ¹ STD 08-441100-00 STD 14-476000-00 WH B 123.00 C 239.00 D 0.70 E 9.04 F 0.85

A 74.85
 B- 19.30
 BØ 75.30
 C 0.80
 D 116.00
 40x90

3.00
 2.50
 3.00

CK P
 P
 NT ²

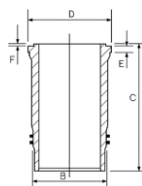

AK KK RT TP

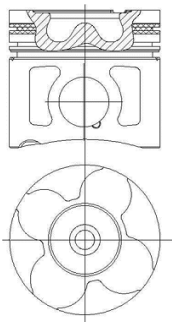





¹ Piston Chamber Volume
 [ccm] 73.400
² Steel





¹ Volumen der Kolbenmulde
 [ccm] 73.400
² Stahl

¹ Volume de la cavité du piston
 [cm³] 73.400
² Acier

¹ Volumen de cavidad del pistón
 [cc] 73.400
² Acero

¹ Volume camera pistone
 [cm³] 73.400
² Acciaio

		ccm	x 		
4.108 Perkins	Diesel	1760	4	79.38	6
160 D100	Diesel	1929	4	82.60	18
182 B9.000 Euro 3	Diesel	1910	4	82.00	14
192 A5.000 Euro 3	Diesel	1910	4	82.00	15
192 B1.000	Diesel	1910	4	82.00	15
198 A5.000	Diesel	1956	4	83.00	23
199 A3.000	Diesel	1248	4	69.60	1
350 A1.000 Euro 4/5	Petrol	1368	4	72.00	2
839 A6.000 Euro 3	Diesel	2387	5	82.00	14
841 C.000 Euro 3	Diesel	2387	5	82.00	14
841 G.000 Euro 3	Diesel	2387	5	82.00	15
841 M.000	Diesel	2387	5	82.00	15
841 N.000	Diesel	2387	5	82.00	15
844 A2.000	Diesel	1956	4	83.00	23
932 A2.000	Petrol	1970	4	83.00	20
937 A1.000	Petrol	1970	4	83.00	20
937 A2.000 Euro 3	Diesel	1910	4	82.00	14
937 A4.000 Euro 3	Diesel	1910	4	82.00	15
937 A5.000	Diesel	1910	4	82.00	15
937 A6.000	Diesel	1910	4	82.00	16
937 A7.000	Diesel	1910	4	82.00	14
939 A1.000	Diesel	1910	4	82.00	14
939 A2.000	Diesel	1910	4	82.00	15
939 A3.000 Euro 4	Diesel	2387	5	82.00	15
939 A4.000	Petrol	1796	4	82.00	8
939 B4.000	Diesel	1956	4	83.00	23
939 B5.000	Diesel	1956	4	83.00	23
940 A4.000	Diesel	1956	4	83.00	23
940 A5.000 Euro 5	Diesel	1956	4	83.00	23
940 A7.000 Euro 5	Diesel	1956	4	83.00	23
940 A8.000 Euro 5	Diesel	1956	4	83.00	23
8140.27R.2700/8140.27S.2700 Sofim	Diesel	2499	4	93.00	35
8144.61	Diesel	2445	4	93.00	36
8140.21.200 D.I.	Diesel	2445	4	93.00	34
8140.61.200	Diesel	2445	4	93.00	36
8144.21.220 Sofim	Diesel	2445	4	93.00	34
8144.61.200	Diesel	2445	4	93.00	36
8144.67.220	Diesel	2500	4	93.00	37
AR 00512	Petrol	1962	4	84.00	25
AR 00526	Petrol	1567	4	78.00	4
AR 00530	Petrol	1290	4	74.00	3
AR 00536	Petrol	1567	4	78.00	4
AR 00548	Petrol	1779	4	80.00	7
AR 01544	Petrol	1962	4	84.00	25
AR 01588	Petrol	1962	4	84.00	26
AR 01600	Petrol	1567	4	78.00	4
AR 01608	Petrol	1779	4	80.00	7
AR 01608 X	Petrol	1779	4	80.00	7
AR 01623	Petrol	1962	4	84.00	25
AR 01655	Petrol	1962	4	84.00	27
AR 01678	Petrol	1779	4	80.00	7
AR 01713	Petrol	1962	4	84.00	25
AR 06100	Petrol	1567	4	78.00	4
AR 06166	Petrol	1962	4	84.00	28
AR 06168	Petrol	1779	4	80.00	7
AR 06202	Petrol	1779	4	80.00	7
AR 06212	Petrol	1962	4	84.00	27
AR 06224	Petrol	1962	4	84.00	26
AR 06410	Petrol	2959	V6	93.00	33
AR 06412	Petrol	2959	V6	93.00	33
AR 06416	Petrol	1962	4	84.00	28
AR 06420	Petrol	1962	4	84.00	28
AR 06476	Petrol	1995	4	84.00	29
AR 10512	Petrol	1962	4	84.00	25
AR 11633	Petrol	1962	4	84.00	24
AR 11634	Petrol	1962	4	84.00	24
AR 11671	Petrol	1962	4	84.00	25
AR 16201	Petrol	1970	4	83.00	21
AR 19510	Petrol	1962	4	84.00	25

		ccm	x 		9
AR 32102 Euro 2	Petrol	1598	4	82.00	9
AR 32103 Euro 3	Petrol	1598	4	82.00	10
AR 32104 Euro 3	Petrol	1598	4	82.00	10
AR 32201	Petrol	1747	4	82.00	11
AR 32205	Petrol	1747	4	82.00	11
AR 32301	Petrol	1970	4	83.00	21
AR 32302 Euro 2	Diesel	1910	4	82.00	17
AR 32310 Euro 4	Petrol	1970	4	83.00	22
AR 32501 Euro 2	Diesel	2387	5	82.00	17
AR 33503	Petrol	1371	4	82.00	12
AR 33601	Diesel	1929	4	82.60	18
AR 34103	Petrol	1970	4	83.00	21
AR 34202 Euro 2	Diesel	2387	5	82.00	17
AR 36202 Euro 3	Diesel	2387	5	82.00	14
AR 36301 Euro 4	Petrol	1970	4	83.00	22
AR 37101 Euro 3	Diesel	1910	4	82.00	14
AR 37203 Euro 3	Petrol	1598	4	82.00	13
AR 38201 Euro 2	Petrol	1598	4	82.00	9
AR 38401	Petrol	1747	4	82.00	11
AR 38501	Petrol	1371	4	82.00	12
AR 61101	Petrol	1567	4	78.00	5
AR 61102	Petrol	1779	4	80.00	7
AR 61201	Petrol	1779	4	80.00	7
AR 64103	Petrol	1995	4	84.00	25
AR 64301	Petrol	2959	V6	93.00	33
AR 67106	Petrol	1747	4	82.00	11
AR 67201	Petrol	1995	4	84.00	25
AR 67202	Petrol	1995	4	84.00	25
AR 67203	Petrol	1995	4	84.00	30
AR 67204	Petrol	1970	4	83.00	21
AR 67501	Diesel	1929	4	82.60	18
AR 67502	Diesel	1929	4	82.60	19
AR 67601 Euro 2	Petrol	1598	4	82.00	9
M 722 BT 24.T Euro 2	Diesel	2387	5	82.00	17
VM 4HT 2.4	Diesel	2393	4	92.00	31
VM 07 B	Diesel	2500	4	92.00	32
VM 08 B	Diesel	2500	4	92.00	32
VM 31 B	Diesel	2500	4	92.00	32
VM 32 B	Diesel	2500	4	92.00	32
VM 81 A	Diesel	2393	4	92.00	31
VM 82 A	Diesel	1779	3	92.00	31
VM 84 A	Diesel	2500	4	92.00	32
VM 96 A	Diesel	1779	3	92.00	31

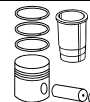
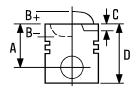

1 69.60

Mito 1.3 MultiJet

09/08 →

199 A3.000

4 Cyl.

18:1

1248cc

66kW (90PS)

Diesel

Turbo Intercooled

TD23450

87-425600-00

STD

08-425600-00

STD

14-022060-00 **D**

B 72.50 C 142.00 D 74.00 E 5.00

87-425606-00

0.40mm

08-425606-00

0.40mm

08-425608-00

0.60mm

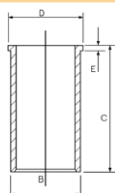

A 40.43

B- 12.41

BØ 38.00

C 0.91

C 0.91

D 62.43

 23x55

2.00



CK P

1.50



NT

2.00



CR P

AK KK RT TP

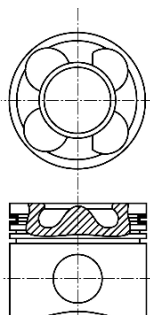

06933

2 72.00

Mito 1.4

03/11 →

350 A1.000 Euro 4/5

4 Cyl.

11.7:1

1368cc

57kW (78PS)

TD26416

87-436800-00

STD

08-436800-00

STD

87-436806-00

0.40mm

08-436806-00

0.40mm

A 26.00

B- 4.75

C 2.05

D 49.00

 18x49

1.00



NT 

1.20



P

2.00



CR P

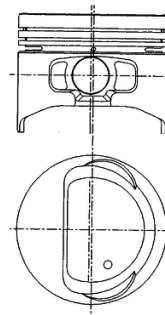

 Steel

 Stahl

 Acier

 Acero

 Acciaio

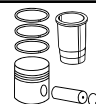
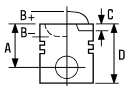

3 74.00

Giulia 1300 Super, Giulia GT 1300 Super	01/74→12/78	AR 00530			
GT 1300 Junior	01/66→12/77		4 Cyl.		
Spider 1300	01/68→12/77		1290cc	64-65kW (87-89PS)	

TD23

87-530400-00	STD	08-530400-00	STD	15-632500-00 	B 80.50 C 139.00 D 90.00 E 89.20	89-530400-00 87-530400-00 + 15-632500-00
---------------------	-----	---------------------	-----	---	----------------------------------	---

A 32.50
B- 13.60
D 79.10
 20x64

1.50
1.75
4.00

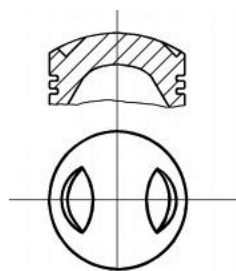
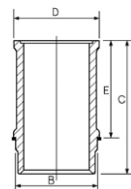

 Includes seals

 Schließt Dichtungen ein

 Inclut des joints

 Incluye los sellos

 Comprende le guarnizioni

4 78.00

Giulia 1600 Super	06/64→12/78	AR 00526			
Giulia GT 1600 Super	01/74→12/78		4 Cyl.	9:1	
Spider 1600	03/66→12/90		1567cc	71-81kW (97-110PS)	

TD22

GT 1600	01/66→12/77	AR 00536			
Spider 1600	03/66→12/79		4 Cyl.	9:1	
			1567cc	80kW (109PS)	

TD24

Alfetta 1.6	01/75→12/84	AR 01600			
Alfetta GT 1.6	01/76→09/82		4 Cyl.	9:1	
Giulietta 1.6	10/77→04/85		1567cc	79-80kW (108-109PS)	
Spider 1600	03/66→12/68				

TD32

75 1.6	05/85→09/89	AR 06100			
			4 Cyl.		
			1567cc	81kW (110PS)	

TD47

87-527200-00	STD	08-527200-00	STD		B 84.00 C 150.00 D 94.00 E 95.50	89-527200-00
---------------------	-----	---------------------	-----	---	----------------------------------	---------------------

A 33.70
B- 15.80
D 82.50
 22x68

1.50 CR P
1.75 P
4.00 P

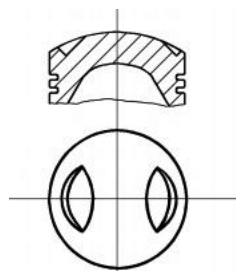
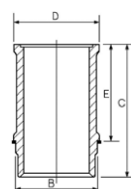

 Liner available in Kit Set only

 Zylinderlaufbüchse nur in Assemblies verfügbar

 Chemise disponible en kit seulement

 Camisas disponible en conjuntos solamente

 Cilindro disponibile solo in kit motore

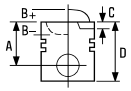



5 78.00

75 1.6 05/85 → 02/92 AR 61101 4 Cyl. 1567cc 76-81kW (103-110PS) TD102

87-527300-00 STD

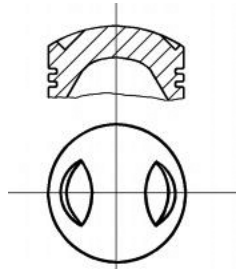
A 33.70
B- 16.70
D 82.90
 22x68



 Includes seals

08-527300-00 STD

1.50
1.75
3.50
 CR P
P
P

 Schließt Dichtungen ein

15-632100-00 WH  B 84.00 C 150.00 D 94.00 E 95.50

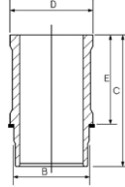

 Incluye los sellos

89-527300-00
87-527300-00 +
15-632100-00

 Comprende le guarnizioni

6 79.38

Giulia 1.8 D 06/76 → 12/78 4.108 Perkins 4 Cyl. 22:1 1760cc 38kW (52PS) Diesel TD141

87-315200-00 STD

A 50.24
D 105.41
 27x68

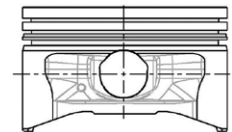

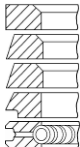

08-315200-00 STD

1.99
1.60
1.60
3.16
4.74
 CR P
P
P
P
P

 Schließt Dichtungen ein

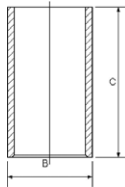
14-010900-00 D B 82.63 C 165.10



 Incluye los sellos

 Comprende le guarnizioni

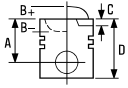

7 80.00

1750-2000 1750 Berlina 1.8 GT V 1750 Spider 1750	03/68→10/72 09/68→12/72 01/67→12/72 01/67→12/71	AR 00548	4 Cyl. 1779cc	83-97kW (113-132PS)	TD18
Alfetta 1.8 Alfetta GT 1.8 Berlina 1.8	10/79→12/84 01/74→12/76 09/68→12/72	AR 01608	4 Cyl. 1779cc	87-89kW (118-121PS)	TD5340
Alfetta 1.8 Alfetta GT 1.8	07/74→12/77 01/74→12/76	AR 01608 X	4 Cyl. 1779cc	85kW (115PS)	TD33
Alfetta 1.8 Giulietta 1.8	10/79→12/84 04/79→07/85	AR 01678	4 Cyl. 1779cc	88-90kW (120-122PS)	TD38
75 1.8	09/88→02/92	AR 06168	4 Cyl. 1779cc	88kW (120PS)	TD54
75 1.8 90 1.8	09/85→06/89 10/84→07/87	AR 06202	4 Cyl. 1779cc	9.5:1 85-89kW (116-121PS)	TD55
75 1.8	09/88→02/92	AR 61102	4 Cyl. 1779cc	9:1 88kW (120PS)	TD10149
75 1.8	08/89→02/92	AR 61201	4 Cyl. 1779cc	90kW (122PS)	TD103

87-528500-00 STD

A 33.25
B- 13.35
D 80.10
 22x69

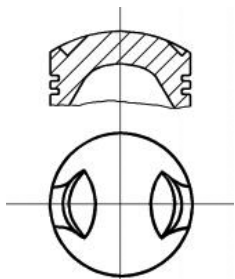

 Includes seals

08-528500-00 STD

1.50
1.75
3.50
 CR P
P
P

 Schließt Dichtungen ein

15-632600-00 WH  B 85.00 C 152.00 D 98.00 E 107.50

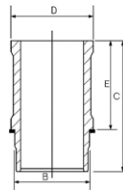

 Incluye los sellos

89-528500-00
87-528500-00 +
15-632600-00

 Comprende le guarnizioni

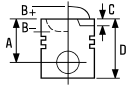





8 82.00

159 1.8 MPI	03/07→11/11	939 A4.000	4 Cyl.	1796cc	96-103kW (131-140PS)	TD20270
-------------	-------------	------------	--------	--------	----------------------	---------

87-145400-10	STD	08-145400-00	STD
87-145406-10	0.40mm	08-145406-00	0.40mm

A	28.45
B-	1.20
BØ	68.00
C	3.54
C	1.49
D	50.45
	20x52

1.20		NT 
1.20		P
2.00		

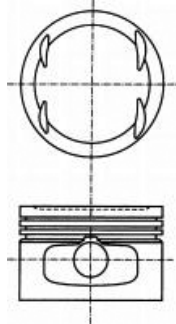

 Steel

 Stahl

 Acier

 Acero

 Acciaio

9 82.00



145 1.6 16V T.S., 146 1.6 16V T.S.	09/97→12/00	AR 32102 Euro 2	4 Cyl.	1598cc	82-88kW (112-120PS)	TD14369
156 1.6 16V T.SPARK	09/97→05/06					

145 1.6 i.e. 16V T.S.	12/96→01/01	AR 38201 Euro 2	4 Cyl.	1598cc	88kW (120PS)	TD9754
146 1.6 i.e. 16V T.S.	11/96→01/01					

145 1.6 i.e. 16V T.S.	12/96→01/01	AR 67601 Euro 2	4 Cyl.	1598cc	10.3:1	TD19
146 1.6 i.e. 16V T.S.	11/96→01/01				88kW (120PS)	
155 1.6 16V T.S.	05/96→12/97					
156 1.6 16V T.SPARK	09/97→05/06					

87-118000-10	STD	08-118000-00	STD
87-118006-10	0.40mm	08-118006-00	0.40mm
		08-118008-00	0.60mm

A	32.90
B+	1.80
C	1.90
D	56.70
	20x52

1.19		NT
1.20		P
2.00		P

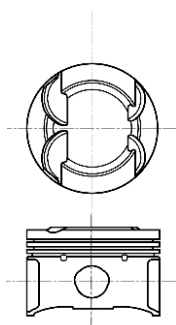

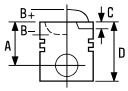





10 82.00

156 1.6 16V T.SPARK	09/97→05/06	AR 32103 Euro 3	4 Cyl.	1598cc	88kW (120PS)	TD15389
147 1.6 16V T.SPARK	01/01→03/10	AR 32104 Euro 3	4 Cyl.	1598cc	88kW (120PS)	TD15388
156 1.6 16V T.SPARK	09/97→05/06					

87-145400-30	STD	08-145400-00	STD
87-145406-30	0.40mm	08-145406-00	0.40mm

A	28.47
B+	0.20
C	1.88
D	50.47
	20x52

1.20		NT 
1.20		P
2.00		

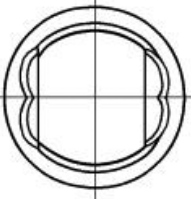

 Steel

 Stahl

 Acier

 Acero

 Acciaio

11 82.00

145 1.8 i.e. 16V, 146 1.8 i.e. 16V T.S.	03/98→01/01	AR 32201	4 Cyl.	10.3:1		
156 1.8 16V T.SPARK	09/97→10/00		1747cc	106kW (144PS)		TD9462
GTV 1.8 16V	05/98→10/05					
Spider 1.8 16V	05/98→04/05					
156 1.8 16V T.SPARK	10/00→05/06	AR 32205	4 Cyl.	10.3:1		
GT 1.8 TS	11/03→09/10		1747cc	103kW (140PS)		TD15390
145 1.8 i.e. 16V T.S.	12/96→12/98	AR 38401	4 Cyl.	10.3:1		
146 1.8 i.e. 16V T.S.	11/96→01/01		1747cc	103kW (140PS)		TD9755



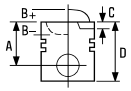



145 1.8 i.e. 16V T.S.	12/96→12/98	AR 67106		
146 1.8 i.e. 16V T.S.	11/96→01/01		4 Cyl.	10.3:1
155 1.7 T.S. 16V	05/96→12/97		1747cc	103kW (140PS)
TD5070				

87-118000-00	STD	08-118000-00	STD
87-118006-00	0.40mm	08-118006-00	0.40mm
		08-118008-00	0.60mm

A 36.15
B- 0.50
D 60.15
 20x52

1.19  NT
 1.20  P
 2.00  P

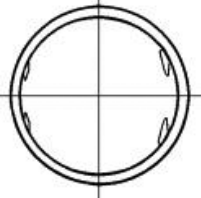
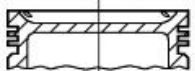





12 82.00

145 1.4 i.e. 16V T.S.	12/96→01/01	AR 33503		
146 1.4 i.e. 16V T.S.	11/96→01/01		4 Cyl.	10.5:1
			1371cc	76kW (103PS)
TD9752				

145 1.4 i.e. 16V T.S.	12/96→01/01	AR 38501		
146 1.4 i.e. 16V T.S.	11/96→01/01		4 Cyl.	
			1371cc	76kW (103PS)
TD9753				

87-787000-10	STD	08-787000-00	STD
87-787006-10	0.40mm	08-787006-00	0.40mm

A 34.46
B+ 4.90
D 63.36
 20x52

1.50  CR P
 1.50  P
 3.00  CR 

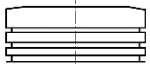
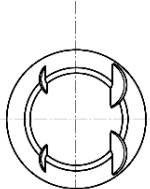

 Steel

 Stahl

 Acier

 Acero

 Acciaio

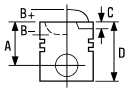





13 82.00

147 1.6 16V T.SPARK ECO	01/01→03/10	AR 37203 Euro 3	4 Cyl.	1598cc	76kW (103PS)	TD15508
-------------------------	-------------	-----------------	--------	--------	--------------	---------

87-145400-00	STD	08-145400-00	STD
87-145406-00	0.40mm	08-145406-00	0.40mm

A	28.47
B-	0.30
D	50.47
	20x51

1.20		NT 
1.20		P
2.00		

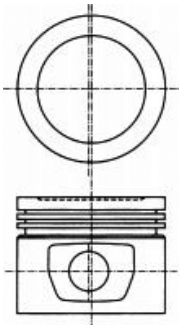

 Steel

 Stahl

 Acier

 Acero

 Acciaio

14 82.00

147 1.9 JTD	06/03→03/10	182 B9.000 Euro 3	4 Cyl.	18.45:1		
			1910cc	74-77kW (101-105PS)		
		Diesel	Turbo Intercooled			TD18312
147 1.9 JTD	04/01→03/10	937 A2.000 Euro 3	4 Cyl.	18.5:1		
156 1.9 JTD	05/01→05/06		1910cc	85kW (115PS)		
		Diesel	Turbo Intercooled			TD16382
159 1.9 JTDM 8V	09/05→11/11	937 A7.000	4 Cyl.			
			1910cc	85kW (115PS)		
		Diesel	Turbo Intercooled			TD20933
159 1.9 JTDM 8V	09/05→11/11	939 A1.000	4 Cyl.			
			1910cc	88kW (120PS)		
		Diesel	Turbo Intercooled			TD18915
156 1.9 JTD	10/00→05/01	AR 37101 Euro 3	4 Cyl.	18.5:1		
			1910cc	81kW (110PS)		
		Diesel	Turbo Intercooled			TD15510
156 2.4 JTD	10/00→05/06	839 A6.000 Euro 3	5 Cyl.	18.45:1		
166 2.4 JTD	10/00→06/07		2387cc	103kW (140PS)		
		Diesel	Turbo Intercooled			TD18819
156 2.4 JTD	03/02→05/06	841 C.000 Euro 3	5 Cyl.	18.5:1		
166 2.4 JTD	04/02→06/07		2387cc	110kW (150PS)		
		Diesel	Turbo Intercooled			TD16383



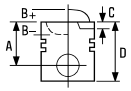



166 2.4 JTD	10/00→05/02	AR 36202 Euro 3	5 Cyl. 2387cc	103kW (140PS)	
		Diesel	Turbo Intercooled		TD15636

87-124000-30	STD	08-124000-00	STD	14-021051-00 D	B 85.57 C 155.00 D 88.53 E 4.00
87-124008-30	0.60mm	08-124006-00	0.40mm	14-028960-00 D	B 85.00 C 155.00 D 88.00 E 4.50
		08-124008-00	0.60mm		

- A** 46.50
- B-** 17.45
- BØ** 37.55
- C** 0.65
- D** 72.50
-  26x61

- 2.00  CK P
- 2.00  P
- 2.00  CR P

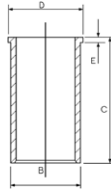

NB RT

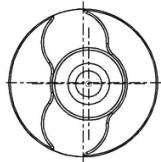
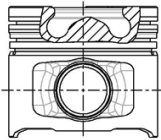

15 82.00

147 1.9 JTD 16V	11/02→03/10	192 A5.000 Euro 3	4 Cyl.	18.5:1	
156 1.9 JTD 16V	11/02→05/06		1910cc	103kW (140PS)	
		Diesel	Turbo Intercooled		TD17981
147 1.9 JTD 16V	10/04→03/10	192 B1.000	4 Cyl.	18.5:1	
156 1.9 JTD	11/02→11/04		1910cc	100kW (136PS)	
		Diesel	Turbo Intercooled		TD19061
147 1.9 JTD 16V	09/03→09/04	937 A4.000 Euro 3	4 Cyl.		
156 1.9 JTD	11/03→05/06		1910cc	93-103kW (126-140PS)	
		Diesel	Turbo Intercooled		TD18844
147 1.9 JTDM 16V	09/04→03/10	937 A5.000	4 Cyl.		
156 1.9 JTD	07/04→05/06		1910cc	110kW (150PS)	
156 1.9 JTD 16V Q4	07/04→05/06		Diesel	Turbo Intercooled	TD18078
GT 1.9 JTD	11/03→09/10				
159 1.9 JTDM 16V	09/05→11/11	939 A2.000	4 Cyl.	17.5:1	
			1910cc	110kW (150PS)	
		Diesel	Turbo Intercooled		TD18473
156 2.4 JTD	10/03→05/06	841 G.000 Euro 3	5 Cyl.		
166 2.4 JTD	10/03→06/07		2387cc	129kW (175PS)	
		Diesel	Turbo Intercooled		TD18292



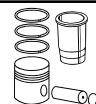
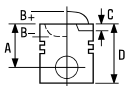

156 2.4 JTD	06/03→05/06	841 M.000			
166 2.4 JTD	10/03→06/07		5 Cyl.	18:1	
			2387cc	120-147kW (163-200PS)	
		Diesel	Turbo Intercooled		TD20934
156 2.4 JTD	06/03→05/06	841 N.000			
166 2.4 JTD	10/03→06/07		5 Cyl.	18:1	
			2387cc	120-147kW (163-200PS)	
		Diesel	Turbo Intercooled		TD22510
159 2.4 JTDM	09/05→11/11	939 A3.000 Euro 4			
BRERA 2.4 JTDM 20V	01/06→06/10		5 Cyl.	17:1	
Spider 2.4 JTDM	04/07→06/10		2387cc	147-154kW (200-209PS)	
		Diesel	Turbo Intercooled		TD18474

87-146100-00
87-146108-00

STD
0.60mm

08-146100-00
08-146106-00
08-146108-00

STD
0.40mm
0.60mm

14-021051-00 D
14-028960-00 D

B 85.57 C 155.00 D 88.53 E 4.00
B 85.00 C 155.00 D 88.00 E 4.50

A 46.50
B- 15.40
BØ 41.50
C 1.03
D 72.50
26x61

2.00
2.00
2.00



CK P
P
CK P

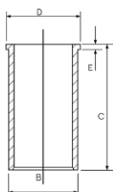

AK KK NB RT TP

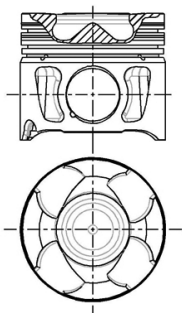

08256-102

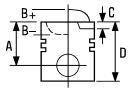



16 82.00

147 1.9 JTDM 16V GT 1.9 JTD	06/08→03/10 05/08→09/10	937 A6.000	4 Cyl. 1910cc	17.5:1 125kW (170PS)	
		Diesel	Turbo Intercooled		TD24643

87-146100-10	STD	08-146100-00	STD
87-146106-10	0.40mm	08-146106-00	0.40mm
		08-146108-00	0.60mm

A	46.50
B-	15.40
BØ	41.50
C	1.07
C	1.02
D	72.50
	30x67

2.00		CK P
2.00		P
2.00		CK P

AK KK RT TP

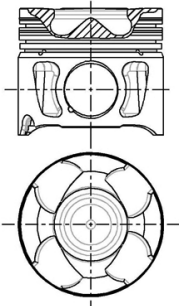

08269-503

17 82.00

145 1.9 JTD, 146 1.9 JTD 156 1.9 JTD	02/99→01/01 09/97→10/00	AR 32302 Euro 2	4 Cyl. 1910cc	18.5:1 77kW (105PS)	
		Diesel	Turbo Intercooled		TD9769
156 2.4 JTD	09/97→09/03	AR 32501 Euro 2	5 Cyl. 2387cc	18.5:1 99-100kW (135-136PS)	
		Diesel	Turbo Intercooled		TD9770
166 2.4 JTD	09/98→10/00	AR 34202 Euro 2	5 Cyl. 2387cc	18.5:1 100kW (136PS)	
		Diesel	Turbo Intercooled		TD11604



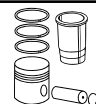
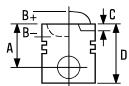

156 2.4 JTD 10/97→09/00 M 722 BT 24.T Euro 2
 5 Cyl. 18.5:1
 2387cc 96-100kW (131-136PS)
 Diesel Turbo Intercooled TD22434

87-108000-00	STD	08-108000-00	STD	14-021051-00 D	B 85.57 C 155.00 D 88.53 E 4.00
87-108008-00	0.60mm	08-108008-00	0.60mm	14-028960-00 D	B 85.00 C 155.00 D 88.00 E 4.50

A 47.25
 B- 17.50
 BØ 37.45
 D 73.25
 26x61

3.00
 2.00
 3.00



CK P
 P
 CR P

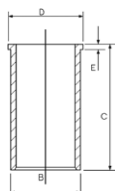

AK NB RT

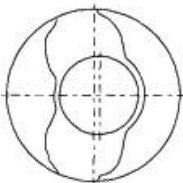

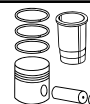
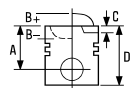

18 82.60

AR 6 1.9 D	04/85→12/89	160 D100	4 Cyl.	20:1	
			1929cc	51kW (69PS)	
			Diesel	Turbo Intercooled	TD10307
145 1.9 TD	10/94→02/99	AR 33601	4 Cyl.	19.2:1	
146 1.9 TD	12/94→02/99		1929cc	66-68kW (90-92PS)	
			Diesel	Turbo Intercooled	TD5069
145 1.9 D	07/94→02/99	AR 67501	4 Cyl.	19.2:1	
145 1.9 TD	10/94→02/99		1929cc	66-68kW (90-92PS)	
146 1.9 D	05/95→09/96		Diesel	Turbo Intercooled	TD140
146 1.9 TD	12/94→02/99				
155 1.9 TD	04/93→12/97				

87-783800-10 STD
87-783808-10 0.60mm

A 43.00
B+ 2.30
D 76.00
 26x69

AK HA RT

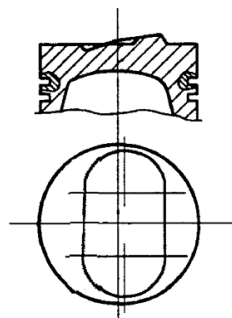

08-783800-00 STD
08-783808-00 0.60mm

3.00 MOL P
2.00 P
3.00 CR P

14-021311-00 D B 86.06 C 154.00 D 89.00 E 4.50
14-023560-00 D B 86.00 C 154.00 D 89.00 E 4.50
14-023751-00 D B 87.00 C 154.00 D 89.00 E 4.55

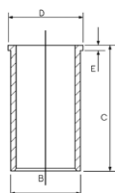

14-014730-00 D B 86.09 C 154.00

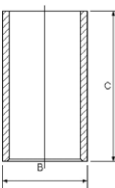

87-783800-30 STD
87-783808-30 0.60mm

A 42.40
B+ 2.50
D 76.00
 26x69

HA RT

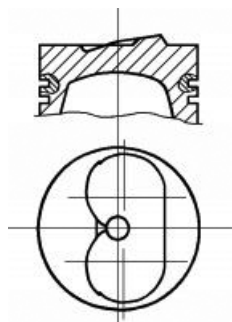

08-783800-00 STD
08-783808-00 0.60mm

3.00 MOL P
2.00 P
3.00 CR P

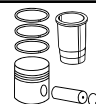
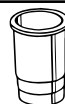
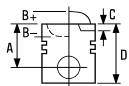

19 82.60

155 1.9 TD	04/93→04/96	AR 67502	4 Cyl.	19.2:1
			1929cc	66-68kW (90-92PS)
			Diesel	Turbo Intercooled
				TD21140

14-021311-00 D	B 86.06 C 154.00 D 89.00 E 4.50
14-023560-00 D	B 86.00 C 154.00 D 89.00 E 4.50
14-023751-00 D	B 87.00 C 154.00 D 89.00 E 4.55

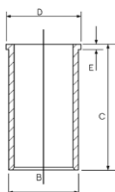

14-014730-00 D	B 86.09 C 154.00
----------------	------------------

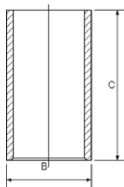





20 83.00

156 2.0 JTS	11/97→05/06	932 A2.000	4 Cyl.	
GT 2.0 JTS	11/03→09/10		1970cc	119-121kW (162-165PS)
				TD18076

147 2.0	07/02→05/05	937 A1.000	4 Cyl.	11.3:1
156 2.0 JTS	03/02→05/06		1970cc	119-122kW (162-166PS)
GT 2.0 JTS	11/03→09/10			
GTV 2.0 JTS	04/03→10/05			
Spider 2.0 JTS	04/03→04/05			TD16381

87-145200-00	STD	08-145200-00	STD
87-145206-00	0.40mm	08-145206-00	0.40mm

A	31.00	1.20		NT 
B-	5.15	1.20		P
B+	3.05	2.00		NT
C	1.76			
D	51.30			
	20x52			

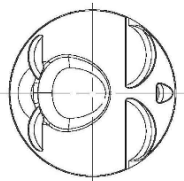
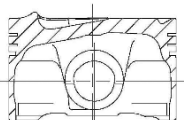

 Steel

 Stahl

 Acier

 Acero

 Acciaio

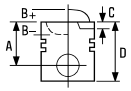

21  **83.00**

GTV 2.0 T.SPARK 16V Spider 2.0 T.SPARK 16V	06/95→10/05 06/95→04/05	AR 16201	4 Cyl. 1970cc	10:1 110kW (150PS)	TD4188
145 2.0 16V Quadrifoglio 146 2.0 16V Quadrifoglio 156 2.0 16V T.SPARK GTV 2.0 T.SPARK 16V, Spider 2.0 T.SPARK 16V	03/98→01/01 09/97→06/02 05/98→08/00	AR 32301	4 Cyl. 1970cc	10.1:1 114kW (155PS)	TD9463
166 2.0 T.SPARK	09/98→10/00	AR 34103	4 Cyl. 1970cc	10:1 114kW (155PS)	TD11599
145 2.0 16V T.S., 146 2.0 16V T.S. 155 2.0 T.S. 16V	10/95→01/01 03/95→12/97	AR 67204	4 Cyl. 1970cc	110kW (150PS)	TD4190

87-110900-00
87-110906-00

STD
0.40mm

08-110900-00
08-110906-00

STD
0.40mm

A 32.00
B- 3.10
D 56.00
 20x52

1.20
1.50
3.00



CR 
P
CR P

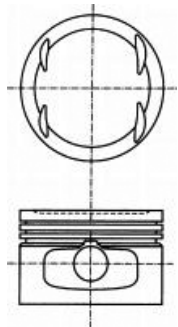

 Steel

 Stahl

 Acier



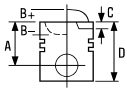

 Acero

 Acciaio



22 83.00

147 2.0 16V T.SPARK	01/01→03/10	AR 32310 Euro 4		
156 2.0 16V T.SPARK	10/00→03/02	4 Cyl.	10:1	
GTV 2.0 T.SPARK 16V	06/95→10/05	1970cc	110kW (150PS)	
Spider 2.0 T.SPARK 16V	06/95→04/05			TD15391
166 2.0 T.Spark	10/00→06/07	AR 36301 Euro 4		
		4 Cyl.	10:1	
		1970cc	110kW (150PS)	
				TD15392

87-145300-00	STD	08-145300-00	STD
87-145306-00	0.40mm	08-145306-00	0.40mm
A	31.30	1.20	 NT 
B-	3.80	1.20	 P
BØ	69.00	2.00	 P
D	51.30		
	20x52		

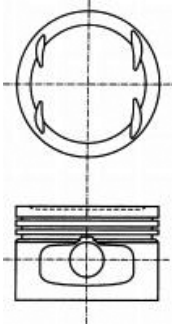

 Steel

 Stahl

 Acier

 Acero

 Acciaio

23 83.00

Brera 2.0 JTDM	03/08→06/10	198 A5.000		
		4 Cyl.	16.5:1	
		1956cc	121kW (165PS)	
		Diesel	Turbo Intercooled	TD24647
159 2.0 JTDM	05/09→11/11	844 A2.000		
Brera 2.0 JTDM	03/08→06/10	4 Cyl.	16.5:1	
Spider 2.0 JTDM	04/09→06/10	1956cc	120kW (163PS)	
		Diesel	Turbo Intercooled	TD24594
159 2.0 JTDM	06/10→11/11	939 B4.000		
		4 Cyl.		
		1956cc	100kW (136PS)	
		Diesel	Turbo Intercooled	TD24644
159 2.0 JTDM	06/10→11/11	939 B5.000		
		4 Cyl.	16.5:1	
		1956cc	125kW (170PS)	
		Diesel	Turbo Intercooled	TD24645
Giulietta 2.0 JTDM	04/10→	940 A4.000		
		4 Cyl.	16.5:1	
		1956cc	125kW (170PS)	
		Diesel	Turbo Intercooled	TD23924
Giulietta 2.0 JTDM	04/10→	940 A5.000 Euro 5		
		4 Cyl.	16.5:1	
		1956cc	103kW (140PS)	
		Diesel	Turbo Intercooled	TD24578



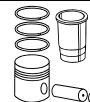
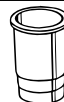
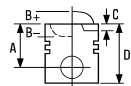

Giulietta 2.0 JTDM	04/10 →	940 A7.000 Euro 5	4 Cyl.	16.5:1
			1956cc	120kW (163PS)
		Diesel	Turbo Intercooled	TD24793

Giulietta 2.0 JTDM	04/10 →	940 A8.000 Euro 5	4 Cyl.	16.5:1
			1956cc	100kW (136PS)
		Diesel	Turbo Intercooled	TD25424

87-436500-00	STD	08-436500-00	STD
87-436506-00	0.40mm	08-436506-00	0.40mm

A	43.63	1.50		GDC P
B-	15.80	1.50		P
BØ	43.50	2.00		CR P

D 72.63
 30x66



KK RT TP

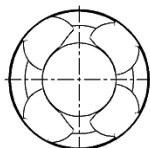
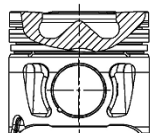

08344A406

24 84.00

2000 GT (USA only), 2000 Spider (USA only)	01/73 → 12/81	AR 11633	4 Cyl.	9:1
2000 Veloce (USA only)			1962cc	82-96kW (112-131PS)
				TD22398

Alfetta GT 2.0	09/74 → 12/77	AR 11634	4 Cyl.	10:1
Sprint 2.0	09/76 → 12/79		1962cc	82kW (112PS)
				TD68

87-107100-30	STD	08-107100-00	STD	15-632000-00 WH	B 89.00 C 152.00 D 98.00 E 107.50	89-107100-30 87-107100-30 + 15-632000-00
A	32.75	1.50		CR P		
B-	14.75	1.75		P		
D	81.00	4.50		P		
	22x71					

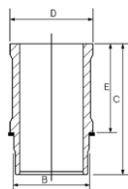
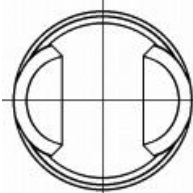
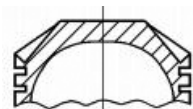

Includes seals

Schließt Dichtungen ein

Inclut des joints

Incluye los sellos

Comprende le guarnizioni

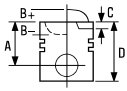

25  **84.00**

Spider 2000	01/71→12/77	AR 00512	4 Cyl. 1962cc	9:1 96kW (131PS)	TD75
Spider 2000	08/86→12/90	AR 01544	4 Cyl. 1962cc	85kW (116PS)	TD28
Alfetta 2.0 Alfetta GT 2.0 Sport 2.0	09/74→02/80 07/78→01/86 09/77→12/79	AR 01623	4 Cyl. 1962cc	82-90kW (112-122PS)	TD34
90 2.0 i.e. Alfetta 2.0	10/84→07/87 07/78→12/84	AR 01713	4 Cyl. 1962cc	94-97kW (128-132PS)	TD41
GTV 2.0	11/80→01/86	AR 10512	4 Cyl. 1962cc	10:1 96kW (131PS)	TD5351
Giulietta 2.0	06/80→04/85	AR 11671	4 Cyl. 1962cc	10:1 96kW (131PS)	TD70
164 2.0	09/87→08/92	AR 19510	4 Cyl. 1962cc	10:1 104-109kW (142-148PS)	TD23344
164 2.0 164 2.0 T.S.	11/87→10/92 09/92→09/98	AR 64103	4 Cyl. 1995cc	106kW (144PS)	TD129
155 2.0 T.S.	02/92→04/93	AR 67201	4 Cyl. 1995cc	10:1 106kW (144PS)	TD136
155 2.0 T.S.	02/92→02/95	AR 67202	4 Cyl. 1995cc	10:1 104kW (141PS)	TD137

15-632000-00 WH  B 89.00 C 152.00 D 98.00 E 107.50

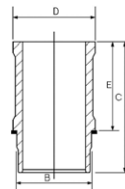

 Includes seals

 Schließt Dichtungen ein

 Inclut des joints

 Incluye los sellos

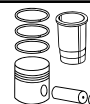
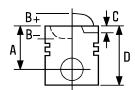

 Comprende le guarnizioni



26 84.00

Spider 2000	01/90 → 12/93	AR 01588	4 Cyl. 1962cc	88kW (120PS)	TD30
--------------------	---------------	-----------------	-------------------------	---------------------	-------------

75 2.0 T.S.	05/85 → 02/92	AR 06224	4 Cyl. 1962cc	107-109kW (146-148PS)	TD58
--------------------	---------------	-----------------	-------------------------	------------------------------	-------------

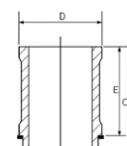
87-110200-40 STD	08-110200-00 STD	15-632000-00 WH  B 89.00 C 152.00 D 98.00 E 107.50	89-110200-40 87-110200-40 + 15-632000-00
A 32.75 B- 12.85 D 79.10  22x71	1.50 1.50 3.50 	CR P P P 	

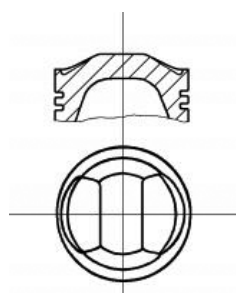

 Includes seals

 Schließt Dichtungen ein

 Inclut des joints



 Incluye los sellos

 Comprende le guarnizioni

27 84.00

Alfetta 2.0	07/78 → 12/84	AR 01655	4 Cyl.		
Alfetta GT 2.0	06/77 → 12/84				
Giulietta 2.0	06/80 → 04/85		1962cc	96kW (131PS)	TD37
GTV 2.0	07/78 → 01/86				

75 2.0	05/85 → 10/88	AR 06212	4 Cyl.	9.1:1	
90 2.0 i.e.	10/84 → 07/87		1962cc	94-96kW (128-131PS)	TD57
GTV 2.0	07/78 → 01/86				

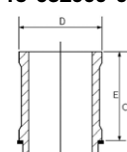
87-107100-40 STD	08-107100-10 STD	15-632000-00 WH  B 89.00 C 152.00 D 98.00 E 107.50	89-107100-40 87-107100-40 + 15-632000-00
A 33.20 B- 18.80 D 85.50  22x71	1.50 1.75 4.00 	CR P P P 	

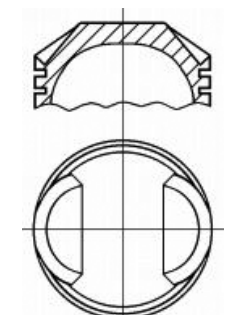

 Includes seals

 Schließt Dichtungen ein

 Inclut des joints





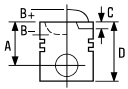

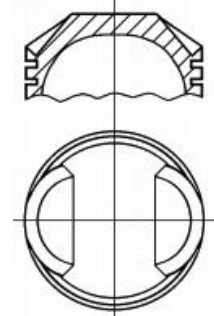

 Incluye los sellos

 Comprende le guarnizioni

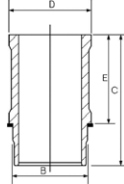
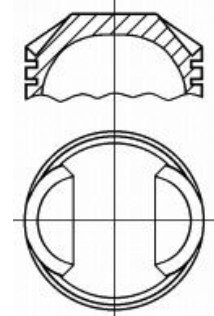



28 84.00

75 2.0 T.S.	01/87→02/92	AR 06166	4 Cyl. 1962cc	10:1 107kW (146PS)	TD53
164 2.0 164 2.0 T.S. 164 2.0 Twin Spark	06/87→09/98 06/87→09/92 07/90→10/92	AR 06416	4 Cyl. 1962cc	102-105kW (138-143PS)	TD62
164 2.0 T.S. 164 2.0 Twin Spark	06/87→12/90 06/87→06/90	AR 06420	4 Cyl. 1962cc	109kW (148PS)	TD63

87-110200-30 STD A 33.75 B+ 1.25 D 67.50  22x71 	08-110200-00 STD 1.50 1.50 3.50  CR P P P	15-632000-00 WH  B 89.00 C 152.00 D 98.00 E 107.50 	89-110200-30 87-110200-30 + 15-632000-00 	
 Includes seals	 Schließt Dichtungen ein	 Inclut des joints	 Incluye los sellos	 Comprende le guarnizioni

29 84.00

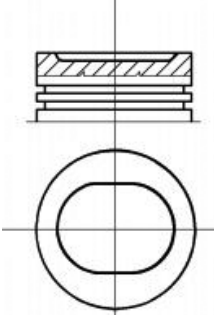
164 2.0 Turbo	10/87→09/98	AR 06476	4 Cyl. 1995cc Turbo Intercooled	128-129kW (174-175PS)	TD65
---------------	-------------	----------	---------------------------------------	-----------------------	-------------

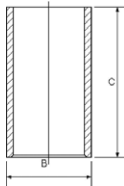
87-215300-10 STD 87-215308-10 0.60mm A 39.50 B- 4.50 D 79.00  22x69 	08-215300-10 STD 08-215306-10 0.40mm 08-215308-10 0.60mm 1.50 2.00 3.94  CR P P P	14-011041-00 D B 88.06 C 152.00 
---	---	---

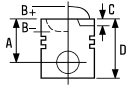

30 84.00

155 2.0 16V Turbo Q4

01/92→12/97

AR 67203

4 Cyl.

1995cc

137-140kW (186-190PS)

Turbo Intercooled

TD138

87-142400-00

STD

08-142400-00

STD

14-011041-00 D

B 88.06 C 152.00

87-142406-00

0.40mm

08-142406-00

0.40mm

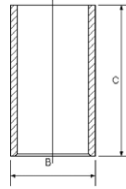

A 39.00

B- 6.00

BØ 72.00

C 2.00

D 69.00

 22x69

1.50

1.50

3.00



CK

P

P

AK

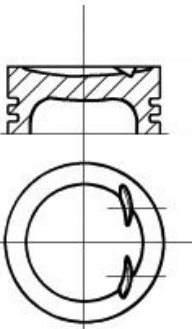

31 92.00

33 1.8 TD

01/86→06/90

VM 82 A

3 Cyl.

22:1

1779cc

54kW (73PS)

Diesel

Turbo

TD153

33 1.8 TD

01/86→09/94

VM 96 A

3 Cyl.

22:1

1779cc

62kW (84PS)

Diesel

Turbo

TD155

Alfetta 2.4 TD

04/83→12/84

VM 4HT 2.4

4 Cyl.

22.1:1

2393cc

69-70kW (94-95PS)

Diesel

Turbo

TD159

75 2.4 TD

01/89→02/92

VM 81 A

4 Cyl.

22.1:1

90 2.4 TD

10/84→07/87

2393cc

81kW (110PS)

Diesel

Turbo

TD152

14-676420-00 WH B 101.50 C 166.80 D 110.00 E 8.90 F 1.20

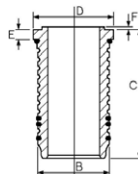

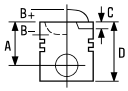

32 92.00



155 2.5 TD	04/93→12/97	VM 07 B	4 Cyl. 2500cc Turbo	22:1 92kW (125PS)	TD149
164 2.5 TD	09/92→09/98	VM 08 B	4 Cyl. 2500cc Turbo	22:1 92kW (125PS)	TD9771
155 2.5 TD	04/93→12/97	VM 31 B	4 Cyl. 2500cc Turbo	22:1 92-125kW (125-170PS)	TD9768
164 2.5 TD	09/92→09/98	VM 32 B	4 Cyl. 2500cc Turbo	22:1 92kW (125PS)	TD127
164 2.5 TD	06/87→09/92	VM 84 A	4 Cyl. 2500cc Turbo	22:1 84kW (114PS)	TD154

87-110100-00 STD

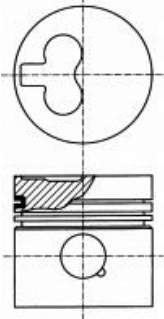
A 51.00
B- 2.10
D 86.00
 30x76



08-110100-00 STD

2.50  CR P
2.00  P
4.00  CR P

14-676420-00 WH B 101.50 C 166.80 D 110.00 E 8.90 F 1.20

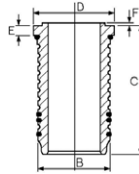

89-110100-00
87-110100-00 +
14-676420-00

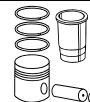
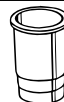
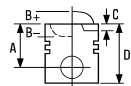

33 93.00

164 3.0	11/87→12/93	AR 06410	V6 Cyl.			
164 3.0 V6	06/87→09/92		2959cc	136-141kW (184-192PS)		TD59
164 3.0 V6	06/87→09/92	AR 06412	V6 Cyl.			
			2959cc	135kW (184PS)		TD61
164 3.0 i.e. QV	09/90→09/92	AR 64301	V6 Cyl.	10:1		
			2959cc	147kW (200PS)		TD106

15-632400-00  **B 99.00 C 119.00 D 109.00 E 78.00**

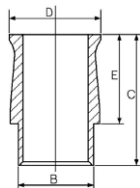

 Includes seals

 Schließt Dichtungen ein

 Inclut des joints

 Incluye los sellos

 Comprende le guarnizioni

34 93.00

AR 8 2.4 TD	04/85→12/89	8140.21.200 D.I.	4 Cyl.	18:1		
			2445cc	68kW (92PS)		TD143
		Diesel Turbo				
AR 6 2.4 TD	09/86→12/89	8144.21.220 Sofim	4 Cyl.	18:1		
			2445cc	68kW (92PS)		TD145
		Diesel Turbo				

87-245200-30 STD
87-245208-30 0.60mm

08-245200-00 STD
08-245208-00 0.60mm

STD
0.60mm

14-021371-00 D B 96.01 C 171.00 D 98.92 E 5.00
14-021372-00 D B 96.05 C 171.00 D 98.92 E 5.00
14-021480-00 DH  B 97.03 C 171.00 D 100.00 E 5.00

A 59.65
B- 14.80
BØ 51.90
D 97.65
 32x75

3.00 
2.00 
3.00 

CR P
P
CR P

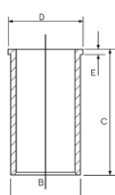

RT

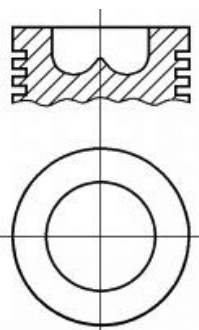

 Nitrided

 Nitriert

 Nitridé

 Niturado

 Niturato

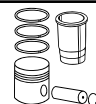
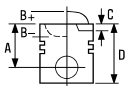

35  **93.00**

AR8 **8140.27R.2700/8140.27S.2700 Sofim**
 4 Cyl. 18:1
 2499cc
 Diesel Turbo **FM9102**



87-245200-40 STD
87-245208-40 0.60mm

A 58.75
B- 17.90
BØ 38.00
D 96.75
 32x75

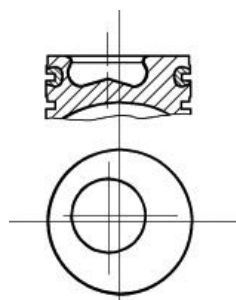
RT



08-245200-00 STD
08-245208-00 0.60mm

3.00  CR P
 2.00  P
 3.00  CR P

14-021371-00 D B 96.01 C 171.00 D 98.92 E 5.00
14-021372-00 D B 96.05 C 171.00 D 98.92 E 5.00
14-021480-00 DH 1 B 97.03 C 171.00 D 100.00 E 5.00

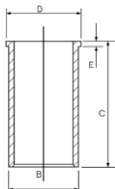



87-245200-50 STD
87-245208-50 0.60mm

A 58.75
B- 17.90
BØ 38.00
D 96.75
 32x78

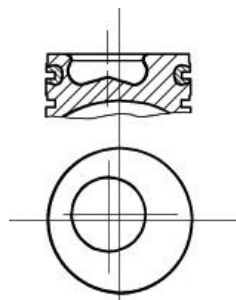
AK NB RT



08-245200-00 STD
08-245208-00 0.60mm

3.00  CR P
 2.00  P
 3.00  CR P

 Nitrided

 Nitriert

 Nitridé

 Nitrurado

 Nitrurato

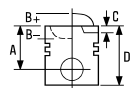

36 93.00

AR 8 2.4 D	04/78→08/86	8140.61.200	4 Cyl. 2445cc	22:1 53kW (72PS)	
		Diesel			TD144
AR 8 Furgone	01/78→12/79	8144.61	4 Cyl. 2445cc	22:1 53kW (72PS)	
		Diesel			FM566
AR 6 2.4 D	04/85→02/86	8144.61.200	4 Cyl. 2445cc	22:1 53kW (72PS)	
		Diesel			TD146

87-214500-00 STD
87-214508-00 0.60mm

A 54.80
B- 2.20
D 89.80
 32x75

STD
0.60mm

08-214500-10 STD
08-214508-10 0.60mm

3.00
2.00
4.00



STD
0.60mm

CR P
P
CR P

14-022560-00 D
14-028930-00 D
14-028931-00 D
14-028932-00 D

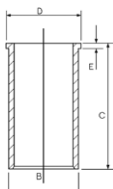

B 96.00 C 167.30 D 98.90 E 5.00
B 97.50 C 167.00 D 100.90 E 5.00
B 97.58 C 167.00 D 100.90 E 5.00
B 97.70 C 167.00 D 100.90 E 5.00

HA RT

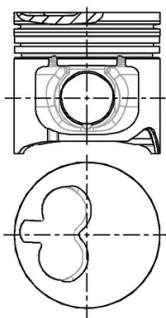

37 93.00

AR 6 2.5 D	03/86→12/89	8144.67.220	4 Cyl. 2500cc	22:1 55kW (75PS)	
AR 8 2.5 D	09/86→12/89				
		Diesel	Turbo		TD147

87-783300-00 STD
87-783308-00 0.60mm

A 54.00
B- 2.20
D 89.00
 32x75

STD
0.60mm

08-783300-00 STD
08-783308-00 0.60mm

3.00
2.00
3.00



STD
0.60mm

CR P
P
CR P



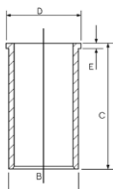

14-022560-00 D
14-028930-00 D
14-028931-00 D
14-028932-00 D

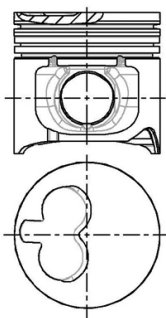

B 96.00 C 167.30 D 98.90 E 5.00
B 97.50 C 167.00 D 100.90 E 5.00
B 97.58 C 167.00 D 100.90 E 5.00
B 97.70 C 167.00 D 100.90 E 5.00

HA RT



		ccm	x 		
810-02	Petrol	1289	4	73.00	1
C3G 702	Petrol	1239	4	74.00	2
F8M 700	Diesel	1596	4	78.00	4
HN	Petrol	1595	4	81.00	5
IAP 810-R-99 (C2J)	Petrol	1397	4	76.00	3
XD3P	Diesel	2498	4	94.00	7
XD4.90/XDP90	Diesel	2112	4	90.00	6
XDP 4-90/XDP4-90	Diesel	2112	4	90.00	6



3  **76.00**



10 1.4 06/84→10/99 **IAP 810-R-99 (C2J)**
 4 Cyl. **1397cc** **46-49kW (62-67PS)** **TD201**

87-333500-00 STD

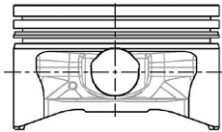
A 37.50
D 64.00
 20x67



08-333500-00 STD
08-333505-00 0.25mm
08-333507-00 0.50mm

1.75  CR P
 2.00  P
 4.00  CR ²

15-630820-00 WH ¹ **B 80.60 C 134.00 D 90.20 E 95.00**

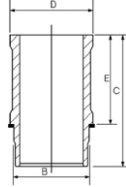

89-333500-00
 87-333500-00 +
 15-630820-00

¹ Includes seals
² Steel

¹ Schließt Dichtungen ein
² Stahl

¹ Inclut des joints
² Acier

¹ Incluye los sellos
² Acero

¹ Comprende le guarnizioni
² Acciaio

4  **78.00**

10 1.6 D 09/86→10/99 **F8M 700**
 4 Cyl. **1596cc** **22.5:1** **40kW (55PS)** **TD21933**
Diesel

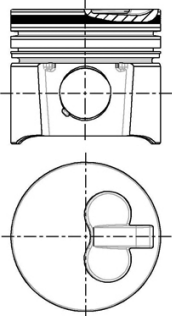

87-335000-10 ¹ STD
87-335007-10 ¹ 0.50mm

A 47.25
B- 1.50
D 74.50
 24x67



¹ No oil-jet cut out

08-335000-10 STD
08-335003-10 0.125mm
08-335005-10 0.25mm
08-335007-10 0.50mm

2.00  CR P
 2.00  P
 3.00  CR P

¹ Ohne Aussparung für
 Kühllöspritzdüse

14-023730-00 D **C 149.00 D 83.50 E 4.50**

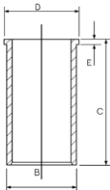

¹ Sans encoche en bas de jupe pour
 le passage de la pissette d'huile sous
 pression

¹ Sin escotadura

¹ Senza passaggio per
 spruzzatore olio

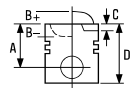

5  **81.00**

10 1.6	06/88→10/99	HN	4 Cyl. 1595cc	9:1 53-55kW (72-75PS)	TD24106
--------	-------------	-----------	-------------------------	---------------------------------	----------------

87-109707-20  0.50mm

- A** 35.30
- B-** 2.30
- B+** 2.20
- D** 66.50
-  20x57

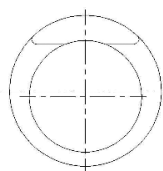
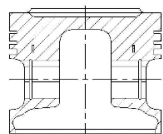



08132E

 A = 35.300, D = 66.500



 A = 35.300, D = 66.500

 A = 35.300, D = 66.500

 A = 35.300, D = 66.500

 A = 35.300, D = 66.500

08-109700-00 STD
08-109705-00 0.25mm
08-109707-00 0.50mm

- 1.50  CR P
- 1.75  P
- 3.00  CR P

6  **90.00**

ARO 24	01/80→12/84	XD4.90/XDP90	4 Cyl. 2112cc	22.5:1	FM1425
		Diesel			

ARO 24	01/80→12/84	XDP 4-90/XDP4-90	4 Cyl. 2112cc	22:01:1 42/48kW (57/65PS)	FM11425
		Diesel			

14-604060-00 WH B 96.00 C 173.00 D 106.30 E 129.00

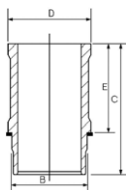

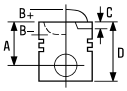

7  **94.00**

240-244 2.5 D

01/83→12/98 **XD3P**

4 Cyl.
2498cc

23:1
52-55kW (71-75PS)

Diesel



TD202

- 87-318700-10 STD
- 87-318706-10 0.40mm
- 87-318708-10 0.60mm
- 87-318710-10 0.80mm

→12/93

- A** 54.00
- B-** 1.80
- D** 96.42
-  30x79

- 08-318700-10 STD
- 08-318704-10 0.20mm
- 08-318706-10 0.40mm
- 08-318707-10 0.50mm
- 08-318708-10 0.60mm
- 08-318710-10 0.80mm
- 08-318711-10 1.00mm

- 2.00  CR P
- 2.00  P
- 4.00  CR P

- 14-020660-00 **D** **B** 97.00 **C** 170.60 **D** 99.50 **E** 4.00
- 14-021520-00 **D** **B** 98.00 **C** 170.60 **D** 100.00 **E** 6.00

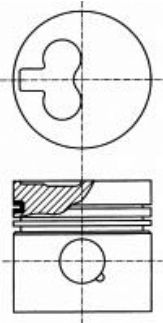
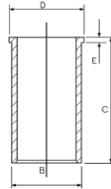



- 87-318700-30 STD
- 87-318706-30 0.40mm
- 87-318708-30 0.60mm
- 87-318710-30 0.80mm





01/94→



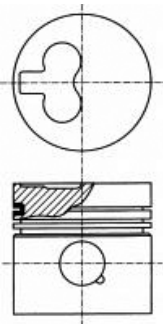

- A** 54.00
- B-** 1.75
- D** 91.42
-  30x79





- 08-318700-10 STD
- 08-318704-10 0.20mm
- 08-318706-10 0.40mm
- 08-318707-10 0.50mm
- 08-318708-10 0.60mm
- 08-318710-10 0.80mm
- 08-318711-10 1.00mm

- 2.00  CR P
- 2.00  P
- 4.00  CR P



		ccm	x 		
1T	Diesel	2461	5	81.00	30
1Y	Diesel	1896	4	79.50	10
1Z	Diesel	1896	4	79.50	11
3D	Diesel	2370	5	79.50	10
4B	Petrol	1781	4	81.00	20
AAH	Petrol	2771	V6	82.50	35
AAS	Diesel	2370	5	79.50	10
AAT	Diesel	2461	5	81.00	30
AAZ	Diesel	1896	4	79.50	12
ABK	Petrol	1984	4	82.50	36
ABM	Petrol	1595	4	81.00	21
ABP	Diesel	2461	5	81.00	30
ADA	Petrol	1595	4	81.00	21
ADE	Diesel	1896	4	79.50	12
ADP	Petrol	1595	4	81.00	22
ADR	Petrol	1781	4	81.00	23
AEB	Petrol	1781	4	81.00	24
AEH	Petrol	1595	4	81.00	22
AEJ	Petrol	2771	V6	82.50	35
AEL	Diesel	2461	5	81.00	30
AFB	Diesel	2496	V6	78.30	8
AFC	Petrol	2771	V6	82.50	35
AFF	Diesel	1896	4	79.50	11
AFN	Diesel	1896	4	79.50	11
AGN	Petrol	1781	4	81.00	23
AGR	Diesel	1896	4	79.50	11
AGU Euro 2	Petrol	1781	4	81.00	24
AHF	Diesel	1896	4	79.50	11
AHH	Diesel	1896	4	79.50	11
AHL	Petrol	1595	4	81.00	25
AHU	Diesel	1896	4	79.50	11
AJL	Petrol	1781	4	81.00	24
AJM	Diesel	1896	4	79.50	13
AJP	Petrol	1781	4	81.00	23
AJQ	Petrol	1781	4	81.00	24
AKE	Diesel	2496	V6	78.30	9
AKL	Petrol	1595	4	81.00	22
AKN	Diesel	2496	V6	78.30	8
ALH	Diesel	1896	4	79.50	11
ALZ	Petrol	1595	4	81.00	26
AMB	Petrol	1781	4	81.00	27
AMF	Diesel	1422	3	79.50	14
ANA	Petrol	1595	4	81.00	26
ANB	Petrol	1781	4	81.00	24
ANU	Diesel	1896	4	79.50	15
APF	Petrol	1595	4	81.00	22
APG	Petrol	1781	4	81.00	23
APP	Petrol	1781	4	81.00	24
APT	Petrol	1781	4	81.00	23
APU	Petrol	1781	4	81.00	24
AQA	Petrol	1781	4	81.00	24
AQE	Petrol	1781	4	81.00	23
ARG	Petrol	1781	4	81.00	23
ARH	Petrol	1781	4	81.00	23
ARK	Petrol	1781	4	81.00	24
ARM	Petrol	1595	4	81.00	22
ARX	Petrol	1781	4	81.00	27
ARY	Petrol	1781	4	81.00	27
ARZ	Petrol	1781	4	81.00	24
ASB	Diesel	2967	V6	83.00	40
ASV	Diesel	1896	4	79.50	11
ASZ	Diesel	1896	4	79.50	16
ATC	Petrol	1781	4	81.00	27
ATD	Diesel	1896	4	79.50	15
ATJ	Diesel	1896	4	79.50	13
ATL	Diesel	1422	3	79.50	17
AUA	Petrol	1390	4	76.50	2
AUM Euro 4	Petrol	1781	4	81.00	27
AUQ	Petrol	1781	4	81.00	27

		ccm	x 		9
AVB	Diesel	1896	4	79.50	15
AVF	Diesel	1896	4	79.50	16
AVG	Diesel	1896	4	79.50	11
AVJ	Petrol	1781	4	81.00	27
AVU	Petrol	1595	4	81.00	26
AVV	Petrol	1781	4	81.00	23
AWA	Petrol	1984	4	82.50	37
AWM	Petrol	1781	4	81.00	27
AWP	Petrol	1781	4	81.00	27
AWT	Petrol	1781	4	81.00	27
AWX	Diesel	1896	4	79.50	16
AXR	Diesel	1896	4	79.50	15
AXW	Petrol	1984	4	82.50	37
AXX	Petrol	1984	4	82.50	38
AYM	Diesel	2496	V6	78.30	9
AZV	Diesel	1968	4	81.00	31
BAU	Diesel	2496	V6	78.30	9
BBY	Petrol	1390	4	76.50	2
BCZ	Diesel	2496	V6	78.30	9
BDG	Diesel	2496	V6	78.30	9
BEX	Petrol	1781	4	81.00	27
BFB	Petrol	1781	4	81.00	27
BFC	Diesel	2496	V6	78.30	9
BFQ	Petrol	1595	4	81.00	26
BGU	Petrol	1595	4	81.00	26
BHC	Diesel	1422	3	79.50	14
BKC	Diesel	1896	4	79.50	15
BKD	Diesel	1968	4	81.00	31
BKE	Diesel	1896	4	79.50	11
BKN	Diesel	2967	V6	83.00	40
BLB	Diesel	1968	4	81.00	31
BLR	Petrol	1984	4	82.50	37
BLS	Diesel	1896	4	79.50	15
BLX	Petrol	1984	4	82.50	37
BLY	Petrol	1984	4	82.50	37
BMB	Petrol	1984	4	82.50	37
BMK	Diesel	2967	V6	83.00	40
BMM	Diesel	1968	4	81.00	32
BMN	Diesel	1968	4	81.00	31
BNA	Diesel	1968	4	81.00	31
BNG	Diesel	2967	V6	83.00	40
BPW	Diesel	1968	4	81.00	32
BRB	Diesel	1896	4	79.50	18
BRD	Diesel	1968	4	81.00	31
BRE	Diesel	1968	4	81.00	31
BRF	Diesel	1968	4	81.00	31
BSE	Petrol	1595	4	81.00	26
BSF	Petrol	1595	4	81.00	26
BUG	Diesel	2967	V6	83.00	40
BUN	Diesel	2967	V6	83.00	40
BUY	Diesel	1968	4	81.00	31
BVA	Diesel	1968	4	81.00	31
BVF	Diesel	1968	4	81.00	31
BVG	Diesel	1968	4	81.00	31
BVP	Petrol	1781	4	81.00	27
BVR	Petrol	1781	4	81.00	27
BVY	Petrol	1984	4	82.50	37
BVZ	Petrol	1984	4	82.50	37
BWA	Petrol	1984	4	82.50	38
BXE	Diesel	1896	4	79.50	15
CAGA	Diesel	1968	4	81.00	33
CAGB	Diesel	1968	4	81.00	33
CAGC	Diesel	1968	4	81.00	33
CAHA	Diesel	1968	4	81.00	33
CAHB	Diesel	1968	4	81.00	33
CAVG	Petrol	1390	4	76.50	3
CAXA	Petrol	1390	4	76.50	4
CAXC	Petrol	1390	4	76.50	4
CAYB	Diesel	1598	4	79.50	19

		ccm	x 		
CAYC	Diesel	1598	4	79.50	19
CBAA	Diesel	1968	4	81.00	33
CBAB	Diesel	1968	4	81.00	33
CBBB	Diesel	1968	4	81.00	33
CBZA	Petrol	1197	4	71.00	1
CBZB	Petrol	1197	4	71.00	1
CDAA	Petrol	1798	4	82.50	39
CDHA	Petrol	1798	4	82.50	39
CDHB	Petrol	1798	4	82.50	39
CFFA	Diesel	1968	4	81.00	34
CFFB	Diesel	1968	4	81.00	34
CFGB	Diesel	1968	4	81.00	34
CFGC	Diesel	1968	4	81.00	34
CFGD	Diesel	1968	4	81.00	34
CFHB	Diesel	1968	4	81.00	34
CFHD	Diesel	1968	4	81.00	34
CGLA	Diesel	1968	4	81.00	34
CGLB	Diesel	1968	4	81.00	34
CGLC	Diesel	1968	4	81.00	34
CGLD	Diesel	1968	4	81.00	34
CGLE	Diesel	1968	4	81.00	34
CJCA	Diesel	1968	4	81.00	34
CJCB	Diesel	1968	4	81.00	34
CLJA	Diesel	1968	4	81.00	34
CLLB	Diesel	1968	4	81.00	34
CMEA	Diesel	1968	4	81.00	33
CMGA	Diesel	1968	4	81.00	34
CMGB	Diesel	1968	4	81.00	34
CMSA	Petrol	1390	4	76.50	4
CN	Diesel	1986	5	76.50	6
CNVA	Petrol	1390	4	76.50	4
CR	Diesel	1588	4	76.50	6
CTHG	Petrol	1390	4	76.50	3
CTJA	Petrol	1390	4	76.50	3
CY	Diesel	1588	4	76.50	7
DE	Diesel	1986	5	76.50	7
DR	Petrol	1781	4	81.00	20
DS	Petrol	1781	4	81.00	28
DT	Petrol	1595	4	81.00	21
DTA	Petrol	1595	4	81.00	21
DZ	Petrol	1781	4	81.00	28
JK	Diesel	1588	4	76.50	6
JT	Petrol	2226	5	81.00	29
JU	Petrol	1595	4	81.00	21
JV	Petrol	1781	4	81.00	28
KX	Petrol	2226	5	81.00	29
KZ	Petrol	2226	5	81.00	29
MG	Petrol	1781	4	81.00	20
MU	Petrol	1781	4	81.00	28
NC	Diesel	1986	5	76.50	7
NE	Petrol	1781	4	81.00	28
PH	Petrol	1781	4	81.00	28
PM	Petrol	1781	4	81.00	20
PP	Petrol	1595	4	81.00	21
PV	Petrol	1781	4	81.00	28
RA	Diesel	1588	4	76.50	7
RN	Petrol	1595	4	81.00	21
RS	Petrol	1781	4	81.00	20
RU	Petrol	1781	4	81.00	20
SA	Petrol	1595	4	81.00	21
SB	Diesel	1588	4	76.50	7
SF	Petrol	1781	4	81.00	20
SH	Petrol	1781	4	81.00	20
YJ	Petrol	1471	4	76.50	5
ZB	Petrol	1471	4	76.50	5
ZC	Petrol	1471	4	76.50	5

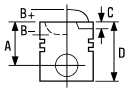

1  **71.00**





A1 1.2 TFSI	05/10→	CBZA	4 Cyl. 1197cc Turbo Intercooled	10:1 63kW (86PS)	TD24385
--------------------	--------	-------------	---	----------------------------	----------------

A3 1.2 TFSI	03/10→05/13	CBZB	4 Cyl. 1197cc Turbo Intercooled	77kW (105PS)	TD23907
A3 1.2 TSI	04/10→03/13				

87-442300-00   **STD**

- A** 28.00
- B+** 0.70
- C** 3.52
- C** 3.52
- D** 48.00
-  17x49

08-442300-00 **STD**

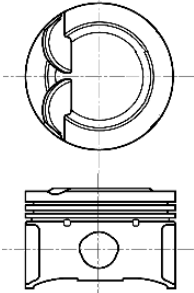

- 1.20  **NT** 
- 1.20  **P**
- 2.00  **NT**

AK HA TP





07124A101



 Earlier pistons to be replaced in Engine sets only

-  Elastoval ®
-  Steel



 Frühere Kolben nur in Motorsätzen zu ersetzen

-  Elastoval ®
-  Stahl



 Premier piston à remplacer dans le jeu moteur

-  Elastoval ®
-  Acier

 Pistones más antiguos para ser reemplados en juego de motores solamente

-  Elastoval ®
-  Acero

 Con i pistone di vecchia versione è necessario sostituire tutta la serie

-  Elastoval ®
-  Acciaio

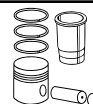
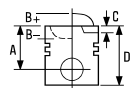

2  **76.50**

A2 1.4	02/00→08/05	AUA	4 Cyl. 1390cc	55kW (75PS)	TD15248
--------	-------------	-----	-------------------------	--------------------	----------------

A2 1.4	02/00→08/05	BBY	4 Cyl. 1390cc	10.5:1 55kW (75PS)	TD16414
--------	-------------	-----	-------------------------	------------------------------	----------------

87-116100-00
87-116107-00 ¹

STD
0.50mm

08-116100-00
08-116107-00

STD
0.50mm

A 28.92
B- 1.98
BØ 61.90
C 2.32
D 49.92
 17x54

1.20
1.50
2.50



NT ²
P
CR ²

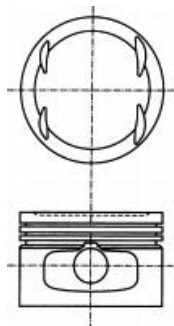

¹ A = 28.670, D = 49.670
² Steel

¹ A = 28.670, D = 49.670
² Stahl

¹ A = 28.670, D = 49.670
² Acier

¹ A = 28.670, D = 49.670
² Acero

¹ A = 28.670, D = 49.670
² Acciaio

3  **76.50**

A1 1.4 TFSI	01/11→	CAVG	4 Cyl. 1390cc Turbo Intercooled	136kW (185PS)	TD24937
-------------	--------	------	--	----------------------	----------------



A1 1.4 TFSI	01/11→	CTHG	4 Cyl. 1390cc Turbo Intercooled	136kW (185PS)	TD25659
-------------	--------	------	--	----------------------	----------------

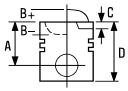



A1 1.4 TFSI	01/11→	CTJA	4 Cyl.	1390cc	136kW (185PS)	Turbo Intercooled	TD25660
--------------------	--------	-------------	--------	---------------	----------------------	--------------------------	----------------

87-433900-10 ¹	STD	08-433900-00	STD
87-433907-10 ¹	0.50mm	08-433907-00	0.50mm

A	29.00	1.20	 NT ²
B-	4.55	1.50	P
B+	1.85	2.00	NT ²
C	1.00		
C	3.80		
D	49.85		
	19x54		

RT TP

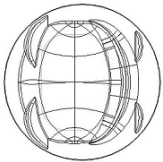
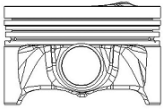

- ¹ Pistons to be replaced in Engine Sets only
- ² Steel
- ¹ Kolben nur Motorsätzen zu ersetzen
- ² Stahl
- ¹ Piston à remplacer dans jeu moteur
- ² Acier
- ¹ Pistones de repuesto para juegos de motores solamente
- ² Acero
- ¹ Il pistone può essere rimpiazzato solamente completo
- ² Acciaio

4  **76.50**



A1 1.4 TFSI	05/10→	CAXA	4 Cyl.	10:1	1390cc	90kW (122PS)	Turbo Intercooled	TD24386
A3 1.4 TFSI	09/07→05/13	CAXC	4 Cyl.	10:1	1390cc	92kW (125PS)	Turbo Intercooled	TD20715
A3 1.4 TFSI	09/07→03/13	CMSA	4 Cyl.		1390cc	92kW (125PS)	Turbo Intercooled	TD23936

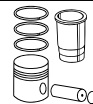
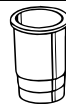
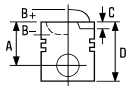



A1 1.4 TFSI	05/10→	CNVA	4 Cyl.	10:1	TD24951
			1390cc	90kW (122PS)	
			Turbo Intercooled		

87-429900-00 ①	STD	08-429900-00	STD
87-429907-00 ①	0.50mm	08-429907-00	0.50mm

A	29.20	1.20	 NT ②
B-	4.50	1.20	P
C	3.60	2.00	NT ②
D	48.20		
	19x52		

HA

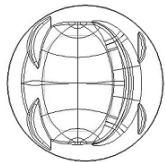
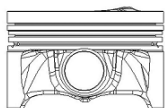

① Elastoval ®	① Elastoval ®	① Elastoval ®	① Elastoval ®	① Elastoval ®
② Steel	② Stahl	② Acier	② Acero	② Acciaio

5  **76.50**

80 1.5	05/72→08/75	YJ	4 Cyl.	8.2:1	TD4213
			1471cc	55kW (75PS)	

80 1.5	05/72→08/75	ZB	4 Cyl.	8.1:1	TD366
			1471cc	55kW (75PS)	

80 1.5	05/72→07/76	ZC	4 Cyl.	9.7:1	TD367
			1471cc	63kW (85PS)	

14-021571-00 D	B 79.56 C 142.00 D 82.50 E 4.50
14-023470-00 D ①	B 79.50 C 142.00 D 82.50 E 4.70
14-024670-00 D	B 79.50 C 145.00 D 81.50 E 4.70
14-028360-00 D ②	B 79.50 C 145.00 D 81.50 E 4.70

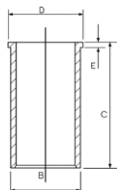



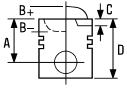



① Phosphated	① Phosphated	① Phosphated	① Phosphated	① Phosphated
② With recesses on crankshaft side	② Mit kurbelwellenseitigen Aussparungen	② Avec évidements côté vilebrequin	② Con escotaduras en la cara del cigüeñal	② Con nicchie sul lato albero motore



6  **76.50**

80 1.6 D	08/80→08/86	CR	4 Cyl. 1588cc	23:1 40kW (54PS)	TD248
		Diesel			
80 1.6 D	08/80→07/89	JK	4 Cyl. 1588cc	23:1 40kW (54PS)	TD269
		Diesel			
100 2.0 D	08/78→11/90	CN	5 Cyl. 1986cc	23:1 51kW (69PS)	TD247
		Diesel			

87-109500-00  STD
87-109505-00  0.25mm
87-109507-00   0.50mm
87-109511-00   1.00mm

A 41.70
B- 1.60
D 71.70
 24x64

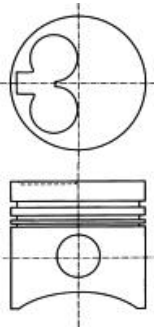

RT



07633



08-109500-00 STD
08-109505-00 0.25mm
08-109507-00 0.50mm
08-109511-00 1.00mm

12/81→

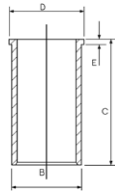

1.75  **CR P**
 2.00  **P**
 3.00  **CR P**

14-021571-00 D **B** 79.56 **C** 142.00 **D** 82.50 **E** 4.50
14-028360-00 D  **B** 79.50 **C** 145.00 **D** 81.50 **E** 4.70





 With recesses on crankshaft side
 No oil-jet cut out



 A = 41.450

 Mit kurbelwellenseitigen Aussparungen
 Ohne Aussparung für Kühllölspritzdüse



 A = 41.450

 Avec évidements côté vilebrequin
 Sans encoche en bas de jupe pour le passage de la pissette d'huile sous pression

 A = 41.450

 Con escotaduras en la cara del cigüeñal
 Sin escotadura

 A = 41.450

 Con nicchie sul lato albero motore
 Senza passaggio per spruzzatore olio

 A = 41.450

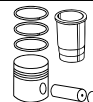
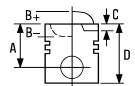

7  **76.50**

80 1.6 TD 90 1.6 TD	08/81 → 05/86 10/85 → 01/87	CY	4 Cyl. 1588cc	23/23.5:1 51kW (70PS)	TD4205
		Diesel	Turbo Intercooled		
80 1.6 TD 90 1.6 TD	09/86 → 08/91 04/87 → 09/91	RA	4 Cyl. 1588cc	23:1 59kW (80PS)	TD313
		Diesel	Turbo Intercooled		
80 1.6 TD 90 1.6 TD	09/86 → 08/91 04/87 → 09/91	SB	4 Cyl. 1588cc	23:1 59kW (80PS)	TD4211
		Diesel	Turbo Intercooled		
100 2.0 D Turbo 100 2.0 TD	08/82 → 02/88 03/83 → 10/87	DE	5 Cyl. 1986cc	23:1 64kW (87PS)	TD251
		Diesel	Turbo Intercooled		
100 2.0 D Turbo, 100 2.0 TD	03/88 → 11/90	NC	5 Cyl. 1986cc	23:1 74kW (100PS)	TD299
		Diesel	Turbo Intercooled		

87-109800-10 STD
87-109807-10 ② 0.50mm
87-109811-10 ② 1.00mm

08-109800-00 STD
08-109807-00 0.50mm
08-109811-00 1.00mm

14-021571-00 D B 79.56 C 142.00 D 82.50 E 4.50
14-028360-00 D ① B 79.50 C 145.00 D 81.50 E 4.70

A 41.70
B- 1.60
D 71.70
 24x64

1.75
2.00
3.00



CR P
CR P
CR P

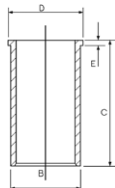

AK H A R T T P

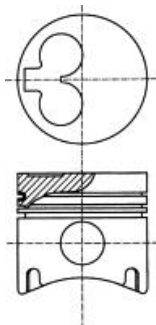

① With recesses on crankshaft side

① Mit kurbelwellenseitigen Aussparungen

① Avec évidements côté vilebrequin

① Con escotaduras en la cara del cigüeñal

① Con nicchie sul lato albero motore

② A = 41.450

② A = 41.450

② A = 41.450

② A = 41.450

② A = 41.450



8  **78.30**

A4 2.5 TDI	09/97→09/01	AFB			
A6 2.5 TDI	07/97→01/05		V6 Cyl.	19.5:1	
A8 2.5 TDI	01/97→04/00		2496cc	110kW (150PS)	
		Diesel	Turbo Intercooled		TD9517

A4 2.5 TDI	09/97→09/01	AKN			
A6 2.5 TDI	07/97→01/05		V6 Cyl.	19.5:1	
A8 2.5 TDI	01/97→04/00		2496cc	110kW (150PS)	
		Diesel	Turbo Intercooled		TD11356



87-103000-00  STD

- A** 47.83
- B-** 16.50
- BØ** 35.80
- C** 1.38
- D** 71.83
-  26x66

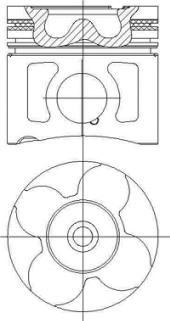
AK KK RT



08-103000-00 STD
08-103007-00 0.50mm

- 1.75  CK P
- 2.00  P
- 3.00  CR P



87-103000-10  STD

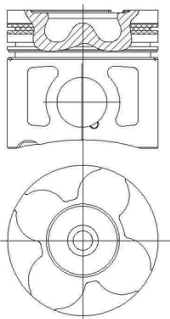

- A** 47.83
- B-** 16.50
- BØ** 35.80
- C** 1.38
- D** 71.83
-  26x66



AK KK RT







08-103000-00 STD
08-103007-00 0.50mm



- 1.75  CK P
- 2.00  P
- 3.00  CR P

 To cylinder 1 - 3
 To cylinder 4 - 6

 zum Zylinder 1 - 3
 zum Zylinder 4 - 6

 sous cylindre 1 - 3
 sous cylindre 4 - 6

 A cilindro 1 - 3
 A cilindro 4 - 6

 al cilindro 1 - 3
 al cilindro 4 - 6

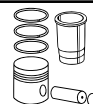
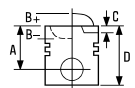

9  **78.30**

A4 2.5 TDI	11/00 → 12/04	AKE			
A6 2.5 TDI	02/00 → 01/05		V6 Cyl.	18.5:1	
A8 2.5 TDI	09/00 → 09/02		2496cc	132kW (180PS)	
ALLROAD 2.5 TDI	05/00 → 08/05	Diesel	Turbo Intercooled		TD15312
A4 2.5 TDI	08/01 → 07/02	AYM			
A6 2.5 TDI	08/01 → 01/05		V6 Cyl.	18.5:1	
			2496cc	114kW (155PS)	
		Diesel	Turbo Intercooled		TD16384
A4 2.5 TDI	11/00 → 12/04	BAU			
A6 2.5 TDI	02/00 → 01/05		V6 Cyl.	18.5:1	
ALLROAD 2.5 TDI	05/00 → 08/05		2496cc	132kW (180PS)	
		Diesel	Turbo Intercooled		TD17033
A4 2.5 TDI	07/02 → 12/05	BCZ			
A6 2.5 TDI	07/02 → 01/05		V6 Cyl.	19.5:1	
ALLROAD 2.5 TDI	05/03 → 08/05		2496cc	120kW (163PS)	
		Diesel	Turbo Intercooled		TD16859
A4 2.5 TDI	07/02 → 05/06	BDG			
A6 2.5 TDI	07/02 → 01/05		V6 Cyl.	18.5:1	
			2496cc	120kW (163PS)	
		Diesel	Turbo Intercooled		TD16860
A4 2.5 TDI	07/02 → 12/05	BFC			
A6 2.5 TDI	07/02 → 01/05		V6 Cyl.	19.5:1	
			2496cc	120kW (163PS)	
		Diesel	Turbo Intercooled		TD16858



87-103000-30  STD

- A 47.83
- B- 17.25
- BØ 36.00
- C 1.38
- C 1.38
- D 71.83
-  26x58

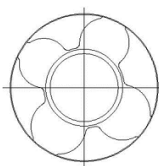
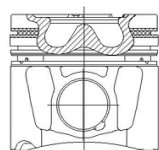
AK KK RT TP



08-103000-00 STD
08-103007-00 0.50mm

- 1.75  CK P
- 2.00  P
- 3.00  CR P



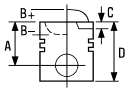

87-103000-40 ② STD

- A 78.31
- B- 17.25
- BØ 36.00
- C 1.38
- C 1.38
- D 71.83
- 26x58

AK KK RT TP

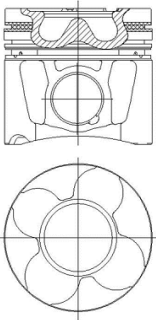

- ① To cylinder 1 - 3
- ② To cylinder 4 - 6

08-103000-00 STD
08-103007-00 0.50mm

- 1.75 CK P
- 2.00 P
- 3.00 CR P

- ① zum Zylinder 1 - 3
- ② zum Zylinder 4 - 6

- ① sous cylindre 1 - 3
- ② sous cylindre 4 - 6

- ① A cilindro 1 - 3
- ② A cilindro 4 - 6

- ① al cilindro 1 - 3
- ② al cilindro 4 - 6

10 **79.50**

80 1.9 D	08/89→08/91	1Y	4 Cyl.	22.5:1	TD213
			1896cc	50kW (68PS)	
			Diesel		
100 2.4 D	08/89→07/91	3D	5 Cyl.	23:1	TD218
			2370cc	60kW (82PS)	
			Diesel		



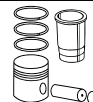
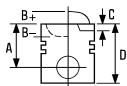

100 2.4 D	12/90→06/94	AAS	5 Cyl. 2370cc	23:1 60kW (82PS)					
		Diesel							TD227

87-990100-40	STD
87-990105-40	0.25mm
87-990107-40 ¹	0.50mm
87-990111-40 ¹	1.00mm

08-990100-00	STD
08-990105-00	0.25mm
08-990107-00	0.50mm
08-990111-00	1.00mm

A	39.65
B-	1.90
D	65.70
	24x64

1.75		CR P
2.00		P
3.00		CR P

14-027950-00 D B 82.50 C 152.00 D 85.50 E 4.70

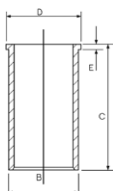

AK RT

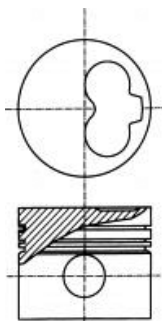

07945

¹ A = 39.400

¹ A = 39.400

¹ A = 39.400

¹ A = 39.400

¹ A = 39.400

11 79.50

80 1.9 TDI	09/91→01/96	1Z	4 Cyl.	19.5:1		
A4 1.9 TDI	01/95→09/01		1896cc	66kW (90PS)		
A6 1.9 TDI	06/94→12/97	Diesel	Turbo Intercooled			TD214
Cabriolet 1.9 TDI	06/95→08/00					
A4 1.9 TDI	12/95→09/01	AFF	4 Cyl.	19.5:1		
			1896cc	55kW (75PS)		
		Diesel	Turbo Intercooled			TD11597
A4 1.9 TDI	10/95→09/01	AFN	4 Cyl.	19.5:1		
A6 1.9 TDI	04/97→04/01		1896cc	81kW (110PS)		
		Diesel	Turbo Intercooled			TD4202
A3 1.9 TDI	09/96→07/01	AGR	4 Cyl.	19.5:1		
			1896cc	66kW (90PS)		
		Diesel	Turbo Intercooled			TD5076
A3 1.9 TDI	08/97→07/01	AHF	4 Cyl.	19.5:1		
			1896cc	81kW (110PS)		
		Diesel	Turbo Intercooled			TD9371
A4 1.9 TDI	01/95→09/01	AHH	4 Cyl.	19.5:1		
			1896cc	66kW (90PS)		
		Diesel	Turbo Intercooled			TD16413



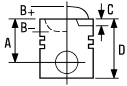

A4 1.9 DUO	03/98→09/01	AHU			
A4 1.9 TDI	01/95→09/01		4 Cyl.	19.5:1	
A6 1.9 TDI	06/94→12/97		1896cc	66kW (90PS)	
Cabriolet 1.9 TDI	06/95→08/00	Diesel	Turbo Intercooled		TD10814
A3 1.9 TDI	09/96→07/01	ALH			
			4 Cyl.	19.5:1	
			1896cc	66kW (90PS)	
		Diesel	Turbo Intercooled		TD11595
A3 1.9 TDI	08/97→07/01	ASV			
			4 Cyl.	19.5:1	
			1896cc	81kW (110PS)	
		Diesel	Turbo Intercooled		TD15354
A4 1.9 TDI	10/95→09/01	AVG			
A6 1.9 TDI	04/97→10/00		4 Cyl.	19.5:1	
			1896cc	81kW (110PS)	
		Diesel	Turbo Intercooled		TD13774
A4 1.9 TDI	06/04→06/08	BKE			
			4 Cyl.	19:1	
			1896cc	85kW (116PS)	
		Diesel	Turbo Intercooled		TD17596

- 87-114900-60 1 3 STD
- 87-114905-60 1 3 0.25mm
- 87-114907-60 1 3 5 0.50mm
- 87-114911-60 1 3 5 1.00mm

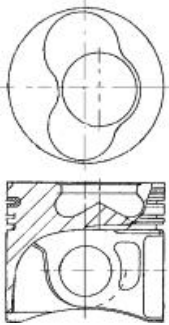

- A** 45.80
- B-** 17.65
- BØ** 38.00
- C** 1.10
- D** 68.80
-  26x66

AK KK NB RT



07987

- 08-114900-00 STD
- 08-114905-00 0.25mm
- 08-114907-00 0.50mm
- 08-114911-00 1.00mm

- 1.75  CK P
- 2.00  P
- 3.00  CR P

14-027950-00 D B 82.50 C 152.00 D 85.50 E 4.70

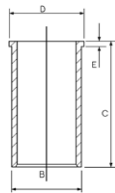

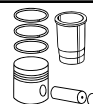
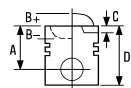



87-114900-70 ② ③ STD
 87-114905-70 ② ③ 0.25mm
 87-114907-70 ② ③ ⑤ 0.50mm
 87-114911-70 ② ③ ⑤ 1.00mm

08-114900-00 STD
 08-114905-00 0.25mm
 08-114907-00 0.50mm
 08-114911-00 1.00mm

A 45.80
 B- 17.65
 BØ 38.00
 C 1.10
 D 68.80
 26x66

1.75  CK P
 2.00  P
 3.00  CR P

AK KK NB RT

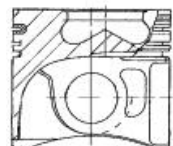
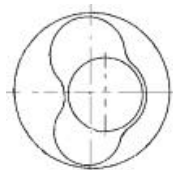



07987A

87-114900-90 ① STD
 87-114905-90 ① 0.25mm
 87-114907-90 ① ④ 0.50mm
 87-114911-90 ① ④ 1.00mm

08-114900-00 STD
 08-114905-00 0.25mm
 08-114907-00 0.50mm
 08-114911-00 1.00mm

A 45.80
 B- 17.65
 BØ 38.00
 C 1.10
 D 71.80
 26x66

1.75  CK P
 2.00  P
 3.00  CR P

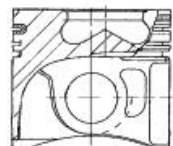
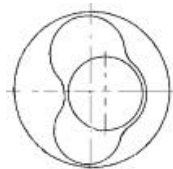

AK NB RT





87-114900-95 [2]	STD	08-114900-00	STD
87-114905-95 [2]	0.25mm	08-114905-00	0.25mm
87-114907-95 [2] [4]	0.50mm	08-114907-00	0.50mm
87-114911-95 [2] [4]	1.00mm	08-114911-00	1.00mm

A	45.80
B-	17.65
BØ	38.00
C	1.10
D	71.80
	26x66

1.75		CK P
2.00		P
3.00		CR P

AK NB RT

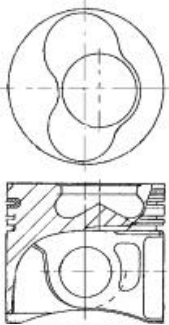

- [1] To cylinder 1 & 2
- [2] To cylinder 3 & 4
- [3] Piston Chamber Volume [ccm] 23.54
- [4] A = 45.550, D = 71.550
- [5] A = 45.550, D = 68.550

- [1] zum Zylinder 1 & 2
- [2] zum Zylinder 3 & 4
- [3] Volumen der Kolbenmulde [ccm] 23.54
- [4] A = 45.550, D = 71.550
- [5] A = 45.550, D = 68.550

- [1] sous cylindre 1 & 2
- [2] sous cylindre 3 & 4
- [3] Volume de la cavité du piston [cm³] 23.54
- [4] A = 45.550, D = 71.550
- [5] A = 45.550, D = 68.550

- [1] A cilindro 1 & 2
- [2] A cilindro 3 & 4
- [3] Volumen de cavidad del pistón [cc] 23.54
- [4] A = 45.550, D = 71.550
- [5] A = 45.550, D = 68.550

- [1] al cilindro 1 & 2
- [2] al cilindro 3 & 4
- [3] Volume camera pistone [cm³] 23.54
- [4] A = 45.550, D = 71.550
- [5] A = 45.550, D = 68.550

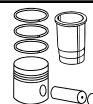
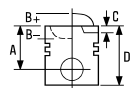

12 **79.50**

80 1.9 TD	09/91 → 12/94	AAZ	4 Cyl. 1896cc	22.5:1 55kW (75PS)	
		Diesel	Turbo		TD229

Engine	04/94 → 01/02	ADE	4 Cyl. 1896cc	22.5:1 55kW (75PS)	
		Diesel	Turbo		TD22656

87-990100-10	STD	08-990100-00	STD	14-027950-00 D	B 82.50 C 152.00 D 85.50 E 4.70
87-990105-10	0.25mm	08-990105-00	0.25mm		
87-990107-10	0.50mm	08-990107-00	0.50mm		
87-990111-10	1.00mm	08-990111-00	1.00mm		

A	45.65	1.75		CR P
B-	1.90	2.00		P
D	71.70	3.00		CR P
	26x66			

AK HA RT

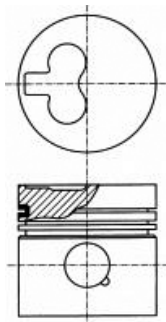

A = 45.430

A = 45.430

A = 45.430

A = 45.430





A = 45.430



13  **79.50**

A4 1.9 TDI	03/00→09/01	AJM			
A6 1.9 TDI	07/00→01/05		4 Cyl.	19.5:1	
		Diesel	1896cc	85kW (115PS)	
			Turbo Intercooled		TD11527

A4 1.9 TDI	03/00→09/01	ATJ			
		Diesel	4 Cyl.	19.5:1	
			1896cc	85kW (115PS)	
			Turbo Intercooled		TD15989

87-114900-05   STD
 87-114907-05    0.50mm

→09/02

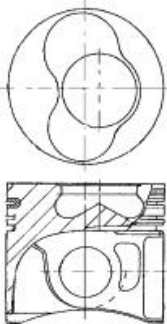

- A** 45.80
- B-** 17.80
- BØ** 38.00
- C** 1.30
- D** 68.80
-  26x66

AK KK NB RT TP







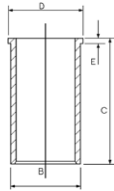

07969L-101

08-114900-00 STD
 08-114905-00 0.25mm
 08-114907-00 0.50mm
 08-114911-00 1.00mm

- 1.75  CK P
- 2.00  P
- 3.00  CR P

14-027950-00 D B 82.50 C 152.00 D 85.50 E 4.70



87-114900-15   STD
 87-114907-15    0.50mm

→09/02

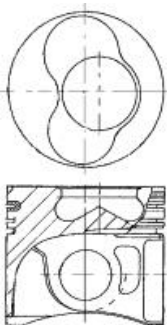

- A** 45.80
- B-** 17.80
- BØ** 38.00
- C** 1.30
- D** 68.80
-  26x66

AK KK NB RT TP



07969L-102

08-114900-00 STD
 08-114905-00 0.25mm
 08-114907-00 0.50mm
 08-114911-00 1.00mm

- 1.75  CK P
- 2.00  P
- 3.00  CR P



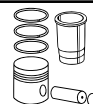
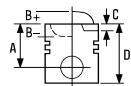



87-114900-55 1 3 5 STD
87-114907-55 1 6 5 0.50mm

09/02→

A 45.80
B- 17.60
BØ 38.00
C 1.10
D 68.80
 26x66

08-114900-00 STD
08-114905-00 0.25mm
08-114907-00 0.50mm
08-114911-00 1.00mm

1.75  CK P
2.00  P
3.00  CR P

AK KK NB RT TP

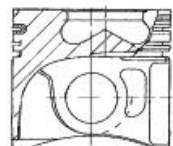
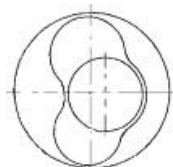



07901D101

87-114900-56 2 3 5 STD
87-114907-56 2 6 5 0.50mm

09/02→

A 45.80
B- 17.60
BØ 38.00
C 1.10
D 68.60
 26x66

08-114900-00 STD
08-114905-00 0.25mm
08-114907-00 0.50mm
08-114911-00 1.00mm

1.75  CK P
2.00  P
3.00  CR P

AK KK NB RT TP

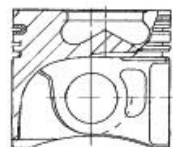
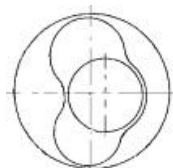

07901D102

- 1 To cylinder 1 & 2
- 2 To cylinder 3 & 4
- 3 Piston Chamber Volume [ccm] 23.60
- 4 For side angled injection nozzle
- 5 For newer design straight injection nozzle
- 6 A = 45.550, D = 68.550

- 1 zum Zylinder 1 & 2
- 2 zum Zylinder 3 & 4
- 3 Volumen der Kolbenmulde [ccm] 23.60
- 4 Nur für schräg angeordnete Einspritzdüsen
- 5 Für neuere Ausführungen, direkt einspritzende Düsen
- 6 A = 45.550, D = 68.550

- 1 sous cylindre 1 & 2
- 2 sous cylindre 3 & 4
- 3 Volume de la cavité du piston [cm³] 23.60
- 4 Pour buse d'injection latérale angulaire
- 5 Pour buse d'injection droite à conception plus récente
- 6 A = 45.550, D = 68.550

- 1 A cilindro 1 & 2
- 2 A cilindro 3 & 4
- 3 Volumen de cavidad del pistón [cc] 23.60
- 4 Para la boquilla de inyección lateral angular
- 5 Para el más reciente diseño de boquilla de inyección directa
- 6 A = 45.550, D = 68.550



- 1 al cilindro 1 & 2
- 2 al cilindro 3 & 4
- 3 Volume camera pistone [cm³] 23.60
- 4 Per il lato angolato dell'ugello olio
- 5 Per la più recente progettazione dell'ugello olio non angolato
- 6 A = 45.550, D = 68.550



14  **79.50**



A2 1.4 TDI	02/00→08/05	AMF	3 Cyl.	19.5:1
		Diesel	1422cc	55kW (75PS)
			Turbo Intercooled	TD17156

A2 1.4 TDI	02/00→08/05	BHC	3 Cyl.	19.5:1
		Diesel	1422cc	55kW (75PS)
			Turbo Intercooled	TD18133

87-114900-80   STD
87-114907-80  0.50mm

A 45.80
B- 17.65
BØ 38.00
C 1.10
D 69.80
 26x63

08-114900-00 STD
08-114905-00 0.25mm
08-114907-00 0.50mm
08-114911-00 1.00mm

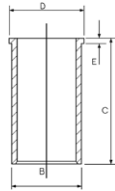

1.75  CK P
 2.00  P
 3.00  CR P

14-027950-00 D B 82.50 C 152.00 D 85.50 E 4.70



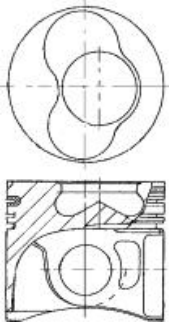

AK KK NB RT TP



87-114900-85   STD
87-114907-85  0.50mm



A 45.80
B- 17.65
BØ 38.00
C 1.10
D 69.80
 26x63



08-114900-00 STD
08-114905-00 0.25mm
08-114907-00 0.50mm
08-114911-00 1.00mm

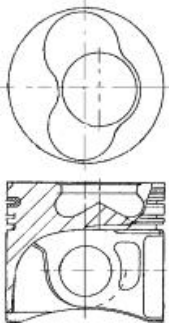

1.75  CK P
 2.00  P
 3.00  CR P



AK KK NB RT TP





 To cylinder 1 & 2
 To cylinder 3
 Piston Chamber Volume
 [ccm] 23.75

 zum Zylinder 1 & 2
 zum Zylinder 3
 Volumen der Kolbenmulde
 [ccm] 23.75

 sous cylindre 1 & 2
 sous cylindre 3
 Volume de la cavité du piston
 [cm³] 23.75



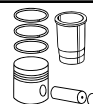
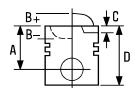

 A cilindro 1 & 2
 A cilindro 3
 Volumen de cavidad del pistón
 [cc] 23.75

 al cilindro 1 & 2
 al cilindro 3
 Volume camera pistone
 [cm³] 23.75





15  **79.50**

A3 1.9 TDI	10/00 → 05/03	ANU	4 Cyl. 1896cc Diesel	18:1 66kW (90PS) Turbo Intercooled	TD11596
A3 1.9 TDI	10/00 → 05/03	ATD	4 Cyl. 1896cc Diesel	19:1 74kW (101PS) Turbo Intercooled	TD16028
A4 1.9 TDI	05/01 → 12/04	AVB	4 Cyl. 1896cc Diesel	19:1 74kW (101PS) Turbo Intercooled	TD16518
A3 1.9 TDI	10/00 → 05/03	AXR	4 Cyl. 1896cc Diesel	19:1 74kW (100PS) Turbo Intercooled	TD16416
A3 1.9 TDI	05/03 → 05/10	BKC	4 Cyl. 1896cc Diesel	19:1 77kW (105PS) Turbo Intercooled	TD17026
A3 1.9 TDI	05/03 → 05/10	BLS	4 Cyl. 1896cc Diesel	19:1 77kW (105PS) Turbo Intercooled	TD20823
A3 1.9 TDI	05/03 → 05/10	BXE	4 Cyl. 1896cc Diesel	19:1 77kW (105PS) Turbo Intercooled	TD22657

87-114900-65   STD
87-114907-65   0.50mm

A 45.80
B- 17.20
BØ 38.00
C 1.10
D 68.80
 26x66

08-114900-00 STD
08-114905-00 0.25mm
08-114907-00 0.50mm
08-114911-00 1.00mm

1.75  CK P
2.00  P
3.00  CR P

14-027950-00 D B 82.50 C 152.00 D 85.50 E 4.70

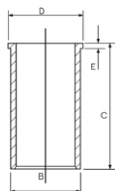

AK KK NB RT TP

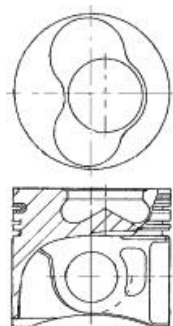

07901D-301





87-114900-66 ② ③ STD
87-114907-66 ② ④ 0.50mm

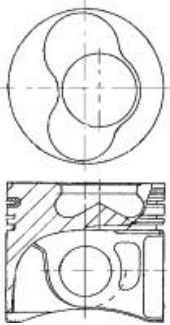

A 45.80
B- 17.20
BØ 38.00
C 1.10
D 68.80
 26x66

AK KK NB RT TP



07901D-302

08-114900-00 STD
08-114905-00 0.25mm
08-114907-00 0.50mm
08-114911-00 1.00mm

1.75  CK P
2.00  P
3.00  CR P

- ① To cylinder 1 & 2
- ② To cylinder 3 & 4
- ③ Piston Chamber Volume [ccm] 22.85
- ④ A = 45.550, D = 68.550

- ① zum Zylinder 1 & 2
- ② zum Zylinder 3 & 4
- ③ Volumen der Kolbenmulde [ccm] 22.85
- ④ A = 45.550, D = 68.550

- ① sous cylindre 1 & 2
- ② sous cylindre 3 & 4
- ③ Volume de la cavité du piston [cm³] 22.85
- ④ A = 45.550, D = 68.550

- ① A cilindro 1 & 2
- ② A cilindro 3 & 4
- ③ Volumen de cavidad del pistón [cc] 22.85
- ④ A = 45.550, D = 68.550

- ① al cilindro 1 & 2
- ② al cilindro 3 & 4
- ③ Volume camera pistone [cm³] 22.85
- ④ A = 45.550, D = 68.550

16  79.50

A3 1.9 TDI	08/00→05/03	ASZ	4 Cyl.	19.5:1	
			1896cc	96kW (130PS)	
		Diesel	Turbo Intercooled		TD15351
A4 1.9 TDI	11/00→12/04	AVF	4 Cyl.	19:1	
A6 1.9 TDI	08/01→01/05		1896cc	96kW (130PS)	
		Diesel	Turbo Intercooled		TD15348



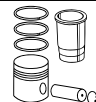
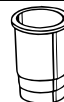
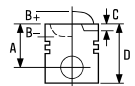

A4 1.9 TDI	11/00 → 12/04	AWX		
A6 1.9 TDI	08/01 → 01/05		4 Cyl.	19:1
			1896cc	96kW (130PS)
		Diesel	Turbo Intercooled	
				TD16133

87-114900-25 STD
 87-114907-25 0.50mm
 →09/02
A 45.80
B- 17.90
BØ 38.00
C 1.10
D 68.80
 26x66

08-114900-00 STD
 08-114905-00 0.25mm
 08-114907-00 0.50mm
 08-114911-00 1.00mm

1.75 CK P
 2.00 P
 3.00 CR P

14-027950-00 D B 82.50 C 152.00 D 85.50 E 4.70

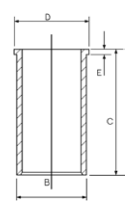

AK KK NB RT TP

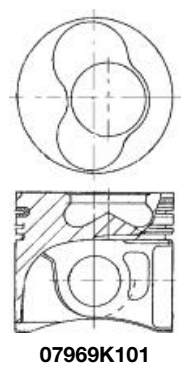

87-114900-35 STD
 87-114907-35 0.50mm
 →09/02
A 45.80
B- 17.90
BØ 38.00
C 1.10
D 68.80
 26x66

08-114900-00 STD
 08-114905-00 0.25mm
 08-114907-00 0.50mm
 08-114911-00 1.00mm

1.75 CK P
 2.00 P
 3.00 CR P

AK KK NB RT TP

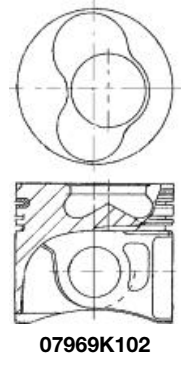

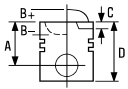

87-114900-45 1 3 STD
87-114907-45 1 5 0.50mm

09/02 →

A 45.80
B- 17.50
BØ 38.00
C 1.10
D 68.80
 26x66

AK KK NB RT TP

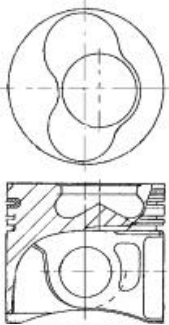

07901C105

08-114900-00 STD
08-114905-00 0.25mm
08-114907-00 0.50mm
08-114911-00 1.00mm

1.75 CK P
2.00 P
3.00 CR P

87-114900-46 2 3 STD
87-114907-46 2 5 0.50mm

09/02 →

A 45.80
B- 17.50
BØ 38.00
C 1.10
D 68.80
 26x66

AK KK NB RT TP

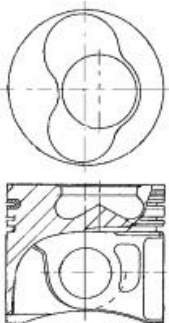

07901C106

08-114900-00 STD
08-114905-00 0.25mm
08-114907-00 0.50mm
08-114911-00 1.00mm

1.75 CK P
2.00 P
3.00 CR P

- 1 To cylinder 1 & 2
- 2 To cylinder 3 & 4
- 3 Piston Chamber Volume [ccm] 24.05
- 4 Piston Chamber Volume [ccm] 24.60
- 5 A = 45.550, D = 68.550

- 1 zum Zylinder 1 & 2
- 2 zum Zylinder 3 & 4
- 3 Volumen der Kolbenmulde [ccm] 24.05
- 4 Volumen der Kolbenmulde [ccm] 24.60
- 5 A = 45.550, D = 68.550

- 1 sous cylindre 1 & 2
- 2 sous cylindre 3 & 4
- 3 Volume de la cavité du piston [cm³] 24.05
- 4 Volume de la cavité du piston [cm³] 24.60
- 5 A = 45.550, D = 68.550

- 1 A cilindro 1 & 2
- 2 A cilindro 3 & 4
- 3 Volumen de cavidad del pistón [cc] 24.05
- 4 Volumen de cavidad del pistón [cc] 24.60
- 5 A = 45.550, D = 68.550

- 1 al cilindro 1 & 2
- 2 al cilindro 3 & 4
- 3 Volume camera pistone [cm³] 24.05
- 4 Volume camera pistone [cm³] 24.60
- 5 A = 45.550, D = 68.550

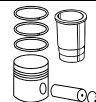
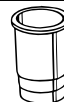
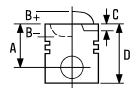

17  **79.50**

A2 1.4 TDI	11/03→08/05	ATL	3 Cyl.	18:1
		Diesel	1422cc	66kW (90PS)
			Turbo Intercooled	TD17071



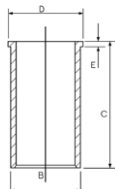



14-027950-00 D B 82.50 C 152.00 D 85.50 E 4.70



18  **79.50**



A4 1.9 TDI	11/04→06/08	BRB	4 Cyl.	19:1
		Diesel	1896cc	85kW (116PS)
			Turbo Intercooled	TD20492

14-027950-00 D B 82.50 C 152.00 D 85.50 E 4.70

87-114900-55    STD
 87-114907-55    0.50mm

08-114900-00 STD
 08-114905-00 0.25mm
 08-114907-00 0.50mm
 08-114911-00 1.00mm

A 45.80
 B- 17.60
 BØ 38.00
 C 1.10
 D 68.80
 26x66

1.75  CK P
 2.00  P
 3.00  CR P

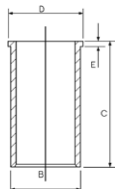

AK KK NB RT TP

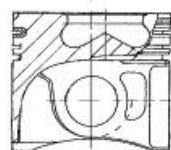
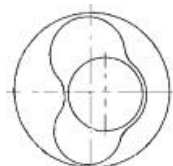

07901D101



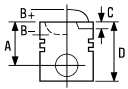

87-114900-56 2 3 4 STD
 87-114907-56 2 5 4 0.50mm

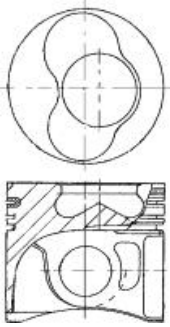

A 45.80
 B- 17.60
 BØ 38.00
 C 1.10
 D 68.60
 26x66

AK KK NB RT TP



07901D102

08-114900-00 STD
 08-114905-00 0.25mm
 08-114907-00 0.50mm
 08-114911-00 1.00mm

1.75  CK P
 2.00  P
 3.00  CR P

- 1 To cylinder 1 & 2
- 2 To cylinder 3 & 4
- 3 Piston Chamber Volume [ccm] 23.60
- 4 For newer design straight injection nozzle
- 5 A = 45.550, D = 68.550

- 1 zum Zylinder 1 & 2
- 2 zum Zylinder 3 & 4
- 3 Volumen der Kolbenmulde [ccm] 23.60
- 4 Für neuere Ausführungen, direkt einspritzende Düsen
- 5 A = 45.550, D = 68.550

- 1 sous cylindre 1 & 2
- 2 sous cylindre 3 & 4
- 3 Volume de la cavité du piston [cm³] 23.60
- 4 Pour buse d'injection droite à conception plus récente
- 5 A = 45.550, D = 68.550

- 1 A cilindro 1 & 2
- 2 A cilindro 3 & 4
- 3 Volumen de cavidad del pistón [cc] 23.60
- 4 Para el más reciente diseño de boquilla de inyección directa
- 5 A = 45.550, D = 68.550

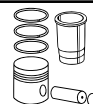
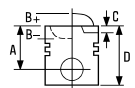

- 1 al cilindro 1 & 2
- 2 al cilindro 3 & 4
- 3 Volume camera pistone [cm³] 23.60
- 4 Per la più recente progettazione dell'ugello olio non angolato
- 5 A = 45.550, D = 68.550



19  **79.50**

A1 1.6 TDI	03/11→	CAYB			
A3 1.6 TDI	05/09→03/13		4 Cyl.	16.5:1	
			1598cc	66kW (90PS)	
		Diesel	Turbo Intercooled		TD22661
A1 1.6 TDI	05/10→	CAYC			
A3 1.6 TDI	05/09→05/13		4 Cyl.	16.5:1	
			1598cc	77kW (105PS)	
		Diesel	Turbo Intercooled		TD22662

87-432900-00 	STD	08-432900-00	STD
87-432905-00	0.25mm	08-432905-00	0.25mm
87-432907-00	0.50mm	08-432907-00	0.50mm

A	45.30	1.75		GDC P
B-	10.70	2.00		P
B-	4.70	3.00		CR P

BØ 49.00
D 67.80
 26x66



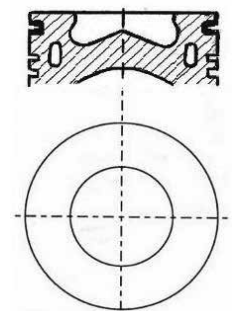

KK RT TP





0790MA-104

 Piston Chamber Volume
 [ccm] 19.750

 Volumen der Kolbenmulde
 [ccm] 19.750

 Volume de la cavité du piston
 [cm³] 19.750

 Volumen de cavidad del pistón
 [cc] 19.750

 Volume camera pistone
 [cm³] 19.750

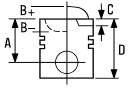



20  **81.00**

100 1.8 CAT	03/85→11/90	4B	4 Cyl. 1781cc	9:1 66kW (90PS)	TD219
100 1.8	08/82→12/87	DR	4 Cyl. 1781cc	8.75:1 55kW (75PS)	TD252
80 1.8	09/83→12/86	MG	4 Cyl. 1781cc	10:1 76-79kW (103-107PS)	TD297
80 1.8 S	09/86→10/91	PM	4 Cyl. 1781cc	9:1 66kW (90PS)	TD306
100 1.8	08/82→12/87	RS	4 Cyl. 1781cc	8.75:1 55kW (75PS)	TD317
80 1.8	10/86→01/90	RU	4 Cyl. 1781cc	8.75:1 55kW (75PS)	TD320
80 1.8 80 1.8 S Coupe 1.8 GT	02/86→07/86 08/86→07/90 04/86→10/88	SF	4 Cyl. 1781cc	10:1 65kW (88PS)	TD325
100 1.8	02/86→07/90	SH	4 Cyl. 1781cc	9:1 65-66kW (88-90PS)	TD326

87-109707-10 0.50mm
A 31.90
B- 8.10
B+ 1.10
BØ 56.80
D 62.00
 20x54

08-109700-00 STD
08-109705-00 0.25mm
08-109707-00 0.50mm

1.50  CR P
 1.75  P
 3.00  CR P

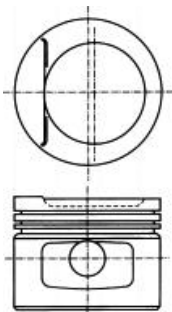

08131-122

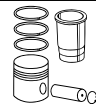
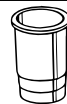
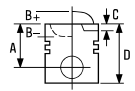

21  **81.00**



80 1.6	09/91→12/94	ABM	4 Cyl. 1595cc	9:1 52kW (71PS)	TD234
80 1.6 E	06/93→01/96	ADA	4 Cyl. 1595cc	10.3:1 74kW (101PS)	TD240
80 1.6	08/78→07/86	DT	4 Cyl. 1595cc	9:1 55kW (75PS)	TD4206
80 1.6	01/83→12/87	DTA	4 Cyl. 1595cc	9:1 51-55kW (69-75PS)	TD255
80 1.6	08/87→09/91	JU	4 Cyl. 1595cc	9:1 55kW (75PS)	TD277
80 1.6	08/87→09/91	PP	4 Cyl. 1595cc	9:1 51kW (70PS)	TD307
80 1.6	09/86→08/91	RN	4 Cyl. 1595cc	9:1 55kW (75PS)	TD314
80 1.6	02/86→07/86	SA	4 Cyl. 1595cc	9:1 54kW (73PS)	TD321

87-109707-20 

0.50mm

- 08-109700-00** STD
- 08-109705-00** 0.25mm
- 08-109707-00** 0.50mm

- A** 35.30
- B-** 2.30
- B+** 2.20
- D** 66.50
-  20x57

- 1.50  CR P
- 1.75  P
- 3.00  CR P

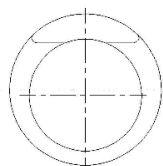
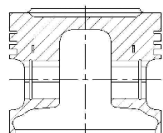



08132E

 A = 35.300, D = 66.500

 A = 35.300, D = 66.500

 A = 35.300, D = 66.500

 A = 35.300, D = 66.500

 A = 35.300, D = 66.500







22  **81.00**

A4 1.6	11/94→09/01	ADP	4 Cyl. 1595cc	10.3:1 74kW (101PS)	TD4198
A3 1.6	09/96→05/03	AEH	4 Cyl. 1595cc	10.3:1 74kW (101PS)	TD5074
A3 1.6	09/96→05/03	AKL	4 Cyl. 1595cc	10.3:1 74kW (101PS)	TD9990
A3 1.6	09/96→05/03	APF	4 Cyl. 1595cc	12:1 74kW (101PS)	TD11588
A4 1.6	11/94→09/01	ARM	4 Cyl. 1595cc	10.3:1 74kW (100PS)	TD14148



87-105900-00 STD
87-105907-00  0.50mm



A 32.00
B- 2.30
B+ 0.70
BØ 61.40
D 53.70
 **20x57**

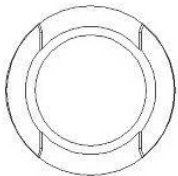
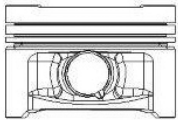

08-105900-00 STD
08-105907-00 0.50mm



1.20  **NT** 
 1.50  **P**
 2.00  **CR** 





 A = 31.700, D = 53.400
 Steel

 A = 31.700, D = 53.400
 Stahl

 A = 31.700, D = 53.400
 Acier

 A = 31.700, D = 53.400
 Acero

 A = 31.700, D = 53.400
 Acciaio

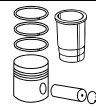
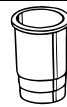
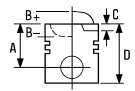





23  **81.00**

A4 1.8 A6 1.8 Cabriolet 1.8	01/95→09/01 12/95→12/97 01/97→08/00	ADR	4 Cyl. 1781cc	10.3:1 92-95kW (125-129PS)	TD241
A3 1.8	09/96→05/03	AGN	4 Cyl. 1781cc	10.3:1 92kW (125PS)	TD5073
A6 1.8	07/97→01/05	AJP	4 Cyl. 1781cc	10.3:1 92kW (125PS)	TD9518
A3 1.8	09/96→05/03	APG	4 Cyl. 1781cc	10.3:1 92kW (125PS)	TD11589
A4 1.8	01/95→09/01	APT	4 Cyl. 1781cc	10.3:1 92kW (125PS)	TD13775
A6 1.8	07/97→01/05	AQE	4 Cyl. 1781cc	10.3:1 92kW (125PS)	TD14029
A4 1.8	01/95→09/01	ARG	4 Cyl. 1781cc	10.3:1 92kW (125PS)	TD13776
A6 1.8	07/97→01/05	ARH	4 Cyl. 1781cc	10.3:1 92kW (125PS)	TD15329
A4 1.8	01/95→09/01	AVV	4 Cyl. 1781cc	10.3:1 92kW (125PS)	TD16412

87-502900-00 ¹ STD
87-502907-00 ¹ ² 0.50mm

08-502900-00 STD
08-502905-00 0.25mm
08-502907-00 0.50mm

A 32.55
C 3.60
D 56.55
 20x59

1.50  CK P
1.75  P
2.00  CR P

AK

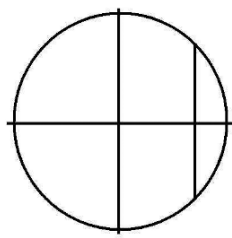
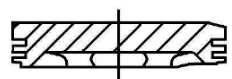

08192

¹ Conrod gap 27.50mm
² A = 32.250, D = 56.250

¹ Pleuelaugenabstand 27.50mm
² A = 32.250, D = 56.250

¹ Distance entre bielle 27.50mm
² A = 32.250, D = 56.250

¹ Distancia del biela 27.50mm
² A = 32.250, D = 56.250

¹ Distanza dalla bielle 27.50mm
² A = 32.250, D = 56.250

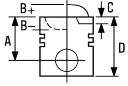

24  **81.00**

A4 1.8 T A6 1.8 T	01/95→09/01 01/97→01/05	AEB	4 Cyl. 1781cc Turbo Intercooled	9.5:1 110-112kW (150-152PS)	TD4199
A3 1.8 T	12/96→05/03	AGU Euro 2	4 Cyl. 1781cc Turbo Intercooled	9.5:1 110kW (150PS)	TD5075
A4 1.8 T A6 1.8 T	12/97→09/01 12/97→01/05	AJL	4 Cyl. 1781cc Turbo Intercooled	9.5:1 132kW (180PS)	TD9470
A3 1.8 T TT 1.8 T	10/98→05/03 10/98→06/06	AJQ	4 Cyl. 1781cc Turbo Intercooled	10.3:1 132kW (180PS)	TD11347
A4 1.8 T A6 1.8 T	01/95→09/01 01/97→01/05	ANB	4 Cyl. 1781cc Turbo Intercooled	9.5:1 110kW (150PS)	TD13949
A3 1.8 T TT 1.8 T	12/98→05/03 10/98→06/06	APP	4 Cyl. 1781cc Turbo Intercooled	9.5:1 132kW (180PS)	TD11591
A4 1.8 T A6 1.8 T	01/95→09/01 01/97→01/05	APU	4 Cyl. 1781cc Turbo Intercooled	9.5:1 110kW (150PS)	TD13950
A3 1.8 T	12/96→05/03	AQA	4 Cyl. 1781cc Turbo Intercooled	9.5:1 110kW (150PS)	TD11592
A4 1.8 T A6 1.8 T	01/95→09/01 01/97→01/05	ARK	4 Cyl. 1781cc Turbo Intercooled	9.5:1 110kW (150PS)	TD13929



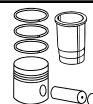
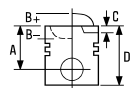



A3 1.8 T 12/96 → 05/03 **ARZ** 4 Cyl. 9.5:1
1781cc **110kW (150PS)**
Turbo Intercooled **TD11593**

87-502900-10	STD	08-502900-00	STD
87-502905-10	0.25mm	08-502905-00	0.25mm
87-502907-10	0.50mm	08-502907-00	0.50mm

A 32.70
B- 2.05
BØ 70.00
D 53.70
 20x59

1.50		CK P
1.75		P
2.00		CR P

AK

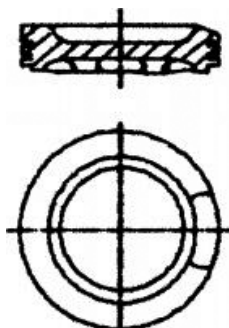







25  **81.00**

A4 1.6 11/94 → 09/01 **AHL** 4 Cyl. 10.3:1
1595cc **74kW (100PS)**
TD10816

87-105900-00	STD	08-105900-00	STD
87-105907-00 	0.50mm	08-105907-00	0.50mm

→8D X 400 000

A 32.00
B- 2.30
B+ 0.70
BØ 61.40
D 53.70
 20x57

1.20		NT 
1.50		P
2.00		CR 

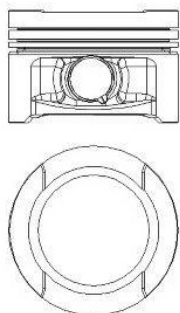



87-148300-00
87-148307-00

STD
0.50mm

08-148300-00
08-148307-00

STD
0.50mm

8D X 400 001 →

A 29.08
B- 2.70
BØ 62.30
D 50.70
19x42

1.00
1.20
2.00



NT 2
P
CR P

TP

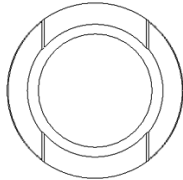
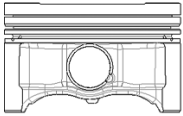

1 A = 31.700, D = 53.400
2 Steel

1 A = 31.700, D = 53.400
2 Stahl

1 A = 31.700, D = 53.400
2 Acier

1 A = 31.700, D = 53.400
2 Acero

1 A = 31.700, D = 53.400
2 Acciaio

26  81.00

A4 1.6	07/00 → 06/08	ALZ	4 Cyl. 1595cc	10.3:1 75kW (102PS)	TD15748
A4 1.6	11/94 → 09/01	ANA	4 Cyl. 1595cc	10.3:1 74kW (100PS)	TD14128
A3 1.6	08/00 → 05/03	AVU	4 Cyl. 1595cc	10.3:1 75kW (102PS)	TD15350
A3 1.6	08/00 → 05/03	BFQ	4 Cyl. 1595cc	10.2:1 75kW (102PS)	TD17166
A3 1.6	05/03 → 03/13	BGU	4 Cyl. 1595cc	10.3:1 75kW (102PS)	TD16871
A3 1.6	05/03 → 03/13	BSE	4 Cyl. 1595cc	75kW (102PS)	TD20711



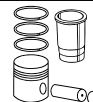
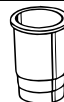
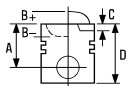





A3 1.6	05/03→03/13	BSF	4 Cyl.	1595cc	75kW (102PS)	TD20712
---------------	-------------	------------	--------	---------------	---------------------	----------------

87-148300-00	STD	08-148300-00	STD
87-148307-00	0.50mm	08-148307-00	0.50mm

A 29.08
B- 2.70
BØ 62.30
D 50.70
 19x42

1.00  NT 
 1.20  P
 2.00  CR P

TP

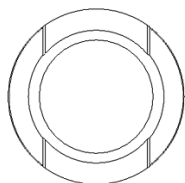
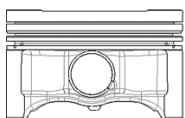

 Steel

 Stahl

 Acier

 Acero

 Acciaio

27  **81.00**

A4 1.8	05/00→09/00	AMB	4 Cyl.			
A4 1.8 T	07/01→10/05		1781cc	125-127kW (170-173PS)	Turbo Intercooled	TD17864
A3 1.8 T	12/96→05/03	ARX	4 Cyl.	9.5:1		
			1781cc	110kW (150PS)	Turbo Intercooled	TD15988
A3 1.8 T	10/98→05/03	ARY	4 Cyl.	9.5:1		
TT 1.8 T	10/98→06/06		1781cc	132kW (180PS)	Turbo Intercooled	TD15352
TT 1.8 T	10/98→06/06	ATC	4 Cyl.	9.5:1		
			1781cc	132kW (180PS)	Turbo Intercooled	TD15357
A3 1.8 T	12/96→05/03	AUM Euro 4	4 Cyl.	9.5:1		
TT 1.8 T	01/01→06/06		1781cc	110kW (150PS)	Turbo Intercooled	TD15629
A3 1.8 T	12/98→05/03	AUQ	4 Cyl.	9.5:1		
TT 1.8 T	10/98→06/06		1781cc	132kW (180PS)	Turbo Intercooled	TD15353



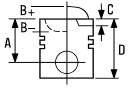

A4 1.8 T	11/00→07/02	AVJ	4 Cyl. 1781cc Turbo Intercooled	9.3:1 110kW (150PS)	TD15349
A4 1.8 T	01/95→11/00	AWM	4 Cyl. 1781cc Turbo Intercooled	125kW (170PS)	TD29751
TT 1.8 T	10/99→08/02	AWP	4 Cyl. 1781cc Turbo Intercooled	9.5:1 132-134kW (180-182PS)	TD15356
A4 1.8 T A6 1.8 T	01/95→09/01 01/97→01/05	AWT	4 Cyl. 1781cc Turbo Intercooled	9.5:1 110kW (150PS)	TD15335
A4 1.8 T	11/02→12/04	BEX	4 Cyl. 1781cc Turbo Intercooled	9.3:1 140kW (190PS)	TD16730
A4 1.8 T	07/02→03/09	BFB	4 Cyl. 1781cc Turbo Intercooled	9.3:1 120kW (163PS)	TD16728
TT 1.8 T	09/05→06/06	BVP	4 Cyl. 1781cc Turbo Intercooled	120kW (163PS)	TD18490
TT 1.8 T	09/05→06/06	BVR	4 Cyl. 1781cc Turbo Intercooled	140kW (190PS)	TD18493



87-502900-30
87-502907-30

STD
0.50mm

08-502900-00
08-502905-00
08-502907-00

STD
0.25mm
0.50mm

A 32.70
C 1.90
D 53.70
 19x49

1.50  **CK P**
1.75  **P**
2.00  **CR P**

TP

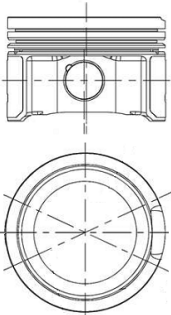

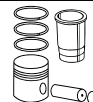
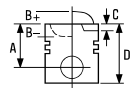

28  **81.00**

80 1.8 100 1.8 Coupe 1.8 GT	01/83→08/86 08/83→07/89 09/82→10/88	DS	4 Cyl. 1781cc	10:1 66kW (90PS)	TD253
80 1.8 E 80 1.8 GTE Coupe 1.8 Coupe 1.8 GT	06/86→08/91 08/84→08/86 08/89→07/91 12/84→10/88	DZ	4 Cyl. 1781cc	10:1 82kW (112PS)	TD256
80 1.8 80 1.8 CC Coupe 1.8 GT	01/83→08/86 08/84→08/86 09/82→10/88	JV	4 Cyl. 1781cc	10:1 66kW (90PS)	TD278
80 1.8 CC	08/84→08/86	MU	4 Cyl. 1781cc	10:1 82kW (112PS)	TD298
80 1.8 CC 80 1.8 S	08/84→08/86 09/86→10/91	NE	4 Cyl. 1781cc	10:1 66kW (90PS)	TD4210
100 1.8 CAT	03/85→11/90	PH	4 Cyl. 1781cc	9:1 66kW (90PS)	TD305
80 1.8 GTE Coupe 1.8 GT	03/85→08/86 08/86→10/87	PV	4 Cyl. 1781cc	10:1 79-81kW (107-110PS)	TD311

87-109400-50 

STD

08-109400-10

STD

87-109407-50  

0.50mm

08-109407-10

0.50mm

A 32.20

B- 4.40

B+ 1.30

BØ 55.70

D 62.50

 20x57

1.50

1.75

3.00



P PS

P

CR P

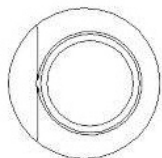
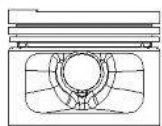

08130E-101

 Pistons to be replaced in Engine Sets only

 A = 31.900, D = 62.200

 Kolben nur Motorsätzen zu ersetzen

 A = 31.900, D = 62.200

 Piston à remplacer dans jeu moteur

 A = 31.900, D = 62.200

 Pistones de repuesto para juegos de motores solamente

 A = 31.900, D = 62.200

 Il pistone può essere rimpiazzato solamente completo

 A = 31.900, D = 62.200





29  **81.00**

80 2.2	09/83→12/87	JT			
90 2.2 E	08/85→03/87		5 Cyl.	10:1	
Coupe 2.2	08/85→10/88		2226cc	82-89kW (112-121PS)	
Quattro 2.2	12/84→07/87				TD276
80 2.2	09/84→12/86	KX			
90 2.2	01/85→03/87		5 Cyl.	10:1	
Coupe 2.2	09/83→12/87		2226cc	75-85kW (102-116PS)	
Coupe 2.2 GT	07/81→10/87				TD293
100 2.2	10/84→12/87	KZ			
			5 Cyl.	8.5:1	
			2226cc	82-85kW (112-116PS)	
					TD294

87-109707-00  0.50mm

A 31.90
B- 8.10
B+ 1.10
D 62.00
 20x57

08-109700-00 STD
 08-109705-00 0.25mm
 08-109707-00 0.50mm

1.50  CR P
 1.75  P
 3.00  CR P

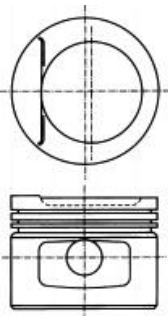

 A = 31.900, D = 62.000

 A = 31.900, D = 62.000

 A = 31.900, D = 62.000

 A = 31.900, D = 62.000

 A = 31.900, D = 62.000

30  **81.00**

100 2.5 TDI	01/90→11/90	1T			
			5 Cyl.	20:1	
			2461cc	88kW (120PS)	
		Diesel	Turbo Intercooled		TD212
100 2.5 TDI	12/90→06/94	AAT			
A6 2.5 TDI	06/94→12/97		5 Cyl.	20:1	
			2461cc	84-85kW (114-116PS)	
		Diesel	Turbo Intercooled		TD228
100 2.5 TDI	12/90→06/94	ABP			
			5 Cyl.	20:1	
			2461cc	85kW (115PS)	
		Diesel	Turbo Intercooled		TD235



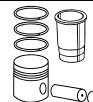
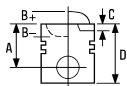

A6 2.5 TDI 08/94 → 12/97 **AEL** 5 Cyl. 20:1
2461cc **103kW (140PS)**
Diesel **Turbo Intercooled** **TD245**

87-501500-20 ① STD **08-501500-00** STD
87-501507-20 ① ③ 0.50mm **08-501507-00** 0.50mm

A	45.75	2.50		P PS
B-	17.25	2.00		CR P
BØ	39.60	3.00		CR P
C	1.35			
D	69.75			
	26x68			

AK NB RT

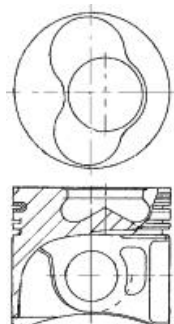

87-501500-30 ② STD **08-501500-00** STD
87-501507-30 ② ③ 0.50mm **08-501507-00** 0.50mm

A	45.75	2.50		P PS
B-	17.25	2.00		CR P
BØ	39.60	3.00		CR P
C	1.35			
D	69.75			
	26x68			

AK NB RT

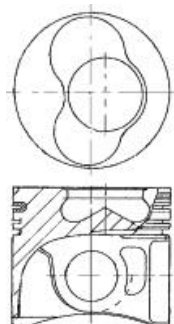

- | | | | | |
|--------------------------|--------------------------|--------------------------|--------------------------|--------------------------|
| ① To cylinder 1 & 2 | ① zum Zylinder 1 & 2 | ① sous cylindre 1 & 2 | ① A cilindro 1 & 2 | ① al cilindro 1 & 2 |
| ② To cylinder 3 - 5 | ② zum Zylinder 3 - 5 | ② sous cylindre 3 - 5 | ② A cilindro 3 - 5 | ② al cilindro 3 - 5 |
| ③ A = 45.500, D = 69.500 | ③ A = 45.500, D = 69.500 | ③ A = 45.500, D = 69.500 | ③ A = 45.500, D = 69.500 | ③ A = 45.500, D = 69.500 |

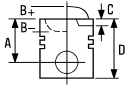

31  **81.00**





A3 2.0 TDI	05/03→03/13	AZV	4 Cyl. 1968cc	18:1 100kW (136PS)	TD17027
		Diesel	Turbo Intercooled		
A3 2.0 TDI 16V	05/03→03/13	BKD	4 Cyl. 1968cc	18:1 103kW (140PS)	TD17025
		Diesel	Turbo Intercooled		
A4 2.0 TDI 16V A6 2.0 TDI	11/04→06/08 07/04→10/08	BLB	4 Cyl. 1968cc	103kW (140PS)	TD17377
		Diesel	Turbo Intercooled		
A3 2.0 TDI	03/06→03/13	BMN	4 Cyl. 1968cc	18.5:1 125kW (170PS)	TD18991
		Diesel	Turbo Intercooled		
A4 2.0 TDI A6 2.0 TDI	11/04→06/08 07/04→08/11	BNA	4 Cyl. 1968cc	100kW (136PS)	TD18009
		Diesel	Turbo Intercooled		
A4 2.0 TDI	06/06→06/08	BRD	4 Cyl. 1968cc	125kW (170PS)	TD20402
		Diesel	Turbo Intercooled		
A4 2.0 TDI 16V A6 2.0 TDI	11/04→06/08 07/04→10/08	BRE	4 Cyl. 1968cc	103kW (140PS)	TD18029
		Diesel	Turbo Intercooled		
A4 2.0 TDI A6 2.0 TDI	11/04→06/08 07/04→08/11	BRF	4 Cyl. 1968cc	100kW (136PS)	TD18748
		Diesel	Turbo Intercooled		
A3 2.0 TDI	06/06→06/08	BUY	4 Cyl. 1968cc	18:1 120kW (163PS)	TD20403
		Diesel	Turbo Intercooled		
A4 2.0 TDI	06/06→06/08	BVA	4 Cyl. 1968cc	18:1 120kW (163PS)	TD20529
		Diesel	Turbo Intercooled		
A4 2.0 TDI	11/05→11/06	BVF	4 Cyl. 1968cc	18:1 93kW (126PS)	TD20497
		Diesel	Turbo Intercooled		





A4 2.0 TDI	09/05 → 09/06	BVG			
A6 2.0 TDI	09/05 → 06/06		4 Cyl.	18:1	
		Diesel	1968cc	89kW (121PS)	
			Turbo Intercooled		TD20496

87-139500-00 ①	STD	08-139500-00	STD
87-139507-00 ②	0.50mm	08-139507-00	0.50mm

A	45.83	1.75		CK P
B-	17.80	2.00		P
BØ	38.00	3.00		CR P
D	68.80			
	26x66			

AK KK NB RT TP

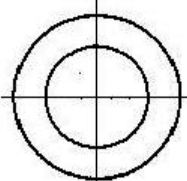

07901J

① Piston Chamber Volume
[ccm] 23.75
② A = 45.550, D = 68.550

① Volumen der Kolbenmulde
[ccm] 23.75
② A = 45.550, D = 68.550

① Volume de la cavité du piston
[cm³] 23.75
② A = 45.550, D = 68.550

① Volumen de cavidad del pistón
[cc] 23.75
② A = 45.550, D = 68.550



① Volume camera pistone
[cm³] 23.75
② A = 45.550, D = 68.550



32  **81.00**



A3 2.0 TDI	06/05→06/08	BMM	4 Cyl.	18:1
			1968cc	103kW (140PS)
		Diesel	Turbo Intercooled	TD18203

A4 2.0 TDI	11/04→03/09	BPW	4 Cyl.	103kW (140PS)
			1968cc	
		Diesel	Turbo Intercooled	TD18010

87-139500-10   STD
87-139507-10  0.50mm

08-139500-00 STD
08-139507-00 0.50mm



A 45.55
B- 17.50
BØ 38.00
C 0.70
D 68.80
 26x66

1.75  CK P
 2.00  P
 3.00  CR P

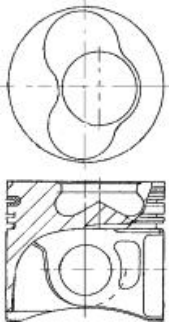
AK KK NB RT TP





07901D833

87-139500-20   STD
87-139507-20  0.50mm

08-139500-00 STD
08-139507-00 0.50mm



A 45.83
B- 17.50
BØ 38.00
C 0.70
D 68.80
 26x66

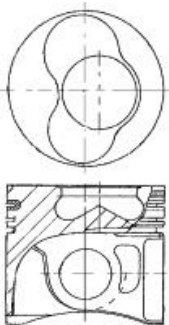

1.75  CK P
 2.00  P
 3.00  CR P



AK KK NB RT TP









07901D834

 To cylinder 1 & 2
 To cylinder 3 & 4
 Piston Chamber Volume
 [ccm] 23.30

 zum Zylinder 1 & 2
 zum Zylinder 3 & 4
 Volumen der Kolbenmulde
 [ccm] 23.30

 sous cylindre 1 & 2
 sous cylindre 3 & 4
 Volume de la cavité du piston
 [cm³] 23.30

 A cilindro 1 & 2
 A cilindro 3 & 4
 Volumen de cavidad del pistón
 [cc] 23.30

 al cilindro 1 & 2
 al cilindro 3 & 4
 Volume camera pistone
 [cm³] 23.30

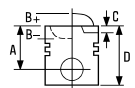

33  **81.00**

A4 2.0 TDI	11/07→	CAGA			
A5 2.0 TDI	09/09→		4 Cyl.	16:1	
Q5 2.0 TDI	08/09→		1968cc	105kW (143PS)	
		Diesel	Turbo Intercooled		TD20597
A4 2.0 TDI	11/07→	CAGB			
A5 2.0 TDI	09/09→		4 Cyl.	16:1	
A6 2.0 TDI	07/04→08/11		1968cc	100kW (136PS)	
Q5 2.0 TDI	08/09→	Diesel	Turbo Intercooled		TD20598
A4 2.0 TDI	06/08→12/15	CAGC			
			4 Cyl.	16.5:1	
			1968cc	88kW (120PS)	
		Diesel	Turbo Intercooled		TD21118
A4 2.0 TDI	01/08→	CAHA			
A5 2.0 TDI	08/08→		4 Cyl.	16:1	
A6 2.0 TDI	10/08→08/11		1968cc	125kW (170PS)	
Q5 2.0 TDI	11/08→	Diesel	Turbo Intercooled		TD20602
A4 2.0 TDI	08/08→	CAHB			
A5 2.0 TDI	08/08→		4 Cyl.	16:1	
A6 2.0 TDI	04/09→08/11		1968cc	120kW (163PS)	
Q5 2.0 TDI	11/08→	Diesel	Turbo Intercooled		TD20864
A3 2.0 TDI	05/03→05/13	CBA A			
			4 Cyl.	16:1	
			1968cc	100kW (136PS)	
		Diesel	Turbo Intercooled		TD20825
A3 2.0 TDI	04/08→05/13	CBAB			
A3 2.0 TDI 16V	05/03→03/13		4 Cyl.	16:1	
			1968cc	103kW (140PS)	
		Diesel	Turbo Intercooled		TD20828
A3 2.0 TDI	03/06→03/13	CBBB			
TT 2.0 TDI	06/08→06/14		4 Cyl.	16:1	
			1968cc	125kW (170PS)	
		Diesel	Turbo Intercooled		TD20939



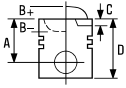

A4 2.0 TDI A5 2.0 TDI	11/07→12/15 09/09→	CMEA	4 Cyl. 1968cc 105kW (143PS)	Diesel Turbo Intercooled	TD23939
--------------------------	-----------------------	------	-----------------------------------	-----------------------------	---------

87-432300-00 ①	STD	08-432300-00 ②	STD
87-432307-00 ①	0.50mm	08-432307-00	0.50mm

A	45.80	1.75		GDC P
B-	12.70	2.00		P
BØ	50.88	3.00		CR P

D 68.80
26x66



HA KK NB RT TP

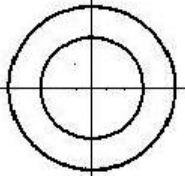

07901G202

① OE 03L 107 065G, Gen 1 engine only ① OE 03L 107 065G, nur für Motoren der Generation 1 ① N°OE 03L 107 065G, uniquement pour Moteur de génération 1 ① OE 03L 107 065G, Generación 1 solo motor ① Solo motore Generation 1
 ② 08-432300-00 OE: 03L198151A ② 08-432300-00 OE: 03L198151A ② 08-432300-00 OE: 03L198151A ② 08-432300-00 OE: 03L198151A ② 08-432300-00 OE: 03L198151A

34 81.00

A3 2.0 TDI Q3 2.0 TDI	05/03→05/13 09/11→	CFFA	4 Cyl. 1968cc 100kW (136PS)	16.5:1 Diesel Turbo Intercooled	TD23858
A3 2.0 TDI A3 2.0 TDI 16V Q3 2.0 TDI	04/08→05/13 05/03→03/13 09/11→	CFFB	4 Cyl. 1968cc 103kW (140PS)	16.5:1 Diesel Turbo Intercooled	TD23859
A3 2.0 TDI TT 2.0 TDI	03/06→03/13 06/08→06/14	CFGB	4 Cyl. 1968cc 125kW (170PS)	16.5:1 Diesel Turbo Intercooled	TD23857
Q3 2.0 TDI	06/11→	CFGC	4 Cyl. 1968cc 130kW (177PS)	16.5:1 Diesel Turbo Intercooled	TD25727
Q3 2.0 TDI	06/11→	CFGD	4 Cyl. 1968cc 120kW (163PS)	16.5:1 Diesel Turbo Intercooled	TD25728
A1 2.0 TDI	05/12→	CFHB	4 Cyl. 1968cc 100kW (136PS)	16.5:1 Diesel Turbo Intercooled	TD25662



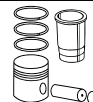
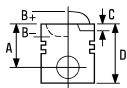

A1 2.0 TDI	09/11→	CFHD	4 Cyl. 1968cc	16.5:1 105kW (143PS)	TD24939
		Diesel	Turbo Intercooled		
Q5 2.0 TDI	11/08→	CGLA	4 Cyl. 1968cc	120kW (163PS)	TD24406
		Diesel	Turbo Intercooled		
Q5 2.0 TDI	11/08→	CGLB	4 Cyl. 1968cc	125kW (170PS)	TD24948
		Diesel	Turbo Intercooled		
A4 2.0 TDI	11/11→	CGLC	4 Cyl. 1968cc	130kW (177PS)	TD24870
A5 2.0 TDI	10/11→				
A6 2.0 TDI	03/11→				
Q5 2.0 TDI	06/12→	Diesel	Turbo Intercooled		
A4 2.0 TDI	08/08→	CGLD	4 Cyl. 1968cc	120kW (163PS)	TD24943
A5 2.0 TDI	08/08→				
A6 2.0 TDI	03/11→				
Q5 2.0 TDI	11/08→	Diesel	Turbo Intercooled		
A6 2.0 TDI	01/12→	CGLE	4 Cyl. 1968cc	100kW (136PS)	TD26329
		Diesel	Turbo Intercooled		
A4 2.0 TDI	11/07→	CJCA	4 Cyl. 1968cc	105kW (143PS)	TD24949
A5 2.0 TDI	09/09→				
Q5 2.0 TDI	08/09→	Diesel	Turbo Intercooled		
A4 2.0 TDI	11/07→	CJCB	4 Cyl. 1968cc	100kW (136PS)	TD24941
A5 2.0 TDI	09/09→				
Q5 2.0 TDI	08/09→	Diesel	Turbo Intercooled		
A3 2.0 TDI 16V	05/03→03/13	CLJA	4 Cyl. 1968cc	16.5:1 103kW (140PS)	TD23938
Q3 2.0 TDI	09/11→	Diesel	Turbo Intercooled		
Q3 2.0 TDI	06/11→	CLLB	4 Cyl. 1968cc	130kW (177PS)	TD25729
		Diesel	Turbo Intercooled		
Q5 2.0 TDI	11/08→	CMGA	4 Cyl. 1968cc	125kW (170PS)	TD25767
		Diesel	Turbo Intercooled		



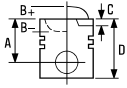

A4 2.0 TDI	11/11→12/15	CMGB			
A6 2.0 TDI	03/11→		4 Cyl.		
Q5 2.0 TDI	06/12→		1968cc	130kW (177PS)	
		Diesel	Turbo Intercooled		TD24871

87-432300-10 ①	STD	08-432300-10 ② ③	STD
87-432307-10 ①	0.50mm	08-432307-10 ② ③	0.50mm

A	45.80	1.75		GDC P
B-	13.10	2.00		MO P
BØ	50.88	3.00		CR P

D 68.80
 26x66



AK KK NB RT TP

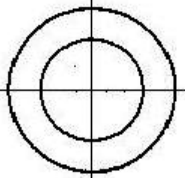

07901G220

① OE 03L 107 065S, Gen 2 engine only	① OE 03L 107 065S, nur für Motoren der Generation 2	① N°OE 03L 107 065S, uniquement pour Moteur de génération 2	① OE 03L 107 065G, Generación 2 solo motor	① Solo motore Generation 2
② Only fit to pistons equivalent to OE 03L 107065 AG, 03L 107065 S	② Nur gepasst worden zu den Kolben gleichwertig mit OE 03L 107065 AG und 03L 107065 S	② Seulement adapté aux pistons équivalents à OE 03L 107065 AGet 03L 107065 S	② Cabido solamente a los pistones equivalentes a OE 03L 107065 AG y 03L 107065 S	② Adattato soltanto ai pistoni equivalenti a OE 03L 107065 AGe 03L 107065 S
③ 08-432300-10 OE: 03L198151C	③ 08-432300-10 OE: 03L198151C	③ 08-432300-10 OE: 03L198151C	③ 08-432300-10 OE: 03L198151C	③ 08-432300-10 OE: 03L198151C

35 **82.50**



80 2.8	09/91→01/96	AAH			
100 2.8 E	12/90→06/94		V6 Cyl.	10:1	
A4 2.8	01/95→07/97		2771cc	128kW (174PS)	
A6 2.8	06/94→12/97				TD224
A8 2.8	03/94→03/96				
Cabriolet 2.8	11/92→08/00				
Coupe 2.8	08/91→12/96				
A6 2.8	06/94→12/97	AEJ			
A8 2.8	07/95→03/96		V6 Cyl.	10.3:1	
			2771cc	120-128kW (163-174PS)	TD9541

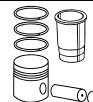
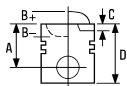



A6 2.8 06/94 → 10/97 **AFC** V6 Cyl. 10.3:1
2771cc **120-128kW (163-174PS)** **TD246**

87-501800-10 ② STD **08-501800-00** STD
87-501807-10 ① ② 0.50mm **08-501807-00** 0.50mm

A 30.80 1.20  PS
B- 4.25 1.50  P
B+ 0.70 2.00  CR P

BØ 61.00
D 52.50

 21x55

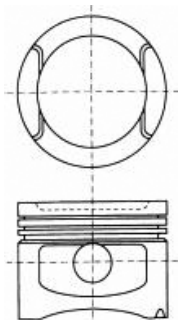

08245-103

① A = 30.500, D = 52.200
 ② Pistons to be replaced in Engine Sets only

① A = 30.500, D = 52.200
 ② Kolben nur Motorsätzen zu ersetzen

① A = 30.500, D = 52.200
 ② Piston à remplacer dans jeu moteur



① A = 30.500, D = 52.200
 ② Pistones de repuesto para juegos de motores solamente

① A = 30.500, D = 52.200
 ② Il pistone può essere rimpiazzato solamente completo

36  **82.50**

80 2.0 E 09/91 → 01/96 **ABK** 4 Cyl. 10.3:1
100 2.0 E 12/90 → 06/94 **1984cc** **85kW (115PS)**
A6 2.0 06/94 → 12/97
Cabriolet 2.0 E 01/93 → 07/98 **TD233**
Coupe 2.0 05/89 → 12/96

87-501800-20 STD **08-501800-00** STD
87-501807-20 ① 0.50mm **08-501807-00** 0.50mm

A 30.90 1.20  PS
B- 5.70 1.50  P
B+ 0.90 2.00  CR P

BØ 64.00
D 51.80

 21x55

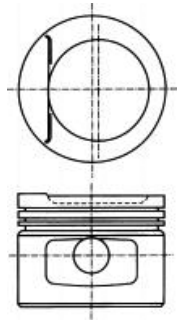

08241B-103

① A = 30.600, D = 51.500

① A = 30.600, D = 51.500

① A = 30.600, D = 51.500

① A = 30.600, D = 51.500

① A = 30.600, D = 51.500

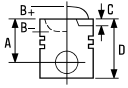

37		82.50				
A4 2.0 FSI	07/02→12/04	AWA	4 Cyl. 1984cc	11.5:1 110kW (150PS)	TD17035	
A3 2.0 FSI	05/03→06/08	AXW	4 Cyl. 1984cc	11.5:1 110kW (150PS)	TD16872	
A3 2.0 FSI	05/03→06/08	BLR	4 Cyl. 1984cc	11.5:1 110kW (150PS)	TD18199	
A3 2.0 FSI	05/03→06/08	BLX	4 Cyl. 1984cc	11.5:1 110kW (150PS)	TD17404	
A3 2.0 FSI	05/03→06/08	BLY	4 Cyl. 1984cc	11.5:1 110kW (150PS)	TD17405	
A3 2.0 FSI	05/03→06/08	BMB	4 Cyl. 1984cc	11.5:1 110kW (150PS)	TD17406	
A3 2.0 FSI	05/03→06/08	BVY	4 Cyl. 1984cc	11.5:1 110kW (150PS)	TD18200	
A3 2.0 FSI	05/03→06/08	BVZ	4 Cyl. 1984cc	11.5:1 110kW (150PS)	TD18201	

87-435100-00 ¹ STD

- A** 29.38
- B+** 12.46
- D** 59.84
- 19x44

TP

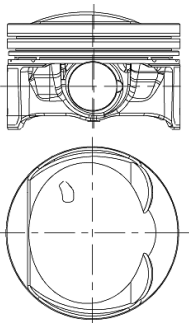

08240B301

08-435100-10 STD

- 1.20 NT PVD ²
- 1.50
- 2.00 CR

¹ Elastoval ®
² Steel

¹ Elastoval ®
² Stahl

¹ Elastoval ®
² Acier

¹ Elastoval ®
² Accero

¹ Elastoval ®
² Acciaio

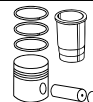
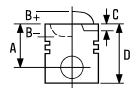

38  **82.50**

A3 2.0 TFSI	09/04→03/13	AXX	4 Cyl.	10.5:1	
			1984cc	147kW (200PS)	
			Turbo Intercooled		TD17450

A3 2.0 TFSI	09/04→03/13	BWA	4 Cyl.	10.3:1	
TT 2.0 TFSI	08/06→06/10		1984cc	147kW (200PS)	
			Turbo Intercooled		TD19199





87-438500-00
87-438507-00

STD
0.50mm

08-438500-00
08-438507-00

STD
0.50mm

- A** 29.50
- B-** 6.10
- BØ** 49.52
- C** 1.36
- C** 1.36
- D** 50.50
-  20x59

- 1.20  PVD 
- 1.50  P
- 2.00  CR P

AK RT TP

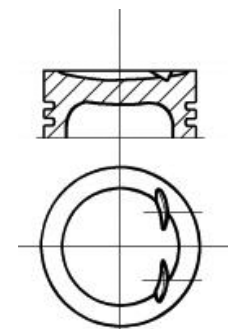

 Steel

 Stahl

 Acier

 Acero

 Acciaio



39  **82.50**





A3 1.8 TFSI	11/06→05/13	CDAA	4 Cyl.	9.6:1	
TT 1.8 TFSI	06/08→06/14		1798cc	118kW (160PS)	
					Turbo Intercooled
					TD20938

A4 1.8 TFSI	01/08→12/15	CDHA	4 Cyl.	9.6:1	
			1798cc	88kW (120PS)	
					Turbo Intercooled
					TD21113

A4 1.8 TFSI	11/07→03/12	CDHB	4 Cyl.	9.6:1	
A5 1.8 TFSI	05/09→		1798cc	118kW (160PS)	
					Turbo Intercooled
					TD21114

87-443800-00	STD	08-443800-00	STD
87-443807-00	0.50mm	08-443807-00	0.50mm

- A** 29.85
- B-** 4.70
- B+** 5.65
- C** 2.00
- D** 56.00
-  23x54

- 1.20  NT PVD 
- 1.20  P
- 2.00  CR P



RT TP

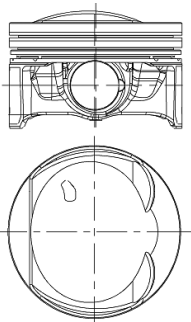

 Steel

 Stahl

 Acier

 Acero

 Acciaio

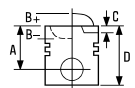





40  **83.00**

A4 3.0 TDI	01/06→03/09	ASB			
A6 3.0 TDi	05/06→08/11		V6 Cyl.		
A8 3.0 TDI	08/03→07/10		2967cc	171kW (233PS)	
		Diesel	Turbo Intercooled		TD17336
A4 3.0 TDI	11/04→03/09	BKN			
			V6 Cyl.		
			2967cc	150kW (204PS)	
		Diesel	Turbo Intercooled		TD18027
A6 3.0 TDI	05/04→05/06	BMK			
			V6 Cyl.		
			2967cc	165kW (225PS)	
		Diesel	Turbo Intercooled		TD17845
A6 3.0 TDI	05/04→08/11	BNG			
A8 3.0 TDI	11/03→07/10		V6 Cyl.		
			2967cc	155kW (211PS)	
		Diesel	Turbo Intercooled		TD17337
Q7 3.0 TDI	03/06→05/08	BUG			
			V6 Cyl.		
			2967cc	171kW (233PS)	
		Diesel	Turbo Intercooled		TD18996
Q7 3.0 TDI	03/06→05/10	BUN			
			V6 Cyl.		
			2967cc	155kW (211PS)	
		Diesel	Turbo Intercooled		TD19881

87-434300-00 STD
87-434307-00 0.50mm





08-434300-00 STD
08-434307-00 0.50mm

A 46.30
B- 15.10
BØ 45.00
D 70.80
 30x68

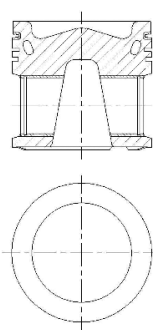
2.00  **CK**
 2.00  **CR**
 3.00  **CR**

AK KK RT









		ccm	x 		9
12CC	Petrol	1275	4	70.62	6
12 H	Petrol	1275	4	70.62	4
12 HA85AA	Petrol	1275	4	70.62	5
19 J	Diesel	2495	4	90.47	11
22 UA	Diesel	2178	4	82.55	9
A+ Series (12 H)	Petrol	1275	4	70.62	4
A+ Series (12 H996)	Petrol	1275	4	70.62	6
A+ Series (12 H999)	Petrol	1275	4	70.62	6
A+ Series (12 HA)	Petrol	1275	4	70.62	6
A+ Series (12 HC)	Petrol	1275	4	70.62	6
A+ Series (12 HE)	Petrol	1275	4	70.62	4
A+ Series (12 HL)	Petrol	1275	4	70.62	4
A+ Series (99H)	Petrol	998	4	64.56	1
A+ Series (99H)	Petrol	998	4	64.56	3
A/A+ Series (99H)	Petrol	998	4	64.56	3
A Series	Petrol	1098	4	64.56	2
A Series (10H)	Petrol	1098	4	64.56	2
A Series (12 H)	Petrol	1275	4	70.62	4
A Series (12 H)	Petrol	1275	4	70.62	6
A Series (12 L)	Petrol	1275	4	70.62	4
A Series 1275cc Overbored To 1380cc	Petrol	1380	4	73.50	7
B Series	Petrol	1798	4	80.25	8
B Series (18 H)	Petrol	1798	4	80.25	8
C Series	Petrol	2912	6	83.32	10



1 64.56



Metro 1.0 Surf HLE	10/80→04/90	A+ Series (99H)	4 Cyl. 998cc	10.3:1 35kW (48PS)	TD383
Mini 1000 Mayfair	08/82→06/93	A+ Series (99H)	4 Cyl. 998cc	10.3:1 31kW (42PS)	TD5474
Mini 1000 Mayfair	08/82→06/93	A+ Series (99H)	4 Cyl. 998cc	10.3:1 31kW (42PS)	TD5472
Mini 1000 Mayfair Sport	09/88→06/93	A+ Series (99H)	4 Cyl. 998cc	10.3:1 30kW (41PS)	TD5471

87-524307-10   .020
 87-524311-10   .040
 87-524314-10   .060

A 33.86
D 53.79
 16x51

08-524300-10 STD
 08-524307-10 .020
 08-524311-10 .040
 08-524314-10 .060

01/86→06/92

1.50  CK P
 1.50  P
 3.00  P

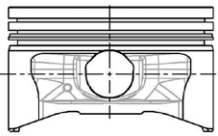



 Piston pin press fit
in conrod

 Pistons to be replaced in
Engine Sets only

 Kolbenbolzen in Pleuel
eingepreßt

 Kolben nur Motorsätzen
zu ersetzen

 Axe serré sur bielle

 Piston à remplacer dans
jeu moteur

 Bulón del pistón montado a
presión en la biela

 Pistones de repuesto para juegos
de motores solamente

 Spinotto inserto a spinta
nella biella

 Il pistone può essere rimpiazzato
solamente completo

2 64.56

1100	01/66→12/69	A Series	4 Cyl.	8.5:1	
A40 MkII 1100, A35 6cwt.	01/62→12/67		1098cc		
Healey Sprite MkIII	03/64→09/66				
Minor 1100	01/63→12/69				FM78
1100 Countryman, 1100 MkII	01/62→12/74	A Series	4 Cyl.	7.5:1	
Minor 1000, Minor 1100	01/63→12/69		1098cc		FM2941



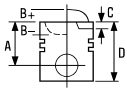





Allegro 1.1 Mini 1100 Special	05/73→10/81 01/76→08/81	A Series (10H)	4 Cyl. 1098cc	8.5:1 33-36kW (45-49PS)	TD384
--	----------------------------	-----------------------	-------------------------	-----------------------------------	--------------

87-522307-00 1	.020
87-522309-00 1	.030
87-522311-00 1	.040
87-522314-00 1	.060

08-522300-00	STD
08-522307-00	.020
08-522309-00	.030
08-522311-00	.040
08-522314-00	.060

A	30.33
B-	5.28
D	50.05
	16x56

1.60		NT
1.58		P
1.58		P
3.17		P

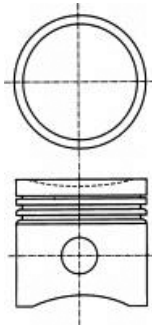

1 Pistons to be replaced in Engine Sets only

1 Kolben nur Motorsätzen zu ersetzen

1 Piston à remplacer dans jeu moteur

1 Pistones de repuesto para juegos de motores solamente

1 Il pistone può essere rimpiazzato solamente completo

3 64.56





Allegro 1.0 Metro 1.0 Mini 1000	01/80→10/83 10/80→04/90 10/67→09/84	A/A+ Series (99H)	4 Cyl. 998cc	8.3:1 29-33kW (39-45PS)	TD4215
--	---	--------------------------	------------------------	-----------------------------------	---------------

Mini 1000 Mayfair	08/82→06/93	A+ Series (99H)	4 Cyl. 998cc	8.3:1 31kW (42PS)	TD5473
--------------------------	-------------	------------------------	------------------------	-----------------------------	---------------

87-522400-00 1 2	STD
87-522407-00 1 2	.020
87-522411-00 1 2	.040
87-522414-00 1 2	.060

08-522400-00	STD
08-522407-00	.020
08-522411-00	.040
08-522414-00	.060

A	34.09
B-	4.93
D	65.77
	16x56

01/80→12/85		
1.58		P
1.58		P
1.58		P
4.00		CR P

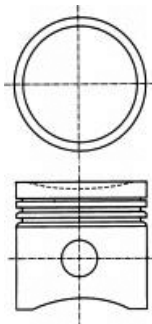

1 Pin retained by circlips
2 Pistons to be replaced in Engine Sets only

1 Bolzen mit Sicherungsbügeln gehalten
2 Kolben nur Motorsätzen zu ersetzen

1 Axe retenu par circlips
2 Piston à remplacer dans jeu moteur





1 Bulón retenido por anillos de retención
2 Pistones de repuesto para juegos de motores solamente

1 Spinotto trattenuto da fermi
2 Il pistone può essere rimpiazzato solamente completo





4 70.62

Marina II 1.3 Minor 1.3	11/75→10/80 09/64→12/71	12 H	4 Cyl. 1275cc	41-42kW (56-57PS)	TD22166
Allegro 1.3 America 1.3 Maestro 1.3 Maestro 1.3 LS Metro 1.3 L;HLE;S Mini 1.3	05/73→12/84 09/67→12/72 03/83→09/92 03/83→08/90 10/80→04/90 04/74→09/80	A Series (12 H)	4 Cyl. 1275cc	9.4/9.75:1 40-49kW (54-67PS)	TD381
Allegro 1.3	01/75→03/82	A Series (12 L)	4 Cyl. 1275cc	43kW (58PS)	TD22494
Metro 1.3 Surf	11/85→04/90	A+ Series (12 H)	4 Cyl. 1275cc	9.4/9.75:1 44kW (60PS)	TD5470
Maestro 1.3	01/86→09/92	A+ Series (12 HE)	4 Cyl. 1275cc	50kW (68PS)	TD22435
Metro 1.3 Montego 1.3	10/80→12/83 04/84→10/88	A+ Series (12 HL)	4 Cyl. 1275cc	9.4/9.75:1 46-51kW (63-69PS)	TD16446

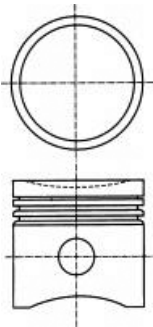

87-521700-00 	STD
87-521707-00 	.020
87-521711-00 	.040
87-521714-00 	.060

A	37.24
B-	5.74
D	57.24
	21x56



 Pistons to be replaced in Engine Sets only

08-521700-00	STD
08-521707-00	.020
08-521711-00	.040
08-521714-00	.060

1.48		P
1.48		P
4.00		P

 Kolben nur Motorsätzen zu ersetzen

14-010890-00 D **B 73.09 C 141.28**

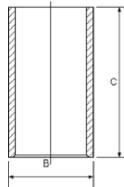

 Piston à remplacer dans jeu moteur

 Pistones de repuesto para juegos de motores solamente

 Il pistone può essere rimpiazzato solamente completo

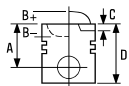

5 70.62

Metro 1.3 Turbo	10/83→04/90	12 HA85AA	4 Cyl. 1275cc Turbo	66kW (90PS)	TD5469
-----------------	-------------	-----------	---------------------------	-------------	--------

14-010890-00 D B 73.09 C 141.28

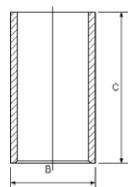

6 70.62

Sprite MK.IV 1.3	03/66→10/71	12CC	4 Cyl. 1275cc	48kW (65PS)	TD22427
1275 GT	01/67→12/73	A Series (12 H)			
1300	01/71→12/74		4 Cyl.		
1300 GT	01/67→12/73		1275cc	53kW (72PS)	TD22493
Marina 1300	01/72→12/80				
Mini 1.3	09/69→09/80				
Mini Cooper S	01/64→12/71				
Maestro 1.3	03/83→08/85	A+ Series (12 H999)			
Mini 1.3	01/85→		4 Cyl.	10/10.5:1	
Mini Cooper	01/90→		1275cc	46kW (63PS)	TD5458
Vanden Plas 1.3	01/82→12/88				
Metro 1.3	10/80→12/85	A+ Series (12 H996)	4 Cyl. 1275cc	10/10.5:1 52kW (71PS)	TD13429
Metro 1.3	10/80→04/90	A+ Series (12 HA)	4 Cyl. 1275cc	10/10.5:1 51kW (69PS)	TD5468





Maestro 1.3 03/83 → 08/85 **A+ Series (12 HC)** 4 Cyl. 10/10.5:1
1275cc **46kW (63PS)** **TD5459**

87-524100-00 STD
 87-524107-00 .020
 87-524111-00 .040
 87-524114-00 .060

A 38.74
B- 5.74
D 58.74
 21x56

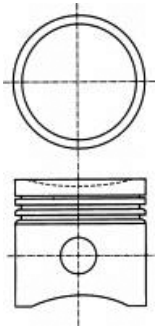

Pistons to be replaced in Engine Sets only

08-524100-00 STD
 08-524107-00 .020
 08-524111-00 .040
 08-524114-00 .060

1.50 NT
 1.50 P
 3.00 P

14-010890-00 D **B** 73.09 **C** 141.28

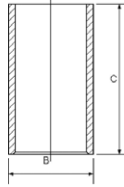

Piston à remplacer dans jeu moteur

Pistones de repuesto para juegos de motores solamente

Il pistone può essere rimpiazzato solamente completo

7 73.50

Marina 01/64 → 12/91 **A Series 1275cc Overbored To 1380cc** 4 Cyl. 9.6:1
Metro 1275, Mini 1275 **1380cc** **FM1180**

87-526600-00 STD

A 37.78
B- 6.21
D 58.36
 21x64

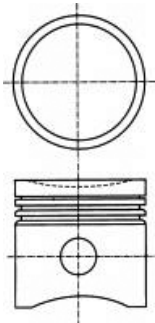





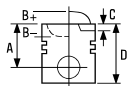

08-526600-00 STD

1.50 CR P
 1.50 P
 4.00 CR P



8 80.25

1800S MkII	01/71→12/72	B Series	4 Cyl. 1798cc	9.5:1	FM2953
1800	01/73→12/75	B Series	4 Cyl. 1798cc	9:1	FM2951
1800HL	01/73→12/75				
1800 MkII	01/68→12/71				
1800 MkII, 1800 MkIII	01/69→12/75				
Marina 1.8GT, Marina 1.8HL, Marina 1.8TC	01/71→12/78				
Princess 1.8 HL	01/75→12/78				
1800 MkII	01/64→12/68	B Series	4 Cyl. 1798cc	8.4:1	FM2950
Princess 1800 HL	04/76→09/78	B Series (18 H)	4 Cyl. 1798cc	8.5:1 60kW (82PS)	TD5478

87-521907-00   .020
 87-521911-00   .040
 87-521914-00   .060

A 42.11
B- 3.76
D 61.06
 21x57

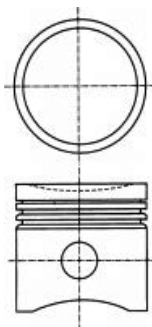





87-525900-00 ①	STD	08-525900-00	STD
87-525907-00 ①	.020	08-525907-00	.020
87-525909-00 ①	.030	08-525909-00	.030
87-525911-00 ①	.040	08-525911-00	.040
87-525914-00 ①	.060	08-525914-00	.060

01/71→12/78

A 42.16
B- 3.76
BØ 64.50
D 61.11
 21x57

1.59		P
1.59		P
4.00		P

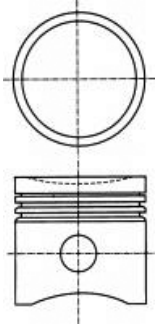

- ① Piston pin press fit in conrod
- ② Short skirt design
- ③ Pin retained by circlips

- ① Kolbenbolzen in Pleuel eingepreßt
- ② Kurzschaftausführung
- ③ Bolzen mit Sicherungsbügeln gehalten

- ① Axe serré sur bielle
- ② A jupe courte
- ③ Axe retenu par circlips

- ① Bulón del pistón montado a presión en la biela
- ② Diseño de falda corta
- ③ Bulón retenido por anillos de retención

- ① Spinotto inserto a spinta nella biella
- ② A mantello corto
- ③ Spinotto trattenuto da fermi

9 82.55

Gypsy Series 2 1-1.5 ton FG/K	22 UA		
Gypsy Series 2 1-1.5 ton G4		4 Cyl.	20:1
Gypsy Series 2 1-1.5 ton LD/M		2178cc	
Gypsy Series 2 1-1.5 ton WE		Diesel	FM101
Gypsy Series 2 1-1.5 ton WF/K	01/60→12/68		
Taxicab FX3D, Taxicab FX4, Trucks 1-1.5 ton	01/55→12/71		

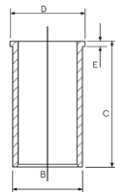

14-021130-00 D B 86.59 C 193.68 D 89.61 E 4.70

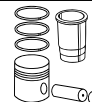









10 83.32

3 Litre Healey 3	01/68→12/72 01/59→12/68	C Series	6 Cyl. 2912cc	9:1	FM1186
-----------------------------------	----------------------------	-----------------	-------------------------	-----	---------------

87-530100-00  STD	08-530100-00 STD
87-530107-00  .020	08-530107-00 .020
87-530109-00  .030	08-530109-00 .030

A	47.73
D	87.31
	22x72

1.98		P
1.98		P
1.98		P
4.74		P
4.76		P

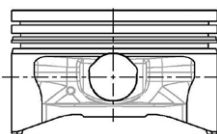

 Pistons to be replaced in Engine Sets only

 Kolben nur Motorsätzen zu ersetzen

 Piston à remplacer dans jeu moteur

 Pistones de repuesto para juegos de motores solamente



 Il pistone può essere rimpiazzato solamente completo

11 90.47

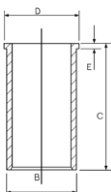
Metropolitan Taxi	01/83→	19 J	4 Cyl. 2495cc	21:1	FM3829
		Diesel	Turbo		

87-524200-00 STD	08-524200-00 STD	14-024710-00 D	B 94.52 C 191.36 D 99.70 E 4.76
87-524207-00 .020	08-524207-00 .020		
87-524211-00 .040	08-524211-00 .040		



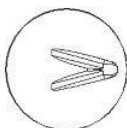
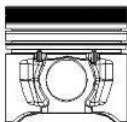

A	54.60
B-	3.63
D	86.31
	30x75

1.99		CR P
1.95		P
3.00		CR P

HA RT



14-010920-00 D	B 94.50 C 191.36
	

		ccm	x 		
4.108	Diesel	1760	4	79.38	5
13 S	Petrol	1297	4	75.00	2
14 NV	Petrol	1389	4	77.60	3
16 D	Diesel	1598	4	80.00	6
16 DA	Diesel	1598	4	80.00	6
16 SV	Petrol	1598	4	79.00	4
17 D	Diesel	1699	4	82.50	7
21 D	Diesel	2068	4	88.00	9
23 D	Diesel	2260	4	92.00	10
220	Diesel	3614	4	103.19	11
330	Diesel	5420	6	103.19	11
C 190	Diesel	1952	4	86.00	8
F 10A	Petrol	970	4	65.50	1



1 65.50

Rascal 1.0

06/86→06/90 **F 10A**

4 Cyl.
970cc



8.7:1
34kW (46PS)

TD9933

87-960200-00 STD
87-960207-00 0.50mm

08-960200-00 STD
08-960207-00 0.50mm

A 24.65
B- 2.00
C 5.30
C 4.60
D 55.00
 16x50

1.50  CR P
1.50  P
2.80  P

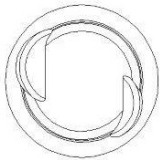
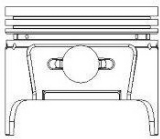

2 75.00

Astra 1.3

09/84→09/89 **13 S**

4 Cyl.
1297cc



9.2:1
42-55kW (57-75PS)

TD410

87-306307-00  0.50mm
87-306311-00 1.00mm

08-306300-00 STD
08-306307-00 0.50mm
08-306311-00 1.00mm

A 35.80
B- 3.60
C 5.30
C 5.30
D 62.40
 20x65

1.50  CR P
1.50  P
4.00  CR P

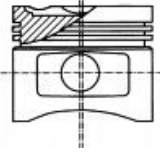
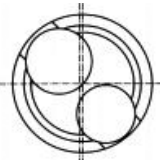

 Pistons to be replaced in Engine Sets only

 Kolben nur Motorsätzen zu ersetzen

 Piston à remplacer dans jeu moteur

 Pistones de repuesto para juegos de motores solamente

 Il pistone può essere rimpiazzato solamente completo







3 77.60

Astra 1.4	09/89→08/91	14 NV		
Astramax 1.4	09/89→06/90		4 Cyl. 1389cc	9.4:1 44-55kW (60-75PS)

TD411

87-307100-20	STD	08-307100-00	STD
87-307107-20	0.50mm	08-307107-00	0.50mm

A	32.10	1.50		CR P
B-	3.40	1.50		P
D	52.50	3.00		CR 1

 18x55

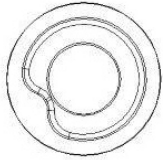
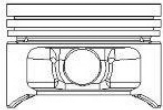

 Steel

 Stahl

 Acier

 Acero



 Acciaio

4 79.00

Astra 1.6	09/84→08/91	16 SV		
			4 Cyl. 1598cc	10:1 60-66kW (82-90PS)

TD413

87-306900-10	STD	08-306900-00	STD
87-306907-10	0.50mm	08-306907-00	0.50mm

A	28.00	1.20		CR 1
B-	1.60	1.50		P
B+	0.40	3.00		CR 1

BØ 59.00

D 48.40

 18x55

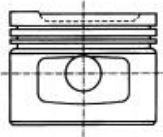
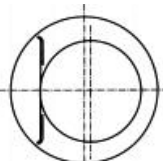

 Steel

 Stahl

 Acier

 Acero

 Acciaio



5  **79.38**



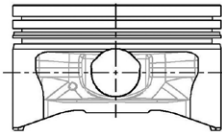

CF 220, CF 250	01/69→12/76	4.108	4 Cyl.	22:1	
			1760cc		
Diesel					FM1346

87-315200-00 STD

- A** 50.24
- D** 105.41
-  27x68



08-315200-00 STD

- 1.99  CR P
- 1.60  P
- 1.60  P
- 3.16  P
- 4.74  P

14-010900-00 D **B 82.63 C 165.10**

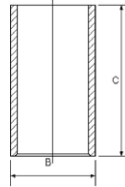

6  **80.00**

Astra 1.6 D	07/82→08/88	16 D	4 Cyl.	23:1	
AstraMax 1.6 D	09/85→08/88		1598cc	39-40kW (53-54PS)	
Diesel					TD412

Astra 1.6 D	09/87→08/89	16 DA	4 Cyl.	23:1	
AstraMax 1.6 D	09/85→08/88		1598cc	40-42kW (54-57PS)	
Diesel					TD26851



87-305900-00 STD
87-305907-00 0.50mm
87-305911-00 1.00mm

- A** 44.95
- B-** 1.50
- D** 76.95
-  26x65

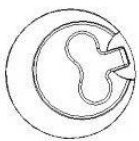
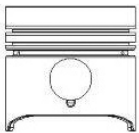
HA RT



08-305900-10 STD
08-305907-10 0.50mm
08-305911-10 1.00mm

- 2.00  CR P
- 2.00  P
- 3.00  CR P

14-023520-00 D **B 83.00 C 143.50 D 84.90 E 4.50**

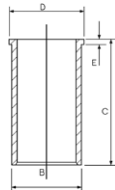







7 82.50

Astra 1.7 D	09/88→08/91	17 D			
Astramax 1.7 D	09/88→06/90		4 Cyl.	23:1	
			1699cc	42kW (57PS)	
Diesel					TD26850

87-306700-10	STD	08-306700-00	STD
87-306707-10	0.50mm	08-306707-00	0.50mm
87-306711-10	1.00mm	08-306711-00	1.00mm

A	44.95	2.00		CR P
C	1.60	2.00		P
D	72.95	3.00		CR P
	26x65			

HA RT

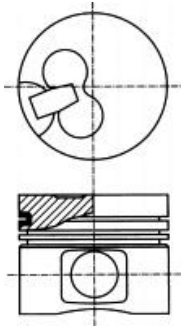

8 86.00

KBD26 Pick-up	06/81→12/87	C 190			
KBD41 Pick-up	06/82→12/87		4 Cyl.	20:1	
			1952cc	34kW (46PS)	
Diesel					FM883

14-021180-00 D **B 90.13 C 178.50 D 94.00 E 4.00**

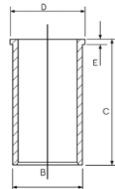

9 88.00

Blitz 2.1 D (CF97)	09/81→10/87	21 D			
			4 Cyl.	21/22/24:1	
			2068cc	44kW (60PS)	
Diesel					TD9935

14-024160-00 D **B 92.00 C 172.00 D 93.90 E 4.55**

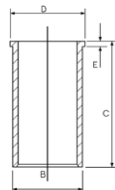

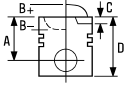

10 92.00

Blitz 2.3 D

01/73→10/87

23 D

4 Cyl.
2260cc

22:1
46-48kW (63-65PS)

Diesel

TD418

14-024100-00 D

B 95.00 C 172.00 D 97.00 E 4.70

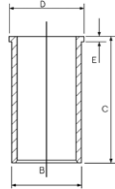

11 103.19

220

4 Cyl.
3614cc

17:1
48-52kW (65-71PS)

Diesel

TD6483

330

6 Cyl.
5420cc
Turbo

17:1
72-99kW (98-135PS)

Diesel



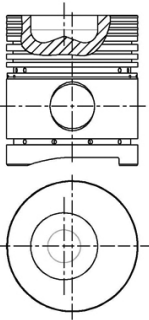

TD6485

87-126300-10 STD
87-126307-10 .020
87-126309-10 .030
87-126311-10 .040

A 71.50
B- 21.46
BØ 52.70
D 118.24
 35x88





08-126300-10 STD
08-126305-10 .010
08-126307-10 .020
08-126309-10 .030
08-126311-10 .040
08-126314-10 .060

2.38  P
2.38  P
2.38  P
4.74  P
4.74  P

14-021140-00 D 

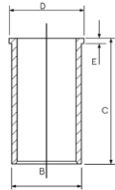
B 108.05 C 216.15 D 111.04 E 4.76



 Push fit cast iron liner to replace original steel liner

 Ausdrückbare Laufbüchse aus Gueisen als Ersatz der originalStahlbüchse

 Chemise fonte à emmenchement gras remplaçant la chemise acied'origine

 Ajustar a presión la camisa de hierro fundido para reemplazacamisa original de acero

 Cilindri in ghisa, piantati a pressione, in sostituzione di qin acciaio



1  **110.00**

4.8 D Tractor

4 Cyl.





4800cc

Diesel

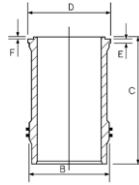
FM6376

14-376210-00 *WH* B 125.00 C 246.00 D 132.75 E 9.15 F 1.00



		ccm	x 		9
M21 D24 (246TA)	Diesel	2443	6	80.00	3
M21 D24 (246TB)	Diesel	2443	6	80.00	3
M21 D24W	Diesel	2443	6	80.00	3
M41 D17 (174T1)	Diesel	1665	4	80.00	4
M43 194E1	Petrol	1895	4	85.00	16
M43 B18 (184E2)	Petrol	1796	4	84.00	5
M43 B19 (194E1)	Petrol	1895	4	85.00	16
M47 204D1	Diesel	1951	4	84.00	9
M47 D20	Diesel	1951	4	84.00	10
M47 N204D4 Euro 4	Diesel	1995	4	84.00	11
M47 N204D5TU Euro 4	Diesel	1995	4	84.00	11
M47 TUD20 Euro 4	Diesel	1995	4	84.00	12
M50 B20TU	Petrol	1991	6	80.00	1
M51 D25	Diesel	2498	6	80.00	4
M54 226S1	Petrol	2171	6	80.00	2
M54 256S5	Petrol	2494	6	84.00	6
M54 B22 (226 S1)	Petrol	2171	6	80.00	2
M54 B25 (256 S3)	Petrol	2494	6	84.00	6
M54 B25 (256 S5)	Petrol	2494	6	84.00	6
M57 D30 (306D1)	Diesel	2926	6	84.00	13
M57 D30 (306D2)	Diesel	2993	6	84.00	12
M57 D30 (306D3)	Diesel	2993	6	84.00	12
M57 N306D2 Euro 4	Diesel	2993	6	84.00	12
M57 N306D4	Diesel	2993	6	84.00	14
M57 N2306D2 Euro 4	Diesel	2993	6	84.00	12
M57 N2306D3	Diesel	2993	6	84.00	12
M57 TU2D30 Euro 4	Diesel	2993	6	84.00	12
N20 B20A	Petrol	1997	4	84.00	7
N20 B20B	Petrol	1997	4	84.00	8
N47 D2 A	Diesel	1995	4	84.00	15
N47 D20B	Diesel	1995	4	84.00	15
N47 D20C	Diesel	1995	4	84.00	15
N47 SD20D	Diesel	1995	4	84.00	15
N57 306D2 Euro 4	Diesel	2993	6	84.00	12

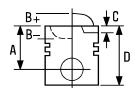

1 **80.00**

3 (E36) 320 i	09/90→02/98	M50 B20TU		
5 (E34) 520 i	09/89→01/97		6 Cyl.	11:1
			1991cc	110kW (150PS)

TD21239

87-705000-00	STD	08-705000-00	STD
87-705007-00	0.50mm	08-705007-00	0.50mm

08/92→12/95

05/92→

A 31.64
B+ 1.86
C 2.94
D 51.00

1.50 CR P
 1.50 P
 2.00 P

22x51

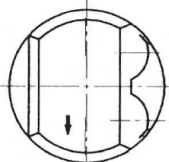
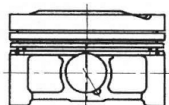

2 **80.00**

3 (E46) 320 Ci	09/00→12/07	M54 226S1		
3 (E46) 320 i	09/00→02/05		6 Cyl.	10.8:1
5 (E39) 520 i	09/00→05/04		2171cc	125kW (170PS)
5 (E60) 520 i	07/03→03/10			TD17522
Z3 (E36) 2.2	08/00→01/03			
Z4 (E85) 2.2 i	10/03→10/05			

3 (E46) 320 Ci	09/00→12/07	M54 B22 (226 S1)		
3 (E46) 320 i	09/00→02/05		6 Cyl.	10.8:1
5 (E39) 520 i	09/00→05/04		2171cc	120-125kW (163-170PS)
5 (E60) 520 i	07/03→03/10			TD28215
Z3 (E36) 2.2	08/00→01/03			
Z4 (E85) 2.2 i	10/03→10/05			

87-422200-10	STD	08-422200-00	STD
87-422207-10	0.50mm	08-422207-00	0.50mm

A 29.60
C 2.90
C 3.40
D 49.50

1.20 CK
 1.50 P
 2.00 P

22x51

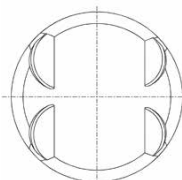
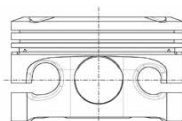

Steel

Stahl

Acier

Acero

Acciaio

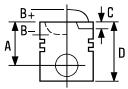



3  **80.00**

5 (E28) 524 td	09/83→12/87	M21 D24 (246TA)	6 Cyl.	22:1	
			2443cc	85kW (115PS)	
		Diesel	Turbo Intercooled		TD28350
3 (E30) 324 td	09/87→06/93	M21 D24 (246TB)	6 Cyl.	22:1	
5 (E34) 524 td	03/88→09/95		2443cc	85kW (115PS)	
		Diesel	Turbo Intercooled		TD28351
3 (E30) 324 D	09/85→08/91	M21 D24W	6 Cyl.	23:1	
			2443cc	63kW (86PS)	
		Diesel			TD5165

87-133100-00	STD	08-133100-10	STD
87-133107-00	0.50mm	08-133105-10	0.25mm
		08-133107-10	0.50mm

- A** 46.40
- B-** 2.00
- D** 76.30
-  26x69

- 2.50  CR P
- 2.00  P
- 3.50  CR P

AK KK RT

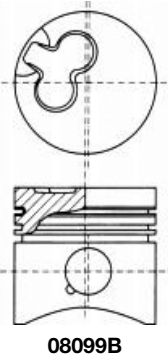

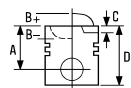





4  **80.00**

3 (E36) 318 tds	01/95→08/00	M41 D17 (174T1)	4 Cyl.	22:1	
			1665cc	66kW (90PS)	
		Diesel	Turbo Intercooled		TD28369

5 (E34) 525 tds	12/91→01/97	M51 D25	6 Cyl.	22:1	
			2498cc	105kW (143PS)	
		Diesel	Turbo Intercooled		TD5285

87-704500-00	STD	08-704500-00	STD
87-704507-00	0.50mm	08-704507-00	0.50mm

A	39.45	3.00		CR P
B-	2.50	1.75		P
D	62.45	3.00		CR P
	27x63			

AK KK RT

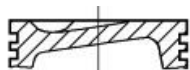





08034X

5  **84.00**

3 (E36) 318 i	10/93→10/99	M43 B18 (184E2)	4 Cyl.	9.7:1	
5 (E34) 518 g	11/95→06/96				
5 (E34) 518 i	08/89→01/97		1796cc	83-85kW (113-116PS)	
Z3 (E36) 1.8	10/95→10/98				TD28372

87-704200-10	STD	08-704200-00	STD
87-704207-10	0.50mm	08-704207-00	0.50mm

A	31.65	1.50		CR P
B-	3.03	1.50		P
BØ	70.30	2.00		CR 
D	57.65			
	22x54			

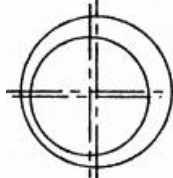
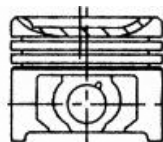

 Steel  Stahl  Acier  Acero  Acciaio







6  **84.00**

3 (E46) 325 i	09/00→12/07	M54 256S5	6 Cyl. 2494cc	10.5:1 137-141kW (186-192PS)	TD17516
5 (E39) 525 i	09/00→05/04	M54 B25 (256 S3)	6 Cyl. 2494cc	10.5:1 141kW (192PS)	TD28216
3 (E46) 325 Ci	09/00→12/07	M54 B25 (256 S5)	6 Cyl. 2494cc	10.5:1 137-141kW (186-192PS)	TD28217
3 (E46) 325 i	09/00→02/05				
5 (E39) 525 i	09/00→05/04				
5 (E60) 525 i	07/03→03/10				
X3 (E83) 2.5 i	01/04→12/06				
Z3 (E36) 2.5	09/00→12/02				
Z4 (E85) 2.5 i	02/03→12/05				

87-425300-00 STD
87-425307-00 0.50mm

- A** 27.60
- C** 2.60
- D** 47.60
-  22x56

08-425300-00 STD

- 1.20  NT 
- 1.50  P
- 2.00  P

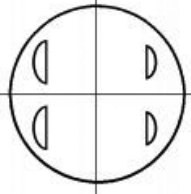
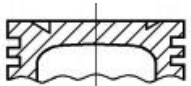

 Steel

 Stahl

 Acier

 Acero

 Acciaio

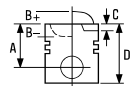

7  **84.00**

1 (F20) 125 i	08/11→	N20 B20A		
1 (F21) 125 i	12/11→		4 Cyl.	10:1
2 (F22; F87) 228 i	07/14→		1997cc	115-180kW (156-245PS)
3 (E93) 328 i	09/11→12/13		Turbo Intercooled	TD25629
3 (F30; F35; F80) 320 i	02/12→			
3 (F30; F35; F80) 328 i xDrive	10/11→			
4 (F32; F82) 420 i	11/13→			
4 (F32; F82) 428 i				
4 (F36) 420 i xDrive	03/14→			
4 (F36) 428 i				
5 (F07) 528 i	08/13→			
5 (F10; F18) 520 i, 5 (F10; F18) 528 i	09/11→			
5 (F10; F18) 528 i xDrive				
5 (F11) 520 i, 5 (F11) 528 i	09/11→			
5 (F11) 528 i xDrive				
X1 (E84) sDrive 20 i, X1 (E84) sDrive 28 i	09/11→06/15			
X3 (F25) sDrive 20 i	02/14→			
X3 (F25) sDrive 28 i	08/11→			
X4 (F26) xDrive 20 i, X4 (F26) xDrive 28 i	04/14→			
X5 (F15; F85) xDrive 28 i	09/15→			
X5 (F15; F85) xDrive 40e				
X6 (F16; F86) xDrive 28 i				
Z4 (E89) sDrive 18 i	04/13→			
Z4 (E89) sDrive 20 i, Z4 (E89) sDrive 28 i	09/11→			





87-434600-00

STD

08-434600-00

STD

- A** 32.40
- B-** 3.72
- BØ** 52.50
- C** 3.09
- C** 3.16
- D** 51.10
-  22x51

- 1.20  NT 
- 1.50  P
- 2.00  NT 

TP

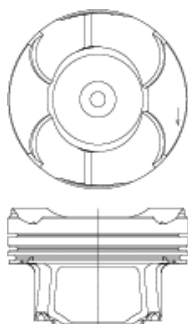

0841W-407

ECOTOUGH

-  Steel
-  Stahl
-  Acier
-  Acero
-  Acciaio

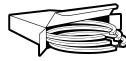
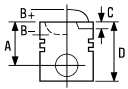

8  **84.00**

2 (F22; F87) 220 i	10/13→	N20 B20B		
2 (F23) 220 i	11/14→		4 Cyl.	11:1
3 (F30; F35; F80) 320 i	03/12→		1997cc	120-135kW (163-184PS)
3 (F30; F35; F80) 320 i xDrive	09/12→		Turbo Intercooled	TD26908
3 (F31) 320 i				
3 (F31) 320 i xDrive	06/12→			
3 (F34) 320 i				
3 (F34) 320 i xDrive	03/13→			
4 (F32; F82) 420 i				
4 (F32; F82) 420 i xDrive	11/13→			
4 (F33; F83) 420 i	07/14→			
4 (F36) 420 i				
4 (F36) 420 i xDrive	03/14→			
5 (F11) 520 i	09/11→			





87-434600-10

STD

08-434600-00

STD

- A** 32.40
- B-** 4.20
- BØ** 47.63
- C** 3.16
- C** 3.09
- D** 51.10
-  22x48

- 1.20  NT 
- 1.50  P
- 2.00  NT 

TP

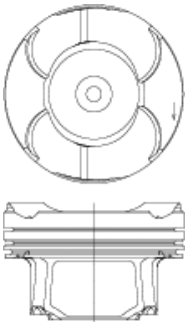

0841WA307

ECOTOUGH

 Steel

 Stahl

 Acier



 Acero

 Acciaio





9  **84.00**

3 (E46) 318 d, 320 d	04/98 → 02/05	M47 204D1			
5 (E39) 520 d	02/00 → 09/03		4 Cyl.	1951cc	85-100kW (116-136PS)
		Diesel		Turbo Intercooled	TD18305

87-114400-30 	STD	08-114400-00	STD
87-114405-30 	0.25mm	08-114405-00	0.25mm

03/01 →

- A** 44.87
- B-** 13.50
- BØ** 46.90
- C** 1.40
- D** 70.62
-  **30x66**

- 3.00  CK P
- 2.00  P
- 3.00  CR P

AK KK NB RT

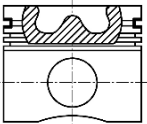
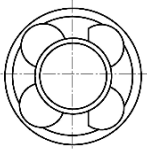

08408-F105

 Euro 3

 Euro 3

 Euro 3

 Euro 3

 Euro 3

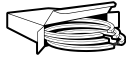
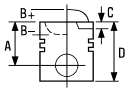





10  **84.00**

3 (E46) 318 d, 320 d	04/98→02/05	M47 D20	4 Cyl.	19:1
5 (E39) 520 d	02/00→09/03		1951cc	85-100kW (116-136PS)
Diesel			Turbo Intercooled	
				TD9521

87-114400-00	STD	08-114400-00	STD
87-114405-00	0.25mm	08-114405-00	0.25mm

→02/01

- A** 47.00
- B-** 15.05
- BØ** 41.70
- C** 1.30
- D** 71.00
-  30x66

3.00		CK P
2.00		P
3.00		CR P

KK RT

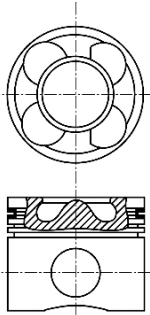

08452-L160

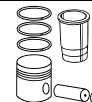
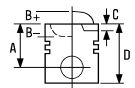





11  **84.00**

3 (E90) 320 d	01/05 → 12/08	M47 N204D4 Euro 4	4 Cyl.	17:1	
			1995cc	85-130kW (116-177PS)	
		Diesel	Turbo Intercooled		TD17523

3 (E90) 320 d 5 (E60) 520 d	09/05 → 07/05 →	M47 N204D5TU Euro 4	4 Cyl.	17:1	
			1995cc	120kW (163PS)	
		Diesel	Turbo Intercooled		TD18171

87-114400-60	STD	08-114400-40	STD
87-114405-60	0.25mm	08-114405-40	0.25mm



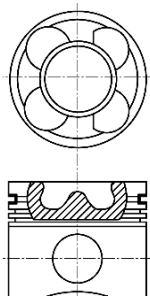

A	44.87	3.00		CK P
B-	14.50	2.00		P
BØ	47.50	2.00		CK P
C	1.48			
D	70.37			
	30x66			

AK KK RT TP



08487 E103

87-114400-65 ¹	STD	08-114400-45	STD
----------------------------------	-----	---------------------	-----

01/08 →		01/08 →		
A	44.87	3.00		CK P
B-	14.50	2.00		P
BØ	47.50	2.00		CR P
C	1.48			
C	1.36			
D	70.37			
	30x68			



AK KK RT TP

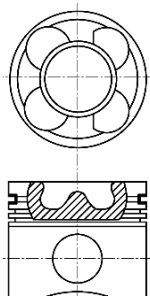

0840C-105

¹ Piston Chamber Volume [ccm] 24.430

¹ Volumen der Kolbenmulde [ccm] 24.430

¹ Volume de la cavité du piston [cm³] 24.430

¹ Volumen de cavidad del pistón [cc] 24.430

¹ Volume camera pistone [cm³] 24.430

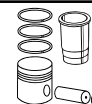

12  **84.00**

320 d	01/01→	M47 TUD20 Euro 4 4 Cyl. 1995cc Diesel Turbo Intercooled		FM19230
3 (E46) 330 Cd	03/03→12/07	M57 D30 (306D2) 6 Cyl. 17:1 2993cc 150-160kW (204-218PS) Diesel Turbo Intercooled		TD27248
3 (E46) 330 d, 3 (E46) 330 xd	03/03→02/05			
5 (E60) 530 d	07/03→03/10			
5 (E61) 530 d	06/04→12/10			
7 (E65; E66; E67) 730 d	10/02→07/08			
X3 (E83) 3.0 d	01/04→08/05			
X5 (E53) 3.0 d	09/03→12/06			
3 (E90) 325 d	09/06→12/11	M57 D30 (306D3) 6 Cyl. 17:1 2993cc 145-173kW (197-235PS) Diesel Turbo Intercooled		TD27267
3 (E90) 330 d, 3 (E90) 330 xd	09/05→12/11			
3 (E91) 325 d	09/06→06/12			
3 (E91) 330 d, 3 (E91) 330 xd	09/05→06/12			
3 (E92) 325 d	01/07→12/13			
3 (E92) 330 d, 3 (E92) 330 xd	09/06→12/13			
3 (E93) 325 d	01/07→12/13			
3 (E93) 330 d	03/07→12/13			
5 (E60) 525 d	01/07→03/10			
5 (E60) 525 d xDrive	09/08→03/10			
5 (E60) 525 xd	01/07→03/10			
5 (E60) 530 d	07/03→03/10			
5 (E60) 530 d xDrive	09/08→03/10			
5 (E60) 530 xd	07/05→03/10			
5 (E61) 525 d, 5 (E61) 525 xd	01/07→12/10			
5 (E61) 525 d xDrive	09/08→12/10			
5 (E61) 530 d, 5 (E61) 530 xd	07/05→12/10			
5 (E61) 530 d xDrive				
7 (E65; E66; E67) 730 d	10/02→07/08			
7 (E65; E66; E67) 730 Ld	07/05→12/09			
X3 (E83) 3.0 d	01/04→08/08			
X3 (E83) xDrive 30 d	09/08→04/11			
X5 (E70) 3.0 d	02/07→09/08			
X6 (E71; E72) 30 d	05/08→08/08			
3 (E46) 330 d	03/03→05/05	M57 N2306D2 Euro 4 6 Cyl. 2993cc 160kW (218PS) Diesel Turbo Intercooled		TD20589
X5 (E70) 3.0 d	09/03→09/06	M57 N2306D3 6 Cyl. 17:1 2993cc 150-180kW (204-245PS) Diesel Turbo Intercooled		TD24615
3 (E46) 330 d	03/03→05/05	M57 N306D2 Euro 4 6 Cyl. 17:1 2993cc 150-155kW (204-211PS) Diesel Turbo Intercooled		TD17525
X5 (E60) 530 d	07/03→03/10	M57 TU2D30 Euro 4 6 Cyl. 17:1 2993cc 145-173kW (197-235PS) Diesel Turbo Intercooled		TD20843



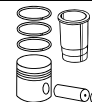
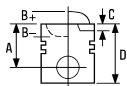

5 (E60) 530 d 07/03→05/10 **N57 306D2 Euro 4**
 6 Cyl.
2993cc **160kW (218PS)**
Diesel **Turbo Intercooled** **TD18307**

87-114400-40 STD **08-114400-40** STD
87-114405-40 0.25mm **08-114405-40** 0.25mm

A 44.87 3.00 CK P
B- 14.50 2.00 P
BØ 47.50 2.00 CK P
C 1.00
D 70.62
 30x66

AK KK NB RT

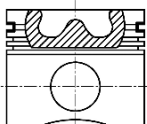
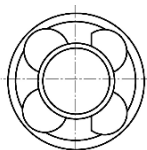

08408U105

Only for engines with parallel conrod Nur für Motoren mit Parallelpleuel Uniquement pour les moteurs à bielle parallèle Solo para motores con cabezal de biela paralela Solo per motori con biella parallela

13 **84.00**

3 (E46) 330 d 10/99→02/05 **M57 D30 (306D1)**
3 (E46) 330 xd 06/00→02/05 6 Cyl. 17:1
5 (E39) 530 d 08/98→05/04 **2926cc** **135-142kW (184-193PS)**
7 (E38) 730 d 08/98→11/01 **Diesel** **Turbo Intercooled** **TD27992**
X5 (E53) 3.0 d 05/01→12/03

87-114400-10 STD **08-114400-00** STD
87-114405-10 0.25mm **08-114405-00** 0.25mm

A 47.00 3.00 CK P
B- 16.55 2.00 P
BØ 41.60 3.00 CR P
C 1.40
D 71.10
 30x66

AK KK RT

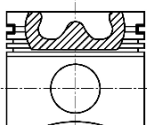
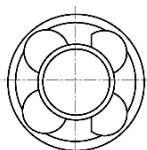

08452-L165

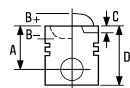

15  **84.00**

1 (E81) 116 d	11/08→09/12	N47 D2 A			
1 (E81) 118 d, 1 (E81) 120 d	09/06→09/12		4 Cyl.	17:1	
1 (E82) 120 d	10/07→10/13		1995cc	66-130kW (90-177PS)	
1 (E87) 116 d	12/08→09/12	Diesel	Turbo Intercooled		TD19922
1 (E87) 118 d, 1 (E87) 120 d	11/03→09/12				
1 (E88) 118 d	09/08→12/13				
1 (E88) 120 d	03/08→12/13				
3 (E90) 318 d	09/05→12/11				
3 (E90) 320 d	09/07→12/11				
3 (E91) 318 d, 3 (E91) 320 d	09/07→06/12				
3 (E91) 320 xd					
3 (E92) 320 d, 3 (E92) 320 xd					
3 (E93) 320 d	03/07→12/13				
5 (E60) 520 d	07/05→03/10				
5 (E61) 520 d	07/05→12/10				
X3 (E83) 2.0 d	09/07→03/09				

1 (E81) 123 d, 1 (E87) 123 d	03/07→09/12	N47 D20B			
1 (E82) 123 d	10/07→10/13		4 Cyl.	16:1	
1 (E88) 123 d	09/08→12/13		1995cc	150kW (204PS)	
		Diesel	Bi-Turbo Intercooled		TD20845

1 (E81) 116 d	11/08→09/12	N47 D20C			
1 (E81) 118 d, 1 (E81) 120 d	09/06→09/12		4 Cyl.	16:1	
1 (E82) 118 d	09/09→10/13		1995cc	66-150kW (90-204PS)	
1 (E82) 120 d	10/07→10/13	Diesel	Turbo Intercooled		TD24405
1 (E87) 116 d	01/11→12/11				
1 (E87) 118 d, 1 (E87) 120 d	11/03→09/12				
1 (E87) 123 d	03/07→09/12				
1 (E88) 118 d	09/08→12/13				
1 (E88) 120 d	03/08→12/13				
1 (F20) 116 d, 1 (F20) 118 d	12/10→				
1 (F20) 118 d xDrive	07/13→				
1 (F20) 120 d	12/10→				
1 (F20) 120 d xDrive	01/11→				
1 (F21) 116 d	01/12→				
1 (F21) 118 d	12/11→				
1 (F21) 118 d xDrive	05/13→				
1 (F21) 120 d, 1 (F21) 120 d xDrive	01/12→				
2 (F22; F87) 218 d	01/14→				
2 (F22; F87) 220 d	10/13→				
3 (E90) 316 d	07/09→12/11				
3 (E90) 318 d	09/05→12/11				
3 (E90) 320 d	01/05→12/11				
3 (E90) 320 d xDrive	07/08→12/11				
3 (E90) 320 xd	09/07→12/11				
3 (E91) 316 d	09/09→06/12				
3 (E91) 318 d	07/07→06/12				
3 (E91) 320 d	09/05→06/12				
3 (E91) 320 d xDrive	09/08→06/12				
3 (E92) 320 d	01/07→12/13				
3 (E92) 320 d xDrive	09/08→12/13				
3 (E93) 320 d	03/07→12/13				
3 (F30; F35; F80) 316 d					
3 (F30; F35; F80) 318 d	02/12→				
3 (F30; F35; F80) 318 d xDrive	11/12→				
3 (F30; F35; F80) 320 d	10/11→				
3 (F30; F35; F80) 320 d xDrive					
3 (F31) 316 d, 3 (F31) 318 d					
3 (F31) 318 d xDrive	01/13→				
3 (F31) 320 d	10/11→				



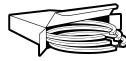
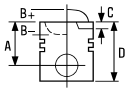

3 (F31) 320 d xDrive	06/12→
3 (F34) 318 d	
3 (F34) 320 d	
3 (F34) 320 d xDrive	03/13→
4 (F32; F82) 420 d	07/13→
4 (F32; F82) 420 d xDrive	11/13→
4 (F33; F83) 420 d	10/13→
4 (F36) 418 d	03/14→
4 (F36) 420 d	
4 (F36) 420 d xDrive	
5 (E60) 520 d	07/05→03/10
5 (E61) 520 d	07/05→12/10
5 (F07) 520 d	03/10→
5 (F10; F18) 518 d	01/13→
5 (F10; F18) 520 d	03/10→
5 (F10; F18) 520 d xDrive	02/13→
5 (F11) 518 d	01/13→
5 (F11) 520 d	04/10→
5 (F11) 520 d xDrive	02/13→
X1 (E84) sDrive 16 d	04/12→06/15
X1 (E84) sDrive 18 d	03/09→06/15
X1 (E84) sDrive 20 d	10/09→06/15
X1 (E84) xDrive 18 d	03/09→06/15
X1 (E84) xDrive 20 d, X1 (E84) xDrive 23 d	10/09→06/15
X3 (E83) 2.0 d	09/07→03/09
X3 (E83) xDrive 18 d	09/08→12/11
X3 (E83) xDrive 20 d	09/08→08/10
X3 (F25) sDrive 18 d	08/11→
X3 (F25) xDrive 20 d	09/10→
X3 (F25) xDrive 28 d	09/14→

X1 (E84) xDrive 23 d	10/09→06/15	N47 SD20D	4 Cyl.	16.1:1
			1995cc	150kW (204PS)
		Diesel	Bi-Turbo Intercooled	
				TD24642

87-432200-00	STD	08-432200-00	STD
87-432205-00	0.25mm	08-432205-00	0.25mm
87-432207-00	0.50mm	08-432207-00	0.50mm

09/08→

- A** 47.00
- B-** 14.50
- BØ** 47.50
- D** 73.00

32x63

AK KK RT TP

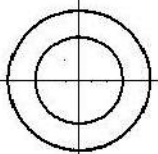

0840BB

1.75		GDC P
1.75		P
2.00		CR



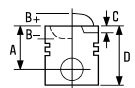







16  **85.00**

3 (E36) 316 i	12/98→08/00	M43 194E1			
3 (E46) 316 i	09/98→02/05		4 Cyl.		
3 (E46) 318 Ci	11/99→09/01		1895cc	85-87kW (116-118PS)	
3 (E46) 318 i	02/98→09/01				TD18439
Z3 (E36) 1.9	07/98→01/03				

3 (E36) 316 i	12/98→08/00	M43 B19 (194E1)			
3 (E46) 316 i	09/98→02/05		4 Cyl.	9.7:1	
3 (E46) 318 Ci	11/99→09/01		1895cc	85-87kW (116-118PS)	
3 (E46) 318 i	02/98→09/01				TD27701
Z3 (E36) 1.9	07/98→01/03				

87-425700-00	STD	08-425700-00	STD
87-425707-00	0.50mm	08-425707-00	0.50mm

A	30.40	1.20		NT 
B-	4.00	1.50		P
BØ	70.00	2.00		NT 
D	53.90			
	22x54			

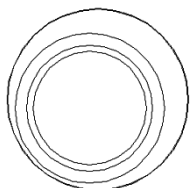
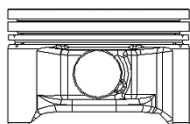

 Steel

 Stahl

 Acier

 Acero

 Acciaio



1 82.00

BLS 1.9 D	04/06 →	Z19DTH	4 Cyl.	17.5:1
			1910cc	110kW (150PS)
		Diesel	Turbo Intercooled Direct Injection	TD20109

87-146100-00 STD
87-146108-00 0.60mm

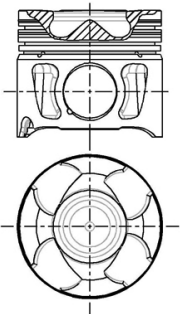

A 46.50
B- 15.40
BØ 41.50
C 1.03
D 72.50
 26x61

AK KK NB RT TP



08256-102

08-146100-00 STD
08-146106-00 0.40mm
08-146108-00 0.60mm

2.00  CK P
 2.00  P
 2.00  CK P

87-146100-10 STD
87-146106-10 0.40mm

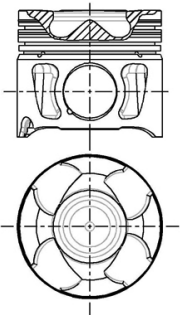

A 46.50
B- 15.40
BØ 41.50
C 1.07
C 1.02
D 72.50
 30x67

AK KK RT TP



08269-503

08-146100-00 STD
08-146106-00 0.40mm
08-146108-00 0.60mm

2.00  CK P
 2.00  P
 2.00  CK P



1 75.00

Seven 1.4	04/91 →	14 K4F	4 Cyl.			
Seven 1.4 i	01/92 →		1396cc	74-97kW (101-132PS)		
						TD29219

<p>87-520500-00 STD</p> <p>01/95 →</p> <p>A 23.84 D 46.79 18x48</p> <p> Steel</p>	<p>08-520500-00 STD</p> <p>1.00 1 1.20 1 2.00 NT 1</p> <p> Stahl</p>	<p>14-710030-00 WH B 84.10 C 129.50 D 87.50 E 50.00</p> <p> Acier</p>	<p>88-520500-00</p> <p>87-520500-00 + 14-710030-00</p> <p> Acciaio</p>
---	--	--	---

2 80.00

Seven 1.8	04/07 → 12/08	18 K4F	4 Cyl.			
			1796cc	118kW (160PS)		
						TD31747

<p>87-522700-00 STD</p> <p>A 22.70 B- 0.53 BØ 68.20 C 2.65 D 45.65 18x53</p> <p>TP</p> <p> Steel</p>	<p>08-522700-00 STD</p> <p>1.00 CR 1 1.20 P 2.00 CR 1</p> <p> Stahl</p>	<p>14-710020-00 WH B 84.10 C 129.50 D 87.50 E 50.00</p> <p> Acier</p>	<p>88-522700-00</p> <p>87-522700-00 + 14-710020-00</p> <p> Acciaio</p>
--	--	--	---



3  **86.00**

Seven HPC

C 20 XE

4 Cyl.
1998cc



10.5:1
110-115kW (150-156PS)

TD19841

87-306800-10 STD
87-306807-10 0.50mm

08-306800-00 STD
08-306807-00 0.50mm
08-306811-00 1.00mm

A 30.43
B- 0.85
BØ 70.00
C 2.20
D 55.43
 21x62

1.50  CR P
1.50  P
3.00  CR 1

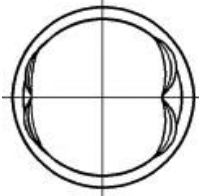
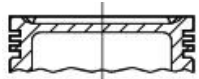





 Steel

 Stahl

 Acier

 Acero

 Acciaio

		ccm	x 		
4JA1	Diesel	2499	4	93.00	15
A 14 NET Euro 5	Petrol	1364	4	72.50	1
A 14 XER	Petrol	1398	4	73.40	3
C 14 NZ	Petrol	1389	4	77.60	4
C 16 SE	Petrol	1598	4	79.00	6
C 16 XE Ecotec	Petrol	1598	4	79.00	7
C 20 NE	Petrol	1998	4	86.00	13
X 14 YEH	Petrol	1389	4	77.60	4
X 16 XE Ecotec	Petrol	1598	4	79.00	7
X 20 XEV Ecotec	Petrol	1998	4	86.00	14
Y 17 DT	Diesel	1686	4	79.00	9
Y 20 DTH	Diesel	1995	4	84.00	12
Z 12 XE Ecotec	Petrol	1199	4	72.50	2
Z 14 XE Ecotec	Petrol	1389	4	77.60	5
Z 16 SE	Petrol	1598	4	79.00	8
Z 16 XE Ecotec	Petrol	1598	4	79.00	8
Z 18 XE Ecotec	Petrol	1796	4	80.50	10
Z 20 S	Diesel	1991	4	83.00	11
Z 20 S1	Diesel	1991	4	83.00	11



1 72.50

Cruze 1.4	09/10→	A 14 NET Euro 5		
Trax 1.4 LPG	04/13→	4 Cyl.	9.5:1	
		1364cc	103kW (140PS)	
		Turbo Intercooled		TD29268

87-437400-00 STD

08-437400-00 STD

A 25.87

B- 2.90



BØ 54.78

C 2.10



C 1.87

D 44.18

 18x48

1.20  DLC NT 

1.20  P

2.00  NT 

CARBOGLIDE®

TP

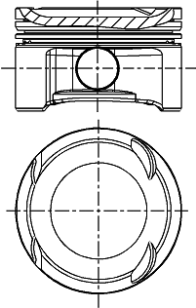

07279-212

 Steel

 Stahl

 Acier

 Acero

 Acciaio

2 72.50

Sail 1.2	01/12→	Z 12 XE Ecotec		
Spark 1.2	12/09→	4 Cyl.	10.1:1	
Spark 1.2 LPG	01/11→	1199cc	59-63kW (80-86PS)	
				TD26428

87-102700-10 STD

08-102700-00 STD

87-102707-10 0.50mm



08-102707-00 0.50mm

A 24.00



C 1.25

D 45.00

 18x51

1.20  NT 

1.50  P

2.00  CR 

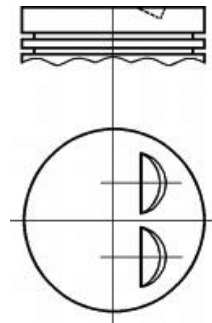

 Steel

 Stahl

 Acier

 Acero







 Acciaio



3 73.40

Aveo 1.4	04/08 →	A 14 XER			
Cruze 1.4	07/13 →		4 Cyl.	1398cc	74kW (101PS)
					TD25431

87-429500-30	STD	08-429500-00	STD
87-429507-30	0.50mm	08-429507-00	0.50mm

A	25.80	1.20	 NT 
B-	1.60	1.20	 P
C	1.90	2.00	 CR 
C	3.83		
D	46.80		
	18x53		

TP

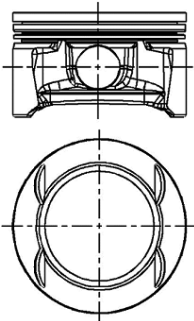

 Steel

 Stahl

 Acier

 Acero





 Acciaio

4 77.60

Chevy 1.4	12/95 → 07/06	C 14 NZ			
Corsa 1.4 GLS	08/94 → 07/97		4 Cyl.	1389cc	9:1
Monza 1.4	12/95 → 09/02				44kW (60PS)
					TD19861

Agile 1.4	10/09 →	X 14 YEH			
Corsa 1.4	01/09 →		4 Cyl.	1389cc	68-77kW (92-105PS)
Corsa 1.4 Flex	06/07 →				
Meriva 1.4, Meriva 1.4 Flex	07/07 → 07/12				
Montana 1.4	01/11 →				
					TD26868

87-307100-20	STD	08-307100-00	STD
87-307107-20	0.50mm	08-307107-00	0.50mm

A	32.10	1.50	 CR P
B-	3.40	1.50	 P
D	52.50	3.00	 CR 
	18x55		

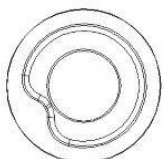
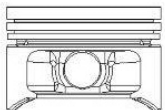

 Steel

 Stahl

 Acier

 Acero

 Acciaio









5 77.60

Chevy 1.4	08/02→09/06	Z 14 XE Ecotec		
Corsa 1.4	09/01→07/02	4 Cyl.	10.5:1	
		1389cc	66kW (90PS)	

TD28086

87-144200-00	STD	08-144200-00	STD
87-144207-00	0.50mm	08-144207-00	0.50mm

A	31.30	1.20		NT 
B+	2.45	1.50		P
D	55.75	2.00		CR 
	18x55			

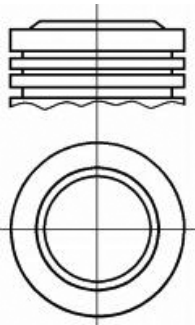

 Steel

 Stahl

 Acier

 Acero







 Acciaio

6 79.00

Tigra 1.6	08/97→12/99	C 16 SE		
		4 Cyl.		
		1598cc	74kW (100PS)	

TD28280

87-306900-10	STD	08-306900-00	STD
87-306907-10	0.50mm	08-306907-00	0.50mm

A	28.00	1.20		CR 
B-	1.60	1.50		P
B+	0.40	3.00		CR 
BØ	59.00			
D	48.40			
	18x55			

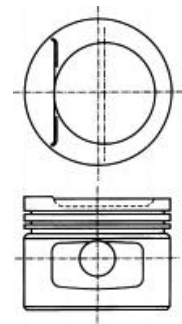

 Steel

 Stahl

 Acier

 Acero

 Acciaio









7 79.00

Corsa 1.6 GSI	08/94→07/97	C 16 XE Ecotec	4 Cyl.	10:1
			1598cc	80kW (109PS)
TD23209				

Corsa 1.6 GS	08/97→07/02	X 16 XE Ecotec	4 Cyl.	10:1
Corsa 1.6 GSI	08/94→07/97		1598cc	75-80kW (102-108PS)
TD19866				

87-307800-10	STD	08-307800-00	STD
87-307807-10	0.50mm	08-307807-00	0.50mm
		08-307811-00	1.00mm

A	28.00
B-	0.80
BØ	60.20
C	1.90
C	2.15
D	48.00
	18x55

1.20		CR 
1.50		P
2.50		CR 

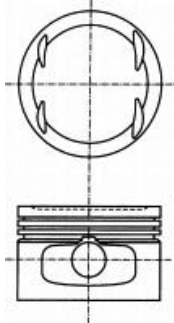

 Steel

 Stahl

 Acier

 Acero

 Acciaio





8 79.00

Combo 1.6	04/01→	Z 16 SE	4 Cyl.	9.6:1
Corsa 1.6	08/01→		1598cc	62-64kW (84-87PS)
TD19869				

Chevy 1.6	08/02→	Z 16 XE Ecotec	4 Cyl.	10.5:1
			1598cc	74kW (101PS)
TD27250				

87-125600-00	STD	08-125600-00	STD
87-125607-00	0.50mm	08-125607-00	0.50mm

A	27.20
D	50.20
	18x55

1.20		NT 
1.50		P
2.50		CR 

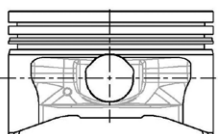

 Steel

 Stahl

 Acier

 Acero





 Acciaio



9 79.00

Astra 1.7 Di	08/00→08/03	Y 17 DT			
Corsa 1.7 DTi	08/01→		4 Cyl.	18.4:1	
			1686cc	55kW (75PS)	
		Diesel	Turbo		TD19867

87-307600-40	STD	08-307600-00	STD
87-307607-40	0.50mm	08-307607-00	0.50mm

A	39.75	2.00		CR P
B-	14.00	1.50		CR P
BØ	38.70	3.00		CR P
C	1.10			
D	84.00			
	27x64			



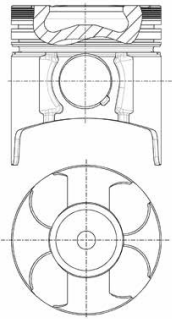



RT



10 80.50

Astra 1.8	08/02→06/05	Z 18 XE Ecotec			
Meriva 1.8	05/03→05/08		4 Cyl.	10.5:1	
Niva 1.8	01/07→12/09		1796cc	90-92kW (122-125PS)	
VIVA 1.8	09/03→03/08				TD21857
Zafira 1.8	07/00→06/05				

87-141200-00	STD	08-141200-00	STD
87-141207-00	0.50mm	08-141207-00	0.50mm

A	24.10	1.20		NT 
D	44.70	1.20		P
	18x55	2.00		CR 

TP

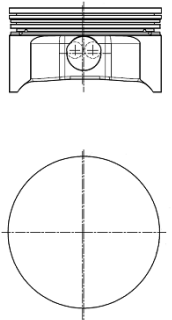

 Steel

 Stahl

 Acier

 Acero

 Acciaio



11 83.00

Captiva 2.0 D, Captiva 2.0 D 4WD	10/06→	Z 20 S			
Epica 2.0 D, Nubira 2.0 D	01/07→		4 Cyl.	17.5:1	
Nubira 2.0 D	01/05→		1991cc	89-110kW (121-150PS)	
		Diesel			TD21855
Cruze 2.0 CDI	05/09→	Z 20 S1			
Optra 2.0 TCDi	01/07→		4 Cyl.	17.5:1	
			1991cc	92-110kW (125-150PS)	
		Diesel	Turbo Intercooled		TD24614



87-879200-00
87-879207-00

STD
0.50mm

08-879200-00
08-879207-00

STD
0.50mm

A 46.35
B- 13.95
BØ 51.90
D 72.35
 28x67

2.00  CR P
2.00  P
3.00  NT

AK KK RT TP

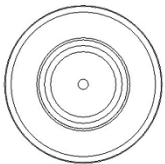
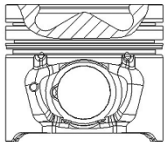

12 84.00

Astra 2.0 DTi	08/02→	Y 20 DTH			
Astra 2.0 DTi GLS	08/02→12/11		4 Cyl.	18.5:1	
			1995cc	74kW (101PS)	
		Diesel	Turbo Intercooled		TD19868



87-126000-00
87-126007-00

STD
0.50mm

08-126000-00
08-126007-00

STD
0.50mm

A 45.85
B- 14.68
BØ 41.00
C 1.05
D 70.80
 29x68

1.75  CK P
1.75  P
3.00  CR P

AK KK RT TP

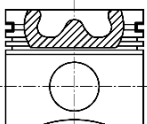
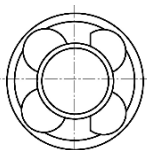

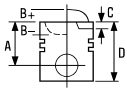





13 86.00

Astra 2.0	02/96→	C 20 NE		
Ipanema 2.0, Ipanema 2.0 Álcool	03/91→12/97		4 Cyl.	9.2:1
Kadett 2.0	03/91→12/98		1998cc	81-90kW (110-122PS)
Kadett 2.0 Álcool	03/91→12/97			
Omega 2.0	02/92→12/94			
Omega 2.0 Álcool	03/93→12/95			
Omega 2.0 Flex, Omega Suprema 2.0	09/91→07/97			
Vectra 2.0	03/96→12/05			
Zafira 2.0	04/01→07/04			

TD28278

87-306800-30	STD	08-306800-00	STD
87-306807-30	0.50mm	08-306807-00	0.50mm
87-306811-30	1.00mm	08-306811-00	1.00mm

A	30.40	1.50		CR P
B-	5.00	1.50		P
BØ	57.00	3.00		CR 1
D	50.40			
	21x62			

TP

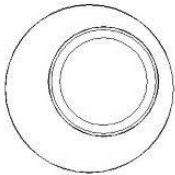
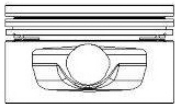

 Steel

 Stahl

 Acier

 Acero





 Acciaio

14 86.00

Astra 2.0	10/99→07/02	X 20 XEV Ecotec		
Astra 2.0, Astra 2.0 GLS	03/99→07/02		4 Cyl.	10:1
			1998cc	94kW (128PS)

TD26430

87-306800-20	STD	08-306800-00	STD
87-306807-20	0.50mm	08-306807-00	0.50mm
		08-306811-00	1.00mm

A	30.40	1.50		CR P
B-	3.16	1.50		P
C	2.00	3.00		CR 1
D	55.40			
	21x62			

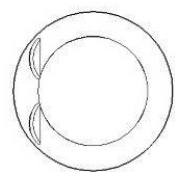
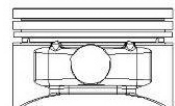

 Steel

 Stahl

 Acier

 Acero

 Acciaio



15  **93.00**

Blazer S10 2.5 D

10/94→05/05

4JA1

4 Cyl.
2499cc

18.5:1
81kW (110PS)

Diesel



TD26440

87-248000-00

STD



08-248000-10 

STD

14-021450-00 DH    B 95.04 C 156.31 D 101.00 E 0.92

88-248000-00
87-248000-00 +
14-021450-00



A 47.80
B- 14.65
BØ 44.20
C 1.80
D 87.80
 31x76

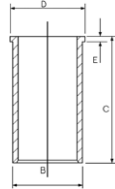

2.00 
2.00 
4.00 

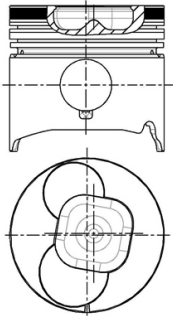







AK RT





 Not suitable for use with pistons having chrome rings
 Chrome Bore
 Ringset only for AE/Nural piston

 Nicht geeignet zur Verwendung mit Kolben mit Chromringen
 Bohrung verchromte
 Ringsätze Ringset nur für AE/Nural Kolben

 Ne pas utiliser avec des pistons équipés de segments chromés
 Alésage chromée
 Ringset seulement pour le piston d'AE/Nural

 No es adecuada para usar con pistones que tengan aros de croma
 Cromado de cilindro
 Ringset solamente para el pistón de AE/Nural

 Non utilizzabile con pistoni equipaggiati con segmenti crom
 Cilindro cromato
 Ringset soltanto per il pistone di AE/Nural



1 83.00

Delta 2.0 D Multijet

08/11 →



198 A5.000 Multijet

4 Cyl. 16.1:1
 1956cc 121kW (165PS)
 Diesel Turbo Intercooled

TD26560

87-436500-00 STD 08-436500-00 STD
 87-436506-00 0.40mm 08-436506-00 0.40mm

A 43.63
 B- 15.80
 BØ 43.50
 D 72.63
 30x66

1.50  GDC P
 1.50  P
 2.00  CR P

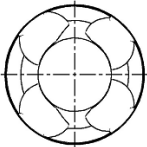
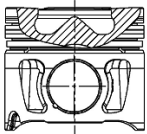

08344A406

2 86.00

Jeep CJ7 2.1 D

01/88 →



J8S

4 Cyl. 21.5:1
 2068cc 59-64kW (80-87PS)
 Diesel

TD4254

87-337100-00 STD 08-337100-00 STD 14-000320-00 WH  B 93.60 C 166.00 E 93.05 89-337100-00

A 50.95
 B- 2.20
 D 87.95
 28x75

2.25  P PS
 2.00  P
 3.00  CR P

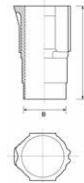

87-337100-00 +
 14-000320-00

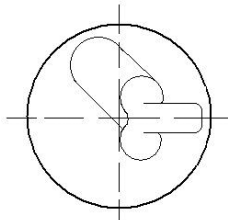

 Phosphated

 Phosphated

 Phosphated

 Phosphated

 Phosphated



3 92.00

Voyager 2.5 TD	01/92 → 09/95	M00 (HR 425 CL)	4 Cyl. 2499cc	22:1 85-87kW (116-118PS)	TD4253
		Diesel			
Voyager II 2.5 TD	01/95 →	VM 425HR (M51)	4 Cyl. 2499cc	22:1 85-89kW (115-121PS)	TD4257
		Diesel Turbo			
Voyager II 2.5 TD	01/95 →	VM 425HS (M52)	4 Cyl. 2499cc	22:1 85kW (115PS)	TD535
		Diesel Turbo			

87-110100-00 STD 08-110100-00 STD 14-676420-00 WH B 101.50 C 166.80 D 110.00 E 8.90 F 1.20 89-110100-00

A 51.00
B- 2.10
D 86.00
 30x76

2.50
2.00
4.00





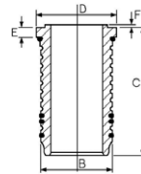



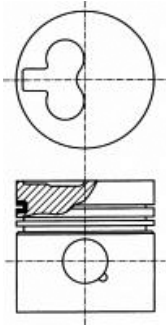

CR P
P
CR P







87-110100-00 +
14-676420-00



		ccm	x 		9
129/5	Petrol	1219	4	75.00	6
159B	Petrol	1905	4	83.00	23
169B	Petrol	1796	4	84.00	28
171C	Petrol	1580	4	83.00	23
220 A2.000	Petrol	1581	4	86.40	40
829.A5	Petrol	1995	4	88.00	41
8140.43N Euro 3	Diesel	2798	4	94.40	49
8140.43S Euro 3	Diesel	2798	4	94.40	49
8140.63 (F28D)	Diesel	2798	4	94.40	50
B6E	Petrol	1580	4	83.00	23
B25/637	Diesel	2500	4	93.00	46
CRD93B	Diesel	2499	4	93.00	46
CRD93L (U25/661)	Diesel	2500	4	93.00	46
CRD93LS (U25/673)	Diesel	2500	4	93.00	47
D2E	Petrol	1905	4	83.00	24
DJ5 (T9A)	Diesel	2446	4	92.00	43
DJ5T (T8A)	Diesel	2446	4	92.00	44
DJ5T (THZ)	Diesel	2446	4	92.00	44
DJ5TED (THX)	Diesel	2446	4	92.00	45
DK5ATE (THY)	Diesel	2446	4	92.00	44
DT17ED4	Diesel	2720	V6	81.00	19
DT17TED4 (UHZ)	Diesel	2720	V6	81.00	19
DV4C (8HR)	Diesel	1398	4	73.70	4
DV4D	Diesel	1398	4	73.70	4
DV4TD (8HT)	Diesel	1398	4	73.70	4
DV4TD (8HX) Euro 3/4	Diesel	1399	4	73.70	4
DV4TD (8HZ)	Diesel	1398	4	73.70	4
DV4TED4 (8HY)	Diesel	1399	4	73.70	5
DV6ATED4 (9HX) Euro 4	Diesel	1560	4	75.00	11
DV6BTED4 (9HT) Euro 4	Diesel	1560	4	75.00	12
DV6BTED4 (9HW) Euro 4	Diesel	1560	4	75.00	12
DV6BUTED4 (9HT) Euro 4	Diesel	1560	4	75.00	12
DV6C (9HL)	Diesel	1560	4	75.00	12
DV6C (9HR)	Diesel	1560	4	75.00	12
DV6DBM (9HE) Euro 4	Diesel	1560	4	75.00	13
DV6DTED (9HF) Euro 4	Diesel	1560	4	75.00	12
DV6DTED (9HP) Euro 4	Diesel	1560	4	75.00	12
DV6DTEDM (9HJ) Euro 4	Diesel	1560	4	75.00	12
DV6ETED (9HN) Euro 4	Diesel	1560	4	75.00	13
DV6ETED (9HW) Euro 4	Diesel	1560	4	75.00	12
DV6ETEDM (9HK) Euro 4	Diesel	1560	4	75.00	12
DV6TED4 (9HY)	Diesel	1560	4	75.00	11
DV6TED4 (9HZ) Euro 4	Diesel	1560	4	75.00	11
DV6UTED4 (9HU)	Diesel	1560	4	75.00	11
DW8 (WJZ) / DW8B (WJY)	Diesel	1868	4	82.20	20
DW8B (WJX)	Diesel	1868	4	82.20	21
DW8B (WJY)	Diesel	1868	4	82.20	20
DW10ATED (RHS)	Diesel	1997	4	85.00	29
DW10ATED (RHZ)	Diesel	1998	4	85.00	29
DW10ATED4 (RHM)	Diesel	1997	4	85.00	30
DW10ATED4 (RHT)	Diesel	1997	4	85.00	30
DW10ATED4 (RHW)	Diesel	1997	4	85.00	30
DW10BTED (RHX)	Diesel	1997	4	85.00	29
DW10BTED4 (RHF)	Diesel	1997	4	85.00	31
DW10BTED4 (RHJ) Euro 4	Diesel	1997	4	85.00	31
DW10BTED4 (RHR) Euro 4	Diesel	1997	4	85.00	31
DW10CTED4 (RHC) Euro 5	Diesel	1997	4	85.00	32
DW10CTED4 (RHD) Euro 4	Diesel	1997	4	85.00	32
DW10CTED4 (RHE)	Diesel	1997	4	85.00	32
DW10CTED4 (RHH) Euro 5	Diesel	1997	4	85.00	32
DW10FC (AHW) Euro 5	Diesel	1997	4	85.00	33
DW10FD (AHR) Euro 5	Diesel	1997	4	85.00	33
DW10FD (AHX) Euro 5	Diesel	1997	4	85.00	33
DW10FDD (AHV) Euro 5	Diesel	1997	4	85.00	33
DW10TD (RHV)	Diesel	1997	4	85.00	29
DW10TD (RHY)	Diesel	1998	4	85.00	29
DW10UTD (RHV)	Diesel	1997	4	85.00	29
DW10UTED4 (RHK) Euro 4	Diesel	1997	4	85.00	31
DW12BTED4 (4HP) Euro 4	Diesel	2179	4	85.00	34

		ccm	x 		
DW12BTED4 (4HR) Euro 4	Diesel	2179	4	85.00	34
DW12BTED4 (4HT) Euro 4	Diesel	2179	4	85.00	34
DW12C (4HL)	Diesel	2179	4	85.00	35
DW12MTED4 (4HN)	Diesel	2179	4	85.00	34
DW12TED4 (4HW)	Diesel	2179	4	85.00	36
DW12TED4/FAP (4HX)	Diesel	2179	4	85.00	36
E1A	Petrol	1118	4	72.00	1
F28TDCR Euro 3	Diesel	2798	4	94.40	49
J6TA 500 / J6RA 500	Petrol	2165	4	88.00	41
K1B	Petrol	1360	4	75.00	7
K1G	Petrol	1360	4	75.00	7
KAZ	Petrol	1360	4	75.00	7
M22-629	Diesel	2499	4	93.00	46
M25-629	Diesel	2500	4	93.00	46
M25-637	Diesel	2499	4	93.00	46
M25-648	Diesel	2500	4	93.00	47
M25-660	Diesel	2500	4	93.00	46
M25-661	Diesel	2499	4	93.00	46
M25-669	Diesel	2500	4	93.00	47
M705	Diesel	1930	4	82.60	22
P22DTE (4HU) Euro 4	Diesel	2198	4	86.00	38
P22DTE (4HV) Euro 4	Diesel	2198	4	86.00	39
R6A	Petrol	1998	4	86.00	37
TU1 (H1B)	Petrol	1124	4	72.00	2
TU1CP (HAZ)	Petrol	1124	4	72.00	2
TU1JP (HFX)	Petrol	1124	4	72.00	3
TU1 K (H1A)	Petrol	1124	4	72.00	2
TU1M (HDZ)	Petrol	1124	4	72.00	2
TU1M+ (HDY)	Petrol	1124	4	72.00	2
TU2.4	Petrol	1294	4	75.00	8
TU3 (K3A)	Petrol	1360	4	75.00	7
TU3A (K1H)	Petrol	1360	4	75.00	7
TU3A (K6D)	Petrol	1360	4	75.00	7
TU3A (K6E)	Petrol	1360	4	75.00	7
TU3A (K6F)	Petrol	1360	4	75.00	7
TU3A (KFT)	Petrol	1360	4	75.00	7
TU3A (KFV)	Petrol	1360	4	75.00	7
TU3A (KFW)	Petrol	1360	4	75.00	7
TU3A (KFX)	Petrol	1360	4	75.00	7
TU3CP (KAY)	Petrol	1360	4	75.00	7
TU3F2 (K1F)	Petrol	1360	4	75.00	7
TU3F2 (K2B)	Petrol	1360	4	75.00	7
TU3FJ2 (K2D)	Petrol	1360	4	75.00	7
TU3FJ2 (KFY)	Petrol	1360	4	75.00	7
TU3FJ2 (KFZ)	Petrol	1360	4	75.00	7
TU3FM (K2A)	Petrol	1360	4	75.00	7
TU3FM (KDY)	Petrol	1360	4	75.00	7
TU3JP	Petrol	1360	4	75.00	9
TU3JP (KFW)	Petrol	1360	4	75.00	10
TU3JP (KFX)	Petrol	1360	4	75.00	10
TU3JP-L4 (KFV)	Petrol	1360	4	75.00	10
TU3M (KDX)	Petrol	1360	4	75.00	7
TU3M (KDY)	Petrol	1360	4	75.00	7
TU3M/Z (KDZ)	Petrol	1360	4	75.00	7
TU5J4 (NFX)	Petrol	1587	4	78.50	15
TU5JP (NFV)	Petrol	1587	4	78.50	16
TU5JP (NFZ)	Petrol	1587	4	78.50	16
TU5JP4 (N6A)	Petrol	1587	4	78.50	16
TU5JP4 (NFU)	Petrol	1587	4	78.50	15
TU5JPL4	Petrol	1587	4	78.50	16
TUD5 (VJY)	Diesel	1527	4	77.00	14
TUD5 (VJZ)	Diesel	1527	4	77.00	14
XD3/P	Diesel	2498	4	94.00	48
XM7T (169)	Petrol	1796	4	84.00	28
XN1T (170A)	Petrol	1971	4	88.00	42
XN1T (170B)	Petrol	1971	4	88.00	42
XN1T (170C)	Petrol	1971	4	88.00	42
XU5 (171A)	Petrol	1580	4	83.00	25
XU5 (B1AA)	Petrol	1580	4	83.00	25

		ccm	x 		9
XU5CP (BAY/BAZ)	Petrol	1580	4	83.00	23
XU5J (180A/B6D)	Petrol	1580	4	83.00	23
XU5J (180Z)	Petrol	1580	4	83.00	25
XU5JA (B6D)	Petrol	1580	4	83.00	23
XU5J/J2/JA	Petrol	1580	4	83.00	23
XU5JP (BFZ)	Petrol	1580	4	83.00	25
XU5M (BDY/B4A)	Petrol	1580	4	83.00	23
XU5M (BDZ)	Petrol	1580	4	83.00	23
XU5S (171B)	Petrol	1580	4	83.00	25
XU5S (171D)	Petrol	1580	4	83.00	25
XU7JB (LFX)	Petrol	1761	4	83.00	23
XU7JP (LFW/LFZ)	Petrol	1761	4	83.00	23
XU7JP4 (LFY)	Petrol	1761	4	83.00	23
XU9J1 (DFZ)	Petrol	1905	4	83.00	24
XU9J2 (D6A)	Petrol	1905	4	83.00	24
XU9J4 (D6C/DFW)	Petrol	1905	4	83.00	23
XU9J4 (DFW)	Petrol	1905	4	83.00	23
XU9JA (D6E)	Petrol	1905	4	83.00	24
XU9JA (DKZ)	Petrol	1905	4	83.00	24
XU9M (DDZ)	Petrol	1905	4	83.00	23
XU9S (159A)	Petrol	1905	4	83.00	23
XU10J2 (RFZ)	Petrol	1998	4	86.00	37
XU10J2C (RFU)	Petrol	1998	4	86.00	37
XU10J2C (RFX)	Petrol	1998	4	86.00	37
XU10J2C/Z L3 (RFX)	Petrol	1998	4	86.00	37
XU10J2U (RFW)	Petrol	1998	4	86.00	37
XU51C (B1E)	Petrol	1580	4	83.00	23
XU52C	Petrol	1580	4	83.00	23
XU92C (D2A)	Petrol	1905	4	83.00	24
XU92C (D2C)	Petrol	1905	4	83.00	24
XU92C (D2F)	Petrol	1905	4	83.00	24
XUD7 (161)	Diesel	1769	4	80.00	17
XUD7 (161A)	Diesel	1769	4	80.00	17
XUD7 (A9A/161A)	Diesel	1769	4	80.00	17
XUD7TE (A8A)	Diesel	1769	4	80.00	18
XUD7TE (AJZ)	Diesel	1769	4	80.00	18
XUD9 (162)	Diesel	1905	4	83.00	26
XUD9 (D9A)	Diesel	1905	4	83.00	26
XUD9 (DJZ)	Diesel	1905	4	83.00	26
XUD9A (DJY)	Diesel	1905	4	83.00	26
XUD9A/L (D9B)	Diesel	1905	4	83.00	26
XUD9A/U (D9B)	Diesel	1905	4	83.00	26
XUD9BSD (DHV)	Diesel	1905	4	83.00	27
XUD9BTF (DHX)	Diesel	1905	4	83.00	27
XUD9SD (DHW)	Diesel	1905	4	83.00	27
XUD9TE (DHY)	Diesel	1905	4	83.00	27
XUD9TF (D8B)	Diesel	1905	4	83.00	27
XUD9UTF (D8C)	Diesel	1905	4	83.00	27
XW7 (109/5)	Petrol	1124	4	72.00	1
XW7 (109/5E)	Petrol	1124	4	72.00	1
XW7 (109/5F)	Petrol	1124	4	72.00	1
XW7 (109K)	Petrol	1124	4	72.00	1
XY8 (150B)	Petrol	1360	4	75.00	9



1 72.00

C15 1.1	10/84→12/96	E1A	4 Cyl. 1118cc	9.6:1 35kW (48PS)	TD648
Visa 11 E	09/78→03/91	XW7 (109/5)	4 Cyl. 1124cc	37-42kW (50-57PS)	TD564
LNA 1.1	07/82→04/85	XW7 (109/5E)	4 Cyl. 1124cc	9.7:1 33-37kW (45-50PS)	TD565
Visa 11 E	09/78→03/91	XW7 (109/5F)	4 Cyl. 1124cc	9.7:1 33-37kW (45-50PS)	TD566
Visa 11 RE	03/83→10/88		4 Cyl. 1124cc	9.7:1 33-37kW (45-50PS)	TD566
C15 1.1	10/84→12/96	XW7 (109K)	4 Cyl. 1124cc	9.7:1 34-36kW (48-50PS)	TD563
Visa 11 E	09/78→06/88		4 Cyl. 1124cc	9.7:1 34-36kW (48-50PS)	TD563

14-636470-00 WH B 79.50 C 122.00 D 89.20 E 85.00

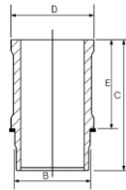

2 72.00

AX 11	09/86→12/97	TU1 (H1B)	4 Cyl. 1124cc	9.2:1 40-44kW (55-60PS)	TD658
ZX 1.1	03/91→08/93		4 Cyl. 1124cc	9.2:1 40-44kW (55-60PS)	TD658
AX 11	12/86→04/94	TU1 K (H1A)	4 Cyl. 1124cc	9.2:1 40-44kW (54-60PS)	TD6562
BX 11	10/86→06/92		4 Cyl. 1124cc	9.2:1 40-44kW (54-60PS)	TD6562
C15 1.1	11/88→07/96		4 Cyl. 1124cc	9.2:1 40-44kW (54-60PS)	TD6562
ZX 1.1	03/91→08/93		4 Cyl. 1124cc	9.2:1 40-44kW (54-60PS)	TD6562
AX 11 CAT	09/88→12/89	TU1CP (HAZ)	4 Cyl. 1124cc	9.2:1 40kW (54PS)	TD5083
AX 11	09/86→12/97	TU1M (HDZ)	4 Cyl. 1124cc	9.7:1 40-44kW (55-60PS)	TD661
Berlingo 1.1 i	07/96→		4 Cyl. 1124cc	9.7:1 40-44kW (55-60PS)	TD661
BX 11	10/88→06/92		4 Cyl. 1124cc	9.7:1 40-44kW (55-60PS)	TD661
C15 1.1	08/88→07/96		4 Cyl. 1124cc	9.7:1 40-44kW (55-60PS)	TD661
C15 1.1 i	07/88→12/96		4 Cyl. 1124cc	9.7:1 40-44kW (55-60PS)	TD661
Saxo 1.1 BiFuel	07/00→06/03		4 Cyl. 1124cc	9.7:1 40-44kW (55-60PS)	TD661
Saxo 1.1 X;SX	05/96→09/03		4 Cyl. 1124cc	9.7:1 40-44kW (55-60PS)	TD661
ZX 1.1	03/91→06/97		4 Cyl. 1124cc	9.7:1 40-44kW (55-60PS)	TD661



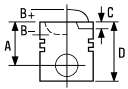

AX 1.1 06/92→09/03 **TU1M+ (HDY)** 4 Cyl. 9.2:1
1124cc **40kW (54PS)** **TD26411**

87-154300-00 STD

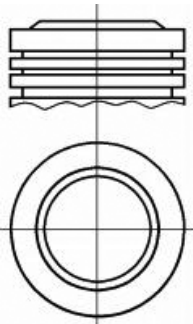

A 40.05
B+ 2.97
D 64.05
 20x62



 Steel

08-154300-00 STD
08-154307-00 0.50mm

01/87→

1.50  CR P
 2.00  P
 3.00  CR **1**

 Stahl

 Acier

14-636470-00 WH B 79.50 C 122.00 D 89.20 E 85.00

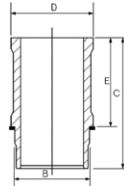

 Acero

88-154300-00
 87-154300-00 +
 14-636470-00

 Acciaio

3 72.00



Berlingo 1.1 i 07/96→ **TU1JP (HFX)** 4 Cyl. 10.5:1
C2 1.1 09/03→ **1124cc** **44kW (60PS)**
C3 I 1.1 i 02/02→
C3 II 1.1 11/09→ **TD14730**
Saxo 1.1 X;SX 05/96→09/03

87-426300-00 STD

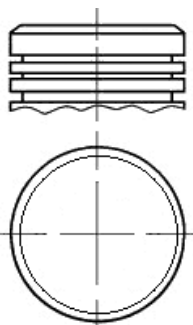
A 27.70
B+ 0.10
D 47.50
 18x55



08-426300-00 STD

1.50  NT
 1.50  P
 2.50  P



4 73.70

C3 II 1.4 HDi 70	11/09→	DV4C (8HR)			
DS3 1.4 HDi 70	04/10→07/15		4 Cyl.	18:1	
			1398cc	50kW (68PS)	
		Diesel	Turbo Intercooled		TD25061
C1 1.4 HDi	06/05→	DV4D			
			4 Cyl.		
			1398cc	40kW (54PS)	
		Diesel	Turbo Intercooled		TD18550
C1 1.4 HDi	06/05→	DV4TD (8HT)			
			4 Cyl.	17.9:1	
			1398cc	40kW (54PS)	
		Diesel	Turbo Intercooled		TD25062
C2 1.4 HDi	09/03→	DV4TD (8HX) Euro 3/4			
C2 ENTERPRISE 1.4 HDi	04/09→		4 Cyl.	17.9:1	
C3 I 1.4 HDi	02/02→		1399cc	50-55kW (68-75PS)	
C3 Pluriel 1.4 HDi	04/04→	Diesel	Turbo Intercooled		TD16425
Xsara 1.4 HDi	01/03→08/05				
C2 1.4 HDi	09/03→	DV4TD (8HZ)			
C3 I 1.4 HDi	07/03→		4 Cyl.	17.9:1	
C3 II 1.4 HDi 70	11/09→		1398cc	50-52kW (68-71PS)	
		Diesel	Turbo Intercooled		TD23773

87-135300-00 STD
 87-135305-00 0.25mm
 87-135307-00 0.50mm

08-135300-00 STD
 08-135305-00 0.25mm
 08-135307-00 0.50mm

14-020760-00 D B 76.70 C 136.00 D 78.20 E 5.00
 14-020761-00 D B 76.95 C 136.00 D 78.45 E 5.25

A 42.94
 B- 14.70
 BØ 37.16
 C 1.55
 D 65.44
 25x60

2.50
 1.95
 2.50



CK P
 P
 CR P

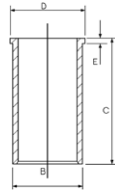

AK RT TP

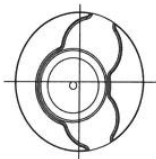
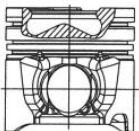







5 73.70

C3 I 1.4 16V HDi 02/02→ DV4TED4 (8HY) 4 Cyl. 17.5:1
 1399cc 66kW (90PS)
 Diesel Turbo Intercooled TD16426

87-135300-10 STD 08-135300-00 STD
 87-135307-10 0.50mm 08-135305-00 0.25mm
 08-135307-00 0.50mm

A 42.94
 B- 14.40
 BØ 37.15
 C 1.15
 C 1.15
 D 65.44
 25x60

2.50  CK P
 1.95  P
 2.50  CR P

KK RT TP

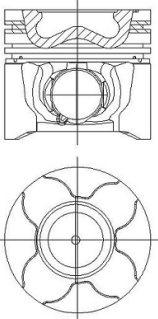

6 75.00

Visa II Super X 07/80→06/82 129/5 4 Cyl. 9.3:1
 1219cc 47kW (64PS) TD574

15-636700-00 WH  B 79.50 C 122.00 D 89.20 E 82.50

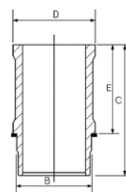

 Includes seals

 Schließt Dichtungen ein

 Includ des joints

 Incluye los sellos

 Comprende le guarnizioni

7 75.00

AX 14 01/89→12/91 K1B 4 Cyl. 9.3:1
 BX 14 E 04/83→07/89 1360cc 44kW (61PS) TD665

AX 14 01/89→12/91 K1G 4 Cyl. 9.3:1
 BX 14 E 04/83→07/89 1360cc 51-52kW (69-71PS) TD6567





C15 1.4 E	07/87→12/96	KAZ	4 Cyl. 1360cc	9.3:1 44-55kW (54-75PS)	TD6566
C15 1.4 E	07/87→12/96	TU3 (K3A)	4 Cyl. 1360cc	9.3:1 40-46kW (54-63PS)	TD6569
BX 14 C15 1.4	01/89→12/89 07/87→12/96	TU3A (K1H)	4 Cyl. 1360cc	9.3:1 47-49kW (64-67PS)	TD4272
BX 14 C15 1.4	01/89→12/89 07/87→12/96	TU3A (K6D)	4 Cyl. 1360cc	10.2:1 53kW (72PS)	TD25067
BX 14 C15 1.4	01/89→12/89 07/87→12/96	TU3A (K6E)	4 Cyl. 1360cc	10.2:1 53kW (72PS)	TD25069
BX 14 C15 1.4	01/89→12/89 07/87→12/96	TU3A (K6F)	4 Cyl. 1360cc	10.2:1 53kW (72PS)	TD25068
C3 II 1.4 Nemo 1.4	11/09→ 04/09→	TU3A (KFT)	4 Cyl. 1360cc	10.2:1 54kW (73PS)	TD25070
C3 I 1.4 C3 I 1.4 i C3 II 1.4 Nemo 1.4	12/05→07/12 02/02→ 11/09→ 02/08→	TU3A (KFV)	4 Cyl. 1360cc	9.3:1 49-59kW (67-80PS)	TD23774
Xsara 1.4 i	09/00→	TU3A (KFW)	4 Cyl. 1360cc	10.2:1 55kW (75PS)	TD25066
Saxo 1.4 i	02/96→09/03	TU3A (KFX)	4 Cyl. 1360cc	10.2:1 55kW (75PS)	TD25074
AX 14	12/86→12/88	TU3CP (KAY)	4 Cyl. 1360cc	9.3:1 44kW (60PS)	TD9546
AX 1.4, AX 1.4 Allure AX 14	08/92→04/94 06/88→12/89	TU3F2 (K1F)	4 Cyl. 1360cc	9.3:1 48-49kW (65-67PS)	TD666
AX 14	01/88→12/92	TU3F2 (K2B)	4 Cyl. 1360cc	9.3:1 62-65kW (85-89PS)	TD669





AX 14	04/87→04/97	TU3FJ2 (K2D)	4 Cyl. 1360cc	9.3:1 55kW (75PS)	TD6568
AX 1.4 GTi	08/91→12/96	TU3FJ2 (KFY)	4 Cyl. 1360cc	9.3:1 66kW (90PS)	TD5078
AX 1.4 GTi	06/91→12/96	TU3FJ2 (KFZ)	4 Cyl. 1360cc	9.6:1 69-74kW (94-100PS)	TD5096
AX 1.4 AX 14	09/86→07/92 01/88→12/92	TU3FM (K2A)	4 Cyl. 1360cc	9.3:1 61-65kW (84-88PS)	TD668
AX 14 C15 1.4 i	04/87→04/97 05/91→12/96	TU3FM (KDY)	4 Cyl. 1360cc	9.3:1 55-58kW (75-79PS)	TD4277
AX 14 ZX 1.4 i	04/87→04/97 03/91→10/97	TU3M (KDX)	4 Cyl. 1360cc	9.3:1 55kW (75PS)	TD5080
AX 14 BX 14 C15 1.4 C15 1.4 i ZX 1.4 i	04/87→04/97 01/89→02/93 05/91→07/96 05/91→12/96 10/93→10/97	TU3M (KDY)	4 Cyl. 1360cc	9.3:1 55-58kW (75-79PS)	TD5160
AX 14 AX 14 GT BX 14 ZX 1.4, ZX 1.4 i	04/87→04/97 01/89→12/91 01/89→02/93 03/91→06/97	TU3M/Z (KDZ)	4 Cyl. 1360cc	9.3:1 55-59kW (75-80PS)	TD683

87-154400-00

STD

A 40.50
B- 1.10
BØ 62.00
D 64.50

20x62

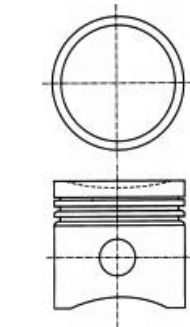

08-154400-00

STD

08-154407-00

0.50mm

1.75
2.00
3.00



CR P
P
P

14-636600-00 WH

B 79.50 C 134.50 D 89.20 E 90.00

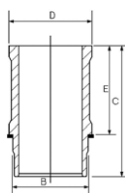

88-154400-00
87-154400-00 +
14-636600-00

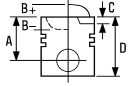

8 75.00

AX 1.3 Sport	04/87→12/88	TU2.4	4 Cyl. 1294cc	9.6:1 69-70kW (94-95PS)	TD706
--------------	-------------	-------	------------------	----------------------------	-------

14-638630-00 WH B 79.50 C 120.50 D 89.20 E 85.00

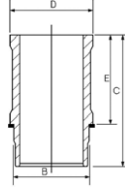

9 75.00

Elysee 1.4	08/07→04/08	TU3JP	4 Cyl. 1360cc	10.2:1 55kW (75PS)	TD23431
------------	-------------	-------	------------------	-----------------------	---------

Visa 14 GT	03/82→03/91	XY8 (150B)	4 Cyl. 1360cc	9.3:1 55-58kW (75-79PS)	TD577
------------	-------------	------------	------------------	----------------------------	-------

14-636600-00 WH B 79.50 C 134.50 D 89.20 E 90.00

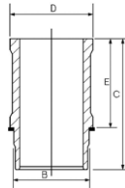

10 75.00

Berlingo 1.4	11/02→10/05	TU3JP (KFW)			
Berlingo 1.4, Berlingo 1.4 bivalent	11/02→		4 Cyl.	10.2:1	
Berlingo 1.4 bivalent	11/02→		1360cc	47-55kW (64-75PS)	TD14731
Berlingo 1.4 i	07/96→				
Berlingo 1.4 i bivalent	04/03→				
Saxo 1.4 VTS	05/96→06/03				
Xsara 1.4 i	04/97→08/05				
Xsara 1.4 LPG	05/98→08/00				

Berlingo 1.4 i	07/96→	TU3JP (KFX)			
Saxo 1.4 VTS	05/96→06/03		4 Cyl.	10.2:1	
Xsara 1.4 i	04/97→08/05		1360cc	53-55kW (72-75PS)	TD6554
ZX 1.4 i	03/91→10/97				



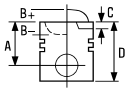

C2 1.4	09/03→	TU3JP-L4 (KFV)		
C3 I 1.4 Bioflex	01/09→		4 Cyl.	10.5:1
C3 I 1.4 Flex	12/05→07/12		1360cc	54-59kW (73-80PS)
C3 I 1.4 i, C3 I 1.4 i Bivalent	02/02→			TD16464
C3 Pluriel 1.4	05/03→			
C3 Pluriel 1.4 Hybrid	05/05→			

87-138900-10 STD

→01/04

A 27.75

B- 1.30

BØ 65.00

D 49.75

18x58

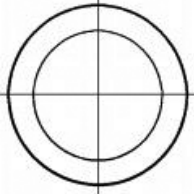
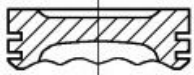

08-138900-00 STD

1.50

1.50

2.50



CK P

P

P

14-636600-00 WH B 79.50 C 134.50 D 89.20 E 90.00

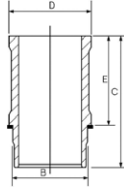

87-138900-30 STD

01/04→

A 27.75

B+ 0.18

D 49.75

18x56

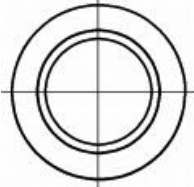

08-138900-00 STD

1.50

1.50

2.50



CK P

P

P

14-636600-00 WH B 79.50 C 134.50 D 89.20 E 90.00

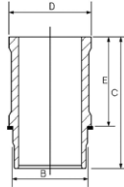

88-138900-30

87-138900-30 +

14-636600-00

Euro 4

Euro 4

Euro 4

Euro 4

Euro 4



11 75.00

Berlingo 1.6 HDi 90	07/05→	DV6ATED4 (9HX) Euro 4			
Berlingo 1.6 HDi 90 16V	04/08→		4 Cyl.	18:1	
C3 I 1.6 16V HDi	10/05→		1560cc	66-68kW (90-92PS)	
C3 II 1.6 HDi 90	11/09→	Diesel	Turbo Intercooled		TD19913
C3 Picasso 1.6 HDi	02/09→				
C4 I 1.6 HDi, C4 1.6 HDi	11/04→07/11				
Xsara Picasso 1.6 Hdi	09/05→				
C4 1.6 HDi	11/04→	DV6TED4 (9HY)			
C4 Grand Picasso I 1.6 HDi	10/06→		4 Cyl.	17.6:1	
C4 I 1.6 HDi	11/04→07/11		1560cc	80-85kW (109-116PS)	
C4 Picasso I 1.6 HDi	02/07→08/13	Diesel	Turbo Intercooled		TD19911
C5 II 1.6 HDi	09/04→				
Xsara Picasso 1.6 Hdi	05/04→				
Berlingo 1.6 HDi 110	08/05→	DV6TED4 (9HZ) Euro 4			
C3 I 1.6 16V HDi, C2 1.6 HDi	09/05→		4 Cyl.	18:1	
C3 Picasso 1.6 HDi	02/09→		1560cc	80kW (109PS)	
C4 1.6 HDi	11/04→07/11	Diesel	Turbo Intercooled		TD19824
C4 Grand Picasso I 1.6 HDi	10/06→				
C4 I 1.6 HDi	11/04→07/11				
C4 Picasso I 1.6 HDi	02/07→08/13				
C5 II 1.6 HDi	09/04→				
C5 III 1.6 HDi	02/08→				
Xsara Picasso 1.6 Hdi	05/04→				
Jumpy 1.6 HDi 90 16V	01/07→	DV6UTED4 (9HU)			
			4 Cyl.	18:1	
			1560cc	66kW (90PS)	
		Diesel	Turbo Intercooled		TD24692

87-424000-00

STD

08-424000-00

STD

14-020900-00 D

B 78.00 C 142.00 D 79.50 F 5.00

87-424008-00

0.60mm

08-424007-00

0.50mm

08-424008-00

0.60mm

A 41.70

B- 13.25

BØ 41.80

C 1.20

D 65.30

 26x61

3.00

1.95

2.50



CK P

P

CR P

LKZ-Ring®

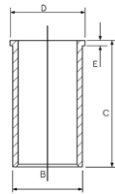

AK KK RT TP

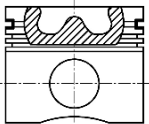
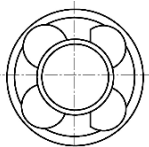

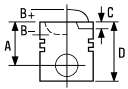

12  **75.00**

Berlingo 1.6 HDi 75	04/08→	DV6BTED4 (9HT) Euro 4 4 Cyl. 17.6:1 1560cc 55kW (75PS) Diesel Turbo Intercooled	TD21321
Berlingo 1.6 HDi 75	07/05→	DV6BTED4 (9HW) Euro 4 4 Cyl. 1560cc 55kW (75PS) Diesel Turbo Intercooled	TD27840
Berlingo 1.6 HDi 75	04/08→	DV6BUTED4 (9HT) Euro 4 4 Cyl. 1560cc 55kW (75PS) Diesel Turbo Intercooled	TD21322
Berlingo 1.6 HDi 110 Berlingo 1.6 HDi 115 C4 Aircross 1.6 HDi 115 C4 Aircross 1.6 HDi 115 AWC C4 Grand Picasso I 1.6 HDi 110 C5 III 1.6 HDi 110 C5 III 1.6 HDi 115 DS3 1.6 HDi 115, DS4 1.6 HDi 115	07/10→ 04/12→ 05/12→ 09/10→ 07/10→ 01/12→ 08/12→07/15	DV6C (9HL) 4 Cyl. 17.6:1 1560cc 82-84kW (112-114PS) Diesel Turbo Intercooled	TD26985
Berlingo 1.6 HDi 110 Berlingo 1.6 HDi 110, Berlingo 1.6 HDi 115 C3 II 1.6 HDi 110 C3 Picasso 1.6 HDi 110 C4 Grand Picasso I 1.6 HDi 110 C4 II 1.6 HDi 110 C4 II 1.6 HDi 115 C4 Picasso I 1.6 HDi 110 C5 III 1.6 HDi 110 C5 III 1.6 HDi 115 DS3 1.6 HDi 110 DS4 1.6 HDi 110 DS5 1.6 HDi 110	07/10→ 11/09→ 05/10→ 09/10→ 11/09→ 07/12→ 09/10→08/13 07/10→ 01/12→ 11/09→07/15 04/11→07/15 11/11→07/15	DV6C (9HR) 4 Cyl. 17.6:1 1560cc 82-84kW (112-114PS) Diesel Turbo Intercooled	TD25690
Berlingo 1.6 HDi 90	07/10→	DV6DTE4 (9HF) Euro 4 4 Cyl. 18:1 1560cc 66kW (90PS) Diesel Turbo Intercooled	TD25094
Berlingo 1.6 HDi 90 C3 II 1.6 HDi C3 Picasso 1.6 HDi 90 C4 Cactus 1.6 HDi 90 C4 Grand Picasso II 1.6 HDi 90 C4 II 1.6 HDi 90 C4 Picasso II 1.6 HDi 90 C-Elysee 1.6 HDi 92 DS3 1.6 HDi 90 DS4 1.6 HDi 90	07/10→ 11/09→ 07/10→ 09/14→ 09/13→ 11/09→ 02/13→ 11/12→ 11/09→07/15 05/11→07/15	DV6DTE4 (9HP) Euro 4 4 Cyl. 18:1 1560cc 68-69kW (92-94PS) Diesel Turbo Intercooled	TD25092
Berlingo 1.6 HDi 92 C-Elysee 1.6 HDi 92	07/10→ 11/12→	DV6DTE4M (9HJ) Euro 4 4 Cyl. 18:1 1560cc 68kW (92PS) Diesel Turbo Intercooled	TD25093
		DV6ETED (9HW) Euro 4 4 Cyl. 17.6:1 1560cc 55kW (75PS) Diesel Turbo Intercooled	TD25632





DV6ETEDM (9HK) Euro 4

4 Cyl.

17.6:1

1560cc

55kW (75PS)

Diesel

Turbo Intercooled

TD25097

87-433600-00
87-433607-00

STD
0.50mm

08-433600-00
08-433607-00

STD
0.50mm

14-020900-00 D B 78.00 C 142.00 D 79.50 F 5.00

A 41.75
B- 13.85
BØ 45.00
D 65.20
26x61

2.50
1.95
2.00



CK P
P
CR P

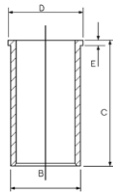

AK KK RT TP

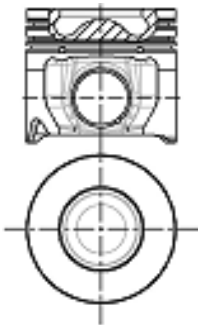

13  75.00

DV6DBM (9HE) Euro 4

4 Cyl.

18:1

1560cc

66kW (90PS)

Diesel

Turbo Intercooled

TD25095

Berlingo 1.6 BlueHDi 75

04/15 →

DV6ETED (9HN) Euro 4

4 Cyl.

17.6:1

1560cc

55kW (75PS)

Diesel

Turbo Intercooled

TD25096

14-020900-00 D B 78.00 C 142.00 D 79.50 F 5.00

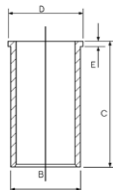



14  **77.00**



AX 15 D	08/94→12/97	TUD5 (VJY)			
Saxo 1.5 D	09/96→09/03		4 Cyl.	23:1	
ZX 1.5 D	06/96→02/98		1527cc	40-42kW (54-57PS)	
Diesel					TD11890

AX 15 D	08/94→12/97	TUD5 (VJZ)			
Saxo 1.5 D	09/96→06/01		4 Cyl.	23:1	
Xsara 1.5 D	04/97→09/00		1527cc	42-43kW (57-58PS)	
Diesel					TD4296

87-325800-00 STD
87-325806-00 0.40mm

08-325800-00 STD
08-325806-00 0.40mm

A 40.37
B- 1.65
D 66.32
 23x60

2.00  CK P
 1.75  P
 3.00  CR P

RT

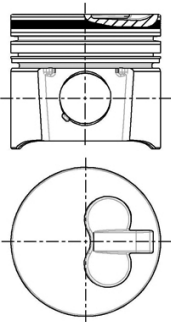







15 78.50

C3 Ii 1.6 Flex	11/09→	TU5J4 (NFX)			
C3 Picasso 1.6, C3 Picasso 1.6 Flex	05/11→		4 Cyl.	10.8:1	
C4 Aircross 1.6 Flex	08/10→		1587cc	82-88kW (112-120PS)	
C4 II 1.6 Flex	11/09→				TD10788
Saxo 1.6	02/96→04/04				
Saxo 1.6 VTR	05/96→07/99				
Saxo 1.6 VTS	06/96→09/03				

Berlingo 1.6	04/08→	TU5JP4 (NFU)			
Berlingo 1.6 16V	10/00→		4 Cyl.	10.8:1	
C2 1.6	09/03→		1587cc	80-81kW (109-110PS)	
C3 I 1.6 16V	02/02→				TD15308
C3 I 1.6 Bioflex	06/05→				
C3 Pluriel 1.6	05/03→				
C4 1.6 16V	07/06→07/11				
C4 I 1.6 16V Bio-Flex	09/07→07/08				
C4 I 1.6 16V, C4 1.6 16V	11/04→07/11				
Xsara 1.6 16V	09/00→08/05				
Xsara Picasso 1.6 16V	06/05→				
Xsara Picasso 1.6 Flex	10/06→				

87-139400-00	STD	08-139400-00	STD
87-139407-00	0.50mm	08-139406-00	0.40mm
		08-139407-00	0.50mm
A	32.35		
B+	1.30	1.20	 CK P
D	51.30	1.50	 P
 20x57		2.50	 P

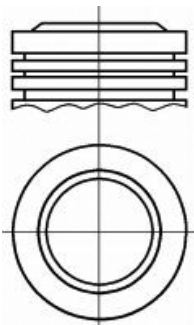

16 78.50

Xsara Picasso 1.6	12/99→	TU5JP (NFV)			
			4 Cyl.	10.2:1	
			1587cc	70kW (95PS)	
					TD23392

Saxo 1.6	02/96→06/03	TU5JP (NFZ)			
Saxo 1.6 VTL;VTR	05/96→06/03		4 Cyl.	9.6:1	
Xsara 1.6 i	04/97→09/00		1587cc	65-66kW (88-90PS)	
Xsara Picasso 1.6	12/99→				TD9458

		TU5JP4 (N6A)			
			4 Cyl.	10.5:1	
			1587cc	78-80kW (106-109PS)	
					TD21504



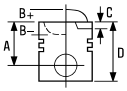



Xsara Picasso MPV 1.6 Chrono		09/01→03/07	TU5JPL4	4 Cyl.	10:1	
				1587cc	65kW (88PS)	
TD22282						

87-103800-00	STD	08-103800-00	STD
87-103806-00	0.50mm	08-103806-00	0.40mm

A 32.25
B- 1.50
BØ 68.50
D 57.50
 20x62

→922897

1.50  CK P
 1.50  P
 3.00  CR P

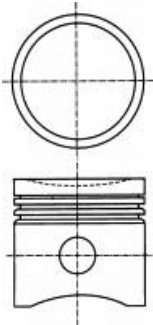

17 80.00



BX 1.8 D	10/85→09/93	XUD7 (161)	4 Cyl.	23:1	
			1769cc	44kW (60PS)	
Diesel					
TD586					

BX 18 D	10/85→09/93	XUD7 (161A)	4 Cyl.	23:1	
C15 1.8 D	07/86→12/00		1769cc	43-44kW (58-60PS)	
Visa 17 D	04/84→03/91				
Xsara 1.8 D	04/97→09/00	Diesel			
ZX 1.8 D	06/93→10/97				
TD4258					

Berlingo 1.8 D	07/96→	XUD7 (A9A/161A)	4 Cyl.	23:1	
Xsara 1.8 D	04/97→09/00		1769cc	43-44kW (58-60PS)	
Diesel					
TD6555					

87-321500-10	STD	08-321500-00	STD	14-024740-00 D	B 83.50 C 154.00 D 85.70 E 4.60
87-321507-10	0.50mm	08-321507-00	0.50mm	14-024830-00 D	B 83.00 C 154.00 D 86.00 E 4.50
87-321510-10	0.80mm	08-321510-00	0.80mm		

A 46.80
B- 2.00
D 84.50
 25x70

2.00  CR P
 2.00  P
 3.00  CR P

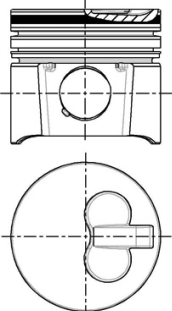
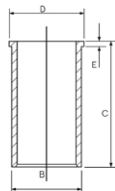



18 80.00

BX TRD Turbo	03/88→12/94	XUD7TE (A8A)	4 Cyl.	22:1	
			1769cc	66kW (90PS)	
		Diesel	Turbo Intercooled		TD602
BX TRD Turbo	03/88→12/94	XUD7TE (AJZ)	4 Cyl.	22:1	
			1769cc	66kW (90PS)	
		Diesel	Turbo Intercooled		TD604

87-323600-00	STD	08-323600-00	STD	14-024740-00 D	B 83.50 C 154.00 D 85.70 E 4.60
87-323607-00	0.50mm	08-323607-00	0.50mm	14-024830-00 D	B 83.00 C 154.00 D 86.00 E 4.50

A 46.80
B- 2.20
D 84.50
 28x68

3.00 **MOL P**
 2.00 **P**
 3.00 **CR P**

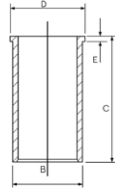

AK RT

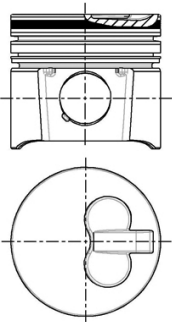

19 81.00

C5 III 2.7 HDi	02/08→	DT17ED4	V6 Cyl.	17.3:1	
C6 2.7 HDi	09/05→		2720cc	150kW (204PS)	
		Diesel	Bi-Turbo Intercooled		TD19827
C5 III 2.7 HDi	02/08→	DT17TED4 (UHZ)	V6 Cyl.	17.3:1	
C6 2.7 HDi	09/05→		2720cc	150kW (204PS)	
		Diesel	Bi-Turbo Intercooled		TD24868

87-432400-00	STD	08-432400-00	STD
A 47.00		2.00	CK P
B- 14.05		2.00	P
BØ 44.00		2.00	P
C 0.50			
D 71.00			
29x62			

AK KK RT TP

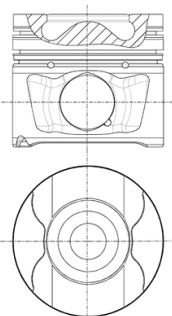







20 82.20

Berlingo 1.9 D	07/98→10/05	DW8 (WJZ) / DW8B (WJY)			
Berlingo 1.9 D 4WD	07/98→		4 Cyl.	23.1:1	
Berlingo 1.9 D 70	04/99→		1868cc	51-52kW (69-70PS)	
Berlingo 1.9 D 70 4WD	07/98→	Diesel			TD10708
Jumpy 1.9 D 70	04/98→				
Xsara 1.9 D	07/98→08/05				

Berlingo 1.9 D	07/98→12/11	DW8B (WJY)			
Berlingo 1.9 D 4WD	07/98→		4 Cyl.	23.1:1	
Berlingo 1.9 D 70	04/99→		1868cc	51-52kW (69-70PS)	
Berlingo 1.9 D 70 4WD	07/98→	Diesel			TD15310
C15 1.9 D	10/00→10/02				
Jumpy 1.9 D 70	04/98→				
Xsara 1.9 D	07/98→08/05				

87-104000-00	STD	08-104000-00	STD	14-020290-00 D	B 85.00 C 154.00 D 87.00 E 5.00	88-104000-00
87-104008-00	0.60mm	08-104008-00	0.60mm			87-104000-00 + 14-020290-00

A 46.80
B- 1.30
D 78.00
 25x65

2.00  CK P
 2.00  P
 3.00  CR P

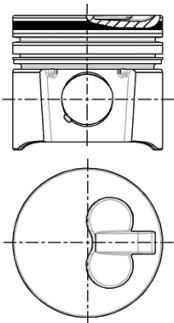
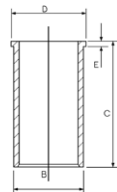

21 82.20

C15 1.9 D	12/00→12/05	DW8B (WJX)			
			4 Cyl.	23:1	
			1868cc	44kW (60PS)	
		Diesel			TD26981

14-020290-00 D	B 85.00 C 154.00 D 87.00 E 5.00
-----------------------	--

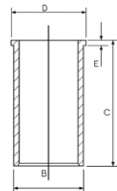

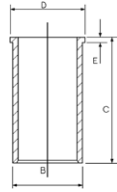
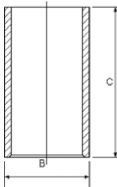

22 82.60

C25 1.9 TD	04/92 → 02/94	M705	4 Cyl. 1930cc Diesel Turbo	21:1 60kW (82PS)	TD6574
			14-021311-00 D B 86.06 C 154.00 D 89.00 E 4.50 14-023560-00 D B 86.00 C 154.00 D 89.00 E 4.50 14-023751-00 D B 87.00 C 154.00 D 89.00 E 4.55		
					
			14-014730-00 D B 86.09 C 154.00		
					

23 83.00

BX 19	05/85 → 06/86	159B	4 Cyl. 1905cc	9.5:1 74kW (101PS)	TD21529
BX 16	10/82 → 01/92	171C	4 Cyl. 1580cc	9.5:1 66-68kW (90-92PS)	TD593
BX 1.6	01/87 → 01/92	B6E	4 Cyl. 1580cc	9.8:1 85kW (116PS)	TD21866
BX 16	09/88 → 12/94	XU5CP (BAY/BAZ)	4 Cyl. 1580cc	9.5:1 55kW (75PS)	TD9550
Visa 16 GTI	01/85 → 06/86	XU5J (180A/B6D)	4 Cyl. 1580cc	9.8:1 76kW (103PS)	TD596
BX 16	09/88 → 12/94	XU5J/J2/JA	4 Cyl. 1580cc	9.5:1 55kW (75PS)	TD9551
BX 1.6 Visa 16 GTI	01/87 → 01/92 06/86 → 03/91	XU5JA (B6D)	4 Cyl. 1580cc	9.8:1 83-85kW (113-116PS)	TD4262





BX 1.6	01/91→06/94	XU5M (BDY/B4A)				
BX 16	05/89→12/94		4 Cyl.	9:1		
BX 16 E	05/89→02/93		1580cc	65kW (88PS)		
ZX 1.6	07/94→10/97					TD5097
ZX 1.6 i	03/91→10/97					
BX 16	05/89→12/94	XU5M (BDZ)				
BX 16 E	05/89→02/93		4 Cyl.	9:1		
			1580cc	65kW (89PS)		TD615
Berlingo 1.8 i	05/97→	XU7JB (LFX)				
Berlingo 1.8 i 4WD	04/97→		4 Cyl.	9.5:1		
Xantia 1.8 i	04/97→04/03		1761cc	66kW (90PS)		
Xsara 1.8 i	04/97→09/00					TD9457
Evasion 1.8	05/97→07/02	XU7JP (LFW/LFZ)				
Xantia 1.8 i	03/93→01/98		4 Cyl.	9.25:1		
Xsara 1.8 i	02/98→09/00		1761cc	73-76kW (99-103PS)		
Xsara 1.8 i Aut.	04/97→09/00					TD5116
ZX 1.8	07/94→10/97					
ZX 1.8 i	07/92→10/97					
Xantia 1.8 i 16V	06/95→04/03	XU7JP4 (LFY)				
Xsara 1.8 Bifuel	07/97→08/00		4 Cyl.	10.4:1		
Xsara 1.8 i 16V	04/97→09/00		1761cc	81-85kW (110-116PS)		
Xsara 1.8 LPG	01/98→08/00					TD4279
ZX 1.8	04/96→10/97					
ZX 1.8 i 16V	01/96→02/98					
BX 19 GTi 16V	09/87→12/88	XU9J4 (D6C/DFW)				
			4 Cyl.	10.4:1		
			1905cc	116kW (158PS)		TD632
BX 19 GTi 16V	03/88→02/93	XU9J4 (DFW)				
			4 Cyl.	10.4:1		
			1905cc	108-110kW (147-150PS)		TD640
BX 19	06/88→12/94	XU9M (DDZ)				
BX 19 E	06/88→02/93		4 Cyl.	9.2:1		
			1905cc	80kW (109PS)		TD639
BX 19	07/86→05/89	XU9S (159A)				
			4 Cyl.	9.3:1		
			1905cc	75-77kW (102-105PS)		TD584
BX 15	10/87→05/92	XU51C (B1E)				
BX 16	01/87→12/94		4 Cyl.	9.5:1		
			1580cc	53-59kW (72-80PS)		TD607
BX 16	10/82→12/92	XU52C				
			4 Cyl.	8.95:1		
			1580cc	65-85kW (88-116PS)		TD14648

14-634910-00 WH B 88.00 C 141.00 D 97.00 E 95.13

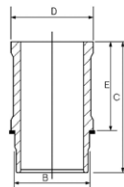

Use also: 1 NB O-Ring HR566

Mitverwenden: 1 NB O-Ring HR566

A utiliser aussi: 1 joint toriques HR566

Utilizar también: 1 NB junta toricas HR566

Usare anche: 1 NB O-Ring HR566



24  **83.00**

BX 19	06/89→05/91	D2E	4 Cyl. 1905cc	9:1 78-79kW (107-108PS)	TD22449
BX 19 CAT	07/86→12/94	XU9J1 (DFZ)	4 Cyl. 1905cc	9.3:1 75kW (102PS)	TD9548
BX 1.9 TZI	02/92→12/94	XU9J2 (D6A)			
BX 19	07/86→01/92		4 Cyl. 1905cc	9.3:1 90-92kW (122-125PS)	TD631
BX 19 GTi	07/86→02/93				
ZX 1.9	03/91→06/97	XU9JA (D6E)	4 Cyl. 1905cc	93kW (126PS)	TD22622
BX 19	06/88→12/94	XU9JA (DKZ)			
BX 19 GTi	06/88→02/93		4 Cyl. 1905cc	9.3:1 88kW (120PS)	TD647
ZX 1.9 i	03/91→06/97				
BX 19	07/86→12/94	XU92C (D2A)	4 Cyl. 1905cc	9.3:1 75-77kW (102-105PS)	TD628
BX 19	09/86→12/89	XU92C (D2C)	4 Cyl. 1905cc	9.3:1 70kW (95PS)	TD629
BX 19 E	04/89→02/93	XU92C (D2F)	4 Cyl. 1905cc	9:1 80kW (109PS)	TD630

②

A 37.50
B- 8.90
D 67.50

 22x66

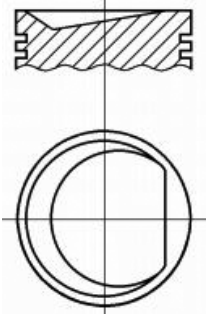

08-322400-00

STD

1.50
1.50
4.00



MO P
P
CR P

14-634910-00 WH ① **B 88.00 C 141.00 D 97.00 E 95.13**

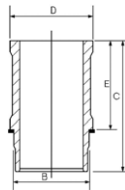

89-322400-00

① Use also: 1 NB O-Ring
HR566

② Piston available in
Kit Set only

① Mitverwenden: 1 NB O-Ring
HR566

② Kolben nur im Assembly
erhältlich

① A utiliser aussi: 1 joint toriques
HR566

② Piston disponible en
kit seulement

① Utilizar también: 1 NB junta toricas
HR566

② Pistón disponible en
conjuntos solamente



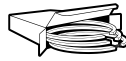

① Usare anche: 1 NB O-Ring
HR566

② I pistoni sono disponibili solo in
kit motore

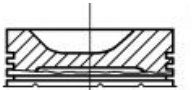
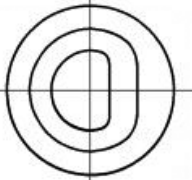

25 83.00

BX 16	10/82→06/88	XU5 (171A)	4 Cyl. 1580cc	9.5:1 66-67kW (90-92PS)	TD591
BX 16	09/87→02/93	XU5 (B1AA)	4 Cyl. 1580cc	9.5:1 58-59kW (79-80PS)	TD12428
BX 16	03/86→12/94	XU5J (180Z)	4 Cyl. 1580cc	9.8:1 76kW (103PS)	TD597
Xantia 1.6 i	03/93→01/98	XU5JP (BFZ)	4 Cyl. 1580cc	9.25:1 65kW (88PS)	TD5101
Xantia 1.6 i SX	01/98→03/01				
ZX 1.6	07/94→10/97				
ZX 1.6 i	03/91→10/97				
BX 16	10/82→06/94	XU5S (171B)	4 Cyl. 1580cc	9.5:1 66-67kW (90-92PS)	TD592
BX 16	07/85→12/94	XU5S (171D)	4 Cyl. 1580cc	9.5:1 64kW (87PS)	TD594

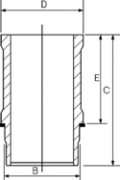
<p>2</p> <p>A 37.55 B- 2.10 D 67.50  22x66</p>   <p>1 Use also: 1 NB O-Ring HR566 2 Piston available in Kit Set only 3 Steel</p>	<p>08-151200-00 STD</p> <p>1.75  1.75  4.00 </p> <p>CR P P CR 3</p> <p>1 Mitverwenden: 1 NB O-Ring HR566 2 Kolben nur im Assembly erhältlich 3 Stahl</p>	<p>14-634910-00 WH 1 B 88.00 C 141.00 D 97.00 E 95.13</p>  <p>1 A utiliser aussi: 1 joint toriques HR566 2 Piston disponible en kit seulement 3 Acier</p>	<p>89-151200-00</p> <p>1 Utilizar también: 1 NB junta toricas HR566 2 Pistón disponible en conjuntos solamente 3 Acero</p>	<p>1 Usare anche: 1 NB O-Ring HR566 2 I pistoni sono disponibili motore solo in kit 3 Acciaio</p>
--	--	--	--	--

26 83.00

BX 19 D	09/83→11/94	XUD9 (162)	4 Cyl. 1905cc	23.5:1 47kW (65PS)	TD587
Diesel					





BX 19 D	09/83→11/94	XUD9 (D9A)	4 Cyl. 1905cc	23.5:1 47kW (64PS)	TD4265
		Diesel			
BX 19 D	09/83→11/94	XUD9 (DJZ)	4 Cyl. 1905cc	23.5:1 47-50kW (65-68PS)	TD646
Xantia 1.9 D	06/94→01/98				
ZX 1.9 D	03/91→10/97				
		Diesel			
Berlingo 1.9 D	07/96→	XUD9A (DJY)	4 Cyl. 1905cc	23.5:1 50-52kW (68-71PS)	TD6556
C25 1.9 D 1400	01/88→01/94				
Jumper 1.9 D	07/99→04/02				
Xsara 1.9 D	04/97→09/00	Diesel			
ZX 1.9 D	07/93→06/97				
Berlingo 1.9 D	07/96→	XUD9A/L (D9B)	4 Cyl. 1905cc	23.5:1 50-51kW (68-69PS)	TD4267
Xantia 1.9 D	06/94→01/98				
		Diesel			
BX 19 D	03/87→12/94	XUD9A/U (D9B)	4 Cyl. 1905cc	23.5:1 50-51kW (68-69PS)	TD4266
C25 1.9 D	07/87→02/94				
Jumper 1.9 D	02/94→04/02				
Jumpy 1.9 D	10/95→08/98	Diesel			
ZX 1.9 D	07/93→10/97				

87-152000-10	STD	08-152000-00	STD	14-020530-00 D	B 85.60 C 153.50 D 88.50 E 3.90	88-152000-30
87-152007-10	0.50mm	08-152003-00	0.125mm			87-152000-10 + 14-020530-00
87-152010-10	0.80mm	08-152007-00	0.50mm			
		08-152010-00	0.80mm			
		08-152011-00	1.00mm			
A 46.80						
B- 2.20						
D 84.30						
25x72						
2.00		CR P				
2.00		P				
3.00		CR P				

27 **83.00**

Xsara 1.9 D, Xsara 1.9 SD	01/98→09/00	XUD9BSD (DHV)	4 Cyl. 1905cc	55kW (75PS)	TD22991
		Diesel			
Evasion 1.9 TD	11/94→07/02	XUD9BTF (DHX)	4 Cyl. 1905cc	21.8:1 66-68kW (90-92PS)	TD4268
Jumper 1.9 TD	03/94→04/02				
Jumpy 1.9 TD	10/95→				
Xantia 1.9 Turbo D	10/94→04/03	Diesel	Turbo Intercooled		



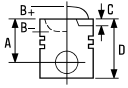

Xantia 1.9 SD	02/96→04/03	XUD9SD (DHW)	4 Cyl.	21.8:1	
			1905cc	50-55kW (68-75PS)	
		Diesel	Turbo Intercooled		TD10689
Xantia 1.9 Turbo D	10/94→04/03	XUD9TE (DHY)	4 Cyl.	21.8:1	
Xsara 1.9 TD	04/97→09/00		1905cc	66kW (90PS)	
ZX 1.9 DT	06/92→06/94	Diesel	Turbo Intercooled		TD4269
ZX 1.9 TD	07/92→10/97				
Evasion 1.9 TD	11/94→07/02	XUD9TF (D8B)	4 Cyl.	21.8:1	
Jumpy 1.9 TD	04/96→		1905cc	66-68kW (90-92PS)	
Xantia 1.9 Turbo D	06/95→04/03	Diesel	Turbo Intercooled		TD5046
Jumper 1.9 TD	02/94→04/02	XUD9UTF (D8C)	4 Cyl.	21.8:1	
			1905cc	66-68kW (90-92PS)	
		Diesel	Turbo Intercooled		TD4264

87-105500-00

STD

08-105500-00

STD

14-020530-00 D

B 85.60 C 153.50 D 88.50 E 3.90

87-105507-00

0.50mm

08-105507-00

0.50mm

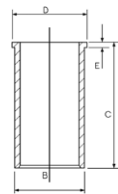

08-105510-00

0.80mm

A 46.75

B- 3.50

D 75.00

28x68

01/97→

3.00



CK

NT

CR P

AK HA RT TP

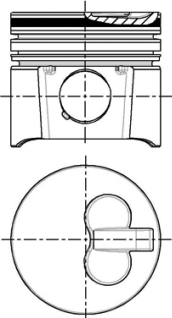

28 **84.00**

C25 1.8

11/81→01/94

169B

C25 1.8 E

07/87→02/94

4 Cyl.

7.5:1

1796cc

49-51kW (69-69PS)

TD6575

C25 1.8

11/81→01/94

XM7T (169)

C25 1.8 E

07/87→02/94

4 Cyl.

7.5:1

1796cc

49-51kW (67-69PS)

TD588

14-606670-00 WH B 93.00 C 136.20 D 99.20 E 90.01

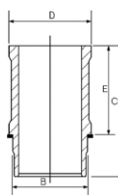

Use also: 1 NB O-Ring
HR566

Mitverwenden: 1 NB O-Ring
HR566

A utiliser aussi: 1 joint toriques
HR566

Utilizar también: 1 NB junta toricas
HR566





Usare anche: 1 NB O-Ring
HR566



29  **85.00**

C5 I 2.0 HDi	03/01→08/04	DW10ATED (RHS)	4 Cyl.	17.6:1	
			1997cc	79kW (107PS)	
		Diesel	Turbo Intercooled		TD20782
C4 2.0 HDi	04/07→12/11	DW10ATED (RHZ)	4 Cyl.	18:1	
C4 I 2.0 HDi	04/07→07/08		1998cc	79-81kW (107-110PS)	
C5 I 2.0 HDi	03/01→08/04	Diesel	Turbo Intercooled		TD12829
Evasion 2.0 HDi	08/99→07/02				
Jumpy 2.0 HDi 110	03/00→				
Xantia 2.0 HDi 109	02/99→04/03				
Xsara 2.0 HDi 109	05/01→08/05				
Xsara Picasso 2.0 HDi	12/99→				
Jumpy 2.0 HDi 95	10/99→	DW10BTED (RHX)	4 Cyl.	17.6:1	
			1997cc	69kW (94PS)	
		Diesel	Turbo Intercooled		TD21039
Jumper 2.0 HDi	04/02→	DW10TD (RHV)	4 Cyl.	18:1	
			1997cc	62kW (84PS)	
		Diesel	Turbo Intercooled		TD24877
Berlingo 2.0 HDi	11/02→10/05	DW10TD (RHY)	4 Cyl.	18:1	
Berlingo 2.0 HDi 90	12/99→		1998cc	66kW (90PS)	
Berlingo 2.0 HDi 90 4WD	11/00→	Diesel	Turbo Intercooled		TD15311
C5 I 2.0 HDi	03/01→08/04				
Xantia 2.0 HDi 90	03/99→04/03				
Xsara 2.0 HDi	09/00→03/05				
Xsara 2.0 HDi 90	02/99→08/05				
Xsara Picasso 2.0 HDi	12/99→				
Jumper 2.0 HDi	11/01→	DW10UTD (RHV)	4 Cyl.	17.3:1	
			1997cc	62kW (84PS)	
		Diesel	Turbo Intercooled		TD16739

87-114700-00	STD	08-114700-00	STD
87-114708-00	0.60mm	08-114708-00	0.60mm

A	46.75	3.50		CK P
B-	18.30	2.00		P
BØ	38.00	3.00		CR P
C	1.00			
D	80.75			
	28x70			

AK RT TP

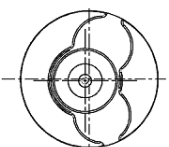
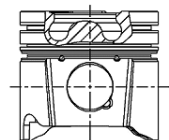







30  **85.00**

C8 2.0 HDi	07/02→	DW10ATED4 (RHM)	4 Cyl.	17.6:1	
			1997cc	79kW (107PS)	
		Diesel	Turbo Intercooled		TD20786
C8 2.0 HDi	07/02→	DW10ATED4 (RHT)	4 Cyl.	17.3:1	
			1997cc	79kW (107PS)	
		Diesel	Turbo Intercooled		TD20785
C8 2.0 HDi	07/02→	DW10ATED4 (RHW)	4 Cyl.	17.6:1	
Evasion 2.0 HDi 16V	09/99→07/02		1997cc	79-80kW (107-109PS)	
Jumpy 2.0 HDi 110	03/00→				
Jumpy 2.0 HDi 110 16V	12/03→10/06	Diesel	Turbo Intercooled		TD20784

87-114700-10	STD	08-114700-00	STD
87-114708-10	0.60mm	08-114708-00	0.60mm

A	46.73	3.50		CK P
B-	18.80	2.00		P
BØ	39.80	3.00		CR P
C	1.67			
D	72.70			
	28x68			

AK KK RT TP

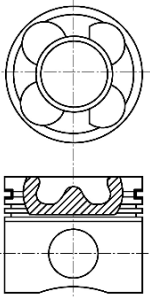

08517-103



31  **85.00**

C4 I 2.0 HDi, C4 2.0 HDi	07/08→07/11	DW10BTED4 (RHF)			
C5 III 2.0 HDi	02/08→	4 Cyl.	17.6:1		
C5 III 2.0 HDi 140	04/09→	1997cc	100-103kW (136-140PS)		
		Diesel	Turbo Intercooled		TD26795
C4 Grand Picasso I 2.0 HDi 138	10/06→	DW10BTED4 (RHJ) Euro 4			
C4 Picasso I 2.0 HDi 138	02/07→08/13	4 Cyl.	18:1		
		1997cc	100kW (136PS)		
		Diesel	Turbo Intercooled		TD19825
C4 2.0 HDi	11/04→12/10	DW10BTED4 (RHR) Euro 4			
C4 Grand Picasso I 2.0 HDi 138	10/06→	4 Cyl.	18:1		
C4 I 2.0 HDi	11/04→07/11	1997cc	100kW (136PS)		
C4 Picasso I 2.0 HDi 138	02/07→08/13	Diesel	Turbo Intercooled		TD19912
C5 II 2.0 HDi	09/04→				
C5 III 2.0 HDi	02/08→				
C8 2.0 HDi 135	03/06→				
Jumpy 2.0 HDi 140	01/07→				
C8 2.0 HDi	02/07→	DW10UTED4 (RHK) Euro 4			
Jumpy 2.0 HDi 120	01/07→	4 Cyl.	17.5:1		
		1997cc	79-88kW (107-120PS)		
		Diesel	Turbo Intercooled		TD20787

87-114700-40

STD

08-114700-00

STD

87-114708-40

0.60mm

08-114708-00

0.60mm

A 46.70

3.50



CK P

B- 15.40

2.00



P

BØ 44.80

3.00



CR P

C 0.57

D 72.70

 28x70

AK KK RT TP

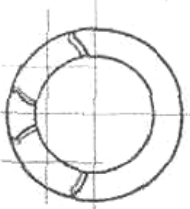







08570-109



32  **85.00**

DS5 2.0 HDi 165 Hybrid4	12/11→07/15	DW10CTED4 (RHC) Euro 5	4 Cyl.	16:1	1997cc 120kW (163PS)	Diesel Turbo Intercooled	TD28242
C8 2.0 HDi 135	03/06→	DW10CTED4 (RHD) Euro 4	4 Cyl.	18:1	1997cc 100kW (136PS)	Diesel Turbo Intercooled	TD29706
C4 Grand Picasso I 2.0 HDi 150	07/09→	DW10CTED4 (RHE)	4 Cyl.	16:1	1997cc 110-120kW (150-163PS)	Diesel Turbo Intercooled	TD24935
C4 II 2.0 BlueHDi 150	11/09→						
C4 Picasso I 2.0 HDi 150	07/09→08/13						
C5 III 2.0 HDi 150/BlueHDi 150	04/09→						
C8 2.0 HDi 165	03/06→						
DS4 2.0 HDi 135	09/11→07/15						
C4 Grand Picasso I 2.0 HDi 165	09/10→	DW10CTED4 (RHH) Euro 5	4 Cyl.	16:1	1997cc 120kW (163PS)	Diesel Turbo Intercooled	TD23770
C4 Picasso I 2.0 HDi 165	09/10→08/13						
C5 III 2.0 HDi 165	04/09→						
C8 2.0 HDi 165	03/06→						
DS4 2.0 HDi 165	04/11→07/15						
DS5 2.0 HDi 165	11/11→07/15						
Jumpy 2.0 HDi 165	07/10→						

87-443100-00  STD 08-443100-00 STD
 87-443108-00  0.60mm 08-443108-00 0.60mm

A 46.70 2.00  GDC P
 B- 13.71 2.00  P
 BØ 50.40 2.00  CR P
 C 0.45
 D 74.70
 30x68

AK KK RT TP

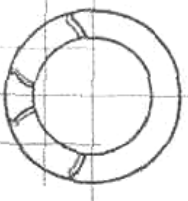
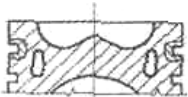



0850H-228

 Piston Chamber Volume
[ccm] 26.320

 Volumen der Kolbenmulde
[ccm] 26.320

 Volume de la cavité du piston
[cm³] 26.320

 Volumen de cavidad del pistón
[cc] 26.320

 Volume camera pistone
[cm³] 26.320



33  **85.00**

C5 III 2.0 HDi 180	03/15→	DW10FC (AHW) Euro 5		
DS4 2.0 BlueHDi 180	07/14→07/15	4 Cyl.	16.7:1	
DS5 2.0 BlueHDi 180	08/13→07/15	1997cc	133kW (181PS)	
		Diesel	Turbo Intercooled	TD28616
C5 III 2.0 HDi 150/BlueHDi 150	04/09→	DW10FD (AHR) Euro 5		
DS4 2.0 BlueHDi 150 Hybrid	07/14→07/15	4 Cyl.	16.7:1	
		1997cc	110kW (150PS)	
		Diesel	Turbo Intercooled	TD31846
C4 Grand Picasso II 2.0 BlueHDi 150	09/13→	DW10FD (AHX) Euro 5		
C4 Picasso II 2.0 BlueHDi 150		4 Cyl.	16.7:1	
DS4 2.0 BlueHDi 150, DS5 2.0 BlueHDi 150	07/14→07/15	1997cc	110kW (150PS)	
DS5 2.0 HDi 150 Hybrid	11/11→07/15	Diesel	Turbo Intercooled	TD28615
C4 Grand Picasso II 2.0 BlueHDi 135	09/13→	DW10FDD (AHV) Euro 5		
C4 Picasso II 2.0 BlueHDi 135		4 Cyl.	16.7:1	
		1997cc	100kW (136PS)	
		Diesel	Turbo Intercooled	TD28617

87-443100-10  STD

STD

08-443100-00 STD

STD

87-443108-10  0.60mm

0.60mm

08-443108-00 0.60mm

0.60mm

A 46.60

B- 12.71

B- 4.90

BØ 51.30

D 72.00

 30x72

2.00

2.00

2.00





GDC P

P

CR P

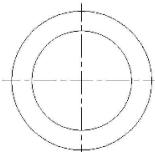
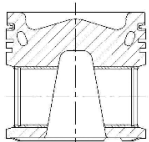
AK KK RT TP



 Piston Chamber Volume

[ccm] 23.180

 Volumen der Kolbenmulde

[ccm] 23.180

 Volume de la cavité du piston

[cm³] 23.180

 Volumen de cavidad del pistón

[cc] 23.180

 Volume camera pistone

[cm³] 23.180

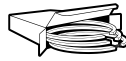
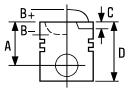





34  **85.00**

C5 II 2.2 HDi	05/06→	DW12BTED4 (4HP) Euro 4		
C5 III 2.2 HDi 165	02/08→	4 Cyl.	16.6:1	
C6 2.2 HDi	06/06→	2179cc	120kW (163PS)	
C8 2.2 HDi	06/07→	Diesel	Bi-Turbo Intercooled	TD29271
C5 II 2.2 HDi	05/06→	DW12BTED4 (4HR) Euro 4		
C8 2.2 HDi	06/07→	4 Cyl.	16.6:1	
		2179cc	120kW (163PS)	
		Diesel	Bi-Turbo Intercooled	TD29272
C5 II 2.2 HDi	04/06→	DW12BTED4 (4HT) Euro 4		
C5 III 2.2 HDi	02/08→	4 Cyl.	16.6:1	
C6 2.2 HDi, C8 2.2 HDi	06/06→	2179cc	125kW (170PS)	
		Diesel	Bi-Turbo Intercooled	TD20812
C-Crosser 2.2 Hdi	02/07→	DW12MTED4 (4HN)		
C-Crosser Enterprise 2.2 Hdi	01/09→	4 Cyl.	16.6:1	
		2179cc	115kW (156PS)	
		Diesel	Turbo Intercooled	TD24713

87-436700-10  STD
87-436708-10  0.60mm

08-436700-00 STD
08-436708-00 0.60mm

A 48.70
B- 13.47
BØ 52.40
C 0.38
D 74.70
 30x68

2.50  GDC P
 2.00  P
 2.00  CK



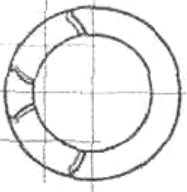
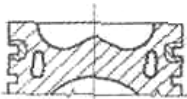

AK KK RT TP





0850HA127

 For pistons with a 24.3mm con rod gap measured at pin centre line

 Für Kolben mit einem Pleuelaugenabstand von 24,3 MM, gemessen an der Kolbenbolzen-Mitte

 Pour pistons avec un écart de bielle de 24,3 mm mesuré au centre de l'axe bielle-piston



 Para pistones con una distancia de paso de biela en el centro del bulón de 24,3mm

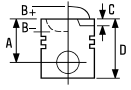

 Per pistoni con passaggio biella di 24,3 mm misurato sull'asse foro spinotto



35  **85.00**

C5 III 2.2 HDi 200 07/10→ **DW12C (4HL)**
 4 Cyl.
2179cc **150kW (204PS)**
Diesel **Turbo Intercooled** **TD26899**

87-436700-00  STD **08-436700-00** STD
87-436708-00  0.60mm **08-436708-00** 0.60mm

A 48.60 2.50  GDC P
B- 15.12 2.00  P
BØ 50.40 2.00  CK
C 0.38
D 74.60

 30x68



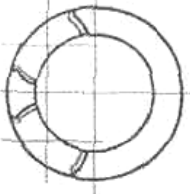
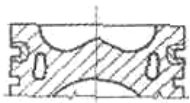

AK KK RT TP





0850HA324

 For pistons with a 24.3mm con rod gap measured at pin centre line

 Für Kolben mit einem Pleuelaugenabstand von 24,3 MM, gemessen an der Kolbenbolzen-Mitte

 Pour pistons avec un écart de bielle de 24,3 mm mesuré au centre de l'axe bielle-piston

 Para pistones con una distancia de paso de biela en el centro del bulón de 24,3mm





 Per pistoni con passaggio biella di 24,3 mm misurato sull' asse foro spinotto



36 85.00

C8 2.2 HDi	07/02→	DW12TED4 (4HW)	4 Cyl.	17.6:1	
			2179cc	94kW (128PS)	
		Diesel	Turbo Intercooled		TD20024
C5 I 2.2 HDi	03/01→08/04	DW12TED4/FAP (4HX)	4 Cyl.		
C5 II 2.2 HDi	09/04→		2179cc	94-98kW (128-133PS)	
		Diesel	Turbo Intercooled		TD16165

87-114700-30	STD	08-114700-00	STD
87-114708-30	0.60mm	08-114708-00	0.60mm

A	48.70	3.50		CK P
B-	18.00	2.00		P
BØ	40.80	3.00		CR P
C	0.40			
C	0.40			
D	77.70			
	30x68			

AK KK RT

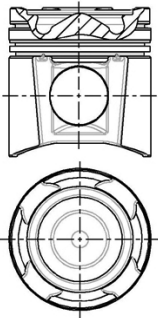

37 86.00

XM 2.0	05/89→06/94	R6A	4 Cyl.		
			1998cc	90-96kW (122-130PS)	
					TD22606
XM 2.0 i	05/89→06/94	XU10J2 (RFZ)	4 Cyl.	8.8:1	
			1998cc	89-90kW (121-122PS)	
					TD729
Evasion 2.0	06/94→07/02	XU10J2C (RFU)	4 Cyl.	9.5:1	
			1998cc	89kW (121PS)	
					TD4284
Xantia 2.0 i	03/93→04/03	XU10J2C (RFX)	4 Cyl.	9.5:1	
ZX 2.0	07/94→10/97		1998cc	89-90kW (120-122PS)	
ZX 2.0 i	07/92→06/97				TD727
		XU10J2C/Z L3 (RFX)	4 Cyl.	9.5:1	
			1998cc	89-95kW (121-129PS)	
					TD4286





Jumper 2.0 02/94 → 04/02 **XU10J2U (RFW)** 4 Cyl. 1998cc 9.5:1 80kW (109PS) **TD4285**

87-154600-00 STD
87-154608-00 0.60mm

08-154600-00 STD
08-154605-00 0.25mm
08-154608-00 0.60mm

A 40.00
B- 5.02
D 65.00
22x62

1.50
1.75
3.00



MO P
P
CR 1

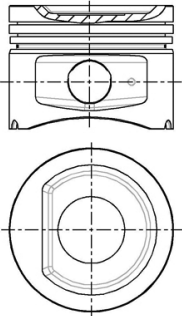

1 Steel

1 Stahl

1 Acier

1 Acero

1 Acciaio

38 86.00

Jumper 2.2 HDi 120 04/06 → **P22DTE (4HU) Euro 4** 4 Cyl. 2198cc 17.5:1 88kW (120PS) **TD24538**

Diesel Turbo Intercooled

87-427700-10 STD
87-427707-10 0.50mm

08-427700-00 STD
08-427707-00 0.50mm

A 43.42
B- 15.85
BØ 46.90
D 69.82
30x67

2.00
2.00
2.00



CK P
P
NT 1

14-021120-00 D B 89.00 C 156.00 D 90.90 E 5.00

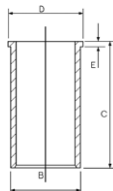

KK RT TP

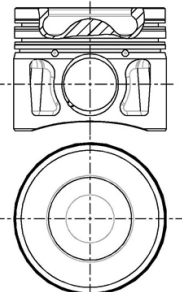

8648B105

1 Steel

1 Stahl

1 Acier

1 Acero

1 Acciaio



39 86.00

Jumper 2.2 HDi 100

04/06 →

P22DTE (4HV) Euro 4

4 Cyl.

17.5:1

2198cc

74kW (101PS)

Diesel

Turbo Intercooled

TD24537

87-427700-30

STD

08-427700-00

STD

14-021120-00 D

B 89.00 C 156.00 D 90.90 E 5.00

87-427707-30

0.50mm

08-427707-00

0.50mm

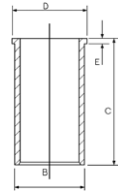

A 43.42

B- 15.85

BØ 46.90

D 69.82

 30x67

2.00

2.00

2.00



CK P

P

NT 

RT TP

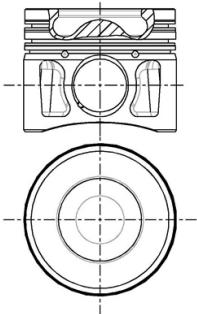

08650A105

 Steel

 Stahl

 Acier

 Acero

 Acciaio

40 86.40

Jumpy 1.6

10/95 →

220 A2.000

Jumpy 1.6 l

10/95 →

4 Cyl.

1581cc

59-60kW (80-81PS)

TD6587

87-783700-00

STD

08-783700-00

STD

87-783706-00

0.40mm

08-783706-00

0.40mm

87-783708-00

0.60mm

08-783708-00

0.60mm

08-783711-00

1.00mm

A 33.30

B- 2.30

D 72.80

 22x63

1.50

1.75

3.00



CR P

P

CR 

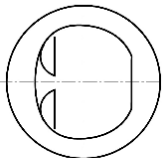

 Steel

 Stahl

 Acier

 Acero

 Acciaio



41 88.00

CX I 2000	06/79→08/85	829.A5		
CX II 20	08/85→08/86		4 Cyl.	9.2:1
CX II 20 RE	08/85→12/92		1995cc	75-78kW (102-106PS)
TD4259				

CX I 2200	06/81→08/85	J6TA 500 / J6RA 500		
CX II 22 TRS	07/85→12/92		4 Cyl.	9.8:1
CX II 22TRS	07/85→07/89		2165cc	83-85kW (113-115PS)
TD663				

87-334400-00	STD	08-334400-00	STD	14-637160-00 WH	B 93.60 C 140.50 D 104.00 E 93.08	89-334400-00 87-334400-00 + 14-637160-00
A 40.50		1.75	MO P			
B+ 1.55		2.00	P			
D 69.05		4.00	CR			
23x75						
Steel		Stahl		Acier		Acciaio

42 88.00

C25 2.0 E	09/81→03/94	XN1T (170A)		
			4 Cyl.	8.1:1
			1971cc	58kW (79PS)
TD5164				

C25 2.0 E	09/81→03/94	XN1T (170B)		
			4 Cyl.	8.1:1
			1971cc	58-62kW (79-84PS)
TD589				

C25 2.0	01/87→03/94	XN1T (170C)		
			4 Cyl.	8:1
			1971cc	62kW (84PS)
TD590				

	08-316900-00	STD	14-636500-00 WH	B 93.00 C 135.70 D 101.90 E 89.98	89-316900-00
	08-316907-00	0.50mm			
A 38.25	1.50		CR P		
B+ 0.65	2.00		P		
D 71.85	4.00		CR		
23x74					





①

A 37.90
B+ 1.35
D 72.20
 23x74

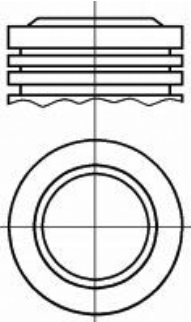

① Piston available in Kit Set only
 ② Steel

08-316900-00
08-316907-00

1.50
 2.00
 4.00



STD
 0.50mm

CR P
 P
 CR ②

① Kolben nur im Assembly erhältlich
 ② Stahl

14-636500-00 WH B 93.00 C 135.70 D 101.90 E 89.98

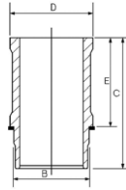

① Piston disponible en kit seulement
 ② Acier

① Pistón disponible en conjuntos solamente
 ② Acero

89-316900-10

① I pistoni sono disponibili solo in kit motore
 ② Acciaio

43 92.00

Jumper 2.5 D

03/94 → 04/02

DJ5 (T9A)

4 Cyl.

24:1

2446cc

63kW (86PS)

Diesel

Turbo Intercooled

TD4293

87-112400-00
87-112407-00

STD
 0.50mm

A 49.90
B- 3.00
D 80.00
 34x58

AK TP

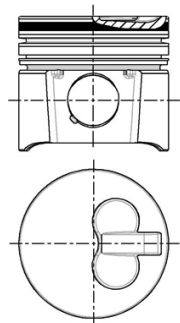

08-112400-00
08-112407-00

2.25
 2.00
 2.00



STD
 0.50mm

CK P
 P
 CR P

14-020190-00 D B 96.00 C 160.00 D 99.00 E 5.00

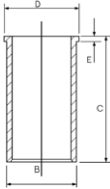



44  **92.00**

Jumper 2.5 TD	03/94→04/02	DJ5T (T8A)	4 Cyl.	21:1	
			2446cc	76kW (103PS)	
		Diesel	Turbo Intercooled		TD4292
Jumper 2.5 DT	10/96→08/97	DJ5T (THZ)	4 Cyl.	22:1	
			2446cc	76kW (103PS)	
		Diesel	Turbo Intercooled		TD6585
XM 2.5 TD	05/94→10/00	DK5ATE (THY)	4 Cyl.	22:1	
			2446cc	95kW (129PS)	
		Diesel	Turbo Intercooled		TD4294

87-326300-00

STD

08-326300-00

STD

87-326307-00 

0.50mm

08-326307-00

0.50mm

A 49.84

B- 2.30

D 82.00

 34x68

3.00

1.75

3.50





P PS

CR P

CR P

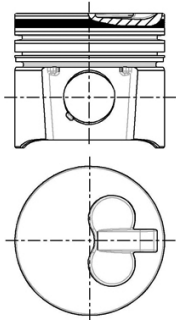
AK HA KK RT TP



 A = 49.470, B = 81.600

 A = 49.470, B = 81.600

 A = 49.470, B = 81.600

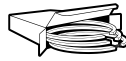

 A = 49.470, B = 81.600

 A = 49.470, B = 81.600

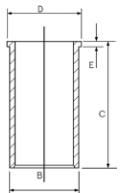

45 92.00

Jumper 2.5 TDi	12/96→04/02	DJ5TED (THX)	4 Cyl.	20:1
			2446cc	79kW (107PS)
		Diesel	Turbo Intercooled	
				TD11889

87-135800-00	STD	08-135800-00	STD	14-020190-00 D	B 96.00 C 160.00 D 99.00 E 5.00
		08-135807-00	0.50mm		
A	57.00				
B-	18.25				
BØ	40.00				
C	1.50				
D	89.00				
	34x68				

AK KK RT

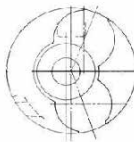
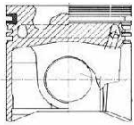

46 93.00

C35 2.5 D	02/80→01/94	B25/637	4 Cyl.	22.25:1
			2500cc	51kW (69PS)
		Diesel		
				TD6895
C25 2.5 D	11/81→02/94	CRD93B	4 Cyl.	22.25:1
			2499cc	50kW (70PS)
		Diesel		
				TD6577
C25 2.5 D	11/81→02/94	CRD93L (U25/661)	4 Cyl.	22.5:1
			2500cc	54-55kW (73-75PS)
		Diesel		
				TD625
CX I 2500 D	02/78→08/85	M22-629	4 Cyl.	22.25:1
			2499cc	55kW (75PS)
		Diesel		
				TD23453
CX I 2500 D	02/78→08/85	M25-629	4 Cyl.	22.25:1
			2500cc	55kW (75PS)
		Diesel		
				TD693
CX II 25 D	08/85→12/92	M25-637	4 Cyl.	22.25:1
			2499cc	55kW (75PS)
		Diesel		
				TD23454
CX II 25 D	08/85→12/92	M25-660	4 Cyl.	22.25:1
			2500cc	54kW (75PS)
		Diesel		
				TD696





CX II 25 D	08/85 → 12/92	M25-661	4 Cyl. 2499cc	22.25:1 55kW (75PS)	
Diesel					TD23455

87-152700-00 STD
87-152707-00 0.50mm

08-152700-00 STD
08-152707-00 0.50mm

14-013481-00 D B 96.10 C 163.00

A 52.75
B- 7.30
D 87.75
 30x78

08/84 →
2.50
2.00
4.00



MOL P
P
CR P

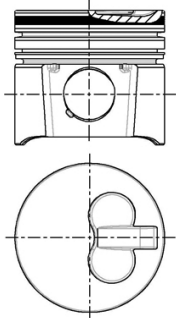
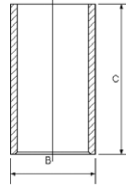

47 93.00

C25 2.5 DT C25 2.5 D Turbo	01/87 → 01/94 08/87 → 02/94	CRD93LS (U25/673)	4 Cyl. 2500cc	22.5:1 70kW (95PS)	
Diesel					TD626
CX I 25 D Turbo, CX I 2500 D Turbo CX II 25 D Turbo, CX II 2500 D Turbo	04/83 → 08/85 08/85 → 12/86	M25-648	4 Cyl. 2500cc	21:1 70kW (95PS)	
Diesel					TD694
CX II 25 D Turbo, CX II 25 D Turbo 2	01/87 → 12/92	M25-669	4 Cyl. 2500cc	21.25:1 88kW (120PS)	
Diesel					TD702

14-013481-00 D B 96.10 C 163.00

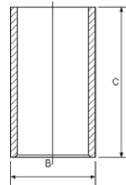

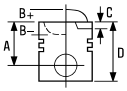

48  **94.00**

C35 D

01/74→12/92 **XD3/P**

4 Cyl.
2498cc

23:1

Diesel

FM2303



87-318700-10 STD
87-318706-10 0.40mm
87-318708-10 0.60mm
87-318710-10 0.80mm

→12/93

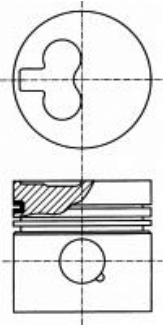
A 54.00
B- 1.80
D 96.42
 30x79



08-318700-10 STD
08-318704-10 0.20mm
08-318706-10 0.40mm
08-318707-10 0.50mm
08-318708-10 0.60mm
08-318710-10 0.80mm

2.00  CR P
 2.00  P
 4.00  CR P

14-020660-00 D B 97.00 C 170.60 D 99.50 E 4.00
14-021520-00 D B 98.00 C 170.60 D 100.00 E 6.00

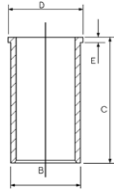



87-318700-30 STD
87-318706-30 0.40mm
87-318708-30 0.60mm
87-318710-30 0.80mm

01/94→

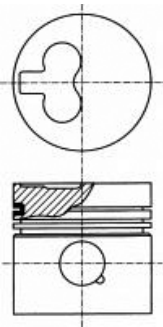
A 54.00
B- 1.75
D 91.42
 30x79



08-318700-10 STD
08-318704-10 0.20mm
08-318706-10 0.40mm
08-318707-10 0.50mm
08-318708-10 0.60mm
08-318710-10 0.80mm

2.00  CR P
 2.00  P
 4.00  CR P



49 94.40

Jumper 2.8 HDi	05/04→	8140.43N Euro 3	4 Cyl.	18.5:1	
			2798cc	107kW (146PS)	
		Diesel	Turbo Intercooled		TD18297
Jumper 2.8 HDi	09/00→	8140.43S Euro 3	4 Cyl.	18:1	
Jumper 2.8 HDi All-wheel Drive	04/02→		2798cc	92-94kW (125-128PS)	
		Diesel	Turbo Intercooled		TD17849
Jumper 2.8 HDi	02/02→06/06	F28TDCR Euro 3	4 Cyl.	18:1	
			2798cc	94kW (128PS)	
		Diesel	Turbo Intercooled		TD16741

87-122200-00

STD

08-122200-00

STD

14-021321-00 *D*

B 97.54 C 167.00 D 100.90 E 5.00

87-122208-00

0.60mm

08-122208-00

0.60mm

14-028930-00 *D*

B 97.50 C 167.00 D 100.90 E 5.00

A 58.70

B- 21.30

BØ 39.40

D 87.60

 32x72

2.50



CK P

2.00



P

2.50



CR P

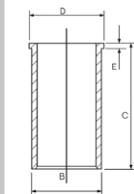

AK KK RT TP

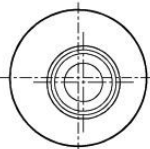
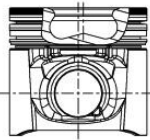

50 94.40

Jumper 2.8 D	01/99→02/02	8140.63 (F28D)	4 Cyl.	21:1	
			2798cc	64kW (87PS)	
		Diesel			TD24977

87-108200-00

STD

08-108200-00

STD

14-021321-00 *D*

B 97.54 C 167.00 D 100.90 E 5.00

87-108208-00

0.60mm

08-108208-00

0.60mm

14-028930-00 *D*

B 97.50 C 167.00 D 100.90 E 5.00

A 55.00

B- 2.80

D 90.00

 32x68

3.00



CR P

2.00



P

2.50



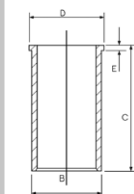

CR P

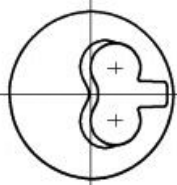
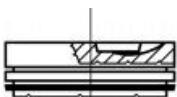

AK HA RT TP

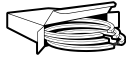
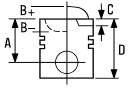



1  **66.69**

13.5 CU.FT/15 CU.FT.
Air Compressor

1 Cyl.

FM353

87-522200-00

STD

08-522200-00

STD

14-010960-00 WH **B 72.90 C 88.90 D 79.36 E 77.29**

A 22.02

D 44.25

 11x57

1.97





1.97

1.97

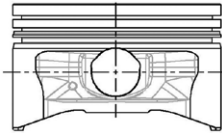
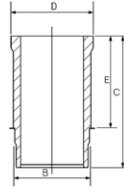
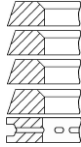
1.97

3.96



		ccm	x 		
Knorr Bremse Iveco ACX82	Petrol		2	82.00	2
MAN D25/28	Petrol		1/2	90.00	4
Mercedes-Benz OM360/400/420/440	Petrol		1/2	90.00	5
Mercedes-Benz OM402/501/502/541/542/LA	Petrol		1	100.00	6
Westinghouse MB OM457/904/906, DAF 825/1160	Petrol		1	85.00	3
Westinghouse WB15 Volvo TD100	Petrol		2	75.00	1



1 75.00

Westinghouse WB15 Volvo TD100 2 Cyl.

FM1846

87-990700-00	STD	08-990700-00	STD
87-990705-00	0.25mm	08-990705-00	0.25mm
87-990707-00	0.50mm	08-990707-00	0.50mm

A	32.20	2.38		P
D	52.65	2.38		P
	16x60	3.94		P

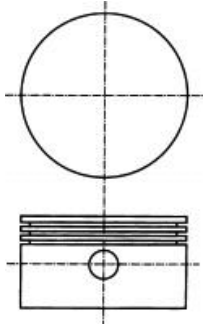

2 82.00

Knorr Bremse Iveco ACX82 2 Cyl.

FM9263

87-529200-00	STD	08-529200-00	STD
		08-529207-00	0.50mm

A	28.50	1.50		P
D	52.00	1.50		P
	14x48	3.00		P

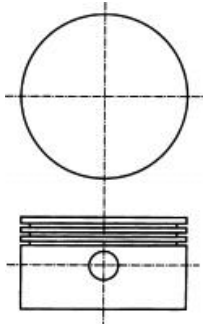

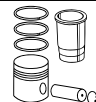
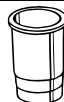
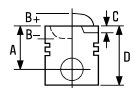

3 85.00

Westinghouse MB OM457/904/906, 1 Cyl.
DAF 825/1160

FM15572

87-741200-10	STD	08-741200-00	STD
87-741207-10	0.50mm	08-741204-00	0.20mm
		08-741205-00	0.25mm
		08-741207-00	0.50mm

A 33.30
D 59.15
 19x60

2.00		P
2.00		P
4.00		P

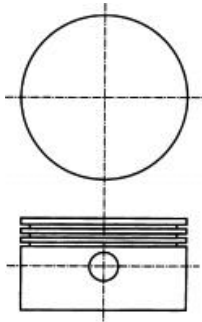

4 90.00

MAN D25/28

1/2 Cyl.

FM5548

14-000240-00 WH B 95.00 C 104.00 D 140.00 E 94.00

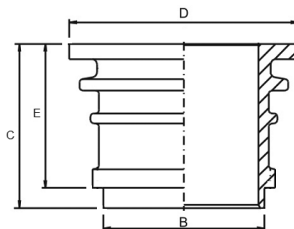

14-000230-00 DH B 95.00 C 104.00 D 127.00 E 94.00

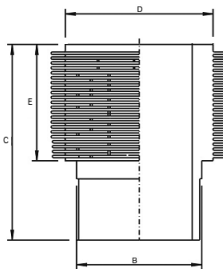

- Air cooled
- Water cooled

- Luftgekühlt
- Wassergekühlt

- Refroidi par air
- Refroidi par eau

- Refrigerado por aire
- Refrigerado por agua

- Raffreddamento ad aria
- Raffreddamento ad acqua



5 90.00

Mercedes-Benz OM360/400/420/440 1/2 Cyl.

FM5572

87-404500-00
87-404507-00
87-404511-00

STD
0.50mm
1.00mm

08-404500-00

STD

14-000240-00 **WH** ² B 95.00 C 104.00 D 140.00 E 94.00

88-404500-00
87-404500-00 +
14-000240-00

A 35.00
D 57.50
 20x60

2.50
2.50
4.00



P
CR ³

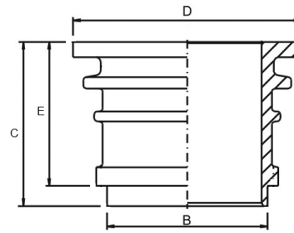

14-000230-00 **DH** ¹ B 95.00 C 104.00 D 127.00 E 94.00

88-404500-10
87-404500-00 +
14-000230-00

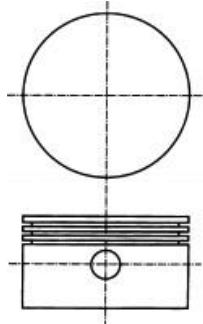
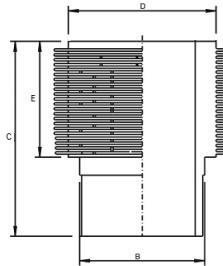

- ¹ Air cooled
- ² Water cooled
- ³ Steel

- ¹ Luftgekühlt
- ² Wassergekühlt
- ³ Stahl

- ¹ Refroidi par air
- ² Refroidi par eau
- ³ Acier

- ¹ Refrigerado por aire
- ² Refrigerado por agua
- ³ Acero

- ¹ Raffreddamento ad aria
- ² Raffreddamento ad acqua
- ³ Acciaio

6 100.00

Mercedes-Benz OM402/501/502/541/542/LA 1 Cyl.

FM15603

87-140500-00
87-140507-00

STD
0.50mm

08-140500-00
08-140507-00

STD
0.50mm

14-000310-00 **DH** B 115.00 C 102.00 D 131.00 E 94.00
14-000350-00 **DH** B 106.00 C 101.00 D 130.00 E 94.00

88-140500-00
87-140500-00 +
14-000310-00

A 30.40
D 52.20
 20x50

2.50
2.50
4.00



P
P
CR

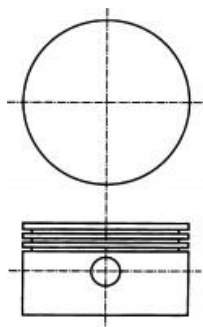
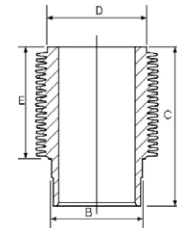

88-140500-10
87-140500-00 +
14-000350-00

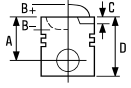



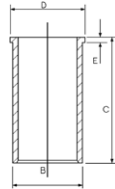

1 102.00

6 BT	6 Cyl.	17:1	5880cc	118kW (160PS)	Diesel Turbo Direct Injection	TD6966
6 BT5.9	6 Cyl.	17:1	5880cc	100-117kW (136-159PS)	Diesel Turbo Direct Injection	TD6613
6 BTA-5.9	6 Cyl.	17:1	5880cc	118kW (160PS)	Diesel Turbo Intercooled Direct Injection	TD7047

14-020610-00 D **B** 106.12 **C** 204.85 **D** 108.91 **E** 4.10 **F** 0.94



		ccm	x 		
810-02/-99	Petrol	1289	4	73.00	2
D4F 732	Petrol	1149	4	69.00	1
F8Q 600	Diesel	1870	4	80.00	11
F8Q 630	Diesel	1870	4	80.00	12
K4M 690	Petrol	1598	4	79.50	7
K4M 694	Petrol	1598	4	79.50	7
K7J 710	Petrol	1390	4	79.50	8
K7J 714	Petrol	1390	4	79.50	8
K7M 710	Petrol	1598	4	79.50	9
K7M 732 Euro 4	Petrol	1598	4	79.50	10
K9K 612	Diesel	1461	4	76.00	3
K9K 790	Diesel	1461	4	76.00	4
K9K 792 Euro 4	Diesel	1461	4	76.00	5
K9K 796	Diesel	1461	4	76.00	6
K9K 856 Euro 5	Diesel	1461	4	76.00	3
K9K 858 Euro 5	Diesel	1461	4	76.00	3
K9K 892	Diesel	1461	4	76.00	3
K9K 894	Diesel	1461	4	76.00	3
K9K 896	Diesel	1461	4	76.00	3
K9K 898	Diesel	1461	4	76.00	3



1 69.00

Logan 1.2 16V	02/06→	D4F 732		
Logan II 1.2	10/12→		4 Cyl.	9.8:1
Logan MCV II 1.2	02/13→		1149cc	55kW (75PS)
Sandero 1.2 16V, Sandero 1.2 16V LPG	11/08→			TD23529
Sandero II 1.2, Sandero II 1.2 LPG	10/12→			

87-450000-00	STD	08-450000-10	STD
87-450007-00	0.50mm	08-450007-10	0.50mm

A	26.70	1.20	NT 1
B-	1.10	1.50	P
BØ	60.30	2.50	CR 1
D	44.70		
18x54			

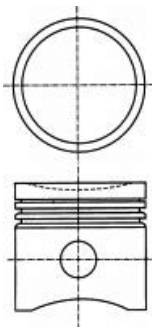

1 Steel 1 Stahl 1 Acier 1 Acero 1 Acciaio

2 73.00

1300 1.3	12/72→05/83	810-02/-99		
1304 1.3	06/83→08/90		4 Cyl.	8.5:1
1310 1.3	05/83→07/04		1289cc	40kW (54PS)
				TD13436

87-333400-00	STD	08-333400-10	STD	15-636590-00 WH 1 B 78.50 C 134.00 D 87.70 E 95.00
---------------------	-----	---------------------	-----	---

A	37.50	1.75	CR P
D	62.50	2.00	P
20x64		4.00	CR 2

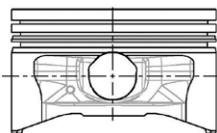
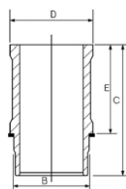

1 Includes seals 1 Schließt Dichtungen ein 1 Inclut des joints 1 Incluye los sellos 1 Comprende le guarnizioni
 2 Steel 2 Stahl 2 Acier 2 Acero 2 Acciaio





3 76.00

Dokker 1.5 dCi	11/12→	K9K 612				
Dokker Express 1.5 dCi	12/12→		4 Cyl.			
Lodgy 1.5 dCi	03/12→		1461cc	55-66kW (75-90PS)		
Logan II 1.5 dCi	10/12→	Diesel	Turbo Intercooled			TD28005
Logan MCV II 1.5 dCi	02/13→					
Sandero II 1.5 dCi	10/12→					
Duster 1.5 dCi	04/13→	K9K 856 Euro 5				
			4 Cyl.	15.2:1		
			1461cc	80kW (109PS)		
		Diesel	Turbo Intercooled			TD28611
Duster 1.5 dCi	04/13→	K9K 858 Euro 5				
			4 Cyl.	15.2:1		
			1461cc	80kW (109PS)		
		Diesel	Turbo Intercooled			TD28610
Duster 1.5 dCi	10/10→	K9K 892				
Logan 1.5 dCi, Logan EXPRESS 1.5 dCi	05/10→		4 Cyl.	17.6:1		
Logan 1.5 dCi, Logan MCV 1.5 dCi			1461cc	55-66kW (75-90PS)		
Sandero 1.5 dCi		Diesel	Turbo Intercooled			TD24780
Duster 1.5 dCi	10/10→	K9K 894				
			4 Cyl.	17.6:1		
			1461cc	66-67kW (90-91PS)		
		Diesel	Turbo Intercooled			TD24783
Duster 1.5 dCi	06/10→	K9K 896				
			4 Cyl.	17.6:1		
			1461cc	79kW (107PS)		
		Diesel	Turbo Intercooled			TD24784
Duster 1.5 dCi	06/10→	K9K 898				
			4 Cyl.	17.6:1		
			1461cc	79-81kW (107-110PS)		
		Diesel	Turbo Intercooled			TD24785

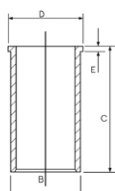
14-020650-00 D B 79.10 C 142.00 D 81.00 E 5.00

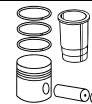
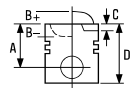



4  **76.00**

Logan 1.5 dCi 09/05 → K9K 790 4 Cyl. 18.3:1
 1461cc 48kW (65PS)
 Diesel Turbo Intercooled TD18514



87-123400-00 STD
 87-123407-00 0.50mm

A 41.69
 B- 13.70
 BØ 39.70
 C 0.60
 D 66.05
 25x60

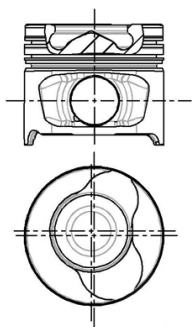
RT TP



08-123400-00 STD
 08-123407-00 0.50mm

2.00  CK P
 2.00  P
 2.50  NT

14-020650-00 D B 79.10 C 142.00 D 81.00 E 5.00

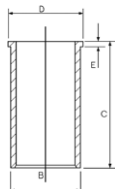

87-123400-10 STD
 87-123407-10 0.50mm

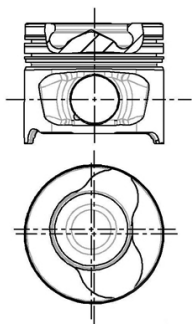

A 41.82
 B- 13.70
 BØ 39.70
 C 0.60
 D 66.05
 26x60

RT TP



557.503

08-123400-00 STD
 08-123407-00 0.50mm

2.00  CK P
 2.00  P
 2.50  NT

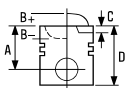



5  **76.00**

Logan 1.5 dCi	01/06→	K9K 792 Euro 4		
Logan EXPRESS 1.5 dCi	03/09→		4 Cyl.	17.9:1
Logan MCV 1.5 dCi	02/07→		1461cc	50kW (68PS)
Sandero 1.5 dCi	11/08→	Diesel	Turbo Intercooled	TD19223

87-123400-10	STD	08-123400-00	STD	14-020650-00 D	B 79.10 C 142.00 D 81.00 E 5.00
87-123407-10	0.50mm	08-123407-00	0.50mm		

A	41.82
B-	13.70
BØ	39.70
C	0.60
D	66.05
	26x60

2.00		CK P
2.00		P
2.50		NT

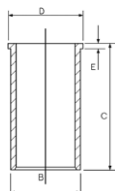

RT TP

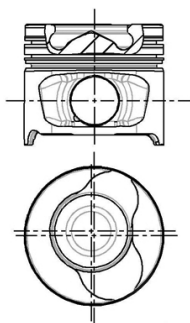





557.503

6  **76.00**

Duster 1.5 dCi	04/10→	K9K 796		
Logan 1.5 dCi	09/07→		4 Cyl.	18.8:1
Logan EXPRESS 1.5 dCi	03/09→		1461cc	63kW (86PS)
Logan MCV 1.5 dCi	09/07→	Diesel	Turbo Intercooled	TD22403
Sandero 1.5 dCi	11/08→			

87-123400-20	STD	08-123400-00	STD	14-020650-00 D	B 79.10 C 142.00 D 81.00 E 5.00
87-123407-20	0.50mm	08-123407-00	0.50mm		

A	41.70
B-	14.00
BØ	39.70
C	0.43
C	0.25
D	66.00
	26x60

2.00		CK P
2.00		P
2.50		NT

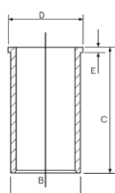

AK KK RT TP

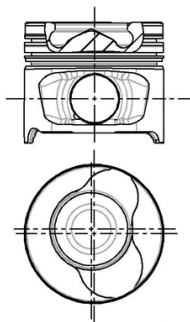

07657-101

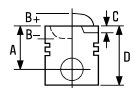

7  **79.50**

Duster 1.6 16V	04/10→	K4M 690			
Logan 1.6 16V	02/06→		4 Cyl.	9.8:1	
Logan MCV 1.6 16V	02/07→		1598cc	77kW (105PS)	
Logan MCV 1.6 16V Hi-Flex	11/09→				TD20941
Sandero 1.6 16V	07/11→				
Sandero 1.6 16V Bifuel	01/11→				

Logan MCV 1.6 16V Hi-Flex	11/09→	K4M 694			
Sandero 1.6 16V Bifuel	01/11→		4 Cyl.	9.8:1	
			1598cc	77kW (105PS)	
					TD24876

87-104200-30 STD

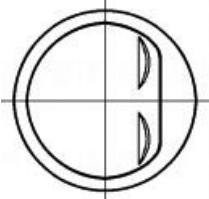
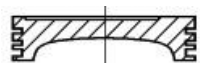

- A** 31.70
 - B-** 1.30
 - C** 1.60
 - D** 55.00
-  20x62



 Steel

 Stahl

08-104200-00 STD
08-104207-00 0.50mm

- 1.50  CR P
- 1.50  P
- 2.50  CR 1

 Acier

 Acero

 Acciaio

8  **79.50**

Logan 1.4	09/04→	K7J 710			
Logan 1.4 MPI LPG	02/06→		4 Cyl.	9.5:1	
Logan EXPRESS 1.4	03/09→		1390cc	55kW (75PS)	
Logan MCV 1.4	02/07→				TD18140
Sandero 1.4	06/08→				
Solenza 1.4	02/03→				

Logan 1.4 MPI LPG	02/06→	K7J 714			
Sandero 1.4 MPI LPG	01/09→		4 Cyl.	9.5:1	
			1390cc	53-55kW (72-75PS)	
					TD23531

87-104200-40 STD

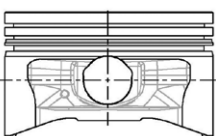

- 87-104207-40** 0.50mm
- A** 35.83
 - D** 58.00
-  19x62



 Steel

 Stahl

08-104200-00 STD
08-104207-00 0.50mm

- 1.50  CR P
- 1.50  P
- 2.50  CR 1

 Acier



 Acero

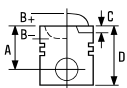



 Acciaio





9  **79.50**



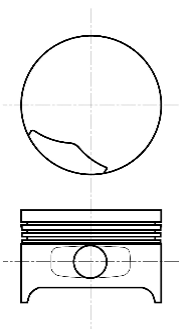

Logan 1.6	09/04→	K7M 710		
Logan EXPRESS 1.6	03/09→		4 Cyl.	9.5:1
Logan MCV 1.6	02/07→		1598cc	64kW (87PS)
Logan MCV 1.6 Bifuel	11/08→			
Sandero 1.6	06/08→			TD18141

87-104200-00 	STD	08-104200-00	STD
87-104207-00 	0.50mm	08-104207-00	0.50mm









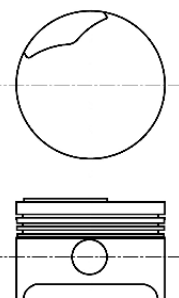





A 31.80	1.50		CR P
B+ 2.55	1.50		P
D 56.30	2.50		CR 
 19x63			







87-104200-10 	STD	08-104200-00	STD
87-104207-10 	0.50mm	08-104207-00	0.50mm

A 31.80	1.50		CR P
B+ 2.55	1.50		P
D 56.30	2.50		CR 
 19x63			



- | | | | | |
|---|--|---|--|---|
|  To cylinder 1 & 2 |  zum Zylinder 1 & 2 |  sous cylindre 1 & 2 |  A cilindro 1 & 2 |  al cilindro 1 & 2 |
|  To cylinder 3 & 4 |  zum Zylinder 3 & 4 |  sous cylindre 3 & 4 |  A cilindro 3 & 4 |  al cilindro 3 & 4 |
|  Steel |  Stahl |  Acier |  Acero |  Acciaio |

		ccm	x 		
C20NE	Petrol	1998	4	86.00	1
M 104.992	Petrol	3199	6	89.90	2
M 104.995	Petrol	3199	6	89.90	2
M 111.970	Petrol	2295	4	90.90	3
M 161.970	Petrol	2295	4	90.90	3
M 161.974	Petrol	2295	4	90.90	3



2 89.90

Musso 3.2	01/99 →	M 104.992	6 Cyl. 3199cc	10:1 162kW (220PS)	TD22988
Korando 3.2	01/99 →	M 104.995	6 Cyl. 3199cc	9.2:1 154-156kW (209-212PS)	TD22990

87-287500-10	STD	08-287500-00	STD
87-287505-10	0.25mm	08-287505-00	0.25mm
		08-287507-00	0.50mm

A	31.12
B-	3.25
BØ	70.00
C	2.60
D	56.12
	22x55

1.50		NT
1.75		P
3.00		CR P

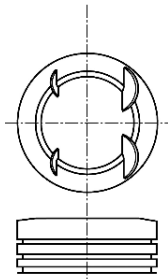

09034

87-287500-30	STD	08-287500-00	STD
87-287505-30	0.25mm	08-287505-00	0.25mm
87-287507-30	0.50mm	08-287507-00	0.50mm

A	31.12
B-	2.60
BØ	74.00
C	1.30
C	1.80
D	56.10
	22x56

1.50		NT
1.75		P
3.00		CR P

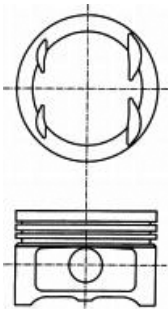

09024

Elastoval ®
 Steel

Elastoval ®
 Stahl

Elastoval ®
 Acier

Elastoval ®
 Acero

Elastoval ®
 Acciaio



3  **90.90**

Musso 2.3	01/99 →	M 111.970	4 Cyl. 2295cc	10.4:1 103-110kW (140-150PS)	TD22989
------------------	---------	------------------	-------------------------	--	----------------

Korando 2.3	01/99 →	M 161.970	4 Cyl. 2295cc	10.4:1 103-110kW (140-150PS)	TD26690
--------------------	---------	------------------	-------------------------	--	----------------

Rexton 2.3 RX230	05/02 →	M 161.974	4 Cyl. 2295cc	10.4:1 110kW (150PS)	TD26679
-------------------------	---------	------------------	-------------------------	--------------------------------	----------------

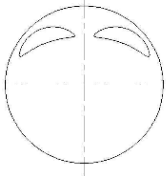
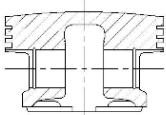

87-109100-00 STD
87-109107-00 ¹ 0.50mm

- A** 30.00
- B+** 2.90
- C** 1.00
- D** 57.90
-  22x56



09128

08-109100-00 STD
08-109107-00 0.50mm

- 1.50  NT ²
- 1.75  NT ²
- 3.00  NT ²

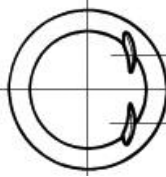
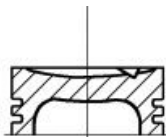

87-109100-10 STD
87-109107-10 0.50mm

- 01/96 →
- A** 30.00
- B-** 1.10
- BØ** 70.00
- C** 0.85
- D** 55.00
-  22x56



09130

08-109100-00 STD
08-109107-00 0.50mm

- 1.50  NT ²
- 1.75  NT ²
- 3.00  NT ²





¹ B+ = 1.700
² Steel





¹ B+ = 1.700
² Stahl

¹ B+ = 1.700
² Acier

¹ B+ = 1.700
² Acciaio

¹ B+ = 1.700
² Acciaio

		ccm	x 		
110E	Petrol	1108	4	70.00	1
110F	Petrol	1108	4	70.00	1
110G	Petrol	1108	4	70.00	1
810/03/25/26/29	Petrol	1289	4	73.00	2
B13,0S	Petrol	1298	4	73.00	2
DF 615	Diesel	6150	6	104.18	6
DH 825	Diesel	8250	6	118.00	9
DHB 825	Diesel	8250	6	118.00	9
DHR 825	Diesel	8250	6	118.00	9
DHS 825	Diesel	8250	6	118.00	9
DHS 825SM	Diesel	8250	6	118.00	9
DHT 825	Diesel	8250	6	118.00	9
DHTD 825	Diesel	8250	6	118.00	9
DHU 825	Diesel	8250	6	118.00	9
DJ5T	Diesel	2446	4	92.00	3
DK 1160	Diesel	11630	6	130.00	12
DKA 1160	Diesel	11600	6	130.00	12
DKB 1160	Diesel	11600	6	130.00	12
DKCL 1160	Diesel	11630	6	130.00	13
DKD 1160	Diesel	11630	6	130.00	12
DKDL 1160	Diesel	11630	6	130.00	12
DKFL 1160	Diesel	11630	6	130.00	13
DKL 1160	Diesel	11630	6	130.00	12
DKS 1160	Diesel	11600	6	130.00	13
DKS 1160 E	Diesel	11600	6	130.00	13
DKSB 1160	Diesel	11630	6	130.00	13
DKSE 1160	Diesel	11630	6	130.00	14
DKT 1160	Diesel	11600	6	130.00	13
DKTD 1160	Diesel	11600	6	130.00	13
DKTL 1160	Diesel	11600	6	130.00	13
DKV 1160	Diesel	11600	6	130.00	14
DKVL 1160	Diesel	11600	6	130.00	13
DKX 1160	Diesel	11600	6	130.00	13
DKX 1160 ATi	Diesel	11600	6	130.00	14
DKXE 1160	Diesel	11600	6	130.00	14
DKXE 1160 ATi	Diesel	11630	6	130.00	14
DKZ 1160	Diesel	11630	6	130.00	14
DKZ 1160 ATi	Diesel	11600	6	130.00	14
DNS 620	Diesel	6240	6	104.18	7
DNT 620	Diesel	6240	6	104.18	7
DNTD 620	Diesel	6240	6	104.18	7
DT 615	Diesel	6150	6	104.18	6
DTD 615	Diesel	6150	6	104.18	6
DU 825	Diesel	8250	6	118.00	9
EN 55	Diesel	2498	4	94.00	4
ET 70	Diesel	2498	4	94.00	5
HS 200	Diesel	8250	6	118.00	9
HS 825	Diesel	8250	6	118.00	9
HT 168	Diesel	8250	6	118.00	9
HT 825	Diesel	8250	6	118.00	9
KT 191	Diesel	11627	6	130.00	13
LT 160	Diesel	11630	6	130.00	13
LT 195 1160	Diesel	11627	6	130.00	13
LT 210	Diesel	11630	6	130.00	13
MX 13 303 Euro 6	Diesel	12900	6	130.00	15
MX 13 340 Euro 6	Diesel	12900	6	130.00	15
MX 13 375 Euro 6	Diesel	12900	6	130.00	15
MX 265 Euro 4/5 Paccar MX	Diesel	12900	6	130.00	15
MX 300 Euro 4/5 Paccar MX	Diesel	12900	6	130.00	15
MX 340 Euro 4/5 Paccar MX	Diesel	12900	6	130.00	15
MX 375 Euro 4/5 Paccar MX	Diesel	12900	6	130.00	15
NS 156	Diesel	6240	6	104.18	8
NT 133	Diesel	6240	6	104.18	8
PE 183 C Euro 3	Diesel	9200	6	118.00	9
PE 212 C Euro 3	Diesel	9200	6	118.00	9
PE 228 C Euro 3	Diesel	9200	6	118.00	10
PE 235 C Euro 3	Diesel	9200	6	118.00	11
PE 265 C Euro 3	Diesel	9200	6	118.00	10
PE 310 C Euro 3	Diesel	9200	6	118.00	10

		ccm	x 		
PE 360 C Euro 3	Diesel	9200	6	118.00	10
PF 183 M Euro 2	Diesel	9200	6	118.00	9
PF 212 M Euro 2	Diesel	9200	6	118.00	9
PF 235 M Euro 2	Diesel	9200	6	118.00	9
RS 180	Diesel	8661	6	118.00	9
RS 180 L Euro 1	Diesel	8650	6	118.00	9
RS 180 M Euro 2	Diesel	8650	6	118.00	9
RS 200	Diesel	8650	6	118.00	9
RS 200 L Euro 1	Diesel	8650	6	118.00	9
RS 200 M Euro 2	Diesel	8650	6	118.00	9
RS 222	Diesel	8661	6	118.00	9
RS 222 L Euro 1	Diesel	8650	6	118.00	9
RS 222 M Euro 2	Diesel	8650	6	118.00	9
WS 222 G	Diesel	11630	6	130.00	16
WS 222 L	Diesel	11630	6	130.00	17
WS 222 M	Diesel	11630	6	130.00	12
WS 225	Diesel	11600	6	130.00	18
WS 225 ATi	Diesel	11630	6	130.00	12
WS 242	Diesel	11600	6	130.00	17
WS 242 G	Diesel	11630	6	130.00	12
WS 242 L Euro 1	Diesel	11600	6	130.00	16
WS 242 M Euro 2	Diesel	11600	6	130.00	19
WS 259	Diesel	11600	6	130.00	18
WS 259 ATi	Diesel	11630	6	130.00	12
WS 268	Diesel	11600	6	130.00	17
WS 268 G	Diesel	11600	6	130.00	12
WS 268 L Euro 1	Diesel	11600	6	130.00	16
WS 268 M Euro 2	Diesel	11600	6	130.00	19
WS 282	Diesel	11600	6	130.00	18
WS 282 ATi	Diesel	11630	6	130.00	12
WS 282 L	Diesel	11630	6	130.00	12
WS 295	Diesel	11600	6	130.00	17
WS 295 G	Diesel	11600	6	130.00	12
WS 295 L Euro 1	Diesel	11600	6	130.00	16
WS 295 M Ati	Diesel	11627	6	130.00	12
WS 295 M Euro 2	Diesel	11600	6	130.00	19
WS 315	Diesel	11600	6	130.00	12
WS 315 G	Diesel	11627	6	130.00	12
WS 315 L Euro 1	Diesel	11600	6	130.00	16
WS 315 M Euro 2	Diesel	11600	6	130.00	19
XD 3P	Diesel	2498	4	94.00	4
XD 3T	Diesel	2498	4	94.00	5
XE 250 C Euro 3	Diesel	12580	6	130.00	12
XE 280 C1 Euro 3	Diesel	12580	6	130.00	20
XE 280 C Euro 3	Diesel	12580	6	130.00	12
XE 315 C1 Euro 3	Diesel	12580	6	130.00	20
XE 315 C Euro 3	Diesel	12580	6	130.00	12
XE 355 C1 Euro 3	Diesel	12580	6	130.00	12
XE 355 C Euro 3	Diesel	12580	6	130.00	12
XE 390 C1 Euro 3	Diesel	12580	6	130.00	12
XE 390 C Euro 3	Diesel	12580	6	130.00	12
XF 250 M Euro 2	Diesel	12580	6	130.00	21
XF 280 M Euro 2	Diesel	12580	6	130.00	21
XF 315 M Euro 2	Diesel	12580	6	130.00	21
XF 355 M Euro 2	Diesel	12580	6	130.00	21

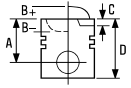

1 **70.00**

110E	4 Cyl.	1108cc	35kW (48PS)	TD21909
110F	4 Cyl.	1108cc	40kW (54PS)	TD21910
110G	4 Cyl.	1108cc	40kW (54PS)	TD21911

87-334600-00	STD	08-334600-00	STD	14-636730-00 WH	B 75.50 C 135.00 D 85.70 E 94.80	89-334600-00 87-334600-00 + 14-636730-00
A	40.00	1.75		CR P		
D	68.00	2.00		P		
	18x62	3.50		CR		

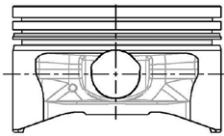

Steel Stahl Acier Acero Acciaio

2 **73.00**

810/03/25/26/29	4 Cyl.	1289cc	40kW (54PS)	FM1486
B13,0S	4 Cyl. 8.5:1	1298cc	42kW (57PS)	TD5226

15-636590-00 WH **B 78.50 C 134.00 D 87.70 E 95.00**

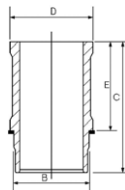

Includes seals Schließt Dichtungen ein Inclut des joints Incluye los sellos Comprende le guarnizioni

3 **92.00**

DJ5T	4 Cyl.	22:1	2446cc	76-96kW (103-131PS)	Diesel Turbo Intercooled	TD22210
-------------	--------	------	---------------	----------------------------	---------------------------------	----------------

87-326300-00	STD	08-326300-00	STD	
87-326307-00	0.50mm	08-326307-00	0.50mm	
A	49.84	3.00		P PS
B-	2.30	1.75		CR P
D	82.00	3.50		CR P
	34x68			

AK HA KK RT TP

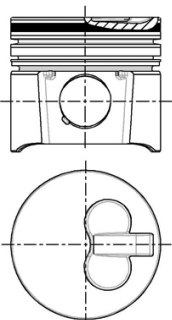

A = 49.470, B = 81.600 A = 49.470, B = 81.600 A = 49.470, B = 81.600 A = 49.470, B = 81.600 A = 49.470, B = 81.600

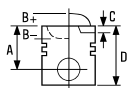

4  **94.00**

EN 55 4 Cyl. 23:1 **2498cc** **53kW (72PS)** **Diesel** **TD763**

XD 3P 4 Cyl. 23:1 **2498cc** **51-58kW (70-79PS)** **Diesel** **TD22215**

87-318700-10 STD
87-318706-10 0.40mm
87-318708-10 0.60mm
87-318710-10 0.80mm

→12/93

A 54.00

B- 1.80

D 96.42

 30x79

08-318700-10 STD
08-318704-10 0.20mm
08-318706-10 0.40mm
08-318707-10 0.50mm
08-318708-10 0.60mm
08-318710-10 0.80mm
08-318711-10 1.00mm

2.00  CR P

2.00  P

4.00  CR P

14-020660-00 D B 97.00 C 170.60 D 99.50 E 4.00
14-021520-00 D B 98.00 C 170.60 D 100.00 E 6.00

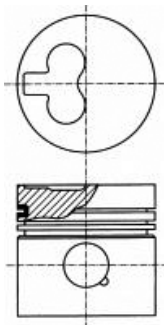
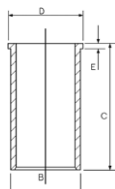

87-318700-30 STD
87-318706-30 0.40mm
87-318708-30 0.60mm
87-318710-30 0.80mm

01/94→

A 54.00

B- 1.75

D 91.42

 30x79

08-318700-10 STD
08-318704-10 0.20mm
08-318706-10 0.40mm
08-318707-10 0.50mm
08-318708-10 0.60mm
08-318710-10 0.80mm
08-318711-10 1.00mm

2.00  CR P

2.00  P

4.00  CR P

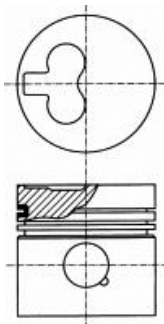

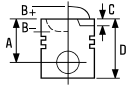

5  **94.00**





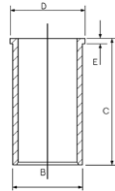

ET 70	4 Cyl.	21:1	2498cc	71kW (96PS)	Diesel Turbo Intercooled	TD764
XD 3T	4 Cyl.	21:1	2498cc	54-70kW (73-95PS)	Diesel Turbo Intercooled	TD22216

14-020660-00 D B 97.00 C 170.60 D 99.50 E 4.00
14-021520-00 D B 98.00 C 170.60 D 100.00 E 6.00

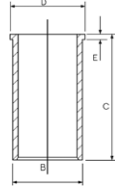

6  **104.18**

DF 615	6 Cyl.	16:1	6150cc	85kW (115PS)	Diesel	TD6601
DT 615	6 Cyl.	16:1	6150cc	111kW (151PS)	Diesel Turbo	TD6602
DTD 615	6 Cyl.	16:1	6150cc	101-123kW (137-167PS)	Diesel Turbo	TD6616

87-179000-10	STD	08-179000-10	STD	14-025530-00 DH	B 109.00 C 239.00 D 117.06 E 8.09	88-179000-10 87-179000-10 + 14-025530-00
A	81.97	2.50	 CR P			
B-	23.15	2.50	 P			
C	2.20	2.50	 P			
C	2.20	6.00	 P			
D	132.72	6.00	 P			
	38x88					

RT

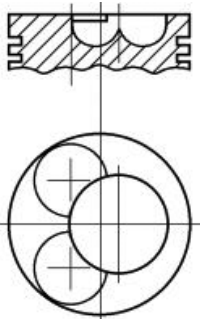

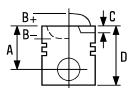





7  **104.18**

DNS 620	6 Cyl.	15:1	6240cc	156kW (212PS)	Diesel Turbo Intercooled	TD6617
DNT 620	6 Cyl.	15:1	6240cc	132kW (180PS)	Diesel Turbo	TD6615
DNTD 620	6 Cyl.	15:1	6240cc	116kW (158PS)	Diesel Turbo	TD6614

87-741600-00 STD **08-741600-00** STD **14-025530-00 DH** B 109.00 C 239.00 D 117.06 E 8.09

A 80.00
B- 23.50
BØ 60.00
D 124.00
 42x88

3.00  CR P
 2.50  CR P
 4.00  CR P

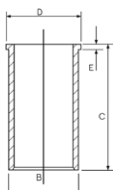

RT

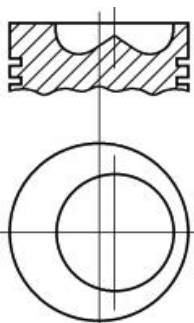

8  **104.18**

NS 156	6 Cyl.	15:1	6240cc	156kW (212PS)	Diesel Turbo Intercooled	TD12928
NT 133	6 Cyl.	15:1	6240cc	133kW (181PS)	Diesel Turbo	TD12909

14-025530-00 DH B 109.00 C 239.00 D 117.06 E 8.09

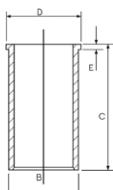

9  **118.00**

DH 825	6 Cyl.	16:1	8250cc	115-121kW (156-165PS)	Diesel	TD6603
DHB 825	6 Cyl.	16:1	8250cc	148kW (201PS)	Diesel Turbo	TD13229
DHR 825	6 Cyl.	15:1	8250cc	150kW (204PS)	Diesel Turbo	TD6619
DHS 825	6 Cyl.	15:1	8250cc	184-195kW (250-265PS)	Diesel Turbo Intercooled	TD6625
DHS 825SM	6 Cyl.	15:1	8250cc	217kW (294PS)	Diesel Turbo Intercooled	TD6626
DHT 825	6 Cyl.	15:1	8250cc	162-167kW (220-228PS)	Diesel Turbo	TD6620
DHTD 825	6 Cyl.	15:1	8250cc	151kW (205PS)	Diesel Turbo	TD6621
DHU 825	6 Cyl.	15:1	8250cc	169kW (230PS)	Diesel Turbo	TD6623
DU 825	6 Cyl.	16:1	8250cc	159kW (216PS)	Diesel Turbo	TD6618
HS 200	6 Cyl.	15:1	8250cc	200kW (272PS)	Diesel Turbo Intercooled	TD6628
HS 825	6 Cyl.	15:1	8250cc	200kW (272PS)	Diesel Turbo Intercooled	TD12890
HT 168	6 Cyl.	15:1	8250cc	168kW (228PS)	Diesel Turbo	TD6624



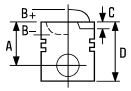

HT 825	6 Cyl.	15:1	8250cc	168kW (228PS)	Diesel Turbo	TD12891
PE 183 C Euro 3	6 Cyl.	16.3:1	9200cc	183kW (249PS)	Diesel Turbo Intercooled	TD13328
PE 212 C Euro 3	6 Cyl.	16.3:1	9200cc	212kW (288PS)	Diesel Turbo Intercooled	TD13329
PF 183 M Euro 2	6 Cyl.	16.3:1	9200cc	183kW (249PS)	Diesel Turbo Intercooled	TD11909
PF 212 M Euro 2	6 Cyl.	16.3:1	9200cc	191-212kW (260-288PS)	Diesel Turbo Intercooled	TD11910
PF 235 M Euro 2	6 Cyl.	16.3:1	9200cc	235kW (320PS)	Diesel Turbo Intercooled	TD11911
RS 180	6 Cyl.	16.5:1	8661cc	180kW (245PS)	Diesel Turbo Intercooled	TD12553
RS 180 L Euro 1	6 Cyl.	16.1:1	8650cc	180kW (245PS)	Diesel Turbo Intercooled	TD6654
RS 180 M Euro 2	6 Cyl.	16.1:1	8650cc	180kW (245PS)	Diesel Turbo Intercooled	TD6655
RS 200	6 Cyl.	16.5:1	8650cc	200kW (272PS)	Diesel Turbo Intercooled	TD12554
RS 200 L Euro 1	6 Cyl.	16.1:1	8650cc	200kW (272PS)	Diesel Turbo Intercooled	TD6656
RS 200 M Euro 2	6 Cyl.	16.1:1	8650cc	200kW (272PS)	Diesel Turbo Intercooled	TD6657
RS 222	6 Cyl.	16.5:1	8661cc	222kW (302PS)	Diesel Turbo Intercooled	TD12555
RS 222 L Euro 1	6 Cyl.	16.1:1	8650cc	222kW (302PS)	Diesel Turbo Intercooled	TD6658
RS 222 M Euro 2	6 Cyl.	16.1:1	8650cc	222kW (302PS)	Diesel Turbo Intercooled	TD6659

14-024070-00 DH B 123.50 C 262.00 D 133.60 E 10.05

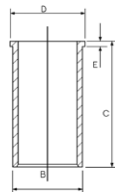

10 118.00

PE 228 C Euro 3	6 Cyl.	17.4:1	9200cc	228kW (310PS)	Diesel Turbo Intercooled	TD16701
PE 265 C Euro 3	6 Cyl.	17.4:1	9200cc	265kW (360PS)	Diesel Turbo Intercooled	TD16700
PE 310 C Euro 3	6 Cyl.	17.4:1	9200cc	228kW (310PS)	Diesel Turbo Intercooled	TD22814
PE 360 C Euro 3	6 Cyl.	17.4:1	9200cc	265kW (360PS)	Diesel Turbo Intercooled	TD22815

87-140200-00 STD

STD

08-140200-00

STD

- A 88.00
- B- 14.07
- BØ 87.00
- D 132.00
- 48x97

- 3.50 CK P
- 3.00 NT
- 4.00 CR P

AK RT TP

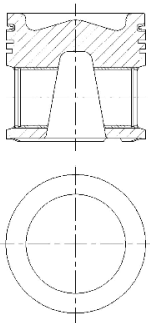

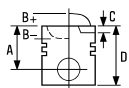





11  **118.00**

PE 235 C Euro 3 6 Cyl. 16.3:1 **9200cc** **235kW (320PS)** **Diesel Turbo Intercooled** **TD13330**

87-140200-00 STD **08-140200-00** STD **14-024070-00 DH** B 123.50 C 262.00 D 133.60 E 10.05

A 88.00
B- 14.07
BØ 87.00
D 132.00
 48x97

3.50  CK P
 3.00  NT
 4.00  CR P

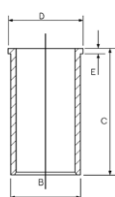

AK RT TP

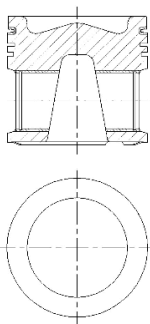

12  **130.00**

DK 1160	6 Cyl.	16:1	11630cc	156kW (212PS)	Diesel Turbo Intercooled	TD6606
DKA 1160	6 Cyl.	16:1	11600cc	169kW (230PS)	Diesel	TD6608
DKB 1160	6 Cyl.	16:1	11600cc	226kW (308PS)	Diesel Turbo	TD6627
DKD 1160	6 Cyl.	16:1	11630cc	121kW (165PS)	Diesel Turbo	TD6605
DKDL 1160	6 Cyl.	16:1	11630cc	121kW (164PS)	Diesel Turbo Intercooled	TD6640
DKL 1160	6 Cyl.	16:1	11630cc	148-151kW (201-205PS)	Diesel Turbo Intercooled	TD6641
WS 222 M	6 Cyl.	16:1	11630cc	222kW (302PS)	Diesel Turbo Intercooled	TD6661
WS 225 ATi	6 Cyl.	14.5:1	11630cc	225kW (306PS)	Diesel Turbo Intercooled	TD7517
WS 242 G	6 Cyl.	14.8:1	11630cc	242kW (330PS)	Diesel Turbo Intercooled	TD22214
WS 259 ATi	6 Cyl.	14.5:1	11630cc	259kW (352PS)	Diesel Turbo Intercooled	TD7518
WS 268 G	6 Cyl.	14.5:1	11600cc	268kW (364PS)	Diesel Turbo Intercooled	TD6672
WS 282 ATi	6 Cyl.	14.5:1	11630cc	282kW (383PS)	Diesel Turbo Intercooled	TD7519
WS 282 L	6 Cyl.	14.5:1	11630cc	282kW (383PS)	Diesel Turbo Intercooled	TD6674
WS 295 G	6 Cyl.	14.5:1	11600cc	295kW (401PS)	Diesel Turbo Intercooled	TD6676
WS 295 M Ati	6 Cyl.	16:1	11627cc	295kW (401PS)	Diesel Turbo Intercooled	TD6666
WS 315	6 Cyl.	14.5:1	11600cc	315kW (428PS)	Diesel Turbo Intercooled	TD11908
WS 315 G	6 Cyl.	16:1	11627cc	315kW (428PS)	Diesel Turbo	TD6679
XE 250 C Euro 3	6 Cyl.	16:1	12580cc	250kW (340PS)	Diesel Turbo Intercooled	TD13331
XE 280 C Euro 3	6 Cyl.	16:1	12580cc	280kW (381PS)	Diesel Turbo Intercooled	TD13332
XE 315 C Euro 3	6 Cyl.	16:1	12580cc	315kW (428PS)	Diesel Turbo Intercooled	TD13333
XE 355 C Euro 3	6 Cyl.	16:1	12580cc	355kW (483PS)	Diesel Turbo Intercooled	TD13334
XE 355 C1 Euro 3	6 Cyl.	17:1	12580cc	355kW (483PS)	Diesel Turbo Intercooled	TD22219



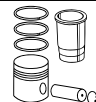
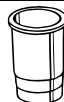
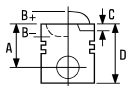

XE 390 C Euro 3	6 Cyl.	16:1	12580cc	390kW (530PS)	Diesel Turbo Intercooled	TD13335
XE 390 C1 Euro 3	6 Cyl.	17:1	12580cc	390kW (530PS)	Diesel Turbo Intercooled	TD22220

14-021410-00 DH B 136.02 C 288.30 D 143.60 E 10.05

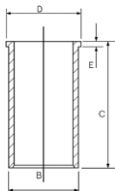

13  **130.00**

DKCL 1160	6 Cyl.	15:1	11630cc	156kW (212PS)	Diesel Turbo Intercooled	TD20105
DKFL 1160	6 Cyl.	15:1	11630cc	191kW (260PS)	Diesel Turbo Intercooled	TD20107
DKS 1160	6 Cyl.	15:1	11600cc	228kW (310PS)	Diesel Turbo	TD6629
DKS 1160 E	6 Cyl.	15:1	11600cc	206kW (280PS)	Diesel Turbo Intercooled	TD6630
DKSB 1160	6 Cyl.	15:1	11630cc	228kW (310PS)	Diesel Turbo Intercooled	TD20106
DKT 1160	6 Cyl.	15:1	11600cc	213kW (290PS)	Diesel Turbo	TD6631
DKTD 1160	6 Cyl.	15:1	11600cc	188-191kW (256-260PS)	Diesel Turbo	TD6632
DKTL 1160	6 Cyl.	15:1	11600cc	185kW (252PS)	Diesel Turbo	TD6642
DKVL 1160	6 Cyl.	15:1	11600cc	206kW (280PS)	Diesel Turbo	TD13288
DKX 1160	6 Cyl.	15:1	11600cc	243kW (330PS)	Diesel Turbo Intercooled	TD6637
KT 191	6 Cyl.	15:1	11627cc	256kW (348PS)	Diesel Turbo Intercooled	FM5278
LT 160	6 Cyl.	15.5:1	11630cc	160-170kW (218-231PS)	Diesel Turbo Intercooled	TD24104
LT 195 1160	6 Cyl.		11627cc	195kW (265PS)	Diesel	FM5310
LT 210	6 Cyl.	15.5:1	11630cc	206-210kW (280-286PS)	Diesel Turbo Intercooled	TD7173



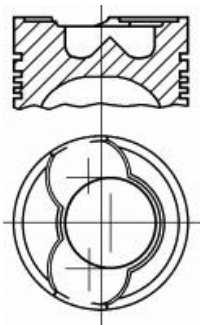

87-174100-00 STD

- A 101.00
- B- 29.30
- BØ 74.50
- C 3.00
- D 169.50
-  48x111

AK HA RT



08-174100-10 STD

- 3.16  CR P
- 3.16  CR P
- 3.16  CR P
- 6.33  CR P

14-021410-00 DH B 136.02 C 288.30 D 143.60 E 10.05

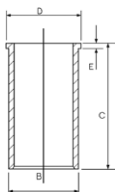

88-174100-00
87-174100-00 +
14-021410-00

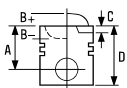

14  **130.00**

DKSE 1160	6 Cyl.	15:1	11630cc	206kW (280PS)	Diesel Turbo Intercooled	TD22211
DKV 1160	6 Cyl.	15:1	11600cc	212kW (290PS)	Diesel Turbo	TD6633
DKX 1160 ATi	6 Cyl.	15:1	11600cc	260kW (354PS)	Diesel Turbo Intercooled	TD6638
DKXE 1160	6 Cyl.	15:1	11600cc	212kW (280PS)	Diesel Turbo Intercooled	TD6634
DKXE 1160 ATi	6 Cyl.	15:1	11630cc	139-274kW (189-373PS)	Diesel Turbo Intercooled	TD22212
DKZ 1160	6 Cyl.	15:1	11630cc	139-274kW (189-373PS)	Diesel Turbo Intercooled	TD22213
DKZ 1160 ATi	6 Cyl.	15:1	11600cc	274kW (373PS)	Diesel Turbo Intercooled	TD6639



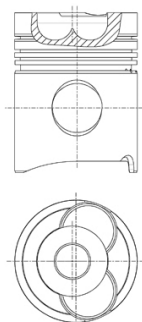

87-174100-30 STD

- A** 101.00
- B-** 29.10
- BØ** 74.50
- C** 4.00
- D** 169.50
-  52x106

AK HA RT



08-174100-10 STD

- 3.16  CR P
- 3.16  CR P
- 3.16  CR P
- 6.33  CR P

14-021410-00 DH B 136.02 C 288.30 D 143.60 E 10.05

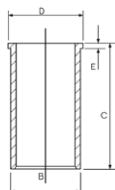

88-174100-30
87-174100-30 +
14-021410-00

15  **130.00**

MX 13 303 Euro 6	6 Cyl.	17.7:1	12900cc	300-303kW (408-412PS)	Diesel Turbo Intercooled	TD28147
MX 13 340 Euro 6	6 Cyl.	17.7:1	12900cc	340kW (462PS)	Diesel Turbo Intercooled	TD28148
MX 13 375 Euro 6	6 Cyl.	16.5:1	12900cc	375kW (510PS)	Diesel Turbo Intercooled	TD28149
MX 265 Euro 4/5 Paccar MX	6 Cyl.	16.4:1	12900cc	265kW (360PS)	Diesel Turbo Intercooled	TD20056
MX 300 Euro 4/5 Paccar MX	6 Cyl.	16.4:1	12900cc	300kW (408PS)	Diesel Turbo Intercooled	TD18902
MX 340 Euro 4/5 Paccar MX	6 Cyl.	16.4:1	12900cc	340kW (462PS)	Diesel Turbo Intercooled	TD18903
MX 375 Euro 4/5 Paccar MX	6 Cyl.	16.4:1	12900cc	375kW (510PS)	Diesel Turbo Intercooled	TD18904

15-451230-00 WH  B 146.00 C 268.00 D 157.60 E 12.00 F 0.95

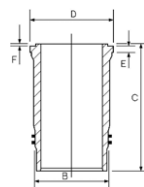

 Includes Anti-Polish Ring (Fire Ring)

 Enthält Ölschlitzring

 Contient le segment racleur

 Incluye el segmento rascador

 Include anello raschiaolio

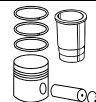
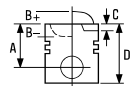

16 **130.00**

WS 222 G	6 Cyl.	16:1	11630cc	222kW (302PS)	Diesel Turbo Intercooled	TD6667
WS 242 L Euro 1	6 Cyl.	16:1	11600cc	242kW (330PS)	Diesel Turbo Intercooled	TD6662
WS 268 L Euro 1	6 Cyl.	16:1	11600cc	268kW (365PS)	Diesel Turbo Intercooled	TD6664
WS 295 L Euro 1	6 Cyl.	16:1	11600cc	295kW (401PS)	Diesel Turbo Intercooled	TD6677
WS 315 L Euro 1	6 Cyl.	16:1	11600cc	315kW (428PS)	Diesel Turbo Intercooled	TD6680

87-743400-40 STD

- A** 101.00
- B-** 24.75
- BØ** 75.00
- C** 0.80
- D** 155.00
- 52x106

RT

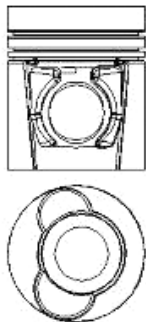

08-743400-00 STD

- 4.00 P PS
- 3.16 CR P
- 4.00 CR P

14-021410-00 DH B 136.02 C 288.30 D 143.60 E 10.05

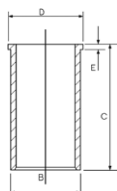

88-743400-40
87-743400-40 +
14-021410-00

17 **130.00**

WS 222 L	6 Cyl.	16:1	11630cc	222kW (302PS)	Diesel Turbo Intercooled	TD6660
WS 242	6 Cyl.	16:1	11600cc	242kW (330PS)	Diesel Turbo Intercooled	TD6669
WS 268	6 Cyl.	16:1	11600cc	268kW (365PS)	Diesel Turbo Intercooled	TD6671
WS 295	6 Cyl.	14.51:1	11600cc	295kW (401PS)	Diesel Turbo Intercooled	TD6675

87-743400-10 STD

- A** 101.00
- B-** 26.60
- BØ** 79.00
- D** 157.00
- 52x106

HA RT

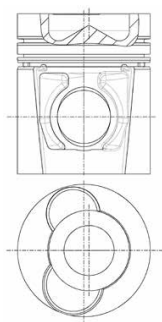

08-743400-00 STD

- 4.00 P PS
- 3.16 CR P
- 4.00 CR P

14-021410-00 DH B 136.02 C 288.30 D 143.60 E 10.05

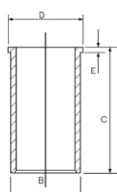

88-743400-10
87-743400-10 +
14-021410-00

F80-300

F80-300

F80-300



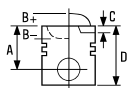

F80-300

F80-300

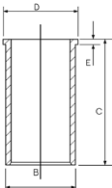

18  **130.00**

WS 225	6 Cyl.	14.51:1	11600cc	225kW (306PS)	Diesel Turbo Intercooled	TD6668
WS 259	6 Cyl.	14.51:1	11600cc	259kW (352PS)	Diesel Turbo Intercooled	TD6670
WS 282	6 Cyl.	14.51:1	11600cc	282kW (384PS)	Diesel Turbo Intercooled	TD11907



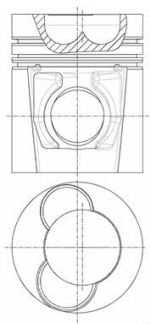

87-743400-00	STD	08-743400-00	STD	14-021410-00 DH	B 136.02 C 288.30 D 143.60 E 10.05	88-743400-00 87-743400-00 + 14-021410-00
A	101.00	4.00	 P PS			
B-	29.74	3.16	 CR P			
BØ	75.00	4.00	 CR P			
C	0.80					
C	1.50					
D	157.00					
	52x106					

HA RT

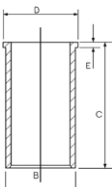

19  **130.00**

WS 242 M Euro 2	6 Cyl.	16:1	11600cc	242kW (330PS)	Diesel Turbo Intercooled	TD6663
WS 268 M Euro 2	6 Cyl.	16:1	11600cc	268kW (365PS)	Diesel Turbo Intercooled	TD6665
WS 295 M Euro 2	6 Cyl.	16:1	11600cc	295kW (401PS)	Diesel Turbo Intercooled	TD6678
WS 315 M Euro 2	6 Cyl.	16:1	11600cc	315kW (428PS)	Diesel Turbo Intercooled	TD6681

87-743400-50	STD	08-743400-00	STD	14-021410-00 DH	B 136.02 C 288.30 D 143.60 E 10.05	88-743400-50 87-743400-50 + 14-021410-00
A	101.00	4.00	 P PS			
B-	21.15	3.16	 CR P			
BØ	82.00	4.00	 CR P			
D	155.00					
	52x106					

RT

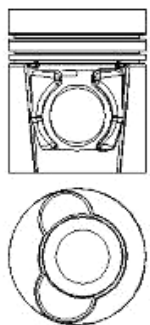

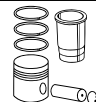
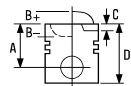





20  **130.00**

XE 280 C1 Euro 3 6 Cyl. 17:1 **12580cc 280kW (381PS)** Diesel Turbo Intercooled **TD22217**

XE 315 C1 Euro 3 6 Cyl. 17:1 **12580cc 315kW (428PS)** Diesel Turbo Intercooled **TD22218**

87-433300-00 STD **08-433300-00** STD **14-021410-00 DH** B 136.02 C 288.30 D 143.60 E 10.05 **88-433300-00**

A 95.00
B- 15.44
BØ 99.60
C 1.00
D 143.00
 52x106

4.00  CK
3.16  CR P
4.00  CR P

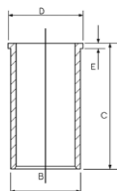

87-433300-00 +
14-021410-00

AK RT TP

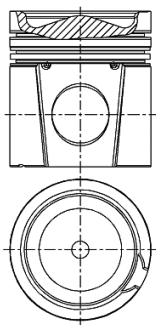

21  **130.00**

XF 250 M Euro 2 6 Cyl. 16:1 **12580cc 250kW (340PS)** Diesel Turbo Intercooled **TD11912**



XF 280 M Euro 2 6 Cyl. 16:1 **12580cc 280kW (381PS)** Diesel Turbo Intercooled **TD11913**

XF 315 M Euro 2 6 Cyl. 16:1 **12580cc 315kW (428PS)** Diesel Turbo Intercooled **TD11914**

XF 355 M Euro 2 6 Cyl. 16:1 **12580cc 355kW (483PS)** Diesel Turbo Intercooled **TD11915**

87-743400-30 STD **08-743400-00** STD **14-021410-00 DH** B 136.02 C 288.30 D 143.60 E 10.05 **88-743400-30**

A 95.00
B- 21.75
BØ 82.00
C 1.00
D 143.00
 52x106

4.00  P PS
3.16  CR P
4.00  CR P

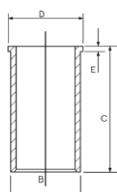

87-743400-30 +
14-021410-00

RT TP

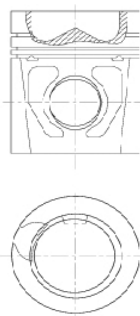

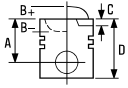

1 100.04

AD3/49	3 Cyl.	17:1	2395cc	Diesel	FM428
AD4/49	4 Cyl.	17:1	3195cc	Diesel	FM429
AD4/55T	4 Cyl.	16:1	3594cc	Diesel Turbo	FM433
AD6/55	6 Cyl.	17:1	5392cc	Diesel	FM3822
AD6/55T	6 Cyl.	16:1	5392cc	Diesel Turbo	FM3823

14-010950-00 D B 105.08 C 212.22

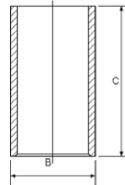

2 100.04

AD3/55	3 Cyl.	17:1	2695cc	Diesel	FM430
AD4/55	4 Cyl.	17:1	3594cc	Diesel	FM431



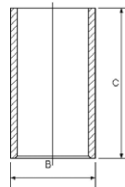

87-520600-00 STD
 87-520607-00 .020
 87-520611-00 .040

08-520600-00 STD
 08-520607-00 .020
 08-520611-00 .040





14-010950-00 D B 105.08 C 212.22



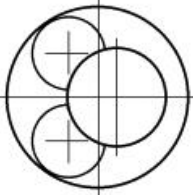



A 60.38
 B- 19.29
 C 5.44
 C 5.44
 D 105.56
 32x87

2.38  CR
 2.38 
 2.38 
 4.76 



		ccm	x 		
8360.05.670 Magirus-Deutz	Diesel	8100	6	115.00	29
BF 2L 912	Diesel	1884	2	100.00	8
BF 3L 912	Diesel	2826	3	100.00	8
BF 3L 914	Diesel	3236	3	102.00	13
BF 3L 2011	Diesel	2332	3	94.00	4
BF 3M 2011	Diesel	2332	3	94.00	4
BF 4L 912	Diesel	3768	4	100.00	8
BF 4L 913	Diesel	4068	4	102.00	14
BF 4L 913 C	Diesel	4086	4	102.00	14
BF 4L 913 T	Diesel	4086	4	102.00	15
BF 4L 914	Diesel	4314	4	102.00	13
BF 4L 1011 F	Diesel	2731	4	91.00	1
BF 4L 1011 FT	Diesel	2732	4	91.00	1
BF 4L 2011	Diesel	3110	4	94.00	4
BF 4M 1012 C Euro 1	Diesel	3192	4	94.00	5
BF 4M 1012 EC	Diesel	3192	4	94.00	5
BF 4M 1012 E Euro 2	Diesel	3192	4	94.00	5
BF 4M 1012 Euro 1	Diesel	3192	4	94.00	5
BF 4M 1013 C Euro 1	Diesel	4764	4	108.00	23
BF 4M 1013 EC Euro 2	Diesel	4764	4	108.00	25
BF 4M 1013 E Euro 2	Diesel	4764	4	108.00	24
BF 4M 1013 Euro 1	Diesel	4764	4	108.00	23
BF 4M 1013 FC Euro 2/3	Diesel	4764	4	108.00	25
BF 4M 2011	Diesel	3110	4	94.00	4
BF 4M 2012 C Euro 2	Diesel	4038	4	101.00	12
BF 4M 2012 Euro 2	Diesel	4038	4	101.00	12
BF 4M 2013 C	Diesel	3802	4	98.00	7
BF 5L 912	Diesel	4710	5	100.00	8
BF 6L 413 FR	Diesel	9572	V6	125.00	32
BF 6L 513	Diesel	9572	6	125.00	32
BF 6L 513 C	Diesel	9572	V6	125.00	32
BF 6L 912	Diesel	5655	6	100.00	8
BF 6L 913	Diesel	6128	6	102.00	14
BF 6L 913 C	Diesel	6128	6	102.00	16
BF 6L 913 T	Diesel	6128	6	102.00	15
BF 6L 914	Diesel	6472	6	102.00	13
BF 6L 914 C	Diesel	6472	6	102.00	17
BF 6M 1012 C Euro 1	Diesel	4788	6	94.00	5
BF 6M 1012 E	Diesel	4788	6	94.00	5
BF 6M 1012 EC	Diesel	4788	6	94.00	5
BF 6M 1012 Euro 1	Diesel	4788	6	94.00	5
BF 6M 1013 C Euro 1	Diesel	7145	6	108.00	23
BF 6M 1013 CP Euro 1	Diesel	7145	6	108.00	26
BF 6M 1013 EC Euro 2	Diesel	7145	6	108.00	25
BF 6M 1013 ECP Euro 2/3	Diesel	7145	6	108.00	25
BF 6M 1013 E Euro 2	Diesel	7145	6	108.00	24
BF 6M 1013 Euro 1	Diesel	7145	6	108.00	23
BF 6M 1013 FC Euro 2/3	Diesel	7145	6	108.00	27
BF 6M 1015	Diesel	11905	V6	132.00	34
BF 6M 1015 C Euro 2	Diesel	11905	V6	132.00	35
BF 6M 1015 CP	Diesel	11905	V6	132.00	34
BF 6M 2012 C Euro 2	Diesel	6057	6	101.00	12
BF 6M 2013	Diesel	5702	6	98.00	7
BF 6M 2013 C	Diesel	5702	6	98.00	7
BF 8L 413 F	Diesel	12763	V8	125.00	32
BF 8L 513	Diesel	12763	V8	125.00	32
BF 8L 513 C	Diesel	13738	8	125.00	32
BF 8M 1015	Diesel	15874	V8	132.00	34
BF 8M 1015 C Euro 2	Diesel	15874	V8	132.00	35
BF 8M 1015 CP	Diesel	15874	V8	132.00	34
BF 10L 413 F	Diesel	15953	V10	125.00	32
BF 10L 513	Diesel	15954	V10	125.00	32
BF 10L 513 C	Diesel	15954	V10	125.00	32
BF 10L 513 F	Diesel	15945	V10	125.00	32
BF 12L 413 F	Diesel	19144	V12	125.00	32
BF 12L 513	Diesel	19144	V12	125.00	32
BF 12L 513 C	Diesel	19144	V12	125.00	32
BF 12L 513 F	Diesel	19144	V12	125.00	32
F 1L 511 D	Diesel	825	1	100.00	9

		ccm	x 		9
F 2L 511 D	Diesel	1650	2	100.00	9
F 2L 912	Diesel	1885	2	100.00	10
F 2L 912 D	Diesel	1885	2	100.00	10
F 2L 912 W	Diesel	1884	2	100.00	11
F 2L 1011 F	Diesel	1366	2	91.00	2
F 2L 2011	Diesel	1554	2	94.00	6
F 2M 1011	Diesel	1366	2	91.00	3
F 2M 2011	Diesel	1555	2	94.00	6
F 3L 912 D	Diesel	2826	3	100.00	10
F 3L 912 W	Diesel	2826	3	100.00	11
F 3L 913 G	Diesel	3064	3	102.00	18
F 3L 913 G	Diesel	3064	3	102.00	19
F 3L 914	Diesel	3236	3	102.00	20
F 3L 1011 F	Diesel	2049	3	91.00	2
F 3L 2011	Diesel	2332	3	94.00	6
F 3M 1011 F	Diesel	2185	3	91.00	3
F 3M 2011	Diesel	2332	3	94.00	6
F 4L 413 FR	Diesel	6381	4	125.00	33
F 4L 912 D	Diesel	3770	4	100.00	10
F 4L 912 F	Diesel	4086	4	102.00	21
F 4L 912 W	Diesel	3770	4	100.00	11
F 4L 913	Diesel	4086	4	102.00	19
F 4L 913 D	Diesel	4086	4	102.00	22
F 4L 914	Diesel	4314	4	102.00	20
F 4L 1011 F	Diesel	2732	4	91.00	2
F 4L 2011	Diesel	3110	4	94.00	6
F 4M 1011 F	Diesel	2732	4	91.00	3
F 4M 2011	Diesel	3110	4	94.00	6
F 5L 413	Diesel	7070	5	120.00	30
F 5L 413 FR	Diesel	7976	5	125.00	33
F 5L 912 D	Diesel	4712	5	100.00	10
F 5L 912 F	Diesel	5107	5	102.00	21
F 5L 912 W	Diesel	4710	5	100.00	11
F 5L 914	Diesel	5393	5	102.00	20
F 6L 413	Diesel	8478	V6	120.00	31
F 6L 413 F	Diesel	9572	V6	125.00	33
F 6L 413 FR	Diesel	9572	V6	125.00	33
F 6L 413 FW	Diesel	9572	V6	125.00	32
F 6L 413 L	Diesel	8482	V6	120.00	30
F 6L 912 D	Diesel	5655	6	100.00	10
F 6L 912 F	Diesel	6128	6	102.00	21
F 6L 912 W	Diesel	5655	6	100.00	11
F 6L 913	Diesel	6128	6	102.00	19
F 6L 913 D	Diesel	6128	6	102.00	22
F 6L 914	Diesel	6472	6	102.00	20
F 8L 413	Diesel	11310	V8	120.00	31
F 8L 413 F	Diesel	12763	V8	125.00	33
F 8L 413 FW	Diesel	12763	V8	125.00	32
F 8L 413 L	Diesel	11310	V8	120.00	30
F 10L 413	Diesel	14140	V10	120.00	31
F 10L 413 F	Diesel	15953	V10	125.00	33
F 10L 413 FW	Diesel	15953	V10	125.00	32
F 10L 413 L	Diesel	14137	V10	120.00	30
F 12L 413	Diesel	16960	V12	120.00	31
F 12L 413 F	Diesel	19144	V12	125.00	33
F 12L 413 FW	Diesel	19144	V12	125.00	32
TCD 2013 L4 2V Euro 2	Diesel	4764	4	108.00	24
TCD 2013 L4 4V Euro 4	Diesel	4764	4	108.00	28
TCD 2013 L6 2V Euro 2	Diesel	7145	6	108.00	24
TCD 2013 L6 4V Euro 4	Diesel	7145	6	108.00	28

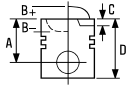

1 **91.00**

BF 4L 1011 F	4 Cyl.	17:1	2731cc	28-55kW (38-75PS)	Diesel Turbo	TD17230
---------------------	--------	------	---------------	--------------------------	---------------------	----------------

BF 4L 1011 FT	4 Cyl.	17:1	2732cc	46kW (63PS)	Diesel Turbo	TD17228
----------------------	--------	------	---------------	--------------------	---------------------	----------------

87-103200-00	STD	08-103200-00	STD	14-029750-00 DH	B 94.01 C 175.50 D 98.90 E 4.55	88-103200-00
87-103207-00	0.50mm	08-103207-00	0.50mm			87-103200-00 + 14-029750-00
A	55.20	3.00	MO P			
B-	18.00	2.00	P			
BØ	45.00	3.00	P			
D	86.15					
	30x68					

RT

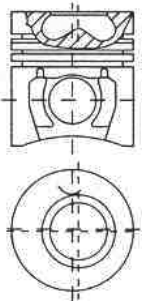

2 **91.00**

F 2L 1011 F	2 Cyl.	18.5:1	1366cc	20-22kW (27-30PS)	Diesel	TD17224
--------------------	--------	--------	---------------	--------------------------	---------------	----------------

F 3L 1011 F	3 Cyl.	18.5:1	2049cc	16-33kW (22-45PS)	Diesel	TD17225
--------------------	--------	--------	---------------	--------------------------	---------------	----------------

F 4L 1011 F	4 Cyl.	18.5:1	2732cc	24-47kW (33-64PS)	Diesel	TD17227
--------------------	--------	--------	---------------	--------------------------	---------------	----------------

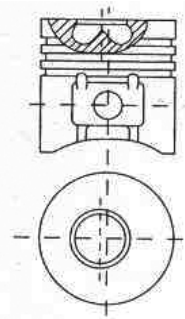

87-252500-10	STD	08-252500-00	STD	14-029750-00 DH	B 94.01 C 175.50 D 98.90 E 4.55	
87-252507-10	0.50mm	08-252507-00	0.50mm			
A	55.37	03/89→				
B-	19.80	2.00	CR P			
BØ	40.00	2.00	P			
D	86.37	3.00	P			
	26x65					









3 91.00

F 2M 1011	2 Cyl.	18.5:1	1366cc	21-23kW (29-31PS)	Diesel	TD17231
F 3M 1011 F	3 Cyl.	11.2:1	2185cc	17-36kW (23-49PS)	Diesel	TD17232
F 4M 1011 F	4 Cyl.	18.5:1	2732cc	24-48kW (33-65PS)	Diesel	TD18488

87-252500-30  STD **08-252500-10** STD **14-029750-00 DH** B 94.01 C 175.50 D 98.90 E 4.55
87-252507-30  0.50mm **08-252507-10** 0.50mm

A 51.70
B- 19.20
BØ 42.00
D 80.30
 26x65

2.00  CR P
 2.00  P
 3.00  P

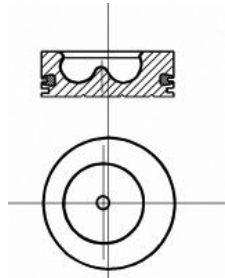
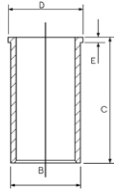

 Piston Chamber Volume
 [ccm] 29.100

 Volumen der Kolbenmulde
 [ccm] 29.100

 Volume de la cavité du piston
 [cm³] 29.100

 Volumen de cavidad del pistón
 [cc] 29.100



 Volume camera pistone
 [cm³] 29.100

4 94.00

BF 3L 2011	3 Cyl.	17.5:1	2332cc	42-45kW (57-61PS)	Diesel Turbo	TD17389
BF 3M 2011	3 Cyl.	17.5:1	2332cc	46-49kW (63-67PS)	Diesel Turbo	TD17384
BF 4L 2011	4 Cyl.	17.5:1	3110cc	55-58kW (75-79PS)	Diesel Turbo	TD17391
BF 4M 2011	4 Cyl.	17.5:1	3110cc	62-65kW (84-88PS)	Diesel Turbo	TD17386

87-142100-00 STD **08-142100-00** STD
87-142107-00 0.50mm **08-142107-00** 0.50mm

A 51.70
B- 17.60
BØ 52.00
D 81.65
 30x68

3.00  CK P
 2.00  P
 3.00  CR P

KK RT

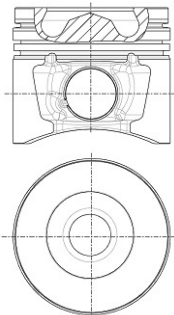

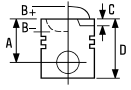

5 94.00

BF 4M 1012 C Euro 1	4 Cyl.	17.5:1	3192cc	74-82kW (101-112PS)	Diesel Turbo Intercooled	TD17236
BF 4M 1012 E Euro 2	4 Cyl.	17.5:1	3192cc	50-68kW (68-92PS)	Diesel Turbo	TD17239
BF 4M 1012 EC	4 Cyl.	17.5:1	3192cc	60-84kW (81-114PS)	Diesel Turbo Intercooled	TD17233
BF 4M 1012 Euro 1	4 Cyl.	17.5:1	3192cc	58-65kW (79-88PS)	Diesel Turbo Intercooled	TD17235
BF 6M 1012 C Euro 1	6 Cyl.	17.5:1	4788cc	111-123kW (151-167PS)	Diesel Turbo Intercooled	TD17238
BF 6M 1012 E	6 Cyl.	17.5:1	4788cc	70-100kW (95-136PS)	Diesel Turbo	TD17240
BF 6M 1012 EC	6 Cyl.	17.5:1	4788cc	113-125kW (154-170PS)	Diesel Turbo Intercooled	TD17234
BF 6M 1012 Euro 1	6 Cyl.	17.5:1	4788cc	73-98kW (99-133PS)	Diesel Turbo Intercooled	TD17237

87-252800-00  STD

A 61.20

B- 18.36

BØ 49.65

D 98.00

 34x78

RT TP

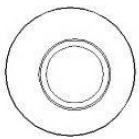

 Piston Chamber Volume
[ccm] 37.00

08-252800-00 STD
08-252807-00

3.00

2.00

3.00



STD
0.50mm

CR P

P

CR P

14-020490-00 *DH*

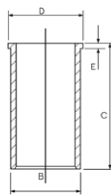

 Volume de la cavité du piston
[cm³] 37.00

B 98.50 C 196.00 D 102.60 E 5.00

 Volumen de cavidad del pistón
[cc] 37.00

88-252800-00
87-252800-00 +
14-020490-00





 Volume camera pistone
[cm³] 37.00





6  **94.00**

F 2L 2011	2 Cyl.	18.5:1	1554cc	21-23kW (29-31PS)	Diesel	TD17387
F 2M 2011	2 Cyl.	18.5:1	1555cc	23-24kW (31-33PS)	Diesel	TD17382
F 3L 2011	3 Cyl.	18.5:1	2332cc	34-36kW (46-49PS)	Diesel	TD17388
F 3M 2011	3 Cyl.	18.5:1	2332cc	34-37kW (46-50PS)	Diesel	TD17383
F 4L 2011	4 Cyl.	18.5:1	3110cc	45-48kW (61-65PS)	Diesel	TD17390
F 4M 2011	4 Cyl.	18.5:1	3110cc	46-49kW (63-67PS)	Diesel	TD17385

87-146500-00	STD	08-146500-00	STD
87-146507-00	0.50mm	08-146507-00	0.50mm

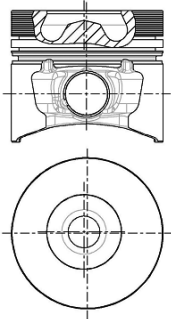



A	51.70	2.00		CR
B-	19.00	2.00		P
BØ	46.00	3.00		P
D	81.65			
	26x65			



7  **98.00**

BF 4M 2013 C	4 Cyl.	18.5:1	3802cc	125kW (170PS)	Diesel Turbo Intercooled	TD17316
BF 6M 2013	6 Cyl.	18:1	5702cc	92kW (125PS)	Diesel Turbo	TD17318
BF 6M 2013 C	6 Cyl.	18:1	5702cc	118-190kW (160-258PS)	Diesel Turbo Intercooled	TD17317

87-127800-00	STD	08-127800-00	STD
---------------------	-----	---------------------	-----

A	50.65	3.00		CK P
B-	17.50	2.00		P
BØ	61.06	3.00		NT
D	86.15			
	38x76			

AK RT TP

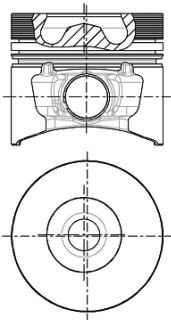

09837-

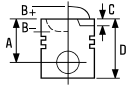

8  **100.00**

BF 2L 912	2 Cyl.		1884cc		Diesel Turbo	FM6110
BF 3L 912	3 Cyl.		2826cc		Diesel Turbo	FM6111
BF 4L 912	4 Cyl.		3768cc		Diesel Turbo	FM6112
BF 5L 912	5 Cyl.		4710cc		Diesel Turbo	FM6113
BF 6L 912	6 Cyl.	15.5:1	5655cc	88-100kW (120-136PS)	Diesel Turbo	TD18348

14-900080-00 DH B 110.00 C 222.30 D 120.00 E 137.30

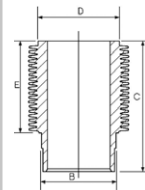

9  **100.00**

F 1L 511 D	1 Cyl.	19:1	825cc	11-13kW (15-18PS)	Diesel	TD17869
F 2L 511 D	2 Cyl.	17:1	1650cc	22-26kW (30-35PS)	Diesel	TD17872

87-741800-20	STD	08-741800-00	STD
87-741807-20	0.50mm	08-741807-00	0.50mm
87-741811-20	1.00mm	08-741811-00	1.00mm

A	56.75	04/78→
B-	21.44	
B+	5.70	2.94
BØ	50.00	2.55
D	95.95	5.00
	35x75	

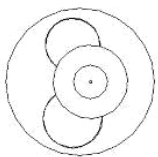
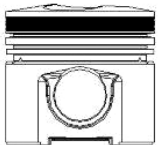

10005

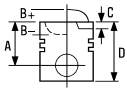

10  **100.00**

F 2L 912	2 Cyl.	18:1	1885cc	16-28kW (22-38PS)	Diesel	TD18128
F 2L 912 D	2 Cyl.	17:1	1885cc	21-28kW (29-38PS)	Diesel	FM7020
F 3L 912 D	3 Cyl.	17.1:1	2826cc	24-44kW (33-60PS)	Diesel	TD19020
F 4L 912 D	4 Cyl.	19:1	3770cc	38-62kW (52-84PS)	Diesel	TD19021
F 5L 912 D	5 Cyl.	17:1	4712cc	58-78kW (79-106PS)	Diesel	TD19023
F 6L 912 D	6 Cyl.	17:1	5655cc	42-92kW (57-125PS)	Diesel	TD19030





87-172500-00  STD
87-172507-00 0.50mm
87-172511-00 1.00mm

08-172500-00 STD
08-172507-00 0.50mm
08-172511-00 1.00mm

14-900080-00 DH B 110.00 C 222.30 D 120.00 E 137.30

88-172500-00
 87-172500-00 +
 14-900080-00

- A 71.90
- B- 21.40
- B+ 5.70
- BØ 55.00
- D 123.60
-  35x80

- 3.00  CR P
- 2.50  P
- 2.50  P
- 5.00  CR P

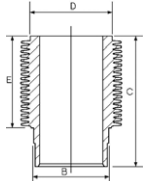



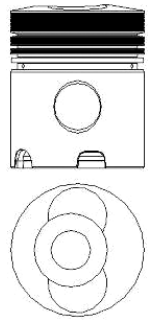

AK



87-741800-00 STD
87-741807-00 0.50mm
87-741811-00 1.00mm

08-741800-00 STD
08-741807-00 0.50mm
08-741811-00 1.00mm

- A 71.90
- B- 21.40
- B+ 5.70
- BØ 55.00
- C 1.10
- D 123.60
-  35x80

- 2.94  CR P
- 2.55  P
- 5.00  CR P

AK RT

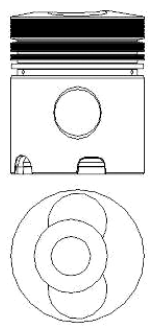

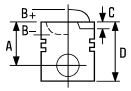

87-744600-00 ¹
87-744607-00
87-744611-00

STD
 0.50mm
 1.00mm

08-744600-00
08-744607-00
08-744611-00

2.94
 2.00
 3.50



STD
 0.50mm
 1.00mm

CR P
 P
 CR P

14-900080-00 DH B 110.00 C 222.30 D 120.00 E 137.30

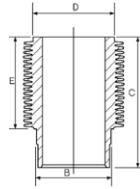

88-744600-00
 87-744600-00 +
 14-900080-00

A 71.90
B- 21.40
B+ 5.70
BØ 55.00
C 1.10
D 123.60
 35x80

AK

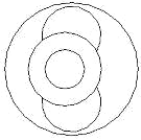
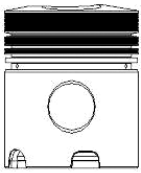

10091D

¹ Piston Chamber Volume
 [ccm] 45.40

¹ Volumen der Kolbenmulde
 [ccm] 45.40

¹ Volume de la cavité du piston
 [cm³] 45.40

¹ Volumen de cavidad del pistón
 [cc] 45.40

¹ Volume camera pistone
 [cm³] 45.40

11  **100.00**

F 2L 912 W	2 Cyl.	17:1	1884cc	22kW (30PS)	Diesel	FM6565
F 3L 912 W	3 Cyl.	17.1:1	2826cc	25-43kW (34-58PS)	Diesel	TD19019
F 4L 912 W	4 Cyl.	19:1	3770cc	38-49kW (52-67PS)	Diesel	TD19022
F 5L 912 W	5 Cyl.	17:1	4710cc	61kW (82PS)	Diesel	FM6566
F 6L 912 W	6 Cyl.	19:1	5655cc	57-74kW (78-101PS)	Diesel	TD19024

87-179400-00

STD

08-179400-00
08-179407-00
08-179411-00

01/69→

3.00
 2.50
 2.50
 5.00

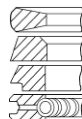

STD
 0.50mm
 1.00mm

CR P
 P
 P
 CR P

14-900080-00 DH B 110.00 C 222.30 D 120.00 E 137.30

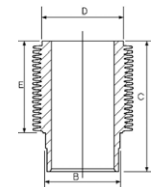

88-179400-00
 87-179400-00 +
 14-900080-00

A 71.90
B- 7.50
B+ 5.70
D 123.60
 35x80

AK

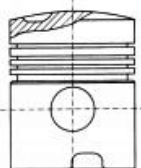
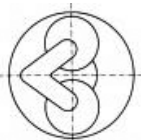







10082



12  **101.00**

BF 4M 2012 C Euro 2	4 Cyl.	19:1	4038cc	93-103kW (126-140PS)	Diesel Turbo Intercooled	TD17259
BF 4M 2012 Euro 2	4 Cyl.	19:1	4038cc	74-75kW (101-102PS)	Diesel Turbo Intercooled	TD17258
BF 6M 2012 C Euro 2	6 Cyl.	19:1	6057cc	140-155kW (190-211PS)	Diesel Turbo Intercooled	TD17261

87-127900-00 	STD	08-127900-00	STD
87-127907-00 	0.50mm	08-127907-00	0.50mm

A	50.65	01/01→	
B-	18.00		
BØ	61.03	2.50	 CK P
D	86.15	2.00	 P
	38x76	3.00	 CR P

AK RT TP

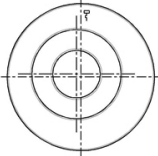
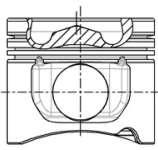



10102C

 Piston Chamber Volume
[ccm] 43.70

 Volumen der Kolbenmulde
[ccm] 43.70

 Volume de la cavité du piston
[cm³] 43.70





 Volumen de cavidad del pistón
[cc] 43.70

 Volume camera pistone
[cm³] 43.70

13  **102.00**

BF 3L 914	3 Cyl.	18:1	3236cc	48-56kW (65-76PS)	Diesel Turbo	TD17215
BF 4L 914	4 Cyl.	18:1	4314cc	63-75kW (86-102PS)	Diesel Turbo	TD17216
BF 6L 914	6 Cyl.	18:1	6472cc	80-116kW (109-158PS)	Diesel Turbo	TD17217

87-442400-10	STD	08-442400-00	STD	14-900120-00 DH B 109.90 C 220.40 D 124.50 E 135.40
87-442407-10	0.50mm	08-442407-00	0.50mm	

A	65.60	2.94	 CR
B-	16.90	3.00	 CR
B-	5.20	3.00	 CR
B+	6.00		
BØ	70.10		
D	117.10		
	35x80		

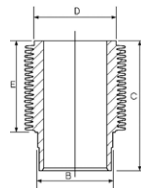

AK KK RT

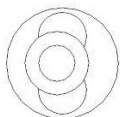





14 102.00

BF 4L 913	4 Cyl.	17:1	4068cc	47-81kW (64-110PS)	Diesel Turbo	TD17203
BF 4L 913 C	4 Cyl.	17:1	4086cc	78-92kW (106-125PS)	Diesel Turbo Intercooled	TD21059
BF 6L 913	6 Cyl.	17:1	6128cc	70-125kW (95-170PS)	Diesel Turbo	TD17205

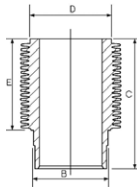
14-900060-00 DH 	B 109.50 C 222.30 D 120.00 E 136.80
14-900100-00 DH	B 109.50 C 222.30 D 120.00 E 137.30
14-900110-00 DH	B 109.50 C 220.40 D 124.50 E 134.90
14-900120-00 DH	B 109.90 C 220.40 D 124.50 E 135.40



 Hone-Lapped

 Hongeläppt

 Rodée à la pierre

 Lapeado buñido

 Parzialmente rodati

15 102.00

BF 4L 913 T	4 Cyl.	15.5:1	4086cc	60-78kW (82-106PS)	Diesel Turbo	TD18347
BF 6L 913 T	6 Cyl.	15.5:1	6128cc	85-112kW (115-152PS)	Diesel Turbo	TD18350





87-174600-00 STD
87-174607-00 0.50mm

08-174600-10 STD
08-174607-10 0.50mm

14-900100-00 DH  **B** 109.50 **C** 222.30 **D** 120.00 **E** 137.30

88-174600-00
87-174600-00 +
14-900100-00

A 69.10
B- 23.60
B+ 6.00
BØ 58.00
D 123.60
 40x80

3.00  **MO P**
 2.50  **P**
 2.50  **P**
 5.00  **CR P**

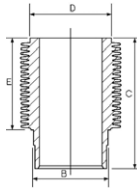

AK KK RT

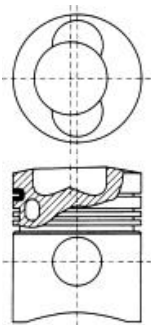

10214-



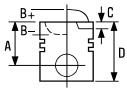

87-174600-30
87-174607-30

STD
0.50mm

08-174600-10
08-174607-10

STD
0.50mm

14-900100-00 DH B 109.50 C 222.30 D 120.00 E 137.30

88-174600-30
87-174600-30 +
14-900100-00

A 69.10
B- 17.60
B+ 6.00
BØ 58.00
D 123.60
 35x80

3.00
2.50
2.50
5.00

MO P
P
P
CR P

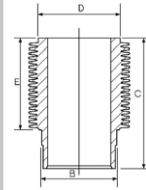

AK KK RT

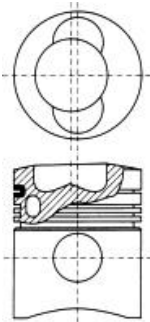

14-900060-00 DH B 109.50 C 222.30 D 120.00 E 136.80
14-900110-00 DH B 109.50 C 220.40 D 124.50 E 134.90
14-900120-00 DH B 109.90 C 220.40 D 124.50 E 135.40

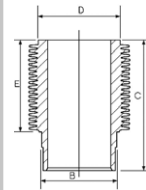

Hone-Lapped

Hongeläppt

Rodée à la pierre

Lapeado buñido

Parzialmente rodati

16 102.00

BF 6L 913 C 6 Cyl. 17:1 6128cc 81-162kW (110-220PS) Diesel Turbo Intercooled TD17206

87-178400-00
87-178407-00

STD
0.50mm

08-178400-10
08-178407-10

STD
0.50mm

14-900060-00 DH B 109.50 C 222.30 D 120.00 E 136.80
14-900100-00 DH B 109.50 C 222.30 D 120.00 E 137.30

88-178400-10
87-178400-00 +
14-900060-00

A 69.10
B- 24.10
B+ 6.00
BØ 58.00
D 123.60
 40x80

3.00
3.00
2.50
5.00

MO P
CR P
CR P

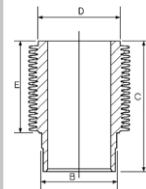

AK KK RT

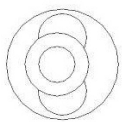

10214

14-900110-00 DH B 109.50 C 220.40 D 124.50 E 134.90
14-900120-00 DH B 109.90 C 220.40 D 124.50 E 135.40

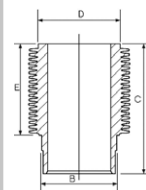

Hone-Lapped

Hongeläppt

Rodée à la pierre

Lapeado buñido



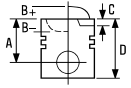

Parzialmente rodati



17  **102.00**

BF 6L 914 C 6 Cyl. 18:1 **6472cc** **107-147kW (145-200PS)** **Diesel Turbo Intercooled** **TD17218**

87-442400-00 STD **08-442400-00** STD **14-900120-00 DH** **B 109.90 C 220.40 D 124.50 E 135.40**
87-442407-00 0.50mm **08-442407-00** 0.50mm

A 65.60 2.94  CR
B- 17.00 3.00  CR
B+ 56.00 3.00  CR
B+ 6.00
BØ 65.15
D 117.10
 40x80

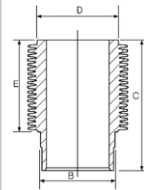

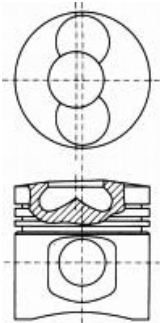

AK KK RT



18  **102.00**

F 3L 913 G 3 Cyl. 19.6:1 **3064cc** **25-44kW (34-60PS)** **Diesel** **FM6601**

87-740900-10 STD **08-740900-00** STD **14-900100-00 DH** **B 109.50 C 222.30 D 120.00 E 137.30**
87-740907-10 0.50mm **08-740907-00** 0.50mm

7469870→ 2.94  MO P
 2.55  P
 5.00  CR P

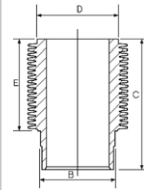

88-740900-10
87-740900-10 +
14-900100-00

A 69.10
B- 18.80
B+ 6.00
BØ 42.00
D 123.60
 35x80

AK

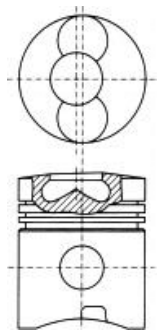

10234D



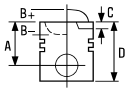

87-740900-20
87-740907-20

STD
0.50mm

08-740900-00
08-740907-00

STD
0.50mm

→7469869

A 57.28
B- 19.21
B+ 5.52
BØ 42.00
D 105.80
 35x80

2.94 MO P
2.55 P
5.00 CR P

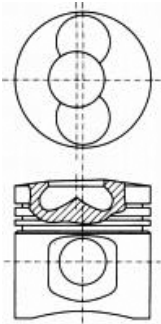

10237C

87-744100-00
87-744107-00

STD
0.50mm

08-744100-00
08-744107-00

STD
0.50mm

802086→

A 69.10
B- 21.10
B+ 6.00
BØ 56.50
D 123.60
 35x80

2.94 CR P
2.55 P
3.50 CR P

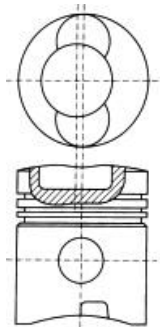

10234

AK



19 102.00

F 3L 913 G	3 Cyl.	19.6:1	3064cc	25-44kW (34-60PS)	Diesel	TD17201
F 4L 913	4 Cyl.	17:1	4086cc	50-78kW (68-106PS)	Diesel	TD7277
F 6L 913	6 Cyl.	18:1	6128cc	96kW (130PS)	Diesel	TD7451

87-740900-00  **2**
87-740907-00

STD
0.50mm

A 69.10
B- 16.60
B+ 5.00
BØ 56.10
D 123.60
 35x80

08-740900-00
08-740907-00

STD
0.50mm

2.94
 2.55
 5.00



MO P
 P
 CR P

14-900100-00 DH **1** B 109.50 C 222.30 D 120.00 E 137.30

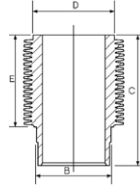

88-740900-00
 87-740900-00 +
 14-900100-00

14-900060-00 DH **1** B 109.50 C 222.30 D 120.00 E 136.80

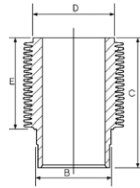

AK

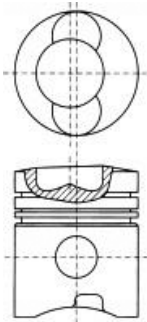

10234

87-740900-30
87-740907-30

STD
0.50mm

A 69.10
B- 19.50
B+ 6.00
BØ 56.00
D 123.60
 35x80

08-740900-00
08-740907-00

STD
0.50mm

2.94
 2.55
 5.00



MO P
 P
 CR P

AK KK RT

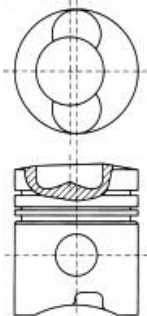

1 Hone-Lapped
2 Piston Chamber Volume
 [ccm] 49.50

1 Hongeläppt
2 Volumen der Kolbenmulde
 [ccm] 49.50

1 Rodée à la pierre
2 Volume de la cavité du piston
 [cm³] 49.50

1 Lapeado buñido
2 Volumen de cavidad del pistón
 [cc] 49.50

1 Parzialmente rodati
2 Volume camera pistone
 [cm³] 49.50



20  **102.00**

F 3L 914	3 Cyl.	20:1	3236cc	41-46kW (56-63PS)	Diesel	TD17211
F 4L 914	4 Cyl.	20:1	4314cc	51-61kW (69-83PS)	Diesel	TD17212
F 5L 914	5 Cyl.	20:1	5393cc	75kW (102PS)	Diesel	TD17213
F 6L 914	6 Cyl.	20:1	6472cc	92kW (125PS)	Diesel	TD17214

14-900120-00 DH B 109.90 C 220.40 D 124.50 E 135.40

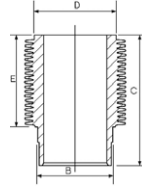



21  **102.00**

F 4L 912 F	4 Cyl.		4086cc		Diesel	FM5922
F 5L 912 F	5 Cyl.		5107cc		Diesel	FM5925
F 6L 912 F	6 Cyl.		6128cc		Diesel	FM5926

14-900060-00 DH  B 109.50 C 222.30 D 120.00 E 136.80

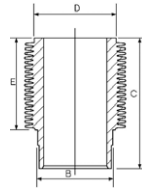
14-900100-00 DH B 109.50 C 222.30 D 120.00 E 137.30





 Hone-Lapped

 Hongeläppt

 Rodée à la pierre

 Lapeado buñido

 Parzialmente rodati

22  **102.00**

F 4L 913 D	4 Cyl.	17:1	4086cc	34-66kW (46-90PS)	Diesel	TD17202
F 6L 913 D	6 Cyl.	18:1	6128cc	51-101kW (69-138PS)	Diesel	TD17204





87-174600-10 STD
87-174607-10 0.50mm

08-174600-10 STD
08-174607-10 0.50mm

14-900100-00 DH B 109.50 C 222.30 D 120.00 E 137.30

88-174600-10
87-174600-10 +
14-900100-00

A 69.10
B- 16.60
B+ 6.00
BØ 56.00
D 123.60
 35x80

3.00  **MO P**
2.50  **P**
2.50  **P**
5.00  **CR P**

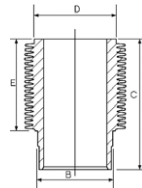

14-900060-00 DH  B 109.50 C 222.30 D 120.00 E 136.80

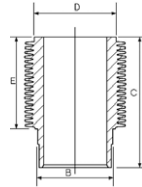

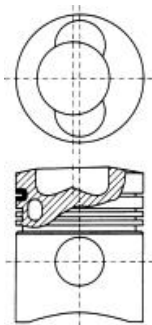

AK KK RT



10214

 Hone-Lapped

 Hongeläppt

 Rodée à la pierre

 Lapeado buñido

 Parzialmente rodati



23 108.00

BF 4M 1013 C Euro 1	4 Cyl.	17.6:1	4764cc	104-115kW (141-156PS)	Diesel Turbo Intercooled	TD17247
BF 4M 1013 Euro 1	4 Cyl.	17.6:1	4764cc	84-93kW (114-126PS)	Diesel Turbo	TD17246
BF 6M 1013 C Euro 1	6 Cyl.	17.6:1	7145cc	153-170kW (208-231PS)	Diesel Turbo Intercooled	TD17249
BF 6M 1013 Euro 1	6 Cyl.	17.6:1	7145cc	126-141kW (171-192PS)	Diesel Turbo	TD17248

87-136900-00 STD
A 71.15
B- 16.60
BØ 71.00
D 108.00
 42x86

08-136900-00 STD
 3.00 CK P
 2.00 P
 3.50 CR P

14-480040-00 WH B 120.00 C 229.10 D 128.50 E 9.00 F 1.10

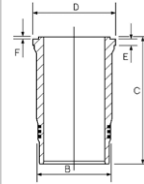

88-136900-00
 87-136900-00 +
 14-480040-00

AK RT

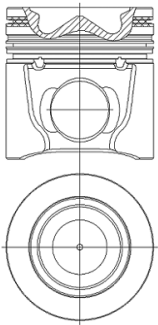

15-480040-00 WH B 120.00 C 229.10 D 128.50 E 9.00 F 1.10

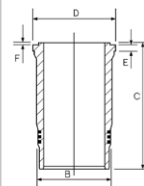

Includes seals

Schließt Dichtungen ein

Inclut des joints

Incluye los sellos

Comprende le guarnizioni

24 108.00

BF 4M 1013 E Euro 2	4 Cyl.	17.6:1	4764cc	77-95kW (105-129PS)	Diesel Turbo Intercooled	TD17244
TCD 2013 L4 2V Euro 2	4 Cyl.	18:1	4764cc	120kW (163PS)	Diesel Turbo Intercooled	TD20766
BF 6M 1013 E Euro 2	6 Cyl.	17.6:1	7145cc	85-145kW (115-197PS)	Diesel Turbo Intercooled	TD17245
TCD 2013 L6 2V Euro 2	6 Cyl.	18:1	7145cc	139-200kW (189-272PS)	Diesel Turbo Intercooled	TD19988

87-136900-10 STD
A 71.15
B- 19.60
BØ 64.00
D 108.00
 42x86

08-136900-00 STD
 3.00 CK P
 2.00 P
 3.50 CR P

14-480040-00 WH B 120.00 C 229.10 D 128.50 E 9.00 F 1.10

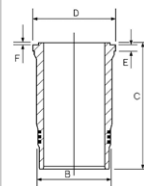

88-136900-00

AK RT TP

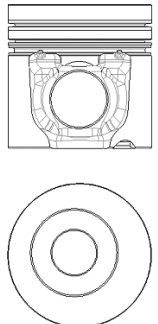

15-480040-00 WH B 120.00 C 229.10 D 128.50 E 9.00 F 1.10

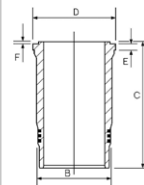

Includes seals

Schließt Dichtungen ein

Inclut des joints

Incluye los sellos

Comprende le guarnizioni

Piston Chamber Volume

Volumen der Kolbenmulde

Volume de la cavité du piston

Volumen de cavidad del pistón

Volume camera pistone

[ccm] 54.000

[ccm] 54.000

[cm³] 54.000

[cc] 54.000

[cm³] 54.000

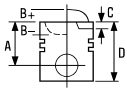



25  **108.00**

BF 4M 1013 EC Euro 2	4 Cyl.	17.6:1	4764cc	92-125kW (125-170PS)	Diesel Turbo Intercooled	TD17241
BF 4M 1013 FC Euro 2/3	4 Cyl.	17.5:1	4764cc	105-140kW (143-190PS)	Diesel Turbo Intercooled	TD20767
BF 6M 1013 EC Euro 2	6 Cyl.	17.6:1	7145cc	139-191kW (189-260PS)	Diesel Turbo Intercooled	TD17242
BF 6M 1013 ECP Euro 2/3	6 Cyl.	17.6:1	7145cc	176-195kW (239-265PS)	Diesel Turbo Intercooled	TD17243

87-136900-10 ³ STD

A 71.15
B- 19.60
BØ 64.00
D 108.00
 42x86

08-136900-00 STD

3.00  CK P
 2.00  P
 3.50  CR P

14-480040-00 WH B 120.00 C 229.10 D 128.50 E 9.00 F 1.10

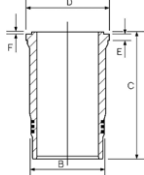

AK RT TP

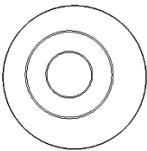
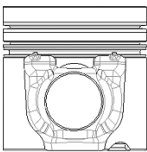

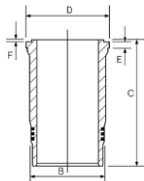

15-480040-00 WH ¹ B 120.00 C 229.10 D 128.50 E 9.00 F 1.10



87-136900-30 ² STD

A 71.75
B- 19.85
B- 10.25
BØ 63.00
D 108.00
 42x87

08-136900-00 STD

3.00  CK P
 2.00  P
 3.50  CR P

AK RT TP

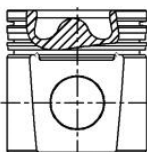

- ¹ Includes seals
- ² Piston Chamber Volume [ccm] 50.700
- ³ Piston Chamber Volume [ccm] 54.000

- ¹ Schließt Dichtungen ein
- ² Volumen der Kolbenmulde [ccm] 50.700
- ³ Volumen der Kolbenmulde [ccm] 54.000

- ¹ Inclut des joints
- ² Volume de la cavité du piston [cm³] 50.700
- ³ Volume de la cavité du piston [cm³] 54.000

- ¹ Incluye los sellos
- ² Volumen de cavidad del pistón [cc] 50.700
- ³ Volumen de cavidad del pistón [cc] 54.000

- ¹ Comprende le guarnizioni
- ² Volume camera pistone [cm³] 50.700
- ³ Volume camera pistone [cm³] 54.000





26 108.00

BF 6M 1013 CP Euro 1 6 Cyl. 17.6:1 **7145cc** **171-190kW (233-258PS)** **Diesel Turbo Intercooled** **TD17250**

87-136900-00 STD **08-136900-00** STD **14-480040-00 WH** **B 120.00 C 229.10 D 128.50 E 9.00 F 1.10** **88-136900-00**

A 71.15
B- 16.60
BØ 71.00
D 108.00
 42x86

3.00  CK P
 2.00  P
 3.50  CR P

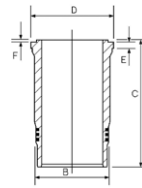

87-136900-00 +
 14-480040-00

AK RT

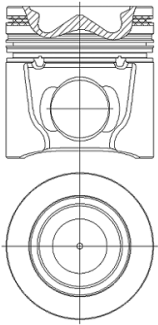



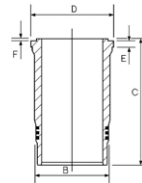

15-480040-00 WH ¹ **B 120.00 C 229.10 D 128.50 E 9.00 F 1.10**



87-136900-30 ² STD

08-136900-00 STD

A 71.75
B- 19.85
B- 10.25
BØ 63.00
D 108.00
 42x87

3.00  CK P
 2.00  P
 3.50  CR P

AK RT TP

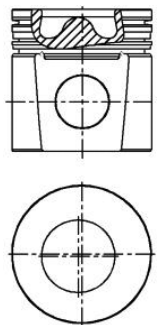

¹ Includes seals
² Piston Chamber Volume
 [ccm] 50.700

¹ Schließt Dichtungen ein
² Volumen der Kolbenmulde
 [ccm] 50.700

¹ Inclut des joints
² Volume de la cavité du piston
 [cm³] 50.700

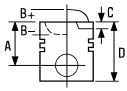

¹ Incluye los sellos
² Volumen de cavidad del pistón
 [cc] 50.700

¹ Comprende le guarnizioni
² Volume camera pistone
 [cm³] 50.700





27  **108.00**

BF 6M 1013 FC Euro 2/3 6 Cyl. 17.5:1 **7145cc** **147-210kW (200-286PS)** Diesel Turbo Intercooled **TD20768**

87-136900-30  STD **08-136900-00** STD **14-480040-00 WH** B 120.00 C 229.10 D 128.50 E 9.00 F 1.10
15-480040-00 WH  B 120.00 C 229.10 D 128.50 E 9.00 F 1.10

A 71.75
B- 19.85
B- 10.25
BØ 63.00
D 108.00
 42x87

3.00  CK P
 2.00  P
 3.50  CR P

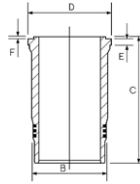

AK RT TP

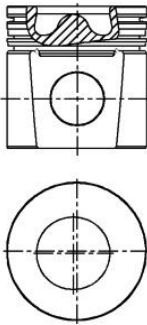



 Includes seals

 Piston Chamber Volume
 [ccm] 50.700

 Schließt Dichtungen ein

 Volumen der Kolbenmulde
 [ccm] 50.700

 Inclut des joints

 Volume de la cavité du piston
 [cm³] 50.700

 Incluye los sellos

 Volumen de cavidad del pistón
 [cc] 50.700

 Comprende le guarnizioni

 Volume camera pistone
 [cm³] 50.700



28  **108.00**

TCD 2013 L4 4V Euro 4 4 Cyl. 18:1 **4764cc** **140-158kW (190-215PS)** Diesel Turbo Intercooled **TD20769**

TCD 2013 L6 4V Euro 4 6 Cyl. 18:1 **7145cc** **147-243kW (200-330PS)** Diesel Turbo Intercooled **TD20765**

87-430000-00 STD **08-430000-00** STD **15-480450-00 WH**  B 120.00 C 228.00 D 131.70 E 8.06

A 70.90
B- 19.60
BØ 64.50
D 107.80
 45x86

3.00  CK
 2.00  P
 3.50  CR

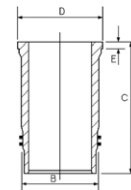

89-430000-00
 87-430000-00 +
 15-480450-00

KK RT TP

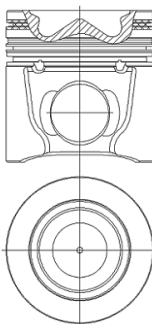

 Includes seals

 Schließt Dichtungen ein

 Inclut des joints

 Incluye los sellos

 Comprende le guarnizioni



29 115.00

8360.05.670 Magirus-Deutz 6 Cyl. 17:1 8100cc 119kW (162PS) Diesel TD7572



87-523000-00 STD

08-523000-00 STD

14-684840-00 WH B 122.00 C 235.00 D 129.70 E 167.00

88-523000-00
87-523000-00 +
14-684840-00

A 76.50
B- 29.40
BØ 54.00
D 140.50
 42x97

2.50  CR P
2.50  P
4.00  CR P

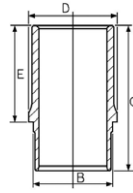

RT

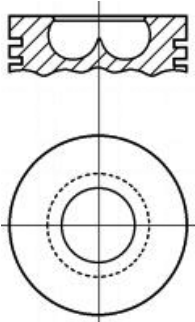

14-633860-00 WH B 122.00 C 235.00 D 129.90 E 167.00

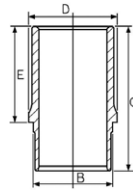

30 120.00

F 5L 413 5 Cyl. 7070cc Diesel FM6143

F 6L 413 L V6 Cyl. 18.5:1 8482cc 137kW (186PS) Diesel FM5381

F 8L 413 L V8 Cyl. 18.5:1 11310cc 179kW (243PS) Diesel FM5382

F 10L 413 L V10 Cyl. 18.5:1 14137cc 198-224kW (270-305PS) Diesel FM5383

14-900070-00 DH B 255.40 C 145.00 D 170.20 E 124.80

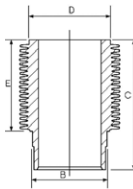







31  **120.00**

F 6L 413	V6 Cyl.	18:1	8478cc	99-130kW (135-177PS)	Diesel	TD18362
F 8L 413	V8 Cyl.	18:1	11310cc	169kW (230PS)	Diesel	TD18363
F 10L 413	V10 Cyl.	18:1	14140cc	167-224kW (227-305PS)	Diesel	TD18352
F 12L 413	V12 Cyl.	18:1	16960cc	250kW (340PS)	Diesel	TD18354

87-167600-00 	STD	08-167600-10	STD	14-900070-00 DH	B 255.40 C 145.00 D 170.20 E 124.80	88-167600-00
87-167607-00	0.50mm	08-167607-10	0.50mm			87-167600-00 +
87-167611-00	1.00mm	08-167611-10	1.00mm			14-900070-00

A	90.16
B-	39.46
B+	5.09
BØ	46.00
D	145.25

3.00		CR P
3.00		P
3.00		P
6.00		CR P

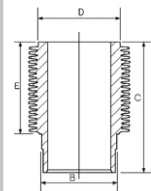

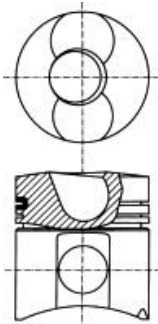

AK RT



 Piston Chamber Volume
[ccm] 63.00

 Volumen der Kolbenmulde
[ccm] 63.00

 Volume de la cavité du piston
[cm³] 63.00

 Volumen de cavidad del pistón
[cc] 63.00

 Volume camera pistone
[cm³] 63.00

32  **125.00**

BF 6L 513	6 Cyl.	15.8:1	9572cc	141-210kW (192-286PS)	Diesel	TD19240
BF 8L 513 C	8 Cyl.	18:1	13738cc	265kW (360PS)	Diesel Turbo Intercooled	TD26618
BF 6L 413 FR	V6 Cyl.	16.5:1	9572cc	143-177kW (194-241PS)	Diesel Turbo	TD19028
BF 6L 513 C	V6 Cyl.	16.5:1	9572cc	112-177kW (152-241PS)	Diesel Turbo Intercooled	TD21275
F 6L 413 FW	V6 Cyl.	18:1	9572cc	96-121kW (131-165PS)	Diesel	TD17883
BF 8L 413 F	V8 Cyl.	16.5:1	12763cc	212-235kW (288-320PS)	Diesel Turbo	TD18351
BF 8L 513	V8 Cyl.	15.8:1	12763cc	235-250kW (320-340PS)	Diesel Turbo	TD18495
F 8L 413 FW	V8 Cyl.	18:1	12763cc	129-150kW (175-204PS)	Diesel	TD17885
BF 10L 413 F	V10 Cyl.	16.5:1	15953cc	265-294kW (360-400PS)	Diesel Turbo	TD18344
BF 10L 513	V10 Cyl.	15.8:1	15954cc	218-305kW (296-415PS)	Diesel Turbo	TD18127
BF 10L 513 C	V10 Cyl.	16.5:1	15954cc	265-294kW (360-400PS)	Diesel Turbo Intercooled	TD21060
BF 10L 513 F	V10 Cyl.	17:1	15945cc	253-294kW (344-400PS)	Diesel Turbo	TD19241
F 10L 413 FW	V10 Cyl.	18:1	15953cc	161-202kW (219-275PS)	Diesel	TD17886
BF 12L 413 F	V12 Cyl.	16.5:1	19144cc	268-353kW (364-480PS)	Diesel Turbo	TD18346
BF 12L 513	V12 Cyl.	17:1	19144cc	353-367kW (480-499PS)	Diesel Turbo	TD18496
BF 12L 513 C	V12 Cyl.	17:1	19144cc	386-405kW (525-551PS)	Diesel Turbo Intercooled	TD18498





BF 12L 513 F	V12 Cyl. 17:1	19144cc	282-353kW (384-480PS)	Diesel Turbo	TD19029
F 12L 413 FW	V12 Cyl. 18:1	19144cc	193-243kW (262-330PS)	Diesel	TD17888

14-900030-00 DH ② B 139.00 C 250.80 D 154.00 E 169.50
14-900050-00 DH ① B 139.00 C 250.76 D 150.00 E 169.50

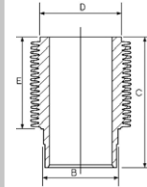

① Phosphated
 ② Hone-Lapped

① Phosphated
 ② Hongeläppt

① Phosphated
 ② Rodée à la pierre

① Phosphated
 ② Lapeado buñido

① Phosphated
 ② Parzialmente rodati

33 125.00

F 4L 413 FR	4 Cyl. 18:1	6381cc	94kW (128PS)	Diesel	TD18340
F 5L 413 FR	5 Cyl. 18:1	7976cc	94-118kW (128-160PS)	Diesel	TD17882
F 6L 413 F	V6 Cyl. 18:1	9572cc	104-188kW (141-256PS)	Diesel	TD18341
F 6L 413 FR	V6 Cyl. 18:1	9572cc	112-141kW (152-192PS)	Diesel	TD21274
F 8L 413 F	V8 Cyl. 18:1	12763cc	147-188kW (200-256PS)	Diesel	TD18342
F 10L 413 F	V10 Cyl. 18:1	15953cc	235kW (320PS)	Diesel	TD18353
F 12L 413 F	V12 Cyl. 18:1	19144cc	224-282kW (305-384PS)	Diesel	TD18355

87-740300-00 STD
87-740307-00 0.50mm
87-740311-00 1.00mm

08-740300-00 STD
08-740307-00 0.50mm
08-740311-00 1.00mm

A 87.40
B- 47.65
B+ 5.25
BØ 48.00
C 1.00
C 1.20
D 138.65
 45x102

3.00
 2.50
 4.00



MO P
 P
 CR P

14-900030-00 DH ② B 139.00 C 250.80 D 154.00 E 169.50
14-900050-00 DH ① B 139.00 C 250.76 D 150.00 E 169.50

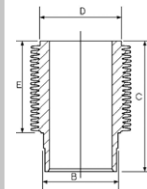

88-740300-10
 87-740300-00 +
 14-900030-00

88-740300-00
 87-740300-00 +
 14-900050-00

HART

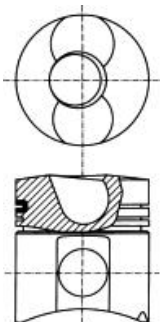

12544

① Phosphated
 ② Hone-Lapped

① Phosphated
 ② Hongeläppt

① Phosphated
 ② Rodée à la pierre

① Phosphated
 ② Lapeado buñido

① Phosphated
 ② Parzialmente rodati

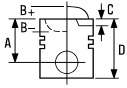

34  **132.00**

BF 6M 1015	V6 Cyl.	17:1	11905cc	195-250kW (265-340PS)	Diesel Turbo	TD17254
BF 6M 1015 CP	V6 Cyl.	17:1	11905cc	300-384kW (408-522PS)	Diesel Turbo Intercooled	TD17255
BF 8M 1015	V8 Cyl.	17:1	15874cc	290kW (394PS)	Diesel	TD18499
BF 8M 1015 CP	V8 Cyl.	17:1	15874cc	399-517kW (543-703PS)	Diesel Turbo Intercooled	TD17256

14-450960-00 WH B 147.00 C 268.50 D 158.00 E 9.00 F 1.25

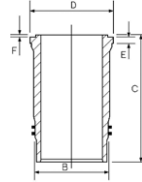

35  **132.00**

BF 6M 1015 C Euro 2	V6 Cyl.	17:1	11905cc	250-345kW (340-469PS)	Diesel Turbo Intercooled	TD17252
BF 8M 1015 C Euro 2	V8 Cyl.	17:1	15874cc	333-459kW (453-624PS)	Diesel Turbo Intercooled	TD17253



87-123900-10 STD

08-123900-10 STD

14-450960-00 WH B 147.00 C 268.50 D 158.00 E 9.00 F 1.25

88-123900-10

- A** 96.80
- B-** 18.80
- BØ** 84.00
- D** 133.80
-  52x110



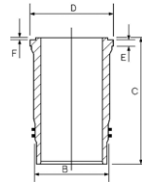

- 3.50  CK
- 2.45  CR
- 4.00  CR



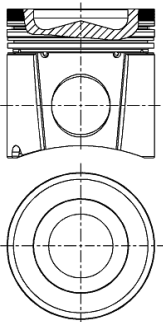









87-123900-10 +
14-450960-00





AK KK RT TP



		ccm	x 		
4HP	Diesel	2179	4	85.00	65
4HR	Diesel	2179	4	85.00	65
4HS Euro 4	Diesel	2179	4	85.00	65
4HT (DW12BTED4) Euro 4	Diesel	2179	4	85.00	65
4HU Euro 4	Diesel	2198	4	86.00	71
4HV Euro 4	Diesel	2198	4	86.00	72
4HW (DW12ATED4)	Diesel	2179	4	85.00	66
4HX (DW12TED4)	Diesel	2179	4	85.00	66
9HU	Diesel	1560	4	75.00	24
100 G.000	Petrol	843	4	65.00	1
100 G.002	Petrol	844	4	65.00	1
100 GC.000	Petrol	844	4	65.00	1
100 GF 000	Petrol	903	4	65.00	1
100 GL.000	Petrol	903	4	65.00	1
100 GL.048	Petrol	903	4	65.00	1
100 GL3.000	Petrol	903	4	65.00	1
110 D.000	Petrol	499	2	70.00	11
110 F.000	Petrol	499	2	67.40	6
120.000	Petrol	499	2	67.40	6
124 B.0000	Petrol	1438	4	80.00	28
125 A.000	Petrol	1608	4	80.00	28
125 B.000	Petrol	1608	4	80.00	28
126 A.000	Petrol	594	2	73.50	23
126 A1.000	Petrol	652	2	77.00	27
126 A1.048	Petrol	652	2	77.00	27
126 A2.000	Petrol	704	2	80.00	29
126 A2.048	Petrol	704	2	80.00	29
127 A.000	Petrol	903	4	65.00	1
127 A5.000	Diesel	1301	4	76.00	25
128 A.000	Petrol	1116	4	80.00	30
128 A.048	Petrol	1116	4	80.00	30
128 A 064	Petrol	1116	4	80.00	30
128 AC5.000	Petrol	1116	4	80.00	30
132 A.C1.000	Petrol	1756	4	84.00	61
132 BB OA O	Petrol	1585	4	80.00	28
132 C3.031	Petrol	1995	4	84.00	61
138 AE 0A.0	Petrol	1116	4	80.00	30
138 B.000	Petrol	1116	4	80.00	30
138 B6.000	Diesel	1714	4	83.00	56
138 C.000	Diesel	1677	4	82.60	47
141 B.000	Petrol	770	4	65.00	2
146 A.000	Petrol	903	4	65.00	3
146 A.048	Petrol	903	4	65.00	1
146 A.1000	Petrol	903	4	65.00	3
146 B1.000	Diesel	1301	4	76.00	26
146 B2.000	Diesel	1697	4	82.60	48
146 C1.000	Petrol	1372	4	80.50	31
146 C5.000	Petrol	1372	4	80.50	31
146 D5.000	Petrol	1372	4	80.50	31
146 D7.000	Diesel	1697	4	82.60	49
149 A1.000	Diesel	1929	4	82.60	50
149 B1.000	Diesel	1929	4	82.60	50
149 B3.000	Diesel	1697	4	82.60	48
149 B4.000	Diesel	1697	4	82.60	48
149 B4.046	Diesel	1697	4	82.60	47
149 B5.046	Diesel	1929	4	82.60	51
154 A1.000	Petrol	1995	4	84.00	61
154 A2.000	Petrol	1995	4	84.00	62
154 B.000	Diesel	1929	4	82.60	51
154 C3.046	Petrol	1995	4	84.00	61
154 C4.046	Petrol	1995	4	84.00	62
154 C6.000	Diesel	1929	4	82.60	52
154 D1.000	Diesel	1929	4	82.60	51
154 E1.000	Petrol	1995	4	84.00	61
156 A2.000	Petrol	999	4	70.00	12
156 A2.0157	Petrol	999	4	70.00	13
156 A2.050	Petrol	999	4	70.00	13
156 A2.100 Fire	Petrol	999	4	70.00	12
156 A2.246 Fire	Petrol	999	4	70.00	14

		ccm	x 		
156 A3.000	Petrol	999	4	70.00	12
156 A4.000 Fire	Petrol	770	4	65.00	4
156 A4.048 Fire	Petrol	770	4	65.00	4
156 A5.000	Diesel	1301	4	76.00	26
156 C.046 Fire	Petrol	1108	4	70.00	14
159 A2.000	Petrol	1372	4	80.50	31
159 A3.000	Petrol	1581	4	86.40	73
159 A3.046	Petrol	1585	4	86.40	73
159 A3.048	Petrol	1585	4	86.40	73
159 A4.000	Petrol	1756	4	84.00	61
159 A4.046	Petrol	1756	4	84.00	61
159 A6.046	Petrol	1995	4	84.00	61
160 A1.000	Petrol	1372	4	80.50	31
160 A1.046	Petrol	1372	4	80.50	31
160 A1.048	Petrol	1372	4	80.50	31
160 A2.000	Petrol	1585	4	86.40	73
160 A3.000 Fire	Petrol	1108	4	70.00	15
160 A6.000	Diesel	1929	4	82.60	53
160 A6.046	Diesel	1929	4	82.60	53
160 A7.000	Diesel	1929	4	82.60	50
160 B6.046	Diesel	1929	4	82.60	53
160 D1.000	Diesel	1929	4	82.60	53
169 A1.000	Diesel	1248	4	69.60	7
169 B (XM7T)	Petrol	1783	4	84.00	63
170 A.000	Petrol	704	2	80.00	29
170 A.046	Petrol	704	2	80.00	29
170 A1.000	Petrol	903	4	65.00	5
170 A1.046	Petrol	903	4	65.00	5
170 B	Petrol	1971	4	88.00	75
170 D	Petrol	1971	4	88.00	75
175 A1.000	Petrol	1995	4	84.00	64
175 A3.000	Petrol	1998	5	82.00	33
176 A3.000	Diesel	1697	4	82.60	54
176 A5.000	Diesel	1697	4	82.60	49
176 A6.000 Fire	Petrol	1108	4	70.00	16
176 A7.000 Fire	Petrol	1242	4	70.80	17
176 A8.000 Fire	Petrol	1242	4	70.80	18
176 A9.000	Petrol	1581	4	86.40	73
176 B2.000 Euro 2 Fire	Petrol	1108	4	70.00	16
176 B3.000	Diesel	1697	4	82.60	48
176 B4.000 Fire	Petrol	1242	4	70.80	18
176 B7.000	Diesel	1697	4	82.60	49
176 B9.000 Fire	Petrol	1242	4	70.80	19
178 B3.000 Euro 2	Petrol	1581	4	86.40	74
178 B5.000 Euro 3 Fire	Petrol	1242	4	70.80	18
178 E2.000 Fire	Petrol	1242	4	70.80	18
178 E8.011	Petrol	1242	4	70.80	20
178 E9.011	Petrol	1242	4	70.80	20
182 A1.000 Euro 2	Petrol	1998	5	82.00	34
182 A2.000 Euro 2	Petrol	1747	4	82.00	35
182 A3.000	Petrol	1371	4	82.00	36
182 A4.000 Euro 2	Petrol	1581	4	86.40	74
182 A5.000	Petrol	1371	4	82.00	36
182 A6.000 Euro 2	Petrol	1581	4	86.40	74
182 A7.000	Diesel	1910	4	82.00	38
182 A8.000	Diesel	1910	4	82.00	38
182 B2.000 Fire	Petrol	1242	4	70.80	19
182 B3.000 Euro 2	Petrol	1998	5	82.00	34
182 B4.000 Euro 2	Diesel	1910	4	82.00	39
182 B6.000 Euro 3	Petrol	1596	4	80.50	32
182 B7.000 Euro 2	Petrol	1998	5	82.00	34
182 B9.000 Euro 3	Diesel	1910	4	82.00	40
183 A1.000 Euro 2	Petrol	1747	4	82.00	35
185 A2.000	Diesel	2387	5	82.00	38
185 A3.000 Euro 2	Petrol	1581	4	86.40	74
185 A6.000 Euro 2	Diesel	2387	5	82.00	39
185 A8.000 Euro 3	Petrol	1998	5	82.00	37
186 A6.000 Euro 3	Diesel	1910	4	82.00	41
186 A8.000	Diesel	1910	4	82.00	40

		ccm	x 		
186 A9.000	Diesel	1910	4	82.00	40
187 A1.000 Euro 3 Fire	Petrol	1108	4	70.00	16
188 A2.000 Euro 3	Diesel	1910	4	82.00	41
188 A3.000	Diesel	1910	4	82.00	42
188 A4.000 Euro 3 Fire	Petrol	1242	4	70.80	18
188 A5.000 Euro 3 Fire	Petrol	1242	4	70.80	21
188 A7.000 Euro 3	Diesel	1910	4	82.00	41
188 A8.000	Diesel	1248	4	69.60	8
188 A9.000	Diesel	1248	4	69.60	8
188 B2.000	Diesel	1910	4	82.00	40
192 A1.000	Diesel	1910	4	82.00	40
192 A3.000 Euro 3	Diesel	1910	4	82.00	41
192 A5.000	Diesel	1910	4	82.00	43
192 A8.000	Diesel	1910	4	82.00	40
192 B1.000	Diesel	1910	4	82.00	43
198 A5.000	Diesel	1956	4	83.00	57
199 A2.000	Diesel	1248	4	69.60	8
199 A3.000	Diesel	1248	4	69.60	9
199 A5.000	Diesel	1910	4	82.00	40
199 A9.000 Euro 5	Diesel	1248	4	69.60	7
199 B1.000 Euro 5	Diesel	1248	4	69.60	10
199 B2.000 Euro 5	Diesel	1248	4	69.60	7
220 A 2.000	Petrol	1581	4	86.40	73
223 A5.000 Euro 3 Fire	Petrol	1242	4	70.80	18
223 A6.000 Euro 3	Diesel	1910	4	82.00	42
223 A7.000	Diesel	1910	4	82.00	40
223 A9.000	Diesel	1248	4	69.60	9
230 A2.000	Diesel	1929	4	82.60	50
230 A3.000	Diesel	1929	4	82.60	53
230 A4.000 Euro 2	Diesel	1929	4	82.60	53
263 A2.000	Diesel	1248	4	69.60	10
263 A6.000	Diesel	1248	4	69.60	7
280 A1.000	Diesel	1929	4	82.60	53
312 A4.000	Petrol	964	2	83.50	60
312 A6.000	Petrol	964	2	83.50	60
350 A1.000 Euro 4/5	Petrol	1368	4	72.00	22
605 D	Diesel	1901	4	82.00	44
831 D1.000	Diesel	1929	4	82.60	50
834 B.000	Petrol	1995	4	84.00	61
834 B.048	Petrol	1995	4	84.00	61
834 B.146	Petrol	1995	4	84.00	61
834 C.146	Petrol	1995	4	84.00	62
835 C1.000	Petrol	1581	4	86.40	73
835 C2.000	Petrol	1756	4	84.00	61
835 C4.000	Petrol	1756	4	84.00	61
836 A3.000	Petrol	1995	4	84.00	61
836 A4.000	Petrol	1372	4	80.50	31
836 A5.000	Petrol	1756	4	84.00	61
839 A5.000 Euro 2	Diesel	2387	5	82.00	39
844 A2.000	Diesel	1956	4	83.00	57
937A4.000	Diesel	1910	4	82.00	43
937A5.000	Diesel	1910	4	82.00	43
937A7.000	Diesel	1910	4	82.00	40
939 A1.000	Diesel	1910	4	82.00	40
939A2.000	Diesel	1910	4	82.00	43
939A3.000	Diesel	2387	5	82.00	43
939 B5.000	Diesel	1956	4	83.00	57
940 A5.000 Euro 5	Diesel	1956	4	83.00	57
1170 A1.046	Petrol	899	4	65.00	5
8140.07	Diesel	2499	4	93.00	80
8140.21.201-203 Sofim	Diesel	2445	4	93.00	81
8140.27.2100	Diesel	2500	4	93.00	82
8140.27.2700/27R/S Sofim	Diesel	2499	4	93.00	82
8140.27S.3700 Euro 1	Diesel	2499	4	93.00	83
8140.27 Sofim	Diesel	2500	4	93.00	82
8140.43	Diesel	2800	4	94.40	90
8140.43N Euro 3	Diesel	2798	4	94.40	91
8140.43S Euro 3	Diesel	2800	4	94.40	91
8140.47	Diesel	2499	4	93.00	83

		ccm	x 		9
8140.47.3700	Diesel	2499	4	93.00	83
8140.47R.2210	Diesel	2499	4	93.00	83
8140.47R Sofim	Diesel	2499	4	93.00	83
8140.61	Diesel	2445	4	93.00	84
8140.61.204	Diesel	2445	4	93.00	85
8140.63 Sofim	Diesel	2798	4	94.40	92
8140.67	Diesel	2500	4	93.00	86
8140.67.2700	Diesel	2499	4	93.00	86
8142.61	Diesel	2445	4	93.00	84
8144.21.220	Diesel	2445	4	93.00	81
8144.21 Sofim	Diesel	2445	4	93.00	81
8144.61	Diesel	2445	4	93.00	84
8144.61.200 (Sofim)	Diesel	2445	4	93.00	84
8144.61.500.81	Diesel	2445	4	93.00	84
8144.67	Diesel	2500	4	93.00	87
8144.67.220	Diesel	2499	4	93.00	87
8144.81.2000	Diesel	2445	4	93.00	85
8144.91	Diesel	2445	4	93.00	85
8144.97.2200	Diesel	2499	4	93.00	85
8144.97.2400	Diesel	2499	4	93.00	88
8144.97.2500	Diesel	2500	4	93.00	85
8144.97 Sofim	Diesel	2499	4	93.00	88
8144.97 S Sofim	Diesel	2500	4	93.00	88
8144.97 Y Sofim	Diesel	2500	4	93.00	88
B 25.637	Diesel	2498	4	93.00	89
CRD93L (U25-661)	Diesel	2500	4	93.00	89
D8B	Diesel	1905	4	83.00	58
D9B (XUD9/A/B/L/Y)	Diesel	1905	4	83.00	59
D9B (XUD9A)	Diesel	1905	4	83.00	59
D19AA	Diesel	1910	4	82.00	40
DHX (XUD9TE)	Diesel	1905	4	83.00	58
DHX (XUD9 TF/L)	Diesel	1905	4	83.00	58
DJY (XUD9)	Diesel	1905	4	83.00	59
DJY XUD9A	Diesel	1905	4	83.00	59
DW10 (RHV)	Diesel	1997	4	85.00	67
DW10 (RHX)	Diesel	1998	4	85.00	67
DW10 (RHZ)	Diesel	1997	4	85.00	67
DW10ATED4 (RHM)	Diesel	1997	4	85.00	68
DW10ATED4 (RHS)	Diesel	1997	4	85.00	68
F1AE 0481 C Euro 3	Diesel	2287	4	88.00	77
F1AE0481D Euro 4	Diesel	2286	4	88.00	78
F1CE0481D Euro 4	Diesel	2999	4	95.80	93
LFW (XU7 JP)	Petrol	1762	4	83.00	55
RFU (XU10 J2C)	Petrol	1998	4	86.00	70
RFW (XU10J2)	Petrol	1998	4	86.00	70
RHK	Diesel	1997	4	85.00	69
THY (DK5ATE)	Diesel	2446	4	92.00	79
WJY (DW8)	Diesel	1868	4	82.20	45
WJY (DW8B)	Diesel	1868	4	82.20	45
WJZ (DW8)	Diesel	1868	4	82.20	46
XN 1T	Petrol	1971	4	88.00	76

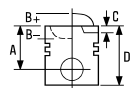

1  **65.00**

850 0.8	07/64→10/72	100 G.000	4 Cyl. 843cc	8:1 25kW (34PS)	TD863
850 0.8	07/64→10/72	100 G.002	4 Cyl. 844cc	8.5:1 27kW (37PS)	TD864
850 0.8 Special		100 GC.000	4 Cyl. 844cc	9.3:1 38kW (52PS)	TD868
900 T/E 0.9, 900 T/E Pulmino 0.9	01/78→01/86	100 GF 000	4 Cyl. 903cc	9:1 26kW (35PS)	TD6939
127 0.9 147 0.9 Fiorino 900 Uno 0.9	06/71→12/86 04/77→12/81 10/77→12/84 02/84→08/89	100 GL.000	4 Cyl. 903cc	9:1 30-33kW (41-45PS)	TD870
127 0.9	06/71→05/83	100 GL.048	4 Cyl. 903cc	9:1 29kW (40PS)	TD4413
Panda 900	10/80→06/94	100 GL3.000	4 Cyl. 903cc	9:1 33kW (45PS)	TD869
127 1.0 147 1.0 Fiorino 1.0, Fiorino 1050	01/77→05/96 10/76→12/95 01/80→12/87	127 A.000	4 Cyl. 903cc	9:1 37-41kW (50-56PS)	TD887
Duna 0.9 Panda 0.9 Fire S All-wheel Drive	07/91→10/95 10/80→04/86	146 A.048	4 Cyl. 903cc	9:1 33kW (45PS)	TD934

87-209800-00 STD
87-209806-00 0.40mm
87-209808-00 0.60mm

08-209800-00 STD
08-209806-00 0.40mm
08-209808-00 0.60mm

14-011001-00 D B 68.04 C 115.00

A 30.75
D 61.25
 20x54

1.75
2.00
3.94
 CR P
P
P

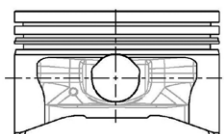
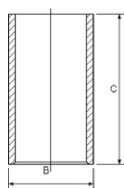







2  **65.00**

Panda 750	01/86→01/95	141 B.000	4 Cyl. 770cc	9.2:1 25kW (34PS)	TD4370
------------------	-------------	------------------	------------------------	-----------------------------	---------------

87-209800-30 STD
87-209806-30 0.40mm

A 36.80
D 61.80
 20x54

08-209800-00 STD
08-209806-00 0.40mm
08-209808-00 0.60mm

1.75  CR P
2.00  P
3.94  P

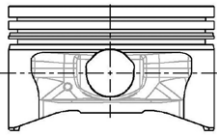
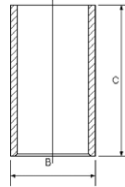

14-011001-00 D B 68.04 C 115.00



3  **65.00**



Panda 900	10/80→06/94	146 A.000	4 Cyl. 903cc	9:1 33kW (45PS)	TD4371
Uno 45 0.9	03/83→07/96				

Uno 45 0.9	03/83→07/96	146 A.1000	4 Cyl. 903cc	9:1 33kW (45PS)	TD4372
-------------------	-------------	-------------------	------------------------	---------------------------	---------------

87-209800-10  STD
87-209806-10  0.40mm
87-209808-10  0.60mm

A 31.25
D 61.75
 20x54

08-209800-00 STD
08-209806-00 0.40mm
08-209808-00 0.60mm

1.75  CR P
2.00  P
3.94  P

14-011001-00 D B 68.04 C 115.00

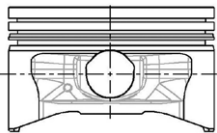
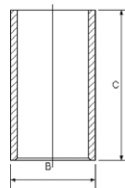

 Without circlips

 Ohne Sicherungsbugeln

 Sans circlips

 Sin anillos de retención

 Pistone con spinotto montato a caldo

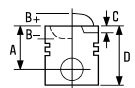



4  **65.00**

Panda 750	01/86 → 01/95	156 A4.000 Fire	4 Cyl. 770cc	9.4:1 25kW (34PS)	TD11307
-----------	---------------	------------------------	------------------------	-----------------------------	----------------

Panda 750	01/95 → 10/03	156 A4.048 Fire	4 Cyl. 770cc	9.4:1 25kW (34PS)	TD11308
-----------	---------------	------------------------	------------------------	-----------------------------	----------------

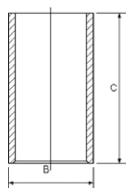
14-011001-00 D B 68.04 C 115.00



5  **65.00**

Cinquecento 0.9	07/91 → 12/93	170 A1.000	4 Cyl. 903cc	8.8:1 30kW (41PS)	TD15810
-----------------	---------------	-------------------	------------------------	-----------------------------	----------------

Cinquecento 0.9 i.e.	07/91 → 12/93	170 A1.046	4 Cyl. 903cc	8.8:1 30kW (41PS)	TD15811
----------------------	---------------	-------------------	------------------------	-----------------------------	----------------

Cinquecento 0.9 i.e. S	07/91 → 07/99	1170 A1.046			
Panda 900	04/92 → 12/96		4 Cyl.	8.8:1	
Seicento/600 0.9	01/98 → 01/10		899cc	29kW (39PS)	TD872



87-145100-00 STD
87-145106-00 0.40mm
87-145108-00 0.60mm

08-145100-00 STD
08-145106-00 0.40mm
08-145108-00 0.60mm

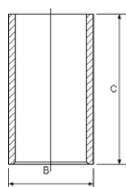
14-011001-00 D B 68.04 C 115.00



A 31.25
D 54.25
 20x54

1.50  NT
 1.50  P
 3.00  P

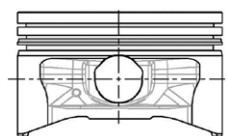

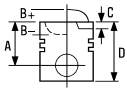

6  **67.40**

500 0.5	01/65→12/75	110 F.000	2 Cyl.	7:1	
			499cc	13kW (18PS)	
					TD871

500 0.5	01/60→12/75	120.000	2 Cyl.	7:1	
			499cc	13kW (18PS)	
					TD873





87-527600-00	STD
87-527606-00	0.40mm
87-527608-00	0.60mm

08-527600-00	STD
08-527606-00	0.40mm
08-527608-00	0.60mm

1 B 75.00 C 130.90 E 89.90

88-527600-00

A	37.95
B+	2.75
D	74.70
	20x55

2.00		CR P
2.00		P
2.00		P
3.96		P

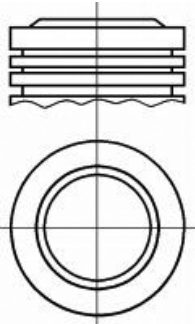
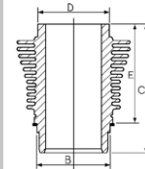

1 Liner available in Kit Set only

1 Zylinderlaufbüchse nur in Assemblies verfügbar

1 Chemise disponible en kit seulement

1 Camisas disponible en conjuntos solamente

1 Cilindro disponibile solo in kit motore

7  **69.60**

500 1.3 D Multijet	10/07→	169 A1.000			
500 C 1.3 D Multijet	09/09→		4 Cyl.	17.6:1	
Panda 1.3 D Multijet	01/06→		1248cc	55kW (75PS)	
			Diesel	Turbo Intercooled	TD20236

Fiorino 1.3 D Multijet	11/07→	199 A9.000 Euro 5			
Panda 1.3 D Multijet	02/12→		4 Cyl.	17.6:1	
Punto 1.3 D Multijet	04/08→		1248cc	55kW (75PS)	
Punto Evo 1.3 D Multijet	10/09→02/12	Diesel	Turbo Intercooled		TD23573
Qubo 1.3 D Multijet	02/08→				

Grande Punto 1.3 D Multijet	07/08→	199 B2.000 Euro 5			
Punto Evo 1.3 D Multijet	07/08→02/12		4 Cyl.	17.6:1	
			1248cc	51kW (69PS)	
			Diesel	Turbo Intercooled	TD23578



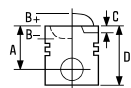

Doblo 1.3 D Multijet	11/13→	263 A6.000	4 Cyl.	16.8:1	
			1248cc	55kW (75PS)	
		Diesel	Turbo Intercooled		TD31011

87-435700-10	STD	08-435700-00	STD
87-435706-10	0.40mm	08-435706-00	0.40mm

- A 40.43
- B- 12.70
- BØ 37.00
- C 1.15
- C 0.90
- D 62.43
- 23x57

1.50		GDC P
1.50		P
2.00		CR P



AK KK RT

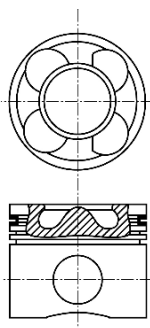

8 **69.60**

Doblo 1.3 JTD 16V	05/04→12/06	188 A8.000	4 Cyl.	18:1	
Panda 1.3 D Multijet	09/03→		1248cc	51kW (70PS)	
		Diesel	Turbo Intercooled		TD23866

Doblo 1.3 JTD 16V	05/04→12/06	188 A9.000	4 Cyl.	18:1	
Doblo MPV 1.3 JTD 16V	12/04→05/05		1248cc	51-55kW (70-75PS)	
Idea 1.3 JTD	01/04→		Diesel	Turbo Intercooled	TD17456
Palio 1.3 D Multijet	03/08→				
Palio 1.3 JTD Multijet	06/03→				
Panda 1.3 D Multijet	09/03→				
Punto 1.3 D Multijet	02/05→10/09				
Punto 1.3 JTD	06/03→10/05				
Punto 1.3 JTD 16V	06/03→				
Siena 1.3 JTD	09/03→				







Doblo 1.3 D Multijet	10/05→01/10	199 A2.000		
Doblo MPV 1.3 JTD	05/05→		4 Cyl.	17.6:1
Fiorino 1.3 D Multijet	11/07→		1248cc	55-68kW (75-93PS)
Grande Punto 1.3 D Multijet	10/05→	Diesel	Turbo Intercooled	TD20240
Linea 1.3 D Multijet	01/08→			
Linea 1.3 L Multijet	01/13→			
Punto 1.3 D Multijet	04/08→			
Punto Evo 1.3 D Multijet	10/09→			
Qubo 1.3 D Multijet	02/08→			

87-137600-00	STD	08-137600-00	STD	14-022060-00 D	B 72.50 C 142.00 D 74.00 E 5.00
87-137606-00	0.40mm	08-137606-00	0.40mm		

A	40.43
B-	12.40
BØ	37.00
C	1.20
D	63.43
	23x56

2.00		CK P
1.50		P
2.00		P

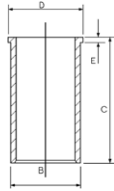

AK RT TP

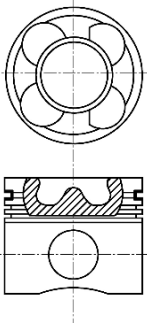

9  69.60

Doblo 1.3 D Multijet	02/10→	199 A3.000		
Doblo MPV 1.3 D Multijet			4 Cyl.	17.6:1
Grande Punto 1.3 D Multijet	10/05→		1248cc	66-70kW (90-95PS)
Idea 1.3 D Multijet		Diesel	Turbo Intercooled	TD20241
Linea 1.3 D Multijet	06/07→			
Punto 1.3 D Multijet	01/10→02/12			
Punto Evo 1.3 D Multijet	10/09→			



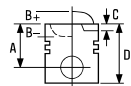

Doblo 1.3 JTD 16V Multijet	08/06→	223 A9.000		
Doblo MPV 1.3 D Multijet	10/05→		4 Cyl.	17.6:1
Grande Punto 1.3 D Multijet	04/10→		1248cc	62kW (84PS)
Punto Evo 1.3 D Multijet	10/09→02/12	Diesel	Turbo Intercooled	TD20243
Strada 1.3 D Multijet	05/06→			

87-425600-00	STD	08-425600-00	STD	14-022060-00 D	B 72.50 C 142.00 D 74.00 E 5.00
87-425606-00	0.40mm	08-425606-00	0.40mm		
		08-425608-00	0.60mm		

- A 40.43
- B- 12.41
- BØ 38.00
- C 0.91
- C 0.91
- D 62.43
- 23x55

- 2.00
- 1.50
- 2.00
- CK P
- NT
- CR P

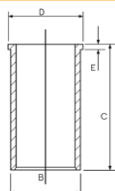

AK KK RT TP

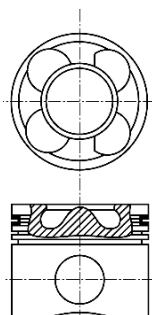

06933

10 69.60



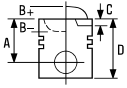

500 1.3 D Multijet	12/09→	199 B1.000 Euro 5		
500 C 1.3 D Multijet	09/09→		4 Cyl.	16.8:1
Fiorino 1.3 D Multijet	07/09→		1248cc	70kW (95PS)
Idea 1.3 D Multijet	05/08→	Diesel	Turbo Intercooled	TD23574
Panda 1.3 D Multijet	04/15→			
Punto 1.3 D Multijet	03/09→			
Punto Evo 1.3 D Multijet	10/09→02/12			
Qubo 1.3 D Multijet	07/10→			
Strada 1.3 D Multijet	10/10→			





Doblo 1.3 D Multijet 02/10→ **263 A2.000** 4 Cyl. 16.8:1
Doblo MPV 1.3 D Multijet **1248cc** **66kW (90PS)**
Diesel Turbo Intercooled **TD24796**

87-435700-00 STD **08-435700-00** STD
87-435706-00 0.40mm **08-435706-00** 0.40mm

A 40.30 **1.50**  **GDC P**
B- 12.70 **1.50**  **P**
BØ 37.00 **2.00**  **CR P**
C 1.15
C 0.90
D 62.43
 23x57





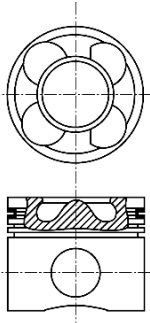

AK KK RT



11  **70.00**

500 0.5 01/60→12/74 **110 D.000** 2 Cyl. 7:1
499cc **13kW (18PS)** **TD23456**

87-528300-00 STD **08-528300-00** STD **1** **B 75.00 C 130.00 E 90.00** **88-528300-00**
87-528306-00 0.40mm **08-528306-00** 0.40mm

A 39.80 **2.00**  **CR P**
B+ 4.00 **2.00**  **P**
D 72.30 **3.50**  **P**
 20x58

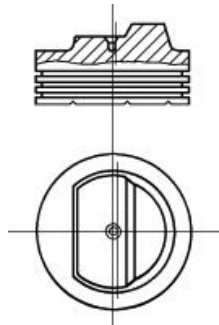
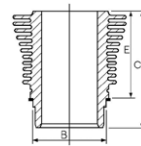

1 Liner available in Kit Set only

1 Zylinderlaufbüchse nur in Assemblies verfügbar

1 Chemise disponible en kit seulement

1 Camisas disponible en conjuntos solamente

1 Cilindro disponibile solo in kit motore

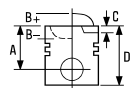

12  **70.00**

Uno 1.0	06/89→02/92	156 A2.000	4 Cyl. 999cc	9.5:1 31-37kW (42-50PS)	TD16230
---------	-------------	------------	-----------------	----------------------------	---------

Panda 1000	01/86→04/92	156 A2.100 Fire	4 Cyl. 999cc	9:1 32-33kW (44-45PS)	TD4387
Uno 45 1.0	06/86→12/93				

Panda 1000	01/85→12/92	156 A3.000	4 Cyl. 999cc	9.8:1 37kW (50PS)	TD16209
------------	-------------	------------	-----------------	----------------------	---------

87-154200-00 STD
87-154206-00 0.40mm
87-154208-00 0.60mm

08-154200-00 STD
08-154206-00 0.40mm
08-154208-00 0.60mm

14-010991-00 D B 73.02 C 116.00

A 33.90
B- 0.50
D 57.40
 18x53

1.50
1.50
3.00
 CR P
P
CR 1

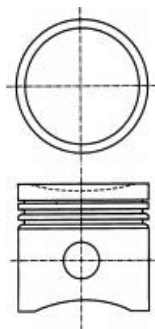
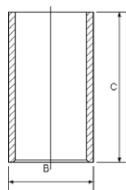

 Steel  Stahl  Acier  Acero  Acciaio

13  **70.00**

Uno 45 1.0	07/85→03/94	156 A2.0157	4 Cyl. 999cc	9:1 33kW (45PS)	TD22227
------------	-------------	-------------	-----------------	--------------------	---------

Uno 45 1.0	07/85→03/94	156 A2.050	4 Cyl. 999cc	9:1 33kW (45PS)	TD22228
------------	-------------	------------	-----------------	--------------------	---------

14-010991-00 D B 73.02 C 116.00

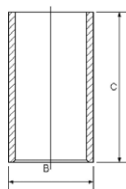



14 **70.00**

Fiorino 1.0 iE	11/92→04/96	156 A2.246 Fire			
Panda 1000	05/86→12/94		4 Cyl.	9.5:1	
Panda 1000 i.e	08/92→02/04		999cc	33kW (45PS)	
Panda 1000 i.e. CAT	10/87→08/98				TD994
Uno 1.0 Álcool	09/98→12/03				
Uno 1.0 iE	05/98→08/00				
Uno 1.0 MPI	09/98→12/03				
Uno 45 i.e. 1.0	04/84→10/95				

Panda 1.1	05/91→03/95	156 C.046 Fire			
Panda 1100	05/91→12/99		4 Cyl.	9.6:1	
Panda 1100 Trekking	10/91→07/04		1108cc	37-43kW (50-58PS)	
Uno 50 1.1	01/90→12/93				TD4389

87-154200-10	STD
87-154206-10	0.40mm
87-154208-10	0.60mm

08-154200-00	STD
08-154206-00	0.40mm
08-154208-00	0.60mm

14-010991-00 D B 73.02 C 116.00

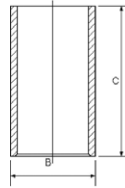

A	33.90
B-	1.50
D	57.40
	18x53

1.50		CR P
1.50		P
3.00		CR 1

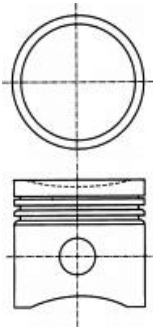

Steel

Stahl

Acier

Acero

Acciaio

15 **70.00**

Tipo 1.1	01/88→10/91	160 A3.000 Fire			
Uno 1.1	10/88→06/06		4 Cyl.	9.6:1	
Uno 60 1.1	04/89→12/92		1108cc	41-42kW (56-57PS)	
					TD10189

87-154200-30	STD
87-154206-30	0.40mm
87-154208-30	0.60mm

08-154200-00	STD
08-154206-00	0.40mm
08-154208-00	0.60mm

14-010991-00 D B 73.02 C 116.00

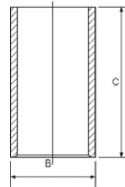

A	30.00
B-	1.80
D	54.00
	18x53

1.50		CR P
1.50		P
3.00		CR 1

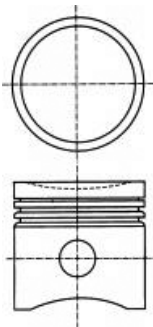

Steel

Stahl

Acier

Acero

Acciaio

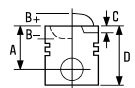

16  **70.00**

Punto 55 1.1	09/93→09/99	176 A6.000 Fire	4 Cyl. 1108cc	9.6:1 40kW (54PS)	TD1036
--------------	-------------	------------------------	-------------------------	-----------------------------	---------------

Cinquecento 1.1 Sporting	10/94→01/98	176 B2.000 Euro 2 Fire	4 Cyl. 1108cc	9.6:1 40kW (54PS)	TD4396
Panda 1100	02/95→07/04				
Punto 1.1	04/96→02/00				
Punto 55 1.1	09/93→09/99				
Seicento/600 1.1	01/98→01/10				

Palio 1.1	06/06→	187 A1.000 Euro 3 Fire	4 Cyl. 1108cc	9.6:1 40-42kW (54-57PS)	TD17847
Panda 1.1	09/00→				
Panda 1100	02/95→09/03				
Seicento/600 1.1	01/98→01/10				

87-142300-00 STD
87-142306-00 0.40mm
87-142308-00 0.60mm

08-142300-00 STD
08-142306-00 0.40mm
08-142308-00 0.60mm

14-010991-00 D B 73.02 C 116.00

A 30.00
B- 1.80
BØ 60.00
D 50.00
 18x53

1.20
 1.20
 2.50



CR P
 P
 P

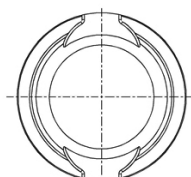
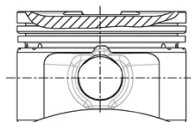
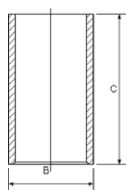

17  **70.80**

Punto 60 1.2	01/94→06/00	176 A7.000 Fire	4 Cyl. 1242cc	9.6:1 43-44kW (58-60PS)	TD1037
--------------	-------------	------------------------	-------------------------	-----------------------------------	---------------

87-138400-10 STD
87-138406-10 0.40mm
87-138408-10 0.60mm

08-138400-00 STD
08-138406-00 0.40mm
08-138408-00 0.60mm

A 28.00
B- 2.50
D 47.50
 18x53

1.19
 1.20
 2.50



NT P
 P
 P

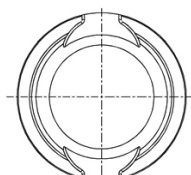
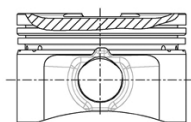







18  **70.80**

Palio 1.2 Punto 75 1.2	06/98→ 10/93→09/99	176 A8.000 Fire 4 Cyl. 1242cc	9.8:1 54kW (73PS)	TD1038
Punto 60 1.2	03/94→06/00	176 B4.000 Fire 4 Cyl. 1242cc	9.8:1 44kW (60PS)	TD1076
Fiorino 1.2 Palio 1.2 Palio Weekend 1.2 Siena 1.2 Strada 1.2	01/04→ 06/98→ 04/96→02/01 09/98→12/09 06/99→	178 B5.000 Euro 3 Fire 4 Cyl. 1242cc	9.8:1 50-55kW (68-75PS)	TD10188
Palio 1.2 Palio Weekend 1.2	06/98→ 06/99→10/02	178 E2.000 Fire 4 Cyl. 1242cc	9.8:1 50-54kW (68-73PS)	TD16737
Palio 1.2, Palio Weekend 1.2 Flex Palio Weekend 1.2 Palio Weekend 1.2 LPG Panda 1.2 Panda 1.2 LPG Panda 1.2 Natural Power Punto 1.2 60 Punto 1.2 Bifuel Punto 1.2 Natural Power Siena 1.2 Strada 1.2 Uno 1.2	07/97→08/02 02/01→ 09/03→ 04/09→ 01/07→11/09 09/99→ 08/07→ 09/03→ 09/01→12/09 04/03→ 08/00→04/10	188 A4.000 Euro 3 Fire 4 Cyl. 1242cc	9.5:1 44kW (60PS)	TD12790
Doblo 1.2, Doblo MPV 1.2	03/01→	223 A5.000 Euro 3 Fire 4 Cyl. 1242cc	9.8:1 48kW (65PS)	TD15828

87-138400-40 STD
87-138406-40 0.40mm

A 28.00
B- 1.80
C 1.10
D 48.00
 **18x53**

08-138400-00 STD
08-138406-00 0.40mm
08-138408-00 0.60mm

1.19  NT P
1.20  P
2.50  P

14-021080-00 D B 73.80 C 128.00 D 75.00 E 5.00

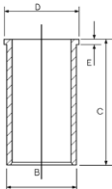
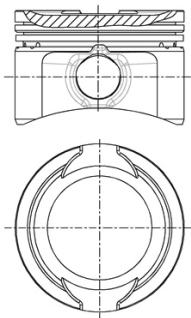

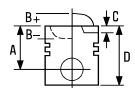



19  **70.80**

Punto 1.2 16V	04/97→09/99	176 B9.000 Fire		
Punto 85 16V 1.2	04/97→06/00	4 Cyl.	9.8:1	
		1242cc	63kW (86PS)	
				TD9727

Brava 1.2 16V, Brava 1.2 16V 80	12/98→12/02	182 B2.000 Fire		
Bravo I 1.2 16V 80	12/98→10/01	4 Cyl.	9.8:1	
Marea 1.2 16V, Marea Weekend 1.2 16V	10/98→05/02	1242cc	60-64kW (82-87PS)	
				TD11807

87-138400-00	STD	08-138400-00	STD
87-138406-00	0.40mm	08-138406-00	0.40mm
		08-138408-00	0.60mm

A	28.05		
B-	5.70	1.19	 NT P
C	1.50	1.20	 P
D	48.00	2.50	 P
	18x53		

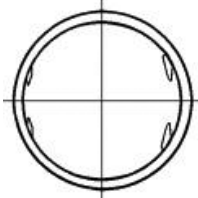
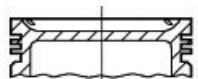

20  **70.80**

Siena 1.2	09/02→02/04	178 E8.011		
Strada 1.2	06/04→	4 Cyl.	9.8:1	
Uno 1.2	01/04→04/10	1242cc	48-49kW (65-67PS)	
				TD25005

Fiorino 1.2 Flex	02/08→	178 E9.011		
Palio 1.2	06/04→	4 Cyl.	11:1	
Palio 1.2 Flex	11/03→05/05	1242cc	50-52kW (68-71PS)	
Palio Weekend 1.2	06/04→			TD24630
Palio Weekend 1.2 Flex	01/04→12/05			
Siena 1.2	06/04→12/09			
Siena 1.2 Flex	03/04→05/05			
Uno 1.2	11/05→			
Uno 1.2 Bipower	10/06→04/10			
Uno 1.2 Flex	01/07→			
Uno 1.2 Flexfuel	01/09→04/10			

14-021080-00 D B 73.80 C 128.00 D 75.00 E 5.00

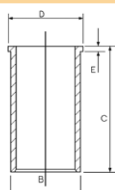

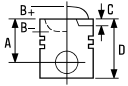





21  **70.80**

Brava 1.2 16V 80, Bravo I 1.2 16V 80	10/00→10/01	188 A5.000 Euro 3 Fire	
Idea 1.2 16V	01/04→	4 Cyl.	
Palio 1.2, Palio Weekend 1.2	09/01→	1242cc	57-59kW (78-80PS)
Punto 1.2 16V 80	09/99→		TD12791
Siena 1.2	09/01→12/09		
Stilo 1.2 16V	02/02→11/06		

87-138400-30 STD
87-138406-30 0.40mm

A 28.00
B- 5.10
D 48.00
 18x49

08-138400-00 STD
08-138406-00 0.40mm
08-138408-00 0.60mm

1.19  NT P
1.20  P
2.50  P

14-021080-00 D B 73.80 C 128.00 D 75.00 E 5.00

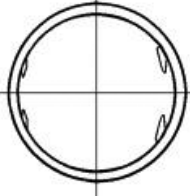
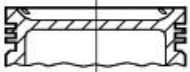
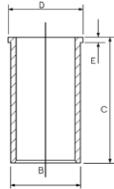

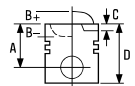

22  **72.00**

Doblo 1.4, Doblo MPV 1.4	10/05→	350 A1.000 Euro 4/5		
Fiorino 1.4	10/09→	4 Cyl.	11:1	
Fiorino 1.4 Natural Power		1368cc	51-57kW (69-78PS)	
Grande Punto 1.4	10/05→			TD20248
Grande Punto 1.4 LPG	12/08→			
Grande Punto 1.4 Natural Power	07/08→			
Idea 1.4	10/05→			
Idea 1.4 LPG	03/09→			
Linea 1.4	06/07→			
Palio 1.4	10/05→			
Panda 1.4 Natural Power	10/09→			
Punto 1.4	04/08→			
Punto 1.4 LPG	03/09→			
Punto 1.4 Natural Power				
Punto 1.4, Punto 1.4 Bifuel	03/12→			
Punto EVO 1.4	10/09→02/12			
Punto EVO 1.4 LPG	06/09→02/12			
Punto EVO 1.4 Natural Power	10/09→02/12			
Qubo 1.4, Qubo 1.4 Natural Power	10/09→			
Siena 1.4	01/07→12/09			





87-436800-00
87-436806-00

STD
0.40mm

08-436800-00
08-436806-00

STD
0.40mm

A 26.00
B- 4.75
C 2.05
D 49.00
 18x49

1.00  NT 
1.20  P
2.00  CR P

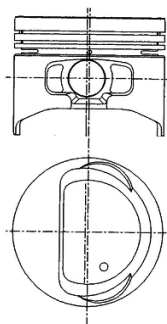

 Steel  Stahl  Acier  Acero  Acciaio



23  **73.50**

126 600 09/72→06/77 126 A.000 2 Cyl. 7.5:1
 594cc 17kW (23PS) **TD880**

87-528400-00 STD
 87-528406-00 0.40mm
 87-528408-00 0.60mm

08-528400-00 STD
 08-528406-00 0.40mm
 08-528408-00 0.60mm

A 40.00
 D 79.50
 20x61

1.50
 2.00
 3.94



CR P
 P
 P

1

B 81.50 C 130.40 E 79.90

88-528400-00

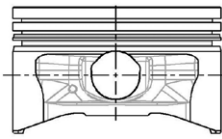
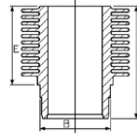

1 Liner available in Kit Set only

1 Zylinderlaufbüchse nur in Assemblies verfügbar

1 Chemise disponible en kit seulement

1 Camisas disponible en conjuntos solamente

1 Cilindro disponibile solo in kit motore

24  **75.00**

Scudo 1.6 D Multijet 01/07→ 9HU 4 Cyl. 18:1
 1560cc 66kW (90PS) **TD24776**
 Diesel Turbo Intercooled

87-424000-00 STD
 87-424008-00 0.60mm

08-424000-00 STD
 08-424007-00 0.50mm
 08-424008-00 0.60mm

A 41.70
 B- 13.25
 BØ 41.80
 C 1.20
 D 65.30
 26x61

3.00
 1.95
 2.50



CK P
 P
 CR P



14-020900-00 D

B 78.00 C 142.00 D 79.50 F 5.00

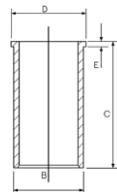

AK KK RT TP

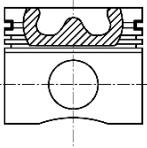
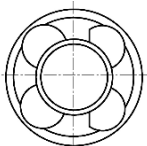

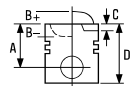

25  **76.00**

127 1.3 D	06/81→12/86	127 A5.000			
127 1.3 Diesel	04/81→12/86		4 Cyl.	20:1	
147 1.3 D	10/80→10/95		1301cc	33kW (45PS)	
Elba 1.3 D	04/86→10/92	Diesel			TD4346
Fiorino 1.3 D	03/82→12/88				
Uno 1.3 Super Diesel	06/83→03/92				



87-215200-00 STD
87-215208-00 0.60mm

A 46.95
B+ 4.90
D 83.85
 22x64

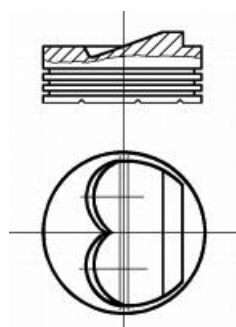
RT



08-215200-10 STD
08-215206-10 0.40mm
08-215208-10 0.60mm
08-215211-10 1.00mm

2.50  CR P
2.00  P
3.00  CR P

14-021260-00 D B 80.00 C 133.50 D 81.00 E 5.00

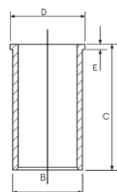

14-012470-00 D B 79.00 C 139.00

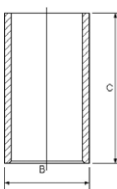

26  **76.00**

Uno 1.3 Super Diesel	06/83→03/92	146 B1.000			
			4 Cyl.		
			1301cc	33kW (45PS)	
		Diesel			TD948
Panda 1300 D	04/86→12/92	156 A5.000			
			4 Cyl.	20:1	
			1301cc	27kW (37PS)	
		Diesel			TD999

14-021260-00 D B 80.00 C 133.50 D 81.00 E 5.00

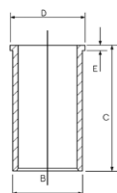

14-012470-00 D B 79.00 C 139.00

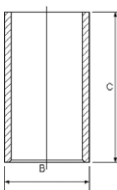



27  **77.00**



126 650	07/77→09/87	126 A1.000	2 Cyl. 652cc	7.5:1 17kW (23PS)	TD4343
---------	-------------	------------	-----------------	----------------------	--------

126 650 133 0.65	07/77→09/00 06/74→12/76	126 A1.048	2 Cyl. 652cc	7.5:1 17-20kW (23-27PS)	TD881
---------------------	----------------------------	------------	-----------------	----------------------------	-------

87-785500-00	STD
87-785506-00	0.40mm
87-785508-00	0.60mm

08-785500-00	STD
08-785506-00	0.40mm
08-785507-00	0.50mm
08-785508-00	0.60mm

A 40.00
D 79.50
 20x61

1.50		CR P
2.00		P
3.94		CR 2

1 B 83.00 C 130.40 E 79.90

88-785500-00

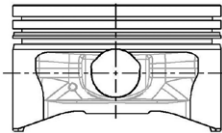
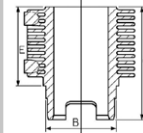

1 Liner available in Kit Set only
2 Steel

1 Zylinderlaufbüchse nur in Assemblies verfügbar
2 Stahl

1 Chemise disponible en kit seulement
2 Acier

1 Camisas disponible en conjuntos solamente
2 Acero

1 Cilindro disponibile solo in kit motore
2 Acciaio

28  **80.00**

124 Familiare 1.4	09/67→05/71	124 B.0000	4 Cyl. 1438cc	9:1 51kW (69PS)	TD18853
-------------------	-------------	------------	------------------	--------------------	---------

125 1.6	07/67→03/74	125 A.000	4 Cyl. 1608cc	8.8:1 66kW (90PS)	TD878
---------	-------------	-----------	------------------	----------------------	-------

124 1600 125 1.6	04/70→10/73 05/69→10/73	125 B.000	4 Cyl. 1608cc	8.8:1 74kW (100PS)	TD879
---------------------	----------------------------	-----------	------------------	-----------------------	-------

132 1.6	04/72→01/76	132 BB OA O	4 Cyl. 1585cc	9:1 71-72kW (97-98PS)	TD6825
---------	-------------	-------------	------------------	--------------------------	--------

14-028710-00 D B 86.53 C 125.10 D 95.00 E 7.80

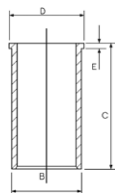

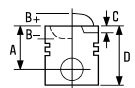

29  **80.00**

126 700	09/87→06/96	126 A.2.000	2 Cyl. 704cc	19kW (26PS)	TD4342
126 700	09/87→06/96	126 A.2.048	2 Cyl. 704cc	19kW (26PS)	TD4344
Cinquecento 0.7	12/91→01/96	170 A.000	2 Cyl. 704cc	9:1 23kW (31PS)	TD1028
Cinquecento 0.7 I	07/94→01/98	170 A.046	2 Cyl. 704cc	9:1 22kW (30PS)	TD15809

87-203106-10 0.40mm
 87-203108-10 0.60mm
 A 34.00
 D 60.00
 20x54

08-203100-00 STD
 08-203104-00 0.20mm
 08-203106-00 0.40mm
 08-203108-00 0.60mm
 08-203110-00 0.80mm
 08-203111-00 1.00mm

14-028710-00 D B 86.53 C 125.10 D 95.00 E 7.80

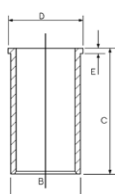

1.50
 2.00
 3.94
 CR P
 P
 P

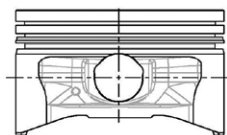

30  **80.00**

147 1.1	10/84→08/89	128 A 064	4 Cyl. 1116cc	9.2:1 40-44kW (54-60PS)	TD23118
128 1.1 128 Familiare 1.1	03/69→12/84 10/69→10/82	128 A.000	4 Cyl. 1116cc	8.8:1 33-48kW (45-65PS)	TD888
128 1.1 128 Familiare 1.1	02/75→09/81 02/75→02/81	128 A.048	4 Cyl. 1116cc	8.8:1 33kW (45PS)	TD5378
128 1.1	03/72→02/81	128 AC5.000	4 Cyl. 1116cc	9.2:1 48kW (65PS)	TD891
128 1.1	03/72→02/81	138 AE 0A.0	4 Cyl. 1116cc	9.2:1 44kW (60PS)	TD23461



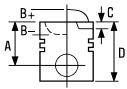

Ritmo II 60 1.1 Uno 55 1.1	10/82→12/87 01/83→08/89	138 B.000	4 Cyl. 1116cc	9.2:1 40-44kW (55-60PS)	TD923
-------------------------------	----------------------------	------------------	-------------------------	-----------------------------------	--------------

87-203100-00	STD
87-203106-00	0.40mm
87-203108-00	0.60mm

A 35.05
B+ 0.60
D 77.05
22x71

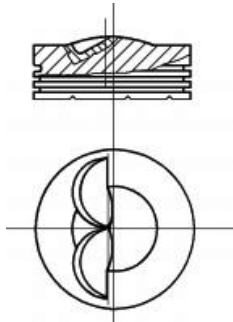

08-203100-00	STD
08-203104-00	0.20mm
08-203106-00	0.40mm
08-203108-00	0.60mm
08-203110-00	0.80mm
08-203111-00	1.00mm

1.50
2.00
3.94



CR P
P
P

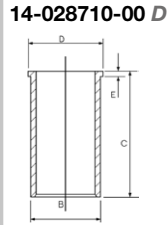

14-028710-00 D B 86.53 C 125.10 D 95.00 E 7.80

31 **80.50**

Uno 1.4 Uno 70 i.e. 1.4	05/92→08/94 09/89→12/93	146 C1.000	4 Cyl. 1372cc	9.2:1 51-53kW (69-72PS)	TD18821
Fiorino 1.4 Fiorino 70 i.e. 1.4	01/89→03/00 05/94→05/01	146 C5.000	4 Cyl. 1372cc	9.2:1 49-52kW (67-71PS)	TD6816
Elba 1.4 Fiorino 1.4 Fiorino 70 i.e. 1.4	10/93→02/95 01/89→05/01 05/94→05/01	146 D5.000	4 Cyl. 1372cc	9.2:1 49kW (67PS)	TD6817
Tempra 1.4 i.e. Tipo 1.4 i.e.	03/91→08/96 05/89→04/95	159 A2.000	4 Cyl. 1372cc	9.2:1 57kW (78PS)	TD9728
Tipo 1.4	07/87→12/89	160 A1.000	4 Cyl. 1372cc	9.2:1 52-56kW (71-76PS)	TD1015
Duna 1.4 Tempra 1.4 i.e. Tipo 1.4 i.e. Uno 1.4 Uno 70 i.e. 1.4	07/91→07/96 03/92→08/96 05/89→04/95 10/88→03/01 09/89→12/93	160 A1.046	4 Cyl. 1372cc	9.2:1 49-51kW (67-69PS)	TD1016



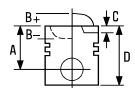

Tipo 1.4	07/87→10/92	160 A1.048		
Uno 1.4	05/92→08/94		4 Cyl.	9.2:1
Uno 70 S 1.4	09/89→10/92		1372cc	50-52kW (69-71PS)

TD4393

Tempra 1.4 i.e.	03/92→08/96	836 A4.000		
Tipo 1.4 i.e.	05/89→04/95		4 Cyl.	9.2:1
			1372cc	51kW (69PS)

TD893



87-783600-00	STD	08-783600-00	STD
87-783606-00	0.40mm	08-783606-00	0.40mm
87-783608-00	0.60mm	08-783608-00	0.60mm
		08-783610-00	0.80mm
		08-783611-00	1.00mm

A 33.30

B- 2.90

D 65.00

 22x58

1.50		CR P
1.75		P
3.00		CR 1

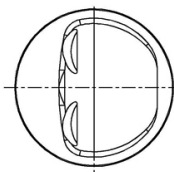
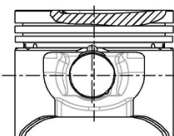

1 Steel

1 Stahl

1 Acier

1 Acero



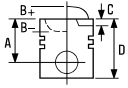

1 Acciaio



32  **80.50**

Brava 1.6 16V	01/99→12/02	182 B6.000 Euro 3		
Bravo I 1.6	09/00→10/01	4 Cyl.	10.5:1	
Doblo 1.6 16V	10/01→	1596cc	68-100kW (92-136PS)	
Doblo 1.6 Natural Power, Doblo MPV 1.6	09/02→			TD16166
Doblo MPV 1.6 16V	10/01→			
Doblo MPV 1.6 Natural Power	09/02→			
Marea 1.6, Marea Weekend 1.6	09/00→12/07			
Multipla 1.6	09/00→06/10			
Multipla 1.6 16V	04/02→06/10			
Multipla 1.6 16V Bipower	10/01→06/10			
Multipla 1.6 16V GPL				
Palio 1.6	06/96→			
Palio Weekend 1.6 16V	02/01→			
Siena 1.6	11/00→12/09			
Siena 1.6 16V	08/03→12/05			
Stilo 1.6	04/05→11/06			
Stilo 1.6 16V	10/01→11/06			
Stilo Multi Wagon 1.6 16V	01/03→08/08			

87-124800-00	STD	08-124800-00	STD
87-124806-00	0.40mm	08-124806-00	0.40mm
		08-124808-00	0.60mm

A	28.65			
B-	1.20	1.20		NT P
BØ	62.00	1.20		P
C	2.49	2.00		P
C	1.98			
D	50.65			
	21x56			

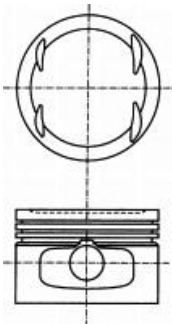

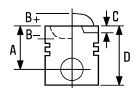





33  **82.00**

Coupe 2.0 20V Turbo	08/96 → 08/00	175 A3.000	5 Cyl.	8.5:1	
			1998cc	162kW (220PS)	
			Turbo Intercooled		TD5491

87-529300-00	STD	08-529300-00	STD
87-529306-00	0.40mm	08-529306-00	0.40mm

A	32.90	1.20	 NT
C	2.80	1.50	 P
D	56.90	3.00	 P
	22x54		

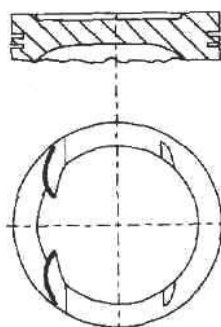





34  **82.00**

Bravo I 2.0 HGT 20V	10/95 → 07/98	182 A1.000 Euro 2			
Coupe 2.0 20V	08/96 → 04/98		5 Cyl.	10:1	
Marea 2.0 150 20V, Marea Weekend 2.0 150 20V	09/96 → 04/99		1998cc	108kW (147PS)	TD4397

Coupe 2.0 20V	04/98 → 08/00	182 B3.000 Euro 2			
			5 Cyl.	10:1	
			1998cc	113kW (154PS)	TD11789

Brava 2.0	09/98 → 08/00	182 B7.000 Euro 2			
Bravo I 2.0 HGT 20V	07/98 → 10/01		5 Cyl.	10.7:1	
Marea 2.0 155 20V	04/99 → 01/01		1998cc	113kW (154PS)	
Marea Weekend 2.0 155 20V	04/99 → 02/03				TD15498

87-787000-00	STD	08-787000-00	STD
87-787006-00	0.40mm	08-787006-00	0.40mm

A	32.90	1.50	 CR P
B+	0.80	1.50	 P
D	57.70	3.00	 CR 
	20x52		

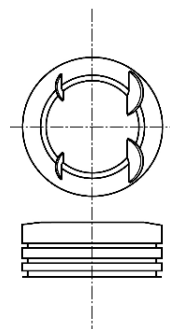

 Steel  Stahl  Acier  Acero  Acciaio

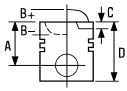





35  **82.00**

Brava 1.8 GT 16V, Bravo I 1.8 GT	10/95→10/01	182 A2.000 Euro 2		
Marea 1.8 115 16V, Marea Weekend 1.8 115 16V	09/96→05/02	4 Cyl.	10.3:1	
		1747cc	83kW (113PS)	TD4398

Barchetta 1.8 16V	04/95→05/05	183 A1.000 Euro 2		
Brava 1.8 16V	02/00→06/03	4 Cyl.	10.3:1	
Coupe 1.8 16V	03/96→08/00	1747cc	92-97kW (125-132PS)	
Marea 1.8	09/96→12/07			TD4405
Marea Weekend 1.8	08/99→12/07			
Punto 1.8 130 HGT	09/99→			

87-118000-00	STD	08-118000-00	STD
87-118006-00	0.40mm	08-118006-00	0.40mm
		08-118008-00	0.60mm

A	36.15			
B-	0.50	1.19		NT
D	60.15	1.20		P
	20x52	2.00		P

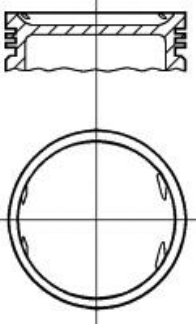





36  **82.00**

Brava 1.4 12 V	10/95→08/98	182 A3.000		
Bravo I 1.4	10/95→10/01	4 Cyl.	9.8:1	
Marea 1.4 80 12V, Marea Weekend 1.4 80 12V	09/96→05/02	1371cc	59kW (80PS)	TD4399

Brava 1.4, Bravo I 1.4	10/95→10/01	182 A5.000		
		4 Cyl.	9.8:1	
		1371cc	55kW (75PS)	TD4401

87-787000-30	STD	08-787000-00	STD
87-787006-30	0.40mm	08-787006-00	0.40mm

A	34.11	1.50		CR P
B-	5.10	1.50		P
D	58.11	3.00		CR 
	20x52			

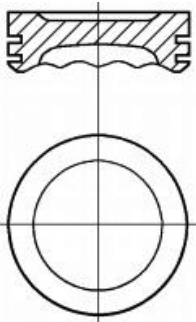

 Steel

 Stahl

 Acier

 Acero

 Acciaio

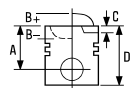



37  **82.00**

Marea 2.0 150 20V, Marea Weekend 2.0 150 20V 01/01→05/02 **185 A8.000 Euro 3**
 5 Cyl. 10.5:1
1998cc 110kW (150PS)
TD15830

87-118000-30 STD **08-118000-00** STD
87-118006-30 0.40mm **08-118006-00** 0.40mm
08-118008-00 0.60mm

A 31.90
B+ 1.10
D 55.00
 20x52

1.19  NT
 1.20  P
 2.00  P

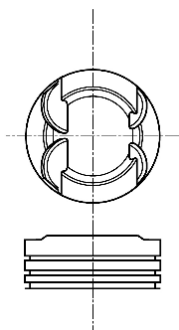

38  **82.00**



Brava 1.9 TD 100 S, Bravo I 1.9 TD 100 S 03/96→10/01 **182 A7.000**
 Marea 1.9 TD 100 09/96→05/02 4 Cyl. 20.7:1
1910cc 74kW (100PS)
Diesel Turbo Intercooled TD4403

Brava 1.9 TD 75 S, Bravo I 1.9 TD 75 S 03/96→10/01 **182 A8.000**
 Marea 1.9 TD 75, Marea Weekend 1.9 TD 75 09/96→05/02 4 Cyl. 20.7:1
1910cc 55kW (75PS)
Diesel Turbo Intercooled TD4404

Marea 2.4 TD 125, Marea Weekend 2.4 TD 125 09/96→04/99 **185 A2.000**
 5 Cyl. 20.7:1
2387cc 91kW (125PS)
Diesel Turbo Intercooled TD4406

87-523100-00 STD **08-523100-00** STD **14-021051-00 D** B 85.57 C 155.00 D 88.53 E 4.00
87-523108-00 0.60mm **08-523108-00** 0.60mm **14-028960-00 D** B 85.00 C 155.00 D 88.00 E 4.50

A 45.20
B- 2.15
D 71.15
 26x65

3.00  CK P
 2.00  P
 3.00  CR P

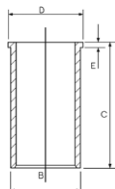

AK RT

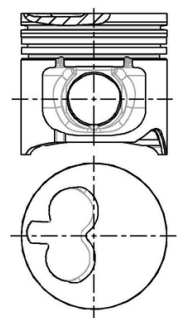







39  **82.00**

Brava 1.9 JTD	01/01→12/02	182 B4.000 Euro 2		
Brava 1.9 JTD 105, Bravo I 1.9 JTD 105	12/98→10/01	4 Cyl.	18.5:1	
Marea 1.9 JTD	01/01→12/07	1910cc	77-79kW (105-107PS)	
Marea 1.9 JTD 105	04/99→01/01	Diesel	Turbo Intercooled	TD11168
Marea Weekend 1.9 JTD	01/01→12/07			
Marea Weekend 1.9 JTD 105	04/99→05/02			
Multipla 1.9 JTD 105	04/99→06/10			

Marea 2.4 JTD 130, Marea Weekend 2.4 JTD 130	04/99→05/02	185 A6.000 Euro 2		
		5 Cyl.	18.45:1	
		2387cc	96kW (130PS)	
		Diesel	Turbo Intercooled	TD18145

Marea 2.4 JTD 130, Marea Weekend 2.4 JTD 130	04/99→05/02	839 A5.000 Euro 2		
		5 Cyl.	18.5:1	
		2387cc	96-99kW (131-135PS)	
		Diesel	Turbo Intercooled	TD14408

87-108000-00	STD	08-108000-00	STD	14-021051-00 D	B 85.57 C 155.00 D 88.53 E 4.00
87-108008-00	0.60mm	08-108008-00	0.60mm	14-028960-00 D	B 85.00 C 155.00 D 88.00 E 4.50
A	47.25	3.00			
B-	17.50	2.00			
BØ	37.45	3.00			
D	73.25				
	26x61				

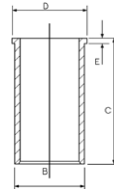

AK NB RT

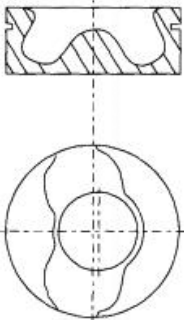

40  **82.00**

Brava 1.9 JTD, Bravo I 1.9 JTD	09/00→10/01	182 B9.000 Euro 3		
Doblo 1.9 JTD, Doblo MPV 1.9 JTD	10/01→	4 Cyl.	18.45:1	
Marea 1.9 JTD	01/01→12/07	1910cc	74-77kW (100-105PS)	
Marea Weekend 1.9 JTD	01/01→12/07	Diesel	Turbo Intercooled	TD16399
Marea Weekend 1.9 TD 100	09/96→05/02			

Multipla 1.9 JTD 115	07/02→06/10	186 A8.000		
		4 Cyl.		
		1910cc	85kW (115PS)	
		Diesel	Turbo Intercooled	TD18309

Doblo 1.9 JTD Multijet	12/06→	186 A9.000		
Doblo MPV 1.9 D Multijet	10/05→	4 Cyl.		
Multipla 1.9 JTD	04/02→06/10	1910cc	88kW (120PS)	
		Diesel	Turbo Intercooled	TD19306

Idea 1.9 JTD	01/04→	188 B2.000		
Punto 1.9 JTD	06/03→	4 Cyl.	18:1	
		1910cc	74kW (101PS)	
		Diesel	Turbo Intercooled	TD18291



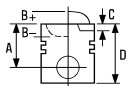



Bravo II 1.9 D Multijet Stilo 1.9 JTD Stilo Multi Wagon 1.9 JTD	11/06→ 10/01→11/06 01/03→08/08	192 A1.000	4 Cyl. 1910cc	18.5:1 85kW (115PS)	Diesel Turbo Intercooled	TD16398
Bravo II 1.9 D Multijet Stilo 1.9 D Multijet Stilo Multi Wagon 1.9 D Multijet	04/07→ 09/05→11/06 09/05→08/08	192 A8.000	4 Cyl. 1910cc	18:1 88kW (120PS)	Diesel Turbo Intercooled	TD20238
Grande Punto 1.9 D Multijet	10/05→	199 A5.000	4 Cyl. 1910cc	18:1 96kW (131PS)	Diesel Turbo Intercooled	TD20762
Doblo 1.9 JTD, Doblo MPV 1.9 JTD	07/03→	223 A7.000	4 Cyl. 1910cc	18.5:1 77kW (105PS)	Diesel Turbo Intercooled	TD18318
Stilo 1.9 JTD Stilo Multi Wagon 1.9 JTD	10/01→11/06 01/03→08/08	937A7.000	4 Cyl. 1910cc	18:1 85kW (115PS)	Diesel Turbo Intercooled	TD19307
Croma 1.9 D Multijet Grande Punto 1.9 D Multijet	06/05→ 10/05→	939 A1.000	4 Cyl. 1910cc	18:1 88kW (120PS)	Diesel Turbo Intercooled	TD18448
Sedici 1.9 D Multijet	06/06→	D19AA	4 Cyl. 1910cc	18:1 88kW (120PS)	Diesel Turbo Intercooled	TD20930

87-124000-30	STD	08-124000-00	STD	14-021051-00 D	B 85.57 C 155.00 D 88.53 E 4.00
87-124008-30	0.60mm	08-124006-00	0.40mm	14-028960-00 D	B 85.00 C 155.00 D 88.00 E 4.50
		08-124008-00	0.60mm		

- A 46.50
- B- 17.45
- BØ 37.55
- C 0.65
- D 72.50
-  26x61

06/00→

- 2.00  CK P
- 2.00  P
- 2.00  CR P

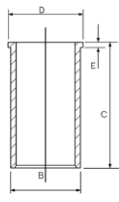

NB RT

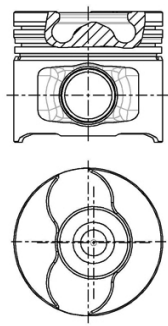

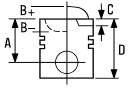

41  **82.00**

Marea 1.9 JTD 110, Marea Weekend 1.9 JTD 110	01/01→05/02	186 A6.000 Euro 3		
Multipla 1.9 JTD 110	03/01→07/02	4 Cyl.	18.45:1	
		1910cc	81kW (110PS)	
		Diesel	Turbo Intercooled	TD15831

Palio Weekend 1.9 JTD	09/01→	188 A2.000 Euro 3		
Punto 1.9 JTD 80	09/99→	4 Cyl.	18.4:1	
Strada 1.9 JTD	04/03→	1910cc	59kW (80PS)	
		Diesel	Turbo Intercooled	TD12788

Punto 1.9 JTD	02/00→	188 A7.000 Euro 3		
		4 Cyl.	18.5:1	
		1910cc	63kW (86PS)	
		Diesel	Turbo Intercooled	TD16409



Stilo 1.9 JTD	02/02→11/06	192 A3.000 Euro 3		
Stilo Multi Wagon 1.9 JTD	01/03→08/08	4 Cyl.	18.5:1	
		1910cc	59kW (80PS)	
		Diesel	Turbo Intercooled	TD16397

87-107900-00 STD
87-107908-00 0.60mm

08-107900-00 STD
08-107908-00 0.60mm

14-021051-00 D B 85.57 C 155.00 D 88.53 E 4.00
14-028960-00 D B 85.00 C 155.00 D 88.00 E 4.50

- A 46.50
- B- 17.50
- BØ 37.50
- C 0.80
- D 72.50
-  26x65

- 06/00
- 2.50  CR P
- 2.00  P
- 2.00  CR P

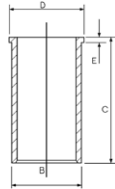

AK RT

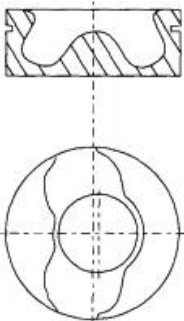

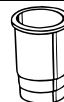
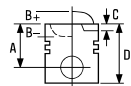

87-124000-10	STD	08-124000-00	STD
87-124008-10	0.60mm	08-124006-00	0.40mm
		08-124008-00	0.60mm

A	46.50
B-	17.50
BØ	37.50
C	0.55
D	72.50
	26x65

06/00→

2.00		CK P
2.00		P
2.00		CR P

AK RT

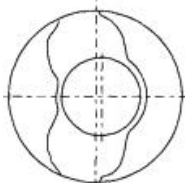
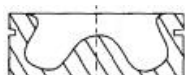

Piston Chamber Volume [ccm] 19.91

Volumen der Kolbenmulde [ccm] 19.91

Volume de la cavité du piston [cm³] 19.91

Volumen de cavidad del pistón [cc]

Volume camera pistone [cm³] 19.91

42 82.00

Punto 1.9 D 60	02/00→10/09	188 A3.000			
Punto 1.9 DS 60	09/99→		4 Cyl.	22.6:1	
			1910cc	44kW (60PS)	
		Diesel			TD12789

Doblo 1.9 D, Doblo MPV 1.9 D	03/01→	223 A6.000 Euro 3			
Palio 1.9 D	09/00→		4 Cyl.	22.6:1	
Palio Weekend 1.9 D	03/01→		1910cc	46-48kW (63-65PS)	
Siena 1.9 D	11/00→12/09	Diesel			TD15829
Strada 1.9 D	12/00→				

87-124000-00	STD	08-124000-00	STD	14-021051-00 D	B 85.57 C 155.00 D 88.53 E 4.00
87-124008-00	0.60mm	08-124006-00	0.40mm	14-028960-00 D	B 85.00 C 155.00 D 88.00 E 4.50
		08-124008-00	0.60mm		

A	44.45
B-	2.60
D	70.40
	26x65

06/00→

2.00		CK P
2.00		P
2.00		CR P

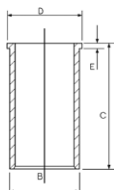

RT

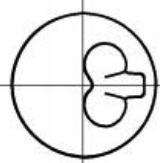
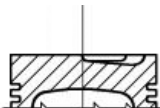







43  **82.00**

Stilo 1.9 JTD	01/04→11/06	192 A5.000				
Stilo Multi Wagon 1.9 JTD	01/04→08/08		4 Cyl.	18.5:1		
			1910cc	103kW (140PS)		
		Diesel	Turbo Intercooled			TD17980
Stilo 1.9 JTD	04/04→11/06	192 B1.000				
Stilo Multi Wagon 1.9 JTD	04/04→08/08		4 Cyl.	18.5:1		
			1910cc	100kW (136PS)		
		Diesel	Turbo Intercooled			TD18944
Stilo 1.9 JTD	09/03→11/06	937A4.000				
Stilo Multi Wagon 1.9 JTD	09/03→08/08		4 Cyl.			
			1910cc	93kW (126PS)		
		Diesel	Turbo Intercooled			TD18943
Bravo II 1.9 D Multijet	04/07→	937A5.000				
Stilo 1.9 D Multijet	09/05→11/06		4 Cyl.	17.5:1		
Stilo Multi Wagon 1.9 D Multijet	09/05→08/08		1910cc	110kW (150PS)		
		Diesel	Turbo Intercooled			TD18929
Croma 1.9 D Multijet	06/05→	939A2.000				
			4 Cyl.	17.5:1		
			1910cc	110kW (150PS)		
		Diesel	Turbo Intercooled			TD18449
Croma 2.4 D Multijet	06/05→	939A3.000				
			5 Cyl.			
			2387cc	147kW (200PS)		
		Diesel	Turbo Intercooled			TD18450

87-146100-00 STD
 87-146108-00 0.60mm

A 46.50
 B- 15.40
 BØ 41.50
 C 1.03
 D 72.50
 26x61

08-146100-00 STD
 08-146106-00 0.40mm
 08-146108-00 0.60mm

2.00  CK P
 2.00  P
 2.00  CK P

14-021051-00 D B 85.57 C 155.00 D 88.53 E 4.00
 14-028960-00 D B 85.00 C 155.00 D 88.00 E 4.50

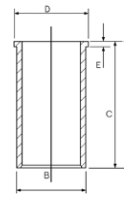

AK KK NB RT TP

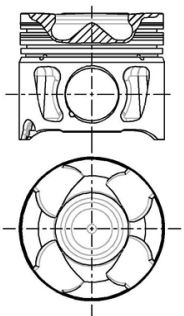

08256-102

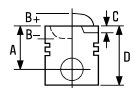

44  **82.00**

Campagnola 1.9D B 01/62 → 12/68 **605 D** 4 Cyl. 20:1
1901cc **40kW (54PS)**
Diesel **FM19243**

2 **3** **1** **B 89.00 C 164.80 D 95.00 E 99.60 F 0.80** **88-530300-00**

A 47.00
B- 3.80
D 100.00
 26x72

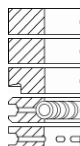
3
 3.00
 3.00
 3.00
 5.50
 5.00
 **CR**

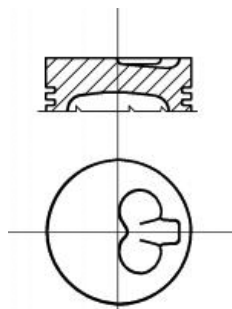
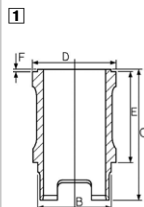

1 Liner available in Kit Set only
2 Piston available in Kit Set only
3 Ringset available in Kitset only

1 Zylinderlaufbüchse nur in Assemblies verfügbar
2 Kolben nur im Assembly erhältlich
3 Ringsätze nur im Assembly erhältlich

1 Chemise disponible en kit seulement
2 Piston disponible en kit seulement
3 Jeux de segments disponible en kit seulement

1 Camisas disponible en conjuntos solamente
2 Pistón disponible en conjuntos solamente
3 Juegos de segmentos disponible en conjuntos solamente

1 Cilindro disponibile solo in kit motore
2 I pistoni sono disponibili solo in kit motore
3 I set anelli piston sono disponibili solo in kit motore

45  **82.20**

WJY (DW8) 4 Cyl. 23:1
1868cc **51kW (69PS)**
Diesel **TD21266**

Scudo 1.9 D 04/98 → 12/06 **WJY (DW8B)** 4 Cyl. 23:1
1868cc **51kW (69PS)**
Diesel **TD22240**

14-020290-00 D **B 85.00 C 154.00 D 87.00 E 5.00**

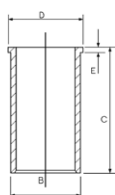



46  **82.20**

Scudo 1.9 D 04/98→12/06 **WJZ (DW8)** 4 Cyl. 23.1:1
1868cc **51-52kW (69-71PS)**
Diesel **TD16300**



87-104000-00 STD
87-104008-00 0.60mm

08-104000-00 STD
08-104008-00 0.60mm

14-020290-00 D B 85.00 C 154.00 D 87.00 E 5.00

88-104000-00
 87-104000-00 +
 14-020290-00

A 46.80
B- 1.30
D 78.00
 25x65

2.00  CK P
 2.00  P
 3.00  CR P

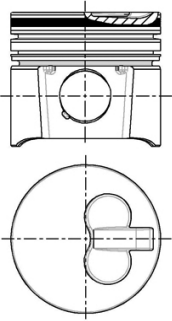
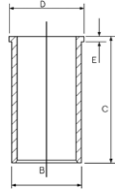

47  **82.60**

Ritmo II 60 Diesel 1.7 05/85→12/87 **138 C.000** 4 Cyl. 20:1
1677cc **44kW (60PS)**
Diesel **TD925**

Uno 1.7 D 02/88→02/92 **149 B4.046** 4 Cyl. 20:1
1697cc **42-44kW (57-60PS)**
Diesel **TD969**

14-023751-00 D B 87.00 C 154.00 D 89.00 E 4.55
14-785400-00 D B 86.00 C 144.00 D 89.00 E 4.50

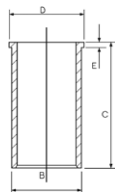

14-014730-00 D B 86.09 C 154.00

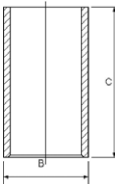

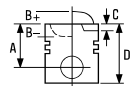

48  **82.60**

Elba 1.7 D	04/89→10/97	146 B2.000			
Fiorino 1.7 D	01/88→10/99		4 Cyl.	20.5:1	
Fiorino 60 1.7 D	05/88→10/96		1697cc	42-44kW (57-60PS)	
Uno 1.7 D	02/88→08/00	Diesel			TD949
Uno 60 Diesel 1.7	09/89→12/93				
Duna 1.7 DS, Duna Weekend 1.7 DS	01/87→12/91	149 B3.000			
Fiorino 1.7 D	12/87→10/99		4 Cyl.	20.5:1	
Fiorino 60 1.7 D	05/88→05/00		1697cc	44kW (60PS)	
Penny 1.7 D	01/86→12/90	Diesel			TD967
Regata 60 Diesel 1.7	05/85→03/89				
Regata Weekend 60 Diesel 1.7	01/84→12/89				
Ritmo II 60 Diesel 1.7	05/85→12/87				
Uno 60 Diesel 1.7	07/86→08/89				
Tipo 1.7 D	01/88→10/95	149 B4.000			
			4 Cyl.	20:1	
			1697cc	42-45kW (57-61PS)	
		Diesel			TD968
Punto 1.7 D	04/94→02/00	176 B3.000			
			4 Cyl.	20.5:1	
			1697cc	42kW (57PS)	
		Diesel			TD9477



87-782300-00 STD
87-782308-00 0.60mm

08-782300-00 STD
08-782308-00 0.60mm

→690650

→690650

A 42.60
B+ 2.40
D 81.80
 25x70

2.50  MOL P
2.00  P
4.00  CR P

14-023751-00 D
14-785400-00 D

B 87.00 C 154.00 D 89.00 E 4.55
B 86.00 C 144.00 D 89.00 E 4.50

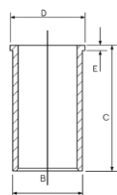

RT

14-014730-00 D

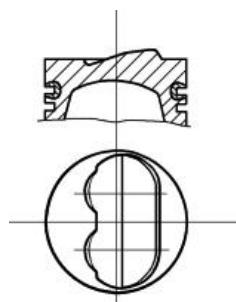
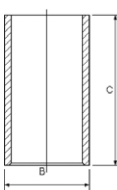

B 86.09 C 154.00





87-785400-00	STD	08-785400-00	STD
87-785408-00	0.60mm	08-785408-00	0.60mm

A 42.60
B+ 2.50
D 75.80
 25x70

690651→
 2.50  MOL P
 2.00  P
 3.00  CR P

RT

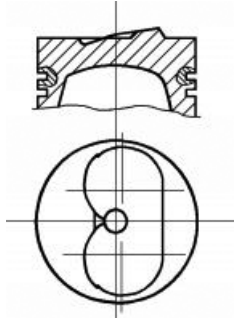



49  **82.60**

Fiorino 1.7 TD	11/96→05/00	146 D7.000			
Fiorino 1.7 TD, Fiorino 65 1.7 TD	01/97→05/01		4 Cyl.	20:1	
			1697cc	46kW (63PS)	
			Diesel	Turbo	TD9472
Palio 1.7 TD	02/97→	176 A5.000			
Palio Weekend 1.7 TD	07/97→		4 Cyl.	19.1:1	
Punto 1.7 TD	01/94→02/00		1697cc	52-59kW (71-80PS)	
			Diesel	Turbo	TD1035
Punto 1.7 TD	09/96→09/99	176 B7.000			
Siena 1.7 D	05/99→12/09		4 Cyl.	19.1:1	
			1697cc	46-47kW (63-64PS)	
			Diesel	Turbo	TD5493

87-783800-00	STD	08-783800-00	STD
87-783808-00	0.60mm	08-783808-00	0.60mm

A 42.80
B+ 2.60
D 78.60
 26x69

3.00  MOL P
 2.00  P
 3.00  CR P

AK RT

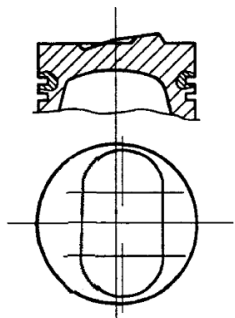

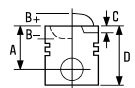

87-783800-30
87-783808-30

STD
0.60mm

08-783800-00
08-783808-00

STD
0.60mm

A 42.40
B+ 2.50
D 76.00
 26x69

3.00
2.00
3.00

MOL P
P
CR P

HA RT

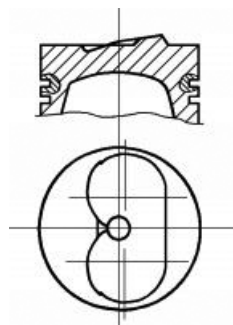

50 82.60

Regata 65 Diesel 1.9 Regata Weekend 65 Diesel 1.9	04/84→07/89	149 A1.000	4 Cyl.	21:1	
Tempra 1.9 D Tipo 1.9 D	07/91→08/96 07/91→08/95	1929cc Diesel	48kW (65PS)		TD4378
Ducato 1.9 D Talento 1.9 D	02/87→05/94 03/89→03/94	149 B1.000	4 Cyl.	21:1	
		Diesel	1929cc	51-52kW (70-71PS)	TD963
Brava 1.9 D, Bravo I 1.9 D Tempra 1.9 D Tipo 1.9 D	10/95→10/01 07/91→08/96 07/91→08/95	160 A7.000	4 Cyl.	21:1	
		Diesel	1929cc	48kW (65PS)	TD1023
Ducato 1.9 D	03/94→04/02	230 A2.000	4 Cyl.	20:1	
		Diesel	1929cc	51kW (70PS)	TD862



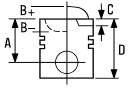

Regata 80 Turbo Diesel 1.9	05/86→07/89	831 D1.000				
Regata Weekend 80 Turbo Diesel 1.9			4 Cyl.			
Ritmo II 80 Turbo Diesel 1.9	12/85→12/87		1929cc	59kW (80PS)		
		Diesel	Turbo			TD4410

87-785400-00 STD
87-785408-00 0.60mm

08-785400-00 STD
08-785408-00 0.60mm

14-021311-00 D B 86.06 C 154.00 D 89.00 E 4.50
14-023560-00 D B 86.00 C 154.00 D 89.00 E 4.50
14-023751-00 D B 87.00 C 154.00 D 89.00 E 4.55

A 42.60
B+ 2.50
D 75.80
25x70

690651→
2.50
2.00
3.00
MOL P
P
CR P

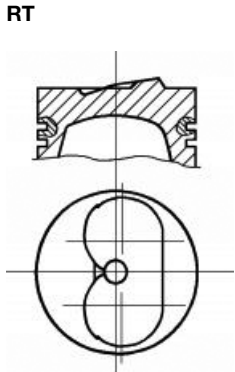
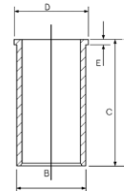

14-014730-00 D B 86.09 C 154.00

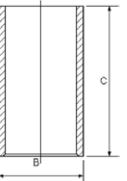

51 **82.60**

Uno 1.9 D	09/89→03/94	149 B5.046	4 Cyl.	20:1		
			1929cc	44kW (60PS)		
		Diesel				TD9602
Croma 1900 Turbo		154 B.000	4 Cyl.	20:1		
			1929cc	68kW (92PS)		
		Diesel	Turbo Intercooled			TD21460
Croma 1900 Turbo D i.d.	11/92→12/96	154 D1.000	4 Cyl.	20:1		
			1929cc	69kW (94PS)		
		Diesel	Turbo Intercooled			TD9622

14-021311-00 D B 86.06 C 154.00 D 89.00 E 4.50
14-023560-00 D B 86.00 C 154.00 D 89.00 E 4.50
14-023751-00 D B 87.00 C 154.00 D 89.00 E 4.55

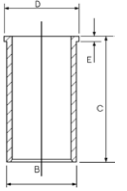

14-014730-00 D B 86.09 C 154.00

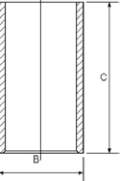

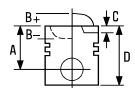

52  **82.60**

Croma 1900 Turbo D i.d.	05/89→10/92	154 C6.000	4 Cyl.	18:1	
			1929cc	66-68kW (90-92PS)	
			Diesel	Turbo Intercooled	TD9621



87-783400-00 STD

- A** 43.00
- B-** 13.20
- BØ** 43.50
- D** 71.00
-  26x65

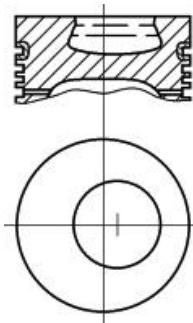
AK RT



08-783400-00 STD

- 2.50  MOL P
- 2.00  P
- 4.00  CR P

- 14-021311-00 D** B 86.06 C 154.00 D 89.00 E 4.50
- 14-023560-00 D** B 86.00 C 154.00 D 89.00 E 4.50
- 14-023751-00 D** B 87.00 C 154.00 D 89.00 E 4.55

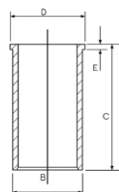

14-014730-00 D B 86.09 C 154.00

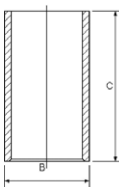

53  **82.60**

Tempra 1.9 TD	05/90→08/96	160 A6.000	4 Cyl.	19.2:1	
Tipo 1.9 TD	09/90→04/95		1929cc	66-68kW (90-92PS)	
			Diesel	Turbo Intercooled	TD4394
Tipo 1.9 TD	09/90→04/95	160 A6.046	4 Cyl.	19.2:1	
			1929cc	66kW (90PS)	
			Diesel	Turbo Intercooled	TD1022
Tempra 1.9 TD	07/92→08/96	160 B6.046	4 Cyl.		
Tempra 1.9 TD, Tipo 1.9 TD	03/92→06/93		1929cc	59kW (82PS)	
			Diesel	Turbo Intercooled	TD1025
Tempra 1.9 TD	05/90→08/96	160 D1.000	4 Cyl.		
Tipo 1.9 TD	09/90→04/95		1929cc	65-66kW (88-90PS)	
			Diesel	Turbo Intercooled	TD1026
Ducato 1.9 TD	03/94→04/02	230 A3.000	4 Cyl.	20:1	
Ducato 1.9 TD/Combinato			1929cc	60kW (82PS)	
			Diesel	Turbo	TD5481
Ducato 1.9 TD		230 A4.000 Euro 2	4 Cyl.	19:1	
Ducato 1.9 TD CAT	08/94→04/02		1929cc	59kW (80PS)	
			Diesel	Turbo	TD4407





Ducato 1.9 TD 03/89→03/94 **280 A1.000**

4 Cyl. 20:1
1929cc **60kW (82PS)**

Diesel **Turbo** **TD1043**

87-783800-10 STD
87-783808-10 0.60mm

A 43.00
B+ 2.30
D 76.00
 26x69

08-783800-00 STD
08-783808-00 0.60mm

3.00 **MOL P**
 2.00 **P**
 3.00 **CR P**

14-021311-00 D **B 86.06 C 154.00 D 89.00 E 4.50**
14-023560-00 D **B 86.00 C 154.00 D 89.00 E 4.50**
14-023751-00 D **B 87.00 C 154.00 D 89.00 E 4.55**

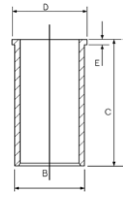

AK HA RT

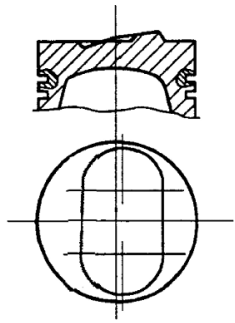

14-014730-00 D **B 86.09 C 154.00**

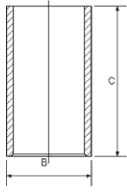

87-783800-30 STD
87-783808-30 0.60mm

A 42.40
B+ 2.50
D 76.00
 26x69

08-783800-00 STD
08-783808-00 0.60mm

3.00 **MOL P**
 2.00 **P**
 3.00 **CR P**

HA RT

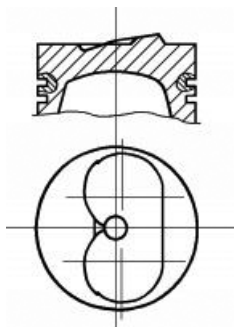

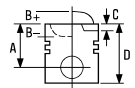





54  **82.60**

Fiorino 1.7 TD	01/04→12/05	176 A3.000			
Palio 1.7 TD	02/97→		4 Cyl.	20.3:1	
Palio Weekend 1.7 TD	04/96→03/01		1697cc	51-53kW (69-72PS)	
Punto 1.7 TD	01/94→09/99	Diesel	Turbo		TD1033
Siena 1.7 D	03/02→12/09				
Siena 1.7 TD	02/06→12/09				
Strada 1.7 TD	06/99→				

87-783800-10	STD	08-783800-00	STD
87-783808-10	0.60mm	08-783808-00	0.60mm

A	43.00	3.00		MOL P
B+	2.30	2.00		P
D	76.00	3.00		CR P
	26x69			

AK HA RT

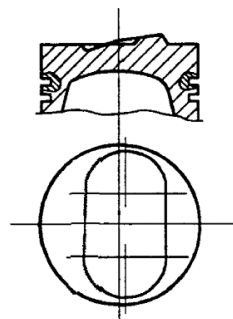

55  **83.00**

Ulysse 1.8	05/97→08/02	LFW (XU7 JP)			
			4 Cyl.	9.5:1	
			1762cc	73kW (99PS)	
					TD10167

14-634910-00 WH  **B 88.00 C 141.00 D 97.00 E 95.13**

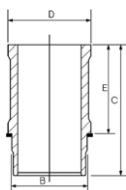





 Use also: 1 NB O-Ring HR566  Mitverwenden: 1 NB O-Ring HR566  A utiliser aussi: 1 joint toriques HR566  Utilizar también: 1 NB junta toricas HR566  Usare anche: 1 NB O-Ring HR566



56  **83.00**

Regata 60 Diesel 1.7	09/83→12/86	138 B6.000			
Ritmo II 60 Diesel 1.7	10/82→10/85		4 Cyl.	20.5:1	
			1714cc	43kW (58PS)	
Diesel					TD922

87-215100-10	STD	08-215100-10	STD
87-215108-10	0.60mm	08-215108-10	0.60mm
		08-215110-10	0.80mm
A	45.90		
B-	2.80	2.50	 MOL P
D	85.00	2.00	 P
	25x71	4.00	 CR P

RT

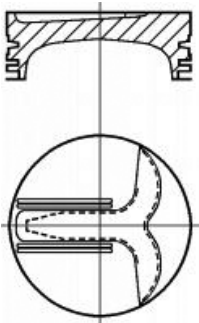

57  **83.00**

Bravo II 2.0 D Multijet	09/08→	198 A5.000			
			4 Cyl.	16.5:1	
			1956cc	121kW (165PS)	
			Diesel	Turbo Intercooled	TD24569
Bravo II 2.0 D Multijet	09/08→	844 A2.000			
			4 Cyl.	16.5:1	
			1956cc	120kW (163PS)	
			Diesel	Turbo Intercooled	TD24593
Freemont 2.0 JTD	08/11→	939 B5.000			
			4 Cyl.		
			1956cc	100-125kW (140-170PS)	
			Diesel	Turbo Intercooled	TD26620



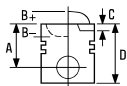

Freemont 2.0 JTD 08/11→ 940 A5.000 Euro 5
 4 Cyl. 16.5:1
 1956cc 103kW (140PS)
 Diesel Turbo Intercooled TD26672

87-436500-00 STD 08-436500-00 STD
 87-436506-00 0.40mm 08-436506-00 0.40mm

A 43.63 1.50 GDC P
 B- 15.80 1.50 P
 BØ 43.50 2.00 CR P
 D 72.63

30x66



KK RT TP

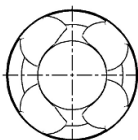
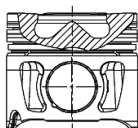

08344A406

58 83.00

Scudo 1.9 TD 02/96→12/06 D8B
 4 Cyl. 21.8:1
 1905cc 68kW (92PS)
 Diesel Turbo Intercooled TD6828

Ducato 1.9 TD 04/98→04/02 DHX (XUD9 TF/L)
 Scudo 1.9 TD 09/96→12/06 4 Cyl. 21.8:1
 Scudo 1.9 TD, Scudo 1.9 TD Eco 02/96→12/06 1905cc 66-68kW (90-92PS)
 Ulysse 1.9 TD 02/95→08/02 Diesel Turbo Intercooled TD4352

Ducato 1.9 D DHX (XUD9TE)
 Scudo 1.9 D 4 Cyl. 21.8:1
 Ulysse 1.9 D 1905cc 66-69kW (90-94PS)
 Diesel Turbo Intercooled TD21264

87-105500-00 STD 08-105500-00 STD 14-020530-00 D B 85.60 C 153.50 D 88.50 E 3.90
 87-105507-00 0.50mm 08-105507-00 0.50mm
 08-105510-00 0.80mm

A 46.75 3.00 CK
 B- 3.50 2.00 NT
 D 75.00 3.00 CR P

AK HA RT TP

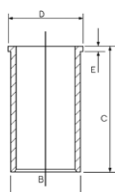
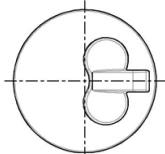
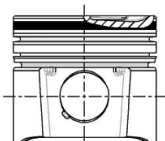

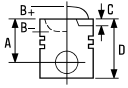

59  **83.00**



Ducato 1.9 D Scudo 1.9 D	04/98→04/02 02/96→12/06	D9B (XUD9/A/B/L/Y) 4 Cyl. 1905cc Diesel	23.5:1 50-51kW (68-69PS)	TD6827
Ducato 1.9 D	04/98→04/02	D9B (XUD9A) 4 Cyl. 1905cc Diesel	23:1 47-52kW (64-71PS)	TD21265
Ducato 1.9 D	04/98→04/02	DJY (XUD9) 4 Cyl. 1905cc Diesel	23.5:1 50-52kW (68-71PS)	TD21267
Ducato 1.9 D	04/98→04/02	DJY XUD9A 4 Cyl. 1905cc Diesel	23.8:1 50kW (68PS)	TD12748

87-152000-10 STD
87-152007-10 0.50mm
87-152010-10 0.80mm

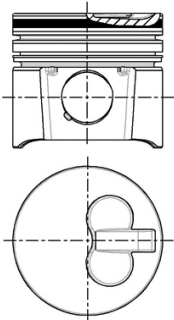
A 46.80
B- 2.20
D 84.30
 25x72



08-152000-00 STD
08-152003-00 0.125mm
08-152007-00 0.50mm
08-152010-00 0.80mm
08-152011-00 1.00mm

2.00  CR P
2.00  P
3.00  CR P

14-020530-00 D B 85.60 C 153.50 D 88.50 E 3.90

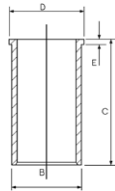

88-152000-30
87-152000-10 +
14-020530-00

60  **83.50**

500 C 0.9, 500 0.9 Panda 0.9	09/12→ 02/12→	312 A4.000 2 Cyl. 964cc Twin Air	11.1:1 44-48kW (60-65PS)	TD26432
---------------------------------	------------------	--	------------------------------------	----------------





500 0.9, Panda 0.9	12/13→	312 A6.000	2 Cyl. 964cc Twin Air	11.1:1 44kW (60PS)	TD31245
--------------------	--------	------------	-----------------------------	-----------------------	---------

87-441900-00 1 2 STD 08-441900-00 STD

A 25.43
B- 1.13
BØ 60.88
D 42.93
21x46

1.00 NT 3
1.20 P
1.50 P



TP

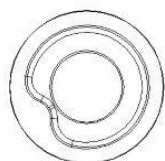
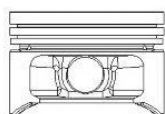

1 Piston Chamber Volume
[ccm] 4.140
2 Elastoval ®
3 Steel

1 Volumen der Kolbenmulde
[ccm] 4.140
2 Elastoval ®
3 Stahl

1 Volume de la cavité du piston
[cm³] 4.140
2 Elastoval ®
3 Acier

1 Volumen de cavidad del pistón
[cc] 4.140
2 Elastoval ®
3 Acero

1 Volume camera pistone
[cm³] 4.140
2 Elastoval ®
3 Acciaio

61 84.00

124 Spider 1800 Rally Abarth 124 Spider 1800 Sport	09/72→07/75 01/72→12/77	132 A.C1.000	4 Cyl. 1756cc	9.8:1 87kW (118PS)	TD23121
124 Spider 2000	03/82→11/85	132 C3.031	4 Cyl. 1995cc	8.9:1 76-77kW (103-105PS)	TD908
Croma 2000 CHT	12/85→09/92	154 A1.000	4 Cyl. 1995cc Turbo Intercooled	8:1 66kW (90PS)	TD1077
Croma 2000 i.e.	10/87→08/96	154 C3.046	4 Cyl. 1995cc	9.5:1 85kW (116PS)	TD984
Croma 2000 16V Tempra 2.0	08/92→08/96 10/95→12/98	154 E1.000	4 Cyl. 1995cc	101kW (137PS)	TD989
Tempra 1.8 i.e. Tipo 1.8 i.e.	03/90→08/96 10/90→10/95	159 A4.000	4 Cyl. 1756cc	9.5:1 74-81kW (101-110PS)	TD1008



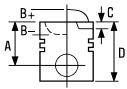

Tempra 1.8 i.e. Tipo 1.8 i.e.	03/92→08/96 10/90→06/93	159 A4.046 4 Cyl. 1756cc	9.5:1 77kW (105PS)	TD1009
Tempra 2.0 Tempra 2.0 i.e. Tipo 2.0 Tipo 2.0 i.e.	05/94→12/98 10/90→08/96 10/90→10/92 03/90→04/95	159 A6.046 4 Cyl. 1995cc	9.5:1 83-85kW (113-116PS)	TD1012
Croma 2000 i.e.	03/87→09/92	834 B.000 4 Cyl. 1995cc	9.7:1 88kW (120PS)	TD1084
Croma 2000 i.e.	03/86→09/90	834 B.048 4 Cyl. 1995cc	9.7:1 83kW (113PS)	TD1085
Croma 2000 i.e.	10/87→08/96	834 B.146 4 Cyl. 1995cc	9.7:1 85kW (116PS)	TD11707
Tempra 1.8 i.e. Tipo 1.8 i.e.	09/93→08/96 04/93→04/95	835 C2.000 4 Cyl. 1756cc	9.5:1 76kW (103PS)	TD1068
Tempra 1.8 i.e. Tipo 1.8 i.e.	09/93→08/96 09/93→04/95	835 C4.000 4 Cyl. 1756cc	66kW (90PS)	TD1069
Coupe 2.0 16V Tipo 2.0 i.e. 16V Sport	11/93→08/96 03/93→04/95	836 A3.000 4 Cyl. 1995cc	10.5:1 102kW (139PS)	TD1071
Tempra 1.8 Tempra 1.8 i.e. Tipo 1.8 i.e. Tipo 1.8 i.e.	07/94→12/98 10/94→08/96 03/93→04/95 10/94→10/95	836 A5.000 4 Cyl. 1756cc	71-74kW (97-101PS)	TD892

14-011041-00 D

B 88.06 C 152.00

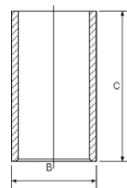

62  84.00

Croma 2000 i.e. Turbo	12/85→06/90	154 A2.000 4 Cyl. 1995cc Turbo Intercooled	8:1 114kW (155PS)	TD1083
Croma 2000 i.e. Turbo	06/87→08/96	154 C4.046 4 Cyl. 1995cc Turbo Intercooled	8:1 110kW (150PS)	TD986



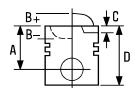

Croma 2000 i.e. Turbo 11/86→08/96 **834 C.146** 4 Cyl. 8:1
1995cc **110-112kW (150-152PS)**
Turbo Intercooled **TD1064**

87-215300-10 STD
87-215308-10 0.60mm

08-215300-10 STD
08-215306-10 0.40mm
08-215308-10 0.60mm

A 39.50
B- 4.50
D 79.00
 22x69

02/88→

1.50
 2.00
 3.94



CR P
 P
 P

14-011041-00 D B 88.06 C 152.00

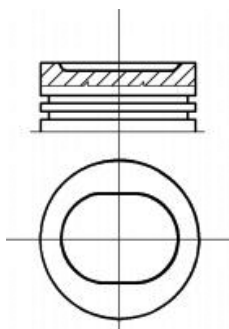
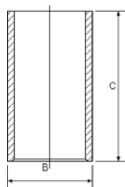

63 **84.00**

Ducato 1.8 01/82→10/88 **169 B (XM7T)** 4 Cyl. 7.5:1
1783cc **49kW (67PS)**
TD12750

14-606670-00 WH B 93.00 C 136.20 D 99.20 E 90.01

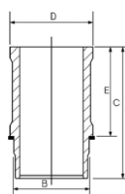

Use also: 1 NB O-Ring HR566

Mitverwenden: 1 NB O-Ring HR566

A utiliser aussi: 1 joint toriques HR566

Utilizar también: 1 NB junta toricas HR566

Usare anche: 1 NB O-Ring HR566

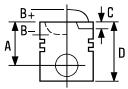

64  **84.00**



Coupe 2.0 16V Turbo	11/93→08/96	175 A1.000	4 Cyl.	8:1	
			1995cc	140kW (190PS)	
			Turbo Intercooled		TD4395

87-142400-00 STD
87-142406-00 0.40mm

08-142400-00 STD
08-142406-00 0.40mm

14-011041-00 D B 88.06 C 152.00

- A 39.00
- B- 6.00
- BØ 72.00
- C 2.00
- D 69.00
-  22x69

- 1.50 
- 1.50 
- 3.00 
- CK
- P
- P

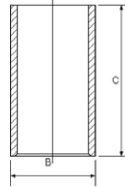

AK

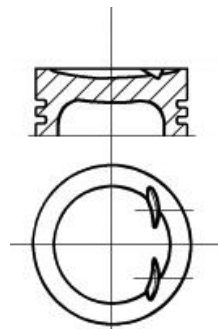

65  **85.00**



Ulysse 2.2 JTD	03/08→06/11	4HP	4 Cyl.		
			2179cc	120kW (163PS)	
		Diesel	Turbo Intercooled		TD24945
Ulysse 2.2 JTD	03/08→06/11	4HR	4 Cyl.		
			2179cc	120kW (163PS)	
		Diesel	Turbo Intercooled		TD24946
Ulysse 2.2 D Multijet	03/08→06/11	4HS Euro 4	4 Cyl.	16.6:1	
			2179cc	125kW (170PS)	
		Diesel	Turbo Intercooled		TD24775

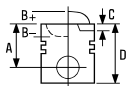



Ulysse 2.2 D Multijet 03/08 → 06/11 **4HT (DW12BTED4) Euro 4**
 4 Cyl. 16.6:1
2179cc 125kW (170PS)
Diesel Bi-Turbo Intercooled TD25656

87-436700-10 1 STD **08-436700-00** STD
87-436708-10 1 0.60mm **08-436708-00** 0.60mm

A 48.70 **2.50**  **GDC P**
B- 13.47 **2.00**  **P**
BØ 52.40 **2.00**  **CK**

C 0.38
D 74.70
 30x68



AK KK RT TP

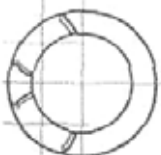

0850HA127

1 For pistons with a 24.3mm rod gap measured at pin centre line

1 Für Kolben mit einem Pleuelaugenabstand von 24,3 MM, gemessen an der Kolbenbolzen-Mitte

1 Pour pistons avec un écart de bielle de 24,3 mm mesuré au centre de l'axe bielle-piston

1 Para pistones con una distancia de paso de biela en el centro del bulón de 24,3mm



1 Per pistoni con passaggio biella di 24,3 mm misurato sull'asse foro spinotto

66  **85.00**

Ulysse 2.2 JTD 08/02 → 08/06 **4HW (DW12ATED4)**
 4 Cyl. 18:1
2179cc 94kW (128PS)
Diesel Turbo Intercooled TD16790

Ulysse 2.2 JTD **4HX (DW12TED4)**
 4 Cyl. 18:1
2179cc 94-100kW (128-136PS)
Diesel Turbo Intercooled TD22230

87-114700-30 STD **08-114700-00** STD
87-114708-30 0.60mm **08-114708-00** 0.60mm

A 48.70 **3.50**  **CK P**
B- 18.00 **2.00**  **P**
BØ 40.80 **3.00**  **CR P**

C 0.40
C 0.40
D 77.70
 30x68

AK KK RT

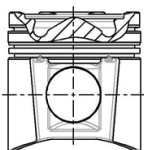







67  **85.00**

Ducato 2.0 JTD	07/01→	DW10 (RHV)	4 Cyl.	18:1
			1997cc	62kW (84PS)
		Diesel	Turbo Intercooled	TD16406

Scudo 2.0 JTD	12/99→12/06	DW10 (RHX)	4 Cyl.	17.6:1
			1998cc	69kW (94PS)
		Diesel	Turbo Intercooled	TD16299

Scudo 2.0 JTD	12/99→12/06	DW10 (RHZ)	4 Cyl.	17.6:1
Ulysse 2.0 JTD	10/99→08/02		1997cc	80kW (109PS)
		Diesel	Turbo Intercooled	TD16324

87-114700-00	STD	08-114700-00	STD
87-114708-00	0.60mm	08-114708-00	0.60mm

A	46.75	3.50		CK P
B-	18.30	2.00		P
BØ	38.00	3.00		CR P
C	1.00			
D	80.75			
	28x70			

AK RT TP

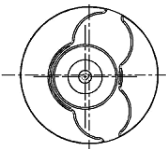
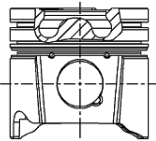

68  **85.00**

Scudo 2.0 JTD 16V	05/99→12/06	DW10ATED4 (RHM)	4 Cyl.	
Ulysse 2.0 JTD	05/03→08/06		1997cc	79kW (107PS)
		Diesel	Turbo Intercooled	TD18906





Scudo 2.0 JTD 16V	05/99→12/06	DW10ATED4 (RHS)		
Ulysse 2.0 JTD	08/02→08/06	4 Cyl.	18:1	
Ulysse 2.0 JTD 16V	05/99→08/02	1997cc	80kW (109PS)	
		Diesel	Turbo Intercooled	TD16789

87-114700-10	STD	08-114700-00	STD
87-114708-10	0.60mm	08-114708-00	0.60mm

A	46.73	3.50		CK P
B-	18.80	2.00		P
BØ	39.80	3.00		CR P

C 1.67
D 72.70
 28x68

AK KK RT TP

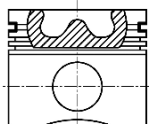
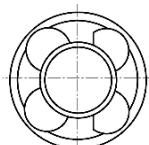

08517-103

69 85.00

Scudo 2.0 D Multijet	01/07→	RHK		
Ulysse 2.0 D Multijet	05/06→06/11	4 Cyl.	17.5:1	
		1997cc	88kW (120PS)	
		Diesel	Turbo Intercooled	TD20267

87-114700-40	STD	08-114700-00	STD
87-114708-40	0.60mm	08-114708-00	0.60mm

A	46.70	3.50		CK P
B-	15.40	2.00		P
BØ	44.80	3.00		CR P

C 0.57
D 72.70
 28x70

AK KK RT TP

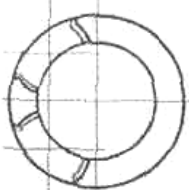

08570-109



70  **86.00**

Ulysse 2.0	06/94→08/02	RFU (XU10 J2C)	4 Cyl.	8.8:1
			1998cc	89kW (121PS)
TD4349				

Ducato 2.0	03/94→04/02	RFW (XU10J2)	4 Cyl.	8.8:1
Ducato 2.0/Combinato	03/94→04/02		1998cc	80kW (109PS)
TD6808				



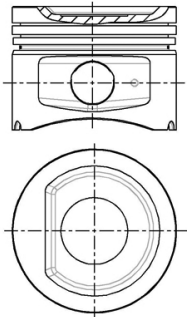

87-154600-00 STD
87-154608-00 0.60mm

A 40.00
B- 5.02
D 65.00
 22x62



 Steel

08-154600-00 STD
08-154605-00 0.25mm
08-154608-00 0.60mm

1.50  MO P
 1.75  P
 3.00  CR 

 Acier

 Acero

 Acciaio

71  **86.00**

Ducato 2.2 120		4HU Euro 4	4 Cyl.	17.5:1
			2198cc	88kW (120PS)
		Diesel	Turbo Intercooled	
TD25655				

87-427700-10 STD
87-427707-10 0.50mm

A 43.42
B- 15.85
BØ 46.90
D 69.82
 30x67

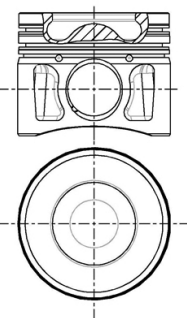

8648B105

 Steel





 Stahl

 Acier

 Acero

 Acciaio

08-427700-00 STD
08-427707-00 0.50mm

2.00  CK P
 2.00  P
 2.00  NT 

14-021120-00 D B 89.00 C 156.00 D 90.90 E 5.00

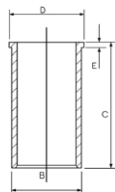

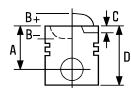





72  **86.00**

Ducato 100 Multijet 2.2 D 07/06 → **4HV Euro 4**
 4 Cyl. 17.5:1
2198cc **74kW (101PS)**
Diesel Turbo Intercooled **TD20266**

87-427700-30 STD **08-427700-00** STD **14-021120-00 D** **B 89.00 C 156.00 D 90.90 E 5.00**
87-427707-30 0.50mm **08-427707-00** 0.50mm

A 43.42
B- 15.85
BØ 46.90
D 69.82
 30x67

2.00  **CK P**
 2.00  **P**
 2.00  **NT 1**

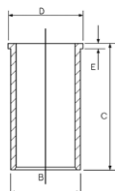

RT TP

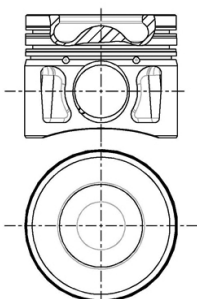

08650A105

 Steel  Stahl  Acier  Acero  Acciaio

73  **86.40**

Duna 1.6	02/96 → 09/00	159 A3.000			
Elba 1.6	04/89 → 12/93		4 Cyl.	9.2:1	
Premio 1.6	03/85 → 12/96	1581cc		62-66kW (84-90PS)	
Tempra 1.6	03/90 → 04/93				TD9787
Tipo 1.6 SX DGT	05/89 → 10/95				
Tempra 1.6 i.e.	06/90 → 08/96	159 A3.046			
Tipo 1.6	03/93 → 10/95		4 Cyl.	9.2:1	
Tipo 1.6 i.e.	07/90 → 01/93	1585cc		57-65kW (78-88PS)	
Uno 1.6	12/89 → 12/93				TD1006
Tempra 1.6	04/90 → 07/96	159 A3.048			
Tempra 1.6 i.e.	06/92 → 08/96		4 Cyl.	9.2:1	
Tipo 1.6	03/93 → 10/95	1585cc		51-66kW (69-90PS)	
Tipo 1.6 i.e.	10/92 → 04/95				TD1007
Uno 1.6 R	12/92 → 12/95				
Tipo 1.6	01/88 → 10/92	160 A2.000			
			4 Cyl.	9.2:1	
			1585cc	58-62kW (79-84PS)	
					TD1019
Punto 1.6	01/94 → 04/97	176 A9.000			
Punto 90 1.6	04/94 → 04/97		4 Cyl.	9.5:1	
			1581cc	65kW (88PS)	
					TD1039
Scudo 1.6	02/96 → 12/06	220 A 2.000			
			4 Cyl.		
			1581cc	58kW (79PS)	
					TD6826



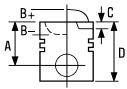





Tempra 1.6 i.e.	10/90→08/96	835 C1.000		
Tipo 1.6	03/93→10/95		4 Cyl.	9.2:1
Tipo 1.6 i.e.	10/92→04/95		1581cc	55-57kW (75-78PS)

TD1067

87-783700-00	STD	08-783700-00	STD
87-783706-00	0.40mm	08-783706-00	0.40mm
87-783708-00	0.60mm	08-783708-00	0.60mm
		08-783711-00	1.00mm

A 33.30
B- 2.30
D 72.80
 22x63

1.50		CR P
1.75		P
3.00		CR 1

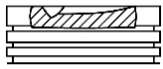
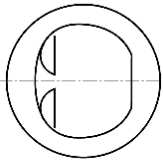

1 Steel

1 Stahl

1 Acier

1 Acero

1 Acciaio

74  **86.40**

Palio 1.6	04/96→02/03	178 B3.000 Euro 2		
Palio 1.6 16V	04/96→		4 Cyl.	10.15:1
Palio Weekend 1.6 16V	04/96→02/01		1581cc	74-78kW (100-106PS)
Siena 1.6	05/04→12/06			TD10187
Siena 1.6 16V	09/98→12/09			
Brava 1.6 16V	02/96→10/01	182 A4.000 Euro 2		
Bravo I 1.6 16V	03/96→10/01		4 Cyl.	10.5:1
Marea 1.6 100 16V, Marea Weekend 1.6 100 16V	09/96→05/02		1581cc	76kW (103PS)
Multipla 1.6 100 16V	04/99→06/10			TD4400
Brava 1.6 16V, Bravo I 1.6 16V	10/95→10/01	182 A6.000 Euro 2	4 Cyl.	10.1:1
			1581cc	66kW (90PS)
				TD4402



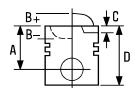

Marea 1.6	03/99→08/00	185 A3.000 Euro 2		
Marea 1.6 16V	04/97→02/99	4 Cyl.	10.1:1	
Marea 1.6 100 16V Bipower	04/99→05/02	1581cc	68-76kW (92-103PS)	TD15650

87-786800-00	STD	08-786800-00	STD
87-786806-00	0.40mm	08-786806-00	0.40mm

A 34.17
 B+ 0.25
 D 59.42
 22x56

1.50 CR P
 1.50 P
 3.00 CR 1

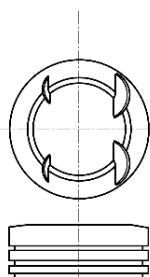

1 Steel

1 Stahl

1 Acier

1 Acero

1 Acciaio

75 **88.00**

Ducato 2.0	07/85→08/90	170 B		
Talento 2.0	03/89→03/94	4 Cyl.	55kW (75PS)	
		1971cc		TD4417

Ducato 2.0	08/88→05/94	170 D		
		4 Cyl.	62kW (84PS)	
		1971cc		TD5102

14-636500-00 WH B 93.00 C 135.70 D 101.90 E 89.98

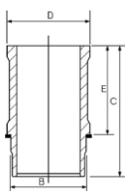



76  **88.00**









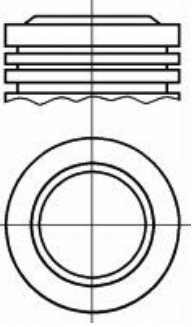

Ducato 2.0

01/82→08/90 XN 1T

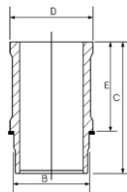
4 Cyl.
1971cc

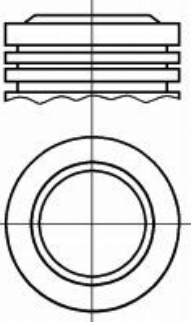
8:1
58-60kW (79-82PS)

TD4418

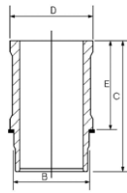

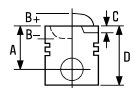

<p>1</p> <p>A 38.25 B+ 0.65 D 71.85  23x74</p> 	<p>08-316900-00 STD 08-316907-00 0.50mm</p> <p>1.50  CR P 2.00  P 4.00  CR 2</p>	<p>14-636500-00 WH B 93.00 C 135.70 D 101.90 E 89.98</p> 	<p>89-316900-00</p>
<p>1</p> <p>A 37.90 B+ 1.35 D 72.20  23x74</p> 	<p>08-316900-00 STD 08-316907-00 0.50mm</p> <p>1.50  CR P 2.00  P 4.00  CR 2</p>	<p>14-636500-00 WH B 93.00 C 135.70 D 101.90 E 89.98</p> 	<p>89-316900-10</p>
<p>1 Piston available in Kit Set only 2 Steel</p>	<p>1 Kolben nur im Assembly erhältlich 2 Stahl</p>	<p>1 Piston disponible en kit seulement 2 Acier</p>	<p>1 I pistoni sono disponibili solo in kit motore 2 Acciaio</p>



77  **88.00**

Ducato 2.3 JTD 04/02→ F1AE 0481 C Euro 3
 4 Cyl. 18.5:1
 2287cc 81kW (110PS)
 Diesel Turbo Intercooled TD16407

87-138000-00	STD	08-138000-00	STD
87-138006-00	0.40mm	08-138006-00	0.40mm
87-138008-00	0.60mm	08-138008-00	0.60mm

A	57.00	2.50	 CK P
B-	18.18	2.00	 P
BØ	38.00	2.50	 CR P
D	84.00		
	31x67		



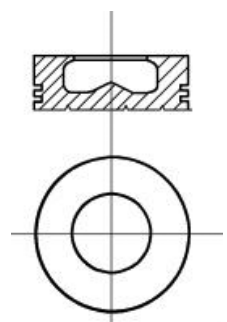

AK RT TP



78  **88.00**

Ducato 120 Multijet 2.3 D 07/06→ F1AE0481D Euro 4
 4 Cyl. 19:1
 2286cc 88kW (120PS)
 Diesel Turbo Intercooled TD20264

87-138000-10	STD	08-138000-00	STD
87-138006-10	0.40mm	08-138006-00	0.40mm
87-138008-10	0.60mm	08-138008-00	0.60mm

A	57.00	2.50	 CK P
B-	13.75	2.00	 P
BØ	50.10	2.50	 CR P
D	84.00		
	31x67		

AK KK RT TP

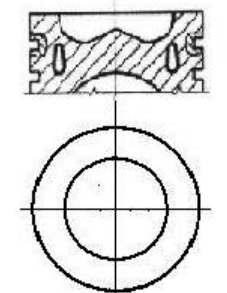







79  **92.00**

Ducato II 2.5 TD 07/94→03/98 **THY (DK5ATE)** 4 Cyl. 22:1
2446cc **96kW (131PS)**
Diesel **Turbo Intercooled** **TD22239**

87-326300-00 STD **08-326300-00** STD
87-326307-00  0.50mm **08-326307-00** 0.50mm

A 49.84 **3.00**  **P PS**
B- 2.30 **1.75**  **CR P**
D 82.00 **3.50**  **CR P**
 **34x68**

AK HA KK RT TP

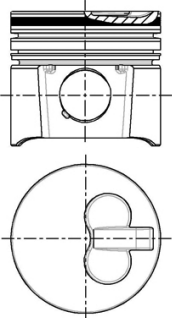

 **A = 49.470, B = 81.600**

 **A = 49.470, B = 81.600**

 **A = 49.470, B = 81.600**





 **A = 49.470, B = 81.600**

 **A = 49.470, B = 81.600**

80  **93.00**

Daily 2.5D **8140.07** 4 Cyl. 19:1
Ducato 2.5D 01/89→ **2499cc** **55kW (75PS)**
Diesel **FM19101**

87-425000-00 STD **08-425000-00** STD **14-021371-00 D** **B 96.01 C 171.00 D 98.92 E 5.00**
87-425008-00 0.60mm **08-425008-00** 0.60mm **14-021372-00 D** **B 96.05 C 171.00 D 98.92 E 5.00**
14-021480-00 DH  **B 97.03 C 171.00 D 100.00 E 5.00**

A 58.75 **3.00**  **CR P**
B- 16.90 **2.00**  **P**
BØ 40.00 **3.00**  **CR P**
D 96.75
 **32x75**

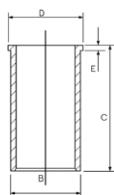

RT

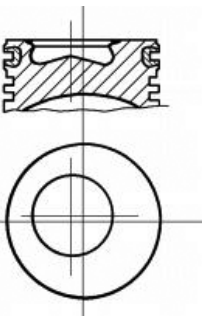

 **Nitrided**

 **Nitriert**

 **Nitridé**

 **Nitrurado**

 **Nitrurato**

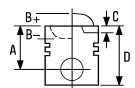

81  **93.00**

Ducato 2.5TD	01/89→12/94	8140.21.201-203 Sofim	4 Cyl. 2445cc Diesel Turbo	68kW (92PS)	FM9240
Ducato 2.5 TD	01/86→09/90	8144.21 Sofim	4 Cyl. 2445cc Diesel Turbo	18:1 68kW (92PS)	TD4419
Ducato 2.5 TD	01/87→08/90	8144.21.220	4 Cyl. 2445cc Diesel Turbo	18:1 68kW (92PS)	TD6803

87-245200-30

STD

08-245200-00

STD

14-021371-00 D

B 96.01 C 171.00 D 98.92 E 5.00

87-245208-30

0.60mm

08-245208-00

0.60mm

14-021372-00 D

B 96.05 C 171.00 D 98.92 E 5.00

A 59.65

B- 14.80

BØ 51.90

D 97.65

 32x75

3.00

2.00

3.00



CR P

P

CR P

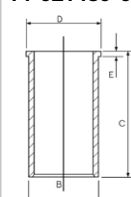

RT

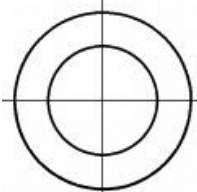
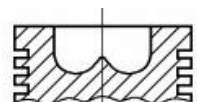

 Nitrided

 Nitriert

 Nitridé

 Niturado

 Niturato

82  **93.00**

Ducato 2.5 TD	09/86→04/02	8140.27 Sofim	4 Cyl. 2500cc Diesel Turbo	18:1 70kW (95PS)	TD1047
Ducato 2.5 TD	09/86→04/02	8140.27.2100	4 Cyl. 2500cc Diesel Turbo	18.5:1 70kW (95PS)	TD6800



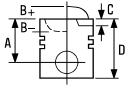

Ducato Maxi Turbo id, Ducato Turbo id 01/89→ 8140.27.2700/27R/S Sofim
 4 Cyl. 18:1
 2499cc
 Diesel Turbo FM9102

87-245200-40 STD
 87-245208-40 0.60mm

A 58.75
 B- 17.90
 BØ 38.00
 D 96.75
 32x75

RT

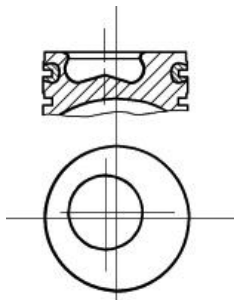

08-245200-00 STD
 08-245208-00 0.60mm

3.00 CR P
 2.00 P
 3.00 CR P



14-021371-00 D B 96.01 C 171.00 D 98.92 E 5.00
 14-021372-00 D B 96.05 C 171.00 D 98.92 E 5.00
 14-021480-00 DH ¹ B 97.03 C 171.00 D 100.00 E 5.00

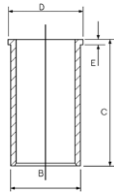

87-245200-50 STD
 87-245208-50 0.60mm

A 58.75
 B- 17.90
 BØ 38.00
 D 96.75
 32x78

AK NB RT

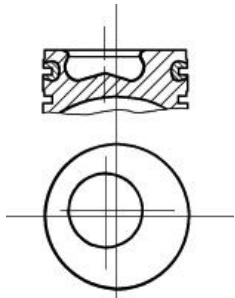

08-245200-00 STD
 08-245208-00 0.60mm

3.00 CR P
 2.00 P
 3.00 CR P



¹ Nitrided

¹ Nitriert

¹ Nitridé

¹ Nitrurado

¹ Niturato





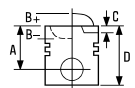

83  93.00

Ducato II 2.5 TD 10/90→04/96 8140.27S.3700 Euro 1
 4 Cyl. 18.5:1
 2499cc 77kW (105PS)
 Diesel Turbo Intercooled TD20152

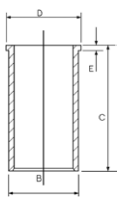

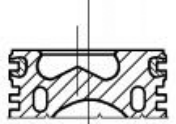
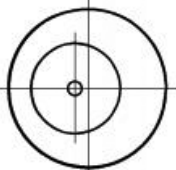

Ducato 2.5 TD	06/94→09/01	8140.47			
Ducato 2.5 TDI	03/94→04/02		4 Cyl.	18:1	
Ducato 2.5 TDI/Combinato	03/94→04/02		2499cc	80-85kW (109-116PS)	
		Diesel	Turbo Intercooled		TD1048
Ducato 2.5 TD	06/94→09/01	8140.47.3700			
Ducato 2.5 TDI	03/94→04/02		4 Cyl.	18.5:1	
Ducato 2.5 TDI/Combinato	03/94→04/02		2499cc	85kW (116PS)	
		Diesel	Turbo Intercooled		TD6809
Ducato 2.5 TDI	03/94→04/02	8140.47R Sofim			
Ducato 2.5 TDI/Combinato	07/94→04/02		4 Cyl.	18.5:1	
			2499cc	80kW (110PS)	
		Diesel	Turbo Intercooled		TD1049
Ducato 2.5 TD		8140.47R.2210			
			4 Cyl.	18.5:1	
			2499cc	80kW (110PS)	
		Diesel	Turbo Intercooled		TD6811

87-520200-00	STD	08-520200-00	STD	14-021371-00 D	B 96.01 C 171.00 D 98.92 E 5.00
A 58.75		3.00	CR	14-021372-00 D	B 96.05 C 171.00 D 98.92 E 5.00
B- 18.40		2.00	P	14-021480-00 DH 1	B 97.03 C 171.00 D 100.00 E 5.00
BØ 38.00		3.00	CR P		
D 96.75					
 32x78					
AK KK NB RT					
					
					
 Nitriert	 Nitriert	 Nitridé	 Niturado	 Niturato	

84  **93.00**

Ducato 2.5 D	09/86→05/90	8140.61			
			4 Cyl.	21:1	
			2445cc	53-55kW (72-75PS)	
		Diesel			TD1050
131 2.5 TD	06/78→12/84	8142.61			
			4 Cyl.	22:1	
			2445cc	53kW (72PS)	
		Diesel			TD1053
131 2.5 D	06/78→02/84	8144.61			
131 2.5 Super Diesel	03/79→12/84		4 Cyl.	22:1	
132 2.5 D	07/78→07/82		2445cc	53-55kW (72-75PS)	
Argenta 2500 Diesel	06/81→11/85	Diesel			TD4408
Ducato 2.4 D	01/82→08/90				
Ducato 2.5 D	09/86→05/90				



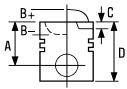

Campagnola 2.4 D	06/74→10/89	8144.61.200 (Sofim)	4 Cyl. 2445cc	22:1 53kW (72PS)	
		Diesel			TD6796

Argenta 2500 Turbodiesel	07/83→08/85	8144.61.500.81	4 Cyl. 2445cc	22:1 66kW (90PS)	
		Diesel	Turbo		TD1054

87-214500-00 STD
87-214508-00 0.60mm

08-214500-10 STD
08-214508-10 0.60mm

14-022560-00 D
14-028930-00 D
14-028931-00 D
14-028932-00 D

B 96.00 C 167.30 D 98.90 E 5.00
B 97.50 C 167.00 D 100.90 E 5.00
B 97.58 C 167.00 D 100.90 E 5.00
B 97.70 C 167.00 D 100.90 E 5.00

A 54.80
B- 2.20
D 89.80
 32x75

06/81→
3.00
2.00
4.00



CR P
P
CR P

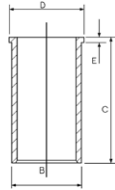

HA RT

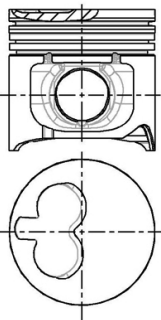

85  **93.00**

Daily	04/78→07/82	8140.61.204	4 Cyl. 2445cc	21:1 53kW (72PS)	
		Diesel			TD1051

Ducato	01/84→12/86	8144.81.2000	4 Cyl. 2445cc	22:1 66-74kW (90-101PS)	
		Diesel			TD1057

Croma 2500 TD	12/85→08/89	8144.91	4 Cyl. 2445cc	18:1 74kW (101PS)	
		Diesel	Turbo Intercooled		TD1058

Croma 2500 TD	12/85→08/89	8144.97.2200	4 Cyl. 2499cc	22:1 86-87kW (117-118PS)	
		Diesel	Turbo Intercooled		TD1062



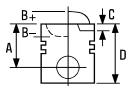

Croma 2500 TD	12/85 → 08/89	8144.97.2500	4 Cyl. 2500cc	22.5:1 85kW (118PS)	
			Diesel	Turbo Intercooled	TD1063

14-022560-00 D	B 96.00 C 167.30 D 98.90 E 5.00
14-028930-00 D	B 97.50 C 167.00 D 100.90 E 5.00
14-028931-00 D	B 97.58 C 167.00 D 100.90 E 5.00
14-028932-00 D	B 97.70 C 167.00 D 100.90 E 5.00

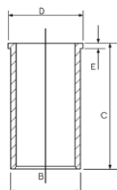

86 **93.00**

Ducato 2.5 D	03/94 → 04/02	8140.67	4 Cyl. 2500cc	22:1 55-62kW (75-84PS)	
			Diesel	Turbo	TD1052

Ducato 2.5 TD		8140.67.2700	4 Cyl. 2499cc	22:1 62kW (85PS)	
			Diesel	Turbo	TD6810

87-425000-10	STD	08-425000-00	STD	14-021371-00 D	B 96.01 C 171.00 D 98.92 E 5.00
87-425008-10	0.60mm	08-425008-00	0.60mm	14-021372-00 D	B 96.05 C 171.00 D 98.92 E 5.00
				14-021480-00 DH	B 97.03 C 171.00 D 100.00 E 5.00

A	54.00
B-	2.20
D	89.00
	32x68

3.00		CR P
2.00		P
3.00		CR P

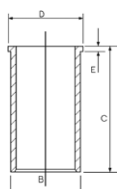

HA RT

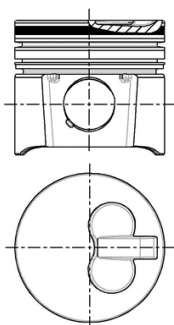

Nitrided

Nitriert

Nitridé

Niturado

Niturato





87 **93.00**

Croma 2500 D	12/85 → 12/89	8144.67	4 Cyl. 2500cc	22:1 55kW (75PS)	
Ducato 2.5 D	01/82 → 05/94		Diesel		TD1056



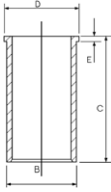

Ducato 2.5 D		8144.67.220		4 Cyl.	22:1	
				2499cc	55kW (75PS)	
		Diesel				TD6797

87-783300-00	STD	08-783300-00	STD	14-022560-00 D	B 96.00 C 167.30 D 98.90 E 5.00
87-783308-00	0.60mm	08-783308-00	0.60mm	14-028930-00 D	B 97.50 C 167.00 D 100.90 E 5.00
A	54.00	3.00		14-028931-00 D	B 97.58 C 167.00 D 100.90 E 5.00
B-	2.20	2.00		14-028932-00 D	B 97.70 C 167.00 D 100.90 E 5.00
D	89.00	3.00			
	32x75				

HA RT

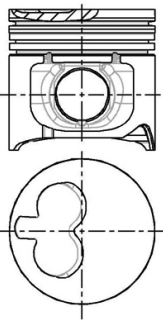

88  **93.00**

Croma 2500 TDE	12/91→08/96	8144.97 S Sofim	4 Cyl.	18:1	
			2500cc	77kW (105PS)	
		Diesel	Turbo Intercooled		TD1059
Croma 2500 TD	05/89→08/96	8144.97 Sofim	4 Cyl.	18:1	
			2499cc	85kW (115PS)	
		Diesel	Turbo Intercooled		TD1061
Croma 2500 TD	05/89→08/96	8144.97 Y Sofim	4 Cyl.	18:1	
			2500cc	85kW (115PS)	
		Diesel	Turbo Intercooled		TD1060
Croma 2500 TD	05/89→08/96	8144.97.2400	4 Cyl.	21:1	
			2499cc	83-87kW (113-118PS)	
		Diesel	Turbo Intercooled		TD22316

14-021371-00 D	B 96.01 C 171.00 D 98.92 E 5.00
14-021372-00 D	B 96.05 C 171.00 D 98.92 E 5.00
14-021480-00 DH 	B 97.03 C 171.00 D 100.00 E 5.00

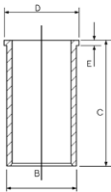

 Nitrided

 Nitriert

 Nitridé

 Niturado

 Nitrurato

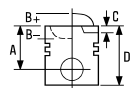

89  **93.00**

242-Serie 2.5 D	08/80 → 07/82	B 25.637	4 Cyl. 2498cc	22.25:1 51kW (69PS)	TD21463
Diesel					

Ducato 2.5 D	01/82 → 08/90	CRD93L (U25-661)	4 Cyl. 2500cc	22.25:1 54-55kW (73-75PS)	TD22981
Diesel					



87-152700-00 STD
87-152707-00 0.50mm

08-152700-00 STD
08-152707-00 0.50mm

14-013481-00 D B 96.10 C 163.00

A 52.75
B- 7.30
D 87.75
 30x78

08/84 →

2.50  MOL P
2.00  P
4.00  CR P

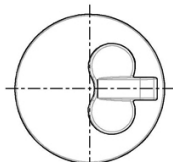
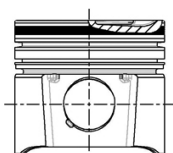
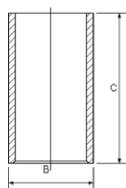

90  **94.40**

Ducato 2.8 iDTD	05/98 → 09/01	8140.43	4 Cyl.	18.5:1	
Ducato 2.8 JTD	11/03 → 07/06		2800cc	90kW (122PS)	
Ducato 2.8 TD	05/98 → 07/06		Turbo		TD11769
Ducato 2.8 TDI	10/97 → 04/02	Diesel			



87-122200-10 STD
87-122208-10 0.60mm

08-122200-00 STD
08-122208-00 0.60mm

14-021321-00 D B 97.54 C 167.00 D 100.90 E 5.00
14-028930-00 D B 97.50 C 167.00 D 100.90 E 5.00
14-028931-00 D B 97.58 C 167.00 D 100.90 E 5.00
14-028932-00 D B 97.70 C 167.00 D 100.90 E 5.00

A 58.75
B- 19.40
BØ 39.25
D 87.60
 32x72

2572280 →

2.50  CK P
2.00  P
2.50  CR P

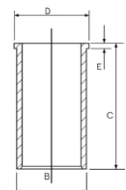

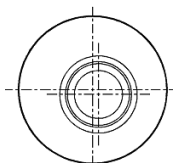
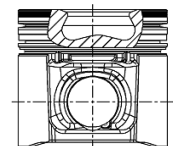

AK KK RT TP

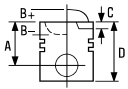



87-854700-00 STD 08-854700-00 STD
 87-854708-00 0.60mm 08-854708-00 0.60mm

A 58.75
 B- 19.40
 BØ 39.40
 D 96.65
 32x78

→2572279
 3.00  CR
 2.00  P
 3.00  CR

AK KK RT

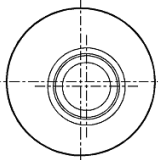
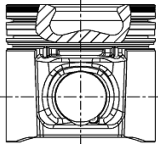



91  94.40

Ducato 2.8 JTD	04/04→07/06	8140.43N Euro 3	4 Cyl.	18.5:1	
Ducato 2.8 JTD Power	05/04→		2798cc	107kW (146PS)	
		Diesel	Turbo Intercooled		TD20450
Ducato 2.8 JTD	11/00→	8140.43S Euro 3	4 Cyl.	18.5:1	
			2800cc	94kW (128PS)	
		Diesel	Turbo Intercooled		TD16196

87-122200-00 STD 08-122200-00 STD 14-021321-00 D B 97.54 C 167.00 D 100.90 E 5.00
 87-122208-00 0.60mm 08-122208-00 0.60mm 14-028930-00 D B 97.50 C 167.00 D 100.90 E 5.00
 14-028931-00 D B 97.58 C 167.00 D 100.90 E 5.00
 14-028932-00 D B 97.70 C 167.00 D 100.90 E 5.00

A 58.70
 B- 21.30
 BØ 39.40
 D 87.60
 32x72

2.50  CK P
 2.00  P
 2.50  CR P

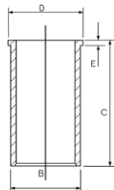



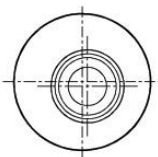
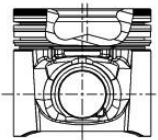

AK KK RT TP





92  **94.40**

Ducato 2.8 D	02/98→04/02	8140.63 Sofim		
Ducato 2.8 TD	05/98→11/01		4 Cyl.	21:1
			2798cc	64kW (87PS)
Diesel				TD12749

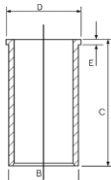

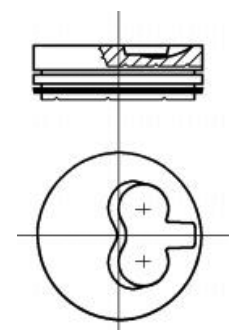

87-108200-00	STD	08-108200-00	STD	14-021321-00 D	B 97.54 C 167.00 D 100.90 E 5.00
87-108208-00	0.60mm	08-108208-00	0.60mm	14-028930-00 D	B 97.50 C 167.00 D 100.90 E 5.00
A 55.00		3.00		14-028931-00 D	B 97.58 C 167.00 D 100.90 E 5.00
B- 2.80		2.00		14-028932-00 D	B 97.70 C 167.00 D 100.90 E 5.00
D 90.00		2.50			
 32x68					

AK HA RT TP







93  **95.80**

Ducato 160 Multijet 3;0 D		F1CE0481D Euro 4		
Ducato 160 Multijet 3.0 D	07/06→		4 Cyl.	19:1
			2999cc	115-116kW (156-158PS)
Diesel				TD20265
Turbo Intercooled				

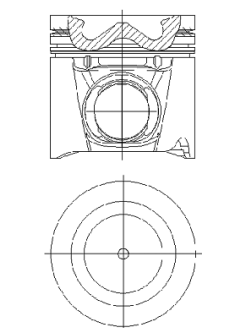



87-421600-00	STD	08-421600-00	STD	
A 63.00		2.50		CK P
B- 16.00		2.00		P
BØ 50.50		2.50		CR P
D 93.50				
 36x80				





AK KK RT TP











		ccm	x 		9
---	---	-----	--	---	----------





1Z	Petrol	1558	4	82.55	38
	Diesel	1896	4	79.50	17
4AA 2401E York Parent Block	Diesel	2358	4	93.67	69
4AB	Diesel	2496	4	93.67	70
4BA	Diesel	2496	4	93.67	70
4BC	Diesel	2496	4	93.67	71
4CA	Diesel	2496	4	93.67	70
4CC	Diesel	2496	4	93.67	70
4DA	Diesel	2496	4	93.67	70
4EA	Diesel	2496	4	93.67	72
4EB	Diesel	2496	4	93.67	72
4EC	Diesel	2496	4	93.67	72
4ED	Diesel	2496	4	93.67	73
4FA	Diesel	2496	4	93.67	71
4FB	Diesel	2496	4	93.67	71
4FC	Diesel	2496	4	93.67	71
4FD	Diesel	2496	4	93.67	71
4GA	Diesel	2496	4	93.67	71
4GB	Diesel	2496	4	93.67	74
4GC	Diesel	2496	4	93.67	74
4GD	Diesel	2496	4	93.67	74
4GE	Diesel	2496	4	93.67	74
4GF	Diesel	2496	4	93.67	74
4HA	Diesel	2496	4	93.67	74
4HB	Diesel	2496	4	93.67	71
4HC	Diesel	2496	4	93.67	71
4HD	Diesel	2496	4	93.67	74
4RC TL20L	Petrol	1993	4	90.80	63
4.108	Diesel	1760	4	79.38	16
711M	Petrol	1599	4	80.98	26
711M uprated	Petrol	1599	4	80.98	27
2402E York Parent Block	Diesel	3537	6	93.67	69
2737E Low compression	Petrol	1599	4	80.98	26
A9A	Petrol	1299	4	74.00	4
A9B	Petrol	1299	4	74.00	4
AAA	Petrol	2792	V6	81.00	30
ABFA Dura Torq DI	Diesel	1998	4	86.00	44
AFN	Diesel	1896	4	79.50	17
AHU	Diesel	1896	4	79.50	17
AJM	Diesel	1896	4	79.50	18
AMY	Petrol	2792	V6	81.00	30
ANU	Diesel	1896	4	79.50	19
AODA	Petrol	1999	4	87.50	51
AODB	Petrol	1999	4	87.50	51
AODE	Petrol	1999	4	87.50	51
ASDA	Petrol	1388	4	76.00	10
ASDB	Petrol	1388	4	76.00	10
ASZ	Diesel	1896	4	79.50	20
AUY	Diesel	1896	4	79.50	18
AVG	Diesel	1896	4	79.50	17
BAA	Petrol	1299	4	74.00	5
BHDA Endura DI	Diesel	1753	4	82.50	32
BHDB Endura DI	Diesel	1753	4	82.50	32
BHPA Endura DI	Diesel	1753	4	82.50	33
C9DA Endura DI	Diesel	1753	4	82.50	32
C9DB Endura DI	Diesel	1753	4	82.50	32
C9DC Endura DI	Diesel	1753	4	82.50	32
CGBA Duratec HE	Petrol	1796	4	83.00	39
CGBB Duratec HE	Petrol	1796	4	83.00	39
CHBA Duratec HE	Petrol	1796	4	83.00	39
CHBB Duratec HE	Petrol	1796	4	83.00	39
CJBA Duratec HE	Petrol	1999	4	87.50	51
CJBB Duratec HE	Petrol	1999	4	87.50	51
CSDA Duratec HE	Petrol	1798	4	83.00	39
CSDB Duratec HE	Petrol	1798	4	83.00	39
CVF5 Duratorq	Diesel	2198	4	86.00	45
CVRA Duratorq	Diesel	2198	4	86.00	45
CVRB Duratorq	Diesel	2198	4	86.00	45
CVRC Duratorq	Diesel	2198	4	86.00	45

		ccm	x 		9
CYRA Duratorq	Diesel	2198	4	86.00	46
CYRB Duratorq	Diesel	2198	4	86.00	46
D2FA Duratorq	Diesel	2402	4	89.90	55
D2FB Duratorq	Diesel	2402	4	89.90	55
D2FE	Diesel	2402	4	89.90	55
D3FA	Diesel	1998	4	86.00	44
D4FA Duratorq	Diesel	2402	4	89.90	56
D5BA Dura Torq DI	Diesel	1998	4	86.00	44
D6BA Dura Torq DI	Diesel	1998	4	86.00	47
DOFA (DT24) Duratorq	Diesel	2402	4	89.90	57
E5FA	Petrol	2295	4	89.60	54
E5FC	Petrol	2295	4	89.60	54
EDBA Zetec E	Petrol	1988	4	84.80	40
EDBB Zetec E	Petrol	1988	4	84.80	40
EDBC Zetec E	Petrol	1988	4	84.80	40
EDBD Zetec E	Petrol	1988	4	84.80	40
EDDB Zetec E	Petrol	1988	4	84.80	40
EDDC Zetec E	Petrol	1988	4	84.80	40
EDDF Zetec E	Petrol	1988	4	84.80	40
F3FA Duratorq	Diesel	1998	4	86.00	44
F4FA Duratorq	Diesel	2402	4	89.90	55
F6JA (DV4TD)	Diesel	1399	4	73.70	3
F6JB (DV4TD)	Diesel	1399	4	73.70	3
F9DA	Diesel	1753	4	82.50	34
F9DB	Diesel	1753	4	82.50	34
FFDA	Diesel	1753	4	82.50	34
FHA Zetec SE	Petrol	1388	4	76.00	11
FHD Zetec SE	Petrol	1388	4	76.00	11
FHE Zetec SE	Petrol	1388	4	76.00	11
FHF Zetec SE	Petrol	1388	4	76.00	11
FIFA Duratorq	Diesel	1998	4	86.00	47
FMBA	Diesel	1998	4	86.00	47
FXDA Zetec SE	Petrol	1388	4	76.00	10
FXDB Zetec SE	Petrol	1388	4	76.00	10
FXDC Zetec SE	Petrol	1388	4	76.00	10
FXDD Zetec SE	Petrol	1388	4	76.00	10
FXFA Duratorq	Diesel	2402	4	89.90	56
FXJA	Petrol	1388	4	76.00	10
FXJB	Petrol	1388	4	76.00	10
FYDA Zetec SE	Petrol	1596	4	79.00	13
FYDB Zetec SE	Petrol	1596	4	79.00	13
FYDC Zetec SE	Petrol	1596	4	79.00	13
FYDD Zetec SE	Petrol	1596	4	79.00	13
FYDH Zetec SE	Petrol	1596	4	79.00	13
FYJA	Petrol	1596	4	79.00	13
FYJB	Petrol	1597	4	79.00	13
G6A	Petrol	1118	4	68.70	1
G8DA	Diesel	1560	4	75.00	8
G8DB	Diesel	1560	4	75.00	8
GBVAJPF Duratorq	Diesel	2198	4	86.00	45
GBVAJQJ Duratorq	Diesel	2198	4	86.00	45
GBVAJQW Duratorq	Diesel	2198	4	86.00	45
GLC	Petrol	1117	4	74.00	6
GSE	Petrol	1117	4	74.00	6
GSF	Petrol	1117	4	74.00	6
GSG	Petrol	1117	4	74.00	6
GUD	Petrol	1118	4	68.70	2
GUE	Petrol	1118	4	68.70	2
GUF	Petrol	1118	4	68.70	1
H9FA Euro 4	Diesel	2402	4	89.90	58
H9FB Euro 4	Diesel	2402	4	89.90	59
HCPA Duratorq	Diesel	1753	4	82.50	33
HCPB Duratorq	Diesel	1753	4	82.50	33
HHDA Euro 4	Diesel	1560	4	75.00	8
HHDB Euro 4	Diesel	1560	4	75.00	8
HHJA	Diesel	1560	4	75.00	8
HHJB	Diesel	1560	4	75.00	8
HHJC Duratorq	Diesel	1560	4	75.00	8
HHJD Duratorq	Diesel	1560	4	75.00	8

		ccm	x 		9
HHJE Duratorq	Diesel	1560	4	75.00	8
HJBA	Diesel	1998	4	86.00	47
HJBB	Diesel	1998	4	86.00	47
HJBC	Diesel	1998	4	86.00	47
HWDA	Petrol	1596	4	79.00	14
HWDB	Petrol	1596	4	79.00	14
HXDA Duratec	Petrol	1596	4	79.00	14
HXDB Duratec	Petrol	1596	4	79.00	14
J2	Petrol	1298	4	80.98	28
J4B / BL13 Endura E	Petrol	1299	4	74.00	7
J4C Endura E	Petrol	1299	4	74.00	5
J4D Endura E	Petrol	1299	4	74.00	5
J4J Endura E	Petrol	1299	4	74.00	5
J4K Endura E	Petrol	1299	4	74.00	5
J4L Endura E	Petrol	1299	4	74.00	5
J4M Endura E	Petrol	1299	4	74.00	5
J4N Endura E	Petrol	1299	4	74.00	5
J4P Endura E	Petrol	1299	4	74.00	5
J4Q Endura E	Petrol	1299	4	74.00	5
J4R Endura E	Petrol	1299	4	74.00	5
J4S Endura E	Petrol	1299	4	74.00	5
J4T Endura E	Petrol	1299	4	74.00	5
J6A	Petrol	1299	4	74.00	7
J6B	Petrol	1299	4	74.00	7
JBA	Petrol	1299	4	74.00	5
JBB	Petrol	1299	4	74.00	5
JBC	Petrol	1299	4	74.00	5
JBD	Petrol	1299	4	74.00	5
JBE	Petrol	1299	4	74.00	7
JJA Endura E	Petrol	1299	4	74.00	5
JJB/Endura E	Petrol	1299	4	74.00	5
JJC Endura E	Petrol	1299	4	74.00	5
JJD Endura E	Petrol	1299	4	74.00	5
JJE/Endura E	Petrol	1299	4	74.00	5
JJF Endura E	Petrol	1299	4	74.00	5
JJG Endura E	Petrol	1299	4	74.00	5
JJH Endura E	Petrol	1299	4	74.00	5
JJJ Endura E	Petrol	1299	4	74.00	5
JJK Endura E	Petrol	1299	4	74.00	5
JJL Endura E	Petrol	1299	4	74.00	5
JJM Endura E	Petrol	1299	4	74.00	5
JLB	Petrol	1299	4	74.00	5
JXFA Euro 4	Diesel	2402	4	89.90	59
KKDA Euro 4	Diesel	1753	4	82.50	37
KL16L (751M)	Petrol	1599	4	80.98	26
KNBA Duratorq	Diesel	2179	4	85.00	41
KNBB Duratorq	Diesel	2179	4	85.00	41
KNWA Duratorq	Diesel	2179	4	85.00	41
KNWB Duratorq	Diesel	2179	4	85.00	41
L1E Zetec	Petrol	1597	4	76.00	12
L1F Zetec	Petrol	1597	4	76.00	12
L1G Zetec	Petrol	1597	4	76.00	12
L1H Zetec E	Petrol	1597	4	76.00	12
L1V Zetec SE	Petrol	1596	4	79.00	15
L1J Zetec E	Petrol	1597	4	76.00	12
L1K Zetec E	Petrol	1597	4	76.00	12
L1T Zetec SE	Petrol	1596	4	79.00	15
L1W	Petrol	1596	4	79.00	15
L3E	Petrol	1599	4	80.98	29
L4B	Petrol	1598	4	79.96	22
LC	Petrol	1599	4	80.98	29
LCE	Petrol	1593	4	87.65	52
LCK	Petrol	1593	4	87.65	52
LCN	Petrol	1593	4	87.65	52
LCS	Petrol	1593	4	81.30	31
LCT	Petrol	1593	4	81.30	31
LEC	Petrol	1593	4	87.65	52
LHA	Petrol	1597	4	79.96	23
LJB	Petrol	1597	4	79.96	22

		ccm	x 		9
LNB	Petrol	1597	4	79.96	23
LP1	Petrol	1597	4	79.96	22
LP2	Petrol	1597	4	79.96	22
LPA	Petrol	1597	4	79.96	22
LR1	Petrol	1597	4	79.96	22
LR2	Petrol	1597	4	79.96	22
LRA	Petrol	1597	4	79.96	22
LRB	Petrol	1597	4	79.96	22
LSD TL16E E-MAX	Petrol	1593	4	81.30	31
LSE TL16E E-MAX	Petrol	1593	4	81.30	31
LTA	Diesel	1608	4	80.00	24
LTB	Diesel	1608	4	80.00	24
LTC	Diesel	1608	4	80.00	24
LUA	Petrol	1597	4	79.96	22
LUB	Petrol	1597	4	79.96	22
LUC	Petrol	1597	4	79.96	22
LUD	Petrol	1597	4	79.96	22
LUG	Petrol	1597	4	79.96	22
LUJ	Petrol	1597	4	79.96	22
LUK	Petrol	1597	4	79.96	22
N4A	Petrol	1993	4	90.80	64
N4I	Petrol	1993	4	90.80	64
N4JB Duratec ST	Petrol	1999	4	87.50	51
N7BA	Diesel	1998	4	86.00	47
N8C (DL20H)	Petrol	1998	4	86.00	42
N8D	Petrol	1993	4	90.80	64
N9C	Petrol	1998	4	86.00	42
N9F	Petrol	1998	4	86.00	42
N9K	Petrol	1998	4	86.00	42
NAE TL20L	Petrol	1993	4	90.80	65
NAT TL20L	Petrol	1993	4	90.80	65
NAV TL20L	Petrol	1993	4	90.80	65
NE	Petrol	1993	4	90.80	66
NE1	Petrol	1993	4	90.80	64
NE4	Petrol	1993	4	90.80	64
NE5	Petrol	1993	4	90.80	64
NEE	Petrol	1993	4	90.80	66
NEG	Petrol	1993	4	90.80	66
NEJ	Petrol	1993	4	90.80	64
NEK	Petrol	1993	4	90.80	66
NEL	Petrol	1993	4	90.80	64
NEN	Petrol	1993	4	90.80	66
NEP	Petrol	1993	4	90.80	66
NER	Petrol	1993	4	90.80	66
NES	Petrol	1993	4	90.80	64
NET	Petrol	1993	4	90.80	64
NGA Zetec E	Petrol	1988	4	84.80	40
NR2	Petrol	1993	4	90.80	64
NRA	Petrol	1993	4	90.80	64
NRB	Petrol	1993	4	90.80	64
NRI	Petrol	1993	4	90.80	64
NSD	Petrol	1998	4	86.00	43
NSE	Petrol	1998	4	86.00	43
NSF	Petrol	1998	4	86.00	43
P7PA Duratorq	Diesel	1753	4	82.50	33
P7PB Duratorq	Diesel	1753	4	82.50	33
P8FA	Diesel	2198	4	86.00	48
P8FB	Diesel	2198	4	86.00	48
P9PA Duratorq	Diesel	1753	4	82.50	33
P9PB Duratorq	Diesel	1753	4	82.50	33
P9PC Duratorq	Diesel	1753	4	82.50	33
P9PD Duratorq	Diesel	1753	4	82.50	33
PGFA Euro 4	Diesel	2198	4	86.00	50
PGFB	Diesel	2198	4	86.00	50
PHFA	Diesel	2402	4	89.90	60
PHFC Euro 4	Diesel	2402	4	89.90	60
PNBA	Petrol	1596	4	79.00	14
Q7DA Duratec HE	Petrol	1798	4	83.00	39
QJBA Duratorq	Diesel	2198	4	86.00	49

		ccm	x 		9
QJBB Duratorq	Diesel	2198	4	86.00	49
QJBC Duratorq	Diesel	2198	4	86.00	49
QJBD Duratorq	Diesel	2198	4	86.00	49
QQDA Duratec HE	Petrol	1798	4	83.00	39
QQDB Duratec HE	Petrol	1798	4	83.00	39
QVFA Euro 4	Diesel	2198	4	86.00	49
QWFA	Diesel	2198	4	86.00	49
R2C	Petrol	1769	4	79.94	21
R2PA Duratorq	Diesel	1753	4	82.50	33
R3PA Duratorq	Diesel	1753	4	82.50	33
R6A	Petrol	1769	4	79.94	21
RDA Zetec	Petrol	1796	4	80.60	25
RDB Zetec	Petrol	1796	4	80.60	25
RFA	Diesel	1753	4	82.50	35
RFB	Diesel	1753	4	82.50	35
RFD	Diesel	1753	4	82.50	35
RFK	Diesel	1753	4	82.50	35
RFL	Diesel	1753	4	82.50	35
RFM	Diesel	1753	4	82.50	35
RFN	Diesel	1753	4	82.50	35
RFS Endura-DE	Diesel	1753	4	82.50	35
RFU	Diesel	1753	4	82.50	35
RKA Zetec	Petrol	1796	4	80.60	25
RKB Zetec E	Petrol	1796	4	80.60	25
RKC Zetec E	Petrol	1796	4	80.60	25
RKF Zetec E	Petrol	1796	4	80.60	25
RKH Zetec E	Petrol	1796	4	80.60	25
RKJ Zetec E	Petrol	1796	4	80.60	25
RKK Zetec E	Petrol	1796	4	80.60	25
RQB Zetec	Petrol	1796	4	80.60	25
RQC Zetec	Petrol	1796	4	80.60	25
RTA (D18NA)	Diesel	1753	4	82.50	36
RTB (D18NA)	Diesel	1753	4	82.50	36
RTC (D18NA)	Diesel	1753	4	82.50	36
RTD (D18NA)	Diesel	1753	4	82.50	36
RTE (D18NA)	Diesel	1753	4	82.50	36
RTF (D18NA)	Diesel	1753	4	82.50	36
RTG (D18NA)	Diesel	1753	4	82.50	36
RTH (D18NA)	Diesel	1753	4	82.50	36
RTJ Endura-DE	Diesel	1753	4	82.50	36
RTK Endura-DE	Diesel	1753	4	82.50	36
RVA Endura-DE	Diesel	1753	4	82.50	35
RWPA Duratorq	Diesel	1753	4	82.50	37
RWPC Duratorq	Diesel	1753	4	82.50	37
RWPD Duratorq	Diesel	1753	4	82.50	37
RWPE Duratorq	Diesel	1753	4	82.50	33
RWPF Duratorq	Diesel	1753	4	82.50	33
SAFA Duratorq	Diesel	3199	5	89.90	61
SAFB Duratorq	Diesel	3199	5	89.90	61
SCB	Diesel	2500	4	92.00	67
SCC	Diesel	2500	4	92.00	68
SDBA Duratorq	Diesel	1998	4	86.00	44
SFA (XD3T)	Diesel	2498	4	94.00	75
SFB (XD3T)	Diesel	2498	4	94.00	75
SHDA	Petrol	1596	4	79.00	14
SHDB	Petrol	1596	4	79.00	14
SHDC	Petrol	1596	4	79.00	14
SIDA Duratec	Petrol	1596	4	79.00	14
SRFA	Diesel	2198	4	86.00	46
SRFB	Diesel	2198	4	86.00	46
SRFC	Diesel	2198	4	86.00	46
SRFD	Diesel	2198	4	86.00	46
SRFE	Diesel	2198	4	86.00	46
STP (XD3/XD3P)	Diesel	2498	4	94.00	76
STR (XD3/XD3P)	Diesel	2498	4	94.00	76
SYDA Duratec HE	Petrol	1999	4	87.50	51
T1DA Duratorq	Diesel	1560	4	75.00	9
T1DB Duratorq	Diesel	1560	4	75.00	9
T3DA Duratorq	Diesel	1560	4	75.00	9

		ccm	x 		
T3DB Duratorq	Diesel	1560	4	75.00	9
T3JA Duratorq	Diesel	1560	4	75.00	9
T3JB	Diesel	1560	4	75.00	9
TD27	Diesel	2664	4	96.00	78
TD27E	Diesel	2664	4	96.00	78
TD27 T	Diesel	2664	4	96.00	78
TKA	Petrol	957	4	74.00	6
TKB	Petrol	957	4	74.00	6
TKW	Petrol	957	4	74.00	6
TL 20 H	Petrol	1993	4	90.80	66
TL 20 LC	Petrol	1994	4	90.80	63
TLA	Petrol	957	4	74.00	6
TLB	Petrol	999	4	68.70	2
TZJA Duratorq	Diesel	1560	4	75.00	9
TZJB Duratorq	Diesel	1560	4	75.00	9
UBJA Duratorq	Diesel	1560	4	75.00	8
UHFA Duratorq	Diesel	2198	4	86.00	46
UHFB Duratorq	Diesel	2198	4	86.00	46
UHFC Duratorq	Diesel	2198	4	86.00	46
WTA (XD90)	Diesel	2112	V4	90.00	62
XD2S	Diesel	2304	4	94.00	75
XD3P	Diesel	2498	4	94.00	75
XD3T	Diesel	2498	4	94.00	75
XD/P88	Diesel	1948	4	88.00	53
Y5A	Petrol	2295	4	89.60	54
Y5B	Petrol	2295	4	89.60	54
YTR (XD2/XD2P/XD94)	Diesel	2304	4	94.00	77
YTT (XD2/XD2P/XD94)	Diesel	2304	4	94.00	77
Zetec-SE	Petrol	1597	4	79.00	15
ZVSA	Petrol	1998	4	86.00	43







1 68.70

Fiesta III 1.1	03/89→12/95	G6A	4 Cyl. 1118cc	8.8:1 37kW (50PS)	TD4455
-----------------------	-------------	------------	-------------------------	-----------------------------	---------------

Escort 1.1	07/90→12/94	GUF	4 Cyl. 1118cc	8.8:1 40kW (54PS)	TD1211
-------------------	-------------	------------	-------------------------	-----------------------------	---------------

87-784100-10	STD	08-784100-00	STD
87-784107-10	0.50mm	08-784107-00	0.50mm
		08-784111-00	1.00mm

A	29.40
B-	3.50
BØ	36.00
D	53.90
	18x59

1.50		MO P
1.75		P
3.00		CR 

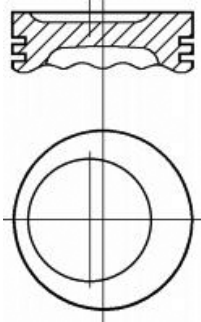

 Steel

 Stahl

 Acier

 Acero

 Acciaio

2 68.70





Fiesta III 1.1	03/89→12/95	GUD	4 Cyl. 1118cc	9.5:1 40kW (55PS)	TD1209
-----------------------	-------------	------------	-------------------------	-----------------------------	---------------

Fiesta III 1.1	03/89→12/95	GUE	4 Cyl. 1118cc	9.5:1 40kW (55PS)	TD1210
-----------------------	-------------	------------	-------------------------	-----------------------------	---------------

Fiesta II 1.0	09/83→11/89	TLB	4 Cyl. 999cc	9.5:1 33kW (45PS)	TD1454
Fiesta III 1.0	03/89→12/95				

87-784100-00	STD	08-784100-00	STD
87-784107-00	0.50mm	08-784107-00	0.50mm
		08-784111-00	1.00mm

A	29.40
D	53.90
	18x59

1.50		MO P
1.75		P
3.00		CR 

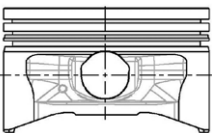

 Steel

 Stahl

 Acier

 Acero

 Acciaio







3 73.70

Fiesta V 1.4 TDCi	11/01→12/10	F6JA (DV4TD)		
Fusion 1.4 TDCi	08/02→07/05		4 Cyl.	17.9:1
			1399cc	50-51kW (68-69PS)
		Diesel	Turbo Intercooled	TD17307

Fiesta V 1.4 TDCi	11/01→12/10	F6JB (DV4TD)		
Fiesta VI 1.4 TDCi	01/09→		4 Cyl.	18:1
Fusion 1.4 TDCi	08/02→07/05		1399cc	50kW (68PS)
		Diesel	Turbo Intercooled	TD17346

87-135300-00	STD	08-135300-00	STD	14-020760-00 D	B 76.70 C 136.00 D 78.20 E 5.00
87-135305-00	0.25mm	08-135305-00	0.25mm	14-020761-00 D	B 76.95 C 136.00 D 78.45 E 5.25
87-135307-00	0.50mm	08-135307-00	0.50mm		

A	42.94	2.50		CK P
B-	14.70	1.95		P
BØ	37.16	2.50		CR P
C	1.55			
D	65.44			
	25x60			

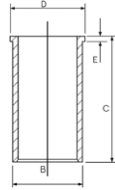

AK RT TP

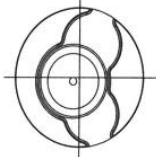
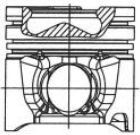





4 74.00

Ka 1.3 i	08/02→11/08	A9A		
			4 Cyl.	10.2:1
			1299cc	51kW (70PS)
				TD18764

Ka 1.3 i	08/02→11/08	A9B		
			4 Cyl.	10.2:1
			1299cc	51kW (70PS)
				TD18765

87-449000-00	STD	08-449000-00	STD	
87-449007-00	0.50mm	08-449007-00	0.50mm	

A	24.90	1.20		CR P
B-	2.80	1.50		P
BØ	35.00	2.00		CR P
D	48.90			
	18x54			



5  **74.00**

Ka 1.3 i	09/96→11/08	BAA	4 Cyl. 1299cc	44kW (60PS)	TD17169
Fiesta 1.3 Fiesta IV 1.3 i	02/96→ 08/95→01/02	J4C Endura E	4 Cyl. 1299cc	9.5:1 44kW (60PS)	TD11087
Ka 1.3 i	09/96→11/08	J4D Endura E	4 Cyl. 1299cc	9.5:1 44kW (60PS)	TD12084
Fiesta IV 1.3 i	08/95→01/02	J4J Endura E	4 Cyl. 1299cc	44kW (60PS)	TD12073
Ka 1.3 i	09/96→11/08	J4K Endura E	4 Cyl. 1299cc	44kW (60PS)	TD12085
Fiesta IV 1.3 i	08/95→01/02	J4L Endura E	4 Cyl. 1299cc	44kW (60PS)	TD15930
Ka 1.3 i	09/96→11/08	J4M Endura E	4 Cyl. 1299cc	44kW (60PS)	TD15952
Ka 1.3 i	09/96→11/08	J4N Endura E	4 Cyl. 1299cc	44kW (60PS)	TD15953
Ka 1.3 i	09/96→11/08	J4P Endura E	4 Cyl. 1299cc	44kW (60PS)	TD15954
Fiesta IV 1.3 i	08/95→01/02	J4Q Endura E	4 Cyl. 1299cc	44kW (60PS)	TD15931
Fiesta IV 1.3 i	08/95→01/02	J4R Endura E	4 Cyl. 1299cc	44kW (60PS)	TD15932
Ka 1.3 i	09/96→11/08	J4S Endura E	4 Cyl. 1299cc	44kW (60PS)	TD15955
Fiesta IV 1.3 i	08/95→01/02	J4T Endura E	4 Cyl. 1299cc	44kW (60PS)	TD15933





Escort '86 Express 1.3 Escort IV 1.3	07/88→07/90 07/88→10/90	JBA	4 Cyl. 1299cc	9.5:1 44-46kW (60-63PS)	TD1227
Escort '86 Express 1.3 Escort IV 1.3 Orion II 1.3	02/86→07/90 01/86→07/90 12/85→07/90	JBB	4 Cyl. 1299cc	9.5:1 44kW (60PS)	TD4459
Fiesta III 1.3 Fiesta IV 1.3 i	03/89→12/92 08/95→01/02	JBC	4 Cyl. 1299cc	9.5:1 44kW (60PS)	TD1229
Escort '91 Express 1.3	07/90→12/94	JBD	4 Cyl. 1299cc	46kW (63PS)	TD1230
Fiesta IV 1.3 i	08/95→01/02	JJA Endura E	4 Cyl. 1299cc	9.5:1 37kW (50PS)	TD12071
Ka 1.3 i	09/96→10/02	JJB/Endura E	4 Cyl. 1299cc	9.5:1 37kW (50PS)	TD12083
Fiesta IV 1.3 i	08/95→01/02	JJC Endura E	4 Cyl. 1299cc	37kW (50PS)	TD12072
Ka 1.3 i	06/98→11/08	JJD Endura E	4 Cyl. 1299cc	9.5:1 36kW (49PS)	TD12082
Fiesta IV 1.3 i	08/95→01/02	JJE/Endura E	4 Cyl. 1299cc	37kW (50PS)	TD15926
Ka 1.3 i	06/98→11/08	JJF Endura E	4 Cyl. 1299cc	36kW (49PS)	TD15948
Ka 1.3 i	06/98→11/08	JJG Endura E	4 Cyl. 1299cc	36kW (49PS)	TD15949
Ka 1.3 i	06/98→11/08	JJH Endura E	4 Cyl. 1299cc	36kW (49PS)	TD15950
Fiesta IV 1.3 i	08/95→01/02	JJJ Endura E	4 Cyl. 1299cc	37kW (50PS)	TD15927





Fiesta IV 1.3 i	08/95→01/02	JJK Endura E	4 Cyl. 1299cc	37kW (50PS)	TD15928
Ka 1.3 i	06/98→11/08	JJL Endura E	4 Cyl. 1299cc	36kW (49PS)	TD15951
Fiesta IV 1.3 i	08/95→01/02	JJM Endura E	4 Cyl. 1299cc	9.5:1 37kW (50PS)	TD15929
Escort '86 Express 1.3 Escort IV 1.3 Orion II 1.3	02/86→07/90 01/86→07/90 12/85→07/90	JLB	4 Cyl. 1299cc	9.3:1 44kW (60PS)	TD1237

87-785000-00	STD	08-785000-00	STD
87-785007-00	0.50mm	08-785007-00	0.50mm
87-785011-00	1.00mm	08-785011-00	1.00mm
A 29.40		1.50	CR P
D 53.90		1.75	P
18x64		3.00	CR 1

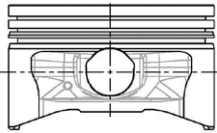

1 Steel

1 Stahl

1 Acier

1 Acero

1 Acciaio

6 74.00

Fiesta II 1.1	09/83→02/89	GLC	4 Cyl. 1117cc	9.5:1 37kW (50PS)	TD1198
Escort III 1.1	08/83→12/85	GSE	4 Cyl. 1117cc	9.1/9.5:1 37-40kW (50-55PS)	TD1203
Fiesta II 1.1	09/83→02/89	GSF	4 Cyl. 1117cc	9.1/9.5:1 37kW (50PS)	TD1204
Escort '86 Express 1.1 Escort IV 1.1	05/86→07/90 10/85→09/90	GSG	4 Cyl. 1117cc	9.1/9.5:1 37kW (50PS)	TD1205



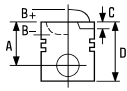

Fiesta 1.0 Fiesta I 0.9	10/77→11/86 05/76→08/83	TKA	4 Cyl. 957cc	8.3/8.5/9:1 29kW (40PS)	TD4495
Fiesta 1.0 Fiesta II 1.0	08/83→11/89 09/83→02/89	TKB	4 Cyl. 957cc	8.5:1 33kW (45PS)	TD1452
Fiesta I 0.9	05/76→08/83	TKW	4 Cyl. 957cc	8.3/8.5/9:1 29kW (40PS)	TD4496
Fiesta I 0.9	05/76→08/83	TLA	4 Cyl. 957cc	8.3/8.5/9:1 33kW (45PS)	TD1453

87-208800-00 ¹
87-208807-00
87-208811-00

STD
0.50mm
1.00mm

08-208800-00
08-208807-00
08-208811-00

STD
0.50mm
1.00mm

14-010830-00 ^D B 77.16 C 119.61

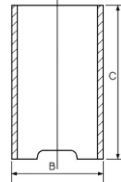

A 39.20
D 65.00
 21x55

1.60
2.00
4.00



CR P
P
CR ²

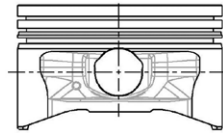

¹ Earlier pistons to be replaced in Engine sets only

¹ Frühere Kolben nur in Motorsätzen zu ersetzen

¹ Premier piston à remplacer dans le jeu moteur

¹ Pistones más antiguos para ser reemplados en juego de motores solamente

¹ Con i pistone di vecchia versione è necessario sostituire tutta la serie

² Steel

² Stahl

² Acier

² Acero

² Acciaio

7  **74.00**



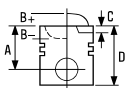

Escort V 1.3 Escort VI 1.3 Escort VII 1.3 Orion III 1.3	07/90→09/92 09/92→01/95 01/95→02/99 07/90→12/93	J4B / BL13 Endura E	4 Cyl. 1299cc	8.8:1 44kW (60PS)	TD4458
Escort V 1.3 Escort VI 1.3 Escort VII 1.3 Orion III 1.3	07/90→09/92 09/92→01/95 01/95→02/99 07/90→12/93	J6A	4 Cyl. 1299cc	8.8:1 44kW (60PS)	TD1223
Fiesta 1.3 Fiesta III 1.3 CAT	09/91→02/96 05/91→01/97	J6B	4 Cyl. 1299cc	8.8:1 44kW (60PS)	TD1224





Bantam 1.3	09/90→09/94	JBE	4 Cyl.	8.8:1	1299cc	44kW (60PS)	TD1231
-------------------	-------------	------------	--------	-------	---------------	--------------------	---------------

87-785000-10	STD	08-785000-00	STD
87-785007-10	0.50mm	08-785007-00	0.50mm
87-785011-10	1.00mm	08-785011-00	1.00mm

A	29.40	1.50		CR P
B-	3.50	1.75		P
BØ	39.00	3.00		CR 1
D	53.90			
	18x64			

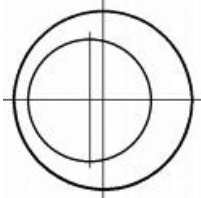
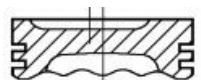

1 Steel

1 Stahl

1 Acier

1 Acero

1 Acciaio

8  **75.00**

C-Max 1.6 TDCi	02/07→09/10	G8DA	4 Cyl.	18.3:1	1560cc	80kW (109PS)	TD18508
Focus C-MAX 1.6 TDCi	10/03→03/07						
Focus II 1.6 TDCi	07/04→09/12						
		Diesel	Turbo Intercooled				
C-Max 1.6 TDCi	02/07→09/10	G8DB	4 Cyl.	18.3:1	1560cc	80kW (109PS)	TD18509
Focus C-MAX 1.6 TDCi	10/03→03/07						
Focus II 1.6 TDCi	07/04→09/12						
		Diesel	Turbo Intercooled				
C-Max 1.6 TDCi	02/07→09/10	HHDA Euro 4	4 Cyl.	18.3:1	1560cc	66kW (90PS)	TD18478
Focus C-MAX 1.6 TDCi	02/05→03/07						
Focus II 1.6 TDCi	07/04→09/12						
		Diesel	Turbo Intercooled				
C-Max 1.6 TDCi	02/07→09/10	HHDB Euro 4	4 Cyl.	18.3:1	1560cc	66kW (90PS)	TD18479
Focus C-MAX 1.6 TDCi	02/05→03/07						
Focus II 1.6 TDCi	07/04→09/12						
		Diesel	Turbo Intercooled				
Fiesta V 1.6 TDCi	11/04→09/09	HHJA	4 Cyl.	18:1	1560cc	66kW (90PS)	TD17988
Fusion 1.6 TDCi	11/04→12/12						
		Diesel	Turbo Intercooled				
Fiesta V 1.6 TDCi	11/04→09/09	HHJB	4 Cyl.	18:1	1560cc	66kW (90PS)	TD17989
Fusion 1.6 TDCi	11/04→12/12						
		Diesel	Turbo Intercooled				
Fiesta 1.6 TDCi	10/10→	HHJC Duratorq	4 Cyl.	18:1	1560cc	66kW (90PS)	TD24416
Fiesta VI 1.6 TDCi	06/08→						
		Diesel	Turbo Intercooled				





Fiesta VI 1.6 TDCi	06/08→	HHJD Duratorq	4 Cyl.	18:1	
			1560cc	66kW (90PS)	
		Diesel	Turbo Intercooled		TD23543
Fiesta VI 1.6 TDCi	06/08→	HHJE Duratorq	4 Cyl.	18:1	
			1560cc	66kW (90PS)	
		Diesel	Turbo Intercooled		TD24417
Fiesta VI 1.6 TDCi	06/08→	UBJA Duratorq	4 Cyl.		
			1560cc	55kW (75PS)	
		Diesel	Turbo Intercooled		TD24419

87-424000-00
87-424008-00

STD
0.60mm

08-424000-00
08-424007-00
08-424008-00

STD
0.50mm
0.60mm

14-020900-00 D B 78.00 C 142.00 D 79.50 F 5.00

A 41.70
B- 13.25
BØ 41.80
C 1.20
D 65.30
26x61

3.00
1.95
2.50



CK P
P
CR P

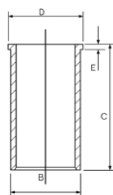

AK KK RT TP

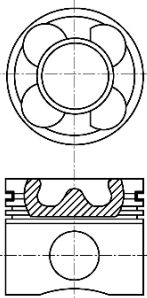

9 **75.00**

C-Max II 1.6 TDCi	12/10→	T1DA Duratorq	4 Cyl.		
Focus III 1.6 TDCi	07/10→		1560cc	85kW (116PS)	
Focus III Turnier 1.6 TDCi		Diesel	Turbo Intercooled		TD25883
Grand C-Max 1.6 TDCi	12/10→				
C-Max II 1.6 TDCi	12/10→	T1DB Duratorq	4 Cyl.		
Focus III 1.6 TDCi	07/10→		1560cc	85kW (116PS)	
Focus III Turnier 1.6 TDCi		Diesel	Turbo Intercooled		TD25884
Grand C-Max 1.6 TDCi	12/10→				
C-Max II 1.6 TDCi	12/10→	T3DA Duratorq	4 Cyl.		
Focus III 1.6 TDCi	07/10→		1560cc	70kW (95PS)	
Focus III Turnier 1.6 TDCi		Diesel	Turbo Intercooled		TD25881
Grand C-Max 1.6 TDCi	12/10→				
C-Max II 1.6 TDCi	12/10→	T3DB Duratorq	4 Cyl.		
Focus III 1.6 TDCi	07/10→		1560cc	70kW (95PS)	
Focus III Turnier 1.6 TDCi		Diesel	Turbo Intercooled		TD25882
Grand C-Max 1.6 TDCi	12/10→				





Fiesta VI 1.6 TDCi	02/10→	T3JA Duratorq	4 Cyl. 1560cc	70kW (95PS)	
		Diesel	Turbo Intercooled		TD26473
B-Max 1.6 TDCi	10/12→	T3JB	4 Cyl. 1560cc	70kW (95PS)	
		Diesel	Turbo Intercooled		TD28069
Fiesta VI 1.6 TDCi	02/10→	TZJA Duratorq	4 Cyl. 1560cc	70kW (95PS)	
		Diesel	Turbo Intercooled		TD24420
Fiesta VI 1.6 TDCi	02/10→	TZJB Duratorq	4 Cyl. 1560cc	70kW (95PS)	
		Diesel	Turbo Intercooled		TD24421

87-433600-00
87-433607-00

STD
0.50mm

08-433600-00
08-433607-00

STD
0.50mm

14-020900-00 D B 78.00 C 142.00 D 79.50 F 5.00

A 41.75
B- 13.85
BØ 45.00
D 65.20
 26x61

2.50
1.95
2.00



CK P
P
CR P

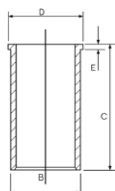

AK KK RT TP

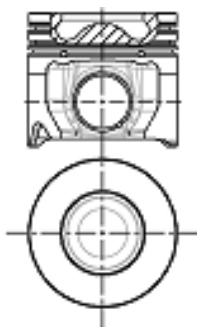

10  **76.00**

Focus II 1.4	07/04→09/12	ASDA	4 Cyl. 1388cc	11:1 59kW (80PS)	
					TD18501
Focus II 1.4	07/04→09/12	ASDB	4 Cyl. 1388cc	11:1 59kW (80PS)	
					TD18502
Focus 1.4 16V	10/98→11/04	FXDA Zetec SE	4 Cyl. 1388cc	10.3:1 55kW (75PS)	
					TD12075
Focus 1.4 16V	10/98→11/04	FXDB Zetec SE	4 Cyl. 1388cc	10.3:1 55kW (75PS)	
					TD15892



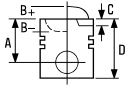

Focus 1.4 16V	10/98→11/04	FXDC Zetec SE	4 Cyl. 1388cc	10.3:1 55kW (75PS)	TD12076
Focus 1.4 16V	10/98→11/04	FXDD Zetec SE	4 Cyl. 1388cc	10.3:1 55kW (75PS)	TD15893
Fiesta V 1.4 16V Fusion 1.4	11/01→06/08 08/02→12/12	FXJA	4 Cyl. 1388cc	11:1 59kW (80PS)	TD17304
Fiesta V 1.4 16V Fusion 1.4	11/01→06/08 08/02→12/12	FXJB	4 Cyl. 1388cc	11:1 59kW (80PS)	TD17305

87-426100-00 ¹
87-426107-00 ¹

STD
0.50mm

08-426100-00
08-426107-00

STD
0.50mm

A 28.25
B+ 1.25
D 55.50
 19x50

1.20
1.50
2.50



NT ²
P
NT ²

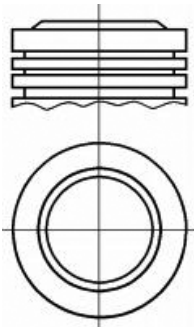

¹ Elastoval ®
² Steel

¹ Elastoval ®
² Stahl

¹ Elastoval ®
² Acier

¹ Elastoval ®
² Acero

¹ Elastoval ®
² Acciaio

11  **76.00**

Fiesta 1.4 i Fiesta IV 1.4 i 16V	04/96→10/99 04/96→01/02	FHA Zetec SE	4 Cyl. 1388cc	10.3:1 66kW (90PS)	TD12074
Puma 1.4 16V	11/97→10/00	FHD Zetec SE	4 Cyl. 1388cc	10.3:1 66kW (90PS)	TD11327
Fiesta IV 1.4 i 16V	04/96→01/02	FHE Zetec SE	4 Cyl. 1388cc	10.3:1 66kW (90PS)	TD15934



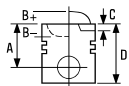





Puma 1.4 16V	11/97→10/00	FHF Zetec SE	4 Cyl.	10.3:1	
			1388cc	66kW (90PS)	TD15919

87-102300-00	STD	08-102300-00	STD
87-102307-00	0.50mm	08-102307-00	0.50mm

A 28.55
D 50.80
 19x57

1.20  NT 
 1.50  P
 2.50  CR 

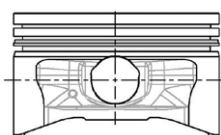

 Steel

 Stahl

 Acier

 Acero

 Acciaio

12 76.00





Escort Classic 1.6 16V	10/98→07/00	L1E Zetec			
Escort Classic Turnier 1.6 16V	02/99→07/00		4 Cyl.	10.3:1	
Escort VI 1.6 16V XR3i	12/92→01/95		1597cc	66kW (90PS)	
Escort VI 1.6 i 16V	09/92→01/95				TD1249
Escort VII 1.6 16V	01/95→02/99				
Escort VII 1.6 16V XR3i	02/95→09/99				
Escort VII 1.6 i 16V					
Orion III 1.6 i 16V	07/92→12/93				
Mondeo I 1.6 i 16V	02/93→08/96	L1F Zetec	4 Cyl.	10.3:1	
			1597cc	66kW (90PS)	
					TD10069
Fiesta III 1.6 i 16V	01/94→12/95	L1G Zetec	4 Cyl.	10.3:1	
			1597cc	65-66kW (88-90PS)	
					TD9467
Escort VI 1.6 i 16V	01/94→01/95	L1H Zetec E			
Escort VII 1.6 16V XR3i	02/95→12/96		4 Cyl.	10.3:1	
Escort VII 1.6 i 16V	01/95→08/95		1597cc	65kW (88PS)	
					TD5105
Mondeo I 1.6 i 16V	07/94→08/96	L1J Zetec E			
Mondeo II 1.6 i	08/96→09/00		4 Cyl.	10.3:1	
			1597cc	65-66kW (88-90PS)	
					TD4464





Escort VI 1.6 i 16V	08/93→01/95	L1K Zetec E		
Escort VII 1.6	01/01→08/02		4 Cyl.	10.3:1
Escort VII 1.6 i 16V	01/95→02/99		1597cc	66-70kW (90-95PS)
Orion III 1.6 i 16V	07/92→12/93			TD10849

87-786300-00	STD	08-786300-00	STD
87-786307-00	0.50mm	08-786307-00	0.50mm

A	32.65	1.50		CR P
B+	1.70	1.60		P
BØ	61.40	2.50		P
D	58.33			
	21x64			

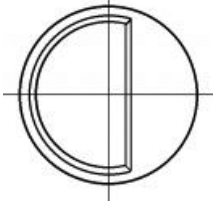

13 79.00

Focus 1.6 16V	10/98→11/04	FYDA Zetec SE	4 Cyl.	11:1	
			1596cc	74-75kW (100-102PS)	TD12077
Focus 1.6 16V	10/98→11/04	FYDB Zetec SE	4 Cyl.	11:1	
			1596cc	74kW (100PS)	TD15894
Focus 1.6 16V	10/98→11/04	FYDC Zetec SE	4 Cyl.	11:1	
			1596cc	74kW (100PS)	TD12078
Focus 1.6 16V	10/98→11/04	FYDD Zetec SE	4 Cyl.	11:1	
			1596cc	74kW (100PS)	TD15895
Focus 1.6 16V	10/98→11/04	FYDH Zetec SE	4 Cyl.	11:1	
Focus 1.6 16V Flexifuel	01/02→11/04		1596cc	74-75kW (100-102PS)	TD18776
Fiesta V 1.6 16V	11/01→06/08	FYJA	4 Cyl.	11:1	
Fusion 1.6	08/02→11/08		1596cc	74kW (100PS)	TD17306



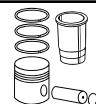
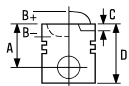





Fiesta V 1.6 16V	11/01→06/08	FYJB		
Fusion 1.6	08/02→11/08		4 Cyl. 1597cc	11:1 74kW (100PS)
				TD18778

87-141300-00 ①	STD	08-141300-00	STD
87-141307-00 ② ①	0.50mm	08-141307-00	0.50mm

→01/03

A 25.05
D 48.10
 18x50

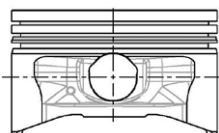

1.20		NT ③
1.50		P
2.00		CR ③



87-141300-10	STD	08-141300-00	STD
87-141307-10	0.50mm	08-141307-00	0.50mm

01/03→

A 25.50
B- 0.65
BØ 57.30
D 48.05
 18x51

1.20		NT ③
1.50		P
2.00		CR ③

TP

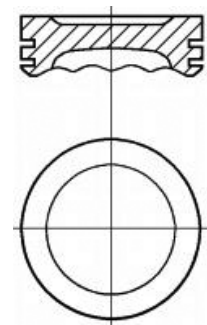

- ① Elastoval ®
- ② Oval piston skirt form
- ③ Steel

- ① Elastoval ®
- ② ovale Kolbenschaftform
- ③ Stahl

- ① Elastoval ®
- ② forme ovale du corps de piston
- ③ Acier

- ① Elastoval ®
- ② sin molde vástago pistón
- ③ Acero

- ① Elastoval ®
- ② Fascia pistone a forma ovale
- ③ Acciaio



14  **79.00**

C-Max 1.6	02/07→09/10	HWDA			
Focus C-MAX 1.6	10/03→03/07		4 Cyl.	11:1	
Focus II 1.6	07/04→09/12		1596cc	74kW (100PS)	
TD18503					
C-Max 1.6	02/07→09/10	HWDB			
Focus C-MAX 1.6	10/03→03/07		4 Cyl.	11:1	
Focus II 1.6	07/04→09/12		1596cc	74kW (100PS)	
TD18504					
C-Max 1.6	04/07→09/10	HXDA Duratec			
Focus C-MAX 1.6 Ti	08/04→03/07		4 Cyl.	11:1	
Focus II 1.6 Ti	07/04→09/12		1596cc	85kW (115PS)	
TD18505					
C-Max 1.6	04/07→09/10	HXDB Duratec			
Focus II 1.6 Ti	07/04→09/12		4 Cyl.		
			1596cc	85kW (115PS)	
TD23365					
Mondeo IV 1.6 Ti	03/07→09/14	PNBA			
Mondeo IV Turnier 1.6 Ti	03/07→12/10		4 Cyl.	11:1	
			1596cc	92kW (125PS)	
TD23302					
C-Max 1.6	02/07→09/10	SHDA			
Focus II 1.6	07/04→09/12		4 Cyl.		
			1596cc	74kW (101PS)	
TD21247					
C-Max 1.6	02/07→09/10	SHDB			
Focus II 1.6	07/04→09/12		4 Cyl.		
			1596cc	74kW (101PS)	
TD24345					
C-Max 1.6	02/07→09/10	SHDC			
Focus II 1.6	07/04→09/12		4 Cyl.		
			1596cc	74kW (101PS)	
TD24346					
C-Max 1.6	04/07→09/10	SIDA Duratec			
Focus C-MAX 1.6 Ti	08/04→03/07		4 Cyl.		
Focus II 1.6 LPG	10/09→09/12		1596cc	85kW (115PS)	
Focus II 1.6 Ti	07/04→09/12				
TD23366					

87-141300-20 STD
87-141307-20 0.50mm

08-141300-00 STD
08-141307-00 0.50mm

01/07→

A 25.40
B- 0.70
BØ 50.90
C 3.80
C 2.76
D 53.40
 18x51

1.20
1.50
2.00



NT 
P
CR 

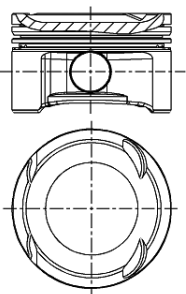

 Steel

 Stahl

 Acier

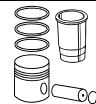
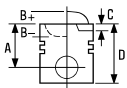

 Acero

 Acciaio









15 79.00

Fiesta IV 1.6 16V Sport	02/00→01/02	L1T Zetec SE	4 Cyl. 1596cc	11:1 76kW (103PS)	TD15935
Fiesta IV 1.6 16V Sport	02/00→01/02	L1V Zetec SE	4 Cyl. 1596cc	11:1 76kW (103PS)	TD15936
Puma 1.6 16V	08/00→06/02	L1W	4 Cyl. 1596cc	11:1 76kW (103PS)	TD18770
Fiesta 16v Focus 16v Puma 16v	02/00→ 10/98→ 08/00→	Zetec-SE	4 Cyl. 1597cc	11:1 74-76kW (100-103PS)	FM5700

87-141300-00  STD
87-141307-00   0.50mm

08-141300-00 STD
08-141307-00 0.50mm

A 25.05
D 48.10
 18x50

1.20  NT 
 1.50  P
 2.00  CR 

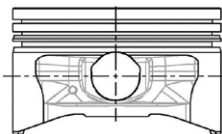

 Elastoval®

 Oval piston skirt form

 Steel

 Elastoval®

 ovale Kolbenschaftform

 Stahl

 Elastoval®

 forme ovale du corps de piston

 Acier

 Elastoval®

 sin molde vástago pistón

 Acero

 Elastoval®

 Fascia pistone a forma ovale

 Acciaio

16 79.38





Transit 90, Transit 115, Transit 125	01/70→12/78	4.108			
Transit 130, Transit 150, Transit 175			4 Cyl.	22:1	
Transit V20, Transit V30, Transit V40	01/65→12/70		1760cc		
Transit V50, Transit V60		Diesel			FM1346

87-315200-00 STD

08-315200-00 STD

14-010900-00 D B 82.63 C 165.10

A 50.24
D 105.41
 27x68



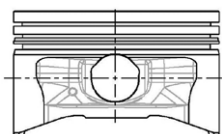
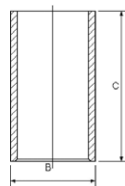





1.99  CR P
 1.60  P
 1.60  P
 3.16  P
 4.74  P





17 79.50

Galaxy 1.9 TDI	03/95 → 05/06	1Z	4 Cyl. 1896cc	19.5:1 66kW (90PS)	
		Diesel	Turbo Intercooled		TD11370
Galaxy 1.9 TDI	08/97 → 04/00	AFN	4 Cyl. 1896cc	19.5:1 81kW (110PS)	
		Diesel	Turbo Intercooled		TD11368
Galaxy 1.9 TDI	03/95 → 05/06	AHU	4 Cyl. 1896cc	19.5:1 66kW (90PS)	
		Diesel	Turbo Intercooled		TD11369
Galaxy 1.9 TDI	08/97 → 04/00	AVG	4 Cyl. 1896cc	19.5:1 81kW (110PS)	
		Diesel	Turbo Intercooled		TD17557



87-114900-60   STD
 87-114905-60   0.25mm
 87-114907-60    0.50mm
 87-114911-60    1.00mm

08-114900-00 STD
 08-114905-00 0.25mm
 08-114907-00 0.50mm
 08-114911-00 1.00mm

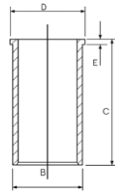
14-027950-00 **D** B 82.50 C 152.00 D 85.50 E 4.70



A 45.80
B- 17.65
BØ 38.00
C 1.10
D 68.80
 26x66

1.75  CK P
 2.00  P
 3.00  CR P

AK KK NB RT

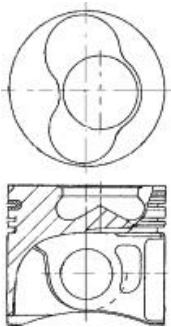





07987





87-114900-70	② ③	STD	08-114900-00	STD
87-114905-70	② ③	0.25mm	08-114905-00	0.25mm
87-114907-70	② ③ ④	0.50mm	08-114907-00	0.50mm
87-114911-70	② ③ ④	1.00mm	08-114911-00	1.00mm

A	45.80
B-	17.65
BØ	38.00
C	1.10
D	68.80
	26x66

1.75		CK P
2.00		P
3.00		CR P

AK KK NB RT

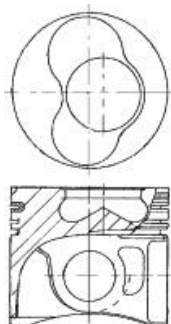

07987A

① To cylinder 1 & 2	① zum Zylinder 1 & 2	① sous cylindre 1 & 2	① A cilindro 1 & 2	① al cilindro 1 & 2
② To cylinder 3 & 4	② zum Zylinder 3 & 4	② sous cylindre 3 & 4	② A cilindro 3 & 4	② al cilindro 3 & 4
③ Piston Chamber Volume [ccm] 23.54	③ Volumen der Kolbenmulde [ccm] 23.54	③ Volume de la cavité du piston [cm³] 23.54	③ Volumen de cavidad del pistón [cc] 23.54	③ Volume camera pistone [cm³] 23.54
④ A = 45.550, D = 68.550	④ A = 45.550, D = 68.550	④ A = 45.550, D = 68.550	④ A = 45.550, D = 68.550	④ A = 45.550, D = 68.550



18  **79.50**

AJM

4 Cyl. 18:1
1896cc **85kW** (116PS)
Diesel Turbo

TD14108





Galaxy 1.9 TDI

04/00 → 05/06

AUY

4 Cyl. 18:1
1896cc **85kW** (115PS)
Diesel Turbo Intercooled



TD14918

87-114900-05   STD
87-114907-05    0.50mm

→09/02

A 45.80
B- 17.80
BØ 38.00
C 1.30
D 68.80
 26x66

08-114900-00 STD
08-114905-00 0.25mm
08-114907-00 0.50mm
08-114911-00 1.00mm

1.75  CK P
 2.00  P
 3.00  CR P



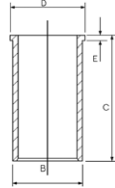

14-027950-00 D B 82.50 C 152.00 D 85.50 E 4.70

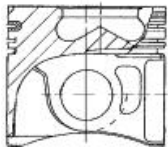
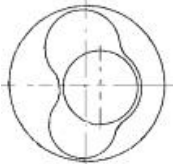

AK KK NB RT TP





07969L-101

87-114900-15   STD
87-114907-15    0.50mm

→09/02

A 45.80
B- 17.80
BØ 38.00
C 1.30
D 68.80
 26x66

08-114900-00 STD
08-114905-00 0.25mm
08-114907-00 0.50mm
08-114911-00 1.00mm

1.75  CK P
 2.00  P
 3.00  CR P

AK KK NB RT TP

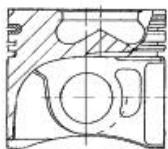
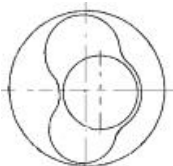

07969L-102



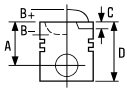

87-114900-55 1 3 5 STD
87-114907-55 1 6 5 0.50mm

09/02 →

A 45.80
B- 17.60
BØ 38.00
C 1.10
D 68.80
 26x66

AK KK NB RT TP

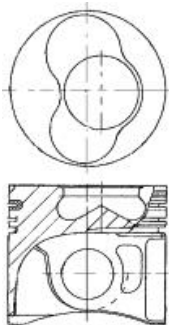

07901D101

08-114900-00 STD
08-114905-00 0.25mm
08-114907-00 0.50mm
08-114911-00 1.00mm

1.75 CK P
2.00 P
3.00 CR P

87-114900-56 2 3 5 STD
87-114907-56 2 6 5 0.50mm

09/02 →

A 45.80
B- 17.60
BØ 38.00
C 1.10
D 68.60
 26x66

AK KK NB RT TP

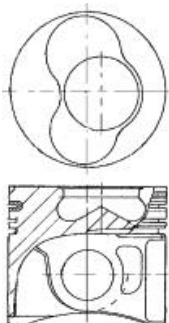

07901D102

08-114900-00 STD
08-114905-00 0.25mm
08-114907-00 0.50mm
08-114911-00 1.00mm

1.75 CK P
2.00 P
3.00 CR P

1 To cylinder 1 & 2

2 To cylinder 3 & 4

3 Piston Chamber Volume [ccm] 23.60

4 For side angled injection nozzle

5 For newer design straight injection nozzle

6 A = 45.550, D = 68.550

1 zum Zylinder 1 & 2

2 zum Zylinder 3 & 4

3 Volumen der Kolbenmulde [ccm] 23.60

4 Nur für schräg angeordnete Einspritzdüsen

5 Für neuere Ausführungen,

direkt einspritzende Düsen

6 A = 45.550, D = 68.550

1 sous cylindre 1 & 2

2 sous cylindre 3 & 4

3 Volume de la cavité du piston [cm³] 23.60

4 Pour buse d'injection latérale angulaire

5 Pour buse d'injection droite à

conception plus récente

6 A = 45.550, D = 68.550

1 A cilindro 1 & 2

2 A cilindro 3 & 4

3 Volumen de cavidad del pistón [cc] 23.60

4 Para la boquilla de inyección lateral angular

5 Para el más reciente diseño de

boquilla de inyección directa

6 A = 45.550, D = 68.550

1 al cilindro 1 & 2

2 al cilindro 3 & 4

3 Volume camera pistone [cm³] 23.60

4 Per il lato angolato dell'ugello olio

5 Per la più recente progettazione

dell'ugello olio non angolato

6 A = 45.550, D = 68.550



19  **79.50**

Galaxy 1.9 TDI

03/95 → 05/06

ANU

4 Cyl.

18:1



1896cc

66kW (90PS)



Diesel

Turbo Intercooled

TD14917

87-114900-65   STD

STD

87-114907-65   0.50mm

0.50mm

A 45.80

B- 17.20

BØ 38.00

C 1.10

D 68.80

 26x66

08-114900-00 STD

STD

08-114905-00 0.25mm

0.25mm

08-114907-00 0.50mm

0.50mm

08-114911-00 1.00mm

1.00mm

1.75



CK P

2.00



P

3.00



CR P

14-027950-00 D

B 82.50 C 152.00 D 85.50 E 4.70

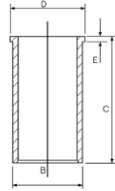

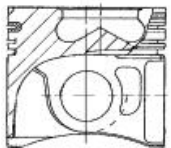
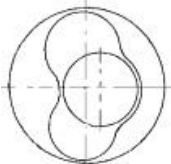

AK KK NB RT TP



07901D-301

87-114900-66   STD

STD

87-114907-66   0.50mm

0.50mm

A 45.80

B- 17.20

BØ 38.00

C 1.10

D 68.80

 26x66

08-114900-00 STD

STD

08-114905-00 0.25mm

0.25mm

08-114907-00 0.50mm

0.50mm

08-114911-00 1.00mm

1.00mm

1.75



CK P

2.00



P

3.00



CR P

AK KK NB RT TP

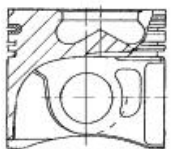
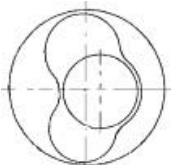

07901D-302

 To cylinder 1 & 2

 To cylinder 3 & 4

 Piston Chamber Volume

[ccm] 22.85

 A = 45.550, D = 68.550

 zum Zylinder 1 & 2

 zum Zylinder 3 & 4

 Volumen der Kolbenmulde

[ccm] 22.85

 A = 45.550, D = 68.550

 sous cylindre 1 & 2

 sous cylindre 3 & 4

 Volume de la cavité du piston

[cm³] 22.85

 A = 45.550, D = 68.550

 A cilindro 1 & 2

 A cilindro 3 & 4

 Volumen de cavidad del pistón

[cc] 22.85

 A = 45.550, D = 68.550

 al cilindro 1 & 2

 al cilindro 3 & 4

 Volume camera pistone

[cm³] 22.85

 A = 45.550, D = 68.550



20  **79.50**

Galaxy 1.9 TDI

02/03→05/06

ASZ

4 Cyl.



1896cc

96kW (130PS)

Diesel

Turbo Intercooled

TD17167

87-114900-45   STD
87-114907-45   0.50mm

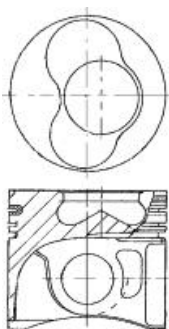

A 45.80
B- 17.50
BØ 38.00
C 1.10
D 68.80
 26x66

AK KK NB RT TP







07901C105

08-114900-00 STD
08-114905-00 0.25mm
08-114907-00 0.50mm
08-114911-00 1.00mm

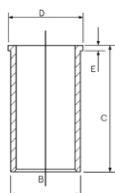
1.75  CK P
2.00  P
3.00  CR P

14-027950-00 D B 82.50 C 152.00 D 85.50 E 4.70



87-114900-46   STD
87-114907-46   0.50mm



A 45.80
B- 17.50
BØ 38.00
C 1.10
D 68.80
 26x66

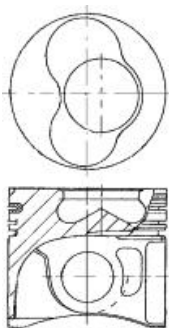



AK KK NB RT TP











07901C106





08-114900-00 STD
08-114905-00 0.25mm
08-114907-00 0.50mm
08-114911-00 1.00mm





1.75  CK P
2.00  P
3.00  CR P

 To cylinder 1 & 2
 To cylinder 3 & 4
 Piston Chamber Volume
[ccm] 24.05
 A = 45.550, D = 68.550

 zum Zylinder 1 & 2
 zum Zylinder 3 & 4
 Volumen der Kolbenmulde
[ccm] 24.05
 A = 45.550, D = 68.550

 sous cylindre 1 & 2
 sous cylindre 3 & 4
 Volume de la cavité du piston
[cm³] 24.05
 A = 45.550, D = 68.550





 A cilindro 1 & 2
 A cilindro 3 & 4
 Volumen de cavidad del piston
[cc] 24.05
 A = 45.550, D = 68.550

 al cilindro 1 & 2
 al cilindro 3 & 4
 Volume camera pistone
[cm³] 24.05
 A = 45.550, D = 68.550



21 79.94

Sierra 1.8	05/88→02/93	R2C	4 Cyl. 1769cc	9.3:1 64kW (87PS)	TD1418
Sierra 1.8	05/88→02/93	R6A	4 Cyl. 1769cc	9.3:1 64-66kW (87-90PS)	TD17422

87-785107-00	0.50mm	08-785100-00	STD
08-785107-00	0.50mm	08-785107-00	0.50mm
A	33.10	1.50	 MO P
B-	2.75	1.50	 P
C	1.80	3.00	 P
C	2.60		
D	63.06		
	21x67		

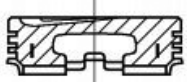

22 79.96

Escort III 1.6 i	07/85→12/85	L4B			
Escort IV 1.6 i	01/86→07/90		4 Cyl.	9.5:1	
Orion II 1.6 i CAT	03/86→07/90		1598cc	66kW (90PS)	TD1252
Escort IV 1.6 i	08/89→07/90	LJB			
Orion II 1.6 i			4 Cyl.	9.5:1	
			1597cc	75kW (102PS)	TD1275
Escort III 1.6	09/80→12/85	LP1			
Orion I 1.6	07/83→03/86		4 Cyl.	9.5:1	
			1597cc	52-58kW (71-79PS)	TD1283
Escort IV 1.6	01/86→07/90	LP2			
Orion II 1.6	04/86→12/88		4 Cyl.	9.5:1	
			1597cc	58kW (79PS)	TD1284
Escort III 1.6	09/80→12/85	LPA			
Escort IV 1.6	01/86→12/87		4 Cyl.	9.5:1	
Orion I 1.6	07/83→03/86		1597cc	58kW (79PS)	TD1286
Escort III 1.6 i	09/83→12/85	LR1			
Escort III 1.6 XR3i	10/82→12/85		4 Cyl.	9.5:1	
Orion I 1.6 i	07/83→03/86		1597cc	77kW (105PS)	TD1287





Escort IV 1.6 XR3i	01/86→07/90	LR2	4 Cyl. 1597cc	9.5:1 77kW (105PS)	TD1288
Escort III 1.6 i	09/83→12/85	LRA	4 Cyl.	9.5:1	TD1289
Escort III 1.6 XR3i	10/82→12/85		1597cc	77kW (105PS)	
Orion I 1.6 i	07/83→03/86				
Escort IV 1.6 XR3i	01/86→07/90	LRB	4 Cyl. 1597cc	9.5:1 77kW (105PS)	TD1290
Orion II 1.6 i	03/86→07/90				
Escort III 1.6	09/80→10/82	LUA	4 Cyl. 1597cc	9.5:1 71kW (96PS)	TD1298
Fiesta II 1.6 XR2	04/84→02/89	LUB	4 Cyl. 1597cc	9.5:1 70-71kW (95-97PS)	TD1300
Escort '86 Express 1.6	02/86→07/90	LUC	4 Cyl. 1597cc	9.5:1 60-66kW (81-90PS)	TD1301
Orion II 1.6	12/85→07/90				
Fiesta II 1.6 XR2	03/84→02/89	LUD	4 Cyl. 1597cc	9.5:1 70kW (95PS)	TD1302
Bantam 1.6	03/86→08/90	LUG	4 Cyl.	9.5:1	TD1304
Escort IV 1.6	04/89→07/90		1597cc	65-66kW (88-90PS)	
Meteor 1.6	03/83→08/90				
Orion II 1.6	03/86→08/90				
Bantam 1.6	09/90→10/94	LUJ	4 Cyl.	9.5:1	TD1306
Escort V 1.6	07/90→08/92		1597cc	65-66kW (88-90PS)	
Orion III 1.6	07/90→12/92				







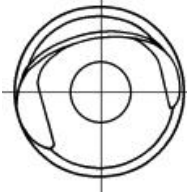

Escort V 1.6	07/90 → 08/92	LUK		
Orion III 1.6	07/90 → 12/92		4 Cyl. 1597cc	9.5:1 65-66kW (88-90PS)
				TD1308

87-214107-00 0.50mm
87-214111-00 1.00mm
 →01/86

A 36.60
B- 11.55
D 66.60
 21x67



08-214100-00 STD
08-214107-00 0.50mm
08-214109-00 0.75mm
08-214111-00 1.00mm



1.60  MO P
 2.00  P
 4.00  CR **1**

87-214100-10 STD
87-214107-10 0.50mm
87-214111-10 1.00mm

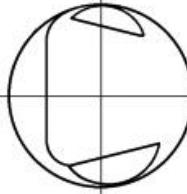
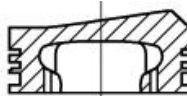
01/86 →
A 36.59
B+ 7.12
D 66.59
 21x67



08-214100-00 STD
08-214107-00 0.50mm
08-214109-00 0.75mm
08-214111-00 1.00mm

1.60  MO P
 2.00  P
 4.00  CR **1**

1 Steel

1 Stahl

1 Acier

1 Accero

1 Acciaio







23 79.96

Fiesta III 1.6 Turbo	03/90→10/92	LHA	4 Cyl. 1597cc Turbo Intercooled	8.2:1 96-98kW (131-133PS)	TD1273
-----------------------------	-------------	------------	---	-------------------------------------	---------------

Escort IV 1.6 Turbo RS	01/86→07/90	LNB	4 Cyl. 1597cc Turbo Intercooled	8.2:1 97kW (132PS)	TD1282
-------------------------------	-------------	------------	---	------------------------------	---------------

87-529000-00	STD	08-529000-00	STD
87-529007-00	0.50mm	08-529007-00	0.50mm

A	38.86	1.50		MO P
C	2.20	2.00		P
D	68.81	4.00		CR P
	21x64			

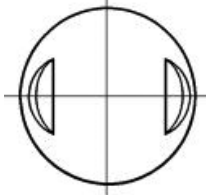
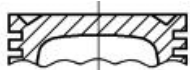





24 80.00

Escort '81 Express 1.6 D	02/84→02/86	LTA			
Escort '86 Express 1.6 D	02/86→07/90		4 Cyl.	21.5:1	
Escort III 1.6 D	02/84→12/85		1608cc	40kW (54PS)	
Orion I 1.6 D	02/84→03/86	Diesel			TD1295

Fiesta 1.6 D	09/83→09/89	LTB			
Fiesta II 1.6 D	04/84→02/89		4 Cyl.	21.5:1	
			1608cc	40kW (54PS)	
		Diesel			TD1296

Escort IV 1.6 D	01/86→01/89	LTC			
Orion II 1.6 D	12/85→01/89		4 Cyl.	21.5:1	
			1608cc	40kW (54PS)	
		Diesel			TD1297

87-215507-00	0.50mm	08-215500-10	STD
		08-215507-10	0.50mm
		08-215511-10	1.00mm

A	46.70	2.00		CR P
B-	1.75	2.00		P
C	0.01	3.00		CR P
D	76.70			
	24x62			

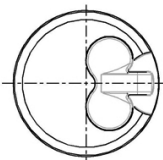
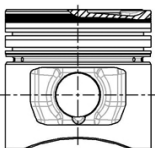



25  **80.60**

Escort V 1.8 16V		RDA Zetec			
Escort V 1.8 16V XR3i	02/92→12/92		4 Cyl.	10:1	
Escort VI 1.8 16V XR3i	12/92→01/95		1796cc	77kW (105PS)	
Escort VI 1.8 i 16V	09/92→01/95				TD1419
Escort VI 1.8 XR3i 16V	08/93→01/95				
Escort VII 1.8 16V	01/95→08/95				
Escort VII 1.8 16V XR3i	02/95→08/98				
Orion III 1.8 i 16V	02/92→12/93				
Fiesta III 1.8 16V	02/92→12/95	RDB Zetec			
			4 Cyl.	10:1	
			1796cc	77kW (105PS)	
					TD1420
Courier 1.8	03/98→02/02	RKA Zetec			
Mondeo I 1.8			4 Cyl.	10:1	
Mondeo I 1.8 i 16V	02/93→08/96		1796cc	85kW (115PS)	
Ranger 1.8	06/99→02/02				TD4487
Mondeo I 1.8 i 16V	01/94→08/96	RKB Zetec E			
Mondeo II 1.8 i	08/96→09/00		4 Cyl.	10:1	
			1796cc	82-85kW (111-116PS)	
					TD12091
Escort VII 1.8 16V	01/95→02/99	RKC Zetec E			
Escort VII 1.8 16V XR3i	10/95→08/98		4 Cyl.	10:1	
			1796cc	85kW (115PS)	
					TD5107
Mondeo II 1.8 i	08/96→09/00	RKF Zetec E			
			4 Cyl.	10:1	
			1796cc	85kW (115PS)	
					TD12088
Mondeo II 1.8 i	08/96→09/00	RKH Zetec E			
			4 Cyl.	10:1	
			1796cc	85kW (115PS)	
					TD15991
Mondeo II 1.8 i	08/96→09/00	RKJ Zetec E			
			4 Cyl.	10:1	
			1796cc	85kW (115PS)	
					TD12089
Mondeo II 1.8 i	08/96→09/00	RKK Zetec E			
			4 Cyl.	10:1	
			1796cc	85kW (115PS)	
					TD16011
Escort V 1.8 16V XR3i	02/92→12/92	RQB Zetec			
Escort VI 1.8 16V XR3i	09/92→01/95		4 Cyl.	10:1	
Escort VI 1.8 i 16V	02/93→01/95		1796cc	96kW (130PS)	
Escort VI 1.8 XR3i 16V	08/93→01/95				TD1431
Escort VII 1.8 16V XR3i	02/95→08/00				
Orion III 1.8 i 16V	01/92→12/93				



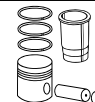
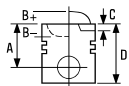





Fiesta III 1.8 XR2i 16V 02/92→12/95 **RQC Zetec** 4 Cyl. 10:1
1796cc **96kW (130PS)** **TD1432**

87-136600-00 STD **08-136600-00** STD
87-136607-00 0.50mm **08-136607-00** 0.50mm

06/99→

A 28.09
B- 1.27
BØ 65.00
C 0.88
D 52.09
 **19x50**

05/98→

1.20  NT **1**
1.50  P
2.50  CR **1**

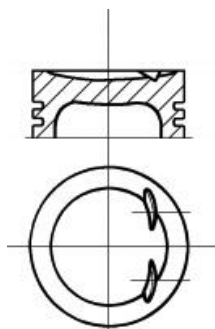

TP



87-786500-00 STD **08-786500-00** STD
87-786507-00 0.50mm **08-786507-00** 0.50mm

A 33.20
D 57.20
 **21x64**

01/93→08/95

1.50  MOL P
1.60  P
2.50  P

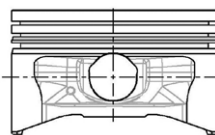

1 Steel

1 Stahl

1 Acier

1 Acero

1 Acciaio



26 80.98

Capri 1600	01/68→12/72	711M			
Cortina 1600	01/71→12/75		4 Cyl.	8:1	
					FM2361
Capri 1600	01/68→12/72	2737E Low compression			
Capri 1600 GT	01/67→12/70		4 Cyl.	8:1	
Capri GT 1716cc (overbored engine)	01/68→12/70		1599cc		
Cortina 1600 GT, Cortina 1600 MkII	01/67→12/70				
Cortina 1600 MkIII	01/70→12/73				
Cortina GT 1716cc (overbored engine)	01/68→12/70				
					FM2405
Transit 75, Transit 90, Transit 115	01/75→12/77	KL16L (751M)	4 Cyl.	8:1	
					FM2382

14-010880-00 D B 84.21 C 150.37

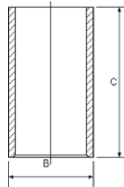



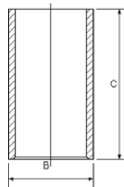

27 80.98

Capri 1600, Capri 1600 GT	01/68→12/72	711M updated			
Cortina 1600	01/71→12/75		4 Cyl.	9:1	
					FM2350

14-010880-00 D B 84.21 C 150.37



87-780600-10	STD	08-780600-10	STD
87-780607-10	.020	08-780607-10	.020
87-780609-10	.030	08-780609-10	.030
87-780611-10	.040	08-780611-10	.040
87-780614-10	.060	08-780614-10	.060
87-780617-10	.090	08-780617-10	.090

A	44.12	1.60		CR P
B-	12.86	2.00		P
C	3.10	3.94		P
C	2.80			
D	62.00			
	21x71			

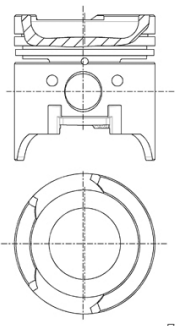



28 80.98

Escort I 1300	06/70→02/76	J2		
Escort II 1.3	12/74→08/80		4 Cyl. 1298cc	8/9:1 42-44kW (57-60PS)
				TD1217



87-780607-00	.020
87-780609-00	.030
87-780614-00	.060
87-780617-00	.090

A	44.22
B-	13.72
C	2.77
C	2.77
D	83.82

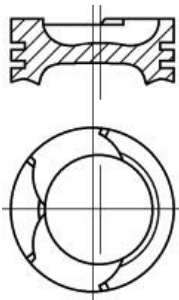
 21x71



08-780600-10	STD
08-780607-10	.020
08-780609-10	.030
08-780611-10	.040
08-780614-10	.060
08-780617-10	.090

1.60		CR P
2.00		P
3.94		P

14-010880-00 D B 84.21 C 150.37

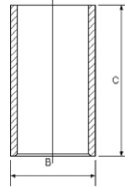

29 80.98

Fiesta I 1.6 XR2	08/81→08/83	L3E		
			4 Cyl. 1599cc	9:1 62kW (84PS)
				TD1251
Escort II 1.6 RS	12/74→08/80	LC		
			4 Cyl. 1599cc	9:1 62kW (84PS)
				TD1261



87-780600-20	STD
87-780607-20	.020
87-780609-20	.030
87-780611-20	.040
87-780614-20	.060

A	44.22
B-	12.68
BØ	62.00
C	2.77
C	2.77
D	83.82

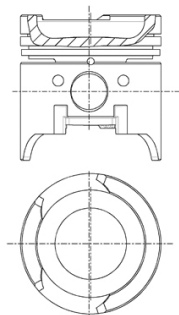
 21x71



08-780600-10	STD
08-780607-10	.020
08-780609-10	.030
08-780611-10	.040
08-780614-10	.060
08-780617-10	.090

1.60		CR P
2.00		P
3.94		P

14-010880-00 D B 84.21 C 150.37

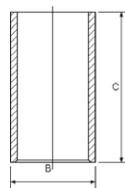







30 81.00

Galaxy 2.8 i V6	11/95 → 04/00	AAA	V6 Cyl. 2792cc	10.1:1 128kW (174PS)	TD5106
Galaxy 2.8 i V6	11/95 → 04/00	AMY	V6 Cyl. 2792cc	10.1:1 128kW (174PS)	TD17559

87-501900-00	STD	08-501900-00	STD
87-501907-00	0.50mm	08-501907-00	0.50mm

A	30.52	1.50	 P PS
B+	4.26	1.75	 P
BØ	57.00	3.00	 CR P
C	6.22		
D	55.78		
	20x57		

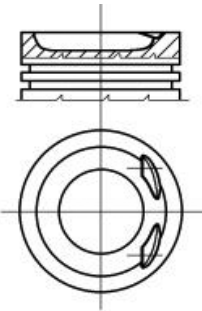

31 81.30





Sierra 1.6	08/82 → 12/86	LCS	4 Cyl. 1593cc	9.5:1 55kW (75PS)	TD1268
Sierra 1.6	08/82 → 12/86	LCT	4 Cyl. 1593cc	9.5:1 55kW (75PS)	TD1269
Sierra 1.6	08/82 → 12/86	LSD TL16E E-MAX	4 Cyl. 1593cc	9.5:1 55-58kW (75-79PS)	TD1291





Sierra 1.6 01/87→02/93 **LSE TL16E E-MAX**
 4 Cyl. 9.5:1
1593cc **55kW (75PS)**
TD1293

87-784600-00	STD	08-784600-00	STD
87-784607-00	0.50mm	08-784607-00	0.50mm
87-784611-00	1.00mm	08-784611-00	1.00mm

A	41.55	1.60		MO P
D	71.55	2.00		P
	24x69	4.00		CR 

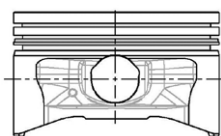

 Steel

 Stahl

 Acier

 Acero

 Acciaio

32  **82.50**

Focus 1.8 DI/TDDi	08/99→11/04	BHDA Endura DI	4 Cyl.	19.4:1	
Focus 1.8 Turbo DI/TDDi	08/01→03/05		1753cc	55-57kW (75-78PS)	TD15903
		Diesel	Turbo		
Focus 1.8 DI/TDDi	08/99→11/04	BHDB Endura DI	4 Cyl.	19.4:1	
Focus 1.8 Turbo DI/TDDi	08/01→03/05		1753cc	55-57kW (75-78PS)	TD15904
		Diesel	Turbo		
Focus 1.8 Turbo DI/TDDi	10/98→11/04	C9DA Endura DI	4 Cyl.	19.4:1	
			1753cc	66kW (90PS)	TD15905
		Diesel	Turbo Intercooled		
Focus 1.8 Turbo DI/TDDi	10/98→11/04	C9DB Endura DI	4 Cyl.	19.4:1	
			1753cc	66kW (90PS)	TD15906
		Diesel	Turbo Intercooled		





Focus 1.8 Turbo DI/TDDi	10/98→11/04	C9DC Endura DI	4 Cyl. 1753cc	19.4:1 66kW (90PS)	TD12081
		Diesel	Turbo		

87-107000-00	STD	08-107000-00	STD
87-107007-00	0.50mm	08-107007-00	0.50mm
		08-107011-00	1.00mm

A	45.70	2.50		CK P
B-	16.10	2.00		P
BØ	36.75	3.00		CR P
D	70.70			
	28x66			

RT TP

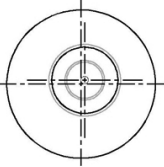
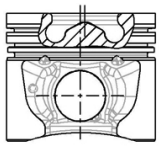

33 82.50

Tourneo Connect 1.8 TDCi /TDDi /DI Transit Connect 1.8 Di	06/02→12/13	BHPA Endura DI	4 Cyl. 1753cc	55-57kW (75-78PS)	TD20062
		Diesel	Turbo Intercooled		
Tourneo Connect 1.8 TDCi Transit Connect 1.8 TDCi	06/02→12/13	HCPA Duratorq	4 Cyl. 1753cc	66kW (90PS)	TD18779
		Diesel	Turbo Intercooled		
Tourneo Connect 1.8 TDCi Transit Connect 1.8 TDCi	06/02→12/13	HCPB Duratorq	4 Cyl. 1753cc	66kW (90PS)	TD18780
		Diesel	Turbo Intercooled		
Tourneo Connect 1.8 TDCi /TDDi /DI Transit Connect 1.8 Di	06/02→12/13	P7PA Duratorq	4 Cyl. 1753cc	55kW (75PS)	TD24465
		Diesel	Turbo Intercooled		
Tourneo Connect 1.8 TDCi /TDDi /DI Transit Connect 1.8 Di	06/02→12/13	P7PB Duratorq	4 Cyl. 1753cc	55kW (75PS)	TD24466
		Diesel	Turbo Intercooled		
Tourneo Connect 1.8 TDCi Transit Connect 1.8 TDCi	06/02→12/13	P9PA Duratorq	4 Cyl. 1753cc	66kW (90PS)	TD25795
		Diesel	Turbo Intercooled		
Tourneo Connect 1.8 TDCi Transit Connect 1.8 TDCi	06/02→12/13	P9PB Duratorq	4 Cyl. 1753cc	66kW (90PS)	TD25796
		Diesel	Turbo Intercooled		





Tourneo Connect 1.8 TDCi Transit Connect 1.8 TDCi	06/02→12/13	P9PC Duratorq 4 Cyl. 1753cc 66kW (90PS) Diesel Turbo Intercooled	TD25797
Tourneo Connect 1.8 TDCi Transit Connect 1.8 TDCi	06/02→12/13	P9PD Duratorq 4 Cyl. 1753cc 66kW (90PS) Diesel Turbo Intercooled	TD25798
Tourneo Connect 1.8 TDCi /TDDi /DI Transit Connect 1.8 Di	06/02→12/13	R2PA Duratorq 4 Cyl. 1753cc 55kW (75PS) Diesel Turbo Intercooled	TD24467
Tourneo Connect 1.8 TDCi Transit Connect 1.8 TDCi	06/02→12/13	R3PA Duratorq 4 Cyl. 1753cc 66kW (90PS) Diesel Turbo Intercooled	TD25799
Tourneo Connect 1.8 TDCi Transit Connect 1.8 TDCi	06/02→12/13	RWPE Duratorq 4 Cyl. 1753cc 66kW (90PS) Diesel Turbo Intercooled	TD25800
Tourneo Connect 1.8 TDCi Transit Connect 1.8 TDCi	06/02→12/13	RWPF Duratorq 4 Cyl. 1753cc 66kW (90PS) Diesel Turbo Intercooled	TD25801



87-107000-10	STD	08-107000-00	STD
87-107007-10	0.50mm	08-107007-00	0.50mm
87-107011-10	1.00mm	08-107011-00	1.00mm

→12/06

A	45.50
B-	14.10
BØ	41.50
D	70.70
	28x66

KK RT TP

→12/06

2.50		CK P
2.00		P
3.00		CR P

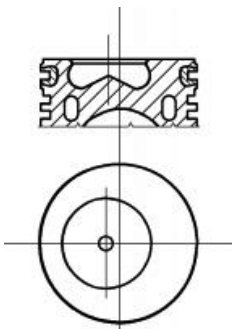



87-437000-10
87-437007-10

STD
0.50mm





08-437000-00
08-437007-00

STD
0.50mm

01/07→

01/07→

A 45.70
B- 12.50
BØ 45.30
D 71.20
 28x66

1.75  NT 
2.00  P
2.00  NT 

RT TP

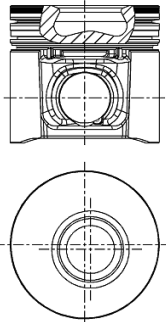

 Steel

 Stahl

 Acier

 Acero

 Acciaio

34  **82.50**

Focus 1.8 TDCi	03/01→11/04	F9DA	4 Cyl.	18.5:1	
			1753cc	85kW (115PS)	
		Diesel	Turbo Intercooled		TD17524
Focus 1.8 TDCi	03/01→11/04	F9DB	4 Cyl.	18.5:1	
			1753cc	85kW (115PS)	
		Diesel	Turbo Intercooled		TD17526
Focus 1.8 TDCi	08/02→11/04	FFDA	4 Cyl.	18.5:1	
			1753cc	74kW (100PS)	
		Diesel	Turbo Intercooled		TD17521



87-107000-10
87-107007-10
87-107011-10

STD
0.50mm
1.00mm

08-107000-00
08-107007-00
08-107011-00

STD
0.50mm
1.00mm

A 45.50
B- 14.10
BØ 41.50
D 70.70
 28x66

2.50  CK P
2.00  P
3.00  CR P

KK RT TP

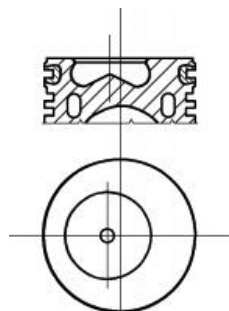



35 82.50

P 100 II 1.8 TD Sierra 1.8 TD	10/87→12/92 08/88→02/93	RFA	4 Cyl. 1753cc	21.5:1 55-57kW (75-78PS)	TD1426
		Diesel	Turbo		
Sierra 1.8 TD	08/88→02/93	RFB	4 Cyl. 1753cc	21.5:1 55-57kW (75-78PS)	TD1427
		Diesel	Turbo		
Escort '95 1.8 TD Escort Classic 1.8 TD Escort Classic Turnier 1.8 TD	01/95→ 10/98→07/00 02/99→07/00	RFD	4 Cyl. 1753cc	21.5:1 66kW (90PS)	TD4484
Escort VI 1.8 TD Escort VII 1.8 TD Orion III 1.8 TD	02/93→01/95 01/95→02/99 03/92→12/93	Diesel	Turbo Intercooled		
Escort '95 1.8 TD Escort Classic 1.8 TD Escort Classic Turnier 1.8 TD	01/95→ 10/98→07/00 02/99→07/00	RFK	4 Cyl. 1753cc	21.5:1 66kW (90PS)	TD4485
Escort VI 1.8 TD Escort VII 1.8 TD Orion III 1.8 TD	02/93→01/95 01/95→02/99 03/92→12/93	Diesel	Turbo Intercooled		
Fiesta III 1.8 TD Sierra 1.8 TD	03/93→12/95 08/88→02/93	RFL	4 Cyl. 1753cc	21.5:1 55-57kW (75-78PS)	TD4486
		Diesel	Turbo		
Mondeo I 1.8 TD	06/93→08/96	RFM	4 Cyl. 1753cc	21.5:1 65-66kW (88-90PS)	TD1428
		Diesel	Turbo Intercooled		
Mondeo I 1.8 TD Mondeo II 1.8 TD	06/93→08/96 08/96→09/00	RFN	4 Cyl. 1753cc	21.5:1 65-66kW (88-90PS)	TD1429
		Diesel	Turbo Intercooled		
Escort '95 1.8 TD Escort VI 1.8 TD	01/95→ 02/93→01/95	RFS Endura-DE	4 Cyl. 1753cc	21.5:1 66kW (90PS)	TD16143
		Diesel	Turbo Intercooled		
Fiesta 1.8 TD	03/93→11/95	RFU	4 Cyl. 1753cc	21.5:1 57kW (78PS)	TD23181
		Diesel	Turbo		



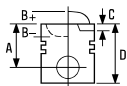

Escort '95 1.8 Turbo D	12/95 → 06/01	RVA Endura-DE	4 Cyl.	21.5:1	TD5104
Escort VII 1.8 Turbo D	12/95 → 08/99	1753cc Turbo		51kW (70PS)	
Diesel					

87-785200-00	STD	08-785200-00	STD
87-785207-00	0.50mm	08-785207-00	0.50mm

A	45.65	2.50		CR P
B-	1.50	2.00		P
D	75.80	3.00		CR P
	26x69			

RT

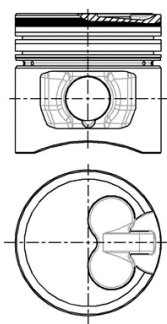

36 82.50

Escort '86 Express 1.8 D	07/88 → 07/90	RTA (D18NA)	4 Cyl.	21.5:1	TD1434
Escort IV 1.8 D	01/89 → 07/90	1753cc		44kW (60PS)	
Orion II 1.8 D		Diesel			

Escort '86 Express 1.8 D	07/88 → 07/90	RTB (D18NA)	4 Cyl.	21.5:1	TD1435
Escort IV 1.8 D	01/89 → 07/90	1753cc		44kW (60PS)	
Orion II 1.8 D		Diesel			

Fiesta 1.8 D	03/89 → 02/96	RTC (D18NA)	4 Cyl.	21.5:1	TD4489
Fiesta III 1.8 D	03/89 → 12/95	1753cc		43-44kW (58-60PS)	
		Diesel			

Fiesta 1.8 D	03/89 → 02/96	RTD (D18NA)	4 Cyl.	21.5:1	TD1437
Fiesta III 1.8 D	03/89 → 12/95	1753cc		43-44kW (58-60PS)	
		Diesel			

Escort V 1.8 D	07/90 → 12/92	RTE (D18NA)	4 Cyl.	21.5:1	TD1438
Escort VI 1.8 D	09/92 → 01/95	1753cc		44kW (60PS)	
Escort VII 1.8 D	01/95 → 02/99	Diesel			
Orion III 1.8 D	11/90 → 12/93				

Escort '95 1.8 D	01/95 →	RTF (D18NA)	4 Cyl.	21.5:1	TD1439
Escort V 1.8 D	07/90 → 12/92	1753cc		44kW (60PS)	
Escort VI 1.8 D	09/92 → 01/95	Diesel			
Escort VII 1.8 D	01/95 → 02/99				
Orion III 1.8 D	11/90 → 12/93				





Fiesta 1.8 D	03/89 → 02/96	RTG (D18NA)	4 Cyl.	21.5:1	TD1440
Fiesta III 1.8 D	03/89 → 12/95	1753cc		43-44kW (58-60PS)	
		Diesel			





Escort '91 Express 1.8 D	07/90→12/94	RTH (D18NA)			
Escort '95 1.8 D	01/95→		4 Cyl.	21.5:1	
Escort V 1.8 D	07/90→12/92		1753cc	44kW (60PS)	
Escort VI 1.8 D	09/92→01/95	Diesel			TD1441
Escort VII 1.8 D	01/95→02/99				
Orion III 1.8 D	11/90→12/93				
Fiesta D 1.8	05/98→04/02	RTJ Endura-DE			
Fiesta IV 1.8 D	08/95→04/00		4 Cyl.	21.5:1	
			1753cc	44kW (60PS)	
		Diesel			TD10068
Courier 1.8 D	06/99→02/02	RTK Endura-DE			
Fiesta 1.8 D	02/96→04/02		4 Cyl.	21.5:1	
Fiesta D 1.8	05/98→04/02		1753cc	44kW (60PS)	
Fiesta IV 1.8 D	08/95→04/00	Diesel			TD10067

87-783500-10	STD	08-783500-00	STD
87-783507-10	0.50mm	08-783507-00	0.50mm
87-783511-10	1.00mm	08-783511-00	1.00mm

A	45.70	2.00		CR P
B-	1.60	2.00		P
D	73.70	3.00		CR P
	26x59			

RT

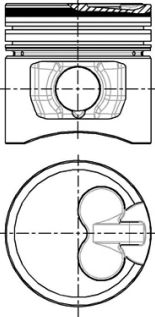

37 82.50

C-Max 1.8 TDCi	02/07→09/10	KKDA Euro 4			
Focus C-Max 1.8 TDCi	01/05→03/07		4 Cyl.	17:1	
Focus II 1.8 TDCi	07/04→09/12		1753cc	85kW (115PS)	
		Diesel	Turbo Intercooled		TD18480
Tourneo Connect 1.8 TDCi	08/06→12/13	RWPA Duratorq			
Transit Connect 1.8 TDCi			4 Cyl.		
			1753cc	81kW (110PS)	
		Diesel	Turbo Intercooled		TD20063
Tourneo Connect 1.8 TDCi	08/06→12/13	RWPC Duratorq			
Transit Connect 1.8 TDCi			4 Cyl.		
			1753cc	81kW (110PS)	
		Diesel	Turbo Intercooled		TD25793









Tourneo Connect 1.8 TDCi 08/06→12/13 **RWPD Duratorq**
Transit Connect 1.8 TDCi 4 Cyl. **1753cc** **81kW (110PS)**
Diesel **Turbo Intercooled** **TD25794**

87-437000-00 STD **08-437000-00** STD
87-437007-00 0.50mm **08-437007-00** 0.50mm

01/07→

A 45.65
B- 12.47
BØ 45.29
D 71.15
 28x66

01/07→

1.75  NT ①
2.00  P
2.00  NT ①

KK RT TP

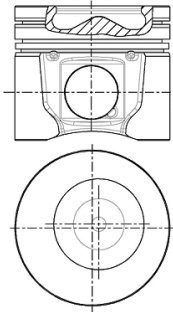

① Steel

① Stahl

① Acier



① Acero

① Acciaio

38  **82.55**

Escort Twin Cam 01/68→12/71 4 Cyl. 9.5:1
Lotus Cortina 01/65→12/70 **1558cc**
FM2963

87-522811-00 ① .040 ②

A 39.45 1.58  CR
C 0.01 1.98 
C 0.01 4.73 
D 68.61
 21x64

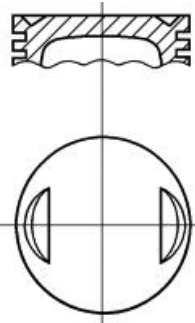

① Suitable for standard and high lift camshafts

② Ringset available in Kitset only

① Geeignet für Standard-und Hochhub-Nockenwellen

② Ringsätze nur im Assembly erhältlich

① Convient pour arbre à cames standard ou a levée majorée

② Jeux de segments disponible en kit seulement

① Apropriada para alzador de árbol de leva estandar y alto

② Juegos de segmentos disponible en conjuntos solamente

① Adatto per alberi a camme standard o maggiorati

② I set anelli piston sono disponibili solo in kit motore

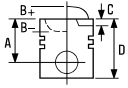

39  **83.00**

Mondeo III 1.8 16V	10/00→03/07	CGBA Duratec HE 4 Cyl. 1796cc	10.8:1 81kW (110PS)	TD15907
Mondeo III 1.8 16V	10/00→03/07	CGBB Duratec HE 4 Cyl. 1796cc	10.8:1 81kW (110PS)	TD15908
Mondeo III 1.8 16V	10/00→03/07	CHBA Duratec HE 4 Cyl. 1796cc	10.8:1 92kW (125PS)	TD15909
Mondeo III 1.8 16V	10/00→03/07	CHBB Duratec HE 4 Cyl. 1796cc	10.8:1 92kW (125PS)	TD15910
Focus C-MAX 1.8	10/03→03/07	CSDA Duratec HE 4 Cyl. 1798cc	10.8:1 88kW (120PS)	TD18975
Focus C-MAX 1.8	10/03→03/07	CSDB Duratec HE 4 Cyl. 1798cc	10.8:1 88kW (120PS)	TD18976
C-Max 1.8 Flexifuel Focus C-MAX 1.8 Focus C-MAX 1.8 Flexifuel Focus II 1.8 Focus II 1.8 Flexifuel	02/07→09/10 04/04→03/07 01/06→03/07 03/06→09/12 01/06→09/12	Q7DA Duratec HE 4 Cyl. 1798cc	92kW (125PS)	TD18974
C-Max 1.8 Focus C-MAX 1.8	02/07→09/10 04/04→03/07	QQDA Duratec HE 4 Cyl. 1798cc	92kW (125PS)	TD18788
C-Max 1.8 Focus C-MAX 1.8 Focus II 1.8	02/07→09/10 04/04→03/07 03/06→09/12	QQDB Duratec HE 4 Cyl. 1798cc	92kW (125PS)	TD18787





87-429400-00 STD
87-429407-00 0.50mm

STD
0.50mm

08-429400-00 STD
08-429407-00 0.50mm

STD
0.50mm

A 28.50
D 51.00
 21x51

1.20  NT 
1.20  P
2.50  NT 

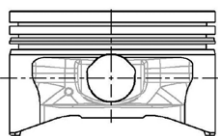

 Steel

 Stahl

 Acier

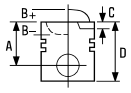

 Acero

 Acciaio







40  **84.80**

Cougar 2.0 16V	08/98→12/01	EDBA Zetec E	4 Cyl. 1988cc	10:1 96kW (131PS)	TD12068
Cougar 2.0 16V	08/98→12/01	EDBB Zetec E	4 Cyl. 1988cc	10:1 96kW (131PS)	TD15916
Cougar 2.0 16V	08/98→12/01	EDBC Zetec E	4 Cyl. 1988cc	10:1 96kW (131PS)	TD15917
Cougar 2.0 16V	08/98→12/01	EDBD Zetec E	4 Cyl. 1988cc	10:1 96kW (131PS)	TD15918
Focus 2.0 16V	10/98→11/04	EDDB Zetec E	4 Cyl. 1988cc	10:1 96kW (131PS)	TD15900
Focus 2.0 16V	10/98→11/04	EDDC Zetec E	4 Cyl. 1988cc	10:1 96kW (131PS)	TD12080
Focus 2.0 16V	10/98→11/04	EDDF Zetec E	4 Cyl. 1988cc	10:1 96kW (131PS)	TD15902
Mondeo I 2.0 i 16V Mondeo II 2.0 i	01/93→08/96 08/96→09/00	NGA Zetec E	4 Cyl. 1988cc	10:1 96-100kW (131-136PS)	TD4475



87-786400-00  **STD**
87-786407-00  **0.50mm**

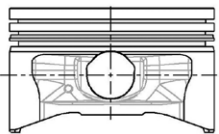

08-786400-00 **STD**
08-786407-00 **0.50mm**

A 32.92
D 56.90
 21x64



1.50  **CR P**
1.75  **P**
3.00  **CR 2**





 Pistons to be replaced in Engine Sets only
 Steel

 Kolben nur Motorsätzen zu ersetzen
 Stahl

 Piston à remplacer dans jeu moteur
 Acier





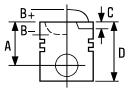



 Pistones de repuesto para juegos de motores solamente
 Acero

 Il pistone può essere rimpiazzato solamente completo
 Acciaio



41 85.00

Mondeo IV 2.2 TDCi Mondeo IV Turnier 2.2 TDCi	07/10→09/14	KNBA Duratorq 4 Cyl. 2179cc Diesel Turbo Intercooled	147kW (200PS)	TD26808
Mondeo IV 2.2 TDCi Mondeo IV Turnier 2.2 TDCi	07/10→09/14	KNBB Duratorq 4 Cyl. 2179cc Diesel Turbo Intercooled	146kW (199PS)	TD26809
Galaxy 2.2 TDCi S-Max 2.2 TDCi	11/10→06/15 07/10→	KNWA Duratorq 4 Cyl. 2179cc Diesel Turbo Intercooled	147kW (200PS)	TD26488
Galaxy 2.2 TDCi S-Max 2.2 TDCi	11/10→06/15 07/10→	KNWB Duratorq 4 Cyl. 2179cc Diesel Turbo Intercooled	146kW (199PS)	TD26489

87-436700-00 	STD	08-436700-00	STD
87-436708-00 	0.60mm	08-436708-00	0.60mm
A	48.60	2.50	 GDC P
B-	15.12	2.00	 P
BØ	50.40	2.00	 CK
C	0.38	 	
D	74.60		
 30x68			

AK KK RT TP

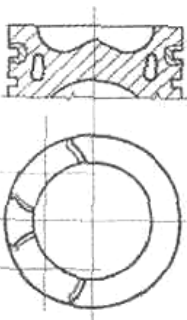



0850HA324

 For pistons with a 24.3mm con rod gap measured at pin centre line

 Für Kolben mit einem Pleuelaugenabstand von 24,3 MM, gemessen an der Kolbenbolzen-Mitte

 Pour pistons avec un écart de bielle de 24,3 mm mesuré au centre de l'axe bielle-piston

 Para pistones con una distancia de paso de biela en el centro del bulón de 24,3mm

 Per pistoni con passaggio biella di 24,3 mm misurato sull'asse foro spinotto

42 86.00

Sierra 2.0	01/87→02/93	N8C (DL20H) 4 Cyl. 1998cc	10.3:1 77kW (105PS)	TD1332
Sierra 2.0 Sierra 2.0 i Sierra 2.0, Sierra 2.0 i	10/91→03/93 06/89→02/93 05/89→02/93	N9C 4 Cyl. 1998cc	10.3:1 88-92kW (120-125PS)	TD1337



Scorpio I 2.0 i	09/91 → 09/94	N9F	4 Cyl. 1998cc	10.3:1 85kW (115PS)	TD1339
Transit 2.0 i	08/94 → 12/99	N9K	4 Cyl. 1998cc	9.8:1 84kW (114PS)	TD7014

87-784200-00
87-784207-00

STD
0.50mm

08-784200-00
08-784207-00

STD
0.50mm

→05/94

A 32.27
D 62.27
21x64

1.60
1.75
3.00



MO P
P
CR 1

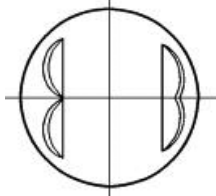
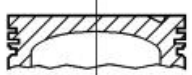

1 Steel

1 Stahl

1 Acier

1 Acero

1 Acciaio

43 **86.00**

Scorpio II 2.0 i	10/94 → 08/98	NSD	4 Cyl. 1998cc	10.3:1 85kW (115PS)	TD4476
Galaxy 2.0 i	11/95 → 05/06	NSE	4 Cyl. 1998cc	10.3:1 85kW (116PS)	TD5109
Transit 2.0	06/94 → 03/06	NSF	4 Cyl. 1998cc	9.8:1 84kW (114PS)	TD4477



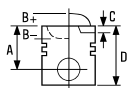

Galaxy 2.0 i 11/95→05/06 **ZVSA** 4 Cyl. 10.3:1
1998cc **85kW (116PS)** **TD17158**



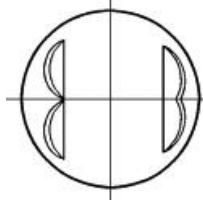
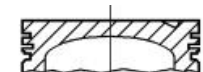

87-784200-00 STD
87-784207-00 0.50mm

→05/94

A 32.27
D 62.27
 21x64



08-784200-00 STD
08-784207-00 0.50mm

1.60  MO P
 1.75  P
 3.00  CR 



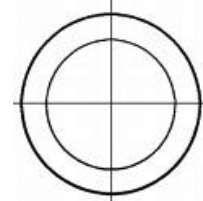
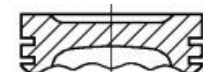

87-784200-10 STD
87-784207-10 0.50mm

05/94→

A 32.25
B- 1.17
BØ 60.00
D 62.20
 21x63



08-784200-00 STD
08-784207-00 0.50mm

1.60  MO P
 1.75  P
 3.00  CR 

 Steel

 Stahl

 Acier

 Acero

 Acciaio

44  **86.00**

Transit 2.0 DI 08/00→05/06 **ABFA Dura Torq DI** 4 Cyl. 19:1
1998cc **74kW (100PS)**
Diesel Turbo Intercooled **TD15888**

Transit 2.0 DI 08/00→05/06 **D3FA** 4 Cyl. 19:1
1998cc **55kW (75PS)**
Diesel Turbo **TD15551**





Mondeo III 2.0 16V DI/TDDi/TDCi	10/00→03/07	D5BA Dura Torq DI 4 Cyl. 1998cc Diesel	19:1 66kW (90PS) Turbo Intercooled	TD15914
Transit 2.0 DI	08/00→05/06	F3FA Duratorq 4 Cyl. 1998cc Diesel	63kW (86PS) Turbo	TD18777
Mondeo III 2.0 16V DI/TDDi/TDCi	10/00→03/07	SDBA Duratorq 4 Cyl. 1998cc Diesel	19.5:1 66kW (90PS) Turbo Intercooled	TD18763

87-140800-00 ¹
87-140807-00

STD
0.50mm

08-140800-00 ²
08-140807-00 ²

STD
0.50mm

A 47.58
B- 16.50
BØ 40.20
D 73.98
 30x66

2.00 CK P
2.00 P
2.00 NT ³

RT TP

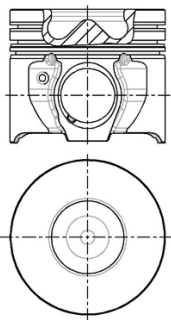

¹ Piston Chamber Volume
[ccm] 20.14

² Only fit to pistons equivalent to
OE 24878 and 24879

³ Steel

¹ Volumen der Kolbenmulde
[ccm] 20.14

² Nur gepasst worden zu den Kolben
gleichwertig mit OE 24878 und 24879

³ Stahl

¹ Volume de la cavité du piston
[cm³] 20.14

² Seulement adapté aux pistons
équivalents à OE 24878 et 24879

³ Acier

¹ Volumen de cavidad del pistón
[cc] 20.14

² Cabido solamente a los pistones
equivalentes a OE 24878 y 24879

³ Acero

¹ Volume camera pistone
[cm³] 20.14

² Adattato soltanto ai pistoni equivalenti
a OE 24878 e 24879

³ Acciaio

45 **86.00**

Transit 2.2 TDCi	08/13→	CVF5 Duratorq 4 Cyl. 2198cc Diesel	114kW (155PS) Turbo Intercooled	TD29676
Transit 2.2 TDCi [RWD]	10/11→08/14	CVRA Duratorq 4 Cyl. 2198cc Diesel	114kW (155PS) Turbo Intercooled	TD26453
Transit 2.2 TDCi [RWD]	10/11→08/14	CVRB Duratorq 4 Cyl. 2198cc Diesel	114kW (155PS) Turbo Intercooled	TD26454



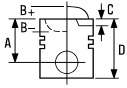

Transit 2.2 TDCi [RWD]	10/11→08/14	CVRC Duratorq 4 Cyl. 2198cc 114kW (155PS) Diesel Turbo Intercooled	TD26455
Ranger 2.2 TDCi	04/11→	GBVAJPF Duratorq 4 Cyl. 15.6:1 2198cc 88kW (120PS) Diesel Turbo Intercooled	TD26487
Ranger 2.2 TDCi	04/11→	GBVAJQJ Duratorq 4 Cyl. 15.6:1 2198cc 110kW (150PS) Diesel Turbo Intercooled	TD26483
Ranger 2.2 TDCi	04/11→	GBVAJQW Duratorq 4 Cyl. 2198cc 92kW (125PS) Diesel Turbo Intercooled	TD26486

87-427700-50
87-427707-50



STD
0.50mm

08-427700-00
08-427707-00

STD
0.50mm

14-022110-00 D B 89.00 C 165.00 D 90.05 E 5.00

A 48.42
B- 16.17
BØ 49.04
D 74.82
 30x67

2.00  **CK P**
2.00  **P**
2.00  **NT 1**

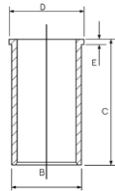

AK KK RT TP

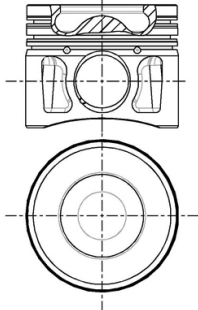

08683-607

 Steel

 Stahl

 Acier

 Acero

 Acciaio

46  **86.00**

Transit 2.2 TDCi [RWD]	10/11→08/14	CYRA Duratorq 4 Cyl. 2198cc 92kW (125PS) Diesel Turbo Intercooled	TD26716
Transit 2.2 TDCi Transit 2.2 TDCi [RWD]	10/11→08/14	CYRB Duratorq 4 Cyl. 2198cc 92kW (125PS) Diesel Turbo Intercooled	TD26465
Transit 2.2 TDCi Transit Tourneo 2.2 TDCi	10/08→08/14	SRFA 4 Cyl. 2198cc 85kW (115PS) Diesel Turbo Intercooled	TD24458





Transit 2.2 TDCi Transit Tourneo 2.2 TDCi	10/08→08/14	SRFB	4 Cyl. 2198cc Diesel Turbo Intercooled	85kW (115PS)	TD24459
Transit 2.2 TDCi Transit Tourneo 2.2 TDCi	10/08→08/14	SRFC	4 Cyl. 2198cc Diesel Turbo Intercooled	85kW (115PS)	TD24460
Transit 2.2 TDCi Transit Tourneo 2.2 TDCi	10/08→08/14	SRFD	4 Cyl. 2198cc Diesel Turbo Intercooled	85kW (115PS)	TD24461
Transit 2.2 TDCi Transit Tourneo 2.2 TDCi	10/08→08/14	SRFE	4 Cyl. 2198cc Diesel Turbo Intercooled	85kW (115PS)	TD24462
Transit 2.2 TDCi Transit Tourneo 2.2 TDCi	10/07→08/14 10/07→08/14	UHFA Duratorq	4 Cyl. 2198cc Diesel Turbo Intercooled	103kW (140PS)	TD26467
Transit 2.2 TDCi Transit Tourneo 2.2 TDCi	10/07→08/14 10/07→08/14	UHFB Duratorq	4 Cyl. 2198cc Diesel Turbo Intercooled	103kW (140PS)	TD26468
Transit 2.2 TDCi	10/07→08/14	UHFC Duratorq	4 Cyl. 2198cc Diesel Turbo Intercooled	103kW (140PS)	TD26469

87-427700-40
87-427707-40

STD
0.50mm

08-427700-00
08-427707-00

STD
0.50mm

14-021120-00 D B 89.00 C 156.00 D 90.90 E 5.00

A 48.42
B- 15.85
BØ 46.90
D 74.82
30x66

2.00
2.00
2.00

CK P
P
NT

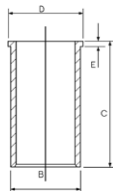

AK KK RT TP

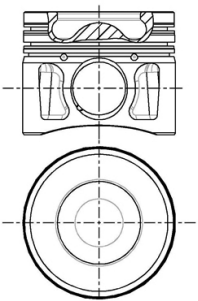

08683-101

Steel

Stahl

Acier

Acero

Acciaio



47  **86.00**

Mondeo III 2.0 16V TDDi/TDCi	10/00→03/07	D6BA Dura Torq DI	4 Cyl.	19:1	
		Diesel	1998cc	85kW (115PS)	
			Turbo Intercooled		TD15915
Transit 2.0 TDCi	08/02→05/06	FIFA Duratorq	4 Cyl.		
		Diesel	1998cc	92kW (125PS)	
			Turbo Intercooled		TD18839
Mondeo III 2.0 TDCi	10/01→03/07	FMBA	4 Cyl.	18.2:1	
		Diesel	1998cc	96kW (130PS)	
			Turbo Intercooled		TD18761
Mondeo III 2.0 16V TDDi/TDCi	10/00→03/07	HJBA	4 Cyl.	19:1	
		Diesel	1998cc	85kW (115PS)	
			Turbo Intercooled		TD17547
Mondeo III 2.0 16V TDDi/TDCi	10/00→03/07	HJBB	4 Cyl.	19:1	
		Diesel	1998cc	85kW (115PS)	
			Turbo Intercooled		TD17548
Mondeo III 2.0 16V TDDi/TDCi	10/00→03/07	HJBC	4 Cyl.	19:1	
		Diesel	1998cc	85kW (115PS)	
			Turbo Intercooled		TD17549
Mondeo III 2.0 TDCi	10/01→03/07	N7BA	4 Cyl.	18.2:1	
		Diesel	1998cc	96kW (130PS)	
			Turbo Intercooled		TD18762

87-140800-10 ¹

STD

08-140800-00 ²

STD

87-140807-10

0.50mm

08-140807-00 ²

0.50mm

A 47.70

2.00



CK P

B- 15.20

2.00



P

BØ 43.30

2.00



NT ³

D 74.10

 30x66

KK RT TP

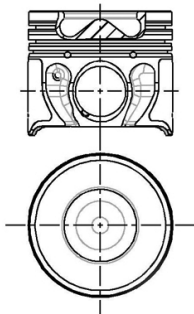

8662

¹ Piston Chamber Volume
[ccm] 21.49

¹ Volumen der Kolbenmulde
[cm³] 21.49

¹ Volume de la cavité du piston
[cm³] 21.49

¹ Volumen de cavidad del pistón
[cc] 21.49

¹ Volume camera pistone
[cm³] 21.49

² Only fit to pistons equivalent to
OE 24878 and 24879

² Nur gepasst worden zu den Kolben
gleichwertig mit OE 24878 und 24879

² Seulement adapté aux pistons
équivalents à OE 24878 et 24879

² Cabido solamente a los pistones
equivalentes a OE 24878 y 24879

² Adattato soltanto ai pistoni equivalenti x
equivalentes a OE 24878 y 24879

³ Steel

³ Stahl

³ Acier

³ Accro

³ Acciaio



48 **86.00**

Transit 2.2 TDCi	04/06→08/14	P8FA	4 Cyl.	2198cc	63kW (85PS)	
		Diesel	Turbo Intercooled			TD20042
Transit 2.2 TDCi	04/06→08/14	P8FB	4 Cyl.	2198cc	63kW (85PS)	
		Diesel	Turbo Intercooled			TD21066

87-427700-30
87-427707-30

STD
0.50mm

08-427700-00
08-427707-00

STD
0.50mm

14-021120-00 D B 89.00 C 156.00 D 90.90 E 5.00

A 43.42
B- 15.85
BØ 46.90
D 69.82
 30x67

2.00
2.00
2.00

CK P
P
NT

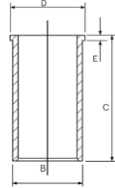

RT TP

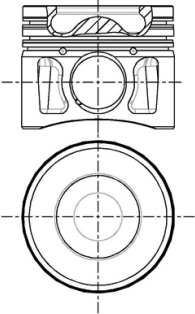

08650A105

Steel

Stahl

Acier

Acero

Acciaio

49 **86.00**

Mondeo III 2.2 TDCi	09/04→03/07	QJBA Duratorq	4 Cyl.	2198cc	17.5:1 114kW (155PS)	
		Diesel	Turbo Intercooled			TD18756
Mondeo III 2.2 TDCi	09/04→03/07	QJBB Duratorq	4 Cyl.	2198cc	17.5:1 114kW (155PS)	
		Diesel	Turbo Intercooled			TD18757
Mondeo III 2.2 TDCi	09/04→03/07	QJBC Duratorq	4 Cyl.	2198cc	17.5:1 110kW (150PS)	
		Diesel	Turbo Intercooled			TD18782
Mondeo III 2.2 TDCi	09/04→03/07	QJBD Duratorq	4 Cyl.	2198cc	17.5:1 110kW (150PS)	
		Diesel	Turbo Intercooled			TD18783
Transit 2.2 TDCi	04/06→08/14	QVFA Euro 4	4 Cyl.	2198cc	81kW (110PS)	
Transit Tourneo 2.2 TDCi	07/06→08/14					TD20043



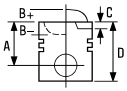

Transit 2.2 TDCi	04/06→08/14	QWFA			
Transit Tourneo 2.2 TDCi	07/06→08/14		4 Cyl.	2198cc	96kW (130PS)
		Diesel		Turbo Intercooled	TD20044

87-427700-10 STD
87-427707-10 0.50mm

A 43.42
B- 15.85
BØ 46.90
D 69.82
 30x67



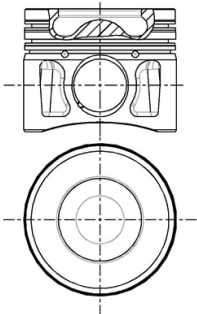

KK RT TP



8648B105

 Steel

08-427700-00 STD
08-427707-00 0.50mm

2.00  CK P
 2.00  P
 2.00  NT 

14-021120-00 D **B** 89.00 **C** 156.00 **D** 90.90 **E** 5.00

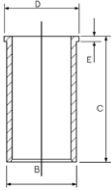

 Acier

 Acero

 Acciaio

50 86.00

Transit 2.2 TDCi	10/07→08/14	PGFA Euro 4			
Transit Tourneo 2.2 TDCi	10/07→08/14		4 Cyl.	2198cc	103kW (140PS)
		Diesel		Turbo Intercooled	TD21067

Transit 2.2 TDCi	10/07→08/14	PGFB			
Transit Tourneo 2.2 TDCi	10/07→08/14		4 Cyl.	2198cc	103kW (140PS)
		Diesel		Turbo Intercooled	TD24463

87-427700-40 STD
87-427707-40 0.50mm



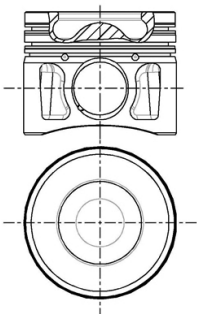

A 48.42
B- 15.85
BØ 46.90
D 74.82
 30x66

AK KK RT TP



08683-101

08-427700-00 STD
08-427707-00 0.50mm

2.00  CK P
 2.00  P
 2.00  NT 

14-021120-00 D **B** 89.00 **C** 156.00 **D** 90.90 **E** 5.00

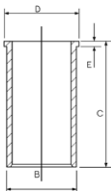

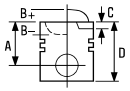
87-427700-10
87-427707-10

STD
0.50mm

08-427700-00
08-427707-00

STD
0.50mm

14-021120-00 D

B 89.00 C 156.00 D 90.90 E 5.00

A 43.42
B- 15.85
BØ 46.90
D 69.82
 30x67

2.00
2.00
2.00



CK P
P
NT 1

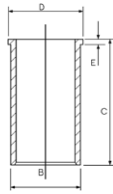

KK RT TP

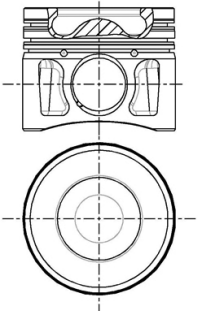

8648B105

1 Steel

1 Stahl

1 Acier

1 Acero

1 Acciaio

51  87.50





C-Max 2.0 Focus C-MAX 2.0 Focus II 2.0	02/07→09/10 03/04→03/07 07/04→09/12	AODA	4 Cyl. 1999cc	10.8:1 107kW (145PS)	TD18506
C-Max 2.0 Focus C-MAX 2.0 Focus II 2.0	02/07→09/10 03/04→03/07 07/04→09/12	AODB	4 Cyl. 1999cc	10.8:1 107kW (145PS)	TD18507
C-Max 2.0	02/07→09/10	AODE	4 Cyl. 1999cc	10.8:1 107kW (145PS)	TD24347
Mondeo III 2.0 Mondeo III 2.0 16V	10/00→03/07	CJBA Duratec HE	4 Cyl. 1999cc	10.8:1 106-107kW (144-146PS)	TD15911
Mondeo III 2.0 16V	10/00→03/07	CJBB Duratec HE	4 Cyl. 1999cc	10.8:1 107kW (146PS)	TD15912
Fiesta V ST150	03/05→06/08	N4JB Duratec ST	4 Cyl. 1999cc	10.8:1 110kW (150PS)	TD18781





C-Max 2.0	02/07→09/10	SYDA Duratec HE		
C-Max 2.0 CNG	04/09→09/10		4 Cyl.	
C-Max 2.0 LPG	06/08→09/10		1999cc	107kW (145PS)
Focus C-MAX 2.0	03/04→03/07			TD23368
Focus II 2.0	04/10→			
Focus II 2.0 Cng	04/09→07/11			
Focus II 2.0 Flex	10/08→03/10			
Focus II 2.0 LPG	06/08→07/11			

87-423400-00	STD	08-423400-00	STD
87-423407-00	0.50mm	08-423407-00	0.50mm

A	28.50	1.20		CR P 1
B-	0.35	1.20		P
BØ	76.50	2.50		CR 1
D	51.00			
	21x60			

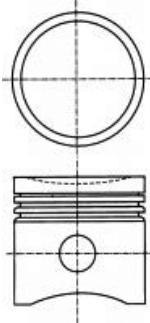

1 Steel

1 Stahl

1 Acier

1 Acero

1 Acciaio

52 87.65

Capri II 1.6	02/74→12/77	LCE	4 Cyl.	9.2:1	
			1593cc	53kW (72PS)	TD1263
Granada 1.6	07/81→08/85	LCK	4 Cyl.	9.5:1	
			1593cc	55kW (75PS)	TD1265
Capri III 1.6	01/78→04/87	LCN	4 Cyl.	9.2:1	
			1593cc	54kW (73PS)	TD1266



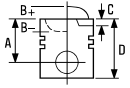

Capri II 1.6	02/74→12/77	LEC	4 Cyl. 1593cc	9:1 65kW (88PS)	TD11229
---------------------	-------------	------------	-------------------------	---------------------------	----------------

87-205800-00	STD	08-205800-00	STD
87-205807-00	0.50mm	08-205807-00	0.50mm
87-205811-00	1.00mm		

→08/82

A 41.10
D 73.10
24x73

2.00		CR P
2.50		P
4.00		CR 1

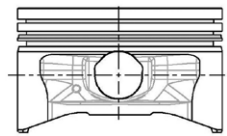

1 Steel

1 Stahl

1 Acier

1 Acero

1 Acciaio

53 88.00

Granada 1.9 D, Granada 1.9 D GL	01/77→12/82	XD/P88	4 Cyl. 1948cc	21.8:1	FM1421
Granada 1.9 D L, Granada 1.9 D Turnier					
		Diesel			

14-600420-00 WH 1 B 96.00 C 173.00 D 106.30 E 129.00

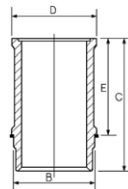

1 Use also: HT022

1 Mitverwenden: HT022

1 A utiliser aussi: HT022

1 Utilizar también: HT022

1 Usare anche HT022

54 89.60

Transit 2.3	08/00→03/06	E5FA	4 Cyl.		
Transit 2.3 16V	04/01→05/06				
Transit 2.3 16V [RWD]	08/00→05/06		2295cc	107kW (146PS)	TD16167

Transit 2.3	03/01→03/06	E5FC	4 Cyl.		
Transit 2.3 16V	04/01→05/06				
Transit 2.3 16V [RWD]	08/00→05/06		2295cc	103-107kW (140-146PS)	TD20058

Scorpio II 2.3 i 16V	06/96→08/98	Y5A	4 Cyl. 2295cc	10:1 108kW (147PS)	TD12092
-----------------------------	-------------	------------	-------------------------	------------------------------	----------------





Galaxy 2.3	09/96→04/00	Y5B		
Galaxy 2.3 16V	01/97→05/06		4 Cyl. 2295cc	10:1 107kW (146PS)
TD5497				

87-107600-00	STD	08-107600-00	STD
87-107607-00	0.50mm	08-107607-00	0.50mm

A	29.25
D	54.20
	21x63

1.60		P PS
1.50		P
2.50		CR 1

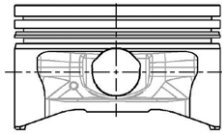

1 Steel

1 Stahl

1 Acier

1 Acero

1 Acciaio

55 89.90

Transit 2.4 DI	01/00→05/06	D2FA Duratorq	4 Cyl.	19:1
			2402cc	66kW (90PS)
		Diesel	Turbo Intercooled	TD15549

Transit 2.4 DI	01/00→05/06	D2FB Duratorq	4 Cyl.	
			2402cc	66kW (90PS)
		Diesel	Turbo Intercooled	TD20037

Transit 2.4 DI	01/00→05/06	D2FE	4 Cyl.	
Transit 2.4 TDDi	10/01→03/06		2402cc	66kW (90PS)
		Diesel	Turbo Intercooled	TD15552

Transit 2.4 DI	01/00→05/06	F4FA Duratorq	4 Cyl.	19:1
Transit 2.4 DI [RWD]	01/00→05/06		2402cc	55kW (75PS)
Transit 2.4 TD				
Transit 2.4 TD All-wheel Drive	08/00→08/03	Diesel	Turbo Intercooled	TD15548

87-113500-00	STD	08-113500-00	STD	14-020540-00 DH	B 92.50 C 165.00 E 3.00
87-113507-00	0.50mm	08-113507-00	0.50mm		
87-113511-00	1.00mm	08-113511-00	1.00mm		

A	53.54	2.50		CK P
B-	17.60	2.00		P
BØ	41.00	3.00		CR P
D	80.50			
	32x65			

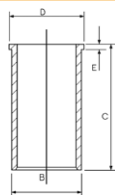

RT TP

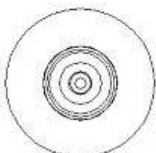
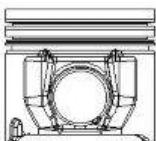



56 89.90

Transit 2.4 DI	01/00→05/06	D4FA Duratorq			
Transit 2.4 DI [RWD]	01/00→05/06		4 Cyl.	19:1	
Transit 2.4 TDdi	08/00→08/03		2402cc	88kW (120PS)	
		Diesel	Turbo Intercooled		TD15550
Transit 2.4 TDE	03/04→05/06	FXFA Duratorq			
			4 Cyl.	19:1	
			2402cc	85kW (115PS)	
		Diesel	Turbo Intercooled		TD18798

87-113500-10  STD 08-113500-00 STD **14-020540-00 DH** B 92.50 C 165.00 E 3.00

87-113507-10 0.50mm
87-113511-10 1.00mm

08-113507-00 0.50mm
08-113511-00 1.00mm

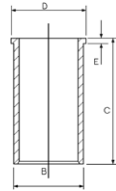

A 53.50

B- 17.24

BØ 40.40

D 80.50

 32x71

2.50

2.00

3.00





CK P

P

CR P

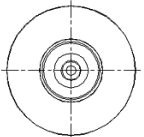
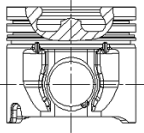
KK RT TP



 Piston Chamber Volume
[ccm] 25.34

 Volumen der Kolbenmulde
[ccm] 25.34

 Volume de la cavité du piston
[cm³] 25.34

 Volumen de cavidad del pistón
[cc] 25.34

 Volume camera pistone
[cm³] 25.34



57 89.90

Transit 2.4 TDE

07/01→05/06

DOFA (DT24) Duratorq

4 Cyl.

18.5:1

2402cc

92kW (125PS)

Diesel

Turbo Intercooled

TD20038

87-148100-00

STD

08-148100-00

STD

14-020540-00 *DH* B 92.50 C 165.00 E 3.00

87-148105-00

0.25mm

08-148105-00

0.25mm

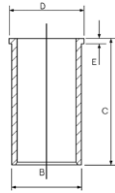

87-148107-00

0.50mm

08-148107-00

0.50mm

A 53.50

2.00



CK P

B- 17.24

2.00

P

BØ 40.40

2.00

NT 1

D 80.50

 32x71

AK KK RT TP

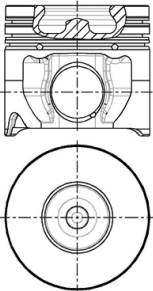

08900B201

1 Steel

1 Stahl

1 Acier

1 Acero

1 Acciaio

58 89.90

Transit 2.4 TDCi

03/04→05/06

H9FA Euro 4

4 Cyl.

18:1

2402cc

101kW (137PS)

Diesel

Turbo Intercooled

TD20036

87-148100-10 1

STD

08-148100-00

STD

14-020540-00 *DH* B 92.50 C 165.00 E 3.00

87-148105-10

0.25mm

08-148105-00

0.25mm

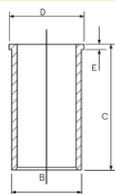

87-148107-10

0.50mm

08-148107-00

0.50mm

03/04→

2.00



CK P

A 53.50

2.00

P

B- 15.62

2.00

NT 2

BØ 47.10

D 80.50

 32x71

AK KK RT TP

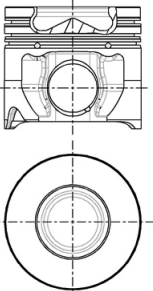

8900B301

1 Piston Chamber Volume
[ccm] 27.03

2 Steel

1 Volumen der Kolbenmulde
[ccm] 27.03

2 Stahl

1 Volume de la cavité du piston
[cm³] 27.03

2 Acier

1 Volumen de cavidad del pistón
[cc] 27.03

2 Acero

1 Volume camera pistone
[cm³] 27.03

2 Acciaio



59  **89.90**

Transit 2.4 TDCi	11/06→08/14	H9FB Euro 4	4 Cyl.	18:1
			2402cc	103kW (140PS)
		Diesel	Turbo Intercooled	TD20033

Transit 2.4 TDCi	04/06→08/14	JXFA Euro 4	4 Cyl.	18:1
Transit 2.4 TDCi [RWD]			2402cc	85kW (115PS)
		Diesel	Turbo Intercooled	TD20034

87-148100-30 STD **08-148100-00** STD **14-020540-00 DH** B 92.50 C 165.00 E 3.00

87-148107-30 0.50mm **08-148105-00** 0.25mm

08-148107-00 0.50mm

A 53.50

B- 16.30

BØ 49.00

D 80.50

 32x71

2.00 

2.00 

2.00 

CK P

P

NT 

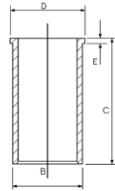

AK KK RT TP

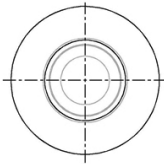
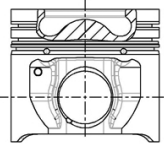

08900B102

 Steel

 Stahl

 Acier

 Acero

 Acciaio

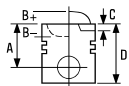

60  **89.90**





Transit 2.4 TDCi		PHFA			
Transit 2.4 TDCi [RWD]	04/06→08/14		4 Cyl.		
			2402cc	74kW (100PS)	
		Diesel	Turbo Intercooled		TD20035

Transit 2.4 TDCi		PHFC Euro 4			
Transit 2.4 TDCi [RWD]	04/06→08/14		4 Cyl.	18:1	
			2402cc	74kW (100PS)	
		Diesel	Turbo Intercooled		TD21068

87-148100-40 STD
87-148107-40 0.50mm

A 53.50
B- 16.30
BØ 49.00
D 80.50
 32x66

08-148100-00 STD
08-148105-00 0.25mm
08-148107-00 0.50mm

2.00  CK P
 2.00  P
 2.00  NT 

14-020540-00 *DH* B 92.50 C 165.00 E 3.00

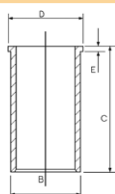

AK RT TP

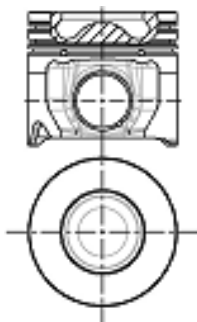

08998A101

 Steel

 Stahl

 Acier

 Acero

 Acciaio



61 **89.90**

Ranger 3.2 TDCi	04/11→	SAFA Duratorq			
Transit 3.2 TDCi	02/08→08/14		5 Cyl.	15.7:1	
Transit 3.2 TDCi [RWD]	09/07→08/14		3199cc	147kW (200PS)	
		Diesel	Bi-Turbo Intercooled		TD21069
Transit 3.2 TDCi	02/08→08/14	SAFB Duratorq			
Transit 3.2 TDCi [RWD]	09/07→08/14		5 Cyl.		
			3199cc	147kW (200PS)	
		Diesel	Turbo Intercooled		TD23369

87-148100-80 STD
87-148105-80 0.25mm
87-148107-80 0.50mm

A 48.22
B- 16.70
BØ 50.20
D 75.22
 32x74

AK KK RT TP

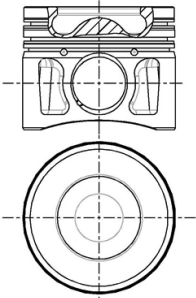

0899BA-105

08-148100-00 STD
08-148105-00 0.25mm
08-148107-00 0.50mm

2.00 CK P
 2.00 P
 2.00 NT

14-020540-00 DH B 92.50 C 165.00 E 3.00

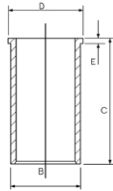

87-148100-85 STD
87-148107-85 0.50mm

A 48.34
B- 17.93
BØ 51.43
D 75.34
 32x71

AK KK RT TP

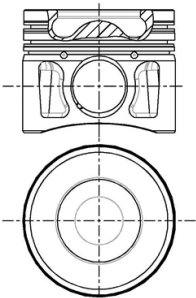

0899E-301

08-148100-00 STD
08-148105-00 0.25mm
08-148107-00 0.50mm

2.00 CK P
 2.00 P
 2.00 NT

Piston Chamber Volume
 [ccm] 36.149

Steel

Volumen der Kolbenmulde
 [ccm] 36.149

Stahl

Volume de la cavité du piston
 [cm³] 36.149

Acier

Volumen de cavidad del pistón
 [cc] 36.149

Acero

Volume camera pistone
 [cm³] 36.149

Acciaio

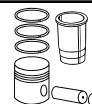
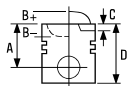

62 90.00

Granada 2.1 D	08/77→08/82	WTA (XD90)	V4 Cyl. 2112cc	22.2:1 46kW (63PS)	
Diesel					TD1478

14-604060-00 WH B 96.00 C 173.00 D 106.30 E 129.00

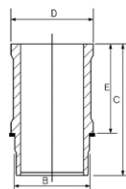

63 90.80





Transit 2.0	11/77→10/86	4RC TL20L	4 Cyl. 1993cc	8.2:1 43-57kW (59-78PS)	
					TD9441

Granada 2.0	01/75→07/79	TL 20 LC	4 Cyl. 1994cc	8.2:1 64-73kW (87-99PS)	
					TD19004

87-206600-00	STD
87-206607-00	0.50mm
87-206611-00	1.00mm

08-206600-00	STD
08-206607-00	0.50mm
08-206611-00	1.00mm
08-206617-00	2.286mm

A 40.25
D 78.25
 24x73

2.00		CR P
2.50		P
4.00		CR 

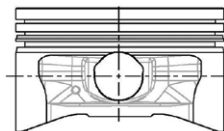

 Steel

 Stahl

 Acier

 Acero

 Acciaio



64  **90.80**

Sierra 2.0 i	01/87→02/93	N4A	4 Cyl. 1993cc	9.2:1 85kW (115PS)	TD1318
Sierra 2.0 i	01/87→02/93	N4I	4 Cyl. 1993cc	9.2:1 85kW (115PS)	TD1320
Scorpio I 2.0	04/85→08/89	N8D	4 Cyl. 1993cc	9.2:1 77kW (105PS)	TD1334
Sierra 2.0 i	01/87→02/93	NE1	4 Cyl. 1993cc	9.2:1 74-77kW (101-105PS)	TD1347
Sierra 2.0 i	01/87→02/93	NE4	4 Cyl. 1993cc	9.2:1 74kW (100PS)	TD1350
Sierra 2.0 i	01/87→02/93	NE5	4 Cyl. 1993cc	9.2:1 74kW (100PS)	TD1351
Sierra 2.0 i	01/87→02/93	NEJ	4 Cyl. 1993cc	9.2:1 74kW (100PS)	TD1355
Scorpio I 2.0	04/85→08/89	NEL	4 Cyl. 1993cc	9.2:1 77kW (105PS)	TD1357
Sierra 2.0	01/87→02/93	NES	4 Cyl. 1993cc	9.2:1 77kW (105PS)	TD1361
Sierra 2.0	08/82→12/86	NET	4 Cyl. 1993cc	9.2:1 74-77kW (101-105PS)	TD1362
Sierra 2.0, Sierra 2.0 i	03/85→12/86	NR2	4 Cyl. 1993cc	9.2:1 85kW (115PS)	TD1364
Scorpio I 1.9 Scorpio I 2.0 i	11/92→09/93 04/85→09/94	NRA	4 Cyl. 1993cc	9.2:1 85kW (115PS)	TD1365
Sierra 2.0, Sierra 2.0 i	03/85→12/86	NRB	4 Cyl. 1993cc	9.2:1 85kW (115PS)	TD1367



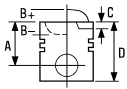





Scorpio I 2.0 i 04/85→09/94 **NRI** 4 Cyl. 1993cc 9.2:1 85kW (115PS) **TD1370**

87-780300-10 ①	STD
87-780307-10	0.50mm
87-780311-10 ②	1.00mm
87-780314-10 ②	1.50mm

08-780300-00	STD
08-780307-00	0.50mm
08-780309-00	0.75mm
08-780311-00	1.00mm
08-780314-00	1.50mm

A 41.55
D 69.55
 24x69

1.60		MO P
2.00		P
4.00		CR ③

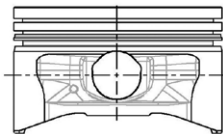

① Earlier pistons to be replaced in Engine sets only

① Frühere Kolben nur in Motorsätzen zu ersetzen

① Premier piston à remplacer dans le jeu moteur

① Pistones más antiguos para ser reemplados en juego de motores solamente

① Con i pistone di vecchia versione è necessario sostituire tutta la serie

② Recommended maximum oversize is 1.00mm (.0394in)

② Empfohlenes überma maximal 1.00mm (.0394in)

② Cote maxi recommandée de 1.00mm (.0394in)

② La sobremedida máxima recomendada es de 1.00mm (.0394in)

② Maggiorazione massima raccomandata 1.00mm

③ Steel

③ Stahl

③ Acier

③ Acero

③ Acciaio

65 90.80

P 100 II 2.0 10/87→12/92 **NAE TL20L** 4 Cyl. 1993cc 8.2:1 57kW (78PS) **TD1342**



Transit 2.0 09/85→09/92 **NAT TL20L** 4 Cyl. 1993cc 8.2:1 57kW (78PS) **TD4472**

Transit 2.0 09/85→09/92 **NAV TL20L** 4 Cyl. 1993cc 8:1 55-57kW (75-78PS) **TD1344**

87-780300-30 ①	STD
87-780307-30	0.50mm
87-780309-30	0.75mm
87-780311-30 ②	1.00mm
87-780314-30 ②	1.50mm

08-780300-00	STD
08-780307-00	0.50mm
08-780309-00	0.75mm
08-780311-00	1.00mm
08-780314-00	1.50mm

A 40.25
D 68.25
 24x72

1.60		MO P
2.00		P
4.00		CR ③

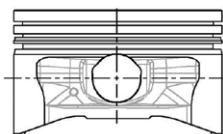

① Earlier pistons to be replaced in Engine sets only

① Frühere Kolben nur in Motorsätzen zu ersetzen

① Premier piston à remplacer dans le jeu moteur

① Pistones más antiguos para ser reemplados en juego de motores solamente

① Con i pistone di vecchia versione è necessario sostituire tutta la serie

② Recommended maximum oversize is 1.00mm (.0394in)

② Empfohlenes überma maximal 1.00mm (.0394in)

② Cote maxi recommandée de 1.00mm (.0394in)

② La sobremedida máxima recomendada es de 1.00mm (.0394in)

② Maggiorazione massima raccomandata 1.00mm

③ Steel

③ Stahl

③ Acier

③ Acero

③ Acciaio







66  **90.80**

Escort II 2.0 RS	08/75→08/80	NE	4 Cyl. 1993cc	9.2:1 77-80kW (105-110PS)	TD4473
Taurus 2000	08/73→02/76	NEE	4 Cyl. 1993cc	9.2:1 72kW (98PS)	TD1353
Taurus 2.0 Taurus 2000 Taurus Turnier 2.0	08/76→07/79 08/73→02/76 08/76→07/79	NEG	4 Cyl. 1993cc	9.2:1 70-73kW (95-99PS)	TD1354
Granada 2.0	08/81→08/85	NEK	4 Cyl. 1993cc	9.2:1 74-77kW (101-105PS)	TD1356
Capri III 2.0	01/78→12/85	NEN	4 Cyl. 1993cc	9.2:1 73-74kW (99-101PS)	TD1358
Granada 2.0	08/79→08/85	NEP	4 Cyl. 1993cc	9.2:1 74-77kW (101-105PS)	TD1359
Taurus '80 Turnier 2.0, Taurus '80 2.0	07/79→07/82	NER	4 Cyl. 1993cc	9.2:1 74kW (100PS)	TD4474
Capri II 2.0 Capri III 2.0 Taurus 2.0, Taurus Turnier 2.0	04/74→12/77 01/78→12/85 08/76→07/79	TL 20 H	4 Cyl. 1993cc	9.2:1 70-74kW (95-101PS)	TD1391

87-206600-10	STD	08-206600-00	STD
87-206607-10	0.50mm	08-206607-00	0.50mm
87-206617-10	2.25mm	08-206611-00	1.00mm
		08-206617-00	2.286mm

A 41.55
D 79.55
 24x72

2.00		CR P
2.50		P
4.00		CR 

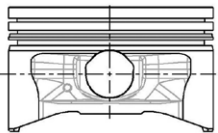

 Steel

 Stahl

 Acier

 Acero

 Acciaio

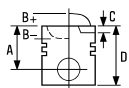

67  **92.00**

Scorpio I 2.5 TD

08/93→09/94

SCB

4 Cyl.

21.5:1

2500cc

85kW (115PS)

Diesel

Turbo Intercooled

TD1443

87-110100-00

STD

08-110100-00

STD

14-676420-00 WH B 101.50 C 166.80 D 110.00 E 8.90 F 1.20

89-110100-00

87-110100-00 +
14-676420-00

A 51.00

B- 2.10

D 86.00

 30x76

2.50

2.00

4.00



CR P

P

CR P

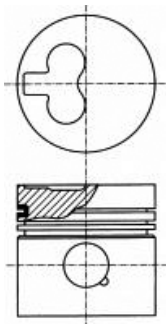
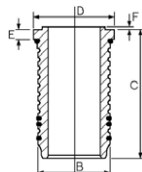

68  **92.00**

Scorpio II 2.5 TD

10/94→08/98

SCC

4 Cyl.

21:1

2500cc

85kW (115PS)

Diesel

Turbo Intercooled

TD4490

14-676420-00 WH B 101.50 C 166.80 D 110.00 E 8.90 F 1.20

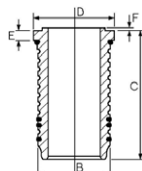



69 93.67

Transit 2.4 D	11/77→10/86	4AA 2401E York Parent Block	4 Cyl.	21.5/22:1
			2358cc	46kW (62PS)
		Diesel		TD17094
A-Series AO409, A-Series AO509 A-Series AO609, A-Series AO709	09/73→09/83	2402E York Parent Block	6 Cyl.	21.5/22:1
			3537cc	
		Diesel		FM2463

87-207311-00 1.00mm 08-207300-10 STD 14-014090-00 D B 96.94 C 171.45

87-207321-00 0.65mm 08-207311-10 1.00mm

08-207321-10 0.65mm

A 61.67

B- 0.53

D 108.00

 29x75

2.38

2.38

4.74



CR P

P

CR P

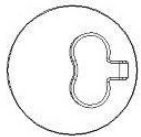
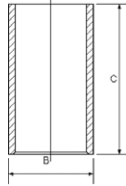

70 93.67

Transit 2.5 D	10/83→09/92	4AB		
Transit 2.5 DI	09/91→08/94		4 Cyl.	19:1
			2496cc	50-52kW (68-71PS)
		Diesel		TD1113
Transit 2.5 D	09/88→09/92	4BA		
Transit 2.5 DI			4 Cyl.	19:1
			2496cc	52kW (71PS)
		Diesel		TD1114
Transit 2.5 D	09/88→09/92	4CA		
Transit 2.5 DI			4 Cyl.	19:1
			2496cc	52kW (71PS)
		Diesel		TD1116
Transit 2.5 DI	05/91→08/94	4CC		
			4 Cyl.	19:1
			2496cc	52kW (70PS)
		Diesel		TD1117







Transit 2.5 DI	05/91→08/94	4DA	4 Cyl. 2496cc	19:1 59kW (80PS)	TD1118
Diesel					

87-784800-00	STD
87-784811-00	1.00mm
87-784821-00	0.65mm

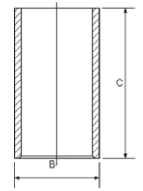

08-784800-00	STD
08-784811-00	1.00mm
08-784821-00	0.65mm

14-014090-00 D B 96.94 C 171.45



- A** 59.47
- B-** 18.00
- BØ** 40.00
- D** 94.00
-  29x77

11/88→12/94

- 2.50  MOL P
- 2.00  P
- 4.00  CR P

RT

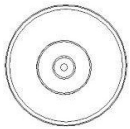

71 93.67

Transit 2.5 DI	05/91→08/94	4BC	4 Cyl. 2496cc	19:1 52kW (70PS)	TD1115
Diesel					
Transit 2.5 DI	05/91→03/00	4FA	4 Cyl. 2496cc	19:1 51-52kW (69-70PS)	TD1120
Transit Tourneo 2.5 DI	11/94→12/00				
Diesel					
Transit 2.5 DI	06/94→03/00	4FB	4 Cyl. 2496cc	19:1 51kW (70PS)	TD4426
Transit Tourneo 2.5 DI	11/94→12/00				
Diesel					
Transit 2.5 DI	06/94→03/00	4FC	4 Cyl. 2496cc	19:1 51kW (70PS)	TD4428
Transit Tourneo 2.5 DI	11/94→12/00				
Diesel					
Transit 2.5 DI	06/94→03/00	4FD	4 Cyl. 2496cc	19:1 51kW (69PS)	TD15209
Transit Tourneo 2.5 DI	11/94→12/00				
Diesel					
Transit 2.5 DI	10/92→06/94	4GA	4 Cyl. 2496cc	20.6:1 63kW (85PS)	TD4430
Transit 2.5 TD	10/92→03/00				
Transit Tourneo 2.5 TD	11/94→12/00				
Diesel Turbo					





Transit 2.5 DI	06/94 → 03/00	4HB			
Transit Tourneo 2.5 DI	11/94 → 12/00		4 Cyl.	19:1	
			2496cc	56kW (76PS)	
		Diesel			TD4436
Transit 2.5 DI	06/94 → 03/00	4HC			
Transit Tourneo 2.5 DI	11/94 → 12/00		4 Cyl.	19:1	
			2496cc	56kW (76PS)	
		Diesel			TD15210

87-123700-30	STD	08-123700-00	STD	14-014090-00 D	B 96.94 C 171.45
87-123711-30	1.00mm	08-123711-00	1.00mm		
87-123721-30	0.65mm	08-123721-00	0.65mm		

01/95 →

A	59.51
B-	18.00
BØ	40.00
D	94.00
	29x76

RT

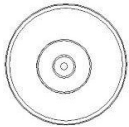

01/95 →

2.50		MOL P
2.00		P
4.00		CR P

87-784800-00	STD	08-784800-00	STD
87-784811-00	1.00mm	08-784811-00	1.00mm
87-784821-00	0.65mm	08-784821-00	0.65mm

→12/94

A	59.47
B-	18.00
BØ	40.00
D	94.00
	29x77

RT

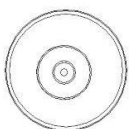

→12/94

2.50		MOL P
2.00		P
4.00		CR P

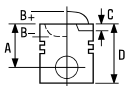

72  **93.67**

Transit 2.5 TD	05/91→08/94	4EA	4 Cyl. 2496cc Turbo	18.3:1 74kW (100PS)	TD1119
Transit 2.5 TD	07/94→03/00	4EB			
Transit 2.5 TDI	06/94→03/00		4 Cyl. 2496cc Turbo	18.3:1 74kW (101PS)	TD4424
Transit Tourneo 2.5 TD	04/98→12/00				
Transit 2.5 TD	07/94→03/00	4EC			
Transit 2.5 TDI	06/94→03/00		4 Cyl. 2496cc Turbo	18.3:1 74kW (101PS)	TD15214
Transit Tourneo 2.5 TD	04/98→12/00				



87-123700-00  STD
87-123711-00 1.00mm
87-123721-00 0.65mm

08-123700-00 STD
08-123711-00 1.00mm
08-123721-00 0.65mm

14-014090-00 D B 96.94 C 171.45

10/91→

A 59.44
B- 18.46
BØ 44.00
D 93.95
 29x80

2.50  MOL P
 2.00  P
 4.00  CR P

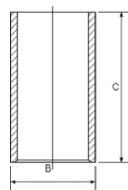

RT

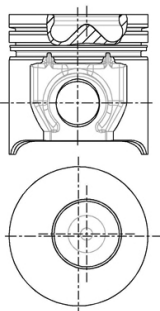



87-784800-10
87-784811-10
87-784821-10

STD
1.00mm
0.65mm

2.50
2.00
4.00





P
CR P

→10/91

A 59.42
B- 18.40
BØ 44.00
D 93.95
 29x79

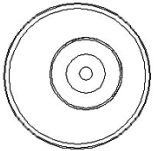
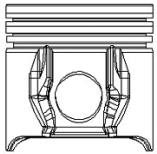
RT



 Increased power

 Erhöhter power

 Augmented power

 Aumentado power

 Motore potenziato

73  **93.67**

Transit 2.5 DI

08/97→03/00

4ED

4 Cyl.
2496cc

19:1
85kW (116PS)

Diesel

Turbo Intercooled

TD12093

87-123700-30
87-123711-30
87-123721-30

STD
1.00mm
0.65mm

08-123700-00
08-123711-00
08-123721-00

STD
1.00mm
0.65mm

2.50
2.00
4.00



MOL P
P
CR P

14-014090-00 D

B 96.94 C 171.45

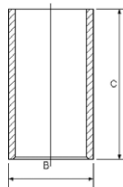

11/88→

A 59.51
B- 18.00
BØ 40.00
D 94.00
 29x76

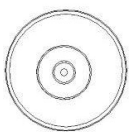

RT









74 93.67

Transit 2.5 TD Transit Tourneo 2.5 TD	10/92→03/00 11/94→12/00	4GB	4 Cyl. 2496cc Turbo	20.6:1 63kW (85PS)	TD4432
Transit 2.5 TD Transit Tourneo 2.5 TD	10/92→03/00 11/94→12/00	4GC	4 Cyl. 2496cc Turbo	20.6:1 63kW (85PS)	TD4433
Transit 2.5 TD	06/94→03/00	4GD	4 Cyl. 2496cc Turbo	20.6:1 63kW (86PS)	TD15211
Transit 2.5 TD	06/94→03/00	4GE	4 Cyl. 2496cc Turbo	63kW (86PS)	TD15212
Transit 2.5 TD	06/94→03/00	4GF	4 Cyl. 2496cc Turbo	20.6:1 63kW (85PS)	TD15213
Transit 2.5 TD Transit Tourneo 2.4 D Transit Tourneo 2.5 DI	08/94→07/00 08/94→06/00 11/94→12/00	4HA	4 Cyl. 2496cc Turbo	20.6:1 55-56kW (75-76PS)	TD4434
Transit 2.5 TD	08/94→07/00	4HD	4 Cyl. 2496cc Turbo	55kW (75PS)	TD16250

87-123700-10  STD
87-123711-10  1.00mm
87-123721-10  0.65mm

08-123700-00 STD
08-123711-00 1.00mm
08-123721-00 0.65mm

A 59.49
B- 17.86
BØ 44.00
D 94.00
 29x80

2.50 
2.00 
4.00 
MOL P
P
CR P

14-014090-00 **D** B 96.94 C 171.45

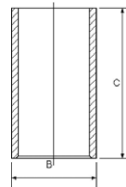

RT

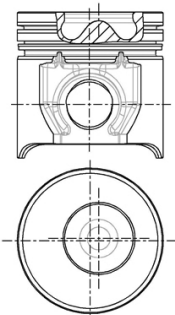

 Normal power

 Normal Macht

 Naturelle power

 Normalemente power

 Potenza normale



75  **94.00**

Scorpio I 2.5 TD	06/88→07/93	SFA (XD3T)	4 Cyl. 2498cc	21:1 68kW (92PS)	TD4492
		Diesel Turbo			
Scorpio I 2.5 TD	06/88→07/93	SFB (XD3T)	4 Cyl. 2498cc	21:1 68kW (92PS)	TD4493
		Diesel Turbo			
Granada 2.3 D, Scorpio 2.3 D, Sierra 2.3 D Sierra 2300 Ghia, Sierra 2300 GL	01/82→ 01/82→12/85	XD2S	4 Cyl. 2304cc	21:1 51kW (69PS)	FM1429
		Diesel Turbo Intercooled			
Sierra 2.5 D	01/82→	XD3P	4 Cyl. 2498cc	23:1 53-58kW (72-79PS)	TD22249
		Diesel			
Sierra 2.5 D	01/82→	XD3T	4 Cyl. 2498cc	21:1 66-70kW (90-95PS)	TD22250
		Diesel Turbo Intercooled			

14-020660-00 D

B 97.00 C 170.60 D 99.50 E 4.00

14-021520-00 D

B 98.00 C 170.60 D 100.00 E 6.00

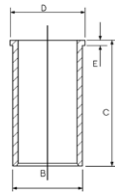

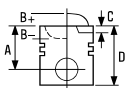

76  **94.00**

Granada 2.5 D	08/82→08/85	STP (XD3/XD3P)	4 Cyl.	23:1	TD1448
			2498cc	51kW (69PS)	
Diesel					

Scorpio I 2.5 D	12/85→12/94	STR (XD3/XD3P)	4 Cyl.	23:1	TD1449
			2498cc	51kW (69PS)	
Diesel					

87-318700-10	STD
87-318706-10	0.40mm
87-318708-10	0.60mm
87-318710-10	0.80mm

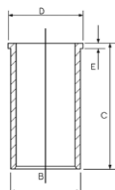

08-318700-10	STD
08-318704-10	0.20mm
08-318706-10	0.40mm
08-318707-10	0.50mm
08-318708-10	0.60mm
08-318710-10	0.80mm
08-318711-10	1.00mm

14-020660-00 D	B 97.00 C 170.60 D 99.50 E 4.00
14-021520-00 D	B 98.00 C 170.60 D 100.00 E 6.00



→12/93

A	54.00
B-	1.80
D	96.42
	30x79

2.00		CR P
2.00		P
4.00		CR P

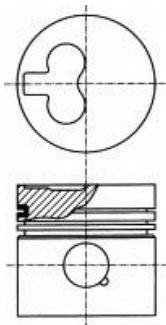



87-318700-30	STD
87-318706-30	0.40mm
87-318708-30	0.60mm
87-318710-30	0.80mm

08-318700-10	STD
08-318704-10	0.20mm
08-318706-10	0.40mm
08-318707-10	0.50mm
08-318708-10	0.60mm
08-318710-10	0.80mm
08-318711-10	1.00mm

01/94→

A	54.00
B-	1.75
D	91.42
	30x79



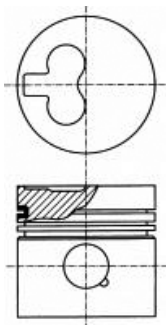

2.00		CR P
2.00		P
4.00		CR P





77 94.00



Sierra 2.3 D	01/87→02/93	YTR (XD2/XD2P/XD94)	4 Cyl.	22.2:1	
			2304cc	49kW (67PS)	
		Diesel			TD1482
Sierra 2.3 D	08/82→09/89	YTT (XD2/XD2P/XD94)	4 Cyl.	22.2:1	
			2304cc	49kW (67PS)	
		Diesel			TD1483

87-318700-00 	STD
87-318706-00 	0.40mm
87-318708-00 	0.60mm
87-318711-00 	1.00mm

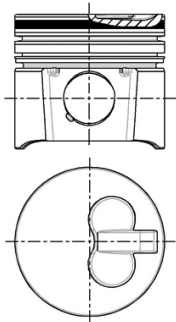
A	57.42
B-	2.00
D	99.90
	30x79





08-318700-10	STD
08-318704-10	0.20mm
08-318706-10	0.40mm
08-318707-10	0.50mm
08-318708-10	0.60mm
08-318710-10	0.80mm
08-318711-10	1.00mm

2.00		CR P
2.00		P
4.00		CR P

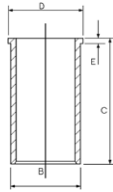
14-020660-00 D	B 97.00 C 170.60 D 99.50 E 4.00
14-021520-00 D	B 98.00 C 170.60 D 100.00 E 6.00



 Pistons to be replaced in Engine Sets only

 Kolben nur Motorsätzen zu ersetzen

 Piston à remplacer dans jeu moteur

 Pistones de repuesto para juegos de motores solamente





 Il pistone può essere rimpiazzato solamente completo

78 96.00

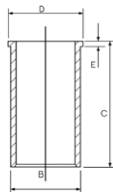
Maverick 2.7 TD	02/93→04/98	TD27	4 Cyl.	21.9:1	
			2664cc	74kW (100PS)	
		Diesel	Turbo		TD4494
Maverick 2.7 TD	02/93→04/98	TD27 T	4 Cyl.	22:1	
			2664cc	73-74kW (100-101PS)	
		Diesel	Turbo		TD1450
Maverick 2.7 TD	02/93→04/98	TD27E	4 Cyl.	21.9:1	
			2664cc	92kW (125PS)	
		Diesel	Turbo Intercooled		TD9466

14-020110-00 D	B 99.08 C 160.00 D 105.03 E 5.09
-----------------------	----------------------------------



		ccm	x 		9
90/5 AA-Dover	Diesel	4162	4	107.21	8
110/6 AA-Dover	Diesel	5944	6	104.77	4
130/7 AA-Dover	Diesel	6223	6	107.21	8
150/6 CA-Dover	Diesel	5944	6	104.78	6
590E	Diesel	5416	6	100.00	1
592E	Diesel	3610	4	100.00	1
2501E, 2502E, 2503E	Diesel	2589	3	106.69	7
2504E, 2508E 175 cu.in.	Diesel	2867	3	106.69	7
2701E, 2706E 240 cu.in.	Diesel	3933	4	104.77	2
2704E, 2709E	Diesel	5944	6	104.77	2
2704ET 360 cu.in.	Diesel	5944	6	104.77	3
2711E 255 cu.in.	Diesel	4178	4	107.21	9
2712E 254 cu.in. Parent Block	Diesel	4162	4	107.21	9
2713E 365 cu.in. Parent Block	Diesel	5981	6	104.77	4
2714E 380 cu.in	Diesel	6227	6	107.21	9
2715E D-Series parent blk 380 cu.in	Diesel	6227	6	107.21	9
D233, 2508E	Diesel	3819	4	106.69	7
Dover 6.0TCI	Diesel	5946	6	104.77	5



1 100.00

592E	4 Cyl.	16:1	3610cc	Diesel	FM2503
590E	6 Cyl.	16:1	5416cc	Diesel	FM2506

87-203500-00	STD	08-203500-10	STD	14-370870-00 WH	B 111.76 C 223.00 D 120.00 E 11.16 F 0.65	88-203500-00 87-203500-00 + 14-370870-00
A	71.04	2.38	CR P			89-203500-00 87-203500-00 + 14-370870-00
B-	24.74	2.38	P			
BØ	49.90	2.38	P			
C	1.74	4.74	CR P			
C	1.74	4.74	P			
D	118.14					
	35x86					

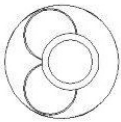
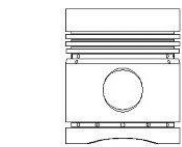

14-455210-00 WH **B 109.60 C 223.00 D 117.60 E 11.20 F 0.80**

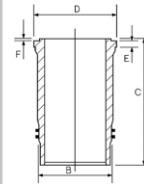

2 104.77

2701E, 2706E 240 cu.in.	4 Cyl.		3933cc	Diesel	FM2512
2704E, 2709E	6 Cyl.	16.5:1	5944cc	Diesel	FM2514

87-202800-00 ¹	STD	08-202800-00	STD	14-013700-00 D	B 108.80 C 219.00	
87-202807-00	.020	08-202807-00	.020			
87-202809-00	.030	08-202809-00	.030			
87-202811-00	.040	08-202811-00	.040			
A	71.03	2.38	CR P			
B-	25.81	2.38	P			
BØ	51.50	2.38	P			
C	1.65	4.74	CR P			
C	1.65					
D	118.11					
	35x90					
				14-045570-00 D	B 109.37 C 219.55 D 112.85 E 4.76	

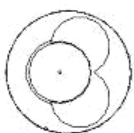
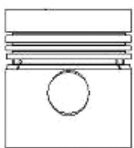

¹ Must not be fitted to 365/6 parent bloc engine

¹ Darf nicht an dem Stammblockmotor 365/6 angebracht werden

¹ A ne pas utiliser sur le bloc non chemisé 365/6

¹ No debe ser instalado a motores de bloque padre a 365/6

¹ Non devono essere montati su blocchi motore marchiati 365/6



3 104.77





2704ET 360 cu.in. 6 Cyl. 15.7:1 5944cc Diesel Turbo FM2537

87-523500-00 STD

08-523500-00 STD

14-013700-00 D B 108.80 C 219.00

- A 71.29
- B- 27.94
- BØ 51.50
- C 1.65
- C 1.65
- D 119.89
-  37x90

- 3.17  P
- 2.38  P
- 2.38  P
- 4.76  CR P

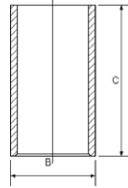

RT

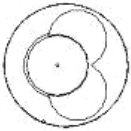
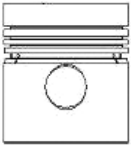

14-045570-00 D B 109.37 C 219.55 D 112.85 E 4.76

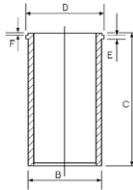

4 104.77

2713E 365 cu.in. Parent Block 6 Cyl. 16.5:1 5981cc Diesel FM2542

110/6 AA-Dover 6 Cyl. 15.9:1 5944cc 81kW (110PS) Diesel TD22248

14-013700-00 D B 108.80 C 219.00

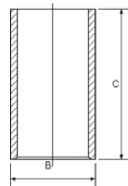

14-045570-00 D B 109.37 C 219.55 D 112.85 E 4.76

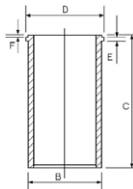

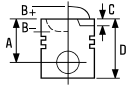





5 104.77

Dover 6.0TCI 6 Cyl. 5946cc 185PS Diesel Turbo Intercooled FM12537

87-432100-00 STD

A	71.25	3.00		P PS
B-	21.50	2.50		P
BØ	55.00	4.00		P
C	2.30			
D	119.90			
	41x87			

HA RT

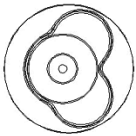
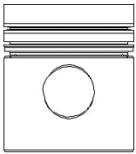



6 104.78

150/6 CA-Dover 6 Cyl. 15.7:1 5944cc 110kW (150PS) Diesel TD6957

87-520900-00 STD

08-520900-00 STD

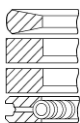
14-013700-00 **D** B 108.80 C 219.00

A	71.25	3.17		MOL
B-	21.94	2.38		
BØ	60.50	2.38		
C	2.30	4.74		
C	2.30			
D	119.91			
	41x87			

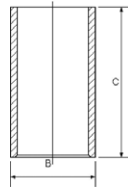

14-045570-00 **D** B 109.37 C 219.55 D 112.85 E 4.76

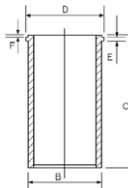

RT

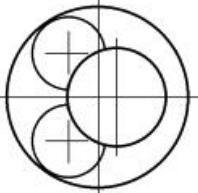



7 106.69

2501E, 2502E, 2503E	3 Cyl.	17:1	2589cc	Diesel	FM6738
2504E, 2508E 175 cu.in.	3 Cyl.	17.3:1	2867cc	Diesel	FM6732
D233, 2508E	4 Cyl.		3819cc	Diesel	FM2974

14-020730-00 D

B 110.80 C 209.60 D 111.80 E 5.00

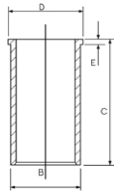



14-010770-00 D

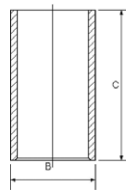

B 110.78 C 209.55



8 107.21

90/5 AA-Dover	4 Cyl.	16:1	4162cc	63-66kW (86-90PS)	Diesel	TD6954
130/7 AA-Dover	6 Cyl.	16:1	6223cc	94kW (128PS)	Diesel	TD6956

87-782900-00	STD	08-782900-00 	STD
87-782906-00	.015	08-782906-00 	.015
87-782910-00	.035	08-782910-00 	.035

A	71.25	2.38		CR P
B-	23.20	2.38		P
BØ	58.50	4.74		CR P

C 2.30
C 2.30

D 119.89

 37x86

RT

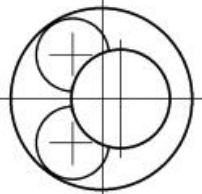

 For Cast Iron Bores only

 Nur für Gußeisenbohrungen

 Pour intérieur cylindre seulement

 Para diámetro internos de hierro fundido solamente



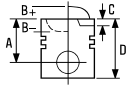

 Solo per cilindri in ghisa







9 107.21

2711E 255 cu.in.	4 Cyl.	16.5:1	4178cc	Diesel	FM2558
2712E 254 cu.in. Parent Block	4 Cyl.	16.5:1	4162cc	Diesel	FM2559
2714E 380 cu.in	6 Cyl.	16.5:1	6227cc	Diesel	FM2560
2715E D-Series parent blk 380 cu.in	6 Cyl.	16.5:1	6227cc	Diesel	FM2562

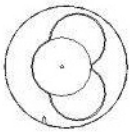
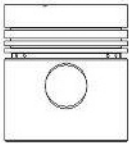
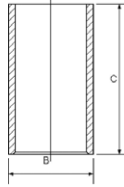
87-214800-10	STD	08-214800-10	STD	14-014120-00 D	B 111.40 C 213.00
87-214807-10	.020	08-214807-10	.020	14-014640-00 D	B 110.78 C 213.00
87-214809-10	.030	08-214809-10	.030		
87-214811-10	.040	08-214811-10	.040		

A	71.20	2.38	 CR P
B-	27.77	2.38	 P
BØ	51.56	2.38	 P
C	1.65	4.74	 CR P
C	1.65		
D	119.89		
	37x90		









		ccm	x 		9
3.152	Diesel	2500	3	91.49	1
6Y, 7A series 256 cu.in.	Diesel	4195	4	111.77	6
6Y, 7A series 256 cu.in.	Diesel	4196	4	111.77	7
6Y series 32D 158 cu.in.	Diesel	2589	3	106.69	4
6Y series 40D 175 cu.in.	Diesel	2867	3	106.69	3
6Y series 256 cu.in.	Diesel	4195	4	106.69	3
7A series 32D 158 cu.in.	Diesel	2589	3	106.69	4
7A series 32D 180 cu.in.	Diesel	2950	3	106.69	4
7A series 40D 175 cu.in.	Diesel	2867	3	106.69	3
7A series 201 cu.in.	Diesel	3294	3	111.77	8
7A series 256 cu.in.	Diesel	4195	4	106.69	3
56G	Diesel	3819	4	106.69	4
268 cu.in.	Diesel	4391	4	111.77	9
401 cu.in. TW20,TW30	Diesel	6571	6	111.77	9
592E	Diesel	3610	4	100.00	2
2715E D-Series parent blk 380 cu.in	Diesel	6227	6	107.21	5
BSD 332 (192 cu.in.)	Diesel	3146	3	111.77	7
BSD333 >87 201 cu.in.	Diesel	3294	3	111.77	7
BSD333 201 cu.in.	Diesel	3294	3	111.77	10
BSD333H 201 cu.in.	Diesel	3294	3	111.77	8
BSD442 256 cu.in.	Diesel	4195	4	111.77	6
BSD444 268 cu.in.	Diesel	4391	4	111.77	10
BSD444T 268 cu.in.	Diesel	4391	4	111.77	9



1 91.49

3.152 **3 Cyl.** **17.4:1** **2500cc** **22-33kW (30-45PS)** **Diesel** **FM1351**

87-314600-00 ⁴	STD	08-314600-00 ⁵	STD	14-021220-00 ²	B 93.71 C 216.00 D 96.72 E 3.81
1935854 →		1935854 →		14-021221-00 ^D	B 93.96 C 216.00 D 96.72 E 3.81
A 57.20		2.38		14-021222-00 ^D	B 94.50 C 216.00 D 96.72 E 3.81
D 107.70		2.38		14-021223-00 ^D	B 96.25 C 216.00 D 97.10 E 3.81
 32x75		3.16		14-022960-00 ^D	B 93.66 C 216.00 D 96.72 E 3.76
		6.33		14-024680-00 ^D	B 93.73 C 216.00 D 96.72 E 3.76
		6.33		14-025833-00 ^D	B 95.31 C 216.00 D 98.16 E 5.00
				14-025871-00 ^D	B 93.76 C 216.14 D 96.85 E 5.00
				14-480320-00 ^{DH} ¹	B 93.66 C 216.03 D 96.72 E 3.81

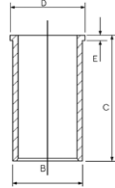
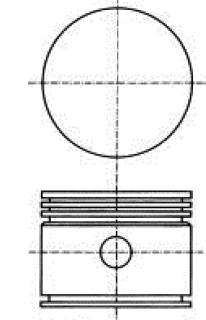





87-525100-10 ³ STD **08-525100-00** STD

→1935853

A 56.95
D 107.70
 32x75

→1935853

2.38  P
2.38  P
3.16  P
6.35  P
6.35  P

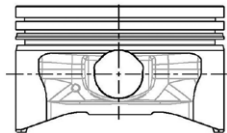

¹ Push fit cast iron liner to replace original steel liner

² Press fit cast iron liner to replace original steel liner

³ Pre-topped piston which may require machining

⁴ Topping allowance piston which requires machining to conform to engine manufacturers recommendations

⁵ Not for chromed cylinders

¹ Ausdrückbare Laufbüchse aus Gueisen als Ersatz der originalStahlbüchse

² Anpressbare Laufbüchse aus G ueisen als Ersatz der originalStahlbüchse

³ Vorgeschliffener Kolben, der möglicherweise etwas BearbeitenEmpfehlungen des Herstellers zu entsprechen.

⁴ Nicht vorgeschliffener Kolben, der etwas Bearbeitung braucht, um den Empfehlungen des Herstellers zu entsprechen

⁵ Nicht für verchromte Zylinder

¹ Chemise fonte à emmencement gras remplaçant la chemise acied'origine

² Chemise fonte à emmancher àa la presse pour remplacer la chemise d'origine en acier

³ Piston à tete semie finie pouv ant nécessiter un usinage pouaux recommandations du constructeur

⁴ Piston à tete avec surépaisseur nécessitant un usinage pourmise en conformité avec les recommandations du constructeur.

⁵ Non appropriés pour cylindres chromés

¹ Ajustar a presión la camisa de hierro fundido para reemplazacamisa original de acero

² Ajuste a presión la camisa de hierro fundido para reemplazer la camisa original de acero

³ Pistón coronado que puede necesitar fresado para ajustarse adel fabricante

⁴ Pistón con margen para corona que requiere fresado para ajustarse a las recomendaciones del fabricante del motor

⁵ No se usan para cilindros cromados

¹ Cilindri in ghisa, piantati a pressione, in sostituzione di qin acciaio

² Canna in ghisa per sostituire canne originali in acciaio

³ Il pistone a testa ribassata puo' richiedere una lavorazioneadattarloalle prescrizioni del costruttore. fare riferimentoalle istruzioni contenute nella confezione

⁴ La superficie superiore della testa può essere lavorata peradattare l'altezza del pistone al pms.Fare riferimento allanorme di montaggio

⁵ Non per cilindri cromati









2 100.00

592E 4 Cyl. 16:1 **3610cc** **Diesel** **FM2503**

87-203500-00 STD **08-203500-10** STD **14-370870-00 WH** **B 111.76 C 223.00 D 120.00 E 11.16 F 0.65** **88-203500-00**
 87-203500-00 +
 14-370870-00

01/57 →

- A** 71.04
- B-** 24.74
- BØ** 49.90
- C** 1.74
- C** 1.74
- D** 118.14
-  **35x86**

- 2.38  CR P
- 2.38  P
- 2.38  P
- 4.74  CR P
- 4.74  P

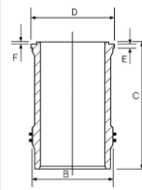

89-203500-00
 87-203500-00 +
 14-370870-00

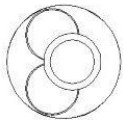
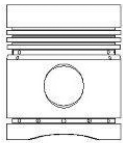

14-455210-00 WH **B 109.60 C 223.00 D 117.60 E 11.20 F 0.80**

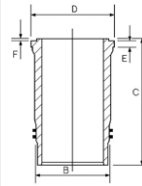

3 106.69

6Y series 40D 175 cu.in. 3 Cyl. **2867cc** **Diesel** **FM6733**

7A series 40D 175 cu.in. 3 Cyl. **2867cc** **Diesel** **FM6734**

6Y series 256 cu.in. 4 Cyl. **4195cc** **Diesel** **FM6757**

7A series 256 cu.in. 4 Cyl. **4195cc** **Diesel** **FM6756**





87-208100-10 STD **08-208100-00** STD **14-020730-00 D** **B 110.80 C 209.60 D 111.80 E 5.00**

08-208107-00 .020

08-208109-00 .030

08-208111-00 .040

- A** 70.18
- B-** 17.12
- BØ** 63.32
- D** 129.01
-  **38x89**

- 2.38  CR P
- 2.38  P
- 2.38  P
- 4.74  CR P

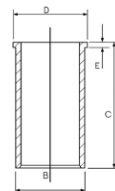

RT

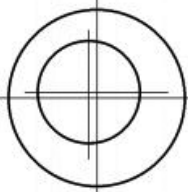
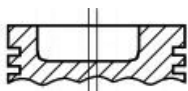

14-010770-00 D **B 110.78 C 209.55**

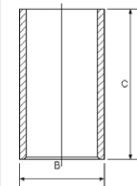

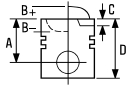

4 106.69

6Y series 32D 158 cu.in	3 Cyl.	2589cc	Diesel	FM6738
7A series 32D 158 cu.in	3 Cyl.	2589cc	Diesel	FM6736
7A series 32D 180 cu.in.	3 Cyl.	2950cc	Diesel	FM6735
56G	4 Cyl.	3819cc	Diesel	FM2974

14-020730-00 D

B 110.80 C 209.60 D 111.80 E 5.00

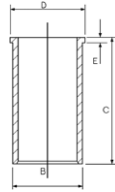

14-010770-00 D

B 110.78 C 209.55

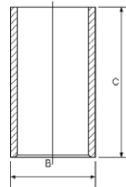

5 107.21

2715E D-Series parent blk 380 cu.in	6 Cyl.	16.5:1	6227cc	Diesel	FM2562
-------------------------------------	--------	--------	--------	--------	--------

87-214800-10	STD
87-214807-10	.020
87-214809-10	.030
87-214811-10	.040

08-214800-10	STD
08-214807-10	.020
08-214809-10	.030
08-214811-10	.040

14-014120-00 D



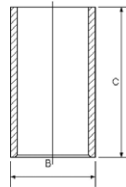

B 111.40 C 213.00

14-014640-00 D

B 110.78 C 213.00



A	71.20
B-	27.77
BØ	51.56
C	1.65
C	1.65
D	119.89
	37x90

2.38		CR P
2.38		P
2.38		P
4.74		CR P

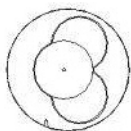
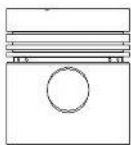







6 111.77

6Y, 7A series 256 cu.in. 4 Cyl. 16.5:1 4195cc Diesel FM6745

BSD442 256 cu.in. 4 Cyl. 4195cc Diesel FM6747

87-202400-00	STD	08-202400-10	STD	14-020740-00 D	B 114.45 C 208.50 D 120.35 E 2.60
87-202407-00	.020	08-202407-10	.020	14-020741-00 D	B 116.00 C 208.50 D 120.35 E 2.60
87-202411-00	.040	08-202409-10	.030	14-020742-00 D	B 116.99 C 208.50 D 120.35 E 2.60

A	70.66
B-	18.62
BØ	63.50
D	129.50
	38x89

2.38		CR P
2.38		P
2.38		P
4.74		CR P

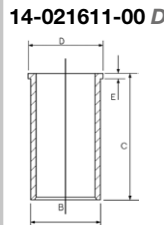

RT

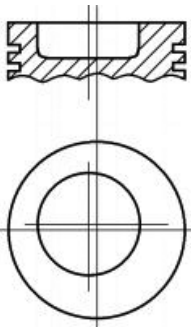

7 111.77

BSD 332 (192 cu.in.) 3 Cyl. 16.3:1 3146cc Diesel FM3456

BSD333 >87 201 cu.in. 3 Cyl. 16.1:1 3294cc Diesel FM3518

6Y, 7A series 256 cu.in. 4 Cyl. 16.5:1 4196cc 55-58kW (75-79PS) Diesel FM6752

14-020740-00 D	B 114.45 C 208.50 D 120.35 E 2.60
14-020741-00 D	B 116.00 C 208.50 D 120.35 E 2.60
14-020742-00 D	B 116.99 C 208.50 D 120.35 E 2.60
14-021610-00 D	B 114.43 C 208.53 D 120.35 E 2.56
14-021611-00 D	B 116.97 C 208.53 D 120.35 E 2.57

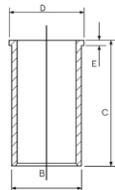

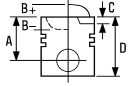

8 111.77





7A series 201 cu.in. 3 Cyl. 15.3:1 3294cc Diesel FM6730

BSD333H 201 cu.in. 3 Cyl. 15.3:1 3294cc Diesel FM3519

87-202400-10	STD	08-202400-10	STD	14-020740-00 D	B 114.45 C 208.50 D 120.35 E 2.60
87-202407-10	.020	08-202407-10	.020	14-020741-00 D	B 116.00 C 208.50 D 120.35 E 2.60
87-202409-10	.030	08-202409-10	.030	14-020742-00 D	B 116.99 C 208.50 D 120.35 E 2.60
87-202411-10	.040			14-021610-00 D	B 114.43 C 208.53 D 120.35 E 2.56
				14-021611-00 D	B 116.97 C 208.53 D 120.35 E 2.57

A 68.12
 B- 19.76
 BØ 63.50
 D 127.00
 38x89

01/68→09/72

2.38  CR P
 2.38  P
 2.38  P
 4.74  CR P

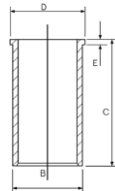

RT

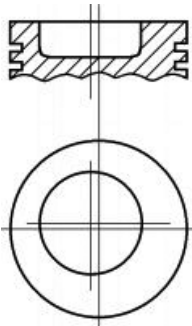

9 111.77

268 cu.in. 4 Cyl. 4391cc Diesel FM6753

268 cu.in. 4 Cyl. 4391cc Diesel FM6749





BSD444T 268 cu.in. 4 Cyl. 15.6:1 4391cc Diesel Turbo FM3522

401 cu.in. TW20,TW30 6 Cyl. 16:1 6571cc Diesel Turbo FM6768

87-100100-00	STD	08-100100-00	STD	14-020740-00 D	B 114.45 C 208.50 D 120.35 E 2.60
		08-100107-00	.020	14-020741-00 D	B 116.00 C 208.50 D 120.35 E 2.60
		08-100109-00	.030	14-020742-00 D	B 116.99 C 208.50 D 120.35 E 2.60
		08-100111-00	.040	14-021610-00 D	B 114.43 C 208.53 D 120.35 E 2.56
				14-021611-00 D	B 116.97 C 208.53 D 120.35 E 2.57

A 67.80
 B- 19.00
 BØ 63.70
 D 127.00
 41x89

10/72→

3.16  CR P
 2.38  P
 2.38  P
 4.74  CR P

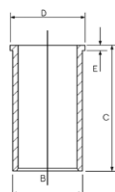

RT

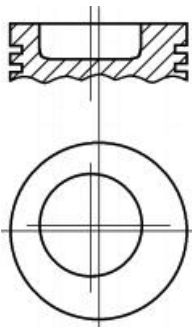

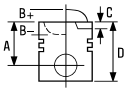

10 111.77

BSD333 201 cu.in. 3 Cyl. **3294cc** **Diesel** **FM33519**





BSD444 268 cu.in. 4 Cyl. 16.3:1 **4391cc** **Diesel** **FM3521**

87-202400-10	STD	08-202400-10	STD	14-020740-00 D	B 114.45 C 208.50 D 120.35 E 2.60
87-202407-10	.020	08-202407-10	.020	14-020741-00 D	B 116.00 C 208.50 D 120.35 E 2.60
87-202409-10	.030	08-202409-10	.030	14-020742-00 D	B 116.99 C 208.50 D 120.35 E 2.60
87-202411-10	.040			14-021610-00 D	B 114.43 C 208.53 D 120.35 E 2.56
				14-021611-00 D	B 116.97 C 208.53 D 120.35 E 2.57

→07/87

- A** 68.12
- B-** 19.76
- BØ** 63.50
- D** 127.00
-  38x89

01/68→09/72

- 2.38  CR P
- 2.38  P
- 2.38  P
- 4.74  CR P

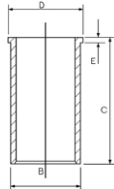

RT

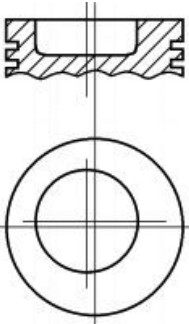

87-202400-30 STD

08/87→



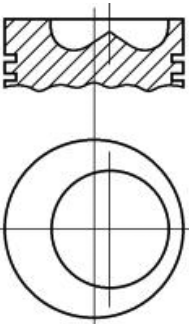

- A** 68.12
- B-** 19.26
- BØ** 61.85
- D** 127.00
-  38x89





RT



08-202400-10 STD
08-202407-10 .020
08-202409-10 .030

01/68→09/72

- 2.38  CR P
- 2.38  P
- 2.38  P
- 4.74  CR P

		ccm	x 		
100 GF 000	Petrol	903	4	65.00	1
100 GL.000	Petrol	903	4	65.00	1
126 A1.048	Petrol	652	2	77.00	3
128 A.000	Petrol	1116	4	80.00	4
Rover K16 DOHC	Petrol	1396	4	75.00	2
XUD 9A	Diesel	1905	4	83.00	5

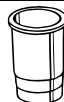
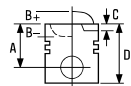

3 **77.00**

126P 0.6	07/77→12/91	126 A.1.048	
126P 650	07/81→09/00	2 Cyl.	7.5:1
		652cc	17-22kW (23-30PS)

TD24116

87-785500-00	STD
87-785506-00	0.40mm
87-785508-00	0.60mm

08-785500-00	STD
08-785506-00	0.40mm
08-785507-00	0.50mm
08-785508-00	0.60mm

①

B 83.00 C 130.40 E 79.90

88-785500-00
87-785500-00

A 40.00
D 79.50
 20x61

1.50		CR P
2.00		P
3.94		CR ②

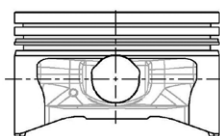
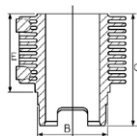

① Liner available in Kit Set only

① Zylinderlaufbüchse nur in Assembles verfügbar

① Chemise disponible en kit seulement

① Camisas disponible en conjuntos solamente

① Cilindro disponibile solo in kit motore

② Steel

② Stahl

② Acier

② Acero

② Acciaio

4 **80.00**

128 H		128 A.000	
		4 Cyl.	8.8:1
		1116cc	37-48kW (50-65PS)

TD22258

87-203100-00	STD
87-203106-00	0.40mm
87-203108-00	0.60mm

08-203100-00	STD
08-203104-00	0.20mm
08-203106-00	0.40mm
08-203108-00	0.60mm
08-203110-00	0.80mm
08-203111-00	1.00mm

A 35.05
B+ 0.60
D 77.05
 22x71

1.50		CR P
2.00		P
3.94		P

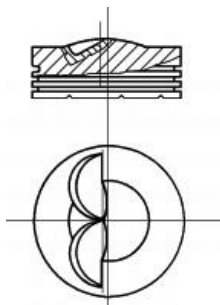

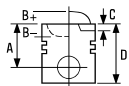

5  **83.00**



Polonez 1.9 D	04/94→09/98	XUD 9A			
Polonez II 1.9 D	08/88→08/92		4 Cyl.	23:1	
			1905cc	51kW (69PS)	
Diesel					TD1493

87-152000-10	STD
87-152007-10	0.50mm
87-152010-10	0.80mm

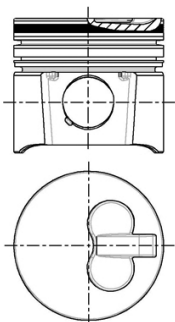
A	46.80
B-	2.20
D	84.30
	25x72



08-152000-00	STD
08-152003-00	0.125mm
08-152007-00	0.50mm
08-152010-00	0.80mm
08-152011-00	1.00mm

2.00		CR P
2.00		P
3.00		CR P

14-020530-00 D **B 85.60 C 153.50 D 88.50 E 3.90**

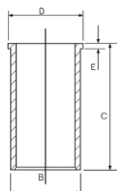

88-152000-30
87-152000-10 +
14-020530-00



1 75.00

E71/E75/ES71/ES75 1 Cyl. 23:1 **353cc** **34kW (46PS)** **Diesel** **FM3693**

87-143200-00 STD

A 48.50

B- 1.15

C 1.50

D 79.50

 25x64

RT

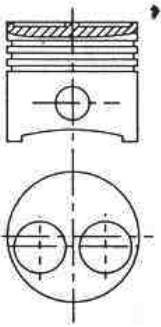

2 90.00

E89/E89 FG/E89 FL/E89 G 1 Cyl. **668cc** **7-9kW (9-12PS)** **Diesel** **FM3697**

87-143400-00 STD

87-143407-00 0.50mm

A 53.50

B- 8.80

BØ 28.80

D 103.50

 30x78

RT

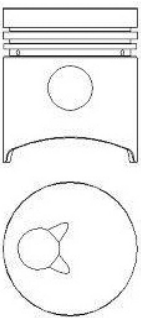

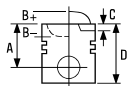

3 108.00

E180	1 Cyl.	17.5:1	1010cc	13-14.5kW (18-20PS)	Diesel	FM4003
Z108	2 Cyl.	17.5:1	2010cc	26-29kW (36-40PS)	Diesel	FM8643
D108	3 Cyl.	17.5:1	3020cc	34.5-44kW (54-60PS)	Diesel	FM5648
V108	4 Cyl.	17.5:1	4030cc	53-59kW (72-80PS)	Diesel	FM5649

87-143500-00 STD
87-143507-00 0.50mm

- A 71.00
- B- 20.00
- BØ 55.00
- C 0.90
- D 109.00
-  35x85

RT

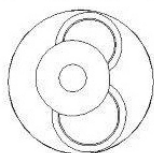
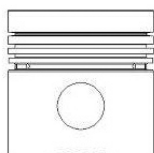



1 97.00

OM 352 6 Cyl. 17:1 **5673cc** **52-96kW (70-131PS)** **Diesel** **FM1149**

14-021850-00 D **B 101.00 C 222.00 D 103.50 E 5.50**

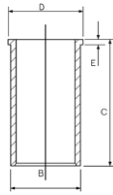

2 115.00

OM 360 6 Cyl. 16.8:1 **8725cc** **125-141kW (170-192PS)** **Diesel** **FM1153**

14-024240-00 D **B 120.00 C 253.50 D 125.00 E 5.50**



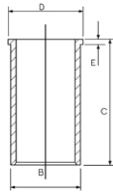



14-024241-00 D **B 121.00 C 253.50 D 126.00 E 6.00**

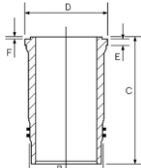

3 125.00

OM 402 V8 Cyl. **12763cc** **188kW (256PS)** **Diesel** **FM4255**

OM 403 V10 Cyl. **15953cc** **235kW (320PS)** **Diesel** **FM4259**

87-176800-00  STD	08-176800-10 STD	14-451660-00 WH B 140.00 C 253.00 D 152.00 E 10.07 F 1.00	88-176800-00 87-176800-00 + 14-451660-00
A 87.25	3.00 		
B- 23.50	3.00 		
BØ 65.00	6.00 		
D 137.25			89-176800-20 87-176800-00 + 14-451660-00
 46x97			

AK RT

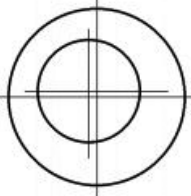
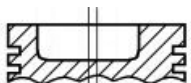

14-458110-00 WH **1** **B 144.50 C 253.00 D 153.80 E 9.92 F 1.00**

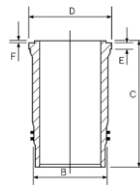

1 O ring = HL5070

2 Not suitable for .911/.933/.935

1 Ringdichtungen = HL5070

2 Nicht geeignet für .911/.933/.935

1 Joints toriques = HL5070

2 Ne pas monter sur .911/.933/.935

1 Juntas tóricas para = HL5070

2 No es adecuado para .911/.933/.935

1 Gommini a Corredo = HL5070

2 Non adattabile .911/.933/.935



1 95.00

B 4 Cyl. 21:1 **2977cc** **59kW (80PS)** **Diesel** **FM1716**

87-526300-00  STD **08-526300-00** STD **14-040150-00 D** **B 102.00 C 190.22 D 107.75 E 2.55 F 1.20**

A 52.20

B- 2.50

D 101.20

 29x79

01/78→12/80

2.50

2.50

4.50





CR

CR

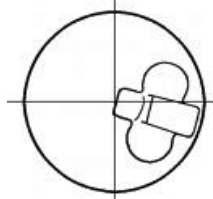
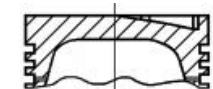
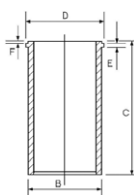
CR



 Pistons to be replaced in Engine Sets only

 Kolben nur Motorsätzen zu ersetzen

 Piston à remplacer dans jeu moteur

 Pistones de repuesto para juegos de motores solamente

 Il pistone può essere rimpiazzato solamente completo

2 102.00

3B/3BK 4 Cyl. 20:1 **3432cc** **Diesel** **FM3346**

14-040140-00 D **B 106.00 C 190.26 D 111.65 E 2.51 F 1.19**

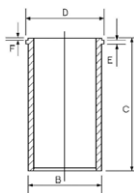

3 137.00

EF-750 8 Cyl. 17.7:1 **16745cc** **Diesel** **FM3371**

EF750T 8 Cyl. **16745cc** **Diesel Turbo** **FM9657**

14-112900-00 WH **B 151.00 C 248.00 D 165.00 E 12.12 F 0.80**

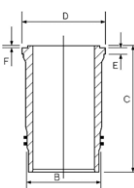









1 75.00

Civic II Shuttle 1.6	01/88→12/92	D16A		
CRX II 1.6 i 16V	10/87→05/88		4 Cyl.	9.1:1
Domani 1.6, Domani 1.6 All-wheel Drive	10/95→09/99		1590cc	79-91kW (107-124PS)
TD17638				
Civic V 1.6 i	01/94→03/96	D16Y7		
Civic VI 1.6	10/95→12/00		4 Cyl.	9.2:1
Civic VI 1.6 i	03/96→03/00		1590cc	77-79kW (105-107PS)
TD11128				

87-433700-00	STD	08-433700-00	STD
87-433707-00	0.50mm	08-433707-00	0.50mm

01/96→12/01

A	30.00
B-	3.47
BØ	63.63
C	3.60
C	2.00
D	50.00
	19x56

1.00		CR 
1.20		P
2.85		CR 

TP

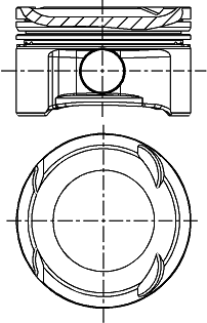

 Steel

 Stahl

 Acier

 Acero

 Acciaio

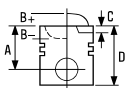



2 80.00

City 1.8 D	02/97→11/99	XUD7T	4 Cyl.	22:1	
			1769cc	58-65kW (79-88PS)	
		Diesel	Turbo		TD18393

87-323600-00	STD	08-323600-00	STD	14-024740-00 D	B 83.50 C 154.00 D 85.70 E 4.60
87-323607-00	0.50mm	08-323607-00	0.50mm	14-024830-00 D	B 83.00 C 154.00 D 86.00 E 4.50

A	46.80
B-	2.20
D	84.50
	28x68

3.00		MOL P
2.00		P
3.00		CR P

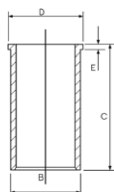

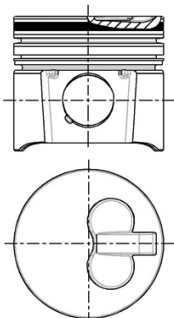

AK RT





3 84.45

Accord V 2.0 TDi	04/96→10/98	20T2N (L Series)	4 Cyl.	19.5:1	
Accord VI 2.0 TDi	12/99→10/00		1994cc	74-77kW (101-105PS)	
Accord VI 2.0 Turbo DI	02/99→12/02	Diesel	Turbo		TD5390
Civic VI 2.0 TDiC					
Civic VI Aerodeck 2.0 I D	04/98→02/01				
Civic VI Fastback 2.0 TDiC	11/98→10/00				

Civic	04/98→	20T2R (L Series)	4 Cyl.	19.5:1	
			1994cc	63kW (86PS)	
		Diesel	Turbo		TD22035

87-119800-00	STD	08-119800-00 	STD
87-119807-00	0.50mm	08-119807-00 	0.50mm

A	47.97
B-	17.00
BØ	38.00
D	76.97
	30x70

→(V) 10P13888B		
3.00		PS
2.00		P
3.00		CR

AK RT TP

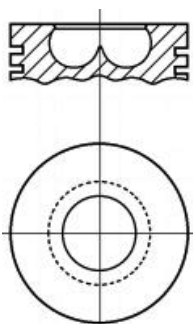





 15 degree Wedge Top Ring

 15-Grad Keiloberring

 Segment trapezoidal angle 15 de grés.

 Anillo superior en cuña de 15 grados

 Segmento trapezio con inclinazione fianchi = 15







		ccm	x 		9
4D31	Diesel	3298	4	100.00	13
4D31T	Diesel	3298	4	100.00	13
4D55	Diesel	2346	4	91.10	8
4D55T	Diesel	2346	4	91.10	9
4D56T	Diesel	2477	4	91.10	10
4D56Ti	Diesel	2476	4	91.10	11
D3EA	Diesel	1493	3	83.00	5
D4BB	Diesel	2477	4	91.10	12
D4CB Euro 4	Diesel	2497	4	91.00	7
D4EA	Diesel	1991	4	83.00	5
D4FA	Diesel	1493	4	75.00	1
DJY	Diesel	1905	4	83.00	6
G4ED Euro 4	Petrol	1599	4	76.50	4
G4EE Euro 4	Petrol	1399	4	75.50	2
G4EK	Petrol	1495	4	75.50	3



1 75.00

Accent III 1.5 CRDi GLS	11/05→11/10	D4FA			
Accent IV 1.5 D	08/10→		4 Cyl.		
Elantra 1.5 D	06/00→07/06		1493cc	65-82kW (88-112PS)	
Getz 1.5 CRDi	08/05→06/09	Diesel			TD18229
Getz 1.5 CRDi GLS	07/04→06/09				
Matrix 1.5 CRDi	12/04→08/10				
Matrix 1.5 CRDi VGT	08/05→08/10				

87-849000-00	STD	08-849000-00	STD
87-849007-00	0.50mm	08-849007-00	0.50mm

A	41.95	1.75		NT 
B-	12.20	1.75		CR P
BØ	43.40	3.00		NT 
C	0.50			
D	65.70			
	28x62			

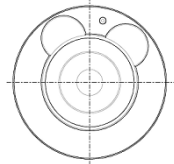
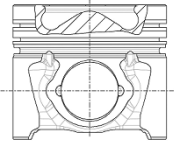

 Steel

 Stahl

 Acier







 Acero

 Acciaio

2 75.50

Accent III 1.4 GL	11/05→11/10	G4EE Euro 4			
Getz 1.4 i	08/05→		4 Cyl.	10:1	
			1399cc	71kW (97PS)	
					TD20722

87-849200-00	STD	08-849200-50	STD
87-849207-00	0.50mm	08-849207-50	0.50mm

A	28.75	1.20		CR 
B+	2.20	1.20		P
C	2.95	2.00		
D	47.90			
	18x48			

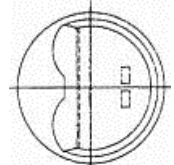
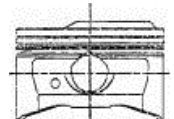

 Steel

 Stahl

 Acier

 Acero





 Acciaio



3 75.50

Accent 1.5	10/94→12/99	G4EK			
Accent 1.5 i 12V	10/94→01/00		4 Cyl.	10:1	
Accent I 1.5	10/94→12/97		1495cc	63-70kW (85-95PS)	
Accent I 1.5 i 12V	10/94→01/00				TD4569
Accent II 1.5	09/99→10/02				
Accent II 1.5 LPG	01/00→				
Accent III 1.5					
Accent III 1.5 CNG	01/09→01/10				
Accent III 1.5 LPG	01/08→11/10				
Lantra II 1.5 12V	12/96→09/00				
Lantra II Wagon 1.5 12V	04/97→10/00				
S 1.5 I	04/92→05/96				
S 1.5 Turbo	09/92→12/95				

87-435400-00	STD	08-435400-00	STD
87-435407-00	0.50mm	08-435407-00	0.50mm

A	31.37	1.50		CR P
B-	0.70	1.50		P
BØ	64.30	3.00		CR 1
C	2.20			
D	54.40			
	18x48			

TP

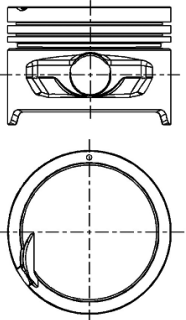

 Steel

 Stahl

 Acier

 Acero



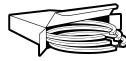
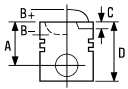



 Acciaio



4 76.50

Accent II 1.6	01/00→12/05	G4ED Euro 4		
Accent III 1.6 GLS	11/05→11/10		4 Cyl.	10:1
Accent IV 1.6	08/10→		1599cc	76-82kW (104-112PS)
Lantra II 1.6 16V	11/95→10/00			TD20721

87-424200-00	STD	08-424200-00	STD
87-424207-00	0.50mm	08-424207-00	0.50mm

A	28.14	1.20	 CR 
B-	0.40	1.20	 P
BØ	60.40	2.00	 NT 
C	3.00		
D	50.14		
	18x48		

TP

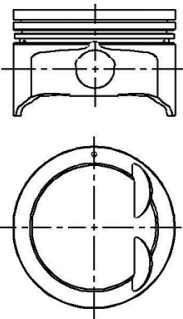

 Steel

 Stahl

 Acier

 Acero

 Acciaio



5 83.00

Accent II 1.5 CRDi	01/02→11/05	D3EA			
Getz 1.5 CRDi	03/03→09/05		3 Cyl.	17.7:1	
Matrix 1.5 CRDi	10/01→08/10		1493cc	60kW (82PS)	
		Diesel			TD16283
Elantra 2.0 CRDi	04/01→07/06	D4EA			
i30 2.0 CRDi	10/07→11/11		4 Cyl.	17.7:1	
i30 CW 2.0 CRDi	02/08→06/12		1991cc	83-110kW (113-150PS)	
Santa FÉ I 2.0 CRDi	04/01→03/06	Diesel	Turbo Intercooled		TD16321
Santa FÉ I 2.0 CRDi All-wheel Drive	11/03→02/06				
Santa FÉ II 2.0 CRDi	03/06→				
Sonata IV 2.0 CRDi Dynamic	10/01→11/04				
Sonata V 2.0 CRDi	02/06→12/10				
Trajjet 2.0 CRDi	04/01→07/08				
Tucson 2.0 CRDi					
Tucson 2.0 CRDi All-wheel Drive	08/04→03/10				

87-431900-00	STD	08-431900-00	STD
87-431907-00	0.50mm	08-431907-00	0.50mm

A	46.30	1.95		CK
B-	13.90	2.00		CR P
BØ	46.95	3.00		NT
D	72.30			
	28x66			

AK NB RT

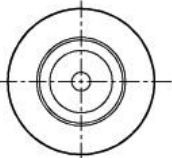
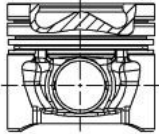

Steel

Stahl

Acier

Acero

Acciaio



6 83.00

Lantra II 1.9 D	03/98→09/00	DJY			
Lantra II Wagon 1.9 D	03/98→10/00		4 Cyl.	23.5:1	
			1905cc	50-52kW (68-71PS)	
Diesel					TD22267

87-152000-10	STD
87-152007-10	0.50mm
87-152010-10	0.80mm

A	46.80
B-	2.20
D	84.30
	25x72

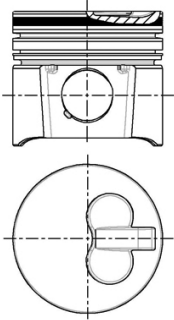

08-152000-00	STD
08-152003-00	0.125mm
08-152007-00	0.50mm
08-152010-00	0.80mm
08-152011-00	1.00mm

2.00		CR P
2.00		P
3.00		CR P

14-020530-00 D

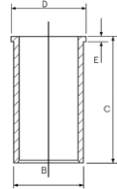

B 85.60 C 153.50 D 88.50 E 3.90

88-152000-30
87-152000-10 +
14-020530-00

7 91.00

H-1 2.5 CRDi	07/01→	D4CB Euro 4		
H-1/Starex 2.5 CRDi	06/97→		4 Cyl.	17.7:1
H-1/Starex 2.5 CRDi 4WD	12/02→04/04		2497cc	81-125kW (110-170PS)
H-1 Travel 2.5 CRDi	02/08→	Diesel	Turbo Intercooled	
H100 2.5 CRDi	01/04→			TD21021
H350 2.5 CRDi	04/15→			
Porter 2.5 CRDi	02/03→			
Porter 2.5 D	01/12→			

87-431700-00	STD
87-431707-00	0.50mm

A	54.25
B-	15.00
BØ	52.00
C	0.30
D	83.75
	33x75

08-431700-00	STD
08-431707-00	0.50mm

2.50		CK P
2.00		CR P
3.00		NT

AK KK RT

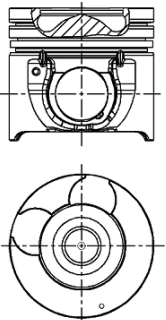

Steel

Stahl

Acier

Acero

Acciaio

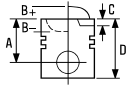

8 91.10

Gallopier Jeep 2.4, Grace 2.4 1 ton
Porter Truck 2.4

01/80 → 12/86 4D55

4 Cyl.
2346cc

21:1

Diesel

FM3377

87-288000-00
87-288007-00

STD
0.50mm

08-288000-10
08-288007-10

STD
0.50mm

14-015590-00 D B 94.13 C 164.50

A 48.70
B- 3.10
C 2.30
C 2.30
D 88.70
 29x75

2.50
2.00
4.00



CK P
CR
CR

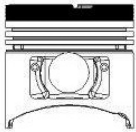
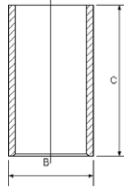

9 91.10

Gallopier 2.4

4D55T

4 Cyl.
2346cc
Turbo Intercooled

21:1

49kW (67PS)

Diesel

FM3828

87-287100-30
87-287107-30

STD
0.50mm

08-287100-00
08-287107-00

STD
0.50mm

14-015590-00 D B 94.13 C 164.50

A 48.70
B- 3.10
C 2.30
D 88.70
 29x75

2.50
2.00
4.00



MO P
CR P
CR P

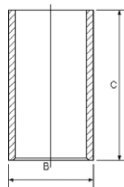

RT

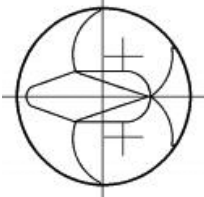
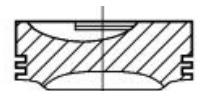

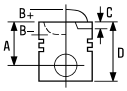

10  **91.10**



Galopper I 2.5 TD		4D56T		
Galopper I 2.5 TD intercooler	08/91→07/98		4 Cyl.	21:1
H100 2.5 TD	11/06→		2477cc	62-74kW (84-101PS)
		Diesel	Turbo Intercooled	TD18860

87-287100-30 STD
87-287107-30 0.50mm

08-287100-00 STD
08-287107-00 0.50mm

14-020600-00 DH B 94.64 C 165.10 D 96.91 E 5.06

- A** 48.70
- B-** 3.10
- C** 2.30
- D** 88.70
-  29x75

- 2.50  MO P
- 2.00  CR P
- 4.00  CR P

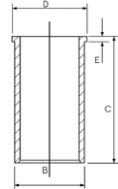

RT

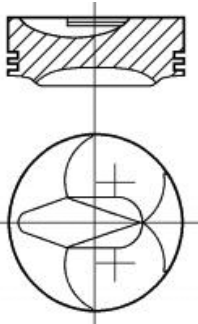

14-015590-00 D B 94.13 C 164.50

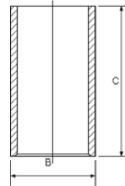





11  **91.10**

Galopper 2.5	01/96→	4D56Ti		
			4 Cyl.	21:1
			2476cc	73kW (99PS)
		Diesel	Turbo Intercooled	FM15062

87-287100-00  STD

08-287100-00 STD
08-287107-00 0.50mm

- A** 48.70
- B-** 2.61
- D** 88.70
-  29x75

- 2.50  MO P
- 2.00  CR P
- 4.00  CR P

AK KK RT

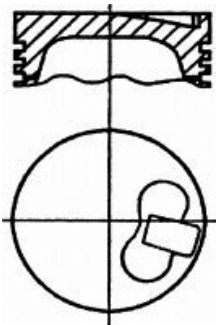







87-287100-10 ②
87-287107-10 ②

STD
0.50mm

08-287100-00
08-287107-00

STD
0.50mm

A 48.70
B- 2.61
D 88.70
 29x75

2.50  MO P
2.00  CR P
4.00  CR P

AK KK RT

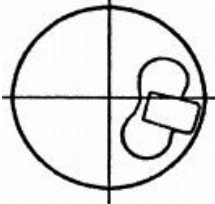
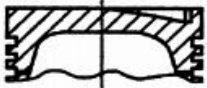

① To cylinder 1 & 3
② To cylinder 2 & 4

① zum Zylinder 1 & 3
② zum Zylinder 2 & 4

① sous cylindre 1 & 3
② sous cylindre 2 & 4

① A cilindro 1 & 3
② A cilindro 2 & 4

① al cilindro 1 & 3
② al cilindro 2 & 4

12 91.10

Galopper II 2.6 TD All-wheel Drive
H-1 2.6 CRDi
H-1/Starex 2.6 TDiC
H100 2.6 D
H100 2.6 TD
Porter 2.6 TD

08/98→06/03
10/97→12/07
10/97→04/04
01/04→
07/93→05/98
07/94→04/04

D4BB



4 Cyl. 21:1
2477cc 57-79kW (78-107PS)
Diesel Turbo Intercooled

TD16110

87-432000-00
87-432007-00

STD
0.50mm

A 48.70
B- 3.20
C 1.90
C 2.50
D 88.70
 29x75

2.00  CR P
2.00  CR P
3.00  CR P

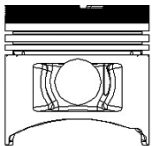

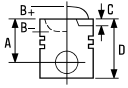

13  **100.00**

Canter 3.3	01/87→	4D31			
Rosa 3.3	01/85→12/86		4 Cyl.	17.5:1	
		Diesel	3298cc		FM19502

Truck 3.5 ton	01/82→09/85	4D31T			
		Diesel	4 Cyl.		
			3298cc	Turbo Intercooled	FM9515

14-010970-00 D **B 104.00 C 196.50**

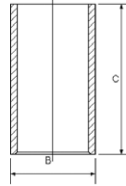

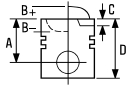

1  120.00

4VD14.5

4 Cyl.

6600cc

Diesel

FM6397

14-378270-00 WH  B 134.50 C 287.00 D 140.00 E 10.00 F 1.00

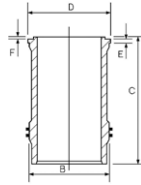

 Phosphated

 Phosphated

 Phosphated

 Phosphated

 Phosphated



1  **88.90**

BD-154 4 Cyl. 23.1:1 **2720cc** **Diesel** **FM852**

14-440260-00 WH **B 97.10 C 185.70 D 101.50 E 5.77**

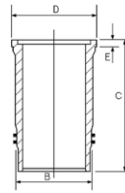

2  **98.42**



D-155 3 Cyl. 16:1 **2540cc** **25-36kW (34-49PS)** **Diesel Direct Injection** **TD18801**

D-206 4 Cyl. 16:1 **3380cc** **40-44kW (54-60PS)** **Diesel Direct Injection** **TD18803**

D-310 6 Cyl. 16:1 **5070cc** **62-88kW (84-120PS)** **Diesel Direct Injection** **TD18806**

87-243300-00 **STD** **08-243300-00** **STD** **14-450270-00 WH** **B 110.75 C 200.00 D 119.00 E 7.70 F 1.10** **89-243300-10**

A 67.00
B- 19.90
BØ 55.00
D 101.50
 **36x82**

3.16  **CR P**
 2.38  **P**
 4.74  **CR P**

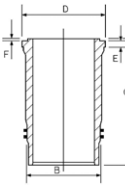

87-243300-00 +
14-450270-00

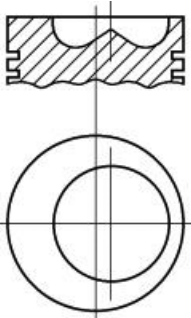

3  **98.42**



D-179 3 Cyl. 16:1 **2930cc** **33-38kW (45-52PS)** **Diesel Direct Injection** **TD18802**

D-239 4 Cyl. 16:1 **3915cc** **45-56kW (61-76PS)** **Diesel Direct Injection** **TD18804**

D-358 6 Cyl. 16:1 **5863cc** **66-101kW (90-137PS)** **Diesel Direct Injection** **TD18807**

87-243600-00 **STD** **08-243600-00** **STD** **14-451170-00 WH** **B 110.75 C 215.00 D 119.00 E 7.70 F 1.10**

A 67.00
B- 24.00
BØ 56.00
D 107.00
 **36x82**

3.16  **CR P**
 2.38  **P**
 4.74  **CR P**

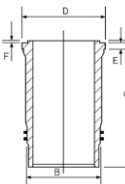

RT

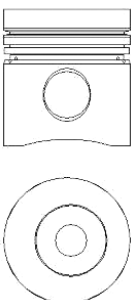

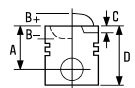



4  **98.42**

DT-239	4 Cyl.	16:1	3911cc	59-63kW (80-86PS)	Diesel Turbo Direct Injection	TD18810
DT-358	6 Cyl.	16:1	5667cc	88-100kW (120-136PS)	Diesel Turbo Direct Injection	TD18808

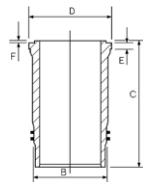
14-451170-00 WH B 110.75 C 215.00 D 119.00 E 7.70 F 1.10





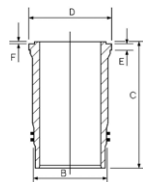

5  **100.00**

D-246	4 Cyl.	16:1	4025cc	53-60kW (72-82PS)	Diesel Direct Injection	TD18805
D-268	4 Cyl.	15:1	4389cc	57-63kW (78-86PS)	Diesel Direct Injection	TD18811
DT-402	6 Cyl.	16:1	6582cc	107-120kW (145-163PS)	Diesel Turbo Direct Injection	TD18809

14-452670-00 WH B 111.40 C 216.10 D 119.00 E 7.70 F 1.10



		ccm	x 		
4EC1	Diesel	1488	4	76.00	1
4EC1T	Diesel	1488	4	76.00	1
4JA1	Diesel	2499	4	93.00	6
4JB1	Diesel	2771	4	93.00	7
4JB1-T	Diesel	2772	4	93.00	8
4JB-1TC	Diesel	2752	4	93.00	8
C 20 NE	Petrol	1998	4	86.00	2
C190	Diesel	1951	4	86.00	4
C 223	Diesel	2238	4	88.00	5
C 240	Diesel	2369	4	86.00	3
TD27	Diesel	2663	4	96.00	9

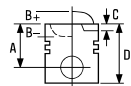



1  **76.00**

Gemini 1.5 D	09/80 → 12/90	4EC1	4 Cyl. 1488cc	23:1 37kW (50PS)	
		Diesel			TD4575

Gemini 1.5 TD	02/88 → 12/90	4EC1T	4 Cyl. 1488cc	22.5:1 49-54kW (67-73PS)	
		Diesel Turbo			TD4576

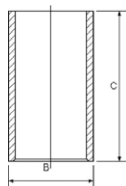



14-010870-00 D B 80.00 C 138.00



2  **86.00**

KB 2.0, KB 2.0 4WD	07/02 → 06/04	C 20 NE	4 Cyl. 1998cc	9.2:1 85kW (115PS)	
					TD26802

87-306800-30	STD	08-306800-00	STD
87-306807-30	0.50mm	08-306807-00	0.50mm
87-306811-30	1.00mm	08-306811-00	1.00mm

A	30.40	1.50	 CR P
B-	5.00	1.50	 P
BØ	57.00	3.00	 CR 1
D	50.40		
	21x62		

TP

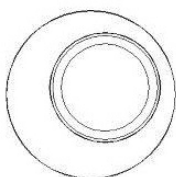
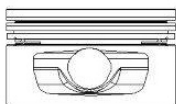

 Steel

 Stahl

 Acier

 Acero

 Acciaio



3  **86.00**

Elf 2.4 **C 240** 4 Cyl. 20:1
2369cc **44-55kW (60-75PS)**
Diesel **TD26269**

87-247200-00 STD

STD

08-247200-10 STD

STD

14-021430-00 DH ¹ ² B 88.01 C 178.46 D 93.98 E 0.92

88-247200-00

→12/81

2.00

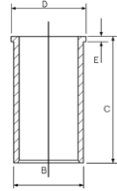
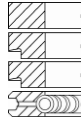

→12/81
 87-247200-00 +
 14-021430-00

A 51.50
B- 3.00
D 95.50
 27x73

2.00
 2.00
 2.00
 5.00

14-021180-00 D

B 90.13 C 178.50 D 94.00 E 4.00

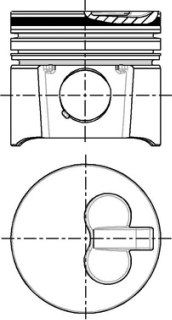
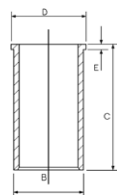

¹ Not suitable for use with pistons having chrome rings

¹ Nicht geeignet zur Verwendung mit Kolben mit Chromringen

¹ Ne pas utiliser avec des pistons équipés de segments chromés

¹ No es adecuada para usar con pistones que tengan aros de croma

¹ Non utilizzabile con pistoni equipaggiati con segmenti cromati

² Chrome Bore

² Bohrung verchromt

² Alésage chromée

² Cromado de cilindro

² Cilindro cromato

4  **86.00**

Campo **C190** 4 Cyl. 20:1
 Elf 150 **1951cc** **40kW (54PS)**
 Gemini 2.0 D **Diesel** **TD1685**

14-021180-00 D

B 90.13 C 178.50 D 94.00 E 4.00

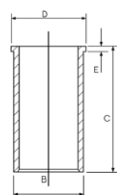



5 88.00

Campo 2.2 D	01/83→12/91	C 223		
Campo 2.2 D 4WD	01/83→12/90		4 Cyl.	21:1
KB 2.2 D	01/83→07/86		2238cc	39-54kW (53-73PS)
Trooper 2.2 D	05/84→12/89	Diesel		
Trooper Open Off-Road Vehicle 2.2 D	05/84→07/89			TD1686

87-247600-10 STD

A 48.00
B- 2.40
D 82.75
 27x68

RT

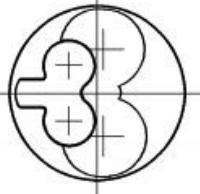
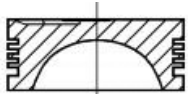

- 1 Not suitable for use with pistons having chrome rings
- 2 Chrome Bore

08-247600-00 STD

12/83→
 2.00
 2.00
 4.00



P
 P
 P

- 1 Nicht geeignet zur Verwendung mit Kolben mit Chromringen
- 2 Bohrung verchromte

14-021440-00 DH 1 2 B 89.97 C 163.32 D 94.89 E 0.89

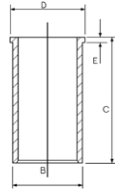

14-021190-00 D B 92.13 C 163.50 D 95.00 E 4.00

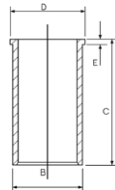

- 1 No es adecuada para usar con pistones que tengan aros de cromado
- 2 Cromado de cilindro

88-247600-10
 87-247600-10 +
 14-021440-00

- 1 Non utilizzabile con pistoni equipaggiati con segmenti cromati
- 2 Cilindro cromato

6 93.00

Campo 2.5 D, Campo 2.5 D 4WD	01/83→12/90	4JA1		
KB 2.5 D 4WD	01/83→11/90		4 Cyl.	18.5:1
KB 2.5 DiTD, KB 2.5 DiTD 4WD	07/02→09/08		2499cc	50-94kW (68-128PS)
Rodeo 2.5 D	08/06→04/07	Diesel		
TFR/TFS 2.5 D	07/94→08/99			TD1668

87-248000-00 STD

A 47.80
B- 14.65
BØ 44.20
C 1.80
D 87.80
 31x76

AK RT

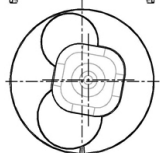
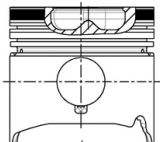

- 1 Not suitable for use with pistons having chrome rings
- 2 Chrome Bore
- 3 Ringset only for AE/Nural piston

08-248000-10 3 STD

2.00
 2.00
 4.00



- 1 Nicht geeignet zur Verwendung mit Kolben mit Chromringen
- 2 Bohrung verchromte
- 3 Ringsätze Ringset nur für AE/Nural Kolben

14-021450-00 DH 1 2 B 95.04 C 156.31 D 101.00 E 0.92

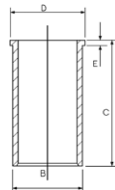

- 1 No es adecuada para usar con pistones que tengan aros de cromado
- 2 Cromado de cilindro
- 3 Ringset solamente para el pistón de AE/Nural

88-248000-00
 87-248000-00 +
 14-021450-00

- 1 Non utilizzabile con pistoni equipaggiati con segmenti cromati
- 2 Cilindro cromato
- 3 Ringset soltanto per il pistone di AE/Nural

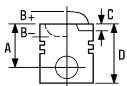

7 **93.00**

ELF 2.8 D	10/85→09/03	4JB1				
Frontier 2.8 D	11/97→08/03		4 Cyl.			
TFR/TFS 2.8 D			2771cc		42-74kW (57-101PS)	
TFR/TFS 2.8 D All-wheel Drive	09/91→08/99	Diesel				TD1670

87-248000-10	STD	08-248000-10 ³	STD	14-021460-00 <i>DH</i> ¹ ²	B 95.04 C 181.00 D 101.00 E 0.92	88-248000-10 87-248000-10 + 14-021460-00
A	51.85	2.00				
B-	13.80	2.00				
BØ	50.70	4.00				
C	0.54					
D	91.85					
	31x76					

AK RT

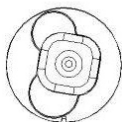
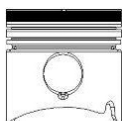

- | | | | | |
|--|---|---|---|--|
| ¹ Not suitable for use with pistons having chrome rings | ¹ Nicht geeignet zur Verwendung mit Kolben mit Chromringen | ¹ Ne pas utiliser avec des pistons équipés de segments chromés | ¹ No es adecuada para usar con pistones que tengan aros de croma | ¹ Non utilizzabile con pistoni equipaggiati con segmenti crom |
| ² Chrome Bore | ² Bohrung verchromte | ² Alésage chromée | ² Cromado de cilindro | ² Cilindro cromato |
| ³ Ringset only for AE/Nural piston | ³ Ringsätze Ringset nur für AE/Nural Kolben | ³ Ringset seulement pour le piston d'AE/Nural | ³ Ringset solamente para el pistón de AE/Nural | ³ Ringset soltanto per il pistone di AE/Nural |

8 **93.00**

ELF 2.8 TD	10/85→09/92	4JB1-T				
MU 2.8 TD All-wheel Drive	05/90→07/93		4 Cyl.	18.2:1		
Pickup 2.8 TD	07/96→		2772cc		57-88kW (77-120PS)	
TF 2.8 TD	05/00→09/03	Diesel	Turbo			TD1671
Trooper 2.8 TD	10/87→12/91					
Vega 2.8 TD	08/98→12/02					

ELF 2.8 TD	10/03→	4JB-1TC				
KB 2.8 TD	12/90→09/03		4 Cyl.	17.5:1		
KB 2.8 TD 4WD	12/90→04/00		2752cc		67-85kW (91-116PS)	
Trooper 2.8 TD	10/88→12/91	Diesel	Turbo Intercooled			TD1672

14-021460-00 *DH* ¹ ² **B 95.04 C 181.00 D 101.00 E 0.92**

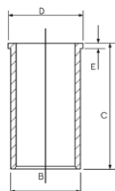

- | | | | | |
|--|---|---|---|--|
| ¹ Not suitable for use with pistons having chrome rings | ¹ Nicht geeignet zur Verwendung mit Kolben mit Chromringen | ¹ Ne pas utiliser avec des pistons équipés de segments chromés | ¹ No es adecuada para usar con pistones que tengan aros de croma | ¹ Non utilizzabile con pistoni equipaggiati con segmenti crom |
| ² Chrome Bore | ² Bohrung verchromte | ² Alésage chromée | ² Cromado de cilindro | ² Cilindro cromato |









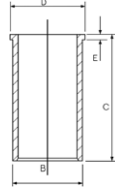

9  **96.00**





Elf 2.7 TD		TD27			
Elf 2.7 TD All-wheel Drive	10/99→09/01		4 Cyl.	21.8:1	
			2663cc	58-73kW (79-99PS)	
		Diesel			TD21156





14-020110-00 D **B 99.08 C 160.00 D 105.03 E 5.09**











		ccm	x 		9
203 A/61	Diesel	11548	6	130.00	58
203 H 61	Diesel	11548	6	130.00	58
310 H/61	Diesel	11548	6	130.00	58
803 A.062 (8030.01)	Diesel	2339	3	95.00	18
804A (8040.01)	Diesel	3119	4	95.00	18
806 A (8060.01/.11)	Diesel	4678	6	95.00	18
8025.01	Diesel	1559	2	95.00	18
8025.02	Diesel	1728	2	100.00	20
8030.02	Diesel	2592	3	100.00	20
8035.02	Diesel	2592	3	100.00	20
8035.04	Diesel	2748	3	103.00	25
8035.04.265	Diesel	2749	3	103.00	25
8035.04.270	Diesel	2749	3	103.00	25
8035.05	Diesel	2930	3	104.00	29
8035.05.214	Diesel	2931	3	104.00	30
8035.05.215	Diesel	2931	3	104.00	30
8035.06	Diesel	2708	3	100.00	21
8035.06.200	Diesel	2708	3	100.00	21
8035.06.206	Diesel	2708	3	100.00	21
8035.06.208	Diesel	2708	3	100.00	21
8035.06.216	Diesel	2708	3	100.00	21
8035.06.220	Diesel	2708	3	100.00	21
8035.06.222	Diesel	2708	3	100.00	21
8035.06.223	Diesel	2708	3	100.00	21
8035.06.306	Diesel	2708	3	100.00	21
8035.06.307	Diesel	2708	3	100.00	21
8035.06.308	Diesel	2708	3	100.00	21
8035.06.309	Diesel	2708	3	100.00	21
8035.06.317	Diesel	2708	3	100.00	21
8035.06.320	Diesel	2708	3	100.00	21
8035.06.321	Diesel	2708	3	100.00	21
8035.06.322	Diesel	2708	3	100.00	21
8035.06.323	Diesel	2708	3	100.00	21
8040.02	Diesel	3455	4	100.00	22
8040.02	Diesel	3456	4	100.00	22
8040.02.041	Diesel	3456	4	100.00	22
8040.02.267	Diesel	3456	4	100.00	22
8040.02.300	Diesel	3455	4	100.00	22
8040.02.360	Diesel	3456	4	100.00	22
8040.02.367	Diesel	3456	4	100.00	22
8040.04.200	Diesel	3666	4	103.00	25
8040.05.200	Diesel	3908	4	104.00	31
8040.05.203	Diesel	3908	4	104.00	31
8040.05.230	Diesel	3908	4	104.00	31
8040.05.233	Diesel	3908	4	104.00	31
8040.05.235	Diesel	3908	4	104.00	31
8040.05.4990	Diesel	3908	4	104.00	30
8040.05.4990	Diesel	3908	4	104.00	32
8040.25.000	Diesel	3908	4	104.00	33
8040.25.200	Diesel	3908	4	104.00	33
8040.25.220	Diesel	3908	4	104.00	33
8040.25.230	Diesel	3908	4	104.00	33
8040.25.4990	Diesel	3908	4	104.00	30
8040.25 B.4200	Diesel	3908	4	104.00	32
8040.25X.4000	Diesel	3908	4	104.00	32
8040.45.400	Diesel	3908	4	104.00	34
8040.45.4180	Diesel	3908	4	104.00	30
8040.45.4380	Diesel	3908	4	104.00	30
8040.45.5200	Diesel	3908	4	104.00	30
8040.45.5200 Euro 2	Diesel	3908	4	104.00	35
8040.45.5201 Euro 2	Diesel	3908	4	104.00	30
8040.45.5203 Euro 2	Diesel	3908	4	104.00	30
8040.45.5280 Euro 2	Diesel	3908	4	104.00	30
8040.45.5281	Diesel	3908	4	104.00	30
8040.45.5281 Euro 2	Diesel	3908	4	104.00	30
8040.45D.5100	Diesel	3908	4	104.00	30
8040.45D.5100 Euro 2	Diesel	3908	4	104.00	35
8040.45D.5101 Euro 2	Diesel	3908	4	104.00	30
8040.45D.5103	Diesel	3908	4	104.00	30





		ccm	x 		9
8040.45D.5103 Euro 2	Diesel	3908	4	104.00	30
8040.45D.5105 Euro 2	Diesel	3908	4	104.00	30
8040.45X.4180	Diesel	3908	4	104.00	36
8041 L	Diesel	3666	4	103.00	26
8045.02	Diesel	3456	4	100.00	20
8045.04	Diesel	3666	4	103.00	25
8045.04.270	Diesel	3666	4	103.00	25
8045.05	Diesel	3908	4	104.00	29
8045.05.000	Diesel	3908	4	104.00	30
8045.05.213	Diesel	3908	4	104.00	30
8045.05.215	Diesel	3908	4	104.00	30
8045.06	Diesel	3613	4	100.00	21
8045.06.200	Diesel	3613	4	100.00	21
8045.06.208	Diesel	3613	4	100.00	21
8045.06.213	Diesel	3613	4	100.00	21
8045.06.214	Diesel	3613	4	100.00	21
8045.06.215	Diesel	3613	4	100.00	21
8045.06.225	Diesel	3613	4	100.00	21
8045.06.319	Diesel	3613	4	100.00	21
8045.06.326	Diesel	3613	4	100.00	21
8045.25.310	Diesel	3908	4	104.00	30
8045.25.370	Diesel	3908	4	104.00	30
8045.25.375	Diesel	3908	4	104.00	30
8045.25.376	Diesel	3908	4	104.00	30
8045.25.381	Diesel	3908	4	104.00	30
8055.04	Diesel	4583	5	103.00	25
8055.04.200	Diesel	4583	5	103.00	25
8055.05.000	Diesel	4885	5	104.00	31
8060.02.000	Diesel	5184	6	100.00	20
8060.02.001	Diesel	5184	6	100.00	20
8060.02.003	Diesel	5184	6	100.00	20
8060.02.070	Diesel	5184	6	100.00	20
8060.04	Diesel	5499	6	103.00	25
8060.04.000	Diesel	5499	6	103.00	25
8060.04.055	Diesel	5499	6	103.00	25
8060.04.060	Diesel	5499	6	103.00	25
8060.04.070	Diesel	5499	6	103.00	25
8060.04.620	Diesel	5499	6	103.00	25
8060.04.621	Diesel	5499	6	103.00	25
8060.04.630	Diesel	5499	6	103.00	25
8060.04.639	Diesel	5499	6	103.00	25
8060.04.658	Diesel	5499	6	103.00	25
8060.04.660	Diesel	5499	6	103.00	25
8060.04.669	Diesel	5499	6	103.00	25
8060.04.670	Diesel	5499	6	103.00	25
8060.04.672	Diesel	5499	6	103.00	25
8060.04.675	Diesel	5499	6	103.00	25
8060.04.689	Diesel	5499	6	103.00	25
8060.05	Diesel	5861	6	104.00	31
8060.05.000	Diesel	5861	6	104.00	31
8060.05.200	Diesel	5861	6	104.00	31
8060.05.200	Diesel	5868	6	104.00	31
8060.05.246	Diesel	5861	6	104.00	31
8060.05.246	Diesel	5868	6	104.00	31
8060.05.270	Diesel	5861	6	104.00	31
8060.05.280	Diesel	5861	6	104.00	31
8060.05.285	Diesel	5861	6	104.00	31
8060.05.289	Diesel	5861	6	104.00	31
8060.24.601	Diesel	5499	6	103.00	28
8060.24.670	Diesel	5499	6	103.00	28
8060.24.671	Diesel	5499	6	103.00	28
8060.24.678	Diesel	5499	6	103.00	28
8060.25.600	Diesel	5861	6	104.00	33
8060.25.600	Diesel	5868	6	104.00	33
8060.25.621	Diesel	5861	6	104.00	33
8060.25.630	Diesel	5861	6	104.00	33
8060.25.631	Diesel	5861	6	104.00	33
8060.25.641	Diesel	5861	6	104.00	33
8060.25.662	Diesel	5861	6	104.00	33





		ccm	x 		9
8060.25.663	Diesel	5861	6	104.00	33
8060.25.669	Diesel	5861	6	104.00	33
8060.25.670	Diesel	5861	6	104.00	33
8060.25.673	Diesel	5861	6	104.00	33
8060.25.678	Diesel	5861	6	104.00	33
8060.25.679	Diesel	5861	6	104.00	33
8060.25R.4200	Diesel	5861	6	104.00	34
8060.25R.4200 LTC	Diesel	5861	6	104.00	34
8060.25R.4210 Euro 1	Diesel	5861	6	104.00	30
8060.25R.4220 Euro 1	Diesel	5861	6	104.00	30
8060.25R.4225 Euro 1	Diesel	5861	6	104.00	30
8060.25R.4230 Euro 1	Diesel	5861	6	104.00	30
8060.25R.4240 Euro 1	Diesel	5861	6	104.00	30
8060.25R.4250 Euro 1	Diesel	5861	6	104.00	30
8060.25R.4280	Diesel	5861	6	104.00	32
8060.25R.4280	Diesel	5861	6	104.00	34
8060.25R.4285 Euro 1	Diesel	5861	6	104.00	30
8060.25R.4290 Euro 1	Diesel	5861	6	104.00	30
8060.25R.4295 Euro 1	Diesel	5861	6	104.00	30
8060.25R.4360 Euro 1	Diesel	5861	6	104.00	30
8060.25R.4362 Euro 1	Diesel	5861	6	104.00	30
8060.25R.4750	Diesel	5861	6	104.00	30
8060.25R.4755	Diesel	5861	6	104.00	30
8060.25R.4760	Diesel	5861	6	104.00	30
8060.25R.4764	Diesel	5861	6	104.00	30
8060.25R.4960 Euro 1	Diesel	5861	6	104.00	30
8060.25R.4967 Euro 1	Diesel	5861	6	104.00	30
8060.25R.4968 Euro 1	Diesel	5861	6	104.00	30
8060.25R.4970 Euro 1	Diesel	5861	6	104.00	30
8060.25R.4973 Euro 1	Diesel	5861	6	104.00	30
8060.25R.4980 Euro 1	Diesel	5861	6	104.00	30
8060.25R 4200 Euro 1	Diesel	5861	6	104.00	32
8060.25R 4300	Diesel	5861	6	104.00	32
8060.25V.4000	Diesel	5861	6	104.00	30
8060.25V.4000 Euro 1	Diesel	5868	6	104.00	32
8060.25V.4080	Diesel	5861	6	104.00	32
8060.25V.4800	Diesel	5861	6	104.00	32
8060.45.4100 Euro 1	Diesel	5861	6	104.00	34
8060.45.4100 TCA Euro 1	Diesel	5861	6	104.00	34
8060.45.4300/8060.45.4400/	Diesel	5861	6	104.00	30
8060.45.4700	Diesel	5861	6	104.00	34
8060.45.4702 Euro 1	Diesel	5861	6	104.00	30
8060.45.4704 Euro 1	Diesel	5861	6	104.00	30
8060.45.4706 Euro 1	Diesel	5861	6	104.00	30
8060.45.4708	Diesel	5861	6	104.00	30
8060.45.5200/8060.45B 5100 Euro 2	Diesel	5861	6	104.00	30
8060.45.5200 Euro 2	Diesel	5861	6	104.00	30
8060.45.5201 Euro 2	Diesel	5861	6	104.00	30
8060.45.5203 Euro 2	Diesel	5861	6	104.00	30
8060.45.5205 Euro 2	Diesel	5861	6	104.00	30
8060.45.5220 Euro 2	Diesel	5861	6	104.00	30
8060.45.5221 Euro 2	Diesel	5861	6	104.00	30
8060.45.5223 Euro 2	Diesel	5861	6	104.00	30
8060.45.5232 Euro 2	Diesel	5861	6	104.00	30
8060.45.5233 Euro 2	Diesel	5861	6	104.00	30
8060.45.5234 Euro 2	Diesel	5861	6	104.00	30
8060.45.5235 Euro 2	Diesel	5861	6	104.00	30
8060.45.5250 Euro 2	Diesel	5861	6	104.00	30
8060.45.5251	Diesel	5861	6	104.00	30
8060.45.5255	Diesel	5861	6	104.00	30
8060.45.600	Diesel	5861	6	104.00	34
8060.45B.5101 Euro 2	Diesel	5861	6	104.00	30
8060.45B.5103 Euro 2	Diesel	5861	6	104.00	30
8060.45B.5105 Euro 2	Diesel	5861	6	104.00	30
8060.45B.5111 Euro 2	Diesel	5861	6	104.00	30
8060.45B.5112 Euro 2	Diesel	5861	6	104.00	30
8060.45B.5113 Euro 2	Diesel	5861	6	104.00	30
8060.45B.5120 Euro 2	Diesel	5861	6	104.00	30
8060.45B.5121 Euro 2	Diesel	5861	6	104.00	30





		ccm	x 		
8060.45B.5123 Euro 2	Diesel	5861	6	104.00	30
8060.45B.5124 Euro 2	Diesel	5861	6	104.00	30
8060.45B.5145 Euro 2	Diesel	5861	6	104.00	30
8060.45B.5146 Euro 2	Diesel	5861	6	104.00	30
8060.45B.5150 Euro 2	Diesel	5861	6	104.00	30
8060.45B.5151 Euro 2	Diesel	5861	6	104.00	30
8060.45B.5185 Euro 2	Diesel	5861	6	104.00	30
8060.45B.5186 Euro 2	Diesel	5861	6	104.00	30
8060.45B 5100 Euro 2	Diesel	5861	6	104.00	35
8060.45B Euro 2	Diesel	5861	6	104.00	35
8060.45 Euro 1	Diesel	5861	6	104.00	34
8060.45K.6090 Euro 1	Diesel	5861	6	104.00	30
8060.45M.7200/8060.45S.7200 Euro 2	Diesel	5861	6	104.00	30
8060.45R.5000 Euro 2	Diesel	5861	6	104.00	36
8060.45R.5001 Euro 2	Diesel	5861	6	104.00	30
8060.45R.5003 Euro 2	Diesel	5861	6	104.00	30
8060.45R.5050	Diesel	5861	6	104.00	30
8060.45S.6000	Diesel	5861	6	104.00	30
8060.45S.6000 Euro 1	Diesel	5861	6	104.00	30
8060.45S.6203 Euro 1	Diesel	5861	6	104.00	30
8060.45S.6800 Euro 1	Diesel	5861	6	104.00	30
8060.45S.7200 Euro 2	Diesel	5861	6	104.00	30
8060.45S TCA	Diesel	5861	6	104.00	30
8061.05	Diesel	5861	6	104.00	31
8061.25	Diesel	5868	6	104.00	33
8061 L	Diesel	5499	6	103.00	26
8062.24.070	Diesel	5499	6	103.00	28
8065.02.007	Diesel	5184	6	100.00	20
8065.02.200	Diesel	5184	6	100.00	20
8065.02.207	Diesel	5184	6	100.00	20
8065.02.217	Diesel	5184	6	100.00	20
8065.04	Diesel	5499	6	103.00	25
8065.04.200	Diesel	5499	6	103.00	25
8065.04-H	Diesel	5499	6	103.00	25
8065.05.000	Diesel	5863	6	104.00	30
8065.05.330	Diesel	5863	6	104.00	30
8065.06.000	Diesel	5418	6	100.00	21
8065.24.000	Diesel	5499	6	103.00	27
8065.24.300	Diesel	5499	6	103.00	27
8065.25	Diesel	5863	6	104.00	37
8065.25.320	Diesel	5863	6	104.00	30
8065.E	Diesel	5861	6	104.00	29
8140.07.2585 Euro 1	Diesel	2499	4	93.00	3
8140.07.2700	Diesel	2499	4	93.00	3
8140.07.2701	Diesel	2499	4	93.00	3
8140.07.2710	Diesel	2499	4	93.00	4
8140.07.2711	Diesel	2499	4	93.00	4
8140.07.2712	Diesel	2499	4	93.00	4
8140.07.3700 Euro 1	Diesel	2499	4	93.00	3
8140.07.3710 Euro 1	Diesel	2499	4	93.00	3
8140.07.3711 Euro 1	Diesel	2499	4	93.00	4
8140.07.3712 Euro 1	Diesel	2499	4	93.00	4
8140.07.3713 Euro 1	Diesel	2499	4	93.00	4
8140.21	Diesel	2445	4	93.00	5
8140.21.200	Diesel	2445	4	93.00	5
8140.21.201	Diesel	2445	4	93.00	4
8140.21.202	Diesel	2445	4	93.00	4
8140.21.203	Diesel	2445	4	93.00	4
8140.21.212	Diesel	2445	4	93.00	4
8140.21.214 Sofim	Diesel	2445	4	93.00	5
8140.21.290	Diesel	2445	4	93.00	4
8140.23.	Diesel	2798	4	94.40	13
8140.23.2585 Euro 2 Sofim	Diesel	2799	4	94.40	13
8140.23.3700 Euro 2 Sofim	Diesel	2799	4	94.40	13
8140.23.3701 Euro 2	Diesel	2798	4	94.40	13
8140.23.3710 Euro 2	Diesel	2798	4	94.40	13
8140.23.3711 Euro 2	Diesel	2798	4	94.40	13
8140.23.3713 Euro 2	Diesel	2798	4	94.40	13
8140.23.3720 Euro 2	Diesel	2798	4	94.40	13





		ccm	x 		
8140.23.3721 Euro 2	Diesel	2798	4	94.40	13
8140.23.3730 Euro 2	Diesel	2798	4	94.40	13
8140.23.3731 Euro 2	Diesel	2798	4	94.40	13
8140.23.3750 Euro 2	Diesel	2798	4	94.40	13
8140.23.3751 Euro 2	Diesel	2798	4	94.40	13
8140.23.3760 Euro 2	Diesel	2798	4	94.40	13
8140.27.210/8140.27.213	Diesel	2445	4	93.00	6
8140.27.215	Diesel	2499	4	93.00	4
8140.27.218	Diesel	2499	4	93.00	4
8140.27.218	Diesel	2499	4	93.00	7
8140.27.2582	Diesel	2499	4	93.00	7
8140.27.2700	Diesel	2499	4	93.00	7
8140.27.2720	Diesel	2499	4	93.00	7
8140.27.2811	Diesel	2499	4	93.00	7
8140.27R.2700	Diesel	2499	4	93.00	7
8140.27R.2780	Diesel	2499	4	93.00	4
8140.27R.2782	Diesel	2499	4	93.00	4
8140.27R.2786	Diesel	2499	4	93.00	4
8140.27R.2787	Diesel	2499	4	93.00	4
8140.27 S	Diesel	2445	4	93.00	4
8140.27S.2700 Sofim	Diesel	2499	4	93.00	7
8140.27S.2701	Diesel	2499	4	93.00	4
8140.27S.2710	Diesel	2499	4	93.00	4
8140.27S.2711	Diesel	2499	4	93.00	4
8140.27S.2720	Diesel	2499	4	93.00	4
8140.27S.2721	Diesel	2499	4	93.00	4
8140.27S.2730	Diesel	2499	4	93.00	4
8140.27S.2731	Diesel	2499	4	93.00	4
8140.27S.2750	Diesel	2499	4	93.00	4
8140.27S.2751	Diesel	2499	4	93.00	4
8140.27S.2760	Diesel	2499	4	93.00	4
8140.27S.2761	Diesel	2499	4	93.00	4
8140.27S.2770	Diesel	2499	4	93.00	4
8140.27S.2771	Diesel	2499	4	93.00	4
8140.27S.2801 Sofim	Diesel	2499	4	93.00	7
8140.27S.2811	Diesel	2499	4	93.00	4
8140.27S.2885 Sofim	Diesel	2499	4	93.00	7
8140.27S.3700	Diesel	2499	4	93.00	8
8140.27S.3701	Diesel	2499	4	93.00	8
8140.27S.3711	Diesel	2499	4	93.00	8
8140.27S.3720	Diesel	2499	4	93.00	8
8140.27S.3721	Diesel	2499	4	93.00	8
8140.27S.3750	Diesel	2499	4	93.00	8
8140.27S.3751	Diesel	2499	4	93.00	8
8140.27S.3760	Diesel	2499	4	93.00	8
8140.27S.3761	Diesel	2499	4	93.00	8
8140.27S.3770	Diesel	2499	4	93.00	8
8140.27S.3771	Diesel	2499	4	93.00	8
8140.27S.3780	Diesel	2499	4	93.00	8
8140.27S.3781	Diesel	2499	4	93.00	8
8140.27S.3811	Diesel	2499	4	93.00	8
8140.43.2585 Euro 2 Sofim	Diesel	2798	4	94.40	13
8140.43.3700 Euro 2 Sofim	Diesel	2799	4	94.40	13
8140.43.3711 Euro 2	Diesel	2798	4	94.40	13
8140.43.3713 Euro 2	Diesel	2798	4	94.40	13
8140.43.3718 Euro 2	Diesel	2798	4	94.40	13
8140.43.3721 Euro 2	Diesel	2798	4	94.40	13
8140.43.3723 Euro 2	Diesel	2798	4	94.40	13
8140.43.3728 Euro 2	Diesel	2798	4	94.40	13
8140.43.3731 Euro 2	Diesel	2798	4	94.40	13
8140.43.3900 Euro 2	Diesel	2798	4	94.40	13
8140.43.3911 Euro 2	Diesel	2798	4	94.40	13
8140.43.3921 Euro 2	Diesel	2798	4	94.40	13
8140.43.3931 Euro 2	Diesel	2798	4	94.40	14
8140.43B.4300 Euro 3	Diesel	2798	4	94.40	15
8140.43B.4305 Euro 3	Diesel	2798	4	94.40	15
8140.43B.4320 Euro 3	Diesel	2798	4	94.40	15
8140.43B.4325 Euro 3	Diesel	2798	4	94.40	15
8140.43B.4330 Euro 3	Diesel	2798	4	94.40	15





		ccm	x 		9
8140.43B.4335 Euro 3	Diesel	2798	4	94.40	15
8140.43B Euro 3	Diesel	2798	4	94.40	15
8140.43C.4000 Euro 3	Diesel	2798	4	94.40	14
8140.43C.4005 Euro 3	Diesel	2798	4	94.40	14
8140.43C.4020 Euro 3	Diesel	2798	4	94.40	14
8140.43C.4021 Euro 3	Diesel	2798	4	94.40	14
8140.43C.4025 Euro 3	Diesel	2798	4	94.40	14
8140.43C.4026 Euro 3	Diesel	2798	4	94.40	14
8140.43C.4035 Euro 3	Diesel	2798	4	94.40	14
8140.43C.4036 Euro 3	Diesel	2798	4	94.40	14
8140.43C Euro 2	Diesel	2798	4	94.40	13
8140.43 Euro 2	Diesel	2798	4	94.40	13
8140.43N.4300 Euro 3	Diesel	2798	4	94.40	16
8140.43N.4320 Euro 3	Diesel	2798	4	94.40	16
8140.43N.4330 Euro 3	Diesel	2798	4	94.40	16
8140.43N.4400 Euro 3	Diesel	2798	4	94.40	16
8140.43N.4430 Euro 3	Diesel	2798	4	94.40	16
8140.43N Euro 3	Diesel	2798	4	94.40	16
8140.43S.4000 Euro 3	Diesel	2798	4	94.40	16
8140.43S.4020 Euro 3	Diesel	2798	4	94.40	16
8140.43S.4030 Euro 3	Diesel	2798	4	94.40	16
8140.43S.4140 Euro 3	Diesel	2798	4	94.40	16
8140.43S.4300 Euro 3	Diesel	2798	4	94.40	16
8140.43S.4320 Euro 3	Diesel	2798	4	94.40	16
8140.43S.4330 Euro 3	Diesel	2798	4	94.40	16
8140.43S.4400 Euro 3	Diesel	2798	4	94.40	16
8140.43S.4420 Euro 3	Diesel	2798	4	94.40	16
8140.43S.4430 Euro 3	Diesel	2798	4	94.40	16
8140.43S Euro 3	Diesel	2798	4	94.40	16
8140.47.2700 Euro 1	Diesel	2499	4	93.00	8
8140.47.2711 Euro 1	Diesel	2499	4	93.00	8
8140.47.2721 Euro 1	Diesel	2499	4	93.00	8
8140.47.2785 Euro 1	Diesel	2499	4	93.00	8
8140.47.3700 Euro 1	Diesel	2499	4	93.00	8
8140.47.3711 Euro 1	Diesel	2499	4	93.00	8
8140.47.3721 Euro 1	Diesel	2499	4	93.00	8
8140.47.3731 Euro 1	Diesel	2499	4	93.00	8
8140.47B.3790 Euro 1	Diesel	2499	4	93.00	8
8140.47B.3795 Euro 1	Diesel	2499	4	93.00	8
8140.47 R	Diesel	2499	4	93.00	8
8140.47R.2790	Diesel	2499	4	93.00	8
8140.47R.2795	Diesel	2499	4	93.00	8
8140.47S Euro 1	Diesel	2499	4	93.00	8
8140.61.200	Diesel	2445	4	93.00	9
8140.61.300	Diesel	2445	4	93.00	9
8140.63.4000 Euro 3 Sofim	Diesel	2798	4	94.40	17
8140.63. Euro 2	Diesel	2798	4	94.40	17
8140.67 (290B7W)/8144.67	Diesel	2500	4	93.00	10
8140.67.2585 Euro 2	Diesel	2499	4	93.00	3
8140.67F.3700 Euro 2	Diesel	2449	4	93.00	11
8140.67F.3701 Euro 2	Diesel	2499	4	93.00	11
8140.67F.3710 Euro 2	Diesel	2499	4	93.00	11
8140.67F.3711 Euro 2	Diesel	2499	4	93.00	11
8140.67F.3713 Euro 2	Diesel	2499	4	93.00	11
8140.67F.3721 Euro 2	Diesel	2499	4	93.00	11
8140.67F. Euro 2	Diesel	2449	4	93.00	11
8140.97.2781	Diesel	2499	4	93.00	12
8140.97.2783	Diesel	2499	4	93.00	12
8144.61.200	Diesel	2445	4	93.00	9
8200.02	Diesel	9820	6	122.00	52
8200.02.220	Diesel	9820	6	122.00	52
8200.03	Diesel	10308	6	125.00	53
8200.12	Diesel	9820	6	122.00	52
8200.12.000	Diesel	9820	6	122.00	52
8200.13	Diesel	10308	6	125.00	53
8205.02	Diesel	9820	6	122.00	52
8205.03	Diesel	10308	6	125.00	53
8210.02	Diesel	13798	6	137.00	61
8210.02.000	Diesel	13798	6	137.00	61

		ccm	x 		9
8210.02.020	Diesel	13798	6	137.00	61
8210.02.022	Diesel	13798	6	137.00	61
8210.02.032	Diesel	13798	6	137.00	61
8210.02.053	Diesel	13798	6	137.00	61
8210.02.067	Diesel	13798	6	137.00	61
8210.02.069	Diesel	13798	6	137.00	61
8210.02.081	Diesel	13798	6	137.00	61
8210.02.266	Diesel	13798	6	137.00	61
8210.02.267	Diesel	13798	6	137.00	61
8210.02.371	Diesel	13798	6	137.00	61
8210.02.373	Diesel	13798	6	137.00	61
8210.02.377	Diesel	13798	6	137.00	61
8210.02.385	Diesel	13798	6	137.00	61
8210.02.393	Diesel	13798	6	137.00	61
8210.02.405	Diesel	13798	6	137.00	61
8210.02.426	Diesel	13798	6	137.00	61
8210.02.440	Diesel	13798	6	137.00	61
8210.02.441	Diesel	13798	6	137.00	61
8210.02.731	Diesel	13798	6	137.00	61
8210.02.731	Diesel	13798	B6	137.00	61
8210.22	Diesel	13798	6	137.00	62
8210.22.000	Diesel	13798	6	137.00	62
8210.22.069	Diesel	13798	6	137.00	62
8210.22.101	Diesel	13798	6	137.00	62
8210.22.105	Diesel	13798	6	137.00	63
8210.22.171	Diesel	13798	6	137.00	63
8210.22.175	Diesel	13798	6	137.00	62
8210.22.183	Diesel	13798	6	137.00	62
8210.22.210	Diesel	13798	6	137.00	63
8210.22.235	Diesel	13798	6	137.00	62
8210.22.236	Diesel	13798	6	137.00	63
8210.22.269	Diesel	13798	6	137.00	62
8210.22.317	Diesel	13798	6	137.00	62
8210.22.327	Diesel	13798	6	137.00	63
8210.22.373	Diesel	13798	6	137.00	62
8210.22.385	Diesel	13798	6	137.00	62
8210.22.406	Diesel	13798	6	137.00	62
8210.22.511	Diesel	13798	6	137.00	63
8210.22.521	Diesel	13798	6	137.00	63
8210.22.523	Diesel	13798	6	137.00	62
8210.22.525	Diesel	13798	6	137.00	63
8210.22.535	Diesel	13798	6	137.00	63
8210.22.537	Diesel	13798	6	137.00	63
8210.22.569	Diesel	13798	6	137.00	63
8210.22.800	Diesel	13798	6	137.00	63
8210.22.869	Diesel	13798	6	137.00	63
8210.22X.069	Diesel	13798	6	137.00	63
8210.22X.235	Diesel	13798	6	137.00	62
8210.22X.523	Diesel	13798	6	137.00	63
8210.22X.575	Diesel	13798	6	137.00	63
8210.42	Diesel	13798	6	137.00	64
8210.42.009	Diesel	13798	6	137.00	64
8210.42.101	Diesel	13798	6	137.00	64
8210.42.115	Diesel	13798	6	137.00	64
8210.42.151	Diesel	13798	6	137.00	64
8210.42.152	Diesel	13798	6	137.00	64
8210.42.154	Diesel	13798	6	137.00	64
8210.42.155	Diesel	13798	6	137.00	64
8210.42.161	Diesel	13798	6	137.00	64
8210.42.162	Diesel	13798	6	137.00	64
8210.42.165	Diesel	13798	6	137.00	64
8210.42.171	Diesel	13798	6	137.00	64
8210.42.172	Diesel	13798	6	137.00	63
8210.42.175	Diesel	13798	6	137.00	64
8210.42.181	Diesel	13798	6	137.00	64
8210.42.182	Diesel	13798	6	137.00	64
8210.42.185	Diesel	13798	6	137.00	64
8210.42.186	Diesel	13798	6	137.00	64
8210.42.191	Diesel	13798	6	137.00	64

		ccm	x 		
8210.42.195	Diesel	13798	6	137.00	64
8210.42.500 Euro 2	Diesel	13798	6	137.00	63
8210.42 K	Diesel	13798	6	137.00	65
8210.42K (TCA) Euro 1	Diesel	13798	6	137.00	63
8210.42K Euro 1/2	Diesel	13798	6	137.00	65
8210.42L (TCA) Euro 2	Diesel	13790	6	137.00	66
8210.42L.(TCA) Euro 1	Diesel	13798	6	137.00	65
8210.42L.400	Diesel	13798	6	137.00	65
8210.42L.400 Euro 1	Diesel	13798	6	137.00	65
8210.42L Euro 2	Diesel	13798	6	137.00	66
8210.42M (TCA) Euro 2	Diesel	13798	6	137.00	63
8211.02	Diesel	13798	6	137.00	61
8211.02.032	Diesel	13798	6	137.00	61
8211.22	Diesel	13798	6	137.00	62
8212.00	Diesel	13800	6	137.00	63
8215.00	Diesel	13800	6	137.00	63
8215.02	Diesel	13798	6	137.00	61
8215.22.520	Diesel	13798	6	137.00	63
8217.00	Diesel	13798	6	137.00	63
8217.32	Diesel	13798	6	137.00	63
8220.02.701	Diesel	9572	6	125.00	54
8220.02.834	Diesel	9572	6	125.00	54
8220.02.847	Diesel	9572	6	125.00	54
8220.02.856	Diesel	9572	6	125.00	54
8220.02.870	Diesel	9572	6	125.00	54
8220.12	Diesel	9572	6	125.00	54
8220.12.709	Diesel	9572	6	125.00	54
8220.22.002	Diesel	9572	6	125.00	55
8220.22.102	Diesel	9572	6	125.00	55
8220.22.104	Diesel	9572	6	125.00	55
8220.22.106	Diesel	9572	6	125.00	55
8220.22.708	Diesel	9570	6	125.00	55
8220.22.709	Diesel	9570	6	125.00	55
8220.32	Diesel	9572	6	125.00	55
8220.32.701	Diesel	9572	6	125.00	55
8220.32.721	Diesel	9570	6	125.00	55
8220.32.723	Diesel	9570	6	125.00	55
8260.01	Diesel	12800	6	137.00	63
8260.02	Diesel	12880	6	145.00	67
8260.02.405	Diesel	12880	6	145.00	67
8261.02.002	Diesel	12880	6	145.00	67
8261.1.002	Diesel	12880	6	145.00	67
8280.01	Diesel	17174	V8	145.00	67
8280.01.000	Diesel	17174	V8	145.00	67
8280.02.000	Diesel	17174	V8	145.00	67
8280.02.024	Diesel	17174	V8	145.00	67
8280.02.082	Diesel	17174	V8	145.00	67
8280.02.109	Diesel	17174	V8	145.00	67
8280.02.125-135	Diesel	17174	V8	145.00	67
8280.02.265/8280.02.273/	Diesel	17174	V8	145.00	67
8280.02.269	Diesel	17174	V8	145.00	67
8280.02.274	Diesel	17174	V8	145.00	67
8280.02.275	Diesel	17174	V8	145.00	67
8280.02.289	Diesel	17174	V8	145.00	67
8280.02.405	Diesel	17174	V8	145.00	67
8280.22.	Diesel	17174	V8	145.00	68
8280.22.007	Diesel	17174	V8	145.00	68
8280.22.009	Diesel	17200	V8	145.00	68
8280.22.033	Diesel	17174	V8	145.00	68
8280.22.054	Diesel	17174	V8	145.00	68
8280.22.201	Diesel	17174	V8	145.00	68
8280.22.205	Diesel	17174	V8	145.00	68
8280.42.001	Diesel	17174	V8	145.00	69
8280.42.050	Diesel	17174	V8	145.00	70
8280.42S (TCA)	Diesel	17173	V8	145.00	70
8280.42S.342 Euro 2	Diesel	17174	V8	145.00	70
8280.42S.350 Euro 2	Diesel	17174	V8	145.00	70
8280.42S.352 Euro 2	Diesel	17174	V8	145.00	70
8280.42S.362 Euro 2	Diesel	17174	V8	145.00	70

		ccm	x 		9
8281.02	Diesel	17174	V8	145.00	67
8281.22.201	Diesel	17174	V8	145.00	68
8285.02	Diesel	17174	V8	145.00	67
8285.22	Diesel	17174	V8	145.00	68
8340.04.040	Diesel	4570	4	115.00	42
8340.04.200	Diesel	4570	4	115.00	42
8340.04.250	Diesel	4570	4	115.00	42
8340.04.300	Diesel	4570	4	115.00	42
8340.04.350	Diesel	4570	4	115.00	42
8340.04.362	Diesel	4570	B4	115.00	42
8340.05	Diesel	5401	4	115.00	43
8340.05.200	Diesel	5401	4	115.00	43
8360.04	Diesel	6855	6	115.00	42
8360.05	Diesel	8100	6	115.00	43
8360.05.200	Diesel	8100	6	115.00	43
8360.05.254	Diesel	8100	6	115.00	43
8360.05.673	Diesel	8100	6	115.00	43
8360.05.B	Diesel	8100	6	115.00	43
8360.46	Diesel	7685	6	112.00	41
8360.46B.4591	Diesel	7684	6	112.00	41
8360.46R.416 (TCA)	Diesel	7685	6	112.00	41
8361.04	Diesel	6850	6	115.00	42
8361.05	Diesel	8102	6	115.00	43
8361.25.510	Diesel	8101	6	115.00	44
8361.45.530-836 L	Diesel	8101	6	115.00	44
8365.05.500	Diesel	8101	6	115.00	43
8365.05.520	Diesel	8101	6	115.00	43
8365.05.530	Diesel	8101	6	115.00	43
8365.05.531	Diesel	8101	6	115.00	43
8365.05.555	Diesel	8101	6	115.00	43
8365.05.560	Diesel	8101	6	115.00	43
8365.05.570	Diesel	8101	6	115.00	43
8365.05.580	Diesel	8101	6	115.00	43
8365.05.590	Diesel	8101	6	115.00	43
8365.25.500	Diesel	8102	6	115.00	45
8365.25.501	Diesel	8102	6	115.00	45
8365.25.502	Diesel	8102	6	115.00	45
8365.25.503	Diesel	8102	6	115.00	45
8365.25.533	Diesel	8102	6	115.00	45
8460.21.002	Diesel	9498	6	120.00	50
8460.21.002	Diesel	9500	6	120.00	49
8460.21.010	Diesel	9500	6	120.00	50
8460.21.042/8460.21.106/	Diesel	9500	6	120.00	49
8460.21.102	Diesel	9500	6	120.00	49
8460.21.202	Diesel	9500	6	120.00	50
8460.21.206	Diesel	9500	6	120.00	50
8460.21.601	Diesel	9498	6	120.00	50
8460.21.611	Diesel	9498	6	120.00	50
8460.21B.613/8460.21B.615	Diesel	9500	6	120.00	51
8460.41.102	Diesel	9500	6	120.00	50
8460.41.124	Diesel	9500	6	120.00	50
8460.41.160	Diesel	9500	6	120.00	50
8460.41C	Diesel	9500	6	120.00	51
8460.41C (TCA)	Diesel	9500	6	120.00	51
8460.41C.320	Diesel	9500	6	120.00	51
8460.41K.406	Diesel	9500	6	120.00	51
8460.41K.410	Diesel	9500	6	120.00	51
8460.41K. TCA Euro 1	Diesel	9500	6	120.00	51
8460.41K Euro 2	Diesel	9500	6	120.00	51
8460.41L (TCA)	Diesel	9500	6	120.00	51
8460.41L.5020	Diesel	9500	6	120.00	51
8460.41 M	Diesel	9500	6	120.00	50
8460.41 R	Diesel	9500	6	120.00	51
8460.41 S	Diesel	9500	6	120.00	51
8460.41S.733	Diesel	9498	6	120.00	50
8460.41 T	Diesel	9500	6	120.00	50
C02/C03 D/C055	Diesel	4397	4	108.00	38
C 03	Diesel	4940	4	110.00	39
C03/C70/C100	Diesel	4941	4	110.00	40

		ccm	x 		
C 03-13OT	Diesel	5401	4	115.00	45
C 21/C20/C41/CO3/CO40	Diesel	4562	4	110.00	39
CN3	Diesel	3706	3	110.00	40
CO2 D	Diesel	4397	4	108.00	38
CP 3	Diesel	7412	6	110.00	40
CP 3/32.1.200	Diesel	7412	6	110.00	40
F1AE 0481 A Euro 3	Diesel	2287	4	88.00	1
F1AE 0481 B Euro 3	Diesel	2287	4	88.00	1
F1AE 0481 C Euro 3	Diesel	2287	4	88.00	1
F1AE 0481 FA Euro 4	Diesel	2287	4	88.00	2
F1AE 0481 GA Euro 4	Diesel	2287	4	88.00	2
F1AE 0481 HA Euro 4	Diesel	2287	4	88.00	2
F1AE 0481 M	Diesel	2287	4	88.00	2
F1CE 0481 A	Diesel	2998	4	95.80	19
F1CE0481B Euro 3	Diesel	2998	4	95.80	19
F1CE 0481 FA Euro 4	Diesel	2998	4	95.80	19
F1CE 0481 HA Euro 4	Diesel	2998	4	95.80	19
F1CE 0481 HC Euro 4	Diesel	2998	4	95.80	19
F1CE0481L Euro 4	Diesel	2998	4	95.80	19
F2BE 0681 A/B/C/D/F Euro 3	Diesel	7790	6	115.00	47
F2BE 0681 A Euro 2 Cursor 8-350	Diesel	7790	6	115.00	46
F2BE 0681 B Euro 2 Cursor 8-310	Diesel	7790	6	115.00	46
F2BE 0681 C Euro 2 Cursor 8-270 I	Diesel	7790	6	115.00	46
F2BE0681DA Euro 2 Cursor 8	Diesel	7790	6	115.00	46
F2BE0681DB Euro 2 Cursor 8	Diesel	7790	6	115.00	46
F2BE 0681 D Euro 2 Cursor 8-240	Diesel	7790	6	115.00	46
F2BE 0681 E Euro 2 Cursor 8-300	Diesel	7790	6	115.00	46
F2BE 0681 F Euro 2 Cursor 8-270 R	Diesel	7790	6	115.00	46
F2BE1682 G Euro 3	Diesel	7790	6	115.00	47
F2CE0681A Cursor 9	Diesel	8708	6	117.00	48
F2CE0682A Cursor 9	Diesel	8708	6	117.00	48
F2CE0683A Cursor 9	Diesel	8708	6	117.00	48
F2CE0684A Cursor 9	Diesel	8708	6	117.00	48
F3AE 0681 B Euro 3 Cursor 10-400	Diesel	10300	6	125.00	56
F3AE 0681 D Euro 2 Cursor 10-430	Diesel	10300	6	125.00	56
F3AE 0681 E Euro 2 Cursor 10-390	Diesel	10300	6	125.00	56
F3AE0681H Euro 3	Diesel	10300	6	125.00	56
F3AE3681D Euro 4/5 Cursor 10 E 42	Diesel	10300	6	125.00	57
F3B3681A Euro 4/5 Cursor 13 E 56	Diesel	12880	6	135.00	59
F3B3681B Euro 4/5 Cursor 13 E 50	Diesel	12880	6	135.00	59
F3B3681C Euro 4/5 Cursor 13 E 45	Diesel	12880	6	135.00	59
F3B3681D Euro 4/5 Cursor 13 E 41	Diesel	12880	6	135.00	59
F3B3681E Euro 4/5 Cursor 13 E 48	Diesel	12880	6	135.00	59
F3B3681G Euro 4/5 Cursor 13 E 44	Diesel	12880	6	135.00	59
F3BE 0681 A Euro 3 Cursor 13-540	Diesel	12880	6	135.00	60
F3BE 0681 B Euro 3 Cursor 13-500	Diesel	12880	6	135.00	60
F3BE 0681 C Euro 3 Cursor 13-440	Diesel	12880	6	135.00	60
F3BE 0681 D Euro 3 Cursor 13	Diesel	12880	6	135.00	60
F3BE 0681 E Euro 3 Cursor 13-480	Diesel	12880	6	135.00	60
F3BE 0681 F Euro 3 Cursor 13	Diesel	12880	6	135.00	60
F3BE 0681 G Euro 3 Cursor 13-380	Diesel	12880	6	135.00	60
F3BE3681A Euro 4/5 Cursor 13	Diesel	12880	6	135.00	59
F3BE3681B Euro 4/5 Cursor 13 E 50	Diesel	12880	6	135.00	59
F3BE3681C Euro 4/5 Cursor 13 E 45	Diesel	12880	6	135.00	59
F3BE3681D Euro 4/5 Cursor 13 E 41	Diesel	12880	6	135.00	59
F3BE3681E Euro 4/5 Cursor 13	Diesel	12880	6	135.00	59
F3BE3681F Euro 4/5 Cursor 13	Diesel	12880	6	135.00	59
F3BE3681G Euro 4/5 Cursor 13 E 44	Diesel	12880	6	135.00	59
F4AE 0481 A Euro 3 Tector E17	Diesel	3920	4	102.00	23
F4AE 0481 C Euro 3 Tector E15	Diesel	3920	4	102.00	23
F4AE 0481 D Euro 3 Tector E13	Diesel	3920	4	102.00	23
F4AE 0681 A Euro 3 Tector E28	Diesel	5880	6	102.00	23
F4AE 0681 B Euro 3 Tector E24	Diesel	5880	6	102.00	23
F4AE0681C Euro 3 Tector E24	Diesel	5880	6	102.00	23
F4AE 0681 D Euro 3 Tector E21	Diesel	5880	6	102.00	23
F4AE 0681 E Euro 3 Tector E18	Diesel	5880	6	102.00	23
F4AE3481A Euro 4/5 Tector E18	Diesel	3920	4	102.00	24
F4AE3481B Euro 4/5 Tector E18	Diesel	3920	4	102.00	24
F4AE3481C Euro 4/5 Tector E14	Diesel	3920	4	102.00	24

		ccm	x 		9
---	---	-----	--	---	----------



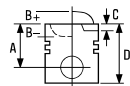

F4AE3481D Euro 4/5 Tector E16	Diesel	3920	4	102.00	24
F4AE3681A Euro 4/5 Tector E30	Diesel	5880	6	102.00	24
F4AE3681B Euro 4/5 Tector E22	Diesel	5880	6	102.00	24
F4AE3681C Euro 4/5 Tector E22	Diesel	5880	6	102.00	24
F4AE3681D Euro 4/5 Tector E25	Diesel	5880	6	102.00	24
F4AE3681E Euro 4/5 Tector E28	Diesel	5880	6	102.00	24



1  **88.00**

F1AE 0481 A Euro 3	4 Cyl.	2287cc	70kW (95PS)	Diesel Turbo Intercooled	TD17144
F1AE 0481 B Euro 3	4 Cyl.	2287cc	85kW (116PS)	Diesel Turbo Intercooled	TD17145
F1AE 0481 C Euro 3	4 Cyl.	2287cc	81kW (110PS)	Diesel Turbo Intercooled	FM9055

87-138000-00	STD	08-138000-00	STD
87-138006-00	0.40mm	08-138006-00	0.40mm
87-138008-00	0.60mm	08-138008-00	0.60mm

A	57.00	2.50	 CK P
B-	18.18	2.00	 P
BØ	38.00	2.50	 CR P
D	84.00		
	31x67		



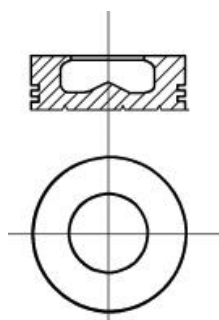

AK RT TP



2  **88.00**

F1AE 0481 FA Euro 4	4 Cyl.	2287cc	70-78kW (95-106PS)	Diesel Turbo Intercooled	TD19231
F1AE 0481 GA Euro 4	4 Cyl.	2287cc	85-93kW (116-126PS)	Diesel Turbo Intercooled	TD19232
F1AE 0481 HA Euro 4	4 Cyl.	2287cc	100kW (136PS)	Diesel Turbo Intercooled	TD19233
F1AE 0481 M	4 Cyl.	2287cc	100kW (136PS)	Diesel Turbo Intercooled	TD19156

87-138000-10	STD	08-138000-00	STD
87-138006-10	0.40mm	08-138006-00	0.40mm
87-138008-10	0.60mm	08-138008-00	0.60mm

A	57.00	2.50	 CK P
B-	13.75	2.00	 P
BØ	50.10	2.50	 CR P
D	84.00		
	31x67		

AK KK RT TP

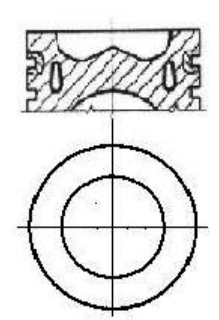

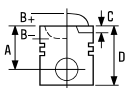



3  **93.00**



8140.07.2585 Euro 1	4 Cyl.	19:1	2499cc	55kW (75PS)	Diesel	TD20437
8140.07.2700	4 Cyl.	18:1	2499cc	55kW (75PS)	Diesel	TD1700
8140.07.2701	4 Cyl.	18:1	2499cc	55kW (75PS)	Diesel	TD1701
8140.07.3700 Euro 1	4 Cyl.	19:1	2499cc	53kW (72PS)	Diesel	TD27364
8140.07.3710 Euro 1	4 Cyl.	19:1	2499cc	53kW (72PS)	Diesel	TD20418
8140.67.2585 Euro 2	4 Cyl.	18.5:1	2499cc	55-63kW (75-86PS)	Diesel Turbo Intercooled	TD20427

87-425000-00 STD
87-425008-00 0.60mm

08-425000-00 STD
08-425008-00 0.60mm

14-021371-00 D B 96.01 C 171.00 D 98.92 E 5.00
14-021372-00 D B 96.05 C 171.00 D 98.92 E 5.00
14-021480-00 DH  B 97.03 C 171.00 D 100.00 E 5.00

A 58.75
B- 16.90
BØ 40.00
D 96.75
 32x75

3.00  CR P
2.00  P
3.00  CR P

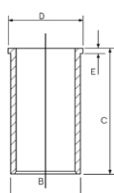

RT

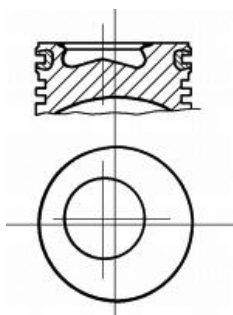

 Nitrided

 Nitriert

 Nitridé

 Nitrurado

 Nitratato

4  **93.00**

8140.07.2710	4 Cyl.	18:1	2499cc	55kW (75PS)	Diesel	TD27358
8140.07.2711	4 Cyl.	18:1	2499cc	55kW (75PS)	Diesel	TD27359
8140.07.2712	4 Cyl.	18:1	2499cc	55kW (75PS)	Diesel	TD1702
8140.07.3711 Euro 1	4 Cyl.	19:1	2499cc	53kW (72PS)	Diesel	TD27365
8140.07.3712 Euro 1	4 Cyl.	19:1	2499cc	53kW (72PS)	Diesel	TD27366
8140.07.3713 Euro 1	4 Cyl.	19:1	2499cc	53kW (72PS)	Diesel	TD27367
8140.21.201	4 Cyl.	18:1	2445cc	68kW (92PS)	Diesel Turbo	TD27368
8140.21.202	4 Cyl.	18:1	2445cc	68kW (92PS)	Diesel Turbo	TD27369
8140.21.203	4 Cyl.	18:1	2445cc	68kW (92PS)	Diesel Turbo	TD27370
8140.21.212	4 Cyl.	18:1	2445cc	68kW (92PS)	Diesel Turbo	TD27371
8140.21.290	4 Cyl.	18:1	2445cc	68kW (92PS)	Diesel Turbo	TD27372
8140.27 S	4 Cyl.	18:1	2445cc	68kW (92PS)	Diesel Turbo	TD1705
8140.27.215	4 Cyl.	18.5:1	2499cc	76kW (103PS)	Diesel Turbo	TD27387
8140.27.218	4 Cyl.	18.5:1	2499cc	76kW (103PS)	Diesel Turbo Intercooled	TD26268
8140.27R.2780	4 Cyl.	18:1	2499cc	67-70kW (91-95PS)	Diesel Turbo	TD27393
8140.27R.2782	4 Cyl.	18:1	2499cc	70kW (96PS)	Diesel Turbo	TD1710
8140.27R.2786	4 Cyl.	18:1	2499cc	67-70kW (91-95PS)	Diesel Turbo	TD27394
8140.27R.2787	4 Cyl.	18:1	2499cc	67-70kW (91-95PS)	Diesel Turbo	TD27395
8140.27S.2701	4 Cyl.	18:1	2499cc	76kW (103PS)	Diesel Turbo	TD27396

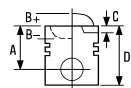

8140.27S.2710	4 Cyl.	18:1	2499cc	76kW (103PS)	Diesel Turbo	TD27397
8140.27S.2711	4 Cyl.	18:1	2499cc	76kW (103PS)	Diesel Turbo	TD27398
8140.27S.2720	4 Cyl.	18:1	2499cc	76kW (103PS)	Diesel Turbo	TD27399
8140.27S.2721	4 Cyl.	18:1	2499cc	76kW (103PS)	Diesel Turbo	TD27400
8140.27S.2730	4 Cyl.	18:1	2499cc	76kW (103PS)	Diesel Turbo	TD27401
8140.27S.2731	4 Cyl.	18:1	2499cc	76kW (103PS)	Diesel Turbo	TD27402
8140.27S.2750	4 Cyl.	18:1	2499cc	76kW (103PS)	Diesel Turbo	TD27403
8140.27S.2751	4 Cyl.	18:1	2499cc	76kW (103PS)	Diesel Turbo	TD27404
8140.27S.2760	4 Cyl.	18:1	2499cc	76kW (103PS)	Diesel Turbo	TD27405
8140.27S.2761	4 Cyl.	18:1	2499cc	76kW (103PS)	Diesel Turbo	TD27406
8140.27S.2770	4 Cyl.	18:1	2499cc	76kW (103PS)	Diesel Turbo	TD27407
8140.27S.2771	4 Cyl.	18:1	2499cc	76kW (103PS)	Diesel Turbo	TD27408
8140.27S.2811	4 Cyl.	18:1	2499cc	76kW (103PS)	Diesel Turbo	TD27409

14-021371-00 **D** B 96.01 C 171.00 D 98.92 E 5.00
 14-021372-00 **D** B 96.05 C 171.00 D 98.92 E 5.00
 14-021480-00 **DH** **I** B 97.03 C 171.00 D 100.00 E 5.00

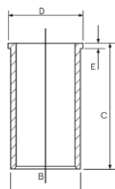

I Nitrided

I Nitriert

I Nitridé

I Niturado

I Niturato

5 **93.00**

8140.21	4 Cyl.	18:1	2445cc		Diesel Turbo	FM9103
8140.21.200	4 Cyl.	18:1	2445cc	68kW (92PS)	Diesel Turbo	TD1703
8140.21.214 Sofim	4 Cyl.	18:1	2445cc	77kW (105PS)	Diesel Turbo	TD1704

87-245200-30 STD **08-245200-00** STD **14-021371-00 D** B 96.01 C 171.00 D 98.92 E 5.00
 87-245208-30 0.60mm **08-245208-00** 0.60mm **14-021372-00 D** B 96.05 C 171.00 D 98.92 E 5.00
14-021480-00 DH **I** B 97.03 C 171.00 D 100.00 E 5.00

A 59.65
B- 14.80
BØ 51.90
D 97.65
 32x75

3.00 **CR P**
 2.00 **P**
 3.00 **CR P**

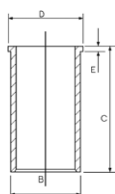

RT

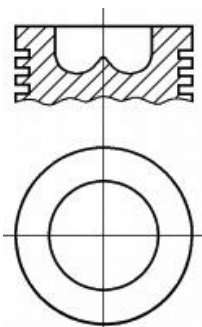

I Nitrided

I Nitriert

I Nitridé

I Niturado

I Niturato

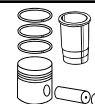
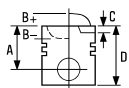



6  **93.00**



8140.27.210/8140.27.213 4 Cyl. 18:1 2445cc 77kW (105PS) Diesel Turbo FM9131

87-245200-60 STD

08-245200-00 STD
08-245208-00 0.60mm

14-021371-00 *D* B 96.01 C 171.00 D 98.92 E 5.00
14-021372-00 *D* B 96.05 C 171.00 D 98.92 E 5.00
14-021480-00 *DH*  B 97.03 C 171.00 D 100.00 E 5.00

A 58.65
B- 14.80
BØ 51.90
D 75.20
 32x75

3.00  CR P
2.00  P
3.00  CR P

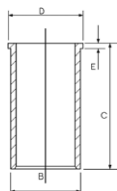

RT

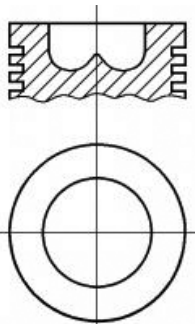

 Nitrided

 Nitriert

 Nitridé

 Niturado

 Nitratato

7  **93.00**

8140.27.218 4 Cyl. 18.5:1 2499cc 76kW (103PS) Diesel Turbo Intercooled FM19131

8140.27.2582 4 Cyl. 18.5:1 2499cc 74-79kW (101-107PS) Diesel Turbo TD7260

8140.27.2700 4 Cyl. 18:1 2499cc 76kW (103PS) Diesel Turbo TD1706

8140.27.2720 4 Cyl. 18:1 2499cc 76kW (103PS) Diesel Turbo TD1707

8140.27.2811 4 Cyl. 18:1 2499cc 76kW (103PS) Diesel Turbo TD1708

8140.27R.2700 4 Cyl. 18:1 2499cc 67-70kW (92-95PS) Diesel Turbo TD20420

8140.27S.2700 Sofim 4 Cyl. 18:1 2499cc 76kW (103PS) Diesel Turbo TD20421

8140.27S.2801 Sofim 4 Cyl. 18:1 2499cc 76kW (103PS) Diesel Turbo TD20419



8140.27S.2885 Sofim 4 Cyl. 18:1 2499cc 76kW (103PS) Diesel Turbo TD20422

87-245200-40 STD
87-245208-40 0.60mm

08-245200-00 STD
08-245208-00 0.60mm

14-021371-00 *D* B 96.01 C 171.00 D 98.92 E 5.00
14-021372-00 *D* B 96.05 C 171.00 D 98.92 E 5.00
14-021480-00 *DH*  B 97.03 C 171.00 D 100.00 E 5.00

A 58.75
B- 17.90
BØ 38.00
D 96.75
 32x75

3.00  CR P
2.00  P
3.00  CR P

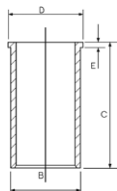

RT

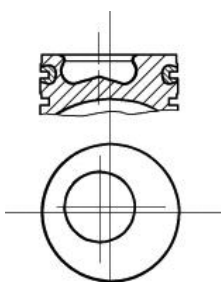

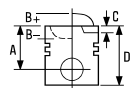

87-245200-50
87-245208-50

STD
0.60mm

08-245200-00
08-245208-00

STD
0.60mm

A 58.75
B- 17.90
BØ 38.00
D 96.75
 32x78

3.00
2.00
3.00



CR P
P
CR P

AK NB RT

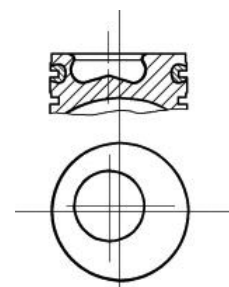

 Nitrided

 Nitriert

 Nitridé

 Niturado

 Nitrurato

8  **93.00**

8140.27S.3700	4 Cyl.	18.5:1	2499cc	77kW (104PS)	Diesel Turbo	TD27410
8140.27S.3701	4 Cyl.	18.5:1	2499cc	77kW (104PS)	Diesel Turbo	TD27411
8140.27S.3711	4 Cyl.	18.5:1	2499cc	77kW (104PS)	Diesel Turbo	TD27412
8140.27S.3720	4 Cyl.	18.5:1	2499cc	77kW (104PS)	Diesel Turbo	TD27413
8140.27S.3721	4 Cyl.	18.5:1	2499cc	77kW (104PS)	Diesel Turbo	TD27414
8140.27S.3750	4 Cyl.	18.5:1	2499cc	77kW (104PS)	Diesel Turbo	TD27415
8140.27S.3751	4 Cyl.	18.5:1	2499cc	77kW (104PS)	Diesel Turbo	TD27416
8140.27S.3760	4 Cyl.	18.5:1	2499cc	77kW (104PS)	Diesel Turbo	TD27419
8140.27S.3761	4 Cyl.	18.5:1	2499cc	77kW (104PS)	Diesel Turbo	TD27420
8140.27S.3770	4 Cyl.	18.5:1	2499cc	77kW (104PS)	Diesel Turbo	TD27422
8140.27S.3771	4 Cyl.	18.5:1	2499cc	77kW (104PS)	Diesel Turbo	TD27423
8140.27S.3780	4 Cyl.	18.5:1	2499cc	77kW (104PS)	Diesel Turbo	TD27424
8140.27S.3781	4 Cyl.	18.5:1	2499cc	77kW (104PS)	Diesel Turbo	TD27425
8140.27S.3811	4 Cyl.	18.5:1	2499cc	77kW (104PS)	Diesel Turbo	TD27426
8140.47 R	4 Cyl.	18:1	2499cc	80kW (109PS)	Diesel Turbo Intercooled	TD7234
8140.47.2700 Euro 1	4 Cyl.	18:1	2499cc	85kW (116PS)	Diesel Turbo Intercooled	TD1711
8140.47.2711 Euro 1	4 Cyl.	18:1	2499cc	85kW (116PS)	Diesel Turbo Intercooled	TD1712
8140.47.2721 Euro 1	4 Cyl.	18:1	2499cc	85kW (116PS)	Diesel Turbo Intercooled	TD1713
8140.47.2785 Euro 1	4 Cyl.	18:1	2499cc	85kW (116PS)	Diesel Turbo Intercooled	TD1715
8140.47.3700 Euro 1	4 Cyl.	18:1	2499cc	85kW (116PS)	Diesel Turbo Intercooled	TD20477
8140.47.3711 Euro 1	4 Cyl.	18.5:1	2499cc	85kW (116PS)	Diesel Turbo Intercooled	TD26005
8140.47.3721 Euro 1	4 Cyl.	18.5:1	2499cc	85kW (116PS)	Diesel Turbo Intercooled	TD26006
8140.47.3731 Euro 1	4 Cyl.	18.5:1	2499cc	85kW (116PS)	Diesel Turbo Intercooled	TD26007
8140.47B.3790 Euro 1	4 Cyl.	18.5:1	2499cc	78-83kW (106-113PS)	Diesel Turbo Intercooled	TD26008





8140.47B.3795 Euro 1	4 Cyl.	18.5:1	2499cc	78-83kW (106-113PS)	Diesel Turbo Intercooled	TD26009
8140.47R.2790	4 Cyl.	18.5:1	2499cc	76-80kW (103-109PS)	Diesel Turbo Intercooled	TD1716
8140.47R.2795	4 Cyl.	18.5:1	2499cc	80kW (109PS)	Diesel Turbo Intercooled	TD26010
8140.47S Euro 1	4 Cyl.	18.5:1	2499cc	85kW (116PS)	Diesel Turbo Intercooled	TD20453

87-520200-00 STD

A 58.75
B- 18.40
BØ 38.00
D 96.75

32x78

08-520200-00 STD

3.00
2.00
3.00

CR
P
CR P

14-021371-00 D B 96.01 C 171.00 D 98.92 E 5.00
14-021372-00 D B 96.05 C 171.00 D 98.92 E 5.00
14-021480-00 DH B 97.03 C 171.00 D 100.00 E 5.00

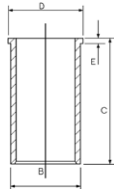

AK KK NB RT

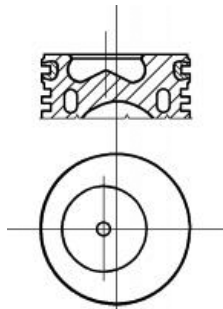

1 Nitrided

1 Nitriert

1 Nitridé

1 Nitrurado

1 Nitrurato

9 **93.00**

8140.61.200	4 Cyl.	22:1	2445cc	53kW (72PS)	Diesel	TD7225
8140.61.300	4 Cyl.	21:1	2445cc	53kW (72PS)	Diesel	TD20426
8144.61.200	4 Cyl.	22:1	2445cc	53kW (72PS)	Diesel	TD20429

87-214500-00 STD
87-214508-00 0.60mm

A 54.80
B- 2.20
D 89.80

32x75

08-214500-10 STD
08-214508-10 0.60mm

06/81→

3.00
2.00
4.00

CR P
P
CR P

14-022560-00 D B 96.00 C 167.30 D 98.90 E 5.00
14-028930-00 D B 97.50 C 167.00 D 100.90 E 5.00
14-028931-00 D B 97.58 C 167.00 D 100.90 E 5.00
14-028932-00 D B 97.70 C 167.00 D 100.90 E 5.00

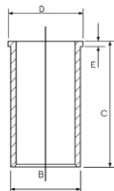

HA RT

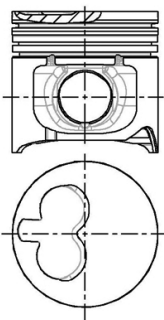

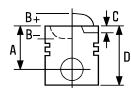





10  **93.00**

8140.67 (290B7W)/8144.67 4 Cyl. 22:1 **2500cc** **Diesel** **FM9170**

87-783300-00	STD	08-783300-00	STD	14-022560-00 D	B 96.00 C 167.30 D 98.90 E 5.00
87-783308-00	0.60mm	08-783308-00	0.60mm	14-028930-00 D	B 97.50 C 167.00 D 100.90 E 5.00
				14-028931-00 D	B 97.58 C 167.00 D 100.90 E 5.00
				14-028932-00 D	B 97.70 C 167.00 D 100.90 E 5.00

A 54.00
B- 2.20
D 89.00
 32x75

3.00  CR P
 2.00  P
 3.00  CR P

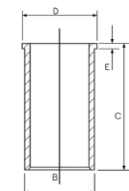

HA RT

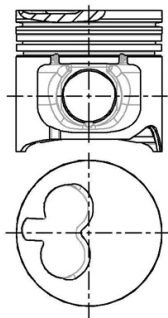





11  **93.00**

8140.67F. Euro 2	4 Cyl.	21:1	2449cc	60kW (82PS)	Diesel	TD7226
8140.67F.3700 Euro 2	4 Cyl.	21:1	2449cc	60-63kW (82-86PS)	Diesel	TD20428
8140.67F.3701 Euro 2	4 Cyl.	21:1	2499cc	60kW (82PS)	Diesel	TD26292
8140.67F.3710 Euro 2	4 Cyl.	21:1	2499cc	60kW (82PS)	Diesel	TD26293
8140.67F.3711 Euro 2	4 Cyl.	21:1	2499cc	60kW (82PS)	Diesel	TD26294
8140.67F.3713 Euro 2	4 Cyl.	21:1	2499cc	60kW (82PS)	Diesel	TD26295
8140.67F.3721 Euro 2	4 Cyl.	21:1	2499cc	60kW (82PS)	Diesel	TD26296

87-425000-10	STD	08-425000-00	STD	14-021371-00 D	B 96.01 C 171.00 D 98.92 E 5.00
87-425008-10	0.60mm	08-425008-00	0.60mm	14-021372-00 D	B 96.05 C 171.00 D 98.92 E 5.00
				14-021480-00 DH 1	B 97.03 C 171.00 D 100.00 E 5.00

→2573053

A 54.00
B- 2.20
D 89.00
 32x68

3.00  CR P
 2.00  P
 3.00  CR P

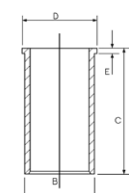

HA RT

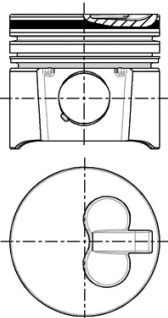

 Nitrided

 Nitriert

 Nitridé

 Niturado

 Niturato

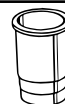
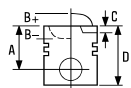

12  **93.00**

8140.97.2781	4 Cyl.	18:1	2499cc	68kW (92PS)	Diesel Turbo Intercooled	TD1717
8140.97.2783	4 Cyl.		2499cc		Diesel Turbo	FM29100

14-022560-00 D B 96.00 C 167.30 D 98.90 E 5.00
14-028930-00 D B 97.50 C 167.00 D 100.90 E 5.00
14-028931-00 D B 97.58 C 167.00 D 100.90 E 5.00
14-028932-00 D B 97.70 C 167.00 D 100.90 E 5.00

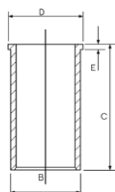

13  **94.40**

8140.23.	4 Cyl.	18.5:1	2798cc	76kW (103PS)	Diesel Turbo Intercooled	TD7229
8140.23.2585 Euro 2 Sofim	4 Cyl.	18.5:1	2799cc	78kW (106PS)	Diesel Turbo Intercooled	TD16183
8140.23.3700 Euro 2 Sofim	4 Cyl.	18.5:1	2799cc	76kW (103PS)	Diesel Turbo Intercooled	TD10387
8140.23.3701 Euro 2	4 Cyl.	18.5:1	2798cc	76kW (103PS)	Diesel Turbo Intercooled	TD27373
8140.23.3710 Euro 2	4 Cyl.	18.5:1	2798cc	76kW (103PS)	Diesel Turbo Intercooled	TD27374
8140.23.3711 Euro 2	4 Cyl.	18.5:1	2798cc	76kW (103PS)	Diesel Turbo Intercooled	TD27375
8140.23.3713 Euro 2	4 Cyl.	18.5:1	2798cc	76kW (103PS)	Diesel Turbo Intercooled	TD27376
8140.23.3720 Euro 2	4 Cyl.	18.5:1	2798cc	76kW (103PS)	Diesel Turbo Intercooled	TD27377
8140.23.3721 Euro 2	4 Cyl.	18.5:1	2798cc	76kW (103PS)	Diesel Turbo Intercooled	TD27378
8140.23.3730 Euro 2	4 Cyl.	18.5:1	2798cc	76kW (103PS)	Diesel Turbo Intercooled	TD27379
8140.23.3731 Euro 2	4 Cyl.	18.5:1	2798cc	76kW (103PS)	Diesel Turbo Intercooled	TD27380
8140.23.3750 Euro 2	4 Cyl.	18.5:1	2798cc	76kW (103PS)	Diesel Turbo Intercooled	TD27381
8140.23.3751 Euro 2	4 Cyl.	18.5:1	2798cc	76kW (103PS)	Diesel Turbo Intercooled	TD27382
8140.23.3760 Euro 2	4 Cyl.	18.5:1	2798cc	76kW (103PS)	Diesel Turbo Intercooled	TD27383
8140.43 Euro 2	4 Cyl.	18.5:1	2798cc	90kW (122PS)	Diesel Turbo Intercooled	TD7235
8140.43.2585 Euro 2 Sofim	4 Cyl.	18.5:1	2798cc	84-90kW (114-122PS)	Diesel Turbo Intercooled	TD20423
8140.43.3700 Euro 2 Sofim	4 Cyl.	18.5:1	2799cc	85kW (116PS)	Diesel Turbo Intercooled	TD20424
8140.43.3711 Euro 2	4 Cyl.	18.5:1	2798cc	90kW (122PS)	Diesel Turbo Intercooled	TD27427
8140.43.3713 Euro 2	4 Cyl.	18.5:1	2798cc	90kW (122PS)	Diesel Turbo Intercooled	TD27428
8140.43.3718 Euro 2	4 Cyl.	18.5:1	2798cc	90kW (122PS)	Diesel Turbo Intercooled	TD27429
8140.43.3721 Euro 2	4 Cyl.	18.5:1	2798cc	90kW (122PS)	Diesel Turbo Intercooled	TD27430
8140.43.3723 Euro 2	4 Cyl.	18.5:1	2798cc	90kW (122PS)	Diesel Turbo Intercooled	TD27431
8140.43.3728 Euro 2	4 Cyl.	18.5:1	2798cc	77-85kW (105-116PS)	Diesel Turbo Intercooled	TD27432
8140.43.3731 Euro 2	4 Cyl.	18.5:1	2798cc	90kW (122PS)	Diesel Turbo Intercooled	TD27433
8140.43.3900 Euro 2	4 Cyl.	18.5:1	2798cc	84-90kW (114-122PS)	Diesel Turbo Intercooled	TD20425
8140.43.3911 Euro 2	4 Cyl.	18.5:1	2798cc	90kW (122PS)	Diesel Turbo Intercooled	TD27434



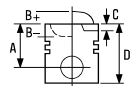

8140.43.3921 Euro 2 4 Cyl. 18.5:1 **2798cc** **90kW (122PS)** **Diesel Turbo Intercooled** **TD27435**

8140.43C Euro 2 4 Cyl. **2798cc** **78kW (106PS)** **Diesel Turbo Intercooled** **TD14449**

87-122200-10	STD	08-122200-00	STD	14-021321-00 D	B 97.54 C 167.00 D 100.90 E 5.00
87-122208-10	0.60mm	08-122208-00	0.60mm	14-028930-00 D	B 97.50 C 167.00 D 100.90 E 5.00
				14-028931-00 D	B 97.58 C 167.00 D 100.90 E 5.00
				14-028932-00 D	B 97.70 C 167.00 D 100.90 E 5.00
A	58.75	2572280→			
B-	19.40				
BØ	39.25	2.50		CK P	
D	87.60	2.00		P	
	32x72	2.50		CR P	

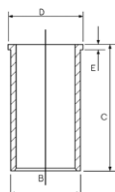

AK KK RT TP

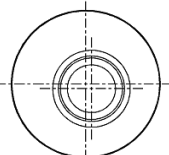
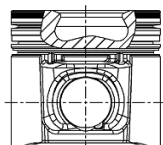

87-854700-00 STD **08-854700-00** STD
87-854708-00 0.60mm **08-854708-00** 0.60mm

A	58.75	→2572279		
B-	19.40			
BØ	39.40	3.00		CR
D	96.65	2.00		P
	32x78	3.00		CR

AK KK RT

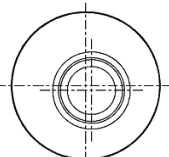
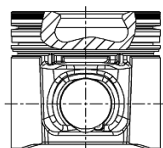



14  **94.40**

8140.43.3931 Euro 2	4 Cyl.	18.5:1	2798cc	90kW (122PS)	Diesel Turbo Intercooled	TD27436
8140.43C.4000 Euro 3	4 Cyl.	18.5:1	2798cc	77kW (105PS)	Diesel Turbo Intercooled	TD25972
8140.43C.4005 Euro 3	4 Cyl.	18.5:1	2798cc	77kW (105PS)	Diesel Turbo Intercooled	TD25973
8140.43C.4020 Euro 3	4 Cyl.	18.5:1	2798cc	77kW (105PS)	Diesel Turbo Intercooled	TD25974
8140.43C.4021 Euro 3	4 Cyl.	18.5:1	2798cc	77kW (105PS)	Diesel Turbo Intercooled	TD25975
8140.43C.4025 Euro 3	4 Cyl.	18.5:1	2798cc	77kW (105PS)	Diesel Turbo Intercooled	TD25976
8140.43C.4026 Euro 3	4 Cyl.	18.5:1	2798cc	77kW (105PS)	Diesel Turbo Intercooled	TD25977
8140.43C.4035 Euro 3	4 Cyl.	18.5:1	2798cc	77kW (105PS)	Diesel Turbo Intercooled	TD25980
8140.43C.4036 Euro 3	4 Cyl.	18.5:1	2798cc	77kW (105PS)	Diesel Turbo Intercooled	TD25981

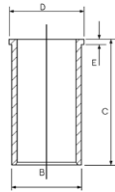

14-021321-00 D B 97.54 C 167.00 D 100.90 E 5.00
 14-028930-00 D B 97.50 C 167.00 D 100.90 E 5.00
 14-028931-00 D B 97.58 C 167.00 D 100.90 E 5.00
 14-028932-00 D B 97.70 C 167.00 D 100.90 E 5.00



15  **94.40**

8140.43B Euro 3	4 Cyl.	18:1	2798cc	78kW (105PS)	Diesel Turbo Intercooled	TD16514
8140.43B.4300 Euro 3	4 Cyl.	18:1	2798cc	77kW (105PS)	Diesel Turbo Intercooled	TD25968
8140.43B.4305 Euro 3	4 Cyl.	18:1	2798cc	77kW (105PS)	Diesel Turbo Intercooled	TD25966
8140.43B.4320 Euro 3	4 Cyl.	18:1	2798cc	77kW (105PS)	Diesel Turbo Intercooled	TD25967
8140.43B.4325 Euro 3	4 Cyl.	18:1	2798cc	77kW (105PS)	Diesel Turbo Intercooled	TD25969
8140.43B.4330 Euro 3	4 Cyl.	18:1	2798cc	77kW (105PS)	Diesel Turbo Intercooled	TD25970
8140.43B.4335 Euro 3	4 Cyl.	18:1	2798cc	77kW (105PS)	Diesel Turbo Intercooled	TD25971

87-122200-20 STD
 A 58.75
 B- 23.35
 BØ 39.30
 D 87.60
 32x72

08-122200-00 STD
 08-122208-00 0.60mm
 2.50  CK P
 2.00  P
 2.50  CR P

14-021321-00 D B 97.54 C 167.00 D 100.90 E 5.00
 14-028930-00 D B 97.50 C 167.00 D 100.90 E 5.00
 14-028931-00 D B 97.58 C 167.00 D 100.90 E 5.00
 14-028932-00 D B 97.70 C 167.00 D 100.90 E 5.00

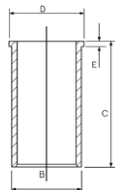

AK RT TP

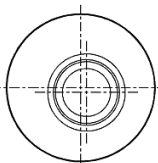
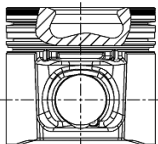

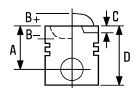

16  **94.40**

8140.43N Euro 3	4 Cyl.	18.5:1	2798cc	107kW (146PS)	Diesel Turbo Intercooled	TD16873
8140.43N.4300 Euro 3	4 Cyl.	18.5:1	2798cc	108kW (147PS)	Diesel Turbo Intercooled	TD25984
8140.43N.4320 Euro 3	4 Cyl.	18.5:1	2798cc	108kW (147PS)	Diesel Turbo Intercooled	TD25985
8140.43N.4330 Euro 3	4 Cyl.	18.5:1	2798cc	108kW (147PS)	Diesel Turbo Intercooled	TD25986
8140.43N.4400 Euro 3	4 Cyl.	18.5:1	2798cc	108kW (147PS)	Diesel Turbo Intercooled	TD25987
8140.43N.4430 Euro 3	4 Cyl.	18.5:1	2798cc	108kW (147PS)	Diesel Turbo Intercooled	TD25988
8140.43S Euro 3	4 Cyl.	18.5:1	2798cc	92-100kW (125-136PS)	Diesel Turbo Intercooled	TD16874
8140.43S.4000 Euro 3	4 Cyl.	18.5:1	2798cc	92kW (125PS)	Diesel Turbo Intercooled	TD25995
8140.43S.4020 Euro 3	4 Cyl.	18.5:1	2798cc	92kW (125PS)	Diesel Turbo Intercooled	TD25996
8140.43S.4030 Euro 3	4 Cyl.	18.5:1	2798cc	92kW (125PS)	Diesel Turbo Intercooled	TD25997
8140.43S.4140 Euro 3	4 Cyl.	18.5:1	2798cc	92kW (125PS)	Diesel Turbo Intercooled	TD25998
8140.43S.4300 Euro 3	4 Cyl.	18.5:1	2798cc	92kW (125PS)	Diesel Turbo Intercooled	TD25999
8140.43S.4320 Euro 3	4 Cyl.	18.5:1	2798cc	92kW (125PS)	Diesel Turbo Intercooled	TD26000
8140.43S.4330 Euro 3	4 Cyl.	18.5:1	2798cc	92kW (125PS)	Diesel Turbo Intercooled	TD26001
8140.43S.4400 Euro 3	4 Cyl.	18.5:1	2798cc	92kW (125PS)	Diesel Turbo Intercooled	TD26002
8140.43S.4420 Euro 3	4 Cyl.	18.5:1	2798cc	92kW (125PS)	Diesel Turbo Intercooled	TD26003
8140.43S.4430 Euro 3	4 Cyl.	18.5:1	2798cc	92kW (125PS)	Diesel Turbo Intercooled	TD26004

87-122200-00 STD
87-122208-00 0.60mm

A 58.70
B- 21.30
BØ 39.40
D 87.60
 32x72

AK KK RT TP

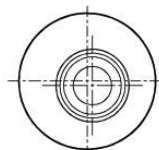
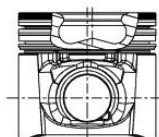

08-122200-00 STD
08-122208-00 0.60mm

2.50
2.00
2.50



CK P
P
CR P

14-021321-00 D B 97.54 C 167.00 D 100.90 E 5.00
14-028930-00 D B 97.50 C 167.00 D 100.90 E 5.00
14-028931-00 D B 97.58 C 167.00 D 100.90 E 5.00
14-028932-00 D B 97.70 C 167.00 D 100.90 E 5.00

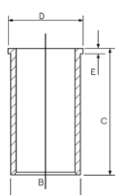







17  **94.40**

8140.63. Euro 2	4 Cyl.	21.7:1	2798cc	62kW (84PS)	Diesel	TD10389
8140.63.4000 Euro 3 Sofim	4 Cyl.	21.7:1	2798cc	62kW (84PS)	Diesel Turbo Intercooled	TD20478

87-108200-00	STD	08-108200-00	STD	14-021321-00 D	B 97.54 C 167.00 D 100.90 E 5.00
87-108208-00	0.60mm	08-108208-00	0.60mm	14-028930-00 D	B 97.50 C 167.00 D 100.90 E 5.00
				14-028931-00 D	B 97.58 C 167.00 D 100.90 E 5.00
				14-028932-00 D	B 97.70 C 167.00 D 100.90 E 5.00

A	55.00
B-	2.80
D	90.00
	32x68

3.00		CR P
2.00		P
2.50		CR P

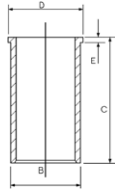

AK HA RT TP

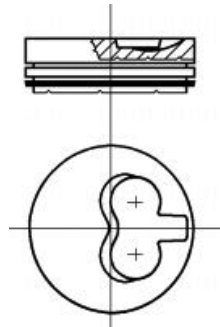



18  **95.00**

8025.01	2 Cyl.	17:1	1559cc	Diesel	FM569
803 A.062 (8030.01)	3 Cyl.	17:1	2339cc	Diesel	FM570
804A (8040.01)	4 Cyl.		3119cc	Diesel	FM4009
806 A (8060.01/.11)	6 Cyl.	17:1	4678cc	Diesel	FM572

87-207200-00	STD	08-207200-00	STD	14-010620-00 D	B 99.00 C 187.00
87-207208-00	0.60mm	08-207208-00	0.60mm	14-011061-00 D	B 99.10 C 187.00

A	59.60
B-	23.50
BØ	42.20
D	101.15
	32x84

2.50		CR P
2.50		P
5.50		CR P

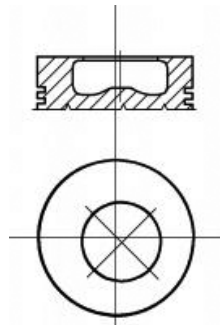
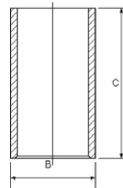

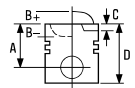





19  **95.80**

F1CE 0481 A	4 Cyl.	19:1	2998cc	100-114kW (136-155PS)	Diesel Turbo Intercooled	TD19195
F1CE 0481 FA Euro 4	4 Cyl.		2998cc	107kW (146PS)	Diesel Turbo Intercooled	TD19224
F1CE 0481 HA Euro 4	4 Cyl.		2998cc	125-130kW (170-177PS)	Diesel Turbo Intercooled	TD19225
F1CE 0481 HC Euro 4	4 Cyl.		2998cc	130kW (176PS)	Diesel Turbo Intercooled	TD19230
F1CE0481B Euro 3	4 Cyl.	19:1	2998cc	122kW (166PS)	Diesel Turbo Intercooled	TD22675
F1CE0481L Euro 4	4 Cyl.		2998cc	107-110kW (146-150PS)	Diesel Turbo Intercooled	TD27239

87-421600-00 STD **08-421600-00** STD

A	63.00	2.50		CK P
B-	16.00	2.00		P
BØ	50.50	2.50		CR P
D	93.50			
	36x80			

AK KK RT TP

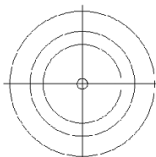
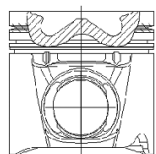

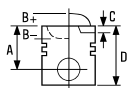

20  **100.00**



8025.02	2 Cyl.	17:1	1728cc		Diesel	FM573
8030.02	3 Cyl.	17:1	2592cc	46kW (62PS)	Diesel	TD6922
8030.02	3 Cyl.	17:1	2592cc	46kW (62PS)	Diesel	FM574
8035.02	3 Cyl.	17:1	2592cc	33-40kW (45-54PS)	Diesel	TD25194
8045.02	4 Cyl.	17:1	3456cc	44-50kW (60-68PS)	Diesel	TD25195
8060.02.000	6 Cyl.	17:1	5184cc	90kW (122PS)	Diesel	TD6852
8060.02.001	6 Cyl.	17:1	5184cc	90kW (122PS)	Diesel	TD10468
8060.02.003	6 Cyl.	17:1	5184cc	90kW (122PS)	Diesel	TD10469
8060.02.070	6 Cyl.	17:1	5184cc	90kW (122PS)	Diesel	TD6843
8065.02.007	6 Cyl.	17:1	5184cc	74kW (101PS)	Diesel	TD25315
8065.02.200	6 Cyl.	17:1	5184cc	70-74kW (95-101PS)	Diesel	TD25316
8065.02.207	6 Cyl.	17:1	5184cc	74kW (101PS)	Diesel	TD25317
8065.02.217	6 Cyl.	17:1	5184cc	74kW (101PS)	Diesel	TD25318

87-206800-00  STD
87-206808-00  0.60mm

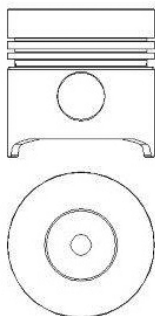
A 59.60
B- 23.70
BØ 47.00
D 101.15
 32x84



08-206800-00 STD
08-206808-00 0.60mm

2.50  CR P
2.50  P
5.50  CR P

14-021540-00 D B 103.00 C 187.00 D 104.00 E 5.00

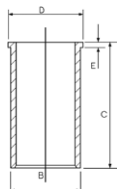

14-010170-00 D B 103.00 C 187.00
14-011021-00 D B 103.06 C 187.00
14-011022-00 D B 103.10 C 187.00
14-013401-00 D B 103.04 C 187.00

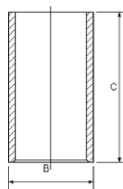



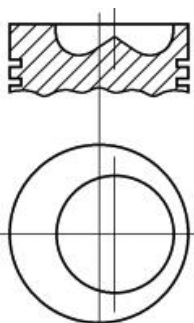

87-206800-10 STD
87-206808-10 0.60mm

A 59.60
B- 23.70
BØ 45.40
D 101.15
 32x84





08-206800-10 STD
08-206808-10 0.60mm

2.50  CR P
2.50  P
5.50  CR P

 Piston with central combustion chamber

 Kolben mit zentraler Verbrennungskammer

 Piston à chambre de combustion centrale

 Pistón con cámara de combustión central

 Pistone con camera di combustione centrale



21 100.00

8035.06	3 Cyl.	17:1	2708cc	33-40kW (45-54PS)	Diesel	FM4008
8035.06.200	3 Cyl.	17:1	2708cc	33-41kW (45-56PS)	Diesel	TD25535
8035.06.206	3 Cyl.	17:1	2708cc	38-40kW (52-54PS)	Diesel	TD25536
8035.06.208	3 Cyl.	17:1	2708cc	38-40kW (52-54PS)	Diesel	TD25537
8035.06.216	3 Cyl.	17:1	2708cc	38-40kW (52-55PS)	Diesel	TD25538
8035.06.220	3 Cyl.	17:1	2708cc	33kW (45PS)	Diesel	TD25539
8035.06.222	3 Cyl.	17:1	2708cc	33-40kW (45-54PS)	Diesel	TD25540
8035.06.223	3 Cyl.	17:1	2708cc	38kW (52PS)	Diesel	TD25541
8035.06.306	3 Cyl.	17:1	2708cc	38kW (52PS)	Diesel	TD25542
8035.06.307	3 Cyl.	17:1	2708cc	38-40kW (52-54PS)	Diesel	TD25543
8035.06.308	3 Cyl.	17:1	2708cc	38-40kW (52-54PS)	Diesel	TD25544
8035.06.309	3 Cyl.	17:1	2708cc	38kW (52PS)	Diesel	TD25545
8035.06.317	3 Cyl.	17:1	2708cc	38-40kW (52-55PS)	Diesel	TD25546
8035.06.320	3 Cyl.	17:1	2708cc	34kW (46PS)	Diesel	TD25547
8035.06.321	3 Cyl.	17:1	2708cc	33-34kW (45-46PS)	Diesel	TD25548
8035.06.322	3 Cyl.	17:1	2708cc	38kW (52PS)	Diesel	TD25549
8035.06.323	3 Cyl.	17:1	2708cc	33-40kW (45-54PS)	Diesel	TD25550
8045.06	4 Cyl.	17:1	3613cc	44-73kW (60-99PS)	Diesel	FM8778
8045.06.200	4 Cyl.	17:1	3613cc	51kW (69PS)	Diesel	TD25521
8045.06.208	4 Cyl.	17:1	3613cc	51kW (69PS)	Diesel	TD25522
8045.06.213	4 Cyl.	17:1	3613cc	48-51kW (65-69PS)	Diesel	TD25523
8045.06.214	4 Cyl.	17:1	3613cc	73kW (99PS)	Diesel	TD25524
8045.06.215	4 Cyl.	17:1	3613cc	73kW (99PS)	Diesel	TD25525
8045.06.225	4 Cyl.	17:1	3613cc	48kW (65PS)	Diesel	TD25526
8045.06.319	4 Cyl.	17:1	3613cc	48kW (65PS)	Diesel	TD25527
8045.06.326	4 Cyl.	17:1	3613cc	48kW (65PS)	Diesel	TD25528
8065.06.000	6 Cyl.	17:1	5418cc	74kW (100PS)	Diesel	TD25390

87-781900-10
87-781908-10

STD
0.60mm

08-781900-00
08-781908-00

STD
0.60mm

14-010780-00 D
14-010781-00 D
14-010782-00 D

B 103.02 C 196.00
B 103.06 C 196.00
B 103.10 C 196.00

A 65.15
B- 22.70
D 108.50
 38x85

2.50
2.50
4.00



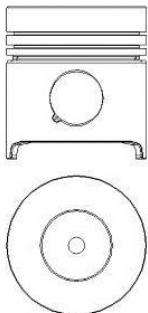
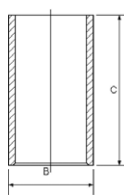

MOL P
P
CR P

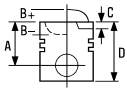



22  **100.00**



8040.02	4 Cyl.	17:1	3456cc	60kW (82PS)	Diesel	TD6840
8040.02	4 Cyl.	17:1	3455cc		Diesel	FM575
8040.02.041	4 Cyl.	17:1	3456cc	56kW (76PS)	Diesel	TD6925
8040.02.267	4 Cyl.	17:1	3456cc	56kW (76PS)	Diesel	TD5606
8040.02.300	4 Cyl.	17:1	3455cc	56kW (76PS)	Diesel	TD5605
8040.02.360	4 Cyl.	17:1	3456cc	56kW (76PS)	Diesel	TD5944
8040.02.367	4 Cyl.	17:1	3456cc	56kW (76PS)	Diesel	TD5945

87-206800-00  STD
87-206808-00  0.60mm

08-206800-00 STD
08-206808-00 0.60mm

14-021540-00 *D* B 103.00 C 187.00 D 104.00 E 5.00

A 59.60
B- 23.70
BØ 47.00
D 101.15
 32x84

2.50  CR P
2.50  P
5.50  CR P

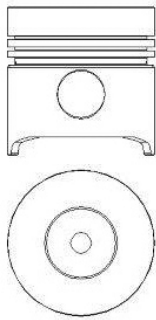
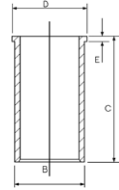



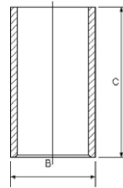

14-010170-00 *D* B 103.00 C 187.00
14-011021-00 *D* B 103.06 C 187.00
14-011022-00 *D* B 103.10 C 187.00
14-013401-00 *D* B 103.04 C 187.00



87-206800-10 STD
87-206808-10 0.60mm

08-206800-00 STD
08-206808-00 0.60mm

A 59.60
B- 23.70
BØ 45.40
D 101.15
 32x84

2.50  CR P
2.50  P
5.50  CR P

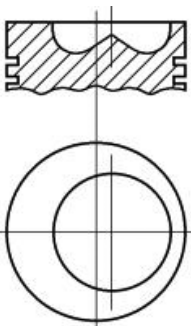

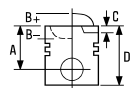





87-781900-30
87-781908-30

STD
0.60mm

08-781900-00
08-781908-00

STD
0.60mm

A 59.60
B- 23.70
BØ 47.10
D 101.15
 34x84

2.50  MOL P
2.50  P
4.00  CR P

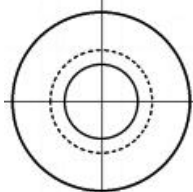

 Piston with central combustion chamber

 Kolben mit zentraler Verbrennungskammer

 Piston à chambre de combustion centrale

 Pistón con cámara de combustión central

 Pistone con camera di combustione centrale

23  **102.00**

F4AE 0481 A Euro 3 Tector E17	4 Cyl.	3920cc	125kW (170PS)	Diesel Turbo Intercooled	TD16294
F4AE 0481 C Euro 3 Tector E15	4 Cyl.	3920cc	110kW (149PS)	Diesel Turbo Intercooled	TD16293
F4AE 0481 D Euro 3 Tector E13	4 Cyl.	3920cc	95kW (130PS)	Diesel Turbo Intercooled	TD16292
F4AE 0681 A Euro 3 Tector E28	6 Cyl.	5880cc	202-220kW (275-299PS)	Diesel Turbo Intercooled	TD16520
F4AE 0681 B Euro 3 Tector E24	6 Cyl.	5880cc	176kW (240PS)	Diesel Turbo Intercooled	TD16519
F4AE 0681 D Euro 3 Tector E21	6 Cyl.	5880cc	132-155kW (180-211PS)	Diesel Turbo Intercooled	TD16296
F4AE 0681 E Euro 3 Tector E18	6 Cyl. 17:1	5880cc	132-134kW (180-181PS)	Diesel Turbo Intercooled	TD16295
F4AE0681C Euro 3 Tector E24	6 Cyl.	5880cc	154kW (210PS)	Diesel Turbo Intercooled	TD24238



87-145000-00
87-145007-00

STD
0.50mm

08-145000-00
08-145007-00
08-145008-00

STD
0.50mm
0.60mm

A 71.38
B- 18.55
BØ 56.50
D 105.38
 40x83

3.00  CK P
2.39  P
4.00  CR P

AK KK RT TP

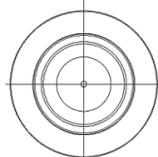
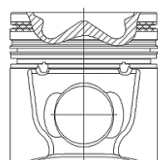

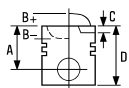

24  **102.00**

F4AE3481A Euro 4/5 Tector E18	4 Cyl.		3920cc	134kW (182PS)	Diesel Turbo Intercooled	TD21097
F4AE3481B Euro 4/5 Tector E18	4 Cyl.		3920cc	130kW (177PS)	Diesel Turbo Intercooled	TD21096
F4AE3481C Euro 4/5 Tector E14	4 Cyl.		3920cc	103kW (140PS)	Diesel Turbo Intercooled	TD21092
F4AE3481D Euro 4/5 Tector E16	4 Cyl.		3920cc	118kW (160PS)	Diesel Turbo Intercooled	TD21095
F4AE3681A Euro 4/5 Tector E30	6 Cyl.		5880cc	220kW (299PS)	Diesel Turbo Intercooled	TD22585
F4AE3681B Euro 4/5 Tector E22	6 Cyl.		5880cc	160kW (218PS)	Diesel Turbo Intercooled	TD21098
F4AE3681C Euro 4/5 Tector E22	6 Cyl.		5880cc	135kW (183PS)	Diesel Turbo Intercooled	TD22602
F4AE3681D Euro 4/5 Tector E25	6 Cyl.		5880cc	185kW (251PS)	Diesel Turbo Intercooled	TD21099
F4AE3681E Euro 4/5 Tector E28	6 Cyl.	17:1	5880cc	205-206kW (279-280PS)	Diesel Turbo Intercooled	TD21100



87-427900-00

- A 71.40
- B- 17.15
- BØ 56.80
- D 105.30
-  40x83

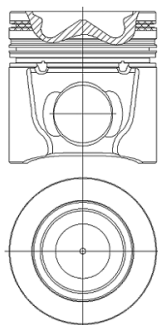
AK KK RT TP



08-427900-00

- 3.00  CK P
- 2.39  P
- 4.00  CR P

STD

25  **103.00**

8035.04	3 Cyl.		2748cc		Diesel	FM4007
8035.04.265	3 Cyl.	17:1	2749cc	35-37kW (48-50PS)	Diesel	TD25325
8035.04.270	3 Cyl.	17:1	2749cc	43kW (58PS)	Diesel	TD25326
8040.04.200	4 Cyl.	17:1	3666cc	63kW (86PS)	Diesel	TD10397
8045.04	4 Cyl.	17:1	3666cc		Diesel	FM3483
8045.04.270	4 Cyl.	17:1	3666cc	57kW (78PS)	Diesel	TD25335
8055.04	5 Cyl.	17:1	4583cc		Diesel	FM3484
8055.04.200	5 Cyl.	17:1	4583cc	63-66kW (86-90PS)	Diesel	TD25345
8060.04	6 Cyl.	17:1	5499cc	96kW (131PS)	Diesel	TD10457
8060.04.000	6 Cyl.	17:1	5499cc	99kW (135PS)	Diesel	TD6853
8060.04.055	6 Cyl.	17:1	5499cc	96kW (131PS)	Diesel	TD10420
8060.04.060	6 Cyl.	17:1	5499cc	96kW (131PS)	Diesel	TD10417
8060.04.070	6 Cyl.	17:1	5499cc	99kW (135PS)	Diesel	TD10413
8060.04.620	6 Cyl.	17:1	5499cc	99kW (135PS)	Diesel	TD10408
8060.04.621	6 Cyl.	17:1	5499cc	99kW (135PS)	Diesel	TD10409
8060.04.630	6 Cyl.	17:1	5499cc	99kW (135PS)	Diesel	TD10470



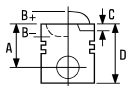

8060.04.639	6 Cyl.	17:1	5499cc	99kW (135PS)	Diesel	TD10463
8060.04.658	6 Cyl.	17:1	5499cc	99kW (135PS)	Diesel	TD10390
8060.04.660	6 Cyl.	17:1	5499cc	96-99kW (131-135PS)	Diesel	TD10421
8060.04.669	6 Cyl.	17:1	5499cc	99-102kW (135-139PS)	Diesel	TD10460
8060.04.670	6 Cyl.	17:1	5499cc	99kW (135PS)	Diesel	TD10449
8060.04.672	6 Cyl.	17:1	5499cc	73kW (99PS)	Diesel	TD10450
8060.04.675	6 Cyl.	17:1	5499cc	99kW (135PS)	Diesel	TD10464
8060.04.689	6 Cyl.	17:1	5499cc	99-102kW (135-139PS)	Diesel	TD10462
8065.04	6 Cyl.		5499cc		Diesel	FM14933
8065.04.200	6 Cyl.	17:1	5499cc	81-85kW (110-116PS)	Diesel	TD25322
8065.04-H	6 Cyl.	17:1	5499cc		Diesel	FM13486

87-782000-00
87-782008-00

STD
0.60mm

08-782000-00
08-782008-00

STD
0.60mm

14-023551-00 D
14-023552-00 D
14-023553-00 D

B 107.06 C 187.00 D 110.00 E 5.00
B 107.18 C 187.00 D 110.00 E 5.00
B 107.48 C 187.00 D 110.50 E 5.00

A 59.60
B- 22.70
BØ 50.00
D 101.15
 34x90

2.50
2.50
4.00



MOL P
P
CR P

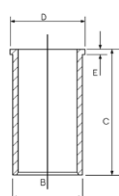

14-010180-00 D
14-010181-00 D
14-010182-00 D

B 107.06 C 187.00
B 107.06 C 187.00
B 107.10 C 187.00

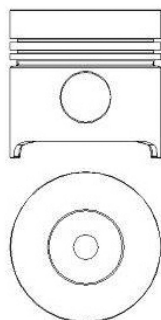
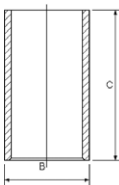

87-782000-10

STD

08-782000-00
08-782008-00

STD
0.60mm

A 59.60
B- 22.70
BØ 49.80
D 101.15
 34x90

2.50
2.50
4.00



MOL P
P
CR P

RT

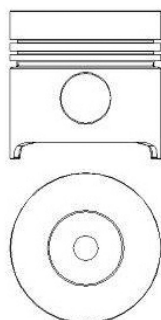

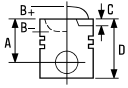

26  **103.00**



8041 L	4 Cyl.	3666cc	Diesel	FM13483
8061 L	6 Cyl.	5499cc	Diesel	FM23487

87-783900-00 STD

08-783900-00 STD

14-010180-00 D B 107.00 C 187.00

- A 59.61
- B- 22.50
- BØ 53.30
- D 59.60
-  34x90

- 3.00  MOL P
- 2.50  P
- 4.00  CR

14-010181-00 D B 107.06 C 187.00

14-010182-00 D B 107.10 C 187.00

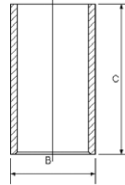

RT

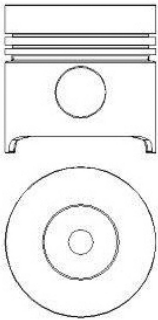

27  **103.00**

8065.24.000	6 Cyl.	15.7:1	5499cc	99kW (135PS)	Diesel	TD25348
8065.24.300	6 Cyl.	15.7:1	5499cc	90-91kW (121-124PS)	Diesel	TD25352

14-023551-00 D B 107.06 C 187.00 D 110.00 E 5.00

14-023552-00 D B 107.18 C 187.00 D 110.00 E 5.00

14-023553-00 D B 107.48 C 187.00 D 110.50 E 5.00

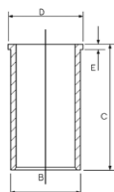

14-010180-00 D B 107.00 C 187.00

14-010181-00 D B 107.06 C 187.00

14-010182-00 D B 107.10 C 187.00

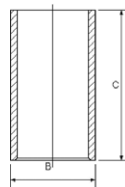

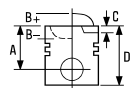

28 **103.00**

8060.24.601	6 Cyl.	17:1	5499cc	124kW (169PS)	Diesel Turbo	TD10472
8060.24.670	6 Cyl.	17:1	5499cc	118kW (160PS)	Diesel Turbo	TD10447
8060.24.671	6 Cyl.	17:1	5499cc	118kW (160PS)	Diesel Turbo	TD10448
8060.24.678	6 Cyl.	17:1	5499cc	123kW (167PS)	Diesel Turbo	TD10465
8062.24.070	6 Cyl.		5499cc	118kW (160PS)	Diesel Turbo	TD10458

87-783900-10 STD
A 59.60
B- 22.80
BØ 49.80
D 101.15
 34x90

08-783900-00 STD
 3.00 MOL P
 2.50 P
 4.00 CR P

14-023551-00 **D** B 107.06 C 187.00 D 110.00 E 5.00
 14-023552-00 **D** B 107.18 C 187.00 D 110.00 E 5.00
 14-023553-00 **D** B 107.48 C 187.00 D 110.50 E 5.00

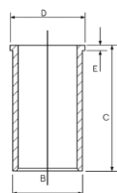

14-010180-00 **D** B 107.00 C 187.00
 14-010181-00 **D** B 107.06 C 187.00
 14-010182-00 **D** B 107.10 C 187.00

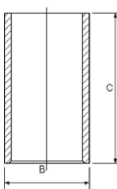

AK RT

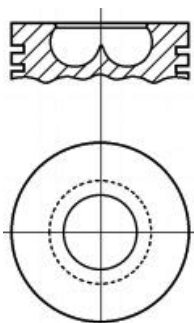

29 **104.00**

8035.05	3 Cyl.		2930cc		Diesel	FM4032
8045.05	4 Cyl.	17:1	3908cc	54-60kW (73-82PS)	Diesel	FM5567
8065.E	6 Cyl.		5861cc	82kW (112PS)	Diesel	TD28430

87-247800-00 STD
 87-247808-00 0.60mm
A 65.15
B- 22.50
BØ 52.20
D 108.50
 38x85

08-247800-00 STD
 08-247808-00 0.60mm
 2.50 MOL P
 2.50 P
 4.00 CR P

14-021361-00 **D** B 107.02 C 198.00 D 110.87 E 5.00
 14-021362-00 **D** B 107.14 C 198.00 D 110.87 E 5.00
 14-021363-00 **D** B 107.44 C 198.00 D 110.87 E 5.00
 14-021491-00 **D** B 107.01 C 198.00 D 109.87 E 5.00
 14-021492-00 **D** B 107.05 C 198.00 D 109.87 E 5.00
 14-021493-00 **D** B 107.17 C 198.00 D 109.87 E 5.00
 14-021494-00 **D** B 107.47 C 198.00 D 109.87 E 5.00
 14-024781-00 **D** B 107.02 C 198.00 D 109.95 E 5.00

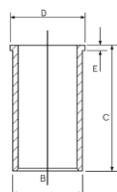

14-010940-00 **D** B 107.00 C 198.00
 14-010941-10 **D** B 107.10 C 198.00
 14-010943-10 **D** B 107.52 C 198.00

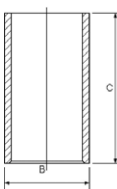

TP

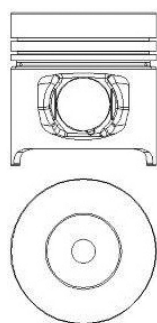

30  **104.00**

8035.05.214	3 Cyl.	17:1	2931cc	37-44kW (50-60PS)	Diesel	TD22233
8035.05.215	3 Cyl.	17:1	2931cc	37-44kW (50-60PS)	Diesel	TD22234
8040.05.4990	4 Cyl.	17.7:1	3908cc	80kW (109PS)	Diesel	TD22235
8040.25.4990	4 Cyl.		3908cc	85kW (116PS)	Diesel Turbo Intercooled	FM24132
8040.45.4180	4 Cyl.	17:1	3908cc	100kW (136PS)	Diesel Turbo Intercooled	TD10406
8040.45.4380	4 Cyl.	17.7:1	3908cc	100kW (136PS)	Diesel Turbo Intercooled	TD20438
8040.45.5200	4 Cyl.	18:1	3908cc	100kW (136PS)	Diesel	TD21462
8040.45.5201 Euro 2	4 Cyl.	17.7:1	3908cc	100kW (136PS)	Diesel Turbo Intercooled	TD27290
8040.45.5203 Euro 2	4 Cyl.	17.7:1	3908cc	100kW (136PS)	Diesel Turbo Intercooled	TD27291
8040.45.5280 Euro 2	4 Cyl.	18:1	3908cc	100kW (136PS)	Diesel Turbo Intercooled	TD27293
8040.45.5281	4 Cyl.	18:1	3908cc	100kW (136PS)	Diesel	TD22236
8040.45.5281 Euro 2	4 Cyl.	18:1	3908cc	100kW (136PS)	Diesel Turbo Intercooled	TD27294
8040.45D.5100	4 Cyl.	18:1	3908cc	85kW (116PS)	Diesel	TD22237
8040.45D.5101 Euro 2	4 Cyl.	18:1	3908cc	85kW (116PS)	Diesel Turbo Intercooled	TD27295
8040.45D.5103	4 Cyl.	18:1	3908cc	85kW (116PS)	Diesel	TD22238
8040.45D.5103 Euro 2	4 Cyl.	18:1	3908cc	85kW (116PS)	Diesel Turbo Intercooled	TD27296
8040.45D.5105 Euro 2	4 Cyl.	18:1	3908cc	85kW (116PS)	Diesel Turbo Intercooled	TD27297
8045.05.000	4 Cyl.	17:1	3908cc	59kW (80PS)	Diesel	TD25496
8045.05.213	4 Cyl.	17:1	3908cc	55kW (75PS)	Diesel	TD25500
8045.05.215	4 Cyl.	17:1	3908cc	55kW (75PS)	Diesel	TD25501
8045.25.310	4 Cyl.	17:1	3908cc	63kW (85PS)	Diesel	TD25364
8045.25.370	4 Cyl.	17:1	3908cc	75-103kW (102-140PS)	Diesel	TD25365
8045.25.375	4 Cyl.	17:1	3908cc	63-103kW (85-140PS)	Diesel	TD25366
8045.25.376	4 Cyl.	17:1	3908cc	75-103kW (102-140PS)	Diesel	TD25367
8045.25.381	4 Cyl.	17:1	3908cc	80-103kW (109-140PS)	Diesel	TD25369
8060.25R.4210 Euro 1	6 Cyl.	17.7:1	5861cc	105kW (143PS)	Diesel Turbo	TD27309
8060.25R.4220 Euro 1	6 Cyl.	17.7:1	5861cc	105kW (143PS)	Diesel Turbo	TD27310
8060.25R.4225 Euro 1	6 Cyl.	17.7:1	5861cc	105kW (143PS)	Diesel Turbo	TD27311
8060.25R.4230 Euro 1	6 Cyl.	17.7:1	5861cc	105kW (143PS)	Diesel Turbo	TD27312
8060.25R.4240 Euro 1	6 Cyl.	17.7:1	5861cc	105kW (143PS)	Diesel Turbo	TD27313
8060.25R.4250 Euro 1	6 Cyl.	17.7:1	5861cc	105kW (143PS)	Diesel Turbo	TD27314
8060.25R.4285 Euro 1	6 Cyl.	17.7:1	5861cc	105kW (143PS)	Diesel Turbo	TD27315
8060.25R.4290 Euro 1	6 Cyl.	17.7:1	5861cc	105kW (143PS)	Diesel Turbo	TD27316
8060.25R.4295 Euro 1	6 Cyl.	17.7:1	5861cc	105kW (143PS)	Diesel Turbo	TD27317
8060.25R.4360 Euro 1	6 Cyl.	17.7:1	5861cc	105kW (143PS)	Diesel Turbo	TD27318
8060.25R.4362 Euro 1	6 Cyl.	17.7:1	5861cc	105kW (143PS)	Diesel Turbo	TD27319
8060.25R.4750	6 Cyl.	17.7:1	5861cc	105kW (143PS)	Diesel Turbo Intercooled	TD10907
8060.25R.4755	6 Cyl.	17.7:1	5861cc	105kW (143PS)	Diesel Turbo	TD10908
8060.25R.4760	6 Cyl.	17.7:1	5861cc	105kW (143PS)	Diesel Turbo Intercooled	TD10909
8060.25R.4764	6 Cyl.	17.7:1	5861cc	105kW (143PS)	Diesel Turbo Intercooled	TD10910
8060.25R.4960 Euro 1	6 Cyl.	17.7:1	5861cc	105kW (143PS)	Diesel Turbo	TD27321
8060.25R.4967 Euro 1	6 Cyl.	17.7:1	5861cc	105kW (143PS)	Diesel Turbo	TD27322
8060.25R.4968 Euro 1	6 Cyl.	17.7:1	5861cc	105kW (143PS)	Diesel Turbo	TD27323

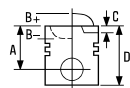

8060.25R.4970 Euro 1	6 Cyl.	17.7:1	5861cc	105kW (143PS)	Diesel Turbo	TD27324
8060.25R.4973 Euro 1	6 Cyl.	17.7:1	5861cc	105kW (143PS)	Diesel Turbo	TD27325
8060.25R.4980 Euro 1	6 Cyl.	17.7:1	5861cc	105kW (143PS)	Diesel Turbo	TD27326
8060.25V.4000	6 Cyl.	17.7:1	5861cc	130kW (177PS)	Diesel	TD7283
8060.45.4300/8060.45.4400/ 8060.45L.4400	6 Cyl.	17:1	5861cc		Diesel Turbo	FM19257
8060.45.4702 Euro 1	6 Cyl.	17:1	5861cc	152kW (207PS)	Diesel Turbo	TD10914
8060.45.4704 Euro 1	6 Cyl.	17:1	5861cc	152kW (207PS)	Diesel Turbo	TD10915
8060.45.4706 Euro 1	6 Cyl.	17:1	5861cc	152kW (207PS)	Diesel Turbo	TD10916
8060.45.4708	6 Cyl.	17:1	5861cc	152kW (207PS)	Diesel Turbo	TD10917
8060.45.5200 Euro 2	6 Cyl.	18:1	5861cc	152-169kW (207-230PS)	Diesel Turbo Intercooled	TD27106
8060.45.5200/8060.45B 5100 Euro 2	6 Cyl.	18:1	5861cc	152-169kW (207-230PS)	Diesel Turbo Intercooled	FM29257
8060.45.5201 Euro 2	6 Cyl.	18:1	5861cc	152kW (207PS)	Diesel Turbo Intercooled	TD27107
8060.45.5203 Euro 2	6 Cyl.	18:1	5861cc	152kW (207PS)	Diesel Turbo Intercooled	TD27108
8060.45.5205 Euro 2	6 Cyl.	18:1	5861cc	152kW (207PS)	Diesel Turbo Intercooled	TD27109
8060.45.5220 Euro 2	6 Cyl.	18:1	5861cc	152kW (207PS)	Diesel Turbo Intercooled	TD27112
8060.45.5221 Euro 2	6 Cyl.	18:1	5861cc	152kW (207PS)	Diesel Turbo Intercooled	TD27113
8060.45.5223 Euro 2	6 Cyl.	18:1	5861cc	152kW (207PS)	Diesel Turbo Intercooled	TD27114
8060.45.5232 Euro 2	6 Cyl.	18:1	5861cc	152kW (207PS)	Diesel Turbo Intercooled	TD27115
8060.45.5233 Euro 2	6 Cyl.	18:1	5861cc	152kW (207PS)	Diesel Turbo Intercooled	TD27116
8060.45.5234 Euro 2	6 Cyl.	18:1	5861cc	152kW (207PS)	Diesel Turbo Intercooled	TD27117
8060.45.5235 Euro 2	6 Cyl.	18:1	5861cc	152kW (207PS)	Diesel Turbo Intercooled	TD27118
8060.45.5250 Euro 2	6 Cyl.	17:1	5861cc	152kW (207PS)	Diesel Turbo Intercooled	TD10918
8060.45.5251	6 Cyl.	17:1	5861cc	152kW (207PS)	Diesel Turbo	TD10919
8060.45.5255	6 Cyl.	17:1	5861cc	152kW (207PS)	Diesel Turbo	TD10920
8060.45B.5101 Euro 2	6 Cyl.	18:1	5861cc	130kW (177PS)	Diesel Turbo Intercooled	TD27121
8060.45B.5103 Euro 2	6 Cyl.	18:1	5861cc	130kW (177PS)	Diesel Turbo Intercooled	TD27122
8060.45B.5105 Euro 2	6 Cyl.	18:1	5861cc	130kW (177PS)	Diesel Turbo Intercooled	TD27123
8060.45B.5111 Euro 2	6 Cyl.	18:1	5861cc	130kW (177PS)	Diesel Turbo Intercooled	TD27125
8060.45B.5112 Euro 2	6 Cyl.	18:1	5861cc	130kW (177PS)	Diesel Turbo Intercooled	TD27126
8060.45B.5113 Euro 2	6 Cyl.	18:1	5861cc	130kW (177PS)	Diesel Turbo Intercooled	TD27127
8060.45B.5120 Euro 2	6 Cyl.	18:1	5861cc	130kW (177PS)	Diesel Turbo Intercooled	TD27128
8060.45B.5121 Euro 2	6 Cyl.	18:1	5861cc	130kW (177PS)	Diesel Turbo Intercooled	TD27129
8060.45B.5123 Euro 2	6 Cyl.	18:1	5861cc	130kW (177PS)	Diesel Turbo Intercooled	TD27130
8060.45B.5124 Euro 2	6 Cyl.	18:1	5861cc	130kW (177PS)	Diesel Turbo Intercooled	TD27131
8060.45B.5145 Euro 2	6 Cyl.	18:1	5861cc	130kW (177PS)	Diesel Turbo Intercooled	TD27132
8060.45B.5146 Euro 2	6 Cyl.	18:1	5861cc	130kW (177PS)	Diesel Turbo Intercooled	TD27133
8060.45B.5150 Euro 2	6 Cyl.	18:1	5861cc	130kW (177PS)	Diesel Turbo Intercooled	TD27134
8060.45B.5151 Euro 2	6 Cyl.	18:1	5861cc	130kW (177PS)	Diesel Turbo Intercooled	TD27136
8060.45B.5185 Euro 2	6 Cyl.	18:1	5861cc	130kW (177PS)	Diesel Turbo Intercooled	TD27139
8060.45B.5186 Euro 2	6 Cyl.	18:1	5861cc	130kW (177PS)	Diesel Turbo Intercooled	TD27140
8060.45K.6090 Euro 1	6 Cyl.	18:1	5861cc	167kW (227PS)	Diesel Turbo Intercooled	TD20471
8060.45M.7200/8060.45S.7200 Euro 2	6 Cyl.	18:1	5861cc	167kW (227PS)	Diesel Turbo Intercooled	FM59257
8060.45R.5001 Euro 2	6 Cyl.	17:1	5861cc	105kW (143PS)	Diesel Turbo	TD16718





8060.45R.5003 Euro 2	6 Cyl.	17:1	5861cc	105kW (143PS)	Diesel Turbo	TD16719
8060.45R.5050	6 Cyl.	17:1	5861cc	105kW (143PS)	Diesel Turbo	TD10911
8060.45S TCA	6 Cyl.	17:1	5861cc	167kW (227PS)	Diesel Turbo Intercooled	TD10482
8060.45S.6000	6 Cyl.	17:1	5861cc	167kW (227PS)	Diesel	TD7307
8060.45S.6000 Euro 1	6 Cyl.	17:1	5861cc	167kW (227PS)	Diesel Turbo	TD10480
8060.45S.6203 Euro 1	6 Cyl.	17:1	5861cc	167kW (227PS)	Diesel Turbo	FM89257
8060.45S.6800 Euro 1	6 Cyl.	17:1	5861cc	167kW (227PS)	Diesel Turbo	TD10478
8060.45S.7200 Euro 2	6 Cyl.	18:1	5861cc	167kW (227PS)	Diesel Turbo Intercooled	TD20472
8065.05.000	6 Cyl.	18:1	5863cc	85kW (116PS)	Diesel	TD25488
8065.05.330	6 Cyl.	18:1	5863cc	73kW (99PS)	Diesel	TD25495
8065.25.320	6 Cyl.	17:1	5863cc	105-110kW (143-150PS)	Diesel	TD25477

- 14-021361-00 D** B 107.02 C 198.00 D 110.87 E 5.00
- 14-021362-00 D** B 107.14 C 198.00 D 110.87 E 5.00
- 14-021363-00 D** B 107.44 C 198.00 D 110.87 E 5.00
- 14-021491-00 D** B 107.01 C 198.00 D 109.87 E 5.00
- 14-021492-00 D** B 107.05 C 198.00 D 109.87 E 5.00
- 14-021493-00 D** B 107.17 C 198.00 D 109.87 E 5.00
- 14-021494-00 D** B 107.47 C 198.00 D 109.87 E 5.00
- 14-024781-00 D** B 107.02 C 198.00 D 109.95 E 5.00

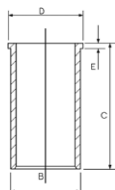

- 14-010940-00 D** B 107.00 C 198.00
- 14-010941-10 D** B 107.10 C 198.00
- 14-010943-10 D** B 107.52 C 198.00

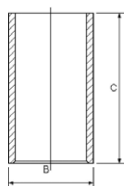

31 104.00

8040.05.200	4 Cyl.	17:1	3908cc	65kW (88PS)	Diesel	TD10399
8040.05.200	4 Cyl.	17:1	3908cc	65kW (88PS)	Diesel	TD7265
8040.05.203	4 Cyl.	17:1	3908cc	65kW (88PS)	Diesel	TD16721
8040.05.230	4 Cyl.	17:1	3908cc	65kW (88PS)	Diesel	TD10398
8040.05.230	4 Cyl.	17:1	3908cc	65kW (88PS)	Diesel	TD7264
8040.05.233	4 Cyl.	17:1	3908cc	65kW (88PS)	Diesel	TD16723
8040.05.235	4 Cyl.	17:1	3908cc	65kW (88PS)	Diesel	TD16724
8055.05.000	5 Cyl.	17:1	4885cc	66kW (90PS)	Diesel	TD25384
8060.05	6 Cyl.	17:1	5861cc	101kW (137PS)	Diesel	TD10424
8060.05.000	6 Cyl.	17:1	5861cc	79-102kW (108-139PS)	Diesel	TD7282
8060.05.200	6 Cyl.	17:1	5868cc	99-102kW (135-139PS)	Diesel	TD10471



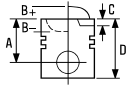

8060.05.200	6 Cyl.	17:1	5861cc	99-102kW (135-139PS)	Diesel	TD7299
8060.05.246	6 Cyl.	17:1	5868cc	101kW (137PS)	Diesel	TD10391
8060.05.246	6 Cyl.	17:1	5861cc	101kW (138PS)	Diesel	TD7262
8060.05.270	6 Cyl.	17:1	5861cc	101-102kW (138-139PS)	Diesel	TD7278
8060.05.270	6 Cyl.	17:1	5861cc	101kW (137PS)	Diesel	TD10412
8060.05.280	6 Cyl.	17:1	5861cc	102kW (139PS)	Diesel	TD7281
8060.05.280	6 Cyl.	17:1	5861cc	101kW (137PS)	Diesel	TD10423
8060.05.285	6 Cyl.	17:1	5861cc	101kW (138PS)	Diesel	TD7274
8060.05.285	6 Cyl.	17:1	5861cc	101kW (137PS)	Diesel	TD10411
8060.05.289	6 Cyl.	17:1	5861cc	102kW (139PS)	Diesel	TD7293
8060.05.289	6 Cyl.	17:1	5861cc	101kW (137PS)	Diesel	TD10461
8061.05	6 Cyl.		5861cc	82kW (112PS)	Diesel	TD28429

87-247800-10 STD
87-247808-10 0.60mm

STD
 0.60mm

08-247800-00 STD
08-247808-00 0.60mm

STD
 0.60mm

A 65.15
B- 22.50
BØ 52.00
D 108.50
 38x85

2.50
 2.50
 4.00



MOL P
 P
 CR P

14-021361-00 D B 107.02 C 198.00 D 110.87 E 5.00
14-021362-00 D B 107.14 C 198.00 D 110.87 E 5.00
14-021363-00 D B 107.44 C 198.00 D 110.87 E 5.00
14-021491-00 D B 107.01 C 198.00 D 109.87 E 5.00
14-021492-00 D B 107.05 C 198.00 D 109.87 E 5.00
14-021493-00 D B 107.17 C 198.00 D 109.87 E 5.00
14-021494-00 D B 107.47 C 198.00 D 109.87 E 5.00
14-024781-00 D B 107.02 C 198.00 D 109.95 E 5.00

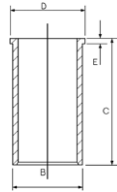

14-010940-00 D B 107.00 C 198.00
14-010941-10 D B 107.10 C 198.00
14-010943-10 D B 107.52 C 198.00

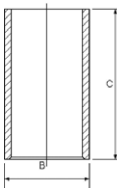

RT TP

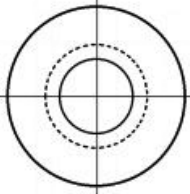
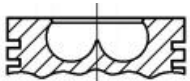

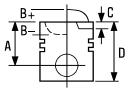



32  **104.00**

8040.05.4990	4 Cyl.	17.7:1	3908cc	80kW (109PS)	Diesel Turbo	TD16725
8040.25 B.4200	4 Cyl.	17:1	3908cc	75kW (102PS)	Diesel Turbo	TD10403
8040.25X.4000	4 Cyl.	17.7:1	3908cc	85kW (116PS)	Diesel Turbo	TD10404
8060.25R 4200 Euro 1	6 Cyl.	17.7:1	5861cc	105kW (143PS)	Diesel Turbo	TD10479
8060.25R 4300	6 Cyl.	17.7:1	5861cc	105kW (143PS)	Diesel Turbo Intercooled	TD20414
8060.25R.4280	6 Cyl.	17.7:1	5861cc	105kW (143PS)	Diesel Turbo	TD10475
8060.25V.4000 Euro 1	6 Cyl.	17.7:1	5868cc	130kW (177PS)	Diesel Turbo Intercooled	TD10454
8060.25V.4080	6 Cyl.	17.7:1	5861cc	130kW (177PS)	Diesel Turbo Intercooled	TD10476
8060.25V.4800	6 Cyl.	17.7:1	5861cc	130kW (177PS)	Diesel Turbo Intercooled	TD10481

87-103900-40 STD
 87-103908-40 0.60mm
 A 65.25
 B- 21.00
 BØ 46.00
 D 104.20
 38x85

08-103900-00 STD
 08-103906-00 0.40mm
 08-103908-00 0.60mm
 08-103910-00 0.80mm
 3.50  MO P
 2.50  P
 4.00  CR P

14-021361-00 D B 107.02 C 198.00 D 110.87 E 5.00
 14-021362-00 D B 107.14 C 198.00 D 110.87 E 5.00
 14-021363-00 D B 107.44 C 198.00 D 110.87 E 5.00
 14-021491-00 D B 107.01 C 198.00 D 109.87 E 5.00
 14-021492-00 D B 107.05 C 198.00 D 109.87 E 5.00
 14-021493-00 D B 107.17 C 198.00 D 109.87 E 5.00
 14-021494-00 D B 107.47 C 198.00 D 109.87 E 5.00
 14-024781-00 D B 107.02 C 198.00 D 109.95 E 5.00

AK HA RT TP

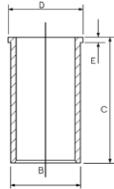
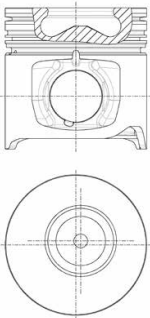

14-010940-00 D B 107.00 C 198.00
 14-010941-10 D B 107.10 C 198.00
 14-010943-10 D B 107.52 C 198.00

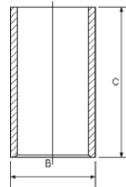

33  **104.00**

8040.25.000	4 Cyl.	17:1	3908cc	74-85kW (101-116PS)	Diesel Turbo	TD21461
8040.25.200	4 Cyl.	17:1	3908cc	85kW (115PS)	Diesel	TD7272
8040.25.200	4 Cyl.	17:1	3908cc	85kW (116PS)	Diesel Turbo	TD10407
8040.25.220	4 Cyl.	17:1	3908cc	85kW (115PS)	Diesel	TD7280
8040.25.220	4 Cyl.	17:1	3908cc	85kW (116PS)	Diesel Turbo	TD10416
8040.25.230	4 Cyl.	17:1	3908cc	74kW (101PS)	Diesel	TD7271
8060.25.600	6 Cyl.	16.5:1	5868cc	130kW (177PS)	Diesel Turbo	TD10473
8060.25.600	6 Cyl.	16.5:1	5861cc	130kW (175PS)	Diesel	TD7301
8060.25.621	6 Cyl.	17:1	5861cc	110kW (150PS)	Diesel	TD7243
8060.25.630	6 Cyl.	17:1	5861cc	100kW (135PS)	Diesel	TD5604
8060.25.631	6 Cyl.	17:1	5861cc	100kW (135PS)	Diesel	TD5943
8060.25.641	6 Cyl.	17:1	5861cc	103kW (140PS)	Diesel	TD7242
8060.25.662	6 Cyl.	17:1	5861cc	96kW (130PS)	Diesel	TD5599



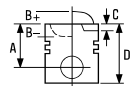



8060.25.663	6 Cyl.	17:1	5861cc	88-96kW (118-131PS)	Diesel	TD5936
8060.25.669	6 Cyl.	16.5:1	5861cc	125kW (170PS)	Diesel Turbo	TD10459
8060.25.670	6 Cyl.	16.5:1	5861cc	125kW (170PS)	Diesel Turbo	TD10453
8060.25.673	6 Cyl.	17:1	5861cc	96kW (130PS)	Diesel	TD5938
8060.25.678	6 Cyl.	17:1	5861cc	130kW (177PS)	Diesel Turbo	TD10466
8060.25.679	6 Cyl.	17:1	5861cc	130kW (177PS)	Diesel Turbo	TD10467
8061.25	6 Cyl.		5868cc	114kW (155PS)	Diesel Turbo	FM24133

87-244500-10 **STD**

A 65.15
B- 22.50
BØ 54.50
D 104.15
 38x85

08-244500-00 **STD**

3.00  **CR P**
 2.50  **P**
 4.00  **CR P**

14-021361-00 D **B** 107.02 **C** 198.00 **D** 110.87 **E** 5.00
14-021362-00 D **B** 107.14 **C** 198.00 **D** 110.87 **E** 5.00
14-021363-00 D **B** 107.44 **C** 198.00 **D** 110.87 **E** 5.00
14-021491-00 D **B** 107.01 **C** 198.00 **D** 109.87 **E** 5.00
14-021492-00 D **B** 107.05 **C** 198.00 **D** 109.87 **E** 5.00
14-021493-00 D **B** 107.17 **C** 198.00 **D** 109.87 **E** 5.00
14-021494-00 D **B** 107.47 **C** 198.00 **D** 109.87 **E** 5.00
14-024781-00 D **B** 107.02 **C** 198.00 **D** 109.95 **E** 5.00

AK RT TP

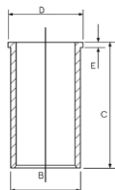
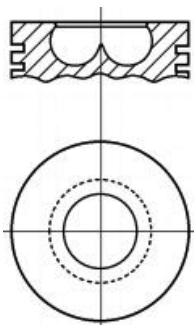

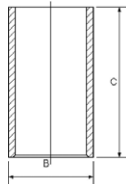

14-010940-00 D **B** 107.00 **C** 198.00
14-010941-10 D **B** 107.10 **C** 198.00
14-010943-10 D **B** 107.52 **C** 198.00



87-244500-30 **STD**

A 65.15
B- 20.88
BØ 54.50
D 104.15
 38x85

08-244500-00 **STD**

3.00  **CR P**
 2.50  **P**
 4.00  **CR P**

AK RT TP

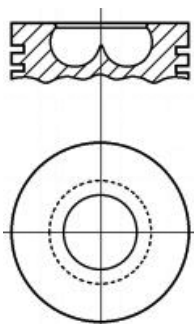

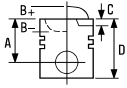





34  **104.00**

8040.45.400	4 Cyl.	17:1	3908cc	100kW (136PS)	Diesel Turbo Intercooled	TD10405
8060.25R.4200	6 Cyl.	17.7:1	5861cc	105kW (143PS)	Diesel	TD7276
8060.25R.4200 LTC	6 Cyl.	17.7:1	5861cc	105kW (143PS)	Diesel Turbo Intercooled	TD10415
8060.25R.4280	6 Cyl.	17.7:1	5861cc	105kW (143PS)	Diesel	TD7302
8060.45 Euro 1	6 Cyl.	17:1	5861cc	152kW (207PS)	Diesel Turbo Intercooled	TD27439
8060.45.4100 Euro 1	6 Cyl.	17:1	5861cc	152kW (207PS)	Diesel Turbo Intercooled	TD10497
8060.45.4100 TCA Euro 1	6 Cyl.	17:1	5861cc	152kW (207PS)	Diesel Turbo	TD10455
8060.45.4700	6 Cyl.	17:1	5861cc	152kW (207PS)	Diesel Turbo	TD10913
8060.45.600	6 Cyl.	17:1	5861cc	152kW (207PS)	Diesel	TD7295

87-103900-00 STD
87-103908-00 0.60mm

A 65.33
B- 22.10
BØ 54.40
D 104.33
 38x85

08-103900-00 STD
08-103906-00 0.40mm
08-103908-00 0.60mm
08-103910-00 0.80mm

3.50  MO P
2.50  P
4.00  CR P

14-021361-00 D B 107.02 C 198.00 D 110.87 E 5.00
14-021362-00 D B 107.14 C 198.00 D 110.87 E 5.00
14-021363-00 D B 107.44 C 198.00 D 110.87 E 5.00
14-021491-00 D B 107.01 C 198.00 D 109.87 E 5.00
14-021492-00 D B 107.05 C 198.00 D 109.87 E 5.00
14-021493-00 D B 107.17 C 198.00 D 109.87 E 5.00
14-021494-00 D B 107.47 C 198.00 D 109.87 E 5.00
14-024781-00 D B 107.02 C 198.00 D 109.95 E 5.00

AK RT TP

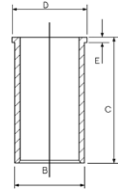
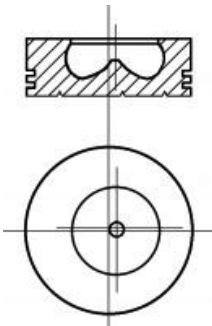

14-010940-00 D B 107.00 C 198.00
14-010941-10 D B 107.10 C 198.00
14-010943-10 D B 107.52 C 198.00

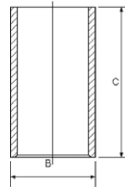

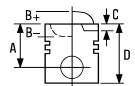

35  **104.00**

8040.45.5200 Euro 2	4 Cyl.	18:1	3908cc	100kW (136PS)	Diesel Turbo Intercooled	TD20439
8040.45D.5100 Euro 2	4 Cyl.	18:1	3908cc	85-100kW (116-136PS)	Diesel Turbo Intercooled	TD20440
8060.45B 5100 Euro 2	6 Cyl.	18:1	5861cc	130-152kW (177-207PS)	Diesel Turbo Intercooled	TD20415
8060.45B Euro 2	6 Cyl.	18:1	5861cc	130kW (177PS)	Diesel Turbo Intercooled	TD27442



87-103900-10 STD

- A** 65.30
- B-** 21.70
- BØ** 52.00
- D** 104.30
-  38x85

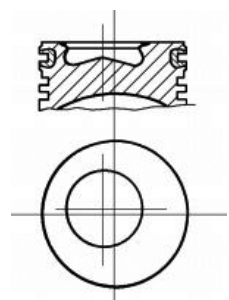
AK RT TP



- 08-103900-00** STD
- 08-103906-00** 0.40mm
- 08-103908-00** 0.60mm
- 08-103910-00** 0.80mm

- 3.50  MO P
- 2.50  P
- 4.00  CR P

- 14-021361-00 D** B 107.02 C 198.00 D 110.87 E 5.00
- 14-021362-00 D** B 107.14 C 198.00 D 110.87 E 5.00
- 14-021363-00 D** B 107.44 C 198.00 D 110.87 E 5.00
- 14-021491-00 D** B 107.01 C 198.00 D 109.87 E 5.00
- 14-021492-00 D** B 107.05 C 198.00 D 109.87 E 5.00
- 14-021493-00 D** B 107.17 C 198.00 D 109.87 E 5.00
- 14-021494-00 D** B 107.47 C 198.00 D 109.87 E 5.00
- 14-024781-00 D** B 107.02 C 198.00 D 109.95 E 5.00

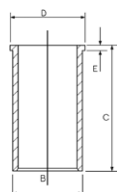

- 14-010940-00 D** B 107.00 C 198.00
- 14-010941-10 D** B 107.10 C 198.00
- 14-010943-10 D** B 107.52 C 198.00

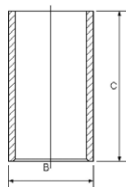

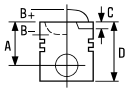





36  **104.00**

8040.45X.4180	4 Cyl.	3908cc	100kW (136PS)	Diesel Turbo Intercooled	TD20441
8060.45R.5000 Euro 2	6 Cyl. 17:1	5861cc	105kW (143PS)	Diesel Turbo	TD16717

87-103900-30 STD

A 65.33
 B- 21.40
 BØ 48.10
 D 104.33
 38x85

08-103900-00 STD
 08-103906-00 0.40mm
 08-103908-00 0.60mm
 08-103910-00 0.80mm

3.50  MO P
 2.50  P
 4.00  CR P

14-021361-00 D B 107.02 C 198.00 D 110.87 E 5.00
 14-021362-00 D B 107.14 C 198.00 D 110.87 E 5.00
 14-021363-00 D B 107.44 C 198.00 D 110.87 E 5.00
 14-021491-00 D B 107.01 C 198.00 D 109.87 E 5.00
 14-021492-00 D B 107.05 C 198.00 D 109.87 E 5.00
 14-021493-00 D B 107.17 C 198.00 D 109.87 E 5.00
 14-021494-00 D B 107.47 C 198.00 D 109.87 E 5.00
 14-024781-00 D B 107.02 C 198.00 D 109.95 E 5.00

AK RT TP

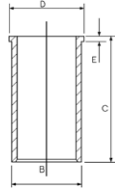
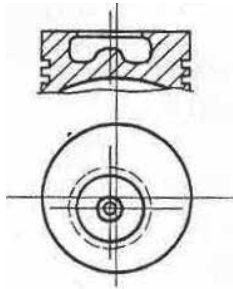

14-010940-00 D B 107.00 C 198.00
 14-010941-10 D B 107.10 C 198.00
 14-010943-10 D B 107.52 C 198.00

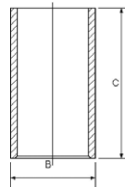



37  **104.00**

8065.25	6 Cyl. 16.5:1	5863cc	103-105kW (140-143PS)	Diesel	TD25475
---------	---------------	--------	-----------------------	--------	---------

87-244500-40 STD

A 65.15
 B- 22.50
 BØ 54.45
 D 108.50
 38x89

08-244500-00 STD

3.00  CR P
 2.50  P
 4.00  CR P

14-021361-00 D B 107.02 C 198.00 D 110.87 E 5.00
 14-021362-00 D B 107.14 C 198.00 D 110.87 E 5.00
 14-021363-00 D B 107.44 C 198.00 D 110.87 E 5.00
 14-021491-00 D B 107.01 C 198.00 D 109.87 E 5.00
 14-021492-00 D B 107.05 C 198.00 D 109.87 E 5.00
 14-021493-00 D B 107.17 C 198.00 D 109.87 E 5.00
 14-021494-00 D B 107.47 C 198.00 D 109.87 E 5.00
 14-024781-00 D B 107.02 C 198.00 D 109.95 E 5.00

AK RT

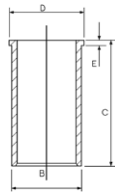
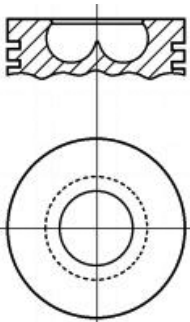

14-010940-00 D B 107.00 C 198.00
 14-010941-10 D B 107.10 C 198.00
 14-010943-10 D B 107.52 C 198.00

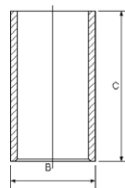

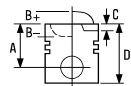







38  **108.00**

C02/C03 D/C055 4 Cyl. 16:1 **4397cc** Diesel **FM21303**

CO2 D 4 Cyl. 16:1 **4397cc** Diesel **FM1303**

87-528100-00 STD **08-528100-00** STD **14-630100-00 WH** B 116.00 C 243.00 D 128.00 E 150.00 F 1.00 **88-528100-00**
87-528100-00 +
14-630100-00

A 80.20
B- 26.50
BØ 49.00
D 145.20
 38x89

2.50  CR P
2.50  P
2.50  P
2.50  P
5.00  P
5.00  P

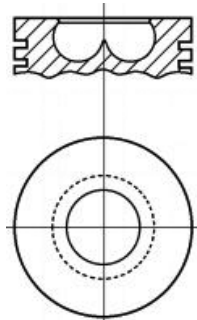
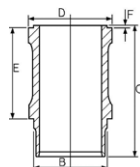





39  **110.00**

C 03 4 Cyl. 16:1 **4940cc** 55-67kW (75-91PS) Diesel **TD6844**

C 21/C20/C41/CO3/CO40 4 Cyl. 17:1 **4562cc** Diesel **FM1307**

87-207500-00 STD **08-207500-00** STD **14-611250-00 WH** B 118.00 C 237.00 D 129.50 E 170.00 F 1.00 **88-207500-00**
87-207500-00 +
14-611250-00

A 75.20
B- 27.50
BØ 51.00
D 150.20
 40x94

2.50  CR P
2.50  P
2.50  P
5.00  CR P

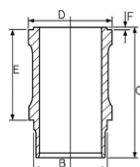

14-615230-00 WH B 118.00 C 236.00 D 129.50 E 170.00 F 1.00

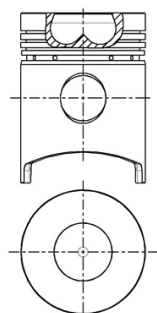
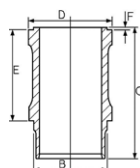



40  **110.00**



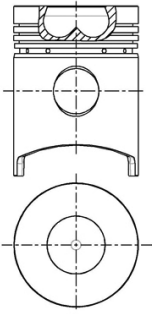

CN3	3 Cyl.	3706cc	Diesel	FM4028
C03/C70/C100	4 Cyl.	4941cc	Diesel	FM4029
CP 3	6 Cyl. 16:1	7412cc 107kW (145PS)	Diesel	TD6861
CP 3/32.1.200	6 Cyl. 16:1	7412cc 107-110kW (145-150PS)	Diesel	TD6855

87-207500-10 STD

- A** 70.20
- B-** 28.00
- BØ** 55.00
- D** 140.20
-  40x94



08-207500-00 STD

- 2.50  CR P
- 2.50  P
- 2.50  P
- 5.00  CR P

14-611250-00 WH B 118.00 C 237.00 D 129.50 E 170.00 F 1.00

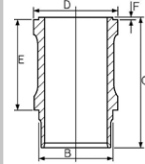



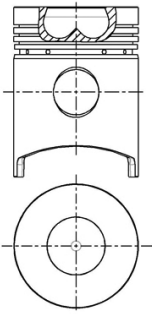

88-207500-10
87-207500-10 +
14-611250-00

87-207500-30 STD

- A** 70.20
- B-** 28.00
- BØ** 55.00
- D** 140.20
-  40x94



08-207500-00 STD

- 2.50  CR P
- 2.50  P
- 2.50  P
- 5.00  CR P

14-611250-00 WH B 118.00 C 237.00 D 129.50 E 170.00 F 1.00

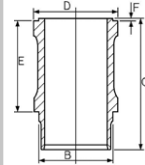

88-207500-30
87-207500-30 +
14-611250-00

RT

14-615230-00 WH B 118.00 C 236.00 D 129.50 E 170.00 F 1.00

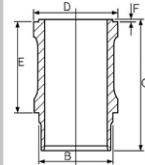

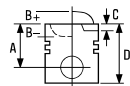

41 112.00

8360.46	6 Cyl.	17:1	7685cc	196kW (267PS)	Diesel Turbo	TD27452
8360.46B.4591	6 Cyl.	17:1	7684cc	162-196kW (220-267PS)	Diesel	TD24862
8360.46R.416 (TCA)	6 Cyl.	17:1	7685cc	176kW (239PS)	Diesel Turbo Intercooled	TD10511

87-142900-00	STD	08-142900-00	STD	14-740060-00 <i>WH</i>	B 120.50 C 232.00 D 128.90 E 87.00	88-142900-00 87-142900-00 + 14-740060-00
A 76.50		3.50		CK P		
B- 25.00		2.50	CR P			
BØ 52.00		4.00	CR P			
D 126.50						
42x93						

AK KK RT TP

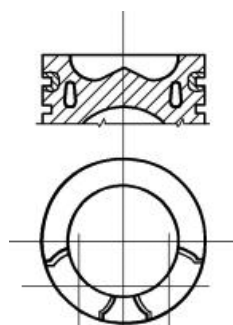

Euro 1

Euro 1

Euro 1

Euro 1

Euro 1

42 115.00

8340.04.040	4 Cyl.	17:1	4570cc	73kW (99PS)	Diesel	TD10400
8340.04.200	4 Cyl.	17:1	4570cc	74kW (101PS)	Diesel	TD10392
8340.04.250	4 Cyl.	17:1	4570cc	74kW (101PS)	Diesel	TD10393
8340.04.300	4 Cyl.	17:1	4570cc	74kW (101PS)	Diesel	TD10394
8340.04.350	4 Cyl.	17:1	4570cc	74kW (101PS)	Diesel	TD10395
8360.04	6 Cyl.		6855cc	106kW (145PS)	Diesel	FM3523
8361.04	6 Cyl.		6850cc	106kW (145PS)	Diesel	FM4951
8340.04.362	B4 Cyl.	17:1	4570cc	74kW (101PS)	Diesel	TD10396

87-523000-10	STD	08-523000-00	STD	14-610020-00 <i>WH</i>	B 122.00 C 215.00 D 129.70 E 147.00	88-523000-10 87-523000-10 + 14-610020-00
A 76.50		2.50		CR P		
B- 27.00		2.50	P			
BØ 51.80		4.00	CR P			
D 140.50						
42x97						

RT

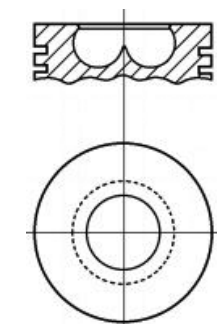

Liner with "anti-cavitation" galvanized exterior

Laufbüchse mit "hohlraumfreiem", verzinktem Äußerem

Chemise à extérieur galvanisé "anti-cavitation"

Camisa con exterior galvanizado "anticavitación"

Canna con esterno zincato "anticavitazione"



43  **115.00**

8340.05	4 Cyl.	17:1	5401cc	63kW (86PS)	Diesel	TD6849
8340.05.200	4 Cyl.	17:1	5401cc	84kW (114PS)	Diesel	TD10410
8360.05	6 Cyl.	17:1	8100cc	95-124kW (129-169PS)	Diesel	TD6854
8360.05.200	6 Cyl.	17:1	8100cc	124kW (169PS)	Diesel	TD10484
8360.05.254	6 Cyl.	17:1	8100cc	124kW (169PS)	Diesel	TD10488
8360.05.673	6 Cyl.	17:1	8100cc	118-121kW (160-165PS)	Diesel	TD10494
8360.05.B	6 Cyl.	17:1	8100cc	95-110kW (129-150PS)	Diesel	TD6856
8361.05	6 Cyl.	17:1	8102cc	118kW (160PS)	Diesel	FM4952
8365.05.500	6 Cyl.	17:1	8101cc	114kW (155PS)	Diesel	TD25353
8365.05.520	6 Cyl.	17:1	8101cc	104kW (141PS)	Diesel	TD25354
8365.05.530	6 Cyl.	17:1	8101cc	99kW (135PS)	Diesel	TD25355
8365.05.531	6 Cyl.	17:1	8101cc	104kW (141PS)	Diesel	TD25356
8365.05.555	6 Cyl.	17:1	8101cc	96kW (130PS)	Diesel	TD25357
8365.05.560	6 Cyl.	17:1	8101cc	94kW (128PS)	Diesel	TD25358
8365.05.570	6 Cyl.	17:1	8101cc	94kW (128PS)	Diesel	TD25359
8365.05.580	6 Cyl.	17:1	8101cc	94kW (128PS)	Diesel	TD25360
8365.05.590	6 Cyl.	17:1	8101cc	94kW (128PS)	Diesel	TD25361



87-523000-00 STD

- A 76.50
- B- 29.40
- BØ 54.00
- D 140.50
-  42x97

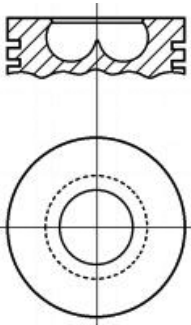
RT



08-523000-00 STD

- 2.50  CR P
- 2.50  P
- 4.00  CR P

14-684840-00 WH B 122.00 C 235.00 D 129.70 E 167.00

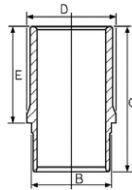

88-523000-00
87-523000-00 +
14-684840-00

14-633860-00 WH B 122.00 C 235.00 D 129.90 E 167.00

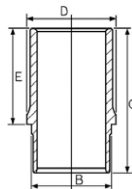

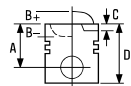

44  **115.00**

8361.25.510 6 Cyl. 8101cc Diesel FM19113

8361.45.530-836 L 6 Cyl. 8101cc Diesel Turbo Intercooled FM9113

87-245500-10 STD

STD

08-245500-00

STD



14-684840-00 WH

B 122.00 C 235.00 D 129.70 E 167.00

88-245500-10

87-245500-10 +
14-684840-00

- A 76.50
- B- 27.70
- BØ 59.00
- D 140.50
-  42x97

- 3.00  CR P
- 2.50  P
- 4.00  CR P

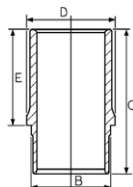

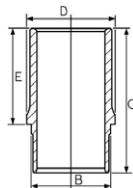

14-633860-00 WH

B 122.00 C 235.00 D 129.90 E 167.00

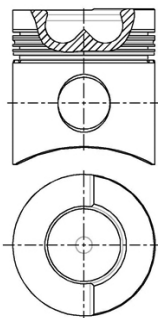

RT



45  **115.00**

C 03-130T 4 Cyl. 5401cc Diesel FM4030

8365.25.500 6 Cyl. 15.5:1 8102cc 132kW (180PS) Diesel Turbo TD18678

8365.25.501 6 Cyl. 15.5:1 8102cc 118kW (160PS) Diesel Turbo TD18679

8365.25.502 6 Cyl. 15.5:1 8102cc 118-133kW (160-181PS) Diesel Turbo TD18680

8365.25.503 6 Cyl. 15.5:1 8102cc 118kW (160PS) Diesel Turbo TD18681

8365.25.533 6 Cyl. 15.5:1 8102cc 133kW (181PS) Diesel Turbo TD18682

14-633860-00 WH B 122.00 C 235.00 D 129.90 E 167.00

14-684840-00 WH B 122.00 C 235.00 D 129.70 E 167.00

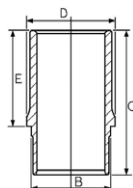

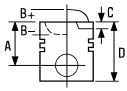

46  **115.00**

F2BE 0681 A Euro 2 Cursor 8-350	6 Cyl.	17:1	7790cc	259kW (352PS)	Diesel Turbo Intercooled	TD10828
F2BE 0681 B Euro 2 Cursor 8-310	6 Cyl.	17:1	7790cc	228kW (310PS)	Diesel Turbo Intercooled	TD10829
F2BE 0681 C Euro 2 Cursor 8-270 I	6 Cyl.	17:1	7790cc	200kW (272PS)	Diesel Turbo Intercooled	TD10832
F2BE 0681 D Euro 2 Cursor 8-240	6 Cyl.	17:1	7790cc	180kW (245PS)	Diesel Turbo Intercooled	TD10833
F2BE 0681 E Euro 2 Cursor 8-300	6 Cyl.	17:1	7790cc	218kW (296PS)	Diesel Turbo Intercooled	TD10830
F2BE 0681 F Euro 2 Cursor 8-270 R	6 Cyl.	17:1	7790cc	200kW (272PS)	Diesel Turbo Intercooled	TD10831
F2BE0681DA Euro 2 Cursor 8	6 Cyl.	17:1	7790cc	180kW (245PS)	Diesel Turbo Intercooled	TD28228
F2BE0681DB Euro 2 Cursor 8	6 Cyl.	17:1	7790cc	180kW (245PS)	Diesel Turbo Intercooled	TD28229



87-121800-10 STD

- A** 72.10
- B-** 21.50
- BØ** 60.00
- D** 117.10
-  46x96

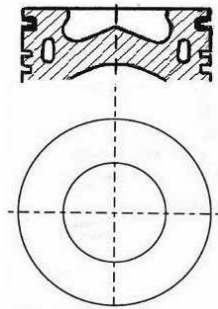
KK RT TP



08-121800-00 STD

- 3.00  CR P
- 2.50  CR P
- 4.00  CR P

14-260070-00 WH B 128.50 C 211.10 D 136.50 E 8.90 F 1.20

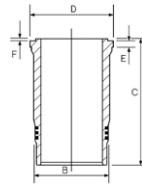

47  **115.00**

F2BE 0681 A/B/C/D/F Euro 3	6 Cyl.	7790cc	180-259kW (245-352PS)	Diesel Turbo Intercooled	FM15537
F2BE1682 G Euro 3	6 Cyl.	7790cc	228-259kW (310-352PS)	Diesel Turbo Intercooled	TD20019

87-121800-00 STD

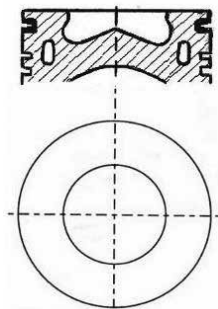

- A** 72.10
- B-** 19.30
- BØ** 59.30
- D** 117.10
-  46x96

AK HA KK RT TP



11570-101

08-121800-00 STD

- 3.00  CR P
- 2.50  CR P
- 4.00  CR P

14-260070-00 WH B 128.50 C 211.10 D 136.50 E 8.90 F 1.20

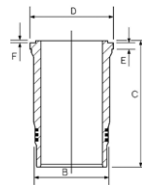

88-121800-00
87-121800-00 +
14-260070-00

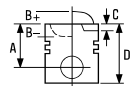

48  **117.00**

F2CE0681A Cursor 9	6 Cyl.	8708cc	294kW (400PS)	Diesel Turbo Intercooled	TD25715
F2CE0682A Cursor 9	6 Cyl.	8708cc	294kW (400PS)	Diesel Turbo Intercooled	TD25716
F2CE0683A Cursor 9	6 Cyl.	8708cc	294kW (400PS)	Diesel Turbo Intercooled	TD25717
F2CE0684A Cursor 9	6 Cyl.	8708cc	294kW (400PS)	Diesel Turbo Intercooled	TD25718

87-428800-00 STD

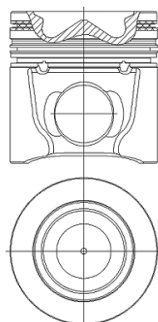

- A** 80.00
- B-** 20.70
- BØ** 65.60
- D** 125.50
-  52x93

AK KK RT TP



11701A423

08-428800-00 STD

- 3.00  GDC P
- 2.50  NT
- 4.00  CR P



49  **120.00**

8460.21.002	6 Cyl.	16:1	9500cc	177kW (241PS)	Diesel Turbo	TD10502
8460.21.042/8460.21.106/8460.21.708/8460.21.710	6 Cyl.		9500cc	177kW (240PS)	Diesel Turbo	FM4130
8460.21.102	6 Cyl.	16:1	9500cc	191kW (260PS)	Diesel Turbo	TD10521



87-785300-00 STD

- A** 84.70
- B-** 22.60
- BØ** 72.20
- D** 134.70
-  48x108

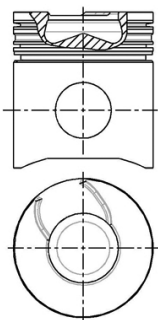
KK RT



08-785300-00 STD

- 3.50  CR P
- 3.00  CR P
- 5.00  CR P

14-450880-00 **WH**  **B** 134.00 **C** 250.00 **D** 144.80 **E** 10.02 **F** 1.00

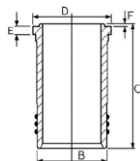

88-785300-00
87-785300-00 +
14-450880-00

 Nitrided

 Nitriet

 Nitridé

 Nitruado

 Nitruato



50  **120.00**

8460.21.002	6 Cyl.	16:1	9498cc	154-192kW (209-261PS)	Diesel	TD24863
8460.21.010	6 Cyl.	16:1	9500cc	177kW (241PS)	Diesel Turbo	TD10503
8460.21.202	6 Cyl.	16:1	9500cc	177kW (241PS)	Diesel Turbo	TD10518
8460.21.206	6 Cyl.	16:1	9500cc	177kW (241PS)	Diesel Turbo	TD10519
8460.21.601	6 Cyl.	16:1	9498cc	191kW (260PS)	Diesel Turbo	TD20435
8460.21.611	6 Cyl.	16:1	9498cc	154kW (209PS)	Diesel Turbo	TD20436
8460.41 M	6 Cyl.	17:1	9500cc	278kW (378PS)	Diesel Turbo Intercooled	TD7250
8460.41 T	6 Cyl.	15:1	9500cc	185kW (251PS)	Diesel	TD24262
8460.41.102	6 Cyl.	16:1	9500cc	234kW (318PS)	Diesel Turbo Intercooled	TD10548
8460.41.124	6 Cyl.	16:1	9500cc	234kW (318PS)	Diesel Turbo Intercooled	TD10599
8460.41.160	6 Cyl.	15:1	9500cc	236kW (321PS)	Diesel Turbo Intercooled	TD10547
8460.41S.733	6 Cyl.	16.8:1	9498cc	254kW (345PS)	Diesel	TD24865

14-450880-00 WH  B 134.00 C 250.00 D 144.80 E 10.02 F 1.00

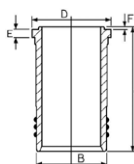

 Nitrided

 Nitriert

 Nitridé

 Niturado

 Nitrurato

51  **120.00**

8460.21B.613/8460.21B.615	6 Cyl.		9500cc	162kW (220PS)	Diesel	FM19114
8460.41 R	6 Cyl.	17:1	9500cc	214-276kW (290-375PS)	Diesel Turbo Intercooled	TD7248
8460.41 S	6 Cyl.	15:1	9500cc	254kW (345PS)	Diesel	TD7249
8460.41C	6 Cyl.	16.8:1	9500cc	221kW (301PS)	Diesel Turbo	TD10807
8460.41C (TCA)	6 Cyl.	17:1	9500cc	221kW (301PS)	Diesel Turbo Intercooled	TD10595
8460.41C.320	6 Cyl.	16.8:1	9500cc	221kW (301PS)	Diesel Turbo	TD10512
8460.41K Euro 2	6 Cyl.	16.8:1	9500cc	254kW (345PS)	Diesel Turbo	TD10808
8460.41K. TCA Euro 1	6 Cyl.	16.8:1	9500cc	254kW (345PS)	Diesel Turbo Intercooled	TD7342
8460.41K.406	6 Cyl.	16.8:1	9500cc	254kW (345PS)	Diesel Turbo	TD10513
8460.41K.410	6 Cyl.	16.8:1	9500cc	254kW (345PS)	Diesel Turbo	TD10709



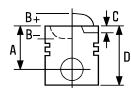





8460.41L (TCA) 6 Cyl. 16.8:1 **9500cc** **276kW (375PS)** **Diesel Turbo** **TD10573**

8460.41L.5020 6 Cyl. 16.8:1 **9500cc** **276kW (375PS)** **Diesel Turbo** **TD10514**

87-785300-10 STD **08-785300-00** STD **14-450880-00** *WH* **B 134.00 C 250.00 D 144.80 E 10.02 F 1.00** **88-785300-10**

A 84.70
B- 27.00
BØ 59.50
D 134.70
 48x96

3.50  CR P
 3.00  CR P
 5.00  CR P

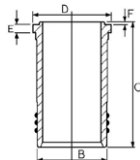

87-785300-10 +
 14-450880-00

AK HA KK NB RT

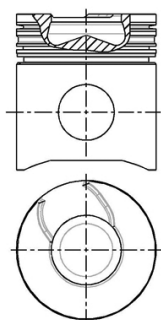

 Nitrided

 Nitriert

 Nitridé

 Niturado

 Nitratato

52  **122.00**

8200.02 6 Cyl. **9820cc** **Diesel** **FM9108**

8200.02.220 6 Cyl. 16.7:1 **9820cc** **147kW (200PS)** **Diesel** **TD6935**





8200.12 6 Cyl. **9820cc** **Diesel** **FM9109**

8200.12.000 6 Cyl. 16.7:1 **9820cc** **140kW (190PS)** **Diesel** **TD6906**

8205.02 6 Cyl. 16.7:1 **9820cc** **Diesel** **FM3500**

87-207700-00 STD **08-207700-00** STD **14-020200-00** *D* **B 128.00 C 252.00 D 132.00 E 6.00**

A 80.20
B- 28.00
BØ 66.50
D 150.00
 42x104

3.50  CR P
 3.00  P
 3.00  P
 5.50  CR P

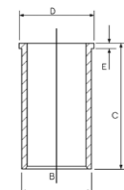

RT

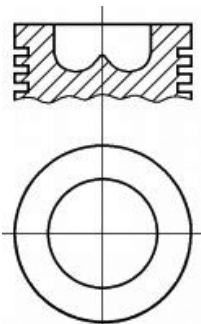

 Nitrided

 Nitriert

 Nitridé

 Niturado

 Nitratato

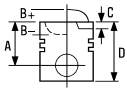

53  **125.00**

8200.03	6 Cyl.	16.7:1	10308cc	Diesel	FM595
8200.13	6 Cyl.	16.7:1	10308cc	Diesel	FM9110
8205.03	6 Cyl.	16.7:1	10308cc	Diesel	FM595

87-527900-00 STD

08-527900-00 STD

14-021580-00 DH ¹ B 130.02 C 252.00 D 136.00 E 6.00

A 80.20
 B- 30.00
 BØ 68.40
 D 150.00
 44x106

3.50
 3.00
 3.00
 5.50



CR P
 P
 CR

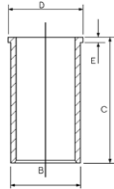

RT

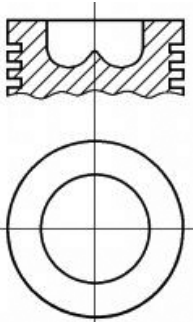

¹ Nitrided

¹ Nitriert

¹ Nitridé

¹ Nitrurado

¹ Nitrurato

54  **125.00**

8220.02.701	6 Cyl.	17:1	9572cc	148kW (201PS)	Diesel	TD7252
8220.02.834	6 Cyl.	17:1	9572cc	148kW (201PS)	Diesel	TD7361
8220.02.847	6 Cyl.	17:1	9572cc	151kW (205PS)	Diesel	TD6866
8220.02.856	6 Cyl.	17:1	9572cc	151kW (205PS)	Diesel	TD6867
8220.02.870	6 Cyl.	17:1	9572cc	148kW (201PS)	Diesel	TD7327
8220.02.870	6 Cyl.	17:1	9572cc	148kW (201PS)	Diesel	TD10517
8220.12	6 Cyl.		9572cc	148kW (201PS)	Diesel	FM4020
8220.12.709	6 Cyl.	17:1	9572cc	149kW (203PS)	Diesel	TD7370

87-528200-00 STD

08-528200-00 STD

14-459010-00 WH ¹ ² B 133.50 C 241.00 D 145.00 E 164.00

A 83.50
 B- 31.80
 BØ 59.00
 D 151.50
 46x106

3.00
 3.00
 5.50



CR P
 P
 CR

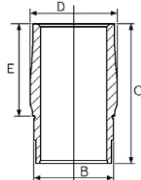

RT

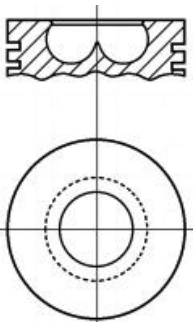

¹ Nitrided

¹ Nitriert

¹ Nitridé

¹ Nitrurado

¹ Nitrurato

² "Anti-cavitation" galvanized exterior

² "Hohlraumfreier" Außenverzinkung

² Galvanisage extérieure "anti-cavitation"

² Exterior galvanizado "anticavitación"

² Esterno galvanizzato "Anti-cavitation"

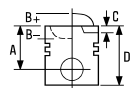

55  **125.00**

8220.22.002	6 Cyl.	15.6:1	9572cc	177kW (240PS)	Diesel Turbo	TD5618
8220.22.002	6 Cyl.	15.6:1	9572cc	177kW (241PS)	Diesel Turbo	TD10495
8220.22.102	6 Cyl.	15.6:1	9572cc	177kW (240PS)	Diesel Turbo	TD5601
8220.22.102	6 Cyl.	15.6:1	9572cc	177kW (241PS)	Diesel Turbo	TD10496
8220.22.104	6 Cyl.	15.6:1	9572cc	177kW (240PS)	Diesel Turbo	TD5940
8220.22.106	6 Cyl.	15.6:1	9572cc	177kW (240PS)	Diesel Turbo	TD6258
8220.22.708	6 Cyl.	15.6:1	9570cc	177kW (240PS)	Diesel Turbo	TD5640
8220.22.709	6 Cyl.	15.6:1	9570cc	177kW (240PS)	Diesel Turbo	TD5981
8220.32	6 Cyl.		9572cc	177kW (240PS)	Diesel Turbo	FM9115
8220.32.701	6 Cyl.	15.6:1	9572cc	177kW (240PS)	Diesel Turbo	TD7379
8220.32.721	6 Cyl.	15.6:1	9570cc	177kW (240PS)	Diesel Turbo	TD7380
8220.32.723	6 Cyl.	15.6:1	9570cc	177kW (240PS)	Diesel Turbo	TD7373

87-781000-00

STD

08-781000-00

STD

14-459010-00 WH ¹ ² B 133.50 C 241.00 D 145.00 E 164.00

A 83.60
 B- 28.60
 BØ 65.80
 D 151.60
 46x106

4.00
 3.00
 3.00
 4.00



CR P
 P
 P
 CR P

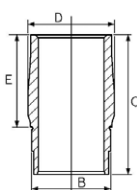

RT

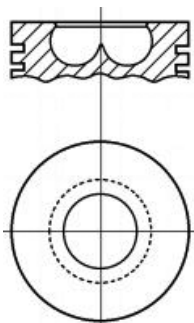





- ¹ Nitrided ¹ Nitriert ¹ Nitridé ¹ Nitrurado ¹ Niturato
- ² "Anti-cavitation" galvanized exterior ² "Hohlraumfreier" Außenverzinkung ² Galvanisage extérieur "anti-cavitation" ² Exterior galvanizado "anticavitación" ² Esterno galvanizzato "Anti-cavitation"





56  **125.00**

F3AE 0681 B Euro 3 Cursor 10-400	6 Cyl.	17:1	10300cc	294kW (400PS)	Diesel Turbo Intercooled	TD16551
F3AE 0681 D Euro 2 Cursor 10-430	6 Cyl.	17:1	10300cc	316kW (430PS)	Diesel Turbo Intercooled	TD14970
F3AE 0681 E Euro 2 Cursor 10-390	6 Cyl.	17:1	10300cc	287kW (390PS)	Diesel Turbo Intercooled	TD14968
F3AE0681H Euro 3	6 Cyl.	17:1	10300cc	294kW (400PS)	Diesel Turbo Intercooled	TD24541

87-121900-00 STD
A 85.50
B- 21.20
BØ 88.00
D 133.50
 50x101

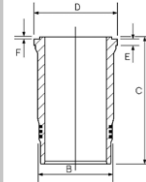
08-121900-00 STD
 3.50  CK P
 3.00  CR P
 4.00 



15-260040-00 WH  **B 141.00 C 239.00 D 150.60 E 9.96 F 1.20**
89-121900-30
 87-121900-00 +
 15-260040-00

AK KK RT TP

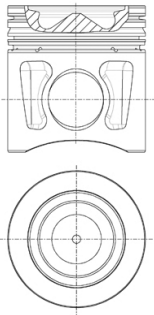



 Includes seals

 Schließt Dichtungen ein

 Inclut des joints

 Incluye los sellos

 Comprende le guarnizioni

57  **125.00**

F3AE3681D Euro 4/5 Cursor 10 E 42	6 Cyl.	17:1	10300cc	310kW (422PS)	Diesel Turbo Intercooled	TD24603
15-260040-00 WH  B 141.00 C 239.00 D 150.60 E 9.96 F 1.20						

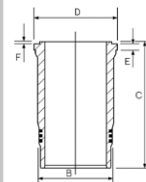

 Includes seals

 Schließt Dichtungen ein

 Inclut des joints

 Incluye los sellos

 Comprende le guarnizioni

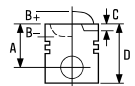

58  **130.00**

203 A/61	6 Cyl.	16:1	11548cc	130-132kW (177-180PS)	Diesel	TD22229
203 H 61	6 Cyl.	16:1	11548cc	132kW (180PS)	Diesel	TD7348
310 H/61	6 Cyl.		11548cc		Diesel	FM3512

87-420100-00 STD **08-420100-00** STD **14-018002-00 D** **B 136.10 C 282.00**
87-420108-00 0.60mm **08-420108-00** 0.60mm

A 92.50
B- 30.00
BØ 61.00
D 200.00
 48x110

4.00
 3.00
 3.00
 5.50

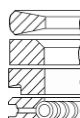

CR P
 P
 P
 P

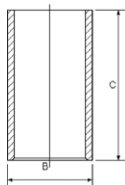

RT

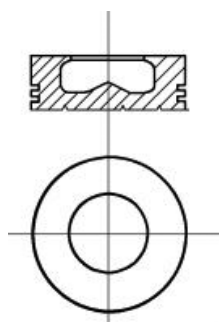

87-420200-00 STD **08-420200-00** STD
87-420208-00 0.60mm **08-420208-00** 0.60mm

A 92.50
B- 30.00
BØ 61.00
D 200.00
 48x110

4.00
 3.00
 3.00
 5.50
 5.50

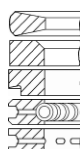

CR P
 P
 P
 P
 P

RT

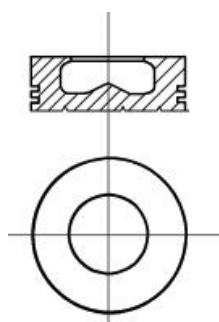

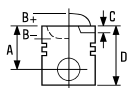

59  **135.00**

F3B3681A Euro 4/5 Cursor 13 E 56	6 Cyl.	16.5:1	12880cc	412kW (560PS)	Diesel Turbo Intercooled	TD20481
F3B3681B Euro 4/5 Cursor 13 E 50	6 Cyl.	16.5:1	12880cc	368kW (500PS)	Diesel Turbo Intercooled	TD20480
F3B3681C Euro 4/5 Cursor 13 E 45	6 Cyl.	16.5:1	12880cc	332kW (450PS)	Diesel Turbo Intercooled	TD20474
F3B3681D Euro 4/5 Cursor 13 E 41	6 Cyl.		12880cc	301kW (410PS)	Diesel Turbo Intercooled	TD20470
F3B3681E Euro 4/5 Cursor 13 E 48	6 Cyl.		12880cc	382kW (520PS)	Diesel Turbo Intercooled	TD20479
F3B3681G Euro 4/5 Cursor 13 E 44	6 Cyl.		12880cc	324kW (440PS)	Diesel Turbo Intercooled	TD20473
F3BE3681A Euro 4/5 Cursor 13	6 Cyl.		12880cc	412kW (560PS)	Diesel Turbo Intercooled	TD20645
F3BE3681B Euro 4/5 Cursor 13 E 50	6 Cyl.		12880cc	368kW (500PS)	Diesel Turbo Intercooled	TD21089
F3BE3681C Euro 4/5 Cursor 13 E 45	6 Cyl.		12880cc	332kW (450PS)	Diesel Turbo Intercooled	TD21057
F3BE3681D Euro 4/5 Cursor 13 E 41	6 Cyl.		12880cc	302kW (410PS)	Diesel Turbo Intercooled	TD20632
F3BE3681E Euro 4/5 Cursor 13	6 Cyl.		12880cc	382kW (520PS)	Diesel Turbo Intercooled	TD20644
F3BE3681F Euro 4/5 Cursor 13	6 Cyl.		12880cc	353kW (480PS)	Diesel Turbo Intercooled	TD20641
F3BE3681G Euro 4/5 Cursor 13 E 44	6 Cyl.		12880cc	324kW (440PS)	Diesel Turbo Intercooled	TD20633

87-428000-00  STD

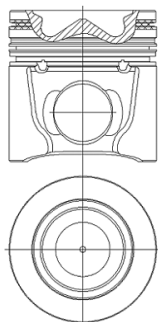

- A 90.40
- B- 23.10
- BØ 94.00
- D 142.40
-  54x107

AK KK NB RT TP





13501B112

08-428000-00 STD

- 3.00  CK P
- 3.00  CR P
- 5.00  CR P

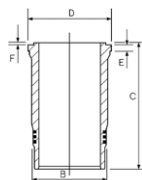
15-260050-00 WH  B 151.00 C 254.00 D 161.60 E 9.96 F 1.20





 Includes seals

 Piston Chamber Volume
[ccm] 99.70

 Schließt Dichtungen ein

 Volumen der Kolbenmulde
[ccm] 99.70

 Inclut des joints

 Volume de la cavité du piston
[cm³] 99.70

 Incluye los sellos

 Volumen de cavidad del pistón
[cc] 99.70

 Comprende le guarnizioni

 Volume camera pistone
[cm³] 99.70

60  **135.00**



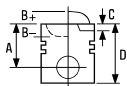

F3BE 0681 A Euro 3 Cursor 13-540	6 Cyl.		12880cc	397kW (540PS)	Diesel Turbo Intercooled	TD16505
F3BE 0681 B Euro 3 Cursor 13-500	6 Cyl.		12880cc	368kW (500PS)	Diesel Turbo Intercooled	TD16550
F3BE 0681 C Euro 3 Cursor 13-440	6 Cyl.		12880cc	324kW (440PS)	Diesel Turbo Intercooled	TD16507
F3BE 0681 D Euro 3 Cursor 13	6 Cyl.		12880cc	330kW (450PS)	Diesel Turbo Intercooled	TD20620
F3BE 0681 E Euro 3 Cursor 13-480	6 Cyl.		12880cc	353kW (480PS)	Diesel Turbo Intercooled	TD16506



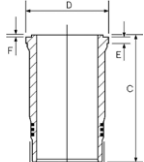

F3BE 0681 F Euro 3 Cursor 13 6 Cyl. **12880cc** **367kW (500PS)** **Diesel Turbo Intercooled** **TD20622**

F3BE 0681 G Euro 3 Cursor 13-380 6 Cyl. **12880cc** **280kW (380PS)** **Diesel Turbo Intercooled** **TD16591**

87-122000-00	STD	08-122000-00	STD	15-260050-00 ¹ WH	B 151.00 C 254.00 D 161.60 E 9.96 F 1.20	89-122000-30
A 90.40		08-122008-00	0.60mm			87-122000-00 + 15-260050-00
B- 23.10		4.00		CK P		
BØ 94.00		3.00		CR P		
D 142.40		5.00		CR P		
 54x107						

AK KK RT TP

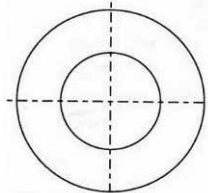
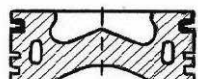

¹ Includes seals

¹ Schließt Dichtungen ein

¹ Inclut des joints

¹ Incluye los sellos

¹ Comprende le guarnizioni

61  **137.00**

8210.02	6 Cyl.	16:1	13798cc	191kW (260PS)	Diesel	TD10598
8210.02.000	6 Cyl.	16:1	13798cc	191kW (260PS)	Diesel	TD6868
8210.02.020	6 Cyl.	16:1	13798cc	191kW (260PS)	Diesel	TD6864
8210.02.022	6 Cyl.	16:1	13798cc	191kW (260PS)	Diesel	TD6877
8210.02.032	6 Cyl.	16:1	13798cc	191kW (260PS)	Diesel	TD6923
8210.02.053	6 Cyl.	16:1	13798cc	191kW (260PS)	Diesel	TD6266
8210.02.067	6 Cyl.	16:1	13798cc	191kW (260PS)	Diesel	TD5622
8210.02.067	6 Cyl.	16:1	13798cc	191kW (260PS)	Diesel	TD10523
8210.02.069	6 Cyl.	16:1	13798cc	191kW (260PS)	Diesel	TD10525
8210.02.069	6 Cyl.	16:1	13798cc	191kW (260PS)	Diesel	TD5959
8210.02.081	6 Cyl.	16:1	13798cc	191kW (260PS)	Diesel	TD6865
8210.02.266	6 Cyl.	16:1	13798cc	191kW (260PS)	Diesel	TD5635
8210.02.267	6 Cyl.	16:1	13798cc	191kW (260PS)	Diesel	TD5976
8210.02.371	6 Cyl.	16:1	13798cc	191kW (260PS)	Diesel	TD10507
8210.02.371	6 Cyl.	16:1	13798cc	191kW (260PS)	Diesel	TD5619
8210.02.373	6 Cyl.	16:1	13798cc	191kW (260PS)	Diesel	TD5621
8210.02.373	6 Cyl.	16:1	13798cc	191kW (260PS)	Diesel	TD10508
8210.02.377	6 Cyl.	16:1	13798cc	191kW (260PS)	Diesel	TD5958
8210.02.377	6 Cyl.	16:1	13798cc	191kW (260PS)	Diesel	TD10509
8210.02.385	6 Cyl.	16:1	13798cc	191kW (260PS)	Diesel	TD6899
8210.02.393	6 Cyl.	16:1	13798cc	191kW (260PS)	Diesel	TD6259
8210.02.393	6 Cyl.	16:1	13798cc	191kW (260PS)	Diesel	TD10510
8210.02.405	6 Cyl.	16:1	13798cc	191kW (260PS)	Diesel	TD7254



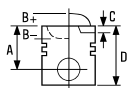

8210.02.426	6 Cyl.	16:1	13798cc	191kW (260PS)	Diesel	TD7359
8210.02.440	6 Cyl.	16:1	13798cc	191kW (260PS)	Diesel	TD5617
8210.02.440	6 Cyl.	16:1	13798cc	191kW (260PS)	Diesel	TD10491
8210.02.441	6 Cyl.	16:1	13798cc	191kW (260PS)	Diesel	TD5956
8210.02.441	6 Cyl.	16:1	13798cc	191kW (260PS)	Diesel	TD10492
8210.02.731	6 Cyl.	16:1	13798cc	191kW (260PS)	Diesel	TD5973
8211.02	6 Cyl.	16:1	13798cc		Diesel	FM10601
8211.02.032	6 Cyl.	16:1	13798cc	191kW (260PS)	Diesel	TD6376
8215.02	6 Cyl.	16:1	13798cc		Diesel	FM3514
8210.02.731	B6 Cyl.	16:1	13798cc	191kW (260PS)	Diesel	TD10524





87-207800-00





STD

A 92.00
 B- 32.40
 BØ 67.00
 D 167.00
 48x117

08-207800-30

STD

4.00  CR P
 3.00  P
 3.00  P
 5.50  CR P

14-021230-00 DH  B 143.02 C 282.00 D 147.00 E 6.00
 14-021231-00 DH  B 143.07 C 282.00 D 147.00 E 6.00
 14-021232-00 DH  B 143.27 C 282.00 D 147.00 E 6.00
 14-021560-10 DH B 143.00 C 282.00 D 147.00 E 6.06
 14-021561-10 DH B 143.05 C 282.00 D 147.00 E 6.06
 14-021562-10 DH B 143.25 C 282.00 D 147.00 E 6.06
 14-021563-10 DH B 143.50 C 282.00 D 147.00 E 6.06
 14-021590-00 DH  B 143.04 C 282.00 D 149.00 E 6.04

RT

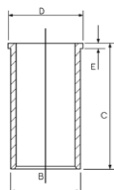
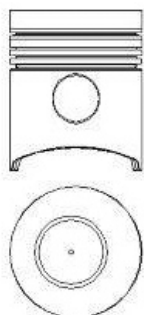

 Nitrided

 Nitriert

 Nitridé

 Nitruado

 Nitruato

62  137.00

8210.22	6 Cyl.	15:1	13798cc	221-224kW (300-305PS)	Diesel Turbo	FM4024
8210.22.000	6 Cyl.	15:1	13798cc	224kW (305PS)	Diesel	TD22223
8210.22.069	6 Cyl.	15:1	13798cc	221-224kW (300-305PS)	Diesel Turbo	TD6885
8210.22.101	6 Cyl.	15:1	13798cc	224kW (305PS)	Diesel Turbo	TD6881
8210.22.175	6 Cyl.	15:1	13798cc	224kW (305PS)	Diesel Turbo	TD10528
8210.22.175	6 Cyl.	15:1	13798cc	224kW (304PS)	Diesel Turbo	TD5960
8210.22.183	6 Cyl.	15:1	13798cc	224kW (304PS)	Diesel Turbo	TD7340
8210.22.183	6 Cyl.	15:1	13798cc	224kW (305PS)	Diesel Turbo	TD10579
8210.22.235	6 Cyl.	15:1	13798cc	224kW (304PS)	Diesel Turbo	TD7352
8210.22.269	6 Cyl.	15:1	13798cc	224kW (305PS)	Diesel Turbo	TD10584
8210.22.269	6 Cyl.	15:1	13798cc	224kW (304PS)	Diesel Turbo	TD5630
8210.22.317	6 Cyl.	15:1	13798cc	224kW (304PS)	Diesel Turbo	TD6260
8210.22.317	6 Cyl.	15:1	13798cc	224kW (305PS)	Diesel Turbo	TD10531
8210.22.373	6 Cyl.	15:1	13798cc	224kW (305PS)	Diesel Turbo	TD6878
8210.22.385	6 Cyl.	15:1	13798cc	224kW (305PS)	Diesel Turbo	TD10586



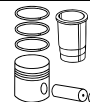
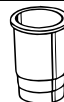
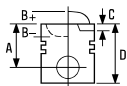



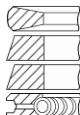

8210.22.385	6 Cyl.	15:1	13798cc	224kW (304PS)	Diesel Turbo	TD6264
8210.22.406	6 Cyl.	15:1	13798cc	224kW (304PS)	Diesel Turbo	TD7255
8210.22.523	6 Cyl.	15:1	13798cc	224kW (305PS)	Diesel Turbo	TD11391
8210.22X.235	6 Cyl.	15:1	13798cc	224kW (305PS)	Diesel Turbo	TD11407
8211.22	6 Cyl.		13798cc		Diesel Turbo	FM24024

87-207800-10 STD
A 92.00
B- 33.00
BØ 72.00
D 162.00
 50x117

08-207800-10 STD
 4.00
 3.00
 3.00
 5.50

 CR P
 P
 P
 CR P

14-021230-00 DH  **B** 143.02 **C** 282.00 **D** 147.00 **E** 6.00
14-021231-00 DH  **B** 143.07 **C** 282.00 **D** 147.00 **E** 6.00
14-021232-00 DH  **B** 143.27 **C** 282.00 **D** 147.00 **E** 6.00
14-021560-10 DH **B** 143.00 **C** 282.00 **D** 147.00 **E** 6.06
14-021561-10 DH **B** 143.05 **C** 282.00 **D** 147.00 **E** 6.06
14-021562-10 DH **B** 143.25 **C** 282.00 **D** 147.00 **E** 6.06
14-021563-10 DH **B** 143.50 **C** 282.00 **D** 147.00 **E** 6.06
14-021590-00 DH  **B** 143.04 **C** 282.00 **D** 149.00 **E** 6.04

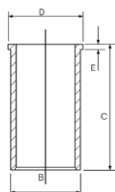
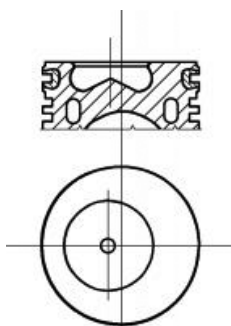
AK KK RT



 Nitrided

 Nitriet

 Nitridé

 Niturado

 Nitratato

63  **137.00**

8210.22.105	6 Cyl.	15:1	13798cc	243kW (330PS)	Diesel Turbo Intercooled	TD10550
8210.22.171	6 Cyl.	15:1	13798cc	224kW (305PS)	Diesel Turbo	TD10530
8210.22.210	6 Cyl.	15:1	13798cc	224kW (305PS)	Diesel Turbo	TD11387
8210.22.236	6 Cyl.	15:1	13798cc	224kW (305PS)	Diesel Turbo	TD11388
8210.22.327	6 Cyl.	15:1	13798cc	224kW (305PS)	Diesel Turbo	TD10585
8210.22.511	6 Cyl.	15:1	13798cc	224kW (305PS)	Diesel Turbo	TD11389
8210.22.521	6 Cyl.	15:1	13798cc	224kW (305PS)	Diesel Turbo	TD11390
8210.22.525	6 Cyl.	15:1	13798cc	224kW (305PS)	Diesel Turbo	TD11392
8210.22.535	6 Cyl.	15:1	13798cc	224kW (305PS)	Diesel Turbo	TD11393
8210.22.537	6 Cyl.	15:1	13798cc	224kW (305PS)	Diesel Turbo	TD11394
8210.22.569	6 Cyl.	15:1	13798cc	224kW (304PS)	Diesel Turbo	TD7330
8210.22.569	6 Cyl.	15:1	13798cc	224kW (305PS)	Diesel Turbo	TD10529
8210.22.800	6 Cyl.	16:1	13798cc		Diesel	FM5053
8210.22.869	6 Cyl.	17:1	13798cc	235kW (320PS)	Diesel Turbo	TD7333
8210.22.869	6 Cyl.	17:1	13798cc	235kW (320PS)	Diesel Turbo	TD10549
8210.22X.069	6 Cyl.	15:1	13798cc	224kW (305PS)	Diesel Turbo	TD11329
8210.22X.523	6 Cyl.	15:1	13798cc	224kW (305PS)	Diesel Turbo	TD11408
8210.22X.575	6 Cyl.	15:1	13798cc	224kW (305PS)	Diesel Turbo	TD11330
8210.42.172	6 Cyl.	16.5:1	13798cc	277kW (377PS)	Diesel Turbo Intercooled	TD10581
8210.42.500 Euro 2	6 Cyl.	16:1	13798cc	346kW (471PS)	Diesel Turbo Intercooled	TD18332



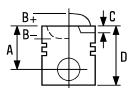

8210.42K (TCA) Euro 1	6 Cyl.	16.5:1	13798cc	272kW (370PS)	Diesel Turbo Intercooled	TD7377
8210.42M (TCA) Euro 2	6 Cyl.		13798cc	345kW (469PS)	Diesel Turbo Intercooled	TD10576
8212.00	6 Cyl.		13800cc		Diesel	FM8846
8215.00	6 Cyl.		13800cc		Diesel	FM18846
8215.22.520	6 Cyl.		13798cc		Diesel Turbo	FM9116
8217.00	6 Cyl.		13798cc		Diesel	FM28846
8217.32	6 Cyl.		13798cc		Diesel Turbo	FM9116
8260.01	6 Cyl.		12800cc		Diesel	FM8847

- 14-021230-00 DH B 143.02 C 282.00 D 147.00 E 6.00
- 14-021231-00 DH B 143.07 C 282.00 D 147.00 E 6.00
- 14-021232-00 DH B 143.27 C 282.00 D 147.00 E 6.00
- 14-021560-10 DH B 143.00 C 282.00 D 147.00 E 6.06
- 14-021561-10 DH B 143.05 C 282.00 D 147.00 E 6.06
- 14-021562-10 DH B 143.25 C 282.00 D 147.00 E 6.06
- 14-021563-10 DH B 143.50 C 282.00 D 147.00 E 6.06
- 14-021590-00 DH B 143.04 C 282.00 D 149.00 E 6.04

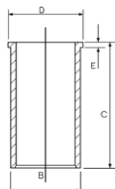

Nitrided

Nitriert

Nitridé

Nitruado

Niturato

64 137.00

8210.42	6 Cyl.	16.5:1	13798cc	277kW (377PS)	Diesel Turbo Intercooled	TD10564
8210.42.009	6 Cyl.	15:1	13798cc	265kW (360PS)	Diesel Turbo Intercooled	TD7356
8210.42.101	6 Cyl.	15:1	13798cc	265kW (360PS)	Diesel Turbo Intercooled	TD10563
8210.42.101	6 Cyl.	15:1	13798cc	265kW (360PS)	Diesel Turbo Intercooled	TD7336
8210.42.115	6 Cyl.	15:1	13798cc	265kW (360PS)	Diesel Turbo Intercooled	TD10582
8210.42.115	6 Cyl.	15:1	13798cc	265kW (360PS)	Diesel Turbo Intercooled	TD7341
8210.42.151	6 Cyl.	16.5:1	13798cc	277kW (377PS)	Diesel Turbo Intercooled	TD10552
8210.42.152	6 Cyl.	16.5:1	13798cc	277kW (377PS)	Diesel Turbo Intercooled	TD10555
8210.42.154	6 Cyl.		13798cc	277kW (377PS)	Diesel Turbo Intercooled	TD10556
8210.42.155	6 Cyl.	16.5:1	13798cc	277kW (377PS)	Diesel Turbo Intercooled	TD10580
8210.42.161	6 Cyl.		13798cc	277kW (377PS)	Diesel Turbo Intercooled	TD10553
8210.42.162	6 Cyl.		13798cc	277kW (377PS)	Diesel Turbo Intercooled	TD10557
8210.42.165	6 Cyl.		13798cc	277kW (377PS)	Diesel Turbo Intercooled	TD10588
8210.42.171	6 Cyl.		13798cc	277kW (377PS)	Diesel Turbo Intercooled	TD10554
8210.42.175	6 Cyl.	16.5:1	13798cc	277kW (377PS)	Diesel Turbo Intercooled	TD10590
8210.42.181	6 Cyl.	16.5:1	13798cc	277kW (377PS)	Diesel Turbo Intercooled	TD10558
8210.42.182	6 Cyl.		13798cc	277kW (377PS)	Diesel Turbo Intercooled	TD10559
8210.42.185	6 Cyl.	16.5:1	13798cc	277kW (377PS)	Diesel Turbo Intercooled	TD10591
8210.42.186	6 Cyl.		13798cc	277kW (377PS)	Diesel Turbo Intercooled	TD10592



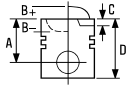

8210.42.191 6 Cyl. **13798cc 277kW (377PS)** Diesel Turbo Intercooled **TD10560**

8210.42.195 6 Cyl. **13798cc 277kW (377PS)** Diesel Turbo Intercooled **TD10593**

87-783000-00 STD

08-783000-00 STD

14-021230-00 DH B 143.02 C 282.00 D 147.00 E 6.00

14-021231-00 DH B 143.07 C 282.00 D 147.00 E 6.00

14-021232-00 DH B 143.27 C 282.00 D 147.00 E 6.00

14-021560-10 DH B 143.00 C 282.00 D 147.00 E 6.06

14-021561-10 DH B 143.05 C 282.00 D 147.00 E 6.06

14-021562-10 DH B 143.25 C 282.00 D 147.00 E 6.06

14-021563-10 DH B 143.50 C 282.00 D 147.00 E 6.06

14-021590-00 DH B 143.04 C 282.00 D 149.00 E 6.04

A 92.00

B- 33.00

BØ 72.00

D 157.00

50x117

4.00

3.00

5.50



CR P

CR P

CR P

AK KK RT TP

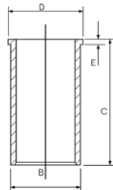
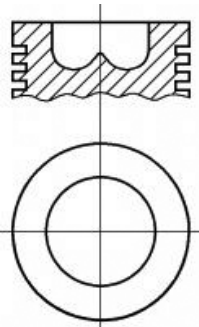

Nitrided

Nitriet

Nitridé

Nitruado

Nitruato

65 **137.00**

8210.42 K 6 Cyl. 16.5:1 **13798cc 272kW (370PS)** Diesel **TD7358**

8210.42K Euro 1/2 6 Cyl. **13798cc 272kW (370PS)** Diesel Turbo Intercooled **TD10809**

8210.42L.(TCA) Euro 1 6 Cyl. 16.5:1 **13798cc 309kW (420PS)** Diesel Turbo Intercooled **TD7366**

8210.42L.400 6 Cyl. 16.5:1 **13798cc 309kW (420PS)** Diesel Turbo Intercooled **TD7320**

8210.42L.400 Euro 1 6 Cyl. 16.8:1 **13798cc 309kW (420PS)** Diesel Turbo **TD10515**

87-783000-10 STD

08-783000-00 STD

14-021230-00 DH B 143.02 C 282.00 D 147.00 E 6.00

14-021231-00 DH B 143.07 C 282.00 D 147.00 E 6.00

14-021232-00 DH B 143.27 C 282.00 D 147.00 E 6.00

14-021560-10 DH B 143.00 C 282.00 D 147.00 E 6.06

14-021561-10 DH B 143.05 C 282.00 D 147.00 E 6.06

14-021562-10 DH B 143.25 C 282.00 D 147.00 E 6.06

14-021563-10 DH B 143.50 C 282.00 D 147.00 E 6.06

14-021590-00 DH B 143.04 C 282.00 D 149.00 E 6.04

A 92.00

B- 21.00

BØ 83.80

D 157.00

50x115

4.00

3.00

5.50



CR P

CR P

CR P

AK HA KK RT TP

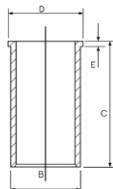
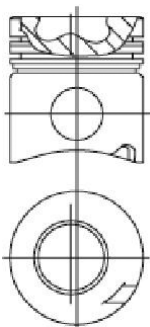

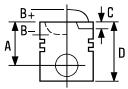



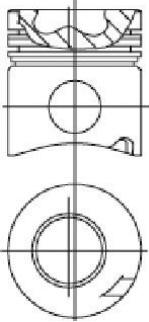

87-783000-15 STD

A 91.80
B- 21.00
BØ 83.80
D 156.80
 50x115

AK HA KK RT TP



08-783000-00 STD

4.00  CR P
 3.00  CR P
 5.50  CR P



87-783000-30 ² STD

A 92.00
B- 25.50
BØ 72.00
D 157.00
 50x115

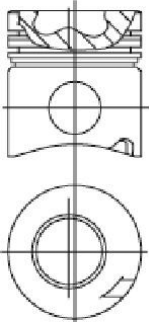
AK KK NB RT TP



08-783000-00 STD

4.00  CR P
 3.00  CR P
 5.50  CR P

¹ Nitrided
² Euro 2

¹ Nitriert
² Euro 2

¹ Nitridé
² Euro 2

¹ Nitrurado
² Euro 2

¹ Nitrurato
² Euro 2

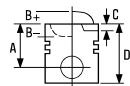

66 **137.00**

8210.42L (TCA) Euro 2	6 Cyl.	16:1	13790cc	309kW (420PS)	Diesel Turbo Intercooled	TD7378
-----------------------	--------	------	---------	---------------	--------------------------	--------

8210.42L Euro 2	6 Cyl.		13798cc	309kW (420PS)	Diesel Turbo	TD10812
-----------------	--------	--	---------	---------------	--------------	---------

87-783000-10 STD

08-783000-00 STD

- A 92.00
- B- 21.00
- BØ 83.80
- D 157.00
- 50x115

- 4.00 CR P
- 3.00 CR P
- 5.50 CR P

- 14-021230-00 DH B 143.02 C 282.00 D 147.00 E 6.00
- 14-021231-00 DH B 143.07 C 282.00 D 147.00 E 6.00
- 14-021232-00 DH B 143.27 C 282.00 D 147.00 E 6.00
- 14-021560-10 DH B 143.00 C 282.00 D 147.00 E 6.06
- 14-021561-10 DH B 143.05 C 282.00 D 147.00 E 6.06
- 14-021562-10 DH B 143.25 C 282.00 D 147.00 E 6.06
- 14-021563-10 DH B 143.50 C 282.00 D 147.00 E 6.06
- 14-021590-00 DH B 143.04 C 282.00 D 149.00 E 6.04

AK HA KK RT TP

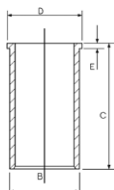
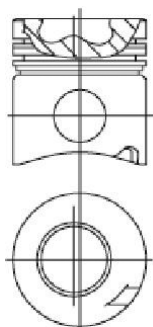

Nitrided

Nitriert

Nitridé

Nitruado

Nitruato

67 **145.00**

8260.02	6 Cyl.		12880cc		Diesel	FM4023
8260.02.405	6 Cyl.	16:1	12880cc	191kW (260PS)	Diesel	TD7362
8261.02.002	6 Cyl.	16:1	12880cc	165kW (224PS)	Diesel	TD20430
8261.1.002	6 Cyl.	16:1	12880cc		Diesel	FM14023
8280.01	V8 Cyl.	16:1	17174cc		Diesel	FM603
8280.01.000	V8 Cyl.	16:1	17174cc	246kW (335PS)	Diesel	TD6869
8280.02.000	V8 Cyl.	16.5:1	17174cc	259kW (352PS)	Diesel	TD6879
8280.02.024	V8 Cyl.	16:1	17174cc	259kW (352PS)	Diesel	TD6873
8280.02.082	V8 Cyl.	16:1	17174cc	259kW (352PS)	Diesel	TD6882
8280.02.109	V8 Cyl.	16:1	17174cc	259kW (352PS)	Diesel	TD10551
8280.02.125-135	V8 Cyl.	16:1	17174cc	259kW (352PS)	Diesel	TD5638
8280.02.265/8280.02.273/ 8280.02.279/8280.02.410/ 8280.02.412	V8 Cyl.		17174cc		Diesel	FM4026
8280.02.269	V8 Cyl.	16:1	17174cc	259kW (352PS)	Diesel	TD20431
8280.02.274	V8 Cyl.	16:1	17174cc	259kW (352PS)	Diesel	TD5639
8280.02.275	V8 Cyl.	16:1	17174cc	259kW (352PS)	Diesel	TD5980
8280.02.289	V8 Cyl.	16:1	17174cc	259kW (352PS)	Diesel	TD7354
8280.02.405	V8 Cyl.	16:1	17174cc	259kW (352PS)	Diesel	TD7360



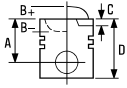

8281.02 V8 Cyl. 17174cc Diesel FM14026

8285.02 V8 Cyl. 17174cc Diesel FM9234

87-782100-00 STD

08-782100-00 STD

14-260080-00 WH 1 B 158.50 C 262.00 D 174.00 E 10.06 F 0.94

15-260080-00 WH 1 2 B 158.50 C 262.00 D 174.00 E 10.06 F 0.94

A 95.00
B- 30.20
BØ 72.00
D 157.00
 55x122

4.00 CR P
3.00 CR P
6.00 CR P

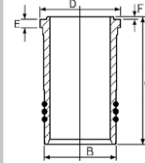

RT

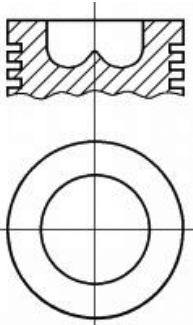

1 Nitrided

2 Contains 3 seals of 3.00mm

1 Nitriert

2 Enthält drei 3,00mm Dichtungen

1 Nitridé

2 Contient 3 joints de 3 mm

1 Nitrurado

2 Contiene 3 retenes de 3.00mm

1 Nitrurato

2 Contiene 3 OR di 3,00 millimetri

68  145.00

8280.22. V8 Cyl. 15.5:1 17174cc 280kW (381PS) Diesel Turbo TD10565

8280.22.007 V8 Cyl. 15.5:1 17174cc 280kW (381PS) Diesel Turbo TD10566

8280.22.009 V8 Cyl. 15.5:1 17200cc 280kW (381PS) Diesel Turbo TD10583

8280.22.033 V8 Cyl. 15.5:1 17174cc 280kW (381PS) Diesel Turbo TD10594

8280.22.054 V8 Cyl. 15.5:1 17174cc 280kW (381PS) Diesel Turbo TD10567

8280.22.201 V8 Cyl. 15.5:1 17174cc 309kW (420PS) Diesel Turbo Intercooled TD10569

8280.22.205 V8 Cyl. 15.5:1 17174cc 309kW (420PS) Diesel Turbo Intercooled TD10570

8281.22.201 V8 Cyl. 15.5:1 17174cc 309kW (420PS) Diesel Turbo Intercooled TD6378

8285.22 V8 Cyl. 17174cc Diesel Turbo FM14027

14-260080-00 WH 1 B 158.50 C 262.00 D 174.00 E 10.06 F 0.94

15-260080-00 WH 1 2 B 158.50 C 262.00 D 174.00 E 10.06 F 0.94

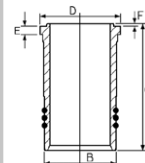

1 Nitrided

2 Contains 3 seals of 3.00mm

1 Nitriert

2 Enthält drei 3,00mm Dichtungen

1 Nitridé

2 Contient 3 joints de 3 mm

1 Nitrurado

2 Contiene 3 retenes de 3.00mm

1 Nitrurato

2 Contiene 3 OR di 3,00 millimetri



69 **145.00**

8280.42.001 V8 Cyl. 15.5:1 17174cc 350kW (476PS) Diesel Turbo Intercooled TD10572

87-782100-40 STD 08-782100-00 STD 14-260080-00 WH ① B 158.50 C 262.00 D 174.00 E 10.06 F 0.94
 15-260080-00 WH ① ② B 158.50 C 262.00 D 174.00 E 10.06 F 0.94

A 95.30 4.00 CR P
 B- 18.60 3.00 CR P
 BØ 99.00 6.00 CR P
 D 157.30
 55x122

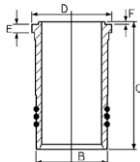

AK KK RT TP

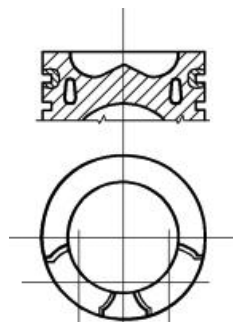

- ① Nitrided ① Nitriert ① Nitridé ① Niturado ① Niturato
- ② Contains 3 seals of 3.00mm ② Enthält drei 3,00mm Dichtungen ② Contient 3 joints de 3 mm ② Contiene 3 retenes de 3.00mm ② Contiene 3 OR di 3,00 millimetri





70 **145.00**

8280.42.050 V8 Cyl. 15.5:1 17174cc 350kW (476PS) Diesel Turbo Intercooled TD10571
 8280.42S (TCA) V8 Cyl. 16:1 17173cc 378kW (514PS) Diesel Turbo Intercooled TD10577
 8280.42S.342 Euro 2 V8 Cyl. 16:1 17174cc 378kW (514PS) Diesel Turbo Intercooled TD20432
 8280.42S.350 Euro 2 V8 Cyl. 16:1 17174cc 375kW (510PS) Diesel Turbo Intercooled TD10516
 8280.42S.352 Euro 2 V8 Cyl. 16:1 17174cc 378kW (514PS) Diesel Turbo Intercooled TD20433
 8280.42S.362 Euro 2 V8 Cyl. 16:1 17174cc 378kW (514PS) Diesel Turbo Intercooled TD20434

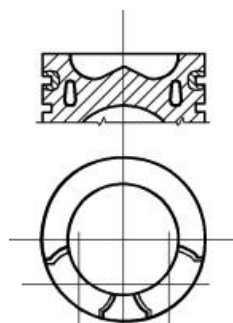
87-782100-30 STD 08-782100-00 STD
 A 95.30 4.00 CR P
 B- 23.90 3.00 CR P
 BØ 79.90 6.00 CR P
 C 0.80
 D 157.30
 55x122

KK RT







		ccm	x 		
3.8	Petrol	3781	6	86.99	6
8L (85-87)	Petrol	4235	6	92.07	10
224DT	Diesel	2179	4	85.00	3
AJD	Diesel	2720	V6	81.00	1
FMBA	Diesel	1998	4	86.00	4
FMBB	Diesel	1998	4	86.00	4
V 12 (75-79)	Petrol	5343	V12	90.00	8
V 12 (90-93)	Petrol	5343	V12	90.00	9
LJ46G	Diesel	2198	4	86.00	5
QJBA Duratorq	Diesel	2198	4	86.00	5
XK (3.4)	Petrol	3442	6	82.99	2
XK (3.8)	Petrol	3781	6	86.99	7
XK (4.2)	Petrol	4235	6	92.07	11
XK 4.2 (-79)	Petrol	4235	6	92.07	10
XK 4.2 (82-87)	Petrol	4235	6	92.07	10



1 81.00

S-Type 2.7 D	06/04→10/07	AJD			
XF 2.7 D	03/08→04/15		V6 Cyl.		
XJ 2.7 D	10/05→03/09		2720cc	152kW (207PS)	
		Diesel	Turbo Intercooled		TD25810

87-432400-00 STD **08-432400-00** STD

A	47.00	2.00		CK P
B-	14.05	2.00		P
BØ	44.00	2.00		P
C	0.50			
D	71.00			
	29x62			



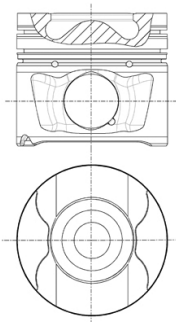

AK KK RT TP



2 82.99

340	01/67→12/68	XK (3.4)			
Daimler Sovereign 3.4 Series II	04/75→02/79		6 Cyl.	8/8.4:1	
Mk7, Mk7M	01/50→12/57		3442cc		
Mk8	01/56→12/59				FM895
MkI 3.4, MkII 3.4	01/57→12/68				
XJ 6, XJ 6 Series II, XJ 6 Series III	01/75→12/86				
XK 120, XK 140	01/48→12/57				
XK 150	01/57→12/61				
XK 150 S-type	01/58→12/61				

87-529907-00	.020	08-529907-00	.020
87-529909-00	.030	08-529909-00	.030
87-529911-00	.040	08-529911-00	.040

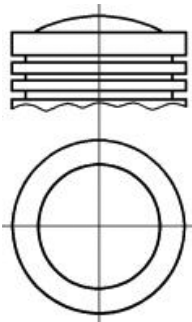

A	43.05	2.00		P
B+	12.01	2.00		P
D	103.42	3.96		P
	22x72	3.96		P

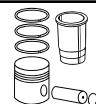







3  **85.00**

XF 2.2 D	04/11→04/15	224DT			
XF SPORTBRAKE 2.2 D	09/12→04/14		4 Cyl.	16.5:1	
			2179cc	110-147kW (150-200PS)	
		Diesel	Turbo Intercooled		TD26822

87-436700-00 	STD	08-436700-00	STD
87-436708-00 	0.60mm	08-436708-00	0.60mm

A	48.60
B-	15.12
BØ	50.40
C	0.38
D	74.60
	30x68

2.50		GDC P
2.00		P
2.00		CK



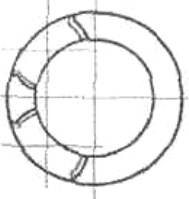

AK KK RT TP





0850HA324

 For pistons with a 24.3mm con rod gap measured at pin centre line

 Für Kolben mit einem Pleuelaugenabstand von 24,3 MM, gemessen an der Kolbenbolzen-Mitte

 Pour pistons avec un écart de bielle de 24,3 mm mesuré au centre de l'axe bielle-piston

 Para pistones con una distancia de paso de biela en el centro del bulón de 24,3mm

 Per pistoni con passaggio biella di 24,3 mm misurato sull'asse foro spinotto







4  **86.00**

X-Type 2.0 D	07/03→12/09	FMBA	4 Cyl.	19:1	
			1998cc	96kW (130PS)	
		Diesel	Turbo Intercooled		TD24398
X-Type 2.0 D	07/03→12/09	FMBB	4 Cyl.	19:1	
			1998cc	96kW (130PS)	
		Diesel	Turbo Intercooled		TD24399

87-140800-10 ¹ STD
87-140807-10 0.50mm

08-140800-00 ² STD
08-140807-00 ² 0.50mm

A 47.70
B- 15.20
BØ 43.30
D 74.10
 30x66

2.00  CK P
 2.00  P
 2.00  NT ³

KK RT TP

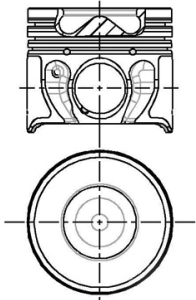

8662

¹ Piston Chamber Volume
 [ccm] 21.49

² Only fit to pistons equivalent to
 OE 24878 and 24879

³ Steel

¹ Volumen der Kolbenmulde
 [ccm] 21.49

² Nur gepasst worden zu den Kolben
 gleichwertig mit OE 24878 und 24879

³ Stahl

¹ Volume de la cavité du piston
 [cm³] 21.49

² Seulement adapté aux pistons
 équivalents à OE 24878 et 24879

³ Acier

¹ Volumen de cavidad del pistón
 [cc] 21.49

² Cabido solamente a los pistones
 equivalentes a OE 24878 y 24879

³ Acero

¹ Volume camera pistone
 [cm³] 21.49

² Adattato soltanto ai pistoni equivalenti
 a OE 24878 e 24879

³ Acciaio

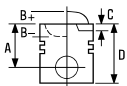

5 86.00

X-Type 2.2 D 10/05→12/09 LJ46G 4 Cyl. 2198cc 107-114kW (146-155PS)
 Diesel Turbo Intercooled TD24454



X-Type 2.2 D QJBA Duratorq 4 Cyl. 19:1 2198cc 114kW (155PS)
 Diesel Turbo Intercooled TD24400

87-427700-10 STD
 87-427707-10 0.50mm

08-427700-00 STD
 08-427707-00 0.50mm

14-021120-00 D B 89.00 C 156.00 D 90.90 E 5.00

A 43.42
 B- 15.85
 BØ 46.90
 D 69.82
 30x67

2.00  CK P
 2.00 P
 2.00  NT 

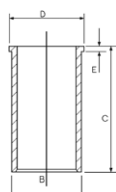

KK RT TP

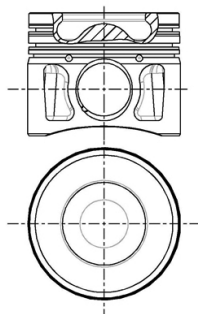

8648B105

 Steel

 Stahl

 Acier

 Acero

 Acciaio



6 86.99

MkIX 3.8, MkX 3.8, XK 150 3.8 01/59→12/68 3.8 6 Cyl. 9:1 3781cc FM2524

87-522600-00 STD
 87-522607-00 .020

08-522600-00 STD
 08-522607-00 .020

A 41.89
 B+ 15.19
 D 105.39
 22x76

1.97  CR P
 1.99 P
 3.97  P

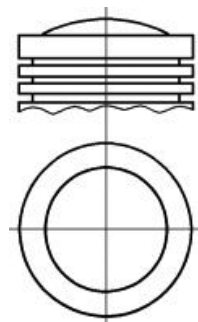







7 86.99

E-Type Series I	01/61→12/65	XK (3.8)			
Mk9 3.8	01/58→12/61		6 Cyl.	8:1	
Mk10 3.8	01/61→12/65		3781cc		
MkII 3.8	01/59→12/68				
XK 150 3.8	01/59→12/61				FM896

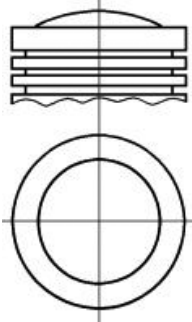

87-525500-00	STD	08-525500-00	STD
87-525507-00	.020	08-525507-00	.020
87-525509-00	.030	08-525509-00	.030

A	42.52	1.99	 P
B+	10.03	1.99	 P
D	100.86	3.97	 P
	22x76		

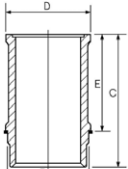

8 90.00

XJ 12 5.3	05/75→12/82	V 12 (75-79)			
			V12 Cyl.	9/10:1	
			5343cc	211kW (287PS)	
					TD1731

87-523600-00	STD	08-523600-00	STD	14-710010-00 WH	B 98.01 C 144.53 D 109.22 E 44.40
A	39.70	1.60	 CR P		88-523600-00 87-523600-00 + 14-710010-00
B-	7.15	2.00	 P		
BØ	77.20	4.00			
D	80.98				
	24x79				

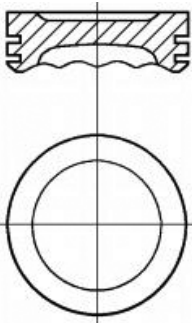

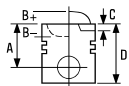

9 90.00

XJ 5.3	01/86→12/89	V 12 (90-93)			
XJSC 5.3	01/86→05/88		V12 Cyl.	11.5/12.5:1	
XJ Sovereign V12	07/85→12/92		5343cc	197kW (268PS)	

TD4583

14-710010-00 WH B 98.01 C 144.53 D 109.22 E 44.40

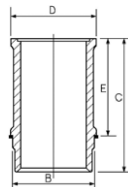

10 92.07

E-Type 4.2	03/71→04/75	8L (85-87)			
XJ 6 4.2	01/75→12/86		6 Cyl.		
			4235cc	127-133kW (173-181PS)	



TD5202

XJ 6 4.2	10/69→09/79	XK 4.2 (-79)			
			6 Cyl.		
			4235cc	124kW (169PS)	



TD1737

E-Type 4.2	05/64→05/71	XK 4.2 (82-87)			
XJ 6 4.2	09/79→12/87		6 Cyl.		
			4235cc	151kW (205PS)	

TD5199

87-524000-00 	STD
87-524007-00 	.020
87-524009-00 	.030

08-524000-00	STD
08-524007-00	.020

1.99		CR P
1.99		P
4.77		CR P

A	41.50
B+	11.05
D	85.49
	22x76

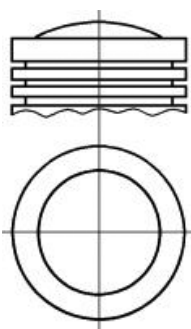





87-524000-10 ① STD
87-524007-10 ① .020

A 41.50
B+ 5.74
D 74.44
 22x76

08-524000-00 STD
08-524007-00 .020

1.99  CR P
 1.99  P
 4.77  CR P

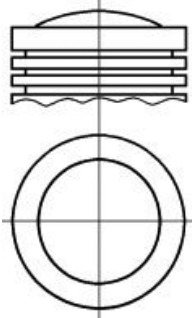

① Pistons to be replaced in Engine Sets only
 ② Recommended maximum oversize for Series 3 XJ6 from Engine no. 8L89109/8L104020 is +0.020in (0.508mm). In all other models +0.030in (0.762mm)

① Kolben nur Motorsätzen zu ersetzen
 ② Empfohlenes übermaß für Serie 3 XJ6 4.2 liter as motor nr 8L89109/8L104020 maximal +0.020in zoll 0.508mm in allen anderen Modellen +0.030in (0.762mm)

① Piston à remplacer dans jeu moteur
 ② Dimensions maxi. recommandées pour séries 3 XJ6 4.2 litres du moteur no. 8L89109/8L104020 is +0.020in (0.508mm).

① Pistones de repuesto para juegos de motores solamente
 ② La sobremedida maxima recomendada para series 3 XJ6 4.2 litros desde motor no. 8L89109/8L104020 es +0.020plg (0.508mm) en todos los otros modelos +0.030plg

① Il pistone può essere rimpiazzato solamente completo
 ② Maggiorazione massima raccomandata 0.40 iper Serie 3XJ delMotore 8L89109/8L104020 is +0.020in (0.508mm). In tutti i mdelli +0.030in (0.762mm)



11 92.07

Daimler Sovereign 4.2 Series I	10/69→08/73	XK (4.2)	6 Cyl.	4235cc	124kW (168PS)	FM898
Daimler Sovereign 4.2 Series II	09/73→02/79					
Daimler Sovereign 4.2 Series III	09/79→07/86					
E-Type 420	01/65→12/71					
Mk10	01/64→12/66					
XJ 6 4.2	01/71→12/78					

87-524000-00 ① ③ STD
87-524007-00 ① ③ .020
87-524009-00 ① ③ ④ .030

A 41.50
B+ 11.05
D 85.49
 22x76

08-524000-00 STD
08-524007-00 .020

1.99  CR P
 1.99  P
 4.77  CR P

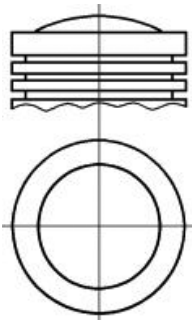





87-524000-10 ② ③ STD
87-524007-10 ② ③ .020

A 41.50
B+ 5.74
D 74.44
 22x76

08-524000-00 STD
08-524007-00 .020

1.99  CR P
 1.99  P
 4.77  CR P

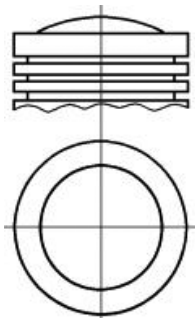





- ① C.R. = 8.7:1
- ② C.R. = 7.8:1
- ③ Pistons to be replaced in Engine Sets only
- ④ Recommended maximum oversize for Series 3 XJ6 from Engine no. 8L89109/8L104020 is +0.020in (0.508mm). In all other models +0.030in (0.762mm)

- ① C.R. = 8.7:1
- ② C.R. = 7.8:1
- ③ Kolben nur Motorsätzen zu ersetzen
- ④ Empfohlenes übermaß für Serie 3 XJ6 4.2 liter as motor nr 8L89109/8L104020 maximal +0.020in zoll 0.508mm in allen anderen Modellen +0.030in (0.762mm)

- ① C.R. = 8.7:1
- ② C.R. = 7.8:1
- ③ Piston à remplacer dans jeu moteur
- ④ Dimensions maxi. recommandées pour séries 3 XJ6 4.2 litres du moteur no. 8L89109/8L104020 is +0.020in (0.508mm).

- ① C.R. = 8.7:1
- ② C.R. = 7.8:1
- ③ Pistones de repuesto para juegos de motores solamente
- ④ La sobremedida máxima recomendada para series 3 XJ6 4.2 litros desde motor no. 8L89109/8L104020 es +0.020plg (0.508mm) en todos los otros modelos +0.030plg

- ① C.R. = 8.7:1
- ② C.R. = 7.8:1
- ③ Il pistone può essere rimpiazzato solamente completo
- ④ Maggiorazione massima raccomandata 0.40 iper Serie 3XJ delMotore 8L89109/8L104020 is +0.020in (0.508mm). In tutti i mdelli +0.030in (0.762mm)

		ccm	x 		
829/J6R/ZEJ	Petrol	1995	4	88.00	4
BMM	Diesel	1968	4	81.00	1
J5R-800	Petrol	1995	4	88.00	4
J8S-800	Diesel	2068	4	86.00	3
J8S-814	Diesel	2068	4	86.00	3
J8S-890	Diesel	2068	4	86.00	3
J8S/J8S	Diesel	2068	4	86.00	3
OM 651.925	Diesel	2143	4	83.00	2



1  **81.00**

Patriot	01/07→	BMM	4 Cyl.	18.5:1
		Diesel	1968cc	103kW (140PS)
			Turbo Intercooled	TD24007

87-139500-10 1 2 5 7 STD
87-139507-10 1 2 5 0.50mm

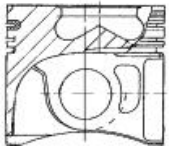
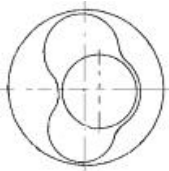

A 45.55
B- 17.50
BØ 38.00
C 0.70
D 68.80
 26x66

AK KK NB RT TP



07901D833

08-139500-00 STD
08-139507-00 0.50mm

1.75  CK P
 2.00  P
 3.00  CR P

87-139500-20 3 4 6 7 STD
87-139507-20 3 4 6 0.50mm

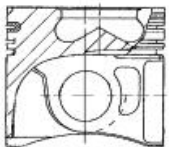
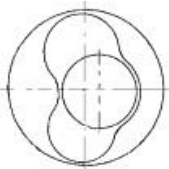

A 45.83
B- 17.50
BØ 38.00
C 0.70
D 68.80
 26x66

AK KK NB RT TP



07901D834

08-139500-00 STD
08-139507-00 0.50mm

1.75  CK P
 2.00  P
 3.00  CR P

- 1 to cylinder 1
- 2 to cylinder 2
- 3 to cylinder 3
- 4 to cylinder 4
- 5 To cylinder 1 & 2
- 6 To cylinder 3 & 4
- 7 Piston Chamber Volume [ccm] 23.30

- 1 zum Zylinder 1
- 2 zum Zylinder 2
- 3 zum Zylinder 3
- 4 zum Zylinder 4
- 5 zum Zylinder 1 & 2
- 6 zum Zylinder 3 & 4
- 7 Volumen der Kolbenmulde [ccm] 23.30

- 1 au cylindre 1
- 2 au cylindre 2
- 3 au cylindre 3
- 4 au cylindre 4
- 5 sous cylindre 1 & 2
- 6 sous cylindre 3 & 4
- 7 Volume de la cavité du piston [ccm] 23.30

- 1 al cilindro 1
- 2 al cilindro 2
- 3 al cilindro 3
- 4 al cilindro 4
- 5 A cilindro 1 & 2
- 6 A cilindro 3 & 4
- 7 Volumen de cavidad del pistón [cc] 23.30

- 1 al cilindro 1
- 2 al cilindro 2
- 3 al cilindro 3
- 4 al cilindro 4
- 5 al cilindro 1 & 2
- 6 al cilindro 3 & 4
- 7 Volume camera pistone [cm³] 23.30

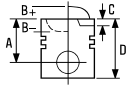

2 **83.00**

Compass 2.2 CRD	12/10→	OM 651.925	4 Cyl.	2143cc	100-120kW (136-163PS)	
		Diesel	Turbo			TD25244

87-433400-00	STD	08-433400-00	STD
87-433405-00	0.25mm	08-433405-00	0.25mm
87-433407-00	0.50mm	08-433407-00	0.50mm

A	48.50	2.00		GDC P
B-	13.25	1.75		P
BØ	49.40	2.00		CR P
D	75.50			

30x66



AK KK RT

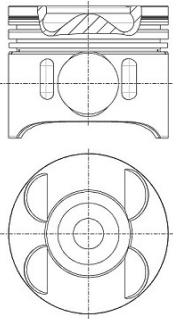

→ 120kW

→ 120kW

→ 120kW

→ 120kW

→ 120kW

3 **86.00**

Cherokee 2.1 TD	10/84→09/01	J8S/J8S	4 Cyl.	21.5:1		
		Diesel	2068cc	59-64kW (80-87PS)		TD22946
CJ5 - CJ8 2.1 D	01/83→12/87	J8S-800	4 Cyl.	21.5:1		
		Diesel	2068cc	44kW (60PS)		TD1750
Comanche 2.1 D	01/86→09/90	J8S-814	4 Cyl.	21.5:1		
		Diesel	2068cc	63-65kW (86-88PS)	Turbo Intercooled	TD1745



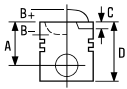



Cherokee 2.1 D **J8S-890** 4 Cyl. 21.5:1
2068cc **65kW (88PS)**
Diesel Turbo **TD1749**

87-337100-00 STD **08-337100-00** STD **14-000320-00** WH **1** B 93.60 C 166.00 E 93.05 **89-337100-00**
 87-337100-00 +
 14-000320-00

A 50.95
B- 2.20
D 87.95
 28x75

2.25  P PS
 2.00  P
 3.00  CR P

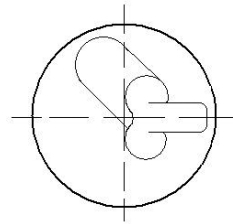
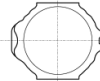
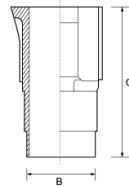

1 Phosphated

1 Phosphated

1 Phosphated

1 Phosphated

1 Phosphated



4  **88.00**

CJ-7, CJ-7 Laredo 01/85→ **829/J6R/ZEJ** 4 Cyl. 9.2:1
1995cc **FM319**

CJ5, CJ8 2.0 01/83→02/87 **J5R-800** 4 Cyl. 9.2:1
1995cc **61-63kW (85-86PS)** **TD1747**

87-334400-00 STD **08-334400-00** STD **14-637160-00** WH **B** 93.60 **C** 140.50 **D** 104.00 **E** 93.08 **89-334400-00**
 87-334400-00 +
 14-637160-00

A 40.50
B+ 1.55
D 69.05
 23x75

1.75  MO P
 2.00  P
 4.00  CR **1**

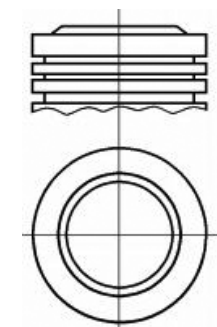
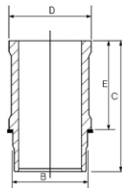





1 Steel

1 Stahl

1 Acier

1 Acero





1 Acciaio



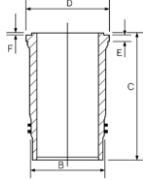

		ccm	x 		
300 T	Diesel	5878	6	106.50	2
3164DL03	Diesel	2696	3	102.00	1
3179 T	Diesel	2938	3	106.50	2
3239DL	Diesel	2983	3	106.50	3
4039T	Diesel	3918	4	106.50	2
4045 D/4045 T	Diesel	4525	4	106.50	4
4219 DL 01	Diesel	3588	4	102.00	1
4219 DL 03	Diesel	3588	4	102.00	1
4239 A	Diesel	3918	4	106.50	2
4239 DL	Diesel	3918	4	106.50	3
4239 T	Diesel	3918	4	106.50	5
4276	Diesel	4524	4	106.50	5
6059.T	Diesel	5878	6	106.50	2
6068 D/6068 T	Diesel	6788	6	106.50	6
6329 DL 03	Diesel	5395	6	102.00	1
6359A	Diesel	5876	6	106.50	2
6359DL	Diesel	5876	6	106.50	3
6414	Diesel	6800	6	106.50	5

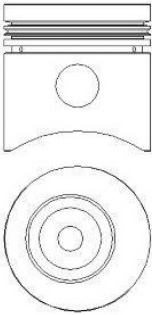

1 102.00

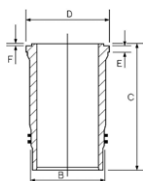
3164DL03	3 Cyl.	16.7:1	2696cc		Diesel	FM5568
4219 DL 01	4 Cyl.	16.7:1	3588cc	50-53kW (68-72PS)	Diesel	TD19035
4219 DL 03	4 Cyl.	16.7:1	3588cc	50-53kW (68-72PS)	Diesel	TD19033
6329 DL 03	6 Cyl.	16.7:1	5395cc	63-68kW (86-92PS)	Diesel	TD19034

87-181800-00	STD	08-181800-00	STD	14-452740-00 WH	B 111.00 C 197.00 D 125.00 E 6.04 F 0.81	88-181800-00 87-181800-00 + 14-452740-00
A 57.30		3.17	 MO P			
B- 16.50		2.38	 P			
BØ 58.50		5.00	 CR P			
D 103.10						
 30x85						
						

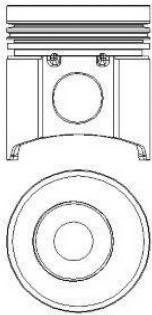
87-181800-10	STD	08-181800-00	STD	14-452740-00 WH	B 111.00 C 197.00 D 125.00 E 6.04 F 0.81	88-181800-10 87-181800-10 + 14-452740-00
A 66.30		3.17	 MO P			
B- 21.20		2.38	 P			
BØ 54.00		5.00	 CR P			
D 110.80						
 35x84						
RT						
						

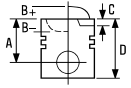

2 106.50

3179 T	3 Cyl.	2938cc	59kW (80PS)	Diesel Turbo	FM13180
4039T	4 Cyl.	3918cc	82kW (111PS)	Diesel Turbo	FM13182
4239 A	4 Cyl.	3918cc	87kW (118PS)	Diesel Turbo Intercooled	FM18779
300 T	6 Cyl. 16.3:1	5878cc	130kW (177PS)	Diesel Turbo Intercooled	FM23185
6059.T	6 Cyl. 17.8:1	5878cc	123kW (167PS)	Diesel Turbo	TD19032
6359A	6 Cyl.	5876cc	131kW (178PS)	Diesel Turbo Intercooled	FM28781

87-181100-20 STD

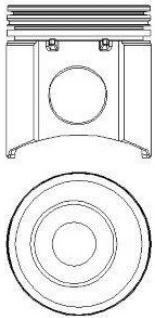

A 66.30
 B- 18.80
 BØ 58.50
 D 112.00
 41x84

RT



08-181100-00 STD

3.15
 2.38
 3.46

 MOL P
 P
 CR P

14-450710-00 WH B 115.69 C 196.00 D 126.00 E 6.86 F 0.81

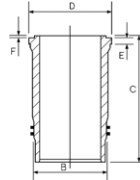

88-181100-20
 87-181100-20 +
 14-450710-00

3 106.50

3239DL	3 Cyl. 16.2:1	2983cc	Diesel	FM6423
4239 DL	4 Cyl. 16.2:1	3918cc	Diesel	FM8779
6359DL	6 Cyl. 16.2:1	5876cc	Diesel	FM8781

87-181100-10 STD

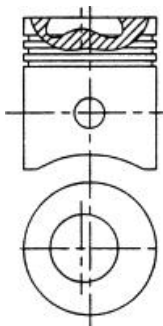

A 66.30
 B- 18.75
 BØ 58.40
 D 112.00
 35x84

RT



08-181100-00 STD

3.15
 2.38
 3.46

 MOL P
 P
 CR P

14-450710-00 WH B 115.69 C 196.00 D 126.00 E 6.86 F 0.81

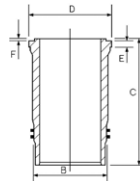

88-181100-10
 87-181100-10 +
 14-450710-00

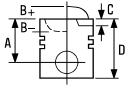

4 106.50

4045 D/4045 T 4 Cyl. 17.8:1 4525cc 55-63kW (75-85PS) Diesel Turbo FM18848

87-181100-20 STD 08-181100-00 STD 14-450660-00 WH  B 120.00 C 219.00 D 125.90 E 6.05 F 0.80

A 66.30
B- 18.80
BØ 58.50
D 112.00
 41x84

3.15
2.38
3.46



MOL P
P
CR P

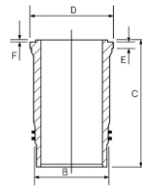

RT

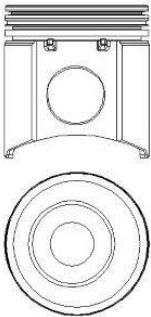

 OE R121867

 OE R121867

 OE R121867

 OE R121867

 OE R121867

5 106.50

4239 T 4 Cyl. 17.8:1 3918cc Diesel Turbo FM8780

4276 4 Cyl. 4524cc Diesel FM8848

6414 6 Cyl. 6800cc Diesel FM8849

14-450710-00 WH  B 115.69 C 196.00 D 126.00 E 6.86 F 0.81

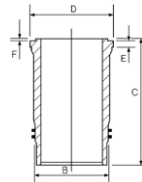

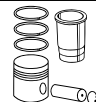
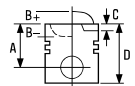





6 106.50

6068 D/6068 T 6 Cyl. 16.3:1 6788cc 130kW (177PS) Diesel FM18849

87-181100-30 STD **08-181100-00** STD **14-450660-00 WH**  **B 120.00 C 219.00 D 125.90 E 6.05 F 0.80** **88-181100-30**

87-181100-30 +
14-450660-00

A 71.50
B- 25.80
BØ 56.80
D 104.80
 41x72

3.15  MOL P
2.38  P
3.46  CR P

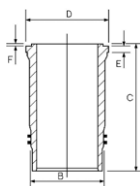

RT TP

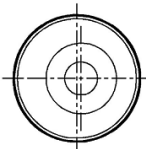
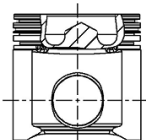

 OE R121867

 OE R121867

 OE R121867

 OE R121867

 OE R121867

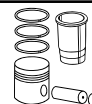
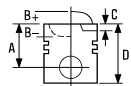

1  **120.00**

53212	V8 Cyl.	10857cc	155kW (211PS)	Diesel	FM16424
54112	V8 Cyl.	10857cc	155kW (211PS)	Diesel	FM6424

14-458500-00 WH  **B 134.00 C 224.00 D 146.00 E 10.30 F 1.30**

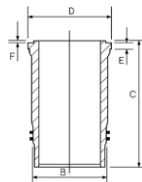





 Phosphated

 Phosphated

 Phosphated

 Phosphated

 Phosphated







		ccm	x 		
D4CB Euro 4	Diesel	2497	4	91.00	6
D4EA Euro 3	Diesel	1991	4	83.00	4
D4FA Euro 3	Diesel	1493	4	75.00	1
G4ED Euro 4	Petrol	1599	4	76.50	3
G4EE Euro 4	Petrol	1399	4	75.50	2
J2	Diesel	2665	4	94.50	7
R2	Diesel	2184	4	86.00	5
SL	Diesel	3455	4	100.00	8







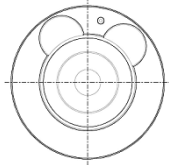
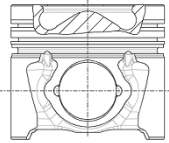

1  **75.00**

Cerato 1.5 CRDi	07/05→	D4FA Euro 3		
Pride 1.5 CRDi LX, Rio II 1.5 CRDi	03/05→		4 Cyl.	17.8:1
Rio II 1.5 CRDi			1493cc	65-81kW (88-110PS)
		Diesel	Turbo Intercooled	TD18454

87-849000-00	STD	08-849000-00	STD
87-849007-00	0.50mm	08-849007-00	0.50mm

A	41.95	1.75	 NT 
B-	12.20	1.75	 CR P
BØ	43.40	3.00	 NT 
C	0.50		
D	65.70		
	28x62		









 Steel  Stahl  Acier  Acero  Acciaio





2  **75.50**

Pride 1.4 LX, Rio II 1.4 16V	03/05→	G4EE Euro 4		
Rio II 1.4 16V			4 Cyl.	10:1
			1399cc	71kW (97PS)
				TD19959

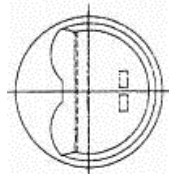
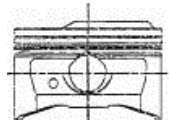
87-849200-00	STD	08-849200-50	STD
87-849207-00	0.50mm	08-849207-50	0.50mm

A	28.75	1.20	 CR 
B+	2.20	1.20	 P
C	2.95	2.00	 
D	47.90		
	18x48		



 Steel  Stahl  Acier  Acero  Acciaio

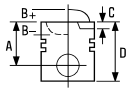

3 **76.50**

Cerato 1.6	04/04→	G4ED Euro 4		
Pride 1.6 CVVT LX, Rio II 1.6 CVVT	03/05→		4 Cyl.	10:1
Rio II 1.6 16V			1599cc	77-82kW (105-112PS)

TD18452

87-424200-00	STD	08-424200-00	STD
87-424207-00	0.50mm	08-424207-00	0.50mm

- A** 28.14
- B-** 0.40
- BØ** 60.40
- C** 3.00
- D** 50.14
- 18x48

- 1.20 **CR**
- 1.20 **P**
- 2.00 **NT**

TP

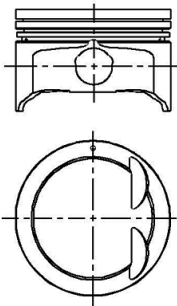

- Steel
- Stahl
- Acier
- Acero
- Acciaio

4 **83.00**

Carens II 2.0 CRDi	07/02→	D4EA Euro 3		
Carens III 2.0 CRDi 115	05/07→		4 Cyl.	17.7:1
Carens III 2.0 CRDi 135	08/09→		1991cc	83-110kW (113-150PS)
Carens III 2.0 CRDi 140	09/06→	Diesel	Turbo Intercooled	
Cee'd 2.0 CRDi	06/07→12/12			
Cerato 2.0 CRDi	04/04→			
Magentis 2.0 CRDi	11/05→			
Sportage 2.0 CRDi	02/05→			
Sportage 2.0 CRDi 4WD	09/04→			

TD18131

87-431900-00	STD	08-431900-00	STD
87-431907-00	0.50mm	08-431907-00	0.50mm

- A** 46.30
- B-** 13.90
- BØ** 46.95
- D** 72.30
- 28x66

- 1.95 **CK**
- 2.00 **CR P**
- 3.00 **NT**

AK NB RT

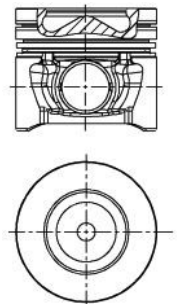

- Steel
- Stahl
- Acier
- Acero
- Acciaio



5  **86.00**



Besta 2.2 D	07/92→12/03	R2	4 Cyl.	23:1
			2184cc	48kW (65PS)
Diesel				TD11132

87-283600-00 STD
 87-283607-00 0.50mm
 87-283611-00 1.00mm

08-283600-00 STD
 08-283607-00 0.50mm
 08-283611-00 1.00mm

14-010840-00 D B 90.00 C 179.96

A 47.25
 B- 0.01
 C 1.60
 D 82.31
 25x68

2.00  CR P
 2.00  P
 4.00  CR P

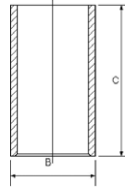

RT

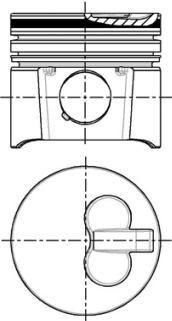





6  **91.00**

Bongo 2.5 CRDi	01/12→	D4CB Euro 4	4 Cyl.	17.7:1
K2500 2.5 CRDi	01/10→		2497cc	96-131kW (131-178PS)
Sorento I 2.5 CRDi	08/02→		Turbo Intercooled	
Diesel				TD19955

87-431700-00 STD
 87-431707-00 0.50mm

08-431700-00 STD
 08-431707-00 0.50mm

A 54.25
 B- 15.00
 BØ 52.00
 C 0.30
 D 83.75
 33x75

2.50  CK P
 2.00  CR P
 3.00  NT 

AK KK RT

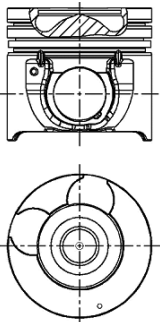

 Steel

 Stahl

 Acier





 Acero

 Acciaio



7  **94.50**

Bongo 2.7 D	03/97→09/03	J2			
Bongo 2.7 D, Bongo MPV 2.7 D	10/03→		4 Cyl.		
K2700 2.7 D	03/97→		2665cc	59-61kW (80-83PS)	
Pregio 2.7 D	10/97→	Diesel			TD22112



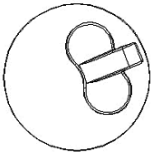
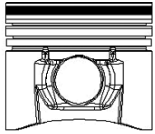

87-431800-00	STD	08-431800-00	STD
		08-431807-00	0.50mm
A	50.00		
B-	2.00		CR P
D	81.65		CR P
	30x76		CR P

AK RT



8  **100.00**

Jumbo Titan 3.5, P-WEL4 Series 3.5	01/84→03/89	SL			
Trade 3.5			4 Cyl.	18.1:1	
			3455cc	66-77kW (90-105PS)	
		Diesel			FM3814

87-111900-00	STD	08-111900-00	STD	
A	58.00	2.50		CR P
B-	21.30	2.00		CR P
BØ	29.00	4.50		CR P
D	105.00			
	34x82			

AK HA TP

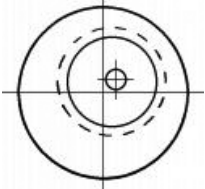
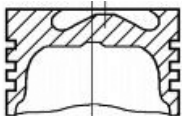

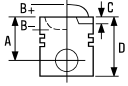





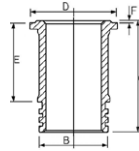

1 105.00

4D105-1	4 Cyl.	3980cc	Diesel	FM9659
4D105-2	4 Cyl.	3980cc	Diesel	FM9666
6D105-1	6 Cyl.	6490cc	Diesel	FM3529
6D105-2	6 Cyl.	6490cc	Diesel	FM9512
S6D105/S6D105-3	6 Cyl.	6490cc	Diesel Turbo	FM9670

14-693800-00 WH B 114.90 C 223.00 D 127.10 E 10.10 F 0.90





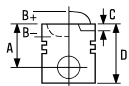

		ccm	x 		
BA3 2101	Petrol	1198	4	76.00	1
BA3 2103	Petrol	1452	4	76.00	1
BA3 2103 (KAT)	Petrol	1451	4	76.00	1
BA3 2105	Petrol	1294	4	79.00	2
BA3 2106	Petrol	1570	4	79.00	2
BA3 2111	Petrol	1499	4	82.00	3
BA3 21083	Petrol	1499	4	82.00	3
BA37 2102/3/4/5/7	Petrol	1452	4	76.00	1
C 20 XE	Petrol	1998	4	86.00	7
VAZ-2111	Petrol	1499	4	82.00	3
VAZ-21126	Petrol	1597	4	82.00	4
XUD9A	Diesel	1905	4	83.00	5
XUD9SD	Diesel	1905	4	83.00	6



1 76.00

1200-1500 1200	09/73→08/84	BA3 2101			
1200-1600 1200 L/S	01/70→06/86		4 Cyl.	8.8:1	
Nova 1200 Junior/L	09/81→		1198cc	44kW (60PS)	TD5182
1200-1500 1500	09/73→06/85	BA3 2103			
1200-1600 1500	09/72→08/84		4 Cyl.	8.5:1	
1200-1600 1500 N/S	11/75→10/86		1452cc	49-56kW (66-76PS)	TD5181
1200-1600 1600	01/84→01/90				
Nova 1.5 1500	10/86→04/98				
Nova 1500	09/85→				
Nova 1500 Special	03/85→				
Toscana 1500	09/83→02/93				
Nova 1500	09/87→12/88	BA3 2103 (KAT)			
			4 Cyl.	8.5:1	
			1451cc	49-55kW (67-75PS)	TD5389
2104	10/84→08/97	BA37 2102/3/4/5/7			
2107	10/83→11/91		4 Cyl.	8.8:1	
Niva	07/77→10/91		1452cc	55kW (75PS)	FM919

87-269700-00	STD	08-269700-00	STD
87-269706-00	0.40mm	08-269704-00	0.20mm
		08-269706-00	0.40mm
A 38.00		08-269710-00	0.80mm
D 77.00			
 22x64		1.50	 CR P
		2.00	 P
		3.94	 CR 1

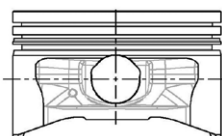

1 Steel

1 Stahl

1 Acier

1 Acero

1 Acciaio







2  **79.00**

1200-1500 1300	01/81→12/82	BA3 2105			
1200-1600 1300	08/74→08/84		4 Cyl.	8.5:1	
2107 1.3	05/82→		1294cc	48-68kW (65-92PS)	
Nova 1300	09/83→12/91				TD5183
Nova 1300 Spezial/L	05/81→				
Toscana 1300	12/85→05/12				

1200-1600 1600	09/72→08/84	BA3 2106			
1200-1600 1600 N/L	03/79→10/86		4 Cyl.	8.5:1	
2107 1.6	05/82→		1570cc	54-58kW (73-79PS)	
Nova 1.6	02/93→10/98				TD5190
Nova 1600	01/88→10/01				

87-269800-00	STD	08-269800-00	STD
87-269806-00	0.40mm	08-269806-00	0.40mm
		08-269820-00	0.70mm

A	38.00			
B-	2.00	1.50		CR P
BØ	56.00	2.00		P
D	77.00	3.94		P
	22x64			

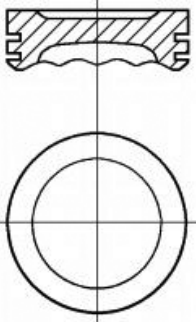

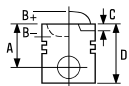





3  **82.00**

Nova 1500 S	06/89→	BA3 21083			
Samara 1500	01/86→		4 Cyl.	9.6:1	
Samara FORMA 1500	07/91→		1499cc	50-55kW (68-75PS)	TD5188
110 1.5	01/95→	BA3 2111			
111 1.5	01/97→		4 Cyl.	9.8:1	
Samara 1500	02/95→		1499cc	52-54kW (71-73PS)	TD13353
Samara FORMA 1500	11/94→				
110 1.5	01/95→	VAZ-2111			
111 1.5	01/96→		4 Cyl.	9.8:1	
112 1.5	01/95→		1499cc	54-59kW (73-80PS)	TD11748
Samara 1.5	04/96→				
Samara FORMA 1.5	01/00→				

87-269900-00 STD

- A** 38.00
- B-** 6.60
- C** 6.00
- D** 66.00
-  22x64

08-269900-00 STD
08-269906-00 0.40mm
08-269910-00 0.80mm

- 1.50  CR P
- 2.00  P
- 3.94  CR 

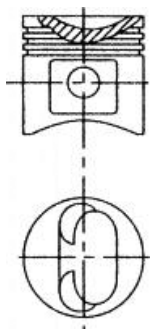

 Steel

 Stahl

 Acier

 Acero

 Acciaio

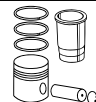
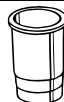
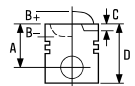





4  **82.00**

Granta 1.6	10/11→	VAZ-21126		
Kalina 1.6	06/13→	4 Cyl.		
Priora 1.6	10/09→	1597cc	71-72kW (96-98PS)	
Priora 1.6 LPG	12/08→			TD22996

87-425200-00 STD 08-425200-00 STD

A 25.40
 C 1.70
 C 1.49
 D 45.40
 18x52

1.20  NT 
 1.50  P
 2.00  P

TP

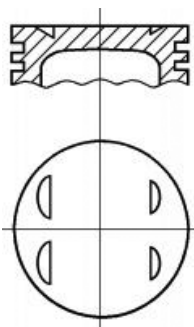





 Steel  Stahl  Acier  Acero  Acciaio

5  **83.00**

Niva 1900 Diesel	01/93→	XUD9A	4 Cyl.	23.5:1
		Diesel	1905cc	47-52kW (64-71PS)
				TD13350

87-152000-10 STD 08-152000-00 STD 14-020530-00 D B 85.60 C 153.50 D 88.50 E 3.90 88-152000-30
 87-152007-10 0.50mm 08-152003-00 0.125mm
 87-152010-10 0.80mm 08-152007-00 0.50mm
 08-152010-00 0.80mm
 08-152011-00 1.00mm

A 46.80
 B- 2.20
 D 84.30
 25x72

2.00  CR P
 2.00  P
 3.00  CR P

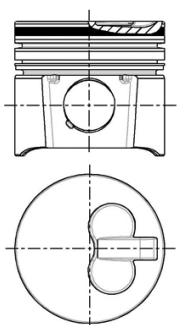
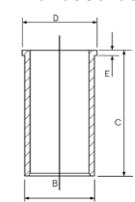

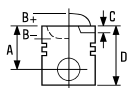

6  **83.00**

Niva 1900 Diesel 01/99→ XUD9SD 4 Cyl. 23:1
 1905cc 55kW (75PS)
 Diesel TD17345

87-105500-00 STD
 87-105507-00 0.50mm

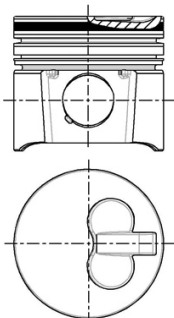

A 46.75
 B- 3.50
 D 75.00
 28x68

AK HA RT TP





08-105500-00 STD
 08-105507-00 0.50mm
 08-105510-00 0.80mm

01/97→

3.00  CK
 2.00  NT
 3.00  CR P

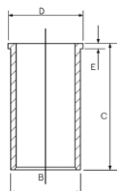
14-020530-00 D B 85.60 C 153.50 D 88.50 E 3.90



7  **86.00**

C 20 XE



4 Cyl. 10.5:1
 1998cc 110kW (150PS)

TD22868

87-306800-10 STD
 87-306807-10 0.50mm

A 30.43
 B- 0.85
 BØ 70.00
 C 2.20
 D 55.43
 21x62

08-306800-00 STD
 08-306807-00 0.50mm
 08-306811-00 1.00mm

1.50  CR P
 1.50  P
 3.00  CR 1

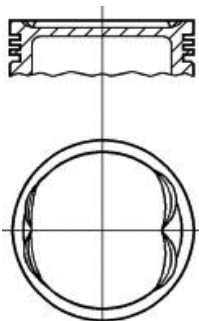





 Steel





 Stahl

 Acier

 Acero

 Acciaio

		ccm	x 		
4HP	Diesel	2179	4	85.00	34
4HR	Diesel	2179	4	85.00	34
4HS Euro 4	Diesel	2179	4	85.00	34
4HT Euro 4	Diesel	2179	4	85.00	34
149 C2.000	Petrol	1585	4	84.00	31
156 A 2.000	Petrol	999	4	70.00	6
156 A 2.100	Petrol	999	4	70.00	6
156 A2.246	Petrol	999	4	70.00	7
156 C.000	Petrol	1108	4	70.00	7
156 C.046	Petrol	1108	4	70.00	7
160 A1.046	Petrol	1372	4	80.50	14
160 D1.000	Diesel	1929	4	82.60	26
175 A3.000	Petrol	1998	5	82.00	16
175 A4.000	Petrol	1995	4	84.00	32
176 B2.000 Euro 2 Fire	Petrol	1108	4	70.00	8
176 B9.000 Fire	Petrol	1242	4	70.80	9
182 A2.000	Petrol	1747	4	82.00	17
182 A4.000	Petrol	1581	4	86.40	39
182 A6.000	Petrol	1581	4	86.40	39
182 B6.000	Petrol	1596	4	80.50	15
182 B7.000 Euro 2	Petrol	1998	5	82.00	18
183 A1.000	Petrol	1747	4	82.00	17
185 A8.000 Euro 3	Petrol	1998	5	82.00	19
188 A4.000 Euro 3 Fire	Petrol	1242	4	70.80	10
188 A5.000 Euro 3 Fire	Petrol	1242	4	70.80	11
188 A9.000	Diesel	1248	4	69.60	4
188 B2.000	Diesel	1910	4	82.00	21
198 A5.000 Multijet	Diesel	1956	4	83.00	30
199 A2.000	Diesel	1248	4	69.60	4
199 A3.000	Diesel	1248	4	69.60	5
350 A1.000	Petrol	1368	4	72.00	13
828 B4.000	Petrol	1995	4	84.00	31
831 B4.000	Petrol	1995	4	84.00	31
831 B5.000	Petrol	1995	4	84.00	33
831 B7.000	Petrol	1585	4	84.00	31
831 C5.000	Petrol	1995	4	84.00	31
831 C5.046	Petrol	1995	4	84.00	31
831 D.000	Diesel	1929	4	82.60	27
831 D1.000	Diesel	1929	4	82.60	28
831 D5.000	Petrol	1995	4	84.00	31
831 E5.000	Petrol	1995	4	84.00	32
831 E5.046	Petrol	1995	4	84.00	32
834 B.000	Petrol	1995	4	84.00	31
834 B.048	Petrol	1995	4	84.00	31
834 B.146	Petrol	1995	4	84.00	31
834 B1.000	Petrol	1995	4	84.00	31
834 B2.246	Petrol	1995	4	84.00	31
834 C.000	Petrol	1995	4	84.00	33
834 C.146	Petrol	1995	4	84.00	33
834 C1.000	Petrol	1995	4	84.00	32
834 F1.000	Petrol	1995	4	84.00	31
834 F2.000	Petrol	1995	4	84.00	32
835 A1.000	Petrol	1581	4	86.40	40
835 A1.046	Petrol	1581	4	86.40	40
835 A2.000	Petrol	1756	4	84.00	31
835 A2.046	Petrol	1756	4	84.00	31
835 A4.000	Diesel	1929	4	82.60	29
835 A4.046	Diesel	1929	4	82.60	29
835 A5.046	Petrol	1995	4	84.00	33
835 A7.000	Petrol	1995	4	84.00	33
835 A7.046	Petrol	1995	4	84.00	33
835 C1.000	Petrol	1581	4	86.40	40
835 C2.000	Petrol	1756	4	84.00	31
835 C4.000	Petrol	1756	4	84.00	31
836 A2.000	Petrol	1995	4	84.00	32
836 A3.000	Petrol	1995	4	84.00	31
836 A4.000	Petrol	1372	4	80.50	14
836 A5.000	Petrol	1756	4	84.00	31
836 A6.000	Petrol	1756	4	84.00	31

		ccm	x 		
836 C4.000	Petrol	1756	4	84.00	31
838 A1.000 Euro 2	Petrol	1998	5	82.00	18
838 A3.000	Diesel	2387	5	82.00	22
838 A4.000	Petrol	1995	4	84.00	32
838 A6.000 Euro 2	Petrol	1998	5	82.00	18
838 A7.000	Diesel	2387	5	82.00	22
838 A8.000 Euro 2	Diesel	2387	5	82.00	23
839 A4.000	Petrol	1747	4	82.00	17
839 A5.000	Diesel	2387	5	82.00	23
839 A6.000 Euro 3	Diesel	2387	5	82.00	21
840 A2.000	Petrol	1370	4	82.00	20
840 A3.000 Fire	Petrol	1242	4	70.80	12
840 A4.000	Petrol	1371	4	82.00	20
841 C.000 Euro 3	Diesel	2387	5	82.00	21
841 G.000	Diesel	2387	5	82.00	24
841 M.000	Diesel	2387	5	82.00	24
841 N.000	Diesel	2387	5	82.00	24
844 A2.000	Diesel	1956	4	83.00	30
937 A2.000 Euro 3	Diesel	1910	4	82.00	21
937 A5.000	Diesel	1910	4	82.00	24
8144.91 Sofim	Diesel	2445	4	93.00	42
8144.97.2200	Diesel	2499	4	93.00	41
8144.97.2400	Diesel	2499	4	93.00	42
8144. 97S	Diesel	2500	4	93.00	41
8144.97 Sofim	Diesel	2499	4	93.00	41
8144.97 Y Sofim	Diesel	2499	4	93.00	41
A112 A.000	Petrol	903	4	65.00	1
A112 A2.000	Petrol	1050	4	67.20	3
A112 A5.000	Petrol	903	4	65.00	2
A112 B2.000	Petrol	896	4	65.00	1
AR 32302	Diesel	1910	4	82.00	23
AR 32501	Diesel	2387	5	82.00	23
AR 37101	Diesel	1910	4	82.00	25
DW10ATED4 (RHW) Euro 3	Diesel	1997	4	85.00	35
DW12ATED4 (4HW)	Diesel	2179	4	85.00	36
RHK (DW10UTED4) Euro 4	Diesel	1997	4	85.00	37
RHM (DW10ATED4)	Diesel	1997	4	85.00	35
RHZ (DW10ATED)	Diesel	1997	4	85.00	38

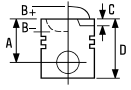

1 65.00



A 112 0.9 Junior	03/81→06/86	A112 A.000	4 Cyl. 903cc	9:1 21-32kW (29-44PS)	TD1856
-------------------------	-------------	-------------------	------------------------	---------------------------------	---------------

A 112 0.9 Junior	03/81→06/86	A112 B2.000	4 Cyl. 896cc	9:1 29-32kW (40-44PS)	TD4622
-------------------------	-------------	--------------------	------------------------	---------------------------------	---------------

87-209800-00	STD
87-209806-00	0.40mm
87-209808-00	0.60mm



A 30.75
D 61.25
 20x54

08-209800-00	STD
08-209806-00	0.40mm
08-209808-00	0.60mm

1.75  CR P
2.00  P
3.94  P

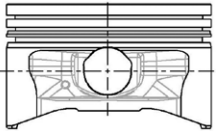
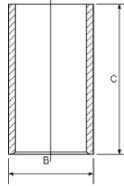

14-011001-00 D B 68.04 C 115.00





87-209800-10 	STD
87-209806-10 	0.40mm
87-209808-10 	0.60mm

A 31.25
D 61.75
 20x54

08-209800-00	STD
08-209806-00	0.40mm
08-209808-00	0.60mm

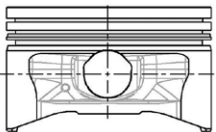
1.75  CR P
2.00  P
3.94  P



 Without circlips

 Ohne Sicherungsbeugeln

 Sans circlips

 Sin anillos de retención

 Pistone con spinotto montato a caldo

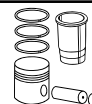

2 65.00

A 112 0.9 Junior

03/81 → 06/86

A112 A5.000

4 Cyl.
903cc

9:1
29-31kW (40-42PS)



TD1803

87-209800-00 STD
87-209806-00 0.40mm
87-209808-00 0.60mm

08-209800-00 STD
08-209806-00 0.40mm
08-209808-00 0.60mm

14-011001-00 D B 68.04 C 115.00

A 30.75
D 61.25
 20x54

1.75  CR P
2.00  P
3.94  P

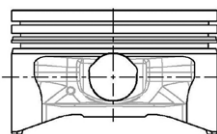
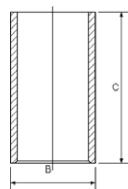

3 67.20

A 112 1.0 Abarth

03/78 → 02/84

A112 A2.000

4 Cyl.
1050cc





10.2:1
51kW (69PS)

TD4621

87-782606-00 0.40mm
87-782608-00 0.60mm

08-782600-00 STD
08-782606-00 0.40mm
08-782608-00 0.60mm

A 30.75
B- 1.50
D 54.75
 18x56

1.50  CR P
1.75  P
3.94  CR 

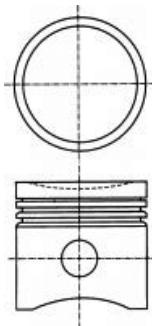

 Steel

 Stahl

 Acier

 Acero

 Acciaio

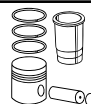
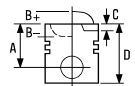

4 69.60

Musa 1.3 D Multijet	10/04→09/12	188 A9.000			
Ypsilon 1.3 JTD	10/03→12/11		4 Cyl.	18:1	
			1248cc	51kW (70PS)	
			Diesel	Turbo Intercooled	TD18314
Ypsilon 1.3 D Multijet	09/06→12/11	199 A2.000			
			4 Cyl.	18:1	
			1248cc	55kW (75PS)	
			Diesel	Turbo Intercooled	TD20272

87-137600-00
87-137606-00

STD
0.40mm

08-137600-00
08-137606-00

STD
0.40mm

14-022060-00 D B 72.50 C 142.00 D 74.00 E 5.00

A 40.43
B- 12.40
BØ 37.00
C 1.20
D 63.43
 23x56

2.00
1.50
2.00



CK P
P
P

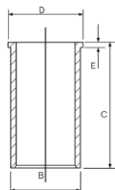

AK RT TP

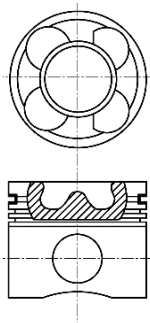

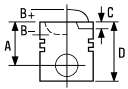

5 69.60

Musa 1.3 D Multijet	09/06→09/12	199 A3.000	4 Cyl.	17.6:1
Ypsilon 1.3 D Multijet	09/06→12/11		1248cc	66-77kW (90-105PS)
Diesel			Turbo Intercooled	
TD20273				

87-425600-00 STD
87-425606-00 0.40mm

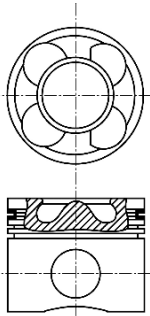

A 40.43
B- 12.41
BØ 38.00
C 0.91
C 0.91
D 62.43
 23x55

AK KK RT TP



06933

08-425600-00 STD
08-425606-00 0.40mm
08-425608-00 0.60mm

2.00  CK P
1.50  NT
2.00  CR P

14-022060-00 D B 72.50 C 142.00 D 74.00 E 5.00

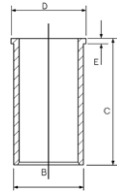

6 70.00

Y10 1.0 Fire	03/85→02/90	156 A 2.000	4 Cyl.	9.5:1
Y10 1.0 Fire All-wheel Drive	12/87→02/92		999cc	33-37kW (45-50PS)
TD4592				



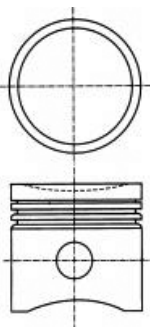

Y10 1.0 Fire	06/85→06/91	156 A 2.100	4 Cyl.	9:1
Y10 1.0 Fire All-wheel Drive	12/86→02/89		999cc	32kW (44PS)
TD4593				

87-154200-00 STD
87-154206-00 0.40mm
87-154208-00 0.60mm

A 33.90
B- 0.50
D 57.40
 18x53



08-154200-00 STD
08-154206-00 0.40mm
08-154208-00 0.60mm

1.50  CR P
1.50  P
3.00  CR 

14-010991-00 D B 73.02 C 116.00

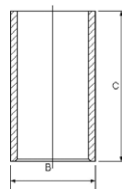

 Steel

 Stahl

 Acier

 Acero

 Acciaio

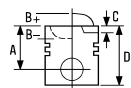

7 70.00

Y10 1.0 Fire	10/87→02/92	156 A2.246	4 Cyl.	9.5:1
Y10 1.0 Fire All-wheel Drive	12/87→02/92		999cc	33kW (45PS)

TD5423

Y10 1.1 i.e Fire		156 C.000	4 Cyl.	9:1
Y10 1.1 i.e Fire All-wheel Drive	08/89→06/92		1108cc	42kW (57PS)

TD1854

Y10 1.1 i.e. Fire	07/89→09/95	156 C.046	4 Cyl.	9:1
Y10 1.1 i.e. Fire All-wheel Drive	09/92→12/95		1108cc	37-40kW (50-54PS)



TD4597

87-154200-10 STD
87-154206-10 0.40mm
87-154208-10 0.60mm

08-154200-00 STD
08-154206-00 0.40mm
08-154208-00 0.60mm

14-010991-00 D B 73.02 C 116.00

A 33.90
B- 1.50
D 57.40
 18x53

1.50  CR P
1.50  P
3.00  CR **I**

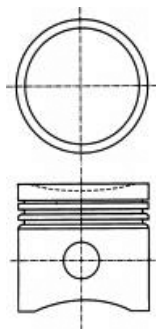
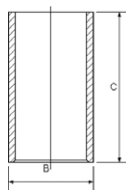

I Steel **I** Stahl **I** Acier **I** Acero **I** Acciaio

8 70.00

Y 1.1	11/95→09/03	176 B2.000 Euro 2 Fire	4 Cyl.	9.6:1
Y10 1.1 Fire	01/95→12/95		1108cc	40kW (54PS)



TD11847

87-142300-00 STD
87-142306-00 0.40mm
87-142308-00 0.60mm

08-142300-00 STD
08-142306-00 0.40mm
08-142308-00 0.60mm

14-010991-00 D B 73.02 C 116.00

A 30.00
B- 1.80
BØ 60.00
D 50.00
 18x53

1.20  CR P
1.20  P
2.50  P

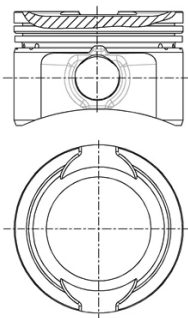
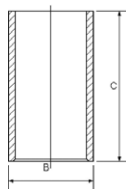







13 72.00

Musa 1.4	09/05→09/12	350 A1.000		
Musa 1.4 LPG	11/10→09/12		4 Cyl.	11:1
Ypsilon 1.4	02/06→12/11		1368cc	55-57kW (75-78PS)
Ypsilon 1.4 LPG	11/10→12/11			

TD20274

87-436800-00	STD	08-436800-00	STD
87-436806-00	0.40mm	08-436806-00	0.40mm

A	26.00
B-	4.75
C	2.05
D	49.00
	18x49

1.00		NT 
1.20		P
2.00		CR P

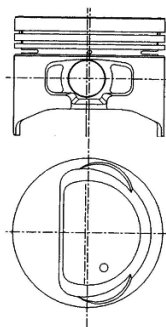

 Steel

 Stahl

 Acier

 Acero

 Acciaio

14 80.50

Delta II 1.4 i.e.	10/94→08/99	160 A1.046		
			4 Cyl.	9.2:1
			1372cc	51kW (69PS)





TD4599

Delta II 1.4 i.e.	10/94→08/99	836 A4.000		
			4 Cyl.	9.2:1
			1372cc	51kW (69PS)

TD14568

87-783600-00	STD	08-783600-00	STD
87-783606-00	0.40mm	08-783606-00	0.40mm
87-783608-00	0.60mm	08-783608-00	0.60mm
		08-783610-00	0.80mm
		08-783611-00	1.00mm

A	33.30
B-	2.90
D	65.00
	22x58

1.50		CR P
1.75		P
3.00		CR 

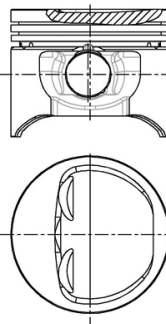

 Steel

 Stahl

 Acier

 Acero

 Acciaio



15 80.50

Lybra 1.6, Lybra SW 1.6

10/00→10/05

182 B6.000

4 Cyl.
1596cc



10.1:1
76kW (103PS)

TD15632

87-124800-00 STD
87-124806-00 0.40mm

08-124800-00 STD
08-124806-00 0.40mm
08-124808-00 0.60mm

A 28.65
B- 1.20
BØ 62.00
C 2.49
C 1.98
D 50.65
 21x56

1.20  NT P
1.20  P
2.00  P

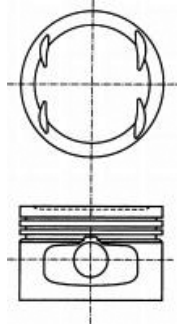

16 82.00

Kappa 2.0 20V Turbo

06/98→10/01

175 A3.000

Kappa SW 2.0 20V Turbo

06/98→10/01

5 Cyl.
1998cc

8.5:1
162kW (220PS)



Turbo Intercooled

TD11550

87-529300-00 STD
87-529306-00 0.40mm

08-529300-00 STD
08-529306-00 0.40mm

A 32.90
C 2.80
D 56.90
 22x54

1.20  NT
1.50  P
3.00  P

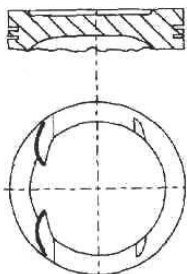

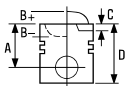



17  **82.00**

Dedra 1.8 16V LE, Dedra SW 1.8 16V LE	03/96→07/99	182 A2.000			
Delta II 1.8	02/96→09/99		4 Cyl.	10:1	
Delta II 1.8 i.e. 16V	03/96→08/99		1747cc	83kW (113PS)	TD9473
Dedra 1.8 GT 16V, Dedra SW 1.8 GT 16V	03/96→07/99	183 A1.000			
Delta II 1.8 i.e. 16V GT	03/96→08/99		4 Cyl.	10.3:1	
			1747cc	96kW (131PS)	TD9474
Lybra 1.8 16V, Lybra SW 1.8 16V	07/99→10/05	839 A4.000			
			4 Cyl.		
			1747cc	96kW (131PS)	TD14468

87-118000-00 STD
87-118006-00 0.40mm
A 36.15
B- 0.50
D 60.15
 20x52

08-118000-00 STD
08-118006-00 0.40mm
08-118008-00 0.60mm

1.19  NT
 1.20  P
 2.00  P

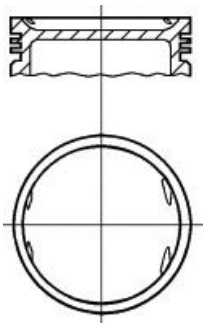

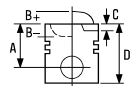

18 82.00

Lybra 2.0 20V, Lybra SW 2.0 20V	07/99→09/00	182 B7.000 Euro 2	5 Cyl. 1998cc	10.7:1 113kW (154PS)	TD14389
---------------------------------	-------------	-------------------	------------------	-------------------------	---------

Kappa 2.0 20V	10/94→10/01	838 A1.000 Euro 2	5 Cyl. 1998cc	10:1 107kW (146PS)	TD4616
---------------	-------------	-------------------	------------------	-----------------------	--------

Kappa 2.0 20V	07/96→10/01	838 A6.000 Euro 2	5 Cyl. 1998cc	10.4:1 114kW (155PS)	TD5436
Kappa SW 2.0 20V	07/96→10/01				

87-787000-00	STD	08-787000-00	STD
87-787006-00	0.40mm	08-787006-00	0.40mm

A	32.90	1.50		CR P
B+	0.80	1.50		P
D	57.70	3.00		CR 1
	20x52			

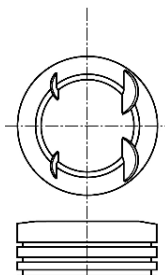

Steel
 Stahl
 Acier
 Acero
 Acciaio

19 82.00

Lybra 2.0 20V, Lybra SW 2.0 20V	09/00→10/05	185 A8.000 Euro 3	5 Cyl. 1998cc	10.5:1 110kW (150PS)	TD15630
---------------------------------	-------------	-------------------	------------------	-------------------------	---------

87-118000-30	STD	08-118000-00	STD
87-118006-30	0.40mm	08-118006-00	0.40mm
		08-118008-00	0.60mm

A	31.90	1.19		NT
B+	1.10	1.20		P
D	55.00	2.00		P
	20x52			

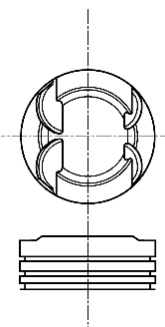

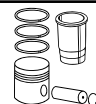
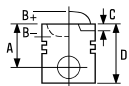

20  **82.00**

Y 1.4 12V	10/96→09/03	840 A2.000	4 Cyl. 1370cc	9.85:1 55-59kW (75-80PS)	TD1858
-----------	-------------	-------------------	-------------------------	------------------------------------	---------------

Y 1.4 12V	03/96→09/03	840 A4.000	4 Cyl. 1371cc	9.85:1 55kW (75PS)	TD4596
-----------	-------------	-------------------	-------------------------	------------------------------	---------------



87-787000-30
87-787006-30

STD
0.40mm

08-787000-00
08-787006-00

STD
0.40mm

A 34.11
B- 5.10
D 58.11
 20x52

1.50  CR P
1.50  P
3.00  CR **1**

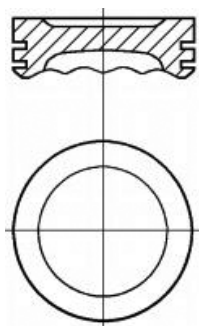

1 Steel

1 Stahl

1 Acier

1 Acero

1 Acciaio

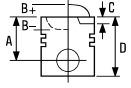

21 82.00

Musa 1.9 D Multijet	10/04→09/12	188 B2.000	4 Cyl.	18:1	
			1910cc	74kW (101PS)	
			Diesel	Turbo Intercooled	TD18316
Lybra 1.9 JTD, Lybra SW 1.9 JTD	05/01→10/05	937 A2.000 Euro 3	4 Cyl.	18.5:1	
			1910cc	85kW (116PS)	
			Diesel	Turbo Intercooled	TD18313
Lybra 2.4 JTD	09/00→05/02	839 A6.000 Euro 3	5 Cyl.	18.45:1	
Lybra SW 2.4 JTD	09/00→10/05		2387cc	103kW (140PS)	
			Diesel	Turbo Intercooled	TD15631
Lybra 2.4 JTD, Lybra SW 2.4 JTD	05/02→10/05	841 C.000 Euro 3	5 Cyl.	18.5:1	
Thesis 2.4 JTD	07/02→07/09		2387cc	110kW (150PS)	
			Diesel	Turbo Intercooled	TD16472

87-124000-30

STD

08-124000-00

STD

14-021051-00 D

B 85.57 C 155.00 D 88.53 E 4.00

87-124008-30

0.60mm

08-124006-00

0.40mm

14-028960-00 D

B 85.00 C 155.00 D 88.00 E 4.50

08-124008-00

0.60mm

A 46.50

B- 17.45

BØ 37.55

C 0.65

D 72.50

 26x61

2.00



CK P

2.00



P

2.00



CR P

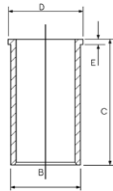

NB RT

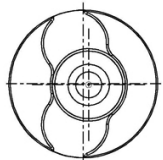
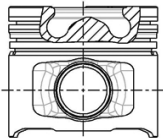

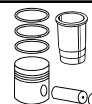
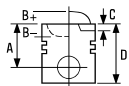

22 82.00



Kappa 2.4 T.DS	08/94→10/01	838 A3.000			
Kappa SW 2.4 T.DS	07/96→10/01		5 Cyl.	21:1	
			2387cc	91kW (124PS)	
			Diesel	Turbo Intercooled	TD4618
Kappa 2.4 T.DS	08/94→10/01	838 A7.000			
Kappa SW 2.4 T.DS	07/96→10/01		5 Cyl.	21:1	
			2387cc	91kW (124PS)	
			Diesel	Turbo Intercooled	TD5437

87-523100-00 STD
87-523108-00 0.60mm

08-523100-00 STD
08-523108-00 0.60mm

14-021051-00 D B 85.57 C 155.00 D 88.53 E 4.00
14-028960-00 D B 85.00 C 155.00 D 88.00 E 4.50

A 45.20
B- 2.15
D 71.15
 26x65

3.00  CK P
 2.00  P
 3.00  CR P

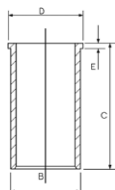

AK RT

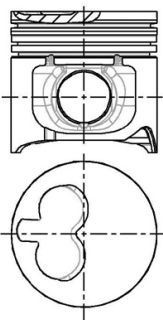



23 82.00

Lybra 1.9 JTD, Lybra SW 1.9 JTD	07/99→09/00	AR 32302	4 Cyl. 1910cc	18.5:1 77kW (105PS)	
			Diesel	Turbo Intercooled	TD17398
Kappa 2.4 JTD, Kappa SW 2.4 JTD	06/98→10/01	838 A8.000 Euro 2	5 Cyl. 2387cc	18.5:1 100kW (136PS)	
			Diesel	Turbo Intercooled	TD11551
Lybra 2.4 JTD Lybra SW 2.4 JTD	07/99→02/01 10/99→09/00	839 A5.000	5 Cyl. 2387cc	18.5:1 96-99kW (131-135PS)	
			Diesel	Turbo Intercooled	TD17399
Lybra 2.4 JTD Lybra SW 2.4 JTD	07/99→02/01 10/99→09/00	AR 32501	5 Cyl. 2387cc	18.5:1 99-100kW (135-136PS)	
			Diesel	Turbo Intercooled	TD17400

87-108000-00
87-108008-00

STD
0.60mm

08-108000-00
08-108008-00

STD
0.60mm

14-021051-00 D
14-028960-00 D

B 85.57 C 155.00 D 88.53 E 4.00
B 85.00 C 155.00 D 88.00 E 4.50

A 47.25
B- 17.50
BØ 37.45
D 73.25
 26x61

3.00
2.00
3.00



CK P
P
CR P

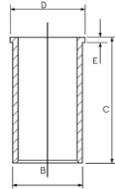

AK NB RT

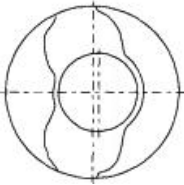
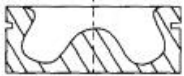

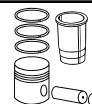
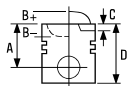

24  **82.00**

Lybra 1.9 JTD		937 A5.000	4 Cyl.	18.5:1	
			1910cc	110kW (150PS)	
		Diesel	Turbo Intercooled		TD21086
Thesis 2.4 JTD	05/03→07/09	841 G.000	5 Cyl.		
			2387cc	129kW (175PS)	
		Diesel	Turbo Intercooled		TD18317
Thesis 2.4 JTD	09/03→07/09	841 M.000	5 Cyl.	18:1	
			2387cc	120-147kW (163-200PS)	
		Diesel	Turbo Intercooled		TD19057
Thesis 2.4 JTD	09/03→07/09	841 N.000	5 Cyl.		
			2387cc	120kW (163PS)	
		Diesel	Turbo Intercooled		TD19058

87-146100-00

STD

87-146108-00

0.60mm

A 46.50

B- 15.40

BØ 41.50

C 1.03

D 72.50

 26x61

08-146100-00

STD

08-146106-00

0.40mm

08-146108-00

0.60mm

2.00



CK P

2.00



P

2.00



CK P

14-021051-00 D

B 85.57 **C** 155.00 **D** 88.53 **E** 4.00

14-028960-00 D

B 85.00 **C** 155.00 **D** 88.00 **E** 4.50

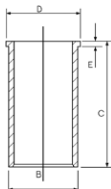

AK KK NB RT TP

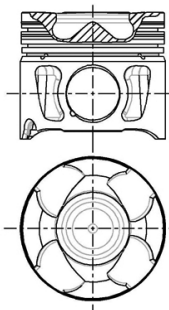

08256-102

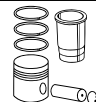
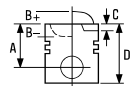

25  **82.00**

Lybra 1.9 JTD, Lybra SW 1.9 JTD

09/00→05/01

AR 37101

4 Cyl.

18.5:1

1910cc

80-85kW (109-116PS)

Diesel

Turbo Intercooled

TD17890

87-107900-00

STD

08-107900-00

STD

14-021051-00 D

B 85.57 C 155.00 D 88.53 E 4.00

87-107908-00

0.60mm

08-107908-00

0.60mm

14-028960-00 D

B 85.00 C 155.00 D 88.00 E 4.50

A 46.50

B- 17.50

BØ 37.50

C 0.80

D 72.50

 26x65

→06/00

2.50



CR P

2.00



P

2.00



CR P

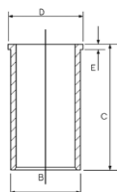

AK RT

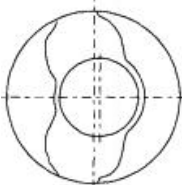
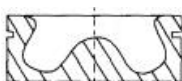

87-124000-10 

STD

08-124000-00

STD

87-124008-10 

0.60mm

08-124006-00

0.40mm

08-124008-00

0.60mm

A 46.50

B- 17.50

BØ 37.50

C 0.55

D 72.50

 26x65

06/00→

2.00



CK P

2.00



P

2.00



CR P

AK RT

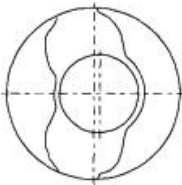
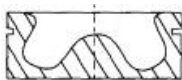

 Piston Chamber Volume

[ccm] 19.91

 Volumen der Kolbenmulde

[ccm] 19.91

 Volume de la cavité du piston

[cm³] 19.91

 Volumen de cavidad del pistón

[cc] 19.91

 Volume camera pistone

[cm³] 19.91

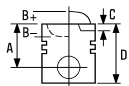

26 82.60

Dedra 1.9 TDS	04/89→07/99	160 D1.000		
Dedra SW 1.9 TDS	07/94→07/99		4 Cyl.	19.2:1
Delta II 1.9 TD	10/94→08/99		1929cc	66kW (90PS)
		Diesel	Turbo Intercooled	TD4610



87-783800-10 STD
87-783808-10 0.60mm

A 43.00
B+ 2.30
D 76.00
 26x69

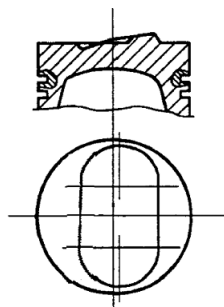
AK HA RT



08-783800-00 STD
08-783808-00 0.60mm

3.00  MOL P
2.00  P
3.00  CR P

14-021311-00 D B 86.06 C 154.00 D 89.00 E 4.50
14-023560-00 D B 86.00 C 154.00 D 89.00 E 4.50
14-023751-00 D B 87.00 C 154.00 D 89.00 E 4.55

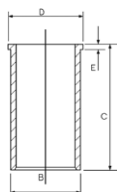

14-014730-00 D B 86.09 C 154.00

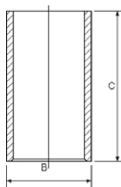



87-783800-30 STD
87-783808-30 0.60mm

A 42.40
B+ 2.50
D 76.00
 26x69

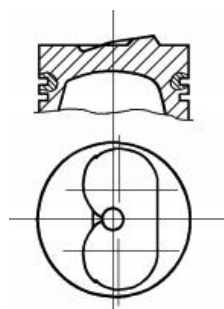
HA RT



08-783800-00 STD
08-783808-00 0.60mm

3.00  MOL P
2.00  P
3.00  CR P

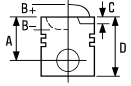

27  **82.60**

Prisma 1.9 Diesel	01/83→02/92	831 D.000	4 Cyl.	21:1
			1929cc	48kW (65PS)
			Diesel	Turbo Intercooled
				TD1813

- 14-021311-00 D B 86.06 C 154.00 D 89.00 E 4.50
- 14-023560-00 D B 86.00 C 154.00 D 89.00 E 4.50
- 14-023751-00 D B 87.00 C 154.00 D 89.00 E 4.55

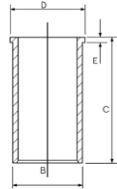

- 14-014730-00 D B 86.09 C 154.00

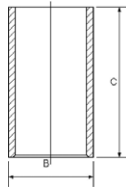



28  **82.60**

Delta I 1.9 Turbo DS	10/86→12/89	831 D1.000	4 Cyl.	20:1
Prisma 1.9 Turbo Diesel	05/85→12/89		1929cc	48-59kW (55-80PS)
			Diesel	Turbo Intercooled
				TD4607

- 87-785400-00 STD 08-785400-00 STD 14-021311-00 D B 86.06 C 154.00 D 89.00 E 4.50
- 87-785408-00 0.60mm 08-785408-00 0.60mm 14-023560-00 D B 86.00 C 154.00 D 89.00 E 4.50
- 14-023751-00 D B 87.00 C 154.00 D 89.00 E 4.55

A 42.60
 B+ 2.50
 D 75.80
 25x70

690651→
 2.50  MOL P
 2.00  P
 3.00  CR P

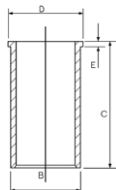

RT

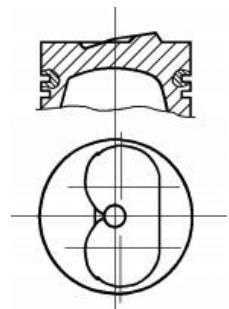

- 14-014730-00 D B 86.09 C 154.00

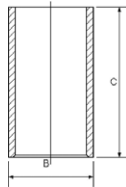

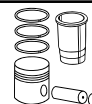
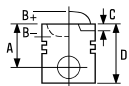

29 82.60

Dedra 1.9 TDS	04/89→07/99	835 A4.000		
Dedra SW 1.9 TDS	07/94→07/99		4 Cyl.	19.9:1
Delta II 1.9 TD	10/94→08/99		1929cc	66kW (90PS)
		Diesel	Turbo Intercooled	TD1846

Dedra 1.9 TDS	04/89→07/99	835 A4.046		
			4 Cyl.	20:1
			1929cc	66kW (90PS)
		Diesel	Turbo Intercooled	TD5425



87-783800-30 STD
87-783808-30 0.60mm

A 42.40
B+ 2.50
D 76.00
 26x69

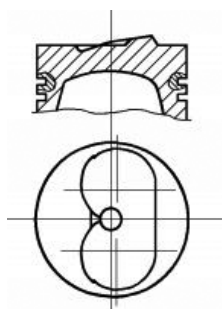
HA RT



08-783800-00 STD
08-783808-00 0.60mm

3.00  MOL P
2.00  P
3.00  CR P

14-021311-00 D B 86.06 C 154.00 D 89.00 E 4.50
14-023560-00 D B 86.00 C 154.00 D 89.00 E 4.50
14-023751-00 D B 87.00 C 154.00 D 89.00 E 4.55

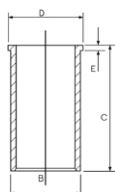

14-014730-00 D B 86.09 C 154.00

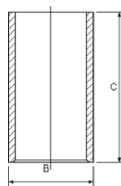



30  **83.00**



Delta III 2.0 D Multijet	09/08→08/14	198 A5.000 Multijet	4 Cyl.	16.1:1
		Diesel	1956cc	121kW (165PS)
			Turbo Intercooled	TD21043
Delta III 2.0 D Multijet	09/08→08/14	844 A2.000	4 Cyl.	16.5:1
		Diesel	1956cc	120kW (163PS)
			Turbo Intercooled	TD24652

87-436500-00
87-436506-00

STD
0.40mm

08-436500-00 STD
08-436506-00 0.40mm

A 43.63
B- 15.80
BØ 43.50
D 72.63
 30x66

1.50  GDC P
1.50  P
2.00  CR P



KK RT TP

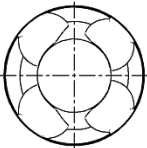
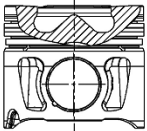

08344A406



31 84.00

Delta I 1.6 GT i.e. Prisma 1.6 i.e. Super	05/87→08/92 05/87→12/89	149 C2.000	4 Cyl. 1585cc	9.5:1 66kW (90PS)	TD5432
Beta 2000 i.e. Beta H.P.E. 2000 i.e. Trevi 2000 i.e.	12/81→12/84 05/81→09/84 05/80→01/87	828 B4.000	4 Cyl. 1995cc	8.9:1 90kW (122PS)	TD4602
Prisma 2.0 i.e. All-wheel Drive	04/86→12/89	831 B4.000	4 Cyl. 1995cc	9.7:1 85kW (115PS)	TD1812
Delta I 1.6 GT i.e. Prisma 1.6 i.e.	08/86→08/88 05/86→12/89	831 B7.000	4 Cyl. 1585cc	9.5:1 80kW (109PS)	TD1817
Delta I 2.0 HF Integrale	10/87→02/89	831 C5.000	4 Cyl. 1995cc Turbo Intercooled	8:1 133kW (181PS)	TD1821
Delta I 2.0 HF Integrale	12/86→12/92	831 C5.046	4 Cyl. 1995cc Turbo Intercooled	8:1 130kW (177PS)	TD1822
Delta I 2.0 16V HF Integrale	03/89→09/91	831 D5.000	4 Cyl. 1995cc Turbo Intercooled	8:1 144kW (196PS)	TD1825
Thema 2000 i.e.	11/84→09/88	834 B.000	4 Cyl. 1995cc	9.8:1 88kW (120PS)	TD1833
Thema 2000 i.e.	03/86→09/88	834 B.048	4 Cyl. 1995cc	9.8:1 83-85kW (112-113PS)	TD1829
Thema 2000 i.e.	09/87→05/92	834 B.146	4 Cyl. 1995cc	9.8:1 85kW (116PS)	TD1818
Thema 2000 i.e.	09/88→05/92	834 B1.000	4 Cyl. 1995cc	9.5:1 86kW (117PS)	TD1830
Thema 2000 i.e. 16V, Thema SW 2000 i.e. 16V	02/89→05/92	834 B2.246	4 Cyl. 1995cc Turbo Intercooled	8:1 104kW (141PS)	TD1832
Thema 2000 16V Thema SW 2000 16V	08/92→12/93 05/92→07/94	834 F1.000	4 Cyl. 1995cc	110-112kW (150-152PS)	TD1831



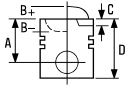

Dedra 1.8 i.e.	09/89→06/94	835 A2.000	4 Cyl. 1756cc	9.5:1 80kW (108PS)	TD1845
Dedra 1.8 i.e.	09/89→07/99	835 A2.046	4 Cyl. 1756cc	9.5:1 74-77kW (101-105PS)	TD1844
Delta II 1.8 i.e.	06/93→08/99	835 C2.000	4 Cyl. 1756cc	9.5:1 76kW (103PS)	TD4612
Delta II 1.8 i.e.	07/94→08/99	835 C4.000	4 Cyl. 1756cc	9.5:1 66kW (90PS)	TD5433
Dedra 2.0 16V, Dedra SW 2.0 16V Dedra SW 2.0 Integrale Delta II 2.0 16V	07/94→07/99 06/93→08/99	836 A3.000	4 Cyl. 1995cc	10:1 102-108kW (139-147PS)	TD4614
Dedra 1.8 i.e., Dedra SW 1.8 i.e.	07/94→07/99	836 A5.000	4 Cyl. 1756cc	9.5:1 74kW (101PS)	TD4615
Delta II 1.8 i.e.	07/94→08/99	836 A6.000	4 Cyl. 1756cc	9.5:1 66kW (90PS)	TD11918
Delta II 1.8 i.e.	07/94→08/99	836 C4.000	4 Cyl. 1756cc	9.5:1 66kW (90PS)	TD5434

14-011041-00 D

B 88.06 C 152.00

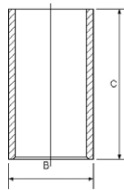

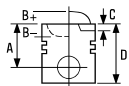

32 84.00

Delta II 2.0 16V Turbo	07/96→08/99	175 A4.000	4 Cyl. 1995cc Turbo Intercooled	8:1 142kW (193PS)	TD11827
Delta I 2.0 16V HF Evo Integrale	06/93→01/94	831 E5.000	4 Cyl. 1995cc Turbo Intercooled	8:1 155kW (211PS)	TD1827
Delta I 2.0 16V HF Evo Integrale	06/93→01/94	831 E5.046	4 Cyl. 1995cc Turbo Intercooled	8:1 155kW (211PS)	TD1826
Thema 2000 16V Turbo Thema SW 2000 i.e. 16V Turbo	12/88→06/90	834 C1.000	4 Cyl. 1995cc Turbo Intercooled	8:1 133kW (181PS)	TD1835
Thema 2000 16V Turbo Thema SW 2000 Turbo 16V	10/92→07/94 11/92→07/94	834 F2.000	4 Cyl. 1995cc Turbo Intercooled	8:1 148kW (202PS)	TD1840
Delta II 2.0 16V Turbo	06/93→08/99	836 A2.000	4 Cyl. 1995cc Turbo Intercooled	10:1 137kW (186PS)	TD5435
Kappa 2.0 16V Turbo Kappa SW 2.0 16V Turbo	02/95→10/01 07/96→10/01	838 A4.000	4 Cyl. 1995cc Turbo Intercooled	8:1 151kW (205PS)	TD4619

87-142400-00
87-142406-00

STD
0.40mm

A 39.00
B- 6.00
BØ 72.00
C 2.00
D 69.00
 22x69

AK

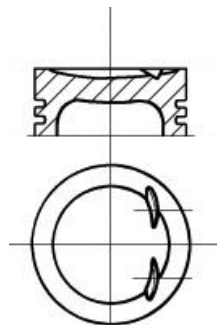

08-142400-00
08-142406-00

STD
0.40mm

1.50
1.50
3.00



CK
P
P

14-011041-00 D B 88.06 C 152.00

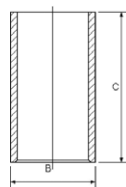



33 84.00

Delta I 2.0 HF Integrale	11/86→08/88	831 B5.000	4 Cyl. 1995cc Turbo Intercooled	8:1 122kW (166PS)	TD1823
Thema 2000 i.e. Turbo	11/84→12/87	834 C.000	4 Cyl. 1995cc Turbo Intercooled	8:1 122kW (166PS)	TD1834
Thema 2000 i.e. Turbo Thema SW 2000 Turbo	07/86→05/90 01/89→03/92	834 C.146	4 Cyl. 1995cc Turbo Intercooled	8:1 110kW (150PS)	TD1837
Dedra 2.0 i.e.	09/89→07/99	835 A5.046	4 Cyl. 1995cc	9.3:1 82-83kW (112-113PS)	TD1848
Dedra 2.0 i.e. Turbo Integrale	05/90→07/94	835 A7.000	4 Cyl. 1995cc Turbo Intercooled	8:1 121kW (165PS)	TD1849
Dedra 2.0 HF Integrale	11/90→07/94	835 A7.046	4 Cyl. 1995cc Turbo Intercooled	8:1 124kW (169PS)	TD1850

87-215300-10

STD

87-215308-10

0.60mm

A 39.50

B- 4.50

D 79.00

 22x69

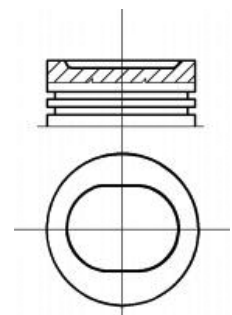

08-215300-10

STD

08-215306-10

0.40mm

08-215308-10

0.60mm

02/88→

1.50

2.00

3.94



CR P

P

P

14-011041-00 D

B 88.06 C 152.00

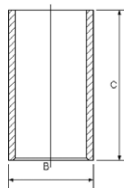



34  **85.00**

Phedra 2.2 JTD	04/06→11/10	4HP	4 Cyl. 2179cc Diesel	Turbo Intercooled	120kW (163PS)	TD24689
Phedra 2.2 JTD	04/06→11/10	4HR	4 Cyl. 2179cc Diesel	Turbo Intercooled	120kW (163PS)	TD24690
Phedra 2.2 D Multijet	03/08→11/10	4HS Euro 4	4 Cyl. 2179cc Diesel	Turbo Intercooled	16.6:1 125kW (170PS)	TD24688
Phedra 2.2 D Multijet	03/08→11/10	4HT Euro 4	4 Cyl. 2179cc Diesel	Bi-Turbo Intercooled	17.5:1 125kW (170PS)	TD24686

87-436700-10 

STD

08-436700-00 STD

STD

87-436708-10 

0.60mm

08-436708-00

0.60mm

A 48.70

B- 13.47

BØ 52.40

C 0.38

D 74.70

 30x68

2.50

2.00

2.00



GDC P

P

CK



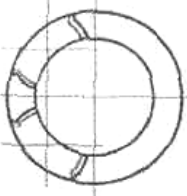

AK KK RT TP





0850HA127

 For pistons with a 24.3mm con rod gap measured at pin centre line

 Für Kolben mit einem Pleuelaugenabstand von 24,3 MM, gemessen an der Kolbenbolzen-Mitte

 Pour pistons avec un écart de bielle d e 24,3 mm mesuré au centre de l'axe bielle-piston

 Para pistones con una distancia de paso de biela en el centro del bulón de 24,3mm



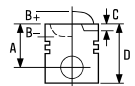

 Per pistoni con passaggio biella di 24,3 mm misurato sull' asse spinotto



35  **85.00**

Phedra 2.0 JTD	09/02→11/10	DW10ATED4 (RHW) Euro 3		
Zeta 2.0 JTD 16V	09/99→09/02	4 Cyl.	17.6:1	
		1997cc	80kW (109PS)	
		Diesel	Turbo Intercooled	TD16735
Phedra 2.0 JTD	07/03→11/10	RHM (DW10ATED4)		
		4 Cyl.	17.6:1	
		1997cc	79kW (107PS)	
		Diesel	Turbo Intercooled	TD26957

87-114700-10	STD	08-114700-00	STD
87-114708-10	0.60mm	08-114708-00	0.60mm

A	46.73	3.50		CK P
B-	18.80	2.00		P
BØ	39.80	3.00		CR P
C	1.67			
D	72.70			
	28x68			

AK KK RT TP

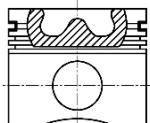
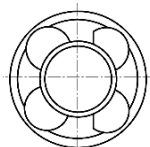



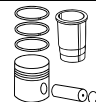
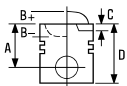

08517-103



36 85.00

Phedra 2.2 JTD 09/02→11/10 DW12ATED4 (4HW)
 4 Cyl. 18:1
 2179cc 94kW (128PS)
 Diesel Turbo Intercooled TD16736

87-114700-30 STD 08-114700-00 STD
 87-114708-30 0.60mm 08-114708-00 0.60mm

A 48.70 3.50  CK P
 B- 18.00 2.00  P
 BØ 40.80 3.00  CR P
 C 0.40
 C 0.40
 D 77.70
 30x68



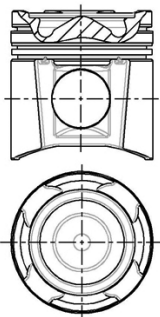

AK KK RT



37 85.00

Phedra 2.0 JTD 06/06→11/10 RHK (DW10UTED4) Euro 4
 4 Cyl. 17.5:1
 1997cc 79-88kW (107-120PS)
 Diesel Turbo Intercooled TD26952

87-114700-40 STD 08-114700-00 STD
 87-114708-40 0.60mm 08-114708-00 0.60mm

A 46.70 3.50  CK P
 B- 15.40 2.00  P
 BØ 44.80 3.00  CR P
 C 0.57
 D 72.70
 28x70

AK KK RT TP

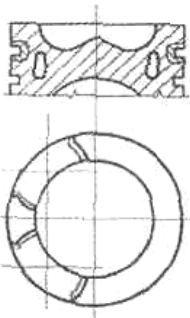



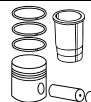
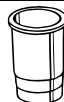
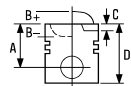

08570-109



38 85.00

Zeta 2.0 JTD	04/00 → 09/02	RHZ (DW10ATED)	4 Cyl.	18:1
			1997cc	80kW (109PS)
		Diesel	Turbo Intercooled	TD26954

87-114700-00	STD	08-114700-00	STD
87-114708-00	0.60mm	08-114708-00	0.60mm

A	46.75	3.50		CR P
B-	18.30	2.00		P
BØ	38.00	3.00		CR P
C	1.00			
D	80.75			
	28x70			

AK RT TP

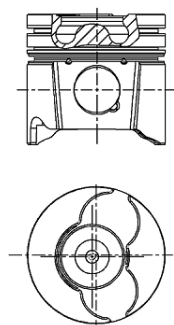





39 86.40

Dedra 1.6 16V, Dedra SW 1.6 16V	01/96 → 07/99	182 A4.000	4 Cyl.	10.2:1
Delta II 1.6 i.e. 16V	01/96 → 08/99		1581cc	76kW (103PS)
Lybra 1.6 16V, Lybra SW 1.6 16V	07/99 → 10/05			TD9476

Delta II 1.6 i.e.	03/96 → 08/99	182 A6.000	4 Cyl.	10.1:1
			1581cc	66kW (90PS)
				TD9475

87-786800-00	STD	08-786800-00	STD
87-786806-00	0.40mm	08-786806-00	0.40mm

A	34.17	1.50		CR P
B+	0.25	1.50		P
D	59.42	3.00		CR 
	22x56			

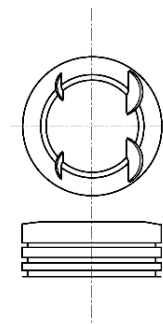

 Steel

 Stahl

 Acier

 Acero

 Acciaio

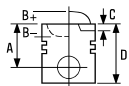





40 86.40

Dedra 1.6 i.e.	08/89→06/94	835 A1.000	4 Cyl. 1581cc	9.2:1 65-66kW (88-90PS)	TD1842
Dedra 1.6 i.e.	08/89→03/93	835 A1.046	4 Cyl. 1581cc	9.2:1 57kW (77PS)	TD1843
Dedra 1.6 i.e. Delta II 1.6 i.e.	04/93→07/99 06/93→08/99	835 C1.000	4 Cyl. 1581cc	9.2:1 55kW (75PS)	TD4611

87-783700-00	STD	08-783700-00	STD
87-783706-00	0.40mm	08-783706-00	0.40mm
87-783708-00	0.60mm	08-783708-00	0.60mm
		08-783711-00	1.00mm

A	33.30
B-	2.30
D	72.80
	22x63

1.50		CR P
1.75		P
3.00		CR 

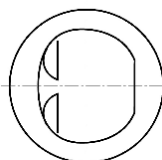

 Steel

 Stahl

 Acier

 Acero

 Acciaio



41 93.00

Thema 2500 Turbo DS, Thema SW 2500 Turbo DS	05/88→07/92	8144.97S	4 Cyl.	21:1	
			2500cc	77kW (105PS)	
			Diesel	Turbo Intercooled	TD1785
Thema 2500 Turbo DS, Thema SW 2500 Turbo DS	06/88→05/92	8144.97 Sofim	4 Cyl.	18:1	
			2499cc	85kW (115PS)	
			Diesel	Turbo Intercooled	TD4601
Thema 2500 Turbo DS	05/92→07/94	8144.97 Y Sofim	4 Cyl.	18:1	
Thema SW 2500 Turbo DS	09/92→07/94		2499cc	85kW (115PS)	
			Diesel	Turbo Intercooled	TD1786
		8144.97.2200	4 Cyl.	22:1	
			2499cc	85-87kW (116-118PS)	
			Diesel	Turbo Intercooled	TD19036

14-021371-00 D B 96.01 C 171.00 D 98.92 E 5.00
14-021372-00 D B 96.05 C 171.00 D 98.92 E 5.00
14-021480-00 DH  B 97.03 C 171.00 D 100.00 E 5.00

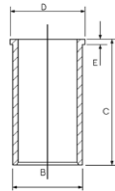

 Nitrided

 Nitriert

 Nitridé

 Niturado





 Nitratato

42 93.00

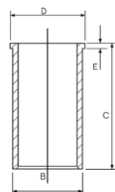
Thema 2500 Turbo D	11/84→09/88	8144.91 Sofim	4 Cyl.	18:1	
Thema SW 2500 Turbo DS	03/87→09/90		2445cc	74kW (101PS)	
			Diesel	Turbo Intercooled	TD4600
		8144.97.2400	4 Cyl.	21:1	
			2499cc	83-87kW (113-118PS)	
			Diesel	Turbo Intercooled	TD22318

14-022560-00 D B 96.00 C 167.30 D 98.90 E 5.00
14-028930-00 D B 97.50 C 167.00 D 100.90 E 5.00
14-028931-00 D B 97.58 C 167.00 D 100.90 E 5.00
14-028932-00 D B 97.70 C 167.00 D 100.90 E 5.00



		ccm	x 		9
2 1/4L	Petrol	2286	4	90.47	15
2.3L 3 Main Bearing Crankshaft	Diesel	2286	4	90.47	17
3.5L Carburettor	Petrol	3528	V8	88.86	12
3.5L EFI	Petrol	3528	V8	88.86	12
10 H	Petrol	2286	4	90.47	15
10 J 5 Main Bearing Crankshaft	Diesel	2286	4	90.47	17
11 A (VM492HT)	Diesel	2376	4	92.00	22
11 D	Petrol	3528	V8	88.86	12
11H	Petrol	2286	4	90.47	15
11 L (200Tdi)	Diesel	2495	4	90.47	18
12J	Diesel	2495	4	90.47	19
12 L (200Tdi)	Diesel	2495	4	90.47	18
16 L (300Tdi)	Diesel	2495	4	90.47	20
17H	Petrol	2495	4	90.47	16
17 L (300Tdi)	Diesel	2495	4	90.47	20
18 K4F K Series	Petrol	1796	4	80.00	1
19J	Diesel	2495	4	90.47	21
19 L (300Tdi)	Diesel	2495	4	90.47	20
20 T2N (L Series)	Diesel	1994	4	84.50	8
21 L (200Tdi)	Diesel	2495	4	90.47	18
22 D	Petrol	3528	V8	88.86	13
24 D	Petrol	3528	V8	88.86	13
25 6T (BMW M51D25)	Diesel	2497	6	80.00	3
25 D	Petrol	3528	V8	88.86	13
25 K4F	Petrol	2497	V6	80.00	2
31 D	Petrol	3528	V8	88.86	12
35 D	Petrol	3950	V8	94.00	23
36 D	Petrol	3950	V8	94.00	23
37 D	Petrol	3950	V8	94.00	23
38 D	Petrol	3950	V8	94.00	23
40 D	Petrol	4275	V8	94.00	23
42 D	Petrol	3950	V8	94.00	23
46 D	Petrol	4553	V8	94.00	24
224DT	Diesel	2179	4	85.00	9
244DT	Diesel	2402	4	89.90	14
276DT Euro 4	Diesel	2720	V6	81.00	4
DW12BTED4 Euro 4	Diesel	2179	4	85.00	10
M 47 R	Diesel	1950	4	84.00	5
M57D30 (TD6)	Diesel	2926	6	84.00	6
TD5 (10P)	Diesel	2495	5	84.45	7
V8	Petrol	3950	V8	94.00	25
ZSD-422	Diesel	2198	4	86.00	11



1 80.00

Freelander 1.8 16V	11/00→10/06	18 K4F K Series		
Freelander 1.8 i 16V	02/98→11/00	4 Cyl.	10.5:1	
Freelander Soft Top 1.8	10/00→09/03	1796cc	85-88kW (116-120PS)	
Freelander Soft Top 1.8 i 16V	02/98→10/06			TD20740

87-522700-00	STD	08-522700-00	STD	14-710020-00 WH	B 84.10 C 129.50 D 87.50 E 50.00	88-522700-00 87-522700-00 + 14-710020-00
A	22.70	1.00		CR		
B-	0.53	1.20		P		
BØ	68.20	2.00		CR		
C	2.65					
D	45.65					
	18x53					

TP

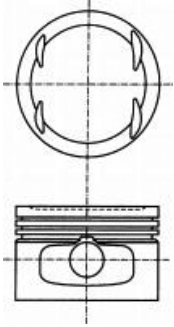

Steel

Stahl

Acier

Acero

Acciaio

2 80.00

Freelander 2.5 V6	11/00→10/06	25 K4F		
		V6 Cyl.	10.5:1	
		2497cc	129-130kW (175-177PS)	
				TD19716

87-521600-00	STD	08-521600-00	STD	14-710020-00 WH	B 84.10 C 129.50 D 87.50 E 50.00	
A	27.35	1.20		CR		
C	1.20	1.50				
D	50.30	2.50		CR		
	18x53					

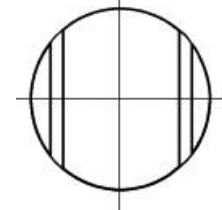
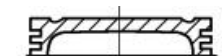

Steel

Stahl

Acier

Acero





Acciaio



3 80.00

Range Rover II 2.5 D	07/94→03/02	25 6T (BMW M51D25)	6 Cyl.	22:1
			2497cc	100kW (136PS)
		Diesel	Turbo Intercooled	TD22933

87-704500-00	STD	08-704500-00	STD
87-704507-00	0.50mm	08-704507-00	0.50mm

A	39.45	3.00		CR P
B-	2.50	1.75		P
D	62.45	3.00		CR P
	27x63			

AK KK RT

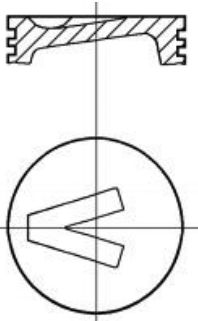





08034X

4 81.00

Discovery III 2.7 TD	07/04→09/09	276DT Euro 4	V6 Cyl.	18:1
Discovery IV 2.7 TD	09/09→		2720cc	140kW (190PS)
Range Rover Sport 2.7 D	02/05→03/13		Turbo Intercooled	TD24908

87-432400-00	STD	08-432400-00	STD
--------------	-----	--------------	-----

A	47.00	2.00		CK P
B-	14.05	2.00		P
BØ	44.00	2.00		P
C	0.50			
D	71.00			
	29x62			

AK KK RT TP

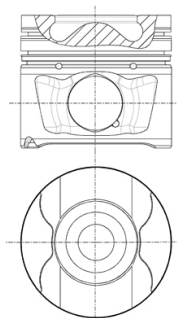







5 84.00

Freelander	01/01 →	M 47 R	4 Cyl.	19.5:1
			1950cc	85kW (116PS)
		Diesel	Turbo Intercooled	TD24392

87-114400-00	STD	08-114400-00	STD
87-114405-00	0.25mm	08-114405-00	0.25mm

A	47.00	3.00		CK P
B-	15.05	2.00		P
BØ	41.70	3.00		CR P
C	1.30			
D	71.00			
	30x66			

KK RT

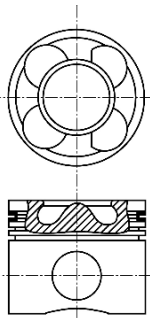





08452-L160

6 84.00

Range Rover	03/02 →	M57D30 (TD6)	6 Cyl.	18:1
			2926cc	130-142kW (177-193PS)
		Diesel	Turbo Intercooled	TD22322

87-114400-10	STD	08-114400-00	STD
87-114405-10	0.25mm	08-114405-00	0.25mm

A	47.00	3.00		CK P
B-	16.55	2.00		P
BØ	41.60	3.00		CR P
C	1.40			
D	71.10			
	30x66			

AK KK RT

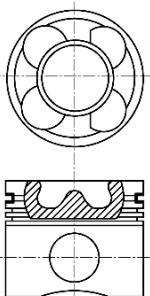

08452-L165





7 84.45

Defender 2.5 Td5 Discovery II 2.5 Td5	06/98→ 11/98→06/04	TD5 (10P)	5 Cyl. 2495cc Turbo	90-102kW (122-139PS)	TD25823
Diesel					

87-140000-00	STD	08-140000-00	STD
87-140007-00	0.50mm	08-140007-00	0.50mm

A	47.94
B-	17.40
BØ	39.00
D	78.94
	30x70

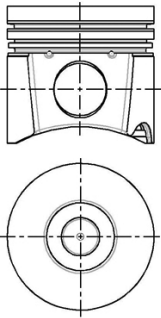

3.00		P PS
2.00		P
3.00		CR P

KK RT TP





8 84.50

Freelander 2.0 DI Freelander Soft Top 2.0 DI	02/98→11/00 02/98→10/06	20 T2N (L Series)	4 Cyl. 1994cc Turbo	19.5:1 72kW (98PS)	TD26632
Diesel					

87-119800-00	STD	08-119800-00 	STD
87-119807-00	0.50mm	08-119807-00 	0.50mm

A	47.97
B-	17.00
BØ	38.00
D	76.97
	30x70

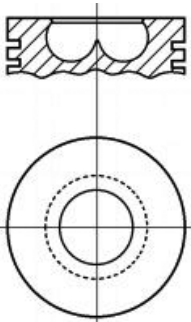

→10P13888B		
3.00		PS
2.00		P
3.00		CR

AK RT TP



 15 degree Wedge Top Ring

 15-Grad Keiloberring



 Segment trapézoïdal angle 15 de grés.  Anillo superior en cuña de 15 grados

 Segmento trapezio con inclinazione fianchi = 15





9  **85.00**

Discovery Sport 2.2 D 4WD	12/14→	224DT		
Freelander 2 2.2 eD4			4 Cyl.	16.5:1
Freelander 2 2.2 SD4	08/10→10/14		2179cc	110-140kW (150-190PS)
Freelander 2 2.2 TD4	10/06→10/14	Diesel	Turbo Intercooled	TD24922
Range Rover Evoque 2.2 D	06/11→			

87-436700-00 	STD	08-436700-00	STD
87-436708-00 	0.60mm	08-436708-00	0.60mm

A	48.60
B-	15.12
BØ	50.40
C	0.38
D	74.60
	30x68

2.50		GDC P
2.00		P
2.00		CK



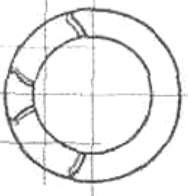
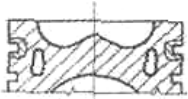

AK KK RT TP





0850HA324

 For pistons with a 24.3mm con rod gap measured at pin centre line

 Für Kolben mit einem Pleuelaugenabstand von 24,3 MM, gemessen an der Kolbenbolzen-Mitte

 Pour pistons avec un écart de bielle de 24,3 mm mesuré au centre de l'axe bielle-piston



 Para pistones con una distancia de paso de biela en el centro del bulón de 24,3mm



 Per pistoni con passaggio biella di 24,3 mm misurato sull'asse foro spinotto



10 85.00

Freelander 2 2.2 eD4	08/10→10/14	DW12BTED4 Euro 4		
Freelander 2 2.2 TD4	10/06→10/14	4 Cyl.	16.6:1	
		2179cc	110kW (150PS)	
		Diesel	Bi-Turbo Intercooled	TD26064

87-436700-10 	STD	08-436700-00	STD
87-436708-10 	0.60mm	08-436708-00	0.60mm

A	48.70	2.50	 GDC P
B-	13.47	2.00	 P
BØ	52.40	2.00	 CK



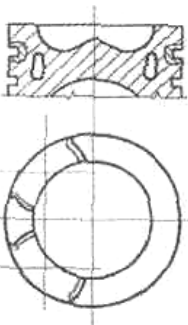

AK KK RT TP





0850HA127

 For pistons with a 24.3mm con rod gap measured at pin centre line

 Für Kolben mit einem Pleuelaugenabstand von 24,3 MM, gemessen an der Kolbenbolzen-Mitte

 Pour pistons avec un écart de bielle de 24,3 mm mesuré au centre de l'axe bielle-piston





 Para pistones con una distancia de paso de biela en el centro del bulón de 24,3mm

 Per pistoni con passaggio biella di 24,3 mm misurato sull'asse foro spinotto

11 86.00

Defender 2.2 Td4	08/11→	ZSD-422		
		4 Cyl.		
		2198cc	90kW (122PS)	
		Diesel		TD31976

87-427700-40	STD	08-427700-00	STD	14-021120-00 D	B 89.00 C 156.00 D 90.90 E 5.00
87-427707-40	0.50mm	08-427707-00	0.50mm		

A	48.42	2.00	 CK P
B-	15.85	2.00	 P
BØ	46.90	2.00	 NT 
D	74.82		
	30x66		

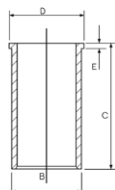

AK KK RT TP

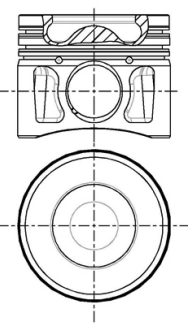

08683-101





87-427700-10
87-427707-10

STD
0.50mm

08-427700-00
08-427707-00

STD
0.50mm

14-021120-00 D

B 89.00 C 156.00 D 90.90 E 5.00

A 43.42
B- 15.85
BØ 46.90
D 69.82
 30x67

2.00
2.00
2.00



CK P
P
NT

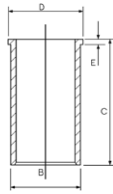

KK RT TP

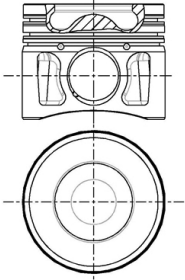

8648B105

Steel

Stahl

Acier

Acero

Acciaio

12 88.86

90	01/83→12/90	3.5L Carburettor		
109 Series III	01/81→12/85	V8 Cyl.	8.13:1	
110	01/83→12/90	3528cc		
Range Rover	01/77→12/85			FM2683
Discovery V8 i, Discovery V8 iS	01/90→09/93	3.5L EFi		
Discovery V8i, Discovery V8iS		V8 Cyl.	8.13:1	
Range Rover V8	01/86→12/88	3528cc		
Range Rover Vogue EFi	01/85→12/89			FM5059
Range Rover Vogue SE	01/88→10/89			
Defender 3.5	09/90→08/93	11 D		
Range Rover I 3.5	07/70→08/91	V8 Cyl.	8.13:1	
Range Rover I 3.5 Vogue	08/81→09/90	3528cc	86-97kW (117-132PS)	TD22941
Range Rover I 3.5	01/87→09/90	31 D		
		V8 Cyl.	8.13:1	
		3528cc	107kW (146PS)	TD22942

87-520100-00
87-520107-00

STD
.020

08-520100-00
08-520107-00

STD
.020

A 47.37
B- 5.26
BØ 71.12
D 77.09
 22x73

1.58
1.58
4.73



CR P
P
P

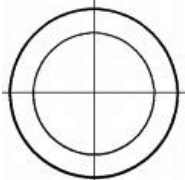
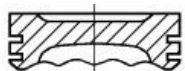

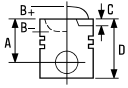





13 88.86

Defender 3.5 Discovery I 3.5	09/90→12/98 06/89→06/94	22 D	V8 Cyl. 3528cc	9.35:1 100-122kW (136-166PS)	TD22934
Range Rover I 3.5 Vogue	10/85→09/90	24 D	V8 Cyl. 3528cc	9.35:1 120kW (163PS)	TD22939
Range Rover I 3.5 Vogue	10/85→09/90	25 D	V8 Cyl. 3528cc	9.35:1 120kW (163PS)	TD22940

87-520100-10 STD
87-520107-10 .020

08-520100-00 STD
08-520107-00 .020

A 47.17
B- 2.36
BØ 71.12
D 77.09
 22x73

1.58  CR P
1.58  P
4.73  P

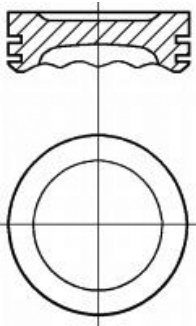







14 89.90

Defender Cabrio	05/07→	244DT		
Defender Station Wagon	05/07→		4 Cyl.	17.5:1
			2402cc	90kW (122PS)
		Diesel	Turbo Intercooled	
				TD24907

87-148100-00	STD	08-148100-00	STD	14-020540-00 DH	B 92.50 C 165.00 E 3.00
87-148105-00	0.25mm	08-148105-00	0.25mm		
87-148107-00	0.50mm	08-148107-00	0.50mm		

A	53.50
B-	17.24
BØ	40.40
D	80.50
	32x71

2.00		CK P
2.00		P
2.00		NT 1

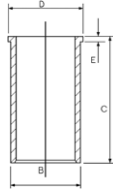



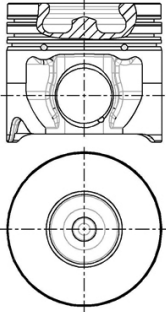

AK KK RT TP



08900B201

87-148100-30	STD	08-148100-00	STD
87-148107-30	0.50mm	08-148105-00	0.25mm
		08-148107-00	0.50mm

A	53.50
B-	16.30
BØ	49.00
D	80.50
	32x71

2.00		CK P
2.00		P
2.00		NT 1

AK KK RT TP

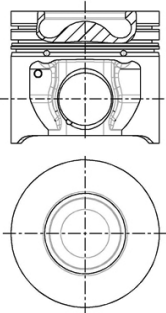

08900B102

 Steel

 Stahl

 Acier

 Acero

 Acciaio

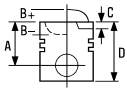

15 90.47

88 Series II	01/57→12/85	2 1/4L			
88 Series IIA, 88 Series III	01/58→12/85		4 Cyl.	8:1	
90	01/84→12/85		2286cc	51-52kW (69-71PS)	
109 Series II	01/57→12/85				FM944
109 Series IIA, 109 Series III	01/58→12/85				
110	01/83→08/86				

88/109 2.3	09/63→12/86	10 H			
90/110 2.3	01/84→08/87		4 Cyl.	8:1	
			2286cc	51-52kW (69-71PS)	
					TD25821

88/109 2.3	09/61→12/86	11H			
88/109 Hardtop 2.3	09/63→12/86		4 Cyl.	8:1	
			2286cc	51-57kW (69-78PS)	
					TD25824

87-263100-00 STD
87-263107-00 .020

A 58.52
D 99.92
 25x76

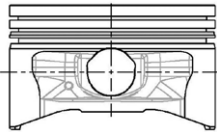

08-263100-00 STD
08-263107-00 .020

1.79 CR P
1.79 P
4.74 P

14-024710-00 D B 94.52 C 191.36 D 99.70 E 4.76

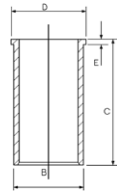

14-010920-00 D B 94.50 C 191.36

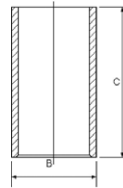

16 90.47

90/110 2.5	09/85→07/90	17H			
Defender 2.5	09/90→12/94		4 Cyl.	8:1	
			2495cc	61kW (83PS)	
					TD19656

87-263100-10 STD
87-263107-10 .020

A 54.48
B- 0.91
D 89.23
 25x76

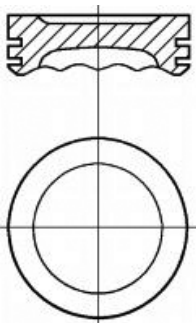

08-263100-00 STD
08-263107-00 .020

1.79 CR P
1.79 P
4.74 P

14-024710-00 D B 94.52 C 191.36 D 99.70 E 4.76

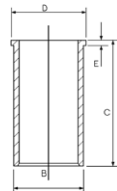

14-010920-00 D B 94.50 C 191.36

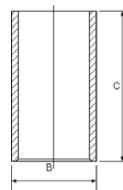



17 90.47

88 Series II, 88 Series IIA, 88 Series III	01/58→12/85	2.3L 3 Main Bearing Crankshaft		
90 Series II, 90 Series IIA, 90 Series III			4 Cyl.	23:1
109 Series III	01/71→12/84		2286cc	
109 Series IIA	09/61→12/71	Diesel		FM945
88/109 2.3 D, 88/109 Hardtop 2.3 D	09/63→12/86	10 J 5 Main Bearing Crankshaft		
90/110 2.3 D	06/84→08/87		4 Cyl.	23:1
			2286cc	46-51kW (63-69PS)
		Diesel		TD25822





87-526400-00 STD
87-526411-00 .040

08-526400-00 STD
08-526411-00 .040

14-024710-00 D B 94.52 C 191.36 D 99.70 E 4.76

A 58.65
B- 6.50
D 100.05
 30x75

36615200A→

2.38  NT
2.38  P
2.38  P
4.77  CR P

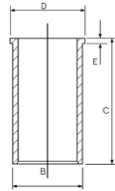

14-010920-00 D B 94.50 C 191.36

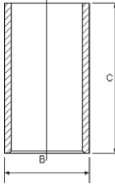



18 90.47

Defender 2.5 90;110 TDI	09/90→12/98	11 L (200tdi)			
Defender 2.5 90 TDI	09/90→		4 Cyl.	19.5:1	
Defender 2.5 TD	08/98→12/05		2495cc	79-83kW (107-113PS)	
		Diesel	Turbo Intercooled		TD20407
Discovery I 2.5 TDI	10/89→10/98	12 L (200Tdi)			
			4 Cyl.	19.5:1	
			2495cc	83kW (113PS)	
		Diesel	Turbo Intercooled		TD20408
Discovery I 2.5 TDI	10/89→10/98	21 L (200Tdi)			
Range Rover I 2.5 TD	10/89→04/94		4 Cyl.	19.5:1	
			2495cc	83kW (113PS)	
		Diesel	Turbo Intercooled		TD20410



87-524400-00 STD
87-524407-00 .020

A 55.40
B- 18.85
BØ 39.50
D 91.90
 30x77

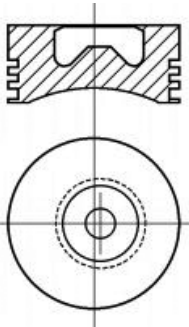
RT TP



08-524400-00 STD
08-524407-00 .020

2.50  CR P
 2.00  P
 3.00  CR P

14-024710-00 D B 94.52 C 191.36 D 99.70 E 4.76

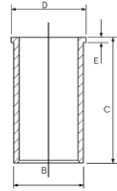

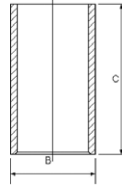

14-010920-00 D B 94.50 C 191.36





19 90.47

90/110 2.5 D	09/83→07/90	12J			
Defender 2.5 D	09/90→09/01		4 Cyl.	21:1	
			2495cc	51kW (69PS)	
		Diesel	Turbo		TD24370

87-714400-00 	STD
87-714407-00 	.020
87-714411-00 	.040

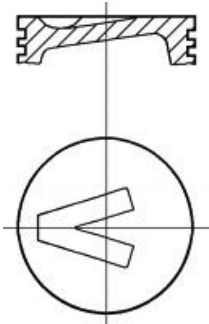

A	54.60
B-	3.52
D	86.31
	30x75

RT



 Earlier pistons to be replaced in Engine sets only

08-714400-00	STD
08-714407-00	.020
08-714411-00	.040

2.00		CR P
2.00		P
4.00		CR P

 Frühere Kolben nur in Motorsätzen zu ersetzen

14-024710-00 D B 94.52 C 191.36 D 99.70 E 4.76

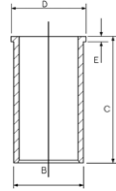

14-010920-00 D B 94.50 C 191.36

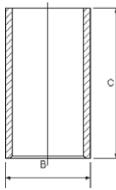

 Premier piston à remplacer dans le jeu moteur

 Pistones más antiguos para ser reemplados en juego de motores solamente





 Con i pistone di vecchia versione è necessario sostituire tutta la serie



20 90.47

Defender 2.5 TDI	09/90→	16 L (300Tdi)	4 Cyl.	2495cc	83kW (113PS)	
			Diesel	Turbo Intercooled		TD20411
Discovery I 2.5 TDI	10/89→10/98	17 L (300Tdi)	4 Cyl.	2495cc	83kW (113PS)	
			Diesel	Turbo		TD20412
Discovery I 2.5 D	10/93→10/98	19 L (300Tdi)	4 Cyl.	2495cc	19.5:1	
Discovery I 2.5 TDI	10/89→10/98					
Range Rover II 2.5 D	08/94→03/02				83-90kW (113-122PS)	
			Diesel	Turbo Intercooled		TD20409

87-521800-20	STD	08-521800-20	STD
87-521807-20	.020	08-521807-20	.020
87-521811-20	.040	08-521811-20	.040

A	55.40	3.00		
B-	18.45	2.50		
BØ	39.00	3.00		CR
D	91.90			
	30x77			

RT TP

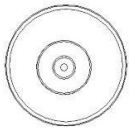







21 90.47

90/110 2.5 TD 09/86→07/90 19J 4 Cyl. 21:1
 2495cc 63kW (86PS)
 Diesel Turbo TD24369

87-524200-00 STD 08-524200-00 STD 14-024710-00 D B 94.52 C 191.36 D 99.70 E 4.76
 87-524207-00 .020 08-524207-00 .020
 87-524211-00 .040 08-524211-00 .040

A 54.60
 B- 3.63
 D 86.31
 30x75

1.99  CR P
 1.95  P
 3.00  CR P

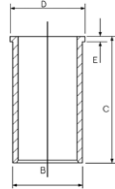

HA RT

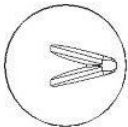
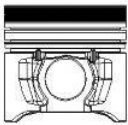

14-010920-00 D B 94.50 C 191.36

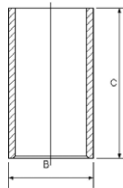

22 92.00

Range Rover I 2.4 TD 10/85→07/94 11 A (VM492HT) 4 Cyl. 22:1
 2376cc 78-89kW (106-121PS)
 Diesel Turbo TD22936

14-676420-00 WH B 101.50 C 166.80 D 110.00 E 8.90 F 1.20

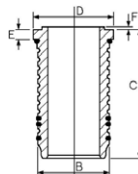



23 94.00

Discovery I 3.9 V8	09/93→10/98	35 D			
Range Rover I 3.9	11/88→12/92		V8 Cyl.		
Range Rover I 3.9 Vogue SEI	11/88→07/94		3950cc	134kW (182PS)	TD22930
Discovery I 3.9 V8	09/93→10/98	36 D			
Range Rover I 3.9 Vogue SEI	11/88→07/94		V8 Cyl.		
			3950cc	134kW (182PS)	TD22929
Range Rover I 3.9 CAT	11/88→07/94	37 D			
			V8 Cyl.		
			3950cc	127kW (173PS)	TD22937
Range Rover I 3.9 CAT	11/88→07/94	38 D			
			V8 Cyl.		
			3950cc	127kW (173PS)	TD22938
Range Rover I 4.3 Vogue LSE	09/92→07/94	40 D			
			V8 Cyl.		
			4275cc	149kW (203PS)	TD22935
Range Rover II 3.9	07/94→03/02	42 D			
Range Rover II 4.0	06/98→03/02		V8 Cyl.	9.35:1	
			3950cc	136-140kW (185-190PS)	TD22932

14-010860-00 D

B 97.77 C 136.75

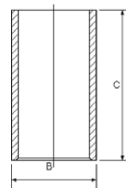

24 94.00

Discovery II 4.6	09/99→12/02	46 D			
Range Rover II 4.6	07/94→03/02		V8 Cyl.	9.35:1	
			4553cc	165-168kW (224-228PS)	TD22931

87-521500-10  STD

08-521500-00 STD

14-010860-00 D

B 97.77 C 136.75

A 35.90

B- 5.83

BØ 77.00

D 66.35

 24x60

09/94→

1.20

1.50

3.00



CR 

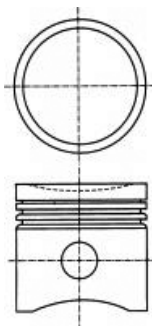
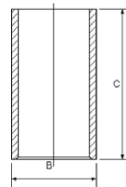

 High Compression

 Steel

 Hohe Kompression

 Stahl

 Une forte compression

 Acier

 La alta compresión

 Acero

 Alta compressione

 Acciaio

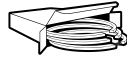
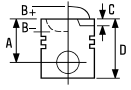

25  **94.00**

Range Rover 4.0 V8, Range Rover 4.0 V8 SE 09/94→
Range Rover 4.6 V8 HSE

V8

V8 Cyl.
3950cc



9.35:1

FM6884

87-521500-00  STD

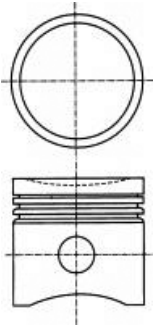
A 35.90
B- 3.38
BØ 77.00
D 66.35
 24x60





 High Compression
 Steel

08-521500-00 STD

09/94→
1.20
1.50
3.00







CR 

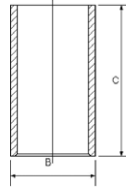

 Hohe Kompression
 Stahl

14-010860-00 D B 97.77 C 136.75



 Une forte compression
 Acier

 La alta compresión
 Acero

 Alta compressione
 Acciaio



1 **83.00**

200 1.9 D Pilot 1.9 D	10/94→03/96 04/96→10/05	XUD9	4 Cyl. 1905cc	23.5:1 47-52kW (64-71PS)	TD26905
Diesel					

87-152000-10 STD
87-152007-10 0.50mm
87-152010-10 0.80mm

A 46.80
B- 2.20
D 84.30
 25x72

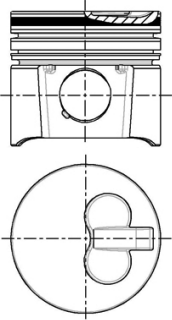

08-152000-00 STD
08-152003-00 0.125mm
08-152007-00 0.50mm
08-152010-00 0.80mm
08-152011-00 1.00mm

2.00 CR P
2.00 P
3.00 CR P

14-020530-00 D B 85.60 C 153.50 D 88.50 E 3.90

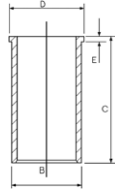

2 **92.00**

Maxus 2.5 D	02/05→12/09	VM39C	4 Cyl. 2499cc	70-88kW (95-120PS)	TD26107
Diesel					

Maxus 2.5 D	02/05→12/08	VM40C	4 Cyl. 2499cc	70kW (95PS)	TD26108
Diesel					

87-429200-00 STD
A 55.00
B- 18.00
BØ 44.00
D 83.00
 32x68

AK KK RT TP

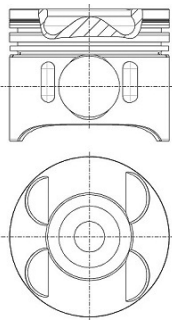



08-429200-00 STD
2.50 GDC P
1.50 P
2.00 NT

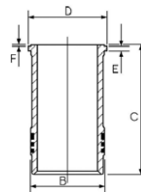

14-260090-00 WH B 101.50 C 167.80 D 110.00 E 6.90 F 1.00

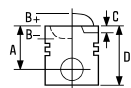





3  **94.00**

400 2.5 D	04/89→10/96	EN 55		
Convoy 2.5 D	04/96→02/02		4 Cyl.	23:1
Convoy 2.5 DI	10/98→04/09		2498cc	53-56kW (72-76PS)
Diesel				TD22927

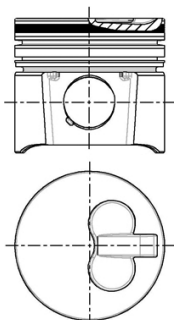

87-318700-00 	STD
87-318706-00 	0.40mm
87-318708-00 	0.60mm
87-318711-00 	1.00mm

A 57.42
B- 2.00
D 99.90
 30x79





 Pistons to be replaced in Engine Sets only

08-318700-10	STD
08-318704-10	0.20mm
08-318706-10	0.40mm
08-318707-10	0.50mm
08-318708-10	0.60mm
08-318710-10	0.80mm
08-318711-10	1.00mm

2.00  CR P
 2.00  P
 4.00  CR P

 Kolben nur Motorsätzen zu ersetzen

 Piston à remplacer dans jeu moteur

 Pistones de repuesto para juegos de motores solamente

 Il pistone può essere rimpiazzato solamente completo

14-020660-00 D	B 97.00 C 170.60 D 99.50 E 4.00
14-021520-00 D	B 98.00 C 170.60 D 100.00 E 6.00

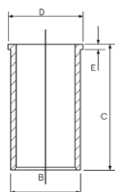



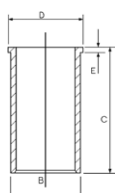

4  **94.00**

400 2.5 D	04/89→03/96	ET 70 (XD3T)		
400 2.5 TD	11/95→10/98		4 Cyl.	21:1
Convoy 2.5 D	04/96→06/06		2496cc	71-74kW (96-101PS)
Convoy 2.5 TDI	10/98→04/09	Diesel	Turbo Intercooled	TD22928

14-020660-00 D	B 97.00 C 170.60 D 99.50 E 4.00
14-021520-00 D	B 98.00 C 170.60 D 100.00 E 6.00



		ccm	x 		9
3.5L Carburettor Sherpa 350	Petrol	3528	V8	88.86	3
4.212	Diesel	3470	4	98.48	9
4/98 DT	Diesel	3770	4	98.00	7
4/98 NT	Diesel	3770	4	98.00	8
4/98 NV	Diesel	3771	4	98.00	8
4/98 TT	Diesel	3770	4	98.00	7
4/98 TV	Diesel	3770	4	98.00	7
6.354.2	Diesel	5800	6	98.48	9
6.354.4	Diesel	5800	6	98.48	10
6/98 DT/6/98 NT	Diesel	5650	6	98.00	8
6/98 DV	Diesel	5655	6	98.00	8
6/98 E	Diesel	5650	6	98.00	7
6/98 NV	Diesel	5655	6	98.00	8
6/98 TV	Diesel	5650	6	98.00	7
12J Sherpa	Diesel	2494	4	90.47	4
22 UA	Diesel	2178	4	82.55	1
57J/57JC/57VD	Diesel	5655	6	100.00	11
AD 3.152	Diesel	2500	3	91.49	5
KT 191	Diesel	11627	6	130.00	12
OEJ	Diesel	5655	6	100.00	11
TL 11	Diesel	11100	6	130.00	13
XD3/XD3P / Convoy Ser.400	Diesel	2498	4	94.00	6
XUD9/XUD9A/XUD9B Pilot	Diesel	1905	4	83.00	2



4 90.47

12J Sherpa 4 Cyl. 21:1 **2494cc** Diesel **FM3610**

87-714400-00 ① STD
87-714407-00 ① .020
87-714411-00 ① .040

A 54.60
B- 3.52
D 86.31
 30x75

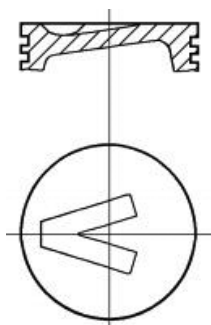

RT



① Earlier pistons to be replaced in Engine sets only

08-714400-00 STD
08-714407-00 .020
08-714411-00 .040

01/84→12/89

2.00  CR P
 2.00  P
 4.00  CR P

① Frühere Kolben nur in Motorsätzen zu ersetzen

14-024710-00 D B 94.52 C 191.36 D 99.70 E 4.76

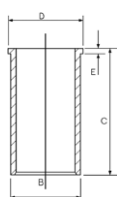

14-010920-00 D B 94.50 C 191.36

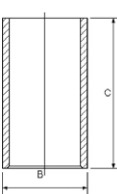

① Premier piston à remplacer dans le jeu moteur

① Pistones más antiguos para ser reemplados en juego de motores solamente

① Con i pistone di vecchia versione è necessario sostituire tutta la serie

5 91.49

AD 3.152 3 Cyl. 17.4:1 **2500cc** Diesel **FM11352**

87-322000-00 ③ STD

A 61.62
B- 18.70
BØ 55.00
D 109.24
 32x75

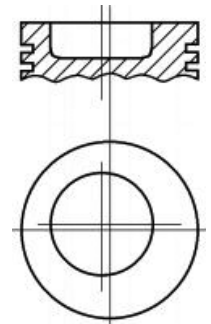





① Push fit cast iron liner to replace original steel liner

② Press fit cast iron liner to replace original steel liner

③ Pre-topped piston which may require machining

④ Not for chromed cylinders

08-322000-00 ④ STD

2.38  CR P
 2.38  P
 2.38  P
 4.74  CR P

① Ausdrückbare Laufbüchse aus Gueisen als Ersatz der originalStahlbüchse

② Anpressbare Laufbüchse aus Gueisen als Ersatz der originalStahlbüchse

③ Vorgeschliffener Kolben, der möglicherweise etwas BearbeitenEmpfehlungen des Herstellers zu entsprechen.

④ Nicht für verchromte Zylinder

14-021220-00 D ② B 93.71 C 216.00 D 96.72 E 3.81
14-021221-00 D B 93.96 C 216.00 D 96.72 E 3.81
14-021222-00 D B 94.50 C 216.00 D 96.72 E 3.81
14-021223-00 D B 96.25 C 216.00 D 97.10 E 3.81
14-024680-00 D B 93.73 C 216.00 D 96.72 E 3.76
14-025871-00 D B 93.76 C 216.14 D 96.85 E 5.00
14-480320-00 DH ① B 93.66 C 216.03 D 96.72 E 3.81

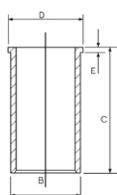

① Chemise fonte à emménagement gras remplaçant la chemise acied'origine.

② Chemise fonte à emmancher à la presse pour remplacer la chemise d'origine en acier

③ Piston à tete semie finie pouv ant nécessiter un usinage pouaux recommandations du constructeur.

④ Non appropriés pour cylindres chromés ④ No se usan para cilindros cromados

① Ajustar a presión la camisa de hierro fundido para reemplazacamisa original de acero

② Ajuste a presión la camisa de hierro fundido para reemplazar la camisa original de acero

③ Pistón coronado que puede necesitar fresado para ajustarse adel fabricante.

① Cilindri in ghisa, piantati a pressione, in sostituzione di qin acciaio

② Canna in ghisa per sostituire canne originali in acciaio

③ Il pistone a testa ribassata puo' richiedere una lavorazioneadattarfoalle prescrizioni del costruttore. fare riferimentoalle istruzioni contenute nella confezione.

④ Non per cilindri cromati







6 94.00

XD3/XD3P / Convoy Ser.400 4 Cyl. 23:1 **2498cc** **Diesel** **FM2303**

87-318700-10	STD	08-318700-10	STD	14-020660-00 D	B 97.00 C 170.60 D 99.50 E 4.00
87-318706-10	0.40mm	08-318704-10	0.20mm	14-021520-00 D	B 98.00 C 170.60 D 100.00 E 6.00
87-318708-10	0.60mm	08-318706-10	0.40mm		
87-318710-10	0.80mm	08-318707-10	0.50mm		

→12/93

A 54.00
B- 1.80
D 96.42
 30x79

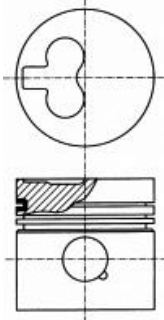
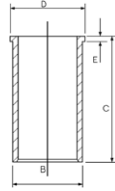

2.00  CR P
 2.00  P
 4.00  CR P



87-318700-30	STD	08-318700-10	STD
87-318706-30	0.40mm	08-318704-10	0.20mm
87-318708-30	0.60mm	08-318706-10	0.40mm
87-318710-30	0.80mm	08-318707-10	0.50mm
		08-318708-10	0.60mm
		08-318710-10	0.80mm
		08-318711-10	1.00mm

01/94→

A 54.00
B- 1.75
D 91.42
 30x79

2.00  CR P
 2.00  P
 4.00  CR P

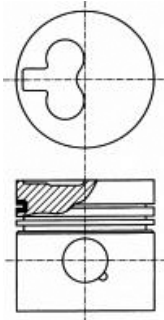



7 98.00

4/98 DT	4 Cyl.	16.8:1	3770cc	Diesel Turbo	FM3751
4/98 TT	4 Cyl.	16.8:1	3770cc	Diesel Turbo	FM6804
4/98 TV	4 Cyl.	16.8:1	3770cc	Diesel Turbo	FM3750
6/98 E	6 Cyl.	16.8:1	5650cc	Diesel	FM2794
6/98 TV	6 Cyl.	16.8:1	5650cc	Diesel Turbo	FM3748

14-452080-00 WH B 109.04 C 220.72 D 117.10 E 8.89 F 0.83
 14-452080-10 WH B 108.18 C 221.54 D 117.09 E 8.89 F 0.88
 15-450870-00 WH ² B 108.18 C 218.36 D 117.09 E 8.89 F 0.88

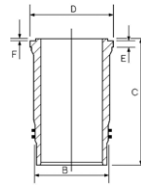

14-470110-00 WH ¹ B 108.18 C 217.55 D 117.10 E 8.89 F 0.83

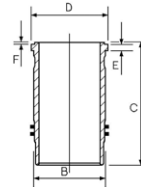

¹ Phosphated
² Includes seals

¹ Phosphated
² Schließt Dichtungen ein

¹ Phosphated
² Inclut des joints





¹ Phosphated
² Incluye los sellos

¹ Phosphated
² Comprende le guarnizioni

8 98.00

4/98 NT	4 Cyl.	16.8:1	3770cc	Diesel Turbo	FM6803
4/98 NV	4 Cyl.	16.8:1	3771cc	46-55kW (63-75PS)	Diesel TD7513
6/98 DT/6/98 NT	6 Cyl.	17.3:1	5650cc	Diesel	FM6806
6/98 DV	6 Cyl.	16.8:1	5655cc	71-84kW (97-114PS)	Diesel TD7488
6/98 NV	6 Cyl.	16.8:1	5655cc	71-86kW (97-117PS)	Diesel TD7490

87-525300-00 STD
 A 68.21
 B- 25.00
 BØ 56.00
 C 2.40
 C 0.01
 D 116.31
 35x83

08-525300-00 STD
 2.38  CR P
 2.38  P
 2.38  P
 6.35  P
 4.76  P

15-450870-00 WH ² B 108.18 C 218.36 D 117.09 E 8.89 F 0.88

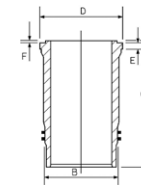

89-525300-00
 87-525300-00 +
 15-450870-00

14-452080-00 WH B 109.04 C 220.72 D 117.10 E 8.89 F 0.83
 14-452080-10 WH B 108.18 C 221.54 D 117.09 E 8.89 F 0.88

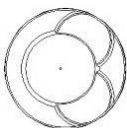
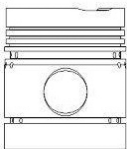
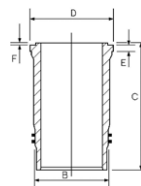



14-470110-00 WH ① B 108.18 C 217.55 D 117.10 E 8.89 F 0.83

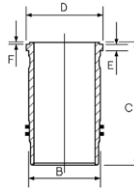

- ① Phosphated
- ② Includes seals

- ① Phosphated
- ② Schließt Dichtungen ein

- ① Phosphated
- ② Inclut des joints

- ① Phosphated
- ② Incluye los sellos

- ① Phosphated
- ② Comprende le guarnizioni

9 **98.48**

4.212	4 Cyl.	15.5:1	3470cc	Diesel	FM1359
6.354.2	6 Cyl.	16:1	5800cc	Diesel	FM1364

14-021250-00 DH ① B 104.20 C 226.44 D 107.37 E 3.81

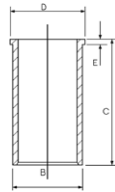

14-040110-00 D ② B 103.24 C 227.28 D 106.23 E 3.86 F 0.88

14-040180-00 D ② B 103.24 C 227.28 D 106.43 E 3.71 F 1.04

14-040200-00 DH ② B 103.19 C 227.28 D 106.45 E 3.86 F 0.88

14-045820-00 D B 103.33 C 227.28 D 106.42 E 3.80 F 0.90

14-045821-00 D B 103.83 C 227.28 D 106.42 E 3.80 F 0.90

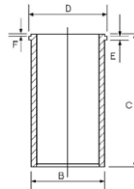

- ① Push fit, flanged, cast iron liner with 0.040" oversized outside diameter
- ② Press fit cast iron liner to replace original steel liner

- ① Geflanschte Gußeisen-Laufbüchse mit Schiebeseitz und Außendurübermaß
- ② Anpressbare Laufbüchse aus Gueisen als Ersatz der originalStahlbüchse

- ① Chemise en fonte, à collerette ajustage gras, avec diamètre
- ② Chemise fonte à emmancher à la presse pour remplacer la chemise d'origine en acier

- ① Camisa de fundición embrizada, ajuste suave, con diámetro ext
- ② Ajuste a presión la camisa de hierro fundido para reemplazar la camisa original de acero

- ① Cilindri in ghisa, con flangia, piantati a pressione, con diariparazione.
- ② Canna in ghisa per sostituire canne originali in acciaio



10 98.48

6.354.4 6 Cyl. 16:1 5800cc Diesel FM1367



87-318900-10  STD

08-318900-10 STD
08-318905-10 0.25mm



14-021250-00 **DH**  B 104.20 C 226.44 D 107.37 E 3.81

01/76 →

A 70.02
B- 25.60
BØ 54.00
D 120.84
 35x84

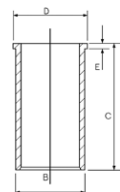
2.38  CR P
2.38  P
4.74  CR P





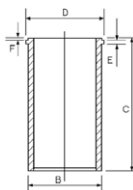



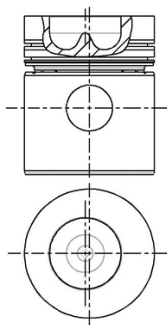

14-040110-00 **D**  B 103.24 C 227.28 D 106.23 E 3.86 F 0.88
14-040180-00 **D**  B 103.24 C 227.28 D 106.43 E 3.71 F 1.04
14-040200-00 **DH**  B 103.19 C 227.28 D 106.45 E 3.86 F 0.88
14-045820-00 **D** B 103.33 C 227.28 D 106.42 E 3.80 F 0.90
14-045821-00 **D** B 103.83 C 227.28 D 106.42 E 3.80 F 0.90









RT





87-525200-00    STD
87-525209-00    .030
87-525211-00    .040

08-525200-00 STD
08-525209-00 .030

A 69.91
B- 25.61
BØ 53.90
D 120.71
 35x84

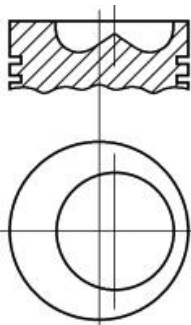
2.38  CR P
2.38  P
2.38  P
6.35  P
6.35  P





 Push fit, flanged, cast iron liner with 0.040" oversized outside diameter

 Geflanschte Gußeisen-Laufbuchse mit Schiebeseitz und Außendurübermaß

 Chemise en fonte, à collerette ajustage gras, avec diamètre

 Camisa de fundición embridada, ajuste suave, con diámetro ext

 Cilindri in ghisa, con flangia, piantati a pressione, con diariparazione.

 Press fit cast iron liner to replace original steel liner

 Anpressbare Laufbüchse aus Gueisen als Ersatz der original Stahlbüchse

 Chemise fonte à emmancher la presse pour remplacer la chemise d'origine en acier

 Ajuste a presión la camisa de hierro fundido para reemplazar la camisa original de acero

 Canna in ghisa per sostituire canne originali in acciaio

 Recommended maximum oversize is .040in/1.016mm

 Empfohlenes überma maximal 0.040 Zoll 1.016mm

 Cote maxi recommandée de 0.040in/1.016mm

 La sobremedida máxima recomendada es de 0.040plg/1.016mm

 Maggiorazione massima raccomandata es 0.040in/1.016mm

 For Cast Iron Bores only

 Nur für Gußeisenbohrungen

 Pour intérieur cylindre seulement

 Para diámetro internos de hierro fundido solamente

 Solo per cilindri in ghisa

 Pre-topped piston which may require machining

 Vorgeschliffener Kolben, der möglicherweise etwas Bearbeiten Empfehlungen des Herstellers zu entsprechen.

 Piston à tête semie finie pour nécessiter un usinage pousse recommandations du constructeur.



 Pistón coronado que puede necesitar fresado para ajustarse a del fabricante.

 Il pistone a testa ribassata può richiedere una lavorazione adatarlo alle prescrizioni del costruttore. fare riferimento alle istruzioni contenute nella confezione.



11 100.00



57J/57JC/57VD	6 Cyl.	16.5:1	5655cc	Diesel	FM1012
OEJ	6 Cyl.	16.5:1	5655cc	Diesel	FM116

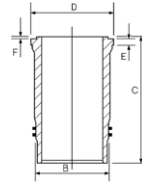

15-450870-00 WH   B 108.18 C 218.36 D 117.09 E 8.89 F 0.88

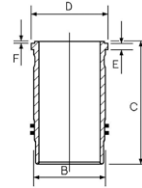





14-470110-00 WH  B 108.18 C 217.55 D 117.10 E 8.89 F 0.83





 Phosphated
 Includes seals

 Phosphated
 Schließt Dichtungen ein

 Phosphated
 Inclut des joints

 Phosphated
 Incluye los sellos

 Phosphated
 Comprende le guarnizioni

12 130.00

KT 191	6 Cyl.	15:1	11627cc	256kW (348PS)	Diesel Turbo Intercooled	FM5278
---------------	--------	------	----------------	----------------------	---------------------------------	---------------

87-174100-00	STD	08-174100-10	STD	14-021410-00 DH	B 136.02 C 288.30 D 143.60 E 10.05	88-174100-00
01/89→		3.16				87-174100-00 +
		3.16				14-021410-00

A 101.00
B- 29.30
BØ 74.50
C 3.00
D 169.50
 48x111

AK HA RT

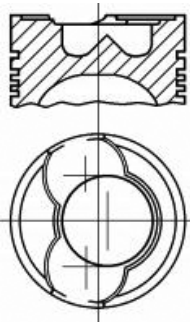



13  **130.00**

TL 11 **6 Cyl.** **15.8:1** **11100cc** **Diesel Turbo** **FM1036**

87-521000-00 STD **08-521000-00** ¹ STD

01/81→, 8561442→

B- 29.46

C 2.64

C 2.64

D 169.58

 51x105

3.17

2.37

4.73



HA RT

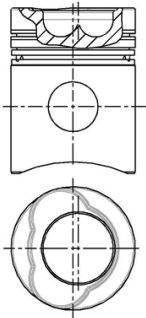

¹ 6 degree Wedge Top Ring

¹ 6-Grad Keiloberring

¹ Segment trapézoidal angle 6 de grés.

¹ Anillo superior en cuña de 6 grados

¹ Segmento trapezio con inclinazione fianchi = 6



1 87.32

PH1	1 Cyl.	659cc	Diesel	FM2516
PH1W	1 Cyl.	659cc	Diesel	FM3855
PH2	2 Cyl.	1318cc	Diesel	FM3856
PH2W	2 Cyl.	1318cc	Diesel	FM3857

87-525000-00	STD	08-525000-00	STD
87-525007-00	.020	08-525007-00	.020
87-525011-00	.040	08-525011-00	.040
87-525014-00	.060	08-525014-00	.060

A	63.60	2.38		CR
B-	25.10	2.38		
C	0.61	2.38		
C	0.61	4.76		P
D	105.99			
	30x75			

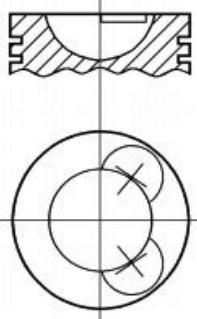

2 95.25

ST1	1 Cyl.	630cc	Diesel	FM965
TS1	1 Cyl.	635cc	Diesel	FM3398
ST2	2 Cyl.	1270cc	Diesel	FM5323
TS2	2 Cyl.	1270cc	Diesel	FM5325
ST3	3 Cyl.	1900cc	Diesel	FM5324
TS3	3 Cyl.	1900cc	Diesel	FM5326

87-523800-00	STD	08-523800-00	STD
87-523807-00	.020	08-523807-00	.020
87-523811-00	.040	08-523811-00	.040

A	65.09	3.18		CR
B-	16.14	2.39		
BØ	44.96	2.39		
D	103.19	4.75		CR
	33x79	4.76		

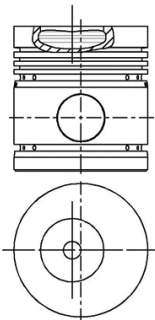

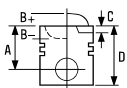

1 **80.00**

Elise 1.8 08/95→08/05 **18 K4F K Series** 4 Cyl. 10.5:1
 1796cc **85-90kW** (116-122PS) **TD18865**

87-522700-00 STD

- A 22.70
- B- 0.53
- BØ 68.20
- C 2.65
- D 45.65
- 18x53

TP

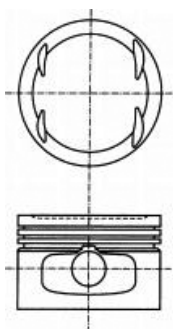

Steel

08-522700-00 STD

- 1.00 CR
- 1.20 P
- 2.00 CR

Stahl

14-710020-00 WH B 84.10 C 129.50 D 87.50 E 50.00

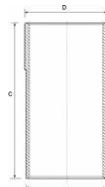

Acier

Acero

Acciaio

88-522700-00
 87-522700-00 +
 14-710020-00

2 **80.00**

Elise 1.8 11/98→01/01 **18 K4K (VVC) K Series** 4 Cyl. 10.5:1
 Elise 111 S 03/99→11/00 1796cc **107-118kW** (146-160PS) **TD22926**

87-522700-10 STD

- A 22.70
- B- 0.53
- BØ 68.00
- C 1.00
- D 45.65
- 18x53

TP

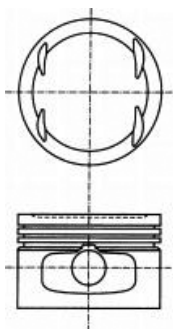

Steel

08-522700-00 STD

- 1.00 CR
- 1.20 P
- 2.00 CR

Stahl

Acier

Acero

Acciaio

14-710020-00 WH B 84.10 C 129.50 D 87.50 E 50.00

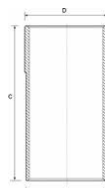





3  **82.55**

Cortina	01/63→12/69	Twin Cam		
Elan+2	01/68→12/70		4 Cyl.	9.5:1
Elan+2S	01/69→12/71		1558cc	
Elan+2S 54	01/69→12/71			FM2963
Elan+2S 130	01/72→12/72			
Elan+2S 130/5	01/73→12/74			
Elan Series I, Elan Series II	01/62→12/66			
Elan Sprint, Elan Sprint 5	01/71→12/73			

87-522811-00 ¹ .040 ²

A 39.45
C 0.01
C 0.01
D 68.61
 21x64

1.58
 1.98
 4.73
 CR

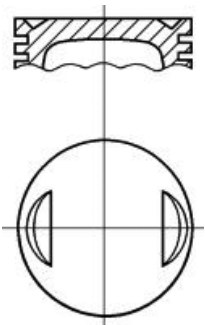





- ¹ Suitable for standard and high lift camshafts
- ² Ringset available in Kitset only





- ¹ Geeignet für Standard- und Hochhub-Nockenwellen
- ² Ringsätze nur im Assembly erhältlich





- ¹ Convient pour arbre à cames standard ou a levée majorée
- ² Jeux de segments disponible en kit seulement.





- ¹ Apropriada para alizador de árbol de leva estandar y alto
- ² Juegos de segmentos disponible en conjuntos solamente.





- ¹ Adatto per alberi a camme standard o maggiorati
- ² I set anelli piston sono disponibili solo in kit motore





		ccm	x 		
D 0226 MK	Diesel	5687	6	102.00	1
D 0226 MKF	Diesel	5687	6	102.00	1
D 0226 MKF/170	Diesel	5687	6	102.00	1
D 0226 MKFA	Diesel	5687	6	102.00	1
D 0226 MKH	Diesel	5687	6	102.00	1
D 0226 MLE	Diesel	5687	6	102.00	1
D 0226 MTE Euro 3	Diesel	5687	6	102.00	1
D 0824 Euro 2	Diesel	4580	4	108.00	4
D 0824 FL01 Euro 1	Diesel	4580	4	108.00	4
D 0824 GF	Diesel	4580	4	108.00	5
D 0824 GF01	Diesel	4580	4	108.00	5
D 0824 GF02 Euro 1	Diesel	4580	4	108.00	4
D 0824 GF03 Euro 1	Diesel	4580	4	108.00	4
D 0824 GF/D 0824 GF01	Diesel	4580	4	108.00	4
D 0824 LF01 Euro 1	Diesel	4580	4	108.00	6
D 0824 LF02 Euro 2	Diesel	4580	4	108.00	7
D 0824 LF03 Euro 1	Diesel	4580	4	108.00	6
D 0824 LF04 Euro 1	Diesel	4580	4	108.00	6
D 0824 LF05 Euro 1	Diesel	4580	4	108.00	6
D 0824 LF06 Euro 1	Diesel	4580	4	108.00	6
D 0824 LF07 Euro 1	Diesel	4580	4	108.00	6
D 0824 LF08 Euro 1	Diesel	4580	4	108.00	6
D 0824 LF09 Euro 1	Diesel	4580	4	108.00	6
D 0824 LF10 Euro 1	Diesel	4580	4	108.00	6
D 0824 LF/D 0824 LFL Euro 1	Diesel	4580	4	108.00	4
D 0824 LF/D 0824 LFL Euro 2	Diesel	4580	4	108.00	4
D 0824 LFL01 Euro 1	Diesel	4580	4	108.00	6
D 0824 LFL02 Euro 2	Diesel	4580	4	108.00	7
D 0824 LFL04 Euro 2	Diesel	4580	4	108.00	7
D 0824 LFL05 Euro 1	Diesel	4580	4	108.00	6
D 0824 LFL06 Euro 2	Diesel	4580	4	108.00	7
D 0824 LFL07 Euro 2	Diesel	4580	4	108.00	7
D 0824 LFL08 Euro 2	Diesel	4580	4	108.00	7
D 0824 LFL09 Euro 1	Diesel	4580	4	108.00	6
D 0824 LFL10 Euro 2	Diesel	4580	4	108.00	7
D 0824 LFO01 Euro 1	Diesel	4580	4	108.00	7
D 0824 LFO Euro 1	Diesel	4580	4	108.00	4
D 0824 LOH01 Euro 1	Diesel	4580	4	108.00	6
D 0824 LOH02 Euro 1	Diesel	4580	4	108.00	7
D 0824 LOH03 Euro 1	Diesel	4580	4	108.00	7
D 0824 LOH04 Euro 1	Diesel	4580	4	108.00	7
D 0824 LOH05 Euro 2	Diesel	4580	4	108.00	7
D 0826 F01	Diesel	6871	6	108.00	4
D 0826 F02	Diesel	6871	6	108.00	4
D 0826 FG001	Diesel	6871	6	108.00	4
D 0826 FG002	Diesel	6871	6	108.00	4
D 0826 FO01	Diesel	6871	6	108.00	4
D 0826 FO02	Diesel	6871	6	108.00	4
D 0826 GF	Diesel	6871	6	108.00	5
D 0826 GF01 Euro 1	Diesel	6871	6	108.00	4
D 0826 GF02	Diesel	6871	6	108.00	4
D 0826 GF03	Diesel	6871	6	108.00	4
D 0826 GF04 Euro 1	Diesel	6871	6	108.00	4
D 0826 GFA	Diesel	6871	6	108.00	4
D 0826 GFA03	Diesel	6871	6	108.00	4
D 0826 GFA04 Euro 1	Diesel	6871	6	108.00	4
D 0826 LE51	Diesel	6871	6	108.00	4
D 0826 LE52	Diesel	6871	6	108.00	4
D 0826 LE521	Diesel	6871	6	108.00	4
D 0826 LE522 Euro 1	Diesel	6871	6	108.00	4
D 0826 LE523 Euro 1	Diesel	6871	6	108.00	4
D 0826 LE524 Euro 1	Diesel	6871	6	108.00	4
D 0826 LE530 Euro 1	Diesel	6871	6	108.00	4
D 0826 LE531 Euro 1	Diesel	6871	6	108.00	4
D 0826 LF01	Diesel	6871	6	108.00	6
D 0826 LF01/D 0826 LF02/D 0826 LFOH	Diesel	6871	6	108.00	4
D 0826 LF02 Euro 1	Diesel	6871	6	108.00	6
D 0826 LF04 Euro 1	Diesel	6871	6	108.00	6
D 0826 LF05	Diesel	6871	6	108.00	6





		ccm	x 		
D 0826 LF06	Diesel	6871	6	108.00	6
D 0826 LF07 Euro 1	Diesel	6871	6	108.00	6
D 0826 LF08 Euro 1	Diesel	6871	6	108.00	6
D 0826 LF09 Euro 1	Diesel	6871	6	108.00	4
D 0826 LF11 Euro 2	Diesel	6871	6	108.00	7
D 0826 LF12 Euro 2	Diesel	6871	6	108.00	4
D 0826 LF13 Euro 2	Diesel	6871	6	108.00	4
D 0826 LF15 Euro 2	Diesel	6871	6	108.00	7
D 0826 LF17 Euro 2	Diesel	6871	6	108.00	7
D 0826 LF18 Euro 2	Diesel	6871	6	108.00	6
D 0826 LF/217/Silent	Diesel	6870	6	108.00	4
D 0826 LF/D 0826 LFL Euro 1	Diesel	6870	6	108.00	4
D 0826 LF/D 0826 LOH/D 0826 OH	Diesel	6590	6	108.00	4
D 0826 LFG15 Euro 2	Diesel	6871	6	108.00	7
D 0826 LFG16 Euro 2	Diesel	6871	6	108.00	7
D 0826 LFL02 Euro 1	Diesel	6871	6	108.00	6
D 0826 LFL03 Euro 1	Diesel	6871	6	108.00	6
D 0826 LFL05 Euro 1	Diesel	6871	6	108.00	6
D 0826 LFL06 Euro 1	Diesel	6871	6	108.00	6
D 0826 LFL07 Euro 1	Diesel	6871	6	108.00	6
D 0826 LFL08 Euro 1	Diesel	6871	6	108.00	6
D 0826 LFL09 Euro 2	Diesel	6871	6	108.00	7
D 0826 LFL10 Euro 1	Diesel	6871	6	108.00	6
D 0826 LFL Euro 1	Diesel	6871	6	108.00	6
D 0826 LOH01	Diesel	6871	6	108.00	4
D 0826 LOH02	Diesel	6871	6	108.00	4
D 0826 LOH03	Diesel	6871	6	108.00	4
D 0826 LOH04	Diesel	6871	6	108.00	6
D 0826 LOH05	Diesel	6871	6	108.00	6
D 0826 LOH06 Euro 1	Diesel	6871	6	108.00	6
D 0826 LOH07 Euro 1	Diesel	6871	6	108.00	4
D 0826 LOH10 Euro 1	Diesel	6871	6	108.00	4
D 0826 LOH15 Euro 2	Diesel	6871	6	108.00	7
D 0826 LOH17 Euro 2	Diesel	6871	6	108.00	7
D 0826 LOH18 Euro 2	Diesel	6871	6	108.00	7
D 0826 LOH19 Euro 2	Diesel	6871	6	108.00	7
D 0826 LOH/D 0826 LUH Euro 2	Diesel	6870	6	108.00	4
D 0826 LUE51 Euro 1	Diesel	6870	B6	108.00	4
D 0826 LUH	Diesel	6871	6	108.00	7
D 0826 LUH01 Euro 1	Diesel	6871	6	108.00	6
D 0826 LUH02 Euro 1	Diesel	6871	6	108.00	6
D 0826 LUH03 Euro 1	Diesel	6871	6	108.00	6
D 0826 LUH04	Diesel	6871	6	108.00	6
D 0826 LUH05 Euro 1	Diesel	6871	6	108.00	6
D 0826 LUH06 Euro 1	Diesel	6871	6	108.00	6
D 0826 LUH08 Euro 2	Diesel	6871	6	108.00	4
D 0826 LUH09 Euro 2	Diesel	6871	6	108.00	4
D 0826 LUH10 Euro 1	Diesel	6871	6	108.00	6
D 0826 LUH11 Euro 2	Diesel	6871	6	108.00	7
D 0826 LUH12 Euro 1	Diesel	6870	6	108.00	6
D 0826 LUH13 Euro 2	Diesel	6871	6	108.00	7
D 0826 LUH Euro 1	Diesel	6870	B6	108.00	6
D 0826 OH	Diesel	6871	6	108.00	8
D 0826 OH01	Diesel	6871	6	108.00	4
D 0826 OH02	Diesel	6871	6	108.00	4
D 0826 OH03 Euro 1	Diesel	6871	6	108.00	4
D 0826 TE520	Diesel	6596	6	108.00	4
D 0826 TF	Diesel	6596	6	108.00	4
D 0826 TOH	Diesel	6596	6	108.00	4
D 0826 TUE51	Diesel	6871	6	108.00	4
D 0834 LFL01 Euro 3	Diesel	4580	4	108.00	9
D 0834 LFL02 Euro 3	Diesel	4580	4	108.00	9
D 0834 LFL03 Euro 3	Diesel	4580	4	108.00	9
D 0834 LFL04 Euro 3	Diesel	4580	4	108.00	9
D 0834 LFL20 Euro 3	Diesel	4580	4	108.00	9
D 0834 LFL40 Euro 3	Diesel	4580	4	108.00	10
D 0834 LFL41 Euro 3	Diesel	4580	4	108.00	10
D 0834 LFL42 Euro 3	Diesel	4580	4	108.00	10
D 0834 LFL50 Euro 4	Diesel	4580	4	108.00	11





		ccm	x 		
D 0834 LFL51 Euro 4	Diesel	4580	4	108.00	11
D 0834 LFL52 Euro 4	Diesel	4580	4	108.00	11
D 0834 LFL53 Euro 4	Diesel	4580	4	108.00	11
D 0834 LFL54 Euro 4	Diesel	4580	4	108.00	11
D 0834 LFL55 Euro 4	Diesel	4580	4	108.00	11
D 0834 LFL60 EEV	Diesel	4580	4	108.00	12
D 0834 LFL61 EEV	Diesel	4580	4	108.00	12
D 0834 LFL62 EEV	Diesel	4580	4	108.00	12
D 0834 LFL63 Euro 5	Diesel	4580	4	108.00	12
D 0834 LFL64 Euro 5	Diesel	4580	4	108.00	12
D 0834 LFL65 Euro 5	Diesel	4580	4	108.00	12
D 0834 LOH01 Euro 3	Diesel	4580	4	108.00	4
D 0834 LOH02 Euro 3	Diesel	4580	4	108.00	4
D 0834 LOH03 Euro 3	Diesel	4580	4	108.00	4
D 0834 LOH40 Euro 4	Diesel	4580	4	108.00	4
D 0834 LOH50 Euro 4	Diesel	4580	4	108.00	11
D 0834 LOH51 Euro 4	Diesel	4580	4	108.00	11
D 0834 LOH52 Euro 4	Diesel	4580	4	108.00	11
D 0834 LOH53 Euro 4	Diesel	4580	4	108.00	11
D 0834 LOH61 Euro 5	Diesel	4580	4	108.00	12
D 0836 LE 510	Diesel	6871	6	108.00	13
D 0836 LF01 Euro 2	Diesel	6871	6	108.00	9
D 0836 LF02 Euro 3	Diesel	6871	6	108.00	9
D 0836 LF03 Euro 3	Diesel	6871	6	108.00	9
D 0836 LF04 Euro 3	Diesel	6871	6	108.00	9
D 0836 LF05 Euro 3	Diesel	6871	6	108.00	9
D 0836 LF41 Euro 3	Diesel	6871	6	108.00	10
D 0836 LF44 Euro 3	Diesel	6871	6	108.00	10
D 0836 LFG50 Euro 4/5	Diesel	6871	6	108.00	11
D 0836 LFL01 Euro 2/3	Diesel	6871	6	108.00	9
D 0836 LFL02 Euro 2/3	Diesel	6871	6	108.00	9
D 0836 LFL03 Euro 3	Diesel	6871	6	108.00	9
D 0836 LFL04 Euro 3	Diesel	6871	6	108.00	9
D 0836 LFL05 Euro 3	Diesel	6871	6	108.00	9
D 0836 LFL06 Euro 3	Diesel	6871	6	108.00	4
D 0836 LFL07 Euro 3	Diesel	6871	6	108.00	9
D 0836 LFL10 Euro 3	Diesel	6871	6	108.00	9
D 0836 LFL40 Euro 3	Diesel	6871	6	108.00	10
D 0836 LFL41 Euro 3	Diesel	6871	6	108.00	10
D 0836 LFL44 Euro 3	Diesel	6871	6	108.00	10
D 0836 LFL50 Euro 4	Diesel	6871	6	108.00	11
D 0836 LFL51 Euro 4	Diesel	6871	6	108.00	11
D 0836 LFL52 Euro 4	Diesel	6871	6	108.00	11
D 0836 LFL53 Euro 4	Diesel	6871	6	108.00	11
D 0836 LFL54 Euro 4	Diesel	6871	6	108.00	11
D 0836 LFL55 Euro 4	Diesel	6871	6	108.00	11
D 0836 LFL61 EEV	Diesel	6871	6	108.00	12
D 0836 LFL62 EEV	Diesel	6871	6	108.00	12
D 0836 LFL63 Euro 5	Diesel	6871	6	108.00	12
D 0836 LFL64 Euro 5	Diesel	6871	6	108.00	12
D 0836 LFL65 Euro 5	Diesel	6871	6	108.00	12
D 0836 LFL69 Euro 5	Diesel	6871	6	108.00	12
D 0836 LFL70 Euro 5	Diesel	6871	6	108.00	12
D 0836 LFL71 Euro 5	Diesel	6871	6	108.00	12
D 0836 LOH01 Euro 3	Diesel	6871	6	108.00	9
D 0836 LOH02 Euro 3	Diesel	6871	6	108.00	9
D 0836 LOH03 Euro 3	Diesel	6871	6	108.00	9
D 0836 LOH40 Euro 3	Diesel	6871	6	108.00	10
D 0836 LOH41 Euro 3	Diesel	6871	6	108.00	10
D 0836 LOH51 Euro 4	Diesel	6871	6	108.00	11
D 0836 LOH52 Euro 4	Diesel	6871	6	108.00	11
D 0836 LOH55 Euro 4	Diesel	6871	6	108.00	11
D 0836 LOH56 Euro 4	Diesel	6871	6	108.00	11
D 0836 LOH60 EEV	Diesel	6871	6	108.00	11
D 0836 LOH61 EEV	Diesel	6871	6	108.00	11
D 0836 LOH62 Euro 4	Diesel	6871	6	108.00	11
D 0836 LOH63 EEV	Diesel	6871	6	108.00	11
D 0836 LOH64 Euro 5	Diesel	6871	6	108.00	11
D 0836 LOH65 Euro 5	Diesel	6871	6	108.00	11





		ccm	x 		
D 0836 LOH66 Euro 6	Diesel	6871	6	108.00	11
D 0836 M2	Diesel	7030	6	108.00	14
D 0846 HM2	Diesel	7250	6	108.00	15
D 0846 HM42U	Diesel	7252	6	108.00	14
D 0846 HM81H	Diesel	7252	6	108.00	14
D 0846 HM82U	Diesel	7252	6	108.00	14
D 0846 HM91H	Diesel	7252	6	108.00	14
D 0846 HM91U	Diesel	7250	6	108.00	14
D 0846 HM95U	Diesel	7252	6	108.00	14
D 0846 HMN	Diesel	7252	6	108.00	14
D 0846 HMN2	Diesel	7252	6	108.00	15
D 0846 HMN80	Diesel	7252	6	108.00	14
D 0846 HMX-011	Diesel	7250	6	108.00	14
D 0846 HMXU-015	Diesel	7250	6	108.00	14
D 0846 HMY-011	Diesel	7250	6	108.00	15
D 0846 HMYH	Diesel	7252	6	108.00	14
D 0846 HMYN-014	Diesel	7252	6	108.00	14
D 2066 LF01 Euro 4 D 20	Diesel	10520	6	120.00	17
D 2066 LF02 Euro 4 D 20	Diesel	10520	6	120.00	17
D 2066 LF03 Euro 4 D 20	Diesel	10520	6	120.00	17
D 2066 LF04 Euro 4 D 20	Diesel	10520	6	120.00	16
D 2066 LF06 Euro 4 D 20	Diesel	10520	6	120.00	16
D 2066 LF06 Euro 4 D 20	Diesel	10520	6	120.00	17
D 2066 LF07 Euro 3 D 20	Diesel	10518	6	120.00	16
D 2066 LF11 Euro 4 D 20	Diesel	10520	6	120.00	17
D 2066 LF12 Euro 4 D 20	Diesel	10520	6	120.00	17
D 2066 LF13 Euro 4 D 20	Diesel	10520	6	120.00	17
D 2066 LF14 Euro 4 D 20	Diesel	10520	6	120.00	17
D 2066 LF17 Euro 5	Diesel	10518	6	120.00	18
D 2066 LF18 Euro 5	Diesel	10518	6	120.00	18
D 2066 LF19 Euro 5	Diesel	10518	6	120.00	18
D 2066 LF20 Euro 5	Diesel	10518	6	120.00	18
D 2066 LF21 Euro 5	Diesel	10518	6	120.00	18
D 2066 LF22 Euro 5	Diesel	10518	6	120.00	18
D 2066 LF23 Euro 5 D 20	Diesel	10518	6	120.00	18
D 2066 LF24 Euro 5 D 20	Diesel	10518	6	120.00	18
D 2066 LF25 Euro 5 D 20	Diesel	10518	6	120.00	18
D 2066 LF26 Euro 5 D 20	Diesel	10518	6	120.00	18
D 2066 LF27 Euro 5 D 20	Diesel	10518	6	120.00	18
D 2066 LF28 Euro 4 D 20	Diesel	10520	6	120.00	19
D 2066 LF29 Euro 4 D 20	Diesel	10520	6	120.00	17
D 2066 LF30 Euro 4 D 20	Diesel	10520	6	120.00	17
D 2066 LF31 Euro 4 D 20	Diesel	10520	6	120.00	17
D 2066 LF32 Euro 4 D 20	Diesel	10520	6	120.00	17
D 2066 LF33 Euro 4 D 20	Diesel	10520	6	120.00	17
D 2066 LF35 Euro 4 D 20	Diesel	10520	6	120.00	17
D 2066 LF36 Euro 4 D 20	Diesel	10520	6	120.00	17
D 2066 LF37 Euro 4 D 20	Diesel	10520	6	120.00	17
D 2066 LF38 Euro 4 D 20	Diesel	10520	6	120.00	17
D 2066 LF39 Euro 4 D 20	Diesel	10520	6	120.00	17
D 2066 LF40 Euro 5 D 20	Diesel	10518	6	120.00	18
D 2066 LF41 Euro 5 D 20	Diesel	10518	6	120.00	18
D 2066 LF42 Euro 5 D 20	Diesel	10518	6	120.00	18
D 2066 LF43 Euro 5	Diesel	10518	6	120.00	18
D 2066 LF44 Euro 5	Diesel	10518	6	120.00	18
D 2066 LF45 Euro 5	Diesel	10518	6	120.00	18
D 2066 LF46 Euro 5	Diesel	10518	6	120.00	18
D 2066 LF47 Euro 5	Diesel	10518	6	120.00	18
D 2066 LF48 Euro 3	Diesel	10518	6	120.00	16
D 2066 LF49 Euro 3	Diesel	10518	6	120.00	16
D 2066 LF50 Euro 3	Diesel	10518	6	120.00	16
D 2066 LF51 Euro 5 D 20	Diesel	10518	6	120.00	18
D 2066 LF52 Euro 5 D 20	Diesel	10518	6	120.00	18
D 2066 LF53 Euro 5	Diesel	10518	6	120.00	18
D 2066 LF57 EEV	Diesel	10518	6	120.00	19
D 2066 LF58 EEV	Diesel	10518	6	120.00	19
D 2066 LF59 EEV	Diesel	10518	6	120.00	19
D 2066 LF60 EEV	Diesel	10518	6	120.00	19
D 2066 LF62 Euro 4	Diesel	10520	6	120.00	19

		ccm	x 		
D 2066 LF63 Euro 4	Diesel	10520	6	120.00	19
D 2066 LF64 Euro 4	Diesel	10520	6	120.00	19
D 2066 LF65 Euro 4	Diesel	10520	6	120.00	19
D 2066 LF69 Euro 4	Diesel	10520	6	120.00	17
D 2066 LF70 Euro 4	Diesel	10520	6	120.00	17
D 2066 LF71 Euro 4	Diesel	10520	6	120.00	17
D 2066 LF72 Euro 4	Diesel	10520	6	120.00	19
D 2066 LF Euro 2/3	Diesel	10518	6	120.00	16
D 2066 LF Euro 3	Diesel	10518	6	120.00	16
D 2066 LOH01 Euro 4	Diesel	10520	6	120.00	17
D 2066 LOH02 Euro 4	Diesel	10520	6	120.00	17
D 2066 LOH03 Euro 4	Diesel	10520	6	120.00	17
D 2066 LOH04 Euro 4	Diesel	10520	6	120.00	17
D 2066 LOH05 Euro 4	Diesel	10520	6	120.00	17
D 2066 LOH06 Euro 4	Diesel	10520	6	120.00	17
D 2066 LOH07 Euro 4	Diesel	10520	6	120.00	17
D 2066 LOH08 Euro 4	Diesel	10520	6	120.00	17
D 2066 LOH10 Euro 3	Diesel	10518	6	120.00	16
D 2066 LOH11 Euro 3	Diesel	10518	6	120.00	16
D 2066 LOH12 Euro 3	Diesel	10518	6	120.00	16
D 2066 LOH26 EEV	Diesel	10518	6	120.00	19
D 2066 LOH27 EEV	Diesel	10518	6	120.00	19
D 2066 LOH28 Euro 5	Diesel	10518	6	120.00	18
D 2066 LUH01 Euro 4	Diesel	10520	6	120.00	17
D 2066 LUH07 Euro 3	Diesel	10520	6	120.00	16
D 2066 LUH08 Euro 3	Diesel	10520	6	120.00	16
D 2066 LUH09 Euro 3	Diesel	10520	6	120.00	16
D 2066 LUH11 Euro 4	Diesel	10520	6	120.00	17
D 2066 LUH12 Euro 4	Diesel	10520	6	120.00	17
D 2066 LUH13 Euro 4	Diesel	10520	6	120.00	17
D 2066 LUH14 Euro 4	Diesel	10520	6	120.00	17
D 2066 LUH15 Euro 4	Diesel	10520	6	120.00	17
D 2066 LUH21 Euro 4	Diesel	10520	6	120.00	17
D 2066 LUH22 Euro 4	Diesel	10520	6	120.00	17
D 2066 LUH23 Euro 4	Diesel	10520	6	120.00	17
D 2066 LUH24 Euro 4	Diesel	10520	6	120.00	17
D 2066 LUH32 Euro 5	Diesel	10518	6	120.00	18
D 2066 LUH33 Euro 5	Diesel	10518	6	120.00	18
D 2066 LUH34 Euro 5	Diesel	10518	6	120.00	18
D 2066 LUH41 EEV	Diesel	10518	6	120.00	20
D 2066 LUH42 EEV	Diesel	10518	6	120.00	20
D 2066 LUH43 EEV	Diesel	10518	6	120.00	20
D 2066 LUH46 EEV	Diesel	10518	6	120.00	20
D 2066 LUH47 EEV	Diesel	10518	6	120.00	20
D 2066 LUH48 EEV	Diesel	10518	6	120.00	20
D 2146	Diesel	9660	6	121.00	21
D 2156 HM2	Diesel	10344	6	121.00	21
D 2156 HM3	Diesel	10344	6	121.00	21
D 2156 HM9	Diesel	10344	6	121.00	21
D 2156 HMN1	Diesel	10344	6	121.00	21
D 2156 HMN6	Diesel	10344	6	121.00	21
D 2156 HNY	Diesel	10344	6	121.00	21
D 2156 MGN	Diesel	10344	6	121.00	21
D 2156 MNY	Diesel	10344	6	121.00	21
D 2156 MTN1	Diesel	10344	6	121.00	22
D 2156 MTX	Diesel	10344	6	121.00	22
D 2156 MY	Diesel	10344	6	121.00	21
D 2156 MYN	Diesel	10344	6	121.00	21
D 2156 MYN-31	Diesel	10344	6	121.00	21
D 2530 ME	Diesel	15945	V10	125.00	23
D 2530 MF	Diesel	15945	V10	125.00	23
D 2530 MTE	Diesel	15953	V10	125.00	23
D 2530 MTFX	Diesel	15953	V10	125.00	23
D 2530 MTFX/360	Diesel	15900	V10	125.00	23
D 2530 MXF	Diesel	15945	V10	125.00	23
D 2538 M	Diesel	12763	V8	125.00	23
D 2538 ME	Diesel	12763	V8	125.00	23
D 2538 MF	Diesel	12763	V8	125.00	23
D 2538 MT	Diesel	12763	V8	125.00	23

		ccm	x 		
D 2538 MTE	Diesel	12763	V8	125.00	23
D 2540 MT	Diesel	17426	V10	125.00	23
D 2540 MTF	Diesel	17426	V10	125.00	23
D 2542 MLE	Diesel	20911	V12	125.00	23
D 2542 MTE	Diesel	20911	V12	125.00	23
D 2555 M	Diesel	9200	5	125.00	24
D 2555 MF	Diesel	9200	5	125.00	24
D 2555 MX	Diesel	9200	5	125.00	24
D 2555 MXF	Diesel	9200	5	125.00	24
D 2556 M	Diesel	11045	6	125.00	24
D 2556 MX	Diesel	11045	6	125.00	24
D 2556 MXF	Diesel	11045	6	125.00	24
D 2556 MXUH/175	Diesel	11045	6	125.00	24
D 2556 MXUH/192	Diesel	11045	6	125.00	24
D 2556 MXUH/240	Diesel	11045	6	125.00	24
D 2556 MXUM	Diesel	11045	6	125.00	24
D 2565 HM	Diesel	9510	5	125.00	25
D 2565 M	Diesel	9510	5	125.00	25
D 2565 ME	Diesel	9510	5	125.00	25
D 2565 MF	Diesel	9510	5	125.00	25
D 2565 MFR	Diesel	9510	5	125.00	25
D 2565 MK	Diesel	9510	5	125.00	26
D 2565 MKUL	Diesel	9510	5	125.00	26
D 2565 MR	Diesel	9510	5	125.00	24
D 2565 MT	Diesel	9510	5	125.00	26
D 2565 MUE	Diesel	9510	5	125.00	24
D 2565 MUH	Diesel	9510	5	125.00	25
D 2565 MUL	Diesel	9510	5	125.00	25
D 2566 M	Diesel	11413	6	125.00	25
D 2566 ME	Diesel	11413	6	125.00	25
D 2566 MF	Diesel	11413	6	125.00	25
D 2566 MH	Diesel	11413	6	125.00	25
D 2566 MK	Diesel	11413	6	125.00	26
D 2566 MKF	Diesel	11413	6	125.00	26
D 2566 MKUH/320	Diesel	11413	6	125.00	26
D 2566 MKUL	Diesel	11413	6	125.00	26
D 2566 MLUH	Diesel	11413	6	125.00	26
D 2566 MLUM	Diesel	11413	6	125.00	26
D 2566 MT	Diesel	11413	6	125.00	26
D 2566 MTE	Diesel	11413	6	125.00	26
D 2566 MTF	Diesel	11413	6	125.00	26
D 2566 MTH	Diesel	11413	6	125.00	26
D 2566 MTHO	Diesel	11413	6	125.00	26
D 2566 MTUH/280	Diesel	11413	6	125.00	26
D 2566 MUE	Diesel	11413	6	125.00	25
D 2566 MUH	Diesel	11413	6	125.00	25
D 2566 MUL	Diesel	11413	6	125.00	25
D 2566 MUM	Diesel	11413	6	125.00	25
D 2566 MXF	Diesel	11413	6	125.00	25
D 2566 UH	Diesel	11413	6	125.00	24
D 2676 LF01 Euro 4	Diesel	12418	6	126.00	27
D 2676 LF02 Euro 3	Diesel	12412	6	126.00	27
D 2676 LF03 Euro 2	Diesel	12412	6	126.00	27
D 2676 LF04 Euro 2	Diesel	12412	6	126.00	27
D 2676 LF05 Euro 4	Diesel	12412	6	126.00	27
D 2676 LF06 Euro 5	Diesel	12412	6	126.00	27
D 2676 LF07 Euro 5	Diesel	12412	6	126.00	27
D 2676 LF08 Euro 5	Diesel	12412	6	126.00	27
D 2676 LF10 Euro 4	Diesel	12412	6	126.00	27
D 2676 LF11 Euro 4	Diesel	12418	6	126.00	27
D 2676 LF12 Euro 4	Diesel	12418	6	126.00	27
D 2676 LF13 Euro 5	Diesel	12412	6	126.00	27
D 2676 LF14 Euro 5	Diesel	12412	6	126.00	27
D 2676 LF15 Euro 5	Diesel	12412	6	126.00	27
D 2676 LF16 Euro 5	Diesel	12412	6	126.00	27
D 2676 LF17 EEV	Diesel	12412	6	126.00	27
D 2676 LF18 EEV	Diesel	12412	6	126.00	27
D 2676 LF19 Euro 4	Diesel	12412	6	126.00	27
D 2676 LF20 Euro 4	Diesel	12412	6	126.00	27

		ccm	x 		
D 2676 LF21 Euro 5	Diesel	12412	6	126.00	27
D 2676 LF22 Euro 5	Diesel	12412	6	126.00	27
D 2676 LF25 Euro 6	Diesel	12412	6	126.00	27
D 2676 LF26 Euro 6	Diesel	12412	6	126.00	27
D 2676 LF28 Euro 5	Diesel	12412	6	126.00	27
D 2676 LF31 Euro 3	Diesel	12412	6	126.00	27
D 2676 LF32 Euro 4	Diesel	12412	6	126.00	27
D 2676 LF33 Euro 4	Diesel	12412	6	126.00	27
D 2676 LOH01 Euro 4	Diesel	12418	6	126.00	28
D 2676 LOH02 Euro 4	Diesel	12418	6	126.00	28
D 2676 LOH03 Euro 4	Diesel	12412	6	126.00	28
D 2676 LOH04 Euro 4	Diesel	12412	6	126.00	28
D 2676 LOH10 Euro 3	Diesel	12412	6	126.00	28
D 2676 LOH26 Euro 5	Diesel	12412	6	126.00	28
D 2676 LOH27 Euro 5	Diesel	12412	6	126.00	28
D 2676 LOH28 Euro 5	Diesel	12412	6	126.00	28
D 2840 LE	Diesel	18273	V10	128.00	31
D 2840 LE403	Diesel	18273	V10	128.00	31
D 2840 LE423	Diesel	18270	V10	128.00	29
D 2840 LF01	Diesel	18273	V10	128.00	29
D 2840 LF04 Euro 1	Diesel	18273	V10	128.00	29
D 2840 LF06 Euro 1	Diesel	18273	V10	128.00	29
D 2840 LF20 Euro 2	Diesel	18273	V10	128.00	29
D 2840 LF21 Euro 2	Diesel	18273	V10	128.00	29
D 2840 LF25 Euro 3	Diesel	18273	V10	128.00	29
D 2840 LF/460	Diesel	18273	V10	128.00	32
D 2840 LXF	Diesel	18273	V10	128.00	32
D 2840 ME	Diesel	18273	V10	128.00	29
D 2840 MF	Diesel	18273	V10	128.00	29
D 2840 MFG	Diesel	18273	V10	128.00	29
D 2840 MFR	Diesel	18273	V10	128.00	29
D 2840 MH	Diesel	18273	V10	128.00	29
D 2840 TL	Diesel	18273	V10	128.00	29
D 2842 LE202	Diesel	21930	V12	128.00	33
D 2842 LE211	Diesel	21930	V12	128.00	29
D 2842 LE402	Diesel	21930	V12	128.00	31
D 2842 LE403	Diesel	21930	V12	128.00	29
D 2842 LE404	Diesel	21930	V12	128.00	33
D 2842 LE406	Diesel	21930	V12	128.00	31
D 2842 LE408	Diesel	21930	V12	128.00	31
D 2842 LE414	Diesel	21930	V12	128.00	33
D 2842 LE415	Diesel	21930	V12	128.00	33
D 2842 LE416	Diesel	21930	V12	128.00	33
D 2842 LE417	Diesel	21930	V12	128.00	33
D 2842 LE423	Diesel	21930	V12	128.00	29
D 2842 LE433	Diesel	21930	V12	128.00	29
D 2842 LE622	Diesel	21927	V12	128.00	29
D 2842 LF10 Euro 3	Diesel	21927	V12	128.00	29
D 2842 LF/D 2842 LFX/D 2842 LXE/D 2842 LYE/D 2842 LZE	Diesel	21927	V12	128.00	29
D 2842 LXE	Diesel	21927	V12	128.00	29
D 2842 LYE	Diesel	21927	V12	128.00	29
D 2842 LZE	Diesel	21927	V12	128.00	29
D 2842 ME	Diesel	21927	V12	128.00	29
D 2842 ME/D 2842 MF	Diesel	21927	V12	128.00	29
D 2848 LE	Diesel	14618	V8	128.00	31
D 2848 LE423	Diesel	14618	V8	128.00	29
D 2848 LXE	Diesel	14618	V8	128.00	29
D 2848 LXE/D 2848 LYE	Diesel	14618	V8	128.00	29
D 2848 LYE	Diesel	14618	V8	128.00	29
D 2848 M	Diesel	14618	V8	128.00	29
D 2848 M/D 2848 MF/D 2848 MH	Diesel	14618	V8	128.00	29
D 2848 MH	Diesel	14618	V8	128.00	29
D 2865 LF02	Diesel	9973	5	128.00	35
D 2865 LF03	Diesel	9973	5	128.00	35
D 2865 LF05 Euro 1	Diesel	9973	5	128.00	35
D 2865 LF06 Euro 1	Diesel	9973	5	128.00	35
D 2865 LF09	Diesel	9973	5	128.00	36
D 2865 LF21 Euro 2	Diesel	9973	5	128.00	37
D 2865 LF22 Euro 1	Diesel	9973	5	128.00	35

		ccm	x 		
D 2865 LF23 Euro 1	Diesel	9973	5	128.00	35
D 2865 LF24 Euro 2	Diesel	9973	5	128.00	37
D 2865 LF/260	Diesel	9973	5	128.00	34
D 2865 LFR	Diesel	9973	5	128.00	36
D 2865 LOH01 Euro 1	Diesel	9973	5	128.00	35
D 2865 LOH02 Euro 1	Diesel	9973	5	128.00	35
D 2865 LOH05 Euro 1	Diesel	9973	5	128.00	36
D 2865 LOH07 Euro 2	Diesel	9973	5	128.00	36
D 2865 LOH09 Euro 2	Diesel	9973	5	128.00	36
D 2865 LU01/Silent Euro 1	Diesel	9973	5	128.00	35
D 2865 LUH02 Euro 1	Diesel	9973	5	128.00	35
D 2865 LUH05 Euro 1	Diesel	9973	5	128.00	35
D 2865 LUH07 Euro 2	Diesel	9973	5	128.00	37
D 2865 LUH08 Euro 1	Diesel	9973	5	128.00	35
D 2865 LUH09 Euro 2	Diesel	9973	5	128.00	37
D 2865 LXF	Diesel	9973	5	128.00	36
D 2865 LXFR	Diesel	9973	5	128.00	36
D 2866 F/240	Diesel	11967	6	128.00	38
D 2866 FR	Diesel	11967	6	128.00	38
D 2866 KF	Diesel	11967	6	128.00	34
D 2866 KFZ	Diesel	11967	6	128.00	34
D 2866 KOH/360	Diesel	11967	6	128.00	34
D 2866 KOH/373	Diesel	11967	6	128.00	36
D 2866 KUH/360 Euro 1	Diesel	11967	6	128.00	34
D 2866 KUL	Diesel	11967	6	128.00	34
D 2866 LF03	Diesel	11967	6	128.00	35
D 2866 LF04	Diesel	11967	6	128.00	34
D 2866 LF05 Euro 1	Diesel	11967	6	128.00	34
D 2866 LF06	Diesel	11967	6	128.00	35
D 2866 LF09 Euro 1	Diesel	11967	6	128.00	35
D 2866 LF10 Euro 1	Diesel	11967	6	128.00	35
D 2866 LF14 Euro 2	Diesel	11967	6	128.00	37
D 2866 LF15 Euro 1	Diesel	11967	6	128.00	35
D 2866 LF16 Euro 2	Diesel	11967	6	128.00	37
D 2866 LF17 Euro 2	Diesel	11967	6	128.00	37
D 2866 LF20 Euro 2	Diesel	11967	6	128.00	37
D 2866 LF21 Euro 1	Diesel	11967	6	128.00	35
D 2866 LF22 Euro 1	Diesel	11967	6	128.00	35
D 2866 LF23 Euro 3	Diesel	11967	6	128.00	39
D 2866 LF24 Euro 3	Diesel	11967	6	128.00	39
D 2866 LF25 Euro 3	Diesel	11967	6	128.00	39
D 2866 LF26 Euro 3	Diesel	11967	6	128.00	39
D 2866 LF27 Euro 4	Diesel	11967	6	128.00	39
D 2866 LF28 Euro 3	Diesel	11967	6	128.00	39
D 2866 LF29 Euro 2	Diesel	11967	6	128.00	37
D 2866 LF30 Euro 2	Diesel	11967	6	128.00	37
D 2866 LF31 Euro 2	Diesel	11967	6	128.00	40
D 2866 LF32 Euro 2	Diesel	11967	6	128.00	40
D 2866 LF34 Euro 2	Diesel	11967	6	128.00	37
D 2866 LF35 Euro 2	Diesel	11967	6	128.00	37
D 2866 LF36 Euro 2	Diesel	11967	6	128.00	37
D 2866 LF37 Euro 2	Diesel	11967	6	128.00	37
D 2866 LF39 Euro 2	Diesel	11967	6	128.00	40
D 2866 LF40 Euro 2	Diesel	11967	6	128.00	40
D 2866 LF41 Euro 2	Diesel	11967	6	128.00	40
D 2866 LF42 Euro 2	Diesel	11967	6	128.00	40
D 2866 LF43 Euro 2	Diesel	11967	6	128.00	40
D 2866 LF/290	Diesel	11967	6	128.00	34
D 2866 LFZ/290	Diesel	11967	6	128.00	34
D 2866 LFZ/330	Diesel	11967	6	128.00	36
D 2866 LOH	Diesel	11967	6	128.00	35
D 2866 LOH03	Diesel	11967	6	128.00	35
D 2866 LOH06 Euro 1	Diesel	11967	6	128.00	35
D 2866 LOH07	Diesel	11967	6	128.00	35
D 2866 LOH20 Euro 1	Diesel	11967	6	128.00	35
D 2866 LOH22 Euro 1	Diesel	11967	6	128.00	35
D 2866 LOH23 Euro 2	Diesel	11967	6	128.00	37
D 2866 LOH24 Euro 1	Diesel	11970	6	128.00	35
D 2866 LOH25 Euro 2	Diesel	11967	6	128.00	37
D 2866 LOH26 Euro 2	Diesel	11967	6	128.00	37

		ccm	x 		
D 2866 LOH27 Euro 3	Diesel	11967	6	128.00	39
D 2866 LOH28 Euro 3	Diesel	11967	6	128.00	39
D 2866 LOH29 Euro 3	Diesel	11967	6	128.00	39
D 2866 LOH32 Euro 3	Diesel	11967	6	128.00	39
D 2866 LOH33 Euro 3	Diesel	11967	6	128.00	39
D 2866 LOH34 Euro 3	Diesel	11967	6	128.00	39
D 2866 LU 01	Diesel	11967	6	128.00	35
D 2866 LU 03 Euro 1	Diesel	11967	6	128.00	35
D 2866 LU/330	Diesel	11967	6	128.00	34
D 2866 LUH21 Euro 2	Diesel	11967	6	128.00	37
D 2866 LUH22 Euro 2	Diesel	11967	6	128.00	37
D 2866 LUH23 Euro 3	Diesel	11967	6	128.00	39
D 2866 LUH24 Euro 3	Diesel	11967	6	128.00	39
D 2866 LUH25 Euro 3	Diesel	11967	6	128.00	39
D 2866 LUH26 Euro 2	Diesel	11967	6	128.00	37
D 2866 LUH30 Euro 3	Diesel	11967	6	128.00	39
D 2866 LUH/330	Diesel	11967	6	128.00	34
D 2866 LUL/330	Diesel	11967	6	128.00	34
D 2866 LX	Diesel	11967	6	128.00	35
D 2866 LXF	Diesel	11967	6	128.00	35
D 2866 LXOH	Diesel	11967	6	128.00	35
D 2866 OH	Diesel	11967	6	128.00	38
D 2866 T	Diesel	11967	6	128.00	34
D 2866 TOH	Diesel	11967	6	128.00	34
D 2866 TOH/290	Diesel	11967	6	128.00	34
D 2866 TOH/310	Diesel	11967	6	128.00	34
D 2866 TUH	Diesel	11967	6	128.00	34
D 2866 TUH01	Diesel	11967	6	128.00	34
D 2866 TUH/290	Diesel	11967	6	128.00	34
D 2866 U	Diesel	11967	6	128.00	38
D 2866 UH	Diesel	11967	6	128.00	38
D 2866 UH/240	Diesel	11967	6	128.00	38
D 2866 UM	Diesel	11967	6	128.00	38
D 2876 LF02 Euro 2	Diesel	12816	6	128.00	41
D 2876 LF03 Euro 3	Diesel	12816	6	128.00	42
D 2876 LF04 Euro 3	Diesel	12816	6	128.00	42
D 2876 LF05 Euro 3	Diesel	12816	6	128.00	36
D 2876 LF06 Euro 2	Diesel	12816	6	128.00	42
D 2876 LF07 Euro 2	Diesel	12816	6	128.00	42
D 2876 LF10 Euro 2	Diesel	12816	6	128.00	42
D 2876 LF11 Euro 2	Diesel	12816	6	128.00	36
D 2876 LF12 Euro 3	Diesel	12816	6	128.00	43
D 2876 LF13 Euro 3	Diesel	12816	6	128.00	43
D 2876 LF17	Diesel	12816	6	128.00	42
D 2876 LF25 Euro 3	Diesel	12816	6	128.00	43
D 2876 LOH02 Euro 3	Diesel	12816	6	128.00	42
D 2876 LOH03 Euro 3	Diesel	12816	6	128.00	42
D 2876 LOH20 Euro 3	Diesel	12816	6	128.00	43
D 2876 LOH21 Euro 3	Diesel	12816	6	128.00	43
D 2876 LOH/LUH01 Euro 2	Diesel	12816	6	128.00	41
D 2876 LUE604	Diesel	12816	6	128.00	36
D 2876 LUE605	Diesel	12816	6	128.00	36
D 2876 LUE606	Diesel	12816	6	128.00	36
D 2876 LUH01 Euro 2	Diesel	12816	6	128.00	41
D 2876 LUH02 Euro 2	Diesel	12816	6	128.00	41
E 0824 E301	CNG/LPG	4580	4	108.00	2
E 0826 E301	CNG/LPG	6596	6	108.00	2
E 0834 E302	CNG/LPG	4580	4	108.00	2
E 0834 E312	CNG/LPG	4580	4	108.00	2
E 0836 E302	CNG/LPG	6871	6	108.00	2
E 0836 E312	CNG/LPG	6871	6	108.00	2
E 0836 LE202	CNG/LPG	6871	6	108.00	3
E 2842 E312	CNG/LPG	21927	V12	128.00	29
E 2842 LE312	CNG/LPG	21927	V12	128.00	29
E 2842 LE322	CNG/LPG	21927	V12	128.00	29
E 2848 LE322	CNG/LPG	14618	V8	128.00	29
E 2876 LUH01 EEV	CNG/LPG	12816	6	128.00	30
E 2876 LUH 02 EEV	CNG/LPG	12816	6	128.00	30
E 2876 LUH03 EEV	CNG/LPG	12816	6	128.00	30
E 2876 LUH04 EEV	CNG/LPG	12816	6	128.00	30

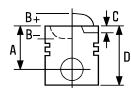



1  **102.00**

D 0226 MK	6 Cyl.	17.5:1	5687cc	125-154kW (170-209PS)	Diesel Turbo Intercooled	TD19077
D 0226 MKF	6 Cyl.	17.5:1	5687cc	141kW (192PS)	Diesel Turbo Intercooled	TD7685
D 0226 MKF/170	6 Cyl.	17.5:1	5687cc	125kW (170PS)	Diesel Turbo Intercooled	TD7684
D 0226 MKFA	6 Cyl.	17.5:1	5687cc	125-154kW (170-209PS)	Diesel Turbo Intercooled	TD19436
D 0226 MKH	6 Cyl.	17.5:1	5687cc	125-154kW (170-209PS)	Diesel Turbo Intercooled	TD19078
D 0226 MLE	6 Cyl.	17.5:1	5687cc	125-154kW (170-209PS)	Diesel Turbo Intercooled	TD19438
D 0226 MTE Euro 3	6 Cyl.	17.5:1	5687cc	81-135kW (110-184PS)	Diesel Turbo	TD19071

87-283300-00 STD

A 77.50
B- 37.50
D 115.50
 40x83

08-283300-00 STD

3.00  CR P
2.50  P
4.00  CR P

HA RT

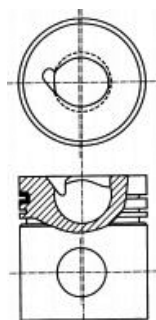

10225D



2  **108.00**

E 0824 E301	4 Cyl.		4580cc	47-58kW (64-79PS)	CNG/LPG	TD25680
E 0834 E302	4 Cyl.	13:1	4580cc	54-62kW (73-84PS)	CNG/LPG	TD25700
E 0834 E312	4 Cyl.	13:1	4580cc	37-53kW (50-72PS)	CNG/LPG	TD25699
E 0826 E301	6 Cyl.		6596cc	70-88kW (95-120PS)	CNG/LPG Turbo Intercooled	TD25681
E 0836 E302	6 Cyl.	13:1	6871cc	75kW (102PS)	CNG/LPG	TD23749
E 0836 E312	6 Cyl.	13:1	6871cc	56-64kW (76-87PS)	CNG/LPG	TD23748

87-429100-00 STD

A 62.80
B- 14.90
BØ 81.70
D 101.90
 42x85

08-429100-00 STD

2.50  CK P
2.50  P
4.00  CR P

14-027680-00 DH B 111.50 C 217.00 D 115.85 E 4.00
14-027681-00 DH B 112.00 C 217.00 D 115.85 E 4.00

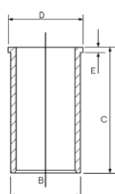

RT TP

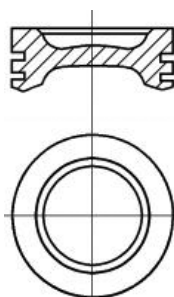

10838F403

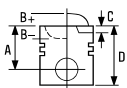



3  **108.00**

E 0836 LE202 6 Cyl. 11:1 **6871cc** **110kW (150PS)** **CNG/LPG Turbo Intercooled FM35935**

87-431600-00 STD **08-431600-00** STD **14-027680-00 DH** B 111.50 C 217.00 D 115.85 E 4.00
14-027681-00 DH B 112.00 C 217.00 D 115.85 E 4.00

A 63.40
B- 20.35
BØ 70.00
D 102.50
 42x85

3.00  CK P
 2.50  CR P
 4.00  CR P

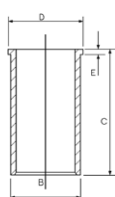

RT TP

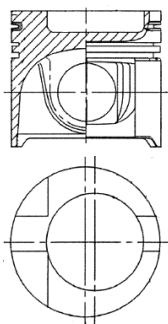

10842-113

4  **108.00**

D 0824 Euro 2	4 Cyl.		4580cc		Diesel	FM4696
D 0824 FL01 Euro 1	4 Cyl.	17:1	4580cc	75kW (102PS)	Diesel Turbo Intercooled	TD7655
D 0824 GF/D 0824 GF01	4 Cyl.	18:1	4580cc	75kW (102PS)	Diesel	FM7103
D 0824 GF02 Euro 1	4 Cyl.	18:1	4580cc	75kW (102PS)	Diesel	TD7639
D 0824 GF03 Euro 1	4 Cyl.	17:1	4580cc	75kW (102PS)	Diesel	TD21287
D 0824 LF/D 0824 LFL Euro 1	4 Cyl.	16.5/17:1	4580cc	114kW (155PS)	Diesel	FM5695
D 0824 LF/D 0824 LFL Euro 2	4 Cyl.	16.5/17/18:1	4580cc	83-162kW (113-220PS)	Diesel	FM5696
D 0824 LFO Euro 1	4 Cyl.	16.5:1	4580cc	118kW (160PS)	Diesel Turbo Intercooled	TD7657
D 0834 LOH01 Euro 3	4 Cyl.		4580cc	125kW (170PS)	Diesel Turbo Intercooled	TD16748
D 0834 LOH02 Euro 3	4 Cyl.		4580cc	125kW (170PS)	Diesel Turbo Intercooled	TD16749
D 0834 LOH03 Euro 3	4 Cyl.		4580cc	125kW (170PS)	Diesel Turbo Intercooled	TD16750
D 0834 LOH40 Euro 4	4 Cyl.		4580cc	132kW (180PS)	Diesel Turbo Intercooled	TD23680
D 0826 F01	6 Cyl.	18:1	6871cc	110-114kW (150-155PS)	Diesel	TD7681
D 0826 F02	6 Cyl.	18:1	6871cc	110kW (150PS)	Diesel	TD7682
D 0826 FG001	6 Cyl.	17:1	6871cc	169kW (230PS)	Diesel	TD22324
D 0826 FG002	6 Cyl.	17:1	6871cc	169kW (230PS)	Diesel	TD22326
D 0826 FO01	6 Cyl.	18:1	6871cc	114kW (155PS)	Diesel	TD23134
D 0826 FO02	6 Cyl.	18:1	6871cc	110kW (150PS)	Diesel	TD23135
D 0826 GF01 Euro 1	6 Cyl.	17:1	6871cc	110-114kW (150-155PS)	Diesel	TD7649
D 0826 GF02	6 Cyl.	17:1	6871cc	169kW (230PS)	Diesel	TD22328
D 0826 GF03	6 Cyl.	17:1	6871cc	110kW (150PS)	Diesel	TD7648
D 0826 GF04 Euro 1	6 Cyl.	17:1	6871cc	110-114kW (150-155PS)	Diesel	TD19440
D 0826 GFA	6 Cyl.	17:1	6871cc	114kW (155PS)	Diesel	TD23139
D 0826 GFA03	6 Cyl.	17:1	6871cc	110kW (150PS)	Diesel	TD23142



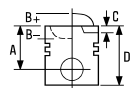

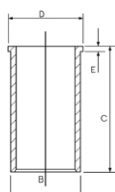

D 0826 GFA04 Euro 1	6 Cyl.	17:1	6871cc	107kW (146PS)	Diesel	TD23143
D 0826 LE51	6 Cyl.	17:1	6871cc	132kW (180PS)	Diesel Turbo Intercooled	TD19441
D 0826 LE52	6 Cyl.	17:1	6871cc	132kW (180PS)	Diesel Turbo Intercooled	TD19442
D 0826 LE521	6 Cyl.		6871cc	140kW (190PS)	Diesel Turbo Intercooled	TD22331
D 0826 LE522 Euro 1	6 Cyl.		6871cc	154kW (209PS)	Diesel Turbo Intercooled	TD23144
D 0826 LE523 Euro 1	6 Cyl.		6871cc	169kW (230PS)	Diesel Turbo Intercooled	TD23146
D 0826 LE524 Euro 1	6 Cyl.		6871cc	125kW (170PS)	Diesel Turbo Intercooled	TD23147
D 0826 LE530 Euro 1	6 Cyl.		6871cc	147kW (200PS)	Diesel Turbo Intercooled	TD23149
D 0826 LE531 Euro 1	6 Cyl.		6871cc	191kW (260PS)	Diesel Turbo Intercooled	TD23150
D 0826 LF/217/Silent	6 Cyl.	16.5:1	6870cc	160kW (217PS)	Diesel Turbo Intercooled	TD7723
D 0826 LF/D 0826 LOH/D 0826 OH	6 Cyl.		6590cc	169kW (230PS)	Diesel Turbo Intercooled	FM6810
D 0826 LF/D 0826 LFL Euro 1	6 Cyl.	16.5:1	6870cc	114-198kW (190-270PS)	Diesel	FM5697
D 0826 LF01/D 0826 LF02/D 0826 LFOH	6 Cyl.	16.5:1	6871cc	140kW (190PS)	Diesel Turbo Intercooled	FM7026
D 0826 LF09 Euro 1	6 Cyl.	16.5:1	6871cc	169kW (230PS)	Diesel Turbo Intercooled	TD22332
D 0826 LF12 Euro 2	6 Cyl.	18:1	6871cc	140kW (190PS)	Diesel Turbo Intercooled	TD22337
D 0826 LF13 Euro 2	6 Cyl.	16.5:1	6871cc	191kW (260PS)	Diesel Turbo Intercooled	TD7694
D 0826 LOH/D 0826 LUH Euro 2	6 Cyl.	16.5/18:1	6870cc	162-191kW (220-260PS)	Diesel	FM5698
D 0826 LOH01	6 Cyl.	16.5:1	6871cc	140kW (190PS)	Diesel Turbo Intercooled	TD7601
D 0826 LOH02	6 Cyl.	16.5:1	6871cc	140kW (190PS)	Diesel Turbo Intercooled	TD7679
D 0826 LOH03	6 Cyl.	17:1	6871cc	169kW (230PS)	Diesel Turbo Intercooled	TD16465
D 0826 LOH07 Euro 1	6 Cyl.	17:1	6871cc	169kW (230PS)	Diesel Turbo Intercooled	TD16246
D 0826 LOH10 Euro 1	6 Cyl.		6871cc	184kW (250PS)	Diesel Turbo Intercooled	TD16247
D 0826 LUH08 Euro 2	6 Cyl.	16.5:1	6871cc	162-169kW (220-230PS)	Diesel Turbo Intercooled	TD21304
D 0826 LUH09 Euro 2	6 Cyl.	16.5:1	6871cc	169-206kW (230-280PS)	Diesel Turbo Intercooled	TD21305
D 0826 OH01	6 Cyl.	18:1	6871cc	114kW (155PS)	Diesel	TD23157
D 0826 OH02	6 Cyl.	18:1	6871cc	110-114kW (150-155PS)	Diesel	TD7599
D 0826 OH03 Euro 1	6 Cyl.	18:1	6871cc	107kW (146PS)	Diesel	TD23158
D 0826 TE520	6 Cyl.		6596cc	121-125kW (165-170PS)	Diesel Turbo	TD23159
D 0826 TF	6 Cyl.	17:1	6596cc	137kW (186PS)	Diesel Turbo	TD7689
D 0826 TOH	6 Cyl.	17:1	6596cc	132-137kW (180-186PS)	Diesel Turbo	TD7600
D 0826 TUE51	6 Cyl.	17:1	6871cc	132kW (180-180PS)	Diesel Turbo Intercooled	TD23162
D 0836 LFL06 Euro 3	6 Cyl.	18:1	6871cc	162kW (220PS)	Diesel Turbo Intercooled	TD23163
D 0826 LUE51 Euro 1	B6 Cyl.	17:1	6870cc	132kW (180PS)	Diesel Turbo Intercooled	TD19444

14-027680-00 DH B 111.50 C 217.00 D 115.85 E 4.00
 14-027681-00 DH B 112.00 C 217.00 D 115.85 E 4.00

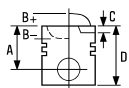



5  **108.00**

D 0824 GF	4 Cyl.	18:1	4580cc	75kW (102PS)	Diesel	TD5648
D 0824 GF01	4 Cyl.	18:1	4580cc	75kW (102PS)	Diesel	TD5988
D 0826 GF	6 Cyl.	17:1	6871cc	110-114kW (150-155PS)	Diesel Turbo	TD7647



87-285800-00 STD

08-285800-00 STD

14-027680-00 DH B 111.50 C 217.00 D 115.85 E 4.00

14-027681-00 DH B 112.00 C 217.00 D 115.85 E 4.00

- A 72.90
- B- 21.52
- BØ 63.00
- D 115.90
-  40x83

- 2.50  CR P
- 2.50  P
- 4.00  CR P

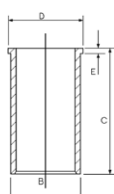

AK RT

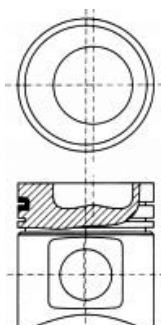

10830

6  **108.00**

D 0824 LF01 Euro 1	4 Cyl.	16.5:1	4580cc	114kW (155PS)	Diesel Turbo Intercooled	TD7680
D 0824 LF03 Euro 1	4 Cyl.	16.5:1	4580cc	118kW (160PS)	Diesel Turbo Intercooled	TD21278
D 0824 LF04 Euro 1	4 Cyl.	16.5:1	4580cc	118kW (160PS)	Diesel Turbo Intercooled	TD21279
D 0824 LF05 Euro 1	4 Cyl.	16.5:1	4580cc	118kW (160PS)	Diesel Turbo Intercooled	TD21280
D 0824 LF06 Euro 1	4 Cyl.	16.5:1	4580cc	118kW (160PS)	Diesel Turbo Intercooled	TD21281
D 0824 LF07 Euro 1	4 Cyl.	16.5:1	4580cc	118kW (160PS)	Diesel Turbo Intercooled	TD21282
D 0824 LF08 Euro 1	4 Cyl.	16.5:1	4580cc	118kW (160PS)	Diesel Turbo Intercooled	TD21283
D 0824 LF09 Euro 1	4 Cyl.	16.5:1	4580cc	118kW (160PS)	Diesel Turbo Intercooled	TD21284
D 0824 LF10 Euro 1	4 Cyl.	16.5:1	4580cc	118kW (160PS)	Diesel Turbo Intercooled	TD21285
D 0824 LFL01 Euro 1	4 Cyl.	16.5:1	4580cc	114kW (155PS)	Diesel Turbo Intercooled	TD7658
D 0824 LFL05 Euro 1	4 Cyl.	16.5:1	4580cc	114kW (155PS)	Diesel Turbo Intercooled	TD7659
D 0824 LFL09 Euro 1	4 Cyl.	18:1	4580cc	114kW (155PS)	Diesel Turbo Intercooled	TD9707
D 0824 LOH01 Euro 1	4 Cyl.	16.5:1	4580cc	114kW (155PS)	Diesel Turbo Intercooled	TD7598
D 0826 LF01	6 Cyl.	16.5:1	6871cc	140kW (190PS)	Diesel Turbo Intercooled	TD7686
D 0826 LF02 Euro 1	6 Cyl.	16.5:1	6871cc	169kW (230PS)	Diesel Turbo Intercooled	TD7691
D 0826 LF04 Euro 1	6 Cyl.	16.5:1	6871cc	198kW (270PS)	Diesel Turbo Intercooled	TD7695
D 0826 LF05	6 Cyl.	16.5:1	6871cc	140kW (190PS)	Diesel Turbo Intercooled	TD7687
D 0826 LF06	6 Cyl.	16.5:1	6871cc	169kW (230PS)	Diesel Turbo Intercooled	TD7692
D 0826 LF07 Euro 1	6 Cyl.	16.5:1	6871cc	140kW (190PS)	Diesel Turbo Intercooled	TD7688
D 0826 LF08 Euro 1	6 Cyl.	16.5:1	6871cc	169kW (230PS)	Diesel Turbo Intercooled	TD7693
D 0826 LF18 Euro 2	6 Cyl.	18:1	6871cc	162kW (220PS)	Diesel Turbo Intercooled	TD10227
D 0826 LFL Euro 1	6 Cyl.	16.5:1	6871cc	162-165kW (220-224PS)	Diesel Turbo Intercooled	TD19443



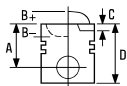

D 0826 LFL02 Euro 1	6 Cyl.	16.5:1	6871cc	169kW (230PS)	Diesel Turbo Intercooled	TD7664
D 0826 LFL03 Euro 1	6 Cyl.	16.5:1	6871cc	162kW (220PS)	Diesel Turbo Intercooled	TD7663
D 0826 LFL05 Euro 1	6 Cyl.	16.5:1	6871cc	114kW (155PS)	Diesel Turbo Intercooled	TD21291
D 0826 LFL06 Euro 1	6 Cyl.	16.5:1	6871cc	162kW (220PS)	Diesel Turbo Intercooled	TD7665
D 0826 LFL07 Euro 1	6 Cyl.	16.5:1	6871cc	188kW (256PS)	Diesel Turbo Intercooled	TD21292
D 0826 LFL08 Euro 1	6 Cyl.	16.5:1	6871cc	162kW (220PS)	Diesel Turbo Intercooled	TD21293
D 0826 LFL10 Euro 1	6 Cyl.	16.5:1	6871cc	162kW (220PS)	Diesel Turbo Intercooled	TD10207
D 0826 LOH04	6 Cyl.	17:1	6871cc	169kW (230PS)	Diesel Turbo Intercooled	TD16466
D 0826 LOH05	6 Cyl.	15.5:1	6871cc	169kW (230PS)	Diesel Turbo Intercooled	TD21295
D 0826 LOH06 Euro 1	6 Cyl.	16.5:1	6871cc	140kW (190PS)	Diesel Turbo Intercooled	TD7587
D 0826 LUH01 Euro 1	6 Cyl.	17:1	6871cc	198kW (270PS)	Diesel Turbo Intercooled	TD7596
D 0826 LUH02 Euro 1	6 Cyl.	16.5:1	6871cc	169-198kW (230-269PS)	Diesel Turbo Intercooled	TD21301
D 0826 LUH03 Euro 1	6 Cyl.	16.5:1	6871cc	157kW (213PS)	Diesel Turbo Intercooled	TD7584
D 0826 LUH04	6 Cyl.	16.5:1	6871cc	157-169kW (214-230PS)	Diesel Turbo Intercooled	TD21302
D 0826 LUH05 Euro 1	6 Cyl.	16.5:1	6871cc	169kW (230PS)	Diesel Turbo Intercooled	TD7585
D 0826 LUH06 Euro 1	6 Cyl.	16.5:1	6871cc	169-198kW (230-269PS)	Diesel Turbo Intercooled	TD21303
D 0826 LUH10 Euro 1	6 Cyl.	16.5:1	6871cc	169-198kW (230-269PS)	Diesel Turbo Intercooled	TD21306
D 0826 LUH12 Euro 1	6 Cyl.	16.5:1	6870cc	162kW (220PS)	Diesel Turbo Intercooled	TD7586
D 0826 LUH Euro 1	B6 Cyl.	16.5:1	6870cc	184kW (250PS)	Diesel Turbo Intercooled	TD7583

87-285900-10

STD

- A 72.90
- B- 20.50
- BØ 62.48
- C 1.70
- C 1.70
- D 111.50
- 40x90

08-285900-00

STD

- 3.00 CR P
- 2.50 P
- 4.00 CR P

14-027680-00 DH

B 111.50 C 217.00 D 115.85 E 4.00

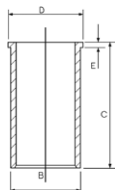

88-285900-10
87-285900-10 +
14-027680-00

AK RT

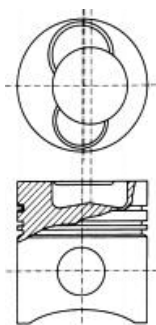

10836B159



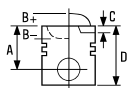

87-285900-15

STD

- A 72.70
- B- 20.50
- BØ 62.48
- C 1.70
- C 1.70
- D 111.30
-  40x90

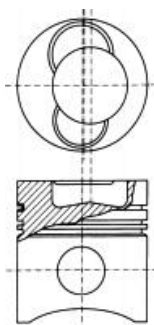

AK RT



10836B160

08-285900-00

STD

- 3.00  CR P
- 2.50  P
- 4.00  CR P

14-027680-00 DH B 111.50 C 217.00 D 115.85 E 4.00

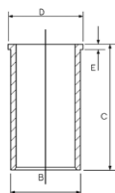

88-285900-15
87-285900-15 +
14-027680-00

87-285900-16

STD

- A 72.50
- B- 20.50
- BØ 62.48
- C 1.70
- C 1.70
- D 111.10
-  40x90

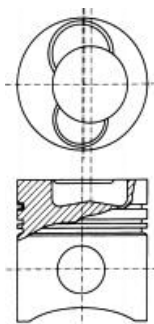

AK RT



10836B161

08-285900-00

STD

- 3.00  CR P
- 2.50  P
- 4.00  CR P

14-027680-00 DH B 111.50 C 217.00 D 115.85 E 4.00

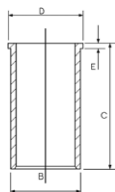

88-285900-16
87-285900-16 +
14-027680-00

14-027681-00 DH B 112.00 C 217.00 D 115.85 E 4.00

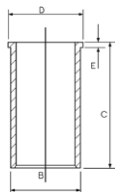

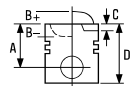

7  **108.00**

D 0824 LFO2 Euro 2	4 Cyl.	16.5:1	4580cc	118kW (160PS)	Diesel Turbo Intercooled	TD7683
D 0824 LFL02 Euro 2	4 Cyl.	16.5:1	4580cc	118kW (160PS)	Diesel Turbo Intercooled	TD7660
D 0824 LFL04 Euro 2	4 Cyl.		4580cc	81kW (110PS)	Diesel Turbo Intercooled	TD7656
D 0824 LFL06 Euro 2	4 Cyl.	18:1	4580cc	114kW (155PS)	Diesel Turbo Intercooled	TD7661
D 0824 LFL07 Euro 2	4 Cyl.	18:1	4580cc	104kW (141PS)	Diesel Turbo Intercooled	TD7662
D 0824 LFL08 Euro 2	4 Cyl.		4580cc	83kW (113PS)	Diesel Turbo Intercooled	TD16523
D 0824 LFL10 Euro 2	4 Cyl.	18:1	4580cc	92-162kW (125-220PS)	Diesel Turbo Intercooled	TD21286
D 0824 LFO01 Euro 1	4 Cyl.	16.5:1	4580cc	114kW (155PS)	Diesel Turbo Intercooled	TD23129
D 0824 LOH02 Euro 1	4 Cyl.	16.5:1	4580cc	114kW (155PS)	Diesel Turbo Intercooled	TD21288
D 0824 LOH03 Euro 1	4 Cyl.	16.5:1	4580cc	114kW (155PS)	Diesel Turbo Intercooled	TD21289
D 0824 LOH04 Euro 1	4 Cyl.	16.5:1	4580cc	114kW (155PS)	Diesel Turbo Intercooled	TD21290
D 0824 LOH05 Euro 2	4 Cyl.	16.5:1	4580cc	114kW (155PS)	Diesel Turbo Intercooled	TD20537
D 0826 LF11 Euro 2	6 Cyl.	18:1	6871cc	162kW (220PS)	Diesel Turbo Intercooled	TD7690
D 0826 LF15 Euro 2	6 Cyl.	18:1	6871cc	162kW (220PS)	Diesel Turbo Intercooled	TD7726
D 0826 LF17 Euro 2	6 Cyl.	16.5:1	6871cc	191kW (260PS)	Diesel Turbo Intercooled	TD7727
D 0826 LFG15 Euro 2	6 Cyl.	18:1	6871cc	162kW (220PS)	Diesel Turbo Intercooled	TD23154
D 0826 LFG16 Euro 2	6 Cyl.	18:1	6871cc	191kW (260PS)	Diesel Turbo Intercooled	TD23155
D 0826 LFL09 Euro 2	6 Cyl.	16.5:1	6871cc	191kW (260PS)	Diesel Turbo Intercooled	TD7725
D 0826 LOH15 Euro 2	6 Cyl.	17:1	6871cc	162kW (220PS)	Diesel Turbo Intercooled	TD7588
D 0826 LOH17 Euro 2	6 Cyl.	17:1	6871cc	162kW (220PS)	Diesel Turbo Intercooled	TD17419
D 0826 LOH18 Euro 2	6 Cyl.	17:1	6871cc	191kW (260PS)	Diesel Turbo Intercooled	TD17420
D 0826 LOH19 Euro 2	6 Cyl.	16.5:1	6871cc	162kW (220PS)	Diesel Turbo Intercooled	TD23156
D 0826 LUH	6 Cyl.	16.5:1	6871cc	157kW (213PS)	Diesel Turbo Intercooled	TD7597
D 0826 LUH11 Euro 2	6 Cyl.	18:1	6871cc	162kW (220PS)	Diesel Turbo Intercooled	TD21307
D 0826 LUH13 Euro 2	6 Cyl.	16.5:1	6871cc	191kW (260PS)	Diesel Turbo Intercooled	TD16248

87-285900-00

STD

- A 72.90
- B- 17.80
- BØ 70.52
- C 1.70
- C 1.70
- D 111.50
-  40x90

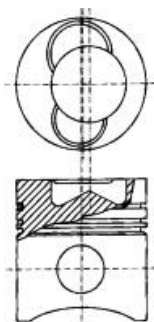

AK RT



10836B170

08-285900-00

STD

- 3.00  CR P
- 2.50  P
- 4.00  CR P

14-027680-00 DH

B 111.50 C 217.00 D 115.85 E 4.00

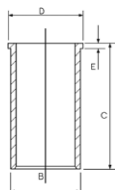

88-285900-00
87-285900-00 +
14-027680-00



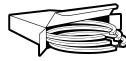
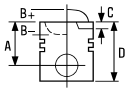

87-285900-05

STD

- A 72.70
- B- 17.80
- BØ 70.52
- C 1.70
- C 1.70
- D 111.30
- 40x90

AK RT

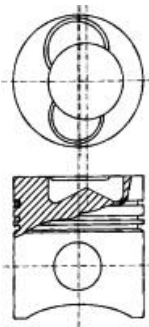

10836B270

08-285900-00

STD

- 3.00 CR P
- 2.50 P
- 4.00 CR P

14-027680-00 DH

B 111.50 C 217.00 D 115.85 E 4.00

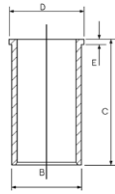

88-285900-05
87-285900-05 +
14-027680-00

87-285900-06

STD

- A 72.50
- B- 17.80
- BØ 70.52
- C 1.70
- C 1.70
- D 111.10
- 40x90

AK RT

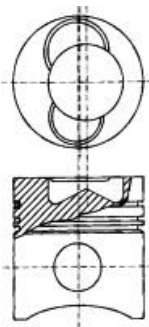

10836B370

08-285900-00

STD

- 3.00 CR P
- 2.50 P
- 4.00 CR P

14-027680-00 DH

B 111.50 C 217.00 D 115.85 E 4.00

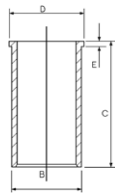

88-285900-06
87-285900-06 +
14-027680-00

14-027681-00 DH

B 112.00 C 217.00 D 115.85 E 4.00

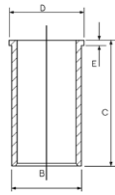

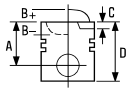



8  **108.00**

D 0826 OH 6 Cyl. 17:1 **6871cc** **110kW (150PS)** **Diesel** **TD19445**

87-285900-30 STD **08-285900-00** STD **14-027680-00 DH** **B 111.50 C 217.00 D 115.85 E 4.00** **88-285900-30**
 87-285900-30 +
 14-027680-00

A 72.70
B- 21.35
BØ 62.48
D 115.70
 40x90

3.00  CR P
 2.50  P
 4.00  CR P

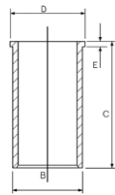

AK HA RT

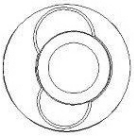
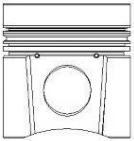

10830B

87-285900-40 STD **08-285900-00** STD **14-027680-00 DH** **B 111.50 C 217.00 D 115.85 E 4.00** **88-285900-40**
 87-285900-40 +
 14-027680-00

A 72.90
B- 21.35
BØ 62.48
D 115.90
 40x90

3.00  CR P
 2.50  P
 4.00  CR P

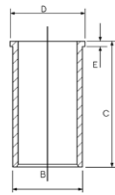

AK HA RT

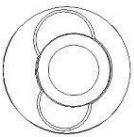
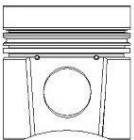

10830B

14-027681-00 DH **B 112.00 C 217.00 D 115.85 E 4.00**

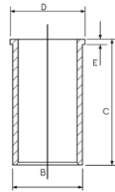

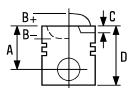

9  **108.00**

D 0834 LFL01 Euro 3	4 Cyl.	18:1	4580cc	103kW (140PS)	Diesel Turbo Intercooled	TD17044
D 0834 LFL02 Euro 3	4 Cyl.	18:1	4580cc	103kW (140PS)	Diesel Turbo Intercooled	TD6591
D 0834 LFL03 Euro 3	4 Cyl.	18:1	4580cc	132kW (180PS)	Diesel Turbo Intercooled	TD16498
D 0834 LFL04 Euro 3	4 Cyl.	18:1	4580cc	110kW (150PS)	Diesel Turbo Intercooled	TD18096
D 0834 LFL20 Euro 3	4 Cyl.		4580cc	125kW (170PS)	Diesel Turbo Intercooled	TD16829
D 0836 LF01 Euro 2	6 Cyl.		6871cc	206kW (280PS)	Diesel Turbo Intercooled	TD14289
D 0836 LF02 Euro 3	6 Cyl.	17:1	6871cc	162kW (220PS)	Diesel Turbo Intercooled	TD17045
D 0836 LF03 Euro 3	6 Cyl.	18:1	6871cc	206kW (280PS)	Diesel Turbo Intercooled	TD16503
D 0836 LF04 Euro 3	6 Cyl.	18:1	6871cc	162kW (220PS)	Diesel Turbo Intercooled	TD16500
D 0836 LF05 Euro 3	6 Cyl.	18:1	6871cc	180kW (245PS)	Diesel Turbo Intercooled	TD16504
D 0836 LFL01 Euro 2/3	6 Cyl.	18:1	6871cc	206-215kW (280-292PS)	Diesel Turbo Intercooled	TD16875
D 0836 LFL02 Euro 2/3	6 Cyl.	18:1	6871cc	162kW (220PS)	Diesel Turbo Intercooled	TD16499
D 0836 LFL03 Euro 3	6 Cyl.	18:1	6871cc	206kW (280PS)	Diesel Turbo Intercooled	TD16502
D 0836 LFL04 Euro 3	6 Cyl.	18:1	6871cc	162kW (220PS)	Diesel Turbo Intercooled	TD17049
D 0836 LFL05 Euro 3	6 Cyl.	18:1	6871cc	180kW (245PS)	Diesel Turbo Intercooled	TD16501
D 0836 LFL07 Euro 3	6 Cyl.		6871cc	162kW (220PS)	Diesel Turbo Intercooled	TD16830
D 0836 LFL10 Euro 3	6 Cyl.		6871cc	162kW (220PS)	Diesel Turbo Intercooled	TD16831
D 0836 LOH01 Euro 3	6 Cyl.		6871cc	206kW (280PS)	Diesel Turbo Intercooled	TD16753
D 0836 LOH02 Euro 3	6 Cyl.		6871cc	206kW (280PS)	Diesel Turbo Intercooled	TD16752
D 0836 LOH03 Euro 3	6 Cyl.		6871cc	162kW (220PS)	Diesel Turbo Intercooled	TD16751

87-136500-00  STD

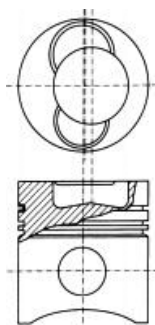

- A** 63.90
- B-** 16.15
- BØ** 70.52
- C** 1.70
- D** 103.00
-  42x85

RT TP



10838W-139

08-136500-00 STD

- 3.00  CK P
- 2.50  P
- 4.00  CR P

14-027680-00 DH B 111.50 C 217.00 D 115.85 E 4.00

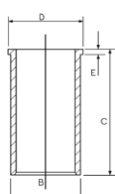

88-136500-00
87-136500-00 +
14-027680-00

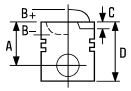

87-136500-10

STD

01/03→

- A 63.90
- B- 16.15
- BØ 70.52
- C 1.70
- D 103.00
-  42x86

RT TP

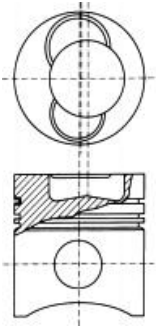



10838W-151

 Piston Chamber Volume
[ccm] 56.56

08-136500-10

STD

01/03→

- 3.00  CK P
- 2.50  P
- 3.00  CR P

 Volumen der Kolbenmulde
[ccm] 56.56

14-027680-00 DH

B 111.50 C 217.00 D 115.85 E 4.00

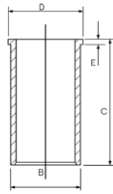

14-027681-00 DH

B 112.00 C 217.00 D 115.85 E 4.00

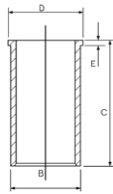

 Volumen de cavidad del pistón
[cc] 56.56

88-136500-10
87-136500-10 +
14-027680-00

 Volume camera pistone
[cm³] 56.56

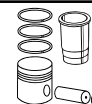
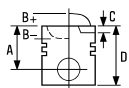

10  **108.00**

D 0834 LFL40 Euro 3	4 Cyl.	18:1	4580cc	110kW (150PS)	Diesel Turbo Intercooled	TD18179
D 0834 LFL41 Euro 3	4 Cyl.	18:1	4580cc	132kW (180PS)	Diesel Turbo Intercooled	TD18180
D 0834 LFL42 Euro 3	4 Cyl.	18:1	4580cc	151kW (206PS)	Diesel Turbo Intercooled	TD18181
D 0836 LF41 Euro 3	6 Cyl.		6871cc	206kW (280PS)	Diesel Turbo Intercooled	TD16827
D 0836 LF44 Euro 3	6 Cyl.		6871cc	240kW (326PS)	Diesel Turbo Intercooled	TD16828
D 0836 LFL40 Euro 3	6 Cyl.	18:1	6871cc	176kW (240PS)	Diesel Turbo Intercooled	TD18185
D 0836 LFL41 Euro 3	6 Cyl.		6871cc	206kW (280PS)	Diesel Turbo Intercooled	TD18703
D 0836 LFL44 Euro 3	6 Cyl.		6871cc	240kW (326PS)	Diesel Turbo Intercooled	TD18704
D 0836 LOH40 Euro 3	6 Cyl.		6871cc	206kW (280PS)	Diesel Turbo Intercooled	TD16754
D 0836 LOH41 Euro 3	6 Cyl.		6871cc	177kW (240PS)	Diesel Turbo Intercooled	TD16755

87-136500-30 STD

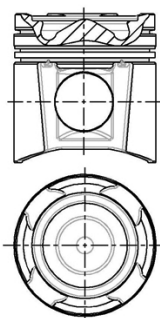

- A** 63.90
- B-** 17.39
- BØ** 65.40
- C** 1.70
- D** 103.00
-  42x86

RT TP



10838F109

08-136500-30 STD
08-136507-30 0.50mm

- 3.00  CK P
- 2.50  P
- 3.00  CR P

14-027680-00 DH B 111.50 C 217.00 D 115.85 E 4.00

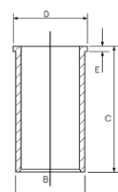

88-136500-30
87-136500-30 +
14-027680-00

14-027681-00 DH B 112.00 C 217.00 D 115.85 E 4.00

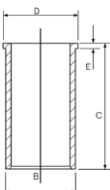



87-136500-40 STD

- A** 63.70
- B-** 17.39
- BØ** 65.40
- C** 1.70
- D** 102.80
-  42x86

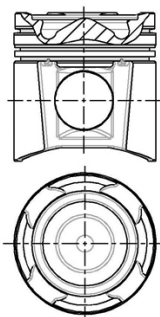
RT TP



08-136500-30 STD
08-136507-30 0.50mm

- 3.00  CK P
- 2.50  P
- 3.00  CR P



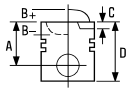



87-136500-60

STD

- A 63.90
- B- 17.39
- BØ 65.40
- C 1.70
- D 103.00
-  42x86

08-136500-30
08-136507-30

STD
0.50mm

- 3.00  CK P
- 2.50  P
- 3.00  CR P

KK RT TP

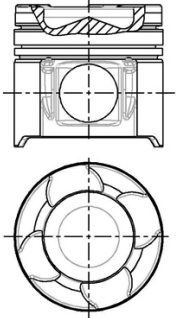

10843B101



87-136500-70

STD

- A 63.70
- B- 17.39
- BØ 65.40
- C 1.70
- D 102.80
-  42x86

08-136500-30
08-136507-30

STD
0.50mm

- 3.00  CK P
- 2.50  P
- 3.00  CR P

KK RT TP

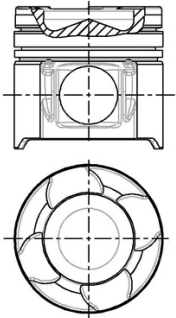

10843B101



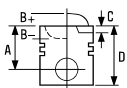

87-136500-80



STD

- A 63.50
- B- 17.39
- BØ 65.40
- C 1.70
- D 102.60
-  42x86

08-136500-30
08-136507-30

STD

0.50mm

- 3.00  CK P
- 2.50  P
- 3.00  CR P

KK RT TP

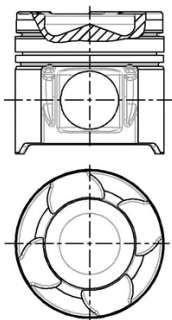

10843B101

11  **108.00**

D 0834 LFL50 Euro 4	4 Cyl.	18:1	4580cc	110kW (150PS)	Diesel Turbo Intercooled	TD18182
D 0834 LFL51 Euro 4	4 Cyl.	18:1	4580cc	132kW (180PS)	Diesel Turbo Intercooled	TD18183
D 0834 LFL52 Euro 4	4 Cyl.	18:1	4580cc	151kW (206PS)	Diesel Turbo Intercooled	TD18184
D 0834 LFL53 Euro 4	4 Cyl.		4580cc	110kW (150PS)	Diesel Turbo Intercooled	TD22957
D 0834 LFL54 Euro 4	4 Cyl.		4580cc	132kW (180PS)	Diesel Turbo Intercooled	TD22958
D 0834 LFL55 Euro 4	4 Cyl.		4580cc	151kW (206PS)	Diesel Turbo Intercooled	TD22969
D 0834 LOH50 Euro 4	4 Cyl.		4580cc	132kW (160PS)	Diesel Turbo Intercooled	TD19968
D 0834 LOH51 Euro 4	4 Cyl.	17.3:1	4580cc	151kW (205PS)	Diesel Turbo Intercooled	TD19969
D 0834 LOH52 Euro 4	4 Cyl.	17.3:1	4580cc	132kW (180PS)	Diesel Turbo Intercooled	TD23057
D 0834 LOH53 Euro 4	4 Cyl.	17.3:1	4580cc	151kW (206PS)	Diesel Turbo Intercooled	TD23058
D 0836 LFG50 Euro 4/5	6 Cyl.	18:1	6871cc	240kW (326PS)	Diesel Turbo Intercooled	TD20228
D 0836 LFL50 Euro 4	6 Cyl.	18:1	6871cc	176kW (240PS)	Diesel Turbo Intercooled	TD18186
D 0836 LFL51 Euro 4	6 Cyl.	18:1	6871cc	206kW (280PS)	Diesel Turbo Intercooled	TD19114
D 0836 LFL52 Euro 4	6 Cyl.	18:1	6871cc	240kW (326PS)	Diesel Turbo Intercooled	TD19113
D 0836 LFL53 Euro 4	6 Cyl.		6871cc	176kW (240PS)	Diesel Turbo Intercooled	TD22970
D 0836 LFL54 Euro 4	6 Cyl.		6871cc	206kW (280PS)	Diesel Turbo Intercooled	TD22971
D 0836 LFL55 Euro 4	6 Cyl.		6871cc	240kW (326PS)	Diesel Turbo Intercooled	TD22972
D 0836 LOH51 Euro 4	6 Cyl.	17.4:1	6871cc	206kW (280PS)	Diesel Turbo Intercooled	TD19971
D 0836 LOH52 Euro 4	6 Cyl.	17.4:1	6871cc	177kW (240PS)	Diesel Turbo Intercooled	TD19970
D 0836 LOH55 Euro 4	6 Cyl.	17.4:1	6871cc	206kW (280PS)	Diesel Turbo Intercooled	TD23060
D 0836 LOH56 Euro 4	6 Cyl.	17.4:1	6871cc	177kW (240PS)	Diesel Turbo Intercooled	TD23059
D 0836 LOH60 EEV	6 Cyl.		6871cc	213kW (290PS)	Diesel Turbo Intercooled	TD23671
D 0836 LOH61 EEV	6 Cyl.		6871cc	184kW (250PS)	Diesel Turbo Intercooled	TD23670
D 0836 LOH62 Euro 4	6 Cyl.	17.4:1	6871cc	191kW (260PS)	Diesel Turbo Intercooled	TD23164



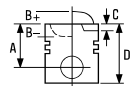



D 0836 LOH63 EEV	6 Cyl.	6871cc	191kW (260PS)	Diesel Turbo Intercooled	TD23962
D 0836 LOH64 Euro 5	6 Cyl.	6871cc	213kW (290PS)	Diesel Turbo Intercooled	TD23682
D 0836 LOH65 Euro 5	6 Cyl.	6871cc	184kW (250PS)	Diesel Turbo Intercooled	TD23681
D 0836 LOH66 Euro 6	6 Cyl.	6871cc	213kW (290PS)	Diesel Turbo Intercooled	TD30438

87-136500-65 STD
87-136507-65 0.50mm

A 63.90
B- 17.39
BØ 65.00
C 1.70
D 103.00
 44x88

08-136500-30 STD
08-136507-30 0.50mm

3.00  CK P
 2.50  P
 3.00  CR P

14-027680-00 DH B 111.50 C 217.00 D 115.85 E 4.00

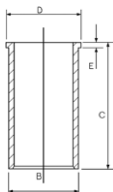

88-136500-65
 87-136500-65 +
 14-027680-00

KK RT TP

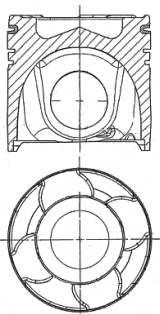

10844A113

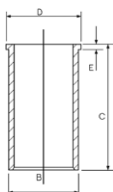

14-027681-00 DH B 112.00 C 217.00 D 115.85 E 4.00



87-136500-75 STD

A 63.70
B- 17.39
BØ 65.00
C 1.70
D 102.80
 44x88

08-136500-30 STD
08-136507-30 0.50mm

3.00  CK P
 2.50  P
 3.00  CR P

KK RT TP

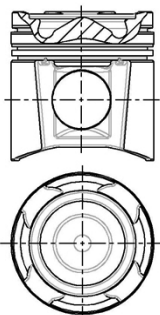

10844A113



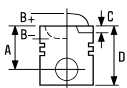



87-136500-85

STD

- A 63.50
- B- 17.39
- BØ 65.00
- C 1.70
- D 102.60
-  44x88

08-136500-30
08-136507-30

STD
0.50mm

- 3.00  CK P
- 2.50  P
- 3.00  CR P

KK RT TP

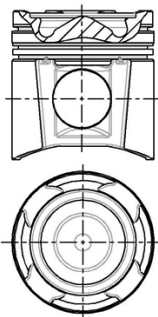

10844A113

12  108.00

D 0834 LFL60 EEV	4 Cyl.	4580cc	110kW (150PS)	Diesel Turbo Intercooled	TD22962
D 0834 LFL61 EEV	4 Cyl.	4580cc	132kW (180PS)	Diesel Turbo Intercooled	TD22963
D 0834 LFL62 EEV	4 Cyl.	4580cc	162kW (220PS)	Diesel Turbo Intercooled	TD22965
D 0834 LFL63 Euro 5	4 Cyl.	4580cc	110kW (150PS)	Diesel Turbo Intercooled	TD22959
D 0834 LFL64 Euro 5	4 Cyl.	4580cc	132kW (180PS)	Diesel Turbo Intercooled	TD22960
D 0834 LFL65 Euro 5	4 Cyl.	4580cc	162kW (220PS)	Diesel Turbo Intercooled	TD22961
D 0834 LOH61 Euro 5	4 Cyl.	4580cc	132kW (180PS)	Diesel Turbo Intercooled	TD23679
D 0836 LFL61 EEV	6 Cyl.	6871cc	213kW (290PS)	Diesel Turbo Intercooled	TD23686
D 0836 LFL62 EEV	6 Cyl.	6871cc	250kW (340PS)	Diesel Turbo Intercooled	TD23687
D 0836 LFL63 Euro 5	6 Cyl.	6871cc	184kW (250PS)	Diesel Turbo Intercooled	TD22967
D 0836 LFL64 Euro 5	6 Cyl.	6871cc	213kW (290PS)	Diesel Turbo Intercooled	TD22984
D 0836 LFL65 Euro 5	6 Cyl.	6871cc	250kW (340PS)	Diesel Turbo Intercooled	TD22995
D 0836 LFL69 Euro 5	6 Cyl.	6871cc	184kW (250PS)	Diesel Turbo Intercooled	TD27708



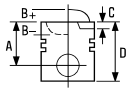





D 0836 LFL70 Euro 5 6 Cyl. **6871cc** **213kW (290PS)** **Diesel Turbo Intercooled** **TD27709**

D 0836 LFL71 Euro 5 6 Cyl. **6871cc** **250kW (340PS)** **Diesel Turbo Intercooled** **TD27710**

87-136500-90 STD **08-136500-30** STD **14-027680-00 DH** **B 111.50 C 217.00 D 115.85 E 4.00**
08-136507-30 0.50mm **14-027681-00 DH** **B 112.00 C 217.00 D 115.85 E 4.00**

A 63.90
B- 18.47
BØ 65.00
C 1.70
D 103.00
 44x88

3.00  CK P
 2.50  P
 3.00  CR P

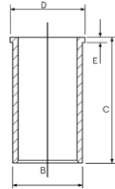

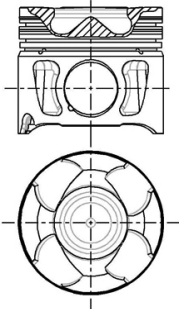

AK KK NB RT TP



10848-311

87-136500-91 ¹ STD **08-136500-30** STD
08-136507-30 0.50mm

A 63.70
B- 18.47
BØ 88.00
C 1.70
D 102.80
 44x88

3.00  CK P
 2.50  P
 3.00  CR P

AK KK NB RT TP

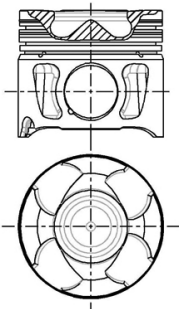

10848-311

¹ A = 63.700, D = 102.800

¹ A = 63.700, D = 102.800

¹ A = 63.700, D = 102.800

¹ A = 63.700, D = 102.800

¹ A = 63.700, D = 102.800

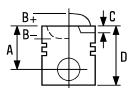

13  **108.00**



D 0836 LE 510 6 Cyl. 18:1 **6871cc** **221-228kW (301-310PS)** **Diesel Direct Injection** **TD32926**

87-136500-95 STD

08-136500-10 STD

14-027680-00 DH B 111.50 C 217.00 D 115.85 E 4.00
14-027681-00 DH B 112.00 C 217.00 D 115.85 E 4.00

B- 63.900;16.1
BØ 70.52
C 1.70
D 103.00
 42x86

3.00  CK P
 2.50  P
 3.00  CR P

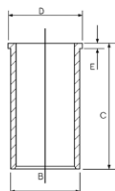

KK RT TP

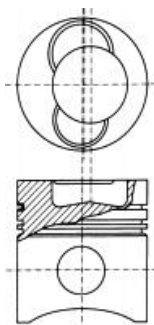

10843C101

14  **108.00**

D 0836 M2 6 Cyl. 18:1 **7030cc** **99kW (135PS)** **Diesel** **TD7644**

D 0846 HM42U 6 Cyl. 18:1 **7252cc** **117kW (160PS)** **Diesel** **TD8656**

D 0846 HM81H 6 Cyl. 18:1 **7252cc** **117kW (160PS)** **Diesel** **TD8741**

D 0846 HM82U 6 Cyl. 18:1 **7252cc** **117kW (160PS)** **Diesel** **TD8745**

D 0846 HM91H 6 Cyl. 18:1 **7252cc** **117kW (160PS)** **Diesel** **TD7818**

D 0846 HM91U 6 Cyl. 18:1 **7250cc** **117kW (160PS)** **Diesel** **TD7822**

D 0846 HM95U 6 Cyl. 18:1 **7252cc** **117kW (160PS)** **Diesel** **TD7827**

D 0846 HMN 6 Cyl. 18:1 **7252cc** **117kW (160PS)** **Diesel** **TD7651**

D 0846 HMN80 6 Cyl. 18:1 **7252cc** **132kW (180PS)** **Diesel** **TD8779**

D 0846 HMX-011 6 Cyl. 18:1 **7250cc** **117kW (160PS)** **Diesel** **TD8781**

D 0846 HMXU-015 6 Cyl. 18:1 **7250cc** **117kW (160PS)** **Diesel** **TD7627**

D 0846 HMYH 6 Cyl. 18:1 **7252cc** **123kW (168PS)** **Diesel** **TD7168**

D 0846 HMYN-014 6 Cyl. 18:1 **7252cc** **123kW (168PS)** **Diesel** **TD7702**

14-030350-00 DH B 112.99 C 254.00 D 118.00 E 5.00

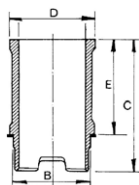

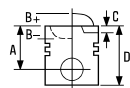

15  **108.00**

D 0846 HM2	6 Cyl.	18:1	7250cc	117kW (160PS)	Diesel	TD7654
D 0846 HMN2	6 Cyl.	18:1	7252cc	117-118kW (160-160PS)	Diesel	TD19037
D 0846 HMY-011	6 Cyl.	18:1	7250cc	123kW (168PS)	Diesel	TD7707



87-280000-00 STD

08-280000-10 STD

14-030350-00 *DH* B 112.99 C 254.00 D 118.00 E 5.00

A 89.00
 B- 42.00
 BØ 43.00
 D 145.50
 42x90

01/73→

2.50  CR P
 2.50  P
 5.00  CR P

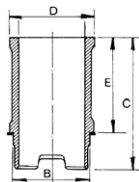

RT

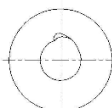
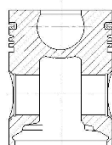

10808E

16  **120.00**

D 2066 LF Euro 2/3	6 Cyl.		10518cc	265-307kW (360-430PS)	Diesel Turbo Intercooled	FM16161
D 2066 LF Euro 3	6 Cyl.		10518cc		Diesel Turbo Intercooled	FM46161
D 2066 LF04 Euro 4 D 20	6 Cyl.	19:1	10520cc	228kW (310PS)	Diesel Turbo Intercooled	TD17373
D 2066 LF06 Euro 4 D 20	6 Cyl.	19:1	10520cc	294kW (400PS)	Diesel Turbo Intercooled	FM26161
D 2066 LF07 Euro 3 D 20	6 Cyl.		10518cc	265kW (360PS)	Diesel Turbo Intercooled	TD22899
D 2066 LF07 Euro 3 D 20	6 Cyl.		10518cc	265kW (360PS)	Diesel Turbo Intercooled	FM36161
D 2066 LF48 Euro 3	6 Cyl.		10518cc	265kW (360PS)	Diesel Turbo Intercooled	TD25598
D 2066 LF49 Euro 3	6 Cyl.		10518cc	294kW (400PS)	Diesel Turbo Intercooled	TD25599
D 2066 LF50 Euro 3	6 Cyl.		10518cc	324kW (441PS)	Diesel Turbo Intercooled	TD25600
D 2066 LOH10 Euro 3	6 Cyl.	20.5:1	10518cc	316kW (430PS)	Diesel Turbo Intercooled	TD23073
D 2066 LOH11 Euro 3	6 Cyl.	20.5:1	10518cc	287kW (390PS)	Diesel Turbo Intercooled	TD23072
D 2066 LOH12 Euro 3	6 Cyl.	20.5:1	10518cc	257kW (350PS)	Diesel Turbo Intercooled	TD23070
D 2066 LUH07 Euro 3	6 Cyl.	20.5:1	10520cc	228kW (310PS)	Diesel Turbo Intercooled	TD23074



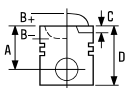

D 2066 LUH08 Euro 3 6 Cyl. 20.5:1 **10520cc 257kW (350PS)** Diesel Turbo Intercooled **TD23075**

D 2066 LUH09 Euro 3 6 Cyl. 20.5:1 **10520cc 287kW (390PS)** Diesel Turbo Intercooled **TD23076**



87-423000-10 STD

08-423000-00 STD

14-450630-00 WH B 139.50 C 260.00 D 150.00 E 8.07

88-423000-10

- A 76.80
- B- 20.00
- BØ 84.00
- C 2.00
- D 123.30
-  52x96

- 3.50  CK P
- 3.00  CR P
- 4.00  CR P

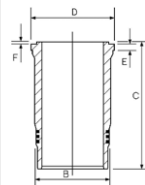

87-423000-10 +
14-450630-00

KK RT TP

15-450630-00 WH  B 139.50 C 260.00 D 150.00 E 8.07

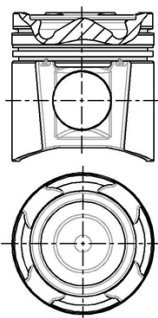

12081 B105

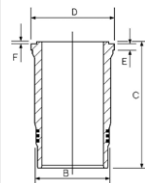

 Includes seals

 Schließt Dichtungen ein

 Includ des joints

 Incluye los sellos

 Comprende le guarnizioni

17  **120.00**

D 2066 LF01 Euro 4 D 20	6 Cyl.	19:1	10520cc	316kW (430PS)	Diesel Turbo Intercooled	TD17370
D 2066 LF02 Euro 4 D 20	6 Cyl.	19:1	10520cc	287kW (390PS)	Diesel Turbo Intercooled	TD17371
D 2066 LF03 Euro 4 D 20	6 Cyl.	19:1	10520cc	257kW (350PS)	Diesel Turbo Intercooled	TD17372
D 2066 LF06 Euro 4 D 20	6 Cyl.	19:1	10520cc	294kW (400PS)	Diesel Turbo Intercooled	TD19951
D 2066 LF11 Euro 4 D 20	6 Cyl.	19:1	10520cc	316kW (430PS)	Diesel Turbo Intercooled	TD18098
D 2066 LF12 Euro 4 D 20	6 Cyl.	19:1	10520cc	287kW (390PS)	Diesel Turbo Intercooled	TD18097
D 2066 LF13 Euro 4 D 20	6 Cyl.	19:1	10520cc	257kW (350PS)	Diesel Turbo Intercooled	TD19111
D 2066 LF14 Euro 4 D 20	6 Cyl.	19:1	10520cc	228kW (310PS)	Diesel Turbo Intercooled	TD19109
D 2066 LF29 Euro 4 D 20	6 Cyl.	19:1	10520cc	265kW (360PS)	Diesel Turbo Intercooled	TD25603
D 2066 LF30 Euro 4 D 20	6 Cyl.	19:1	10520cc	235kW (320PS)	Diesel Turbo Intercooled	TD25604
D 2066 LF31 Euro 4 D 20	6 Cyl.	19:1	10520cc	324kW (440PS)	Diesel Turbo Intercooled	TD19094
D 2066 LF32 Euro 4 D 20	6 Cyl.	19:1	10520cc	294kW (400PS)	Diesel Turbo Intercooled	TD19095
D 2066 LF33 Euro 4 D 20	6 Cyl.	19:1	10520cc	265kW (360PS)	Diesel Turbo Intercooled	TD19096
D 2066 LF35 Euro 4 D 20	6 Cyl.	19:1	10520cc	235kW (320PS)	Diesel Turbo Intercooled	TD19097
D 2066 LF36 Euro 4 D 20	6 Cyl.	19:1	10520cc	324kW (440PS)	Diesel Turbo Intercooled	TD20368
D 2066 LF37 Euro 4 D 20	6 Cyl.	19:1	10520cc	294kW (400PS)	Diesel Turbo Intercooled	TD20369
D 2066 LF38 Euro 4 D 20	6 Cyl.	19:1	10520cc	265kW (360PS)	Diesel Turbo Intercooled	TD20370
D 2066 LF39 Euro 4 D 20	6 Cyl.	19:1	10520cc	235kW (320PS)	Diesel Turbo Intercooled	TD20396
D 2066 LF69 Euro 4	6 Cyl.		10520cc	324kW (440PS)	Diesel Turbo Intercooled	TD25620
D 2066 LF70 Euro 4	6 Cyl.		10520cc	294kW (400PS)	Diesel Turbo Intercooled	TD25619
D 2066 LF71 Euro 4	6 Cyl.		10520cc	265kW (360PS)	Diesel Turbo Intercooled	TD25618



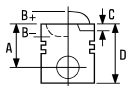

D 2066 LOH01 Euro 4	6 Cyl.	20.5:1	10520cc	235kW (320PS)	Diesel Turbo Intercooled	TD19972
D 2066 LOH02 Euro 4	6 Cyl.	20.5:1	10520cc	265kW (360PS)	Diesel Turbo Intercooled	TD19973
D 2066 LOH03 Euro 4	6 Cyl.	20.5:1	10520cc	294kW (400PS)	Diesel Turbo Intercooled	TD19974
D 2066 LOH04 Euro 4	6 Cyl.	20.5:1	10520cc	324kW (440PS)	Diesel Turbo Intercooled	TD19975
D 2066 LOH05 Euro 4	6 Cyl.	20.5:1	10520cc	225kW (320PS)	Diesel Turbo Intercooled	TD23061
D 2066 LOH06 Euro 4	6 Cyl.	20.5:1	10520cc	265kW (360PS)	Diesel Turbo Intercooled	TD23062
D 2066 LOH07 Euro 4	6 Cyl.	20.5:1	10520cc	294kW (400PS)	Diesel Turbo Intercooled	TD23063
D 2066 LOH08 Euro 4	6 Cyl.	20.5:1	10520cc	324kW (440PS)	Diesel Turbo Intercooled	TD23064
D 2066 LUH01 Euro 4	6 Cyl.	20.5:1	10520cc	228kW (310PS)	Diesel Turbo Intercooled	TD28905
D 2066 LUH11 Euro 4	6 Cyl.	20.5:1	10520cc	199kW (271PS)	Diesel Turbo Intercooled	TD19976
D 2066 LUH12 Euro 4	6 Cyl.	20.5:1	10520cc	228kW (310PS)	Diesel Turbo Intercooled	TD19977
D 2066 LUH13 Euro 4	6 Cyl.	20.5:1	10520cc	257kW (350PS)	Diesel Turbo Intercooled	TD19978
D 2066 LUH14 Euro 4	6 Cyl.	20.5:1	10520cc	287kW (390PS)	Diesel Turbo Intercooled	TD19979
D 2066 LUH15 Euro 4	6 Cyl.	20.5:1	10520cc	316kW (430PS)	Diesel Turbo Intercooled	TD19980
D 2066 LUH21 Euro 4	6 Cyl.	20.5:1	10520cc	199kW (271PS)	Diesel Turbo Intercooled	TD22860
D 2066 LUH22 Euro 4	6 Cyl.	20.5:1	10520cc	228kW (310PS)	Diesel Turbo Intercooled	TD23065
D 2066 LUH23 Euro 4	6 Cyl.	20.5:1	10520cc	257kW (350PS)	Diesel Turbo Intercooled	TD23066
D 2066 LUH24 Euro 4	6 Cyl.	20.5:1	10520cc	287kW (390PS)	Diesel Turbo Intercooled	TD23067

87-423000-00

STD

- A 76.80
- B- 19.70
- BØ 76.00
- C 2.00
- D 123.30
- 52x96

08-423000-00

STD

- 3.50
- 3.00
- 4.00
-
- CK P
- CR P
- CR P

14-450630-00 WH B 139.50 C 260.00 D 150.00 E 8.07

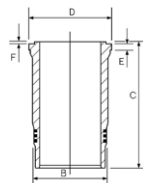

88-423000-00

87-423000-00 +
14-450630-00

KK RT TP

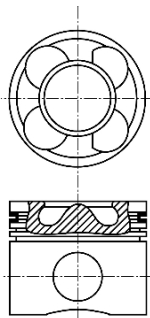

12081B154

15-450630-00 WH ¹ B 139.50 C 260.00 D 150.00 E 8.07

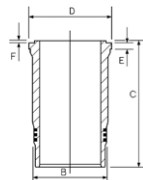

¹ Includes seals

¹ Schließt Dichtungen ein

¹ Inclut des joints

¹ Incluye los sellos

¹ Comprende le guarnizioni

18 120.00

D 2066 LF17 Euro 5	6 Cyl.		10518cc	324kW (440PS)	Diesel Turbo Intercooled	TD23081
D 2066 LF18 Euro 5	6 Cyl.		10518cc	294kW (400PS)	Diesel Turbo Intercooled	TD23083
D 2066 LF19 Euro 5	6 Cyl.		10518cc	265kW (360PS)	Diesel Turbo Intercooled	TD23084
D 2066 LF20 Euro 5	6 Cyl.		10518cc	235kW (320PS)	Diesel Turbo Intercooled	TD23085
D 2066 LF21 Euro 5	6 Cyl.	19:1	10518cc	321kW (437PS)	Diesel Turbo Intercooled	TD20230



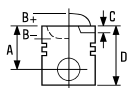

D 2066 LF22 Euro 5	6 Cyl.	19:1	10518cc	294kW (400PS)	Diesel Turbo Intercooled	TD20229
D 2066 LF23 Euro 5 D 20	6 Cyl.	19:1	10518cc	324kW (440PS)	Diesel Turbo Intercooled	TD19098
D 2066 LF24 Euro 5 D 20	6 Cyl.	19:1	10518cc	294kW (400PS)	Diesel Turbo Intercooled	TD19099
D 2066 LF25 Euro 5 D 20	6 Cyl.	19:1	10518cc	324kW (440PS)	Diesel Turbo Intercooled	TD20363
D 2066 LF26 Euro 5 D 20	6 Cyl.	19:1	10518cc	294kW (400PS)	Diesel Turbo Intercooled	TD20364
D 2066 LF27 Euro 5 D 20	6 Cyl.	19:1	10518cc	265kW (360PS)	Diesel Turbo Intercooled	TD20365
D 2066 LF40 Euro 5 D 20	6 Cyl.		10518cc	324kW (440PS)	Diesel Turbo Intercooled	TD23119
D 2066 LF41 Euro 5 D 20	6 Cyl.		10518cc	294kW (400PS)	Diesel Turbo Intercooled	TD23104
D 2066 LF42 Euro 5 D 20	6 Cyl.		10518cc	265kW (360PS)	Diesel Turbo Intercooled	TD23094
D 2066 LF43 Euro 5	6 Cyl.	19:1	10518cc	235kW (320PS)	Diesel Turbo Intercooled	TD23003
D 2066 LF44 Euro 5	6 Cyl.		10518cc	324kW (440PS)	Diesel Turbo Intercooled	TD25456
D 2066 LF45 Euro 5	6 Cyl.		10518cc	294kW (400PS)	Diesel Turbo Intercooled	TD25455
D 2066 LF46 Euro 5	6 Cyl.		10518cc	265kW (360PS)	Diesel Turbo Intercooled	TD25454
D 2066 LF47 Euro 5	6 Cyl.		10518cc	235kW (320PS)	Diesel Turbo Intercooled	TD25453
D 2066 LF51 Euro 5 D 20	6 Cyl.		10518cc	294kW (400PS)	Diesel Turbo Intercooled	TD23436
D 2066 LF52 Euro 5 D 20	6 Cyl.		10518cc	265kW (360PS)	Diesel Turbo Intercooled	TD23437
D 2066 LF53 Euro 5	6 Cyl.	19:1	10518cc	235kW (320PS)	Diesel Turbo Intercooled	TD23438
D 2066 LOH28 Euro 5	6 Cyl.		10518cc	294kW (400PS)	Diesel Turbo Intercooled	TD23396
D 2066 LUH32 Euro 5	6 Cyl.	20.5:1	10518cc	235kW (320PS)	Diesel Turbo Intercooled	TD23683
D 2066 LUH33 Euro 5	6 Cyl.	20.5:1	10518cc	265kW (360PS)	Diesel Turbo Intercooled	TD23684
D 2066 LUH34 Euro 5	6 Cyl.	20.5:1	10518cc	294kW (400PS)	Diesel Turbo Intercooled	TD23685

87-428600-00

STD

- A 76.80
- B- 19.70
- BØ 68.77
- C 2.00
- C 1.60
- D 123.30
-  52x96

KK RT

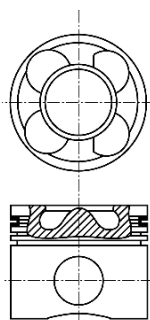



12081B113

 Includes seals

08-428600-00

STD

- 3.50  CK P
- 3.00  CR P
- 4.00  CR P

 Schließt Dichtungen ein

14-450630-00 WH

B 139.50 C 260.00 D 150.00 E 8.07

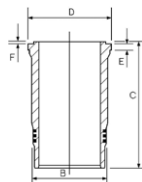

15-450630-00 WH  B 139.50 C 260.00 D 150.00 E 8.07

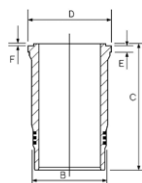

 Incluye los sellos

 Comprende le guarnizioni

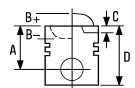

19  **120.00**

D 2066 LF28 Euro 4 D 20	6 Cyl.	19:1	10520cc	235kW (320PS)	Diesel Turbo Intercooled	TD20366
D 2066 LF57 EEV	6 Cyl.		10518cc	324kW (440PS)	Diesel Turbo Intercooled	TD25452
D 2066 LF58 EEV	6 Cyl.		10518cc	294kW (400PS)	Diesel Turbo Intercooled	TD25451
D 2066 LF59 EEV	6 Cyl.		10518cc	265kW (360PS)	Diesel Turbo Intercooled	TD23688
D 2066 LF60 EEV	6 Cyl.		10518cc	235kW (320PS)	Diesel Turbo Intercooled	TD23689
D 2066 LF62 Euro 4	6 Cyl.		10520cc	324kW (441PS)	Diesel Turbo Intercooled	TD25612
D 2066 LF63 Euro 4	6 Cyl.		10520cc	294kW (400PS)	Diesel Turbo Intercooled	TD25613
D 2066 LF64 Euro 4	6 Cyl.		10520cc	265kW (360PS)	Diesel Turbo Intercooled	TD25614
D 2066 LF65 Euro 4	6 Cyl.		10520cc	235kW (320PS)	Diesel Turbo Intercooled	TD25611
D 2066 LF72 Euro 4	6 Cyl.		10520cc	235kW (320PS)	Diesel Turbo Intercooled	TD25617
D 2066 LOH26 EEV	6 Cyl.		10518cc	235kW (320PS)	Diesel Turbo Intercooled	TD23672
D 2066 LOH27 EEV	6 Cyl.		10518cc	265kW (360PS)	Diesel Turbo Intercooled	TD23673

14-450630-00 WH B 139.50 C 260.00 D 150.00 E 8.07

15-450630-00 WH **1** B 139.50 C 260.00 D 150.00 E 8.07

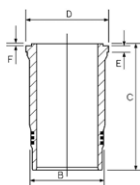

1 Includes seals

1 Schließt Dichtungen ein

1 Inclut des joints

1 Incluye los sellos

1 Comprende le guarnizioni

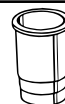
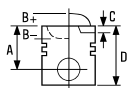



20  **120.00**

D 2066 LUH41 EEV	6 Cyl.	20.5:1	10518cc	206kW (280PS)	Diesel Turbo Intercooled	TD23963
D 2066 LUH42 EEV	6 Cyl.	20.5:1	10518cc	235kW (320PS)	Diesel Turbo Intercooled	TD23964
D 2066 LUH43 EEV	6 Cyl.	20.5:1	10518cc	257kW (350PS)	Diesel Turbo Intercooled	TD23965
D 2066 LUH46 EEV	6 Cyl.	20.5:1	10518cc	206kW (280PS)	Diesel Turbo Intercooled	TD23674
D 2066 LUH47 EEV	6 Cyl.	20.5:1	10518cc	235kW (320PS)	Diesel Turbo Intercooled	TD23675
D 2066 LUH48 EEV	6 Cyl.	20.5:1	10518cc	265kW (360PS)	Diesel Turbo Intercooled	TD23676

87-428600-10 ² STD

- A** 76.80
- B-** 11.39
- B-** 22.45
- BØ** 68.00
- C** 2.00
- D** 123.30
-  52x96

08-428600-00 STD

- 3.50  CK P
- 3.00  CR P
- 4.00  CR P

14-450630-00 WH B 139.50 C 260.00 D 150.00 E 8.07

15-450630-00 WH ¹ B 139.50 C 260.00 D 150.00 E 8.07

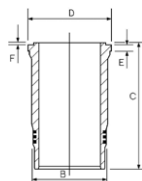

KK RT TP

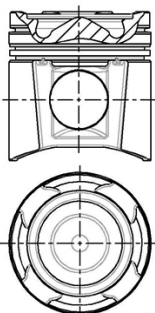

12081 B167

- ¹ Includes seals
- ² Piston Chamber Volume [ccm] 90.100

- ¹ Schließt Dichtungen ein
- ² Volumen der Kolbenmulde [ccm] 90.100

- ¹ Inclut des joints
- ² Volume de la cavité du piston [cm³] 90.100

- ¹ Incluye los sellos
- ² Volumen de cavidad del pistón [cc] 90.100

- ¹ Comprende le guarnizioni
- ² Volume camera pistone [cm³] 90.100



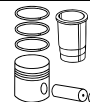
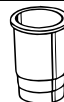
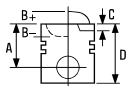

21  **121.00**

D 2146	6 Cyl.		9660cc	123kW (186PS)	Diesel	TD7666
D 2156 HM2	6 Cyl.	17:1	10344cc	141-173kW (192-235PS)	Diesel	TD23165
D 2156 HM3	6 Cyl.	17:1	10344cc	158-169kW (215-230PS)	Diesel	TD7675
D 2156 HM9	6 Cyl.	17:1	10344cc	158-169kW (215-230PS)	Diesel	TD7734
D 2156 HMN1	6 Cyl.	17:1	10344cc	158kW (215PS)	Diesel	TD7700
D 2156 HMN6	6 Cyl.	17:1	10344cc	172kW (235PS)	Diesel	TD8783
D 2156 HNY	6 Cyl.	17:1	10344cc	141-169kW (192-230PS)	Diesel	TD19066
D 2156 MGN	6 Cyl.	17:1	10344cc	141-169kW (192-230PS)	Diesel	TD19067
D 2156 MNY	6 Cyl.	17:1	10344cc	141-169kW (192-230PS)	Diesel	TD19068
D 2156 MY	6 Cyl.	17:1	10344cc	141-169kW (192-230PS)	Diesel	TD19069



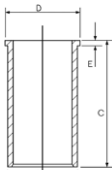



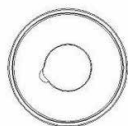
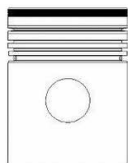

D 2156 MYN 6 Cyl. 17:1 **10344cc** **141-169kW** (192-230PS) **Diesel** **TD19070**

D 2156 MYN-31 6 Cyl. 17:1 **10344cc** **141kW** (192PS) **Diesel** **TD7697**

87-274800-00	STD	08-274800-10	STD	14-022830-00 DH	B 125.99 C 287.00 D 132.00 E 8.00	88-274800-00 87-274800-00 + 14-022830-00
A 94.00		3.50	 CR P			
B- 48.60		3.00	 P			
BØ 47.00		3.00	 P			
D 162.00		5.50	 CR P			
 45x102						

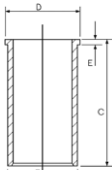
HART



87-274800-30	STD	08-274800-10	STD	14-022830-00 DH	B 125.99 C 287.00 D 132.00 E 8.00	88-274800-30 87-274800-30 + 14-022830-00
A 93.60		3.50	 CR P			
B- 48.60		3.00	 P			
BØ 47.00		3.00	 P			
D 161.60		5.50	 CR P			
 45x102						

HART

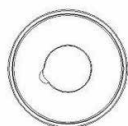
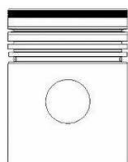

22  **121.00**

D 2156 MTN1 6 Cyl. 17:1 **10344cc** **188kW** (256PS) **Diesel Turbo Intercooled** **TD7715**

D 2156 MTX 6 Cyl. 16.5:1 **10344cc** **188kW** (256PS) **Diesel Turbo** **TD19116**

14-022830-00 DH **B 125.99 C 287.00 D 132.00 E 8.00**

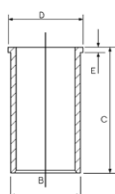

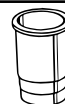



23  **125.00**

D 2538 M	V8 Cyl.	17.4:1	12763cc	188kW (256PS)	Diesel	TD7743
D 2538 ME	V8 Cyl.	17:1	12763cc	188kW (256PS)	Diesel	TD19447
D 2538 MF	V8 Cyl.	17.4:1	12763cc	188kW (256PS)	Diesel	TD7737
D 2538 MT	V8 Cyl.	17:1	12763cc	178-235kW (242-320PS)	Diesel Turbo	TD7748
D 2538 MTE	V8 Cyl.	17:1	12763cc	178-235kW (242-320PS)	Diesel Turbo	TD19064
D 2530 ME	V10 Cyl.	17:1	15945cc	156-235kW (212-320PS)	Diesel	TD19446
D 2530 MF	V10 Cyl.	17:1	15945cc	235kW (320PS)	Diesel	TD5650
D 2530 MTE	V10 Cyl.	17:1	15953cc	223-294kW (303-400PS)	Diesel Turbo	TD19065
D 2530 MTFX	V10 Cyl.	17:1	15953cc	294kW (400PS)	Diesel Turbo	TD7813
D 2530 MTFX/360	V10 Cyl.	17:1	15900cc	265kW (360PS)	Diesel Turbo	TD7760
D 2530 MFX	V10 Cyl.	17:1	15945cc	156-235kW (212-320PS)	Diesel	TD19038
D 2540 MT	V10 Cyl.	17:1	17426cc	287-324kW (390-441PS)	Diesel Turbo	TD19448
D 2540 MTF	V10 Cyl.	17:1	17426cc	324kW (440PS)	Diesel Turbo	TD7814
D 2542 MLE	V12 Cyl.	17:1	20911cc	420-515kW (571-700PS)	Diesel Turbo Intercooled	TD19449
D 2542 MTE	V12 Cyl.	17:1	20911cc	283-405kW (385-551PS)	Diesel Turbo	TD19450

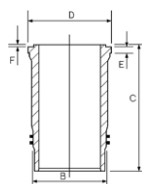
14-451090-00 WH B 140.00 C 253.00 D 152.00 E 10.05 F 1.00





24  **125.00**

D 2555 M	5 Cyl.	17:1	9200cc	123kW (168PS)	Diesel	TD7708
D 2555 MF	5 Cyl.	17:1	9200cc	123kW (168PS)	Diesel	TD7703
D 2555 MX	5 Cyl.	17:1	9200cc	141kW (192PS)	Diesel	TD7710
D 2555 MFX	5 Cyl.	17:1	9200cc	141kW (192PS)	Diesel	TD7705
D 2565 MR	5 Cyl.	17:1	9510cc	141kW (192PS)	Diesel	TD23168
D 2565 MUE	5 Cyl.	17:1	9510cc	141kW (192PS)	Diesel	TD23169
D 2556 M	6 Cyl.	17:1	11045cc	147kW (200PS)	Diesel	TD7730
D 2556 MX	6 Cyl.	17:1	11045cc	147-194kW (200-264PS)	Diesel	TD7733
D 2556 MFX	6 Cyl.	17:1	11045cc	172-177kW (232-240PS)	Diesel	TD7731
D 2556 MXUH/175	6 Cyl.	17:1	11045cc	129kW (175PS)	Diesel	TD7613
D 2556 MXUH/192	6 Cyl.	17:1	11045cc	141kW (192PS)	Diesel	TD7606
D 2556 MXUH/240	6 Cyl.	17:1	11045cc	177kW (240PS)	Diesel	TD7607
D 2556 MXUM	6 Cyl.	18:1	11045cc	161kW (220PS)	Diesel	TD7439
D 2566 UH	6 Cyl.	18:1	11413cc	155kW (211PS)	Diesel	TD7616

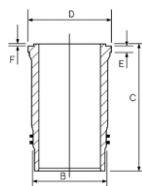
14-450370-00 WH B 140.00 C 270.00 D 152.00 E 10.05 F 1.00

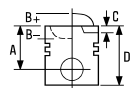



25  **125.00**

D 2565 HM	5 Cyl.	18:1	9510cc	92-141kW (125-192PS)	Diesel	TD19039
D 2565 M	5 Cyl.	18:1	9510cc	141kW (192PS)	Diesel	TD7711
D 2565 ME	5 Cyl.	17:1	9510cc	84-141kW (114-192PS)	Diesel	TD19040
D 2565 MF	5 Cyl.	18:1	9510cc	141kW (192PS)	Diesel	TD7706
D 2565 MFR	5 Cyl.	17:1	9510cc	92-141kW (125-192PS)	Diesel	TD19041
D 2565 MUH	5 Cyl.	17:1	9510cc	92-141kW (125-192PS)	Diesel	TD19042
D 2565 MUL	5 Cyl.	18:1	9510cc	141kW (192PS)	Diesel	TD7721
D 2566 M	6 Cyl.	18:1	11413cc	177kW (240PS)	Diesel	TD7735
D 2566 ME	6 Cyl.	17:1	11413cc	125-177kW (170-241PS)	Diesel	TD19451
D 2566 MF	6 Cyl.	18:1	11413cc	177kW (240PS)	Diesel	TD7732
D 2566 MH	6 Cyl.	17:1	11413cc	177kW (240PS)	Diesel	TD7414
D 2566 MUE	6 Cyl.	17:1	11413cc	125-177kW (170-241PS)	Diesel	TD19452
D 2566 MUH	6 Cyl.	18:1	11413cc	177kW (240PS)	Diesel Turbo	TD7407
D 2566 MUL	6 Cyl.	18:1	11413cc	177kW (240PS)	Diesel	TD7803
D 2566 MUM	6 Cyl.	18:1	11413cc	147-177kW (200-241PS)	Diesel	TD7440
D 2566 MXF	6 Cyl.	17:1	11413cc	125-177kW (211-241PS)	Diesel	TD19043

87-280200-10

STD

08-280200-00

STD

14-450370-00 WH B 140.00 C 270.00 D 152.00 E 10.05 F 1.00

89-280200-10

87-280200-10 +
14-450370-00

A 89.87
B- 45.87
BØ 49.50
D 141.87
 46x105

3.00
3.00
5.00



CR P
P
CR P

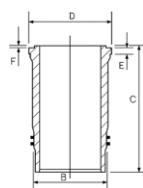

HA RT

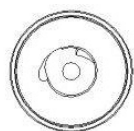
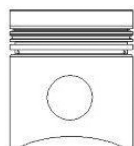

12572

26  **125.00**

D 2565 MK	5 Cyl.	17:1	9510cc	169kW (230PS)	Diesel Turbo	TD19117
D 2565 MKUL	5 Cyl.	17:1	9510cc	169kW (230PS)	Diesel Turbo	TD19072
D 2565 MT	5 Cyl.	17:1	9510cc	169kW (230PS)	Diesel Turbo	TD19073
D 2566 MK	6 Cyl.	17:1	11413cc	235kW (320PS)	Diesel Turbo	TD7801
D 2566 MKF	6 Cyl.	17:1	11413cc	235kW (320PS)	Diesel Turbo Intercooled	TD7758
D 2566 MKUH/320	6 Cyl.	17:1	11413cc	235kW (320PS)	Diesel Turbo Intercooled	TD7633
D 2566 MKUL	6 Cyl.	17:1	11413cc	235kW (320PS)	Diesel Turbo Intercooled	TD7804
D 2566 MLUH	6 Cyl.	17:1	11413cc	192kW (260PS)	Diesel Turbo Intercooled	TD7632
D 2566 MLUM	6 Cyl.	17:1	11413cc	227kW (310PS)	Diesel Turbo Intercooled	TD7625



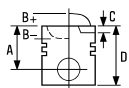





D 2566 MT	6 Cyl.	17:1	11413cc	206kW (280PS)	Diesel Turbo	TD7799
D 2566 MTE	6 Cyl.	17:1	11413cc	162-235kW (220-320PS)	Diesel Turbo	TD19074
D 2566 MTF	6 Cyl.	17:1	11413cc	206kW (280PS)	Diesel Turbo	TD7738
D 2566 MTH	6 Cyl.	17:1	11413cc	213kW (290PS)	Diesel Turbo	TD7418
D 2566 MTHO	6 Cyl.	17:1	11413cc	206-235kW (280-320PS)	Diesel Turbo	TD7744
D 2566 MTUH/280	6 Cyl.	17:1	11413cc	206-235kW (280-320PS)	Diesel Turbo	TD7603

87-280400-00	STD	08-280400-10	STD	14-450370-00 WH	B 140.00 C 270.00 D 152.00 E 10.05 F 1.00	89-280400-00 87-280400-00 + 14-450370-00
---------------------	-----	---------------------	-----	------------------------	---	---

01/79 →

- A 89.80
- B- 43.00
- BØ 52.50
- C 1.70
- D 141.80
-  46x105

- 3.50  CR P
- 3.00  P
- 5.00  CR P

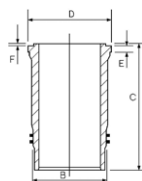

AK HA KK RT

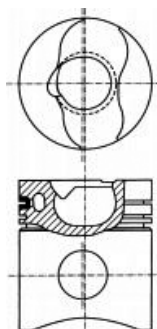

12574

27  **126.00**

D 2676 LF01 Euro 4	6 Cyl.	19:1	12418cc	353kW (480PS)	Diesel Turbo Intercooled	TD19100
D 2676 LF02 Euro 3	6 Cyl.	19:1	12412cc	353kW (480PS)	Diesel Turbo Intercooled	TD20542
D 2676 LF03 Euro 2	6 Cyl.	19:1	12412cc	353kW (480PS)	Diesel Turbo Intercooled	TD20543
D 2676 LF04 Euro 2	6 Cyl.	19:1	12412cc	324-324kW (440-441PS)	Diesel Turbo Intercooled	TD22906
D 2676 LF05 Euro 4	6 Cyl.	19:1	12412cc	353kW (480PS)	Diesel Turbo Intercooled	TD20371
D 2676 LF06 Euro 5	6 Cyl.	19:1	12412cc	397kW (540PS)	Diesel Turbo Intercooled	TD23145
D 2676 LF07 Euro 5	6 Cyl.	19:1	12412cc	353kW (480PS)	Diesel Turbo Intercooled	TD23137
D 2676 LF08 Euro 5	6 Cyl.		12412cc	397kW (540PS)	Diesel Turbo Intercooled	TD25462
D 2676 LF10 Euro 4	6 Cyl.		12412cc	324kW (440PS)	Diesel Turbo Intercooled	TD27718
D 2676 LF11 Euro 4	6 Cyl.		12418cc	397kW (540PS)	Diesel Turbo Intercooled	TD19104
D 2676 LF12 Euro 4	6 Cyl.	19:1	12418cc	353kW (480PS)	Diesel Turbo Intercooled	TD19103
D 2676 LF13 Euro 5	6 Cyl.		12412cc	397kW (540PS)	Diesel Turbo Intercooled	TD20372
D 2676 LF14 Euro 5	6 Cyl.		12412cc	353kW (480PS)	Diesel Turbo Intercooled	TD20373
D 2676 LF15 Euro 5	6 Cyl.	19:1	12412cc	397kW (540PS)	Diesel Turbo Intercooled	TD23087
D 2676 LF16 Euro 5	6 Cyl.	19:1	12412cc	353kW (480PS)	Diesel Turbo Intercooled	TD23088
D 2676 LF17 EEV	6 Cyl.		12412cc	397kW (540PS)	Diesel Turbo Intercooled	TD25460
D 2676 LF18 EEV	6 Cyl.		12412cc	353kW (480PS)	Diesel Turbo Intercooled	TD25461



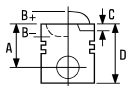

D 2676 LF19 Euro 4	6 Cyl.		12412cc	397kW (540PS)	Diesel Turbo Intercooled	TD25615
D 2676 LF20 Euro 4	6 Cyl.		12412cc	353kW (480PS)	Diesel Turbo Intercooled	TD25616
D 2676 LF21 Euro 5	6 Cyl.	19:1	12412cc	353kW (480PS)	Diesel Turbo Intercooled	TD23691
D 2676 LF22 Euro 5	6 Cyl.	19:1	12412cc	324kW (440PS)	Diesel Turbo Intercooled	TD23692
D 2676 LF25 Euro 6	6 Cyl.		12412cc	353kW (480PS)	Diesel Turbo Intercooled	TD27720
D 2676 LF26 Euro 6	6 Cyl.		12412cc	324kW (440PS)	Diesel Turbo Intercooled	TD27722
D 2676 LF28 Euro 5	6 Cyl.		12412cc	324kW (440PS)	Diesel Turbo Intercooled	TD27723
D 2676 LF31 Euro 3	6 Cyl.		12412cc	353kW (480PS)	Diesel Turbo Intercooled	TD25610
D 2676 LF32 Euro 4	6 Cyl.		12412cc	397kW (540PS)	Diesel Turbo Intercooled	TD25621
D 2676 LF33 Euro 4	6 Cyl.		12412cc	353kW (480PS)	Diesel Turbo Intercooled	TD25623



87-431000-00

STD

- A 76.25
- B- 20.10
- BØ 71.40
- BØ 95.60
- C 2.00
- D 121.84
-  52x103

08-431000-00

STD

- 4.00  GDC P
- 3.00  CR P
- 4.00  CR P



14-451040-00 WH

B 139.50 C 257.50 D 150.00 E 8.07

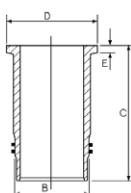

89-431000-00

87-431000-00 +
14-451040-00

AK KK NB RT

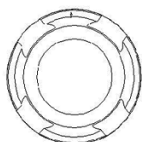
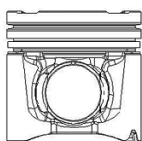

28  **126.00**

D 2676 LOH01 Euro 4	6 Cyl.	19:1	12418cc	338kW (460PS)	Diesel Turbo Intercooled	TD19102
D 2676 LOH02 Euro 4	6 Cyl.	19:1	12418cc	353kW (480PS)	Diesel Turbo Intercooled	TD19101
D 2676 LOH03 Euro 4	6 Cyl.	19:1	12412cc	338kW (460PS)	Diesel Turbo Intercooled	TD23068
D 2676 LOH04 Euro 4	6 Cyl.	19:1	12412cc	353kW (480PS)	Diesel Turbo Intercooled	TD23069
D 2676 LOH10 Euro 3	6 Cyl.	19:1	12412cc	338kW (460PS)	Diesel Turbo Intercooled	TD23077
D 2676 LOH26 Euro 5	6 Cyl.	19:1	12412cc	324kW (440PS)	Diesel Turbo Intercooled	TD23400



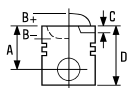

D 2676 LOH27 Euro 5 6 Cyl. 19:1 **12412cc** **353kW (480PS)** Diesel Turbo Intercooled **TD23401**

D 2676 LOH28 Euro 5 6 Cyl. 19:1 **12412cc** **371kW (505PS)** Diesel Turbo Intercooled **TD23678**

87-431000-10

STD

08-431000-00

STD

14-451040-00 WH B 139.50 C 257.50 D 150.00 E 8.07

89-431000-10

87-431000-10 +

14-451040-00

A 76.25

B- 20.00

BØ 70.90

BØ 95.00

C 2.00

D 121.84

52x103

4.00 GDC P

3.00 CR P

4.00 CR P

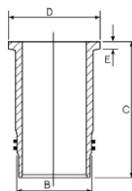

AK KK NB RT

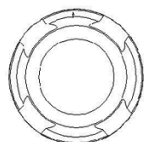
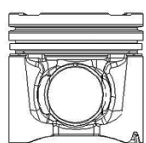

29 **128.00**

E 2848 LE322	V8 Cyl.	12:1	14618cc	265-295kW (360-401PS)	CNG/LPG	Turbo Intercooled	TD28166
E 2842 E312	V12 Cyl.	11:1	21927cc	250-280kW (340-381PS)	CNG/LPG		TD28171
E 2842 LE312	V12 Cyl.	12:1	21927cc	360-420kW (490-571PS)	CNG/LPG	Turbo Intercooled	TD27925
E 2842 LE322	V12 Cyl.	12:1	21927cc	380-420kW (517-571PS)	CNG/LPG	Turbo Intercooled	TD27639
D 2848 LE423	V8 Cyl.	15.5:1	14618cc	662kW (900PS)	Diesel	Turbo Intercooled	TD27920
D 2848 LXE	V8 Cyl.	13.5:1	14618cc	500kW (680PS)	Diesel	Turbo Intercooled	TD19118
D 2848 LXE/D 2848 LYE	V8 Cyl.	13.5:1	14618cc	500kW (680PS)	Diesel	Turbo Intercooled	FM5424
D 2848 LYE	V8 Cyl.	13.5:1	14618cc	500kW (680PS)	Diesel	Turbo Intercooled	TD19119
D 2848 M	V8 Cyl.	17:1	14618cc	206kW (280PS)	Diesel		TD19075
D 2848 M/D 2848 MF/D 2848 MH	V8 Cyl.	17:1	14618cc	206kW (280PS)	Diesel		FM5422
D 2848 MH	V8 Cyl.	17:1	14618cc	206kW (280PS)	Diesel		TD19076
D 2840 LE423	V10 Cyl.	15.5:1	18270cc	809kW (1100PS)	Diesel	Turbo Intercooled	TD27921
D 2840 LF01	V10 Cyl.	17:1	18273cc	368kW (500PS)	Diesel	Turbo Intercooled	TD7796
D 2840 LF04 Euro 1	V10 Cyl.	15.9:1	18273cc	368kW (500PS)	Diesel	Turbo Intercooled	TD7797
D 2840 LF06 Euro 1	V10 Cyl.	16:1	18273cc	368kW (500PS)	Diesel	Turbo Intercooled	TD7798
D 2840 LF20 Euro 2	V10 Cyl.	17:1	18273cc	441kW (600PS)	Diesel	Turbo Intercooled	TD7774
D 2840 LF21 Euro 2	V10 Cyl.	17:1	18273cc	441kW (600PS)	Diesel	Turbo Intercooled	TD18099
D 2840 LF25 Euro 3	V10 Cyl.		18273cc	485-515kW (660-700PS)	Diesel	Turbo Intercooled	TD16824
D 2840 ME	V10 Cyl.	17.5:1	18273cc	244-268kW (332-364PS)	Diesel		TD19125
D 2840 MF	V10 Cyl.	17.5:1	18273cc	268kW (365PS)	Diesel		TD7811
D 2840 MFG	V10 Cyl.	17.5:1	18273cc	268kW (365PS)	Diesel		TD7812
D 2840 MFR	V10 Cyl.	17:1	18273cc	245-268kW (333-364PS)	Diesel		TD19456



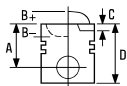

D 2840 MH	V10 Cyl.	17.5:1	18273cc	244-268kW (332-364PS)	Diesel	TD19126
D 2840 TL	V10 Cyl.	13.5:1	18273cc	603kW (820PS)	Diesel Turbo Intercooled	FM5425
D 2842 LE211	V12 Cyl.	16.5:1	21930cc	446kW (607PS)	Diesel Turbo Intercooled	TD27955
D 2842 LE403	V12 Cyl.		21930cc	529kW (805PS)	Diesel Turbo Intercooled	TD27862
D 2842 LE423	V12 Cyl.	15.5:1	21930cc	1000kW (1360PS)	Diesel Turbo Intercooled	TD27922
D 2842 LE433	V12 Cyl.	15.5:1	21930cc	1140kW (1550PS)	Diesel Turbo Intercooled	TD27923
D 2842 LE622	V12 Cyl.	15.5:1	21927cc	588kW (800PS)	Diesel Turbo Intercooled	TD20231
D 2842 LF/D 2842 LFX/D 2842 LXE/ 2842 LYE/D 2842 LZE	V12 Cyl.	13.5:1	21927cc	735-808kW (100-1099PS)	Diesel Turbo Intercooled	FM5426
D 2842 LF10 Euro 3	V12 Cyl.	17:1	21927cc	735kW (1000PS)	Diesel Turbo Intercooled	TD20177
D 2842 LXE	V12 Cyl.	13.5:1	21927cc	662-735kW (900-1000PS)	Diesel Turbo Intercooled	TD19121
D 2842 LYE	V12 Cyl.	13.5:1	21927cc	735-808kW (100-1099PS)	Diesel Turbo Intercooled	TD19122
D 2842 LZE	V12 Cyl.	13.5:1	21927cc	735-808kW (100-1099PS)	Diesel Turbo Intercooled	TD19123
D 2842 ME	V12 Cyl.	17:1	21927cc	275-338kW (374-460PS)	Diesel	TD19120
D 2842 ME/D 2842 MF	V12 Cyl.	17:1	21927cc	275-338kW (374-460PS)	Diesel	FM5423

14-452910-00 WH 1 2 B 144.50 C 253.00 D 153.80 E 10.05 F 1.00

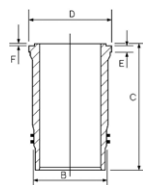

1 Use also: 4 O-rings, Set HT019

1 Mitverwenden: 4 O-Ringe, Satz: HT019

1 A utiliser aussi: 4 joints toriques. Pochette HT019

1 Utilizar también: 4 juntas toricas. Juego HT019

1 Usare anche: 4 O ring serie HT019

2 Interference fit = 145.8mm

2 Preßsitz = 145.8mm

2 Ajustement pressé = 145.8mm

2 Encaje a presión = 145.8mm

2 Interferenza di montaggio=145.8mm

30  **128.00**

E 2876 LUH 02 EEV	6 Cyl.	12:1	12816cc	228kW (310PS)	CNG/LPG Turbo Intercooled	TD19966
E 2876 LUH01 EEV	6 Cyl.	12:1	12816cc	228kW (310PS)	CNG/LPG Turbo Intercooled	TD28243
E 2876 LUH03 EEV	6 Cyl.	12:1	12816cc	228-235kW (310-320PS)	CNG/LPG Turbo Intercooled	TD23804
E 2876 LUH04 EEV	6 Cyl.	12:1	12816cc	200kW (272PS)	CNG/LPG Turbo Intercooled	TD25459

87-433800-00 STD



STD

08-433800-00 STD

STD

14-452920-00 WH 1 B 144.50 C 270.00 D 153.80 E 10.07 F 1.00

A 78.70
 B- 28.75
 BØ 93.43
 D 133.75
 50x107

3.50  CK
 3.00  CR
 4.00

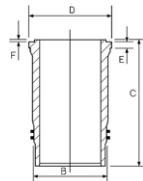

AK RT TP

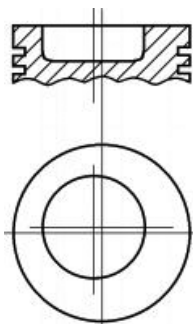

1 Use also: 4 O-rings, Set HT019

1 Mitverwenden: 4 O-Ringe, Satz: HT019

1 A utiliser aussi: 4 joints toriques. Pochette HT019

1 Utilizar también: 4 juntas toricas. Juego HT019

1 Usare anche: 4 O ring serie HT019

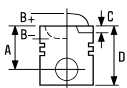

31  **128.00**

D 2848 LE	V8 Cyl.	14618cc	206-500kW (280-680PS)	Diesel	FM25422
D 2840 LE	V10 Cyl. 17:1	18273cc	346-460kW (471-626PS)	Diesel Turbo Intercooled	TD19453
D 2840 LE403	V10 Cyl. 13.5:1	18273cc	772kW (1050PS)	Diesel Turbo Intercooled	TD27911
D 2842 LE402	V12 Cyl.	21930cc	809kW (1100PS)	Diesel Turbo Intercooled	TD27861
D 2842 LE406	V12 Cyl.	21930cc	882kW (1200PS)	Diesel Turbo Intercooled	TD27864
D 2842 LE408	V12 Cyl.	21930cc	735kW (1000PS)	Diesel Turbo Intercooled	TD27866

87-124500-40 STD **08-124500-00** STD **14-452910-00 WH** ¹ ² B 144.50 C 253.00 D 153.80 E 10.05 F 1.00 **89-124500-40**

A 81.25
B- 27.20
BØ 76.00
C 1.30
D 130.30
 46x105

4.00
3.00
4.00



CK P
P
CR P

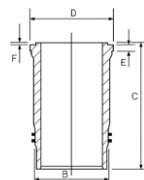

87-124500-40 +
14-452910-00

AK KK NB RT TP

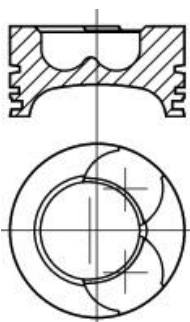

¹ Use also: 4 O-rings, Set HT019
² Interference fit = 145.8mm

¹ Mitverwenden: 4 O-Ringe, Satz: HT019
² Preßsitz = 145.8mm

¹ A utiliser aussi: 4 joints toriques, Pochette HT019
² Ajustement pressé = 145.8mm

¹ Utilizar también: 4 juntas toricas, Juego HT019
² Encaje a presiⁿ = 145.8mm

¹ Usare anche: 4 O ring serie HT019
² Interferenza di montaggio=145.8mm

32  **128.00**

D 2840 LF/460	V10 Cyl. 15.9:1	18273cc	338kW (460PS)	Diesel Turbo Intercooled	TD7795
D 2840 LXF	V10 Cyl. 15.9:1	18273cc	338kW (460PS)	Diesel Turbo Intercooled	TD19455

87-283100-10 STD **08-283100-00** STD **14-452910-00 WH** ¹ ² B 144.50 C 253.00 D 153.80 E 10.05 F 1.00

A 81.30
B- 30.00
BØ 66.50
D 128.30
 46x105

3.50
3.00
5.00



CR P
P
CR P

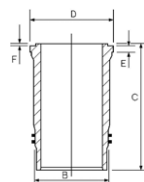

AK RT

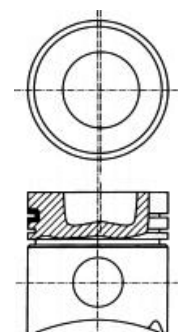

12821

¹ Use also: 4 O-rings, Set HT019
² Interference fit = 145.8mm

¹ Mitverwenden: 4 O-Ringe, Satz: HT019
² Preßsitz = 145.8mm

¹ A utiliser aussi: 4 joints toriques, Pochette HT019
² Ajustement pressé = 145.8mm

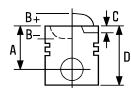

¹ Utilizar también: 4 juntas toricas, Juego HT019
² Encaje a presiⁿ = 145.8mm

¹ Usare anche: 4 O ring serie HT019
² Interferenza di montaggio=145.8mm



33  **128.00**

D 2842 LE202	V12 Cyl.	16.5:1	21930cc	446-587kW (607-798PS)	Diesel Turbo Intercooled	TD25682
D 2842 LE404	V12 Cyl.	13.5:1	21930cc	956kW (1300PS)	Diesel Turbo Intercooled	TD27702
D 2842 LE414	V12 Cyl.	15.5:1	21930cc		Diesel Turbo Intercooled	FM45426
D 2842 LE415	V12 Cyl.	15.5:1	21930cc		Diesel Turbo Intercooled	FM55426
D 2842 LE416	V12 Cyl.	15.5:1	21930cc		Diesel Turbo Intercooled	FM65426
D 2842 LE417	V12 Cyl.	15.5:1	21930cc		Diesel Turbo Intercooled	FM75426

87-124500-30 STD **08-124500-00** STD **14-452910-00** WH   **B 144.50 C 253.00 D 153.80 E 10.05 F 1.00** **88-124500-30**

A 81.25
B- 27.10
BØ 80.20
C 1.30
D 130.00
 46x105

4.00
 3.00
 4.00



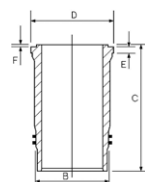

CK P
 P
 CR P



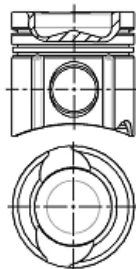

87-124500-30 +
 14-452910-00

AK KK NB RT





 Use also: 4 O-rings, Set HT019

 Mitverwenden: 4 O-Ringe, Satz: HT019

 A utiliser aussi: 4 joints toriques. Pochette HT019

 Utilizar también: 4 juntas toricas. Juego HT019

 Usare anche: 4 O ring serie HT019

 Interference fit = 145.8mm

 Preßsitz = 145.8mm

 Ajustement pressé = 145.8mm

 Encaje a presiⁿ = 145.8mm

 Interferenza di montaggio=145.8mm

34  **128.00**



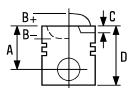

D 2865 LF/260	5 Cyl.	15.5:1	9973cc	191kW (260PS)	Diesel Turbo Intercooled	TD7776
D 2866 KF	6 Cyl.	15:1	11967cc	265kW (360PS)	Diesel Turbo Intercooled	TD5651
D 2866 KFZ	6 Cyl.	15:1	11967cc	265kW (360PS)	Diesel Turbo Intercooled	TD7761
D 2866 KOH/360	6 Cyl.	15:1	11967cc	265kW (360PS)	Diesel Turbo Intercooled	TD16487
D 2866 KUH/360 Euro 1	6 Cyl.	15:1	11967cc	265kW (360PS)	Diesel Turbo Intercooled	TD7591
D 2866 KUL	6 Cyl.	15:1	11967cc	265kW (360PS)	Diesel Turbo Intercooled	TD7786
D 2866 LF/290	6 Cyl.	15.5:1	11967cc	213kW (290PS)	Diesel Turbo Intercooled	TD7778
D 2866 LF04	6 Cyl.	15.5:1	11967cc	220kW (300PS)	Diesel Turbo Intercooled	TD7779
D 2866 LF05 Euro 1	6 Cyl.	16:1	11967cc	272kW (370PS)	Diesel Turbo Intercooled	TD7788
D 2866 LFZ/290	6 Cyl.	15:1	11967cc	213kW (290PS)	Diesel Turbo Intercooled	TD7757
D 2866 LU/330	6 Cyl.	16:1	11967cc	243kW (330PS)	Diesel Turbo Intercooled	TD7809
D 2866 LUH/330	6 Cyl.	17:1	11967cc	243kW (330PS)	Diesel Turbo Intercooled	TD7593
D 2866 LUL/330	6 Cyl.	15:1	11967cc	243kW (330PS)	Diesel Turbo Intercooled	TD7783
D 2866 T	6 Cyl.	15:1	11967cc	213kW (290PS)	Diesel Turbo Intercooled	TD7580
D 2866 TOH	6 Cyl.	15:1	11967cc	229kW (311PS)	Diesel Turbo Intercooled	TD7745
D 2866 TOH/290	6 Cyl.	15:1	11967cc	213kW (290PS)	Diesel Turbo Intercooled	TD7746
D 2866 TOH/310	6 Cyl.	15:1	11967cc	229kW (311PS)	Diesel Turbo Intercooled	TD7747
D 2866 TUH	6 Cyl.	15:1	11967cc	224-229kW (305-311PS)	Diesel Turbo Intercooled	TD7186



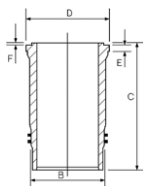

D 2866 TUH/290 6 Cyl. 15:1 **11967cc** 213-224kW (290-305PS) **Diesel Turbo Intercooled** **TD7589**



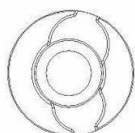
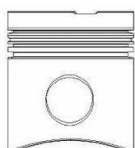

D 2866 TUH01 6 Cyl. 15:1 **11967cc** 222kW (302PS) **Diesel Turbo Intercooled** **TD7176**

87-283100-30	STD	08-283100-00	STD	14-452920-00 WH ② B 144.50 C 270.00 D 153.80 E 10.07 F 1.00	89-283100-30 87-283100-30 + 14-452920-00
A 89.80		3.50	 CR P		
B- 32.20		3.00	 P		
BØ 69.60		5.00	 CR P		
C 2.30					
D 141.80					
 46x105					

AK RT

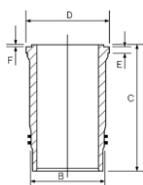

12828

87-283100-40	STD	08-283100-00	STD	14-452920-00 WH ② B 144.50 C 270.00 D 153.80 E 10.07 F 1.00	88-283100-40 87-283100-40 + 14-452920-00
A 89.60		3.50	 CR P		
B- 32.20		3.00	 P		
BØ 69.60		5.00	 CR P		
C 2.30					
D 141.60					
 46x105					

AK RT

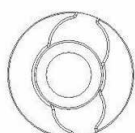
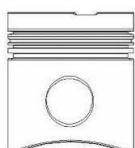

12828

14-450030-00 WH ② B 144.50 C 270.00 D 153.80 E 10.27 F 1.00
14-452921-10 WH ① ② B 145.50 C 270.00 D 154.30 E 10.07 F 1.00
14-452930-00 WH ② B 144.50 C 270.00 D 153.80 E 10.57 F 1.00

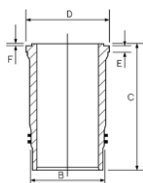



① Phosphated
 ② Use also: 4 O-rings, Set HT019

① Phosphated
 ② Mitverwenden: 4 O-Ringe,
 Satz: HT019

① Phosphated
 ② A utiliser aussi: 4 joints toriques.
 Pochette HT019

① Phosphated
 ② Utilizar también: 4 juntas toricas.
 Juego HT019

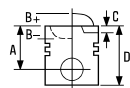
① Phosphated
 ② Usare anche: 4 O ring serie HT019

35  **128.00**

D 2865 LF02	5 Cyl.	15.5:1	9973cc	198kW (270PS)	Diesel Turbo Intercooled	TD7696
D 2865 LF03	5 Cyl.	15.5:1	9973cc	235kW (320PS)	Diesel Turbo Intercooled	TD7780
D 2865 LF05 Euro 1	5 Cyl.	16:1	9973cc	198kW (270PS)	Diesel Turbo Intercooled	TD7777
D 2865 LF06 Euro 1	5 Cyl.	16:1	9973cc	235kW (320PS)	Diesel Turbo Intercooled	TD7781
D 2865 LF22 Euro 1	5 Cyl.	15.5:1	9973cc	198kW (270PS)	Diesel Turbo Intercooled	TD7764
D 2865 LF23 Euro 1	5 Cyl.	15.5:1	9973cc	235kW (320PS)	Diesel Turbo Intercooled	TD7767
D 2865 LOH01 Euro 1	5 Cyl.	16:1	9973cc	198kW (270PS)	Diesel Turbo Intercooled	TD9087
D 2865 LOH02 Euro 1	5 Cyl.	16:1	9973cc	235kW (320PS)	Diesel Turbo Intercooled	TD7754
D 2865 LU01/Silent Euro 1	5 Cyl.	15:1	9973cc	198kW (270PS)	Diesel Turbo Intercooled	TD7724
D 2865 LUH02 Euro 1	5 Cyl.	15:1	9973cc	198kW (270PS)	Diesel Turbo Intercooled	TD7578
D 2865 LUH05 Euro 1	5 Cyl.	15:1	9973cc	198kW (270PS)	Diesel Turbo Intercooled	TD7579
D 2865 LUH08 Euro 1	5 Cyl.	16.5:1	9973cc	235kW (320PS)	Diesel Turbo Intercooled	TD7612
D 2866 LF03	6 Cyl.	16:1	11967cc	272kW (370PS)	Diesel Turbo Intercooled	TD7787
D 2866 LF06	6 Cyl.	15.5:1	11967cc	309kW (420PS)	Diesel Turbo Intercooled	TD7792
D 2866 LF09 Euro 1	6 Cyl.	16:1	11967cc	309kW (420PS)	Diesel Turbo Intercooled	TD7793
D 2866 LF10 Euro 1	6 Cyl.	15.5:1	11967cc	309kW (420PS)	Diesel Turbo Intercooled	TD7794
D 2866 LF15 Euro 1	6 Cyl.	15.5:1	11967cc	272kW (370PS)	Diesel Turbo Intercooled	TD7789
D 2866 LF21 Euro 1	6 Cyl.	15.5:1	11967cc	272kW (370PS)	Diesel Turbo Intercooled	TD7770
D 2866 LF22 Euro 1	6 Cyl.	15.5:1	11967cc	309kW (420PS)	Diesel Turbo Intercooled	TD7772
D 2866 LOH	6 Cyl.	17:1	11967cc	243-309kW (330-420PS)	Diesel Turbo Intercooled	TD7750
D 2866 LOH03	6 Cyl.	17:1	11967cc	309kW (420PS)	Diesel Turbo Intercooled	TD7808
D 2866 LOH06 Euro 1	6 Cyl.	17:1	11967cc	309kW (420PS)	Diesel Turbo Intercooled	TD7755
D 2866 LOH07	6 Cyl.	17:1	11967cc	272kW (370PS)	Diesel Turbo Intercooled	TD7602
D 2866 LOH20 Euro 1	6 Cyl.	16:1	11967cc	309kW (420PS)	Diesel Turbo Intercooled	TD5647
D 2866 LOH22 Euro 1	6 Cyl.	17:1	11967cc	272kW (370PS)	Diesel Turbo Intercooled	TD7420
D 2866 LOH24 Euro 1	6 Cyl.	17:1	11970cc	230kW (310PS)	Diesel Turbo Intercooled	TD7752
D 2866 LU 01	6 Cyl.	15:1	11967cc	272kW (370PS)	Diesel Turbo Intercooled	TD21312
D 2866 LU 03 Euro 1	6 Cyl.	16:1	11967cc	272kW (370PS)	Diesel Turbo Intercooled	TD21313
D 2866 LX	6 Cyl.	15:1	11967cc	198-344kW (269-468PS)	Diesel Turbo Intercooled	TD19128



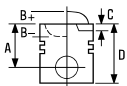

D 2866 LXF 6 Cyl. 15:1 **11967cc** 198-274kW (269-372PS) Diesel Turbo Intercooled **TD7785**

D 2866 LXOH 6 Cyl. 15:1 **11967cc** 265-274kW (360-373PS) Diesel Turbo Intercooled **TD6728**



87-283100-00 STD

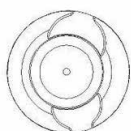

A 89.75
B- 24.40
BØ 75.60
C 2.05
D 141.75
 46x105

AK RT



08-283100-00 STD

3.50  CR P
 3.00  P
 5.00  CR P

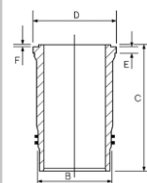

14-452920-00 WH  **B** 144.50 **C** 270.00 **D** 153.80 **E** 10.07 **F** 1.00
14-452930-00 WH  **B** 144.50 **C** 270.00 **D** 153.80 **E** 10.57 **F** 1.00



89-283100-00
 87-283100-00 +
 14-452920-00

89-283100-40
 87-283100-00 +
 14-452930-00

14-450030-00 WH  **B** 144.50 **C** 270.00 **D** 153.80 **E** 10.27 **F** 1.00

14-452921-10 WH   **B** 145.50 **C** 270.00 **D** 154.30 **E** 10.07 **F** 1.00

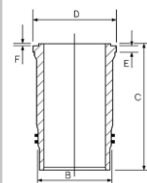



87-283100-01 STD

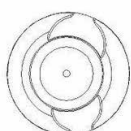

A 89.55
B- 24.40
BØ 75.60
C 2.05
D 141.55
 46x105



AK RT







08-283100-00 STD



3.50  CR P
 3.00  P
 5.00  CR P

 Phosphated
 Use also: 4 O-rings, Set HT019

 Phosphated
 Mitverwenden: 4 O-Ringe,
 Satz: HT019

 Phosphated
 A utiliser aussi: 4 joints toriques.
 Pochette HT019



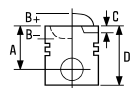

 Phosphated
 Utilizar también: 4 juntas toricas.
 Juego HT019

 Phosphated
 Usare anche: 4 O ring serie HT019



36  **128.00**

D 2865 LF09	5 Cyl.	17:1	9973cc	250kW (340PS)	Diesel Turbo Intercooled	TD7784
D 2865 LFR	5 Cyl.	15.5:1	9973cc	191-235kW (260-320PS)	Diesel Turbo Intercooled	TD25851
D 2865 LOH05 Euro 1	5 Cyl.	16:1	9973cc	191-235kW (260-320PS)	Diesel Turbo Intercooled	TD25854
D 2865 LOH07 Euro 2	5 Cyl.	16:1	9973cc	191-250kW (260-340PS)	Diesel Turbo Intercooled	TD25855
D 2865 LOH09 Euro 2	5 Cyl.	16:1	9973cc	228kW (310PS)	Diesel Turbo Intercooled	TD25858
D 2865 LXF	5 Cyl.	15.5:1	9973cc	191-235kW (260-320PS)	Diesel Turbo Intercooled	TD25860
D 2865 LXFR	5 Cyl.	15.5:1	9973cc	191-235kW (260-320PS)	Diesel Turbo Intercooled	TD25861
D 2866 KOH/373	6 Cyl.	15:1	11967cc	274kW (373PS)	Diesel Turbo Intercooled	TD7415
D 2866 LFZ/330	6 Cyl.	15.5:1	11967cc	243kW (330PS)	Diesel Turbo Intercooled	TD7759
D 2876 LF05 Euro 3	6 Cyl.	17:1	12816cc	375kW (510PS)	Diesel Turbo Intercooled	TD16206
D 2876 LF11 Euro 2	6 Cyl.	17:1	12816cc	338kW (460PS)	Diesel Turbo Intercooled	TD20603
D 2876 LUE604	6 Cyl.	15.5:1	12816cc	375kW (510PS)	Diesel Turbo Intercooled	TD27939
D 2876 LUE605	6 Cyl.	15.5:1	12816cc	338kW (460PS)	Diesel Turbo Intercooled	TD27938
D 2876 LUE606	6 Cyl.	15.5:1	12816cc	301kW (409PS)	Diesel Turbo Intercooled	TD27937

14-450030-00 WH  B 144.50 C 270.00 D 153.80 E 10.27 F 1.00
 14-452920-00 WH  B 144.50 C 270.00 D 153.80 E 10.07 F 1.00
 14-452921-10 WH   B 145.50 C 270.00 D 154.30 E 10.07 F 1.00
 14-452930-00 WH  B 144.50 C 270.00 D 153.80 E 10.57 F 1.00

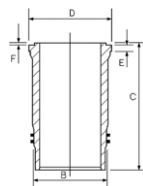

 Phosphated

 Use also: 4 O-rings, Set HT019

 Phosphated

 Mitverwenden: 4 O-Ringe, Satz: HT019

 Phosphated

 A utiliser aussi: 4 joints toriques. Pochette HT019

 Phosphated

 Utilizar también: 4 juntas toricas. Juego HT019

 Phosphated

 Usare anche: 4 O ring serie HT019

37  **128.00**

D 2865 LF21 Euro 2	5 Cyl.	17:1	9973cc	110-250kW (290-340PS)	Diesel Turbo Intercooled	TD7769
D 2865 LF24 Euro 2	5 Cyl.	15.5:1	9973cc	213kW (290PS)	Diesel Turbo Intercooled	TD7766
D 2865 LUH07 Euro 2	5 Cyl.	16.5:1	9973cc	228kW (310PS)	Diesel Turbo Intercooled	TD7581
D 2865 LUH09 Euro 2	5 Cyl.	18:1	9973cc	191kW (260PS)	Diesel Turbo Intercooled	TD7594
D 2866 LF14 Euro 2	6 Cyl.	17:1	11967cc	294-309kW (400-420PS)	Diesel Turbo Intercooled	TD21308
D 2866 LF16 Euro 2	6 Cyl.	17:1	11967cc	294-309kW (400-420PS)	Diesel Turbo Intercooled	TD7791
D 2866 LF17 Euro 2	6 Cyl.	17:1	11967cc	260kW (354PS)	Diesel Turbo Intercooled	TD21309
D 2866 LF20 Euro 2	6 Cyl.	17:1	11967cc	294-309kW (400-420PS)	Diesel Turbo Intercooled	TD7771
D 2866 LF29 Euro 2	6 Cyl.	19:1	11967cc	294kW (400PS)	Diesel Turbo Intercooled	TD21310
D 2866 LF30 Euro 2	6 Cyl.	17:1	11967cc	301kW (409PS)	Diesel Turbo Intercooled	TD21311
D 2866 LF34 Euro 2	6 Cyl.	17:1	11967cc	228kW (310PS)	Diesel Turbo Intercooled	TD14308
D 2866 LF35 Euro 2	6 Cyl.	17:1	11967cc	265kW (360PS)	Diesel Turbo Intercooled	TD14311
D 2866 LF36 Euro 2	6 Cyl.	19:1	11967cc	228kW (310PS)	Diesel Turbo Intercooled	TD16202
D 2866 LF37 Euro 2	6 Cyl.	19:1	11967cc	265kW (360PS)	Diesel Turbo Intercooled	TD16203
D 2866 LOH23 Euro 2	6 Cyl.	16:1	11967cc	294kW (400PS)	Diesel Turbo Intercooled	TD7592
D 2866 LOH25 Euro 2	6 Cyl.	17:1	11967cc	228kW (310PS)	Diesel Turbo Intercooled	TD7753
D 2866 LOH26 Euro 2	6 Cyl.	17:1	11967cc	257kW (350PS)	Diesel Turbo Intercooled	TD7590



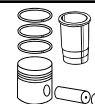
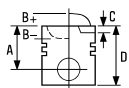

D 2866 LUH21 Euro 2	6 Cyl.	18:1	11967cc	257kW (350PS)	Diesel Turbo Intercooled	TD11167
D 2866 LUH22 Euro 2	6 Cyl.	18:1	11967cc	191kW (260PS)	Diesel Turbo Intercooled	TD11133
D 2866 LUH26 Euro 2	6 Cyl.	16:1	11967cc	228kW (310PS)	Diesel Turbo	TD11134

87-283100-80 STD

- A** 89.75
- B-** 21.60
- BØ** 81.20
- C** 2.10
- D** 141.75
- 46x105

AK RT

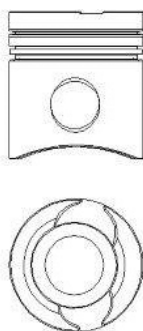

08-283100-00 STD

- 3.50 CR P
- 3.00 P
- 5.00 CR P

14-452920-00 WH **B 144.50 C 270.00 D 153.80 E 10.07 F 1.00**

14-452930-00 WH **B 144.50 C 270.00 D 153.80 E 10.57 F 1.00**

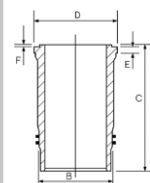

89-283100-80
87-283100-80 +
14-452920-00

89-283100-41
87-283100-80 +
14-452930-00

87-283100-85 STD

- A** 89.55
- B-** 21.60
- BØ** 81.20
- C** 2.10
- D** 141.55
- 46x105

AK RT

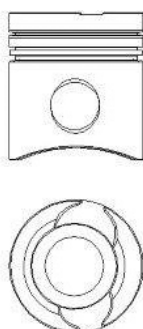

08-283100-00 STD

- 3.50 CR P
- 3.00 P
- 5.00 CR P

14-452920-00 WH **B 144.50 C 270.00 D 153.80 E 10.07 F 1.00**

14-452930-00 WH **B 144.50 C 270.00 D 153.80 E 10.57 F 1.00**

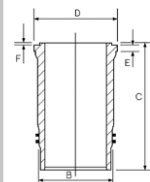

89-283100-85
87-283100-85 +
14-452920-00

89-283100-42
87-283100-85 +
14-452930-00



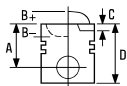

87-283100-86

STD

- A 89.35
- B- 21.60
- BØ 81.20
- C 2.10
- D 141.35
- 46x105

AK RT

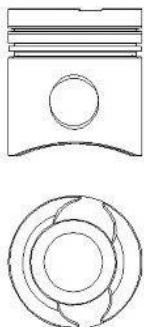

- 1 Phosphated
- 2 Use also: 4 O-rings, Set HT019

08-283100-00

STD

- 3.50 CR P
- 3.00 P
- 5.00 CR P

- 1 Phosphated
- 2 Mitverwenden: 4 O-Ringe, Satz: HT019

14-452920-00 WH 2 B 144.50 C 270.00 D 153.80 E 10.07 F 1.00
 14-452930-00 WH 2 B 144.50 C 270.00 D 153.80 E 10.57 F 1.00

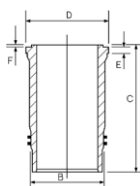

14-450030-00 WH 2 B 144.50 C 270.00 D 153.80 E 10.27 F 1.00
 14-452921-10 WH 1 B 145.50 C 270.00 D 154.30 E 10.07 F 1.00

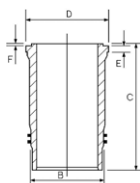

- 1 Phosphated
- 2 A utiliser aussi: 4 joints toriques. Pochette HT019
- 1 Phosphated
- 2 Utilizar también: 4 juntas toricas. Juego HT019

89-283100-86
 87-283100-86 +
 14-452920-00

89-283100-43
 87-283100-86 +
 14-452930-00

38 128.00

D 2866 F/240	6 Cyl.	17.5:1	11967cc	177kW (240PS)	Diesel	TD7775
D 2866 FR	6 Cyl.	17.5:1	11967cc	177-213kW (241-290PS)	Diesel	TD19127
D 2866 OH	6 Cyl.	17.5:1	11967cc	177-213kW (241-290PS)	Diesel	TD23745
D 2866 U	6 Cyl.	17.5:1	11967cc	160-180kW (218-245PS)	Diesel	TD28964
D 2866 UH	6 Cyl.	17.5:1	11967cc	177-186kW (241-253PS)	Diesel	TD7419
D 2866 UH/240	6 Cyl.	17.5:1	11967cc	177kW (240PS)	Diesel Turbo	TD7577
D 2866 UM	6 Cyl.	17.5:1	11967cc	152-177kW (206-241PS)	Diesel	TD7174

87-283100-60

STD

- A 89.87
- B- 31.00
- BØ 67.00
- D 141.87
- 46x105

AK RT

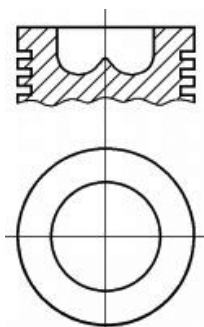

12828-400

08-283100-00

STD

- 3.50 CR P
- 3.00 P
- 5.00 CR P

14-452920-00 WH 2 B 144.50 C 270.00 D 153.80 E 10.07 F 1.00

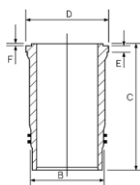

14-450030-00 WH 2 B 144.50 C 270.00 D 153.80 E 10.27 F 1.00
 14-452921-10 WH 1 B 145.50 C 270.00 D 154.30 E 10.07 F 1.00
 14-452930-00 WH 2 B 144.50 C 270.00 D 153.80 E 10.57 F 1.00

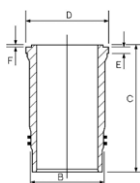

89-283100-60
 87-283100-60 +
 14-452920-00



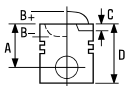



87-283100-70

STD

A 89.67
 B- 31.00
 BØ 67.00
 D 141.67
 46x105

08-283100-00

STD

3.50  CR P
 3.00  P
 5.00  CR P

AK RT

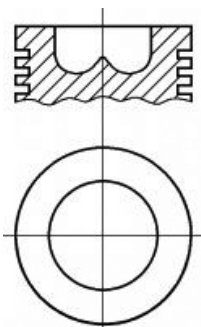

12828-400

1 Phosphated

2 Use also: 4 O-rings, Set HT019

1 Phosphated

2 Mitverwenden: 4 O-Ringe,
 Satz: HT019

1 Phosphated

2 A utiliser aussi: 4 joints toriques.
 Pochette HT019

1 Phosphated

2 Utilizar también: 4 juntas toricas.
 Juego HT019

1 Phosphated

2 Usare anche: 4 O ring serie HT019

39  128.00

D 2866 LF23 Euro 3	6 Cyl.	17:1	11967cc	228kW (310PS)	Diesel Turbo Intercooled	TD16521
D 2866 LF24 Euro 3	6 Cyl.	17:1	11967cc	265kW (360PS)	Diesel Turbo Intercooled	TD16522
D 2866 LF25 Euro 3	6 Cyl.	19:1	11967cc	301kW (410PS)	Diesel Turbo Intercooled	TD16467
D 2866 LF26 Euro 3	6 Cyl.	19:1	11967cc	228kW (310PS)	Diesel Turbo Intercooled	TD16204
D 2866 LF27 Euro 4	6 Cyl.	19:1	11967cc	265kW (360PS)	Diesel Turbo Intercooled	TD16205
D 2866 LF28 Euro 3	6 Cyl.	19:1	11967cc	301kW (410PS)	Diesel Turbo Intercooled	TD15050
D 2866 LOH27 Euro 3	6 Cyl.	17:1	11967cc	228kW (310PS)	Diesel Turbo Intercooled	TD16760
D 2866 LOH28 Euro 3	6 Cyl.	17:1	11967cc	265kW (360PS)	Diesel Turbo Intercooled	TD16761
D 2866 LOH29 Euro 3	6 Cyl.	19:1	11967cc	301kW (410PS)	Diesel Turbo Intercooled	TD16493
D 2866 LOH32 Euro 3	6 Cyl.	19:1	11967cc	228kW (310PS)	Diesel Turbo Intercooled	TD16746
D 2866 LOH33 Euro 3	6 Cyl.	19:1	11967cc	265kW (360PS)	Diesel Turbo Intercooled	TD16747
D 2866 LOH34 Euro 3	6 Cyl.	19:1	11967cc	301kW (410PS)	Diesel Turbo Intercooled	TD16297
D 2866 LUH23 Euro 3	6 Cyl.	18:1	11967cc	191kW (260PS)	Diesel Turbo Intercooled	TD16764
D 2866 LUH24 Euro 3	6 Cyl.	18:1	11967cc	228kW (310PS)	Diesel Turbo Intercooled	TD16765



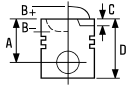

D 2866 LUH25 Euro 3 6 Cyl. 18:1 **11967cc** **265kW (360PS)** **Diesel Turbo Intercooled** **TD16766**

D 2866 LUH30 Euro 3 6 Cyl. 16:1 **11967cc** **301kW (410PS)** **Diesel Turbo Intercooled** **TD16767**

87-143800-30 STD **08-143800-00** STD **14-452920-00 WH 2** B 144.50 C 270.00 D 153.80 E 10.07 F 1.00 **89-143800-30**
87-143800-30 +
14-452920-00

A 89.75
B- 22.00
BØ 80.00
C 1.90
D 141.75
 46x105

4.00 CK P
3.00 CR P
4.00 CR P

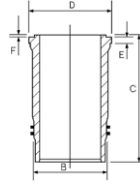

AK RT

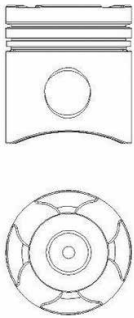

14-450030-00 WH 2 B 144.50 C 270.00 D 153.80 E 10.27 F 1.00
14-452921-10 WH 1 2 B 145.50 C 270.00 D 154.30 E 10.07 F 1.00
14-452930-00 WH 2 B 144.50 C 270.00 D 153.80 E 10.57 F 1.00

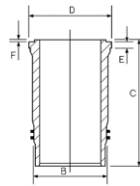

87-143800-40 STD **08-143800-00** STD

A 89.55
B- 22.00
BØ 80.00
C 1.90
D 141.75
 46x105

4.00 CK P
3.00 CR P
4.00 CR P

AK RT

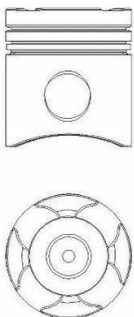

1 Phosphated
2 Use also: 4 O-rings, Set HT019

1 Phosphated
2 Mitverwenden: 4 O-Ringe,
Satz: HT019

1 Phosphated
2 A utiliser aussi: 4 joints toriques.
Pochette HT019

1 Phosphated
2 Utilizar también: 4 juntas toricas.
Juego HT019

1 Phosphated
2 Usare anche: 4 O ring serie HT019

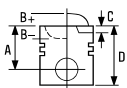

40  **128.00**

D 2866 LF31 Euro 2	6 Cyl.	17:1	11967cc	301kW (409PS)	Diesel Turbo Intercooled	TD14312
D 2866 LF32 Euro 2	6 Cyl.	19:1	11967cc	301kW (410PS)	Diesel Turbo Intercooled	TD15048
D 2866 LF32 Euro 2	6 Cyl.	19:1	11967cc	301kW (410PS)	Diesel Turbo Intercooled	FM117034
D 2866 LF39 Euro 2	6 Cyl.	19:1	11967cc	265kW (360PS)	Diesel Turbo Intercooled	TD28931
D 2866 LF39 Euro 2	6 Cyl.	19:1	11967cc	265kW (360PS)	Diesel Turbo Intercooled	FM127034
D 2866 LF40 Euro 2	6 Cyl.	19:1	11967cc	301kW (410PS)	Diesel Turbo Intercooled	TD23662
D 2866 LF41 Euro 2	6 Cyl.	19:1	11967cc	301kW (410PS)	Diesel Turbo Intercooled	TD23005
D 2866 LF42 Euro 2	6 Cyl.		11967cc	228-301kW (310-410PS)	Diesel Turbo Intercooled	FM157034
D 2866 LF43 Euro 2	6 Cyl.	19:1	11967cc	265kW (360PS)	Diesel Turbo Intercooled	TD23004



87-104300-00 STD

A 89.75
B- 22.70
C 1.98
D 141.75
 46x105

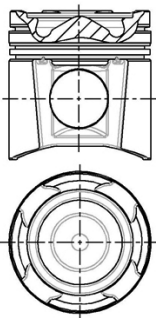
AK RT



08-104300-00 STD

4.00  CK P
 3.00  P
 4.00  CR P

14-452920-00 WH  **B** 144.50 **C** 270.00 **D** 153.80 **E** 10.07 **F** 1.00

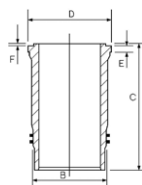

88-104300-00
 87-104300-00 +
 14-452920-00



87-104300-10 STD

A 89.55
B- 22.70
C 1.98
D 141.55
 46x105

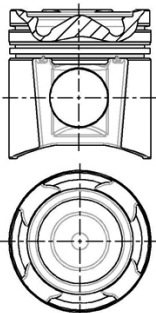
AK RT





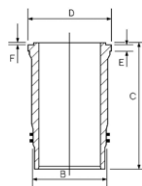

08-104300-00 STD

4.00  CK P
 3.00  P
 4.00  CR P



14-452920-00 WH  **B** 144.50 **C** 270.00 **D** 153.80 **E** 10.07 **F** 1.00





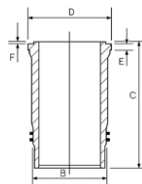

88-104300-10
 87-104300-10 +
 14-452920-00



14-450030-00 WH  **B** 144.50 **C** 270.00 **D** 153.80 **E** 10.27 **F** 1.00
14-452921-10 WH   **B** 145.50 **C** 270.00 **D** 154.30 **E** 10.07 **F** 1.00
14-452930-00 WH  **B** 144.50 **C** 270.00 **D** 153.80 **E** 10.57 **F** 1.00





 Phosphated
 Use also: 4 O-rings, Set HT019

 Phosphated
 Mitverwenden: 4 O-Ringe,
 Satz: HT019

 Phosphated
 A utiliser aussi: 4 joints toriques.
 Pochette HT019

 Phosphated
 Utilizar también: 4 juntas toricas.
 Juego HT019

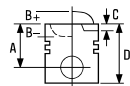

 Phosphated
 Usare anche: 4 O ring serie HT019





41  **128.00**

D 2876 LF02 Euro 2	6 Cyl.	17:1	12816cc	338kW (460PS)	Diesel Turbo Intercooled	TD7773
D 2876 LOH/LUH01 Euro 2	6 Cyl.		12816cc	338kW (460PS)	Diesel Turbo Intercooled	TD16249
D 2876 LUH01 Euro 2	6 Cyl.		12816cc	294kW (400PS)	Diesel Turbo Intercooled	TD28969
D 2876 LUH02 Euro 2	6 Cyl.		12816cc	316kW (430PS)	Diesel Turbo Intercooled	TD28970

87-124500-00 STD
A 79.25
B- 23.10
BØ 81.28
C 2.10
D 134.25
 50x107

08-124500-00 STD
 4.00  CK P
 3.00  P
 4.00  CR P

14-452920-00 WH  **B** 144.50 **C** 270.00 **D** 153.80 **E** 10.07 **F** 1.00
14-452930-00 WH  **B** 144.50 **C** 270.00 **D** 153.80 **E** 10.57 **F** 1.00

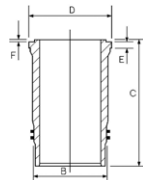



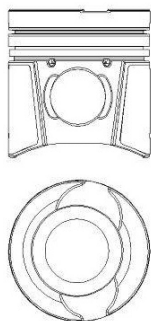

89-124500-00
 87-124500-00 +
 14-452920-00
89-124500-05
 87-124500-00 +
 14-452930-00

AK RT TP



87-124500-10 STD
A 79.05
B- 23.10
BØ 81.28
C 2.10
D 134.04
 50x107

08-124500-00 STD
 4.00  CK P
 3.00  P
 4.00  CR P

14-452920-00 WH  **B** 144.50 **C** 270.00 **D** 153.80 **E** 10.07 **F** 1.00
14-452930-00 WH  **B** 144.50 **C** 270.00 **D** 153.80 **E** 10.57 **F** 1.00

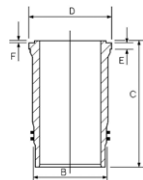

89-124500-10
 87-124500-10 +
 14-452920-00

AK RT TP

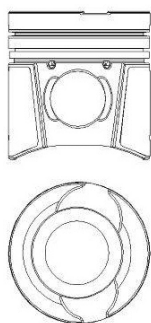

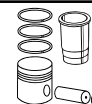
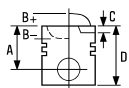

87-124500-20

STD

A 78.85
 B- 23.10
 BØ 81.28
 C 2.10
 D 133.85
 50x107

AK RT TP

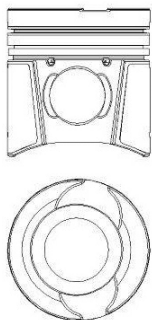

1 Phosphated
 2 Use also: 4 O-rings, Set HT019

08-124500-00

STD

4.00
 3.00
 4.00



CK P
 P
 CR P

1 Phosphated
 2 Mitverwenden: 4 O-Ringe,
 Satz: HT019

14-452920-00 WH 2 B 144.50 C 270.00 D 153.80 E 10.07 F 1.00
 14-452930-00 WH 2 B 144.50 C 270.00 D 153.80 E 10.57 F 1.00

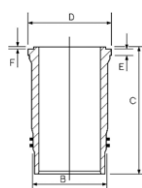

14-450030-00 WH 2 B 144.50 C 270.00 D 153.80 E 10.27 F 1.00
 14-452921-10 WH 1 2 B 145.50 C 270.00 D 154.30 E 10.07 F 1.00

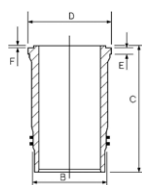

1 Phosphated
 2 A utiliser aussi: 4 joints toriques.
 Pochette HT019

1 Phosphated
 2 Utilizar también: 4 juntas toricas.
 Juego HT019

89-124500-20
 87-124500-20 +
 14-452920-00

89-124500-25
 87-124500-20 +
 14-452930-00

1 Phosphated
 2 Usare anche: 4 O ring serie HT019

42  128.00

D 2876 LF03 Euro 3	6 Cyl.	17:1	12816cc	338kW (460PS)	Diesel Turbo Intercooled	TD17050
D 2876 LF04 Euro 3	6 Cyl.	17:1	12816cc	338kW (460PS)	Diesel Turbo Intercooled	TD15051
D 2876 LF06 Euro 2	6 Cyl.	17:1	12816cc	338kW (460PS)	Diesel Turbo Intercooled	TD14313
D 2876 LF07 Euro 2	6 Cyl.	17:1	12816cc	338kW (460PS)	Diesel Turbo Intercooled	TD15049
D 2876 LF10 Euro 2	6 Cyl.	17:1	12816cc	338kW (460PS)	Diesel Turbo Intercooled	TD28966
D 2876 LF17	6 Cyl.	17:1	12816cc	338kW (460PS)	Diesel Turbo Intercooled	TD28967
D 2876 LOH02 Euro 3	6 Cyl.	17:1	12816cc	338kW (460PS)	Diesel Turbo Intercooled	TD16509
D 2876 LOH03 Euro 3	6 Cyl.	17:1	12816cc	338kW (460PS)	Diesel Turbo Intercooled	TD16298

87-143800-00

STD

A 79.25
 B- 21.74
 BØ 85.05
 C 1.90
 D 134.25
 50x107

AK RT TP

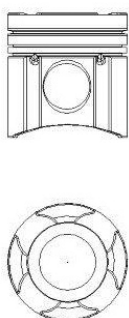

08-143800-00

STD

4.00
 3.00
 4.00



CK P
 CR P
 CR P

1 Phosphated

14-452920-00 WH 2 B 144.50 C 270.00 D 153.80 E 10.07 F 1.00

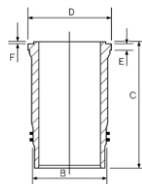

1 Phosphated

1 Phosphated

89-143800-00
 87-143800-00 +
 14-452920-00



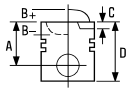

87-143800-10

STD

A 79.05
 B- 21.74
 BØ 85.05
 C 1.90
 D 134.05
 50x107

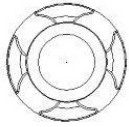

AK RT TP



08-143800-00

STD

4.00
 3.00
 4.00

CK P
 CR P
 CR P

14-452920-00 WH ② B 144.50 C 270.00 D 153.80 E 10.07 F 1.00

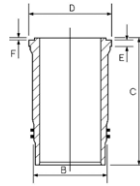

89-143800-10
 87-143800-10 +
 14-452920-00

87-143800-20

STD

A 78.85
 B- 21.74
 BØ 85.05
 C 1.90
 D 133.85
 50x107

AK RT TP

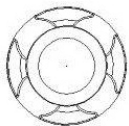

08-143800-00

STD

4.00
 3.00
 4.00





CK P
 CR P
 CR P

14-452920-00 WH ② B 144.50 C 270.00 D 153.80 E 10.07 F 1.00

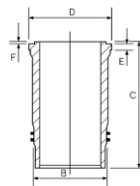

89-143800-20
 87-143800-20 +
 14-452920-00

14-450030-00 WH ② B 144.50 C 270.00 D 153.80 E 10.27 F 1.00

14-452921-10 WH ① ② B 145.50 C 270.00 D 154.30 E 10.07 F 1.00

14-452930-00 WH ② B 144.50 C 270.00 D 153.80 E 10.57 F 1.00

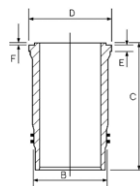

① Phosphated

② Use also: 4 O-rings, Set HT019

① Phosphated

② Mitverwenden: 4 O-Ringe,
 Satz: HT019

① Phosphated

② A utiliser aussi: 4 joints toriques.
 Pochette HT019

① Phosphated

② Utilizar también: 4 juntas toricas.
 Juego HT019

① Phosphated

② Usare anche: 4 O ring serie HT019

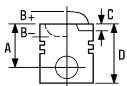

43  **128.00**

D 2876 LF12 Euro 3	6 Cyl.	12816cc	353kW (480PS)	Diesel Turbo Intercooled	TD16825
D 2876 LF13 Euro 3	6 Cyl.	12816cc	390kW (530PS)	Diesel Turbo Intercooled	TD16826
D 2876 LF25 Euro 3	6 Cyl.	12816cc	353kW (480PS)	Diesel Turbo Intercooled	TD19115
D 2876 LOH20 Euro 3	6 Cyl.	12816cc	353kW (480PS)	Diesel Turbo Intercooled	TD16762
D 2876 LOH21 Euro 3	6 Cyl.	12816cc	390kW (530PS)	Diesel Turbo Intercooled	TD18041



87-143800-50 STD

- A 79.25
- B- 23.75
- BØ 76.16
- C 1.90
- D 134.25
-  52x103

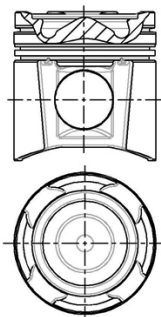
KK RT TP



08-143800-00 STD

- 4.00  CK P
- 3.00  CR P
- 4.00  CR P

14-670050-00 WH B 144.50 C 268.00 D 153.80 E 8.07

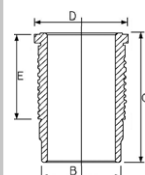

88-143800-50
87-143800-50 +
14-670050-00



87-143800-60 STD

- A 79.05
- B- 23.75
- BØ 76.16
- D 134.05
-  52x103

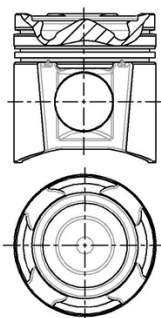
AK RT TP



08-143800-00 STD

- 4.00  CK P
- 3.00  CR P
- 4.00  CR P

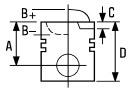

1  **65.00**

AC 60/903

1 Cyl.

FM9226

87-528600-00 STD 08-528600-00 STD
 87-528607-00 0.50mm 08-528607-00 0.50mm

A 28.00 2.00  P
 D 53.00 2.00  P
 14x57 4.00  P

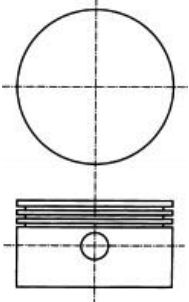

2  **70.00**

AC 63/200 - AC 66

1 Cyl.

FM9227

87-528700-00 STD 08-528700-00 STD
 87-528707-00 0.50mm 08-528707-00 0.50mm

A 28.50 2.00  P
 D 53.00 2.00  P
 14x72 4.00  P

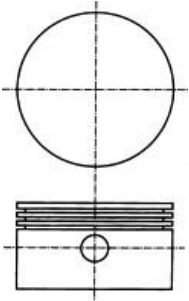

3  **80.00**

AC 74.300/500

1 Cyl.

FM9228

87-524800-10 STD 08-524800-00 STD 14-011051-00 D B 84.04 C 93.00
 87-524807-10 0.50mm 08-524804-00 0.20mm
 08-524807-00 0.50mm
 08-524811-00 1.00mm

A 28.50 2.00  P
 D 63.50 2.00  P
 14x72 4.00  P

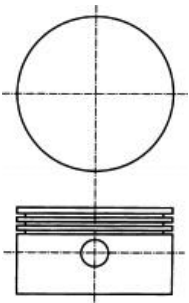
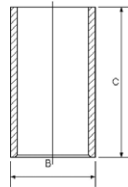



4  **80.00**

AC 75.400 - AC 79.300

2 Cyl.



FM9229

87-524800-00 STD
 87-524804-00 0.20mm
 87-524807-00 0.50mm
 87-524811-00 1.00mm

08-524800-00 STD
 08-524804-00 0.20mm
 08-524807-00 0.50mm
 08-524811-00 1.00mm

14-011051-00 D B 84.04 C 93.00

A 33.50
 D 68.50
 14x72

2.00  P
 2.00  P
 4.00  P

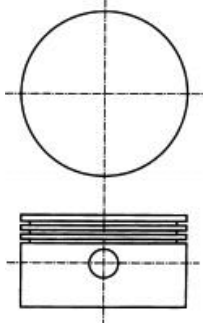
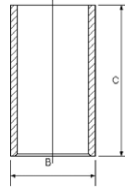

5  **82.00**

ACX 32/20



2 Cyl.

FM9263





87-529200-00 STD

08-529200-00 STD
 08-529207-00 0.50mm

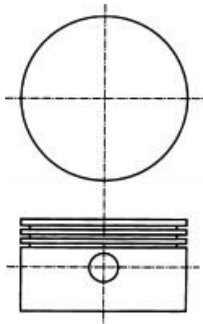
A 28.50
 D 52.00
 14x48

1.50  P
 1.50  P
 3.00  P



		ccm	x 		
4EE1-T	Diesel	1686	4	79.00	5
F6JA	Diesel	1399	4	73.70	1
F6JB	Diesel	1399	4	73.70	1
FXJA	Petrol	1388	4	76.00	4
J4R	Petrol	1299	4	74.00	2
J4T	Petrol	1299	4	74.00	2
JJA Endura E	Petrol	1299	4	74.00	2
JJK	Petrol	1299	4	74.00	2
JJM	Petrol	1299	4	74.00	2
LF17	Petrol	1999	4	87.50	8
LF18	Petrol	1999	4	87.50	8
LFF7	Petrol	1999	4	87.50	8
R2	Diesel	2184	4	86.00	7
RF46	Diesel	1998	4	86.00	7
RF83	Diesel	1998	4	86.00	7
RTJ Endura-DE	Diesel	1753	4	82.50	6
RTK Endura-DE	Diesel	1753	4	82.50	6
SL	Diesel	3455	4	100.00	9
Y601	Diesel	1560	4	75.00	3



1 73.70

2 1.4 CD	04/03→	F6JA	4 Cyl. 1399cc	17.9:1 50kW (68PS)	TD18693
		Diesel	Turbo		
2 1.4 CD	04/03→	F6JB	4 Cyl. 1399cc	17.9:1 50kW (68PS)	TD20951
		Diesel	Turbo		

87-135300-00 STD
87-135305-00 0.25mm
87-135307-00 0.50mm

08-135300-00 STD
08-135305-00 0.25mm
08-135307-00 0.50mm

14-020760-00 D B 76.70 C 136.00 D 78.20 E 5.00
14-020761-00 D B 76.95 C 136.00 D 78.45 E 5.25

A 42.94
B- 14.70
BØ 37.16
C 1.55
D 65.44
 25x60

2.50
1.95
2.50



CK P
P
CR P

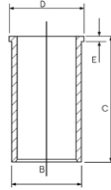

AK RT TP

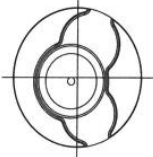
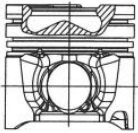

2 74.00



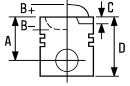

121 III 1.3	03/96→04/03	J4R	4 Cyl. 1299cc	44kW (60PS)	TD24680
121 III 1.3	03/96→04/03	J4T	4 Cyl. 1299cc	44kW (60PS)	TD24681
121 III 1.3	03/96→04/03	JJA Endura E	4 Cyl. 1299cc	8.8:1 37kW (50PS)	TD25845
121 III 1.3	03/96→04/03	JJK	4 Cyl. 1299cc	37kW (50PS)	TD24678





121 III 1.3 03/96 → 04/03 **JJM** 4 Cyl. 9.5:1
1299cc **37kW (50PS)** **TD24679**

87-785000-00	STD	08-785000-00	STD
87-785007-00	0.50mm	08-785007-00	0.50mm
87-785011-00	1.00mm	08-785011-00	1.00mm

A	29.40	1.50	 CR P
D	53.90	1.75	 P
	18x64	3.00	 CR ①

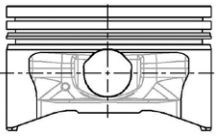

① Steel

① Stahl

① Acier



① Acero

① Acciaio

3 75.00

3 1.6 DI Turbo 06/04 → 06/09 **Y601** 4 Cyl. Diesel 80-81kW (109-110PS)
3 1.6 MZR CD 12/08 → **Turbo Intercooled** **1560cc** **TD18512**

87-424000-00	STD	08-424000-00	STD
87-424008-00	0.60mm	08-424007-00	0.50mm
		08-424008-00	0.60mm

A	41.70	3.00	 CK P
B-	13.25	1.95	 P
BØ	41.80	2.50	 CR P
C	1.20		
D	65.30		

 26x61



AK KK RT TP

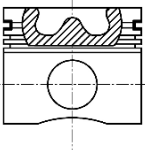
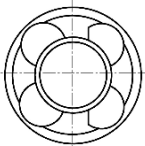

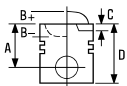









4  **76.00**









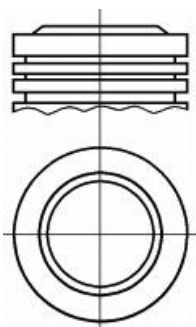

2 1.4	02/03→	FXJA			
3 1.4	02/04→06/09		4 Cyl.	11:1	
			1388cc	59kW (80PS)	

TD18695

87-426100-00 	STD	08-426100-00	STD
87-426107-00 	0.50mm	08-426107-00	0.50mm

A	28.25	1.20	 NT 
B+	1.25	1.50	 P
D	55.50	2.50	 NT 
	19x50		







-  Elastoval®
-  Steel
-  Elastoval®
-  Stahl
-  Elastoval®
-  Acier
-  Elastoval®
-  Acero
-  Elastoval®
-  Acciaio

5  **79.00**

323 S V 1.6 TD	05/94→09/98	4EE1-T			
			4 Cyl.	22:1	
			1686cc	60-65kW (82-88PS)	
		Diesel	Turbo		

TD9465

87-307600-30	STD	08-307600-00	STD
87-307607-30	0.50mm	08-307607-00	0.50mm

A	39.70	2.00	 CR P
B-	1.50	1.50	 CR P
D	69.60	3.00	 CR P
	27x64		

AK RT

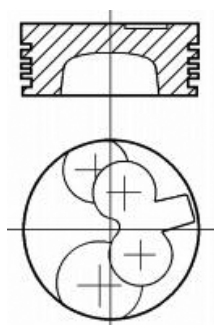

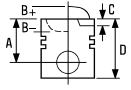





6  **82.50**

121 III 1.8 D	03/96 → 04/03	RTJ Endura-DE	4 Cyl.	21.5:1
			1753cc	44kW (60PS)
		Diesel		TD18697
121 III 1.8 D	03/96 → 04/03	RTK Endura-DE	4 Cyl.	21.5:1
			1753cc	44kW (60PS)
		Diesel		TD18698

87-783500-10	STD	08-783500-00	STD
87-783507-10	0.50mm	08-783507-00	0.50mm
87-783511-10	1.00mm	08-783511-00	1.00mm

A	45.70	2.00		CR P
B-	1.60	2.00		P
D	73.70	3.00		CR P
	26x59			

RT

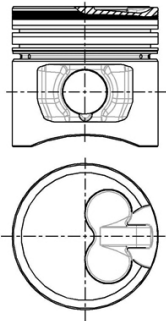



7 86.00

B-Serie 2.2 D	03/85→10/89	R2				
E-Serie E2200 D	02/97→08/02		4 Cyl.		22.9:1	
E-Serie E2200 D 4WD	01/84→05/03		2184cc		47-52kW (64-71PS)	
Spectron 2.2 TD	08/86→10/95	Diesel				TD2030
626 IV 2.0 D GLX Comprex	10/92→04/97	RF OHC				
626 IV Hatchback 2.0 D GLX Comprex	01/93→04/97		4 Cyl.		22.7:1	
			1998cc		55kW (75PS)	
		Diesel				TD2042
626 II 2.0 D	01/83→06/87	RF46				
626 II Hatchback 2.0 D	03/84→06/87		4 Cyl.		22.7:1	
Spectron 2.0 D	08/86→10/95		1998cc		46-53kW (63-72PS)	
		Diesel				TD2043
626 2.0 D	01/88→03/92	RF83				
			4 Cyl.		22.7:1	
			1998cc		55-60kW (75-82PS)	
		Diesel				TD2044



87-283600-00 STD
 87-283607-00 0.50mm
 87-283611-00 1.00mm

A 47.25
B- 0.01
C 1.60
D 82.31
 25x68

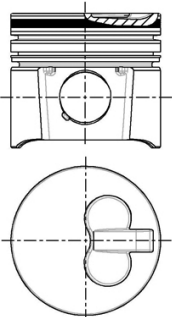
RT



08-283600-00 STD
 08-283607-00 0.50mm
 08-283611-00 1.00mm

2.00  CR P
 2.00  P
 4.00  CR P

14-010840-00 D B 90.00 C 179.96

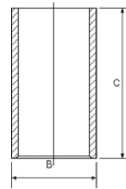



8 87.50

3 2.0	10/03→06/09	LF17			
3 2.0 MZR	06/09→		4 Cyl.	10.8:1	
6 2.0	06/02→08/07		1999cc	104-110kW (141-150PS)	
6 2.0 MZR	08/07→				TD18206
6 2.0	06/02→08/07	LF18			
			4 Cyl.	10.8:1	
			1999cc	104kW (141PS)	
					TD18207
5 2.0	03/05→	LFF7			
6 2.0	03/05→08/07		4 Cyl.		
Premacy 2.0	02/05→03/05		1999cc	107kW (146PS)	
					TD19205

87-423400-00
87-423407-00

STD
0.50mm

08-423400-00
08-423407-00

STD
0.50mm

A 28.50
B- 0.35
BØ 76.50
D 51.00
 21x60

1.20 **CR P**
1.20 **P**
2.50 **CR**

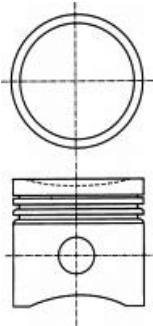

Steel

Stahl

Acier

Acero

Acciaio

9 100.00

Titan 3.2	02/84→	SL			
			4 Cyl.	18.1:1	
			3455cc	66-77kW (90-105PS)	
		Diesel			TD7869

87-111900-00

STD

08-111900-00





STD



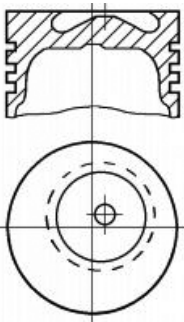

A 58.00
B- 21.30
BØ 29.00
D 105.00
 34x82





2.50 **CR P**
2.00 **CR P**
4.50 **CR P**





AK HA TP



		ccm	x 		9
M 102.910	Petrol	1797	4	89.00	27
M 102.919	Petrol	1797	4	89.00	27
M 102.920	Petrol	1997	4	89.00	28
M 102.921	Petrol	1997	4	89.00	28
M 102.922	Petrol	1997	4	89.00	28
M 102.924	Petrol	1997	4	89.00	28
M 102.938	Petrol	1997	4	89.00	27
M 102.939	Petrol	1997	4	89.00	27
M 102.961	Petrol	1997	4	89.00	28
M 102.962	Petrol	1997	4	89.00	28
M 102.963	Petrol	1997	4	89.00	28
M 102.964	Petrol	1997	4	89.00	27
M 102.965	Petrol	1996	4	89.00	27
M 102.979	Petrol	2299	4	95.50	45
M 102.980	Petrol	2299	4	95.50	46
M 102.981	Petrol	2299	4	95.50	45
M 102.982	Petrol	2299	4	95.50	45
M 102.985	Petrol	2299	4	95.50	45
M 102.987	Petrol	2299	4	95.50	45
M 103.940	Petrol	2599	6	82.90	5
M 103.941	Petrol	2599	6	82.90	5
M 103.942 (KAT)	Petrol	2599	6	82.90	5
M 103.943	Petrol	2599	6	82.90	5
M 103.980	Petrol	2962	6	88.50	26
M 103.981 (KAT)	Petrol	2962	6	88.50	26
M 103.982	Petrol	2962	6	88.50	26
M 103.983	Petrol	2962	6	88.50	26
M 103.984	Petrol	2962	6	88.50	26
M 103.985	Petrol	2962	6	88.50	26
M 103.987	Petrol	2962	6	88.50	26
M 104.900	Petrol	2792	VR6	81.00	3
M 104.941	Petrol	2799	6	89.90	34
M 104.942	Petrol	2799	6	89.90	34
M 104.943	Petrol	2799	6	89.90	34
M 104.944	Petrol	2799	6	89.90	34
M 104.945	Petrol	2799	6	89.90	34
M 104.990	Petrol	3199	6	89.90	35
M 104.991	Petrol	3199	6	89.90	35
M 104.992	Petrol	3199	6	89.90	35
M 104.994	Petrol	3199	6	89.90	35
M 104.995	Petrol	3199	6	89.90	35
M 104.996	Petrol	3199	6	89.90	35
M 110.921	Petrol	2746	6	86.00	12
M 110.922	Petrol	2746	6	86.00	12
M 110.923	Petrol	2746	6	86.00	12
M 110.924	Petrol	2746	6	86.00	12
M 110.926	Petrol	2746	6	86.00	12
M 110.981	Petrol	2746	6	86.00	12
M 110.982	Petrol	2746	6	86.00	12
M 110.983	Petrol	2746	6	86.00	12
M 110.984	Petrol	2746	6	86.00	12
M 110.985	Petrol	2746	6	86.00	12
M 110.986	Petrol	2746	6	86.00	12
M 110.987	Petrol	2746	6	86.00	12
M 110.988	Petrol	2746	6	86.00	12
M 110.989	Petrol	2746	6	86.00	12
M 110.990	Petrol	2746	6	86.00	12
M 111.960	Petrol	2199	4	89.90	36
M 111.961	Petrol	2199	4	89.90	36
M 111.970	Petrol	2295	4	90.90	38
M 111.973	Petrol	2295	4	90.90	39
M 111.974	Petrol	2295	4	90.90	38
M 111.975	Petrol	2295	4	90.90	39
M 111.977	Petrol	2295	4	90.90	40
M 111.978	Petrol	2295	4	90.90	39
M 111.979	Petrol	2295	4	90.90	39
M 111.980	Petrol	2295	4	90.90	40
M 111.981	Petrol	2295	4	90.90	39
M 111.982	Petrol	2295	4	90.90	39

		ccm	x 		9
M 111.983	Petrol	2295	4	90.90	39
M 111.984	Petrol	2295	4	90.90	38
M 112.940	Petrol	3199	V6	89.90	37
M 112.941	Petrol	3199	V6	89.90	37
M 112.942	Petrol	3199	V6	89.90	37
M 112.943	Petrol	3199	V6	89.90	37
M 112.944	Petrol	3199	V6	89.90	37
M 112.945	Petrol	3199	V6	89.90	37
M 112.946	Petrol	3199	V6	89.90	37
M 112.947	Petrol	3199	V6	89.90	37
M 112.949	Petrol	3199	V6	89.90	37
M 113.940	Petrol	4266	V8	89.90	37
M 113.941	Petrol	4266	V8	89.90	37
M 113.942	Petrol	4266	V8	89.90	37
M 113.943	Petrol	4266	V8	89.90	37
M 113.944	Petrol	4266	V8	89.90	37
M 160 E6AL B03	Petrol	599	3	63.50	1
M 160 E6AL B04	Petrol	599	3	63.50	1
M 160 E6AL B05	Petrol	599	3	63.50	1
M 271.948 M271 SE18	Petrol	1796	4	82.00	4
M 272.911	Petrol	2496	V6	88.00	18
M 272.920	Petrol	2496	V6	88.00	18
M 272.921	Petrol	2496	V6	88.00	18
M 272.922	Petrol	2496	V6	88.00	18
M 272.940	Petrol	2996	V6	88.00	18
M 272.941	Petrol	2996	V6	88.00	18
M 272.942	Petrol	2996	V6	88.00	18
M 272.943	Petrol	2996	V6	88.00	18
M 272.944	Petrol	2996	V6	88.00	18
M 272.945	Petrol	2996	V6	88.00	18
M 272.946	Petrol	2996	V6	88.00	18
M 272.947	Petrol	2996	V6	88.00	18
M 272.949	Petrol	2996	V6	88.00	18
M 272.952	Petrol	2996	V6	88.00	18
M 274.920	Petrol	1991	4	83.00	6
OM 601A.970 OM 601	Diesel	2299	4	89.00	30
OM 601.911	Diesel	1978	4	87.00	13
OM 601.912	Diesel	1978	4	87.00	13
OM 601.913	Diesel	1997	4	87.00	13
OM 601.915	Diesel	1997	4	87.00	13
OM 601.940 OM 601	Diesel	2299	4	89.00	29
OM 601.941 OM 601	Diesel	2299	4	89.00	29
OM 601.942 OM 601	Diesel	2299	4	89.00	29
OM 601.943 OM 601	Diesel	2299	4	89.00	29
OM 602A.962	Diesel	2497	5	87.00	14
OM 602A.993 OM 602	Diesel	2497	5	87.00	14
OM 602.911	Diesel	2497	5	87.00	13
OM 602.912	Diesel	2497	5	87.00	13
OM 602.930	Diesel	2497	5	87.00	13
OM 602.931	Diesel	2497	5	87.00	13
OM 602.938	Diesel	2497	5	87.00	13
OM 602.939	Diesel	2497	5	87.00	13
OM 602.940 OM 602	Diesel	2874	5	89.00	29
OM 602.942	Diesel	2874	5	89.00	29
OM 602.946	Diesel	2874	5	89.00	29
OM 602.947	Diesel	2874	5	89.00	29
OM 602.961	Diesel	2497	5	87.00	14
OM 602.980 OM 602 DE 29LA	Diesel	2874	5	89.00	31
OM 602.982	Diesel	2874	5	89.00	31
OM 602.983	Diesel	2874	5	89.00	31
OM 602.984 OM 602 LA	Diesel	2874	5	89.00	31
OM 602.985 OM 602 LA	Diesel	2874	5	89.00	31
OM 602.986	Diesel	2874	5	89.00	31
OM 602.991 OM 602	Diesel	2874	5	89.00	29
OM 602.995 OM 602	Diesel	2874	5	89.00	29
OM 603A.960	Diesel	2996	6	87.00	14
OM 603A.963	Diesel	2996	6	87.00	14
OM 603A.970	Diesel	3449	6	89.00	32
OM 603A.971	Diesel	3449	6	89.00	30

		ccm	x 		9
OM 603A.972	Diesel	3449	6	89.00	30
OM 603.912	Diesel	2996	6	87.00	13
OM 603.913	Diesel	2996	6	87.00	13
OM 603.931	Diesel	2996	6	87.00	13
OM 603.950	Diesel	2996	6	87.00	15
OM 603.961	Diesel	2996	6	87.00	14
OM 603.962	Diesel	2996	6	87.00	15
OM 604.910	Diesel	2155	4	89.00	33
OM 604.912	Diesel	2155	4	89.00	33
OM 604.915	Diesel	1997	4	87.00	16
OM 604.917	Diesel	1997	4	87.00	16
OM 605.910	Diesel	2497	5	87.00	16
OM 605.911	Diesel	2497	5	87.00	16
OM 605.912	Diesel	2497	5	87.00	16
OM 605.960	Diesel	2497	5	87.00	15
OM 605.962	Diesel	2497	5	87.00	15
OM 606.910	Diesel	2996	6	87.00	16
OM 606.912	Diesel	2996	6	87.00	16
OM 606.961	Diesel	2996	6	87.00	15
OM 606.962	Diesel	2996	6	87.00	15
OM 606.964	Diesel	2996	6	87.00	15
OM 611A (60 KW CDI)	Diesel	2148	4	88.00	23
OM 611LA (75 KW CDI)	Diesel	2148	4	88.00	20
OM 611.960	Diesel	2148	4	88.00	19
OM 611.961	Diesel	2148	4	88.00	20
OM 611.962	Diesel	2148	4	88.00	21
OM 611.980 Euro 3 OM 611LA (90 KW CDI)	Diesel	2148	4	88.00	20
OM 611.987 Euro 3	Diesel	2148	4	88.00	21
OM 612.961	Diesel	2688	5	88.00	21
OM 612.962	Diesel	2685	5	88.00	21
OM 612.963	Diesel	2685	5	88.00	21
OM 612.966	Diesel	2685	5	88.00	21
OM 612.967	Diesel	2685	5	88.00	21
OM 612.981	Diesel	2685	5	88.00	21
OM 613.960	Diesel	3222	6	88.00	22
OM 613.961	Diesel	3226	6	88.00	22
OM 615.940	Diesel	1988	4	87.00	17
OM 616.910 OM 616	Diesel	2399	4	90.90	41
OM 616.912	Diesel	2404	4	91.00	43
OM 616.913 OM 616	Diesel	2399	4	90.90	41
OM 616.914 OM 616	Diesel	2399	4	90.90	41
OM 616.916	Diesel	2404	4	91.00	44
OM 616.917 OM 616	Diesel	2404	4	91.00	43
OM 616.918 OM 616	Diesel	2399	4	91.00	42
OM 616.919 OM 616	Diesel	2399	4	91.00	42
OM 616.930 OM 616	Diesel	2399	4	90.90	41
OM 616.933 OM 616	Diesel	2404	4	91.00	42
OM 616.934 OM 616	Diesel	2399	4	90.90	41
OM 616.936	Diesel	2399	4	90.90	41
OM 616.937 OM 616	Diesel	2399	4	90.90	41
OM 616.938	Diesel	2399	4	90.90	41
OM 616.939 OM 616	Diesel	2399	4	90.90	41
OM 616.940 OM 616	Diesel	2399	4	90.90	41
OM 616.944 OM 616	Diesel	2399	4	91.00	42
OM 616.960 OM 616	Diesel	2399	4	91.00	42
OM 616.961 OM 616	Diesel	2399	4	91.00	42
OM 616.962 OM 616	Diesel	2399	4	91.00	42
OM 616.963 OM 616	Diesel	2399	4	90.90	41
OM 617.910	Diesel	2998	5	91.00	44
OM 617.912	Diesel	2998	5	91.00	43
OM 617.913 OM 617	Diesel	2998	5	90.90	41
OM 617.919 OM 617	Diesel	2998	5	91.00	42
OM 617.931	Diesel	2998	5	90.90	41
OM 617.932	Diesel	2998	5	90.90	41
OM 617.933	Diesel	2998	5	91.00	42
OM 617.950	Diesel	2998	5	91.00	42
OM 617.951	Diesel	2998	5	91.00	42
OM 617.952	Diesel	2998	5	91.00	42
OM 639.939 Euro 4	Diesel	1493	3	83.00	7



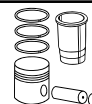
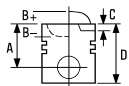

		ccm	x 		9
OM 640.940	Diesel	1991	4	83.00	7
OM 640.941	Diesel	1991	4	83.00	7
OM 640.942	Diesel	1991	4	83.00	7
OM 642.838	Diesel	2987	V6	83.00	8
OM 642.853	Diesel	2987	V6	83.00	8
OM 642.854 OM 642 LS DE 30 LA	Diesel	2987	V6	83.00	8
OM 642.858	Diesel	2987	V6	83.00	8
OM 642.862	Diesel	2987	V6	83.00	8
OM 642.868	Diesel	2987	V6	83.00	8
OM 642.872	Diesel	2987	V6	83.00	8
OM 642.910	Diesel	2987	6	83.00	9
OM 642.920 OM 642 D 30	Diesel	2987	V6	83.00	9
OM 642.921	Diesel	2987	V6	83.00	9
OM 642.930	Diesel	2987	V6	83.00	9
OM 642.932	Diesel	2987	V6	83.00	9
OM 642.940	Diesel	2987	V6	83.00	9
OM 642.950	Diesel	2987	V6	83.00	9
OM 642.960	Diesel	2987	V6	83.00	9
OM 642.961	Diesel	2987	V6	83.00	9
OM 642.970	Diesel	2987	V6	83.00	9
OM 642.975	Diesel	2987	V6	83.00	9
OM 642.990	Diesel	2987	V6	83.00	9
OM 642.992	Diesel	2987	V6	83.00	9
OM 642.993	Diesel	2987	V6	83.00	9
OM 646.951	Diesel	2148	4	88.00	24
OM 646.961	Diesel	2148	4	88.00	24
OM 646.962	Diesel	2148	4	88.00	24
OM 646.963	Diesel	2148	4	88.00	24
OM 646.966	Diesel	2148	4	88.00	24
OM 646.980	Diesel	2148	4	88.00	24
OM 646.981	Diesel	2148	4	88.00	24
OM 646.982 Euro 4	Diesel	2148	4	88.00	24
OM 646.983	Diesel	2148	4	88.00	24
OM 646.984	Diesel	2148	4	88.00	24
OM 646.985	Diesel	2148	4	88.00	24
OM 646.986 Euro 4	Diesel	2148	4	88.00	25
OM 646.989	Diesel	2148	4	88.00	24
OM 646.990	Diesel	2148	4	88.00	24
OM 647.961	Diesel	2685	5	88.00	24
OM 647.981	Diesel	2685	5	88.00	24
OM 648.960	Diesel	3222	6	88.00	24
OM 648.961	Diesel	3222	6	88.00	24
OM 651.911	Diesel	2143	4	83.00	10
OM 651.912	Diesel	2143	4	83.00	10
OM 651.913	Diesel	2143	4	83.00	11
OM 651.916	Diesel	2143	4	83.00	11
OM 651.924	Diesel	2143	4	83.00	10
OM 651.925	Diesel	2143	4	83.00	11
OM 651.930	Diesel	2143	4	83.00	11
OM 651.940	Diesel	2143	4	83.00	11
OM 651.955	Diesel	2143	4	83.00	11
OM 651.956	Diesel	2143	4	83.00	11
OM 651.957	Diesel	2143	4	83.00	11
OM 651.960	Diesel	2143	4	83.00	10
OM 651.961	Diesel	2143	4	83.00	10
OM 651.980	Diesel	2143	4	83.00	10
OM 660.950	Diesel	799	3	65.50	2
OM 661.911	Diesel	2299	4	89.00	29
OM 661.940	Diesel	2299	4	89.00	29
OM 662.911	Diesel	2874	5	89.00	29



1 63.50

Smart 600	07/98 →	M 160 E6AL B03	3 Cyl.	9.5:1	
			599cc	40kW (55PS)	
			Turbo Intercooled		TD9520
Smart 600	07/98 →	M 160 E6AL B04	3 Cyl.	9.5:1	
			599cc	33kW (45PS)	
					TD16490
Smart 600	07/98 →	M 160 E6AL B05	3 Cyl.	9.5:1	
			599cc	45kW (61PS)	
					TD16491

87-136700-00	STD	08-136700-00	STD
87-136705-00	0.25mm	08-136705-00	0.25mm
87-136707-00	0.50mm	08-136707-00	0.50mm

A	27.00	1.20	 CR 1
B-	2.75	1.50	 P
BØ	50.00	2.50	 CR 1
D	43.50		
	16x48		

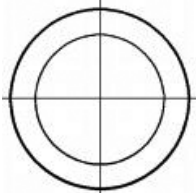
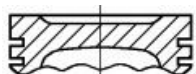

 Steel

 Stahl

 Acier

 Acero





 Acciaio



2 65.50

Fortwo 800 CDI 04/07 → **OM 660.950**
 3 Cyl. 18:1
799cc **33kW (45PS)**
Diesel **Turbo Intercooled** **TD23765**

87-140600-00 STD **08-140600-00** STD

A	36.00	1.50		CK P
B-	11.10	1.50		P
BØ	38.70	2.50		CR P
C	0.95			
C	0.95			
D	60.00			
	23x53			



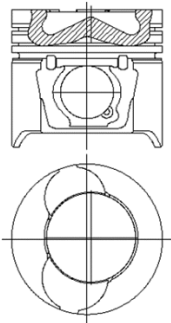

RT



3 81.00

V-Class (638/2) V 280 08/97 → 07/03 **M 104.900**
 VR6 Cyl. 10.1:1
2792cc **128kW (174PS)**
TD8023

87-501900-00 STD **08-501900-00** STD
87-501907-00 0.50mm **08-501907-00** 0.50mm

A	30.52	1.50		P PS
B+	4.26	1.75		P
BØ	57.00	3.00		CR P
C	6.22			
D	55.78			
	20x57			

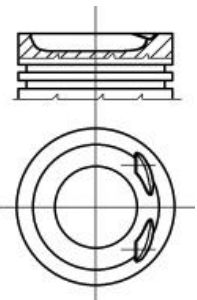

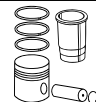
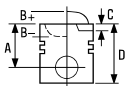

4 82.00

C-Class (CL203) C 230 Kompressor	05/02→05/08	M 271.948 M271 SE18		
C-Class (W203) C 230 Kompressor	02/04→02/07	4 Cyl.	10.5:1	
C-Class T-Model (S203) C 230 Kompressor	02/04→08/07	1796cc	141kW (192PS)	
Supercharged				TD17434



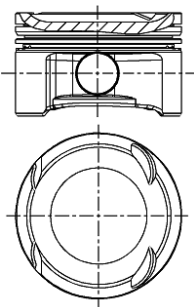

87-427600-10

A	29.90
B-	4.61
BØ	71.20
C	1.00
C	4.00
D	50.90
	20x56



 Steel

08-427600-10

1.20		NT 
1.50		P
2.50		NT 

 Stahl

 Acier

 Acero



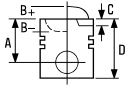

 Acciaio



5 82.90

Kombi (S124) 260 TE FGST.	09/85→08/92	M 103.940	6 Cyl.	8:1	
Saloon (W124) 260 E			2599cc	118-122kW (160-166PS)	
Saloon (W124) 260 E 4-matic	12/86→12/89				TD9435
S-Class (W126) 260 SE	09/85→06/91	M 103.941	6 Cyl.	9.2:1	
			2599cc	118-122kW (160-166PS)	
					TD2096
190 (W201) 2.6	10/82→09/88	M 103.942 (KAT)	6 Cyl.	9.2:1	
190 (W201) E 2.6	09/86→08/93		2599cc	118-122kW (160-166PS)	
					TD2097
Saloon (W124) 260 E 4-matic	09/86→08/92	M 103.943	6 Cyl.	9/9.2:1	
			2599cc	118kW (160PS)	
					TD2098

87-183100-00	STD	08-183100-00	STD
87-183107-00	0.50mm	08-183107-00	0.50mm
87-183111-00	1.00mm	08-183111-00	1.00mm

A	33.00	1.50		CK P
B-	1.00	1.75		P
BØ	52.38	3.00		CR P
D	65.00			
	22x52			

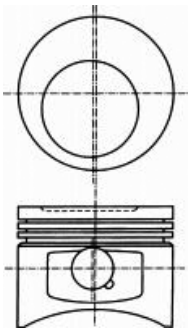

08316

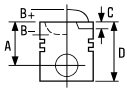

6 83.00

Model	Year	Part No.	Specs	Code
C-Class (C205) C 200		M 274.920	4 Cyl. 9.8:1	
C-Class (C205) C 250			1991cc 115-180kW (156-245PS)	
C-Class (C205) C 300	10/15→		Turbo Intercooled	TD28178
C-Class (W205) C 200				
C-Class (W205) C 200 4-matic	04/15→			
C-Class (W205) C 250	03/14→			
C-Class (W205) C 300	09/15→			
C-Class (W205) C 300 4-matic	12/13→			
C-Class (W205) C 350 e	02/15→			
C-Class T-model (S204) C 250	03/14→08/14			
C-Class T-Model (S205) C 200				
C-Class T-Model (S205) C 200 4-matic	04/15→			
C-Class T-Model (S205) C 250	09/14→			
C-Class T-Model (S205) C 300	09/15→			
C-Class T-Model (S205) C 350 e	02/15→			
CLS (C218) CLS 260	01/15→			
E-Class (A207) E 200	03/13→			
E-Class (A207) E 250	06/13→			
E-Class (C207) E 200				
E-Class (C207) E 250				
E-Class (W212) E 200, E-Class (W212) E 250	01/13→			
E-Class (W212) E 200 NGT	07/13→			
E-Class (W213) E 200	01/16→			
E-Class T-Model (S212) E 200	11/12→			
E-Class T-Model (S212) E 250				
GLC (X253) 250 4-matic	06/15→			
GLC (X253) 300	01/16→			
GLC (X253) 300 4-matic	07/15→			
GLC (X253) 350 e 4-matic	01/16→			
GLK-Class (X204) 200				
GLK-Class (X204) 250	08/13→			
GLK-Class (X204) 250 4-matic				
SLC (R172) 200, SLC (R172) 300	01/16→			
SLK (R172) 200	04/15→			
SLK (R172) 300	07/15→			
Vito (W447) 2.0, Vito Tourer (W447) 2.0	09/15→			

87-440500-00  STD

- A 33.80
- B- 7.20
- BØ 75.00
- C 1.78
- C 1.63
- D 51.10
-  20x54

KK

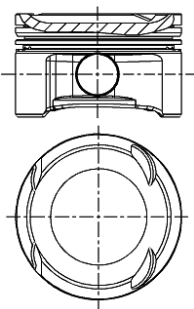

 Elastothermic ®

 Steel

 Elastothermic ®

 Stahl

 Elastothermic ®

 Acier

 Elastothermic ®

 Acero

 Elastothermic ®

 Acciaio





7 83.00

Forfour 1.5 CDI	03/04→	OM 639.939 Euro 4	3 Cyl.	18:1	
			1493cc	50-70kW (58-95PS)	
		Diesel	Turbo Intercooled		TD23799
A-Class (W169) A 180 CDI	09/04→06/12	OM 640.940	4 Cyl.	18:1	
B-Class (W245) B 180 CDI	03/05→11/11		1991cc	80kW (109PS)	
		Diesel	Turbo Intercooled		TD18151
A-Class (W169) A 200 CDI	09/04→06/12	OM 640.941	4 Cyl.	18:1	
B-Class (W245) B 200 CDI	03/05→11/11		1991cc	100-103kW (136-140PS)	
		Diesel	Turbo Intercooled		TD18152
A-Class (W169) A 160 CDI	09/04→06/12	OM 640.942	4 Cyl.	18:1	
			1991cc	60kW (82PS)	
		Diesel	Turbo Intercooled		TD18153

87-427500-00 STD 08-427500-00 STD
 87-427507-00 0.50mm 08-427507-00 0.50mm

A 45.65
 B- 14.65
 BØ 43.40
 C 1.18
 C 1.02
 D 71.65
 30x66

2.00  CK
 2.00  P
 2.00  CR P



AK KK RT

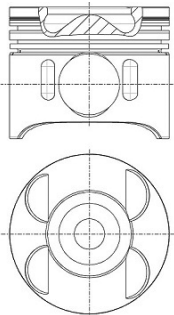

8340A

8 83.00

E-Class (A207) E 350 BlueTEC	06/13→	OM 642.838	V6 Cyl.	15.5:1	
E-Class (A207) E 350 BlueTEC/d	05/14→		2987cc	185-195kW (252-265PS)	
E-Class (A207) E 350 CDI	04/11→				
E-Class (C207) E 350 BlueTEC	03/13→	Diesel	Turbo Intercooled		TD26599
E-Class (C207) E 350 BlueTEC/d	05/14→				
E-Class (C207) E 350 CDI	04/11→				
CLS (C218) CLS 350 BlueTEC/d	06/14→	OM 642.853	V6 Cyl.	15.5:1	
CLS (C218) CLS 350 CDI	01/11→		2987cc	190-195kW (258-265PS)	
CLS Shooting Brake (X218) CLS 350 BlueTEC/d	05/14→				
CLS Shooting Brake (X218) CLS 350 CDI	10/12→	Diesel	Turbo Intercooled		TD26065
CLS (C218) CLS 350 CDI 4-matic	09/11→	OM 642.854 OM 642 LS DE 30 LA	V6 Cyl.	15.5:1	
CLS (C218) CLS 350 d 4-matic	04/15→		2987cc	190-195kW (258-265PS)	
CLS Shooting Brake (X218) CLS 350 CDI 4-matic	10/12→				
CLS Shooting Brake (X218) CLS 350 d 4-matic	04/15→	Diesel	Turbo Intercooled		TD26045



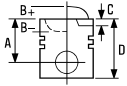

CLS (C218) CLS 350 BlueTEC 4-matic	11/12→	OM 642.858			
CLS (C218) CLS 350 d 4-matic	04/15→		V6 Cyl.	15.5:1	
CLS Shooting Brake (X218)	05/14→		2987cc	185-195kW (252-265PS)	
CLS 350 BlueTEC 4-matic		Diesel	Turbo Intercooled		TD23791
CLS Shooting Brake (X218) CLS 350 d 4-matic	04/15→				
E-Class (W212) E 350 BlueTEC 4-matic	11/12→				
E-Class (W212) E 350 CDI 4-matic	03/11→				
E-Class T-Model (S212) E 350 BlueTEC 4-matic	11/12→				
E-Class T-Model (S212) E 350 CDI 4-matic	07/11→				
S-Class (W221) S 350 BlueTec	04/11→12/13	OM 642.862			
			V6 Cyl.	15.5:1	
			2987cc	190kW (258PS)	
		Diesel	Turbo Intercooled		TD26082
S-Class (W221) S 350 BlueTEC 4-matic	04/11→12/13	OM 642.868			
			V6 Cyl.	15.5:1	
			2987cc	190kW (258PS)	
		Diesel	Turbo Intercooled		TD25099
R-Class (W251; V251) R 280 CDI	05/06→	OM 642.872			
R-Class (W251; V251) R 300 CDI	07/09→		V6 Cyl.	15.5:1	
R-Class (W251; V251) R 350 CDI 4-matic	08/10→		2987cc	140-195kW (190-265PS)	
		Diesel	Turbo Intercooled		TD25098

87-427400-20 STD

A 45.65
 B- 15.51
 BØ 47.10
 C 1.49
 C 1.33
 D 71.65
 30x65

08-427400-00 STD
 08-427407-00 0.50mm

2.00 CK P
 2.00 P
 2.00 CR P



AK KK NB RT TP

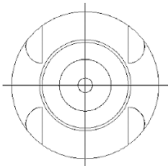
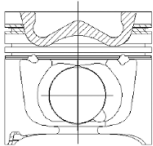

8370B110

DuraBowl®





87-427400-30 ② STD

A 45.65
 B- 15.51
 BØ 47.10
 C 1.49
 C 1.33
 D 71.65
 30x65

AK KK NB RT TP

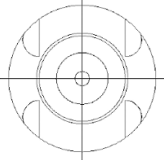
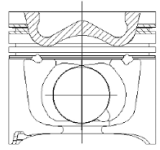

8370B210

DuraBowl®

① To cylinder 1 - 3
 ② To cylinder 4 - 6

① zum Zylinder 1 - 3
 ② zum Zylinder 4 - 6

08-427400-00 STD
 08-427407-00 0.50mm

2.00 CK P
 2.00 P
 2.00 CR P



① sous cylindre 1 - 3
 ② sous cylindre 4 - 6

① A cilindro 1 - 3
 ② A cilindro 4 - 6

① al cilindro 1 - 3
 ② al cilindro 4 - 6

9 83.00

C-Class (W203) C 320 CDI	01/05→02/07	OM 642.910			
C-Class T-Model (S203) C 320 CDI	06/05→08/07		6 Cyl.	17.7:1	
CLK (A209) CLK 320 CDI	03/05→03/10		2987cc	165kW (224PS)	
CLK (C209) 320 CDI	01/05→05/09	Diesel	Turbo Intercooled		TD18416
E-Class (W211) E 320 CDI 4-matic	03/05→12/08				
CLS (C219) CLS 320 CDI	01/05→12/10	OM 642.920 OM 642 D 30			
CLS (C219) CLS 350 CDI	04/09→12/10		V6 Cyl.	18:1	
E-Class (W211) E 280 CDI			2987cc	140-200kW (190-272PS)	
E-Class (W211) E 300 BlueTEC	09/07→12/08	Diesel	Turbo Intercooled		TD18431
E-Class (W211) E 320 Bluetec	09/08→03/09				
E-Class (W211) E 320 CDI	03/05→12/08				
E-Class (W211) E320 CDI	09/06→12/08				
E-Class T-Model (S211) E 280 T CDI					
E-Class T-Model (S211) E 320 T CDI					
E-Class T-Model (S211) E 320 T CDI 4-matic	03/05→07/09				
E-Class (W211) E 280 CDI 4-matic	03/05→12/08	OM 642.921			
E-Class T-Model (S211) E 280 T CDI 4-matic	03/05→07/09		V6 Cyl.	18:1	
			2987cc	140kW (190PS)	
		Diesel	Turbo Intercooled		TD18428
S-Class (W221) S 320 CDI	10/05→12/13	OM 642.930			
S-Class (W221) S 350 CDI	06/09→12/13		V6 Cyl.	17.7:1	
			2987cc	155-173kW (211-235PS)	
		Diesel	Turbo Intercooled		TD19213
S-Class (W221) S 320 CDI 4-matic	10/05→12/13	OM 642.932			
			V6 Cyl.	17.7:1	
			2987cc	155-173kW (211-235PS)	
		Diesel	Turbo Intercooled		TD23761



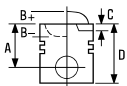

GL-CLASS (X164) GL 320 CDI 4-matic	09/06→12/09	OM 642.940			
GL-CLASS (X164) GL 350 CDI 4-matic	05/09→		V6 Cyl.	18:1	
M-Class (W164) ML 280 CDI 4-matic			2987cc	140-170kW (190-231PS)	
M-Class (W164) ML 300 CDI 4-matic		Diesel	Turbo Intercooled		TD18197
M-Class (W164) ML 320 CDI 4-matic	07/05→07/09				
M-Class (W164) ML 350 CDI 4-matic	07/09→				
M-Class (W166) ML 350 CDI 4-matic	06/11→				
R-Class (W251; V251) R 280 CDI		OM 642.950			
R-Class (W251; V251) R 280 CDI 4-matic	05/06→		V6 Cyl.	17.7:1	
R-Class (W251; V251) R 300 CDI			2987cc	140-165kW (190-224PS)	
R-Class (W251; V251) R 300 CDI 4-matic	07/09→	Diesel	Turbo Intercooled		TD19206
R-Class (W251; V251) R 320 CDI 4-matic					
R-Class (W251; V251) R 350 CDI 4-matic	01/06→				
C-Class (W204) C 320 CDI	01/07→01/14	OM 642.960			
C-Class (W204) C 350 CDI	07/09→01/14		V6 Cyl.	17.7:1	
C-Class T-Model (S204) C 320 CDI	08/07→08/14		2987cc	165kW (224PS)	
		Diesel	Turbo Intercooled		TD20361
C-Class (W204) C 320 CDI 4-matic	07/07→01/14	OM 642.961			
C-Class (W204) C 350 CDI 4-matic	07/09→01/14		V6 Cyl.	17.7:1	
C-Class T-Model (S204) C 320 CDI 4-matic	08/07→08/14		2987cc	165kW (224PS)	
GLK-Class (X204) 320 CDI 4-matic	06/08→	Diesel	Turbo Intercooled		TD20986
G-Class (W463) G 320 CDI	09/06→	OM 642.970			
			V6 Cyl.	18:1	
			2987cc	165kW (224PS)	
		Diesel	Turbo Intercooled		TD20729
G-Class (W463) G 320 CDI	09/06→	OM 642.975			
			V6 Cyl.	18:1	
			2987cc	150kW (204PS)	
		Diesel	Turbo Intercooled		TD28790
Viano (W639) CDI 3.0	03/06→	OM 642.990			
Vito (W639) 120 CDI	07/06→		V6 Cyl.	18:1	
Vito/Mixto (W639) 120 CDI			2987cc	150-165kW (204-224PS)	
		Diesel	Turbo Intercooled		TD22148
Sprinter 3-t (906) 218 CDI	06/06→	OM 642.992			
Sprinter 3-t (906) 219 CDI/BlueTEC	03/09→		V6 Cyl.	18:1	
Sprinter 3.5-t (906) 318 CDI	06/06→		2987cc	135-140kW (184-190PS)	
Sprinter 3.5-t (906) 319 CDI/BlueTEC	03/09→	Diesel	Turbo Intercooled		TD22149
Sprinter 4.6-t (906) 418 CDI	06/06→				
Sprinter 4.6-t (906) 419 CDI	03/09→				
Sprinter 5-t (906) 518 CDI	06/06→				
Sprinter 5-t (906) 519 CDI/BlueTEC	03/09→				
Sprinter 5-t 519 CDI/BlueTEC					



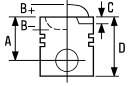

Sprinter 3-t (906) 218 CDI	06/06→	OM 642.993		
Sprinter 3.5-t (906) 318 CDI	06/06→		V6 Cyl.	18:1
Sprinter 4.6-t (906) 418 CDI			2987cc	135kW (184PS)
Sprinter 5-t (906) 518 CDI		Diesel	Turbo Intercooled	TD25661

87-427400-00	STD	08-427400-00	STD
87-427407-00	0.50mm	08-427407-00	0.50mm

A	45.65	2.00		CK P
B-	14.65	2.00		P
BØ	43.40	2.00		CR P
C	1.49			
C	1.33			
D	71.65			
	30x65			



AK KK RT

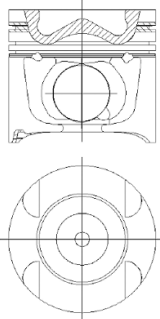

08340F111

87-427400-10	STD	08-427400-00	STD
87-427407-10	0.50mm	08-427407-00	0.50mm

A	45.65	2.00		CK P
B-	14.65	2.00		P
BØ	43.40	2.00		CR P
C	1.49			
C	1.33			
D	71.65			
	30x65			



AK KK RT

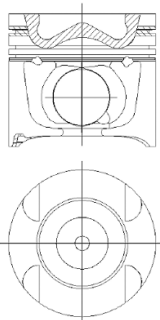

08340F211

To cylinder 1 - 3

To cylinder 4 - 6

zum Zylinder 1 - 3

zum Zylinder 4 - 6

sous cylindre 1 - 3

sous cylindre 4 - 6

A cilindro 1 - 3

A cilindro 4 - 6

al cilindro 1 - 3

al cilindro 4 - 6



10  **83.00**

C-Class (C204) C 220 CDI		OM 651.911		
C-Class (C204) C 250 CDI	06/11→		4 Cyl.	16.2:1
C-Class (W204) C 220 CDI	10/08→01/14		2143cc	120-150kW (163-204PS)
C-Class (W204) C 250 CDI	08/08→01/14	Diesel	Turbo Intercooled	TD23727
C-Class T-Model (S204) C 220 CDI	12/08→08/14			
C-Class T-Model (S204) C 250 CDI	01/09→08/14			
E-Class (A207) E 220 BlueTEC	05/14→			
E-Class (A207) E 220 CDI	02/10→			
E-Class (A207) E 220 CDI/BlueTEC/d,	01/10→			
E-Class (A207) E 250 CDI/BlueTEC/d				
E-Class (C207) E 220 BlueTEC	05/14→			
E-Class (C207) E 220 CDI	07/14→			
E-Class (C207) E 220 CDI/d	01/10→			
E-Class (C207) E 250 CDI/d	01/09→			
C-Class (W204) C 220 CDI 4-matic	02/13→01/14	OM 651.912		
C-Class (W204) C 250 CDI 4-matic	01/11→01/14		4 Cyl.	16.2:1
C-Class T-Model (S204) C 220 CDI 4-matic	02/13→08/14		2143cc	120-150kW (163-204PS)
C-Class T-Model (S204) C 250 CDI 4-matic	04/10→08/14	Diesel	Turbo Intercooled	TD23754
GLK-Class (X204) 220 CDI 4-matic	12/08→			
GLK-Class (X204) 250 CDI 4-matic	09/09→			
CLS (C218) CLS 220 BlueTEC		OM 651.924		
CLS (C218) CLS 220 BlueTEC/d	05/14→		4 Cyl.	16.2:1
CLS (C218) CLS 250 BlueTEC/d 4-matic	05/14→		2143cc	120-150kW (163-204PS)
CLS (C218) CLS 250 CDI/BlueTEC/d	04/11→	Diesel	Turbo Intercooled	TD23782
CLS Shooting Brake (X218) CLS 220 BlueTEC	05/14→			
CLS Shooting Brake (X218) CLS 220 BlueTEC/d, CLS Shooting Brake (X218)				
CLS 250 BlueTEC/d 4-matic				
CLS Shooting Brake (X218)	10/12→			
CLS 250 CDI/BlueTEC/d				
E-Class (W212) E 220 BlueTEC	05/14→			
E-Class (W212) E 220 BlueTEC 4-matic	01/15→			
E-Class (W212) E 220 CDI				
E-Class (W212) E 220 CDI/BlueTEC	01/09→			
E-Class (W212) E 250 CDI/BlueTEC				
E-Class (W212) E 250 CDI/BlueTEC 4-matic				
E-Class (W212) E 300 Hybrid/BlueTEC Hybrid	12/11→			
E-Class T-Model (S212) E 220 BlueTEC	05/15→			
E-Class T-Model (S212) E 220 BlueTEC 4-matic	12/14→			
E-Class T-Model (S212) E 220 CDI	08/09→			
E-Class T-Model (S212) E 220 CDI/BlueTEC	11/09→			
E-Class T-Model (S212) E 250 CDI/BlueTEC				
E-Class T-Model (S212) E 250 CDI/BlueTEC 4-matic	07/10→			
E-Class T-Model (S212) E 300 Hybrid/BlueTEC Hybrid	12/11→			
GLE (W166) 250 d, GLE (W166) 250 d 4-matic	04/15→	OM 651.960		
M-Class (W166) ML 250 CDI/BlueTEC 4-matic	06/11→		4 Cyl.	16.2:1
			2143cc	150kW (204PS)
		Diesel	Turbo Intercooled	TD26549
S-Class (W221) S 250 CDI	01/11→12/13	OM 651.961		
			4 Cyl.	16.2:1
			2143cc	150kW (204PS)
		Diesel	Turbo Intercooled	TD25277





SLC (R172) 250 D	01/16→	OM 651.980		
SLK (R172) 250 CDI/d	01/12→		4 Cyl.	16.2:1
			2143cc	150kW (204PS)
		Diesel	Turbo Intercooled	TD26369

87-433400-10	STD	08-433400-00	STD
87-433407-10	0.50mm	08-433405-00	0.25mm
		08-433407-00	0.50mm

- A** 48.50
- B-** 13.25
- B** 4.00
- BØ** 49.40
- C** 1.55
- D** 75.50
- 30x66

2.00		GDC P
1.75		P
2.00		CR P



AK KK NB RT TP

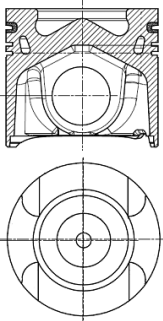

Piston Chamber Volume
[ccm] 25.520

Volumen der Kolbenmulde
[ccm] 25.520

Volume de la cavité du piston
[cm³] 25.520

Volumen de cavidad del pistón
[cc] 25.520

Volume camera pistone
[cm³] 25.520

11 83.00

C-Class (W204) C 180 CDI		OM 651.913		
C-Class (W204) C 200 CDI	01/11→01/14		4 Cyl.	16.2:1
C-Class T-Model (S204) C 180 CDI	01/11→08/14		2143cc	88-105kW (120-143PS)
C-Class T-Model (S204) C 200 CDI	08/10→08/14	Diesel	Turbo Intercooled	TD24407
GLK-Class (X204) 200 CDI	07/10→			
GLK-Class (X204) 200 CDI	07/10→	OM 651.916		
GLK-Class (X204) 220 CDI	12/08→		4 Cyl.	16.2:1
			2143cc	100-125kW (136-170PS)
		Diesel	Turbo Intercooled	TD23755
E-Class (W212) E 200 CDI/BlueTEC	01/09→	OM 651.925		
E-Class T-Model (S212) E 200 CDI/BlueTEC	11/09→		4 Cyl.	16.2:1
			2143cc	100kW (136PS)
		Diesel	Turbo Intercooled	TD23783
A220 CDI	09/12→	OM 651.930		
			4 Cyl.	16.2:1
			2143cc	
		Diesel	Turbo Intercooled	TD26817



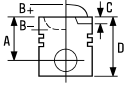

Viano (W639) CDI 2.0		OM 651.940		
Viano (W639) CDI 2.0 4-matic			4 Cyl.	16.2:1
Viano (W639) CDI 2.2			2143cc	70-120kW (95-163PS)
Viano (W639) CDI 2.2 4-matic	07/10→	Diesel	Turbo Intercooled	TD25280
Vito (W639) 110 CDI				
Vito (W639) 113 CDI				
Vito (W639) 116 CDI	09/10→			
Vito/Mixto (W639) 110 CDI				
Vito/Mixto (W639) 113 CDI				
Vito/Mixto (W639) 116 CDI				

Sprinter 3-t (906) 210 CDI		OM 651.955		
Sprinter 3-t (906) 213 CDI	06/06→		4 Cyl.	16.2:1
Sprinter 3-t (906) 216 CDI	03/09→		2143cc	70-120kW (95-163PS)
Sprinter 3.5-t (906) 310 CDI		Diesel	Turbo Intercooled	TD24545
Sprinter 3.5-t (906) 313 CDI	06/06→			
Sprinter 3.5-t (906) 316 CDI	03/09→			
Sprinter 4.6-t (906) 413 CDI	06/06→			
Sprinter 5-t (906) 510 CDI	03/09→			
Sprinter 5-t (906) 513 CDI	06/06→			
Sprinter 5-t (906) 513 CDI,	05/11→			
Sprinter 5-t (906) 516 CDI				
Sprinter 5-t (906) 516 CDI				

Sprinter 3-t (906) 213 CDI	06/06→	OM 651.956		
Sprinter 3.5-t (906) 310 CDI	03/09→		4 Cyl.	16.2:1
Sprinter 3.5-t (906) 313 CDI	06/06→		2143cc	70-95kW (95-129PS)
Sprinter 4.6-t (906) 413 CDI	06/06→	Diesel	Turbo Intercooled	TD25279
Sprinter 5-t (906) 513 CDI				
Sprinter 5-t 513 CDI				

Sprinter 3-t (906) 216 CDI	06/06→	OM 651.957		
Sprinter 3.5-t (906) 316 CDI	03/09→		4 Cyl.	16.2:1
Sprinter 4;6-t 415 Cdi	06/06→		2143cc	120kW (163PS)
Sprinter 4.6-t (906) 416 CDI		Diesel	Turbo Intercooled	TD24544
Sprinter 5-t (906) 516 CDI				
Sprinter 5-t 515 CDI	06/06→			
Sprinter 5-t 516 CDI	03/09→			

87-433400-00	STD	08-433400-00	STD
87-433405-00	0.25mm	08-433405-00	0.25mm
87-433407-00	0.50mm	08-433407-00	0.50mm

A	48.50	2.00		GDC P
B-	13.25	1.75		P
BØ	49.40	2.00		CR P

D 75.50
 30x66



AK KK RT

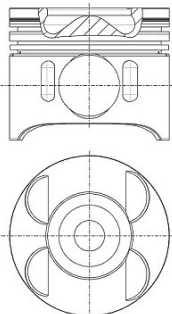

08349P202

→ 120kW

→ 120kW

→ 120kW

→ 120kW

→ 120kW

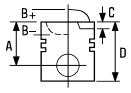

12  **86.00**

/8 (W114) 280 /8 (W114) 280 C	06/72→11/76 06/72→02/77	M 110.921	6 Cyl. 2746cc	8.7/9:1 118kW (160PS)	TD2115
S-Class (W116) 280 S	08/72→07/80	M 110.922	6 Cyl. 2746cc	8.7/9:1 115-118kW (156-160PS)	TD2116
Coupe (C123) 280 C Saloon (W123) 280	03/77→03/80 02/76→08/81	M 110.923	6 Cyl. 2746cc	8.7/9:1 115kW (156PS)	TD2117
S-Class (W126) 280 S	12/79→07/85	M 110.924	6 Cyl. 2746cc	8.7/9:1 115kW (156PS)	TD2118
S-Class (W126) 280 S	12/79→07/85	M 110.926	6 Cyl. 2746cc	8.7/9:1 115kW (156PS)	TD2119
/8 (W114) 280 CE /8 (W114) 280 E	06/72→01/77 06/72→11/76	M 110.981	6 Cyl. 2746cc	9:1 136kW (185PS)	TD2120
SL (C107) 280 SLC SL (R107) 280 SL	08/74→09/81 08/74→07/85	M 110.982	6 Cyl. 2746cc	9:1 130-136kW (177-185PS)	TD2121
S-Class (W116) 280 SE;SEL	08/72→07/80	M 110.983	6 Cyl. 2746cc	9:1 130-136kW (177-185PS)	TD2122
Saloon (W123) 280 E	02/76→11/85	M 110.984	6 Cyl. 2746cc	9:1 136kW (185PS)	TD4659
S-Class (W116) 280 SE;SEL	08/72→07/80	M 110.985	6 Cyl. 2746cc	9:1 101-136kW (137-185PS)	TD2124
SL (C107) 280 SLC SL (R107) 280 SL	08/74→09/81 08/74→07/85	M 110.986	6 Cyl. 2746cc	9:1 130-136kW (177-185PS)	TD2125
S-Class (W126) 280 SE;SEL	10/79→07/85	M 110.987	6 Cyl. 2746cc	9:1 136kW (185PS)	TD2126
Coupe (C123) 280 CE Kombi (S123) 280 TE Saloon (W123) 280 E	03/77→11/85 09/77→11/85 02/76→11/85	M 110.988	6 Cyl. 2746cc	9:1 130-136kW (177-185PS)	TD2127





S-Class (W126) 280 SE;SEL	10/79→07/85	M 110.989	6 Cyl. 2746cc	9:1 136kW (185PS)	TD2128
SL (C107) 280 SLC SL (R107) 280 SL	08/74→09/81 08/74→07/85	M 110.990	6 Cyl. 2746cc	9:1 130-136kW (177-185PS)	TD2129

87-176600-00	STD	08-176600-00	STD
87-176607-00	0.50mm	08-176607-00	0.50mm
87-176611-00	1.00mm	08-176611-00	1.00mm

A	42.70	1.75		MOL P
B+	14.90	2.50		P
D	89.60	4.00		CR P
	23x69			

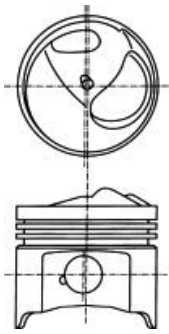

08614A

A = 41.900

A = 41.900

A = 41.900

A = 41.900

A = 41.900

13 87.00

190 (W201) D 2.0	08/83→08/93	OM 601.911	4 Cyl. 1978cc	22:1 53-55kW (72-75PS)	TD2206
		Diesel			
E-Class (W124) E 200 D	06/93→06/95	OM 601.912	4 Cyl. 1978cc	22:1 53-55kW (72-75PS)	TD2207
Kombi (S124) 200 T D	09/85→08/91				
Saloon (W124) 200 D	12/84→06/93				
		Diesel			
C-Class (W202) C 200 D	03/93→05/00	OM 601.913	4 Cyl. 1997cc	22:1 55kW (75PS)	TD2208
		Diesel			
C-Class (W202) C 200 D	03/93→05/00	OM 601.915	4 Cyl. 1997cc	22:1 55kW (75PS)	TD5237
		Diesel			
190 (W201) D 2.5	04/85→08/93	OM 602.911	5 Cyl. 2497cc	22:1 66-69kW (90-94PS)	TD2211
		Diesel			





Kombi (S124) 250 T D Saloon (W124) 250 D	09/85 → 06/93 04/85 → 06/93	OM 602.912	5 Cyl. 2497cc	22:1 66-69kW (90-94PS)	TD2212
Diesel					
G-Class (W460) 250 GD	10/87 → 12/92	OM 602.930	5 Cyl. 2497cc	22:1 62-69kW (84-94PS)	TD2213
Diesel					
G-Class (W463) 250 GD	06/90 →	OM 602.931	5 Cyl. 2497cc	22:1 69kW (94PS)	TD2214
Diesel					
G-Class (W461) 250 GD	02/90 →	OM 602.938	5 Cyl. 2497cc	22:1 68kW (92PS)	TD17816
Diesel					
G-Class (W461) 250 GD	02/90 →	OM 602.939	5 Cyl. 2497cc	22:1 68kW (92PS)	TD9422
Diesel					
E-Class (S124) E 300 TD G-Class (W460) 300 GD Kombi (S124) 300 T D Saloon (W124) 300 D	06/93 → 06/96 03/79 → 07/93 09/86 → 06/93 12/84 → 06/93	OM 603.912	6 Cyl. 2996cc	22:1 80-83kW (109-113PS)	TD2218
Diesel					
Saloon (W124) 300 D 4-matic	09/86 → 06/93	OM 603.913	6 Cyl. 2996cc	22:1 80-83kW (109-113PS)	TD2219
Diesel					
G-Class (W463) 300 GD	09/89 →	OM 603.931	6 Cyl. 2996cc	22:1 83kW (113PS)	TD2220
Diesel					

87-743600-10 1 2 STD
87-743607-10 1 2 0.50mm

A 44.85
B- 9.05
C 1.25
C 1.05
D 74.85
26x55

RT

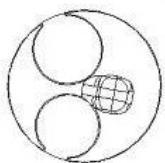
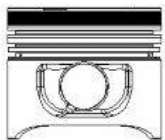

08753B

08-743600-00 STD
08-743607-00 0.50mm

2.50 CR P
2.00 P
3.00 CR P



14-026240-00 D B 90.10 C 148.50 D 92.57 E 4.70

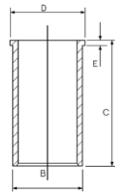

14-026241-00 D B 90.20 C 148.50 D 92.75 E 4.70

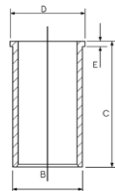

88-743600-10
87-743600-10 +
14-026240-00

1 Conrod gap 22.15mm
2 Conrod guided in Piston

1 Pleuelaugenabstand 22.15mm
2 Kolbengeführtes Pleuel

1 Distance entre bielle 22.15mm
2 Bielle guidée dans le piston

1 Distancia del biela 22.15mm
2 Biela montada en el pistón

1 Distanza dalla biella 22.15mm
2 Billea montata sul pistone



14 87.00

190 (W201) Turbo-D 2.5	02/88→08/93	OM 602.961	5 Cyl. 2497cc	22:1 90-93kW (122-126PS)	TD2216
E-Class (S124) E 250 Turbo D	06/93→06/96	OM 602A.962			
E-Class (W124) E 250 Turbo-D	06/93→06/95		5 Cyl. 2497cc	22:1 93kW (126PS)	TD2217
Kombi (S124) 250 TD Turbo	03/88→07/93				
Saloon (W124) 250 Turbo-D	09/88→06/93	Diesel Turbo			
E-Class (S124) E 250 Turbo D	06/93→06/96	OM 602A.993 OM 602			
E-Class (W124) E 250 Turbo-D	06/93→06/95		5 Cyl. 2497cc	22:1 93kW (126PS)	TD17821
Kombi (S124) 250 TD Turbo	03/88→07/93				
Saloon (W124) 250 Turbo-D	09/88→06/93	Diesel Turbo			
S-Class (W126) 300 SDL	09/85→12/87	OM 603.961	6 Cyl. 2996cc	22:1 107-110kW (143-148PS)	TD2222
E-Class (S124) E 300 T Turbo-D	06/93→06/96	OM 603A.960			
E-Class (W124) E 300 Turbo-D	06/93→06/95		6 Cyl. 2996cc	22:1 100-108kW (136-147PS)	TD2221
Kombi (S124) 300 TD T	06/92→05/93				
Kombi (S124) 300 T Turbo-D	09/86→06/93	Diesel Turbo			
Kombi (S124) 300 T Turbo-D 4-matic	01/89→06/93				
Saloon (W124) 300 Turbo-D	09/86→06/93				
Saloon (W124) 300 Turbo-D 4-matic	09/86→09/88				
E-Class (S124) E 300 T Turbo-D 4-matic	06/93→06/96	OM 603A.963			
E-Class (W124) E 300 Turbo-D 4-matic	06/93→06/95		6 Cyl. 2996cc	22:1 105-108kW (143-147PS)	TD2223
Kombi (S124) 300 T Turbo-D 4-matic	09/86→01/89	Diesel Turbo			
Saloon (W124) 300 Turbo-D	09/86→09/88				
Saloon (W124) 300 Turbo-D 4-matic	09/86→06/93				

87-183300-00  STD

87-183307-00  0.50mm

A 44.85

B- 9.10

C 1.05

C 1.25

D 74.85

 28x70

08-183300-00 STD

08-183307-00 0.50mm

2.50

2.00

3.00



P PS

P PS

CR P

14-026240-00 D

14-026241-00 D

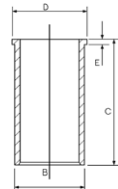

B 90.10 C 148.50 D 92.57 E 4.70

B 90.20 C 148.50 D 92.75 E 4.70

HA KK RT

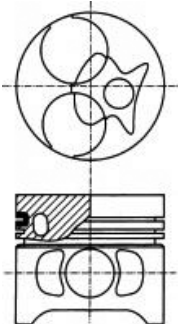

08762P

 Conrod guided in Piston

 Kolbengeführtes Pleuel

 Bielle guidée dans le piston

 Biela montada en el pistón

 Billea montata sul pistone

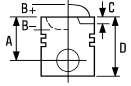

15 87.00

C-Class (S202) C 250 T Turbo-D	06/96→03/01	OM 605.960	5 Cyl.	22:1	
C-Class (W202) C 250 Turbo-D	10/95→05/00		2497cc	110kW (150PS)	
		Diesel	Turbo Intercooled		TD4679
E-Class (S210) E 250 T Turbo-D		OM 605.962	5 Cyl.	22:1	
E-Class (W210) E 250 Turbo-D	06/97→07/99		2497cc	110kW (150PS)	
		Diesel	Turbo Intercooled		TD9892
Engine	10/88→	OM 603.950	6 Cyl.	22:1	
			2996cc	100-105kW (136-143PS)	
		Diesel	Turbo		TD21143
300 D	11/85→12/87	OM 603.962	6 Cyl.	22:1	
			2996cc	105kW (143PS)	
		Diesel	Turbo		TD21144
S-Class (W140) S 300 Turbo-D	05/96→10/98	OM 606.961	6 Cyl.	22:1	
			2996cc	130kW (177PS)	
		Diesel	Turbo Intercooled		TD5238
E-Class (S210) E 300 T Turbo-D		OM 606.962	6 Cyl.	22:1	
E-Class (W210) E 300 Turbo-D	12/96→07/99		2996cc	130kW (177PS)	
		Diesel	Turbo Intercooled		TD9416
G-Class (W463) G 300 TD	08/96→	OM 606.964	6 Cyl.	22:1	
			2996cc	130kW (177PS)	
		Diesel	Turbo Intercooled		TD9425

14-026240-00 D B 90.10 C 148.50 D 92.57 E 4.70

14-026241-00 D B 90.20 C 148.50 D 92.75 E 4.70

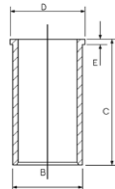

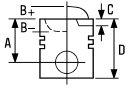

16 87.00

C-Class (S202) C 200 T D C-Class (W202) C 200 D	10/96→03/01 10/96→05/00	OM 604.915	4 Cyl. 1997cc	22:1 65-85kW (88-116PS)	
		Diesel			TD4677
E-Class (W210) E 200 D	01/96→03/02	OM 604.917	4 Cyl. 1997cc	22:1 65kW (88PS)	
		Diesel			TD9424
C-Class (W202) C 250 D	05/93→05/00	OM 605.910	5 Cyl. 2497cc	22:1 83kW (113PS)	
		Diesel			TD2228
E-Class (S124) E 250 TD E-Class (W124) E 250 D	06/93→06/96 07/93→06/95	OM 605.911	5 Cyl. 2497cc	22:1 83kW (113PS)	
		Diesel			TD2229
E-Class (S210) E 250 T D E-Class (W210) E 250 D	06/96→07/99 06/95→07/99	OM 605.912	5 Cyl. 2497cc	22:1 83kW (113PS)	
		Diesel			TD4678
E-Class (S124) E 300 TD E-Class (W124) E 300 D	06/93→06/96 07/93→06/95	OM 606.910	6 Cyl. 2996cc	22:1 100kW (136PS)	
		Diesel			TD2230
E-Class (W210) E 300 D	06/95→06/97	OM 606.912	6 Cyl. 2996cc	22:1 100kW (136PS)	
		Diesel			TD4680

87-743600-00 STD
87-743607-00 0.50mm

08-743600-00 STD
08-743607-00 0.50mm

14-026240-00 D
14-026241-00 D

B 90.10 C 148.50 D 92.57 E 4.70
B 90.20 C 148.50 D 92.75 E 4.70

A 44.90
B- 4.60
B+ 1.32
C 2.26
C 2.41
D 76.22
 26x55

2.50
2.00
3.00



CR P
P
CR P

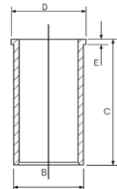

RT

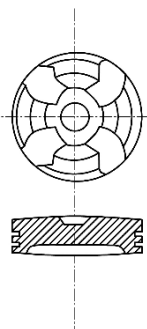





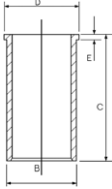

17 87.00

Saloon (W123) 200 D	07/76→11/85	OM 615.940	4 Cyl. 1988cc	21:1 40-44kW (55-60PS)	
Diesel					TD2238

87-170707-00	0.50mm	08-170700-10	STD	14-022190-00 D	B 90.00 C 158.40 D 92.00 E 4.70
01/79→		08-170707-10	0.50mm		
		08-170711-10	1.00mm		

A	52.90
B-	8.20
C	1.20
D	91.40
	26x72

2.00		CR P
2.00		P
4.00		CR P

RT

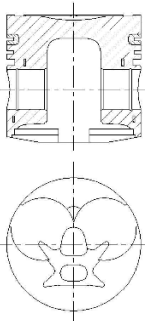

08738/08741B

18 88.00

C-Class (W204) C 230 4-matic	07/07→01/14	M 272.911	V6 Cyl. 2496cc	11.2:1 150kW (204PS)	TD22142
C-Class (CL203) C 230	01/05→05/08	M 272.920			
C-Class (W203) C 230	01/05→02/07		V6 Cyl. 2496cc	11.2:1 150kW (204PS)	
C-Class T-Model (S203) C 230	01/05→08/07				TD18425
CLC-Class (CL203) CLC 230	05/08→06/11				
CLC-Class (CL203) CLC 250	06/09→06/11				
C-Class (W204) C 230	01/07→01/14	M 272.921			
C-Class T-Model (S204) C 230	08/07→08/14		V6 Cyl. 2496cc	11.2:1 150kW (204PS)	TD20357
E-Class (W211) E 230	09/07→12/08	M 272.922			
E-Class T-Model (S211) E 230 T	05/07→07/09		V6 Cyl. 2496cc	11.2:1 150kW (204PS)	TD22143
C-Class (W203) C 280	01/05→02/07	M 272.940			
C-Class T-Model (S203) C 280	01/05→08/07		V6 Cyl. 2996cc	11.3:1 170kW (231PS)	
CLK (A209) CLK 280	01/05→03/10				TD18420
CLK (C209) 280	01/05→05/09				
C-Class (W203) C 280 4-matic	01/05→02/07	M 272.941			
C-Class T-Model (S203) C 280 4-matic	01/05→08/07		V6 Cyl. 2996cc	11.3:1 170kW (231PS)	TD18423



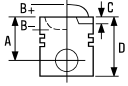

SLK (R171) 280	01/05→02/11	M 272.942			
SLK (R171) 300	04/09→02/11		V6 Cyl.	11.3:1	
			2996cc	170kW (231PS)	TD18427
CLS (C219) CLS 280	07/08→12/10	M 272.943			
CLS (C219) CLS 300	04/09→12/10		V6 Cyl.	11.1:1	
E-Class (W211) E 280	03/05→12/08		2996cc	170kW (231PS)	
E-Class (W211) E 280 4-matic	01/06→12/08				TD18430
E-Class T-Model (S211) E 280 T					
E-Class T-Model (S211) E 280 T 4-matic	03/05→07/09				
		M 272.944			
			V6 Cyl.	11.1:1	
			2996cc	170kW (231PS)	TD23758
R-Class (W251; V251) R 280	01/07→	M 272.945			
R-Class (W251; V251) R 280 4-matic	05/07→		V6 Cyl.	11.1:1	
R-Class (W251; V251) R 300	07/09→		2996cc	170kW (231PS)	
					TD20570
S-Class (W221) S 280, S-Class (W221) S 300	08/06→12/13	M 272.946			
			V6 Cyl.	11.1:1	
			2996cc	170kW (231PS)	TD26966
C-Class (W204) C 280	01/07→01/14	M 272.947			
C-Class (W204) C 300	07/09→01/14		V6 Cyl.	11.3:1	
C-Class T-Model (S204) C 280			2996cc	170kW (231PS)	
C-Class T-Model (S204) C 300	08/07→08/14				TD20356
SL (R230) 280	03/08→01/12	M 272.949			
SL (R230) 300	04/09→01/12		V6 Cyl.	11.1:1	
			2996cc	170kW (231PS)	TD20863
E-Class (W212) E 300	01/09→	M 272.952			
E-Class T-Model (S212) E 300	11/09→		V6 Cyl.	11.1:1	
			2996cc	170kW (231PS)	TD25212





87-440900-00

STD

08-440900-00

STD

A 30.85
 B+ 4.41
 C 1.39
 C 1.39
 D 56.16
 22x47

1.50  NT 
 1.75  P
 2.50  NT 

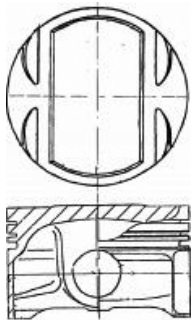

7.08861D104

 Steel

 Stahl

 Acier

 Acero

 Acciaio





19  **88.00**

C-Class (S202) C 200 T CDI	03/98→03/01	OM 611.960		
C-Class (S202) C 220 T CDI	09/97→03/01		4 Cyl.	18:1
C-Class (W202) C 200 CDI	03/98→05/00		2148cc	75-92kW (102-125PS)
C-Class (W202) C 220 CDI	09/97→05/00	Diesel	Turbo Intercooled	TD9529

87-117900-00 STD **08-117900-00** STD **14-020300-00 D** B 91.00 C 147.00 D 93.00 E 5.00
87-117907-00 0.50mm **08-117907-00** 0.50mm

A 42.30
B- 13.80
BØ 43.50
C 2.48
D 72.30
 30x70

2.50  CK P
 2.00  P
 3.00  CR P

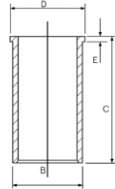



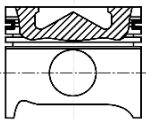
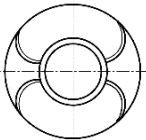

AK KK RT



08857-118

87-117900-10 STD **08-117900-00** STD
87-117907-10 0.50mm **08-117907-00** 0.50mm

→12/99
A 42.30
B- 13.30
BØ 43.10
C 2.48
D 72.30
 28x68

2.50  CK P
 2.00  P
 3.00  CR P

AK KK RT

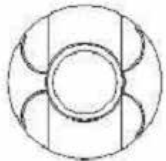
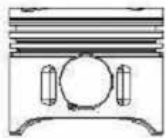

08853-110



20  **88.00**

E-Class (S210) E 220 T CDI	06/98→03/03	OM 611.961			
E-Class (W210) E 200 CDI			4 Cyl.	18:1	
E-Class (W210) E 220 CDI	06/98→03/02		2148cc	75-105kW (102-143PS)	
		Diesel	Turbo Intercooled		TD17005
V-Class (638/2) V 200 CDI		OM 611.980 Euro 3 OM 611LA (90 KW CDI)			
V-Class (638/2) V 220 CDI	03/99→07/03		4 Cyl.	18:1	
Vito (638) 112 CDI 2.2			2148cc	60-90kW (82-122PS)	
		Diesel	Turbo Intercooled		TD14350
Vito (638) 110 CDI 2.2	03/99→07/03	OM 611LA (75 KW CDI)			
			4 Cyl.		
			2148cc	75kW (102PS)	
		Diesel			TD14349

87-117900-10
87-117907-10

STD
0.50mm

08-117900-00
08-117907-00

STD
0.50mm

14-020300-00 D

B 91.00 C 147.00 D 93.00 E 5.00

→063815

2.50
2.00
3.00



CK P
P
CR P

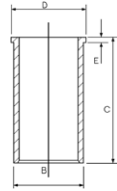

A 42.30
B- 13.30
BØ 43.10
C 2.48
D 72.30
 28x68

AK KK RT

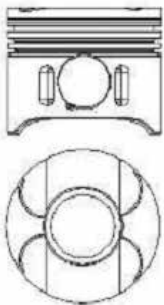

08853-110



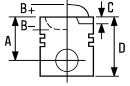

87-117900-20
87-117907-20

STD
0.50mm

08-117900-00
08-117907-00

STD
0.50mm

063816→

A 42.30
B- 13.80
BØ 43.50
C 2.48
D 72.30
 30x70

2.50
2.00
3.00



CK P
P
CR P

AK KK RT TP

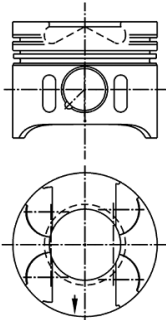

08854-209

21  **88.00**

C-Class (CL203) C 220 CDI	03/01→01/04	OM 611.962			
C-Class (W203) C 200 CDI	09/00→02/07		4 Cyl.	18:1	
C-Class (W203) C 220 CDI	05/00→02/07		2148cc	75-105kW (102-143PS)	
C-Class T-Model (S203) C 200 CDI		Diesel	Turbo Intercooled		TD15449
C-Class T-Model (S203) C 220 CDI	03/01→08/07				
Sprinter 2-t (901; 902) 208 CDI	04/00→05/06	OM 611.987 Euro 3			
Sprinter 3-t (903) 308 CDI			4 Cyl.	18:1	
Sprinter 4-t (904) 408 CDI			2148cc	60kW (82PS)	
		Diesel	Turbo Intercooled		TD17730
E-Class (S210) E 270 T CDI	07/99→03/03	OM 612.961			
E-Class (W210) E 270 CDI	07/99→03/02		5 Cyl.	18:1	
			2688cc	120-125kW (163-170PS)	
		Diesel	Turbo Intercooled		TD15455
C-Class (W203) C 270 CDI	12/00→02/07	OM 612.962			
C-Class T-Model (S203) C 270 CDI	03/01→08/07		5 Cyl.	18:1	
CLK (C209) 270 CDI	10/02→05/09		2685cc	125kW (170PS)	
		Diesel	Turbo Intercooled		TD15451
M-Class (W163) ML 270 CDI	12/99→06/05	OM 612.963			
			5 Cyl.	18:1	
			2685cc	120kW (163PS)	
		Diesel	Turbo Intercooled		TD17009
G-Class (W461) G 270 CDI	01/03→	OM 612.966			
			5 Cyl.	18:1	
			2685cc	115kW (156PS)	
		Diesel	Turbo Intercooled		TD16895



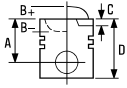

CLK (C209) 270 CDI	10/02→05/09	OM 612.967	5 Cyl.	18:1	
			2685cc	120-125kW (163-170PS)	
		Diesel	Turbo Intercooled		TD17323
Sprinter (905) 616 CDI	04/01→	OM 612.981	5 Cyl.	18:1	
Sprinter 2-t (901; 902) 216 CDI	04/00→05/06		2685cc	110-115kW (150-156PS)	
Sprinter 3-t (903) 316 CDI		Diesel	Turbo Intercooled		TD17731
Sprinter 4-t (904) 416 CDI	04/00→05/06				
Sprinter 5-t (905) 616 CDI	04/01→05/06				

87-117900-20 STD 08-117900-00 STD 14-020300-00 D B 91.00 C 147.00 D 93.00 E 5.00
 87-117907-20 0.50mm 08-117907-00 0.50mm

A 42.30
 B- 13.80
 BØ 43.50
 C 2.48
 D 72.30
 30x70

2.50
 2.00
 3.00



CK P
 P
 CR P

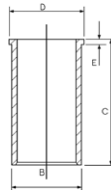

AK KK RT TP

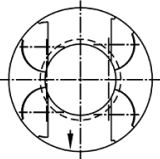
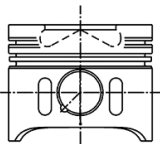

08854-209

22 88.00

Sprinter 2-t (901; 902) 211 CDI		OM 611.981 Euro 3	4 Cyl.	18:1	
Sprinter 2-t (901; 902) 211 CDI,			2148cc	80-95kW (109-129PS)	
Sprinter 2-t (901; 902) 213 CDI	04/00→05/06	Diesel	Turbo Intercooled		TD17729
Sprinter 3-t (903) 311 CDI					
Sprinter 3-t (903) 311 CDI,	08/02→05/06				
Sprinter 3-t (903) 313 CDI					
Sprinter 3-t (903) 313 CDI					
Sprinter 4-t (904) 411 CDI	04/00→05/06				
Sprinter 4-t (904) 413 CDI					
S-Class (W220) S 320 CDI	08/99→09/02	OM 613.960	6 Cyl.	18:1	
			3222cc	145kW (197PS)	
		Diesel	Turbo Intercooled		TD15461





E-Class (S210) E 320 T CDI	07/99 → 03/03	OM 613.961		
E-Class (W210) E 320 CDI	07/99 → 03/02		6 Cyl.	18:1
			3226cc	145kW (197PS)
		Diesel	Turbo Intercooled	TD15454

87-117900-00 STD 08-117900-00 STD 14-020300-00 D B 91.00 C 147.00 D 93.00 E 5.00
 87-117907-00 0.50mm 08-117907-00 0.50mm

→007289

A 42.30
 B- 13.80
 BØ 43.50
 C 2.48
 D 72.30
 30x70

2.50
 2.00
 3.00



CK P
 P
 CR P

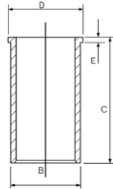

AK KK RT

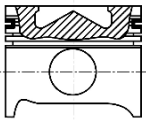
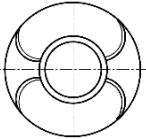

08857-118

87-117900-20 STD 08-117900-00 STD
 87-117907-20 0.50mm 08-117907-00 0.50mm

007290→

A 42.30
 B- 13.80
 BØ 43.50
 C 2.48
 D 72.30
 30x70

2.50
 2.00
 3.00



CK P
 P
 CR P

AK KK RT TP

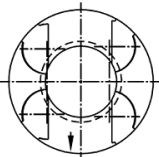
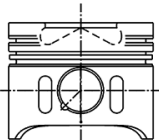

08854-209



23 88.00

Vito (638) 108 CDI 2.2	03/99→07/03	OM 611A (60 KW CDI) 4 Cyl. 2148cc	60kW (82PS)	TD14348
		Diesel		

14-020300-00 D B 91.00 C 147.00 D 93.00 E 5.00

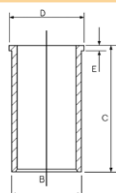

24 88.00



E-Class (W211) E 200 CDI	07/02→12/08	OM 646.951 4 Cyl. 2148cc	18:1 75-90kW (102-122PS)	TD18129
		Diesel	Turbo Intercooled	
E-Class (W211) E 220 CDI	03/02→12/08	OM 646.961 4 Cyl. 2148cc	18:1 100-110kW (136-150PS)	TD17007
E-Class T-Model (S211) E 220 CDI	03/03→07/09			
E-Class T-Model (S211) E 220 T CDI		Diesel	Turbo Intercooled	
C-Class (CL203) C 200 CDI	03/03→05/08	OM 646.962 4 Cyl. 2148cc	18:1 75-110kW (102-150PS)	TD17542
C-Class (W203) C 200 CDI	02/01→02/07			
C-Class T-Model (S203) C 200 CDI	03/01→08/07			
CLC-Class (CL203) CLC 200 CDI	05/08→06/11	Diesel	Turbo Intercooled	
C-Class (CL203) C 220 CDI	02/04→05/08	OM 646.963 4 Cyl. 2148cc	18:1 100-110kW (136-150PS)	TD17543
C-Class (W203) C 220 CDI	02/03→02/07			
C-Class T-Model (S203) C 220 CDI	02/04→08/07			
CLC-Class (CL203) CLC 220 CDI	05/08→06/11	Diesel	Turbo Intercooled	
CLK (C209) 220 CDI	01/05→05/09	OM 646.966 4 Cyl. 2148cc	18:1 100-110kW (136-150PS)	TD22844
		Diesel	Turbo Intercooled	
Viano (W639) CDI 2.2	09/03→	OM 646.980 4 Cyl. 2148cc	18:1 70-110kW (95-150PS)	TD24573
Vito (W639) 109 CDI	09/06→			
Vito (W639) 111 CDI	09/07→			
Vito/Mixto (W639) 109 CDI	08/06→	Diesel	Turbo Intercooled	
Vito/Mixto (W639) 111 CDI	09/07→			
Vito/Mixto (W639) 115 CDI	09/03→			
Vito (W639) 109 CDI	09/07→	OM 646.981 4 Cyl. 2148cc	18:1 70kW (95PS)	TD20984
Vito/Mixto (W639) 109 CDI	08/06→			
		Diesel	Turbo Intercooled	
Viano (W639) CDI 2.0 4-matic		OM 646.982 Euro 4 4 Cyl. 2148cc	18:1 80-110kW (109-150PS)	TD18289
Viano (W639) CDI 2.0, Viano (W639) CDI 2.2	09/03→			
Viano (W639) CDI 2.2 4-matic	07/05→			
Vito (W639) 111 CDI		Diesel	Turbo Intercooled	
Vito (W639) 115 CDI	09/03→			
Vito/Mixto (W639) 111 CDI				
Vito/Mixto (W639) 115 CDI	09/03→			
Vito (W639) 109 CDI	09/03→	OM 646.983 4 Cyl. 2148cc	18.1:1 65-80kW (88-109PS)	TD20921
Vito/Mixto (W639) 109 CDI				
		Diesel	Turbo Intercooled	

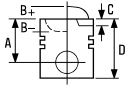



Sprinter 3-t (906) 209 CDI		OM 646.984			
Sprinter 3.5-t (906) 309 CDI	06/06→		4 Cyl.	18.1:1	
Sprinter 5-t (906) 509 CDI			2148cc	65kW (88PS)	
		Diesel	Turbo Intercooled		TD22140
Sprinter 3-t (906) 211 CDI	06/06→	OM 646.985			
Sprinter 3.5-t (906) 311 CDI	06/06→		4 Cyl.	18:1	
Sprinter 4.6-t (906) 411 CDI	06/09→		2148cc	80kW (109PS)	
Sprinter 5-t (906) 511 CDI	06/06→	Diesel	Turbo Intercooled		TD20730
Sprinter 3-t (906) 215 CDI	06/06→	OM 646.989			
Sprinter 3.5-t (906) 315 CDI	06/06→		4 Cyl.	18:1	
Sprinter 4.6-t (906) 415 CDI			2148cc	110kW (150PS)	
Sprinter 5-t (906) 515 CDI	06/06→	Diesel	Turbo Intercooled		TD26257
Sprinter 3-t (906) 215 CDI	06/06→	OM 646.990			
Sprinter 3.5-t (906) 315 CDI	06/06→		4 Cyl.	18:1	
Sprinter 4.6-t (906) 415 CDI			2148cc	110kW (150PS)	
Sprinter 5-t (906) 515 CDI	06/06→	Diesel	Turbo Intercooled		TD23618
E-Class (W211) E 270 CDI	03/02→12/08	OM 647.961			
E-Class T-Model (S211) E 270 T CDI	03/03→07/09		5 Cyl.	18:1	
			2685cc	120-130kW (163-177PS)	
		Diesel	Turbo Intercooled		TD17008
E-Class T-Model (S211) E 270 T CDI	03/03→07/09	OM 647.981			
			5 Cyl.	18:1	
			2685cc	60-130kW (82-177PS)	
		Diesel	Turbo Intercooled		TD21142
S-Class (W220) S 320 CDI	09/02→08/05	OM 648.960			
			6 Cyl.	18:1	
			3222cc	150kW (204PS)	
		Diesel	Turbo Intercooled		TD17187
E-Class (W211) E 280 CDI	05/04→12/08	OM 648.961			
E-Class (W211) E 320 CDI	11/02→12/08		6 Cyl.	18:1	
E-Class T-Model (S211) E 280 T CDI	05/04→07/09		3222cc	130-150kW (177-204PS)	
E-Class T-Model (S211) E 320 T CDI	03/03→07/09	Diesel	Turbo Intercooled		TD17328

87-136400-00 STD 08-136400-00 STD
 87-136407-00 0.50mm 08-136407-00 0.50mm

A 42.30 2.50  CK P
 B- 14.10 2.00  P
 BØ 46.00 3.00  CR P
 C 2.29
 D 72.30

 30x70

KK RT TP

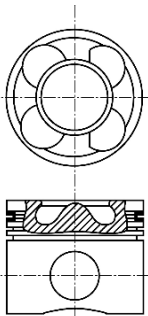





08854-108



25  **88.00**

Sprinter 3-t (906) 213 CDI		OM 646.986 Euro 4		
Sprinter 3-t (906) 215 CDI			4 Cyl.	18:1
Sprinter 3.5-t (906) 313 CDI	06/06→		2148cc	95-110kW (129-150PS)
Sprinter 4.6-t (906) 413 CDI		Diesel	Turbo Intercooled	TD23620
Sprinter 5-t (906) 513 CDI				
Sprinter 5-t (906) 515 CDI				

87-428700-00	STD	08-428700-00	STD
87-428707-00	0.50mm	08-428707-00	0.50mm

A	42.30	2.50		GDC P
B-	14.10	2.00		CR P
BØ	46.00	2.00		CR P
C	2.03			
C	1.78			
D	72.30			
	30x70			



KK NB RT TP

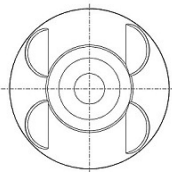
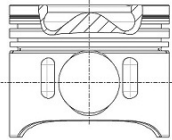

8867A-101

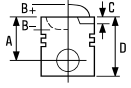

26 88.50

Saloon (W124) 300 E	01/85→12/85	M 103.980	6 Cyl. 2962cc	9/10:1 138kW (188PS)	TD2099
S-Class (W126) 300 SE;SEL	09/85→06/91	M 103.981 (KAT)	6 Cyl. 2962cc	9/10:1 132-138kW (180-188PS)	TD9436
SL (R107) 300 SL	09/85→08/89	M 103.982	6 Cyl. 2962cc	9/10:1 132-138kW (180-188PS)	TD9444
Coupe (C124) 300 CE	03/87→05/93	M 103.983	6 Cyl. 2962cc	9/10:1 132-138kW (179-188PS)	TD9437
Kombi (S124) 300 TE	01/86→08/92				
Kombi (S124) 300 TE 4-matic	09/86→12/89				
Saloon (W124) 300 E	06/85→08/92				
Saloon (W124) 300 E 4-matic	09/86→02/92				
SL (R129) 300 SL	03/89→08/93	M 103.984	6 Cyl. 2962cc	9/10:1 140kW (190PS)	TD2103
E-Class (S124) E 300 T 4-matic	06/93→06/96	M 103.985	6 Cyl. 2962cc	9/10:1 132kW (180PS)	TD2104
E-Class (W124) E 300 4-matic	06/93→06/95				
Kombi (S124) 300 TE 4-matic	09/86→06/93				
Saloon (W124) 300 E 4-matic					
G-Class (W463) 300 GE	09/89→	M 103.987	6 Cyl. 2962cc	9/10:1 125-128kW (170-174PS)	TD2105

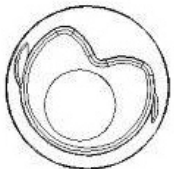
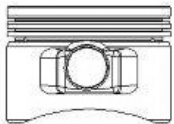

87-183000-00 STD
 87-183007-00 ① 0.50mm
 87-183011-00 ② 1.00mm

A 33.00
 B- 2.70
 C 0.82
 C 2.02
 D 63.00
 22x52



08942A/08946A

08-183000-00 STD
 08-183007-00 0.50mm

1.50  CK P
 1.75  P
 3.00  CR P

① B- = 3.300
 ② B- = 3.600

① B- = 3.300
 ② B- = 3.600

① B- = 3.300
 ② B- = 3.600

① B- = 3.300
 ② B- = 3.600

① B- = 3.300
 ② B- = 3.600



27 89.00

190 (W201) E 1.8	04/90→08/93	M 102.910	4 Cyl. 1797cc	9:1 80kW (109PS)	TD2061
190 E 1.8	04/92→08/93	M 102.919	4 Cyl. 1797cc	9.1:1 77kW (105PS)	TD2062
190 E 2.0	10/82→09/88	M 102.938	4 Cyl. 1997cc	8:1 63kW (86PS)	TD22701
Kombi (S123) 200 T Saloon (W123) 200	11/80→11/85 06/80→11/85	M 102.939	4 Cyl. 1997cc	9.1:1 74-80kW (100-109PS)	TD2069
200 GE	05/85→	M 102.964	4 Cyl. 1997cc	9.1:1 80kW (109PS)	TD17723
G-Class (W463) 200 GE	01/90→07/93	M 102.965	4 Cyl. 1996cc	9:1 80-85kW (109-116PS)	TD2080

14-025480-00 D

B 92.02 C 165.00 D 95.05 E 4.10

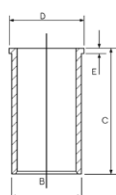

28 89.00

Kombi (S123) 200 T Saloon (W123) 200	11/80→11/85 06/80→11/85	M 102.920	4 Cyl. 1997cc	9:1 74-80kW (100-109PS)	TD2063
190 (W201) 2.0	10/82→10/84	M 102.921	4 Cyl. 1997cc	9:1 63-77kW (86-105PS)	TD2064
Kombi (S124) 200 E Kombi (S124) 200 T Saloon (W124) 200 Saloon (W124) 200 E	11/92→05/93 09/85→05/90 12/85→05/90 11/92→05/93	M 102.922	4 Cyl. 1997cc	9.1:1 75-80kW (102-109PS)	TD2065
190 (W201) 2.0	09/84→05/90	M 102.924	4 Cyl. 1997cc	9.1:1 75-77kW (102-105PS)	TD4653
190 (W201) E 2.0	10/82→06/93	M 102.961	4 Cyl. 1997cc	9.1:1 83-93kW (113-126PS)	TD5050







190 (W201) E 2.0 Kombi (S124) 200 TE	10/82 → 08/93 09/88 → 12/89	M 102.962	4 Cyl. 1997cc	9.1:1 83-90kW (115-122PS)	TD4655
Kombi (S124) 200 TE Saloon (W124) 200 E	09/88 → 08/92	M 102.963	4 Cyl. 1997cc	9.1:1 87-90kW (118-122PS)	TD2078

87-179500-10 ② ③ STD
87-179507-10 ① ③ 0.50mm
87-179511-10 ① ③ 1.00mm

A 43.20
BØ 50.00
C 2.15
C 1.62
D 71.20
 22x56

08-179500-00 STD
08-179505-00 0.25mm
08-179507-00 0.50mm
08-179511-00 1.00mm

1.75 
 2.00 
 3.50 

CR P
 P
 CR P

14-025480-00 D B 92.02 C 165.00 D 95.05 E 4.10

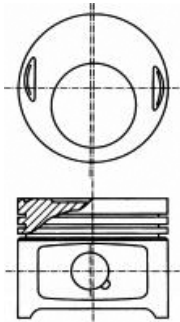
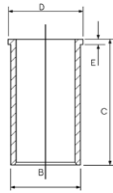

08941/08937A

- | | | | | |
|--------------------------------------|--------------------------------------|---|--------------------------------------|--|
| ① A = 42.900, D = 70.900, B- = 1.100 | ① A = 42.900, D = 70.900, B- = 1.100 | ① A = 42.900, D = 70.900, B- = 1.100 | ① A = 42.900, D = 70.900, B- = 1.100 | ① A = 42.900, D = 70.900, B- = 1.100 |
| ② Std Piston no combustion cavity | ② Std Kolben-keine Mulde | ② Piston de contrepression, sans cavité | ② Pistón estándar sin concavidad | ② Pistoni standard senza cavità di combustione |
| ③ Conrod gap 22.00mm | ③ Pleuelaugenabstand 22.00mm | ③ Distance entre bielle 22.00mm | ③ Distancia del biela 22.05mm | ③ Distanza dalla biella 22.00mm |



29  **89.00**

T1 (601) 208 D 2.3 T1 (602) 308 D 2.3 T1/TN 408 D	10/88→02/96 11/88→02/96 11/88→06/95	OM 601.940 OM 601 4 Cyl. 2299cc	22:1 58-60kW (79-82PS)	TD2210
		Diesel		
T2/LN1 508 D	03/89→12/94	OM 601.941 OM 601 4 Cyl. 2299cc	22:1 58-60kW (79-82PS)	TD8041
		Diesel		
Vito (638) 108 D 2.3	02/96→07/03	OM 601.942 OM 601 4 Cyl. 2299cc	22:1 58kW (79PS)	TD5398
		Diesel		
Sprinter 2-t (901; 902) 208 D Sprinter 3-t (903) 2.3 D Sprinter 3-t (903) 308 D Sprinter 3-t (903) 308 D 2.3 Sprinter 4-t (904) 2.3 D Sprinter 4-t (904) 408 D	01/95→04/00 06/97→12/99 02/95→04/00 02/95→04/00 06/97→12/99 02/96→05/06	OM 601.943 OM 601 4 Cyl. 2299cc	22:1 58-60kW (79-82PS)	TD5400
		Diesel		
MB100 (KPA) 2.3 D	11/99→01/03	OM 661.911 4 Cyl. 2299cc	21:1 57-58kW (77-79PS)	TD8942
		Diesel		
MB100 (KPA) 2.3 D	11/99→01/03	OM 661.940 4 Cyl. 2299cc	21:1 58kW (79PS)	TD28791
		Diesel		
T1 (601) 210 D 2.8 T1 (601) 210 D 2.9 T1 (602) 310 D 2.9 T1/TN 410 D	10/88→02/96 11/88→02/96 06/89→02/96 11/88→06/95	OM 602.940 OM 602 5 Cyl. 2874cc	22:1 70-72kW (95-98PS)	TD2215
		Diesel		
G-Class (W461) 290 GD/G 290 D	04/92→	OM 602.942 5 Cyl. 2874cc	22:1 70-72kW (95-98PS)	TD2054
		Diesel		
G-Class (W461) 290 GD/G 290 D	04/92→	OM 602.946 5 Cyl. 2874cc	21:1 70kW (95PS)	TD17817
		Diesel		
G-Class (W461) 290 GD/G 290 D	04/92→	OM 602.947 5 Cyl. 2874cc	21:1 72kW (98PS)	TD17818
		Diesel		
G-Class (W461) 290 GD/G 290 D	04/92→	OM 602.991 OM 602 5 Cyl. 2874cc	21:1 70kW (95PS)	TD17820
		Diesel		
G-Class (W461) 290 GD/G 290 D	04/92→	OM 602.995 OM 602 5 Cyl. 2874cc	21:1 72kW (98PS)	TD28784
		Diesel		





MB100 (KPA) 2.9 D, Mb140 (KPA) 2.9 D

10/01 → 05/05

OM 662.911

5 Cyl.
2874cc

21:1
70kW (95PS)

Diesel

TD22700

87-743100-10 STD
87-743107-10 0.50mm
87-743120-10 0.70mm

STD
0.50mm
0.70mm

08-743100-00 STD
08-743107-00 0.50mm
08-743120-00 0.70mm

STD
0.50mm
0.70mm

14-026380-00 **D**
14-027210-00 **D**

B 91.50 C 156.50 D 96.55 E 4.70
B 91.50 C 156.50 D 94.05 E 4.70

A 44.65
B- 8.25
C 1.25
C 1.50
D 74.65
 26x62

2.50
2.00
3.00

CR P
P
CR P

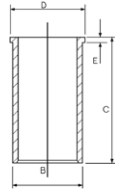

AK RT

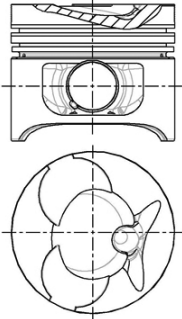

08953

87-743120-20 0.70mm

0.70mm

08-743100-00 STD
08-743107-00 0.50mm
08-743120-00 0.70mm

STD
0.50mm
0.70mm

A 44.45
B- 8.25
C 1.50
C 1.25
D 74.45
 26x62

2.50
2.00
3.00

CR P
P
CR P

AK RT

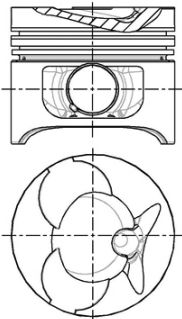

08953

Conrod guided in Piston

Kolbengeführtes Pleuel

Bielle guidée dans le piston

Biela montada en el pistón

Billea montata sul pistone

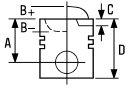



30  **89.00**

V-Class (638/2) V 230 TD Vito (638) 110 D 2.3 Vito (638) 110 TD 2.3	09/96→07/03 03/97→07/03 02/96→07/03	OM 601A.970 OM 601 4 Cyl. 2299cc Diesel Turbo Intercooled	22:1 72kW (98PS)	TD4674
Saloon (W124) 300 TD SD S-Class (W140) S 350 Turbo-D	06/91→05/93 01/93→10/98	OM 603A.971 6 Cyl. 3449cc Diesel Turbo	22:1 100-110kW (136-150PS)	TD2225
G-Class (W463) 350 G Turbo-D G-Class (W463) 350 Turbo GD	09/91→09/97 09/91→	OM 603A.972 6 Cyl. 3449cc Diesel Turbo	22:1 100kW (136PS)	TD2226

87-743100-40 STD
87-743107-40 0.50mm
A 44.65
B- 8.25
C 1.05
C 1.25
D 74.65
 28x70

08-743100-00 STD
08-743107-00 0.50mm
08-743120-00 0.70mm

2.50  CR P
2.00  P
3.00  CR P

14-026380-00 D B 91.50 C 156.50 D 96.55 E 4.70
14-027210-00 D B 91.50 C 156.50 D 94.05 E 4.70

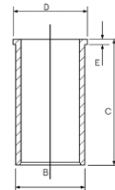

KK RT

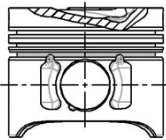

08981

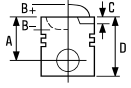

31  **89.00**

Sprinter 2-t (901; 902) 210 D	01/97→04/00	OM 602.980 OM 602 DE 29LA			
Sprinter 2-t (901; 902) 212 D	02/95→04/00		5 Cyl.	22:1	
Sprinter 3-t (903) 310 D	01/97→12/99		2874cc	75-90kW (102-122PS)	
Sprinter 3-t (903) 310 D 2.9	02/95→04/00	Diesel	Turbo Intercooled		TD8032
Sprinter 3-t (903) 312 D 2.9					
Sprinter 4-t (904) 410 D	02/96→05/06				
Sprinter 4-t (904) 412 D					
Sprinter 4-t (904) 414 D					
E-Class (S210) E 290 T Turbo-D	06/96→07/99	OM 602.982			
E-Class (W210) E 290 Turbo-D	03/96→07/99		5 Cyl.	22:1	
			2874cc	95kW (129PS)	
		Diesel	Turbo Intercooled		TD4675
G-Class (W461) G 290 TD	07/97→	OM 602.983			
			5 Cyl.	22:1	
			2874cc	88kW (120PS)	
		Diesel	Turbo Intercooled		TD12910
Vario 512 D		OM 602.984 OM 602 LA			
Vario 512 D, Vario O 812			5 Cyl.	19.5:1	
Vario 612 D			2874cc	90kW (122PS)	
Vario 612 D, Vario 812 D		Diesel	Turbo Intercooled		TD5682
Vario 812 D	09/96→				
Vario 612 D		OM 602.985 OM 602 LA			
Vario 612 D, Vario 812 D			5 Cyl.	19.5:1	
Vario 612 D, Vario O 812			2874cc	90kW (122PS)	
Vario 812 D	09/96→	Diesel	Turbo Intercooled		TD6020
		OM 602.986			
			5 Cyl.	19.5:1	
			2874cc	75-90kW (102-122PS)	
		Diesel	Turbo		TD9459

87-743100-00

STD

08-743100-00

STD

14-026380-00 D

B 91.50 C 156.50 D 96.55 E 4.70

87-743107-00

0.50mm

08-743107-00

0.50mm

14-027210-00 D

B 91.50 C 156.50 D 94.05 E 4.70

08-743120-00

0.70mm

A 44.75

B- 16.74

BØ 42.00

C 0.60

C 0.30

D 74.75

 **28x70**

2.50

2.00

3.00



CR P

P

CR P

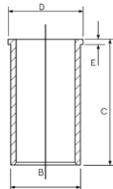

KK RT

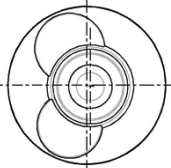
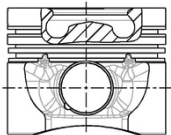

08980C



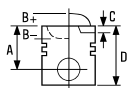

87-743107-50

0.50mm

08-743100-00

STD

08-743107-00

0.50mm

08-743120-00

0.70mm

A 44.55

B- 16.74

BØ 42.00

C 0.30

C 0.60

D 74.55

28x70

2.50



CR P

2.00



P

3.00



CR P

KK RT

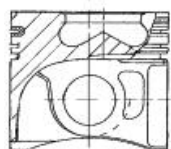
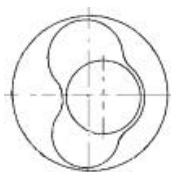

08980C

32 **89.00**

350 D Turbo

03/90→06/91

OM 603A.970

6 Cyl.

22:1

3449cc

100kW (136PS)

Diesel

Turbo

TD2224

14-026380-00 D

B 91.50 **C** 156.50 **D** 96.55 **E** 4.70

14-027210-00 D

B 91.50 **C** 156.50 **D** 94.05 **E** 4.70

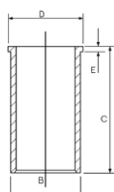

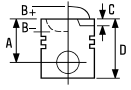

33 89.00

C-Class (S202) C 220 T D	06/96→03/01	OM 604.910			
C-Class (W202) C 220 D	08/93→05/00		4 Cyl.	22:1	
			2155cc	55-70kW (75-95PS)	
		Diesel			TD2227
E-Class (W210) E 220 D	06/95→03/02	OM 604.912			
			4 Cyl.	22:1	
			2155cc	55-70kW (75-95PS)	
		Diesel			TD4676

87-743100-30 STD **08-743100-00** STD **14-027210-00 D** B 91.50 C 156.50 D 94.05 E 4.70

87-743107-30 0.50mm **08-743107-00** 0.50mm

08-743120-00 0.70mm

A 43.55

B- 4.55

C 2.35

D 73.55

 26x55

2.50

2.00

3.00



CR P

P

CR P

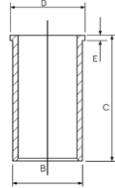

KK RT

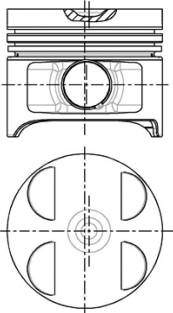

08976G

34 89.90

C-Class (W202) C 280	05/93→05/00	M 104.941			
			6 Cyl.	10:1	
			2799cc	142kW (193PS)	
					TD2106
E-Class (S124) E 280 T	06/93→06/96	M 104.942			
E-Class (W124) E 280	06/93→06/95		6 Cyl.	10:1	
Kombi (S124) 280 TE	10/92→06/93		2799cc	142-145kW (193-197PS)	
Saloon (W124) 280 E					TD2107
SL (R129) 280	08/93→10/01	M 104.943			
			6 Cyl.	10:1	
			2799cc	142-150kW (193-204PS)	
					TD2108
S-Class (W140) 300 SE 2.8	01/93→10/98	M 104.944			
S-Class (W140) S 280	02/93→10/98		6 Cyl.	10:1	
			2799cc	142-145kW (193-197PS)	
					TD2109







E-Class (W210) E 280	01/96→06/97	M 104.945	6 Cyl.	10:1	
			2799cc	142kW (193PS)	TD9423

87-287500-20	STD	08-287500-00	STD
87-287507-20 ¹	0.50mm	08-287505-00	0.25mm
		08-287507-00	0.50mm

A	32.38
B-	2.54
BØ	59.00
C	1.20
D	58.58
	22x56

1.50		NT ²
1.75		P
3.00		CR P

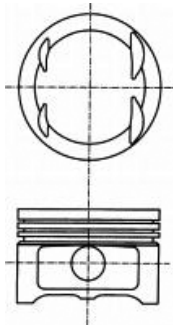

09029

¹ A = 32.075, D = 58.075

² Steel

¹ A = 32.075, D = 58.075

² Stahl

¹ A = 32.075, D = 58.075

² Acier

¹ A = 32.075, D = 58.075

² Acero

¹ A = 32.075, D = 58.075

² Acciaio

35 89.90

S-Class (W140) 300 SE;SEL;S320	03/91→10/98	M 104.990	6 Cyl.	10:1	
S-Class (W140) S 320	10/95→08/98		3199cc	162-170kW (220-231PS)	TD2112

SL (R129) 320	09/93→10/01	M 104.991	6 Cyl.	10:1	
SL (R129) SL 320	09/94→12/97		3199cc	170kW (231PS)	TD2113

Coupe (C124) 320 CE	10/92→05/93	M 104.992	6 Cyl.	10:1	
E-Class (A124) E 320	06/93→03/98		3199cc	162kW (220PS)	TD2114
E-Class (C124) E 320	06/93→06/97				
E-Class (S124) E 320 T	06/93→06/96				
E-Class (W124) E 320	06/93→06/95				
Kombi (S124) 320 TE	10/92→06/93				
Saloon (W124) 320 E					

S-Class (W140) 300 SE;SEL;S320	03/91→10/98	M 104.994	6 Cyl.	10:1	
			3199cc	170kW (231PS)	TD11250

E-Class (A124) E 320	06/93→03/98	M 104.995	6 Cyl.	10:1	
E-Class (W210) E 320	06/95→06/97		3199cc	162kW (220PS)	TD4658



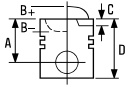





G-Class (W463) 320 GE	09/94 → 11/97	M 104.996		
G-Class (W463) G 320	09/94 → 12/97		6 Cyl.	9.2:1
			3199cc	155kW (211PS)

TD11251

87-287500-10	STD	08-287500-00	STD
87-287505-10	0.25mm	08-287505-00	0.25mm
		08-287507-00	0.50mm

A 31.12
 B- 3.25
 BØ 70.00
 C 2.60
 D 56.12
 22x55

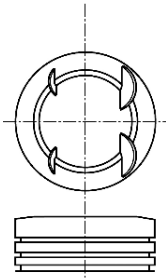

1.50  NT ¹
 1.75  P
 3.00  CR P



09034

87-287500-30 ¹	STD	08-287500-00	STD
87-287505-30 ¹	0.25mm	08-287505-00	0.25mm
87-287507-30 ¹	0.50mm	08-287507-00	0.50mm

A 31.12
 B- 2.60
 BØ 74.00
 C 1.30
 C 1.80
 D 56.10
 22x56

1.50  NT ²
 1.75  P
 3.00  CR P

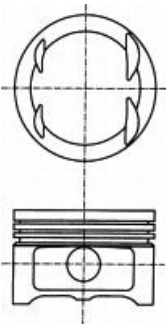

09024

¹ Elastoval ®
² Steel

¹ Elastoval ®
² Stahl

¹ Elastoval ®
² Acier

¹ Elastoval ®
² Acero

¹ Elastoval ®
² Acciaio

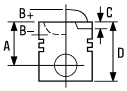

36 89.90

Coupe (C124) 220 CE	10/92→05/93	M 111.960			
E-Class (A124) E 220	06/93→03/98		4 Cyl.	9.8:1	
E-Class (C124) E 220	06/93→06/97		2199cc	110kW (150PS)	
E-Class (S124) E 220 T	06/93→06/96				TD2134
E-Class (W124) E 220	06/93→06/95				
Kombi (S124) 220 TE	10/92→05/93				
Saloon (W124) 220 E	10/92→06/93				
<hr/>					
C-Class (W202) C 220	03/93→05/00	M 111.961			
			4 Cyl.	9.8:1	
			2199cc	110kW (150PS)	
					TD2135

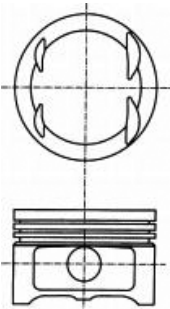

87-287500-00 ¹ STD

A 32.90
 B- 4.80
 BØ 74.00
 C 2.98
 C 1.53
 D 57.90
 22x56



09032

08-287500-00 STD
 08-287505-00 0.25mm
 08-287507-00 0.50mm

1.50  NT ²
 1.75  P
 3.00  CR P

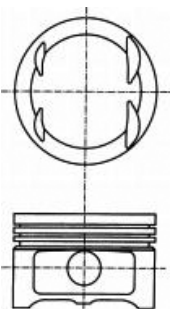

87-287500-40 ¹ STD
 87-287507-40 ¹ 0.50mm

A 32.90
 B- 1.45
 BØ 70.00
 C 2.98
 C 2.44
 D 57.90
 22x56



09025-/09027

08-287500-00 STD
 08-287505-00 0.25mm
 08-287507-00 0.50mm

1.50  NT ²
 1.75  P
 3.00  CR P

¹ Elastoval ®
² Steel

¹ Elastoval ®
² Stahl

¹ Elastoval ®
² Acier

¹ Elastoval ®
² Accero

¹ Elastoval ®
² Acciaio

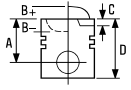

37  **89.90**

CLK (A208) 320	03/98→03/02	M 112.940				
CLK (C208) 320	06/97→06/02		V6 Cyl.	10:1	160-162kW (218-220PS)	TD9407
E-Class (S210) E 320	09/97→12/98	M 112.941				
E-Class (S210) E 320 T			V6 Cyl.	10:1	160-165kW (218-224PS)	TD9418
E-Class (S210) E 320 T 4-matic	12/96→03/03		3199cc			
E-Class (W210) E 320						
E-Class (W210) E 320 4-matic	06/97→03/02					
M-Class (W163) ML 320	02/98→08/02	M 112.942				
			V6 Cyl.	10:1	160kW (218PS)	TD9898
			3199cc			
SL (R129) 320	05/98→10/01	M 112.943				
			V6 Cyl.	10:1	165kW (224PS)	TD11494
			3199cc			
S-Class (W220) S 320	10/98→08/05	M 112.944				
			V6 Cyl.	10:1	165kW (224PS)	TD11491
			3199cc			
G-Class (W463) G 320	07/97→	M 112.945				
			V6 Cyl.	10:1	158kW (215PS)	TD9888
			3199cc			
C-Class (CL203) C 320	09/02→05/08	M 112.946				
C-Class (W203) C 320	05/00→02/07		V6 Cyl.	10:1	160kW (218PS)	TD15452
C-Class T-Model (S203) C 320	03/01→08/07		3199cc			
SLK (R170) 320	03/00→04/04	M 112.947				
			V6 Cyl.	10:1	160kW (218PS)	TD14773
			3199cc			
E-Class (W211) E 320	03/02→12/08	M 112.949				
E-Class T-Model (S211) E 320 T	03/03→07/09		V6 Cyl.	10:1	165kW (224PS)	TD16894
			3199cc			
E-Class (S210) E 430 T	06/97→03/03	M 113.940				
E-Class (S210) E 430 T 4-matic	05/99→03/03		V8 Cyl.	9.8:1	205kW (279PS)	TD9889
E-Class (W210) E 430	06/97→03/02		4266cc			
E-Class (W210) E 430 4-matic	05/99→03/02					
S-Class (W220) S 430	10/98→08/05	M 113.941				
			V8 Cyl.	9.8:1	205kW (279PS)	TD11492
			4266cc			
M-Class (W163) ML 430	02/98→06/05	M 113.942				
			V8 Cyl.	9.8:1	199kW (271PS)	TD10949
			4266cc			
CLK (A208) 430	09/98→03/02	M 113.943				
CLK (C208) 430	07/98→06/02		V8 Cyl.	9.8:1	205kW (279PS)	TD10947
			4266cc			





C-Class (S202) C 43 AMG	08/97→03/01	M 113.944		
C-Class (W202) C 43 AMG	08/97→05/00		V8 Cyl. 4266cc	9.8:1 205-225kW (279-306PS)

TD11489

87-119000-00	STD	08-119000-00	STD
A 31.30		08-119005-00	0.25mm
B- 2.42		08-119007-00	0.50mm
BØ 65.82		1.50	NT <input type="checkbox"/>
C 1.82		1.75	P <input type="checkbox"/>
D 53.30		3.00	CR <input type="checkbox"/>
22x52			

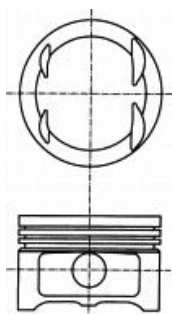

09044

Steel

Stahl

Acier

Acero





Acciaio



38 90.90

E-Class (S210) E 230 T	06/96→06/97	M 111.970		
E-Class (W210) E 230	06/95→06/97		4 Cyl.	10.4:1
			2295cc	110kW (150PS)
TD4664				
C-Class (S202) C 230 T	06/96→06/98	M 111.974		
C-Class (W202) C 230	06/96→06/97		4 Cyl.	10.4:1
			2295cc	110kW (150PS)
TD4666				
Sprinter 2-t (901; 902) 214	02/95→05/06	M 111.984		
Sprinter 2-t (901; 902) 214 NGT	04/00→05/06		4 Cyl.	8.8:1
Sprinter 3-t (903) 314	02/95→05/06		2295cc	92-105kW (125-143PS)
Sprinter 3-t (903) 314 NGT	04/00→05/06			
TD17850				



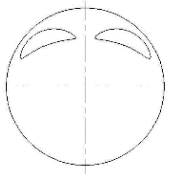
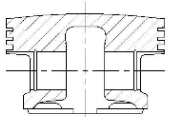

87-109100-00 STD **08-109100-00** STD
87-109107-00 ¹ 0.50mm **08-109107-00** 0.50mm

A 30.00 1.50  NT ²
B+ 2.90 1.75  NT ²
C 1.00 3.00  NT ²
D 57.90
 22x56



09128

87-109100-10 STD **08-109100-00** STD
87-109107-10 0.50mm **08-109107-00** 0.50mm

01/96→
A 30.00 1.50  NT ²
B- 1.10 1.75  NT ²
BØ 70.00 3.00  NT ²
C 0.85
D 55.00
 22x56

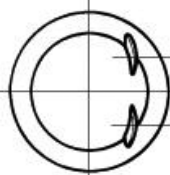
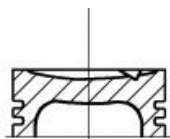







09130

¹ B+ = 1.700 ¹ B+ = 1.700 ¹ B+ = 1.700 ¹ B+ = 1.700 ¹ B+ = 1.700
² Steel ² Stahl ² Acier ² Acero ² Acciaio



39 90.90

CLK (A208) 230 Kompressor	03/98→06/00	M 111.973			
CLK (C208) 230 Kompressor	06/97→06/00		4 Cyl.	8.8:1	
SLK (R170) 230 Kompressor	09/96→12/00		2295cc	138-142kW (188-193PS)	
			Supercharged		TD4665
C-Class (S202) C 230 T Kompressor	06/97→09/00	M 111.975			
C-Class (W202) C 230	09/98→05/00		4 Cyl.	8.8:1	
C-Class (W202) C 230 Kompressor	10/95→05/00		2295cc	138-142kW (188-193PS)	
CLK (A208) 230 Kompressor	03/98→06/00		Supercharged		TD4667
CLK (C208) 230 Kompressor	06/97→06/00				
V-Class (638/2) V 230	10/96→07/03	M 111.978			
Vito (638) 114 2.3	12/96→07/03		4 Cyl.	8.8:1	
			2295cc	105kW (143PS)	
					TD4668
Sprinter 2-t (901; 902) 214	02/95→05/06	M 111.979			
Sprinter 3-t (903) 314			4 Cyl.	8.8:1	
Sprinter 4-t (904) 414	02/96→05/06		2295cc	105kW (143PS)	
					TD5241
C-Class (CL203) C 230 Kompressor	03/01→12/02	M 111.981			
			4 Cyl.	9:1	
			2295cc	143-145kW (194-197PS)	
					TD17177
CLK (A208) 230 Kompressor	06/00→03/02	M 111.982			
CLK (C208) 230 Kompressor	06/00→06/02		4 Cyl.	9:1	
			2295cc	145kW (197PS)	
			Supercharged		TD16884
SLK (R170) 230	09/00→04/04	M 111.983			
SLK (R170) 230 Kompressor	03/00→04/04		4 Cyl.	9:1	
			2295cc	143-145kW (194-197PS)	
			Supercharged		TD14750

87-109100-10	STD	08-109100-00	STD
87-109107-10	0.50mm	08-109107-00	0.50mm
A	30.00	1.50	 NT 
B-	1.10	1.75	 NT 
BØ	70.00	3.00	 NT 
C	0.85		
D	55.00		
	22x56		

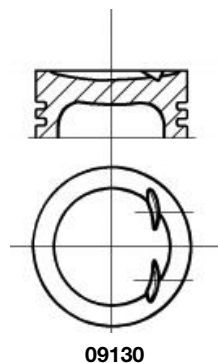

09130

 Steel

 Stahl

 Acier

 Acero



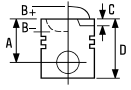

 Acciaio



40  **90.90**

M-Class (W163) ML 230	02/98 → 06/05	M 111.977	4 Cyl. 2295cc	10.4:1 110kW (150PS)	TD10948
V230	11/95 → 09/03	M 111.980	4 Cyl. 2295cc	8.8:1 105kW (143PS)	TD22703

87-109100-00	STD	08-109100-00	STD
87-109107-00 ¹	0.50mm	08-109107-00	0.50mm

A	30.00	1.50	 NT ²
B+	2.90	1.75	 NT ²
C	1.00	3.00	 NT ²
D	57.90		
	22x56		

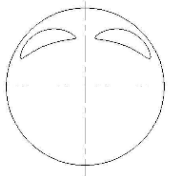
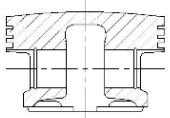

09128

¹ B+ = 1.700	¹ B+ = 1.700	¹ B+ = 1.700	¹ B+ = 1.700	¹ B+ = 1.700
² Steel	² Stahl	² Acier	² Acero	² Acciaio



41 90.90

T2/L L 407 D	01/75→12/88	OM 616.910 OM 616 4 Cyl. 2399cc	21:1 48-53kW (65-72PS)	TD2245
		Diesel		
T1/TN 407 D	07/81→01/89	OM 616.913 OM 616 4 Cyl. 2399cc	21:1 53kW (72PS)	TD2247
		Diesel		
T2/LN1 507 D T2/LN1 507 DK	04/86→04/89	OM 616.914 OM 616 4 Cyl. 2399cc	21:1 53kW (72PS)	TD8040
		Diesel		
U60	05/69→	OM 616.930 OM 616 4 Cyl. 2399cc	21:1 44kW (60PS)	TD5677
		Diesel		
T1 (601) 207 D 2.4	05/77→12/82	OM 616.934 OM 616 4 Cyl. 2399cc	21:1 48kW (65PS)	TD2250
		Diesel		
G-Class (W460) 240 GD	03/79→08/87	OM 616.936 4 Cyl. 2399cc	21:1 53kW (72PS)	TD2251
		Diesel		
T1 (601) 207 D 2.4 T1 (602) 307 D 2.4	12/77→01/90 04/77→01/90	OM 616.937 OM 616 4 Cyl. 2399cc	21:1 48-53kW (65-72PS)	TD2252
		Diesel		
240 GD	09/78→	OM 616.938 4 Cyl. 2399cc	21:1 53kW (72PS)	TD17733
		Diesel		
T1 (601) 207 D 2.4 T1 (602) 307 D 2.4 T1/TN 407 D	06/82→01/90 06/82→01/90 07/81→01/89	OM 616.939 OM 616 4 Cyl. 2399cc	21:1 53kW (72PS)	TD2253
		Diesel		
240 GD	09/78→	OM 616.940 OM 616 4 Cyl. 2399cc	21:1 53kW (72PS)	TD22836
		Diesel		
100 (631) 2.4 D 100 (631) D	01/93→01/96 02/88→02/96	OM 616.963 OM 616 4 Cyl. 2399cc	21:1 53-56kW (72-76PS)	TD2257
		Diesel		
T1 (601) 209 D 2.9 T1 (602) 309 D 3.0 T1/TN 409 D	12/82→01/90 10/82→01/90 04/82→01/89	OM 617.913 OM 617 5 Cyl. 2998cc	21:1 65kW (88PS)	TD2261
		Diesel		
G-Class (W460) 300 GD	12/79→12/91	OM 617.931 5 Cyl. 2998cc	21:1 65kW (88PS)	TD2262
		Diesel		



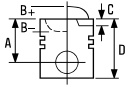

300 GD	12/79→08/90	OM 617.932	5 Cyl. 2998cc	21:1 65kW (88PS)	
Diesel					TD17743

87-176700-00	STD	08-176700-00	STD	14-021350-00 D	B 94.00 C 158.40 D 96.00 E 4.70
87-176708-00	0.60mm	08-176707-00	0.50mm		
		08-176708-00	0.60mm		
		08-176711-00	1.00mm		

A	48.35
B-	8.75
C	1.15
D	79.65
	26x74

08/78→

3.00		MOL P
2.00		P
4.00		CR P

RT

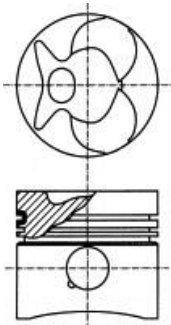

09105H/09113C

Bore = 90.90mm

Bohrung = 90.90mm

Alésage = 90.90mm

Tamaño del diámetro = 90.90mm

Alessagio = 90.90mm

42 91.00

Engine	02/73→07/78	OM 616.918 OM 616	4 Cyl. 2399cc	21:1 35-48kW (48-65PS)	TD28786
Diesel					
240 D	07/73→05/77	OM 616.919 OM 616	4 Cyl. 2399cc	21:1 38-48kW (52-65PS)	TD28787
Diesel					
U60	08/73→07/78	OM 616.933 OM 616	4 Cyl. 2404cc	21:1 44kW (60PS)	TD16998
Diesel					
U600	05/88→02/01	OM 616.944 OM 616	4 Cyl. 2399cc	21:1 44kW (60PS)	TD16937
Diesel					
O309	12/80→06/89	OM 616.960 OM 616	4 Cyl. 2399cc	21:1 53kW (72PS)	TD2255
Diesel					
Engine	12/80→12/86	OM 616.961 OM 616	4 Cyl. 2399cc	21:1 53kW (72PS)	TD2256
Diesel					



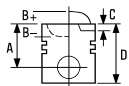

Engine	12/80→12/86	OM 616.962 OM 616 4 Cyl. 2399cc	21:1 33-53kW (45-72PS)	TD28788
		Diesel		
Engine	08/74→11/85	OM 617.919 OM 617 5 Cyl. 2998cc	21:1 65kW (88PS)	TD28789
		Diesel		
300 GD	12/79→08/90	OM 617.933 5 Cyl. 2998cc	21:1 65kW (88PS)	TD26550
		Diesel		
300 SD	02/78→08/90	OM 617.950 5 Cyl. 2998cc	21.5:1 85-92kW (116-125PS)	TD2263
		Diesel Turbo		
S-Class (W126) 300 SD	09/80→12/85	OM 617.951 5 Cyl. 2998cc	21.5:1 92kW (125PS)	TD2264
		Diesel Turbo		
Coupe (C123) 300 C Turbo-D Kombi (S123) 300 T Turbo-D Saloon (W123) 300 Turbo-D	09/81→07/85 10/80→11/85 08/81→07/85	OM 617.952 5 Cyl. 2998cc	21:1 92kW (125PS)	TD2265
		Diesel Turbo		

14-021350-00 D

B 94.00 C 158.40 D 96.00 E 4.70

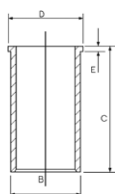

43  **91.00**

Kombi (S123) 240 T D Saloon (W123) 240 D	09/77→12/85 02/76→11/85	OM 616.912 4 Cyl. 2404cc	21:1 46-53kW (63-72PS)	TD9432
		Diesel		
T1 (601) 207 D 2.4 T1 (602) 307 D 2.4 T2/L L 407 D	04/77→12/82 01/77→12/90 01/75→12/88	OM 616.917 OM 616 4 Cyl. 2404cc	21:1 48kW (65PS)	TD2249
		Diesel		



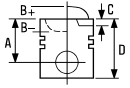

Kombi (S123) 300 T D	09/77 → 11/85	OM 617.912	5 Cyl.	21:1	TD2260
Saloon (W123) 300 D	02/76 → 11/85		2998cc	59-65kW (80-88PS)	
Diesel					

87-173800-10	STD	08-173800-00	STD	14-021350-00 D	B 94.00 C 158.40 D 96.00 E 4.70
87-173807-10	0.50mm	08-173805-00	0.25mm		
		08-173807-00	0.50mm		
		08-173811-00	1.00mm		
02/73 → 07/78					

A 48.35
B- 6.25
D 79.65
 26x74

→ 07/78

3.00 MO P
 2.00 P
 4.00 CR P

RT

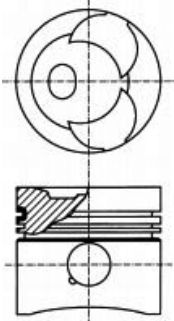

09105-/09113

87-176700-00	STD	08-176700-00	STD		
87-176708-00	0.60mm	08-176707-00	0.50mm		
		08-176708-00	0.60mm		
08/78 →		08-176711-00	1.00mm		

A 48.35
B- 8.75
C 1.15
D 79.65
 26x74

08/78 →

3.00 MOL P
 2.00 P
 4.00 CR P

RT

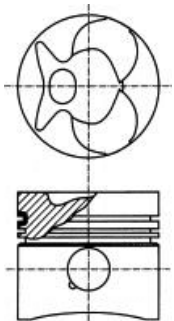

09105H/09113C

Bore = 90.90mm

Bohrung = 90.90mm

Alésage = 90.90mm

Tamaño del diámetro = 90.90mm

Alessagio = 90.90mm

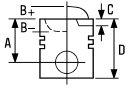

44 91.00

/8 (W115) 240 D	08/73→01/77	OM 616.916	4 Cyl.	21:1
			2404cc	48kW (65PS)
		Diesel		TD2248

/8 (W115) 240 D 3.0	08/74→11/76	OM 617.910	5 Cyl.	21:1
			2998cc	59kW (80PS)
		Diesel		TD2259

87-173800-10 STD
87-173807-10 0.50mm

02/73→07/78

A 48.35
B- 6.25
D 79.65
 26x74

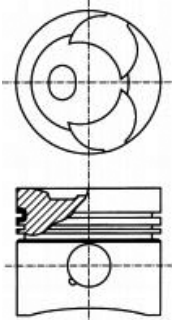

RT



09105-/09113

08-173800-00 STD
08-173805-00 0.25mm
08-173807-00 0.50mm
08-173811-00 1.00mm

→07/78

3.00  MO P
2.00  P
4.00  CR P

14-021350-00 D B 94.00 C 158.40 D 96.00 E 4.70

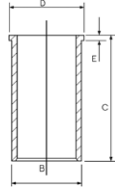







45  **95.50**

G-Class (W460) 230 GE	05/87→08/92	M 102.979	4 Cyl.	9:1		
G-Class (W461) 230 GE	02/93→		2299cc	90kW (122PS)		TD2081
G-Class (W460) 230 GE	04/82→08/92	M 102.981	4 Cyl.	9:1		
			2299cc	92kW (125PS)		TD2083
Coupe (C124) 230 CE	03/87→12/92	M 102.982	4 Cyl.	9:1		
Kombi (S124) 230 TE	09/85→08/92		2299cc	97-100kW (132-136PS)		TD4656
Saloon (W124) 230 E	12/84→06/93					
190 (W201) 2.3	09/87→09/88	M 102.985	4 Cyl.	9:1		
190 (W201) 2.3 E	10/82→09/88		2299cc	97-100kW (132-136PS)		TD4657
190 (W201) E 2.3	09/86→08/93					
G-Class (W460) 230 GE	04/82→08/92	M 102.987	4 Cyl.	9:1		
			2299cc	90-92kW (122-125PS)		TD2089

87-179700-10 ¹	STD	08-179700-00	STD
87-179707-10 ^{1 2}	0.50mm	08-179707-00	0.50mm
87-179711-10 ^{1 2}	1.00mm	08-179711-00	1.00mm

A	43.20	1.75	 MOL P
B-	1.85	2.00	 P
BØ	70.00	3.50	 CR P
C	3.46		
C	1.53		
D	78.70		
	22x56		

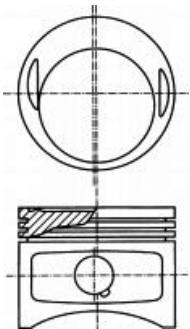

09596

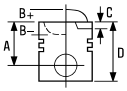

¹ Conrod gap 22.00mm	¹ Pleuelaugenabstand 22.00mm	¹ Distance entre bielle 22.00mm	¹ Distancia del biela 22.15mm	¹ Distanza dalla biella 22.00mm
² A = 42.850, B = 1.500, D = 75.850	² A = 42.850, B = 1.500, D = 75.850	² A = 42.850, B = 1.500, D = 75.850	² A = 42.850, B = 1.500, D = 75.850	² A = 42.850, B = 1.500, D = 75.850



46 95.50



Coupe (C123) 230 CE	04/80→12/85	M 102.980		
Kombi (S123) 230 TE	04/80→11/85		4 Cyl.	9:1
Saloon (W123) 230 E	04/80→12/85		2299cc	100kW (136PS)

TD2082

87-179700-00 	STD	08-179700-00	STD
87-179707-00 	0.50mm	08-179707-00	0.50mm
87-179711-00 	1.00mm	08-179711-00	1.00mm



→12/83

A	43.20
B-	1.85
BØ	70.00
C	2.33
C	1.53
D	83.20
	24x62

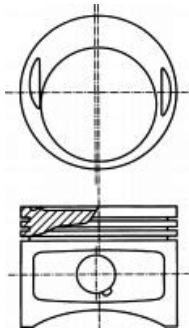
1.75		MOL P
2.00		P
3.50		CR P





09589

87-179700-10 	STD	08-179700-00	STD
87-179707-10 	0.50mm	08-179707-00	0.50mm
87-179711-10 	1.00mm	08-179711-00	1.00mm

09/83→

A	43.20
B-	1.85
BØ	70.00
C	3.46
C	1.53
D	78.70
	22x56

1.75		MOL P
2.00		P
3.50		CR P

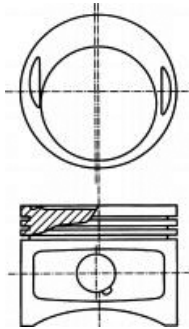



09596

 Conrod gap 31.00mm

 Conrod gap 22.00mm

 A = 42.850, B = 1.500, D = 75.850

 Pleuelaugenabstand 31.00mm

 Pleuelaugenabstand 22.00mm

 A = 42.850, B = 1.500, D = 75.850

 Distance entre bielle 31.00mm

 Distance entre bielle 22.00mm

 A = 42.850, B = 1.500, D = 75.850

 Distancia del biela 31.00mm





 Distancia del biela 22.15mm





 A = 42.850, B = 1.500, D = 75.850





 Distanza dalla biella 31.00mm

 Distanza dalla biella 22.00mm





 A = 42.850, B = 1.500, D = 75.850





		ccm	x 		9
M 476.921	Petrol	11967	6	128.00	29
M 476.925	Petrol	11967	6	128.00	29
M 476.926	Petrol	11967	6	128.00	29
M 476.927	Petrol	11967	6	128.00	29
M 476.930 Euro 2 M 447 HLA G	Petrol	11967	6	128.00	29
OM 314.900	Diesel	3782	4	97.00	9
OM 314.910 OM 314	Diesel	3782	4	97.00	10
OM 314.914	Diesel	3782	4	97.00	9
OM 314.915 OM 314	Diesel	3782	4	97.00	10
OM 314.916 OM 314	Diesel	3782	4	97.00	10
OM 314.917 OM 314	Diesel	3782	4	97.00	10
OM 314.918	Diesel	3782	4	97.00	9
OM 314.919	Diesel	3782	4	97.00	9
OM 314.920	Diesel	3782	4	97.00	9
OM 314.921	Diesel	3782	4	97.00	9
OM 314.922	Diesel	3782	4	97.00	9
OM 314.940	Diesel	3782	4	97.00	9
OM 314.941	Diesel	3782	4	97.00	9
OM 314.942	Diesel	3782	4	97.00	9
OM 314.943	Diesel	3782	4	97.00	9
OM 314.944 OM 314	Diesel	3782	4	97.00	10
OM 314.945	Diesel	3782	4	97.00	9
OM 314.946 OM 314	Diesel	3782	4	97.00	10
OM 314.947	Diesel	3782	4	97.00	9
OM 314.948 OM 314	Diesel	3782	4	97.00	10
OM 314.949	Diesel	3782	4	97.00	9
OM 314.950	Diesel	3782	4	97.00	9
OM 314.951	Diesel	3782	4	97.00	9
OM 314.953 OM 314	Diesel	3782	4	97.00	10
OM 314.954	Diesel	3782	4	97.00	9
OM 314.956 OM 314	Diesel	3782	4	97.00	10
OM 314.957 OM 314	Diesel	3782	4	97.00	10
OM 314.958	Diesel	3782	4	97.00	9
OM 314.959 OM 314	Diesel	3782	4	97.00	10
OM 314.960	Diesel	3782	4	97.00	9
OM 314.961 OM 314	Diesel	3782	4	97.00	10
OM 314.962 OM 314	Diesel	3782	4	97.00	10
OM 314.963 OM 314	Diesel	3782	4	97.00	10
OM 314.964 OM 314	Diesel	3782	4	97.00	10
OM 314.970 OM 314 A	Diesel	3782	4	97.00	9
OM 345.913 OM 355 A	Diesel	11581	6	128.00	30
OM 345.960 OM 355 A	Diesel	11581	6	128.00	30
OM 352.901-964	Diesel	5673	6	97.00	10
OM 352.913 OM 352 A	Diesel	5673	6	97.00	11
OM 352.916 OM 352 A	Diesel	5673	6	97.00	11
OM 352.918 OM 352 A	Diesel	5673	6	97.00	11
OM 352.937 OM 352 A	Diesel	5673	6	97.00	11
OM 352.946 OM 352 A	Diesel	5673	6	97.00	11
OM 352.949 OM 352 A	Diesel	5673	6	97.00	11
OM 352.950 OM 352 A	Diesel	5673	6	97.00	11
OM 352.965	Diesel	5673	6	97.00	9
OM 352.966	Diesel	5673	6	97.00	9
OM 352.967	Diesel	5673	6	97.00	9
OM 352.968 OM 352 A	Diesel	5673	6	97.00	11
OM 352.969-998	Diesel	5673	6	97.00	10
OM 352.988 OM 352 A	Diesel	5673	6	97.00	11
OM 352.994 OM 352 A	Diesel	5673	6	97.00	11
OM 352.999	Diesel	5673	6	97.00	9
OM 353.900 OM 352	Diesel	5673	6	97.00	10
OM 353.902 OM 352	Diesel	5673	6	97.00	10
OM 353.903 OM 352	Diesel	5673	6	97.00	10
OM 353.904 OM 352	Diesel	5673	6	97.00	10
OM 353.905 OM 352	Diesel	5673	6	97.00	10
OM 353.909 OM 352 A	Diesel	5673	6	97.00	9
OM 353.910 OM 352 A	Diesel	5673	6	97.00	9
OM 353.911 OM 352 A	Diesel	5673	6	97.00	11
OM 353.912 OM 352 A	Diesel	5673	6	97.00	11
OM 353.913 OM 352 A	Diesel	5673	6	97.00	11
OM 353.914 OM 352 A	Diesel	5673	6	97.00	11

		ccm	x 		9
OM 353.915 OM 352	Diesel	5673	6	97.00	10
OM 353.916 OM 352	Diesel	5673	6	97.00	10
OM 353.917 OM 352	Diesel	5673	6	97.00	10
OM 353.941 OM 352	Diesel	5673	6	97.00	10
OM 353.942 OM 352	Diesel	5673	6	97.00	10
OM 353.943 OM 352	Diesel	5673	6	97.00	10
OM 353.944 OM 352	Diesel	5673	6	97.00	10
OM 353.945 OM 352	Diesel	5673	6	97.00	10
OM 353.946 OM 352	Diesel	5673	6	97.00	10
OM 353.949 OM 352	Diesel	5673	6	97.00	10
OM 353.950 OM 352 A	Diesel	5673	6	97.00	11
OM 353.951 OM 352 A	Diesel	5673	6	97.00	11
OM 353.952 OM 352 A	Diesel	5673	6	97.00	11
OM 353.953 OM 352 A	Diesel	5673	6	97.00	11
OM 353.954 OM 352 A	Diesel	5673	6	97.00	11
OM 353.957 OM 352 A	Diesel	5673	6	97.00	9
OM 353.958 OM 353 A	Diesel	5673	6	97.00	11
OM 353.959 OM 352 A	Diesel	5673	6	97.00	11
OM 353.960 OM 352	Diesel	5673	6	97.00	10
OM 353.963 OM 352	Diesel	5673	6	97.00	10
OM 353.964 OM 352	Diesel	5673	6	97.00	10
OM 353.965 OM 352	Diesel	5673	6	97.00	10
OM 353.966 OM 352	Diesel	5673	6	97.00	10
OM 353.967 OM 352	Diesel	5673	6	97.00	10
OM 353.968 OM 352	Diesel	5673	6	97.00	10
OM 353.969 OM 352	Diesel	5673	6	97.00	10
OM 353.970 OM 352 A	Diesel	5673	6	97.00	11
OM 353.971 OM 352 A	Diesel	5673	6	97.00	11
OM 353.972 OM 352 A	Diesel	5673	6	97.00	11
OM 353.973 OM 352 A	Diesel	5673	6	97.00	11
OM 353.974 OM 352 A	Diesel	5673	6	97.00	11
OM 353.975 OM 352 A	Diesel	5673	6	97.00	11
OM 353.976 OM 352 A	Diesel	5673	6	97.00	11
OM 353.977	Diesel	5673	6	97.00	9
OM 353.978 OM 352 A	Diesel	5673	6	97.00	11
OM 353.981 OM 352	Diesel	5673	6	97.00	10
OM 353.982 OM 352	Diesel	5673	6	97.00	10
OM 353.983 OM 352	Diesel	5673	6	97.00	10
OM 353.984 OM 352	Diesel	5673	6	97.00	10
OM 353.989 OM 352	Diesel	5673	6	97.00	10
OM 353.991 OM 352 A	Diesel	5673	6	97.00	11
OM 353.995 OM 352 A	Diesel	5673	6	97.00	9
OM 353.996 OM 352	Diesel	5675	6	97.00	9
OM 353.997 OM 352 A	Diesel	5673	6	97.00	11
OM 354.900 Euro 2 OM 364 LA	Diesel	3972	4	97.50	12
OM 354.901 Euro 2 OM 364 LA	Diesel	3972	4	97.50	12
OM 354.902 Euro 2 OM 364 LA	Diesel	3972	4	97.50	12
OM 354.903 Euro 2 OM 364 LA	Diesel	3972	4	97.50	12
OM 354.920 Euro 2 OM 364 LA	Diesel	3972	4	97.50	12
OM 354.921 Euro 2 OM 364 LA	Diesel	3972	4	97.50	12
OM 354.922 Euro 2 OM 364 LA	Diesel	3972	4	97.50	12
OM 354.923 Euro 2 OM 364 LA	Diesel	3972	4	97.50	12
OM 354.924 Euro 2 OM 364 LA	Diesel	3972	4	97.50	12
OM 354.925 Euro 2 OM 364 LA	Diesel	3972	4	97.50	12
OM 354.926 Euro 2	Diesel	3972	4	97.50	12
OM 355.910 OM 355	Diesel	11581	6	128.00	31
OM 355.911 OM 355	Diesel	11581	6	128.00	31
OM 355.912 OM 355	Diesel	11581	6	128.00	31
OM 355.913 OM 355	Diesel	11581	6	128.00	31
OM 355.914 OM 355	Diesel	11581	6	128.00	31
OM 355.915 OM 355	Diesel	11581	6	128.00	31
OM 355.916	Diesel	11581	6	128.00	31
OM 355.918 OM 355	Diesel	11581	6	128.00	31
OM 355.960 OM 355	Diesel	11581	6	128.00	31
OM 355.961 OM 355 H	Diesel	11581	6	128.00	31
OM 355.962 OM 355	Diesel	11581	6	128.00	31
OM 355.963 OM 355	Diesel	11581	6	128.00	31
OM 355.964 OM 355	Diesel	11581	6	128.00	31
OM 355.966 OM 355	Diesel	11581	6	128.00	31





		ccm	x 		9
---	---	-----	---	---	----------





OM 355.967 OM 355	Diesel	11581	6	128.00	31
OM 355.968 OM 355	Diesel	11581	6	128.00	30
OM 355.969 OM 355 A	Diesel	11581	6	128.00	30
OM 355.970 OM 355	Diesel	11581	6	128.00	31
OM 355.972 OM 355 H	Diesel	11581	6	128.00	31
OM 355.973 OM 355 H	Diesel	11581	6	128.00	31
OM 355.974 OM 355	Diesel	11581	6	128.00	31
OM 355.975 OM 355	Diesel	11600	6	128.00	31
OM 355.976 OM 355	Diesel	11581	6	128.00	31
OM 355.977 OM 355 A	Diesel	11581	6	128.00	30
OM 355.978 OM 355	Diesel	11581	6	128.00	31
OM 355.979 OM 355	Diesel	11581	6	128.00	31
OM 355.980 OM 355	Diesel	11581	6	128.00	31
OM 355.981 OM 355	Diesel	11581	6	128.00	31
OM 355.982 OM 355	Diesel	11581	6	128.00	31
OM 355.983 OM 355	Diesel	11581	6	128.00	31
OM 355.984 OM 355	Diesel	11581	6	128.00	31
OM 356.901 Euro 1 OM 366	Diesel	5958	6	97.50	13
OM 356.902 Euro 1 OM 366	Diesel	5958	6	97.50	13
OM 356.903 Euro 1 OM 366	Diesel	5958	6	97.50	13
OM 356.904 Euro 1 OM 366	Diesel	5958	6	97.50	13
OM 356.905 Euro 1 OM 366	Diesel	5958	6	97.50	13
OM 356.906 Euro 1 OM 366	Diesel	5958	6	97.50	13
OM 356.907 Euro 1 OM 366	Diesel	5958	6	97.50	13
OM 356.908 Euro 1 OM 366	Diesel	5958	6	97.50	13
OM 356.909 Euro 1 OM 366	Diesel	5958	6	97.50	13
OM 356.910 Euro 1 OM 366	Diesel	5958	6	97.50	13
OM 356.911 Euro 1 OM 366	Diesel	5958	6	97.50	13
OM 356.913 Euro 1 OM 366	Diesel	5958	6	97.50	13
OM 356.914 Euro 1 OM 366	Diesel	5958	6	97.50	13
OM 356.915 Euro 1 OM 366	Diesel	5958	6	97.50	13
OM 356.916 Euro 1 OM 366	Diesel	5958	6	97.50	13
OM 356.940 Euro 1 OM 366 A	Diesel	5958	6	97.50	14
OM 356.941 Euro 1 OM 366 A	Diesel	5958	6	97.50	15
OM 356.943 Euro 1 OM 366 A	Diesel	5958	6	97.50	15
OM 356.944 Euro 1 OM 366 A	Diesel	5958	6	97.50	15
OM 356.945 Euro 1 OM 366 A	Diesel	5958	6	97.50	15
OM 356.946 Euro 1 OM 366 A	Diesel	5958	6	97.50	15
OM 356.947 Euro 1 OM 366 A	Diesel	5958	6	97.50	15
OM 356.948 Euro 1 OM 366 A	Diesel	5958	6	97.50	15
OM 356.949 Euro 1 OM 366 A	Diesel	5958	6	97.50	15
OM 356.951 Euro 1 OM 366 A	Diesel	5958	6	97.50	15
OM 356.952 Euro 1 OM 366 A	Diesel	5958	6	97.50	15
OM 356.953 Euro 1 OM 366 A	Diesel	5958	6	97.50	15
OM 356.956 Euro 1 OM 366 A	Diesel	5958	6	97.50	16
OM 356.958 Euro 1 OM 366 A	Diesel	5958	6	97.50	15
OM 356.959 Euro 1 OM 366 A	Diesel	5958	6	97.50	15
OM 356.977 Euro 1 OM 366 LA	Diesel	5958	6	97.50	17
OM 356.978 Euro 1 OM 366 LA	Diesel	5958	6	97.50	17
OM 356.979 OM 366 LA	Diesel	5958	6	97.50	17
OM 356.980 OM 366 LA	Diesel	5958	6	97.50	17
OM 356.983 Euro 1 OM 366 LA	Diesel	5958	6	97.50	17
OM 356.984 OM 366 LA	Diesel	5958	6	97.50	14
OM 356.985 OM 366 LA	Diesel	5958	6	97.50	14
OM 356.986 OM 366 LA	Diesel	5958	6	97.50	17
OM 356.987 Euro 1 OM 366 LA	Diesel	5958	6	97.50	17
OM 356.988 Euro 1	Diesel	5958	6	97.50	17
OM 356.989 OM 366 LA	Diesel	5958	6	97.50	17
OM 356.990 OM 366 LA	Diesel	5958	6	97.50	17
OM 356.991 OM 366 LA	Diesel	5958	6	97.50	17
OM 356.992 OM 366 LA	Diesel	5958	6	97.50	17
OM 356.993 OM 366 LA	Diesel	5958	6	97.50	17
OM 356.994 OM 366 LA	Diesel	5958	6	97.50	17
OM 356.995 OM 366 LA	Diesel	5958	6	97.50	17
OM 356.996 OM 366 LA	Diesel	5958	6	97.50	17
OM 356.997 OM 366 LA	Diesel	5958	6	97.50	17
OM 356.998 OM 366 LA	Diesel	5958	6	97.50	17
OM 356.999 OM 366 LA	Diesel	5958	6	97.50	17
OM 357.900 OM 366 LA	Diesel	5958	6	97.50	12

		ccm	x 		9
OM 357.901 OM 366 LA	Diesel	5958	6	97.50	12
OM 357.902 OM 366 LA	Diesel	5958	6	97.50	12
OM 357.903 OM 366 LA	Diesel	5958	6	97.50	12
OM 357.904 OM 366 LA	Diesel	5958	6	97.50	12
OM 357.906 OM 366 LA	Diesel	5958	6	97.50	12
OM 357.907 OM 366 LA	Diesel	5958	6	97.50	12
OM 357.908 OM 366 LA	Diesel	5958	6	97.50	12
OM 357.909 OM 366 LA	Diesel	5958	6	97.50	12
OM 357.910 OM 366 LA	Diesel	5958	6	97.50	12
OM 357.915 OM 366 LA	Diesel	5958	6	97.50	12
OM 357.916 OM 366 LA	Diesel	5958	6	97.50	12
OM 357.917 OM 366 LA	Diesel	5958	6	97.50	12
OM 357.918 OM 366 LA	Diesel	5958	6	97.50	12
OM 357.919 OM 366 LA	Diesel	5958	6	97.50	12
OM 357.920 OM 366 LA	Diesel	5958	6	97.50	12
OM 357.921 OM 366 LA	Diesel	5958	6	97.50	12
OM 357.922 OM 366 LA	Diesel	5958	6	97.50	12
OM 357.924 Euro 2 OM 366 LA	Diesel	5958	6	97.50	12
OM 357.925 OM 366 LA	Diesel	5958	6	97.50	12
OM 357.926 OM 366 LA	Diesel	5958	6	97.50	12
OM 357.927 OM 366 LA	Diesel	5958	6	97.50	12
OM 357.929 OM 366 LA	Diesel	5958	6	97.50	12
OM 357.930 OM 366 LA	Diesel	5958	6	97.50	12
OM 357.931 Euro 2 OM 366 LA	Diesel	5958	6	97.50	12
OM 357.932 OM 366 LA	Diesel	5958	6	97.50	12
OM 357.933 OM 366 LA	Diesel	5958	6	97.50	12
OM 357.934 OM 366 LA	Diesel	5958	6	97.50	12
OM 357.935 OM 366 LA	Diesel	5958	6	97.50	12
OM 357.936 Euro 2 OM 366 LA	Diesel	5958	6	97.50	12
OM 357.937 Euro 2 OM 366 LA	Diesel	5958	6	97.50	12
OM 357.938 Euro 2	Diesel	5958	6	97.50	12
OM 357.940 OM 366 LA	Diesel	5958	6	97.50	12
OM 357.941 OM 366 LA	Diesel	5958	6	97.50	12
OM 357.942 OM 366 LA	Diesel	5958	6	97.50	12
OM 357.943 OM 366 LA	Diesel	5958	6	97.50	12
OM 357.944 OM 366 LA	Diesel	5958	6	97.50	12
OM 357.945 Euro 2 OM 366 LA	Diesel	5958	6	97.50	12
OM 357.946 OM 366 LA	Diesel	5958	6	97.50	12
OM 357.947 OM 366 LA	Diesel	5958	6	97.50	12
OM 357.948 OM 366 LA	Diesel	5958	6	97.50	12
OM 357.949 Euro 2 OM 366 LA	Diesel	5958	6	97.50	12
OM 357.961 OM 366 LA	Diesel	5958	6	97.50	12
OM 357.962 OM 366 LA	Diesel	5958	6	97.50	12
OM 357.963 OM 366 LA	Diesel	5958	6	97.50	12
OM 360.911 OM 360 H	Diesel	8720	6	115.00	22
OM 360.912	Diesel	8720	6	115.00	22
OM 360.914 OM 360	Diesel	8720	6	115.00	22
OM 360.915 OM 360	Diesel	8720	6	115.00	22
OM 360.916 OM 360	Diesel	8720	6	115.00	22
OM 360.917 OM 360	Diesel	8720	6	115.00	22
OM 360.918 OM 360	Diesel	8720	6	115.00	22
OM 360.931 OM 360	Diesel	8720	6	115.00	22
OM 360.933 OM 360	Diesel	8720	6	115.00	22
OM 360.934	Diesel	8720	6	115.00	22
OM 360.936 OM 360	Diesel	8725	6	115.00	22
OM 360.937 OM 360	Diesel	8725	6	115.00	22
OM 360.938 OM 360	Diesel	8725	6	115.00	22
OM 360.939 OM 360	Diesel	8720	6	115.00	22
OM 360.940 OM 360	Diesel	8725	6	115.00	22
OM 360.941 OM 360	Diesel	8725	6	115.00	22
OM 360.942 OM 360	Diesel	8725	6	115.00	22
OM 360.943 OM 360	Diesel	8725	6	115.00	22
OM 360.944 OM 360	Diesel	8725	6	115.00	22
OM 360.946 OM 360	Diesel	8725	6	115.00	22
OM 360.947	Diesel	8725	6	115.00	22
OM 360.948 OM 360	Diesel	8725	6	115.00	22
OM 360.949 OM 360	Diesel	8725	6	115.00	22
OM 360.954	Diesel	8725	6	115.00	22
OM 360.955	Diesel	8725	6	115.00	22





		ccm	x 		9
---	---	-----	---	---	----------





OM 360.956	Diesel	8725	6	115.00	22
OM 360.959	Diesel	8725	6	115.00	22
OM 360.974	Diesel	8725	6	115.00	22
OM 360.976	Diesel	8725	6	115.00	22
OM 360.978	Diesel	8725	6	115.00	22
OM 360.980 OM 360	Diesel	8720	6	115.00	22
OM 360.981 OM 360	Diesel	8720	6	115.00	22
OM 360.984 OM 360 A	Diesel	8720	6	115.00	22
OM 360.985 OM 360 A	Diesel	8720	6	115.00	22
OM 360.986 OM 360 A	Diesel	8720	6	115.00	22
OM 362.906 OM 362 LA	Diesel	5700	6	97.00	9
OM 362.909 OM 362 LA	Diesel	5700	6	97.00	9
OM 362.910 OM 362 LA	Diesel	5675	6	97.00	9
OM 364.901 OM 364 A	Diesel	3972	4	97.50	12
OM 364.906 OM 364	Diesel	3972	4	97.50	18
OM 364.907 OM 364	Diesel	3970	4	97.50	18
OM 364.908 OM 364	Diesel	3972	4	97.50	16
OM 364.911 OM 364	Diesel	3972	4	97.50	16
OM 364.912 OM 364	Diesel	3972	4	97.50	18
OM 364.913 OM 364	Diesel	3972	4	97.50	18
OM 364.918 OM 364	Diesel	3970	4	97.50	13
OM 364.919 OM 364	Diesel	3972	4	97.50	13
OM 364.920 OM 364	Diesel	3972	4	97.50	13
OM 364.921 Euro 1 OM 364	Diesel	3972	4	97.50	13
OM 364.950 OM 364 A	Diesel	3972	4	97.50	14
OM 364.952 OM 364 A	Diesel	3972	4	97.50	14
OM 364.954 OM 364	Diesel	3972	4	97.50	14
OM 364.957 OM 364 A	Diesel	3972	4	97.50	16
OM 364.958 OM 364 A	Diesel	3972	4	97.50	16
OM 364.980 OM 364 LA	Diesel	3972	4	97.50	14
OM 364.981 OM 364 LA	Diesel	3972	4	97.50	14
OM 364.984 OM 364 LA	Diesel	3972	4	97.50	14
OM 366.905 OM 366	Diesel	5958	6	97.50	18
OM 366.906 OM 366	Diesel	5960	6	97.50	18
OM 366.907 OM 366	Diesel	5958	6	97.50	18
OM 366.908 OM 366	Diesel	5958	6	97.50	18
OM 366.909 OM 366	Diesel	5960	6	97.50	18
OM 366.910 OM 366	Diesel	5958	6	97.50	18
OM 366.912 OM 366	Diesel	5958	6	97.50	16
OM 366.913 OM 366	Diesel	5958	6	97.50	18
OM 366.914 OM 366	Diesel	5958	6	97.50	18
OM 366.917 OM 366	Diesel	5958	6	97.50	18
OM 366.918 OM 366	Diesel	5960	6	97.50	18
OM 366.919 OM 366	Diesel	5958	6	97.50	18
OM 366.930 OM 366	Diesel	5958	6	97.50	18
OM 366.931 OM 366	Diesel	5958	6	97.50	18
OM 366.932 OM 366	Diesel	5958	6	97.50	18
OM 366.933 OM 366	Diesel	5958	6	97.50	18
OM 366.935 OM 366	Diesel	5958	6	97.50	16
OM 366.936 OM 366	Diesel	5960	6	97.50	18
OM 366.937 OM 366	Diesel	5960	6	97.50	18
OM 366.938 OM 366	Diesel	5958	6	97.50	18
OM 366.939 OM 366	Diesel	5958	6	97.50	18
OM 366.940 OM 366	Diesel	5958	6	97.50	18
OM 366.941 Euro 1 OM 366 A	Diesel	5958	6	97.50	15
OM 366.942 Euro 1 OM 366 A	Diesel	5958	6	97.50	15
OM 366.943 Euro 1 OM 366 A	Diesel	5958	6	97.50	15
OM 366.944-979	Diesel	5958	6	97.50	14
OM 366.956 OM 366 A	Diesel	5958	6	97.50	12
OM 366.980 OM 366 LA	Diesel	5960	6	97.50	14
OM 366.981 OM 366 LA	Diesel	5958	6	97.50	14
OM 366.983 OM 366 LA	Diesel	5958	6	97.50	14
OM 366.984 OM 366 LA	Diesel	5958	6	97.50	14
OM 366.988 OM 366 LA	Diesel	5960	6	97.50	14
OM 366.990 OM 366 LA	Diesel	5958	6	97.50	14
OM 366.992 OM 366 LA	Diesel	5958	6	97.50	14
OM 366.993 OM 366 LA	Diesel	5958	6	97.50	14
OM 366.994 OM 366 LA	Diesel	5958	6	97.50	14
OM 366.995 OM 366 LA	Diesel	5958	6	97.50	14

		ccm	x 		9
OM 366.996 OM 366 LA	Diesel	5958	6	97.50	14
OM 366.997 Euro 1 OM 366 LA	Diesel	5960	6	97.50	14
OM 366.999 Euro 1 OM 366 LA	Diesel	5958	6	97.50	17
OM 376.941 OM 366 LA	Diesel	5958	6	97.50	14
OM 386.952	Diesel	5958	6	97.50	14
OM 401.905 OM 401	Diesel	9570	V6	125.00	23
OM 401.906 OM 401	Diesel	9570	V6	125.00	23
OM 401.907 OM 401	Diesel	9572	V6	125.00	23
OM 401.908 OM 401	Diesel	9572	V6	125.00	23
OM 401.909 OM 401	Diesel	9570	V6	125.00	23
OM 401.912 OM 401	Diesel	9572	V6	125.00	23
OM 401.913 OM 401	Diesel	9570	V6	125.00	23
OM 401.914 OM 401	Diesel	9570	V6	125.00	23
OM 401.915 OM 401	Diesel	9570	V6	125.00	23
OM 401.916 OM 401	Diesel	9570	V6	125.00	23
OM 401.917 OM 401 A	Diesel	9570	V6	125.00	23
OM 401.918 OM 401	Diesel	9570	V6	125.00	23
OM 401.919 OM 401	Diesel	9570	V6	125.00	23
OM 401.921 OM 401	Diesel	9570	V6	125.00	23
OM 401.922 OM 401	Diesel	9570	V6	125.00	23
OM 401.923 OM 401	Diesel	9570	V6	125.00	23
OM 401.925 OM 401	Diesel	9570	V6	125.00	23
OM 401.926 OM 401	Diesel	9570	V6	125.00	23
OM 401.927 OM 401	Diesel	9570	V6	125.00	23
OM 401.928 OM 401	Diesel	9570	V6	125.00	23
OM 401.970 OM 401 LA	Diesel	9600	V6	125.00	24
OM 401.972 OM 401 LA	Diesel	9572	V6	125.00	24
OM 401.973 OM 401 LA	Diesel	9572	V6	125.00	24
OM 401.974 Euro 1 OM 401 LA	Diesel	9572	V6	125.00	25
OM 401.975 Euro 1 OM 401 LA	Diesel	9572	V6	125.00	25
OM 401.977 Euro 1 OM 401 LA	Diesel	9572	V6	125.00	25
OM 401.978 Euro 1 OM 401 LA	Diesel	9572	V6	125.00	25
OM 401.979 Euro 1 OM 401 LA	Diesel	9572	V6	125.00	25
OM 401.980 Euro 1 OM 401 LA	Diesel	9572	V6	125.00	25
OM 401.981 Euro 1 OM 401 LA	Diesel	9572	V6	125.00	25
OM 401.982 Euro 1 OM 401 LA	Diesel	9572	V6	125.00	25
OM 401.983 OM 401 LA	Diesel	9572	V6	125.00	26
OM 401.984 OM 401 LA	Diesel	9572	V6	125.00	24
OM 401.985 OM 401 LA	Diesel	9600	V6	125.00	24
OM 401.986 OM 401 LA	Diesel	9572	V6	125.00	24
OM 401.987 OM 401 LA	Diesel	9572	V6	125.00	24
OM 401.989 OM 401 LA	Diesel	9572	V6	125.00	24
OM 401.990 OM 401 LA	Diesel	9572	V6	125.00	24
OM 401.991 OM 401 LA	Diesel	9600	V6	125.00	24
OM 401.992 OM 401 LA	Diesel	9572	V6	125.00	24
OM 401.993 OM 401 LA	Diesel	9572	V6	125.00	24
OM 401.994 OM 401 LA	Diesel	9600	V6	125.00	24
OM 402.905 OM 402	Diesel	12800	V8	125.00	23
OM 402.906 OM 402	Diesel	12800	V8	125.00	23
OM 402.907 OM 402	Diesel	12800	V8	125.00	23
OM 402.910 OM 402	Diesel	12800	V8	125.00	23
OM 402.912 OM 402	Diesel	12800	V8	125.00	23
OM 402.913 OM 402	Diesel	12760	V8	125.00	23
OM 402.914 OM 402	Diesel	12800	V8	125.00	23
OM 402.916 OM 402	Diesel	12800	V8	125.00	23
OM 402.917 OM 402	Diesel	12760	V8	125.00	23
OM 402.919 OM 402	Diesel	12800	V8	125.00	23
OM 402.921 OM 402	Diesel	12760	V8	125.00	23
OM 402.923 OM 402	Diesel	12800	V8	125.00	23
OM 402.924 OM 402	Diesel	12800	V8	125.00	23
OM 402.925 OM 402	Diesel	12760	V8	125.00	23
OM 402.926 OM 402	Diesel	12800	V8	125.00	23
OM 402.927 OM 402	Diesel	12800	V8	125.00	23
OM 402.928 OM 402	Diesel	12800	V8	125.00	23
OM 402.970 Euro 1 OM 402 LA	Diesel	12763	V8	125.00	25
OM 402.971 Euro 1 OM 402 LA	Diesel	12763	V8	125.00	25
OM 402.972 Euro 1 OM 402 LA	Diesel	12763	V8	125.00	25
OM 402.973 Euro 1 OM 402 LA	Diesel	12763	V8	125.00	25
OM 402.974 Euro 1 OM 402 LA	Diesel	12760	V8	125.00	25





		ccm	x 		9
---	---	-----	---	---	----------





OM 402.975 Euro 1 OM 402 LA	Diesel	12763	V8	125.00	25
OM 402.977 Euro 1 OM 402 LA	Diesel	12763	V8	125.00	25
OM 402.978 Euro 1 OM 402 LA	Diesel	12763	V8	125.00	25
OM 402.982 Euro 1 OM 402 LA	Diesel	12763	V8	125.00	25
OM 402.983 Euro 1 OM 402 LA	Diesel	12763	V8	125.00	25
OM 402.984 Euro 1 OM 402 LA	Diesel	12763	V8	125.00	24
OM 402.985 Euro 1 OM 402 LA	Diesel	12763	V8	125.00	25
OM 402.986 Euro 1 OM 402 LA	Diesel	12763	V8	125.00	25
OM 402.987 Euro 1 OM 402 LA	Diesel	12763	V8	125.00	25
OM 402.989 Euro 1 OM 402 LA	Diesel	12763	V8	125.00	25
OM 402.990 Euro 1 OM 402 LA	Diesel	12763	V8	125.00	25
OM 402.995 OM 402 LA	Diesel	12763	V8	125.00	26
OM 402.996 Euro 1 OM 402 LA	Diesel	12763	V8	125.00	25
OM 403.910 OM 403	Diesel	15950	V10	125.00	26
OM 403.915 OM 403	Diesel	15900	V10	125.00	23
OM 403.916 OM 403	Diesel	15900	V10	125.00	23
OM 403.917 OM 403	Diesel	15950	V10	125.00	23
OM 403.918 OM 403	Diesel	15900	V10	125.00	23
OM 403.919 OM 403	Diesel	15950	V10	125.00	23
OM 403.930 OM 403	Diesel	15950	V10	125.00	23
OM 403.931 OM 403	Diesel	15900	V10	125.00	23
OM 403.932 OM 403	Diesel	15900	V10	125.00	23
OM 403.933 OM 403	Diesel	15950	V10	125.00	26
OM 403.934 OM 403	Diesel	15950	V10	125.00	23
OM 403.935 OM 403	Diesel	15900	V10	125.00	26
OM 404	Diesel	20911	V12	125.00	23
OM 404 A	Diesel	20911	V12	125.00	26
OM 407.905 OM 407 H	Diesel	11000	6	125.00	27
OM 407.907 OM 407 H	Diesel	11045	6	125.00	27
OM 407.908 OM 407 H	Diesel	11000	6	125.00	27
OM 407.909 OM 407 H	Diesel	11000	6	125.00	27
OM 407.910 OM 407 H	Diesel	11000	6	125.00	27
OM 407.911 OM 407 H	Diesel	11000	6	125.00	28
OM 407.913 OM 407 H	Diesel	11400	6	125.00	28
OM 407.914 OM 407 H	Diesel	11400	6	125.00	28
OM 407.915 OM 407 H	Diesel	11400	6	125.00	28
OM 407.916 OM 407 H	Diesel	11400	6	125.00	28
OM 407.917 OM 407 H	Diesel	11400	6	125.00	28
OM 407.918 OM 407 H	Diesel	11400	6	125.00	28
OM 407.919 OM 407 H	Diesel	11400	6	125.00	28
OM 407.920 OM 407 H	Diesel	11412	6	125.00	28
OM 407.951 OM 407 HA	Diesel	11413	6	125.00	27
OM 407.955 OM 407 HA	Diesel	11413	6	125.00	27
OM 409	Diesel	9204	5	125.00	27
OM 409.906 OM 409	Diesel	9204	5	125.00	27
OM 409.907 OM 409	Diesel	9204	5	125.00	27
OM 409.908 OM 409	Diesel	9204	5	125.00	27
OM 421.905 OM 421	Diesel	10964	V6	128.00	32
OM 421.906 OM 421	Diesel	10900	V6	128.00	32
OM 421.907 OM 421	Diesel	10964	V6	128.00	32
OM 421.908 OM 421	Diesel	10964	V6	128.00	32
OM 421.909 OM 421	Diesel	10964	V6	128.00	32
OM 421.910 OM 421	Diesel	10964	V6	128.00	32
OM 421.951 OM 421 A	Diesel	10964	V6	128.00	33
OM 422.901 OM 422	Diesel	14618	V8	128.00	33
OM 422.905 OM 422	Diesel	14618	V8	128.00	32
OM 422.906 OM 422	Diesel	14618	V8	128.00	32
OM 422.907 OM 422	Diesel	14618	V8	128.00	32
OM 422.908 OM 422	Diesel	14600	V8	128.00	32
OM 422.909 OM 422	Diesel	14618	V8	128.00	32
OM 422.910 OM 422	Diesel	14618	V8	128.00	32
OM 422.911 OM 422	Diesel	14618	V8	128.00	32
OM 422.912 OM 422	Diesel	14618	V8	128.00	32
OM 422.913 OM 422	Diesel	14618	V8	128.00	32
OM 422.914 OM 422	Diesel	14600	V8	128.00	32
OM 422.915 OM 422	Diesel	14618	V8	128.00	32
OM 422.916 OM 422	Diesel	14618	V8	128.00	32
OM 422.917 OM 422	Diesel	14618	V8	128.00	32
OM 422.918 ÈM 422	Diesel	14618	V8	128.00	32

		ccm	x 		9
OM 422.919 ÈM 422	Diesel	14618	V8	128.00	32
OM 422.920 OM 422	Diesel	14618	V8	128.00	32
OM 422.921 OM 422	Diesel	14618	V8	128.00	32
OM 422.922 ÈM 422	Diesel	14618	V8	128.00	32
OM 422.923 ÈM 422	Diesel	14618	V8	128.00	32
OM 422.951 OM 422 A	Diesel	14600	V8	128.00	33
OM 422.952 OM 422 A	Diesel	14600	V8	128.00	33
OM 422.953 OM 422 LA	Diesel	14618	V8	128.00	33
OM 422.954 OM 422 A	Diesel	14618	V8	128.00	33
OM 422.955 OM 422 LA	Diesel	14618	V8	128.00	33
OM 422.956 OM 422 A	Diesel	14600	V8	128.00	33
OM 422.957 OM 422 A	Diesel	14620	V8	128.00	33
OM 422.958 OM 422 A	Diesel	14620	V8	128.00	33
OM 422.959 OM 422 A	Diesel	14618	V8	128.00	33
OM 422.963 OM 422 A	Diesel	14618	V8	128.00	33
OM 423.905 OM 423	Diesel	18300	V10	128.00	32
OM 423.906 OM 423	Diesel	18273	V10	128.00	32
OM 423.907 OM 423	Diesel	18273	V10	128.00	32
OM 423.908 OM 423	Diesel	18300	V10	128.00	32
OM 423.909 OM 423	Diesel	18273	V10	128.00	32
OM 423.950 OM 423 LA	Diesel	18273	V10	128.00	33
OM 424.900 OM 424	Diesel	21930	V12	128.00	32
OM 424.901-510 OM 424 LA	Diesel	21930	V12	128.00	33
OM 424.901 OM 424 LA	Diesel	21930	V12	128.00	33
OM 427 A	Diesel	11967	6	128.00	29
OM 427 LA	Diesel	11967	6	128.00	29
OM 427.905 OM 427 H	Diesel	11967	6	128.00	34
OM 427.910 OM 427 H	Diesel	11967	6	128.00	34
OM 427.911 OM 427 H	Diesel	11967	6	128.00	34
OM 427.950 OM 427 HA	Diesel	11967	6	128.00	29
OM 427.951 OM 427 HA	Diesel	11967	6	128.00	29
OM 427.952 OM 427 HA	Diesel	11967	6	128.00	29
OM 429.951 OM 429 LA	Diesel	9970	5	128.00	29
OM 429.952 OM 429 LA	Diesel	9970	5	128.00	29
OM 429.953 OM 429	Diesel	9970	5	128.00	29
OM 429.955 OM 429 LA	Diesel	9970	5	128.00	29
OM 440.907 Euro 1 OM 442	Diesel	15080	V8	130.00	50
OM 440.908 Euro 1 OM 442	Diesel	15080	V8	130.00	51
OM 440.909 OM 442	Diesel	15080	V8	130.00	52
OM 440.910 Euro 1 OM 442	Diesel	15080	V8	130.00	51
OM 440.911 Euro 1 OM 442	Diesel	15080	V8	130.00	51
OM 440.940 OM 442 A	Diesel	14618	V8	128.00	35
OM 440.941 OM 442 A	Diesel	14618	V8	128.00	35
OM 440.942 OM 442 A	Diesel	14618	V8	128.00	35
OM 440.943 OM 442 A	Diesel	14618	V8	128.00	35
OM 440.945 Euro 1 OM 442 A	Diesel	14618	V8	128.00	36
OM 440.948 OM 442 A	Diesel	14618	V8	128.00	37
OM 440.949 OM 442 A	Diesel	14618	V8	128.00	37
OM 440.970 Euro 1 OM 442 LA	Diesel	14618	V8	128.00	38
OM 440.971 Euro 1 OM 442 LA	Diesel	14618	V8	128.00	38
OM 440.972 Euro 1 OM 442 LA	Diesel	14618	V8	128.00	38
OM 440.973 Euro 1 OM 442 LA	Diesel	14618	V8	128.00	38
OM 440.974 OM 442 LA	Diesel	14618	V8	128.00	37
OM 440.975 Euro 1 OM 442 LA	Diesel	14618	V8	128.00	38
OM 440.976 Euro 1 OM 442 LA	Diesel	14618	V8	128.00	38
OM 440.978 Euro 1 OM 442 LA	Diesel	14618	V8	128.00	38
OM 440.979 Euro 1 OM 442 LA	Diesel	14618	V8	128.00	38
OM 440.980 Euro 1 OM 442 LA	Diesel	14618	V8	128.00	38
OM 440.981 Euro 1 OM 442 LA	Diesel	14618	V8	128.00	38
OM 440.982 Euro 1 OM 442 LA	Diesel	14618	V8	128.00	38
OM 440.983 Euro 1 OM 442 LA	Diesel	14618	V8	128.00	38
OM 440.984 Euro 1 OM 442 LA	Diesel	14618	V8	128.00	38
OM 440.985 Euro 1 OM 442 LA	Diesel	14618	V8	128.00	38
OM 440.986 Euro 1 OM 442 LA	Diesel	14618	V8	128.00	38
OM 440.987 Euro 1 OM 442 LA	Diesel	14618	V8	128.00	38
OM 440.988 Euro 1 OM 442 LA	Diesel	14618	V8	128.00	38
OM 440.989 Euro 1 OM 442 LA	Diesel	14618	V8	128.00	38
OM 440.990 Euro 1 OM 442 LA	Diesel	14618	V8	128.00	38
OM 440.991 Euro 1 OM 442 LA	Diesel	14618	V8	128.00	38





		ccm	x 		9
---	---	-----	---	---	----------





OM 441 / Euro 1	Diesel	11309	6	130.00	50
OM 441.905 OM 441	Diesel	10964	V6	130.00	52
OM 441.906 OM 441	Diesel	10964	V6	130.00	52
OM 441.907 OM 441	Diesel	10964	V6	130.00	52
OM 441.908 OM 441	Diesel	10964	V6	130.00	52
OM 441.909 OM 441	Diesel	10964	V6	130.00	52
OM 441.911 OM 441	Diesel	10964	V6	130.00	52
OM 441.912 OM 441	Diesel	11309	V6	130.00	52
OM 441.913 OM 441	Diesel	10964	V6	130.00	52
OM 441.914 OM 441	Diesel	11309	V6	130.00	52
OM 441.915 OM 441	Diesel	10964	V6	130.00	52
OM 441.916 OM 441	Diesel	11309	V6	130.00	52
OM 441.917 OM 441	Diesel	10964	V6	130.00	52
OM 441.918 OM 441	Diesel	11309	V6	130.00	52
OM 441.919 OM 441	Diesel	11309	V6	130.00	52
OM 441.920 OM 441	Diesel	11309	V6	130.00	52
OM 441.922 Euro 1 OM 441	Diesel	11300	V6	130.00	50
OM 441.923 OM 441	Diesel	10964	V6	130.00	52
OM 441.924 OM 441	Diesel	11309	V6	130.00	52
OM 441.925 OM 441	Diesel	10964	V6	130.00	52
OM 441.926 OM 441	Diesel	10964	V6	130.00	52
OM 441.927 OM 441	Diesel	10964	V6	130.00	52
OM 441.932 OM 441	Diesel	11309	V6	130.00	50
OM 441.933 Euro 1 OM 441	Diesel	11309	V6	130.00	50
OM 441.951 OM 441 LA	Diesel	10964	V6	128.00	39
OM 441.952 OM 441 A	Diesel	10964	V6	128.00	37
OM 441.953 OM 441 A	Diesel	10964	V6	128.00	39
OM 441.960 OM 441 LA	Diesel	10964	V6	128.00	39
OM 441.961 OM 441 LA	Diesel	10964	V6	128.00	39
OM 441.962 OM 441 LA	Diesel	10964	V6	128.00	39
OM 441.980 OM 441 LA	Diesel	10964	V6	128.00	38
OM 441.981 OM 441 LA	Diesel	10964	V6	128.00	39
OM 441.982 OM 441 A	Diesel	10964	V6	128.00	39
OM 441.983 OM 441 LA	Diesel	10964	V6	128.00	39
OM 441.985 OM 441 LA	Diesel	10964	V6	128.00	39
OM 441.986 Euro 1 OM 441 LA	Diesel	10964	V6	128.00	38
OM 441.987 Euro 1 OM 441 LA	Diesel	10964	V6	128.00	38
OM 441.988 Euro 1 OM 441 LA	Diesel	10964	V6	128.00	38
OM 441.989 Euro 1 OM 441 LA	Diesel	10964	V6	128.00	38
OM 441.990 Euro 1 OM 441 LA	Diesel	10964	V6	128.00	38
OM 441.991 Euro 1 OM 441 LA	Diesel	10964	V6	128.00	38
OM 441.992 Euro 1 OM 441 LA	Diesel	10964	V6	128.00	38
OM 441.993 Euro 1 OM 441 LA	Diesel	10964	V6	128.00	38
OM 441.994 Euro 1 OM 441 LA	Diesel	10964	V6	128.00	38
OM 441.995 Euro 1 OM 441 LA	Diesel	10964	V6	128.00	38
OM 441.996 Euro 1 OM 441 LA	Diesel	10964	V6	128.00	38
OM 441.997 Euro 1 OM 441 LA	Diesel	10964	V6	128.00	38
OM 441.998 Euro 1 OM 441 LA	Diesel	10964	V6	128.00	38
OM 441.999 Euro 1 OM 441 LA	Diesel	10964	V6	128.00	38
OM 442 A Euro 1	Diesel	14618	V8	128.00	36
OM 442 Euro 1	Diesel	15080	V8	130.00	50
OM 442.905 OM 442	Diesel	15080	V8	130.00	52
OM 442.906 OM 442	Diesel	15080	V8	130.00	52
OM 442.907 OM 442	Diesel	15080	V8	130.00	52
OM 442.908 OM 442	Diesel	15080	V8	130.00	52
OM 442.909 OM 442	Diesel	15080	V8	130.00	52
OM 442.910 OM 442	Diesel	15080	V8	130.00	52
OM 442.911 OM 442	Diesel	15080	V8	130.00	52
OM 442.914 OM 442	Diesel	15080	V8	130.00	52
OM 442.915 OM 442	Diesel	15078	V8	130.00	52
OM 442.916 OM 442	Diesel	15078	V8	130.00	52
OM 442.917 OM 442	Diesel	15080	V8	130.00	52
OM 442.918 OM 442	Diesel	15080	V8	130.00	52
OM 442.919 OM 442	Diesel	15080	V8	130.00	52
OM 442.920 OM 442	Diesel	15080	V8	130.00	52
OM 442.921 OM 442	Diesel	15080	V8	130.00	52
OM 442.922 OM 442	Diesel	15080	V8	130.00	52
OM 442.923 OM 442	Diesel	15080	V8	130.00	52
OM 442.924 OM 442	Diesel	15080	V8	130.00	52





		ccm	x 		9
OM 442.925 OM 442	Diesel	15080	V8	130.00	52
OM 442.926 OM 442	Diesel	15080	V8	130.00	52
OM 442.927 OM 442	Diesel	15078	V8	130.00	52
OM 442.928 OM 442	Diesel	15078	V8	130.00	52
OM 442.929 OM 442	Diesel	15080	V8	130.00	52
OM 442.930 OM 442	Diesel	15100	V8	130.00	52
OM 442.931 OM 442	Diesel	15100	V8	130.00	50
OM 442.932 OM 442	Diesel	15080	V8	130.00	52
OM 442.933 OM 442	Diesel	15080	V8	130.00	52
OM 442.934 OM 442	Diesel	15080	V8	130.00	52
OM 442.935 OM 442	Diesel	15080	V8	130.00	52
OM 442.939 OM 442	Diesel	15080	V8	130.00	52
OM 442.940 OM 442 A	Diesel	14618	V8	128.00	39
OM 442.941 OM 442 A	Diesel	14618	V8	128.00	39
OM 442.942 OM 442 A	Diesel	14618	V8	128.00	39
OM 442.943 OM 442 A	Diesel	14620	V8	128.00	39
OM 442.944 OM 442 A	Diesel	14618	V8	128.00	39
OM 442.945 OM 442 A	Diesel	14618	V8	128.00	39
OM 442.946 OM 442 A	Diesel	14618	V8	128.00	39
OM 442.950 OM 442 A	Diesel	14618	V8	128.00	39
OM 442.951 OM 442 LA	Diesel	14618	V8	128.00	39
OM 442.952 OM 442 A	Diesel	14618	V8	128.00	39
OM 442.953 OM 442 LA	Diesel	14618	V8	128.00	39
OM 442.954 OM 442 A	Diesel	14618	V8	128.00	39
OM 442.955 OM 442 A	Diesel	14618	V8	128.00	39
OM 442.957 OM 442 A	Diesel	14618	V8	128.00	39
OM 442.958 OM 442 A	Diesel	14618	V8	128.00	39
OM 442.959 OM 442 A	Diesel	14618	V8	128.00	39
OM 442.960 OM 442 A	Diesel	14618	V8	128.00	39
OM 442.961 OM 442 A	Diesel	14618	V8	128.00	39
OM 442.962 OM 442 A	Diesel	14618	V8	128.00	39
OM 442.963 OM 442 A	Diesel	14618	V8	128.00	39
OM 442.964 OM 442 A	Diesel	14618	V8	128.00	39
OM 442.965 OM 442 A	Diesel	14618	V8	128.00	39
OM 442.966 OM 442 A	Diesel	14618	V8	128.00	39
OM 442.967 OM 442 A	Diesel	14618	V8	128.00	39
OM 442.968 OM 442 A	Diesel	14618	V8	128.00	39
OM 442.970 OM 442 A	Diesel	14618	V8	128.00	39
OM 442.971 OM 442 A	Diesel	14620	V8	128.00	39
OM 442.972 OM 442 A	Diesel	14620	V8	128.00	39
OM 442.976 OM 442 A	Diesel	14618	V8	128.00	39
OM 442.977 OM 442 A	Diesel	14618	V8	128.00	36
OM 442.978 OM 442 A	Diesel	14620	V8	128.00	36
OM 442.980 OM 442 LA	Diesel	14618	V8	128.00	39
OM 442.982 OM 442 LA	Diesel	14618	V8	128.00	39
OM 442.983 OM 442 LA	Diesel	14618	V8	128.00	39
OM 442.985 OM 442 LA	Diesel	14618	V8	128.00	39
OM 442.989 OM 442 LA	Diesel	14618	V8	128.00	39
OM 442.991 OM 442 LA	Diesel	14618	V8	128.00	39
OM 442.992 OM 442 LA	Diesel	14618	V8	128.00	39
OM 442.993 OM 442 LA	Diesel	14618	V8	128.00	39
OM 442.994 OM 442 LA	Diesel	14618	V8	128.00	39
OM 442.995 Euro 1 OM 442 LA	Diesel	14618	V8	128.00	38
OM 442.996 Euro 1 OM 442 LA	Diesel	14618	V8	128.00	38
OM 442.997 Euro 1 OM 442 LA	Diesel	14618	V8	128.00	38
OM 442.998 Euro 1 OM 442 LA	Diesel	14618	V8	128.00	38
OM 442.999 Euro 1 OM 442 LA	Diesel	14618	V8	128.00	38
OM 443.900 OM 443	Diesel	18848	V10	130.00	51
OM 443.905 OM 443	Diesel	18848	V10	130.00	52
OM 443.940 OM 443 A	Diesel	18270	V10	128.00	39
OM 443.980 OM 443 LA	Diesel	18270	V10	128.00	39
OM 444	Diesel	22618	V12	130.00	52
OM 444 LA	Diesel	21927	V12	128.00	40
OM 445.920 Euro 2 OM 441 LA	Diesel	10964	V6	128.00	41
OM 445.921 Euro 2 OM 441 LA	Diesel	10964	V6	128.00	41
OM 445.922 Euro 2 OM 441 LA	Diesel	10964	V6	128.00	41
OM 445.923 Euro 2 OM 441 LA	Diesel	10964	V6	128.00	41
OM 445.924 Euro 2 OM 441 LA	Diesel	10960	V6	128.00	41
OM 445.925 Euro 2 OM 441 LA	Diesel	10964	V6	128.00	41





		ccm	x 		9
---	---	-----	---	---	----------

OM 445.926 Euro 2 OM 441 LA	Diesel	10964	V6	128.00	41
OM 445.927 Euro 2 OM 441 LA	Diesel	10964	V6	128.00	41
OM 445.929 Euro 2 OM 441 LA	Diesel	10964	V6	128.00	41
OM 445.930 Euro 2 OM 441 LA	Diesel	10964	V6	128.00	41
OM 445.931 Euro 2 OM 441 LA	Diesel	10964	V6	128.00	41
OM 445.933 Euro 2 OM 441 LA	Diesel	10964	V6	128.00	41
OM 445.934 Euro 2 OM 441 LA	Diesel	10964	V6	128.00	41
OM 445.935 Euro 2 OM 441 LA	Diesel	10964	V6	128.00	41
OM 445.936 Euro 2 OM 441 LA	Diesel	10964	V6	128.00	41
OM 445.937 Euro 2 OM 441 LA	Diesel	10964	V6	128.00	41
OM 445.938 Euro 2 OM 441 LA	Diesel	10960	V6	128.00	41
OM 445.939 Euro 2 OM 441 LA	Diesel	10964	V6	128.00	41
OM 445.940 Euro 2 OM 441 LA	Diesel	10964	V6	128.00	41
OM 445.941 Euro 2 OM 441 LA	Diesel	10960	V6	128.00	41
OM 446.920 Euro 2 OM 442 LA	Diesel	14618	V8	128.00	41
OM 446.922 Euro 2 OM 442 LA	Diesel	14618	V8	128.00	41
OM 446.924 Euro 2 OM 442 LA	Diesel	14618	V8	128.00	41
OM 446.925 Euro 2 OM 442 LA	Diesel	14618	V8	128.00	41
OM 446.926 Euro 2 OM 442 LA	Diesel	14618	V8	128.00	41
OM 446.927 Euro 2 OM 442 LA	Diesel	14618	V8	128.00	41
OM 446.928 Euro 2 OM 442 LA	Diesel	14618	V8	128.00	41
OM 446.929 Euro 2 OM 442 LA	Diesel	14618	V8	128.00	41
OM 446.930 Euro 2 OM 442 LA	Diesel	14618	V8	128.00	41
OM 446.931 Euro 2 OM 442 LA	Diesel	14618	V8	128.00	41
OM 446.932 Euro 2 OM 442 LA	Diesel	14618	V8	128.00	41
OM 446.933 Euro 2 OM 442 LA	Diesel	14618	V8	128.00	41
OM 446.934 Euro 2 OM 442 LA	Diesel	14618	V8	128.00	41
OM 446.935 Euro 2 OM 442 LA	Diesel	14618	V8	128.00	41
OM 446.936 Euro 2 OM 442 LA	Diesel	14618	V8	128.00	41
OM 446.938 Euro 2 OM 442 LA	Diesel	14618	V8	128.00	41
OM 446.939 Euro 2 OM 442 LA	Diesel	14618	V8	128.00	41
OM 446.940 Euro 2 OM 442 LA	Diesel	14618	V8	128.00	41
OM 446.941 Euro 2 OM 442 LA	Diesel	14618	V8	128.00	41
OM 446.942 Euro 2 OM 442 LA	Diesel	14618	V8	128.00	41
OM 446.943 Euro 2 OM 442 LA	Diesel	14618	V8	128.00	41
OM 446.945 Euro 2 OM 442 LA	Diesel	14618	V8	128.00	41
OM 446.946 Euro 2 OM 442 LA	Diesel	14618	V8	128.00	41
OM 446.948 Euro 2 OM 442 LA	Diesel	14618	V8	128.00	41
OM 447	Diesel	11967	6	128.00	42
OM 447 A	Diesel	11967	6	128.00	29
OM 447 LA	Diesel	11967	6	128.00	29
OM 447.902	Diesel	11967	6	128.00	43
OM 447.905 OM 447 H	Diesel	11967	6	128.00	34
OM 447.906 OM 447 H	Diesel	11967	6	128.00	34
OM 447.907 OM 447 H	Diesel	11967	6	128.00	34
OM 447.908 OM 447 H	Diesel	11967	6	128.00	34
OM 447.910 OM 447 H	Diesel	11967	6	128.00	34
OM 447.911 OM 447 H	Diesel	11967	6	128.00	34
OM 447.912 OM 447 H	Diesel	11970	6	128.00	34
OM 447.913 Euro 1 OM 447 H	Diesel	11967	6	128.00	42
OM 447.914 Euro 1 OM 447 H	Diesel	11967	6	128.00	42
OM 447.915 OM 447 HO	Petrol	11967	6	128.00	29
OM 447.916 OM 447 HO	Petrol	11967	6	128.00	29
OM 447.947 Euro 1 OM 447 HLA	Diesel	11967	6	128.00	29
OM 447.948 Euro 2 OM 447 HLA	Diesel	11967	6	128.00	29
OM 447.949 Euro 2 OM 447 HLA	Diesel	11967	6	128.00	29
OM 447.950 OM 447 HA	Diesel	11967	6	128.00	29
OM 447.951 OM 447 HA	Diesel	11967	6	128.00	29
OM 447.952 Euro 1 OM 447 HA	Diesel	11967	6	128.00	29
OM 447.953 Euro 1 OM 447 HA	Diesel	11967	6	128.00	29
OM 447.954 Euro 1 OM 447 HA	Diesel	11967	6	128.00	43
OM 447.955 Euro 1 OM 447 HA	Diesel	11967	6	128.00	43
OM 447.956 Euro 1 OM 447 HA	Diesel	11967	6	128.00	43
OM 447.957 Euro 1 OM 447 HA	Diesel	11967	6	128.00	43
OM 447.958 Euro 1 OM 447 HA	Diesel	11970	6	128.00	43
OM 447.959 Euro 1 OM 447 HA	Diesel	11970	6	128.00	43
OM 447.960 Euro 1 OM 447 HLA	Diesel	11970	6	128.00	29
OM 447.970 Euro 2 OM 447 HLA	Diesel	11967	6	128.00	44
OM 447.971 Euro 2 OM 447 HLA	Diesel	11967	6	128.00	44





		ccm	x 		9
OM 447.972 Euro 2 OM 447 HLA	Diesel	11967	6	128.00	44
OM 447.973 Euro 2 OM 447 HLA	Diesel	11967	6	128.00	44
OM 447.974 Euro 2 OM 447 HLA	Diesel	11967	6	128.00	44
OM 447.975 Euro 1 OM 447 HLA	Diesel	11967	6	128.00	44
OM 447.976 Euro 2 OM 447 HLA	Diesel	11967	6	128.00	44
OM 447.977 Euro 2 OM 447 HLA	Diesel	11967	6	128.00	44
OM 447.978 OM 447 HLA	Diesel	11967	6	128.00	44
OM 447.979 Euro 2 OM 447 HLA	Diesel	11967	6	128.00	44
OM 447.980 Euro 1 OM 447 HLA	Diesel	11967	6	128.00	43
OM 447.981 Euro 1 OM 447 HLA	Diesel	11967	6	128.00	43
OM 447.982 Euro 1 OM 447 HLA	Diesel	11967	6	128.00	43
OM 447.983 Euro 1 OM 447 HLA	Diesel	11967	6	128.00	43
OM 447.984 Euro 1 OM 447 HLA	Diesel	11970	6	128.00	43
OM 447.985 Euro 1 OM 447 HLA	Diesel	11967	6	128.00	43
OM 447.986 Euro 1 OM 447 HLA	Diesel	11967	6	128.00	43
OM 447.987 Euro 1 OM 447 HLA	Diesel	11970	6	128.00	43
OM 447.988 Euro 2 OM 447 HLA	Diesel	11970	6	128.00	44
OM 447.990 Euro 2 OM 447 HLA	Diesel	11967	6	128.00	44
OM 447.991 Euro 2 OM 447 HLA	Diesel	11967	6	128.00	44
OM 447.992 Euro 2 OM 447 HLA	Diesel	11967	6	128.00	44
OM 447.993 Euro 2 OM 447 HLA	Diesel	11967	6	128.00	44
OM 447.994 Euro 2 OM 447 HLA	Diesel	11967	6	128.00	44
OM 447.995 Euro 1 OM 447 HA	Diesel	11967	6	128.00	43
OM 447.996 Euro 2 OM 447 HLA	Diesel	11970	6	128.00	44
OM 447.998 Euro 2 OM 447 HLA	Diesel	11967	6	128.00	44
OM 447.999 Euro 2 OM 447 HLA	Diesel	11967	6	128.00	44
OM457/904/906 Compressor	Petrol		1	85.00	1
OM 457.910 Euro 5 OM 457 LA	Diesel	11967	6	128.00	45
OM 457.914 Euro 3 OM 457 LA	Diesel	11967	6	128.00	46
OM 457.915 Euro 3 OM 457 LA	Diesel	11967	6	128.00	47
OM 457.916 Euro 3 OM 457 LA	Diesel	11967	6	128.00	47
OM 457.917 Euro 2/3 OM 457 LA	Diesel	11967	6	128.00	46
OM 457.918 Euro 3 OM 457 LA	Diesel	11967	6	128.00	47
OM 457.919 Euro 3 OM 457 LA	Diesel	11967	6	128.00	47
OM 457.920 Euro 3 OM 457 LA	Diesel	11967	6	128.00	47
OM 457.922 Euro 3 OM 457 LA	Diesel	11967	6	128.00	46
OM 457.923 Euro 3 OM 457 LA	Diesel	11967	6	128.00	47
OM 457.924 Euro 3 OM 457 LA	Diesel	11967	6	128.00	47
OM 457.925 Euro 3 OM 457 LA	Diesel	11967	6	128.00	46
OM 457.926 Euro 3 OM 457 LA	Diesel	11967	6	128.00	47
OM 457.927 Euro 3 OM 457 LA	Diesel	11967	6	128.00	46
OM 457.928 Euro 3 OM 457 LA	Diesel	11967	6	128.00	47
OM 457.929 Euro 3 OM 457 LA	Diesel	11967	6	128.00	46
OM 457.931 Euro 3 OM 457 LA	Diesel	11967	6	128.00	47
OM 457.932 Euro 3 OM 457 LA	Diesel	11967	6	128.00	47
OM 457.933 Euro 2 OM 457 HLA	Diesel	11967	6	128.00	48
OM 457.934 Euro 2 OM 457 HLA	Diesel	11967	6	128.00	48
OM 457.935 Euro 2 OM 457 HLA	Diesel	11967	6	128.00	48
OM 457.936 Euro 2 OM 457 LA	Diesel	11967	6	128.00	48
OM 457.937 Euro 2 OM 457 LA	Diesel	11967	6	128.00	48
OM 457.938 Euro 2 OM 457 HLA	Diesel	11967	6	128.00	48
OM 457.939 Euro 2 OM 457 LA	Diesel	11967	6	128.00	48
OM 457.940 Euro 2 OM 457 LA	Diesel	11967	6	128.00	48
OM 457.941 Euro 2 OM 457 HLA	Diesel	11967	6	128.00	48
OM 457.942 Euro 2 OM 457 HLA	Diesel	11967	6	128.00	48
OM 457.943 Euro 2 OM 457 LA	Diesel	11967	6	128.00	48
OM 457.944 Euro 2 OM 457 LA	Diesel	11967	6	128.00	48
OM 457.945 Euro 2 OM 457 LA	Diesel	11967	6	128.00	48
OM 457.946 Euro 2 OM 457 LA	Diesel	11967	6	128.00	48
OM 457.947 Euro 2 OM 457 LA	Diesel	11967	6	128.00	46
OM 457.948 Euro 4 OM 457 LA	Diesel	11967	6	128.00	49
OM 457.949 Euro 2 OM 457 LA	Diesel	11967	6	128.00	48
OM 457.950 Euro 4 OM 457 HLA	Diesel	11967	6	128.00	49
OM 457.951 Euro 4 OM 457 LA	Diesel	11967	6	128.00	49
OM 457.952 Euro 4 OM 457 HLA	Diesel	11967	6	128.00	49
OM 457.953 Euro 4 OM 457 LA	Diesel	11967	6	128.00	49
OM 457.954 Euro 4 OM 457 HLA	Diesel	11967	6	128.00	49
OM 457.955 Euro 3 OM 457 LA	Diesel	11967	6	128.00	46
OM 457.956 Euro 3 OM 457 LA	Diesel	11967	6	128.00	46

		ccm	x 		9
OM 457.957 Euro 4 OM 457 LA	Diesel	11967	6	128.00	49
OM 457.958 Euro 2/3 OM 457 LA	Diesel	11967	6	128.00	46
OM 457.959 Euro 4 OM 457 HLA	Diesel	11967	6	128.00	49
OM 457.960 Euro 2 OM 457 LA	Diesel	11967	6	128.00	46
OM 457.961 Euro 4 OM 457 LA	Diesel	11967	6	128.00	49
OM 457.962 Euro 3 OM 457 LA	Diesel	11967	6	128.00	46
OM 457.964 Euro 4 OM 457 HLA	Diesel	11967	6	128.00	49
OM 457.965 Euro 4 OM 457 HLA	Diesel	11967	6	128.00	49
OM 457.966 Euro 4 OM 457 HLA	Diesel	11967	6	128.00	49
OM 457.967 Euro 4	Diesel	11967	6	128.00	49
OM 457.968 Euro 4 OM 457 LA	Diesel	11967	6	128.00	49
OM 457.969 Euro 4 OM 457 LA	Diesel	11967	6	128.00	49
OM 457.973 Euro 4 OM 457 HLA	Diesel	11967	6	128.00	49
OM 457.974 Euro 4 OM 457 HLA	Diesel	11967	6	128.00	49
OM 457.976 Euro 3	Diesel	11967	6	128.00	49
OM 457.977 Euro 4 OM 457 HLA	Diesel	11967	6	128.00	49
OM 457.980 Euro 2 OM 457 LA	Diesel	11967	6	128.00	49
OM 457.981 Euro 3 OM 457 LA	Diesel	11967	6	128.00	49
OM 458.960 Euro 3 OM 457 LA	Diesel	11967	6	128.00	47
OM 458.970 Euro 3 OM 457 LA	Diesel	11967	6	128.00	47
OM 458.980 Euro 3 OM 457 LA	Diesel	11967	6	128.00	47
OM 458.990 OM 460 LA	Diesel	11967	6	128.00	45
OM 458.991 OM 460 LA	Diesel	11967	6	128.00	45
OM 460.900 Euro 3 OM 460 LA	Diesel	12816	6	128.00	46
OM 460.901 Euro 3 OM 460 LA	Diesel	12816	6	128.00	46
OM 460.902 Euro 3 OM 460 LA	Diesel	12816	6	128.00	46
OM 460.903 Euro 3 OM 460 LA	Diesel	12816	6	128.00	46
OM 460.904 Euro 3 OM 460 LA	Diesel	12816	6	128.00	46
OM 460.905 Euro 3 OM 460 LA	Diesel	12816	6	128.00	46
OM 460.906 Euro 3 OM 460 LA	Diesel	12816	6	128.00	46
OM 460.907 Euro 3 OM 460 LA	Diesel	12816	6	128.00	46
OM 460.908 Euro 3 OM 460 LA	Diesel	12816	6	128.00	46
OM 460.909 Euro 3 OM 460 LA	Diesel	12816	6	128.00	46
OM 460.910 Euro 3 OM 460 LA	Diesel	12816	6	128.00	46
OM 460.911 Euro 3 OM 460 LA	Diesel	12816	6	128.00	46
OM 460.912 Euro 3 OM 460 LA	Diesel	12816	6	128.00	46
OM 460.913 Euro 3 OM 460 LA	Diesel	12816	6	128.00	46
OM 460.914 Euro 3 OM 460 LA	Diesel	12816	6	128.00	46
OM 460.915 Euro 3 OM 460 LA	Diesel	12816	6	128.00	46
OM 460.916 Euro 3 OM 460 LA	Diesel	12816	6	128.00	46
OM 460.917 Euro 3 OM 460 LA	Diesel	12816	6	128.00	46
OM 460.918 Euro 3 OM 460 LA	Diesel	12816	6	128.00	46
OM 460.919 Euro 3 OM 460 LA	Diesel	12816	6	128.00	46
OM 460.920 Euro 3 OM 460 LA	Diesel	12816	6	128.00	46
OM 460.921 Euro 3 OM 460 LA	Diesel	12816	6	128.00	46
OM 460.922 Euro 3 OM 460 LA	Diesel	12816	6	128.00	46
OM 460.923 Euro 3 OM 460 LA	Diesel	12816	6	128.00	46
OM 460.925 Euro 3 OM 460 LA	Diesel	12816	6	128.00	46
OM 460.929 Euro 3 OM 460 LA	Diesel	12816	6	128.00	46
OM 460.931 Euro 3 OM 460 LA	Diesel	12816	6	128.00	46
OM 471.900 Euro 6 OM 471 LA	Diesel	12800	6	132.00	58
OM 471.902 OM 471 LA	Diesel	12809	6	132.00	58
OM 471.906 Euro 6 OM 471 LA	Diesel	12809	6	132.00	58
OM 471.909 Euro 5 OM 471 LA	Diesel	12809	6	132.00	58
OM 475.950 OM 449 A	Diesel	9973	5	128.00	29
OM 475.951 OM 449 A	Diesel	9973	5	128.00	29
OM 475.952 OM 449 A	Diesel	9973	5	128.00	29
OM 475.953 OM 449 A	Diesel	9973	5	128.00	29
OM 475.954 OM 449 A	Diesel	9973	5	128.00	29
OM 475.982 OM 449 LA	Diesel	9973	5	128.00	29
OM 521.940 Euro 2 OM 501 LA	Diesel	11946	V6	130.00	53
OM 521.950 Euro 2 OM 501 LA	Diesel	11946	V6	130.00	53
OM 521.951 Euro 2 OM 501 LA	Diesel	11946	V6	130.00	53
OM 522 LA Euro 2	Diesel	15928	V8	130.00	54
OM 522.940 Euro 2 OM 502 LA	Diesel	15928	V8	130.00	53
OM 522.941 Euro 2 OM 502 LA	Diesel	15928	V8	130.00	53
OM 522.942 Euro 2 OM 502 LA	Diesel	15928	V8	130.00	53
OM 522.943 Euro 2 OM 502 LA	Diesel	15928	V8	130.00	53
OM 522.950 Euro 2 OM 502 LA	Diesel	15928	V8	130.00	53

		ccm	x 		9
OM 541.920 Euro 2 OM 501 LA	Diesel	11946	V6	130.00	53
OM 541.921 Euro 2 OM 501 LA	Diesel	11946	V6	130.00	53
OM 541.922 Euro 2 OM 501 LA	Diesel	11946	V6	130.00	53
OM 541.923 Euro 2 OM 501 LA	Diesel	11946	V6	130.00	53
OM 541.924 Euro 2 OM 501 LA	Diesel	11946	V6	130.00	53
OM 541.925 Euro 2 OM 501 LA	Diesel	11946	V6	130.00	53
OM 541.926 Euro 2 OM 501 LA	Diesel	11946	V6	130.00	53
OM 541.927 Euro 2 OM 501 LA	Diesel	11946	V6	130.00	53
OM 541.928 Euro 2 OM 501 LA	Diesel	11946	V6	130.00	53
OM 541.940 Euro 2/3 OM 501 LA	Diesel	11946	V6	130.00	53
OM 541.941 Euro 2/3 OM 501 LA	Diesel	11946	V6	130.00	53
OM 541.942 Euro 3 OM 501 LA	Diesel	11946	V6	130.00	55
OM 541.943 Euro 3 OM 501 LA	Diesel	11946	V6	130.00	55
OM 541.944 Euro 3 OM 501 LA	Diesel	11946	V6	130.00	55
OM 541.945 Euro 3 OM 501 LA	Diesel	11946	V6	130.00	55
OM 541.946 Euro 3 OM 501 LA	Diesel	11946	V6	130.00	55
OM 541.947 Euro 3 OM 501 LA	Diesel	11946	V6	130.00	55
OM 541.948 Euro 3 OM 501 LA	Diesel	11946	V6	130.00	55
OM 541.949 Euro 3 OM 501 LA	Diesel	11946	V6	130.00	55
OM 541.950 Euro 3 OM 501 LA	Diesel	11946	V6	130.00	55
OM 541.951 Euro 2/3 OM 501 LA	Diesel	11946	V6	130.00	53
OM 541.952 Euro 2/3 OM 501 LA	Diesel	11946	V6	130.00	53
OM 541.953 Euro 4/5 OM 501 LA	Diesel	11946	V6	130.00	56
OM 541.959 Euro 4/5 OM 501 LA	Diesel	11946	V6	130.00	56
OM 541.960 Euro 2 OM 501 LA	Diesel	11946	V6	130.00	53
OM 541.970 Euro 4 OM 501 LA	Diesel	11946	V6	130.00	56
OM 541.971 Euro 4/5 OM 501 LA	Diesel	11946	V6	130.00	56
OM 541.972 Euro 4 OM 501 LA	Diesel	11946	V6	130.00	56
OM 541.973 Euro 4 OM 501 LA	Diesel	11946	V6	130.00	56
OM 541.974 Euro 4 OM 501 LA	Diesel	11946	V6	130.00	56
OM 541.975 Euro 4 OM 501 LA	Diesel	11946	V6	130.00	56
OM 541.976 Euro 4 OM 501 LA	Diesel	11946	V6	130.00	56
OM 541.977 Euro 4 OM 501 LA	Diesel	11946	V6	130.00	56
OM 541.978 Euro 4 OM 501 LA	Diesel	11946	V6	130.00	56
OM 541.979 Euro 4/5 OM 501 LA	Diesel	11946	V6	130.00	56
OM 541.980 Euro 4 OM 501 LA	Diesel	11946	V6	130.00	56
OM 541.981 Euro 4 OM 501 LA	Diesel	11946	V6	130.00	56
OM 541.990 Euro 5 OM 501 LA	Diesel	11946	V6	130.00	56
OM 541.991 OM 501 LA	Diesel	11946	V6	130.00	57
OM 541.992 Euro 5 OM 501 LA	Diesel	11946	V6	130.00	56
OM 541.994 Euro 5 OM 501 LA	Diesel	11946	V6	130.00	56
OM 541.995 OM 501 LA	Diesel	11946	V6	130.00	55
OM 541.996 Euro 5 OM 501 LA	Diesel	11946	V6	130.00	56
OM 541.997 OM 501 LA	Diesel	11946	V6	130.00	56
OM 541.998 Euro 5 OM 501 LA	Diesel	11946	V6	130.00	56
OM 541.999 OM 501 LA	Diesel	11946	V6	130.00	56
OM 542.920 OM 502 LA	Diesel	15928	V8	130.00	53
OM 542.921 OM 502 LA	Diesel	15928	V8	130.00	53
OM 542.922 OM 502 LA	Diesel	15928	V8	130.00	53
OM 542.923 OM 502 LA	Diesel	15928	V8	130.00	53
OM 542.924 OM 502 LA	Diesel	15928	V8	130.00	53
OM 542.925 Euro 2 OM 502 LA	Diesel	15928	V8	130.00	53
OM 542.926 OM 502 LA	Diesel	15928	V8	130.00	53
OM 542.940 Euro 3 OM 502 LA	Diesel	15928	V8	130.00	55
OM 542.941 Euro 3 OM 502 LA	Diesel	15928	V8	130.00	55
OM 542.942 Euro 3 OM 502 LA	Diesel	15928	V8	130.00	55
OM 542.943 Euro 3 OM 502 LA	Diesel	15928	V8	130.00	55
OM 542.944 Euro 3 OM 502 LA	Diesel	15928	V8	130.00	55
OM 542.945 Euro 3 OM 502 LA	Diesel	15928	V8	130.00	55
OM 542.947 OM 502 LA	Diesel	15928	V8	130.00	53
OM 542.948 Euro 3 OM 502 LA	Diesel	15928	V8	130.00	55
OM 542.956 Euro 3 OM 502 LA	Diesel	15928	V8	130.00	55
OM 542.957 Euro 3 OM 502 LA	Diesel	15928	V8	130.00	55
OM 542.958 Euro 3 OM 502 LA	Diesel	15928	V8	130.00	53
OM 542.960 Euro 5	Diesel	15928	V8	130.00	56
OM 542.961 Euro 5	Diesel	15928	V8	130.00	56
OM 542.962 Euro 5 OM 502 LA	Diesel	15928	V8	130.00	56
OM 542.963 Euro 5 OM 502 LA	Diesel	15928	V8	130.00	56
OM 542.964 Euro 5	Diesel	15928	V8	130.00	56

		ccm	x 		9
---	---	-----	---	---	----------

OM 542.965	Diesel	15928	V8	130.00	56
OM 542.966 Euro 5	Diesel	15928	V8	130.00	56
OM 542.970 Euro 5	Diesel	15928	V8	130.00	56
OM 542.971 Euro 5	Diesel	15928	V8	130.00	56
OM 542.972 Euro 5	Diesel	15928	V8	130.00	56
OM 601.900 Euro 2 OM 601 XIII/1	Diesel	2299	4	89.00	5
OM 602.941 OM 602	Diesel	2874	5	89.00	5
OM 602.948 OM 602	Diesel	2874	5	89.00	5
OM 602.981 Euro 2 OM 602 D29 LA	Diesel	2874	5	89.00	6
OM 602.989 Euro 2 OM 602 D29 LA	Diesel	2874	5	89.00	6
OM 602.990 OM 602	Diesel	2497	5	87.00	2
OM 602.994 OM 602	Diesel	2874	5	89.00	5
OM 612.966	Diesel	2685	5	88.00	4
OM 615.911 OM 615	Diesel	2197	4	87.00	3
OM 616.911 OM 616	Diesel	2404	4	91.00	8
OM 616.932 OM 616	Diesel	2404	4	91.00	8
OM 616.942 OM 616	Diesel	2399	4	90.90	7
OM 616.943 OM 616	Diesel	2399	4	90.90	7
OM 621.932 OM 621	Diesel	1990	4	87.00	3
OM 900.911 Euro 4 OM 904 LA	Diesel	4249	4	102.00	19
OM 900.912 Euro 4 OM 904 LA	Diesel	4249	4	102.00	19
OM 900.913 Euro 4 OM 904 LA	Diesel	4249	4	102.00	19
OM 900.915 Euro 4 OM 904 LA	Diesel	4249	4	102.00	19
OM 900.916 Euro 4 OM 904 LA	Diesel	4249	4	102.00	19
OM 900.917 Euro 4 OM 904 LA	Diesel	4249	4	102.00	19
OM 900.918 Euro 4 OM 904 LA	Diesel	4249	4	102.00	19
OM 900.919 Euro 4 OM 904 LA	Diesel	4249	4	102.00	19
OM 900.920 Euro 4 OM 904 LA	Diesel	4249	4	102.00	19
OM 900.921 Euro 4 OM 904 LA	Diesel	4249	4	102.00	19
OM 900.922 Euro 4 OM 904 LA	Diesel	4249	4	102.00	19
OM 902.910 Euro 4 OM 906 LA	Diesel	6374	6	102.00	20
OM 902.911 Euro 4 OM 906 LA	Diesel	6374	6	102.00	20
OM 902.912 Euro 4 OM 906 LA	Diesel	6374	6	102.00	20
OM 902.913 Euro 4 OM 906 LA	Diesel	6374	6	102.00	19
OM 902.914 Euro 4 OM 906 LA	Diesel	6374	6	102.00	19
OM 902.915 Euro 4 OM 906 LA	Diesel	6374	6	102.00	19
OM 902.916 Euro 4 OM 906 LA	Diesel	6374	6	102.00	19
OM 902.917 Euro 4 OM 906 LA	Diesel	6374	6	102.00	19
OM 902.918 Euro 4 OM 906 LA	Diesel	6374	6	102.00	19
OM 902.919 Euro 4 OM 906 LA	Diesel	6374	6	102.00	20
OM 902.923 Euro 4 OM 906 LA	Diesel	6374	6	102.00	19
OM 902.924 Euro 4 OM 906 LA	Diesel	6374	6	102.00	19
OM 902.925 Euro 4 OM 906 LA	Diesel	6374	6	102.00	19
OM 902.926 Euro 4 OM 906 LA	Diesel	6374	6	102.00	19
OM 902.927 Euro 4 OM 906 LA	Diesel	6374	6	102.00	19
OM 902.930 Euro 4 OM 906 LA	Diesel	6374	6	102.00	19
OM 902.931 Euro 4 OM 906 LA	Diesel	6374	6	102.00	19
OM 902.932 Euro 4 OM 906 LA	Diesel	6374	6	102.00	19
OM 902.933 Euro 4 OM 906 LA	Diesel	6374	6	102.00	19
OM 902.934 Euro 4 OM 906 LA	Diesel	6374	6	102.00	19
OM 902.936 Euro 4 OM 906 LA	Diesel	6374	6	102.00	19
OM 904 LA Euro 3	Diesel	4249	4	102.00	20
OM 904.903-950 Euro 2 OM 904 LA	Diesel	4249	4	102.00	21
OM 904.955 Euro 3 OM 904 LA.III/2	Diesel	4250	4	102.00	21
OM 904.956 Euro 2 OM 904 LA	Diesel	4249	4	102.00	21
OM 904.957 Euro 3 OM 904 LA	Diesel	4249	4	102.00	21
OM 904.959 Euro 2 OM 904 LA	Diesel	4249	4	102.00	21
OM 904.962 Euro 3 OM 904 LA	Diesel	4249	4	102.00	21
OM 904.965 Euro 3 OM 904 LA.III/2	Diesel	4249	4	102.00	21
OM 904.966 Euro 3 OM 904 LA.III/2	Diesel	4249	4	102.00	21
OM 904.967 Euro 3 OM 904 LA	Diesel	4249	4	102.00	21
OM 904.968 Euro 3 OM 904 LA	Diesel	4249	4	102.00	21
OM 904.970 Euro 3 OM 904 LA	Diesel	4249	4	102.00	21
OM 904.972 Euro 3 OM 904 LA	Diesel	4249	4	102.00	21
OM 904.974 Euro 2 OM 904 LA	Diesel	4249	4	102.00	21
OM 906 LA Euro 3	Diesel	6374	6	102.00	20
OM 906.910-988 OM 906 LA	Diesel	6374	6	102.00	21
OM 907.910 Euro 2 OM 904 LA	Diesel	4250	4	102.00	21
OM 907.920 Euro 2 OM 904 LA	Diesel	4250	4	102.00	21

		ccm	x 		9
OM 907.930 Euro 2 OM 904 LA	Diesel	4249	4	102.00	21
OM 907.940 Euro 2 OM 904 LA	Diesel	4250	4	102.00	21
OM 907.941 Euro 2 OM 904 LA	Diesel	4249	4	102.00	21
OM 907.960 Euro 2 OM 904 LA	Diesel	4250	4	102.00	21
OM 907.970 Euro 2 OM 904 LA	Diesel	4250	4	102.00	21
OM 907.980 Euro 2 OM 904 LA	Diesel	4249	4	102.00	21
OM 907.990 Euro 2 OM 904 LA	Diesel	4250	4	102.00	21
OM 909.900 OM 906 HLA	Diesel	6374	6	102.00	21
OM 909.901 OM 906 HLA	Diesel	6374	6	102.00	21
OM 909.910 OM 906 LA	Diesel	6374	6	102.00	21
OM 909.911 OM 906 LA	Diesel	6374	6	102.00	21
OM 909.920 OM 906 LA	Diesel	6374	6	102.00	21
OM 909.921 OM 906 LA	Diesel	6374	6	102.00	21
OM 909.960 OM 906 LA	Diesel	6374	6	102.00	21
OM 909.970 OM 906 LA	Diesel	6374	6	102.00	21
OM 909.971 OM 906 LA	Diesel	6374	6	102.00	21
OM 941.910 Euro 2 OM 501 LA	Diesel	11946	V6	130.00	53
OM 941.920 Euro 2 OM 501 LA	Diesel	11946	V6	130.00	53
OM 941.921 Euro 2 OM 501 LA	Diesel	11946	V6	130.00	53
OM 941.929 Euro 2 OM 501 LA	Diesel	11946	V6	130.00	53
OM 941.930 Euro 2 OM 501 LA	Diesel	11946	V6	130.00	53
OM 941.940 Euro 2 OM 501 LA	Diesel	11946	V6	130.00	53
OM 941.960 Euro 2 OM 501 LA	Diesel	11946	V6	130.00	53
OM 941.970 Euro 2 OM 501 LA	Diesel	11946	V6	130.00	53
OM 941.980 Euro 2 OM 501 LA	Diesel	11946	V6	130.00	53
OM 941.981 Euro 2 OM 501 LA	Diesel	11946	V6	130.00	53
OM 941.990 Euro 2 OM 501 LA	Diesel	11946	V6	130.00	53
OM 941.991 OM 501 LA	Diesel	11946	V6	130.00	57
OM 942.900 Euro 2 OM 502 LA	Diesel	15928	V8	130.00	53
OM 942.910 Euro 2 OM 502 LA	Diesel	15928	V8	130.00	53
OM 942.911 Euro 2 OM 502 LA	Diesel	15928	V8	130.00	53
OM 942.912 Euro 2 OM 502 LA	Diesel	15928	V8	130.00	53
OM 942.925 Euro 2 OM 502 LA	Diesel	15928	V8	130.00	53
OM 942.930 Euro 2 OM 502 LA	Diesel	15928	V8	130.00	53
OM 942.960 Euro 2 OM 502 LA	Diesel	15928	V8	130.00	53
OM 942.967 Euro 2 OM 502 LA	Diesel	15928	V8	130.00	53
OM 942.970 Euro 2 OM 502 LA	Diesel	15928	V8	130.00	53
OM 942.980 Euro 2 OM 502 LA	Diesel	15928	V8	130.00	53
OM 942.990 Euro 2 OM 502 LA	Diesel	15928	V8	130.00	53

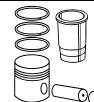
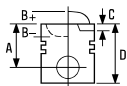

1 85.00

OM457/904/906 Compressor

1 Cyl.

FM15572

87-741200-10 STD

0.50mm

08-741200-00 STD

0.20mm

87-741207-10

08-741204-00 0.20mm

08-741205-00 0.25mm

A 33.30

D 59.15

19x60

08-741207-00 0.50mm

2.00

2.00

P

4.00

P

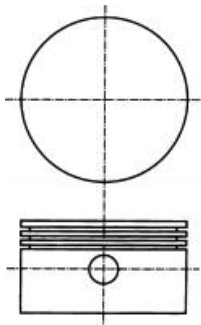

2 87.00

OM 602.990 OM 602

5 Cyl.

22:1

2497cc

63kW (86PS)

Diesel

TD17819

87-743600-10 1 2 STD

0.50mm

08-743600-00 STD

0.50mm

87-743607-10 1 2

08-743607-00

A 44.85

B- 9.05

C 1.25

C 1.05

D 74.85

26x55

08/89→

2.50

CR P

2.00

P

3.00

CR P

RT

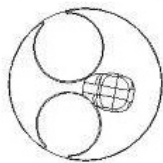
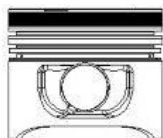

08753B

1 Conrod gap 22.15mm

2 Conrod guided in Piston

1 Pleuellaugenabstand 22.15mm

2 Kolbengeführtes Pleuel

1 Distance entre bielle 22.15mm

2 Bielle guidée dans le piston

1 Distancia del biela 22.15mm

2 Biela montada en el pistón

1 Distanza dalla biella 22.15mm

2 Billea montata sul pistone

14-026240-00 D

B 90.10 C 148.50 D 92.57 E 4.70

88-743600-10

87-743600-10 +

14-026240-00

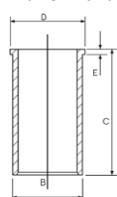

14-026241-00 D

B 90.20 C 148.50 D 92.75 E 4.70

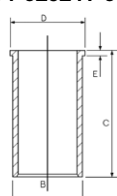

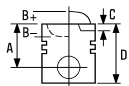

3 87.00

OM 615.911 OM 615	4 Cyl.	21:1	2197cc	33kW (45PS)	Diesel	TD7970
OM 621.932 OM 621	4 Cyl.	21:1	1990cc	40kW (55PS)	Diesel	TD2272

14-022190-00 D B 90.00 C 158.40 D 92.00 E 4.70

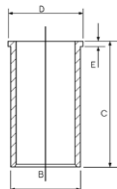



4 88.00

OM 612.966	5 Cyl.	18:1	2685cc	115kW (156PS)	Diesel Turbo Intercooled	TD16895
------------	--------	------	--------	---------------	--------------------------	---------

87-117900-20	STD	08-117900-00	STD	14-020300-00 D	B 91.00 C 147.00 D 93.00 E 5.00
87-117907-20	0.50mm	08-117907-00	0.50mm		

A	42.30
B-	13.80
BØ	43.50
C	2.48
D	72.30
	30x70

2.50		CK P
2.00		P
3.00		CR P

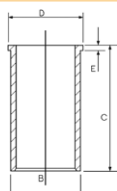

AK KK RT TP

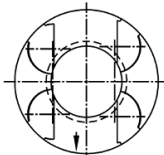
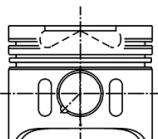



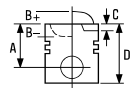

08854-209





5  **89.00**

OM 601.900 Euro 2 OM 601 XIII/1	4 Cyl.	22:1	2299cc	62kW (85PS)	Diesel	TD16185
OM 602.941 OM 602	5 Cyl.	21:1	2874cc	65-70kW (88-95PS)	Diesel	TD8013
OM 602.948 OM 602	5 Cyl.	22:1	2874cc	71kW (97PS)	Diesel	TD8014
OM 602.994 OM 602	5 Cyl.	21:1	2874cc	72kW (98PS)	Diesel	TD17822

87-743100-10 	STD	08-743100-00	STD	14-026380-00 D	B 91.50 C 156.50 D 96.55 E 4.70
87-743107-10 	0.50mm	08-743107-00	0.50mm	14-027210-00 D	B 91.50 C 156.50 D 94.05 E 4.70
87-743120-10 	0.70mm	08-743120-00	0.70mm		

A	44.65
B-	8.25
C	1.25
C	1.50
D	74.65
	26x62

2.50		CR P
2.00		P
3.00		CR P

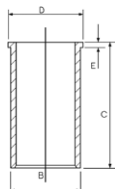



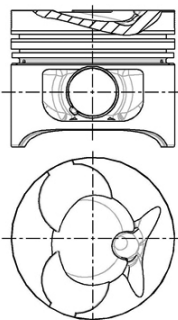

AK RT



08953

87-743120-20 	0.70mm	08-743100-00	STD
		08-743107-00	0.50mm
		08-743120-00	0.70mm

A	44.45
B-	8.25
C	1.50
C	1.25
D	74.45
	26x62

2.50		CR P
2.00		P
3.00		CR P

AK RT

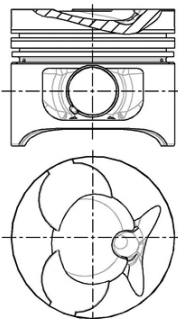

08953

 Conrod guided in Piston

 Kolbengeführtes Pleuel

 Bielle guidée dans le piston

 Biela montada en el pistón

 Billea montata sul pistone

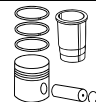
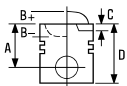

6  **89.00**

OM 602.981 Euro 2 OM 602 D29 LA 5 Cyl. 19.5:1 2874cc 85-90kW (116-122PS) Diesel Turbo Intercooled TD14670

OM 602.989 Euro 2 OM 602 D29 LA 5 Cyl. 19.5:1 2874cc 85-90kW (116-122PS) Diesel Turbo Intercooled TD14672

87-743100-00

STD

08-743100-00

STD

14-027210-00 D

B 91.50 C 156.50 D 94.05 E 4.70

87-743107-00

0.50mm

08-743107-00

0.50mm

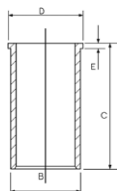

08-743120-00

0.70mm

A 44.75

B- 16.74

BØ 42.00

C 0.60

C 0.30

D 74.75

 28x70

2.50



CR P

2.00



P

3.00



CR P

KK RT

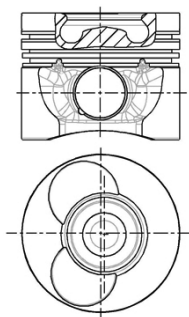

08980C

87-743107-50

0.50mm

08-743100-00

STD

A 44.55

B- 16.74

BØ 42.00

C 0.30

C 0.60

D 74.55

 28x70

2.50



CR P

2.00



P

3.00



CR P

KK RT

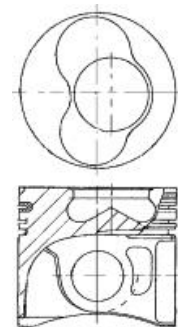

08980C

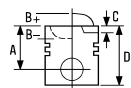

7 90.90

OM 616.942 OM 616 4 Cyl. 21:1 **2399cc** **38kW (52PS)** **Diesel** **TD7991**

OM 616.943 OM 616 4 Cyl. 21:1 **2399cc** **44kW (60PS)** **Diesel** **TD7992**

87-176700-00  STD **08-176700-00** STD **14-021350-00 D** B 94.00 C 158.40 D 96.00 E 4.70

87-176708-00  0.60mm **08-176707-00** 0.50mm

A 48.35

B- 8.75

C 1.15

D 79.65

 26x74

RT

08/78 →

3.00  MOL P

2.00  P

4.00  CR P

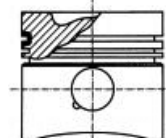
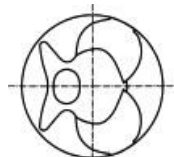
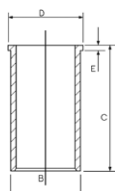

09105H/09113C

 Bore = 90.90mm

 Bohrung = 90.90mm

 Alésage = 90.90mm

 Tamaño del diámetro = 90.90mm

 Alessagio = 90.90mm

8 91.00

OM 616.911 OM 616 4 Cyl. 21:1 **2404cc** **38kW (52PS)** **Diesel** **TD5675**

OM 616.932 OM 616 4 Cyl. 21:1 **2404cc** **44kW (60PS)** **Diesel** **TD6015**

87-173800-10 STD **08-173800-00** STD **14-021350-00 D** B 94.00 C 158.40 D 96.00 E 4.70

87-173807-10 0.50mm **08-173805-00** 0.25mm

A 48.35

B- 6.25

D 79.65

 26x74

RT

→07/78

3.00  MO P

2.00  P

4.00  CR P

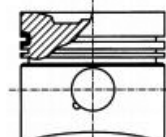
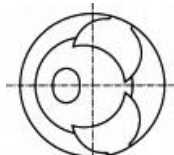
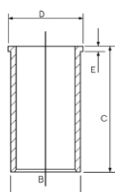

09105-/09113



9 97.00

OM 314.900	4 Cyl.	17:1	3782cc	46-63kW (63-86PS)	Diesel	TD22733
OM 314.914	4 Cyl.	17:1	3782cc	35-62kW (48-84PS)	Diesel	TD22546
OM 314.918	4 Cyl.	17:1	3782cc	53kW (72PS)	Diesel	TD22545
OM 314.919	4 Cyl.	17:1	3782cc	53kW (72PS)	Diesel	TD22547
OM 314.920	4 Cyl.	17:1	3782cc	55kW (75PS)	Diesel	TD28222
OM 314.921	4 Cyl.	17:1	3782cc	48kW (65PS)	Diesel	TD28223
OM 314.922	4 Cyl.	17:1	3782cc	57kW (78PS)	Diesel	TD28585
OM 314.940	4 Cyl.	17:1	3782cc	35-62kW (48-84PS)	Diesel	TD22548
OM 314.941	4 Cyl.	17:1	3782cc	35-62kW (48-84PS)	Diesel	TD22549
OM 314.942	4 Cyl.	17:1	3782cc	35-62kW (48-84PS)	Diesel	TD22550
OM 314.943	4 Cyl.	17:1	3782cc	35-62kW (48-84PS)	Diesel	TD22551
OM 314.945	4 Cyl.	17:1	3782cc	35-62kW (48-84PS)	Diesel	TD22552
OM 314.947	4 Cyl.	17:1	3782cc	35-62kW (48-84PS)	Diesel	TD22553
OM 314.949	4 Cyl.	17:1	3782cc	35-62kW (48-84PS)	Diesel	TD22554
OM 314.950	4 Cyl.	17:1	3782cc	35-62kW (48-84PS)	Diesel	TD22555
OM 314.951	4 Cyl.	17:1	3782cc	35-66kW (48-90PS)	Diesel	TD22556
OM 314.954	4 Cyl.	17:1	3782cc	35-62kW (48-84PS)	Diesel	TD22557
OM 314.958	4 Cyl.	17:1	3782cc	35-62kW (48-84PS)	Diesel	TD22558
OM 314.960	4 Cyl.	17:1	3782cc	35-62kW (48-84PS)	Diesel	TD22559
OM 314.970 OM 314 A	4 Cyl.	16:1	3782cc	63kW (85PS)	Diesel Turbo	TD17852
OM 352.965	6 Cyl.	17:1	5673cc	69kW (94PS)	Diesel	TD22738
OM 352.966	6 Cyl.	17:1	5673cc	79kW (107PS)	Diesel	TD22739
OM 352.967	6 Cyl.	17:1	5673cc	74kW (101PS)	Diesel	TD22740
OM 352.999	6 Cyl.	17:1	5673cc	79kW (107PS)	Diesel	TD22743
OM 353.909 OM 352 A	6 Cyl.	16.5:1	5673cc	124-125kW (168-170PS)	Diesel Turbo	TD8091
OM 353.910 OM 352 A	6 Cyl.	16.5:1	5673cc	124kW (168PS)	Diesel Turbo	TD8162
OM 353.957 OM 352 A	6 Cyl.	17:1	5673cc	92kW (125PS)	Diesel Turbo	TD16995
OM 353.977	6 Cyl.	16:1	5673cc	124kW (169PS)	Diesel Turbo	TD22744
OM 353.995 OM 352 A	6 Cyl.	16.5:1	5673cc	92kW (125PS)	Diesel Turbo	TD7999
OM 353.996 OM 352	6 Cyl.	17:1	5675cc	51-96kW (69-131PS)	Diesel	TD28655
OM 362.906 OM 362 LA	6 Cyl.	16.8:1	5700cc	141kW (192PS)	Diesel Turbo Intercooled	TD5750
OM 362.909 OM 362 LA	6 Cyl.	16.8:1	5700cc	141kW (192PS)	Diesel Turbo Intercooled	TD6080
OM 362.910 OM 362 LA	6 Cyl.	17:1	5675cc	141kW (192PS)	Diesel Turbo Intercooled	TD16699

14-021850-00 D B 101.00 C 222.00 D 103.50 E 5.50
14-025800-00 D B 100.40 C 222.00 D 103.50 E 5.20
14-025801-00 D B 101.00 C 222.00 D 104.00 E 5.20
14-025802-00 D B 102.00 C 222.00 D 105.00 E 5.20
14-025804-00 D B 103.00 C 222.00 D 106.00 E 5.20
14-025881-00 D B 101.50 C 222.00 D 104.50 E 4.75
14-025883-00 D B 103.00 C 222.00 D 106.00 E 4.75

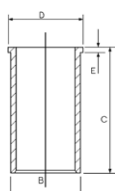

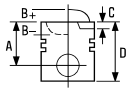

10  **97.00**

OM 314.910 OM 314	4 Cyl.	17:1	3782cc	63kW (85PS)	Diesel	TD5691
OM 314.915 OM 314	4 Cyl.	17:1	3782cc	63kW (85PS)	Diesel	TD16557
OM 314.916 OM 314	4 Cyl.	17:1	3782cc	40kW (54PS)	Diesel	TD7971
OM 314.917 OM 314	4 Cyl.	17:1	3782cc	48-55kW (66-75PS)	Diesel	TD7973
OM 314.944 OM 314	4 Cyl.	17:1	3782cc	63kW (85PS)	Diesel	TD6028
OM 314.946 OM 314	4 Cyl.	17:1	3782cc	63kW (85PS)	Diesel	TD2202
OM 314.948 OM 314	4 Cyl.	17:1	3782cc	63kW (85PS)	Diesel	TD2203
OM 314.953 OM 314	4 Cyl.	17:1	3782cc	59kW (80PS)	Diesel	TD7975
OM 314.956 OM 314	4 Cyl.	17:1	3782cc	48kW (65PS)	Diesel	TD16999
OM 314.957 OM 314	4 Cyl.	17:1	3782cc	53kW (72PS)	Diesel	TD17000
OM 314.959 OM 314	4 Cyl.	17:1	3782cc	63kW (85PS)	Diesel	TD2204
OM 314.961 OM 314	4 Cyl.	17:1	3782cc	63kW (85PS)	Diesel	TD16552
OM 314.962 OM 314	4 Cyl.	17:1	3782cc	63kW (85PS)	Diesel	TD16553
OM 314.963 OM 314	4 Cyl.	17:1	3782cc	63kW (85PS)	Diesel	TD16554
OM 314.964 OM 314	4 Cyl.	17:1	3782cc	63kW (85PS)	Diesel	TD16555
OM 352.901-964	6 Cyl.	17:1	5673cc	52-96kW (70-131PS)	Diesel	
OM 352.969-998	6 Cyl.	17:1	5673cc	59-96kW (80-130PS)	Diesel	
OM 353.900 OM 352	6 Cyl.	17:1	5673cc	96kW (130PS)	Diesel	TD16651
OM 353.902 OM 352	6 Cyl.	17:1	5673cc	62kW (84PS)	Diesel	TD5678
OM 353.903 OM 352	6 Cyl.	17:1	5673cc	81kW (110PS)	Diesel	TD16652
OM 353.904 OM 352	6 Cyl.	17:1	5673cc	96kW (130PS)	Diesel	TD5697
OM 353.905 OM 352	6 Cyl.	17:1	5673cc	74kW (100PS)	Diesel	TD7988
OM 353.915 OM 352	6 Cyl.	17:1	5673cc	81kW (110PS)	Diesel	TD16653
OM 353.916 OM 352	6 Cyl.	17:1	5673cc	81kW (110PS)	Diesel	TD16654
OM 353.917 OM 352	6 Cyl.	17:1	5673cc	96kW (130PS)	Diesel	TD16655
OM 353.941 OM 352	6 Cyl.	17:1	5673cc	96kW (130PS)	Diesel	TD16656
OM 353.942 OM 352	6 Cyl.	17:1	5673cc	96kW (130PS)	Diesel	TD5709
OM 353.943 OM 352	6 Cyl.	17:1	5673cc	96kW (130PS)	Diesel	TD5727
OM 353.944 OM 352	6 Cyl.	17:1	5673cc	96kW (130PS)	Diesel	TD5728
OM 353.945 OM 352	6 Cyl.	17:1	5673cc	96kW (130PS)	Diesel	TD5710
OM 353.946 OM 352	6 Cyl.	17:1	5673cc	96kW (130PS)	Diesel	TD6044
OM 353.949 OM 352	6 Cyl.	17:1	5673cc	81kW (110PS)	Diesel	TD16994
OM 353.960 OM 352	6 Cyl.	17:1	5673cc	88kW (120PS)	Diesel	TD7980
OM 353.963 OM 352	6 Cyl.	17:1	5673cc	96kW (130PS)	Diesel	TD5690
OM 353.964 OM 352	6 Cyl.	17:1	5673cc	96kW (130PS)	Diesel	TD6284
OM 353.965 OM 352	6 Cyl.	17:1	5673cc	96kW (130PS)	Diesel	TD5715
OM 353.966 OM 352	6 Cyl.	17:1	5673cc	96kW (130PS)	Diesel	TD6027
OM 353.967 OM 352	6 Cyl.	17:1	5673cc	74kW (101PS)	Diesel	TD16657
OM 353.968 OM 352	6 Cyl.	17:1	5673cc	96kW (130PS)	Diesel	TD16658
OM 353.969 OM 352	6 Cyl.	17:1	5673cc	96kW (130PS)	Diesel	TD16659
OM 353.981 OM 352	6 Cyl.	17:1	5673cc	96kW (130PS)	Diesel	TD6034
OM 353.982 OM 352	6 Cyl.	17:1	5673cc	96kW (130PS)	Diesel	TD6048
OM 353.983 OM 352	6 Cyl.	17:1	5673cc	96kW (130PS)	Diesel	TD17016



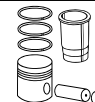
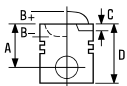

OM 353.984 OM 352 6 Cyl. 17:1 **5673cc** **96kW (130PS)** **Diesel** **TD17017**





OM 353.989 OM 352 6 Cyl. 17:1 **5673cc** **96kW (130PS)** **Diesel** **TD16663**

87-174300-00	STD	08-174300-10 ⁴	STD	14-021850-00 D	B 101.00 C 222.00 D 103.50 E 5.50
87-174307-00 ¹	0.50mm	08-174305-10 ⁴	0.25mm	14-025800-00 D	B 100.40 C 222.00 D 103.50 E 5.20
87-174311-00 ³	1.00mm	08-174307-10 ⁴	0.50mm	14-025801-00 D	B 101.00 C 222.00 D 104.00 E 5.20
		08-174309-10 ⁴	0.75mm	14-025802-00 D	B 102.00 C 222.00 D 105.00 E 5.20
		08-174311-10 ⁴	1.00mm	14-025804-00 D	B 103.00 C 222.00 D 106.00 E 5.20
		08-174314-10 ⁴	1.50mm	14-025881-00 D	B 101.50 C 222.00 D 104.50 E 4.75
				14-025883-00 D	B 103.00 C 222.00 D 106.00 E 4.75

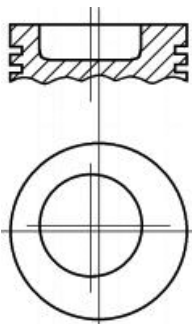
A 65.20
B- 20.00
BØ 55.00
D 115.70
 36x83

RT



3.00		CR P
3.00		P
3.00		P
5.50		CR P
5.50		P

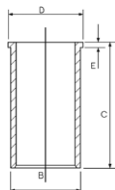



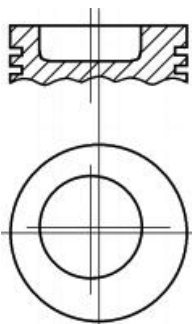

87-178800-00	STD	08-178800-00	STD
87-178807-00 ²	0.50mm	08-178807-00	0.50mm
87-178811-00 ³	1.00mm	08-178811-00	1.00mm

A 65.20
B- 20.00
BØ 55.00
D 115.70
 36x83

RT



3.00		CR P
3.00		P
3.00		P
5.50		CR P

- ¹ A = 64.800, D = 115.300
- ² A = 64.900, D = 115.400
- ³ A = 64.600, D = 115.100
- ⁴ For 5 ring piston

- ¹ A = 64.800, D = 115.300
- ² A = 64.900, D = 115.400
- ³ A = 64.600, D = 115.100
- ⁴ Für den Kolben mit 5 Ringen

- ¹ A = 64.800, D = 115.300
- ² A = 64.900, D = 115.400
- ³ A = 64.600, D = 115.100
- ⁴ Pour le piston de 5 anneaux

- ¹ A = 64.800, D = 115.300
- ² A = 64.900, D = 115.400
- ³ A = 64.600, D = 115.100
- ⁴ Para el pistón de 5 anillos

- ¹ A = 64.800, D = 115.300
- ² A = 64.900, D = 115.400
- ³ A = 64.600, D = 115.100
- ⁴ Per un pistone dei 5 anelli



11  **97.00**

OM 352.913 OM 352 A	6 Cyl.	16:1	5673cc	115kW (156PS)	Diesel Turbo	TD16643
OM 352.916 OM 352 A	6 Cyl.	16:1	5673cc	110-111kW (150-151PS)	Diesel Turbo	TD7923
OM 352.918 OM 352 A	6 Cyl.	16:1	5673cc	110kW (150PS)	Diesel Turbo	TD16641
OM 352.937 OM 352 A	6 Cyl.	16:1	5673cc	110kW (150PS)	Diesel Turbo	TD16644
OM 352.946 OM 352 A	6 Cyl.	16:1	5673cc	110kW (150PS)	Diesel Turbo	TD16645
OM 352.949 OM 352 A	6 Cyl.	16:1	5673cc	115kW (156PS)	Diesel Turbo	TD16646
OM 352.950 OM 352 A	6 Cyl.	16:1	5673cc	110kW (150PS)	Diesel Turbo	TD16647
OM 352.968 OM 352 A	6 Cyl.	16:1	5673cc	115kW (156PS)	Diesel Turbo	TD16648
OM 352.988 OM 352 A	6 Cyl.	16:1	5673cc	96kW (130PS)	Diesel Turbo	TD16649
OM 352.994 OM 352 A	6 Cyl.	16:1	5673cc	110kW (150PS)	Diesel Turbo	TD16650
OM 353.911 OM 352 A	6 Cyl.	16.5:1	5673cc	124kW (168PS)	Diesel Turbo	TD8090
OM 353.912 OM 352 A	6 Cyl.	16.5:1	5673cc	124kW (168PS)	Diesel Turbo	TD8159
OM 353.913 OM 352 A	6 Cyl.	16.5:1	5673cc	124kW (168PS)	Diesel Turbo	TD8097
OM 353.914 OM 352 A	6 Cyl.	16.5:1	5673cc	124kW (168PS)	Diesel Turbo	TD16662
OM 353.950 OM 352 A	6 Cyl.	16.5:1	5673cc	124kW (168PS)	Diesel Turbo	TD5711
OM 353.951 OM 352 A	6 Cyl.	16.5:1	5673cc	124kW (168PS)	Diesel Turbo	TD5747
OM 353.952 OM 352 A	6 Cyl.	16.5:1	5673cc	124kW (168PS)	Diesel Turbo	TD6045
OM 353.953 OM 352 A	6 Cyl.	16.5:1	5673cc	124kW (168PS)	Diesel Turbo	TD6092
OM 353.954 OM 352 A	6 Cyl.	16.5:1	5673cc	124kW (168PS)	Diesel Turbo	TD8096
OM 353.958 OM 353 A	6 Cyl.	16.5:1	5673cc	110kW (150PS)	Diesel Turbo	TD7990
OM 353.959 OM 352 A	6 Cyl.	16.5:1	5673cc	124kW (168PS)	Diesel Turbo	TD8009
OM 353.970 OM 352 A	6 Cyl.	16.5:1	5673cc	124kW (168PS)	Diesel Turbo	TD5712
OM 353.971 OM 352 A	6 Cyl.	16.5:1	5673cc	124kW (168PS)	Diesel Turbo	TD6060
OM 353.972 OM 352 A	6 Cyl.	16:1	5673cc	124kW (168PS)	Diesel Turbo	TD16660
OM 353.973 OM 352 A	6 Cyl.	16.5:1	5673cc	92kW (125PS)	Diesel Turbo	TD7981
OM 353.974 OM 352 A	6 Cyl.	16:1	5673cc	127kW (172PS)	Diesel Turbo	TD16661
OM 353.975 OM 352 A	6 Cyl.	16.5:1	5673cc	124kW (168PS)	Diesel Turbo	TD6321
OM 353.976 OM 352 A	6 Cyl.	16.5:1	5673cc	110kW (150PS)	Diesel Turbo	TD17860
OM 353.978 OM 352 A	6 Cyl.	16:1	5673cc	127kW (172PS)	Diesel Turbo	TD16664



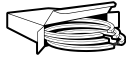
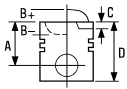

OM 353.991 OM 352 A 6 Cyl. 16:1 **5673cc** **124kW (168PS)** **Diesel Turbo** **TD16665**

OM 353.997 OM 352 A 6 Cyl. 16:1 **5673cc** **124kW (168PS)** **Diesel Turbo** **TD16666**



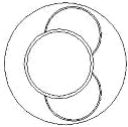
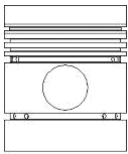

87-174307-10 ③ 0.50mm
87-174311-10 ④ 1.00mm

A 64.90
B- 19.90
BØ 55.00
C 2.40
D 115.40
 **36x83**

RT



08-174300-10 ⑤ STD
08-174305-10 ⑤ 0.25mm
08-174307-10 ⑤ 0.50mm
08-174309-10 ⑤ 0.75mm
08-174311-10 ⑤ 1.00mm
08-174314-10 ⑤ 1.50mm

3.00  CR P
 3.00  P
 3.00  P
 5.50  CR P
 5.50  P

14-021850-00 D **B** 101.00 **C** 222.00 **D** 103.50 **E** 5.50
14-025800-00 D **B** 100.40 **C** 222.00 **D** 103.50 **E** 5.20
14-025801-00 D **B** 101.00 **C** 222.00 **D** 104.00 **E** 5.20
14-025802-00 D **B** 102.00 **C** 222.00 **D** 105.00 **E** 5.20
14-025804-00 D **B** 103.00 **C** 222.00 **D** 106.00 **E** 5.20
14-025881-00 D **B** 101.50 **C** 222.00 **D** 104.50 **E** 4.75
14-025883-00 D **B** 103.00 **C** 222.00 **D** 106.00 **E** 4.75

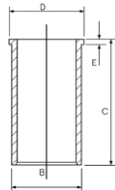



87-178200-20 STD
87-178207-20 ① 0.50mm
87-178211-20 ② 1.00mm

A 65.20
B- 20.00
BØ 55.00
C 2.20
D 105.20
 **36x83**

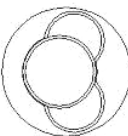
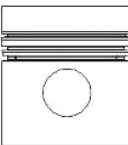
RT



08-178200-00 STD
08-178207-00 0.50mm
08-178211-00 1.00mm

2.50  MOL P
 2.50  MO P
 4.00  CR P

- ① A = 64.900, D = 104.900
- ② A = 64.600, D = 104.600
- ③ A = 64.900, D = 115.400
- ④ A = 64.600, D = 115.100
- ⑤ For 5 ring piston

- ① A = 64.900, D = 104.900
- ② A = 64.600, D = 104.600
- ③ A = 64.900, D = 115.400
- ④ A = 64.600, D = 115.100
- ⑤ Für den Kolben mit 5 Ringen

- ① A = 64.900, D = 104.900
- ② A = 64.600, D = 104.600
- ③ A = 64.900, D = 115.400
- ④ A = 64.600, D = 115.100
- ⑤ Pour le piston de 5 anneaux

- ① A = 64.900, D = 104.900
- ② A = 64.600, D = 104.600
- ③ A = 64.900, D = 115.400
- ④ A = 64.600, D = 115.100
- ⑤ Para el pistón de 5 anillos

- ① A = 64.900, D = 104.900
- ② A = 64.600, D = 104.600
- ③ A = 64.900, D = 115.400
- ④ A = 64.600, D = 115.100
- ⑤ Per un pistone dei 5 anelli

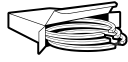
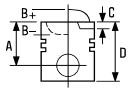

12  **97.50**

OM 354.900 Euro 2 OM 364 LA	4 Cyl.	18:1	3972cc	77kW (105PS)	Diesel Turbo Intercooled	TD8054
OM 354.901 Euro 2 OM 364 LA	4 Cyl.	18:1	3972cc	77kW (105PS)	Diesel Turbo Intercooled	TD8084
OM 354.902 Euro 2 OM 364 LA	4 Cyl.	18:1	3972cc	77kW (105PS)	Diesel Turbo Intercooled	TD5695
OM 354.903 Euro 2 OM 364 LA	4 Cyl.	18:1	3972cc	77kW (105PS)	Diesel Turbo Intercooled	TD8083
OM 354.920 Euro 2 OM 364 LA	4 Cyl.	18:1	3972cc	103kW (140PS)	Diesel Turbo Intercooled	TD8059
OM 354.921 Euro 2 OM 364 LA	4 Cyl.	18:1	3972cc	103kW (140PS)	Diesel Turbo Intercooled	TD8066
OM 354.922 Euro 2 OM 364 LA	4 Cyl.	18:1	3972cc	103kW (140PS)	Diesel Turbo Intercooled	TD8061
OM 354.923 Euro 2 OM 364 LA	4 Cyl.	18:1	3972cc	103kW (140PS)	Diesel Turbo Intercooled	TD8057
OM 354.924 Euro 2 OM 364 LA	4 Cyl.	18:1	3972cc	103kW (140PS)	Diesel Turbo Intercooled	TD8085
OM 354.925 Euro 2 OM 364 LA	4 Cyl.	18:1	3972cc	103kW (140PS)	Diesel Turbo Intercooled	TD8087
OM 354.926 Euro 2	4 Cyl.	18:1	3972cc	103kW (140PS)	Diesel Turbo Intercooled	TD22745
OM 364.901 OM 364 A	4 Cyl.	17:1	3972cc	83kW (113PS)	Diesel Turbo	TD21464
OM 357.900 OM 366 LA	6 Cyl.	16.5:1	5958cc	125kW (170PS)	Diesel Turbo Intercooled	TD8069
OM 357.901 OM 366 LA	6 Cyl.	16.5:1	5958cc	125kW (170PS)	Diesel Turbo Intercooled	TD5708
OM 357.902 OM 366 LA	6 Cyl.	16.5:1	5958cc	125kW (170PS)	Diesel Turbo Intercooled	TD5740
OM 357.903 OM 366 LA	6 Cyl.	16.5:1	5958cc	125kW (170PS)	Diesel Turbo Intercooled	TD5742
OM 357.904 OM 366 LA	6 Cyl.	18:1	5958cc	125kW (170PS)	Diesel Turbo Intercooled	TD16528
OM 357.906 OM 366 LA	6 Cyl.	16.5:1	5958cc	125kW (170PS)	Diesel Turbo Intercooled	TD8095
OM 357.907 OM 366 LA	6 Cyl.	16.5:1	5958cc	125kW (170PS)	Diesel Turbo Intercooled	TD8138
OM 357.908 OM 366 LA	6 Cyl.	16.5:1	5958cc	125kW (170PS)	Diesel Turbo Intercooled	TD8074
OM 357.909 OM 366 LA	6 Cyl.	16.5:1	5958cc	125kW (170PS)	Diesel Turbo Intercooled	TD5706
OM 357.910 OM 366 LA	6 Cyl.	16.5:1	5958cc	125kW (170PS)	Diesel Turbo Intercooled	TD6041
OM 357.915 OM 366 LA	6 Cyl.	16.5:1	5958cc	125kW (170PS)	Diesel Turbo Intercooled	TD8147
OM 357.916 OM 366 LA	6 Cyl.	16.5:1	5958cc	125kW (170PS)	Diesel Turbo Intercooled	TD8075
OM 357.917 OM 366 LA	6 Cyl.	16.5:1	5958cc	125kW (170PS)	Diesel Turbo Intercooled	TD8079
OM 357.918 OM 366 LA	6 Cyl.	16.5:1	5958cc	125kW (170PS)	Diesel Turbo Intercooled	TD6043
OM 357.919 OM 366 LA	6 Cyl.	16.5:1	5958cc	125kW (170PS)	Diesel Turbo Intercooled	TD8106
OM 357.920 OM 366 LA	6 Cyl.	16.5:1	5958cc	155kW (211PS)	Diesel Turbo Intercooled	TD5720
OM 357.921 OM 366 LA	6 Cyl.	16.5:1	5958cc	155kW (211PS)	Diesel Turbo Intercooled	TD5743
OM 357.922 OM 366 LA	6 Cyl.	16.5:1	5958cc	155kW (211PS)	Diesel Turbo Intercooled	TD8166
OM 357.924 Euro 2 OM 366 LA	6 Cyl.	16.5:1	5958cc	155kW (211PS)	Diesel Turbo Intercooled	TD14688
OM 357.925 OM 366 LA	6 Cyl.	16.5:1	5958cc	155kW (211PS)	Diesel Turbo Intercooled	TD8196
OM 357.926 OM 366 LA	6 Cyl.	16.5:1	5958cc	155kW (211PS)	Diesel Turbo Intercooled	TD16931
OM 357.927 OM 366 LA	6 Cyl.	16.5:1	5958cc	155kW (211PS)	Diesel Turbo Intercooled	TD5723
OM 357.929 OM 366 LA	6 Cyl.	16.5:1	5958cc	155kW (211PS)	Diesel Turbo Intercooled	TD8113
OM 357.930 OM 366 LA	6 Cyl.	16.5:1	5958cc	155kW (211PS)	Diesel Turbo Intercooled	TD8168
OM 357.931 Euro 2 OM 366 LA	6 Cyl.	18:1	5958cc	155kW (211PS)	Diesel Turbo Intercooled	TD16820
OM 357.932 OM 366 LA	6 Cyl.	16.5:1	5958cc	155kW (211PS)	Diesel Turbo Intercooled	TD6056
OM 357.933 OM 366 LA	6 Cyl.	16.5:1	5958cc	155kW (211PS)	Diesel Turbo Intercooled	TD8115
OM 357.934 OM 366 LA	6 Cyl.	16.5:1	5958cc	155kW (211PS)	Diesel Turbo Intercooled	TD17097
OM 357.935 OM 366 LA	6 Cyl.	16.5:1	5958cc	155kW (211PS)	Diesel Turbo Intercooled	TD17098
OM 357.936 Euro 2 OM 366 LA	6 Cyl.	18:1	5958cc	155kW (211PS)	Diesel Turbo Intercooled	TD16821
OM 357.937 Euro 2 OM 366 LA	6 Cyl.	18:1	5958cc	155kW (211PS)	Diesel Turbo Intercooled	TD16822



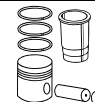
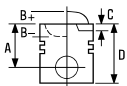

OM 357.938 Euro 2	6 Cyl.	18:1	5958cc	155kW (211PS)	Diesel Turbo Intercooled	TD22748
OM 357.940 OM 366 LA	6 Cyl.	16.5:1	5958cc	177kW (240PS)	Diesel Turbo Intercooled	TD5746
OM 357.941 OM 366 LA	6 Cyl.	16.5:1	5958cc	177kW (240PS)	Diesel Turbo Intercooled	TD8169
OM 357.942 OM 366 LA	6 Cyl.	16.5:1	5958cc	177kW (240PS)	Diesel Turbo Intercooled	TD8116
OM 357.943 OM 366 LA	6 Cyl.	16.5:1	5958cc	177kW (240PS)	Diesel Turbo Intercooled	TD5725
OM 357.944 OM 366 LA	6 Cyl.	16.5:1	5958cc	177kW (240PS)	Diesel Turbo Intercooled	TD6058
OM 357.945 Euro 2 OM 366 LA	6 Cyl.	16.5:1	5958cc	177kW (241PS)	Diesel Turbo Intercooled	TD14690
OM 357.946 OM 366 LA	6 Cyl.	16.5:1	5958cc	177kW (240PS)	Diesel Turbo Intercooled	TD8125
OM 357.947 OM 366 LA	6 Cyl.	16.5:1	5958cc	177kW (240PS)	Diesel Turbo Intercooled	TD8170
OM 357.948 OM 366 LA	6 Cyl.	16.5:1	5958cc	177kW (240PS)	Diesel Turbo Intercooled	TD6077
OM 357.949 Euro 2 OM 366 LA	6 Cyl.	18:1	5958cc	177kW (240PS)	Diesel Turbo Intercooled	TD16823
OM 357.961 OM 366 LA	6 Cyl.	16.5:1	5958cc	125kW (170PS)	Diesel Turbo Intercooled	TD6073
OM 357.962 OM 366 LA	6 Cyl.	16.5:1	5958cc	125kW (170PS)	Diesel Turbo Intercooled	TD6074
OM 357.963 OM 366 LA	6 Cyl.	16.5:1	5958cc	125kW (170PS)	Diesel Turbo Intercooled	TD6090
OM 366.956 OM 366 A	6 Cyl.	16.5:1	5958cc	100kW (136PS)	Diesel Turbo	TD6320

87-740000-00 STD

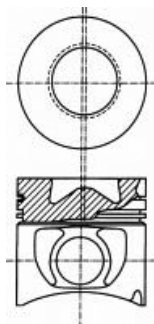

A 63.00
B- 23.00
BØ 54.45
D 108.00
 36x83

RT TP



08-740000-00 STD
08-740007-00 0.50mm

04/84→

2.50  MOL P
 2.50  CR P
 4.00  CR P

14-025800-00 D B 100.40 C 222.00 D 103.50 E 5.20
14-025801-00 D B 101.00 C 222.00 D 104.00 E 5.20
14-025802-00 D B 102.00 C 222.00 D 105.00 E 5.20
14-025804-00 D B 103.00 C 222.00 D 106.00 E 5.20
14-025881-00 D B 101.50 C 222.00 D 104.50 E 4.75
14-025883-00 D B 103.00 C 222.00 D 106.00 E 4.75

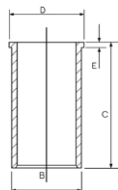

14-012260-00 D B 100.40 C 224.00

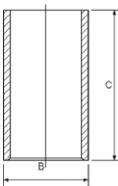

87-740000-01 STD

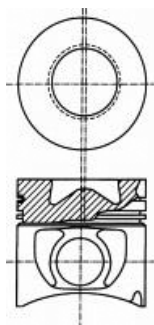

A 62.70
B- 23.00
BØ 54.45
D 107.70
 36x83

RT TP



08-740000-00 STD
08-740007-00 0.50mm

04/84→

2.50  MOL P
 2.50  CR P
 4.00  CR P

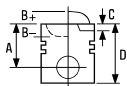

13 97.50

OM 364.918 OM 364	4 Cyl.	17.3:1	3970cc	63kW (86PS)	Diesel	TD8053
OM 364.919 OM 364	4 Cyl.	17.3:1	3972cc	63kW (86PS)	Diesel	TD5692
OM 364.920 OM 364	4 Cyl.	17.3:1	3972cc	63kW (86PS)	Diesel	TD8082
OM 364.921 Euro 1 OM 364	4 Cyl.	17.3:1	3972cc	63kW (86PS)	Diesel	TD6029
OM 356.901 Euro 1 OM 366	6 Cyl.	17.3:1	5958cc	95kW (129PS)	Diesel	TD5704
OM 356.902 Euro 1 OM 366	6 Cyl.	17.3:1	5958cc	95kW (129PS)	Diesel	TD8064
OM 356.903 Euro 1 OM 366	6 Cyl.	17.3:1	5958cc	95kW (129PS)	Diesel	TD8093
OM 356.904 Euro 1 OM 366	6 Cyl.	17.3:1	5958cc	95kW (129PS)	Diesel	TD8098
OM 356.905 Euro 1 OM 366	6 Cyl.	17.3:1	5958cc	95kW (129PS)	Diesel	TD8062
OM 356.906 Euro 1 OM 366	6 Cyl.	17.3:1	5958cc	95kW (129PS)	Diesel	TD8067
OM 356.907 Euro 1 OM 366	6 Cyl.	17.3:1	5958cc	95kW (129PS)	Diesel	TD8099
OM 356.908 Euro 1 OM 366	6 Cyl.	17.3:1	5958cc	95kW (129PS)	Diesel	TD8134
OM 356.909 Euro 1 OM 366	6 Cyl.	17.3:1	5958cc	95kW (129PS)	Diesel	TD8133
OM 356.910 Euro 1 OM 366	6 Cyl.	17.3:1	5958cc	95kW (129PS)	Diesel	TD8132
OM 356.911 Euro 1 OM 366	6 Cyl.	17.3:1	5958cc	95kW (129PS)	Diesel	TD6039
OM 356.913 Euro 1 OM 366	6 Cyl.	17.25:1	5958cc	100kW (136PS)	Diesel	TD16810
OM 356.914 Euro 1 OM 366	6 Cyl.	17.3:1	5958cc	75kW (102PS)	Diesel	TD7994
OM 356.915 Euro 1 OM 366	6 Cyl.	17.25:1	5958cc	97kW (132PS)	Diesel	TD16811
OM 356.916 Euro 1 OM 366	6 Cyl.	17.25:1	5958cc	97kW (132PS)	Diesel	TD17096

87-288800-00 STD

STD

08-288800-00 STD

STD

14-025800-00 D

B 100.40 C 222.00 D 103.50 E 5.20

87-288807-00 

0.50mm

08-288807-00

0.50mm

14-025801-00 D

B 101.00 C 222.00 D 104.00 E 5.20

A 62.80

B- 22.38

BØ 43.00

D 107.80

 36x83

2.50



MOL P

14-025802-00 D

B 102.00 C 222.00 D 105.00 E 5.20

2.50



CR P

14-025804-00 D

B 103.00 C 222.00 D 106.00 E 5.20

4.00



CR P

14-025881-00 D

B 101.50 C 222.00 D 104.50 E 4.75

14-025883-00 D

B 103.00 C 222.00 D 106.00 E 4.75

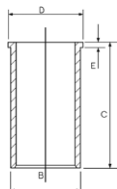

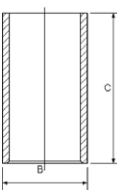

14-012260-00 D

B 100.40 C 224.00



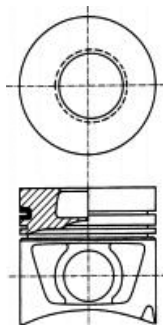

RT



 A = 62.500, D = 107.500

 A = 62.500, D = 107.500

 A = 62.500, D = 107.500

 A = 62.500, D = 107.500

 A = 62.500, D = 107.500

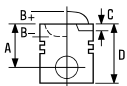

14 97.50

OM 364.950 OM 364 A	4 Cyl.	16.5:1	3972cc	85kW (115PS)	Diesel Turbo	TD5696
OM 364.952 OM 364 A	4 Cyl.	16.5:1	3972cc	85kW (115PS)	Diesel Turbo	TD6033
OM 364.954 OM 364	4 Cyl.	16.5:1	3972cc	85kW (115PS)	Diesel	TD8045
OM 364.980 OM 364 LA	4 Cyl.		3972cc	100kW (136PS)	Diesel Turbo Intercooled	TD8047
OM 364.981 OM 364 LA	4 Cyl.		3972cc	100kW (136PS)	Diesel Turbo Intercooled	TD8086
OM 364.984 OM 364 LA	4 Cyl.		3972cc	100kW (136PS)	Diesel Turbo Intercooled	TD8088
OM 356.940 Euro 1 OM 366 A	6 Cyl.	17.3:1	5958cc	129kW (175PS)	Diesel Turbo	TD6098
OM 356.984 OM 366 LA	6 Cyl.	16.5:1	5958cc	155kW (211PS)	Diesel Turbo Intercooled	TD8148
OM 356.985 OM 366 LA	6 Cyl.	16.5:1	5958cc	150kW (204PS)	Diesel Turbo Intercooled	TD8189
OM 366.944-979	6 Cyl.	16.5:1	5958cc	100-132kW (136-170PS)	Diesel Turbo	
OM 366.980 OM 366 LA	6 Cyl.	16.5:1	5960cc	148kW (201PS)	Diesel Turbo Intercooled	TD8141
OM 366.981 OM 366 LA	6 Cyl.	16.5:1	5958cc	148kW (201PS)	Diesel Turbo Intercooled	TD16817
OM 366.983 OM 366 LA	6 Cyl.	16.5:1	5958cc	150kW (204PS)	Diesel Turbo Intercooled	TD8150
OM 366.984 OM 366 LA	6 Cyl.	16.5:1	5958cc	150-157kW (204-214PS)	Diesel Turbo Intercooled	TD8007
OM 366.988 OM 366 LA	6 Cyl.	16.5:1	5960cc	148-150kW (201-204PS)	Diesel Turbo Intercooled	TD5744
OM 366.990 OM 366 LA	6 Cyl.	16.5:1	5958cc	150kW (204PS)	Diesel Turbo Intercooled	TD16818
OM 366.992 OM 366 LA	6 Cyl.	16.5:1	5958cc	150kW (204PS)	Diesel Turbo Intercooled	TD5722
OM 366.993 OM 366 LA	6 Cyl.	16.5:1	5958cc	150kW (204PS)	Diesel Turbo Intercooled	TD8114
OM 366.994 OM 366 LA	6 Cyl.	16.5:1	5958cc	150kW (204PS)	Diesel Turbo Intercooled	TD6055
OM 366.995 OM 366 LA	6 Cyl.	16.5:1	5958cc	150kW (204PS)	Diesel Turbo Intercooled	TD8167
OM 366.996 OM 366 LA	6 Cyl.	16.5:1	5958cc	150kW (204PS)	Diesel Turbo Intercooled	TD16819
OM 366.997 Euro 1 OM 366 LA	6 Cyl.	16.5:1	5960cc	148-150kW (201-204PS)	Diesel Turbo Intercooled	TD6075
OM 376.941 OM 366 LA	6 Cyl.	17.25:1	5958cc	150kW (204PS)	Diesel Turbo Intercooled	TD23015
OM 386.952	6 Cyl.	16.5:1	5958cc	125kW (170PS)	Diesel Turbo	TD22796

87-740000-50
87-740007-50



STD
0.50mm

A 62.80
B- 22.35
BØ 55.50
D 107.80
 36x82

08-740000-00
08-740007-00

STD
0.50mm

04/84→

2.50  MOL P
2.50  CR P
4.00  CR P

14-012260-00 D B 100.40 C 224.00

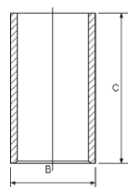

88-740000-50
87-740000-50 +
14-012260-00

RT

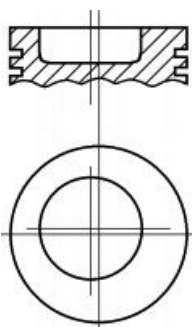

14-025800-00 D B 100.40 C 222.00 D 103.50 E 5.20
14-025801-00 D B 101.00 C 222.00 D 104.00 E 5.20
14-025802-00 D B 102.00 C 222.00 D 105.00 E 5.20
14-025804-00 D B 103.00 C 222.00 D 106.00 E 5.20
14-025881-00 D B 101.50 C 222.00 D 104.50 E 4.75
14-025883-00 D B 103.00 C 222.00 D 106.00 E 4.75

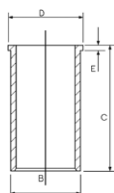

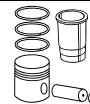
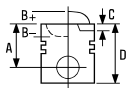

87-740000-51

STD

08-740000-00

STD

08-740007-00

0.50mm

A 62.50

B- 22.35

BØ 55.50

D 107.50

 36x82

04/84→

2.50



MOL P

2.50



CR P

4.00

CR P

RT

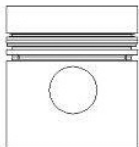

15  **97.50**

OM 356.941 Euro 1 OM 366 A	6 Cyl.	17.3:1	5958cc	116kW (158PS)	Diesel Turbo	TD5705
OM 356.943 Euro 1 OM 366 A	6 Cyl.	17.3:1	5958cc	121kW (165PS)	Diesel Turbo	TD8146
OM 356.944 Euro 1 OM 366 A	6 Cyl.	17.3:1	5958cc	116kW (158PS)	Diesel Turbo	TD8136
OM 356.945 Euro 1 OM 366 A	6 Cyl.	17.3:1	5958cc	116kW (158PS)	Diesel Turbo	TD8137
OM 356.946 Euro 1 OM 366 A	6 Cyl.	17.3:1	5958cc	116kW (158PS)	Diesel Turbo	TD5756
OM 356.947 Euro 1 OM 366 A	6 Cyl.	17.3:1	5958cc	116kW (158PS)	Diesel Turbo	TD8103
OM 356.948 Euro 1 OM 366 A	6 Cyl.	17.3:1	5958cc	116kW (158PS)	Diesel Turbo	TD8078
OM 356.949 Euro 1 OM 366 A	6 Cyl.	17.3:1	5958cc	116kW (158PS)	Diesel Turbo	TD8105
OM 356.951 Euro 1 OM 366 A	6 Cyl.	17.3:1	5958cc	116kW (158PS)	Diesel Turbo	TD8073
OM 356.952 Euro 1 OM 366 A	6 Cyl.	17.3:1	5958cc	116kW (158PS)	Diesel Turbo	TD16941
OM 356.953 Euro 1 OM 366 A	6 Cyl.	17.3:1	5958cc	116kW (158PS)	Diesel Turbo	TD6089
OM 356.958 Euro 1 OM 366 A	6 Cyl.	16.5:1	5958cc	116kW (158PS)	Diesel Turbo	TD16812
OM 356.959 Euro 1 OM 366 A	6 Cyl.	16.5:1	5958cc	121kW (165PS)	Diesel Turbo	TD16813
OM 366.941 Euro 1 OM 366 A	6 Cyl.	16.5:1	5958cc	116kW (158PS)	Diesel Turbo	TD8102



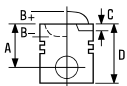

OM 366.942 Euro 1 OM 366 A 6 Cyl. 16.5:1 **5958cc** **121kW (165PS)** **Diesel Turbo** **TD8076**

OM 366.943 Euro 1 OM 366 A 6 Cyl. 16.5:1 **5958cc** **116kW (158PS)** **Diesel Turbo** **TD8070**

87-740000-10 STD **08-740000-00** STD **14-025800-00 D** B 100.40 C 222.00 D 103.50 E 5.20

87-740007-10 0.50mm **08-740007-00** 0.50mm **14-025801-00 D** B 101.00 C 222.00 D 104.00 E 5.20

14-025802-00 D B 102.00 C 222.00 D 105.00 E 5.20

14-025804-00 D B 103.00 C 222.00 D 106.00 E 5.20

14-025881-00 D B 101.50 C 222.00 D 104.50 E 4.75

14-025883-00 D B 103.00 C 222.00 D 106.00 E 4.75

A 62.80
B- 23.00
BØ 54.30
D 107.80
36x83

04/84→
2.50 MOL P
2.50 CR P
4.00 CR P

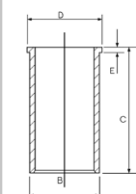

RT

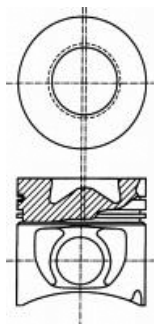

14-012260-00 D B 100.40 C 224.00

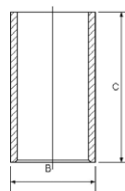

A = 62.500, D = 107.500

A = 62.500, D = 107.500

A = 62.500, D = 107.500

A = 62.500, D = 107.500

A = 62.500, D = 107.500

16 **97.50**

OM 364.908 OM 364 4 Cyl. 17.3:1 **3972cc** **50kW (68PS)** **Diesel** **TD17853**

OM 364.911 OM 364 4 Cyl. 17.3:1 **3972cc** **63-66kW (86-90PS)** **Diesel** **TD8081**

OM 364.957 OM 364 A 4 Cyl. 16.5:1 **3972cc** **77kW (105PS)** **Diesel Turbo** **TD5693**

OM 364.958 OM 364 A 4 Cyl. 16.5:1 **3972cc** **77kW (105PS)** **Diesel Turbo** **TD6030**

OM 356.956 Euro 1 OM 366 A 6 Cyl. 17.3:1 **5958cc** **114-115kW (155-156PS)** **Diesel Turbo** **TD6018**

OM 366.912 OM 366 6 Cyl. 17.3:1 **5958cc** **74kW (100PS)** **Diesel** **TD17857**

OM 366.935 OM 366 6 Cyl. 17.3:1 **5958cc** **100kW (136PS)** **Diesel** **TD6050**

14-025800-00 D B 100.40 C 222.00 D 103.50 E 5.20

14-025801-00 D B 101.00 C 222.00 D 104.00 E 5.20

14-025802-00 D B 102.00 C 222.00 D 105.00 E 5.20

14-025804-00 D B 103.00 C 222.00 D 106.00 E 5.20

14-025881-00 D B 101.50 C 222.00 D 104.50 E 4.75

14-025883-00 D B 103.00 C 222.00 D 106.00 E 4.75

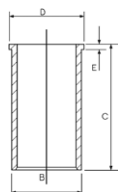

14-012260-00 D B 100.40 C 224.00

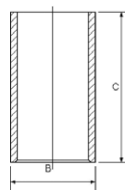

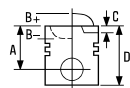

17 97.50

OM 356.977 Euro 1 OM 366 LA	6 Cyl.	16.5:1	5958cc	177kW (240PS)	Diesel Turbo Intercooled	TD16814
OM 356.978 Euro 1 OM 366 LA	6 Cyl.	16.5:1	5958cc	155kW (211PS)	Diesel Turbo Intercooled	TD16815
OM 356.979 OM 366 LA	6 Cyl.	16.5:1	5958cc	177kW (240PS)	Diesel Turbo Intercooled	TD5726
OM 356.980 OM 366 LA	6 Cyl.	16.5:1	5958cc	177kW (240PS)	Diesel Turbo Intercooled	TD8005
OM 356.983 Euro 1 OM 366 LA	6 Cyl.	16.5:1	5958cc	177kW (240PS)	Diesel Turbo Intercooled	TD5724
OM 356.986 OM 366 LA	6 Cyl.	16.5:1	5958cc	155kW (211PS)	Diesel Turbo Intercooled	TD8108
OM 356.987 Euro 1 OM 366 LA	6 Cyl.	16.5:1	5958cc	155kW (211PS)	Diesel Turbo Intercooled	TD8149
OM 356.988 Euro 1	6 Cyl.	16.5:1	5958cc	177kW (241PS)	Diesel Turbo Intercooled	TD22747
OM 356.989 OM 366 LA	6 Cyl.	16.5:1	5958cc	177kW (240PS)	Diesel Turbo Intercooled	TD6057
OM 356.990 OM 366 LA	6 Cyl.	16.5:1	5958cc	155kW (211PS)	Diesel Turbo Intercooled	TD8165
OM 356.991 OM 366 LA	6 Cyl.	16.5:1	5958cc	177kW (240PS)	Diesel Turbo Intercooled	TD6282
OM 356.992 OM 366 LA	6 Cyl.	16.5:1	5958cc	155kW (211PS)	Diesel Turbo Intercooled	TD8140
OM 356.993 OM 366 LA	6 Cyl.	16.5:1	5958cc	155kW (211PS)	Diesel Turbo Intercooled	TD8112
OM 356.994 OM 366 LA	6 Cyl.	16.5:1	5958cc	155kW (211PS)	Diesel Turbo Intercooled	TD5721
OM 356.995 OM 366 LA	6 Cyl.	16.5:1	5958cc	155kW (211PS)	Diesel Turbo Intercooled	TD6054
OM 356.996 OM 366 LA	6 Cyl.	16.5:1	5958cc	155kW (211PS)	Diesel Turbo Intercooled	TD8110
OM 356.997 OM 366 LA	6 Cyl.	16.5:1	5958cc	157kW (214PS)	Diesel Turbo Intercooled	TD5681
OM 356.998 OM 366 LA	6 Cyl.	16.5:1	5958cc	132kW (180PS)	Diesel Turbo Intercooled	TD6019
OM 356.999 OM 366 LA	6 Cyl.	16.5:1	5958cc	177kW (240PS)	Diesel Turbo Intercooled	TD8124
OM 366.999 Euro 1 OM 366 LA	6 Cyl.	16.5:1	5958cc	170kW (231PS)	Diesel Turbo Intercooled	TD8126

87-740000-20 STD

0.50mm

08-740000-00 STD

0.50mm

14-025800-00 D

B 100.40 C 222.00 D 103.50 E 5.20

87-740007-20 

0.50mm

08-740007-00

0.50mm

14-025801-00 D

B 101.00 C 222.00 D 104.00 E 5.20

A 62.80

04/84→

14-025802-00 D

B 102.00 C 222.00 D 105.00 E 5.20

B- 22.60

BØ 54.65

D 107.80

 36x83

2.50



MOL P

14-025804-00 D

B 103.00 C 222.00 D 106.00 E 5.20

14-025881-00 D

B 101.50 C 222.00 D 104.50 E 4.75

14-025883-00 D

B 103.00 C 222.00 D 106.00 E 4.75

2.50



CR P

4.00



CR P

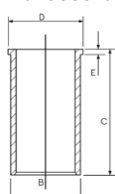

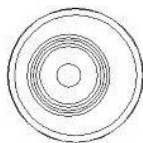
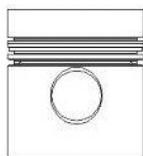

RT TP



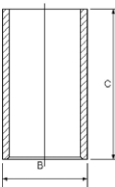

14-012260-00 D

B 100.40 C 224.00



 A = 62.500, D = 107.500

 A = 62.500, D = 107.500

 A = 62.500, D = 107.500

 A = 62.500, D = 107.500

 A = 62.500, D = 107.500



18 97.50

OM 364.906 OM 364	4 Cyl.	17.3:1	3972cc	66kW (90PS)	Diesel	TD8048
OM 364.907 OM 364	4 Cyl.	17.3:1	3970cc	66kW (90PS)	Diesel	TD8052
OM 364.912 OM 364	4 Cyl.	17.3:1	3972cc	66kW (90PS)	Diesel	TD16804
OM 364.913 OM 364	4 Cyl.	17.3:1	3972cc	66kW (90PS)	Diesel	TD8044
OM 366.905 OM 366	6 Cyl.	17.3:1	5958cc	100kW (136PS)	Diesel Turbo Intercooled	TD5698
OM 366.906 OM 366	6 Cyl.	17.3:1	5960cc	100kW (136PS)	Diesel	TD5748
OM 366.907 OM 366	6 Cyl.	17.3:1	5958cc	100kW (136PS)	Diesel	TD5716
OM 366.908 OM 366	6 Cyl.	17.3:1	5958cc	81kW (110PS)	Diesel	TD17858
OM 366.909 OM 366	6 Cyl.	17.3:1	5960cc	100kW (136PS)	Diesel	TD6078
OM 366.910 OM 366	6 Cyl.	17.3:1	5958cc	100kW (136PS)	Diesel	TD8065
OM 366.913 OM 366	6 Cyl.	17.3:1	5958cc	100kW (136PS)	Diesel	TD17100
OM 366.914 OM 366	6 Cyl.	17.3:1	5958cc	100kW (136PS)	Diesel	TD6049
OM 366.917 OM 366	6 Cyl.	17.3:1	5958cc	100kW (136PS)	Diesel	TD7887
OM 366.918 OM 366	6 Cyl.	17.3:1	5960cc	100kW (136PS)	Diesel	TD5739
OM 366.919 OM 366	6 Cyl.	17.25:1	5958cc	100kW (136PS)	Diesel	TD16808
OM 366.930 OM 366	6 Cyl.	17.3:1	5958cc	100kW (136PS)	Diesel	TD8094
OM 366.931 OM 366	6 Cyl.	17.3:1	5958cc	100kW (136PS)	Diesel	TD5717
OM 366.932 OM 366	6 Cyl.	17.3:1	5958cc	100kW (136PS)	Diesel	TD8068
OM 366.933 OM 366	6 Cyl.	17.3:1	5958cc	100kW (136PS)	Diesel	TD8100
OM 366.936 OM 366	6 Cyl.	17.3:1	5960cc	100kW (136PS)	Diesel	TD8135
OM 366.937 OM 366	6 Cyl.	17.3:1	5960cc	100kW (136PS)	Diesel	TD6072
OM 366.938 OM 366	6 Cyl.	17.25:1	5958cc	100kW (136PS)	Diesel	TD16809
OM 366.939 OM 366	6 Cyl.	17.3:1	5958cc	81kW (110PS)	Diesel	TD7993
OM 366.940 OM 366	6 Cyl.	17.3:1	5958cc	100kW (136PS)	Diesel	TD6040

87-740000-40

STD

08-740000-00

STD

14-025800-00 D

B 100.40 C 222.00 D 103.50 E 5.20

87-740007-40 

0.50mm

08-740007-00

0.50mm

14-025801-00 D

B 101.00 C 222.00 D 104.00 E 5.20

A 62.80

04/84→

14-025802-00 D

B 102.00 C 222.00 D 105.00 E 5.20

B- 22.70

14-025804-00 D

B 103.00 C 222.00 D 106.00 E 5.20

BØ 48.00

2.50



MOL P

14-025881-00 D

B 101.50 C 222.00 D 104.50 E 4.75

D 107.80

2.50



CR P

14-025883-00 D

B 103.00 C 222.00 D 106.00 E 4.75

 36x82

4.00



CR P

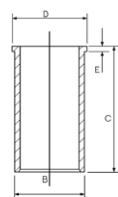

RT

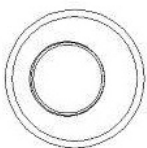
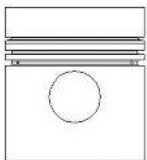

14-012260-00 D

B 100.40 C 224.00

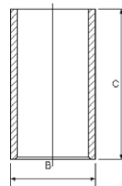

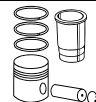
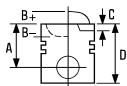

87-740000-41

STD

- A 62.50
- B- 22.70
- BØ 48.00
- D 107.50
-  36x82

RT

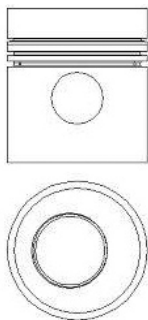

ⓘ A = 62.500, D = 107.500

08-740000-00
08-740007-00

STD

0.50mm

04/84→

- 2.50
- 2.50
- 4.00



- MOL P
- CR P
- CR P

ⓘ A = 62.500, D = 107.500

ⓘ A = 62.500, D = 107.500

ⓘ A = 62.500, D = 107.500

19 102.00

OM 900.911 Euro 4 OM 904 LA	4 Cyl.	17.4:1	4249cc	95kW (129PS)	Diesel Turbo Intercooled	TD18918
OM 900.912 Euro 4 OM 904 LA	4 Cyl.	17.4:1	4249cc	115kW (156PS)	Diesel Turbo Intercooled	TD18919
OM 900.913 Euro 4 OM 904 LA	4 Cyl.	17.4:1	4249cc	130kW (177PS)	Diesel Turbo Intercooled	TD18920
OM 900.915 Euro 4 OM 904 LA	4 Cyl.	17.4:1	4249cc	110-115kW (150-156PS)	Diesel Turbo Intercooled	TD23299
OM 900.916 Euro 4 OM 904 LA	4 Cyl.	17.4:1	4249cc	110-115kW (150-156PS)	Diesel Turbo Intercooled	TD23300
OM 900.917 Euro 4 OM 904 LA	4 Cyl.	17.4:1	4249cc	95kW (129PS)	Diesel Turbo Intercooled	TD18921
OM 900.918 Euro 4 OM 904 LA	4 Cyl.	17.4:1	4249cc	115kW (156PS)	Diesel Turbo Intercooled	TD18922
OM 900.919 Euro 4 OM 904 LA	4 Cyl.	17.4:1	4249cc	130kW (177PS)	Diesel Turbo Intercooled	TD18923
OM 900.920 Euro 4 OM 904 LA	4 Cyl.	17.4:1	4249cc	115kW (156PS)	Diesel Turbo Intercooled	TD22696
OM 900.921 Euro 4 OM 904 LA	4 Cyl.	17.4:1	4249cc	130kW (177PS)	Diesel Turbo Intercooled	TD22697
OM 900.922 Euro 4 OM 904 LA	4 Cyl.	17.4:1	4249cc	95kW (129PS)	Diesel Turbo Intercooled	TD22698
OM 902.913 Euro 4 OM 906 LA	6 Cyl.	17.4:1	6374cc	175kW (238PS)	Diesel Turbo Intercooled	TD20250
OM 902.914 Euro 4 OM 906 LA	6 Cyl.	17.4:1	6374cc	188kW (256PS)	Diesel Turbo Intercooled	TD20251
OM 902.915 Euro 4 OM 906 LA	6 Cyl.	17.4:1	6374cc	210kW (286PS)	Diesel Turbo Intercooled	TD20252
OM 902.916 Euro 4 OM 906 LA	6 Cyl.		6374cc	175kW (238PS)	Diesel Turbo Intercooled	TD18924
OM 902.917 Euro 4 OM 906 LA	6 Cyl.		6374cc	188kW (256PS)	Diesel Turbo Intercooled	TD18930
OM 902.918 Euro 4 OM 906 LA	6 Cyl.		6374cc	210kW (286PS)	Diesel Turbo Intercooled	TD18931
OM 902.923 Euro 4 OM 906 LA	6 Cyl.	17.4:1	6374cc	175kW (238PS)	Diesel Turbo Intercooled	TD23293
OM 902.924 Euro 4 OM 906 LA	6 Cyl.	17.4:1	6374cc	210kW (286PS)	Diesel Turbo Intercooled	TD23294
OM 902.925 Euro 4 OM 906 LA	6 Cyl.	17.4:1	6374cc	210kW (286PS)	Diesel Turbo Intercooled	TD23295
OM 902.926 Euro 4 OM 906 LA	6 Cyl.	17.4:1	6374cc	210kW (286PS)	Diesel Turbo Intercooled	TD23296
OM 902.927 Euro 4 OM 906 LA	6 Cyl.	17.4:1	6374cc	210kW (286PS)	Diesel Turbo Intercooled	TD20257
OM 902.930 Euro 4 OM 906 LA	6 Cyl.	17.4:1	6374cc	175kW (238PS)	Diesel Turbo Intercooled	TD20258
OM 902.931 Euro 4 OM 906 LA	6 Cyl.	17.4:1	6374cc	188kW (256PS)	Diesel Turbo Intercooled	TD20259
OM 902.932 Euro 4 OM 906 LA	6 Cyl.	17.4:1	6374cc	210kW (286PS)	Diesel Turbo Intercooled	TD20260





OM 902.933 Euro 4 OM 906 LA	6 Cyl.	17.4:1	6374cc	175kW (238PS)	Diesel Turbo Intercooled	TD20261
OM 902.934 Euro 4 OM 906 LA	6 Cyl.	17.4:1	6374cc	210kW (286PS)	Diesel Turbo Intercooled	TD23297
OM 902.936 Euro 4 OM 906 LA	6 Cyl.	17.4:1	6374cc	210kW (286PS)	Diesel Turbo Intercooled	TD23298



87-428900-00 STD

A 64.40
B- 13.90
BØ 73.23
D 102.40
 42x80

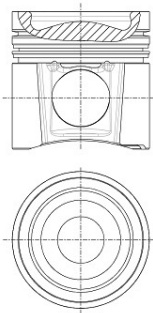
AK RT TP



08-428900-00 STD

3.50  GDC P
 2.50  CR P
 4.00  CK P



14-028610-00 D B 106.00 C 220.00 D 109.50 E 6.20

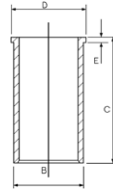

20 102.00

OM 904 LA Euro 3	4 Cyl.	17.4-18.1:1	4249cc	75-130kW (102-177PS)	Diesel Turbo Intercooled	
OM 902.910 Euro 4 OM 906 LA	6 Cyl.	17.4:1	6374cc	187kW (250PS)	Diesel Turbo Intercooled	TD20244
OM 902.911 Euro 4 OM 906 LA	6 Cyl.	17.4:1	6374cc	172kW (230PS)	Diesel Turbo Intercooled	TD20247
OM 902.912 Euro 4 OM 906 LA	6 Cyl.	17.4:1	6374cc	194kW (264PS)	Diesel Turbo Intercooled	TD20249
OM 902.919 Euro 4 OM 906 LA	6 Cyl.	17.4:1	6374cc	157-172kW (213-234PS)	Diesel Turbo Intercooled	TD20253
OM 906 LA Euro 3	6 Cyl.	17.4-18.1:1	6374cc	130-206kW (177-279PS)	Diesel Turbo Intercooled	

14-028610-00 D B 106.00 C 220.00 D 109.50 E 6.20

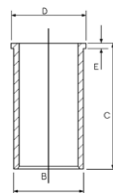

21 102.00

OM 904.903-950 Euro 2 OM 904 LA	4 Cyl.	17-17.4:1	4249cc	90-125kW (122-170PS)	Diesel Turbo Intercooled	
OM 904.955 Euro 3 OM 904 LA.III/2	4 Cyl.	17.8:1	4250cc	110kW (150PS)	Diesel Turbo Intercooled	TD16915
OM 904.956 Euro 2 OM 904 LA	4 Cyl.	17.4:1	4249cc	142kW (193PS)	Diesel Turbo Intercooled	TD17744
OM 904.957 Euro 3 OM 904 LA	4 Cyl.	17.8:1	4249cc	110kW (150PS)	Diesel Turbo Intercooled	TD17745
OM 904.959 Euro 2 OM 904 LA	4 Cyl.	17.4:1	4249cc	128kW (174PS)	Diesel Turbo Intercooled	TD17746
OM 904.962 Euro 3 OM 904 LA	4 Cyl.	17.4:1	4249cc	130kW (177PS)	Diesel Turbo Intercooled	TD17747
OM 904.965 Euro 3 OM 904 LA.III/2	4 Cyl.	17.8:1	4249cc	110kW (150PS)	Diesel Turbo Intercooled	TD17748
OM 904.966 Euro 3 OM 904 LA.III/2	4 Cyl.	17.8:1	4249cc	110kW (150PS)	Diesel Turbo Intercooled	TD17749
OM 904.967 Euro 3 OM 904 LA	4 Cyl.	18.1:1	4249cc	130kW (177PS)	Diesel Turbo Intercooled	TD17750



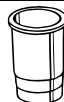
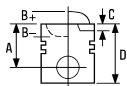

OM 904.968 Euro 3 OM 904 LA	4 Cyl.	18.1:1	4249cc	130kW (177PS)	Diesel Turbo Intercooled	TD17751
OM 904.970 Euro 3 OM 904 LA	4 Cyl.	18.1:1	4249cc	110kW (150PS)	Diesel Turbo Intercooled	TD24856
OM 904.972 Euro 3 OM 904 LA	4 Cyl.	18.1:1	4249cc	130kW (177PS)	Diesel Turbo Intercooled	TD24857
OM 904.974 Euro 2 OM 904 LA	4 Cyl.	17.4:1	4249cc	125kW (170PS)	Diesel Turbo Intercooled	TD28797
OM 907.910 Euro 2 OM 904 LA	4 Cyl.	17:1	4250cc	75kW (102PS)	Diesel Turbo Intercooled	TD16840
OM 907.920 Euro 2 OM 904 LA	4 Cyl.	17:1	4250cc	90kW (122PS)	Diesel Turbo Intercooled	TD16841
OM 907.930 Euro 2 OM 904 LA	4 Cyl.		4249cc	100kW (136PS)	Diesel Turbo Intercooled	TD17754
OM 907.940 Euro 2 OM 904 LA	4 Cyl.	17:1	4250cc	125kW (170PS)	Diesel Turbo Intercooled	TD16842
OM 907.941 Euro 2 OM 904 LA	4 Cyl.	17:1	4249cc	125kW (170PS)	Diesel Turbo Intercooled	TD17753
OM 907.960 Euro 2 OM 904 LA	4 Cyl.	17:1	4250cc	75kW (102PS)	Diesel Turbo Intercooled	TD16843
OM 907.970 Euro 2 OM 904 LA	4 Cyl.	17:1	4250cc	90kW (122PS)	Diesel Turbo Intercooled	TD16844
OM 907.980 Euro 2 OM 904 LA	4 Cyl.		4249cc	100kW (136PS)	Diesel Turbo Intercooled	TD17755
OM 907.990 Euro 2 OM 904 LA	4 Cyl.	17:1	4250cc	125kW (170PS)	Diesel Turbo Intercooled	TD16845
OM 906.910-988 OM 906 LA	6 Cyl.	17.4-18.1:1	6374cc	142-224kW (193-305PS)	Diesel Turbo Intercooled	
OM 909.900 OM 906 HLA	6 Cyl.	17:1	6374cc	170kW (231PS)	Diesel Turbo Intercooled	TD17443
OM 909.901 OM 906 HLA	6 Cyl.	17:1	6374cc	205kW (279PS)	Diesel Turbo Intercooled	TD17445
OM 909.910 OM 906 LA	6 Cyl.	17:1	6374cc	170kW (231PS)	Diesel Turbo Intercooled	TD16846
OM 909.911 OM 906 LA	6 Cyl.	17:1	6374cc	170kW (231PS)	Diesel Turbo Intercooled	TD17444
OM 909.920 OM 906 LA	6 Cyl.	17:1	6374cc	205kW (279PS)	Diesel Turbo Intercooled	TD16847
OM 909.921 OM 906 LA	6 Cyl.	17:1	6374cc	205kW (279PS)	Diesel Turbo Intercooled	TD17446
OM 909.960 OM 906 LA	6 Cyl.	17:1	6374cc	170kW (231PS)	Diesel Turbo Intercooled	TD16848
OM 909.970 OM 906 LA	6 Cyl.	17:1	6374cc	205kW (279PS)	Diesel Turbo Intercooled	TD16849
OM 909.971 OM 906 LA	6 Cyl.	17:1	6374cc	205kW (279PS)	Diesel Turbo Intercooled	TD16850

87-289300-00



STD

A 64.40
 B- 13.90
 BØ 73.00
 D 102.40
 40x78

08-289300-00

STD

→551836

3.00  CK P
 2.50  CR P
 4.00  CR P

14-028610-00 D

B 106.00 C 220.00 D 109.50 E 6.20

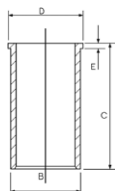

88-289300-00

87-289300-00 +
 14-028610-00

AK RT TP

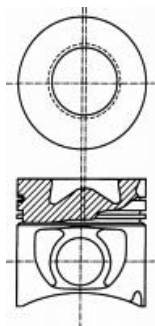

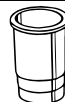
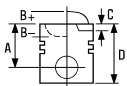

87-289300-10 STD

A 64.40
B- 13.90
BØ 73.00
D 102.50
 42x80

08-289300-00 STD

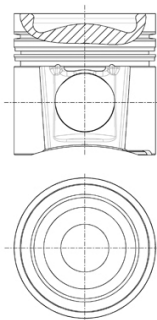

→551836
 3.00  CK P
 2.50  CR P
 4.00  CR P

AK RT TP



87-289300-20 STD

A 64.40
B- 13.90
BØ 73.00
D 102.50
 42x80

→551836
 3.00  CK
 2.50  CR
 4.00  CR

RT

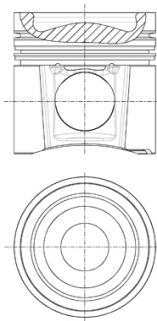

22  **115.00**

OM 360.911 OM 360 H	6 Cyl.	16.8:1	8720cc	125kW (170PS)	Diesel Turbo Intercooled	TD7902
OM 360.912	6 Cyl.	16.8:1	8720cc	125-141kW (170-192PS)	Diesel	TD23186
OM 360.914 OM 360	6 Cyl.	16.8:1	8720cc	141kW (192PS)	Diesel	TD5658
OM 360.915 OM 360	6 Cyl.	16.8:1	8720cc	141kW (192PS)	Diesel	TD5996
OM 360.916 OM 360	6 Cyl.	16.8:1	8720cc	125kW (170PS)	Diesel	TD5659
OM 360.917 OM 360	6 Cyl.	16.8:1	8720cc	125kW (170PS)	Diesel	TD5997
OM 360.918 OM 360	6 Cyl.	16.8:1	8720cc	125kW (170PS)	Diesel	TD7894
OM 360.931 OM 360	6 Cyl.	16.8:1	8720cc	141kW (192PS)	Diesel	TD6269
OM 360.933 OM 360	6 Cyl.	16.8:1	8720cc	125kW (170PS)	Diesel	TD6270



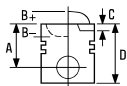



OM 360.934	6 Cyl.	16.8:1	8720cc	125-141kW (170-192PS)	Diesel	TD23188
OM 360.936 OM 360	6 Cyl.	16.8:1	8725cc	125kW (170PS)	Diesel	TD16688
OM 360.937 OM 360	6 Cyl.	16.8:1	8725cc	127kW (172PS)	Diesel	TD16689
OM 360.938 OM 360	6 Cyl.	16.8:1	8725cc	127kW (172PS)	Diesel	TD16690
OM 360.939 OM 360	6 Cyl.	16.8:1	8720cc	125kW (170PS)	Diesel	TD8195
OM 360.940 OM 360	6 Cyl.	16.8:1	8725cc	127kW (172PS)	Diesel	TD16691
OM 360.941 OM 360	6 Cyl.	16.8:1	8725cc	141kW (192PS)	Diesel	TD16698
OM 360.942 OM 360	6 Cyl.	16.8:1	8725cc	127kW (172PS)	Diesel	TD16692
OM 360.943 OM 360	6 Cyl.	16.8:1	8725cc	127kW (172PS)	Diesel	TD16693
OM 360.944 OM 360	6 Cyl.	16.8:1	8725cc	127kW (172PS)	Diesel	TD16694
OM 360.946 OM 360	6 Cyl.	16.8:1	8725cc	127kW (172PS)	Diesel	TD16695
OM 360.947	6 Cyl.	16.8:1	8725cc	125-141kW (170-192PS)	Diesel	TD23189
OM 360.948 OM 360	6 Cyl.	16.8:1	8725cc	125kW (170PS)	Diesel	TD16696
OM 360.949 OM 360	6 Cyl.	16.8:1	8725cc	125kW (170PS)	Diesel	TD16697
OM 360.954	6 Cyl.	16.8:1	8725cc	125-141kW (170-192PS)	Diesel	TD23190
OM 360.955	6 Cyl.	16.8:1	8725cc	125-141kW (170-192PS)	Diesel	TD23191
OM 360.956	6 Cyl.	16.8:1	8725cc	125-141kW (170-192PS)	Diesel	TD23192
OM 360.959	6 Cyl.	16.8:1	8725cc	125-141kW (170-192PS)	Diesel	TD23193
OM 360.974	6 Cyl.	16.8:1	8725cc	125-141kW (170-192PS)	Diesel	TD23194
OM 360.976	6 Cyl.	16.8:1	8725cc	125-141kW (170-192PS)	Diesel	TD23195
OM 360.978	6 Cyl.	16.8:1	8725cc	125-141kW (170-192PS)	Diesel	TD23196
OM 360.980 OM 360	6 Cyl.	16.8:1	8720cc	141kW (192PS)	Diesel	TD17020
OM 360.981 OM 360	6 Cyl.	16.8:1	8720cc	141kW (192PS)	Diesel	TD17021
OM 360.984 OM 360 A	6 Cyl.	16.8:1	8720cc	154kW (210PS)	Diesel Turbo	TD17022
OM 360.985 OM 360 A	6 Cyl.	16.8:1	8720cc	141kW (192PS)	Diesel Turbo	TD17024
OM 360.986 OM 360 A	6 Cyl.	16.8:1	8720cc	154kW (210PS)	Diesel Turbo	TD17023

87-176400-00 STD
 87-176407-00 0.50mm
 87-176411-00 1.00mm

A 85.30
 B- 22.00
 BØ 65.00
 C 0.70
 D 133.30
 42x98

08-176400-10 STD
 08-176407-10 0.50mm
 08-176411-10 1.00mm
 08-176414-10 1.50mm

3.50  MOL P
 3.00  MO P
 5.50  CR P

14-024240-00 D B 120.00 C 253.50 D 125.00 E 5.50
 14-024241-00 D B 121.00 C 253.50 D 126.00 E 6.00

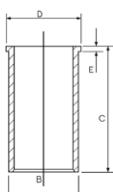

RT

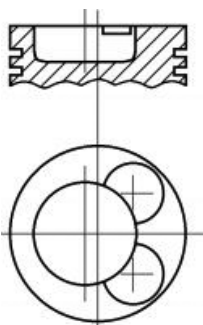



23  **125.00**

OM 401.905 OM 401	V6 Cyl.	17.2:1	9570cc	141kW (192PS)	Diesel	TD5730
OM 401.906 OM 401	V6 Cyl.	17.2:1	9570cc	141kW (192PS)	Diesel	TD6062
OM 401.907 OM 401	V6 Cyl.		9572cc	141kW (192PS)	Diesel	TD16942
OM 401.908 OM 401	V6 Cyl.		9572cc	141kW (192PS)	Diesel	TD16943
OM 401.909 OM 401	V6 Cyl.	17.2:1	9570cc	141kW (192PS)	Diesel	TD5767
OM 401.912 OM 401	V6 Cyl.	17.2:1	9572cc	141kW (192PS)	Diesel	TD7895
OM 401.913 OM 401	V6 Cyl.		9570cc	141kW (192PS)	Diesel	TD16944
OM 401.914 OM 401	V6 Cyl.	17.2:1	9570cc	141kW (192PS)	Diesel	TD5729
OM 401.915 OM 401	V6 Cyl.	17.2:1	9570cc	141kW (192PS)	Diesel	TD6061
OM 401.916 OM 401	V6 Cyl.	17.2:1	9570cc	141kW (192PS)	Diesel	TD6099
OM 401.917 OM 401 A	V6 Cyl.	17.2:1	9570cc	188kW (256PS)	Diesel Turbo	TD16949
OM 401.918 OM 401	V6 Cyl.	17.2:1	9570cc	141kW (192PS)	Diesel	TD8118
OM 401.919 OM 401	V6 Cyl.	17.2:1	9570cc	141kW (192PS)	Diesel	TD9596
OM 401.921 OM 401	V6 Cyl.		9570cc	141kW (192PS)	Diesel	TD16945
OM 401.922 OM 401	V6 Cyl.		9570cc	141kW (192PS)	Diesel	TD16946
OM 401.923 OM 401	V6 Cyl.	17.2:1	9570cc	141kW (192PS)	Diesel	TD6081
OM 401.925 OM 401	V6 Cyl.	17.2:1	9570cc	141kW (192PS)	Diesel	TD8229
OM 401.926 OM 401	V6 Cyl.	17.2:1	9570cc	141kW (192PS)	Diesel	TD9597
OM 401.927 OM 401	V6 Cyl.	17.2:1	9570cc	141kW (192PS)	Diesel	TD9598
OM 401.928 OM 401	V6 Cyl.	17.2:1	9570cc	141kW (192PS)	Diesel	TD16948
OM 402.905 OM 402	V8 Cyl.	17:1	12800cc	188kW (256PS)	Diesel	TD8179
OM 402.906 OM 402	V8 Cyl.	17:1	12800cc	188kW (256PS)	Diesel	TD5814
OM 402.907 OM 402	V8 Cyl.	17:1	12800cc	188kW (256PS)	Diesel	TD7896
OM 402.910 OM 402	V8 Cyl.	17:1	12800cc	176kW (240PS)	Diesel	TD5752
OM 402.912 OM 402	V8 Cyl.	17:1	12800cc	188kW (256PS)	Diesel	TD5758
OM 402.913 OM 402	V8 Cyl.	17.2:1	12760cc	177kW (240PS)	Diesel	TD17803
OM 402.914 OM 402	V8 Cyl.	17:1	12800cc	176kW (240PS)	Diesel	TD8230
OM 402.916 OM 402	V8 Cyl.	17:1	12800cc	188kW (256PS)	Diesel	TD5798
OM 402.917 OM 402	V8 Cyl.	17.2:1	12760cc	177kW (240PS)	Diesel	TD17804
OM 402.919 OM 402	V8 Cyl.	17:1	12800cc	176kW (240PS)	Diesel	TD8154
OM 402.921 OM 402	V8 Cyl.	17.2:1	12760cc	177kW (240PS)	Diesel	TD17805
OM 402.923 OM 402	V8 Cyl.	17:1	12800cc	176kW (240PS)	Diesel	TD8183
OM 402.924 OM 402	V8 Cyl.	17:1	12800cc	188kW (256PS)	Diesel	TD6291
OM 402.925 OM 402	V8 Cyl.	17.2:1	12760cc	188kW (256PS)	Diesel	TD17806
OM 402.926 OM 402	V8 Cyl.	17:1	12800cc	188kW (256PS)	Diesel	TD6296
OM 402.927 OM 402	V8 Cyl.	17:1	12800cc	176kW (240PS)	Diesel	TD9606
OM 402.928 OM 402	V8 Cyl.	17:1	12800cc	176kW (240PS)	Diesel	TD9607
OM 403.915 OM 403	V10 Cyl.	17.2:1	15900cc	236kW (320PS)	Diesel	TD8180
OM 403.916 OM 403	V10 Cyl.	17.2:1	15900cc	235kW (320PS)	Diesel	TD5816
OM 403.917 OM 403	V10 Cyl.	17.2:1	15950cc	236kW (320PS)	Diesel	TD16953
OM 403.918 OM 403	V10 Cyl.	17.2:1	15900cc	235kW (320PS)	Diesel	TD7897
OM 403.919 OM 403	V10 Cyl.	17.2:1	15950cc	236kW (320PS)	Diesel	TD16954
OM 403.930 OM 403	V10 Cyl.	17.2:1	15950cc	236kW (320PS)	Diesel	TD16955



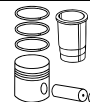
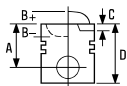

OM 403.931 OM 403	V10 Cyl.	17.2:1	15900cc	235kW (320PS)	Diesel	TD5759
OM 403.932 OM 403	V10 Cyl.	17.2:1	15900cc	235kW (320PS)	Diesel	TD6133
OM 403.934 OM 403	V10 Cyl.	17.2:1	15950cc	236kW (320PS)	Diesel	TD16957
OM 404	V12 Cyl.	17.5:1	20911cc	184-236kW (250-320PS)	Diesel	FM3816



87-176800-00 STD

A 87.25
B- 23.50
BØ 65.00
D 137.25
 46x97

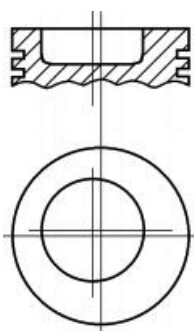
AK RT



08-176800-10 STD

3.00  CR P
 3.00  P
 6.00  CR P

14-451660-00 WH B 140.00 C 253.00 D 152.00 E 10.07 F 1.00
14-452310-00 WH B 140.00 C 253.00 D 152.00 E 10.07 F 1.00

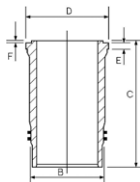

14-458110-00 WH B 144.50 C 253.00 D 153.80 E 9.92 F 1.00

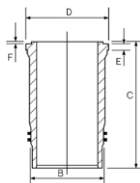

88-176800-00

87-176800-00 +
 14-451660-00

89-176800-20

87-176800-00 +
 14-451660-00

88-176800-10

87-176800-00 +
 14-452310-00

1 Use also: 3 O-rings and
 1 Tombak ring, Set HL5070

2 4 O ring = HT020

3 Includes seals

1 Mitverwenden: 3 O-Ringe und
 1 Tombakring, Satz: HL5070

2 4 Ringdichtungen = HT020

3 Schließt Dichtungen ein

1 A utiliser aussi: 3 joints toriques et
 1 joint Tombak. Poche

2 4 Joints toriques = HT020

3 Inclut des joints

1 Utilizar también: 3 juntas toricas y 1
 junta Tombak. Juego HL5070

2 4 Juntas tóricas para = HT020

3 Incluye los sellos

1 Usre anche: 3 O Ring e
 1 Segmento tomback HL5070

2 4 Gommini a Corredo = HT020

3 Comprende le guarnizioni

24  **125.00**

OM 401.970 OM 401 LA	V6 Cyl.		9600cc	213kW (290PS)	Diesel Turbo Intercooled	TD7938
OM 401.972 OM 401 LA	V6 Cyl.		9572cc	230kW (313PS)	Diesel Turbo Intercooled	TD5777
OM 401.973 OM 401 LA	V6 Cyl.		9572cc	200kW (272PS)	Diesel Turbo Intercooled	TD5733
OM 401.984 OM 401 LA	V6 Cyl.		9572cc	180kW (245PS)	Diesel Turbo Intercooled	TD8127
OM 401.985 OM 401 LA	V6 Cyl.		9600cc	200kW (272PS)	Diesel Turbo Intercooled	TD5753
OM 401.986 OM 401 LA	V6 Cyl.		9572cc	230kW (313PS)	Diesel Turbo Intercooled	TD8199
OM 401.987 OM 401 LA	V6 Cyl.		9572cc	230kW (313PS)	Diesel Turbo Intercooled	TD6163
OM 401.989 OM 401 LA	V6 Cyl.		9572cc	200kW (272PS)	Diesel Turbo Intercooled	TD6068
OM 401.990 OM 401 LA	V6 Cyl.		9572cc	180kW (245PS)	Diesel Turbo Intercooled	TD16950
OM 401.991 OM 401 LA	V6 Cyl.		9600cc	200kW (272PS)	Diesel Turbo Intercooled	TD6086
OM 401.992 OM 401 LA	V6 Cyl.		9572cc	200kW (272PS)	Diesel Turbo Intercooled	TD17113
OM 401.993 OM 401 LA	V6 Cyl.		9572cc	230kW (313PS)	Diesel Turbo Intercooled	TD6113









OM 401.994 OM 401 LA V6 Cyl. **9600cc** **180kW (245PS)** **Diesel Turbo Intercooled** **TD6084**

OM 402.984 Euro 1 OM 402 LA V8 Cyl. 16.75:1 **12763cc** **280kW (381PS)** **Diesel Turbo Intercooled** **TD11268**

87-176000-10 STD

A 87.45
B- 25.00
BØ 66.84
D 132.45
 46x102

08-176000-00 STD

3.00  **MOL** ²
3.00  **MO P**
4.00  **CR P**

14-458110-00 WH ¹ **B** 144.50 **C** 253.00 **D** 153.80 **E** 9.92 **F** 1.00

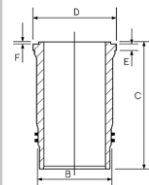

89-176000-10
87-176000-10 +
14-458110-00

AK HA RT TP

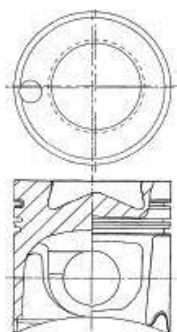

12581E

14-451660-00 WH ⁴ **B** 140.00 **C** 253.00 **D** 152.00 **E** 10.07 **F** 1.00

14-452310-00 WH ³ **B** 140.00 **C** 253.00 **D** 152.00 **E** 10.07 **F** 1.00

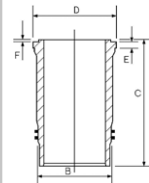

¹ Use also: 3 O-rings and 1 Tombak ring, Set HL5070

² Steel

³ 4 O ring = HT020

⁴ 3 O ring = 24-32419-80/0

¹ Mitverwenden: 3 O-Ringe und 1 Tombakring, Satz: HL5070

² Stahl

³ 4 Ringdichtungen = HT020

⁴ 3 Ringdichtungen = 24-32419-80/0

¹ A utiliser aussi: 3 joints toriques et 1 joint Tombak. Poche

² Acier

³ 4 Joints toriques = HT020

⁴ 3 Joints toriques = 24-32419-80/0

¹ Utilizar también: 3 juntas toricas y 1 junta Tombak. Juego HL5070

² Acero

³ 4 Juntas tóricas para = HT020

⁴ 3 Juntas tóricas para = 24-32419-80/0

¹ Usre anche: 3 O Ring e

1 Segmento tomback HL5070

² Acciaio

³ 4 Gommini a Corredo = HT020

⁴ 3 Gommini a Corredo = 24-32419-80/0

25  **125.00**



OM 401.974 Euro 1 OM 401 LA	V6 Cyl.	16.75:1	9572cc	200kW (272PS)	Diesel Turbo Intercooled	TD7939
OM 401.975 Euro 1 OM 401 LA	V6 Cyl.	16.75:1	9572cc	180kW (245PS)	Diesel Turbo Intercooled	TD5751
OM 401.977 Euro 1 OM 401 LA	V6 Cyl.	16.75:1	9572cc	200kW (272PS)	Diesel Turbo Intercooled	TD5801
OM 401.978 Euro 1 OM 401 LA	V6 Cyl.	16.75:1	9572cc	200kW (272PS)	Diesel Turbo Intercooled	TD6065
OM 401.979 Euro 1 OM 401 LA	V6 Cyl.	16.75:1	9572cc	230kW (313PS)	Diesel Turbo Intercooled	TD5780
OM 401.980 Euro 1 OM 401 LA	V6 Cyl.	16.75:1	9572cc	200kW (272PS)	Diesel Turbo Intercooled	TD6293
OM 401.981 Euro 1 OM 401 LA	V6 Cyl.	16.75:1	9572cc	230kW (313PS)	Diesel Turbo Intercooled	TD6162
OM 401.982 Euro 1 OM 401 LA	V6 Cyl.	16.75:1	9572cc	230kW (313PS)	Diesel Turbo Intercooled	TD17103
OM 402.970 Euro 1 OM 402 LA	V8 Cyl.		12763cc	280kW (381PS)	Diesel Turbo Intercooled	TD7940
OM 402.971 Euro 1 OM 402 LA	V8 Cyl.		12763cc	280kW (381PS)	Diesel Turbo Intercooled	TD5783
OM 402.972 Euro 1 OM 402 LA	V8 Cyl.		12763cc	280kW (381PS)	Diesel Turbo Intercooled	TD5784
OM 402.973 Euro 1 OM 402 LA	V8 Cyl.		12763cc	280kW (381PS)	Diesel Turbo Intercooled	TD5832
OM 402.974 Euro 1 OM 402 LA	V8 Cyl.	16.75:1	12760cc	280-295kW (381-401PS)	Diesel Turbo Intercooled	TD17807
OM 402.975 Euro 1 OM 402 LA	V8 Cyl.		12763cc	280kW (381PS)	Diesel Turbo Intercooled	TD5818
OM 402.977 Euro 1 OM 402 LA	V8 Cyl.		12763cc	280kW (381PS)	Diesel Turbo Intercooled	TD5826
OM 402.978 Euro 1 OM 402 LA	V8 Cyl.		12763cc	280kW (381PS)	Diesel Turbo Intercooled	TD5786
OM 402.982 Euro 1 OM 402 LA	V8 Cyl.		12763cc	280kW (381PS)	Diesel Turbo Intercooled	TD5830
OM 402.983 Euro 1 OM 402 LA	V8 Cyl.		12763cc	280kW (381PS)	Diesel Turbo Intercooled	TD6182
OM 402.985 Euro 1 OM 402 LA	V8 Cyl.		12763cc	280kW (381PS)	Diesel Turbo Intercooled	TD5806

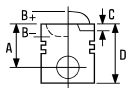



OM 402.986 Euro 1 OM 402 LA	V8 Cyl.	12763cc	280kW (381PS)	Diesel Turbo Intercooled	TD6151
OM 402.987 Euro 1 OM 402 LA	V8 Cyl.	12763cc	280kW (381PS)	Diesel Turbo Intercooled	TD6178
OM 402.989 Euro 1 OM 402 LA	V8 Cyl.	12763cc	280kW (381PS)	Diesel Turbo Intercooled	TD5807
OM 402.990 Euro 1 OM 402 LA	V8 Cyl.	12763cc	280kW (381PS)	Diesel Turbo Intercooled	TD6153
OM 402.996 Euro 1 OM 402 LA	V8 Cyl.	12763cc	280kW (381PS)	Diesel Turbo Intercooled	TD6121

87-176000-00 STD
A 87.30
B- 25.00
BØ 68.20
D 133.30
 46x102

08-176000-00 STD
 3.00  **MOL** ³
 3.00  **MO P**
 4.00  **CR P**

14-458110-00 WH ¹ **B** 144.50 **C** 253.00 **D** 153.80 **E** 9.92 **F** 1.00

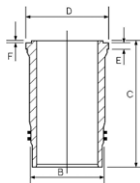



89-176000-00
 87-176000-00 +
 14-458110-00

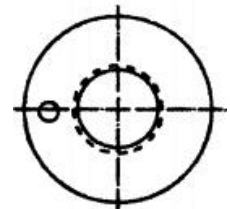

AK HA RT TP

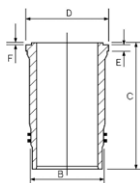

14-451660-00 WH **B** 140.00 **C** 253.00 **D** 152.00 **E** 10.07 **F** 1.00
14-452310-00 WH ² **B** 140.00 **C** 253.00 **D** 152.00 **E** 10.07 **F** 1.00



87-176000-01 STD
A 87.00
B- 25.00
BØ 68.20
D 133.00
 46x102

08-176000-00 STD
 3.00  **MOL** ³
 3.00  **MO P**
 4.00  **CR P**

AK HA RT TP

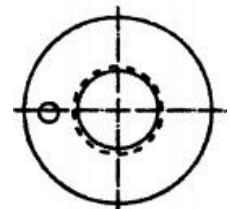
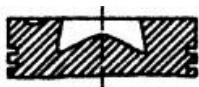

- ¹ Use also: 3 O-rings and 1 Tombak ring, Set HL5070
- ² 4 O ring = HT020
- ³ Steel

- ¹ Mitverwenden: 3 O-Ringe und 1 Tombakring, Satz: HL5070
- ² 4 Ringdichtungen = HT020
- ³ Stahl

- ¹ A utiliser aussi: 3 joints toriques et 1 joint Tombak. Poche
- ² 4 Joints toriques = HT020
- ³ Acier

- ¹ Utilizar también: 3 juntas tóricas y 1 junta Tombak. Juego HL5070
- ² 4 Juntas tóricas para = HT020
- ³ Acero

- ¹ Usre anche: 3 O Ring e 1 Segmento tomback HL5070
- ² 4 Gomini a Corredo = HT020
- ³ Acciaio

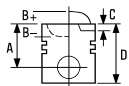

26 125.00

OM 401.983 OM 401 LA	V6 Cyl.	16.75:1	9572cc	180kW (245PS)	Diesel Turbo Intercooled	TD17104
OM 402.995 OM 402 LA	V8 Cyl.	16.75:1	12763cc	280kW (381PS)	Diesel Turbo Intercooled	TD11267
OM 403.910 OM 403	V10 Cyl.	17.2:1	15950cc	184-236kW (250-321PS)	Diesel	TD28696
OM 403.933 OM 403	V10 Cyl.	17.2:1	15950cc	261kW (355PS)	Diesel	TD16956
OM 403.935 OM 403	V10 Cyl.	17.2:1	15900cc	236kW (320PS)	Diesel	TD6299
OM 404 A	V12 Cyl.		20911cc	386kW (525PS)	Diesel Turbo	FM4262

14-451660-00 WH B 140.00 C 253.00 D 152.00 E 10.07 F 1.00

14-452310-00 WH  B 140.00 C 253.00 D 152.00 E 10.07 F 1.00

14-458110-00 WH  B 144.50 C 253.00 D 153.80 E 9.92 F 1.00

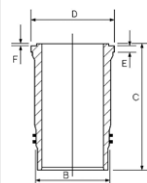

 Use also: 3 O-rings and 1 Tombak ring, Set HL5070

 4 O ring = HT020

 Mitverwenden: 3 O-Ringe und 1 Tombakring, Satz: HL5070

 4 Ringdichtungen = HT020

 A utiliser aussi: 3 joints toriques et 1 joint Tombak. Poche

 4 Joints toriques = HT020

 Utilizar también: 3 juntas toricas y 1 junta Tombak. Juego HL5070

 4 Juntas tóricas para = HT020

 Usre anche: 3 O Ring e 1 Segmento tombak HL5070

 4 Gommini a Corredo = HT020

27 125.00

OM 409	5 Cyl.		9204cc	137-141kW (185-192PS)	Diesel	FM6360
OM 409.906 OM 409	5 Cyl.	17:1	9204cc	135kW (184PS)	Diesel	TD18812
OM 409.907 OM 409	5 Cyl.	17:1	9204cc	135kW (184PS)	Diesel	TD18813
OM 409.908 OM 409	5 Cyl.	17:1	9204cc	135kW (184PS)	Diesel	TD18814
OM 407.905 OM 407 H	6 Cyl.	17:1	11000cc	132kW (180PS)	Diesel	TD5664
OM 407.907 OM 407 H	6 Cyl.	17:1	11045cc	155kW (211PS)	Diesel	TD10767
OM 407.908 OM 407 H	6 Cyl.	17:1	11000cc	132kW (180PS)	Diesel Turbo Intercooled	TD6002
OM 407.909 OM 407 H	6 Cyl.	17:1	11000cc	155kW (210PS)	Diesel	TD5665
OM 407.910 OM 407 H	6 Cyl.	17:1	11000cc	155kW (210PS)	Diesel	TD6003
OM 407.951 OM 407 HA	6 Cyl.	16.5:1	11413cc	206kW (280PS)	Diesel Turbo	TD5668
OM 407.955 OM 407 HA	6 Cyl.	16.5:1	11413cc	206kW (280PS)	Diesel Turbo	TD6007

14-452370-00 WH  B 140.00 C 265.00 D 152.00 E 10.07 F 1.00

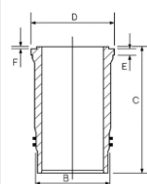

 4 O ring = HT020

 4 Ringdichtungen = HT020

 4 Joints toriques = HT020

 4 Juntas tóricas para = HT020

 4 Gommini a Corredo = HT020

28 125.00

OM 407.911 OM 407 H	6 Cyl.	17:1	11000cc	155kW (210PS)	Diesel	TD6273
OM 407.913 OM 407 H	6 Cyl.	16.5:1	11400cc	147kW (200PS)	Diesel	TD5666
OM 407.914 OM 407 H	6 Cyl.	16.5:1	11400cc	147kW (200PS)	Diesel	TD6004
OM 407.915 OM 407 H	6 Cyl.	16.5:1	11400cc	147kW (200PS)	Diesel	TD6274
OM 407.916 OM 407 H	6 Cyl.	16.5:1	11400cc	177kW (240PS)	Diesel	TD5667
OM 407.917 OM 407 H	6 Cyl.	16.5:1	11400cc	177kW (240PS)	Diesel	TD6005

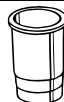
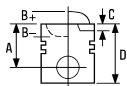

OM 407.918 OM 407 H	6 Cyl.	16.5:1	11400cc	177kW (240PS)	Diesel	TD6275
OM 407.919 OM 407 H	6 Cyl.	16.5:1	11400cc	177kW (240PS)	Diesel	TD6006
OM 407.920 OM 407 H	6 Cyl.	16.5:1	11412cc	177kW (240PS)	Diesel	TD17808

87-176800-30	STD	08-176800-10	STD	14-452370-00 WH B 140.00 C 265.00 D 152.00 E 10.07 F 1.00	89-176800-30 87-176800-30 + 14-452370-00
---------------------	-----	---------------------	-----	--	---

01/76→12/80

A 84.75
B- 26.50
BØ 70.00
D 139.75
 46x97

3.00
3.00
6.00



CR P
P
CR P

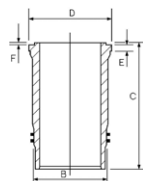

AK RT

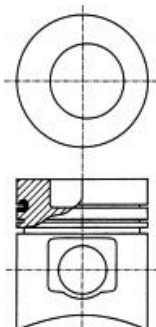

12575

87-176800-40	STD	08-176800-10	STD	14-452370-00 WH B 140.00 C 265.00 D 152.00 E 10.07 F 1.00	89-176800-40 87-176800-40 + 14-452370-00
---------------------	-----	---------------------	-----	--	---

01/80→12/86

A 84.75
B- 23.00
BØ 75.00
D 139.75
 46x97

3.00
3.00
6.00



CR P
P
CR P

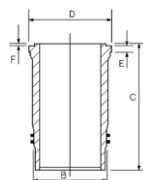

AK RT

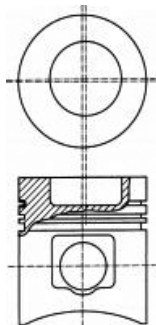

12575

4 O ring = HT020

4 Ringdichtungen = HT020

4 Joints toriques = HT020

4 Juntas tóricas para = HT020

4 Gommini a Corredo = HT020

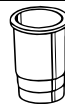
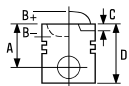



29  **128.00**

M 476.921	6 Cyl.		11967cc	175kW (238PS)	Turbo Intercooled	TD22729
M 476.925	6 Cyl.		11967cc	177kW (241PS)	Turbo Intercooled	TD22730
M 476.926	6 Cyl.		11967cc	177kW (241PS)	Turbo Intercooled	TD22731
M 476.927	6 Cyl.		11967cc	177kW (241PS)	Turbo Intercooled	TD22732
M 476.930 Euro 2 M 447 HLA G	6 Cyl.	10.5:1	11967cc	240kW (326PS)	Turbo Intercooled	TD17490
OM 447.915 OM 447 HO	6 Cyl.	18.1:1	11967cc	185kW (252PS)		TD16986
OM 447.916 OM 447 HO	6 Cyl.	18.1:1	11967cc	185kW (252PS)		TD16987
OM 429.951 OM 429 LA	5 Cyl.	17.25:1	9970cc	175kW (235PS)	Diesel Turbo Intercooled	TD8164
OM 429.952 OM 429 LA	5 Cyl.	17.25:1	9970cc	175kW (235PS)	Diesel Turbo Intercooled	TD18818
OM 429.953 OM 429	5 Cyl.	17.25:1	9970cc	186kW (250PS)	Diesel Turbo	TD5755
OM 429.955 OM 429 LA	5 Cyl.	17.25:1	9970cc	186kW (250PS)	Diesel Turbo Intercooled	TD6088
OM 475.950 OM 449 A	5 Cyl.	16.25:1	9973cc	184kW (250PS)	Diesel Turbo	TD23240
OM 475.951 OM 449 A	5 Cyl.	16.25:1	9973cc	184kW (250PS)	Diesel Turbo	TD23241
OM 475.952 OM 449 A	5 Cyl.	16.25:1	9973cc	184kW (250PS)	Diesel Turbo	TD23242
OM 475.953 OM 449 A	5 Cyl.	16.25:1	9973cc	184kW (250PS)	Diesel Turbo	TD23243
OM 475.954 OM 449 A	5 Cyl.	16.25:1	9973cc	184kW (250PS)	Diesel Turbo	TD23244
OM 475.982 OM 449 LA	5 Cyl.	16.25:1	9973cc	221kW (300PS)	Diesel Turbo Intercooled	TD23246
OM 427 A	6 Cyl.	16.6:1	11967cc	206kW (280PS)	Diesel Turbo	FM7065
OM 427 LA	6 Cyl.	16.6:1	11967cc		Diesel Turbo Intercooled	FM6707
OM 427.950 OM 427 HA	6 Cyl.	16.25:1	11967cc	206kW (280PS)	Diesel Turbo	TD7946
OM 427.951 OM 427 HA	6 Cyl.	16.25:1	11967cc	206kW (280PS)	Diesel Turbo	TD16964
OM 427.952 OM 427 HA	6 Cyl.	16.25:1	11967cc	206kW (280PS)	Diesel Turbo	TD16965
OM 447 A	6 Cyl.	16.6:1	11967cc	206kW (280PS)	Diesel Turbo	FM7004
OM 447 LA	6 Cyl.	18:1	11967cc		Diesel Turbo Intercooled	FM6705
OM 447.947 Euro 1 OM 447 HLA	6 Cyl.	16.25:1	11967cc	220kW (299PS)	Diesel Turbo Intercooled	TD22805
OM 447.948 Euro 2 OM 447 HLA	6 Cyl.	16.25:1	11967cc	220kW (299PS)	Diesel Turbo Intercooled	TD22806
OM 447.949 Euro 2 OM 447 HLA	6 Cyl.	16.25:1	11967cc	157kW (214PS)	Diesel Turbo Intercooled	TD22807
OM 447.950 OM 447 HA	6 Cyl.	16.25:1	11967cc	206kW (280PS)	Diesel Turbo	TD5673
OM 447.951 OM 447 HA	6 Cyl.	16.25:1	11967cc	206kW (280PS)	Diesel Turbo	TD6012
OM 447.952 Euro 1 OM 447 HA	6 Cyl.	16.25:1	11967cc	206kW (280PS)	Diesel Turbo	TD16988
OM 447.953 Euro 1 OM 447 HA	6 Cyl.	16.25:1	11967cc	206kW (280PS)	Diesel Turbo	TD16989
OM 447.960 Euro 1 OM 447 HLA	6 Cyl.	18:1	11970cc	184kW (250PS)	Diesel Turbo Intercooled	TD22808

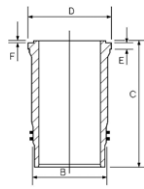
14-456980-00 WH  B 144.50 C 270.00 D 153.80 E 9.92 F 1.00



 Use also: 3 O-rings and
1 Tombak ring, Set HL5070

 Mitverwenden: 3 O-Ringe und
1 Tombakring, Satz: HL5070

 A utiliser aussi: 3 joints toriques et
1 joint Tombak. Poche

 Utilizar también: 3 juntas toricas y 1
junta Tombak. Juego HL5070

 Usre anche: 3 O Ring e
1 Segmento tombback HL5070

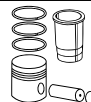
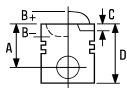





30 128.00

OM 345.913 OM 355 A	6 Cyl.	16.5:1	11581cc	210kW (286PS)	Diesel Turbo	TD28601
OM 345.960 OM 355 A	6 Cyl.	16.5:1	11581cc	210kW (286PS)	Diesel Turbo	TD28642
OM 355.968 OM 355	6 Cyl.	17:1	11581cc	191kW (260PS)	Diesel	TD23185
OM 355.969 OM 355 A	6 Cyl.	16.5:1	11581cc	206kW (280PS)	Diesel Turbo	TD8212
OM 355.977 OM 355 A	6 Cyl.	16.5:1	11581cc	205kW (275PS)	Diesel Turbo	TD16683

87-176911-10  1.00mm

A 90.06
B- 28.30
BØ 70.00
C 2.00
C 2.20
D 161.03
 48x108

08-176900-10 STD
08-176907-10 0.50mm
08-176911-10 1.00mm
08-176914-10 1.50mm



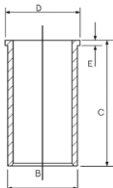

3.50  MOL P
3.50  P
3.50  P
6.50  CR P

14-025890-00 D B 133.56 C 287.50 D 137.50 E 5.50
14-025891-00 D B 134.06 C 287.50 D 138.00 E 5.50
14-025892-00 D B 134.56 C 287.50 D 138.50 E 5.50

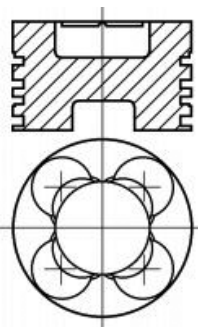

RT



 A = 90.060, B- = 28.300, D = 161.030  A = 90.060, B- = 28.300, D = 161.030  A = 90.060, B- = 28.300, D = 161.030  A = 90.060, B- = 28.300, D = 161.030  A = 90.060, B- = 28.300, D = 161.030

31 128.00

OM 355.910 OM 355	6 Cyl.	17.2:1	11581cc	169kW (230PS)	Diesel	TD16668
OM 355.911 OM 355	6 Cyl.	17.2:1	11581cc	169kW (230PS)	Diesel	TD16669
OM 355.912 OM 355	6 Cyl.	17.2:1	11581cc	169kW (230PS)	Diesel	TD16670
OM 355.913 OM 355	6 Cyl.	17.2:1	11581cc	169kW (230PS)	Diesel	TD16671
OM 355.914 OM 355	6 Cyl.	17.2:1	11581cc	169kW (230PS)	Diesel	TD16672
OM 355.915 OM 355	6 Cyl.	17.2:1	11581cc	169kW (230PS)	Diesel	TD7892
OM 355.916	6 Cyl.	17.2:1	11581cc	169kW (230PS)	Diesel	TD22746
OM 355.918 OM 355	6 Cyl.	17.2:1	11581cc	169kW (230PS)	Diesel	TD16673
OM 355.960 OM 355	6 Cyl.	17.2:1	11581cc	176kW (240PS)	Diesel	TD5813
OM 355.961 OM 355 H	6 Cyl.	17.2:1	11581cc	155kW (210PS)	Diesel	TD16675
OM 355.962 OM 355	6 Cyl.	17.2:1	11581cc	177kW (240PS)	Diesel	TD16676
OM 355.963 OM 355	6 Cyl.	17.2:1	11581cc	176kW (240PS)	Diesel	TD5812
OM 355.964 OM 355	6 Cyl.	17.2:1	11581cc	177kW (240PS)	Diesel	TD16677
OM 355.966 OM 355	6 Cyl.	17.2:1	11581cc	155kW (210PS)	Diesel	TD16678
OM 355.967 OM 355	6 Cyl.	17.2:1	11581cc	177kW (240PS)	Diesel	TD7893
OM 355.970 OM 355	6 Cyl.	17.2:1	11581cc	191kW (260PS)	Diesel	TD16679
OM 355.972 OM 355 H	6 Cyl.	17.2:1	11581cc	136kW (185PS)	Diesel	TD16680
OM 355.973 OM 355 H	6 Cyl.	17.2:1	11581cc	177kW (240PS)	Diesel	TD16681
OM 355.974 OM 355	6 Cyl.	17.2:1	11581cc	177kW (240PS)	Diesel	TD16682



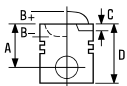

OM 355.975 OM 355	6 Cyl.	17.2:1	11600cc	176kW (240PS)	Diesel	TD6160
OM 355.976 OM 355	6 Cyl.	17.2:1	11581cc	176kW (240PS)	Diesel	TD6159
OM 355.978 OM 355	6 Cyl.	17.2:1	11581cc	177kW (240PS)	Diesel	TD16684
OM 355.979 OM 355	6 Cyl.	16.5:1	11581cc	177kW (240PS)	Diesel	TD16685
OM 355.980 OM 355	6 Cyl.	17.2:1	11581cc	177kW (240PS)	Diesel	TD16686
OM 355.981 OM 355	6 Cyl.	17.2:1	11581cc	184kW (250PS)	Diesel	TD16687
OM 355.982 OM 355	6 Cyl.	17.2:1	11581cc	184kW (250PS)	Diesel	TD16674
OM 355.983 OM 355	6 Cyl.	17.2:1	11581cc	177kW (240PS)	Diesel	TD5811
OM 355.984 OM 355	6 Cyl.	17.2:1	11581cc	177kW (240PS)	Diesel	TD6158

87-176900-00	STD
87-176907-00	0.50mm
87-176911-00	1.00mm
87-176914-00	1.50mm

08-176900-10	STD
08-176907-10	0.50mm
08-176911-10	1.00mm
08-176914-10	1.50mm

14-025890-00 D	B 133.56 C 287.50 D 137.50 E 5.50
14-025891-00 D	B 134.06 C 287.50 D 138.00 E 5.50
14-025892-00 D	B 134.56 C 287.50 D 138.50 E 5.50

A	90.26
B-	27.00
BØ	70.00
C	1.10
D	161.26
	48x108

3.50		MOL P
3.50		P
3.50		P
6.50		CR P

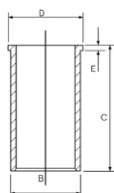

RT

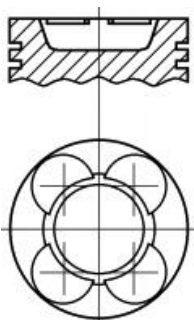

A = 90.060, B = 26.800, D = 161.060 A = 90.060, B = 26.800, D = 161.060 A = 90.060, B = 26.800, D = 161.060 A = 90.060, B = 26.800, D = 161.060 A = 90.060, B = 26.800, D = 161.060

32 128.00

OM 421.905 OM 421	V6 Cyl.	16.9:1	10964cc	159kW (216PS)	Diesel	TD5799
OM 421.906 OM 421	V6 Cyl.	16.9:1	10900cc	159kW (216PS)	Diesel	TD8120
OM 421.907 OM 421	V6 Cyl.	16.9:1	10964cc	159kW (216PS)	Diesel	TD6139
OM 421.908 OM 421	V6 Cyl.	16.9:1	10964cc	159kW (216PS)	Diesel	TD7898
OM 421.909 OM 421	V6 Cyl.	16.9:1	10964cc	159kW (216PS)	Diesel	TD17056
OM 421.910 OM 421	V6 Cyl.	16.9:1	10964cc	159kW (216PS)	Diesel	TD16958
OM 422.905 OM 422	V8 Cyl.	16.9:1	14618cc	206kW (280PS)	Diesel	TD5760
OM 422.906 OM 422	V8 Cyl.	16.9:1	14618cc	206kW (280PS)	Diesel	TD6093
OM 422.907 OM 422	V8 Cyl.	16.9:1	14618cc	206kW (280PS)	Diesel	TD5805
OM 422.908 OM 422	V8 Cyl.	16.9:1	14600cc	206kW (280PS)	Diesel	TD7900
OM 422.909 OM 422	V8 Cyl.	16.9:1	14618cc	184kW (250PS)	Diesel	TD8157
OM 422.910 OM 422	V8 Cyl.	16.9:1	14618cc	206kW (280PS)	Diesel	TD6132
OM 422.911 OM 422	V8 Cyl.	16.9:1	14618cc	206kW (280PS)	Diesel	TD6140
OM 422.912 OM 422	V8 Cyl.	16.9:1	14618cc	184kW (250PS)	Diesel	TD8231



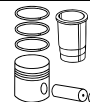
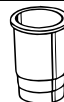
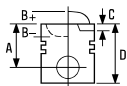

OM 422.913 OM 422	V8 Cyl.	16.9:1	14618cc	206kW (280PS)	Diesel	TD6149
OM 422.914 OM 422	V8 Cyl.	16.9:1	14600cc	206kW (280PS)	Diesel	TD5828
OM 422.915 OM 422	V8 Cyl.	16.9:1	14618cc	184kW (250PS)	Diesel	TD16959
OM 422.916 OM 422	V8 Cyl.	16.9:1	14618cc	206kW (280PS)	Diesel	TD17111
OM 422.917 OM 422	V8 Cyl.	16.9:1	14618cc	206kW (280PS)	Diesel	TD11029
OM 422.918 ÔM 422	V8 Cyl.	16.9:1	14618cc	206kW (280PS)	Diesel	TD16960
OM 422.919 ÔM 422	V8 Cyl.	16.9:1	14618cc	206kW (280PS)	Diesel	TD5821
OM 422.920 OM 422	V8 Cyl.	16.9:1	14618cc	184kW (250PS)	Diesel	TD8249
OM 422.921 OM 422	V8 Cyl.	16.9:1	14618cc	206kW (280PS)	Diesel	TD6173
OM 422.922 ÔM 422	V8 Cyl.	16.9:1	14618cc	206kW (280PS)	Diesel	TD16961
OM 422.923 ÔM 422	V8 Cyl.	16.9:1	14618cc	206kW (280PS)	Diesel	TD16962
OM 423.905 OM 423	V10 Cyl.	16.9:1	18300cc	261kW (355PS)	Diesel	TD5762
OM 423.906 OM 423	V10 Cyl.	16.9:1	18273cc	261kW (355PS)	Diesel	TD6126
OM 423.907 OM 423	V10 Cyl.	16.9:1	18273cc	261kW (355PS)	Diesel	TD6289
OM 423.908 OM 423	V10 Cyl.	16.9:1	18300cc	261kW (355PS)	Diesel	TD6096
OM 423.909 OM 423	V10 Cyl.	16.9:1	18273cc	261kW (355PS)	Diesel	TD16963
OM 424.900 OM 424	V12 Cyl.	16.5:1	21930cc	309kW (420PS)	Diesel	TD18815

87-181700-00

STD

A 81.35
B- 24.10
BØ 70.00
D 126.35
46x99

RT

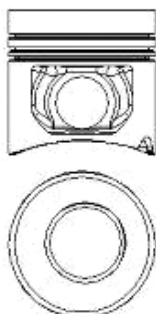

12814E

08-181700-00

STD

3.00
3.00
4.00



MOL P
MO P
CR P

14-451160-00 WH 2 B 144.50 C 253.00 D 153.80 E 10.07 F 1.00

14-452030-00 WH 1 B 144.50 C 253.00 D 153.80 E 9.92 F 1.00

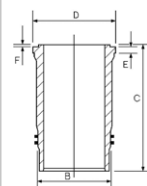

14-452390-00 WH 2 B 144.50 C 253.00 D 153.80 E 10.57 F 1.00

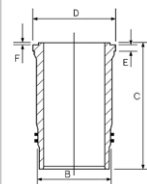

89-181700-60

87-181700-00 +
14-451160-00

89-181700-61

87-181700-00 +
14-452030-00

1 O ring = HL5070

2 O ring = HT018

1 Ringdichtungen = HL5070

2 Ringdichtungen = HT018

1 Joints toriques = HL5070

2 Joints toriques = HT018

1 Juntas tóricas para = HL5070

2 Juntas tóricas para = HT018

1 Gommini a Corredo = HL5070

2 Gommini a Corredo = HT018

33 128.00

OM 421.951 OM 421 A	V6 Cyl.	16.25:1	10964cc	184kW (250PS)	Diesel Turbo	TD7899
OM 422.901 OM 422	V8 Cyl.	16.25:1	14618cc	243-276kW (330-375PS)	Diesel Turbo	TD18973
OM 422.951 OM 422 A	V8 Cyl.	16.25:1	14600cc	243kW (330PS)	Diesel Turbo	TD7901
OM 422.952 OM 422 A	V8 Cyl.	16.25:1	14600cc	243kW (330PS)	Diesel Turbo	TD5761
OM 422.953 OM 422 LA	V8 Cyl.	16.25:1	14618cc	276kW (375PS)	Diesel Turbo Intercooled	TD5763
OM 422.954 OM 422 A	V8 Cyl.	16.25:1	14618cc	243kW (330PS)	Diesel Turbo	TD6095





OM 422.955 OM 422 LA	V8 Cyl.	16.25:1	14618cc	276kW (375PS)	Diesel Turbo Intercooled	TD5800
OM 422.956 OM 422 A	V8 Cyl.	16.25:1	14600cc	243kW (330PS)	Diesel Turbo	TD6134
OM 422.957 OM 422 A	V8 Cyl.	16.25:1	14620cc	243kW (330PS)	Diesel Turbo	TD9613
OM 422.958 OM 422 A	V8 Cyl.	16.25:1	14620cc	243kW (330PS)	Diesel Turbo	TD9614
OM 422.959 OM 422 A	V8 Cyl.	16.25:1	14618cc	276kW (375PS)	Diesel Turbo	TD6141
OM 422.963 OM 422 A	V8 Cyl.	16.25:1	14618cc	243kW (330PS)	Diesel Turbo	TD11028
OM 423.950 OM 423 LA	V10 Cyl.	16.25:1	18273cc	368kW (500PS)	Diesel Turbo Intercooled	TD5827
OM 424.901 OM 424 LA	V12 Cyl.	16.25:1	21930cc	441kW (600PS)	Diesel Turbo Intercooled	TD18816
OM 424.901-510 OM 424 LA	V12 Cyl.	16.25:1	21930cc	441kW (600PS)	Diesel Turbo Intercooled	TD18817

87-179300-70 STD

A 81.35
B- 25.40
BØ 70.00
D 126.35
 46x105

AK RT

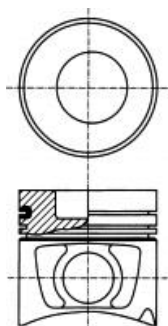

12824C

- 1 O ring = HL5070
- 2 O ring = HT018
- 3 Steel

08-179300-10 STD

3.00
 3.00
 4.00



MOL 3
 CR P
 CR P

- 1 Ringdichtungen = HL5070
- 2 Ringdichtungen = HT018
- 3 Stahl

14-451160-00 WH 2 B 144.50 C 253.00 D 153.80 E 10.07 F 1.00
14-452030-00 WH 1 B 144.50 C 253.00 D 153.80 E 9.92 F 1.00

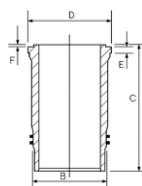

14-452390-00 WH 2 B 144.50 C 253.00 D 153.80 E 10.57 F 1.00

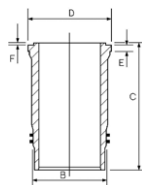

- 1 Joints toriques = HL5070
- 2 Joints toriques = HT018
- 3 Acier

- 1 Juntas tóricas para = HL5070
- 2 Juntas tóricas para = HT018
- 3 Acero

89-179300-70
 87-179300-70 +
 14-451160-00

89-179300-71
 87-179300-70 +
 14-452030-00

- 1 Gommini a Corredo = HL5070
- 2 Gommini a Corredo = HT018
- 3 Acciaio

34  **128.00**

OM 427.905 OM 427 H	6 Cyl.	16.6:1	11967cc	150kW (204PS)	Diesel	TD7951
OM 427.910 OM 427 H	6 Cyl.	16.6:1	11967cc	177kW (240PS)	Diesel	TD5671
OM 427.911 OM 427 H	6 Cyl.	16.6:1	11967cc	177kW (240PS)	Diesel	TD6010
OM 447.905 OM 447 H	6 Cyl.	16.6:1	11967cc	150-177kW (204-241PS)	Diesel	TD7947
OM 447.906 OM 447 H	6 Cyl.	16.6:1	11967cc	177-184kW (240-250PS)	Diesel	TD5674
OM 447.907 OM 447 H	6 Cyl.	16.6:1	11967cc	177-184kW (240-250PS)	Diesel	TD5672
OM 447.908 OM 447 H	6 Cyl.	16.6:1	11967cc	177-184kW (240-250PS)	Diesel	TD6011
OM 447.910 OM 447 H	6 Cyl.	16.6:1	11967cc	177-184kW (240-250PS)	Diesel	TD7956



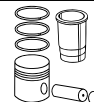
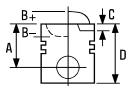





OM 447.911 OM 447 H 6 Cyl. 16.6:1 **11967cc 150-157kW (204-214PS) Diesel** **TD7957**

OM 447.912 OM 447 H 6 Cyl. 16.6:1 **11970cc 184kW (250PS) Diesel** **TD7961**

87-179300-30 STD **08-179300-10** STD **14-456980-00 WH** ¹ B 144.50 C 270.00 D 153.80 E 9.92 F 1.00 **89-179300-30**

A 90.00
B- 30.00
BØ 59.90
D 140.00
 46x99

3.00  **MOL** ²
3.00  **CR P**
4.00  **CR P**

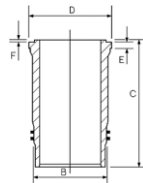

87-179300-30 +
14-456980-00

AK HA RT

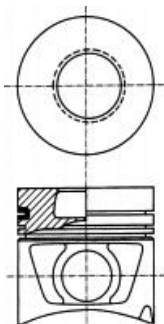

¹ Use also: 3 O-rings and 1 Tombak ring, Set HL5070
² Steel

¹ Mitverwenden: 3 O-Ringe und 1 Tombakring, Satz: HL5070
² Stahl

¹ A utiliser aussi: 3 joints toriques et 1 joint Tombak. Poche
² Acier

¹ Utilizar también: 3 juntas toricas y 1 junta Tombak. Juego HL5070
² Acero

¹ Usre anche: 3 O Ring e 1 Segmento tomback HL5070
² Acciaio

35  **128.00**

OM 440.940 OM 442 A V8 Cyl. 16.9:1 **14618cc 250kW (340PS) Diesel Turbo** **TD8194**



OM 440.941 OM 442 A V8 Cyl. 16.9:1 **14618cc 250kW (340PS) Diesel Turbo** **TD5794**

OM 440.942 OM 442 A V8 Cyl. 16.9:1 **14618cc 250kW (340PS) Diesel Turbo** **TD6130**

OM 440.943 OM 442 A V8 Cyl. 18:1 **14618cc 250kW (340PS) Diesel Turbo** **TD17122**

87-179300-80 STD **08-179300-10** STD **14-451160-00 WH** ² B 144.50 C 253.00 D 153.80 E 10.07 F 1.00 **89-179300-80**

01/85→
A 81.35
B- 26.00
BØ 65.44
D 126.35
 46x105

3.00  **MOL** ³
3.00  **CR P**
4.00  **CR P**

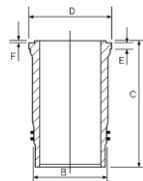

01/85→
87-179300-80 +
14-451160-00

89-179300-81
01/85→
87-179300-80 +
14-452030-00

AK HA NB RT

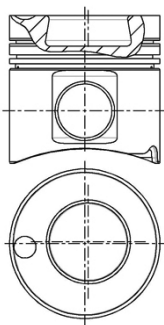

12824H101

¹ O ring = HL5070
² O ring = HT018
³ Steel

¹ Ringdichtungen = HL5070
² Ringdichtungen = HT018
³ Stahl

¹ Joints toriques = HL5070
² Joints toriques = HT018
³ Acier

¹ Juntas tóricas para = HL5070
² Juntas tóricas para = HT018
³ Acero

¹ Gommini a Corredo = HL5070
² Gommini a Corredo = HT018
³ Acciaio

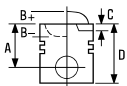

36 128.00

OM 440.945 Euro 1 OM 442 A	V8 Cyl.	18:1	14618cc	250kW (340PS)	Diesel Turbo	TD16967
OM 442 A Euro 1	V8 Cyl.	16.75:1	14618cc	250kW (340PS)	Diesel Turbo	FM7008
OM 442.977 OM 442 A	V8 Cyl.	16.25:1	14618cc	250kW (340PS)	Diesel Turbo	TD8219
OM 442.978 OM 442 A	V8 Cyl.	16.25:1	14620cc	250kW (340PS)	Diesel Turbo	TD8216

87-179300-60 STD

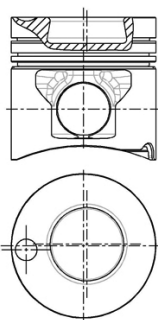

A 81.30
B- 23.10
BØ 65.00
D 126.29
 46x105

AK HA RT TP



- 1 O ring = HL5070
- 2 O ring = HT018
- 3 Steel

08-179300-10 STD

3.00  MOL 3
3.00  CR P
4.00  CR P

- 1 Ringdichtungen = HL5070
- 2 Ringdichtungen = HT018
- 3 Stahl

STD

1 Joints toriques = HL5070
2 Joints toriques = HT018
3 Acier

14-452030-00 WH 1 B 144.50 C 253.00 D 153.80 E 9.92 F 1.00

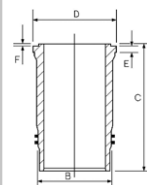

14-451160-00 WH 2 B 144.50 C 253.00 D 153.80 E 10.07 F 1.00

14-452390-00 WH 2 B 144.50 C 253.00 D 153.80 E 10.57 F 1.00

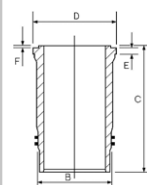

- 1 Juntas tóricas para = HL5070
- 2 Juntas tóricas para = HT018
- 3 Acero

89-179300-60
87-179300-60 +
14-452030-00

- 1 Gommini a Corredo = HL5070
- 2 Gommini a Corredo = HT018
- 3 Acciaio

37 128.00

OM 441.952 OM 441 A	V6 Cyl.	16.25:1	10964cc	191kW (260PS)	Diesel Turbo	TD17128
OM 440.948 OM 442 A	V8 Cyl.	18:1	14618cc	269kW (366PS)	Diesel Turbo	TD17123
OM 440.949 OM 442 A	V8 Cyl.	18:1	14618cc	250kW (340PS)	Diesel Turbo	TD17124
OM 440.974 OM 442 LA	V8 Cyl.	16.25:1	14618cc	320kW (435PS)	Diesel Turbo Intercooled	TD17125

14-451160-00 WH 2 B 144.50 C 253.00 D 153.80 E 10.07 F 1.00

14-452030-00 WH 1 B 144.50 C 253.00 D 153.80 E 9.92 F 1.00

14-452390-00 WH 2 B 144.50 C 253.00 D 153.80 E 10.57 F 1.00

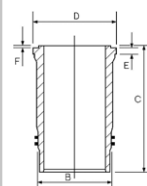

- 1 O ring = HL5070
- 2 O ring = HT018

- 1 Ringdichtungen = HL5070
- 2 Ringdichtungen = HT018

- 1 Joints toriques = HL5070
- 2 Joints toriques = HT018

- 1 Juntas tóricas para = HL5070
- 2 Juntas tóricas para = HT018

- 1 Gommini a Corredo = HL5070
- 2 Gommini a Corredo = HT018

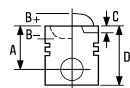

38  **128.00**

OM 441.980 OM 441 LA	V6 Cyl.	16.25:1	10964cc	250kW (340PS)	Diesel Turbo Intercooled	TD7943
OM 441.986 Euro 1 OM 441 LA	V6 Cyl.	16.25:1	10964cc	250kW (340PS)	Diesel Turbo Intercooled	TD5779
OM 441.987 Euro 1 OM 441 LA	V6 Cyl.	16.25:1	10964cc	250kW (340PS)	Diesel Turbo Intercooled	TD5782
OM 441.988 Euro 1 OM 441 LA	V6 Cyl.	16.25:1	10964cc	250kW (340PS)	Diesel Turbo Intercooled	TD5825
OM 441.989 Euro 1 OM 441 LA	V6 Cyl.	16.25:1	10964cc	250kW (340PS)	Diesel Turbo Intercooled	TD5736
OM 441.990 Euro 1 OM 441 LA	V6 Cyl.	16.25:1	10964cc	250kW (340PS)	Diesel Turbo Intercooled	TD6177
OM 441.991 Euro 1 OM 441 LA	V6 Cyl.	16.25:1	10964cc	250kW (340PS)	Diesel Turbo Intercooled	TD6118
OM 441.992 Euro 1 OM 441 LA	V6 Cyl.	16.25:1	10964cc	250kW (340PS)	Diesel Turbo Intercooled	TD6302
OM 441.993 Euro 1 OM 441 LA	V6 Cyl.	16.25:1	10964cc	250kW (340PS)	Diesel Turbo Intercooled	TD6069
OM 441.994 Euro 1 OM 441 LA	V6 Cyl.	16.25:1	10964cc	250kW (340PS)	Diesel Turbo Intercooled	TD16974
OM 441.995 Euro 1 OM 441 LA	V6 Cyl.	16.25:1	10964cc	250kW (340PS)	Diesel Turbo Intercooled	TD16975
OM 441.996 Euro 1 OM 441 LA	V6 Cyl.	16.25:1	10964cc	250kW (340PS)	Diesel Turbo Intercooled	TD6116
OM 441.997 Euro 1 OM 441 LA	V6 Cyl.	16.25:1	10964cc	230kW (313PS)	Diesel Turbo Intercooled	TD16976
OM 441.998 Euro 1 OM 441 LA	V6 Cyl.	16.25:1	10964cc	230kW (313PS)	Diesel Turbo Intercooled	TD8222
OM 441.999 Euro 1 OM 441 LA	V6 Cyl.	16.25:1	10964cc	250kW (340PS)	Diesel Turbo Intercooled	TD16977
OM 440.970 Euro 1 OM 442 LA	V8 Cyl.	16.25:1	14618cc	320kW (435PS)	Diesel Turbo Intercooled	TD5797
OM 440.971 Euro 1 OM 442 LA	V8 Cyl.	16.25:1	14618cc	370kW (503PS)	Diesel Turbo Intercooled	TD5788
OM 440.972 Euro 1 OM 442 LA	V8 Cyl.	16.75:1	14618cc	320kW (435PS)	Diesel Turbo Intercooled	TD16968
OM 440.973 Euro 1 OM 442 LA	V8 Cyl.	16.25:1	14618cc	370kW (503PS)	Diesel Turbo Intercooled	TD6124
OM 440.975 Euro 1 OM 442 LA	V8 Cyl.	16.25:1	14618cc	370kW (503PS)	Diesel Turbo Intercooled	TD5833
OM 440.976 Euro 1 OM 442 LA	V8 Cyl.	16.25:1	14618cc	370kW (503PS)	Diesel Turbo Intercooled	TD8227
OM 440.978 Euro 1 OM 442 LA	V8 Cyl.	16.25:1	14618cc	320kW (435PS)	Diesel Turbo Intercooled	TD5787
OM 440.979 Euro 1 OM 442 LA	V8 Cyl.	16.25:1	14618cc	320kW (435PS)	Diesel Turbo Intercooled	TD6138
OM 440.980 Euro 1 OM 442 LA	V8 Cyl.	16.25:1	14618cc	320kW (435PS)	Diesel Turbo Intercooled	TD6179
OM 440.981 Euro 1 OM 442 LA	V8 Cyl.	16.25:1	14618cc	370kW (503PS)	Diesel Turbo Intercooled	TD6152
OM 440.982 Euro 1 OM 442 LA	V8 Cyl.	16.25:1	14618cc	370kW (503PS)	Diesel Turbo Intercooled	TD6185
OM 440.983 Euro 1 OM 442 LA	V8 Cyl.	16.25:1	14618cc	370kW (503PS)	Diesel Turbo Intercooled	TD6306
OM 440.984 Euro 1 OM 442 LA	V8 Cyl.	16.25:1	14618cc	320kW (435PS)	Diesel Turbo Intercooled	TD6305
OM 440.985 Euro 1 OM 442 LA	V8 Cyl.	16.25:1	14618cc	320kW (435PS)	Diesel Turbo Intercooled	TD8256
OM 440.986 Euro 1 OM 442 LA	V8 Cyl.	16.25:1	14618cc	320kW (435PS)	Diesel Turbo Intercooled	TD16969
OM 440.987 Euro 1 OM 442 LA	V8 Cyl.	16.25:1	14618cc	280kW (381PS)	Diesel Turbo Intercooled	TD16970
OM 440.988 Euro 1 OM 442 LA	V8 Cyl.	16.25:1	14618cc	280kW (381PS)	Diesel Turbo Intercooled	TD17126
OM 440.989 Euro 1 OM 442 LA	V8 Cyl.	16.25:1	14618cc	280kW (381PS)	Diesel Turbo Intercooled	TD16971
OM 440.990 Euro 1 OM 442 LA	V8 Cyl.	16.25:1	14618cc	280kW (381PS)	Diesel Turbo Intercooled	TD8225
OM 440.991 Euro 1 OM 442 LA	V8 Cyl.	16.25:1	14618cc	320kW (435PS)	Diesel Turbo Intercooled	TD6122
OM 442.995 Euro 1 OM 442 LA	V8 Cyl.	16.75:1	14618cc	320kW (435PS)	Diesel Turbo Intercooled	TD16979
OM 442.996 Euro 1 OM 442 LA	V8 Cyl.	16.75:1	14618cc	370kW (503PS)	Diesel Turbo Intercooled	TD16980
OM 442.997 Euro 1 OM 442 LA	V8 Cyl.	16.9:1	14618cc	370kW (503PS)	Diesel Turbo Intercooled	TD5810



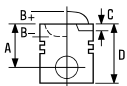

OM 442.998 Euro 1 OM 442 LA V8 Cyl. 16.25:1 **14618cc 370kW (503PS)** Diesel Turbo Intercooled **TD6157**

OM 442.999 Euro 1 OM 442 LA V8 Cyl. **14618cc 370kW (503PS)** Diesel Turbo Intercooled **TD17810**

87-179300-15

STD

A 81.35
B- 24.30
BØ 66.90
D 126.35
 46x105



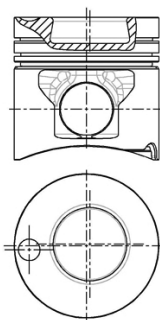

AK HA KK RT TP



12833H101

08-179300-10

STD

3.00  **MOL**  **CR P**
 3.00  **CR P**
 4.00  **CR P**

14-452030-00 WH  **B** 144.50 **C** 253.00 **D** 153.80 **E** 9.92 **F** 1.00

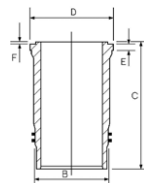

89-179300-15
 87-179300-15 +
 14-452030-00

87-179300-16

STD

A 81.05
B- 24.30
BØ 66.90
D 126.05
 46x105



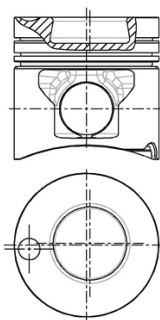

AK HA KK RT TP



12833H101

08-179300-10

STD

3.00  **MOL**  **CR P**
 3.00  **CR P**
 4.00  **CR P**

14-452030-00 WH  **B** 144.50 **C** 253.00 **D** 153.80 **E** 9.92 **F** 1.00

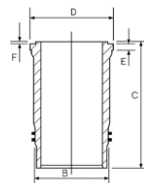



89-179300-16
 87-179300-16 +
 14-452030-00

14-451160-00 WH  **B** 144.50 **C** 253.00 **D** 153.80 **E** 10.07 **F** 1.00

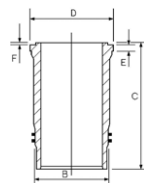
14-452390-00 WH  **B** 144.50 **C** 253.00 **D** 153.80 **E** 10.57 **F** 1.00



 O ring = HL5070

 O ring = HT018

 Steel

 Ringdichtungen = HL5070

 Ringdichtungen = HT018

 Stahl

 Joints toriques = HL5070

 Joints toriques = HT018

 Acier

 Juntas tóricas para = HL5070

 Juntas tóricas para = HT018

 Acero

 Gommini a Corredo = HL5070

 Gommini a Corredo = HT018

 Acciaio

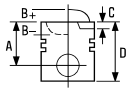

39  **128.00**

OM 441.951 OM 441 LA	V6 Cyl.	16.25:1	10964cc	243kW (330PS)	Diesel Turbo Intercooled	TD8187
OM 441.953 OM 441 A	V6 Cyl.	16.25:1	10964cc	191-200kW (260-272PS)	Diesel Turbo	TD5999
OM 441.960 OM 441 LA	V6 Cyl.	16.25:1	10964cc	243-250kW (330-340PS)	Diesel Turbo Intercooled	TD5772
OM 441.961 OM 441 LA	V6 Cyl.	16.25:1	10964cc	250kW (340PS)	Diesel Turbo Intercooled	TD16973
OM 441.962 OM 441 LA	V6 Cyl.	16.25:1	10964cc	243-249kW (330-340PS)	Diesel Turbo Intercooled	TD6104
OM 441.981 OM 441 LA	V6 Cyl.	16.25:1	10964cc	243-249kW (330-340PS)	Diesel Turbo Intercooled	TD6103
OM 441.982 OM 441 A	V6 Cyl.	16.25:1	10964cc	250kW (340PS)	Diesel Turbo Intercooled	TD5824
OM 441.983 OM 441 LA	V6 Cyl.	16.25:1	10964cc	243-249kW (330-340PS)	Diesel Turbo Intercooled	TD6322
OM 441.985 OM 441 LA	V6 Cyl.	16.25:1	10964cc	250kW (340PS)	Diesel Turbo Intercooled	TD6176
OM 442.940 OM 442 A	V8 Cyl.	16.25:1	14618cc	260kW (354PS)	Diesel Turbo	TD17131
OM 442.941 OM 442 A	V8 Cyl.	16.25:1	14618cc	269kW (366PS)	Diesel Turbo	TD16978
OM 442.942 OM 442 A	V8 Cyl.	16.9:1	14618cc	260-269kW (354-366PS)	Diesel Turbo	TD5774
OM 442.943 OM 442 A	V8 Cyl.	16.9:1	14620cc	269kW (366PS)	Diesel Turbo	TD5793
OM 442.944 OM 442 A	V8 Cyl.	16.9:1	14618cc	260-269kW (354-366PS)	Diesel Turbo	TD5773
OM 442.945 OM 442 A	V8 Cyl.	16.9:1	14618cc	269kW (366PS)	Diesel Turbo	TD5829
OM 442.946 OM 442 A	V8 Cyl.	16.9:1	14618cc	266kW (366PS)	Diesel Turbo	TD5831
OM 442.950 OM 442 A	V8 Cyl.	16.9:1	14618cc	260-269kW (354-366PS)	Diesel Turbo	TD5764
OM 442.951 OM 442 LA	V8 Cyl.		14618cc	320kW (435PS)	Diesel Turbo Intercooled	TD5765
OM 442.952 OM 442 A	V8 Cyl.		14618cc	260-269kW (354-366PS)	Diesel Turbo	TD6135
OM 442.953 OM 442 LA	V8 Cyl.		14618cc	320-329kW (435-447PS)	Diesel Turbo Intercooled	TD5819
OM 442.954 OM 442 A	V8 Cyl.	16.25:1	14618cc	269kW (366PS)	Diesel Turbo	TD10972
OM 442.955 OM 442 A	V8 Cyl.	16.25:1	14618cc	269kW (366PS)	Diesel Turbo	TD10973
OM 442.957 OM 442 A	V8 Cyl.	16.9:1	14618cc	266-269kW (366-366PS)	Diesel Turbo	TD6183
OM 442.958 OM 442 A	V8 Cyl.	16.9:1	14618cc	260-269kW (354-366PS)	Diesel Turbo	TD6290
OM 442.959 OM 442 A	V8 Cyl.	16.9:1	14618cc	269kW (366PS)	Diesel Turbo	TD6161
OM 442.960 OM 442 A	V8 Cyl.	16.9:1	14618cc	260-269kW (354-365PS)	Diesel Turbo	TD5663
OM 442.961 OM 442 A	V8 Cyl.	16.9:1	14618cc	260-269kW (354-365PS)	Diesel Turbo	TD6001
OM 442.962 OM 442 A	V8 Cyl.	16.9:1	14618cc	260-269kW (354-366PS)	Diesel Turbo	TD8215
OM 442.963 OM 442 A	V8 Cyl.	16.9:1	14618cc	260-269kW (354-366PS)	Diesel Turbo	TD5802
OM 442.964 OM 442 A	V8 Cyl.	16.9:1	14618cc	260-269kW (354-366PS)	Diesel Turbo	TD6146
OM 442.965 OM 442 A	V8 Cyl.	16.25:1	14618cc	260-269kW (354-366PS)	Diesel Turbo	TD6292
OM 442.966 OM 442 A	V8 Cyl.	16.25:1	14618cc	260-269kW (354-366PS)	Diesel Turbo	TD6300
OM 442.967 OM 442 A	V8 Cyl.	16.25:1	14618cc	269kW (366PS)	Diesel Turbo	TD17809
OM 442.968 OM 442 A	V8 Cyl.	16.25:1	14618cc	260-269kW (354-366PS)	Diesel Turbo	TD6147
OM 442.970 OM 442 A	V8 Cyl.	16.25:1	14618cc	260kW (354PS)	Diesel Turbo	TD17132
OM 442.971 OM 442 A	V8 Cyl.	16.9:1	14620cc	269kW (366PS)	Diesel Turbo	TD5795
OM 442.972 OM 442 A	V8 Cyl.	16.25:1	14620cc	269kW (366PS)	Diesel Turbo	TD6131
OM 442.976 OM 442 A	V8 Cyl.	16.25:1	14618cc	260-269kW (354-366PS)	Diesel Turbo	TD6323
OM 442.980 OM 442 LA	V8 Cyl.	16.25:1	14618cc	320kW (435PS)	Diesel Turbo Intercooled	TD6169
OM 442.982 OM 442 LA	V8 Cyl.	16.9:1	14618cc	320-362kW (435-492PS)	Diesel Turbo Intercooled	TD5796
OM 442.983 OM 442 LA	V8 Cyl.	16.25:1	14618cc	329kW (447PS)	Diesel Turbo Intercooled	TD8248
OM 442.985 OM 442 LA	V8 Cyl.	16.9:1	14618cc	320-362kW (435-492PS)	Diesel Turbo Intercooled	TD5775
OM 442.989 OM 442 LA	V8 Cyl.	16.9:1	14618cc	362kW (492PS)	Diesel Turbo Intercooled	TD5817
OM 442.991 OM 442 LA	V8 Cyl.	16.25:1	14618cc	362kW (492PS)	Diesel Turbo Intercooled	TD17137
OM 442.992 OM 442 LA	V8 Cyl.	16.25:1	14618cc	320-362kW (435-492PS)	Diesel Turbo Intercooled	TD6301

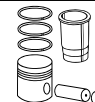
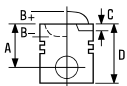

OM 442.993 OM 442 LA	V8 Cyl.	16.25:1	14618cc	362kW (492PS)	Diesel Turbo Intercooled	TD8259
OM 442.994 OM 442 LA	V8 Cyl.	16.25:1	14618cc	362kW (492PS)	Diesel Turbo Intercooled	TD6165
OM 443.940 OM 443 A	V10 Cyl.	16.25:1	18270cc	340kW (462PS)	Diesel Turbo	TD8214
OM 443.980 OM 443 LA	V10 Cyl.	16.25:1	18270cc	412kW (560PS)	Diesel Turbo Intercooled	TD8254

87-179300-10 STD

622824 →

A 81.30
B- 27.50
BØ 66.50
D 126.35
 46x105

AK HA RT TP

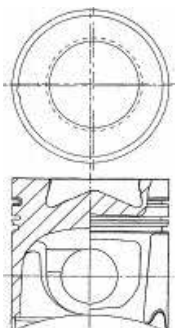

08-179300-10 STD

3.00 MOL
 3.00 CR P
 4.00 CR P

14-451160-00 WH **B** 144.50 **C** 253.00 **D** 153.80 **E** 10.07 **F** 1.00
14-452030-00 WH **B** 144.50 **C** 253.00 **D** 153.80 **E** 9.92 **F** 1.00

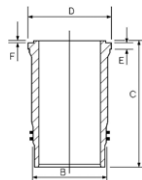

88-179300-10
 87-179300-10 +
 14-451160-00

89-179300-18
 87-179300-10 +
 14-452030-00

87-179300-65 STD

→02/91, →622823

A 81.35
B- 27.50
BØ 66.60
D 126.35
 46x105

AK HA NB RT

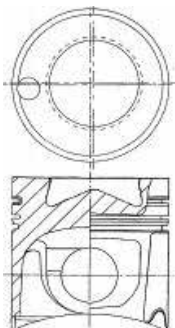

08-179300-10 STD

3.00 MOL
 3.00 CR P
 4.00 CR P

14-451160-00 WH **B** 144.50 **C** 253.00 **D** 153.80 **E** 10.07 **F** 1.00
14-452030-00 WH **B** 144.50 **C** 253.00 **D** 153.80 **E** 9.92 **F** 1.00

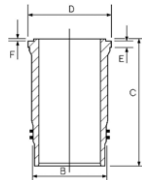

89-179300-65
 →02/91
 87-179300-65 +
 14-451160-00

89-179300-66
 →02/91
 87-179300-65 +
 14-452030-00



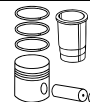
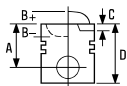

87-179300-85

STD

03/91 →, 622824 →

A 81.45
B- 27.50
BØ 66.60
D 126.45
 46x105

HA KK RT TP

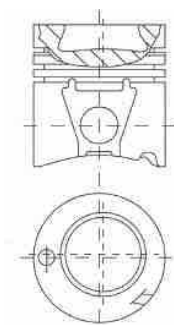

08-179300-10

STD

3.00
 3.00
 4.00



MOL ⁴
 CR P
 CR P

14-451160-00 WH ² **B** 144.50 **C** 253.00 **D** 153.80 **E** 10.07 **F** 1.00
14-452030-00 WH ¹ **B** 144.50 **C** 253.00 **D** 153.80 **E** 9.92 **F** 1.00

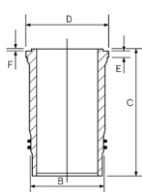

89-179300-85

03/91 →
 87-179300-85 +
 14-451160-00

89-179300-86

03/91 →
 87-179300-85 +
 14-452030-00

87-179300-90

STD

03/91 →

A 81.35
B- 27.50
BØ 66.17
D 126.35
 46x105

AK HA RT TP

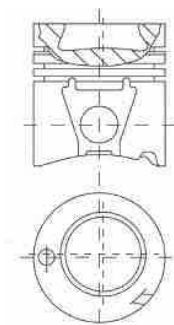

12827A201

08-179300-10

STD

3.00
 3.00
 4.00



MOL ⁴
 CR P
 CR P

14-451160-00 WH ² **B** 144.50 **C** 253.00 **D** 153.80 **E** 10.07 **F** 1.00
14-452030-00 WH ¹ **B** 144.50 **C** 253.00 **D** 153.80 **E** 9.92 **F** 1.00

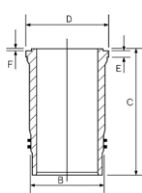

89-179300-90

03/91 →
 87-179300-90 +
 14-451160-00

89-179300-91

03/91 →
 87-179300-90 +
 14-452030-00

14-452390-00 WH ² **B** 144.50 **C** 253.00 **D** 153.80 **E** 10.57 **F** 1.00

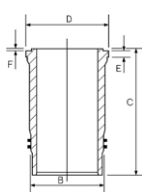

- ¹ O ring = HL5070
- ² O ring = HT018
- ³ Version with domed crown bowl
- ⁴ Steel

- ¹ Ringdichtungen = HL5070
- ² Ringdichtungen = HT018
- ³ Version mit Erhebung in der Mulde
- ⁴ Stahl

- ¹ Joints toriques = HL5070
- ² Joints toriques = HT018
- ³ Version avec dôme de chambre arrondi
- ⁴ Acier

- ¹ Juntas tóricas para = HL5070
- ² Juntas tóricas para = HT018
- ³ Versión con cabeza convexa
- ⁴ Acero

- ¹ Gommini a Corredo = HL5070
- ² Gommini a Corredo = HT018
- ³ Versione con camera di combustione convessa
- ⁴ Acciaio





40 128.00

OM 444 LA V12 Cyl. **21927cc** **478-610kW (530-830PS)** Diesel Turbo Intercooled **FM6642**

87-179300-25 STD





08-179300-10 STD

STD

14-451160-00 WH  **B 144.50 C 253.00 D 153.80 E 10.07 F 1.00**
14-452030-00 WH  **B 144.50 C 253.00 D 153.80 E 9.92 F 1.00**

89-179300-25
87-179300-25 +
14-452030-00

A 81.35
B- 27.50
BØ 66.20
D 126.35
 **46x105**

3.00  **MOL** 
3.00  **CR P**
4.00  **CR P**

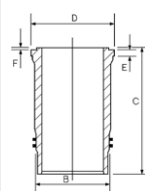

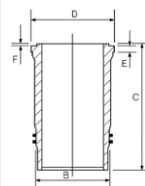

14-452390-00 WH  **B 144.50 C 253.00 D 153.80 E 10.57 F 1.00**



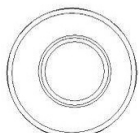
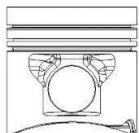





AK RT TP









12827B

-  O ring = HL5070
-  O ring = HT018
-  Steel

-  Ringdichtungen = HL5070
-  Ringdichtungen = HT018
-  Stahl

-  Joints toriques = HL5070
-  Joints toriques = HT018
-  Acier

-  Juntas tóricas para = HL5070
-  Juntas tóricas para = HT018
-  Acero

-  Gommini a Corredo = HL5070
-  Gommini a Corredo = HT018
-  Acciaio

41 128.00

OM 445.920 Euro 2 OM 441 LA	V6 Cyl.	16.25:1	10964cc	250kW (340PS)	Diesel Turbo Intercooled	TD5781
OM 445.921 Euro 2 OM 441 LA	V6 Cyl.	16.25:1	10964cc	250kW (340PS)	Diesel Turbo Intercooled	TD8200
OM 445.922 Euro 2 OM 441 LA	V6 Cyl.	16.25:1	10964cc	250kW (340PS)	Diesel Turbo Intercooled	TD8252
OM 445.923 Euro 2 OM 441 LA	V6 Cyl.	16.25:1	10964cc	250kW (340PS)	Diesel Turbo Intercooled	TD5737
OM 445.924 Euro 2 OM 441 LA	V6 Cyl.	16.25:1	10960cc	180kW (245PS)	Diesel Turbo Intercooled	TD5754
OM 445.925 Euro 2 OM 441 LA	V6 Cyl.	16.25:1	10964cc	180kW (245PS)	Diesel Turbo Intercooled	TD8197
OM 445.926 Euro 2 OM 441 LA	V6 Cyl.	16.25:1	10964cc	200kW (272PS)	Diesel Turbo Intercooled	TD5776
OM 445.927 Euro 2 OM 441 LA	V6 Cyl.	16.25:1	10964cc	200kW (272PS)	Diesel Turbo Intercooled	TD8235
OM 445.929 Euro 2 OM 441 LA	V6 Cyl.	16.25:1	10964cc	230kW (313PS)	Diesel Turbo Intercooled	TD5778
OM 445.930 Euro 2 OM 441 LA	V6 Cyl.	16.25:1	10964cc	230kW (313PS)	Diesel Turbo Intercooled	TD6164
OM 445.931 Euro 2 OM 441 LA	V6 Cyl.	16.25:1	10964cc	230kW (313PS)	Diesel Turbo Intercooled	TD6298
OM 445.933 Euro 2 OM 441 LA	V6 Cyl.	16.25:1	10964cc	200kW (272PS)	Diesel Turbo Intercooled	TD6070
OM 445.934 Euro 2 OM 441 LA	V6 Cyl.	17.25:1	10964cc	250kW (340PS)	Diesel Turbo Intercooled	TD10969
OM 445.935 Euro 2 OM 441 LA	V6 Cyl.	17.25:1	10964cc	213kW (290PS)	Diesel Turbo Intercooled	TD10970
OM 445.936 Euro 2 OM 441 LA	V6 Cyl.	16.25:1	10964cc	200kW (272PS)	Diesel Turbo Intercooled	TD6109
OM 445.937 Euro 2 OM 441 LA	V6 Cyl.	16.25:1	10964cc	230kW (313PS)	Diesel Turbo Intercooled	TD6112
OM 445.938 Euro 2 OM 441 LA	V6 Cyl.	16.25:1	10960cc	180kW (245PS)	Diesel Turbo Intercooled	TD6087
OM 445.939 Euro 2 OM 441 LA	V6 Cyl.	16.25:1	10964cc	250kW (340PS)	Diesel Turbo Intercooled	TD6117
OM 445.940 Euro 2 OM 441 LA	V6 Cyl.	16.25:1	10964cc	200kW (272PS)	Diesel Turbo Intercooled	TD6148
OM 445.941 Euro 2 OM 441 LA	V6 Cyl.	17.25:1	10960cc	180kW (245PS)	Diesel Turbo Intercooled	TD6288
OM 446.920 Euro 2 OM 442 LA	V8 Cyl.	16.25:1	14618cc	390kW (530PS)	Diesel Turbo Intercooled	TD5789

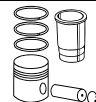
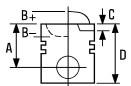

OM 446.922 Euro 2 OM 442 LA	V8 Cyl.	16.25:1	14618cc	320kW (435PS)	Diesel Turbo Intercooled	TD8207
OM 446.924 Euro 2 OM 442 LA	V8 Cyl.	16.25:1	14618cc	280kW (381PS)	Diesel Turbo Intercooled	TD5785
OM 446.925 Euro 2 OM 442 LA	V8 Cyl.	16.25:1	14618cc	280kW (381PS)	Diesel Turbo Intercooled	TD6120
OM 446.926 Euro 2 OM 442 LA	V8 Cyl.	16.25:1	14618cc	280kW (381PS)	Diesel Turbo Intercooled	TD5834
OM 446.927 Euro 2 OM 442 LA	V8 Cyl.	16.25:1	14618cc	280kW (381PS)	Diesel Turbo Intercooled	TD8203
OM 446.928 Euro 2 OM 442 LA	V8 Cyl.	16.25:1	14618cc	280kW (381PS)	Diesel Turbo Intercooled	TD5808
OM 446.929 Euro 2 OM 442 LA	V8 Cyl.	16.25:1	14618cc	280kW (381PS)	Diesel Turbo Intercooled	TD6155
OM 446.930 Euro 2 OM 442 LA	V8 Cyl.	16.25:1	14618cc	280kW (381PS)	Diesel Turbo Intercooled	TD6186
OM 446.931 Euro 2 OM 442 LA	V8 Cyl.	16.25:1	14618cc	280kW (381PS)	Diesel Turbo Intercooled	TD8257
OM 446.932 Euro 2 OM 442 LA	V8 Cyl.	16.25:1	14618cc	390kW (530PS)	Diesel Turbo Intercooled	TD8260
OM 446.933 Euro 2 OM 442 LA	V8 Cyl.	16.25:1	14618cc	390kW (530PS)	Diesel Turbo Intercooled	TD5820
OM 446.934 Euro 2 OM 442 LA	V8 Cyl.	17.25:1	14618cc	280kW (381PS)	Diesel Turbo Intercooled	TD10974
OM 446.935 Euro 2 OM 442 LA	V8 Cyl.	17.25:1	14618cc	320kW (435PS)	Diesel Turbo Intercooled	TD16982
OM 446.936 Euro 2 OM 442 LA	V8 Cyl.	16.25:1	14618cc	320kW (435PS)	Diesel Turbo Intercooled	TD8247
OM 446.938 Euro 2 OM 442 LA	V8 Cyl.	17.25:1	14618cc	280kW (381PS)	Diesel Turbo Intercooled	TD10975
OM 446.939 Euro 2 OM 442 LA	V8 Cyl.	16.25:1	14618cc	320kW (435PS)	Diesel Turbo Intercooled	TD5835
OM 446.940 Euro 2 OM 442 LA	V8 Cyl.	16.25:1	14618cc	320kW (435PS)	Diesel Turbo Intercooled	TD6187
OM 446.941 Euro 2 OM 442 LA	V8 Cyl.	16.25:1	14618cc	320kW (435PS)	Diesel Turbo Intercooled	TD16983
OM 446.942 Euro 2 OM 442 LA	V8 Cyl.	16.25:1	14618cc	320kW (435PS)	Diesel Turbo Intercooled	TD5809
OM 446.943 Euro 2 OM 442 LA	V8 Cyl.	16.25:1	14618cc	320kW (435PS)	Diesel Turbo Intercooled	TD8204
OM 446.945 Euro 2 OM 442 LA	V8 Cyl.	16.25:1	14618cc	390kW (530PS)	Diesel Turbo Intercooled	TD6171
OM 446.946 Euro 2 OM 442 LA	V8 Cyl.	16.25:1	14618cc	390kW (530PS)	Diesel Turbo Intercooled	TD6125
OM 446.948 Euro 2 OM 442 LA	V8 Cyl.	16.25:1	14618cc	320kW (435PS)	Diesel Turbo Intercooled	TD6156

87-179300-05

STD

A 81.35
B- 24.00
BØ 72.60
D 126.35
46x105

AK KK RT TP

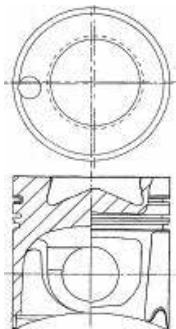

12833E102

- 1 O ring = HL5070
- 2 O ring = HT018
- 3 Steel

08-179300-10

STD

3.00
3.00
4.00



MOL 3
CR P
CR P

- 1 Ringdichtungen = HL5070
- 2 Ringdichtungen = HT018
- 3 Stahl

14-452030-00 WH 1 B 144.50 C 253.00 D 153.80 E 9.92 F 1.00

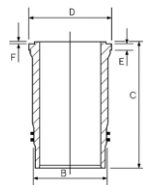

14-451160-00 WH 2 B 144.50 C 253.00 D 153.80 E 10.07 F 1.00

14-452390-00 WH 2 B 144.50 C 253.00 D 153.80 E 10.57 F 1.00

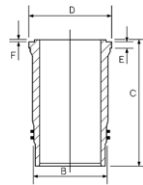

- 1 Juntas tóricas para = HL5070
- 2 Juntas tóricas para = HT018
- 3 Acero





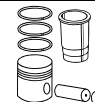
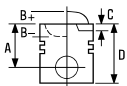



89-179300-05
87-179300-05 +
14-452030-00

- 1 Gommini a Corredo = HL5070
- 2 Gommini a Corredo = HT018
- 3 Acciaio



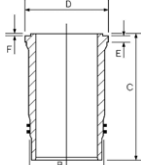

42 128.00

OM 447	6 Cyl.	18:1	11967cc	147kW (200PS)	Diesel	FM7067
OM 447.913 Euro 1 OM 447 H	6 Cyl.	18.1:1	11967cc	150-157kW (204-214PS)	Diesel	TD7948
OM 447.914 Euro 1 OM 447 H	6 Cyl.	18.1:1	11967cc	150-157kW (204-214PS)	Diesel	TD7958

87-179300-40	STD	08-179300-10	STD	14-456980-00  WH  B 144.50 C 270.00 D 153.80 E 9.92 F 1.00	89-179300-40 87-179300-40 + 14-456980-00
A 90.00		3.00	 MOL 		
B- 25.50		3.00	 CR P		
BØ 62.50		4.00	 CR P		
D 140.00					
 46x99					

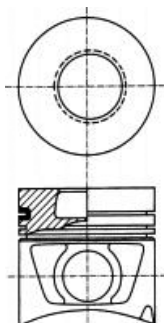
AK RT



 Use also: 3 O-rings and 1 Tombak ring, Set HL5070

 Steel

 Mitverwenden: 3 O-Ringe und 1 Tombakring, Satz: HL5070

 Stahl

 A utiliser aussi: 3 joints toriques et 1 joint Tombak. Poche

 Acier

 Utilizar también: 3 juntas toricas y 1 junta Tombak. Juego HL5070

 Acero

 Usre anche: 3 O Ring e

1 Segmento tomback HL5070

 Acciaio

43 128.00

OM 447.902	6 Cyl.	16.6:1	11967cc	184kW (250PS)	Diesel Turbo	TD28723
OM 447.954 Euro 1 OM 447 HA	6 Cyl.	18:1	11967cc	184kW (250PS)	Diesel Turbo	TD10976
OM 447.955 Euro 1 OM 447 HA	6 Cyl.	18:1	11967cc	184kW (250PS)	Diesel Turbo	TD10977
OM 447.956 Euro 1 OM 447 HA	6 Cyl.	16.25:1	11967cc	184kW (250PS)	Diesel Turbo	TD7949
OM 447.957 Euro 1 OM 447 HA	6 Cyl.	16.25:1	11967cc	184kW (250PS)	Diesel Turbo	TD7959
OM 447.958 Euro 1 OM 447 HA	6 Cyl.	16.25:1	11970cc	184kW (250PS)	Diesel Turbo	TD7962
OM 447.959 Euro 1 OM 447 HA	6 Cyl.	16.25:1	11970cc	184kW (250PS)	Diesel Turbo	TD7954
OM 447.980 Euro 1 OM 447 HLA	6 Cyl.	18:1	11967cc	220kW (299PS)	Diesel Turbo Intercooled	TD11008
OM 447.981 Euro 1 OM 447 HLA	6 Cyl.	16.25:1	11967cc	220kW (300PS)	Diesel Turbo Intercooled	TD7950
OM 447.982 Euro 1 OM 447 HLA	6 Cyl.	18:1	11967cc	220kW (300PS)	Diesel Turbo Intercooled	TD17811
OM 447.983 Euro 1 OM 447 HLA	6 Cyl.	18:1	11967cc	220kW (300PS)	Diesel Turbo Intercooled	TD17812
OM 447.984 Euro 1 OM 447 HLA	6 Cyl.	16.25:1	11970cc	220kW (300PS)	Diesel Turbo Intercooled	TD7955
OM 447.985 Euro 1 OM 447 HLA	6 Cyl.	18:1	11967cc	220kW (299PS)	Diesel Turbo Intercooled	TD10986
OM 447.986 Euro 1 OM 447 HLA	6 Cyl.	16.25:1	11967cc	220kW (300PS)	Diesel Turbo Intercooled	TD7960



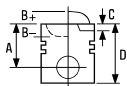

OM 447.987 Euro 1 OM 447 HLA 6 Cyl. 16.25:1 **11970cc 220kW (300PS)** Diesel Turbo Intercooled **TD7963**

OM 447.995 Euro 1 OM 447 HA 6 Cyl. 18:1 **11967cc 184kW (250PS)** Diesel Turbo **TD17813**

87-179300-20	STD	08-179300-10	STD	14-456980-00 WH ¹ B 144.50 C 270.00 D 153.80 E 9.92 F 1.00	89-179300-21 87-179300-20 + 14-456980-00
A 90.00		3.00	MOL ²		
B- 24.00		3.00	CR P		
BØ 75.00		4.00	CR P		
D 139.85					
 46x105					

AK HA RT

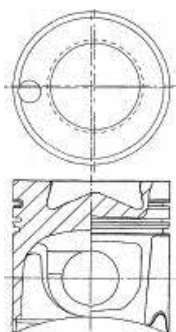

¹ Use also: 3 O-rings and 1 Tombak ring, Set HL5070

² Steel

¹ Mitverwenden: 3 O-Ringe und 1 Tombakring, Satz: HL5070

² Stahl

¹ A utiliser aussi: 3 joints toriques et 1 joint Tombak. Poche

² Acier

¹ Utilizar también: 3 juntas toricas y 1 junta Tombak. Juego HL5070

² Acero

¹ Usre anche: 3 O Ring e 1 Segmento tomback HL5070

² Acciaio

44 128.00

OM 447.970 Euro 2 OM 447 HLA	6 Cyl.	18:1	11967cc 157kW (214PS)	Diesel Turbo Intercooled	TD10978
OM 447.971 Euro 2 OM 447 HLA	6 Cyl.	18:1	11967cc 184kW (250PS)	Diesel Turbo Intercooled	TD10979
OM 447.972 Euro 2 OM 447 HLA	6 Cyl.	18:1	11967cc 220kW (299PS)	Diesel Turbo Intercooled	TD10980
OM 447.973 Euro 2 OM 447 HLA	6 Cyl.	18:1	11967cc 157kW (214PS)	Diesel Turbo Intercooled	TD10981
OM 447.974 Euro 2 OM 447 HLA	6 Cyl.	18:1	11967cc 184kW (250PS)	Diesel Turbo Intercooled	TD10982
OM 447.975 Euro 1 OM 447 HLA	6 Cyl.	18:1	11967cc 220kW (299PS)	Diesel Turbo Intercooled	TD11007
OM 447.976 Euro 2 OM 447 HLA	6 Cyl.	18:1	11967cc 184kW (250PS)	Diesel Turbo Intercooled	TD10983
OM 447.977 Euro 2 OM 447 HLA	6 Cyl.	18:1	11967cc 220kW (299PS)	Diesel Turbo Intercooled	TD11009
OM 447.978 OM 447 HLA	6 Cyl.	18:1	11967cc 184kW (250PS)	Diesel Turbo Intercooled	TD10984
OM 447.979 Euro 2 OM 447 HLA	6 Cyl.	18:1	11967cc 220kW (299PS)	Diesel Turbo Intercooled	TD10985
OM 447.988 Euro 2 OM 447 HLA	6 Cyl.	18:1	11970cc 220kW (300PS)	Diesel Turbo Intercooled	TD16990
OM 447.990 Euro 2 OM 447 HLA	6 Cyl.	18:1	11967cc 184kW (250PS)	Diesel Turbo Intercooled	TD10987
OM 447.991 Euro 2 OM 447 HLA	6 Cyl.	18:1	11967cc 220kW (299PS)	Diesel Turbo Intercooled	TD10988
OM 447.992 Euro 2 OM 447 HLA	6 Cyl.	18:1	11967cc 184kW (250PS)	Diesel Turbo Intercooled	TD10989
OM 447.993 Euro 2 OM 447 HLA	6 Cyl.	18:1	11967cc 220kW (299PS)	Diesel Turbo Intercooled	TD10990
OM 447.994 Euro 2 OM 447 HLA	6 Cyl.	18:1	11967cc 220kW (299PS)	Diesel Turbo Intercooled	TD16991
OM 447.996 Euro 2 OM 447 HLA	6 Cyl.	18:1	11970cc 184kW (250PS)	Diesel Turbo Intercooled	TD22810



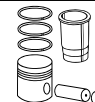
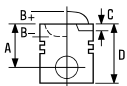

OM 447.998 Euro 2 OM 447 HLA 6 Cyl. 18:1 **11967cc 220kW (299PS)** Diesel Turbo Intercooled **TD11010**

OM 447.999 Euro 2 OM 447 HLA 6 Cyl. 18:1 **11967cc 220kW (299PS)** Diesel Turbo Intercooled **TD23187**



87-179300-50 STD

08-179300-10 STD

14-456980-00 WH ¹ B 144.50 C 270.00 D 153.80 E 9.92 F 1.00

89-179300-50

A 89.93
B- 23.88
BØ 75.15
D 139.93
 46x105

3.00  **MOL** ²
3.00  **CR P**
4.00  **CR P**

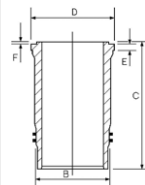

87-179300-50 +
14-456980-00

AK HA RT TP

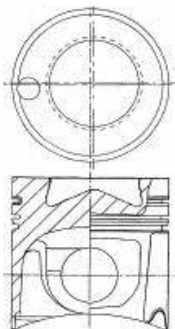





87-179300-55 STD

08-179300-10 STD

14-456980-00 WH ¹ B 144.50 C 270.00 D 153.80 E 9.92 F 1.00

89-179300-55

A 89.63
B- 23.88
BØ 75.15
D 139.63
 46x105

3.00  **MOL** ²
3.00  **CR P**
4.00  **CR P**

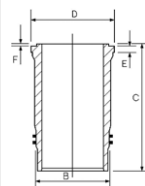

87-179300-55 +
14-456980-00

AK HA RT TP

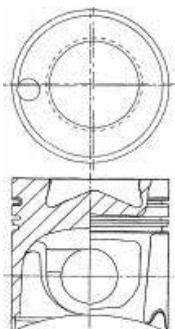

¹ Use also: 3 O-rings and
1 Tombak ring, Set HL5070
² Steel

¹ Mitverwenden: 3 O-Ringe und
1 Tombakring, Satz: HL5070
² Stahl

¹ A utiliser aussi: 3 joints toriques et
1 joint Tombak. Poche
² Acier

¹ Utilizar también: 3 juntas toricas y 1
junta Tombak. Juego HL5070
² Acero

¹ Usre anche: 3 O Ring e
1 Segmento tomback HL5070
² Acciaio

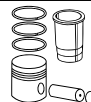
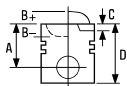

45 128.00

OM 457.910 Euro 5 OM 457 LA	6 Cyl.	17.2:1	11967cc	260-315kW (354-428PS)	Diesel Turbo Intercooled	TD25467
OM 458.990 OM 460 LA	6 Cyl.	18:1	11967cc	220-260kW (299-354PS)	Diesel Turbo Intercooled	TD28731
OM 458.991 OM 460 LA	6 Cyl.	18:1	11967cc	295-375kW (401-510PS)	Diesel Turbo Intercooled	TD28732

15-451070-10 WH ① ② B 144.50 C 266.30 D 155.50 E 10.12 F 1.10

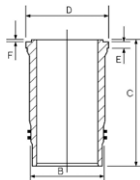

① Includes Anti-Polish Ring (Fire Ring) 13-451070-00, also available separately

① Enthält Ölschlitzring 13-451070-00, auch einzeln erhältlich

① Contient le segment racleur 13-451070-00 (disponible également séparément)

① Incluye el segmento rascador 13-451070-00, también disponible por separado

① Include anello raschiaolio 13-451070-00, disponibili anchese separatamente

② Relief 6.50mm

② Entlastung 6.50mm

② Le relief 6.50mm

② Relevación 6.50mm

② Rilievo 6.50mm

46 128.00

OM 457.914 Euro 3 OM 457 LA	6 Cyl.	17.2:1	11967cc	250kW (340PS)	Diesel Turbo Intercooled	TD20335
OM 457.917 Euro 2/3 OM 457 LA	6 Cyl.	17.3:1	11967cc	260-315kW (354-428PS)	Diesel Turbo Intercooled	TD20324
OM 457.922 Euro 3 OM 457 LA	6 Cyl.	17.2:1	11967cc	320kW (435PS)	Diesel Turbo Intercooled	TD20308
OM 457.925 Euro 3 OM 457 LA	6 Cyl.	17.2:1	11967cc	265kW (360PS)	Diesel Turbo Intercooled	TD20311
OM 457.927 Euro 3 OM 457 LA	6 Cyl.	17.2:1	11967cc	295kW (401PS)	Diesel Turbo Intercooled	TD20336
OM 457.929 Euro 3 OM 457 LA	6 Cyl.	17.2:1	11967cc	265kW (360PS)	Diesel Turbo Intercooled	TD20314
OM 457.947 Euro 2 OM 457 LA	6 Cyl.	17.2:1	11967cc	260-315kW (354-428PS)	Diesel Turbo Intercooled	TD20320
OM 457.955 Euro 3 OM 457 LA	6 Cyl.	17.3:1	11967cc	260-315kW (354-428PS)	Diesel Turbo Intercooled	TD20323
OM 457.956 Euro 3 OM 457 LA	6 Cyl.	17.2:1	11967cc	260-315kW (354-428PS)	Diesel Turbo Intercooled	TD20282
OM 457.958 Euro 2/3 OM 457 LA	6 Cyl.	17.2:1	11967cc	230-315kW (313-428PS)	Diesel Turbo Intercooled	TD20340
OM 457.960 Euro 2 OM 457 LA	6 Cyl.	17.2:1	11967cc	260-315kW (354-428PS)	Diesel Turbo Intercooled	TD20322
OM 457.962 Euro 3 OM 457 LA	6 Cyl.	17.2:1	11967cc	260-315kW (354-428PS)	Diesel Turbo Intercooled	TD23253
OM 460.900 Euro 3 OM 460 LA	6 Cyl.	18:1	12816cc	324kW (441PS)	Diesel Turbo Intercooled	TD23255
OM 460.901 Euro 3 OM 460 LA	6 Cyl.	18:1	12816cc	261kW (355PS)	Diesel Turbo Intercooled	TD23256
OM 460.902 Euro 3 OM 460 LA	6 Cyl.	18:1	12816cc	276kW (375PS)	Diesel Turbo Intercooled	TD23257
OM 460.903 Euro 3 OM 460 LA	6 Cyl.	18:1	12816cc	276kW (375PS)	Diesel Turbo Intercooled	TD23258
OM 460.904 Euro 3 OM 460 LA	6 Cyl.	18:1	12816cc	306kW (416PS)	Diesel Turbo Intercooled	TD23259
OM 460.905 Euro 3 OM 460 LA	6 Cyl.	18:1	12816cc	306kW (416PS)	Diesel Turbo Intercooled	TD23260
OM 460.906 Euro 3 OM 460 LA	6 Cyl.	18:1	12816cc	261-276kW (355-375PS)	Diesel Turbo Intercooled	TD23261
OM 460.907 Euro 3 OM 460 LA	6 Cyl.	18:1	12816cc	336kW (457PS)	Diesel Turbo Intercooled	TD23262
OM 460.908 Euro 3 OM 460 LA	6 Cyl.	18:1	12816cc	261-336kW (355-457PS)	Diesel Turbo Intercooled	TD23263
OM 460.909 Euro 3 OM 460 LA	6 Cyl.	18:1	12816cc	261-276kW (355-375PS)	Diesel Turbo Intercooled	TD23264
OM 460.910 Euro 3 OM 460 LA	6 Cyl.	18:1	12816cc	261-276kW (355-375PS)	Diesel Turbo Intercooled	TD23265
OM 460.911 Euro 3 OM 460 LA	6 Cyl.	18:1	12816cc	306-336kW (416-457PS)	Diesel Turbo Intercooled	TD23266
OM 460.912 Euro 3 OM 460 LA	6 Cyl.	18:1	12816cc	261-276kW (355-375PS)	Diesel Turbo Intercooled	TD23267
OM 460.913 Euro 3 OM 460 LA	6 Cyl.	18:1	12816cc	306-336kW (416-457PS)	Diesel Turbo Intercooled	TD23268
OM 460.914 Euro 3 OM 460 LA	6 Cyl.	18:1	12816cc	306-336kW (416-457PS)	Diesel Turbo Intercooled	TD23269
OM 460.915 Euro 3 OM 460 LA	6 Cyl.	18:1	12816cc	261-276kW (355-375PS)	Diesel Turbo Intercooled	TD23270
OM 460.916 Euro 3 OM 460 LA	6 Cyl.	18:1	12816cc	261-276kW (355-375PS)	Diesel Turbo Intercooled	TD23271



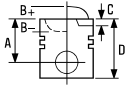

OM 460.917 Euro 3 OM 460 LA	6 Cyl.	18:1	12816cc	306-336kW (416-457PS)	Diesel Turbo Intercooled	TD23272
OM 460.918 Euro 3 OM 460 LA	6 Cyl.	18:1	12816cc	261-276kW (355-375PS)	Diesel Turbo Intercooled	TD23273
OM 460.919 Euro 3 OM 460 LA	6 Cyl.	18:1	12816cc	306-336kW (416-457PS)	Diesel Turbo Intercooled	TD23274
OM 460.920 Euro 3 OM 460 LA	6 Cyl.	18:1	12816cc	306-336kW (416-457PS)	Diesel Turbo Intercooled	TD23275
OM 460.921 Euro 3 OM 460 LA	6 Cyl.	18:1	12816cc	306-336kW (416-457PS)	Diesel Turbo Intercooled	TD23276
OM 460.922 Euro 3 OM 460 LA	6 Cyl.	18:1	12816cc	261-276kW (355-375PS)	Diesel Turbo Intercooled	TD23277
OM 460.923 Euro 3 OM 460 LA	6 Cyl.	18:1	12816cc	306-336kW (416-457PS)	Diesel Turbo Intercooled	TD23278
OM 460.925 Euro 3 OM 460 LA	6 Cyl.	18:1	12816cc	306-336kW (416-457PS)	Diesel Turbo Intercooled	TD23279
OM 460.929 Euro 3 OM 460 LA	6 Cyl.	18:1	12816cc	306-336kW (416-457PS)	Diesel Turbo Intercooled	TD23280
OM 460.931 Euro 3 OM 460 LA	6 Cyl.	18:1	12816cc	306-336kW (416-457PS)	Diesel Turbo Intercooled	TD23281

14-450380-00 WH 1 B 144.50 C 266.30 D 155.60 E 10.12 F 1.10

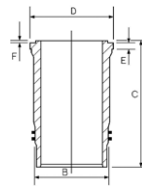

14-450480-00 WH 2 1 B 144.50 C 266.30 D 155.60 E 10.12 F 1.10

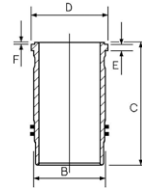

1 Use 2 O-rings and
1 Tombak ring, set HL5077

2 Chrome plated outside diameter

1 Mitverwenden: 2 O-rings +
1 Tombak ring, HL5077

2 äußere Mantel ist verchromt

1 A utiliser aussi: 2 O-Rings +
1 Tombak ring, HL5077

2 Diamètre extérieur chromé

1 Utilizar también: 2 O-rings +
1 Tombak ring, HL5077

2 Diámetro exterior cromado

1 Usare anche 2 O-rings +
1 Tombak ring, HL5077

2 Trattamento di cromatura sul
diametro esterno

47 128.00

OM 457.915 Euro 3 OM 457 LA	6 Cyl.	17.2:1	11967cc	265kW (360PS)	Diesel Turbo Intercooled	TD20303
OM 457.916 Euro 3 OM 457 LA	6 Cyl.	17.2:1	11967cc	265kW (360PS)	Diesel Turbo Intercooled	TD20304
OM 457.918 Euro 3 OM 457 LA	6 Cyl.	17.2:1	11967cc	260-315kW (354-428PS)	Diesel Turbo Intercooled	TD20305
OM 457.919 Euro 3 OM 457 LA	6 Cyl.	17.2:1	11967cc	315kW (428PS)	Diesel Turbo Intercooled	TD20306
OM 457.920 Euro 3 OM 457 LA	6 Cyl.	17.2:1	11967cc	280kW (381PS)	Diesel Turbo Intercooled	TD20307
OM 457.923 Euro 3 OM 457 LA	6 Cyl.	17.2:1	11967cc	280kW (381PS)	Diesel Turbo Intercooled	TD20309
OM 457.924 Euro 3 OM 457 LA	6 Cyl.	17.2:1	11967cc	280kW (381PS)	Diesel Turbo Intercooled	TD20310
OM 457.926 Euro 3 OM 457 LA	6 Cyl.	17.2:1	11967cc	265kW (360PS)	Diesel Turbo Intercooled	TD20312
OM 457.928 Euro 3 OM 457 LA	6 Cyl.	17.2:1	11967cc	280kW (381PS)	Diesel Turbo Intercooled	TD20313
OM 457.931 Euro 3 OM 457 LA	6 Cyl.	17.2:1	11967cc	280kW (381PS)	Diesel Turbo Intercooled	TD20315
OM 457.932 Euro 3 OM 457 LA	6 Cyl.	17.2:1	11967cc	265kW (360PS)	Diesel Turbo Intercooled	TD20316
OM 458.960 Euro 3 OM 457 LA	6 Cyl.	17.2:1	11967cc	260kW (354PS)	Diesel Turbo Intercooled	TD17668



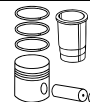
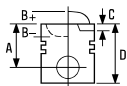





OM 458.970 Euro 3 OM 457 LA 6 Cyl. 17.2:1 **11967cc 295kW (401PS)** Diesel Turbo Intercooled **TD17669**

OM 458.980 Euro 3 OM 457 LA 6 Cyl. **11967cc 335kW (456PS)** Diesel Turbo Intercooled **TD17670**

87-141800-00 STD **08-141800-00** STD **14-450380-00 WH 1** B 144.50 C 266.30 D 155.60 E 10.12 F 1.10 **88-141800-00**
87-141800-00 +
14-450380-00

A 90.05
B- 16.00
BØ 93.15
D 140.05
 52x103

3.00  **CK 3**
3.00  **CR**
4.00  **CK**

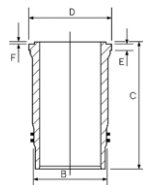

AK KK RT TP

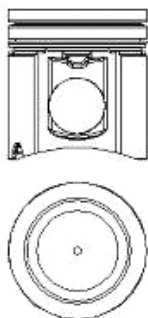

1 Use 2 O-rings and
1 Tombak ring, set HL5077
2 Chrome plated outside diameter

1 Mitverwenden: 2 O-rings +
1 Tombak ring, HL5077
2 äußere Mantel ist verchromt

1 A utiliser aussi: 2 O-Rings +
1 Tombak ring, HL5077
2 Diamètre extérieur chromé

1 Utilizar también: 2 O-rings +
1 Tombak ring, HL5077
2 Diámetro exterior cromado

1 Usare anche 2 O-rings +
1 Tombak ring, HL5077
2 Trattamento di cromatura sul
diametro esterno

3 Steel

3 Stahl

3 Acier

3 Acero

3 Acciaio

48  **128.00**

OM 457.933 Euro 2 OM 457 HLA	6 Cyl.	17.2:1	11967cc	260kW (354PS)	Diesel Turbo Intercooled	TD17662
OM 457.934 Euro 2 OM 457 HLA	6 Cyl.	17.2:1	11967cc	220kW (299PS)	Diesel Turbo Intercooled	TD17473
OM 457.935 Euro 2 OM 457 HLA	6 Cyl.	17.2:1	11967cc	185kW (252PS)	Diesel Turbo Intercooled	TD17502
OM 457.936 Euro 2 OM 457 LA	6 Cyl.	17.2:1	11967cc	300kW (408PS)	Diesel Turbo Intercooled	TD17653
OM 457.937 Euro 2 OM 457 LA	6 Cyl.	17.2:1	11967cc	260-315kW (354-428PS)	Diesel Turbo Intercooled	TD16489
OM 457.938 Euro 2 OM 457 HLA	6 Cyl.	17.2:1	11967cc	300kW (408PS)	Diesel Turbo Intercooled	TD17645
OM 457.939 Euro 2 OM 457 LA	6 Cyl.	17.2:1	11967cc	260kW (354PS)	Diesel Turbo Intercooled	TD20317
OM 457.940 Euro 2 OM 457 LA	6 Cyl.	17.2:1	11967cc	260kW (354PS)	Diesel Turbo Intercooled	TD17654
OM 457.941 Euro 2 OM 457 HLA	6 Cyl.	17.2:1	11967cc	185-300kW (252-408PS)	Diesel Turbo Intercooled	TD17641
OM 457.942 Euro 2 OM 457 HLA	6 Cyl.	17.2:1	11967cc	185-260kW (252-354PS)	Diesel Turbo Intercooled	TD17448
OM 457.943 Euro 2 OM 457 LA	6 Cyl.	17.2:1	11967cc	185-260kW (252-354PS)	Diesel Turbo Intercooled	TD17666
OM 457.944 Euro 2 OM 457 LA	6 Cyl.	17.2:1	11967cc	260-310kW (354-422PS)	Diesel Turbo Intercooled	TD17644
OM 457.945 Euro 2 OM 457 LA	6 Cyl.	17.2:1	11967cc	260kW (354PS)	Diesel Turbo Intercooled	TD20318



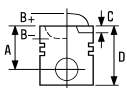

OM 457.946 Euro 2 OM 457 LA 6 Cyl. 17.2:1 **11967cc 220kW (299PS)** Diesel Turbo Intercooled **TD20319**

OM 457.949 Euro 2 OM 457 LA 6 Cyl. 17.2:1 **11967cc 220kW (299PS)** Diesel Turbo Intercooled **TD20321**



87-115800-00 STD

08-115800-00 STD

14-450380-00 WH 1 B 144.50 C 266.30 D 155.60 E 10.12 F 1.10

88-115800-00

A 90.05
B- 18.00
BØ 89.50
D 138.00
 52x96

3.00  **CK 3**
3.00  **CR P**
4.00  **CR P**

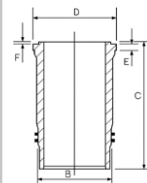

87-115800-00 +
14-450380-00

AK KK RT TP

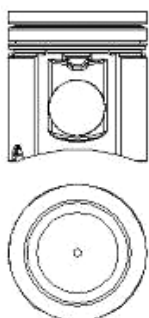

14-450480-00 WH 2 1 B 144.50 C 266.30 D 155.60 E 10.12 F 1.10

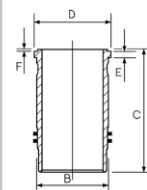

1 Use 2 O-rings and
1 Tombak ring, set HL5077

2 Chrome plated outside diameter

3 Steel

1 Mitverwenden: 2 O-rings +
1 Tombak ring, HL5077

2 äußere Mantel ist verchromt

3 Stahl

1 A utiliser aussi: 2 O-Rings +
1 Tombak ring, HL5077

2 Diamètre extérieur chromé

3 Acier

1 Utilizar también: 2 O-rings +
1 Tombak ring, HL5077

2 Diámetro exterior cromado

3 Acero

1 Usare anche 2 O-rings +
1 Tombak ring, HL5077

2 Trattamento di cromatura sul
diametro esterno

3 Acciaio

49  **128.00**

OM 457.948 Euro 4 OM 457 LA 6 Cyl. 17.2:1 **11967cc 260-315kW (354-428PS)** Diesel Turbo Intercooled **TD20227**

OM 457.950 Euro 4 OM 457 HLA 6 Cyl. 17.2:1 **11967cc 220-260kW (299-354PS)** Diesel Turbo Intercooled **TD20337**

OM 457.951 Euro 4 OM 457 LA 6 Cyl. 17.2:1 **11967cc 260kW (354PS)** Diesel Turbo Intercooled **TD23250**

OM 457.952 Euro 4 OM 457 HLA 6 Cyl. 17.2:1 **11967cc 220-300kW (299-408PS)** Diesel Turbo Intercooled **TD20338**

OM 457.953 Euro 4 OM 457 LA 6 Cyl. 17.3:1 **11967cc 260-315kW (354-428PS)** Diesel Turbo Intercooled **TD23251**

OM 457.954 Euro 4 OM 457 HLA 6 Cyl. 17.2:1 **11967cc 220-260kW (299-354PS)** Diesel Turbo Intercooled **TD20339**

OM 457.957 Euro 4 OM 457 LA 6 Cyl. 17.2:1 **11967cc 260-315kW (354-428PS)** Diesel Turbo Intercooled **TD20283**

OM 457.959 Euro 4 OM 457 HLA 6 Cyl. 17.2:1 **11967cc 220-260kW (299-354PS)** Diesel Turbo Intercooled **TD20341**

OM 457.961 Euro 4 OM 457 LA 6 Cyl. 17.2:1 **11967cc 260-355kW (354-483PS)** Diesel Turbo Intercooled **TD23252**

OM 457.964 Euro 4 OM 457 HLA 6 Cyl. 17.2:1 **11967cc 220-260kW (299-408PS)** Diesel Turbo Intercooled **TD23247**

OM 457.965 Euro 4 OM 457 HLA 6 Cyl. 17.2:1 **11967cc 220-300kW (299-408PS)** Diesel Turbo Intercooled **TD23248**

OM 457.966 Euro 4 OM 457 HLA 6 Cyl. 17.2:1 **11967cc 220-260kW (299-354PS)** Diesel Turbo Intercooled **TD23249**

OM 457.967 Euro 4 6 Cyl. 17.2:1 **11967cc 220-260kW (299-354PS)** Diesel Turbo Intercooled **TD28150**

OM 457.968 Euro 4 OM 457 LA 6 Cyl. 17.2:1 **11967cc 265-315kW (360-428PS)** Diesel Turbo Intercooled **TD28726**

OM 457.969 Euro 4 OM 457 LA 6 Cyl. 17.2:1 **11967cc 265kW (360PS)** Diesel Turbo Intercooled **TD28727**

OM 457.973 Euro 4 OM 457 HLA 6 Cyl. 17.2:1 **11967cc 220-260kW (299-354PS)** Diesel Turbo Intercooled **TD27003**

OM 457.974 Euro 4 OM 457 HLA 6 Cyl. 17.2:1 **11967cc 220-300kW (299-408PS)** Diesel Turbo Intercooled **TD28728**

OM 457.976 Euro 3 6 Cyl. 17.2:1 **11967cc 260-335kW (354-456PS)** Diesel Turbo Intercooled **TD28729**



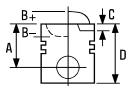

OM 457.977 Euro 4 OM 457 HLA 6 Cyl. 17.2:1 **11967cc 220-260kW (299-354PS)** Diesel Turbo Intercooled **TD28730**



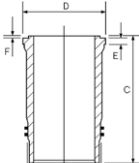

OM 457.980 Euro 2 OM 457 LA 6 Cyl. 17.2:1 **11967cc** **260-315kW (354-428PS)** **Diesel Turbo Intercooled** **TD25446**

OM 457.981 Euro 3 OM 457 LA 6 Cyl. 17.2:1 **11967cc** **260-315kW (354-428PS)** **Diesel Turbo Intercooled** **TD25447**

87-427000-00	STD	08-427000-00	STD	15-451070-10 WH 1 2 B 144.50 C 266.30 D 155.50 E 10.12 F 1.10	89-427000-00 87-427000-00 + 15-451070-10
A 85.00		3.00	 GDC 3		
B- 17.70		3.00	 CR		
BØ 87.00		4.00	 GDC P		
D 135.00					
 52x103					



KK NB RT TP

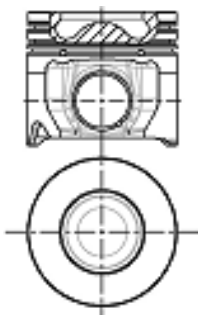

1 Includes Anti-Polish Ring (Fire Ring) 13-451070-00, also available separately

1 Enthält Ölschlitzring 13-451070-00, auch einzeln erhältlich

1 Contient le segment rascleur 13-451070-00 (disponible également séparément)

1 Incluye el segmento rascador 13-451070-00, también disponible por separado

1 Include anello raschiaolio 13-451070-00, disponibili anchese separatamente

2 Relief 6.50mm
3 Steel

2 Entlastung 6.50mm
3 Stahl





2 Le relief 6.50mm
3 Acier

2 Relevación 6.50mm
3 Acero

2 Rilievo 6.50mm
3 Acciaio

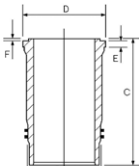
50 130.00

OM 441 / Euro 1	6 Cyl.	18:1	11309cc	151kW (205PS)	Diesel	FM17010
OM 441.922 Euro 1 OM 441	V6 Cyl.	16.9:1	11300cc	151kW (205PS)	Diesel	TD7942
OM 441.932 OM 441	V6 Cyl.	16.9:1	11309cc	151kW (205PS)	Diesel	TD8190
OM 441.933 Euro 1 OM 441	V6 Cyl.	16.9:1	11309cc	151kW (205PS)	Diesel	TD8191
OM 440.907 Euro 1 OM 442	V8 Cyl.	18:1	15080cc	195kW (265PS)	Diesel	TD16966
OM 442 Euro 1	V8 Cyl.	16.9:1	15080cc	195kW (265PS)	Diesel	FM17011
OM 442.931 OM 442	V8 Cyl.	16.9:1	15100cc	195kW (265PS)	Diesel	TD7945

87-743200-10	STD	08-743200-00	STD	14-456330-00 WH 1 B 144.50 C 253.00 D 153.80 E 9.92 F 1.00	89-743200-10 87-743200-10 + 14-456330-00
A 81.45		512444→			
B- 26.10		3.00	 MOL P		
BØ 59.00		3.00	 CR P		
D 126.45		4.00	 CR P		
 46x99					

AK HA RT

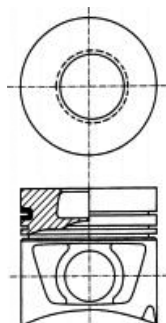

1 O ring = HL5070

1 Ringdichtungen = HL5070

1 Joints toriques = HL5070

1 Juntas tóricas para = HL5070

1 Gommini a Corredo = HL5070

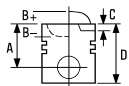

51 130.00

OM 440.908 Euro 1 OM 442	V8 Cyl.	18:1	15080cc	206kW (280PS)	Diesel	TD17118
OM 440.910 Euro 1 OM 442	V8 Cyl.	18:1	15080cc	218kW (296PS)	Diesel	TD17119
OM 440.911 Euro 1 OM 442	V8 Cyl.	18:1	15080cc	218kW (296PS)	Diesel	TD17120
OM 443.900 OM 443	V10 Cyl.	16.9:1	18848cc	331kW (450PS)	Diesel	TD28720

14-456330-00 WH  B 144.50 C 253.00 D 153.80 E 9.92 F 1.00

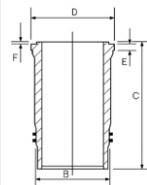

 O ring = HL5070

 Ringdichtungen = HL5070

 Joints toriques = HL5070

 Juntas tóricas para = HL5070

 Gommini a Corredo = HL5070

52 130.00

OM 441.905 OM 441	V6 Cyl.	17.2:1	10964cc	165kW (224PS)	Diesel	TD5731
OM 441.906 OM 441	V6 Cyl.	17.2:1	10964cc	150kW (204PS)	Diesel	TD8184
OM 441.907 OM 441	V6 Cyl.	17.2:1	10964cc	150kW (204PS)	Diesel	TD8185
OM 441.908 OM 441	V6 Cyl.	17.2:1	10964cc	160-165kW (218-224PS)	Diesel	TD5660
OM 441.909 OM 441	V6 Cyl.	17.2:1	10964cc	160-165kW (218-224PS)	Diesel	TD5998
OM 441.911 OM 441	V6 Cyl.	17.2:1	10964cc	160-165kW (218-224PS)	Diesel	TD6271
OM 441.912 OM 441	V6 Cyl.	16.9:1	11309cc	165kW (224PS)	Diesel	TD6142
OM 441.913 OM 441	V6 Cyl.	17.2:1	10964cc	165kW (224PS)	Diesel Turbo Intercooled	TD6063
OM 441.914 OM 441	V6 Cyl.	16.9:1	11309cc	165kW (224PS)	Diesel	TD6101
OM 441.915 OM 441	V6 Cyl.	17.2:1	10964cc	165kW (224PS)	Diesel	TD8121
OM 441.916 OM 441	V6 Cyl.	16.9:1	11309cc	153kW (208PS)	Diesel	TD5768
OM 441.917 OM 441	V6 Cyl.	17.2:1	10964cc	160kW (218PS)	Diesel	TD8122
OM 441.918 OM 441	V6 Cyl.	16.9:1	11309cc	165kW (224PS)	Diesel	TD10968
OM 441.919 OM 441	V6 Cyl.	16.9:1	11309cc	150-165kW (204-224PS)	Diesel	TD16972
OM 441.920 OM 441	V6 Cyl.	16.9:1	11309cc	153kW (208PS)	Diesel	TD6100
OM 441.923 OM 441	V6 Cyl.	17.2:1	10964cc	160kW (218PS)	Diesel	TD5732
OM 441.924 OM 441	V6 Cyl.	16.9:1	11309cc	160kW (218PS)	Diesel	TD6143
OM 441.925 OM 441	V6 Cyl.	17.2:1	10964cc	160kW (218PS)	Diesel	TD6064
OM 441.926 OM 441	V6 Cyl.	17.2:1	10964cc	160kW (218PS)	Diesel	TD8119
OM 441.927 OM 441	V6 Cyl.	17.2:1	10964cc	153kW (208PS)	Diesel	TD8123
OM 440.909 OM 442	V8 Cyl.	16.9:1	15080cc	195kW (265PS)	Diesel	TD8192
OM 442.905 OM 442	V8 Cyl.	16.9:1	15080cc	191kW (260PS)	Diesel	TD8186
OM 442.906 OM 442	V8 Cyl.	16.9:1	15080cc	218kW (296PS)	Diesel	TD5769
OM 442.907 OM 442	V8 Cyl.	16.9:1	15080cc	213-218kW (290-296PS)	Diesel	TD5771
OM 442.908 OM 442	V8 Cyl.	16.9:1	15080cc	210kW (286PS)	Diesel	TD5790
OM 442.909 OM 442	V8 Cyl.	16.9:1	15080cc	210kW (286PS)	Diesel	TD5791
OM 442.910 OM 442	V8 Cyl.	16.9:1	15080cc	213-218kW (290-296PS)	Diesel	TD5662
OM 442.911 OM 442	V8 Cyl.	16.9:1	15080cc	218kW (296PS)	Diesel	TD10971
OM 442.914 OM 442	V8 Cyl.	16.9:1	15080cc	195kW (265PS)	Diesel	TD5734
OM 442.915 OM 442	V8 Cyl.	16.9:1	15078cc	218kW (296PS)	Diesel	TD5822
OM 442.916 OM 442	V8 Cyl.	16.9:1	15078cc	218kW (296PS)	Diesel	TD6174



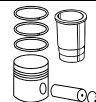
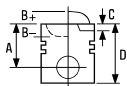

OM 442.917 OM 442	V8 Cyl.	16.9:1	15080cc	218kW (296PS)	Diesel	TD6297
OM 442.918 OM 442	V8 Cyl.	16.9:1	15080cc	213-218kW (290-296PS)	Diesel	TD6000
OM 442.919 OM 442	V8 Cyl.	16.9:1	15080cc	213-218kW (290-296PS)	Diesel	TD6272
OM 442.920 OM 442	V8 Cyl.	16.9:1	15080cc	195kW (265PS)	Diesel	TD5735
OM 442.921 OM 442	V8 Cyl.	16.9:1	15080cc	195kW (265PS)	Diesel	TD6144
OM 442.922 OM 442	V8 Cyl.	16.9:1	15080cc	195kW (265PS)	Diesel	TD5770
OM 442.923 OM 442	V8 Cyl.	16.9:1	15080cc	210kW (286PS)	Diesel	TD6127
OM 442.924 OM 442	V8 Cyl.	16.9:1	15080cc	210kW (286PS)	Diesel	TD6128
OM 442.925 OM 442	V8 Cyl.	16.9:1	15080cc	213kW (290PS)	Diesel	TD5815
OM 442.926 OM 442	V8 Cyl.	16.9:1	15080cc	213kW (290PS)	Diesel	TD5792
OM 442.927 OM 442	V8 Cyl.	16.9:1	15078cc	213kW (290PS)	Diesel	TD5823
OM 442.928 OM 442	V8 Cyl.	16.9:1	15078cc	213kW (290PS)	Diesel	TD6175
OM 442.929 OM 442	V8 Cyl.	16.9:1	15080cc	213kW (290PS)	Diesel	TD6129
OM 442.930 OM 442	V8 Cyl.	16.9:1	15100cc	213kW (290PS)	Diesel	TD7944
OM 442.932 OM 442	V8 Cyl.	16.9:1	15080cc	195kW (265PS)	Diesel	TD6066
OM 442.933 OM 442	V8 Cyl.	16.9:1	15080cc	195kW (265PS)	Diesel	TD6067
OM 442.934 OM 442	V8 Cyl.	16.9:1	15080cc	195kW (265PS)	Diesel	TD6324
OM 442.935 OM 442	V8 Cyl.	16.9:1	15080cc	195kW (265PS)	Diesel	TD6102
OM 442.939 OM 442	V8 Cyl.	16.9:1	15080cc	213-218kW (290-296PS)	Diesel	TD6319
OM 443.905 OM 443	V10 Cyl.	16.9:1	18848cc	271kW (369PS)	Diesel	TD16981
OM 444	V12 Cyl.		22618cc		Diesel	FM6641

87-743200-00

STD

A 81.35
B- 27.20
BØ 60.50
D 126.35
④ 46x99

AK HA RT

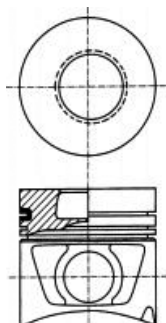

13039C

① O ring = HL5070

08-743200-00

STD

512444→

3.00
3.00
4.00



MOL P
CR P
CR P

① Ringdichtungen = HL5070

14-456330-00 WH ① B 144.50 C 253.00 D 153.80 E 9.92 F 1.00

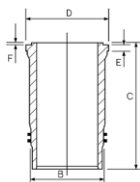

① Joints toriques = HL5070

① Juntas tóricas para = HL5070

89-743200-00
87-743200-00 +
14-456330-00

① Gommini a Corredo = HL5070

53 ① 130.00

OM 521.940 Euro 2 OM 501 LA	V6 Cyl.	17.25:1	11946cc	315kW (428PS)	Diesel Turbo Intercooled	TD16791
OM 521.950 Euro 2 OM 501 LA	V6 Cyl.	17.25:1	11946cc	260kW (354PS)	Diesel Turbo Intercooled	TD17671
OM 521.951 Euro 2 OM 501 LA	V6 Cyl.	17.25:1	11946cc	335kW (456PS)	Diesel Turbo Intercooled	TD28776



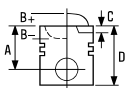

OM 541.920 Euro 2 OM 501 LA	V6 Cyl.	17.25:1	11946cc	230kW (313PS)	Diesel Turbo Intercooled	TD7872
OM 541.921 Euro 2 OM 501 LA	V6 Cyl.	17.25:1	11946cc	315kW (428PS)	Diesel Turbo Intercooled	TD9673
OM 541.922 Euro 2 OM 501 LA	V6 Cyl.	17.25:1	11946cc	260kW (354PS)	Diesel Turbo Intercooled	TD7873
OM 541.923 Euro 2 OM 501 LA	V6 Cyl.	17.25:1	11946cc	290-300kW (394-408PS)	Diesel Turbo Intercooled	TD7874
OM 541.924 Euro 2 OM 501 LA	V6 Cyl.	17.25:1	11946cc	290kW (394PS)	Diesel Turbo Intercooled	TD7880
OM 541.925 Euro 2 OM 501 LA	V6 Cyl.	17.25:1	11946cc	315kW (428PS)	Diesel Turbo Intercooled	TD7875
OM 541.926 Euro 2 OM 501 LA	V6 Cyl.	17.25:1	11946cc	230kW (313PS)	Diesel Turbo Intercooled	TD7879
OM 541.927 Euro 2 OM 501 LA	V6 Cyl.	17.25:1	11946cc	260kW (354PS)	Diesel Turbo Intercooled	TD9679
OM 541.928 Euro 2 OM 501 LA	V6 Cyl.	17.25:1	11946cc	315kW (428PS)	Diesel Turbo Intercooled	TD17679
OM 541.940 Euro 2/3 OM 501 LA	V6 Cyl.	17.75:1	11946cc	230-235kW (313-320PS)	Diesel Turbo Intercooled	TD16897
OM 541.941 Euro 2/3 OM 501 LA	V6 Cyl.	17.75:1	11946cc	230-235kW (313-320PS)	Diesel Turbo Intercooled	TD16898
OM 541.951 Euro 2/3 OM 501 LA	V6 Cyl.	17.75:1	11946cc	230-235kW (313-320PS)	Diesel Turbo Intercooled	TD17684
OM 541.952 Euro 2/3 OM 501 LA	V6 Cyl.	17.75:1	11946cc	230-260kW (313-354PS)	Diesel Turbo Intercooled	TD17685
OM 541.960 Euro 2 OM 501 LA	V6 Cyl.	17.25:1	11946cc	240kW (326PS)	Diesel Turbo Intercooled	TD25520
OM 941.910 Euro 2 OM 501 LA	V6 Cyl.	17.25:1	11946cc	230kW (313PS)	Diesel Turbo Intercooled	TD17693
OM 941.920 Euro 2 OM 501 LA	V6 Cyl.	17.25:1	11946cc	260kW (354PS)	Diesel Turbo Intercooled	TD16793
OM 941.921 Euro 2 OM 501 LA	V6 Cyl.	17.25:1	11946cc	260kW (354PS)	Diesel Turbo Intercooled	TD17694
OM 941.929 Euro 2 OM 501 LA	V6 Cyl.	17.25:1	11946cc	290kW (394PS)	Diesel Turbo Intercooled	TD16794
OM 941.930 Euro 2 OM 501 LA	V6 Cyl.	17.25:1	11946cc	300kW (408PS)	Diesel Turbo Intercooled	TD16795
OM 941.940 Euro 2 OM 501 LA	V6 Cyl.	17.25:1	11946cc	315kW (428PS)	Diesel Turbo Intercooled	TD16796
OM 941.960 Euro 2 OM 501 LA	V6 Cyl.	17.25:1	11946cc	230kW (313PS)	Diesel Turbo Intercooled	TD16797
OM 941.970 Euro 2 OM 501 LA	V6 Cyl.	17.25:1	11946cc	260kW (354PS)	Diesel Turbo Intercooled	TD16798
OM 941.980 Euro 2 OM 501 LA	V6 Cyl.	17.25:1	11946cc	290kW (394PS)	Diesel Turbo Intercooled	TD17695
OM 941.981 Euro 2 OM 501 LA	V6 Cyl.	17.25:1	11946cc	290-315kW (394-428PS)	Diesel Turbo Intercooled	TD17696
OM 941.990 Euro 2 OM 501 LA	V6 Cyl.	17.25:1	11946cc	315kW (428PS)	Diesel Turbo Intercooled	TD16799
OM 522.940 Euro 2 OM 502 LA	V8 Cyl.	17.25:1	15928cc	420kW (571PS)	Diesel Turbo Intercooled	TD16800
OM 522.941 Euro 2 OM 502 LA	V8 Cyl.	17.25:1	15928cc	413kW (562PS)	Diesel Turbo Intercooled	TD17672
OM 522.942 Euro 2 OM 502 LA	V8 Cyl.	17.25:1	15928cc	362kW (496PS)	Diesel Turbo Intercooled	TD17673
OM 522.943 Euro 2 OM 502 LA	V8 Cyl.	17.25:1	15928cc	362kW (496PS)	Diesel Turbo Intercooled	TD17674
OM 522.950 Euro 2 OM 502 LA	V8 Cyl.	17.25:1	15928cc	530kW (721PS)	Diesel Turbo Intercooled	TD22822
OM 542.920 OM 502 LA	V8 Cyl.	17.25:1	15928cc	390kW (530PS)	Diesel Turbo Intercooled	TD7877
OM 542.921 OM 502 LA	V8 Cyl.	17.25:1	15928cc	350kW (476PS)	Diesel Turbo Intercooled	TD7876
OM 542.922 OM 502 LA	V8 Cyl.		15928cc	420kW (571PS)	Diesel Turbo Intercooled	TD7878
OM 542.923 OM 502 LA	V8 Cyl.		15928cc	420kW (571PS)	Diesel Turbo Intercooled	TD16905
OM 542.924 OM 502 LA	V8 Cyl.		15928cc	420kW (571PS)	Diesel Turbo Intercooled	TD17686
OM 542.925 Euro 2 OM 502 LA	V8 Cyl.	17.25:1	15928cc	350kW (476PS)	Diesel Turbo Intercooled	TD9683
OM 542.926 OM 502 LA	V8 Cyl.	17.25:1	15928cc	390kW (530PS)	Diesel Turbo Intercooled	TD17687
OM 542.947 OM 502 LA	V8 Cyl.	17.25:1	15928cc	390-420kW (530-571PS)	Diesel Turbo Intercooled	TD17690
OM 542.958 Euro 3 OM 502 LA	V8 Cyl.	17.2:1	15928cc	450kW (612PS)	Diesel Turbo Intercooled	TD24684
OM 942.900 Euro 2 OM 502 LA	V8 Cyl.	17.25:1	15928cc	350kW (476PS)	Diesel Turbo Intercooled	TD17697
OM 942.910 Euro 2 OM 502 LA	V8 Cyl.	17.25:1	15928cc	350kW (470PS)	Diesel Turbo Intercooled	TD17698
OM 942.911 Euro 2 OM 502 LA	V8 Cyl.	17.25:1	15928cc	350kW (476PS)	Diesel Turbo Intercooled	TD16801
OM 942.912 Euro 2 OM 502 LA	V8 Cyl.	17.25:1	15928cc	350kW (470PS)	Diesel Turbo Intercooled	TD17699



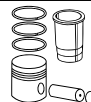
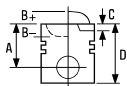

OM 942.925 Euro 2 OM 502 LA	V8 Cyl.	17.25:1	15928cc	400kW (544PS)	Diesel Turbo Intercooled	TD17700
OM 942.930 Euro 2 OM 502 LA	V8 Cyl.	17.25:1	15928cc	420kW (570PS)	Diesel Turbo Intercooled	TD16802
OM 942.960 Euro 2 OM 502 LA	V8 Cyl.	17.25:1	15928cc	350kW (470PS)	Diesel Turbo Intercooled	TD17701
OM 942.967 Euro 2 OM 502 LA	V8 Cyl.	17.25:1	15928cc	370-380kW (503-517PS)	Diesel Turbo Intercooled	TD17702
OM 942.970 Euro 2 OM 502 LA	V8 Cyl.	17.25:1	15928cc	390kW (570PS)	Diesel Turbo Intercooled	TD17703
OM 942.980 Euro 2 OM 502 LA	V8 Cyl.	17.25:1	15928cc	420kW (570PS)	Diesel Turbo Intercooled	TD16803
OM 942.990 Euro 2 OM 502 LA	V8 Cyl.	17.25:1	15928cc	330-448kW (570-609PS)	Diesel Turbo Intercooled	TD17704

87-289600-00 STD

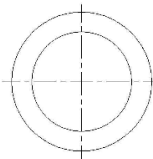
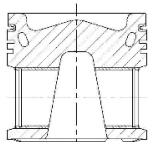

A 78.55
B- 18.10
BØ 88.56
D 119.55
 52x103

AK KK RT TP



13049A

08-289600-00 ⁴ STD

3.00  **CK** ⁵
 3.00  **CR P**
 4.00  **CR P**

14-458580-00 ² **WH** ² **B** 150.00 **C** 258.00 **D** 164.10 **E** 10.12 **F** 1.10

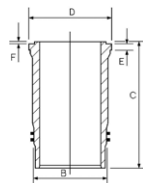

89-289600-00
 87-289600-00 +
 14-458580-00

14-450250-00 ¹ ³ **WH** ¹ ³ **B** 150.00 **C** 258.00 **D** 164.10 **E** 10.12 **F** 1.10

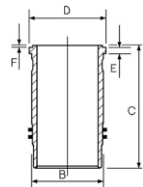

88-289600-30
 87-289600-00 +
 14-450250-00

87-289600-20 STD

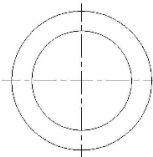
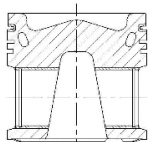

A 78.35
B- 18.10
BØ 89.00
D 119.35
 52x103

AK KK RT TP



13049A

08-289600-00 ⁴ STD

3.00  **CK** ⁵
 3.00  **CR P**
 4.00  **CR P**

14-458580-00 ² **WH** ² **B** 150.00 **C** 258.00 **D** 164.10 **E** 10.12 **F** 1.10

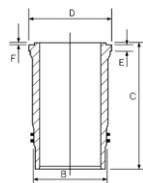

89-289600-20
 87-289600-20 +
 14-458580-00

¹ Has different upper register design compared to 14-458580-00

¹ Hat unterschiedliche obere Flanschführung im Vergleich zu 14-458580-00

¹ Profil inférieur de la colerette different de 14-45880-00

¹ Tiene un registro superior diferente comparado al 14-45880-00

¹ Profilo inferiore del colletto diverso da 14-45880-00

² Rectangular water channel immediately below flange

² Rechteckiger Wasserkanal unter dem Buchsenbund

² Canal d'eau rectangulaire sous la bride

² Canal de agua rectangular bajo la pestaña

² Passaggio acqua rettangolare sotto flangia

³ Round water channel 20mm below flange

³ Runder Wasserkanal

³ Canal d'eau rond

³ Canal de agua redondo

³ Passaggio acqua circolare

⁴ OE 541 030 0024

⁴ OE 541 030 0024

⁴ OE 541 030 0024

⁴ OE 541 030 0024

⁴ OE 541 030 0024

⁵ Steel

⁵ Stahl

⁵ Acier

⁵ Acero

⁵ Acciaio

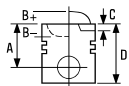

54 130.00

OM 522 LA Euro 2 V8 Cyl. 17.25:1 **15928cc** **362-420kW (496-570PS)** Diesel Turbo Intercooled **FM15588**

14-458580-00 WH  **B 150.00 C 258.00 D 164.10 E 10.12 F 1.10**

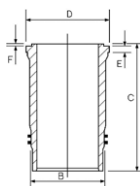

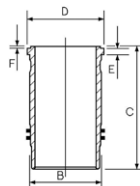

14-450250-00 WH  **B 150.00 C 258.00 D 164.10 E 10.12 F 1.10**





 Has different upper register design compared to 14-458580-00

 Hat unterschiedliche obere Flanschausführung im Vergleich zu 14-458580-00

 Profil inférieur de la colerette différent de 14-45880-00

 Tiene un registro superior diferente comparado al 14-458580-00

 Profilo inferiore del colletto diverso da 14-45880-00

 Rectangular water channel immediately below flange

 Rechteckiger Wasserkanal unter dem Buchsenbund

 Canal d'eau rectangulaire sous la bride

 Canal de agua rectangular bajo la pestaña

 Passaggio acqua rettangolare sotto flangia

 Round water channel 20mm below flange

 Runder Wasserkanal

 Canal d'eau rond

 Canal de agua redondo

 Passaggio acqua circolare

55 130.00



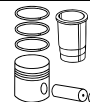
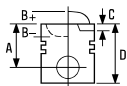

OM 541.942 Euro 3 OM 501 LA	V6 Cyl.	17.75:1	11946cc	260-265kW (354-360PS)	Diesel Turbo Intercooled	TD16899
OM 541.943 Euro 3 OM 501 LA	V6 Cyl.	17.75:1	11946cc	260-265kW (354-360PS)	Diesel Turbo Intercooled	TD16900
OM 541.944 Euro 3 OM 501 LA	V6 Cyl.	17.75:1	11946cc	290-300kW (394-408PS)	Diesel Turbo Intercooled	TD16901
OM 541.945 Euro 3 OM 501 LA	V6 Cyl.	17.75:1	11946cc	290-300kW (394-408PS)	Diesel Turbo Intercooled	TD16902
OM 541.946 Euro 3 OM 501 LA	V6 Cyl.	17.75:1	11946cc	315-320kW (428-435PS)	Diesel Turbo Intercooled	TD16903
OM 541.947 Euro 3 OM 501 LA	V6 Cyl.	17.75:1	11946cc	315-320kW (428-435PS)	Diesel Turbo Intercooled	TD16904
OM 541.948 Euro 3 OM 501 LA	V6 Cyl.	17.75:1	11946cc	335-355kW (456-483PS)	Diesel Turbo Intercooled	TD16913
OM 541.949 Euro 3 OM 501 LA	V6 Cyl.	17.75:1	11946cc	335-355kW (456-483PS)	Diesel Turbo Intercooled	TD16914
OM 541.950 Euro 3 OM 501 LA	V6 Cyl.	17.75:1	11946cc	260-300kW (354-408PS)	Diesel Turbo Intercooled	TD17682
OM 541.995 OM 501 LA	V6 Cyl.	17.75:1	11946cc	335kW (456PS)	Diesel Turbo Intercooled	TD25696
OM 542.940 Euro 3 OM 502 LA	V8 Cyl.	17.75:1	15928cc	350-375kW (476-510PS)	Diesel Turbo Intercooled	TD16909
OM 542.941 Euro 3 OM 502 LA	V8 Cyl.	17.75:1	15928cc	370kW (503PS)	Diesel Turbo Intercooled	TD16911
OM 542.942 Euro 3 OM 502 LA	V8 Cyl.	17.75:1	15928cc	390-395kW (530-537PS)	Diesel Turbo Intercooled	TD16906
OM 542.943 Euro 3 OM 502 LA	V8 Cyl.	17.75:1	15928cc	390-395kW (530-537PS)	Diesel Turbo Intercooled	TD16907
OM 542.944 Euro 3 OM 502 LA	V8 Cyl.	17.75:1	15928cc	420-425kW (571-578PS)	Diesel Turbo Intercooled	TD16912
OM 542.945 Euro 3 OM 502 LA	V8 Cyl.	17.75:1	15928cc	420-425kW (571-578PS)	Diesel Turbo Intercooled	TD17689
OM 542.948 Euro 3 OM 502 LA	V8 Cyl.	17.75:1	15928cc	320-370kW (435-503PS)	Diesel Turbo Intercooled	TD17655





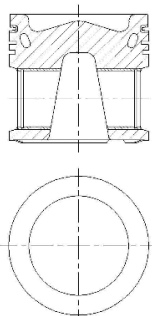

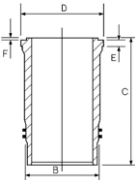
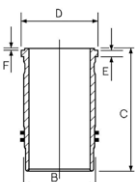

OM 542.956 Euro 3 OM 502 LA V8 Cyl. 17.2:1 **15928cc 448kW (609PS)** **Diesel Turbo Intercooled** **TD17691**

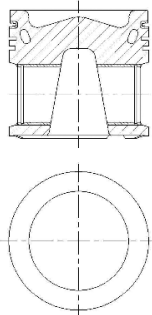
OM 542.957 Euro 3 OM 502 LA V8 Cyl. 17.2:1 **15928cc 448kW (609PS)** **Diesel Turbo Intercooled** **TD17692**

<p>87-136000-00 STD</p> <p>A 78.55 B- 16.50 BØ 92.80 D 119.55</p>  <p>52x102</p> <p>AK KK NB RT TP</p>  <p>13050E203</p>	<p>08-136000-00 ^④ STD</p> <p>3.00  CK ^⑤ 3.00  CR P 4.00  CK P</p> 	<p>14-458580-00 WH ^② B 150.00 C 258.00 D 164.10 E 10.12 F 1.10</p>  <p>14-450250-00 WH ^① ^③ B 150.00 C 258.00 D 164.10 E 10.12 F 1.10</p> 	<p>89-136000-00 87-136000-00 + 14-458580-00</p> <p>88-136000-20 87-136000-00 + 14-450250-00</p>
--	--	--	---

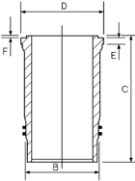
<p>87-136000-10 STD</p> <p>A 78.35 B- 16.50 BØ 92.80 D 119.35</p>  <p>52x102</p> <p>AK KK NB RT TP</p>  <p>13050E</p>	<p>08-136000-00 ^④ STD</p> <p>3.00  CK ^⑤ 3.00  CR P 4.00  CK P</p> 	<p>14-458580-00 WH ^② B 150.00 C 258.00 D 164.10 E 10.12 F 1.10</p> 	<p>89-136000-10 87-136000-10 + 14-458580-00</p>
---	--	--	--

^① Has different upper register design compared to 14-458580-00

^① Hat unterschiedliche obere Flanschausführung im Vergleich zu 14-458580-00

^① Profil inférieur de la colerette different de 14-45880-00

^① Tiene un registro superior diferente comparado al 14-45880-00

^① Profilo inferiore del colletto diverso da 14-45880-00

^② Rectangular water channel immediately below flange

^② Rechteckiger Wasserkanal unter dem Buchsenbund

^② Canal d'eau rectangulaire sous la bride

^② Canal de agua rectangular bajo la pestaña

^② Passaggio acqua rettangolare sotto flangia

^③ Round water channel 20mm below flange

^③ Runder Wasserkanal

^③ Canal d'eau rond

^③ Canal de agua redondo

^③ Passaggio acqua circolare

^④ OE 541 030 0424

^④ OE 541 030 0424

^④ OE 541 030 0424

^④ OE 541 030 0424

^④ OE 541 030 0424

^⑤ Steel

^⑤ Stahl

^⑤ Acier

^⑤ Acero

^⑤ Acciaio



56  **130.00**

OM 541.953 Euro 4/5 OM 501 LA	V6 Cyl.	18.5:1	11946cc	320kW (435PS)	Diesel Turbo Intercooled	TD28777
OM 541.959 Euro 4/5 OM 501 LA	V6 Cyl.	18.5:1	11946cc	300kW (408PS)	Diesel Turbo Intercooled	TD28778
OM 541.970 Euro 4 OM 501 LA	V6 Cyl.	17.75:1	11946cc	235kW (320PS)	Diesel Turbo Intercooled	TD19250
OM 541.971 Euro 4/5 OM 501 LA	V6 Cyl.	17.75:1	11946cc	235kW (320PS)	Diesel Turbo Intercooled	TD21001
OM 541.972 Euro 4 OM 501 LA	V6 Cyl.	17.75:1	11946cc	265kW (360PS)	Diesel Turbo Intercooled	TD19251
OM 541.973 Euro 4 OM 501 LA	V6 Cyl.	17.75:1	11946cc	265kW (360PS)	Diesel Turbo Intercooled	TD21022
OM 541.974 Euro 4 OM 501 LA	V6 Cyl.	17.75:1	11946cc	300kW (408PS)	Diesel Turbo Intercooled	TD18997
OM 541.975 Euro 4 OM 501 LA	V6 Cyl.	17.75:1	11946cc	300kW (408PS)	Diesel Turbo Intercooled	TD21023
OM 541.976 Euro 4 OM 501 LA	V6 Cyl.	17.75:1	11946cc	320kW (435PS)	Diesel Turbo Intercooled	TD19000
OM 541.977 Euro 4 OM 501 LA	V6 Cyl.	17.75:1	11946cc	320kW (435PS)	Diesel Turbo Intercooled	TD21024
OM 541.978 Euro 4 OM 501 LA	V6 Cyl.	17.75:1	11946cc	350kW (476PS)	Diesel Turbo Intercooled	TD21007
OM 541.979 Euro 4/5 OM 501 LA	V6 Cyl.	18.5:1	11946cc	350kW (476PS)	Diesel Turbo Intercooled	TD28783
OM 541.980 Euro 4 OM 501 LA	V6 Cyl.	17.75:1	11946cc	335kW (456PS)	Diesel Turbo Intercooled	TD21000
OM 541.981 Euro 4 OM 501 LA	V6 Cyl.	17.75:1	11946cc	335kW (456PS)	Diesel Turbo Intercooled	TD21003
OM 541.990 Euro 5 OM 501 LA	V6 Cyl.	17.75:1	11946cc	300kW (408PS)	Diesel Turbo Intercooled	TD23767
OM 541.992 Euro 5 OM 501 LA	V6 Cyl.	17.75:1	11946cc	320kW (435PS)	Diesel Turbo Intercooled	TD23768
OM 541.994 Euro 5 OM 501 LA	V6 Cyl.	17.75:1	11946cc	335kW (456PS)	Diesel Turbo Intercooled	TD23769
OM 541.996 Euro 5 OM 501 LA	V6 Cyl.	17.75:1	11946cc	235kW (320PS)	Diesel Turbo Intercooled	TD25486
OM 541.997 OM 501 LA	V6 Cyl.		11946cc	235kW (320PS)	Diesel Turbo Intercooled	TD25697
OM 541.998 Euro 5 OM 501 LA	V6 Cyl.	17.75:1	11946cc	265kW (360PS)	Diesel Turbo Intercooled	TD25487
OM 541.999 OM 501 LA	V6 Cyl.		11946cc	265kW (360PS)	Diesel Turbo Intercooled	TD25698
OM 542.960 Euro 5	V8 Cyl.	17.5:1	15928cc	375kW (510PS)	Diesel Turbo Intercooled	TD19999
OM 542.961 Euro 5	V8 Cyl.	18.5:1	15928cc	375kW (510PS)	Diesel Turbo Intercooled	TD21026
OM 542.962 Euro 5 OM 502 LA	V8 Cyl.	17.75:1	15928cc	405kW (551PS)	Diesel Turbo Intercooled	TD18840
OM 542.963 Euro 5 OM 502 LA	V8 Cyl.	17.75:1	15928cc	405kW (551PS)	Diesel Turbo Intercooled	TD21025
OM 542.964 Euro 5	V8 Cyl.	18.5:1	15928cc	440kW (598PS)	Diesel Turbo Intercooled	TD20000
OM 542.965	V8 Cyl.	18.5:1	15928cc	440kW (598PS)	Diesel Turbo Intercooled	TD25688
OM 542.966 Euro 5	V8 Cyl.	18.5:1	15928cc	350-370kW (476-503PS)	Diesel Turbo Intercooled	TD25103
OM 542.970 Euro 5	V8 Cyl.	18.5:1	15928cc	448kW (609PS)	Diesel Turbo Intercooled	TD28779



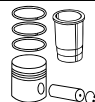
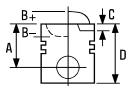

OM 542.971 Euro 5 V8 Cyl. 18.5:1 **15928cc 448kW (609PS)** Diesel Turbo Intercooled **TD28780**

OM 542.972 Euro 5 V8 Cyl. 18.5:1 **15928cc 405-480kW (551-653PS)** Diesel Turbo Intercooled **TD28781**



87-420900-00 STD

08-420900-00 ¹ STD

14-450790-00 WH B 151.20 C 258.00 D 164.10 E 10.12 F 1.10

88-420900-00

A 78.55
B- 17.60
BØ 87.00
D 119.55
 52x102

3.00  GDC ⁴
3.00  CR P
4.00  GDC P

15-451220-00 WH ² ³ B 151.20 C 258.00 D 164.10 E 10.12 F 1.10

87-420900-00 +
14-450790-00

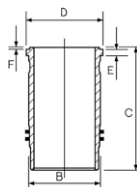

89-420900-30 ²
87-420900-00 +
15-451220-00

AK KK NB RT TP

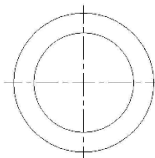
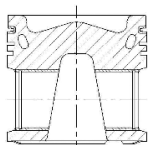

13065D203



87-420900-10 STD

08-420900-00 ¹ STD

14-450790-00 WH B 151.20 C 258.00 D 164.10 E 10.12 F 1.10

88-420900-10

A 78.35
B- 17.60
BØ 87.00
D 119.35
 52x102

3.00  GDC ⁴
3.00  CR P
4.00  GDC P

15-451220-00 WH ² ³ B 151.20 C 258.00 D 164.10 E 10.12 F 1.10

87-420900-10 +
14-450790-00

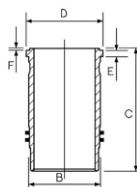

89-420900-40 ²
87-420900-10 +
15-451220-00

AK KK NB RT TP

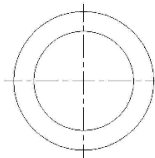
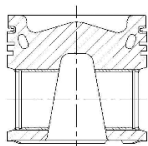

13065D203

¹ OE 541 030 0624

¹ OE 541 030 0624

¹ OE 541 030 0624

¹ OE 541 030 0624

¹ OE 541 030 0624

² Includes Scraper ring 13-451220-00, also available separately

² Enthält Ölschlitzring 13-451070-00, auch einzeln erhältlich

² Contient le segment racleur 13-451220-00 (disponible également séparément)

² Incluye el segmento rascador 13-451220-00, también disponible por separado

² Include anello Raschiaolio 13-451220-00, disponibili anche separatamente

³ Includes seals

³ Schließt Dichtungen ein

³ Inclut des joints

³ Incluye los sellos

³ Comprende le guarnizioni

⁴ Steel

⁴ Stahl

⁴ Acier

⁴ Acero

⁴ Acciaio

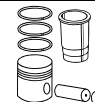
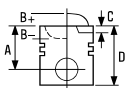

57 130.00

OM 541.991 OM 501 LA V6 Cyl. 17.75:1 **11946cc 300kW (408PS)** Diesel Turbo Intercooled **TD25686**

OM 941.991 OM 501 LA V6 Cyl. 17.25:1 **11946cc 260-315kW (354-428PS)** Diesel Turbo Intercooled **TD28855**

87-420900-50 ¹ STD

A 78.55
B- 14.97
BØ 110.00
D 119.55
 52x102

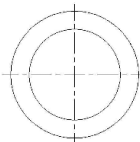
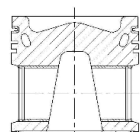

AK KK NB RT TP



13065D302

- ¹ OE 541 030 4417
- ² OE 541 030 0624
- ³ OE 541 030 4237
- ⁴ Includes seals
- ⁵ Steel
- ⁶ Includes Scraper ring 13-451220-00, also available separately

08-420900-00 ² STD

3.00  GDC ⁵
 3.00  CR P
 4.00  GDC P



- ¹ OE 541 030 4417
- ² OE 541 030 0624
- ³ OE 541 030 4237
- ⁴ Schließt Dichtungen ein
- ⁵ Stahl
- ⁶ Enthält Ölschlitzring 13-451070-00, auch einzeln erhältlich

15-451220-00 ³ ⁴ ⁶ **B 151.20 C 258.00 D 164.10 E 10.12 F 1.10**

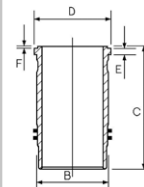

- ¹ OE 541 030 4417
- ² OE 541 030 0624
- ³ OE 541 030 4237
- ⁴ Inclut des joints
- ⁵ Acier
- ⁶ Contient le segment racleur 13-451220-00 (disponible également séparément)

- ¹ OE 541 030 4417
- ² OE 541 030 0624
- ³ OE 541 030 4237
- ⁴ Incluye los sellos
- ⁵ Acero
- ⁶ Incluye el segmento rascador 13-451220-00, también disponible por separado

89-420900-50
 87-420900-50 +
 15-451220-00

- ¹ OE 541 030 4417
- ² OE 541 030 0624
- ³ OE 541 030 4237
- ⁴ Comprende le guarnizioni
- ⁵ Acciaio
- ⁶ Include anello Raschiaolio 13-451220-00, disponibili anche separatamente

58 132.00

OM 471.900 Euro 6 OM 471 LA 6 Cyl. 17:1 **12800cc 310-375kW (422-510PS)** Diesel Turbo Intercooled **TD25519**

OM 471.902 OM 471 LA 6 Cyl. 17:1 **12809cc 315-375kW (428-510PS)** Diesel Turbo Intercooled **TD28759**

OM 471.906 Euro 6 OM 471 LA 6 Cyl. 17:1 **12809cc 310-375kW (422-510PS)** Diesel Turbo Intercooled **TD29331**

OM 471.909 Euro 5 OM 471 LA 6 Cyl. 17:1 **12809cc 310-375kW (422-510PS)** Diesel Turbo Intercooled **TD28082**

87-440600-00 ¹ STD

A 75.00
B- 17.20
BØ 94.00
D 113.00
 55x82

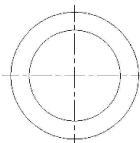
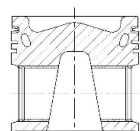

AK KK TP



P5834F75

- ¹ MonoSteel ®
- ² Steel

08-440600-00 STD

3.50  GDC ²
 2.50  CR P
 3.50  GDC P







- ¹ MonoSteel ®
- ² Stahl

- ¹ MonoSteel ®
- ² Acier

- ¹ MonoSteel ®
- ² Acero



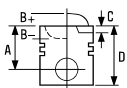

- ¹ MonoSteel ®
- ² Acciaio

		ccm	x 		
14 K4F	Petrol	1396	4	75.00	4
16 K4F K Series	Petrol	1589	4	80.00	5
18 K4F K Series	Petrol	1796	4	80.00	5
18 K4K (VVC)	Petrol	1796	4	80.00	6
20 T2N	Diesel	1994	4	84.50	10
25 K4F	Petrol	2497	V6	80.00	7
A+ Series	Petrol	1275	4	70.62	2
A Series	Petrol	1275	4	70.62	1
A Series 1275cc Overbored To 1380cc	Petrol	1380	4	73.50	3
B Series	Petrol	1798	4	80.25	8
C Series	Petrol	2912	6	83.32	9



1  **70.62**



Mk II 1300 Midget Mk II	01/68→12/72 01/67→12/73	A Series	4 Cyl. 1275cc	8.8:1	FM1176
----------------------------	----------------------------	-----------------	-------------------------	-------	---------------

87-521700-00 	STD
87-521707-00 	.020
87-521711-00 	.040
87-521714-00 	.060

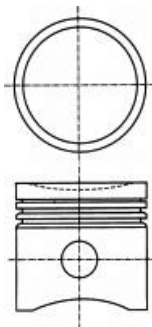
A	37.24
B-	5.74
D	57.24
	21x56





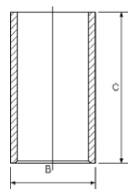

08-521700-00	STD
08-521707-00	.020
08-521711-00	.040
08-521714-00	.060

1.48		P
1.48		P
4.00		P

14-010890-00 D **B 73.09 C 141.28**





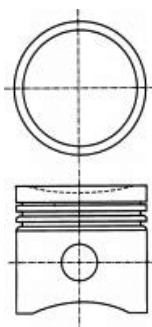

87-524100-00 	STD
87-524107-00 	.020
87-524111-00 	.040
87-524114-00 	.060

A	38.74
B-	5.74
D	58.74
	21x56





08-524100-00	STD
08-524107-00	.020
08-524111-00	.040
08-524114-00	.060

1.50		NT
1.50		P
3.00		P

 Pistons to be replaced in Engine Sets only

 Kolben nur Motorsätzen zu ersetzen

 Piston à remplacer dans jeu moteur





 Pistones de repuesto para juegos de motores solamente

 Il pistone può essere rimpiazzato solamente completo



2  **70.62**

MG Metro 1300 01/82→12/87 **A+ Series** 4 Cyl. 10:1
1275cc **FM2934**



87-524100-00  STD
87-524107-00  .020
87-524111-00  .040
87-524114-00  .060

08-524100-00 STD
08-524107-00 .020
08-524111-00 .040
08-524114-00 .060

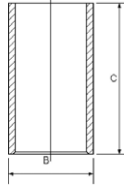
14-010890-00 D B 73.09 C 141.28



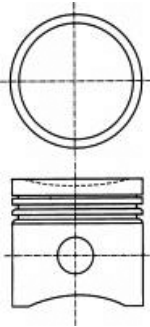

A 38.74
B- 5.74
D 58.74
 21x56

1.50  NT
 1.50  P
 3.00  P



 Pistons to be replaced in Engine Sets only

 Kolben nur Motorsätzen zu ersetzen

 Piston à remplacer dans jeu moteur

 Pistones de repuesto para juegos de motores solamente

 Il pistone può essere rimpiazzato solamente completo



3  **73.50**

Midget Mk III 01/67→12/73 **A Series 1275cc Overbored To 1380cc** 4 Cyl. 9.6:1
1380cc **FM1180**

87-526600-00 STD

08-526600-00 STD

A 37.78
B- 6.21
D 58.36
 21x64

1.50  CR P
 1.50  P
 4.00  CR P

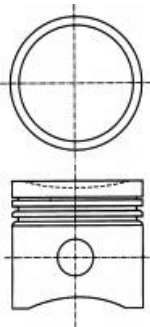



4 **75.00**

Express 1.4 MG ZR 105	03/03→05/05 06/01→04/05	14 K4F	4 Cyl. 1396cc	9.5:1 76kW (103PS)	TD18866
--	----------------------------	---------------	-------------------------	------------------------------	----------------

<p>87-520500-00 STD</p> <p>01/95→</p> <p>A 23.84 D 46.79 18x48</p> <p> Steel</p>	<p>08-520500-00 STD</p> <p>1.00 1.20 2.00 NT </p> <p> Stahl</p>	<p>14-710030-00 WH B 84.10 C 129.50 D 87.50 E 50.00</p> <p> Acero</p>	<p>88-520500-00 87-520500-00 + 14-710030-00</p> <p> Acciaio</p>
--	--	---	--

5 **80.00**

MGF 1.6 MG TF 115 MG ZS 1.6	02/00→03/02 03/02→12/09 11/01→10/05	16 K4F K Series	4 Cyl. 1589cc	10.5:1 79-86kW (107-117PS)	TD17597
--	---	------------------------	-------------------------	--------------------------------------	----------------

Express 1.8 MGF 1.8 i 16V MG TF 120, MG TF 135 MG ZR 120 MG ZS 120 MG ZT 1.8 16V, MG ZT- T 1.8 16V	03/03→05/05 03/95→03/02 03/02→12/09 06/01→04/05 07/01→10/05 01/03→07/05	18 K4F K Series	4 Cyl. 1796cc	10.5:1 86-100kW (117-136PS)	TD18234
---	--	------------------------	-------------------------	---------------------------------------	----------------

<p>87-522700-00 STD</p> <p>A 22.70 B- 0.53 BØ 68.20 C 2.65 D 45.65 18x53</p> <p>TP</p> <p> Steel</p>	<p>08-522700-00 STD</p> <p>1.00 1.20 2.00 CR </p> <p> Stahl</p>	<p>14-710020-00 WH B 84.10 C 129.50 D 87.50 E 50.00</p> <p> Acero</p>	<p>88-522700-00 87-522700-00 + 14-710020-00</p> <p> Acciaio</p>
---	--	---	--

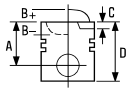

6 **80.00**

Express 160	03/03→05/05	18 K4K (VVC)		
MGF 1.8 i VVC	03/95→03/02		4 Cyl.	10.5:1
MG TF 160	03/02→12/09		1796cc	107-118kW (146-160PS)
MG ZR 160	06/01→04/05			TD18235

87-522700-10 STD

- A** 22.70
- B-** 0.53
- BØ** 68.00
- C** 1.00
- D** 45.65
- 18x53

TP

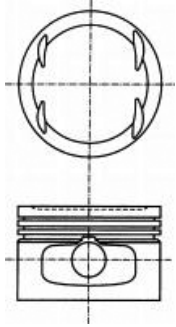

Steel

08-522700-00 STD

- 1.00 CR
- 1.20 P
- 2.00 CR

Stahl

14-710020-00 WH B 84.10 C 129.50 D 87.50 E 50.00



Acier

Acero

Acciaio

7 **80.00**

MG ZS 180	07/01→10/05	25 K4F		
MG ZT 160	06/01→07/05		V6 Cyl.	10.5:1
MG ZT 180	01/03→07/05		2497cc	118-140kW (160-190PS)
MG ZT 190	06/01→07/05			TD18236
MG ZT- T 160	10/01→07/05			
MG ZT- T 180	01/03→07/05			
MG ZT- T 190	10/01→07/05			

87-521600-00 STD

- A** 27.35
- C** 1.20
- D** 50.30
- 18x53

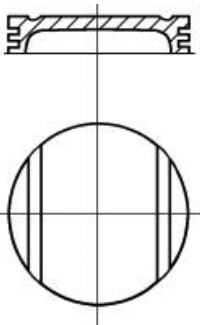

Steel

08-521600-00 STD

- 1.20 CR
- 1.50
- 2.50 CR

Stahl

14-710020-00 WH B 84.10 C 129.50 D 87.50 E 50.00



Acier

Acero

Acciaio



8  **80.25**







MGB, MGB GT

01/63→12/80 **B Series**





4 Cyl.
1798cc

8.75:1





FM1184

- 87-521907-00   .020
- 87-521911-00   .040
- 87-521914-00   .060

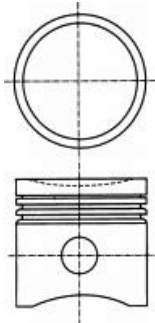
A 42.11
B- 3.76
D 61.06
 21x57



- 1.58 
- 1.58 
- 1.58 
- 3.96 





- 87-525900-00  STD
- 87-525907-00  .020
- 87-525909-00  .030
- 87-525911-00  .040
- 87-525914-00  .060

A 42.16
B- 3.76
BØ 64.50
D 61.11
 21x57

- 08-525900-00 STD
- 08-525907-00 .020
- 08-525909-00 .030
- 08-525911-00 .040
- 08-525914-00 .060

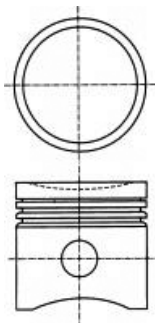
- 1.59  P
- 1.59  P
- 4.00  P





 Piston pin press fit in conrod

 Kolbenbolzen in Pleuel eingepreßt

 Axe serré sur bielle

 Bulón del pistón montado a presión en la biela

 Spinotto inserito a spinta nella biella

 Short skirt design

 Kurzschaftausführung

 A jupe courte

 Diseno de falda corta

 A mantello corto

 Pin retained by circlips

 Bolzen mit Sicherungsbügeln gehalten

 Axe retenu par circlips







 Bulón retenido por anillos de retención

 Spinotto trattenuto da fermi







9  **83.32**





MGC, MGC GT	01/68 → 12/70	C Series	6 Cyl.	9:1	
					FM1186

87-530100-00 	STD	08-530100-00 	STD
87-530107-00 	.020	08-530107-00 	.020
87-530109-00 	.030	08-530109-00 	.030

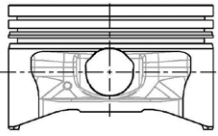
A	47.73
D	87.31
	22x72



1.98		P
1.98		P
1.98		P
4.74		P
4.76		P







 Pistons to be replaced in Engine Sets only  Kolben nur Motorsätzen zu ersetzen  Piston à remplacer dans jeu moteur  Pistones de repuesto para juegos de motores solamente  Il pistone può essere rimpiazzato solamente completo

10  **84.50**

Express 2.0 TD	03/03 → 05/05	20 T2N			
MG ZR 2.0 TD	06/01 → 04/05		4 Cyl.	19.5:1	
MG ZS 2.0 TD	01/04 → 10/05		1994cc	74-83kW (101-113PS)	
			Diesel	Turbo Intercooled	TD24113





87-119800-00	STD	08-119800-00 	STD
87-119807-00	0.50mm	08-119807-00 	0.50mm

A	47.97
B-	17.00
BØ	38.00
D	76.97
	30x70

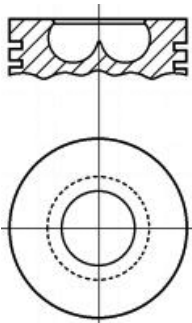
→10P13888B		
3.00		PS
2.00		P
3.00		CR

AK RT TP







 15 degree Wedge Top Ring  15-Grad Keiloberring  Segment trapézoïdal angle 15 de grés.  Anillo superior en cuña de 15 grados  Segmento trapezio con inclinazione fianchi = 15







1  **64.60**

Mini 1000	10/67→09/84	99 H			
Mini 1000 Mayfair	08/82→06/93		4 Cyl.	999cc	29-33kW (39-45PS)
					TD26960





87-522400-00 	STD	08-522400-00	STD
87-522407-00 	.020	08-522407-00	.020
87-522411-00 	.040	08-522411-00	.040
87-522414-00 	.060	08-522414-00	.060

A 34.09
 B- 4.93
 D 65.77
 16x56

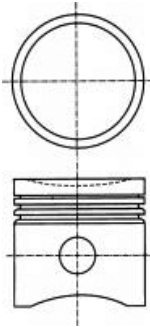
01/80→12/85

1.58		P
1.58		P
1.58		P
4.00		CR P









 Pin retained by circlips  Bolzen mit Sicherungsbügeln gehalten  Axe retenu par circlips  Bulón retenido por anillos de retención  Spinotto trattenuto da fermi

2  **73.00**

Mini One D	06/03→09/06	1ND			
			4 Cyl.	1364cc	55kW (75PS)
			Diesel	Direct Injection	
					TD18565
Mini One D	06/03→09/06	1ND-TV			
			4 Cyl.	1364cc	17.5:1
			Diesel	Turbo Intercooled	55-65kW (75-88PS)
					TD22098





87-898407-02	0.50mm	08-898407-00	0.50mm
--------------	--------	--------------	--------

A 41.94
 B- 14.70
 BØ 36.50
 C 0.90
 C 0.90
 D 64.35
 27x59

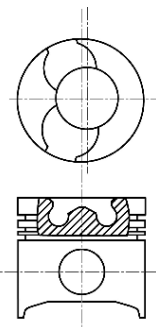
1.50		NT 
1.50		CR P
3.00		NT 

KK RT



 Steel  Stahl  Acier  Acero  Acciaio

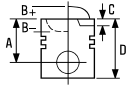

3  **75.00**

Mini Clubman Cooper D	10/07→02/10	9HZ (DV6TED4)		
Mini Cooper D	11/06→09/10	4 Cyl.	17.5:1	
Mini One D	06/09→07/10	1560cc	66-80kW (90-109PS)	
		Diesel	Turbo Intercooled	TD20982

87-424000-00	STD	08-424000-00	STD	14-020900-00 D	B 78.00 C 142.00 D 79.50 F 5.00
87-424008-00	0.60mm	08-424007-00	0.50mm		
		08-424008-00	0.60mm		

A	41.70
B-	13.25
BØ	41.80
C	1.20
D	65.30
	26x61

3.00		CK P
1.95		P
2.50		CR P

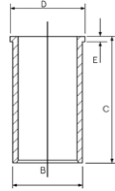



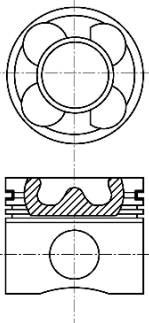

AK KK RT TP



4  **77.00**

Mini One	01/06→	W10B16A		
Mini Cooper	01/06→	4 Cyl.		
		1598cc	66-85kW (90-116PS)	
				TD18563

87-433500-00	STD	08-433500-00	STD
87-433505-00	0.25mm	08-433505-00	0.25mm
87-433507-00	0.50mm	08-433507-00	0.50mm

A	24.90	1.20		NT 1
D	45.05	1.20		P
	19x54	2.50		CR 1

TP

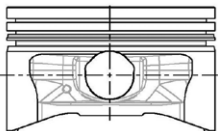





1 Steel

1 Stahl

1 Acier

1 Acero

1 Acciaio



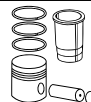
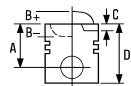

		ccm	x 		9
4D30	Diesel	3297	4	100.00	12
4D31	Diesel	3298	4	100.00	12
4D31T	Diesel	3298	4	100.00	12
4D34-1ATA Euro 2	Diesel	3908	4	104.00	13
4D34-OA (new type)	Diesel	3907	4	104.00	14
4D34-T	Diesel	3907	4	104.00	14
4 D 55	Diesel	2347	4	91.10	5
4 D 55 T	Diesel	2346	4	91.10	6
4 D 56 (8V)	Diesel	2477	4	91.10	8
4 D 56 (12V) Euro 3	Diesel	2476	4	91.10	7
4 D 56 HP	Diesel	2477	4	91.10	9
4 D 56 T	Diesel	2476	4	91.10	6
4 D 56 TD	Diesel	2477	4	91.10	10
4HK	Diesel	2179	4	85.00	4
4HN	Diesel	2179	4	85.00	4
4P10-T2 (F1C) Euro 5	Diesel	2998	4	95.80	11
4P10-T6 (F1C) Euro 5	Diesel	2998	4	95.80	11
BKD	Diesel	1968	4	81.00	2
F8Q 784	Diesel	1870	4	80.00	1
OM 639.939 Euro 4	Diesel	1493	3	83.00	3



1 80.00

Carisma 1.9 D	05/96 → 06/00	F8Q 784	4 Cyl.	20.5:1
			1870cc	66-70kW (90-95PS)
		Diesel	Turbo	TD22343

87-103500-00	STD	08-103500-00	STD
87-103507-00	0.50mm	08-103507-00	0.50mm

A	41.71	2.50		CK P
B-	0.70	2.00		NT
D	66.69	3.00		CR P
	26x67			



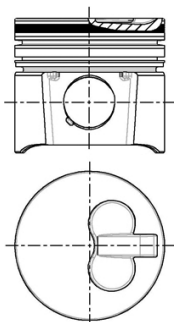

AK KK RT



2 81.00

Lancer 2.0 DI-D	01/08 →	BKD	4 Cyl.	18:1
			1968cc	103kW (140PS)
		Diesel	Turbo Intercooled	TD22162

87-139500-00 ¹	STD	08-139500-00	STD
87-139507-00 ²	0.50mm	08-139507-00	0.50mm

A	45.83	1.75		CK P
B-	17.80	2.00		P
BØ	38.00	3.00		CR P
D	68.80			
	26x66			

AK KK NB RT TP

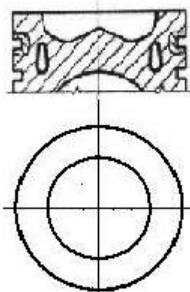

07901J

¹ Piston Chamber Volume

[ccm] 23.75

² A = 45.550, D = 68.550

¹ Volumen der Kolbenmulde

[ccm] 23.75

² A = 45.550, D = 68.550

¹ Volume de la cavité du piston

[cm³] 23.75

² A = 45.550, D = 68.550

¹ Volumen de cavidad del pistón

[cc] 23.75

² A = 45.550, D = 68.550

¹ Volume camera pistone

[cm³] 23.75



² A = 45.550, D = 68.550



3  **83.00**

Colt VI 1.5 DI-D 08/04→06/12 **OM 639.939 Euro 4**
 3 Cyl. 18:1
 1493cc **50-70kW (58-95PS)**
 Diesel Turbo **TD27273**

87-427500-00 STD **08-427500-00** STD
87-427507-00 0.50mm **08-427507-00** 0.50mm

A 45.65 2.00  CK
B- 14.65 2.00  P
BØ 43.40 2.00  CR P

C 1.18
C 1.02
D 71.65
 30x66



AK KK RT

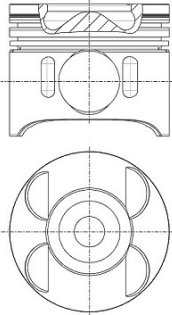



8340A







4  **85.00**

Outlander II 2.2 DI-D 4WD	08/07→11/12	4HK	4 Cyl.	16.6:1	
			2179cc	115kW (156PS)	
		Diesel	Turbo Intercooled		TD24800
Outlander II 2.2 DI-D 4WD	08/07→11/12	4HN	4 Cyl.	16.6:1	
			2179cc	115kW (156PS)	
		Diesel	Turbo Intercooled		TD24440

87-436700-10  STD
87-436708-10  0.60mm

08-436700-00 STD
08-436708-00 0.60mm

A 48.70
B- 13.47
BØ 52.40
C 0.38
D 74.70
 30x68

2.50  GDC P
 2.00  P
 2.00  CK



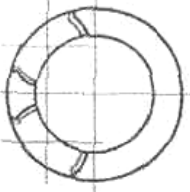
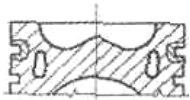

AK KK RT TP





0850HA127

 For pistons with a 24.3mm con rod gap measured at pin centre line

 Für Kolben mit einem Pleuelaugenabstand von 24,3 MM, gemessen an der Kolbenbolzen-Mitte

 Pour pistons avec un écart de bielle de 24,3 mm mesuré au centre de l'axe bielle-piston

 Para pistones con una distancia de paso de biela en el centro del bulón de 24,3mm

 Per pistoni con passaggio biella di 24,3 mm misurato sull' asse foro spinotto



5 91.10

L 200 2.3 D	10/82→08/84	4 D 55		
L 200 2.3 D 4WD	10/82→10/86		4 Cyl.	21:1
L 300 2.3 D	04/83→10/86		2347cc	48-62kW (65-84PS)
Pajero I 2.3 D	10/84→09/86	Diesel		TD5331

87-288000-00 STD
87-288007-00 0.50mm



08-288000-10 STD
08-288007-10 0.50mm

14-020600-00 DH B 94.64 C 165.10 D 96.91 E 5.06

01/86→

01/86→12/00

- A** 48.70
- B-** 3.10
- C** 2.30
- C** 2.30
- D** 88.70
-  29x75

- 2.50  CK P
- 2.00  CR
- 4.00  CR

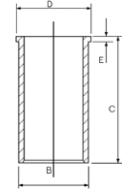

14-015590-00 D B 94.13 C 164.50

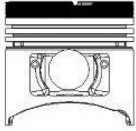
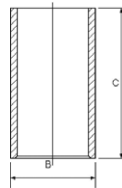



6 91.10

Galant II 2.3 Turbo-D	09/80→05/84	4 D 55 T			
Pajero I Canvas Top 2.3 TD	12/82→04/86		4 Cyl.	21:1	
			2346cc	62-70kW (84-95PS)	
		Diesel	Turbo		TD2292
L 200 2.5 Di-D	01/04→	4 D 56 T			
L 200 2.5 TD	09/90→11/05		4 Cyl.	22:1	
L 200 2.5 TD 4WD	11/92→12/07		2476cc	62-110kW (84-150PS)	
L 300 2.5 TD	02/87→05/03	Diesel	Turbo Intercooled		TD4682
L 300 2.5 TD 4WD	11/88→				
L 400 2500 TD, L 400 2500 TD 4WD	09/96→06/05				
L 400/SPACE GEAR 2500 TD	05/95→06/05				
Pajero Classic 2.5 TD	07/02→				
Pajero I 2.5 TD	11/89→12/91				
Pajero I 2.5 TD 4WD	10/86→05/91				
Pajero I Canvas Top 2.5 TD	05/86→11/90				
Pajero II 2.5 TDiC	03/91→08/99				
Pajero II Canvas Top 2.5 TDiC					
Pajero III 2.5 TDi	04/00→12/06				
Pajero III Open Off-Road Vehicle 2.5 TDi					
Pajero Sport 2.5 D	04/05→				
Pajero Sport 2.5 TD	11/98→				
Pajero Sport 2.5 TD 4WD	11/97→10/98				
Pajero Sport II 2.5 TD	09/08→				

87-287100-30

STD

08-287100-00

STD

14-020600-00 *DH*

B 94.64 C 165.10 D 96.91 E 5.06

87-287107-30

0.50mm

08-287107-00

0.50mm

A 48.70

B- 3.10

C 2.30

D 88.70

 29x75

2.50

2.00

4.00



MO P

CR P

CR P

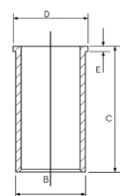

RT

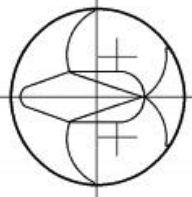
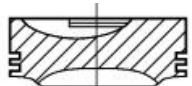

14-015590-00 *D*

B 94.13 C 164.50

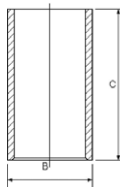



7 91.10

Canter 2.5 D	09/92→09/96	4 D 56 (12V) Euro 3		
Freeca 2.5 D	06/98→	4 Cyl.	21:1	
L 200 2.5 D	10/86→12/07	2476cc	51-85kW (69-116PS)	
L 200 2.5 D 4WD	12/86→10/96	Diesel		TD8288
L 200 2.5 TD 4WD	07/97→12/03			
L 300 2.5 D	11/86→			

14-020600-00 DH B 94.64 C 165.10 D 96.91 E 5.06

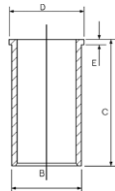

14-015590-00 D B 94.13 C 164.50

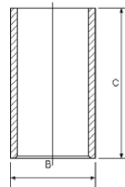

8 91.10

Canter 2.5 D	09/92→09/96	4 D 56 (8V)		
Freeca 2.5 D	06/98→	4 Cyl.	21:1	
L 200 2.5 D	10/86→12/07	2477cc	51-64kW (69-87PS)	
L 200 2.5 D 4WD	12/86→10/96	Diesel		TD2293
L 200 2.5 TD 4WD	07/97→12/03			
L 300 2.5 D	11/86→			

87-288000-10 STD
87-288007-10 0.50mm

08-288000-10 STD
08-288007-10 0.50mm

14-020600-00 DH B 94.64 C 165.10 D 96.91 E 5.06

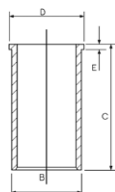

01/98→

01/86→12/00

A 48.70
B- 0.20
D 88.70
 29x75

2.50 CK P
 2.00 CR
 4.00 CR

14-015590-00 D B 94.13 C 164.50

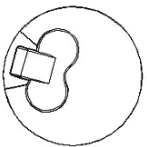
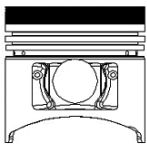
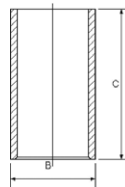







9 91.10

L 200 2.5 DiD	11/05→	4 D 56 HP		
L 200 2.5 DI-D	08/07→		4 Cyl.	16.5:1
L 200 2.5 DI-D 4WD	11/05→		2477cc	94-131kW (128-178PS)
Pajero Sport II 2.5 CRTD		Diesel	Turbo Intercooled	TD24055
Pajero Sport II 2.5 CRTD 4WD	09/08→			
Pajero Sport II 2.5 DI-D				
Pajero Sport II 2.5 DI-D 4WD	07/08→			
Pajero Sport III 2.5 Di-D	08/15→			



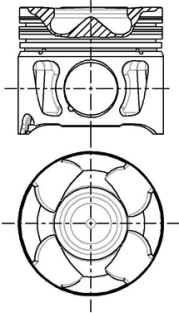

87-443500-00 ¹	STD	08-443500-00	STD
87-443507-00 ¹	0.50mm	08-443507-00	0.50mm

A	48.25	2.55	 NT ³
B-	18.90	2.05	 CR
BØ	44.00	4.00	 NT ³
C	2.00		
C	2.50		
D	78.25		
	32x75		

AK KK RT TP



87-443500-10 ²	STD	08-443500-00	STD
87-443507-10 ²	0.50mm	08-443507-00	0.50mm

A	48.25	2.55	 NT ³
B-	18.90	2.05	 CR
BØ	44.00	4.00	 NT ³
C	2.00		
C	2.50		
D	78.25		
	32x75		

AK KK RT TP

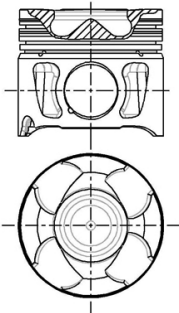

- ¹ To cylinder 1 & 2
- ² To cylinder 3 & 4
- ³ Steel

- ¹ zum Zylinder 1 & 2
- ² zum Zylinder 3 & 4
- ³ Stahl

- ¹ sous cylindre 1 & 2
- ² sous cylindre 3 & 4
- ³ Acier

- ¹ A cilindro 1 & 2
- ² A cilindro 3 & 4
- ³ Acero

- ¹ al cilindro 1 & 2
- ² al cilindro 3 & 4
- ³ Acciaio

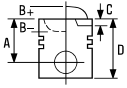

10 91.10

L 200 2.5 TD 4WD	06/96→12/07	4 D 56 TD		
L 300 2.5 TD	09/94→		4 Cyl.	21:1
L 400/SPACE GEAR 2.5 TD			2477cc	73kW (99PS)
L 400/SPACE GEAR 2.5 TD 4WD	05/95→05/00	Diesel	Turbo Intercooled	TD2294
Pajero II 2.5 TD 4WD	12/90→10/99			
Pajero II Canvas Top 2.5 TD 4WD	12/90→04/00			

87-287100-00 STD

- A 48.70
- B- 2.61
- D 88.70
- 29x75

AK KK RT

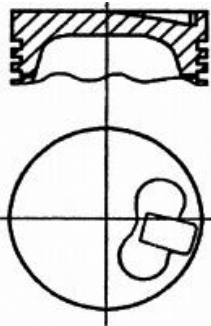

08-287100-00 STD
08-287107-00 0.50mm

- 2.50 MO P
- 2.00 CR P
- 4.00 CR P

14-020600-00 DH B 94.64 C 165.10 D 96.91 E 5.06

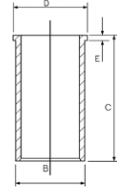

14-015590-00 D B 94.13 C 164.50

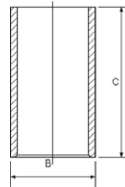

87-287100-10 STD
87-287107-10 0.50mm

- A 48.70
- B- 2.61
- D 88.70
- 29x75

AK KK RT

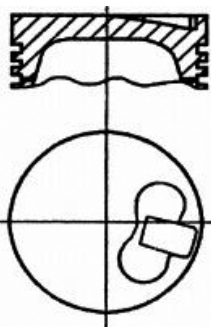

08-287100-00 STD
08-287107-00 0.50mm

- 2.50 MO P
- 2.00 CR P
- 4.00 CR P

- To cylinder 1 & 3
- To cylinder 2 & 4

- zum Zylinder 1 & 3
- zum Zylinder 2 & 4

- sous cylindre 1 & 3
- sous cylindre 2 & 4





- A cilindro 1 & 3
- A cilindro 2 & 4

- al cilindro 1 & 3
- al cilindro 2 & 4



11 95.80

Canter 3.0 D	07/09 →	4P10-T2 (F1C) Euro 5	4 Cyl.	17.5:1	
			2998cc	96kW (131PS)	
		Diesel	Turbo Intercooled		TD27035
Canter 3.0 D	08/05 →	4P10-T6 (F1C) Euro 5	4 Cyl.		
			2998cc	129kW (175PS)	
		Diesel	Turbo Intercooled		TD27057

87-421600-00	STD	08-421600-00	STD
A	63.00	2.50	 CK P
B-	16.00	2.00	 P
BØ	50.50	2.50	 CR P
D	93.50		
	36x80		

AK KK RT TP

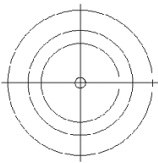
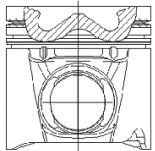

12 100.00

Canter/Rosa 3.3 D	11/79 →	4D30	4 Cyl.	19.5:1	
			3297cc	64kW (87PS)	
		Diesel			TD8268
Canter 3.3 D	08/82 →	4D31	4 Cyl.	17.5:1	
			3298cc	71kW (96PS)	
		Diesel			TD8293
Canter	07/86 →	4D31T	4 Cyl.	16:1	
			3298cc	86kW (117PS)	
		Diesel	Turbo		TD8269

14-010970-00 D B 104.00 C 196.50

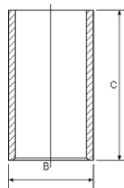







13  **104.00**

Canter 3.9 D	04/06 →	4D34-1ATA Euro 2		
Canter 3.9 TDi	10/96 → 11/10	4 Cyl.	18.5:1	
		3908cc	100-114kW (136-155PS)	
		Diesel	Turbo Intercooled	TD16262

87-288300-10	STD	08-288300-00	STD
87-288307-10	0.50mm	08-288307-00	0.50mm

A	62.20	3.00	 CR P
B-	23.00	2.00	 CR P
BØ	49.00	4.00	 CR P
D	112.20		
 36x88			

AK KK RT

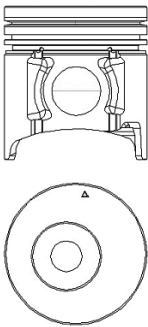

14  **104.00**

Canter	4D34-OA (new type)		
	4 Cyl.		
	3907cc		
	Diesel		FM26447

Canter 3.9 TD	4D34-T		
	4 Cyl.		
	3907cc	90kW (122PS)	
	Diesel	Turbo Intercooled	TD20188

14-015400-00 D B 108.01 C 197.40

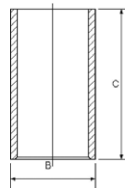



1  **105.00**

D 226-2	2 Cyl.	18:1	2080cc	27-30kW (37-41PS)	Diesel	TD18060
D 226-3	3 Cyl.	18:1	3120cc	33-44kW (45-60PS)	Diesel	TD18061
D 226-4	4 Cyl.	18:1	4160cc	44-64kW (60-87PS)	Diesel	TD6993
D 226-6	6 Cyl.	18:1	6234cc	66-96kW (90-131PS)	Diesel	TD18062





87-279600-10

STD





08-279600-00

STD

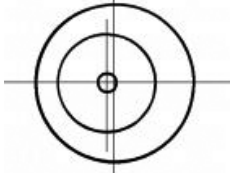
- A 60.40
- B- 20.00
- BØ 62.00
- D 113.40
-  35x82

- 3.00  CR P
- 2.00  CR P
- 2.00  CR P
- 4.00  CR P









		ccm	x 		
605D/610D	Diesel	1901	4	82.00	1
614.010/614.010	Diesel	1134	2	85.00	2
615.000	Diesel	2270	4	85.00	2
8025.01	Diesel	1559	2	95.00	3
8025.02	Diesel	1728	2	100.00	4
8035.01 / 8035.01.265	Diesel	2338	3	95.00	3
8035.02	Diesel	2592	3	100.00	4
8035.04	Diesel	2748	3	103.00	6
8035.05	Diesel	2930	3	104.00	9
8035.06	Diesel	2708	3	100.00	5
8045.01	Diesel	3119	4	95.00	3
8045.02	Diesel	3455	4	100.00	4
8045.04	Diesel	3666	4	103.00	6
8045.05	Diesel	3908	4	104.00	9
8045.06	Diesel	3613	4	100.00	5
8045.25	Diesel	3908	4	104.00	10
8055.04	Diesel	4583	5	103.00	6
8055.05	Diesel	4882	5	104.00	9
8061.05	Diesel	5419	6	104.00	11
8061 L/8061L	Diesel	5499	6	103.00	7
8065.02	Diesel	5184	6	100.00	4
8065.04	Diesel	5499	6	103.00	8
8065.05	Diesel	5861	6	104.00	9
8065.06	Diesel	5420	6	100.00	5
8065.24	Diesel	5499	6	103.00	7
8065.25	Diesel	5863	6	104.00	10
8210.02	Diesel	13798	6	137.00	22
8215.22/8215.22.520	Diesel	13798	6	137.00	23
8365.05.500	Diesel	8102	6	115.00	18
8365.05.590	Diesel	8102	6	115.00	18
8365.25.500/502	Diesel	8102	6	115.00	19
8365.25.501/503/533/8365.25.503	Diesel	8102	6	115.00	19
8365.25.590	Diesel	8102	6	115.00	18
8460.21/8460.21.002/8460.21.042/8460.21.102/ 8460.21.106/8460	Diesel	9500	6	120.00	21
C03/20/21/41	Diesel	4562	4	110.00	13
C03/C03	Diesel	4941	4	110.00	14
CN3/CN3	Diesel	3706	3	110.00	14
CO2D/CO3D/CO20/60/CO130	Diesel	4397	4	108.00	12
CO3-130T/CO3-130T	Diesel	5401	4	115.00	20
CP 3/100	Diesel	7412	6	110.00	14
Genesis 5640	Diesel	4400	4	111.77	15
Genesis 6640	Diesel	5000	4	111.77	16
Genesis 7740	Diesel	5000	4	111.77	17
Genesis 7840	Diesel	6600	6	111.77	15
Genesis 8240, 8340	Diesel	7500	6	111.77	16

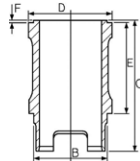

1 82.00

605D/610D 4 Cyl. 20:1 **1901cc** **40kW (54PS)** **Diesel** **FM9243**

2	STD	3		1	B 89.00 C 164.80 D 95.00 E 99.60 F 0.80	88-530300-00
A	47.00	3.00		CR		
B-	3.80	3.00				
D	100.00	3.00				
	26x72	5.50				
		5.00				

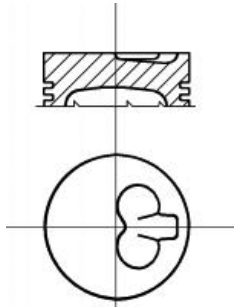

1 Liner available in Kit Set only

2 Piston available in Kit Set only

3 Ringset available in Kitset only

1 Zylinderlaufbüchse nur in Assembles verfügbar

2 Kolben nur im Assembly erhältlich

3 Ringsätze nur im Assembly erhältlich

1 Chemise disponible en kit seulement

2 Piston disponible en kit seulement

3 Jeux de segments disponible en kit seulement

1 Camisas disponible en conjuntos solamente

2 Pistón disponible en conjuntos solamente

3 Juegos de segmentos disponible en conjuntos solamente

1 Cilindro disponibile solo in kit motore







2 I pistoni sono disponibili solo in kit motore

3 I set anelli piston sono disponibili solo in kit motore

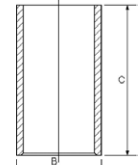
2 85.00

614.010/614.010 2 Cyl. **1134cc** **Diesel** **FM4129**

615.000 4 Cyl. **2270cc** **Diesel** **FM4127**

87-527800-00	STD	08-527800-00	STD	14-011031-00 D	B 90.04 C 178.00
87-527808-00	0.60mm	08-527808-00	0.60mm		
A	50.30	3.00		CR P	
B-	4.50	3.00		P	
D	90.00	3.00		P	
	28x69	5.50		P	

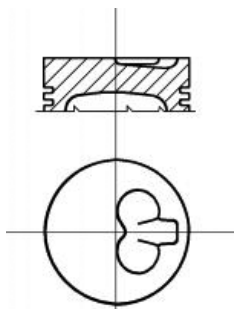



3 95.00

8025.01	2 Cyl.	17:1	1559cc	Diesel	FM569
8035.01 / 8035.01.265	3 Cyl.		2338cc	Diesel	FM4006
8045.01	4 Cyl.	17:1	3119cc	Diesel	FM571

87-207200-00 STD
87-207208-00 0.60mm

08-207200-00 STD
08-207208-00 0.60mm

14-010620-00 D B 99.00 C 187.00
14-011061-00 D B 99.10 C 187.00

A 59.60
B- 23.50
BØ 42.20
D 101.15
 32x84

2.50
2.50
5.50



CR P
P
CR P

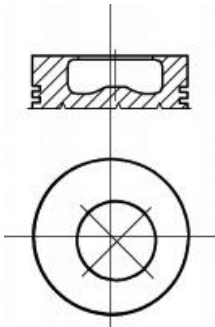
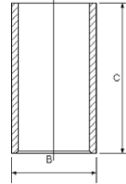

4 100.00

8025.02	2 Cyl.	17:1	1728cc	Diesel	FM573
8035.02	3 Cyl.	17:1	2592cc	33-40kW (45-54PS)	Diesel FM3475
8045.02	4 Cyl.	17:1	3455cc	44-50kW (60-68PS)	Diesel FM3476
8065.02	6 Cyl.	17:1	5184cc	Diesel	FM3477

87-206800-00 STD
87-206808-00 0.60mm

08-206800-00 STD
08-206808-00 0.60mm

14-021540-00 D B 103.00 C 187.00 D 104.00 E 5.00

A 59.60
B- 23.70
BØ 47.00
D 101.15
 32x84

2.50
2.50
5.50



CR P
P
CR P

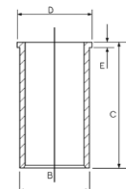

14-010170-00 D B 103.00 C 187.00
14-011021-00 D B 103.06 C 187.00
14-011022-00 D B 103.10 C 187.00

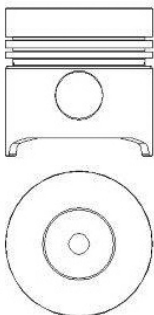
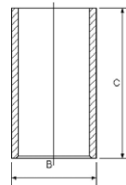







87-206800-10
87-206808-10

STD
0.60mm

08-206800-00
08-206808-00

STD
0.60mm

A 59.60
B- 23.70
BØ 45.40
D 101.15
 32x84

2.50  CR P
2.50  P
5.50  CR P

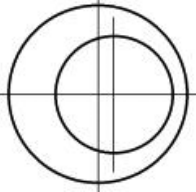
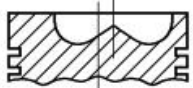





87-781900-30
87-781908-30

STD
0.60mm

08-781900-00
08-781908-00

STD
0.60mm

A 59.60
B- 23.70
BØ 47.10
D 101.15
 34x84

2.50  MOL P
2.50  P
4.00  CR P

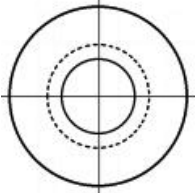

 Piston with central combustion chamber

 Kolben mit zentraler Verbrennungskammer

 Piston à chambre de combustion centrale

 Pistón con cámara de combustión central

 Pistone con camera di combustione centrale



5 100.00



8035.06	3 Cyl.	17:1	2708cc	33-40kW (45-54PS)	Diesel	FM4008
8045.06	4 Cyl.		3613cc		Diesel	FM4013
8065.06	6 Cyl.		5420cc		Diesel	FM4017

87-781900-10 STD
87-781908-10 0.60mm

08-781900-00 STD
08-781908-00 0.60mm

14-010780-00 D B 103.02 C 196.00
14-010781-00 D B 103.06 C 196.00
14-010782-00 D B 103.10 C 196.00

A 65.15
B- 22.70
D 108.50
 38x85

01/70 →
2.50  MOL P
2.50  P
4.00  CR P

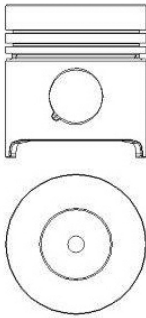
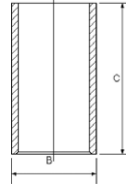

6 103.00



8035.04	3 Cyl.		2748cc		Diesel	FM4007
8045.04	4 Cyl.	17:1	3666cc		Diesel	FM3483
8055.04	5 Cyl.	17:1	4583cc		Diesel	FM3484

87-782000-00 STD
87-782008-00 0.60mm

08-782000-00 STD
08-782008-00 0.60mm

14-010180-00 D B 107.00 C 187.00

A 59.60
B- 22.70
BØ 50.00
D 101.15
 34x90

2.50  MOL P
2.50  P
4.00  CR P

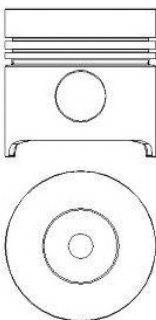
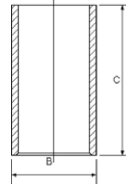

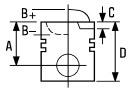

87-782000-10

STD

08-782000-00
08-782008-00

STD
0.60mm

A 59.60
B- 22.70
BØ 49.80
D 101.15
 34x90

2.50 MOL P
2.50 P
4.00 CR P

RT

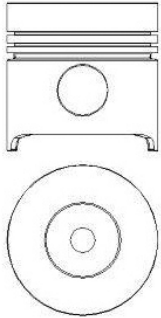

7 103.00

8061 L/8061L

6 Cyl.

5499cc

Diesel

FM23487

8065.24

6 Cyl.

5499cc

Diesel Turbo

FM3487

87-783900-00

STD

08-783900-00

STD

14-023551-00 D

B 107.06 **C** 187.00 **D** 110.00 **E** 5.00

A 59.61
B- 22.50
BØ 53.30
D 59.60
 34x90

3.00 MOL P
2.50 P
4.00 CR

14-023552-00 D

B 107.18 **C** 187.00 **D** 110.00 **E** 5.00

14-023553-00 D

B 107.48 **C** 187.00 **D** 110.50 **E** 5.00

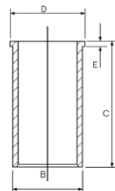

RT

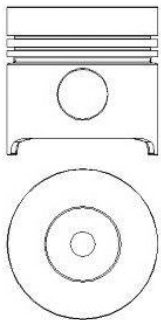

14-010180-00 D

B 107.00 **C** 187.00

14-010181-00 D

B 107.06 **C** 187.00

14-010182-00 D

B 107.10 **C** 187.00

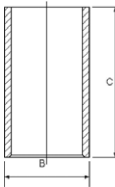



8 103.00



8065.04 6 Cyl. 17:1 5499cc Diesel FM3486

87-782000-00 STD
87-782008-00 0.60mm

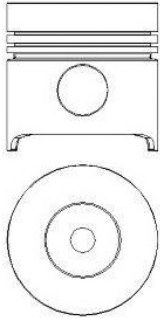
A 59.60
B- 22.70
BØ 50.00
D 101.15
 34x90



08-782000-00 STD
08-782008-00 0.60mm

2.50  MOL P
2.50  P
4.00  CR P

14-023551-00 D B 107.06 C 187.00 D 110.00 E 5.00
14-023552-00 D B 107.18 C 187.00 D 110.00 E 5.00
14-023553-00 D B 107.48 C 187.00 D 110.50 E 5.00

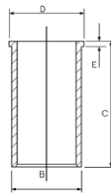

14-010180-00 D B 107.00 C 187.00
14-010181-00 D B 107.06 C 187.00
14-010182-00 D B 107.10 C 187.00

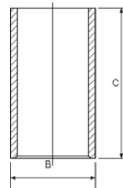



87-782000-10 STD

A 59.60
B- 22.70
BØ 49.80
D 101.15
 34x90

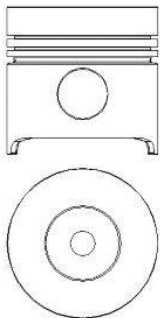
RT



08-782000-00 STD
08-782008-00 0.60mm

2.50  MOL P
2.50  P
4.00  CR P

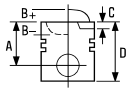

9 104.00

8035.05	3 Cyl.	2930cc	Diesel	FM4032
8045.05	4 Cyl.	3908cc	Diesel	FM4012
8055.05	5 Cyl.	4882cc	Diesel	FM4014
8065.05	6 Cyl.	5861cc	Diesel	FM4016

87-247800-00
87-247808-00

STD
0.60mm

08-247800-00
08-247808-00

STD
0.60mm

14-021361-00 D
14-021362-00 D
14-021363-00 D
14-021491-00 D
14-021492-00 D
14-021493-00 D
14-021494-00 D

B 107.02 C 198.00 D 110.87 E 5.00
B 107.14 C 198.00 D 110.87 E 5.00
B 107.44 C 198.00 D 110.87 E 5.00
B 107.01 C 198.00 D 109.87 E 5.00
B 107.05 C 198.00 D 109.87 E 5.00
B 107.17 C 198.00 D 109.87 E 5.00
B 107.47 C 198.00 D 109.87 E 5.00

A 65.15
B- 22.50
BØ 52.20
D 108.50
38x85

2.50
2.50
4.00



MOL P
P
CR P

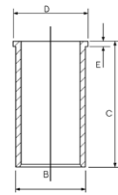

14-010940-00 D
14-010941-10 D
14-010943-10 D

B 107.00 C 198.00
B 107.10 C 198.00
B 107.52 C 198.00

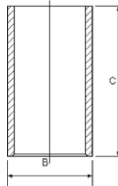

TP

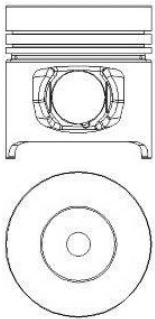

10 104.00

8045.25	4 Cyl.	3908cc	Diesel Turbo	FM9242
8065.25	6 Cyl.	5863cc	94-110kW (128-150PS) Diesel Turbo	FM4018

87-244500-40

STD

08-244500-00

STD

14-021361-00 D
14-021362-00 D
14-021363-00 D
14-021491-00 D
14-021492-00 D
14-021493-00 D
14-021494-00 D

B 107.02 C 198.00 D 110.87 E 5.00
B 107.14 C 198.00 D 110.87 E 5.00
B 107.44 C 198.00 D 110.87 E 5.00
B 107.01 C 198.00 D 109.87 E 5.00
B 107.05 C 198.00 D 109.87 E 5.00
B 107.17 C 198.00 D 109.87 E 5.00
B 107.47 C 198.00 D 109.87 E 5.00

A 65.15
B- 22.50
BØ 54.45
D 108.50
38x89

3.00
2.50
4.00



CR P
P
CR P

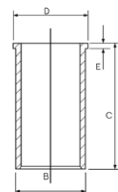

14-010940-00 D
14-010941-10 D
14-010943-10 D

B 107.00 C 198.00
B 107.10 C 198.00
B 107.52 C 198.00

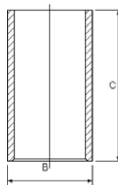



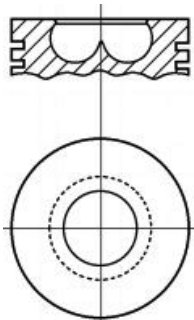

AK RT





11 104.00

8061.05 6 Cyl. 17:1 5419cc Diesel FM13485

87-247800-10	STD	08-247800-00	STD	14-021361-00 D	B 107.02 C 198.00 D 110.87 E 5.00
87-247808-10	0.60mm	08-247808-00	0.60mm	14-021362-00 D	B 107.14 C 198.00 D 110.87 E 5.00
A	65.15	2.50	 MOL P	14-021363-00 D	B 107.44 C 198.00 D 110.87 E 5.00
B-	22.50	2.50	 P	14-021491-00 D	B 107.01 C 198.00 D 109.87 E 5.00
BØ	52.00	2.50	 P	14-021492-00 D	B 107.05 C 198.00 D 109.87 E 5.00
D	108.50	4.00	 CR P	14-021493-00 D	B 107.17 C 198.00 D 109.87 E 5.00
 38x85				14-021494-00 D	B 107.47 C 198.00 D 109.87 E 5.00

RT TP

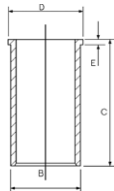
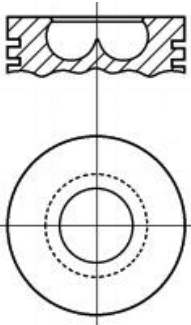



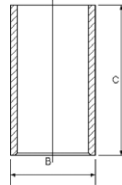



14-010940-00 D	B 107.00 C 198.00
14-010941-10 D	B 107.10 C 198.00
14-010943-10 D	B 107.52 C 198.00

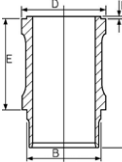

12 108.00

CO2D/CO3D/CO20/60/CO130 4 Cyl. 16:1 4397cc Diesel FM11303

87-528100-00	STD	08-528100-00	STD	14-630100-00 WH	B 116.00 C 243.00 D 128.00 E 150.00 F 1.00
A	80.20	2.50	 CR P		88-528100-00 87-528100-00 + 14-630100-00
B-	26.50	2.50	 P		
BØ	49.00	2.50	 P		
D	145.20	2.50	 P		
 38x89		5.00	 P		
		5.00	 P		

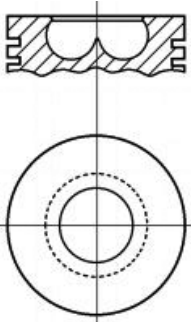



13 110.00

C03/20/21/41 4 Cyl. 17:1 **4562cc** **Diesel** **FM11307**

87-207500-00 STD **08-207500-00** STD **14-611250-00 WH** B 118.00 C 237.00 D 129.50 E 170.00 F 1.00 **88-207500-00**
87-207500-00 +
14-611250-00

A 75.20
B- 27.50
BØ 51.00
D 150.20
 40x94

2.50 CR P
2.50 P
2.50 P
5.00 CR P

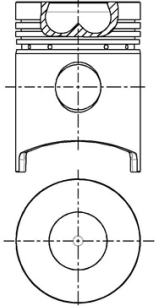
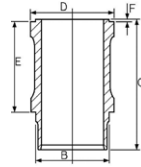

14 110.00

CN3/CN3 3 Cyl. **3706cc** **Diesel** **FM4028**

C03/C03 4 Cyl. **4941cc** **Diesel** **FM14029**

CP 3/100 6 Cyl. 17.4:1 **7412cc** **Diesel** **FM11310**

87-207500-10 STD **08-207500-00** STD **14-611250-00 WH** B 118.00 C 237.00 D 129.50 E 170.00 F 1.00 **88-207500-10**
87-207500-10 +
14-611250-00

A 70.20
B- 28.00
BØ 55.00
D 140.20
 40x94

2.50 CR P
2.50 P
2.50 P
5.00 CR P

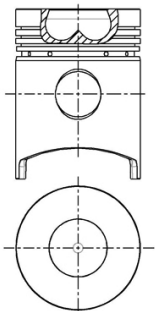
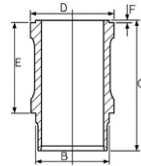



87-207500-30

STD

A 70.20
B- 28.00
BØ 55.00
D 140.20
 40x94

08-207500-00

STD

2.50
 2.50
 2.50
 5.00

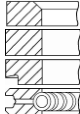

CR P
 P
 P
 CR P

14-611250-00 WH B 118.00 C 237.00 D 129.50 E 170.00 F 1.00

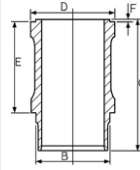

88-207500-30
 87-207500-30 +
 14-611250-00

RT

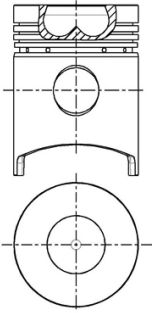

15 111.77

Genesis 5640 4 Cyl. 4400cc Diesel **FM6763**

Genesis 7840 6 Cyl. 6600cc Diesel **FM6764**

87-521300-00 STD
87-521307-00 .020

08-521300-00 STD
08-521307-00 .020

14-010820-00 D B 114.40 C 205.60

A 80.85
B- 18.50
BØ 61.85
D 134.20
 38x89

11/91 →

2.38
 2.38
 4.76



CR
 CR

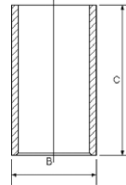

RT TP

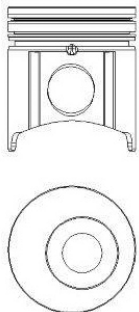







16 111.77

Genesis 6640	4 Cyl.	5000cc	Diesel	FM6765
Genesis 8240, 8340	6 Cyl.	7500cc	Diesel	FM6766

87-521300-10 STD 08-521300-00 STD 14-010820-00 D B 114.40 C 205.60
 87-521307-10 .020 08-521307-00 .020

A 73.25
 B- 21.67
 BØ 61.80
 D 126.60
 38x89

11/91→

2.38  CR
 2.38  CR
 4.76  CR

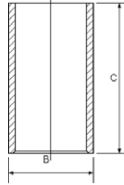

RT TP

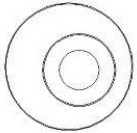
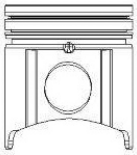



17 111.77

Genesis 7740	4 Cyl.	5000cc	Diesel Turbo	FM6767
---------------------	--------	---------------	---------------------	---------------

87-521400-00 STD 08-521400-00 STD 14-010820-00 D B 114.40 C 205.60
 87-521407-00 .020 08-521407-00 .020

A 72.90
 B- 19.86
 BØ 61.80
 D 126.30
 41x95

11/91→

3.00  CR
 2.38  CR
 4.76  CR

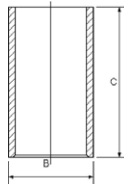

RT TP

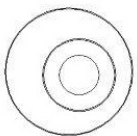
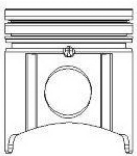

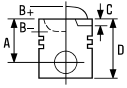

18 115.00

8365.05.500	6 Cyl.	17:1	8102cc	Diesel	FM3494
8365.05.590	6 Cyl.	17:1	8102cc	Diesel	FM13494
8365.25.590	6 Cyl.		8102cc	Diesel Turbo	FM19107



87-523000-00 STD

08-523000-00 STD

14-684840-00 WH B 122.00 C 235.00 D 129.70 E 167.00

88-523000-00
87-523000-00 +
14-684840-00

A 76.50
B- 29.40
BØ 54.00
D 140.50
 42x97

2.50  CR P
2.50  P
4.00  CR P

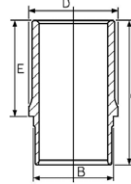

RT

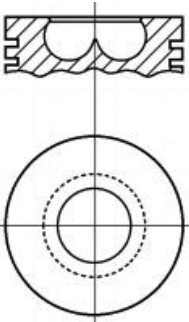

19 115.00

8365.25.500/502	6 Cyl.		8102cc	Diesel Turbo	FM9107
8365.25.501/503/533/8365.25.503	6 Cyl.		8102cc	Diesel Turbo	FM29107



87-245500-00 STD

08-245500-00 STD

14-684840-00 WH B 122.00 C 235.00 D 129.70 E 167.00

88-245500-00
87-245500-00 +
14-684840-00

A 76.50
B- 29.00
BØ 59.30
D 140.50
 42x97

3.00  CR P
2.50  P
4.00  CR P

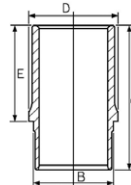

RT

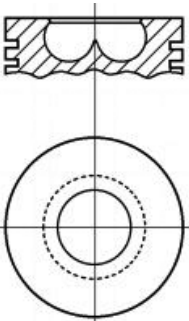



87-245500-10

STD

08-245500-00

STD

14-684840-00 WH B 122.00 C 235.00 D 129.70 E 167.00

88-245500-10

87-245500-10 +
14-684840-00

A 76.50
B- 27.70
BØ 59.00
D 140.50
 42x97

3.00
2.50
4.00



CR P
P
CR P

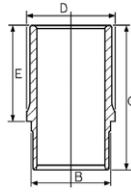

RT

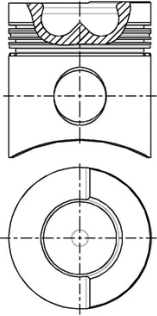

20 **115.00**

CO3-130T/CO3-130T

4 Cyl.

5401cc

Diesel

FM4030

14-633860-00 WH B 122.00 C 235.00 D 129.90 E 167.00
14-684840-00 WH B 122.00 C 235.00 D 129.70 E 167.00

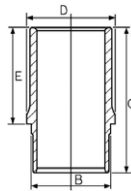

21 **120.00**

8460.21/8460.21.002/8460.21.042/
8460.21.102/8460.21.106/8460

6 Cyl.

9500cc 177kW (240PS)

Diesel Turbo

FM4130

87-785300-00

STD

08-785300-00

STD

14-450880-00 WH B 134.00 C 250.00 D 144.80 E 10.02 F 1.00

88-785300-00
87-785300-00 +
14-450880-00

A 84.70
B- 22.60
BØ 72.20
D 134.70
 48x108

3.50
3.00
5.00



CR P
CR P
CR P

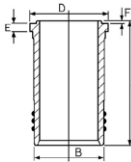

KK RT

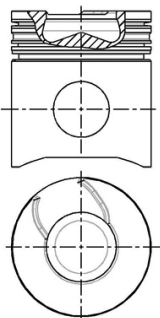

Nitrided

Nitriert

Nitridé



Nitruado

Niturato



22 137.00

8210.02 6 Cyl. 16:1 13798cc Diesel FM10601

87-207800-00	STD	08-207800-30	STD	14-021231-00 DH 	B 143.07 C 282.00 D 147.00 E 6.00
A	92.00	4.00	CR P	14-021232-00 DH 	B 143.27 C 282.00 D 147.00 E 6.00
B-	32.40	3.00	P	14-021560-10 DH	B 143.00 C 282.00 D 147.00 E 6.06
BØ	67.00	3.00	P	14-021561-10 DH	B 143.05 C 282.00 D 147.00 E 6.06
D	167.00	5.50	CR P	14-021562-10 DH	B 143.25 C 282.00 D 147.00 E 6.06
	48x117			14-021563-10 DH	B 143.50 C 282.00 D 147.00 E 6.06

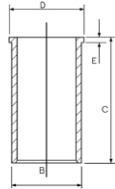
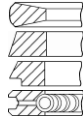

RT

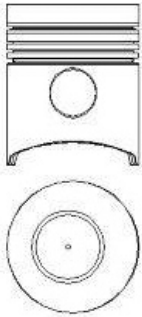

 Nitrided

 Nitriert



 Nitridé

 Niturado

 Niturato

23 137.00

8215.22/8215.22.520 6 Cyl. 13798cc Diesel Turbo FM9116

14-021231-00 DH 	B 143.07 C 282.00 D 147.00 E 6.00
14-021232-00 DH 	B 143.27 C 282.00 D 147.00 E 6.00
14-021560-10 DH	B 143.00 C 282.00 D 147.00 E 6.06
14-021561-10 DH	B 143.05 C 282.00 D 147.00 E 6.06
14-021562-10 DH	B 143.25 C 282.00 D 147.00 E 6.06
14-021563-10 DH	B 143.50 C 282.00 D 147.00 E 6.06

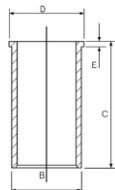





 Nitrided

 Nitriert

 Nitridé

 Niturado

 Niturato







		ccm	x 		9
4.165	Diesel	2710	4	92.00	19
D4F 712	Petrol	1149	4	69.00	1
D7F 764	Petrol	1149	4	69.00	2
F9Q 760	Diesel	1870	4	80.00	9
F9Q 762	Diesel	1870	4	80.00	9
F9Q 772	Diesel	1870	4	80.00	9
F9Q 774	Diesel	1870	4	80.00	9
G9T 722	Diesel	2188	4	87.00	16
G9T 750	Diesel	2188	4	87.00	16
G9U 720 Euro 3	Diesel	2463	4	89.00	17
G9U 730 Euro 3	Diesel	2463	4	89.00	17
K4M 752	Petrol	1598	4	79.50	8
K9K 276	Diesel	1461	4	76.00	3
K9K 292	Diesel	1461	4	76.00	3
K9K 700	Diesel	1461	4	76.00	4
K9K 702	Diesel	1461	4	76.00	4
K9K 704 Euro 3	Diesel	1461	4	76.00	4
K9K 708	Diesel	1461	4	76.00	4
K9K 710	Diesel	1461	4	76.00	4
K9K 714	Diesel	1461	4	76.00	4
K9K 722 Euro 3	Diesel	1461	4	76.00	4
K9K 728	Diesel	1461	4	76.00	5
K9K 732	Diesel	1461	4	76.00	6
K9K 764	Diesel	1461	4	76.00	6
K9K 772	Diesel	1461	4	76.00	3
LD20	Diesel	1952	4	85.00	13
LD20iIL	Diesel	1952	4	85.00	13
M9R	Diesel	1995	4	84.00	11
M9R 630	Diesel	1995	4	84.00	12
M9R 760	Diesel	1995	4	84.00	11
M9R 780 Euro 4	Diesel	1995	4	84.00	11
M9R 782	Diesel	1995	4	84.00	11
M9T	Diesel	2299	4	85.00	14
M9T 670 Euro 5	Diesel	2298	4	85.00	14
M9T 672 Euro 5	Diesel	2298	4	85.00	14
M9T 676 Euro 4	Diesel	2298	4	85.00	14
M9T 678	Diesel	2298	4	85.00	14
M9T 680	Diesel	2298	4	85.00	14
M9T 686 Euro 5	Diesel	2298	4	85.00	14
M9T 690 Euro 5	Diesel	2298	4	85.00	14
M9T 692 Euro 4	Diesel	2298	4	85.00	14
M9T 694 Euro 4	Diesel	2298	4	85.00	14
M9T 696 Euro 4	Diesel	2298	4	85.00	14
M9T 698 Euro 5	Diesel	2298	4	85.00	14
M9T 870 Euro 5	Diesel	2299	4	85.00	14
M9T 880 Euro 5	Diesel	2299	4	85.00	14
RD28	Diesel	2825	6	85.00	15
SD22	Diesel	2164	4	83.00	10
SD23	Diesel	2289	4	89.00	18
SD25	Diesel	2488	4	89.00	18
SD33	Diesel	3246	6	83.00	10
SD33T	Diesel	3246	6	83.00	10
TD15 (TUD5)	Diesel	1527	4	77.00	7
TD25	Diesel	2494	4	92.90	20
TD27	Diesel	2663	4	96.00	21
TD27ETi	Diesel	2664	4	96.00	21
TD27T	Diesel	2663	4	96.00	21
TD27TI	Diesel	2664	4	96.00	21
TD42	Diesel	4169	6	96.00	21
TD42T	Diesel	4169	6	96.00	21





1 69.00

Kubistar 1.2 16V 04/06 → **D4F 712** 4 Cyl. 9.8:1
1149cc **55kW (75PS)** **TD18984**

87-450000-00 STD **08-450000-10** STD
87-450007-00 0.50mm **08-450007-10** 0.50mm

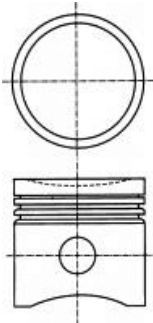
A	26.70	1.20		NT 
B-	1.10	1.50		P
BØ	60.30	2.50		CR 
D	44.70			
	18x54			







 Steel  Stahl  Acier  Acero  Acciaio

2 69.00

Kubistar 1.2 08/03 → **D7F 764** 4 Cyl. 9.6:1
1149cc **44kW (60PS)** **TD22375**

87-104100-00 STD **08-104100-00** STD
87-104105-00 0.25mm **08-104105-00** 0.25mm
87-104107-00 0.50mm **08-104107-00** 0.50mm

A	27.00	1.50		CR P
D	50.50	1.50		P
	18x52	2.50		CR P

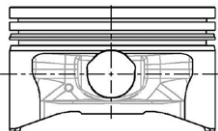



3 76.00

Kubistar 1.5 dCi 85	04/06→10/09	K9K 276			
Micra III 1.5 dCi	06/05→06/10		4 Cyl.	18.8:1	
Note 1.5 dCi	03/06→		1461cc	62-66kW (84-90PS)	
NP200 1.5 dCi	10/08→	Diesel	Turbo Intercooled		TD23877
Note 1.5 dCi	07/08→	K9K 292			
			4 Cyl.	18.8:1	
			1461cc	76kW (103PS)	
		Diesel	Turbo Intercooled		TD24675
Sunny 1.5 dCi	01/11→	K9K 772			
Tiida 1.5 dCi, Versa 1.5 dCi	01/07→		4 Cyl.	15.6:1	
			1461cc	63-76kW (86-103PS)	
		Diesel	Turbo Intercooled		TD28006

14-020650-00 D B 79.10 C 142.00 D 81.00 E 5.00

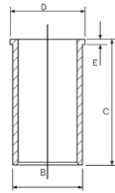

4 76.00

Kubistar 1.5 dCi 70	04/06→10/09	K9K 700			
Micra IV 1.5 D	11/10→		4 Cyl.	18.8:1	
Note 1.5 dCi	03/06→		1461cc	48-50kW (65-68PS)	
		Diesel	Turbo Intercooled		TD21368
Kubistar 1.5 dCi	09/03→	K9K 702			
			4 Cyl.	18.8:1	
			1461cc	60kW (82PS)	
		Diesel			TD23878
Kubistar 1.5 dCi	08/03→	K9K 704 Euro 3			
Micra III 1.5 dCi	01/03→06/10		4 Cyl.	18.8:1	
Micra IV 1.5 D	11/10→		1461cc	48kW (65PS)	
		Diesel	Turbo Intercooled		TD17660
Micra III 1.5 dCi	06/05→06/10	K9K 708			
			4 Cyl.	18.8:1	
			1461cc	48-50kW (65-68PS)	
		Diesel	Turbo Intercooled		TD26291
Kubistar 1.5 dCi	08/03→	K9K 710			
			4 Cyl.	18.8:1	
			1461cc	42-45kW (57-61PS)	
		Diesel	Turbo Intercooled		TD26066
Kubistar 1.5 dCi	08/03→	K9K 714			
			4 Cyl.	18.8:1	
			1461cc	42-45kW (57-61PS)	
		Diesel	Turbo Intercooled		TD26067





Almera II 1.5 dCi	01/03→	K9K 722 Euro 3		
Kubistar 1.5 dCi	08/03→		4 Cyl.	18.8:1
Micra III 1.5 dCi	09/03→06/10		1461cc	60kW (82PS)
		Diesel	Turbo Intercooled	
				TD20971

87-123400-00 STD
87-123407-00 0.50mm

A 41.69
B- 13.70
BØ 39.70
C 0.60
D 66.05
 25x60

RT TP

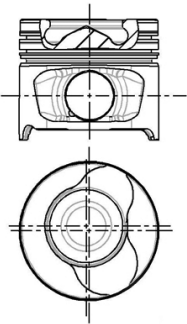

08-123400-00 STD
08-123407-00 0.50mm

2.00 CK P
 2.00 P
 2.50 NT

14-020650-00 D B 79.10 C 142.00 D 81.00 E 5.00

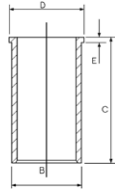

87-123400-10 STD
87-123407-10 0.50mm

A 41.82
B- 13.70
BØ 39.70
C 0.60
D 66.05
 26x60

RT TP

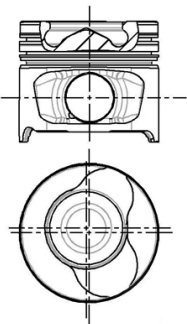

557.503

08-123400-00 STD
08-123407-00 0.50mm

2.00 CK P
 2.00 P
 2.50 NT

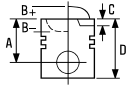



5  **76.00**

Tiida 1.5 dCi 09/07 → **K9K 728** 4 Cyl. 18.8:1
1461cc **74-78kW (101-106PS)**
Diesel Turbo Intercooled **TD24669**

87-123400-20 STD **08-123400-00** STD **14-020650-00 D** **B 79.10 C 142.00 D 81.00 E 5.00**
87-123407-20 0.50mm **08-123407-00** 0.50mm

A 41.70
B- 14.00
BØ 39.70
C 0.43
C 0.25
D 66.00
 26x60

2.00  **CK P**
 2.00  **P**
 2.50  **NT**

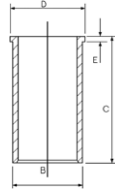

AK KK RT TP

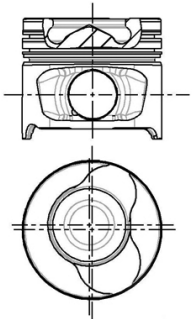

07657-101

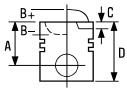

6  **76.00**

Qashqai/Qashqai +2 1.5 dCi	02/07→	K9K 732	4 Cyl.	18.8:1
			1461cc	78kW (106PS)
		Diesel	Turbo Intercooled	TD29682

Qashqai/Qashqai +2 1.5 dCi	02/07→	K9K 764	4 Cyl.	15.6:1
			1461cc	78kW (106PS)
		Diesel	Turbo Intercooled	TD29684

87-123400-30 STD
87-123407-30 0.50mm

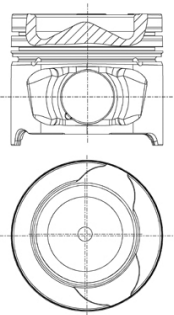

- A** 41.70
- B-** 12.80
- BØ** 49.00
- C** 0.43
- C** 0.25
- D** 66.00
-  26x60

AK KK RT TP



07657-401

08-123400-30 STD
08-123407-30 0.50mm

- 2.00  CK P
- 2.00  P
- 2.50  CR P



14-020650-00 D B 79.10 C 142.00 D 81.00 E 5.00

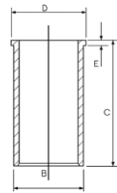

7  **77.00**

Micra II 1.5 D	02/98→02/03	TD15 (TUD5)	4 Cyl.	23:1
			1527cc	42kW (57PS)
		Diesel		TD16316



87-325800-00 STD
87-325806-00 0.40mm

- A** 40.37
- B-** 1.65
- D** 66.32
-  23x60

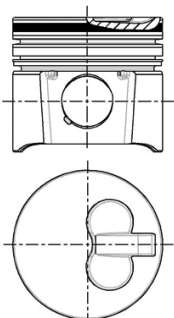
RT



08-325800-00 STD
08-325806-00 0.40mm

- 2.00  CK P
- 1.75  P
- 3.00  CR P







8  **79.50**

Kubistar 1.6 16V	08/03 →	K4M 752	4 Cyl. 1598cc	10:1 70kW (95PS)	TD21398
-------------------------	---------	----------------	-------------------------	----------------------------	----------------

87-104200-30 STD

08-104200-00 STD
08-104207-00 0.50mm

- A** 31.70
- B-** 1.30
- C** 1.60
- D** 55.00
-  20x62

- 1.50  CR P
- 1.50  P
- 2.50  CR 1

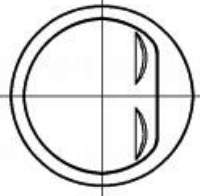
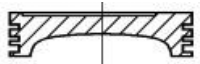

 Steel

 Stahl

 Acier

 Acero

 Acciaio

9  **80.00**

Primastar 1.9 dCi	07/02 → 08/06	F9Q 760	4 Cyl. 1870cc	19:1 74kW (101PS)	TD20980
Primastar dCi 100	03/01 →	Diesel	Turbo Intercooled		
Primastar dCi 80	03/01 →	F9Q 762	4 Cyl. 1870cc	19:1 60kW (82PS)	TD20991
		Diesel	Turbo Intercooled		
Interstar dCi 80	07/02 →	F9Q 772	4 Cyl. 1870cc	18.3:1 60kW (82PS)	TD19378
		Diesel	Turbo Intercooled		



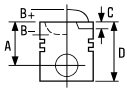

Interstar 1.9 dCi	10/03→	F9Q 774	4 Cyl.	18.3:1	
			1870cc	60kW (82PS)	
		Diesel	Turbo Intercooled		TD26548

87-101500-00	STD	08-101500-00	STD	14-020280-00 D	B 83.00 C 155.00 D 85.00 E 5.00
87-101507-00	0.50mm	08-101507-00	0.50mm		

A	47.06
B-	17.80
BØ	38.00
C	0.75
D	77.00
	28x60

→01/00

2.50		P
2.00		P
3.00		CR P

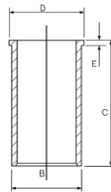

AK RT TP

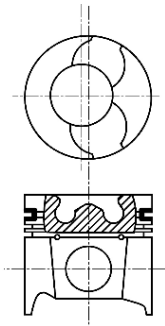

10 83.00

720 Cab & Chassis 2.2 D		SD22		
720 Cab & Chassis 2.2 D 4WD	09/80→12/83		4 Cyl.	20.8:1
720 Extended Cab 2.2 D			2164cc	46-47kW (63-64PS)
720 Extended Cab 2.2 D 4WD		Diesel		TD2512
Pick Up I 2.2 D	01/82→01/84			
Pick Up I 2.2 D 4WD	01/82→09/84			
Urvan 2.2 D	11/80→07/83			
Homy 3.2 D	10/93→10/97	SD33		
Patrol GR V Wagon 3.2 D	05/98→06/01		6 Cyl.	20.8:1
Patrol III/1 3.2 D	11/79→08/88		3246cc	70kW (95PS)
Patrol III/1 3.3 D	06/80→12/87	Diesel		TD2515
Patrol III/1 Hardtop 3.2 D	11/79→08/88			
Urvan 3.2 D	02/92→04/97			
Patrol III/1 3.2 TD	07/83→08/88	SD33T		
Patrol III/1 3.3 TD	01/84→12/87		6 Cyl.	20.8:1
Patrol III/1 Hardtop 3.2 TD	07/83→08/88		3246cc	81-88kW (110-120PS)
Patrol III/2 3.2 D		Diesel	Turbo	TD2516
Patrol III/2 Hardtop 3.2 D	08/88→06/90			
Urvan 3.2 TD	02/92→04/97			

14-021160-00 D	B 87.00 C 175.50 D 92.96 E 5.00
14-021170-00 DH	B 87.01 C 175.50 D 93.00 E 5.11

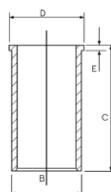







11 84.00

Qashqai/Qashqai +2 2.0 dCi		M9R			
Qashqai/Qashqai +2 2.0 dCi All-wheel Drive	02/07→		4 Cyl.	16:1	
X-Trail 2.0 dCi, X-Trail 2.0 dCi FWD	06/07→11/13		1995cc	110kW (150PS)	
		Diesel	Turbo Intercooled		TD22892
X-Trail 2.0 dCi	06/07→11/13	M9R 760			
			4 Cyl.	16:1	
			1995cc	127-130kW (173-177PS)	
		Diesel	Turbo Intercooled		TD20981
Primastar dCi 120	09/06→	M9R 780 Euro 4			
			4 Cyl.	16:1	
			1995cc	66-84kW (90-114PS)	
		Diesel	Turbo Intercooled		TD20890
Primastar dCi 90	09/06→	M9R 782			
			4 Cyl.	17:1	
			1995cc	66kW (90PS)	
		Diesel	Turbo Intercooled		TD24668

87-422000-00	STD	08-422000-00	STD
87-422007-00	0.50mm	08-422007-00	0.50mm

A	47.92	2.50		MOL P
B-	14.90	2.00		MOL P
BØ	49.07	2.00		CR P
C	0.40			
C	0.40			
D	76.00			
	32x65			

AK KK RT TP

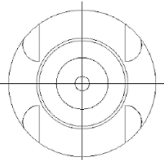
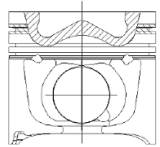







12  **84.00**

Primastar 2.0 dCi 90	09/06 →	M9R 630		
		4 Cyl.	15.5:1	
		1995cc	66-84kW (90-114PS)	
		Diesel	Turbo Intercooled	TD26730

87-422000-10	STD	08-422000-00	STD
87-422007-10	0.50mm	08-422007-00	0.50mm

A	48.00	2.50		MOL P
B-	14.00	2.00		MOL P
BØ	50.00	2.00		CR P
D	76.00			
	32x65			

KK RT TP

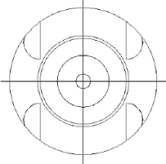
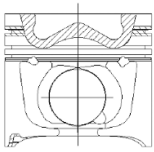



13  **85.00**

Bluebird 2.0 D	01/80→03/97	LD20			
Bluebird Traveller 2.0 D	01/80→05/84		4 Cyl.	22:1	
Bobby 2.0 DLX, Bobby 2.0 DX	11/87→11/94		1952cc	43-49kW (58-67PS)	
Ichi 2.0 D	09/90→05/01	Diesel			TD2482
Laurel 2.0 D	04/81→10/84				
Serena 2.0 D	11/92→09/01				
Skyline 2.0 D	08/81→07/84				
Trade 2.0 D	11/86→10/98				
Urvan 2.0 D	02/92→09/94				
Vanette 2.0 D	11/82→				

Vanette 2.0 D	04/87→11/94	LD20iL			
			4 Cyl.	21.3:1	
			1952cc	47-49kW (64-67PS)	
		Diesel			TD2488

87-295400-00

STD

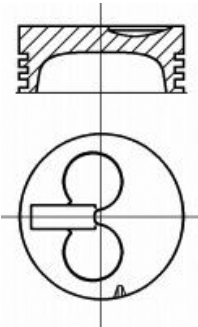

- A 46.50
- B- 2.53
- C 1.20
- D 78.00
-  25x67

RT



08-295400-00

STD

- 2.00  CR P
- 2.00  P
- 4.00  CR P

14-020350-00 D

B 88.60 C 150.00 D 90.50 E 4.50

14-020351-00 D

B 90.00 C 150.00 D 92.00 E 4.50

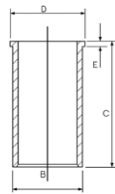



14 85.00



NV400 2.3 dCi NV400 2.3 dCi [RWD] NV400 2.3 dCi, NV400 2.3 dCi [RWD]	06/14→	M9T Diesel	4 Cyl. 2299cc Turbo Intercooled	16:1 74-125kW (100-170PS)	TD31669
NV400 2.3 dCi	11/11→	M9T 670 Euro 5 Diesel	4 Cyl. 2298cc Turbo Intercooled	16:1 74-92kW (101-125PS)	TD26543
NV400 2.3 dCi	11/11→	M9T 672 Euro 5 Diesel	4 Cyl. 2298cc Turbo Intercooled	16:1 74-92kW (101-125PS)	TD26768
NV400 2.3 dCi	11/11→	M9T 676 Euro 4 Diesel	4 Cyl. 2298cc Turbo Intercooled	16:1 74-92kW (101-125PS)	TD26769
NV400 2.3 dCi	11/11→	M9T 678 Diesel	4 Cyl. 2298cc Turbo Intercooled	16:1 107kW (146PS)	TD26770
NV400 2.3 dCi	11/11→	M9T 680 Diesel	4 Cyl. 2298cc Turbo Intercooled	16:1 107kW (146PS)	TD26771
NV400 2.3 dCi [RWD]	11/11→	M9T 686 Euro 5 Diesel	4 Cyl. 2298cc Turbo Intercooled	16:1 92kW (125PS)	TD26772
NV400 2.3 dCi [RWD]	11/11→	M9T 690 Euro 5 Diesel	4 Cyl. 2298cc Turbo Intercooled	16:1 74-92kW (101-125PS)	TD26544
NV400 2.3 dCi [RWD]	11/11→	M9T 692 Euro 4 Diesel	4 Cyl. 2298cc Turbo Intercooled	16:1 92kW (125PS)	TD26773
NV400 2.3 dCi [RWD]	11/11→	M9T 694 Euro 4 Diesel	4 Cyl. 2298cc Turbo Intercooled	16:1 107kW (146PS)	TD26774
NV400 2.3 dCi NV400 2.3 dCi [RWD]	06/14→ 11/11→	M9T 696 Euro 4 Diesel	4 Cyl. 2298cc Turbo Intercooled	16:1 92-107kW (125-146PS)	TD26775
NV400 2.3 dCi NV400 2.3 dCi [RWD]	06/14→ 11/11→	M9T 698 Euro 5 Diesel	4 Cyl. 2298cc Turbo Intercooled	16:1 92-107kW (125-146PS)	TD26776
NV400 2.3 dCi NV400 2.3 dCi [RWD]	06/14→ 11/11→	M9T 870 Euro 5 Diesel	4 Cyl. 2299cc Turbo Intercooled	16:1 74-92kW (100-125PS)	TD31670

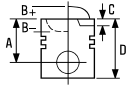



NV400 2.3 dCi		M9T 880 Euro 5	
NV400 2.3 dCi [RWD]	08/14→	4 Cyl.	16:1
NV400 2.3 dCi, NV400 2.3 dCi [RWD]	02/14→	2299cc	110kW (150PS)
		Diesel	Turbo Intercooled
			TD30783

87-435200-00	STD	08-435200-00	STD
87-435207-00	0.50mm	08-435207-00	0.50mm

A	48.00	2.50	 GDC P
B-	16.20	2.00	 MO P
BØ	50.00	2.00	 CR P
C	0.45		
D	76.00		

 32x65



AK KK RT

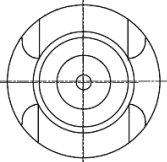
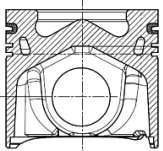

15  **85.00**

Cedric 2.8 TD	06/91→10/95	RD28	
Crew 2.8 D	04/86→08/03		6 Cyl.
Gloria 2.8 TD	06/91→10/95		21.2:1
Laurel 2.8 D	01/85→12/89	Diesel	2825cc
Patrol III/2 2.8 D			66-69kW (90-94PS)
Patrol III/2 Hardtop 2.8 D	03/89→03/96		
			TD4711

14-020350-00 D	B 88.60 C 150.00 D 90.50 E 4.50
14-020351-00 D	B 90.00 C 150.00 D 92.00 E 4.50

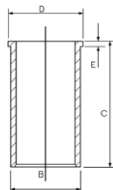

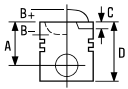





16  **87.00**

Interstar dCI 90	07/02 →	G9T 722	4 Cyl.	18:1
			2188cc	66kW (90PS)
		Diesel	Turbo Intercooled	TD19379

Interstar 2.2 dCI	10/03 →	G9T 750	4 Cyl.	17.8:1
			2188cc	66kW (90PS)
		Diesel	Turbo Intercooled	TD23886

87-127400-00	STD	08-127400-00	STD
87-127407-00	0.50mm	08-127407-00	0.50mm

A	54.53	3.00	 P PS
B-	17.50	1.75	 P
BØ	40.40	2.50	 P
C	2.00		
D	84.20		
	31x65		

AK RT TP

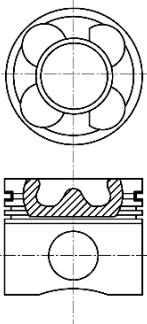





17  **89.00**

Interstar dCi 100	11/03→	G9U 720 Euro 3			
Interstar dCi 120	07/02→		4 Cyl.	21:1	
Primastar dCi 115	09/08→		2463cc	73-84kW (99-114PS)	
		Diesel	Turbo Intercooled		TD21010
Primastar dCi 140	07/03→	G9U 730 Euro 3			
			4 Cyl.	21:1	
			2463cc	99kW (135PS)	
		Diesel	Turbo Intercooled		TD18702

87-137500-10	STD	08-137500-10	STD
87-137507-10	0.50mm	08-137507-10	0.50mm

A	53.03	2.50		MO P
B-	17.85	1.75		P
BØ	43.20	2.50		CR P
C	1.65			
C	1.90			
D	83.09			
	31x65			

AK RT TP

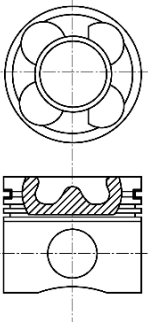

18  **89.00**

Cedric 2.3 D	05/84→08/87	SD23			
I 2.3 D, Pick Up I 2.3 D 4WD	04/83→03/86		4 Cyl.	20.5:1	
Pick Up II 2.3 D	09/85→08/88		2289cc	50-51kW (68-69PS)	
Pick Up II 2.3 D 4WD	09/85→08/87	Diesel			TD2513
Urvan 2.3 D	11/82→11/88				
720 Cab & Chassis 2.5 D		SD25			
720 Cab & Chassis 2.5 D 4WD	09/84→12/86		4 Cyl.	21.4:1	
720 Extended Cab 2.5 D			2488cc	52-55kW (71-75PS)	
720 Extended Cab 2.5 D 4WD	09/83→12/86	Diesel			TD2514
Pick Up I 2.5 D 4WD	04/83→03/86				
Pick Up II 2.5 D	01/86→02/98				
Pick Up II 2.5 D 4WD	09/85→08/91				

14-021150-00 D B 92.08 C 172.00 D 97.99 E 5.12

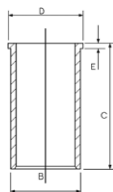

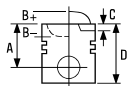

19  **92.00**

Patrol 2.7D	01/80→12/87	4.165	4 Cyl.	2710cc	
		Diesel			FM1358

14-043450-00 D B 96.91 C 191.19 D 101.00 E 3.91 F 0.70

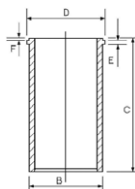



20  **92.90**

Atlas 2.5 D	10/93→10/97	TD25	4 Cyl.	22.2:1	
Cabstar 2.5 D	01/89→12/00				
Cabstar 2.5 TD	01/92→09/93		2494cc	55-71kW (75-97PS)	
Homy 2.5 TD	05/92→10/95	Diesel	Turbo Intercooled		TD4714
III 2.5 D 4WD, Pick Up III 2.5 D	02/98→				
Navara 2.5 D	01/86→03/08				
Navara 2.5 TD	02/98→10/01				
Pick Up II 2.5 D	09/87→02/98				
Pick Up II 2.5 D 4WD	08/87→02/98				
Urvan 2.5 D	12/88→05/97				

87-521100-00 STD **08-521100-00** STD **14-020120-00 D** B 96.01 C 159.89 D 101.85 E 5.00

- A 50.30
- B- 1.50
- C 0.80
- D 87.00
-  28x80

- 2.50  CR
- 2.00  CR
- 4.00  CR

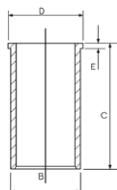

RT











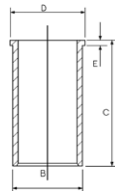



21  **96.00**





Cabstar 2.7 D	10/00→04/04	TD27				
Navara 2.7 D	09/87→08/98		4 Cyl.	21.8:1		
Navara 2.7 TD	01/97→10/01		2663cc	58-73kW (79-99PS)		
Pick Up II 2.7 D 4WD	08/87→02/98	Diesel				TD2532
Pick Up III 2.7 D	02/98→					
Sani Closed Off-Road Vehicle 2.7 TD	01/96→12/99					
Urvan 2.7 D	03/87→09/93					
Urvan 2.7 TD	10/94→04/97					
Pathfinder II 2.7 TD 4WD	09/97→12/04	TD27ETi				
Urvan 2.7 TD	10/95→08/00		4 Cyl.	22.3:1		
		Diesel	2664cc	92-96kW (125-131PS)		
			Turbo Intercooled			TD9896
II 2.7 TD, Pick Up II 2.7 Td 4WD	09/87→12/96	TD27T				
III 2.7 TD, Pick Up III 2.7 Td 4WD	01/97→10/01		4 Cyl.	22:1		
Navara 2.7 TD	03/97→12/01		2663cc	66-74kW (90-101PS)		
Patrol GR V Wagon 2.7 TD	05/98→06/01	Diesel	Turbo			TD2533
Terrano I 2.7 TD 4WD	02/89→02/96					
Terrano II 2.7 TD 4WD	02/93→01/02					
Trade 2.7 TD	11/98→09/04					
Atlas 2.7 TDiC	07/96→10/04	TD27TI				
Homy 2.7 TD	10/93→10/95		4 Cyl.	21.9:1		
Terrano II 2.7 TDi 4WD	05/96→09/07		2664cc	91-92kW (124-125PS)		
Urvan 2.7 TD	10/95→08/00	Diesel	Turbo Intercooled			TD9478
Patrol GR IV 4.2 D	11/88→06/97	TD42				
Patrol GR V Wagon 4.2 D	05/98→03/03		6 Cyl.	22.7:1		
Patrol III/1 4.2 D	01/88→12/97		4169cc	85-92kW (116-125PS)		
Patrol III/2 Hardtop 4.2 D		Diesel				TD2535
Patrol V 4.2 D	05/98→03/03					
Patrol GR V Wagon 4.2 D	05/99→09/04	TD42T				
Patrol GR V Wagon 4.2 TD	06/97→		6 Cyl.	22.8:1		
Patrol V 4.2 D	05/99→09/07		4169cc	85-118kW (116-160PS)		
Patrol V 4.2 TDi 4WD	06/06→	Diesel	Turbo Intercooled			TD10368

14-020110-00 D B 99.08 C 160.00 D 105.03 E 5.09



		ccm	x 		
4 JB1TC	Diesel	2771	4	93.00	58
12 S	Petrol	1196	4	79.00	14
13 S	Petrol	1297	4	75.00	9
13 SB	Petrol	1297	4	75.00	9
14 NV	Petrol	1389	4	77.60	11
15 D (4EC1)	Diesel	1488	4	76.00	10
15 DT (T4EC1)	Diesel	1488	4	76.00	10
16 D	Diesel	1598	4	80.00	27
16 DA	Diesel	1598	4	80.00	27
16 SH	Petrol	1598	4	80.00	26
16 SV	Petrol	1598	4	79.00	15
17 D	Diesel	1699	4	82.50	36
17 D (4EE1)	Diesel	1686	4	79.00	23
17 DR	Diesel	1699	4	82.50	36
17 DT (TC4EE1)	Diesel	1686	4	79.00	24
18 SE	Petrol	1796	4	84.80	46
18 SEH	Petrol	1796	4	84.80	46
18 SV	Petrol	1796	4	84.80	46
20 NE	Petrol	1998	4	86.00	48
20 XE	Petrol	1998	4	86.00	49
21 D	Diesel	2068	4	88.00	53
23 D	Diesel	2260	4	92.00	56
23 DC	Diesel	2260	4	92.00	56
23 DTR	Diesel	2260	4	92.00	56
23 TD	Diesel	2259	4	92.00	56
23 YD	Diesel	2260	4	92.00	56
23 YDT	Diesel	2260	4	92.00	56
25 TDS (VM41B)	Diesel	2500	4	92.00	57
28 TDI (4JB1T)	Diesel	2771	4	93.00	59
8140.23.2585/3700/8140.43.2585/3700/3900 Sofim	Diesel	2800	4	94.40	61
A 14 NET Euro 5	Petrol	1364	4	72.50	3
A 14 XER	Petrol	1398	4	73.40	6
A 16 LET Euro 5	Petrol	1598	4	79.00	16
A 20 DTC Euro 5	Diesel	1956	4	83.00	38
A 20 DT Euro 5	Diesel	1956	4	83.00	38
A 20 DTH Euro 5	Diesel	1956	4	83.00	38
A 20 DTJ Euro 5	Diesel	1956	4	83.00	38
A 20 DTL Euro 5	Diesel	1956	4	83.00	38
C 13 N	Petrol	1297	4	75.00	9
C 14 NZ	Petrol	1389	4	77.60	11
C 14 SEL	Petrol	1389	4	77.60	12
C 16 NZ	Petrol	1598	4	79.00	17
C 16 SE	Petrol	1598	4	79.00	15
C 16 XE Ecotec	Petrol	1598	4	79.00	18
C 18 XE Ecotec	Petrol	1796	4	81.60	32
C 18 XEL Ecotec	Petrol	1796	4	81.60	32
C 20 NE	Petrol	1998	4	86.00	48
C 20 XE	Petrol	1998	4	86.00	49
C 25 XE Ecotec	Petrol	2498	V6	81.60	33
C 223	Diesel	2238	4	88.00	54
E 16 NZ	Petrol	1598	4	79.00	17
E 16 SE	Petrol	1598	4	79.00	15
F8Q 600	Diesel	1870	4	80.00	28
F8Q 606	Diesel	1870	4	80.00	28
F9Q 760	Diesel	1870	4	80.00	29
F9Q 762	Diesel	1870	4	80.00	29
F9Q 770	Diesel	1870	4	80.00	29
F9Q 772	Diesel	1870	4	80.00	29
F9Q 774	Diesel	1870	4	80.00	29
G9T 720	Diesel	2188	4	87.00	52
G9T 722	Diesel	2188	4	87.00	52
G9T 750	Diesel	2188	4	87.00	52
G9U 720 Euro 3	Diesel	2463	4	89.00	55
G9U 724 Euro 3	Diesel	2463	4	89.00	55
G9U 730 Euro 3	Diesel	2463	4	89.00	55
G9U 750	Diesel	2463	4	89.00	55
G9U 754 Euro 3	Diesel	2463	4	89.00	55
M9R 630	Diesel	1995	4	84.00	40
M9R 692 Euro 5	Diesel	1995	4	84.00	40

		ccm	x 		
M9R 780 Euro 4	Diesel	1995	4	84.00	41
M9R 782	Diesel	1995	4	84.00	41
M9R 786 Euro 4	Diesel	1995	4	84.00	41
M9T 670 Euro 5	Diesel	2298	4	85.00	47
M9T 672 Euro 5	Diesel	2298	4	85.00	47
M9T 676 Euro 4	Diesel	2298	4	85.00	47
M9T 678	Diesel	2298	4	85.00	47
M9T 680	Diesel	2298	4	85.00	47
M9T 686 Euro 5	Diesel	2298	4	85.00	47
M9T 690 Euro 5	Diesel	2298	4	85.00	47
M9T 692 Euro 4	Diesel	2298	4	85.00	47
M9T 694 Euro 4	Diesel	2298	4	85.00	47
M9T 696 Euro 4	Diesel	2298	4	85.00	47
M9T 698 Euro 5	Diesel	2298	4	85.00	47
M9T 700	Diesel	2299	4	85.00	47
M9T 702	Diesel	2299	4	85.00	47
M9T 870	Diesel	2299	4	85.00	47
M9T 876	Diesel	2299	4	85.00	47
M9T 880	Diesel	2298	4	85.00	47
M9T 896	Diesel	2298	4	85.00	47
M9T 898	Diesel	2298	4	85.00	47
M 51 D25WA (E34/E36)	Diesel	2498	6	80.00	30
S8U 758	Diesel	2499	4	93.00	60
S8U 780	Diesel	2499	4	93.00	60
S8U 782	Diesel	2499	4	93.00	60
S9W 700	Diesel	2799	4	94.40	61
S9W 702	Diesel	2799	4	94.40	61
X 10 XE Ecotec	Petrol	973	3	72.50	4
X 12 XE Ecotec	Petrol	1199	4	72.50	5
X 14 NZ	Petrol	1389	4	77.60	11
X 14 SZ	Petrol	1389	4	77.60	11
X 14 XE Ecotec	Petrol	1389	4	77.60	12
X 15 DT (T4EC1)	Diesel	1488	4	76.00	10
X 16 SZ	Petrol	1598	4	79.00	17
X 16 SZR	Petrol	1598	4	79.00	19
X 16 XE Ecotec	Petrol	1598	4	79.00	18
X 16 XEL Ecotec	Petrol	1598	4	79.00	18
X 17 D (4EE1)	Diesel	1686	4	79.00	23
X 17 DT (TC4EE1)	Diesel	1686	4	79.00	24
X 17 DTL	Diesel	1699	4	82.50	37
X 18 XE1 Ecotec	Petrol	1796	4	80.50	31
X 18 XE Ecotec	Petrol	1796	4	81.60	32
X 20 DTH	Diesel	1995	4	84.00	42
X 20 DTL	Diesel	1896	4	84.00	43
X 20 XEV Ecotec	Petrol	1998	4	86.00	50
X 22 DTH	Diesel	2172	4	84.00	44
X 25 DT	Diesel	2498	6	80.00	30
X 25 TD	Diesel	2498	6	80.00	30
X 25 XE Ecotec	Petrol	2498	V6	81.60	33
Y 16 XE Ecotec	Petrol	1598	4	79.00	20
Y 17 DT	Diesel	1686	4	79.00	25
Y 17 DTL	Diesel	1686	4	79.00	25
Y 20 DTH	Diesel	1995	4	84.00	45
Y 20 DTL	Diesel	1995	4	84.00	43
Y 22 DTH	Diesel	2172	4	84.00	44
Y 22 DTR	Diesel	2172	4	84.00	44
Z 10 XE Ecotec	Petrol	973	3	72.50	4
Z 12 XE Ecotec	Petrol	1199	4	72.50	5
Z 12 XEP	Petrol	1229	4	73.40	7
Z 13 DT Euro 4	Diesel	1248	4	69.60	1
Z 13 DTH Euro 4	Diesel	1248	4	69.60	2
Z 14 XE Ecotec	Petrol	1389	4	77.60	13
Z 14 XEP EcoTec	Petrol	1364	4	73.40	8
Z 16 SE	Petrol	1598	4	79.00	20
Z 16 XE Ecotec	Petrol	1598	4	79.00	20
Z 16 XEP	Petrol	1598	4	79.00	21
Z 16 XER	Petrol	1598	4	79.00	22
Z 18 XE Ecotec	Petrol	1799	4	80.50	31
Z 18 XEL Ecotec	Petrol	1796	4	80.50	31





		ccm	x 		
Z 19 DT	Diesel	1910	4	82.00	34
Z 19 DTH Euro 4	Diesel	1910	4	82.00	35
Z 19 DTJ	Diesel	1910	4	82.00	35
Z 19 DTL Euro 4	Diesel	1910	4	82.00	34
Z 20 DTJ	Diesel	1956	4	83.00	38
Z 20 S	Diesel	1991	4	83.00	39
Z 22 SE Ecotec	Petrol	2198	4	86.00	51



1  **69.60**

Agila 1.3 CDTI	08/03→12/07	Z 13 DT Euro 4		
Combo 1.3 CDTI 16V	08/05→		4 Cyl.	18:1
Combo Tour 1.3 CDTI 16V	10/04→		1248cc	51kW (70PS)
Corsa C 1.3 CDTI	06/03→12/09	Diesel	Turbo Intercooled	TD17477
Corsa C 1.3 CDTI 16V	08/05→			
Meriva 1.3 CDTI	04/05→05/10			
Tigra TwinTop 1.3 CDTI	06/04→			

87-137600-00	STD	08-137600-00	STD
87-137606-00	0.40mm	08-137606-00	0.40mm

A	40.43	2.00		CK P
B-	12.40	1.50		P
BØ	37.00	2.00		P
C	1.20			
D	63.43			
	23x56			



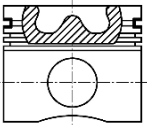
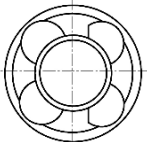

AK RT TP



2  **69.60**

Astra H 1.3 CDTI	08/05→	Z 13 DTH Euro 4		
Astra H GTC 1.3 CDTI	04/05→		4 Cyl.	17.6:1
Corsa D 1.3 CDTI	07/06→		1248cc	66-74kW (90-101PS)
		Diesel	Turbo Intercooled	TD18653

87-425600-00	STD	08-425600-00	STD
87-425606-00	0.40mm	08-425606-00	0.40mm
		08-425608-00	0.60mm

A	40.43	2.00		CK P
B-	12.41	1.50		NT
BØ	38.00	2.00		CR P
C	0.91			
C	0.91			
D	62.43			
	23x55			

AK KK RT TP

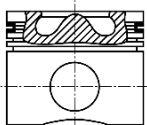
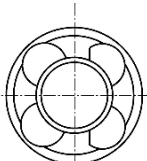

06933

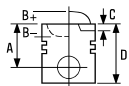

3  **72.50**

Astra GTC J 1.4	10/11→	A 14 NET Euro 5		
Astra J 1.4 LPG	01/12→	4 Cyl.	9.5:1	
Astra J 1.4 Turbo	12/09→	1364cc	103kW (140PS)	
Astra J Sports Tourer 1.4 LPG	01/12→	Turbo Intercooled		TD23882
Astra J Sports Tourer 1.4 Turbo	10/10→			
Cascada 1.4 Turbo	03/13→			
Insignia 1.4	04/11→			
Insignia 1.4 LPG	07/12→			
Meriva B 1.4	06/10→			
Mokka 1.4	06/12→			
Mokka 1.4 LPG	04/13→			
Zafira Tourer C 1.4, Zafira Tourer C 1.4 LPG	10/11→			





87-437400-00

STD

08-437400-00

STD

- A 25.87
- B- 2.90
- BØ 54.78
- C 2.10
- C 1.87
- D 44.18
-  18x48

- 1.20  DLC NT 
- 1.20  P
- 2.00  NT 

CARBOGLIDE®

TP

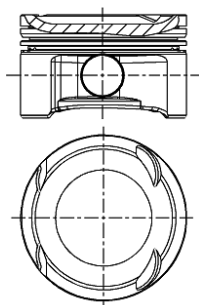

07279-212

 Steel

 Stahl

 Acier

 Acero

 Acciaio

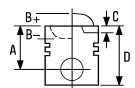







4  **72.50**

Corsa B 1.0 i 12V	11/96→09/00	X 10 XE Ecotec	3 Cyl. 973cc	10:1 40kW (54PS)	TD5512
--------------------------	-------------	-----------------------	------------------------	----------------------------	---------------

Agila 1.0 12V	09/00→12/07	Z 10 XE Ecotec	3 Cyl. 973cc	10:1 43kW (58PS)	TD14008
Corsa C 1.0	09/00→06/03				

87-102700-00	STD	08-102700-00	STD
87-102707-00	0.50mm	08-102707-00	0.50mm

A	24.00	1.20		NT 
B-	1.20	1.50		P
BØ	56.00	2.00		CR 
C	1.25			
D	45.00			
	18x51			

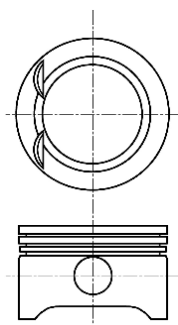







 Steel  Stahl  Acier  Acero  Acciaio

5  **72.50**

Astra G 1.2 16V	02/98→09/00	X 12 XE Ecotec	4 Cyl. 1199cc	10:1 48kW (65PS)	TD9508
Corsa B 1.2 i 16V	03/98→09/00				

Agila 1.2 16V	09/00→12/07	Z 12 XE Ecotec	4 Cyl. 1199cc	10:1 55kW (75PS)	TD14009
Astra G 1.2 16V	09/00→01/05				
Corsa C 1.2	09/00→12/09				
Corsa C 1.2 16V	09/00→				

87-102700-10	STD	08-102700-00	STD
87-102707-10	0.50mm	08-102707-00	0.50mm

A	24.00	1.20		NT 
C	1.25	1.50		P
D	45.00	2.00		CR 
	18x51			

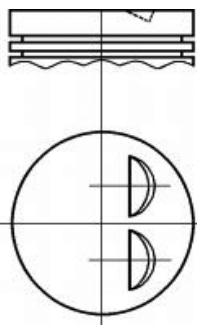



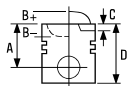



 Steel  Stahl  Acier  Acero  Acciaio



6  **73.40**

Adam 1.4	10/12→	A 14 XER		
Astra GTC J 1.4	10/11→		4 Cyl.	
Astra J 1.4	12/09→		1398cc	74kW (101PS)
Astra J Sports Tourer 1.4	10/10→			
Corsa D 1.4, Meriva B 1.4	06/10→			TD23855

87-429500-30	STD	08-429500-00	STD
87-429507-30	0.50mm	08-429507-00	0.50mm

A	25.80	1.20		NT 
B-	1.60	1.20		P
C	1.90	2.00		CR 
C	3.83			
D	46.80			
	18x53			

TP

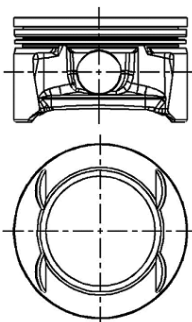

 Steel

 Stahl

 Acier



 Acero

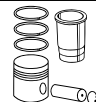
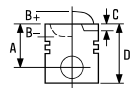





 Acciaio



7  **73.40**









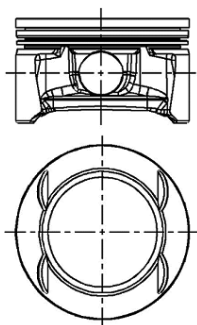

Agila 1.2 16V Twinport	07/04→12/07	Z 12 XEP		
Astra H 1.2, Astra H GTC 1.2	08/05→		4 Cyl.	10.5:1
Corsa C 1.2	07/05→		1229cc	59kW (80PS)
Corsa C 1.2 Twinport	07/04→12/09			TD18012
Corsa D 1.2	07/06→			
Corsa D 1.2 LPG	09/09→			

87-429500-10 	STD	08-429500-00	STD
87-429507-10 	0.50mm	08-429507-00	0.50mm

A	24.00	1.20		NT 
B+	0.53	1.20		P
C	1.46	2.00		CR 
C	1.49			
D	45.33			
	19x50			

TP











 Elastoval®	 Elastoval®	 Elastoval®	 Elastoval®	 Elastoval®
 Steel	 Stahl	 Acier	 Acero	 Acciaio











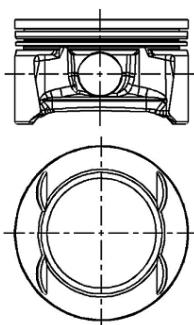

8  **73.40**

Astra F Classic 1.4 Comfort	09/03→01/05	Z 14 XEP EcoTec			
Astra G 1.4	10/04→12/09	4 Cyl.	10.5:1		
Astra H 1.4	03/04→	1364cc	66kW (90PS)		
Astra H 1.4 LPG	08/09→				TD17476
Astra H GTC 1.4	03/05→				
Combo 1.4 16V	08/05→				
Combo Tour 1.4	10/04→				
Corsa C 1.4	08/03→				
Corsa C 1.4 Twinport	06/03→12/09				
Corsa Classic 1.4	07/00→12/03				
Corsa D 1.4, Corsa D 1.4 LPG	07/06→				
Meriva 1.4 16V Twinport	07/04→05/10				
Meriva 1.4 16V Twinport LPG					
Tigra TwinTop 1.4	06/04→				

87-429500-00 	STD	08-429500-00	STD
87-429507-00 	0.50mm	08-429507-00	0.50mm

A	23.00	1.20		NT 
B-	1.25	1.20		P
BØ	53.50	2.00		CR 
C	1.33			
C	1.35			
D	44.00			
	18x49			



 Elastoval®	 Elastoval®	 Elastoval®	 Elastoval®	 Elastoval®
 Steel	 Stahl	 Acier	 Acero	 Acciaio

9  **75.00**

Ascona B 1.3 S	08/79→08/81	13 S			
Ascona C 1.3 S	09/81→08/88		4 Cyl.	9.2:1	
Corsa A 1.3 GL, Corsa A TR 1.3 GL	09/82→03/93		1297cc	42-55kW (57-75PS)	
Kadett D 1.3 S	08/79→08/84				TD4725
Kadett E 1.3	01/85→12/87				
Kadett E 1.3 S	09/84→02/93				
Manta B 1.3 S	08/81→08/86				
Manta B CC 1.3 S	08/79→08/86				

Corsa A 1.3	02/86→04/89	13 SB			
Corsa A 1.3 S	09/82→10/89		4 Cyl.	9.2:1	
Corsa A TR 1.3 S	09/82→10/87		1297cc	51kW (70PS)	
					TD4726



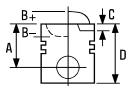

Corsa A 1.3 i	09/86→09/90	C 13 N		
Corsa A TR 1.3	09/85→10/87		4 Cyl.	9:1
Kadett D 1.3 N	08/79→08/84		1297cc	44kW (60PS)
Kadett E 1.3 i CAT	09/85→08/91			

TD4781

87-306307-00	0.50mm	08-306300-00	STD
87-306311-00	1.00mm	08-306307-00	0.50mm
		08-306311-00	1.00mm

A 35.80

B- 3.60

C 5.30

C 5.30

D 62.40

20x65

M.13N1225589→

1.50 CR P

1.50 P

4.00 CR P

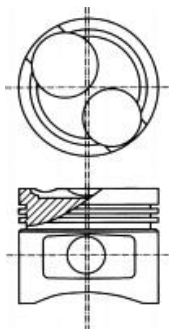

Pistons to be replaced in Engine Sets only

Kolben nur Motorsätzen zu ersetzen

Piston à remplacer dans jeu moteur

Pistones de repuesto para juegos de motores solamente

Il pistone può essere rimpiazzato solamente completo

10 **76.00**

Corsa A 1.5 D	06/87→03/93	15 D (4EC1)		
Corsa A TR 1.5 D	10/87→11/92		4 Cyl.	23:1
Corsa B 1.5 D	03/93→09/00		1488cc	37kW (50PS)

Diesel

TD4732

Corsa A 1.5 TD	03/88→03/93	15 DT (T4EC1)		
Corsa A TR 1.5 TD	10/87→03/93		4 Cyl.	22.5:1
Corsa B 1.5 TD	03/93→09/00		1488cc	49-53kW (67-72PS)

Diesel

Turbo

TD4733

Corsa B 1.5 TD	03/93→09/00	X 15 DT (T4EC1)		
			4 Cyl.	22.5:1
			1488cc	49kW (67PS)

Diesel

Turbo

TD5301

14-010870-00 D B 80.00 C 138.00

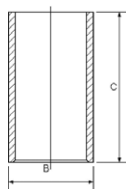



11  **77.60**

Astra F 1.4	09/91→09/93	14 NV			
Corsa A 1.4 S	01/90→03/93		4 Cyl.	9.4:1	
Corsa A TR 1.4 S	09/89→03/93		1389cc	53-55kW (72-75PS)	
Kadett E 1.4 S	07/89→02/93				TD4728
Vectra A 1.4 S	04/88→06/92				

Astra F 1.4 i	09/91→01/99	C 14 NZ			
Combo 1.4	07/94→10/01		4 Cyl.	9:1	
Corsa A 1.4 i	01/85→03/93		1389cc	40-44kW (54-60PS)	
Corsa A TR 1.4 i	10/89→03/93				TD4782
Corsa B 1.4 i	03/93→09/00				
Corsa Classic 1.4	08/94→07/02				
Kadett E 1.4 i	01/90→07/94				



Astra F 1.4 i	09/91→08/02	X 14 NZ			
Astra F Classic 1.4 i	01/98→01/05		4 Cyl.	9.4:1	
			1389cc	44kW (60PS)	
					TD14828

Combo 1.4	07/94→10/01	X 14 SZ			
Corsa B 1.4 i	03/93→09/00		4 Cyl.	9.5:1	
			1389cc	40-44kW (54-60PS)	
					TD8405

87-307100-20 STD
87-307107-20 0.50mm

08-307100-00 STD
08-307107-00 0.50mm

A 32.10
B- 3.40
D 52.50
 18x55

1.50  CR P
1.50  P
3.00  CR 1

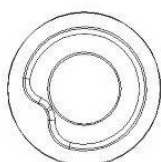
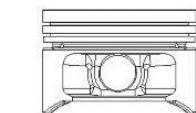

 Steel

 Stahl

 Acier

 Acero

 Acciaio

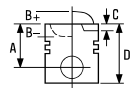





12  **77.60**

Corsa B 1.4 i 16V	08/97→09/00	C 14 SEL	4 Cyl.	9.8:1	63kW (86PS)	TD16393
			1389cc			

Astra F 1.4 i 16V	01/96→03/01	X 14 XE Ecotec	4 Cyl.	10.5:1	63-69kW (86-94PS)	TD2733
Astra G 1.4 16V	02/98→01/05					
Combo 1.4 16V	08/99→10/01		1389cc			
Corsa B 1.4 i 16V	09/94→					
Tigra 1.4 16V	07/94→12/00					

87-307100-30	STD	08-307100-00	STD
87-307107-30	0.50mm	08-307107-00	0.50mm

A	32.15	1.50		CR P
B+	1.10	1.50		P
D	57.00	3.00		CR 
	18x55			

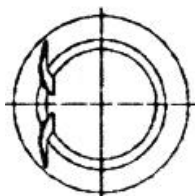







 Steel  Stahl  Acier  Acero  Acciaio



13  **77.60**

Astra G 1.4 16V	02/98→01/05	Z 14 XE Ecotec	4 Cyl.	10.5:1	66kW (90PS)	TD14920
Corsa C 1.4	09/00→12/09					
Corsa Classic 1.4	07/00→05/01		1389cc			
Corsa Utility 1.4	07/00→12/10					

87-144200-00	STD	08-144200-00	STD
87-144207-00	0.50mm	08-144207-00	0.50mm

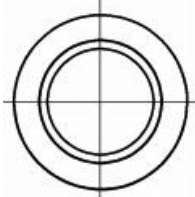
A	31.30	1.20		NT 
B+	2.45	1.50		P
D	55.75	2.00		CR 
	18x55			







 Steel  Stahl  Acier  Acero  Acciaio



14  **79.00**

Ascona A 1.2 S	04/72→08/75	12 S		
Ascona B 1.2 S	09/75→02/79		4 Cyl.	9:1
Corsa A 1.2	09/82→08/90		1196cc	40-44kW (54-60PS)
Corsa A TR 1.2 S	09/82→10/87			TD4720
Kadett B 1.2				
Kadett B 1.2, Kadett B 1.2 S	08/71→08/73			
Kadett C 1.2 S				
Kadett C 1.2 S, Kadett C City 1.2 S	08/73→07/79			
Kadett D 1.2 S	08/79→08/84			
Manta A 1.2	04/72→08/75			
Manta B 1.2 S	09/75→02/79			

87-304207-00	0.50mm	08-304200-00	STD
08-304207-00		08-304207-00	0.50mm
08-304211-00		08-304211-00	1.00mm
A 38.00		2.00 	CR P
C 2.00		2.00 	P
C 2.00		5.00 	P
D 76.00			
 20x65			

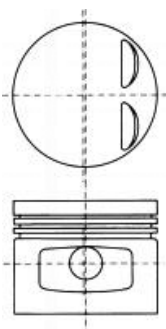

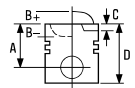







15  **79.00**

Ascona C 1.6	09/86→08/88	16 SV			
Kadett E 1.6	09/86→12/91		4 Cyl.	10:1	
Kadett E 1.6 i	07/89→02/93		1598cc	60kW (82PS)	
Kadett E 1.6, Kadett E 1.6 S	09/86→08/91				TD4740
Kadett E 1.6 S	09/86→08/91				
Vectra A 1.6, Vectra A 1.6 S	09/88→05/93				
Vectra B 1.6 GL	09/95→08/96				

Astra F 1.6 Si	03/92→12/94	C 16 SE			
Corsa A 1.6 GSI CAT	02/92→03/93		4 Cyl.	9.5:1	
			1598cc	74kW (100PS)	
					TD4787

Corsa A 1.6 GSI	05/88→03/92	E 16 SE			
Kadett E 1.6	09/87→08/91		4 Cyl.	9.5:1	
			1598cc	74-75kW (100-102PS)	
					TD4811

87-306900-10	STD	08-306900-00	STD
87-306907-10	0.50mm	08-306907-00	0.50mm

A	28.00	1.20		CR 
B-	1.60	1.50		P
B+	0.40	3.00		CR 
BØ	59.00			
D	48.40			
	18x55			

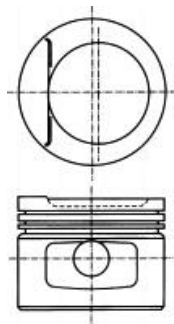

 Steel

 Stahl

 Acier

 Acero







 Acciaio



16  **79.00**

Astra GTC J 1.6	10/11→	A 16 LET Euro 5		
Astra J 1.6 Turbo	12/09→	4 Cyl.	8.8:1	
Astra J Sports Tourer 1.6 Turbo	10/10→	1598cc	132kW (180PS)	
Corsa D 1.6 T	02/07→	Turbo Intercooled		TD22589
Insignia 1.6 Turbo	07/08→			

87-435500-00	STD	08-435500-00	STD
87-435507-00	0.50mm	08-435507-00	0.50mm

A	27.50	1.20	 NT 
B+	0.60	1.20	 P
D	45.10	2.00	 NT 
	19x53		

HA TP

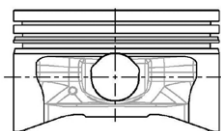

 Steel

 Stahl

 Acier

 Acero

 Acciaio



17  **79.00**

Ascona C 1.6 i CAT	09/86→08/88	C 16 NZ			
Astra F 1.6 i	09/91→09/98		4 Cyl.	9:1	
Corsa A 1.6 GSI	08/88→09/92		1598cc	55-60kW (75-82PS)	
Kadett E 1.6 i	08/89→07/94				TD4785
Kadett E 1.6 i CAT	09/86→02/93				
Vectra A 1.6 i, Vectra A 1.6 i CAT	09/88→11/95				
Ascona C 1.6 i	09/87→08/88	E 16 NZ			
Kadett E 1.6 i	09/86→02/93		4 Cyl.	9:1	
Vectra A 1.6	08/88→06/94		1598cc	55-65kW (75-88PS)	
Vectra A 1.6 i	09/88→11/95				TD4810
Astra F 1.6 i	02/93→08/96	X 16 SZ			
Vectra A 1.6 i	09/93→11/95		4 Cyl.	9.5:1	
			1598cc	52kW (71PS)	TD2734



87-306900-00
87-306907-00

STD
0.50mm

08-306900-00
08-306907-00

STD
0.50mm

A 28.00
B- 2.70
B+ 0.40
BØ 63.00
D 48.40
 18x55

1.20  **CR 1**
1.50  **P**
3.00  **CR 1**

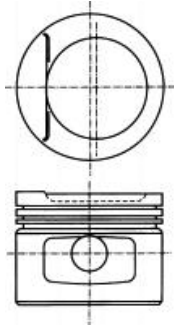

 Steel

 Stahl

 Acier

 Acero

 Acciaio





18  **79.00**

Corsa B 1.6 GSI 16V	03/93→09/00	C 16 XE Ecotec	4 Cyl.	10:1	TD4789
			1598cc	80kW (109PS)	
Corsa B 1.6 i 16V	09/94→09/00	X 16 XE Ecotec	4 Cyl.	10.5:1	
Tigra 1.6 16V	07/94→08/98		1598cc	78kW (106PS)	TD2735
Astra F 1.6 i 16V	08/94→08/02	X 16 XEL Ecotec	4 Cyl.	10.5:1	TD4820
Astra F Classic 1.6 i 16V	01/98→01/05		1598cc	74kW (100PS)	
Astra G 1.6 16V	02/98→01/05				
Vectra B 1.6 i 16V	10/95→07/02				
Zafira A 1.6 16V	04/99→06/05				

87-307800-10	STD	08-307800-00	STD
87-307807-10	0.50mm	08-307807-00	0.50mm
		08-307811-00	1.00mm

- A** 28.00
- B-** 0.80
- BØ** 60.20
- C** 1.90
- C** 2.15
- D** 48.00
-  18x55

1.20		CR 1
1.50		P
2.50		CR 1

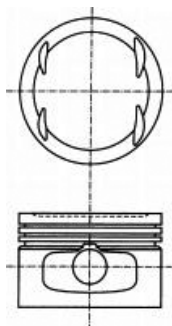

1 Steel

1 Stahl

1 Acier

1 Acero





1 Acciaio



19  **79.00**

Astra F 1.6 i	09/91→08/02	X 16 SZR			
Astra F Classic 1.6 i	01/98→01/05		4 Cyl.	9.6:1	
Astra G 1.6	02/98→09/00		1598cc	55kW (75PS)	
Kadett 1.6	03/95→05/00				TD4819
Vectra B 1.6 i	10/95→07/03				

87-306900-20	STD	08-306900-00	STD
87-306907-20	0.50mm	08-306907-00	0.50mm

A	28.45	1.20	 CR 1
B-	2.75	1.50	 P
BØ	63.00	3.00	 CR 1
D	48.45		
	18x55		

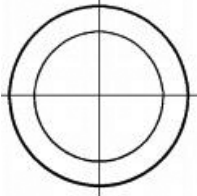

 Steel

 Stahl

 Acier

 Acero

 Acciaio





20  **79.00**

Vectra B 1.6 i 16V	10/95→07/02	Y 16 XE Ecotec			
			4 Cyl.	10.5:1	
			1598cc	74kW (101PS)	
					TD13688

Astra G 1.6	09/00→04/05	Z 16 SE			
Combo 1.6, Tour 1.6	10/01→		4 Cyl.	9.6:1	
Corsa C 1.6	09/00→12/09		1598cc	62-64kW (84-87PS)	
Meriva 1.6	05/03→05/10				TD15089
Zafira B 1.6	01/06→				

Astra G 1.6 16V	02/98→10/05	Z 16 XE Ecotec			
Astra G 1.6 LPG	06/02→01/05		4 Cyl.	10.5:1	
Meriva 1.6 16V	05/03→01/06		1598cc	74kW (101PS)	
Vectra B 1.6 i 16V	10/95→07/02				TD14923
Vectra C 1.6 16V	06/04→				
Vectra C GTS 1.6	08/05→				
Zafira A 1.6 16V	04/99→06/05				

87-125600-00	STD	08-125600-00	STD
87-125607-00	0.50mm	08-125607-00	0.50mm

A	27.20	1.20	 NT 1
D	50.20	1.50	 P
	18x55	2.50	 CR 1

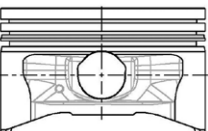

 Steel

 Stahl

 Acier



 Acero

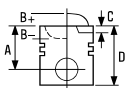





 Acciaio



21  **79.00**









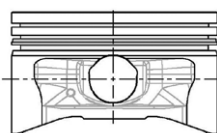

Astra G 1.6	12/02→12/09	Z 16 XEP			
Astra G 1.6 16V	03/00→05/05		4 Cyl.	10.5:1	
Astra H 1.6	02/04→		1598cc	74-77kW (101-105PS)	
Astra H GTC 1.6	03/05→				TD17892
Astra H TwinTop 1.6	09/05→				
Meriva 1.6	01/06→05/10				
Vectra C 1.6	01/06→				
Vectra C GTS 1.6					
Zafira A 1.6	10/03→06/05				
Zafira B 1.6	07/05→				

87-427800-00 	STD	08-427800-00	STD
87-427807-00 	0.50mm	08-427807-00	0.50mm

A	26.73	1.20	 NT 
D	48.73	1.20	 P
	18x52	2.00	 CR 

TP









 Elastoval®	 Elastoval®	 Elastoval®	 Elastoval®	 Elastoval®
 Steel	 Stahl	 Acier	 Acero	 Acciaio

22  **79.00**

Astra H 1.6	12/06→	Z 16 XER			
Astra H 1.6 LPG	08/09→		4 Cyl.	10.5:1	
Astra H GTC 1.6	12/06→		1598cc	85kW (116PS)	
Astra H TwinTop 1.6	12/06→				TD20060
Zafira B 1.6	01/08→				

87-435300-00	STD	08-435300-00	STD
87-435307-00	0.50mm	08-435307-00	0.50mm

A	26.70	1.20	 NT 
B+	1.20	1.20	 P
BØ	52.96	2.00	 NT 
C	1.90		
C	2.70		
D	48.70		
	19x46		

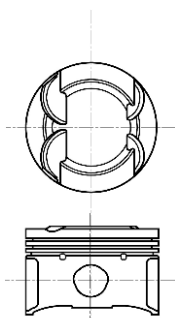

 Steel	 Stahl	 Acier	 Acero	 Acciaio
---	---	---	---	---

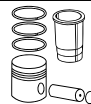
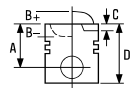

23  **79.00**

Combo 1.7 D	07/94→10/01	17 D (4EE1)			
Corsa B 1.7 D	02/96→09/00		4 Cyl.	22:1	
			1686cc	44kW (60PS)	
		Diesel			TD5284



Combo 1.7 D	07/94→10/01	X 17 D (4EE1)			
Corsa B 1.7 D	02/96→		4 Cyl.	22:1	
Corsa Utility 1.7 D	01/03→12/06		1686cc	42-44kW (57-60PS)	
		Diesel			TD5298

87-307600-10 STD

08-307600-00 STD
08-307607-00 0.50mm

→02/96, →179157

- A** 39.75
- B-** 1.30
- C** 0.25
- D** 69.80
-  27x64

- 2.00  CR P
- 1.50  CR P
- 3.00  CR P

AK RT

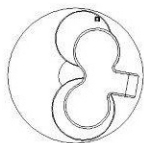
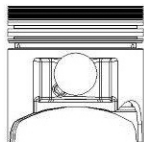



87-307600-20 STD
87-307607-20 0.50mm

08-307600-00 STD
08-307607-00 0.50mm

02/96→, 179158→

- A** 39.75
- B-** 1.30
- C** 0.30
- D** 79.80
-  25x60

- 2.00  CR P
- 1.50  CR P
- 3.00  CR P

RT

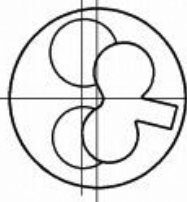
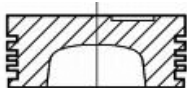

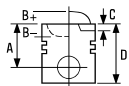





24  **79.00**

Astra F 1.7 TDS	12/91→09/98	17 DT (TC4EE1)		
Vectra A 1.7 TD	03/90→11/95		4 Cyl.	22:1
			1686cc	60kW (82PS)
		Diesel	Turbo	TD477

Astra F 1.7 TD	03/95→02/98	X 17 DT (TC4EE1)		
Astra F 1.7 TDS	12/91→09/98		4 Cyl.	22:1
Vectra A 1.7 TD	03/90→11/95		1686cc	60kW (82PS)
Vectra B 1.7 TD	10/95→12/98	Diesel	Turbo Intercooled	TD4822

87-307600-30	STD	08-307600-00	STD
87-307607-30	0.50mm	08-307607-00	0.50mm

A	39.70	2.00		CR P
B-	1.50	1.50		CR P
D	69.60	3.00		CR P
	27x64			

AK RT

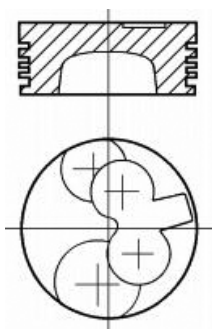

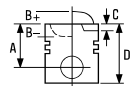





25  **79.00**

Astra G 1.7 DTI 16V	02/00→04/05	Y 17 DT		
Combo 1.7 DTI 16V	10/01→		4 Cyl.	18.4:1
Combo Tour 1.7 DTI 16V			1686cc	55kW (75PS)
Corsa C 1.7 DTI	09/00→12/09	Diesel	Turbo Intercooled	TD13689
Corsa C 1.7 DTI 16V	09/00→			
Corsa Utility 1.7 Dti	08/01→12/10			
Meriva 1.7 DTI	09/03→05/10			

Combo 1.7 DI 16V	10/01→	Y 17 DTL		
Combo Tour 1.7 DI 16V			4 Cyl.	18.4:1
Corsa C 1.7 DI	09/00→12/09		1686cc	48kW (65PS)
Corsa C 1.7 DI 16V	09/00→	Diesel	Turbo Intercooled	TD14921
Corsa Utility 1.7 Di	11/01→06/04			

87-307600-40	STD	08-307600-00	STD
87-307607-40	0.50mm	08-307607-00	0.50mm

A	39.75	2.00		CR P
B-	14.00	1.50		CR P
BØ	38.70	3.00		CR P
C	1.10			
D	84.00			
	27x64			

RT

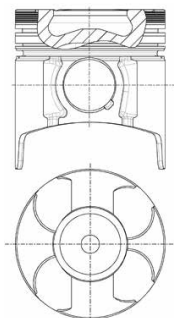







26  **80.00**

Ascona C 1.6 S	09/81→08/86	16 SH			
Kadett D 1.6 S	09/81→08/84		4 Cyl.	9.2:1	
Kadett E 1.6	09/86→06/93		1598cc	66kW (90PS)	
Kadett E 1.6 S	09/84→08/86				TD4739





87-305607-10  0.50mm

A 40.00
B- 3.20
C 3.20
D 72.00
 23x70

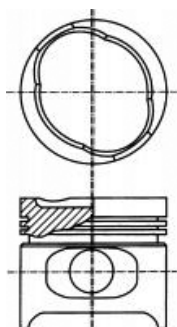
08-305600-00 STD
08-305607-00 0.50mm
08-305611-00 1.00mm

1.50  CR P
 1.75  P
 4.00  CR 



-  Steel
-  Acier
-  Acero
-  Acciaio

27  **80.00**



Ascona C 1.6 D	03/82→08/88	16 D			
Kadett D 1.6 D	03/82→08/84		4 Cyl.	23:1	
Kadett E 1.6 D	08/84→01/89		1598cc	40kW (54PS)	
			Diesel		TD4734

Ascona C 1.6 D	03/82→08/88	16 DA			
Kadett E 1.6 D	08/84→12/89		4 Cyl.	23:1	
			1598cc	40kW (54PS)	
			Diesel		TD4735

87-305900-00 STD
87-305907-00 0.50mm
87-305911-00 1.00mm

A 44.95
B- 1.50
D 76.95
 26x65

08-305900-10 STD
08-305907-10 0.50mm
08-305911-10 1.00mm

2.00  CR P
 2.00  P
 3.00  CR P

14-023520-00 D **B 83.00 C 143.50 D 84.90 E 4.50**

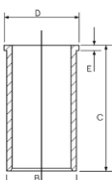

HA RT

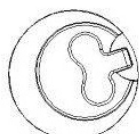
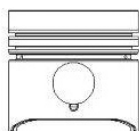

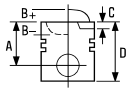





28  **80.00**

Arena 1.9 D	03/98→08/01	F8Q 600	4 Cyl.	21.5:1	
			1870cc	44kW (60PS)	
		Diesel			TD21361
Arena 1.9 D	03/98→08/01	F8Q 606	4 Cyl.	21.5:1	
			1870cc	44kW (60PS)	
		Diesel			TD21359

87-336500-00	STD	08-336500-00	STD
87-336505-00	0.25mm	08-336505-00	0.25mm
87-336507-00	0.50mm	08-336507-00	0.50mm
87-336510-00	0.80mm	08-336510-00	0.80mm

A	42.35	2.00		MO P
B-	0.70	2.00		P
D	70.50	3.00		CR P
	24x63			

RT

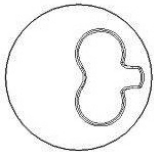
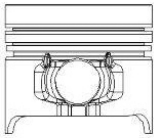

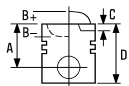

29  **80.00**

Vivaro 1.9 DTI	08/01→	F9Q 760	4 Cyl. 1870cc	18.3:1 74kW (101PS)	TD18872
		Diesel	Turbo Intercooled		
Vivaro 1.9 Di	08/01→	F9Q 762	4 Cyl. 1870cc	18.3:1 59-60kW (80-82PS)	TD18494
		Diesel	Turbo Intercooled		
Movano 1.9 DTI	09/00→10/01	F9Q 770	4 Cyl. 1870cc	18.3:1 59kW (80PS)	TD19374
		Diesel	Turbo Intercooled		
Movano 1.9 DTI	10/01→	F9Q 772	4 Cyl. 1870cc	18.3:1 60kW (82PS)	TD23125
		Diesel	Turbo Intercooled		
Movano 1.9 DTI Vivaro 1.9 DI	10/01→ 08/01→	F9Q 774	4 Cyl. 1870cc	18.3:1 60kW (82PS)	TD18252
		Diesel	Turbo Intercooled		

87-101500-00 STD
87-101507-00 0.50mm

08-101500-00 STD
08-101507-00 0.50mm

14-020280-00 D B 83.00 C 155.00 D 85.00 E 5.00

- A** 47.06
- B-** 17.80
- BØ** 38.00
- C** 0.75
- D** 77.00
-  **28x60**

→01/00

- 2.50
- 2.00
- 3.00



- P
- P
- CR P

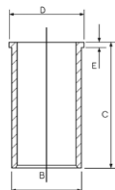

AK RT TP

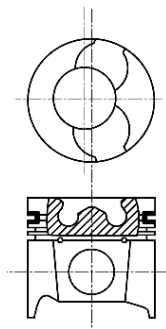

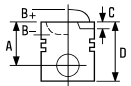





30  **80.00**

Omega	01/94→12/97	M 51 D25WA (E34/E36)	6 Cyl.	22:1	
			2498cc	85-105kW (115-146PS)	
		Diesel	Turbo Intercooled		FM6552
Omega B 2.5 TD	04/94→07/03	X 25 DT	6 Cyl.	22:1	
			2498cc	96kW (130PS)	
		Diesel	Turbo Intercooled		TD4828
Omega B 2.5 D	05/94→05/99	X 25 TD	6 Cyl.	22:1	
Omega B 2.5 TD	04/94→07/03		2498cc	96kW (131PS)	
		Diesel	Turbo Intercooled		TD17322

87-704500-00 STD **08-704500-00** STD
87-704507-00 0.50mm **08-704507-00** 0.50mm

A 39.45 3.00  **CR P**
B- 2.50 1.75  **P**
D 62.45 3.00  **CR P**
 27x63

AK KK RT

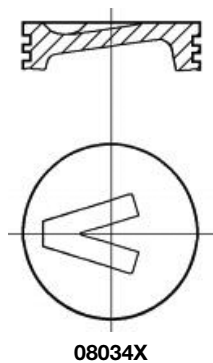

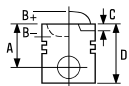





31  **80.50**

Astra G 1.8 16V	02/98→10/00	X 18 XE1 Ecotec			
Vectra B 1.8 i 16V	10/95→09/00	4 Cyl.	10.5:1		
Zafira A 1.8 16V	04/99→09/00	1796cc	85kW (115PS)		TD9509

Astra G 1.8 16V	06/00→10/05	Z 18 XE Ecotec			
Astra H 1.8	03/04→	4 Cyl.	10.5:1		
Astra H GTC 1.8	03/05→	1799cc	90-92kW (122-125PS)		
Astra H TwinTop 1.8	09/05→				TD14922
Corsa C 1.8	09/00→12/09				
Meriva 1.8	05/03→05/10				
Signum 1.8	05/03→				
Tigra TwinTop 1.8	06/04→				
Vectra B 1.8 i 16V	09/00→07/03				
Vectra C 1.8	10/03→				
Vectra C 1.8 16V	04/02→				
Vectra C GTS 1.8 16V	08/02→				
Zafira A 1.8 16V	09/00→06/05				

Astra G 1.8	02/03→01/05	Z 18 XEL Ecotec			
Corsa C 1.8	01/02→12/09	4 Cyl.	10.5:1		
Corsa Classic 1.8	01/02→12/05	1796cc	79-85kW (107-116PS)		
Corsa Utility 1.8	01/03→12/10				TD17894
Vectra B 1.8 i 16V	10/95→09/00				
Vectra C 1.8	04/02→				
Vectra C GTS 1.8 16V	08/02→12/06				
Zafira A 1.8	02/03→06/05				

87-141200-00	STD	08-141200-00	STD
87-141207-00	0.50mm	08-141207-00	0.50mm

A	24.10	1.20		NT 1
D	44.70	1.20		P
	18x55	2.00		CR 1

TP

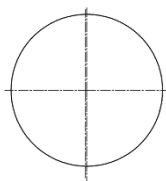
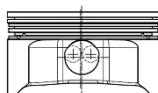

1 Steel

1 Stahl

1 Acier

1 Acero

1 Acciaio







32  **81.60**

Astra F 1.8 i 16V	06/93→01/98	C 18 XE Ecotec	4 Cyl. 1796cc	10.8:1 92kW (125PS)	TD4795
Astra F 1.8 i 16V	07/94→03/01	C 18 XEL Ecotec	4 Cyl. 1796cc	10.8:1 85kW (116PS)	TD4796
Astra F 1.8 i 16V Vectra B 1.8 i 16V	07/94→03/01 10/95→09/00	X 18 XE Ecotec	4 Cyl. 1796cc	10.8:1 85kW (115PS)	TD4823

87-307700-10 STD
87-307707-10 0.50mm
A 30.40
B- 1.80
BØ 50.80
D 50.40
 21x56

08-307700-00 STD
08-307707-00 0.50mm
08-307711-00 1.00mm

1.50  MO P
 1.50  P
 3.00  CR 

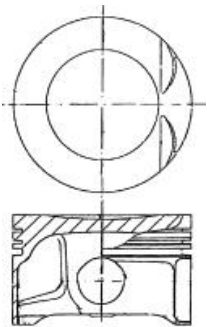

 Steel

 Stahl

 Acier

 Acero

 Acciaio

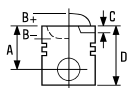





33  **81.60**

Calibra A 2.5 I V6	04/93→07/97	C 25 XE Ecotec		
Vectra A 2.5 CD	08/92→08/95	V6 Cyl.	10.8:1	
Vectra A 2.5 V6	02/93→11/95	2498cc	125kW (170PS)	TD4804

Calibra A 2.5 I V6	04/93→07/97	X 25 XE Ecotec		
Omega B 2.5 V6	03/94→09/00	V6 Cyl.	10.8:1	
Vectra B 2.5	10/99→06/00	2498cc	125-144kW (170-196PS)	TD2738
Vectra B 2.5 i V6	10/95→09/00			
Vectra B i 500 2.5	05/98→09/00			

87-307700-00	STD	08-307700-00	STD
87-307707-00	0.50mm	08-307707-00	0.50mm
		08-307711-00	1.00mm

A	30.45			
B+	0.36	1.50		MO P
C	2.40	1.50		P
D	51.03	3.00		CR 
	21x56			

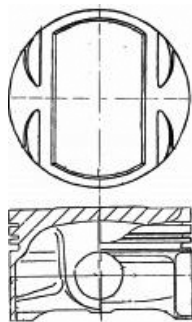

 Steel

 Stahl

 Acier

 Acero





 Acciaio



34  **82.00**

Astra H 1.9 CDTI	06/04→	Z 19 DT			
Astra H GTC 1.9 CDTi			4 Cyl.	17.5:1	
Signum 1.9 CDTI, Vectra C 1.9 CDTI	04/04→		1910cc	88kW (120PS)	
Vectra C 1.9 CDTI		Diesel	Turbo Intercooled		TD18046
Vectra C GTS 1.9 CDTI					
Zafira B 1.9 CDTI	07/05→				
Astra H 1.9 CDTI	09/05→	Z 19 DTL Euro 4			
Astra H GTC 1.9 CDTi	01/06→		4 Cyl.	18:1	
Vectra C 1.9 CDTI	10/05→		1910cc	74kW (101PS)	
Vectra C GTS 1.9 CDTI		Diesel	Turbo Intercooled		TD18671
Zafira B 1.9 CDTI	07/05→				

87-124000-30	STD	08-124000-00	STD
87-124008-30	0.60mm	08-124006-00	0.40mm
		08-124008-00	0.60mm

A	46.50			
B-	17.45	2.00		CK P
BØ	37.55	2.00		P
C	0.65	2.00		CR P
D	72.50			
	26x61			

NB RT

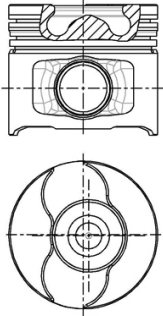

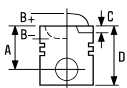





35  **82.00**

Astra H 1.9 CDTI	09/04→	Z 19 DTH Euro 4			
Astra H GTC 1.9 CDTI	03/05→		4 Cyl.	17.5:1	
Astra H TwinTop 1.9 CDTi	09/05→		1910cc	110kW (150PS)	
Signum 1.9 CDTI, Vectra C 1.9 CDTI	04/04→	Diesel	Turbo Intercooled		TD18014
Vectra C 1.9 CDTI					
Vectra C GTS 1.9 CDTI					
Zafira B 1.9 CDTI	07/05→				

Astra H 1.9 CDTI 16V	04/04→	Z 19 DTJ			
Astra H GTC 1.9 CDTi 16V	03/05→		4 Cyl.	17.5:1	
			1910cc	88kW (120PS)	
		Diesel	Turbo Intercooled		TD18011

87-146100-00 STD
87-146108-00 0.60mm
A 46.50
B- 15.40
BØ 41.50
C 1.03
D 72.50
 26x61

08-146100-00 STD
08-146106-00 0.40mm
08-146108-00 0.60mm

2.00  CK P
 2.00  P
 2.00  CK P

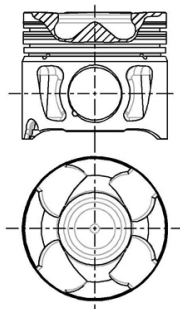

AK KK NB RT TP



08256-102

87-146100-10 STD
87-146106-10 0.40mm
A 46.50
B- 15.40
BØ 41.50
C 1.07
D 72.50
 30x67

08-146100-00 STD
08-146106-00 0.40mm
08-146108-00 0.60mm

2.00  CK P
 2.00  P
 2.00  CK P

AK KK RT TP

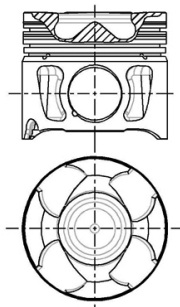

08269-503

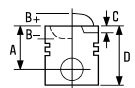





36  **82.50**

Astra F 1.7 D	12/91→09/92	17 D		
Kadett E 1.7 D	08/88→07/94		4 Cyl.	23:1
Vectra A 1.7 D	09/88→09/92		1699cc	42kW (57PS)
Diesel				TD4742

Astra F 1.7 D	07/92→01/99	17 DR		
Kadett E 1.7 D	07/92→07/94		4 Cyl.	23.1:1
Vectra A 1.7 D	07/92→11/95		1699cc	42-44kW (57-60PS)
Diesel				TD4744

87-306700-10	STD	08-306700-00	STD	14-021200-00 D	B 85.58 C 143.35 D 87.40 E 4.55
87-306707-10	0.50mm	08-306707-00	0.50mm		
87-306711-10	1.00mm	08-306711-00	1.00mm		

A	44.95	2.00		CR P
C	1.60	2.00		P
D	72.95	3.00		CR P
	26x65			

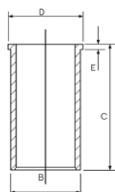



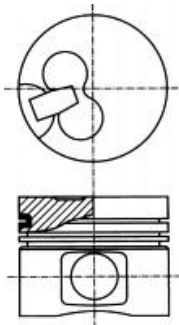

HA RT



37  **82.50**

Astra F 1.7 TD	08/94→01/99	X 17 DTL		
Astra G 1.7 TD	02/98→04/05		4 Cyl.	22:1
			1699cc	50kW (68PS)
Diesel			Turbo Intercooled	
				TD4821

87-306700-00	STD	08-306700-00	STD	14-021200-00 D	B 85.58 C 143.35 D 87.40 E 4.55
87-306707-00	0.50mm	08-306707-00	0.50mm		
87-306711-00	1.00mm	08-306711-00	1.00mm		

A	44.92	2.00		CR P
B-	1.80	2.00		P
D	67.00	3.00		CR P
	26x69			

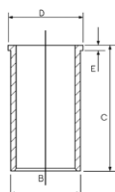

HA RT TP

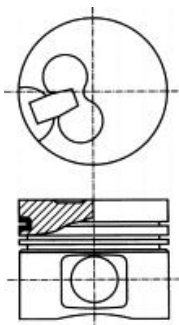

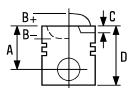





38  **83.00**

Insignia 2.0 CDTI	07/08→	A 20 DT Euro 5	4 Cyl.	16.5:1	
Zafira Tourer C 2.0 CDTi	10/11→		1956cc	96kW (131PS)	
		Diesel	Turbo Intercooled		TD25782
Insignia 2.0 CDTI	07/08→	A 20 DTC Euro 5	4 Cyl.	16.5:1	
			1956cc	81kW (110PS)	
		Diesel	Turbo Intercooled		TD22597
Astra GTC J 2.0 CDTI	10/11→	A 20 DTH Euro 5	4 Cyl.	16.5:1	
Astra J 2.0 CDTI	12/09→		1956cc	118-121kW (160-165PS)	
Astra J Sports Tourer 2.0 CDTI	10/10→				
Cascada 2.0 CDTI	03/13→	Diesel	Turbo Intercooled		TD22601
Insignia 2.0 CDTI	07/08→				
Zafira Tourer C 2.0 CDTi	10/11→				
Insignia 2.0 CDTI	07/08→	A 20 DTJ Euro 5	4 Cyl.	16.5:1	
			1956cc	96kW (131PS)	
		Diesel	Turbo Intercooled		TD22599
Insignia 2.0 CDTI	07/08→	A 20 DTL Euro 5	4 Cyl.	16.5:1	
Zafira Tourer C 2.0 CDTi	10/11→		1956cc	81kW (110PS)	
		Diesel	Turbo Intercooled		TD25724
Zafira Tourer C 2.0 CDTi	10/11→	Z 20 DTJ	4 Cyl.	16.5:1	
			1956cc	96kW (131PS)	
		Diesel	Turbo Intercooled		TD26541

87-436500-00 STD
87-436506-00 0.40mm

08-436500-00 STD
08-436506-00 0.40mm

A 43.63
B- 15.80
BØ 43.50
D 72.63
 30x66

1.50  GDC P
 1.50  P
 2.00  CR P



KK RT TP

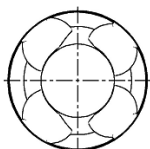
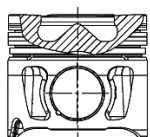



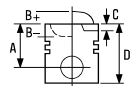

08344A406



39  **83.00**

Antara 2.0 CDTI	05/06→	Z 20 S	4 Cyl.	17.5:1
			1991cc	93-110kW (126-150PS)
		Diesel	Turbo Intercooled	TD20856

87-879200-00	STD	08-879200-00	STD
87-879207-00	0.50mm	08-879207-00	0.50mm

A	46.35	2.00	 CR P
B-	13.95	2.00	 P
BØ	51.90	3.00	 NT
D	72.35		
	28x67		

AK KK RT TP

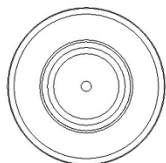
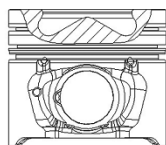





40  **84.00**

Vivaro 2.0 CDTI	01/06→	M9R 630	4 Cyl.	15.5:1
			1995cc	66-84kW (90-114PS)
		Diesel	Turbo Intercooled	TD25646

Vivaro 2.0 CDTI	08/06→	M9R 692 Euro 5	4 Cyl.	15.5:1
			1995cc	84kW (114PS)
		Diesel	Turbo Intercooled	TD28089

87-422000-10	STD	08-422000-00	STD
87-422007-10	0.50mm	08-422007-00	0.50mm

A	48.00	2.50	 MOL P
B-	14.00	2.00	 MOL P
BØ	50.00	2.00	 CR P
D	76.00		
	32x65		

KK RT TP

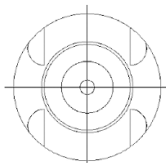
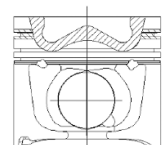

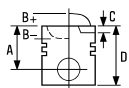





41  **84.00**

Vivaro 2.0 CDTI	01/06→	M9R 780 Euro 4	4 Cyl.	16:1	
			1995cc	66-84kW (90-114PS)	
		Diesel	Turbo Intercooled		TD20888
Vivaro 2.0 CDTI	01/06→	M9R 782	4 Cyl.	17:1	
			1995cc	66-84kW (90-114PS)	
		Diesel	Turbo Intercooled		TD24726
Vivaro 2.0 CDTI	01/06→	M9R 786 Euro 4	4 Cyl.	15.7:1	
			1995cc	66-84kW (90-114PS)	
		Diesel	Turbo Intercooled		TD25139

87-422000-00	STD	08-422000-00	STD
87-422007-00	0.50mm	08-422007-00	0.50mm

A	47.92	2.50		MOL P
B-	14.90	2.00		MOL P
BØ	49.07	2.00		CR P
C	0.40			
C	0.40			
D	76.00			
	32x65			

AK KK RT TP

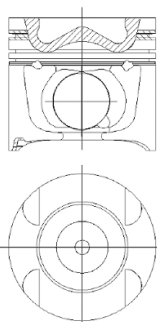

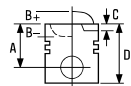





42  **84.00**

Astra G 2.0 DTI 16V	08/99→01/05	X 20 DTH		
Omega B 2.0 DTI 16V	09/97→09/00		4 Cyl.	18.5:1
Vectra B 2.0 DTI 16V	06/97→07/03		1995cc	74kW (101PS)
Diesel			Turbo Intercooled	
TD9729				

87-102900-10	STD	08-102900-00	STD
87-102907-10	0.50mm	08-102907-00	0.50mm

A	45.80	2.50		CK P
B-	14.67	1.75		P
BØ	40.85	3.00		CR P
D	70.80			
	29x68			

AK RT TP

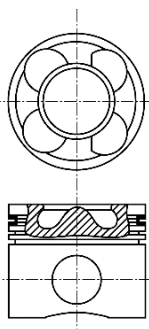





43  **84.00**

Astra G 2.0 DI	02/98→04/05	X 20 DTL		
Vectra B 2.0 DI 16V	11/96→04/02		4 Cyl.	18.5:1
Zafira A 2.0 DI	07/99→06/00		1896cc	60-63kW (82-86PS)
Zafira A 2.0 DI 16V	07/99→06/05	Diesel	Turbo Intercooled	
TD4824				

Astra G 2.0 DI	02/98→01/05	Y 20 DTL		
			4 Cyl.	18.5:1
			1995cc	60-63kW (82-86PS)
Diesel			Turbo Intercooled	
TD15848				

87-102800-10	STD	08-102800-00	STD	14-102800-00 D	B 87.00 C 160.00 D 90.00 E 4.50
87-102807-10	0.50mm	08-102807-00	0.50mm		

A	45.80	2.00		CK P
B-	14.90	1.75		P
BØ	41.00	3.00		CR P
C	1.00			
D	70.80			
	29x68			

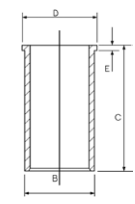

AK RT TP

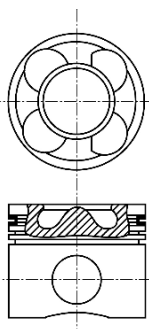

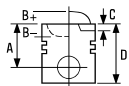





44  **84.00**

Frontera B 2.2 DTI Sintra 2.2 DTI	10/98→09/02 07/97→04/99	X 22 DTH	4 Cyl. 2172cc	18.5:1 85kW (116PS)	Diesel Turbo Intercooled	TD9510
Frontera B 2.2 DTI Omega B 2.2 DTI 16V	10/98→ 09/00→07/03	Y 22 DTH	4 Cyl. 2172cc	19.5:1 81-88kW (110-120PS)	Diesel Turbo Intercooled	TD15091
Astra G 2.2 DTI Omega B 2.2 DTI 16V Signum 2.2 DTI Signum 2.2 DTI 16V Vectra B 2.2 DTI 16V Vectra C 2.2 DTI Vectra C 2.2 DTI 16V Vectra C GTS 2.2 DTI 16V Zafira A 2.2 DTI 16V	09/02→10/05 01/01→ 05/03→ 05/03→06/08 09/00→07/03 10/03→ 04/02→ 08/02→ 01/02→06/05	Y 22 DTR	4 Cyl. 2172cc	18.5:1 86-92kW (117-125PS)	Diesel Turbo Intercooled	TD14924

87-126000-10	STD	08-126000-00	STD
87-126007-10	0.50mm	08-126007-00	0.50mm

A	45.80	1.75		CK P
B-	14.67	1.75		P
BØ	43.00	3.00		CR P
C	1.05			
D	70.80			
	29x68			

AK KK RT TP

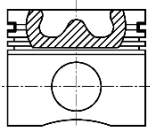
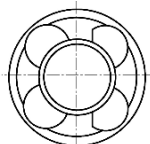

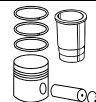
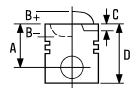





45  **84.00**

Astra G 2.0 DTI 16V	08/99→01/05	Y 20 DTH		
Signum 2.0 DTI	05/03→		4 Cyl.	19.5:1
Vectra B 2.0 DTI 16V	06/97→07/03		1995cc	74kW (101PS)
Vectra C 2.0 DTI	10/03→	Diesel	Turbo Intercooled	TD13752
Vectra C 2.0 DTI 16V	04/02→			
Vectra C GTS 2.0 DTI 16V	08/02→			
Zafira A 2.0 DTI 16V	09/00→06/05			

87-126000-00	STD	08-126000-00	STD
87-126007-00	0.50mm	08-126007-00	0.50mm

A	45.85	1.75		CK P
B-	14.68	1.75		P
BØ	41.00	3.00		CR P
C	1.05			
D	70.80			
	29x68			

AK KK RT TP

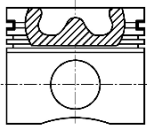
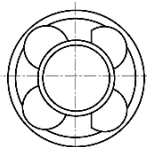



46  **84.80**

Astra F 1.8	11/91→07/93	18 SE			
Astra F 1.8 i 16V	09/95→09/96		4 Cyl.	10:1	
Kadett E 1.8	01/86→08/91		1796cc	82-85kW (112-116PS)	
Kadett E 1.8 i	09/84→08/86				TD4753



Omega A 1.8	09/86→03/94	18 SEH			
			4 Cyl.	10:1	
			1796cc	85kW (115PS)	
					TD4754

Kadett E 1.8 i	09/90→08/91	18 SV			
Omega A 1.8 N	11/86→09/88		4 Cyl.	10:1	
Omega A 1.8 S	09/86→03/94		1796cc	63-66kW (86-90PS)	
Vectra A 1.8 i	09/88→10/90				TD4755
Vectra A 1.8 S	09/89→10/90				

87-307200-00	STD	08-307200-00	STD
87-307207-00	0.50mm	08-307207-00	0.50mm

- A** 33.65
- B-** 4.00
- BØ** 43.00
- D** 53.65
-  21x62

09/86→

1.50		CR P
1.50		P
3.00		CR 1

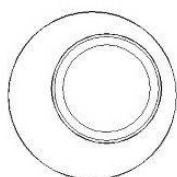
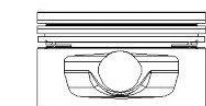

 Steel

 Stahl

 Acier

 Acero

 Acciaio

47  **85.00**

Movano B 2.3 CDTI	12/10→	M9T 670 Euro 5			
Movano B 2.3 CDTI FWD	05/10→		4 Cyl.	16:1	
			2298cc	74-92kW (101-125PS)	
		Diesel	Turbo Intercooled		TD25055

Movano B 2.3 CDTI	12/10→	M9T 672 Euro 5			
Movano B 2.3 CDTI FWD	05/10→		4 Cyl.	16:1	
			2298cc	74-92kW (101-125PS)	
		Diesel	Turbo Intercooled		TD25226

Movano B 2.3 CDTI	12/10→	M9T 676 Euro 4			
Movano B 2.3 CDTI FWD	05/10→		4 Cyl.	16:1	
			2298cc	74-92kW (101-125PS)	
		Diesel	Turbo Intercooled		TD25056

Movano B 2.3 CDTI	12/10→	M9T 678			
Movano B 2.3 CDTI FWD	05/10→		4 Cyl.	16:1	
			2298cc	107kW (146PS)	
		Diesel	Turbo Intercooled		TD25157

Movano B 2.3 CDTI	12/10→	M9T 680			
Movano B 2.3 CDTI FWD	05/10→		4 Cyl.	16:1	
			2298cc	92-107kW (125-146PS)	
		Diesel	Turbo Intercooled		TD25137



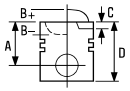



Movano B 2.3 CDTI [RWD]	05/10→	M9T 686 Euro 5 4 Cyl. 2298cc Diesel	16:1 92kW (125PS) Turbo Intercooled	TD25231
Movano B 2.3 CDTI [RWD]	05/10→	M9T 690 Euro 5 4 Cyl. 2298cc Diesel	16:1 74-92kW (101-125PS) Turbo Intercooled	TD25230
Movano B 2.3 CDTI [RWD]	05/10→	M9T 692 Euro 4 4 Cyl. 2298cc Diesel	16:1 74-92kW (101-125PS) Turbo Intercooled	TD25224
Movano B 2.3 CDTI [RWD]	05/10→	M9T 694 Euro 4 4 Cyl. 2298cc Diesel	16:1 107-110kW (146-150PS) Turbo Intercooled	TD25058
Movano B 2.3 CDTI [RWD]	05/10→	M9T 696 Euro 4 4 Cyl. 2298cc Diesel	16:1 92-110kW (125-150PS) Turbo Intercooled	TD25225
Movano B 2.3 CDTI [RWD]	05/10→	M9T 698 Euro 5 4 Cyl. 2298cc Diesel	16:1 92-110kW (125-150PS) Turbo Intercooled	TD25057
Movano B 2.3 CDTI [RWD]	05/14→	M9T 700 4 Cyl. 2299cc Diesel	16:1 100-120kW (136-163PS) Bi-Turbo Intercooled	TD29659
Movano B 2.3 CDTI Movano B 2.3 CDTI FWD	05/14→	M9T 702 4 Cyl. 2299cc Diesel	16:1 100-120kW (136-163PS) Bi-Turbo Intercooled	TD29658
Movano B 2.3 CDTI Movano B 2.3 CDTI FWD	05/14→ 02/12→	M9T 870 4 Cyl. 2299cc Diesel	16:1 81kW (110PS) Turbo Intercooled	TD29657
Movano B 2.3 CDTI Movano B 2.3 CDTI [RWD] Movano B 2.3 CDTI FWD	12/10→ 05/10→	M9T 876 4 Cyl. 2299cc Diesel	16:1 92kW (125PS) Turbo Intercooled	TD31130
Movano B 2.3 CDTI Movano B 2.3 CDTI FWD	01/13→	M9T 880 4 Cyl. 2298cc Diesel	16:1 110kW (150PS) Turbo Intercooled	TD28582
Movano B 2.3 CDTI Movano B 2.3 CDTI FWD	01/13→	M9T 896 4 Cyl. 2298cc Diesel	16:1 110kW (150PS) Turbo Intercooled	TD28580

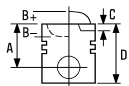



Movano B 2.3 CDTI		M9T 898		
Movano B 2.3 CDTI FWD	01/13→		4 Cyl.	16:1
			2298cc	110kW (150PS)
		Diesel	Turbo Intercooled	TD28581

87-435200-00	STD	08-435200-00	STD
87-435207-00	0.50mm	08-435207-00	0.50mm

A	48.00	2.50		GDC P
B-	16.20	2.00		MO P
BØ	50.00	2.00		CR P

C 0.45
D 76.00

 32x65



AK KK RT

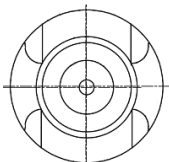
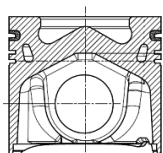

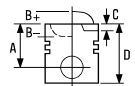





48  **86.00**

Ascona C 2.0 i	09/86→08/88	20 NE			
Kadett E 2.0	01/86→12/93		4 Cyl.	9.2:1	
Kadett E 2.0 GSI	09/86→08/91		1998cc	85-95kW (115-129PS)	
Kadett E 2.0 i	10/86→02/93				TD4759
Rekord E 2.0	12/83→12/91				
Vectra A 2.0 i	09/88→10/90				

Ascona C 2.0 i CAT	09/86→08/88	C 20 NE			
Astra F 2.0 i	09/91→09/98		4 Cyl.	9:1	
Calibra A 2.0 I	06/90→07/97		1998cc	85kW (115PS)	
Frontera A Sport 2.0 I	03/92→10/98				TD4799
Kadett 2.0 i	09/94→05/00				
Kadett E 2.0 GSI CAT	09/86→08/91				
Kadett E 2.0 i CAT	10/86→02/93				
Omega A 2.0	09/87→04/94				
Omega A 2.0 i	09/86→03/94				
Vectra A 2.0 i CAT	09/88→11/95				
Vectra B 2.0 i	10/95→04/02				

87-306800-30	STD	08-306800-00	STD
87-306807-30	0.50mm	08-306807-00	0.50mm
87-306811-30	1.00mm	08-306811-00	1.00mm

A	30.40	1.50		CR P
B-	5.00	1.50		P
BØ	57.00	3.00		CR 1
D	50.40			
	21x62			

TP

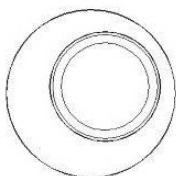
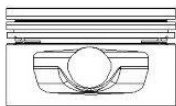

 Steel

 Stahl

 Acier

 Acero

 Acciaio

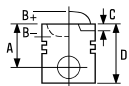





49  **86.00**

Kadett E 2.0 GSI 16V	12/87→08/91	20 XE	4 Cyl. 1998cc	10.5:1 115kW (156PS)	TD4765
----------------------	-------------	--------------	-------------------------	--------------------------------	---------------

Astra F 2.0 GSI 16V	09/91→01/98	C 20 XE			
Astra F 2.0 i 16V	03/93→01/98		4 Cyl. 1998cc	10:1 110kW (150PS)	
Calibra A 2.0 I 16V	06/90→02/94				
Kadett E 2.0	09/90→05/92				TD4801
Kadett E 2.0 GSI 16V CAT	03/88→08/91				
Vectra A 2.0 All-wheel Drive	08/89→08/95				
Vectra A 2.0 i 16V CAT	02/90→11/95				
Vectra A 2000/GT 16V CAT	02/90→11/95				

87-306800-10	STD	08-306800-00	STD
87-306807-10	0.50mm	08-306807-00	0.50mm
		08-306811-00	1.00mm

- A** 30.43
- B-** 0.85
- BØ** 70.00
- C** 2.20
- D** 55.43
-  21x62

1.50		CR P
1.50		P
3.00		CR 1

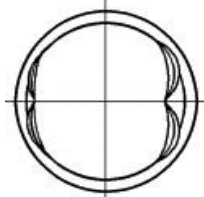

 Steel

 Stahl

 Acier

 Acero

 Acciaio

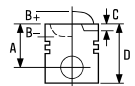



50  **86.00**

Astra F 2.0 i 16V	02/95→09/98	X 20 XEV Ecotec		
Astra G 2.0 16V	02/98→01/05	4 Cyl.	10.8:1	
Calibra A 2.0 i 16V	02/94→07/97	1998cc	100kW (136PS)	
Omega B 2.0 16V	03/94→09/99			TD2737
Vectra A 2.0 i 16V	06/94→11/95			
Vectra B 2.0 i 16V	10/95→09/00			

87-306800-20	STD	08-306800-00	STD
87-306807-20	0.50mm	08-306807-00	0.50mm
		08-306811-00	1.00mm

A	30.40
B-	3.16
C	2.00
D	55.40
	21x62

1.50		CR P
1.50		P
3.00		CR 1

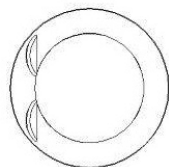
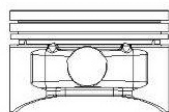

 Steel  Stahl  Acier  Acero  Acciaio

51  **86.00**

Astra G 2.2 16V	06/00→10/05	Z 22 SE Ecotec		
Speedster 2.2	09/00→	4 Cyl.	10:1	
Vectra B 2.2 i 16V	09/00→07/03	2198cc	108kW (147PS)	
Vectra C 2.2 16V	04/02→			TD14668
Vectra C GTS 2.2 16V	08/02→			
Zafira A 2.2 16V	09/00→06/05			

14-020450-00 D **B 89.02 C 137.25 D 95.45 E 4.63**

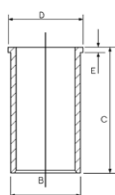







52  **87.00**

Movano 2.2 DTI	09/00→	G9T 720	4 Cyl. 2188cc	18:1 66kW (90PS)	
		Diesel	Turbo Intercooled		TD18875
Movano 2.2 DTI	09/00→	G9T 722	4 Cyl. 2188cc	18:1 66kW (90PS)	
		Diesel	Turbo Intercooled		TD21397
Movano 2.2 DTI	09/00→	G9T 750	4 Cyl. 2188cc	17.8:1 66kW (90PS)	
		Diesel	Turbo Intercooled		TD23885

87-127400-00	STD	08-127400-00	STD
87-127407-00	0.50mm	08-127407-00	0.50mm

A	54.53	3.00	 P PS
B-	17.50	1.75	 P
BØ	40.40	2.50	 P
C	2.00		
D	84.20		
	31x65		

AK RT TP

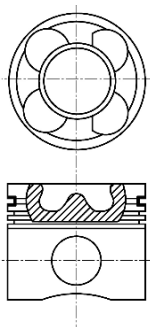

53  **88.00**

Rekord D 2.1 D	09/72→08/77	21 D	4 Cyl.	22:1	
Rekord E 2.1 D	09/77→07/78		2068cc	44kW (60PS)	
		Diesel			TD2658



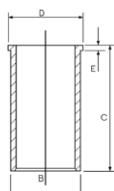

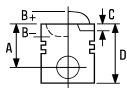
14-024160-00 D B 92.00 C 172.00 D 93.90 E 4.55



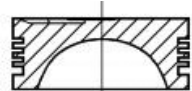

54  **88.00**

Campo 2.2 D	08/87→09/96	C 223	4 Cyl. 2238cc	21:1 39-54kW (53-73PS)
Diesel				TD22878

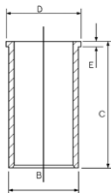
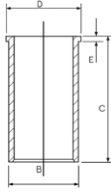
<p>87-247600-10 STD</p> <p>A 48.00 B- 2.40 D 82.75  27x68</p> <p>RT</p>  	<p>08-247600-00 STD</p> <p>12/83→</p> <p>2.00  P 2.00  P 4.00  P</p>	<p>14-021440-00 DH ¹ ² B 89.97 C 163.32 D 94.89 E 0.89</p>  <p>14-021190-00 D B 92.13 C 163.50 D 95.00 E 4.00</p> 	<p>88-247600-10 87-247600-10 + 14-021440-00</p>
---	--	--	--

- | | | | | |
|---|---|--|--|---|
| <p>¹ Not suitable for use with pistons having chrome rings</p> <p>² Chrome Bore</p> | <p>¹ Nicht geeignet zur Verwendung mit Kolben mit Chromringen</p> <p>² Bohrung verchromte</p> | <p>¹ Ne pas utiliser avec des pistons équipés de segments chromés</p> <p>² Alésage chromée</p> | <p>¹ No es adecuada para usar con pistones que tengan aros de croma</p> <p>² Cromado de cilindro</p> | <p>¹ Non utilizzabile con pistoni equipaggiati con segmenti cromati</p> <p>² Cilindro cromato</p> |
|---|---|--|--|---|

55  **89.00**

Movano 2.5 DTI	10/01→	G9U 720 Euro 3	4 Cyl. 2463cc	21:1 84-85kW (114-116PS)
			Diesel	Turbo Intercooled
TD18874				
Movano 2.5 DTI	10/01→	G9U 724 Euro 3	4 Cyl. 2463cc	21:1 84kW (115PS)
			Diesel	Turbo Intercooled
TD19367				
Vivaro 2.5 DTi	05/03→	G9U 730 Euro 3	4 Cyl. 2463cc	99kW (135PS)
			Diesel	Turbo Intercooled
TD18497				
Movano 2.5 DTI	10/01→	G9U 750	4 Cyl. 2463cc	17.75:1 84kW (115PS)
			Diesel	Turbo Intercooled
TD23887				





Movano 2.5 CDTI	10/03→12/06	G9U 754 Euro 3		
Movano 2.5 DTI	10/01→		4 Cyl.	17.75:1
			2463cc	73-84kW (99-115PS)
		Diesel	Turbo Intercooled	TD19817

87-137500-10	STD	08-137500-10	STD
87-137507-10	0.50mm	08-137507-10	0.50mm

A	53.03	2.50		MO P
B-	17.85	1.75		P
BØ	43.20	2.50		CR P
C	1.65			
C	1.90			
D	83.09			
	31x65			

AK RT TP

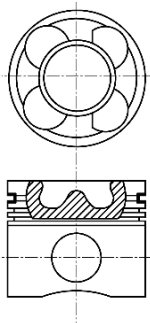

56 **92.00**

Rekord E 2.2 D	08/78→08/86	23 D		
Rekord E 2.3 D	11/82→08/86		4 Cyl.	22:1
			2260cc	46-63kW (63-86PS)
		Diesel		TD2663
Rekord E 2.2 D	08/78→08/86	23 DC		
Rekord E 2.3 D	11/82→08/86		4 Cyl.	
			2260cc	70kW (95PS)
		Diesel		TD2662
Frontera A 2.3 TD	03/92→10/98	23 DTR		
Omega A 2.3 TD Interc.	08/88→03/94		4 Cyl.	23:1
			2260cc	74kW (100PS)
		Diesel	Turbo Intercooled	TD4767
Rekord E 2.2 TD	06/84→08/86	23 TD		
Senator A 2.2 TD	11/84→08/87		4 Cyl.	22:1
			2259cc	63kW (86PS)
		Diesel	Turbo	TD2665
Omega A 2.3 D	09/86→03/94	23 YD		
			4 Cyl.	22:1
			2260cc	54kW (73PS)
		Diesel		TD4768



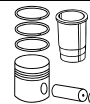
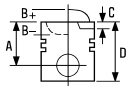

Omega A 2.3 TD	09/86 → 08/88	23 YDT	4 Cyl. 2260cc	23:1 66kW (90PS)	
		Diesel	Turbo		TD4769

14-024100-00 D B 95.00 C 172.00 D 97.00 E 4.70

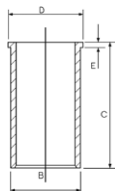

57 **92.00**

Frontera A 2.5 TDS, Frontera A Sport 2.5 TDS	09/96 → 10/98	25 TDS (VM41B)	4 Cyl. 2500cc	22:1 85kW (115PS)	
		Diesel	Turbo Intercooled		TD2673

87-110100-00	STD	08-110100-00	STD	14-676420-00 WH	B 101.50 C 166.80 D 110.00 E 8.90 F 1.20	89-110100-00 87-110100-00 + 14-676420-00
---------------------	-----	---------------------	-----	------------------------	--	---

A 51.00
B- 2.10
D 86.00
 30x76

2.50 CR P
2.00 P
4.00 CR P

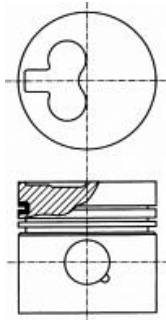
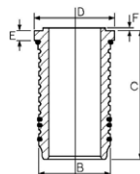

58 **93.00**

Frontera 2.8TD	04/95 → 08/98	4 JB1TC	4 Cyl. 2771cc	17.9:1 82kW (111PS)	
Frontera 2.8TD Sport	04/95 → 08/96		Turbo Intercooled		FM19531

14-021450-00 DH B 95.04 C 156.31 D 101.00 E 0.92

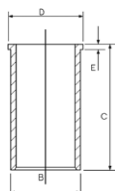

Not suitable for use with pistons having chrome rings

Nicht geeignet zur Verwendung mit Kolben mit Chromringen

Ne pas utiliser avec des pistons équipés de segments chromés

No es adecuada para usar con pistones que tengan aros de croma

Non utilizzabile con pistoni equipaggiati con segmenti cromati

Chrome Bore

Bohrung verchromte

Alésage chromée

Cromado de cilindro

Cilindro cromato

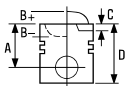

59 **93.00**

Frontera A 2.8 TD	03/95→10/98	28 TDI (4JB1T)	4 Cyl.	17.9:1
Frontera A Sport 2.8 TD	03/95→08/96		2771cc	83kW (113PS)
		Diesel	Turbo Intercooled	TD4774

14-021460-00 DH ¹ ² **B 95.04 C 181.00 D 101.00 E 0.92**

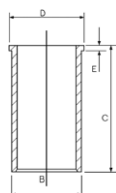

¹ Not suitable for use with pistons having chrome rings
² Chrome Bore

¹ Nicht geeignet zur Verwendung mit Kolben mit Chromringen
² Bohrung verchromte

¹ Ne pas utiliser avec des pistons équipés de segments chromés
² Alésage chromée

¹ No es adecuada para usar con pistones que tengan aros de cromado
² Cromado de cilindro

¹ Non utilizzabile con pistoni equipaggiati con segmenti croma
² Cilindro cromato

60 **93.00**

Arena 2.5 D	03/98→08/01	S8U 758	4 Cyl.	22:1
			2499cc	55-58kW (75-79PS)
		Diesel		TD22880

Arena 2.5 D	03/98→08/01	S8U 780	4 Cyl.	22:1
			2499cc	55kW (75PS)
		Diesel		TD22882

Arena 2.5 D	03/98→08/01	S8U 782	4 Cyl.	22:1
			2499cc	55kW (75PS)
		Diesel		TD24143

87-783300-00 STD
87-783308-00 0.60mm
A 54.00
B- 2.20
D 89.00
 32x75

08-783300-00 STD
08-783308-00 0.60mm
3.00 CR P
2.00 P
3.00 CR P

14-022560-00 D **B 96.00 C 167.30 D 98.90 E 5.00**
14-028930-00 D **B 97.50 C 167.00 D 100.90 E 5.00**
14-028931-00 D **B 97.58 C 167.00 D 100.90 E 5.00**
14-028932-00 D **B 97.70 C 167.00 D 100.90 E 5.00**

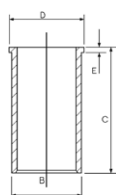

HA RT

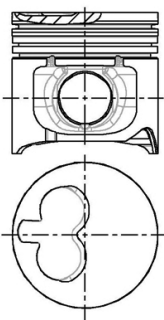

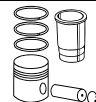
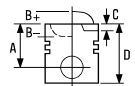



61  **94.40**

Movano	01/99 →	8140.23.2585/3700/8140.43.2585/3700/3900 Sofim	4 Cyl.	18.5:1	
			2800cc	84kW (114PS)	
		Diesel	Turbo Intercooled		FM9256
Movano 2.8 DTI	07/98 → 10/01	S9W 700	4 Cyl.	19:1	
			2799cc	84kW (114PS)	
		Diesel	Turbo Intercooled		TD21149
Movano 2.8 DTI	07/98 → 10/01	S9W 702	4 Cyl.	19:1	
			2799cc	84kW (114PS)	
		Diesel	Turbo Intercooled		TD19360

87-122200-10 STD
 87-122208-10 0.60mm
 2572280 →
A 58.75
B- 19.40
BØ 39.25
D 87.60
 32x72

08-122200-00 STD
 08-122208-00 0.60mm
 2572280 →
 2.50  CK P
 2.00  P
 2.50  CR P

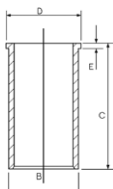

14-021321-00 **D** **B** 97.54 **C** 167.00 **D** 100.90 **E** 5.00
 14-028930-00 **D** **B** 97.50 **C** 167.00 **D** 100.90 **E** 5.00
 14-028931-00 **D** **B** 97.58 **C** 167.00 **D** 100.90 **E** 5.00
 14-028932-00 **D** **B** 97.70 **C** 167.00 **D** 100.90 **E** 5.00

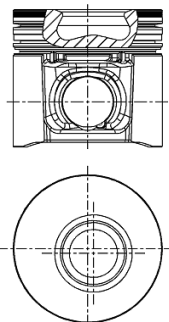

AK KK RT TP





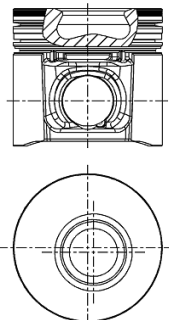

87-854700-00 STD
 87-854708-00 0.60mm
 →2572279
A 58.75
B- 19.40
BØ 39.40
D 96.65
 32x78

08-854700-00 STD
 08-854708-00 0.60mm
 →2572279
 3.00  CR
 2.00  P
 3.00  CR

AK KK RT



		ccm	x 		
3.152	Diesel	2490	3	91.49	4
4.107	Diesel	1760	4	79.38	1
4.108	Diesel	1760	4	79.38	2
4.165	Diesel	2710	4	92.00	8
4.192	Diesel	3140	4	88.90	3
4.203	Diesel	3335	4	91.49	5
4.212	Diesel	3475	4	98.48	9
4.236	Diesel	3864	4	98.48	10
4.248 / A4.248	Diesel	4065	4	101.05	21
6.288	Diesel	4716	6	88.90	3
6.305	Diesel	5000	6	91.49	6
6.354	Diesel	5794	6	98.48	11
6.354.1	Diesel	5800	6	98.48	11
6.354.2	Diesel	5794	6	98.48	12
6.354.4	Diesel	5794	6	98.48	13
6.354 V	Diesel	5794	6	98.48	12
6.372	Diesel	6100	6	101.05	22
1004.42 Euro 1	Diesel	4230	4	103.00	23
1004-40 / 1004-40T	Diesel	3990	4	100.00	16
1103A-33	Diesel	3299	3	105.00	25
1103A-33T	Diesel	3299	3	105.00	24
1103B-33 Euro 2	Diesel	3300	3	105.00	25
1103B-33T	Diesel	3299	3	105.00	24
1103C-33 Euro 2	Diesel	3300	3	105.00	25
1103C-33T	Diesel	3299	3	105.00	24
1103C-33TA	Diesel	3299	3	105.00	24
1103D-33	Diesel	3299	3	105.00	25
1104A-44	Diesel	4399	4	105.00	25
1104A-44T	Diesel	4399	4	105.00	24
1104A-44TA	Diesel	4399	4	105.00	24
1104C-44 Euro 2	Diesel	4400	4	105.00	25
1104C-44T	Diesel	4399	4	105.00	24
1104C-E44	Diesel	4399	4	105.00	25
1104C-E44T	Diesel	4399	4	105.00	24
1104C-E44TA	Diesel	4399	4	105.00	24
AD3.152	Diesel	2499	3	91.49	7
AT4.236	Diesel	3866	4	98.48	14
C4.40	Diesel	3990	4	100.00	17
D3.152	Diesel	2500	3	91.49	5
D235 Phaser 160/180T	Diesel	5985	6	100.00	18
Phaser 90 (1004-4)	Diesel	3990	4	100.00	19
Phaser 110T (1004-4T)	Diesel	3990	4	100.00	17
Phaser 125 (1006-6)	Diesel	5985	6	100.00	19
Phaser 160T (1006-6T) 1989>	Diesel	5985	6	100.00	17
Phaser 180Ti (1006-6TW)	Diesel	5985	6	100.00	17
Phaser 180Ti (CC6.60) Euro 2	Diesel	5985	6	100.00	17
Phaser 200Ti Euro 1	Diesel	5985	6	100.00	20
Phaser 1004-42 Euro 1	Diesel	3990	4	103.00	23
T4.236	Diesel	3866	4	98.48	14
T6.354.1	Diesel	5800	6	98.48	12
T6.354.3	Diesel	5800	6	98.48	12
T6.354.3 CC	Diesel	5800	6	98.48	12
T6.354.4	Diesel	5794	6	98.48	15
T6.60	Diesel	5985	6	100.00	20

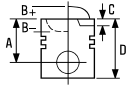

1 **79.38**

4.107 4 Cyl. 22:1 **1760cc** **30kW (41PS)** **Diesel** **TD6333**

87-313400-00 STD **08-313400-00** STD **15-370040-00 WH** **B 85.67 C 163.53 D 93.70 E 6.40** **89-313400-00**
87-313400-00 +
15-370040-00

A 45.63
D 79.73
 24x69

1.99 CR P
 1.60 P
 1.60 P
 4.74 P
 4.74 P

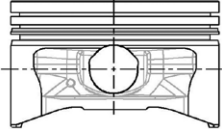
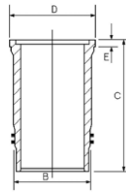

Includes seals

Schließt Dichtungen ein

Inclut des joints

Incluye los sellos

Comprende le guarnizioni

2 **79.38**

4.108 4 Cyl. 22:1 **1760cc** **36-42kW (49-57PS)** **Diesel** **TD6334**

87-315200-00 STD **08-315200-00** STD **14-010900-00 D** **B 82.63 C 165.10**

A 50.24
D 105.41
 27x68

1.99 CR P
 1.60 P
 1.60 P
 3.16 P
 4.74 P

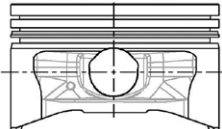
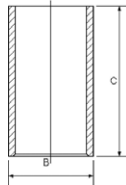

3 **88.90**

4.192 4 Cyl. 16.5:1 **3140cc** **29-37kW (39-50PS)** **Diesel** **TD6396**

6.288 6 Cyl. 16.5:1 **4716cc** **45kW (61PS)** **Diesel** **TD6498**

14-021240-00 D **B 93.71 C 216.03 D 94.41 E 4.76**

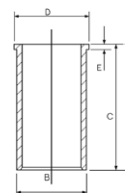



4  **91.49**



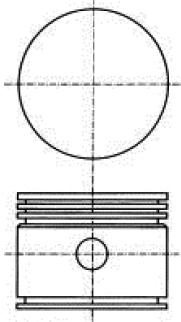

3.152 **3 Cyl.** **17.4:1** **2490cc** **22-33kW (30-45PS)** **Diesel** **TD6788**

87-314600-00 ⁴ STD

A 57.20
D 107.70
 32x75



08-314600-00 ⁵ STD

2.38  CR P
2.38  P
3.16  P
6.33  P
6.33  P

14-021220-00 D ² **B** 93.71 **C** 216.00 **D** 96.72 **E** 3.81
14-021221-00 D **B** 93.96 **C** 216.00 **D** 96.72 **E** 3.81
14-021222-00 D **B** 94.50 **C** 216.00 **D** 96.72 **E** 3.81
14-021223-00 D **B** 96.25 **C** 216.00 **D** 97.10 **E** 3.81
14-022960-00 D **B** 93.66 **C** 216.00 **D** 96.72 **E** 3.76
14-024680-00 D **B** 93.73 **C** 216.00 **D** 96.72 **E** 3.76
14-025833-00 D **B** 95.31 **C** 216.00 **D** 98.16 **E** 5.00
14-025871-00 D **B** 93.76 **C** 216.14 **D** 96.85 **E** 5.00
14-025873-00 D **B** 93.88 **C** 216.14 **D** 96.97 **E** 5.00
14-480320-00 DH ¹ **B** 93.66 **C** 216.03 **D** 96.72 **E** 3.81

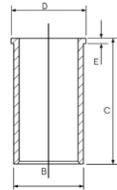



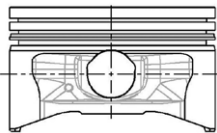

87-525100-10 ³ STD

A 56.95
D 107.70
 32x75



08-525100-00 STD

2.38  P
2.38  P
3.16  P
6.35  P
6.35  P

¹ Push fit cast iron liner to replace original steel liner

² Press fit cast iron liner to replace original steel liner

³ Pre-topped piston which may require machining

⁴ Topping allowance piston which requires machining to conform to engine manufacturers recommendations.

⁵ Not for chromed cylinders

¹ Ausdrückbare Laufbüchse aus Gueisen als Ersatz der originalStahlbüchse

² Anpressbare Laufbüchse aus Gueisen als Ersatz der originalStahlbüchse

³ Vorgeschliffener Kolben, der möglicherweise etwas BearbeitenEmpfehlungen des Herstellers zu entsprechen

⁴ Nicht vorgeschliffener Kolben, der etwas Bearbeitung braucht, um den Empfehlungen des Herstellers zu entsprechen

⁵ Nicht für verchromte Zylinder

¹ Chemise fonte à emménagement gras remplaçant la chemise acier d'origine.

² Chemise fonte à emmancher à la presse pour remplacer la chemise d'origine en acier

³ Piston à tete semie finie pouv ant nécessiter un usinage pouaux recommandations du constructeur

⁴ Piston à tete avec surépaisseur nécessitant un usinage pourmise en conformité avec les recommandations du constructeur

⁵ Non appropriés pour cylindres chromés

¹ Ajustar a presión la camisa de hierro fundido para reemplazacamisa original de acero

² Ajuste a presión la camisa de hierro fundido para reemplazer la camisa original de acero

³ Pistón coronado que puede necesitar fresado para ajustarse adel fabricante

⁴ Pistón con margen para corona que requiere fresado para ajustarse a las recomendaciones del fabricante del motor

⁵ No se usan para cilindros cromados

¹ Cilindri in ghisa, piantati a pressione, in sostituzione di qin acciaio

² Canna in ghisa per sostituire canne originali in acciaio

³ Il pistone a testa ribassata puo' richiedere una lavorazioneadattarloalle prescrizioni del costruttore. fare riferimentoalle istruzioni contenute nella confezione

⁴ La superficie superiore della testa puo essere lavorata peradattare l'altezza del pistone al pms.Fare riferimento allanorme di montaggio

⁵ Non per cilindri cromati

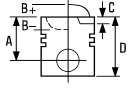



5  **91.49**

D3.152 3 Cyl. 17.4:1 **2500cc** Diesel **FM1352**

4.203 4 Cyl. 17.4:1 **3335cc 44kW (60PS)** Diesel **TD7381**

87-314600-10 STD





08-314600-00  STD

14-021220-00  **D** **B 93.71 C 216.00 D 96.72 E 3.81**

A 62.00
B- 18.55
D 109.60
 32x75

01/60 →, 2939037 →

14-021221-00 **D** **B 93.96 C 216.00 D 96.72 E 3.81**
14-021222-00 **D** **B 94.50 C 216.00 D 96.72 E 3.81**
14-021223-00 **D** **B 96.25 C 216.00 D 97.10 E 3.81**
14-022960-00 **D** **B 93.66 C 216.00 D 96.72 E 3.76**
14-024680-00 **D** **B 93.73 C 216.00 D 96.72 E 3.76**
14-025833-00 **D** **B 95.31 C 216.00 D 98.16 E 5.00**
14-025871-00 **D** **B 93.76 C 216.14 D 96.85 E 5.00**
14-025873-00 **D** **B 93.88 C 216.14 D 96.97 E 5.00**
14-480320-00 **DH**  **B 93.66 C 216.03 D 96.72 E 3.81**



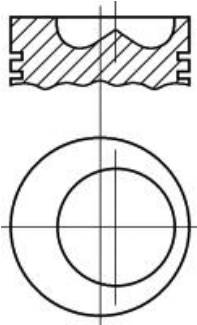
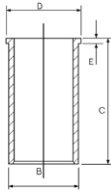

2.38  CR P
 2.38  P
 3.16  P
 6.33  P
 6.33  P



87-322000-00  STD

08-322000-00  STD

A 61.62
B- 18.70
BØ 55.00
D 109.24
 32x75

2.38  CR P
 2.38  P
 2.38  P
 4.74  CR P

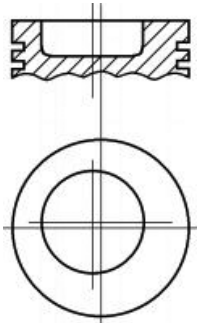

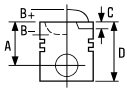

87-525100-00

STD

A 61.90
B- 18.57
BØ 55.20
D 109.50
32x75

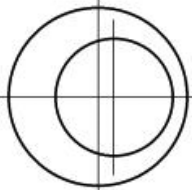

1 Push fit cast iron liner to replace original steel liner

2 Press fit cast iron liner to replace original steel liner

3 Pre-topped piston which may require machining

4 Not for chromed cylinders

08-525100-00

STD

2.38
2.38
3.16
6.35
6.35



1 Ausdrückbare Laufbüchse aus Gueisen als Ersatz der originalStahlbüchse

2 Anpressbare Laufbüchse aus Gueisen als Ersatz der originalStahlbüchse

3 Vorgeschliffener Kolben, der möglicherweise etwas Bearbeiten/Empfehlungen des Herstellers zu entsprechen

4 Nicht für verchromte Zylinder

1 Chemise fonte à emménagement gras remplaçant la chemise acied'origine.

2 Chemise fonte à emmancher à la presse pour remplacer la chemise d'origine en acier

3 Piston à tete semie finie pouv ant nécessiter un usinage pouaux recommandations du constructeur

4 Non appropriés pour cylindres chromés

1 Ajustar a presión la camisa de hierro fundido para reemplazacamisa original de acero

2 Ajuste a presión la camisa de hierro fundido para reemplazer la camisa original de acero

3 Pistón coronado que puede necesitar fresado para ajustarse adel fabricante

4 No se usan para cilindros cromados

1 Cilindri in ghisa, piantati a pressione, in sostituzione di qin acciaio

2 Canna in ghisa per sostituire canne originali in acciaio

3 Il pistone a testa ribassata puo' richiedere una lavorazioneadattarloalle prescrizioni del costruttore. fare riferimentoalle istruzioni contenute nella confezione

4 Non per cilindri cromati

6 91.49

6.305

6 Cyl.

17.4:1

5000cc

73kW (100PS)

Diesel

TD6399

- 14-021220-00 D 2 B 93.71 C 216.00 D 96.72 E 3.81
- 14-021221-00 D B 93.96 C 216.00 D 96.72 E 3.81
- 14-021222-00 D B 94.50 C 216.00 D 96.72 E 3.81
- 14-021223-00 D B 96.25 C 216.00 D 97.10 E 3.81
- 14-022960-00 D B 93.66 C 216.00 D 96.72 E 3.76
- 14-024680-00 D B 93.73 C 216.00 D 96.72 E 3.76
- 14-025833-00 D B 95.31 C 216.00 D 98.16 E 5.00
- 14-025871-00 D B 93.76 C 216.14 D 96.85 E 5.00
- 14-025873-00 D B 93.88 C 216.14 D 96.97 E 5.00
- 14-480320-00 DH 1 B 93.66 C 216.03 D 96.72 E 3.81

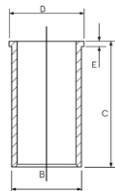

1 Push fit cast iron liner to replace original steel liner

2 Press fit cast iron liner to replace original steel liner

1 Ausdrückbare Laufbüchse aus Gueisen als Ersatz der originalStahlbüchse

2 Anpressbare Laufbüchse aus Gueisen als Ersatz der originalStahlbüchse

1 Chemise fonte à emménagement gras remplaçant la chemise acied'origine.

2 Chemise fonte à emmancher à la presse pour remplacer la chemise d'origine en acier

1 Ajustar a presión la camisa de hierro fundido para reemplazacamisa original de acero

2 Ajuste a presión la camisa de hierro fundido para reemplazer la camisa original de acero





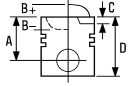





1 Cilindri in ghisa, piantati a pressione, in sostituzione di qin acciaio

2 Canna in ghisa per sostituire canne originali in acciaio





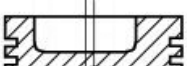
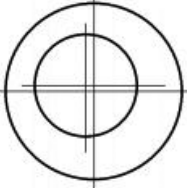



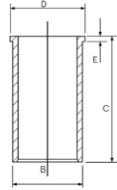













7  **91.49**

AD3.152 **3 Cyl.** **17.4:1** **2499cc** **Diesel** **FM11352**

87-322000-00  STD	08-322000-00  STD	14-021220-00 D 	B 93.71 C 216.00 D 96.72 E 3.81
A 61.62	2.38 	14-021221-00 D	B 93.96 C 216.00 D 96.72 E 3.81
B- 18.70	2.38 	14-021222-00 D	B 94.50 C 216.00 D 96.72 E 3.81
BØ 55.00	2.38 	14-021223-00 D	B 96.25 C 216.00 D 97.10 E 3.81
D 109.24	4.74 	14-022960-00 D	B 93.66 C 216.00 D 96.72 E 3.76
 32x75		14-024680-00 D	B 93.73 C 216.00 D 96.72 E 3.76
		14-025833-00 D	B 95.31 C 216.00 D 98.16 E 5.00
		14-025871-00 D	B 93.76 C 216.14 D 96.85 E 5.00
		14-025873-00 D	B 93.88 C 216.14 D 96.97 E 5.00
		14-480320-00 DH 	B 93.66 C 216.03 D 96.72 E 3.81



- | | | | | |
|---|---|---|--|--|
|  Push fit cast iron liner to replace original steel liner |  Ausdrückbare Laufbüchse aus Gueisen als Ersatz der originalStahlbüchse |  Chemise fonte à emmencement gras remplaçant la chemise acied'origine. |  Ajustar a presión la camisa de hierro fundido para reemplazacamisa original de acero |  Cilindri in ghisa, piantati a pressione, in sostituzione di qin acciaio |
|  Press fit cast iron liner to replace original steel liner |  Anpressbare Laufbüchse aus Gueisen als Ersatz der originalStahlbüchse |  Chemise fonte à emmancher à la presse pour remplacer la chemise d'origine en acier |  Ajuste a presión la camisa de hierro fundido para reemplazer la camisa original de acero |  Canna in ghisa per sostituire canne originali in acciaio |
|  Pre-topped piston which may require machining |  Vorgeschliffener Kolben, der möglicherweise etwas BearbeitenEmpfehlungen des Herstellers zu entsprechen |  Piston à tete semie finie pouv ant nécessiter un usinage pouaux recommandations du constructeur |  Pistón coronado que puede necesitar fresado para ajustarse adel fabricante |  Il pistone a testa ribassata puo' richiedere una lavorazioneadattarloalle prescrizioni del costruttore. fare riferimentoalle istruzioni contenute nella confezione |
|  Not for chromed cylinders |  Nicht für verchromte Zylinder |  Non appropriés pour cylindres chromés |  No se usan para cilindros cromados |  Non per cilindri cromati |

8  **92.00**

4.165 **4 Cyl.** **21:1** **2710cc** **47-51kW (65-70PS)** **Diesel** **TD6734**

14-043450-00 D **B 96.91 C 191.19 D 101.00 E 3.91 F 0.70**

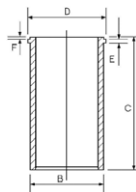

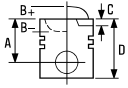

9  **98.48**

4.212

4 Cyl.

15.5:1

3475cc

44-47kW (60-64PS)

Diesel

FM1359

14-021250-00 DH ¹ B 104.20 C 226.44 D 107.37 E 3.81

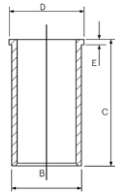

14-040110-00 D ² B 103.24 C 227.28 D 106.23 E 3.86 F 0.88

14-040180-00 D ² B 103.24 C 227.28 D 106.43 E 3.71 F 1.04

14-040200-00 DH ² B 103.19 C 227.28 D 106.45 E 3.86 F 0.88

14-045820-00 D B 103.33 C 227.28 D 106.42 E 3.80 F 0.90

14-045821-00 D B 103.83 C 227.28 D 106.42 E 3.80 F 0.90

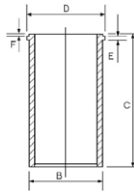

¹ Push fit, flanged, cast iron liner with 0.040" oversized outside diameter

² Press fit cast iron liner to replace original steel liner

¹ Geflanschte Gußeisen-Laufbuchse mit Schiebeseitz und Außendurübermaß

² Anpressbare Laufbüchse aus Gueisen als Ersatz der originalStahlbüchse

¹ Chemise en fonte, à colerette ajustage gras, avec diamètre

² Chemise fonte à emmancher à la presse pour remplacer la chemise d'origine en acier

¹ Camisa de fundición embridada, ajuste suave, con diámetro ext

² Ajuste a presión la camisa de hierro fundido para reemplazer la camisa original de acero

¹ Cilindri in ghisa, con flangia, piantati a pressione, con diariparazione

² Canna in ghisa per sostituire canne originali in acciaio

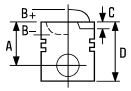

10 **98.48**

4.236 4 Cyl. 16:1 **3864cc** **55-65kW (75-88PS)** **Diesel** **TD6398**

87-107200-00 STD
87-107209-00 .030

A 70.34
B- 20.31
BØ 60.00
D 121.11
 35x84

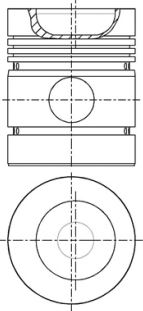

08-107200-00 STD
08-107209-00 .030

01/61 →

2.38 CR P
 2.38 P
 2.38 P
 6.33 CR P
 6.33 P

14-021250-00 DH **B** 104.20 **C** 226.44 **D** 107.37 **E** 3.81

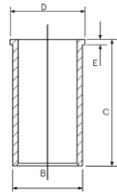

14-040110-00 D **B** 103.24 **C** 227.28 **D** 106.23 **E** 3.86 **F** 0.88
14-040180-00 D **B** 103.24 **C** 227.28 **D** 106.43 **E** 3.71 **F** 1.04
14-040200-00 DH **B** 103.19 **C** 227.28 **D** 106.45 **E** 3.86 **F** 0.88
14-045820-00 D **B** 103.33 **C** 227.28 **D** 106.42 **E** 3.80 **F** 0.90
14-045821-00 D **B** 103.83 **C** 227.28 **D** 106.42 **E** 3.80 **F** 0.90

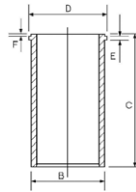

87-107200-10 STD

A 69.92
B- 20.15
BØ 61.00
D 120.65
 35x84

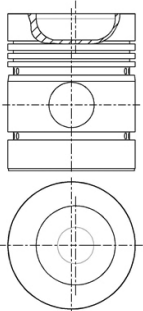

08-107200-00 STD
08-107209-00 .030

01/61 →

2.38 CR P
 2.38 P
 2.38 P
 6.33 CR P
 6.33 P

- Push fit, flanged, cast iron liner with 0.040" oversized outside diameter
- Press fit cast iron liner to replace original steel liner
- For Cast Iron Bores only
- Pre-topped piston which may require machining

- Geflanschte Gußeisen-Laufbuchse mit Schiebeseitz und Außendurübermaß
- Anpressbare Laufbüchse aus Gueisen als Ersatz der originalStahlbüchse
- Nur für Gußeisenbohrungen
- Vorgeschliffener Kolben, der möglicherweise etwas BearbeitenEmpfehlungen des Herstellers zu entsprechen

- Chemise en fonte, à collerette ajustage gras, avec diamètre
- Chemise fonte à emmancher à la presse pour remplacer la chemise d'origine en acier
- Pour intérieur cylindre seulement
- Piston à tete semie finie pouv ant nécessiter un usinage pouaux recommandations du constructeur

- Camisa de fundición embridada, ajuste suave, con diámetro ext
- Ajuste a presión la camisa de hierro fundido para reemplazar la camisa original de acero
- Para diámetro internos de hierro fundido solamente
- Pistón coronado que puede necesitar fresado para ajustarse adel fabricante









- Cilindri in ghisa, con flangia, piantati a pressione, con diarparazione
- Canna in ghisa per sostituire canne originali in acciaio
- Solo per cilindri in ghisa
- Il pistone a testa ribassata puo' richiedere una lavorazioneadattarloalle prescrizioni del costruttore. fare riferimentoalle istruzioni contenute nella confezione



11  98.48





6.354 6 Cyl. 16:1 5794cc 71-82kW (97-112PS) Diesel TD6713



6.354.1 6 Cyl. 5800cc Diesel FM5218

87-525200-00    STD
 87-525209-00    .030
 87-525211-00    .040

A 69.97
 B- 25.67
 BØ 53.90
 D 120.71
 35x84



08-525200-00 STD
 08-525209-00 .030

2.38  CR P
 2.38  P
 2.38  P
 6.35  P
 6.35  P

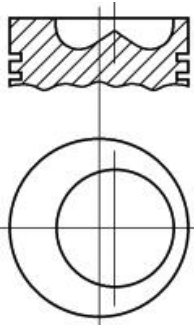
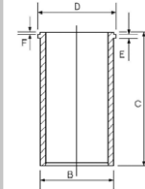
14-040110-00 D  B 103.24 C 227.28 D 106.23 E 3.86 F 0.88
 14-040180-00 D  B 103.24 C 227.28 D 106.43 E 3.71 F 1.04
 14-040200-00 DH  B 103.19 C 227.28 D 106.45 E 3.86 F 0.88
 14-045820-00 D B 103.33 C 227.28 D 106.42 E 3.80 F 0.90
 14-045821-00 D B 103.83 C 227.28 D 106.42 E 3.80 F 0.90





 Press fit cast iron liner to replace original steel liner

 Recommended maximum oversize is .040in/1.016mm
 Pre-topped piston which may require machining



 For Cast Iron Bores only

 Anpressbare Laufbüchse aus Gueisen als Ersatz der originalStahlbüchse

 Empfohlenes überma maximal 0.040 Zoll 1.016mm
 Vorgeschliffener Kolben, der möglicherweise etwas BearbeitenEmpfehlungen des Herstellers zu entsprechen



 Nur für Gußeisenbohrungen

 Chemise fonte à emmancher à la presse pour remplacer la chemise d'origine en acier

 Cote maxi recommandée de 0.040in/1.016mm
 Piston à tete semie finie pouv ant nécessiter un usinag pouaux recommandations du constructeur



 Pour intérieur cylindre seulement

 Ajuste a presión la camisa de hierro fundido para reemplazar la camisa original de acero

 La sobremedida máxima recomendada es de 0.040plg/1.016mm
 Pistón coronado que puede necesitar fresado para ajustarse adel fabricante

 Para diámetro internos de hierro fundido solamente

 Canna in ghisa per sostituire canne originali in acciaio

 Maggiorazione massima raccomandata 0.040in/1.016mm
 Il pistone a testa ribassata puo' richiedere una lavorazioneadattarfoalle prescrizioni del costruttore, fare riferimentoalle istruzioni contenute nella confezione

 Solo per cilindri in ghisa

12  98.48



6.354 V 6 Cyl. 16:1 5794cc 71-87kW (97-118PS) Diesel TD7158

6.354.2 6 Cyl. 16:1 5794cc 84-87kW (114-118PS) Diesel TD6548

T6.354.1 6 Cyl. 16:1 5800cc Diesel Turbo FM1363

T6.354.3 6 Cyl. 16:1 5800cc Diesel Turbo FM1366

T6.354.3 CC 6 Cyl. 5800cc 110-111kW (148-151PS) Diesel TD6747

14-040110-00 D  B 103.24 C 227.28 D 106.23 E 3.86 F 0.88
 14-040180-00 D  B 103.24 C 227.28 D 106.43 E 3.71 F 1.04
 14-040200-00 DH  B 103.19 C 227.28 D 106.45 E 3.86 F 0.88
 14-045820-00 D B 103.33 C 227.28 D 106.42 E 3.80 F 0.90
 14-045821-00 D B 103.83 C 227.28 D 106.42 E 3.80 F 0.90

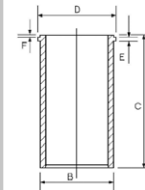

 Press fit cast iron liner to replace original steel liner

 Anpressbare Laufbüchse aus Gueisen als Ersatz der originalStahlbüchse

 Chemise fonte à emmancher à la presse pour remplacer la chemise d'origine en acier









 Ajuste a presión la camisa de hierro fundido para reemplazar la camisa original de acero

 Canna in ghisa per sostituire canne originali in acciaio



13  **98.48**





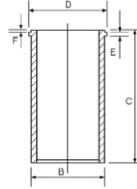



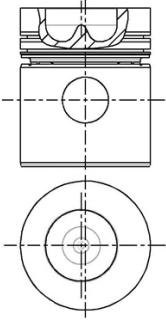





6.354.4 **6 Cyl.** **16:1** **5794cc** **94kW (128PS)** **Diesel** **TD6546**

87-318900-10  STD	08-318900-10 STD	14-040110-00 D 	B 103.24 C 227.28 D 106.23 E 3.86 F 0.88
08-318905-10 0.25mm	0.25mm	14-040180-00 D 	B 103.24 C 227.28 D 106.43 E 3.71 F 1.04
A 70.02	2.38 	14-040200-00 DH 	B 103.19 C 227.28 D 106.45 E 3.86 F 0.88
B- 25.60	2.38 	14-045820-00 D	B 103.33 C 227.28 D 106.42 E 3.80 F 0.90
BØ 54.00	4.74 	14-045821-00 D	B 103.83 C 227.28 D 106.42 E 3.80 F 0.90
D 120.84			
 35x84			









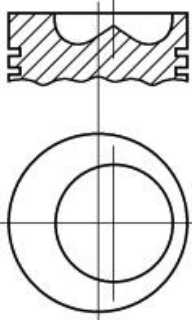













RT



87-525200-00    STD	08-525200-00 STD
87-525209-00    .030	08-525209-00 .030
87-525211-00    .040	
A 69.91	2.38 
B- 25.61	2.38 
BØ 53.90	2.38 
D 120.71	6.35 
 35x84	6.35 



- | | | | | |
|---|---|---|---|---|
| <p> Press fit cast iron liner to replace original steel liner</p> <p> Recommended maximum oversize is .040in/1.016mm</p> <p> For Cast Iron Bores only</p> <p> Pre-topped piston which may require machining</p> | <p> Anpressbare Laufbüchse aus Gueisen als Ersatz der originalStahlbüchse</p> <p> Empfohlenes überma maximal 0.040 Zoll 1.016mm</p> <p> Nur für Gußeisenbohrungen</p> <p> Vorgeschliffener Kolben, der möglicherweise etwas BearbeitenEmpfehlungen des Herstellers zu entsprechen</p> | <p> Chemise fonte à emmancher à la presse pour remplacer la chemise d'origine en acier</p> <p> Cote maxi recommandée de 0.040in/1.016mm</p> <p> Pour intérieur cylindre seulement</p> <p> Piston à tete semie finie pouv ant nécessiter un usinage pouaux recommandations du constructeur</p> | <p> Ajuste a presión la camisa de hierro fundido para reemplazer la camisa original de acero</p> <p> La sobremedida máxima recomendada es de 0.040plg/1.016mm</p> <p> Para diámetro internos de hierro fundido solamente</p> <p> Pistón coronado que puede necesitar fresado para ajustarse adel fabricante</p> | <p> Canna in ghisa per sostituire canne originali in acciaio</p> <p> Maggiorazione massima raccomandata 0.040in/1.016mm</p> <p> Solo per cilindri in ghisa</p> <p> Il pistone a testa ribassata puo' richiedere una lavorazioneadattarloalle prescrizioni del costruttore. fare riferimentoalle istruzioni contenute nella confezione</p> |
|---|---|---|---|---|



14 98.48

AT4.236	4 Cyl.		3866cc		Diesel Turbo	FM13911
T4.236	4 Cyl.	15.5:1	3866cc	66-76kW (90-103PS)	Diesel Turbo	TD6746

87-319000-10 STD
 A 70.25
 B- 19.95
 BØ 60.90
 D 108.25
 38x83

08-319000-10 STD
 08-319005-10 0.25mm
 3.16 MO P
 2.38 P
 4.74 CR P

14-021250-00 DH 1 B 104.20 C 226.44 D 107.37 E 3.81

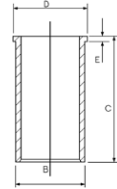

RT TP

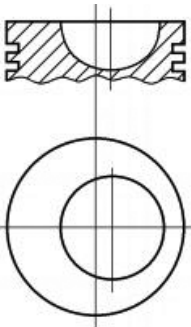

14-040110-00 D 2 B 103.24 C 227.28 D 106.23 E 3.86 F 0.88
 14-040180-00 D 2 B 103.24 C 227.28 D 106.43 E 3.71 F 1.04
 14-040200-00 DH 2 B 103.19 C 227.28 D 106.45 E 3.86 F 0.88
 14-045820-00 D B 103.33 C 227.28 D 106.42 E 3.80 F 0.90
 14-045821-00 D B 103.83 C 227.28 D 106.42 E 3.80 F 0.90

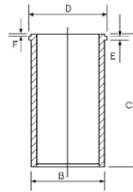

1 Push fit, flanged, cast iron liner with 0.040" oversized outside diameter

2 Press fit cast iron liner to replace original steel liner

1 Geflanschte Gußeisen-Laufbuchse mit Schiebeseit und Außendurübermaß

2 Anpressbare Laufbuchse aus Gueisen als Ersatz der originalStahlbüchse

1 Chemise en fonte, à collerette ajustage gras, avec diamètre

2 Chemise fonte à emmancher à la presse pour remplacer la chemise d'origine en acier

1 Camisa de fundición embrizada, ajuste suave, con diámetro ext

2 Ajuste a presión la camisa de hierro fundido para reemplazar la camisa original de acero

1 Cilindri in ghisa, con flangia, piantati a pressione, con diariparazione

2 Canna in ghisa per sostituire canne originali in acciaio

15 98.48

T6.354.4	6 Cyl.	16:1	5794cc	110-119kW (150-162PS)	Diesel Turbo	TD8703
----------	--------	------	--------	-----------------------	--------------	--------

87-319000-00 STD
 A 69.75
 B- 18.67
 BØ 66.20
 D 107.85
 38x83

08-319000-10 STD
 08-319005-10 0.25mm
 3.16 MO P
 2.38 P
 4.74 CR P

14-021250-00 DH 1 B 104.20 C 226.44 D 107.37 E 3.81

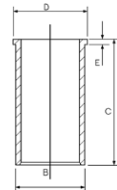

RT TP

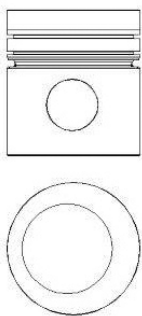

14-040110-00 D 2 B 103.24 C 227.28 D 106.23 E 3.86 F 0.88
 14-040180-00 D 2 B 103.24 C 227.28 D 106.43 E 3.71 F 1.04
 14-040200-00 DH 2 B 103.19 C 227.28 D 106.45 E 3.86 F 0.88
 14-045820-00 D B 103.33 C 227.28 D 106.42 E 3.80 F 0.90
 14-045821-00 D B 103.83 C 227.28 D 106.42 E 3.80 F 0.90

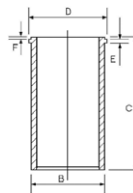

1 Push fit, flanged, cast iron liner with 0.040" oversized outside diameter

2 Press fit cast iron liner to replace original steel liner

1 Geflanschte Gußeisen-Laufbuchse mit Schiebeseit und Außendurübermaß

2 Anpressbare Laufbuchse aus Gueisen als Ersatz der originalStahlbüchse

1 Chemise en fonte, à collerette ajustage gras, avec diamètre

2 Chemise fonte à emmancher à la presse pour remplacer la chemise d'origine en acier

1 Camisa de fundición embrizada, ajuste suave, con diámetro ext

2 Ajuste a presión la camisa de hierro fundido para reemplazar la camisa original de acero

1 Cilindri in ghisa, con flangia, piantati a pressione, con diariparazione

2 Canna in ghisa per sostituire canne originali in acciaio

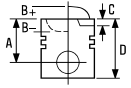



16  **100.00**

1004-40 / 1004-40T 4 Cyl. 18:1 **3990cc** **48-52kW (65-71PS)** **Diesel** **TD20891**

87-422100-00 STD **08-422100-00** STD **14-049300-00 D** **B 104.28 C 227.56 D 107.44 E 3.86 F 0.94**

A 70.30
B- 21.75
BØ 52.80
D 108.23
 40x78

3.50  CK P
 2.50  P
 3.50  CR P

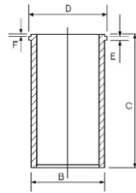

RT TP

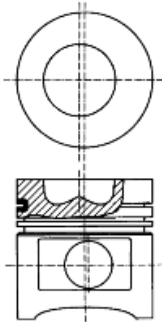

17  **100.00**

C4.40 4 Cyl. 16:1 **3990cc** **88kW (120PS)** **Diesel Turbo Intercooled** **FM5069**

Phaser 110T (1004-4T) 4 Cyl. 16:1 **3990cc** **82kW (111PS)** **Diesel Turbo** **TD8659**



Phaser 160T (1006-6T) 1989> 6 Cyl. 16:1 **5985cc** **119kW (160PS)** **Diesel Turbo** **TD6547**

Phaser 180Ti (1006-6TW) 6 Cyl. 16:1 **5985cc** **134kW (180PS)** **Diesel Turbo** **TD6404**

Phaser 180Ti (CC6.60) Euro 2 6 Cyl. 16:1 **5985cc** **131-134kW (177-182PS)** **Diesel Turbo Intercooled** **TD8922**

87-325600-10 STD **08-325600-00** STD **14-025380-10 DH** **B 104.23 C 226.44 D 107.44 E 3.86**

A 70.05
B- 20.14
BØ 52.00
D 108.00
 38x83

01/92→
 3.50  MO P
 2.50  P
 4.00  CR P

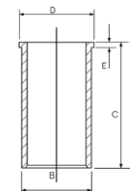

88-325600-10
 87-325600-10 +
 14-025380-10

RT TP

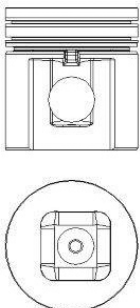



87-325600-30 1



STD

08-325600-00

STD

- A 70.02
- B- 19.48
- B- 10.28
- BØ 55.80
- D 108.60
-  38x83

01/92→

- 3.50  MO P
- 2.50  P
- 4.00  CR P

RT TP

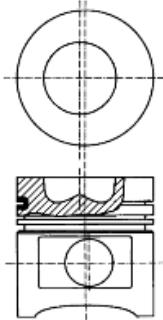

1 Original bowl design

1 Original Schüssel Design

1 Conception de bol Original

1 Diseño Cuenco de Original

1 Disegno ciotola Original

18  **100.00**

D235 Phaser 160/180T 6 Cyl. 16:1 **5985cc** **119kW (160PS)** **Diesel Turbo** **TD6412**

87-324300-10



STD

08-324300-00

STD

14-025380-10 DH B 104.23 C 226.44 D 107.44 E 3.86

- A 70.16
- B- 19.48
- BØ 55.80
- D 108.06
-  38x83

- 3.00  CK P
- 2.50  P
- 4.00  CR P

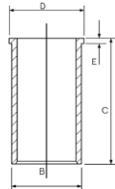

HA RT

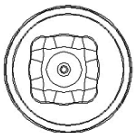
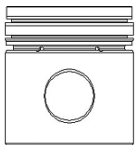





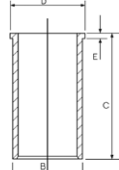

19 100.00

Phaser 90 (1004-4) 4 Cyl. 16.5:1 **3990cc** **Diesel** **FM5072**

Phaser 125 (1006-6) 6 Cyl. 16.5:1 **5985cc** **Diesel** **FM5073**

87-101700-00	STD	08-101700-00	STD	14-025380-10 DH	B 104.23 C 226.44 D 107.44 E 3.86	88-101700-30 87-101700-00 + 14-025380-10
A 70.00		2.50 	MO			
B- 20.14		2.50 	P			
BØ 51.88		4.00 	CR P			
D 108.00						
 35x84						

RT

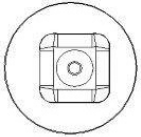
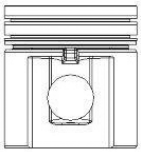

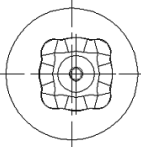
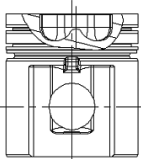

87-101700-10 	STD	08-101700-00	STD			
A 70.00		2.50 	MO			
B- 10.92		2.50 	P			
B- 20.14		4.00 	CR P			
BØ 55.30						
D 108.00						
 35x84						

AK RT



 Original bowl design

 Original Schüssel Design

 Conception de bol Original

 Diseño Cuenco de Original

 Disegno ciotola Original





20  **100.00**

Phaser 200Ti Euro 1	6 Cyl.		5985cc	148kW (201PS)	Diesel Turbo	FM6366
T6.60	6 Cyl.	16:1	5985cc	154kW (210PS)	Diesel Turbo	FM6365

87-325600-00 STD **08-325600-00** STD **14-025380-10 DH** **B 104.23 C 226.44 D 107.44 E 3.86**

A 70.30
B- 21.75
BØ 52.80
D 108.23
 40x78

01/92 →

3.50  MO P
 2.50  P
 4.00  CR P

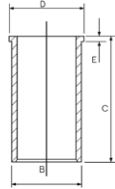

RT TP

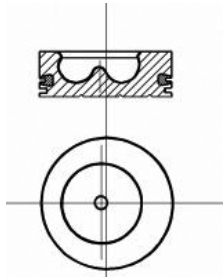





21  **101.05**

4.248 / A4.248	4 Cyl.	16:1	4065cc	53-61kW (72-83PS)	Diesel	FM26364
-----------------------	--------	------	---------------	--------------------------	---------------	----------------

87-318000-00 STD **08-318000-10** STD **14-040120-00 D** **B 104.25 C 227.28 D 107.44 E 3.86 F 0.76**

A 69.92
B- 20.72
BØ 61.45
D 120.72
 35x84

2.38  CR P
 2.38  P
 2.38  CR P
 6.33  CR P

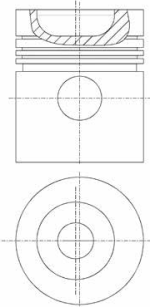
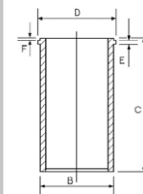

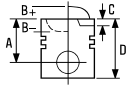





87-322700-00

STD

08-322700-00

STD

A 70.30
B- 21.10
BØ 61.45
D 121.10
 35x84

2.50  MO P
 2.50  P
 5.00  CR P

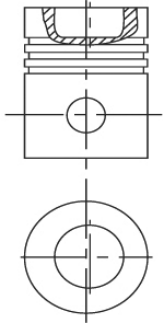

22  **101.05**

6.372 6 Cyl. 16:1 **6100cc** **87kW (118PS)** **Diesel** **FM8787**

- 14-040120-00 D** **B** 104.25 **C** 227.28 **D** 107.44 **E** 3.86 **F** 0.76
- 14-040190-00 DH** **B** 104.20 **C** 227.28 **D** 107.44 **E** 3.86 **F** 0.83
- 14-041140-00 D** **B** 104.35 **C** 227.28 **D** 107.44 **E** 3.80 **F** 0.90
- 14-041610-00 D** **B** 104.28 **C** 227.28 **D** 107.38 **E** 3.80 **F** 0.90
- 14-044690-00 D** **B** 103.26 **C** 222.25 **D** 106.37 **E** 3.65 **F** 1.00

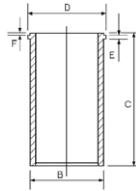



23  **103.00**



1004.42 Euro 1 4 Cyl. 18.5:1 **4230cc** **45-59kW (61-80PS)** **Diesel** **TD23905**

Phaser 1004-42 Euro 1 4 Cyl. **3990cc** **Diesel** **FM16364**

87-425400-00 STD **08-425400-00** STD **14-020590-00 D** **B 107.05 C 228.00 D 110.05 E 4.00**

87-425407-00 0.50mm **08-425407-00** 0.50mm

87-425411-00 1.00mm **08-425411-00** 1.00mm

A	70.30	2.50		CK P
B-	22.00	2.50		P
BØ	52.35	3.50		CR P

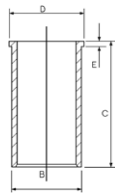

C 1.10

C 1.50

D 108.23

 **40x74**

TP

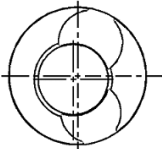
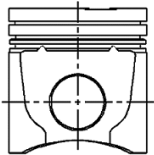

24  **105.00**

1103A-33T 3 Cyl. **3299cc** **Diesel Turbo** **FM26365**

1103B-33T 3 Cyl. **3299cc** **49kW (67PS)** **Diesel Turbo** **FM36365**

1103C-33T 3 Cyl. 18.2:1 **3299cc** **55kW (75PS)** **Diesel Turbo** **TD17274**

1103C-33TA 3 Cyl. **3299cc** **Diesel Turbo Intercooled** **FM46365**

1104A-44T 4 Cyl. **4399cc** **74-81kW (101-110PS)** **Diesel Turbo** **FM56365**

1104A-44TA 4 Cyl. **4399cc** **Diesel Turbo Intercooled** **FM66365**

1104C-44T 4 Cyl. 19.3:1 **4399cc** **68-74kW (92-101PS)** **Diesel Turbo** **TD17277**





1104C-E44T	4 Cyl.	19.3:1	4399cc	74kW (101PS)	Diesel Turbo	TD17278
-------------------	--------	--------	---------------	---------------------	---------------------	----------------

1104C-E44TA	4 Cyl.	19.3:1	4399cc	74-97kW (101-132PS)	Diesel Turbo	TD17281
--------------------	--------	--------	---------------	----------------------------	---------------------	----------------

87-426200-00	STD	08-426200-00	STD	14-020870-00 D	B 108.00 C 227.00 D 109.50 E 5.00
---------------------	-----	---------------------	-----	-----------------------	--

A 70.14
B- 22.00
BØ 55.10
D 108.00
 40x78

3.50 CK P
 2.50 P
 3.50 CR P

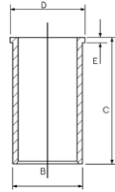

RT TP

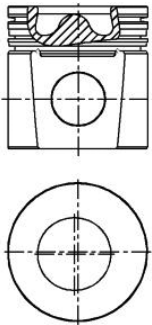

25 105.00

1103A-33	3 Cyl.		3299cc	28-35kW (38-48PS)	Diesel	FM16365
-----------------	--------	--	---------------	--------------------------	---------------	----------------

1103B-33 Euro 2	3 Cyl.	19.25:1	3300cc	43kW (58PS)	Diesel	TD23904
------------------------	--------	---------	---------------	--------------------	---------------	----------------

1103C-33 Euro 2	3 Cyl.	19.25:1	3300cc	41-43kW (56-58PS)	Diesel Turbo	TD17273
------------------------	--------	---------	---------------	--------------------------	---------------------	----------------

1103D-33	3 Cyl.		3299cc	37-41kW (50-56PS)	Diesel	TD19961
-----------------	--------	--	---------------	--------------------------	---------------	----------------

1104A-44	4 Cyl.	19.3:1	4399cc	50-64kW (68-87PS)	Diesel	TD29589
-----------------	--------	--------	---------------	--------------------------	---------------	----------------

1104C-44 Euro 2	4 Cyl.	19.3:1	4400cc	50-64kW (68-87PS)	Diesel Turbo	TD17275
------------------------	--------	--------	---------------	--------------------------	---------------------	----------------

1104C-E44	4 Cyl.	18.3:1	4399cc	64kW (87PS)	Diesel Turbo	TD17276
------------------	--------	--------	---------------	--------------------	---------------------	----------------

87-441300-00	STD	08-441300-00	STD	14-020870-00 D	B 108.00 C 227.00 D 109.50 E 5.00
---------------------	-----	---------------------	-----	-----------------------	--



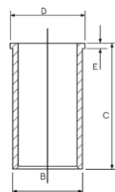

A 70.14
B- 22.35
BØ 51.30
D 108.00
 40x70



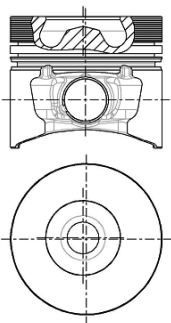

2.50 CK P
 2.50 P
 3.50 CR P







RT TP



		ccm	x 		
8140.43N Euro 3	Diesel	2798	4	94.40	55
8140.43S (F28DTCR) Euro 3	Diesel	2798	4	94.40	55
8140.63 (F28D)	Diesel	2798	4	94.40	56
AHV (DW10FD)	Diesel	1997	4	85.00	30
AHW (DW10FC)	Diesel	1997	4	85.00	30
CRD93	Diesel	2498	4	93.00	50
CRD93 (U25/661)	Diesel	2500	4	93.00	50
CRD93L	Diesel	2498	4	93.00	50
CRD93LS (U25/673)	Diesel	2500	4	93.00	51
DJ5 (T9A)	Diesel	2446	4	92.00	47
DJ5T (T8A/THZ)	Diesel	2446	4	92.00	48
DJ5TED (THX)	Diesel	2446	4	92.00	49
DK5ATE (THY)	Diesel	2446	4	92.00	48
DT17TED4	Diesel	2721	6	81.00	21
DV4TD (8HT)	Diesel	1398	4	73.70	4
DV4TD (8HX) Euro 3/4	Diesel	1399	4	73.70	4
DV4TD (8HZ)	Diesel	1398	4	73.70	4
DV4TED4 (8HY)	Diesel	1399	4	73.70	5
DV6ATED4 (9HV)	Diesel	1560	4	75.00	12
DV6ATED4 (9HX) Euro 4	Diesel	1560	4	75.00	12
DV6BTED4 (9HT) Euro 4	Diesel	1560	4	75.00	13
DV6BTED4 (9HW) Euro 4	Diesel	1560	4	75.00	13
DV6C (9HL)	Diesel	1560	4	75.00	13
DV6C (9HR)	Diesel	1560	4	75.00	13
DV6CTED (9HD)	Diesel	1560	4	75.00	13
DV6DTED (9HF) Euro 4	Diesel	1560	4	75.00	13
DV6DTED (9HP) Euro 4	Diesel	1560	4	75.00	13
DV6DTEDM (9HJ) Euro 4	Diesel	1560	4	75.00	14
DV6ETEDM (9HK) Euro 4	Diesel	1560	4	75.00	14
DV6TED4 (9HV)	Diesel	1560	4	75.00	12
DV6TED4 (9HY) Euro 4	Diesel	1560	4	75.00	12
DV6TED4 (9HZ) Euro 4	Diesel	1560	4	75.00	12
DV6UTED4 (9HU)	Diesel	1560	4	75.00	12
DW8 (WJZ)	Diesel	1868	4	82.20	22
DW8B (WJY)	Diesel	1868	4	82.20	22
DW10ATED (RHS)	Diesel	1997	4	85.00	31
DW10ATED (RHZ)	Diesel	1997	4	85.00	31
DW10ATED4 (RHM)	Diesel	1997	4	85.00	32
DW10ATED4 (RHT)	Diesel	1997	4	85.00	32
DW10ATED4 (RHW)	Diesel	1997	4	85.00	32
DW10BTED (RHX)	Diesel	1997	4	85.00	31
DW10BTED4 (RHF)	Diesel	1997	4	85.00	33
DW10BTED4 (RHR)	Diesel	1997	4	85.00	33
DW10CTED4 (RHC) Euro 5	Diesel	1997	4	85.00	34
DW10CTED4 (RHE) Euro 5	Diesel	1997	4	85.00	34
DW10CTED4 (RHH) Euro 5	Diesel	1997	4	85.00	34
DW10FD (AHX) Euro 5	Diesel	1997	4	85.00	30
DW10TD (RHV)	Diesel	1997	4	85.00	31
DW10TD (RHY)	Diesel	1997	4	85.00	31
DW10UTD (RHV)	Diesel	1997	4	85.00	31
DW10UTED4 (RHK) Euro 4	Diesel	1997	4	85.00	33
DW12BTED4 (4HP)/DW12BTED4 (4HP)	Diesel	2179	4	85.00	35
DW12BTED4 (4HR)	Diesel	2179	4	85.00	35
DW12BTED4 (4HS) Euro 4	Diesel	2179	4	85.00	35
DW12BTED4 (4HT) Euro 4	Diesel	2179	4	85.00	35
DW12BTED4 (4HW)	Diesel	2179	4	85.00	35
DW12C (4HL) Euro 5	Diesel	2179	4	85.00	36
DW12MTED4 (4HK)	Diesel	2179	4	85.00	35
DW12MTED4 (4HN)	Diesel	2179	4	85.00	35
DW12TED4 (4HX/4HW)	Diesel	2179	4	85.00	37
DW12TED4 (4HZ)	Diesel	2179	4	85.00	37
EN 55	Diesel	2498	4	94.00	52
ET 70	Diesel	2496	4	94.00	53
KF6	Petrol	1796	4	84.00	28
P22DTE (4HU) Euro 4	Diesel	2198	4	86.00	39
P22DTE (4HV) Euro 4	Diesel	2198	4	86.00	40
TU1 (H1A/H1B/H3A)	Petrol	1124	4	72.00	1
TU1JP (HFX)	Petrol	1124	4	72.00	2
TU1JP (HFZ)	Petrol	1124	4	72.00	2

		ccm	x 		9
TU1M (HDY)	Petrol	1124	4	72.00	1
TU1M (HDZ)	Petrol	1124	4	72.00	1
TU2.4	Petrol	1294	4	75.00	6
TU3 (K5A)	Petrol	1360	4	75.00	7
TU3A (K1D)	Petrol	1360	4	75.00	7
TU3A (K6D)	Petrol	1360	4	75.00	7
TU3A (K6E)	Petrol	1360	4	75.00	7
TU3A (K6F)	Petrol	1360	4	75.00	7
TU3A (KFT)	Petrol	1360	4	75.00	7
TU3A (KFV)	Petrol	1360	4	75.00	7
TU3A (KFW)	Petrol	1360	4	75.00	7
TU3CP (KAY)	Petrol	1360	4	75.00	7
TU3J2 (KFZ)	Petrol	1360	4	75.00	7
TU3JP (KFW)	Petrol	1360	4	75.00	8
TU3JP (KFX)	Petrol	1360	4	75.00	8
TU3JP-L4	Petrol	1360	4	75.00	9
TU3M (KDY)	Petrol	1360	4	75.00	7
TU3M (KDZ)	Petrol	1360	4	75.00	7
TU3MC (KDX)	Petrol	1360	4	75.00	7
TU3S (K2B)	Petrol	1360	4	75.00	7
TU5J4 (NFX)	Petrol	1587	4	78.50	16
TU5JP (NFZ)	Petrol	1587	4	78.50	17
TU5JP4 (N6A)	Petrol	1587	4	78.50	17
TU5JP4 (NFU)	Petrol	1587	4	78.50	16
TU32	Petrol	1360	4	75.00	7
TUD5 (VJX)	Diesel	1527	4	77.00	15
TUD5 (VJY)	Diesel	1527	4	77.00	15
XC6	Petrol	1618	4	84.00	28
XC7	Petrol	1618	4	84.00	28
XC7P	Petrol	1618	4	84.00	29
XD2	Diesel	2304	4	94.00	53
XD2 (134)	Diesel	2304	4	94.00	54
XD2P / XD94	Diesel	2304	4	94.00	54
XD2S	Diesel	2304	4	94.00	53
XD2S (147)	Diesel	2304	4	94.00	53
XD3 (155)	Diesel	2498	4	94.00	52
XD3P	Diesel	2498	4	94.00	52
XD3T	Diesel	2498	4	94.00	53
XD3T (152A)	Diesel	2498	4	94.00	53
XD3TE	Diesel	2498	4	94.00	53
XD3TE (152B)	Diesel	2498	4	94.00	53
XD 4.88	Diesel	1948	4	88.00	45
XD 88	Diesel	1948	4	88.00	45
XD90	Diesel	2112	4	90.00	46
XDP 4.88	Diesel	1948	4	88.00	45
XDP 4.90	Diesel	2112	4	90.00	46
XDP 6.90	Diesel	3168	6	90.00	46
XDP90	Diesel	2112	4	90.00	46
XID (149)	Diesel	1548	4	80.00	18
XM	Petrol	1796	4	84.00	28
XM7	Petrol	1796	4	84.00	28
XM7 (105)	Petrol	1796	4	84.00	28
XM7A (105C)	Petrol	1796	4	84.00	28
XM7P	Petrol	1796	4	84.00	28
XM7T (169B)	Petrol	1796	4	84.00	28
XN1	Petrol	1971	4	88.00	41
XN1 (106)	Petrol	1971	4	88.00	41
XN1A (106E)	Petrol	1971	4	88.00	42
XN1P	Petrol	1971	4	88.00	41
XN1T	Petrol	1971	4	88.00	41
XN1T (170)	Petrol	1971	4	88.00	41
XN1T (170B)	Petrol	1971	4	88.00	41
XN1TA	Petrol	1971	4	88.00	41
XN1TA (170C)	Petrol	1971	4	88.00	42
XN2 (107)	Petrol	1971	4	88.00	41
XU5CP (BAZ)	Petrol	1580	4	83.00	23
XU5J (180)	Petrol	1580	4	83.00	23
XU5J (180A)	Petrol	1580	4	83.00	23
XU5J (B6B)	Petrol	1580	4	83.00	23

		ccm	x 		9
XU5JP (BFZ)	Petrol	1580	4	83.00	24
XU5M (BDZ)	Petrol	1580	4	83.00	23
XU5M2Z (BDY)	Petrol	1580	4	83.00	23
XU5M3Z (BDY)	Petrol	1580	4	83.00	23
XU5S (171)	Petrol	1580	4	83.00	24
XU7JB (LFX)	Petrol	1761	4	83.00	23
XU7JP (LFW)	Petrol	1761	4	83.00	23
XU7JP (LFZ)	Petrol	1761	4	83.00	23
XU7JP4 (LFY)	Petrol	1761	4	83.00	23
XU9J1 (DFZ)	Petrol	1905	4	83.00	25
XU9J2 (D6A)	Petrol	1905	4	83.00	25
XU9J4 (D6C/DFW)	Petrol	1905	4	83.00	23
XU9J4 (DFW)	Petrol	1905	4	83.00	23
XU9JA (D6B)	Petrol	1905	4	83.00	25
XU9JAZ (DKZ)	Petrol	1905	4	83.00	23
XU9M (DDZ)	Petrol	1905	4	83.00	23
XU9S (D2B)	Petrol	1905	4	83.00	25
XU10J2 (RFU)	Petrol	1998	4	86.00	38
XU10J2 (RFW)	Petrol	1998	4	86.00	38
XU10J2 (RFX)	Petrol	1998	4	86.00	38
XU51C (B1A)	Petrol	1580	4	83.00	24
XU51C (B1D)	Petrol	1580	4	83.00	23
XU51C (B1E)	Petrol	1580	4	83.00	23
XU52C/K (B2A)	Petrol	1580	4	83.00	23
XU92C	Petrol	1905	4	83.00	25
XU92C (D2A)	Petrol	1905	4	83.00	25
XU92C (D2C)	Petrol	1905	4	83.00	25
XUD7 (161)	Diesel	1769	4	80.00	19
XUD7 (161A)	Diesel	1769	4	80.00	19
XUD7 (A9A)	Diesel	1769	4	80.00	19
XUD7T	Diesel	1769	4	80.00	20
XUD7TE (A8A)	Diesel	1769	4	80.00	20
XUD7TE (A8B)	Diesel	1769	4	80.00	20
XUD7TE (AJZ)	Diesel	1769	4	80.00	20
XUD9	Diesel	1905	4	83.00	26
XUD9 (162)	Diesel	1905	4	83.00	26
XUD9 (D9A)	Diesel	1905	4	83.00	26
XUD9 (DJZ)	Diesel	1905	4	83.00	26
XUD9A (D9B)	Diesel	1905	4	83.00	26
XUD9A (D9B/DJY)	Diesel	1905	4	83.00	26
XUD9A (DJY)	Diesel	1905	4	83.00	26
XUD9BSD (DHV)	Diesel	1905	4	83.00	27
XUD9SD (DHW)	Diesel	1905	4	83.00	27
XUD9TE	Diesel	1905	4	83.00	27
XUD9TE (D8B)	Diesel	1905	4	83.00	27
XUD9TE (DHX)	Diesel	1905	4	83.00	27
XUD9TE (DHY)	Diesel	1905	4	83.00	27
XUD9UTF (D8C)	Diesel	1905	4	83.00	27
XW3 (109)	Petrol	1124	4	72.00	3
XW3S	Petrol	1124	4	72.00	3
XW3S (121)	Petrol	1124	4	72.00	3
XW7 (109F)	Petrol	1124	4	72.00	3
XW7 (109N)	Petrol	1124	4	72.00	3
XY8 (150B)	Petrol	1360	4	75.00	10
XZ5 (129)	Petrol	1219	4	75.00	11
ZDJ (851)	Petrol	2165	4	88.00	43
ZDJL (851B)	Petrol	2165	4	88.00	44
ZDJL (851X)	Petrol	2165	4	88.00	44
ZEJ (829)	Petrol	1995	4	88.00	44



1 72.00

205 1.1	08/87→07/90	TU1 (H1A/H1B/H3A)			
205 I 1.1	08/87→12/94	4 Cyl.	9.4:1		
205 II 1.1	10/87→10/90	1124cc	40kW (54PS)		
309 II 1.1	09/89→10/93				TD2758
106 II 1.1 i	01/97→	TU1M (HDY)			
		4 Cyl.	9.2:1		
		1124cc	40kW (54PS)		
					TD9404
106 I 1.1	09/91→04/96	TU1M (HDZ)			
106 II 1.1 i	05/96→	4 Cyl.	9.4:1		
205 I 1.1 CJ	10/89→12/94	1124cc	44kW (60PS)		
205 II 1.1	07/89→09/98				TD4834
306 1.1	05/93→05/01				
309 II 1.1	08/90→12/93				
Partner 1.1, Partnerspace 1.1	06/96→				



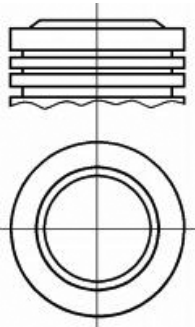

87-154300-00 STD

A 40.05
B+ 2.97
D 64.05
 20x62



 Steel

08-154300-00 STD
 08-154307-00 0.50mm

1.50  CR P
 2.00  P
 3.00  CR 

 Stahl

14-636470-00 WH B 79.50 C 122.00 D 89.20 E 85.00

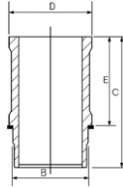

 Acero

88-154300-00
 87-154300-00 +
 14-636470-00

 Acciaio



2 72.00



106 II 1.1 i	05/96→	TU1JP (HFX)			
206+ 1.1	01/09→		4 Cyl.	10.5:1	
206 1.1 i	09/98→		1124cc	44kW (60PS)	
206 SW 1.1	07/02→				TD14728
Partnerspace 1.1	06/96→				

206 1.1 i	09/98→	TU1JP (HFZ)			
			4 Cyl.	10.5:1	
			1124cc	44kW (60PS)	
					TD9848

87-426300-00 STD

08-426300-00 STD

A 27.70
B+ 0.10
D 47.50
 18x55

1.50  NT
 1.50  P
 2.50  P

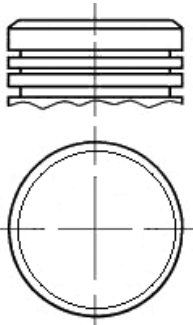

3 72.00

104 1.1	07/76→06/83	XW3 (109)			
			4 Cyl.	9.2:1	
			1124cc	42kW (57PS)	
					TD2895

104 1.1	09/73→09/79	XW3S			
			4 Cyl.	9.7:1	
			1124cc	48kW (66PS)	
					TD12688

104 1.1	08/75→06/80	XW3S (121)			
			4 Cyl.	9.7:1	
			1124cc	49kW (67PS)	
					TD2896

104 1.1	08/79→06/88	XW7 (109F)			
205 I 1.1	02/83→10/87		4 Cyl.	10.2:1	
			1124cc	37kW (50PS)	
					TD2899

205 I 1.1	02/83→10/87	XW7 (109N)			
205 II 1.1	10/87→10/90		4 Cyl.	10.2:1	
			1124cc	36kW (50PS)	
					TD2900

14-636470-00 WH B 79.50 C 122.00 D 89.20 E 85.00

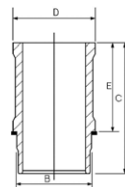



4 73.70

107 1.4 HDi	06/05→	DV4TD (8HT)	4 Cyl.	17.9:1	
			1398cc	40kW (54PS)	
		Diesel	Turbo Intercooled		TD24924
206+ 1.4 HDi eco 70	01/09→	DV4TD (8HX) Euro 3/4	4 Cyl.	17.9:1	
206 1.4 HDi	09/01→03/09		1399cc	50-51kW (68-69PS)	
206 1.4 HDi eco 70	09/01→				
206 SW 1.4 HDi	07/02→	Diesel	Turbo Intercooled		TD16368
307 1.4 HDi	10/01→				
1007 1.4 HDi	04/05→				
206+ 1.4 HDi eco 70	01/09→	DV4TD (8HZ)	4 Cyl.	17.9:1	
206 1.4 HDi	09/01→03/09		1398cc	50-51kW (68-69PS)	
206 1.4 HDi eco 70	09/01→				
207 1.4 HDi	02/06→	Diesel	Turbo Intercooled		TD17509
307 1.4 HDi	10/01→				
307 Sw 1.4 Hdi	04/02→06/05				
307 SW 1.4 HDi 70	03/02→01/05				
1007 1.4 HDi	04/05→				

87-135300-00 STD

STD

08-135300-00 STD

STD

14-020760-00 D

B 76.70 C 136.00 D 78.20 E 5.00

87-135305-00 0.25mm

0.25mm

08-135305-00 0.25mm

0.25mm

14-020761-00 D

B 76.95 C 136.00 D 78.45 E 5.25

87-135307-00 0.50mm

0.50mm

08-135307-00 0.50mm

0.50mm

A 42.94

2.50



CK P

B- 14.70

1.95



P

BØ 37.16

2.50



CR P

C 1.55

D 65.44

 25x60

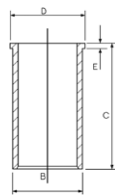

AK RT TP

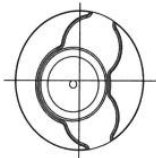
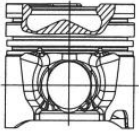

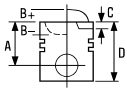





5 73.70

206 1.4 TD, 307 1.4 TD 01/02→ **DV4TED4 (8HY)**
 4 Cyl. **1399cc** **66kW (89PS)**
Diesel **Turbo Intercooled** **FM19023**

87-135300-10 STD **08-135300-00** STD **14-020760-00 D** B 76.70 C 136.00 D 78.20 E 5.00
87-135307-10 0.50mm **08-135305-00** 0.25mm **14-020761-00 D** B 76.95 C 136.00 D 78.45 E 5.25
08-135307-00 0.50mm

A 42.94
B- 14.40
BØ 37.15
C 1.15
C 1.15
D 65.44
 **25x60**

2.50  CK P
 1.95  P
 2.50  CR P

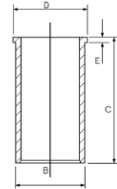

KK RT TP

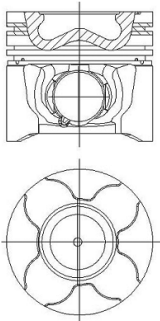

6 75.00

205 II 1.3 Rallye 10/87→10/90 **TU2.4**
 4 Cyl. 9.6:1
1294cc **74-76kW (101-103PS)**
TD12689

14-638630-00 WH B 79.50 C 120.50 D 89.20 E 85.00

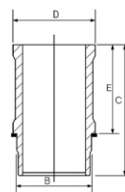

7 75.00

106 I 1.4 08/91→03/96 **TU3 (K5A)**
 405 I 1.4 01/87→07/92 4 Cyl. 10.2:1
1360cc **47-51kW (64-69PS)**
TD26412

205 I 1.4 CJ 03/89→12/94 **TU3A (K1D)**
 205 II 1.4 10/87→10/90 4 Cyl. 9.3:1
 309 I 1.4 03/89→07/89 **1360cc** **49kW (67PS)**
 309 II 1.4 07/90→12/93 **TD2766**



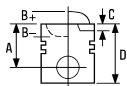

309 II 1.4	07/90→12/93	TU3A (K6D)	4 Cyl. 1360cc	10.2:1 53kW (72PS)	TD24928
309 II 1.4	07/90→12/93	TU3A (K6E)	4 Cyl. 1360cc	10.2:1 53kW (72PS)	TD24930
309 II 1.4	07/90→12/93	TU3A (K6F)	4 Cyl. 1360cc	10.2:1 53kW (72PS)	TD24929
206+ 1.4 i	09/10→	TU3A (KFT)	4 Cyl. 1360cc	10.2:1 54kW (73PS)	TD24931
206+ 1.4 i 206 1.4 206 1.4 Flex 206 SW 1.4 206 SW 1.4 Flex 207 1.4 207 SW 1.4 Bipper 1.4 Bipper Tepee 1.4 Hoggar 1.4, Hoggar 1.4 Flex Partner 1.4	01/09→ 03/07→ 01/06→11/09 07/02→ 01/06→07/08 02/06→ 06/07→ 02/08→ 04/08→ 05/10→ 11/02→10/06	TU3A (KFV)	4 Cyl. 1360cc	9.3:1 54-60kW (73-82PS)	TD21111
206+ 1.4 i 206 1.4 CNG 207 1.4 207 1.4 Flex 306 1.4	01/09→ 05/06→09/07 08/08→ 11/08→ 03/96→07/01	TU3A (KFW)	4 Cyl. 1360cc	10.2:1 55-60kW (75-82PS)	TD24927
205 I 1.4 CJ CAT 205 II 1.4 CAT	01/89→09/93 08/87→09/93	TU3CP (KAY)	4 Cyl. 1360cc	9.3:1 44kW (60PS)	TD2767
106 I 1.4	09/91→04/96	TU3J2 (KFZ)	4 Cyl. 1360cc	9.9:1 69kW (94PS)	TD2770
106 I 1.4 205 I 1.4 CJ 205 II 1.4 309 I 1.4 309 II 1.4	09/91→04/96 05/91→12/94 07/88→09/98 03/89→07/89 07/89→12/93	TU3M (KDY)	4 Cyl. 1360cc	9.3:1 55-58kW (75-79PS)	TD4836
205 I 1.4 CJ 205 II 1.4 309 I 1.4 309 II 1.4	05/91→12/94 07/88→09/98 03/89→07/89 07/89→12/93	TU3M (KDZ)	4 Cyl. 1360cc	9.3:1 55kW (75PS)	TD2775
106 I 1.4 205 II 1.4 306 1.4 306 1.4 SL 405 II 1.4	09/91→04/96 08/90→07/98 05/93→05/01 06/94→05/01 08/92→10/96	TU3MC (KDX)	4 Cyl. 1360cc	9.3:1 55-58kW (75-79PS)	TD2777





205 I 1.4	08/87→06/94	TU3S (K2B)		
205 II 1.4	06/87→12/89		4 Cyl.	9.3:1
309 I 1.4	03/89→07/89		1360cc	62kW (85PS)

TD2779

205 II 1.4	08/90→07/98	TU32		
Partner 1.4, Partnerspace 1.4	06/96→		4 Cyl.	9.3:1
			1360cc	51-55kW (70-75PS)

TD8507

87-154400-00	STD	08-154400-00	STD	14-636600-00 WH	B 79.50 C 134.50 D 89.20 E 90.00	88-154400-00
		08-154407-00	0.50mm			87-154400-00 + 14-636600-00
A 40.50		1.75	CR P	D, E, C		
B- 1.10		2.00	P			
BØ 62.00		3.00	P			
D 64.50						
20x62						
A, B, C, D						

8 75.00

106 II 1.4 i	05/96→	TU3JP (KFW)		
206 1.4	03/07→		4 Cyl.	10.2:1
206 1.4 i	09/98→		1360cc	47-60kW (64-82PS)
206 SW 1.4, 206 SW 1.4 Lpg	07/02→			
207 1.4	01/11→			
207 1.4 Bioflex	08/08→			
207 SW 1.4 Flex	08/08→			
306 1.4	05/93→04/02			
306 1.4 SL	06/94→05/01			
307 1.4	08/00→			
307 SW 1.4, 307 1.4	04/02→09/03			
Partner 1.4 BiFuel	04/03→			
Partnerspace 1.4	06/96→			

TD14729





106 II 1.4 i	05/96 →	TU3JP (KFX)		
205 II 1.4	07/88 → 09/98		4 Cyl.	10.2:1
206 1.4 i	09/98 →		1360cc	49-55kW (67-75PS)
306 1.4	05/93 → 04/02			
306 1.4 SL	06/94 → 05/01			
Partner 1.4, Partnerspace 1.4	06/96 →			TD5396



87-138900-10 STD

→01/04

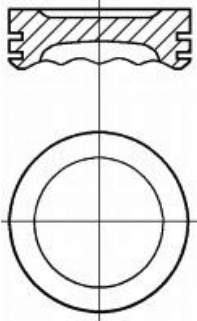
A 27.75
B- 1.30
BØ 65.00
D 49.75
 18x58



08-138900-00 STD

1.50  CK P
 1.50  P
 2.50  P

14-636600-00 WH B 79.50 C 134.50 D 89.20 E 90.00

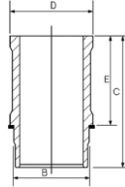

88-138900-10

87-138900-10 +
 14-636600-00



87-138900-30  STD

01/04 →

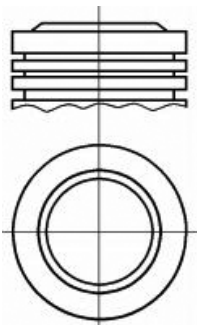
A 27.75
B+ 0.18
D 49.75
 18x56



08-138900-00 STD

1.50  CK P
 1.50  P
 2.50  P

14-636600-00 WH B 79.50 C 134.50 D 89.20 E 90.00

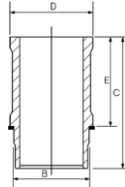

88-138900-30

87-138900-30 +
 14-636600-00

 Euro 4

 Euro 4

 Euro 4

 Euro 4

 Euro 4

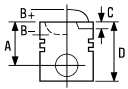

9 75.00

206 1.4 LPG	05/06→09/07	TU3JP-L4			
1007 1.4	04/05→	4 Cyl.	10.5:1		
Partnerspace 1.4	10/05→	1360cc	48-55kW (65-75PS)		



TD18518

87-138900-30 STD

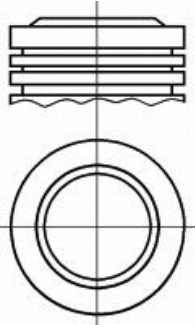
A 27.75
B+ 0.18
D 49.75
 18x56



08-138900-00 STD

1.50  CK P
 1.50  P
 2.50  P

14-636600-00 WH B 79.50 C 134.50 D 89.20 E 90.00

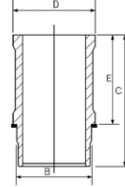

88-138900-30

87-138900-30 +
 14-636600-00

10 75.00

205 I 1.4	02/83→10/87	XY8 (150B)			
205 I 1.4 CT	04/86→12/88	4 Cyl.	9.3:1		
205 II 1.4	07/88→05/89	1360cc	58-59kW (79-80PS)		

TD2905

14-636600-00 WH B 79.50 C 134.50 D 89.20 E 90.00

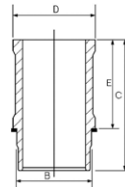

11 75.00

104 1.2	08/79→06/83	XZ5 (129)			
		4 Cyl.	9.3:1		
		1219cc	42kW (57PS)		

TD2906

15-636700-00 WH  B 79.50 C 122.00 D 89.20 E 82.50

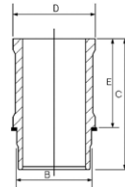

 Includes seals

 Schließt Dichtungen ein

 Inclut des joints

 Incluye los sellos

 Comprende le guarnizioni



12  **75.00**

307 1.6 HDi	04/05→	DV6ATED4 (9HV)			
307 SW 1.6 HDi 90	12/06→	4 Cyl.	17.6:1		
308 SW 1.6 HDi	09/07→	1560cc	66kW (90PS)		
		Diesel	Turbo Intercooled		TD24730
207 1.6 HDi	02/06→	DV6ATED4 (9HX) Euro 4			
207 SW 1.6 HDi	06/07→	4 Cyl.	17.6:1		
307 1.6 HDi	04/05→	1560cc	66-68kW (90-92PS)		
307 SW 1.6 HDi 90	12/06→	Diesel	Turbo Intercooled		TD20147
308 SW 1.6 HDi	09/07→				
Partner 1.6 HDi 16V	04/08→				
Partner 1.6 HDi 90	02/06→				
Partnerspace 1.6 HDi 90	10/05→				
Partner Tepee 1.6 HDi 16V	04/08→				
207 1.6 HDi	02/06→	DV6TED4 (9HV)			
307 1.6 HDi	04/05→	4 Cyl.	17.6:1		
Partner Tepee 1.6 HDi 16V	04/08→	1560cc	66kW (90PS)		
		Diesel	Turbo Intercooled		TD28634
206 1.6 HDi 110	05/04→	DV6TED4 (9HY) Euro 4			
207 1.6 HDi	02/06→	4 Cyl.	17.6:1		
307 1.6 HDi 110	02/04→	1560cc	80kW (109PS)		
307 SW 1.6 HDi 110		Diesel	Turbo Intercooled		TD17506
206 CC 1.6 HDi 110	04/05→	DV6TED4 (9HZ) Euro 4			
206 SW 1.6 HDi 110, 206 1.6 HDi 110	05/04→	4 Cyl.	17.6:1		
207 1.6 HDi	02/06→	1560cc	80-82kW (109-112PS)		
207 CC 1.6 HDi	02/07→	Diesel	Turbo Intercooled		TD18520
207 SW 1.6 HDi	06/07→				
307 1.6 HDi 110	02/04→				
307 SW 1.6 HDi 110					
308 SW 1.6 HDi, 308 1.6 HDi	09/07→				
407 SW 1.6 HDi 110, 407 1.6 HDi 110	05/04→				
1007 1.6 HDi	06/07→				
3008 1.6 HDi	06/09→				
5008 1.6 HDi	09/09→				
Partner 1.6 HDi, Partner Tepee 1.6 HDi	04/08→				
Expert 1.6 HDi 90		DV6UTED4 (9HU)			
Expert 1.6 HDi 90 16V	01/07→	4 Cyl.	18:1		
Expert Tepee 1.6 HDi 90 16V		1560cc	66kW (90PS)		
		Diesel	Turbo Intercooled		TD24693

87-424000-00 STD
87-424008-00 0.60mm

08-424000-00 STD
08-424007-00 0.50mm
08-424008-00 0.60mm

14-020900-00 D B 78.00 C 142.00 D 79.50 F 5.00

A 41.70
B- 13.25
BØ 41.80
C 1.20
D 65.30
 26x61

3.00
1.95
2.50



CK P
P
CR P

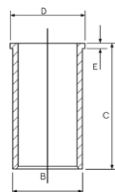

AK KK RT TP

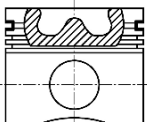
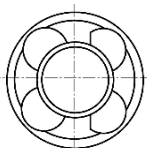



13 75.00

Partner 1.6 HDi	04/08→	DV6BTED4 (9HT) Euro 4			
Partner Tepee 1.6 HDi	04/08→	4 Cyl.			
		1560cc	55kW (75PS)		
		Diesel	Turbo Intercooled		TD23537
Partner 1.6 HDi	04/08→	DV6BTED4 (9HW) Euro 4			
Partner 1.6 HDi 75	02/06→	4 Cyl.			
Partnerspace 1.6 HDi 75	02/06→	1560cc	55kW (75PS)		
Partner Tepee 1.6 HDi	04/08→	Diesel	Turbo Intercooled		TD24701
408 1.6 HDi	11/10→	DV6C (9HL)			
Partner 1.6 HDi	03/13→	4 Cyl.	17.6:1		
Partner Tepee 1.6 HDi	08/10→	1560cc	82-85kW (112-116PS)		
		Diesel	Turbo Intercooled		TD26986
207 CC 1.6 HDi, 207 1.6 HDi 110	08/09→	DV6C (9HR)			
207 SW 1.6 HDi		4 Cyl.	17.6:1		
308 1.6 HDi	12/09→	1560cc	82kW (112PS)		
308 CC 1.6 HDi	06/09→	Diesel	Turbo Intercooled		TD26421
308 SW 1.6 HDi	12/09→				
508 SW 1.6 HDi, 508 1.6 HDi	11/10→				
3008 1.6 HDi, 5008 1.6 HDi	08/10→				
208 1.6 HDi	03/12→	DV6CTED (9HD)			
508 SW 1.6 HDi, 508 1.6 HDi	02/12→	4 Cyl.			
2008 1.6 HDi, 3008 1.6 HDi, 5008 1.6 HDi	03/13→	1560cc	84kW (115PS)		
		Diesel	Turbo Intercooled		TD26896
301 1.6 HDi 90	11/12→	DV6DTEd (9HF) Euro 4			
Partner 1.6 HDi	03/13→	4 Cyl.	18:1		
Partner Tepee 1.6 HDi		1560cc	66-68kW (90-92PS)		
		Diesel	Turbo Intercooled		TD26710
207 SW 1.6 HDi, 207 1.6 HDi	11/09→	DV6DTEd (9HP) Euro 4			
208 1.6 HDi	03/12→	4 Cyl.	18:1		
308 SW 1.6 HDi, 308 1.6 HDi	11/09→	1560cc	68kW (92PS)		
2008 1.6 HDi	03/13→	Diesel	Turbo Intercooled		TD27064
Partner 1.6 HDi 90	04/10→				
Partner Tepee 1.6 HDi 90					

87-433600-00
87-433607-00

STD
0.50mm

A 41.75
B- 13.85
BØ 45.00
D 65.20
 26x61

AK KK RT TP

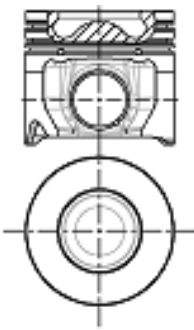

08-433600-00
08-433607-00

STD
0.50mm

2.50
1.95
2.00



LKZ-Ring®

14-020900-00 D B 78.00 C 142.00 D 79.50 F 5.00

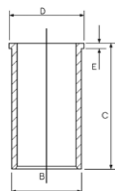



14 75.00

308 1.6 HDi	11/09→	DV6DTEDM (9HJ) Euro 4	4 Cyl.	18:1	
			1560cc	68kW (92PS)	
		Diesel	Turbo Intercooled		TD27967
208 1.6 HDi/BlueHDi 75	01/13→	DV6ETEDM (9HK) Euro 4	4 Cyl.	17.6:1	
			1560cc	55kW (75PS)	
		Diesel	Turbo Intercooled		TD27968



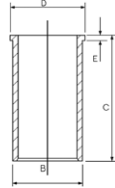

14-020900-00 D B 78.00 C 142.00 D 79.50 F 5.00



15 77.00

106 1.5 D	10/00→03/01	TUD5 (VJX)			
106 II 1.5 D	04/98→		4 Cyl.	23:1	
			1527cc	42kW (57PS)	
		Diesel			TD16193
106 1.5 D	05/96→03/01	TUD5 (VJY)			
106 I 1.5 D	06/94→04/96		4 Cyl.	23:1	
106 II 1.5 D	05/96→		1527cc	40-43kW (54-58PS)	
		Diesel			TD4842

87-325800-00 STD 08-325800-00 STD
 87-325806-00 0.40mm 08-325806-00 0.40mm

A 40.37 2.00  CK P
 B- 1.65 1.75  P
 D 66.32 3.00  CR P
 23x60

RT

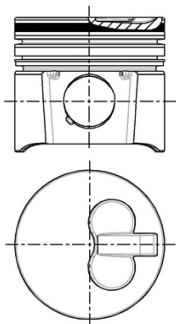







16 78.50

106 II 1.6 S16	05/96→	TU5J4 (NFX)	4 Cyl. 1587cc	10.8:1 87kW (118PS)	TD4839
206+ 1.6 16V	07/10→	TU5JP4 (NFU)	4 Cyl.	10.8:1	
206 1.6 16V	12/00→		1587cc	78-90kW (106-122PS)	TD15668
206 1.6 Flex	05/05→07/08				
206 CC 1.6 16V	09/00→				
206 SW 1.6 16V	07/02→				
206 SW 1.6 Flex	05/05→07/08				
206 SW 1.6 Lpg	07/02→				
207 1.6 16V	02/06→				
207 SW 1.6	01/10→				
208 1.6 Flex	01/13→				
307 1.6	07/06→				
307 1.6 16V	08/00→				
307 1.6, 307 1.6 Flex	08/06→				
307 1.6 BioFlex	09/07→				
307 CC 1.6 16V	02/05→				
307 SW 1.6 16V	03/02→				
307 SW 1.6 BioFlex	09/07→				
308 1.6 BioFlex	04/08→				
308 SW 1.6 Bioflex	03/09→				
405 II 1.6	08/92→05/97				
1007 1.6 16V	04/05→				
Hoggar 1.6, Hoggar 1.6 Flex	05/10→				
Partner 1.6	09/00→				
Partner 1.6 Bioflex	09/00→10/02				
Partner 1.6 Flex	09/08→				
Partnerspace 1.6 16V	07/01→				
Partnerspace 1.6 Flexfuel	09/00→				
Partner Tepee 1.6	04/08→				
Partner Tepee 1.6 Flex	09/08→				

87-139400-00	STD	08-139400-00	STD
87-139407-00	0.50mm	08-139406-00	0.40mm
		08-139407-00	0.50mm

A	32.35			
B+	1.30	1.20		CK P
D	51.30	1.50		P
	20x57	2.50		P

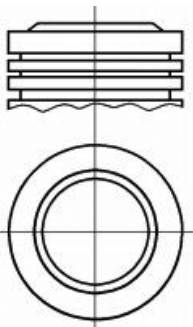







17 78.50

106 I 1.6	06/93→04/96	TU5JP (NFZ)			
106 II 1.6 i	05/96→		4 Cyl.	9.6:1	
206 1.6 i	09/98→12/00		1587cc	65kW (88PS)	
306 1.6	05/93→05/01				TD4840
306 1.6 SR	06/94→10/00				

207 1.6, 207 1.6 Flex	08/08→	TU5JP4 (N6A)			
207 1.6 Bioflex	01/08→		4 Cyl.	10.5:1	
207 SW 1.6, 207 SW 1.6 Flex	08/08→		1587cc	78-83kW (106-113PS)	
307 1.6 Flex	07/06→				TD21503

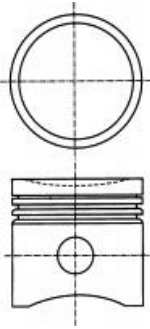

87-103800-00	STD	08-103800-00	STD
87-103806-00	0.50mm	08-103806-00	0.40mm

A	32.25	1.50		CK P
B-	1.50	1.50		P
BØ	68.50	3.00		CR P
D	57.50			
	20x62			







18 80.00

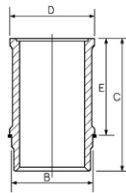

305 I 1.5 Diesel	11/77→09/82	XID (149)			
			4 Cyl.	22.5:1	
			1548cc	36kW (49PS)	
		Diesel			TD2812



14-634110-00 WH   **B 84.50 C 133.50 D 100.00 E 97.50**





 Phosphated
 Use also: 1 x HT006

 Phosphated
 Mitverwenden: 1 x HT006

 Phosphated
 A utiliser aussi: 1 x HT006

 Phosphated
 Utilizar también: 1 x HT006

 Phosphated
 Usare anche 1 x HT006



19 80.00



306 1.8 D	05/97→06/00	XUD7 (161)	4 Cyl. 1769cc	23:1 44kW (60PS)	TD21268
Diesel					
205 1.7 Diesel	03/94→	XUD7 (161A)	4 Cyl. 1769cc	23:1 44kW (60PS)	TD2882
205 I 1.7 Diesel	08/83→10/87				
205 II 1.7 Diesel	07/87→09/98				
305 II 1.8 D	11/82→12/88	Diesel			
309 II 1.8 Diesel	07/89→12/93				
205 1.8 D	02/83→07/90	XUD7 (A9A)	4 Cyl. 1769cc	23:1 43-44kW (58-60PS)	TD12351
306 1.8 D	04/93→05/01				
Partner 1.8 D	06/96→	Diesel			

87-321500-10 STD
87-321507-10 0.50mm
87-321510-10 0.80mm

08-321500-00 STD
08-321507-00 0.50mm
08-321510-00 0.80mm

14-024740-00 D B 83.50 C 154.00 D 85.70 E 4.60
14-024830-00 D B 83.00 C 154.00 D 86.00 E 4.50

A 46.80
B- 2.00
D 84.50
 25x70

2.00  CR P
2.00  P
3.00  CR P

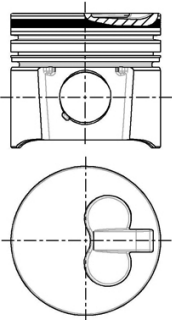
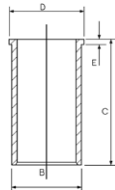



20  **80.00**

205 II 1.8 XDT	08/90→05/97	XUD7T	4 Cyl.	22:1	
		Diesel	1769cc	58kW (79PS)	TD18394
			Turbo Intercooled		
405 I 1.8 D	10/87→07/92	XUD7TE (A8A)			
405 I 1.8 DT	05/90→07/92		4 Cyl.	22:1	
405 I 1.8 TD	10/88→08/92		1769cc	66kW (90PS)	
405 I 1.8 Turbo Diesel	03/88→12/92	Diesel	Turbo Intercooled		TD2884
205 II 1.8 TD	01/90→09/98	XUD7TE (A8B)			
309 II 1.8 TD	08/89→12/93		4 Cyl.	22:1	
		Diesel	1769cc	57kW (78PS)	TD10789
			Turbo		
405 I 1.8 TD	10/88→08/92	XUD7TE (AJZ)			
405 I 1.8 Turbo Diesel	03/88→12/92		4 Cyl.	22:1	
		Diesel	1769cc	66kW (90PS)	TD2885
			Turbo Intercooled		

87-323600-00

STD

08-323600-00

STD

14-024740-00 D

B 83.50 C 154.00 D 85.70 E 4.60

87-323607-00

0.50mm

08-323607-00

0.50mm

14-024830-00 D

B 83.00 C 154.00 D 86.00 E 4.50

A 46.80

B- 2.20

D 84.50

 28x68

3.00

2.00

3.00



MOL P

P

CR P

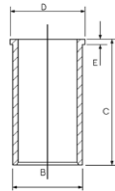

AK RT

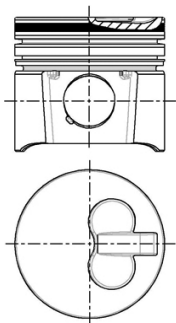







21 81.00

607 2.7 HDi 24V	12/04→	DT17TED4	6 Cyl.	17.3:1
			2721cc	150kW (204PS)
		Diesel	Turbo Intercooled	TD18175

87-432400-00 STD **08-432400-00** STD

A 47.00
B- 14.05
BØ 44.00
C 0.50
D 71.00
 29x62

2.00  CK P
 2.00  P
 2.00  P

AK KK RT TP

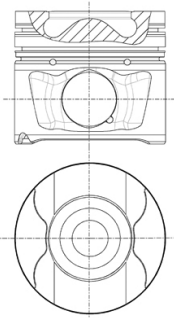





22 82.20

206 1.9 D	09/98→05/07	DW8 (WJZ)		
207 1.9 D	10/08→		4 Cyl.	23.1:1
306 1.9 D	09/98→08/02		1868cc	51kW (69PS)
Expert 1.9 D	06/98→	Diesel		TD9868
Expert 1.9 D 70	12/98→			
Partner 1.9 D	06/96→			
Partnerspace 1.9 D	12/98→			

206 1.9 D	09/98→11/01	DW8B (WJY)		
207 1.9 XSD	12/07→		4 Cyl.	23.1:1
306 1.9 D	09/98→08/02		1868cc	51kW (69PS)
Expert 1.9 D	06/98→	Diesel		TD13788
Expert 1.9 D 70	12/98→			
Partner 1.9 D	06/96→			
Partnerspace 1.9 D	12/98→			

87-104000-00 STD **08-104000-00** STD **14-020290-00 D** **B 85.00 C 154.00 D 87.00 E 5.00** **88-104000-00**
87-104008-00 0.60mm **08-104008-00** 0.60mm

A 46.80
B- 1.30
D 78.00
 25x65

2.00  CK P
 2.00  P
 3.00  CR P

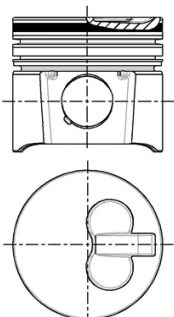
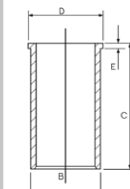



23  **83.00**

205 I 1.6	08/86→10/87	XU5CP (BAZ)				
205 II 1.6	10/87→09/98		4 Cyl.	9.5:1		
305 II 1.6	11/86→12/88		1580cc	54-55kW (74-75PS)		
309 I 1.6 CAT	09/86→12/89					TD2859
405 I 1.6	07/87→08/92					
205 I 1.6 CTI	04/86→10/90	XU5J (180)				
205 II 1.6 GTI	10/87→12/89		4 Cyl.	9.8:1		
309 I 1.6	11/85→09/88		1580cc	76kW (103PS)		TD2862
205 I 1.6 CTI	04/86→10/90	XU5J (180A)				
205 I 1.6 GTI	12/84→10/87		4 Cyl.	9.8:1		
205 II 1.6 GTI	10/87→12/89		1580cc	76kW (104PS)		TD2861
309 I 1.6	11/85→09/88	XU5J (B6B)				
			4 Cyl.	9.8:1		
			1580cc	76kW (103PS)		TD2858
309 II 1.6	07/89→12/93	XU5M (BDZ)				
405 I 1.6	07/87→12/92		4 Cyl.	9:1		
405 I 1.6 SRi	04/88→07/92		1580cc	65-66kW (88-90PS)		
405 II 1.6	08/92→10/96					TD2839
205 II 1.6 Aut.	05/90→09/98	XU5M2Z (BDY)				
309 II 1.6	07/89→12/93		4 Cyl.	9:1		
405 I 1.6	07/87→12/92		1580cc	65-71kW (88-97PS)		
405 II 1.6	08/92→10/96					TD4846
205 I 1.6 CJ	08/92→12/94	XU5M3Z (BDY)				
205 II 1.6 Aut.	05/90→09/98		4 Cyl.	9.3:1		
309 II 1.6	07/89→12/93		1580cc	65-66kW (88-90PS)		
405 I 1.6	10/88→08/92					TD2864
405 II 1.6	08/92→10/96					
406 1.8	05/97→10/04	XU7JB (LFX)				
Partner 1.8	03/97→08/00		4 Cyl.	9.5:1		
Partnerspace 1.8	05/97→		1761cc	66kW (90PS)		TD12708
806 1.8	07/95→08/02	XU7JP (LFW)				
			4 Cyl.	9.3:1		
			1761cc	73kW (99PS)		TD2867
306 1.8	05/93→04/02	XU7JP (LFZ)				
306 1.8 ST	06/94→05/01		4 Cyl.			
405 II 1.8	08/92→11/99		1761cc	74-76kW (101-103PS)		
406 1.8	10/96→03/99					TD2866
Expert 1.8	10/96→09/00					
306 1.8 16V	03/97→10/03	XU7JP4 (LFY)				
406 1.8 16V	11/95→10/00		4 Cyl.	10.4:1		
406 1.8 Bifuel	04/99→05/03		1761cc	81-86kW (110-117PS)		TD4849
309 II 1.9 GTI 16V	08/89→07/90	XU9J4 (D6C/DFW)				
405 I 1.9	06/87→07/92		4 Cyl.	10.4:1		
405 I 1.9 All-wheel Drive			1905cc	116-118kW (158-160PS)		
405 I 1.9 Sport MI-16	07/87→11/91					TD2873
309 II 1.9 GTI 16V	10/90→12/93	XU9J4 (DFW)				
405 I 1.9 Sport MI-16	04/88→12/92		4 Cyl.	9.3:1		
			1905cc	108kW (147PS)		TD2875



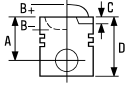

205 I 1.9 CTI	08/90→07/92	XU9JAZ (DKZ)			
205 II 1.9	08/90→05/97		4 Cyl.	9.3:1	
205 II 1.9 GTI	10/87→10/94		1905cc	88-90kW (120-122PS)	
309 I 1.9 GTI	07/88→07/89				TD2877
309 II 1.9 GTI	07/89→12/93				
405 I 1.9	06/87→12/92				
309 I 1.9	07/88→07/89	XU9M (DDZ)			
309 II 1.9	10/90→12/93		4 Cyl.	9.3:1	
405 I 1.9	07/88→12/92		1905cc	80kW (109PS)	
					TD2878
309 I 1.6	10/85→07/89	XU51C (B1D)			
			4 Cyl.	9.3:1	
			1580cc	55kW (75PS)	
					TD2762
205 I 1.6	03/87→10/87	XU51C (B1E)			
205 II 1.6	10/87→09/98		4 Cyl.	9:1	
309 I 1.6	08/87→07/89		1580cc	53-55kW (72-75PS)	
405 I 1.6	07/87→12/92				TD2856
309 II 1.6	07/89→12/93	XU52C/K (B2A)			
405 I 1.6	01/87→12/92		4 Cyl.	9.5:1	
405 II 1.6	08/92→05/97		1580cc	66-68kW (90-92PS)	
					TD12430

14-634910-00 WH ¹ B 88.00 C 141.00 D 97.00 E 95.13

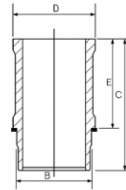

¹ Use also: 1 NB O-Ring HR566

¹ Mitverwenden: 1 NB O-Ring HR566

¹ A utiliser aussi: 1 joint toriques HR566





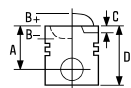

¹ Utilizar también: 1 NB junta toricas HR566

¹ Usare anche: 1 NB O-Ring HR566

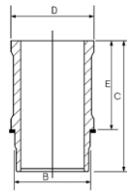

24 83.00

405 II 1.6	08/92→05/97	XU5JP (BFZ)		
406 1.6	11/95→05/04		4 Cyl. 1580cc	9.25:1 65-66kW (88-90PS)
TD2863				
205 II 1.6	08/90→07/92	XU5S (171)		
305 II 1.6	10/82→06/88		4 Cyl. 1580cc	9.5:1 66-71kW (90-97PS)
TD2865				
205 I 1.6	08/86→10/87	XU51C (B1A)		
205 II 1.6	10/87→09/98		4 Cyl. 1580cc	9:1 55-58kW (75-79PS)
305 II 1.6	10/82→12/88			
309 I 1.6	10/85→07/89			
TD2857				

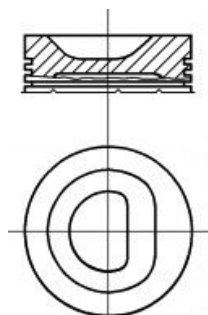
	08-151200-00	STD	14-634910-00  1 B 88.00 C 141.00 D 97.00 E 95.13	89-151200-00
A 37.55	1.75	 CR P		
B- 2.10	1.75	 P		
D 67.50	4.00	 CR 		
 22x66				
				
1 Use also: 1 NB O-Ring HR566	1 Mitverwenden: 1 NB O-Ring HR566	1 A utiliser aussi: 1 joint toriques HR566	1 Utilizar también: 1 NB junta toricas HR566	1 Usare anche: 1 NB O-Ring HR566
2 Piston available in Kit Set only	2 Kolben nur im Assembly erhältlich	2 Piston disponible en kit selement	2 Pistón disponible en conjuntos solamente	2 I pistoni sono disponibili solo in kit motore
3 Steel	3 Stahl	3 Acier	3 Acero	3 Acciaio

25 83.00

205 I 1.9	05/86→07/87	XU9J1 (DFZ)		
205 I 1.9 CTI	08/87→12/94		4 Cyl. 1905cc	9.3:1 72-77kW (98-105PS)
205 I 1.9 GTI	03/87→10/87			
205 II 1.9	08/92→05/97			
205 II 1.9 GTI CAT	10/87→07/94			
305 II 1.9	11/86→12/88			
309 I 1.9	03/86→07/89			
309 II 1.9	08/89→12/93			
405 I 1.9	05/88→08/92			
405 I 1.9 All-wheel Drive	09/88→07/92			
405 I 1.9 Injection	07/87→12/92			
TD2870				
405 I 1.9	07/87→12/93	XU9J2 (D6A)		
			4 Cyl. 1905cc	9.3:1 90-93kW (122-126PS)
TD22159				
205 I 1.9 GTI	10/86→10/87	XU9JA (D6B)		
205 II 1.9 GTI	10/87→09/98		4 Cyl. 1905cc	9.3:1 94-96kW (128-131PS)
309 I 1.9 GTI	10/86→07/89			
309 II 1.9 GTI	09/89→10/93			
TD2872				





309 I 1.9	10/85→07/89	XU9S (D2B)	4 Cyl. 1905cc	9.3:1 75kW (102PS)	TD2772
305 II 1.9	10/82→10/87	XU92C	4 Cyl. 1905cc	9.3:1 75kW (102PS)	TD2879
205 II 1.9 GTI	10/87→05/89	XU92C (D2A)	4 Cyl. 1905cc	9.3:1 75kW (102PS)	TD2869
405 I 1.9	07/87→12/92	XU92C (D2C)	4 Cyl. 1905cc	9.3:1 70kW (95PS)	TD2871

<p>②</p> <p>A 37.50 B- 8.90 D 67.50 22x66</p> <p>① Use also: 1 NB O-Ring HR566 ② Piston available in Kit Set only</p>	<p>08-322400-00</p> <p>1.50 1.50 4.00</p> <p>MO P P CR P</p> <p>① Mitverwenden: 1 NB O-Ring HR566 ② Kolben nur im Assembly erhältlich</p>	<p>14-634910-00 WH ① B 88.00 C 141.00 D 97.00 E 95.13</p> <p>① A utiliser aussi: 1 joint toriques HR566 ② Piston disponible en kit seulement</p>	<p>89-322400-00</p> <p>① Utilizar también: 1 NB junta toricas HR566 ② Pistón disponible en conjuntos solamente</p> <p>① Usare anche: 1 NB O-Ring HR566 ② I pistoni sono disponibili solo in kit motore</p>
--	--	---	---

26 **83.00**

205 II 1.9 Diesel	08/87→06/94	XUD9			
306 1.9 D	04/93→05/99		4 Cyl. 1905cc	23.5:1 47-52kW (64-71PS)	
306 1.9 STD	02/94→10/95				
405 II 1.9 D	09/93→12/95	Diesel			TD8478
406 1.9 SL	09/97→03/99				
J5 1.9 D	09/87→08/90				
Partnerspace 1.9 D	05/96→12/98				
305 II 1.9 D	10/82→07/88	XUD9 (162)			
305 II 1.9 Diesel	10/82→12/88		4 Cyl. 1905cc	23.5:1 47-48kW (64-65PS)	
309 I 1.9 D	06/86→07/89				
309 II 1.9 Diesel	07/89→12/93	Diesel			TD2886
305 II 1.9 D	10/82→07/88	XUD9 (D9A)			
305 II 1.9 Diesel	10/82→12/88		4 Cyl. 1905cc	23.5:1 47kW (64PS)	
309 I 1.9 D	06/86→07/89				
309 II 1.9 Diesel	07/89→12/93	Diesel			TD2754



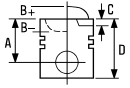

205 II 1.9 Diesel	10/87→09/98	XUD9 (DJZ)			
306 1.9 D	05/93→05/01		4 Cyl.	23.5:1	
306 1.9 SLD	06/94→05/01		1905cc	47kW (64PS)	
309 II 1.9 Diesel	07/89→12/93	Diesel			TD2891
405 I 1.9 D	10/88→08/92				
405 I 1.9 Diesel	07/88→09/92				
405 II 1.9 D	08/92→10/96				
Boxer 1.9 D, er 1.9 D	03/94→04/02	XUD9A (D9B)			
Expert 1.9 D	02/96→		4 Cyl.	23:1	
		Diesel	1905cc	51kW (70PS)	TD2880
405 I 1.9 D	10/88→08/92	XUD9A (D9B)			
405 I 1.9 Diesel	03/88→12/92		4 Cyl.	23.5:1	
405 II 1.9 D	08/97→11/99		1905cc	51-52kW (69-71PS)	
J5 1.9 D	09/87→03/94	Diesel			TD2834
405 II 1.9 D	08/97→11/99	XUD9A (D9B/DJY)			
			4 Cyl.	23:1	
		Diesel	1905cc	51kW (69PS)	TD10827
306 1.9 D	06/94→04/02	XUD9A (DJY)			
306 1.9 SLD	06/94→05/01		4 Cyl.	23.5:1	
405 I 1.9 D	10/88→08/92		1905cc	50-51kW (68-69PS)	
405 II 1.9 D	08/92→10/96	Diesel			TD2887
Boxer 1.9 D	07/99→04/02				
Partner 1.9 D	05/96→				
Partnerspace 1.9 D	06/96→				

87-152000-10
87-152007-10
87-152010-10

STD
0.50mm
0.80mm

A 46.80
B- 2.20
D 84.30
 25x72

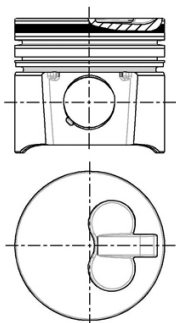

08-152000-00
08-152003-00
08-152007-00
08-152010-00
08-152011-00

STD
0.125mm
0.50mm
0.80mm
1.00mm

2.00
2.00
3.00



CR P
P
CR P

14-020530-00 D

B 85.60 C 153.50 D 88.50 E 3.90

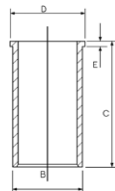

88-152000-30
87-152000-10 +
14-020530-00

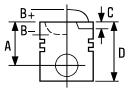

27  **83.00**

306 1.9 D	03/98→04/02	XUD9BSD (DHV) 4 Cyl. 1905cc	55kW (75PS)	TD9867
		Diesel		
406 1.9 D	10/96→10/04	XUD9SD (DHW) 4 Cyl. 1905cc	21.8:1 55kW (75PS)	TD9365
		Diesel	Turbo Intercooled	
306 1.9 D	04/93→04/99	XUD9TE		
405 II 1.9 TD	08/92→05/97	4 Cyl. 1905cc	21.8:1 66-69kW (90-94PS)	
Boxer 1.9 DT	03/96→09/98			
Boxer 1.9 TD	06/94→04/02	Diesel	Turbo Intercooled	TD18953
Expert 1.9 D	10/95→05/98			
406 1.9 TD	10/95→10/97	XUD9TE (D8B)		
Expert 1.9 TD	02/96→	4 Cyl. 1905cc	21.8:1 68-69kW (92-94PS)	TD2751
		Diesel	Turbo Intercooled	
406 1.9 TD	01/96→10/04	XUD9TE (DHX)		
806 1.9 TD	07/95→08/02	4 Cyl. 1905cc	21.8:1 66kW (90PS)	
Expert 1.9 TD	02/96→			
		Diesel	Turbo Intercooled	TD2889
306 1.9 DT	05/93→05/01	XUD9TE (DHY)		
306 1.9 SRDT	06/94→05/01	4 Cyl. 1905cc	21.8:1 66-69kW (90-93PS)	
306 1.9 TD	02/97→04/02			
405 II 1.9 TD	08/92→10/96	Diesel	Turbo Intercooled	TD2888
406 1.9 TD	01/96→05/04			
806 1.9 TD	05/97→08/02			
Boxer 1.9 TD	06/94→04/02			
Boxer 1.9 TD	07/94→04/02	XUD9UTF (D8C)		
Boxer 1.9 TD, er 1.9 TD	03/94→04/02	4 Cyl. 1905cc	21.8:1 68kW (92PS)	
		Diesel	Turbo	TD2890

87-105500-00

STD

08-105500-00

STD

14-020530-00 D

B 85.60 C 153.50 D 88.50 E 3.90

87-105507-00

0.50mm

08-105507-00

0.50mm

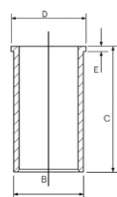

08-105510-00

0.80mm

A 46.75

B- 3.50

D 75.00

 28x68

01/97→

3.00



CK

2.00



NT

3.00



CR P

AK HA RT TP

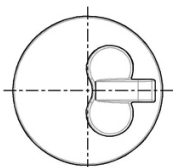
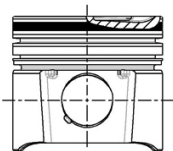





28  **84.00**

504 1.8 Injection	07/68→02/71	KF6	4 Cyl. 1796cc	8.35:1 71kW (97PS)	TD2755
404 1.6 404 1.6 GT	04/63→12/71 07/71→12/71	XC6	4 Cyl. 1618cc	8.35:1 48-60kW (65-82PS)	TD2793
404 1.6	07/70→12/71	XC7	4 Cyl. 1618cc	7.6:1 54kW (73PS)	TD22472
504 1.8	07/68→02/71	XM	4 Cyl. 1796cc	8.35:1 60kW (82PS)	TD2824
504 1.8 505 1.8	01/71→10/99 04/82→09/85	XM7	4 Cyl. 1796cc	53-58kW (72-79PS)	TD2825
505 1.8	06/81→10/85	XM7 (105)	4 Cyl. 1796cc	8.8:1 55-60kW (75-82PS)	TD2826
505 1.8	09/85→09/89	XM7A (105C)	4 Cyl. 1796cc	8.8:1 62-66kW (84-90PS)	TD2827
J7 1.8	07/70→03/80	XM7P	4 Cyl. 1796cc	7.5:1 48-50kW (65-68PS)	TD8497
J5 1.8	01/83→01/94	XM7T (169B)	4 Cyl. 1796cc	7.5:1 49-51kW (67-69PS)	TD6793

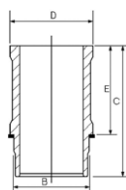
14-606670-00 WH  **B 93.00 C 136.20 D 99.20 E 90.01**



 Use also: 1 NB O-Ring

 Mitverwenden: 1 NB O-Ring HR566

 A utiliser aussi: 1 joint toriques HR566

 Utilizar también: 1 NB junta toricas HR566

 Usare anche: 1 NB O-Ring HR566

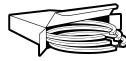

29 84.00

504 1.6	01/80→06/87	XC7P			
J7 1.6	08/68→03/80		4 Cyl.	7.6:1	
J9 1.6	03/80→06/87		1618cc	44-46kW (60-63PS)	

TD8496

②

A 41.60
B+ 3.35
D 80.70
 23x70

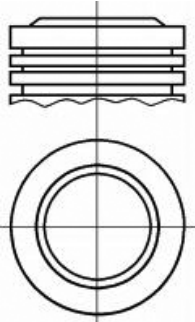



① Use also: 1 NB O-Ring HR566

② Piston available in Kit Set only

08-520300-00

STD

2.00 
 2.00 
 4.50 

CR P
 P
 P

① Mitverwenden: 1 NB O-Ring HR566

② Kolben nur im Assembly erhältlich

14-606670-00 WH ① **B 93.00 C 136.20 D 99.20 E 90.01**

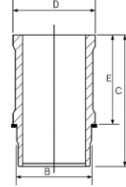

① A utiliser aussi: 1 joint toriques HR566

② Piston disponible en kit seulement

① Utilizar también: 1 NB junta toricas HR566

② Pistón disponible en conjuntos solamente



① Usare anche: 1 NB O-Ring HR566





② I pistoni sono disponibili solo in kit motore



30  **85.00**

5008 2.0 HDi 136/BlueHDi 136	02/12→	AHV (DW10FD)	4 Cyl.	1997cc	100kW (136PS)	
		Diesel				TD31484
508 SW 2.0 BlueHDi 180, 508 2.0 BlueHDi 180	04/14→	AHW (DW10FC)	4 Cyl.	1997cc	16.7:1 133kW (180PS)	
		Diesel		Turbo Intercooled		TD30806
508 SW 2.0 BlueHDi 150, 508 2.0 BlueHDi 150	04/14→	DW10FD (AHX) Euro 5	4 Cyl.	1997cc	16.7:1 110kW (150PS)	
3008 2.0 HDi 150/BlueHDi 150	06/09→					
5008 2.0 HDi 150/BlueHDi 150		Diesel		Turbo Intercooled		TD28614

87-443100-10 	STD	08-443100-00	STD
87-443108-10 	0.60mm	08-443108-00	0.60mm

A	46.60	2.00		GDC P
B-	12.71	2.00		P
B-	4.90	2.00		CR P
BØ	51.30			
D	72.00			
	30x72			

AK KK RT TP

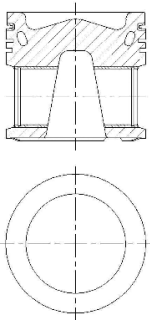

 **Piston Chamber Volume**
[ccm] 23.180

 **Volumen der Kolbenmulde**
[ccm] 23.180

 **Volume de la cavité du piston**
[cm³] 23.180

 **Volumen de cavidad del pistón**
[cc] 23.180



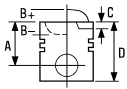

 **Volume camera pistone**
[cm³] 23.180



31 85.00

307 2.0 HDi 110	08/00→	DW10ATED (RHS)			
307 SW 2.0 HDi 110, 307 2.0 HDi 110	03/02→		4 Cyl.	17.6:1	
406 2.0 HDi 110	08/01→10/04		1997cc	79kW (107PS)	
607 2.0 HDi	03/01→07/04	Diesel	Turbo Intercooled		TD20417
307 2.0 HDi	08/08→	DW10ATED (RHZ)			
406 2.0 HDi 110	06/98→10/04		4 Cyl.	18:1	
607 2.0 HDi	05/00→		1997cc	79-80kW (107-109PS)	
806 2.0 HDi	08/99→08/02	Diesel	Turbo Intercooled		TD10727
Expert 2.0 HDi	07/00→				
		DW10BTED (RHX)			
			4 Cyl.	17.6:1	
			1997cc	69kW (94PS)	
		Diesel	Turbo Intercooled		TD17515
Boxer 2.0 HDi		DW10TD (RHV)			
Boxer 2.0 HDi, er 2.0 HDi	04/02→		4 Cyl.	18:1	
			1997cc	62kW (84PS)	
		Diesel	Turbo Intercooled		TD24911
206 2.0 HDi 90	12/99→	DW10TD (RHY)			
206 SW 2.0 HDi	07/02→		4 Cyl.	18:1	
207 2.0 HDi	12/07→		1997cc	66kW (90PS)	
207 SW 2.0 HDi	10/08→	Diesel	Turbo Intercooled		TD12569
306 2.0 HDi	08/98→06/00				
306 2.0 HDi 90	06/99→04/02				
307 2.0 HDi 90	08/00→				
307 SW 2.0 HDi 90, 307 2.0 HDi 90	03/02→				
406 2.0 HDi 90	02/99→10/04				
Partner 2.0 HDi	04/00→				
Partnerspace 2.0 HDi	02/00→				
Boxer 2.0 HDi	08/01→	DW10UTD (RHV)			
			4 Cyl.	18:1	
			1997cc	62kW (84PS)	
		Diesel	Turbo Intercooled		TD17512

87-114700-00	STD	08-114700-00	STD
87-114708-00	0.60mm	08-114708-00	0.60mm

A	46.75	3.50	 CK P
B-	18.30	2.00	 P
BØ	38.00	3.00	 CR P
C	1.00		
D	80.75		
	28x70		

AK RT TP

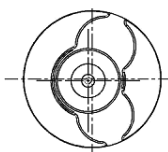
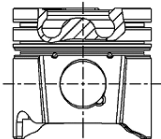







32  **85.00**

807 2.0 HDI	06/02→	DW10ATED4 (RHM)	4 Cyl.	17.6:1	
			1997cc	79kW (107PS)	
		Diesel	Turbo Intercooled		TD20790
807 2.0 HDI	06/02→	DW10ATED4 (RHT)	4 Cyl.	17.6:1	
			1997cc	79kW (107PS)	
		Diesel	Turbo Intercooled		TD20789
806 2.0 HDI 16V	08/99→08/02	DW10ATED4 (RHW)	4 Cyl.	17.6:1	
807 2.0 HDI	06/02→		1997cc	79-80kW (107-109PS)	
Expert 2.0 HDi	10/00→10/06				
Expert 2.0 HDI, Expert 2.0 HDI 16V	07/00→	Diesel	Turbo Intercooled		TD17510

87-114700-10	STD	08-114700-00	STD
87-114708-10	0.60mm	08-114708-00	0.60mm

A	46.73	3.50	 CK P
B-	18.80	2.00	 P
BØ	39.80	3.00	 CR P
C	1.67		
D	72.70		
	28x68		

AK KK RT TP

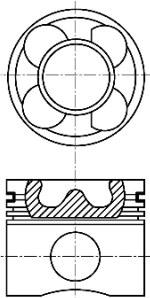

08517-103



33  **85.00**

308 CC 2.0 HDi	04/09→	DW10BTED4 (RHF)			
407 2.0 HDi	08/08→	4 Cyl.	17.6:1		
508 SW 2.0 HDi, 508 2.0 HDi	11/10→	1997cc	103kW (140PS)		
		Diesel	Turbo Intercooled		TD26794
307 2.0 HDi 135	10/03→	DW10BTED4 (RHR)			
307 CC 2.0 HDi 135	06/05→	4 Cyl.	17.6:1		
307 SW 2.0 HDi 135	02/04→	1997cc	100-103kW (136-140PS)		
308 2.0 HDi	09/07→	Diesel	Turbo Intercooled		TD17507
308 CC 2.0 HDi	04/09→				
308 SW 2.0 HDi	09/07→				
407 2.0 HDi	10/05→				
407 2.0 HDi 135	05/04→				
407 SW 2.0 HDi	08/08→				
407 SW 2.0 HDi 135	05/04→				
508 SW 2.0 HDi, 508 2.0 HDi	11/10→				
607 2.0 HDi	09/05→				
807 2.0 HDi	06/06→				
Expert 2.0 HDi 140	01/07→				
Expert Tepee 2.0 HDi 140					
807 2.0 HDi	02/06→	DW10UTED4 (RHK) Euro 4			
Expert 2.0 HDi 120	01/07→	4 Cyl.	17.5:1		
Expert Tepee 2.0 HDi 120		1997cc	79-88kW (107-120PS)		
		Diesel	Turbo Intercooled		TD19814

87-114700-40

STD

08-114700-00

STD

87-114708-40

0.60mm

08-114708-00

0.60mm

A 46.70

3.50



CK P

B- 15.40

2.00



P

BØ 44.80

3.00



CR P

C 0.57

D 72.70

 28x70

AK KK RT TP

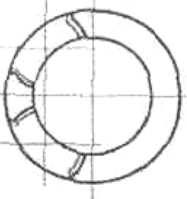







08570-109



34  **85.00**

508 2.0 HDi Hybrid4 AWC	11/10→	DW10CTED4 (RHC) Euro 5		
508 SW 2.0 HDi RXH Hybrid4		4 Cyl.	16:1	
3008 2.0 HDi Hybrid4	02/11→	1997cc	120kW (163PS)	
		Diesel	Turbo Intercooled	TD28710
308 2.0 HDi	10/11→	DW10CTED4 (RHE) Euro 5		
308 SW 2.0 HDi	04/11→	4 Cyl.	16:1	
407 2.0 HDi	02/10→	1997cc	110kW (150PS)	
407 SW 2.0 HDi		Diesel	Turbo Intercooled	TD25633
3008 2.0 HDi 150/BlueHDi 150	06/09→			
5008 2.0 HDi 150/BlueHDi 150				
308 2.0 HDi	04/12→	DW10CTED4 (RHH) Euro 5		
308 CC 2.0 HDi, 308 SW 2.0 HDi	06/09→	4 Cyl.	16:1	
407 2.0 HDi	06/09→	1997cc	120kW (163PS)	
407 SW 2.0 HDi	07/09→	Diesel	Turbo Intercooled	TD23536
508 SW 2.0 HDi, 508 2.0 HDi	11/10→			
807 2.0 HDi, 3008 2.0 Hdi	06/09→			
5008 2.0 Hdi, Expert 2.0 HDi 165	09/09→			
Expert Tepee 2.0 HDi 165				
RCZ 2.0 Hdi	03/10→			

87-443100-00  STD 08-443100-00 STD
 87-443108-00  0.60mm 08-443108-00 0.60mm

A	46.70	2.00		GDC P
B-	13.71	2.00		P
BØ	50.40	2.00		CR P
C	0.45			
D	74.70			
	30x68			

AK KK RT TP

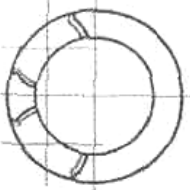
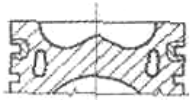



0850H-228

 Piston Chamber Volume
[ccm] 26.320

 Volumen der Kolbenmulde
[ccm] 26.320

 Volume de la cavité du piston
[cm³] 26.320

 Volumen de cavidad del pistón
[cc] 26.320

 Volume camera pistone
[cm³] 26.320



35  **85.00**

407 SW 2.2 Hdi, 407 2.2 Hdi	06/08→	DW12BTED4 (4HP)/DW12BTED4 (4HP) 4 Cyl. 2179cc	120kW (163PS)	Diesel	TD24729
407 2.2 Hdi	08/06→	DW12BTED4 (4HR) 4 Cyl. 2179cc	17.6:1 120kW (163PS)	Diesel Turbo Intercooled	TD24914
607 2.2 HDi	07/11→	DW12BTED4 (4HS) Euro 4 4 Cyl. 2179cc	16.6:1 125kW (170PS)	Diesel Turbo Intercooled	TD24915
407 SW 2.2 HDi 170, 407 2.2 HDi 170 607 2.2 HDi 807 2.2 HDi	05/06→ 06/06→	DW12BTED4 (4HT) Euro 4 4 Cyl. 2179cc	16.6:1 120-125kW (163-170PS)	Diesel Bi-Turbo Intercooled	TD20028
807 2.2 HDi	06/02→	DW12BTED4 (4HW) 4 Cyl. 2179cc	17.6:1 94kW (128PS)	Diesel Turbo Intercooled	TD24913
4007 2.2 HDi	02/07→	DW12MTED4 (4HK) 4 Cyl. 2179cc	16.6:1 115kW (156PS)	Diesel Turbo Intercooled	TD24916
4007 2.2 HDi	02/07→	DW12MTED4 (4HN) 4 Cyl. 2179cc	16.6:1 115kW (156PS)	Diesel Turbo Intercooled	TD24727

87-436700-10 

STD

08-436700-00

STD

87-436708-10 

0.60mm

08-436708-00

0.60mm

A 48.70

B- 13.47

BØ 52.40

C 0.38

D 74.70

 30x68

2.50

2.00

2.00



GDC P

P

CK

GDC  **LKZ-Ring**[®]

AK KK RT TP

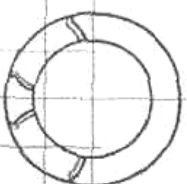



0850HA127

 For pistons with a 24.3mm con rod gap measured at pin centre line

 Für Kolben mit einem Pleuelaugenabstand von 24,3 MM, gemessen an der Kolbenbolzen-Mitte

 Pour pistons avec un écart de bielle de 24,3 mm mesuré au centre de l'axe bielle-piston

 Para pistones con una distancia de paso de biela en el centro del bulón de 24,3mm

 Per pistoni con passaggio biella di 24,3 mm misurato sull'asse foro spinotto



36  **85.00**

508 SW 2.2 HDi, 508 2.2 HDi

11/10→

DW12C (4HL) Euro 5

4 Cyl.

2179cc

147-150kW (200-204PS)

Diesel

Turbo Intercooled

TD24921

87-436700-00 

STD

08-436700-00

STD

87-436708-00 

0.60mm

08-436708-00

0.60mm

A 48.60

B- 15.12

BØ 50.40

C 0.38

D 74.60

 30x68

2.50 

GDC P

2.00 

P

2.00 

CK



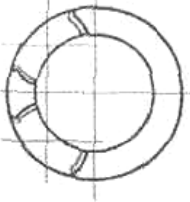
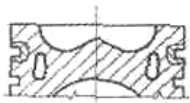

AK KK RT TP





0850HA324

 For pistons with a 24.3mm con rod gap measured at pin centre line

 Für Kolben mit einem Pleuelaugenabstand von 24,3 MM, gemessen an der Kolbenbolzen-Mitte

 Pour pistons avec un écart de bielle de 24,3 mm mesuré au centre de l'axe bielle-piston

 Para pistones con una distancia de paso de biela en el centro del bulón de 24,3mm



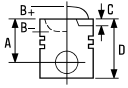

 Per pistoni con passaggio biella di 24,3 mm misurato sull'asse foro spinotto



37  **85.00**

406 2.2 HDI	03/00→12/04	DW12TED4 (4HX/4HW)			
607 2.2 HDI	02/00→	4 Cyl.	18:1		
807 2.2 HDi	06/02→	2179cc	94-98kW (128-133PS)		
		Diesel	Turbo Intercooled		TD16128
807 2.2 HDi	04/04→	DW12TED4 (4HZ)			
		4 Cyl.	18:1		
		2179cc	100kW (136PS)		
		Diesel	Turbo Intercooled		TD24912

87-114700-30	STD	08-114700-00	STD
87-114708-30	0.60mm	08-114708-00	0.60mm

A	48.70	3.50		CK P
B-	18.00	2.00		P
BØ	40.80	3.00		CR P
C	0.40			
C	0.40			
D	77.70			
	30x68			

AK KK RT

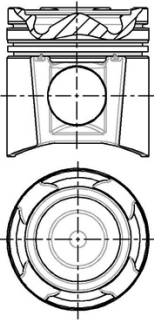







38  **86.00**

806 2.0	06/94→08/02	XU10J2 (RFU)	4 Cyl. 1998cc	8.8:1 89-90kW (121-123PS)	TD2848
Boxer 2.0 i	03/94→04/02	XU10J2 (RFW)	4 Cyl. 1998cc	8.8:1 80kW (109PS)	TD2847
306 2.0	03/94→04/02	XU10J2 (RFX)			
306 2.0 ST	07/94→05/01		4 Cyl. 1998cc	8.8:1 89-96kW (121-131PS)	TD2846
306 2.0 XSi	05/93→05/01				
405 II 2.0	08/92→10/96				
405 II 2.0, 405 II 2.0 X4	08/92→10/95				

87-154600-00	STD	08-154600-00	STD
87-154608-00	0.60mm	08-154605-00	0.25mm
		08-154608-00	0.60mm

A 40.00
B- 5.02
D 65.00
 22x62

1.50  MO P
 1.75  P
 3.00  CR **1**

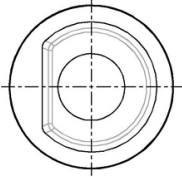
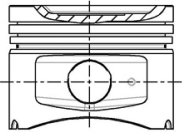

1 Steel

1 Stahl

1 Acier

1 Acero

1 Acciaio



39  **86.00**





Boxer 2.2 HDi 120 04/06 → P22DTE (4HU) Euro 4
 4 Cyl. 17.5:1
 2198cc 88kW (120PS)
 Diesel Turbo Intercooled TD24470

87-427700-10 STD
 87-427707-10 0.50mm

08-427700-00 STD
 08-427707-00 0.50mm

14-021120-00 D B 89.00 C 156.00 D 90.90 E 5.00

A 43.42
 B- 15.85
 BØ 46.90
 D 69.82
 30x67

2.00 
 2.00 
 2.00  CK P
 P
 NT 

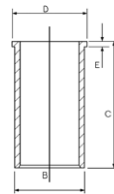

KK RT TP

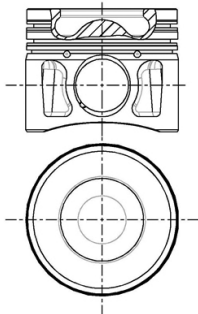

8648B105

 Steel

 Stahl

 Acier

 Acero

 Acciaio

40  **86.00**





Boxer 2.2 HDi 100 P22DTE (4HV) Euro 4
 Boxer 2.2 HDi 100, er 2.2 HDi 100 04/06 → 4 Cyl. 17.5:1
 2198cc 74kW (101PS)
 Diesel Turbo Intercooled TD24469

87-427700-30 STD
 87-427707-30 0.50mm

08-427700-00 STD
 08-427707-00 0.50mm

14-021120-00 D B 89.00 C 156.00 D 90.90 E 5.00

A 43.42
 B- 15.85
 BØ 46.90
 D 69.82
 30x67

2.00 
 2.00 
 2.00  CK P
 P
 NT 

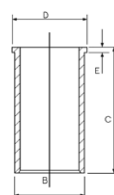

RT TP

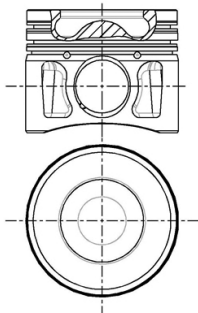

08650A105

 Steel

 Stahl

 Acier

 Acero

 Acciaio



41  **88.00**

504 2.0 505 2.0	04/71→ 09/80→09/85	XN1	4 Cyl. 1971cc	8.4:1 64-79kW (87-107PS)	TD2833
504 2.0 505 2.0	03/71→06/86 11/80→12/85	XN1 (106)	4 Cyl. 1971cc	8.35:1 68-71kW (93-97PS)	TD2830
J5 2.0, J5 2.0 Super J9 2.0	09/81→08/90 03/80→06/87	XN1P	4 Cyl. 1971cc	8.4:1 57kW (78PS)	TD8502
J5 2.0	09/87→08/90	XN1T	4 Cyl. 1971cc	8:1 55-63kW (75-86PS)	TD22486
J5 2.0	01/83→09/90	XN1T (170)	4 Cyl. 1971cc	8:1 58kW (79PS)	TD2837
J5 2.0	09/81→09/90	XN1T (170B)	4 Cyl. 1971cc	8.1:1 55kW (75PS)	TD2836
J5 2.0	09/90→01/94	XN1TA	4 Cyl. 1971cc	8:1 62-72kW (84-98PS)	TD8490
504 2.0 504 2.0 TI	10/74→08/84 01/71→06/83	XN2 (107)	4 Cyl. 1971cc	78kW (107PS)	TD2831

①

A 38.25
B+ 0.65
D 71.85
 23x74

08-316900-00
08-316907-00

STD
0.50mm

1.50
2.00
4.00



CR P
P
CR ②

14-636500-00 WH B 93.00 C 135.70 D 101.90 E 89.98

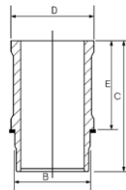

89-316900-00

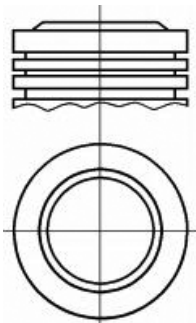

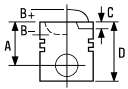

1

A 37.90

B+ 1.35

D 72.20

 23x74

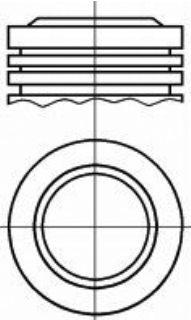

1 Piston available in Kit Set only

2 Steel

08-316900-00
08-316907-00

1.50

2.00

4.00



STD
0.50mm

CR P
P
CR 2

1 Kolben nur im Assembly erhältlich

2 Stahl

1 Piston disponible en kit seulement

2 Acier

14-636500-00 WH B 93.00 C 135.70 D 101.90 E 89.98

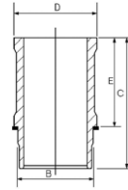

1 Pistón disponible en conjuntos solamente

2 Acero

89-316900-10

1 I pistoni sono disponibili solo in kit motore

2 Acciaio

42  **88.00**

505 2.0

09/85→09/95

XN1A (106E)

4 Cyl.
1971cc

8.8:1
72kW (98PS)

TD4845

J5

07/87→12/93

XN1TA (170C)

4 Cyl.
1971cc

8:1
62kW (85PS)

TD6804

14-636500-00 WH B 93.00 C 135.70 D 101.90 E 89.98

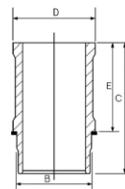

43  **88.00**

505 2.2

05/81→10/84

ZDJ (851)

4 Cyl.
2165cc

9.8:1
85kW (115PS)

TD2908



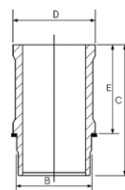





14-637160-00 WH B 93.60 C 140.50 D 104.00 E 93.08

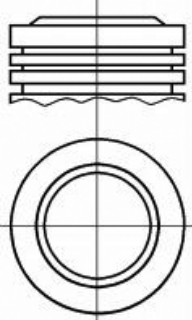

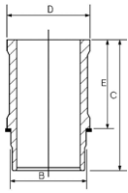

44 88.00

505 2.2 GTI	08/83→12/93	ZDJL (851B)	4 Cyl. 2165cc	9.8:1 90kW (122PS)	TD2909
505 2.2	01/86→12/93	ZDJL (851X)	4 Cyl. 2165cc	9.8:1 84kW (114PS)	TD2910
505 2.0 505 2.0 TI;STI	10/85→09/89 08/79→10/86	ZEJ (829)	4 Cyl. 1995cc	9.2:1 77-81kW (105-110PS)	TD2911





87-334400-00 STD A 40.50 B+ 1.55 D 69.05  23x75 	08-334400-00 STD 1.75 2.00 4.00  MO P P CR 	14-637160-00 WH B 93.60 C 140.50 D 104.00 E 93.08 	89-334400-00 87-334400-00 + 14-637160-00	
 Steel	 Stahl	 Acier	 Acero	 Acciaio

45 88.00

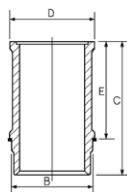
504 1.9 D	03/73→12/89	XD 4.88	4 Cyl. 1948cc	21.8:1 40kW (54PS)	TD2807
		Diesel			
404 1.9 D	01/63→12/75	XD 88	4 Cyl. 1948cc	21:1 44kW (60PS)	TD23802
		Diesel			
J7 1.9 D	08/68→07/78	XDP 4.88	4 Cyl. 1948cc	21.8:1 40kW (55PS)	TD8499
		Diesel			
404 2.0 D 504 2.0 D J7 1.9 D	01/71→12/75 01/71→12/90 10/67→10/78	XDP 4.88	4 Cyl. 1948cc	21.8:1 36-46kW (49-63PS)	TD22477
		Diesel			

14-600420-00 WH  B 96.00 C 173.00 D 106.30 E 129.00



 Use also: HT022  Mitverwenden: HT022  A utiliser aussi: HT022  Utilizar también: HT022  Usare anche HT022



46 90.00

504 2.1 D	02/71→07/86	XD90	4 Cyl. 2112cc	22:1 48kW (65PS)	TD2808
		Diesel			
J7 2.1 D	08/68→07/77	XDP 4.90	4 Cyl. 2112cc	22:1 43-55kW (58-75PS)	TD21440
		Diesel			
J7 2.1 D	08/68→07/77	XDP90	4 Cyl. 2112cc	22.5:1 42kW (57PS)	TD8500
		Diesel			
J7 3.2 D	01/67→12/82	XDP 6.90	6 Cyl. 3168cc	22.1:1 78kW (106PS)	TD22478
		Diesel			

14-604060-00 WH B 96.00 C 173.00 D 106.30 E 129.00

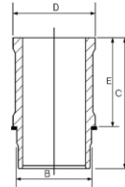

47 92.00

Boxer 2.5 D	03/94→04/02	DJ5 (T9A)	4 Cyl. 2446cc	24:1 63kW (86PS)	TD4830
		Diesel			

87-112400-00 STD 08-112400-00 STD **14-020190-00 D** B 96.00 C 160.00 D 99.00 E 5.00
 87-112407-00 0.50mm 08-112407-00 0.50mm

A 49.90
 B- 3.00
 D 80.00
 34x58

2.25
 2.00
 2.00

CK P
 P
 CR P

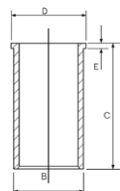

AK TP

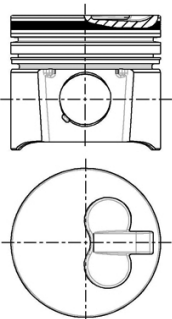



48 92.00

Boxer 2.5 TD	03/94→04/02	DJ5T (T8A/THZ)	4 Cyl.	21:1
			2446cc	76kW (103PS)
		Diesel	Turbo Intercooled	TD4831
605 2.5 Turbo Diesel	07/94→09/99	DK5ATE (THY)	4 Cyl.	22:1
			2446cc	95kW (129PS)
		Diesel	Turbo Intercooled	TD2748

87-326300-00	STD	08-326300-00	STD
87-326307-00	0.50mm	08-326307-00	0.50mm

A	49.84	3.00		P PS
B-	2.30	1.75		CR P
D	82.00	3.50		CR P
	34x68			

AK HA KK RT TP

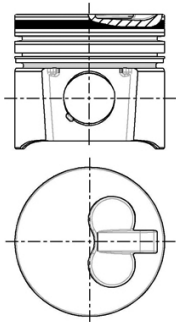

A = 49.470, B = 81.600

A = 49.470, B = 81.600

A = 49.470, B = 81.600

A = 49.470, B = 81.600

A = 49.470, B = 81.600

49 92.00

Boxer 2.5 TDI	01/97→04/02	DJ5TED (THX)	4 Cyl.	
Boxer 2.5 TDI, er 2.5 TDI	01/97→04/02		2446cc	79kW (107PS)
		Diesel	Turbo Intercooled	TD11067

87-135800-00	STD	08-135800-00	STD	14-020190-00 D	B 96.00 C 160.00 D 99.00 E 5.00
		08-135807-00	0.50mm		

A	57.00	3.50		P PS
B-	18.25	2.00		P
BØ	40.00	3.50		CR P
C	1.50			
D	89.00			
	34x68			

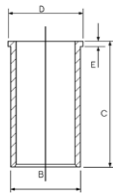

AK KK RT

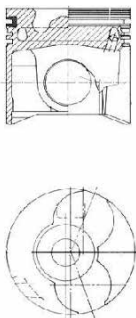



50  **93.00**

J5 2.5 D	09/81→01/94	CRD93			
J5 2.5 D All-wheel Drive	09/81→08/90		4 Cyl.	22.25:1	
			2498cc	54kW (73PS)	
		Diesel			TD21168

J5 2.5 D	09/81→03/94	CRD93 (U25/661)			
			4 Cyl.	22.25:1	
			2500cc	54kW (73PS)	
		Diesel			TD2747

J5 2.5 DT	09/81→01/94	CRD93L			
J5 2.5 DT All-wheel Drive	09/81→08/90		4 Cyl.	22.25:1	
			2498cc	70kW (95PS)	
		Diesel			TD18876



87-152700-00 STD
87-152707-00 0.50mm

08-152700-00 STD
08-152707-00 0.50mm

14-013481-00 D B 96.10 C 163.00

A 52.75
B- 7.30
D 87.75
 30x78

08/84→

2.50  **MOL P**
 2.00  **P**
 4.00  **CR P**

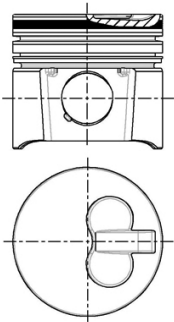
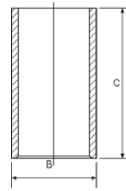

51  **93.00**

J5 2.5 DT	09/81→08/90	CRD93LS (U25/673)			
J5 2.5 TD	10/90→03/94		4 Cyl.	22.5:1	
			2500cc	70kW (95PS)	
		Diesel	Turbo		TD4829

14-013481-00 D B 96.10 C 163.00

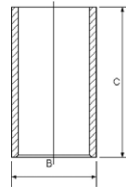



52 94.00

J3 2.5 D	01/82 → 08/84	EN 55	4 Cyl. 2498cc	23:1 53-56kW (72-76PS)	TD6685
		Diesel			
505 2.5 Diesel	06/81 → 12/93	XD3 (155)	4 Cyl. 2498cc	23:1 51-55kW (70-75PS)	TD2803
		Diesel			
504 2.5 D	08/90 → 10/99	XD3P	4 Cyl. 2498cc	23:1 53-58kW (72-79PS)	TD8505
J9 2.5 D	07/82 → 06/87				
		Diesel			



87-318700-10 STD
87-318706-10 0.40mm
87-318708-10 0.60mm
87-318710-10 0.80mm

→12/93

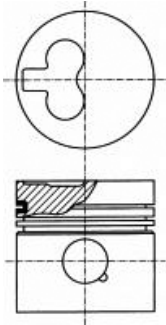
A 54.00
B- 1.80
D 96.42
 30x79



08-318700-10 STD
08-318704-10 0.20mm
08-318706-10 0.40mm
08-318707-10 0.50mm
08-318708-10 0.60mm
08-318710-10 0.80mm
08-318711-10 1.00mm

2.00  CR P
 2.00  P
 4.00  CR P

14-020660-00 D B 97.00 C 170.60 D 99.50 E 4.00
14-021520-00 D B 98.00 C 170.60 D 100.00 E 6.00

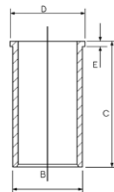



87-318700-30 STD
87-318706-30 0.40mm
87-318708-30 0.60mm
87-318710-30 0.80mm

01/94 →

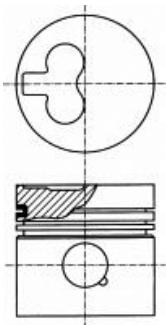
A 54.00
B- 1.75
D 91.42
 30x79



08-318700-10 STD
08-318704-10 0.20mm
08-318706-10 0.40mm
08-318707-10 0.50mm
08-318708-10 0.60mm
08-318710-10 0.80mm
08-318711-10 1.00mm

2.00  CR P
 2.00  P
 4.00  CR P

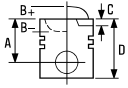

53  **94.00**

505 2.5 TD 604 2.5 TD	10/86→12/93 10/86→12/93	ET 70	4 Cyl. 2496cc	21:1 71kW (96PS)	TD6686
		Diesel	Turbo		
505 2.3 D	05/79→09/84	XD2	4 Cyl. 2304cc	22.2:1 44-53kW (60-72PS)	TD22473
		Diesel			
505 2.3 TD 604 2.3 TD	09/80→06/86 02/79→06/83	XD2S	4 Cyl. 2304cc	21:1 54-59kW (73-80PS)	TD22474
		Diesel	Turbo		
505 2.3 Diesel 505 2.3 Turbo Diesel 604 2.3 TD	04/82→06/86 09/80→06/86 09/79→05/83	XD2S (147)	4 Cyl. 2304cc	21:1 59kW (80PS)	TD2802
		Diesel	Turbo		
505 2.5 D 505 2.5 Turbo Diesel	10/85→08/91 10/83→12/90	XD3T	4 Cyl. 2498cc	21:1 66-70kW (90-95PS)	TD22475
		Diesel	Turbo Intercooled		
505 2.5 Turbo Diesel 604 2.5 TD	10/83→12/93 08/83→12/86	XD3T (152A)	4 Cyl. 2498cc	21:1 66kW (90PS)	TD2805
		Diesel	Turbo		
505 2.5 TD 604 2.5 TD	10/86→12/93 10/86→12/93	XD3TE	4 Cyl. 2498cc	21:1 54-77kW (73-105PS)	TD22476
		Diesel	Turbo Intercooled		
505 2.5 Turbo Diesel	10/86→12/93	XD3TE (152B)	4 Cyl. 2498cc	21:1 77kW (105PS)	TD2806
		Diesel	Turbo		

14-020660-00 D

B 97.00 C 170.60 D 99.50 E 4.00

14-021520-00 D



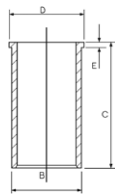

B 98.00 C 170.60 D 100.00 E 6.00







54  **94.00**

504 2.3 D	07/75 → 12/89	XD2 (134)	4 Cyl. 2304cc	22.2:1 51kW (69PS)	TD2800
Diesel					
J9 2.3 D	03/80 → 07/82	XD2P / XD94	4 Cyl. 2304cc	22.2:1 49kW (67PS)	TD8504
Diesel					

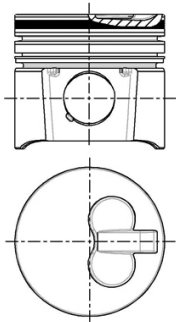

87-318700-00 	STD
87-318706-00 	0.40mm
87-318708-00 	0.60mm
87-318711-00 	1.00mm

A	57.42
B-	2.00
D	99.90
	30x79



 Pistons to be replaced in Engine Sets only

08-318700-10	STD
08-318704-10	0.20mm
08-318706-10	0.40mm
08-318707-10	0.50mm
08-318708-10	0.60mm
08-318710-10	0.80mm
08-318711-10	1.00mm

2.00		CR P
2.00		P
4.00		CR P

 Kolben nur Motorsätzen zu ersetzen

14-020660-00 D	B 97.00 C 170.60 D 99.50 E 4.00
14-021520-00 D	B 98.00 C 170.60 D 100.00 E 6.00

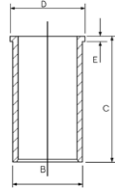

 Piston à remplacer dans jeu moteur

 Pistones de repuesto para juegos de motores solamente



 Il pistone può essere rimpiazzato solamente completo



55 94.40

Boxer 2.8 HDI		8140.43N Euro 3		
Boxer 2.8 HDI, er 2.8 HDI	04/04→	4 Cyl.	18.5:1	
		2798cc	107kW (146PS)	
		Diesel	Turbo Intercooled	TD24923
Boxer 2.8 HDi	10/00→	8140.43S (F28DTCR) Euro 3		
Boxer 2.8 HDi All-wheel Drive	10/00→11/01	4 Cyl.	18.5:1	
Boxer 2.8 HDi, er 2.8 HDI	10/00→	2798cc	92-125kW (125-170PS)	
		Diesel	Turbo Intercooled	TD17514

87-122200-00	STD
87-122208-00	0.60mm
A	58.70
B-	21.30
BØ	39.40
D	87.60
	32x72

08-122200-00	STD	
08-122208-00	0.60mm	
2.50		CK P
2.00		P
2.50		CR P

14-021321-00 D	B 97.54 C 167.00 D 100.90 E 5.00
14-028930-00 D	B 97.50 C 167.00 D 100.90 E 5.00
14-028931-00 D	B 97.58 C 167.00 D 100.90 E 5.00
14-028932-00 D	B 97.70 C 167.00 D 100.90 E 5.00

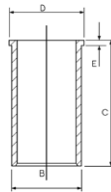



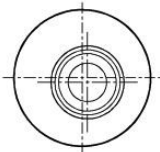
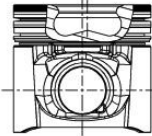

AK KK RT TP



56 94.40

Boxer 2.8 D		8140.63 (F28D)		
Boxer 2.8 D, er 2.8 D	01/99→02/02	4 Cyl.	21:1	
		2798cc	64kW (87PS)	
		Diesel		TD24917

87-108200-00	STD
87-108208-00	0.60mm
A	55.00
B-	2.80
D	90.00
	32x68

08-108200-00	STD	
08-108208-00	0.60mm	
3.00		CR P
2.00		P
2.50		CR P

14-021321-00 D	B 97.54 C 167.00 D 100.90 E 5.00
14-028930-00 D	B 97.50 C 167.00 D 100.90 E 5.00
14-028931-00 D	B 97.58 C 167.00 D 100.90 E 5.00
14-028932-00 D	B 97.70 C 167.00 D 100.90 E 5.00

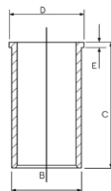

AK HA RT TP

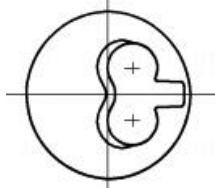
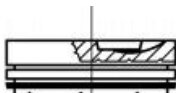

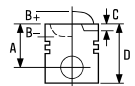









1  **121.00**



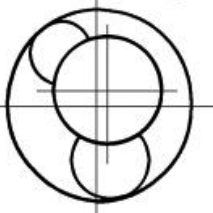
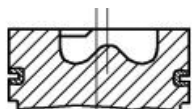

D10UT 150 Euro 1 **6 Cyl.** **15.2:1** **10350cc** **150kW (204PS)** **Diesel Turbo Intercooled** **FM8540**





87-337600-00 STD **08-337600-00** STD





A	94.00	3.50		CK P
B-	28.00	2.00		NT
C	2.40	3.50		CR P
D	155.00			
	45x102			











		ccm	x 		9
129	Petrol	1218	4	75.00	9
150	Petrol	1360	4	75.00	10
670.800	Petrol	845	4	58.00	1
688.11	Petrol	1108	4	70.00	4
800	Petrol	847	4	58.00	1
800.02	Petrol	845	4	58.00	1
810.01	Petrol	1289	4	73.00	6
810.02	Petrol	1289	4	73.00	6
810.02/97	Petrol	1289	4	73.00	6
810.03	Petrol	1289	4	73.00	6
810.05	Petrol	1289	4	73.00	6
810.06	Petrol	1289	4	73.00	6
810.10	Petrol	1289	4	73.00	6
810.19	Petrol	1289	4	73.00	6
810.25	Petrol	1289	4	73.00	6
810.26	Petrol	1289	4	73.00	6
810.29	Petrol	1289	4	73.00	6
810.96	Petrol	1289	4	73.00	7
810.97	Petrol	1289	4	73.00	7
829	Petrol	1995	4	88.00	47
829.01	Petrol	1995	4	88.00	47
841.25	Petrol	1647	4	79.00	24
841.26	Petrol	1647	4	79.00	24
852	Diesel	2068	4	86.00	40
8140.07.2530	Diesel	2499	4	93.00	51
8140.07.2585 Euro 1	Diesel	2499	4	93.00	51
8140.07.2700	Diesel	2499	4	93.00	51
8140.07.2701/8140.07.2710	Diesel	2499	4	93.00	51
8140.07.3700 Euro 1	Diesel	2499	4	93.00	51
8140.21.235 IDS	Diesel	2445	4	93.00	52
8140.27.2560	Diesel	2499	4	93.00	54
8140.27.2565 Sofim	Diesel	2499	4	93.00	55
8140.27.2582	Diesel	2499	4	93.00	53
8140.27.2585	Diesel	2499	4	93.00	56
8140.27.2700	Diesel	2499	4	93.00	53
8140.27 Sofim	Diesel	2499	4	93.00	53
8140.47.2530 IDR Sofim	Diesel	2499	4	93.00	54
8140.47.2535	Diesel	2499	4	93.00	54
8140.47.2585 Euro 1	Diesel	2499	4	93.00	54
8140.47.2590 Euro 1	Diesel	2499	4	93.00	54
8140.47.2700 Euro 1	Diesel	2499	4	93.00	54
8140.47.2721 Euro 1	Diesel	2499	4	93.00	54
8140.47.2785 Euro 1	Diesel	2499	4	93.00	54
8140.61.2300	Diesel	2445	4	93.00	57
8140.61.235	Diesel	2445	4	93.00	57
8140.61.240 Sofim	Diesel	2445	4	93.00	57
8140.67.2500	Diesel	2499	4	93.00	58
8140.67.2550	Diesel	2499	4	93.00	58
8140.67.2580 Euro 2	Diesel	2499	4	93.00	59
8140.67.2585 Euro 2	Diesel	2499	4	93.00	59
8140-07 Sofim	Diesel	2499	4	93.00	51
8140-27 IDS	Diesel	2499	4	93.00	56
8140-47	Diesel	2499	4	93.00	54
688 02	Petrol	1108	4	70.00	4
688 03	Petrol	1108	4	70.00	4
688 10	Petrol	1108	4	70.00	4
688 11	Petrol	1108	4	70.00	4
688 12	Petrol	1108	4	70.00	4
688 13	Petrol	1108	4	70.00	4
688 13	Petrol	1108	4	70.00	5
800 01	Petrol	845	4	58.00	1
800 05	Petrol	845	4	58.00	1
800 705	Petrol	845	4	58.00	1
800 710	Petrol	845	4	58.00	1
829 730	Petrol	1995	4	88.00	47
829 731	Petrol	1995	4	88.00	47
841 717	Petrol	1647	4	79.00	24
847 700	Petrol	1397	4	76.00	14
847 701	Petrol	1397	4	76.00	14





		ccm	x 		9
847 720	Petrol	1397	4	76.00	14
851 700	Petrol	2165	4	88.00	48
852 720	Diesel	2068	4	86.00	40
852 750	Diesel	2068	4	86.00	40
A1M	Petrol	1647	4	79.00	24
A2M 723	Petrol	1647	4	79.00	24
B1B 707	Petrol	845	4	58.00	1
C1E (688.01)	Petrol	1108	4	70.00	4
C1E 700	Petrol	1108	4	70.00	4
C1E 715	Petrol	1108	4	70.00	4
C1E 720	Petrol	1108	4	70.00	5
C1E 750	Petrol	1108	4	70.00	4
C1E 752	Petrol	1108	4	70.00	4
C1E 754	Petrol	1108	4	70.00	4
C1E 756	Petrol	1108	4	70.00	4
C1E 760	Petrol	1108	4	70.00	4
C1E 762	Petrol	1108	4	70.00	4
C1E 764	Petrol	1108	4	70.00	4
C1E 792	Petrol	1108	4	70.00	4
C1J 700	Petrol	1397	4	76.00	14
C1J 715	Petrol	1397	4	76.00	14
C1J 742	Petrol	1397	4	76.00	14
C1J 760	Petrol	1397	4	76.00	15
C1J 768	Petrol	1397	4	76.00	14
C1J 770	Petrol	1397	4	76.00	15
C1J 780	Petrol	1397	4	76.00	14
C1J 782	Petrol	1397	4	76.00	15
C1J 788	Petrol	1397	4	76.00	15
C1J 792	Petrol	1397	4	76.00	15
C1J 796	Petrol	1397	4	76.00	15
C2J 700	Petrol	1397	4	76.00	14
C2J 713	Petrol	1397	4	76.00	14
C2J 717	Petrol	1397	4	76.00	14
C2J 772	Petrol	1397	4	76.00	14
C2J 782	Petrol	1397	4	76.00	14
C2J 784	Petrol	1397	4	76.00	14
C3G 700	Petrol	1239	4	74.00	8
C3G 702	Petrol	1239	4	74.00	8
C3G 710	Petrol	1239	4	74.00	8
C3G 712	Petrol	1239	4	74.00	8
C3G 720	Petrol	1239	4	74.00	8
C3G 750	Petrol	1239	4	74.00	8
C3J 700	Petrol	1397	4	76.00	14
C3J 702	Petrol	1397	4	76.00	14
C3J 710	Petrol	1397	4	76.00	14
C3J 760	Petrol	1397	4	76.00	14
C3J 762	Petrol	1397	4	76.00	14
D4F 702	Petrol	1149	4	69.00	2
D4F 704	Petrol	1149	4	69.00	2
D4F 706	Petrol	1149	4	69.00	2
D4F 708 Euro 3	Petrol	1149	4	69.00	2
D4F 712	Petrol	1149	4	69.00	2
D4F 714	Petrol	1149	4	69.00	2
D4F 716	Petrol	1149	4	69.00	2
D4F 722	Petrol	1149	4	69.00	2
D4F 728	Petrol	1149	4	69.00	2
D4F 730	Petrol	1149	4	69.00	2
D4F 732	Petrol	1149	4	69.00	2
D4F 740	Petrol	1149	4	69.00	2
D4F 742	Petrol	1149	4	69.00	2
D4F 764	Petrol	1149	4	69.00	2
D4F 772	Petrol	1149	4	69.00	2
D4F 790	Petrol	1149	4	69.00	2
D7F 700	Petrol	1149	4	69.00	3
D7F 701	Petrol	1149	4	69.00	3
D7F 702	Petrol	1149	4	69.00	3
D7F 703	Petrol	1149	4	69.00	3
D7F 704	Petrol	1149	4	69.00	3
D7F 706	Petrol	1149	4	69.00	3





		ccm	x 		9
D7F 710	Petrol	1149	4	69.00	3
D7F 720	Petrol	1149	4	69.00	3
D7F 722	Petrol	1149	4	69.00	3
D7F 726	Petrol	1149	4	69.00	3
D7F 730	Petrol	1149	4	69.00	3
D7F 746	Petrol	1149	4	69.00	3
D7F 764	Petrol	1149	4	69.00	3
D7F 766 Euro 4	Petrol	1149	4	69.00	3
E5F 710	Petrol	1171	4	75.80	11
E5F 716	Petrol	1171	4	75.80	11
E6J 700	Petrol	1390	4	75.80	12
E6J 701	Petrol	1390	4	75.80	12
E6J 706	Petrol	1390	4	75.80	13
E6J 712	Petrol	1390	4	75.80	13
E6J 713	Petrol	1390	4	75.80	13
E6J 718	Petrol	1390	4	75.80	13
E6J 734	Petrol	1390	4	75.80	12
E6J 738	Petrol	1390	4	75.80	12
E6J 760	Petrol	1390	4	75.80	13
E7F 700	Petrol	1171	4	75.80	11
E7F 704	Petrol	1171	4	75.80	13
E7F 706	Petrol	1171	4	75.80	11
E7F 708	Petrol	1171	4	75.80	11
E7F 730	Petrol	1171	4	75.80	13
E7F 750	Petrol	1171	4	75.80	11
E7J 601	Petrol	1390	4	75.80	13
E7J 624	Petrol	1390	4	75.80	12
E7J 626	Petrol	1390	4	75.80	12
E7J 634	Petrol	1390	4	75.80	12
E7J 635	Petrol	1390	4	75.80	12
E7J 700	Petrol	1390	4	75.80	13
E7J 706	Petrol	1390	4	75.80	13
E7J 707	Petrol	1390	4	75.80	13
E7J 710	Petrol	1390	4	75.80	13
E7J 711	Petrol	1390	4	75.80	13
E7J 718	Petrol	1390	4	75.80	12
E7J 719	Petrol	1390	4	75.80	12
E7J 720	Petrol	1390	4	75.80	12
E7J 724	Petrol	1390	4	75.80	12
E7J 726	Petrol	1390	4	75.80	12
E7J 728	Petrol	1390	4	75.80	12
E7J 742	Petrol	1390	4	75.80	12
E7J 745	Petrol	1390	4	75.80	13
E7J 754	Petrol	1390	4	75.80	12
E7J 756	Petrol	1390	4	75.80	13
E7J 757	Petrol	1390	4	75.80	13
E7J 764	Petrol	1390	4	75.80	12
E7J 770	Petrol	1390	4	75.80	13
E7J 771	Petrol	1390	4	75.80	13
E7J 773	Petrol	1390	4	75.80	12
E7J 780	Petrol	1390	4	75.80	12
F1N 720	Petrol	1721	4	81.00	35
F1N 722	Petrol	1721	4	81.00	35
F1N 724	Petrol	1721	4	81.00	35
F2N 708	Petrol	1721	4	81.00	35
F2N 710	Petrol	1721	4	81.00	35
F2N 712	Petrol	1721	4	81.00	35
F2N 720	Petrol	1721	4	81.00	35
F2N 721	Petrol	1721	4	81.00	35
F2N 726	Petrol	1721	4	81.00	35
F2N 727	Petrol	1721	4	81.00	35
F2N 728	Petrol	1721	4	81.00	35
F2N 740	Petrol	1721	4	81.00	35
F2N 742	Petrol	1721	4	81.00	35
F2N 750	Petrol	1721	4	81.00	35
F2N 752	Petrol	1721	4	81.00	35
F2N 770	Petrol	1721	4	81.00	35
F3N 702	Petrol	1721	4	81.00	35
F3N 716	Petrol	1721	4	81.00	35





		ccm	x 		9
F3N 717	Petrol	1721	4	81.00	35
F3N 718	Petrol	1721	4	81.00	35
F3N 722	Petrol	1721	4	81.00	35
F3N 723	Petrol	1721	4	81.00	35
F3N 726	Petrol	1721	4	81.00	35
F3N 740	Petrol	1721	4	81.00	35
F3N 741	Petrol	1721	4	81.00	35
F3N 742	Petrol	1721	4	81.00	35
F3N 743	Petrol	1721	4	81.00	35
F7P 700	Petrol	1763	4	82.00	36
F7P 704	Petrol	1763	4	82.00	36
F7P 720	Petrol	1763	4	82.00	36
F7P 722	Petrol	1763	4	82.00	36
F8M 700	Diesel	1595	4	78.00	22
F8M 720	Diesel	1595	4	78.00	23
F8M 730	Diesel	1595	4	78.00	23
F8M 736	Diesel	1595	4	78.00	23
F8M 760	Diesel	1595	4	78.00	23
F8Q 606	Diesel	1870	4	80.00	29
F8Q 610	Diesel	1870	4	80.00	30
F8Q 620	Diesel	1870	4	80.00	29
F8Q 630	Diesel	1870	4	80.00	31
F8Q 632	Diesel	1870	4	80.00	31
F8Q 640	Diesel	1870	4	80.00	29
F8Q 662	Diesel	1870	4	80.00	31
F8Q 676	Diesel	1870	4	80.00	29
F8Q 706	Diesel	1870	4	80.00	29
F8Q 710	Diesel	1870	4	80.00	29
F8Q 714	Diesel	1870	4	80.00	29
F8Q 722	Diesel	1870	4	80.00	29
F8Q 724	Diesel	1870	4	80.00	29
F8Q 730	Diesel	1870	4	80.00	29
F8Q 732	Diesel	1870	4	80.00	29
F8Q 740	Diesel	1870	4	80.00	30
F8Q 742	Diesel	1870	4	80.00	29
F8Q 744	Diesel	1870	4	80.00	30
F8Q 768	Diesel	1870	4	80.00	30
F8Q 774	Diesel	1870	4	80.00	29
F8Q 776	Diesel	1870	4	80.00	29
F8Q 784	Diesel	1870	4	80.00	30
F8Q 785	Diesel	1870	4	80.00	30
F8Q 786	Diesel	1870	4	80.00	30
F9Q 650	Diesel	1870	4	80.00	32
F9Q 664	Diesel	1870	4	80.00	32
F9Q 670	Diesel	1870	4	80.00	32
F9Q 674	Diesel	1870	4	80.00	32
F9Q 710	Diesel	1870	4	80.00	33
F9Q 717	Diesel	1870	4	80.00	33
F9Q 718	Diesel	1870	4	80.00	33
F9Q 730	Diesel	1870	4	80.00	33
F9Q 731	Diesel	1870	4	80.00	34
F9Q 732	Diesel	1870	4	80.00	33
F9Q 733	Diesel	1870	4	80.00	33
F9Q 734	Diesel	1870	4	80.00	33
F9Q 736	Diesel	1870	4	80.00	33
F9Q 738	Diesel	1870	4	80.00	33
F9Q 740	Diesel	1870	4	80.00	33
F9Q 744	Diesel	1870	4	80.00	33
F9Q 748	Diesel	1870	4	80.00	33
F9Q 750	Diesel	1870	4	80.00	32
F9Q 752	Diesel	1870	4	80.00	33
F9Q 754	Diesel	1870	4	80.00	33
F9Q 756	Diesel	1870	4	80.00	32
F9Q 758	Diesel	1870	4	80.00	32
F9Q 759	Diesel	1870	4	80.00	32
F9Q 760	Diesel	1870	4	80.00	33
F9Q 762	Diesel	1870	4	80.00	33
F9Q 770	Diesel	1870	4	80.00	33
F9Q 772	Diesel	1870	4	80.00	33

		ccm	x 		9
F9Q 774	Diesel	1870	4	80.00	33
F9Q 780	Diesel	1870	4	80.00	33
F9Q 782	Diesel	1870	4	80.00	33
F9Q 790	Diesel	1870	4	80.00	33
F9Q 796	Diesel	1870	4	80.00	33
F9Q 800	Diesel	1870	4	80.00	32
F9Q 808	Diesel	1870	4	80.00	32
F9Q 812	Diesel	1870	4	80.00	32
F9Q 816	Diesel	1870	4	80.00	32
F9Q 818	Diesel	1870	4	80.00	32
F9Q 820	Diesel	1870	4	80.00	32
F9Q 826	Diesel	1870	4	80.00	32
G8T 706	Diesel	2188	4	87.00	44
G8T 752	Diesel	2188	4	87.00	44
G8T 790	Diesel	2188	4	87.00	44
G8T 792	Diesel	2188	4	87.00	44
G8T 794	Diesel	2188	4	87.00	44
G9T 605 Euro 4	Diesel	2188	4	87.00	45
G9T 606 Euro 4	Diesel	2188	4	87.00	45
G9T 607	Diesel	2188	4	87.00	46
G9T 642	Diesel	2188	4	87.00	45
G9T 645 Euro 4	Diesel	2188	4	87.00	45
G9T 700	Diesel	2188	4	87.00	45
G9T 702 Euro 3	Diesel	2188	4	87.00	45
G9T 703	Diesel	2188	4	87.00	45
G9T 704	Diesel	2188	4	87.00	45
G9T 706	Diesel	2188	4	87.00	45
G9T 707	Diesel	2188	4	87.00	45
G9T 710	Diesel	2188	4	87.00	46
G9T 720	Diesel	2188	4	87.00	46
G9T 722	Diesel	2188	4	87.00	46
G9T 742 Euro 3	Diesel	2188	4	87.00	45
G9T 743 Euro 3	Diesel	2188	4	87.00	45
G9T 750	Diesel	2188	4	87.00	46
G9U 630 Euro 4	Diesel	2464	4	89.00	49
G9U 632 Euro 4	Diesel	2464	4	89.00	49
G9U 650 Euro 4	Diesel	2464	4	89.00	49
G9U 720 Euro 3	Diesel	2463	4	89.00	50
G9U 724 Euro 3	Diesel	2463	4	89.00	50
G9U 730 Euro 3	Diesel	2464	4	89.00	50
G9U 750 Euro 3	Diesel	2463	4	89.00	50
G9U 754 Euro 3	Diesel	2463	4	89.00	50
J5R 716	Petrol	1995	4	88.00	47
J5R 718	Petrol	1995	4	88.00	47
J5R 722	Petrol	1995	4	88.00	47
J5R 726	Petrol	1995	4	88.00	47
J5R 728	Petrol	1995	4	88.00	47
J6R 234	Petrol	1995	4	88.00	47
J6R 236	Petrol	1995	4	88.00	47
J6R 706	Petrol	1995	4	88.00	47
J6R 707	Petrol	1995	4	88.00	47
J6R 710	Petrol	1995	4	88.00	47
J6R 712	Petrol	1995	4	88.00	47
J6R 713	Petrol	1995	4	88.00	47
J6R 715	Petrol	1995	4	88.00	47
J6R 716	Petrol	1995	4	88.00	47
J6R 758	Petrol	1995	4	88.00	47
J6R 759	Petrol	1995	4	88.00	47
J6R 760	Petrol	1995	4	88.00	47
J6R 762	Petrol	1995	4	88.00	47
J6R 792	Petrol	1995	4	88.00	47
J6R 793	Petrol	1995	4	88.00	47
J7R 720	Petrol	1995	4	88.00	48
J7R 722	Petrol	1995	4	88.00	47
J7R 723	Petrol	1995	4	88.00	47
J7R 732	Petrol	1995	4	88.00	48
J7R 740	Petrol	1995	4	88.00	47
J7R 746	Petrol	1995	4	88.00	47
J7R 747	Petrol	1995	4	88.00	47

		ccm	x 		9
J7R 751	Petrol	1995	4	88.00	47
J7R 754	Petrol	1995	4	88.00	48
J7R 760	Petrol	1995	4	88.00	47
J7R 768	Petrol	1995	4	88.00	47
J7T 706	Petrol	2165	4	88.00	48
J7T 707	Petrol	2165	4	88.00	48
J7T 714	Petrol	2165	4	88.00	48
J7T 715	Petrol	2165	4	88.00	48
J7T 730	Petrol	2165	4	88.00	48
J7T 754	Petrol	2165	4	88.00	48
J7T 760	Petrol	2165	4	88.00	48
J7T 762	Petrol	2165	4	88.00	48
J7T 770	Petrol	2165	4	88.00	47
J7T 772	Petrol	2165	4	88.00	47
J7T 780	Petrol	2165	4	88.00	48
J7T 782	Petrol	2165	4	88.00	48
J7T 788	Petrol	2165	4	88.00	48
J8S 120	Diesel	2068	4	86.00	40
J8S 232 (852.232)	Diesel	2068	4	86.00	40
J8S 234	Diesel	2068	4	86.00	40
J8S 240	Diesel	2068	4	86.00	41
J8S 330	Diesel	2068	4	86.00	42
J8S 600	Diesel	2068	4	86.00	42
J8S 604	Diesel	2068	4	86.00	43
J8S 610	Diesel	2068	4	86.00	43
J8S 612	Diesel	2068	4	86.00	43
J8S 620	Diesel	2068	4	86.00	40
J8S 702	Diesel	2068	4	86.00	41
J8S 704	Diesel	2068	4	86.00	42
J8S 706	Diesel	2068	4	86.00	42
J8S 708	Diesel	2068	4	86.00	40
J8S 711	Diesel	2068	4	86.00	40
J8S 712	Diesel	2068	4	86.00	42
J8S 714	Diesel	2068	4	86.00	40
J8S 736	Diesel	2068	4	86.00	42
J8S 738	Diesel	2068	4	86.00	41
J8S 740	Diesel	2068	4	86.00	42
J8S 742	Diesel	2068	4	86.00	40
J8S 746	Diesel	2068	4	86.00	40
J8S 758	Diesel	2068	4	86.00	42
J8S 760	Diesel	2068	4	86.00	43
J8S 772	Diesel	2068	4	86.00	41
J8S 774	Diesel	2068	4	86.00	41
J8S 776	Diesel	2068	4	86.00	41
J8S 778	Diesel	2068	4	86.00	40
J8S 784	Diesel	2068	4	86.00	42
J8S 786 (KAT)	Diesel	2068	4	86.00	43
J8S 788	Diesel	2068	4	86.00	41
J8S 814	Diesel	2068	4	86.00	40
J8S 852	Diesel	2068	4	86.00	42
J8S 890	Diesel	2068	4	86.00	40
K4M 690	Petrol	1598	4	79.50	25
K4M 697	Petrol	1598	4	79.50	25
K4M 698	Petrol	1598	4	79.50	25
K4M 700	Petrol	1598	4	79.50	25
K4M 701	Petrol	1598	4	79.50	25
K4M 704	Petrol	1598	4	79.50	25
K4M 706	Petrol	1598	4	79.50	25
K4M 708	Petrol	1598	4	79.50	25
K4M 709	Petrol	1598	4	79.50	25
K4M 710	Petrol	1598	4	79.50	25
K4M 711	Petrol	1598	4	79.50	25
K4M 712	Petrol	1598	4	79.50	25
K4M 714	Petrol	1598	4	79.50	25
K4M 716	Petrol	1598	4	79.50	25
K4M 720	Petrol	1598	4	79.50	25
K4M 724	Petrol	1598	4	79.50	25
K4M 730	Petrol	1598	4	79.50	25
K4M 732	Petrol	1598	4	79.50	25

		ccm	x 		9
K4M 734	Petrol	1598	4	79.50	25
K4M 736	Petrol	1598	4	79.50	25
K4M 740	Petrol	1598	4	79.50	25
K4M 742	Petrol	1598	4	79.50	25
K4M 743	Petrol	1598	4	79.50	25
K4M 744 Euro 4	Petrol	1598	4	79.50	25
K4M 745 Euro 4	Petrol	1598	4	79.50	25
K4M 748	Petrol	1598	4	79.50	25
K4M 752	Petrol	1598	4	79.50	25
K4M 760	Petrol	1598	4	79.50	25
K4M 790	Petrol	1598	4	79.50	25
K4M 830 Euro 4	Petrol	1598	4	79.50	25
K4M 831 Euro 4	Petrol	1598	4	79.50	25
K4M 834 Euro 4	Petrol	1598	4	79.50	25
K7J 710	Petrol	1390	4	79.50	26
K7J 714	Petrol	1390	4	79.50	26
K7M 702	Petrol	1598	4	79.50	27
K7M 703	Petrol	1598	4	79.50	27
K7M 710	Petrol	1598	4	79.50	27
K7M 720	Petrol	1598	4	79.50	27
K7M 732 Euro 4	Petrol	1598	4	79.50	28
K7M 744	Petrol	1598	4	79.50	27
K7M 745	Petrol	1598	4	79.50	27
K7M 746	Petrol	1598	4	79.50	27
K7M 790	Petrol	1598	4	79.50	27
K9K 276	Diesel	1461	4	76.00	17
K9K 608	Diesel	1461	4	76.00	17
K9K 612	Diesel	1461	4	76.00	17
K9K 636 Euro 5	Diesel	1461	4	76.00	17
K9K 700 Euro 3	Diesel	1461	4	76.00	18
K9K 702 Euro 3	Diesel	1461	4	76.00	18
K9K 704 Euro 3	Diesel	1461	4	76.00	18
K9K 706	Diesel	1461	4	76.00	18
K9K 708	Diesel	1461	4	76.00	18
K9K 710 Euro 3	Diesel	1461	4	76.00	18
K9K 712 Euro 3	Diesel	1461	4	76.00	19
K9K 714 Euro 4	Diesel	1461	4	76.00	18
K9K 716	Diesel	1461	4	76.00	18
K9K 718 Euro 4	Diesel	1461	4	76.00	19
K9K 722 Euro 3	Diesel	1461	4	76.00	18
K9K 724 Euro 4	Diesel	1461	4	76.00	19
K9K 728 Euro 3	Diesel	1461	4	76.00	19
K9K 729 Euro 3	Diesel	1461	4	76.00	19
K9K 732 Euro 4	Diesel	1461	4	76.00	20
K9K 734	Diesel	1461	4	76.00	17
K9K 740 Euro 4	Diesel	1461	4	76.00	18
K9K 742 Euro 5	Diesel	1461	4	76.00	21
K9K 750 Euro 3	Diesel	1461	4	76.00	18
K9K 752 Euro 3	Diesel	1461	4	76.00	18
K9K 760 Euro 4	Diesel	1461	4	76.00	19
K9K 762 Euro 4	Diesel	1461	4	76.00	18
K9K 764 Euro 4	Diesel	1461	4	76.00	20
K9K 766 Euro 4	Diesel	1461	4	76.00	19
K9K 768 Euro 4	Diesel	1461	4	76.00	18
K9K 770 Euro 5	Diesel	1461	4	76.00	16
K9K 772	Diesel	1461	4	76.00	17
K9K 780 Euro 4	Diesel	1461	4	76.00	20
K9K 782 Euro 5	Diesel	1461	4	76.00	16
K9K 790	Diesel	1461	4	76.00	18
K9K 792	Diesel	1461	4	76.00	18
K9K 794	Diesel	1461	4	76.00	18
K9K 796	Diesel	1461	4	76.00	18
K9K 800	Diesel	1461	4	76.00	17
K9K 802 Euro 4	Diesel	1461	4	76.00	19
K9K 804 Euro 4	Diesel	1461	4	76.00	20
K9K 806 Euro 4	Diesel	1461	4	76.00	20
K9K 808 Euro 5	Diesel	1461	4	76.00	16
K9K 812	Diesel	1461	4	76.00	17
K9K 814 Euro 5	Diesel	1461	4	76.00	21

		ccm	x 		9
K9K 816 Euro 5	Petrol	1461	4	76.00	16
K9K 820	Diesel	1461	4	76.00	16
K9K 830	Diesel	1461	4	76.00	17
K9K 832 Euro 4	Diesel	1461	4	76.00	20
K9K 834	Diesel	1461	4	76.00	16
K9K 836 Euro 5	Diesel	1461	4	76.00	16
K9K 837 Euro 5	Diesel	1461	4	76.00	17
K9K 840	Diesel	1461	4	76.00	17
K9K 846 Euro 5	Diesel	1461	4	76.00	17
K9K 884 Euro 5	Diesel	1461	4	76.00	17
K9K F 830	Diesel	1461	4	76.00	17
K9K G 724	Diesel	1461	4	76.00	19
K9K G 832	Diesel	1461	4	76.00	17
K9K H 834 Euro 5	Diesel	1461	4	76.00	16
K9K J 836 Euro 5	Diesel	1461	4	76.00	16
K9K N 837	Diesel	1461	4	76.00	17
K9K P 732	Diesel	1461	4	76.00	20
M9R 610	Diesel	1995	4	84.00	37
M9R 615	Diesel	1995	4	84.00	37
M9R 630	Diesel	1995	4	84.00	37
M9R 692 Euro 5	Diesel	1995	4	84.00	37
M9R 700	Diesel	1995	4	84.00	38
M9R 721	Diesel	1995	4	84.00	38
M9R 722	Diesel	1995	4	84.00	38
M9R 724	Diesel	1995	4	84.00	38
M9R 740	Diesel	1995	4	84.00	38
M9R 742	Diesel	1995	4	84.00	38
M9R 744	Diesel	1995	4	84.00	38
M9R 746	Diesel	1995	4	84.00	38
M9R 748	Diesel	1995	4	84.00	38
M9R 750	Diesel	1995	4	84.00	38
M9R 760	Diesel	1995	4	84.00	38
M9R 761	Diesel	1995	4	84.00	38
M9R 762	Diesel	1995	4	84.00	38
M9R 763	Diesel	1995	4	84.00	38
M9R 780 Euro 4	Diesel	1995	4	84.00	38
M9R 782	Diesel	1995	4	84.00	38
M9R 786 Euro 4	Diesel	1995	4	84.00	38
M9R 800	Diesel	1995	4	84.00	38
M9R 802	Diesel	1995	4	84.00	38
M9R 809	Diesel	1995	4	84.00	38
M9R 816	Diesel	1995	4	84.00	38
M9R 828	Diesel	1995	4	84.00	37
M9R 830	Diesel	1995	4	84.00	38
M9R 854	Diesel	1995	4	84.00	37
M9R 856	Diesel	1995	4	84.00	37
M9R 857	Diesel	1995	4	84.00	37
M9R 858	Diesel	1995	4	84.00	37
M9R 859	Diesel	1995	4	84.00	37
M9R 862	Diesel	1995	4	84.00	37
M9R 864	Diesel	1995	4	84.00	37
M9R 865	Diesel	1995	4	84.00	37
M9R 866	Diesel	1995	4	84.00	37
M9T 670 Euro 5	Diesel	2298	4	85.00	39
M9T 672 Euro 5	Diesel	2298	4	85.00	39
M9T 676 Euro 4	Diesel	2298	4	85.00	39
M9T 678	Diesel	2298	4	85.00	39
M9T 680	Diesel	2298	4	85.00	39
M9T 686 Euro 5	Diesel	2298	4	85.00	39
M9T 690 Euro 5	Diesel	2298	4	85.00	39
M9T 692 Euro 4	Diesel	2298	4	85.00	39
M9T 694 Euro 4	Diesel	2298	4	85.00	39
M9T 696 Euro 4	Diesel	2298	4	85.00	39
M9T 698 Euro 5	Diesel	2298	4	85.00	39
M9T 870 Euro 5	Diesel	2298	4	85.00	39
M9T 880 Euro 5	Diesel	2298	4	85.00	39
M9T 890 Euro 5	Diesel	2298	4	85.00	39
M9T 896 Euro 4	Diesel	2298	4	85.00	39
M9T 898 Euro 5	Diesel	2298	4	85.00	39

		ccm	x 		9
S8U 720	Diesel	2445	4	93.00	57
S8U 722	Diesel	2445	4	93.00	57
S8U 730	Diesel	2445	4	93.00	57
S8U 731	Diesel	2445	4	93.00	57
S8U 742	Diesel	2499	4	93.00	58
S8U 748	Diesel	2445	4	93.00	57
S8U 750	Diesel	2499	4	93.00	58
S8U 752	Diesel	2499	4	93.00	58
S8U 758	Diesel	2499	4	93.00	58
S8U 780	Diesel	2499	4	93.00	58
S8U 782	Diesel	2499	4	93.00	58
S9U 714	Diesel	2499	4	93.00	54



1  **58.00**

670.800

4 Cyl.
845cc 8:1
19-26kW (26-35PS)

TD22489

4 0.8 10/62 → 09/83 **800**

4 Cyl.
847cc 8:1
19kW (26PS)

TD3023

4 0.8 09/66 → 12/88 **800 01**
Rodeo 4 0.8 08/71 → 11/81

4 Cyl.
845cc 8:1
25kW (34PS)

TD3024

4 0.8 **800 05**

4 Cyl.
845cc 8:1
22-25kW (30-34PS)

TD3025

4 0.8 10/62 → 07/89 **800 705**

4 Cyl.
845cc 8:1
19-26kW (26-35PS)

TD4852

5 0.8 10/72 → 12/84 **800 710**

4 Cyl.
845cc 8:1
26-27kW (36-37PS)

TD3028

6 0.8 10/69 → 04/80 **800.02**
Rodeo 6 0.8 05/70 → 08/73

4 Cyl.
845cc 8:1
21-26kW (29-35PS)

TD21383

4 0.8 04/83 → 07/89 **B1B 707**

4 Cyl.
845cc 8:1
21kW (29PS)

TD4855

87-333300-00

STD

A 30.00
D 64.00
 16x50

08-333300-00

STD

01/69 →

1.75
2.00
3.50



CR P
P
P

15-632200-00 WH  B 62.50 C 126.00 D 69.80 E 112.80

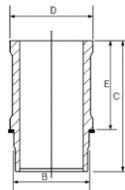

89-333300-00
87-333300-00 +
15-632200-00

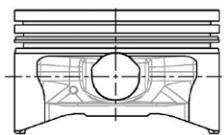

 Includes seals

 Schließt Dichtungen ein

 Inclut des joints

 Incluye los sellos

 Comprende le guarnizioni

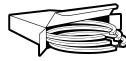

2  **69.00**

Twingo I 1.2 16V	01/01→	D4F 702	4 Cyl. 1149cc	9.8:1 55kW (75PS)	TD16272
		D4F 704	4 Cyl. 1149cc	9.8:1 55kW (75PS)	TD16273
Clio II 1.2 16V	06/01→	D4F 706	4 Cyl. 1149cc	9.8:1 55kW (75PS)	TD21205
Twingo I 1.2 16V	08/04→06/07	D4F 708 Euro 3	4 Cyl. 1149cc	9.8:1 44kW (60PS)	TD19014
Clio II 1.2 16V, Kangoo 1.2 16V Kangoo Express 1.2 16V Thalia I 1.2 16V Twingo I 1.0	06/01→ 10/01→ 04/02→ 03/01→05/07	D4F 712	4 Cyl. 1149cc	9.8:1 55kW (75PS)	TD16186
Clio II 1.2 16V, Kangoo 1.2 16V Kangoo Express 1.2 16V	06/01→ 10/01→	D4F 714	4 Cyl. 1149cc	9.8:1 55kW (75PS)	TD16187
Kangoo 1.2 16V	06/01→	D4F 716	4 Cyl. 1149cc	9.8:1 55kW (75PS)	TD17270
Clio II 1.2 16V	06/01→	D4F 722	4 Cyl. 1149cc	9.8:1 55kW (75PS)	TD19671
Clio II 1.2 16V Thalia II 1.2 16V Thalia II 1.2 LPG	06/01→ 09/08→ 01/10→12/13	D4F 728	4 Cyl. 1149cc	9.8:1 55kW (75PS)	TD21206
Kangoo 1.2 16V Kangoo Express 1.2 16V	06/01→ 10/01→	D4F 730	4 Cyl. 1149cc	9.8:1 55kW (75PS)	TD21207
Logan II 1.2 Logan II 1.2 16V Logan II 1.2 16V LPG Sander/Stepway II 1.2 16V Thalia III 1.2 16V	11/13→ 12/13→	D4F 732	4 Cyl. 1149cc	9.8:1 55kW (75PS)	TD23528
Clio Grandtour 1.2 16V Clio Grandtour 1.2 16V Hi-Flex Clio Grandtour IV 1.2 16V Clio III 1.2 16V Clio III 1.2 16V Hi-Flex Clio IV 1.2 16V Modus/Grand Modus 1.2 Modus/Grand Modus 1.2 16V Hi-Flex	02/08→ 07/08→ 01/13→ 06/05→ 07/08→ 11/12→ 12/04→ 10/08→	D4F 740	4 Cyl. 1149cc	9.8:1 48-55kW (65-75PS)	TD18421



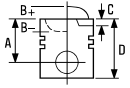

Clio III 1.2 16V Hi-Flex	07/08→	D4F 742	4 Cyl. 1149cc	9.8:1 55kW (75PS)	TD24895
Clio Grandtour 1.2 16V	02/08→	D4F 764			
Clio III 1.2	10/05→		4 Cyl. 1149cc	10.6:1 43-58kW (58-79PS)	TD18530
Clio III 1.2 16V	06/05→				
Modus/Grand Modus 1.2	12/04→				
Twingo II 1.2 16V	03/07→				
Twingo II 1.2 16V	03/07→	D4F 772	4 Cyl. 1149cc	9.8:1 55-56kW (75-76PS)	TD20444
		D4F 790	4 Cyl. 1149cc	9.8:1 55kW (75PS)	TD29123

87-450000-00
87-450007-00

STD
0.50mm

08-450000-10
08-450007-10

STD
0.50mm

A 26.70
B- 1.10
BØ 60.30
D 44.70
 18x54

1.20
1.50
2.50



NT 
P
CR 

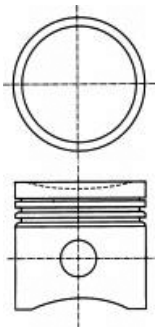

 Steel

 Stahl

 Acier

 Acero

 Acciaio

3  **69.00**

Twingo I 1.2	05/96→	D7F 700	4 Cyl. 1149cc	9.6:1 40-43kW (54-58PS)	TD5520
Twingo I 1.2	05/96→	D7F 701	4 Cyl. 1149cc	9.6:1 40-43kW (54-58PS)	TD5521
Twingo I 1.2	05/96→	D7F 702	4 Cyl. 1149cc	9.6:1 43-44kW (58-60PS)	TD16274
Twingo I 1.2 LPG	10/03→				
Twingo I 1.2	05/96→	D7F 703	4 Cyl. 1149cc	9.6:1 43kW (58PS)	TD16275





Twingo I 1.2	05/96→	D7F 704	4 Cyl. 1149cc	9.6:1 43-44kW (58-60PS)	TD16276
Twingo I 1.2	05/96→	D7F 706	4 Cyl. 1149cc	9.6:1 43kW (58PS)	TD18178
Kangoo 1.2, Kangoo Express 1.2 Kangoo Express 1.2 BiFuel	08/97→ 07/98→07/01	D7F 710	4 Cyl. 1149cc	9.6:1 43kW (58PS)	TD9624
Clio II 1.1, Clio II 1.2 Kangoo 1.2, Kangoo Express 1.2	09/98→ 08/97→	D7F 720	4 Cyl. 1149cc	9.65:1 43kW (58PS)	TD14328
Clio II 1.2 Kangoo 1.2, Kangoo Express 1.2	03/99→10/03 08/97→	D7F 722	4 Cyl. 1149cc	9.6:1 43-44kW (58-60PS)	TD16326
Clio II 1.1, Clio II 1.2 Clio II 1.2 Kangoo 1.2, Kangoo Express 1.2	09/98→ 03/99→10/03 08/97→	D7F 726	4 Cyl. 1149cc	9.6:1 43kW (58PS)	TD14329
Clio I 1.2	01/96→09/98	D7F 730	4 Cyl. 1149cc	9.6:1 40-43kW (54-58PS)	TD5522
Clio II 1.1, Clio II 1.2 Clio II 1.2 Kangoo 1.2, Kangoo Express 1.2 Thalia I 1.2	09/98→ 03/99→10/03 08/97→ 02/98→10/03	D7F 746	4 Cyl. 1149cc	9.6:1 43kW (58PS)	TD17267
Clio II 1.2 Clio II 1.2 LPG Kangoo Express 1.2	09/98→ 09/98→06/09 07/98→07/01	D7F 764	4 Cyl. 1149cc	9.6:1 43kW (58PS)	TD20903
Clio II 1.2 Clio II 1.2 LPG Clio III 1.2 Kangoo Express 1.2	09/98→ 09/98→06/09 05/05→06/09 07/98→07/01	D7F 766 Euro 4	4 Cyl. 1149cc	9.6:1 43kW (58PS)	TD19670

87-104100-00	STD	08-104100-00	STD
87-104105-00	0.25mm	08-104105-00	0.25mm
87-104107-00	0.50mm	08-104107-00	0.50mm

A	27.00	1.50		CR P
D	50.50	1.50		P
	18x52	2.50		CR P

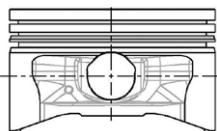

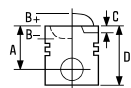







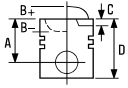



4 70.00

8 1.1 10 1.1	11/62→10/72 05/66→10/72	688 02	4 Cyl. 1108cc	9:1 41kW (56PS)	TD3012
8 1.1 10 1.1	11/62→10/72 05/66→10/72	688 03	4 Cyl. 1108cc	9:1 25-39kW (34-53PS)	TD22492
6 1.1 Rodeo 6 1.1	08/70→04/87 08/73→11/81	688 10	4 Cyl. 1108cc	9.5:1 25-39kW (34-53PS)	TD21382
4 1.1	10/76→07/89	688 11	4 Cyl. 1108cc	9.25:1 25kW (34PS)	TD3014
4 1.1 Rodeo 5 1.1	10/76→06/90 11/81→12/87	688 12	4 Cyl. 1108cc	25-35kW (34-48PS)	TD3015
5 1.1	09/80→12/85	688 13	4 Cyl. 1108cc	9.5:1 33kW (45PS)	TD3013
5 1.1	09/80→12/85	688.11	4 Cyl. 1108cc	8.3:1 25-39kW (34-53PS)	TD28180
8 1.1 10 1.1 Estafette 1.1	11/62→10/72 05/66→10/72 02/62→12/81	C1E (688.01)	4 Cyl. 1108cc	9:1 25-39kW (34-53PS)	TD22490
19 l Chamade 1.1 TR Clio I 1.1	07/88→04/92 01/91→09/98	C1E 700	4 Cyl. 1108cc	8.5:1 35-36kW (48-49PS)	TD3100
9 1.1 11 1.1	09/81→05/87 03/83→06/86	C1E 715	4 Cyl. 1108cc	9:1 35kW (48PS)	TD3102
5 1.1 Rapid 1.1 Super 5 1.1	09/80→12/85 07/85→04/95 10/84→12/96	C1E 750	4 Cyl. 1108cc	9.5:1 33-35kW (45-48PS)	TD3106
5 1.1 Rapid 1.1 Super 5 1.1	09/80→12/85 07/85→04/95 10/84→12/96	C1E 752	4 Cyl. 1108cc	9.5:1 33-34kW (45-46PS)	TD3107
5 1.1 Rapid 1.1 Super 5 1.1	09/80→12/85 07/85→04/95 10/84→12/96	C1E 754	4 Cyl. 1108cc	8.8:1 33-34kW (45-46PS)	TD3108

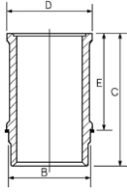
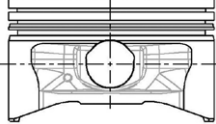



Rapid 1.1 Super 5 1.1	06/87→09/91 01/86→03/95	C1E 756	4 Cyl. 1108cc	8.8:1 33kW (45PS)	TD3109
Rapid 1.1 Super 5 1.1	07/85→04/95 01/86→03/95	C1E 760	4 Cyl. 1108cc	8.8:1 33kW (45PS)	TD3110
Rapid 1.1	07/85→04/95	C1E 762	4 Cyl. 1108cc	8.8:1 33-36kW (45-49PS)	TD3111
Rapid 1.1	07/85→04/95	C1E 764	4 Cyl. 1108cc	8.8:1 36kW (49PS)	TD3112
Rapid 1.1	07/85→04/95	C1E 792	4 Cyl. 1108cc	8.8:1 33kW (45PS)	TD3113

87-334600-00	STD	08-334600-00	STD	14-636730-00 WH	B 75.50 C 135.00 D 85.70 E 94.80	89-334600-00 87-334600-00 + 14-636730-00
A 40.00 D 68.00  18x62		1.75 2.00 3.50 	CR P P CR 			
						
 Steel	 Stahl	 Acier	 Acero	 Acciaio		

5 70.00

9 1.1 11 1.1	09/81→05/87 03/83→06/86	688 13	4 Cyl. 1108cc	8.5:1 33kW (45PS)	TD23801
9 1.1 11 1.1	09/81→05/87 03/83→06/86	C1E 720	4 Cyl. 1108cc	9.5:1 35kW (48PS)	TD3105

14-636730-00 WH B 75.50 C 135.00 D 85.70 E 94.80

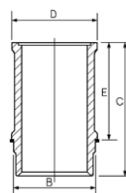



6 73.00

Estatette 1.3	08/69→12/81	810.01	4 Cyl. 1289cc	8.5:1 26-32kW (37-44PS)	TD8555
12 Variable 1.3, 12 1.3	07/75→04/80	810.02	4 Cyl. 1289cc	8.5:1 37kW (50PS)	TD3033
12 1.3 12 Variable 1.3	10/69→08/80 10/70→08/80	810.02/97	4 Cyl. 1289cc	8.5:1 40kW (54PS)	TD3032
10 1.3	07/69→10/72	810.03	4 Cyl. 1289cc	8.5:1 35kW (48PS)	TD23613
12 1.3 TS 12 Variable 1.3 15 1.3	08/72→08/80 08/73→08/80 03/72→10/80	810.05	4 Cyl. 1289cc	9.5:1 31-45kW (42-61PS)	TD21386
12 1.3 TS 12 Variable 1.3	08/72→08/80 08/73→08/80	810.06	4 Cyl. 1289cc	9.5:1 44kW (60PS)	TD3034
5 1.3	06/79→09/84	810.10	4 Cyl. 1289cc	9.5:1 44kW (60PS)	TD21387
5 1.3	06/79→09/84	810.19	4 Cyl. 1289cc	8.2:1 33kW (45PS)	TD3035
5 1.3	09/75→09/84	810.25	4 Cyl. 1289cc	9.5:1 47kW (64PS)	TD3036
5 1.3	09/75→09/84	810.25	4 Cyl. 1289cc	9.5:1 31-50kW (42-68PS)	TD22391
5 1.3	03/76→08/82	810.26	4 Cyl. 1289cc	9.5:1 31-43kW (42-58PS)	TD3037
5 1.3	03/76→08/82	810.26	4 Cyl. 1289cc	9.5:1 31-50kW (42-68PS)	TD22392







5 1.3 Automatik 06/79→09/84 **810.29** 4 Cyl. 9.5:1
1289cc **40kW (54PS)** **TD3038**

87-333400-00 STD



A 37.50
D 62.50
 20x64

08-333400-10 STD

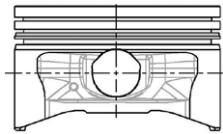
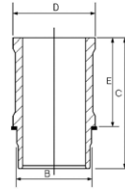

1.75
 2.00
 4.00
 CR P
 P
 CR 



15-636590-00 WH  **B 78.50 C 134.00 D 87.70 E 95.00**





 Includes seals
 Steel

 Schließt Dichtungen ein
 Stahl

 Inclut des joints
 Acier

 Incluye los sellos
 Acero

 Comprende le guarnizioni
 Acciaio

7  **73.00**

5 1.3 09/75→ **810.96** 4 Cyl. 9.6:1
1289cc **49kW (68PS)** **TD3039**

5 1.3 09/75→ **810.97** 4 Cyl. 9.6:1
1289cc **41kW (57PS)** **TD3040**

15-636590-00 WH  **B 78.50 C 134.00 D 87.70 E 95.00**

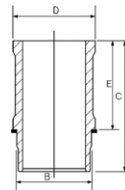



 Includes seals

 Schließt Dichtungen ein

 Inclut des joints

 Incluye los sellos

 Comprende le guarnizioni

8  **74.00**

Twingo I 1.2 03/93→10/96 **C3G 700** 4 Cyl. 9.2:1
1239cc **40kW (55PS)** **TD3172**



Twingo I 1.2 03/93→10/96 **C3G 702** 4 Cyl. 9.2:1
1239cc **40kW (55PS)** **TD5515**

Express 1.2 07/95→10/99 **C3G 710** 4 Cyl. 9.2:1
Rapid 1.2 09/91→03/98 **1239cc** **40kW (55PS)** **TD3173**







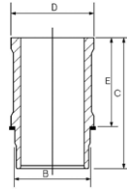
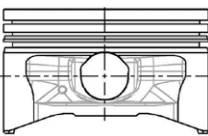

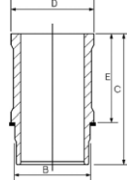

Rapid 1.2	09/91→03/98	C3G 712	4 Cyl. 1239cc	9.2:1 40kW (55PS)	TD16545
Clio I 1.2	06/94→02/98	C3G 720	4 Cyl. 1239cc	9.2:1 40kW (54PS)	TD14314
Clio I 1.2	01/96→12/96	C3G 750	4 Cyl. 1239cc	9.2:1 40kW (54PS)	TD22356

87-337300-00	STD	08-337300-00	STD	14-630120-00 WH	B 78.60 C 135.00 D 88.20 E 94.90	89-337300-00 87-337300-00 + 14-630120-00
A 40.05 D 61.00  18x62		1.50 1.75 3.00	 CR P P P			
						

9 75.00

14 1.2	05/76→12/83	129	4 Cyl. 1218cc	9.3:1 42-43kW (57-58PS)	TD3007
				15-636700-00 WH  B 79.50 C 122.00 D 89.20 E 82.50	
					
 Includes seals	 Schließt Dichtungen ein	 Inclut des joints	 Incluye los sellos	 Comprende le guarnizioni	

10 75.00

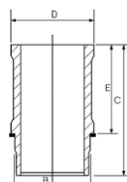
14 1.4	09/79→06/83	150	4 Cyl. 1360cc	9.3:1 51-52kW (70-71PS)	TD3008
				14-636600-00 WH B 79.50 C 134.50 D 89.20 E 90.00	
					

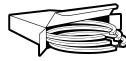

11 75.80

Clio I 1.2	05/90→03/96	E5F 710	4 Cyl. 1171cc	8.8:1 40-44kW (55-60PS)	TD3181
Clio I Box 1.2	01/91→09/98	E5F 716	4 Cyl. 1171cc	8.8:1 40-44kW (55-60PS)	TD3182
Clio I 1.2	05/90→09/98	E7F 700	4 Cyl. 1171cc	9.25:1 43-44kW (58-60PS)	TD3192
Clio I 1.2	01/91→09/98	E7F 706	4 Cyl. 1171cc	8.8:1 40-43kW (54-58PS)	TD3194
Clio I 1.2 Rapid 1.2	05/90→09/98 05/95→11/98	E7F 708	4 Cyl. 1171cc	9.25:1 43-48kW (58-65PS)	TD3195
Clio I 1.2	05/90→09/98	E7F 750	4 Cyl. 1171cc	9.25:1 43-44kW (58-60PS)	TD3197

②

A 35.10
B- 1.20
D 56.60
 19x60

08-336400-00
08-336407-00

STD
0.50mm

1.50
1.75
3.00



CR P
P
P

15-638390-00 WH ① **B** 80.60 **C** 130.00 **D** 90.20 **E** 91.50

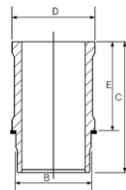

89-336400-00

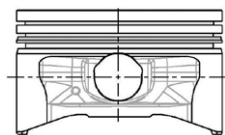

① Includes seals

② Piston available in
Kit Set only

① Schließt Dichtungen ein

② Kolben nur im
Assembly erhältlich

① Inclut des joints

② Piston disponible en
kit seulement

① Incluye los sellos

② Pistón disponible en
conjuntos solamente

① Comprende le guarnizioni

② I pistoni sono disponibili solo in
kit motore

12 75.80

19 I 1.4	01/88→12/92	E6J 700	4 Cyl. 1390cc	9.5:1 57-59kW (78-80PS)	TD3183
19 I Chamade 1.4	07/88→08/90				
19 II 1.4	01/92→12/95				
19 II Chamade 1.4	10/94→11/95				
19 I 1.4	01/88→12/92	E6J 701	4 Cyl. 1390cc	9.5:1 57-59kW (78-80PS)	TD3184
19 I Chamade 1.4	07/88→08/90				





Rapid 1.4 RN	09/91→08/93	E6J 734	4 Cyl. 1390cc	9.5:1 43-44kW (60-60PS)	TD3189
Clio I 1.4	01/91→09/98	E6J 738	4 Cyl. 1390cc	8.9:1 43kW (60PS)	TD3190
Megane I 1.4 Eco	01/96→03/99	E7J 624	4 Cyl. 1390cc	9.5:1 52kW (71PS)	TD5526
Megane I 1.4 e Megane I Classic 1.4 Megane I Grandtour 1.4 e	01/96→08/03 09/96→08/03 03/99→08/03	E7J 626	4 Cyl. 1390cc	9.5:1 55kW (75PS)	TD16362
Clio II 1.4 Kangoo 1.4, Kangoo Express 1.4	09/98→05/05 08/97→	E7J 634	4 Cyl. 1390cc	9.5:1 55kW (75PS)	TD17271
Kangoo 1.4, Kangoo Express 1.4	08/97→	E7J 635	4 Cyl. 1390cc	9.5:1 55kW (75PS)	TD17272
Clio I 1.4	01/91→09/98	E7J 718	4 Cyl. 1390cc	9.5:1 58kW (79PS)	TD3205
Clio I 1.4	01/91→09/98	E7J 719	4 Cyl. 1390cc	9.5:1 58kW (79PS)	TD3206
Rapid 1.4	09/91→03/98	E7J 720	4 Cyl. 1390cc	9.5:1 43-59kW (58-80PS)	TD3207
Rapid 1.4	09/91→03/98	E7J 724	4 Cyl. 1390cc	9.5:1 54-59kW (73-80PS)	TD3208
Rapid 1.4	09/91→03/98	E7J 726	4 Cyl. 1390cc	9.5:1 55-59kW (75-80PS)	TD5508
Rapid 1.4	01/94→03/98	E7J 728	4 Cyl. 1390cc	9.5:1 58-59kW (79-80PS)	TD3209
19 II 1.4 19 II Chamade 1.4	01/92→12/95 11/93→12/95	E7J 742	4 Cyl. 1390cc	9.5:1 55kW (75PS)	TD3212



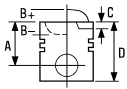

Clio I 1.4	01/91→09/98	E7J 754	4 Cyl. 1390cc	9.5:1 55-59kW (75-80PS)	TD3211
Megane I 1.4 e	01/96→08/03	E7J 764	4 Cyl. 1390cc	9.5:1 55kW (75PS)	TD4858
Megane I Classic 1.4	09/96→08/03				
Megane Scenic 1.4 i	01/97→09/99				
Rapid 1.4	09/91→03/98	E7J 773	4 Cyl. 1390cc	9.5:1 55-59kW (75-80PS)	TD3213
Clio II 1.4	09/98→05/05	E7J 780	4 Cyl. 1390cc	9.5:1 55kW (75PS)	TD9623
Kangoo 1.4, Kangoo Express 1.4	08/97→				

<p>②</p> <p>08-336400-00 08-336407-00</p> <p>A 31.70 D 52.70 19x60</p>	<p>08-336400-00 STD 08-336407-00 0.50mm</p> <p>1.50 CR P 1.75 P 3.00 P</p>	<p>15-638390-00 WH ① B 80.60 C 130.00 D 90.20 E 91.50</p>	<p>89-336400-10</p>
<p>① Includes seals</p> <p>② Piston available in Kit Set only</p>	<p>① Schließt Dichtungen ein</p> <p>② Kolben nur im Assembly erhältlich</p>	<p>① Inclut des joints</p> <p>② Piston disponible en kit seulement</p>	<p>① Incluye los sellos</p> <p>② Pistón disponible en conjuntos solamente</p>
			<p>① Comprende le guarnizioni</p> <p>② I pistoni sono disponibili solo in kit motore</p>

13 75.80

19 II 1.4, 19 II Chamade 1.4	10/96→06/01	E6J 706	4 Cyl. 1390cc	9.5:1 58-60kW (79-82PS)	TD3185
Clio I 1.4	05/90→02/98	E6J 712	4 Cyl. 1390cc	8.9:1 55-57kW (75-80PS)	TD3186
Clio I 1.4	05/90→02/98	E6J 713	4 Cyl. 1390cc	9.5:1 55-57kW (75-80PS)	TD3187
Clio I 1.4	05/90→02/98	E6J 718	4 Cyl. 1390cc	9.5:1 55-57kW (75-78PS)	TD3188





Clio I 1.4	05/90→02/98	E6J 760	4 Cyl. 1390cc	9.5:1 55-57kW (75-78PS)	TD3191
19 II 1.2, 19 II Chamade 1.2	05/92→09/94	E7F 704	4 Cyl. 1171cc	9.25:1 44kW (60PS)	TD3193
19 II 1.2, 19 II Chamade 1.2	05/92→09/94	E7F 730	4 Cyl. 1171cc	9.25:1 44-46kW (60-63PS)	TD3196
Clio I 1.4	01/91→09/98	E7J 601	4 Cyl. 1390cc	9.5:1 58-59kW (80-80PS)	TD3198
19 I 1.4, 19 I Chamade 1.4	09/90→04/92	E7J 700	4 Cyl. 1390cc	9.5:1 55-59kW (75-80PS)	TD3199
19 II 1.4 19 II Chamade 1.4	01/92→12/95 10/94→11/95	E7J 706	4 Cyl. 1390cc	9.5:1 55-59kW (75-80PS)	TD3200
19 II 1.4 19 II Chamade 1.4	01/92→12/95 10/94→11/95	E7J 707	4 Cyl. 1390cc	9.5:1 55-59kW (75-80PS)	TD3201
Clio I 1.4	01/91→09/98	E7J 710	4 Cyl. 1390cc	9.5:1 58-59kW (80-80PS)	TD3203
Clio I 1.4	01/91→09/98	E7J 711	4 Cyl. 1390cc	9.5:1 58-59kW (80-80PS)	TD3204
Clio I 1.4	01/91→09/98	E7J 745	4 Cyl. 1390cc	9.5:1 55-59kW (75-80PS)	TD3210
Clio I 1.4	01/91→09/98	E7J 756	4 Cyl. 1390cc	9.5:1 55kW (75PS)	TD17279
Clio I 1.4	01/91→09/98	E7J 757	4 Cyl. 1390cc	9.5:1 55kW (75PS)	TD17282
Clio I 1.4	01/91→09/98	E7J 770	4 Cyl. 1390cc	9.5:1 55-59kW (75-80PS)	TD20896





Clio I 1.4	01/91→09/98	E7J 771	4 Cyl. 1390cc	9.5:1 55-59kW (75-80PS)	TD20897
-------------------	-------------	----------------	-------------------------	-----------------------------------	----------------

15-638390-00 WH B 80.60 C 130.00 D 90.20 E 91.50

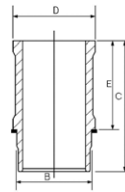

Includes seals

Schließt Dichtungen ein

Inclut des joints

Incluye los sellos

Comprende le guarnizioni

14 **76.00**

Trafic 1.4	03/80→04/89	847 700	4 Cyl. 1397cc	8.25:1 35kW (48PS)	TD3067
Trafic 1.4	03/80→04/89	847 701	4 Cyl. 1397cc	9.25:1 35kW (48PS)	TD3072
18 1.4 18 Variable 1.4, 18 1.4 Fuego 1.4 TL/GTL	04/78→07/86 05/79→07/86 02/80→10/85	847 720	4 Cyl. 1397cc	9.25:1 47kW (64PS)	TD5054
Trafic 1.4	03/80→06/91	C1J 700	4 Cyl. 1397cc	8.25:1 35-36kW (48-50PS)	TD3122
9 1.4 11 1.4	12/81→12/88 03/83→12/88	C1J 715	4 Cyl. 1397cc	9.25:1 44kW (60PS)	TD3123
19 II Chamade 1.4	05/92→09/94	C1J 742	4 Cyl. 1397cc	9.25:1 43-44kW (58-60PS)	TD3125
Rapid 1.4 Super 5 1.4	07/85→08/91 10/84→06/88	C1J 768	4 Cyl. 1397cc	9:1 43-44kW (58-60PS)	TD3128
Rapid 1.4 Super 5 1.4	07/85→08/91 10/84→06/88	C1J 780	4 Cyl. 1397cc	9.25:1 43kW (58PS)	TD3130
Super 5 1.4	10/84→07/89	C2J 700	4 Cyl. 1397cc	9:1 52-53kW (71-72PS)	TD3137
5 1.4	01/82→12/85	C2J 713	4 Cyl. 1397cc	9.25:1 46kW (63PS)	TD3138





9 1.4 11 1.4	09/81→12/85 05/83→12/85	C2J 717	4 Cyl. 1397cc	9.25:1 53kW (72PS)	TD3141
19 I 1.4 19 I Chamade 1.4 19 II Chamade 1.4	01/89→12/89 07/88→04/92 05/92→09/94	C2J 772	4 Cyl. 1397cc	9:1 43-44kW (58-60PS)	TD3154
Super 5 1.4	06/87→07/89	C2J 782	4 Cyl. 1397cc	9:1 49kW (67PS)	TD3158
Rapid 1.4 Super 5 1.4	03/86→08/91 06/87→08/90	C2J 784	4 Cyl. 1397cc	9:1 44kW (60PS)	TD3161
Rapid 1.4 Super 5 1.4	08/88→03/98 09/85→12/96	C3J 700	4 Cyl. 1397cc	9:1 43-44kW (58-60PS)	TD4856
Rapid 1.4 Super 5 1.4	08/88→03/98 10/85→12/96	C3J 702	4 Cyl. 1397cc	9:1 43-44kW (58-60PS)	TD3175
19 I 1.4 19 I Chamade 1.4 19 II 1.4, 19 II Chamade 1.4	01/89→04/92 07/88→04/92 04/92→12/95	C3J 710	4 Cyl. 1397cc	9.2:1 43-44kW (58-60PS)	TD3176
Rapid 1.4 Super 5 1.4	08/88→03/98 10/85→12/96	C3J 760	4 Cyl. 1397cc	9:1 43-44kW (58-60PS)	TD3179
Rapid 1.4	08/88→03/98	C3J 762	4 Cyl. 1397cc	9:1 43-44kW (58-60PS)	TD3180

87-333500-00

STD

A 37.50

D 64.00

 20x67

08-333500-00

STD

08-333505-00

0.25mm

08-333507-00

0.50mm

1.75

2.00

4.00



CR P

P

CR 

15-630820-00 **WH**  B 80.60 C 134.00 D 90.20 E 95.00

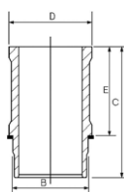

89-333500-00

87-333500-00 +

15-630820-00

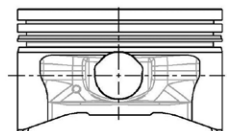

 Includes seals

 Steel

 Schließt Dichtungen ein

 Stahl

 Inclut des joints

 Acier

 Incluye los sellos

 Acero

 Comprende le guarnizioni

 Acciaio

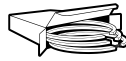

15 76.00

9 1.4 Turbo 11 1.4 Turbo	04/84→12/89 04/84→12/86	C1J 760	4 Cyl. 1397cc Turbo Intercooled	8.05:1 77kW (105PS)	TD3126
11 1.4 Turbo	10/86→12/88	C1J 770	4 Cyl. 1397cc Turbo Intercooled	8.05:1 85kW (115PS)	TD3129
11 1.4 Turbo Super 5 1.4 Turbo	10/86→12/88 04/85→08/90	C1J 782	4 Cyl. 1397cc Turbo Intercooled	8:1 85-88kW (115-120PS)	TD3131
Super 5 1.4 Super 5 1.4 Turbo	04/85→10/87 04/85→08/90	C1J 788	4 Cyl. 1397cc Turbo Intercooled	8:1 85-88kW (115-120PS)	TD3134
9 1.4	12/81→12/88	C1J 792	4 Cyl. 1397cc	9.25:1 44kW (60PS)	TD3135
9 1.4	12/81→12/88	C1J 796	4 Cyl. 1397cc	9.25:1 44kW (60PS)	TD3136

15-630820-00 WH  B 80.60 C 134.00 D 90.20 E 95.00

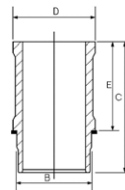

 Includes seals

 Schließt Dichtungen ein

 Inclut des joints

 Incluye los sellos

 Comprende le guarnizioni

16 76.00

Megane III 1.5 dCi	02/09→	K9K 816 Euro 5	4 Cyl. 1461cc	81kW (110PS)	FM38839
Clio Grandtour 1.5 dCi, Clio III 1.5 dCi Modus/Grand Modus 1.5 dCi 75	08/10→ 10/10→	K9K 770 Euro 5	4 Cyl. 1461cc Diesel Turbo Intercooled	17.9:1 55-65kW (75-88PS)	TD25691
Latitude 1.5 dCi	07/10→	K9K 782 Euro 5	4 Cyl. 1461cc Diesel Turbo Intercooled	15.2:1 81kW (110PS)	TD27990
Kangoo BE BOP 1.5 dCi Kangoo Express 1.5 dCi 75 Kangoo Express 1.5 dCi 90 Kangoo/Grand Kangoo 1.5 dCi	06/09→ 09/10→ 11/12→	K9K 808 Euro 5	4 Cyl. 1461cc Diesel Turbo Intercooled	15.6:1 55-66kW (75-90PS)	TD26258
Twingo II 1.5 dCi 75, Twingo II 1.5 dCi 90	10/10→	K9K 820	4 Cyl. 1461cc Diesel Turbo Intercooled	17.9:1 55-63kW (75-86PS)	TD25692





Fluence 1.5 dCi	02/10→	K9K 834			
Megane III Grandtour 1.5 dCi	05/09→		4 Cyl.	15.2:1	
Thalia II 1.5 dCi	01/09→		1461cc	66kW (90PS)	
		Diesel	Turbo Intercooled		TD23742
Fluence 1.5 dCi	02/10→	K9K 836 Euro 5			
Grand Scénic III 1.5 dCi	04/09→		4 Cyl.	15.2:1	
Megane III 1.5 dCi			1461cc	78-81kW (106-110PS)	
Megane III Grandtour 1.5 dCi	02/09→	Diesel	Turbo Intercooled		TD23743
Scénic III 1.5 dCi	04/09→				
Megane III 1.5 dCi	11/08→	K9K H 834 Euro 5			
			4 Cyl.	15.2:1	
			1461cc	66kW (90PS)	
		Diesel	Turbo Intercooled		TD23569
Megane III 1.5 dCi	02/09→	K9K J 836 Euro 5			
			4 Cyl.	15.2:1	
			1461cc	81kW (110PS)	
		Diesel	Turbo Intercooled		TD23567

87-123400-40
87-123407-40

STD
0.50mm

08-123400-30
08-123407-30

STD
0.50mm

14-020650-00 D B 79.10 C 142.00 D 81.00 E 5.00

A 41.70
B- 13.50
BØ 47.00
C 0.43
C 0.25
D 66.00
26x66

2.00
2.00
2.50



CK P
P
CR P

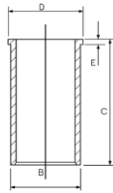

AK KK RT TP

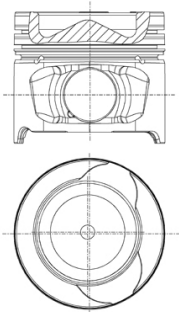

7657-701



17 76.00

Captur 1.5 dCi 90	06/13→	K9K 276				
Clio Grandtour IV 1.5 dCi 90	01/13→		4 Cyl.	18.8:1		
Clio IV 1.5 dCi 90	11/12→		1461cc	62kW (84PS)		
Kangoo/Grand Kangoo 1.5 dCi		Diesel	Turbo Intercooled			TD23876
Captur 1.5 dCi 90	06/13→	K9K 608				
Clio Grandtour IV 1.5 dCi 90	01/13→		4 Cyl.			
Clio IV 1.5 dCi 90	11/12→		1461cc	55-66kW (75-90PS)		
Kangoo/Grand Kangoo 1.5 dCi		Diesel	Turbo Intercooled			TD27682
Clio Grandtour IV 1.5 dCi 75	01/13→	K9K 612				
Clio IV 1.5 dCi 75	11/12→		4 Cyl.			
Thalia II 1.5 dCi	11/12→06/14		1461cc	55kW (75PS)		
Thalia III 1.5 dCi	12/13→	Diesel	Turbo Intercooled			TD27683
Grand Scénic III 1.5 dCi	04/09→	K9K 636 Euro 5				
Kangoo Express 1.5 dCi 110	09/13→		4 Cyl.	15.2:1		
Kangoo/Grand Kangoo 1.5 dCi 110	03/13→		1461cc	81kW (110PS)		
Megane III 1.5 dCi		Diesel	Turbo Intercooled			TD28220
Megane III Grandtour 1.5 dCi	02/09→					
Scénic III 1.5 dCi	04/09→					
Grand Scénic II 1.5 dCi	06/06→11/08	K9K 734				
Megane II 1.5 dCi	05/05→06/08		4 Cyl.	18.8:1		
Megane II 1.5 dCi, Scénic II 1.5 dCi	01/07→		1461cc	74-78kW (103-106PS)		
Megane II Coupé-Cabriolet 1.5 dCi	01/07→06/09	Diesel	Turbo Intercooled			TD22192
Clio Grandtour 1.5 dCi	02/08→	K9K 772				
Clio III 1.5 dCi	06/05→		4 Cyl.	15.6:1		
Modus/Grand Modus 1.5 dCi	05/07→		1461cc	63-76kW (86-103PS)		
		Diesel	Turbo Intercooled			TD23549
Kangoo Express 1.5 dCi		K9K 800				
Kangoo Express 1.5 dCi 85	02/08→		4 Cyl.	18.8:1		
Kangoo/Grand Kangoo 1.5 dCi			1461cc	50-63kW (75-86PS)		
		Diesel	Turbo Intercooled			TD22193
Kangoo Express 1.5 dCi		K9K 812				
Kangoo Express 1.5 dCi 85	02/08→		4 Cyl.	15.6:1		
Kangoo/Grand Kangoo 1.5 dCi			1461cc	60kW (82PS)		
		Diesel	Turbo Intercooled			TD24967
Fluence 1.5 dCi	02/10→	K9K 830				
Grand Scénic III 1.5 dCi	04/09→		4 Cyl.	17.6:1		
Lodgy 1.5 dCi	01/15→		1461cc	63kW (86PS)		
Megane III 1.5 dCi	11/08→	Diesel	Turbo Intercooled			TD25693
Megane III Grandtour 1.5 dCi	03/09→					
Sandero/Stepway II 1.5 dCi	12/13→					
Scénic III 1.5 dCi	04/09→					
Fluence 1.5 dCi	02/10→	K9K 837 Euro 5				
Grand Scénic III 1.5 dCi	04/09→		4 Cyl.	15.2:1		
Megane CC 1.5 dCi	06/10→		1461cc	81kW (110PS)		
Megane III 1.5 dCi	02/09→	Diesel	Turbo Intercooled			TD26246
Megane III Grandtour 1.5 dCi						
Scénic III 1.5 dCi	04/09→					
Kangoo Express 1.5 dCi		K9K 840				
Kangoo Express 1.5 dCi 85	02/08→		4 Cyl.			
Kangoo/Grand Kangoo 1.5 dCi			1461cc	50kW (68PS)		
		Diesel	Turbo Intercooled			TD22194



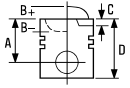

Grand Scénic III 1.5 dCi	11/10→	K9K 846 Euro 5			
Laguna 1.5 dCi	03/12→		4 Cyl.		
Lodgy 1.5 dCi	01/15→		1461cc	70-81kW (95-110PS)	
Megane III 1.5 dCi	07/14→	Diesel	Turbo Intercooled		TD24579
Megane III Grandtour 1.5 dCi	02/09→				
Scénic III 1.5 dCi	11/10→				
Duster 1.5 dCi	06/11→	K9K 884 Euro 5			
			4 Cyl.		
			1461cc	66kW (90PS)	
		Diesel	Turbo Intercooled		TD27697
Megane III 1.5 dCi	02/09→	K9K F 830			
			4 Cyl.	17.6:1	
			1461cc	63kW (86PS)	
		Diesel	Turbo Intercooled		TD23566
Megane III 1.5 dCi	02/09→	K9K G 832			
			4 Cyl.	15.3:1	
			1461cc	78kW (106PS)	
		Diesel	Turbo Intercooled		TD23522
Megane III 1.5 dCi	02/09→	K9K N 837			
			4 Cyl.	15.2:1	
			1461cc	81kW (110PS)	
		Diesel	Turbo Intercooled		TD24968

14-020650-00 D B 79.10 C 142.00 D 81.00 E 5.00

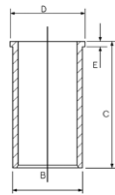

18  **76.00**

Clio II 1.5 dCi	06/01→	K9K 700 Euro 3			
Kangoo 1.5 dCi, Kangoo Express 1.5 dCi	12/01→		4 Cyl.	18.8:1	
Thalia I 1.5 dCi	04/02→		1461cc	48-50kW (65-68PS)	
Thalia II 1.5 dCi	01/09→	Diesel	Turbo Intercooled		TD16219
Clio II 1.5 dCi	06/01→	K9K 702 Euro 3			
Kangoo 1.5 dCi	07/02→		4 Cyl.	18.8:1	
Kangoo Express 1.5 dCi	12/01→		1461cc	48-60kW (65-82PS)	
Thalia I 1.5 dCi	06/01→	Diesel	Turbo Intercooled		TD16344
Clio II 1.5 dCi	06/01→	K9K 704 Euro 3			
Kangoo 1.5 dCi, Kangoo Express 1.5 dCi	12/01→		4 Cyl.	18.8:1	
			1461cc	42-48kW (57-65PS)	
		Diesel	Turbo Intercooled		TD16343
Thalia I 1.5 dCi	04/04→11/09	K9K 706			
			4 Cyl.	18.8:1	
			1461cc	48-58kW (65-79PS)	
		Diesel	Turbo Intercooled		TD20974
Clio II 1.5 dCi	06/01→	K9K 708			
Kangoo 1.5 dCi, Kangoo Express 1.5 dCi	12/01→		4 Cyl.	18.8:1	
			1461cc	48-50kW (65-68PS)	
		Diesel	Turbo Intercooled		TD26047



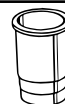

Clio II 1.5 dCi	11/03→	K9K 710 Euro 3			
Kangoo 1.5 dCi	07/02→		4 Cyl.	18.8:1	
Kangoo Express 1.5 dCi	04/03→		1461cc	60kW (82PS)	
		Diesel	Turbo Intercooled		TD17488
Clio Grandtour 1.5 dCi	02/08→	K9K 714 Euro 4			
Clio II 1.5 dCi	04/04→		4 Cyl.	18.8:1	
Clio III 1.5 dCi, Kangoo 1.5 dCi	06/05→		1461cc	50kW (68PS)	
Kangoo Express 1.5 dCi		Diesel	Turbo Intercooled		TD21173
Thalia I 1.5 dCi	02/03→				
Clio II 1.5 dCi	11/03→	K9K 716			
Kangoo Express 1.5 dCi	10/05→		4 Cyl.	18.8:1	
			1461cc	45-60kW (61-82PS)	
		Diesel	Turbo Intercooled		TD22179
Grand Scénic II 1.5 dCi	04/04→	K9K 722 Euro 3			
Megane II 1.5 dCi	11/02→		4 Cyl.	18.8:1	
Scénic II 1.5 dCi	06/03→		1461cc	60-63kW (82-86PS)	
		Diesel	Turbo Intercooled		TD16534
Clio II 1.5 dCi	06/05→	K9K 740 Euro 4			
Pulse 1.5 dCi	01/12→		4 Cyl.	18.8:1	
Sandero/Stepway I 1.5 dCi	02/08→		1461cc	47kW (64PS)	
Thalia I 1.5 dCi	06/05→	Diesel	Turbo Intercooled		TD20446
Thalia II 1.5 dCi	09/08→				
Twingo II 1.5 dCi	03/07→				
Clio III 1.5 dCi	11/07→	K9K 750 Euro 3			
Modus/Grand Modus 1.5 dCi	09/04→		4 Cyl.	18.3:1	
Modus/Grand Modus 1.5 dCi 90	10/10→		1461cc	57-65kW (78-88PS)	
		Diesel	Turbo Intercooled		TD21133
Clio Grandtour 1.5 dCi	02/10→	K9K 752 Euro 3			
Clio III 1.5 dCi	05/05→		4 Cyl.	18.8:1	
Modus/Grand Modus 1.5 dCi	12/04→		1461cc	47-50kW (64-68PS)	
		Diesel	Turbo Intercooled		TD21134
Modus/Grand Modus 1.5 dCi	12/04→	K9K 762 Euro 4			
			4 Cyl.	18.8:1	
			1461cc	50kW (68PS)	
		Diesel	Turbo Intercooled		TD20922
Clio Grandtour 1.5 dCi	02/08→	K9K 768 Euro 4			
Clio III 1.5 dCi	06/05→		4 Cyl.	17.9:1	
Modus/Grand Modus 1.5 dCi	12/04→		1461cc	50kW (68PS)	
		Diesel	Turbo Intercooled		TD18536
Logan I 1.5 dCi	06/11→	K9K 790			
			4 Cyl.	18.3:1	
			1461cc	48kW (65PS)	
		Diesel	Turbo Intercooled		TD21438
Logan EXPRESS 1.5 dCi, Logan I 1.5 dCi	04/07→	K9K 792			
Logan I 1.5 dCi			4 Cyl.	18.3:1	
			1461cc	50kW (68PS)	
		Diesel	Turbo Intercooled		TD21439
Logan I 1.5 dCi	06/11→	K9K 794			
			4 Cyl.	18.3:1	
			1461cc	48-50kW (65-68PS)	
		Diesel	Turbo Intercooled		TD23795







Logan I 1.5 dCi 02/08 → **K9K 796** 4 Cyl. 18.8:1
1461cc **63kW (86PS)**
Diesel **Turbo Intercooled** **TD26080**

87-123400-00 STD **08-123400-00** STD **14-020650-00 D** B 79.10 C 142.00 D 81.00 E 5.00
87-123407-00 0.50mm **08-123407-00** 0.50mm

A 41.69
B- 13.70
BØ 39.70
C 0.60
D 66.05
 25x60

2.00  CK P
2.00  P
2.50  NT

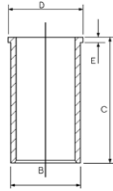

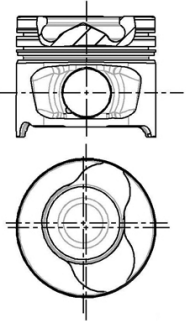

RT TP



87-123400-10 STD **08-123400-00** STD
87-123407-10 0.50mm **08-123407-00** 0.50mm

A 41.82
B- 13.70
BØ 39.70
C 0.60
D 66.05
 26x60

2.00  CK P
2.00  P
2.50  NT

RT TP

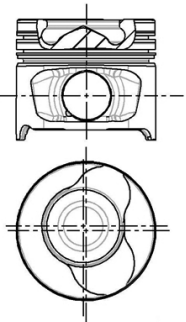

557.503



19  **76.00**

Clio II 1.5 dCi	01/04→	K9K 712 Euro 3	4 Cyl.	18.8:1		
			1461cc	74kW (100PS)		
		Diesel	Turbo Intercooled			TD18419
Clio II 1.5 dCi	02/07→	K9K 718 Euro 4	4 Cyl.	18.8:1		
Kangoo 1.5 dCi, Kangoo Express 1.5 dCi	06/05→		1461cc	62kW (84PS)		
Thalia II 1.5 dCi	09/08→					
Twingo II 1.5 dCi	04/08→	Diesel	Turbo Intercooled			TD21171
Megane II 1.5 dCi	05/05→07/09	K9K 724 Euro 4	4 Cyl.	18.8:1		
Megane II 1.5 dCi, Scénic II 1.5 dCi	05/05→		1461cc	63kW (86PS)		
		Diesel	Turbo Intercooled			TD20988
Megane II 1.5 dCi	10/03→	K9K 728 Euro 3	4 Cyl.	18.8:1		
Scénic II 1.5 dCi	11/03→		1461cc	74kW (101PS)		
		Diesel	Turbo Intercooled			TD20707
Grand Scénic II 1.5 dCi	04/04→	K9K 729 Euro 3	4 Cyl.	18.8:1		
Megane II 1.5 dCi	10/03→		1461cc	74-78kW (101-106PS)		
Scénic II 1.5 dCi	11/03→					
		Diesel	Turbo Intercooled			TD20706
Modus/Grand Modus 1.5 dCi	12/04→	K9K 760 Euro 4	4 Cyl.	18.8:1		
			1461cc	50-63kW (68-86PS)		
		Diesel	Turbo Intercooled			TD21135
Clio Grandtour 1.5 dCi	02/08→	K9K 766 Euro 4	4 Cyl.	17.9:1		
Clio III 1.5 dCi	06/05→		1461cc	63kW (86PS)		
Modus/Grand Modus 1.5 dCi	12/04→					
Scala 1.5 dCi	01/12→	Diesel	Turbo Intercooled			TD18537
Kangoo BE BOP 1.5 dCi 75	09/10→	K9K 802 Euro 4	4 Cyl.	15.6:1		
Kangoo Express 1.5 dCi 85	02/08→		1461cc	55-63kW (75-86PS)		
Kangoo/Grand Kangoo 1.5 dCi						
		Diesel	Turbo Intercooled			TD20830
		K9K G 724	4 Cyl.	18.8:1		
			1461cc	63kW (86PS)		
		Diesel	Turbo Intercooled			TD19692

87-123400-20
87-123407-20

STD
0.50mm

08-123400-00
08-123407-00

STD
0.50mm

14-020650-00 D B 79.10 C 142.00 D 81.00 E 5.00

A 41.70
B- 14.00
BØ 39.70
C 0.43
C 0.25
D 66.00
 26x60

2.00
2.00
2.50



CK P
P
NT

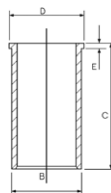

AK KK RT TP

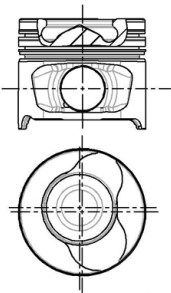

07657-101



20  **76.00**

Megane II 1.5 dCi	05/05→06/08	K9K 732 Euro 4			
Megane II 1.5 dCi, Scénic II 1.5 dCi	05/05→	4 Cyl.	18.8:1		
Megane II Coupé-Cabriolet 1.5 dCi	03/06→06/08	1461cc	78kW (106PS)		
		Diesel	Turbo Intercooled		TD20829
Clio Grandtour 1.5 dCi	02/08→	K9K 764 Euro 4			
Clio III 1.5 dCi	06/05→	4 Cyl.	15.6:1		
Modus/Grand Modus 1.5 dCi	05/05→	1461cc	78kW (106PS)		
		Diesel	Turbo Intercooled		TD18538
Laguna III 1.5 dCi	10/07→	K9K 780 Euro 4			
Laguna III Grandtour 1.5 dCi		4 Cyl.	15.6:1		
		1461cc	76-81kW (103-110PS)		
		Diesel	Turbo Intercooled		TD20817
Kangoo BE BOP 1.5 dCi	06/09→	K9K 804 Euro 4			
Kangoo Express 1.5 dCi 110	09/10→	4 Cyl.	15.6:1		
Kangoo/Grand Kangoo 1.5 dCi	02/08→	1461cc	76-80kW (103-110PS)		
Kangoo/Grand Kangoo 1.5 dCi 110	09/10→	Diesel	Turbo Intercooled		TD20831
Kangoo BE BOP 1.5 dCi	02/09→	K9K 806 Euro 4			
Kangoo Express 1.5 dCi	02/08→	4 Cyl.	15.6:1		
Kangoo/Grand Kangoo 1.5 dCi		1461cc	76kW (103PS)		
		Diesel	Turbo Intercooled		TD20832
Fluence 1.5 dCi	02/10→	K9K 832 Euro 4			
Grand Scénic III 1.5 dCi	02/09→	4 Cyl.	15.3:1		
Megane III 1.5 dCi, Scénic III 1.5 dCi		1461cc	78kW (106PS)		
		Diesel	Turbo Intercooled		TD23521
Grand Scénic II 1.5 dCi	05/05→	K9K P 732			
		4 Cyl.	18.8:1		
		1461cc	78kW (106PS)		
		Diesel	Turbo Intercooled		TD19693

87-123400-30

STD

08-123400-30

STD

14-020650-00 D

B 79.10 C 142.00 D 81.00 E 5.00

87-123407-30

0.50mm

08-123407-30

0.50mm

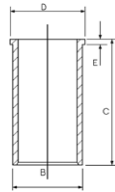

A 41.70

B- 12.80

BØ 49.00

C 0.43

C 0.25

D 66.00

 26x60

2.00

2.00

2.50



CK P

P

CR P

LKZ-Ring®

AK KK RT TP

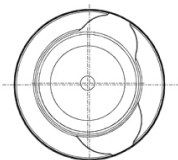
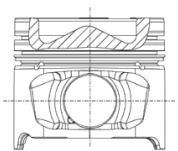

07657-401

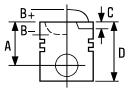

21 76.00

Clio IV 1.5 dCi	K9K 742 Euro 5	4 Cyl.	1461cc	50kW (68PS)	FM18839
	Diesel				

Clio IV 1.5 dCi	K9K 814 Euro 5	4 Cyl.	1461cc	50kW (68PS)	FM28839
	Diesel				

87-123400-50
87-123407-50

STD
0.50mm

08-123400-30
08-123407-30

STD
0.50mm

14-020650-00 D B 79.10 C 142.00 D 81.00 E 5.00

A 41.74
B- 13.50
BØ 47.00
C 0.43
C 0.25
D 66.00
 26x60

2.00
2.00
2.50



CK P
P
CR P

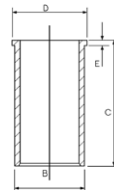

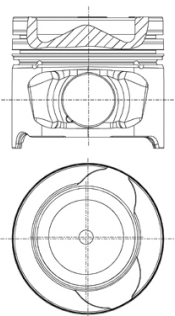

AK RT TP



7658-502

22 78.00

9 1.6 D 11 1.6 D	10/82→12/88 08/83→12/88	F8M 700	4 Cyl.	22.5:1 1595cc	40kW (55PS)	TD3282
		Diesel				

87-335000-10 
87-335007-10 

STD
0.50mm

08-335000-10
08-335003-10
08-335005-10
08-335007-10

STD
0.125mm
0.25mm
0.50mm

14-023730-00 D C 149.00 D 83.50 E 4.50

A 47.25
B- 1.50
D 74.50
 24x67

2.00
2.00
3.00



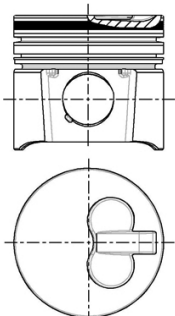
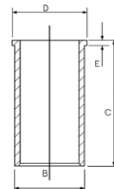

CR P
P
CR P



 No oil-jet cut out

 Ohne Aussparung für
Kühlölspritzdüse

 Sans encoche en bas de jupe pour
le passage de la pissette d'huile sous
pression

 Sin escotadura

 Senza passaggio per
sprizzatore olio



23 78.00

9 1.6 D	10/82 → 12/88	F8M 720			
11 1.6 D	08/83 → 12/88		4 Cyl.	22.5:1	
Rapid 1.6 D	03/86 → 08/98		1595cc	40kW (55PS)	
Super 5 1.6 D	10/84 → 12/96	Diesel			TD3283
9 1.6 D	10/82 → 12/88	F8M 730			
11 1.6 D	08/83 → 12/88		4 Cyl.	22.5:1	
Rapid 1.6 D	03/86 → 08/98		1595cc	40kW (55PS)	
Super 5 1.6 D	04/85 → 12/96	Diesel			TD3284
Rapid 1.6 D	03/86 → 08/98	F8M 736			
			4 Cyl.	22.5:1	
			1595cc	40kW (55PS)	
		Diesel			TD3285
Rapid 1.6 D	03/86 → 08/98	F8M 760			
			4 Cyl.	22.5:1	
			1595cc	40kW (55PS)	
		Diesel			TD3286

87-335000-00
87-335007-00

STD
0.50mm



08-335000-10
08-335003-10
08-335005-10
08-335007-10

STD
0.125mm
0.25mm
0.50mm

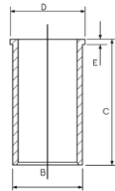
14-023730-00 D C 149.00 D 83.50 E 4.50



A 47.25
B- 1.50
D 74.50
 24x67

2.00 
2.00 
3.00 

CR P
P
CR P

AK

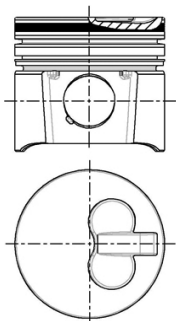



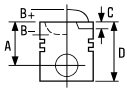

24 79.00

18 1.6	04/82 → 07/86	841 717			
18 Variable 1.6	01/82 → 07/86		4 Cyl.	9.3:1	
			1647cc	54kW (73PS)	
					TD4854
18 1.6	04/78 → 09/82	841.25			
18 Variable 1.6	02/79 → 09/82		4 Cyl.	9.3:1	
			1647cc	58kW (79PS)	
					TD3056
18 1.6	04/78 → 09/82	841.26			
18 Variable 1.6	05/79 → 09/82		4 Cyl.	9.3:1	
			1647cc	58kW (79PS)	
					TD3055
Trafic 1.6	01/83 → 06/86	A1M			
			4 Cyl.	9.3:1	
			1647cc	48-49kW (65-67PS)	
					TD3083



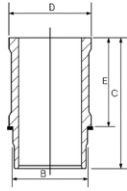

18 1.6	04/82→11/93	A2M 723			
18 Variable 1.6	01/82→11/93		4 Cyl.	9.3:1	
Fuego 1.6	04/83→10/85		1647cc	52-54kW (71-73PS)	TD5055

87-334300-00	STD	08-334300-00	STD	1	B 84.00 C 143.50 D 96.00 E 92.60	89-334300-00
A 40.50		1.75		CR P		
D 65.90		2.00		P		
 21x69		4.00		CR 2		

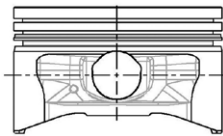

- 1** Liner available in Kit Set only
- 1** Zylinderlaufbüchse nur in Assemblies verfügbar
- 1** Chemise disponible en kit seulement
- 1** Camisas disponible en conjuntos solamente
- 1** Cilindro disponibile solo in kit motore
- 2** Steel
- 2** Stahl
- 2** Acier
- 2** Acero
- 2** Acciaio

25		79.50
Duster 1.6 16V	01/11→	K4M 690
Duster 1.6 Flex	10/11→	4 Cyl.
Logan I 1.6	04/07→	1598cc
Sandero/Stepway I 1.6	12/07→	77-85kW (105-116PS)
		TD22187
Logan I 1.6	04/07→	K4M 697
		4 Cyl.
		1598cc
		77-82kW (105-112PS)
		TD23897
Logan I 1.6 Flex	07/07→	K4M 698
		4 Cyl.
		1598cc
		77kW (105PS)
		TD23898
Megane I 1.6 16V	03/99→08/03	K4M 700
Megane I Classic 1.6 16V		4 Cyl.
Megane I Coach 1.6 16V		1598cc
Megane I Grandtour 1.6 16V		79kW (107PS)
		TD13308
Megane II 1.6 16V	05/06→01/11	
Megane Scenic 1.6 16V	04/98→10/99	
Scénic I 1.6	09/99→09/03	
Megane I 1.6 16V	03/99→08/03	K4M 701
Megane I Classic 1.6 16V		4 Cyl.
Megane I Coach 1.6 16V		1598cc
Megane I Grandtour 1.6 16V		79-81kW (107-110PS)
		TD13309
Megane Scenic 1.6 16V	04/98→10/99	
Scénic I 1.6	06/01→09/03	
Megane I 1.6 16V	03/99→08/03	K4M 704
Megane I 1.6 LPG	10/00→08/02	4 Cyl.
Megane I Grandtour 1.6 16V	03/99→08/03	1598cc
Megane I Grandtour 1.6 BiFuel	03/99→09/00	79-80kW (107-109PS)
		TD16346
Megane Scenic 1.6 16V	04/98→10/99	
Scénic I 1.6 BiFuel	09/99→04/01	



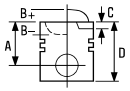

Kangoo 1.6	09/06→12/09	K4M 706			
Kangoo Express 1.6	02/08→12/09		4 Cyl.	10:1	
Scénic I 1.6	09/99→09/03		1598cc	71-80kW (97-109PS)	TD21193
Clio II 1.6 16V	09/98→	K4M 708			
Megane I 1.6 16V	03/99→08/03		4 Cyl.	10:1	
Megane I Classic 1.6 16V			1598cc	75-79kW (102-107PS)	TD16345
Megane I Coach 1.6 16V					
Megane I Grandtour 1.6 16V					
Megane Scenic 1.6 16V	04/98→10/99				
Scénic I 1.6	03/01→09/03				
Scénic I 1.6	03/01→08/03	K4M 709			
			4 Cyl.	10:1	
			1598cc	75-79kW (102-107PS)	TD21194
Laguna II 1.6	03/01→05/05	K4M 710			
Laguna II 1.6 16V	03/01→		4 Cyl.	10:1	
Laguna II Grandtour 1.6	03/01→10/05		1598cc	76-79kW (103-107PS)	TD16214
Laguna II Grandtour 1.6 16V					
Laguna II	03/01→	K4M 711			
Laguna Grandtour 1.6			4 Cyl.	10:1	
			1598cc	79kW (107PS)	TD16215
Megane 1.6 i	03/99→	K4M 712			
			4 Cyl.	10:1	
			1598cc	79kW (107PS)	TD21163
Laguna II 1.6 16V	03/01→	K4M 714			
Laguna II 1.6 Lpg	03/01→05/05		4 Cyl.	10:1	
Laguna II Grandtour 1.6 16V	03/01→		1598cc	79kW (107PS)	TD21164
Laguna II Grandtour 1.6 Bifuel	06/05→12/07				
Laguna II 1.6 16V	02/05→	K4M 716			
Laguna II Grandtour 1.6 16V			4 Cyl.	10:1	
			1598cc	82kW (112PS)	TD21200
Laguna I 1.6 16V, Laguna I Grandtour 1.6 16V	11/97→03/01	K4M 720			
			4 Cyl.	10:1	
			1598cc	79kW (107PS)	TD16269
Laguna I 1.6 16V, Laguna I Grandtour 1.6 16V	11/97→03/01	K4M 724			
			4 Cyl.	10:1	
			1598cc	79kW (107PS)	TD16270
Kangoo 1.6 Flex	01/07→	K4M 730			
			4 Cyl.	10:1	
			1598cc	70kW (95PS)	TD21195
Kangoo 1.6 i 16V	09/01→	K4M 732			
			4 Cyl.	10:1	
			1598cc	66-70kW (90-95PS)	TD20911
19 li 1.6	10/97→06/99	K4M 734			
			4 Cyl.	10:1	
			1598cc	58-66kW (79-90PS)	TD20912



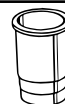

Thalia I 1.6	01/04→12/08	K4M 736	4 Cyl. 1598cc	10:1 79-82kW (107-112PS)	TD21201
Clio II 1.6 16V Thalia I 1.6 16V	09/98→ 04/02→	K4M 740	4 Cyl. 1598cc	10:1 79kW (107PS)	TD18445
Clio II 1.6 16V	09/98→	K4M 742	4 Cyl. 1598cc	10:1 66-79kW (90-107PS)	TD20913
Clio II 1.6 16V Thalia I 1.6 Flex Thalia II 1.6 16V	09/98→ 11/04→02/09 09/08→	K4M 743	4 Cyl. 1598cc	10:1 66-81kW (90-110PS)	TD20914
19 li 1.6 19 li Chamade 1.6 Clio II 1.6 16V Thalia II 1.6 16V	07/98→06/01 10/96→06/01 09/98→ 01/09→	K4M 744 Euro 4	4 Cyl. 1598cc	10:1 55-79kW (75-107PS)	TD19674
Clio II 1.6 16V Thalia II 1.6 16V	09/98→ 01/09→	K4M 745 Euro 4	4 Cyl. 1598cc	10:1 79kW (107PS)	TD19675
Clio II 1.6 Clio II 1.6 16V Clio II 1.6 Hi-Flex, Clio III 1.6 Clio III 1.6 Hi-Flex	11/04→02/09 09/98→ 01/05→02/10 05/05→02/10	K4M 748	4 Cyl. 1598cc	10:1 79-86kW (107-117PS)	TD11567
Kangoo 1.6 16V Kangoo Express 1.6 16V	06/01→	K4M 752	4 Cyl. 1598cc	10:1 70kW (95PS)	TD16370
Megane II 1.6 Megane II 1.6 16V Megane II Coupé-Cabriolet 1.6 Megane II Coupé-Cabriolet 1.6 16V	08/03→ 11/02→08/09 09/03→03/09 01/06→06/08	K4M 760	4 Cyl. 1598cc	10:1 81-83kW (110-113PS)	TD16532
Modus/Grand Modus 1.6	12/04→	K4M 790	4 Cyl. 1598cc	10:1 82kW (112PS)	TD18898
Kangoo BE BOP 1.6 Kangoo Express 1.6 16V Kangoo/grand Kangoo 1.6 Kangoo/Grand Kangoo 1.6 16V	02/09→ 02/08→ 01/10→	K4M 830 Euro 4	4 Cyl. 1598cc	9.8:1 70-78kW (95-106PS)	TD23581
Kangoo/Grand Kangoo 1.6 16V	02/08→	K4M 831 Euro 4	4 Cyl. 1598cc	9.8:1 78-79kW (105-107PS)	TD26526





Kangoo Express 1.6 16V LPG Kangoo/Grand Kangoo 1.6 16V Hi-Flex	02/08 →	K4M 834 Euro 4	4 Cyl. 1598cc	9.8:1 72-78kW (98-106PS)	TD26128
--	---------	-----------------------	-------------------------	------------------------------------	----------------

87-104200-30	STD	08-104200-00	STD		
87-104207-40	0.50mm	08-104207-00	0.50mm		
A 31.70		1.50		CR P	
B- 1.30		1.50		P	
C 1.60		2.50		CR 1	
D 55.00					
20x62					
1 Steel	1 Stahl	1 Acier	1 Acero	1 Acciaio	

26 79.50

Logan I 1.4 Sandero/Stepway I 1.4	09/04 → 02/09 →	K7J 710	4 Cyl. 1390cc	9.5:1 55kW (75PS)	TD18138
---	--------------------	----------------	-------------------------	-----------------------------	----------------

Clio, Logan, Sandero 1.4 i		K7J 714	4 Cyl. 1390cc	9.5:1 53kW (72PS)	TD23530
-----------------------------------	--	----------------	-------------------------	-----------------------------	----------------

87-104200-40	STD	08-104200-00	STD		
87-104207-40	0.50mm	08-104207-00	0.50mm		
A 35.83		1.50		CR P	
D 58.00		1.50		P	
19x62		2.50		CR 1	
1 Steel	1 Stahl	1 Acier	1 Acero	1 Acciaio	



27 79.50

Megane I 1.6 e	01/96→03/99	K7M 702				
Megane I 1.6 LPG	08/95→03/99		4 Cyl.	9.5:1		
Megane I Classic 1.6 e	09/96→03/99		1598cc	66kW (90PS)		
Megane I Coach 1.6 e	03/96→03/99					TD4876
Megane I Grandtour 1.6 e	03/99→08/03					
Megane Scenic 1.6 e	10/96→10/99					
19 li Chamade 1.6	10/96→06/01	K7M 703				
Megane I 1.6 e	01/96→03/99		4 Cyl.	9.5:1		
Megane I Classic 1.6 e	09/96→03/99		1598cc	66kW (90PS)		
Megane I Coach 1.6 e	03/96→03/99					TD4877
Megane I Grandtour 1.6 e	03/99→08/03					
Megane Scenic 1.6 e	10/96→10/99					
Logan EXPRESS 1.6	04/07→	K7M 710				
Logan I 1.6	09/04→		4 Cyl.	9.5:1		
Sandero/Stepway I 1.6	12/07→		1598cc	64-75kW (87-102PS)		TD18139
Megane I 1.6 i	01/96→03/99	K7M 720				
Megane I Classic 1.6 i	09/96→03/99		4 Cyl.	9:1		
Megane Scenic 1.6 i	01/97→09/99		1598cc	55kW (75PS)		TD4878
Clio II 1.6	09/98→05/05	K7M 744				
			4 Cyl.	9.7:1		
			1598cc	66kW (90PS)		TD14332
Clio II 1.6	09/98→05/05	K7M 745				
			4 Cyl.	9.7:1		
			1598cc	66kW (90PS)		TD14333
Kangoo 1.6, Kangoo Express 1.6	09/99→06/01	K7M 746				
Thalia I 1.6	03/98→		4 Cyl.	9.7:1		
			1598cc	66kW (90PS)		TD20918
Megane I 1.6 e	01/96→03/99	K7M 790				
Megane I Classic 1.6 e	09/96→03/99		4 Cyl.	9.6:1		
			1598cc	66kW (90PS)		TD4879

87-104200-00 

STD

08-104200-00

STD

87-104207-00 

0.50mm

08-104207-00

0.50mm

A 31.80

B+ 2.55

D 56.30

 19x63

1.50

1.50

2.50



CR P

P

CR 

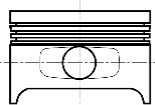
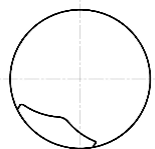



87-104200-10 ②
87-104207-10 ②

STD
 0.50mm

08-104200-00
08-104207-00

STD
 0.50mm

A 31.80
B+ 2.55
D 56.30
 19x63

1.50
 1.50
 2.50



CR P
 P
 CR ③

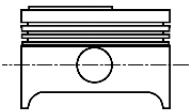
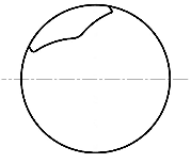

- ① To cylinder 1 & 2
- ② To cylinder 3 & 4
- ③ Steel

- ① zum Zylinder 1 & 2
- ② zum Zylinder 3 & 4
- ③ Stahl

- ① sous cylindre 1 & 2
- ② sous cylindre 3 & 4
- ③ Acier

- ① A cilindro 1 & 2
- ② A cilindro 3 & 4
- ③ Acero

- ① al cilindro 1 & 2
- ② al cilindro 3 & 4
- ③ Acciaio

28 **79.50**

Logan 1.6 i

07/04 →

K7M 732 Euro 4

4 Cyl.
1598cc

9.5:1
64kW (87PS)

TD23532

87-443700-00
87-443707-00

STD
 0.50mm

08-443700-00
08-443707-00

STD
 0.50mm

A 28.31
D 52.81
 19x62

1.50
 1.50
 2.50



CR P
 P
 CR ①

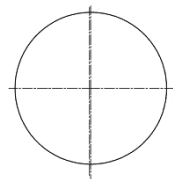
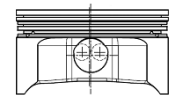

- ① Steel

- ① Stahl

- ① Acier

- ① Acero

- ① Acciaio



29  **80.00**





Trafic 1.9 D	06/97→03/01	F8Q 606	4 Cyl. 1870cc	21.5:1 44kW (60PS)	TD9690
		Diesel			
Megane I 1.9 D Eco	01/96→08/03	F8Q 620	4 Cyl. 1870cc	21.5:1 47kW (64PS)	TD4867
Megane I Classic 1.9 D	09/96→08/03				
		Diesel			
Express 1.9 D	07/95→10/97	F8Q 640	4 Cyl. 1870cc	21.5:1 40kW (54PS)	TD5510
Rapid 1.9 D	09/94→03/98				
		Diesel			
Clio I 1.9 D	05/96→02/98	F8Q 676	4 Cyl. 1870cc	21.5:1 48kW (65PS)	TD23895
		Diesel			
19 I 1.9 D	01/88→12/92	F8Q 706	4 Cyl. 1870cc	21.5:1 47-48kW (64-65PS)	TD3287
19 I Chamade 1.9 D	10/89→04/92				
19 II 1.9 D	03/92→12/95				
		Diesel			
21 1.9 D	03/86→08/94	F8Q 710	4 Cyl. 1870cc	21.5:1 47kW (64PS)	TD3288
		Diesel			
21 1.9 D	03/86→08/94	F8Q 714	4 Cyl. 1870cc	21.5:1 47-48kW (64-65PS)	TD3289
		Diesel			
Rapid 1.9 D	09/91→03/98	F8Q 722	4 Cyl. 1870cc	21.5:1 47-48kW (64-67PS)	TD3290
		Diesel			
Express 1.9 D	07/95→10/99	F8Q 724	4 Cyl. 1870cc	21.5:1 47-48kW (64-67PS)	TD3291
Rapid 1.9 D	09/91→03/98				
		Diesel			
Clio I 1.9 D	01/91→09/98	F8Q 730	4 Cyl. 1870cc	21.5:1 47-48kW (64-65PS)	TD4868
		Diesel			
Clio I 1.9 D	01/91→09/98	F8Q 732	4 Cyl. 1870cc	21.5:1 47-48kW (64-65PS)	TD4869
		Diesel			
19 I 1.9 D	01/88→12/92	F8Q 742	4 Cyl. 1870cc	21.5:1 47-48kW (64-65PS)	TD3295
19 I Chamade 1.9 D	10/89→04/92				
19 II 1.9 D	03/92→12/95				
19 II Chamade 1.9 D	04/92→12/95				
		Diesel			
Rapid 1.9 D	09/91→03/98	F8Q 774	4 Cyl. 1870cc	21.5:1 47-48kW (64-67PS)	TD3298
		Diesel			







Express 1.9 D	07/95 → 10/99	F8Q 776			
Rapid 1.9 D	09/91 → 03/98		4 Cyl.	21.5:1	
			1870cc	47-48kW (64-67PS)	
		Diesel			TD3299

87-336500-00	STD	08-336500-00	STD
87-336505-00	0.25mm	08-336505-00	0.25mm
87-336507-00	0.50mm	08-336507-00	0.50mm
87-336510-00	0.80mm	08-336510-00	0.80mm

A	42.35	2.00	 MO P
B-	0.70	2.00	 P
D	70.50	3.00	 CR P
	24x63		

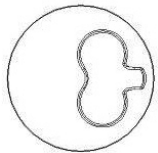
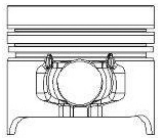
RT



30  **80.00**





19 I 1.9 DT	09/90 → 04/92	F8Q 610	4 Cyl.	20.5:1	
		Diesel	1870cc	66-69kW (90-94PS)	
			Turbo		TD19666
19 I 1.9 DT, 19 I Chamade 1.9 TD	09/90 → 04/92	F8Q 740	4 Cyl.	20.5:1	
19 I Chamade 1.9 DT			1870cc	66-68kW (90-93PS)	
19 II 1.9 dT	03/92 → 12/95	Diesel	Turbo		TD3294
19 II 1.9 dT, 19 II Chamade 1.9 dT	04/92 → 12/95	F8Q 744	4 Cyl.	20.5:1	
19 II Chamade 1.9 D	05/92 → 11/95	Diesel	1870cc	66-68kW (90-92PS)	
			Turbo		TD3296
Megane I 1.9 dT	01/96 →	F8Q 768	4 Cyl.	20.5:1	
		Diesel	1870cc	66-69kW (90-94PS)	
			Turbo		TD19234
Megane I 1.9 D	04/96 → 02/01	F8Q 784	4 Cyl.	20.5:1	
Megane I 1.9 dT	01/96 → 08/03		1870cc	66-69kW (90-94PS)	
Megane I 1.9 TDI, Megane I Classic 1.9 TDI	09/96 → 08/03	Diesel	Turbo Intercooled		TD4870
Megane I Classic 1.9 dT					
Megane Scenic 1.9 dT	01/97 → 09/99				
Megane I 1.9 D	04/96 → 02/01	F8Q 785	4 Cyl.	20.5:1	
Megane I 1.9 dT	01/96 → 08/03		1870cc	68-70kW (92-95PS)	
Megane I 1.9 TDI, Megane I Classic 1.9 TDI	09/96 → 08/03	Diesel	Turbo		TD22363
Megane I Classic 1.9 dT					
Megane Scenic 1.9 dT	01/97 → 09/99				





Megane I 1.9 dT	01/96→08/03	F8Q 786			
Megane I Classic 1.9 dT	09/96→08/03		4 Cyl.	20.5:1	
Megane Scenic 1.9 dT	01/97→09/99		1870cc	66kW (90PS)	
		Diesel	Turbo		TD16352

87-103500-00	STD	08-103500-00	STD
87-103507-00	0.50mm	08-103507-00	0.50mm

A	41.71	2.50		CK P
B-	0.70	2.00		NT
D	66.69	3.00		CR P
	26x67			

AK KK RT

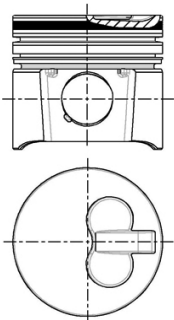





31 80.00

Clio II 1.9 D	09/98→	F8Q 630			
Kangoo D 65 1.9, Kangoo Express D 65 1.9	08/97→		4 Cyl.	21.5:1	
Thalia I 1.9 D	02/98→05/01		1870cc	47kW (64PS)	
		Diesel			TD9626

Clio II 1.9 D	02/00→05/01	F8Q 632			
Kangoo 1.9 RXED	09/99→06/01		4 Cyl.	21.5:1	
Kangoo D 65 1.9	08/97→		1870cc	47-48kW (64-65PS)	
Kangoo Express 1.9 D	09/99→06/03	Diesel			TD17431
Kangoo Express D 65 1.9	08/97→				

Clio II 1.9 D	03/99→01/00	F8Q 662			
Kangoo D 55 1.9, Kangoo Express D 55 1.9	08/97→		4 Cyl.	21.5:1	
		Diesel	1870cc	40-48kW (54-65PS)	
					TD9625

87-336500-10	STD	08-336500-00	STD
87-336507-10	0.50mm	08-336505-00	0.25mm
		08-336507-00	0.50mm
		08-336510-00	0.80mm

A	42.25	2.00		MO P
B-	1.58	2.00		P
D	70.50	3.00		CR P
	24x63			

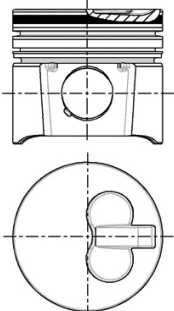

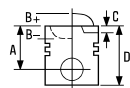

32  **80.00**



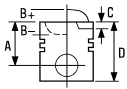

Laguna II 1.9 dCi	03/01→	F9Q 650	4 Cyl. 1870cc	18.3:1 88kW (120PS)	
		Diesel	Turbo Intercooled		TD21223
Laguna II 1.9 dCi	03/04→	F9Q 664	4 Cyl. 1870cc	18.3:1 68kW (92PS)	
Laguna II Grandtour 1.9 dCi	08/03→				TD19677
		Diesel	Turbo Intercooled		
Laguna II 1.9 dCi	03/01→	F9Q 670	4 Cyl. 1870cc	18.3:1 88kW (120PS)	
Laguna II Grandtour 1.9 dCi					TD21224
		Diesel	Turbo Intercooled		
Laguna II 1.9 dCi	03/01→	F9Q 674	4 Cyl. 1870cc	18.3:1 81-88kW (110-120PS)	
Laguna II Grandtour 1.9 dCi					TD21225
		Diesel	Turbo Intercooled		
Laguna II 1.9 dCi	03/01→	F9Q 750	4 Cyl. 1870cc	19:1 88kW (120PS)	
Laguna II Grandtour 1.9 dCi					TD17028
		Diesel	Turbo Intercooled		
Laguna II 1.9 dCi	03/01→	F9Q 756	4 Cyl. 1870cc	19:1 88kW (120PS)	
Laguna II Grandtour 1.9 dCi					TD17064
		Diesel	Turbo Intercooled		
Laguna II 1.9 dCi	01/05→	F9Q 758	4 Cyl. 1870cc	17:1 81-96kW (110-130PS)	
Laguna II Grandtour 1.9 dCi					TD19678
		Diesel	Turbo Intercooled		
Laguna II 1.9 dCi	05/05→	F9Q 759	4 Cyl. 1870cc	17:1 85-96kW (116-130PS)	
Laguna II Grandtour 1.9 dCi					TD19679
		Diesel	Turbo Intercooled		
Megane II 1.9 dCi	11/02→	F9Q 800	4 Cyl. 1870cc	18.3:1 88kW (120PS)	
Megane II Coupé-Cabriolet 1.9 dCi	09/03→03/09				TD16535
		Diesel	Turbo Intercooled		
Megane II 1.9 dCi	11/02→	F9Q 808	4 Cyl. 1870cc	18.3:1 66-75kW (90-102PS)	
					TD21147
		Diesel	Turbo Intercooled		
Grand Scénic II 1.9 dCi	04/04→	F9Q 812	4 Cyl. 1870cc	18.3:1 85-88kW (116-120PS)	
Scénic II 1.9 D	06/06→				
Scénic II 1.9 dCi	06/03→				TD20392
		Diesel	Turbo Intercooled		
Grand Scénic II 1.9 dCi	05/05→	F9Q 816	4 Cyl. 1870cc	18.3:1 81-96kW (110-131PS)	
Megane II 1.9 dCi	11/02→12/09				
Megane II 1.9 dCi, Scénic II 1.9 dCi	05/05→				TD22184
Megane II Coupé-Cabriolet 1.9 dCi	09/03→03/09	Diesel	Turbo Intercooled		
Grand Scénic II 1.9 dCi	05/05→	F9Q 818	4 Cyl. 1870cc	18.3:1 81-96kW (110-131PS)	
Megane II 1.9 dCi	11/02→12/09				
Megane II 1.9 dCi, Scénic II 1.9 dCi	05/05→				TD22185
Megane II Coupé-Cabriolet 1.9 dCi	09/03→03/09	Diesel	Turbo Intercooled		





Espace IV 1.9 dCi	11/02→	F9Q 820	4 Cyl.	18.3:1	
			1870cc	85-88kW (115-120PS)	
		Diesel	Turbo Intercooled		TD18287
Espace IV 1.9 dCi	11/02→	F9Q 826	4 Cyl.	18.3:1	
			1870cc	88kW (120PS)	
		Diesel	Turbo Intercooled		TD18288

87-422300-00	STD	08-422300-00	STD
87-422307-00	0.50mm	08-422307-00	0.50mm

A	47.04	2.50		MO P
B-	17.80	2.00		P
BØ	38.00	3.00		CR P
C	0.75			
D	77.00			
	28x60			

AK KK RT TP

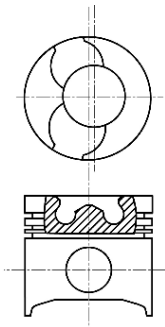

33  **80.00**

Laguna I 1.9 dTi, Laguna I Grandtour 1.9 dTi	10/97→03/01	F9Q 710	4 Cyl.	18.3:1	
			1870cc	72kW (98PS)	
		Diesel	Turbo Intercooled		TD16190
Laguna I 1.9 dTi, Laguna I Grandtour 1.9 dTi	10/97→03/01	F9Q 717	4 Cyl.	18.3:1	
			1870cc	72-75kW (98-102PS)	
		Diesel	Turbo Intercooled		TD21136
Laguna I 1.9 dCi, Laguna I Grandtour 1.9 dCi	09/99→03/01	F9Q 718	4 Cyl.	18.3:1	
Laguna II 1.9 dCi	03/01→		1870cc	79kW (107PS)	
Laguna II Grandtour 1.9 dCi			Turbo Intercooled		TD16192
Megane I 1.9 dTi, Megane I Classic 1.9 dTi	03/97→02/01	F9Q 730	4 Cyl.	18.3:1	
Megane Scenic 1.9 dTi	04/97→09/99		1870cc	72kW (98PS)	
		Diesel	Turbo Intercooled		TD11427
Megane I 1.9 dCi	03/99→08/03	F9Q 732	4 Cyl.	18.3:1	
Megane I Classic 1.9 dCi	02/01→08/03		1870cc	74-77kW (101-105PS)	
Megane I Coach 1.9 dCi	03/99→08/03		Turbo Intercooled		TD16347
Megane I Grandtour 1.9 dCi		Diesel			
Scénic I 1.9 dCi	09/99→08/03				
Scénic I 1.9 dCi RX4	12/02→08/03				



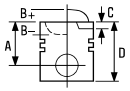

Megane I 1.9 dCi	02/01→08/03	F9Q 733			
Megane I Classic 1.9 dCi	03/99→08/03		4 Cyl.	19:1	
Megane I Coach 1.9 dCi	02/01→08/03		1870cc	75-77kW (102-105PS)	
Megane I Grandtour 1.9 dCi		Diesel	Turbo		TD16363
Scénic I 1.9 dCi	09/99→08/03				
Megane I 1.9 dTi, Megane I Classic 1.9 dTi	03/97→02/01	F9Q 734			
Megane I Coach 1.9 dTi			4 Cyl.	18.3:1	
Megane Scenic 1.9 dTi	04/97→09/99		1870cc	72kW (98PS)	
Scénic I 1.9 dTi	09/99→08/03	Diesel	Turbo Intercooled		TD11428
Megane I 1.9 dTi, Megane I Classic 1.9 dTi	03/97→02/01	F9Q 736			
Megane I Coach 1.9 dTi			4 Cyl.	18.3:1	
Megane I Grandtour 1.9 dTi	03/99→02/01		1870cc	72kW (98PS)	
Scénic I 1.9 dTi	09/99→08/03	Diesel	Turbo		TD16354
Megane I 1.9 dCi	03/99→08/03	F9Q 738			
Megane I Classic 1.9 dCi	02/01→08/03		4 Cyl.	19:1	
Megane I Coach 1.9 dCi	03/99→09/00		1870cc	74-79kW (101-107PS)	
Megane I Grandtour 1.9 dCi	02/01→08/03	Diesel	Turbo Intercooled		TD21137
Scénic I 1.9 dCi RX4	11/00→08/03	F9Q 740			
			4 Cyl.	18.3:1	
			1870cc	75kW (102PS)	
		Diesel	Turbo Intercooled		TD16341
Megane I 1.9 dTi, Megane I Classic 1.9 dTi	02/01→08/03	F9Q 744			
Megane I Grandtour 1.9 dTi, Scénic I 1.9 dTi			4 Cyl.	19:1	
			1870cc	59kW (80PS)	
		Diesel	Turbo		TD16361
Scénic I 1.9 dCi RX4	12/02→08/03	F9Q 748			
			4 Cyl.	19:1	
			1870cc	74-79kW (101-107PS)	
		Diesel	Turbo Intercooled		TD21138
Laguna II 1.9 dCi	06/01→	F9Q 752			
Laguna II Grandtour 1.9 dCi			4 Cyl.	19:1	
			1870cc	74-77kW (101-105PS)	
		Diesel	Turbo Intercooled		TD21139
Laguna II 1.9 dCi	03/01→	F9Q 754			
Laguna II Grandtour 1.9 dCi			4 Cyl.	19:1	
			1870cc	74-79kW (101-107PS)	
		Diesel	Turbo Intercooled		TD20841
Trafic II 1.9 dCi		F9Q 760			
Trafic II 1.9 dCi 80	03/01→		4 Cyl.	19:1	
Trafic II 1.9 dCi 100			1870cc	60-75kW (82-102PS)	
		Diesel	Turbo Intercooled		TD16529
Trafic II 1.9 dCi	04/01→07/03	F9Q 762			
Trafic II 1.9 dCi 80	03/01→		4 Cyl.	19:1	
			1870cc	60kW (82PS)	
		Diesel	Turbo		TD18691
Master II 1.9 dTi	09/00→	F9Q 770			
			4 Cyl.	18.3:1	
			1870cc	59kW (80PS)	
		Diesel	Turbo		TD15688
Master II 1.9 dCi 80	11/01→	F9Q 772			
			4 Cyl.	18.3:1	
			1870cc	60kW (82PS)	
		Diesel	Turbo		TD16304





Master II 1.9 dCi 80	11/01→	F9Q 774	4 Cyl. 1870cc Diesel	18.3:1 60kW (82PS)	TD19370
Clio II 1.9 DTi Kangoo 1.9 dTi, Kangoo Express 1.9 dTi	12/99→05/05 02/00→	F9Q 780	4 Cyl. 1870cc Diesel	18.3:1 59kW (80PS) Turbo Intercooled	TD16339
Kangoo 1.9 dCi Kangoo Express 1.9 dCi	10/01→	F9Q 782	4 Cyl. 1870cc Diesel	18.3:1 59-62kW (80-84PS) Turbo Intercooled	TD17498
Kangoo 1.9 dCi Kangoo Express 1.9 dCi	10/01→	F9Q 790	4 Cyl. 1870cc Diesel	19:1 59-62kW (80-84PS) Turbo	TD16358
Scénic I 1.9 dCi RX4	12/02→08/03	F9Q 796	4 Cyl. 1870cc Diesel	19:1 75kW (102PS) Turbo Intercooled	TD24972

87-101500-00
87-101507-00

STD
0.50mm

08-101500-00
08-101507-00

STD
0.50mm

14-020280-00 D

B 83.00 C 155.00 D 85.00 E 5.00

A 47.06
B- 17.80
BØ 38.00
C 0.75
D 77.00
 28x60

→01/00

2.50
2.00
3.00



P
P
CR P

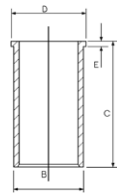

AK RT TP

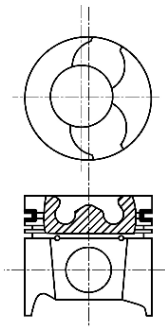

34  **80.00**

Megane I 1.9 dTi, Megane I Classic 1.9 dTi	03/97→02/01	F9Q 731	4 Cyl. 1870cc Diesel	18.3:1 72kW (98PS)	TD16353
Megane I Coach 1.9 dTi	03/99→02/01				
Megane I Grandtour 1.9 dTi	09/99→08/03				

14-020280-00 D

B 83.00 C 155.00 D 85.00 E 5.00

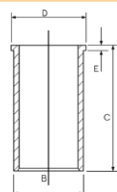



35  **81.00**

Trafic 1.7	08/92→08/94	F1N 720	4 Cyl. 1721cc	9.5:1 50kW (68PS)	TD3216
Trafic 1.7	06/86→08/94	F1N 722	4 Cyl. 1721cc	9.5:1 50kW (68PS)	TD3217
Trafic 1.7	06/86→08/94	F1N 724	4 Cyl. 1721cc	9.5:1 50-51kW (68-69PS)	TD3218
9 1.7, 11 1.7	10/86→12/88	F2N 708	4 Cyl. 1721cc	10:1 65kW (88PS)	TD3221
9 1.7, 11 1.7 21 1.7	10/86→12/88 03/86→04/95	F2N 710	4 Cyl. 1721cc	10:1 65kW (88PS)	TD3222
21 1.7	03/86→05/93	F2N 712	4 Cyl. 1721cc	9.2:1 55kW (75PS)	TD3224
19 I 1.7 19 I Chamade 1.7 19 II Chamade 1.7	09/88→04/92 09/88→12/92 01/93→08/95	F2N 720	4 Cyl. 1721cc	9.5:1 65-68kW (88-92PS)	TD4862
19 I 1.7 19 I Chamade 1.7 19 II Chamade 1.7	07/88→04/92 09/88→12/92 01/93→08/95	F2N 721	4 Cyl. 1721cc	9.5:1 68-69kW (92-94PS)	TD3228
19 I 1.7 19 I Chamade 1.7 19 II Chamade 1.7	07/88→04/92 09/88→12/92 01/93→08/95	F2N 726	4 Cyl. 1721cc	9.5:1 68kW (92PS)	TD3231
19 I 1.7 19 I Chamade 1.7 19 II Chamade 1.7	07/88→04/92 09/88→12/92 01/93→08/95	F2N 727	4 Cyl. 1721cc	9.5:1 68kW (92PS)	TD3232
21 1.7	03/86→05/93	F2N 728	4 Cyl. 1721cc	9.2:1 55kW (75PS)	TD3233
Super 5 1.7	06/87→03/95	F2N 740	4 Cyl. 1721cc	10:1 64-66kW (87-90PS)	TD3236
11 1.7 Super 5 1.7	06/87→12/88 06/87→03/95	F2N 742	4 Cyl. 1721cc	10:1 64-66kW (87-90PS)	TD4861





21 1.7	06/86→02/94	F2N 750	4 Cyl. 1721cc	9.2:1 54kW (73PS)	TD3238
21 1.7	06/87→04/89	F2N 752	4 Cyl. 1721cc	10:1 64kW (87PS)	TD3239
Clio I 1.7	01/91→12/93	F2N 770	4 Cyl. 1721cc	9.5:1 66-68kW (90-92PS)	TD3242
Super 5 1.7 I	10/86→08/91	F3N 702	4 Cyl. 1721cc	10:1 68-69kW (92-94PS)	TD3249
Super 5 1.7	10/86→03/95	F3N 716	4 Cyl. 1721cc	10:1 54-55kW (73-75PS)	TD3251
Super 5 1.7	10/86→03/95	F3N 717	4 Cyl. 1721cc	10:1 54-55kW (73-75PS)	TD3252
9 1.7 11 1.7	10/86→12/88 10/84→12/88	F3N 718	4 Cyl. 1721cc	10:1 54-55kW (73-75PS)	TD4863
21 1.7 Super 5 1.7 I	03/86→06/94 10/86→08/91	F3N 722	4 Cyl. 1721cc	10:1 66-70kW (90-95PS)	TD3254
21 1.7	03/86→06/94	F3N 723	4 Cyl. 1721cc	10:1 66-70kW (90-95PS)	TD3255
21 1.7	07/86→02/94	F3N 726	4 Cyl. 1721cc	10:1 54kW (73PS)	TD3256
19 I 1.7 19 I Chamade 1.7 19 II 1.7, 19 II Chamade 1.7	09/88→04/92 10/89→04/92 04/92→12/95	F3N 740	4 Cyl. 1721cc	10:1 54-55kW (73-75PS)	TD3257
19 I 1.7 19 I Chamade 1.7 19 II 1.7, 19 II Chamade 1.7	09/88→04/92 10/89→04/92 04/92→12/95	F3N 741	4 Cyl. 1721cc	10:1 54-55kW (73-75PS)	TD3258
19 I 1.7 19 I Chamade 1.7 19 II 1.7 19 II Chamade 1.7	09/88→04/92 07/88→04/92 04/92→09/93 04/92→12/95	F3N 742	4 Cyl. 1721cc	10:1 66-70kW (90-95PS)	TD3259









19 I 1.7	09/88 → 04/92	F3N 743		
19 I Chamade 1.7	07/88 → 04/92		4 Cyl.	10:1
19 II 1.7	04/92 → 12/95		1721cc	66kW (90PS)
19 II Chamade 1.7	04/92 → 12/95			TD3260

87-335100-10	STD	08-335100-00	STD
87-335107-10	0.50mm	08-335105-00	0.25mm
		08-335107-00	0.50mm

A 44.05
B- 13.87
D 70.00
 21x65

1.75  MO P
 2.00  P
 3.00  CR 

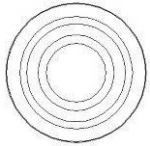
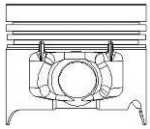

 Steel

 Stahl

 Acier

 Acero

 Acciaio





36 82.00

19 I 1.8 16V	06/89 → 04/92	F7P 700		
19 I Chamade 1.8 16V	06/89 → 08/90		4 Cyl.	10:1
			1763cc	101-103kW (137-140PS)
				TD3277

19 I 1.8 16V	06/89 → 04/92	F7P 704		
19 I Chamade 1.8 16V	10/89 → 04/92		4 Cyl.	10:1
19 II 1.8 16V	04/92 → 06/96		1763cc	99-101kW (135-137PS)
19 II Chamade 1.8 16V	04/92 → 12/95			TD3278

Clio 16V	03/01 → 03/96	F7P 720		
			4 Cyl.	10:1
			1763cc	101-103kW (137-140PS)
				TD3279

Clio I 1.8 16V	01/91 → 03/96	F7P 722		
			4 Cyl.	10:1
			1763cc	99kW (135PS)
				TD3280

87-336600-00	STD	08-336600-00	STD
A 35.45		1.50	 MO P
D 56.00		1.50	 P
 21x59		3.00	 P

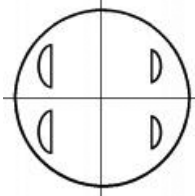
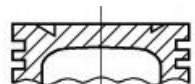

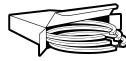

37  **84.00**





Grand Scénic III 2.0 dCi	04/09→	M9R 610				
Megane CC 2.0 dCi	06/10→		4 Cyl.	15.5:1		
Megane III 2.0 dCi	04/09→		1995cc	118-120kW (160-163PS)		
Megane III Grandtour 2.0 dCi		Diesel	Turbo Intercooled			TD23557
Scénic III 2.0 dCi						
Grand Scénic III 2.0 dCi	02/09→	M9R 615				
Megane III 2.0 dCi	04/09→		4 Cyl.	15.5:1		
Megane III Grandtour 2.0 dCi	10/10→		1995cc	110kW (150PS)		
Scénic III 2.0 dCi	02/09→	Diesel	Turbo Intercooled			TD23559
Trafic II 2.0 dCi 90	08/06→	M9R 630				
Trafic II 2.0 dCi 115			4 Cyl.	15.5:1		
			1995cc	66-84kW (90-114PS)		
		Diesel	Turbo Intercooled			TD26729
Trafic II 2.0 dCi 115	08/06→	M9R 692 Euro 5				
			4 Cyl.	15.5:1		
			1995cc	84kW (114PS)		
		Diesel	Turbo Intercooled			TD26569
Laguna II 2.0 dCi	10/07→	M9R 828				
			4 Cyl.	15.7:1		
			1995cc	131kW (178PS)		
		Diesel	Turbo Intercooled			TD31477
Laguna II 2.0 dCi	10/07→	M9R 854				
			4 Cyl.	15.7:1		
			1995cc	96-110kW (131-150PS)		
		Diesel	Turbo Intercooled			TD31478
Koleos 2.0 dCi	09/08→	M9R 856				
			4 Cyl.	15.7:1		
			1995cc	110kW (150PS)		
		Diesel	Turbo Intercooled			TD26249
Laguna II 2.0 dCi	10/07→	M9R 857				
			4 Cyl.	15.7:1		
			1995cc	127kW (173PS)		
		Diesel	Turbo Intercooled			TD31479
Laguna II 2.0 dCi	10/07→	M9R 858				
			4 Cyl.	15.7:1		
			1995cc	110-127kW (150-173PS)		
		Diesel	Turbo Intercooled			TD31480
Laguna II 2.0 dCi	10/07→	M9R 859				
			4 Cyl.	15.7:1		
			1995cc	127kW (173PS)		
		Diesel	Turbo Intercooled			TD31481
Koleos 2.0 dCi	09/08→	M9R 862				
			4 Cyl.	15.7:1		
			1995cc	110kW (150PS)		
		Diesel	Turbo Intercooled			TD26255
Laguna II 2.0 dCi	10/07→	M9R 864				
			4 Cyl.	15.7:1		
			1995cc	127kW (173PS)		
		Diesel	Turbo Intercooled			TD26256
Koleos 2.0 dCi	09/08→	M9R 865				
			4 Cyl.	15.7:1		
			1995cc	110kW (150PS)		
		Diesel	Turbo Intercooled			TD26250





Koleos 2.0 dCi	09/08 →	M9R 866	4 Cyl.	15.7:1	
			1995cc	110kW (150PS)	
		Diesel	Turbo Intercooled		TD26251

87-422000-10	STD	08-422000-00	STD
87-422007-10	0.50mm	08-422007-00	0.50mm

A	48.00	2.50		MOL P
B-	14.00	2.00		MOL P
BØ	50.00	2.00		CR P
D	76.00			
	32x65			

KK RT TP

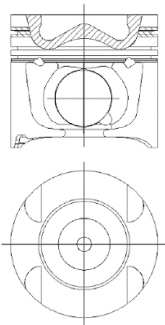

38 84.00

Grand Scénic II 2.0 dCi	09/05 →	M9R 700	4 Cyl.	15.7:1	
Megane II 2.0 dCi	09/05 → 07/09		1995cc	110kW (150PS)	
Megane II 2.0 dCi, Scénic II 2.0 dCi	09/05 →	Diesel	Turbo Intercooled		TD20708
Megane II Coupé-Cabriolet 2.0 dCi	09/05 → 03/09				
Grand Scénic II 2.0 dCi, Scénic II 2.0 dCi	09/05 →	M9R 721	4 Cyl.	15.7:1	
			1995cc	110kW (150PS)	
		Diesel	Turbo Intercooled		TD23502
Grand Scénic II 2.0 dCi	09/05 →	M9R 722	4 Cyl.	15.7:1	
Megane II 2.0 dCi	09/05 → 07/09		1995cc	110kW (150PS)	
Megane II 2.0 dCi, Scénic II 2.0 dCi	09/05 →	Diesel	Turbo Intercooled		TD23503
Megane II Coupé-Cabriolet 2.0 dCi	09/05 → 03/09				
Megane II 2.0 dCi	01/07 → 02/08	M9R 724	4 Cyl.	15.7:1	
			1995cc	127kW (173PS)	
		Diesel	Turbo Intercooled		TD22195
Espace IV 2.0 dCi	01/06 →	M9R 740	4 Cyl.	16:1	
Laguna II 2.0 dCi	08/05 →		1995cc	96-110kW (131-150PS)	
Laguna II Grandtour 2.0 dCi		Diesel	Turbo Intercooled		TD19680
Laguna III 2.0 dCi	10/07 →	M9R 742	4 Cyl.	15.7:1	
Laguna III Grandtour 2.0 dCi			1995cc	96-110kW (131-150PS)	
		Diesel	Turbo Intercooled		TD23504
Laguna III 2.0 dCi	10/07 →	M9R 744	4 Cyl.	15.7:1	
Laguna III Grandtour 2.0 dCi			1995cc	96-110kW (131-150PS)	
		Diesel	Turbo Intercooled		TD23505



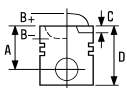





Laguna 2.0 dCi	09/08→	M9R 746			
Laguna III 2.0 dCi	10/07→		4 Cyl.	15.7:1	
Laguna III Grandtour 2.0 dCi			1995cc	110kW (150PS)	
		Diesel	Turbo Intercooled		TD23506
Laguna 2.0 dCi	09/08→	M9R 748			
Laguna III 2.0 dCi	10/07→		4 Cyl.	15.7:1	
Laguna III Grandtour 2.0 dCi			1995cc	110kW (150PS)	
		Diesel	Turbo Intercooled		TD23507
Espace IV 2.0 dCi	01/06→	M9R 750			
			4 Cyl.	15.7:1	
			1995cc	96-110kW (131-150PS)	
		Diesel	Turbo Intercooled		TD23508
Espace IV 2.0 dCi, Laguna II 2.0 dCi	01/06→	M9R 760			
Laguna II Grandtour 2.0 dCi			4 Cyl.	16:1	
Vel Satis 2.0 dCi	08/05→		1995cc	96-127kW (131-173PS)	
		Diesel	Turbo Intercooled		TD19681
Espace IV 2.0 dCi	01/06→	M9R 761			
			4 Cyl.	15.7:1	
			1995cc	96-127kW (131-173PS)	
		Diesel	Turbo Intercooled		TD23899
Espace IV 2.0 dCi, Vel Satis 2.0 dCi	01/06→	M9R 762			
			4 Cyl.	15.7:1	
			1995cc	96-127kW (131-173PS)	
		Diesel	Turbo Intercooled		TD23900
Espace IV 2.0 dCi, Vel Satis 2.0 dCi	01/06→	M9R 763			
			4 Cyl.	15.7:1	
			1995cc	96-127kW (131-173PS)	
		Diesel	Turbo Intercooled		TD23901
Trafic II 2.0 dCi 90	08/06→	M9R 780 Euro 4			
Trafic II 2.0 dCi 115			4 Cyl.	16:1	
			1995cc	66-84kW (90-114PS)	
		Diesel	Turbo Intercooled		TD19714
Trafic II 2.0 dCi 90	08/06→	M9R 782			
Trafic II 2.0 dCi 115			4 Cyl.	15.7:1	
			1995cc	66-84kW (90-114PS)	
		Diesel	Turbo Intercooled		TD23109
Trafic II 2.0 dCi 115	08/06→	M9R 786 Euro 4			
			4 Cyl.	15.7:1	
			1995cc	66-84kW (90-114PS)	
		Diesel	Turbo Intercooled		TD24966
Laguna 2.0 dCi	09/08→	M9R 800			
Laguna III 2.0 dCi	01/08→		4 Cyl.		
Laguna III Grandtour 2.0 dCi			1995cc	127kW (173PS)	
		Diesel	Turbo Intercooled		TD22196
Laguna 2.0 dCi	09/08→	M9R 802			
Laguna III 2.0 dCi	10/07→		4 Cyl.	15.7:1	
Laguna III Grandtour 2.0 dCi			1995cc	96-110kW (131-150PS)	
		Diesel	Turbo Intercooled		TD22197
Laguna 2.0 dCi	09/08→	M9R 809			
Laguna III 2.0 dCi	01/08→		4 Cyl.		
Laguna III Grandtour 2.0 dCi			1995cc	127kW (173PS)	
		Diesel	Turbo Intercooled		TD22198





Laguna 2.0 dCi GT	09/08→	M9R 816			
Laguna III 2.0 dCi GT	03/08→		4 Cyl.	15.7:1	
Laguna III Grandtour 2.0 dCi GT			1995cc	127-132kW (173-180PS)	
		Diesel	Turbo Intercooled		TD22199
Koleos 2.0 dCi	09/08→	M9R 830			
			4 Cyl.	15.7:1	
			1995cc	127-130kW (173-177PS)	
		Diesel	Turbo Intercooled		TD22206

87-422000-00	STD	08-422000-00	STD
87-422007-00	0.50mm	08-422007-00	0.50mm

A	47.92	2.50		MOL P
B-	14.90	2.00		MOL P
BØ	49.07	2.00		CR P
C	0.40			
C	0.40			
D	76.00			
	32x65			

AK KK RT TP

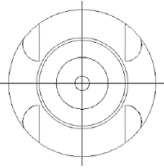
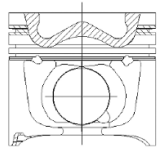

39  **85.00**

Master III 2.3 dCi [RWD]		M9T 670 Euro 5			
Master III 2.3 dCi 100 FWD			4 Cyl.	16:1	
Master III 2.3 dCi 125 FWD	02/11→		2298cc	74-92kW (101-125PS)	
Master III 2.3 dCi FWD	02/10→	Diesel	Turbo Intercooled		TD24269
Master III 2.3 dCi 100 FWD		M9T 672 Euro 5			
Master III 2.3 dCi 125 FWD	02/11→		4 Cyl.	16:1	
Master III 2.3 dCi FWD	02/10→		2298cc	74-92kW (101-125PS)	
		Diesel	Turbo Intercooled		TD25154
Master III 2.3 dCi 100 FWD		M9T 676 Euro 4			
Master III 2.3 dCi 125 FWD	02/11→		4 Cyl.	16:1	
Master III 2.3 dCi FWD	02/10→		2298cc	74-92kW (101-125PS)	
		Diesel	Turbo Intercooled		TD24268
Master III 2.3 dCi FWD	02/10→	M9T 678			
			4 Cyl.	16:1	
			2298cc	107kW (146PS)	
		Diesel	Turbo Intercooled		TD25158
Master III 2.3 dCi FWD	02/10→	M9T 680			
			4 Cyl.	16:1	
			2298cc	107kW (146PS)	
		Diesel	Turbo Intercooled		TD24295



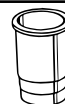



Master III 2.3 dCi [RWD]	02/10→	M9T 686 Euro 5	4 Cyl.	16:1	
			2298cc	92kW (125PS)	
		Diesel	Turbo Intercooled		TD25151
Master III 2.3 dCi [RWD]	02/10→	M9T 690 Euro 5	4 Cyl.	16:1	
			2298cc	74-92kW (101-125PS)	
		Diesel	Turbo Intercooled		TD24270
Master III 2.3 dCi [RWD]	02/10→	M9T 692 Euro 4	4 Cyl.	16:1	
			2298cc	74-92kW (101-125PS)	
		Diesel	Turbo Intercooled		TD24271
Master III 2.3 dCi [RWD] Master III 2.3 dCi FWD	02/10→	M9T 694 Euro 4	4 Cyl.	16:1	
			2298cc	107kW (146PS)	
		Diesel	Turbo Intercooled		TD24272
Master III 2.3 dCi [RWD] Master III 2.3 dCi FWD	02/10→	M9T 696 Euro 4	4 Cyl.	16:1	
			2298cc	92-107kW (125-146PS)	
		Diesel	Turbo Intercooled		TD25150
Master III 2.3 dCi [RWD] Master III 2.3 dCi FWD	02/10→	M9T 698 Euro 5	4 Cyl.	16:1	
			2298cc	92-107kW (125-146PS)	
		Diesel	Turbo Intercooled		TD24273
Master III 2.3 dCi Master III 2.3 dCi [RWD] Master III 2.3 dCi 100 FWD Master III 2.3 dCi 125 FWD Master III 2.3 dCi FWD	09/14→ 02/11→ 02/10→	M9T 870 Euro 5	4 Cyl.	16:1	
			2298cc	74-92kW (100-125PS)	
		Diesel	Turbo Intercooled		TD29755
Master III 2.3 dCi [RWD] Master III 2.3 dCi 150 Master III 2.3 dCi FWD	10/12→ 03/13→	M9T 880 Euro 5	4 Cyl.	16:1	
			2298cc	110kW (150PS)	
		Diesel	Turbo Intercooled		TD29756
Master III 2.3 dCi Master III 2.3 dCi [RWD] Master III 2.3 dCi FWD	09/14→ 02/10→	M9T 890 Euro 5	4 Cyl.	16:1	
			2298cc	74-92kW (100-125PS)	
		Diesel	Turbo Intercooled		TD29758
Master III 2.3 dCi [RWD] Master III 2.3 dCi FWD	02/10→	M9T 896 Euro 4	4 Cyl.	16:1	
			2298cc	92-107kW (125-146PS)	
		Diesel	Turbo Intercooled		TD29759





Master III 2.3 dCi [RWD]		M9T 898 Euro 5		
Master III 2.3 dCi FWD	03/13→		4 Cyl.	16:1
			2298cc	110kW (150PS)
		Diesel	Turbo Intercooled	TD29757

87-435200-00	STD	08-435200-00	STD
87-435207-00	0.50mm	08-435207-00	0.50mm

A	48.00	2.50		GDC P
B-	16.20	2.00		MO P
BØ	50.00	2.00		CR P

C	0.45
D	76.00
	32x65



AK KK RT

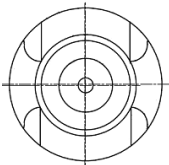
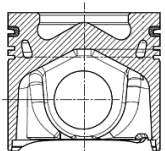

40  **86.00**

20 2.1 Diesel	10/80→12/83	852	4 Cyl.	21.5:1	
			2068cc	47kW (64PS)	
		Diesel			TD3077
Trafic 2.1 D	03/80→06/94	852 720	4 Cyl.	21.5:1	
Trafic 2.1 D [RWD]	05/89→06/94		2068cc	43-44kW (58-60PS)	
		Diesel			TD3079
Trafic 2.1 D	03/80→06/94	852 750	4 Cyl.	21.5:1	
			2068cc	43-44kW (58-60PS)	
		Diesel			TD3080
Trafic 2.1 D	03/80→06/94	J8S 120	4 Cyl.	21.5:1	
			2068cc	65-66kW (88-90PS)	
		Diesel			TD3383
Trafic 2.1 D	03/80→06/94	J8S 232 (852.232)	4 Cyl.	21:1	
			2068cc	43kW (60PS)	
		Diesel			TD3384
Trafic 2.1 D	03/80→06/94	J8S 234	4 Cyl.	21:1	
			2068cc	57kW (78PS)	
		Diesel			TD3385





Trafic 2.1 D Trafic 2.1 D [RWD]	06/94→04/98	J8S 620	4 Cyl. 2068cc	21.5:1 47kW (64PS)	TD5564
		Diesel			
25 2.1 Turbo-D FWD	04/84→12/92	J8S 708	4 Cyl. 2068cc	21.5:1 63kW (86PS)	TD3393
		Diesel	Turbo Intercooled		
18 2.1 Diesel 18 Variable 2.1 Diesel	11/81→07/86 05/79→07/86	J8S 711	4 Cyl. 2068cc	21.5:1 49-53kW (67-72PS)	TD5431
		Diesel			
21 2.1 Turbo-D	03/86→06/94	J8S 714	4 Cyl. 2068cc	21.5:1 65kW (88PS)	TD3395
		Diesel	Turbo		
21 2.1 Turbo-D	03/86→06/94	J8S 742	4 Cyl. 2068cc	21.5:1 65kW (88PS)	TD3399
		Diesel	Turbo		
21 2.1 Turbo-D	03/86→06/94	J8S 746	4 Cyl. 2068cc	21.5:1 65kW (88PS)	TD3400
		Diesel	Turbo		
Espace II 2.1 TD	01/91→10/96	J8S 778	4 Cyl. 2068cc	21.5:1 65kW (88PS)	TD3405
		Diesel	Turbo		
Espace II 2.1 TD	01/91→10/96	J8S 814	4 Cyl. 2068cc	21.5:1 65kW (88PS)	TD21257
		Diesel	Turbo Intercooled		
Espace II 2.1 TD	01/91→10/96	J8S 890	4 Cyl. 2068cc	21.5:1 65kW (88PS)	TD21258
		Diesel	Turbo		

14-000320-00 WH 1 B 93.60 C 166.00 E 93.05

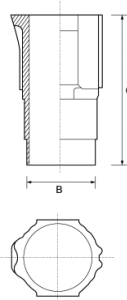

1 Phosphated

1 Phosphated

1 Phosphated

1 Phosphated

1 Phosphated

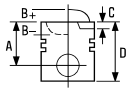

41  **86.00**

Espace I 2.1 TD	10/84→12/90	J8S 240	4 Cyl. 2068cc	21.5:1 65kW (88PS)	TD3386
		Diesel	Turbo Intercooled		
20 2.1 TD	01/82→12/83	J8S 702	4 Cyl. 2068cc	21.5:1 63kW (86PS)	TD3382
30 2.1 Turbo-D	02/82→03/86		Diesel	Turbo	
25 2.1 Turbo-D FWD	04/84→12/92	J8S 738	4 Cyl. 2068cc	21.5:1 63kW (86PS)	TD3397
		Diesel	Turbo Intercooled		
Espace II 2.1 RTDT Quadra	01/91→05/92	J8S 772	4 Cyl. 2068cc	21.5:1 65kW (88PS)	TD3402
Espace II 2.1 TD	01/91→10/96		Diesel	Turbo Intercooled	
Espace I 2.1 TD	10/84→12/90	J8S 774	4 Cyl. 2068cc	21.5:1 65kW (88PS)	TD3403
		Diesel	Turbo Intercooled		
Espace II 2.1 TD	01/91→10/96	J8S 776	4 Cyl. 2068cc	21.5:1 65kW (88PS)	TD3404
		Diesel	Turbo Intercooled		
21 2.1 Turbo-D	03/86→06/94	J8S 788	4 Cyl. 2068cc	21.5:1 65kW (88PS)	TD3408
		Diesel	Turbo		

②

A 51.01
B- 4.00
D 92.90
 28x68

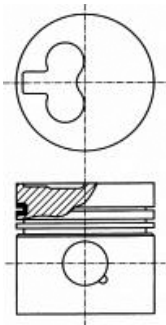



① Phosphated
② Piston available in Kit Set only

08-337000-00

STD

01/91→

2.50  P PS
2.50  P
3.00  CR P

① Phosphated
② Kolben nur im Assembly erhältlich

14-000320-00  **B** 93.60 **C** 166.00 **E** 93.05

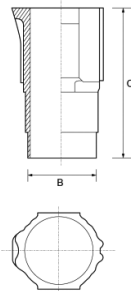

① Phosphated
② Piston disponible en kit seulement

89-337000-00

① Phosphated
② Pistón disponible en conjuntos solamente

① Phosphated
② I pistoni sono disponibili solo in kit motore



42  **86.00**

Master I 2.1 D Master I 28-35 2.1 D	11/89→04/95 08/80→07/98	J8S 330	4 Cyl. 2068cc Turbo	21.5:1 44-46kW (60-63PS)	TD3387
21 2.1 D	05/89→06/94	J8S 600	4 Cyl. 2068cc Turbo	21.5:1 53kW (72PS)	TD3388
21 2.1 D 21 2.1 TD	03/86→08/94 04/86→06/89	J8S 704	4 Cyl. 2068cc Turbo	21.5:1 48-50kW (65-68PS)	TD3391
25 2.1 Diesel	04/84→05/89	J8S 706	4 Cyl. 2068cc Turbo	21.5:1 46kW (63PS)	TD3392
18 2.1 TD Fuego 2.1 TD	11/81→07/86 08/82→10/85	J8S 712	4 Cyl. 2068cc Turbo	21.5:1 65kW (88PS)	TD3394
25 2.1 Diesel	06/89→12/92	J8S 736	4 Cyl. 2068cc Turbo	21.5:1 51kW (69PS)	TD3396
21 2.1 D	05/89→06/94	J8S 740	4 Cyl. 2068cc Turbo	21.5:1 53kW (72PS)	TD3398
Trafic 2.1 D Trafic 2.1 D [RWD]	06/94→10/97	J8S 758	4 Cyl. 2068cc Turbo	21.5:1 47kW (64PS)	TD5565
21 2.1 D	07/89→09/95	J8S 784	4 Cyl. 2068cc Turbo	21.5:1 51kW (69PS)	TD3406
R18 GTD		J8S 852	4 Cyl. 2068cc Turbo	63kW (85PS)	TD3081



87-337100-00



STD

A 50.95
B- 2.20
D 87.95
 28x75

08-337100-00

STD

2.25  P PS
2.00  P
3.00  CR P

14-000320-00  WH  B 93.60 C 166.00 E 93.05

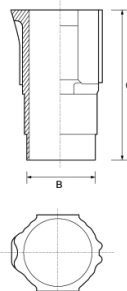

89-337100-00
87-337100-00 +
14-000320-00

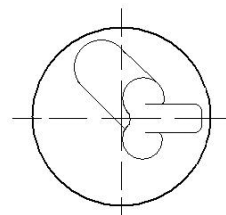

 Phosphated

 Phosphated

 Phosphated





 Phosphated

 Phosphated

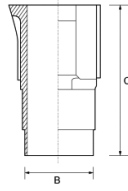

43 86.00

Espace 2.1 TD		J8S 604	4 Cyl. 2068cc	21.5:1 65kW (88PS)	
		Diesel	Turbo		TD3389
Espace II 2.1 TD	01/91→10/96	J8S 610	4 Cyl. 2068cc	21.5:1 65kW (88PS)	
		Diesel	Turbo Intercooled		TD3390
Espace II 2.1 TD	11/94→10/96	J8S 612	4 Cyl. 2068cc	21.5:1 66kW (90PS)	
		Diesel	Turbo Intercooled		TD5525
Safrane I 2.1 dT	11/93→07/96	J8S 760	4 Cyl. 2068cc	21.5:1 65-66kW (88-90PS)	
		Diesel	Turbo		TD3401
21 2.1 Turbo-D	03/86→06/94	J8S 786 (KAT)	4 Cyl. 2068cc	21.5:1 65kW (88PS)	
		Diesel	Turbo		TD3407

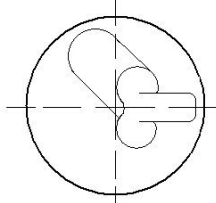
2	08-337000-00	STD	14-000320-00 WH 1 B 93.60 C 166.00 E 93.05	89-337000-10
A 51.01	01/91→			
B- 3.80				
D 84.00	2.50 	P PS		
 28x68	2.50 	P		
	3.00 	CR P		
				
1 Phosphated	1 Phosphated	1 Phosphated	1 Phosphated	1 Phosphated
2 Piston available in Kit Set only	2 Kolben nur im Assembly erhältlich	2 Piston disponible en kit seulement	2 Pistón disponible en conjuntos solamente	2 I pistoni sono disponibili solo in kit motore

44 87.00

Laguna I 2.2 D	11/93→03/01	G8T 706	4 Cyl. 2188cc	23:1 61kW (83PS)	
Laguna I Grandtour 2.2 D	09/95→03/01				TD3301
		Diesel			
Laguna I 2.2 D	11/93→03/01	G8T 752	4 Cyl. 2188cc	23:1 61kW (83PS)	
Laguna I Grandtour 2.2 D	09/95→03/01				TD4872
		Diesel			
Laguna I 2.2 D	11/93→03/01	G8T 790	4 Cyl. 2188cc	23:1 61kW (83PS)	
Laguna I Grandtour 2.2 D	09/95→03/01				TD4873
		Diesel			



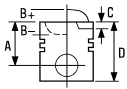

Laguna I 2.2 D	11/93→03/01	G8T 792	4 Cyl. 2188cc	23:1 61kW (83PS)	TD18886
		Diesel			
Laguna I 2.2 D Laguna I Grandtour 2.2 D	11/93→03/01 09/95→03/01	G8T 794	4 Cyl. 2188cc	23:1 61kW (83PS)	TD4874
		Diesel			

87-101600-00	STD	08-101600-00	STD
A 44.98		2.50	MO P
B- 2.10		1.75	P
D 75.00		2.50	CR P
 28x69			



AK RT

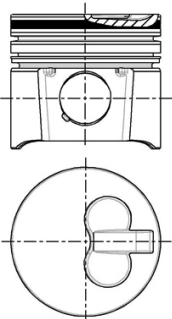

45  **87.00**

Laguna II 2.2 dCi	05/05→	G9T 605 Euro 4	4 Cyl. 2188cc	18:1 102kW (139PS)	TD19682
		Diesel	Turbo Intercooled		
Vel Satis 2.2 dCi	09/04→	G9T 606 Euro 4	4 Cyl. 2188cc	18:1 102kW (139PS)	TD21209
		Diesel	Turbo Intercooled		
Espace III 2.2 dCi	10/00→10/02	G9T 642	4 Cyl. 2188cc	18:1 95-110kW (129-150PS)	TD23177
		Diesel	Turbo Intercooled		
Espace IV 2.2 dCi	02/06→	G9T 645 Euro 4	4 Cyl. 2188cc	18:1 102kW (139PS)	TD21198
		Diesel	Turbo Intercooled		
Laguna II 2.2 dCi Vel Satis 2.2 dCi	10/01→ 09/04→	G9T 700	4 Cyl. 2188cc	18:1 102-110kW (139-150PS)	TD20978
		Diesel	Turbo Intercooled		
Laguna II 2.2 dCi Laguna II Grandtour 2.2 dCi Vel Satis 2.2 dCi	10/01→ 06/02→	G9T 702 Euro 3	4 Cyl. 2188cc	18:1 102-110kW (140-150PS)	TD16288
		Diesel	Turbo Intercooled		





Vel Satis 2.2 dCi	06/02→	G9T 703	4 Cyl. 2188cc Diesel	19:1 110kW (150PS) Turbo Intercooled	TD16377
Vel Satis 2.2 dCi	06/02→	G9T 704	4 Cyl. 2188cc Diesel	19:1 110kW (150PS) Turbo Intercooled	TD20975
Laguna II 2.2 dCi Laguna II Grandtour 2.2 dCi	05/05→	G9T 706	4 Cyl. 2188cc Diesel	19:1 102-110kW (139-150PS) Turbo Intercooled	TD20976
Laguna II 2.2 dCi Laguna II Grandtour 2.2 dCi	05/05→	G9T 707	4 Cyl. 2188cc Diesel	19:1 102-110kW (139-150PS) Turbo Intercooled	TD20977
Espace IV 2.2 dCi	11/02→	G9T 742 Euro 3	4 Cyl. 2188cc Diesel	18:1 110kW (150PS) Turbo Intercooled	TD17062
Espace IV 2.2 dCi	11/02→	G9T 743 Euro 3	4 Cyl. 2188cc Diesel	18:1 110kW (150PS) Turbo Intercooled	TD17063

87-127400-10

STD

08-127400-00

STD

87-127407-10

0.50mm

08-127407-00

0.50mm

A 54.53

3.00



P PS

B- 17.50

1.75



P

BØ 40.40

2.50



P

C 1.70

C 2.00

D 84.20

31x65



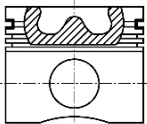
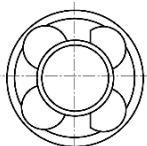

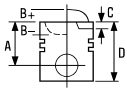
AK KK RT TP





46 87.00

Vel Satis 2.2 dCi	09/04→	G9T 607	4 Cyl. 2188cc	18:1 102-110kW (139-150PS)	TD23896
		Diesel	Turbo Intercooled		
Espace III 2.2 dCi	07/00→10/02	G9T 710	4 Cyl. 2188cc	18:1 85-95kW (115-130PS)	TD16310
		Diesel	Turbo Intercooled		
Master II 2.2 dCi 90	09/00→	G9T 720	4 Cyl. 2188cc	18:1 66kW (90PS)	TD14928
		Diesel	Turbo Intercooled		
Master II 2.2 dCi 90	09/00→	G9T 722	4 Cyl. 2188cc	18:1 66kW (90PS)	TD16302
		Diesel	Turbo Intercooled		
Master II 2.2 dCi 90	09/00→	G9T 750	4 Cyl. 2188cc	17.8:1 66kW (90PS)	TD19088
		Diesel	Turbo Intercooled		

87-127400-00	STD	08-127400-00	STD
87-127407-00	0.50mm	08-127407-00	0.50mm
A	54.53	3.00	 P PS
B-	17.50	1.75	 P
BØ	40.40	2.50	 P
C	2.00		
D	84.20		
 31x65			

AK RT TP

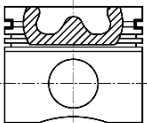
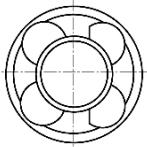

47 88.00

Espace 2.0	07/84→	829	4 Cyl. 1995cc	9.2:1 76-80kW (103-109PS)	TD29261
Master I 2.0	06/85→10/89	829 730	4 Cyl. 1995cc	9.2:1 59kW (80PS)	TD3045
Master I 28-35 2.0	10/82→09/86				
Master I 2.0	07/80→06/85	829 731	4 Cyl. 1995cc	9.2:1 57-59kW (78-82PS)	TD3046
Master I 28-35 2.0	08/80→10/86				



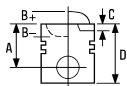

20 2.0	10/77→10/80	829.01	4 Cyl. 1995cc	9.2:1 76-80kW (103-109PS)	TD21390
Master I 2.0 Trafic 2.0	11/89→12/95 05/85→08/90	J5R 716	4 Cyl. 1995cc	9.2:1 59-62kW (80-84PS)	TD3302
Master I 2.0 Master I 28-35 2.0	11/89→07/93 10/86→07/98	J5R 718	4 Cyl. 1995cc	9.2:1 57-60kW (78-82PS)	TD3303
Trafic 2.0	06/86→04/89	J5R 722	4 Cyl. 1995cc	9.2:1 59kW (80PS)	TD3304
Trafic 2.0 Trafic 2.0 [RWD]	03/80→12/91 05/89→10/97	J5R 726	4 Cyl. 1995cc	9.2:1 59kW (80PS)	TD3305
Master I 2.0 Master I 28-35 2.0	06/85→12/95 10/86→07/98	J5R 728	4 Cyl. 1995cc	9.2:1 58-60kW (79-82PS)	TD3306
Espace I 2.0	07/84→12/90	J6R 234	4 Cyl. 1995cc	9.2:1 79-81kW (107-110PS)	TD3308
Espace I 2.0	07/84→12/90	J6R 236	4 Cyl. 1995cc	9.2:1 80kW (108PS)	TD3309
25 2.0	04/84→12/92	J6R 706	4 Cyl. 1995cc	9.2:1 74kW (101PS)	TD3310
25 2.0	04/84→12/92	J6R 707	4 Cyl. 1995cc	9.2:1 74kW (101PS)	TD3311
Fuego 2.0 TX/GTX	10/80→10/85	J6R 710	4 Cyl. 1995cc	9.2:1 81kW (110PS)	TD3312
Fuego 2.0 TX/GTX	10/80→10/85	J6R 712	4 Cyl. 1995cc	9.2:1 81kW (110PS)	TD3314
Fuego 2.0 TX/GTX	10/80→10/85	J6R 713	4 Cyl. 1995cc	9.2:1 81kW (110PS)	TD3315



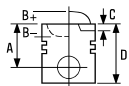

Fuego 2.0 TX/GTX	10/80→10/85	J6R 715	4 Cyl. 1995cc	9.2:1 81kW (110PS)	TD3319
18 2.0 18 Variable 2.0	05/82→07/86 10/81→12/86	J6R 716	4 Cyl. 1995cc	9.2:1 77kW (105PS)	TD5064
21 2.0	03/86→10/93	J6R 758	4 Cyl. 1995cc	9.2:1 75-78kW (102-106PS)	TD3324
21 2.0	03/86→10/93	J6R 759	4 Cyl. 1995cc	9.2:1 75kW (102PS)	TD3325
25 2.0	04/84→12/92	J6R 760	4 Cyl. 1995cc	9.2:1 74kW (101PS)	TD3326
25 2.0	04/84→12/92	J6R 762	4 Cyl. 1995cc	9.2:1 74kW (101PS)	TD3327
21 2.0	03/86→10/93	J6R 792	4 Cyl. 1995cc	9.2:1 75kW (102PS)	TD3329
21 2.0	03/86→10/93	J6R 793	4 Cyl. 1995cc	9.2:1 75kW (102PS)	TD3330
25 2.0	03/87→12/93	J7R 722	4 Cyl. 1995cc	10:1 88kW (120PS)	TD3335
25 2.0	03/87→12/93	J7R 723	4 Cyl. 1995cc	10:1 88kW (120PS)	TD3336
21 2.0 21 2.0 TXi	12/89→06/94 07/89→05/93	J7R 740	4 Cyl. 1995cc	9.3:1 99-100kW (134-136PS)	TD3344
21 2.0	03/86→12/93	J7R 746	4 Cyl. 1995cc	10:1 88kW (120PS)	TD3345
21 2.0	03/86→12/93	J7R 747	4 Cyl. 1995cc	10:1 88kW (120PS)	TD3346



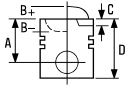

21 2.0	03/86→06/92	J7R 751	4 Cyl. 1995cc	10:1 85-86kW (116-117PS)	TD3348
Espace I 2.0 i Espace I 2.0 i Quadra	01/89→12/90 03/88→12/92	J7R 760	4 Cyl. 1995cc	10:1 87-88kW (118-120PS)	TD3352
Espace II 2.0	01/91→10/96	J7R 768	4 Cyl. 1995cc	9.2:1 76kW (103PS)	TD3353
Espace I 2.2 Espace I 2.2 Quadra	07/86→12/90 06/87→12/90	J7T 770	4 Cyl. 2165cc	10:1 79-81kW (107-110PS)	TD3377
Espace II 2.2	01/91→12/96	J7T 772	4 Cyl. 2165cc	10:1 79-81kW (107-110PS)	TD3378

87-334400-00

STD

08-334400-00

STD

14-637160-00 WH B 93.60 C 140.50 D 104.00 E 93.08

89-334400-00
87-334400-00 +
14-637160-00

A 40.50
B+ 1.55
D 69.05
 23x75

→08/89

1.75
2.00
4.00



MO P
P
CR 

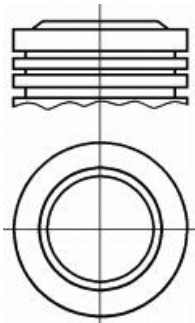
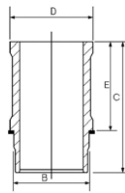

 Steel

 Stahl

 Acier

 Acero

 Acciaio

48  **88.00**

20 2.2	10/80→12/83	851 700	4 Cyl. 2165cc	9.2:1 85kW (116PS)	TD3076
25 2.0 12V	06/88→12/93	J7R 720	4 Cyl. 1995cc	9.3:1 103kW (140PS)	TD3333
Safrane I 2.0	11/92→07/96	J7R 732	4 Cyl. 1995cc	9.2:1 77kW (105PS)	TD3338



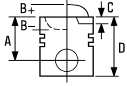

21 2.0 TXi	07/89→08/94	J7R 754	4 Cyl. 1995cc	9.3:1 98-100kW (133-136PS)	TD3350
25 2.2	04/84→12/89	J7T 706	4 Cyl. 2165cc	10:1 89kW (121PS)	TD3355
25 2.2	04/84→12/89	J7T 707	4 Cyl. 2165cc	9.9:1 89kW (121PS)	TD3356
25 2.2	04/84→12/89	J7T 714	4 Cyl. 2165cc	10:1 89-91kW (121-124PS)	TD3358
25 2.2	04/84→12/89	J7T 715	4 Cyl. 2165cc	10:1 89-91kW (121-124PS)	TD3359
25 2.2	04/84→12/89	J7T 730	4 Cyl. 2165cc	10:1 91kW (124PS)	TD3364
21 2.2	06/86→06/94	J7T 754	4 Cyl. 2165cc	10:1 79kW (107PS)	TD3370
Safrane I 2.2	04/92→07/96	J7T 760	4 Cyl. 2165cc	10:1 101kW (137PS)	TD3373
Safrane I 2.2	04/92→07/96	J7T 762	4 Cyl. 2165cc	10:1 79-81kW (107-110PS)	TD3375
Trafic 2.2	05/89→06/94	J7T 780	4 Cyl. 2165cc	10:1 70kW (95PS)	TD3380
Master I 30 2.2	08/80→07/98	J7T 782	4 Cyl. 2165cc	10:1 67-69kW (91-94PS)	TD3381
Master I 2.2 Master I 30 2.2	08/93→02/98 08/80→07/98	J7T 788	4 Cyl. 2165cc	8.6:1 67-71kW (91-97PS)	TD12736

14-637160-00 WH B 93.60 C 140.50 D 104.00 E 93.08

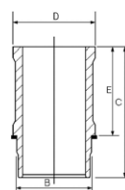



49 89.00

Trafic II Box 2.5 dCi	08/07→	G9U 630 Euro 4			
Trafic II Bus 2.5 dCi 115	02/08→		4 Cyl.	18.1:1	
Trafic II Box 2.5 dCi 145	06/08→		2464cc	84-107kW (114-146PS)	
Trafic II Bus 2.5 dCi 145	06/08→	Diesel	Turbo Intercooled		TD19713
Trafic II Platform/Chassis 2.5 dCi	08/07→				
Trafic II Platform/Chassis 2.5 dCi 145	06/08→				
Master II 2.5 dCi	08/06→	G9U 632 Euro 4			
			4 Cyl.	18.1:1	
			2464cc	88-107kW (120-146PS)	
		Diesel	Turbo Intercooled		TD21013
Master II 2.5 dCi	08/06→	G9U 650 Euro 4			
			4 Cyl.	18.1:1	
			2464cc	74-88kW (101-120PS)	
		Diesel	Turbo Intercooled		TD21011

87-137500-30
87-137507-30

STD
0.50mm

08-137500-00
08-137507-00

STD
0.50mm

A 53.07
B- 16.10
B- 4.90
BØ 48.00
C 2.00
C 1.60
D 83.09
 31x65

3.00
1.75
2.50



MO P
P
P

AK RT TP

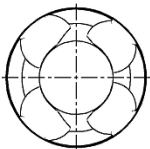
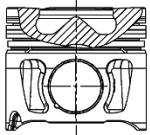

50 89.00

Master II 2.5 dCi 120	10/01→	G9U 720 Euro 3			
			4 Cyl.	21:1	
			2463cc	84kW (115PS)	
		Diesel	Turbo Intercooled		TD16303
Master II 2.5 dCi	10/04→02/12	G9U 724 Euro 3			
Master II 2.5 dCi 120	10/01→		4 Cyl.	21:1	
			2463cc	84-85kW (115-116PS)	
		Diesel	Turbo Intercooled		TD19366
Trafic II 2.5 dCi 135	03/01→	G9U 730 Euro 3			
Trafic II 2.5 DTi	03/03→07/03		4 Cyl.	18:1	
			2464cc	99kW (135PS)	
		Diesel	Turbo Intercooled		TD18275
Master II 2.5 dCi	01/04→	G9U 750 Euro 3			
Master II 2.5 dCi 120	10/01→		4 Cyl.	17.75:1	
			2463cc	84kW (115PS)	
		Diesel	Turbo Intercooled		TD19359





Master II 2.5 dCi	08/06→	G9U 754 Euro 3		
Master II 2.5 dCi 100	10/03→		4 Cyl.	17.75:1
Master II 2.5 dCi 120	10/01→		2463cc	73-85kW (99-115PS)
		Diesel	Turbo Intercooled	TD19085

87-137500-10	STD	08-137500-10	STD
87-137507-10	0.50mm	08-137507-10	0.50mm

A	53.03	2.50		MO P
B-	17.85	1.75		P
BØ	43.20	2.50		CR P
C	1.65			
C	1.90			
D	83.09			
	31x65			

AK RT TP

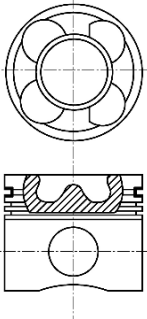

51 **93.00**

Messenger Box	8140.07.2530	4 Cyl.	18.5:1	
		2499cc	56kW (76PS)	
	Diesel			TD3417
Messenger Box	8140.07.2585 Euro 1	4 Cyl.	18.5:1	
		2499cc	55kW (75PS)	
	Diesel			TD12192
Master	8140.07.2700	4 Cyl.	18:1	
		2499cc	55kW (75PS)	
	Diesel			TD22385
Master B80	8140.07.2701/8140.07.2710	4 Cyl.	18:1	
		2499cc	55kW (75PS)	
	Diesel			FM9101
Master	8140.07.3700 Euro 1	4 Cyl.	18.5:1	
		2499cc	55kW (75PS)	
	Diesel	Turbo Intercooled		TD22386





Master **8140-07 Sofim** **4 Cyl.** **18:1**
2499cc **55kW (75PS)**
Diesel **TD8524**

87-425000-00	STD	08-425000-00	STD	14-021371-00 D	B 96.01 C 171.00 D 98.92 E 5.00
87-425008-00	0.60mm	08-425008-00	0.60mm	14-021372-00 D	B 96.05 C 171.00 D 98.92 E 5.00
				14-021480-00 DH 1	B 97.03 C 171.00 D 100.00 E 5.00

A 58.75
B- 16.90
BØ 40.00
D 96.75
 32x75

3.00
 2.00
 3.00

CR P
 P
 CR P

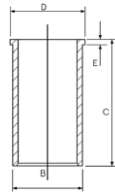

RT

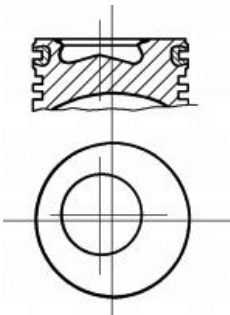

Nitrided

Nitriert

Nitridé

Niturado

Niturato

52 **93.00**

90 **04/86→09/90** **8140.21.235 IDS** **4 Cyl.** **18:1**
B90 **08/90→01/92** **2445cc** **68-71kW (92-96PS)**
Diesel Turbo **TD3418**

87-245200-30	STD	08-245200-00	STD	14-021371-00 D	B 96.01 C 171.00 D 98.92 E 5.00
87-245208-30	0.60mm	08-245208-00	0.60mm	14-021372-00 D	B 96.05 C 171.00 D 98.92 E 5.00
				14-021480-00 DH 1	B 97.03 C 171.00 D 100.00 E 5.00

A 59.65
B- 14.80
BØ 51.90
D 97.65
 32x75

3.00
 2.00
 3.00

CR P
 P
 CR P

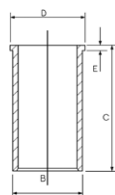

RT

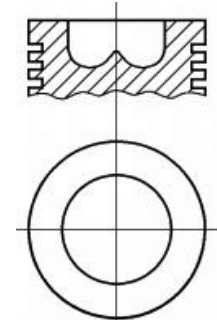

Nitrided

Nitriert

Nitridé

Niturado

Niturato





53  **93.00**

Master	8140.27 Sofim	4 Cyl.	18.5:1
		2499cc	78kW (106PS)
	Diesel	Turbo	TD8529
B90	8140.27.2582	4 Cyl.	
		2499cc	92kW (125PS)
	Diesel	Turbo	TD3424
Master 2.5 TD	8140.27.2700	4 Cyl.	18.5:1
		2499cc	68-76kW (92-103PS)
	Diesel	Turbo	TD21392

87-245200-40 STD
87-245208-40 0.60mm

A 58.75
B- 17.90
BØ 38.00
D 96.75
 32x75

08-245200-00 STD
08-245208-00 0.60mm

3.00  CR P
 2.00  P
 3.00  CR P

14-021371-00 D B 96.01 C 171.00 D 98.92 E 5.00
14-021372-00 D B 96.05 C 171.00 D 98.92 E 5.00
14-021480-00 DH 1 B 97.03 C 171.00 D 100.00 E 5.00

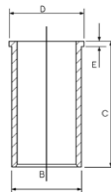

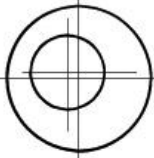
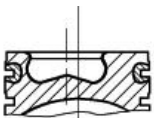

RT



87-245200-50 STD
87-245208-50 0.60mm

A 58.75
B- 17.90
BØ 38.00
D 96.75
 32x78

08-245200-00 STD
08-245208-00 0.60mm

3.00  CR P
 2.00  P
 3.00  CR P

AK NB RT

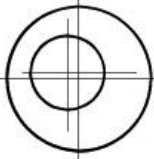
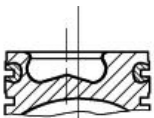

 Nitrided

 Nitriert

 Nitridé

 Nitrurado

 Nitrurato



54  **93.00**

Master 2.5 TD	09/80 →	8140.27.2560	4 Cyl. 2499cc	69kW (94PS)	TD8623
		Diesel			
Master 2.5 TD	09/80 →	8140.47.2530 IDR Sofim	4 Cyl. 2499cc	18:1 85kW (116PS)	TD3425
		Diesel	Turbo Intercooled		
Master 2.5 TD	09/80 →	8140.47.2535	4 Cyl. 2499cc	18.5:1 85kW (116PS)	TD3426
		Diesel	Turbo Intercooled		
Master 2.5 TD	09/80 →	8140.47.2585 Euro 1	4 Cyl. 2499cc	85kW (116PS)	TD3428
		Diesel	Turbo Intercooled		
Master 2.5 TD	09/80 →	8140.47.2590 Euro 1	4 Cyl. 2499cc	18.5:1 85kW (116PS)	TD12199
		Diesel	Turbo Intercooled		
Master 2.5 TD	09/80 →	8140.47.2700 Euro 1	4 Cyl. 2499cc	18.5:1 85kW (116PS)	TD22395
		Diesel	Turbo Intercooled		
Master 2.5 TD	09/80 →	8140.47.2721 Euro 1	4 Cyl. 2499cc	18.5:1 85kW (116PS)	TD22396
		Diesel	Turbo Intercooled		
Master 2.5 TD	09/80 →	8140.47.2785 Euro 1	4 Cyl. 2499cc	18.5:1 85kW (116PS)	TD22397
		Diesel	Turbo Intercooled		
Master 2.5 TD	09/80 →	8140-47	4 Cyl. 2499cc	18.5:1 85kW (116PS)	TD8533
		Diesel	Turbo Intercooled		





Master I 35 2.5 TD 08/89→07/98 **S9U 714** 4 Cyl. 17.5:1
2499cc **69kW (94PS)**
Diesel **Turbo** **TD12732**

87-520200-00 STD

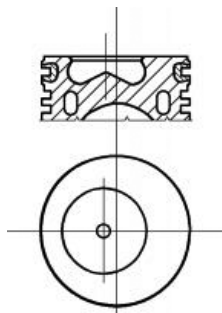

A 58.75
B- 18.40
BØ 38.00
D 96.75
 **32x78**

AK KK NB RT



 Nitrided

08-520200-00 STD

3.00  CR
 2.00  P
 3.00  CR P

 Nitriert

14-021371-00 D B 96.01 C 171.00 D 98.92 E 5.00
14-021372-00 D B 96.05 C 171.00 D 98.92 E 5.00
14-021480-00 DH  B 97.03 C 171.00 D 100.00 E 5.00

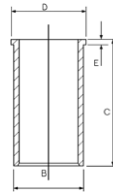

 Niturado

 Nitrurato

55  **93.00**

B110 08/90→08/96 **8140.27.2565 Sofim** 4 Cyl. 18:1
2499cc **78kW (106PS)**
Diesel **TD12197**

87-245200-60 STD

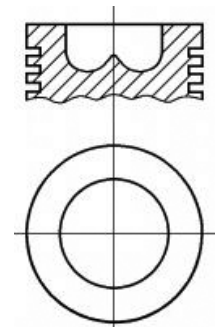

A 58.65
B- 14.80
BØ 51.90
D 75.20
 **32x75**

RT



 Nitrided

08-245200-00 STD
08-245208-00 0.60mm

3.00  CR P
 2.00  P
 3.00  CR P

 Nitriert

14-021371-00 D B 96.01 C 171.00 D 98.92 E 5.00
14-021372-00 D B 96.05 C 171.00 D 98.92 E 5.00
14-021480-00 DH  B 97.03 C 171.00 D 100.00 E 5.00

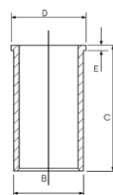

 Niturado

 Nitrurato



56 93.00

B110	05/94→04/96	8140.27.2585	4 Cyl.	18.5:1	
			2499cc	78kW (106PS)	
		Diesel Turbo			TD12195
B110	05/94→04/96	8140-27 IDS	4 Cyl.	18.5:1	
			2499cc	78kW (106PS)	
		Diesel Turbo			TD8530

14-021371-00 D B 96.01 C 171.00 D 98.92 E 5.00
14-021372-00 D B 96.05 C 171.00 D 98.92 E 5.00
14-021480-00 DH  B 97.03 C 171.00 D 100.00 E 5.00

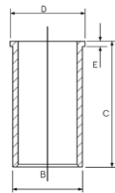

 Nitrided

 Nitriert

 Nitridé

 Niturado

 Nitruato

57 93.00

Master I 28-35 2.4 D	08/80→08/89	8140.61.2300	4 Cyl.	21:1	
Master I 28-35 2.5 D	09/80→07/98		2445cc	52kW (71PS)	
		Diesel			TD3429
Master I 28-35 2.4 D	08/80→08/89	8140.61.235	4 Cyl.	21:1	
Master I 28-35 2.5 D	09/80→07/98		2445cc	53kW (72PS)	
		Diesel			TD3430
Trafic 2.5 D	03/80→03/01	8140.61.240 Sofim	4 Cyl.	22:1	
			2445cc	51kW (69PS)	
		Diesel Turbo Intercooled			TD12871
Trafic 2.5 D	03/80→03/01	S8U 720	4 Cyl.	22:1	
			2445cc	51kW (69PS)	
		Diesel			TD3413
Trafic 2.5 D	03/80→03/01	S8U 722	4 Cyl.	22:1	
			2445cc	51kW (69PS)	
		Diesel			TD3414
Master I 2.4 D	07/83→02/98	S8U 730	4 Cyl.	22:1	
			2445cc	52kW (71PS)	
		Diesel			TD12873
Master I 2.4 D	07/80→10/89	S8U 731	4 Cyl.	22:1	
Master I 28-35 2.4 D	08/80→08/89		2445cc	50-53kW (68-72PS)	
Master I 28-35 2.5 D	09/80→07/98				TD12730
		Diesel			





Master I 2.4 D	07/80→10/89	S8U 748		
Master I 28-35 2.4 D	08/80→08/89		4 Cyl.	22:1
Master I 28-35 2.5 D	09/80→07/98		2445cc	55kW (75PS)
Diesel				TD12735

87-214500-00	STD	08-214500-10	STD	14-022560-00 D	B 96.00 C 167.30 D 98.90 E 5.00
87-214508-00	0.60mm	08-214508-10	0.60mm	14-028930-00 D	B 97.50 C 167.00 D 100.90 E 5.00
				14-028931-00 D	B 97.58 C 167.00 D 100.90 E 5.00
				14-028932-00 D	B 97.70 C 167.00 D 100.90 E 5.00

A 54.80
B- 2.20
D 89.80
 32x75

06/81→
 3.00
 2.00
 4.00



CR P
 P
 CR P

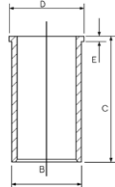

HA RT

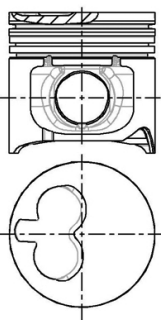





58  **93.00**

Trafic 2.5 D	05/89→03/01	8140.67.2500	4 Cyl.	22:1
			2499cc	55kW (75PS)
Diesel				TD3431
Trafic 2.5 D	05/89→03/01	8140.67.2550	4 Cyl.	21:1
			2499cc	55kW (75PS)
Diesel				TD12872
Master I 2.5 D	07/80→10/89	S8U 742	4 Cyl.	22:1
Master I 28-35 2.5 D	08/89→07/98		2499cc	55kW (75PS)
Diesel				TD5442
Trafic 2.5 D	03/89→03/01	S8U 750	4 Cyl.	22:1
			2499cc	55kW (75PS)
Diesel				TD5566
Trafic 2.5 D	05/89→03/01	S8U 752	4 Cyl.	22:1
			2499cc	55kW (75PS)
Diesel				TD5567
Trafic 2.5 D	05/89→03/01	S8U 758	4 Cyl.	22:1
			2499cc	55-58kW (75-79PS)
Diesel				TD9689
Trafic 2.5 D	05/98→03/01	S8U 780	4 Cyl.	22:1
			2499cc	55kW (75PS)
Diesel				TD16328



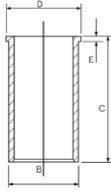

Trafic 05/98 → 03/01 **S8U 782** 4 Cyl. 22:1
2499cc **55kW (75PS)**
Diesel **TD16329**

87-783300-00	STD	08-783300-00	STD	14-022560-00 D	B 96.00 C 167.30 D 98.90 E 5.00
87-783308-00	0.60mm	08-783308-00	0.60mm	14-028930-00 D	B 97.50 C 167.00 D 100.90 E 5.00
A	54.00	3.00		14-028931-00 D	B 97.58 C 167.00 D 100.90 E 5.00
B-	2.20	2.00		14-028932-00 D	B 97.70 C 167.00 D 100.90 E 5.00
D	89.00	3.00			
	32x75				



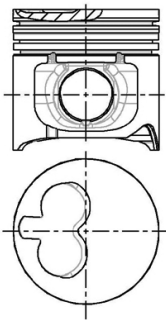

HA RT



59  **93.00**

Trafic 2.5 D 05/89 → 03/01 **8140.67.2580 Euro 2** 4 Cyl. 18.5:1
2499cc **55kW (75PS)**
Diesel **TD3433**

Messenger Box **8140.67.2585 Euro 2** 4 Cyl. 18.5:1
2499cc **55kW (75PS)**
Diesel **Turbo Intercooled** **TD12193**

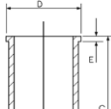
87-425000-10	STD	08-425000-00	STD	14-021371-00 D	B 96.01 C 171.00 D 98.92 E 5.00
87-425008-10	0.60mm	08-425008-00	0.60mm	14-021372-00 D	B 96.05 C 171.00 D 98.92 E 5.00
A	54.00	3.00		14-021480-00 DH 1	B 97.03 C 171.00 D 100.00 E 5.00
B-	2.20	2.00			
D	89.00	3.00			
	32x68				

HA RT

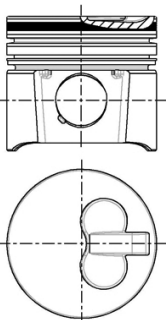





 Nitrided





 Nitriert

 Nitridé

 Niturado

 Nitratato

		ccm	x 		9
712	Diesel	3320	4	98.00	6
712-01-03	Diesel	3320	4	98.00	6
712-01-04	Diesel	3320	4	98.00	6
714	Diesel	3320	4	98.00	6
720	Diesel	3590	4	102.00	7
720-12	Diesel	3590	4	102.00	7
797	Diesel	5453	6	102.00	8
797-20	Diesel	5490	6	102.00	8
797-21	Diesel	5453	6	102.00	8
797-26	Diesel	5490	6	102.00	8
798	Diesel	5490	6	102.00	9
798-10	Diesel	5490	6	102.00	9
798-20	Diesel	5490	6	102.00	9
8140.23.2585 Euro 2 Sofim	Diesel	2800	4	94.40	1
8140.43.2585 Euro 2 Sofim	Diesel	2800	4	94.40	1
8140.43.3700 Euro 2	Diesel	2798	4	94.40	1
8140.43.C.2586	Diesel	2800	4	94.40	2
8140.43.C.3586 Euro 3	Diesel	2800	4	94.40	3
8140.43.C.3588 Euro 3	Diesel	2800	4	94.40	3
8140.43.S.2585 Euro 2	Diesel	2800	4	94.40	3
8140.43.S.3585 Euro 3	Diesel	2800	4	94.40	4
8140.43N.3585 Euro 3	Diesel	2798	4	94.40	4
8140.63.2585 Euro 2	Diesel	2798	4	94.40	5
dCi 6 W Euro 3	Diesel	6177	6	102.00	10
dCi 11C Euro 3	Diesel	11100	6	123.00	22
dCi 11E Euro 3	Diesel	11100	6	123.00	23
DXi 5	Diesel	4800	4	108.00	15
DXi 7	Diesel	7200	6	108.00	15
DXi 11 Euro 4/5	Diesel	10800	6	123.00	24
DXi 12 Euro 3	Diesel	12130	6	131.00	27
DXi 13 Euro 4	Diesel	12800	6	131.00	28
MDS 06.35.40	Diesel	12024	6	135.00	29
MIDR 04.02.26 A/4 Euro 2	Diesel	4120	4	102.00	11
MIDR 04.02.26 B/4 Euro 2	Diesel	4120	4	102.00	11
MIDR 06.02.12	Diesel	5491	6	102.00	12
MIDR 06.02.12 B	Diesel	5490	6	102.00	12
MIDR 06.02.12 C	Diesel	5490	6	102.00	12
MIDR 06.02.12 D	Diesel	5490	6	102.00	12
MIDR 06.02.26	Diesel	6177	6	102.00	13
MIDR 06.02.26 D	Diesel	6177	6	102.00	14
MIDR 06.02.26 H	Diesel	6177	6	102.00	14
MIDR 06.02.26 Q	Diesel	6177	6	102.00	14
MIDR 06.02.26 U/4 Euro 2	Diesel	6177	6	102.00	13
MIDR 06.02.26 U Euro 1	Diesel	6177	6	102.00	14
MIDR 06.02.26 V/41 Euro 2	Diesel	6177	6	102.00	13
MIDR 06.02.26 V/4 Euro 2	Diesel	6177	6	102.00	13
MIDR 06.02.26 V Euro 1	Diesel	6177	6	102.00	14
MIDR 06.02.26 W/4 Euro 2	Diesel	6177	6	102.00	11
MIDR 06.02.26 W Euro 1	Diesel	6177	6	102.00	14
MIDR 06.02.26 X Euro 1	Diesel	6177	6	102.00	14
MIDR 06.02.26 Y/41 Euro 2	Diesel	6177	6	102.00	13
MIDR 06.20.45	Diesel	9771	6	120.00	16
MIDR 06.20.45 A	Diesel	9839	6	120.00	17
MIDR 06.20.45 B3 Euro 1	Diesel	9839	6	120.00	18
MIDR 06.20.45 C	Diesel	9840	6	120.00	17
MIDR 06.20.45 C/4 Euro 2	Diesel	9839	6	120.00	19
MIDR 06.20.45 D	Diesel	9839	6	120.00	20
MIDR 06.20.45 D/41 Euro 2	Diesel	9839	6	120.00	19
MIDR 06.20.45 D3 Euro 1	Diesel	9839	6	120.00	18
MIDR 06.20.45 E	Diesel	9839	6	120.00	21
MIDR 06.20.45 E/41 Euro 2	Diesel	9839	6	120.00	18
MIDR 06.20.45 E2 Euro 1	Diesel	9839	6	120.00	18
MIDR 06.20.45 E3 Euro 1	Diesel	9839	6	120.00	20
MIDR 06.20.45 H	Diesel	9839	6	120.00	18
MIDR 06.20.45 I41 Euro 2	Diesel	9840	6	120.00	16
MIDR 06.20.45 M41 Euro 2	Diesel	9839	6	120.00	19
MIDR 06.23.56 A/3 Euro 2	Diesel	11100	6	123.00	25
MIDR 06.23.56 A/41 Euro 2	Diesel	11100	6	123.00	25
MIDR 06.23.56 B/41 Euro 2	Diesel	11100	6	123.00	25

		ccm	x 		9
MIDR 06.24.65	Diesel	12000	6	124.00	26
MIDR 06.24.65 A/42 Euro 2	Diesel	12000	6	124.00	26
MIDR 06.24.65 B/42 Euro 2	Diesel	12000	6	124.00	26
MIDR 06.24.65 C/42 Euro 2	Diesel	12000	6	124.00	26
MIDR 06.35.40	Diesel	12000	6	135.00	29
MIDR 06.35.40 C	Diesel	11941	6	135.00	29
MIDR 06.35.40 G	Diesel	12024	6	135.00	30
MIDR 06.35.40 H	Diesel	11941	6	135.00	30
MIDR 06.35.40 J/3 Euro 1	Diesel	12024	6	135.00	31
MIDR 06.35.40 J1 Euro 1	Diesel	12024	6	135.00	32
MIDR 06.35.40 L1	Diesel	12024	6	135.00	32
MIDR 06.35.40 M3 Euro 1	Diesel	12024	6	135.00	31
MIDR 06.35.40 N/3 Euro 1	Diesel	12024	6	135.00	31
MIDR 06.35.40 P/41 Euro 2	Diesel	12024	6	135.00	33
MIDS 06.02.12	Diesel	5490	6	102.00	12
MIDS 06.02.12 B	Diesel	5453	6	102.00	12
MIDS 06.02.12 C	Diesel	5490	6	102.00	12
MIDS 06.02.12 D/3	Diesel	5490	6	102.00	12
MIDS 06.20.30	Diesel	8821	6	120.00	16
MIDS 06.20.45 B	Diesel	9839	6	120.00	18
MIDS 06.35.40 D	Diesel	12024	6	135.00	34
MIHR 06.20.45 A41 Euro 2	Diesel	9839	6	120.00	19
MIPR 06.20.45 A3	Diesel	9840	6	120.00	17
MIPR 06.20.45 C3	Diesel	9840	6	120.00	17
MIPS 06.20.30	Diesel	8820	6	120.00	16
S9W 700	Diesel	2799	4	94.40	1
S9W 702	Diesel	2799	4	94.40	1



1 94.40

8140.23.2585 Euro 2 Sofim	4 Cyl.		2800cc	78kW (106PS)	Diesel Turbo Intercooled	TD12194
8140.43.2585 Euro 2 Sofim	4 Cyl.	18.5:1	2800cc	90kW (122PS)	Diesel Turbo Intercooled	TD12198
8140.43.3700 Euro 2	4 Cyl.	18.5:1	2798cc	85kW (116PS)	Diesel Turbo Intercooled	TD22394
S9W 700	4 Cyl.	19:1	2799cc	84kW (114PS)	Diesel Turbo Intercooled	TD19362
S9W 702	4 Cyl.	19:1	2799cc	84kW (114PS)	Diesel Turbo	TD13408

87-122200-10

STD

08-122200-00

STD

14-021321-00 D

B 97.54 C 167.00 D 100.90 E 5.00

87-122208-10

0.60mm

08-122208-00

0.60mm

14-028930-00 D

B 97.50 C 167.00 D 100.90 E 5.00

01/98→

2572280→

14-028931-00 D

B 97.58 C 167.00 D 100.90 E 5.00

14-028932-00 D

B 97.70 C 167.00 D 100.90 E 5.00

A 58.75

2.50



CK P

B- 19.40

2.00



P

BØ 39.25

2.50



CR P

D 87.60

 32x72

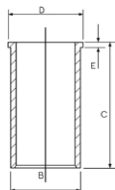

AK KK RT TP

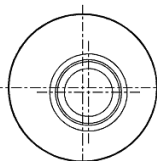
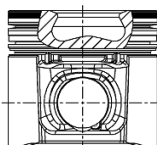

87-854700-00

STD

08-854700-00

STD

87-854708-00

0.60mm

08-854708-00

0.60mm

→12/97

→2572279

A 58.75

3.00



CR

B- 19.40

2.00



P

BØ 39.40

3.00



CR

D 96.65

 32x78

AK KK RT

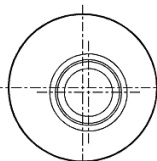
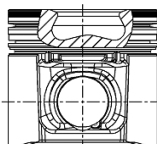

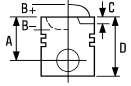

2 94.40

8140.43.C.2586 4 Cyl. 2800cc 78kW (106PS) Diesel Turbo Intercooled TD14090

87-122200-10 STD 08-122200-00 STD 14-021321-00 D B 97.54 C 167.00 D 100.90 E 5.00

87-122208-10 0.60mm 08-122208-00 0.60mm 14-028930-00 D B 97.50 C 167.00 D 100.90 E 5.00

14-028931-00 D B 97.58 C 167.00 D 100.90 E 5.00

14-028932-00 D B 97.70 C 167.00 D 100.90 E 5.00

A 58.75 2572280 →

B- 19.40

BØ 39.25

D 87.60

32x72

2.50

2.00

2.50



CK P

P

CR P

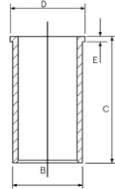

AK KK RT TP

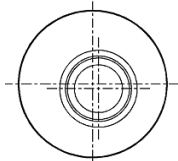
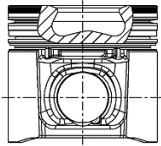

3 94.40

8140.43.C.3586 Euro 3 4 Cyl. 2800cc 78kW (106PS) Diesel Turbo Intercooled TD17194

8140.43.C.3588 Euro 3 4 Cyl. 2800cc 78kW (106PS) Diesel Turbo Intercooled TD17195

8140.43.S.2585 Euro 2 4 Cyl. 2800cc 92kW (125PS) Diesel Turbo Intercooled TD14091

14-021321-00 D B 97.54 C 167.00 D 100.90 E 5.00

14-028930-00 D B 97.50 C 167.00 D 100.90 E 5.00

14-028931-00 D B 97.58 C 167.00 D 100.90 E 5.00

14-028932-00 D B 97.70 C 167.00 D 100.90 E 5.00

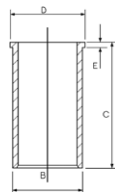







4 94.40

8140.43.S.3585 Euro 3 4 Cyl. 2800cc 92kW (125PS) Diesel Turbo Intercooled TD17196

8140.43N.3585 Euro 3 4 Cyl. 18.5:1 2798cc 107kW (146PS) Diesel Turbo Intercooled TD17197

87-122200-00	STD	08-122200-00	STD	14-021321-00 D	B 97.54 C 167.00 D 100.90 E 5.00
87-122208-00	0.60mm	08-122208-00	0.60mm	14-028930-00 D	B 97.50 C 167.00 D 100.90 E 5.00
				14-028931-00 D	B 97.58 C 167.00 D 100.90 E 5.00
				14-028932-00 D	B 97.70 C 167.00 D 100.90 E 5.00

A	58.70	2572280→			
B-	21.30				
BØ	39.40	2.50		CK P	
D	87.60	2.00		P	
	32x72	2.50		CR P	

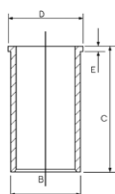

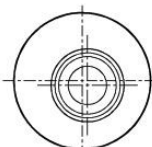
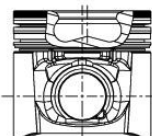

AK KK RT TP



5 94.40

8140.63.2585 Euro 2 4 Cyl. 21:1 2798cc 63kW (86PS) Diesel Turbo Intercooled TD14089

87-108200-00	STD	08-108200-00	STD	14-021321-00 D	B 97.54 C 167.00 D 100.90 E 5.00
87-108208-00	0.60mm	08-108208-00	0.60mm	14-028930-00 D	B 97.50 C 167.00 D 100.90 E 5.00
				14-028931-00 D	B 97.58 C 167.00 D 100.90 E 5.00
				14-028932-00 D	B 97.70 C 167.00 D 100.90 E 5.00

A	55.00	3.00		CR P	
B-	2.80	2.00		P	
D	90.00	2.50		CR P	

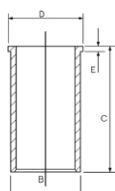

AK HA RT TP

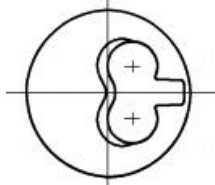



6 98.00

712	4 Cyl.	17.5:1	3320cc	56kW (76PS)	Diesel	TD8669
712-01-03	4 Cyl.	17.5:1	3320cc	53kW (72PS)	Diesel	TD3019
712-01-04	4 Cyl.	17.5:1	3320cc	54kW (73PS)	Diesel	TD3020
714	4 Cyl.	17.5:1	3320cc		Diesel	FM4359

14-261790-00 WH B 114.00 C 220.70 D 120.90 E 8.00 F 0.70
 14-264190-00 WH B 111.95 C 220.50 D 118.90 E 8.00 F 0.80

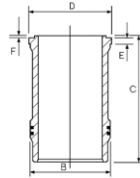

7 102.00

720	4 Cyl.	17.5:1	3590cc	67-72kW (91-98PS)	Diesel	TD3022
720-12	4 Cyl.	17:1	3590cc	67-72kW (90-98PS)	Diesel	TD8609

14-265940-00 WH B 114.00 C 220.70 D 120.70 E 8.00 F 0.70

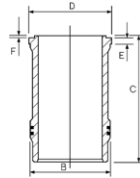

1 Phosphated

1 Phosphated

1 Phosphated

1 Phosphated

1 Phosphated

8 102.00

797	6 Cyl.	18:1	5453cc	96-97kW (130-132PS)	Diesel	TD8610
797-20	6 Cyl.	18:1	5490cc	96-98kW (130-133PS)	Diesel Turbo	TD8607
797-21	6 Cyl.	17.5:1	5453cc	76kW (103PS)	Diesel	TD8658
797-26	6 Cyl.	17.5:1	5490cc	98kW (133PS)	Diesel Turbo	TD8593

87-346500-00 STD

08-346500-10 STD

14-265950-00 WH B 114.00 C 235.30 D 121.00 E 8.00 F 0.80

89-346500-00

A 77.80
 B- 38.40
 D 131.70
 36x86

3.00 CR P
 2.50 P
 5.00 CR P

14-265960-00 WH B 114.00 C 234.30 D 122.50 E 8.00 F 0.80

15-265960-00 WH B 114.00 C 234.00 D 122.50 E 8.00 F 0.80

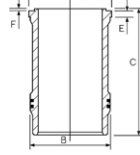

RT

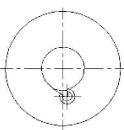
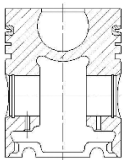

1 Phosphated

1 Phosphated

1 Phosphated

1 Phosphated

1 Phosphated

2 Includes seals

2 Schließt Dichtungen ein

2 Inclut des joints

2 Incluye los sellos

2 Comprende le guarnizioni

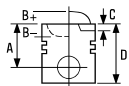

9 102.00

798	6 Cyl.	17:1	5490cc	110kW (150PS)	Diesel Turbo	TD8613
798-10	6 Cyl.	17:1	5490cc	113kW (154PS)	Diesel Turbo	TD6210
798-20	6 Cyl.	17:1	5490cc	113kW (154PS)	Diesel Turbo	TD8606

14-265950-00 WH ① B 114.00 C 235.30 D 121.00 E 8.00 F 0.80
 14-265960-00 WH ① B 114.00 C 234.30 D 122.50 E 8.00 F 0.80
 15-265960-00 WH ② B 114.00 C 234.00 D 122.50 E 8.00 F 0.80

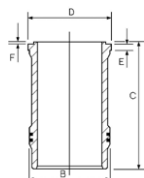

① Phosphated
 ② Includes seals

① Phosphated
 ② Schließt Dichtungen ein

① Phosphated
 ② Inclut des joints

① Phosphated
 ② Incluye los sellos

① Phosphated
 ② Comprende le guarnizioni

10 102.00

dCi 6 W Euro 3	6 Cyl.	6177cc	158kW (215PS)	Diesel Turbo Intercooled	TD17338
----------------	--------	--------	---------------	--------------------------	---------

87-435000-00 STD 08-435000-00 STD 15-480090-00 WH ① B 114.00 C 218.00 D 122.50 E 8.00 F 0.80 89-435000-00

A 71.20
 B- 21.90
 BØ 60.00
 C 0.80
 D 108.30
 42x84

3.50 CK
 2.50 CR
 4.00 CR

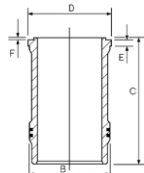

87-435000-00 +
 15-480090-00

RT

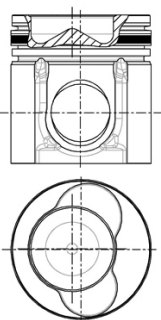



87-435000-10

STD

08-435000-00

STD

15-480090-00 WH 1 B 114.00 C 218.00 D 122.50 E 8.00 F 0.80

89-435000-10

A 71.00
B- 21.90
BØ 60.00
C 0.80
D 108.10
 42x84

3.50
 2.50
 4.00



CK
 CR
 CR

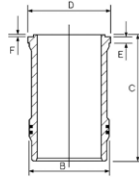

87-435000-10 +
 15-480090-00

RT

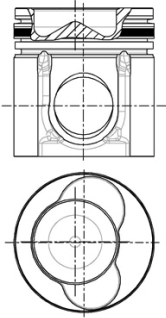

1 Includes seals

1 Schließt Dichtungen ein

1 Inclut des joints

1 Incluye los sellos

1 Comprende le guarnizioni

11  **102.00**

MIDR 04.02.26 A/4 Euro 2 4 Cyl. **4120cc 100kW (136PS)** **Diesel Turbo Intercooled** **TD14509**

MIDR 04.02.26 B/4 Euro 2 4 Cyl. **4120cc 110kW (150PS)** **Diesel Turbo Intercooled** **TD14510**

MIDR 06.02.26 W/4 Euro 2 6 Cyl. 18:1 **6177cc 154kW (209PS)** **Diesel Turbo Intercooled** **TD14511**

87-522900-00

STD

08-522900-00

STD

15-480090-00 WH 2 B 114.00 C 218.00 D 122.50 E 8.00 F 0.80

89-522900-00

A 71.23
B- 20.83
BØ 60.00
C 0.85
D 105.20
 42x84

03/93→

3.50
 2.50
 4.00



MO
 CR
 CR

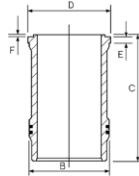

87-522900-00 +
 15-480090-00

RT

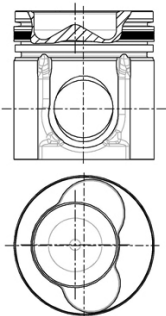

1 Phosphated

1 Phosphated

1 Phosphated

1 Phosphated

1 Phosphated

2 Includes seals

2 Schließt Dichtungen ein

2 Inclut des joints

2 Incluye los sellos

2 Comprende le guarnizioni

14-265960-00 WH 1 B 114.00 C 234.30 D 122.50 E 8.00 F 0.80

15-265960-00 WH 2 B 114.00 C 234.00 D 122.50 E 8.00 F 0.80

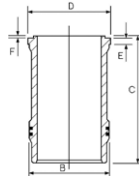



12 102.00

MIDR 06.02.12	6 Cyl.	17:1	5491cc	128-134kW (173-182PS)	Diesel Turbo Intercooled	TD8547
MIDR 06.02.12 B	6 Cyl.		5490cc	117kW (159PS)	Diesel Turbo Intercooled	TD8644
MIDR 06.02.12 C	6 Cyl.	17:1	5490cc	121-133kW (170-181PS)	Diesel Turbo Intercooled	TD5985
MIDR 06.02.12 D	6 Cyl.		5490cc	127-134kW (172-182PS)	Diesel Turbo Intercooled	TD8583
MIDS 06.02.12	6 Cyl.		5490cc	107kW (145PS)	Diesel Turbo	TD8545
MIDS 06.02.12 B	6 Cyl.		5453cc	113-117kW (154-159PS)	Diesel Turbo	TD8608
MIDS 06.02.12 C	6 Cyl.		5490cc	97-103kW (132-140PS)	Diesel Turbo	TD8615
MIDS 06.02.12 D/3	6 Cyl.		5490cc	110kW (150PS)	Diesel Turbo	TD14068

87-522900-40

STD

08-522900-00

STD



15-265960-00 WH  **B 114.00 C 234.00 D 122.50 E 8.00 F 0.80**
15-480090-00 WH  **B 114.00 C 218.00 D 122.50 E 8.00 F 0.80**

89-522900-40

87-522900-40 +
15-265960-00

A 78.25
B- 20.17
BØ 56.00
C 1.40
D 123.25
 **42x84**

03/93→

3.50 
 2.50 
 4.00 

MO
 CR
 CR

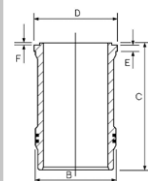



89-522900-50
 87-522900-40 +
 15-480090-00

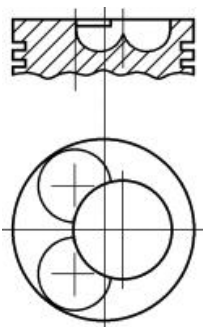

RT

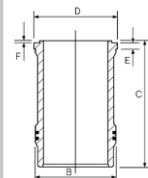





14-265960-00 WH  **B 114.00 C 234.30 D 122.50 E 8.00 F 0.80**





 Phosphated
 Includes seals

 Phosphated
 Schließt Dichtungen ein

 Phosphated
 Inclut des joints

 Phosphated
 Incluye los sellos

 Phosphated
 Comprende le guarnizioni



13 102.00



MIDR 06.02.26	6 Cyl.		6177cc	159kW (216PS)	Diesel Turbo Intercooled	TD14049
MIDR 06.02.26 U/4 Euro 2	6 Cyl.	18:1	6177cc	110kW (150PS)	Diesel Turbo Intercooled	TD12208
MIDR 06.02.26 V/4 Euro 2	6 Cyl.	18:1	6177cc	132kW (180PS)	Diesel Turbo Intercooled	TD14508
MIDR 06.02.26 V/41 Euro 2	6 Cyl.	18:1	6177cc	132kW (180PS)	Diesel Turbo Intercooled	TD12248
MIDR 06.02.26 Y/41 Euro 2	6 Cyl.	18:1	6177cc	184kW (250PS)	Diesel Turbo Intercooled	TD8639

87-522900-10  STD

A 71.23
 B- 20.83
 BØ 60.00
 C 0.85
 D 108.20
 42x84

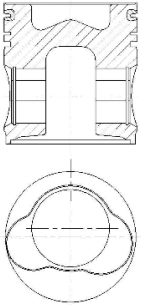

RT







-  Phosphated
-  Includes seals
-  Piston Chamber Volume
[ccm] 51.36

08-522900-00 STD

03/93→

3.50  MO
 2.50  CR
 4.00  CR

-  Phosphated
-  Schließt Dichtungen ein
-  Volumen der Kolbenmulde
[ccm] 51.36

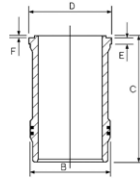

15-480090-00 WH  B 114.00 C 218.00 D 122.50 E 8.00 F 0.80



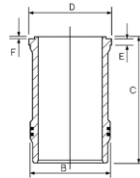

14-265960-00 WH  B 114.00 C 234.30 D 122.50 E 8.00 F 0.80



15-265960-00 WH  B 114.00 C 234.00 D 122.50 E 8.00 F 0.80



-  Phosphated
-  Inclut des joints
-  Volume de la cavité du piston
[cm³] 51.36

-  Phosphated
-  Incluye los sellos
-  Volumen de cavidad del pistón
[cc] 51.36

89-522900-10
 87-522900-10 +
 15-480090-00

-  Phosphated
-  Comprende le guarnizioni
-  Volume camera pistone
[cm³] 51.36

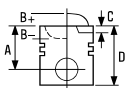

14 102.00

MIDR 06.02.26 D	6 Cyl.	18:1	6177cc	166kW (226PS)	Diesel Turbo Intercooled	TD5862
MIDR 06.02.26 H	6 Cyl.	18:1	6177cc	133-144kW (181-196PS)	Diesel Turbo Intercooled	TD5645
MIDR 06.02.26 Q	6 Cyl.	17:1	6177cc	137-140kW (186-190PS)	Diesel Turbo	TD8584
MIDR 06.02.26 U Euro 1	6 Cyl.	18:1	6177cc	110kW (150PS)	Diesel Turbo Intercooled	TD8616
MIDR 06.02.26 V Euro 1	6 Cyl.	18:1	6177cc	129-132kW (175-180PS)	Diesel Turbo Intercooled	TD8618
MIDR 06.02.26 W Euro 1	6 Cyl.	18:1	6177cc	151kW (205PS)	Diesel Turbo Intercooled	TD8587
MIDR 06.02.26 X Euro 1	6 Cyl.	17.5:1	6177cc	166kW (226PS)	Diesel Turbo Intercooled	TD8536

87-522900-30 STD

A 71.18
B- 20.80
BØ 58.80
C 0.50
D 108.20
 42x84

RT

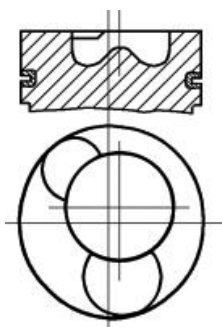

1 Phosphated
2 Includes seals

08-522900-00 STD

03/93→
 3.50 MO
 2.50 CR
 4.00 CR

1 Phosphated
2 Schließt Dichtungen ein

15-480090-00 WH **2** B 114.00 C 218.00 D 122.50 E 8.00 F 0.80

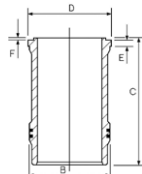

1 Phosphated
2 Includ des joints

14-265960-00 WH **1** B 114.00 C 234.30 D 122.50 E 8.00 F 0.80

15-265960-00 WH **2** B 114.00 C 234.00 D 122.50 E 8.00 F 0.80

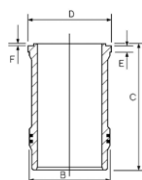

1 Phosphated
2 Incluye los sellos

89-522900-30
 87-522900-30 +
 15-480090-00

1 Phosphated
2 Comprende le guarnizioni

15 108.00

DXi 5	4 Cyl.		4800cc	118-162kW (160-220PS)	Diesel Turbo Intercooled	TD19015
DXi 7	6 Cyl.		7200cc	177-247kW (240-340PS)	Diesel Turbo Intercooled	TD19016

87-430000-00 STD

A 70.90
B- 19.60
BØ 64.50
D 107.80
 45x86

KK RT TP

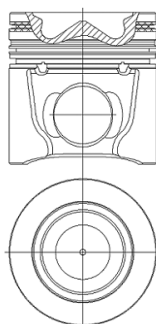

1 Includes seals

08-430000-00 STD

3.00 CK
 2.00 CR
 3.50 CR

1 Schließt Dichtungen ein

15-480450-00 WH **1** B 120.00 C 228.00 D 131.70 E 8.06

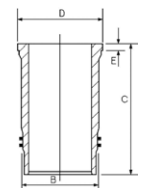

1 Includ des joints

1 Incluye los sellos

89-430000-00
 87-430000-00 +
 15-480450-00

1 Comprende le guarnizioni

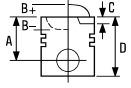



16 120.00

MIDR 06.20.45	6 Cyl.	16:1	9771cc	214-222kW (291-302PS)	Diesel Turbo Intercooled	TD8414
MIDR 06.20.45 I41 Euro 2	6 Cyl.	17:1	9840cc	188kW (256PS)	Diesel Turbo Intercooled	TD12191
MIDS 06.20.30	6 Cyl.		8821cc	159-169kW (216-230PS)	Diesel Turbo	TD8595
MIPS 06.20.30	6 Cyl.	17:1	8820cc	166kW (225PS)	Diesel Turbo	TD8626

15-480050-00 WH  B 135.00 C 261.00 D 147.30 E 9.28 F 0.90
→06/88

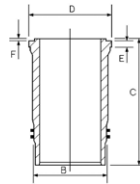
15-480070-00 WH  B 135.00 C 261.00 D 147.30 E 9.35 F 0.90
06/88→



 Includes seals

 Schließt Dichtungen ein

 Includ des joints

 Incluye los sellos

 Comprende le guarnizioni

17 120.00

MIDR 06.20.45 A	6 Cyl.	17:1	9839cc	192kW (260PS)	Diesel Turbo Intercooled	TD8591
MIDR 06.20.45 C	6 Cyl.	17:1	9840cc	206-210kW (280-285PS)	Diesel Turbo Intercooled	TD8580
MIPR 06.20.45 A3	6 Cyl.	17:1	9840cc	222kW (302PS)	Diesel Turbo Intercooled	TD8635
MIPR 06.20.45 C3	6 Cyl.	17:1	9840cc	152kW (206PS)	Diesel	TD8629



87-131500-00  STD

08-131500-10 STD

15-480050-00 WH  B 135.00 C 261.00 D 147.30 E 9.28 F 0.90
→06/88

89-131500-30
87-131500-00 +
15-480050-00

A 83.80
B- 23.34
BØ 74.00
D 134.80
 50x97

3.25  CR P
3.00  CR P
4.00  CR P

15-480070-00 WH  B 135.00 C 261.00 D 147.30 E 9.35 F 0.90
06/88→

89-131400-40
87-131500-00 +
15-480070-00

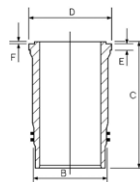

AK RT

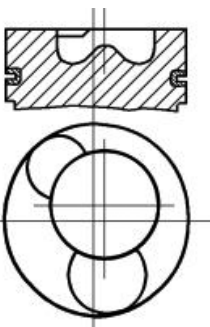

 Includes seals

 Schließt Dichtungen ein

 Includ des joints

 Incluye los sellos

 Comprende le guarnizioni

 < 290 CV

 < 290 CV

 < 290 CV

 < 290 CV

 < 290 CV

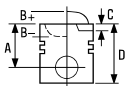

18 120.00

MIDR 06.20.45 B3 Euro 1	6 Cyl.	17:1	9839cc	195kW (265PS)	Diesel Turbo Intercooled	TD8592
MIDR 06.20.45 D3 Euro 1	6 Cyl.	17:1	9839cc	222kW (302PS)	Diesel Turbo Intercooled	TD8539
MIDR 06.20.45 E/41 Euro 2	6 Cyl.	17:1	9839cc	249kW (338PS)	Diesel Turbo Intercooled	TD8642
MIDR 06.20.45 E2 Euro 1	6 Cyl.	17:1	9839cc	249kW (339PS)	Diesel Turbo Intercooled	TD8540
MIDR 06.20.45 H	6 Cyl.	17:1	9839cc	227-240kW (310-326PS)	Diesel Turbo Intercooled	TD6209
MIDS 06.20.45 B	6 Cyl.		9839cc	192-202kW (260-275PS)	Diesel Turbo	TD8537

87-337500-00  STD

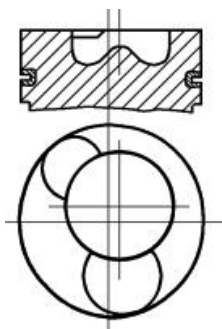

A 83.80
B- 22.70
BØ 74.00
C 1.10
C 0.80
D 134.80
 50x97

AK RT



08-337500-00 STD

01/92→

3.50  CK P
 3.00  CR P
 4.00  CR P

15-480080-00 WH  B 135.00 C 261.00 D 147.30 E 9.38 F 0.30

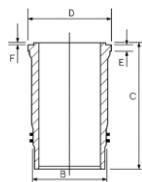

89-337500-00
 87-337500-00 +
 15-480080-00

15-450190-00 WH  B 135.00 C 256.75 D 147.50 E 9.38 F 0.75

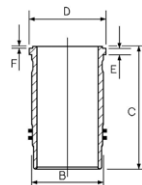

89-337500-40
 87-337500-00 +
 15-450190-00

87-337500-10 STD

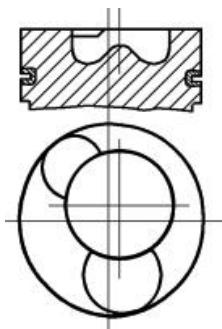

A 83.80
B- 23.35
BØ 70.00
C 1.10
D 134.80
 50x97

AK RT



08-337500-00 STD

01/92→

3.50  CK P
 3.00  CR P
 4.00  CR P

15-480080-00 WH  B 135.00 C 261.00 D 147.30 E 9.38 F 0.30

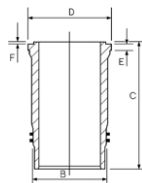

89-337500-10
 87-337500-10 +
 15-480080-00

15-480070-00 WH  B 135.00 C 261.00 D 147.30 E 9.35 F 0.90

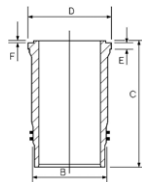

 Includes seals

 290 CV >

 Schließt Dichtungen ein

 290 CV >

 Inclut des joints

 290 CV >

 Incluye los sellos

 290 CV >

 Comprende le guarnizioni

 290 CV >

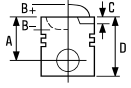

19 120.00

MIDR 06.20.45 C/4 Euro 2	6 Cyl.	17:1	9839cc	188kW (256PS)	Diesel Turbo Intercooled	TD17421
MIDR 06.20.45 D/41 Euro 2	6 Cyl.	17:1	9839cc	219kW (298PS)	Diesel Turbo Intercooled	TD8641
MIDR 06.20.45 M41 Euro 2	6 Cyl.	17:1	9839cc	250kW (340PS)	Diesel Turbo Intercooled	TD21231
MIHR 06.20.45 A41 Euro 2	6 Cyl.	17:1	9839cc	185kW (252PS)	Diesel Turbo Intercooled	TD21269

87-337500-30 STD

A 83.80
B- 22.50
BØ 74.00
C 1.10
D 134.80
 50x97

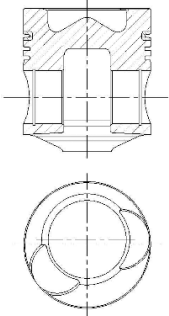

RT



 Includes seals

08-337500-00 STD

01/92→

3.50  CK P
3.00  CR P
4.00  CR P

 Schließt Dichtungen ein

STD

 Inclut des joints

15-450190-00 WH  B 135.00 C 256.75 D 147.50 E 9.38 F 0.75

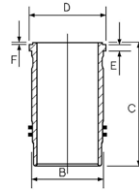

 Incluye los sellos

89-337500-30
87-337500-30 +
15-450190-00

 Comprende le guarnizioni

15-480070-00 WH  B 135.00 C 261.00 D 147.30 E 9.35 F 0.90

15-480080-00 WH  B 135.00 C 261.00 D 147.30 E 9.38 F 0.30

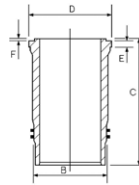

 Incluye los sellos

 Comprende le guarnizioni

20 120.00

MIDR 06.20.45 D	6 Cyl.	17:1	9839cc	210-222kW (286-302PS)	Diesel Turbo Intercooled	TD8538
MIDR 06.20.45 E3 Euro 1	6 Cyl.	17:1	9839cc	249kW (339PS)	Diesel Turbo Intercooled	TD8541

15-480080-00 WH  B 135.00 C 261.00 D 147.30 E 9.38 F 0.30

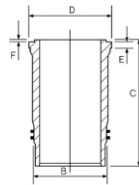

 Includes seals

 Schließt Dichtungen ein

 Inclut des joints

 Incluye los sellos

 Comprende le guarnizioni

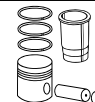
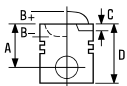

21 120.00

MIDR 06.20.45 E 6 Cyl. 17:1 **9839cc** **240-249kW (326-339PS)** **Diesel Turbo Intercooled** **TD5860**



87-337500-00  STD

A 83.80
B- 22.70
BØ 74.00
C 1.10
C 0.80
D 134.80
 50x97

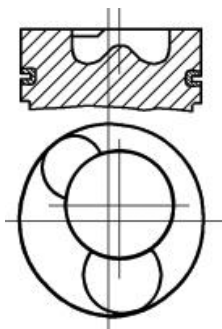
AK RT



08-337500-00 STD

01/92 →
 3.50  CK P
 3.00  CR P
 4.00  CR P

15-480080-00 **WH**  **B 135.00 C 261.00 D 147.30 E 9.38 F 0.30**

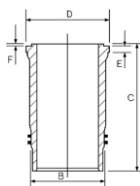

89-337500-00
 87-337500-00 +
 15-480080-00

15-450190-00 **WH**  **B 135.00 C 256.75 D 147.50 E 9.38 F 0.75**

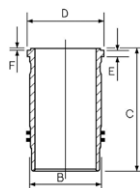

89-337500-40
 87-337500-00 +
 15-450190-00



87-337500-50 STD

A 83.80
B- 23.34
BØ 74.00
C 1.10
C 0.80
D 134.80
 50x97

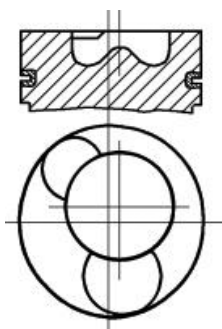
AK RT



08-337500-00 STD

01/92 →
 3.50  CK P
 3.00  CR P
 4.00  CR P

15-480070-00 **WH**  **B 135.00 C 261.00 D 147.30 E 9.35 F 0.90**

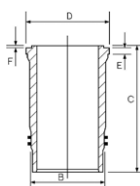

89-337500-50
 87-337500-50 +
 15-480070-00

 Includes seals

 290 CV >

 Schließt Dichtungen ein

 290 CV >

 Inclut des joints

 290 CV >

 Incluye los sellos

 290 CV >

 Comprende le guarnizioni

 290 CV >



22 123.00

dCi 11C Euro 3 6 Cyl. 16.5:1 **11100cc** **303kW (412PS)** **Diesel Turbo Intercooled** **TD16880**

87-135500-10 STD

08-135500-10 STD

14-450920-00 WH ¹ B 134.91 C 257.00 D 147.40 E 9.38 F 0.70

89-135500-10

A 78.48

3.50



CK

B- 24.00

3.00



CR

BØ 72.60

4.00



CR

C 1.60

D 114.48

 **50x102**

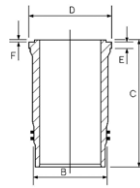

87-135500-10 +
14-450920-00

TP

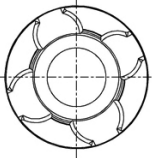
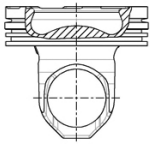

15-450220-00 WH ¹ B 135.20 C 256.75 D 147.50 E 9.41 F 0.75

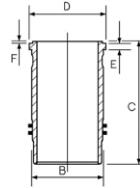

¹ Includes seals

¹ Schließt Dichtungen ein

¹ Inclut des joints

¹ Incluye los sellos

¹ Comprende le guarnizioni

23 123.00

dCi 11E Euro 3 6 Cyl. **11100cc** **266kW (362PS)** **Diesel Turbo Intercooled** **TD16879**

14-450920-00 WH ¹ B 134.91 C 257.00 D 147.40 E 9.38 F 0.70

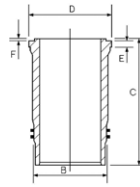

15-450220-00 WH ¹ B 135.20 C 256.75 D 147.50 E 9.41 F 0.75

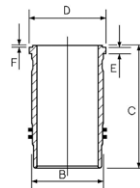

¹ Includes seals

¹ Schließt Dichtungen ein

¹ Inclut des joints

¹ Incluye los sellos

¹ Comprende le guarnizioni





24 123.00

DXi 11 Euro 4/5 **6 Cyl.** **10800cc** **243-339kW (330-460PS)** **Diesel** **TD19017**

87-438800-00 ¹ STD **08-438800-00** STD **14-480440-00** WH ¹ **B 139.00 C 249.55 D 149.00 E 11.20 F 0.85** **89-438800-00**

A 78.40
B- 17.00
BØ 83.60
C 1.00
C 1.00
D 111.70
 54x73

3.50  PVD ²
 2.50  NT ²
 3.00  NT ²

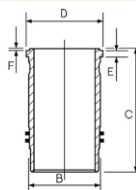

87-438800-00 +
 14-480440-00

TP KK

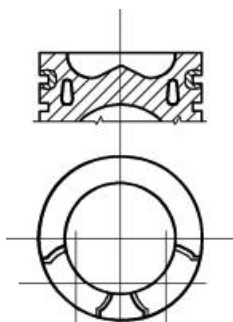

¹ MonoSteel®
² Steel

¹ MonoSteel®
² Stahl

¹ MonoSteel®
² Acier

¹ MonoSteel®
² Acero

¹ MonoSteel®
² Acciaio

25 123.00



MIDR 06.23.56 A/41 Euro 2 **6 Cyl.** **17:1** **11100cc** **280kW (381PS)** **Diesel Turbo Intercooled** **TD8643**

MIDR 06.23.56 A/3 Euro 2 **6 Cyl.** **11100cc** **255kW (347PS)** **Diesel Turbo Intercooled** **TD17528**

MIDR 06.23.56 B/41 Euro 2 **6 Cyl.** **17:1** **11100cc** **288kW (392PS)** **Diesel Turbo Intercooled** **TD12207**

87-135500-00 STD **08-135500-00** STD **15-450220-00** WH ¹ **B 135.20 C 256.75 D 147.50 E 9.41 F 0.75** **89-135500-30**

A 78.30
B- 24.00
BØ 75.00
C 1.20
D 120.30
 50x97

3.50  MOL P
 3.00  CR P
 4.00  CR P

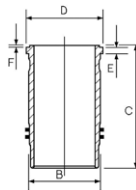

87-135500-00 +
 15-450220-00

AK NB RT TP

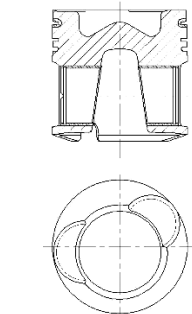

14-450920-00 WH ¹ **B 134.91 C 257.00 D 147.40 E 9.38 F 0.70**

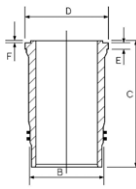

¹ Includes seals

¹ Schließt Dichtungen ein

¹ Inclut des joints

¹ Incluye los sellos

¹ Comprende le guarnizioni

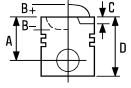

26 124.00

MIDR 06.24.65	6 Cyl.	15.3:1	12000cc	287-412kW (390-560PS)	Diesel Turbo Intercooled	TD29100
MIDR 06.24.65 A/42 Euro 2	6 Cyl.	15.3:1	12000cc	287kW (390PS)	Diesel Turbo Intercooled	TD12148
MIDR 06.24.65 B/42 Euro 2	6 Cyl.	15.3:1	12000cc	316kW (430PS)	Diesel Turbo Intercooled	TD12188
MIDR 06.24.65 C/42 Euro 2	6 Cyl.	15.3:1	12000cc	346kW (471PS)	Diesel Turbo Intercooled	TD12189

87-429600-00  STD

A 93.93
B- 26.30
BØ 82.12
C 2.41
C 2.41
D 142.30
 57x97

AK

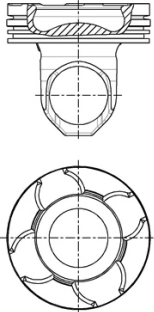

 Articulated piston

08-429600-00 STD

3.150
2.362
4.724



STD

MOL P
CR P
CR P

 Pendelshafttkolben

14-740130-00 WH

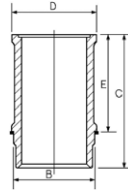

 Piston articulé

B 130.17 C 279.25 D 139.80 E 103.32

 Pistón articulado

88-429600-00
87-429600-00 +
14-740130-00

 Pistone articolato

27 131.00

DXi 12 Euro 3	6 Cyl.	18.1:1	12130cc	324-353kW (441-480PS)	Diesel Turbo Intercooled	TD19083
---------------	--------	--------	---------	-----------------------	--------------------------	---------

87-123200-10  STD

A 87.40
B- 17.21
BØ 89.00
D 125.70
 55x107

AK TP

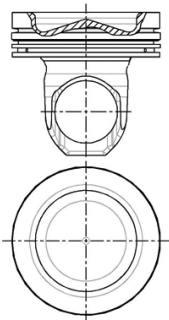

 Includes seals

 Articulated piston

 Steel

08-123200-00 STD

4.00
3.00
4.00



STD

CK P
P
NT 

 Schließt Dichtungen ein

 Pendelshafttkolben

 Stahl

14-450160-00 WH B 150.30 C 276.40 D 159.50 E 11.20 F 3.60

15-450160-00 WH  B 150.32 C 276.42 D 159.50 E 11.21 F 3.62

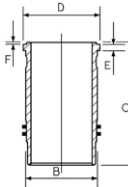

 Inclut des joints

 Piston articulé

 Acier

 Incluye los sellos

 Pistón articulado

 Acero

 Comprende le guarnizioni

 Pistone articolato

 Acciaio

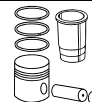
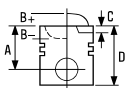

28 131.00

DXi 13 Euro 4 6 Cyl. **12800cc** **323-382kW (440-520PS)** **Diesel Turbo Intercooled** **TD19084**

87-434400-10 ¹ STD **08-434400-00** STD **14-451190-00 W** **B 144.00 C 261.80 D 159.60 E 11.20 F 0.90**

A 75.88
B- 18.10
BØ 89.00
D 112.90
58x76

3.50 **NT PVD** ²
 2.50 **CR**
 3.00 **NT** ²

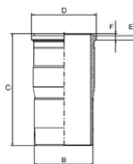

KK

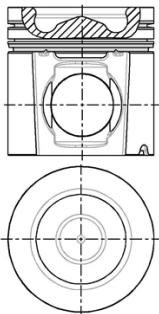

¹ MonoSteel®
² Steel

¹ MonoSteel®
² Stahl

¹ MonoSteel®
² Acier

¹ MonoSteel®
² Acero

¹ MonoSteel®
² Acciaio

29 135.00

MDS 06.35.40 6 Cyl. 15:1 **12024cc** **177-208kW (241-283PS)** **Diesel Turbo Intercooled** **TD8668**

MIDR 06.35.40 6 Cyl. 15:1 **12000cc** **206-226kW (280-307PS)** **Diesel Turbo Intercooled** **TD19965**

MIDR 06.35.40 C 6 Cyl. 15:1 **11941cc** **224-228kW (305-310PS)** **Diesel Turbo Intercooled** **TD8645**

14-020330-00 DH **B 143.00 C 286.00 D 149.00 E 7.40**
14-020510-00 DH **B 143.00 C 286.00 D 147.00 E 7.00**
14-027200-00 DH **B 143.25 C 286.00 D 149.00 E 7.40**

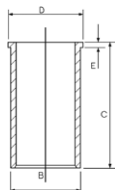



30 135.00

MIDR 06.35.40 G 6 Cyl. 12024cc 243-259kW (330-352PS) Diesel Turbo Intercooled TD12202

MIDR 06.35.40 H 6 Cyl. 15:1 11941cc 264-279kW (359-380PS) Diesel Turbo Intercooled TD8516

87-335900-00 STD

STD

08-335900-00

STD



14-020330-00 *DH*

B 143.00 C 286.00 D 149.00 E 7.40

88-335900-00

87-335900-00 +
14-020330-00

A 90.30
B- 25.85
BØ 78.00
C 0.80
D 170.10
 55x112

4.00  MOL P
3.00  P
4.00  CR P

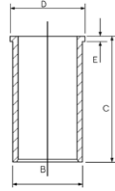

AK RT

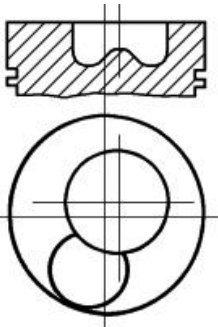

14-040040-00 *DH*

B 143.03 C 288.25 D 149.00 E 7.65 F 1.05

88-335900-10
87-335900-00 +
14-040040-00

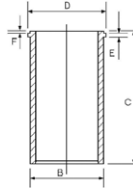

31 135.00

MIDR 06.35.40 J/3 Euro 1 6 Cyl. 12024cc 305kW (415PS) Diesel Turbo Intercooled TD8519

MIDR 06.35.40 M3 Euro 1 6 Cyl. 18:1 12024cc 236kW (321PS) Diesel Turbo Intercooled TD8543

MIDR 06.35.40 N/3 Euro 1 6 Cyl. 15:1 12024cc 283kW (385PS) Diesel Turbo Intercooled TD8518

87-335900-30 STD

STD

08-335900-00

STD



14-040040-00 *DH*

B 143.03 C 288.25 D 149.00 E 7.65 F 1.05

88-335900-30

87-335900-30 +
14-040040-00

A 90.40
B- 21.80
BØ 78.00
C 0.90
D 149.40
 55x108

4.00  MOL P
3.00  P
4.00  CR P

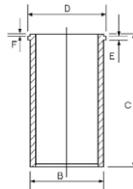

NB RT

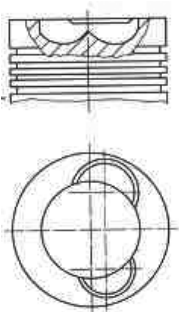

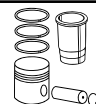
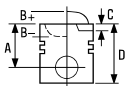





32 135.00

MIDR 06.35.40 J1 Euro 1 6 Cyl. 16.5:1 12024cc 314kW (427PS) Diesel Turbo Intercooled TD8653

MIDR 06.35.40 L1 6 Cyl. 16.5:1 12024cc 283kW (385PS) Diesel Turbo Intercooled TD8517

87-335900-10 STD 08-335900-00 STD 14-040040-00 DH B 143.03 C 288.25 D 149.00 E 7.65 F 1.05

A 90.40
B- 24.00
BØ 78.00
C 0.90
D 149.40
 55x108

4.00  MOL P
3.00  P
4.00  CR P

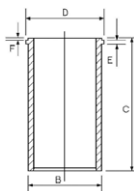

NB RT

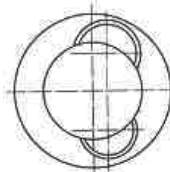
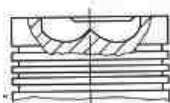

33 135.00

MIDR 06.35.40 P/41 Euro 2 6 Cyl. 12024cc 305kW (415PS) Diesel Turbo Intercooled TD12187

14-040040-00 DH B 143.03 C 288.25 D 149.00 E 7.65 F 1.05

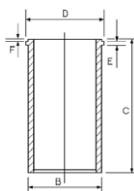



34 135.00

MIDS 06.35.40 D 6 Cyl. 15:1 12024cc 208kW (283PS) Diesel Turbo TD8542

87-335300-00 STD 08-335300-00 STD 14-020330-00 DH B 143.00 C 286.00 D 149.00 E 7.40

A 90.30
B- 29.10
BØ 78.00
C 0.80
D 170.10
 55x115

3.50  CR P
3.00  P
6.00  CR P

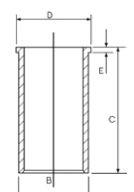

14-020510-00 DH B 143.00 C 286.00 D 147.00 E 7.00



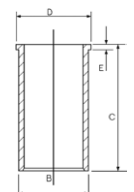

14-027200-00 DH B 143.25 C 286.00 D 149.00 E 7.40

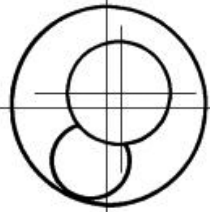
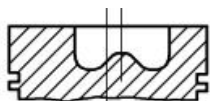

AK RT



88-335300-00
87-335300-00 +
14-020330-00

		ccm	x 		9
3.5L Carburettor	Petrol	3528	V8	88.86	16
11 D	Petrol	3528	V8	88.86	16
11 K2D	Petrol	1120	4	75.00	6
11 K4F	Petrol	1120	4	75.00	6
12 A2B	Petrol	1275	4	70.62	3
12 HE	Petrol	1275	4	70.62	3
12 HL	Petrol	1275	4	70.62	3
12 L	Diesel	2496	4	90.47	19
14 K2A	Petrol	1396	4	75.00	7
14 K2D	Petrol	1396	4	75.00	7
14 K2F	Petrol	1396	4	75.00	7
14 K4C	Petrol	1396	4	75.00	7
14 K4D	Petrol	1396	4	75.00	7
14 K4F	Petrol	1396	4	75.00	7
14 K4M	Petrol	1396	4	75.00	7
16 K4F K Series	Petrol	1588	4	80.00	9
18 K4F K Series	Petrol	1796	4	80.00	9
18 K4K (VVC)	Petrol	1796	4	80.00	9
19 L (300TDi)	Diesel	2496	4	90.47	20
20 T2N (L Series)	Diesel	1994	4	84.45	15
20 T2R (L Series)	Diesel	1994	4	84.45	15
21 L	Diesel	2496	4	90.47	19
22 D	Petrol	3528	V8	88.86	17
24 D	Petrol	3528	V8	88.86	17
25 6T (BMW)	Diesel	2497	6	80.00	11
25 D	Petrol	3528	V8	88.86	17
25 K4F	Petrol	2497	V6	80.00	10
30 A	Petrol	3528	V8	88.86	17
31 A	Petrol	3528	V8	88.86	17
31 D	Petrol	3528	V8	88.86	16
38 A	Petrol	3528	V8	88.86	16
39 A	Petrol	3528	V8	88.86	16
492 4 SHIRG	Diesel	2500	4	92.00	21
2286	Petrol	2286	4	90.47	18
A+ Series (12 A2D)	Petrol	1275	4	70.62	5
A+ Series (12 A2E)	Petrol	1275	4	70.62	5
A+ Series (12 H)	Petrol	1275	4	70.62	5
A+ Series (99H)	Petrol	998	4	64.56	1
A Series (12 A2A)	Petrol	1275	4	70.62	4
A Series (12 A2L)	Petrol	1275	4	70.62	4
A Series (99 H)	Petrol	998	4	64.56	2
HR 492 HI	Diesel	2393	4	92.00	22
HR 492 HT	Diesel	2393	4	92.00	22
KV 6	Petrol	2497	V6	80.00	10
M 47 R	Diesel	1951	4	84.00	14
TUD5	Diesel	1527	4	77.00	8
VM-HR 492.4	Diesel	2393	4	92.00	22
XUD 7TE	Diesel	1769	4	80.00	12
XUD9/A/B/L/Y	Diesel	1905	4	83.00	13

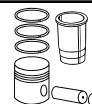
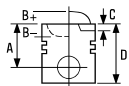

1 64.56

Mini 1000





01/92→06/93

A+ Series (99H)

4 Cyl.
998cc

10.3:1
30kW (41PS)



TD3483

87-524307-10   .020
87-524311-10   .040
87-524314-10   .060

08-524300-10 STD
08-524307-10 .020
08-524311-10 .040
08-524314-10 .060

A 33.86
D 53.79
 16x51

01/86→06/92

1.50  CK P
1.50  P
3.00  R231 P

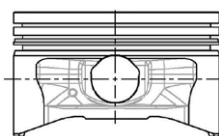



 Piston pin press fit in conrod

 Kolbenbolzen in Pleuel eingepreßt

 Axe serré sur bielle

 Bulón del pistón montado a presión en la biela

 Spinotto inserito a spinta nella biella

 Pistons to be replaced in Engine Sets only

 Kolben nur Motorsätzen zu ersetzen

 Piston à remplacer dans jeu moteur

 Pistones de repuesto para juegos de motores solamente

 Il pistone può essere rimpiazzato solamente completo

2 64.56

Mini 1000









09/86→

A Series (99 H)

4 Cyl.
998cc

26-33kW (35-45PS)





TD27689

87-522400-00   STD
87-522407-00   .020
87-522411-00   .040
87-522414-00   .060

08-522400-00 STD
08-522407-00 .020
08-522411-00 .040
08-522414-00 .060

A 34.09
B- 4.93
D 65.77
 16x56

01/80→12/85

1.58  P
1.58  P
1.58  P
4.00  CR P

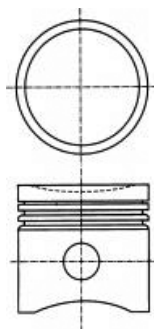



 Pin retained by circlips

 Bolzen mit Sicherungsbügeln gehalten

 Axe retenue par circlips

 Bulón retenido por anillos de retención

 Spinotto trattenuto da fermi

 Pistons to be replaced in Engine Sets only

 Kolben nur Motorsätzen zu ersetzen

 Piston à remplacer dans jeu moteur

 Pistones de repuesto para juegos de motores solamente

 Il pistone può essere rimpiazzato solamente completo



3 70.62

Maestro 1.3	09/90→01/95	12 HE	4 Cyl. 1275cc	49-51kW (67-69PS)	TD26936
Mini 1300	04/92→11/00	12 A2B	4 Cyl. 1275cc	37kW (50PS)	TD4880
Montego 1.3	10/84→10/88	12 HL	4 Cyl. 1275cc	46-50kW (63-68PS)	TD22905



87-521700-00 [1]	STD
87-521707-00 [1]	.020
87-521711-00 [1]	.040
87-521714-00 [1]	.060

08-521700-00	STD
08-521707-00	.020
08-521711-00	.040
08-521714-00	.060

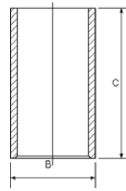
14-010890-00 D B 73.09 C 141.28



A	37.24
B-	5.74
D	57.24
	21x56

1.48		P
1.48		P
4.00		P

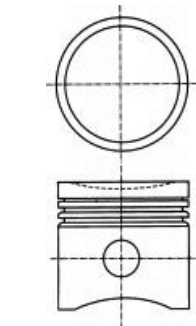

[1] Pistons to be replaced in Engine Sets only

[1] Kolben nur Motorsätzen zu ersetzen

[1] Piston à remplacer dans jeu moteur

[1] Pistones de repuesto para juegos de motores solamente

[1] Il pistone può essere rimpiazzato solamente completo

4 70.62

Mini 1300	01/91→12/91	A Series (12 A2A)	4 Cyl. 1275cc	45kW (61PS)	TD9490
Mini 1300/Cooper	06/91→02/94				
Mini 1.3 S	02/98→05/01	A Series (12 A2L)	4 Cyl. 1275cc	37-46kW (50-63PS)	TD9489
Mini 1300	01/92→11/00				

14-010890-00 D B 73.09 C 141.28

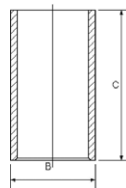

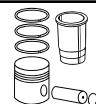
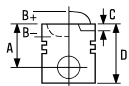





5 70.62

Mini 1300	01/92→11/00	A+ Series (12 A2E) 4 Cyl. 1275cc	46kW (63PS)	TD3487
-----------	-------------	---	-------------	--------

Mini 1300	01/92→04/95	A+ Series (12 A2D) 4 Cyl. 1275cc	39kW (53PS)	TD3473
-----------	-------------	---	-------------	--------

Mini Cooper 1.3		A+ Series (12 H) 4 Cyl. 1275cc	9.8:1 47kW (64PS)	TD2364
-----------------	--	---	----------------------	--------



87-524100-00 	STD
87-524107-00 	.020
87-524111-00 	.040
87-524114-00 	.060

08-524100-00	STD
08-524107-00	.020
08-524111-00	.040
08-524114-00	.060

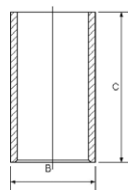
14-010890-00 *D* B 73.09 C 141.28



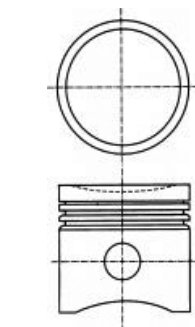

A	38.74
B-	5.74
D	58.74
	21x56

1.50		NT
1.50		P
3.00		P



 Pistons to be replaced in Engine Sets only

 Kolben nur Motorsätzen zu ersetzen

 Piston à remplacer dans jeu moteur

 Pistones de repuesto para juegos de motores solamente

 Il pistone può essere rimpiazzato solamente completo

6 75.00

100 111	04/94→10/97	11 K2D		
100/Metro 111 C/L/S	03/90→12/98	4 Cyl.	9.75:1	
200 211	01/98→03/00	1120cc	44kW (60PS)	TD4884

25 1.1	09/99→06/01	11 K4F		
25 1.1 16V	01/04→05/05	4 Cyl.	55kW (75PS)	TD18365

14-710030-00 *WH* B 84.10 C 129.50 D 87.50 E 50.00

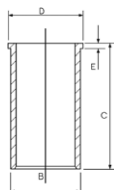



7 75.00

100 114	04/94→10/97	14 K2A			
100/Metro 114 S/L/GTA	03/90→12/98		4 Cyl.	10:1	
200 214	09/93→10/95		1396cc	55kW (75PS)	TD3477
100 114	04/94→10/97	14 K2D			
100/Metro 114 S/L/GTA	03/90→12/98		4 Cyl.	9.75:1	
200 214	09/93→10/95		1396cc	55kW (75PS)	TD3478
200 214 i	11/95→03/00	14 K2F			
400 414	03/96→12/99		4 Cyl.	9.9:1	
			1396cc	55kW (75PS)	TD9499
100/Metro 114 GTI 16V	03/90→08/91	14 K4C			
100/Metro 114 GTI/GT 16V CAT	03/90→12/98		4 Cyl.	9.75:1	
200 214 GSi/Si	01/90→10/95		1396cc	66-70kW (90-95PS)	TD3480
200 214 Si/Gsi	10/89→10/95				
400 414	01/93→04/95				
400 414 GSi/Si	04/90→04/95				
Cabriolet 214 1.4	04/90→11/99				
100/Metro 114 GTI 16V	03/90→08/91	14 K4D			
100/Metro 114 GTI/GT 16V CAT	03/90→12/98		4 Cyl.	10:1	
200 1.4	01/96→12/97		1396cc	66kW (90PS)	TD3488
200 214 Si/Gsi	10/89→10/95				
400 414 GSi/Si	04/90→04/95				
Cabriolet 214 1.4	01/92→11/99				
25 1.4 16V	10/99→05/05	14 K4F			
45 1.4	02/00→05/05		4 Cyl.	9.5:1	
100 114	03/97→10/98		1396cc	76kW (103PS)	TD3481
100/Metro 114 Gsi	10/94→10/95				
100/Metro 114 GTI 16V	08/91→12/98				
200 214 GSi/Si	12/92→10/95				
200 214 Si	11/95→03/00				
400 414 GSi/Si CAT	01/93→04/95				
400 414 Si	05/95→03/00				
Cabriolet 214 1.4i 16V	01/93→11/99				
Streetwise 1.4	08/03→05/05				
25 1.4 16V	10/99→05/05	14 K4M			
Streetwise 1.4	08/03→05/05		4 Cyl.		
			1396cc	62kW (84PS)	TD18231

87-520500-00

STD

01/95→

A 23.84

D 46.79

 18x48

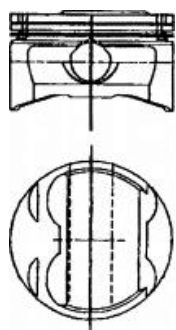

 Steel

08-520500-00

STD

01/95→

1.00

1.20

2.00



 T

NT  T

 Stahl

14-710030-00 WH

B 84.10 C 129.50 D 87.50 E 50.00

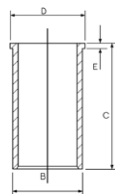

 Acero

88-520500-00

87-520500-00 +

14-710030-00



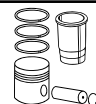
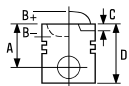

 Acciaio



8  **77.00**

100/Metro 115 D	12/94→12/98	TUD5	4 Cyl.	23:1	
			1527cc	42kW (57PS)	
		Diesel			TD3490

87-325800-00	STD	08-325800-00	STD
87-325806-00	0.40mm	08-325806-00	0.40mm

A	40.37	2.00		CK P
B-	1.65	1.75		P
D	66.32	3.00		CR P
	23x60			

RT

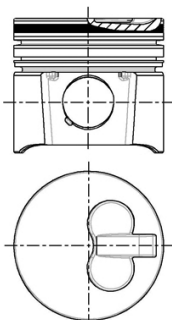

9  **80.00**

25 1.6 16V	10/99→05/05	16 K4F K Series			
45 1.6	02/00→05/05		4 Cyl.	10.5:1	
200 216	01/96→12/97		1588cc	80-86kW (109-117PS)	
200 216 Si	11/95→03/00				TD9358
400 416 Si	05/95→03/00				
Cabriolet 216 1.6i 16V	01/96→11/99				
Coupe 1.6 16 V	03/96→11/99				
Streetwise 1.6	01/04→05/05				

25 1.8 16V	10/99→05/05	18 K4F K Series			
45 1.8	02/00→05/05		4 Cyl.	10.5:1	
200 218 Si	08/99→03/00		1796cc	85-88kW (116-120PS)	
Streetwise 1.8	08/03→05/05				TD9483

75 1.8	02/99→05/05	18 K4F K Series			
75 Tourer 1.8	08/01→05/05		4 Cyl.	10.5:1	
			1796cc	88kW (120PS)	
					TD11607





25 1.8 16V	02/00 → 05/05	18 K4K (VVC)		
200 218 K Vi	11/95 → 03/00		4 Cyl.	10.5:1
400 Tourer 1.8 i	06/96 → 11/98		1796cc	107-110kW (146-150PS)
Coupe 1.8 16 V	03/96 → 11/99			TD3500

87-522700-00	STD	08-522700-00	STD	14-710020-00 WH	B 84.10 C 129.50 D 87.50 E 50.00	88-522700-00 87-522700-00 + 14-710020-00
A 22.70		1.00		CR		
B- 0.53		1.20		P		
BØ 68.20		2.00		CR		
C 2.65						
D 45.65						
18x53						
TP						

10 **80.00**

75 2.5 V6	10/01 → 05/05	25 K4F		
800 2.5, 800 2.5 Si	02/96 → 10/98		V6 Cyl.	10.5:1
800 825 Si, 800 825 Si Lux	04/96 → 02/99		2497cc	129-130kW (175-177PS)
				TD9492

75 2.5 V6	02/99 → 10/01	KV 6		
75 Tourer 2.5 V6	08/01 → 05/05		V6 Cyl.	10.5:1
			2497cc	129kW (175PS)
				TD11608



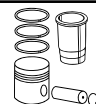
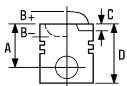

87-521600-00	STD	08-521600-00	STD	14-710020-00 WH	B 84.10 C 129.50 D 87.50 E 50.00	
A 27.35		1.20		CR		
C 1.20		1.50				
D 50.30		2.50		CR		
18x53						



11  **80.00**

Range Rover 2.5 TD 09/94→09/02 **25 6T (BMW)**
 6 Cyl.
 2497cc 100kW (136PS)
 Diesel Turbo Intercooled TD9485

87-704500-00 STD 08-704500-00 STD
 87-704507-00 0.50mm 08-704507-00 0.50mm

A 39.45 3.00  CR P
 B- 2.50 1.75  P
 D 62.45 3.00  CR P
 27x63



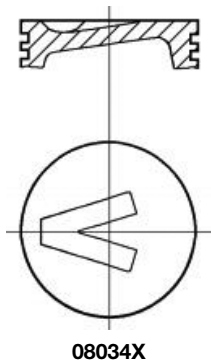

AK KK RT



12  **80.00**

200 218 TD 09/91→10/95 **XUD 7TE**
 400 418 TD 09/91→04/95 4 Cyl. 22:1
 400 Tourer 1.8 TD 09/93→11/98 1769cc 65kW (88PS)
 Diesel Turbo TD3504

87-323600-00 STD 08-323600-00 STD 14-024740-00 D B 83.50 C 154.00 D 85.70 E 4.60
 87-323607-00 0.50mm 08-323607-00 0.50mm 14-024830-00 D B 83.00 C 154.00 D 86.00 E 4.50

A 46.80 3.00  MOL P
 B- 2.20 2.00  P
 D 84.50 3.00  CR P
 28x68

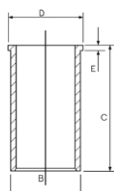

AK RT

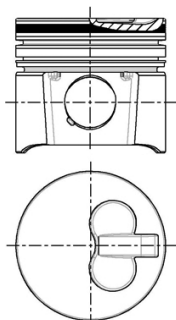



13  **83.00**



218 D, 218 SD	01/91→12/96	XUD9/A/B/L/Y			
418 D, 418 SD, 418 SLD	01/92→12/96	4 Cyl.	23.5:1		
Diesel					1905cc
					FM3219

87-152000-10	STD
87-152007-10	0.50mm
87-152010-10	0.80mm

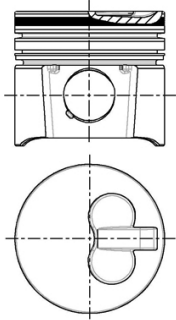
A	46.80
B-	2.20
D	84.30
	25x72



08-152000-00	STD
08-152003-00	0.125mm
08-152007-00	0.50mm
08-152010-00	0.80mm
08-152011-00	1.00mm

2.00		CR P
2.00		P
3.00		CR P

14-020530-00 D **B 85.60 C 153.50 D 88.50 E 3.90**

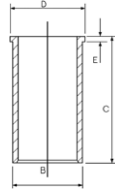

88-152000-30
87-152000-10 +
14-020530-00

14  **84.00**

75 2.0 CDT	02/99→05/05	M 47 R			
75 Tourer 2.0 CDT	08/01→05/05	4 Cyl.	19.5:1		
Diesel					1951cc
Turbo Intercooled					85kW (116PS)
					TD11609

87-114400-00	STD
87-114405-00	0.25mm

A	47.00
B-	15.05
BØ	41.70
C	1.30
D	71.00
	30x66

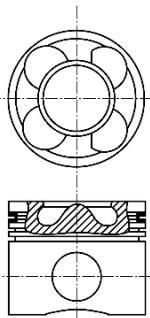

08452-L160

08-114400-00	STD
08-114405-00	0.25mm

3.00		CK P
2.00		P
3.00		CR P

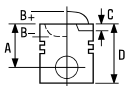

KK RT







15  **84.45**

25 2.0 iDT	10/99→05/05	20 T2N (L Series)		
45 2.0 iDT	02/00→05/05	4 Cyl.	19.5:1	
200 220 SDi	11/95→03/00	1994cc	74-83kW (101-113PS)	
400 420 Di	05/95→03/00	Diesel	Turbo Intercooled	TD9496
600 620 Sdi	12/94→02/99			
Streetwise 2.0 TD	08/03→05/05			

200 220 D/SD, 400 420 D	11/95→03/00	20 T2R (L Series)		
		4 Cyl.	19.5:1	
		1994cc	63kW (86PS)	
		Diesel	Turbo Intercooled	TD9497

87-119800-00	STD	08-119800-00 	STD
87-119807-00	0.50mm	08-119807-00 	0.50mm

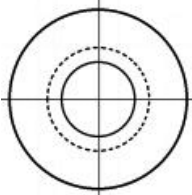
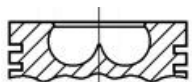

A	47.97	→10P13888B	
B-	17.00		
BØ	38.00	3.00 	PS
D	76.97	2.00 	P
	30x70	3.00 	CR

AK RT TP



 15 degree Wedge Top Ring

 15-Grad Keiloberring

 Segment trapézoidal angle 15 de grés.  Anillo superior en cuña de 15 grados

 Segmento trapezio con inclinazione fianchi = 15







16 88.86

3500, 3500den Plas, 3500 S, 3500 SE	01/77→12/86	3.5L Carburettor	V8 Cyl. 3528cc	8.13:1	FM2683
3500	01/82→08/85	11 D	V8 Cyl. 3528cc	9.35:1 93kW (126PS)	TD3494
Range Rover EFi	01/86→	31 D	V8 Cyl. 3528cc	8.13:1 107kW (146PS)	TD9484
2000-3500 3500	06/76→10/86	38 A	V8 Cyl. 3528cc	8.13:1 115kW (156PS)	TD9501
2000-3500 3500	06/76→10/86	39 A	V8 Cyl. 3528cc	8.13:1 115kW (156PS)	TD9500

87-520100-00 STD
87-520107-00 .020

08-520100-00 STD
08-520107-00 .020

A 47.37
B- 5.26
BØ 71.12
D 77.09
 22x73

1.58  CR P
1.58  P
4.73  P

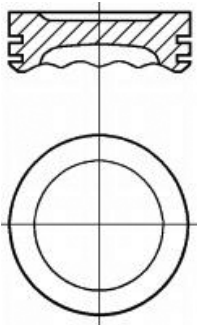

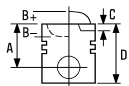





17  **88.86**

3500 3.5	01/89 →	22 D	V8 Cyl. 3528cc	8.13:1 113kW (154PS)	TD3498
Range Rover EFI	01/86 →	24 D	V8 Cyl. 3528cc	9.35:1 120kW (163PS)	TD3496
Range Rover EFI	01/86 →	25 D	V8 Cyl. 3528cc	9.35:1 120kW (163PS)	TD3495
2000-3500 3500 Vitesse	10/82 →10/86	30 A	V8 Cyl. 3528cc	9.35:1 142kW (193PS)	TD3476
2000-3500 3500 Vitesse	10/82 →10/86	31 A	V8 Cyl. 3528cc	9.35:1 142kW (193PS)	TD3475

87-520100-10 STD
87-520107-10 .020

08-520100-00 STD
08-520107-00 .020

A 47.17
B- 2.36
BØ 71.12
D 77.09
 22x73

1.58  CR P
1.58  P
4.73  P

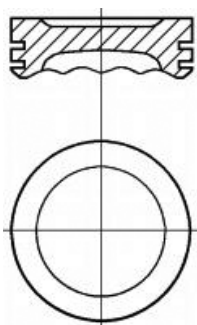

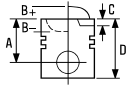

18  **90.47**

80 Mk II, 80 P4

01/58 → 12/62 **2286**

4 Cyl. 7:1
2286cc



FM1533

87-263100-00 STD
87-263107-00 .020

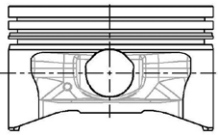
A 58.52
D 99.92
 25x76



08-263100-00 STD
08-263107-00 .020

1.79  CR P
1.79  P
4.74  P

14-010920-00 D B 94.50 C 191.36

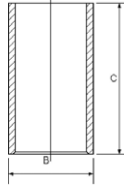

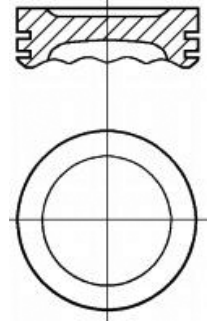

87-263100-10 STD
87-263107-10 .020

A 54.48
B- 0.91
D 89.23
 25x76



08-263100-00 STD
08-263107-00 .020

1.79  CR P
1.79  P
4.74  P

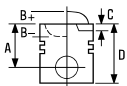

19  **90.47**

2400-2.5 TDi	89/01→	12 L	4 Cyl.	19.5:1
			2496cc	83kW (113PS)
			Diesel	Turbo Intercooled
				TD3461

825 2.5 TDi	08/96→10/98	21 L	4 Cyl.	19.5:1
			2496cc	83kW (113PS)
			Diesel	Turbo Intercooled
				TD15168



87-524400-00 STD
87-524407-00 .020

A 55.40
B- 18.85
BØ 39.50
D 91.90
 30x77

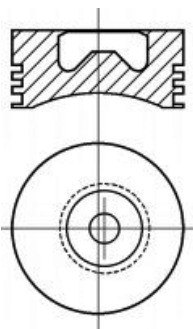
RT TP



08-524400-00 STD
08-524407-00 .020

2.50  CR P
2.00  P
3.00  CR P

14-024710-00 D B 94.52 C 191.36 D 99.70 E 4.76

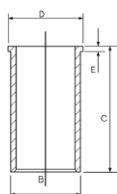

14-010920-00 D B 94.50 C 191.36

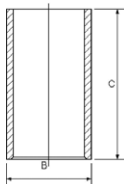

20  **90.47**

LR Discovery	10/89→10/98	19 L (300TDi)	4 Cyl.	19.5:1
			2496cc	83-90kW (113-122PS)
			Diesel	Turbo Intercooled
				TD9482



87-521800-20 STD
87-521807-20 .020
87-521811-20 .040

A 55.40
B- 18.45
BØ 39.00
D 91.90
 30x77

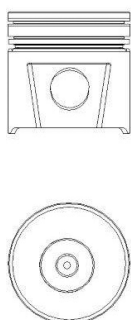
RT TP



08-521800-20 STD
08-521807-20 .020
08-521811-20 .040

3.00  CR
2.50  P
3.00  CR

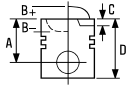



21  **92.00**

800 825 D/SD	01/90→02/99	492 4 SHIRG	4 Cyl.	2500cc	87kW (118PS)	
800 825 SD	09/93→02/99					
Diesel						TD3502

87-110100-00	STD	08-110100-00	STD	14-676420-00 WH	B 101.50 C 166.80 D 110.00 E 8.90 F 1.20	89-110100-00
						87-110100-00 +
						14-676420-00

- A** 51.00
- B-** 2.10
- D** 86.00
-  30x76

- 2.50  CR P
- 2.00  P
- 4.00  CR P

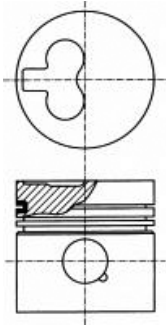
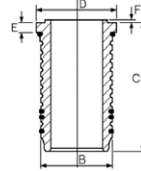

22  **92.00**





2400 SD Turbo	01/84→12/87	HR 492 HI	4 Cyl.	2393cc	22:1	81-84kW (110-114PS)
Diesel						TD22365
Turbo Intercooled						

2000-3500 2400 TD	05/82→10/86	HR 492 HT	4 Cyl.	2393cc	22:1	67kW (91PS)
Diesel						TD22366
Turbo Intercooled						

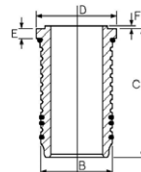
2400 SD Turbo	01/84→12/87	VM-HR 492.4	4 Cyl.	2393cc	22:1	89kW (121PS)
Diesel						TD3503
Turbo						

14-676420-00 WH **B 101.50 C 166.80 D 110.00 E 8.90 F 1.20**





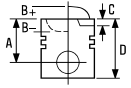



		ccm	x 		
A16 LET Euro 5	Petrol	1598	4	79.00	1
A20 DTH Euro 5	Diesel	1956	4	83.00	6
B258I	Petrol	2498	V6	81.60	3
D223L	Diesel	2171	4	84.00	7
X22 DTH	Diesel	2171	4	84.00	7
Y22 DTH	Diesel	2171	4	84.00	7
Z18XE	Petrol	1796	4	80.50	2
Z19DT	Diesel	1910	4	82.00	5
Z19DTH	Diesel	1910	4	82.00	4
Z19 DTJ	Diesel	1910	4	82.00	4



1  **79.00**

9-5 1.6 Turbo 05/10→01/12 **A16 LET Euro 5** 4 Cyl. 8.8:1
1598cc **132kW (180PS)**
Turbo **TD24444**

87-435500-00 STD **08-435500-00** STD
87-435507-00 0.50mm **08-435507-00** 0.50mm

A 27.50 1.20  NT 
B+ 0.60 1.20  P
D 45.10 2.00  NT 
 19x53

HA TP

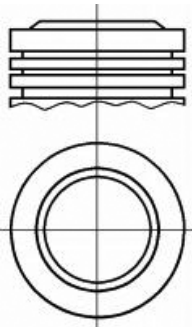







 Steel  Stahl  Acier  Acero  Acciaio

2  **80.50**

9-3 1.8 i 01/04→ **Z18XE** 4 Cyl. 10.5:1
1796cc **90kW (122PS)**
TD18079

87-141200-00 STD **08-141200-00** STD
87-141207-00 0.50mm **08-141207-00** 0.50mm

A 24.10 1.20  NT 
D 44.70 1.20  P
 18x55 2.00  CR 

TP

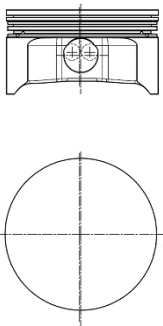

 Steel  Stahl  Acier  Acero  Acciaio

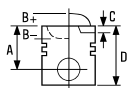





3  **81.60**

900 II 2.5	12/93→12/97	B258I		
900 II 2.5 -24 V6	07/93→02/98		V6 Cyl. 2498cc	10.8:1 125-127kW (170-173PS)
				TD3526

87-307700-00	STD	08-307700-00	STD
87-307707-00	0.50mm	08-307707-00	0.50mm
		08-307711-00	1.00mm

- A** 30.45
- B+** 0.36
- C** 2.40
- D** 51.03
-  21x56

- 1.50  MO P
- 1.50  P
- 3.00  CR 

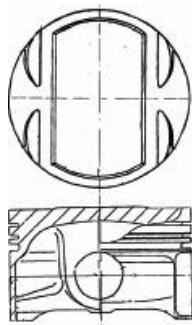

 Steel

 Stahl

 Acier

 Acero

 Acciaio



4  **82.00**

9-3 1.9 TiD	09/04→	Z19 DTJ		
9-5 1.9 TiD	01/06→12/09		4 Cyl. 1910cc	17.5:1 88kW (120PS)
			Diesel	Turbo Intercooled
				TD24819

9-3 1.9 TiD	09/04→	Z19DTH		
9-5 1.9 TiD	01/06→12/09		4 Cyl. 1910cc	17.5:1 110kW (150PS)
			Diesel	Turbo Intercooled
				TD18084

87-146100-00	STD	08-146100-00	STD
87-146108-00	0.60mm	08-146106-00	0.40mm
		08-146108-00	0.60mm

- A** 46.50
- B-** 15.40
- BØ** 41.50
- C** 1.03
- D** 72.50
-  26x61

- 2.00  CK P
- 2.00  P
- 2.00  CK P

AK KK NB RT TP

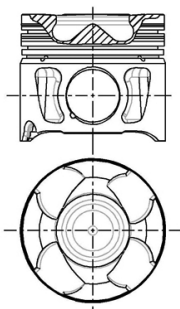

08256-102



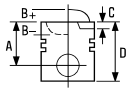





87-146100-10
87-146106-10

STD
0.40mm

08-146100-00
08-146106-00
08-146108-00

STD
0.40mm
0.60mm

A 46.50
B- 15.40
BØ 41.50
C 1.07
C 1.02
D 72.50
 30x67

2.00  CK P
2.00  P
2.00  CK P

AK KK RT TP

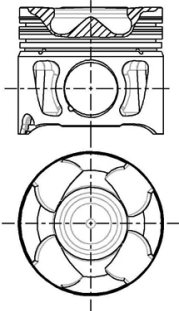

08269-503

5  82.00

9-3 1.9 TiD

09/04 →

Z19DT

4 Cyl. 18:1
1910cc 88kW (120PS)
Diesel Turbo Intercooled Direct Injection

TD18086



87-124000-30
87-124008-30

STD
0.60mm

08-124000-00
08-124006-00
08-124008-00

STD
0.40mm
0.60mm

A 46.50
B- 17.45
BØ 37.55
C 0.65
D 72.50
 26x61

2.00  CK P
2.00  P
2.00  CR P

NB RT

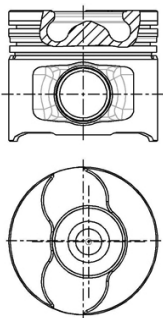

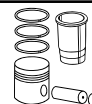
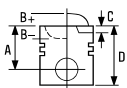





6  **83.00**

9-5 2.0 TiD	05/10→01/12	A20 DTH Euro 5	4 Cyl.	16.5:1	
			1956cc	118kW (160PS)	
		Diesel	Turbo Direct Injection		TD24003

87-436500-00	STD	08-436500-00	STD
87-436506-00	0.40mm	08-436506-00	0.40mm

A	43.63	1.50		GDC P
B-	15.80	1.50		P
BØ	43.50	2.00		CR P
D	72.63			
	30x66			

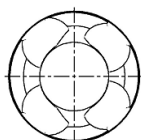
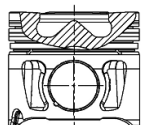

08344A406





7  **84.00**

9-3 2.2 TiD	02/98→	D223L	4 Cyl.		
9-5 2.2 TiD	03/02→12/09		2171cc	85-92kW (115-125PS)	
		Diesel	Turbo Intercooled		TD18087

9-3 2.2 TiD	02/98→	X22 DTH	4 Cyl.	18.5:1	
9-5 2.2 TiD	03/02→12/09		2171cc	85kW (115PS)	
		Diesel	Turbo Intercooled		TD9750

9-3 2.2 TiD	02/98→	Y22 DTH	4 Cyl.	18.5:1	
9-5 2.2 TiD	03/02→12/09		2171cc	85-88kW (116-120PS)	
		Diesel	Turbo Intercooled		TD19130

87-126000-10	STD	08-126000-00	STD
87-126007-10	0.50mm	08-126007-00	0.50mm

A	45.80	1.75		CK P
B-	14.67	1.75		P
BØ	43.00	3.00		CR P
C	1.05			
D	70.80			
	29x68			

AK KK RT TP

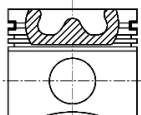
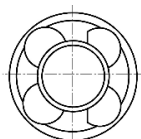

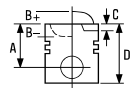





1  **105.00**





1054 P	4 Cyl.	17:1	4156cc	Diesel	FM9146
1055 P	5 Cyl.	17:1	5195cc	Diesel	FM4124
1056 P	6 Cyl.		6234cc	Diesel	FM4125



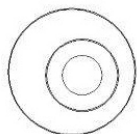
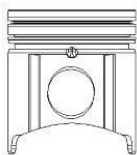

87-523300-00	STD	08-523300-00	STD
87-523307-00	0.50mm	08-523307-00	0.50mm
87-523311-00	1.00mm		





- A** 69.00
- B-** 21.80
- BØ** 59.50
- D** 119.00
-  35x90

2.50		CR P
2.50		P
2.50		P
5.00		CR P



		ccm	x 		
15.5W37 W31/15W37 WB15 Air Compressor	Petrol		2	75.00	1
D 11 R 23	Diesel	11022	6	127.00	10
DC 9.01 Euro 3	Diesel	9000	6	115.00	2
DC 9.02 Euro 3	Diesel	9000	6	115.00	2
DC 9.03 Euro 3	Diesel	9000	6	115.00	2
DC 9.04 Euro 3	Diesel	9000	6	115.00	2
DC 9.05 Euro 3	Diesel	9000	6	115.00	2
DC 9.06	Diesel	9000	6	115.00	2
DC 9.11 Euro 3 DC 9	Diesel	8900	5	127.00	11
DC 9.12 Euro 3 DC 9	Diesel	8900	5	127.00	11
DC 9.13 Euro 3 DC 9	Diesel	8900	5	127.00	11
DC 9.16 Euro 4 DC 9	Diesel	8867	5	127.00	12
DC 9.17 Euro 4 DC 9	Diesel	8867	5	127.00	12
DC 9.19 Euro 3 DC 9	Diesel	8867	5	127.00	11
DC 9.20 Euro 3	Diesel	8867	5	127.00	11
DC 9.21	Diesel	8867	5	127.00	11
DC 11.01 Euro 3	Diesel	10600	6	127.00	13
DC 11.02 Euro 3	Diesel	10600	6	127.00	11
DC 11.03 Euro 3	Diesel	10600	6	127.00	13
DC 11.04 Euro 3	Diesel	10600	6	127.00	11
DC 11.07 Euro 2	Diesel	10600	6	127.00	13
DC 11.08 Euro 3	Diesel	10600	6	127.00	13
DC 11.09 Euro 3	Diesel	10600	6	127.00	11
DC 12.01 Euro 3	Diesel	11700	6	127.00	14
DC 12.02 Euro 2	Diesel	11700	6	127.00	15
DC 12.03 Euro 3	Diesel	11700	6	127.00	14
DC 12.06 Euro 3	Diesel	11700	6	127.00	15
DC 12.09 Euro 3	Diesel	11700	6	127.00	14
DC 12.10 Euro 4	Diesel	11700	6	127.00	16
DC 12.13 Euro 4	Diesel	11700	6	127.00	16
DC 12.14 Euro 3	Diesel	11716	6	127.00	12
DC 12.15	Diesel	11716	6	127.00	12
DC 12.17 Euro 3	Diesel	11716	6	127.00	15
DC 12.18 Euro 5	Diesel	11716	6	127.00	12
DC 12.22 Euro 5	Diesel	11716	6	127.00	12
DC 12.23 Euro 4	Diesel	11716	6	127.00	12
DC 12.24 Euro 4	Diesel	11716	6	127.00	12
DC 12.26 Euro 4	Diesel	11716	6	127.00	12
DC 16.01 Euro 3	Diesel	15600	V8	127.00	15
DC 16.02 Euro 3	Diesel	15600	V8	127.00	14
DC 16.03 Euro 3	Diesel	15600	V8	127.00	15
DC 16.04 Euro 3	Diesel	15600	V8	127.00	17
DC 16.05 Euro 4	Diesel	15600	V8	127.00	17
DC 16.06 Euro 4	Diesel	15600	V8	127.00	17
DC 16.08 Euro 4	Diesel	15600	V8	127.00	17
DC 16.09 Euro 5	Diesel	15600	V8	127.00	17
DC 16.17 Euro 5	Diesel	15600	V8	127.00	17
DC 16.18 Euro 5	Diesel	15600	V8	127.00	17
DC 16.19 Euro 5	Diesel	15600	V8	127.00	17
DC 16.22 EEV	Diesel	15600	V8	127.00	17
DN 8.01	Diesel	7800	6	115.00	3
DN 8.05 L01 . L04	Diesel	7800	6	115.00	3
DN 9.01	Diesel	8500	6	115.00	4
DN 11.01	Diesel	11020	6	127.00	10
DN 11.01 B10	Diesel	11000	6	127.00	10
DN 11.01 C 09	Diesel	11020	6	127.00	10
DN 11.04 B10	Diesel	11000	6	127.00	10
DN 11.04 C 01	Diesel	11000	6	127.00	10
DN 11.06	Diesel	11020	6	127.00	10
DN 11.07	Diesel	11022	6	127.00	10
DN 11.08	Diesel	11022	6	127.00	10
DN 11.08 B01	Diesel	11020	6	127.00	10
DS 8 LB09-LB14	Diesel	7800	6	115.00	5
DS 8.01	Diesel	7800	6	115.00	5
DS 8.05	Diesel	7800	6	115.00	5
DS 8.06	Diesel	7800	6	115.00	5
DS 9.01	Diesel	8475	6	115.00	6
DS 9.02	Diesel	8475	6	115.00	6
DS 9.05 Euro 1	Diesel	8475	6	115.00	7

		ccm	x 		
DS 9.06	Diesel	8475	6	115.00	7
DS 9.08	Diesel	8475	6	115.00	7
DS 11	Diesel	11022	6	127.00	18
DS 11 Agr/Ind 1978>	Diesel	11022	6	127.00	19
DS 11 / D11	Diesel	11022	6	127.00	10
DS 11.01	Diesel	11022	6	127.00	20
DS 11.01 B 06	Diesel	11022	6	127.00	10
DS 11.02	Diesel	11022	6	127.00	20
DS 11.14	Diesel	11022	6	127.00	20
DS 11.15	Diesel	11022	6	127.00	20
DS 11.15 B	Diesel	11022	6	127.00	10
DS 11.18	Diesel	11022	6	127.00	20
DS 11.22	Diesel	11022	6	127.00	21
DS 11.23	Diesel	11022	6	127.00	21
DS 11.34	Diesel	11020	6	127.00	22
DS 11.71	Diesel	11020	6	127.00	22
DS 11.71 C	Diesel	11020	6	127.00	22
DS 11.72	Diesel	11022	6	127.00	22
DS 11.73	Diesel	11020	6	127.00	22
DS 11.74	Diesel	11020	6	127.00	22
DS 11.75	Diesel	11020	6	127.00	21
DS 14	Diesel	14181	V8	127.00	23
DS 14 LB 05	Diesel	14200	V8	127.00	23
DS 14 LB 08	Diesel	14200	V8	127.00	23
DS 14.01	Diesel	14190	V8	127.00	24
DS 14.01 L 01	Diesel	14200	V8	127.00	23
DS 14.02	Diesel	14190	V8	127.00	24
DS 14.06	Diesel	14190	V8	127.00	24
DS 14.06 L01 / L02 / L03	Diesel	14200	V8	127.00	24
DS 14.07	Diesel	14190	V8	127.00	23
DS 14.07 L01/DS 14.07 L02	Diesel	14200	V8	127.00	24
DS 14.46	Diesel	14181	V8	127.00	25
DS 801 LB14/DS 801 LB15/DS 801 LB16	Diesel	7800	6	115.00	5
DSC 9.01	Diesel	8475	6	115.00	6
DSC 9.02	Diesel	8475	6	115.00	6
DSC 9.07 Euro 1	Diesel	8475	6	115.00	7
DSC 9.08 Euro 1	Diesel	8475	6	115.00	7
DSC 9.09 Euro 2	Diesel	8475	6	115.00	7
DSC 9.10 Euro 1	Diesel	8475	6	115.00	8
DSC 9.11 Euro 2	Diesel	9000	6	115.00	9
DSC 9.12 Euro 2	Diesel	9000	6	115.00	9
DSC 9.13 Euro 2	Diesel	9000	6	115.00	9
DSC 9.15 Euro 2	Diesel	9000	6	115.00	9
DSC 11	Diesel	11020	6	127.00	18
DSC 11.01	Diesel	11020	6	127.00	26
DSC 11.02	Diesel	11022	6	127.00	22
DSC 11.04	Diesel	11020	6	127.00	26
DSC 11.08	Diesel	11020	6	127.00	27
DSC 11.10	Diesel	11020	6	127.00	27
DSC 11.12	Diesel	11020	6	127.00	22
DSC 11.13	Diesel	11020	6	127.00	22
DSC 11.16	Diesel	11020	6	127.00	22
DSC 11.17	Diesel	11020	6	127.00	22
DSC 11.18	Diesel	11020	6	127.00	22
DSC 11.21 Euro 1	Diesel	11020	6	127.00	21
DSC 11.22 Euro 1	Diesel	11020	6	127.00	21
DSC 11.23 Euro 1	Diesel	11020	6	127.00	21
DSC 11.35	Diesel	11020	6	127.00	21
DSC 11.36	Diesel	11020	6	127.00	21
DSC 11.39 Euro 1	Diesel	11020	6	127.00	21
DSC 11.70 Euro 2	Diesel	11020	6	127.00	21
DSC 11.70 N/DSC 11.70 S Euro 2	Diesel	11020	6	127.00	27
DSC 11.71	Diesel	11020	6	127.00	21
DSC 11.74 Euro 1	Diesel	11020	6	127.00	21
DSC 11.75 Euro 1	Diesel	11020	6	127.00	21
DSC 11.79 Euro 2	Diesel	11000	6	127.00	21
DSC 11.81	Diesel	11020	6	127.00	21
DSC 12.01 Euro 2	Diesel	11700	6	127.00	14
DSC 12.02 Euro 2	Diesel	11700	6	127.00	14

		ccm	x 		9
DSC 12.03 Euro 2	Diesel	11700	6	127.00	14
DSC 12.05 Euro 3	Diesel	11700	6	127.00	15
DSC 14	Diesel	14181	V8	127.00	23
DSC 14.01	Diesel	14190	V8	127.00	24
DSC 14.02	Diesel	14190	V8	127.00	24
DSC 14.03	Diesel	14190	V8	127.00	28
DSC 14.04	Diesel	14190	V8	127.00	28
DSC 14.05	Diesel	14190	V8	127.00	29
DSC 14.06	Diesel	14190	V8	127.00	29
DSC 14.07 L 01	Diesel	14200	V8	127.00	24
DSC 14.08 Euro 1	Diesel	14190	V8	127.00	28
DSC 14.09 Euro 1	Diesel	14190	V8	127.00	30
DSC 14.10 Euro 1	Diesel	14190	V8	127.00	28
DSC 14.16 Euro 1	Diesel	14190	V8	127.00	30
DSC 14.63	Diesel	14181	V8	127.00	25
DSI 8.01	Diesel	7800	6	115.00	5
DSI 8.01 L01/DSI 8.01 L04	Diesel	7800	6	115.00	5
DSI 11.01	Diesel	11020	6	127.00	20
DSI 14.47	Diesel	14181	V8	127.00	25
DSI 14.50	Diesel	14181	V8	127.00	25
DSI 14.60	Diesel	14181	V8	127.00	25
DSI 14.61	Diesel	14181	V8	127.00	25
DSI 14.63	Diesel	14181	V8	127.00	25
DT 12.02 Euro 3	Diesel	11716	6	127.00	14
DT 12.03 Euro 4	Diesel	11716	6	127.00	16
DT 12.06 Euro 4	Diesel	11716	6	127.00	12
DT 12.08	Diesel	11716	6	127.00	15
DT 12.11 Euro 4	Diesel	11716	6	127.00	16
DT 12.12 Euro 4	Diesel	11716	6	127.00	16
DT 12.14	Diesel	11716	6	127.00	12
DT 12.17 Euro 4	Diesel	11716	6	127.00	16
DT 12.18 Euro 3	Diesel	11716	6	127.00	12
DTC 11.02 Euro 2	Diesel	11020	6	127.00	21



1 75.00

15.5W37 W31/15W37
WB15 Air Compressor

2 Cyl.

FM1846

87-990700-00	STD	08-990700-00	STD
87-990705-00	0.25mm	08-990705-00	0.25mm
87-990707-00	0.50mm	08-990707-00	0.50mm

A	32.20	2.38		P
D	52.65	2.38		P
	16x60	3.94		P

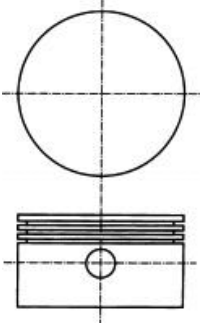

2 115.00

DC 9.01 Euro 3	6 Cyl.	17:1	9000cc	169kW (230PS)	Diesel Turbo Intercooled	TD15408
DC 9.02 Euro 3	6 Cyl.	17:1	9000cc	191kW (260PS)	Diesel Turbo Intercooled	TD15411
DC 9.03 Euro 3	6 Cyl.	17:1	9000cc	221kW (300PS)	Diesel Turbo Intercooled	TD15413
DC 9.04 Euro 3	6 Cyl.	17:1	9000cc	169kW (230PS)	Diesel Turbo Intercooled	TD15410
DC 9.05 Euro 3	6 Cyl.	17:1	9000cc	191kW (260PS)	Diesel Turbo Intercooled	TD15412
DC 9.06	6 Cyl.	17:1	9000cc	221kW (300PS)	Diesel Turbo Intercooled	TD15414

15-600020-00 WH  B 131.00 C 257.50 D 140.74 E 8.07 F 0.18

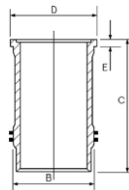

 Includes seals

 Schließt Dichtungen ein

 Inclut des joints

 Incluye los sellos

 Comprende le guarnizioni

3 115.00

DN 8.01	6 Cyl.	17:1	7800cc	123kW (167PS)	Diesel	TD8838
DN 8.05 L01 . L04	6 Cyl.		7800cc	120kW (163PS)	Diesel	FM5022

14-374990-00 WH  B 130.00 C 270.50 D 137.30 E 8.20 F 0.80

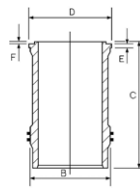

 Use also: HT020

 Mitverwenden: HT020

 A utiliser aussi: HT020

 Utilizar también: HT020

 Usare anche: HT020



4 115.00

DN 9.01 6 Cyl. 16:1 **8500cc** **128-150kW (174-204PS)** **Diesel Turbo** **TD8843**

87-961000-10 STD

A 87.40
B- 22.15
BØ 69.00
C 0.30
D 139.40
 50x92

08-961000-00 STD

2.38 MOL P
 2.38 P
 4.74 CR P

15-608890-00 WH **B 127.90 C 265.60 D 140.82 E 10.26 F 0.83**

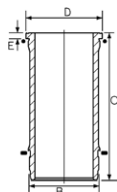

89-961000-20
 87-961000-10 +
 15-608890-00

RT TP

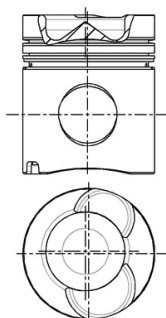

14-374990-00 WH **B 130.00 C 270.50 D 137.30 E 8.20 F 0.80**

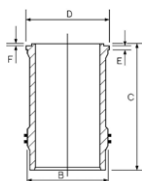

89-961000-10
 87-961000-10 +
 14-374990-00

Use also: HT020

Includes seals

Mitverwenden: HT020

Schließt Dichtungen ein

A utiliser aussi: HT020

Inclut des joints

Utilizar también: HT020

Incluye los sellos

Usare anche: HT020

Comprende le guarnizioni

5 115.00

DS 8 LB09-LB14 6 Cyl. 17:1 **7800cc** **140-148kW (190-202PS)** **Diesel Turbo** **FM3818**

DS 8.01 6 Cyl. 15.5:1 **7800cc** **154-170kW (209-231PS)** **Diesel Turbo** **TD8842**

DS 8.05 6 Cyl. 15.5:1 **7800cc** **155kW (211PS)** **Diesel Turbo** **TD8839**

DS 8.06 6 Cyl. 15.5:1 **7800cc** **140kW (190PS)** **Diesel Turbo** **TD8840**

DS 801 LB14/DS 801 LB15/DS 801 LB16 6 Cyl. **7800cc** **120kW (163PS)** **Diesel Turbo** **FM5017**

DSI 8.01 6 Cyl. 15.5:1 **7800cc** **178kW (242PS)** **Diesel Turbo Intercooled** **TD8841**

DSI 8.01 L01/DSI 8.01 L04 6 Cyl. **7800cc** **170kW (231PS)** **Diesel Turbo Intercooled** **FM5023**

87-961000-00 STD

A 96.25
B- 18.00
BØ 75.00
C 2.50
D 150.16
 46x96

08-961000-00 STD

2.38 MOL P
 2.38 P
 4.74 CR P

14-374990-00 WH **B 130.00 C 270.50 D 137.30 E 8.20 F 0.80**

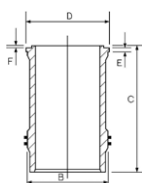

89-961000-00
 87-961000-00 +
 14-374990-00

RT TP

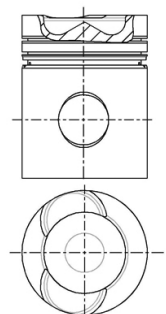

Use also: HT020

Mitverwenden: HT020

A utiliser aussi: HT020

Utilizar también: HT020

Usare anche: HT020



6 115.00

DS 9.01	6 Cyl.	16:1	8475cc	180-185kW (245-252PS)	Diesel Turbo	TD8844
DS 9.02	6 Cyl.	16:1	8475cc	167-185kW (227-252PS)	Diesel Turbo	TD8845
DSC 9.01	6 Cyl.	16:1	8475cc	202kW (275PS)	Diesel Turbo Intercooled	TD8848
DSC 9.02	6 Cyl.	16:1	8475cc	207kW (282PS)	Diesel Turbo Intercooled	TD8849



87-960900-10

STD

A 87.40
B- 22.15
BØ 69.00
C 2.40
C 2.70
D 139.40
 50x92

08-960900-00

STD

3.16  CR P
 2.38  P
 4.74  CR P

15-608890-00 WH  **B** 127.90 **C** 265.60 **D** 140.82 **E** 10.26 **F** 0.83

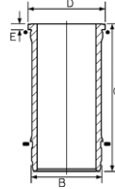

89-960900-10
 87-960900-10 +
 15-608890-00

AK RT TP

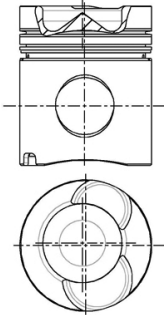

 Includes seals

 Schließt Dichtungen ein

 Inclut des joints

 Incluye los sellos

 Comprende le guarnizioni



7 115.00

DS 9.05 Euro 1	6 Cyl.	17:1	8475cc	185kW (252PS)	Diesel Turbo	TD8846
DS 9.06	6 Cyl.	17:1	8475cc	167kW (227PS)	Diesel Turbo	TD8847
DS 9.08	6 Cyl.	17:1	8475cc	155-185kW (211-252PS)	Diesel Turbo	TD8850
DSC 9.07 Euro 1	6 Cyl.	17:1	8475cc	185kW (252PS)	Diesel Turbo Intercooled	TD8851
DSC 9.08 Euro 1	6 Cyl.	16:1	8475cc	208kW (283PS)	Diesel Turbo Intercooled	TD8810
DSC 9.09 Euro 2	6 Cyl.	17:1	8475cc	184kW (250PS)	Diesel Turbo Intercooled	TD13068

87-960900-00 STD

A 87.40
B- 20.23
BØ 69.00
C 2.40
C 2.70
D 139.40
 50x92

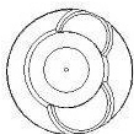

AK RT TP



- 1 Use also: HT020
- 2 Includes seals

08-960900-00 STD

3.16
 2.38
 4.74

 CR P
 P
 CR P

- 1 Mitverwenden: HT020
- 2 Schließt Dichtungen ein

15-608890-00 WH 2 B 127.90 C 265.60 D 140.82 E 10.26 F 0.83

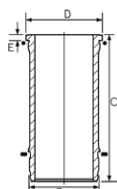

14-374990-00 WH 1 B 130.00 C 270.50 D 137.30 E 8.20 F 0.80

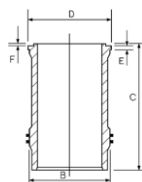

- 1 A utiliser aussi: HT020
- 2 Includ des joints

- 1 Utilizar también: HT020
- 2 Incluye los sellos

- 1 Usare anche: HT020
- 2 Comprende le guarnizioni

89-960900-00
 87-960900-00 +
 15-608890-00

8 115.00

DSC 9.10 Euro 1	6 Cyl.	18:1	8475cc	162kW (220PS)	Diesel Turbo Intercooled	TD8852
------------------------	--------	------	---------------	----------------------	---------------------------------	---------------

15-608890-00 WH 2 B 127.90 C 265.60 D 140.82 E 10.26 F 0.83

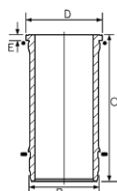

14-374990-00 WH 1 B 130.00 C 270.50 D 137.30 E 8.20 F 0.80

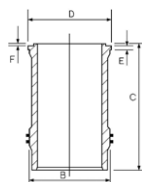

- 1 Use also: HT020
- 2 Includes seals

- 1 Mitverwenden: HT020
- 2 Schließt Dichtungen ein

- 1 A utiliser aussi: HT020
- 2 Includ des joints

- 1 Utilizar también: HT020
- 2 Incluye los sellos

- 1 Usare anche: HT020
- 2 Comprende le guarnizioni

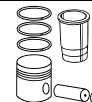
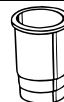
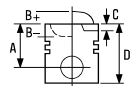

9 115.00

DSC 9.11 Euro 2	6 Cyl.	18:1	9000cc	162kW (220PS)	Diesel Turbo Intercooled	TD8854
DSC 9.12 Euro 2	6 Cyl.	18:1	9000cc	191kW (260PS)	Diesel Turbo Intercooled	TD8855
DSC 9.13 Euro 2	6 Cyl.	18:1	9000cc	228kW (310PS)	Diesel Turbo Intercooled	TD8853
DSC 9.15 Euro 2	6 Cyl.		9000cc	228kW (310PS)	Diesel Turbo Intercooled	TD12608

87-109200-00 STD

A 83.43
B- 20.60
BØ 71.50
C 0.60
D 130.95
 50x92

AK RT

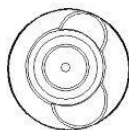
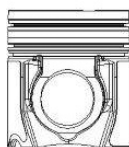

 Includes seals

08-109200-00 STD

3.16
2.38
3.50





CK P
P
CR P

 Schließt Dichtungen ein

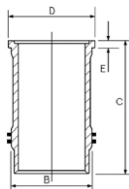
15-600020-00 WH  B 131.00 C 257.50 D 140.74 E 8.07 F 0.18



 Includ des joints



 Incluye los sellos

89-109200-30
87-109200-00 +
15-600020-00

 Comprende le guarnizioni

10 127.00

D 11 R 23	6 Cyl.	15:1	11022cc	143kW (195PS)	Diesel	TD8805
DN 11.01	6 Cyl.	16:1	11020cc	149-153kW (203-208PS)	Diesel	TD8806
DN 11.01 B10	6 Cyl.	17:1	11000cc	155kW (211PS)	Diesel	TD5872
DN 11.01 C 09	6 Cyl.	16:1	11020cc	158kW (215PS)	Diesel	TD8836
DN 11.04 B10	6 Cyl.	17:1	11000cc	155kW (211PS)	Diesel	TD6220
DN 11.04 C 01	6 Cyl.		11000cc	158kW (215PS)	Diesel Turbo	TD8837
DN 11.06	6 Cyl.	16:1	11020cc	134kW (182PS)	Diesel	TD8875
DN 11.07	6 Cyl.	16:1	11022cc	139kW (189PS)	Diesel	TD8808
DN 11.08	6 Cyl.	16:1	11022cc	150kW (204PS)	Diesel	TD8886
DN 11.08 B01	6 Cyl.	16:1	11020cc	149kW (203PS)	Diesel	TD8889
DS 11 / D11	6 Cyl.	15:1	11022cc	140-149kW (190-203PS)	Diesel	TD8794
DS 11.01 B 06	6 Cyl.		11022cc	202kW (275PS)	Diesel Turbo	TD8799
DS 11.15 B	6 Cyl.	15:1	11022cc	224kW (305PS)	Diesel Turbo Intercooled	TD8801

14-450850-00 WH  B 140.00 C 291.00 D 153.80 E 8.20 F 0.80
14-458190-00 WH  B 139.93 C 291.00 D 153.80 E 7.94 F 0.80

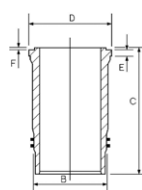

 Use also: HL5190

 Mitverwenden: HL5190

 A utiliser aussi: HL5190

 Utilizar también: HL5190

 Usare anche: HL5190



11 127.00

DC 9.11 Euro 3 DC 9	5 Cyl.	18:1	8900cc	228kW (310PS)	Diesel Turbo Intercooled	TD18048
DC 9.12 Euro 3 DC 9	5 Cyl.	18:1	8900cc	198kW (270PS)	Diesel Turbo Intercooled	TD18047
DC 9.13 Euro 3 DC 9	5 Cyl.	18:1	8900cc	169kW (230PS)	Diesel Turbo Intercooled	TD18045
DC 9.19 Euro 3 DC 9	5 Cyl.	17.5:1	8867cc	169kW (230PS)	Diesel Turbo Intercooled	TD30310
DC 9.20 Euro 3	5 Cyl.		8867cc	198-199kW (269-271PS)	Diesel Turbo Intercooled	TD21006
DC 9.21	5 Cyl.		8867cc	198-228kW (269-310PS)	Diesel Turbo Intercooled	TD30318
DC 11.02 Euro 3	6 Cyl.	18:1	10600cc	280kW (380PS)	Diesel Turbo Intercooled	TD12772
DC 11.04 Euro 3	6 Cyl.	18:1	10600cc	280kW (381PS)	Diesel Turbo Intercooled	TD15416
DC 11.09 Euro 3	6 Cyl.	18:1	10600cc	279kW (380PS)	Diesel Turbo Intercooled	TD17452

87-143600-40

STD

08-143600-10

STD

14-112800-00 WH 1 B 138.50 C 271.12 D 150.00 E 194.27 F 0.85

89-143600-40

87-143600-40 +
14-112800-00

A 92.04
B- 21.15
BØ 75.10
D 136.04
 54x106

3.50
2.38
3.50



CK P
P
CR

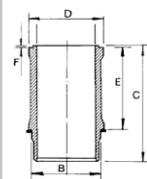

AK NB RT TP

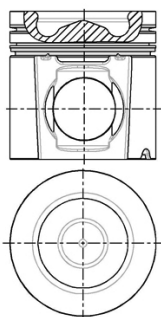

15-570050-00 WH 2 B 138.50 C 271.12 D 150.00 E 194.27 F 0.80

15-570060-00 WH 2 B 139.50 C 270.50 D 151.00 E 194.27 F 0.97

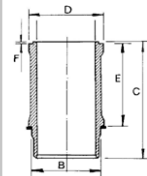

1 Relief 8.25mm
2 Includes seals

1 Entlastung 8.25mm
2 Schließt Dichtungen ein

1 Le relief 8.25mm
2 Includ des joints

1 Relevación 8.25mm
2 Incluye los sellos

1 Rilievo 8.25mm
2 Comprende le guarnizioni

12 127.00

DC 9.16 Euro 4 DC 9	5 Cyl.	17:1	8867cc	169kW (230PS)	Diesel Turbo Intercooled	TD18641
DC 9.17 Euro 4 DC 9	5 Cyl.	17:1	8867cc	198kW (270PS)	Diesel Turbo Intercooled	TD18642
DC 12.14 Euro 3	6 Cyl.	18:1	11716cc	309kW (420PS)	Diesel Turbo Intercooled	TD17453
DC 12.15	6 Cyl.	18:1	11716cc	309kW (420PS)	Diesel Turbo Intercooled	TD18647
DC 12.18 Euro 5	6 Cyl.	18:1	11716cc	279kW (379PS)	Diesel Turbo Intercooled	TD20874
DC 12.22 Euro 5	6 Cyl.	18:1	11716cc	309kW (420PS)	Diesel Turbo Intercooled	TD23694
DC 12.23 Euro 4	6 Cyl.	18:1	11716cc	309kW (420PS)	Diesel Turbo Intercooled	TD23698
DC 12.24 Euro 4	6 Cyl.	18:1	11716cc	280kW (381PS)	Diesel Turbo Intercooled	TD23699
DC 12.26 Euro 4	6 Cyl.	17:1	11716cc	250kW (340PS)	Diesel Turbo Intercooled	TD23700
DT 12.06 Euro 4	6 Cyl.	17:1	11716cc	345kW (470PS)	Diesel Turbo Intercooled	TD17455

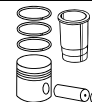
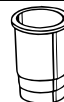
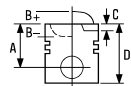

DT 12.14	6 Cyl.	17:1	11716cc	309kW (420PS)	Diesel Turbo Intercooled	TD20876
DT 12.18 Euro 3	6 Cyl.	18:1	11716cc	324kW (440PS)	Diesel Turbo Intercooled	TD20877

15-570050-00 WH 1 B 138.50 C 271.12 D 150.00 E 194.27 F 0.80
15-570060-00 WH 1 B 139.50 C 270.50 D 151.00 E 194.27 F 0.97

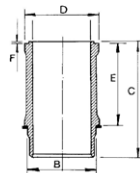

1 Includes seals 1 Schließt Dichtungen ein 1 Inclut des joints 1 Incluye los sellos 1 Comprende le guarnizioni

13 127.00

DC 11.01 Euro 3	6 Cyl.	18:1	10600cc	250kW (340PS)	Diesel Turbo Intercooled	TD12769
DC 11.03 Euro 3	6 Cyl.	18:1	10600cc	250kW (340PS)	Diesel Turbo Intercooled	TD15415
DC 11.07 Euro 2	6 Cyl.		10600cc	237kW (322PS)	Diesel Turbo Intercooled	TD21005
DC 11.08 Euro 3	6 Cyl.	18:1	10600cc	250kW (340PS)	Diesel Turbo Intercooled	TD17451

87-143600-50 STD **08-143600-10** STD **14-112800-00** WH 1 B 138.50 C 271.12 D 150.00 E 194.27 F 0.85
15-570050-00 WH 2 B 138.50 C 271.12 D 150.00 E 194.27 F 0.80
15-570060-00 WH 2 B 139.50 C 270.50 D 151.00 E 194.27 F 0.97

A 92.04
 B- 21.15
 BØ 75.10
 D 136.04

3.50 CK P
 2.38 P
 3.50 CR

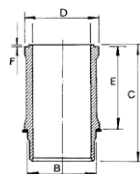

AK RT

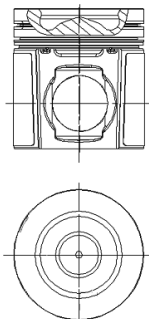

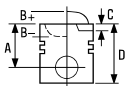

1 Relief 8.25mm 1 Entlastung 8.25mm 1 Le relief 8.25mm 1 Relevación 8.25mm 1 Rilievo 8.25mm
 2 Includes seals 2 Schließt Dichtungen ein 2 Inclut des joints 2 Incluye los sellos 2 Comprende le guarnizioni





14 127.00



DC 12.01 Euro 3	6 Cyl.	18:1	11700cc	309kW (420PS)	Diesel Turbo Intercooled	TD15418
DC 12.03 Euro 3	6 Cyl.	18:1	11700cc	308kW (420PS)	Diesel Turbo Intercooled	TD16852
DC 12.09 Euro 3	6 Cyl.	18:1	11700cc	309kW (420PS)	Diesel Turbo Intercooled	TD22367
DSC 12.01 Euro 2	6 Cyl.	18:1	11700cc	294kW (400PS)	Diesel Turbo Intercooled	TD8892
DSC 12.02 Euro 2	6 Cyl.	18:1	11700cc	265kW (360PS)	Diesel Turbo Intercooled	TD8893
DSC 12.03 Euro 2	6 Cyl.	18:1	11700cc	265-325kW (360-442PS)	Diesel Turbo Intercooled	TD22371
DT 12.02 Euro 3	6 Cyl.	18:1	11716cc	345kW (470PS)	Diesel Turbo Intercooled	TD16495
DC 16.02 Euro 3	V8 Cyl.	18:1	15600cc	353kW (480PS)	Diesel Turbo Intercooled	TD15428

87-143600-00  STD **08-143600-10** STD **14-112800-00 WH**  B 138.50 C 271.12 D 150.00 E 194.27 F 0.85 **89-143600-00**
87-143600-00 +
14-112800-00

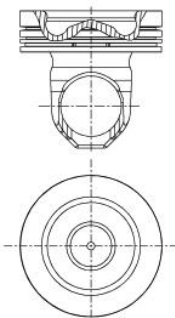
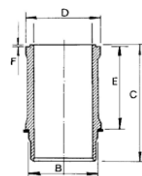

A 85.21
B- 22.15
BØ 78.00
D 125.21
 54x106

3.50  CK P
2.38  P
3.50  CR



87-143600-30  STD **08-143600-10** STD **14-112800-00 WH**  B 138.50 C 271.12 D 150.00 E 194.27 F 0.85 **89-143600-30** 
87-143600-30 +
14-112800-00

A 85.04
B- 22.15
BØ 78.00
D 129.04
 54x106

3.50  CK P
2.38  P
3.50  CR

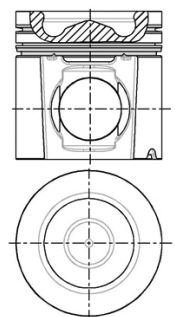
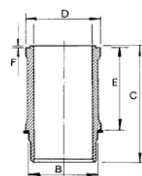

 Relief 8.25mm

 Not to replace kitset with articulated piston

 Articulated piston

 Entlastung 8.25mm

 Nicht mit Pendelschaftkolben ersetzen

 Pendelschaftkolben

 Le relief 8.25mm

 Ne pas remplacer le kit avec un piston articulé

 Piston articulé

 Relevación 8.25mm

 No sustituir el kit por un pistón articulado

 Pistón articulado

 Rilievo 8.25mm

 Non per sostituzione set con pistone articolato

 Pistone articolato

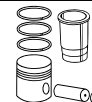
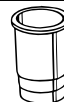
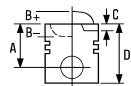

15 127.00

DC 12.02 Euro 2	6 Cyl.	18:1	11700cc	265kW (360PS)	Diesel Turbo Intercooled	TD21080
DC 12.06 Euro 3	6 Cyl.	18:1	11700cc	309kW (420PS)	Diesel Turbo Intercooled	TD20875
DC 12.17 Euro 3	6 Cyl.	18:1	11716cc	279kW (379PS)	Diesel Turbo Intercooled	TD20873
DSC 12.05 Euro 3	6 Cyl.	18:1	11700cc	309kW (420PS)	Diesel Turbo Intercooled	TD12870
DT 12.08	6 Cyl.	18:1	11716cc	324kW (440PS)	Diesel Turbo Intercooled	TD16716
DC 16.01 Euro 3	V8 Cyl.	18:1	15600cc	426kW (580PS)	Diesel Turbo Intercooled	TD15429
DC 16.03 Euro 3	V8 Cyl.	18:1	15600cc	426kW (580PS)	Diesel Turbo Intercooled	TD17458

87-143600-00  STD

A 85.21
B- 22.15
BØ 78.00
D 125.21
 54x106

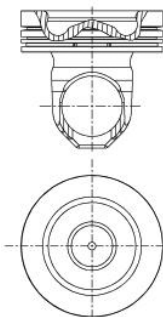

1 Relief 8.25mm
2 Articulated piston

08-143600-10 STD

3.50
 2.38
 3.50



CK P
 P
 CR

1 Entlastung 8.25mm
2 Pendelschaftkolben

14-112800-00 WH **1** B 138.50 C 271.12 D 150.00 E 194.27 F 0.85

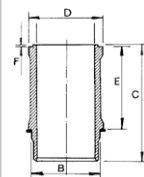

1 Relevación 8.25mm
2 Pistón articulado

89-143600-00
 87-143600-00 +
 14-112800-00

1 Rilievo 8.25mm
2 Pistone articolato

16 127.00

DC 12.10 Euro 4	6 Cyl.	17:1	11700cc	250kW (340PS)	Diesel Turbo Intercooled	TD18644
DC 12.13 Euro 4	6 Cyl.	17:1	11700cc	280kW (380PS)	Diesel Turbo Intercooled	TD18645
DT 12.03 Euro 4	6 Cyl.	17:1	11716cc	345kW (470PS)	Diesel Turbo Intercooled	TD18648
DT 12.11 Euro 4	6 Cyl.	17:1	11716cc	309kW (420PS)	Diesel Turbo Intercooled	TD17454
DT 12.12 Euro 4	6 Cyl.	17:1	11716cc	309kW (420PS)	Diesel Turbo Intercooled	TD18646
DT 12.17 Euro 4	6 Cyl.	17:1	11716cc	353kW (480PS)	Diesel Turbo Intercooled	TD20878

87-437600-00  STD

A 85.20
B- 22.45
BØ 97.00
D 122.71
 54x106

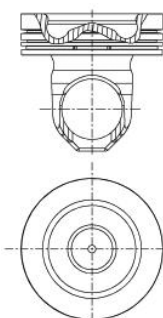

1 Includes seals
2 Articulated piston

08-437600-00 STD

3.50
 2.38
 3.50



CK
 CR
 CK

1 Schließt Dichtungen ein
2 Pendelschaftkolben

15-570050-00 WH **1** B 138.50 C 271.12 D 150.00 E 194.27 F 0.80

15-570060-00 WH **1** B 139.50 C 270.50 D 151.00 E 194.27 F 0.97

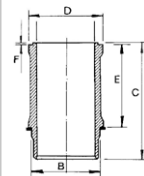

1 Incluye los sellos
2 Pistón articulado

89-437600-00
 87-437600-00 +
 15-570050-00

89-437600-10
 87-437600-00 +
 15-570060-00

1 Comprende le garnizioni
2 Pistone articolato



17  **127.00**

DC 16.04 Euro 3	V8 Cyl.	18:1	15600cc	368kW (500PS)	Diesel Turbo Intercooled	TD17457
DC 16.05 Euro 4	V8 Cyl.	17:1	15600cc	412kW (560PS)	Diesel Turbo Intercooled	TD18649
DC 16.06 Euro 4	V8 Cyl.	17:1	15600cc	368kW (500PS)	Diesel Turbo Intercooled	TD18650
DC 16.08 Euro 4	V8 Cyl.	17:1	15600cc	456kW (620PS)	Diesel Turbo Intercooled	TD18652
DC 16.09 Euro 5	V8 Cyl.	18:1	15600cc	368kW (500PS)	Diesel Turbo Intercooled	TD18651
DC 16.17 Euro 5	V8 Cyl.	17:1	15600cc	456kW (620PS)	Diesel Turbo Intercooled	TD20881
DC 16.18 Euro 5	V8 Cyl.	17:1	15600cc	412kW (560PS)	Diesel Turbo Intercooled	TD20880
DC 16.19 Euro 5	V8 Cyl.	18:1	15600cc	368kW (500PS)	Diesel Turbo Intercooled	TD20879
DC 16.22 EEV	V8 Cyl.	18:1	15600cc	368kW (500PS)	Diesel Turbo Intercooled	TD28138

14-112800-00 WH 1 B 138.50 C 271.12 D 150.00 E 194.27 F 0.85

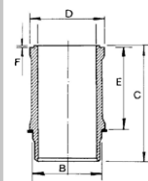

1 Relief 8.25mm

1 Entlastung 8.25mm

1 Le relief 8.25mm

1 Relevación 8.25mm

1 Rilievo 8.25mm

18  **127.00**

DS 11	6 Cyl.	16:1	11022cc	184-202kW (250-275PS)	Diesel Turbo	TD8798
DSC 11	6 Cyl.	15:1	11020cc	220kW (299PS)	Diesel Turbo Intercooled	FM15084

14-450390-00 WH 1 2 B 140.00 C 291.00 D 153.70 E 7.90 F 0.80

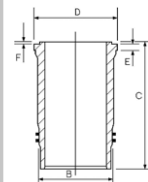

1 Bore recess 22mm deep

1 Höhe der Freidrehung

1 Alésage en retrait sur 22 mm

1 Altura del cordón de fuego 22mm

1 Larghezza del passaggio biella 22mm

2 Use also: HL5190

2 Mitverwenden: HL5190

2 A utiliser aussi: HL5190

2 Utilizar también: HL5190

2 Usare anche: HL5190

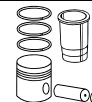
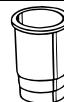
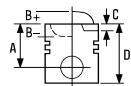

19 127.00

DS 11 Agr/Ind 1978> 6 Cyl. 16:1 **11022cc** **184-202kW (250-275PS)** **Diesel Turbo** **FM5198**

87-526900-00	STD	08-526900-00	STD	14-458190-00 WH B 139.93 C 291.00 D 153.80 E 7.94 F 0.80	89-526900-00 87-526900-00 + 14-458190-00
A 98.76		3.17			
B- 24.50		2.38			
BØ 76.00		2.38			
C 3.00		4.76			
C 2.90					
D 156.26					
50x108					

AK RT TP

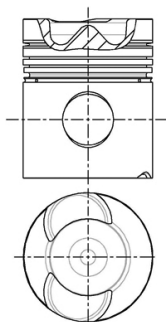

Use also: HL5190

Mitverwenden: HL5190

A utiliser aussi: HL5190

Utilizar también: HL5190

Usare anche: HL5190

20 127.00

DS 11.01 6 Cyl. 15:1 **11022cc** **184-202kW (250-275PS)** **Diesel Turbo** **TD5874**

DS 11.02 6 Cyl. 15:1 **11022cc** **206-245kW (280-333PS)** **Diesel Turbo Intercooled** **TD8864**

DS 11.14 6 Cyl. 15:1 **11022cc** **206-245kW (280-333PS)** **Diesel Turbo Intercooled** **TD6222**

DS 11.15 6 Cyl. 15:1 **11022cc** **224-245kW (305-333PS)** **Diesel Turbo Intercooled** **TD8803**

DS 11.18 6 Cyl. 15:1 **11022cc** **254kW (345PS)** **Diesel Turbo Intercooled** **TD8857**

DSI 11.01 6 Cyl. 15:1 **11020cc** **191kW (260PS)** **Diesel Turbo** **TD8874**

87-990500-00	STD	08-990500-00	STD	14-458190-00 WH B 139.93 C 291.00 D 153.80 E 7.94 F 0.80	89-990500-00 87-990500-00 + 14-458190-00
A 98.81		2.38			
B- 27.10		2.38			
BØ 76.00		4.74			
C 2.90					
C 2.90					
D 156.26					
50x108					

RT TP

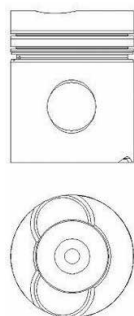

Use also: HL5190

Mitverwenden: HL5190

A utiliser aussi: HL5190

Utilizar también: HL5190

Usare anche: HL5190

DS11 engine from Eng No.880840

Motor DS11 ab Motornr 880840

Moteurs DS11 depuis moteur 880840

Motor DS11 desde motor No. 880840

Per il mod.DS11 dal mot.n.880840

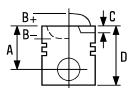

21  **127.00**

DS 11.22	6 Cyl.	17:1	11022cc	280kW (381PS)	Diesel Turbo	TD7436
DS 11.23	6 Cyl.	17:1	11022cc	266kW (362PS)	Diesel Turbo	TD7180
DS 11.75	6 Cyl.	17:1	11020cc	228-230kW (310-313PS)	Diesel Turbo	TD8821
DSC 11.21 Euro 1	6 Cyl.	17:1	11020cc	235-266kW (320-362PS)	Diesel Turbo Intercooled	TD8812
DSC 11.22 Euro 1	6 Cyl.	17:1	11020cc	280kW (381PS)	Diesel Turbo Intercooled	TD8813
DSC 11.23 Euro 1	6 Cyl.	17:1	11020cc	266kW (362PS)	Diesel Turbo Intercooled	TD8814
DSC 11.35	6 Cyl.	17:1	11020cc	235-266kW (320-362PS)	Diesel Turbo Intercooled	TD8815
DSC 11.36	6 Cyl.	17:1	11020cc	235-266kW (320-362PS)	Diesel Turbo Intercooled	TD8816
DSC 11.39 Euro 1	6 Cyl.	17:1	11020cc	258kW (351PS)	Diesel Turbo Intercooled	TD8882
DSC 11.70 Euro 2	6 Cyl.	17:1	11020cc	280kW (381PS)	Diesel Turbo Intercooled	TD8884
DSC 11.71	6 Cyl.	17:1	11020cc	235-266kW (320-362PS)	Diesel Turbo Intercooled	TD8872
DSC 11.74 Euro 1	6 Cyl.	17:1	11020cc	235-266kW (320-362PS)	Diesel Turbo Intercooled	TD22369
DSC 11.75 Euro 1	6 Cyl.	17:1	11020cc	235-266kW (320-362PS)	Diesel Turbo Intercooled	TD22370
DSC 11.79 Euro 2	6 Cyl.	17:1	11000cc	250kW (340PS)	Diesel Turbo Intercooled	TD12768
DSC 11.81	6 Cyl.	17:1	11020cc	305kW (415PS)	Diesel Turbo Intercooled	TD17286
DTC 11.02 Euro 2	6 Cyl.	17:1	11020cc	295kW (401PS)	Diesel Turbo Intercooled	TD8885

87-962000-30 STD

- A 98.76
- B- 16.52
- BØ 90.00
- C 2.96
- D 156.26
-  50x108

AK RT TP

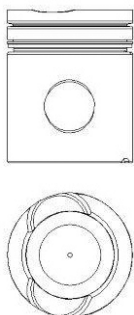

- 1 Use also: HL5190
- 2 Relief 13.00mm
- 3 Relief 12.00mm

08-962000-00 STD

- 3.50 
- 2.38 
- 4.74 

- 1 Mitverwenden: HL5190
- 2 Entlastung 13.00mm
- 3 Entlastung 12.00mm

STD

- CR P
- P
- CR P

- 1 A utiliser aussi: HL5190
- 2 Le relief 13.00mm
- 3 Le relief 12.00mm

14-450040-00 WH 3 B 140.00 C 291.00 D 154.00 E 7.94 F 0.90
 14-450110-00 WH 2 B 140.00 C 291.00 D 153.68 E 7.92 F 0.80

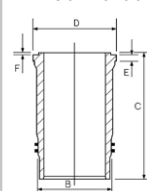

14-450850-00 WH 1 B 140.00 C 291.00 D 153.80 E 8.20 F 0.80

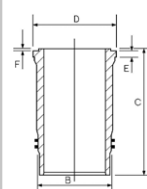

- 1 Utilizar también: HL5190
- 2 Relevación 13.00mm
- 3 Relevación 12.00mm

89-962000-30
 87-962000-30 +
 14-450040-00
 89-962000-35
 87-962000-30 +
 14-450110-00

- 1 Usare anche: HL5190
- 2 Rilievo 13.00mm
- 3 Rilievo 12.00mm

22  **127.00**

DS 11.34	6 Cyl.	16:1	11020cc	228kW (310PS)	Diesel Turbo Intercooled	TD8869
DS 11.71	6 Cyl.	16:1	11020cc	189kW (257PS)	Diesel Turbo	TD8873
DS 11.71 C	6 Cyl.	16:1	11020cc	189kW (257PS)	Diesel Turbo	TD5878
DS 11.72	6 Cyl.	16:1	11022cc	230kW (313PS)	Diesel Turbo	TD8858
DS 11.73	6 Cyl.	16:1	11020cc	228-230kW (310-313PS)	Diesel Turbo	TD8859
DS 11.74	6 Cyl.	17:1	11020cc	194kW (257PS)	Diesel Turbo	TD8820
DSC 11.02	6 Cyl.	16:1	11022cc	267kW (363PS)	Diesel Turbo Intercooled	TD8860

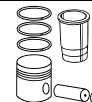
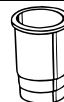
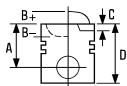

DSC 11.12	6 Cyl.	16:1	11020cc	254kW (345PS)	Diesel Turbo Intercooled	TD8861
DSC 11.13	6 Cyl.	16:1	11020cc	267kW (363PS)	Diesel Turbo Intercooled	TD8878
DSC 11.16	6 Cyl.	16:1	11020cc	239kW (325PS)	Diesel Turbo Intercooled	TD8879
DSC 11.17	6 Cyl.	16:1	11020cc	237kW (322PS)	Diesel Turbo Intercooled	TD8880
DSC 11.18	6 Cyl.	16:1	11020cc	267kW (363PS)	Diesel Turbo Intercooled	TD8826

87-962000-00 STD
A 98.76
B- 24.50
BØ 76.00
C 3.00
D 156.26
 50x108

08-962000-00 STD
 3.50
 2.38
 4.74
 CR P
 P
 CR P

14-458190-00 WH **1** B 139.93 C 291.00 D 153.80 E 7.94 F 0.80

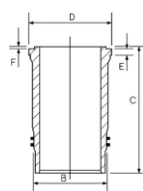

89-962000-00
 87-962000-00 +
 14-458190-00

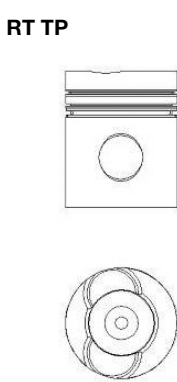

14-450400-00 WH B 140.00 C 291.00 D 153.80 E 7.90 F 0.80
14-450850-00 WH **1** B 140.00 C 291.00 D 153.80 E 8.20 F 0.80

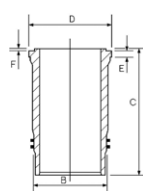

1 Use also: HL5190

1 Mitverwenden: HL5190

1 A utiliser aussi: HL5190

1 Utilizar también: HL5190

1 Usare anche: HL5190

23 127.00

DS 14	V8 Cyl.	15:1	14181cc	257kW (350PS)	Diesel Turbo	TD8835
DS 14 LB 05	V8 Cyl.	15.5:1	14200cc	257kW (350PS)	Diesel Turbo	TD8894
DS 14 LB 08	V8 Cyl.	15.5:1	14200cc	276kW (375PS)	Diesel Turbo	TD8895
DS 14.01 L 01	V8 Cyl.	15.5:1	14200cc	276kW (375PS)	Diesel Turbo	TD8903
DS 14.07	V8 Cyl.	15.5:1	14190cc	293kW (398PS)	Diesel Turbo	TD8897
DSC 14	V8 Cyl.	15.5:1	14181cc		Diesel Turbo Intercooled	FM3866

14-673080-00 WH **1** **4** B 140.00 C 276.00 D 156.00 E 10.05 F 0.40

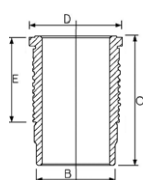

14-670020-00 WH **2** B 140.00 C 276.00 D 156.00 E 10.05 F 0.40
14-671680-00 WH **1** **3** B 140.00 C 276.00 D 156.00 E 10.10 F 0.40

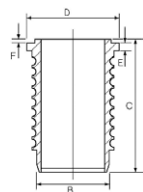

1 Use also: HT013
2 Relief 7.00mm
3 Relief 22.00mm
4 Relief 21.50mm

1 Mitverwenden: HT013
2 Entlastung 7.00mm
3 Entlastung 22.00mm
4 Entlastung 21.50mm

1 A utiliser aussi: HT013
2 Le relief 7.00mm
3 Le relief 22.00mm
4 Le relief 21.50mm

1 Utilizar también: HT013
2 Relevación 7.00mm
3 Relevación 22.00mm
4 Relevación 21.50mm

1 Usare anche: HT013
2 Rilievo 7.00mm
3 Rilievo 22.00mm
4 Rilievo 21.50mm

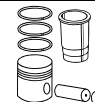
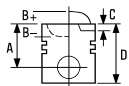

24 127.00

DS 14.01	V8 Cyl.	15.5:1	14190cc	283-293kW (385-398PS)	Diesel Turbo	TD8902
DS 14.02	V8 Cyl.	15.5:1	14190cc	309-320kW (420-435PS)	Diesel Turbo	TD22368
DS 14.06	V8 Cyl.	15.5:1	14190cc	285-291kW (388-396PS)	Diesel Turbo	TD8896
DS 14.06 L01 / L02 / L03	V8 Cyl.	15.5:1	14200cc	290kW (394PS)	Diesel Turbo	TD8904
DS 14.07 L01/DS 14.07 L02	V8 Cyl.		14200cc		Diesel Turbo	FM5086
DSC 14.01	V8 Cyl.	15.5:1	14190cc	309kW (420PS)	Diesel Turbo Intercooled	TD8898
DSC 14.02	V8 Cyl.	15.5:1	14190cc	301kW (409PS)	Diesel Turbo Intercooled	TD8899
DSC 14.07 L 01	V8 Cyl.		14200cc	298kW (405PS)	Diesel Turbo Intercooled	TD8905



87-960800-10 STD

A 94.67
B- 26.20
BØ 75.00
C 2.92
D 146.67
 50x108

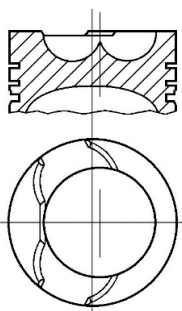
RT TP



08-960800-00 STD

3.16  CR P
 2.38  P
 4.74  CR P

14-671680-00 WH ¹ ³ B 140.00 C 276.00 D 156.00 E 10.10 F 0.40

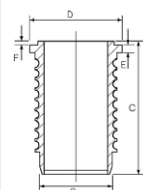

14-673080-00 WH ¹ ⁴ B 140.00 C 276.00 D 156.00 E 10.05 F 0.40

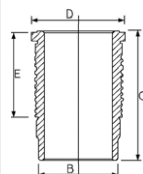

14-670020-00 WH ² B 140.00 C 276.00 D 156.00 E 10.05 F 0.40

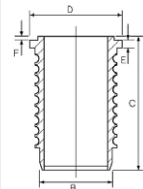

89-960800-10
 87-960800-10 +
 14-671680-00

- ¹ Use also: HT013
- ² Relief 7.00mm
- ³ Relief 22.00mm
- ⁴ Relief 21.50mm

- ¹ Mitverwenden: HT013
- ² Entlastung 7.00mm
- ³ Entlastung 22.00mm
- ⁴ Entlastung 21.50mm

- ¹ A utiliser aussi: HT013
- ² Le relief 7.00mm
- ³ Le relief 22.00mm
- ⁴ Le relief 21.50mm

- ¹ Utilizar también: HT013
- ² Relevación 7.00mm
- ³ Relevación 22.00mm
- ⁴ Relevación 21.50mm

- ¹ Usare anche: HT013
- ² Rilievo 7.00mm
- ³ Rilievo 22.00mm
- ⁴ Rilievo 21.50mm

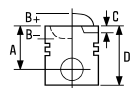

25 127.00

DS 14.46	V8 Cyl.	15:1	14181cc	300kW (408PS)	Diesel	FM18569
DSC 14.63	V8 Cyl.	15:1	14181cc	340kW (462PS)	Diesel Turbo Intercooled	FM13866
DSI 14.47	V8 Cyl.	15:1	14181cc	341kW (464PS)	Diesel Turbo Intercooled	TD19149
DSI 14.50	V8 Cyl.	15:1	14181cc	341kW (464PS)	Diesel Turbo Intercooled	TD19150
DSI 14.60	V8 Cyl.	15:1	14181cc	341kW (464PS)	Diesel Turbo Intercooled	TD19151
DSI 14.61	V8 Cyl.	15:1	14181cc	341kW (464PS)	Diesel Turbo Intercooled	TD19152
DSI 14.63	V8 Cyl.	15:1	14181cc	341kW (464PS)	Diesel Turbo Intercooled	TD19153

14-671680-00 WH **1** **2** B 140.00 C 276.00 D 156.00 E 10.10 F 0.40

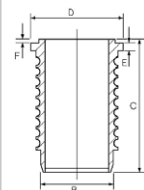

1 Use also: HT013
2 Relief 22.00mm

1 Mitverwenden: HT013
2 Entlastung 22.00mm

1 A utiliser aussi: HT013
2 Le relief 22.00mm

1 Utilizar también: HT013
2 Relevación 22.00mm

1 Usare anche: HT013
2 Rilievo 22.00mm

26 127.00

DSC 11.01	6 Cyl.	15.5:1	11020cc	230kW (313PS)	Diesel Turbo Intercooled	TD8811
DSC 11.04	6 Cyl.	15:1	11020cc	189-245kW (257-333PS)	Diesel Turbo Intercooled	TD8868

87-990500-00 **2** STD

STD

08-990500-00 STD

STD

14-458190-00 WH **1** B 139.93 C 291.00 D 153.80 E 7.94 F 0.80

89-990500-00

01/86→

2.38



MOL P
P
CR P

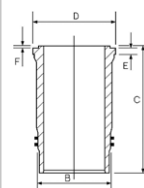

01/86→
87-990500-00 +
14-458190-00

A 98.81
B- 27.10
BØ 76.00
C 2.90
C 2.90
D 156.26
 50x108

2.38

4.74

14-450400-00 WH B 140.00 C 291.00 D 153.80 E 7.90 F 0.80

14-450850-00 WH **1** B 140.00 C 291.00 D 153.80 E 8.20 F 0.80

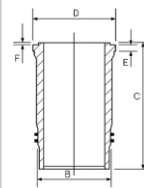

RT TP

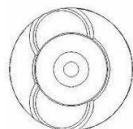
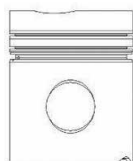

1 Use also: HL5190

2 DS11 engine from Eng No.880840

1 Mitverwenden: HL5190

2 Motor DS11 ab Motornr 880840

1 A utiliser aussi: HL5190

2 Moteurs DS11 depuis moteur 880840

1 Utilizar también: HL5190

2 Motor DS11 desde motor No. 880840



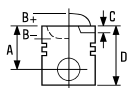

1 Usare anche: HL5190

2 Per il mod.DS11 dal mot.n.880840

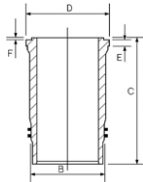

27  **127.00**

DSC 11.08	6 Cyl.	17:1	11020cc	228-280kW (310-381PS)	Diesel Turbo Intercooled	TD8823
DSC 11.10	6 Cyl.	17:1	11020cc	280kW (381PS)	Diesel Turbo Intercooled	TD8877
DSC 11.70 N/DSC 11.70 S Euro 2	6 Cyl.	17:1	11020cc	280kW (381PS)	Diesel Turbo Intercooled	FM35084

87-962000-80	STD	08-962000-00	STD	14-458190-00 <i>WH</i> ¹ B 139.93 C 291.00 D 153.80 E 7.94 F 0.80	89-962000-80 87-962000-80 + 14-458190-00
A 98.76		3.50	 CR P		
B- 22.65		2.38	 P		
BØ 76.00		4.74	 CR P		
C 2.96					
D 156.26					
 50x108					

AK RT TP

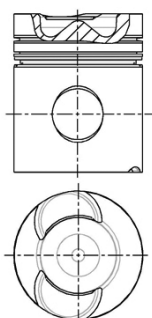

¹ Use also: HL5190

¹ Mitverwenden: HL5190





¹ A utiliser aussi: HL5190

¹ Utilizar también: HL5190

¹ Usare anche: HL5190

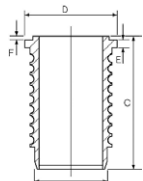
28  **127.00**

DSC 14.03	V8 Cyl.	16:1	14190cc	331kW (450PS)	Diesel Turbo Intercooled	TD8906
DSC 14.04	V8 Cyl.	16:1	14190cc	346kW (470PS)	Diesel Turbo Intercooled	TD8907
DSC 14.08 Euro 1	V8 Cyl.	16:1	14190cc	309-331kW (420-450PS)	Diesel Turbo Intercooled	TD8908
DSC 14.10 Euro 1	V8 Cyl.	16:1	14190cc	333-346kW (453-471PS)	Diesel Turbo Intercooled	TD8910

87-962000-50	STD	08-962000-00	STD	15-679320-00 <i>WH</i> ¹ ² B 139.92 C 275.25 D 155.79 E 10.09 F 0.46	89-962000-50 87-962000-50 + 15-679320-00
A 94.67		3.50	 CR P		
B- 23.85		2.38	 P		
BØ 75.00		4.74	 CR P		
C 2.82					
D 146.67					
 50x108					

AK HA KK RT TP

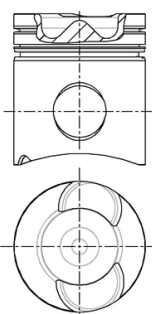

¹ Relief 12.00mm

¹ Entlastung 12.00mm

¹ Le relief 12.00mm

¹ Relevación 12.00mm

¹ Rilievo 12.00mm

² Includes seals

² Schließt Dichtungen ein

² Inclut des joints

² Incluye los sellos

² Comprende le guarnizioni



29 127.00

DSC 14.05 V8 Cyl. 16:1 **14190cc 318kW (432PS)** Diesel Turbo Intercooled **TD8900**

DSC 14.06 V8 Cyl. 16:1 **14190cc 297-309kW (404-420PS)** Diesel Turbo Intercooled **TD8901**

87-962000-40 STD **08-962000-00** STD **14-671680-00** WH ¹ ² B 140.00 C 276.00 D 156.00 E 10.10 F 0.40 **89-962000-40**
87-962000-40 +
14-671680-00

A 94.67
B- 24.00
BØ 75.00
C 2.92
D 146.67
 50x108

3.50
2.38
4.74



CR P
P
CR P

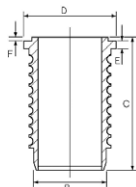

AK RT TP

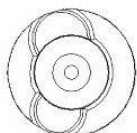

¹ Use also: HT013
² Relief 22.00mm

¹ Mitverwenden: HT013
² Entlastung 22.00mm

¹ A utiliser aussi: HT013
² Le relief 22.00mm

¹ Utilizar también: HT013
² Relevación 22.00mm

¹ Usare anche: HT013
² Rilievo 22.00mm

30 127.00

DSC 14.09 Euro 1 V8 Cyl. 17:1 **14190cc 368kW (500PS)** Diesel Turbo Intercooled **TD8909**

DSC 14.16 Euro 1 V8 Cyl. 16:1 **14190cc 368kW (500PS)** Diesel Turbo Intercooled **TD8912**

87-962000-10 STD **08-962000-00** STD **15-679320-00** WH ¹ ² B 139.92 C 275.25 D 155.79 E 10.09 F 0.46 **89-962000-10**
87-962000-10 +
15-679320-00

A 94.67
B- 15.06
BØ 89.40
C 2.92
D 146.67
 50x108

3.50
2.38
4.74



CR P
P
CR P

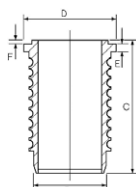

AK HA KK RT TP

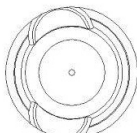
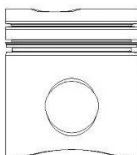





¹ Relief 12.00mm
² Includes seals





¹ Entlastung 12.00mm
² Schließt Dichtungen ein





¹ Le relief 12.00mm
² Inclut des joints

¹ Relevación 12.00mm
² Incluye los sellos

¹ Rilievo 12.00mm
² Comprende le guarnizioni

		ccm	x 		9
1F	Petrol	1595	4	81.00	23
1W	Diesel	1398	4	75.00	5
1Y	Diesel	1896	4	79.50	13
1Z	Diesel	1896	4	79.50	14
2E	Petrol	1984	4	82.50	36
022 A .5000 (138B6.000)	Diesel	1714	4	83.00	41
8144.61	Diesel	2445	4	93.00	43
A112 A5.000 (M020.AA.09.0)	Petrol	903	4	65.00	1
AAU	Petrol	1043	4	75.00	5
AAV	Petrol	1272	4	75.00	5
AAZ	Diesel	1896	4	79.50	15
ABF	Petrol	1984	4	82.50	37
ABN	Petrol	1595	4	81.00	23
ABS	Petrol	1781	4	81.00	24
ACC	Petrol	1781	4	81.00	25
ADY	Petrol	1984	4	82.50	36
ADZ	Petrol	1781	4	81.00	24
AEE	Petrol	1598	4	76.50	6
AEF	Diesel	1896	4	79.50	13
AEH	Petrol	1595	4	81.00	26
AER	Petrol	999	4	67.10	2
AEX	Petrol	1391	4	76.50	7
AEY	Diesel	1896	4	79.50	14
AFH	Petrol	1390	4	76.50	8
AFK	Petrol	1390	4	76.50	8
AFN	Diesel	1896	4	79.50	14
AFT	Petrol	1595	4	81.00	26
AGG	Petrol	1984	4	82.50	36
AGN	Petrol	1781	4	81.00	27
AGP	Diesel	1896	4	79.50	16
AGR	Diesel	1896	4	79.50	14
AGZ	Petrol	2324	V5	81.00	28
AHB	Diesel	1716	4	79.50	17
AHF	Diesel	1896	4	79.50	14
AHU	Diesel	1896	4	79.50	14
AHW	Petrol	1390	4	76.50	8
AJH	Petrol	1781	4	81.00	29
AJQ	Petrol	1781	4	81.00	29
AKL	Petrol	1595	4	81.00	26
AKU	Diesel	1716	4	79.50	17
AKV	Petrol	1391	4	76.50	7
ALH	Diesel	1896	4	79.50	14
ALL	Petrol	999	4	67.10	2
ALM	Petrol	1598	4	76.50	6
ALZ	Petrol	1595	4	81.00	30
AMF	Diesel	1422	3	79.50	18
ANU	Diesel	1896	4	79.50	19
ANX	Petrol	1390	4	76.50	7
APE	Petrol	1390	4	76.50	8
APF	Petrol	1595	4	81.00	26
APP	Petrol	1781	4	81.00	29
APQ	Petrol	1391	4	76.50	7
AQM	Diesel	1896	4	79.50	16
AQQ	Petrol	1390	4	76.50	8
AQX	Petrol	1781	4	81.00	29
ARL	Diesel	1896	4	79.50	20
ARY	Petrol	1781	4	81.00	31
ASV	Diesel	1896	4	79.50	14
ASY	Diesel	1896	4	79.50	16
ASZ	Diesel	1896	4	79.50	20
ATD	Diesel	1896	4	79.50	19
AUA	Petrol	1390	4	76.50	8
AUB	Petrol	1390	4	76.50	8
AUQ	Petrol	1781	4	81.00	31
AUR	Petrol	1595	4	81.00	26
AUY	Diesel	1896	4	79.50	21
AVG	Diesel	1896	4	79.50	14
AWC	Petrol	1781	4	81.00	29
AXP	Petrol	1390	4	76.50	8

		ccm	x 		
AXR	Diesel	1896	4	79.50	19
AYP	Petrol	1781	4	81.00	29
AYQ	Diesel	1896	4	79.50	16
AZQ	Petrol	1198	3	76.50	9
AZV	Diesel	1968	4	81.00	32
BBY	Petrol	1390	4	76.50	8
BBZ	Petrol	1390	4	76.50	8
BCA	Petrol	1390	4	76.50	8
BFQ	Petrol	1595	4	81.00	30
BGU	Petrol	1595	4	81.00	30
BJB	Diesel	1896	4	79.50	19
BJX	Petrol	1781	4	81.00	31
BKC	Diesel	1896	4	79.50	19
BKD	Diesel	1968	4	81.00	32
BKY	Petrol	1390	4	76.50	10
BLR	Petrol	1984	4	82.50	38
BLS	Diesel	1896	4	79.50	19
BLT	Diesel	1896	4	79.50	20
BLY	Petrol	1984	4	82.50	38
BMM	Diesel	1968	4	81.00	33
BMN	Diesel	1968	4	81.00	32
BMT	Diesel	1896	4	79.50	19
BPX	Diesel	1896	4	79.50	17
BRT	Diesel	1968	4	81.00	33
BSE	Petrol	1595	4	81.00	30
BSF	Petrol	1595	4	81.00	30
BTB	Diesel	1896	4	79.50	17
BUK	Diesel	1896	4	79.50	17
BVK	Diesel	1896	4	79.50	21
BVY	Petrol	1984	4	82.50	38
BVZ	Petrol	1984	4	82.50	38
BWA	Petrol	1984	4	82.50	39
BXE	Diesel	1896	4	79.50	19
BXF	Diesel	1896	4	79.50	19
BXJ	Diesel	1896	4	79.50	19
BXW	Petrol	1390	4	76.50	10
CAGA	Diesel	1968	4	81.00	34
CAGC	Diesel	1968	4	81.00	34
CAHA	Diesel	1968	4	81.00	34
CAVA	Petrol	1390	4	76.50	11
CAVE	Petrol	1390	4	76.50	11
CAXA	Petrol	1390	4	76.50	12
CAXC	Petrol	1390	4	76.50	12
CAYA	Diesel	1598	4	79.50	22
CAYB	Diesel	1598	4	79.50	22
CAYC	Diesel	1598	4	79.50	22
CBDB	Diesel	1968	4	81.00	34
CBZA	Petrol	1197	4	71.00	3
CBZB	Petrol	1197	4	71.00	3
CDAA	Petrol	1798	4	82.50	40
CDHA	Petrol	1798	4	82.50	40
CDHB	Petrol	1798	4	82.50	40
CEGA	Diesel	1968	4	81.00	34
CFFA	Diesel	1968	4	81.00	35
CFFB	Diesel	1968	4	81.00	35
CFFE	Diesel	1968	4	81.00	35
CFGB	Diesel	1968	4	81.00	35
CFGC	Diesel	1968	4	81.00	35
CFHC	Diesel	1968	4	81.00	35
CFHD	Diesel	1968	4	81.00	35
CFJA	Diesel	1968	4	81.00	35
CFWA	Diesel	1199	3	79.50	22
CGGB Euro 5	Petrol	1390	4	76.50	10
CGLB	Diesel	1968	4	81.00	35
CHGA	Petrol	1595	4	81.00	30
CHYA	Petrol	999	3	74.50	4
CHYB	Petrol	999	3	74.50	4
CJCA	Diesel	1968	4	81.00	35
CLCB	Diesel	1968	4	81.00	35

		ccm	x 		9
CLNA	Diesel	1598	4	79.50	22
CPGA	Petrol	999	3	74.50	4
CTHA	Petrol	1390	4	76.50	11
CTHE	Petrol	1390	4	76.50	11
EZ	Petrol	1595	4	81.00	23
HM	Petrol	1595	4	81.00	23
MN	Diesel	1272	4	75.00	5
OM 615.912	Diesel	2197	4	87.00	42
RP	Petrol	1781	4	81.00	25

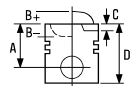

1 65.00

127 0.9	04/72 → 12/82	A112 A5.000 (M020.AA.09.0)	4 Cyl.	9:1
			903cc	29-33kW (40-45PS)
TD20969				

87-209800-00	STD	08-209800-00	STD	14-011001-00 D	B 68.04 C 115.00
87-209806-00	0.40mm	08-209806-00	0.40mm		
87-209808-00	0.60mm	08-209808-00	0.60mm		

A 30.75
D 61.25
 20x54

1.75
 2.00
 3.94



CR P
 P
 P

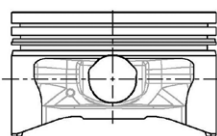
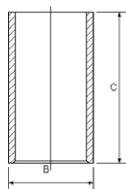

2 67.10

Arosa 1.0	05/97 → 06/04	AER		
Cordoba 1.0 i	09/96 → 06/99		4 Cyl.	10.5:1
Ibiza II 1.0 i	09/96 → 08/99		999cc	37kW (50PS)
TD5533				

Arosa 1.0	05/97 → 06/04	ALL	4 Cyl.	10.5:1
			999cc	37kW (50PS)
TD13891				

87-101300-00	STD	08-101300-00	STD
87-101307-00	0.50mm	08-101307-00	0.50mm

A 31.25
B- 5.65
D 56.27
 17x48

1.00
 1.20
 2.00



NT 
 P
 P

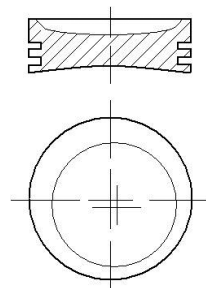

 Steel  Stahl  Acier  Acero  Acciaio



3  **71.00**





Ibiza V 1.2 TSI, Ibiza V Sportcoupe 1.2 TSI	08/12→	CBZA		
Ibiza V ST 1.2 TSI	09/12→		4 Cyl.	10:1
Toledo IV 1.2 TSI	07/12→		1197cc	63kW (86PS)
			Turbo Intercooled	TD23927

Altea 1.2 TSI, Altea XL 1.2 TSI	04/10→	CBZB		
Ibiza V 1.2 TSI, Ibiza V Sportcoupe 1.2 TSI	09/10→		4 Cyl.	10:1
Ibiza V ST 1.2 TSI			1197cc	77kW (105PS)
Leon 1.2 TSI	02/10→12/12		Turbo Intercooled	TD23908
Toledo IV 1.2 TSI	07/12→			

87-442300-00   STD

08-442300-00 STD

A	28.00
B+	0.70
C	3.52
C	3.52
D	48.00
	17x49

1.20		NT 
1.20		P
2.00		NT

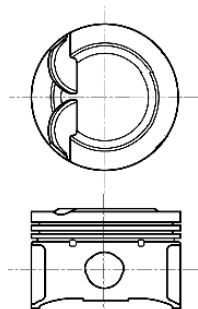
AK HA TP

07124A101

 Earlier pistons to be replaced in Engine sets only

 Frühere Kolben nur in Motorsätzen zu ersetzen

 Premier piston à remplacer dans le jeu moteur

 Pistones más antiguos para ser reemplados en juego de motores solamente

 Con i pistone di vecchia versione è necessario sostituire tutta la serie

 Elastoval ®

 Elastoval ®

 Elastoval ®

 Elastoval ®

 Elastoval ®

 Steel

 Stahl

 Acier

 Acero

 Acciaio

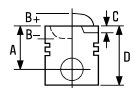

4 74.50

Mii 1.0	10/11→	CHYA	3 Cyl. 999cc	10.5:1 44kW (60PS)	TD26310
Ibiza V 1.0, Ibiza V Sportcoupe 1.0 Ibiza V ST 1.0	05/15→	CHYB	3 Cyl. 999cc	10.5:1 55kW (75PS)	TD26311
Mii 1.0	10/11→				
Mii 1.0 EcoFuel	11/12→	CPGA	3 Cyl. 999cc	10.5:1 50kW (68PS)	TD27264

87-443600-00

STD

08-443600-00

STD

A 27.22
B- 0.56
BØ 58.07
C 2.19
D 42.22
 17x39

1.00
1.20
2.00



NT 
P
CR 

TP

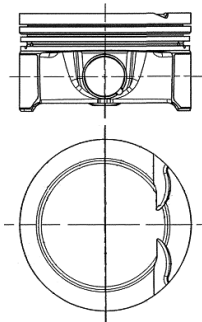

 Steel

 Stahl

 Acier

 Acero

 Acciaio

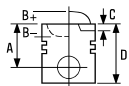

5 75.00

Cordoba 1.0 CL Ibiza II 1.0	02/93→06/96 03/93→09/96	AAU	4 Cyl. 1043cc	10.1:1 33kW (45PS)	TD4892
Cordoba 1.3 Ibiza II 1.3 i	02/93→08/94 03/93→08/99	AAV	4 Cyl. 1272cc	9.2:1 40kW (54PS)	TD4893
Terra 1.4 D	10/90→12/95	1W	4 Cyl. 1398cc	22:1 35kW (48PS)	TD9402
		Diesel			
Terra 1.3 D	03/90→12/94	MN	4 Cyl. 1272cc	22:1 33kW (45PS)	TD9401
		Diesel			

14-025070-00 D B 78.00 C 133.00 D 81.00 E 4.50

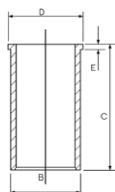



6 76.50





Cordoba 1.6 i Cordoba Vario 1.6 i Ibiza II 1.6 i Inca 1.6 I	02/93→06/99 09/96→06/99 03/93→08/99 06/97→09/00	AEE	4 Cyl. 1598cc	9.8:1 55kW (75PS)	TD10867
Cordoba 1.6 Cordoba 1.6 i Cordoba Vario 1.6 Cordoba Vario 1.6 i Ibiza II 1.6 i Ibiza III 1.6 Inca 1.6 I	06/99→10/02 02/93→06/99 06/99→12/02 09/96→06/99 03/93→08/99 08/99→02/02 06/97→09/00	ALM	4 Cyl. 1598cc	9.8:1 55kW (75PS)	TD12949

87-502800-10 STD
87-502807-10  0.50mm

08-502800-00 STD
08-502807-00 0.50mm

14-021571-00 D B 79.56 C 142.00 D 82.50 E 4.50
14-028360-00 D  B 79.50 C 145.00 D 81.50 E 4.70

A 30.85
C 7.80
D 60.35
 17x52

1.20  NT 
1.50  P
2.50  CR 

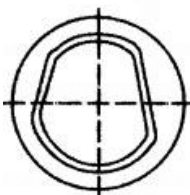
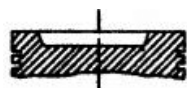
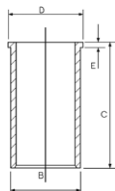



 With recesses on crankshaft side

 Mit kurbelwellenseitigen Aussparungen

 Avec évidements côté vilebrequin

 Con escotaduras en la cara del cigüeñal

 Con nicchie sul lato albero motore

 A = 30.600, D = 52.600

 A = 30.600, D = 52.600

 A = 30.600, D = 52.600

 A = 30.600, D = 52.600

 A = 30.600, D = 52.600

 Steel

 Stahl

 Acier

 Accro

 Acciaio



7 76.50

Arosa 1.4	05/97→06/04	AEX			
Cordoba 1.4 i	06/94→06/99		4 Cyl.	10.2:1	
Cordoba Vario 1.4 i	09/96→06/99		1391cc	44kW (60PS)	
Ibiza II 1.4 i	09/93→08/99				TD5532
Inca 1.4 I	11/95→06/03				
Arosa 1.4	05/97→06/04	AKV			
Cordoba 1.4 i	06/94→06/99		4 Cyl.	10.2:1	
Cordoba Vario 1.4 i	09/96→06/99		1391cc	44kW (60PS)	
Ibiza II 1.4 i	09/93→08/99				TD12513
Inca 1.4 I	11/95→06/03				
Cordoba 1.4, Cordoba Vario 1.4, Ibiza II 1.4	12/97→04/99	ANX			
			4 Cyl.	10.2:1	
			1390cc	40kW (54PS)	
					TD12514
Arosa 1.4	05/97→06/04	APQ			
Cordoba 1.4 i	06/94→06/99		4 Cyl.	10.2:1	
Cordoba Vario 1.4 i	09/96→06/99		1391cc	44kW (60PS)	
Ibiza II 1.4 i	09/93→08/99				TD12515
Inca 1.4 I	11/95→06/03				

87-502800-00

STD

08-502800-00

STD

14-021571-00 **D**

B 79.56 **C** 142.00 **D** 82.50 **E** 4.50

87-502807-00 

0.50mm

08-502807-00

0.50mm

14-028360-00 **D** 

B 79.50 **C** 145.00 **D** 81.50 **E** 4.70

A 28.35

C 5.95

D 50.35

 17x52

1.20

1.50

2.50









NT 

P

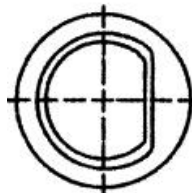
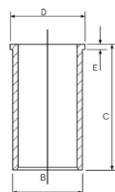
CR 



 With recesses on crankshaft side

 A = 28.100, D = 50.100

 Steel

 Mit kurbelwellenseitigen Aussparungen

 A = 28.100, D = 50.100

 Stahl

 Avec évidements côté vilebrequin

 A = 28.100, D = 50.100

 Acier

 Con escotaduras en la cara del cigüeñal

 A = 28.100, D = 50.100

 Acero

 Con nicchie sul lato albero motore

 A = 28.100, D = 50.100

 Acciaio

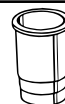

8 76.50

Cordoba 1.4 i 16V Ibiza II 1.4 i 16V	09/96→06/99 06/97→08/99	AFH	4 Cyl. 1390cc	10.5:1 74kW (101PS)	TD5534
Arosa 1.4 16V	01/00→06/04	AFK	4 Cyl. 1390cc	10.5:1 74kW (101PS)	TD13893
Leon 1.4 16V Toledo II 1.4 16V	11/99→06/06 01/00→05/02	AHW	4 Cyl. 1390cc	10.5:1 55kW (75PS)	TD15529
Cordoba 1.4 16V Cordoba Vario 1.4 16V Ibiza III 1.4 16V Leon 1.4 16V Toledo II 1.4 16V	05/00→10/02 06/99→12/02 05/00→02/02 11/99→06/06 01/00→05/02	APE	4 Cyl. 1390cc	10.5:1 55kW (75PS)	TD13268
Arosa 1.4 16V Cordoba 1.4 16V Cordoba Vario 1.4 Ibiza III 1.4 16V	01/00→06/04 02/00→10/02 02/00→12/02 08/99→02/02	AQQ	4 Cyl. 1390cc	10.5:1 74kW (100PS)	TD15528
Cordoba 1.4 16V Cordoba Vario 1.4 16V Ibiza III 1.4 16V Inca 1.4 16V Leon 1.4 16V Toledo II 1.4 16V	05/00→10/02 06/99→12/02 05/00→02/02 04/00→06/03 11/99→06/06 01/00→05/02	AUA	4 Cyl. 1390cc	10.5:1 55kW (75PS)	TD16197
Arosa 1.4 16V Cordoba 1.4 16V Cordoba Vario 1.4 Ibiza III 1.4 16V Ibiza IV 1.4 16V	01/00→06/04 02/00→11/09 02/00→12/02 08/99→02/02 02/02→11/09	AUB	4 Cyl. 1390cc	10.5:1 74kW (100PS)	TD16140
Leon 1.4 16V Toledo II 1.4 16V	11/99→06/06 01/00→05/02	AXP	4 Cyl. 1390cc	10.5:1 55kW (75PS)	TD16134
Cordoba 1.4 16V Ibiza IV 1.4 16V	09/02→12/07 02/02→12/07	BBY	4 Cyl. 1390cc	10.5:1 55kW (75PS)	TD16460
Cordoba 1.4 16V Ibiza IV 1.4 16V	10/02→11/09 02/02→11/09	BBZ	4 Cyl. 1390cc	10.5:1 74kW (100PS)	TD16541







Leon 1.4 16V Toledo II 1.4 16V	11/99 → 06/06 01/00 → 05/02	BCA	4 Cyl. 1390cc	10.5:1 55kW (75PS)	TD16434
---	--------------------------------	------------	-------------------------	------------------------------	----------------

87-116100-00	STD	08-116100-00	STD
87-116107-00 ①	0.50mm	08-116107-00	0.50mm

A 28.92
B- 1.98
BØ 61.90
C 2.32
D 49.92
 17x54

1.20  NT ②
 1.50  P
 2.50  CR ②

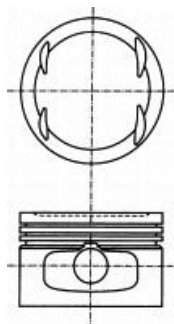

① A = 28.670, D = 49.670
 ② Steel

① A = 28.670, D = 49.670
 ② Stahl

① A = 28.670, D = 49.670
 ② Acier

① A = 28.670, D = 49.670
 ② Acero

① A = 28.670, D = 49.670
 ② Acciaio

9 76.50

Cordoba 1.2 Ibiza IV 1.2	10/02 → 06/06 02/02 → 06/06	AZQ	3 Cyl. 1198cc	10.5:1 47kW (64PS)	TD16459
---	--------------------------------	------------	-------------------------	------------------------------	----------------

14-021571-00 D B 79.56 C 142.00 D 82.50 E 4.50
14-028360-00 D ① B 79.50 C 145.00 D 81.50 E 4.70

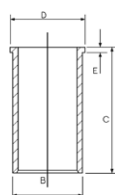

① With recesses on crankshaft side

① Mit kurbelwellenseitigen Aussparungen

① Avec évidements côté vilebrequin

① Con escotaduras en la cara del cigüeñal ① Con nicchie sul lato albero motore

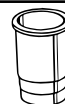

10 76.50

Cordoba 1.4 16V	09/02→12/07	BKY			
Ibiza IV 1.4 16V	02/02→12/07		4 Cyl.	10.5:1	
			1390cc	55kW (75PS)	TD18750
Altea 1.4 16V	05/06→	BXW			
Altea XL 1.4 16V	10/06→		4 Cyl.	10.5:1	
Cordoba 1.4 16V, Ibiza IV 1.4 16V	05/06→11/09		1390cc	63kW (86PS)	
Ibiza V 1.4	03/08→				TD19427
Ibiza V Sportcoupe 1.4	07/08→				
Leon 1.4 16V	06/06→12/12				
Toledo III 1.4 16V	05/06→05/09				
Altea 1.4 16V	05/06→	CGGB Euro 5			
Altea XL 1.4 16V	10/06→		4 Cyl.		
Ibiza V 1.4	03/08→		1390cc	63kW (85PS)	
Ibiza V Sportcoupe 1.4	07/08→				TD23136
Ibiza V ST 1.4	03/10→				
Leon 1.4 16V	06/06→12/12				

87-436900-00  STD

08-436900-00 STD

04/05→

A 28.92

B- 2.28

BØ 61.14

C 1.07

C 1.04

D 46.92

 17x45

1.20

1.20

2.00



NT 

P

CR 

TP

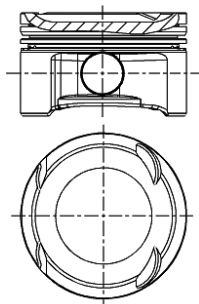

07675-204

ECOTOUGH

 Pistons to be replaced in Engine Sets only

 Steel

 Kolben nur Motorsätzen zu ersetzen

 Stahl

 Piston à remplacer dans jeu moteur

 Acier

 Pistones de repuesto para juegos de motores solamente

 Acero

 Il pistone può essere rimpiazzato solamente completo

 Acciaio

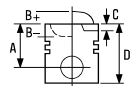
11  **76.50**

Alhambra 1.4 TSI	06/10→	CAVA	4 Cyl. 1390cc Turbo & Supercharged	10:1 110kW (150PS)	TD24449
Ibiza V Sportcoupe 1.4 TSI Cupra	06/09→	CAVE	4 Cyl. 1390cc Turbo & Supercharged	10:1 132kW (180PS)	TD23095
Alhambra 1.4 TSI	06/10→	CTHA	4 Cyl. 1390cc Turbo & Supercharged	110kW (150PS)	TD27527
Ibiza V Sportcoupe 1.4 TSI Cupra	06/09→	CTHE	4 Cyl. 1390cc Turbo & Supercharged	10:1 132kW (180PS)	TD26916

87-433900-10 

STD

08-433900-00

STD

87-433907-10 

0.50mm

08-433907-00

0.50mm

A 29.00

B- 4.55

B+ 1.85

C 1.00

C 3.80

D 49.85

 19x54

1.20

1.50



2.00

NT 

P

NT 

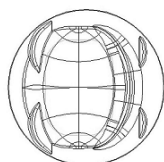
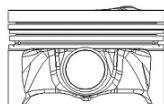
RT TP

 Pistons to be replaced in Engine Sets only

 Steel

 Kolben nur Motorsätzen zu ersetzen

 Stahl

 Piston à remplacer dans jeu moteur

 Acier

 Pistones de repuesto para juegos de motores solamente

 Acero

 Il pistone può essere rimpiazzato solamente completo

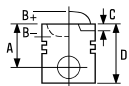

 Acciaio









12  **76.50**

Toledo IV 1.4 TSI	07/12→	CAXA	4 Cyl.	10:1	
			1390cc	90kW (122PS)	
			Turbo Intercooled		TD27223









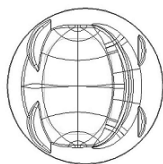
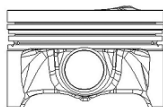

Altea 1.4 TSI, Altea XL 1.4 TSI	11/07→	CAXC	4 Cyl.	9.7:1	
Leon 1.4 TSI	11/07→12/12		1390cc	92kW (125PS)	
			Turbo Intercooled		TD20488

87-429900-00  STD	08-429900-00 STD
87-429907-00  0.50mm	08-429907-00 0.50mm

A 29.20	1.20		NT 
B- 4.50	1.20		P
C 3.60	2.00		NT 
D 48.20			
 19x52			

HA



 Elastoval®	 Elastoval®	 Elastoval®	 Elastoval®	 Elastoval®
 Steel	 Stahl	 Acier	 Acero	 Acciaio

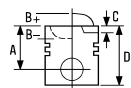

13 79.50

Cordoba 1.9 D	02/93→08/96	1Y		
Ibiza II 1.9 D	04/93→08/96		4 Cyl.	22.5:1
Inca 1.9 D	11/95→06/03		1896cc	47-50kW (64-68PS)
Toledo I 1.9 D	05/91→03/99	Diesel		TD4891

Cordoba 1.9 D	02/93→08/96	AEF		
Ibiza II 1.9 D	04/93→08/96		4 Cyl.	22.5:1
Inca 1.9 D	11/95→		1896cc	47kW (64PS)
Toledo I 1.9 D	05/91→03/99	Diesel		TD9373

87-990100-40	STD	08-990100-00	STD	14-027950-00 D	B 82.50 C 152.00 D 85.50 E 4.70
87-990105-40	0.25mm	08-990105-00	0.25mm		
87-990107-40	0.50mm	08-990107-00	0.50mm		
87-990111-40	1.00mm	08-990111-00	1.00mm		

A	39.65	1.75		CR P
B-	1.90	2.00		P
D	65.70	3.00		CR P

24x64

AK RT

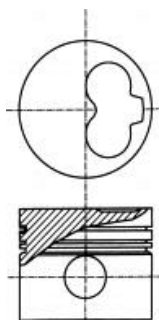

07945

A = 39.400

A = 39.400

A = 39.400

A = 39.400

A = 39.400

14 79.50

Alhambra 1.9 TDI	04/96→03/10	1Z		
Cordoba 1.9 TDI, Cordoba Vario 1.9 TDI	08/96→06/99		4 Cyl.	19.5:1
Ibiza II 1.9 TDI	08/96→08/99		1896cc	66kW (90PS)
Toledo I 1.9 TDI	08/95→03/99	Diesel	Turbo Intercooled	TD5527

Cordoba 1.9 SDI	08/96→06/99	AEY		
Cordoba Vario 1.9 SDI	09/96→06/99		4 Cyl.	19.5:1
Ibiza II 1.9 SDI	08/96→08/99		1896cc	47kW (64PS)
Inca 1.9 SDI	11/95→06/03	Diesel		TD5535

Alhambra 1.9 TDI	08/96→06/00	AFN		
Cordoba 1.9 TDI	03/97→06/99		4 Cyl.	19.5:1
Cordoba Vario 1.9 TDI	07/97→06/99		1896cc	81kW (110PS)
Ibiza II 1.9 TDI	02/97→08/99	Diesel	Turbo Intercooled	TD5531
Toledo I 1.9 TDI	11/96→03/99			

Cordoba 1.9 TDI	06/99→10/02	AGR		
Cordoba Vario 1.9 TDI	06/99→12/02		4 Cyl.	19.5:1
Ibiza III 1.9 TDI	08/99→02/02		1896cc	66kW (90PS)
Leon 1.9 TDI	11/99→06/06	Diesel	Turbo Intercooled	TD13278
Toledo II 1.9 TDI	03/99→07/04			









Leon 1.9 TDI Toledo II 1.9 TDI	11/99→06/06 10/98→07/04	AHF	4 Cyl. 1896cc Turbo Intercooled	19.5:1 81kW (110PS)	TD12512
Alhambra 1.9 TDI Cordoba 1.9 TDI Cordoba Vario 1.9 TDI Ibiza II 1.9 TDI Toledo I 1.9 TDI	04/96→03/10 08/96→10/02 08/96→06/99 08/96→08/99 08/95→03/99	AHU	4 Cyl. 1896cc Turbo Intercooled	19.5:1 66kW (90PS)	TD5528
Cordoba 1.9 TDI Cordoba Vario 1.9 TDI Ibiza III 1.9 TDI Inca 1.9 TDI Leon 1.9 TDI Toledo II 1.9 TDI	06/99→10/02 06/99→12/02 08/99→02/02 09/96→06/03 11/99→06/06 03/99→07/04	ALH	4 Cyl. 1896cc Turbo Intercooled	19.5:1 66kW (90PS)	TD13272
Cordoba 1.9 TDI Cordoba Vario 1.9 TDI Ibiza III 1.9 TDI Leon 1.9 TDI Toledo II 1.9 TDI	06/99→10/02 06/99→12/02 08/99→02/02 11/99→12/12 10/98→07/04	ASV	4 Cyl. 1896cc Turbo Intercooled	19.5:1 81kW (110PS)	TD13273
Alhambra 1.9 TDI	08/96→06/00	AVG	4 Cyl. 1896cc Turbo Intercooled	19.5:1 81kW (110PS)	TD23884

87-114900-60 1 3 STD
87-114905-60 1 3 0.25mm
87-114907-60 1 3 5 0.50mm
87-114911-60 1 3 5 1.00mm

08-114900-00 STD
08-114905-00 0.25mm
08-114907-00 0.50mm
08-114911-00 1.00mm

A 45.80
B- 17.65
BØ 38.00
C 1.10
D 68.80
 26x66

1.75  CK P
2.00  P
3.00  CR P

14-027950-00 D B 82.50 C 152.00 D 85.50 E 4.70

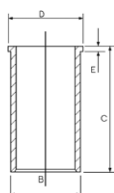

AK KK NB RT

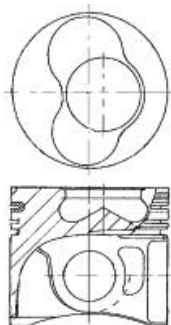

07987







87-114900-70 ② ③ STD
87-114905-70 ② ③ 0.25mm
87-114907-70 ② ③ ⑤ 0.50mm
87-114911-70 ② ③ ⑤ 1.00mm

A 45.80
B- 17.65
BØ 38.00
C 1.10
D 68.80
 26x66

08-114900-00 STD
08-114905-00 0.25mm
08-114907-00 0.50mm
08-114911-00 1.00mm

1.75  CK P
 2.00  P
 3.00  CR P

AK KK NB RT

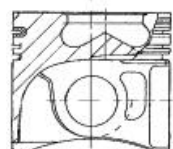
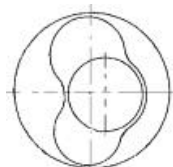



07987A

87-114900-90 ① STD
87-114905-90 ① 0.25mm
87-114907-90 ① ④ 0.50mm
87-114911-90 ① ④ 1.00mm

A 45.80
B- 17.65
BØ 38.00
C 1.10
D 71.80
 26x66

08-114900-00 STD
08-114905-00 0.25mm
08-114907-00 0.50mm
08-114911-00 1.00mm

1.75  CK P
 2.00  P
 3.00  CR P

AK NB RT

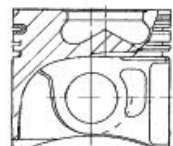
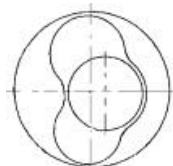

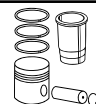
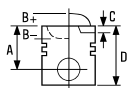

87-114900-95 [2]	STD	08-114900-00	STD
87-114905-95 [2]	0.25mm	08-114905-00	0.25mm
87-114907-95 [2] [4]	0.50mm	08-114907-00	0.50mm
87-114911-95 [2] [4]	1.00mm	08-114911-00	1.00mm

A	45.80
B-	17.65
BØ	38.00
C	1.10
D	71.80
	26x66

1.75		CK P
2.00		P
3.00		CR P

AK NB RT

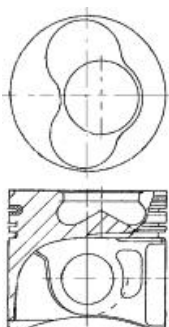

- [1] To cylinder 1 & 2
- [2] To cylinder 3 & 4
- [3] Piston Chamber Volume [ccm] 23.54
- [4] A = 45.550, D = 71.550
- [5] A = 45.550, D = 68.550

- [1] zum Zylinder 1 & 2
- [2] zum Zylinder 3 & 4
- [3] Volumen der Kolbenmulde [ccm] 23.54
- [4] A = 45.550, D = 71.550
- [5] A = 45.550, D = 68.550

- [1] sous cylindre 1 & 2
- [2] sous cylindre 3 & 4
- [3] Volume de la cavité du piston [cm³] 23.54
- [4] A = 45.550, D = 71.550
- [5] A = 45.550, D = 68.550

- [1] A cilindro 1 & 2
- [2] A cilindro 3 & 4
- [3] Volumen de cavidad del pistón [cc] 23.54
- [4] A = 45.550, D = 71.550
- [5] A = 45.550, D = 68.550

- [1] al cilindro 1 & 2
- [2] al cilindro 3 & 4
- [3] Volume camera pistone [cm³] 23.54
- [4] A = 45.550, D = 71.550
- [5] A = 45.550, D = 68.550

15 79.50

Cordoba 1.9 TD	02/93→08/96	AAZ		
Ibiza II 1.9 TD	03/93→08/96		4 Cyl.	22.5:1
Toledo I 1.9 TD	05/91→03/99		1896cc	55kW (75PS)
		Diesel	Turbo	TD4894

87-990100-10	STD	08-990100-00	STD
87-990105-10	0.25mm	08-990105-00	0.25mm
87-990107-10 [1]	0.50mm	08-990107-00	0.50mm
87-990111-10 [1]	1.00mm	08-990111-00	1.00mm

A	45.65
B-	1.90
D	71.70
	26x66

1.75		CR P
2.00		P
3.00		CR P

14-027950-00 D **B 82.50 C 152.00 D 85.50 E 4.70**

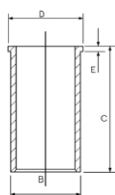

AK HA RT

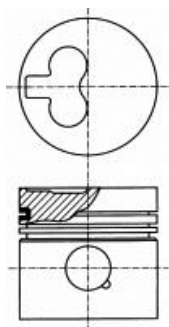

[1] A = 45.430

[1] A = 45.430

[1] A = 45.430





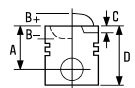

[1] A = 45.430

[1] A = 45.430





16  **79.50**

Cordoba 1.9 SDI	06/99→10/02	AGP			
Cordoba Vario 1.9 SDI	06/99→12/02		4 Cyl.	19.5:1	
Ibiza III 1.9 SDI	08/99→02/02		1896cc	50kW (68PS)	
		Diesel			TD14808
Cordoba 1.9 SDI	06/99→10/02	AQM			
Cordoba Vario 1.9 SDI	06/99→12/02		4 Cyl.	19.5:1	
Ibiza III 1.9 SDI	08/99→02/02		1896cc	50kW (68PS)	
Leon 1.9 SDI	11/99→06/06	Diesel	Turbo Intercooled		TD13271
Cordoba 1.9 SDI	09/02→11/09	ASY			
Ibiza IV 1.9 SDI	02/02→12/05		4 Cyl.	19.5:1	
		Diesel	1896cc	47kW (64PS)	TD16461
Inca 1.9 SDI	11/95→06/03	AYQ			
		Diesel	4 Cyl.	19.5:1	
			1896cc	47kW (64PS)	TD16198

- 87-114900-20   STD
- 87-114907-20   0.50mm
- 87-114911-20   1.00mm

- A** 39.80
- B-** 17.75
- BØ** 38.00
- C** 1.00
- D** 60.80
-  24x58

- 08-114900-00 STD
- 08-114905-00 0.25mm
- 08-114907-00 0.50mm
- 08-114911-00 1.00mm

- 1.75  CK P
- 2.00  P
- 3.00  CR P

14-027950-00 **D** B 82.50 C 152.00 D 85.50 E 4.70

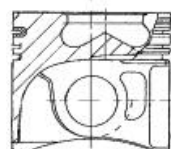
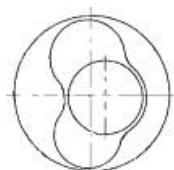
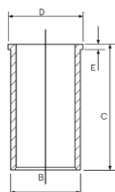

07959-109



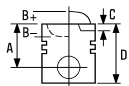



87-114900-30 ② ③ STD
 87-114907-30 ② ④ 0.50mm
 87-114911-30 ② ④ 1.00mm

A 39.80
 B- 17.75
 BØ 38.00
 C 1.00
 D 60.80
 24x58

08-114900-00 STD
 08-114905-00 0.25mm
 08-114907-00 0.50mm
 08-114911-00 1.00mm

1.75  CK P
 2.00  P
 3.00  CR P

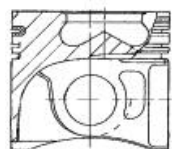
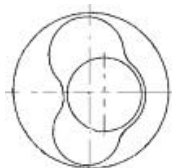

07959A109

- ① To cylinder 1 & 2
- ② To cylinder 3 & 4
- ③ Piston Chamber Volume [ccm] 23.60
- ④ A = 39.550, D = 60.550

- ① zum Zylinder 1 & 2
- ② zum Zylinder 3 & 4
- ③ Volumen der Kolbenmulde [ccm] 23.60
- ④ A = 39.550, D = 60.550

- ① sous cylindre 1 & 2
- ② sous cylindre 3 & 4
- ③ Volume de la cavité du piston [cm³] 23.60
- ④ A = 39.550, D = 60.550

- ① A cilindro 1 & 2
- ② A cilindro 3 & 4
- ③ Volumen de cavidad del pistón [cc] 23.60
- ④ A = 39.550, D = 60.550

- ① al cilindro 1 & 2
- ② al cilindro 3 & 4
- ③ Volume camera pistone [cm³] 23.60
- ④ A = 39.550, D = 60.550

17  79.50

Inca 1.7 D	09/96→06/03	AHB	4 Cyl. 1716cc	19.5:1 42kW (57PS)	TD9403
Arosa 1.7 SDI	08/97→06/04	AKU	4 Cyl. 1716cc	19.5:1 44kW (60PS)	TD13896
Ibiza IV 1.9 TDI Cupra R	03/04→02/08	BPX	4 Cyl. 1896cc Turbo Intercooled	19:1 118kW (160PS)	TD17640
Alhambra 1.9 TDI	05/05→05/07	BTB	4 Cyl. 1896cc Turbo Intercooled	110kW (150PS)	TD20625
Ibiza IV 1.9 TDI Cupra R	03/04→02/08	BUK	4 Cyl. 1896cc Turbo Intercooled	19:1 118kW (160PS)	TD22667

14-027950-00 D B 82.50 C 152.00 D 85.50 E 4.70

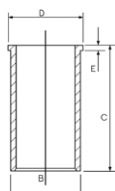

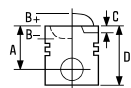

18  **79.50**

Arosa 1.4 TDI	01/00→06/04	AMF		
Cordoba 1.4 TDI	10/02→12/05		3 Cyl.	19.5:1
Ibiza IV 1.4 TDI	05/02→12/05		1422cc	55kW (75PS)
		Diesel	Turbo Intercooled	TD13895

87-114900-80 ¹ ³ STD **08-114900-00** STD **14-027950-00 D** **B 82.50 C 152.00 D 85.50 E 4.70**

87-114907-80 ¹ 0.50mm **08-114905-00** 0.25mm

08-114907-00 0.50mm

08-114911-00 1.00mm

A 45.80

B- 17.65

BØ 38.00

C 1.10

D 69.80

 26x63

1.75

2.00

3.00



CK P



P



CR P

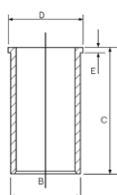

AK KK NB RT TP

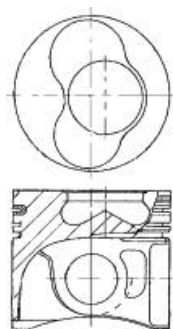

87-114900-85 ² ³ STD

87-114907-85 ² 0.50mm

08-114900-00 STD

08-114905-00 0.25mm

08-114907-00 0.50mm

08-114911-00 1.00mm

A 45.80

B- 17.65

BØ 38.00

C 1.10

D 69.80

 26x63

1.75

2.00

3.00



CK P



P



CR P

AK KK NB RT TP

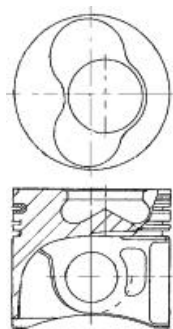

¹ To cylinder 1 & 2

² To cylinder 3

³ Piston Chamber Volume

[ccm] 23.75

¹ zum Zylinder 1 & 2

² zum Zylinder 3

³ Volumen der Kolbenmulde

[ccm] 23.75

¹ sous cylindre 1 & 2

² sous cylindre 3

³ Volume de la cavité du piston

[cm³] 23.75

¹ A cilindro 1 & 2

² A cilindro 3

³ Volumen de cavidad del pistón

[cc] 23.75

¹ al cilindro 1 & 2

² al cilindro 3

³ Volume camera pistone

[cm³] 23.75

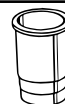
19  **79.50**

Alhambra 1.9 TDI	04/96→03/10	ANU	4 Cyl. 1896cc	18:1 66kW (90PS)	TD14911
		Diesel	Turbo Intercooled		
Cordoba 1.9 TDI	09/02→11/09	ATD	4 Cyl. 1896cc	19:1 74kW (100PS)	TD16462
Ibiza IV 1.9 TDI	02/02→11/09				
		Diesel	Turbo Intercooled		
Cordoba 1.9 TDI	09/02→11/09	AXR	4 Cyl. 1896cc	19:1 74kW (100PS)	TD18739
Ibiza IV 1.9 TDI	02/02→11/09				
Leon 1.9 TDI	10/05→06/06				
Toledo II 1.9 TDI	08/05→05/06	Diesel	Turbo Intercooled		
Altea 1.9 TDI	04/04→	BJB	4 Cyl. 1896cc	19:1 77kW (105PS)	TD17356
Toledo III 1.9 TDI	10/04→05/09				
		Diesel	Turbo Intercooled		
Altea 1.9 TDI	04/04→	BKC	4 Cyl. 1896cc	19:1 77kW (105PS)	TD17355
Altea XL 1.9 TDI	10/06→				
Leon 1.9 TDI	07/05→12/10				
Toledo III 1.9 TDI	10/04→05/09	Diesel	Turbo Intercooled		
Altea 1.9 TDI	04/04→	BLS	4 Cyl. 1896cc	19:1 77kW (105PS)	TD18268
Altea XL 1.9 TDI	10/06→				
Ibiza V 1.9 TDI	03/08→06/10				
Ibiza V SPORTCOUPE 1.9 TDI	07/08→06/10	Diesel	Turbo Intercooled		
Leon 1.9 TDI	07/05→12/10				
Toledo III 1.9 TDI	10/04→05/09				
Cordoba 1.9 TDI	09/02→11/09	BMT	4 Cyl. 1896cc	74kW (101PS)	TD20495
Ibiza IV 1.9 TDI	02/02→11/09				
		Diesel	Turbo Intercooled		
Altea 1.9 TDI	04/04→	BXE	4 Cyl. 1896cc	77kW (105PS)	TD19819
Altea XL 1.9 TDI	10/06→				
Leon 1.9 TDI	07/05→12/10				
Toledo III 1.9 TDI	10/04→05/09	Diesel	Turbo Intercooled		
Altea 1.9 TDI, Altea XL 1.9 TDI	08/09→	BXF	4 Cyl. 1896cc	19:1 66kW (90PS)	TD20866
Leon 1.9 TDI	06/07→12/10				
		Diesel	Turbo Intercooled		



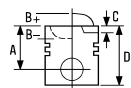

Ibiza V 1.9 TDI, Ibiza V SPORTCOUPE 1.9 TDI 07/08→06/10 BXJ



4 Cyl. 19.5:1
1896cc 66kW (90PS)

Diesel Turbo Intercooled TD20840

87-114900-65 ① ③ STD
87-114907-65 ① ④ 0.50mm

A 45.80
B- 17.20
BØ 38.00
C 1.10
D 68.80
 26x66

08-114900-00 STD
08-114905-00 0.25mm
08-114907-00 0.50mm
08-114911-00 1.00mm

1.75  CK P
 2.00  P
 3.00  CR P

14-027950-00 D B 82.50 C 152.00 D 85.50 E 4.70

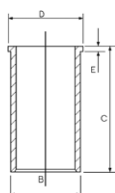

AK KK NB RT TP

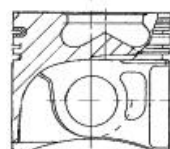
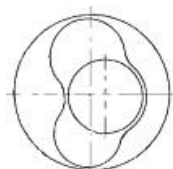



07901D-301

87-114900-66 ② ③ STD
87-114907-66 ② ④ 0.50mm

A 45.80
B- 17.20
BØ 38.00
C 1.10
D 68.80
 26x66

08-114900-00 STD
08-114905-00 0.25mm
08-114907-00 0.50mm
08-114911-00 1.00mm

1.75  CK P
 2.00  P
 3.00  CR P

AK KK NB RT TP

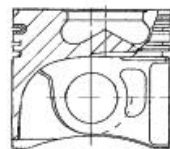
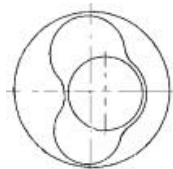

07901D-302

- ① To cylinder 1 & 2
- ② To cylinder 3 & 4
- ③ Piston Chamber Volume [ccm] 22.85
- ④ A = 45.550, D = 68.550

- ① zum Zylinder 1 & 2
- ② zum Zylinder 3 & 4
- ③ Volumen der Kolbenmulde [ccm] 22.85
- ④ A = 45.550, D = 68.550

- ① sous cylindre 1 & 2
- ② sous cylindre 3 & 4
- ③ Volume de la cavité du piston [cm³] 22.85
- ④ A = 45.550, D = 68.550

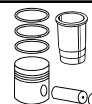
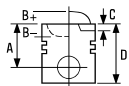

- ① A cilindro 1 & 2
- ② A cilindro 3 & 4
- ③ Volumen de cavidad del pistón [cc] 22.85
- ④ A = 45.550, D = 68.550

- ① al cilindro 1 & 2
- ② al cilindro 3 & 4
- ③ Volume camera pistone [cm³] 22.85
- ④ A = 45.550, D = 68.550



20  **79.50**

Leon 1.9 TDI	09/00→06/06	ARL			
Leon 1.9 TDI Syncro	05/02→06/06		4 Cyl.	19.5:1	
Toledo II 1.9 TDI	10/00→07/04		1896cc	110kW (150PS)	
		Diesel	Turbo Intercooled		TD15768
Alhambra 1.9 Tdi	11/02→11/08	ASZ			
Cordoba 1.9 TDI	10/02→11/09		4 Cyl.	19:1	
Ibiza IV 1.9 TDI	02/02→11/09		1896cc	96kW (130PS)	
Leon 1.9 TDI	05/03→06/06	Diesel	Turbo Intercooled		TD16463
Toledo II 1.9 TDI	05/03→05/06				
Cordoba 1.9 TDI	10/02→11/09	BLT			
Ibiza IV 1.9 TDI	02/02→11/09		4 Cyl.	19:1	
		Diesel	1896cc	96kW (131PS)	TD20516
			Turbo Intercooled		

87-114900-25   STD
 87-114907-25   0.50mm

→09/02

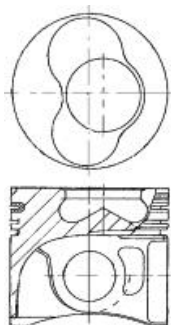

- A** 45.80
- B-** 17.90
- BØ** 38.00
- C** 1.10
- D** 68.80
-  26x66

AK KK NB RT TP



07969K101

08-114900-00 STD
 08-114905-00 0.25mm
 08-114907-00 0.50mm
 08-114911-00 1.00mm

- 1.75  CK P
- 2.00  P
- 3.00  CR P

14-027950-00 D B 82.50 C 152.00 D 85.50 E 4.70

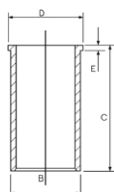

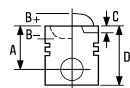



87-114900-35 ② ④ STD
87-114907-35 ② ⑤ 0.50mm

→09/02

A 45.80
B- 17.90
BØ 38.00
C 1.10
D 68.80
 26x66

08-114900-00 STD
08-114905-00 0.25mm
08-114907-00 0.50mm
08-114911-00 1.00mm

1.75  CK P
 2.00  P
 3.00  CR P

AK KK NB RT TP

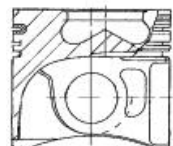
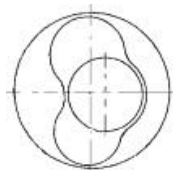



07969K102

87-114900-45 ① ③ STD
87-114907-45 ① ⑤ 0.50mm

09/02→

A 45.80
B- 17.50
BØ 38.00
C 1.10
D 68.80
 26x66

08-114900-00 STD
08-114905-00 0.25mm
08-114907-00 0.50mm
08-114911-00 1.00mm

1.75  CK P
 2.00  P
 3.00  CR P

AK KK NB RT TP

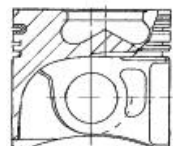
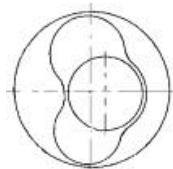

07901C105



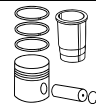
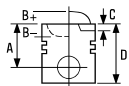

87-114900-46 [2] [3]
87-114907-46 [2] [5]

STD
0.50mm

08-114900-00
08-114905-00
08-114907-00
08-114911-00

STD
0.25mm
0.50mm
1.00mm

09/02 →

A 45.80
B- 17.50
BØ 38.00
C 1.10
D 68.80
 26x66

1.75
2.00
3.00



CK P
P
CR P

AK KK NB RT TP

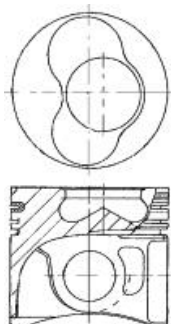

07901C106

- [1] To cylinder 1 & 2
- [2] To cylinder 3 & 4
- [3] Piston Chamber Volume
[ccm] 24.05
- [4] Piston Chamber Volume
[ccm] 24.60
- [5] A = 45.550, D = 68.550

- [1] zum Zylinder 1 & 2
- [2] zum Zylinder 3 & 4
- [3] Volumen der Kolbenmulde
[ccm] 24.05
- [4] Volumen der Kolbenmulde
[ccm] 24.60
- [5] A = 45.550, D = 68.550

- [1] sous cylindre 1 & 2
- [2] sous cylindre 3 & 4
- [3] Volume de la cavité du piston
[cm³] 24.05
- [4] Volume de la cavité du piston
[cm³] 24.60
- [5] A = 45.550, D = 68.550

- [1] A cilindro 1 & 2
- [2] A cilindro 3 & 4
- [3] Volumen de cavidad del pistón
[cc] 24.05
- [4] Volumen de cavidad del pistón
[cc] 24.60
- [5] A = 45.550, D = 68.550

- [1] al cilindro 1 & 2
- [2] al cilindro 3 & 4
- [3] Volume camera pistone
[cm³] 24.05
- [4] Volume camera pistone
[cm³] 24.60
- [5] A = 45.550, D = 68.550

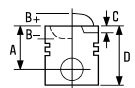

21  **79.50**

Alhambra 1.9 TDI, Alhambra 1.9 TDI 4motion	06/00→03/10	AUY	4 Cyl.	18:1
			1896cc	85kW (115PS)
		Diesel	Turbo Intercooled	TD14912



Alhambra 1.9 TDI, Alhambra 1.9 TDI 4motion	06/00→03/10	BVK	4 Cyl.	18:1
			1896cc	85kW (115PS)
		Diesel	Turbo Intercooled	TD20515

87-114900-05   STD
 87-114907-05    0.50mm

→09/02

- A** 45.80
- B-** 17.80
- BØ** 38.00
- C** 1.30
- D** 68.80
-  26x66

08-114900-00 STD
 08-114905-00 0.25mm
 08-114907-00 0.50mm
 08-114911-00 1.00mm

- 1.75  CK P
- 2.00  P
- 3.00  CR P



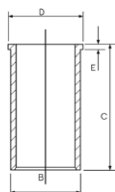

14-027950-00 D B 82.50 C 152.00 D 85.50 E 4.70

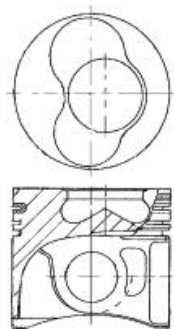

AK KK NB RT TP





07969L-101

87-114900-15   STD
 87-114907-15    0.50mm

→09/02

- A** 45.80
- B-** 17.80
- BØ** 38.00
- C** 1.30
- D** 68.80
-  26x66

08-114900-00 STD
 08-114905-00 0.25mm
 08-114907-00 0.50mm
 08-114911-00 1.00mm

- 1.75  CK P
- 2.00  P
- 3.00  CR P

AK KK NB RT TP

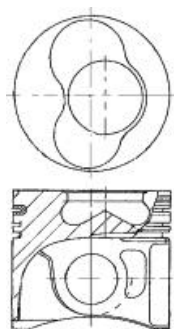

07969L-102



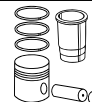
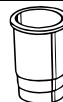

87-114900-55 1 3 5 STD
87-114907-55 1 6 5 0.50mm

09/02 →

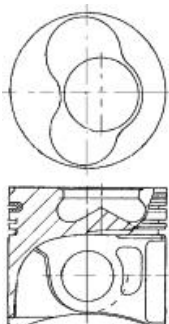

A 45.80
B- 17.60
BØ 38.00
C 1.10
D 68.80
 26x66

AK KK NB RT TP



07901D101

08-114900-00 STD
08-114905-00 0.25mm
08-114907-00 0.50mm
08-114911-00 1.00mm

1.75  CK P
2.00  P
3.00  CR P

87-114900-56 2 3 5 STD
87-114907-56 2 6 5 0.50mm

09/02 →

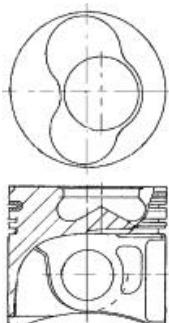

A 45.80
B- 17.60
BØ 38.00
C 1.10
D 68.60
 26x66

AK KK NB RT TP



07901D102

08-114900-00 STD
08-114905-00 0.25mm
08-114907-00 0.50mm
08-114911-00 1.00mm

1.75  CK P
2.00  P
3.00  CR P

- 1 To cylinder 1 & 2
- 2 To cylinder 3 & 4
- 3 Piston Chamber Volume [ccm] 23.60
- 4 For side angled injection nozzle
- 5 For newer design straight injection nozzle
- 6 A = 45.550, D = 68.550

- 1 zum Zylinder 1 & 2
- 2 zum Zylinder 3 & 4
- 3 Volumen der Kolbenmulde [ccm] 23.60
- 4 Nur für schräg angeordnete Einspritzdüsen
- 5 Für neuere Ausführungen, direkt einspritzende Düsen
- 6 A = 45.550, D = 68.550

- 1 sous cylindre 1 & 2
- 2 sous cylindre 3 & 4
- 3 Volume de la cavité du piston [ccm] 23.60
- 4 Pour buse d'injection latérale angulaire
- 5 Pour buse d'injection droite à conception plus récente
- 6 A = 45.550, D = 68.550

- 1 A cilindro 1 & 2
- 2 A cilindro 3 & 4
- 3 Volumen de cavidad del pistón [cc] 23.60
- 4 Para la boquilla de inyección lateral angular
- 5 Para el más reciente diseño de boquilla de inyección directa
- 6 A = 45.550, D = 68.550

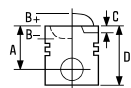

- 1 al cilindro 1 & 2
- 2 al cilindro 3 & 4
- 3 Volume camera pistone [cm³] 23.60
- 4 Per il lato angolato dell'ugello olio
- 5 Per la più recente progettazione dell'ugello olio non angolato
- 6 A = 45.550, D = 68.550



22  79.50

Ibiza V 1.2 TDI, Ibiza V Sportcoupe 1.2 TDI	05/10→	CFWA	3 Cyl.	16.5:1	TD23935
Ibiza V ST 1.2 TDI	04/10→		1199cc	55kW (75PS)	
		Diesel	Turbo Intercooled		
Ibiza TDI	05/10→06/10	CAYA	4 Cyl.	16.5:1	TD25762
			1598cc	55kW (75PS)	
		Diesel	Turbo Intercooled		
Altea 1.6 TDI, Altea XL 1.6 TDI	11/10→	CAYB	4 Cyl.	16.5:1	TD22670
Ibiza V 1.6 TDI, Ibiza V Sportcoupe 1.6 TDI	05/09→		1598cc	66kW (90PS)	
Ibiza V ST 1.6 TDI	03/10→				
Leon 1.6 TDI	11/10→12/12	Diesel	Turbo Intercooled		
Toledo IV 1.6 TDI	06/13→				
Altea 1.6 TDI, Altea XL 1.6 TDI	10/09→	CAYC	4 Cyl.	16.5:1	TD22671
Ibiza V 1.6 TDI, Ibiza V Sportcoupe 1.6 TDI	05/09→		1598cc	77kW (105PS)	
Ibiza V ST 1.6 TDI	03/10→				
Leon 1.6 TDI	02/10→12/12	Diesel	Turbo Intercooled		
Toledo IV 1.6 TDI	07/12→				
Ibiza V 1.6 TDI, Ibiza V Sportcoupe 1.6 TDI	05/09→	CLNA	4 Cyl.	16.5:1	TD23934
Ibiza V ST 1.6 TDI	03/10→		1598cc	77kW (105PS)	
Toledo IV 1.6 TDI	07/12→	Diesel	Turbo Intercooled		

87-432900-00 	STD	08-432900-00	STD
87-432905-00	0.25mm	08-432905-00	0.25mm
87-432907-00	0.50mm	08-432907-00	0.50mm

A	45.30	1.75		GDC P
B-	10.70	2.00		P
B-	4.70	3.00		CR P



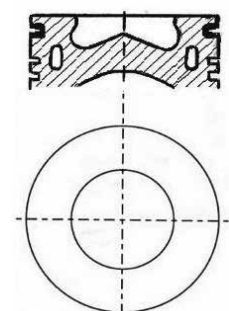

KK RT TP





0790MA-104

 Piston Chamber Volume
[ccm] 19.750

 Volumen der Kolbenmulde
[ccm] 19.750

 Volume de la cavité du piston
[cm³] 19.750

 Volumen de cavidad del pistón
[cc] 19.750

 Volume camera pistone
[cm³] 19.750

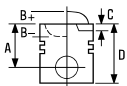

23  **81.00**

Cordoba 1.6 i	05/94→06/99	1F				
Cordoba Vario 1.6 i	05/97→06/99		4 Cyl.	9.5:1		
Ibiza II 1.6 i	09/94→06/99		1595cc	52-55kW (71-75PS)		
Inca 1.6 I	11/95→05/98					TD4890
Toledo I 1.6 I	05/91→03/99	ABN				
			4 Cyl.	9.1:1		
			1595cc	54-55kW (73-75PS)		TD17897
Toledo I 1.6 I	05/91→03/99	EZ				
			4 Cyl.	9.1:1		
			1595cc	52-54kW (71-73PS)		TD4899
Toledo I 1.6 I	05/91→03/99	HM				
			4 Cyl.	9:1		
			1595cc	38-55kW (52-75PS)		TD3590

87-109707-20  0.50mm

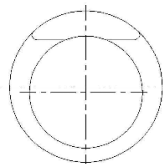
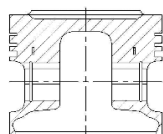

- A** 35.30
- B-** 2.30
- B+** 2.20
- D** 66.50
-  20x57





08132E

 A = 35.300, D = 66.500

- 08-109700-00** STD
- 08-109705-00** 0.25mm
- 08-109707-00** 0.50mm

- 1.50  CR P
- 1.75  P
- 3.00  CR P

 A = 35.300, D = 66.500

 A = 35.300, D = 66.500

 A = 35.300, D = 66.500

 A = 35.300, D = 66.500

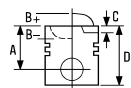

24  **81.00**



Cordoba 1.8 i	02/93→06/99	ABS			
Ibiza II 1.8 i	03/93→08/99		4 Cyl.	10:1	
Toledo I 1.8 i	11/93→12/96		1781cc	66kW (90PS)	TD3576

Cordoba 1.8 i	02/93→06/99	ADZ			
Ibiza II 1.8 i	03/93→08/99		4 Cyl.	9:1	
Toledo I 1.8 i	11/93→12/96		1781cc	66kW (90PS)	TD9384

87-109400-50 ¹ STD
87-109407-50 ¹ ² 0.50mm

08-109400-10 STD
08-109407-10 0.50mm

A 32.20
B- 4.40
B+ 1.30
BØ 55.70
D 62.50
 20x57

1.50  P PS
 1.75  P
 3.00  CR P

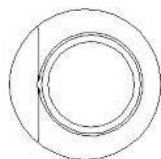
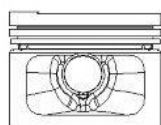

08130E-101

¹ Pistons to be replaced in Engine Sets only
² A = 31.900, D = 62.200

¹ Kolben nur Motorsätzen zu ersetzen
² A = 31.900, D = 62.200

¹ Piston à remplacer dans jeu moteur
² A = 31.900, D = 62.200

¹ Pistones de repuesto para juegos de motores solamente
² A = 31.900, D = 62.200

¹ Il pistone può essere rimpiazzato solamente completo
² A = 31.900, D = 62.200

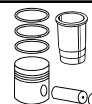
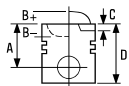



25  **81.00**

Cordoba 1.8 i	02/93→09/02	ACC			
Cordoba Vario 1.8 i	08/96→06/99		4 Cyl.	10:1	
Ibiza II 1.8 i	03/93→08/99		1781cc	66kW (90PS)	
Toledo I 1.8 i	11/93→12/96				TD18752
Toledo I 1.8 i	05/91→12/96	RP	4 Cyl.	9:1	
			1781cc	65kW (88PS)	TD3596

87-109707-10 0.50mm

- A** 31.90
- B-** 8.10
- B+** 1.10
- BØ** 56.80
- D** 62.00
-  20x54

- 08-109700-00** STD
- 08-109705-00** 0.25mm
- 08-109707-00** 0.50mm

- 1.50  CR P
- 1.75  P
- 3.00  CR P

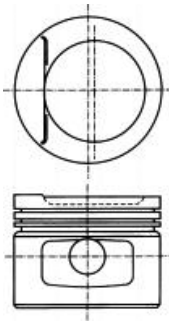

08131-122



26 **81.00**

Cordoba 1.6	06/99→10/02	AEH			
Cordoba Vario 1.6	06/99→12/02		4 Cyl.	10.2:1	
Ibiza III 1.6	08/99→02/02		1595cc	74kW (101PS)	
Leon 1.6	11/99→06/06				TD12488
Toledo II 1.6	10/98→07/04				
Cordoba 1.6 i	07/96→10/99	AFT			
Cordoba Vario 1.6 i	09/96→06/99		4 Cyl.	10.3:1	
Ibiza II 1.6 i	04/96→08/99		1595cc	74kW (101PS)	
Toledo I 1.6 I	11/96→03/99				TD5536
Cordoba 1.6	06/99→10/02	AKL			
Cordoba 1.6 i	07/96→10/99		4 Cyl.	10.3:1	
Cordoba Vario 1.6	06/99→12/02		1595cc	74kW (101PS)	
Ibiza III 1.6	08/99→02/02				TD12509
Leon 1.6	11/99→06/06				
Toledo II 1.6	10/98→07/04				
Cordoba 1.6	06/99→10/02	APF			
Cordoba Vario 1.6	06/99→12/02		4 Cyl.	10.3:1	
Ibiza III 1.6	08/99→02/02		1595cc	74kW (100PS)	
Leon 1.6	11/99→06/06				TD13269
Toledo II 1.6	10/98→07/04				
Cordoba 1.6	06/99→10/02	AUR			
Cordoba Vario 1.6	06/99→12/02		4 Cyl.	10.3:1	
Ibiza III 1.6	08/99→02/02		1595cc	74kW (101PS)	
					TD16200

87-105900-00

STD

08-105900-00

STD

87-105907-00 ¹

0.50mm

08-105907-00

0.50mm

A 32.00

B- 2.30

B+ 0.70

BØ 61.40

D 53.70

20x57

1.20

1.50

2.00



NT ²

P

CR ²

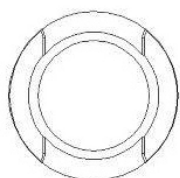
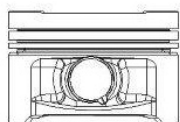

¹ A = 31.700, D = 53.400

² Steel

¹ A = 31.700, D = 53.400

² Stahl

¹ A = 31.700, D = 53.400

² Acier

¹ A = 31.700, D = 53.400

² Acero

¹ A = 31.700, D = 53.400

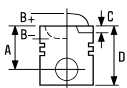

² Acciaio







27  **81.00**

Leon 1.8 20V	11/99→06/06	AGN	4 Cyl.	10.3:1
Toledo II 1.8 20V	10/98→07/04		1781cc	92kW (125PS)

TD12510

87-502900-00 	STD	08-502900-00	STD
87-502907-00 	0.50mm	08-502905-00	0.25mm
		08-502907-00	0.50mm







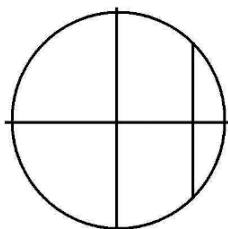



A	32.55
C	3.60
D	56.55
	20x59

1.50		CK P
1.75		P
2.00		CR P

AK



08192

 Conrod gap 27.50mm	 Pleuelaugenabstand 27.50mm	 Distance entre bielle 27.50mm	 Distancia del biela 27.50mm	 Distanza dalla bielle 27.50mm
 A = 32.250, D = 56.250	 A = 32.250, D = 56.250	 A = 32.250, D = 56.250	 A = 32.250, D = 56.250	 A = 32.250, D = 56.250



28  **81.00**

Toledo II 2.3 V5	10/98→11/00	AGZ	V5 Cyl.	10.1:1
			2324cc	110kW (150PS)

TD12511

87-501900-00	STD	08-501900-00	STD
87-501907-00	0.50mm	08-501907-00	0.50mm

A	30.52
B+	4.26
BØ	57.00
C	6.22
D	55.78
	20x57

1.50		P PS
1.75		P
3.00		CR P

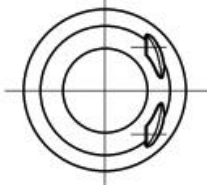







29  **81.00**

Alhambra 1.8 T 20V	10/97→03/10	AJH	4 Cyl. 1781cc Turbo Intercooled	9.5:1 110kW (150PS)	TD17899
Leon 1.8 20V T 4	11/99→06/06	AJQ	4 Cyl. 1781cc Turbo Intercooled	9.5:1 132kW (180PS)	TD16199
Leon 1.8 20V T Toledo II 1.8 20VT	11/99→06/06 09/00→07/04	APP	4 Cyl. 1781cc Turbo Intercooled	9.5:1 132kW (180PS)	TD13270
Cordoba 1.8 T 20V Cupra Ibiza III 1.8 T 20V Cupra	07/00→10/02 07/00→02/02	AQX	4 Cyl. 1781cc Turbo Intercooled	9.5:1 115kW (156PS)	TD13275
Alhambra 1.8 T 20V	10/97→03/10	AWC	4 Cyl. 1781cc Turbo Intercooled	9.5:1 110kW (150PS)	TD14909
Cordoba 1.8 T 20V Cupra Ibiza III 1.8 T 20V Cupra	07/00→10/02 07/00→02/02	AYP	4 Cyl. 1781cc Turbo Intercooled	115kW (156PS)	TD16201

87-502900-10	STD	08-502900-00	STD
87-502905-10	0.25mm	08-502905-00	0.25mm
87-502907-10	0.50mm	08-502907-00	0.50mm

A	32.70	1.50	 CK P
B-	2.05	1.75	 P
BØ	70.00	2.00	 CR P
D	53.70		
	20x59		

AK

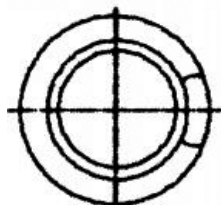
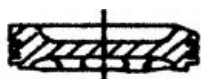



30  **81.00**

Exeo 1.6 Exeo ST 1.6	03/09→09/10 06/09→09/10	ALZ	4 Cyl. 1595cc	10.3:1 75kW (102PS)	TD22242
Leon 1.6 Toledo II 1.6	10/05→06/06 08/05→05/06	BFQ	4 Cyl. 1595cc	10.2:1 75kW (102PS)	TD20621
Altea 1.6 Leon 1.6 Toledo III 1.6	03/04→ 10/05→06/06 10/04→05/09	BGU	4 Cyl. 1595cc	10.3:1 75kW (102PS)	TD17352
Altea 1.6 Altea XL 1.6 Leon 1.6 Toledo III 1.6	03/04→ 10/06→ 07/05→12/12 10/04→05/09	BSE	4 Cyl. 1595cc	75kW (102PS)	TD18245
Altea 1.6 Altea XL 1.6 Leon 1.6 Toledo III 1.6	03/04→ 10/06→ 07/05→12/12 10/04→05/09	BSF	4 Cyl. 1595cc	75kW (102PS)	TD18246
Altea 1.6 LPG, Altea XL 1.6 LPG Leon 1.6 LPG	09/09→ 12/09→12/12	CHGA	4 Cyl. 1595cc	75kW (102PS)	TD22676





87-148300-00
87-148307-00

STD
0.50mm

08-148300-00
08-148307-00

STD
0.50mm

A 29.08
B- 2.70
BØ 62.30
D 50.70
 19x42

1.00  NT 
1.20  P
2.00  CR P

TP

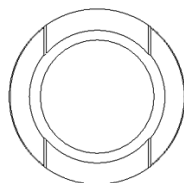
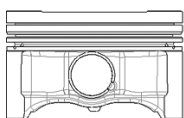

 Steel

 Stahl

 Acier

 Acero



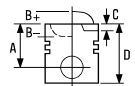

 Acciaio



31  **81.00**

Leon 1.8 20V T 4	11/99→06/06	ARY	4 Cyl. 1781cc Turbo Intercooled	9.5:1 132kW (180PS)	TD16136
Leon 1.8 20V T Toledo II 1.8 20VT	11/99→06/06 09/00→07/04	AUQ	4 Cyl. 1781cc Turbo Intercooled	9.5:1 132kW (180PS)	TD16135
Ibiza IV 1.8 T FR	12/03→05/08	BJX	4 Cyl. 1781cc Turbo Intercooled	9.5:1 110kW (150PS)	TD17320

87-502900-30	STD	08-502900-00	STD
87-502907-30	0.50mm	08-502905-00	0.25mm
		08-502907-00	0.50mm

A	32.70		
C	1.90	1.50	 CK P
D	53.70	1.75	 P
	19x49	2.00	 CR P

TP

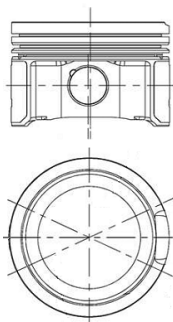

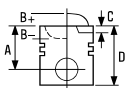

32  **81.00**

Altea 2.0 TDI	03/04→05/09	AZV			
Altea XL 2.0 TDI	11/06→03/09		4 Cyl.	18:1	
Leon 2.0 TDI	07/05→05/10		1968cc	100kW (136PS)	
Toledo III 2.0 TDI	09/04→05/09	Diesel	Turbo Intercooled		TD18247
Altea 2.0 TDI 16V	03/04→	BKD			
Altea XL 2.0 TDI 16V	10/06→		4 Cyl.	18:1	
Leon 2.0 TDI 16V	07/05→12/12		1968cc	103kW (140PS)	
Toledo III 2.0 TDI 16V	04/04→05/09	Diesel	Turbo Intercooled		TD17357
Altea 2.0 TDI	03/06→	BMN			
Altea XL 2.0 TDI	06/07→		4 Cyl.	18.5:1	
Leon 2.0 TDI	05/06→12/12		1968cc	125kW (170PS)	
Toledo III 2.0 TDI	01/06→05/09	Diesel	Turbo Intercooled		TD18977

87-139500-00  STD

STD

08-139500-00 STD

STD

87-139507-00  0.50mm

0.50mm

08-139507-00 0.50mm

0.50mm

A 45.83

B- 17.80

BØ 38.00

D 68.80

 26x66

1.75

2.00

3.00



CK P

P

CR P

AK KK NB RT TP

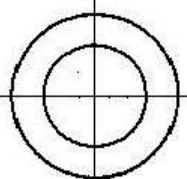



07901J

 Piston Chamber Volume
[ccm] 23.75

 A = 45.550, D = 68.550

 Volumen der Kolbenmulde
[ccm] 23.75

 A = 45.550, D = 68.550

 Volume de la cavité du piston
[cm³] 23.75

 A = 45.550, D = 68.550

 Volumen de cavidad del pistón
[cc] 23.75

 A = 45.550, D = 68.550

 Volume camera pistone
[cm³] 23.75

 A = 45.550, D = 68.550

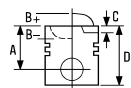





33  **81.00**

Altea 2.0 TDI	11/05→	BMM		
Altea XL 2.0 TDI	10/06→		4 Cyl.	18:1
Leon 2.0 TDI	10/05→10/10		1968cc	103kW (140PS)
Toledo III 2.0 TDI	11/05→05/09	Diesel	Turbo Intercooled	TD18269
Alhambra 2.0 TDI	11/05→03/10	BRT		
		Diesel	4 Cyl.	18.5:1
			1968cc	103kW (140PS)
			Turbo Intercooled	TD19388

87-139500-10   STD
87-139507-10  0.50mm

08-139500-00 STD
08-139507-00 0.50mm



A 45.55
B- 17.50
BØ 38.00
C 0.70
D 68.80
 26x66

1.75  CK P
 2.00  P
 3.00  CR P

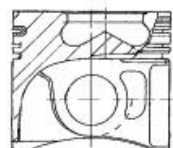
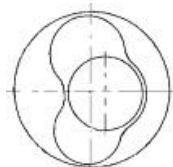
AK KK NB RT TP





07901D833

87-139500-20   STD
87-139507-20  0.50mm

08-139500-00 STD
08-139507-00 0.50mm



A 45.83
B- 17.50
BØ 38.00
C 0.70
D 68.80
 26x66

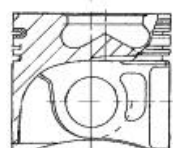
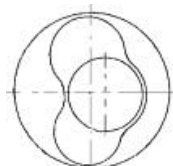

1.75  CK P
 2.00  P
 3.00  CR P



AK KK NB RT TP









07901D834

 To cylinder 1 & 2
 To cylinder 3 & 4
 Piston Chamber Volume
 [ccm³] 23.30

 zum Zylinder 1 & 2
 zum Zylinder 3 & 4
 Volumen der Kolbenmulde
 [ccm³] 23.30

 sous cylindre 1 & 2
 sous cylindre 3 & 4
 Volume de la cavité du piston
 [cm³] 23.30

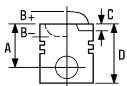

 A cilindro 1 & 2
 A cilindro 3 & 4
 Volumen de cavidad del pistón
 [cc] 23.30

 al cilindro 1 & 2
 al cilindro 3 & 4
 Volume camera pistone
 [cm³] 23.30



34  **81.00**



Exeo 2.0 TDI	12/08→	CAGA				
Exeo ST 2.0 TDI	05/09→		4 Cyl.	16:1		
		Diesel	1968cc	105kW (143PS)		TD22243
			Turbo Intercooled			
Exeo 2.0 TDI	12/08→	CAGC				
Exeo ST 2.0 TDI	07/09→		4 Cyl.	16.5:1		
		Diesel	1968cc	88kW (120PS)		TD22669
			Turbo Intercooled			
Exeo 2.0 TDI	02/09→	CAHA				
Exeo ST 2.0 TDI	05/09→		4 Cyl.	16:1		
		Diesel	1968cc	125kW (170PS)		TD22244
			Turbo Intercooled			
Altea 2.0 TDI	10/10→	CBDB				
		Diesel	4 Cyl.	16:1		
			1968cc	103kW (140PS)		TD24327
			Turbo Intercooled			
Altea 2.0 TDI	03/06→	CEGA				
Altea XL 2.0 TDI	06/07→		4 Cyl.	16:1		
Leon 2.0 TDI	05/06→12/12		1968cc	125kW (170PS)		
Toledo III 2.0 TDI	01/06→05/09	Diesel	Turbo Intercooled			TD22674

87-432300-00 
 87-432307-00 

STD
 0.50mm

08-432300-00 
 08-432307-00

A 45.80
 B- 12.70
 BØ 50.88
 D 68.80
 26x66



1.75  GDC P
 2.00  P
 3.00  CR P



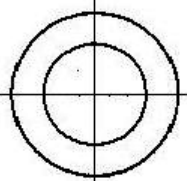



HA KK NB RT TP







07901G202

 OE 03L 107 065G, Gen 1 engine only
 08-432300-00 OE: 03L198151A

 OE 03L 107 065G, nur für Motoren der Generation 1
 08-432300-00 OE: 03L198151A

 N°OE 03L 107 065G, uniquement pour Moteur de génération 1
 08-432300-00 OE: 03L198151A

 OE 03L 107 065G, Generación 1 solo motor
 08-432300-00 OE: 03L198151A

 Solo motore Generation 1
 08-432300-00 OE: 03L198151A

35 **81.00**

Alhambra 2.0 TDI	06/10→05/11	CFFA	4 Cyl. 1968cc	16.5:1 100kW (136PS)	TD25404
		Diesel	Turbo Intercooled		
Alhambra 2.0 TDI	06/10→	CFFB	4 Cyl. 1968cc	16.5:1 103kW (140PS)	TD24450
Alhambra 2.0 TDI 4Drive	05/11→				
		Diesel	Turbo Intercooled		
Alhambra 2.0 TDI	05/11→	CFFE	4 Cyl. 1968cc	16.5:1 85kW (116PS)	TD25403
		Diesel	Turbo Intercooled		
Alhambra 2.0 TDI	06/10→	CFGB	4 Cyl. 1968cc	16.5:1 125kW (170PS)	TD24451
		Diesel	Turbo Intercooled		
Alhambra 2.0 TDI	11/12→	CFGC	4 Cyl. 1968cc	16.5:1 130kW (177PS)	TD27529
		Diesel	Turbo Intercooled		
Altea 2.0 TDI 16V	03/04→	CFHC	4 Cyl. 1968cc	16.5:1 103kW (140PS)	TD24326
Altea XL 2.0 TDI 16V	10/06→				
Leon 2.0 TDI 16V	07/05→12/12				
		Diesel	Turbo Intercooled		
Ibiza V 2.0 TDI, Ibiza V Sportcoupe 2.0 TDI	01/10→	CFHD	4 Cyl. 1968cc	16.5:1 105kW (143PS)	TD23582
		Diesel	Turbo Intercooled		
Altea XL 2.0 TDI	06/07→	CFJA	4 Cyl. 1968cc	16.5:1 125kW (170PS)	TD24333
Leon 2.0 TDI	05/06→12/12				
		Diesel	Turbo Intercooled		
Exeo 2.0 TDI	02/09→	CGLB	4 Cyl. 1968cc	16.05:1 125kW (170PS)	TD26498
Exeo ST 2.0 TDI	05/09→				
		Diesel	Turbo Intercooled		
Exeo 2.0 TDI	12/08→	CJCA	4 Cyl. 1968cc	16.5:1 105kW (143PS)	TD26497
Exeo ST 2.0 TDI	05/09→				
		Diesel	Turbo Intercooled		







Leon 2.0 TDI 16V	07/05→12/12	CLCB	4 Cyl.	16.5:1
			1968cc	103kW (140PS)
		Diesel	Turbo Intercooled	TD25102

87-432300-10 ①	STD	08-432300-10 ② ③	STD
87-432307-10 ①	0.50mm	08-432307-10 ② ③	0.50mm

A 45.80
B- 13.10
BØ 50.88
D 68.80
 26x66

1.75  GDC P
 2.00  MO P
 3.00  CR P



AK KK NB RT TP

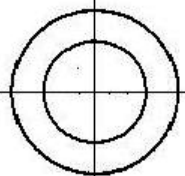

07901G220

- | | | | | |
|--|---|--|--|---|
| ① OE 03L 107 065S, Gen 2 engine only | ① OE 03L 107 065S, nur für Motoren der Generation 2 | ① N°OE 03L 107 065S, uniquement pour Moteur de génération 2 | ① OE 03L 107 065G, Generación 2 solo motor | ① Solo motore Generation 2 |
| ② Only fit to pistons equivalent to OE 03L 107065 AG, 03L 107065 S | ② Nur gepasst worden zu den Kolben gleichwertig mit OE 03L 107065 AG und 03L 107065 S | ② Seulement adapté aux pistons équivalents à OE 03L 107065 AGet 03L 107065 S | ② Cabido solamente a los pistones equivalentes a OE 03L 107065 AG y 03L 107065 S | ② Adattato soltanto ai pistoni equivalenti a OE 03L 107065 AGe 03L 107065 S |
| ③ 08-432300-10 OE: 03L198151C | ③ 08-432300-10 OE: 03L198151C | ③ 08-432300-10 OE: 03L198151C | ③ 08-432300-10 OE: 03L198151C | ③ 08-432300-10 OE: 03L198151C |



36 82.50

Cordoba 2.0 i	02/93→06/99	2E		
Ibiza II 2.0 i	03/93→08/99		4 Cyl.	10.4:1
Toledo I 2.0 i	05/91→03/99		1984cc	85kW (115PS)

TD3570

Alhambra 2.0 i	04/96→03/10	ADY		
			4 Cyl.	10.4:1
			1984cc	85kW (115PS)

TD9386



Cordoba 2.0 i	02/93→06/99	AGG		
Ibiza II 2.0 i	03/93→08/99		4 Cyl.	10:1
Toledo I 2.0 i	05/91→03/99		1984cc	85kW (115PS)

TD5537

87-501800-20 STD
87-501807-20  0.50mm

08-501800-00 STD
08-501807-00 0.50mm

A 30.90
B- 5.70
B+ 0.90
BØ 64.00
D 51.80
 21x55

1.20  PS
 1.50  P
 2.00  CR P

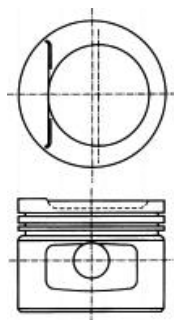



08241B-103

 A = 30.600, D = 51.500

 A = 30.600, D = 51.500

 A = 30.600, D = 51.500

 A = 30.600, D = 51.500

 A = 30.600, D = 51.500

37 82.50



Cordoba 2.0 i 16V	08/96→06/99	ABF		
Ibiza II 2.0 i 16V	08/96→08/99		4 Cyl.	10.4:1
Toledo I 2.0 i 16V	11/93→03/99		1984cc	110kW (150PS)

TD4895

87-501800-40 STD

08-501800-00 STD
08-501807-00 0.50mm

A 31.60
C 3.20
D 51.60
 21x56

1.20  PS
 1.50  P
 2.00  CR P

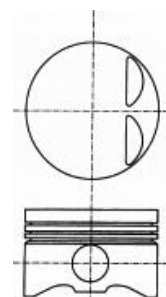

08238A

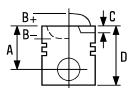

38  **82.50**

Altea 2.0 FSI	05/04→03/09	BLR		
Leon 2.0 FSI	07/05→05/10		4 Cyl.	11.5:1
Toledo III 2.0 FSI	10/04→05/09		1984cc	110kW (150PS)
TD17353				

Altea 2.0 FSI	05/04→03/09	BLY		
Leon 2.0 FSI	07/05→05/10		4 Cyl.	11.5:1
Toledo III 2.0 FSI	10/04→05/09		1984cc	110kW (150PS)
TD17354				

Altea 2.0 FSI	05/04→03/09	BVY		
Altea XL 2.0 FSI	10/06→03/09		4 Cyl.	11.5:1
Leon 2.0 FSI	07/05→05/10		1984cc	110kW (150PS)
Toledo III 2.0 FSI	10/04→05/09			
TD18266				

Altea 2.0 FSI	05/04→03/09	BVZ		
Altea XL 2.0 FSI	10/06→03/09		4 Cyl.	11.5:1
Leon 2.0 FSI	07/05→05/10		1984cc	110kW (150PS)
Toledo III 2.0 FSI	10/04→05/09			
TD18267				

87-435100-00 ¹ STD

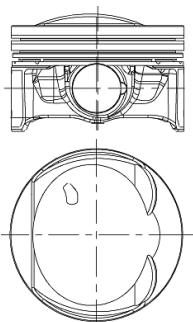

- A** 29.38
- B+** 12.46
- D** 59.84
-  19x44

TP



08240B301

08-435100-10 STD

- 1.20  NT PVD ²
- 1.50 
- 2.00  CR

¹ Elastoval ®
² Steel

¹ Elastoval ®
² Stahl

¹ Elastoval ®
² Acier

¹ Elastoval ®
² Accero

¹ Elastoval ®
² Acciaio

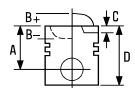





39  **82.50**

Altea 2.0 TFSI	04/06→05/09	BWA		
Altea XL 2.0 TFSI	10/06→05/09		4 Cyl.	10.3:1
Leon 2.0 TFSI	05/05→03/09		1984cc	147kW (200PS)
Toledo III 2.0 TFSI	11/05→05/09		Turbo Intercooled	TD19424

87-438500-00	STD	08-438500-00	STD
87-438507-00	0.50mm	08-438507-00	0.50mm

- A** 29.50
- B-** 6.10
- BØ** 49.52
- C** 1.36
- C** 1.36
- D** 50.50
-  20x59

- 1.20  PVD 
- 1.50  P
- 2.00  CR P

AK RT TP

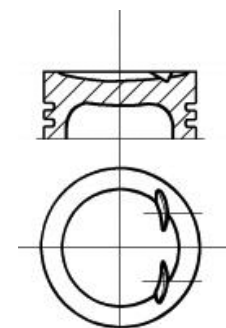

-  Steel
-  Stahl
-  Acier
-  Acero
-  Acciaio

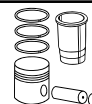
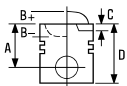

40  **82.50**

Alhambra 1.8 TSI	11/12→	CDAA			
Altea 1.8 TFSI, Altea XL 1.8 TFSI	01/07→		4 Cyl.	9.6:1	
Leon 1.8 TSI	06/07→12/12		1798cc	118kW (160PS)	
Toledo III 1.8 TFSI	01/07→05/09		Turbo Intercooled		TD21590
Exeo 1.8 TSI, Exeo St 1.8 TSI	09/10→	CDHA			
			4 Cyl.	9.6:1	
			1798cc	88kW (120PS)	
			Turbo Intercooled		TD24317
Exeo 1.8 TSI, Exeo St 1.8 TSI	05/10→	CDHB			
			4 Cyl.	9.6:1	
			1798cc	118kW (160PS)	
			Turbo Intercooled		TD24319

87-443800-00

STD

08-443800-00

STD

87-443807-00

0.50mm

08-443807-00

0.50mm

A 29.85

1.20



NT PVD 

B- 4.70

1.20

P

B+ 5.65

2.00



CR P

C 2.00

D 56.00

 23x54



RT TP

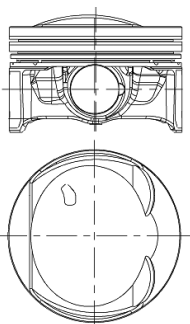

 Steel

 Stahl

 Acier

 Acero



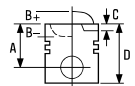

 Acciaio



41  **83.00**

Ibiza I 1.7 D	06/84→05/93	022 A .5000 (138B6.000)		
Malaga 1.7 D	05/85→12/93	4 Cyl.	20:1	
Ritmo 1.7 D	10/79→09/83	1714cc	40-42kW (54-57PS)	
Ronda 1.7 Diesel	06/82→12/86	Diesel		TD9391

87-215100-10	STD	08-215100-10	STD
87-215108-10	0.60mm	08-215108-10	0.60mm
		08-215110-10	0.80mm

A	45.90		
B-	2.80	2.50	 MOL P
D	85.00	2.00	 P
	25x71	4.00	 CR P

RT

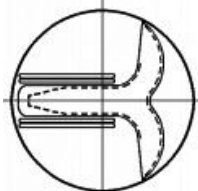
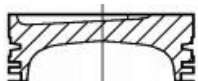

42  **87.00**

132 2.2 D	05/79→12/82	OM 615.912		
		4 Cyl.	21:1	
		2197cc	44kW (60PS)	
		Diesel		TD21374

14-022190-00 D B 90.00 C 158.40 D 92.00 E 4.70

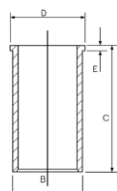

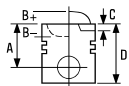

43  **93.00**

131 2.4 Diesel

06/78→12/86

8144.61

4 Cyl.

22:1

2445cc

52-55kW (72-75PS)

Diesel

TD3597

87-214500-00

STD

08-214500-10

STD

14-022560-00 D

B 96.00 C 167.30 D 98.90 E 5.00

87-214508-00

0.60mm

08-214508-10

0.60mm

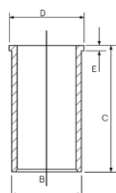

A 54.80

B- 2.20

D 89.80

 32x75

3.00

2.00

4.00









CR P

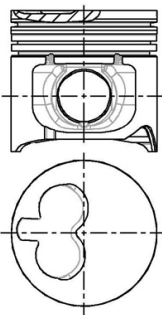



P

CR P

HA RT



		ccm	x 		
ADR	Petrol	1781	4	81.00	17
AEE	Petrol	1598	4	76.50	3
AEF	Diesel	1896	4	79.50	10
AEH	Petrol	1595	4	81.00	18
AEY	Diesel	1896	4	79.50	11
AGN	Petrol	1781	4	81.00	17
AGP	Diesel	1896	4	79.50	12
AGR	Diesel	1896	4	79.50	11
AGU	Petrol	1781	4	81.00	19
AHF	Diesel	1896	4	79.50	11
AKL	Petrol	1595	4	81.00	18
ALH	Diesel	1896	4	79.50	11
AMF	Diesel	1422	3	79.50	13
AQM	Diesel	1896	4	79.50	12
ARX	Petrol	1781	4	81.00	20
ARZ	Petrol	1781	4	81.00	19
ASV	Diesel	1896	4	79.50	11
ASY	Diesel	1896	4	79.50	12
ASZ	Diesel	1896	4	79.50	14
ATD	Diesel	1896	4	79.50	15
AUA	Petrol	1390	4	76.50	4
AUB	Petrol	1390	4	76.50	4
AUM	Petrol	1781	4	81.00	20
AUQ	Petrol	1781	4	81.00	20
AVB	Diesel	1896	4	79.50	15
AVF	Diesel	1896	4	79.50	14
AVU	Petrol	1595	4	81.00	21
AWT	Petrol	1781	4	81.00	20
AWX	Diesel	1896	4	79.50	14
AXP	Petrol	1390	4	76.50	4
AXR	Diesel	1896	4	79.50	15
AYM	Diesel	2496	V6	78.30	9
AZQ	Petrol	1198	3	76.50	5
AZV	Diesel	1968	4	81.00	22
BBY	Petrol	1390	4	76.50	4
BBZ	Petrol	1390	4	76.50	4
BCA	Petrol	1390	4	76.50	4
BDG	Diesel	2496	V6	78.30	9
BFQ	Petrol	1595	4	81.00	21
BGU	Petrol	1595	4	81.00	21
BJB	Diesel	1896	4	79.50	15
BKC	Diesel	1896	4	79.50	15
BKD	Diesel	1968	4	81.00	22
BKY	Petrol	1390	4	76.50	6
BLR	Petrol	1984	4	82.50	26
BLS	Diesel	1896	4	79.50	15
BLT	Diesel	1896	4	79.50	14
BLX	Petrol	1984	4	82.50	26
BLY	Petrol	1984	4	82.50	26
BMM	Diesel	1968	4	81.00	23
BMN	Diesel	1968	4	81.00	22
BMP	Diesel	1968	4	81.00	23
BMS	Diesel	1422	3	79.50	13
BNM	Diesel	1422	3	79.50	13
BNV	Diesel	1422	3	79.50	13
BSE	Petrol	1595	4	81.00	21
BSF	Petrol	1595	4	81.00	21
BSS	Diesel	1968	4	81.00	23
BSW	Diesel	1896	4	79.50	15
BUD	Petrol	1390	4	76.50	6
BVX	Petrol	1984	4	82.50	26
BVY	Petrol	1984	4	82.50	26
BVZ	Petrol	1984	4	82.50	26
BWA	Petrol	1984	4	82.50	27
BWW	Diesel	1984	4	81.00	23
BXE	Diesel	1896	4	79.50	15
BXW	Petrol	1390	4	76.50	6
CAVE	Petrol	1390	4	76.50	7
CAXA	Petrol	1390	4	76.50	8

		ccm	x 		9
CAXC	Petrol	1390	4	76.50	8
CAYA	Diesel	1598	4	79.50	16
CAYB	Diesel	1598	4	79.50	16
CAYC	Diesel	1598	4	79.50	16
CBBB	Diesel	1968	4	81.00	24
CBDB	Diesel	1968	4	81.00	24
CBZA	Petrol	1197	4	71.00	1
CBZB	Petrol	1197	4	71.00	1
CDDA	Petrol	1390	4	76.50	6
CEGA	Diesel	1968	4	81.00	24
CFFB	Diesel	1968	4	81.00	25
CFGB	Diesel	1968	4	81.00	25
CFHA	Diesel	1968	4	81.00	25
CFHC	Diesel	1968	4	81.00	25
CFHF	Diesel	1968	4	81.00	25
CFJA	Diesel	1968	4	81.00	25
CFWA	Diesel	1199	3	79.50	16
CGGA	Petrol	1390	4	76.50	6
CGGB	Petrol	1390	4	76.50	6
CHGA	Petrol	1595	4	81.00	21
CHYA	Petrol	999	3	74.50	2
CHYB	Petrol	999	3	74.50	2
CLCA	Diesel	1968	4	81.00	25
CLCB	Diesel	1968	4	81.00	25
CLJA	Diesel	1968	4	81.00	25
CLNA	Diesel	1598	4	79.50	16
CLPA	Petrol	1390	4	76.50	6
CPGA	Petrol	999	3	74.50	2
CTHE	Petrol	1390	4	76.50	7



1 71.00





Fabia 1.2 TSI	03/10→12/14	CBZA		
Rapid 1.2 TSI, Rapid Spaceback 1.2 TSI	07/12→		4 Cyl.	10:1
Roomster 1.2 TSI, Roomster Praktik 1.2 TSI	03/10→05/15		1197cc	63kW (86PS)
			Turbo Intercooled	TD23928

Fabia 1.2 TSI	03/10→12/14	CBZB		
Octavia 1.2 TSI	02/10→06/13		4 Cyl.	10:1
Rapid 1.2 TSI, Rapid Spaceback 1.2 TSI	07/12→		1197cc	77kW (105PS)
Roomster 1.2 TSI	03/10→05/15		Turbo Intercooled	TD23583
Yeti 1.2 TSI	09/09→			

87-442300-00   STD

08-442300-00 STD

- A** 28.00
- B+** 0.70
- C** 3.52
- C** 3.52
- D** 48.00
-  17x49

- 1.20  NT 
- 1.20  P
- 2.00  NT

AK HA TP

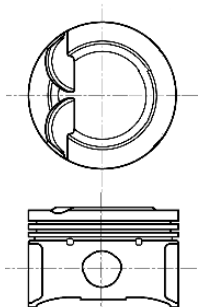



07124A101

 Earlier pistons to be replaced in Engine sets only

 Frühere Kolben nur in Motorsätzen zu ersetzen

 Premier piston à remplacer dans le jeu moteur

 Pistones más antiguos para ser reemplados en juego de motores solamente

 Con i pistone di vecchia versione è necessario sostituire tutta la serie

 Elastoval ®

 Elastoval ®

 Elastoval ®

 Elastoval ®

 Elastoval ®

 Steel

 Stahl

 Acier

 Acero

 Acciaio

2 74.50

Citigo 1.0	10/11→	CHYA		
Fabia 1.0	08/14→		3 Cyl.	10.5:1
			999cc	44kW (60PS)
				TD26323

Citigo 1.0	10/11→	CHYB		
Fabia 1.0	08/14→		3 Cyl.	10.5:1
			999cc	55kW (75PS)
				TD26325



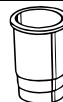

Citigo 1.0 CNG 11/12→ **CPGA** 3 Cyl. 10.5:1
999cc **50kW (68PS)** **TD27817**

87-443600-00	STD	08-443600-00	STD
A 27.22		1.00	NT 1
B- 0.56		1.20	P
BØ 58.07		2.00	CR 1
C 2.19			
D 42.22			
17x39			

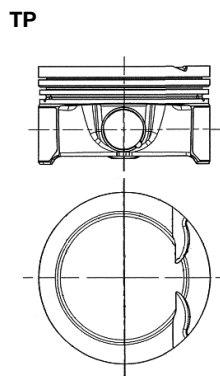

1 Steel 1 Stahl 1 Acier 1 Acero 1 Acciaio

3 76.50

Felicia I 1.6 GLX, Felicia I 1.6 LX 08/95→03/98 **AEE**
Felicia I Fun 1.6 06/97→04/02 4 Cyl. 9.8:1
Felicia II 1.6 01/98→06/01 **1598cc** **55kW (75PS)**
Octavia 1.6 09/96→09/04 **TD13394**

87-502800-10	STD	08-502800-00	STD	14-021571-00 D	B 79.56 C 142.00 D 82.50 E 4.50
87-502807-10 2	0.50mm	08-502807-00	0.50mm	14-028360-00 D 1	B 79.50 C 145.00 D 81.50 E 4.70
A 30.85		1.20	NT 3		
C 7.80		1.50	P		
D 60.35		2.50	CR 3		
17x52					

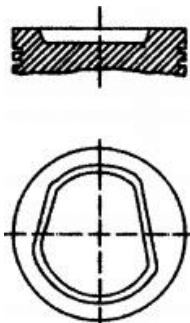
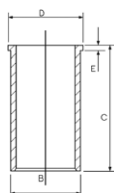

1 With recesses on crankshaft side 1 Mit kurbelwellenseitigen Aussparungen 1 Avec évidements côté vilebrequin 1 Con escotaduras en la cara del cigüeñal 1 Con nicchie sul lato albero motore
2 A = 30.600, D = 52.600 2 A = 30.600, D = 52.600 2 A = 30.600, D = 52.600 2 A = 30.600, D = 52.600 2 A = 30.600, D = 52.600
3 Steel 3 Stahl 3 Acier 3 Acero 3 Acciaio



4 76.50

Fabia 1.4 16V	10/99→03/08	AUA	4 Cyl. 1390cc	10.5:1 55kW (75PS)	TD15374
Fabia 1.4 16V	12/99→03/08	AUB	4 Cyl. 1390cc	10.5:1 74kW (100PS)	TD15375
Octavia 1.4 16V	08/00→12/10	AXP	4 Cyl. 1390cc	10.5:1 55kW (75PS)	TD16050
Fabia 1.4 16V	10/99→03/08	BBY	4 Cyl. 1390cc	10.5:1 55kW (75PS)	TD17471
Fabia 1.4 16V	12/99→03/08	BBZ	4 Cyl. 1390cc	10.5:1 74kW (100PS)	TD17472
Octavia 1.4 Octavia 1.4 16V	05/04→05/06 08/00→12/10	BCA	4 Cyl. 1390cc	10.5:1 55kW (75PS)	TD17495

87-116100-00
87-116107-00 ¹

STD
0.50mm

08-116100-00
08-116107-00

STD
0.50mm

A 28.92
B- 1.98
BØ 61.90
C 2.32
D 49.92
 17x54

1.20
1.50
2.50



NT ²
P
CR ²

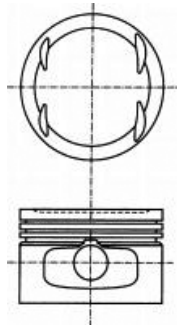

¹ A = 28.670, D = 49.670
² Steel

¹ A = 28.670, D = 49.670
² Stahl

¹ A = 28.670, D = 49.670
² Acier

¹ A = 28.670, D = 49.670
² Acero

¹ A = 28.670, D = 49.670
² Acciaio

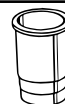



5 76.50

Fabia 1.2	01/03→03/08	AZQ	3 Cyl.	10.5:1	47kW (64PS)	TD17070
Fabia 1.2, Fabia Praktik 1.2	01/03→12/07		1198cc			

14-021571-00 D B 79.56 C 142.00 D 82.50 E 4.50

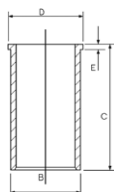
14-028360-00 D  B 79.50 C 145.00 D 81.50 E 4.70



 With recesses on crankshaft side

 Mit kurbelwellenseitigen Aussparungen

 Avec évidements côté vilebrequin

 Con escotaduras en la cara del cigüeñal

 Con nicchie sul lato albero motore

6 76.50

Fabia 1.4 16V	10/99→03/08	BKY	4 Cyl.	10.5:1	55kW (75PS)	TD18696
Fabia 1.4	02/06→10/06	BUD	4 Cyl.	10.5:1	59kW (80PS)	TD20190
Fabia 1.4 16V	04/06→12/07		1390cc			
Octavia 1.4	06/04→06/13					
Fabia 1.4	01/07→12/14	BXW	4 Cyl.		63kW (86PS)	TD19089
Roomster 1.4	09/06→05/15		1390cc			
Roomster Praktik 1.4	03/07→05/15					
Fabia 1.4	01/07→12/14	CDDA	4 Cyl.		63kW (86PS)	TD26495
Roomster 1.4	09/06→05/15		1390cc			
Roomster Praktik 1.4	03/07→05/15					
Octavia 1.4	06/04→06/13	CGGA	4 Cyl.	10.5:1	59kW (80PS)	TD24838
Fabia 1.4	01/07→12/14	CGGB	4 Cyl.		63kW (85PS)	TD24980
Roomster 1.4	09/06→05/15		1390cc			
Roomster Praktik 1.4	03/07→05/15					



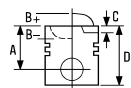





Fabia 1.4	01/07→12/14	CLPA		
Roomster 1.4	09/06→05/15		4 Cyl.	
Roomster Praktik 1.4	03/07→05/15		1390cc	63kW (85PS)

TD26496

87-436900-00 ¹ STD **08-436900-00** STD

04/05→

- A** 28.92
- B-** 2.28
- BØ** 61.14
- C** 1.07
- C** 1.04
- D** 46.92
-  17x45

- 1.20  NT ²
- 1.20  P
- 2.00  CR ²

TP

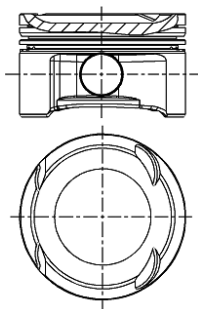

07675-204

ECOTOUGH

¹ Pistons to be replaced in Engine Sets only

² Steel

¹ Kolben nur Motorsätzen zu ersetzen

² Stahl

¹ Piston à remplacer dans jeu moteur

² Acier

¹ Pistones de repuesto para juegos de motores solamente

² Acero

¹ Il pistone può essere rimpiazzato solamente completo

² Acciaio









7 76.50

Fabia 1.4 TSI RS	05/10→12/14	CAVE	4 Cyl.	10:1	
			1390cc	132kW (180PS)	
			Turbo & Supercharged		TD24217

Fabia 1.4 TSI RS	05/10→12/14	CTHE	4 Cyl.	10:1	
			1390cc	132kW (180PS)	
			Turbo & Supercharged		TD27361

87-433900-10 	STD	08-433900-00	STD
87-433907-10 	0.50mm	08-433907-00	0.50mm

A	29.00	1.20		NT 
B-	4.55	1.50		P
B+	1.85	2.00		NT 
C	1.00			
C	3.80			
D	49.85			
	19x54			

RT TP

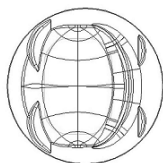
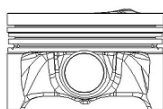

 Pistons to be replaced in Engine Sets only

 Steel

 Kolben nur Motorsätzen zu ersetzen

 Stahl

 Piston à remplacer dans jeu moteur

 Acier

 Pistones de repuesto para juegos de motores solamente

 Acero

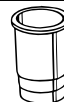
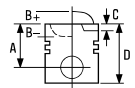

 Il pistone può essere rimpiazzato solamente completo

 Acciaio



8 76.50





Octavia 1.4 TSI	11/08→06/13	CAXA	4 Cyl.	10:1
Rapid 1.4 TSI, Rapid Spaceback 1.4 TSI	07/12→		1390cc	90kW (122PS)
Yeti 1.4 TSI	06/10→		Turbo Intercooled	TD21592
SuperB 1.4 TSI	07/08→05/15	CAXC	4 Cyl.	10:1
			1390cc	92kW (125PS)
			Turbo Intercooled	TD22677

87-429900-00  **1**
87-429907-00  **1**

STD
0.50mm



08-429900-00 STD
08-429907-00 0.50mm

A 29.20
B- 4.50
C 3.60
D 48.20
 19x52

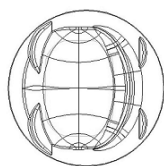
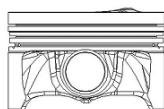

1.20  NT 
 1.20  P
 2.00  NT 



HA





 Elastoval®
 Steel

 Elastoval®
 Stahl

 Elastoval®
 Acier

 Elastoval®
 Acero

 Elastoval®
 Acciaio



9 78.30

Superb 2.5 TDI	12/01→08/03	AYM	V6 Cyl. 2496cc	18.5:1 114kW (155PS)	
		Diesel	Turbo Intercooled		TD16404
Superb 2.5 TDI	06/03→03/08	BDG	V6 Cyl. 2496cc	18.5:1 120kW (163PS)	
		Diesel	Turbo Intercooled		TD17350



87-103000-30  STD

A 47.83
B- 17.25
BØ 36.00
C 1.38
C 1.38
D 71.83
 26x58

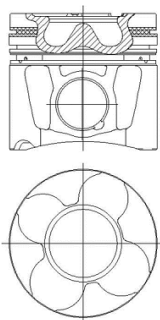
AK KK RT TP



08-103000-00 STD
08-103007-00 0.50mm

1.75  CK P
 2.00  P
 3.00  CR P



87-103000-40  STD

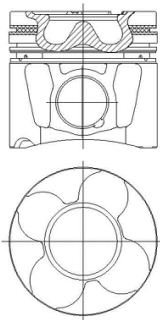

A 78.31
B- 17.25
BØ 36.00
C 1.38
C 1.38
D 71.83
 26x58



AK KK RT TP







08-103000-00 STD
08-103007-00 0.50mm



1.75  CK P
 2.00  P
 3.00  CR P

 To cylinder 1 - 3
 To cylinder 4 - 6

 zum Zylinder 1 - 3
 zum Zylinder 4 - 6

 sous cylindre 1 - 3
 sous cylindre 4 - 6

 A cilindro 1 - 3
 A cilindro 4 - 6

 al cilindro 1 - 3
 al cilindro 4 - 6



10 79.50

Felicia I 1.9 D	10/95→03/98	AEF			
Felicia I Fun 1.9 D	06/97→04/02		4 Cyl.	22.5:1	
Felicia II 1.9 D	01/98→06/01		1896cc	47kW (64PS)	
Diesel					TD13395

87-990100-40	STD	08-990100-00	STD	14-027950-00 D	B 82.50 C 152.00 D 85.50 E 4.70
87-990105-40	0.25mm	08-990105-00	0.25mm		
87-990107-40	0.50mm	08-990107-00	0.50mm		
87-990111-40	1.00mm	08-990111-00	1.00mm		

A 39.65
B- 1.90
D 65.70
 24x64

1.75
 2.00
 3.00

AK RT

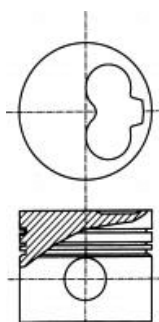

07945

A = 39.400

A = 39.400

A = 39.400

A = 39.400

A = 39.400

11 79.50

Octavia 1.9 SDI	06/97→	AEY			
			4 Cyl.	19.5:1	
			1896cc	47kW (64PS)	
Diesel					TD18729
Octavia 1.9 TDI	09/96→03/10	AGR			
			4 Cyl.	19.5:1	
			1896cc	66kW (90PS)	
Diesel Turbo Intercooled					TD17905
Octavia 1.9 TDI	08/97→01/06	AHF			
			4 Cyl.	19.5:1	
			1896cc	81kW (110PS)	
Diesel Turbo Intercooled					TD17910
Octavia 1.9 TDI	09/96→03/10	ALH			
			4 Cyl.	19.5:1	
			1896cc	66kW (90PS)	
Diesel Turbo Intercooled					TD16090





Octavia 1.9 TDI 08/97→01/06 ASV 4 Cyl. 19.5:1
 1896cc 81kW (110PS)
 Diesel Turbo Intercooled TD16091

87-114900-60 1 3 STD
 87-114905-60 1 3 0.25mm
 87-114907-60 1 3 5 0.50mm
 87-114911-60 1 3 5 1.00mm

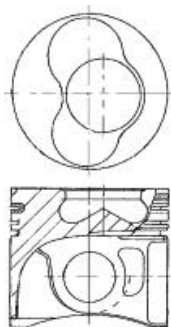

A 45.80
 B- 17.65
 BØ 38.00
 C 1.10
 D 68.80
 26x66

AK KK NB RT



07987

08-114900-00 STD
 08-114905-00 0.25mm
 08-114907-00 0.50mm
 08-114911-00 1.00mm

1.75  CK P
 2.00  P
 3.00  CR P

14-027950-00 D B 82.50 C 152.00 D 85.50 E 4.70

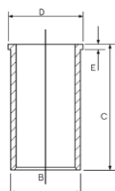

87-114900-70 2 3 STD
 87-114905-70 2 3 0.25mm
 87-114907-70 2 3 5 0.50mm
 87-114911-70 2 3 5 1.00mm

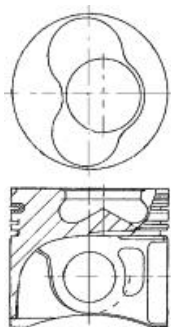

A 45.80
 B- 17.65
 BØ 38.00
 C 1.10
 D 68.80
 26x66

AK KK NB RT



07987A

08-114900-00 STD
 08-114905-00 0.25mm
 08-114907-00 0.50mm
 08-114911-00 1.00mm



1.75  CK P
 2.00  P
 3.00  CR P

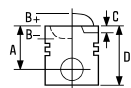



87-114900-90 ¹	STD	08-114900-00	STD
87-114905-90 ¹	0.25mm	08-114905-00	0.25mm
87-114907-90 ¹ ⁴	0.50mm	08-114907-00	0.50mm
87-114911-90 ¹ ⁴	1.00mm	08-114911-00	1.00mm

A 45.80
B- 17.65
BØ 38.00
C 1.10
D 71.80
 26x66

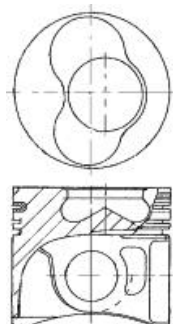

1.75  CK P
 2.00  P
 3.00  CR P

AK NB RT



87-114900-95 ²	STD	08-114900-00	STD
87-114905-95 ²	0.25mm	08-114905-00	0.25mm
87-114907-95 ² ⁴	0.50mm	08-114907-00	0.50mm
87-114911-95 ² ⁴	1.00mm	08-114911-00	1.00mm

A 45.80
B- 17.65
BØ 38.00
C 1.10
D 71.80
 26x66

1.75  CK P
 2.00  P
 3.00  CR P

AK NB RT

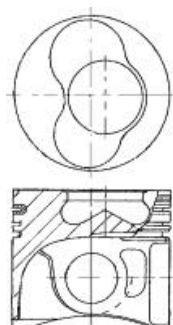

- ¹ To cylinder 1 & 2
- ² To cylinder 3 & 4
- ³ Piston Chamber Volume
[ccm] 23.54
- ⁴ A = 45.550, D = 71.550
- ⁵ A = 45.550, D = 68.550

- ¹ zum Zylinder 1 & 2
- ² zum Zylinder 3 & 4
- ³ Volumen der Kolbenmulde
[ccm] 23.54
- ⁴ A = 45.550, D = 71.550
- ⁵ A = 45.550, D = 68.550

- ¹ sous cylindre 1 & 2
- ² sous cylindre 3 & 4
- ³ Volume de la cavité du piston
[cm³] 23.54
- ⁴ A = 45.550, D = 71.550
- ⁵ A = 45.550, D = 68.550





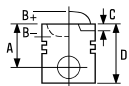

- ¹ A cilindro 1 & 2
- ² A cilindro 3 & 4
- ³ Volumen de cavidad del pistón
[cc] 23.54
- ⁴ A = 45.550, D = 71.550
- ⁵ A = 45.550, D = 68.550

- ¹ al cilindro 1 & 2
- ² al cilindro 3 & 4
- ³ Volume camera pistone
[cm³] 23.54
- ⁴ A = 45.550, D = 71.550
- ⁵ A = 45.550, D = 68.550





12 79.50

Octavia 1.9 SDI	06/97→12/03	AGP	4 Cyl. 1896cc	19.5:1 50kW (68PS)	
		Diesel			TD16424
Octavia 1.9 SDI	06/97→12/03	AQM	4 Cyl. 1896cc	19.5:1 50kW (68PS)	
		Diesel	Turbo Intercooled		TD16089
Fabia 1.9 SDI	11/99→03/08	ASY	4 Cyl. 1896cc	22.5:1 47kW (64PS)	
Fabia Praktik 1.9 SDI	07/01→12/07				
		Diesel			TD15376

87-114900-20   STD
 87-114907-20   0.50mm
 87-114911-20   1.00mm

A 39.80
 B- 17.75
 BØ 38.00
 C 1.00
 D 60.80
 24x58

08-114900-00 STD
 08-114905-00 0.25mm
 08-114907-00 0.50mm
 08-114911-00 1.00mm

1.75  CK P
 2.00  P
 3.00  CR P

14-027950-00 D B 82.50 C 152.00 D 85.50 E 4.70

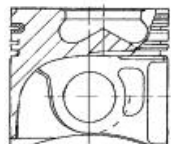
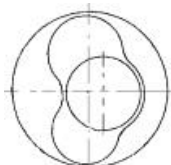
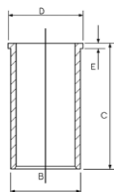

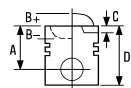

07959-109



87-114900-30 ② ③ STD
 87-114907-30 ② ④ 0.50mm
 87-114911-30 ② ④ 1.00mm

A 39.80
 B- 17.75
 BØ 38.00
 C 1.00
 D 60.80
 24x58

08-114900-00 STD
 08-114905-00 0.25mm
 08-114907-00 0.50mm
 08-114911-00 1.00mm

1.75  CK P
 2.00  P
 3.00  CR P

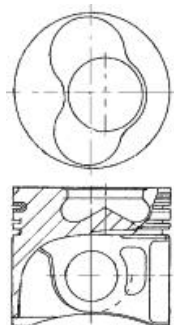

07959A109

① To cylinder 1 & 2
 ② To cylinder 3 & 4
 ③ Piston Chamber Volume
 [ccm] 23.60
 ④ A = 39.550, D = 60.550

① zum Zylinder 1 & 2
 ② zum Zylinder 3 & 4
 ③ Volumen der Kolbenmulde
 [ccm] 23.60
 ④ A = 39.550, D = 60.550

① sous cylindre 1 & 2
 ② sous cylindre 3 & 4
 ③ Volume de la cavité du piston
 [cm³] 23.60
 ④ A = 39.550, D = 60.550

① A cilindro 1 & 2
 ② A cilindro 3 & 4
 ③ Volumen de cavidad del pistón
 [cc] 23.60
 ④ A = 39.550, D = 60.550

① al cilindro 1 & 2
 ② al cilindro 3 & 4
 ③ Volume camera pistone [ccm] 23.60
 ④ A = 39.550, D = 60.550

13  79.50

Fabia 1.4 TDI	04/03→03/08	AMF	3 Cyl.	19.5:1	
			1422cc	55kW (75PS)	
		Diesel	Turbo Intercooled		TD17348
Fabia 1.4 TDI	01/07→03/10	BMS	3 Cyl.	19.5:1	
Roomster 1.4 TDI	09/06→03/10		1422cc	59kW (80PS)	
Roomster Praktik 1.4 TDI	03/07→03/10	Diesel	Turbo Intercooled		TD19092
Fabia 1.4 TDI	10/05→03/10	BNM	3 Cyl.	19.5:1	
Fabia 1.4 TDI, Fabia Praktik 1.4 TDI	10/05→12/07		1422cc	51kW (70PS)	
Roomster 1.4 TDI	07/06→03/10				
Roomster Praktik 1.4 TDI	03/07→03/10	Diesel	Turbo Intercooled		TD18740





Fabia 1.4 TDI	10/05→03/10	BNV		
Roomster 1.4 TDI	09/06→03/10		3 Cyl.	19.5:1
Roomster Praktik 1.4 TDI	03/07→03/10		1422cc	59kW (80PS)
		Diesel	Turbo Intercooled	TD18741

87-114900-80 STD
87-114907-80 0.50mm

A 45.80
B- 17.65
BØ 38.00
C 1.10
D 69.80
 26x63

AK KK NB RT TP

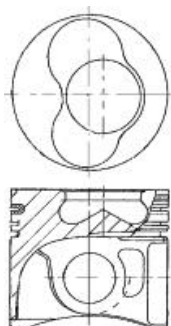

08-114900-00 STD
08-114905-00 0.25mm
08-114907-00 0.50mm
08-114911-00 1.00mm

1.75 CK P
 2.00 P
 3.00 CR P

14-027950-00 D B 82.50 C 152.00 D 85.50 E 4.70

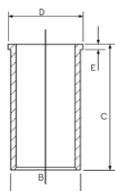

87-114900-85 STD
87-114907-85 0.50mm

A 45.80
B- 17.65
BØ 38.00
C 1.10
D 69.80
 26x63

AK KK NB RT TP

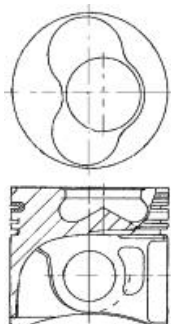

08-114900-00 STD
08-114905-00 0.25mm
08-114907-00 0.50mm
08-114911-00 1.00mm

1.75 CK P
 2.00 P
 3.00 CR P

- To cylinder 1 & 2
- To cylinder 3
- Piston Chamber Volume [ccm] 23.75

- zum Zylinder 1 & 2
- zum Zylinder 3
- Volumen der Kolbenmulde [ccm] 23.75

- sous cylindre 1 & 2
- sous cylindre 3
- Volume de la cavité du piston [cm³] 23.75





- A cilindro 1 & 2
- A cilindro 3
- Volumen de cavidad del pistón [cc] 23.75

- al cilindro 1 & 2
- al cilindro 3
- Volume camera pistone [cm³] 23.75



14 79.50



Fabia 1.9 TDI RS	06/03 → 03/08	ASZ	4 Cyl.	19.5:1	
Octavia 1.9 TDI	09/02 → 09/04		1896cc	96kW (130PS)	
		Diesel	Turbo Intercooled		TD17036
Superb 1.9 TDI	12/01 → 03/08	AVF	4 Cyl.	19:1	
			1896cc	96kW (130PS)	
		Diesel	Turbo Intercooled		TD18239
Superb 1.9 TDI	12/01 → 03/08	AWX	4 Cyl.	19:1	
			1896cc	96kW (130PS)	
		Diesel	Turbo Intercooled		TD16403
Fabia 1.9 TDI RS	06/03 → 03/08	BLT	4 Cyl.	19:1	
			1896cc	96kW (130PS)	
		Diesel	Turbo Intercooled		TD20517

87-114900-25   STD
87-114907-25   0.50mm

→09/02

A 45.80
B- 17.90
BØ 38.00
C 1.10
D 68.80
 26x66

08-114900-00 STD
08-114905-00 0.25mm
08-114907-00 0.50mm
08-114911-00 1.00mm

1.75  CK P
 2.00  P
 3.00  CR P

14-027950-00 D B 82.50 C 152.00 D 85.50 E 4.70

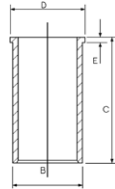

AK KK NB RT TP

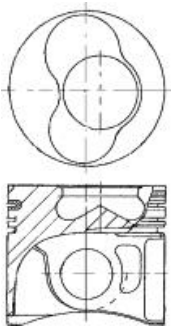

07969K101



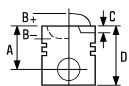

87-114900-35 STD
 87-114907-35 0.50mm

→09/02

A 45.80
 B- 17.90
 BØ 38.00
 C 1.10
 D 68.80
 26x66

AK KK NB RT TP

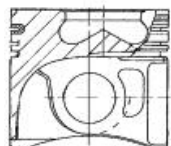
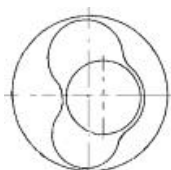

07969K102

08-114900-00 STD
 08-114905-00 0.25mm
 08-114907-00 0.50mm
 08-114911-00 1.00mm

1.75 CK P
 2.00 P
 3.00 CR P

87-114900-45 STD
 87-114907-45 0.50mm

09/02→

A 45.80
 B- 17.50
 BØ 38.00
 C 1.10
 D 68.80
 26x66

AK KK NB RT TP

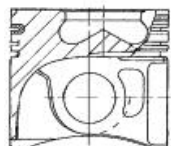
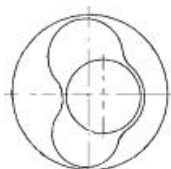

07901C105

08-114900-00 STD
 08-114905-00 0.25mm
 08-114907-00 0.50mm
 08-114911-00 1.00mm

1.75 CK P
 2.00 P
 3.00 CR P







87-114900-46 ② ③ STD
87-114907-46 ② ⑤ 0.50mm

08-114900-00 STD
08-114905-00 0.25mm
08-114907-00 0.50mm
08-114911-00 1.00mm

09/02→

A 45.80
B- 17.50
BØ 38.00
C 1.10
D 68.80
 26x66

1.75
 2.00
 3.00



CK P
 P
 CR P

AK KK NB RT TP

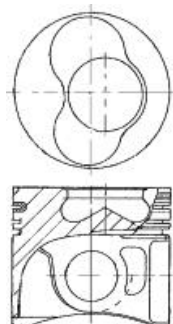

07901C106

- ① To cylinder 1 & 2
- ② To cylinder 3 & 4
- ③ Piston Chamber Volume
[ccm] 24.05
- ④ Piston Chamber Volume
[ccm] 24.60
- ⑤ A = 45.550, D = 68.550

- ① zum Zylinder 1 & 2
- ② zum Zylinder 3 & 4
- ③ Volumen der Kolbenmulde
[ccm] 24.05
- ④ Volumen der Kolbenmulde
[ccm] 24.60
- ⑤ A = 45.550, D = 68.550

- ① sous cylindre 1 & 2
- ② sous cylindre 3 & 4
- ③ Volume de la cavité du piston
[cm³] 24.05
- ④ Volume de la cavité du piston
[cm³] 24.60
- ⑤ A = 45.550, D = 68.550

- ① A cilindro 1 & 2
- ② A cilindro 3 & 4
- ③ Volumen de cavidad del pistón
[cc] 24.05
- ④ Volumen de cavidad del pistón
[cc] 24.60
- ⑤ A = 45.550, D = 68.550

- ① al cilindro 1 & 2
- ② al cilindro 3 & 4
- ③ Volume camera pistone
[cm³] 24.05
- ④ Volume camera pistone
[cm³] 24.60
- ⑤ A = 45.550, D = 68.550

15 79.50

Fabia 1.9 TDI	01/00→03/08	ATD			
Octavia 1.9 TDI	09/00→01/06		4 Cyl.	19:1	
		Diesel	1896cc	74kW (100PS)	
			Turbo Intercooled		TD15377
Superb 1.9 TDI	08/02→10/05	AVB			
			4 Cyl.	19:1	
		Diesel	1896cc	74kW (101PS)	
			Turbo Intercooled		TD17037
Fabia 1.9 TDI	01/00→03/08	AXR			
Octavia 1.9 TDI	08/00→12/10		4 Cyl.	19:1	
Roomster 1.9 TDI	03/06→05/06		1896cc	74kW (100PS)	
		Diesel	Turbo Intercooled		TD20195
Octavia 1.9 TDI	06/04→12/10	BJB			
			4 Cyl.	19:1	
		Diesel	1896cc	77kW (105PS)	
			Turbo Intercooled		TD17499
Octavia 1.9 TDI	06/04→12/10	BKC			
			4 Cyl.	19:1	
		Diesel	1896cc	77kW (105PS)	
			Turbo Intercooled		TD17497





Fabia 1.9 TDI	04/07→03/10	BLS			
Octavia 1.9 TDI	06/04→12/10		4 Cyl.		
Roomster 1.9 TDI	09/06→03/10		1896cc	77kW (105PS)	
Superb 1.9 TDI	03/08→11/10	Diesel	Turbo Intercooled		TD19091
Fabia 1.9 TDI	04/07→03/10	BSW			
Roomster 1.9 TDI	09/06→03/10		4 Cyl.	18.5:1	
			1896cc	77kW (105PS)	
		Diesel	Turbo Intercooled		TD20004
Octavia 1.9 TDI	06/04→12/10	BXE			
Superb 1.9 TDI	03/08→11/10		4 Cyl.	19:1	
			1896cc	77kW (105PS)	
		Diesel	Turbo Intercooled		TD20513

87-114900-65 1 3
87-114907-65 1 4

STD
0.50mm

A 45.80
B- 17.20
BØ 38.00
C 1.10
D 68.80
26x66

08-114900-00
08-114905-00
08-114907-00
08-114911-00

STD
0.25mm
0.50mm
1.00mm

1.75
2.00
3.00



CK P
P
CR P

14-027950-00 D B 82.50 C 152.00 D 85.50 E 4.70

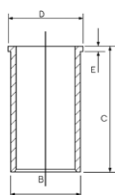

AK KK NB RT TP

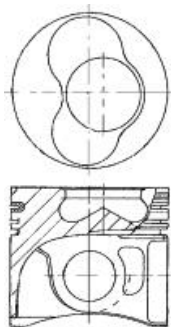

07901D-301





87-114900-66 ② ③ STD
87-114907-66 ② ④ 0.50mm

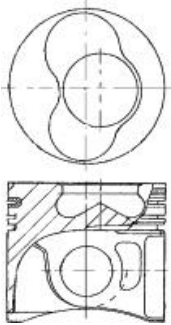

A 45.80
B- 17.20
BØ 38.00
C 1.10
D 68.80
 26x66

AK KK NB RT TP



07901D-302

08-114900-00 STD
08-114905-00 0.25mm
08-114907-00 0.50mm
08-114911-00 1.00mm

1.75  CK P
2.00  P
3.00  CR P

- ① To cylinder 1 & 2
- ② To cylinder 3 & 4
- ③ Piston Chamber Volume
[ccm] 22.85
- ④ A = 45.550, D = 68.550

- ① zum Zylinder 1 & 2
- ② zum Zylinder 3 & 4
- ③ Volumen der Kolbenmulde
[ccm] 22.85
- ④ A = 45.550, D = 68.550

- ① sous cylindre 1 & 2
- ② sous cylindre 3 & 4
- ③ Volume de la cavité du piston
[cm³] 22.85
- ④ A = 45.550, D = 68.550

- ① A cilindro 1 & 2
- ② A cilindro 3 & 4
- ③ Volumen de cavidad del pistón
[cc] 22.85
- ④ A = 45.550, D = 68.550

- ① al cilindro 1 & 2
- ② al cilindro 3 & 4
- ③ Volume camera pistone
[cm³] 22.85
- ④ A = 45.550, D = 68.550

16 79.50

Fabia 1.2 TDI Roomster 1.2 TDI, Roomster Praktik 1.2 TDI	05/10→12/14 03/10→05/15	CFWA	3 Cyl. 1199cc Diesel	16.5:1 55kW (75PS) Turbo Intercooled	TD24261
Fabia 1.6 TDI	04/10→12/14	CAYA	4 Cyl. 1598cc Diesel	16.5:1 55kW (75PS) Turbo Intercooled	TD24216
Fabia 1.6 TDI Rapid 1.6 TDI, Rapid Spaceback 1.6 TDI Roomster 1.6 TDI, Roomster Praktik 1.6 TDI	03/10→12/14 08/13→ 03/10→05/15	CAYB	4 Cyl. 1598cc Diesel	16.5:1 66kW (90PS) Turbo Intercooled	TD23929
Fabia 1.6 TDI Octavia 1.6 TDI Rapid 1.6 TDI, Rapid Spaceback 1.6 TDI Roomster 1.6 TDI SuperB 1.6 TDI Yeti 1.6 TDI	03/10→12/14 06/09→04/13 07/12→ 03/10→05/15 09/10→05/15 11/10→	CAYC	4 Cyl. 1598cc Diesel	16.5:1 77kW (105PS) Turbo Intercooled	TD22678



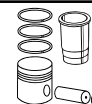
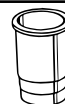



Rapid 1.6 TDI	10/11→	CLNA		
Rapid Spaceback 1.6 TDI	07/12→		4 Cyl.	16.5:1
			1598cc	77kW (105PS)
		Diesel	Turbo Intercooled	TD25764

87-432900-00 ¹	STD	08-432900-00	STD
87-432905-00	0.25mm	08-432905-00	0.25mm
87-432907-00	0.50mm	08-432907-00	0.50mm

A	45.30
B-	10.70
B-	4.70
BØ	49.00
D	67.80
	26x66

1.75		GDC P
2.00		P
3.00		CR P



KK RT TP

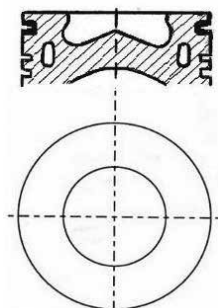

0790MA-104

¹ Piston Chamber Volume
[ccm] 19.750

¹ Volumen der Kolbenmulde
[ccm] 19.750

¹ Volume de la cavité du piston
[cm³] 19.750

¹ Volumen de cavidad del pistón
[cc] 19.750

¹ Volume camera pistone
[cm³] 19.750

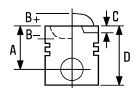

17 81.00



Octavia 1.8	09/96→	ADR	4 Cyl. 1781cc	10.3:1 92kW (125PS)	TD20805
-------------	--------	-----	-------------------------	-------------------------------	----------------

Octavia 1.8	09/96→07/00	AGN	4 Cyl. 1781cc	10.3:1 92kW (125PS)	TD17903
Octavia 1.8 20V	07/98→07/00				

87-502900-00 ¹ STD
87-502907-00 ¹ ² 0.50mm

08-502900-00 STD
08-502905-00 0.25mm
08-502907-00 0.50mm

A 32.55
C 3.60
D 56.55
 20x59

1.50  CK P
1.75  P
2.00  CR P

AK

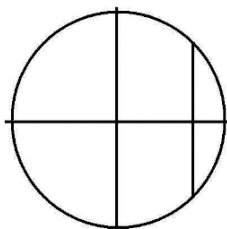

08192

¹ Conrod gap 27.50mm
² A = 32.250, D = 56.250

¹ Pleuelaugenabstand 27.50mm
² A = 32.250, D = 56.250

¹ Distance entre bielle 27.50mm
² A = 32.250, D = 56.250

¹ Distancia del biela 27.50mm
² A = 32.250, D = 56.250

¹ Distanza dalla bielle 27.50mm
² A = 32.250, D = 56.250

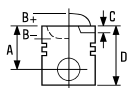

18  **81.00**



Octavia 1.6	02/97→12/07	AEH	4 Cyl. 1595cc	10.3:1 74kW (101PS)	TD12950
-------------	-------------	-----	------------------	------------------------	---------

Octavia 1.6	02/97→12/07	AKL	4 Cyl. 1595cc	10.3:1 74kW (101PS)	TD12951
-------------	-------------	-----	------------------	------------------------	---------

87-105900-00 STD
87-105907-00 ¹ 0.50mm

08-105900-00 STD
08-105907-00 0.50mm

A 32.00
B- 2.30
B+ 0.70
BØ 61.40
D 53.70
 20x57

1.20  NT ²
 1.50  P
 2.00  CR ²

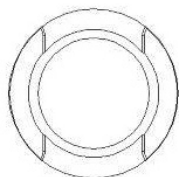
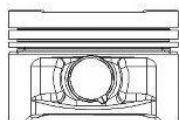

¹ A = 31.700, D = 53.400

² Steel

¹ A = 31.700, D = 53.400

² Stahl

¹ A = 31.700, D = 53.400

² Acier

¹ A = 31.700, D = 53.400

² Acero

¹ A = 31.700, D = 53.400

² Acciaio

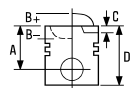





19  **81.00**

Octavia 1.8 T	08/97→12/10	AGU	4 Cyl. 1781cc Turbo Intercooled	9.5:1 110kW (150PS)	TD13396
---------------	-------------	------------	--	-------------------------------	----------------

Octavia 1.8 T	08/97→12/10	ARZ	4 Cyl. 1781cc Turbo Intercooled	9.5:1 110kW (150PS)	TD16030
---------------	-------------	------------	--	-------------------------------	----------------

87-502900-10	STD	08-502900-00	STD
87-502905-10	0.25mm	08-502905-00	0.25mm
87-502907-10	0.50mm	08-502907-00	0.50mm

A	32.70	1.50	 CK P
B-	2.05	1.75	 P
BØ	70.00	2.00	 CR P
D	53.70		
	20x59		

AK

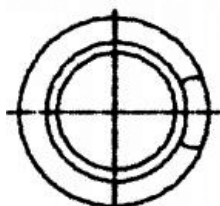
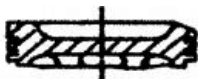







20  **81.00**

Octavia 1.8 T	08/97→12/10	ARX	4 Cyl. 1781cc Turbo Intercooled	9.5:1 110kW (150PS)	TD16069
Octavia 1.8 T	08/97→12/10	AUM	4 Cyl. 1781cc Turbo Intercooled	9.5:1 110kW (150PS)	TD16070
Octavia RS 1.8 T	05/01→01/06	AUQ	4 Cyl. 1781cc Turbo Intercooled	9.5:1 132kW (180PS)	TD16279
SuperB 1.8 T	12/01→03/08	AWT	4 Cyl. 1781cc Turbo Intercooled	9.5:1 110kW (150PS)	TD16365

87-502900-30	STD	08-502900-00	STD
87-502907-30	0.50mm	08-502905-00	0.25mm
		08-502907-00	0.50mm

A	32.70			
C	1.90	1.50		CK P
D	53.70	1.75		P
	19x49	2.00		CR P

TP

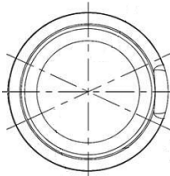
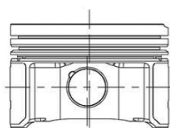



21  **81.00**

Octavia 1.6	09/00→12/10	AVU	4 Cyl. 1595cc	10.3:1 75kW (102PS)	TD16068
Octavia 1.6	09/00→12/10	BFQ	4 Cyl. 1595cc	10.2:1 75kW (102PS)	TD17912
Octavia 1.6	06/04→06/13	BGU	4 Cyl. 1595cc	10.3:1 75kW (102PS)	TD17496
Octavia 1.6	06/04→06/13	BSE	4 Cyl. 1595cc	75kW (102PS)	TD20898
Octavia 1.6	06/04→06/13	BSF	4 Cyl. 1595cc	75kW (102PS)	TD20899
Octavia 1.6 LPG	08/09→11/12	CHGA	4 Cyl. 1595cc	75kW (102PS)	TD22691

87-148300-00
87-148307-00

STD
0.50mm

08-148300-00
08-148307-00

STD
0.50mm

A 29.08
B- 2.70
BØ 62.30
D 50.70
 19x42

1.00
1.20
2.00



NT 
P
CR P

TP

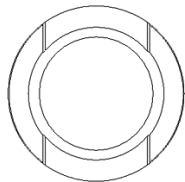
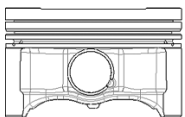

 Steel

 Stahl

 Acier



 Acero





 Acciaio



22 81.00

Octavia 2.0 TDI, Octavia 2.0 TDI 16V	02/04→05/10	AZV	4 Cyl. 1968cc	18:1 100kW (136PS)	
		Diesel	Turbo Intercooled		TD20909
Octavia 2.0 TDI 16V Superb 2.0 TDI 16V	02/04→05/13 01/09→05/15	BKD	4 Cyl. 1968cc	18:1 103kW (140PS)	
		Diesel	Turbo Intercooled		TD17500
Octavia 2.0 TDI RS	04/06→02/13	BMN	4 Cyl. 1968cc	18.5:1 125kW (170PS)	
		Diesel	Turbo Intercooled		TD20735







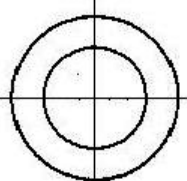



87-139500-00  STD 08-139500-00 STD
 87-139507-00  0.50mm 08-139507-00 0.50mm

A	45.83	1.75		CK P
B-	17.80	2.00		P
BØ	38.00	3.00		CR P
D	68.80			
	26x66			

AK KK NB RT TP



07901J

 Piston Chamber Volume [ccm] 23.75  A = 45.550, D = 68.550	 Volumen der Kolbenmulde [ccm] 23.75  A = 45.550, D = 68.550	 Volume de la cavité du piston [cm³] 23.75  A = 45.550, D = 68.550	 Volumen de cavidad del pistón [cc] 23.75  A = 45.550, D = 68.550	 Volume camera pistone [cm³] 23.75  A = 45.550, D = 68.550
--	--	--	---	--

23 81.00

Octavia 2.0 TDI	11/05→05/10	BMM	4 Cyl. 1968cc	18.5:1 103kW (140PS)	
		Diesel	Turbo Intercooled		TD19315
Superb 2.0 TDI	03/08→05/10	BMP	4 Cyl. 1968cc	18.5:1 103kW (140PS)	
		Diesel	Turbo Intercooled		TD20945
Superb 2.0 TDI	10/05→03/08	BSS	4 Cyl. 1968cc	18.5:1 103kW (140PS)	
		Diesel	Turbo Intercooled		TD19317





Superb 2.0 TDI	02/06 → 02/06	BWW	4 Cyl. 1984cc	18.5:1 91kW (124PS)	TD20500
		Diesel	Turbo Intercooled		

87-139500-10 ① ③	STD	08-139500-00	STD
87-139507-10 ①	0.50mm	08-139507-00	0.50mm

A	45.55	1.75		CK P
B-	17.50	2.00		P
BØ	38.00	3.00		CR P
C	0.70			
D	68.80			
	26x66			

AK KK NB RT TP

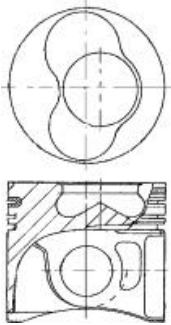

07901D833

87-139500-20 ② ③	STD	08-139500-00	STD
87-139507-20 ②	0.50mm	08-139507-00	0.50mm

A	45.83	1.75		CK P
B-	17.50	2.00		P
BØ	38.00	3.00		CR P
C	0.70			
D	68.80			
	26x66			

AK KK NB RT TP

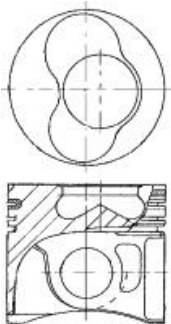

07901D834

① To cylinder 1 & 2
② To cylinder 3 & 4
③ Piston Chamber Volume
[ccm] 23.30

① zum Zylinder 1 & 2
② zum Zylinder 3 & 4
③ Volumen der Kolbenmulde
[ccm] 23.30

① sous cylindre 1 & 2
② sous cylindre 3 & 4
③ Volume de la cavité du piston
[cm³] 23.30

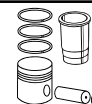

① A cilindro 1 & 2
② A cilindro 3 & 4
③ Volumen de cavidad del pistón
[cc] 23.30

① al cilindro 1 & 2
② al cilindro 3 & 4
③ Volume camera pistone
[cm³] 23.30







24 81.00

Superb 2.0 TDI	07/08→05/15	CBBB	4 Cyl. 1968cc	16:1 125kW (170PS)	
		Diesel	Turbo Intercooled		TD20944
Yeti 2.0 TDI	05/09→	CBDB	4 Cyl. 1968cc	16:1 103kW (140PS)	
		Diesel	Turbo Intercooled		TD23586
Octavia 2.0 TDI RS Yeti 2.0 TDI	04/06→02/13 11/09→	CEGA	4 Cyl. 1968cc	16:1 125kW (170PS)	
		Diesel	Turbo Intercooled		TD20905

87-432300-00  STD
87-432307-00  0.50mm

08-432300-00  STD
08-432307-00 0.50mm

A 45.80
B- 12.70
BØ 50.88
D 68.80
 26x66







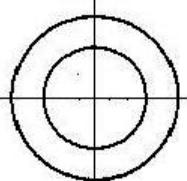

1.75  GDC P
 2.00  P
 3.00  CR P



HA KK NB RT TP



07901G202

-  OE 03L 107 065G, Gen 1 engine only
-  OE 03L 107 065G, nur für Motoren der Generation 1
-  N°OE 03L 107 065G, uniquement pour Moteur de génération 1
-  OE 03L 107 065G, Generación 1 solo motor
-  Solo motore Generation 1
-  08-432300-00 OE: 03L198151A
-  08-432300-00 OE: 03L198151A
-  08-432300-00 OE: 03L198151A
-  08-432300-00 OE: 03L198151A
-  08-432300-00 OE: 03L198151A

25 81.00

Superb 2.0 TDI 16V	01/09→05/15	CFFB	4 Cyl. 1968cc	16.5:1 103kW (140PS)	
		Diesel	Turbo Intercooled		TD23589
Superb 2.0 TDI	07/08→05/15	CFGB	4 Cyl. 1968cc	16.5:1 125kW (170PS)	
		Diesel	Turbo Intercooled		TD23591
Yeti 2.0 TDI	11/09→	CFHA	4 Cyl. 1968cc	16.5:1 81kW (110PS)	
		Diesel	Turbo Intercooled		TD23584
Octavia 2.0 TDI 16V Yeti 2.0 TDI	02/04→05/13 05/09→	CFHC	4 Cyl. 1968cc	16.5:1 103kW (140PS)	
		Diesel	Turbo Intercooled		TD23587



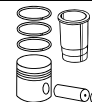
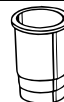
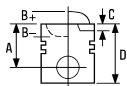





Octavia 2.0 TDI Yeti 2.0 TDI	03/10→06/13 11/09→	CFHF	4 Cyl. 1968cc	16.5:1 81kW (110PS)	TD23585
		Diesel	Turbo Intercooled		
Yeti 2.0 TDI	11/09→	CFJA	4 Cyl. 1968cc	16.5:1 125kW (170PS)	TD23588
		Diesel	Turbo Intercooled		
Octavia 2.0 TDI Yeti 2.0 TDI	03/10→06/13 11/09→	CLCA	4 Cyl. 1968cc	16.5:1 81kW (110PS)	TD24839
		Diesel	Turbo Intercooled		
Octavia 2.0 TDI 16V Yeti 2.0 TDI	02/04→05/13 05/09→	CLCB	4 Cyl. 1968cc	16.5:1 103kW (140PS)	TD24598
		Diesel	Turbo Intercooled		
Superb 2.0 TDI 16V	01/09→05/15	CLJA	4 Cyl. 1968cc	16.5:1 103kW (140PS)	TD23590
		Diesel	Turbo Intercooled		

87-432300-10 ¹ STD
87-432307-10 ¹ 0.50mm

STD
0.50mm

08-432300-10 ² ³ STD
08-432307-10 ² ³ 0.50mm

A 45.80
B- 13.10
BØ 50.88
D 68.80
 26x66

1.75  GDC P
2.00  MO P
3.00  CR P

GDC  **LKZ-Ring®**

AK KK NB RT TP

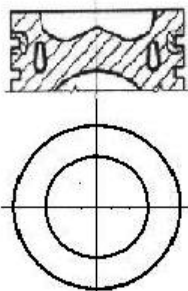

07901G220

¹ OE 03L 107 065S, Gen 2 engine only

¹ OE 03L 107 065S, nur für Motoren der Generation 2

¹ N°OE 03L 107 065S, uniquement pour Moteur de génération 2

¹ OE 03L 107 065G, Generación 2 solo motor

¹ Solo motore Generation 2

² Only fit to pistons equivalent to OE 03L 107065 AG, 03L 107065 S

² Nur gepasst worden zu den Kolben gleichwertig mit OE 03L 107065 AG und 03L 107065 S

² Seulement adapté aux pistons équivalents à OE 03L 107065 AGet 03L 107065 S

² Cabido solamente a los pistones equivalentes a OE 03L 107065 AG y 03L 107065 S

² Adattato soltanto ai pistoni equivalenti a OE 03L 107065 AGe 03L 107065 S

³ 08-432300-10 OE: 03L198151C

³ 08-432300-10 OE: 03L198151C

³ 08-432300-10 OE: 03L198151C

³ 08-432300-10 OE: 03L198151C

³ 08-432300-10 OE: 03L198151C



26 82.50

Octavia 2.0 FSI	11/04→10/08	BLR	4 Cyl. 1984cc	11.5:1 110kW (150PS)	TD18102
Octavia 2.0 FSI	11/04→10/08	BLX	4 Cyl. 1984cc	11.5:1 110kW (150PS)	TD20393
Octavia 2.0 FSI	11/04→10/08	BLY	4 Cyl. 1984cc	11.5:1 110kW (150PS)	TD18101
Octavia 2.0 FSI	11/04→10/08	BVX	4 Cyl. 1984cc	11.5:1 110kW (150PS)	TD20394
Octavia 2.0 FSI	11/04→10/08	BVY	4 Cyl. 1984cc	11.5:1 110kW (150PS)	TD20518
Octavia 2.0 FSI	11/04→10/08	BVZ	4 Cyl. 1984cc	11.5:1 110kW (150PS)	TD20519

87-435100-00 ¹ STD

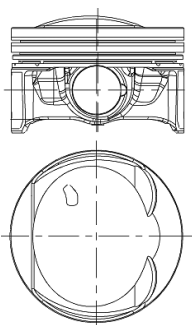

A 29.38
B+ 12.46
D 59.84
 19x44

TP



08240B301

08-435100-10 STD

1.20  NT PVD ²
1.50 
2.00  CR

¹ Elastoval ®
² Steel

¹ Elastoval ®
² Stahl

¹ Elastoval ®
² Acier

¹ Elastoval ®
² Accero

¹ Elastoval ®
² Acciaio

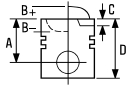





27  **82.50**

Octavia 2.0 RS	10/05 → 02/13	BWA	4 Cyl.	10.3:1
			1984cc	147kW (200PS)
			Turbo Intercooled	TD20395

87-438500-00	STD	08-438500-00	STD
87-438507-00	0.50mm	08-438507-00	0.50mm



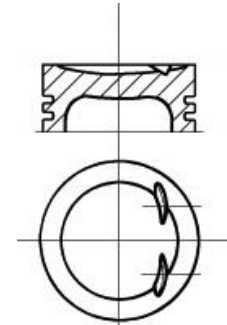

A	29.50
B-	6.10
BØ	49.52
C	1.36
C	1.36
D	50.50
	20x59

1.20		PVD 
1.50		P
2.00		CR P

AK RT TP



-  Steel
-  Stahl
-  Acier
-  Acero
-  Acciaio







		ccm	x 		
M 160 E6AL B03	Petrol	599	3	63.50	1
M 160 E6AL B04	Petrol	599	3	63.50	1
M 160 E6AL B05	Petrol	599	3	63.50	1
M 160.910	Petrol	599	3	66.50	3
M 160.920	Petrol	698	3	63.50	1
M 160.921	Petrol	698	3	66.50	3
M 160.922	Petrol	698	3	66.50	3
OM 639.939 Euro 4	Diesel	1493	3	83.00	4
OM 660.950	Diesel	799	3	65.50	2
OM 660.951	Diesel	799	3	65.50	2



1 63.50

Cabrio 0.6	03/00 → 01/04	M 160 E6AL B03			
City-Coupe 0.6	07/98 → 01/04		3 Cyl.	9.5:1	
			599cc	40kW (55PS)	
			Turbo Intercooled		TD22902
City-Coupe 0.6	07/98 → 01/04	M 160 E6AL B04			
			3 Cyl.	9.5:1	
			599cc	33kW (45PS)	
			Turbo Intercooled		TD22903
Cabrio 0.6, City-Coupe 0.6	01/01 → 01/04	M 160 E6AL B05			
			3 Cyl.	9.5:1	
			599cc	45kW (61PS)	
			Turbo Intercooled		TD22901
Cabrio 0.6	03/00 → 01/04	M 160.920			
City-Coupe 0.6	07/98 → 01/04		3 Cyl.	9:1	
Crossblade 0.6	06/02 → 12/03		698cc	33-55kW (45-75PS)	
Fortwo 0.6	01/04 → 02/07				TD26103
Fortwo 0.6 Brabus	01/04 → 12/06				

87-136700-00	STD	08-136700-00	STD
87-136705-00	0.25mm	08-136705-00	0.25mm
87-136707-00	0.50mm	08-136707-00	0.50mm

A	27.00	1.20		CR 
B-	2.75	1.50		P
BØ	50.00	2.50		CR 
D	43.50			
	16x48			

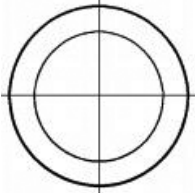

 Steel

 Stahl

 Acier

 Acero

 Acciaio



2  **65.50**



Fortwo 0.8 CDI	08/09→	OM 660.951	3 Cyl.	18:1	
			799cc	40kW (54PS)	
		Diesel	Turbo Intercooled		TD24475

Fortwo 0.8 CDI	01/07→	OM 660.950	3 Cyl.	18:1	
			799cc	33kW (45PS)	
		Diesel	Turbo Intercooled		TD20946

87-140600-00 STD

08-140600-00 STD

- A** 36.00
- B-** 11.10
- BØ** 38.70
- C** 0.95
- C** 0.95
- D** 60.00
-  23x53

- 1.50  CK P
- 1.50  P
- 2.50  CR P

RT

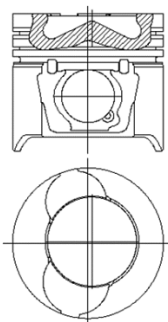

3  **66.50**

Cabrio 0.7	01/01→01/04	M 160.910	3 Cyl.		
City-Coupe 0.7	07/98→01/04		599cc	33-55kW (45-75PS)	
Fortwo 0.7	01/04→01/07		Turbo Intercooled		TD26102

Roadster 0.7	04/03→11/05	M 160.922	3 Cyl.	9:1	
			698cc	45-60kW (61-82PS)	
			Turbo Intercooled		TD26301

Roadster 0.7 Brabus	12/03→11/05	M 160.923	3 Cyl.	9:1	
			698cc	74kW (101PS)	
			Turbo Intercooled		TD26104











0.7, Roadster 0.7 04/03→11/05 **M 160.921** 3 Cyl. 9:1
698cc **45-60kW (61-82PS)**
Turbo Intercooled **TD22100**

87-427100-00	STD	08-427100-00	STD
87-427105-00	0.25mm	08-427105-00	0.25mm
87-427107-00	0.50mm	08-427107-00	0.50mm

A 25.20
B- 3.30
BØ 54.50
D 41.70
 16x52

1.20		NT 
1.20		NT 
2.50		NT 

TP

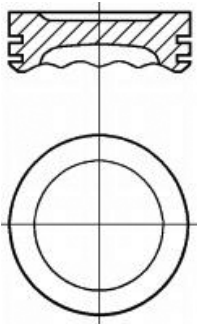

 Steel

 Stahl

 Acier

 Acero



 Acciaio

4  **83.00**

Forfour 1.5 CDI 09/04→06/06 **OM 639.939 Euro 4** 3 Cyl. 18:1
1493cc **50-70kW (58-95PS)**
Diesel **Turbo Intercooled** **TD23800**

87-427500-00	STD	08-427500-00	STD
87-427507-00	0.50mm	08-427507-00	0.50mm

A 45.65
B- 14.65
BØ 43.40
C 1.18
C 1.02
D 71.65
 30x66





2.00		CK
2.00		P
2.00		CR P

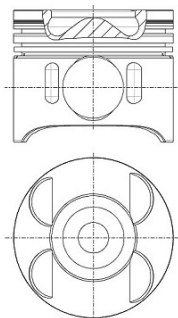

AK KK RT





8340A

		ccm	x 		9
DC23	Diesel	2238	4	88.00	1
M 104.942	Petrol	2799	6	89.90	5
M 104.945	Petrol	2799	6	89.90	5
M 104.992	Petrol	3199	6	89.90	6
M 104.995	Petrol	3199	6	89.90	6
M 111.970	Petrol	2295	4	90.90	7
M 111.974	Petrol	2295	4	90.90	7
M 161.970	Petrol	2295	4	90.90	7
M 161.974	Petrol	2295	4	90.90	7
MB-OM 662	Diesel	2874	5	89.00	2
OM 601.940	Diesel	2299	4	89.00	3
OM 602.940	Diesel	2874	5	89.00	3
OM 602.980 OM 602 DE 29LA	Diesel	2874	5	89.00	4
OM 661.940	Diesel	2299	4	89.00	3
OM 662.940	Diesel	2874	5	89.00	3
OM 662.983	Diesel	2874	5	89.00	2
XD3P	Diesel	2498	4	94.00	9
XD3 T/TE	Diesel	2498	4	94.00	8







1 88.00

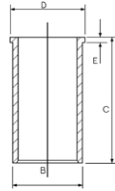

Korando 2.2 D	12/88→12/96	DC23	4 Cyl. 2238cc	21:1 50kW (68PS)	
Diesel					TD3611



14-021190-00 D B 92.13 C 163.50 D 95.00 E 4.00
14-021440-00 DH   B 89.97 C 163.32 D 94.89 E 0.89





 Not suitable for use with pistons having chrome rings
 Chrome Bore

 Nicht geeignet zur Verwendung mit Kolben mit Chromringen
 Bohrung verchromte

 Ne pas utiliser avec des pistons équipés de segments chromés
 Alésage chromée

 No es adecuada para usar con pistones que tengan aros de croma
 Cromado de cilindro

 Non utilizzabile con pistoni equipaggiati con segmenti croma
 Cilindro cromato

2 89.00

Korando 2.9 D	12/96→	MB-OM 662	5 Cyl. 2874cc	72-73kW (98-99PS)	
Musso 2.9 D	03/96→				
Diesel					TD9355

Korando 2.9 D	12/96→	OM 662.983	5 Cyl. 2874cc	19.5:1 88kW (120PS)	
Musso 2.9 D	03/96→				
Diesel			Turbo Intercooled		TD21371

14-026380-00 D B 91.50 C 156.50 D 96.55 E 4.70

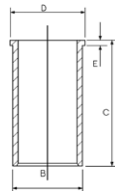

3 89.00

Korando 2.3 D	12/96→	OM 601.940	4 Cyl. 2299cc	22:1 57-59kW (77-80PS)	
Musso 2.3 D	10/95→				
Diesel					TD3612

Musso 2.3 D	03/93→04/97	OM 661.940	4 Cyl. 2299cc	21:1 58kW (79PS)	
Diesel					TD21373

Istana 2.9 D, Istana 2.9 TD	10/92→05/95	OM 602.940	5 Cyl. 2874cc	21:1 70kW (95PS)	
Diesel					TD3613



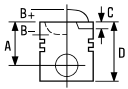

Korando 2.9 D	07/96 →	OM 662.940			
Musso 2.9 D	07/93 →		5 Cyl.	21:1	
			2874cc	70kW (95PS)	
		Diesel	Turbo Intercooled		TD21372

87-743100-10	STD	08-743100-00	STD	14-026380-00 D	B 91.50 C 156.50 D 96.55 E 4.70
87-743107-10	0.50mm	08-743107-00	0.50mm	14-027210-00 D	B 91.50 C 156.50 D 94.05 E 4.70
87-743120-10	0.70mm	08-743120-00	0.70mm		

A	44.65
B-	8.25
C	1.25
C	1.50
D	74.65
	26x62

2.50		CR P
2.00		P
3.00		CR P

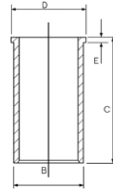

AK RT

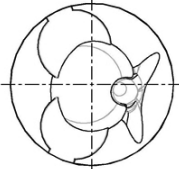
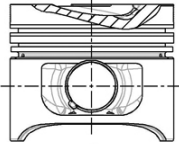

08953

87-743120-20	0.70mm	08-743100-00	STD
		08-743107-00	0.50mm
		08-743120-00	0.70mm

A	44.45
B-	8.25
C	1.50
C	1.25
D	74.45
	26x62

2.50		CR P
2.00		P
3.00		CR P

AK RT

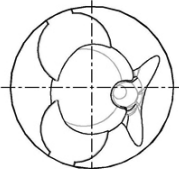
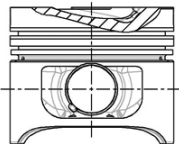

08953

Conrod guided in Piston

Kolbengeführtes Pleuel

Bielle guidée dans le piston

Biela montada en el pistòn

Billea montata sul pistone



4 89.00

Istana 2.9 D 06/95 → **OM 602.980 OM 602 DE 29LA**
 5 Cyl. 19.5:1
2874cc **75-90kW (102-122PS)**
Diesel **Turbo Intercooled** **TD19846**

87-743100-00 STD
87-743107-00 0.50mm

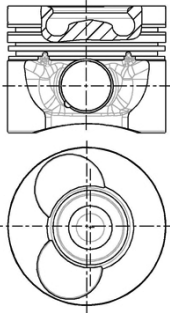

A 44.75
B- 16.74
BØ 42.00
C 0.60
C 0.30
D 74.75
 28x70

KK RT



08980C

08-743100-00 STD
08-743107-00 0.50mm
08-743120-00 0.70mm

2.50  CR P
 2.00  P
 3.00  CR P

14-026380-00 D **B 91.50 C 156.50 D 96.55 E 4.70**
14-027210-00 D **B 91.50 C 156.50 D 94.05 E 4.70**

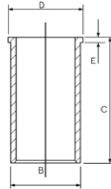

87-743107-50 0.50mm

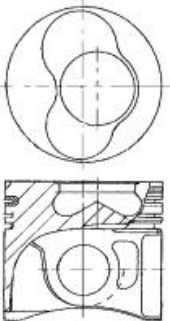

A 44.55
B- 16.74
BØ 42.00
C 0.30
C 0.60
D 74.55
 28x70

KK RT



08980C

08-743100-00 STD
08-743107-00 0.50mm
08-743120-00 0.70mm

2.50  CR P
 2.00  P
 3.00  CR P



5 89.90



Chairman 2.8	07/97 →	M 104.942	6 Cyl. 2799cc	10:1 142-145kW (193-197PS)	TD20447
--------------	---------	-----------	------------------	-------------------------------	---------

Chairman 2.8	08/99 →	M 104.945	6 Cyl. 2799cc	10:1 142kW (193PS)	TD19845
--------------	---------	-----------	------------------	-----------------------	---------

87-287500-20 STD
87-287507-20 ¹ 0.50mm

08-287500-00 STD
08-287505-00 0.25mm
08-287507-00 0.50mm

A 32.38
B- 2.54
BØ 59.00
C 1.20
D 58.58
 22x56

1.50  NT ²
1.75  P
3.00  CR P

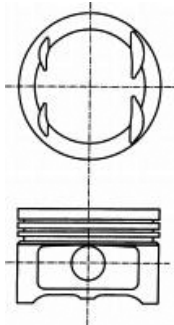

09029

¹ A = 32.075, D = 58.075
² Steel

¹ A = 32.075, D = 58.075
² Stahl

¹ A = 32.075, D = 58.075
² Acier

¹ A = 32.075, D = 58.075
² Acero

¹ A = 32.075, D = 58.075
² Acciaio



6 89.90

Chairman 3.2	07/97 →	M 104.992		
Korando 3.2	06/97 →		6 Cyl.	10:1
Musso 3.2	06/96 →		3199cc	162kW (220PS)
TD9357				
Korando 3.2	12/96 →	M 104.995		
			6 Cyl.	9.2:1
			3199cc	154-156kW (209-212PS)
TD9374				



87-287500-10
87-287505-10

STD
0.25mm

08-287500-00
08-287505-00
08-287507-00

STD
0.25mm
0.50mm

A 31.12
B- 3.25
BØ 70.00
C 2.60
D 56.12
 22x55

1.50  NT ②
1.75  P
3.00  CR P

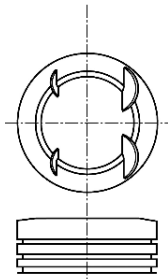

09034



87-287500-30 ①
87-287505-30 ①
87-287507-30 ①

STD
0.25mm
0.50mm

08-287500-00
08-287505-00
08-287507-00

STD
0.25mm
0.50mm

A 31.12
B- 2.60
BØ 74.00
C 1.30
C 1.80
D 56.10
 22x56

1.50  NT ②
1.75  P
3.00  CR P

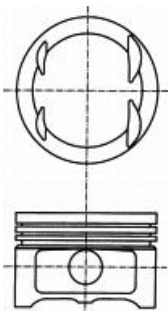

09024

① Elastoval ®
② Steel

① Elastoval ®
② Stahl

① Elastoval ®
② Acier

① Elastoval ®
② Acero

① Elastoval ®
② Acciaio





7 90.90

Chairman 2.3	07/97→	M 111.970			
Korando 2.3	05/97→		4 Cyl.	10.4:1	
Musso 2.3	10/96→		2295cc	103-110kW (140-150PS)	TD5544
Chairman 2.3	07/97→	M 111.974			
			4 Cyl.	10.4:1	
			2295cc	110kW (150PS)	TD19459
Korando 2.3	01/02→	M 161.970			
Kyron 2.3	01/10→		4 Cyl.	10.4:1	
			2295cc	103-110kW (140-150PS)	TD22101
Actyon 2.3 i	03/07→	M 161.974			
Kyron 2.3 i	01/06→		4 Cyl.	10.4:1	
			2295cc	110kW (150PS)	TD22102

87-109100-00 STD
 87-109107-00 ¹ 0.50mm

A 30.00
 B+ 2.90
 C 1.00
 D 57.90
 22x56

08-109100-00 STD
 08-109107-00 0.50mm

1.50  NT ²
 1.75  NT ²
 3.00  NT ²

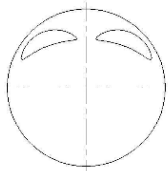
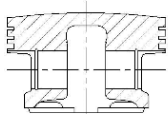



09128

87-109100-10 STD
 87-109107-10 0.50mm

A 30.00
 B- 1.10
 BØ 70.00
 C 0.85
 D 55.00
 22x56

08-109100-00 STD
 08-109107-00 0.50mm

1.50  NT ²
 1.75  NT ²
 3.00  NT ²

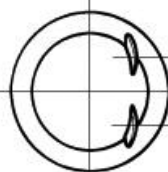
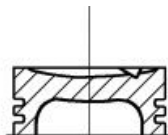

09130

¹ B+ = 1.700
² Steel

¹ B+ = 1.700
² Stahl

¹ B+ = 1.700
² Acier

¹ B+ = 1.700
² Accero

¹ B+ = 1.700
² Acciaio



8 94.00

Korando	01/97→	XD3 T/TE	4 Cyl. 2498cc	21:1 58kW (79PS)	
		Diesel Turbo			FM4386

14-020660-00 D **B 97.00 C 170.60 D 99.50 E 4.00**
14-021520-00 D **B 98.00 C 170.60 D 100.00 E 6.00**

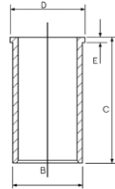

9 94.00

Korando 2.5 D	06/93→05/97	XD3P	4 Cyl. 2498cc	23.1:1 53-58kW (72-79PS)	
		Diesel			TD19458

87-318700-10 STD
87-318706-10 0.40mm
87-318708-10 0.60mm
87-318710-10 0.80mm

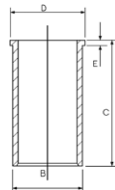

08-318700-10 STD
08-318704-10 0.20mm
08-318706-10 0.40mm
08-318707-10 0.50mm
08-318708-10 0.60mm
08-318710-10 0.80mm
08-318711-10 1.00mm

14-020660-00 D **B 97.00 C 170.60 D 99.50 E 4.00**
14-021520-00 D **B 98.00 C 170.60 D 100.00 E 6.00**



→12/93

A 54.00
B- 1.80
D 96.42
 30x79

2.00  CR P
2.00  P
4.00  CR P

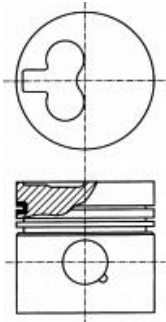

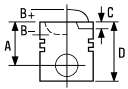



87-318700-30	STD
87-318706-30	0.40mm
87-318708-30	0.60mm
87-318710-30	0.80mm





01/94 →

A	54.00
B-	1.75
D	91.42
	30x79

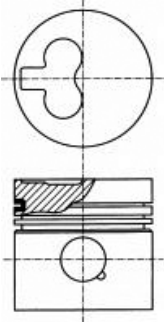
08-318700-10	STD
08-318704-10	0.20mm
08-318706-10	0.40mm
08-318707-10	0.50mm
08-318708-10	0.60mm
08-318710-10	0.80mm
08-318711-10	1.00mm

2.00		CR P
2.00		P
4.00		CR P



		ccm	x 		
WD 208/WD 208	Diesel	1570	2	100.00	1
WD 210.40	Diesel	1996	2	105.00	3
WD 308/WD 308	Diesel	2535	3	100.00	1
WD 311/WD311	Diesel	2590	3	100.00	2
WD 408/WD 408	Diesel	3142	4	100.00	1
WD 410.40	Diesel	3983	4	105.00	3
WD 411/WD411	Diesel	3465	4	100.00	2
WD 610.18	Diesel	5975	6	105.00	3
WD 610.19	Diesel	5980	6	105.00	3
WD 610.20	Diesel	5975	6	105.00	3
WD 610.40	Diesel	5975	6	105.00	3
WD 610.42	Diesel	5975	6	105.00	3
WD 610.44	Diesel	5975	6	105.00	3
WD 610.50	Diesel	5975	6	105.00	3
WD 611/WD611	Diesel	5184	6	100.00	2
WD 612.63	Diesel	6595	6	108.00	4
WD 612.65	Diesel	6595	6	108.00	4
WD 615.00	Diesel	9726	6	126.00	5
WD 615.20	Diesel	9726	6	126.00	5
WD 615.60	Diesel	9726	6	126.00	5
WD 615.61	Diesel	9726	6	126.00	5
WD 615.63	Diesel	9726	6	126.00	5
WD 615.64	Diesel	9726	6	126.00	5
WD 615.65	Diesel	9726	6	126.00	5
WD 615.67	Diesel	9726	6	126.00	5
WD 615.68	Diesel	9726	6	126.00	5
WD 615.69	Diesel	9726	6	126.00	5
WD 615.70	Diesel	9726	6	126.00	5
WD 615.71	Diesel	9726	6	126.00	5
WD 615.73	Diesel	9726	6	126.00	5
WD 615.74	Diesel	9726	6	126.00	5
WD 615.75	Diesel	9726	6	126.00	5
WD 615.77	Diesel	9726	6	126.00	5
WD 615.93	Diesel	9726	6	126.00	5
WD 815.00	Diesel	11964	V8	126.00	6
WD 1015/WD1015	Diesel	14955	10	126.00	6

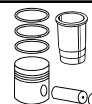
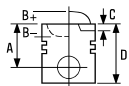

1 100.00

WD 208/WD 208	2 Cyl.	1570cc	22kW (30PS)	Diesel	FM5578
WD 308/WD 308	3 Cyl.	2535cc	34-37kW (40-45PS)	Diesel	FM5579
WD 408/WD 408	4 Cyl.	3142cc		Diesel	FM5580

14-450490-00 WH B 109.40 C 197.00 D 118.00 E 9.00 F 1.10

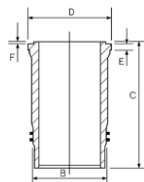

2 100.00

WD 311/WD311	3 Cyl.	2590cc		Diesel	FM6191
WD 411/WD411	4 Cyl.	3465cc		Diesel	FM6192
WD 611/WD611	6 Cyl.	5184cc		Diesel	FM6193

14-451080-00 WH  B 109.40 C 197.00 D 118.00 E 9.00 F 1.10

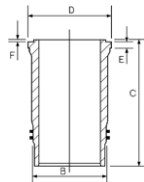

 Water jacket chromed

 Am Wassermantel verchromt

 Chromé sur chambre d'eau

 Camisa de agua cromada

 Superficie cromata

3 105.00

WD 210.40	2 Cyl.	17:1	1996cc	24kW (33PS)	Diesel	FM8854
WD 410.40	4 Cyl.	17:1	3983cc	52kW (71PS)	Diesel	FM8855
WD 610.18	6 Cyl.	17:1	5975cc	81-97kW (110-132PS)	Diesel	TD19048
WD 610.19	6 Cyl.	17:1	5980cc	89-97kW (120-132PS)	Diesel	TD8986
WD 610.20	6 Cyl.	17:1	5975cc	97kW (132PS)	Diesel	TD8975
WD 610.40	6 Cyl.	17:1	5975cc	66-84kW (90-114PS)	Diesel	TD19049
WD 610.42	6 Cyl.	17:1	5975cc	66-84kW (90-114PS)	Diesel	TD19050
WD 610.44	6 Cyl.	17:1	5975cc	66-85kW (90-116PS)	Diesel	TD19051
WD 610.50	6 Cyl.	17:1	5975cc	66-85kW (90-116PS)	Diesel	TD19052

14-027790-00 D B 110.00 C 222.00 D 112.00 E 4.70

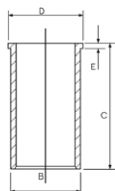

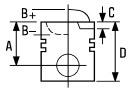





4  **108.00**

WD 612.63	6 Cyl.	16.5:1	6595cc	130-154kW (177-209PS)	Diesel Turbo	TD5881
WD 612.65	6 Cyl.		6595cc	154kW (210PS)	Diesel Turbo Intercooled	TD5882

87-896800-00 STD

- A** 66.90
- B-** 20.15
- BØ** 63.00
- D** 122.40
-  42x90

- 3.00  CK
- 2.50  P
- 4.00  CR P

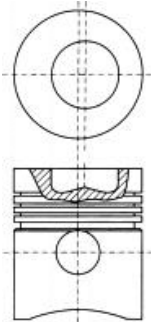



5  **126.00**

WD 615.00	6 Cyl.	16:1	9726cc	148kW (201PS)	Diesel Turbo	TD8990
WD 615.20	6 Cyl.	16:1	9726cc	148kW (201PS)	Diesel Turbo	TD8991
WD 615.60	6 Cyl.	16:1	9726cc	191kW (260PS)	Diesel Turbo	TD8993
WD 615.61	6 Cyl.	16:1	9726cc	191-198kW (260-269PS)	Diesel Turbo	TD8994
WD 615.63	6 Cyl.	16:1	9726cc	204-206kW (278-280PS)	Diesel Turbo Intercooled	TD8962
WD 615.64	6 Cyl.	16:1	9726cc	175-177kW (238-241PS)	Diesel Turbo	TD8960
WD 615.65	6 Cyl.	16:1	9726cc	206kW (280PS)	Diesel Turbo	TD8997
WD 615.67	6 Cyl.	16:1	9726cc	206kW (280PS)	Diesel Turbo	TD5895
WD 615.68	6 Cyl.	16:1	9726cc	225-228kW (306-310PS)	Diesel Turbo Intercooled	TD5883
WD 615.69	6 Cyl.	16:1	9726cc	206kW (280PS)	Diesel Turbo	TD6242
WD 615.70	6 Cyl.	16:1	9726cc	191kW (260PS)	Diesel Turbo	TD8995
WD 615.71	6 Cyl.	16:1	9726cc	191kW (260PS)	Diesel Turbo	TD8996
WD 615.73	6 Cyl.	16:1	9726cc	204kW (278PS)	Diesel Turbo	TD8963
WD 615.74	6 Cyl.	16:1	9726cc	175kW (238PS)	Diesel Turbo	TD8961
WD 615.75	6 Cyl.	16:1	9726cc	206kW (280PS)	Diesel Turbo	TD8998
WD 615.77	6 Cyl.	16:1	9726cc	206kW (280PS)	Diesel Turbo	TD6311
WD 615.93	6 Cyl.	16:1	9726cc	206kW (280PS)	Diesel Turbo	TD9005

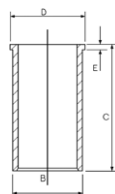
14-028240-00 DH **B 130.00 C 241.00 D 134.30 E 4.75**

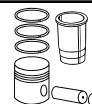
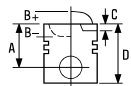



6  **126.00**

WD 1015/WD1015	10 Cyl.	14955cc	Diesel	FM6196
WD 815.00	V8 Cyl. 16:1	11964cc	199kW (270PS)	Diesel Turbo TD8992

14-025420-00 DH **B 132.00 C 241.00 D 136.00 E 7.00**

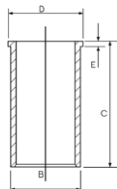







1 69.60

Justy 1.3 TDi 16v 12/03→ **Z 13 DT** 4 Cyl. 18:1
1248cc **51kW (70PS)**
Diesel **Turbo Intercooled** **TD21369**

87-137600-00 STD **08-137600-00** STD
87-137606-00 0.40mm **08-137606-00** 0.40mm

A	40.43	2.00		CK P
B-	12.40	1.50		P
BØ	37.00	2.00		P
C	1.20			
D	63.43			
	23x56			



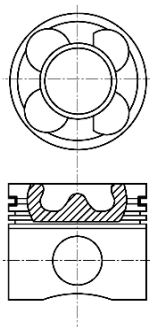



AK RT TP



2 73.00

Trezia 1.4D 03/11→ **1ND-TV** 4 Cyl. 18.5:1
1364cc **55-66kW (75-90PS)**
Diesel **Turbo Intercooled** **TD25016**

87-898407-02 0.50mm **08-898407-00** 0.50mm

A	41.94	1.50		NT 
B-	14.70	1.50		CR P
BØ	36.50	3.00		NT 
C	0.90			
C	0.90			
D	64.35			
	27x59			

KK RT

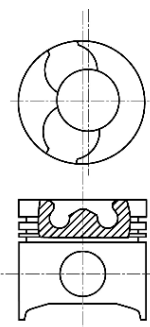





 Steel

 Stahl

 Acier

 Acero

 Acciaio



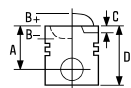

		ccm	x 		
9HX Euro 4	Diesel	1560	4	75.00	4
D19AA	Diesel	1910	4	82.00	6
DHV (XUD9BSD)	Diesel	1905	4	83.00	7
DHW (XUD9SD)	Diesel	1905	4	83.00	7
DW10ATED4 (RHW)	Diesel	1997	4	85.00	9
F10A	Petrol	970	4	65.50	1
K9K 266	Diesel	1461	4	76.00	5
K9K 700	Diesel	1461	4	76.00	5
RHZ	Diesel	1997	4	85.00	10
XUD9	Diesel	1905	4	83.00	8
XUD9A	Diesel	1905	4	83.00	8
XUD9SD	Diesel	1905	4	83.00	7
Z 12 XEP	Petrol	1229	4	73.40	3
Z 13 DT	Diesel	1248	4	69.60	2



1 65.50

Carry 1.0	07/85→03/99	F10A		
Gypsy 1.0	07/06→		4 Cyl.	8.8:1
Samurai 1.0 All-wheel Drive	11/88→12/04		970cc	29-34kW (39-46PS)
SC100 1.0	03/77→12/82			TD3650
Sierra 1.0 All-wheel Drive, SJ 410 1.0	09/81→12/88			
Sierra II All-wheel Drive	12/88→02/00			
SJ 410 1.0	09/81→12/88			
SJ 410 1.0 4WD	09/79→12/85			
Super Carry 1.0	10/85→03/99			

87-960200-00	STD	08-960200-00	STD
87-960207-00	0.50mm	08-960207-00	0.50mm



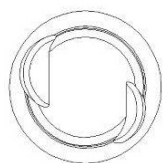
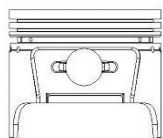

A	24.65	1.50		CR P
B-	2.00	1.50		P
C	5.30	2.80		P
C	4.60			
D	55.00			
	16x50			



2 69.60

Ignis II 1.3 DDiS	09/03→	Z 13 DT		
Swift III 1.3 DDiS	08/05→		4 Cyl.	17.4:1
Wagon R+ 1.3 DDiS	09/03→		1248cc	51kW (69PS)
		Diesel	Turbo Intercooled	TD18265

87-137600-00	STD	08-137600-00	STD
87-137606-00	0.40mm	08-137606-00	0.40mm

A	40.43	2.00		CK P
B-	12.40	1.50		P
BØ	37.00	2.00		P
C	1.20			
D	63.43			
	23x56			

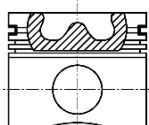
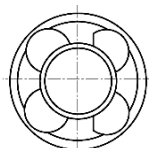

AK RT TP

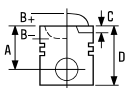









3  **73.40**









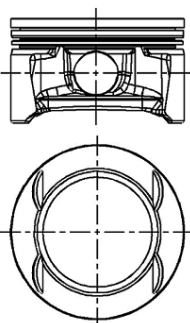

Wagon R 1.2 06/04→08/05 Z 12 XEP 4 Cyl. 10.5:1
 1229cc 59kW (80PS) **TD19903**

87-429500-10  STD 08-429500-00 STD
 87-429507-10  0.50mm 08-429507-00 0.50mm

A 24.00 1.20  NT 
 B+ 0.53 1.20  P
 C 1.46 2.00  CR 
 C 1.49
 D 45.33
 19x50

TP





 Elastoval®  Elastoval®  Elastoval®  Elastoval®  Elastoval®
 Steel  Stahl  Acier  Acero  Acciaio

4  **75.00**

SX4 1.6 DDIS 04/07→ 9HX Euro 4 4 Cyl. 18:1
 1560cc 66kW (90PS)
 Diesel Turbo Intercooled **TD21659**

87-424000-00 STD 08-424000-00 STD 14-020900-00 D B 78.00 C 142.00 D 79.50 F 5.00
 87-424008-00 0.60mm 08-424007-00 0.50mm
 08-424008-00 0.60mm

A 41.70 3.00  CK P
 B- 13.25 1.95  P
 BØ 41.80 2.50  CR P

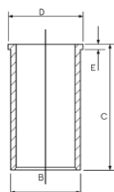

AK KK RT TP

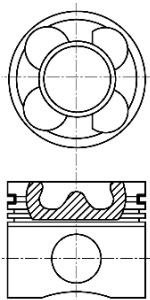

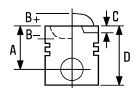





5  **76.00**

Jimny 1.5 DDiS	08/05→	K9K 266	4 Cyl. 1461cc	63kW (86PS)	
		Diesel	Turbo Intercooled		TD24900

Jimny 1.5 DDiS 4WD	12/03→	K9K 700	4 Cyl. 1461cc	18.8:1 48-50kW (65-68PS)	
		Diesel	Turbo Intercooled		TD21367

87-123400-10	STD	08-123400-00	STD	14-020650-00 D	B 79.10 C 142.00 D 81.00 E 5.00
87-123407-10	0.50mm	08-123407-00	0.50mm		

- A** 41.82
- B-** 13.70
- BØ** 39.70
- C** 0.60
- D** 66.05
-  26x60

- 2.00  **CK P**
- 2.00  **P**
- 2.50  **NT**

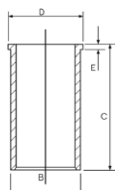

RT TP

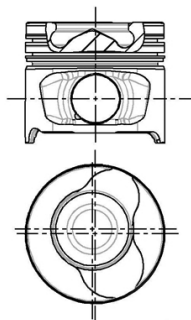





557.503

6  **82.00**

SX4 1.9 DDiS	06/06→	D19AA	4 Cyl. 1910cc	18:1 88kW (120PS)	
		Diesel	Turbo Intercooled		TD20931

87-124000-30	STD	08-124000-00	STD	14-021051-00 D	B 85.57 C 155.00 D 88.53 E 4.00
87-124008-30	0.60mm	08-124006-00	0.40mm	14-028960-00 D	B 85.00 C 155.00 D 88.00 E 4.50
		08-124008-00	0.60mm		

- A** 46.50
- B-** 17.45
- BØ** 37.55
- C** 0.65
- D** 72.50
-  26x61

- 2.00  **CK P**
- 2.00  **P**
- 2.00  **CR P**

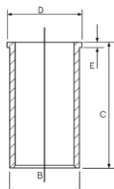

NB RT

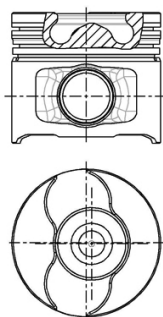

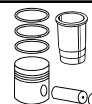
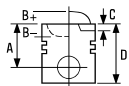



7  **83.00**

Baleno 1.9 TD	04/98→05/02	DHV (XUD9BSD) 4 Cyl. 1905cc	55kW (75PS)	TD30748
		Diesel		
Baleno 1.9 TD	04/98→05/02	DHW (XUD9SD) 4 Cyl. 1905cc	23:1 55kW (75PS)	TD30747
		Diesel		
Vitara 1.9 D Vitara 1.9 D All-wheel Drive	08/96→03/99 08/96→03/98	XUD9SD 4 Cyl. 1905cc	23:1 55kW (75PS)	TD22439
		Diesel		

87-105500-00 STD
87-105507-00 0.50mm
A 46.75
B- 3.50
D 75.00
 28x68

08-105500-00 STD
08-105507-00 0.50mm
08-105510-00 0.80mm

01/97→

3.00  **CK**
 2.00  **NT**
 3.00  **CR P**

14-020530-00 D B 85.60 C 153.50 D 88.50 E 3.90

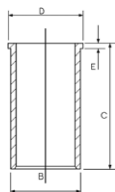

AK HA RT TP

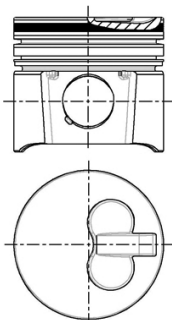



8 83.00

Samurai 1.9 TD	11/98→12/04	XUD9	4 Cyl.	23.5:1	
			1905cc	46-50kW (63-68PS)	
		Diesel	Turbo Intercooled		TD16375

Vitara 1.9 D		XUD9A	4 Cyl.	23:1	
Vitara 1.9 D All-wheel Drive	01/95→03/98		1905cc	50kW (68PS)	
		Diesel			TD5443

87-152000-10	STD	08-152000-00	STD	14-020530-00 D	B 85.60 C 153.50 D 88.50 E 3.90	88-152000-30
87-152007-10	0.50mm	08-152003-00	0.125mm			87-152000-10 + 14-020530-00
87-152010-10	0.80mm	08-152007-00	0.50mm			
		08-152010-00	0.80mm			
		08-152011-00	1.00mm			

A	46.80
B-	2.20
D	84.30
	25x72

2.00		CR P
2.00		P
3.00		CR P

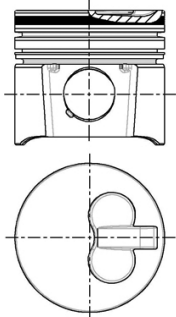

9 85.00

Grand Vitara I 2.0 HDI 110 16V	07/01→09/05	DW10ATED4 (RHW)	4 Cyl.	17.6:1	
Grand Vitara II 2.0 HDi All-wheel Drive	01/06→02/15		1997cc	80kW (109PS)	
		Diesel	Turbo Intercooled		TD18270

87-114700-10	STD	08-114700-00	STD		
87-114708-10	0.60mm	08-114708-00	0.60mm		
A	46.73	3.50		CK P	
B-	18.80	2.00		P	
BØ	39.80	3.00		CR P	
C	1.67				
D	72.70				
	28x68				

AK KK RT TP

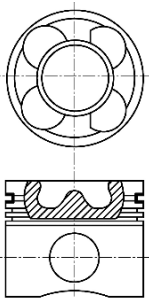

08517-103

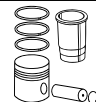
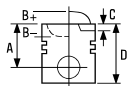





10  **85.00**

Grand Vitara I 2.0 HDI 110 07/01→09/05 **RHZ** 4 Cyl. 17.6:1
 1997cc **80kW (109PS)**
Diesel **Turbo Intercooled** **TD19715**

87-114700-00 STD
87-114708-00 0.60mm





08-114700-00 STD
08-114708-00 0.60mm

- A** 46.75
- B-** 18.30
- BØ** 38.00
- C** 1.00
- D** 80.75
-  28x70

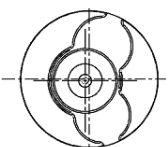
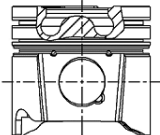
- 3.50  CK P
- 2.00  P
- 3.00  CR P

AK RT TP



		ccm	x 		
CRD93	Diesel	2498	4	93.00	6
M25/648	Diesel	2500	4	93.00	7
U25/651	Diesel	2500	4	93.00	8
U25/673	Diesel	2500	4	93.00	7
XD2	Diesel	2304	4	94.00	9
XD2S (U8)	Diesel	2288	4	94.00	9
XM7T	Petrol	1796	4	84.00	4
XN1TA	Petrol	1971	4	88.00	5
XUD9	Diesel	1905	4	83.00	3
XUD9A	Diesel	1905	4	83.00	3
XW7	Petrol	1124	4	72.00	1
XY8	Petrol	1360	4	75.00	2



1 72.00

Samba 1.1	01/81→06/86	XW7	4 Cyl. 1124cc	10.2:1 37kW (50PS)	TD4927
-----------	-------------	------------	-------------------------	------------------------------	---------------

14-636470-00 WH B 79.50 C 122.00 D 89.20 E 85.00

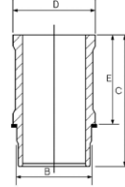

2 75.00

Samba 1.4	01/81→06/86	XY8	4 Cyl. 1360cc	9.3:1 53-58kW (72-79PS)	TD4929
Samba 1.4 Rallye	01/83→10/86				

14-636600-00 WH B 79.50 C 134.50 D 89.20 E 90.00

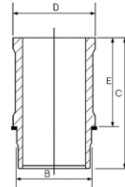



3 83.00

Horizon 1.9 Diesel	07/82→06/86	XUD9	4 Cyl. 1905cc	23.5:1 47-48kW (64-65PS)	TD4924
		Diesel			
Express 1000 -1500 1.9 D	07/87→10/90	XUD9A	4 Cyl. 1905cc	23:1 51kW (69PS)	TD9014
Express 1000 -1800 1.9 D					

87-152000-10 STD
87-152007-10 0.50mm
87-152010-10 0.80mm

A 46.80
B- 2.20
D 84.30
 25x72

08-152000-00 STD
08-152003-00 0.125mm
08-152007-00 0.50mm
08-152010-00 0.80mm
08-152011-00 1.00mm

2.00  CR P
 2.00  P
 3.00  CR P

14-020530-00 D B 85.60 C 153.50 D 88.50 E 3.90

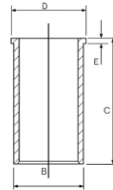

88-152000-30
 87-152000-10 +
 14-020530-00

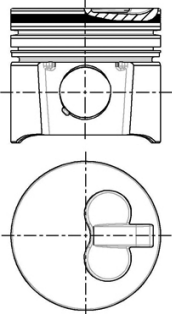



4 84.00

Express 1000 -1500 1.8
Express 1000 -1800 1.8

07/83→10/90 **XM7T**
07/81→10/90

4 Cyl.
1796cc

7.5:1
50-51kW (68-69PS)



TD9013

②

A 38.00
D 71.30
 23x70

08-315300-00
08-315307-00

STD
0.50mm

1.50 
2.00 
4.00 

CR P
P
CR ③

14-606670-00 WH ① **B** 93.00 **C** 136.20 **D** 99.20 **E** 90.01

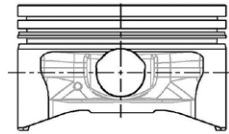
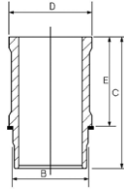

① Use also: 1 NB O-Ring HR566

① Mitverwenden: 1 NB O-Ring HR566

① A utiliser aussi: 1 joint toriques HR566

① Utilizar también: 1 NB junta toricas HR566

① Usare anche: 1 NB O-Ring HR566

② Piston available in Kit Set only

② Kolben nur im Assembly erhältlich

② Piston disponible en kit seulement

② Pistón disponible en conjuntos solamente

② I pistoni sono disponibili solo in kit motore

③ Steel

③ Stahl

③ Acier

③ Acero

③ Acciaio

5 88.00

Express 1000 -1500 2.0
Express 1000 -1800 2.0

07/82→10/94 **XN1TA**
07/82→10/90

4 Cyl.
1971cc

8:1
55-69kW (75-94PS)



TD9015

①

A 38.25
B+ 0.65
D 71.85
 23x74

08-316900-00
08-316907-00

STD
0.50mm

1.50 
2.00 
4.00 

CR P
P
CR ②

14-636500-00 WH ① **B** 93.00 **C** 135.70 **D** 101.90 **E** 89.98

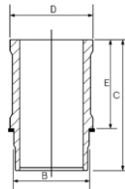



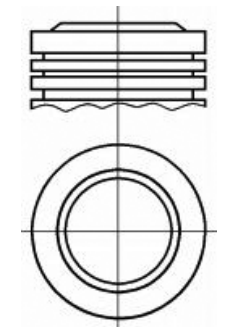

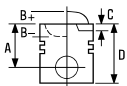
89-316900-00





1 **08-316900-00** STD **14-636500-00 WH** **B 93.00 C 135.70 D 101.90 E 89.98** **89-316900-10**
08-316907-00 0.50mm

A 37.90
B+ 1.35
D 72.20
 23x74

1.50  CR P
 2.00  P
 4.00  CR 2

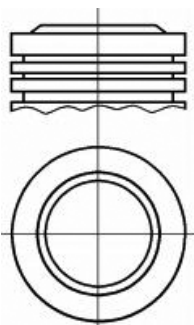
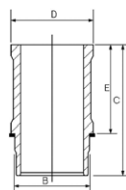





1 Piston available in Kit Set only 1 Kolben nur im Assembly erhältlich 1 Piston disponible en kit seulement 1 Pistón disponible en conjuntos solamente. 1 I pistoni sono disponibili solo in kit motore
2 Steel 2 Stahl 2 Acier 2 Acero 2 Acciaio

6 93.00

Express 1000 -1500 2.5 D	07/82→10/94	CRD93		
Express 1000 -1500 2.5 D All-wheel Drive	11/88→10/94		4 Cyl.	22.2:1
Express 1000 -1800 2.5 D	07/82→10/94		2498cc	54-55kW (73-75PS)
Express 1000 -1800 2.5 D All-wheel Drive	11/88→10/94	Diesel		TD9017

87-152700-00 STD **08-152700-00** STD **14-013481-00 D** **B 96.10 C 163.00**
87-152707-00 0.50mm **08-152707-00** 0.50mm

A 52.75
B- 7.30
D 87.75
 30x78

08/84→
 2.50  MOL P
 2.00  P
 4.00  CR P

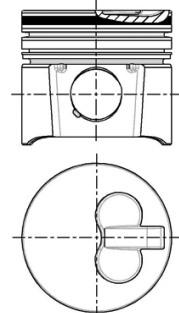
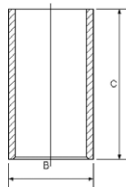



7 93.00

Express 290, Express 310, Express 350	01/90→12/94	M25/648			
Express 1400	01/89→12/90		4 Cyl.	21:1	
Express Sportsman	01/90→12/94		2500cc	70kW (95PS)	
		Diesel	Turbo		FM4338
Express	01/87→12/90	U25/673			
Express 290, Express 310, Express 350	01/90→		4 Cyl.	22.5:1	
Express Sportsman			2500cc	70kW (95PS)	
		Diesel	Turbo		FM3909

14-013481-00 D B 96.10 C 163.00

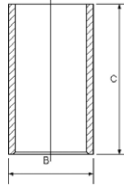

8 93.00

Express	01/82→	U25/651			
Express 290, Express 310, Express 350	01/90→		4 Cyl.	22.5:1	
Express Sportsman			2500cc	52kW (71PS)	
		Diesel			FM1427

14-013481-00 D B 96.10 C 163.00

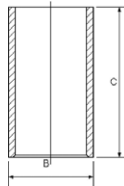



87-152700-00 STD
87-152707-00 0.50mm

08-152700-00 STD
08-152707-00 0.50mm

A 52.75
B- 7.30
D 87.75
 30x78

08/84→

2.50  MOL P
2.00  P
4.00  CR P

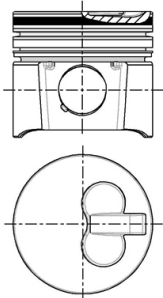



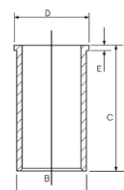

9 94.00

		XD2			
			4 Cyl.	22.2:1	
			2304cc	44-53kW (60-72PS)	
		Diesel			TD21365
Tagora 2.3TD	08/81→12/87	XD2S (U8)			
			4 Cyl.	21:1	
			2288cc	54-59kW (73-80PS)	
		Diesel	Turbo		TD5288

14-020660-00 D B 97.00 C 170.60 D 99.50 E 4.00
14-021520-00 D B 98.00 C 170.60 D 100.00 E 6.00



		ccm	x 		9
11B	Petrol	2977	4	95.00	10
13B	Diesel	3432	4	102.00	14
13BT	Diesel	3431	4	102.00	14
1CD-FTV	Diesel	1995	4	82.20	6
1KD-FTV	Diesel	2982	4	96.00	12
1ND-TV	Diesel	1364	4	73.00	2
2E	Petrol	1296	4	73.00	1
2E-E	Petrol	1296	4	73.00	1
2E-L	Petrol	1296	4	73.00	1
2E-LC	Petrol	1295	4	73.00	1
2J	Diesel	2449	4	88.00	7
2L	Diesel	2446	4	92.00	8
2L-T	Diesel	2446	4	92.00	9
2L-TE	Diesel	2446	4	92.00	9
2L-TII	Diesel	2446	4	92.00	9
2WZ-TV	Diesel	1398	4	73.70	3
3B	Diesel	3432	4	102.00	14
3L	Diesel	2779	4	96.00	13
3WZ-TV	Diesel	1560	4	75.00	4
3ZZ-FE	Petrol	1598	4	79.00	5
B	Diesel	2977	4	95.00	11
H	Diesel	3576	6	88.00	7



1 73.00

Conquest 1.3	01/95→12/99	2E			
Corolla 1.3	08/83→10/01		4 Cyl.	9:1	
Corolla 1.3 I	08/87→12/92		1296cc	48-60kW (65-82PS)	
Corolla FX 1.3	10/84→04/87				TD4935
Corolla Liftback 1.3	08/83→04/92				
Corolla Liftback 1.3 i	08/87→05/95				
Corolla Wagon 1.3 12V	07/92→05/95				
Sprinter 1.3	08/87→04/92				
Starlet 1.3	04/96→07/99				
Starlet 1.3 XL	12/89→12/91				
Tazz 1.3	04/96→07/06				

Corolla 1.3 I	08/87→12/92	2E-E			
Corolla Liftback 1.3 i	08/87→04/92		4 Cyl.	9.5:1	
Sprinter 1.3			1296cc	55kW (75PS)	
Starlet 1.3 12V	12/89→03/96				TD4936

Corolla 1.3	10/84→08/87	2E-L			
Corolla FX 1.3	08/85→08/87		4 Cyl.	9.5:1	
Corolla Liftback 1.3	01/85→08/87		1296cc	55-60kW (75-82PS)	
Sprinter 1.3	06/83→07/87				TD4937

Corolla 1.3	10/84→08/87	2E-LC			
Corolla Liftback 1.3	01/85→08/87		4 Cyl.	9:1	
Starlet 1.3	10/84→12/89		1295cc	52-55kW (71-75PS)	
					TD3756

87-374407-00

0.50mm





- A 30.00
- B- 9.20
- C 5.00
- D 58.00
-  18x59

08-374400-00

STD

08-374407-00

0.50mm

- 1.50  CR P
- 1.50  P
- 3.00  CR 

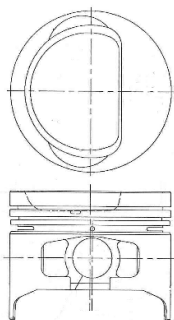

 Steel

 Stahl

 Acier

 Acero



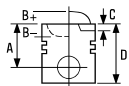



 Acciaio



2 73.00

Auris 1.4 D-4D	03/07→	1ND-TV		
Auris Sports 1.4 D-4D	07/13→		4 Cyl.	18.5:1
Corolla 1.4 D, Corolla 1.4 D4-D	07/04→02/07		1364cc	50-66kW (68-90PS)
Corolla Verso 1.4 D-4D	03/04→03/09	Diesel	Turbo Intercooled	TD16378
Echo 1.4 D4d	01/00→03/03			
Etios 1.4 D-4D	09/11→			
IQ 1.4 D-4D	01/09→			
Probox/Succeed 1.4 D-4D	07/02→			
Urban Cruiser 1.4 D-4D	04/09→			
Verso S 1.4 D4-D	11/10→			
Yaris 1.4 D-4D	12/01→			
Yaris Verso 1.4 D-4D	12/01→09/05			

87-424100-00	STD	08-424100-00	STD
87-424107-00	0.50mm	08-424107-00	0.50mm

A	41.94	1.50		NT 
B-	14.70	1.50		CR P
BØ	36.50	3.00		NT 
C	0.90			
C	0.90			
D	64.35			
	27x59			

KK RT

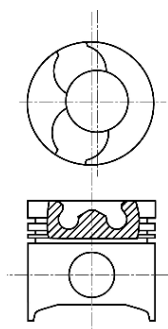

 Steel

 Stahl

 Acier

 Acero

 Acciaio





3 73.70

Aygo 1.4 Hdi	07/05 → 08/10	2WZ-TV	4 Cyl. 1398cc	17.9:1 40kW (54PS)	
Diesel					TD24605

87-135300-00	STD	08-135300-00	STD	14-020760-00 D	B 76.70 C 136.00 D 78.20 E 5.00
87-135305-00	0.25mm	08-135305-00	0.25mm	14-020761-00 D	B 76.95 C 136.00 D 78.45 E 5.25
87-135307-00	0.50mm	08-135307-00	0.50mm		

A	42.94
B-	14.70
BØ	37.16
C	1.55
D	65.44
	25x60

2.50		CK P
1.95		P
2.50		CR P

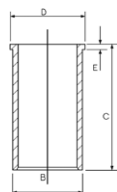

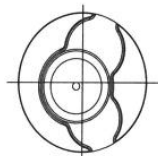
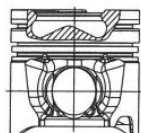

AK RT TP



4 75.00

Proace 1.6 D-4D	06/13 →	3WZ-TV	4 Cyl. 1560cc	66kW (90PS)	
Diesel					TD28203
Turbo Intercooled					

87-433600-00	STD	08-433600-00	STD
87-433607-00	0.50mm	08-433607-00	0.50mm

A	41.75	2.50		CK P
B-	13.85	1.95		P
BØ	45.00	2.00		CR P

D	65.20
	26x61



AK KK RT TP

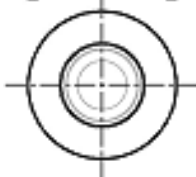
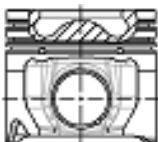







5 79.00

Avensis 1.6 VVT-i	10/00→11/08	3ZZ-FE		
Avensis Liftback 1.6 VVT-i	10/00→02/03		4 Cyl.	10.5:1
Conquest 1.6	01/96→12/99		1598cc	80-81kW (109-110PS)
Corolla 1.6	02/00→01/02			TD14229
Corolla 1.6 CNG	08/07→			
Corolla 1.6 VVT-i	01/02→			
Corolla Liftback 1.6	02/00→01/02			
Corolla Verso 1.6 VVT-i	01/02→03/09			
Corolla Wagon 1.6 16V	02/00→10/01			

87-426700-00	STD	08-426700-00	STD
87-426707-00	0.50mm	08-426707-00	0.50mm

A	32.20	1.20		NT 1
B-	3.80	1.20		P
D	52.20	3.00		NT 1
	20x50			

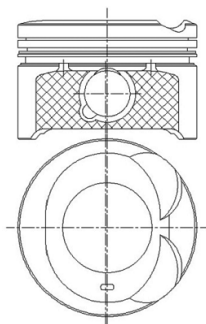

1 Steel

1 Stahl

1 Acier

1 Acero

1 Acciaio

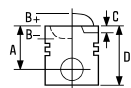

6 82.20

Avensis 2.0 D-4D	10/99→11/08	1CD-FTV		
Avensis Liftback 2.0 D-4D	10/99→02/03		4 Cyl.	17.8:1
Avensis Verso 2.0 D-4D	08/01→08/05		1995cc	66-85kW (90-116PS)
Corolla 2.0 D-4D	08/00→07/07	Diesel	Turbo Intercooled	TD15191
Corolla Liftback 2.0 D-4D	09/00→01/02			
Corolla Verso 2.0 D-4D	09/01→03/09			
Corolla Wagon 2.0 D-4D	04/97→10/01			
Previa 2.0 D-4D	03/01→01/06			
RAV 4 II 2.0 D-4D 4WD	09/01→11/05			

87-426600-00

STD

08-426600-00

STD

08-426607-00

0.50mm

A 47.90

B- 17.50

BØ 36.10

C 0.96

C 0.64

D 74.90

 31x67

2.00

1.50

3.00



CR 

NT 

NT 

AK KK RT TP

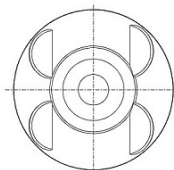
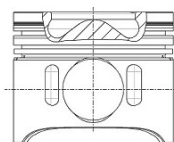

 Steel

 Stahl

 Acier

 Acero

 Acciaio

7 88.00

Dyna 2.4 D	08/77→08/87	2J		
			4 Cyl.	21:1
			2449cc	55kW (75PS)
		Diesel		TD3759
Land Cruiser 3.6 D	01/75→07/80	H		
			6 Cyl.	20.5:1
			3576cc	66kW (90PS)
		Diesel		TD15729

14-040160-00 D

B 93.05 C 183.67 D 97.79 E 2.50 F 1.25

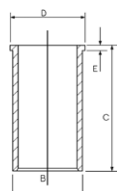

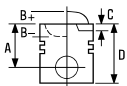

8  **92.00**

4 Runner 2.4 D	07/84→05/88	2L			
Chaser 2.4 D	10/92→08/96		4 Cyl.	22.3:1	
Cresta 2.4 D	09/88→10/96		2446cc	53-63kW (72-86PS)	
Dyna 2.4 D	08/77→07/01	Diesel			TD4938
Hiace II 2.4 D	05/84→11/89				
Hiace II Wagon 2.4 D	08/84→08/89				
Hiace III 2.4 D	09/89→08/95				
Hiace III 2.4 D 4WD	08/89→08/95				
Hiace III Wagon 2.4 D	08/89→08/95				
Hiace IV 2.4 D	08/95→08/06				
Hilux II 2.4 D	01/84→07/05				
Mark II 2.4 D	04/88→09/96				
Kijang 2.4 D	08/89→12/00				
Kijang Innova 2.4 D	08/04→				
Land Cruiser 2.4 D	11/84→10/85				
Qualis 2.4 D	01/99→10/04				
Stallion 2.4 D	08/99→05/05				
Tamaraw FX 2.4 D	01/99→10/04				
Town Ace 2.4 D	04/85→12/91				
TUV 2.4 D	12/96→07/07				

87-373800-00
87-373807-00

STD
0.50mm



08-373800-00
08-373807-00

STD
0.50mm

14-040130-00 D **B 96.00 C 160.00 D 100.80 E 3.50 F 1.00**

→08/88

A 49.20
B- 1.60
D 86.25
 27x74

2.00  CR P
2.00  P
4.00  CR P

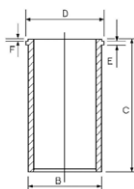

AK

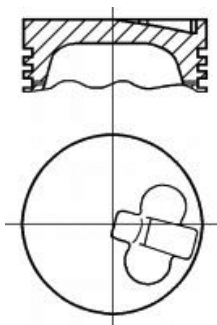



87-373800-10

STD

08-373800-00
08-373807-00

STD

0.50mm

14-010850-00 D

B 96.07 C 179.00

88-373800-10

09/88 →

87-373800-10 +
14-010850-00

09/88 →

A 44.30

B- 1.50

D 80.30

27x70

2.00

2.00

4.00



CR P

P

CR P

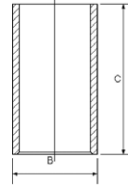

AK TP

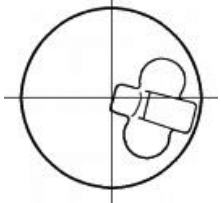

9 **92.00**

4 Runner 2.4 TD	08/89 → 11/95	2L-T			
Cressida 2.4 TD	01/85 → 10/88		4 Cyl.	21:1	
Hiace IV 2.4 TD, Hiace IV 2.4 TD 4WD	08/95 → 08/06		2446cc	63-92kW (85-125PS)	
Hilux Closed Off-Road Vehicle 2.4 TD 4WD	08/88 → 07/01	Diesel	Turbo Intercooled		TD3767
Hilux II 2.4 TD 4WD	08/98 → 01/02				
Land Cruiser 2.4 TD	10/85 → 05/96				
Crown 2.4 TD	08/94 → 07/02	2L-TE			
Hilux Closed Off-Road Vehicle 2.4 TD 4WD	08/89 → 11/95		4 Cyl.	22:1	
Mark II 2.4 TD	11/84 → 09/96		2446cc	66-71kW (90-97PS)	
		Diesel	Turbo Intercooled		TD24627
Blizzard 2.5 TD	10/86 → 10/95	2L-TII			
Chaser 2.4 TD	10/92 → 08/96		4 Cyl.	22.1:1	
Cressida 2.4 TD	11/84 → 01/93		2446cc	60-71kW (82-97PS)	
Mark II 2.4 TD	08/81 → 09/96	Diesel	Turbo Intercooled		TD21259

14-010850-00 D

B 96.07 C 179.00

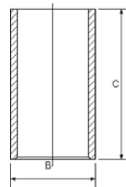

14-040130-00 D

B 96.00 C 160.00 D 100.80 E 3.50 F 1.00

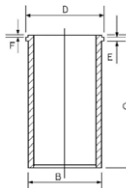



10  **95.00**

Dyna 200 3.0 D

08/88→05/95 **11B**

4 Cyl.
2977cc

21:1
61-75kW (83-102PS)

TD3703

14-040150-00 D

B 102.00 C 190.22 D 107.75 E 2.55 F 1.20

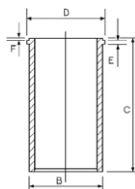

11  **95.00**

Land Cruiser 3.0 D

02/74→10/84 **B**

4 Cyl.
2977cc

21:1
59-63kW (80-86PS)

TD9039

Diesel



87-526300-00  **STD**

08-526300-00 **STD**

14-040150-00 D

B 102.00 C 190.22 D 107.75 E 2.55 F 1.20

A 52.20
B- 2.50
D 101.20
 29x79

2.50  **CR**
2.50  **CR**
4.50  **CR**

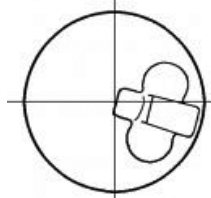
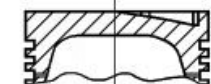
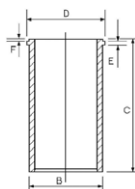

 Pistons to be replaced in Engine Sets only

 Kolben nur Motorsätzen zu ersetzen

 Piston à remplacer dans jeu moteur

 Pistones de repuesto para juegos de motores solamente

 Il pistone può essere rimpiazzato solamente completo

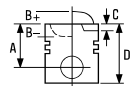

12  **96.00**

Dyna 3.0 D4d	08/01→	1KD-FTV		
Fortuner 3.0 D 4WD	06/04→05/15		4 Cyl.	18.4:1
Hiace/Commuter V 3.0 D, Hiace V 3.0 D	01/05→		2982cc	75-145kW (102-197PS)
Hilux III 3.0 D-4D 4WD	12/07→	Diesel	Turbo Intercooled	TD15208
Hilux III 3.0 D 4WD	02/05→			
Land Cruiser 3.0 D-4D	09/02→07/09			
Land Cruiser 90 3.0 D-4D	02/00→			
Land Cruiser 150 3.0 D-4D	01/10→			
Regiusace 3.0 D-4D	08/04→			

87-422400-00	STD	08-422400-00	STD
87-422407-00	0.50mm	08-422407-00	0.50mm

A	49.60	2.00		NT
B-	16.30	1.50		NT
C	0.55	3.00		NT

D 78.50
 34x73

AK KK RT TP

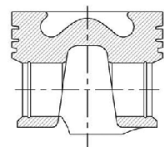
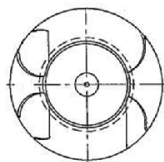

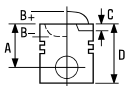

13 **96.00**

4 Runner 2.8 D	05/88→03/96	3L				
Dyna 150 2.8 D	08/88→08/98		4 Cyl.			
Hiace III 2.8 D, Hiace III Wagon 2.8 D	08/89→08/00		2779cc		58-66kW (79-90PS)	
Hilux Closed Off-Road Vehicle 2.8 D	08/95→08/98	Diesel				TD3796
Hilux II 2.8 D 4WD	10/88→07/05					
Kijang 2.7 D	09/93→08/00					
Land Cruiser 2.7 TD	01/90→08/01					
Town Ace 2.8 D	05/95→09/01					

87-528800-00 STD
87-528807-00 0.50mm

08-528800-00 STD
08-528807-00 0.50mm

A 42.35
B- 2.10
D 80.10
 29x75

2.00 CR
2.00 CR
4.00 CR

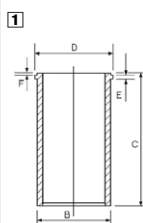

B 100.00 C 190.00 D 107.50 E 2.50 F 1.20

88-528800-00
87-528800-00

AK RT TP

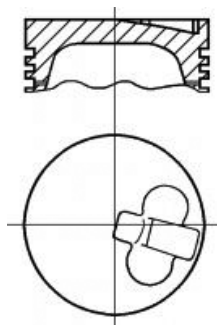

Liner available in Kit Set only

Zylinderlaufbüchse nur in Assemblies verfügbar

Chemise disponible en kit seulement

Camisas disponible en conjuntos solamente

Cilindro disponibile solo in kit motore

14 **102.00**

Dyna 150 3.4 D	09/88→06/95	3B				
Dyna 200 3.4 D	10/92→05/99		4 Cyl.	20:1		
Dyna 300 3.4 D	06/95→05/99		3432cc		66-72kW (90-98PS)	
Land Cruiser 3.4 D	08/80→12/96	Diesel				TD3789
Land Cruiser 80 3.4 D	01/90→12/96					

Dyna 3.4 D	08/77→08/87	13B				
			4 Cyl.	20:1		
			3432cc		66kW (90PS)	
		Diesel				TD3706

Land Cruiser 3.4 TD	10/85→08/86	13BT				
			4 Cyl.			
			3431cc		91kW (124PS)	
		Diesel	Turbo Intercooled			TD3707

14-040140-00 D

B 106.00 C 190.26 D 111.65 E 2.51 F 1.19

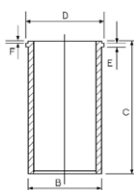

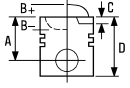

1 74.70

TR6 2.5

01/72→12/76 CF1



6 Cyl.
2498cc

83-90kW (113-122PS)

TD18385

87-525700-00	STD	08-525700-00	STD
87-525707-00	.020	08-525707-00	.020
87-525709-00	.030	08-525709-00	.030
87-525711-00	.040	08-525711-00	.040

A 29.03
D 61.98
 21x62

1.58 
1.58 
4.00  CR

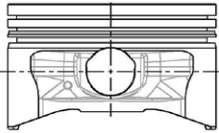

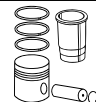
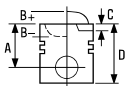

1 70.99



TR6 Trophy
T110 Tiger
T120 Bonneville

2 Cyl. 9-10.75:1
649cc

FM11720

87-525400-00	STD	08-525400-00	STD
87-525407-00	.020	08-525407-00	.020
87-525411-00	.040	08-525411-00	.040
87-525414-00	.060	08-525414-00	.060

A 41.78
D 75.02
 18x50

1.59  P
1.59  P
3.17  P

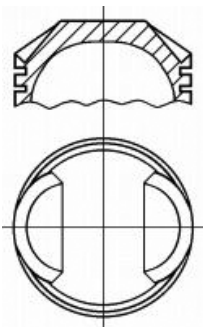

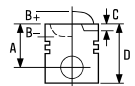





1  **88.00**

Patriot 2.3D 06/06 → **F1AE0481A Euro 3**
 4 Cyl.
2287cc **85kW (116PS)**
Diesel **TD26962**

- | | | | |
|---------------------|--------|---------------------|--------|
| 87-138000-00 | STD | 08-138000-00 | STD |
| 87-138006-00 | 0.40mm | 08-138006-00 | 0.40mm |
| 87-138008-00 | 0.60mm | 08-138008-00 | 0.60mm |

- | | | | |
|--|-------|------|--|
| A | 57.00 | 2.50 |  CK P |
| B- | 18.18 | 2.00 |  P |
| BØ | 38.00 | 2.50 |  CR P |
| D | 84.00 | | |
|  | 31x67 | | |

AK RT TP

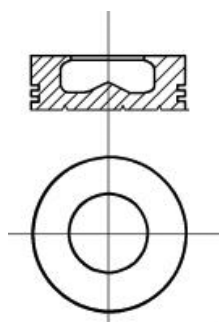

2  **92.00**

2.4TD 4 Cyl.
2400cc
Diesel **FM6199**

14-676420-00 WH B 101.50 C 166.80 D 110.00 E 8.90 F 1.20

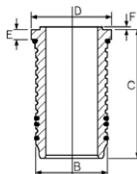

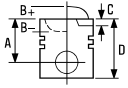



1  **108.00**

D113 **4 Cyl.** **Diesel** **FM5581**

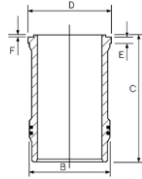
14-260500-00 WH  **B 125.00 C 258.00 D 132.00 E 10.10 F 1.30**







 Phosphated





 Phosphated

 Phosphated

 Phosphated

 Phosphated

		ccm	x 		9
12 S	Petrol	1196	4	79.00	15
13 S	Petrol	1297	4	75.00	10
13 SB	Petrol	1297	4	75.00	10
14 NV	Petrol	1389	4	77.60	12
15 D	Diesel	1488	4	76.00	11
15 DT	Diesel	1488	4	76.00	11
15 DT (T4EC1)	Diesel	1488	4	76.00	11
16 D	Diesel	1598	4	80.00	28
16 DA	Diesel	1598	4	80.00	28
16 SH	Petrol	1598	4	80.00	27
16 SV	Petrol	1598	4	79.00	16
17 D	Diesel	1699	4	82.50	37
17 D (4EE1)	Diesel	1686	4	79.00	24
17 DR	Diesel	1699	4	82.50	37
17 DT (TC4EE1)	Diesel	1686	4	79.00	25
18 SE	Petrol	1796	4	84.80	46
18 SEH	Petrol	1796	4	84.80	46
18 SV	Petrol	1796	4	84.80	46
20 NE	Petrol	1998	4	86.00	48
20 XE	Petrol	1998	4	86.00	49
23 D	Diesel	2260	4	92.00	55
23 DTR	Diesel	2260	4	92.00	55
23 TD	Diesel	2260	4	92.00	55
23 YD	Diesel	2260	4	92.00	55
23 YDT	Diesel	2260	4	92.00	55
25TDS (VM41B)	Diesel	2499	4	92.00	56
8140.23.2585/3700/8140.43.2585/3700/3900 Sofim	Diesel	2800	4	94.40	58
A 14 NET Euro 5	Petrol	1364	4	72.50	4
A 14 XER	Petrol	1398	4	73.40	7
A 16 LET Euro 5	Petrol	1598	4	79.00	17
A 20 DTC Euro 5	Diesel	1956	4	83.00	39
A 20 DT Euro 5	Diesel	1956	4	83.00	39
A 20 DTH Euro 5	Diesel	1956	4	83.00	39
A 20 DTJ Euro 5	Diesel	1956	4	83.00	39
A 20 DTL Euro 5	Diesel	1956	4	83.00	39
C 13 N	Petrol	1297	4	75.00	10
C 14 NZ	Petrol	1389	4	77.60	12
C 14 SEL	Petrol	1389	4	77.60	13
C 16 NZ	Petrol	1598	4	79.00	18
C 16 SE	Petrol	1598	4	79.00	16
C 16 XE Ecotec	Petrol	1598	4	79.00	19
C 18 XE	Petrol	1796	4	81.60	33
C 18 XEL	Petrol	1796	4	81.60	33
C 20 NE	Petrol	1998	4	86.00	48
C 20 XE	Petrol	1998	4	86.00	49
C 25 XE	Petrol	2498	V6	81.60	34
C 223	Diesel	2238	4	88.00	53
E 16 NZ	Petrol	1598	4	79.00	18
E 16 SE	Petrol	1598	4	79.00	16
F8Q 606	Diesel	1870	4	80.00	29
F9Q 760	Diesel	1870	4	80.00	30
F9Q 762	Diesel	1870	4	80.00	30
F9Q 770	Diesel	1870	4	80.00	30
F9Q 772	Diesel	1870	4	80.00	30
F9Q 774	Diesel	1870	4	80.00	30
F 10 A	Petrol	970	4	65.50	1
G9T 720	Diesel	2188	4	87.00	52
G9T 722	Diesel	2188	4	87.00	52
G9T 750	Diesel	2188	4	87.00	52
G9U 720 Euro 3	Diesel	2463	4	89.00	54
G9U 724 Euro 3	Diesel	2463	4	89.00	54
G9U 730 Euro 3	Diesel	2463	4	89.00	54
G9U 750 Euro 3	Diesel	2463	4	89.00	54
G9U 754 Euro 3	Diesel	2463	4	89.00	54
X 10 XE	Petrol	973	3	72.50	5
X 12 XE	Petrol	1199	4	72.50	6
X 14 SZ	Petrol	1389	4	77.60	12
X 14 XE Ecotec	Petrol	1389	4	77.60	13
X 15 DT (T4EC1)	Diesel	1488	4	76.00	11





		ccm	x 		9
X 16 SZ	Petrol	1598	4	79.00	18
X 16 SZR	Petrol	1598	4	79.00	20
X 16 XE Ecotec	Petrol	1598	4	79.00	19
X 16 XEL Ecotec	Petrol	1598	4	79.00	19
X 17 D (4EE1)	Diesel	1686	4	79.00	24
X 17 DT (TC4EE1)	Diesel	1686	4	79.00	25
X 17 DTL	Diesel	1699	4	82.50	38
X 18 XE	Petrol	1796	4	81.60	33
X 18 XE1 Ecotec	Petrol	1796	4	80.50	32
X 20 DTH	Diesel	1995	4	84.00	42
X 20 DTL	Diesel	1995	4	84.00	43
X 20 XEV Ecotec	Petrol	1998	4	86.00	50
X 22 DTH	Diesel	2172	4	84.00	44
X 25 DT	Diesel	2497	6	80.00	31
X 25 TD	Diesel	2498	6	80.00	31
X 25 XE	Petrol	2498	V6	81.60	34
M9R 630	Diesel	1995	4	84.00	40
M9R 780 Euro 4	Diesel	1995	4	84.00	41
M9R 782	Diesel	1995	4	84.00	41
M9R 786 Euro 4	Diesel	1995	4	84.00	41
M9T 670 Euro 5	Diesel	2298	4	85.00	47
M9T 672 Euro 5	Diesel	2298	4	85.00	47
M9T 676 Euro 4	Diesel	2298	4	85.00	47
M9T 678	Diesel	2298	4	85.00	47
M9T 680	Diesel	2298	4	85.00	47
M9T 686 Euro 5	Diesel	2298	4	85.00	47
M9T 690 Euro 5	Diesel	2298	4	85.00	47
M9T 692 Euro 4	Diesel	2298	4	85.00	47
M9T 694 Euro 4	Diesel	2298	4	85.00	47
M9T 696 Euro 4	Diesel	2298	4	85.00	47
M9T 698 Euro 5	Diesel	2298	4	85.00	47
M9T 700	Diesel	2298	4	85.00	47
M9T 702	Diesel	2298	4	85.00	47
M9T 870	Diesel	2298	4	85.00	47
M9T 876	Diesel	2299	4	85.00	47
M9T 880	Diesel	2298	4	85.00	47
S8U 758	Diesel	2499	4	93.00	57
S8U 780	Diesel	2499	4	93.00	57
S8U 782	Diesel	2499	4	93.00	57
S9W 700	Diesel	2799	4	94.40	58
S9W 702	Diesel	2799	4	94.40	58
Y 16 XE Ecotec	Petrol	1598	4	79.00	21
Y 17 DT	Diesel	1686	4	79.00	26
Y 17 DTL	Diesel	1686	4	79.00	26
Y 20 DTH	Diesel	1995	4	84.00	45
Y 20 DTL	Diesel	1995	4	84.00	43
Y 22 DTH	Diesel	2172	4	84.00	44
Y 22 DTR	Diesel	2172	4	84.00	44
Z 10 XE	Petrol	973	3	72.50	5
Z 12 XE Ecotec	Petrol	1199	4	72.50	6
Z 12 XEP	Petrol	1229	4	73.40	8
Z 13 DT Euro 4	Diesel	1248	4	69.60	2
Z 13 DTH	Diesel	1248	4	69.60	3
Z 14 XE Ecotec	Petrol	1389	4	77.60	14
Z 14 XEP EcoTec	Petrol	1364	4	73.40	9
Z 16 SE	Petrol	1598	4	79.00	21
Z 16 XE Ecotec	Petrol	1598	4	79.00	21
Z 16 XEP	Petrol	1598	4	79.00	22
Z 16 XER	Petrol	1598	4	79.00	23
Z 18 XE Ecotec	Petrol	1799	4	80.50	32
Z 18 XEL Ecotec	Petrol	1796	4	80.50	32
Z 19 DT	Diesel	1910	4	82.00	35
Z 19 DTH Euro 4	Diesel	1910	4	82.00	36
Z 19 DTJ	Diesel	1910	4	82.00	36
Z 19 DTL Euro 4	Diesel	1910	4	82.00	35
Z 20 DTJ	Diesel	1956	4	83.00	39
Z 22 SE Ecotec	Petrol	2198	4	86.00	51



1 65.50

Rascal 1.0	07/86→08/93	F 10 A	4 Cyl.	8.7:1
			970cc	34kW (46PS)
TD29536				

87-960200-00	STD	08-960200-00	STD
87-960207-00	0.50mm	08-960207-00	0.50mm



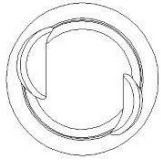
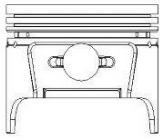

A	24.65	1.50		CR P
B-	2.00	1.50		P
C	5.30	2.80		P
C	4.60			
D	55.00			
	16x50			



2 69.60

Combo Mk II 1.3 CDTI 16V	09/04→02/12	Z 13 DT Euro 4		
Combo Tour Mk II 1.3 CDTI 16V	09/04→09/06		4 Cyl.	18:1
Corsa Mk II 1.3 CDTI 16V	08/00→09/06		1248cc	51-52kW (70-71PS)
Corsavan Mk II 1.3 CDTI 16V	04/04→06/06	Diesel	Turbo Intercooled	
Tigra TwinTop 1.3 CDTI	06/04→08/09			TD18361

87-137600-00	STD	08-137600-00	STD
87-137606-00	0.40mm	08-137606-00	0.40mm

A	40.43	2.00		CK P
B-	12.40	1.50		P
BØ	37.00	2.00		P
C	1.20			
D	63.43			
	23x56			

AK RT TP

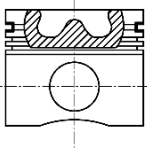
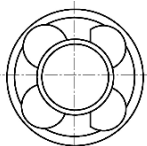







3 69.60

Astra Mk V 1.3 CDTi	01/04→11/10	Z 13 DTH		
AstraVan Mk V 1.3 CDTi	08/05→		4 Cyl.	17.6:1
Corsa Mk III 1.3 CDTi	07/06→08/14		1248cc	66-74kW (90-101PS)
Corsavan Mk III 1.3 CDTi	07/06→	Diesel	Turbo Intercooled	TD18654

87-425600-00	STD	08-425600-00	STD
87-425606-00	0.40mm	08-425606-00	0.40mm
		08-425608-00	0.60mm

A	40.43
B-	12.41
BØ	38.00
C	0.91
C	0.91
D	62.43
	23x55

2.00		CK P
1.50		NT
2.00		CR P

AK KK RT TP

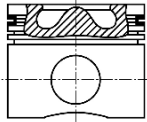
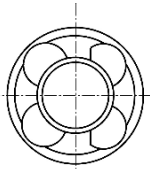

06933



4 72.50

Astra GTC Mk VI 1.4	10/11→	A 14 NET Euro 5		
Astra Mk VI 1.4 Turbo	12/09→	4 Cyl.	9.5:1	
Cascada 1.4	02/13→	1364cc	103kW (140PS)	
Insignia 1.4	04/11→	Turbo Intercooled		TD24731
Insignia 1.4 LPG	07/12→			
Meriva Mk II 1.4	06/10→			
Mokka 1.4	06/12→			
Zafira Mk III 1.4, Zafira Mk III 1.4 LPG	10/11→			





87-437400-00

STD

08-437400-00

STD

A	25.87
B-	2.90
BØ	54.78
C	2.10
C	1.87
D	44.18
	18x48

1.20		DLC NT 
1.20		P
2.00		NT 

CARBOGLIDE®

TP

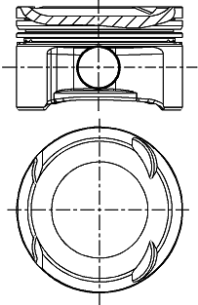

07279-212

 Steel

 Stahl

 Acier

 Acero







 Acciaio



5 72.50

Corsa Mk I 1.0 i 12V	11/96→09/00	X 10 XE	3 Cyl. 973cc	10:1 40kW (54PS)	TD17619
-----------------------------	-------------	----------------	------------------------	----------------------------	----------------

Agila Mk I 1.0 12V	09/00→08/05	Z 10 XE	3 Cyl. 973cc	10:1 43kW (58PS)	TD17630
Corsa Mk II 1.0 12V	09/00→10/03				

87-102700-00	STD	08-102700-00	STD
87-102707-00	0.50mm	08-102707-00	0.50mm
A 24.00		1.20	 NT 
B- 1.20		1.50	 P
BØ 56.00		2.00	 CR 
C 1.25			
D 45.00			
 18x51			

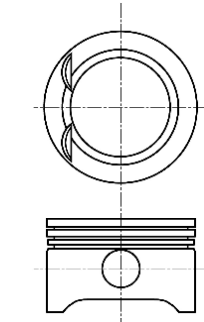

 Steel

 Stahl

 Acier







 Acero

 Acciaio

6 72.50

Astra Mk IV 1.2 16V	02/98→09/00	X 12 XE	4 Cyl. 1199cc	10:1 48kW (65PS)	TD17620
Corsa Mk I 1.2 i 16V	03/98→09/00				

Agila Mk I 1.2 16V	09/00→03/08	Z 12 XE Ecotec	4 Cyl. 1199cc	10:1 55kW (75PS)	TD17935
Astra Mk IV 1.2 16V	09/00→05/05				
Corsa Mk II 1.2 16V	09/00→10/06				
Corsa Mk II 1.2 16V Dualfuel	08/01→10/06				
Corsavan Mk II 1.2 16V	09/00→06/06				
Corsavan Mk II 1.2 16V Dualfuel	08/01→06/06				

87-102700-10	STD	08-102700-00	STD
87-102707-10	0.50mm	08-102707-00	0.50mm
A 24.00		1.20	 NT 
C 1.25		1.50	 P
D 45.00		2.00	 CR 
 18x51			

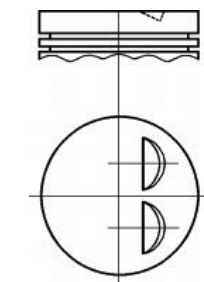

 Steel

 Stahl

 Acier

 Acero





 Acciaio



7 73.40

Adam 1.4	10/12→	A 14 XER		
Astra GTC Mk VI 1.4	10/11→		4 Cyl.	10.5:1
Astra Mk VI 1.4	12/09→		1398cc	74kW (101PS)
Corsa Mk III 1.4	07/10→08/14			
Meriva Mk II 1.4	06/10→			TD24542

87-429500-30	STD	08-429500-00	STD
87-429507-30	0.50mm	08-429507-00	0.50mm

A	25.80	1.20	 NT 1
B-	1.60	1.20	 P
C	1.90	2.00	 CR 1
C	3.83		
D	46.80		
	18x53		

TP

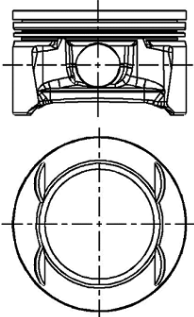

1 Steel

1 Stahl

1 Acier





1 Acero

1 Acciaio

8 73.40

Agila Mk I 1.2 16V Twinport	07/04→11/06	Z 12 XEP		
Corsa Mk II 1.2 Twinport	07/04→10/06		4 Cyl.	10.5:1
Corsa Mk III 1.2	11/06→08/14		1229cc	59kW (80PS)
Corsa Mk III 1.2 LPG	09/09→08/14			
Corsavan Mk III 1.2	07/09→			TD19350

87-429500-10 1	STD	08-429500-00	STD
87-429507-10 1	0.50mm	08-429507-00	0.50mm

A	24.00	1.20	 NT 2
B+	0.53	1.20	 P
C	1.46	2.00	 CR 2
C	1.49		
D	45.33		
	19x50		

TP

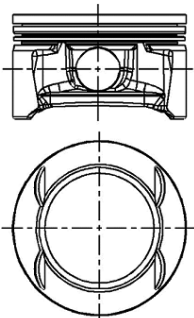

1 Elastoval ®

1 Elastoval ®

1 Elastoval ®

1 Elastoval ®

1 Elastoval ®

2 Steel

2 Stahl

2 Acier



2 Acero







2 Acciaio











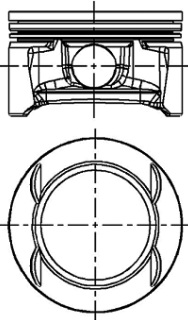

9 73.40

Astra Mk V 1.4	01/04→05/09	Z 14 XEP EcoTec			
Astra Mk V 1.4 i 16V	03/05→11/10		4 Cyl.	10.5:1	
AstraVan Mk V 1.4 i	03/05→		1364cc	66kW (90PS)	
Combo Mk II 1.4 i 16V	01/04→11/11				TD18228
Combo Tour Mk II 1.4	10/04→09/10				
Corsa Mk II 1.4 Twinport	06/03→10/06				
Corsa Mk III 1.4, Corsa Mk III 1.4 LPG	07/06→08/14				
Corsavan Mk II 1.4	11/03→06/06				
Meriva Mk I 1.4 16V Twinport	01/03→10/09				
Tigra TwinTop 1.4	06/04→08/09				

87-429500-00 	STD	08-429500-00	STD
87-429507-00 	0.50mm	08-429507-00	0.50mm

A	23.00	1.20		NT 
B-	1.25	1.20		P
BØ	53.50	2.00		CR 
C	1.33			
C	1.35			
D	44.00			
	18x49			



 Elastoval®	 Elastoval®	 Elastoval®	 Elastoval®	 Elastoval®
 Steel	 Stahl	 Acier	 Acero	 Acciaio

10 75.00

Astra 1.3	09/80→08/84	13 S			
Astra 1.3 S	09/79→08/84		4 Cyl.	9.2:1	
Astra Mk II 1.3	09/84→08/91		1297cc	42-55kW (57-75PS)	
Astra Mk II Belmont 1.3	09/85→08/91				TD17561
AstraMax 1.3 S	08/85→12/89				
Cavalier Mk II 1.3 S	09/81→08/88				
Chevette 1300	03/75→12/85				
Nova 1.3 S	09/82→10/89	13 SB			
			4 Cyl.	9.2:1	
			1297cc	51kW (69PS)	
					TD17600





Astra Mk II Belmont 1.3 i CAT Nova 1.3 i CAT	09/85→08/91 09/89→03/93	C 13 N	4 Cyl. 1297cc	9:1 44kW (60PS)	TD18673
---	----------------------------	---------------	-------------------------	---------------------------	----------------

87-306307-00	0.50mm	08-306300-00	STD
87-306311-00	1.00mm	08-306307-00	0.50mm
		08-306311-00	1.00mm

A	35.80
B-	3.60
C	5.30
C	5.30
D	62.40
	20x65

M.13N1225589→

1.50		CR P
1.50		P
4.00		CR P

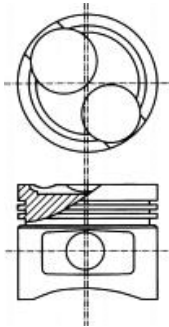

Pistons to be replaced in Engine Sets only

Kolben nur Motorsätzen zu ersetzen

Piston à remplacer dans jeu moteur

Pistones de repuesto para juegos de motores solamente

Il pistone può essere rimpiazzato solamente completo

11 76.00

Corsa Mk I 1.5 D	12/92→12/96	15 D			
Corsavan Mk I 1.5 D	08/94→12/95		4 Cyl.	23:1	
Nova 1.5 D	09/87→03/93		1488cc	37kW (50PS)	
Novavan 1.5 D	01/91→10/94	Diesel			TD21906
Astra Mk II Belmont 1.5 DT	01/87→08/89	15 DT			
			4 Cyl.	23:1	
			1488cc	53kW (73PS)	
		Diesel	Turbo		TD17578
Astra Mk II 1.5 DT	01/88→08/91	15 DT (T4EC1)			
Astra Mk II Belmont 1.5 DT	01/88→08/90		4 Cyl.	22.5:1	
Corsa Mk I 1.5 TD	03/93→10/96		1488cc	49-53kW (67-72PS)	
Nova 1.5 TD	01/90→03/93	Diesel	Turbo Intercooled		TD18227
Corsa Mk I 1.5 TD	03/93→10/96	X 15 DT (T4EC1)			
			4 Cyl.	22.5:1	
			1488cc	49kW (67PS)	
		Diesel	Turbo Intercooled		TD22871

14-010870-00 D **B 80.00 C 138.00**

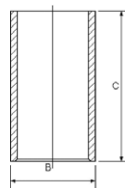







12 77.60

Astra Mk II 1.4 S	01/89→08/91	14 NV			
Astra Mk II Belmont 1.4 S	10/89→12/91		4 Cyl.	9.4:1	
Astra Mk III 1.4 S	09/91→02/98		1389cc	53-55kW (72-75PS)	
AstraMax 1.4 S	07/89→08/91				TD17562
Cavalier Mk III 1.4 S	09/88→11/95				
Nova 1.4 S	01/90→03/93				
Novavan 1.4	11/90→03/93				
Astra Mk II 1.4 i	01/90→08/91	C 14 NZ			
Astra Mk II Belmont 1.4 i	01/90→12/91		4 Cyl.	9.4:1	
Astra Mk III 1.4 i	09/91→09/98		1389cc	44kW (60PS)	
AstraMax 1.4 I	08/91→07/94				TD17581
AstraVan Mk III 1.4 i	01/91→10/94				
Combo Mk I 1.4	07/94→10/01				
Corsa Mk I 1.4 i	03/93→09/00				
Corsavan Mk I 1.4 i	01/94→09/00				
Nova 1.4	10/90→08/92				
Nova 1.4 i	01/90→03/93				
Corsa Mk I 1.4 i	03/93→09/00	X 14 SZ	4 Cyl.	9.6:1	
			1389cc	40-44kW (54-60PS)	
					TD17621

87-307100-20	STD	08-307100-00	STD
87-307107-20	0.50mm	08-307107-00	0.50mm

A	32.10	1.50		CR P
B-	3.40	1.50		P
D	52.50	3.00		CR 

 18x55

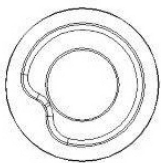
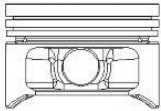

 Steel

 Stahl

 Acier

 Acero

 Acciaio







13 77.60





Corsa Mk I 1.4 i 16V	08/97→09/00	C 14 SEL	4 Cyl.	9.8:1
			1389cc	63kW (86PS)
TD21363				

Astra Mk III 1.4 i 16V	01/96→03/01	X 14 XE Ecotec	4 Cyl.	10.5:1
Astra Mk IV 1.4 16V	02/98→05/05		1389cc	66kW (90PS)
Corsa Mk I 1.4 i 16V	09/94→09/00			
Tigra Mk I 1.4 16V	07/94→12/00			
TD17589				

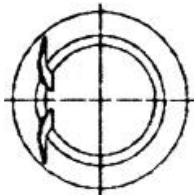
87-307100-30	STD	08-307100-00	STD
87-307107-30	0.50mm	08-307107-00	0.50mm

A	32.15	1.50		CR P
B+	1.10	1.50		P
D	57.00	3.00		CR 1
	18x55			







 Steel  Stahl  Acier  Acero  Acciaio





14 77.60

Astra Mk IV 1.4 16V	02/98→05/05	Z 14 XE Ecotec	4 Cyl.	10.5:1
Combo Mk II 1.4 16V	10/01→05/07		1389cc	66kW (90PS)
Corsa Mk II 1.4 16V	09/00→10/06			
TD17631				

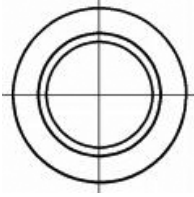
87-144200-00	STD	08-144200-00	STD
87-144207-00	0.50mm	08-144207-00	0.50mm

A	31.30	1.20		NT 1
B+	2.45	1.50		P
D	55.75	2.00		CR 1
	18x55			



 Steel  Stahl  Acier  Acero  Acciaio

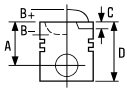

15 79.00

Astra 1.2	10/79→08/82	12 S		
Astra 1.2 S	02/82→08/84		4 Cyl.	9.1:1
Astra Mk II 1.2	09/84→08/91		1196cc	40-44kW (54-60PS)
Nova 1.2 S	01/88→02/90			

TD17556

87-304207-00	0.50mm	08-304200-00	STD
08-304207-00		08-304211-00	0.50mm
08-304211-00			1.00mm
A	38.00	2.00	CR P
C	2.00	2.00	P
C	2.00	2.00	P
D	76.00	5.00	P
	20x65		

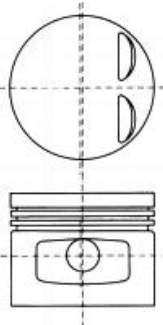

16 79.00

Astra Mk II 1.6	09/84→08/91	16 SV		
Astra Mk II 1.6 i	01/87→12/91		4 Cyl.	10:1
Astra Mk II Belmont 1.6 S	01/89→12/91		1598cc	60kW (82PS)
AstraMax 1.6	09/85→12/91			
Cavalier Mk III 1.6	09/88→05/93			

TD17565

Astra Mk III 1.6	03/94→08/95	C 16 SE		
Astra Mk III 1.6 i	03/92→02/98		4 Cyl.	10:1
Astra Mk III 1.6 Si	03/91→12/94		1598cc	74kW (101PS)
Nova 1.6 GSI CAT	02/92→03/93			

TD17608

Nova 1.6	09/88→08/90	E 16 SE		
Nova 1.6 GSI	05/88→03/92		4 Cyl.	10:1
			1598cc	60-74kW (81-101PS)

TD17586

87-306900-10	STD	08-306900-00	STD
87-306907-10	0.50mm	08-306907-00	0.50mm
A	28.00	1.20	CR 1
B-	1.60	1.50	P
B+	0.40	3.00	CR 1
BØ	59.00		
D	48.40		
	18x55		

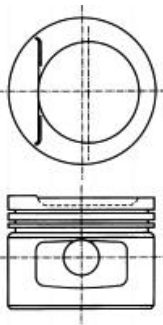

Steel

Stahl

Acier

Acero







Acciaio



17 79.00

Astra GTC Mk VI 1.6	10/11→	A 16 LET Euro 5		
Astra Mk VI 1.6 Turbo	12/09→	4 Cyl.	8.8:1	
Insignia 1.6 Turbo	01/09→	1598cc	132kW (180PS)	
		Turbo Intercooled		TD22590

87-435500-00	STD	08-435500-00	STD
87-435507-00	0.50mm	08-435507-00	0.50mm

A	27.50	1.20	 NT 
B+	0.60	1.20	 P
D	45.10	2.00	 NT 
	19x53		

HA TP

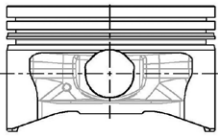

 Steel

 Stahl

 Acier

 Acero

 Acciaio







18 79.00

Astra Mk II 1.6 i CAT	10/87→02/93	C 16 NZ		
Astra Mk III 1.6 i	09/91→09/98	4 Cyl.	9.2:1	
AstraMax 1.6 i	08/91→10/94	1598cc	55kW (75PS)	
AstraVan Mk III 1.6 i	01/91→08/98			TD17583
Cavalier Mk II 1.6 i CAT	08/86→08/88			

Astra Mk II 1.6 i	01/91→08/93	E 16 NZ		
Astra Mk III 1.6 i	09/91→02/98	4 Cyl.	9.2:1	
Cavalier Mk II 1.6 i	08/86→08/88	1598cc	55kW (75PS)	
Cavalier Mk III 1.6 i	09/88→11/95			TD17618

Astra Mk III 1.6 i	02/93→02/98	X 16 SZ		
AstraVan Mk III 1.6 i	02/94→10/96	4 Cyl.	10:1	
Cavalier Mk III 1.6 i	09/93→11/95	1598cc	52kW (71PS)	
				TD17622

87-306900-00	STD	08-306900-00	STD
87-306907-00	0.50mm	08-306907-00	0.50mm

A	28.00	1.20	 CR 
B-	2.70	1.50	 P
B+	0.40	3.00	 CR 
BØ	63.00		
D	48.40		
	18x55		

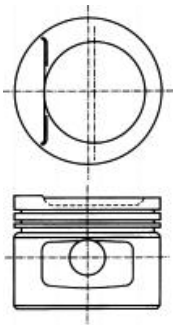

 Steel

 Stahl

 Acier

 Acero

 Acciaio







19 79.00

Corsa Mk I 1.6 GSI 16V	03/93→09/00	C 16 XE Ecotec		
Corsa Mk I 1.6 i 16V	09/94→09/00	4 Cyl.	10.5:1	
		1598cc	78-80kW (106-109PS)	TD17609
Corsa Mk I 1.6 i 16V	09/94→09/00	X 16 XE Ecotec		
Tigra Mk I 1.6 16V	07/94→12/00	4 Cyl.	10.5:1	
		1598cc	78-80kW (106-109PS)	TD17624
Astra Mk III 1.6 i 16V	01/94→09/98	X 16 XEL Ecotec		
Astra Mk IV 1.6 16V	02/98→05/05	4 Cyl.	10.5:1	
Vectra 1.6 i 16V	08/95→10/01	1598cc	74kW (101PS)	
Zafira Mk I 1.6 16V	04/99→08/05			TD17590
Zafira Mk I 1.6 Dualfuel	11/98→08/05			

87-307800-10	STD	08-307800-00	STD
87-307807-10	0.50mm	08-307807-00	0.50mm
		08-307811-00	1.00mm

A	28.00
B-	0.80
BØ	60.20
C	1.90
C	2.15
D	48.00
	18x55

1.20		CR 
1.50		P
2.50		CR 

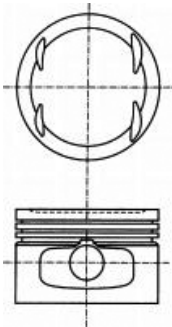

 Steel

 Stahl

 Acier

 Acero

 Acciaio



20 79.00

Astra Mk III 1.6 i	03/92→03/01	X 16 SZR		
Astra Mk IV 1.6	02/98→04/04		4 Cyl.	9.6:1
AstraVan Mk IV 1.6 i	08/98→09/00		1598cc	55kW (75PS)
Vectra 1.6 i	08/95→10/01			TD17623

87-306900-20	STD	08-306900-00	STD
87-306907-20	0.50mm	08-306907-00	0.50mm

A	28.45	1.20	CR
B-	2.75	1.50	P
BØ	63.00	3.00	CR
D	48.45		
	18x55		

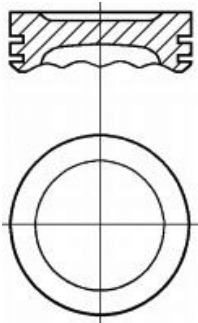

Steel

Stahl

Acier

Acero

Acciaio

21 79.00

Vectra 1.6 i 16V	08/95→10/01	Y 16 XE Ecotec		
			4 Cyl.	10.5:1
			1598cc	74kW (101PS)
				TD22874

Astra Mk IV 1.6	03/98→05/05	Z 16 SE		
Astra Mk IV 1.6 Dualfuel	07/00→05/05		4 Cyl.	9.6:1
AstraVan Mk IV 1.6 i	09/00→08/06		1598cc	62-64kW (84-87PS)
Combo Mk II 1.6	09/01→11/11			TD17632
Combo Tour Mk II 1.6	10/01→06/04			
Corsa Mk II 1.6	08/01→10/04			
Meriva Mk I 1.6 i	01/03→06/10			

Astra Mk IV 1.6 16V	02/98→10/05	Z 16 XE Ecotec		
Astra Mk IV 1.6 Dualfuel	03/98→05/05		4 Cyl.	10.5:1
Meriva Mk I 1.6 i 16V	01/03→09/05		1598cc	63-74kW (85-101PS)
Vectra 1.6 i 16V	08/95→10/01			TD17937
Zafira Mk I 1.6 16V	04/99→08/05			
Zafira Mk I 1.6 Dualfuel	11/98→08/05			

87-125600-00	STD	08-125600-00	STD
87-125607-00	0.50mm	08-125607-00	0.50mm

A	27.20	1.20	NT
D	50.20	1.50	P
	18x55	2.50	CR

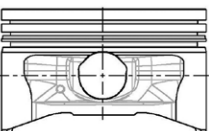

Steel

Stahl

Acier

Acero

Acciaio



22 79.00

Astra Mk IV 1.6	12/02→05/05	Z 16 XEP		
Astra Mk IV 1.6 16V	09/98→10/05		4 Cyl.	10.5:1
Astra Mk V 1.6	01/04→11/10		1598cc	74-77kW (101-105PS)
Astra TwinTop Mk V 1.6	09/05→11/10			
Astravan Mk V 1.6	03/05→			
Meriva Mk I 1.6 I 16V Twinport	05/03→06/10			
Zafira Mk II 1.6	07/05→11/14			TD17939

87-427800-00 ¹	STD	08-427800-00	STD
87-427807-00 ¹	0.50mm	08-427807-00	0.50mm

A	26.73	1.20		NT ²
D	48.73	1.20		P
	18x52	2.00		CR ²

TP

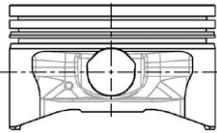

¹ Elastoval®	¹ Elastoval®	¹ Elastoval®	¹ Elastoval®	¹ Elastoval®
² Steel	² Stahl	² Acier	² Acero	² Acciaio

23 79.00

Astra Mk V 1.6	01/04→05/09	Z 16 XER		
Astra Mk V 1.6 i 16V	12/06→11/10		4 Cyl.	10.5:1
Astra TwinTop Mk V 1.6 i 16V	10/06→11/10		1598cc	85kW (116PS)
Zafira Mk II 1.6	12/07→11/14			TD21873

87-435300-00	STD	08-435300-00	STD
87-435307-00	0.50mm	08-435307-00	0.50mm

A	26.70	1.20		NT ¹
B+	1.20	1.20		P
BØ	52.96	2.00		NT ¹
C	1.90			
C	2.70			
D	48.70			
	19x46			

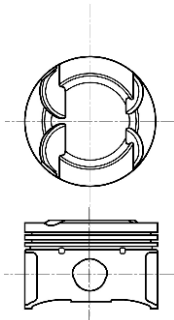

¹ Steel	¹ Stahl	¹ Acier	¹ Acero	¹ Acciaio
--------------------	--------------------	--------------------	--------------------	----------------------



24 **79.00**

Combo Mk I 1.7 D	07/94→10/01	17 D (4EE1)		
Corsa Mk I 1.7 D	02/96→09/00		4 Cyl.	22:1
Corsavan Mk I 1.7 D	01/94→09/00		1686cc	44kW (60PS)
Diesel				TD22845
Combo Mk I 1.7 D	07/94→10/01	X 17 D (4EE1)		
Corsa Mk I 1.7 D	02/96→09/00		4 Cyl.	22:1
Corsavan Mk I 1.7 D	01/94→09/00		1686cc	44kW (60PS)
Diesel				TD22872

87-307600-10 STD

→02/96, →179157

A 39.75

B- 1.30

C 0.25

D 69.80

27x64

AK RT

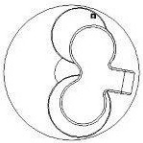
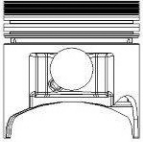

08-307600-00 STD
08-307607-00 0.50mm

2.00 CR P
1.50 CR P
3.00 CR P

87-307600-20 STD
87-307607-20 0.50mm

02/96→, 179158→

A 39.75

B- 1.30

C 0.30

D 79.80

25x60

RT

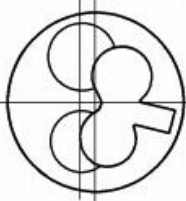
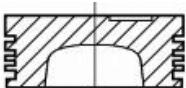

08-307600-00 STD
08-307607-00 0.50mm





2.00 CR P
1.50 CR P
3.00 CR P



25 79.00

Astra Mk III 1.7 TD	12/91→09/98	17 DT (TC4EE1)	4 Cyl.	22:1
Cavalier Mk III 1.7 TD	09/88→11/95		1686cc	60kW (82PS)
		Diesel	Turbo Intercooled	TD22846
Vectra 1.7 TD	10/95→11/96	X 17 DT (TC4EE1)	4 Cyl.	22:1
			1686cc	60kW (82PS)
		Diesel	Turbo Intercooled	TD22873

87-307600-30	STD	08-307600-00	STD
87-307607-30	0.50mm	08-307607-00	0.50mm

A	39.70	2.00		CR P
B-	1.50	1.50		CR P
D	69.60	3.00		CR P
	27x64			

AK RT

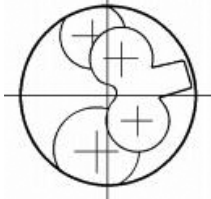
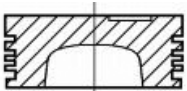

26 79.00





Astra Mk IV 1.7 DTI 16V	02/00→05/05	Y 17 DT	4 Cyl.	18.4:1
Astravan Mk IV 1.7 DTI 16V	04/01→08/06		1686cc	55kW (75PS)
Combo Mk II 1.7 DTI 16V	10/01→11/11		Diesel	Turbo Intercooled
Combo Tour Mk II 1.7 DTI 16V	10/01→02/12			TD18380
Corsa Mk II 1.7 DTI 16V	08/00→09/06			
Corsavan Mk II 1.7 DTI 16V	09/00→06/06			
Meriva Mk I 1.7 DTI 16V	06/03→06/10			





Combo Mk II 1.7 DI 16V	09/01→11/11	Y 17 DTL		
Combo Tour Mk II 1.7 DI 16V	09/01→06/04		4 Cyl.	18.4:1
Corsa Mk II 1.7 DI 16V	08/00→09/06		1686cc	48kW (65PS)
Corsavan Mk II 1.7 DI 16V	09/00→06/06	Diesel	Turbo Intercooled	TD18381

87-307600-40	STD	08-307600-00	STD
87-307607-40	0.50mm	08-307607-00	0.50mm

A	39.75	2.00		CR P
B-	14.00	1.50		CR P
BØ	38.70	3.00		CR P
C	1.10			
D	84.00			
	27x64			



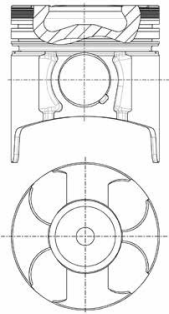

RT



27 80.00

Astra 1.6 S	09/81→08/86	16 SH		
Astra Mk II 1.6 S	09/84→08/86		4 Cyl.	9.2:1
Astra Mk II Belmont 1.6	09/85→08/91		1598cc	66kW (90PS)
Cavalier Mk II 1.6	10/83→08/88			TD17564
Cavalier Mk II 1.6 S	09/81→08/88			

87-305607-10 ¹	0.50mm	08-305600-00	STD
		08-305607-00	0.50mm
		08-305611-00	1.00mm

A	40.00	1.50		CR P
B-	3.20	1.75		P
C	3.20	4.00		CR ²
D	72.00			
	23x70			

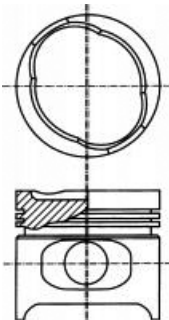

¹ Recommended maximum oversize is 0.50mm (.0197in)
² Steel

¹ Empfohlenes überma maximal 0.50mm Zoll (.0197in)
² Stahl

¹ Cote maxi recommandée de 0.50mm (.0197in)
² Acier

¹ La sobremedida máxima recomendada es de 0.50mm (.0197in)
² Acero

¹ Maggiorazione massima raccomandata 0.50mm
² Acciaio







28 80.00

Astra 1.6 D	02/82→08/86	16 D			
Cavalier Mk II 1.6 D	03/82→08/88		4 Cyl.	23:1	
Cavalier Mk II 1600D			1598cc	40kW (54PS)	
Diesel					TD17563

Astra Mk II 1.6 D	09/84→12/89	16 DA			
Astra Mk II Belmont 1.6 D	09/85→08/91		4 Cyl.	23:1	
AstraMax 1.6 D	05/86→06/90		1598cc	40kW (54PS)	
Cavalier Mk II 1.6 D	03/82→08/88	Diesel			
Cavalier Mk II 1600D					TD17601

87-305900-00	STD	08-305900-10	STD	14-023520-00 D	B 83.00 C 143.50 D 84.90 E 4.50
87-305907-00	0.50mm	08-305907-10	0.50mm		
87-305911-00	1.00mm	08-305911-10	1.00mm		

A	44.95	2.00		CR P
B-	1.50	2.00		P
D	76.95	3.00		CR P
	26x65			



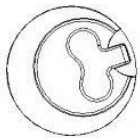
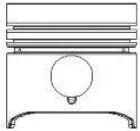

HA RT



29 80.00

Arena 1.9 D	03/98→08/01	F8Q 606			
			4 Cyl.	21.5:1	
			1870cc	44kW (60PS)	
Diesel					TD21358

87-336500-00	STD	08-336500-00	STD	
87-336505-00	0.25mm	08-336505-00	0.25mm	
87-336507-00	0.50mm	08-336507-00	0.50mm	
87-336510-00	0.80mm	08-336510-00	0.80mm	

A	42.35	2.00		MO P
B-	0.70	2.00		P
D	70.50	3.00		CR P
	24x63			

RT

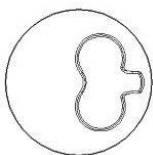
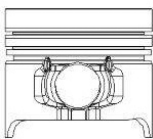







30  **80.00**

Vivaro 1.9 DTI	08/01→12/06	F9Q 760	4 Cyl. 1870cc	18.3:1 74kW (101PS)	TD19375
		Diesel	Turbo Intercooled		
Vivaro 1.9 Di	08/01→07/14	F9Q 762	4 Cyl. 1870cc	19:1 59-60kW (80-82PS)	TD21148
		Diesel	Turbo Intercooled		
Movano Mk I 1.9 DTI	09/00→10/01	F9Q 770	4 Cyl. 1870cc	18.3:1 59kW (80PS)	TD19351
		Diesel	Turbo Intercooled		
Movano Mk I 1.9 DTI	09/00→10/01	F9Q 772	4 Cyl. 1870cc	18.3:1 60kW (82PS)	TD19363
		Diesel	Turbo Intercooled		
Movano Mk I 1.9 DTI	10/01→05/10	F9Q 774	4 Cyl. 1870cc	18.3:1 60kW (82PS)	TD19352
		Diesel	Turbo Intercooled		

87-101500-00 STD **08-101500-00** STD **14-020280-00 D** B 83.00 C 155.00 D 85.00 E 5.00
87-101507-00 0.50mm **08-101507-00** 0.50mm

A 47.06
B- 17.80
BØ 38.00
C 0.75
D 77.00
 28x60

→01/00

2.50  P
 2.00  P
 3.00  CR P

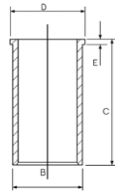



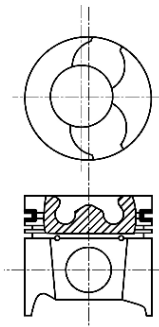

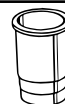
AK RT TP





31 80.00

Omega 2.5 TD	04/94→07/01	X 25 DT	6 Cyl.	22:1
			2497cc	96kW (131PS)
		Diesel	Turbo Intercooled	TD17595
Omega 2.5 TD	04/94→07/01	X 25 TD	6 Cyl.	22:1
			2498cc	96kW (131PS)
		Diesel	Turbo Intercooled	TD17920

87-704500-00	STD	08-704500-00	STD
87-704507-00	0.50mm	08-704507-00	0.50mm
A	39.45	3.00	 CR P
B-	2.50	1.75	 P
D	62.45	3.00	 CR P
	27x63		

AK KK RT



08034X

32 80.50

Astra Mk IV 1.8 16V	02/98→08/05	X 18 XE1 Ecotec	4 Cyl.	10.5:1
Vectra 1.8 i 16V	10/95→09/00		1796cc	85kW (116PS)
Zafira Mk I 1.8 16V	05/99→08/00			TD17626
Astra Mk IV 1.8 16V	02/98→10/05	Z 18 XE Ecotec	4 Cyl.	10.5:1
Astra Mk IV 1.8 16V Dualfuel	02/98→08/05		1799cc	87-92kW (118-125PS)
Astra Mk V 1.8	01/04→11/10			TD17633
Corsa Mk II 1.8 16V	08/00→09/06			
Meriva Mk I 1.8 i 16V	05/03→08/05			
Signum 1.8	06/03→07/05			
Tigra TwinTop 1.8	06/04→08/09			
Vectra 1.8 Dualfuel, Vectra 1.8 i 16V	09/00→07/03			
Vectra Mk II 1.8 16V				
Vectra Mk II 1.8 16V Dualfuel	04/02→07/08			
Zafira Mk I 1.8 16V, Zafira Mk I 1.8 Dualfuel	09/00→08/05			





Astra Mk IV 1.8 16V 03/00 → 08/05 **Z 18 XEL Ecotec**
 4 Cyl. 10.5:1
1796cc **81-85kW (110-116PS)**
TD17987

87-141200-00 STD **08-141200-00** STD
87-141207-00 0.50mm **08-141207-00** 0.50mm

A 24.10
D 44.70
18x55

1.20 NT
 1.20 P
 2.00 CR

TP

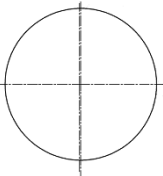
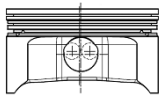

Steel

Stahl

Acier

Acero

Acciaio

33 81.60

Astra Mk III 1.8 09/94 → 08/96 **C 18 XE**
Astra Mk III 1.8 i 16V 06/93 → 02/98 4 Cyl. 10.8:1
1796cc **92kW (125PS)**
TD17611

Astra Mk III 1.8 16V 11/94 → 03/01 **C 18 XEL**
Astra Mk III 1.8 i 16V 01/94 → 02/98 4 Cyl. 10.8:1
1796cc **85kW (116PS)**
TD17636

Astra Mk III 1.8 16V 11/94 → 03/01 **X 18 XE**
Astra Mk III 1.8 i 16V 09/94 → 02/98 4 Cyl. 10.8:1
Vectra 1.8 i 16V 10/95 → 09/00 **1796cc** **85kW (116PS)**
TD17625

87-307700-10 STD **08-307700-00** STD
87-307707-10 0.50mm **08-307707-00** 0.50mm
08-307711-00 1.00mm

A 30.40
B- 1.80
BØ 50.80
D 50.40
21x56

1.50 MO P
 1.50 P
 3.00 CR

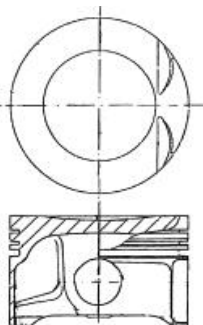

Steel

Stahl

Acier

Acero

Acciaio







34 81.60

Calibra 2.5 I V6	04/93→07/97	C 25 XE		
Cavalier Mk III 2.5 V6	08/88→06/94		V6 Cyl. 2498cc	10.8:1 125kW (170PS)
				TD17635

Calibra 2.5 I V6	04/93→07/97	X 25 XE		
Omega 2.5 V6	03/94→09/00		V6 Cyl. 2498cc	10.8:1 125-143kW (170-194PS)
Vectra 2.5 i GSi	03/98→07/00			
Vectra 2.5 i V6	09/95→08/00			
				TD17634

87-307700-00	STD	08-307700-00	STD
87-307707-00	0.50mm	08-307707-00	0.50mm
		08-307711-00	1.00mm

A	30.45			
B+	0.36	1.50		MO P
C	2.40	1.50		P
D	51.03	3.00		CR 1
	21x56			

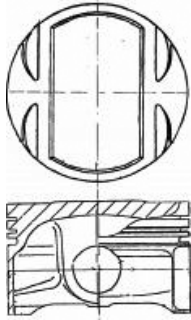

 Steel

 Stahl

 Acier

 Acero

 Acciaio







35  **82.00**

Astra Mk V 1.9 CDTi	01/04→11/10	Z 19 DT			
AstraVan Mk V 1.9 CDTi	03/05→11/11		4 Cyl.	18:1	
Signum 1.9 CDTi	04/04→03/08		1910cc	88kW (120PS)	
Vectra Mk II 1.9 CDTi	04/02→09/08	Diesel	Turbo Intercooled		TD18659
Zafira Mk II 1.9 CDTi	07/05→11/14				

Astra Mk V 1.9 CDTi	08/04→11/10	Z 19 DTL Euro 4			
Signum 1.9 Turbo	01/05→05/08		4 Cyl.	18:1	
Zafira Mk II 1.9 CDTi	07/05→11/14		1910cc	74kW (100PS)	
		Diesel	Turbo Intercooled		TD20149

87-124000-30	STD	08-124000-00	STD
87-124008-30	0.60mm	08-124006-00	0.40mm
		08-124008-00	0.60mm

A	46.50		
B-	17.45	2.00	 CK P
BØ	37.55	2.00	 P
C	0.65	2.00	 CR P
D	72.50		
	26x61		

NB RT

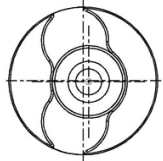
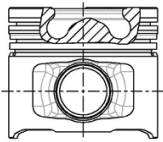







36  **82.00**

Astra Mk V 1.9 CDTi	01/04→11/10	Z 19 DTH Euro 4		
Astra TwinTop Mk V 1.9 CDTi	01/06→11/10		4 Cyl.	17.5:1
AstraVan Mk V 1.9 CDTi	03/05→11/11		1910cc	110kW (150PS)
Signum 1.9 CDTi 16V	04/04→03/08	Diesel	Turbo Intercooled	TD18016
Vectra Mk II 1.9 CDTi 16V	04/04→08/08			
Zafira Mk II 1.9 CDTi	07/05→11/14			

Astra Mk V 1.9 CDTi 16V	01/04→05/09	Z 19 DTJ		
			4 Cyl.	17.5:1
			1910cc	88kW (120PS)
		Diesel	Turbo Intercooled	TD18017

87-146100-00	STD
87-146108-00	0.60mm
A	46.50
B-	15.40
BØ	41.50
C	1.03
D	72.50
	26x61

08-146100-00	STD
08-146106-00	0.40mm
08-146108-00	0.60mm

2.00		CK P
2.00		P
2.00		CK P

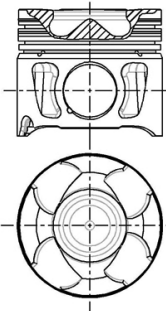

AK KK NB RT TP



08256-102

87-146100-10	STD
87-146106-10	0.40mm
A	46.50
B-	15.40
BØ	41.50
C	1.07
C	1.02
D	72.50
	30x67

08-146100-00	STD
08-146106-00	0.40mm
08-146108-00	0.60mm

2.00		CK P
2.00		P
2.00		CK P

AK KK RT TP

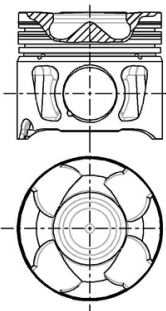

08269-503







37 82.50

Astra Mk II 1.7 D	02/89→08/91	17 D		
Astra Mk II Belmont 1.7 D	01/89→12/91		4 Cyl.	23:1
Astra Mk III 1.7 D	12/91→02/98		1699cc	42kW (57PS)
AstraMax 1.7 D	01/89→07/94	Diesel		TD17566
Cavalier Mk III 1.7 D	09/88→09/92			

Astra Mk II 1.7 D	01/89→08/91	17 DR		
Astra Mk III 1.7 D	03/91→09/98		4 Cyl.	23.1:1
AstraVan Mk III 1.7 D	01/91→08/94		1699cc	42-44kW (57-60PS)
Cavalier Mk III 1.7 D	07/92→11/95	Diesel		TD17567

87-306700-10	STD	08-306700-00	STD	14-021200-00 D	B 85.58 C 143.35 D 87.40 E 4.55
87-306707-10	0.50mm	08-306707-00	0.50mm		
87-306711-10	1.00mm	08-306711-00	1.00mm		

A	44.95	2.00		CR P
C	1.60	2.00		P
D	72.95	3.00		CR P
	26x65			

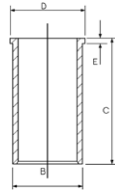



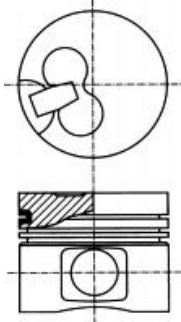

HA RT



38 82.50

Astra Mk III 1.7 TD	01/94→09/98	X 17 DTL		
Astra Mk IV 1.7 TD	02/98→08/00		4 Cyl.	22:1
AstraVan Mk III 1.7 TD	01/94→08/98		1699cc	50kW (68PS)
AstraVan Mk IV 1.7 TD	08/98→08/06	Diesel	Turbo Intercooled	TD17591

87-306700-00	STD	08-306700-00	STD	14-021200-00 D	B 85.58 C 143.35 D 87.40 E 4.55
87-306707-00	0.50mm	08-306707-00	0.50mm		
87-306711-00	1.00mm	08-306711-00	1.00mm		

A	44.92	2.00		CR P
B-	1.80	2.00		P
D	67.00	3.00		CR P
	26x69			

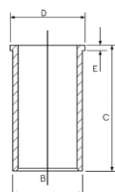

HA RT TP

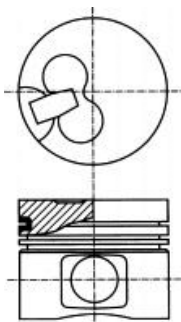

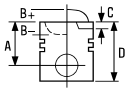





39  **83.00**

Zafira Mk III 2.0 CDTi	10/11→	A 20 DT Euro 5	4 Cyl.	16.5:1	
			1956cc	96kW (131PS)	
		Diesel	Turbo Intercooled		TD25781
Insignia 2.0 CDTi	07/08→	A 20 DTC Euro 5	4 Cyl.	16.5:1	
			1956cc	81kW (110PS)	
		Diesel	Turbo Intercooled		TD22598
Astra GTC Mk VI 2.0 CDTi	10/11→	A 20 DTH Euro 5	4 Cyl.	16.5:1	
Astra Mk VI 2.0 CDTi	12/09→		1956cc	118-121kW (160-165PS)	
Cascada 2.0 CDTi	02/13→		Diesel	Turbo Intercooled	TD22603
Insignia 2.0 CDTi	07/08→				
Zafira Mk III 2.0 CDTi	10/11→				
Insignia 2.0 CDTi	07/08→	A 20 DTJ Euro 5	4 Cyl.	16.5:1	
			1956cc	96kW (131PS)	
		Diesel	Turbo Intercooled		TD22600
Zafira Mk III 2.0 CDTi	10/11→	A 20 DTL Euro 5	4 Cyl.	16.5:1	
			1956cc	81kW (110PS)	
		Diesel	Turbo Intercooled		TD25780
Zafira Mk III 2.0 CDTi	10/11→	Z 20 DTJ	4 Cyl.	16.5:1	
			1956cc	96kW (131PS)	
		Diesel	Turbo Intercooled		TD25783

87-436500-00 STD
87-436506-00 0.40mm

08-436500-00 STD
08-436506-00 0.40mm

A 43.63
B- 15.80
BØ 43.50
D 72.63
 30x66

1.50  GDC P
 1.50  P
 2.00  CR P



KK RT TP

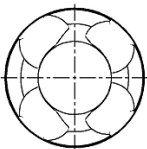
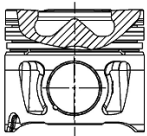





08344A406



40 84.00

Vivaro 2.0 CDTI	01/06→07/14	M9R 630	4 Cyl.	15.5:1	
			1995cc	66-84kW (90-114PS)	
		Diesel	Turbo Intercooled		TD25645

87-422000-10	STD	08-422000-00	STD
87-422007-10	0.50mm	08-422007-00	0.50mm

A	48.00	2.50		MOL P
B-	14.00	2.00		MOL P
BØ	50.00	2.00		CR P
D	76.00			
	32x65			

KK RT TP

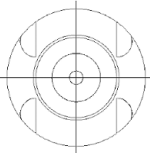
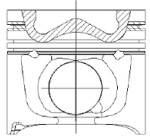





41 84.00

Vivaro 2.0 CDTI	01/06→07/14	M9R 780 Euro 4	4 Cyl.	16:1	
			1995cc	66-84kW (90-114PS)	
		Diesel	Turbo Intercooled		TD20889

Vivaro 2.0 CDTI	01/06→07/14	M9R 782	4 Cyl.	17:1	
			1995cc	66-84kW (90-114PS)	
		Diesel	Turbo Intercooled		TD21889

Vivaro 2.0 CDTI	01/06→07/14	M9R 786 Euro 4	4 Cyl.	15.7:1	
			1995cc	66-84kW (90-114PS)	
		Diesel	Turbo Intercooled		TD25647

87-422000-00	STD	08-422000-00	STD
87-422007-00	0.50mm	08-422007-00	0.50mm

A	47.92	2.50		MOL P
B-	14.90	2.00		MOL P
BØ	49.07	2.00		CR P
C	0.40			
C	0.40			
D	76.00			
	32x65			

AK KK RT TP

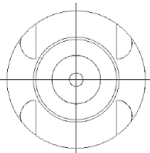
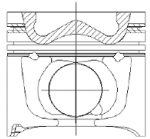







42 84.00

Astra Mk IV 2.0 DTi 16V	02/98→05/05	X 20 DTH		
Omega 2.0 DTi 16V	01/98→09/00		4 Cyl.	18.5:1
Vectra 2.0 DTi 16V	08/95→10/01		1995cc	74kW (101PS)
		Diesel	Turbo Intercooled	TD17592

87-102900-10	STD	08-102900-00	STD
87-102907-10	0.50mm	08-102907-00	0.50mm

A	45.80	2.50		CK P
B-	14.67	1.75		P
BØ	40.85	3.00		CR P
D	70.80			
	29x68			

AK RT TP

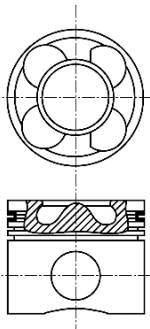





43 84.00

Astra Mk IV 2.0 DI	02/98→05/05	X 20 DTL		
AstraVan Mk IV 2.0 DI	08/98→08/06		4 Cyl.	18.5:1
Vectra 2.0 DI 16V	08/95→10/01		1995cc	60kW (82PS)
Zafira Mk I 2.0 DI 16V	10/99→08/05	Diesel	Turbo Intercooled	TD17627

Astra Mk IV 2.0 DI	02/98→05/05	Y 20 DTL		
			4 Cyl.	18.5:1
			1995cc	60kW (82PS)
		Diesel	Turbo Intercooled	TD17926

87-102800-10	STD	08-102800-00	STD	14-102800-00 D	B 87.00 C 160.00 D 90.00 E 4.50
87-102807-10	0.50mm	08-102807-00	0.50mm		

A	45.80	2.00		CK P
B-	14.90	1.75		P
BØ	41.00	3.00		CR P
C	1.00			
D	70.80			
	29x68			

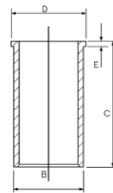

AK RT TP

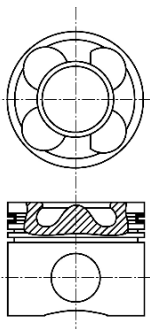

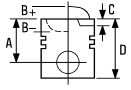





44 84.00

Frontera Mk II 2.2 DTI	10/98→09/04	X 22 DTH			
Sintra 2.2 DTI	07/97→04/99		4 Cyl.	18.5:1	
			2172cc	85kW (116PS)	
		Diesel	Turbo Intercooled		TD17916
Frontera Mk II 2.2 DTI	10/98→09/04	Y 22 DTH			
Omega 2.2 DTI 16V	08/00→07/03		4 Cyl.	18.5:1	
			2172cc	85-88kW (116-120PS)	
		Diesel	Turbo Intercooled		TD17928
Astra Mk IV 2.2 DTI	09/02→05/05	Y 22 DTR			
Signum 2.2 DTI	05/03→05/08		4 Cyl.	18.5:1	
Vectra 2.2 DTI 16V	08/95→10/01		2172cc	92kW (125PS)	
Vectra Mk II 2.2 DTI 16V	04/02→10/08	Diesel	Turbo Intercooled		TD17629
Zafira Mk I 2.2 D	06/01→06/05				

87-126000-10 STD 08-126000-00 STD
 87-126007-10 0.50mm 08-126007-00 0.50mm

A	45.80	1.75		CK P
B-	14.67	1.75		P
BØ	43.00	3.00		CR P
C	1.05			
D	70.80			
	29x68			

AK KK RT TP

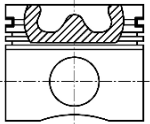
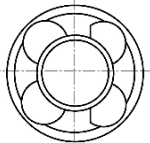







45 84.00

Astra Mk IV 2.0 DTI 16V	02/98→05/05	Y 20 DTH		
AstraVan Mk IV 2.0 DTI	04/04→08/06		4 Cyl.	19.5:1
Signum 2.0 DTI	05/03→05/08		1995cc	74kW (101PS)
Vectra 2.0 DTi 16V	08/95→10/01	Diesel	Turbo Intercooled	TD17924
Vectra Mk II 2.0 DTI 16V	04/02→10/08			
Zafira Mk I 2.0 DTI 16V	04/99→08/05			

87-126000-00	STD	08-126000-00	STD
87-126007-00	0.50mm	08-126007-00	0.50mm

A	45.85	1.75		CK P
B-	14.68	1.75		P
BØ	41.00	3.00		CR P
C	1.05			
D	70.80			
	29x68			

AK KK RT TP

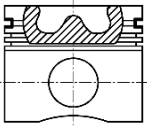
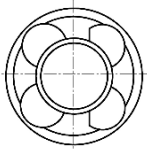

46 84.80

Astra Mk II 1.8 GTE	09/84→08/91	18 SE		
Astra Mk II Belmont 1.8	01/86→12/90		4 Cyl.	10:1
Astra Mk II Belmont 1.8 i	09/85→08/91		1796cc	82-85kW (112-116PS)
Astra Mk III 1.8 i 16V	09/95→02/98			TD17604
Cavalier Mk II 1.8 i	09/81→08/88			
Cavalier Mk II 1800i	03/85→10/88			
Carlton Mk III 1.8 i	09/86→03/94	18 SEH	4 Cyl.	10:1
			1796cc	85kW (115PS)
				TD17570







Carlton Mk III 1.8 S	09/86→03/94	18 SV		
Cavalier Mk III 1.8	09/88→08/95		4 Cyl. 1796cc	10:1 66kW (90PS)
				TD17571

87-307200-00	STD	08-307200-00	STD
87-307207-00	0.50mm	08-307207-00	0.50mm

A 33.65
B- 4.00
BØ 43.00
D 53.65
 21x62

09/86→

1.50  CR P
 1.50  P
 3.00  CR 1

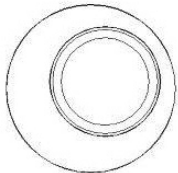
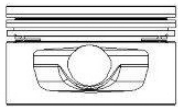

 Steel

 Stahl

 Acier

 Acero

 Acciaio

47  **85.00**

Movano Mk II 2.3 CDTI		M9T 670 Euro 5		
Movano Mk II 2.3 CDTI [RWD]	07/10→		4 Cyl.	16:1
Movano Mk II 2.3 CDTI FWD	05/10→		2298cc	74-92kW (101-125PS)
		Diesel	Turbo Intercooled	TD24749
Movano Mk II 2.3 CDTI		M9T 672 Euro 5		
Movano Mk II 2.3 CDTI FWD	05/10→		4 Cyl.	16:1
			2298cc	74-92kW (101-125PS)
		Diesel	Turbo Intercooled	TD25155
Movano Mk II 2.3 CDTI		M9T 676 Euro 4		
Movano Mk II 2.3 CDTI FWD	05/10→		4 Cyl.	16:1
			2298cc	74-92kW (101-125PS)
		Diesel	Turbo Intercooled	TD24748
Movano Mk II 2.3 CDTI		M9T 678		
Movano Mk II 2.3 CDTI FWD	05/10→		4 Cyl.	16:1
			2298cc	107kW (146PS)
		Diesel	Turbo Intercooled	TD25156
Movano Mk II 2.3 CDTI		M9T 680		
Movano Mk II 2.3 CDTI FWD	05/10→		4 Cyl.	16:1
			2298cc	92-107kW (125-146PS)
		Diesel	Turbo Intercooled	TD25138
Movano Mk II 2.3 CDTI [RWD]	05/10→	M9T 686 Euro 5		
			4 Cyl.	16:1
			2298cc	92kW (125PS)
		Diesel	Turbo Intercooled	TD25152
Movano Mk II 2.3 CDTI [RWD]	05/10→	M9T 690 Euro 5		
			4 Cyl.	16:1
			2298cc	74-92kW (101-125PS)
		Diesel	Turbo Intercooled	TD25105



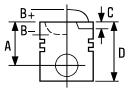

Movano Mk II 2.3 CDTI [RWD]	05/10→	M9T 692 Euro 4	4 Cyl.	16:1	
		2298cc			74-92kW (101-125PS)
		Diesel		Turbo Intercooled	TD25106
Movano Mk II 2.3 CDTI [RWD]	05/10→	M9T 694 Euro 4	4 Cyl.	16:1	
Movano Mk II 2.3 CDTI FWD	01/13→				107-110kW (146-150PS)
		Diesel		Turbo Intercooled	TD24750
Movano Mk II 2.3 CDTI [RWD]	05/10→	M9T 696 Euro 4	4 Cyl.	16:1	
Movano Mk II 2.3 CDTI FWD					92-107kW (125-146PS)
		Diesel		Turbo Intercooled	TD25149
Movano Mk II 2.3 CDTI [RWD]	05/10→	M9T 698 Euro 5	4 Cyl.	16:1	
					92-107kW (125-146PS)
		Diesel		Turbo Intercooled	TD24751
Movano Mk II 2.3 CDTI [RWD]	05/14→	M9T 700	4 Cyl.	16:1	
Movano Mk II 2.3 CDTI FWD					100-120kW (136-163PS)
		Diesel		Bi-Turbo Intercooled	TD29896
Movano Mk II 2.3 CDTI	05/14→	M9T 702	4 Cyl.	16:1	
Movano Mk II 2.3 CDTI FWD					100-120kW (136-163PS)
		Diesel		Bi-Turbo Intercooled	TD29895
Movano Mk II 2.3 CDTI	05/14→	M9T 870	4 Cyl.	16:1	
Movano Mk II 2.3 CDTI [RWD]					74-81kW (100-110PS)
Movano Mk II 2.3 CDTI FWD	05/10→				
		Diesel		Turbo Intercooled	TD29897
Movano Mk II 2.3 CDTI	05/10→	M9T 876	4 Cyl.	16:1	
Movano Mk II 2.3 CDTI [RWD]					92kW (125PS)
Movano Mk II 2.3 CDTI FWD					
		Diesel		Turbo Intercooled	TD31131
Movano Mk II 2.3 CDTI	01/13→	M9T 880	4 Cyl.	16:1	
Movano Mk II 2.3 CDTI [RWD]					110kW (150PS)
Movano Mk II 2.3 CDTI FWD					
		Diesel		Turbo Intercooled	TD31642

87-435200-00

STD

08-435200-00

STD

87-435207-00

0.50mm

08-435207-00

0.50mm

A 48.00

B- 16.20

BØ 50.00

C 0.45

D 76.00

 32x65

2.50

2.00

2.00



GDC P

MO P

CR P



AK KK RT

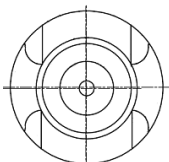
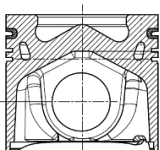







48  **86.00**

Astra Mk II 2.0	09/86→08/91	20 NE		
Astra Mk II 2.0 i	01/87→12/91		4 Cyl.	9.2:1
Cavalier Mk II 2.0 i	09/86→08/88		1998cc	85kW (116PS)
Cavalier Mk III 2.0 i	09/88→10/92			TD17637

Astra Mk II 2.0 i CAT	01/91→08/93	C 20 NE		
Astra Mk III 2.0 i	09/91→09/98		4 Cyl.	9.2:1
Calibra 2.0 I	06/90→07/97		1998cc	85kW (115PS)
Carlton Mk III 2.0	09/86→03/94			TD17584
Cavalier Mk II 2.0 i CAT	09/86→08/88			
Cavalier Mk III 2.0 i CAT	09/90→11/95			
Frontera Mk I 2.0	04/95→08/98			
Frontera Mk I 2.0 I	03/92→10/98			

87-306800-30	STD	08-306800-00	STD
87-306807-30	0.50mm	08-306807-00	0.50mm
87-306811-30	1.00mm	08-306811-00	1.00mm

A	30.40	1.50	 CR P
B-	5.00	1.50	 P
BØ	57.00	3.00	 CR 1

D 50.40
 21x62

TP

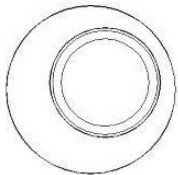
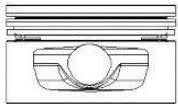

1 Steel

1 Stahl

1 Acier

1 Acero

1 Acciaio







49 86.00

Astra Mk II 2.0 GTE 16V	05/88→08/91	20 XE		
Cavalier Mk III 2.0 GSi	09/89→08/92		4 Cyl. 1998cc	10.5:1 115kW (156PS)
TD17605				

Astra Mk II 1.9	03/88→08/91	C 20 XE		
Astra Mk III 2.0 i 16V	09/91→02/98		4 Cyl. 1998cc	10.5:1 110kW (150PS)
Calibra 2.0 I 16V	06/90→02/94			
Cavalier Mk III 2.0 i 16V	09/88→11/95			
TD17585				

87-306800-10	STD	08-306800-00	STD
87-306807-10	0.50mm	08-306807-00	0.50mm
		08-306811-00	1.00mm

A	30.43	1.50		CR P
B-	0.85	1.50		P
BØ	70.00	3.00		CR 1
C	2.20			
D	55.43			
	21x62			

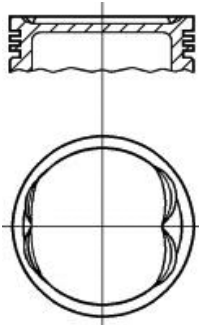

 Steel

 Stahl

 Acier





 Acero

 Acciaio

50 86.00

Astra Mk III 2.0 i 16V	01/94→09/98	X 20 XEV Ecotec		
Astra Mk IV 2.0 16V	02/98→05/05		4 Cyl. 1998cc	10.8:1 100kW (136PS)
Calibra 2.0 I 16V	06/90→07/97			
Cavalier Mk III 2.0 i 16V				
Cavalier Mk III 2.0 SRi 16V	09/93→11/95			
Omega 2.0 16V	03/94→02/01			
Vectra 2.0 i 16V	10/95→01/01			
TD17594				

87-306800-20	STD	08-306800-00	STD
87-306807-20	0.50mm	08-306807-00	0.50mm
		08-306811-00	1.00mm

A	30.40	1.50		CR P
B-	3.16	1.50		P
C	2.00	3.00		CR 1
D	55.40			
	21x62			

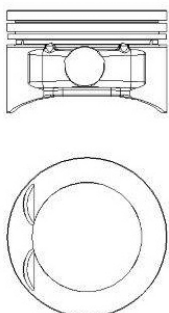

 Steel

 Stahl

 Acier

 Acero

 Acciaio

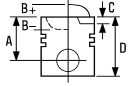

51 86.00

Astra Mk IV 2.2 16V	03/00 → 10/05	Z 22 SE Ecotec			
Speedster 2.2	03/01 → 09/06		4 Cyl.	10:1	
Vectra 2.2 i 16V	08/95 → 07/03		2198cc	106-108kW (144-147PS)	
Vectra Mk II 2.2 16V	01/02 → 10/08				TD17683
VX220 2.2 i	09/00 → 07/05				
Zafira Mk I 2.2 16V	11/98 → 08/04				

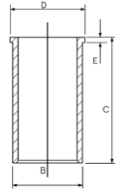

14-020450-00 D B 89.02 C 137.25 D 95.45 E 4.63



52 87.00

Movano Mk I 2.2 DTI	09/00 → 05/10	G9T 720			
			4 Cyl.	18:1	
			2188cc	66kW (90PS)	
		Diesel	Turbo Intercooled		TD19353
Movano Mk I 2.2 DTI	09/00 → 05/10	G9T 722			
			4 Cyl.	18:1	
			2188cc	66kW (90PS)	
		Diesel	Turbo Intercooled		TD19356
Movano Mk I 2.2 DTI	09/00 → 05/10	G9T 750			
			4 Cyl.	17.8:1	
			2188cc	66kW (90PS)	
		Diesel	Turbo Intercooled		TD19355

87-127400-00	STD	08-127400-00	STD
87-127407-00	0.50mm	08-127407-00	0.50mm

A	54.53	3.00	 P PS
B-	17.50	1.75	 P
BØ	40.40	2.50	 P

C	2.00
D	84.20
	31x65



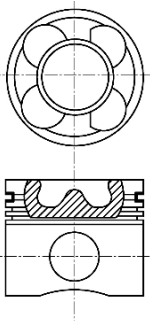

AK RT TP



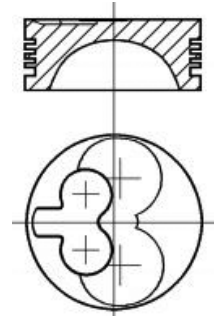

53 88.00

Brava 2.2 D	12/88→09/96	C 223	4 Cyl. 2238cc	21:1 39-54kW (53-73PS)
Diesel			TD22879	

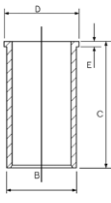
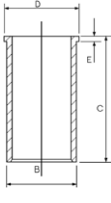
<p>87-247600-10 STD</p> <p>A 48.00 B- 2.40 D 82.75  27x68</p> <p>RT</p>  <p>1 Not suitable for use with pistons having chrome rings 2 Chrome Bore</p>	<p>08-247600-00 STD</p> <p>12/83→</p> <p>2.00  P 2.00  P 4.00  P</p> <p>1 Nicht geeignet zur Verwendung mit Kolben mit Chromringen 2 Bohrung verchromte</p>	<p>14-021440-00 DH 1 2 B 89.97 C 163.32 D 94.89 E 0.89</p>  <p>14-021190-00 D B 92.13 C 163.50 D 95.00 E 4.00</p>  <p>1 Ne pas utiliser avec des pistons équipés de segments chromés 2 Alésage chromée</p>	<p>88-247600-10 87-247600-10 + 14-021440-00</p> <p>1 Non utilizzabile con pistoni equipaggiati con segmenti cromati 2 Cilindro cromato</p>
--	---	--	---

54 89.00

Movano Mk I 2.5 DTI	10/01→05/10	G9U 720 Euro 3	4 Cyl. 2463cc	21:1 84-85kW (115-116PS)
Diesel			Turbo Intercooled	
TD19358				
Movano Mk I 2.5 DTI	10/01→05/10	G9U 724 Euro 3	4 Cyl. 2463cc	21:1 84kW (115PS)
Diesel			Turbo Intercooled	
TD19368				
Vivaro 2.5 CDTI Vivaro 2.5 DTI	04/03→07/14 07/03→07/14	G9U 730 Euro 3	4 Cyl. 2463cc	18:1 99-107kW (135-146PS)
Diesel			Turbo Intercooled	
TD18701				
Movano Mk I 2.5 DTI	10/01→05/10	G9U 750 Euro 3	4 Cyl. 2463cc	17.75:1 84kW (115PS)
Diesel			Turbo Intercooled	
TD19365				



Movano Mk I 2.5 CDTI, Movano Mk I 2.5 DTI	10/01→05/10	G9U 754 Euro 3	4 Cyl.	17.75:1	
			2463cc	73-84kW (99-115PS)	
		Diesel	Turbo Intercooled		TD19369

87-137500-10	STD	08-137500-10	STD
87-137507-10	0.50mm	08-137507-10	0.50mm

A	53.03	2.50		MO P
B-	17.85	1.75		P
BØ	43.20	2.50		CR P
C	1.65			
C	1.90			
D	83.09			
	31x65			

AK RT TP

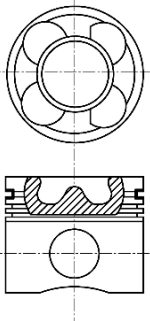

55 92.00

Carlton Mk II 2.3 D	09/80→	23 D	4 Cyl.	22:1	
			2260cc	48-52kW (65-71PS)	
		Diesel			TD17575
Carlton Mk III 2.3 TD Interc.	08/88→03/94	23 DTR	4 Cyl.	23:1	
Frontera Mk I 2.3 TD	09/91→06/98		2260cc	74kW (100PS)	
		Diesel	Turbo Intercooled		TD17576
Carlton Mk II 2.3 TD	09/83→08/86	23 TD	4 Cyl.	22:1	
Royale 2.2 TD, Senator 2.2 TD	11/84→08/87		2260cc	63kW (86PS)	
		Diesel	Turbo		TD17577
Carlton Mk III 2.3 D	09/86→03/94	23 YD	4 Cyl.	22:1	
			2260cc	54kW (73PS)	
		Diesel			TD17914
Carlton Mk III 2.2 TD	09/86→08/88	23 YDT	4 Cyl.	23:1	
			2260cc	66kW (90PS)	
		Diesel	Turbo Intercooled		TD17579

14-024100-00 D B 95.00 C 172.00 D 97.00 E 4.70

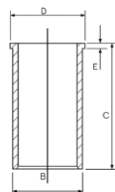

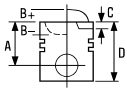





56 92.00

Frontera Mk I 2.5 TDS 11/91→10/98 **25TDS (VM41B)**
 4 Cyl.
2499cc **85kW (115PS)**
Diesel **Turbo Intercooled** **TD22850**

87-110100-00 STD **08-110100-00** STD **14-676420-00 WH** B 101.50 C 166.80 D 110.00 E 8.90 F 1.20 **89-110100-00**
 87-110100-00 +
 14-676420-00

A 51.00
B- 2.10
D 86.00
 30x76

2.50  CR P
 2.00  P
 4.00  CR P

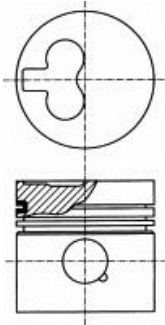
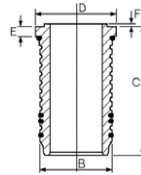

57 93.00



Arena 2.5 D 03/98→08/01 **S8U 758**
 4 Cyl. 22:1
2499cc **55-58kW (75-79PS)**
Diesel **TD22883**

Arena 2.5 D 03/98→08/01 **S8U 780**
 4 Cyl. 22:1
2499cc **55kW (75PS)**
Diesel **TD22884**

Arena 2.5 D 03/98→08/01 **S8U 782**
 4 Cyl. 22:1
2499cc **55kW (75PS)**
Diesel **TD22885**

87-783300-00 STD **08-783300-00** STD **14-022560-00 D** B 96.00 C 167.30 D 98.90 E 5.00
87-783308-00 0.60mm **08-783308-00** 0.60mm **14-028930-00 D** B 97.50 C 167.00 D 100.90 E 5.00
14-028931-00 D B 97.58 C 167.00 D 100.90 E 5.00
14-028932-00 D B 97.70 C 167.00 D 100.90 E 5.00

A 54.00
B- 2.20
D 89.00
 32x75

3.00  CR P
 2.00  P
 3.00  CR P

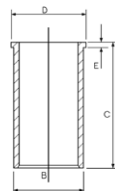

HA RT

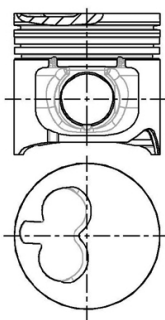

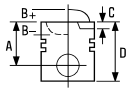

58 94.40

Movano	01/99 →	8140.23.2585/3700/8140.43.2585/3700/3900 Sofim	4 Cyl.	18.5:1	
			2800cc	84kW (114PS)	
		Diesel	Turbo Intercooled		FM9256
Movano 2.8 DTI		S9W 700	4 Cyl.	19:1	
			2799cc	84kW (114PS)	
		Diesel	Turbo Intercooled		TD21150
Movano Mk I 2.8 DTI, Movano Mk I 2.8 TDI	10/98 → 10/01	S9W 702	4 Cyl.	19:1	
			2799cc	84kW (114PS)	
		Diesel	Turbo Intercooled		TD19361

87-122200-10

STD

87-122208-10

0.60mm

2572280 →

A 58.75

B- 19.40

BØ 39.25

D 87.60

 32x72

AK KK RT TP

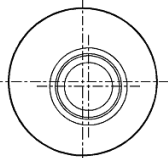
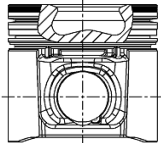

08-122200-00

STD

08-122208-00

0.60mm

2572280 →

2.50

2.00

2.50



CK P

P

CR P

14-021321-00 D

B 97.54 **C** 167.00 **D** 100.90 **E** 5.00

14-028930-00 D

B 97.50 **C** 167.00 **D** 100.90 **E** 5.00

14-028931-00 D

B 97.58 **C** 167.00 **D** 100.90 **E** 5.00

14-028932-00 D

B 97.70 **C** 167.00 **D** 100.90 **E** 5.00

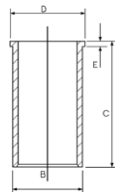

87-854700-00

STD

87-854708-00

0.60mm

→2572279

A 58.75

B- 19.40

BØ 39.40

D 96.65

 32x78

AK KK RT

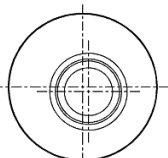
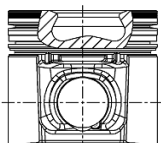

08-854700-00

STD

08-854708-00

0.60mm

→2572279

3.00

2.00

3.00



CR

P

CR

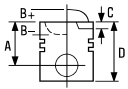

1 **92.00**

HR492HTI 4 Cyl. 22:1 **2500cc** **85kW (116PS)** **Diesel Turbo** **FM4053**

87-110100-00 STD **08-110100-00** STD **14-676420-00 WH** B 101.50 C 166.80 D 110.00 E 8.90 F 1.20 **89-110100-00**
87-110100-00 +
14-676420-00

A 51.00
B- 2.10
D 86.00
 30x76

2.50 CR P
2.00 P
4.00 CR P

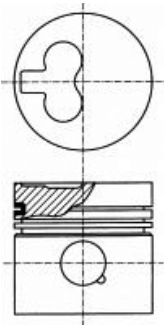
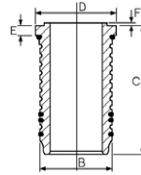

2 **92.00**

R 425 DOHC 4 Cyl. 17.5:1 **2499cc** **105-125kW (143-170PS)** **Diesel Turbo Intercooled** **TD18633**

87-429200-00 STD **08-429200-00** STD **14-260090-00 WH** B 101.50 C 167.80 D 110.00 E 6.90 F 1.00

A 55.00
B- 18.00
BØ 44.00
D 83.00
 32x68

02/05→
2.50 GDC P
1.50 P
2.00 NT

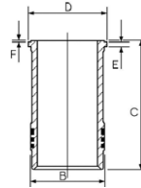

AK KK RT TP

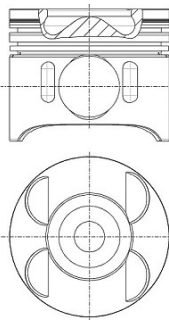

3 **92.00**





VM 392 HT 3 Cyl. **1779cc** **Diesel Turbo** **FM4049**



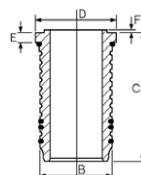

VM 492 HR/VM 492 HS 4 Cyl. 22:1 **2500cc** **Diesel Turbo** **FM9171**





VM 492 HT 4 Cyl. 22.1:1 **2393cc** **Diesel Turbo** **FM4047**





14-676420-00 WH B 101.50 C 166.80 D 110.00 E 8.90 F 1.20







			ccm	x 		9
1C	Diesel		1600	4	76.50	13
1F	Petrol		1595	4	81.00	29
1G	Diesel		2383	6	76.50	13
1V	Diesel		1588	4	76.50	13
1X	Diesel		1896	4	79.50	17
1P	Petrol		1781	4	81.00	30
1S	Diesel		2383	6	76.50	14
1W	Diesel		1398	4	75.00	4
1Y	Diesel		1896	4	79.50	17
1Z	Diesel		1896	4	79.50	18
2E	Petrol		1984	4	82.50	50
2H	Petrol		1781	4	81.00	30
2L	Diesel		2446	4	92.00	56
3F	Petrol		1272	4	75.00	4
28B	Diesel		1896	4	79.50	19
68A	Diesel		1588	4	76.50	13
68C	Diesel		1588	4	76.50	13
262	Petrol		1781	4	81.00	31
685	Diesel		1588	4	76.50	14
686	Diesel		1588	4	76.50	13
AAA	Petrol		2792	V6	81.00	32
AAB	Diesel		2370	5	79.50	17
AAM	Petrol		1781	4	81.00	31
AAU	Petrol		1043	4	75.00	4
AAV	Petrol		1272	4	75.00	4
AAZ	Diesel		1896	4	79.50	20
ABF	Petrol		1984	4	82.50	51
ABL	Diesel		1896	4	79.50	20
ABN	Petrol		1595	4	81.00	29
ABS	Petrol		1781	4	81.00	30
ACC	Petrol		1781	4	81.00	31
ACL	Diesel		2384	6	76.50	13
ACT	Diesel		2384	6	76.50	14
ACV	Diesel		2461	5	81.00	40
ADD	Petrol		1781	4	81.00	31
ADE	Diesel		1896	4	79.50	20
ADF	Petrol		1781	4	81.00	31
ADG	Diesel		1896	4	79.50	17
ADK	Diesel		1588	4	76.50	14
ADP	Petrol		1595	4	81.00	33
ADR	Petrol		1781	4	81.00	34
ADY	Petrol		1984	4	82.50	50
ADZ	Petrol		1781	4	81.00	30
AEA	Petrol		1598	4	76.50	5
AEB	Petrol		1781	4	81.00	35
AEE	Petrol		1598	4	76.50	5
AEF	Diesel		1896	4	79.50	17
AEH	Petrol		1595	4	81.00	33
AEK	Petrol		1595	4	81.00	33
AER	Petrol		999	4	67.10	1
AES	Petrol		2792	V6	81.00	32
AEX	Petrol		1390	4	76.50	6
AEY	Diesel		1896	4	79.50	18
AFB	Diesel		2496	V6	78.30	15
AFD	Diesel		1896	4	79.50	18
AFH	Petrol		1390	4	76.50	7
AFK	Petrol		1390	4	76.50	7
AFN	Diesel		1896	4	79.50	18
AFP	Petrol		2792	V6	81.00	32
AFT	Petrol		1595	4	81.00	33
AGD	Diesel		1896	4	79.50	18
AGG	Petrol		1984	4	82.50	50
AGN	Petrol		1781	4	81.00	34
AGP	Diesel		1896	4	79.50	21
AGR	Diesel		1896	4	79.50	18
AGU Euro 2	Petrol		1781	4	81.00	35
AGX	Diesel		2459	5	81.00	40
AGZ	Petrol		2324	V5	81.00	32
AHB	Diesel		1716	4	79.50	19





		ccm	x 		9
AHD	Diesel	2459	5	81.00	40
AHF	Diesel	1896	4	79.50	18
AHG	Diesel	1716	4	79.50	19
AHH	Diesel	1896	4	79.50	18
AHL	Petrol	1595	4	81.00	36
AHS	Petrol	1588	4	76.50	5
AHU	Diesel	1896	4	79.50	18
AHW	Petrol	1390	4	76.50	7
AHY	Diesel	2461	5	81.00	40
AJA	Diesel	2370	5	79.50	17
AJH	Petrol	1781	4	81.00	35
AJM	Diesel	1896	4	79.50	22
AJT	Diesel	2461	5	81.00	40
AKL	Petrol	1595	4	81.00	33
AKN	Diesel	2496	V6	78.30	15
AKQ	Petrol	1390	4	76.50	7
AKR	Petrol	1984	4	82.50	50
AKS	Petrol	1588	4	81.00	33
AKU	Diesel	1716	4	79.50	19
AKV	Petrol	1390	4	76.50	6
AKW	Diesel	1716	4	79.50	19
ALE	Diesel	1896	4	79.50	18
ALH	Diesel	1896	4	79.50	18
ALL	Petrol	999	4	67.10	1
ALM	Petrol	1598	4	76.50	5
ALZ	Petrol	1595	4	81.00	37
AMF	Diesel	1422	3	79.50	23
AMY	Petrol	2792	V6	81.00	32
ANA	Petrol	1595	4	81.00	37
ANB	Petrol	1781	4	81.00	35
ANC	Diesel	1896	4	79.50	19
ANF	Diesel	2461	5	81.00	41
ANG	Diesel	2461	5	81.00	41
ANH	Diesel	2461	5	81.00	41
ANJ	Diesel	2461	5	81.00	40
ANN	Petrol	1781	4	81.00	31
ANU	Diesel	1896	4	79.50	24
ANX	Petrol	1389	4	76.50	6
APA	Diesel	2461	5	81.00	40
APE	Petrol	1390	4	76.50	7
APF	Petrol	1595	4	81.00	33
APH	Petrol	1781	4	81.00	35
APQ	Petrol	1390	4	76.50	6
APT	Petrol	1781	4	81.00	34
APU	Petrol	1781	4	81.00	35
AQA	Petrol	1781	4	81.00	35
AQM	Diesel	1896	4	79.50	21
AQQ	Petrol	1390	4	76.50	7
ARD	Diesel	1896	4	79.50	18
ARG	Petrol	1781	4	81.00	34
ARL	Diesel	1896	4	79.50	25
ARM	Petrol	1595	4	81.00	33
ARX	Petrol	1781	4	81.00	38
ARZ	Petrol	1781	4	81.00	35
ASV	Diesel	1896	4	79.50	18
ASX	Diesel	1896	4	79.50	21
ASY	Diesel	1896	4	79.50	21
ASZ	Diesel	1896	4	79.50	25
ATD	Diesel	1896	4	79.50	24
ATJ	Diesel	1896	4	79.50	22
AUA	Petrol	1390	4	76.50	7
AUB	Petrol	1390	4	76.50	7
AUF	Diesel	2461	5	81.00	40
AUM	Petrol	1781	4	81.00	38
AUR	Petrol	1595	4	81.00	33
AUY	Diesel	1896	4	79.50	22
AVB	Diesel	1896	4	79.50	24
AVC	Petrol	1781	4	81.00	35
AVF	Diesel	1896	4	79.50	25

			ccm	x 		9
AVG	Diesel		1896	4	79.50	18
AVM Euro 3	Diesel		1896	4	79.50	18
AVQ	Diesel		1896	4	79.50	24
AVR	Diesel		2461	5	81.00	42
AVU	Petrol		1595	4	81.00	37
AWC	Petrol		1781	4	81.00	35
AWD	Petrol		1781	4	81.00	35
AWH	Petrol		1595	4	81.00	33
AWM	Petrol		1781	4	81.00	38
AWP	Petrol		1781	4	81.00	38
AWT	Petrol		1781	4	81.00	38
AWU	Petrol		1781	4	81.00	38
AWV	Petrol		1781	4	81.00	38
AWX	Diesel		1896	4	79.50	25
AXB	Diesel		1896	4	79.50	26
AXC	Diesel		1896	4	79.50	26
AXD	Diesel		2461	5	81.00	43
AXE	Diesel		2461	5	81.00	43
AXG	Diesel		2461	5	81.00	40
AXL	Diesel		2461	5	81.00	40
AXP	Petrol		1390	4	76.50	7
AXR	Diesel		1896	4	79.50	24
AXW	Petrol		1984	4	82.50	52
AXX	Petrol		1984	4	82.50	53
AYC	Diesel		2461	5	81.00	40
AYD	Petrol		1595	4	81.00	37
AYQ	Diesel		1896	4	79.50	21
AYY	Diesel		2461	5	81.00	40
AZQ	Petrol		1198	3	76.50	8
AZV	Diesel		1968	4	81.00	44
BAC	Diesel		2461	5	81.00	43
BAU	Diesel		2496	V6	78.30	16
BAY	Diesel		1422	3	79.50	23
BBE	Diesel		2461	5	81.00	40
BBF	Diesel		2461	5	81.00	40
BBR	Diesel		2461	5	81.00	42
BBY	Petrol		1390	4	76.50	7
BBZ	Petrol		1390	4	76.50	7
BCA	Petrol		1390	4	76.50	7
BCT	Diesel		2461	5	81.00	41
BCU	Diesel		2461	5	81.00	41
BCV	Diesel		2461	5	81.00	41
BDG	Diesel		2496	V6	78.30	16
BDJ	Diesel		1968	4	81.00	45
BDK	Diesel		1968	4	81.00	45
BEQ	Diesel		1896	4	79.50	18
BEU	Diesel		1896	4	79.50	18
BEW	Diesel		1896	4	79.50	24
BFQ	Petrol		1595	4	81.00	37
BFS	Petrol		1595	4	81.00	37
BGG	Diesel		1896	4	79.50	19
BGL	Diesel		1896	4	79.50	19
BGM	Diesel		1896	4	79.50	19
BGU	Petrol		1595	4	81.00	37
BGW	Diesel		1968	4	81.00	46
BJB	Diesel		1896	4	79.50	24
BJC	Diesel		1896	4	79.50	18
BJL	Diesel		2461	5	81.00	47
BJM	Diesel		2461	5	81.00	47
BJX	Petrol		1781	4	81.00	38
BKC	Diesel		1896	4	79.50	24
BKD	Diesel		1968	4	81.00	44
BKP	Diesel		1968	4	81.00	44
BKR	Petrol		1390	4	76.50	9
BKS	Diesel		2967	V6	83.00	55
BKY	Petrol		1390	4	76.50	9
BLG	Petrol		1390	4	76.50	10
BLJ	Diesel		2461	5	81.00	43
BLK	Diesel		2461	5	81.00	43

		ccm	x 		9
BLM	Petrol	1390	4	76.50	7
BLR	Petrol	1984	4	82.50	52
BLS	Diesel	1896	4	79.50	24
BLT	Diesel	1896	4	79.50	27
BLX	Petrol	1984	4	82.50	52
BLY	Petrol	1984	4	82.50	52
BMA	Diesel	1968	4	81.00	44
BMK	Diesel	2967	V6	83.00	55
BMM	Diesel	1968	4	81.00	46
BMN	Diesel	1968	4	81.00	44
BMP	Diesel	1968	4	81.00	46
BMR	Diesel	1968	4	81.00	44
BMT	Diesel	1896	4	79.50	24
BMY	Petrol	1390	4	76.50	10
BNU	Petrol	1781	4	81.00	38
BPD	Diesel	2461	5	81.00	41
BRR	Diesel	1896	4	79.50	27
BRS	Diesel	1896	4	79.50	27
BRT	Diesel	1968	4	81.00	46
BRU	Diesel	1896	4	79.50	24
BSE	Petrol	1595	4	81.00	37
BSF	Petrol	1595	4	81.00	37
BSU	Diesel	1896	4	79.50	24
BSW	Diesel	1896	4	79.50	24
BTW	Diesel	2460	5	81.00	41
BUD	Petrol	1390	4	76.50	9
BUN	Diesel	2967	V6	83.00	55
BUZ	Diesel	1968	4	81.00	44
BVD	Diesel	1968	4	81.00	44
BVE	Diesel	1968	4	81.00	44
BVK	Diesel	1896	4	79.50	22
BVX	Petrol	1984	4	82.50	52
BVY	Petrol	1984	4	82.50	52
BVZ	Petrol	1984	4	82.50	52
BWA	Petrol	1984	4	82.50	53
BWB	Diesel	1422	3	79.50	23
BXE	Diesel	1896	4	79.50	24
BXF	Diesel	1896	4	79.50	24
BXJ	Diesel	1896	4	79.50	24
BXT	Diesel	1896	4	79.50	18
CAAA Euro 5	Diesel	1968	4	81.00	48
CAAB Euro 5	Diesel	1968	4	81.00	48
CAAC Euro 5	Diesel	1968	4	81.00	48
CAAD	Diesel	1968	4	81.00	48
CAAE	Diesel	1968	4	81.00	48
CAVA	Petrol	1390	4	76.50	10
CAVB	Petrol	1390	4	76.50	10
CAVC	Petrol	1390	4	76.50	10
CAVD	Petrol	1390	4	76.50	10
CAVE	Petrol	1390	4	76.50	10
CAXA	Petrol	1390	4	76.50	11
CAYA	Diesel	1598	4	79.50	28
CAYB	Diesel	1598	4	79.50	28
CAYC	Diesel	1598	4	79.50	28
CAYD	Diesel	1598	4	79.50	28
CAYE	Diesel	1598	4	79.50	28
CBAA	Diesel	1968	4	81.00	48
CBAB	Diesel	1968	4	81.00	48
CBAC	Diesel	1968	4	81.00	48
CBBB	Diesel	1968	4	81.00	48
CBDA	Diesel	1968	4	81.00	48
CBDB	Diesel	1968	4	81.00	48
CBDC	Diesel	1968	4	81.00	48
CBZA	Petrol	1197	4	71.00	2
CBZB	Petrol	1197	4	71.00	2
CBZC	Petrol	1197	4	71.00	2
CCHA	Diesel	1968	4	81.00	48
CCHB	Diesel	1968	4	81.00	48
CDAA	Petrol	1798	4	82.50	54

		ccm	x 		9
---	---	-----	---	---	----------

CDAB	Petrol	1798	4	82.50	54
CDBA	Diesel	1968	4	81.00	48
CDCA	Diesel	1968	4	81.00	48
CDDA	Petrol	1390	4	76.50	9
CDXA	Diesel	1896	4	79.50	19
CDXB	Diesel	1896	4	79.50	19
CECA	Diesel	2461	5	81.00	47
CECB	Diesel	2461	5	81.00	47
CEGA	Diesel	1968	4	81.00	48
CFCA Euro 5	Diesel	1968	4	81.00	48
CFFA	Diesel	1968	4	81.00	49
CFFB	Diesel	1968	4	81.00	49
CFFD	Diesel	1968	4	81.00	49
CFFE	Diesel	1968	4	81.00	49
CFGB	Diesel	1968	4	81.00	49
CFGC	Diesel	1968	4	81.00	49
CFHB	Diesel	1968	4	81.00	49
CFHC	Diesel	1968	4	81.00	49
CFHE	Diesel	1968	4	81.00	49
CFHF	Diesel	1968	4	81.00	49
CFJA	Diesel	1968	4	81.00	49
CFJB	Diesel	1968	4	81.00	49
CFWA	Diesel	1199	3	79.50	28
CG	Diesel	2710	4	92.00	57
CGGA	Petrol	1390	4	76.50	9
CGGB	Petrol	1390	4	76.50	9
CHGA	Petrol	1595	4	81.00	37
CHYA	Petrol	999	3	74.50	3
CHYB	Petrol	999	3	74.50	3
CJAA	Diesel	1968	4	81.00	48
CK	Diesel	1471	4	76.50	12
CKTB	Diesel	1968	4	81.00	49
CKTC	Diesel	1968	4	81.00	49
CKUB	Diesel	1968	4	81.00	49
CKUC	Diesel	1968	4	81.00	49
CLCA	Diesel	1968	4	81.00	49
CLCB	Diesel	1968	4	81.00	49
CLJA	Diesel	1968	4	81.00	49
CLLA	Diesel	1968	4	81.00	49
CLNA	Diesel	1598	4	79.50	28
CLPA	Petrol	1390	4	76.50	9
CMSB	Petrol	1390	4	76.50	11
CNEA	Diesel	1968	4	81.00	49
CNFA	Diesel	1968	4	81.00	49
CNFB	Diesel	1968	4	81.00	49
CNWA	Petrol	1390	4	76.50	10
CP	Diesel	2383	6	76.50	14
CPGA	Petrol	999	3	74.50	3
CR	Diesel	1588	4	76.50	14
CS	Diesel	1588	4	76.50	14
CSHA	Diesel	1968	4	81.00	49
CTHA	Petrol	1390	4	76.50	10
CTHB	Petrol	1390	4	76.50	10
CTHC	Petrol	1390	4	76.50	10
CTHD	Petrol	1390	4	76.50	10
CTHE	Petrol	1390	4	76.50	10
CTKA	Petrol	1390	4	76.50	10
CWRA	Petrol	999	3	74.50	3
CY	Diesel	1588	4	76.50	13
CYVD	Petrol	1197	4	71.00	2
DS	Petrol	1781	4	81.00	30
DT	Petrol	1595	4	81.00	29
DTA	Petrol	1595	4	81.00	29
DV	Diesel	2383	6	76.50	13
DW	Diesel	2383	6	76.50	14
DX	Petrol	1781	4	81.00	30
DZ	Petrol	1781	4	81.00	30
EV	Petrol	1781	4	81.00	30
EW	Petrol	1595	4	81.00	29

			ccm	x 		9
EX	Petrol	1781	4	81.00	30	
EZ	Petrol	1595	4	81.00	29	
EZA	Petrol	1595	4	81.00	29	
GK	Petrol	1272	4	75.00	4	
GU	Petrol	1781	4	81.00	30	
GX	Petrol	1781	4	81.00	30	
GZ	Petrol	1781	4	81.00	30	
HK	Petrol	1272	4	75.00	4	
HM	Petrol	1595	4	81.00	29	
HN	Petrol	1595	4	81.00	29	
HT	Petrol	1781	4	81.00	30	
HV	Petrol	1781	4	81.00	30	
HZ	Petrol	1043	4	75.00	4	
JH	Petrol	1781	4	81.00	30	
JK	Diesel	1588	4	76.50	14	
JP	Diesel	1588	4	76.50	14	
JR	Diesel	1588	4	76.50	13	
JT	Petrol	2226	5	81.00	39	
JU	Petrol	1595	4	81.00	29	
JV	Petrol	1781	4	81.00	30	
JX	Diesel	1588	4	76.50	13	
KT	Petrol	1781	4	81.00	30	
KX	Petrol	2226	5	81.00	39	
ME	Diesel	1588	4	76.50	14	
MF	Diesel	1588	4	76.50	13	
MN	Diesel	1272	4	75.00	4	
NZ	Petrol	1272	4	75.00	4	
PB	Petrol	1781	4	81.00	30	
PF	Petrol	1781	4	81.00	30	
PN	Petrol	1595	4	81.00	29	
PP	Petrol	1595	4	81.00	29	
RA	Diesel	1588	4	76.50	13	
RE	Petrol	1595	4	81.00	29	
RF	Petrol	1595	4	81.00	29	
RG	Petrol	1781	4	81.00	30	
RH	Petrol	1781	4	81.00	30	
RL	Petrol	1595	4	81.00	29	
RP	Petrol	1781	4	81.00	31	
RV	Petrol	1781	4	81.00	30	
SB	Diesel	1588	4	76.50	13	
YJ	Petrol	1471	4	76.50	12	
ZB	Petrol	1471	4	76.50	12	
ZC	Petrol	1471	4	76.50	12	

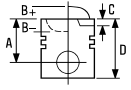

1 67.10

Lupo 1.0	09/98→07/05	AER			
Polo 50 1.0	09/96→10/99		4 Cyl.	10.5:1	
Polo Classic 1.0, Voyage 1.0	08/96→12/01		999cc	37kW (50PS)	TD9519

Lupo 1.0	09/98→07/05	ALL			
Polo 50 1.0	09/96→10/99		4 Cyl.	10.5:1	
			999cc	37kW (50PS)	TD10609

87-101300-00	STD	08-101300-00	STD
87-101307-00	0.50mm	08-101307-00	0.50mm

A	31.25	1.00		NT
B-	5.65	1.20		P
D	56.27	2.00		P
	17x48			

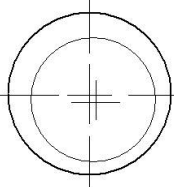
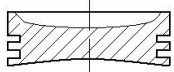

Steel

Stahl

Acier

Acero

Acciaio

2 71.00

Caddy III 1.2 TSI	09/10→	CBZA			
Golf VI 1.2 TSI	05/10→07/13		4 Cyl.	10:1	
Golf Plus 1.2 TSI	05/10→12/13		1197cc	63kW (86PS)	
Polo 1.2 TSI	06/09→		Turbo Intercooled		TD24312

Beetle 1.2 TSI	07/11→	CBZB			
Caddy III 1.2 TSI	09/10→		4 Cyl.	10:1	
Golf VI 1.2 TSI	11/08→		1197cc	77kW (105PS)	
Golf Plus 1.2 TSI	11/09→12/13		Turbo Intercooled		TD23520
Jetta IV 1.2 TSI	02/11→				
Polo 1.2 TSI	11/09→				
Touran 1.2 TSI	05/10→05/15				
Vento 1.2	01/10→				

Polo 1.2 TSI	05/11→05/14	CBZC			
			4 Cyl.		
			1197cc	66kW (90PS)	
			Turbo		TD25703





Beetle 1.2 TSI 16V Golf VI 1.2 TSI 16V	12/14→ 11/13→	CYVD	4 Cyl. 1197cc Turbo Intercooled	77kW (105PS)	TD31806
---	------------------	-------------	---	---------------------	----------------

87-442300-00 1 2 STD

A 28.00
B+ 0.70
C 3.52
C 3.52
D 48.00
 17x49

08-442300-00 STD

1.20  NT 3
 1.20  P
 2.00  NT

AK HA TP

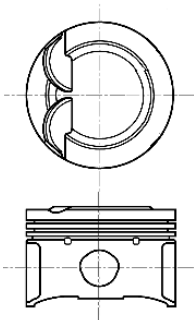

07124A101

1 Earlier pistons to be replaced in Engine sets only

2 Elastoval®
 3 Steel

1 Frühere Kolben nur in Motorsätzen zu ersetzen

2 Elastoval®
 3 Stahl

1 Premier piston à remplacer dans le jeu moteur

2 Elastoval®
 3 Acier

1 Pistones más antiguos para ser reemplados en juego de motores solamente

2 Elastoval®
 3 Acero

1 Con i pistone di vecchia versione è necessario sostituire tutta la serie

2 Elastoval®
 3 Acciaio



3 74.50

Load Up 1.0	12/14→	CHYA				
Polo 1.0	01/14→		3 Cyl.	10.5:1		
Up 1.0	08/11→		999cc	44kW (60PS)		TD26238
Polo 1.0	01/14→	CHYB				
Up 1.0	08/11→		3 Cyl.	10.5:1		
			999cc	55kW (75PS)		TD26239
Load Up 1.0 EcoFuel	12/14→	CPGA				
Up 1.0 EcoFuel	11/12→		3 Cyl.	10.5:1		
			999cc	50kW (68PS)		TD27210
Polo 1.0	01/14→	CWRA				
Up 1.0	08/11→		3 Cyl.	10.5:1		
			999cc	55kW (75PS)		TD31412





87-443600-00

STD

A 27.22
B- 0.56
BØ 58.07
C 2.19
D 42.22
 17x39

08-443600-00

STD

1.00  NT 
 1.20  P
 2.00  CR 

TP

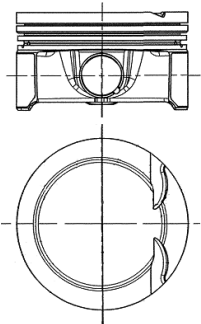

7452-201

 Steel

 Stahl

 Acier

 Acero

 Acciaio



4  **75.00**

Polo 1.3	10/90→09/94	3F					
Polo 1.3 CAT	10/89→09/94		4 Cyl.	1272cc	9.5:1	55-57kW (75-78PS)	TD4968
Polo 1.0	08/92→07/94	AAU					
Polo 1.0 CAT	08/89→09/94		4 Cyl.	1043cc	9.8:1	33kW (45PS)	TD4971
Polo Classic 1.0	01/85→09/94						
Polo 1.3	08/92→07/94	AAV					
Polo 1.3 CAT	07/87→09/94		4 Cyl.	1272cc	9.2:1	40kW (55PS)	TD5159
Derby 1.3	09/82→12/84	GK					
Polo 1.3	09/82→09/89		4 Cyl.	1272cc	9.5:1	55kW (75PS)	TD4094
Derby 1.3	08/83→12/84	HK					
Golf I 1.3	08/83→07/86		4 Cyl.	1272cc	9.5:1	40kW (55PS)	TD5011
Golf II 1.3	08/83→06/87						
Jetta II 1.3	01/84→06/87						
Polo 1.3	08/83→07/88						
Polo Classic 1.3	01/85→07/87						
Scirocco 1.3	08/83→07/84						
Golf II 1.0	08/85→10/91	HZ					
Polo 1.0	08/85→01/92		4 Cyl.	1043cc	9.5:1	33-37kW (45-50PS)	TD5012
Polo Classic 1.0	01/85→09/94						
Golf II 1.3 CAT	06/86→12/92	NZ					
Jetta II 1.3 CAT	06/87→12/91		4 Cyl.	1272cc	9.5:1	40kW (55PS)	TD4136
Polo 1.3 CAT	07/87→08/94						
Polo 1.3 CAT, Polo Classic 1.3 CAT	07/87→09/94						
Polo 1.4 D	08/90→09/94	1W					
Polo Classic 1.4 D	10/90→09/94		4 Cyl.	1398cc	22.5:1	35kW (48PS)	TD4959
		Diesel					
Polo 1.3 D	08/86→08/90	MN					
Polo Classic 1.3 D	08/86→12/88		4 Cyl.	1272cc	22:1	33kW (44PS)	TD4132
		Diesel					

14-025070-00 D

B 78.00 C 133.00 D 81.00 E 4.50

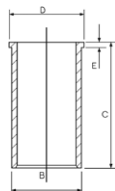



5 76.50

Golf III 1.6	09/92→08/97	AEA			
Polo 1.6	09/94→12/95		4 Cyl.	9.8:1	
Polo 75 1.6	10/94→10/99		1598cc	55kW (75PS)	
Vento 1.6	09/92→09/98				TD4019
Caddy II 1.6	06/96→12/00	AEE			
Caddy II 75 1.6	11/95→09/00		4 Cyl.	9.8:1	
Golf III 1.6	09/92→08/97		1598cc	55kW (75PS)	
Polo 1.6	05/97→09/01				TD4981
Polo 75 1.6	10/94→10/99				
Polo Classic 75 1.6	11/95→09/01				
Vento 1.6	09/92→09/98				
Polo 75 1.6	10/94→10/99	AHS	4 Cyl.	9.8:1	
			1588cc	55kW (75PS)	
					TD12948
Polo 1.6	05/97→09/01	ALM			
Polo Classic 75 1.6	11/95→09/01		4 Cyl.	9.8:1	
			1598cc	55kW (75PS)	
					TD15610

87-502800-10

STD

08-502800-00

STD

14-021571-00 **D**

B 79.56 **C** 142.00 **D** 82.50 **E** 4.50

87-502807-10 

0.50mm

08-502807-00

0.50mm

14-028360-00 **D** 

B 79.50 **C** 145.00 **D** 81.50 **E** 4.70

A 30.85

C 7.80

D 60.35

 17x52

1.20

1.50

2.50









NT 

P

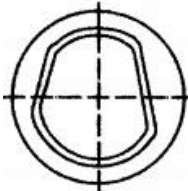
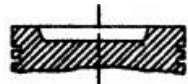
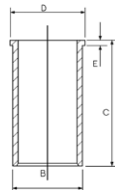
CR 



 With recesses on crankshaft side

 A = 30.600, D = 52.600

 Steel

 Mit kurbelwellenseitigen Aussparungen

 A = 30.600, D = 52.600

 Stahl

 Avec évidements côté vilebrequin

 A = 30.600, D = 52.600

 Acier

 Con escotaduras en la cara del cigüeñal

 A = 30.600, D = 52.600

 Acero

 Con nicchie sul lato albero motore

 A = 30.600, D = 52.600

 Acciaio



6 76.50

Caddy II 1.4, Caddy II 60 1.4	11/95→01/04	AEX				
Golf III 1.4	10/91→04/99		4 Cyl.	10.2:1		
Polo 1.4	05/97→09/01		1390cc	40-44kW (55-60PS)		
Polo 55 1.4	08/95→10/99					TD4984
Polo 60 1.4	07/95→10/99					
Polo Classic 60 1.4	12/95→09/01					
Vento 1.4	11/91→09/98					
Caddy II 1.4	11/95→01/04	AKV				
Polo 1.4	05/97→09/01		4 Cyl.	10.2:1		
Polo 60 1.4	07/95→10/99		1390cc	44kW (60PS)		
Polo Classic 60 1.4	12/95→09/01					TD9688
Polo 1.4	10/99→09/01	ANX				
Polo Classic 54 1.4	01/98→08/99		4 Cyl.	10.2:1		
			1389cc	40kW (54PS)		TD15613
Caddy II 1.4, Caddy II 60 1.4	11/95→01/04	APQ				
Golf III 1.4	07/93→04/99		4 Cyl.	10.2:1		
Polo 1.4	05/97→09/01		1390cc	44kW (60PS)		
Polo 60 1.4	07/95→10/99					TD15614
Polo Classic 60 1.4	12/95→09/01					

87-502800-00 STD
87-502807-00 ² 0.50mm

A 28.35
C 5.95
D 50.35
 17x52

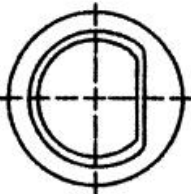
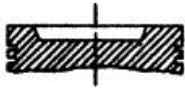



¹ With recesses on crankshaft side

² A = 28.100, D = 50.100

³ Steel

08-502800-00 STD
08-502807-00 0.50mm

1.20  NT ³
1.50  P
2.50  CR ³

¹ Mit kurbelwellenseitigen Aussparungen

² A = 28.100, D = 50.100

³ Stahl

14-021571-00 D B 79.56 C 142.00 D 82.50 E 4.50
14-028360-00 D ¹ B 79.50 C 145.00 D 81.50 E 4.70

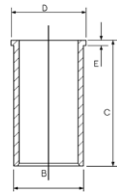

¹ Avec évidements côté vilebrequin

² A = 28.100, D = 50.100

³ Acier

¹ Con escotaduras en la cara del cigüeñal

² A = 28.100, D = 50.100

³ Acero

¹ Con nicchie sul lato albero motore

² A = 28.100, D = 50.100

³ Acciaio



7 76.50



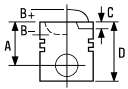

Polo 100 1.4 16V	04/96→10/99	AFH	4 Cyl. 1390cc	10.4:1 74kW (100PS)	TD4986
Lupo 1.4 16V Polo 1.4 16V	08/99→07/05 10/99→09/01	AFK	4 Cyl. 1390cc	10.5:1 74kW (101PS)	TD12028
Bora 1.4 16V Golf IV 1.4 16V Lupo 1.4 16V Polo 1.4 16V	03/00→05/05 08/97→06/06 09/98→07/05 10/99→09/01	AHW	4 Cyl. 1390cc	10.5:1 55kW (75PS)	TD9453
Bora 1.4 16V Golf IV 1.4 16V Lupo 1.4 16V	03/00→05/05 08/97→06/06 09/98→07/05	AKQ	4 Cyl. 1390cc	10.5:1 55kW (75PS)	TD9454
Bora 1.4 16V Golf IV 1.4 16V Lupo 1.4 16V Polo 1.4 16V Polo 1.4 16V, Polo Classic 75 1.4 16V	03/00→05/05 08/97→06/06 09/98→07/05 10/99→09/01	APE	4 Cyl. 1390cc	10.5:1 55kW (75PS)	TD13468
Lupo 1.4 16V Polo 1.4 16V	08/99→07/05 10/99→09/01	AQQ	4 Cyl. 1390cc	10.5:1 74kW (101PS)	TD13469
Caddy II 1.4, Caddy II 1.4 16V Lupo 1.4 16V Polo 1.4 16V Polo 1.4 16V, Polo Classic 75 1.4 16V	08/00→01/04 09/98→07/05 10/99→05/08 10/99→09/01	AUA	4 Cyl. 1390cc	10.5:1 55kW (75PS)	TD13771
Lupo 1.4 16V Polo 1.4 16V	08/99→07/05 10/99→05/08	AUB	4 Cyl. 1390cc	10.5:1 74kW (101PS)	TD13772
Bora 1.4 16V Golf IV 1.4 16V	03/00→05/05 08/97→06/06	AXP	4 Cyl. 1390cc	10.5:1 55kW (75PS)	TD15474
Lupo 1.4 16V Polo 1.4 Polo 1.4 16V	09/98→07/05 07/03→ 10/01→05/08	BBY	4 Cyl. 1390cc	10.5:1 55kW (75PS)	TD16335
Polo 1.4 Polo 1.4 16V	11/03→ 10/01→05/08	BBZ	4 Cyl. 1390cc	10.5:1 74kW (101PS)	TD16540
Bora 1.4 16V Caddy III 1.4 Golf IV 1.4 16V Golf V 1.4 16V Golf Plus 1.4 16V New Beetle 1.4	03/00→05/05 03/04→05/06 08/97→06/06 10/03→05/06 01/05→11/06 11/01→09/10	BCA	4 Cyl. 1390cc	10.5:1 55kW (75PS)	TD16386





Polo Saloon 1.4 12/03→05/05 **BLM** 4 Cyl. 1390cc 63kW (86PS) **TD21076**

87-116100-00 STD **08-116100-00** STD
87-116107-00 ① 0.50mm **08-116107-00** 0.50mm

A 28.92	1.20		NT ②
B- 1.98	1.50		P
BØ 61.90	2.50		CR ②
C 2.32			
D 49.92			
 17x54			

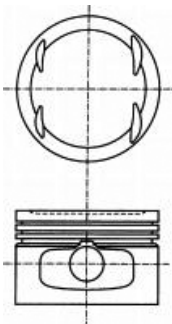

① A = 28.670, D = 49.670
 ② Steel

① A = 28.670, D = 49.670
 ② Stahl

① A = 28.670, D = 49.670
 ② Acier

① A = 28.670, D = 49.670
 ② Acero

① A = 28.670, D = 49.670
 ② Acciaio

8  **76.50**

Polo 1.2 12V 10/01→07/07 **AZQ** 3 Cyl. 1198cc 10.5:1 47kW (64PS) **TD16333**

14-021571-00 D B 79.56 C 142.00 D 82.50 E 4.50
14-028360-00 D ① B 79.50 C 145.00 D 81.50 E 4.70

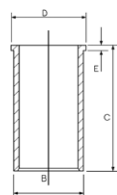

① With recesses on crankshaft side

① Mit kurbelwellenseitigen Aussparungen

① Avec évidements côté vilebrequin

① Con escotaduras en la cara del cigüeñal

① Con nicchie sul lato albero motore

9  **76.50**

Fox 1.4 04/05→ **BKR** 4 Cyl. 1390cc 10.5:1 55kW (75PS) **TD18271**

Polo 1.4 07/03→ **BKY** 4 Cyl. 1390cc 10.5:1 55kW (75PS) **TD18154**
Polo 1.4 16V 10/01→05/08





Caddy III 1.4	05/06→08/10	BUD			
Golf V 1.4	06/07→07/09		4 Cyl.	10.5:1	
Golf V 1.4 16V	05/06→11/08		1390cc	59kW (80PS)	
Golf VI 1.4	07/09→07/13				TD18909
Golf Plus 1.4 16V	05/06→12/13				
Polo 1.4 16V	05/06→11/09				
Polo 1.4	06/09→	CDDA			
			4 Cyl.		
			1390cc	63kW (86PS)	TD25789
Golf VI 1.4	10/08→07/13	CGGA			
Golf Plus 1.4 16V	05/06→12/13		4 Cyl.	10.5:1	
			1390cc	59kW (80PS)	TD20791
Polo 1.4	06/09→	CGGB			
			4 Cyl.		
			1390cc	63kW (85PS)	TD23103
Polo 1.4	06/09→	CLPA			
Polo Vivo 1.4	02/10→		4 Cyl.		
			1390cc	63kW (85PS)	TD26336

87-436900-00 ¹ STD

08-436900-00 STD

04/05→

1.20



NT ²

1.20



P

2.00



CR ²

A 28.92

B- 2.28

BØ 61.14

C 1.07

C 1.04

D 46.92

17x45

TP

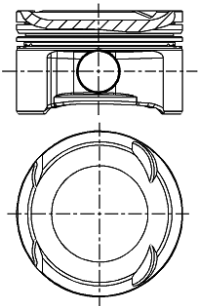

07675-204

ECOTOUGH

¹ Pistons to be replaced in Engine Sets only

² Steel

¹ Kolben nur Motorsätzen zu ersetzen

² Stahl

¹ Piston à remplacer dans jeu moteur

² Acier

¹ Pistones de repuesto para juegos de motores solamente

² Acero

¹ Il pistone può essere rimpiazzato solamente completo

² Acciaio



10  **76.50**

Golf V 1.4 TSI	11/05→07/09	BLG				
Golf Plus 1.4 TSI	05/06→06/08		4 Cyl.	10:1		
Jetta III 1.4 TSI	07/06→10/10		1390cc	125kW (170PS)		
Touran 1.4 FSI	11/06→05/10		Turbo & Supercharged			TD18470
Golf V 1.4 TSI	05/06→07/09	BMV				
Golf Plus 1.4 TSI	05/06→06/08		4 Cyl.	10:1		
Jetta III 1.4 TSI	07/06→10/10		1390cc	103kW (140PS)		
Touran 1.4 TSI	02/06→05/10		Turbo & Supercharged			TD18910
Jetta IV 1.4 TSI	04/11→07/14	CAVA				
Sharan 1.4 TSI	05/10→		4 Cyl.			
Tiguan 1.4 TSI	05/08→		1390cc	110kW (150PS)		
Tiguan 1.4 TSI 4motion	09/07→		Turbo & Supercharged			TD22452
Touran 1.4 FSI	11/06→05/10	CAVB				
Touran 1.4 TSI	05/10→05/15		4 Cyl.	10:1		
			1390cc	125kW (170PS)		
			Turbo Intercooled			TD22173
Touran 1.4 TSI	02/06→05/15	CAVC				
			4 Cyl.	10:1		
			1390cc	103kW (140PS)		
			Turbo Intercooled			TD22174
Beetle 1.4 TSI	10/11→	CAVD				
EOS 1.4 TSI	05/08→		4 Cyl.			
Golf V 1.4 TSI	07/08→07/09		1390cc	118kW (160PS)		
Golf VI 1.4 TSI	10/08→		Turbo & Supercharged			TD20792
Golf Plus 1.4 TSI	06/08→12/13					
Jetta III 1.4 TSI	07/08→10/10					
Jetta IV 1.4 TSI	04/11→					
Scirocco 1.4 TSI	05/08→					
Tiguan 1.4 TSI, Tiguan 1.4 TSI 4motion	05/11→					
Polo 1.4 GTI	05/10→	CAVE				
			4 Cyl.	10:1		
			1390cc	132kW (180PS)		
			Turbo & Supercharged			TD24000
Beetle 1.4 TSI	10/11→	CNWA				
Golf VI 1.4 TSI	10/08→		4 Cyl.			
Golf Plus 1.4 TSI	06/08→12/13		1390cc	118kW (160PS)		
Scirocco 1.4 TSI	05/08→		Turbo & Supercharged			TD24834
Jetta IV 1.4 TSI	04/11→07/14	CTHA				
Sharan 1.4 TSI	05/10→		4 Cyl.			
Tiguan 1.4 TSI	05/08→		1390cc	110kW (150PS)		
Tiguan 1.4 TSI 4motion	09/07→		Turbo & Supercharged			TD26573
Touran 1.4 TSI	05/10→05/15	CTHB				
			4 Cyl.	10:1		
			1390cc	125kW (170PS)		
			Turbo Intercooled			TD26629
Touran 1.4 TSI	05/10→05/15	CTHC				
			4 Cyl.	10:1		
			1390cc	103kW (140PS)		
			Turbo Intercooled			TD26643









Beetle 1.4 TSI	10/11→	CTHD			
CC 1.4 Tsi	11/11→		4 Cyl.		
EOS 1.4 TSI	05/08→		1390cc	118kW (160PS)	
Golf VI 1.4 TSI	10/08→		Turbo & Supercharged		TD26574
Jetta IV 1.4 TSI	04/11→				
Passat 1.4 TSI	11/12→12/14				
Scirocco 1.4 TSI	05/08→				
Tiguan 1.4 TSI, Tiguan 1.4 TSI 4motion	05/11→				

Polo 1.4 GTI	05/10→	CTHE			
			4 Cyl.	10:1	
			1390cc	132kW (180PS)	
			Turbo & Supercharged		TD27355

Beetle 1.4 TSI	10/11→	CTKA			
Golf VI 1.4 TSI	10/08→		4 Cyl.		
Scirocco 1.4 TSI	05/08→		1390cc	118kW (160PS)	
			Turbo & Supercharged		TD26695

87-433900-10 ¹	STD	08-433900-00	STD
87-433907-10 ¹	0.50mm	08-433907-00	0.50mm

A	29.00	1.20	 NT ²
B-	4.55	1.50	 P
B+	1.85	2.00	 NT ²
C	1.00		
C	3.80		
D	49.85		
	19x54		

RT TP

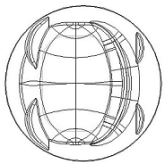
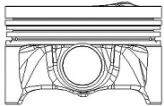

¹ Pistons to be replaced in Engine Sets only

² Steel

¹ Kolben nur Motorsätzen zu ersetzen

² Stahl

¹ Piston à remplacer dans jeu moteur

² Acier

¹ Pistones de repuesto para juegos de motores solamente

² Acero

¹ Il pistone può essere rimpiazzato solamente completo



² Acciaio







11 76.50

EOS 1.4 TSI	11/07→	CAXA			
Golf V 1.4 TSI	05/07→07/09		4 Cyl.	10:1	
Golf VI 1.4 TSI	10/08→		1390cc	90kW (122PS)	
Golf Plus 1.4 TSI	06/07→12/13		Turbo Intercooled		TD20606
Jetta III 1.4 TSI	05/07→10/10				
Jetta IV 1.4 TSI	05/11→				
Passat 1.4 TSI	05/07→12/14				
Scirocco 1.4 TSI	08/08→				
Tiguan 1.4 TSI	08/10→				









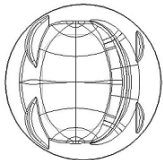
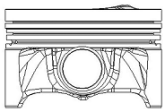

Jetta IV 1.4 TSI	05/11→	CMSB			
Scirocco 1.4 TSI	08/08→		4 Cyl.	10:1	
			1390cc	90kW (122PS)	
			Turbo Intercooled		TD25468

87-429900-00 	STD	08-429900-00	STD
87-429907-00 	0.50mm	08-429907-00	0.50mm

A	29.20	1.20	 NT 
B-	4.50	1.20	P
C	3.60	2.00	NT 
D	48.20		
	19x52		

HA



 Elastoval®	 Elastoval®	 Elastoval®	 Elastoval®	 Elastoval®
 Steel	 Stahl	 Acier	 Acero	 Acciaio

12 76.50

Passat 1.5	07/73→12/75	YJ			
Scirocco 1.5	02/74→08/75		4 Cyl.	8.2:1	
			1471cc	55kW (75PS)	
					TD5033

Passat 1.5	07/73→12/75	ZB			
Scirocco 1.5	02/74→08/75		4 Cyl.	8.1:1	
			1471cc	55kW (75PS)	
					TD5037

Passat 1.5	05/73→12/75	ZC			
			4 Cyl.	9.7:1	
			1471cc	63kW (85PS)	
					TD5141





Golf I 1.5 D Jetta I 1.5 D Passat 1.5 D	08/76→07/80 08/78→07/80 02/77→07/80	CK Diesel	4 Cyl. 1471cc	23.5:1 37kW (50PS)	TD4046
---	---	--------------------------------	-------------------------	------------------------------	---------------

14-023470-00 D ① B 79.50 C 142.00 D 82.50 E 4.70
 14-024670-00 D B 79.50 C 145.00 D 81.50 E 4.70
 14-028360-00 D ② B 79.50 C 145.00 D 81.50 E 4.70

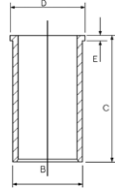

- ① Phosphated
- ② With recesses on crankshaft side
- ① Phosphated
- ② Mit kurbelwellenseitigen Aussparungen
- ① Phosphated
- ② Avec évidements côté vilebrequin
- ① Phosphated
- ② Con escotaduras en la cara del cigüeñal
- ① Phosphated
- ② Con nicchie sul lato albero motore

13 76.50

Iltis 1.6 TD	08/87→12/88	1C Diesel	4 Cyl. 1600cc Turbo	23:1 51kW (69PS)	TD13489
Golf II 1.6 TD Jetta II 1.6 TD	08/89→10/91 01/90→10/91	1V Diesel	4 Cyl. 1588cc Turbo	23:1 44kW (60PS)	TD3996
Industrial	04/83→08/88	68A Diesel	4 Cyl. 1588cc Turbo	23:1 45kW (61PS)	TD22615
Industrial	04/83→03/94	68C Diesel	4 Cyl. 1588cc Turbo	23:1 50kW (68PS)	TD22616
Industrial	03/89→12/90	686 Diesel	4 Cyl. 1588cc Turbo	23:1 45kW (61PS)	TD22614
Golf I 1.6 TD Jetta I 1.6 TD Passat 1.6 TD Santana 1.6 TD	03/82→07/83 03/82→02/84 04/82→03/88 12/81→12/84	CY Diesel	4 Cyl. 1588cc Turbo	23/23.5:1 51kW (70PS)	TD4052
Golf II 1.6 TD Jetta II 1.6 TD	08/83→10/91 01/84→10/91	JR Diesel	4 Cyl. 1588cc Turbo	23:1 51kW (70PS)	TD4121
Transporter III 1.6 TD Transporter III 1.6 TD Syncro	08/84→07/92 03/86→07/92	JX Diesel	4 Cyl. 1588cc Turbo	23.5:1 51kW (69PS)	TD5018
Golf II 1.6 TD Jetta II 1.6 TD	08/83→10/91 01/84→10/91	MF Diesel	4 Cyl. 1588cc Turbo	23:1 51kW (70PS)	TD4130



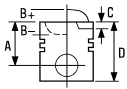

Golf II 1.6 TD, Jetta II 1.6 TD Passat 1.6 TD	04/89→10/91 05/86→09/93	RA	4 Cyl. 1588cc Turbo Intercooled	23:1 59kW (80PS)	TD5024
Golf II 1.6 TD, Jetta II 1.6 TD Passat 1.6 TD Saveiro I 1.6 D	04/89→10/91 08/88→09/93 08/91→07/96	SB	4 Cyl. 1588cc Turbo Intercooled	23:1 59kW (80PS)	TD5028
LT 28-35 I 2.4 TD LT 28-35 I 2.4 TD Syncro LT 40-55 I 2.4 TD LT 40-55 I 2.4 TD Syncro	08/88→08/92 08/91→07/92 08/88→08/92 08/91→07/92	1G	6 Cyl. 2383cc Turbo	23:1 68kW (93PS)	TD3993
LT 28-35 I 2.4 TD LT 28-35 I 2.4 TD Syncro LT 40-55 I 2.4 TD LT 40-55 I 2.4 TD Syncro	06/92→06/96 08/92→04/96 06/92→06/96 08/92→04/96	ACL	6 Cyl. 2384cc Turbo	22:1 70kW (95PS)	TD4012
LT 28-35 I 2.4 TD LT 28-35 I 2.4 TD Syncro LT 40-55 I 2.4 TD LT 40-55 I 2.4 TD 4WD LT 40-55 I 2.4 TD Syncro	12/82→09/93 08/91→07/92 12/82→09/93 08/78→07/92 08/91→07/92	DV	6 Cyl. 2383cc Turbo	23:1 75-80kW (102-109PS)	TD4061

87-109800-10	STD
87-109807-10 ²	0.50mm
87-109811-10 ²	1.00mm

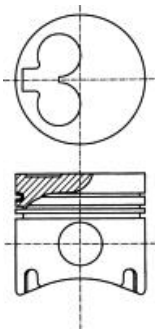

A	41.70
B-	1.60
D	71.70
	24x64

AK HA RT TP



¹ With recesses on crankshaft side
² A = 41.450

08-109800-00	STD
08-109807-00	0.50mm
08-109811-00	1.00mm

1.75		CR P
2.00		CR P
3.00		CR P

¹ Mit kurbelwellenseitigen Aussparungen
² A = 41.450

14-021571-00 D	B 79.56 C 142.00 D 82.50 E 4.50
14-028360-00 D ¹	B 79.50 C 145.00 D 81.50 E 4.70

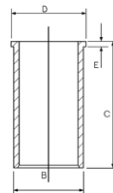

¹ Avec évidements côté vilebrequin
² A = 41.450

¹ Con escotaduras en la cara del cigüeñal
² A = 41.450

¹ Con nicchie sul lato albero motore
² A = 41.450



14 76.50

Industrial	12/81→10/88	685	4 Cyl. 1588cc	23:1 36kW (49PS)	TD22613
		Diesel			
Industrial	04/94→07/96	ADK	4 Cyl. 1588cc	22.5:1 40kW (54PS)	TD22619
		Diesel			
Golf I 1.6 D	08/80→07/83	CR	4 Cyl. 1588cc	23:1 39-40kW (52-54PS)	TD4992
Jetta I 1.6 D	08/80→12/84				
Passat 1.6 D	02/79→03/88				
Santana 1.6 D	08/81→12/84	Diesel			
Transporter III 1.6 D	01/81→07/87	CS	4 Cyl. 1588cc	23:1 37kW (50PS)	TD4048
		Diesel			
Caddy I 1.6 D	08/82→07/92	JK	4 Cyl. 1588cc	23:1 39-40kW (52-54PS)	TD5013
Golf I 1.6 D	08/80→07/83				
Jetta I 1.6 D	08/80→12/84				
Passat 1.6 D	08/80→03/88	Diesel			
Santana 1.6 D	08/81→12/84				
Golf II 1.6 D	08/83→10/91	JP	4 Cyl. 1588cc	23.5:1 40kW (54PS)	TD4120
Jetta II 1.6 D	01/84→10/91				
		Diesel			
Caddy I 1.6 D	08/82→07/92	ME	4 Cyl. 1588cc	23:1 40kW (55PS)	TD4129
Golf II 1.6 D	08/83→10/91				
Jetta II 1.6 D	01/84→10/91				
		Diesel			
LT 28-35 I 2.4 D	08/89→06/96	1S	6 Cyl. 2383cc	23.5:1 51kW (70PS)	TD4958
LT 28-35 I 2.4 D Syncro	08/91→07/92				
LT 40-55 I 2.4 D	07/90→06/96				
		Diesel			
LT 28-35 I 2.4 D	08/89→06/96	ACT	6 Cyl. 2384cc	22:1 51kW (70PS)	TD4014
LT 40-55 I 2.4 D	07/90→06/96				
		Diesel			
LT 28-35 I 2.4 D	12/78→07/92	CP	6 Cyl. 2383cc	23:1 55kW (75PS)	TD4047
LT 40-55 I 2.4 D	12/78→07/92				
		Diesel			





LT 28-35 2.4 D	12/78 → 07/92	DW		
LT 28-35 2.4 D Syncro	08/91 → 07/92		6 Cyl.	23:1
LT 40-55 2.4 D	12/78 → 07/92		2383cc	55-57kW (75-78PS)
LT 40-55 2.4 D 4WD	01/79 → 03/86	Diesel		TD4062

87-109500-00	STD	08-109500-00	STD
87-109505-00	0.25mm	08-109505-00	0.25mm
87-109507-00	0.50mm	08-109507-00	0.50mm
87-109511-00	1.00mm	08-109511-00	1.00mm

12/81 →

A 41.70

B- 1.60

D 71.70

24x64

RT

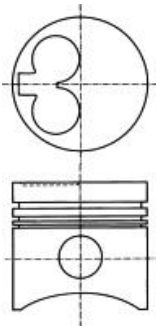

07633

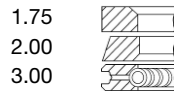

1.75

2.00

3.00

CR P

P

CR P

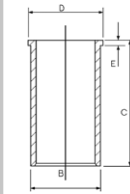

14-021571-00 D B 79.56 C 142.00 D 82.50 E 4.50

14-028360-00 D 1 B 79.50 C 145.00 D 81.50 E 4.70

1 With recesses on crankshaft side

2 No oil-jet cut out

3 A = 41.450

1 Mit kurbelwellenseitigen Aussparungen

2 Ohne Aussparung für Kühllöspritzdüse

3 A = 41.450

1 Avec évidements côté vilebrequin

2 Sans encoche en bas de jupe pour le passage de la pissette d'huile sous pression

3 A = 41.450

1 Con escotaduras en la cara del cigüeñal

2 Sin escotadura

3 A = 41.450

1 Con nicchie sul lato albero motore

2 Senza passaggio per spruzzatore olio

3 A = 41.450



15 78.30

Passat 2.5 TDI	07/98→05/05	AFB		
Passat 2.5 TDI 4motion	11/00→05/05		V6 Cyl.	19.5:1
Passat 2.5 TDI Syncro/4motion	12/98→11/00		2496cc	110kW (150PS)
		Diesel	Turbo Intercooled	TD11499
Passat 2.5 TDI	07/98→05/05	AKN		
Passat 2.5 TDI 4motion	11/00→05/05		V6 Cyl.	19.5:1
Passat 2.5 TDI Syncro/4motion	12/98→11/00		2496cc	110kW (150PS)
		Diesel	Turbo Intercooled	TD11498



87-103000-00  STD

A 47.83
B- 16.50
BØ 35.80
C 1.38
D 71.83
 26x66

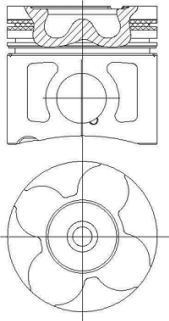
AK KK RT



08-103000-00 STD
08-103007-00 0.50mm

1.75  CK P
 2.00  P
 3.00  CR P



87-103000-10  STD

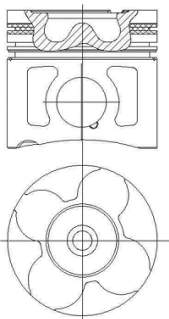

A 47.83
B- 16.50
BØ 35.80
C 1.38
D 71.83
 26x66



AK KK RT







08-103000-00 STD
08-103007-00 0.50mm



1.75  CK P
 2.00  P
 3.00  CR P

 To cylinder 1 - 3
 To cylinder 4 - 6

 zum Zylinder 1 - 3
 zum Zylinder 4 - 6

 sous cylindre 1 - 3
 sous cylindre 4 - 6

 A cilindro 1 - 3
 A cilindro 4 - 6

 al cilindro 1 - 3
 al cilindro 4 - 6



16  **78.30**

Passat 2.5 TDI 4motion	01/03→05/05	BAU	V6 Cyl. 2496cc	18.5:1 132kW (180PS)	
		Diesel	Turbo Intercooled		TD17046
Passat 2.5 TDI	05/03→05/05	BDG	V6 Cyl. 2496cc	18.5:1 120kW (163PS)	
		Diesel	Turbo Intercooled		TD16985



87-103000-30  **STD**

- A** 47.83
- B-** 17.25
- BØ** 36.00
- C** 1.38
- C** 1.38
- D** 71.83
-  26x58

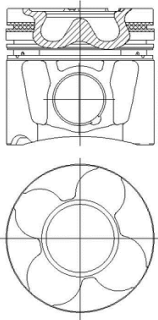
AK KK RT TP



08-103000-00 **STD**
08-103007-00 0.50mm

- 1.75  **CK P**
- 2.00  **P**
- 3.00  **CR P**



87-103000-40  **STD**

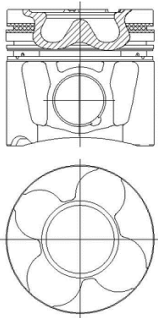

- A** 78.31
- B-** 17.25
- BØ** 36.00
- C** 1.38
- C** 1.38
- D** 71.83
-  26x58



AK KK RT TP







08-103000-00 **STD**
08-103007-00 0.50mm



- 1.75  **CK P**
- 2.00  **P**
- 3.00  **CR P**

-  To cylinder 1 - 3
-  To cylinder 4 - 6

-  zum Zylinder 1 - 3
-  zum Zylinder 4 - 6

-  sous cylindre 1 - 3
-  sous cylindre 4 - 6



-  A cilindro 1 - 3
-  A cilindro 4 - 6

-  al cilindro 1 - 3
-  al cilindro 4 - 6



17 79.50

Transporter IV 1.9 D	07/90→12/95	1X	4 Cyl. 1896cc	22.5:1 44-45kW (60-61PS)	Diesel	TD3997
Caddy II 1.9 D	11/95→01/04	1Y				
Caddy III 1.9 D	10/05→06/09		4 Cyl. 1896cc	22.5:1 47-50kW (64-68PS)		
Golf III 1.9 D	11/91→04/99					
Gol III 1.9 D	06/02→06/05	Diesel				TD4960
Parati III 1.9 D	08/02→					
Passat 1.9 D	05/89→10/93					
Polo Classic 64 1.9 D	01/96→10/96					
Vento 1.9 D	11/91→09/98					
Voyage 1.9 D	06/96→09/01					
Industrial	04/94→	ADG	4 Cyl. 1896cc	22.5:1 48kW (65PS)	Diesel	TD20098
Caddy II 1.9 D	06/96→12/00	AEF				
Polo 1.9 D	10/94→09/01		4 Cyl. 1896cc	22.5:1 47kW (64PS)		
Polo 64 1.9 D	10/94→10/99					TD4020
Transporter IV 2.4 D	07/90→04/98	AAB				
Transporter IV 2.4 D Syncro	10/92→09/98		5 Cyl. 2370cc	22.5:1 57kW (78PS)	Diesel	TD4000
Transporter IV 2.4 D	08/97→04/03	AJA	5 Cyl. 2370cc	55kW (75PS)	Diesel	TD11049

87-990100-40 STD
87-990105-40 0.25mm
87-990107-40  0.50mm
87-990111-40  1.00mm

A 39.65
B- 1.90
D 65.70
 24x64

AK RT

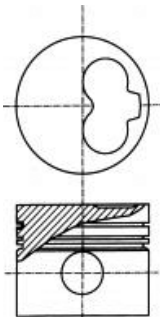



07945

 A = 39.400



 A = 39.400

 A = 39.400

 A = 39.400

 A = 39.400

08-990100-00 STD
08-990105-00 0.25mm
08-990107-00 0.50mm
08-990111-00 1.00mm

1.75  CR P
2.00  P
3.00  CR P

14-027950-00 D

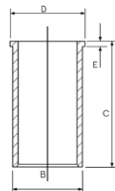

B 82.50 C 152.00 D 85.50 E 4.70



18  **79.50**

Caddy II 1.9 TDI	09/96→01/04	1Z				
Golf III 1.9 TDI	09/93→04/99		4 Cyl.	19.5:1		
Golf III 1.9 TDI Syncro	07/95→04/99		1896cc	66kW (90PS)		
Passat 1.9 TDI	10/93→05/97	Diesel	Turbo Intercooled			TD4961
Sharan 1.9 TDI	09/95→03/10					
Vento 1.9 TDI	09/93→09/98					
Voyage 1.9 TDi	09/99→09/01					
Caddy II 1.9 SDI	11/95→01/04	AEY				
Golf III 1.9 SDI	07/95→04/99		4 Cyl.	19.5:1		
Polo 1.9 SDI	06/97→09/01		1896cc	47-48kW (64-65PS)		
Polo Classic 1.9 SDI	06/96→09/01	Diesel				TD4985
Polo Classic 64 1.9 SDI	12/95→08/99					
Vento 1.9 SDI	04/97→09/98					
Industrial	04/94→01/02	AFD				
			4 Cyl.	20:1		
			1896cc	58kW (79PS)		
		Diesel				TD16184
Golf III 1.9 TDI	04/96→04/99	AFN				
Golf IV 1.9 TDI	06/98→06/02		4 Cyl.	19.5:1		
Passat 1.9 TDI	03/96→11/00		1896cc	81kW (110PS)		
Passat 1.9 TDI Syncro/4motion	10/96→11/00	Diesel	Turbo Intercooled			TD4987
Polo 1.9 TDI	06/98→09/01					
Polo Classic 110 1.9 TDI	06/98→01/02					
Sharan 1.9 TDI	09/96→04/00					
Vento 1.9 TDI	04/96→09/98					
Polo 1.9 SDI	07/96→09/01	AGD				
Polo 64 1.9 SDI	07/96→10/99		4 Cyl.	22.5:1		
			1896cc	47kW (64PS)		
		Diesel				TD9372
Bora 1.9 TDI	10/98→05/05	AGR				
Bora 1.9 TDI 4motion	11/98→04/02		4 Cyl.	19.5:1		
Golf IV 1.9 TDI	10/97→05/06		1896cc	66kW (90PS)		
Golf IV 1.9 TDI 4motion	07/98→04/02	Diesel	Turbo Intercooled			TD9364
Polo 1.9 TDI	05/97→09/01					
Polo Classic 90 1.9 TDI	09/96→09/01					
Bora 1.9 TDI	10/98→06/01	AHF				
Golf IV 1.9 TDI	08/97→05/04		4 Cyl.	19.5:1		
			1896cc	81kW (110PS)		
		Diesel	Turbo Intercooled			TD9788
Passat 1.9 TDI	10/96→11/00	AHH				
			4 Cyl.	19.5:1		
			1896cc	66kW (90PS)		
		Diesel	Turbo Intercooled			TD10927
Caddy II 1.9 TDI	09/96→01/04	AHU				
Golf III 1.9 TDI	09/93→04/99		4 Cyl.	19.5:1		
Golf III 1.9 TDI Syncro	07/95→04/99		1896cc	66-67kW (90-91PS)		
Golf IV 1.9 TDI	06/98→06/02	Diesel	Turbo Intercooled			TD4990
Passat 1.9 TDI	10/93→11/00					
Polo 1.9 TDI	05/97→09/01					
Polo Classic 1.9 TDI	01/97→08/99					
Polo Classic 90 1.9 TDI	09/96→09/01					
Sharan 1.9 TDI	09/95→03/10					
Vento 1.9 TDI	09/93→09/98					





Caddy II 1.9 TDI	10/96→01/04	ALE				
Golf III 1.9 TDI	09/93→04/99		4 Cyl.	19.5:1		
Golf III 1.9 TDI Syncro	07/95→04/99		1896cc	66kW (90PS)		
Golf IV 1.9 TDI	06/98→06/02	Diesel	Turbo Intercooled			TD9512
Polo 1.9 TDI	05/97→09/01					
Polo Classic 90 1.9 TDI	09/96→09/01					
Vento 1.9 TDI	09/93→09/98					
Bora 1.9 TDI	10/98→05/05	ALH				
Caddy II 1.9 TDI	09/96→01/04		4 Cyl.	19.5:1		
Golf IV 1.9 TDI	10/97→05/06		1896cc	66-67kW (90-91PS)		
New Beetle 1.9 TDI	01/98→12/04	Diesel	Turbo Intercooled			TD9455
Polo 1.9 TDI	05/97→09/01					
Polo Classic 90 1.9 TDI	09/96→09/01					
Industrial	01/94→	ARD				
			4 Cyl.	22.5:1		
		Diesel	1896cc	44kW (60PS)		TD20099
Bora 1.9 TDI	10/98→06/01	ASV				
Golf IV 1.9 TDI	08/97→05/04		4 Cyl.	19.5:1		
Polo 1.9 TDI	06/98→09/01		1896cc	81kW (110PS)		
Polo Classic 110 1.9 TDI	06/98→01/02	Diesel	Turbo Intercooled			TD13773
Golf IV 1.9 TDI	06/98→06/02	AVG				
Passat 1.9 TDI			4 Cyl.	19.5:1		
Passat 1.9 TDI, Passat 1.9 TDI Syncro/4motion	10/96→11/00		1896cc	81kW (110PS)		
Passat 1.9 TDI Syncro/4motion	06/97→11/00	Diesel	Turbo Intercooled			TD14988
Sharan 1.9 TDI	09/96→04/00					
Industrial	11/00→	AVM Euro 3				
			4 Cyl.	19:1		
		Diesel	1896cc	63kW (86PS)		TD18705
		BEQ				
			4 Cyl.			
		Diesel	1896cc	33kW (45PS)		TD20100
Industrial	11/02→	BEU				
			4 Cyl.			
		Diesel	1896cc	43kW (58PS)		TD20101
Industrial	11/03→	BJC				
			4 Cyl.	19.5:1		
		Diesel	1896cc	53kW (72PS)		TD22453
			Turbo Intercooled			



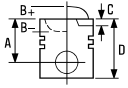

Industrial	05/06→	BXT	4 Cyl.	19:1	
			1896cc	30kW (41PS)	
		Diesel	Turbo		TD25869

87-114900-60 1 3	STD
87-114905-60 1 3	0.25mm
87-114907-60 1 3 5	0.50mm
87-114911-60 1 3 5	1.00mm

A	45.80
B-	17.65
BØ	38.00
C	1.10
D	68.80
	26x66

AK KK NB RT

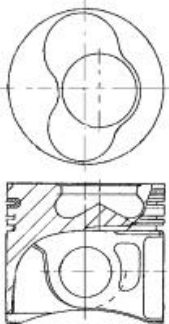

07987

08-114900-00	STD
08-114905-00	0.25mm
08-114907-00	0.50mm
08-114911-00	1.00mm

1.75		CK P
2.00		P
3.00		CR P

14-027950-00 D B 82.50 C 152.00 D 85.50 E 4.70

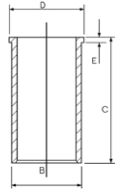

87-114900-70 2 3	STD
87-114905-70 2 3	0.25mm
87-114907-70 2 3 5	0.50mm
87-114911-70 2 3 5	1.00mm

A	45.80
B-	17.65
BØ	38.00
C	1.10
D	68.80
	26x66

AK KK NB RT

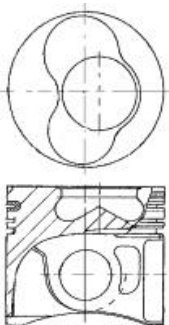

07987A





08-114900-00	STD
08-114905-00	0.25mm
08-114907-00	0.50mm
08-114911-00	1.00mm

1.75		CK P
2.00		P
3.00		CR P







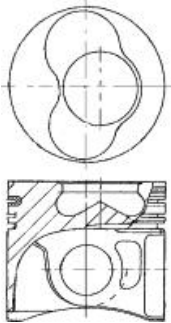

87-114900-90 1	STD	08-114900-00	STD
87-114905-90 1	0.25mm	08-114905-00	0.25mm
87-114907-90 1 4	0.50mm	08-114907-00	0.50mm
87-114911-90 1 4	1.00mm	08-114911-00	1.00mm

A	45.80	1.75		CK P
B-	17.65	2.00		P
BØ	38.00	3.00		CR P
C	1.10			
D	71.80			
	26x66			

AK NB RT



87-114900-95 2	STD	08-114900-00	STD
87-114905-95 2	0.25mm	08-114905-00	0.25mm
87-114907-95 2 4	0.50mm	08-114907-00	0.50mm
87-114911-95 2 4	1.00mm	08-114911-00	1.00mm

A	45.80	1.75		CK P
B-	17.65	2.00		P
BØ	38.00	3.00		CR P
C	1.10			
D	71.80			
	26x66			

AK NB RT

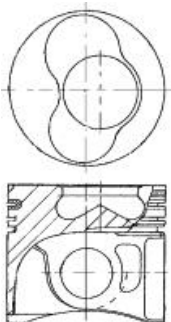

- 1 To cylinder 1 & 2
- 2 To cylinder 3 & 4
- 3 Piston Chamber Volume
[ccm] 23.54
- 4 A = 45.550, D = 71.550
- 5 A = 45.550, D = 68.550

- 1 zum Zylinder 1 & 2
- 2 zum Zylinder 3 & 4
- 3 Volumen der Kolbenmulde
[ccm] 23.54
- 4 A = 45.550, D = 71.550
- 5 A = 45.550, D = 68.550

- 1 sous cylindre 1 & 2
- 2 sous cylindre 3 & 4
- 3 Volume de la cavité du piston
[cm³] 23.54
- 4 A = 45.550, D = 71.550
- 5 A = 45.550, D = 68.550

- 1 A cilindro 1 & 2
- 2 A cilindro 3 & 4
- 3 Volumen de cavidad del pistón
[cm³] 23.54
- 4 A = 45.550, D = 71.550
- 5 A = 45.550, D = 68.550

- 1 al cilindro 1 & 2
- 2 al cilindro 3 & 4
- 3 Volume camera pistone
[cm³] 23.54
- 4 A = 45.550, D = 71.550
- 5 A = 45.550, D = 68.550



19  **79.50**

Industrial	01/90→03/94	28B	4 Cyl. 1896cc	22.5:1 48kW (65PS)	TD22609
		Diesel			
Caddy II 1.7 SDI	07/96→09/00	AHB	4 Cyl. 1716cc	19.5:1 42kW (57PS)	TD15028
		Diesel			
Polo 1.7 SDI	04/97→10/99	AHG	4 Cyl. 1716cc	19.5:1 42-44kW (57-60PS)	TD11207
		Diesel			
Lupo 1.7 SDI	09/98→07/05	AKU	4 Cyl. 1716cc	19.5:1 44kW (60PS)	TD9513
Polo 1.7 SDI	08/97→09/01				
Polo 60 1.7 SDI	08/97→10/99				
		Diesel			
Polo 1.7 SDI	08/97→09/01	AKW	4 Cyl. 1716cc	19.5:1 42kW (57PS)	TD9687
Polo Classic 57 1.7 SDI	07/97→09/01				
		Diesel			
Marine	02/03→	ANC	4 Cyl. 1896cc	22:1 44kW (60PS)	TD20491
		Diesel			
Golf V 1.9 D	12/05→11/08	BGG	4 Cyl. 1896cc	22.5:1 47kW (64PS)	TD21349
Golf Plus 1.9 D	12/05→12/13				
Gol III 1.9 D	06/02→06/05				
Parati III 1.9 D	08/02→	Diesel			
Pointer 1.9 D	12/05→				
Saveiro IV 1.9 D	09/05→08/09				
Marine	02/03→	BGL	4 Cyl. 1896cc	19:1 37kW (50PS)	TD25870
		Diesel			
Marine	02/03→	BGM	4 Cyl. 1896cc	19:1 29kW (39PS)	TD25871
		Diesel			
Marine	10/07→	CDXA	4 Cyl. 1896cc	23:1 55kW (75PS)	TD23291
		Diesel			
Marine	10/07→	CDXB	4 Cyl. 1896cc	23:1 29kW (40PS)	TD23292
		Diesel			

14-027950-00 D

B 82.50 C 152.00 D 85.50 E 4.70

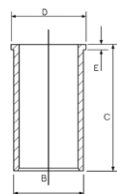



20 79.50

Golf III 1.9 TD	07/93→04/99	AAZ			
Golf III 1.9 TD;GTD	11/91→08/97		4 Cyl.	22.5:1	
Golf IV 1.9 TD	10/97→09/99		1896cc	55kW (75PS)	
Passat 1.9 TD	03/91→05/97	Diesel	Turbo		TD4972
Vento 1.9 TD	11/91→09/98				
Transporter IV 1.9 TD					
	10/92→04/03	ABL			
			4 Cyl.	22.5:1	
			1896cc	50kW (68PS)	
		Diesel	Turbo		TD4009
Industrial					
	04/94→	ADE			
			4 Cyl.	22.5:1	
			1896cc	55kW (75PS)	
		Diesel	Turbo		TD20097

87-990100-10	STD	08-990100-00	STD	14-027950-00 D	B 82.50 C 152.00 D 85.50 E 4.70
87-990105-10	0.25mm	08-990105-00	0.25mm		
87-990107-10	0.50mm	08-990107-00	0.50mm		
87-990111-10	1.00mm	08-990111-00	1.00mm		

A	45.65	1.75		CR P
B-	1.90	2.00		P
D	71.70	3.00		CR P
	26x66			

AK HA RT

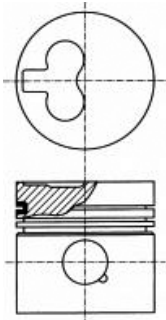

A = 45.430

A = 45.430

A = 45.430

A = 45.430

A = 45.430

21 79.50

Bora 1.9 SDI	10/98→05/05	AGP			
Golf IV 1.9 SDI	08/97→06/06		4 Cyl.	19.5:1	
Polo 1.9 SDI	08/99→09/01		1896cc	50kW (68PS)	
Polo Classic 68 1.9 SDI	08/99→01/02	Diesel			TD9452
Bora 1.9 SDI					
	10/98→05/05	AQM			
Golf IV 1.9 SDI	08/97→06/06		4 Cyl.	19.5:1	
Polo 1.9 SDI	08/99→09/01		1896cc	50kW (68PS)	
Polo Classic 68 1.9 SDI	08/99→01/02	Diesel	Turbo Intercooled		TD11351
Polo 1.9 SDI					
	10/99→09/01	ASX			
			4 Cyl.		
			1896cc	47kW (64PS)	
		Diesel			TD15495
Fox 1.9 D					
	12/07→	ASY			
Polo 1.9 SDI	10/01→		4 Cyl.	19.5:1	
Spacefox/Space Cross 1.9 SDI	09/07→		1896cc	47kW (64PS)	
		Diesel			TD16338



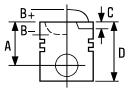





Caddy II 1.9 SDI 11/95 → 01/04 **AYQ** 4 Cyl. 1896cc 47kW (64PS) **TD16863**

Diesel

87-114900-20 1 3 STD
 87-114907-20 1 4 0.50mm
 87-114911-20 1 4 1.00mm

A 39.80
 B- 17.75
 BØ 38.00
 C 1.00
 D 60.80
 24x58

08-114900-00 STD
 08-114905-00 0.25mm
 08-114907-00 0.50mm
 08-114911-00 1.00mm

1.75  CK P
 2.00  P
 3.00  CR P

14-027950-00 D B 82.50 C 152.00 D 85.50 E 4.70

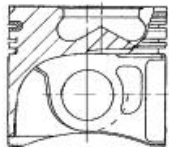
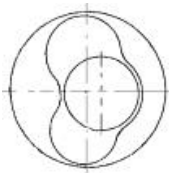
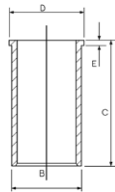



07959-109

87-114900-30 2 3 STD
 87-114907-30 2 4 0.50mm
 87-114911-30 2 4 1.00mm

A 39.80
 B- 17.75
 BØ 38.00
 C 1.00
 D 60.80
 24x58

08-114900-00 STD
 08-114905-00 0.25mm
 08-114907-00 0.50mm
 08-114911-00 1.00mm

1.75  CK P
 2.00  P
 3.00  CR P

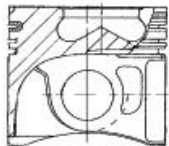
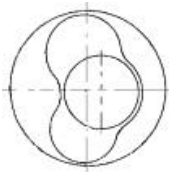

07959A109

1 To cylinder 1 & 2
 2 To cylinder 3 & 4
 3 Piston Chamber Volume [ccm] 23.60
 4 A = 39.550, D = 60.550

1 zum Zylinder 1 & 2
 2 zum Zylinder 3 & 4
 3 Volumen der Kolbenmulde [ccm] 23.60
 4 A = 39.550, D = 60.550

1 sous cylindre 1 & 2
 2 sous cylindre 3 & 4
 3 Volume de la cavité du piston [cm³] 23.60
 4 A = 39.550, D = 60.550





1 A cilindro 1 & 2
 2 A cilindro 3 & 4
 3 Volumen de cavidad del pistón [cc] 23.60
 4 A = 39.550, D = 60.550

1 al cilindro 1 & 2
 2 al cilindro 3 & 4
 3 Volume camera pistone [cm³] 23.60
 4 A = 39.550, D = 60.550



22  **79.50**

Bora 1.9 TDI	12/98→01/02	AJM			
Bora 1.9 TDI 4motion	02/99→06/01		4 Cyl.	19.5:1	
Golf IV 1.9 TDI	12/98→06/01		1896cc	85kW (115PS)	
Golf IV 1.9 TDI 4motion	05/99→06/01	Diesel	Turbo Intercooled		TD12588
Passat 1.9 TDI	08/98→11/00				
Passat 1.9 TDI	08/98→11/00	ATJ			
Passat 1.9 TDI 4motion	08/99→11/00		4 Cyl.	18:1	
			1896cc	85kW (115PS)	
		Diesel	Turbo Intercooled		TD16258
Bora 1.9 TDI	12/98→01/02	AUY			
Bora 1.9 TDI 4motion	02/99→06/01		4 Cyl.	18:1	
Golf IV 1.9 TDI	12/98→06/01		1896cc	85kW (115PS)	
Golf IV 1.9 TDI 4motion	09/99→06/01	Diesel	Turbo Intercooled		TD14915
Sharan 1.9 TDI, Sharan 1.9 TDI 4motion	04/00→03/10				
Sharan 1.9 TDI, Sharan 1.9 TDI 4motion	04/00→03/10	BVK			
			4 Cyl.	18:1	
			1896cc	85kW (115PS)	
		Diesel	Turbo Intercooled		TD20489

87-114900-05   STD
87-114907-05    0.50mm

→09/02

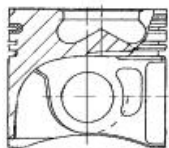
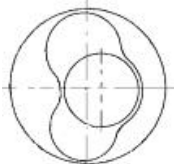

A 45.80
B- 17.80
BØ 38.00
C 1.30
D 68.80
 26x66

AK KK NB RT TP



07969L-101

08-114900-00 STD
08-114905-00 0.25mm
08-114907-00 0.50mm
08-114911-00 1.00mm

1.75  CK P
2.00  P
3.00  CR P

14-027950-00 **D** B 82.50 C 152.00 D 85.50 E 4.70

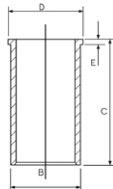

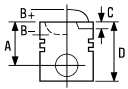

87-114900-15 STD
 87-114907-15 0.50mm

→09/02

A 45.80
 B- 17.80
 BØ 38.00
 C 1.30
 D 68.80
 26x66

AK KK NB RT TP

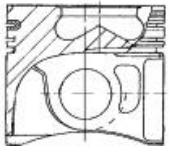
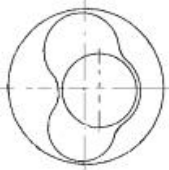

07969L-102

08-114900-00 STD
 08-114905-00 0.25mm
 08-114907-00 0.50mm
 08-114911-00 1.00mm

1.75 CK P
 2.00 P
 3.00 CR P

87-114900-55 STD
 87-114907-55 0.50mm

09/02→

A 45.80
 B- 17.60
 BØ 38.00
 C 1.10
 D 68.80
 26x66

AK KK NB RT TP

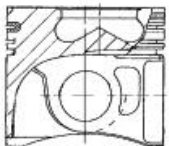
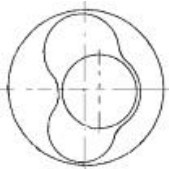

07901D101

08-114900-00 STD
 08-114905-00 0.25mm
 08-114907-00 0.50mm
 08-114911-00 1.00mm

1.75 CK P
 2.00 P
 3.00 CR P







87-114900-56 ② ③ ⑤ STD
87-114907-56 ② ⑥ ⑤ 0.50mm

09/02→

A 45.80
B- 17.60
BØ 38.00
C 1.10
D 68.60
 26x66

08-114900-00 STD
08-114905-00 0.25mm
08-114907-00 0.50mm
08-114911-00 1.00mm

1.75  CK P
 2.00  P
 3.00  CR P

AK KK NB RT TP

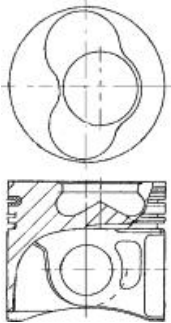

07901D102

- ① To cylinder 1 & 2
- ② To cylinder 3 & 4
- ③ Piston Chamber Volume [ccm] 23.60
- ④ For side angled injection nozzle
- ⑤ For newer design straight injection nozzle
- ⑥ A = 45.550, D = 68.550

- ① zum Zylinder 1 & 2
- ② zum Zylinder 3 & 4
- ③ Volumen der Kolbenmulde [ccm] 23.60
- ④ Nur für schräg angeordnete Einspritzdüsen
- ⑤ Für neuere Ausführungen, direkt einspritzende Düsen
- ⑥ A = 45.550, D = 68.550

- ① sous cylindre 1 & 2
- ② sous cylindre 3 & 4
- ③ Volume de la cavité du piston [cm³] 23.60
- ④ Pour buse d'injection latérale angulaire
- ⑤ Pour buse d'injection droite à conception plus récente
- ⑥ A = 45.550, D = 68.550

- ① A cilindro 1 & 2
- ② A cilindro 3 & 4
- ③ Volumen de cavidad del pistón [cc] 23.60
- ④ Para la boquilla de inyección lateral angular
- ⑤ Para el más reciente diseño de boquilla de inyección directa
- ⑥ A = 45.550, D = 68.550

- ① al cilindro 1 & 2
- ② al cilindro 3 & 4
- ③ Volume camera pistone [cm³] 23.60
- ④ Per il lato angolato dell'ugello olio
- ⑤ Per la più recente progettazione dell'ugello olio non angolato
- ⑥ A = 45.550, D = 68.550

23  **79.50**

Lupo 1.4 TDI	01/99→07/05	AMF			
Polo 1.4 TDI	10/99→06/05		3 Cyl.	19.5:1	
		Diesel	1422cc	55kW (75PS)	
			Turbo Intercooled		TD12589
Polo 1.4 TDI	10/01→	BAY			
			3 Cyl.	19.5:1	
		Diesel	1422cc	55kW (75PS)	
			Turbo Intercooled		TD16336



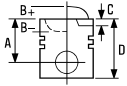

Polo 1.4 TDI 04/05 → 11/09 **BWB** 3 Cyl. 1422cc 19.5:1 51kW (70PS)
Diesel Turbo Intercooled **TD20514**



87-114900-80 1 3 STD
87-114907-80 1 0.50mm

A 45.80
B- 17.65
BØ 38.00
C 1.10
D 69.80
 26x63

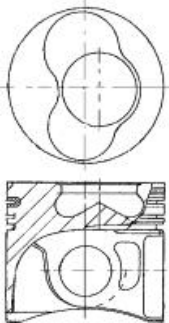
AK KK NB RT TP



08-114900-00 STD
08-114905-00 0.25mm
08-114907-00 0.50mm
08-114911-00 1.00mm

1.75  CK P
 2.00  P
 3.00  CR P

14-027950-00 D B 82.50 C 152.00 D 85.50 E 4.70

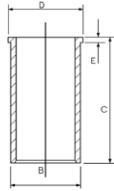



87-114900-85 2 3 STD
87-114907-85 2 0.50mm

A 45.80
B- 17.65
BØ 38.00
C 1.10
D 69.80
 26x63

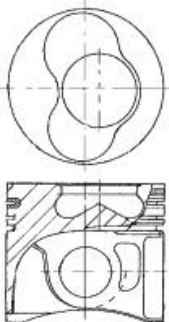
AK KK NB RT TP



08-114900-00 STD
08-114905-00 0.25mm
08-114907-00 0.50mm
08-114911-00 1.00mm

1.75  CK P
 2.00  P
 3.00  CR P

1 To cylinder 1 & 2
 2 To cylinder 3
 3 Piston Chamber Volume
 [ccm] 23.75

1 zum Zylinder 1 & 2
 2 zum Zylinder 3
 3 Volumen der Kolbenmulde
 [ccm] 23.75

1 sous cylindre 1 & 2
 2 sous cylindre 3
 3 Volume de la cavité du piston
 [cm³] 23.75

1 A cilindro 1 & 2
 2 A cilindro 3
 3 Volumen de cavidad del pistón
 [cc] 23.75

1 al cilindro 1 & 2
 2 al cilindro 3
 3 Volume camera pistone
 [cm³] 23.75



24  **79.50**

Sharan 1.9 TDI	09/95→03/10	ANU	4 Cyl. 1896cc	18:1 66kW (90PS)	
		Diesel	Turbo Intercooled		TD13443
Bora 1.9 TDI		ATD	4 Cyl. 1896cc	19:1 74kW (101PS)	
Bora 1.9 TDI 4motion	09/00→05/05				
Bora 1.9 TDI, Bora 1.9 TDI 4motion		Diesel	Turbo Intercooled		TD15473
Golf IV 1.9 TDI	09/00→06/06				
Golf IV 1.9 TDI 4motion	09/00→06/05				
Golf IV 1.9 TDI, Golf IV 1.9 TDI 4motion	02/01→09/10				
New Beetle 1.9 TDI	10/01→				
Polo 1.9 TDi					
Passat 1.9 TDI	02/00→05/05	AVB	4 Cyl. 1896cc	19:1 74kW (101PS)	
		Diesel	Turbo Intercooled		TD15152
Touran 1.9 TDI	02/03→05/04	AVQ	4 Cyl. 1896cc	19:1 74kW (100PS)	
		Diesel	Turbo Intercooled		TD16861
Bora 1.9 TDI	09/00→05/05	AXR	4 Cyl. 1896cc	19:1 74kW (100PS)	
Golf IV 1.9 TDI	09/00→06/06				
New Beetle 1.9 TDI	06/03→09/10				
Polo 1.9 TDI	10/01→11/09	Diesel	Turbo Intercooled		TD16337
New Beetle 1.9 TDI	02/01→09/10	BEW	4 Cyl. 1896cc	19:1 74kW (101PS)	
		Diesel	Turbo Intercooled		TD19255
Caddy III 1.9 TDI	04/04→08/10	BJB	4 Cyl. 1896cc	19:1 77kW (105PS)	
		Diesel	Turbo Intercooled		TD17078
Golf V 1.9 TDI	10/03→11/08	BKC	4 Cyl. 1896cc	19:1 77kW (105PS)	
Golf V 1.9 TDI 4motion	08/04→11/08				
Golf Plus 1.9 TDI	01/05→01/09				
Jetta III 1.9 TDI	08/05→10/10	Diesel	Turbo Intercooled		TD17079
Passat 1.9 TDI	03/05→11/08				
Touran 1.9 TDI	08/03→05/10				
Caddy III 1.9 TDI	04/04→08/10	BLS	4 Cyl. 1896cc	77kW (105PS)	
Caddy III 1.9 TDI 4motion	05/08→08/10				
Golf V 1.9 TDI	10/03→07/09	Diesel	Turbo Intercooled		TD18224
Golf V 1.9 TDI 4motion	08/04→07/09				
Golf Plus 1.9 TDI	01/05→01/09				
Jetta III 1.9 TDI	08/05→10/10				
Passat 1.9 TDI	03/05→11/08				
Touran 1.9 TDI	08/03→05/10				
Polo 1.9 TDI	10/01→11/09	BMT	4 Cyl. 1896cc	74kW (101PS)	
		Diesel	Turbo Intercooled		TD20494
Golf V 1.9 TDI	05/04→11/08	BRU	4 Cyl. 1896cc	19:1 66kW (90PS)	
Golf Plus 1.9 TDI	05/05→12/08				
Touran 1.9 TDI	11/04→05/10	Diesel	Turbo Intercooled		TD17468



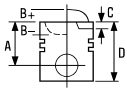

Caddy III 1.9 TDI	09/05→08/10	BSU	4 Cyl. 1896cc	55kW (75PS)	TD18755
		Diesel	Turbo Intercooled		
New Beetle 1.9 TDI	07/05→09/10	BSW	4 Cyl. 1896cc	19:1 77kW (105PS)	TD18771
		Diesel	Turbo Intercooled		
Golf V 1.9 TDI	10/03→07/09	BXE	4 Cyl. 1896cc	19:1 77kW (105PS)	TD18908
Golf V 1.9 TDI 4motion	08/04→11/08				
Golf Plus 1.9 TDI	01/05→01/09				
Jetta III 1.9 TDI	08/05→10/10	Diesel	Turbo Intercooled		
Passat 1.9 TDI	03/05→11/08				
Touran 1.9 TDI	08/03→05/10				
Golf V 1.9 TDI	05/04→11/08	BXF	4 Cyl. 1896cc	19:1 66kW (90PS)	TD18907
Golf Plus 1.9 TDI	05/05→12/08				
Touran 1.9 TDI	11/04→05/10				
		Diesel	Turbo Intercooled		
Golf V 1.9 TDI	05/04→11/08	BXJ	4 Cyl. 1896cc	19.5:1 66kW (90PS)	TD20493
Golf Plus 1.9 TDI	05/05→12/08				
Touran 1.9 TDI	11/04→05/10				
		Diesel	Turbo Intercooled		

87-114900-65 1 3 STD

87-114907-65 1 4 0.50mm

A 45.80

B- 17.20

BØ 38.00

C 1.10

D 68.80

26x66

AK KK NB RT TP

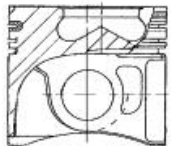
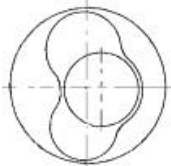

07901D-301

08-114900-00 STD

08-114905-00 0.25mm

08-114907-00 0.50mm

08-114911-00 1.00mm

1.75

2.00

3.00



CK P

P

CR P

14-027950-00 D

B 82.50 C 152.00 D 85.50 E 4.70

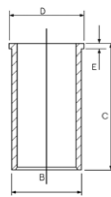





87-114900-66 ② ③ STD
87-114907-66 ② ④ 0.50mm

A 45.80
B- 17.20
BØ 38.00
C 1.10
D 68.80
 26x66

08-114900-00 STD
08-114905-00 0.25mm
08-114907-00 0.50mm
08-114911-00 1.00mm

1.75  CK P
 2.00  P
 3.00  CR P

AK KK NB RT TP

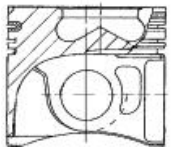
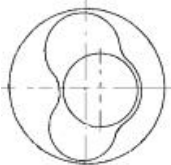

07901D-302

① To cylinder 1 & 2
 ② To cylinder 3 & 4
 ③ Piston Chamber Volume
 [ccm] 22.85
 ④ A = 45.550, D = 68.550

① zum Zylinder 1 & 2
 ② zum Zylinder 3 & 4
 ③ Volumen der Kolbenmulde
 [ccm] 22.85
 ④ A = 45.550, D = 68.550

① sous cylindre 1 & 2
 ② sous cylindre 3 & 4
 ③ Volume de la cavité du piston
 [cm³] 22.85
 ④ A = 45.550, D = 68.550

① A cilindro 1 & 2
 ② A cilindro 3 & 4
 ③ Volumen de cavidad del pistón
 [cc] 22.85
 ④ A = 45.550, D = 68.550

① al cilindro 1 & 2
 ② al cilindro 3 & 4
 ③ Volume camera pistone
 [cm³] 22.85
 ④ A = 45.550, D = 68.550

25 79.50

Bora 1.9 TDI		ARL		
Bora 1.9 TDI 4motion	05/01→05/05		4 Cyl.	18.5:1
Bora 1.9 TDI, Bora 1.9 TDI 4motion	05/00→05/05		1896cc	110kW (150PS)
Golf IV 1.9 TDI	05/00→06/06	Diesel	Turbo Intercooled	TD15484
Golf IV 1.9 TDI 4motion	02/00→06/05			
Bora 1.9 TDI		ASZ		
Bora 1.9 TDI 4motion			4 Cyl.	19.5:1
Bora 1.9 TDI, Bora 1.9 TDI 4motion	11/00→05/05		1896cc	96kW (130PS)
Golf IV 1.9 TDI		Diesel	Turbo Intercooled	TD16231
Golf IV 1.9 TDI 4motion	11/00→06/06			
Golf IV 1.9 TDI, Golf IV 1.9 TDI 4motion	11/00→06/05			
Polo 1.9 TDI	11/03→11/09			
Sharan 1.9 TDI	11/02→03/10			
Passat 1.9 TDI		AVF		
Passat 1.9 TDI 4motion			4 Cyl.	19:1
Passat 1.9 TDI, Passat 1.9 TDI 4motion	11/00→05/05		1896cc	96kW (130PS)
		Diesel	Turbo Intercooled	TD15153



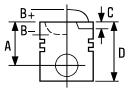

Passat 1.9 TDI 11/00→05/05 **AWX** 4 Cyl. 19:1
1896cc **96kW (130PS)**
Diesel **Turbo Intercooled** **TD15154**

87-114900-25 1 4 STD
87-114907-25 1 5 0.50mm

→09/02

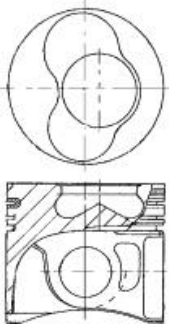

A 45.80
B- 17.90
BØ 38.00
C 1.10
D 68.80
 26x66

AK KK NB RT TP



07969K101

08-114900-00 STD
08-114905-00 0.25mm
08-114907-00 0.50mm
08-114911-00 1.00mm

1.75  CK P
 2.00  P
 3.00  CR P

14-027950-00 D B 82.50 C 152.00 D 85.50 E 4.70

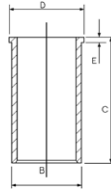

87-114900-35 2 4 STD
87-114907-35 2 5 0.50mm

→09/02

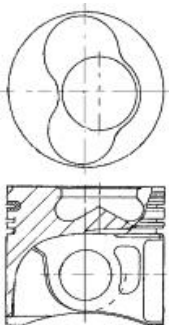

A 45.80
B- 17.90
BØ 38.00
C 1.10
D 68.80
 26x66

AK KK NB RT TP



07969K102

08-114900-00 STD
08-114905-00 0.25mm
08-114907-00 0.50mm
08-114911-00 1.00mm

1.75  CK P
 2.00  P
 3.00  CR P





87-114900-45 ① ③ STD
87-114907-45 ① ⑤ 0.50mm

09/02→

A 45.80
B- 17.50
BØ 38.00
C 1.10
D 68.80
 26x66

AK KK NB RT TP

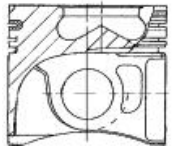
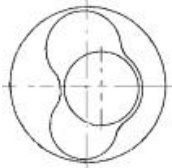

07901C105

08-114900-00 STD
08-114905-00 0.25mm
08-114907-00 0.50mm
08-114911-00 1.00mm

1.75
 2.00
 3.00



CK P
 P
 CR P

87-114900-46 ② ③ STD
87-114907-46 ② ⑤ 0.50mm

09/02→

A 45.80
B- 17.50
BØ 38.00
C 1.10
D 68.80
 26x66

AK KK NB RT TP

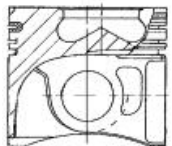
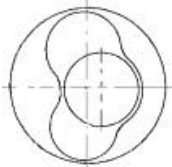

07901C106

08-114900-00 STD
08-114905-00 0.25mm
08-114907-00 0.50mm
08-114911-00 1.00mm

1.75
 2.00
 3.00



CK P
 P
 CR P

- ① To cylinder 1 & 2
- ② To cylinder 3 & 4
- ③ Piston Chamber Volume
[ccm] 24.05
- ④ Piston Chamber Volume
[ccm] 24.60
- ⑤ A = 45.550, D = 68.550

- ① zum Zylinder 1 & 2
- ② zum Zylinder 3 & 4
- ③ Volumen der Kolbenmulde
[ccm] 24.05
- ④ Volumen der Kolbenmulde
[ccm] 24.60
- ⑤ A = 45.550, D = 68.550

- ① sous cylindre 1 & 2
- ② sous cylindre 3 & 4
- ③ Volume de la cavité du piston
[cm³] 24.05
- ④ Volume de la cavité du piston
[cm³] 24.60
- ⑤ A = 45.550, D = 68.550

- ① A cilindro 1 & 2
- ② A cilindro 3 & 4
- ③ Volumen de cavidad del pistón
[cc] 24.05
- ④ Volumen de cavidad del pistón
[cc] 24.60
- ⑤ A = 45.550, D = 68.550





- ① al cilindro 1 & 2
- ② al cilindro 3 & 4
- ③ Volume camera pistone
[cm³] 24.05
- ④ Volume camera pistone
[cm³] 24.60
- ⑤ A = 45.550, D = 68.550



26 79.50

Multivan V 1.9 TDI, Transporter V 1.9 TDI	04/03→11/09	AXB	4 Cyl.	18.5:1
Transporter V 1.9 TDI			1896cc	77kW (105PS)
		Diesel	Turbo Intercooled	TD16867

Multivan V 1.9 TDI, Transporter V 1.9 TDI	04/03→11/09	AXC	4 Cyl.	18.5:1
Transporter V 1.9 TDI			1896cc	63kW (85PS)
		Diesel	Turbo Intercooled	TD16881

87-114900-25   STD
87-114907-25   0.50mm

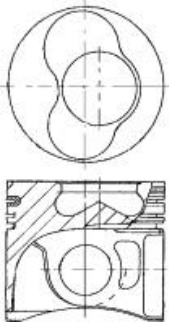

A 45.80
B- 17.90
BØ 38.00
C 1.10
D 68.80
 26x66

AK KK NB RT TP







07969K101

08-114900-00 STD
08-114905-00 0.25mm
08-114907-00 0.50mm
08-114911-00 1.00mm

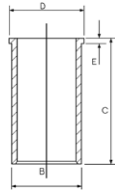
1.75  CK P
2.00  P
3.00  CR P

14-027950-00 D B 82.50 C 152.00 D 85.50 E 4.70



87-114900-35   STD
87-114907-35   0.50mm



A 45.80
B- 17.90
BØ 38.00
C 1.10
D 68.80
 26x66

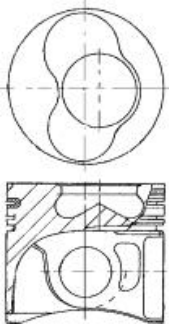



AK KK NB RT TP











07969K102





08-114900-00 STD
08-114905-00 0.25mm
08-114907-00 0.50mm
08-114911-00 1.00mm





1.75  CK P
2.00  P
3.00  CR P

 To cylinder 1 & 2
 To cylinder 3 & 4
 Piston Chamber Volume [ccm] 24.60
 A = 45.550, D = 68.550

 zum Zylinder 1 & 2
 zum Zylinder 3 & 4
 Volumen der Kolbenmulde [ccm] 24.60
 A = 45.550, D = 68.550

 sous cylindre 1 & 2
 sous cylindre 3 & 4
 Volume de la cavité du piston [cm³] 24.60
 A = 45.550, D = 68.550





 A cilindro 1 & 2
 A cilindro 3 & 4
 Volumen de cavidad del pistón [cc] 24.60
 A = 45.550, D = 68.550

 al cilindro 1 & 2
 al cilindro 3 & 4
 Volume camera pistone [cm³] 24.60
 A = 45.550, D = 68.550





27  **79.50**

Polo 1.9 TDI	11/03→11/09	BLT	4 Cyl. 1896cc	19:1 96kW (130PS)	
		Diesel	Turbo Intercooled		TD17467
Multivan V 1.9 TDI, Transporter V 1.9 TDI	01/06→11/09	BRR	4 Cyl. 1896cc	62kW (84PS)	
Transporter V 1.9 TDI		Diesel	Turbo Intercooled		TD20159
Multivan V 1.9 TDI, Transporter V 1.9 TDI	06/06→11/09	BRS	4 Cyl. 1896cc	75kW (102PS)	
Transporter V 1.9 TDI		Diesel	Turbo Intercooled		TD18994

87-114900-45   STD
87-114907-45   0.50mm

A 45.80
B- 17.50
BØ 38.00
C 1.10
D 68.80
 26x66

08-114900-00 STD
08-114905-00 0.25mm
08-114907-00 0.50mm
08-114911-00 1.00mm

1.75  CK P
 2.00  P
 3.00  CR P

14-027950-00 D B 82.50 C 152.00 D 85.50 E 4.70

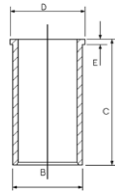

AK KK NB RT TP

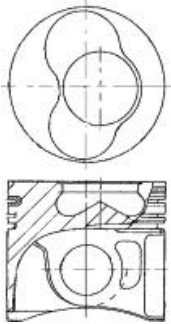

07901C105



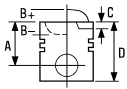

87-114900-46 ② ③ STD
87-114907-46 ② ④ 0.50mm

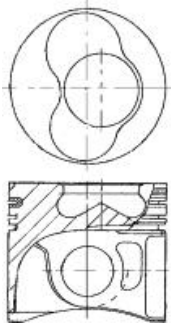

A 45.80
B- 17.50
BØ 38.00
C 1.10
D 68.80
 26x66

AK KK NB RT TP



07901C106

08-114900-00 STD
08-114905-00 0.25mm
08-114907-00 0.50mm
08-114911-00 1.00mm

1.75  CK P
2.00  P
3.00  CR P

- ① To cylinder 1 & 2
- ② To cylinder 3 & 4
- ③ Piston Chamber Volume [ccm] 24.05
- ④ A = 45.550, D = 68.550

- ① zum Zylinder 1 & 2
- ② zum Zylinder 3 & 4
- ③ Volumen der Kolbenmulde [ccm] 24.05
- ④ A = 45.550, D = 68.550

- ① sous cylindre 1 & 2
- ② sous cylindre 3 & 4
- ③ Volume de la cavité du piston [cm³] 24.05
- ④ A = 45.550, D = 68.550

- ① A cilindro 1 & 2
- ② A cilindro 3 & 4
- ③ Volumen de cavidad del pistón [cc] 24.05
- ④ A = 45.550, D = 68.550

- ① al cilindro 1 & 2
- ② al cilindro 3 & 4
- ③ Volume camera pistone [cm³] 24.05
- ④ A = 45.550, D = 68.550

28  **79.50**

Polo 1.2 TDI	10/09→	CFWA	3 Cyl.	16.5:1	
			1199cc	55kW (75PS)	
		Diesel	Turbo Intercooled		TD23610
Polo 1.6 TDI	06/09→	CAYA	4 Cyl.		
			1598cc	55kW (75PS)	
		Diesel	Turbo Intercooled		TD23105
Golf VI 1.6 TDI	02/09→07/13	CAYB			
Golf Plus 1.6 TDI	02/09→12/13		4 Cyl.	16.5:1	
Jetta III 1.6 TDI	12/09→10/10		1598cc	66kW (90PS)	
Polo 1.6 TDI	06/09→	Diesel	Turbo Intercooled		TD22638
Touran 1.6 TDI	05/10→05/15				
Beetle 1.6 TDI	10/11→	CAYC			
Golf VI 1.6 TDI	02/09→		4 Cyl.	16.5:1	
Golf VI 1.6 TDI 4motion	07/09→07/13		1598cc	77kW (105PS)	
Golf Plus 1.6 TDI	03/09→12/13	Diesel	Turbo Intercooled		TD22639
Jetta III 1.6 TDI	06/09→10/10				
Jetta IV 1.6 TDI	02/11→				
Passat 1.6 TDI	08/09→12/14				
Polo 1.6 TDI	06/09→				
Touran 1.6 TDI	05/10→05/15				





Caddy III 1.6 TDI Caddy IV 1.6 TDI	08/10→ 05/15→	CAYD	4 Cyl. 1598cc	75kW (102PS)	TD24364
		Diesel	Turbo Intercooled		
Caddy III 1.6 TDI Caddy IV 1.6 TDI	08/10→ 05/15→	CAYE	4 Cyl. 1598cc	55kW (75PS)	TD24365
		Diesel	Turbo Intercooled		
Polo 1.6 TDI	06/09→	CLNA	4 Cyl. 1598cc	16.5:1 77kW (105PS)	TD25704
		Diesel	Turbo Intercooled		

87-432900-00 ¹	STD	08-432900-00	STD
87-432905-00	0.25mm	08-432905-00	0.25mm
87-432907-00	0.50mm	08-432907-00	0.50mm

A	45.30
B-	10.70
B-	4.70
BØ	49.00
D	67.80
	26x66

1.75		GDC P
2.00		P
3.00		CR P



KK RT TP

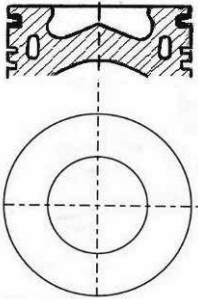

0790MA-104

¹ Piston Chamber Volume
[ccm] 19.750

¹ Volumen der Kolbenmulde
[ccm] 19.750

¹ Volume de la cavité du piston
[cm³] 19.750

¹ Volumen de cavidad del pistón
[cc] 19.750

¹ Volume camera pistone
[cm³] 19.750

29 81.00

Caddy II 1.6, Caddy II 75 1.6	11/95→05/97	1F			
Passat 1.6	02/88→09/91		4 Cyl.	9.5:1	
Polo Classic 75 1.6	11/95→09/97		1595cc	53-55kW (72-75PS)	
Saveiro I 1.6	08/90→07/96				TD4957
Saveiro II 1.6	07/97→02/02				
Golf II 1.6	08/83→07/92	ABN			
Jetta II 1.6	01/84→07/92		4 Cyl.	9:1	
Passat 1.6	02/88→12/88		1595cc	54-55kW (73-75PS)	TD4974
Passat 1.6	08/80→03/88	DT			
Santana 1.6	08/81→12/84		4 Cyl.	9:1	
			1595cc	55kW (75PS)	TD4997





Passat 1.6	08/86→03/88	DTA	4 Cyl. 1595cc	9:1 51-55kW (69-75PS)	TD22646
Caddy I 1.6	01/83→07/92	EW	4 Cyl. 1595cc	9:1 55kW (75PS)	TD4070
Golf I 1.6	01/83→04/92				
Jetta I 1.6	08/82→07/83				
Saveiro I 1.6	08/90→07/96				
Saveiro II 1.6	07/97→02/02				
Scirocco 1.6	01/83→12/89				
Golf II 1.6	08/83→07/92	EZ	4 Cyl. 1595cc	9:1 53-55kW (72-75PS)	TD4074
Jetta II 1.6	01/84→07/92				
Kombi 1.6	08/92→07/00				
Passat 1.6	02/88→09/91				
Golf II 1.6	08/86→07/91	EZA	4 Cyl. 1595cc	9:1 51-55kW (70-75PS)	TD4075
Citygolf 1.6	06/96→12/99				
Fox 1.6	01/87→12/93				
Golf II 1.6	08/83→07/92				
Jetta II 1.6	01/84→07/92				
Saveiro I 1.6 Álcool	07/85→10/89				
Golf I 1.6	08/80→03/88	HN	4 Cyl. 1595cc	9:1 53-55kW (72-75PS)	TD4107
Passat 1.6	08/86→03/88				
Passat 1.6	08/86→03/88				
Passat 1.6	08/86→03/88				
Passat 1.6	08/86→03/88				
Golf II 1.6	08/86→12/92	PN	4 Cyl. 1595cc	9:1 51kW (70PS)	TD4141
Jetta II 1.6	10/86→10/91				
Passat 1.6	08/87→03/88	PP	4 Cyl. 1595cc	9:1 51kW (70PS)	TD5022
Golf I 1.6	04/86→02/90				
Scirocco 1.6	04/86→07/90				
Golf I 1.6	04/86→02/90				
Scirocco 1.6	04/86→07/90				
Golf II 1.6	02/86→10/91	RF	4 Cyl. 1595cc	9:1 53kW (72PS)	TD5025
Jetta II 1.6	03/86→10/91				





Passat 1.6	01/85 → 03/88	RL	4 Cyl. 1595cc	9:1 53kW (72PS)	TD4148
-------------------	---------------	-----------	-------------------------	---------------------------	---------------

87-109707-20	0.50mm	08-109700-00	STD
A	35.30	08-109705-00	0.25mm
B-	2.30	08-109707-00	0.50mm
B+	2.20		
D	66.50	1.50	CR P
20x57		1.75	P
		3.00	CR P

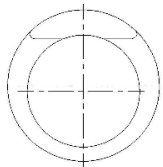
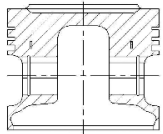

08132E

A = 35.300, D = 66.500

A = 35.300, D = 66.500

A = 35.300, D = 66.500

A = 35.300, D = 66.500

A = 35.300, D = 66.500

30 81.00

Golf II 1.8 Syncro, Jetta II 1.8 Syncro	08/88 → 07/91	1P	4 Cyl. 1781cc	9:1 72kW (98PS)	TD3995
Golf I 1.8	08/89 → 03/93	2H	4 Cyl. 1781cc	9:1 72kW (98PS)	TD4965
Golf III 1.8	11/91 → 04/99	ABS			
Golf III 1.8 Syncro	01/93 → 08/97		4 Cyl. 1781cc	9:1 66kW (90PS)	
Passat 1.8	02/88 → 05/97				TD4975
Polo Classic 90 1.8	01/97 → 09/01				
Vento 1.8	11/91 → 09/98				
Golf III 1.8	11/91 → 04/99	ADZ			
Golf III 1.8 Syncro	01/93 → 04/99		4 Cyl. 1781cc	10:1 66kW (90PS)	
Golf IV 1.8	06/98 → 06/02				TD4980
Passat 1.8	02/88 → 05/97				
Polo 1.8	05/97 → 09/01				
Polo Classic 90 1.8	01/97 → 09/01				
Polo Playa 1.8	01/95 → 10/99				
Vento 1.8	11/91 → 09/98				
Passat 1.8	01/83 → 03/88	DS			
Passat 1.8 Syncro	01/86 → 03/88		4 Cyl. 1781cc	10:1 66kW (90PS)	
Santana 1.8	01/83 → 07/94				TD4996





Golf I 1.8	08/82→12/92	DX			
Golf I 1.8 GTI	08/82→12/83		4 Cyl.	10:1	
Golf II 1.8 GTI	08/83→10/91		1781cc	82kW (112PS)	
Jetta I 1.8	08/82→02/84				TD4063
Scirocco 1.8	08/82→12/89				
Passat 1.8	12/83→03/88	DZ			
			4 Cyl.	10:1	
			1781cc	82kW (112PS)	
					TD4998
Fox 1.8	10/90→12/93	EV			
Golf I 1.8	08/82→12/89		4 Cyl.	10:1	
Golf II 1.8 GTI	08/83→10/91		1781cc	82kW (112PS)	
Jetta II 1.8	01/84→10/91				TD4069
Scirocco 1.8	08/82→12/89				
Golf I 1.8	08/83→09/92	EX			
Scirocco 1.8	08/83→07/92		4 Cyl.	10:1	
			1781cc	66kW (90PS)	
					TD5000
Golf II 1.8	08/84→10/91	GU			
Golf II 1.8 Syncro	02/86→07/91		4 Cyl.	9/10:1	
Jetta II 1.8	08/84→10/91		1781cc	66kW (90PS)	
Jetta II 1.8 Syncro	08/87→12/88				TD5007
Golf II 1.8	08/84→10/91	GX			
Golf II 1.8 i CAT	08/87→10/91		4 Cyl.	10:1	
Golf II 1.8 Syncro	02/86→07/91		1781cc	66kW (90PS)	
Jetta II 1.8	08/84→10/91				TD4100
Jetta II 1.8 CAT	08/87→10/91				
Golf II 1.8 GTI	08/83→10/91	GZ			
Jetta II 1.8	01/84→10/91		4 Cyl.	10:1	
			1781cc	82kW (112PS)	
					TD4102
Golf II 1.8 GTI	01/85→07/85	HT			
Jetta II 1.8	01/85→12/92		4 Cyl.	10:1	
			1781cc	74-77kW (100-104PS)	
					TD4109
Golf II 1.8, Jetta II 1.8	08/84→10/91	HV			
			4 Cyl.	10:1	
			1781cc	66kW (90PS)	
					TD4111
Caddy I 1.8	08/85→07/92	JH			
Golf I 1.8	09/82→04/93		4 Cyl.	8.5:1	
Jetta I 1.8	09/83→02/84		1781cc	66-75kW (90-102PS)	
Parati I 1.8 Hybrid	08/87→07/94				TD4117
Scirocco 1.8	11/85→07/92				
Passat 1.8	01/83→03/88	JV			
Quantum 1.8	04/85→07/90		4 Cyl.	10:1	
Santana 1.8	04/85→12/99		1781cc	66kW (90PS)	
					TD5017
Golf II 1.8 GTI	08/83→10/91	KT			
			4 Cyl.	10:1	
			1781cc	82kW (112PS)	
					TD4124



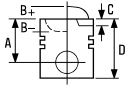

Golf I 1.8	08/82→12/89	PB			
Golf II 1.8 GTI	08/83→10/91		4 Cyl.	10:1	
Jetta II 1.8	01/84→10/91		1781cc	82kW (112PS)	
Passat 1.8	04/88→07/92				TD9367
Scirocco 1.8	08/82→12/89				
Golf II 1.8	09/87→12/92	PF			
Golf II 1.8 GTI CAT	01/87→10/91		4 Cyl.	9/10:1	
Jetta II 1.8	09/86→12/92		1781cc	75-79kW (102-107PS)	
Jetta II 1.8 CAT	01/87→10/91				TD4139
Passat 1.8	04/88→07/93				
Golf II 1.8 GTI	01/85→07/85	RG			
			4 Cyl.	10:1	
			1781cc	79kW (105PS)	
					TD4146
Golf II 1.8	08/86→01/90	RH			
Golf II 1.8 Syncro	08/87→07/88		4 Cyl.	9/10:1	
Jetta II 1.8	08/86→01/90		1781cc	62kW (84PS)	
Jetta II 1.8 Syncro	08/87→07/88				TD5026
Golf II 1.8	09/87→12/92	RV			
Golf II 1.8 GTI	01/85→07/85		4 Cyl.	10:1	
Jetta II 1.8	01/85→12/92		1781cc	75-77kW (102-105PS)	
					TD4151

87-109400-50 ¹

STD

08-109400-10

STD

87-109407-50 ¹ ²

0.50mm

08-109407-10

0.50mm

A 32.20

B- 4.40

B+ 1.30

BØ 55.70

D 62.50

 20x57

1.50

1.75

3.00



P PS

P

CR P

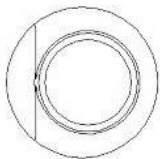
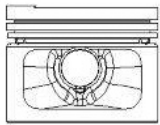

08130E-101

¹ Pistons to be replaced in Engine Sets only

² A = 31.900, D = 62.200

¹ Kolben nur Motorsätzen zu ersetzen

² A = 31.900, D = 62.200

¹ Piston à remplacer dans jeu moteur

² A = 31.900, D = 62.200

¹ Pistones de repuesto para juegos de motores solamente

² A = 31.900, D = 62.200





¹ Il pistone può essere rimpiazzato solamente completo

² A = 31.900, D = 62.200



31 81.00

Industrial	12/77→03/94	262	4 Cyl. 1781cc	50kW (68PS)	TD22608
Golf III 1.8	11/91→04/99	AAM	4 Cyl.	9:1	TD4004
Golf IV 1.8	06/98→06/02		1781cc	55kW (75PS)	
Passat 1.8	08/90→05/97				
Vento 1.8	11/91→09/98				
Golf III 1.8	11/91→08/97	ACC	4 Cyl.	10:1	TD4011
Golf IV 1.8	10/97→09/99		1781cc	66-67kW (90-91PS)	
Vento 1.8	11/91→12/95				
Derby 1.8	09/94→12/09	ADD	4 Cyl.	10:1	
Polo 1.8	10/05→12/08		1781cc	63-75kW (86-102PS)	TD15496
Polo Classic 90 1.8	01/97→09/01				
Van Mini Passenger 1.8	09/07→12/09				
Industrial	04/94→08/09	ADF	4 Cyl.	9:1	
			1781cc	55kW (75PS)	TD21353
Golf III 1.8	07/93→04/99	ANN	4 Cyl.	9:1	TD10847
Golf IV 1.8	06/98→06/02		1781cc	55kW (75PS)	
Golf II 1.8 i CAT, Golf II 1.8 i Syncro CAT	08/87→10/91	RP	4 Cyl.	10:1	TD5027
Jetta II 1.8 CAT			1781cc	66kW (90PS)	
Jetta II 1.8 Syncro	08/87→12/88				
Passat 1.8	02/88→05/97				

87-109707-10	0.50mm	08-109700-00	STD
A	31.90	08-109705-00	0.25mm
B-	8.10	08-109707-00	0.50mm
B+	1.10		
BØ	56.80	1.50	 CR P
D	62.00	1.75	 P
 20x54		3.00	 CR P

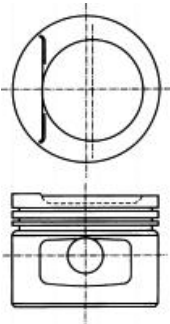

08131-122



32  **81.00**

Bora 2.3 V5	10/98→10/00	AGZ			
Bora 2.3 V5 4motion	12/98→10/00		V5 Cyl.	10:1	
Golf IV 2.3 V5	08/97→10/00		2324cc	110kW (150PS)	
Golf IV 2.3 V5 4motion	12/98→06/06				TD5559
Passat 2.3 VR5	10/96→11/00				
Passat 2.3 VR5 Syncro/4motion	10/97→11/00				
Bora 2.8 VR6	08/02→07/05	AAA			
Corrado 2.8 VR6	09/91→12/95		V6 Cyl.	10.1:1	
Golf III 2.8 VR6	01/92→09/97		2792cc	120-128kW (163-174PS)	
Jetta III 2.8 VR6	10/09→10/10				TD3999
Passat 2.8 VR6	06/91→05/97				
Sharan 2.8 VR6	09/95→04/00				
Sharan 2.8 VR6 Syncro	11/96→04/00				
Vento 2.8 VR6	01/92→09/98				
Transporter IV 2.8	05/96→05/00	AES			
Transporter IV 2.8 VR6	05/96→05/00		V6 Cyl.	10:1	
Transporter IV 2.8 VR 6	11/95→04/00		2792cc	103kW (140PS)	
Transporter IV 2.8 VR6 Syncro	01/96→04/96				TD9346
Bora 2.8 VR6	08/02→07/05	AFP			
Bora 2.8 VR6, Golf IV 2.8 V6	09/00→12/04		V6 Cyl.	10:1	
			2792cc	128-130kW (174-177PS)	
					TD20532
Sharan 2.8 VR6	09/95→04/00	AMY			
Sharan 2.8 VR6 Syncro	11/96→04/00		V6 Cyl.	10.75:1	
			2792cc	128kW (174PS)	
					TD17199

87-501900-00

STD

08-501900-00

STD

87-501907-00

0.50mm

08-501907-00

0.50mm

A 30.52

1.50



P PS

B+ 4.26

1.75



P

BØ 57.00

3.00



CR P

C 6.22

D 55.78

 20x57

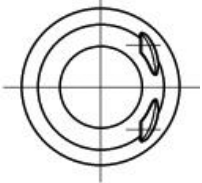



33  **81.00**

Passat 1.6	10/96→11/00	ADP	4 Cyl. 1595cc	10.3:1 74kW (101PS)	TD16253
Bora 1.6	10/98→05/05	AEH			
Golf IV 1.6	08/97→05/04		4 Cyl. 1595cc	10.3:1 74kW (100PS)	TD9450
Polo 1.6	05/97→09/01				
Polo Classic 100 1.6	12/95→09/01				
Golf III 1.6	07/94→04/99	AEK			
Passat 1.6	07/94→08/96		4 Cyl. 1595cc	10.2:1 74kW (101PS)	TD4982
Vento 1.6	10/94→09/98				
Golf III 1.6	07/94→04/99	AFT			
Golf IV 1.6	06/98→06/02		4 Cyl. 1595cc	10.5:1 74kW (101PS)	TD4988
Passat 1.6	07/94→08/96				
Polo 1.6	05/97→09/01				
Polo Classic 100 1.6	12/95→09/01				
Vento 1.6	10/94→09/98				
Bora 1.6	10/98→05/05	AKL			
Golf IV 1.6	08/97→05/04		4 Cyl. 1595cc	10.3:1 74-76kW (100-103PS)	TD9451
Polo 1.6	05/97→09/01				
Polo Classic 100 1.6	12/95→09/01				
Polo Playa 1.6	10/99→10/04				
Golf III 1.6	07/94→04/99	AKS			
Golf IV 1.6	06/98→06/02		4 Cyl. 1588cc	10.3:1 74kW (101PS)	TD9991
Bora 1.6	10/98→05/05	APF			
Golf IV 1.6	08/97→05/04		4 Cyl. 1595cc	12:1 74kW (101PS)	TD12848
Polo 1.6	05/97→09/01				
Polo Classic 100 1.6	12/95→09/01				
Passat 1.6	10/96→11/00	ARM			
			4 Cyl. 1595cc	10.3:1 74kW (101PS)	TD16255
Polo 1.6	05/97→09/01	AUR			
Polo Classic 100 1.6	12/95→09/01		4 Cyl. 1595cc	10.3:1 74kW (101PS)	TD15611







New Beetle 1.6	10/99 → 09/00	AWH	4 Cyl. 1595cc	10.3:1 74kW (101PS)	TD15465
-----------------------	---------------	------------	-------------------------	-------------------------------	----------------

87-105900-00	STD	08-105900-00	STD
87-105907-00 ①	0.50mm	08-105907-00	0.50mm

A 32.00
B- 2.30
B+ 0.70
BØ 61.40
D 53.70
 20x57

1.20  NT ②
 1.50  P
 2.00  CR ②

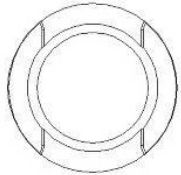
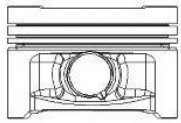

① A = 31.700, D = 53.400
 ② Steel

① A = 31.700, D = 53.400
 ② Stahl

① A = 31.700, D = 53.400
 ② Acier

① A = 31.700, D = 53.400
 ② Acero

① A = 31.700, D = 53.400
 ② Acciaio

34  **81.00**

Passat 1.8		ADR	4 Cyl.	10.3:1	
Passat 1.8, Passat 1.8 Syncro/4motion	10/96 → 11/00		1781cc	92kW (125PS)	TD5557
Passat 1.8 Syncro/4motion	06/97 → 11/00				





Bora 1.8	10/98 → 05/05	AGN	4 Cyl.	10.3:1	
Bora 1.8 4motion	02/99 → 05/05		1781cc	92kW (125PS)	TD9363
Citygolf 1.8	06/96 → 12/99				
Golf IV 1.8	08/97 → 06/05				
Golf IV 1.8 4motion	05/98 → 06/06				

Passat 1.8		APT	4 Cyl.	10.3:1	
Passat 1.8, Passat 1.8 Syncro/4motion	10/96 → 11/00		1781cc	92kW (125PS)	TD11497
Passat 1.8 Syncro/4motion	06/97 → 11/00				





Passat 1.8	ARG			
Passat 1.8, Passat 1.8 Syncro/4motion	10/96→11/00	4 Cyl.	10.3:1	
Passat 1.8 Syncro/4motion	06/97→11/00	1781cc	92kW (125PS)	TD16237

87-502900-00 ①	STD	08-502900-00	STD
87-502907-00 ① ②	0.50mm	08-502905-00	0.25mm
		08-502907-00	0.50mm
A	32.55	1.50	 CK P
C	3.60	1.75	 P
D	56.55	2.00	 CR P
 20x59			

AK

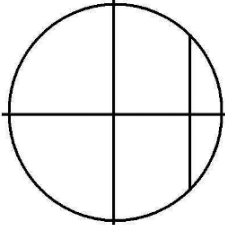
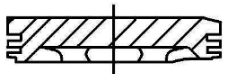

08192

① Conrod gap 27.50mm	① Pleuelaugenabstand 27.50mm	① Distance entre bielle 27.50mm	① Distancia del biela 27.50mm	① Distanza dalla bilie 27.50mm
② A = 32.250, D = 56.250	② A = 32.250, D = 56.250	② A = 32.250, D = 56.250	② A = 32.250, D = 56.250	② A = 32.250, D = 56.250

35 81.00





Passat 1.8	01/00→12/01	AEB			
Passat 1.8 4motion	09/98→12/99		4 Cyl.	9.5:1	
Passat 1.8 T	10/96→11/00		1781cc	110-112kW (150-152PS)	
Passat 1.8 T Syncro	11/96→08/00		Turbo Intercooled		TD5558
Bora 1.8 T	05/00→05/05	AGU Euro 2			
Golf IV 1.8 T	08/97→06/06		4 Cyl.	9.5:1	
New Beetle 1.8 T	10/99→09/10		1781cc	110kW (150PS)	
			Turbo Intercooled		TD9456
Sharan 1.8 T 20V	09/97→03/10	AJH			
			4 Cyl.	9.5:1	
			1781cc	110kW (150PS)	
			Turbo Intercooled		TD10887
Passat 1.8 T	10/96→11/00	ANB			
			4 Cyl.	9.5:1	
			1781cc	110kW (150PS)	
			Turbo Intercooled		TD16256
New Beetle 1.8 T	10/99→09/10	APH			
			4 Cyl.	9.5:1	
			1781cc	110kW (150PS)	
			Turbo Intercooled		TD13441
Passat 1.8 T	10/96→11/00	APU			
			4 Cyl.	9.5:1	
			1781cc	110kW (150PS)	
			Turbo Intercooled		TD16257





Golf IV 1.8 T	08/97→06/06	AQA	4 Cyl. 1781cc Turbo Intercooled	9.5:1 110kW (150PS)	TD22620
Golf IV 1.8 T	08/97→06/06	ARZ	4 Cyl. 1781cc Turbo Intercooled	9.5:1 110kW (150PS)	TD16385
New Beetle 1.8 T	10/99→09/10	AVC	4 Cyl. 1781cc Turbo Intercooled	9.5:1 110kW (150PS)	TD15467
Sharan 1.8 T 20V	09/97→03/10	AWC	4 Cyl. 1781cc Turbo Intercooled	9.5:1 110kW (150PS)	TD14914
Golf IV 1.8 T	08/97→06/06	AWD	4 Cyl. 1781cc Turbo Intercooled	9.5:1 110kW (150PS)	TD20628

87-502900-10	STD	08-502900-00	STD
87-502905-10	0.25mm	08-502905-00	0.25mm
87-502907-10	0.50mm	08-502907-00	0.50mm

A	32.70	1.50	 CK P
B-	2.05	1.75	 P
BØ	70.00	2.00	 CR P
D	53.70		
	20x59		

AK

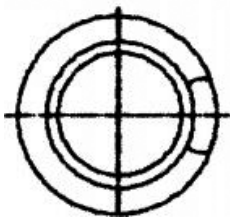
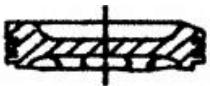









36 81.00

Passat 1.6	10/96→11/00	AHL	4 Cyl. 1595cc	10.3:1 74kW (101PS)	TD5556
------------	-------------	------------	-------------------------	-------------------------------	---------------

87-105900-00	STD	08-105900-00	STD
87-105907-00 	0.50mm	08-105907-00	0.50mm

→8D X 400 000

A	32.00
B-	2.30
B+	0.70
BØ	61.40
D	53.70
 20x57	

1.20		NT 
1.50		P
2.00		CR 

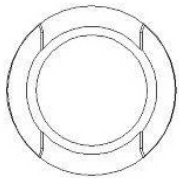
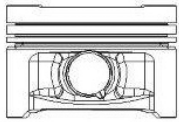

 A = 31.700, D = 53.400

 Steel

 A = 31.700, D = 53.400

 Stahl

 A = 31.700, D = 53.400

 Acier

 A = 31.700, D = 53.400

 Acero

 A = 31.700, D = 53.400

 Acciaio

37 81.00

Passat 1.6	11/00→05/05	ALZ	4 Cyl. 1595cc	75kW (102PS)	TD15148
Passat 1.6	10/96→11/00	ANA	4 Cyl. 1595cc	10.3:1 74kW (101PS)	TD16254
Bora 1.6 Golf IV 1.6	08/00→05/05 08/00→06/06	AVU	4 Cyl. 1595cc	10.3:1 75kW (102PS)	TD15475
New Beetle 1.6	06/00→09/10	AYD	4 Cyl. 1595cc	10.5:1 75kW (102PS)	TD15466
Bora 1.6 Golf IV 1.6	08/00→05/05 08/00→06/06	BFQ	4 Cyl. 1595cc	10.3:1 75kW (102PS)	TD18137
New Beetle 1.6	06/00→09/10	BFS	4 Cyl. 1595cc	10.5:1 75kW (102PS)	TD16743





Caddy III 1.6	04/04→	BGU			
Golf V 1.6	01/04→07/09		4 Cyl.	10.3:1	
Jetta III 1.6	10/05→10/10		1595cc	75kW (102PS)	
Touran 1.6	07/03→05/10				TD17067
Caddy III 1.6	04/04→	BSE			
Golf V 1.6	01/04→07/09		4 Cyl.		
Golf VI 1.6	10/08→07/13		1595cc	75kW (102PS)	
Golf Plus 1.6	05/05→12/13				TD18222
Jetta III 1.6	10/05→10/10				
Passat 1.6	05/05→11/10				
Touran 1.6	07/03→05/10				
Caddy III 1.6	04/04→	BSF			
Golf V 1.6	01/04→07/09		4 Cyl.		
Golf VI 1.6	10/08→07/13		1595cc	75kW (102PS)	
Golf Plus 1.6	05/05→12/13				TD18223
Jetta III 1.6	10/05→10/10				
Passat 1.6	05/05→11/10				
Touran 1.6	07/03→05/10				
Caddy III 1.6 BiFuel	05/11→	CHGA			
Golf VI 1.6 BiFuel	03/09→11/12		4 Cyl.		
Golf Plus 1.6 BiFuel	05/09→12/13		1595cc	75kW (102PS)	
					TD22180

87-148300-00
87-148307-00

STD
0.50mm

08-148300-00
08-148307-00

STD
0.50mm

A 29.08
B- 2.70
BØ 62.30
D 50.70
 19x42

1.00
1.20
2.00



NT 
P
CR P

TP

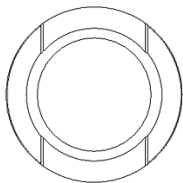
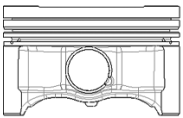

 Steel

 Stahl

 Acier



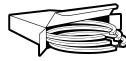
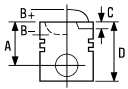

 Acero

 Acciaio



38  **81.00**

Bora 1.8 T	05/00→05/05	ARX	4 Cyl.	9.5:1		
Bora 1.8 T 4motion	10/00→05/01		1781cc	110kW (150PS)		TD15485
			Turbo Intercooled			
Bora 1.8 T	05/00→05/05	AUM	4 Cyl.	9.5:1		
Golf IV 1.8 T	08/97→06/06		1781cc	110kW (150PS)		TD15486
			Turbo Intercooled			
Passat 1.8 4motion		AWM	4 Cyl.			
Passat 1.8 T	02/01→08/05		1781cc	125kW (170PS)		
Passat 1.8 T 4motion	03/01→05/05		Turbo Intercooled			TD16423
New Beetle 1.8 T	11/01→06/05	AWP	4 Cyl.	9.5:1		
			1781cc	132kW (180PS)		TD19253
			Turbo Intercooled			
Passat 1.8 T 20V	11/00→05/05	AWT	4 Cyl.	9.5:1		
			1781cc	110kW (150PS)		TD15149
			Turbo Intercooled			
New Beetle 1.8 T	10/99→09/10	AWU	4 Cyl.	9.5:1		
			1781cc	110kW (150PS)		TD15468
			Turbo Intercooled			
New Beetle 1.8 T	10/99→09/10	AWV	4 Cyl.	9.5:1		
			1781cc	110kW (150PS)		TD15469
			Turbo Intercooled			
Polo 1.8 GTI	09/05→11/09	BJX	4 Cyl.	9.5:1		
			1781cc	110kW (150PS)		TD18799
			Turbo Intercooled			
New Beetle 1.8 T	11/01→06/05	BNU	4 Cyl.	9.5:1		
			1781cc	132kW (180PS)		TD21072
			Turbo Intercooled			

87-502900-30	STD	08-502900-00	STD
87-502907-30	0.50mm	08-502905-00	0.25mm
		08-502907-00	0.50mm
A	32.70	1.50	 CK P
C	1.90	1.75	 P
D	53.70	2.00	 CR P
	19x49		



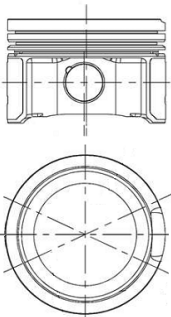

TP







39 81.00

Passat 2.2 Syncro	08/85→12/88	JT	5 Cyl. 2226cc	10:1 82-88kW (112-120PS)	TD5016
Passat 2.2 Santana 2.2	08/84→12/88 09/84→12/85	KX	5 Cyl. 2226cc	10:1 82-85kW (112-116PS)	TD5020

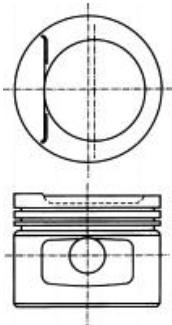
87-109707-00 	0.50mm	08-109700-00	STD
A	31.90	08-109705-00	0.25mm
B-	8.10	08-109707-00	0.50mm
B+	1.10	1.50	 CR P
D	62.00	1.75	 P
 20x57		3.00	 CR P



 A = 31.900, D = 62.000

 A = 31.900, D = 62.000

 A = 31.900, D = 62.000

 A = 31.900, D = 62.000

 A = 31.900, D = 62.000

40 81.00

Transporter IV 2.5 TDI		ACV	5 Cyl. 2461cc	20.5:1 75kW (102PS)	TD4978
Transporter IV 2.5 TDI Syncro	09/95→04/03	Diesel	Turbo Intercooled		
LT 28-35 II 2.5 SDI	07/96→07/06	AGX	5 Cyl. 2459cc	19.5:1 55kW (75PS)	TD9295
LT 28-46 II 2.5 SDI	09/96→07/06	Diesel	Turbo Intercooled		
LT 28-35 II 2.5 TDI	05/96→08/99	AHD	5 Cyl. 2459cc	19.5:1 75kW (102PS)	TD9294
LT 28-46 II 2.5 TDI		Diesel	Turbo Intercooled		
Transporter IV 2.5 TDI	05/98→04/03	AHY	5 Cyl. 2461cc	111kW (151PS)	TD10748
		Diesel	Turbo Intercooled		
Transporter IV 2.5 TDI	05/98→04/03	AJT	5 Cyl. 2461cc	65kW (88PS)	TD10747
		Diesel	Turbo Intercooled		
LT 28-35 II 2.5 TDI	05/99→07/06	ANJ	5 Cyl. 2461cc	19.5:1 80kW (109PS)	TD13446
LT 28-46 II 2.5 TDI		Diesel	Turbo Intercooled		



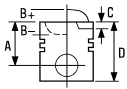

LT 28-35 II 2.5 TDI LT 28-46 II 2.5 TDI	05/99→07/06	APA	5 Cyl. 2461cc Diesel	66kW (90PS) Turbo Intercooled	TD13445
Transporter IV 2.5 TDI	09/95→04/03	AUF	5 Cyl. 2461cc Diesel	75kW (102PS) Turbo Intercooled	TD16857
Transporter IV 2.5 TDI	05/98→04/03	AXG	5 Cyl. 2461cc Diesel	18:1 111kW (151PS) Turbo Intercooled	TD17505
Transporter IV 2.5 TDI Syncro	09/95→04/03	AXL	5 Cyl. 2461cc Diesel	19.5:1 75kW (102PS) Turbo Intercooled	TD18687
Transporter IV 2.5 TDI	09/95→04/03	AYC	5 Cyl. 2461cc Diesel	19.5:1 75kW (102PS) Turbo Intercooled	TD17504
Transporter IV 2.5 TDI	05/98→04/03	AYY	5 Cyl. 2461cc Diesel	18:1 65kW (88PS) Turbo Intercooled	TD17503
LT 28-35 II 2.5 TDI LT 28-46 II 2.5 TDI	05/01→07/06	BBE	5 Cyl. 2461cc Diesel	61kW (83PS) Turbo Intercooled	TD16451
LT 28-35 II 2.5 TDI LT 28-46 II 2.5 TDI	05/01→07/06	BBF	5 Cyl. 2461cc Diesel	70kW (95PS) Turbo Intercooled	TD16452

87-501500-00 1 STD
87-501507-00 1 3 0.50mm

08-501500-00 STD
08-501507-00 0.50mm

14-020420-00 D B 84.00 C 158.00 D 85.00 E 5.00
14-020421-00 D B 84.50 C 158.00 D 85.50 E 5.50

A 45.75
B- 17.20
BØ 39.60
C 1.35
D 69.75
26x68

2.50 P PS
2.00 CR P
3.00 CR P

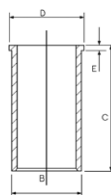

AK HA NB RT

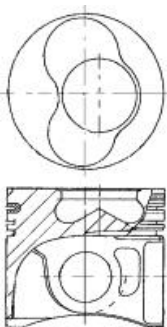







87-501500-10 ②
87-501507-10 ② ③

STD
0.50mm

08-501500-00
08-501507-00

STD
0.50mm

A 45.75
B- 17.20
BØ 39.60
C 1.35
D 69.75
 26x68

2.50 
2.00 
3.00 

P PS
CR P
CR P

AK HA NB RT

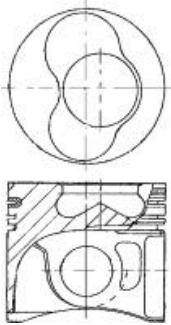

① To cylinder 1 & 2
② To cylinder 3 - 5
③ A = 45.500, D = 69.500

① zum Zylinder 1 & 2
② zum Zylinder 3 - 5
③ A = 45.500, D = 69.500

① sous cylindre 1 & 2
② sous cylindre 3 - 5
③ A = 45.500, D = 69.500

① A cilindro 1 & 2
② A cilindro 3 - 5
③ A = 45.500, D = 69.500

① al cilindro 1 & 2
② al cilindro 3 - 5
③ A = 45.500, D = 69.500

41  **81.00**

Marine	02/02→	ANF	5 Cyl. 2461cc	19.5:1 55kW (75PS)	TD20502
		Diesel			
Marine	02/02→	ANG	5 Cyl. 2461cc	19.5:1 88kW (120PS)	TD20503
		Diesel	Turbo Intercooled		
Marine	02/02→	ANH	5 Cyl. 2461cc	19.5:1 111kW (151PS)	TD20504
		Diesel	Turbo Intercooled		
Marine	02/02→	BCT	5 Cyl. 2461cc	19.5:1 40kW (54PS)	TD22630
		Diesel			
Marine	02/02→	BCU	5 Cyl. 2461cc	19.5:1 74kW (101PS)	TD22631
		Diesel	Turbo Intercooled		
Marine	02/02→	BCV	5 Cyl. 2461cc	19.5:1 108kW (147PS)	TD22632
		Diesel	Turbo Intercooled		
Touareg 2.5 R5 TDI	08/03→05/10	BPD	5 Cyl. 2461cc	18:1 120kW (163PS)	TD20507
		Diesel	Turbo Intercooled		



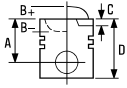

Marine	04/05→	BTW	5 Cyl.	18:1	
			2460cc	121kW (165PS)	
		Diesel	Turbo Intercooled		TD20676

14-020420-00 D B 84.00 C 158.00 D 85.00 E 5.00
14-020421-00 D B 84.50 C 158.00 D 85.50 E 5.50

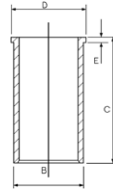





42 81.00

LT 28-35 II 2.5 TDI	05/99→07/06	AVR	5 Cyl.	19.5:1	
LT 28-46 II 2.5 TDI			2461cc	80kW (109PS)	
		Diesel	Turbo Intercooled		TD15497

Industrial	01/03→	BBR	5 Cyl.	19.5:1	
			2461cc	80kW (109PS)	
		Diesel	Turbo Intercooled		TD22627

87-501500-40 STD **08-501500-00** STD
87-501507-40 0.50mm **08-501507-00** 0.50mm

A	45.80	2.50		P PS
B-	16.80	2.00		CR P
BØ	46.00	3.00		CR P
C	1.35			
C	1.35			
D	69.80			
	26x68			

AK NB RT

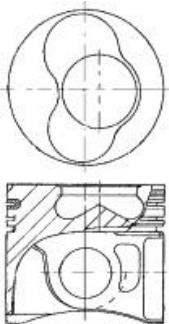



43 81.00

Multivan V 2.5 TDI	04/03→11/09	AXD			
Multivan V 2.5 TDI 4motion	07/04→11/09		5 Cyl.	18:1	
Transporter V 2.5 TDI	04/03→11/09		2461cc	96kW (130PS)	
Transporter V 2.5 TDI 4motion	07/04→11/09	Diesel	Turbo Intercooled		TD16868
Multivan V 2.5 TDI	04/03→11/09	AXE			
Multivan V 2.5 TDI 4motion	07/04→11/09		5 Cyl.	18:1	
Transporter V 2.5 TDI	04/03→11/09		2461cc	128kW (174PS)	
Transporter V 2.5 TDI 4motion	04/04→11/09	Diesel	Turbo Intercooled		TD16869
Touareg 2.5 R5 TDI	01/03→05/10	BAC			
			5 Cyl.	18:1	
			2461cc	128kW (174PS)	
		Diesel	Turbo Intercooled		TD16855
Multivan V 2.5 TDI, Transporter V 2.5 TDI	11/03→11/09	BLJ			
			5 Cyl.	18:1	
			2461cc	120kW (163PS)	
		Diesel	Turbo Intercooled		TD20505
Touareg 2.5 R5 TDI	08/03→05/10	BLK			
			5 Cyl.	18:1	
			2461cc	120kW (163PS)	
		Diesel	Turbo Intercooled		TD20506

87-421000-10 

STD

08-421000-00

STD

14-020420-00 **D**

B 84.00 **C** 158.00 **D** 85.00 **E** 5.00

87-421007-10 

0.50mm

08-421007-00

0.50mm

14-020421-00 **D**

B 84.50 **C** 158.00 **D** 85.50 **E** 5.50

A 45.75

B- 18.20

BØ 37.80

C 1.40

D 69.75

 26x65

2.50

2.00

3.00



CK P

P

CR P

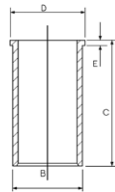



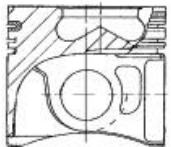
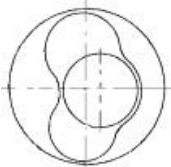

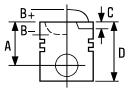
AK KK NB RT





87-421000-20 ② STD 08-421000-00 STD
 87-421007-20 ② 0.50mm 08-421007-00 0.50mm

A 45.75 2.50  CK P
 B- 18.20 2.00  P
 BØ 37.80 3.00  CR P
 C 1.40
 D 69.75
 26x65

AK KK NB RT

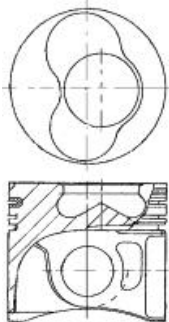

① To cylinder 1 & 2 ① zum Zylinder 1 & 2 ① sous cylindre 1 & 2 ① A cilindro 1 & 2 ① al cilindro 1 & 2
 ② To cylinder 3 - 5 ② zum Zylinder 3 - 5 ② sous cylindre 3 - 5 ② A cilindro 3 - 5 ② al cilindro 3 - 5

44 81.00

Golf V 2.0 TDI	10/03→11/08	AZV			
Golf V 2.0 TDI 4motion	06/07→07/09		4 Cyl.	18:1	
Golf Plus 2.0 TDI	05/05→12/13		1968cc	100kW (136PS)	
Jetta III 2.0 TDI	09/05→10/10	Diesel	Turbo Intercooled		TD16862
Touran 2.0 TDI	02/03→05/10				
Golf V 2.0 TDI 16V	10/03→07/09	BKD			
Golf V 2.0 TDI 16V 4motion	08/04→11/08		4 Cyl.	18:1	
Golf Plus 2.0 TDI 16V	01/05→12/13		1968cc	103kW (140PS)	
Jetta III 2.0 TDI 16V	08/05→10/10	Diesel	Turbo Intercooled		TD17080
Touran 2.0 TDI 16V	08/03→05/10				
Passat 2.0 TDI 16V	03/05→07/10	BKP			
Passat 2.0 TDI 16V 4motion	03/05→11/10		4 Cyl.	18.5:1	
			1968cc	103kW (140PS)	
		Diesel	Turbo Intercooled		TD18135
Passat 2.0 TDI	03/05→11/10	BMA			
			4 Cyl.		
			1968cc	100kW (136PS)	
		Diesel	Turbo Intercooled		TD18225
Golf V 2.0 TDI	11/05→11/08	BMN			
Jetta III 2.0 TDI	10/06→10/10		4 Cyl.	18.5:1	
Touran 2.0 TDI	12/05→05/10		1968cc	125kW (170PS)	
		Diesel	Turbo Intercooled		TD18471
Passat 2.0 TDI	08/05→11/10	BMR			
			4 Cyl.		
			1968cc	125kW (170PS)	
		Diesel	Turbo Intercooled		TD18188





Passat 2.0 TDI	08/05→05/09	BUZ	4 Cyl. 1968cc	18.5:1 120kW (163PS)	TD20499
		Diesel	Turbo Intercooled		
Passat Variant 2.0 TDI	08/05→	BVD	4 Cyl. 1968cc	90kW (122PS)	TD18542
		Diesel	Turbo Intercooled		
Passat 2.0 TDI	08/05→07/06	BVE	4 Cyl. 1968cc	90kW (122PS)	TD18543
		Diesel	Turbo Intercooled		



87-139500-00 ①
87-139507-00 ②

STD
0.50mm

08-139500-00
08-139507-00

STD
0.50mm

A 45.83
B- 17.80
BØ 38.00
D 68.80
 26x66

1.75  CK P
2.00  P
3.00  CR P

AK KK NB RT TP

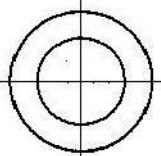
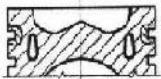

07901J

① Piston Chamber Volume
[ccm] 23.75
② A = 45.550, D = 68.550

① Volumen der Kolbenmulde
[ccm] 23.75
② A = 45.550, D = 68.550

① Volume de la cavité du piston
[cm³] 23.75
② A = 45.550, D = 68.550



① Volumen de cavidad del pistón
[cc] 23.75
② A = 45.550, D = 68.550

① Volume camera pistone
[cm³] 23.75
② A = 45.550, D = 68.550







45  **81.00**

Caddy III 2.0 SDI	03/04→08/10	BDJ	4 Cyl. 1968cc	51kW (70PS)	TD17358
		Diesel			
Golf V 2.0 SDI	01/04→11/08	BDK	4 Cyl. 1968cc	55kW (75PS)	TD17359
		Diesel			

87-139500-30   STD
87-139507-30  0.50mm

08-139500-00 STD
08-139507-00 0.50mm



A 37.80
B- 17.35
BØ 38.00
C 0.70
D 58.80
 22x60

1.75  CK P
 2.00  P
 3.00  CR P

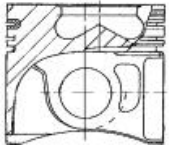
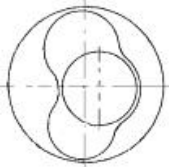
AK RT TP





08102-205

87-139500-40   STD
87-139507-40  0.50mm

08-139500-00 STD
08-139507-00 0.50mm



A 37.80
B- 17.35
BØ 38.00
C 0.70
D 58.80
 22x60

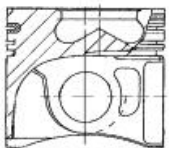
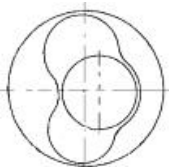

1.75  CK P
 2.00  P
 3.00  CR P



AK RT TP









08102-206

 To cylinder 1 & 2
 To cylinder 3 & 4
 Piston Chamber Volume
 [ccm] 24.50

 zum Zylinder 1 & 2
 zum Zylinder 3 & 4
 Volumen der Kolbenmulde
 [ccm] 24.50

 sous cylindre 1 & 2
 sous cylindre 3 & 4
 Volume de la cavité du piston
 [cm³] 24.50

 A cilindro 1 & 2
 A cilindro 3 & 4
 Volumen de cavidad del pistón
 [cc] 24.50

 al cilindro 1 & 2
 al cilindro 3 & 4
 Volume camera pistone
 [cm³] 24.50

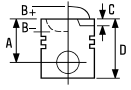

46  **81.00**

Passat 2.0 TDI	12/03→05/05	BGW	4 Cyl. 1968cc	18.5:1 100kW (136PS)	
		Diesel	Turbo Intercooled		TD18539
Caddy III 2.0 TDI	09/07→08/10	BMM	4 Cyl. 1968cc	18.5:1 103kW (140PS)	
EOS 2.0 TDI	06/06→05/08				
Golf V 2.0 TDI	12/04→07/09				
Golf V 2.0 TDI 4motion	08/04→11/08	Diesel	Turbo Intercooled		TD18482
Golf Plus 2.0 TDI	12/05→05/11				
Jetta III 2.0 TDI	10/05→10/10				
Touran 2.0 TDI	12/05→05/10				
Passat 2.0 TDI		BMP	4 Cyl. 1968cc	18.5:1 103kW (140PS)	
Passat 2.0 TDI 4motion	08/05→05/09				
Passat 2.0 TDI, Passat 2.0 TDI 4motion	03/05→05/09	Diesel	Turbo Intercooled		TD18136
Sharan 2.0 TDI	11/05→03/10	BRT	4 Cyl. 1968cc	18.5:1 103kW (140PS)	
		Diesel	Turbo Intercooled		TD19105

87-139500-10  

STD

08-139500-00

STD

87-139507-10 

0.50mm

08-139507-00

0.50mm

A 45.55

B- 17.50

BØ 38.00

C 0.70

D 68.80

 26x66

1.75

2.00

3.00



CK P

P

CR P

AK KK NB RT TP

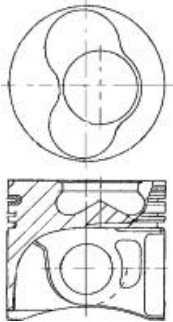



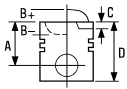

07901D833





87-139500-20 ² ³ STD 08-139500-00 STD
 87-139507-20 ² 0.50mm 08-139507-00 0.50mm

A 45.83 1.75  CK P
 B- 17.50 2.00  P
 BØ 38.00 3.00  CR P
 C 0.70
 D 68.80
 26x66

AK KK NB RT TP

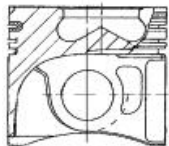
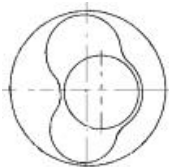

07901D834

- | | | | | |
|---|---|---|--|---|
| ¹ To cylinder 1 & 2 | ¹ zum Zylinder 1 & 2 | ¹ sous cylindre 1 & 2 | ¹ A cilindro 1 & 2 | ¹ al cilindro 1 & 2 |
| ² To cylinder 3 & 4 | ² zum Zylinder 3 & 4 | ² sous cylindre 3 & 4 | ² A cilindro 3 & 4 | ² al cilindro 3 & 4 |
| ³ Piston Chamber Volume
[ccm] 23.30 | ³ Volumen der Kolbenmulde
[ccm] 23.30 | ³ Volume de la cavité du piston
[cm³] 23.30 | ³ Volumen de cavidad del pistón
[cc] 23.30 | ³ Volume camera pistone
[cm³] 23.30 |

47  **81.00**

Crafter 30-35 2.5 TDI Crafter 30-50 2.5 TDI	04/06→	BJL	5 Cyl. 2461cc Turbo Intercooled	100kW (136PS)	TD18893
Crafter 30-35 2.5 TDI Crafter 30-50 2.5 TDI	04/06→07/11	BJM	5 Cyl. 2461cc Turbo Intercooled	120kW (163PS)	TD18894
Crafter 30-35 2.5 TDI Crafter 30-50 2.5 TDI	04/06→	CECA	5 Cyl. 2461cc Turbo Intercooled	100kW (136PS)	TD24721





Crafter 30-35 2.5 TDI Crafter 30-50 2.5 TDI	04/06→07/11	CECB	5 Cyl. 2461cc	120kW (163PS)	
		Diesel	Turbo Intercooled		TD24722

87-421000-30	STD	08-421000-00	STD	14-020420-00 D	B 84.00 C 158.00 D 85.00 E 5.00
87-421007-30	0.50mm	08-421007-00	0.50mm	14-020421-00 D	B 84.50 C 158.00 D 85.50 E 5.50

A	45.75
B-	16.65
BØ	46.00
C	1.35
C	1.35
D	68.75
	26x66

2.50		CK P
2.00		P
3.00		CR P

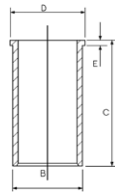

AK KK NB RT TP

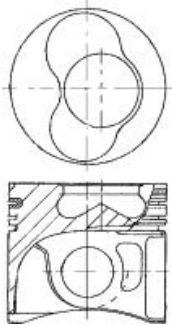

0811C-101

48 81.00

Multivan V 2.0 TDI, Transporter V 2.0 TDI	09/09→	CAAA Euro 5	4 Cyl.		
Transporter V 2.0 TDI			1968cc	62kW (84PS)	
Transporter VI 2.0 TDI	04/15→	Diesel	Turbo Intercooled		TD23411
Multivan V 2.0 TDI	09/09→	CAAB Euro 5	4 Cyl.		
Multivan VI 2.0 TDI	04/15→		1968cc	75kW (102PS)	
Transporter V 2.0 TDI	09/09→	Diesel	Turbo Intercooled		TD23412
Transporter VI 2.0 TDI	04/15→				
Multivan V 2.0 TDI		CAAC Euro 5	4 Cyl.		
Multivan V 2.0 TDI 4motion	09/09→		1968cc	103kW (140PS)	
Multivan VI 2.0 TDI	04/15→	Diesel	Turbo Intercooled		TD23414
Multivan VI 2.0 TDI 4motion	06/15→				
Transporter V 2.0 TDI	09/09→				
Transporter V 2.0 TDI 4motion					
Transporter V 2.0 TDI,					
Transporter V 2.0 TDI 4motion					
Transporter VI 2.0 TDI	04/15→				
Transporter VI 2.0 TDI 4motion	06/15→				
Multivan V 2.0 TDI, Transporter V 2.0 TDI	05/11→	CAAD	4 Cyl.		
Transporter V 2.0 TDI			1968cc	84kW (114PS)	
		Diesel	Turbo Intercooled		TD26334





Multivan V 2.0 TDI		CAAE			
Multivan V 2.0 TDI 4motion	05/10→		4 Cyl.		
Transporter V 2.0 TDI			1968cc	100kW (136PS)	
Transporter V 2.0 TDI 4motion		Diesel	Turbo Intercooled		TD24473
Transporter V 2.0 TDI, Transporter V 2.0 TDI 4motion					
Golf VI 2.0 TDI	10/08→11/12	CBAA			
Passat 2.0 TDI	03/05→11/10		4 Cyl.	16:1	
Passat CC 2.0 TDI	06/08→05/11		1968cc	100kW (136PS)	
Tiguan 2.0 TDI 4motion	11/07→	Diesel	Turbo Intercooled		TD20798
EOS 2.0 TDI 16V	05/08→	CBAB			
Golf VI 2.0 TDI	10/08→05/13		4 Cyl.	16:1	
Golf VI 2.0 TDI 4motion	05/09→11/12		1968cc	103kW (140PS)	
Passat 2.0 TDI 16V	03/05→07/10	Diesel	Turbo Intercooled		TD20799
Passat 2.0 TDI 16V 4motion	03/05→11/10				
Passat CC 2.0 TDI	06/08→01/12				
Passat CC 2.0 TDI 4motion	08/09→01/12				
Tiguan 2.0 TDI	03/08→				
Tiguan 2.0 TDI 4motion	09/07→				
Passat 2.0 BlueTDI	01/09→11/10	CBAC			
Passat CC 2.0 BlueTDI	05/09→11/10		4 Cyl.	16:1	
			1968cc	105kW (143PS)	
		Diesel	Turbo Intercooled		TD20800
Golf VI 2.0 TDI	04/09→11/12	CBBB			
Passat 2.0 TDI	08/05→11/10		4 Cyl.	16:1	
Passat 2.0 TDI 4motion	05/09→11/10		1968cc	125kW (170PS)	
Passat CC 2.0 TDI	06/08→01/12	Diesel	Turbo Intercooled		TD20949
Passat CC 2.0 TDI 4motion	11/09→01/12				
Scirocco 2.0 TDI	05/09→				
Tiguan 2.0 TDI 4motion	09/07→				
Golf VI 2.0 TDI	07/09→07/13	CBDA			
Golf Plus 2.0 TDI	05/05→12/13		4 Cyl.	16:1	
Jetta III 2.0 TDI	09/05→10/10		1968cc	100kW (136PS)	
		Diesel	Turbo Intercooled		TD22715
Golf V 2.0 TDI 16V	06/07→07/09	CBDB			
Golf VI 2.0 TDI 16V	07/09→07/13		4 Cyl.	16:1	
Golf Plus 2.0 TDI 16V	01/05→12/13		1968cc	103kW (140PS)	
Jetta III 2.0 TDI 16V	08/05→10/10	Diesel	Turbo Intercooled		TD21070
Scirocco 2.0 TDI	08/08→				
Golf VI 2.0 TDI	10/08→11/12	CBDC			
Golf Plus 2.0 TDI	01/09→12/13		4 Cyl.	16:1	
Passat 2.0 TDI	11/08→11/10		1968cc	81kW (110PS)	
		Diesel	Turbo Intercooled		TD21109
Multivan V 2.0 TDI		CCHA			
Multivan V 2.0 TDI 4motion	09/09→		4 Cyl.		
Transporter V 2.0 TDI			1968cc	103kW (140PS)	
Transporter V 2.0 TDI 4motion		Diesel	Turbo Intercooled		TD24471
Multivan V 2.0 TDI		CCHB			
Multivan V 2.0 TDI 4motion	05/10→		4 Cyl.		
Transporter V 2.0 TDI			1968cc	100kW (136PS)	
Transporter V 2.0 TDI 4motion		Diesel	Turbo Intercooled		TD24474
Transporter V 2.0 TDI, Transporter V 2.0 TDI 4motion					









Amarok 2.0 TDI	09/11→	CDBA			
Amarok 2.0 TDI, Amarok 2.0 TDI 4motion	09/10→		4 Cyl.	1968cc	90kW (122PS)
		Diesel	Turbo Intercooled		TD24402
Amarok 2.0 BiTDI, Amarok 2.0 BiTDI 4motion	09/10→	CDCA			
Amarok 2.0 TDI			4 Cyl.	1968cc	120kW (163PS)
Amarok 2.0 TDI 4motion	09/11→	Diesel	Turbo Intercooled		TD24403
Jetta III 2.0 TDI	10/06→10/10	CEGA			
			4 Cyl.	1968cc	16:1
		Diesel	Turbo Intercooled	125kW (170PS)	TD24125
Multivan V 2.0 BiTDI		CFCA Euro 5			
Multivan V 2.0 BiTDI 4motion	09/09→		4 Cyl.	1968cc	132kW (180PS)
Multivan VI 2.0 TDI	04/15→	Diesel	Bi-Turbo Intercooled		TD23421
Multivan VI 2.0 TDI 4motion	06/15→				
Transporter V 2.0 BiTDI	09/09→				
Transporter V 2.0 BiTDI 4motion					
Transporter V 2.0 BiTDI,					
Transporter V 2.0 BiTDI 4motion					
Transporter VI 2.0 TDI	04/15→				
Transporter VI 2.0 TDI 4motion	06/15→				
Beetle 2.0 TDI	04/11→	CJAA			
Golf VI 2.0 TDI	10/08→05/13		4 Cyl.	1968cc	103-104kW (140-141PS)
Golf VI 2.0 TDI 16V	07/09→07/13	Diesel	Turbo Intercooled		TD23179
Golf VII 2.0 TDI	07/13→				
Jetta III 2.0 TDI 16V	08/05→10/10				
Jetta IV 2.0 TDI	02/11→				

87-432300-00 ¹ STD
87-432307-00 ¹ 0.50mm

STD
0.50mm

08-432300-00 ² STD
08-432307-00 0.50mm

A 45.80
B- 12.70
BØ 50.88
D 68.80
 26x66

1.75  GDC P
2.00  P
3.00  CR P



HA KK NB RT TP

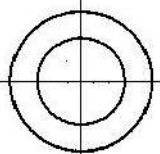
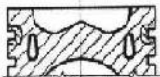

07901G202

¹ OE 03L 107 065G, Gen 1 engine only

¹ OE 03L 107 065G, nur für Motoren der Generation 1

¹ N°OE 03L 107 065G, uniquement pour Moteur de génération 1

¹ OE 03L 107 065G, Generación 1 solo motor

¹ Solo motore Generation 1

² 08-432300-00 OE: 03L198151A

² 08-432300-00 OE: 03L198151A

² 08-432300-00 OE: 03L198151A

² 08-432300-00 OE: 03L198151A

² 08-432300-00 OE: 03L198151A



49  **81.00**

CC 2.0 TDI	11/11→	CFFA				
EOS 2.0 TDI	11/10→		4 Cyl.	16.5:1		
Golf VI 2.0 TDI	10/08→11/12		1968cc	100kW (136PS)		
Passat 2.0 TDI	08/10→12/14	Diesel	Turbo Intercooled			TD23312
Passat CC 2.0 TDI	06/08→05/11					
Sharan 2.0 TDI	05/10→					
Sharan 2.0 TDI 4motion	05/11→05/12					
Tiguan 2.0 TDI 4motion	11/07→					
Beetle 2.0 TDI	04/11→	CFFB				
CC 2.0 TDI, CC 2.0 TDI 4motion	11/11→		4 Cyl.	16.5:1		
EOS 2.0 TDI 16V	05/08→		1968cc	103kW (140PS)		
Golf VI 2.0 TDI	10/08→05/13	Diesel	Turbo Intercooled			TD23178
Golf VI 2.0 TDI 4motion	05/09→11/12					
Jetta IV 2.0 TDI	02/11→					
Passat 2.0 TDI	08/10→12/14					
Passat 2.0 TDI 4motion						
Passat 2.0 TDI, Passat 2.0 TDI 4motion	08/10→12/14					
Passat Alltrack 2.0 TDI						
Passat Alltrack 2.0 TDI 4motion	01/12→12/14					
Passat CC 2.0 TDI	06/08→01/12					
Passat CC 2.0 TDI 4motion	08/09→01/12					
Sharan 2.0 TDI	05/10→					
Sharan 2.0 TDI 4motion	05/11→					
Tiguan 2.0 TDI	03/08→					
Tiguan 2.0 TDI 4motion	09/07→					
Tiguan 2.0 TDI	05/10→	CFFD				
			4 Cyl.	16.5:1		
			1968cc	81kW (110PS)		
		Diesel	Turbo Intercooled			TD24215
Sharan 2.0 TDI	05/11→	CFFE				
			4 Cyl.	16.5:1		
			1968cc	85kW (116PS)		
		Diesel	Turbo Intercooled			TD25739
CC 2.0 TDI, CC 2.0 TDI 4motion	11/11→	CFGB				
Golf VI 2.0 TDI	04/09→11/12		4 Cyl.	16.5:1		
Passat 2.0 TDI	08/10→12/14		1968cc	125kW (170PS)		
Passat 2.0 TDI 4motion	08/10→01/13	Diesel	Turbo Intercooled			TD23180
Passat Alltrack 2.0 TDI 4motion	01/12→12/14					
Passat CC 2.0 TDI	06/08→01/12					
Passat CC 2.0 TDI 4motion	11/09→01/12					
Scirocco 2.0 TDI	05/09→					
Sharan 2.0 TDI	08/10→					
Tiguan 2.0 TDI 4motion	09/07→					
CC 2.0 TDI, CC 2.0 TDI 4motion	12/12→	CFGC				
Passat 2.0 TDI	12/12→12/14		4 Cyl.	16.5:1		
Passat 2.0 TDI 4motion	01/13→12/14		1968cc	130kW (177PS)		
Passat Alltrack 2.0 TDI 4motion		Diesel	Turbo Intercooled			TD26990
Scirocco 2.0 TDI, Sharan 2.0 TDI	01/13→					
Tiguan 2.0 TDI 4motion	11/12→					
Golf VI 2.0 TDI	07/09→07/13	CFHB				
Golf Plus 2.0 TDI	05/05→12/13		4 Cyl.	16.5:1		
Scirocco 2.0 TDI	11/10→		1968cc	100kW (136PS)		
		Diesel	Turbo Intercooled			TD24314



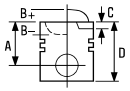

Caddy III 2.0 TDI 16V		CFHC			
Caddy III 2.0 TDI 16V 4motion	11/10→		4 Cyl.	16.5:1	
Caddy IV 2.0 TDI			1968cc	103kW (140PS)	
Caddy IV 2.0 TDI 4motion	05/15→	Diesel	Turbo Intercooled		TD24315
Golf VI 2.0 TDI	11/11→				
Golf VI 2.0 TDI 16V	07/09→07/13				
Golf Plus 2.0 TDI 16V	01/05→12/13				
Jetta IV 2.0 TDI	02/11→				
Scirocco 2.0 TDI	08/08→				
Touran 2.0 TDI	05/10→05/15				
Caddy III 2.0 TDI	11/10→	CFHE			
Caddy III 2.0 TDI 4motion	12/10→		4 Cyl.	16.5:1	
			1968cc	62kW (85PS)	
		Diesel	Turbo Intercooled		TD25438
Caddy III 2.0 TDI 4motion	08/10→	CFHF			
Caddy IV 2.0 TDI 4motion	05/15→		4 Cyl.	16.5:1	
Touran 2.0 TDI	11/10→05/15		1968cc	81kW (110PS)	
		Diesel	Turbo Intercooled		TD24366
Caddy III 2.0 TDI	05/12→	CFJA			
Touran 2.0 TDI	05/10→01/13		4 Cyl.	16.5:1	
			1968cc	125kW (170PS)	
		Diesel	Turbo Intercooled		TD24994
Touran 2.0 TDI	01/13→05/15	CFJB			
			4 Cyl.	16:1	
			1968cc	130kW (177PS)	
		Diesel	Turbo Intercooled		TD27973
Crafter 30-35 2.0 TDI	05/11→	CKTB			
Crafter 30-50 2.0 TDI			4 Cyl.		
			1968cc	80kW (109PS)	
		Diesel	Turbo Intercooled		TD25415
Crafter 30-35 2.0 TDI	05/11→	CKTC			
Crafter 30-50 2.0 TDI			4 Cyl.		
			1968cc	100kW (136PS)	
		Diesel	Turbo Intercooled		TD25416
Crafter 30-35 2.0 TDI	07/11→	CKUB			
Crafter 30-35 2.0 TDI 4motion	11/11→		4 Cyl.		
Crafter 30-50 2.0 TDI	07/11→		1968cc	120kW (163PS)	
Crafter 30-50 2.0 TDI 4motion	11/11→	Diesel	Bi-Turbo Intercooled		TD25417
Crafter 30-35 2.0 TDI	10/11→	CKUC			
Crafter 30-50 2.0 TDI			4 Cyl.		
			1968cc	105kW (142PS)	
		Diesel	Turbo Intercooled		TD25418
Caddy III 2.0 TDI	08/10→	CLCA			
Caddy IV 2.0 TDI	09/15→		4 Cyl.	16.5:1	
Golf VI 2.0 TDI	10/08→07/13		1968cc	81kW (110PS)	
Golf Plus 2.0 TDI	01/09→12/13	Diesel	Turbo Intercooled		TD24835
Jetta III 2.0 TDI	01/10→10/10				
Jetta IV 2.0 TDI	10/10→				
Touran 2.0 TDI	11/10→05/15				
Caddy III 2.0 TDI 16V	11/10→	CLCB			
Caddy IV 2.0 TDI	05/15→		4 Cyl.	16.5:1	
Golf VI 2.0 TDI 16V	07/09→07/13		1968cc	103kW (140PS)	
Jetta IV 2.0 TDI	02/11→	Diesel	Turbo Intercooled		TD24600





Tiguan 2.0 TDI 4motion	09/07→	CLJA	4 Cyl.	16.5:1	
		Diesel	1968cc	103kW (140PS)	TD24963
			Turbo Intercooled		
CC 2.0 TDI	11/11→	CLLA	4 Cyl.	16.5:1	
Passat 2.0 TDI	08/10→12/14		1968cc	125kW (170PS)	TD24441
Passat CC 2.0 TDI	06/08→01/12	Diesel	Turbo Intercooled		
Amarok 2.0 BiTDI, Amarok 2.0 BiTDI 4motion	11/11→	CNEA	4 Cyl.		
Amarok 2.0 TDI			1968cc	132kW (180PS)	TD26330
Amarok 2.0 TDI 4motion	09/11→	Diesel	Bi-Turbo Intercooled		
Amarok 2.0 TDI	09/11→	CNFA	4 Cyl.		
Amarok 2.0 TDI, Amarok 2.0 TDI 4motion	09/10→		1968cc	90kW (122PS)	TD26995
		Diesel	Turbo Intercooled		
Amarok 2.0 TDI	07/12→	CNFB	4 Cyl.		
Amarok 2.0 TDI 4motion	09/11→		1968cc	103kW (140PS)	TD26996
		Diesel	Turbo Intercooled		
Amarok 2.0 BiTDI, Amarok 2.0 BiTDI 4motion	11/11→	CSHA	4 Cyl.		
Amarok 2.0 TDI			1968cc	132kW (180PS)	TD26331
Amarok 2.0 TDI 4motion	09/11→	Diesel	Bi-Turbo Intercooled		

87-432300-10 ① STD

87-432307-10 ① 0.50mm

A 45.80

B- 13.10

BØ 50.88

D 68.80

 26x66

08-432300-10 ② ③ STD

08-432307-10 ② ③ 0.50mm

1.75  GDC P

2.00  MO P

3.00  CR P



AK KK NB RT TP

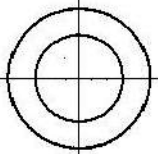
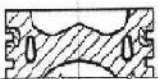

07901G220

① OE 03L 107 065S, Gen 2 engine only

① OE 03L 107 065S, nur für Motoren der Generation 2

① N°OE 03L 107 065S, uniquement pour Moteur de génération 2

① OE 03L 107 065G, Generación 2 solo motor

① Solo motore Generation 2

② Only fit to pistons equivalent to OE 03L 107065 AG, 03L 107065 S

② Nur gepasst worden zu den Kolben gleichwertig mit OE 03L 107065 AG und 03L 107065 S

② Seulement adapté aux pistons équivalents à OE 03L 107065 AGet 03L 107065 S

② Cabido solamente a los pistones equivalentes a OE 03L 107065 AG y 03L 107065 S

② Adattato soltanto ai pistoni equivalenti a OE 03L 107065 AGe 03L 107065 S

③ 08-432300-10 OE: 03L198151C

③ 08-432300-10 OE: 03L198151C

③ 08-432300-10 OE: 03L198151C

③ 08-432300-10 OE: 03L198151C

③ 08-432300-10 OE: 03L198151C



50 82.50

Corrado 2.0 I	04/93→12/95	2E			
Golf III 2.0	11/91→04/99		4 Cyl.	10.4:1	
Passat 2.0	02/90→05/97		1984cc	85kW (115PS)	
Passat 2.0 Syncro	10/90→05/97				TD4963
Vento 2.0	11/91→09/98				
Corrado 2.0 I	04/93→12/95	ADY			
Golf III 2.0	11/91→04/99		4 Cyl.	10.4:1	
Parati II 2.0	01/97→07/99		1984cc	85kW (115PS)	
Passat 2.0	02/90→05/97				TD4979
Passat 2.0 Syncro	10/90→05/97				
Sharan 2.0	09/95→03/10				
Vento 2.0	11/91→09/98				
Golf III 2.0	11/91→04/99	AGG			
Golf III 2.0 Syncro	08/95→04/99		4 Cyl.	10:1	
Golf IV 2.0	06/98→06/02		1984cc	85kW (115PS)	
Passat 2.0	02/90→05/97				TD4989
Passat 2.0 Syncro	10/90→05/97				
Vento 2.0	11/91→09/98				
Golf III 2.0	11/91→04/99	AKR			
Golf IV 2.0	06/98→06/02		4 Cyl.	10.3:1	
Vento 2.0	11/91→09/98		1984cc	85kW (115PS)	
					TD11354

87-501800-20

STD

08-501800-00

STD

87-501807-20 

0.50mm

08-501807-00

0.50mm

A 30.90

1.20



PS

B- 5.70

1.50



P

B+ 0.90

2.00



CR P

BØ 64.00

D 51.80

 21x55

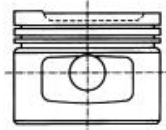
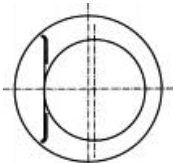



08241B-103

 A = 30.600, D = 51.500

 A = 30.600, D = 51.500

 A = 30.600, D = 51.500

 A = 30.600, D = 51.500



 A = 30.600, D = 51.500



51 82.50

Golf III 2.0 GTI 16V	08/92→08/97	ABF			
Passat 2.0 16V	01/94→05/97		4 Cyl.	10.4:1	
			1984cc	110kW (150PS)	
					TD4007

87-501800-40	STD	08-501800-00	STD
		08-501807-00	0.50mm
A	31.60		
C	3.20		
D	51.60		
	21x56		

1.20		PS
1.50		P
2.00		CR P

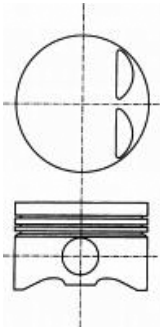

08238A

52 82.50

Golf V 2.0 FSI	01/04→11/08	AXW			
Touran 2.0 FSI	10/03→01/07		4 Cyl.	11.5:1	
			1984cc	110kW (150PS)	
			Turbo Intercooled		
					TD17081
Golf V 2.0 FSI	01/04→11/08	BLR			
Golf Plus 2.0 FSI	05/05→06/08		4 Cyl.	11.5:1	
Jetta III 2.0 FSI	08/05→10/10		1984cc	110kW (150PS)	
Passat 2.0 FSI	03/05→11/10				
Touran 2.0 FSI	10/03→01/07				
					TD18134
Golf V 2.0 FSI	01/04→11/08	BLX			
Golf V 2.0 FSI 4motion	08/04→11/08		4 Cyl.	11.5:1	
Jetta III 2.0 FSI	08/05→10/10		1984cc	110kW (150PS)	
Passat 2.0 FSI 4motion	09/05→11/10				
Touran 2.0 FSI	10/03→01/07				
					TD17985
Golf V 2.0 FSI	01/04→11/08	BLY			
Golf Plus 2.0 FSI	05/05→06/08		4 Cyl.	11.5:1	
Jetta III 2.0 FSI	08/05→10/10		1984cc	110kW (150PS)	
Passat 2.0 FSI	03/05→11/10				
Passat 2.0 FSI 4motion	09/05→11/10				
Touran 2.0 FSI	10/03→01/07				
					TD17986
Golf V 2.0 FSI	01/04→11/08	BVX			
Golf V 2.0 FSI 4motion	08/04→11/08		4 Cyl.	11.5:1	
Passat 2.0 FSI 4motion	09/05→11/10		1984cc	110kW (150PS)	
					TD18912
Eos 2.0 FSI	03/06→05/08	BVY			
Golf V 2.0 FSI	01/04→11/08		4 Cyl.	11.5:1	
Golf Plus 2.0 FSI	05/05→06/08		1984cc	110kW (150PS)	
Jetta III 2.0 FSI	08/05→10/10				
Passat 2.0 FSI	03/05→11/10				
Touran 2.0 FSI	10/03→01/07				
					TD18468



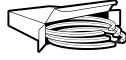
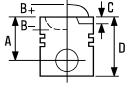

Eos 2.0 FSI	03/06 → 05/08	BVZ		
Golf V 2.0 FSI	01/04 → 11/08		4 Cyl.	11.5:1
Golf Plus 2.0 FSI	05/05 → 06/08		1984cc	110kW (150PS)
Jetta III 2.0 FSI	08/05 → 10/10			TD18469
Passat 2.0 FSI	03/05 → 11/10			
Touran 2.0 FSI	10/03 → 01/07			

87-435100-00 ¹

STD

08-435100-10

STD

A 29.38

B+ 12.46

D 59.84

 19x44

1.20

1.50

2.00



NT PVD ²

CR

TP

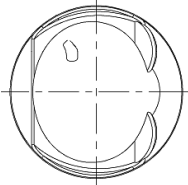
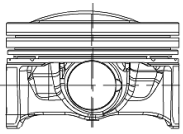

08240B301

¹ Elastoval ®

² Steel

¹ Elastoval ®

² Stahl

¹ Elastoval ®

² Acier

¹ Elastoval ®

² Acero

¹ Elastoval ®

² Acciaio







53 82.50

Golf V 2.0 GTI	10/04→02/09	AXX		
Jetta III 2.0 TFSI	10/05→10/10		4 Cyl.	10.3:1
Passat 2.0 FSI	07/05→11/10		1984cc	147kW (200PS)
				Turbo Intercooled
				TD18540

Eos 2.0 TFSI	03/06→	BWA		
Golf V 2.0	06/07→07/09		4 Cyl.	10.3:1
Golf V 2.0 GTI	10/04→02/09		1984cc	147kW (200PS)
Jetta III 2.0 TFSI	10/05→10/10		Turbo Intercooled	
Passat 2.0 FSI	07/05→11/10			
				TD18541

87-438500-00	STD	08-438500-00	STD
87-438507-00	0.50mm	08-438507-00	0.50mm

A	29.50	1.20		PVD 
B-	6.10	1.50		P
BØ	49.52	2.00		CR P
C	1.36			
C	1.36			
D	50.50			
	20x59			

AK RT TP

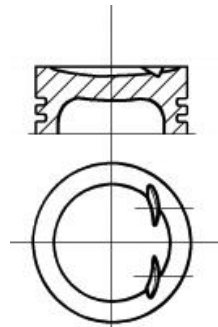

 Steel

 Stahl

 Acier

 Acero

 Acciaio







54  **82.50**

CC 1.8 Tsi	11/11→	CDA4		
Golf VI 1.8 TSI	06/09→01/11		4 Cyl.	9.6:1
Passat 1.8 TSI	05/07→12/14		1798cc	118kW (160PS)
Passat Alltrack 1.8 TSI	01/12→12/14		Turbo Intercooled	TD22641
Passat CC 1.8 TSI	06/08→01/12			
Sharan 1.8 TSI	11/11→			

CC 1.8 Tsi	11/11→	CDAB		
Passat 1.8 TSI	11/09→12/14		4 Cyl.	9.6:1
Passat Alltrack 1.8 TSI	01/12→12/14		1798cc	112kW (152PS)
Passat CC 1.8 TSI	11/08→05/10		Turbo Intercooled	TD23735

87-443800-00	STD	08-443800-00	STD
87-443807-00	0.50mm	08-443807-00	0.50mm

A	29.85	1.20	 NT PVD 
B-	4.70	1.20	 P
B+	5.65	2.00	 CR P
C	2.00		
D	56.00		
	23x54		



RT TP

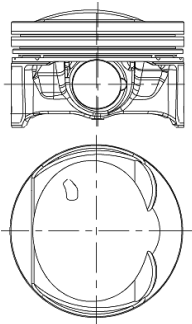

 Steel

 Stahl

 Acier

 Acero





 Acciaio



55  **83.00**

Touareg 3.0 V6 TDI	11/04→05/10	BKS	V6 Cyl. 2967cc	17:1 165kW (224PS)	
		Diesel	Turbo Intercooled		TD18031
Phaeton 3.0 V6 TDI 4motion	09/04→	BMK	V6 Cyl. 2967cc	17:1 165kW (224PS)	
		Diesel	Turbo Intercooled		TD18023
Touareg 3.0 TDI	04/06→05/10	BUN	V6 Cyl. 2967cc	17:1 155kW (211PS)	
		Diesel	Turbo Intercooled		TD21182

87-434300-00	STD	08-434300-00	STD
87-434307-00	0.50mm	08-434307-00	0.50mm

A	46.30	2.00		CK
B-	15.10	2.00		
BØ	45.00	3.00		CR
D	70.80			
	30x68			

AK KK RT

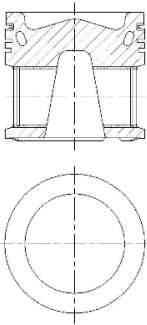



56 **92.00**

Taro 2.4 D 04/89 → 03/97 2L 4 Cyl. 22.3:1 2446cc 58-61kW (79-83PS) Diesel TD4966

87-373800-00 STD
87-373807-00 0.50mm

A 49.20
B- 1.60
D 86.25
 27x74

AK

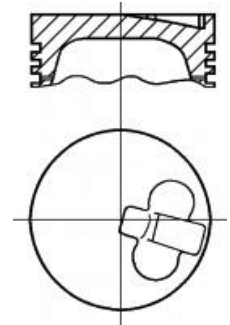

08-373800-00 STD
08-373807-00 0.50mm

2.00 CR P
2.00 P
4.00 CR P

14-040130-00 D

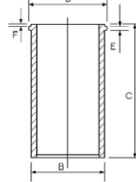

B 96.00 C 160.00 D 100.80 E 3.50 F 1.00

87-373800-10 STD

A 44.30
B- 1.50
D 80.30
 27x70

AK TP

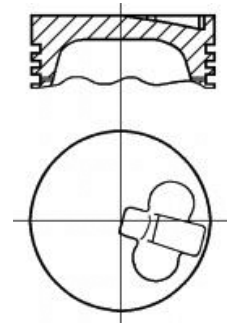

08-373800-00 STD
08-373807-00 0.50mm

2.00 CR P
2.00 P
4.00 CR P

14-010850-00 D

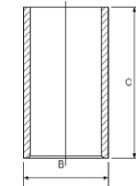

B 96.07 C 179.00

88-373800-10
87-373800-10 +
14-010850-00



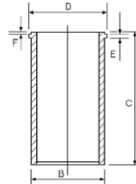

57 **92.00**

LT 28-35 | 2.7 D 11/75 → 01/80 CG 4 Cyl. 21:1 2710cc 48kW (65PS) Diesel TD11148

14-043450-00 D



B 96.91 C 191.19 D 101.00 E 3.91 F 0.70

		ccm	x 		9
B 10	Petrol	1108	4	70.00	1
B 10 E	Petrol	1108	4	70.00	2
B 13	Petrol	1289	4	73.00	3
B 13 E	Petrol	1289	4	73.00	3
B 14 OE	Petrol	1397	4	76.00	6
B 14.4 S	Petrol	1397	4	76.00	6
B 130	Petrol	1289	4	73.00	4
B 143 E	Petrol	1397	4	76.00	6
B 4204 S3	Petrol	1999	4	87.50	15
D 16	Diesel	1595	4	78.00	10
D 19 T	Diesel	1870	4	80.00	11
D 20	Diesel	1986	5	76.50	7
D 24	Diesel	2383	6	76.50	8
D 24 T	Diesel	2383	6	76.50	9
D 24 TIC	Diesel	2383	6	76.50	9
D 4162 T	Diesel	1560	4	75.00	5
D 4192 T	Diesel	1870	4	80.00	11
D 4192 T3	Diesel	1870	4	80.00	12
D 4192 T4	Diesel	1870	4	80.00	12
D 5252 T	Diesel	2461	5	81.00	14
F8Q 768	Diesel	1870	4	80.00	13



1 70.00

66 DL 1.1

08/75→11/79 B 10

4 Cyl.
1108cc

33kW (45PS)

TD3980



87-334600-00 STD

08-334600-00 STD

14-636730-00 WH B 75.50 C 135.00 D 85.70 E 94.80

89-334600-00

A 40.00
D 68.00
 18x62

1.75
2.00
3.50
 CR P
P
CR 

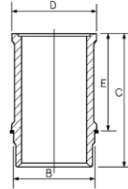

87-334600-00 +
14-636730-00

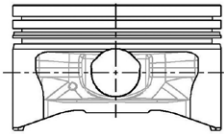

 Steel

 Stahl

 Acier

 Acero

 Acciaio

2 70.00

66 L/DL 1.1

08/75→12/80 B 10 E

4 Cyl.
1108cc

8.5:1
33-35kW (45-48PS)

TD21325

14-636730-00 WH B 75.50 C 135.00 D 85.70 E 94.80

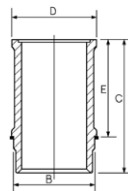

3 73.00

340-360 1.3

01/89→12/90 B 13

4 Cyl.
1289cc

49kW (66PS)

TD3987

340-360 1.3

01/89→12/90 B 13 E

4 Cyl.
1289cc

9:1
42kW (57PS)

TD21326

15-636590-00 WH  B 78.50 C 134.00 D 87.70 E 95.00

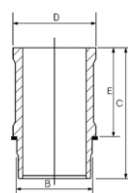

 Includes seals

 Schließt Dichtungen ein

 Inclut des joints

 Incluye los sellos

 Comprende le guarnizioni



4 73.00

66 GL 1.3

08/75→11/79 **B 130**

4 Cyl.
1289cc

9.6:1
42kW (57PS)





TD3904

87-333400-00 STD



08-333400-10 STD



15-636590-00 WH  **B 78.50 C 134.00 D 87.70 E 95.00**

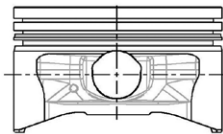
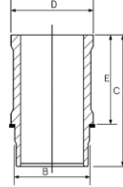

A 37.50
D 62.50
 20x64



1.75  CR P
2.00  P
4.00  CR 





 Includes seals
 Steel

 Schließt Dichtungen ein
 Stahl

 Inclut des joints
 Acier

 Incluye los sellos
 Acero

 Comprende le guarnizioni
 Acciaio

5 75.00

C30 1.6 D2

10/10→12/12 **D 4162 T**

S40 II 1.6 D2

10/10→

4 Cyl.
1560cc

16:1
84kW (114PS)

S60 II DRIVe/D2

01/11→

S80 II 1.6 DRIVe

06/11→

Diesel

Turbo

TD23981

V40 D2

03/12→

V50 1.6 D2

01/10→

V70 III 1.6 DRIVe/D2, V60 1.6 DRIVe



06/11→

87-433600-00 STD
87-433607-00 0.50mm

08-433600-00 STD
08-433607-00 0.50mm

14-020900-00 **D** **B 78.00 C 142.00 D 79.50 F 5.00**

A 41.75
B- 13.85
BØ 45.00
D 65.20
 26x61

2.50  CK P
1.95  P
2.00  CR P

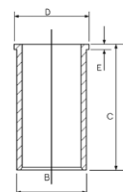

AK KK RT TP

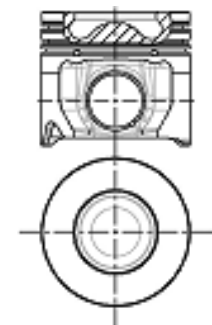







6 76.00

345-360 1.4	02/76→07/79	B 14 OE	4 Cyl. 1397cc	9.3:1 51kW (69PS)	TD23445
340-360 1.4	08/75→12/88	B 14.4 S	4 Cyl. 1397cc	9.25:1 50-53kW (68-72PS)	TD5142
340-360 1.4	08/79→12/86	B 143 E	4 Cyl. 1397cc	9.2:1 46-53kW (63-72PS)	TD3988

87-333500-00	STD	08-333500-00	STD	15-630820-00 WH 1	B 80.60 C 134.00 D 90.20 E 95.00	89-333500-00
08-333505-00		0.25mm				87-333500-00 +
08-333507-00		0.50mm				15-630820-00

A 37.50
D 64.00
 20x67

1.75  CR P
2.00  P
4.00  CR 2

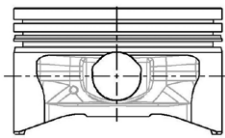
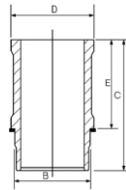

1 Includes seals
2 Steel

1 Schließt Dichtungen ein
2 Stahl

1 Inclut des joints
2 Acier

1 Incluye los sellos
2 Acero

1 Comprende le guarnizioni
2 Acciaio

7 76.50

240 2.0 D	09/78→10/80	D 20	5 Cyl. 1986cc	50kW (68PS)	TD3983
Diesel					

14-021571-00 D **B 79.56 C 142.00 D 82.50 E 4.50**
14-028360-00 D 1 **B 79.50 C 145.00 D 81.50 E 4.70**

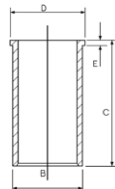

1 With recesses on crankshaft side

1 Mit kurbelwellenseitigen Aussparungen







1 Avec évidements côté vilebrequin

1 Con escotaduras en la cara del cigüeñal 1 Con nicchie sul lato albero motore





8 76.50

240 2.4 D	09/81→12/84	D 24			
240 2.4 Diesel	08/78→08/93		6 Cyl.	23:1	
260 2.4 D	09/79→12/81		2383cc	58-61kW (79-83PS)	
740 2.4 Diesel	08/84→07/92	Diesel			TD3984
760 2.4 D	01/82→07/92				
940 2.4 D	08/90→07/95				

87-109500-00 	STD	08-109500-00	STD	14-021571-00 D	B 79.56 C 142.00 D 82.50 E 4.50
87-109505-00 	0.25mm	08-109505-00	0.25mm	14-028360-00 D 	B 79.50 C 145.00 D 81.50 E 4.70
87-109507-00  	0.50mm	08-109507-00	0.50mm		
87-109511-00  	1.00mm	08-109511-00	1.00mm		

A 41.70
B- 1.60
D 71.70
 24x64



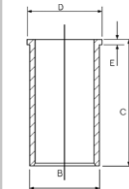



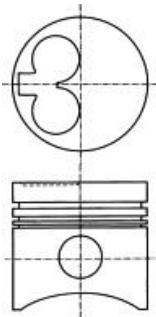







1.75  CR P
 2.00  P
 3.00  CR P



RT



07633

 With recesses on crankshaft side	 Mit kurbelwellenseitigen Aussparungen	 Avec évidements côté vilebrequin	 Con escotaduras en la cara del cigüeñal	 Con nicchie sul lato albero motore
 No oil-jet cut out	 Ohne Aussparung für Kühllöhspritzdüse	 Sans encoche en bas de jupe pour le passage de la pissette d'huile sous pression	 Sin escotadura	 Senza passaggio per spruzzatore olio
 A = 41.450	 A = 41.450	 A = 41.450	 A = 41.450	 A = 41.450



9 76.50

740 2.4 TD	08/84→12/90	D 24 T			
740 2.4 Turbo-Diesel	09/85→07/92		6 Cyl.	23:1	
760 2.4 D	09/82→12/85		2383cc	79-83kW (107-113PS)	
760 2.4 Turbo Diesel	08/82→07/92	Diesel	Turbo		TD3985
940 2.4 Turbo Diesel	08/90→12/94				

740 2.4 TD	08/86→10/88	D 24 TIC			
740 2.4 TD Interc.	08/86→07/88		6 Cyl.	23:1	
760 2.4 TD Interc.	08/87→07/92		2383cc	85-95kW (115-129PS)	
780 2.4 D	04/86→07/90	Diesel	Turbo Intercooled		TD3986
940 2.4 TD Intercooler	08/90→12/94				
940 II 2.4 TD Interc.	08/94→10/98				
960 2.4 Tdi	09/90→08/93				

87-109800-10 STD

87-109807-10  0.50mm

87-109811-10  1.00mm

A 41.70

B- 1.60

D 71.70

 24x64

AK HA RT TP

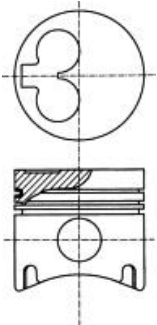

 With recesses on crankshaft side

 A = 41.450

08-109800-00 STD

08-109807-00 0.50mm

08-109811-00 1.00mm

1.75

2.00

3.00



CR P

CR P

CR P

14-021571-00 **D**

14-028360-00 **D** 

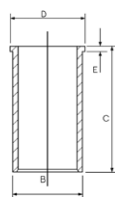



B 79.56 **C** 142.00 **D** 82.50 **E** 4.50

B 79.50 **C** 145.00 **D** 81.50 **E** 4.70

 Mit kurbelwellenseitigen Aussparungen

 A = 41.450

 Avec évidements côté vilebrequin

 A = 41.450

 Con escotaduras en la cara del cigüeñal

 A = 41.450

 Con nicchie sul lato albero motore

 A = 41.450



10 78.00

340-360 1.6 Diesel	08/84→07/91	D 16	4 Cyl.	22.5:1
		Diesel	1595cc	40kW (54PS)
				TD3981



87-335000-00 STD
87-335007-00 0.50mm

A 47.25
B- 1.50
D 74.50
 24x67

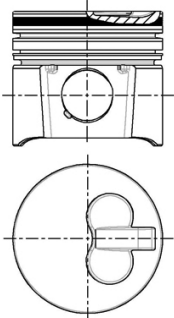
AK



08-335000-10 STD
08-335003-10 0.125mm
08-335005-10 0.25mm
08-335007-10 0.50mm

2.00  CR P
2.00  P
3.00  CR P

14-023730-00 D C 149.00 D 83.50 E 4.50

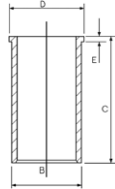

11 80.00

440 K 1.9 Turbo-Diesel	07/94→12/96	D 19 T	4 Cyl.	20.5:1
460 L 1.9 Turbo-Diesel	07/94→07/96	Diesel	1870cc	66kW (90PS)
				TD5044

S40 I 1.9 TD, V40 1.9 TD	07/95→08/99	D 4192 T	4 Cyl.	20.8:1
		Diesel	1870cc	66kW (90PS)
				TD5550



87-103500-00 STD
87-103507-00 0.50mm

A 41.71
B- 0.70
D 66.69
 26x67

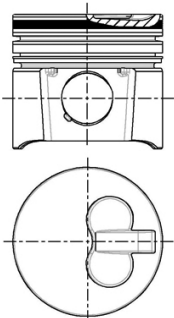
AK KK RT



08-103500-00 STD
08-103507-00 0.50mm

37921→
2.50  CK P
2.00  NT
3.00  CR P







12 80.00

S40 I 1.9 DI	07/00→12/03	D 4192 T3			
V40 1.9 Di	07/00→06/04		4 Cyl.	19:1	
		Diesel	1870cc	85kW (116PS)	
			Turbo		TD17997

S40 I 1.9 DI	07/00→12/03	D 4192 T4			
V40 1.9 Di	07/00→06/04		4 Cyl.	19:1	
		Diesel	1870cc	75kW (102PS)	
			Turbo		TD17996

87-101500-00	STD	08-101500-00	STD	14-020280-00 D	B 83.00 C 155.00 D 85.00 E 5.00
87-101507-00	0.50mm	08-101507-00	0.50mm		

A	47.06
B-	17.80
BØ	38.00
C	0.75
D	77.00
	28x60

2.50		P
2.00		P
3.00		CR P

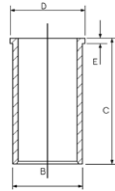

AK RT TP

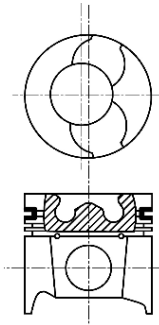



13 80.00

460 1.9D	07/94→	F8Q 768			
		Diesel	4 Cyl.	20.5:1	
			1870cc	66-69kW (90-94PS)	
			Turbo		TD19235

87-103500-00	STD	08-103500-00	STD
87-103507-00	0.50mm	08-103507-00	0.50mm

A	41.71
B-	0.70
D	66.69
	26x67

2.50		CK P
2.00		NT
3.00		CR P

AK KK RT

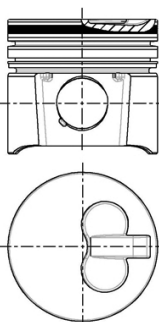

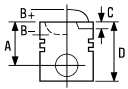





14  **81.00**

850 2.5 TDI	08/95→12/96	D 5252 T		
S70 2.5 TDI	01/97→11/00		5 Cyl.	20.5:1
S70 2.5 TDi AWD	10/99→09/00		2461cc	103kW (140PS)
S80 I 2.5 TDI	01/99→07/06	Diesel	Turbo Direct Injection	TD5145
V70 I 2.5 TDI	01/97→05/00			
V70 I 2.5 TDi AWD	11/96→02/00			
V70 II 2.5 TDI	03/00→08/07			



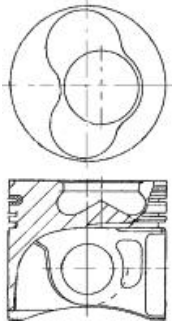

87-501500-20 ¹	STD	08-501500-00	STD
87-501507-20 ¹ ³	0.50mm	08-501507-00	0.50mm

A	45.75	2.50		P PS
B-	17.25	2.00		CR P
BØ	39.60	3.00		CR P
C	1.35			
D	69.75			
	26x68			

AK NB RT



87-501500-30 ²	STD	08-501500-00	STD
87-501507-30 ² ³	0.50mm	08-501507-00	0.50mm

A	45.75	2.50		P PS
B-	17.25	2.00		CR P
BØ	39.60	3.00		CR P
C	1.35			
D	69.75			
	26x68			

AK NB RT

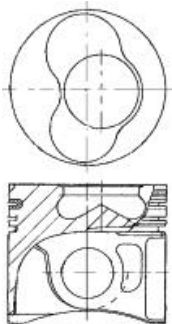

¹ To cylinder 1 & 2

² To cylinder 3 - 5

³ A = 45.500, D = 69.500

¹ zum Zylinder 1 & 2

² zum Zylinder 3 - 5

³ A = 45.500, D = 69.500

¹ sous cylindre 1 & 2

² sous cylindre 3 - 5

³ A = 45.500, D = 69.500

¹ al cilindro 1 & 2

² A cilindro 3 - 5

³ A = 45.500, D = 69.500

¹ al cilindro 1 & 2

² al cilindro 3 - 5





³ A = 45.500, D = 69.500



15 87.50

C30 2.0	10/06→12/12	B 4204 S3		
S40 II 2.0	10/06→		4 Cyl.	10.8:1
S80 II 2.0	01/08→		1999cc	107kW (146PS)
V50 2.0	10/06→			
V70 III 2.0	10/07→			TD19659

87-423400-00	STD	08-423400-00	STD
87-423407-00	0.50mm	08-423407-00	0.50mm

A	28.50	1.20	 CR P 1
B-	0.35	1.20	 P
BØ	76.50	2.50	 CR 1
D	51.00		
	21x60		

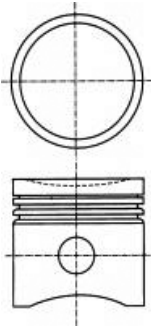





1 Steel





1 Stahl





1 Acier





1 Acero

1 Acciaio

		ccm	x 		9
15.5W37W31 Air Compressor	Petrol		2	75.00	1
D6A180 Euro 3	Diesel	5480	6	98.43	2
D6A210 Euro 3	Diesel	5480	6	98.43	2
D6A230 Euro 3	Diesel	5480	6	98.43	2
D6A250 Euro 3	Diesel	5480	6	98.43	2
D6B Euro 3	Diesel	5480	6	98.43	3
D7A285 Euro 2	Diesel	6730	6	104.775	8
D7B230 Euro 2	Diesel	6730	6	104.775	9
D7B260 Euro 2	Diesel	6730	6	104.775	9
D7C215 Euro 2	Diesel	7300	6	107.00	15
D7C250 Euro 2	Diesel	7300	6	107.00	15
D7C275 Euro 2	Diesel	7300	6	107.00	15
D7C290 Euro 2	Diesel	7300	6	107.00	15
D7C310 Euro 2	Diesel	7300	6	107.00	15
D7DEAE2 Euro 2	Diesel	7146	6	108.00	17
D7DECE2 Euro 2	Diesel	7146	6	108.00	17
D7DEEE2 Euro 2	Diesel	7146	6	108.00	17
D7DLAE2 Euro 2	Diesel	7146	6	108.00	17
D7DLBE2 Euro 2	Diesel	7146	6	108.00	17
D7E240 Euro 4	Diesel	7100	6	108.00	18
D7E280 Euro 4	Diesel	7100	6	108.00	18
D7E290 Euro 4	Diesel	7100	6	108.00	18
D7E320 Euro 4	Diesel	7100	6	108.00	18
D9A260 Euro 3	Diesel	9364	6	120.00	19
D9A300 Euro 3	Diesel	9364	6	120.00	19
D9A340 Euro 3	Diesel	9364	6	120.00	19
D9A380 Euro 3	Diesel	9364	6	120.00	19
D9B260 Euro 4/5	Diesel	9364	6	120.00	20
D9B300 Euro 4	Diesel	9364	6	120.00	20
D9B310 Euro 4/5	Diesel	9364	6	120.00	20
D9B340 Euro 4	Diesel	9364	6	120.00	20
D9B360 Euro 4/5	Diesel	9364	6	120.00	20
D9B380 Euro 4	Diesel	9364	6	120.00	20
D10A320	Diesel	9600	6	120.65	21
D10B320 Euro 2	Diesel	9600	6	120.65	21
D11B430 Euro 4/5	Diesel	10800	6	123.00	33
D11C330 Euro 5	Diesel	10800	6	123.00	33
D11C370 Euro 5	Diesel	10800	6	123.00	33
D11C410 Euro 5	Diesel	10800	6	123.00	33
D12A340 Euro 2	Diesel	12100	6	131.00	41
D12A380 Euro 2	Diesel	12110	6	131.00	41
D12A420 Euro 2	Diesel	12100	6	131.00	41
D12C340 Euro 2	Diesel	12100	6	131.00	42
D12C380	Diesel	12100	6	131.00	42
D12C420	Diesel	12100	6	131.00	42
D12C460	Diesel	12100	6	131.00	42
D12D340 Euro 3	Diesel	12100	6	131.00	42
D12D380 Euro 3	Diesel	12100	6	131.00	42
D12D420 Euro 3	Diesel	12100	6	131.00	42
D12D460 Euro 3	Diesel	12100	6	131.00	42
D12D500 Euro 3	Diesel	12100	6	131.00	42
D12 Euro 2	Diesel	12100	6	131.00	40
D13A360 Euro 5	Diesel	12800	6	131.00	43
D13A400 Euro 5	Diesel	12800	6	131.00	43
D13A440 Euro 5	Diesel	12800	6	131.00	43
D13A480 Euro 5	Diesel	12800	6	131.00	43
D13C380 Euro 5	Diesel	12800	6	131.00	44
D13C420 Euro 5	Diesel	12800	6	131.00	44
D13C460 Euro 5	Diesel	12800	6	131.00	44
D13C500 Euro 5	Diesel	12800	6	131.00	44
D13C540 Euro 5	Diesel	12800	6	131.00	44
D16A	Diesel	16123	6	144.00	46
D16A470 Euro 2	Diesel	16120	6	144.00	46
D16A520	Diesel	16120	6	144.00	46
D16B520	Diesel	16120	6	144.00	46
D36	Diesel	3866	4	98.48	7
D60A	Diesel	5480	6	98.43	4
D70B	Diesel	6730	6	104.775	10
D100A	Diesel	9600	6	120.65	22

		ccm	x 		9
D100B	Diesel	9600	6	120.65	22
D100BHC	Diesel	9600	6	120.65	22
D100BRC	Diesel	9600	6	120.65	22
DH10A Euro 2	Diesel	9600	6	120.65	23
DH12D340 Euro 3	Diesel	12100	6	131.00	45
DH12D420 Euro 3	Diesel	12100	6	131.00	42
HD100A	Diesel	9600	6	120.65	22
HD100D	Diesel	9600	6	120.65	22
MD70	Diesel	6730	6	104.775	10
MD100B	Diesel	9600	6	120.65	22
MD/TMD100	Diesel	9600	6	120.65	22
TAD 740 GE	Diesel	7280	6	107.00	16
TAD1630G/GE/P	Diesel	16120	6	144.00	47
TAD1631G	Diesel	16120	6	144.00	47
TAMD60	Diesel	5480	6	98.43	4
TAMD70	Diesel	6730	6	104.775	10
TAMD120A	Diesel	11977	6	130.175	34
TAMD120B	Diesel	11977	6	130.175	34
TAMD121	Diesel	11975	6	130.175	34
TD60A	Diesel	5480	6	98.43	4
TD60B	Diesel	5480	6	98.43	5
TD60C	Diesel	5480	6	98.43	5
TD60D	Diesel	5480	6	98.43	4
TD60DG	Diesel	5480	6	98.43	5
TD61B	Diesel	5480	6	98.43	5
TD61F	Diesel	5480	6	98.43	5
TD61FB	Diesel	5480	6	98.43	4
TD61G	Diesel	5480	6	98.43	5
TD61GA	Diesel	5480	6	98.43	5
TD61GB	Diesel	5480	6	98.43	5
TD61GC	Diesel	5480	6	98.43	5
TD61GE	Diesel	5480	6	98.43	5
TD61GS	Diesel	5480	6	98.43	5
TD63E	Diesel	5480	6	98.43	6
TD63ES	Diesel	5480	6	98.43	6
TD70A	Diesel	6730	6	104.775	10
TD70B	Diesel	6730	6	104.775	10
TD70C	Diesel	6730	6	104.775	10
TD70E	Diesel	6730	6	104.775	10
TD70ES	Diesel	6730	6	104.775	10
TD70F	Diesel	6730	6	104.775	11
TD70FS	Diesel	6730	6	104.775	11
TD70G	Diesel	6730	6	104.775	11
TD70H	Diesel	6730	6	104.775	10
TD70HA	Diesel	6730	6	104.775	10
TD71A	Diesel	6730	6	104.775	12
TD71ACE	Diesel	6730	6	104.775	12
TD71AG	Diesel	6730	6	104.775	12
TD71AGP	Diesel	6730	6	104.775	12
TD71AP	Diesel	6730	6	104.775	12
TD71APB	Diesel	6730	6	104.775	12
TD71AW	Diesel	6730	6	104.775	12
TD71E	Diesel	6730	6	104.775	12
TD71F	Diesel	6730	6	104.775	12
TD71FA	Diesel	6730	6	104.775	13
TD71FC	Diesel	6730	6	104.775	13
TD71FD	Diesel	6730	6	104.775	12
TD71FQ	Diesel	6730	6	104.775	12
TD71FS	Diesel	6730	6	104.775	12
TD71FSQ	Diesel	6730	6	104.775	12
TD71G	Diesel	6730	6	104.775	12
TD73EA	Diesel	6730	6	104.775	14
TD73EB	Diesel	6730	6	104.775	14
TD73E Euro 1	Diesel	6730	6	104.775	14
TD73ES	Diesel	6730	6	104.775	14
TD100A	Diesel	9600	6	120.65	24
TD100AHC	Diesel	9600	6	120.65	24
TD100ARC	Diesel	9600	6	120.65	24
TD100B	Diesel	9600	6	120.65	25

		ccm	x 		9
TD100BG	Diesel	9600	6	120.65	25
TD100CHC	Diesel	9600	6	120.65	26
TD100F	Diesel	9600	6	120.65	26
TD100G	Diesel	9600	6	120.65	26
TD100GA	Diesel	9600	6	120.65	26
TD100GB	Diesel	9600	6	120.65	27
TD100GG	Diesel	9600	6	120.65	26
TD101	Diesel	9599	6	120.65	27
TD101F	Diesel	9600	6	120.65	26
TD101FA	Diesel	9600	6	120.65	26
TD101FC	Diesel	9600	6	120.65	26
TD101FD	Diesel	9600	6	120.65	26
TD101G	Diesel	9600	6	120.65	26
TD101GA	Diesel	9600	6	120.65	26
TD101GE	Diesel	9600	6	120.65	26
TD102F	Diesel	9600	6	120.65	28
TD102FAQ	Diesel	9600	6	120.65	21
TD102FBQ	Diesel	9600	6	120.65	21
TD102FCQ	Diesel	9600	6	120.65	21
TD102FD Euro 1	Diesel	9600	6	120.65	28
TD102FDQ	Diesel	9600	6	120.65	28
TD102FEQ	Diesel	9600	6	120.65	21
TD102FF	Diesel	9600	6	120.65	28
TD102FGQ	Diesel	9600	6	120.65	21
TD102FH	Diesel	9600	6	120.65	28
TD102FL Euro 1	Diesel	9600	6	120.65	21
TD102FM	Diesel	9600	6	120.65	21
TD102FQ	Diesel	9600	6	120.65	21
TD102FS	Diesel	9600	6	120.65	21
TD102FT	Diesel	9595	6	120.65	21
TD103D10 Euro 2	Diesel	9600	6	120.65	29
TD103EA Euro 1	Diesel	9600	6	120.65	30
TD103E Euro 1	Diesel	9600	6	120.65	30
TD103ES Euro 1	Diesel	9600	6	120.65	30
TD103KBE Euro 1	Diesel	9600	6	120.65	30
TD103KF Euro 1	Diesel	9600	6	120.65	30
TD120A	Diesel	12000	6	130.175	34
TD120A	Diesel	12000	6	130.175	35
TD120C	Diesel	12000	6	130.175	34
TD120D	Diesel	11980	6	130.175	34
TD120E	Diesel	11980	6	130.175	34
TD120F	Diesel	11980	6	130.175	36
TD120FA	Diesel	11980	6	130.175	37
TD120FB	Diesel	11980	6	130.175	37
TD120FC	Diesel	11980	6	130.175	36
TD120FTQ	Diesel	11980	6	130.175	37
TD120G	Diesel	11980	6	130.175	36
TD120GA	Diesel	11980	6	130.175	36
TD120GG	Diesel	11977	6	130.175	34
TD121F	Diesel	11980	6	130.175	36
TD121FD	Diesel	11980	6	130.175	36
TD121FH	Diesel	11980	6	130.175	37
TD121FK	Diesel	11980	6	130.175	37
TD121G	Diesel	11980	6	130.175	36
TD121GD	Diesel	11980	6	130.175	36
TD122	Diesel	11980	6	130.175	38
TD122ED	Diesel	11980	6	130.175	37
TD122F	Diesel	11980	6	130.175	38
TD122FA	Diesel	11980	6	130.175	37
TD122FA	Diesel	11980	6	130.175	38
TD122FAQ	Diesel	11980	6	130.175	37
TD122FBQ	Diesel	11980	6	130.175	37
TD122FCQ	Diesel	11980	6	130.175	37
TD122FH Euro 1	Diesel	11980	6	130.175	37
TD122FK	Diesel	11980	6	130.175	38
TD122FL	Diesel	11980	6	130.175	37
TD122FR	Diesel	11980	6	130.175	38
TD122FS	Diesel	11980	6	130.175	38
TD122KBE	Diesel	11980	6	130.175	36

		ccm	x 		9
TD122KE	Diesel	11980	6	130.175	38
TD163ES	Diesel	16123	6	144.00	46
THD100A	Diesel	9600	6	120.65	22
THD100A/B	Diesel	9600	6	120.65	24
THD100D	Diesel	9600	6	120.65	24
THD100DB	Diesel	9600	6	120.65	31
THD100DC	Diesel	9600	6	120.65	31
THD100DD	Diesel	9600	6	120.65	31
THD100E	Diesel	9600	6	120.65	31
THD100EA	Diesel	9600	6	120.65	31
THD100EB	Diesel	9600	6	120.65	31
THD100EC	Diesel	9600	6	120.65	31
THD100ED	Diesel	9600	6	120.65	31
THD100EE	Diesel	9600	6	120.65	31
THD100EK	Diesel	9600	6	120.65	31
THD101	Diesel	9599	6	120.65	27
THD101B	Diesel	9600	6	120.65	24
THD101G	Diesel	9600	6	120.65	31
THD101GB	Diesel	9600	6	120.65	31
THD101GC	Diesel	9600	6	120.65	31
THD101GD	Diesel	9600	6	120.65	31
THD101KB	Diesel	9600	6	120.65	31
THD101KC	Diesel	9600	6	120.65	31
THD101KE	Diesel	9600	6	120.65	31
THD101KF	Diesel	9600	6	120.65	27
THD102KA	Diesel	9600	6	120.65	32
THD102KB Euro 1	Diesel	9600	6	120.65	32
THD102KD	Diesel	9600	6	120.65	21
THD102KF	Diesel	9600	6	120.65	32
THD102KJ	Diesel	9600	6	120.65	32
THD103KB	Diesel	9600	6	120.65	30
THD103KD	Diesel	9600	6	120.65	30
TID100	Diesel	9600	6	120.65	27
TID120F	Diesel	11977	6	130.175	34
TID121B	Diesel	11979	6	130.175	39
TID121KG	Diesel	11979	6	130.175	39
TID121KP	Diesel	11979	6	130.175	39
TID121LG	Diesel	11979	6	130.175	39
TID121LP	Diesel	11979	6	130.175	39
TID121P	Diesel	11979	6	130.175	39
TMD70	Diesel	6730	6	104.775	10
TMD100A	Diesel	9600	6	120.65	24
TMD102	Diesel	9599	6	120.65	22
TMD102A/TMD102C Marine	Diesel	9599	6	120.65	32
TMD120A	Diesel	11977	6	130.175	34
TWD121G	Diesel	11979	6	130.175	39
TWD 740 GE	Diesel	7280	6	107.00	16
TWD1630G/P	Diesel	16120	6	144.00	47



1 75.00

15.5W37W31 Air Compressor

2 Cyl.

FM1846



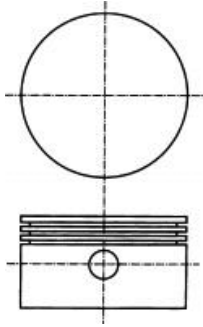

87-990700-00	STD	08-990700-00	STD
87-990705-00	0.25mm	08-990705-00	0.25mm
87-990707-00	0.50mm	08-990707-00	0.50mm

A	32.20	2.38		P
D	52.65	2.38		P
	16x60	3.94		P



2 98.43

D6A180 Euro 3	6 Cyl.	19:1	5480cc	132kW (180PS)	Diesel Turbo Intercooled	TD9219
D6A210 Euro 3	6 Cyl.	19:1	5480cc	154kW (210PS)	Diesel Turbo Intercooled	TD9220
D6A230 Euro 3	6 Cyl.	19:1	5480cc	169kW (230PS)	Diesel Turbo Intercooled	TD9227
D6A250 Euro 3	6 Cyl.	19:1	5480cc	184kW (250PS)	Diesel Turbo Intercooled	TD9228

87-142500-10	STD	08-142500-00	STD	15-450130-00 <i>WH</i> 	B 111.30 C 234.75 D 119.08 E 9.41 F 1.05	89-142500-10 87-142500-10 + 15-450130-00
A	79.70	3.50		MOL		
B-	19.40	2.50		CR		
BØ	52.60	3.50				
C	1.04					
D	124.85					
	40x77					

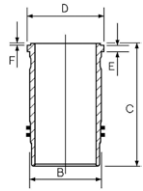

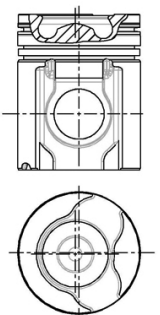

RT TP



 Includes seals

 Schließt Dichtungen ein

 Inclut des joints

 Incluye los sellos

 Comprende le guarnizioni

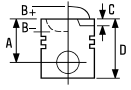

3 98.43

D6B Euro 3 6 Cyl. 19:1 **5480cc** **132-184kW (180-250PS)** **Diesel Turbo Intercooled** **TD17367**

15-450130-00 WH 1 B 111.30 C 234.75 D 119.08 E 9.41 F 1.05

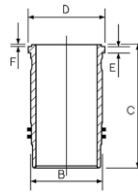

1 Includes seals

1 Schließt Dichtungen ein

1 Inclut des joints

1 Incluye los sellos

1 Comprende le guarnizioni

4 98.43

D60A 6 Cyl. 17:1 **5480cc** **88kW (120PS)** **Diesel** **TD9146**

TAMD60 6 Cyl. 17:1 **5480cc** **113kW (154PS)** **Diesel Turbo** **FM23661**

TD60A 6 Cyl. 16:1 **5480cc** **132kW (180PS)** **Diesel Turbo** **TD9095**

TD60D 6 Cyl. 16:1 **5480cc** **108-113kW (147-154PS)** **Diesel Turbo Intercooled** **TD23336**

TD61FB 6 Cyl. 16:1 **5480cc** **153kW (206PS)** **Diesel Turbo Intercooled** **TD9211**

15-458900-00 WH 2 B 110.00 C 237.20 D 119.10 E 9.66 F 3.60

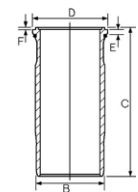

14-400510-00 WH 1 B 110.00 C 234.50 D 119.10 E 11.61 F 0.74

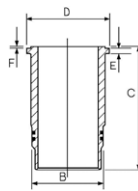

1 Use also: HT005

1 A utiliser aussi: HT005

1 A utiliser aussi: HT005

1 Utilizar también: HT005

1 Usare anche: HT005

2 Includes seals

2 Schließt Dichtungen ein

2 Inclut des joints

2 Incluye los sellos

2 Comprende le guarnizioni

5 98.43

TD60B 6 Cyl. 16:1 **5480cc** **128-132kW (174-180PS)** **Diesel Turbo** **TD9096**

TD60C 6 Cyl. 16:1 **5480cc** **108-113kW (147-154PS)** **Diesel Turbo** **TD9147**

TD60DG 6 Cyl. 16:1 **5480cc** **108-113kW (147-154PS)** **Diesel Turbo Intercooled** **TD23337**

TD61B 6 Cyl. **5480cc** **132kW (180PS)** **Diesel Turbo** **FM5040**

TD61F 6 Cyl. 16:1 **5480cc** **150-152kW (204-207PS)** **Diesel Turbo Intercooled** **TD9225**

TD61G 6 Cyl. 16:1 **5480cc** **108-152kW (147-207PS)** **Diesel Turbo Intercooled** **TD9221**

TD61GA 6 Cyl. 16:1 **5480cc** **112kW (152PS)** **Diesel Turbo** **TD9222**

TD61GB 6 Cyl. 16:1 **5480cc** **131-132kW (179-180PS)** **Diesel Turbo** **TD6249**

TD61GC 6 Cyl. 16:1 **5480cc** **132kW (180PS)** **Diesel Turbo** **TD9226**





TD61GE 6 Cyl. 17:1 **5480cc** **130kW (175PS)** **Diesel Turbo** **TD9210**

TD61GS 6 Cyl. 16:1 **5480cc** **131-132kW (179-180PS)** **Diesel Turbo** **TD5902**



87-405500-10 STD

08-405500-10 STD

15-458900-00 WH ² B 110.00 C 237.20 D 119.10 E 9.66 F 3.60

89-405500-30

A 79.40
B- 21.77
BØ 57.00
D 124.40
 40x77

2.38  CR P
 3.16  P
 4.74  CR P

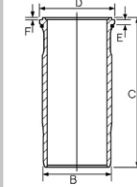

87-405500-10 +
 15-458900-00

RT

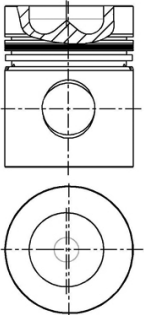

14-400510-00 WH ¹ B 110.00 C 234.50 D 119.10 E 11.61 F 0.74

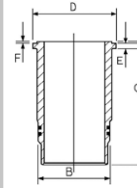

89-405500-10
 87-405500-10 +
 14-400510-00

¹ Use also: HT005

¹ A utiliser aussi: HT005

¹ A utiliser aussi: HT005

¹ Utilizar también: HT005

¹ Usare anche: HT005

² Includes seals

² Schließt Dichtungen ein

² Includ des joints

² Incluye los sellos

² Comprende le guarnizioni

6 98.43

TD63E 6 Cyl. 18.3:1 **5480cc** **132kW (180PS)** **Diesel Turbo Intercooled** **TD9223**

TD63ES 6 Cyl. 18.3:1 **5480cc** **154kW (210PS)** **Diesel Turbo Intercooled** **TD9224**



87-142500-00 STD

08-142500-00 STD

15-459340-00 WH ¹ B 111.50 C 237.41 D 119.11 E 9.66 F 3.60

89-142500-30

A 79.40
B- 20.30
BØ 53.10
D 124.40
 40x77

3.50  MOL
 2.50  CR
 3.50 

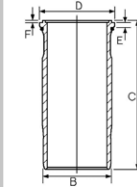

87-142500-00 +
 15-459340-00

AK RT

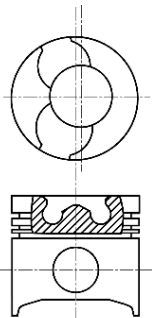

¹ Includes seals

¹ Schließt Dichtungen ein

¹ Includ des joints

¹ Incluye los sellos

¹ Comprende le guarnizioni

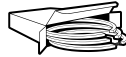
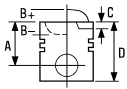



8 104.775

D7A285 Euro 2 6 Cyl. 18:1 **6730cc** **210kW (286PS)** **Diesel Turbo Intercooled** **TD9229**

87-142800-00 STD **08-142800-00** STD **14-450890-00 WH** B 117.00 C 257.00 D 129.40 E 9.40 F 0.70 **88-142800-00**
87-142800-00 +
14-450890-00

A 88.55
B- 20.20
BØ 61.00
C 2.15
C 3.15
D 132.55
 45x82

3.50  CK P
2.50  P
3.50  CR P

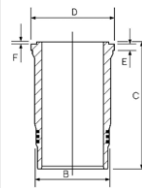

RT TP

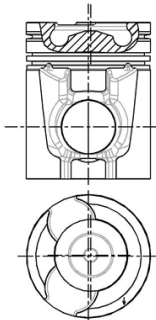

9 104.775

D7B230 Euro 2 6 Cyl. 18:1 **6730cc** **169kW (230PS)** **Diesel Turbo Intercooled** **TD9242**

D7B260 Euro 2 6 Cyl. 18:1 **6730cc** **191kW (260PS)** **Diesel Turbo Intercooled** **TD9243**

14-450890-00 WH B 117.00 C 257.00 D 129.40 E 9.40 F 0.70

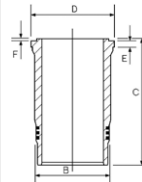

10 104.775

D70B	6 Cyl.	17:1	6730cc	110kW (150PS)	Diesel	TD9129
MD70	6 Cyl.	17:1	6730cc	102-106kW (139-145PS)	Diesel	FM6261
TAMD70	6 Cyl.	15:1	6730cc	206kW (280PS)	Diesel Turbo	FM6263
TD70A	6 Cyl.	15.5:1	6730cc	136kW (185PS)	Diesel Turbo	TD9131
TD70B	6 Cyl.	15.5:1	6730cc	152kW (207PS)	Diesel Turbo	TD9132
TD70C	6 Cyl.	15.5:1	6730cc	149-152kW (202-207PS)	Diesel Turbo	TD9208
TD70E	6 Cyl.	14.5:1	6730cc	154kW (210PS)	Diesel Turbo	TD9133
TD70ES	6 Cyl.	14.5:1	6730cc	155-166kW (211-226PS)	Diesel Turbo	TD9250
TD70H	6 Cyl.	14.5:1	6730cc	157kW (213PS)	Diesel Turbo	TD9097





TD70HA	6 Cyl.	14.5:1	6730cc	143kW (194PS)	Diesel Turbo	TD9130
TMD70	6 Cyl.	16:1	6730cc	110-147kW (150-200PS)	Diesel Turbo	FM6262

15-457590-00 WH ② B 116.96 C 256.79 D 126.98 E 11.66 F 0.76

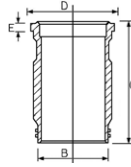

14-573140-00 WH ① B 117.00 C 257.00 D 127.00 E 11.66 F 0.74

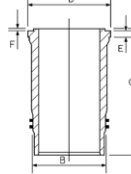

① Use also: HT017

① A utiliser aussi: HT017

① A utiliser aussi: HT017

① Utilizar también: HT017

① Usare anche: HT017

② Includes seals

② Schließt Dichtungen ein

② Includ des joints

② Incluye los sellos

② Comprende le guarnizioni

11 104.775

TD70F	6 Cyl.	14.5:1	6730cc	157-180kW (214-245PS)	Diesel Turbo	TD9148
TD70FS	6 Cyl.	14.5:1	6730cc	157-180kW (214-245PS)	Diesel Turbo	TD9150
TD70G	6 Cyl.	14.5:1	6730cc	147-180kW (200-245PS)	Diesel Turbo	TD9151

87-407000-00

STD

08-407000-10

STD

15-457590-00 WH ② B 116.96 C 256.79 D 126.98 E 11.66 F 0.76

89-407000-00
87-407000-00 +
15-457590-00

A 88.45
B- 26.14
BØ 60.00
C 1.00
C 1.00
D 141.05
 45x86

2.38
3.16
3.16
4.74



CR P
P
P
CR P

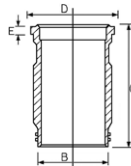

14-573140-00 WH ① B 117.00 C 257.00 D 127.00 E 11.66 F 0.74

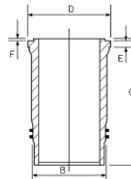

KK RT TP

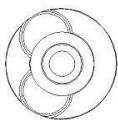
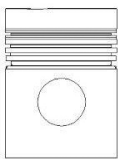

① Use also: HT017

① A utiliser aussi: HT017

① A utiliser aussi: HT017

① Utilizar también: HT017

① Usare anche: HT017

② Includes seals

② Schließt Dichtungen ein

② Includ des joints

② Incluye los sellos

② Comprende le guarnizioni



12 104.775

TD71A	6 Cyl.	15.5:1	6730cc	169kW (220PS)	Diesel Turbo Intercooled	TD23335
TD71ACE	6 Cyl.	15.5:1	6730cc	169kW (220PS)	Diesel Turbo Intercooled	TD23334
TD71AG	6 Cyl.	15.5:1	6730cc	169kW (220PS)	Diesel Turbo Intercooled	TD23333
TD71AGP	6 Cyl.	15.5:1	6730cc	169kW (220PS)	Diesel Turbo Intercooled	TD23332
TD71AP	6 Cyl.	15.5:1	6730cc	169kW (220PS)	Diesel Turbo Intercooled	TD23331
TD71APB	6 Cyl.	15.5:1	6730cc	169kW (220PS)	Diesel Turbo Intercooled	TD23330
TD71AW	6 Cyl.	15.5:1	6730cc	169kW (220PS)	Diesel Turbo Intercooled	TD23329
TD71E	6 Cyl.	15.5:1	6730cc	180kW (245PS)	Diesel Turbo Intercooled	FM5113
TD71F	6 Cyl.	15.5:1	6730cc	169-180kW (220-245PS)	Diesel Turbo Intercooled	TD5903
TD71FD	6 Cyl.	15.5:1	6730cc	180kW (245PS)	Diesel Turbo Intercooled	TD9232
TD71FQ	6 Cyl.	15.5:1	6730cc	169-173kW (220-235PS)	Diesel Turbo Intercooled	TD6250
TD71FS	6 Cyl.	15.5:1	6730cc	178-184kW (242-250PS)	Diesel Turbo Intercooled	TD5904
TD71FSQ	6 Cyl.	15.5:1	6730cc	169-184kW (230-250PS)	Diesel Turbo Intercooled	TD6251
TD71G	6 Cyl.	15.5:1	6730cc	178-184kW (242-250PS)	Diesel Turbo Intercooled	TD26265

87-501400-00

STD

A	88.45
B-	20.95
BØ	65.00
C	1.08
D	141.05
	45x86

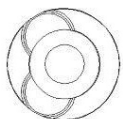
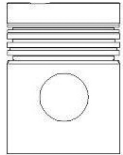

KK RT TP



- 1 Relief 18.25mm
- 2 Includes seals

08-501400-00

STD

2.38		MOL P
3.16		CR P
4.74		CR P

- 1 Entlastung 18.25mm
- 2 Schließt Dichtungen ein

15-458910-00 WH 2 1 B 116.94 C 259.45 D 127.01 E 9.66 F 3.60

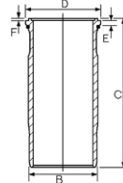

- 1 Le relief 18.25mm
- 2 Includ des joints

14-459050-00 WH 1 B 116.96 C 259.45 D 127.00 E 9.66 F 3.59

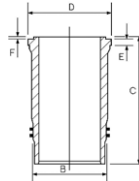

- 1 Relevación 18.25mm
- 2 Incluye los sellos

89-501400-00
87-501400-00 +
15-458910-00

- 1 Rilievo 18.25mm
- 2 Comprende le guarnizioni



13 104.775

TD71FA	6 Cyl.	15.5:1	6730cc	173kW (236PS)	Diesel Turbo Intercooled	TD9212
TD71FC	6 Cyl.	15.5:1	6730cc	173kW (236PS)	Diesel Turbo Intercooled	TD9213

15-458910-00 WH ② ① B 116.94 C 259.45 D 127.01 E 9.66 F 3.60

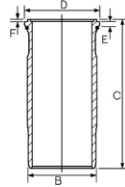

14-459050-00 WH ① B 116.96 C 259.45 D 127.00 E 9.66 F 3.59

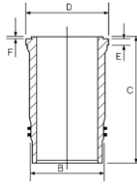

① Relief 18.25mm

① Entlastung 18.25mm

① Le relief 18.25mm

① Relevación 18.25mm

① Rilievo 18.25mm

② Includes seals

② Schließt Dichtungen ein

② Inclut des joints

② Incluye los sellos

② Comprende le guarnizioni

14 104.775

TD73E Euro 1	6 Cyl.	17.6:1	6730cc	169kW (230PS)	Diesel Turbo Intercooled	TD9233
TD73EA	6 Cyl.	17.6:1	6730cc	160kW (215PS)	Diesel Turbo Intercooled	TD9234
TD73EB	6 Cyl.	17.6:1	6730cc	184kW (250PS)	Diesel Turbo Intercooled	TD9235
TD73ES	6 Cyl.	17.6:1	6730cc	191kW (260PS)	Diesel Turbo Intercooled	TD9236

87-502700-00

STD

08-502700-00

STD

A 88.45

B- 20.10

BØ 61.00

C 2.05

C 3.05

D 132.45

45x82

3.00

2.50

4.00



MOL P

P

CR P

RT TP

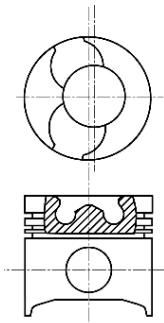







15 107.00

D7C215 Euro 2	6 Cyl.	19:1	7300cc	158kW (215PS)	Diesel Turbo Intercooled	TD18725
D7C250 Euro 2	6 Cyl.	19.5:1	7300cc	184kW (250PS)	Diesel Turbo Intercooled	TD11770
D7C275 Euro 2	6 Cyl.	19.5:1	7300cc	202kW (275PS)	Diesel Turbo Intercooled	TD29197
D7C290 Euro 2	6 Cyl.	19.5:1	7300cc	213kW (290PS)	Diesel Turbo Intercooled	TD11771
D7C310 Euro 2	6 Cyl.	19.5:1	7300cc	228kW (310PS)	Diesel Turbo Intercooled	TD16726

87-141900-00 STD

A 88.48
B- 20.30
BØ 61.00
C 2.00
C 1.35
D 134.45
 47x85

08-141900-00 STD

3.50  CK P
 2.50  P
 3.50  CR P

14-450810-00 WH B 117.00 C 256.80 D 129.40 E 9.40 F 0.95

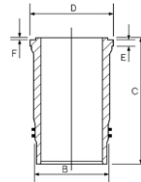

88-141900-00
 87-141900-00 +
 14-450810-00

KK RT TP

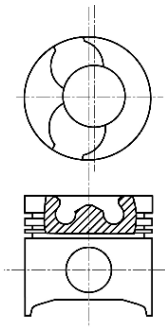

15-450810-00 WH B 117.00 C 256.80 D 129.40 E 9.40 F 0.95

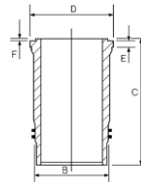

16 107.00

TAD 740 GE	6 Cyl.	17.2:1	7280cc	220-251kW (295-341PS)	Diesel	FM25101
TWD 740 GE	6 Cyl.	17.2:1	7280cc	217kW (295PS)	Diesel	FM35101

14-450810-00 WH B 117.00 C 256.80 D 129.40 E 9.40 F 0.95

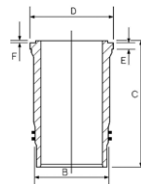

15-450810-00 WH B 117.00 C 256.80 D 129.40 E 9.40 F 0.95





17 108.00

D7DEAE2 Euro 2	6 Cyl.	7146cc	143kW (194PS)	Diesel Turbo	FM76267
D7DECE2 Euro 2	6 Cyl.	7146cc	143kW (194PS)	Diesel Turbo	FM86267
D7DEEE2 Euro 2	6 Cyl.	7146cc	125kW (170PS)	Diesel Turbo	FM96267
D7DLAE2 Euro 2	6 Cyl.	7146cc	165kW (224PS)	Diesel Turbo	FM106267
D7DLBE2 Euro 2	6 Cyl.	7146cc	155kW (210PS)	Diesel Turbo	FM116267

87-136900-10  STD	08-136900-00 STD	14-480040-00 WH  B 120.00 C 229.10 D 128.50 E 9.00 F 1.10	89-136900-10
			87-136900-10 + 14-480040-00



A 71.15
B- 19.60
BØ 64.00
D 108.00
 42x86

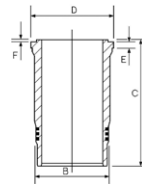

3.00  CK P
2.00  P
3.50  CR P

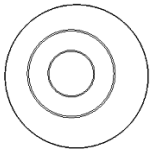
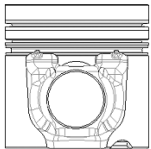





AK RT TP





 Includes seals
 Piston Chamber Volume
[ccm] 54.000

 Schließt Dichtungen ein
 Volumen der Kolbenmulde
[ccm] 54.000

 Inclut des joints
 Volume de la cavité du piston
[cm³] 54.000

 Incluye los sellos
 Volumen de cavidad del pistón
[cc] 54.000

 Comprende le guarnizioni
 Volume camera pistone
[cc] 54.000

15-480040-00 WH  B 120.00 C 229.10 D 128.50 E 9.00 F 1.10

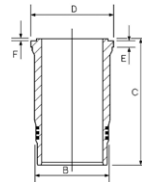



18 108.00

D7E240 Euro 4	6 Cyl.	18:1	7100cc	177kW (240PS)	Diesel Turbo Intercooled	TD18965
D7E280 Euro 4	6 Cyl.	18:1	7100cc	206kW (280PS)	Diesel Turbo Intercooled	TD18964
D7E290 Euro 4	6 Cyl.	18:1	7100cc	213kW (290PS)	Diesel Turbo Intercooled	TD20460
D7E320 Euro 4	6 Cyl.	18:1	7100cc	235kW (320PS)	Diesel Turbo Intercooled	TD18963

87-430000-00 STD	08-430000-00 STD	15-480450-00 WH  B 120.00 C 228.00 D 131.70 E 8.06	89-430000-00
			87-430000-00 + 15-480450-00

A 70.90
B- 19.60
BØ 64.50
D 107.80
 45x86

3.00  CK
2.00  P
3.50  CR

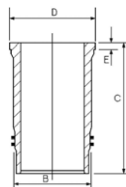

KK RT TP

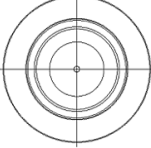
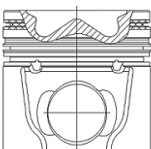

 Includes seals

 Schließt Dichtungen ein

 Inclut des joints

 Incluye los sellos

 Comprende le guarnizioni

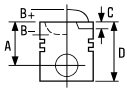

19 120.00



D9A260 Euro 3	6 Cyl.	18.5:1	9364cc	191kW (260PS)	Diesel Turbo Intercooled	TD16780
D9A300 Euro 3	6 Cyl.	18.5:1	9364cc	221-224kW (300-305PS)	Diesel Turbo Intercooled	TD16781
D9A340 Euro 3	6 Cyl.	18.5:1	9364cc	250-251kW (340-341PS)	Diesel Turbo Intercooled	TD16782
D9A380 Euro 3	6 Cyl.	18.5:1	9364cc	279kW (380PS)	Diesel Turbo Intercooled	TD16783

87-142000-00  STD



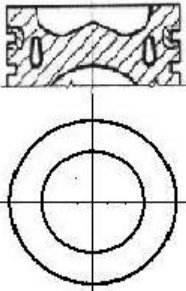

A 85.45
B- 14.60
BØ 77.00
D 130.00
 54x96



AK KK RT TP



 Piston Chamber Volume
 [ccm] 57.00
 Steel



08-142000-00 STD



4.00  CK P
 3.00  P
 3.00  NT 

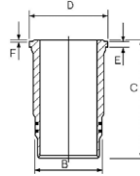

 Volumen der Kolbenmulde
 [ccm] 57.00
 Stahl

14-480230-00 WH B 139.00 C 249.55 D 149.00 E 12.05 F 0.85



 Volume de la cavité du piston
 [cm³] 57.00
 Acier

 Volumen de cavidad del pistón
 [cc] 57.00
 Acero

 Volume camera pistone
 [cm³] 57.00
 Acciaio

88-142000-00
 87-142000-00 +
 14-480230-00

20 120.00

D9B260 Euro 4/5	6 Cyl.	18.1:1	9364cc	191kW (260PS)	Diesel Turbo Intercooled	TD21048
D9B300 Euro 4	6 Cyl.	18.5:1	9364cc	221kW (300PS)	Diesel Turbo Intercooled	TD18978
D9B310 Euro 4/5	6 Cyl.	18.1:1	9364cc	228kW (310PS)	Diesel Turbo Intercooled	TD21049
D9B340 Euro 4	6 Cyl.	18.5:1	9364cc	250kW (340PS)	Diesel Turbo Intercooled	TD18979
D9B360 Euro 4/5	6 Cyl.	18.1:1	9364cc	265kW (360PS)	Diesel Turbo Intercooled	TD21050
D9B380 Euro 4	6 Cyl.	18.5:1	9364cc	280kW (380PS)	Diesel Turbo Intercooled	TD18980

87-438900-00 STD





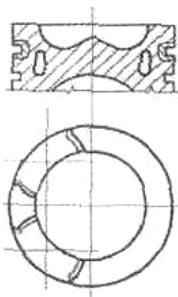

A 85.45
B- 14.85
BØ 79.00
C 1.00
D 129.95
 54x96

AK KK RT



 Steel

08-438900-00 STD

3.50  PVD 
 2.50  NT 
 3.00  NT 

 Stahl

14-480460-00 WH B 139.00 C 250.05 D 149.00 E 0.85 F 11.20

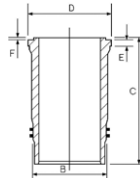

 Acier

 Acero

 Acciaio

89-438900-00
 87-438900-00 +
 14-480460-00



21 120.65

D10A320	6 Cyl.	18:1	9600cc	235kW (320PS)	Diesel	TD9263
D10B320 Euro 2	6 Cyl.		9600cc	235kW (320PS)	Diesel Turbo Intercooled	TD16235
TD102FAQ	6 Cyl.	15:1	9600cc	221kW (301PS)	Diesel Turbo Intercooled	TD9161
TD102FBQ	6 Cyl.		9600cc	228kW (310PS)	Diesel Turbo Intercooled	TD9162
TD102FCQ	6 Cyl.	15:1	9600cc	220kW (299PS)	Diesel Turbo Intercooled	TD9163
TD102FEQ	6 Cyl.	15:1	9600cc	191kW (260PS)	Diesel Turbo Intercooled	TD9165
TD102FGQ	6 Cyl.	15:1	9600cc	205kW (279PS)	Diesel Turbo Intercooled	TD9167
TD102FL Euro 1	6 Cyl.	16:1	9600cc	234kW (318PS)	Diesel Turbo	TD9169
TD102FM	6 Cyl.	16:1	9600cc	230-252kW (313-343PS)	Diesel Turbo Intercooled	TD9170
TD102FQ	6 Cyl.		9600cc	234kW (318PS)	Diesel Turbo	FM5126
TD102FS	6 Cyl.	15:1	9600cc	250kW (340PS)	Diesel Turbo Intercooled	TD9264
TD102FT	6 Cyl.	15:1	9595cc	228kW (310PS)	Diesel Turbo Intercooled	TD9262
THD102KD	6 Cyl.	16:1	9600cc	252kW (343PS)	Diesel Turbo Intercooled	TD9118

14-459040-00 WH B 134.00 C 287.25 D 147.00 E 11.53 F 3.47
 15-459230-00 WH  B 133.82 C 287.30 D 147.00 E 11.50 F 3.50

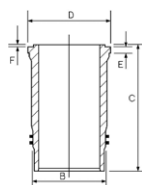

 Includes seals

 Schließt Dichtungen ein

 Inclut des joints

 Incluye los sellos

 Comprende le guarnizioni

22 120.65

D100A	6 Cyl.	17:1	9600cc	122-147kW (166-200PS)	Diesel	TD9204
D100B	6 Cyl.	17:1	9600cc	147kW (200PS)	Diesel	TD9205
D100BHC	6 Cyl.		9600cc		Diesel	FM5114
D100BRC	6 Cyl.		9600cc		Diesel	FM5115
HD100A	6 Cyl.	17:1	9600cc	129kW (175PS)	Diesel	TD9134
HD100D	6 Cyl.	17:1	9600cc	125-132kW (170-180PS)	Diesel	TD9135
MD/TMD100	6 Cyl.		9600cc		Diesel	FM5116
MD100B	6 Cyl.		9600cc		Diesel	FM5117
THD100A	6 Cyl.	17:1	9600cc	139-191kW (200-260PS)	Diesel Turbo	TD9136
TMD102	6 Cyl.	14.3:1	9599cc	158-200kW (215-272PS)	Diesel Turbo Intercooled	FM8860

15-457600-00 WH  B 133.92 C 294.11 D 146.96 E 11.68 F 0.76

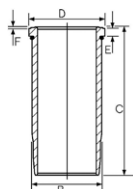



14-450520-00 WH 1 B 134.00 C 294.00 D 147.00 E 11.77 F 0.78

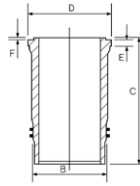

1 Use also: HT008
2 Includes seals

1 A utiliser aussi: HT008
2 Schließt Dichtungen ein

1 A utiliser aussi: HT008
2 Inclut des joints

1 Utilizar también: HT008
2 Incluye los sellos

1 Usare anche: HT008
2 Comprende le guarnizioni

23 120.65

DH10A Euro 2 6 Cyl. 20:1 **9600cc** **180-265kW (245-360PS)** **Diesel Turbo Intercooled** **FM45043**

87-136800-30 2 STD

A 92.50
B- 20.50
BØ 64.00
C 2.50
C 2.00
D 137.50
 52x98

RT TP

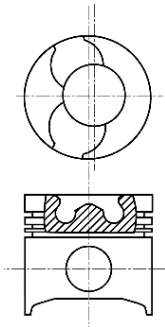

08-136800-00 STD

4.00 MOL P
3.16 P
4.74 CR P

15-459230-00 WH 1 B 133.82 C 287.30 D 147.00 E 11.50 F 3.50

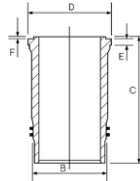

89-136800-30
87-136800-30 +
15-459230-00

87-136800-40 3 STD

A 92.60
B- 22.50
C 2.70
D 137.60
 52x98

RT TP

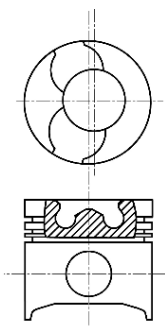

08-136800-00 STD

4.00 MOL P
3.16 P
4.74 CR P

15-459230-00 WH 1 B 133.82 C 287.30 D 147.00 E 11.50 F 3.50

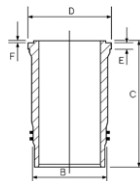

89-136800-40
87-136800-40 +
15-459230-00

14-459040-00 WH B 134.00 C 287.25 D 147.00 E 11.53 F 3.47

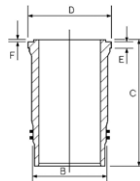

1 Includes seals
2 245-286PS
3 340-360PS

1 Schließt Dichtungen ein
2 245-286PS
3 340-360PS

1 Inclut des joints
2 245-286PS
3 340-360PS

1 Incluye los sellos
2 245-286PS
3 340-360PS

1 Comprende le guarnizioni
2 245-286PS
3 340-360PS

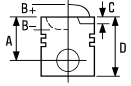

24 120.65

TD100A	6 Cyl.	17:1	9600cc	176-190kW (239-258PS)	Diesel Turbo	TD9152
TD100AHC	6 Cyl.		9600cc		Diesel Turbo	FM5118
TD100ARC	6 Cyl.		9600cc		Diesel Turbo	FM5119
THD100A/B	6 Cyl.	15:1	9600cc		Diesel Turbo	FM5166
THD100D	6 Cyl.	15:1	9600cc	155-177kW (211-241PS)	Diesel Turbo	TD9119
THD101B	6 Cyl.	15:1	9600cc	169-191kW (230-260PS)	Diesel Turbo	TD23324
TMD100A	6 Cyl.		9600cc		Diesel Turbo	FM5048

87-396300-00

STD

A 109.50
B- 27.58
BØ 71.00
C 1.35
C 0.99
D 166.43
 52x106

08-396300-10
08-396305-10

STD
 0.25mm

2.38
 3.16
 3.16
 4.74



CR P
 P
 P
 CR P

15-457600-00 WH  **B** 133.92 **C** 294.11 **D** 146.96 **E** 11.68 **F** 0.76

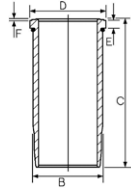

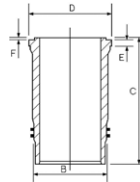

89-396300-00
 87-396300-00 +
 15-457600-00

14-450520-00 WH  **B** 134.00 **C** 294.00 **D** 147.00 **E** 11.77 **F** 0.78

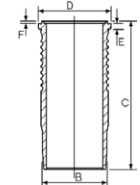

15-677620-00 WH  **B** 133.82 **C** 296.49 **D** 147.02 **E** 11.52 **F** 3.50





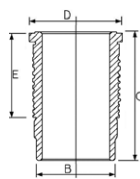

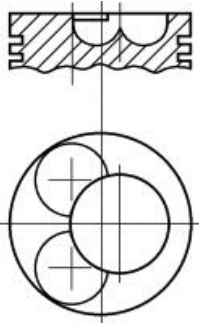

14-673200-00 WH   **B** 134.00 **C** 296.50 **D** 147.00 **E** 11.52 **F** 3.48









RT





-  Water jacket chromed
-  Use also: HT008
-  Includes seals

-  Am Wassermantel verchromt
-  A utiliser aussi: HT008
-  Schließt Dichtungen ein

-  Chromé sur chambre d'eau
-  A utiliser aussi: HT008
-  Inclut des joints

-  Camisa de agua cromada
-  Utilizar también: HT008
-  Incluye los sellos

-  Superficie cromata
-  Usare anche: HT008
-  Comprende le guarnizioni

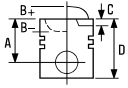



25 120.65

TD100B	6 Cyl.	12.5:1	9600cc	206-220kW (280-299PS)	Diesel Turbo	TD9153
TD100BG	6 Cyl.	14.3:1	9600cc	207kW (282PS)	Diesel Turbo	TD21337

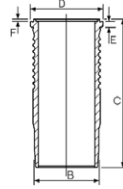
15-677620-00 WH  **B 133.82 C 296.49 D 147.02 E 11.52 F 3.50**





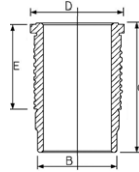

14-673190-00 WH  **B 134.00 C 294.00 D 147.00 E 11.74 F 0.81**



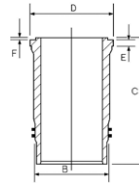

14-673200-00 WH  **B 134.00 C 296.50 D 147.00 E 11.52 F 3.48**











14-458170-00 WH  **B 133.86 C 296.25 D 147.00 E 11.53 F 3.47**







-  Water jacket chromed
-  Use also: HT005
-  Use also: HT008
-  Includes seals

-  Am Wassermantel verchromt
-  A utiliser aussi: HT005
-  A utiliser aussi: HT008
-  Schließt Dichtungen ein

-  Chromé sur chambre d'eau
-  A utiliser aussi: HT005
-  A utiliser aussi: HT008
-  Inclut des joints

-  Camisa de agua cromada
-  Utilizar también: HT005
-  Utilizar también: HT008
-  Incluye los sellos

-  Superficie cromata
-  Usare anche: HT005
-  Usare anche: HT008
-  Comprende le guarnizioni

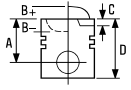

26 120.65

TD100CHC	6 Cyl.	14.3:1	9600cc	200kW (272PS)	Diesel Turbo	TD21338
TD100F	6 Cyl.	14.3:1	9600cc	200kW (272PS)	Diesel Turbo	TD21339
TD100G	6 Cyl.	14.3:1	9600cc	192-202kW (261-275PS)	Diesel Turbo	TD9154
TD100GA	6 Cyl.	14.3:1	9600cc	200kW (272PS)	Diesel Turbo	TD9155
TD100GG	6 Cyl.		9600cc		Diesel Turbo	FM5047
TD101F	6 Cyl.	14.3:1	9600cc	215-220kW (292-299PS)	Diesel Turbo Intercooled	TD9156
TD101FA	6 Cyl.	14.3:1	9600cc	220kW (299PS)	Diesel Turbo Intercooled	TD9157
TD101FC	6 Cyl.	14.3:1	9600cc	221kW (301PS)	Diesel Turbo Intercooled	TD9237
TD101FD	6 Cyl.	14.3:1	9600cc	220-222kW (299-302PS)	Diesel Turbo Intercooled	TD9238
TD101G	6 Cyl.	14.3:1	9600cc	192-202kW (261-275PS)	Diesel Turbo	TD9158
TD101GA	6 Cyl.	14.3:1	9600cc	200kW (272PS)	Diesel Turbo Intercooled	TD9159
TD101GE	6 Cyl.	14.3:1	9600cc	200kW (272PS)	Diesel Turbo Intercooled	TD21340

87-407100-00 STD

A 109.40
B- 23.15
BØ 76.00
C 1.88
D 166.40
 52x106

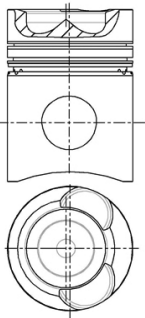

RT



08-407100-10 STD

08-407105-10 0.25mm

→06/86

2.38  CR P
 3.16  CR P
 4.74  CR P

STD

0.25mm

CR P
 CR P
 CR P

15-459350-00 WH  **B** 133.82 **C** 297.00 **D** 147.02 **E** 11.52 **F** 3.50

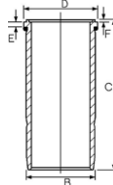

89-407100-00

87-407100-00 +
 15-459350-00

15-677620-00 WH  **B** 133.82 **C** 296.49 **D** 147.02 **E** 11.52 **F** 3.50

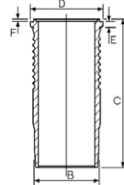

89-407100-10

87-407100-00 +
 15-677620-00

14-673200-00 WH  **B** 134.00 **C** 296.50 **D** 147.00 **E** 11.52 **F** 3.48

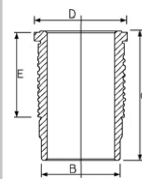

14-458170-00 WH  **B** 133.86 **C** 296.25 **D** 147.00 **E** 11.53 **F** 3.47

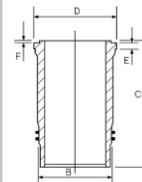



 Water jacket chromed

 Use also: HT005

 Includes seals

 Use also: HT008

 Am Wassermantel verchromt

 A utiliser aussi: HT005

 Schließt Dichtungen ein

 A utiliser aussi: HT008

 Chromé sur chambre d'eau

 A utiliser aussi: HT005

 Inclut des joints

 A utiliser aussi: HT008

 Camisa de agua cromada

 Utilizar también: HT005

 Incluye los sellos

 Utilizar también: HT008

 Superficie cromata

 Usare anche: HT005

 Comprende le guarnizioni

 Usare anche: HT008

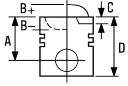

27 120.65

TD100GB	6 Cyl.	12.5:1	9600cc	207-220kW (280-300PS)	Diesel Turbo	FM3723
TD101	6 Cyl.	14.3:1	9599cc	200kW (272PS)	Diesel Turbo Intercooled	FM6227
THD101	6 Cyl.	15:1	9599cc	203-228kW (276-310PS)	Diesel Turbo Intercooled	FM6228
THD101KF	6 Cyl.		9600cc	228kW (310PS)	Diesel Turbo Intercooled	FM5161
TID100	6 Cyl.		9600cc		Diesel Turbo Intercooled	FM6265

15-459350-00 WH ³ B 133.82 C 297.00 D 147.02 E 11.52 F 3.50

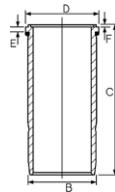

15-677620-00 WH ³ B 133.82 C 296.49 D 147.02 E 11.52 F 3.50

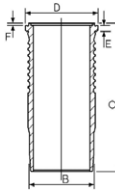

14-673200-00 WH ¹ ⁴ B 134.00 C 296.50 D 147.00 E 11.52 F 3.48

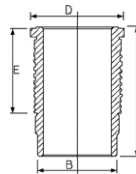

14-458170-00 WH ² B 133.86 C 296.25 D 147.00 E 11.53 F 3.47

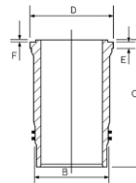

¹ Water jacket chromed

² Use also: HT005

³ Includes seals

⁴ Use also: HT008

¹ Am Wassermantel verchromt

² A utiliser aussi: HT005

³ Schließt Dichtungen ein

⁴ A utiliser aussi: HT008

¹ Chromé sur chambre d'eau

² A utiliser aussi: HT005

³ Inclut des joints

⁴ A utiliser aussi: HT008

¹ Camisa de agua cromada

² Utilizar también: HT005

³ Incluye los sellos

⁴ Utilizar también: HT008

¹ Superficie cromata

² Usare anche: HT005

³ Comprende le guarnizioni

⁴ Usare anche: HT008



28 120.65



TD102F	6 Cyl.	15:1	9600cc	230-234kW (313-318PS)	Diesel Turbo Intercooled	TD9160
TD102FD Euro 1	6 Cyl.	15:1	9600cc	234kW (318PS)	Diesel Turbo Intercooled	TD21341
TD102FDQ	6 Cyl.	15:1	9600cc	232-234kW (316-318PS)	Diesel Turbo Intercooled	TD9164
TD102FF	6 Cyl.	15:1	9600cc	230-234kW (313-318PS)	Diesel Turbo Intercooled	TD9166
TD102FH	6 Cyl.	15:1	9600cc	210-234kW (286-318PS)	Diesel Turbo Intercooled	TD9168

87-431300-00  STD

A 92.55
B- 22.20
BØ 76.00
C 1.95
D 131.05
 52x98

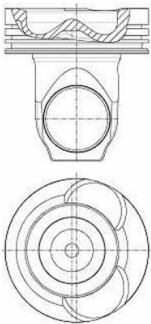
NB



-  Includes seals
-  Articulated piston



STD



08-431300-00 STD

3.00
 3.16
 4.74





CK P
 CR P
 CR P

-  Schließt Dichtungen ein
-  Pendelschaftkolben

-  Inclut des joints
-  Piston articulé

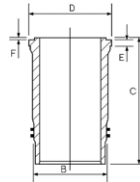
14-459040-00 WH  B 134.00 C 287.25 D 147.00 E 11.53 F 3.47





-  Incluye los sellos
-  Pistón articulado

89-431300-00
 87-431300-00 +
 14-459040-00

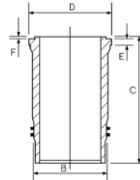
15-459230-00 WH  B 133.82 C 287.30 D 147.00 E 11.50 F 3.50



-  Comprende le guarnizioni
-  Pistone articolato

29 120.65

TD103D10 Euro 2	6 Cyl.	18:1	9600cc	265kW (360PS)	Diesel Turbo Intercooled	FM35043
------------------------	--------	------	---------------	----------------------	---------------------------------	----------------

87-136800-10 STD

A 92.60
B- 22.50
BØ 64.00
C 2.10
D 137.60
 52x98

RT TP

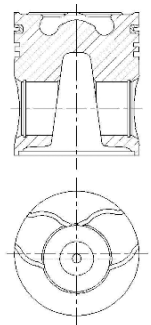

-  Includes seals

STD

08-136800-00 STD

4.00
 3.16
 4.74





MOL P
 P
 CR P

-  Schließt Dichtungen ein

-  Inclut des joints

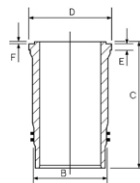
15-459230-00 WH  B 133.82 C 287.30 D 147.00 E 11.50 F 3.50



-  Incluye los sellos

89-136800-10
 87-136800-10 +
 15-459230-00

14-459040-00 WH  B 134.00 C 287.25 D 147.00 E 11.53 F 3.47

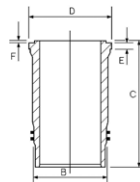



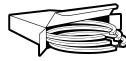
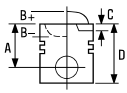



-  Comprende le guarnizioni

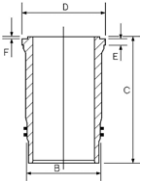

30 120.65

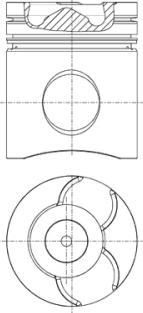
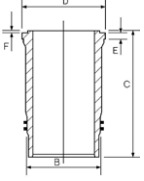
TD103E Euro 1	6 Cyl.	18:1	9600cc	210-235kW (286-320PS)	Diesel Turbo Intercooled	TD5900
TD103EA Euro 1	6 Cyl.	18:1	9600cc	235kW (320PS)	Diesel Turbo Intercooled	TD21342
TD103ES Euro 1	6 Cyl.	18:1	9600cc	210-235kW (286-320PS)	Diesel Turbo Intercooled	TD6247
TD103KBE Euro 1	6 Cyl.	17:1	9600cc	210-235kW (286-320PS)	Diesel Turbo Intercooled	TD19062
TD103KF Euro 1	6 Cyl.	17:1	9600cc	210-235kW (286-320PS)	Diesel Turbo Intercooled	TD19063
THD103KB	6 Cyl.	18:1	9600cc	210kW (286PS)	Diesel Turbo	TD9098
THD103KD	6 Cyl.	18:1	9600cc	250kW (340PS)	Diesel Turbo	TD9099

87-502600-00	STD	08-502600-00	STD	15-459230-00  B 133.82 C 287.30 D 147.00 E 11.50 F 3.50	89-502600-00 87-502600-00 + 15-459230-00
A 92.50		01/92 →			
B- 21.80		3.50		MOL P	
BØ 67.40		3.16		CR P	
C 2.00		4.74		CR P	
D 144.50					
 52x98					
AK RT				14-459040-00  B 134.00 C 287.25 D 147.00 E 11.53 F 3.47	
					

 Includes seals

 Schließt Dichtungen ein

 Inclut des joints

 Incluye los sellos

 Comprende le guarnizioni

31 120.65

THD100DB	6 Cyl.	15:1	9600cc	160-203kW (218-276PS)	Diesel Turbo Intercooled	TD9120
THD100DC	6 Cyl.	15:1	9600cc	160-203kW (218-276PS)	Diesel Turbo Intercooled	TD9104
THD100DD	6 Cyl.	15:1	9600cc	203kW (276PS)	Diesel Turbo	TD9105
THD100E	6 Cyl.	15:1	9600cc	160-203kW (218-276PS)	Diesel Turbo Intercooled	TD9137
THD100EA	6 Cyl.	15:1	9600cc	133-180kW (180-245PS)	Diesel Turbo	TD9106
THD100EB	6 Cyl.	15:1	9600cc	160-203kW (218-276PS)	Diesel Turbo	TD9107
THD100EC	6 Cyl.	15:1	9600cc	160-203kW (218-276PS)	Diesel Turbo	TD9108
THD100ED	6 Cyl.	15:1	9600cc	160-203kW (218-276PS)	Diesel Turbo Intercooled	TD9109
THD100EE	6 Cyl.	15:1	9600cc	212kW (288PS)	Diesel Turbo	TD9110
THD100EK	6 Cyl.	15:1	9600cc	179kW (243PS)	Diesel Turbo	TD9111
THD101G	6 Cyl.		9600cc	203kW (275PS)	Diesel Turbo	FM5168
THD101GB	6 Cyl.	15:1	9600cc	160kW (218PS)	Diesel Turbo	TD9112
THD101GC	6 Cyl.	15:1	9600cc	180kW (245PS)	Diesel Turbo	TD9113
THD101GD	6 Cyl.	15:1	9600cc	160-203kW (218-276PS)	Diesel Turbo	TD9114
THD101KB	6 Cyl.	15:1	9600cc	210kW (286PS)	Diesel Turbo Intercooled	TD9115



THD101KC 6 Cyl. 15:1 **9600cc** **228kW (310PS)** Diesel Turbo Intercooled **TD9116**

THD101KE 6 Cyl. 15:1 **9600cc** **235kW (320PS)** Diesel Bi-Turbo Intercooled **TD9117**

87-407100-10 STD

STD

08-407100-10 STD

STD

15-459350-00 WH ③ B 133.82 C 297.00 D 147.02 E 11.52 F 3.50

89-407100-30

A 109.40

B- 22.20

BØ 74.00

C 1.88

D 166.40

52x106

08-407105-10 0.25mm

→06/86

2.38

3.16

4.74



CR P



CR P



CR P

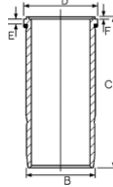

15-677620-00 WH ③ B 133.82 C 296.49 D 147.02 E 11.52 F 3.50

89-407100-20

87-407100-10 +

15-677620-00

RT

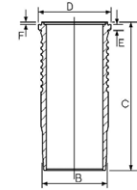
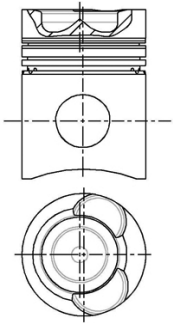

14-673200-00 WH ① ④ B 134.00 C 296.50 D 147.00 E 11.52 F 3.48

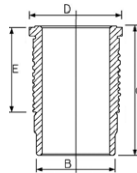

14-458170-00 WH ② B 133.86 C 296.25 D 147.00 E 11.53 F 3.47

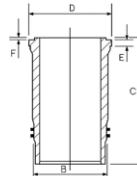

① Water jacket chromed

② Use also: HT005

③ Includes seals

④ Use also: HT008

① Am Wassermantel verchromt

② A utiliser aussi: HT005

③ Schließt Dichtungen ein

④ A utiliser aussi: HT008

① Chromé sur chambre d'eau

② A utiliser aussi: HT005

③ Inclut des joints

④ A utiliser aussi: HT008

① Camisa de agua cromada

② Utilizar también: HT005

③ Incluye los sellos

④ Utilizar también: HT008

① Superficie cromata

② Usare anche: HT005

③ Comprende le guarnizioni

④ Usare anche: HT008

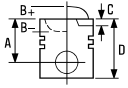

32 120.65

THD102KA	6 Cyl.	16:1	9600cc	210kW (286PS)	Diesel Turbo Intercooled	TD23325
THD102KB Euro 1	6 Cyl.	16:1	9600cc	210kW (286PS)	Diesel Turbo Intercooled	TD23326
THD102KF	6 Cyl.	16:1	9600cc	180-210kW (245-286PS)	Diesel Turbo Intercooled	TD9121
THD102KJ	6 Cyl.	16:1	9600cc	158kW (215PS)	Diesel Turbo Intercooled	TD9138
TMD102A/TMD102C Marine	6 Cyl.	14.3:1	9599cc	158-200kW (215-272PS)	Diesel Turbo Intercooled	FM8859

14-458170-00 WH ¹ B 133.86 C 296.25 D 147.00 E 11.53 F 3.47

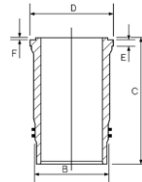

¹ Use also: HT005

¹ A utiliser aussi: HT005

¹ A utiliser aussi: HT005

¹ Utilizar también: HT005

¹ Usare anche: HT005

33 123.00

D11B430 Euro 4/5	6 Cyl.	18.3:1	10800cc	316kW (430PS)	Diesel Turbo Intercooled	TD23373
D11C330 Euro 5	6 Cyl.	17.3:1	10800cc	243kW (330PS)	Diesel Turbo Intercooled	TD22373
D11C370 Euro 5	6 Cyl.	17.3:1	10800cc	272kW (370PS)	Diesel Turbo Intercooled	TD22374
D11C410 Euro 5	6 Cyl.	17.3:1	10800cc	302kW (410PS)	Diesel Turbo Intercooled	TD22376

87-438800-00 ¹ STD

STD

08-438800-00

STD

14-480440-00 WH B 139.00 C 249.55 D 149.00 E 11.20 F 0.85

89-438800-00

A 78.40

B- 17.00

BØ 83.60

C 1.00

C 1.00

D 111.70

 54x73

3.50

2.50

3.00



PVD ²

NT ²

NT ²

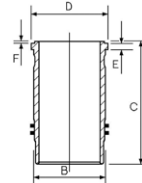

87-438800-00 +
14-480440-00

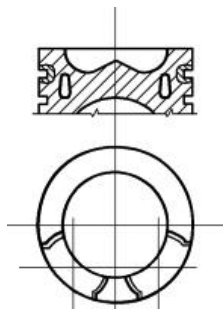

¹ MonoSteel®

² Steel

¹ MonoSteel®

² Stahl

¹ MonoSteel®

² Acier

¹ MonoSteel®

² Acero

¹ MonoSteel®

² Acciaio



34 130.175

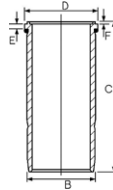

TAMD120A	6 Cyl.		11977cc	225-243kW (306-330PS)	Diesel Turbo	FM5133
TAMD120B	6 Cyl.		11977cc		Diesel Turbo	FM5134
TAMD121	6 Cyl.	14.2:1	11975cc	217-310kW (295-420PS)	Diesel Turbo	FM6266
TD120A	6 Cyl.	15:1	12000cc	243kW (330PS)	Diesel Turbo	TD9206
TD120C	6 Cyl.	13.3:1	12000cc	260kW (354PS)	Diesel Turbo	TD9171
TD120D	6 Cyl.	7:1	11980cc	273kW (371PS)	Diesel Turbo	TD9172
TD120E	6 Cyl.	13.3:1	11980cc	225-273kW (306-371PS)	Diesel Turbo	TD9173
TD120GG	6 Cyl.		11977cc		Diesel Turbo	FM5138
TID120F	6 Cyl.		11977cc		Diesel Turbo	FM5045
TMD120A	6 Cyl.		11977cc	225-243kW (306-330PS)	Diesel	FM5132

15-458840-00 WH  B 143.85 C 313.25 D 157.62 E 10.52 F 3.25





14-450530-00 WH  B 144.00 C 311.00 D 157.60 E 13.52 F 0.76

14-456000-00 WH B 144.00 C 311.00 D 157.60 E 10.52 F 0.76

15-457960-00 WH   B 143.89 C 311.00 D 157.62 E 10.55 F 0.86

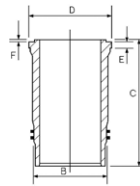
15-459030-00 WH  B 143.91 C 310.52 D 157.58 E 13.55 F 0.68



 Phosphated

 For cylinder block no.470130 only

 Includes seals

 Phosphated

 Nur Zylinderblock Nr.470130

 Schließt Dichtungen ein

 Phosphated

 Bloc-cylindres no.470130 seulement

 Inclut des joints

 Phosphated

 Bloque de cilindro no.470130 unicamente

 Incluye los sellos



 Phosphated

 Solamente per motori Nr.470130

 Comprende le guarnizioni

35 130.175

TD120A	6 Cyl.	15:1	12000cc	243kW (330PS)	Diesel Turbo	FM3027
--------	--------	------	---------	---------------	--------------	--------

15-457960-00 WH   B 143.89 C 311.00 D 157.62 E 10.55 F 0.86

15-459030-00 WH  B 143.91 C 310.52 D 157.58 E 13.55 F 0.68

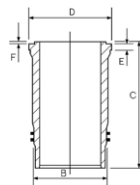



 For cylinder block no.470130 only

 Includes seals

 Nur Zylinderblock Nr.470130

 Schließt Dichtungen ein

 Bloc-cylindres no.470130 seulement

 Inclut des joints

 Bloque de cilindro no.470130 unicamente

 Incluye los sellos

 Solamente per motori Nr.470130

 Comprende le guarnizioni



36 130.175

TD120F	6 Cyl.	14.2:1	11980cc	265kW (360PS)	Diesel Turbo Intercooled	TD9174
TD120FC	6 Cyl.	14.2:1	11980cc	265kW (360PS)	Diesel Turbo Intercooled	TD9175
TD120G	6 Cyl.	14.2:1	11980cc	226-243kW (307-330PS)	Diesel Turbo	TD9177
TD120GA	6 Cyl.	14.2:1	11980cc	227kW (308PS)	Diesel Turbo	TD9178
TD121F	6 Cyl.	14.2:1	11980cc	272-283kW (370-385PS)	Diesel Turbo Intercooled	TD9179
TD121FD	6 Cyl.	14.2:1	11980cc	283kW (385PS)	Diesel Turbo Intercooled	TD9180
TD121G	6 Cyl.	14.8:1	11980cc	235-243kW (320-330PS)	Diesel Turbo	TD9183
TD121GD	6 Cyl.	14.2:1	11980cc	243kW (330PS)	Diesel Turbo	TD9143
TD122KBE	6 Cyl.	14.2:1	11980cc	226-265kW (307-360PS)	Diesel Turbo Intercooled	TD23340



87-405600-70 STD

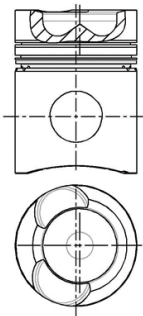

A 114.25
B- 27.81
BØ 79.00
C 2.64
C 2.64
D 175.21
 55x114

RT



08-405600-10 STD

2.38  CR P
 3.16  CR P
 4.74  CR P

15-457960-00 WH   **B** 143.89 **C** 311.00 **D** 157.62 **E** 10.55 **F** 0.86
15-459030-00 WH  **B** 143.91 **C** 310.52 **D** 157.58 **E** 13.55 **F** 0.68

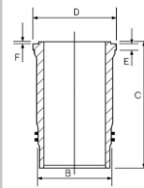

89-405600-80
 87-405600-70 +
 15-457960-00

89-405600-70
 87-405600-70 +
 15-459030-00

15-458840-00 WH  **B** 143.85 **C** 313.25 **D** 157.62 **E** 10.52 **F** 3.25

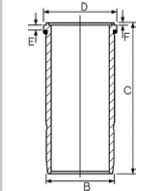

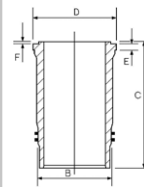

14-450530-00 WH  **B** 144.00 **C** 311.00 **D** 157.60 **E** 13.52 **F** 0.76
14-456000-00 WH **B** 144.00 **C** 311.00 **D** 157.60 **E** 10.52 **F** 0.76



 Phosphated

 For cylinder block no.470130 only

 Includes seals

 Phosphated

 Nur Zylinderblock Nr.470130

 Schließt Dichtungen ein

 Phosphated

 Bloc-cylindres no.470130 seulement

 Inclut des joints

 Phosphated

 Bloque de cilindro no.470130 unicamente

 Incluye los sellos

 Phosphated

 Solamente per motori Nr.470130

 Comprende le guarnizioni

37 130.175

TD120FA	6 Cyl.	14.2:1	11980cc	213kW (290PS)	Diesel Turbo Intercooled	TD9254
TD120FB	6 Cyl.	14.2:1	11980cc	226-265kW (307-360PS)	Diesel Turbo Intercooled	TD9255
TD120FTQ	6 Cyl.	14.2:1	11980cc	220kW (299PS)	Diesel Turbo Intercooled	TD9176
TD121FH	6 Cyl.	14.2:1	11980cc	232kW (315PS)	Diesel Turbo Intercooled	TD9181
TD121FK	6 Cyl.	14.2:1	11980cc	280kW (381PS)	Diesel Turbo Intercooled	TD9182
TD122ED	6 Cyl.	16:1	11980cc	300-310kW (408-422PS)	Diesel Turbo Intercooled	TD9185
TD122FA	6 Cyl.	16:1	11980cc	272kW (370PS)	Diesel Turbo	FM5142
TD122FAQ	6 Cyl.	16:1	11980cc	287kW (390PS)	Diesel Turbo Intercooled	TD9188
TD122FBQ	6 Cyl.	16:1	11980cc	287kW (390PS)	Diesel Turbo Intercooled	TD9189
TD122FCQ	6 Cyl.	16:1	11980cc	287kW (390PS)	Diesel Turbo Intercooled	TD9190



TD122FH Euro 1	6 Cyl.	16:1	11980cc	262kW (356PS)	Diesel Turbo Intercooled	TD9122
TD122FL	6 Cyl.	16:1	11980cc	291kW (396PS)	Diesel Turbo Intercooled	TD9123

15-458840-00 WH ② B 143.85 C 313.25 D 157.62 E 10.52 F 3.25

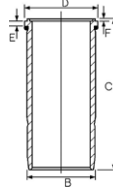

14-456000-00 WH B 144.00 C 311.00 D 157.60 E 10.52 F 0.76

14-458180-00 WH B 143.88 C 313.00 D 157.62 E 10.52 F 3.28

15-457960-00 WH ① ② B 143.89 C 311.00 D 157.62 E 10.55 F 0.86

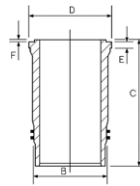

① For cylinder block no.470130 only

① Nur Zylinderblock Nr.470130

① Bloc-cylindres no.470130 seulement

① Bloque de cilindro no.470130 unicamente

① Solamente per motori Nr.470130

② Includes seals

② Schließt Dichtungen ein

② Inclut des joints

② Incluye los sellos

② Comprende le guarnizioni

38 130.175

TD122	6 Cyl.	15:1	11980cc	309kW (420PS)	Diesel Turbo Intercooled	TD9184
TD122F	6 Cyl.	15:1	11980cc	257-262kW (350-356PS)	Diesel Turbo	TD9186
TD122FA	6 Cyl.	16:1	11980cc	272kW (370PS)	Diesel Turbo	TD9187
TD122FK	6 Cyl.	15:1	11980cc	287-291kW (390-396PS)	Diesel Turbo Intercooled	TD9191
TD122FR	6 Cyl.	15:1	11980cc	262-291kW (356-396PS)	Diesel Turbo Intercooled	TD9193
TD122FS	6 Cyl.	15:1	11980cc	287-291kW (395-396PS)	Diesel Turbo Intercooled	TD9194
TD122KE	6 Cyl.	15:1	11980cc	290kW (394PS)	Diesel Turbo Intercooled	TD23339

87-405600-60 STD

STD

08-405600-10 STD

STD

15-458840-00 WH ③ B 143.85 C 313.25 D 157.62 E 10.52 F 3.25

89-405600-60
87-405600-60 +
15-458840-00

A 114.20
B- 25.40
BØ 79.00
C 2.60
D 175.20
 55x114

2.38
3.16
4.74



CR P
CR P
CR P

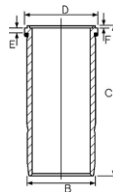

RT

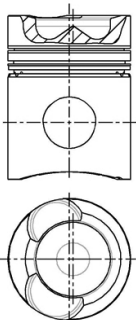

14-450530-00 WH ① B 144.00 C 311.00 D 157.60 E 13.52 F 0.76

14-456000-00 WH B 144.00 C 311.00 D 157.60 E 10.52 F 0.76

14-458180-00 WH B 143.88 C 313.00 D 157.62 E 10.52 F 3.28

15-457960-00 WH ② ③ B 143.89 C 311.00 D 157.62 E 10.55 F 0.86

15-459030-00 WH ③ B 143.91 C 310.52 D 157.58 E 13.55 F 0.68

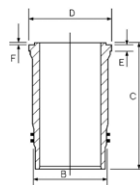

① Phosphated

① Phosphated

① Phosphated

① Phosphated

① Phosphated

② For cylinder block no.470130 only

② Nur Zylinderblock Nr.470130

② Bloc-cylindres no.470130 seulement

② Bloque de cilindro no.470130 unicamente

② Solamente per motori Nr.470130

③ Includes seals

③ Schließt Dichtungen ein

③ Inclut des joints

③ Incluye los sellos

③ Comprende le guarnizioni



39 130.175

TID121B	6 Cyl.	13.3:1	11979cc	217-305kW (295-415PS)	Diesel Turbo Intercooled	FM26267
TID121KG	6 Cyl.	13.3:1	11979cc	217-305kW (295-415PS)	Diesel Turbo Intercooled	FM36267
TID121KP	6 Cyl.	13.3:1	11979cc	217-305kW (295-415PS)	Diesel Turbo Intercooled	FM46267
TID121LG	6 Cyl.	13.3:1	11979cc	217-305kW (295-415PS)	Diesel Turbo Intercooled	FM6267
TID121LP	6 Cyl.	13.3:1	11979cc	217-305kW (295-415PS)	Diesel Turbo Intercooled	FM16267
TID121P	6 Cyl.	13.3:1	11979cc	217-305kW (295-415PS)	Diesel Turbo Intercooled	FM56267
TWD121G	6 Cyl.	13.3:1	11979cc	217-305kW (295-415PS)	Diesel Turbo Intercooled	FM66267

87-501300-00

STD

A 114.20
B- 27.00
BØ 83.00
C 2.50
D 172.20
 55x114

RT

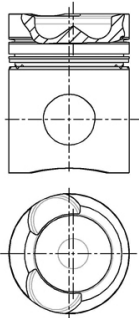



08-501300-00

STD

3.50
 3.16
 4.74



MO P
 CR P
 CR P

15-457960-00 WH   **B** 143.89 **C** 311.00 **D** 157.62 **E** 10.55 **F** 0.86

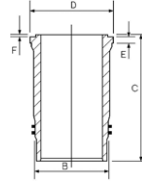



89-501300-00
 87-501300-00 +
 15-457960-00

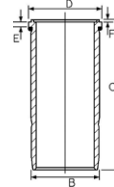

15-458840-00 WH  **B** 143.85 **C** 313.25 **D** 157.62 **E** 10.52 **F** 3.25

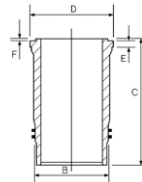





14-456000-00 WH **B** 144.00 **C** 311.00 **D** 157.60 **E** 10.52 **F** 0.76





 For cylinder block no.470130 only
 Includes seals

 Nur Zylinderblock Nr.470130
 Schließt Dichtungen ein

 Bloc-cylindres no.470130 seulement
 Inclut des joints

 Bloque de cilindro no.470130 unicamente
 Incluye los sellos

 Solamente per motori Nr.470130
 Comprende le guarnizioni

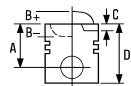





40 131.00

D12 Euro 2 6 Cyl. 18:1 **12100cc** **250-279kW (340-380PS)** **Diesel Turbo Intercooled** **FM8973**

87-123200-00 STD **08-123200-00** STD **14-450160-00 WH** B 150.30 C 276.40 D 159.50 E 11.20 F 3.60 **89-123200-30**
87-123200-00 +
14-450160-00

A 87.22
B- 17.10
BØ 88.95
D 137.45
 55x107

4.00  CK P
3.00  P
4.00  NT 

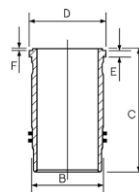



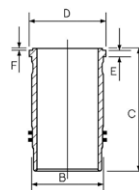

15-450160-00 WH  B 150.32 C 276.42 D 159.50 E 11.21 F 3.62

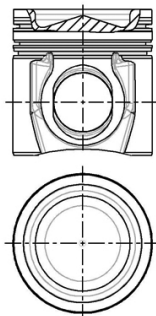





RT TP





 Includes seals
 Steel

 Schließt Dichtungen ein
 Stahl

 Inclut des joints
 Acier

 Incluye los sellos
 Acero

 Comprende le guarnizioni
 Acciaio

41 131.00





D12A340 Euro 2 6 Cyl. 17.5:1 **12100cc** **250kW (340PS)** **Diesel Turbo Intercooled** **TD11727**

D12A380 Euro 2 6 Cyl. 17.5:1 **12110cc** **279kW (380PS)** **Diesel Turbo Intercooled** **TD9215**

D12A420 Euro 2 6 Cyl. 17.5:1 **12100cc** **309kW (420PS)** **Diesel Turbo Intercooled** **TD9216**

87-123200-40  STD **08-123200-00** STD **14-450160-00 WH** B 150.30 C 276.40 D 159.50 E 11.20 F 3.60 **89-123200-40**
87-123200-40 +
14-450160-00

A 87.40
B- 19.72
BØ 86.00
D 129.40
 55x107

4.00  CK P
3.00  P
4.00  NT 

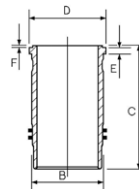



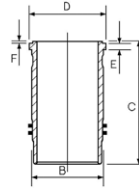

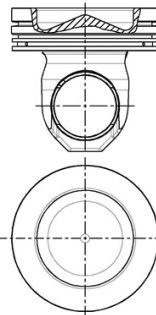

15-450160-00 WH  B 150.32 C 276.42 D 159.50 E 11.21 F 3.62









AK NB TP





 Includes seals
 Articulated piston
 Steel

 Schließt Dichtungen ein
 Pendelschaftkolben
 Stahl

 Inclut des joints
 Piston articulé
 Acier

 Incluye los sellos
 Pistón articulado
 Acero

 Comprende le guarnizioni
 Pistone articolato
 Acciaio



42  **131.00**



D12C380	6 Cyl.	18.5:1	12100cc	279kW (380PS)	Diesel Turbo Intercooled	TD11728
D12C340 Euro 2	6 Cyl.		12100cc	250kW (340PS)	Diesel Turbo Intercooled	TD11731
D12C420	6 Cyl.	18.5:1	12100cc	309kW (420PS)	Diesel Turbo Intercooled	TD11729
D12C460	6 Cyl.	18.5:1	12100cc	338kW (460PS)	Diesel Turbo Intercooled	TD11730
D12D340 Euro 3	6 Cyl.	18.2:1	12100cc	250kW (340PS)	Diesel Turbo Intercooled	TD16784
D12D380 Euro 3	6 Cyl.	18.2:1	12100cc	279kW (379PS)	Diesel Turbo Intercooled	TD16785
D12D420 Euro 3	6 Cyl.	18.1:1	12100cc	309kW (420PS)	Diesel Turbo Intercooled	TD16786
D12D460 Euro 3	6 Cyl.	18.1:1	12100cc	338kW (460PS)	Diesel Turbo Intercooled	TD16787
D12D500 Euro 3	6 Cyl.	18.1:1	12100cc	368kW (500PS)	Diesel Turbo Intercooled	TD16508
DH12D420 Euro 3	6 Cyl.	18.1:1	12100cc	309kW (420PS)	Diesel Turbo Intercooled	TD16513

87-123200-10  STD



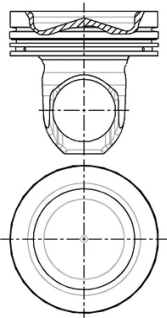

A 87.40
B- 17.21
BØ 89.00
D 125.70
 55x107



AK TP



-  Includes seals
-  Articulated piston
-  Steel

08-123200-00 STD

4.00 
 3.00 
 4.00  CK P
 P
 NT 

-  Schließt Dichtungen ein
-  Pendelschaftkolben
-  Stahl



14-450160-00 WH B 150.30 C 276.40 D 159.50 E 11.20 F 3.60

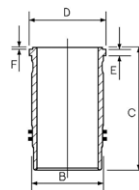

15-450160-00 WH  B 150.32 C 276.42 D 159.50 E 11.21 F 3.62

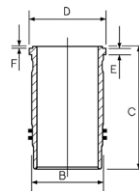



14-450590-00 WH B 144.00 C 272.80 D 159.60 E 11.20 F 0.90



-  Inclut des joints
-  Piston articulé
-  Acier

-  Incluye los sellos
-  Pistón articulado
-  Acero

-  Comprende le guarnizioni
-  Pistone articolato
-  Acciaio



43 131.00

D13A360 Euro 5	6 Cyl.	18.1:1	12800cc	264kW (360PS)	Diesel Turbo Intercooled	TD18826
D13A400 Euro 5	6 Cyl.	18.1:1	12800cc	294kW (400PS)	Diesel Turbo Intercooled	TD18827
D13A440 Euro 5	6 Cyl.	18.1:1	12800cc	324kW (440PS)	Diesel Turbo Intercooled	TD18828
D13A480 Euro 5	6 Cyl.	18.1:1	12800cc	353kW (480PS)	Diesel Turbo Intercooled	TD18829

87-434400-00 STD **08-434400-00** STD **14-451190-00 W** **B 144.00 C 261.80 D 159.60 E 11.20 F 0.90** **89-434400-00**

A 84.15
B- 18.20
BØ 89.00
D 30.70
 58x104

3.50
 2.50
 3.00

NT PVD
 CR
 NT

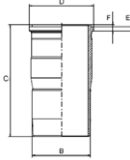

87-434400-00 +
 14-451190-00

AK KK RT

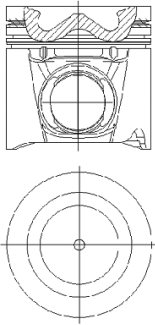

Steel

Stahl

Acier

Acero

Acciaio

44 131.00

D13C380 Euro 5	6 Cyl.	17.8:1	12800cc	280-285kW (380-388PS)	Diesel Turbo Intercooled	TD22378
D13C420 Euro 5	6 Cyl.	17.8:1	12800cc	309kW (420PS)	Diesel Turbo Intercooled	TD22150
D13C460 Euro 5	6 Cyl.	17.8:1	12800cc	338kW (460PS)	Diesel Turbo Intercooled	TD22151
D13C500 Euro 5	6 Cyl.	17.8:1	12800cc	368kW (500PS)	Diesel Turbo Intercooled	TD22152
D13C540 Euro 5	6 Cyl.		12800cc	397kW (540PS)	Diesel Turbo Intercooled	TD22153

87-434400-10 STD **08-434400-00** STD **14-451190-00 W** **B 144.00 C 261.80 D 159.60 E 11.20 F 0.90** **89-434400-10**

A 75.88
B- 18.10
BØ 89.00
D 112.90
 58x76

3.50
 2.50
 3.00

NT PVD
 CR
 NT

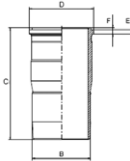

87-434400-10 +
 14-451190-00

KK

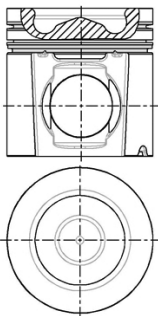

MonoSteel®

MonoSteel®

MonoSteel®

MonoSteel®

MonoSteel®

Steel

Stahl

Acier

Acero

Acciaio

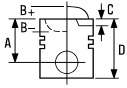

45 131.00

DH12D340 Euro 3 6 Cyl. 18.2:1 **12100cc** **250kW (340PS)** **Diesel Turbo Intercooled** **TD16511**

14-450160-00 WH B 150.30 C 276.40 D 159.50 E 11.20 F 3.60
15-450160-00 WH  B 150.32 C 276.42 D 159.50 E 11.21 F 3.62

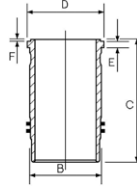

 Includes seals

 Schließt Dichtungen ein

 Inclut des joints

 Incluye los sellos

 Comprende le guarnizioni

46 144.00

D16A 6 Cyl. 17.5:1 **16123cc** **346-382kW (470-520PS)** **Diesel Turbo Intercooled** **TD9217**

D16A470 Euro 2 6 Cyl. 17.5:1 **16120cc** **346kW (470PS)** **Diesel Turbo Intercooled** **TD17534**

D16A520 6 Cyl. 17.5:1 **16120cc** **382kW (520PS)** **Diesel Turbo Intercooled** **TD11767**

D16B520 6 Cyl. 17.5:1 **16120cc** **382kW (520PS)** **Diesel Turbo Intercooled** **TD11768**

TD163ES 6 Cyl. 17.5:1 **16123cc** **368kW (500PS)** **Diesel Turbo Intercooled** **TD9200**



87-101100-10 STD

08-101100-00 STD

15-451030-00 WH  B 158.95 C 315.00 D 171.95 E 13.09 F 2.00

89-101100-10

A 110.50
B- 28.70
BØ 80.00
C 1.65
D 163.50
 60x115

4.50  MOL P
 3.50  P
 5.00  CR P

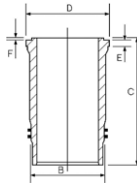

87-101100-10 +
 15-451030-00

HA KK NB RT TP

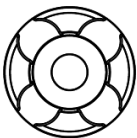
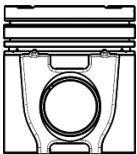

 Includes seals

 Schließt Dichtungen ein

 Inclut des joints





 Incluye los sellos

 Comprende le guarnizioni



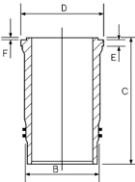

47  **144.00**

TAD1630G/GE/P	6 Cyl.	15:1	16120cc	360-440kW (490-598PS)	Diesel Turbo Intercooled	FM56336
TAD1631G	6 Cyl.	15:1	16120cc	430-585kW (537-730PS)	Diesel Turbo Intercooled	FM46336
TWD1630G/P	6 Cyl.	15:1	16120cc	329-440kW (447-598PS)	Diesel Turbo Intercooled	FM36336

87-101100-00	STD	08-101100-00	STD	15-451030-00 <i>WH</i>  B 158.95 C 315.00 D 171.95 E 13.09 F 2.00	89-101100-00
A 110.50		4.50	 MOL P		87-101100-00 +
B- 33.43		3.50	P		15-451030-00
BØ 88.00		5.00	 CR P		
C 1.65					
D 163.50					
 60x115					

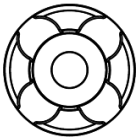
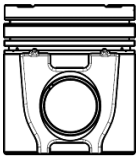
KK RT TP



 Includes seals

 Schließt Dichtungen ein

 Inclut des joints

 Incluye los sellos

 Comprende le guarnizioni

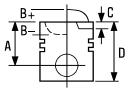

1 70.80

10 1.2 60

10/05 →

188 A4.000

4 Cyl.
1242cc

9.5:1
44kW (60PS)

TD24580

87-138400-40 STD
87-138406-40 0.40mm

08-138400-00 STD
08-138406-00 0.40mm
08-138408-00 0.60mm

14-021080-00 D B 73.80 C 128.00 D 75.00 E 5.00

A 28.00
B- 1.80
C 1.10
D 48.00
 18x53

1.19
1.20
2.50



NT P
P
P

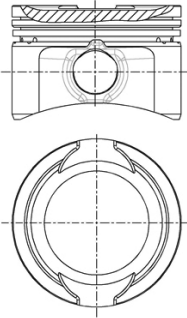
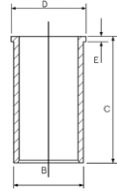

2 72.00

Koral 1.1

10/02 → 11/08 TU1JP

4 Cyl.
1124cc

10.2:1
44kW (60PS)

TD26420

87-426300-00 STD

08-426300-00 STD

A 27.70
B+ 0.10
D 47.50
 18x55

1.50
1.50
2.50



NT
P
P

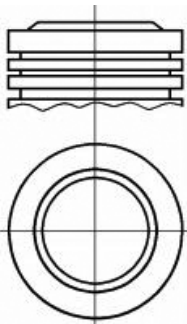

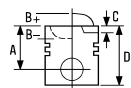

3 80.00

101 1.1 Yugo 55	06/73→01/90 04/80→06/95	128 A.000	4 Cyl. 1116cc	8.8:1 37-47kW (50-64PS)	TD4183
--------------------	----------------------------	-----------	------------------	----------------------------	--------

101 1.1 Koral 1.1	05/75→12/93 10/02→11/08	128 A.064	4 Cyl. 1116cc	9.2:1 40-45kW (54-61PS)	TD9409
----------------------	----------------------------	-----------	------------------	----------------------------	--------

101 1.1 Super	07/79→09/81	128 AC 5000	4 Cyl. 1116cc	9.2:1 47kW (64PS)	TD5045
---------------	-------------	-------------	------------------	----------------------	--------

87-203100-00	STD	08-203100-00	STD
87-203106-00	0.40mm	08-203104-00	0.20mm
87-203108-00	0.60mm	08-203106-00	0.40mm
		08-203108-00	0.60mm
A	35.05	08-203110-00	0.80mm
B+	0.60	08-203111-00	1.00mm
D	77.05		

22x71

1.50		CR P
2.00		P
3.94		P

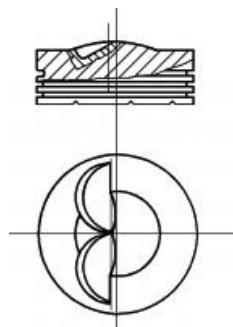

4 80.50

Yugo Florida 1.4	10/88→06/95	160 A1.000	4 Cyl. 1372cc	9.2:1 52kW (71PS)	TD21694
------------------	-------------	------------	------------------	----------------------	---------

87-783600-00	STD	08-783600-00	STD
87-783606-00	0.40mm	08-783606-00	0.40mm
87-783608-00	0.60mm	08-783608-00	0.60mm
		08-783610-00	0.80mm
A	33.30	08-783611-00	1.00mm
B-	2.90		
D	65.00		

22x58

1.50		CR P
1.75		P
3.00		CR

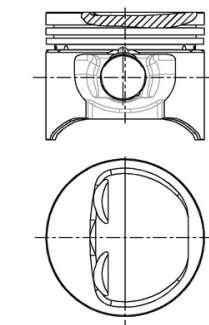

Steel

Stahl







Acier







Acero

Acciaio

NUMERICAL PARTS LIST







Numerische Teilenummernliste • Elenco riferimenti
Liste des références produits







   9				   9			
87-100100-00 STD	FORD TRACTOR	388	9	87-103900-00 STD	IVECO	457	34
87-101100-00 STD	VOLVO COMMERCIAL	1374	47	87-103900-10 STD	IVECO	458	35
87-101100-10 STD	VOLVO COMMERCIAL	1373	46	87-103900-30 STD	IVECO	459	36
87-101300-00 STD	SEAT	1086	2	87-103900-40 STD	IVECO	455	32
87-101300-00 STD	VOLKSWAGEN	1256	1	87-103908-00 0.60mm	IVECO	457	34
87-101307-00 0.50mm	SEAT	1086	2	87-103908-40 0.60mm	IVECO	455	32
87-101307-00 0.50mm	VOLKSWAGEN	1256	1	87-104000-00 STD	CITROEN	149	20
87-101500-00 STD	NISSAN	819	9	87-104000-00 STD	FIAT	265	46
87-101500-00 STD	OPEL	853	29	87-104000-00 STD	PEUGEOT	915	22
87-101500-00 STD	RENAULT	991	33	87-104008-00 0.60mm	CITROEN	149	20
87-101500-00 STD	VAUXHALL	1228	30	87-104008-00 0.60mm	FIAT	265	46
87-101500-00 STD	VOLVO CARS	1338	12	87-104008-00 0.60mm	PEUGEOT	915	22
87-101507-00 0.50mm	NISSAN	819	9	87-104100-00 STD	NISSAN	813	2
87-101507-00 0.50mm	OPEL	853	29	87-104100-00 STD	RENAULT	957	3
87-101507-00 0.50mm	RENAULT	991	33	87-104105-00 0.25mm	NISSAN	813	2
87-101507-00 0.50mm	VAUXHALL	1228	30	87-104105-00 0.25mm	RENAULT	957	3
87-101507-00 0.50mm	VOLVO CARS	1338	12	87-104107-00 0.50mm	NISSAN	813	2
87-101600-00 STD	RENAULT	1005	44	87-104107-00 0.50mm	RENAULT	957	3
87-101700-00 STD	PERKINS	892	19	87-104200-00 STD	DACIA	185	9
87-101700-10 STD	PERKINS	892	19	87-104200-00 STD	RENAULT	983	27
87-102300-00 STD	FORD EUROPE	315	11	87-104200-10 STD	DACIA	185	9
87-102307-00 0.50mm	FORD EUROPE	315	11	87-104200-10 STD	RENAULT	984	27
87-102700-00 STD	OPEL	834	4	87-104200-30 STD	DACIA	184	7
87-102700-00 STD	VAUXHALL	1213	5	87-104200-30 STD	NISSAN	818	8
87-102700-10 STD	CHEVROLET	121	2	87-104200-30 STD	RENAULT	982	25
87-102700-10 STD	OPEL	834	5	87-104200-40 STD	DACIA	184	8
87-102700-10 STD	VAUXHALL	1213	6	87-104200-40 STD	RENAULT	982	26
87-102707-00 0.50mm	OPEL	834	4	87-104207-00 0.50mm	DACIA	185	9
87-102707-00 0.50mm	VAUXHALL	1213	5	87-104207-00 0.50mm	RENAULT	983	27
87-102707-10 0.50mm	CHEVROLET	121	2	87-104207-10 0.50mm	DACIA	185	9
87-102707-10 0.50mm	OPEL	834	5	87-104207-10 0.50mm	RENAULT	984	27
87-102707-10 0.50mm	VAUXHALL	1213	6	87-104207-40 0.50mm	DACIA	184	8
87-102800-10 STD	OPEL	864	43	87-104207-40 0.50mm	RENAULT	982	26
87-102800-10 STD	VAUXHALL	1237	43	87-104300-00 STD	MAN	629	40
87-102807-10 0.50mm	OPEL	864	43	87-104300-10 STD	MAN	629	40
87-102807-10 0.50mm	VAUXHALL	1237	43	87-105500-00 STD	CITROEN	155	27
87-102900-10 STD	OPEL	864	42	87-105500-00 STD	FIAT	274	58
87-102900-10 STD	VAUXHALL	1237	42	87-105500-00 STD	LADA	513	6
87-102907-10 0.50mm	OPEL	864	42	87-105500-00 STD	PEUGEOT	921	27
87-102907-10 0.50mm	VAUXHALL	1237	42	87-105500-00 STD	SUZUKI	1185	7
87-103000-00 STD	AUDI	43	8	87-105507-00 0.50mm	CITROEN	155	27
87-103000-00 STD	VOLKSWAGEN	1272	15	87-105507-00 0.50mm	FIAT	274	58
87-103000-10 STD	AUDI	43	8	87-105507-00 0.50mm	LADA	513	6
87-103000-10 STD	VOLKSWAGEN	1272	15	87-105507-00 0.50mm	PEUGEOT	921	27
87-103000-30 STD	AUDI	44	9	87-105507-00 0.50mm	SUZUKI	1185	7
87-103000-30 STD	SKODA	1139	9	87-105900-00 STD	AUDI	63	22
87-103000-30 STD	VOLKSWAGEN	1273	16	87-105900-00 STD	AUDI	66	25
87-103000-40 STD	AUDI	45	9	87-105900-00 STD	SEAT	1114	26
87-103000-40 STD	SKODA	1139	9	87-105900-00 STD	SKODA	1153	18
87-103000-40 STD	VOLKSWAGEN	1273	16	87-105900-00 STD	VOLKSWAGEN	1302	33
87-103200-00 STD	DEUTZ KHD	208	1	87-105900-00 STD	VOLKSWAGEN	1305	36
87-103207-00 0.50mm	DEUTZ KHD	208	1	87-105907-00 0.50mm	AUDI	63	22
87-103500-00 STD	NISSAN	819	9	87-105907-00 0.50mm	AUDI	66	25
87-103500-00 STD	RENAULT	987	30	87-105907-00 0.50mm	SEAT	1114	26
87-103500-00 STD	VOLVO CARS	1337	11	87-105907-00 0.50mm	SKODA	1153	18
87-103500-00 STD	VOLVO CARS	1338	13	87-105907-00 0.50mm	VOLKSWAGEN	1302	33
87-103507-00 0.50mm	NISSAN	819	9	87-105907-00 0.50mm	VOLKSWAGEN	1305	36
87-103507-00 0.50mm	RENAULT	987	30	87-107000-00 STD	FORD EUROPE	336	32
87-103507-00 0.50mm	VOLVO CARS	1337	11	87-107000-10 STD	FORD EUROPE	337	33
87-103507-00 0.50mm	VOLVO CARS	1338	13	87-107000-10 STD	FORD EUROPE	338	34
87-103800-00 STD	CITROEN	147	16	87-107007-00 0.50mm	FORD EUROPE	336	32
87-103800-00 STD	PEUGEOT	912	17	87-107007-10 0.50mm	FORD EUROPE	337	33
87-103806-00 0.50mm	CITROEN	147	16	87-107007-10 0.50mm	FORD EUROPE	338	34
87-103806-00 0.50mm	PEUGEOT	912	17	87-107011-10 1.00mm	FORD EUROPE	337	33

			9				9
87-107011-10 1.00mm	FORD EUROPE	338	34	87-109511-00 1.00mm	VOLKSWAGEN	1271	14
87-107100-30 STD	ALFA ROMEO	20	24	87-109511-00 1.00mm	VOLVO CARS	1335	8
87-107100-40 STD	ALFA ROMEO	22	27	87-109707-00 0.50mm	AUDI	71	29
87-107200-00 STD	PERKINS	886	10	87-109707-00 0.50mm	VOLKSWAGEN	1308	39
87-107200-00 STD	VOLVO COMMERCIAL	1348	7	87-109707-10 0.50mm	AUDI	61	20
87-107200-10 STD	PERKINS	886	10	87-109707-10 0.50mm	SEAT	1113	25
87-107200-10 STD	VOLVO COMMERCIAL	1348	7	87-109707-10 0.50mm	VOLKSWAGEN	1299	31
87-107209-00 .030	PERKINS	886	10	87-109707-20 0.50mm	ARO	32	5
87-107209-00 .030	VOLVO COMMERCIAL	1348	7	87-109707-20 0.50mm	AUDI	62	21
87-107600-00 STD	FORD EUROPE	357	54	87-109707-20 0.50mm	SEAT	1111	23
87-107607-00 0.50mm	FORD EUROPE	357	54	87-109707-20 0.50mm	VOLKSWAGEN	1296	29
87-107900-00 STD	FIAT	261	41	87-109800-10 STD	AUDI	42	7
87-107900-00 STD	LANCIA	532	25	87-109800-10 STD	VOLKSWAGEN	1269	13
87-107908-00 0.60mm	FIAT	261	41	87-109800-10 STD	VOLVO CARS	1336	9
87-107908-00 0.60mm	LANCIA	532	25	87-109807-10 0.50mm	AUDI	42	7
87-108000-00 STD	ALFA ROMEO	15	17	87-109807-10 0.50mm	VOLKSWAGEN	1269	13
87-108000-00 STD	FIAT	259	39	87-109807-10 0.50mm	VOLVO CARS	1336	9
87-108000-00 STD	LANCIA	530	23	87-109811-10 1.00mm	AUDI	42	7
87-108008-00 0.60mm	ALFA ROMEO	15	17	87-109811-10 1.00mm	VOLKSWAGEN	1269	13
87-108008-00 0.60mm	FIAT	259	39	87-109811-10 1.00mm	VOLVO CARS	1336	9
87-108008-00 0.60mm	LANCIA	530	23	87-110100-00 STD	ALFA ROMEO	25	32
87-108200-00 STD	CITROEN	172	50	87-110100-00 STD	CHRYSLER	130	3
87-108200-00 STD	FIAT	298	92	87-110100-00 STD	FORD EUROPE	367	67
87-108200-00 STD	IVECO	441	17	87-110100-00 STD	OPEL	876	57
87-108200-00 STD	PEUGEOT	943	56	87-110100-00 STD	ROVER	1056	21
87-108200-00 STD	RENAULT TRUCKS	1025	5	87-110100-00 STD	VAUXHALL	1247	56
87-108208-00 0.60mm	CITROEN	172	50	87-110100-00 STD	VM	1249	1
87-108208-00 0.60mm	FIAT	298	92	87-110200-30 STD	ALFA ROMEO	23	28
87-108208-00 0.60mm	IVECO	441	17	87-110200-40 STD	ALFA ROMEO	22	26
87-108208-00 0.60mm	PEUGEOT	943	56	87-110900-00 STD	ALFA ROMEO	18	21
87-108208-00 0.60mm	RENAULT TRUCKS	1025	5	87-110906-00 0.40mm	ALFA ROMEO	18	21
87-109100-00 STD	DAEWOO	191	3	87-111900-00 STD	KIA	506	8
87-109100-00 STD	MERCEDES-BENZ	690	38	87-111900-00 STD	MAZDA	642	9
87-109100-00 STD	MERCEDES-BENZ	692	40	87-112400-00 STD	CITROEN	167	43
87-109100-00 STD	SSANGYONG	1173	7	87-112400-00 STD	PEUGEOT	937	47
87-109100-10 STD	DAEWOO	191	3	87-112407-00 0.50mm	CITROEN	167	43
87-109100-10 STD	MERCEDES-BENZ	690	38	87-112407-00 0.50mm	PEUGEOT	937	47
87-109100-10 STD	MERCEDES-BENZ	691	39	87-113500-00 STD	FORD EUROPE	357	55
87-109100-10 STD	SSANGYONG	1173	7	87-113500-10 STD	FORD EUROPE	358	56
87-109107-00 0.50mm	DAEWOO	191	3	87-113507-00 0.50mm	FORD EUROPE	357	55
87-109107-00 0.50mm	MERCEDES-BENZ	690	38	87-113507-10 0.50mm	FORD EUROPE	358	56
87-109107-00 0.50mm	MERCEDES-BENZ	692	40	87-113511-00 1.00mm	FORD EUROPE	357	55
87-109107-00 0.50mm	SSANGYONG	1173	7	87-113511-10 1.00mm	FORD EUROPE	358	56
87-109107-10 0.50mm	DAEWOO	191	3	87-114400-00 STD	BMW	109	10
87-109107-10 0.50mm	MERCEDES-BENZ	690	38	87-114400-00 STD	LAND ROVER	550	5
87-109107-10 0.50mm	MERCEDES-BENZ	691	39	87-114400-00 STD	ROVER	1050	14
87-109107-10 0.50mm	SSANGYONG	1173	7	87-114400-10 STD	BMW	112	13
87-109200-00 STD	SCANIA	1070	9	87-114400-10 STD	LAND ROVER	550	6
87-109400-50 STD	AUDI	70	28	87-114400-30 STD	BMW	108	9
87-109400-50 STD	SEAT	1112	24	87-114400-40 STD	BMW	112	12
87-109400-50 STD	VOLKSWAGEN	1298	30	87-114400-40 STD	BMW	113	14
87-109407-50 0.50mm	AUDI	70	28	87-114400-60 STD	BMW	110	11
87-109407-50 0.50mm	SEAT	1112	24	87-114400-60 STD	BMW	113	14
87-109407-50 0.50mm	VOLKSWAGEN	1298	30	87-114400-65 STD	BMW	110	11
87-109500-00 STD	AUDI	41	6	87-114405-00 0.25mm	BMW	109	10
87-109500-00 STD	VOLKSWAGEN	1271	14	87-114405-00 0.25mm	LAND ROVER	550	5
87-109500-00 STD	VOLVO CARS	1335	8	87-114405-00 0.25mm	ROVER	1050	14
87-109505-00 0.25mm	AUDI	41	6	87-114405-10 0.25mm	BMW	112	13
87-109505-00 0.25mm	VOLKSWAGEN	1271	14	87-114405-10 0.25mm	LAND ROVER	550	6
87-109505-00 0.25mm	VOLVO CARS	1335	8	87-114405-30 0.25mm	BMW	108	9
87-109507-00 0.50mm	AUDI	41	6	87-114405-40 0.25mm	BMW	112	12
87-109507-00 0.50mm	VOLKSWAGEN	1271	14	87-114405-40 0.25mm	BMW	113	14
87-109507-00 0.50mm	VOLVO CARS	1335	8	87-114405-60 0.25mm	BMW	110	11
87-109511-00 1.00mm	AUDI	41	6	87-114405-60 0.25mm	BMW	113	14

NUMERICAL PARTS LIST







Nummerische Teilenummernliste • Elenco riferimenti
Liste des références produits







   9				   9			
87-114700-00 STD	CITROEN	156	29	87-114900-45 STD	VOLKSWAGEN	1290	25
87-114700-00 STD	FIAT	281	67	87-114900-45 STD	VOLKSWAGEN	1292	27
87-114700-00 STD	LANCIA	544	38	87-114900-46 STD	AUDI	57	16
87-114700-00 STD	PEUGEOT	925	31	87-114900-46 STD	FORD EUROPE	325	20
87-114700-00 STD	SUZUKI	1187	10	87-114900-46 STD	SEAT	1107	20
87-114700-10 STD	CITROEN	157	30	87-114900-46 STD	SKODA	1148	14
87-114700-10 STD	FIAT	282	68	87-114900-46 STD	VOLKSWAGEN	1290	25
87-114700-10 STD	LANCIA	542	35	87-114900-46 STD	VOLKSWAGEN	1293	27
87-114700-10 STD	PEUGEOT	926	32	87-114900-55 STD	AUDI	52	13
87-114700-10 STD	SUZUKI	1186	9	87-114900-55 STD	AUDI	58	18
87-114700-30 STD	CITROEN	163	36	87-114900-55 STD	FORD EUROPE	323	18
87-114700-30 STD	FIAT	280	66	87-114900-55 STD	SEAT	1109	21
87-114700-30 STD	LANCIA	543	36	87-114900-55 STD	VOLKSWAGEN	1283	22
87-114700-30 STD	PEUGEOT	931	37	87-114900-56 STD	AUDI	52	13
87-114700-40 STD	CITROEN	158	31	87-114900-56 STD	AUDI	59	18
87-114700-40 STD	FIAT	282	69	87-114900-56 STD	FORD EUROPE	323	18
87-114700-40 STD	LANCIA	543	37	87-114900-56 STD	SEAT	1109	21
87-114700-40 STD	PEUGEOT	927	33	87-114900-56 STD	VOLKSWAGEN	1284	22
87-114708-00 0.60mm	CITROEN	156	29	87-114900-60 STD	AUDI	47	11
87-114708-00 0.60mm	FIAT	281	67	87-114900-60 STD	FORD EUROPE	320	17
87-114708-00 0.60mm	LANCIA	544	38	87-114900-60 STD	SEAT	1097	14
87-114708-00 0.60mm	PEUGEOT	925	31	87-114900-60 STD	SKODA	1141	11
87-114708-00 0.60mm	SUZUKI	1187	10	87-114900-60 STD	VOLKSWAGEN	1277	18
87-114708-10 0.60mm	CITROEN	157	30	87-114900-65 STD	AUDI	54	15
87-114708-10 0.60mm	FIAT	282	68	87-114900-65 STD	FORD EUROPE	324	19
87-114708-10 0.60mm	LANCIA	542	35	87-114900-65 STD	SEAT	1104	19
87-114708-10 0.60mm	PEUGEOT	926	32	87-114900-65 STD	SKODA	1149	15
87-114708-10 0.60mm	SUZUKI	1186	9	87-114900-65 STD	VOLKSWAGEN	1287	24
87-114708-30 0.60mm	CITROEN	163	36	87-114900-66 STD	AUDI	55	15
87-114708-30 0.60mm	FIAT	280	66	87-114900-66 STD	FORD EUROPE	324	19
87-114708-30 0.60mm	LANCIA	543	36	87-114900-66 STD	SEAT	1104	19
87-114708-30 0.60mm	PEUGEOT	931	37	87-114900-66 STD	SKODA	1150	15
87-114708-40 0.60mm	CITROEN	158	31	87-114900-66 STD	VOLKSWAGEN	1288	24
87-114708-40 0.60mm	FIAT	282	69	87-114900-70 STD	AUDI	48	11
87-114708-40 0.60mm	LANCIA	543	37	87-114900-70 STD	FORD EUROPE	321	17
87-114708-40 0.60mm	PEUGEOT	927	33	87-114900-70 STD	SEAT	1098	14
87-114900-05 STD	AUDI	51	13	87-114900-70 STD	SKODA	1141	11
87-114900-05 STD	FORD EUROPE	322	18	87-114900-70 STD	VOLKSWAGEN	1277	18
87-114900-05 STD	SEAT	1108	21	87-114900-80 STD	AUDI	53	14
87-114900-05 STD	VOLKSWAGEN	1282	22	87-114900-80 STD	SEAT	1102	18
87-114900-15 STD	AUDI	51	13	87-114900-80 STD	SKODA	1145	13
87-114900-15 STD	FORD EUROPE	322	18	87-114900-80 STD	VOLKSWAGEN	1285	23
87-114900-15 STD	SEAT	1108	21	87-114900-85 STD	AUDI	53	14
87-114900-15 STD	VOLKSWAGEN	1283	22	87-114900-85 STD	SEAT	1102	18
87-114900-20 STD	SEAT	1100	16	87-114900-85 STD	SKODA	1145	13
87-114900-20 STD	SKODA	1143	12	87-114900-85 STD	VOLKSWAGEN	1285	23
87-114900-20 STD	VOLKSWAGEN	1281	21	87-114900-90 STD	AUDI	48	11
87-114900-25 STD	AUDI	56	16	87-114900-90 STD	SEAT	1098	14
87-114900-25 STD	SEAT	1105	20	87-114900-90 STD	SKODA	1142	11
87-114900-25 STD	SKODA	1146	14	87-114900-90 STD	VOLKSWAGEN	1278	18
87-114900-25 STD	VOLKSWAGEN	1289	25	87-114900-95 STD	AUDI	49	11
87-114900-25 STD	VOLKSWAGEN	1291	26	87-114900-95 STD	SEAT	1099	14
87-114900-30 STD	SEAT	1101	16	87-114900-95 STD	SKODA	1142	11
87-114900-30 STD	SKODA	1144	12	87-114900-95 STD	VOLKSWAGEN	1278	18
87-114900-30 STD	VOLKSWAGEN	1281	21	87-114905-60 0.25mm	AUDI	47	11
87-114900-35 STD	AUDI	56	16	87-114905-60 0.25mm	FORD EUROPE	320	17
87-114900-35 STD	SEAT	1106	20	87-114905-60 0.25mm	SEAT	1097	14
87-114900-35 STD	SKODA	1147	14	87-114905-60 0.25mm	SKODA	1141	11
87-114900-35 STD	VOLKSWAGEN	1289	25	87-114905-60 0.25mm	VOLKSWAGEN	1277	18
87-114900-35 STD	VOLKSWAGEN	1291	26	87-114905-70 0.25mm	AUDI	48	11
87-114900-45 STD	AUDI	57	16	87-114905-70 0.25mm	FORD EUROPE	321	17
87-114900-45 STD	FORD EUROPE	325	20	87-114905-70 0.25mm	SEAT	1098	14
87-114900-45 STD	SEAT	1106	20	87-114905-70 0.25mm	SKODA	1141	11
87-114900-45 STD	SKODA	1147	14	87-114905-70 0.25mm	VOLKSWAGEN	1277	18

			9				9
87-114905-90 0.25mm	AUDI	48	11	87-114907-66 0.50mm	AUDI	55	15
87-114905-90 0.25mm	SEAT	1098	14	87-114907-66 0.50mm	FORD EUROPE	324	19
87-114905-90 0.25mm	SKODA	1142	11	87-114907-66 0.50mm	SEAT	1104	19
87-114905-90 0.25mm	VOLKSWAGEN	1278	18	87-114907-66 0.50mm	SKODA	1150	15
87-114905-95 0.25mm	AUDI	49	11	87-114907-66 0.50mm	VOLKSWAGEN	1288	24
87-114905-95 0.25mm	SEAT	1099	14	87-114907-70 0.50mm	AUDI	48	11
87-114905-95 0.25mm	SKODA	1142	11	87-114907-70 0.50mm	FORD EUROPE	321	17
87-114905-95 0.25mm	VOLKSWAGEN	1278	18	87-114907-70 0.50mm	SEAT	1098	14
87-114907-05 0.50mm	AUDI	51	13	87-114907-70 0.50mm	SKODA	1141	11
87-114907-05 0.50mm	FORD EUROPE	322	18	87-114907-70 0.50mm	VOLKSWAGEN	1277	18
87-114907-05 0.50mm	SEAT	1108	21	87-114907-80 0.50mm	AUDI	53	14
87-114907-05 0.50mm	VOLKSWAGEN	1282	22	87-114907-80 0.50mm	SEAT	1102	18
87-114907-15 0.50mm	AUDI	51	13	87-114907-80 0.50mm	SKODA	1145	13
87-114907-15 0.50mm	FORD EUROPE	322	18	87-114907-80 0.50mm	VOLKSWAGEN	1285	23
87-114907-15 0.50mm	SEAT	1108	21	87-114907-85 0.50mm	AUDI	53	14
87-114907-15 0.50mm	VOLKSWAGEN	1283	22	87-114907-85 0.50mm	SEAT	1102	18
87-114907-20 0.50mm	SEAT	1100	16	87-114907-85 0.50mm	SKODA	1145	13
87-114907-20 0.50mm	SKODA	1143	12	87-114907-85 0.50mm	VOLKSWAGEN	1285	23
87-114907-20 0.50mm	VOLKSWAGEN	1281	21	87-114907-90 0.50mm	AUDI	48	11
87-114907-25 0.50mm	AUDI	56	16	87-114907-90 0.50mm	SEAT	1098	14
87-114907-25 0.50mm	SEAT	1105	20	87-114907-90 0.50mm	SKODA	1142	11
87-114907-25 0.50mm	SKODA	1146	14	87-114907-90 0.50mm	VOLKSWAGEN	1278	18
87-114907-25 0.50mm	VOLKSWAGEN	1289	25	87-114907-95 0.50mm	AUDI	49	11
87-114907-25 0.50mm	VOLKSWAGEN	1291	26	87-114907-95 0.50mm	SEAT	1099	14
87-114907-30 0.50mm	SEAT	1101	16	87-114907-95 0.50mm	SKODA	1142	11
87-114907-30 0.50mm	SKODA	1144	12	87-114907-95 0.50mm	VOLKSWAGEN	1278	18
87-114907-30 0.50mm	VOLKSWAGEN	1281	21	87-114911-20 1.00mm	SEAT	1100	16
87-114907-35 0.50mm	AUDI	56	16	87-114911-20 1.00mm	SKODA	1143	12
87-114907-35 0.50mm	SEAT	1106	20	87-114911-20 1.00mm	VOLKSWAGEN	1281	21
87-114907-35 0.50mm	SKODA	1147	14	87-114911-30 1.00mm	SEAT	1101	16
87-114907-35 0.50mm	VOLKSWAGEN	1289	25	87-114911-30 1.00mm	SKODA	1144	12
87-114907-35 0.50mm	VOLKSWAGEN	1291	26	87-114911-30 1.00mm	VOLKSWAGEN	1281	21
87-114907-45 0.50mm	AUDI	57	16	87-114911-60 1.00mm	AUDI	47	11
87-114907-45 0.50mm	FORD EUROPE	325	20	87-114911-60 1.00mm	FORD EUROPE	320	17
87-114907-45 0.50mm	SEAT	1106	20	87-114911-60 1.00mm	SEAT	1097	14
87-114907-45 0.50mm	SKODA	1147	14	87-114911-60 1.00mm	SKODA	1141	11
87-114907-45 0.50mm	VOLKSWAGEN	1290	25	87-114911-60 1.00mm	VOLKSWAGEN	1277	18
87-114907-45 0.50mm	VOLKSWAGEN	1292	27	87-114911-70 1.00mm	AUDI	48	11
87-114907-46 0.50mm	AUDI	57	16	87-114911-70 1.00mm	FORD EUROPE	321	17
87-114907-46 0.50mm	FORD EUROPE	325	20	87-114911-70 1.00mm	SEAT	1098	14
87-114907-46 0.50mm	SEAT	1107	20	87-114911-70 1.00mm	SKODA	1141	11
87-114907-46 0.50mm	SKODA	1148	14	87-114911-70 1.00mm	VOLKSWAGEN	1277	18
87-114907-46 0.50mm	VOLKSWAGEN	1290	25	87-114911-90 1.00mm	AUDI	48	11
87-114907-46 0.50mm	VOLKSWAGEN	1293	27	87-114911-90 1.00mm	SEAT	1098	14
87-114907-55 0.50mm	AUDI	52	13	87-114911-90 1.00mm	SKODA	1142	11
87-114907-55 0.50mm	AUDI	58	18	87-114911-90 1.00mm	VOLKSWAGEN	1278	18
87-114907-55 0.50mm	FORD EUROPE	323	18	87-114911-95 1.00mm	AUDI	49	11
87-114907-55 0.50mm	SEAT	1109	21	87-114911-95 1.00mm	SEAT	1099	14
87-114907-55 0.50mm	VOLKSWAGEN	1283	22	87-114911-95 1.00mm	SKODA	1142	11
87-114907-56 0.50mm	AUDI	52	13	87-114911-95 1.00mm	VOLKSWAGEN	1278	18
87-114907-56 0.50mm	AUDI	59	18	87-115800-00 STD	MERCEDES-BENZ COMMERCIAL	765	48
87-114907-56 0.50mm	FORD EUROPE	323	18	87-116100-00 STD	AUDI	38	2
87-114907-56 0.50mm	SEAT	1109	21	87-116100-00 STD	SEAT	1092	8
87-114907-56 0.50mm	VOLKSWAGEN	1284	22	87-116100-00 STD	SKODA	1134	4
87-114907-60 0.50mm	AUDI	47	11	87-116100-00 STD	VOLKSWAGEN	1263	7
87-114907-60 0.50mm	FORD EUROPE	320	17	87-116107-00 0.50mm	AUDI	38	2
87-114907-60 0.50mm	SEAT	1097	14	87-116107-00 0.50mm	SEAT	1092	8
87-114907-60 0.50mm	SKODA	1141	11	87-116107-00 0.50mm	SKODA	1134	4
87-114907-60 0.50mm	VOLKSWAGEN	1277	18	87-116107-00 0.50mm	VOLKSWAGEN	1263	7
87-114907-65 0.50mm	AUDI	54	15	87-117900-00 STD	MERCEDES-BENZ	668	19
87-114907-65 0.50mm	FORD EUROPE	324	19	87-117900-00 STD	MERCEDES-BENZ	672	22
87-114907-65 0.50mm	SEAT	1104	19	87-117900-10 STD	MERCEDES-BENZ	668	19
87-114907-65 0.50mm	SKODA	1149	15	87-117900-10 STD	MERCEDES-BENZ	669	20
87-114907-65 0.50mm	VOLKSWAGEN	1287	24	87-117900-20 STD	MERCEDES-BENZ	670	20

NUMERICAL PARTS LIST







Numerische Teilenummernliste • Elenco riferimenti
Liste des références produits







   9				   9			
87-117900-20 STD	MERCEDES-BENZ	671	21	87-123400-00 STD	NISSAN	815	4
87-117900-20 STD	MERCEDES-BENZ	672	22	87-123400-00 STD	RENAULT	974	18
87-117900-20 STD	MERCEDES-BENZ COMMERCIAL	717	4	87-123400-10 STD	DACIA	182	4
87-117907-00 0.50mm	MERCEDES-BENZ	668	19	87-123400-10 STD	DACIA	183	5
87-117907-00 0.50mm	MERCEDES-BENZ	672	22	87-123400-10 STD	NISSAN	815	4
87-117907-10 0.50mm	MERCEDES-BENZ	668	19	87-123400-10 STD	RENAULT	974	18
87-117907-10 0.50mm	MERCEDES-BENZ	669	20	87-123400-10 STD	SUZUKI	1184	5
87-117907-20 0.50mm	MERCEDES-BENZ	670	20	87-123400-20 STD	DACIA	183	6
87-117907-20 0.50mm	MERCEDES-BENZ	671	21	87-123400-20 STD	NISSAN	816	5
87-117907-20 0.50mm	MERCEDES-BENZ	672	22	87-123400-20 STD	RENAULT	975	19
87-117907-20 0.50mm	MERCEDES-BENZ COMMERCIAL	717	4	87-123400-30 STD	NISSAN	817	6
87-118000-00 STD	ALFA ROMEO	10	11	87-123400-30 STD	RENAULT	976	20
87-118000-00 STD	FIAT	257	35	87-123400-40 STD	RENAULT	970	16
87-118000-00 STD	LANCIA	525	17	87-123400-50 STD	RENAULT	977	21
87-118000-10 STD	ALFA ROMEO	8	9	87-123407-00 0.50mm	DACIA	182	4
87-118000-30 STD	FIAT	258	37	87-123407-00 0.50mm	NISSAN	815	4
87-118000-30 STD	LANCIA	526	19	87-123407-00 0.50mm	RENAULT	974	18
87-118006-00 0.40mm	ALFA ROMEO	10	11	87-123407-10 0.50mm	DACIA	182	4
87-118006-00 0.40mm	FIAT	257	35	87-123407-10 0.50mm	DACIA	183	5
87-118006-00 0.40mm	LANCIA	525	17	87-123407-10 0.50mm	NISSAN	815	4
87-118006-10 0.40mm	ALFA ROMEO	8	9	87-123407-10 0.50mm	RENAULT	974	18
87-118006-30 0.40mm	FIAT	258	37	87-123407-10 0.50mm	SUZUKI	1184	5
87-118006-30 0.40mm	LANCIA	526	19	87-123407-20 0.50mm	DACIA	183	6
87-119000-00 STD	MERCEDES-BENZ	689	37	87-123407-20 0.50mm	NISSAN	816	5
87-119800-00 STD	HONDA	399	3	87-123407-20 0.50mm	RENAULT	975	19
87-119800-00 STD	LAND ROVER	551	8	87-123407-30 0.50mm	NISSAN	817	6
87-119800-00 STD	MG	782	10	87-123407-30 0.50mm	RENAULT	976	20
87-119800-00 STD	ROVER	1051	15	87-123407-40 0.50mm	RENAULT	970	16
87-119807-00 0.50mm	HONDA	399	3	87-123407-50 0.50mm	RENAULT	977	21
87-119807-00 0.50mm	LAND ROVER	551	8	87-123700-00 STD	FORD EUROPE	371	72
87-119807-00 0.50mm	MG	782	10	87-123700-10 STD	FORD EUROPE	373	74
87-119807-00 0.50mm	ROVER	1051	15	87-123700-30 STD	FORD EUROPE	370	71
87-121800-00 STD	IVECO	465	47	87-123700-30 STD	FORD EUROPE	372	73
87-121800-10 STD	IVECO	465	46	87-123711-00 1.00mm	FORD EUROPE	371	72
87-121900-00 STD	IVECO	471	56	87-123711-10 1.00mm	FORD EUROPE	373	74
87-122000-00 STD	IVECO	474	60	87-123711-30 1.00mm	FORD EUROPE	370	71
87-122200-00 STD	CITROEN	172	49	87-123711-30 1.00mm	FORD EUROPE	372	73
87-122200-00 STD	FIAT	297	91	87-123721-00 0.65mm	FORD EUROPE	371	72
87-122200-00 STD	IVECO	440	16	87-123721-10 0.65mm	FORD EUROPE	373	74
87-122200-00 STD	PEUGEOT	943	55	87-123721-30 0.65mm	FORD EUROPE	370	71
87-122200-00 STD	RENAULT TRUCKS	1025	4	87-123721-30 0.65mm	FORD EUROPE	372	73
87-122200-10 STD	FIAT	296	90	87-123900-10 STD	DEUTZ KHD	229	35
87-122200-10 STD	IVECO	438	13	87-124000-00 STD	FIAT	262	42
87-122200-10 STD	OPEL	878	61	87-124000-10 STD	FIAT	262	41
87-122200-10 STD	RENAULT TRUCKS	1023	1	87-124000-10 STD	LANCIA	532	25
87-122200-10 STD	RENAULT TRUCKS	1024	2	87-124000-30 STD	ALFA ROMEO	12	14
87-122200-10 STD	VAUXHALL	1248	58	87-124000-30 STD	FIAT	260	40
87-122200-20 STD	IVECO	439	15	87-124000-30 STD	LANCIA	528	21
87-122208-00 0.60mm	CITROEN	172	49	87-124000-30 STD	OPEL	858	34
87-122208-00 0.60mm	FIAT	297	91	87-124000-30 STD	SAAB	1060	5
87-122208-00 0.60mm	IVECO	440	16	87-124000-30 STD	SUZUKI	1184	6
87-122208-00 0.60mm	PEUGEOT	943	55	87-124000-30 STD	VAUXHALL	1232	35
87-122208-00 0.60mm	RENAULT TRUCKS	1025	4	87-124008-00 0.60mm	FIAT	262	42
87-122208-10 0.60mm	FIAT	296	90	87-124008-10 0.60mm	FIAT	262	41
87-122208-10 0.60mm	IVECO	438	13	87-124008-10 0.60mm	LANCIA	532	25
87-122208-10 0.60mm	OPEL	878	61	87-124008-30 0.60mm	ALFA ROMEO	12	14
87-122208-10 0.60mm	RENAULT TRUCKS	1023	1	87-124008-30 0.60mm	FIAT	260	40
87-122208-10 0.60mm	RENAULT TRUCKS	1024	2	87-124008-30 0.60mm	LANCIA	528	21
87-122208-10 0.60mm	VAUXHALL	1248	58	87-124008-30 0.60mm	OPEL	858	34
87-123200-00 STD	VOLVO COMMERCIAL	1370	40	87-124008-30 0.60mm	SAAB	1060	5
87-123200-10 STD	RENAULT TRUCKS	1038	27	87-124008-30 0.60mm	SUZUKI	1184	6
87-123200-10 STD	VOLVO COMMERCIAL	1371	42	87-124008-30 0.60mm	VAUXHALL	1232	35
87-123200-40 STD	VOLVO COMMERCIAL	1370	41	87-124500-00 STD	MAN	630	41
87-123400-00 STD	DACIA	182	4	87-124500-10 STD	MAN	630	41

			9				9
87-124500-20 STD	MAN	631	41	87-135500-00 STD	RENAULT TRUCKS	1037	25
87-124500-30 STD	MAN	620	33	87-135500-10 STD	RENAULT TRUCKS	1036	22
87-124500-40 STD	MAN	619	31	87-135800-00 STD	CITROEN	169	45
87-124800-00 STD	FIAT	255	32	87-135800-00 STD	PEUGEOT	938	49
87-124800-00 STD	LANCIA	524	15	87-136000-00 STD	MERCEDES-BENZ COMMERCIAL	772	55
87-124806-00 0.40mm	FIAT	255	32	87-136000-10 STD	MERCEDES-BENZ COMMERCIAL	772	55
87-124806-00 0.40mm	LANCIA	524	15	87-136400-00 STD	MERCEDES-BENZ	674	24
87-125600-00 STD	CHEVROLET	124	8	87-136407-00 0.50mm	MERCEDES-BENZ	674	24
87-125600-00 STD	OPEL	846	20	87-136500-00 STD	MAN	597	9
87-125600-00 STD	VAUXHALL	1222	21	87-136500-10 STD	MAN	598	9
87-125607-00 0.50mm	CHEVROLET	124	8	87-136500-30 STD	MAN	599	10
87-125607-00 0.50mm	OPEL	846	20	87-136500-40 STD	MAN	599	10
87-125607-00 0.50mm	VAUXHALL	1222	21	87-136500-60 STD	MAN	600	10
87-126000-00 STD	CHEVROLET	126	12	87-136500-65 STD	MAN	602	11
87-126000-00 STD	OPEL	866	45	87-136500-70 STD	MAN	600	10
87-126000-00 STD	VAUXHALL	1239	45	87-136500-75 STD	MAN	602	11
87-126000-10 STD	OPEL	865	44	87-136500-80 STD	MAN	601	10
87-126000-10 STD	SAAB	1061	7	87-136500-85 STD	MAN	603	11
87-126000-10 STD	VAUXHALL	1238	44	87-136500-90 STD	MAN	604	12
87-126007-00 0.50mm	CHEVROLET	126	12	87-136500-91 STD	MAN	604	12
87-126007-00 0.50mm	OPEL	866	45	87-136500-95 STD	MAN	605	13
87-126007-00 0.50mm	VAUXHALL	1239	45	87-136507-65 0.50mm	MAN	602	11
87-126007-10 0.50mm	OPEL	865	44	87-136600-00 STD	FORD EUROPE	331	25
87-126007-10 0.50mm	SAAB	1061	7	87-136607-00 0.50mm	FORD EUROPE	331	25
87-126007-10 0.50mm	VAUXHALL	1238	44	87-136700-00 STD	MERCEDES-BENZ	647	1
87-126300-10 STD	BEDFORD	99	11	87-136700-00 STD	SMART	1164	1
87-126307-10 .020	BEDFORD	99	11	87-136705-00 0.25mm	MERCEDES-BENZ	647	1
87-126309-10 .030	BEDFORD	99	11	87-136705-00 0.25mm	SMART	1164	1
87-126311-10 .040	BEDFORD	99	11	87-136707-00 0.50mm	MERCEDES-BENZ	647	1
87-127400-00 STD	NISSAN	825	16	87-136707-00 0.50mm	SMART	1164	1
87-127400-00 STD	OPEL	873	52	87-136800-10 STD	VOLVO COMMERCIAL	1362	29
87-127400-00 STD	RENAULT	1007	46	87-136800-30 STD	VOLVO COMMERCIAL	1357	23
87-127400-00 STD	VAUXHALL	1244	52	87-136800-40 STD	VOLVO COMMERCIAL	1357	23
87-127400-10 STD	RENAULT	1006	45	87-136900-00 STD	DEUTZ KHD	222	23
87-127407-00 0.50mm	NISSAN	825	16	87-136900-00 STD	DEUTZ KHD	224	26
87-127407-00 0.50mm	OPEL	873	52	87-136900-10 STD	DEUTZ KHD	222	24
87-127407-00 0.50mm	RENAULT	1007	46	87-136900-10 STD	DEUTZ KHD	223	25
87-127407-00 0.50mm	VAUXHALL	1244	52	87-136900-10 STD	VOLVO COMMERCIAL	1354	17
87-127407-10 0.50mm	RENAULT	1006	45	87-136900-30 STD	DEUTZ KHD	223	25
87-127800-00 STD	DEUTZ KHD	211	7	87-136900-30 STD	DEUTZ KHD	224	26
87-127900-00 STD	DEUTZ KHD	215	12	87-136900-30 STD	DEUTZ KHD	225	27
87-127907-00 0.50mm	DEUTZ KHD	215	12	87-137500-10 STD	NISSAN	826	17
87-131500-00 STD	RENAULT TRUCKS	1032	17	87-137500-10 STD	OPEL	875	55
87-133100-00 STD	BMW	103	3	87-137500-10 STD	RENAULT	1013	50
87-133107-00 0.50mm	BMW	103	3	87-137500-10 STD	VAUXHALL	1246	54
87-135300-00 STD	CITROEN	136	4	87-137500-30 STD	RENAULT	1012	49
87-135300-00 STD	FORD EUROPE	306	3	87-137507-10 0.50mm	NISSAN	826	17
87-135300-00 STD	MAZDA	637	1	87-137507-10 0.50mm	OPEL	875	55
87-135300-00 STD	PEUGEOT	902	4	87-137507-10 0.50mm	RENAULT	1013	50
87-135300-00 STD	TOYOTA	1196	3	87-137507-10 0.50mm	VAUXHALL	1246	54
87-135300-10 STD	CITROEN	137	5	87-137507-30 0.50mm	RENAULT	1012	49
87-135300-10 STD	PEUGEOT	903	5	87-137600-00 STD	FIAT	239	8
87-135305-00 0.25mm	CITROEN	136	4	87-137600-00 STD	LANCIA	518	4
87-135305-00 0.25mm	FORD EUROPE	306	3	87-137600-00 STD	OPEL	832	1
87-135305-00 0.25mm	MAZDA	637	1	87-137600-00 STD	SUBARU	1180	1
87-135305-00 0.25mm	PEUGEOT	902	4	87-137600-00 STD	SUZUKI	1182	2
87-135305-00 0.25mm	TOYOTA	1196	3	87-137600-00 STD	VAUXHALL	1210	2
87-135307-00 0.50mm	CITROEN	136	4	87-137606-00 0.40mm	FIAT	239	8
87-135307-00 0.50mm	FORD EUROPE	306	3	87-137606-00 0.40mm	LANCIA	518	4
87-135307-00 0.50mm	MAZDA	637	1	87-137606-00 0.40mm	OPEL	832	1
87-135307-00 0.50mm	PEUGEOT	902	4	87-137606-00 0.40mm	SUBARU	1180	1
87-135307-00 0.50mm	TOYOTA	1196	3	87-137606-00 0.40mm	SUZUKI	1182	2
87-135307-10 0.50mm	CITROEN	137	5	87-137606-00 0.40mm	VAUXHALL	1210	2
87-135307-10 0.50mm	PEUGEOT	903	5	87-138000-00 STD	FIAT	288	77

NUMERICAL PARTS LIST







Numerische Teilenummernliste • Elenco riferimenti
Liste des références produits









   9				   9			
87-138000-00 STD	IVECO	430	1	87-139507-00 0.50mm	VOLKSWAGEN	1314	44
87-138000-00 STD	UAZ	1206	1	87-139507-10 0.50mm	AUDI	75	32
87-138000-10 STD	FIAT	288	78	87-139507-10 0.50mm	JEEP	493	1
87-138000-10 STD	IVECO	430	2	87-139507-10 0.50mm	SEAT	1120	33
87-138006-00 0.40mm	FIAT	288	77	87-139507-10 0.50mm	SKODA	1158	23
87-138006-00 0.40mm	IVECO	430	1	87-139507-10 0.50mm	VOLKSWAGEN	1316	46
87-138006-00 0.40mm	UAZ	1206	1	87-139507-20 0.50mm	AUDI	75	32
87-138006-10 0.40mm	FIAT	288	78	87-139507-20 0.50mm	JEEP	493	1
87-138006-10 0.40mm	IVECO	430	2	87-139507-20 0.50mm	SEAT	1120	33
87-138008-00 0.60mm	FIAT	288	77	87-139507-20 0.50mm	SKODA	1158	23
87-138008-00 0.60mm	IVECO	430	1	87-139507-20 0.50mm	VOLKSWAGEN	1317	46
87-138008-00 0.60mm	UAZ	1206	1	87-139507-30 0.50mm	VOLKSWAGEN	1315	45
87-138008-10 0.60mm	FIAT	288	78	87-139507-40 0.50mm	VOLKSWAGEN	1315	45
87-138008-10 0.60mm	IVECO	430	2	87-140000-00 STD	LAND ROVER	551	7
87-138400-00 STD	FIAT	246	19	87-140007-00 0.50mm	LAND ROVER	551	7
87-138400-00 STD	LANCIA	521	9	87-140200-00 STD	DAF	198	10
87-138400-10 STD	FIAT	244	17	87-140200-00 STD	DAF	199	11
87-138400-10 STD	LANCIA	522	12	87-140500-00 STD	COMPRESSOR	177	6
87-138400-30 STD	FIAT	247	21	87-140507-00 0.50mm	COMPRESSOR	177	6
87-138400-30 STD	LANCIA	522	11	87-140600-00 STD	MERCEDES-BENZ	648	2
87-138400-40 STD	FIAT	245	18	87-140600-00 STD	SMART	1165	2
87-138400-40 STD	LANCIA	521	10	87-140800-00 STD	FORD EUROPE	348	44
87-138400-40 STD	ZASTAVA	1375	1	87-140800-10 STD	FORD EUROPE	351	47
87-138406-00 0.40mm	FIAT	246	19	87-140800-10 STD	JAGUAR	486	4
87-138406-00 0.40mm	LANCIA	521	9	87-140807-00 0.50mm	FORD EUROPE	348	44
87-138406-10 0.40mm	FIAT	244	17	87-140807-10 0.50mm	FORD EUROPE	351	47
87-138406-10 0.40mm	LANCIA	522	12	87-140807-10 0.50mm	JAGUAR	486	4
87-138406-30 0.40mm	FIAT	247	21	87-141200-00 STD	CHEVROLET	125	10
87-138406-30 0.40mm	LANCIA	522	11	87-141200-00 STD	OPEL	855	31
87-138406-40 0.40mm	FIAT	245	18	87-141200-00 STD	SAAB	1058	2
87-138406-40 0.40mm	LANCIA	521	10	87-141200-00 STD	VAUXHALL	1230	32
87-138406-40 0.40mm	ZASTAVA	1375	1	87-141207-00 0.50mm	CHEVROLET	125	10
87-138408-10 0.60mm	FIAT	244	17	87-141207-00 0.50mm	OPEL	855	31
87-138408-10 0.60mm	LANCIA	522	12	87-141207-00 0.50mm	SAAB	1058	2
87-138900-10 STD	CITROEN	141	10	87-141207-00 0.50mm	VAUXHALL	1230	32
87-138900-10 STD	PEUGEOT	906	8	87-141300-00 STD	FORD EUROPE	317	13
87-138900-30 STD	CITROEN	141	10	87-141300-00 STD	FORD EUROPE	319	15
87-138900-30 STD	PEUGEOT	906	8	87-141300-10 STD	FORD EUROPE	317	13
87-138900-30 STD	PEUGEOT	907	9	87-141300-20 STD	FORD EUROPE	318	14
87-139400-00 STD	CITROEN	146	15	87-141307-00 0.50mm	FORD EUROPE	317	13
87-139400-00 STD	PEUGEOT	911	16	87-141307-00 0.50mm	FORD EUROPE	319	15
87-139407-00 0.50mm	CITROEN	146	15	87-141307-10 0.50mm	FORD EUROPE	317	13
87-139407-00 0.50mm	PEUGEOT	911	16	87-141307-20 0.50mm	FORD EUROPE	318	14
87-139500-00 STD	AUDI	74	31	87-141800-00 STD	MERCEDES-BENZ COMMERCIAL	764	47
87-139500-00 STD	MINISUBISHI	786	2	87-141900-00 STD	VOLVO COMMERCIAL	1353	15
87-139500-00 STD	SEAT	1119	32	87-142000-00 STD	VOLVO COMMERCIAL	1355	19
87-139500-00 STD	SKODA	1157	22	87-142100-00 STD	DEUTZ KHD	209	4
87-139500-00 STD	VOLKSWAGEN	1314	44	87-142107-00 0.50mm	DEUTZ KHD	209	4
87-139500-10 STD	AUDI	75	32	87-142300-00 STD	FIAT	244	16
87-139500-10 STD	JEEP	493	1	87-142300-00 STD	LANCIA	520	8
87-139500-10 STD	SEAT	1120	33	87-142306-00 0.40mm	FIAT	244	16
87-139500-10 STD	SKODA	1158	23	87-142306-00 0.40mm	LANCIA	520	8
87-139500-10 STD	VOLKSWAGEN	1316	46	87-142308-00 0.60mm	FIAT	244	16
87-139500-20 STD	AUDI	75	32	87-142308-00 0.60mm	LANCIA	520	8
87-139500-20 STD	JEEP	493	1	87-142400-00 STD	ALFA ROMEO	24	30
87-139500-20 STD	SEAT	1120	33	87-142400-00 STD	FIAT	279	64
87-139500-20 STD	SKODA	1158	23	87-142400-00 STD	LANCIA	539	32
87-139500-20 STD	VOLKSWAGEN	1317	46	87-142406-00 0.40mm	ALFA ROMEO	24	30
87-139500-30 STD	VOLKSWAGEN	1315	45	87-142406-00 0.40mm	FIAT	279	64
87-139500-40 STD	VOLKSWAGEN	1315	45	87-142406-00 0.40mm	LANCIA	539	32
87-139507-00 0.50mm	AUDI	74	31	87-142500-00 STD	VOLVO COMMERCIAL	1347	6
87-139507-00 0.50mm	MINISUBISHI	786	2	87-142500-10 STD	VOLVO COMMERCIAL	1345	2
87-139507-00 0.50mm	SEAT	1119	32	87-142800-00 STD	VOLVO COMMERCIAL	1349	8
87-139507-00 0.50mm	SKODA	1157	22	87-142900-00 STD	IVECO	462	41

			9				9
87-143200-00 STD	HATZ	394	1	87-148100-00 STD	FORD EUROPE	359	57
87-143400-00 STD	HATZ	394	2	87-148100-00 STD	LAND ROVER	556	14
87-143407-00 0.50mm	HATZ	394	2	87-148100-10 STD	FORD EUROPE	359	58
87-143500-00 STD	HATZ	395	3	87-148100-30 STD	FORD EUROPE	360	59
87-143507-00 0.50mm	HATZ	395	3	87-148100-30 STD	LAND ROVER	556	14
87-143600-00 STD	SCANIA	1073	14	87-148100-40 STD	FORD EUROPE	361	60
87-143600-00 STD	SCANIA	1074	15	87-148100-80 STD	FORD EUROPE	362	61
87-143600-30 STD	SCANIA	1073	14	87-148100-85 STD	FORD EUROPE	362	61
87-143600-40 STD	SCANIA	1071	11	87-148105-00 0.25mm	FORD EUROPE	359	57
87-143600-50 STD	SCANIA	1072	13	87-148105-00 0.25mm	LAND ROVER	556	14
87-143800-00 STD	MAN	631	42	87-148105-10 0.25mm	FORD EUROPE	359	58
87-143800-10 STD	MAN	632	42	87-148105-80 0.25mm	FORD EUROPE	362	61
87-143800-20 STD	MAN	632	42	87-148107-00 0.50mm	FORD EUROPE	359	57
87-143800-30 STD	MAN	628	39	87-148107-00 0.50mm	LAND ROVER	556	14
87-143800-40 STD	MAN	628	39	87-148107-10 0.50mm	FORD EUROPE	359	58
87-143800-50 STD	MAN	633	43	87-148107-30 0.50mm	FORD EUROPE	360	59
87-143800-60 STD	MAN	633	43	87-148107-30 0.50mm	LAND ROVER	556	14
87-144200-00 STD	CHEVROLET	123	5	87-148107-40 0.50mm	FORD EUROPE	361	60
87-144200-00 STD	OPEL	840	13	87-148107-80 0.50mm	FORD EUROPE	362	61
87-144200-00 STD	VAUXHALL	1218	14	87-148107-85 0.50mm	FORD EUROPE	362	61
87-144207-00 0.50mm	CHEVROLET	123	5	87-148300-00 STD	AUDI	67	25
87-144207-00 0.50mm	OPEL	840	13	87-148300-00 STD	AUDI	68	26
87-144207-00 0.50mm	VAUXHALL	1218	14	87-148300-00 STD	SEAT	1117	30
87-145000-00 STD	IVECO	446	23	87-148300-00 STD	SKODA	1156	21
87-145007-00 0.50mm	IVECO	446	23	87-148300-00 STD	VOLKSWAGEN	1306	37
87-145100-00 STD	FIAT	236	5	87-148307-00 0.50mm	AUDI	67	25
87-145106-00 0.40mm	FIAT	236	5	87-148307-00 0.50mm	AUDI	68	26
87-145108-00 0.60mm	FIAT	236	5	87-148307-00 0.50mm	SEAT	1117	30
87-145200-00 STD	ALFA ROMEO	17	20	87-148307-00 0.50mm	SKODA	1156	21
87-145206-00 0.40mm	ALFA ROMEO	17	20	87-148307-00 0.50mm	VOLKSWAGEN	1306	37
87-145300-00 STD	ALFA ROMEO	19	22	87-152000-10 STD	CITROEN	154	26
87-145306-00 0.40mm	ALFA ROMEO	19	22	87-152000-10 STD	FIAT	275	59
87-145400-00 STD	ALFA ROMEO	11	13	87-152000-10 STD	FSO	393	5
87-145400-10 STD	ALFA ROMEO	8	8	87-152000-10 STD	HYUNDAI	405	6
87-145400-30 STD	ALFA ROMEO	9	10	87-152000-10 STD	LADA	512	5
87-145406-00 0.40mm	ALFA ROMEO	11	13	87-152000-10 STD	LDV	565	1
87-145406-10 0.40mm	ALFA ROMEO	8	8	87-152000-10 STD	LEYLAND	568	2
87-145406-30 0.40mm	ALFA ROMEO	9	10	87-152000-10 STD	PEUGEOT	920	26
87-146100-00 STD	ALFA ROMEO	13	15	87-152000-10 STD	ROVER	1050	13
87-146100-00 STD	CADILLAC	117	1	87-152000-10 STD	SUZUKI	1186	8
87-146100-00 STD	FIAT	263	43	87-152000-10 STD	TALBOT	1189	3
87-146100-00 STD	LANCIA	531	24	87-152007-10 0.50mm	CITROEN	154	26
87-146100-00 STD	OPEL	859	35	87-152007-10 0.50mm	FIAT	275	59
87-146100-00 STD	SAAB	1059	4	87-152007-10 0.50mm	FSO	393	5
87-146100-00 STD	VAUXHALL	1233	36	87-152007-10 0.50mm	HYUNDAI	405	6
87-146100-10 STD	ALFA ROMEO	14	16	87-152007-10 0.50mm	LADA	512	5
87-146100-10 STD	CADILLAC	117	1	87-152007-10 0.50mm	LDV	565	1
87-146100-10 STD	OPEL	859	35	87-152007-10 0.50mm	LEYLAND	568	2
87-146100-10 STD	SAAB	1060	4	87-152007-10 0.50mm	PEUGEOT	920	26
87-146100-10 STD	VAUXHALL	1233	36	87-152007-10 0.50mm	ROVER	1050	13
87-146106-10 0.40mm	ALFA ROMEO	14	16	87-152007-10 0.50mm	SUZUKI	1186	8
87-146106-10 0.40mm	CADILLAC	117	1	87-152007-10 0.50mm	TALBOT	1189	3
87-146106-10 0.40mm	OPEL	859	35	87-152010-10 0.80mm	CITROEN	154	26
87-146106-10 0.40mm	SAAB	1060	4	87-152010-10 0.80mm	FIAT	275	59
87-146106-10 0.40mm	VAUXHALL	1233	36	87-152010-10 0.80mm	FSO	393	5
87-146108-00 0.60mm	ALFA ROMEO	13	15	87-152010-10 0.80mm	HYUNDAI	405	6
87-146108-00 0.60mm	CADILLAC	117	1	87-152010-10 0.80mm	LADA	512	5
87-146108-00 0.60mm	FIAT	263	43	87-152010-10 0.80mm	LDV	565	1
87-146108-00 0.60mm	LANCIA	531	24	87-152010-10 0.80mm	LEYLAND	568	2
87-146108-00 0.60mm	OPEL	859	35	87-152010-10 0.80mm	PEUGEOT	920	26
87-146108-00 0.60mm	SAAB	1059	4	87-152010-10 0.80mm	ROVER	1050	13
87-146108-00 0.60mm	VAUXHALL	1233	36	87-152010-10 0.80mm	SUZUKI	1186	8
87-146500-00 STD	DEUTZ KHD	211	6	87-152010-10 0.80mm	TALBOT	1189	3
87-146507-00 0.50mm	DEUTZ KHD	211	6	87-152700-00 STD	CITROEN	170	46

NUMERICAL PARTS LIST







Nummerische Teilenummernliste • Elenco riferimenti
Liste des références produits







   9				   9			
87-152700-00 STD	FIAT	296	89	87-176400-00 STD	MERCEDES-BENZ COMMERCIAL	738	22
87-152700-00 STD	PEUGEOT	939	50	87-176407-00 0.50mm	MERCEDES-BENZ COMMERCIAL	738	22
87-152700-00 STD	TALBOT	1191	6	87-176411-00 1.00mm	MERCEDES-BENZ COMMERCIAL	738	22
87-152700-00 STD	TALBOT	1192	8	87-176600-00 STD	MERCEDES-BENZ	661	12
87-152707-00 0.50mm	CITROEN	170	46	87-176607-00 0.50mm	MERCEDES-BENZ	661	12
87-152707-00 0.50mm	FIAT	296	89	87-176611-00 1.00mm	MERCEDES-BENZ	661	12
87-152707-00 0.50mm	PEUGEOT	939	50	87-176700-00 STD	MERCEDES-BENZ	694	41
87-152707-00 0.50mm	TALBOT	1191	6	87-176700-00 STD	MERCEDES-BENZ	696	43
87-152707-00 0.50mm	TALBOT	1192	8	87-176700-00 STD	MERCEDES-BENZ COMMERCIAL	720	7
87-154200-00 STD	FIAT	242	12	87-176708-00 0.60mm	MERCEDES-BENZ	694	41
87-154200-00 STD	LANCIA	519	6	87-176708-00 0.60mm	MERCEDES-BENZ	696	43
87-154200-10 STD	FIAT	243	14	87-176708-00 0.60mm	MERCEDES-BENZ COMMERCIAL	720	7
87-154200-10 STD	LANCIA	520	7	87-176800-00 STD	HENSCHEL	396	3
87-154200-30 STD	FIAT	243	15	87-176800-00 STD	MERCEDES-BENZ COMMERCIAL	740	23
87-154206-00 0.40mm	FIAT	242	12	87-176800-30 STD	MERCEDES-BENZ COMMERCIAL	744	28
87-154206-00 0.40mm	LANCIA	519	6	87-176800-40 STD	MERCEDES-BENZ COMMERCIAL	744	28
87-154206-10 0.40mm	FIAT	243	14	87-176900-00 STD	MERCEDES-BENZ COMMERCIAL	747	31
87-154206-10 0.40mm	LANCIA	520	7	87-176907-00 0.50mm	MERCEDES-BENZ COMMERCIAL	747	31
87-154206-30 0.40mm	FIAT	243	15	87-176911-00 1.00mm	MERCEDES-BENZ COMMERCIAL	747	31
87-154208-00 0.60mm	FIAT	242	12	87-176911-10 1.00mm	MERCEDES-BENZ COMMERCIAL	746	30
87-154208-00 0.60mm	LANCIA	519	6	87-176914-00 1.50mm	MERCEDES-BENZ COMMERCIAL	747	31
87-154208-10 0.60mm	FIAT	243	14	87-178200-20 STD	MERCEDES-BENZ COMMERCIAL	725	11
87-154208-10 0.60mm	LANCIA	520	7	87-178207-20 0.50mm	MERCEDES-BENZ COMMERCIAL	725	11
87-154208-30 0.60mm	FIAT	243	15	87-178211-20 1.00mm	MERCEDES-BENZ COMMERCIAL	725	11
87-154300-00 STD	CITROEN	135	2	87-178400-00 STD	DEUTZ KHD	217	16
87-154300-00 STD	PEUGEOT	900	1	87-178407-00 0.50mm	DEUTZ KHD	217	16
87-154400-00 STD	CITROEN	139	7	87-178800-00 STD	MERCEDES-BENZ COMMERCIAL	723	10
87-154400-00 STD	PEUGEOT	905	7	87-178807-00 0.50mm	MERCEDES-BENZ COMMERCIAL	723	10
87-154600-00 STD	CITROEN	164	37	87-178811-00 1.00mm	MERCEDES-BENZ COMMERCIAL	723	10
87-154600-00 STD	FIAT	283	70	87-179000-10 STD	DAF	196	6
87-154600-00 STD	PEUGEOT	932	38	87-179300-05 STD	MERCEDES-BENZ COMMERCIAL	758	41
87-154608-00 0.60mm	CITROEN	164	37	87-179300-10 STD	MERCEDES-BENZ COMMERCIAL	755	39
87-154608-00 0.60mm	FIAT	283	70	87-179300-15 STD	MERCEDES-BENZ COMMERCIAL	753	38
87-154608-00 0.60mm	PEUGEOT	932	38	87-179300-16 STD	MERCEDES-BENZ COMMERCIAL	753	38
87-167600-00 STD	DEUTZ KHD	227	31	87-179300-20 STD	MERCEDES-BENZ COMMERCIAL	760	43
87-167607-00 0.50mm	DEUTZ KHD	227	31	87-179300-25 STD	MERCEDES-BENZ COMMERCIAL	757	40
87-167611-00 1.00mm	DEUTZ KHD	227	31	87-179300-30 STD	MERCEDES-BENZ COMMERCIAL	750	34
87-170707-00 0.50mm	MERCEDES-BENZ	666	17	87-179300-40 STD	MERCEDES-BENZ COMMERCIAL	759	42
87-172500-00 STD	DEUTZ KHD	213	10	87-179300-50 STD	MERCEDES-BENZ COMMERCIAL	761	44
87-172507-00 0.50mm	DEUTZ KHD	213	10	87-179300-55 STD	MERCEDES-BENZ COMMERCIAL	761	44
87-172511-00 1.00mm	DEUTZ KHD	213	10	87-179300-60 STD	MERCEDES-BENZ COMMERCIAL	751	36
87-173800-10 STD	MERCEDES-BENZ	696	43	87-179300-65 STD	MERCEDES-BENZ COMMERCIAL	755	39
87-173800-10 STD	MERCEDES-BENZ	697	44	87-179300-70 STD	MERCEDES-BENZ COMMERCIAL	749	33
87-173800-10 STD	MERCEDES-BENZ COMMERCIAL	720	8	87-179300-80 STD	MERCEDES-BENZ COMMERCIAL	750	35
87-173807-10 0.50mm	MERCEDES-BENZ	696	43	87-179300-85 STD	MERCEDES-BENZ COMMERCIAL	756	39
87-173807-10 0.50mm	MERCEDES-BENZ	697	44	87-179300-90 STD	MERCEDES-BENZ COMMERCIAL	756	39
87-173807-10 0.50mm	MERCEDES-BENZ COMMERCIAL	720	8	87-179400-00 STD	DEUTZ KHD	214	11
87-174100-00 STD	DAF	200	13	87-179500-10 STD	MERCEDES-BENZ	678	28
87-174100-00 STD	LEYLAND	574	12	87-179507-10 0.50mm	MERCEDES-BENZ	678	28
87-174100-30 STD	DAF	201	14	87-179511-10 1.00mm	MERCEDES-BENZ	678	28
87-174300-00 STD	MERCEDES-BENZ COMMERCIAL	723	10	87-179700-00 STD	MERCEDES-BENZ	699	46
87-174307-00 0.50mm	MERCEDES-BENZ COMMERCIAL	723	10	87-179700-10 STD	MERCEDES-BENZ	698	45
87-174307-10 0.50mm	MERCEDES-BENZ COMMERCIAL	725	11	87-179700-10 STD	MERCEDES-BENZ	699	46
87-174311-00 1.00mm	MERCEDES-BENZ COMMERCIAL	723	10	87-179707-00 0.50mm	MERCEDES-BENZ	699	46
87-174311-10 1.00mm	MERCEDES-BENZ COMMERCIAL	725	11	87-179707-10 0.50mm	MERCEDES-BENZ	698	45
87-174600-00 STD	DEUTZ KHD	216	15	87-179707-10 0.50mm	MERCEDES-BENZ	699	46
87-174600-10 STD	DEUTZ KHD	221	22	87-179711-00 1.00mm	MERCEDES-BENZ	699	46
87-174600-30 STD	DEUTZ KHD	217	15	87-179711-10 1.00mm	MERCEDES-BENZ	698	45
87-174607-00 0.50mm	DEUTZ KHD	216	15	87-179711-10 1.00mm	MERCEDES-BENZ	699	46
87-174607-10 0.50mm	DEUTZ KHD	221	22	87-181100-10 STD	JOHN DEERE	498	3
87-174607-30 0.50mm	DEUTZ KHD	217	15	87-181100-20 STD	JOHN DEERE	498	2
87-176000-00 STD	MERCEDES-BENZ COMMERCIAL	742	25	87-181100-20 STD	JOHN DEERE	499	4
87-176000-01 STD	MERCEDES-BENZ COMMERCIAL	742	25	87-181100-30 STD	JOHN DEERE	500	6
87-176000-10 STD	MERCEDES-BENZ COMMERCIAL	741	24	87-181700-00 STD	MERCEDES-BENZ COMMERCIAL	748	32

							
87-181800-00 STD	JOHN DEERE	497	1	87-207311-00 1.00mm	FORD EUROPE	368	69
87-181800-10 STD	JOHN DEERE	497	1	87-207321-00 0.65mm	FORD EUROPE	368	69
87-183000-00 STD	MERCEDES-BENZ	676	26	87-207500-00 STD	IVECO	460	39
87-183007-00 0.50mm	MERCEDES-BENZ	676	26	87-207500-00 STD	NEW HOLLAND	806	13
87-183011-00 1.00mm	MERCEDES-BENZ	676	26	87-207500-10 STD	IVECO	461	40
87-183100-00 STD	MERCEDES-BENZ	650	5	87-207500-10 STD	NEW HOLLAND	806	14
87-183107-00 0.50mm	MERCEDES-BENZ	650	5	87-207500-30 STD	IVECO	461	40
87-183111-00 1.00mm	MERCEDES-BENZ	650	5	87-207500-30 STD	NEW HOLLAND	807	14
87-183300-00 STD	MERCEDES-BENZ	663	14	87-207700-00 STD	IVECO	468	52
87-183307-00 0.50mm	MERCEDES-BENZ	663	14	87-207800-00 STD	IVECO	475	61
87-202400-00 STD	FORD TRACTOR	387	6	87-207800-00 STD	NEW HOLLAND	811	22
87-202400-10 STD	FORD TRACTOR	388	8	87-207800-10 STD	IVECO	476	62
87-202400-10 STD	FORD TRACTOR	389	10	87-208100-10 STD	FORD TRACTOR	385	3
87-202400-30 STD	FORD TRACTOR	389	10	87-208800-00 STD	FORD EUROPE	310	6
87-202407-00 .020	FORD TRACTOR	387	6	87-208807-00 0.50mm	FORD EUROPE	310	6
87-202407-10 .020	FORD TRACTOR	388	8	87-208811-00 1.00mm	FORD EUROPE	310	6
87-202407-10 .020	FORD TRACTOR	389	10	87-209800-00 STD	FIAT	234	1
87-202409-10 .030	FORD TRACTOR	388	8	87-209800-00 STD	FSO	391	1
87-202409-10 .030	FORD TRACTOR	389	10	87-209800-00 STD	LANCIA	516	1
87-202411-00 .040	FORD TRACTOR	387	6	87-209800-00 STD	LANCIA	517	2
87-202411-10 .040	FORD TRACTOR	388	8	87-209800-00 STD	SEAT	1086	1
87-202411-10 .040	FORD TRACTOR	389	10	87-209800-10 STD	FIAT	235	3
87-202800-00 STD	FORD COMMERCIAL	378	2	87-209800-10 STD	LANCIA	516	1
87-202807-00 .020	FORD COMMERCIAL	378	2	87-209800-30 STD	FIAT	235	2
87-202809-00 .030	FORD COMMERCIAL	378	2	87-209806-00 0.40mm	FIAT	234	1
87-202811-00 .040	FORD COMMERCIAL	378	2	87-209806-00 0.40mm	FSO	391	1
87-203100-00 STD	FIAT	253	30	87-209806-00 0.40mm	LANCIA	516	1
87-203100-00 STD	FSO	392	4	87-209806-00 0.40mm	LANCIA	517	2
87-203100-00 STD	ZASTAVA	1376	3	87-209806-00 0.40mm	SEAT	1086	1
87-203106-00 0.40mm	FIAT	253	30	87-209806-10 0.40mm	FIAT	235	3
87-203106-00 0.40mm	FSO	392	4	87-209806-10 0.40mm	LANCIA	516	1
87-203106-00 0.40mm	ZASTAVA	1376	3	87-209806-30 0.40mm	FIAT	235	2
87-203106-10 0.40mm	FIAT	252	29	87-209808-00 0.60mm	FIAT	234	1
87-203108-00 0.60mm	FIAT	253	30	87-209808-00 0.60mm	FSO	391	1
87-203108-00 0.60mm	FSO	392	4	87-209808-00 0.60mm	LANCIA	516	1
87-203108-00 0.60mm	ZASTAVA	1376	3	87-209808-00 0.60mm	LANCIA	517	2
87-203108-10 0.60mm	FIAT	252	29	87-209808-00 0.60mm	SEAT	1086	1
87-203500-00 STD	FORD COMMERCIAL	378	1	87-209808-10 0.60mm	FIAT	235	3
87-203500-00 STD	FORD TRACTOR	385	2	87-209808-10 0.60mm	LANCIA	516	1
87-205800-00 STD	FORD EUROPE	356	52	87-214100-10 STD	FORD EUROPE	328	22
87-205807-00 0.50mm	FORD EUROPE	356	52	87-214107-00 0.50mm	FORD EUROPE	328	22
87-205811-00 1.00mm	FORD EUROPE	356	52	87-214107-10 0.50mm	FORD EUROPE	328	22
87-206600-00 STD	FORD EUROPE	363	63	87-214111-00 1.00mm	FORD EUROPE	328	22
87-206600-10 STD	FORD EUROPE	366	66	87-214111-10 1.00mm	FORD EUROPE	328	22
87-206607-00 0.50mm	FORD EUROPE	363	63	87-214500-00 STD	ALFA ROMEO	28	36
87-206607-10 0.50mm	FORD EUROPE	366	66	87-214500-00 STD	FIAT	293	84
87-206611-00 1.00mm	FORD EUROPE	363	63	87-214500-00 STD	IVECO	435	9
87-206617-10 2.25mm	FORD EUROPE	366	66	87-214500-00 STD	RENAULT	1019	57
87-206800-00 STD	IVECO	443	20	87-214500-00 STD	SEAT	1129	43
87-206800-00 STD	IVECO	445	22	87-214508-00 0.60mm	ALFA ROMEO	28	36
87-206800-00 STD	NEW HOLLAND	799	4	87-214508-00 0.60mm	FIAT	293	84
87-206800-10 STD	IVECO	443	20	87-214508-00 0.60mm	IVECO	435	9
87-206800-10 STD	IVECO	445	22	87-214508-00 0.60mm	RENAULT	1019	57
87-206800-10 STD	NEW HOLLAND	800	4	87-214508-00 0.60mm	SEAT	1129	43
87-206808-00 0.60mm	IVECO	443	20	87-214800-10 STD	FORD COMMERCIAL	382	9
87-206808-00 0.60mm	IVECO	445	22	87-214800-10 STD	FORD TRACTOR	386	5
87-206808-00 0.60mm	NEW HOLLAND	799	4	87-214807-10 .020	FORD COMMERCIAL	382	9
87-206808-10 0.60mm	IVECO	443	20	87-214807-10 .020	FORD TRACTOR	386	5
87-206808-10 0.60mm	IVECO	445	22	87-214809-10 .030	FORD COMMERCIAL	382	9
87-206808-10 0.60mm	NEW HOLLAND	800	4	87-214809-10 .030	FORD TRACTOR	386	5
87-207200-00 STD	IVECO	441	18	87-214811-10 .040	FORD COMMERCIAL	382	9
87-207200-00 STD	NEW HOLLAND	799	3	87-214811-10 .040	FORD TRACTOR	386	5
87-207208-00 0.60mm	IVECO	441	18	87-215100-10 STD	FIAT	273	56
87-207208-00 0.60mm	NEW HOLLAND	799	3	87-215100-10 STD	SEAT	1128	41

NUMERICAL PARTS LIST







Numerische Teilenummernliste • Elenco riferimenti
Liste des références produits







   9				   9			
87-215108-10 0.60mm	FIAT	273	56	87-252507-30 0.50mm	DEUTZ KHD	209	3
87-215108-10 0.60mm	SEAT	1128	41	87-252800-00 STD	DEUTZ KHD	210	5
87-215200-00 STD	FIAT	250	25	87-263100-00 STD	LAND ROVER	557	15
87-215208-00 0.60mm	FIAT	250	25	87-263100-00 STD	ROVER	1054	18
87-215300-10 STD	ALFA ROMEO	23	29	87-263100-10 STD	LAND ROVER	557	16
87-215300-10 STD	FIAT	278	62	87-263100-10 STD	ROVER	1054	18
87-215300-10 STD	LANCIA	540	33	87-263107-00 .020	LAND ROVER	557	15
87-215308-10 0.60mm	ALFA ROMEO	23	29	87-263107-00 .020	ROVER	1054	18
87-215308-10 0.60mm	FIAT	278	62	87-263107-10 .020	LAND ROVER	557	16
87-215308-10 0.60mm	LANCIA	540	33	87-263107-10 .020	ROVER	1054	18
87-215507-00 0.50mm	FORD EUROPE	329	24	87-269700-00 STD	LADA	509	1
87-243300-00 STD	IHC	411	2	87-269706-00 0.40mm	LADA	509	1
87-243600-00 STD	IHC	411	3	87-269800-00 STD	LADA	510	2
87-244500-10 STD	IVECO	456	33	87-269806-00 0.40mm	LADA	510	2
87-244500-30 STD	IVECO	456	33	87-269900-00 STD	LADA	511	3
87-244500-40 STD	IVECO	459	37	87-274800-00 STD	MAN	612	21
87-244500-40 STD	NEW HOLLAND	804	10	87-274800-30 STD	MAN	612	21
87-245200-30 STD	ALFA ROMEO	26	34	87-279600-10 STD	MWM	796	1
87-245200-30 STD	FIAT	290	81	87-280000-00 STD	MAN	606	15
87-245200-30 STD	IVECO	432	5	87-280200-10 STD	MAN	614	25
87-245200-30 STD	RENAULT	1014	52	87-280400-00 STD	MAN	615	26
87-245200-40 STD	ALFA ROMEO	27	35	87-283100-00 STD	MAN	623	35
87-245200-40 STD	FIAT	291	82	87-283100-01 STD	MAN	623	35
87-245200-40 STD	IVECO	433	7	87-283100-10 STD	MAN	619	32
87-245200-40 STD	RENAULT	1015	53	87-283100-30 STD	MAN	621	34
87-245200-50 STD	ALFA ROMEO	27	35	87-283100-40 STD	MAN	621	34
87-245200-50 STD	FIAT	291	82	87-283100-60 STD	MAN	626	38
87-245200-50 STD	IVECO	434	7	87-283100-70 STD	MAN	627	38
87-245200-50 STD	RENAULT	1015	53	87-283100-80 STD	MAN	625	37
87-245200-60 STD	IVECO	433	6	87-283100-85 STD	MAN	625	37
87-245200-60 STD	RENAULT	1017	55	87-283100-86 STD	MAN	626	37
87-245208-30 0.60mm	ALFA ROMEO	26	34	87-283300-00 STD	MAN	588	1
87-245208-30 0.60mm	FIAT	290	81	87-283600-00 STD	KIA	505	5
87-245208-30 0.60mm	IVECO	432	5	87-283600-00 STD	MAZDA	641	7
87-245208-30 0.60mm	RENAULT	1014	52	87-283607-00 0.50mm	KIA	505	5
87-245208-40 0.60mm	ALFA ROMEO	27	35	87-283607-00 0.50mm	MAZDA	641	7
87-245208-40 0.60mm	FIAT	291	82	87-283611-00 1.00mm	KIA	505	5
87-245208-40 0.60mm	IVECO	433	7	87-283611-00 1.00mm	MAZDA	641	7
87-245208-40 0.60mm	RENAULT	1015	53	87-285800-00 STD	MAN	591	5
87-245208-50 0.60mm	ALFA ROMEO	27	35	87-285900-00 STD	MAN	594	7
87-245208-50 0.60mm	FIAT	291	82	87-285900-05 STD	MAN	595	7
87-245208-50 0.60mm	IVECO	434	7	87-285900-06 STD	MAN	595	7
87-245208-50 0.60mm	RENAULT	1015	53	87-285900-10 STD	MAN	592	6
87-245500-00 STD	NEW HOLLAND	809	19	87-285900-15 STD	MAN	593	6
87-245500-10 STD	IVECO	464	44	87-285900-16 STD	MAN	593	6
87-245500-10 STD	NEW HOLLAND	810	19	87-285900-30 STD	MAN	596	8
87-247200-00 STD	ISUZU	415	3	87-285900-40 STD	MAN	596	8
87-247600-10 STD	ISUZU	416	5	87-287100-00 STD	HYUNDAI	407	11
87-247600-10 STD	OPEL	874	54	87-287100-00 STD	MITSUBISHI	793	10
87-247600-10 STD	VAUXHALL	1245	53	87-287100-10 STD	HYUNDAI	408	11
87-247800-00 STD	IVECO	450	29	87-287100-10 STD	MITSUBISHI	793	10
87-247800-00 STD	NEW HOLLAND	804	9	87-287100-30 STD	HYUNDAI	406	9
87-247800-10 STD	IVECO	454	31	87-287100-30 STD	HYUNDAI	407	10
87-247800-10 STD	NEW HOLLAND	805	11	87-287100-30 STD	MITSUBISHI	790	6
87-247808-00 0.60mm	IVECO	450	29	87-287107-10 0.50mm	HYUNDAI	408	11
87-247808-00 0.60mm	NEW HOLLAND	804	9	87-287107-10 0.50mm	MITSUBISHI	793	10
87-247808-10 0.60mm	IVECO	454	31	87-287107-30 0.50mm	HYUNDAI	406	9
87-247808-10 0.60mm	NEW HOLLAND	805	11	87-287107-30 0.50mm	HYUNDAI	407	10
87-248000-00 STD	CHEVROLET	128	15	87-287107-30 0.50mm	MITSUBISHI	790	6
87-248000-00 STD	ISUZU	416	6	87-287500-00 STD	MERCEDES-BENZ	687	36
87-248000-10 STD	ISUZU	417	7	87-287500-10 STD	DAEWOO	190	2
87-252500-10 STD	DEUTZ KHD	208	2	87-287500-10 STD	MERCEDES-BENZ	686	35
87-252500-30 STD	DEUTZ KHD	209	3	87-287500-10 STD	SSANGYONG	1172	6
87-252507-10 0.50mm	DEUTZ KHD	208	2	87-287500-20 STD	MERCEDES-BENZ	685	34

   9				   9			
87-287500-20 STD	SSANGYONG	1171	5	87-306711-10 1.00mm	BEDFORD	98	7
87-287500-30 STD	DAEWOO	190	2	87-306711-10 1.00mm	OPEL	860	36
87-287500-30 STD	MERCEDES-BENZ	686	35	87-306711-10 1.00mm	VAUXHALL	1234	37
87-287500-30 STD	SSANGYONG	1172	6	87-306800-10 STD	CATERHAM	119	3
87-287500-40 STD	MERCEDES-BENZ	687	36	87-306800-10 STD	LADA	513	7
87-287505-10 0.25mm	DAEWOO	190	2	87-306800-10 STD	OPEL	871	49
87-287505-10 0.25mm	MERCEDES-BENZ	686	35	87-306800-10 STD	VAUXHALL	1243	49
87-287505-10 0.25mm	SSANGYONG	1172	6	87-306800-20 STD	CHEVROLET	127	14
87-287505-30 0.25mm	DAEWOO	190	2	87-306800-20 STD	OPEL	872	50
87-287505-30 0.25mm	MERCEDES-BENZ	686	35	87-306800-20 STD	VAUXHALL	1243	50
87-287505-30 0.25mm	SSANGYONG	1172	6	87-306800-30 STD	CHEVROLET	127	13
87-287507-20 0.50mm	MERCEDES-BENZ	685	34	87-306800-30 STD	DAEWOO	189	1
87-287507-20 0.50mm	SSANGYONG	1171	5	87-306800-30 STD	ISUZU	414	2
87-287507-30 0.50mm	DAEWOO	190	2	87-306800-30 STD	OPEL	870	48
87-287507-30 0.50mm	MERCEDES-BENZ	686	35	87-306800-30 STD	VAUXHALL	1242	48
87-287507-30 0.50mm	SSANGYONG	1172	6	87-306807-10 0.50mm	CATERHAM	119	3
87-287507-40 0.50mm	MERCEDES-BENZ	687	36	87-306807-10 0.50mm	LADA	513	7
87-288000-00 STD	HYUNDAI	406	8	87-306807-10 0.50mm	OPEL	871	49
87-288000-00 STD	MITSUBISHI	789	5	87-306807-10 0.50mm	VAUXHALL	1243	49
87-288000-10 STD	MITSUBISHI	791	8	87-306807-20 0.50mm	CHEVROLET	127	14
87-288007-00 0.50mm	HYUNDAI	406	8	87-306807-20 0.50mm	OPEL	872	50
87-288007-00 0.50mm	MITSUBISHI	789	5	87-306807-20 0.50mm	VAUXHALL	1243	50
87-288007-10 0.50mm	MITSUBISHI	791	8	87-306807-30 0.50mm	CHEVROLET	127	13
87-288300-10 STD	MITSUBISHI	795	13	87-306807-30 0.50mm	DAEWOO	189	1
87-288307-10 0.50mm	MITSUBISHI	795	13	87-306807-30 0.50mm	ISUZU	414	2
87-288800-00 STD	MERCEDES-BENZ COMMERCIAL	728	13	87-306807-30 0.50mm	OPEL	870	48
87-288807-00 0.50mm	MERCEDES-BENZ COMMERCIAL	728	13	87-306807-30 0.50mm	VAUXHALL	1242	48
87-289300-00 STD	MERCEDES-BENZ COMMERCIAL	736	21	87-306811-30 1.00mm	CHEVROLET	127	13
87-289300-10 STD	MERCEDES-BENZ COMMERCIAL	737	21	87-306811-30 1.00mm	DAEWOO	189	1
87-289300-20 STD	MERCEDES-BENZ COMMERCIAL	737	21	87-306811-30 1.00mm	ISUZU	414	2
87-289600-00 STD	MERCEDES-BENZ COMMERCIAL	770	53	87-306811-30 1.00mm	OPEL	870	48
87-289600-20 STD	MERCEDES-BENZ COMMERCIAL	770	53	87-306811-30 1.00mm	VAUXHALL	1242	48
87-295400-00 STD	NISSAN	822	13	87-306900-00 STD	OPEL	844	17
87-304207-00 0.50mm	OPEL	841	14	87-306900-00 STD	VAUXHALL	1220	18
87-304207-00 0.50mm	VAUXHALL	1219	15	87-306900-10 STD	BEDFORD	96	4
87-305607-10 0.50mm	OPEL	851	26	87-306900-10 STD	CHEVROLET	123	6
87-305607-10 0.50mm	VAUXHALL	1226	27	87-306900-10 STD	OPEL	842	15
87-305900-00 STD	BEDFORD	97	6	87-306900-10 STD	VAUXHALL	1219	16
87-305900-00 STD	OPEL	851	27	87-306900-20 STD	OPEL	846	19
87-305900-00 STD	VAUXHALL	1227	28	87-306900-20 STD	VAUXHALL	1222	20
87-305907-00 0.50mm	BEDFORD	97	6	87-306907-00 0.50mm	OPEL	844	17
87-305907-00 0.50mm	OPEL	851	27	87-306907-00 0.50mm	VAUXHALL	1220	18
87-305907-00 0.50mm	VAUXHALL	1227	28	87-306907-10 0.50mm	BEDFORD	96	4
87-305911-00 1.00mm	BEDFORD	97	6	87-306907-10 0.50mm	CHEVROLET	123	6
87-305911-00 1.00mm	OPEL	851	27	87-306907-10 0.50mm	OPEL	842	15
87-305911-00 1.00mm	VAUXHALL	1227	28	87-306907-10 0.50mm	VAUXHALL	1219	16
87-306307-00 0.50mm	BEDFORD	95	2	87-306907-20 0.50mm	OPEL	846	19
87-306307-00 0.50mm	OPEL	838	9	87-306907-20 0.50mm	VAUXHALL	1222	20
87-306307-00 0.50mm	VAUXHALL	1216	10	87-307100-20 STD	BEDFORD	96	3
87-306311-00 1.00mm	BEDFORD	95	2	87-307100-20 STD	CHEVROLET	122	4
87-306311-00 1.00mm	OPEL	838	9	87-307100-20 STD	OPEL	839	11
87-306311-00 1.00mm	VAUXHALL	1216	10	87-307100-20 STD	VAUXHALL	1217	12
87-306700-00 STD	OPEL	860	37	87-307100-30 STD	OPEL	840	12
87-306700-00 STD	VAUXHALL	1234	38	87-307100-30 STD	VAUXHALL	1218	13
87-306700-10 STD	BEDFORD	98	7	87-307107-20 0.50mm	BEDFORD	96	3
87-306700-10 STD	OPEL	860	36	87-307107-20 0.50mm	CHEVROLET	122	4
87-306700-10 STD	VAUXHALL	1234	37	87-307107-20 0.50mm	OPEL	839	11
87-306707-00 0.50mm	OPEL	860	37	87-307107-20 0.50mm	VAUXHALL	1217	12
87-306707-00 0.50mm	VAUXHALL	1234	38	87-307107-30 0.50mm	OPEL	840	12
87-306707-10 0.50mm	BEDFORD	98	7	87-307107-30 0.50mm	VAUXHALL	1218	13
87-306707-10 0.50mm	OPEL	860	36	87-307200-00 STD	OPEL	867	46
87-306707-10 0.50mm	VAUXHALL	1234	37	87-307200-00 STD	VAUXHALL	1240	46
87-306711-00 1.00mm	OPEL	860	37	87-307207-00 0.50mm	OPEL	867	46
87-306711-00 1.00mm	VAUXHALL	1234	38	87-307207-00 0.50mm	VAUXHALL	1240	46

NUMERICAL PARTS LIST







Numerische Teilenummernliste • Elenco riferimenti
Liste des références produits







   9				   9			
87-307600-10 STD	OPEL	848	23	87-318706-10 0.40mm	CITROEN	171	48
87-307600-10 STD	VAUXHALL	1224	24	87-318706-10 0.40mm	DAF	195	4
87-307600-20 STD	OPEL	848	23	87-318706-10 0.40mm	FORD EUROPE	375	76
87-307600-20 STD	VAUXHALL	1224	24	87-318706-10 0.40mm	LEYLAND	570	6
87-307600-30 STD	MAZDA	639	5	87-318706-10 0.40mm	PEUGEOT	940	52
87-307600-30 STD	OPEL	849	24	87-318706-10 0.40mm	SSANGYONG	1174	9
87-307600-30 STD	VAUXHALL	1225	25	87-318706-30 0.40mm	ARO	33	7
87-307600-40 STD	CHEVROLET	125	9	87-318706-30 0.40mm	CITROEN	171	48
87-307600-40 STD	OPEL	850	25	87-318706-30 0.40mm	DAF	195	4
87-307600-40 STD	VAUXHALL	1226	26	87-318706-30 0.40mm	FORD EUROPE	375	76
87-307607-20 0.50mm	OPEL	848	23	87-318706-30 0.40mm	LEYLAND	570	6
87-307607-20 0.50mm	VAUXHALL	1224	24	87-318706-30 0.40mm	PEUGEOT	940	52
87-307607-30 0.50mm	MAZDA	639	5	87-318706-30 0.40mm	SSANGYONG	1175	9
87-307607-30 0.50mm	OPEL	849	24	87-318708-00 0.60mm	FORD EUROPE	376	77
87-307607-30 0.50mm	VAUXHALL	1225	25	87-318708-00 0.60mm	LDV	566	3
87-307607-40 0.50mm	CHEVROLET	125	9	87-318708-00 0.60mm	PEUGEOT	942	54
87-307607-40 0.50mm	OPEL	850	25	87-318708-10 0.60mm	ARO	33	7
87-307607-40 0.50mm	VAUXHALL	1226	26	87-318708-10 0.60mm	CITROEN	171	48
87-307700-00 STD	OPEL	857	33	87-318708-10 0.60mm	DAF	195	4
87-307700-00 STD	SAAB	1059	3	87-318708-10 0.60mm	FORD EUROPE	375	76
87-307700-00 STD	VAUXHALL	1231	34	87-318708-10 0.60mm	LEYLAND	570	6
87-307700-10 STD	OPEL	856	32	87-318708-10 0.60mm	PEUGEOT	940	52
87-307700-10 STD	VAUXHALL	1230	33	87-318708-10 0.60mm	SSANGYONG	1174	9
87-307707-00 0.50mm	OPEL	857	33	87-318708-30 0.60mm	ARO	33	7
87-307707-00 0.50mm	SAAB	1059	3	87-318708-30 0.60mm	CITROEN	171	48
87-307707-00 0.50mm	VAUXHALL	1231	34	87-318708-30 0.60mm	DAF	195	4
87-307707-10 0.50mm	OPEL	856	32	87-318708-30 0.60mm	FORD EUROPE	375	76
87-307707-10 0.50mm	VAUXHALL	1230	33	87-318708-30 0.60mm	LEYLAND	570	6
87-307800-10 STD	CHEVROLET	124	7	87-318708-30 0.60mm	PEUGEOT	940	52
87-307800-10 STD	OPEL	845	18	87-318708-30 0.60mm	SSANGYONG	1175	9
87-307800-10 STD	VAUXHALL	1221	19	87-318710-10 0.80mm	ARO	33	7
87-307807-10 0.50mm	CHEVROLET	124	7	87-318710-10 0.80mm	CITROEN	171	48
87-307807-10 0.50mm	OPEL	845	18	87-318710-10 0.80mm	DAF	195	4
87-307807-10 0.50mm	VAUXHALL	1221	19	87-318710-10 0.80mm	FORD EUROPE	375	76
87-313400-00 STD	PERKINS	880	1	87-318710-10 0.80mm	LEYLAND	570	6
87-314600-00 STD	FORD TRACTOR	384	1	87-318710-10 0.80mm	PEUGEOT	940	52
87-314600-00 STD	PERKINS	881	4	87-318710-10 0.80mm	SSANGYONG	1174	9
87-314600-10 STD	PERKINS	882	5	87-318710-30 0.80mm	ARO	33	7
87-315200-00 STD	ALFA ROMEO	6	6	87-318710-30 0.80mm	CITROEN	171	48
87-315200-00 STD	BEDFORD	97	5	87-318710-30 0.80mm	DAF	195	4
87-315200-00 STD	FORD EUROPE	319	16	87-318710-30 0.80mm	FORD EUROPE	375	76
87-315200-00 STD	PERKINS	880	2	87-318710-30 0.80mm	LEYLAND	570	6
87-318000-00 STD	PERKINS	893	21	87-318710-30 0.80mm	PEUGEOT	940	52
87-318700-00 STD	FORD EUROPE	376	77	87-318710-30 0.80mm	SSANGYONG	1175	9
87-318700-00 STD	LDV	566	3	87-318711-00 1.00mm	FORD EUROPE	376	77
87-318700-00 STD	PEUGEOT	942	54	87-318711-00 1.00mm	LDV	566	3
87-318700-10 STD	ARO	33	7	87-318711-00 1.00mm	PEUGEOT	942	54
87-318700-10 STD	CITROEN	171	48	87-318900-10 STD	LEYLAND	573	10
87-318700-10 STD	DAF	195	4	87-318900-10 STD	PERKINS	888	13
87-318700-10 STD	FORD EUROPE	375	76	87-319000-00 STD	PERKINS	889	15
87-318700-10 STD	LEYLAND	570	6	87-319000-10 STD	PERKINS	889	14
87-318700-10 STD	PEUGEOT	940	52	87-321500-00 STD	CITROEN	147	17
87-318700-10 STD	SSANGYONG	1174	9	87-321500-10 STD	PEUGEOT	913	19
87-318700-30 STD	ARO	33	7	87-321507-10 0.50mm	CITROEN	147	17
87-318700-30 STD	CITROEN	171	48	87-321507-10 0.50mm	PEUGEOT	913	19
87-318700-30 STD	DAF	195	4	87-321510-10 0.80mm	CITROEN	147	17
87-318700-30 STD	FORD EUROPE	375	76	87-321510-10 0.80mm	PEUGEOT	913	19
87-318700-30 STD	LEYLAND	570	6	87-322000-00 STD	LEYLAND	569	5
87-318700-30 STD	PEUGEOT	940	52	87-322000-00 STD	PERKINS	882	5
87-318700-30 STD	SSANGYONG	1175	9	87-322000-00 STD	PERKINS	884	7
87-318706-00 0.40mm	FORD EUROPE	376	77	87-322700-00 STD	PERKINS	894	21
87-318706-00 0.40mm	LDV	566	3	87-323600-00 STD	CITROEN	148	18
87-318706-00 0.40mm	PEUGEOT	942	54	87-323600-00 STD	HONDA	399	2
87-318706-10 0.40mm	ARO	33	7	87-323600-00 STD	PEUGEOT	914	20

			9				9
87-323600-00 STD	ROVER	1049	12	87-336505-00 0.25mm	VAUXHALL	1227	29
87-323607-00 0.50mm	CITROEN	148	18	87-336507-00 0.50mm	DACIA	186	11
87-323607-00 0.50mm	HONDA	399	2	87-336507-00 0.50mm	OPEL	852	28
87-323607-00 0.50mm	PEUGEOT	914	20	87-336507-00 0.50mm	RENAULT	986	29
87-323607-00 0.50mm	ROVER	1049	12	87-336507-00 0.50mm	VAUXHALL	1227	29
87-324300-10 STD	PERKINS	891	18	87-336507-10 0.50mm	DACIA	187	12
87-325600-00 STD	PERKINS	893	20	87-336507-10 0.50mm	RENAULT	987	31
87-325600-10 STD	PERKINS	890	17	87-336510-00 0.80mm	DACIA	186	11
87-325600-30 STD	PERKINS	891	17	87-336510-00 0.80mm	OPEL	852	28
87-325800-00 STD	CITROEN	145	14	87-336510-00 0.80mm	RENAULT	986	29
87-325800-00 STD	NISSAN	817	7	87-336510-00 0.80mm	VAUXHALL	1227	29
87-325800-00 STD	PEUGEOT	910	15	87-336600-00 STD	RENAULT	994	36
87-325800-00 STD	ROVER	1047	8	87-337100-00 STD	CHRYSLER	129	2
87-325806-00 0.40mm	CITROEN	145	14	87-337100-00 STD	JEEP	495	3
87-325806-00 0.40mm	NISSAN	817	7	87-337100-00 STD	RENAULT	1003	42
87-325806-00 0.40mm	PEUGEOT	910	15	87-337300-00 STD	ARO	30	2
87-325806-00 0.40mm	ROVER	1047	8	87-337300-00 STD	RENAULT	962	8
87-326300-00 STD	CITROEN	168	44	87-337500-00 STD	RENAULT TRUCKS	1033	18
87-326300-00 STD	DAF	194	3	87-337500-00 STD	RENAULT TRUCKS	1035	21
87-326300-00 STD	FIAT	289	79	87-337500-10 STD	RENAULT TRUCKS	1033	18
87-326300-00 STD	PEUGEOT	938	48	87-337500-30 STD	RENAULT TRUCKS	1034	19
87-326307-00 0.50mm	CITROEN	168	44	87-337500-50 STD	RENAULT TRUCKS	1035	21
87-326307-00 0.50mm	DAF	194	3	87-337600-00 STD	RABA	944	1
87-326307-00 0.50mm	FIAT	289	79	87-346500-00 STD	RENAULT TRUCKS	1026	8
87-326307-00 0.50mm	PEUGEOT	938	48	87-373800-00 STD	TOYOTA	1199	8
87-333300-00 STD	RENAULT	954	1	87-373800-00 STD	VOLKSWAGEN	1330	56
87-333400-00 STD	ARO	30	1	87-373800-10 STD	TOYOTA	1200	8
87-333400-00 STD	DACIA	180	2	87-373800-10 STD	VOLKSWAGEN	1330	56
87-333400-00 STD	RENAULT	961	6	87-373807-00 0.50mm	TOYOTA	1199	8
87-333400-00 STD	VOLVO CARS	1333	4	87-373807-00 0.50mm	VOLKSWAGEN	1330	56
87-333500-00 STD	ARO	31	3	87-374407-00 0.50mm	TOYOTA	1194	1
87-333500-00 STD	RENAULT	968	14	87-396300-00 STD	VOLVO COMMERCIAL	1358	24
87-333500-00 STD	VOLVO CARS	1334	6	87-404500-00 STD	COMPRESSOR	177	5
87-334300-00 STD	RENAULT	979	24	87-404507-00 0.50mm	COMPRESSOR	177	5
87-334400-00 STD	CITROEN	166	41	87-404511-00 1.00mm	COMPRESSOR	177	5
87-334400-00 STD	JEEP	495	4	87-405500-10 STD	VOLVO COMMERCIAL	1347	5
87-334400-00 STD	PEUGEOT	936	44	87-405600-60 STD	VOLVO COMMERCIAL	1368	38
87-334400-00 STD	RENAULT	1010	47	87-405600-70 STD	VOLVO COMMERCIAL	1367	36
87-334600-00 STD	DAF	194	1	87-407000-00 STD	VOLVO COMMERCIAL	1350	11
87-334600-00 STD	RENAULT	959	4	87-407100-00 STD	VOLVO COMMERCIAL	1360	26
87-334600-00 STD	VOLVO CARS	1332	1	87-407100-10 STD	VOLVO COMMERCIAL	1364	31
87-335000-00 STD	RENAULT	978	23	87-420100-00 STD	IVECO	472	58
87-335000-00 STD	VOLVO CARS	1337	10	87-420108-00 0.60mm	IVECO	472	58
87-335000-10 STD	ARO	31	4	87-420200-00 STD	IVECO	472	58
87-335000-10 STD	RENAULT	977	22	87-420900-00 STD	MERCEDES-BENZ COMMERCIAL	774	56
87-335007-00 0.50mm	RENAULT	978	23	87-420900-10 STD	MERCEDES-BENZ COMMERCIAL	774	56
87-335007-00 0.50mm	VOLVO CARS	1337	10	87-420900-50 STD	MERCEDES-BENZ COMMERCIAL	775	57
87-335007-10 0.50mm	ARO	31	4	87-421000-10 STD	VOLKSWAGEN	1312	43
87-335007-10 0.50mm	RENAULT	977	22	87-421000-20 STD	VOLKSWAGEN	1313	43
87-335100-10 STD	RENAULT	994	35	87-421000-30 STD	VOLKSWAGEN	1318	47
87-335107-10 0.50mm	RENAULT	994	35	87-421007-10 0.50mm	VOLKSWAGEN	1312	43
87-335300-00 STD	RENAULT TRUCKS	1041	34	87-421007-20 0.50mm	VOLKSWAGEN	1313	43
87-335900-00 STD	RENAULT TRUCKS	1040	30	87-421007-30 0.50mm	VOLKSWAGEN	1318	47
87-335900-10 STD	RENAULT TRUCKS	1041	32	87-421600-00 STD	FIAT	298	93
87-335900-30 STD	RENAULT TRUCKS	1040	31	87-421600-00 STD	IVECO	442	19
87-336500-00 STD	DACIA	186	11	87-421600-00 STD	DAIICHI	794	11
87-336500-00 STD	OPEL	852	28	87-422000-00 STD	NISSAN	820	11
87-336500-00 STD	RENAULT	986	29	87-422000-00 STD	OPEL	863	41
87-336500-00 STD	VAUXHALL	1227	29	87-422000-00 STD	RENAULT	998	38
87-336500-10 STD	DACIA	187	12	87-422000-00 STD	VAUXHALL	1236	41
87-336500-10 STD	RENAULT	987	31	87-422000-10 STD	NISSAN	821	12
87-336505-00 0.25mm	DACIA	186	11	87-422000-10 STD	OPEL	862	40
87-336505-00 0.25mm	OPEL	852	28	87-422000-10 STD	RENAULT	996	37
87-336505-00 0.25mm	RENAULT	986	29	87-422000-10 STD	VAUXHALL	1236	40

NUMERICAL PARTS LIST







Numerische Teilenummernliste • Elenco riferimenti
Liste des références produits







   9				   9			
87-422007-00 0.50mm	NISSAN	820	11	87-425600-00 STD	OPEL	832	2
87-422007-00 0.50mm	OPEL	863	41	87-425600-00 STD	VAUXHALL	1211	3
87-422007-00 0.50mm	RENAULT	998	38	87-425606-00 0.40mm	ALFA ROMEO	4	1
87-422007-00 0.50mm	VAUXHALL	1236	41	87-425606-00 0.40mm	FIAT	240	9
87-422007-10 0.50mm	NISSAN	821	12	87-425606-00 0.40mm	LANCIA	519	5
87-422007-10 0.50mm	OPEL	862	40	87-425606-00 0.40mm	OPEL	832	2
87-422007-10 0.50mm	RENAULT	996	37	87-425606-00 0.40mm	VAUXHALL	1211	3
87-422007-10 0.50mm	VAUXHALL	1236	40	87-425700-00 STD	BMW	116	16
87-422100-00 STD	PERKINS	890	16	87-425707-00 0.50mm	BMW	116	16
87-422200-10 STD	BMW	102	2	87-426100-00 STD	FORD EUROPE	314	10
87-422207-10 0.50mm	BMW	102	2	87-426100-00 STD	MAZDA	639	4
87-422300-00 STD	RENAULT	989	32	87-426107-00 0.50mm	FORD EUROPE	314	10
87-422307-00 0.50mm	RENAULT	989	32	87-426107-00 0.50mm	MAZDA	639	4
87-422400-00 STD	TOYOTA	1202	12	87-426200-00 STD	PERKINS	896	24
87-422407-00 0.50mm	TOYOTA	1202	12	87-426300-00 STD	CITROEN	135	3
87-423000-00 STD	MAN	608	17	87-426300-00 STD	PEUGEOT	901	2
87-423000-10 STD	MAN	607	16	87-426300-00 STD	ZASTAVA	1375	2
87-423400-00 STD	FORD EUROPE	355	51	87-426600-00 STD	TOYOTA	1198	6
87-423400-00 STD	MAZDA	642	8	87-426700-00 STD	TOYOTA	1197	5
87-423400-00 STD	VOLVO CARS	1340	15	87-426707-00 0.50mm	TOYOTA	1197	5
87-423407-00 0.50mm	FORD EUROPE	355	51	87-427000-00 STD	MERCEDES-BENZ COMMERCIAL	766	49
87-423407-00 0.50mm	MAZDA	642	8	87-427100-00 STD	SMART	1166	3
87-423407-00 0.50mm	VOLVO CARS	1340	15	87-427105-00 0.25mm	SMART	1166	3
87-424000-00 STD	CITROEN	142	11	87-427107-00 0.50mm	SMART	1166	3
87-424000-00 STD	FIAT	249	24	87-427400-00 STD	MERCEDES-BENZ	656	9
87-424000-00 STD	FORD EUROPE	312	8	87-427400-10 STD	MERCEDES-BENZ	656	9
87-424000-00 STD	MAZDA	638	3	87-427400-20 STD	MERCEDES-BENZ	653	8
87-424000-00 STD	MINI	784	3	87-427400-30 STD	MERCEDES-BENZ	654	8
87-424000-00 STD	PEUGEOT	908	12	87-427407-00 0.50mm	MERCEDES-BENZ	656	9
87-424000-00 STD	SUZUKI	1183	4	87-427407-10 0.50mm	MERCEDES-BENZ	656	9
87-424008-00 0.60mm	CITROEN	142	11	87-427500-00 STD	MERCEDES-BENZ	652	7
87-424008-00 0.60mm	FIAT	249	24	87-427500-00 STD	MITSUBISHI	787	3
87-424008-00 0.60mm	FORD EUROPE	312	8	87-427500-00 STD	SMART	1166	4
87-424008-00 0.60mm	MAZDA	638	3	87-427507-00 0.50mm	MERCEDES-BENZ	652	7
87-424008-00 0.60mm	MINI	784	3	87-427507-00 0.50mm	MITSUBISHI	787	3
87-424008-00 0.60mm	PEUGEOT	908	12	87-427507-00 0.50mm	SMART	1166	4
87-424008-00 0.60mm	SUZUKI	1183	4	87-427600-10	MERCEDES-BENZ	649	4
87-424100-00 STD	TOYOTA	1195	2	87-427700-10 STD	CITROEN	164	38
87-424107-00 0.50mm	TOYOTA	1195	2	87-427700-10 STD	FIAT	283	71
87-424200-00 STD	HYUNDAI	403	4	87-427700-10 STD	FORD EUROPE	353	49
87-424200-00 STD	KIA	504	3	87-427700-10 STD	FORD EUROPE	354	50
87-424207-00 0.50mm	HYUNDAI	403	4	87-427700-10 STD	JAGUAR	487	5
87-424207-00 0.50mm	KIA	504	3	87-427700-10 STD	LAND ROVER	554	11
87-425000-00 STD	FIAT	289	80	87-427700-10 STD	PEUGEOT	933	39
87-425000-00 STD	IVECO	431	3	87-427700-30 STD	CITROEN	165	39
87-425000-00 STD	RENAULT	1014	51	87-427700-30 STD	FIAT	284	72
87-425000-10 STD	FIAT	294	86	87-427700-30 STD	FORD EUROPE	352	48
87-425000-10 STD	IVECO	436	11	87-427700-30 STD	PEUGEOT	933	40
87-425000-10 STD	RENAULT	1020	59	87-427700-40 STD	FORD EUROPE	350	46
87-425008-00 0.60mm	FIAT	289	80	87-427700-40 STD	FORD EUROPE	353	50
87-425008-00 0.60mm	IVECO	431	3	87-427700-40 STD	LAND ROVER	553	11
87-425008-00 0.60mm	RENAULT	1014	51	87-427700-50 STD	FORD EUROPE	349	45
87-425008-10 0.60mm	FIAT	294	86	87-427707-10 0.50mm	CITROEN	164	38
87-425008-10 0.60mm	IVECO	436	11	87-427707-10 0.50mm	FIAT	283	71
87-425008-10 0.60mm	RENAULT	1020	59	87-427707-10 0.50mm	FORD EUROPE	353	49
87-425200-00 STD	LADA	512	4	87-427707-10 0.50mm	FORD EUROPE	354	50
87-425300-00 STD	BMW	105	6	87-427707-10 0.50mm	JAGUAR	487	5
87-425307-00 0.50mm	BMW	105	6	87-427707-10 0.50mm	LAND ROVER	554	11
87-425400-00 STD	PERKINS	895	23	87-427707-10 0.50mm	PEUGEOT	933	39
87-425407-00 0.50mm	PERKINS	895	23	87-427707-30 0.50mm	CITROEN	165	39
87-425411-00 1.00mm	PERKINS	895	23	87-427707-30 0.50mm	FIAT	284	72
87-425600-00 STD	ALFA ROMEO	4	1	87-427707-30 0.50mm	FORD EUROPE	352	48
87-425600-00 STD	FIAT	240	9	87-427707-30 0.50mm	PEUGEOT	933	40
87-425600-00 STD	LANCIA	519	5	87-427707-40 0.50mm	FORD EUROPE	350	46

			9				9
87-427707-40 0.50mm	FORD EUROPE	353	50	87-432200-00 STD	BMW	115	15
87-427707-40 0.50mm	LAND ROVER	553	11	87-432205-00 0.25mm	BMW	115	15
87-427707-50 0.50mm	FORD EUROPE	349	45	87-432207-00 0.50mm	BMW	115	15
87-427800-00 STD	OPEL	847	21	87-432300-00 STD	AUDI	77	33
87-427800-00 STD	VAUXHALL	1223	22	87-432300-00 STD	SEAT	1121	34
87-427807-00 0.50mm	OPEL	847	21	87-432300-00 STD	SKODA	1159	24
87-427807-00 0.50mm	VAUXHALL	1223	22	87-432300-00 STD	VOLKSWAGEN	1320	48
87-427900-00	IVECO	447	24	87-432300-10 STD	AUDI	79	34
87-428000-00 STD	IVECO	473	59	87-432300-10 STD	SEAT	1123	35
87-428600-00 STD	MAN	609	18	87-432300-10 STD	SKODA	1160	25
87-428600-10 STD	MAN	611	20	87-432300-10 STD	VOLKSWAGEN	1323	49
87-428700-00 STD	MERCEDES-BENZ	675	25	87-432307-00 0.50mm	AUDI	77	33
87-428707-00 0.50mm	MERCEDES-BENZ	675	25	87-432307-00 0.50mm	SEAT	1121	34
87-428800-00 STD	IVECO	466	48	87-432307-00 0.50mm	SKODA	1159	24
87-428900-00 STD	MERCEDES-BENZ COMMERCIAL	735	19	87-432307-00 0.50mm	VOLKSWAGEN	1320	48
87-429100-00 STD	MAN	588	2	87-432307-10 0.50mm	AUDI	79	34
87-429200-00 STD	LDV	565	2	87-432307-10 0.50mm	SEAT	1123	35
87-429200-00 STD	VM	1249	2	87-432307-10 0.50mm	SKODA	1160	25
87-429400-00 STD	FORD EUROPE	343	39	87-432307-10 0.50mm	VOLKSWAGEN	1323	49
87-429407-00 0.50mm	FORD EUROPE	343	39	87-432400-00 STD	CITROEN	148	19
87-429500-00 STD	OPEL	837	8	87-432400-00 STD	JAGUAR	484	1
87-429500-00 STD	VAUXHALL	1215	9	87-432400-00 STD	LAND ROVER	549	4
87-429500-10 STD	OPEL	836	7	87-432400-00 STD	PEUGEOT	915	21
87-429500-10 STD	SUZUKI	1183	3	87-432900-00 STD	AUDI	60	19
87-429500-10 STD	VAUXHALL	1214	8	87-432900-00 STD	SEAT	1110	22
87-429500-30 STD	CHEVROLET	122	3	87-432900-00 STD	SKODA	1151	16
87-429500-30 STD	OPEL	835	6	87-432900-00 STD	VOLKSWAGEN	1294	28
87-429500-30 STD	VAUXHALL	1214	7	87-432905-00 0.25mm	AUDI	60	19
87-429507-00 0.50mm	OPEL	837	8	87-432905-00 0.25mm	SEAT	1110	22
87-429507-00 0.50mm	VAUXHALL	1215	9	87-432905-00 0.25mm	SKODA	1151	16
87-429507-10 0.50mm	OPEL	836	7	87-432905-00 0.25mm	VOLKSWAGEN	1294	28
87-429507-10 0.50mm	SUZUKI	1183	3	87-432907-00 0.50mm	AUDI	60	19
87-429507-10 0.50mm	VAUXHALL	1214	8	87-432907-00 0.50mm	SEAT	1110	22
87-429507-30 0.50mm	CHEVROLET	122	3	87-432907-00 0.50mm	SKODA	1151	16
87-429507-30 0.50mm	OPEL	835	6	87-432907-00 0.50mm	VOLKSWAGEN	1294	28
87-429507-30 0.50mm	VAUXHALL	1214	7	87-433300-00 STD	DAF	204	20
87-429600-00 STD	RENAULT TRUCKS	1038	26	87-433400-00 STD	JEEP	494	2
87-429900-00 STD	AUDI	40	4	87-433400-00 STD	MERCEDES-BENZ	659	11
87-429900-00 STD	SEAT	1095	12	87-433400-10 STD	MERCEDES-BENZ	658	10
87-429900-00 STD	SKODA	1138	8	87-433405-00 0.25mm	JEEP	494	2
87-429900-00 STD	VOLKSWAGEN	1267	11	87-433405-00 0.25mm	MERCEDES-BENZ	659	11
87-429907-00 0.50mm	AUDI	40	4	87-433407-00 0.50mm	JEEP	494	2
87-429907-00 0.50mm	SEAT	1095	12	87-433407-00 0.50mm	MERCEDES-BENZ	659	11
87-429907-00 0.50mm	SKODA	1138	8	87-433407-10 0.50mm	MERCEDES-BENZ	658	10
87-429907-00 0.50mm	VOLKSWAGEN	1267	11	87-433500-00 STD	MINI	784	4
87-430000-00 STD	DEUTZ KHD	225	28	87-433505-00 0.25mm	MINI	784	4
87-430000-00 STD	RENAULT TRUCKS	1031	15	87-433507-00 0.50mm	MINI	784	4
87-430000-00 STD	VOLVO COMMERCIAL	1354	18	87-433600-00 STD	CITROEN	144	12
87-431000-00 STD	MAN	616	27	87-433600-00 STD	FORD EUROPE	313	9
87-431000-10 STD	MAN	617	28	87-433600-00 STD	PEUGEOT	909	13
87-431300-00 STD	VOLVO COMMERCIAL	1362	28	87-433600-00 STD	TOYOTA	1196	4
87-431600-00 STD	MAN	589	3	87-433600-00 STD	VOLVO CARS	1333	5
87-431700-00 STD	HYUNDAI	405	7	87-433607-00 0.50mm	CITROEN	144	12
87-431700-00 STD	KIA	505	6	87-433607-00 0.50mm	FORD EUROPE	313	9
87-431707-00 0.50mm	HYUNDAI	405	7	87-433607-00 0.50mm	PEUGEOT	909	13
87-431707-00 0.50mm	KIA	505	6	87-433607-00 0.50mm	TOYOTA	1196	4
87-431800-00 STD	KIA	506	7	87-433607-00 0.50mm	VOLVO CARS	1333	5
87-431900-00 STD	HYUNDAI	404	5	87-433700-00 STD	HONDA	398	1
87-431900-00 STD	KIA	504	4	87-433707-00 0.50mm	HONDA	398	1
87-431907-00 0.50mm	HYUNDAI	404	5	87-433800-00 STD	MAN	618	30
87-431907-00 0.50mm	KIA	504	4	87-433900-10 STD	AUDI	39	3
87-432000-00 STD	HYUNDAI	408	12	87-433900-10 STD	SEAT	1094	11
87-432007-00 0.50mm	HYUNDAI	408	12	87-433900-10 STD	SKODA	1137	7
87-432100-00 STD	FORD COMMERCIAL	380	5	87-433900-10 STD	VOLKSWAGEN	1266	10

NUMERICAL PARTS LIST







Numerische Teilenummernliste • Elenco riferimenti
Liste des références produits







   9				   9			
87-433907-10 0.50mm	AUDI	39	3	87-436700-10 STD	LANCIA	541	34
87-433907-10 0.50mm	SEAT	1094	11	87-436700-10 STD	LAND ROVER	553	10
87-433907-10 0.50mm	SKODA	1137	7	87-436700-10 STD	MITSUBISHI	788	4
87-433907-10 0.50mm	VOLKSWAGEN	1266	10	87-436700-10 STD	PEUGEOT	929	35
87-434300-00 STD	AUDI	84	40	87-436708-00 0.60mm	CITROEN	162	35
87-434300-00 STD	VOLKSWAGEN	1329	55	87-436708-00 0.60mm	FORD EUROPE	345	41
87-434307-00 0.50mm	AUDI	84	40	87-436708-00 0.60mm	JAGUAR	485	3
87-434307-00 0.50mm	VOLKSWAGEN	1329	55	87-436708-00 0.60mm	LAND ROVER	552	9
87-434400-00 STD	VOLVO COMMERCIAL	1372	43	87-436708-00 0.60mm	PEUGEOT	930	36
87-434400-10 STD	RENAULT TRUCKS	1039	28	87-436708-10 0.60mm	CITROEN	161	34
87-434400-10 STD	VOLVO COMMERCIAL	1372	44	87-436708-10 0.60mm	FIAT	280	65
87-434600-00 STD	BMW	106	7	87-436708-10 0.60mm	LANCIA	541	34
87-434600-10 STD	BMW	107	8	87-436708-10 0.60mm	LAND ROVER	553	10
87-435000-00 STD	RENAULT TRUCKS	1027	10	87-436708-10 0.60mm	MITSUBISHI	788	4
87-435000-10 STD	RENAULT TRUCKS	1028	10	87-436708-10 0.60mm	PEUGEOT	929	35
87-435100-00 STD	AUDI	81	37	87-436800-00 STD	ALFA ROMEO	4	2
87-435100-00 STD	SEAT	1125	38	87-436800-00 STD	FIAT	248	22
87-435100-00 STD	SKODA	1161	26	87-436800-00 STD	LANCIA	523	13
87-435100-00 STD	VOLKSWAGEN	1326	52	87-436806-00 0.40mm	ALFA ROMEO	4	2
87-435200-00 STD	NISSAN	824	14	87-436806-00 0.40mm	FIAT	248	22
87-435200-00 STD	OPEL	869	47	87-436806-00 0.40mm	LANCIA	523	13
87-435200-00 STD	RENAULT	1000	39	87-436900-00 STD	SEAT	1093	10
87-435200-00 STD	VAUXHALL	1241	47	87-436900-00 STD	SKODA	1136	6
87-435207-00 0.50mm	NISSAN	824	14	87-436900-00 STD	VOLKSWAGEN	1264	9
87-435207-00 0.50mm	OPEL	869	47	87-437000-00 STD	FORD EUROPE	342	37
87-435207-00 0.50mm	RENAULT	1000	39	87-437000-10 STD	FORD EUROPE	338	33
87-435207-00 0.50mm	VAUXHALL	1241	47	87-437007-00 0.50mm	FORD EUROPE	342	37
87-435300-00 STD	OPEL	847	22	87-437007-10 0.50mm	FORD EUROPE	338	33
87-435300-00 STD	VAUXHALL	1223	23	87-437400-00 STD	CHEVROLET	121	1
87-435307-00 0.50mm	OPEL	847	22	87-437400-00 STD	OPEL	833	3
87-435307-00 0.50mm	VAUXHALL	1223	23	87-437400-00 STD	VAUXHALL	1212	4
87-435400-00 STD	HYUNDAI	402	3	87-437600-00 STD	SCANIA	1074	16
87-435407-00 0.50mm	HYUNDAI	402	3	87-438500-00 STD	AUDI	82	38
87-435500-00 STD	OPEL	843	16	87-438500-00 STD	SEAT	1126	39
87-435500-00 STD	SAAB	1058	1	87-438500-00 STD	SKODA	1162	27
87-435500-00 STD	VAUXHALL	1220	17	87-438500-00 STD	VOLKSWAGEN	1327	53
87-435507-00 0.50mm	OPEL	843	16	87-438507-00 0.50mm	AUDI	82	38
87-435507-00 0.50mm	SAAB	1058	1	87-438507-00 0.50mm	SEAT	1126	39
87-435507-00 0.50mm	VAUXHALL	1220	17	87-438507-00 0.50mm	SKODA	1162	27
87-435700-00 STD	FIAT	241	10	87-438507-00 0.50mm	VOLKSWAGEN	1327	53
87-435700-10 STD	FIAT	238	7	87-438800-00 STD	RENAULT TRUCKS	1037	24
87-435706-00 0.40mm	FIAT	241	10	87-438800-00 STD	VOLVO COMMERCIAL	1365	33
87-435706-10 0.40mm	FIAT	238	7	87-438900-00 STD	VOLVO COMMERCIAL	1355	20
87-436500-00 STD	ALFA ROMEO	20	23	87-440500-00 STD	MERCEDES-BENZ	651	6
87-436500-00 STD	CHRYSLER	129	1	87-440600-00 STD	MERCEDES-BENZ COMMERCIAL	775	58
87-436500-00 STD	FIAT	274	57	87-440900-00 STD	MERCEDES-BENZ	667	18
87-436500-00 STD	LANCIA	536	30	87-441100-00 STD	AGCO SISU	1	1
87-436500-00 STD	OPEL	861	38	87-441300-00 STD	PERKINS	896	25
87-436500-00 STD	SAAB	1061	6	87-441900-00 STD	FIAT	276	60
87-436500-00 STD	VAUXHALL	1235	39	87-442300-00 STD	AUDI	37	1
87-436506-00 0.40mm	ALFA ROMEO	20	23	87-442300-00 STD	SEAT	1087	3
87-436506-00 0.40mm	CHRYSLER	129	1	87-442300-00 STD	SKODA	1132	1
87-436506-00 0.40mm	FIAT	274	57	87-442300-00 STD	VOLKSWAGEN	1257	2
87-436506-00 0.40mm	LANCIA	536	30	87-442400-00 STD	DEUTZ KHD	218	17
87-436506-00 0.40mm	OPEL	861	38	87-442400-10 STD	DEUTZ KHD	215	13
87-436506-00 0.40mm	SAAB	1061	6	87-442407-00 0.50mm	DEUTZ KHD	218	17
87-436506-00 0.40mm	VAUXHALL	1235	39	87-442407-10 0.50mm	DEUTZ KHD	215	13
87-436700-00 STD	CITROEN	162	35	87-443100-00 STD	CITROEN	159	32
87-436700-00 STD	FORD EUROPE	345	41	87-443100-00 STD	PEUGEOT	928	34
87-436700-00 STD	JAGUAR	485	3	87-443100-10 STD	CITROEN	160	33
87-436700-00 STD	LAND ROVER	552	9	87-443100-10 STD	PEUGEOT	924	30
87-436700-00 STD	PEUGEOT	930	36	87-443108-00 0.60mm	CITROEN	159	32
87-436700-10 STD	CITROEN	161	34	87-443108-00 0.60mm	PEUGEOT	928	34
87-436700-10 STD	FIAT	280	65	87-443108-10 0.60mm	CITROEN	160	33

			9				9
87-443108-10 0.60mm	PEUGEOT	924	30	87-502800-10 STD	SEAT	1089	6
87-443500-00 STD	MITSUBISHI	792	9	87-502800-10 STD	SKODA	1133	3
87-443500-10 STD	MITSUBISHI	792	9	87-502800-10 STD	VOLKSWAGEN	1260	5
87-443507-00 0.50mm	MITSUBISHI	792	9	87-502807-00 0.50mm	SEAT	1090	7
87-443507-10 0.50mm	MITSUBISHI	792	9	87-502807-00 0.50mm	VOLKSWAGEN	1261	6
87-443600-00 STD	SEAT	1088	4	87-502807-10 0.50mm	SEAT	1089	6
87-443600-00 STD	SKODA	1133	2	87-502807-10 0.50mm	SKODA	1133	3
87-443600-00 STD	VOLKSWAGEN	1258	3	87-502807-10 0.50mm	VOLKSWAGEN	1260	5
87-443700-00 STD	DACIA	186	10	87-502900-00 STD	AUDI	64	23
87-443700-00 STD	RENAULT	984	28	87-502900-00 STD	SEAT	1115	27
87-443707-00 0.50mm	DACIA	186	10	87-502900-00 STD	SKODA	1152	17
87-443707-00 0.50mm	RENAULT	984	28	87-502900-00 STD	VOLKSWAGEN	1303	34
87-443800-00 STD	AUDI	83	39	87-502900-10 STD	AUDI	66	24
87-443800-00 STD	SEAT	1127	40	87-502900-10 STD	SEAT	1116	29
87-443800-00 STD	VOLKSWAGEN	1328	54	87-502900-10 STD	SKODA	1154	19
87-443807-00 0.50mm	AUDI	83	39	87-502900-10 STD	VOLKSWAGEN	1304	35
87-443807-00 0.50mm	SEAT	1127	40	87-502900-30 STD	AUDI	69	27
87-443807-00 0.50mm	VOLKSWAGEN	1328	54	87-502900-30 STD	SEAT	1118	31
87-449000-00 STD	FORD EUROPE	306	4	87-502900-30 STD	SKODA	1155	20
87-449007-00 0.50mm	FORD EUROPE	306	4	87-502900-30 STD	VOLKSWAGEN	1307	38
87-450000-00 STD	DACIA	180	1	87-502905-10 0.25mm	AUDI	66	24
87-450000-00 STD	NISSAN	813	1	87-502905-10 0.25mm	SEAT	1116	29
87-450000-00 STD	RENAULT	956	2	87-502905-10 0.25mm	SKODA	1154	19
87-450007-00 0.50mm	DACIA	180	1	87-502905-10 0.25mm	VOLKSWAGEN	1304	35
87-450007-00 0.50mm	NISSAN	813	1	87-502907-00 0.50mm	AUDI	64	23
87-450007-00 0.50mm	RENAULT	956	2	87-502907-00 0.50mm	SEAT	1115	27
87-501300-00 STD	VOLVO COMMERCIAL	1369	39	87-502907-00 0.50mm	SKODA	1152	17
87-501400-00 STD	VOLVO COMMERCIAL	1351	12	87-502907-00 0.50mm	VOLKSWAGEN	1303	34
87-501500-00 STD	VOLKSWAGEN	1309	40	87-502907-10 0.50mm	AUDI	66	24
87-501500-10 STD	VOLKSWAGEN	1310	40	87-502907-10 0.50mm	SEAT	1116	29
87-501500-20 STD	AUDI	72	30	87-502907-10 0.50mm	SKODA	1154	19
87-501500-20 STD	VOLVO CARS	1339	14	87-502907-10 0.50mm	VOLKSWAGEN	1304	35
87-501500-30 STD	AUDI	72	30	87-502907-30 0.50mm	AUDI	69	27
87-501500-30 STD	VOLVO CARS	1339	14	87-502907-30 0.50mm	SEAT	1118	31
87-501500-40 STD	VOLKSWAGEN	1311	42	87-502907-30 0.50mm	SKODA	1155	20
87-501507-00 0.50mm	VOLKSWAGEN	1309	40	87-502907-30 0.50mm	VOLKSWAGEN	1307	38
87-501507-10 0.50mm	VOLKSWAGEN	1310	40	87-520100-00 STD	LAND ROVER	554	12
87-501507-20 0.50mm	AUDI	72	30	87-520100-00 STD	LEYLAND	568	3
87-501507-20 0.50mm	VOLVO CARS	1339	14	87-520100-00 STD	ROVER	1052	16
87-501507-30 0.50mm	AUDI	72	30	87-520100-10 STD	LAND ROVER	555	13
87-501507-30 0.50mm	VOLVO CARS	1339	14	87-520100-10 STD	ROVER	1053	17
87-501507-40 0.50mm	VOLKSWAGEN	1311	42	87-520107-00 .020	LAND ROVER	554	12
87-501800-10 STD	AUDI	80	35	87-520107-00 .020	LEYLAND	568	3
87-501800-20 STD	AUDI	80	36	87-520107-00 .020	ROVER	1052	16
87-501800-20 STD	SEAT	1124	36	87-520107-10 .020	LAND ROVER	555	13
87-501800-20 STD	VOLKSWAGEN	1324	50	87-520107-10 .020	ROVER	1053	17
87-501800-40 STD	SEAT	1124	37	87-520200-00 STD	FIAT	292	83
87-501800-40 STD	VOLKSWAGEN	1325	51	87-520200-00 STD	IVECO	435	8
87-501807-10 0.50mm	AUDI	80	35	87-520200-00 STD	RENAULT	1017	54
87-501807-20 0.50mm	AUDI	80	36	87-520500-00 STD	CATERHAM	118	1
87-501807-20 0.50mm	SEAT	1124	36	87-520500-00 STD	FSO	391	2
87-501807-20 0.50mm	VOLKSWAGEN	1324	50	87-520500-00 STD	MG	779	4
87-501900-00 STD	FORD EUROPE	334	30	87-520500-00 STD	ROVER	1046	7
87-501900-00 STD	MERCEDES-BENZ	648	3	87-520600-00 STD	DAVID BROWN	205	2
87-501900-00 STD	SEAT	1115	28	87-520607-00 .020	DAVID BROWN	205	2
87-501900-00 STD	VOLKSWAGEN	1300	32	87-520611-00 .040	DAVID BROWN	205	2
87-501907-00 0.50mm	FORD EUROPE	334	30	87-520900-00 STD	FORD COMMERCIAL	380	6
87-501907-00 0.50mm	MERCEDES-BENZ	648	3	87-521000-00 STD	LEYLAND	575	13
87-501907-00 0.50mm	SEAT	1115	28	87-521100-00 STD	NISSAN	827	20
87-501907-00 0.50mm	VOLKSWAGEN	1300	32	87-521300-00 STD	NEW HOLLAND	807	15
87-502600-00 STD	VOLVO COMMERCIAL	1363	30	87-521300-10 STD	NEW HOLLAND	808	16
87-502700-00 STD	VOLVO COMMERCIAL	1352	14	87-521307-00 .020	NEW HOLLAND	807	15
87-502800-00 STD	SEAT	1090	7	87-521307-10 .020	NEW HOLLAND	808	16
87-502800-00 STD	VOLKSWAGEN	1261	6	87-521400-00 STD	NEW HOLLAND	808	17

NUMERICAL PARTS LIST







Numerische Teilenummernliste • Elenco riferimenti
Liste des références produits







   9				   9			
87-521407-00 .020	NEW HOLLAND	808	17	87-523000-00 STD	NEW HOLLAND	809	18
87-521500-00 STD	LAND ROVER	564	25	87-523000-10 STD	IVECO	462	42
87-521500-10 STD	LAND ROVER	563	24	87-523100-00 STD	FIAT	258	38
87-521600-00 STD	LAND ROVER	548	2	87-523100-00 STD	LANCIA	529	22
87-521600-00 STD	MG	780	7	87-523108-00 0.60mm	FIAT	258	38
87-521600-00 STD	ROVER	1048	10	87-523108-00 0.60mm	LANCIA	529	22
87-521700-00 STD	AUSTIN MORRIS	88	4	87-523300-00 STD	SAME	1062	1
87-521700-00 STD	MG	777	1	87-523307-00 0.50mm	SAME	1062	1
87-521700-00 STD	ROVER	1044	3	87-523311-00 1.00mm	SAME	1062	1
87-521707-00 .020	AUSTIN MORRIS	88	4	87-523500-00 STD	FORD COMMERCIAL	379	3
87-521707-00 .020	MG	777	1	87-523600-00 STD	JAGUAR	488	8
87-521707-00 .020	ROVER	1044	3	87-523800-00 STD	LISTER	576	2
87-521711-00 .040	AUSTIN MORRIS	88	4	87-523807-00 .020	LISTER	576	2
87-521711-00 .040	MG	777	1	87-523811-00 .040	LISTER	576	2
87-521711-00 .040	ROVER	1044	3	87-524000-00 STD	JAGUAR	489	10
87-521714-00 .060	AUSTIN MORRIS	88	4	87-524000-00 STD	JAGUAR	490	11
87-521714-00 .060	MG	777	1	87-524000-10 STD	JAGUAR	490	10
87-521714-00 .060	ROVER	1044	3	87-524000-10 STD	JAGUAR	491	11
87-521800-20 STD	LAND ROVER	561	20	87-524007-00 .020	JAGUAR	489	10
87-521800-20 STD	ROVER	1055	20	87-524007-00 .020	JAGUAR	490	11
87-521807-20 .020	LAND ROVER	561	20	87-524007-10 .020	JAGUAR	490	10
87-521807-20 .020	ROVER	1055	20	87-524007-10 .020	JAGUAR	491	11
87-521811-20 .040	LAND ROVER	561	20	87-524009-00 .030	JAGUAR	489	10
87-521811-20 .040	ROVER	1055	20	87-524009-00 .030	JAGUAR	490	11
87-521907-00 .020	AUSTIN MORRIS	91	8	87-524100-00 STD	AUSTIN MORRIS	90	6
87-521907-00 .020	MG	781	8	87-524100-00 STD	MG	777	1
87-521911-00 .040	AUSTIN MORRIS	91	8	87-524100-00 STD	MG	778	2
87-521911-00 .040	MG	781	8	87-524100-00 STD	ROVER	1045	5
87-521914-00 .060	AUSTIN MORRIS	91	8	87-524107-00 .020	AUSTIN MORRIS	90	6
87-521914-00 .060	MG	781	8	87-524107-00 .020	MG	777	1
87-522200-00 STD	CLAYTON DEWANDRE	173	1	87-524107-00 .020	MG	778	2
87-522307-00 .020	AUSTIN MORRIS	87	2	87-524107-00 .020	ROVER	1045	5
87-522309-00 .030	AUSTIN MORRIS	87	2	87-524111-00 .040	AUSTIN MORRIS	90	6
87-522311-00 .040	AUSTIN MORRIS	87	2	87-524111-00 .040	MG	777	1
87-522314-00 .060	AUSTIN MORRIS	87	2	87-524111-00 .040	MG	778	2
87-522400-00 STD	AUSTIN MORRIS	87	3	87-524111-00 .040	ROVER	1045	5
87-522400-00 STD	MINI	783	1	87-524114-00 .060	AUSTIN MORRIS	90	6
87-522400-00 STD	ROVER	1043	2	87-524114-00 .060	MG	777	1
87-522407-00 .020	AUSTIN MORRIS	87	3	87-524114-00 .060	MG	778	2
87-522407-00 .020	MINI	783	1	87-524114-00 .060	ROVER	1045	5
87-522407-00 .020	ROVER	1043	2	87-524200-00 STD	AUSTIN MORRIS	93	11
87-522411-00 .040	AUSTIN MORRIS	87	3	87-524200-00 STD	LAND ROVER	562	21
87-522411-00 .040	MINI	783	1	87-524207-00 .020	AUSTIN MORRIS	93	11
87-522411-00 .040	ROVER	1043	2	87-524207-00 .020	LAND ROVER	562	21
87-522414-00 .060	AUSTIN MORRIS	87	3	87-524211-00 .040	AUSTIN MORRIS	93	11
87-522414-00 .060	MINI	783	1	87-524211-00 .040	LAND ROVER	562	21
87-522414-00 .060	ROVER	1043	2	87-524307-10 .020	AUSTIN MORRIS	86	1
87-522600-00 STD	JAGUAR	487	6	87-524307-10 .020	ROVER	1043	1
87-522607-00 .020	JAGUAR	487	6	87-524311-10 .040	AUSTIN MORRIS	86	1
87-522700-00 STD	CATERHAM	118	2	87-524311-10 .040	ROVER	1043	1
87-522700-00 STD	LAND ROVER	548	1	87-524314-10 .060	AUSTIN MORRIS	86	1
87-522700-00 STD	LOTUS	577	1	87-524314-10 .060	ROVER	1043	1
87-522700-00 STD	MG	779	5	87-524400-00 STD	LAND ROVER	559	18
87-522700-00 STD	ROVER	1048	9	87-524400-00 STD	ROVER	1055	19
87-522700-10 STD	LOTUS	577	2	87-524407-00 .020	LAND ROVER	559	18
87-522700-10 STD	MG	780	6	87-524407-00 .020	ROVER	1055	19
87-522811-00 .040	FORD EUROPE	342	38	87-524800-00 STD	MARELLI	635	4
87-522811-00 .040	LOTUS	578	3	87-524800-10 STD	MARELLI	634	3
87-522900-00 STD	RENAULT TRUCKS	1028	11	87-524804-00 0.20mm	MARELLI	635	4
87-522900-10 STD	RENAULT TRUCKS	1030	13	87-524807-00 0.50mm	MARELLI	635	4
87-522900-30 STD	RENAULT TRUCKS	1031	14	87-524807-10 0.50mm	MARELLI	634	3
87-522900-40 STD	RENAULT TRUCKS	1029	12	87-524811-00 1.00mm	MARELLI	635	4
87-523000-00 STD	DEUTZ KHD	226	29	87-525000-00 STD	LISTER	576	1
87-523000-00 STD	IVECO	463	43	87-525007-00 .020	LISTER	576	1

			9				9
87-525011-00 .040	LISTER	576	1	87-528800-00 STD	TOYOTA	1203	13
87-525014-00 .060	LISTER	576	1	87-528807-00 0.50mm	TOYOTA	1203	13
87-525100-00 STD	PERKINS	883	5	87-529000-00 STD	FORD EUROPE	329	23
87-525100-10 STD	FORD TRACTOR	384	1	87-529007-00 0.50mm	FORD EUROPE	329	23
87-525100-10 STD	PERKINS	881	4	87-529200-00 STD	COMPRESSOR	175	2
87-525200-00 STD	LEYLAND	573	10	87-529200-00 STD	MARELLI	635	5
87-525200-00 STD	PERKINS	887	11	87-529300-00 STD	FIAT	256	33
87-525200-00 STD	PERKINS	888	13	87-529300-00 STD	LANCIA	524	16
87-525209-00 .030	LEYLAND	573	10	87-529306-00 0.40mm	FIAT	256	33
87-525209-00 .030	PERKINS	887	11	87-529306-00 0.40mm	LANCIA	524	16
87-525209-00 .030	PERKINS	888	13	87-529907-00 .020	JAGUAR	484	2
87-525211-00 .040	LEYLAND	573	10	87-529909-00 .030	JAGUAR	484	2
87-525211-00 .040	PERKINS	887	11	87-529911-00 .040	JAGUAR	484	2
87-525211-00 .040	PERKINS	888	13	87-530100-00 STD	AUSTIN MORRIS	93	10
87-525300-00 STD	LEYLAND	571	8	87-530100-00 STD	MG	782	9
87-525400-00 STD	TRIUMPH MOTOR CYCLES	1205	1	87-530107-00 .020	AUSTIN MORRIS	93	10
87-525407-00 .020	TRIUMPH MOTOR CYCLES	1205	1	87-530107-00 .020	MG	782	9
87-525411-00 .040	TRIUMPH MOTOR CYCLES	1205	1	87-530109-00 .030	AUSTIN MORRIS	93	10
87-525414-00 .060	TRIUMPH MOTOR CYCLES	1205	1	87-530109-00 .030	MG	782	9
87-525500-00 STD	JAGUAR	488	7	87-530400-00 STD	ALFA ROMEO	5	3
87-525507-00 .020	JAGUAR	488	7	87-704200-10 STD	BMW	104	5
87-525509-00 .030	JAGUAR	488	7	87-704207-10 0.50mm	BMW	104	5
87-525700-00 STD	TRIUMPH	1204	1	87-704500-00 STD	BMW	104	4
87-525707-00 .020	TRIUMPH	1204	1	87-704500-00 STD	LAND ROVER	549	3
87-525709-00 .030	TRIUMPH	1204	1	87-704500-00 STD	OPEL	854	30
87-525711-00 .040	TRIUMPH	1204	1	87-704500-00 STD	ROVER	1049	11
87-525900-00 STD	AUSTIN MORRIS	92	8	87-704500-00 STD	VAUXHALL	1229	31
87-525900-00 STD	MG	781	8	87-704507-00 0.50mm	BMW	104	4
87-525907-00 .020	AUSTIN MORRIS	92	8	87-704507-00 0.50mm	LAND ROVER	549	3
87-525907-00 .020	MG	781	8	87-704507-00 0.50mm	OPEL	854	30
87-525909-00 .030	AUSTIN MORRIS	92	8	87-704507-00 0.50mm	ROVER	1049	11
87-525909-00 .030	MG	781	8	87-704507-00 0.50mm	VAUXHALL	1229	31
87-525911-00 .040	AUSTIN MORRIS	92	8	87-705000-00 STD	BMW	102	1
87-525911-00 .040	MG	781	8	87-705007-00 0.50mm	BMW	102	1
87-525914-00 .060	AUSTIN MORRIS	92	8	87-714400-00 STD	LAND ROVER	560	19
87-525914-00 .060	MG	781	8	87-714400-00 STD	LEYLAND	569	4
87-526300-00 STD	HINO	397	1	87-714407-00 .020	LAND ROVER	560	19
87-526300-00 STD	TOYOTA	1201	11	87-714407-00 .020	LEYLAND	569	4
87-526400-00 STD	LAND ROVER	558	17	87-714411-00 .040	LAND ROVER	560	19
87-526411-00 .040	LAND ROVER	558	17	87-714411-00 .040	LEYLAND	569	4
87-526600-00 STD	AUSTIN MORRIS	90	7	87-740000-00 STD	MERCEDES-BENZ COMMERCIAL	727	12
87-526600-00 STD	MG	778	3	87-740000-01 STD	MERCEDES-BENZ COMMERCIAL	727	12
87-526900-00 STD	SCANIA	1076	19	87-740000-10 STD	MERCEDES-BENZ COMMERCIAL	731	15
87-527200-00 STD	ALFA ROMEO	5	4	87-740000-20 STD	MERCEDES-BENZ COMMERCIAL	732	17
87-527300-00 STD	ALFA ROMEO	6	5	87-740000-40 STD	MERCEDES-BENZ COMMERCIAL	733	18
87-527600-00 STD	FIAT	237	6	87-740000-41 STD	MERCEDES-BENZ COMMERCIAL	734	18
87-527606-00 0.40mm	FIAT	237	6	87-740000-50 STD	MERCEDES-BENZ COMMERCIAL	729	14
87-527608-00 0.60mm	FIAT	237	6	87-740000-51 STD	MERCEDES-BENZ COMMERCIAL	730	14
87-527800-00 STD	NEW HOLLAND	798	2	87-740007-10 0.50mm	MERCEDES-BENZ COMMERCIAL	731	15
87-527808-00 0.60mm	NEW HOLLAND	798	2	87-740007-20 0.50mm	MERCEDES-BENZ COMMERCIAL	732	17
87-527900-00 STD	IVECO	469	53	87-740007-40 0.50mm	MERCEDES-BENZ COMMERCIAL	733	18
87-528100-00 STD	IVECO	460	38	87-740007-50 0.50mm	MERCEDES-BENZ COMMERCIAL	729	14
87-528100-00 STD	NEW HOLLAND	805	12	87-740300-00 STD	DEUTZ KHD	228	33
87-528200-00 STD	IVECO	469	54	87-740307-00 0.50mm	DEUTZ KHD	228	33
87-528300-00 STD	FIAT	241	11	87-740311-00 1.00mm	DEUTZ KHD	228	33
87-528306-00 0.40mm	FIAT	241	11	87-740900-00 STD	DEUTZ KHD	220	19
87-528400-00 STD	FIAT	249	23	87-740900-10 STD	DEUTZ KHD	218	18
87-528406-00 0.40mm	FIAT	249	23	87-740900-20 STD	DEUTZ KHD	219	18
87-528408-00 0.60mm	FIAT	249	23	87-740900-30 STD	DEUTZ KHD	220	19
87-528500-00 STD	ALFA ROMEO	7	7	87-740907-00 0.50mm	DEUTZ KHD	220	19
87-528600-00 STD	MARELLI	634	1	87-740907-10 0.50mm	DEUTZ KHD	218	18
87-528607-00 0.50mm	MARELLI	634	1	87-740907-20 0.50mm	DEUTZ KHD	219	18
87-528700-00 STD	MARELLI	634	2	87-740907-30 0.50mm	DEUTZ KHD	220	19
87-528707-00 0.50mm	MARELLI	634	2	87-741200-10 STD	COMPRESSOR	176	3

NUMERICAL PARTS LIST



Numerische Teilenummernliste • Elenco riferimenti
Liste des références produits







   9				   9			
87-741200-10 STD	MERCEDES-BENZ COMMERCIAL	716	1	87-780607-00 .020	FORD EUROPE	333	28
87-741207-10 0.50mm	COMPRESSOR	176	3	87-780607-10 .020	FORD EUROPE	332	27
87-741207-10 0.50mm	MERCEDES-BENZ COMMERCIAL	716	1	87-780607-20 .020	FORD EUROPE	333	29
87-741600-00 STD	DAF	197	7	87-780609-00 .030	FORD EUROPE	333	28
87-741800-00 STD	DEUTZ KHD	213	10	87-780609-10 .030	FORD EUROPE	332	27
87-741800-20 STD	DEUTZ KHD	212	9	87-780609-20 .030	FORD EUROPE	333	29
87-741807-00 0.50mm	DEUTZ KHD	213	10	87-780611-10 .040	FORD EUROPE	332	27
87-741807-20 0.50mm	DEUTZ KHD	212	9	87-780611-20 .040	FORD EUROPE	333	29
87-741811-00 1.00mm	DEUTZ KHD	213	10	87-780614-00 .060	FORD EUROPE	333	28
87-741811-20 1.00mm	DEUTZ KHD	212	9	87-780614-10 .060	FORD EUROPE	332	27
87-743100-00 STD	MERCEDES-BENZ	682	31	87-780614-20 .060	FORD EUROPE	333	29
87-743100-00 STD	MERCEDES-BENZ COMMERCIAL	719	6	87-780617-00 .090	FORD EUROPE	333	28
87-743100-00 STD	SSANGYONG	1170	4	87-780617-10 .090	FORD EUROPE	332	27
87-743100-10 STD	MERCEDES-BENZ	680	29	87-781000-00 STD	IVECO	470	55
87-743100-10 STD	MERCEDES-BENZ COMMERCIAL	718	5	87-781900-10 STD	IVECO	444	21
87-743100-10 STD	SSANGYONG	1169	3	87-781900-10 STD	NEW HOLLAND	801	5
87-743100-30 STD	MERCEDES-BENZ	684	33	87-781900-30 STD	IVECO	446	22
87-743100-40 STD	MERCEDES-BENZ	681	30	87-781900-30 STD	NEW HOLLAND	800	4
87-743107-00 0.50mm	MERCEDES-BENZ	682	31	87-781908-10 0.60mm	IVECO	444	21
87-743107-00 0.50mm	MERCEDES-BENZ COMMERCIAL	719	6	87-781908-10 0.60mm	NEW HOLLAND	801	5
87-743107-00 0.50mm	SSANGYONG	1170	4	87-781908-30 0.60mm	IVECO	446	22
87-743107-10 0.50mm	MERCEDES-BENZ	680	29	87-781908-30 0.60mm	NEW HOLLAND	800	4
87-743107-10 0.50mm	MERCEDES-BENZ COMMERCIAL	718	5	87-782000-00 STD	IVECO	448	25
87-743107-10 0.50mm	SSANGYONG	1169	3	87-782000-00 STD	NEW HOLLAND	801	6
87-743107-30 0.50mm	MERCEDES-BENZ	684	33	87-782000-00 STD	NEW HOLLAND	803	8
87-743107-40 0.50mm	MERCEDES-BENZ	681	30	87-782000-10 STD	IVECO	448	25
87-743107-50 0.50mm	MERCEDES-BENZ	683	31	87-782000-10 STD	NEW HOLLAND	802	6
87-743107-50 0.50mm	MERCEDES-BENZ COMMERCIAL	719	6	87-782000-10 STD	NEW HOLLAND	803	8
87-743107-50 0.50mm	SSANGYONG	1170	4	87-782008-00 0.60mm	IVECO	448	25
87-743120-10 0.70mm	MERCEDES-BENZ	680	29	87-782008-00 0.60mm	NEW HOLLAND	801	6
87-743120-10 0.70mm	MERCEDES-BENZ COMMERCIAL	718	5	87-782008-00 0.60mm	NEW HOLLAND	803	8
87-743120-10 0.70mm	SSANGYONG	1169	3	87-782100-00 STD	IVECO	481	67
87-743120-20 0.70mm	MERCEDES-BENZ	680	29	87-782100-30 STD	IVECO	482	70
87-743120-20 0.70mm	MERCEDES-BENZ COMMERCIAL	718	5	87-782100-40 STD	IVECO	482	69
87-743120-20 0.70mm	SSANGYONG	1169	3	87-782300-00 STD	FIAT	266	48
87-743200-00 STD	MERCEDES-BENZ COMMERCIAL	768	52	87-782308-00 0.60mm	FIAT	266	48
87-743200-10 STD	MERCEDES-BENZ COMMERCIAL	766	50	87-782606-00 0.40mm	LANCIA	517	3
87-743400-00 STD	DAF	203	18	87-782608-00 0.60mm	LANCIA	517	3
87-743400-10 STD	DAF	202	17	87-782900-00 STD	FORD COMMERCIAL	381	8
87-743400-30 STD	DAF	204	21	87-782906-00 .015	FORD COMMERCIAL	381	8
87-743400-40 STD	DAF	202	16	87-782910-00 .035	FORD COMMERCIAL	381	8
87-743400-50 STD	DAF	203	19	87-783000-00 STD	IVECO	478	64
87-743600-00 STD	MERCEDES-BENZ	665	16	87-783000-10 STD	IVECO	478	65
87-743600-10 STD	MERCEDES-BENZ	662	13	87-783000-10 STD	IVECO	480	66
87-743600-10 STD	MERCEDES-BENZ COMMERCIAL	716	2	87-783000-15 STD	IVECO	479	65
87-743607-00 0.50mm	MERCEDES-BENZ	665	16	87-783000-30 STD	IVECO	479	65
87-743607-10 0.50mm	MERCEDES-BENZ	662	13	87-783300-00 STD	ALFA ROMEO	28	37
87-743607-10 0.50mm	MERCEDES-BENZ COMMERCIAL	716	2	87-783300-00 STD	FIAT	295	87
87-744100-00 STD	DEUTZ KHD	219	18	87-783300-00 STD	IVECO	436	10
87-744107-00 0.50mm	DEUTZ KHD	219	18	87-783300-00 STD	OPEL	877	60
87-744600-00 STD	DEUTZ KHD	214	10	87-783300-00 STD	RENAULT	1020	58
87-744607-00 0.50mm	DEUTZ KHD	214	10	87-783300-00 STD	VAUXHALL	1247	57
87-744611-00 1.00mm	DEUTZ KHD	214	10	87-783308-00 0.60mm	ALFA ROMEO	28	37
87-780300-10 STD	FORD EUROPE	365	64	87-783308-00 0.60mm	FIAT	295	87
87-780300-30 STD	FORD EUROPE	365	65	87-783308-00 0.60mm	IVECO	436	10
87-780307-10 0.50mm	FORD EUROPE	365	64	87-783308-00 0.60mm	OPEL	877	60
87-780307-30 0.50mm	FORD EUROPE	365	65	87-783308-00 0.60mm	RENAULT	1020	58
87-780309-30 0.75mm	FORD EUROPE	365	65	87-783308-00 0.60mm	VAUXHALL	1247	57
87-780311-10 1.00mm	FORD EUROPE	365	64	87-783400-00 STD	FIAT	270	52
87-780311-30 1.00mm	FORD EUROPE	365	65	87-783500-10 STD	FORD EUROPE	341	36
87-780314-10 1.50mm	FORD EUROPE	365	64	87-783500-10 STD	MAZDA	640	6
87-780314-30 1.50mm	FORD EUROPE	365	65	87-783507-10 0.50mm	FORD EUROPE	341	36
87-780600-10 STD	FORD EUROPE	332	27	87-783507-10 0.50mm	MAZDA	640	6
87-780600-20 STD	FORD EUROPE	333	29	87-783511-10 1.00mm	FORD EUROPE	341	36

			9				9
87-783511-10 1.00mm	MAZDA	640	6	87-785000-00 STD	FORD EUROPE	309	5
87-783600-00 STD	FIAT	254	31	87-785000-00 STD	MAZDA	638	2
87-783600-00 STD	LANCIA	523	14	87-785000-10 STD	FORD EUROPE	311	7
87-783600-00 STD	ZASTAVA	1376	4	87-785007-00 0.50mm	FORD EUROPE	309	5
87-783606-00 0.40mm	FIAT	254	31	87-785007-00 0.50mm	MAZDA	638	2
87-783606-00 0.40mm	LANCIA	523	14	87-785007-10 0.50mm	FORD EUROPE	311	7
87-783606-00 0.40mm	ZASTAVA	1376	4	87-785011-00 1.00mm	FORD EUROPE	309	5
87-783608-00 0.60mm	FIAT	254	31	87-785011-00 1.00mm	MAZDA	638	2
87-783608-00 0.60mm	LANCIA	523	14	87-785011-10 1.00mm	FORD EUROPE	311	7
87-783608-00 0.60mm	ZASTAVA	1376	4	87-785107-00 0.50mm	FORD EUROPE	326	21
87-783700-00 STD	CITROEN	165	40	87-785200-00 STD	FORD EUROPE	340	35
87-783700-00 STD	FIAT	285	73	87-785207-00 0.50mm	FORD EUROPE	340	35
87-783700-00 STD	LANCIA	545	40	87-785300-00 STD	IVECO	466	49
87-783706-00 0.40mm	CITROEN	165	40	87-785300-00 STD	NEW HOLLAND	810	21
87-783706-00 0.40mm	FIAT	285	73	87-785300-10 STD	IVECO	468	51
87-783706-00 0.40mm	LANCIA	545	40	87-785400-00 STD	FIAT	267	48
87-783708-00 0.60mm	CITROEN	165	40	87-785400-00 STD	FIAT	269	50
87-783708-00 0.60mm	FIAT	285	73	87-785400-00 STD	LANCIA	534	28
87-783708-00 0.60mm	LANCIA	545	40	87-785408-00 0.60mm	FIAT	267	48
87-783800-00 STD	FIAT	267	49	87-785408-00 0.60mm	FIAT	269	50
87-783800-10 STD	ALFA ROMEO	16	18	87-785408-00 0.60mm	LANCIA	534	28
87-783800-10 STD	FIAT	271	53	87-785500-00 STD	FIAT	251	27
87-783800-10 STD	FIAT	272	54	87-785500-00 STD	FSO	392	3
87-783800-10 STD	LANCIA	533	26	87-785506-00 0.40mm	FIAT	251	27
87-783800-30 STD	ALFA ROMEO	16	18	87-785506-00 0.40mm	FSO	392	3
87-783800-30 STD	FIAT	268	49	87-785508-00 0.60mm	FIAT	251	27
87-783800-30 STD	FIAT	271	53	87-785508-00 0.60mm	FSO	392	3
87-783800-30 STD	LANCIA	533	26	87-786300-00 STD	FORD EUROPE	316	12
87-783800-30 STD	LANCIA	535	29	87-786307-00 0.50mm	FORD EUROPE	316	12
87-783808-00 0.60mm	FIAT	267	49	87-786400-00 STD	FORD EUROPE	344	40
87-783808-10 0.60mm	ALFA ROMEO	16	18	87-786407-00 0.50mm	FORD EUROPE	344	40
87-783808-10 0.60mm	FIAT	271	53	87-786500-00 STD	FORD EUROPE	331	25
87-783808-10 0.60mm	FIAT	272	54	87-786507-00 0.50mm	FORD EUROPE	331	25
87-783808-10 0.60mm	LANCIA	533	26	87-786800-00 STD	FIAT	286	74
87-783808-30 0.60mm	ALFA ROMEO	16	18	87-786800-00 STD	LANCIA	544	39
87-783808-30 0.60mm	FIAT	268	49	87-786806-00 0.40mm	FIAT	286	74
87-783808-30 0.60mm	FIAT	271	53	87-786806-00 0.40mm	LANCIA	544	39
87-783808-30 0.60mm	LANCIA	533	26	87-787000-00 STD	FIAT	256	34
87-783808-30 0.60mm	LANCIA	535	29	87-787000-00 STD	LANCIA	526	18
87-783900-00 STD	IVECO	449	26	87-787000-10 STD	ALFA ROMEO	10	12
87-783900-00 STD	NEW HOLLAND	802	7	87-787000-30 STD	FIAT	257	36
87-783900-10 STD	IVECO	450	28	87-787000-30 STD	LANCIA	527	20
87-784100-00 STD	FORD EUROPE	305	2	87-787006-00 0.40mm	FIAT	256	34
87-784100-10 STD	FORD EUROPE	305	1	87-787006-00 0.40mm	LANCIA	526	18
87-784107-00 0.50mm	FORD EUROPE	305	2	87-787006-10 0.40mm	ALFA ROMEO	10	12
87-784107-10 0.50mm	FORD EUROPE	305	1	87-787006-30 0.40mm	FIAT	257	36
87-784200-00 STD	FORD EUROPE	346	42	87-787006-30 0.40mm	LANCIA	527	20
87-784200-00 STD	FORD EUROPE	347	43	87-849000-00 STD	HYUNDAI	401	1
87-784200-10 STD	FORD EUROPE	347	43	87-849000-00 STD	KIA	503	1
87-784207-00 0.50mm	FORD EUROPE	346	42	87-849007-00 0.50mm	HYUNDAI	401	1
87-784207-00 0.50mm	FORD EUROPE	347	43	87-849007-00 0.50mm	KIA	503	1
87-784207-10 0.50mm	FORD EUROPE	347	43	87-849200-00 STD	HYUNDAI	401	2
87-784600-00 STD	FORD EUROPE	335	31	87-849200-00 STD	KIA	503	2
87-784607-00 0.50mm	FORD EUROPE	335	31	87-849207-00 0.50mm	HYUNDAI	401	2
87-784611-00 1.00mm	FORD EUROPE	335	31	87-849207-00 0.50mm	KIA	503	2
87-784800-00 STD	FORD EUROPE	369	70	87-854700-00 STD	FIAT	297	90
87-784800-00 STD	FORD EUROPE	370	71	87-854700-00 STD	IVECO	438	13
87-784800-10 STD	FORD EUROPE	372	72	87-854700-00 STD	OPEL	878	61
87-784811-00 1.00mm	FORD EUROPE	369	70	87-854700-00 STD	RENAULT TRUCKS	1023	1
87-784811-00 1.00mm	FORD EUROPE	370	71	87-854700-00 STD	VAUXHALL	1248	58
87-784811-10 1.00mm	FORD EUROPE	372	72	87-854708-00 0.60mm	FIAT	297	90
87-784821-00 0.65mm	FORD EUROPE	369	70	87-854708-00 0.60mm	IVECO	438	13
87-784821-00 0.65mm	FORD EUROPE	370	71	87-854708-00 0.60mm	OPEL	878	61
87-784821-10 0.65mm	FORD EUROPE	372	72	87-854708-00 0.60mm	RENAULT TRUCKS	1023	1

NUMERICAL PARTS LIST







Nummerische Teilenummernliste • Elenco riferimenti
Liste des références produits







   9			
87-854708-00 0.60mm	VAUXHALL	1248	58
87-879200-00 STD	CHEVROLET	126	11
87-879200-00 STD	OPEL	862	39
87-879207-00 0.50mm	CHEVROLET	126	11
87-879207-00 0.50mm	OPEL	862	39
87-896800-00 STD	STEYR	1178	4
87-898407-02 0.50mm	MINI	783	2
87-898407-02 0.50mm	SUBARU	1180	2
87-960200-00 STD	BEDFORD	95	1
87-960200-00 STD	SUZUKI	1182	1
87-960200-00 STD	VAUXHALL	1210	1
87-960207-00 0.50mm	BEDFORD	95	1
87-960207-00 0.50mm	SUZUKI	1182	1
87-960207-00 0.50mm	VAUXHALL	1210	1
87-960800-10 STD	SCANIA	1079	24
87-960900-00 STD	SCANIA	1069	7
87-960900-10 STD	SCANIA	1068	6
87-961000-00 STD	SCANIA	1067	5
87-961000-10 STD	SCANIA	1067	4
87-962000-00 STD	SCANIA	1078	22
87-962000-10 STD	SCANIA	1082	30
87-962000-30 STD	SCANIA	1077	21
87-962000-40 STD	SCANIA	1082	29
87-962000-50 STD	SCANIA	1081	28
87-962000-80 STD	SCANIA	1081	27
87-990100-10 STD	AUDI	50	12
87-990100-10 STD	SEAT	1099	15
87-990100-10 STD	VOLKSWAGEN	1280	20
87-990100-40 STD	AUDI	46	10
87-990100-40 STD	SEAT	1096	13
87-990100-40 STD	SKODA	1140	10
87-990100-40 STD	VOLKSWAGEN	1274	17
87-990105-10 0.25mm	AUDI	50	12
87-990105-10 0.25mm	SEAT	1099	15
87-990105-10 0.25mm	VOLKSWAGEN	1280	20
87-990105-40 0.25mm	AUDI	46	10
87-990105-40 0.25mm	SEAT	1096	13
87-990105-40 0.25mm	SKODA	1140	10
87-990105-40 0.25mm	VOLKSWAGEN	1274	17
87-990107-10 0.50mm	AUDI	50	12
87-990107-10 0.50mm	SEAT	1099	15
87-990107-10 0.50mm	VOLKSWAGEN	1280	20
87-990107-40 0.50mm	AUDI	46	10
87-990107-40 0.50mm	SEAT	1096	13
87-990107-40 0.50mm	SKODA	1140	10
87-990107-40 0.50mm	VOLKSWAGEN	1274	17
87-990111-10 1.00mm	AUDI	50	12
87-990111-10 1.00mm	SEAT	1099	15
87-990111-10 1.00mm	VOLKSWAGEN	1280	20
87-990111-40 1.00mm	AUDI	46	10
87-990111-40 1.00mm	SEAT	1096	13
87-990111-40 1.00mm	SKODA	1140	10
87-990111-40 1.00mm	VOLKSWAGEN	1274	17
87-990500-00 STD	SCANIA	1076	20
87-990500-00 STD	SCANIA	1080	26
87-990700-00 STD	COMPRESSOR	175	1
87-990700-00 STD	SCANIA	1066	1
87-990700-00 STD	VOLVO COMMERCIAL	1345	1
87-990705-00 0.25mm	COMPRESSOR	175	1
87-990705-00 0.25mm	SCANIA	1066	1
87-990705-00 0.25mm	VOLVO COMMERCIAL	1345	1
87-990707-00 0.50mm	COMPRESSOR	175	1
87-990707-00 0.50mm	SCANIA	1066	1
87-990707-00 0.50mm	VOLVO COMMERCIAL	1345	1

			9				9
88-101700-30	PERKINS	892	19	88-181800-00	JOHN DEERE	497	1
88-103200-00	DEUTZ KHD	208	1	88-181800-10	JOHN DEERE	497	1
88-104000-00	CITROEN	149	20	88-203500-00	FORD COMMERCIAL	378	1
88-104000-00	FIAT	265	46	88-203500-00	FORD TRACTOR	385	2
88-104000-00	PEUGEOT	915	22	88-207500-00	IVECO	460	39
88-104300-00	MAN	629	40	88-207500-00	NEW HOLLAND	806	13
88-104300-10	MAN	629	40	88-207500-10	IVECO	461	40
88-115800-00	MERCEDES-BENZ COMMERCIAL	765	48	88-207500-10	NEW HOLLAND	806	14
88-121800-00	IVECO	465	47	88-207500-30	IVECO	461	40
88-123900-10	DEUTZ KHD	229	35	88-207500-30	NEW HOLLAND	807	14
88-124500-30	MAN	620	33	88-245500-00	NEW HOLLAND	809	19
88-136000-20	MERCEDES-BENZ COMMERCIAL	772	55	88-245500-10	IVECO	464	44
88-136500-00	MAN	597	9	88-245500-10	NEW HOLLAND	810	19
88-136500-10	MAN	598	9	88-247200-00	ISUZU	415	3
88-136500-30	MAN	599	10	88-247600-10	ISUZU	416	5
88-136500-65	MAN	602	11	88-247600-10	OPEL	874	54
88-136900-00	DEUTZ KHD	222	23	88-247600-10	VAUXHALL	1245	53
88-136900-00	DEUTZ KHD	224	26	88-248000-00	CHEVROLET	128	15
88-138900-10	PEUGEOT	906	8	88-248000-00	ISUZU	416	6
88-138900-30	CITROEN	141	10	88-248000-10	ISUZU	417	7
88-138900-30	PEUGEOT	906	8	88-252800-00	DEUTZ KHD	210	5
88-138900-30	PEUGEOT	907	9	88-274800-00	MAN	612	21
88-140500-00	COMPRESSOR	177	6	88-274800-30	MAN	612	21
88-140500-10	COMPRESSOR	177	6	88-283100-40	MAN	621	34
88-141800-00	MERCEDES-BENZ COMMERCIAL	764	47	88-285900-00	MAN	594	7
88-141900-00	VOLVO COMMERCIAL	1353	15	88-285900-05	MAN	595	7
88-142000-00	VOLVO COMMERCIAL	1355	19	88-285900-06	MAN	595	7
88-142800-00	VOLVO COMMERCIAL	1349	8	88-285900-10	MAN	592	6
88-142900-00	IVECO	462	41	88-285900-15	MAN	593	6
88-143800-50	MAN	633	43	88-285900-16	MAN	593	6
88-152000-30	CITROEN	154	26	88-285900-30	MAN	596	8
88-152000-30	FIAT	275	59	88-285900-40	MAN	596	8
88-152000-30	FSO	393	5	88-289300-00	MERCEDES-BENZ COMMERCIAL	736	21
88-152000-30	HYUNDAI	405	6	88-289600-30	MERCEDES-BENZ COMMERCIAL	770	53
88-152000-30	LADA	512	5	88-325600-10	PERKINS	890	17
88-152000-30	LEYLAND	568	2	88-335300-00	RENAULT TRUCKS	1041	34
88-152000-30	PEUGEOT	920	26	88-335900-00	RENAULT TRUCKS	1040	30
88-152000-30	ROVER	1050	13	88-335900-10	RENAULT TRUCKS	1040	30
88-152000-30	SUZUKI	1186	8	88-335900-30	RENAULT TRUCKS	1040	31
88-152000-30	TALBOT	1189	3	88-373800-10	TOYOTA	1200	8
88-154300-00	CITROEN	135	2	88-373800-10	VOLKSWAGEN	1330	56
88-154300-00	PEUGEOT	900	1	88-404500-00	COMPRESSOR	177	5
88-154400-00	CITROEN	139	7	88-404500-10	COMPRESSOR	177	5
88-154400-00	PEUGEOT	905	7	88-420900-00	MERCEDES-BENZ COMMERCIAL	774	56
88-167600-00	DEUTZ KHD	227	31	88-420900-10	MERCEDES-BENZ COMMERCIAL	774	56
88-172500-00	DEUTZ KHD	213	10	88-423000-00	MAN	608	17
88-174100-00	DAF	200	13	88-423000-10	MAN	607	16
88-174100-00	LEYLAND	574	12	88-428600-00	MAN	609	18
88-174100-30	DAF	201	14	88-429600-00	RENAULT TRUCKS	1038	26
88-174600-00	DEUTZ KHD	216	15	88-433300-00	DAF	204	20
88-174600-10	DEUTZ KHD	221	22	88-520500-00	CATERHAM	118	1
88-174600-30	DEUTZ KHD	217	15	88-520500-00	FSO	391	2
88-176800-00	HENSCHEL	396	3	88-520500-00	MG	779	4
88-176800-00	MERCEDES-BENZ COMMERCIAL	740	23	88-520500-00	ROVER	1046	7
88-176800-10	MERCEDES-BENZ COMMERCIAL	740	23	88-522700-00	CATERHAM	118	2
88-176800-20	MERCEDES-BENZ COMMERCIAL	740	23	88-522700-00	LAND ROVER	548	1
88-178400-00	DEUTZ KHD	217	16	88-522700-00	LOTUS	577	1
88-178400-10	DEUTZ KHD	217	16	88-522700-00	MG	779	5
88-179000-10	DAF	196	6	88-522700-00	ROVER	1048	9
88-179300-10	MERCEDES-BENZ COMMERCIAL	755	39	88-523000-00	DEUTZ KHD	226	29
88-179400-00	DEUTZ KHD	214	11	88-523000-00	IVECO	463	43
88-181100-10	JOHN DEERE	498	3	88-523000-00	NEW HOLLAND	809	18
88-181100-20	JOHN DEERE	498	2	88-523000-10	IVECO	462	42
88-181100-30	JOHN DEERE	500	6	88-523600-00	JAGUAR	488	8

NUMERICAL PARTS LIST







Nummerische Teilenummernliste • Elenco riferimenti
Liste des références produits









			9				9
88-527600-00	FIAT	237	6	89-143600-00	SCANIA	1074	15
88-528100-00	IVECO	460	38	89-143600-30	SCANIA	1073	14
88-528100-00	NEW HOLLAND	805	12	89-143600-40	SCANIA	1071	11
88-528300-00	FIAT	241	11	89-143800-00	MAN	631	42
88-528400-00	FIAT	249	23	89-143800-10	MAN	632	42
88-528800-00	TOYOTA	1203	13	89-143800-20	MAN	632	42
88-530300-00	FIAT	264	44	89-143800-30	MAN	628	39
88-530300-00	NEW HOLLAND	798	1	89-151200-00	CITROEN	153	25
88-740000-50	MERCEDES-BENZ COMMERCIAL	729	14	89-151200-00	PEUGEOT	918	24
88-740300-00	DEUTZ KHD	228	33	89-176000-00	MERCEDES-BENZ COMMERCIAL	742	25
88-740300-10	DEUTZ KHD	228	33	89-176000-10	MERCEDES-BENZ COMMERCIAL	741	24
88-740900-00	DEUTZ KHD	220	19	89-176800-20	HENSCHEL	396	3
88-740900-10	DEUTZ KHD	218	18	89-176800-30	MERCEDES-BENZ COMMERCIAL	744	28
88-743400-00	DAF	203	18	89-176800-40	MERCEDES-BENZ COMMERCIAL	744	28
88-743400-10	DAF	202	17	89-179300-05	MERCEDES-BENZ COMMERCIAL	758	41
88-743400-30	DAF	204	21	89-179300-15	MERCEDES-BENZ COMMERCIAL	753	38
88-743400-40	DAF	202	16	89-179300-16	MERCEDES-BENZ COMMERCIAL	753	38
88-743400-50	DAF	203	19	89-179300-18	MERCEDES-BENZ COMMERCIAL	755	39
88-743600-10	MERCEDES-BENZ	662	13	89-179300-21	MERCEDES-BENZ COMMERCIAL	760	43
88-743600-10	MERCEDES-BENZ COMMERCIAL	716	2	89-179300-25	MERCEDES-BENZ COMMERCIAL	757	40
88-744600-00	DEUTZ KHD	214	10	89-179300-30	MERCEDES-BENZ COMMERCIAL	750	34
88-785300-00	IVECO	466	49	89-179300-40	MERCEDES-BENZ COMMERCIAL	759	42
88-785300-00	NEW HOLLAND	810	21	89-179300-50	MERCEDES-BENZ COMMERCIAL	761	44
88-785300-10	IVECO	468	51	89-179300-55	MERCEDES-BENZ COMMERCIAL	761	44
88-785500-00	FIAT	251	27	89-179300-60	MERCEDES-BENZ COMMERCIAL	751	36
88-785500-00	FSO	392	3	89-179300-65	MERCEDES-BENZ COMMERCIAL	755	39
89-101100-00	VOLVO COMMERCIAL	1374	47	89-179300-66	MERCEDES-BENZ COMMERCIAL	755	39
89-101100-10	VOLVO COMMERCIAL	1373	46	89-179300-70	MERCEDES-BENZ COMMERCIAL	749	33
89-107100-30	ALFA ROMEO	20	24	89-179300-71	MERCEDES-BENZ COMMERCIAL	749	33
89-107100-40	ALFA ROMEO	22	27	89-179300-80	MERCEDES-BENZ COMMERCIAL	750	35
89-109200-30	SCANIA	1070	9	89-179300-81	MERCEDES-BENZ COMMERCIAL	750	35
89-110100-00	ALFA ROMEO	25	32	89-179300-85	MERCEDES-BENZ COMMERCIAL	756	39
89-110100-00	CHRYSLER	130	3	89-179300-86	MERCEDES-BENZ COMMERCIAL	756	39
89-110100-00	FORD EUROPE	367	67	89-179300-90	MERCEDES-BENZ COMMERCIAL	756	39
89-110100-00	OPEL	876	57	89-179300-91	MERCEDES-BENZ COMMERCIAL	756	39
89-110100-00	ROVER	1056	21	89-181700-60	MERCEDES-BENZ COMMERCIAL	748	32
89-110100-00	VAUXHALL	1247	56	89-181700-61	MERCEDES-BENZ COMMERCIAL	748	32
89-110100-00	VM	1249	1	89-203500-00	FORD COMMERCIAL	378	1
89-110200-30	ALFA ROMEO	23	28	89-203500-00	FORD TRACTOR	385	2
89-110200-40	ALFA ROMEO	22	26	89-243300-10	IHC	411	2
89-121900-30	IVECO	471	56	89-280200-10	MAN	614	25
89-122000-30	IVECO	474	60	89-280400-00	MAN	615	26
89-123200-10	VOLVO COMMERCIAL	1371	42	89-283100-00	MAN	623	35
89-123200-30	VOLVO COMMERCIAL	1370	40	89-283100-30	MAN	621	34
89-123200-40	VOLVO COMMERCIAL	1370	41	89-283100-40	MAN	623	35
89-124500-00	MAN	630	41	89-283100-41	MAN	625	37
89-124500-05	MAN	630	41	89-283100-42	MAN	625	37
89-124500-10	MAN	630	41	89-283100-43	MAN	626	37
89-124500-20	MAN	631	41	89-283100-60	MAN	626	38
89-124500-25	MAN	631	41	89-283100-80	MAN	625	37
89-124500-40	MAN	619	31	89-283100-85	MAN	625	37
89-131400-40	RENAULT TRUCKS	1032	17	89-283100-86	MAN	626	37
89-131500-30	RENAULT TRUCKS	1032	17	89-289600-00	MERCEDES-BENZ COMMERCIAL	770	53
89-135500-10	RENAULT TRUCKS	1036	22	89-289600-20	MERCEDES-BENZ COMMERCIAL	770	53
89-135500-30	RENAULT TRUCKS	1037	25	89-313400-00	PERKINS	880	1
89-136000-00	MERCEDES-BENZ COMMERCIAL	772	55	89-316900-00	CITROEN	166	42
89-136000-10	MERCEDES-BENZ COMMERCIAL	772	55	89-316900-00	FIAT	287	76
89-136800-10	VOLVO COMMERCIAL	1362	29	89-316900-00	PEUGEOT	934	41
89-136800-30	VOLVO COMMERCIAL	1357	23	89-316900-00	TALBOT	1190	5
89-136800-40	VOLVO COMMERCIAL	1357	23	89-316900-10	CITROEN	167	42
89-136900-10	VOLVO COMMERCIAL	1354	17	89-316900-10	FIAT	287	76
89-142500-10	VOLVO COMMERCIAL	1345	2	89-316900-10	PEUGEOT	935	41
89-142500-30	VOLVO COMMERCIAL	1347	6	89-316900-10	TALBOT	1191	5
89-143600-00	SCANIA	1073	14	89-322400-00	CITROEN	152	24

			9				9
89-322400-00	PEUGEOT	919	25	89-522900-00	RENAULT TRUCKS	1028	11
89-333300-00	RENAULT	954	1	89-522900-10	RENAULT TRUCKS	1030	13
89-333500-00	ARO	31	3	89-522900-30	RENAULT TRUCKS	1031	14
89-333500-00	RENAULT	968	14	89-522900-40	RENAULT TRUCKS	1029	12
89-333500-00	VOLVO CARS	1334	6	89-522900-50	RENAULT TRUCKS	1029	12
89-334300-00	RENAULT	979	24	89-525300-00	LEYLAND	571	8
89-334400-00	CITROEN	166	41	89-526900-00	SCANIA	1076	19
89-334400-00	JEEP	495	4	89-527200-00	ALFA ROMEO	5	4
89-334400-00	PEUGEOT	936	44	89-527300-00	ALFA ROMEO	6	5
89-334400-00	RENAULT	1010	47	89-528500-00	ALFA ROMEO	7	7
89-334600-00	DAF	194	1	89-530400-00	ALFA ROMEO	5	3
89-334600-00	RENAULT	959	4	89-743200-00	MERCEDES-BENZ COMMERCIAL	768	52
89-334600-00	VOLVO CARS	1332	1	89-743200-10	MERCEDES-BENZ COMMERCIAL	766	50
89-336400-00	RENAULT	963	11	89-960800-10	SCANIA	1079	24
89-336400-10	RENAULT	965	12	89-960900-00	SCANIA	1069	7
89-337000-00	RENAULT	1002	41	89-960900-10	SCANIA	1068	6
89-337000-10	RENAULT	1004	43	89-961000-00	SCANIA	1067	5
89-337100-00	CHRYSLER	129	2	89-961000-10	SCANIA	1067	4
89-337100-00	JEEP	495	3	89-961000-20	SCANIA	1067	4
89-337100-00	RENAULT	1003	42	89-962000-00	SCANIA	1078	22
89-337300-00	ARO	30	2	89-962000-10	SCANIA	1082	30
89-337300-00	RENAULT	962	8	89-962000-30	SCANIA	1077	21
89-337500-00	RENAULT TRUCKS	1033	18	89-962000-35	SCANIA	1077	21
89-337500-00	RENAULT TRUCKS	1035	21	89-962000-40	SCANIA	1082	29
89-337500-10	RENAULT TRUCKS	1033	18	89-962000-50	SCANIA	1081	28
89-337500-30	RENAULT TRUCKS	1034	19	89-962000-80	SCANIA	1081	27
89-337500-40	RENAULT TRUCKS	1033	18	89-990500-00	SCANIA	1076	20
89-337500-40	RENAULT TRUCKS	1035	21	89-990500-00	SCANIA	1080	26
89-337500-50	RENAULT TRUCKS	1035	21				
89-346500-00	RENAULT TRUCKS	1026	8				
89-396300-00	VOLVO COMMERCIAL	1358	24				
89-405500-10	VOLVO COMMERCIAL	1347	5				
89-405500-30	VOLVO COMMERCIAL	1347	5				
89-405600-60	VOLVO COMMERCIAL	1368	38				
89-405600-70	VOLVO COMMERCIAL	1367	36				
89-405600-80	VOLVO COMMERCIAL	1367	36				
89-407000-00	VOLVO COMMERCIAL	1350	11				
89-407100-00	VOLVO COMMERCIAL	1360	26				
89-407100-10	VOLVO COMMERCIAL	1360	26				
89-407100-20	VOLVO COMMERCIAL	1364	31				
89-407100-30	VOLVO COMMERCIAL	1364	31				
89-420900-30	MERCEDES-BENZ COMMERCIAL	774	56				
89-420900-40	MERCEDES-BENZ COMMERCIAL	774	56				
89-420900-50	MERCEDES-BENZ COMMERCIAL	775	57				
89-427000-00	MERCEDES-BENZ COMMERCIAL	766	49				
89-430000-00	DEUTZ KHD	225	28				
89-430000-00	RENAULT TRUCKS	1031	15				
89-430000-00	VOLVO COMMERCIAL	1354	18				
89-431000-00	MAN	616	27				
89-431000-10	MAN	617	28				
89-431300-00	VOLVO COMMERCIAL	1362	28				
89-434400-00	VOLVO COMMERCIAL	1372	43				
89-434400-10	VOLVO COMMERCIAL	1372	44				
89-435000-00	RENAULT TRUCKS	1027	10				
89-435000-10	RENAULT TRUCKS	1028	10				
89-437600-00	SCANIA	1074	16				
89-437600-100	SCANIA	1074	16				
89-438800-00	RENAULT TRUCKS	1037	24				
89-438800-00	VOLVO COMMERCIAL	1365	33				
89-438900-00	VOLVO COMMERCIAL	1355	20				
89-501300-00	VOLVO COMMERCIAL	1369	39				
89-501400-00	VOLVO COMMERCIAL	1351	12				
89-502600-00	VOLVO COMMERCIAL	1363	30				
89-520300-00	PEUGEOT	923	29				

NUMERICAL PARTS LIST







Numerische Teilenummernliste • Elenco riferimenti
Liste des références produits







			9				9
14-000230-00	COMPRESSOR	176	4	14-010890-00	AUSTIN MORRIS	88	4
14-000230-00	COMPRESSOR	177	5	14-010890-00	AUSTIN MORRIS	89	5
14-000240-00	COMPRESSOR	176	4	14-010890-00	AUSTIN MORRIS	90	6
14-000240-00	COMPRESSOR	177	5	14-010890-00	MG	777	1
14-000310-00	COMPRESSOR	177	6	14-010890-00	MG	778	2
14-000320-00	CHRYSLER	129	2	14-010890-00	ROVER	1044	3
14-000320-00	JEEP	495	3	14-010890-00	ROVER	1044	4
14-000320-00	RENAULT	1001	40	14-010890-00	ROVER	1045	5
14-000320-00	RENAULT	1002	41	14-010900-00	ALFA ROMEO	6	6
14-000320-00	RENAULT	1003	42	14-010900-00	BEDFORD	97	5
14-000320-00	RENAULT	1004	43	14-010900-00	FORD EUROPE	319	16
14-000350-00	COMPRESSOR	177	6	14-010900-00	PERKINS	880	2
14-010170-00	IVECO	443	20	14-010920-00	AUSTIN MORRIS	93	11
14-010170-00	IVECO	445	22	14-010920-00	LAND ROVER	557	15
14-010170-00	NEW HOLLAND	799	4	14-010920-00	LAND ROVER	557	16
14-010180-00	IVECO	448	25	14-010920-00	LAND ROVER	558	17
14-010180-00	IVECO	449	26	14-010920-00	LAND ROVER	559	18
14-010180-00	IVECO	449	27	14-010920-00	LAND ROVER	560	19
14-010180-00	IVECO	450	28	14-010920-00	LAND ROVER	562	21
14-010180-00	NEW HOLLAND	801	6	14-010920-00	LEYLAND	569	4
14-010180-00	NEW HOLLAND	802	7	14-010920-00	ROVER	1054	18
14-010180-00	NEW HOLLAND	803	8	14-010920-00	ROVER	1055	19
14-010181-00	IVECO	448	25	14-010940-00	IVECO	450	29
14-010181-00	IVECO	449	26	14-010940-00	IVECO	453	30
14-010181-00	IVECO	449	27	14-010940-00	IVECO	454	31
14-010181-00	IVECO	450	28	14-010940-00	IVECO	455	32
14-010181-00	NEW HOLLAND	802	7	14-010940-00	IVECO	456	33
14-010181-00	NEW HOLLAND	803	8	14-010940-00	IVECO	457	34
14-010182-00	IVECO	448	25	14-010940-00	IVECO	458	35
14-010182-00	IVECO	449	26	14-010940-00	IVECO	459	36
14-010182-00	IVECO	449	27	14-010940-00	IVECO	459	37
14-010182-00	IVECO	450	28	14-010940-00	NEW HOLLAND	804	9
14-010182-00	NEW HOLLAND	802	7	14-010940-00	NEW HOLLAND	804	10
14-010182-00	NEW HOLLAND	803	8	14-010940-00	NEW HOLLAND	805	11
14-010620-00	IVECO	441	18	14-010941-10	IVECO	450	29
14-010620-00	NEW HOLLAND	799	3	14-010941-10	IVECO	453	30
14-010770-00	FORD COMMERCIAL	381	7	14-010941-10	IVECO	454	31
14-010770-00	FORD TRACTOR	385	3	14-010941-10	IVECO	455	32
14-010770-00	FORD TRACTOR	386	4	14-010941-10	IVECO	456	33
14-010780-00	IVECO	444	21	14-010941-10	IVECO	457	34
14-010780-00	NEW HOLLAND	801	5	14-010941-10	IVECO	458	35
14-010781-00	IVECO	444	21	14-010941-10	IVECO	459	36
14-010781-00	NEW HOLLAND	801	5	14-010941-10	IVECO	459	37
14-010782-00	IVECO	444	21	14-010941-10	NEW HOLLAND	804	9
14-010782-00	NEW HOLLAND	801	5	14-010941-10	NEW HOLLAND	804	10
14-010820-00	NEW HOLLAND	807	15	14-010941-10	NEW HOLLAND	805	11
14-010820-00	NEW HOLLAND	808	16	14-010943-10	IVECO	450	29
14-010820-00	NEW HOLLAND	808	17	14-010943-10	IVECO	453	30
14-010830-00	FORD EUROPE	310	6	14-010943-10	IVECO	454	31
14-010840-00	KIA	505	5	14-010943-10	IVECO	455	32
14-010840-00	MAZDA	641	7	14-010943-10	IVECO	456	33
14-010850-00	TOYOTA	1200	8	14-010943-10	IVECO	457	34
14-010850-00	TOYOTA	1200	9	14-010943-10	IVECO	458	35
14-010850-00	VOLKSWAGEN	1330	56	14-010943-10	IVECO	459	36
14-010860-00	LAND ROVER	563	23	14-010943-10	IVECO	459	37
14-010860-00	LAND ROVER	563	24	14-010943-10	NEW HOLLAND	804	9
14-010860-00	LAND ROVER	564	25	14-010943-10	NEW HOLLAND	804	10
14-010870-00	ISUZU	414	1	14-010943-10	NEW HOLLAND	805	11
14-010870-00	OPEL	838	10	14-010950-00	DAVID BROWN	205	1
14-010870-00	VAUXHALL	1216	11	14-010950-00	DAVID BROWN	205	2
14-010880-00	FORD EUROPE	332	26	14-010960-00	CLAYTON DEWANDRE	173	1
14-010880-00	FORD EUROPE	332	27	14-010970-00	HYUNDAI	409	13
14-010880-00	FORD EUROPE	333	28	14-010970-00	MITSUBISHI	794	12
14-010880-00	FORD EUROPE	333	29	14-010991-00	FIAT	242	12

							
14-010991-00	FIAT	242	13	14-014120-00	FORD COMMERCIAL	382	9
14-010991-00	FIAT	243	14	14-014120-00	FORD TRACTOR	386	5
14-010991-00	FIAT	243	15	14-014640-00	FORD COMMERCIAL	382	9
14-010991-00	FIAT	244	16	14-014640-00	FORD TRACTOR	386	5
14-010991-00	LANCIA	519	6	14-014730-00	ALFA ROMEO	16	18
14-010991-00	LANCIA	520	7	14-014730-00	ALFA ROMEO	17	19
14-010991-00	LANCIA	520	8	14-014730-00	CITROEN	150	22
14-011001-00	FIAT	234	1	14-014730-00	FIAT	265	47
14-011001-00	FIAT	235	2	14-014730-00	FIAT	269	50
14-011001-00	FIAT	235	3	14-014730-00	FIAT	269	51
14-011001-00	FIAT	236	4	14-014730-00	FIAT	270	52
14-011001-00	FIAT	236	5	14-014730-00	FIAT	271	53
14-011001-00	FSO	391	1	14-014730-00	LANCIA	533	26
14-011001-00	LANCIA	516	1	14-014730-00	LANCIA	534	27
14-011001-00	LANCIA	517	2	14-014730-00	LANCIA	534	28
14-011001-00	SEAT	1086	1	14-014730-00	LANCIA	535	29
14-011021-00	IVECO	443	20	14-015400-00	MITSUBISHI	795	14
14-011021-00	IVECO	445	22	14-015590-00	HYUNDAI	406	8
14-011021-00	NEW HOLLAND	799	4	14-015590-00	HYUNDAI	406	9
14-011022-00	IVECO	443	20	14-015590-00	HYUNDAI	407	10
14-011022-00	IVECO	445	22	14-015590-00	MITSUBISHI	789	5
14-011022-00	NEW HOLLAND	799	4	14-015590-00	MITSUBISHI	790	6
14-011031-00	NEW HOLLAND	798	2	14-015590-00	MITSUBISHI	791	7
14-011041-00	ALFA ROMEO	23	29	14-015590-00	MITSUBISHI	791	8
14-011041-00	ALFA ROMEO	24	30	14-015590-00	MITSUBISHI	793	10
14-011041-00	FIAT	277	61	14-018002-00	IVECO	472	58
14-011041-00	FIAT	278	62	14-020110-00	FORD EUROPE	376	78
14-011041-00	FIAT	279	64	14-020110-00	ISUZU	418	9
14-011041-00	LANCIA	538	31	14-020110-00	NISSAN	828	21
14-011041-00	LANCIA	539	32	14-020120-00	NISSAN	827	20
14-011041-00	LANCIA	540	33	14-020190-00	CITROEN	167	43
14-011051-00	MARELLI	634	3	14-020190-00	CITROEN	169	45
14-011051-00	MARELLI	635	4	14-020190-00	PEUGEOT	937	47
14-011061-00	IVECO	441	18	14-020190-00	PEUGEOT	938	49
14-011061-00	NEW HOLLAND	799	3	14-020200-00	IVECO	468	52
14-012260-00	MERCEDES-BENZ COMMERCIAL	727	12	14-020280-00	NISSAN	819	9
14-012260-00	MERCEDES-BENZ COMMERCIAL	728	13	14-020280-00	OPEL	853	29
14-012260-00	MERCEDES-BENZ COMMERCIAL	729	14	14-020280-00	RENAULT	991	33
14-012260-00	MERCEDES-BENZ COMMERCIAL	731	15	14-020280-00	RENAULT	991	34
14-012260-00	MERCEDES-BENZ COMMERCIAL	731	16	14-020280-00	VAUXHALL	1228	30
14-012260-00	MERCEDES-BENZ COMMERCIAL	732	17	14-020280-00	VOLVO CARS	1338	12
14-012260-00	MERCEDES-BENZ COMMERCIAL	733	18	14-020290-00	CITROEN	149	20
14-012470-00	FIAT	250	25	14-020290-00	CITROEN	149	21
14-012470-00	FIAT	250	26	14-020290-00	FIAT	264	45
14-013401-00	IVECO	443	20	14-020290-00	FIAT	265	46
14-013401-00	IVECO	445	22	14-020290-00	PEUGEOT	915	22
14-013481-00	CITROEN	170	46	14-020300-00	MERCEDES-BENZ	668	19
14-013481-00	CITROEN	170	47	14-020300-00	MERCEDES-BENZ	669	20
14-013481-00	FIAT	296	89	14-020300-00	MERCEDES-BENZ	671	21
14-013481-00	PEUGEOT	939	50	14-020300-00	MERCEDES-BENZ	672	22
14-013481-00	PEUGEOT	939	51	14-020300-00	MERCEDES-BENZ	673	23
14-013481-00	TALBOT	1191	6	14-020300-00	MERCEDES-BENZ COMMERCIAL	717	4
14-013481-00	TALBOT	1192	7	14-020330-00	RENAULT TRUCKS	1039	29
14-013481-00	TALBOT	1192	8	14-020330-00	RENAULT TRUCKS	1040	30
14-013700-00	FORD COMMERCIAL	378	2	14-020330-00	RENAULT TRUCKS	1041	34
14-013700-00	FORD COMMERCIAL	379	3	14-020350-00	NISSAN	822	13
14-013700-00	FORD COMMERCIAL	379	4	14-020350-00	NISSAN	824	15
14-013700-00	FORD COMMERCIAL	380	6	14-020351-00	NISSAN	822	13
14-014090-00	FORD EUROPE	368	69	14-020351-00	NISSAN	824	15
14-014090-00	FORD EUROPE	369	70	14-020420-00	VOLKSWAGEN	1309	40
14-014090-00	FORD EUROPE	370	71	14-020420-00	VOLKSWAGEN	1311	41
14-014090-00	FORD EUROPE	371	72	14-020420-00	VOLKSWAGEN	1312	43
14-014090-00	FORD EUROPE	372	73	14-020420-00	VOLKSWAGEN	1318	47
14-014090-00	FORD EUROPE	373	74	14-020421-00	VOLKSWAGEN	1309	40

NUMERICAL PARTS LIST









Numerische Teilenummernliste • Elenco riferimenti
Liste des références produits









			9				9
14-020421-00	VOLKSWAGEN	1311	41	14-020660-00	LEYLAND	570	6
14-020421-00	VOLKSWAGEN	1312	43	14-020660-00	PEUGEOT	940	52
14-020421-00	VOLKSWAGEN	1318	47	14-020660-00	PEUGEOT	941	53
14-020450-00	OPEL	872	51	14-020660-00	PEUGEOT	942	54
14-020450-00	VAUXHALL	1244	51	14-020660-00	SSANGYONG	1174	8
14-020490-00	DEUTZ KHD	210	5	14-020660-00	SSANGYONG	1174	9
14-020510-00	RENAULT TRUCKS	1039	29	14-020660-00	TALBOT	1192	9
14-020510-00	RENAULT TRUCKS	1041	34	14-020730-00	FORD COMMERCIAL	381	7
14-020530-00	CITROEN	154	26	14-020730-00	FORD TRACTOR	385	3
14-020530-00	CITROEN	155	27	14-020730-00	FORD TRACTOR	386	4
14-020530-00	FIAT	274	58	14-020740-00	FORD TRACTOR	387	6
14-020530-00	FIAT	275	59	14-020740-00	FORD TRACTOR	387	7
14-020530-00	FSO	393	5	14-020740-00	FORD TRACTOR	388	8
14-020530-00	HYUNDAI	405	6	14-020740-00	FORD TRACTOR	388	9
14-020530-00	LADA	512	5	14-020740-00	FORD TRACTOR	389	10
14-020530-00	LADA	513	6	14-020741-00	FORD TRACTOR	387	6
14-020530-00	LDV	565	1	14-020741-00	FORD TRACTOR	387	7
14-020530-00	LEYLAND	568	2	14-020741-00	FORD TRACTOR	388	8
14-020530-00	PEUGEOT	920	26	14-020741-00	FORD TRACTOR	388	9
14-020530-00	PEUGEOT	921	27	14-020741-00	FORD TRACTOR	389	10
14-020530-00	ROVER	1050	13	14-020742-00	FORD TRACTOR	387	6
14-020530-00	SUZUKI	1185	7	14-020742-00	FORD TRACTOR	387	7
14-020530-00	SUZUKI	1186	8	14-020742-00	FORD TRACTOR	388	8
14-020530-00	TALBOT	1189	3	14-020742-00	FORD TRACTOR	388	9
14-020540-00	FORD EUROPE	357	55	14-020742-00	FORD TRACTOR	389	10
14-020540-00	FORD EUROPE	358	56	14-020760-00	CITROEN	136	4
14-020540-00	FORD EUROPE	359	57	14-020760-00	FORD EUROPE	306	3
14-020540-00	FORD EUROPE	359	58	14-020760-00	MAZDA	637	1
14-020540-00	FORD EUROPE	360	59	14-020760-00	PEUGEOT	902	4
14-020540-00	FORD EUROPE	361	60	14-020760-00	PEUGEOT	903	5
14-020540-00	FORD EUROPE	362	61	14-020760-00	TOYOTA	1196	3
14-020540-00	LAND ROVER	556	14	14-020761-00	CITROEN	136	4
14-020590-00	PERKINS	895	23	14-020761-00	FORD EUROPE	306	3
14-020600-00	HYUNDAI	407	10	14-020761-00	MAZDA	637	1
14-020600-00	MITSUBISHI	789	5	14-020761-00	PEUGEOT	902	4
14-020600-00	MITSUBISHI	790	6	14-020761-00	PEUGEOT	903	5
14-020600-00	MITSUBISHI	791	7	14-020761-00	TOYOTA	1196	3
14-020600-00	MITSUBISHI	791	8	14-020870-00	PERKINS	896	24
14-020600-00	MITSUBISHI	793	10	14-020870-00	PERKINS	896	25
14-020610-00	CUMMINS	178	1	14-020900-00	CITROEN	142	11
14-020650-00	DACIA	181	3	14-020900-00	CITROEN	144	12
14-020650-00	DACIA	182	4	14-020900-00	CITROEN	144	13
14-020650-00	DACIA	183	5	14-020900-00	FIAT	249	24
14-020650-00	DACIA	183	6	14-020900-00	FORD EUROPE	312	8
14-020650-00	NISSAN	814	3	14-020900-00	FORD EUROPE	313	9
14-020650-00	NISSAN	815	4	14-020900-00	MINI	784	3
14-020650-00	NISSAN	816	5	14-020900-00	PEUGEOT	908	12
14-020650-00	NISSAN	817	6	14-020900-00	PEUGEOT	909	13
14-020650-00	RENAULT	970	16	14-020900-00	PEUGEOT	910	14
14-020650-00	RENAULT	972	17	14-020900-00	SUZUKI	1183	4
14-020650-00	RENAULT	974	18	14-020900-00	VOLVO CARS	1333	5
14-020650-00	RENAULT	975	19	14-021051-00	ALFA ROMEO	12	14
14-020650-00	RENAULT	976	20	14-021051-00	ALFA ROMEO	13	15
14-020650-00	RENAULT	977	21	14-021051-00	ALFA ROMEO	15	17
14-020650-00	SUZUKI	1184	5	14-021051-00	FIAT	258	38
14-020660-00	ARO	33	7	14-021051-00	FIAT	259	39
14-020660-00	CITROEN	171	48	14-021051-00	FIAT	260	40
14-020660-00	DAF	195	4	14-021051-00	FIAT	261	41
14-020660-00	DAF	196	5	14-021051-00	FIAT	262	42
14-020660-00	FORD EUROPE	374	75	14-021051-00	FIAT	263	43
14-020660-00	FORD EUROPE	375	76	14-021051-00	LANCIA	528	21
14-020660-00	FORD EUROPE	376	77	14-021051-00	LANCIA	529	22
14-020660-00	LDV	566	3	14-021051-00	LANCIA	530	23
14-020660-00	LDV	566	4	14-021051-00	LANCIA	531	24

			9				9
14-021051-00	LANCIA	532	25	14-021230-00	IVECO	475	61
14-021051-00	SUZUKI	1184	6	14-021230-00	IVECO	476	62
14-021080-00	FIAT	245	18	14-021230-00	IVECO	477	63
14-021080-00	FIAT	246	20	14-021230-00	IVECO	478	64
14-021080-00	FIAT	247	21	14-021230-00	IVECO	478	65
14-021080-00	LANCIA	521	9	14-021230-00	IVECO	480	66
14-021080-00	LANCIA	521	10	14-021231-00	IVECO	475	61
14-021080-00	LANCIA	522	11	14-021231-00	IVECO	476	62
14-021080-00	LANCIA	522	12	14-021231-00	IVECO	477	63
14-021080-00	ZASTAVA	1375	1	14-021231-00	IVECO	478	64
14-021120-00	CITROEN	164	38	14-021231-00	IVECO	478	65
14-021120-00	CITROEN	165	39	14-021231-00	IVECO	480	66
14-021120-00	FIAT	283	71	14-021231-00	NEW HOLLAND	811	22
14-021120-00	FIAT	284	72	14-021231-00	NEW HOLLAND	811	23
14-021120-00	FORD EUROPE	350	46	14-021232-00	IVECO	475	61
14-021120-00	FORD EUROPE	352	48	14-021232-00	IVECO	476	62
14-021120-00	FORD EUROPE	353	49	14-021232-00	IVECO	477	63
14-021120-00	FORD EUROPE	353	50	14-021232-00	IVECO	478	64
14-021120-00	FORD EUROPE	354	50	14-021232-00	IVECO	478	65
14-021120-00	JAGUAR	487	5	14-021232-00	IVECO	480	66
14-021120-00	LAND ROVER	553	11	14-021232-00	NEW HOLLAND	811	22
14-021120-00	PEUGEOT	933	39	14-021232-00	NEW HOLLAND	811	23
14-021120-00	PEUGEOT	933	40	14-021240-00	PERKINS	880	3
14-021130-00	AUSTIN MORRIS	92	9	14-021250-00	LEYLAND	572	9
14-021130-00	LEYLAND	568	1	14-021250-00	LEYLAND	573	10
14-021140-00	BEDFORD	99	11	14-021250-00	PERKINS	885	9
14-021150-00	NISSAN	826	18	14-021250-00	PERKINS	886	10
14-021160-00	NISSAN	819	10	14-021250-00	PERKINS	889	14
14-021170-00	NISSAN	819	10	14-021250-00	PERKINS	889	15
14-021180-00	BEDFORD	98	8	14-021250-00	VOLVO COMMERCIAL	1348	7
14-021180-00	ISUZU	415	3	14-021260-00	FIAT	250	25
14-021180-00	ISUZU	415	4	14-021260-00	FIAT	250	26
14-021190-00	ISUZU	416	5	14-021311-00	ALFA ROMEO	16	18
14-021190-00	OPEL	874	54	14-021311-00	ALFA ROMEO	17	19
14-021190-00	SSANGYONG	1168	1	14-021311-00	CITROEN	150	22
14-021190-00	VAUXHALL	1245	53	14-021311-00	FIAT	269	50
14-021200-00	OPEL	860	36	14-021311-00	FIAT	269	51
14-021200-00	OPEL	860	37	14-021311-00	FIAT	270	52
14-021200-00	VAUXHALL	1234	37	14-021311-00	FIAT	271	53
14-021200-00	VAUXHALL	1234	38	14-021311-00	LANCIA	533	26
14-021220-00	FORD TRACTOR	384	1	14-021311-00	LANCIA	534	27
14-021220-00	LEYLAND	569	5	14-021311-00	LANCIA	534	28
14-021220-00	PERKINS	881	4	14-021311-00	LANCIA	535	29
14-021220-00	PERKINS	882	5	14-021321-00	CITROEN	172	49
14-021220-00	PERKINS	883	6	14-021321-00	CITROEN	172	50
14-021220-00	PERKINS	884	7	14-021321-00	FIAT	296	90
14-021221-00	FORD TRACTOR	384	1	14-021321-00	FIAT	297	91
14-021221-00	LEYLAND	569	5	14-021321-00	FIAT	298	92
14-021221-00	PERKINS	881	4	14-021321-00	IVECO	438	13
14-021221-00	PERKINS	882	5	14-021321-00	IVECO	439	14
14-021221-00	PERKINS	883	6	14-021321-00	IVECO	439	15
14-021221-00	PERKINS	884	7	14-021321-00	IVECO	440	16
14-021222-00	FORD TRACTOR	384	1	14-021321-00	IVECO	441	17
14-021222-00	LEYLAND	569	5	14-021321-00	OPEL	878	61
14-021222-00	PERKINS	881	4	14-021321-00	PEUGEOT	943	55
14-021222-00	PERKINS	882	5	14-021321-00	PEUGEOT	943	56
14-021222-00	PERKINS	883	6	14-021321-00	RENAULT TRUCKS	1023	1
14-021222-00	PERKINS	884	7	14-021321-00	RENAULT TRUCKS	1024	2
14-021223-00	FORD TRACTOR	384	1	14-021321-00	RENAULT TRUCKS	1024	3
14-021223-00	LEYLAND	569	5	14-021321-00	RENAULT TRUCKS	1025	4
14-021223-00	PERKINS	881	4	14-021321-00	RENAULT TRUCKS	1025	5
14-021223-00	PERKINS	882	5	14-021321-00	VAUXHALL	1248	58
14-021223-00	PERKINS	883	6	14-021350-00	MERCEDES-BENZ	694	41
14-021223-00	PERKINS	884	7	14-021350-00	MERCEDES-BENZ	695	42

NUMERICAL PARTS LIST







Numerische Teilenummernliste • Elenco riferimenti
Liste des références produits









							
14-021350-00	MERCEDES-BENZ	696	43	14-021372-00	ALFA ROMEO	27	35
14-021350-00	MERCEDES-BENZ	697	44	14-021372-00	FIAT	289	80
14-021350-00	MERCEDES-BENZ COMMERCIAL	720	7	14-021372-00	FIAT	290	81
14-021350-00	MERCEDES-BENZ COMMERCIAL	720	8	14-021372-00	FIAT	291	82
14-021361-00	IVECO	450	29	14-021372-00	FIAT	292	83
14-021361-00	IVECO	453	30	14-021372-00	FIAT	294	86
14-021361-00	IVECO	454	31	14-021372-00	FIAT	295	88
14-021361-00	IVECO	455	32	14-021372-00	IVECO	431	3
14-021361-00	IVECO	456	33	14-021372-00	IVECO	432	4
14-021361-00	IVECO	457	34	14-021372-00	IVECO	432	5
14-021361-00	IVECO	458	35	14-021372-00	IVECO	433	6
14-021361-00	IVECO	459	36	14-021372-00	IVECO	433	7
14-021361-00	IVECO	459	37	14-021372-00	IVECO	435	8
14-021361-00	NEW HOLLAND	804	9	14-021372-00	IVECO	436	11
14-021361-00	NEW HOLLAND	804	10	14-021372-00	LANCIA	546	41
14-021361-00	NEW HOLLAND	805	11	14-021372-00	RENAULT	1014	51
14-021362-00	IVECO	450	29	14-021372-00	RENAULT	1014	52
14-021362-00	IVECO	453	30	14-021372-00	RENAULT	1015	53
14-021362-00	IVECO	454	31	14-021372-00	RENAULT	1017	54
14-021362-00	IVECO	455	32	14-021372-00	RENAULT	1017	55
14-021362-00	IVECO	456	33	14-021372-00	RENAULT	1018	56
14-021362-00	IVECO	457	34	14-021372-00	RENAULT	1020	59
14-021362-00	IVECO	458	35	14-021410-00	DAF	200	12
14-021362-00	IVECO	459	36	14-021410-00	DAF	200	13
14-021362-00	IVECO	459	37	14-021410-00	DAF	201	14
14-021362-00	NEW HOLLAND	804	9	14-021410-00	DAF	202	16
14-021362-00	NEW HOLLAND	804	10	14-021410-00	DAF	202	17
14-021362-00	NEW HOLLAND	805	11	14-021410-00	DAF	203	18
14-021363-00	IVECO	450	29	14-021410-00	DAF	203	19
14-021363-00	IVECO	453	30	14-021410-00	DAF	204	20
14-021363-00	IVECO	454	31	14-021410-00	DAF	204	21
14-021363-00	IVECO	455	32	14-021410-00	LEYLAND	574	12
14-021363-00	IVECO	456	33	14-021430-00	ISUZU	415	3
14-021363-00	IVECO	457	34	14-021440-00	ISUZU	416	5
14-021363-00	IVECO	458	35	14-021440-00	OPEL	874	54
14-021363-00	IVECO	459	36	14-021440-00	SSANGYONG	1168	1
14-021363-00	IVECO	459	37	14-021440-00	VAUXHALL	1245	53
14-021363-00	NEW HOLLAND	804	9	14-021450-00	CHEVROLET	128	15
14-021363-00	NEW HOLLAND	804	10	14-021450-00	ISUZU	416	6
14-021363-00	NEW HOLLAND	805	11	14-021450-00	OPEL	876	58
14-021371-00	ALFA ROMEO	26	34	14-021460-00	ISUZU	417	7
14-021371-00	ALFA ROMEO	27	35	14-021460-00	ISUZU	417	8
14-021371-00	FIAT	289	80	14-021460-00	OPEL	877	59
14-021371-00	FIAT	290	81	14-021480-00	ALFA ROMEO	26	34
14-021371-00	FIAT	291	82	14-021480-00	ALFA ROMEO	27	35
14-021371-00	FIAT	292	83	14-021480-00	FIAT	289	80
14-021371-00	FIAT	294	86	14-021480-00	FIAT	290	81
14-021371-00	FIAT	295	88	14-021480-00	FIAT	291	82
14-021371-00	IVECO	431	3	14-021480-00	FIAT	292	83
14-021371-00	IVECO	432	4	14-021480-00	FIAT	294	86
14-021371-00	IVECO	432	5	14-021480-00	FIAT	295	88
14-021371-00	IVECO	433	6	14-021480-00	IVECO	431	3
14-021371-00	IVECO	433	7	14-021480-00	IVECO	432	4
14-021371-00	IVECO	435	8	14-021480-00	IVECO	432	5
14-021371-00	IVECO	436	11	14-021480-00	IVECO	433	6
14-021371-00	LANCIA	546	41	14-021480-00	IVECO	433	7
14-021371-00	RENAULT	1014	51	14-021480-00	IVECO	435	8
14-021371-00	RENAULT	1014	52	14-021480-00	IVECO	436	11
14-021371-00	RENAULT	1015	53	14-021480-00	LANCIA	546	41
14-021371-00	RENAULT	1017	54	14-021480-00	RENAULT	1014	51
14-021371-00	RENAULT	1017	55	14-021480-00	RENAULT	1014	52
14-021371-00	RENAULT	1018	56	14-021480-00	RENAULT	1015	53
14-021371-00	RENAULT	1020	59	14-021480-00	RENAULT	1017	54
14-021372-00	ALFA ROMEO	26	34	14-021480-00	RENAULT	1017	55

							
14-021480-00	RENAULT	1018	56	14-021520-00	SSANGYONG	1174	9
14-021480-00	RENAULT	1020	59	14-021520-00	TALBOT	1192	9
14-021491-00	IVECO	450	29	14-021540-00	IVECO	443	20
14-021491-00	IVECO	453	30	14-021540-00	IVECO	445	22
14-021491-00	IVECO	454	31	14-021540-00	NEW HOLLAND	799	4
14-021491-00	IVECO	455	32	14-021560-10	IVECO	475	61
14-021491-00	IVECO	456	33	14-021560-10	IVECO	476	62
14-021491-00	IVECO	457	34	14-021560-10	IVECO	477	63
14-021491-00	IVECO	458	35	14-021560-10	IVECO	478	64
14-021491-00	IVECO	459	36	14-021560-10	IVECO	478	65
14-021491-00	IVECO	459	37	14-021560-10	IVECO	480	66
14-021491-00	NEW HOLLAND	804	9	14-021560-10	NEW HOLLAND	811	22
14-021491-00	NEW HOLLAND	804	10	14-021560-10	NEW HOLLAND	811	23
14-021491-00	NEW HOLLAND	805	11	14-021561-10	IVECO	475	61
14-021492-00	IVECO	450	29	14-021561-10	IVECO	476	62
14-021492-00	IVECO	453	30	14-021561-10	IVECO	477	63
14-021492-00	IVECO	454	31	14-021561-10	IVECO	478	64
14-021492-00	IVECO	455	32	14-021561-10	IVECO	478	65
14-021492-00	IVECO	456	33	14-021561-10	IVECO	480	66
14-021492-00	IVECO	457	34	14-021561-10	NEW HOLLAND	811	22
14-021492-00	IVECO	458	35	14-021561-10	NEW HOLLAND	811	23
14-021492-00	IVECO	459	36	14-021562-10	IVECO	475	61
14-021492-00	IVECO	459	37	14-021562-10	IVECO	476	62
14-021492-00	NEW HOLLAND	804	9	14-021562-10	IVECO	477	63
14-021492-00	NEW HOLLAND	804	10	14-021562-10	IVECO	478	64
14-021492-00	NEW HOLLAND	805	11	14-021562-10	IVECO	478	65
14-021493-00	IVECO	450	29	14-021562-10	IVECO	480	66
14-021493-00	IVECO	453	30	14-021562-10	NEW HOLLAND	811	22
14-021493-00	IVECO	454	31	14-021562-10	NEW HOLLAND	811	23
14-021493-00	IVECO	455	32	14-021563-10	IVECO	475	61
14-021493-00	IVECO	456	33	14-021563-10	IVECO	476	62
14-021493-00	IVECO	457	34	14-021563-10	IVECO	477	63
14-021493-00	IVECO	458	35	14-021563-10	IVECO	478	64
14-021493-00	IVECO	459	36	14-021563-10	IVECO	478	65
14-021493-00	IVECO	459	37	14-021563-10	IVECO	480	66
14-021493-00	NEW HOLLAND	804	9	14-021563-10	NEW HOLLAND	811	22
14-021493-00	NEW HOLLAND	804	10	14-021563-10	NEW HOLLAND	811	23
14-021493-00	NEW HOLLAND	805	11	14-021571-00	AUDI	40	5
14-021494-00	IVECO	450	29	14-021571-00	AUDI	41	6
14-021494-00	IVECO	453	30	14-021571-00	AUDI	42	7
14-021494-00	IVECO	454	31	14-021571-00	SEAT	1089	6
14-021494-00	IVECO	455	32	14-021571-00	SEAT	1090	7
14-021494-00	IVECO	456	33	14-021571-00	SEAT	1092	9
14-021494-00	IVECO	457	34	14-021571-00	SKODA	1133	3
14-021494-00	IVECO	458	35	14-021571-00	SKODA	1135	5
14-021494-00	IVECO	459	36	14-021571-00	VOLKSWAGEN	1260	5
14-021494-00	IVECO	459	37	14-021571-00	VOLKSWAGEN	1261	6
14-021494-00	NEW HOLLAND	804	9	14-021571-00	VOLKSWAGEN	1263	8
14-021494-00	NEW HOLLAND	804	10	14-021571-00	VOLKSWAGEN	1269	13
14-021494-00	NEW HOLLAND	805	11	14-021571-00	VOLKSWAGEN	1271	14
14-021520-00	ARO	33	7	14-021571-00	VOLVO CARS	1334	7
14-021520-00	CITROEN	171	48	14-021571-00	VOLVO CARS	1335	8
14-021520-00	DAF	195	4	14-021571-00	VOLVO CARS	1336	9
14-021520-00	DAF	196	5	14-021580-00	IVECO	469	53
14-021520-00	FORD EUROPE	374	75	14-021590-00	IVECO	475	61
14-021520-00	FORD EUROPE	375	76	14-021590-00	IVECO	476	62
14-021520-00	FORD EUROPE	376	77	14-021590-00	IVECO	477	63
14-021520-00	LDV	566	3	14-021590-00	IVECO	478	64
14-021520-00	LDV	566	4	14-021590-00	IVECO	478	65
14-021520-00	LEYLAND	570	6	14-021590-00	IVECO	480	66
14-021520-00	PEUGEOT	940	52	14-021610-00	FORD TRACTOR	387	6
14-021520-00	PEUGEOT	941	53	14-021610-00	FORD TRACTOR	387	7
14-021520-00	PEUGEOT	942	54	14-021610-00	FORD TRACTOR	388	8
14-021520-00	SSANGYONG	1174	8	14-021610-00	FORD TRACTOR	388	9

NUMERICAL PARTS LIST







Nummerische Teilenummernliste • Elenco riferimenti
Liste des références produits









			9				9
14-021610-00	FORD TRACTOR	389	10	14-023560-00	FIAT	269	51
14-021611-00	FORD TRACTOR	387	6	14-023560-00	FIAT	270	52
14-021611-00	FORD TRACTOR	387	7	14-023560-00	FIAT	271	53
14-021611-00	FORD TRACTOR	388	8	14-023560-00	LANCIA	533	26
14-021611-00	FORD TRACTOR	388	9	14-023560-00	LANCIA	534	27
14-021611-00	FORD TRACTOR	389	10	14-023560-00	LANCIA	534	28
14-021850-00	HENSCHEL	396	1	14-023560-00	LANCIA	535	29
14-021850-00	MERCEDES-BENZ COMMERCIAL	721	9	14-023730-00	ARO	31	4
14-021850-00	MERCEDES-BENZ COMMERCIAL	723	10	14-023730-00	RENAULT	977	22
14-021850-00	MERCEDES-BENZ COMMERCIAL	725	11	14-023730-00	RENAULT	978	23
14-022060-00	ALFA ROMEO	4	1	14-023730-00	VOLVO CARS	1337	10
14-022060-00	FIAT	239	8	14-023751-00	ALFA ROMEO	16	18
14-022060-00	FIAT	240	9	14-023751-00	ALFA ROMEO	17	19
14-022060-00	LANCIA	518	4	14-023751-00	CITROEN	150	22
14-022060-00	LANCIA	519	5	14-023751-00	FIAT	265	47
14-022110-00	FORD EUROPE	349	45	14-023751-00	FIAT	266	48
14-022190-00	MERCEDES-BENZ	666	17	14-023751-00	FIAT	269	50
14-022190-00	MERCEDES-BENZ COMMERCIAL	717	3	14-023751-00	FIAT	269	51
14-022190-00	SEAT	1128	42	14-023751-00	FIAT	270	52
14-022560-00	ALFA ROMEO	28	36	14-023751-00	FIAT	271	53
14-022560-00	ALFA ROMEO	28	37	14-023751-00	LANCIA	533	26
14-022560-00	FIAT	293	84	14-023751-00	LANCIA	534	27
14-022560-00	FIAT	294	85	14-023751-00	LANCIA	534	28
14-022560-00	FIAT	295	87	14-023751-00	LANCIA	535	29
14-022560-00	IVECO	435	9	14-024070-00	DAF	198	9
14-022560-00	IVECO	436	10	14-024070-00	DAF	199	11
14-022560-00	IVECO	437	12	14-024100-00	BEDFORD	99	10
14-022560-00	LANCIA	546	42	14-024100-00	OPEL	876	56
14-022560-00	OPEL	877	60	14-024100-00	VAUXHALL	1246	55
14-022560-00	RENAULT	1019	57	14-024160-00	BEDFORD	98	9
14-022560-00	RENAULT	1020	58	14-024160-00	OPEL	873	53
14-022560-00	SEAT	1129	43	14-024240-00	HENSCHEL	396	2
14-022560-00	VAUXHALL	1247	57	14-024240-00	MERCEDES-BENZ COMMERCIAL	738	22
14-022830-00	MAN	612	21	14-024241-00	HENSCHEL	396	2
14-022830-00	MAN	612	22	14-024241-00	MERCEDES-BENZ COMMERCIAL	738	22
14-022960-00	FORD TRACTOR	384	1	14-024670-00	AUDI	40	5
14-022960-00	PERKINS	881	4	14-024670-00	VOLKSWAGEN	1268	12
14-022960-00	PERKINS	882	5	14-024680-00	FORD TRACTOR	384	1
14-022960-00	PERKINS	883	6	14-024680-00	LEYLAND	569	5
14-022960-00	PERKINS	884	7	14-024680-00	PERKINS	881	4
14-023470-00	AUDI	40	5	14-024680-00	PERKINS	882	5
14-023470-00	VOLKSWAGEN	1268	12	14-024680-00	PERKINS	883	6
14-023520-00	BEDFORD	97	6	14-024680-00	PERKINS	884	7
14-023520-00	OPEL	851	27	14-024710-00	AUSTIN MORRIS	93	11
14-023520-00	VAUXHALL	1227	28	14-024710-00	LAND ROVER	557	15
14-023551-00	IVECO	448	25	14-024710-00	LAND ROVER	557	16
14-023551-00	IVECO	449	27	14-024710-00	LAND ROVER	558	17
14-023551-00	IVECO	450	28	14-024710-00	LAND ROVER	559	18
14-023551-00	NEW HOLLAND	802	7	14-024710-00	LAND ROVER	560	19
14-023551-00	NEW HOLLAND	803	8	14-024710-00	LAND ROVER	562	21
14-023552-00	IVECO	448	25	14-024710-00	LEYLAND	569	4
14-023552-00	IVECO	449	27	14-024710-00	ROVER	1055	19
14-023552-00	IVECO	450	28	14-024740-00	CITROEN	147	17
14-023552-00	NEW HOLLAND	802	7	14-024740-00	CITROEN	148	18
14-023552-00	NEW HOLLAND	803	8	14-024740-00	HONDA	399	2
14-023553-00	IVECO	448	25	14-024740-00	PEUGEOT	913	19
14-023553-00	IVECO	449	27	14-024740-00	PEUGEOT	914	20
14-023553-00	IVECO	450	28	14-024740-00	ROVER	1049	12
14-023553-00	NEW HOLLAND	802	7	14-024781-00	IVECO	450	29
14-023553-00	NEW HOLLAND	803	8	14-024781-00	IVECO	453	30
14-023560-00	ALFA ROMEO	16	18	14-024781-00	IVECO	454	31
14-023560-00	ALFA ROMEO	17	19	14-024781-00	IVECO	455	32
14-023560-00	CITROEN	150	22	14-024781-00	IVECO	456	33
14-023560-00	FIAT	269	50	14-024781-00	IVECO	457	34

							
14-024781-00	IVECO	458	35	14-025833-00	PERKINS	883	6
14-024781-00	IVECO	459	36	14-025833-00	PERKINS	884	7
14-024781-00	IVECO	459	37	14-025871-00	FORD TRACTOR	384	1
14-024830-00	CITROEN	147	17	14-025871-00	LEYLAND	569	5
14-024830-00	CITROEN	148	18	14-025871-00	PERKINS	881	4
14-024830-00	HONDA	399	2	14-025871-00	PERKINS	882	5
14-024830-00	PEUGEOT	913	19	14-025871-00	PERKINS	883	6
14-024830-00	PEUGEOT	914	20	14-025871-00	PERKINS	884	7
14-024830-00	ROVER	1049	12	14-025873-00	PERKINS	881	4
14-025070-00	SEAT	1089	5	14-025873-00	PERKINS	882	5
14-025070-00	VOLKSWAGEN	1259	4	14-025873-00	PERKINS	883	6
14-025380-10	PERKINS	890	17	14-025873-00	PERKINS	884	7
14-025380-10	PERKINS	891	18	14-025881-00	MERCEDES-BENZ COMMERCIAL	721	9
14-025380-10	PERKINS	892	19	14-025881-00	MERCEDES-BENZ COMMERCIAL	723	10
14-025380-10	PERKINS	893	20	14-025881-00	MERCEDES-BENZ COMMERCIAL	725	11
14-025420-00	STEYR	1179	6	14-025881-00	MERCEDES-BENZ COMMERCIAL	727	12
14-025480-00	MERCEDES-BENZ	677	27	14-025881-00	MERCEDES-BENZ COMMERCIAL	728	13
14-025480-00	MERCEDES-BENZ	678	28	14-025881-00	MERCEDES-BENZ COMMERCIAL	729	14
14-025530-00	DAF	196	6	14-025881-00	MERCEDES-BENZ COMMERCIAL	731	15
14-025530-00	DAF	197	7	14-025881-00	MERCEDES-BENZ COMMERCIAL	731	16
14-025530-00	DAF	197	8	14-025881-00	MERCEDES-BENZ COMMERCIAL	732	17
14-025800-00	MERCEDES-BENZ COMMERCIAL	721	9	14-025881-00	MERCEDES-BENZ COMMERCIAL	733	18
14-025800-00	MERCEDES-BENZ COMMERCIAL	723	10	14-025883-00	MERCEDES-BENZ COMMERCIAL	721	9
14-025800-00	MERCEDES-BENZ COMMERCIAL	725	11	14-025883-00	MERCEDES-BENZ COMMERCIAL	723	10
14-025800-00	MERCEDES-BENZ COMMERCIAL	727	12	14-025883-00	MERCEDES-BENZ COMMERCIAL	725	11
14-025800-00	MERCEDES-BENZ COMMERCIAL	728	13	14-025883-00	MERCEDES-BENZ COMMERCIAL	727	12
14-025800-00	MERCEDES-BENZ COMMERCIAL	729	14	14-025883-00	MERCEDES-BENZ COMMERCIAL	728	13
14-025800-00	MERCEDES-BENZ COMMERCIAL	731	15	14-025883-00	MERCEDES-BENZ COMMERCIAL	729	14
14-025800-00	MERCEDES-BENZ COMMERCIAL	731	16	14-025883-00	MERCEDES-BENZ COMMERCIAL	731	15
14-025800-00	MERCEDES-BENZ COMMERCIAL	732	17	14-025883-00	MERCEDES-BENZ COMMERCIAL	731	16
14-025800-00	MERCEDES-BENZ COMMERCIAL	733	18	14-025883-00	MERCEDES-BENZ COMMERCIAL	732	17
14-025801-00	MERCEDES-BENZ COMMERCIAL	721	9	14-025883-00	MERCEDES-BENZ COMMERCIAL	733	18
14-025801-00	MERCEDES-BENZ COMMERCIAL	723	10	14-025890-00	MERCEDES-BENZ COMMERCIAL	746	30
14-025801-00	MERCEDES-BENZ COMMERCIAL	725	11	14-025890-00	MERCEDES-BENZ COMMERCIAL	747	31
14-025801-00	MERCEDES-BENZ COMMERCIAL	727	12	14-025891-00	MERCEDES-BENZ COMMERCIAL	746	30
14-025801-00	MERCEDES-BENZ COMMERCIAL	728	13	14-025891-00	MERCEDES-BENZ COMMERCIAL	747	31
14-025801-00	MERCEDES-BENZ COMMERCIAL	729	14	14-025892-00	MERCEDES-BENZ COMMERCIAL	746	30
14-025801-00	MERCEDES-BENZ COMMERCIAL	731	15	14-025892-00	MERCEDES-BENZ COMMERCIAL	747	31
14-025801-00	MERCEDES-BENZ COMMERCIAL	731	16	14-026240-00	MERCEDES-BENZ	662	13
14-025801-00	MERCEDES-BENZ COMMERCIAL	732	17	14-026240-00	MERCEDES-BENZ	663	14
14-025801-00	MERCEDES-BENZ COMMERCIAL	733	18	14-026240-00	MERCEDES-BENZ	664	15
14-025802-00	MERCEDES-BENZ COMMERCIAL	721	9	14-026240-00	MERCEDES-BENZ	665	16
14-025802-00	MERCEDES-BENZ COMMERCIAL	723	10	14-026240-00	MERCEDES-BENZ COMMERCIAL	716	2
14-025802-00	MERCEDES-BENZ COMMERCIAL	725	11	14-026241-00	MERCEDES-BENZ	662	13
14-025802-00	MERCEDES-BENZ COMMERCIAL	727	12	14-026241-00	MERCEDES-BENZ	663	14
14-025802-00	MERCEDES-BENZ COMMERCIAL	728	13	14-026241-00	MERCEDES-BENZ	664	15
14-025802-00	MERCEDES-BENZ COMMERCIAL	729	14	14-026241-00	MERCEDES-BENZ	665	16
14-025802-00	MERCEDES-BENZ COMMERCIAL	731	15	14-026241-00	MERCEDES-BENZ COMMERCIAL	716	2
14-025802-00	MERCEDES-BENZ COMMERCIAL	731	16	14-026380-00	MERCEDES-BENZ	680	29
14-025802-00	MERCEDES-BENZ COMMERCIAL	732	17	14-026380-00	MERCEDES-BENZ	681	30
14-025802-00	MERCEDES-BENZ COMMERCIAL	733	18	14-026380-00	MERCEDES-BENZ	682	31
14-025804-00	MERCEDES-BENZ COMMERCIAL	721	9	14-026380-00	MERCEDES-BENZ	683	32
14-025804-00	MERCEDES-BENZ COMMERCIAL	723	10	14-026380-00	MERCEDES-BENZ COMMERCIAL	718	5
14-025804-00	MERCEDES-BENZ COMMERCIAL	725	11	14-026380-00	SSANGYONG	1168	2
14-025804-00	MERCEDES-BENZ COMMERCIAL	727	12	14-026380-00	SSANGYONG	1169	3
14-025804-00	MERCEDES-BENZ COMMERCIAL	728	13	14-026380-00	SSANGYONG	1170	4
14-025804-00	MERCEDES-BENZ COMMERCIAL	729	14	14-027200-00	RENAULT TRUCKS	1039	29
14-025804-00	MERCEDES-BENZ COMMERCIAL	731	15	14-027200-00	RENAULT TRUCKS	1041	34
14-025804-00	MERCEDES-BENZ COMMERCIAL	731	16	14-027210-00	MERCEDES-BENZ	680	29
14-025804-00	MERCEDES-BENZ COMMERCIAL	732	17	14-027210-00	MERCEDES-BENZ	681	30
14-025804-00	MERCEDES-BENZ COMMERCIAL	733	18	14-027210-00	MERCEDES-BENZ	682	31
14-025833-00	FORD TRACTOR	384	1	14-027210-00	MERCEDES-BENZ	683	32
14-025833-00	PERKINS	881	4	14-027210-00	MERCEDES-BENZ	684	33
14-025833-00	PERKINS	882	5	14-027210-00	MERCEDES-BENZ COMMERCIAL	718	5

NUMERICAL PARTS LIST







Nummerische Teilenummernliste • Elenco riferimenti
Liste des références produits









			9				9
14-027210-00	MERCEDES-BENZ COMMERCIAL	719	6	14-027950-00	VOLKSWAGEN	1282	22
14-027210-00	SSANGYONG	1169	3	14-027950-00	VOLKSWAGEN	1285	23
14-027210-00	SSANGYONG	1170	4	14-027950-00	VOLKSWAGEN	1287	24
14-027680-00	MAN	588	2	14-027950-00	VOLKSWAGEN	1289	25
14-027680-00	MAN	589	3	14-027950-00	VOLKSWAGEN	1291	26
14-027680-00	MAN	590	4	14-027950-00	VOLKSWAGEN	1292	27
14-027680-00	MAN	591	5	14-028240-00	STEYR	1178	5
14-027680-00	MAN	592	6	14-028360-00	AUDI	40	5
14-027680-00	MAN	593	6	14-028360-00	AUDI	41	6
14-027680-00	MAN	594	7	14-028360-00	AUDI	42	7
14-027680-00	MAN	595	7	14-028360-00	SEAT	1089	6
14-027680-00	MAN	596	8	14-028360-00	SEAT	1090	7
14-027680-00	MAN	597	9	14-028360-00	SEAT	1092	9
14-027680-00	MAN	598	9	14-028360-00	SKODA	1133	3
14-027680-00	MAN	599	10	14-028360-00	SKODA	1135	5
14-027680-00	MAN	602	11	14-028360-00	VOLKSWAGEN	1260	5
14-027680-00	MAN	604	12	14-028360-00	VOLKSWAGEN	1261	6
14-027680-00	MAN	605	13	14-028360-00	VOLKSWAGEN	1263	8
14-027681-00	MAN	588	2	14-028360-00	VOLKSWAGEN	1268	12
14-027681-00	MAN	589	3	14-028360-00	VOLKSWAGEN	1269	13
14-027681-00	MAN	590	4	14-028360-00	VOLKSWAGEN	1271	14
14-027681-00	MAN	591	5	14-028360-00	VOLVO CARS	1334	7
14-027681-00	MAN	593	6	14-028360-00	VOLVO CARS	1335	8
14-027681-00	MAN	595	7	14-028360-00	VOLVO CARS	1336	9
14-027681-00	MAN	596	8	14-028610-00	MERCEDES-BENZ COMMERCIAL	735	19
14-027681-00	MAN	598	9	14-028610-00	MERCEDES-BENZ COMMERCIAL	735	20
14-027681-00	MAN	599	10	14-028610-00	MERCEDES-BENZ COMMERCIAL	736	21
14-027681-00	MAN	602	11	14-028710-00	FIAT	251	28
14-027681-00	MAN	604	12	14-028710-00	FIAT	252	29
14-027681-00	MAN	605	13	14-028710-00	FIAT	253	30
14-027790-00	STEYR	1177	3	14-028930-00	ALFA ROMEO	28	36
14-027950-00	AUDI	46	10	14-028930-00	ALFA ROMEO	28	37
14-027950-00	AUDI	47	11	14-028930-00	CITROEN	172	49
14-027950-00	AUDI	50	12	14-028930-00	CITROEN	172	50
14-027950-00	AUDI	51	13	14-028930-00	FIAT	293	84
14-027950-00	AUDI	53	14	14-028930-00	FIAT	294	85
14-027950-00	AUDI	54	15	14-028930-00	FIAT	295	87
14-027950-00	AUDI	56	16	14-028930-00	FIAT	296	90
14-027950-00	AUDI	58	17	14-028930-00	FIAT	297	91
14-027950-00	AUDI	58	18	14-028930-00	FIAT	298	92
14-027950-00	FORD EUROPE	320	17	14-028930-00	IVECO	435	9
14-027950-00	FORD EUROPE	322	18	14-028930-00	IVECO	436	10
14-027950-00	FORD EUROPE	324	19	14-028930-00	IVECO	437	12
14-027950-00	FORD EUROPE	325	20	14-028930-00	IVECO	438	13
14-027950-00	SEAT	1096	13	14-028930-00	IVECO	439	14
14-027950-00	SEAT	1097	14	14-028930-00	IVECO	439	15
14-027950-00	SEAT	1099	15	14-028930-00	IVECO	440	16
14-027950-00	SEAT	1100	16	14-028930-00	IVECO	441	17
14-027950-00	SEAT	1101	17	14-028930-00	LANCIA	546	42
14-027950-00	SEAT	1102	18	14-028930-00	OPEL	877	60
14-027950-00	SEAT	1104	19	14-028930-00	OPEL	878	61
14-027950-00	SEAT	1105	20	14-028930-00	PEUGEOT	943	55
14-027950-00	SEAT	1108	21	14-028930-00	PEUGEOT	943	56
14-027950-00	SKODA	1140	10	14-028930-00	RENAULT	1019	57
14-027950-00	SKODA	1141	11	14-028930-00	RENAULT	1020	58
14-027950-00	SKODA	1143	12	14-028930-00	RENAULT TRUCKS	1023	1
14-027950-00	SKODA	1145	13	14-028930-00	RENAULT TRUCKS	1024	2
14-027950-00	SKODA	1146	14	14-028930-00	RENAULT TRUCKS	1024	3
14-027950-00	SKODA	1149	15	14-028930-00	RENAULT TRUCKS	1025	4
14-027950-00	VOLKSWAGEN	1274	17	14-028930-00	RENAULT TRUCKS	1025	5
14-027950-00	VOLKSWAGEN	1277	18	14-028930-00	VAUXHALL	1247	57
14-027950-00	VOLKSWAGEN	1279	19	14-028930-00	VAUXHALL	1248	58
14-027950-00	VOLKSWAGEN	1280	20	14-028931-00	ALFA ROMEO	28	36
14-027950-00	VOLKSWAGEN	1281	21	14-028931-00	ALFA ROMEO	28	37

							
14-028931-00	CITROEN	172	49	14-028960-00	FIAT	258	38
14-028931-00	CITROEN	172	50	14-028960-00	FIAT	259	39
14-028931-00	FIAT	293	84	14-028960-00	FIAT	260	40
14-028931-00	FIAT	294	85	14-028960-00	FIAT	261	41
14-028931-00	FIAT	295	87	14-028960-00	FIAT	262	42
14-028931-00	FIAT	296	90	14-028960-00	FIAT	263	43
14-028931-00	FIAT	297	91	14-028960-00	LANCIA	528	21
14-028931-00	FIAT	298	92	14-028960-00	LANCIA	529	22
14-028931-00	IVECO	435	9	14-028960-00	LANCIA	530	23
14-028931-00	IVECO	436	10	14-028960-00	LANCIA	531	24
14-028931-00	IVECO	437	12	14-028960-00	LANCIA	532	25
14-028931-00	IVECO	438	13	14-028960-00	SUZUKI	1184	6
14-028931-00	IVECO	439	14	14-029750-00	DEUTZ KHD	208	1
14-028931-00	IVECO	439	15	14-029750-00	DEUTZ KHD	208	2
14-028931-00	IVECO	440	16	14-029750-00	DEUTZ KHD	209	3
14-028931-00	IVECO	441	17	14-030350-00	MAN	605	14
14-028931-00	LANCIA	546	42	14-030350-00	MAN	606	15
14-028931-00	OPEL	877	60	14-040040-00	RENAULT TRUCKS	1040	30
14-028931-00	OPEL	878	61	14-040040-00	RENAULT TRUCKS	1040	31
14-028931-00	PEUGEOT	943	55	14-040040-00	RENAULT TRUCKS	1041	32
14-028931-00	PEUGEOT	943	56	14-040040-00	RENAULT TRUCKS	1041	33
14-028931-00	RENAULT	1019	57	14-040110-00	LEYLAND	572	9
14-028931-00	RENAULT	1020	58	14-040110-00	LEYLAND	573	10
14-028931-00	RENAULT TRUCKS	1023	1	14-040110-00	PERKINS	885	9
14-028931-00	RENAULT TRUCKS	1024	2	14-040110-00	PERKINS	886	10
14-028931-00	RENAULT TRUCKS	1024	3	14-040110-00	PERKINS	887	11
14-028931-00	RENAULT TRUCKS	1025	4	14-040110-00	PERKINS	887	12
14-028931-00	RENAULT TRUCKS	1025	5	14-040110-00	PERKINS	888	13
14-028931-00	VAUXHALL	1247	57	14-040110-00	PERKINS	889	14
14-028931-00	VAUXHALL	1248	58	14-040110-00	PERKINS	889	15
14-028932-00	ALFA ROMEO	28	36	14-040120-00	PERKINS	893	21
14-028932-00	ALFA ROMEO	28	37	14-040120-00	PERKINS	894	22
14-028932-00	CITROEN	172	49	14-040130-00	TOYOTA	1199	8
14-028932-00	CITROEN	172	50	14-040130-00	TOYOTA	1200	9
14-028932-00	FIAT	293	84	14-040130-00	VOLKSWAGEN	1330	56
14-028932-00	FIAT	294	85	14-040140-00	HINO	397	2
14-028932-00	FIAT	295	87	14-040140-00	TOYOTA	1203	14
14-028932-00	FIAT	297	91	14-040150-00	HINO	397	1
14-028932-00	FIAT	298	92	14-040150-00	TOYOTA	1201	10
14-028932-00	IVECO	435	9	14-040150-00	TOYOTA	1201	11
14-028932-00	IVECO	436	10	14-040160-00	TOYOTA	1198	7
14-028932-00	IVECO	437	12	14-040180-00	LEYLAND	572	9
14-028932-00	IVECO	438	13	14-040180-00	LEYLAND	573	10
14-028932-00	IVECO	439	14	14-040180-00	PERKINS	885	9
14-028932-00	IVECO	439	15	14-040180-00	PERKINS	886	10
14-028932-00	IVECO	440	16	14-040180-00	PERKINS	887	11
14-028932-00	IVECO	441	17	14-040180-00	PERKINS	887	12
14-028932-00	LANCIA	546	42	14-040180-00	PERKINS	888	13
14-028932-00	OPEL	877	60	14-040180-00	PERKINS	889	14
14-028932-00	OPEL	878	61	14-040180-00	PERKINS	889	15
14-028932-00	PEUGEOT	943	55	14-040180-00	VOLVO COMMERCIAL	1348	7
14-028932-00	PEUGEOT	943	56	14-040190-00	PERKINS	893	21
14-028932-00	RENAULT	1019	57	14-040190-00	PERKINS	894	22
14-028932-00	RENAULT	1020	58	14-040200-00	LEYLAND	572	9
14-028932-00	RENAULT TRUCKS	1023	1	14-040200-00	LEYLAND	573	10
14-028932-00	RENAULT TRUCKS	1024	2	14-040200-00	PERKINS	885	9
14-028932-00	RENAULT TRUCKS	1024	3	14-040200-00	PERKINS	886	10
14-028932-00	RENAULT TRUCKS	1025	4	14-040200-00	PERKINS	887	11
14-028932-00	RENAULT TRUCKS	1025	5	14-040200-00	PERKINS	887	12
14-028932-00	VAUXHALL	1247	57	14-040200-00	PERKINS	888	13
14-028932-00	VAUXHALL	1248	58	14-040200-00	PERKINS	889	14
14-028960-00	ALFA ROMEO	12	14	14-040200-00	PERKINS	889	15
14-028960-00	ALFA ROMEO	13	15	14-040200-00	VOLVO COMMERCIAL	1348	7
14-028960-00	ALFA ROMEO	15	17	14-041140-00	PERKINS	893	21

NUMERICAL PARTS LIST







Numerische Teilenummernliste • Elenco riferimenti
Liste des références produits









			9				9
14-041140-00	PERKINS	894	22	14-374990-00	SCANIA	1067	5
14-041610-00	PERKINS	893	21	14-374990-00	SCANIA	1069	7
14-041610-00	PERKINS	894	22	14-374990-00	SCANIA	1069	8
14-043450-00	NISSAN	827	19	14-376210-00	BELARUS	100	1
14-043450-00	PERKINS	884	8	14-378270-00	IFA	410	1
14-043450-00	VOLKSWAGEN	1330	57	14-400510-00	VOLVO COMMERCIAL	1346	4
14-044690-00	PERKINS	893	21	14-400510-00	VOLVO COMMERCIAL	1347	5
14-044690-00	PERKINS	894	22	14-440260-00	IHC	411	1
14-045570-00	FORD COMMERCIAL	378	2	14-450030-00	MAN	621	34
14-045570-00	FORD COMMERCIAL	379	3	14-450030-00	MAN	623	35
14-045570-00	FORD COMMERCIAL	379	4	14-450030-00	MAN	624	36
14-045570-00	FORD COMMERCIAL	380	6	14-450030-00	MAN	626	37
14-045820-00	LEYLAND	572	9	14-450030-00	MAN	626	38
14-045820-00	LEYLAND	573	10	14-450030-00	MAN	628	39
14-045820-00	PERKINS	885	9	14-450030-00	MAN	629	40
14-045820-00	PERKINS	886	10	14-450030-00	MAN	631	41
14-045820-00	PERKINS	887	11	14-450030-00	MAN	632	42
14-045820-00	PERKINS	887	12	14-450040-00	SCANIA	1077	21
14-045820-00	PERKINS	888	13	14-450110-00	SCANIA	1077	21
14-045820-00	PERKINS	889	14	14-450160-00	RENAULT TRUCKS	1038	27
14-045820-00	PERKINS	889	15	14-450160-00	VOLVO COMMERCIAL	1370	40
14-045820-00	VOLVO COMMERCIAL	1348	7	14-450160-00	VOLVO COMMERCIAL	1370	41
14-045821-00	LEYLAND	572	9	14-450160-00	VOLVO COMMERCIAL	1371	42
14-045821-00	LEYLAND	573	10	14-450160-00	VOLVO COMMERCIAL	1373	45
14-045821-00	PERKINS	885	9	14-450250-00	MERCEDES-BENZ COMMERCIAL	770	53
14-045821-00	PERKINS	886	10	14-450250-00	MERCEDES-BENZ COMMERCIAL	771	54
14-045821-00	PERKINS	887	11	14-450250-00	MERCEDES-BENZ COMMERCIAL	772	55
14-045821-00	PERKINS	887	12	14-450270-00	IHC	411	2
14-045821-00	PERKINS	888	13	14-450370-00	MAN	613	24
14-045821-00	PERKINS	889	14	14-450370-00	MAN	614	25
14-045821-00	PERKINS	889	15	14-450370-00	MAN	615	26
14-045821-00	VOLVO COMMERCIAL	1348	7	14-450380-00	MERCEDES-BENZ COMMERCIAL	763	46
14-049300-00	PERKINS	890	16	14-450380-00	MERCEDES-BENZ COMMERCIAL	764	47
14-102800-00	OPEL	864	43	14-450380-00	MERCEDES-BENZ COMMERCIAL	765	48
14-102800-00	VAUXHALL	1237	43	14-450390-00	SCANIA	1075	18
14-112800-00	SCANIA	1071	11	14-450400-00	SCANIA	1078	22
14-112800-00	SCANIA	1072	13	14-450400-00	SCANIA	1080	26
14-112800-00	SCANIA	1073	14	14-450480-00	MERCEDES-BENZ COMMERCIAL	763	46
14-112800-00	SCANIA	1074	15	14-450480-00	MERCEDES-BENZ COMMERCIAL	764	47
14-112800-00	SCANIA	1075	17	14-450480-00	MERCEDES-BENZ COMMERCIAL	765	48
14-112900-00	HINO	397	3	14-450490-00	STEYR	1177	1
14-260070-00	IVECO	465	46	14-450520-00	VOLVO COMMERCIAL	1357	22
14-260070-00	IVECO	465	47	14-450520-00	VOLVO COMMERCIAL	1358	24
14-260080-00	IVECO	481	67	14-450530-00	VOLVO COMMERCIAL	1366	34
14-260080-00	IVECO	481	68	14-450530-00	VOLVO COMMERCIAL	1367	36
14-260080-00	IVECO	482	69	14-450530-00	VOLVO COMMERCIAL	1368	38
14-260090-00	LDV	565	2	14-450590-00	VOLVO COMMERCIAL	1371	42
14-260090-00	VM	1249	2	14-450630-00	MAN	607	16
14-260500-00	UTB	1207	1	14-450630-00	MAN	608	17
14-261790-00	RENAULT TRUCKS	1026	6	14-450630-00	MAN	609	18
14-264190-00	RENAULT TRUCKS	1026	6	14-450630-00	MAN	610	19
14-265940-00	RENAULT TRUCKS	1026	7	14-450630-00	MAN	611	20
14-265950-00	RENAULT TRUCKS	1026	8	14-450660-00	JOHN DEERE	499	4
14-265950-00	RENAULT TRUCKS	1027	9	14-450660-00	JOHN DEERE	500	6
14-265960-00	RENAULT TRUCKS	1026	8	14-450710-00	JOHN DEERE	498	2
14-265960-00	RENAULT TRUCKS	1027	9	14-450710-00	JOHN DEERE	498	3
14-265960-00	RENAULT TRUCKS	1028	11	14-450710-00	JOHN DEERE	499	5
14-265960-00	RENAULT TRUCKS	1029	12	14-450790-00	MERCEDES-BENZ COMMERCIAL	774	56
14-265960-00	RENAULT TRUCKS	1030	13	14-450810-00	VOLVO COMMERCIAL	1353	15
14-265960-00	RENAULT TRUCKS	1031	14	14-450810-00	VOLVO COMMERCIAL	1353	16
14-370870-00	FORD COMMERCIAL	378	1	14-450850-00	SCANIA	1070	10
14-370870-00	FORD TRACTOR	385	2	14-450850-00	SCANIA	1076	20
14-374990-00	SCANIA	1066	3	14-450850-00	SCANIA	1077	21
14-374990-00	SCANIA	1067	4	14-450850-00	SCANIA	1078	22

							
14-450850-00	SCANIA	1080	26	14-452390-00	MERCEDES-BENZ COMMERCIAL	758	41
14-450880-00	IVECO	466	49	14-452670-00	IHC	412	5
14-450880-00	IVECO	467	50	14-452740-00	JOHN DEERE	497	1
14-450880-00	IVECO	468	51	14-452910-00	MAN	618	29
14-450880-00	NEW HOLLAND	810	21	14-452910-00	MAN	619	31
14-450890-00	VOLVO COMMERCIAL	1349	8	14-452910-00	MAN	619	32
14-450890-00	VOLVO COMMERCIAL	1349	9	14-452910-00	MAN	620	33
14-450920-00	RENAULT TRUCKS	1036	22	14-452920-00	MAN	618	30
14-450920-00	RENAULT TRUCKS	1036	23	14-452920-00	MAN	621	34
14-450920-00	RENAULT TRUCKS	1037	25	14-452920-00	MAN	623	35
14-450960-00	DEUTZ KHD	229	34	14-452920-00	MAN	624	36
14-450960-00	DEUTZ KHD	229	35	14-452920-00	MAN	625	37
14-451040-00	MAN	616	27	14-452920-00	MAN	626	37
14-451040-00	MAN	617	28	14-452920-00	MAN	626	38
14-451080-00	STEYR	1177	2	14-452920-00	MAN	628	39
14-451090-00	MAN	613	23	14-452920-00	MAN	629	40
14-451160-00	MERCEDES-BENZ COMMERCIAL	748	32	14-452920-00	MAN	630	41
14-451160-00	MERCEDES-BENZ COMMERCIAL	749	33	14-452920-00	MAN	631	41
14-451160-00	MERCEDES-BENZ COMMERCIAL	750	35	14-452920-00	MAN	631	42
14-451160-00	MERCEDES-BENZ COMMERCIAL	751	36	14-452920-00	MAN	632	42
14-451160-00	MERCEDES-BENZ COMMERCIAL	751	37	14-452921-10	MAN	621	34
14-451160-00	MERCEDES-BENZ COMMERCIAL	753	38	14-452921-10	MAN	623	35
14-451160-00	MERCEDES-BENZ COMMERCIAL	755	39	14-452921-10	MAN	624	36
14-451160-00	MERCEDES-BENZ COMMERCIAL	756	39	14-452921-10	MAN	626	37
14-451160-00	MERCEDES-BENZ COMMERCIAL	757	40	14-452921-10	MAN	626	38
14-451160-00	MERCEDES-BENZ COMMERCIAL	758	41	14-452921-10	MAN	628	39
14-451170-00	IHC	411	3	14-452921-10	MAN	629	40
14-451170-00	IHC	412	4	14-452921-10	MAN	631	41
14-451190-00	RENAULT TRUCKS	1039	28	14-452921-10	MAN	632	42
14-451190-00	VOLVO COMMERCIAL	1372	43	14-452930-00	MAN	621	34
14-451190-00	VOLVO COMMERCIAL	1372	44	14-452930-00	MAN	623	35
14-451660-00	HENSCHEL	396	3	14-452930-00	MAN	624	36
14-451660-00	MERCEDES-BENZ COMMERCIAL	740	23	14-452930-00	MAN	625	37
14-451660-00	MERCEDES-BENZ COMMERCIAL	741	24	14-452930-00	MAN	626	37
14-451660-00	MERCEDES-BENZ COMMERCIAL	742	25	14-452930-00	MAN	626	38
14-451660-00	MERCEDES-BENZ COMMERCIAL	743	26	14-452930-00	MAN	628	39
14-452030-00	MERCEDES-BENZ COMMERCIAL	748	32	14-452930-00	MAN	629	40
14-452030-00	MERCEDES-BENZ COMMERCIAL	749	33	14-452930-00	MAN	630	41
14-452030-00	MERCEDES-BENZ COMMERCIAL	750	35	14-452930-00	MAN	631	41
14-452030-00	MERCEDES-BENZ COMMERCIAL	751	36	14-452930-00	MAN	632	42
14-452030-00	MERCEDES-BENZ COMMERCIAL	751	37	14-455210-00	FORD COMMERCIAL	378	1
14-452030-00	MERCEDES-BENZ COMMERCIAL	753	38	14-455210-00	FORD TRACTOR	385	2
14-452030-00	MERCEDES-BENZ COMMERCIAL	755	39	14-456000-00	VOLVO COMMERCIAL	1366	34
14-452030-00	MERCEDES-BENZ COMMERCIAL	756	39	14-456000-00	VOLVO COMMERCIAL	1367	36
14-452030-00	MERCEDES-BENZ COMMERCIAL	757	40	14-456000-00	VOLVO COMMERCIAL	1368	37
14-452030-00	MERCEDES-BENZ COMMERCIAL	758	41	14-456000-00	VOLVO COMMERCIAL	1368	38
14-452080-00	LEYLAND	571	7	14-456000-00	VOLVO COMMERCIAL	1369	39
14-452080-00	LEYLAND	571	8	14-456330-00	MERCEDES-BENZ COMMERCIAL	766	50
14-452080-10	LEYLAND	571	7	14-456330-00	MERCEDES-BENZ COMMERCIAL	767	51
14-452080-10	LEYLAND	571	8	14-456330-00	MERCEDES-BENZ COMMERCIAL	768	52
14-452310-00	MERCEDES-BENZ COMMERCIAL	740	23	14-456980-00	MERCEDES-BENZ COMMERCIAL	745	29
14-452310-00	MERCEDES-BENZ COMMERCIAL	741	24	14-456980-00	MERCEDES-BENZ COMMERCIAL	750	34
14-452310-00	MERCEDES-BENZ COMMERCIAL	742	25	14-456980-00	MERCEDES-BENZ COMMERCIAL	759	42
14-452310-00	MERCEDES-BENZ COMMERCIAL	743	26	14-456980-00	MERCEDES-BENZ COMMERCIAL	760	43
14-452370-00	MERCEDES-BENZ COMMERCIAL	743	27	14-456980-00	MERCEDES-BENZ COMMERCIAL	761	44
14-452370-00	MERCEDES-BENZ COMMERCIAL	744	28	14-458110-00	HENSCHEL	396	3
14-452390-00	MERCEDES-BENZ COMMERCIAL	748	32	14-458110-00	MERCEDES-BENZ COMMERCIAL	740	23
14-452390-00	MERCEDES-BENZ COMMERCIAL	749	33	14-458110-00	MERCEDES-BENZ COMMERCIAL	741	24
14-452390-00	MERCEDES-BENZ COMMERCIAL	750	35	14-458110-00	MERCEDES-BENZ COMMERCIAL	742	25
14-452390-00	MERCEDES-BENZ COMMERCIAL	751	36	14-458110-00	MERCEDES-BENZ COMMERCIAL	743	26
14-452390-00	MERCEDES-BENZ COMMERCIAL	751	37	14-458170-00	VOLVO COMMERCIAL	1359	25
14-452390-00	MERCEDES-BENZ COMMERCIAL	753	38	14-458170-00	VOLVO COMMERCIAL	1360	26
14-452390-00	MERCEDES-BENZ COMMERCIAL	756	39	14-458170-00	VOLVO COMMERCIAL	1361	27
14-452390-00	MERCEDES-BENZ COMMERCIAL	757	40	14-458170-00	VOLVO COMMERCIAL	1364	31

NUMERICAL PARTS LIST







Nummerische Teilenummernliste • Elenco riferimenti
Liste des références produits

			9				9
14-458170-00	VOLVO COMMERCIAL	1365	32	14-630120-00	ARO	30	2
14-458180-00	VOLVO COMMERCIAL	1368	37	14-630120-00	RENAULT	962	8
14-458180-00	VOLVO COMMERCIAL	1368	38	14-633860-00	DEUTZ KHD	226	29
14-458190-00	SCANIA	1070	10	14-633860-00	IVECO	463	43
14-458190-00	SCANIA	1076	19	14-633860-00	IVECO	464	44
14-458190-00	SCANIA	1076	20	14-633860-00	IVECO	464	45
14-458190-00	SCANIA	1078	22	14-633860-00	NEW HOLLAND	810	20
14-458190-00	SCANIA	1080	26	14-634110-00	PEUGEOT	912	18
14-458190-00	SCANIA	1081	27	14-634910-00	CITROEN	151	23
14-458500-00	KAMAZ	501	1	14-634910-00	CITROEN	152	24
14-458580-00	MERCEDES-BENZ COMMERCIAL	770	53	14-634910-00	CITROEN	153	25
14-458580-00	MERCEDES-BENZ COMMERCIAL	771	54	14-634910-00	FIAT	272	55
14-458580-00	MERCEDES-BENZ COMMERCIAL	772	55	14-634910-00	PEUGEOT	917	23
14-459010-00	IVECO	469	54	14-634910-00	PEUGEOT	918	24
14-459010-00	IVECO	470	55	14-634910-00	PEUGEOT	919	25
14-459040-00	VOLVO COMMERCIAL	1356	21	14-636470-00	CITROEN	134	1
14-459040-00	VOLVO COMMERCIAL	1357	23	14-636470-00	CITROEN	135	2
14-459040-00	VOLVO COMMERCIAL	1362	28	14-636470-00	PEUGEOT	900	1
14-459040-00	VOLVO COMMERCIAL	1362	29	14-636470-00	PEUGEOT	901	3
14-459040-00	VOLVO COMMERCIAL	1363	30	14-636470-00	TALBOT	1189	1
14-459050-00	VOLVO COMMERCIAL	1351	12	14-636500-00	CITROEN	166	42
14-459050-00	VOLVO COMMERCIAL	1352	13	14-636500-00	CITROEN	167	42
14-470110-00	LEYLAND	571	7	14-636500-00	FIAT	286	75
14-470110-00	LEYLAND	572	8	14-636500-00	FIAT	287	76
14-470110-00	LEYLAND	574	11	14-636500-00	PEUGEOT	934	41
14-476000-00	ACCO SISU	1	1	14-636500-00	PEUGEOT	935	41
14-480040-00	DEUTZ KHD	222	23	14-636500-00	PEUGEOT	935	42
14-480040-00	DEUTZ KHD	222	24	14-636500-00	TALBOT	1190	5
14-480040-00	DEUTZ KHD	223	25	14-636500-00	TALBOT	1191	5
14-480040-00	DEUTZ KHD	224	26	14-636600-00	CITROEN	139	7
14-480040-00	DEUTZ KHD	225	27	14-636600-00	CITROEN	140	9
14-480040-00	VOLVO COMMERCIAL	1354	17	14-636600-00	CITROEN	141	10
14-480230-00	VOLVO COMMERCIAL	1355	19	14-636600-00	PEUGEOT	905	7
14-480320-00	FORD TRACTOR	384	1	14-636600-00	PEUGEOT	906	8
14-480320-00	LEYLAND	569	5	14-636600-00	PEUGEOT	907	9
14-480320-00	PERKINS	881	4	14-636600-00	PEUGEOT	907	10
14-480320-00	PERKINS	882	5	14-636600-00	RENAULT	962	10
14-480320-00	PERKINS	883	6	14-636600-00	TALBOT	1189	2
14-480320-00	PERKINS	884	7	14-636730-00	DAF	194	1
14-480440-00	RENAULT TRUCKS	1037	24	14-636730-00	RENAULT	959	4
14-480440-00	VOLVO COMMERCIAL	1365	33	14-636730-00	RENAULT	959	5
14-480460-00	VOLVO COMMERCIAL	1355	20	14-636730-00	VOLVO CARS	1332	1
14-573140-00	VOLVO COMMERCIAL	1350	10	14-636730-00	VOLVO CARS	1332	2
14-573140-00	VOLVO COMMERCIAL	1350	11	14-637160-00	CITROEN	166	41
14-600420-00	FORD EUROPE	356	53	14-637160-00	JEEP	495	4
14-600420-00	PEUGEOT	936	45	14-637160-00	PEUGEOT	935	43
14-604060-00	ARO	32	6	14-637160-00	PEUGEOT	936	44
14-604060-00	FORD EUROPE	363	62	14-637160-00	RENAULT	1010	47
14-604060-00	PEUGEOT	937	46	14-637160-00	RENAULT	1011	48
14-606670-00	CITROEN	155	28	14-638630-00	CITROEN	140	8
14-606670-00	FIAT	278	63	14-638630-00	PEUGEOT	903	6
14-606670-00	PEUGEOT	922	28	14-670020-00	SCANIA	1078	23
14-606670-00	PEUGEOT	923	29	14-670020-00	SCANIA	1079	24
14-606670-00	TALBOT	1190	4	14-670050-00	MAN	633	43
14-610020-00	IVECO	462	42	14-671680-00	SCANIA	1078	23
14-611250-00	IVECO	460	39	14-671680-00	SCANIA	1079	24
14-611250-00	IVECO	461	40	14-671680-00	SCANIA	1080	25
14-611250-00	NEW HOLLAND	806	13	14-671680-00	SCANIA	1082	29
14-611250-00	NEW HOLLAND	806	14	14-673080-00	SCANIA	1078	23
14-611250-00	NEW HOLLAND	807	14	14-673080-00	SCANIA	1079	24
14-615230-00	IVECO	460	39	14-673190-00	VOLVO COMMERCIAL	1359	25
14-615230-00	IVECO	461	40	14-673200-00	VOLVO COMMERCIAL	1358	24
14-630100-00	IVECO	460	38	14-673200-00	VOLVO COMMERCIAL	1359	25
14-630100-00	NEW HOLLAND	805	12	14-673200-00	VOLVO COMMERCIAL	1360	26









							
14-673200-00	VOLVO COMMERCIAL	1361	27	14-900100-00	DEUTZ KHD	217	16
14-673200-00	VOLVO COMMERCIAL	1364	31	14-900100-00	DEUTZ KHD	218	18
14-676420-00	ALFA ROMEO	24	31	14-900100-00	DEUTZ KHD	220	19
14-676420-00	ALFA ROMEO	25	32	14-900100-00	DEUTZ KHD	221	21
14-676420-00	CHRYSLER	130	3	14-900100-00	DEUTZ KHD	221	22
14-676420-00	FORD EUROPE	367	67	14-900110-00	DEUTZ KHD	216	14
14-676420-00	FORD EUROPE	367	68	14-900110-00	DEUTZ KHD	217	15
14-676420-00	LAND ROVER	562	22	14-900110-00	DEUTZ KHD	217	16
14-676420-00	OPEL	876	57	14-900120-00	DEUTZ KHD	215	13
14-676420-00	ROVER	1056	21	14-900120-00	DEUTZ KHD	216	14
14-676420-00	ROVER	1056	22	14-900120-00	DEUTZ KHD	217	15
14-676420-00	UAZ	1206	2	14-900120-00	DEUTZ KHD	217	16
14-676420-00	VAUXHALL	1247	56	14-900120-00	DEUTZ KHD	218	17
14-676420-00	VM	1249	1	14-900120-00	DEUTZ KHD	221	20
14-676420-00	VM	1249	3	15-260040-00	IVECO	471	56
14-684840-00	DEUTZ KHD	226	29	15-260040-00	IVECO	471	57
14-684840-00	IVECO	463	43	15-260050-00	IVECO	473	59
14-684840-00	IVECO	464	44	15-260050-00	IVECO	474	60
14-684840-00	IVECO	464	45	15-260080-00	IVECO	481	67
14-684840-00	NEW HOLLAND	809	18	15-260080-00	IVECO	481	68
14-684840-00	NEW HOLLAND	809	19	15-260080-00	IVECO	482	69
14-684840-00	NEW HOLLAND	810	19	15-265960-00	RENAULT TRUCKS	1026	8
14-684840-00	NEW HOLLAND	810	20	15-265960-00	RENAULT TRUCKS	1027	9
14-693800-00	KOMATSU	507	1	15-265960-00	RENAULT TRUCKS	1028	11
14-710010-00	JAGUAR	488	8	15-265960-00	RENAULT TRUCKS	1029	12
14-710010-00	JAGUAR	489	9	15-265960-00	RENAULT TRUCKS	1030	13
14-710020-00	CATERHAM	118	2	15-265960-00	RENAULT TRUCKS	1031	14
14-710020-00	LAND ROVER	548	1	15-370040-00	PERKINS	880	1
14-710020-00	LAND ROVER	548	2	15-450130-00	VOLVO COMMERCIAL	1345	2
14-710020-00	LOTUS	577	1	15-450130-00	VOLVO COMMERCIAL	1346	3
14-710020-00	LOTUS	577	2	15-450160-00	RENAULT TRUCKS	1038	27
14-710020-00	MG	779	5	15-450160-00	VOLVO COMMERCIAL	1370	40
14-710020-00	MG	780	6	15-450160-00	VOLVO COMMERCIAL	1370	41
14-710020-00	MG	780	7	15-450160-00	VOLVO COMMERCIAL	1371	42
14-710020-00	ROVER	1048	9	15-450160-00	VOLVO COMMERCIAL	1373	45
14-710020-00	ROVER	1048	10	15-450190-00	RENAULT TRUCKS	1033	18
14-710030-00	CATERHAM	118	1	15-450190-00	RENAULT TRUCKS	1034	19
14-710030-00	FSO	391	2	15-450190-00	RENAULT TRUCKS	1035	21
14-710030-00	MG	779	4	15-450220-00	RENAULT TRUCKS	1036	22
14-710030-00	ROVER	1045	6	15-450220-00	RENAULT TRUCKS	1036	23
14-710030-00	ROVER	1046	7	15-450220-00	RENAULT TRUCKS	1037	25
14-740060-00	IVECO	462	41	15-450630-00	MAN	607	16
14-740130-00	RENAULT TRUCKS	1038	26	15-450630-00	MAN	608	17
14-785400-00	FIAT	265	47	15-450630-00	MAN	609	18
14-785400-00	FIAT	266	48	15-450630-00	MAN	610	19
14-900030-00	DEUTZ KHD	228	32	15-450630-00	MAN	611	20
14-900030-00	DEUTZ KHD	228	33	15-450810-00	VOLVO COMMERCIAL	1353	15
14-900050-00	DEUTZ KHD	228	32	15-450810-00	VOLVO COMMERCIAL	1353	16
14-900050-00	DEUTZ KHD	228	33	15-450870-00	LEYLAND	571	7
14-900060-00	DEUTZ KHD	216	14	15-450870-00	LEYLAND	571	8
14-900060-00	DEUTZ KHD	217	15	15-450870-00	LEYLAND	574	11
14-900060-00	DEUTZ KHD	217	16	15-451030-00	VOLVO COMMERCIAL	1373	46
14-900060-00	DEUTZ KHD	220	19	15-451030-00	VOLVO COMMERCIAL	1374	47
14-900060-00	DEUTZ KHD	221	21	15-451070-10	MERCEDES-BENZ COMMERCIAL	762	45
14-900060-00	DEUTZ KHD	221	22	15-451070-10	MERCEDES-BENZ COMMERCIAL	766	49
14-900070-00	DEUTZ KHD	226	30	15-451220-00	MERCEDES-BENZ COMMERCIAL	774	56
14-900070-00	DEUTZ KHD	227	31	15-451220-00	MERCEDES-BENZ COMMERCIAL	775	57
14-900080-00	DEUTZ KHD	212	8	15-451230-00	DAF	201	15
14-900080-00	DEUTZ KHD	213	10	15-457590-00	VOLVO COMMERCIAL	1350	10
14-900080-00	DEUTZ KHD	214	10	15-457590-00	VOLVO COMMERCIAL	1350	11
14-900080-00	DEUTZ KHD	214	11	15-457600-00	VOLVO COMMERCIAL	1356	22
14-900100-00	DEUTZ KHD	216	14	15-457600-00	VOLVO COMMERCIAL	1358	24
14-900100-00	DEUTZ KHD	216	15	15-457960-00	VOLVO COMMERCIAL	1366	34
14-900100-00	DEUTZ KHD	217	15	15-457960-00	VOLVO COMMERCIAL	1366	35

NUMERICAL PARTS LIST

Numerische Teilenummernliste • Elenco riferimenti
Liste des références produits









			9				9
15-457960-00	VOLVO COMMERCIAL	1367	36	15-608890-00	SCANIA	1069	7
15-457960-00	VOLVO COMMERCIAL	1368	37	15-608890-00	SCANIA	1069	8
15-457960-00	VOLVO COMMERCIAL	1368	38	15-630820-00	ARO	31	3
15-457960-00	VOLVO COMMERCIAL	1369	39	15-630820-00	RENAULT	968	14
15-458840-00	VOLVO COMMERCIAL	1366	34	15-630820-00	RENAULT	969	15
15-458840-00	VOLVO COMMERCIAL	1367	36	15-630820-00	VOLVO CARS	1334	6
15-458840-00	VOLVO COMMERCIAL	1368	37	15-632000-00	ALFA ROMEO	20	24
15-458840-00	VOLVO COMMERCIAL	1368	38	15-632000-00	ALFA ROMEO	21	25
15-458840-00	VOLVO COMMERCIAL	1369	39	15-632000-00	ALFA ROMEO	22	26
15-458900-00	VOLVO COMMERCIAL	1346	4	15-632000-00	ALFA ROMEO	22	27
15-458900-00	VOLVO COMMERCIAL	1347	5	15-632000-00	ALFA ROMEO	23	28
15-458910-00	VOLVO COMMERCIAL	1351	12	15-632100-00	ALFA ROMEO	6	5
15-458910-00	VOLVO COMMERCIAL	1352	13	15-632200-00	RENAULT	954	1
15-459030-00	VOLVO COMMERCIAL	1366	34	15-632400-00	ALFA ROMEO	26	33
15-459030-00	VOLVO COMMERCIAL	1366	35	15-632500-00	ALFA ROMEO	5	3
15-459030-00	VOLVO COMMERCIAL	1367	36	15-632600-00	ALFA ROMEO	7	7
15-459030-00	VOLVO COMMERCIAL	1368	38	15-636590-00	ARO	30	1
15-459230-00	VOLVO COMMERCIAL	1356	21	15-636590-00	DACIA	180	2
15-459230-00	VOLVO COMMERCIAL	1357	23	15-636590-00	DAF	194	2
15-459230-00	VOLVO COMMERCIAL	1362	28	15-636590-00	RENAULT	961	6
15-459230-00	VOLVO COMMERCIAL	1362	29	15-636590-00	RENAULT	961	7
15-459230-00	VOLVO COMMERCIAL	1363	30	15-636590-00	VOLVO CARS	1332	3
15-459340-00	VOLVO COMMERCIAL	1347	6	15-636590-00	VOLVO CARS	1333	4
15-459350-00	VOLVO COMMERCIAL	1360	26	15-636700-00	CITROEN	137	6
15-459350-00	VOLVO COMMERCIAL	1361	27	15-636700-00	PEUGEOT	907	11
15-459350-00	VOLVO COMMERCIAL	1364	31	15-636700-00	RENAULT	962	9
15-480040-00	DEUTZ KHD	222	23	15-638390-00	RENAULT	963	11
15-480040-00	DEUTZ KHD	222	24	15-638390-00	RENAULT	965	12
15-480040-00	DEUTZ KHD	223	25	15-638390-00	RENAULT	967	13
15-480040-00	DEUTZ KHD	224	26	15-677620-00	VOLVO COMMERCIAL	1358	24
15-480040-00	DEUTZ KHD	225	27	15-677620-00	VOLVO COMMERCIAL	1359	25
15-480040-00	VOLVO COMMERCIAL	1354	17	15-677620-00	VOLVO COMMERCIAL	1360	26
15-480050-00	RENAULT TRUCKS	1032	16	15-677620-00	VOLVO COMMERCIAL	1361	27
15-480050-00	RENAULT TRUCKS	1032	17	15-677620-00	VOLVO COMMERCIAL	1364	31
15-480070-00	RENAULT TRUCKS	1032	16	15-679320-00	SCANIA	1081	28
15-480070-00	RENAULT TRUCKS	1032	17	15-679320-00	SCANIA	1082	30
15-480070-00	RENAULT TRUCKS	1033	18				
15-480070-00	RENAULT TRUCKS	1034	19				
15-480070-00	RENAULT TRUCKS	1035	21				
15-480080-00	RENAULT TRUCKS	1033	18				
15-480080-00	RENAULT TRUCKS	1034	19				
15-480080-00	RENAULT TRUCKS	1034	20				
15-480080-00	RENAULT TRUCKS	1035	21				
15-480090-00	RENAULT TRUCKS	1027	10				
15-480090-00	RENAULT TRUCKS	1028	10				
15-480090-00	RENAULT TRUCKS	1028	11				
15-480090-00	RENAULT TRUCKS	1029	12				
15-480090-00	RENAULT TRUCKS	1030	13				
15-480090-00	RENAULT TRUCKS	1031	14				
15-480450-00	DEUTZ KHD	225	28				
15-480450-00	RENAULT TRUCKS	1031	15				
15-480450-00	VOLVO COMMERCIAL	1354	18				
15-570050-00	SCANIA	1071	11				
15-570050-00	SCANIA	1072	12				
15-570050-00	SCANIA	1072	13				
15-570050-00	SCANIA	1074	16				
15-570060-00	SCANIA	1071	11				
15-570060-00	SCANIA	1072	12				
15-570060-00	SCANIA	1072	13				
15-570060-00	SCANIA	1074	16				
15-600020-00	SCANIA	1066	2				
15-600020-00	SCANIA	1070	9				
15-608890-00	SCANIA	1067	4				
15-608890-00	SCANIA	1068	6				

NÜRAL PISTONS FITTED WITH GOETZE RING SETS









 Nüral Piston	 GOETZE Rings set	 Nüral Piston	 GOETZE Rings set	 Nüral Piston	 GOETZE Rings set	 Nüral Piston	 GOETZE Rings set
87-102300-00	08-102300-00	87-252500-30	08-252500-10	87-101300-00	08-101300-00	87-107900-00	08-107900-00
87-102307-00	08-102307-00	87-252507-30	08-252507-10	87-101307-00	08-101307-00	87-107908-00	08-107908-00
87-124500-10	08-124500-00	87-325600-30	08-325600-00	87-101500-00	08-101500-00	87-108000-00	08-108000-00
87-133100-00	08-133100-10	87-346500-00	08-346500-10	87-101507-00	08-101507-00	87-108008-00	08-108008-00
87-133107-00	08-133107-10	87-422000-10	08-422000-00	87-101600-00	08-101600-00	87-108200-00	08-108200-00
87-143200-00	08-143200-00	87-422007-10	08-422007-00	87-101700-00	08-101700-00	87-108208-00	08-108208-00
87-143400-00	08-143400-00	87-424100-00	08-424100-00	87-102700-00	08-102700-00	87-109100-00	08-109100-00
87-143407-00	08-143407-00	87-424107-00	08-424107-00	87-102700-10	08-102700-00	87-109100-10	08-109100-00
87-143500-00	08-143500-00	87-424200-00	08-424200-00	87-102707-00	08-102707-00	87-109107-00	08-109107-00
87-143507-00	08-143507-00	87-424207-00	08-424207-00	87-102707-10	08-102707-00	87-109107-10	08-109107-00
87-167607-00	08-167607-10	87-427800-00	08-427800-00	87-102800-10	08-102800-00	87-109200-00	08-109200-00
87-170707-00	08-170707-10	87-427807-00	08-427807-00	87-102807-10	08-102807-00	87-109400-50	08-109400-10
87-174307-10	08-174307-10	87-428600-10	08-428600-00	87-102900-10	08-102900-00	87-109407-50	08-109407-10
87-174311-10	08-174311-10	87-429500-10	08-429500-00	87-102907-10	08-102907-00	87-109500-00	08-109500-00
87-176411-00	08-176411-10	87-429500-30	08-429500-00	87-103000-00	08-103000-00	87-109505-00	08-109505-00
87-176800-30	08-176800-10	87-429507-10	08-429507-00	87-103000-10	08-103000-00	87-109507-00	08-109507-00
87-176911-10	08-176911-10	87-429507-30	08-429507-00	87-103000-30	08-103000-00	87-109511-00	08-109511-00
87-178407-00	08-178407-10	87-432205-00	08-432205-00	87-103000-40	08-103000-00	87-109707-00	08-109707-00
87-179700-00	08-179700-00	87-432207-00	08-432207-00	87-103200-00	08-103200-00	87-109707-10	08-109707-00
87-179707-00	08-179707-00	87-432307-00	08-432307-00	87-103207-00	08-103207-00	87-109707-20	08-109707-00
87-179711-00	08-179711-00	87-432307-10	08-432307-10	87-103500-00	08-103500-00	87-109800-10	08-109800-00
87-183011-00	08-183011-00	87-432900-00	08-432900-00	87-103507-00	08-103507-00	87-109807-10	08-109807-00
87-183111-00	08-183111-00	87-432905-00	08-432907-00	87-103800-00	08-103800-00	87-109811-10	08-109811-00
87-202409-10	08-202409-10	87-432907-00	08-432907-00	87-103806-00	08-103806-00	87-110100-00	08-110100-00
87-207311-00	08-207311-10	87-433400-10	08-433400-00	87-103900-00	08-103900-00	87-110200-30	08-110200-00
87-207321-00	08-207321-10	87-433407-10	08-433407-00	87-103900-10	08-103900-00	87-110200-40	08-110200-00
87-269700-00	08-269700-00	87-433900-10	08-433900-00	87-103900-30	08-103900-00	87-110900-00	08-110900-00
87-269706-00	08-269706-00	87-433907-10	08-433907-00	87-103900-40	08-103900-00	87-110906-00	08-110906-00
87-269800-00	08-269800-00	87-435200-00	08-435200-00	87-103908-00	08-103908-00	87-111900-00	08-111900-00
87-269806-00	08-269806-00	87-435207-00	08-435207-00	87-103908-40	08-103908-00	87-112400-00	08-112400-00
87-306907-20	08-306907-00	87-435700-00	08-435700-00	87-104000-00	08-104000-00	87-112407-00	08-112407-00
87-423000-01	08-423000-00	87-435700-10	08-435700-00	87-104008-00	08-104008-00	87-113500-00	08-113500-00
87-423000-11	08-423000-00	87-435706-00	08-435706-00	87-104100-00	08-104100-00	87-113500-10	08-113500-00
87-428600-01	08-428600-00	87-435706-10	08-435706-00	87-104105-00	08-104105-00	87-113507-00	08-113507-00
87-501800-10	08-501800-00	87-438500-00	08-438500-00	87-104107-00	08-104107-00	87-113507-10	08-113507-00
87-522200-00	08-522200-00	87-438507-00	08-438507-00	87-104200-00	08-104200-00	87-113511-00	08-113511-00
87-740307-00	08-740307-00	87-438900-00	08-438900-00	87-104200-10	08-104200-00	87-113511-10	08-113511-00
87-740311-00	08-740311-00	87-441100-00	08-441100-00	87-104200-30	08-104200-00	87-114400-00	08-114400-00
87-741811-00	08-741811-00	87-441900-00	08-441900-00	87-104200-40	08-104200-00	87-114400-10	08-114400-00
87-743200-10	08-743200-00	87-442300-00	08-442300-00	87-104207-00	08-104207-00	87-114400-30	08-114400-00
87-101100-10	08-101100-00	87-442400-00	08-442400-00	87-104207-10	08-104207-00	87-114400-40	08-114400-40
87-114400-65	08-114400-45	87-442400-10	08-442400-00	87-104207-40	08-104207-00	87-114400-60	08-114400-40
87-114708-40	08-114708-00	87-442407-00	08-442407-00	87-104300-00	08-104300-00	87-114405-00	08-114405-00
87-127907-00	08-127907-00	87-442407-10	08-442407-00	87-104300-10	08-104300-00	87-114405-10	08-114405-00
87-136507-65	08-136507-30	87-443100-00	08-443100-00	87-105500-00	08-105500-00	87-114405-30	08-114405-00
87-136900-10	08-136900-00	87-443100-10	08-443100-00	87-105507-00	08-105507-00	87-114405-40	08-114405-40
87-136900-30	08-136900-00	87-443108-00	08-443108-00	87-105900-00	08-105900-00	87-114405-60	08-114405-40
87-137500-30	08-137500-00	87-443108-10	08-443108-00	87-105907-00	08-105907-00	87-114700-00	08-114700-00
87-137507-30	08-137507-00	87-443500-00	08-443500-00	87-107000-00	08-107000-00	87-114700-10	08-114700-00
87-140200-00	08-140200-00	87-443500-10	08-443500-00	87-107000-10	08-107000-00	87-114700-30	08-114700-00
87-141200-00	08-141200-00	87-443507-00	08-443507-00	87-107007-00	08-107007-00	87-114700-40	08-114700-00
87-141207-00	08-141207-00	87-443507-10	08-443507-00	87-107007-10	08-107007-00	87-114708-00	08-114708-00
87-143600-50	08-143600-10	87-443600-00	08-443600-00	87-107011-10	08-107011-00	87-114708-10	08-114708-00
87-148100-80	08-148100-00	87-443700-00	08-443700-00	87-107100-30	08-107100-00	87-114708-30	08-114708-00
87-148100-85	08-148100-00	87-443707-00	08-443707-00	87-107100-40	08-107100-10	87-114900-05	08-114900-00
87-148105-80	08-148105-00	87-443800-00	08-443800-00	87-107200-00	08-107200-00	87-114900-15	08-114900-00
87-148107-80	08-148107-00	87-443807-00	08-443807-00	87-107200-10	08-107200-00	87-114900-20	08-114900-00
87-148107-85	08-148107-00	87-502900-30	08-502900-00	87-107209-00	08-107209-00	87-114900-25	08-114900-00
87-148300-00	08-148300-00	87-502907-30	08-502907-00	87-107600-00	08-107600-00	87-114900-30	08-114900-00
87-148307-00	08-148307-00	87-100100-00	08-100100-00	87-107607-00	08-107607-00	87-114900-35	08-114900-00

Nüral Kolben ausgestattet mit Goetze Kolbenringsätzen
 Pistons Nüral équipés de jeux de segments Goetze
 Pistones Nüral equipados con conjuntos de segmentos Goetze

Tłoki Nüral z zamontowanymi zestawami pierścieni Goetze
 Поршни Nüral, оснащаемые кольцами Goetze
 Goetze يتم تركيب كيباسات Nüral باستخدام مجموعات حلقات









 Nüral Piston	 GOETZE Rings set	 Nüral Piston	 GOETZE Rings set	 Nüral Piston	 GOETZE Rings set	 Nüral Piston	 GOETZE Rings set
87-114900-45	08-114900-00	87-121900-00	08-121900-00	87-131500-00	08-131500-10	87-139500-20	08-139500-00
87-114900-46	08-114900-00	87-122000-00	08-122000-00	87-135300-00	08-135300-00	87-139500-30	08-139500-00
87-114900-55	08-114900-00	87-122200-00	08-122200-00	87-135300-10	08-135300-00	87-139500-40	08-139500-00
87-114900-56	08-114900-00	87-122200-10	08-122200-00	87-135305-00	08-135305-00	87-139507-00	08-139507-00
87-114900-60	08-114900-00	87-122200-20	08-122200-00	87-135307-00	08-135307-00	87-139507-10	08-139507-00
87-114900-65	08-114900-00	87-122208-00	08-122208-00	87-135307-10	08-135307-00	87-139507-20	08-139507-00
87-114900-66	08-114900-00	87-122208-10	08-122208-00	87-135500-00	08-135500-00	87-139507-30	08-139507-00
87-114900-70	08-114900-00	87-123200-00	08-123200-00	87-135500-10	08-135500-10	87-139507-40	08-139507-00
87-114900-80	08-114900-00	87-123200-10	08-123200-00	87-135800-00	08-135800-00	87-140000-00	08-140000-00
87-114900-85	08-114900-00	87-123200-40	08-123200-00	87-136000-00	08-136000-00	87-140007-00	08-140007-00
87-114900-90	08-114900-00	87-123400-00	08-123400-00	87-136000-10	08-136000-00	87-140500-00	08-140500-00
87-114900-95	08-114900-00	87-123400-10	08-123400-00	87-136400-00	08-136400-00	87-140507-00	08-140507-00
87-114905-60	08-114905-00	87-123400-20	08-123400-00	87-136407-00	08-136407-00	87-140600-00	08-140600-00
87-114905-70	08-114905-00	87-123400-30	08-123400-00	87-136500-00	08-136500-00	87-140800-00	08-140800-00
87-114905-90	08-114905-00	87-123400-40	08-123400-00	87-136500-10	08-136500-10	87-140800-10	08-140800-00
87-114905-95	08-114905-00	87-123400-50	08-123400-00	87-136500-30	08-136500-30	87-140807-00	08-140807-00
87-114907-05	08-114907-00	87-123407-00	08-123407-00	87-136500-40	08-136500-30	87-140807-10	08-140807-00
87-114907-15	08-114907-00	87-123407-10	08-123407-00	87-136500-60	08-136500-30	87-141300-00	08-141300-00
87-114907-20	08-114907-00	87-123407-20	08-123407-00	87-136500-65	08-136500-30	87-141300-10	08-141300-00
87-114907-25	08-114907-00	87-123407-30	08-123407-00	87-136500-70	08-136500-30	87-141300-20	08-141300-00
87-114907-30	08-114907-00	87-123407-40	08-123407-00	87-136500-75	08-136500-30	87-141307-00	08-141307-00
87-114907-35	08-114907-00	87-123407-50	08-123407-00	87-136500-80	08-136500-30	87-141307-10	08-141307-00
87-114907-45	08-114907-00	87-123700-00	08-123700-00	87-136500-85	08-136500-30	87-141307-20	08-141307-00
87-114907-46	08-114907-00	87-123700-10	08-123700-00	87-136500-90	08-136500-30	87-141800-00	08-141800-00
87-114907-55	08-114907-00	87-123700-30	08-123700-00	87-136500-91	08-136500-30	87-141900-00	08-141900-00
87-114907-56	08-114907-00	87-123711-00	08-123711-00	87-136500-95	08-136500-10	87-142000-00	08-142000-00
87-114907-60	08-114907-00	87-123711-10	08-123711-00	87-136600-00	08-136600-00	87-142100-00	08-142100-00
87-114907-65	08-114907-00	87-123711-30	08-123711-00	87-136607-00	08-136607-00	87-142107-00	08-142107-00
87-114907-66	08-114907-00	87-123721-00	08-123721-00	87-136700-00	08-136700-00	87-142300-00	08-142300-00
87-114907-70	08-114907-00	87-123721-10	08-123721-00	87-136705-00	08-136705-00	87-142306-00	08-142306-00
87-114907-80	08-114907-00	87-123721-30	08-123721-00	87-136707-00	08-136707-00	87-142308-00	08-142308-00
87-114907-85	08-114907-00	87-123900-10	08-123900-10	87-136800-10	08-136800-00	87-142400-00	08-142400-00
87-114907-90	08-114907-00	87-124000-00	08-124000-00	87-136800-30	08-136800-00	87-142406-00	08-142406-00
87-114907-95	08-114907-00	87-124000-10	08-124000-00	87-136800-40	08-136800-00	87-142500-00	08-142500-00
87-114911-20	08-114911-00	87-124000-30	08-124000-00	87-136900-00	08-136900-00	87-142500-10	08-142500-00
87-114911-30	08-114911-00	87-124008-00	08-124008-00	87-137500-10	08-137500-10	87-142800-00	08-142800-00
87-114911-60	08-114911-00	87-124008-10	08-124008-00	87-137507-10	08-137507-10	87-142900-00	08-142900-00
87-114911-70	08-114911-00	87-124008-30	08-124008-00	87-137600-00	08-137600-00	87-143600-00	08-143600-10
87-114911-90	08-114911-00	87-124500-00	08-124500-00	87-137606-00	08-137606-00	87-143600-30	08-143600-10
87-114911-95	08-114911-00	87-124500-20	08-124500-00	87-138000-00	08-138000-00	87-143600-40	08-143600-10
87-115800-00	08-115800-00	87-124500-30	08-124500-00	87-138000-10	08-138000-00	87-143800-00	08-143800-00
87-116100-00	08-116100-00	87-124500-40	08-124500-00	87-138006-00	08-138006-00	87-143800-10	08-143800-00
87-116107-00	08-116107-00	87-124800-00	08-124800-00	87-138006-10	08-138006-00	87-143800-20	08-143800-00
87-117900-00	08-117900-00	87-124806-00	08-124806-00	87-138008-00	08-138008-00	87-143800-30	08-143800-00
87-117900-10	08-117900-00	87-125600-00	08-125600-00	87-138008-10	08-138008-00	87-143800-40	08-143800-00
87-117900-20	08-117900-00	87-125607-00	08-125607-00	87-138400-00	08-138400-00	87-143800-50	08-143800-00
87-117907-00	08-117907-00	87-126000-00	08-126000-00	87-138400-10	08-138400-00	87-143800-60	08-143800-00
87-117907-10	08-117907-00	87-126000-10	08-126000-00	87-138400-30	08-138400-00	87-144200-00	08-144200-00
87-117907-20	08-117907-00	87-126007-00	08-126007-00	87-138400-40	08-138400-00	87-144207-00	08-144207-00
87-118000-00	08-118000-00	87-126007-10	08-126007-00	87-138406-00	08-138406-00	87-145000-00	08-145000-00
87-118000-10	08-118000-00	87-126300-10	08-126300-10	87-138406-10	08-138406-00	87-145007-00	08-145007-00
87-118000-30	08-118000-00	87-126307-10	08-126307-10	87-138406-30	08-138406-00	87-145100-00	08-145100-00
87-118006-00	08-118006-00	87-126309-10	08-126309-10	87-138406-40	08-138406-00	87-145106-00	08-145106-00
87-118006-10	08-118006-00	87-126311-10	08-126311-10	87-138408-10	08-138408-00	87-145108-00	08-145108-00
87-118006-30	08-118006-00	87-127400-00	08-127400-00	87-138900-10	08-138900-00	87-145200-00	08-145200-00
87-119000-00	08-119000-00	87-127400-10	08-127400-00	87-138900-30	08-138900-00	87-145206-00	08-145206-00
87-119800-00	08-119800-00	87-127407-00	08-127407-00	87-139400-00	08-139400-00	87-145300-00	08-145300-00
87-119807-00	08-119807-00	87-127407-10	08-127407-00	87-139407-00	08-139407-00	87-145306-00	08-145306-00
87-121800-00	08-121800-00	87-127800-00	08-127800-00	87-139500-00	08-139500-00	87-145400-00	08-145400-00
87-121800-10	08-121800-00	87-127900-00	08-127900-00	87-139500-10	08-139500-00	87-145400-10	08-145400-00

NÜRAL PISTONS FITTED WITH GOETZE RING SETS









 Nüral Piston	 GOETZE Rings set	 Nüral Piston	 GOETZE Rings set	 Nüral Piston	 GOETZE Rings set	 Nüral Piston	 GOETZE Rings set
87-145400-30	08-145400-00	87-176407-00	08-176407-10	87-202411-00	08-202411-10	87-215300-10	08-215300-10
87-145406-00	08-145406-00	87-176600-00	08-176600-00	87-202411-10	08-202411-10	87-215308-10	08-215308-10
87-145406-10	08-145406-00	87-176607-00	08-176607-00	87-202800-00	08-202800-00	87-215507-00	08-215507-10
87-145406-30	08-145406-00	87-176611-00	08-176611-00	87-202807-00	08-202807-00	87-243300-00	08-243300-00
87-146100-00	08-146100-00	87-176700-00	08-176700-00	87-202809-00	08-202809-00	87-243600-00	08-243600-00
87-146100-10	08-146100-00	87-176708-00	08-176708-00	87-202811-00	08-202811-00	87-244500-10	08-244500-00
87-146106-10	08-146106-00	87-176800-00	08-176800-10	87-203100-00	08-203100-00	87-244500-30	08-244500-00
87-146108-00	08-146108-00	87-176800-40	08-176800-10	87-203106-00	08-203106-00	87-244500-40	08-244500-00
87-146500-00	08-146500-00	87-176900-00	08-176900-10	87-203106-10	08-203106-00	87-245200-30	08-245200-00
87-146507-00	08-146507-00	87-176907-00	08-176907-10	87-203108-00	08-203108-00	87-245200-40	08-245200-00
87-148100-00	08-148100-00	87-176911-00	08-176911-10	87-203108-10	08-203108-00	87-245200-50	08-245200-00
87-148100-10	08-148100-00	87-176914-00	08-176914-10	87-203500-00	08-203500-10	87-245200-60	08-245200-00
87-148100-30	08-148100-00	87-178200-20	08-178200-00	87-205800-00	08-205800-00	87-245208-30	08-245208-00
87-148100-40	08-148100-00	87-178207-20	08-178207-00	87-205807-00	08-205807-00	87-245208-40	08-245208-00
87-148105-00	08-148105-00	87-178211-20	08-178211-00	87-205811-00	08-205811-00	87-245208-50	08-245208-00
87-148105-10	08-148105-00	87-178400-00	08-178400-10	87-206600-00	08-206600-00	87-245500-00	08-245500-00
87-148107-00	08-148107-00	87-178800-00	08-178800-00	87-206600-10	08-206600-00	87-245500-10	08-245500-00
87-148107-10	08-148107-00	87-178807-00	08-178807-00	87-206607-00	08-206607-00	87-247200-00	08-247200-10
87-148107-30	08-148107-00	87-178811-00	08-178811-00	87-206607-10	08-206607-00	87-247600-10	08-247600-00
87-148107-40	08-148107-00	87-179000-10	08-179000-10	87-206611-00	08-206611-00	87-247800-00	08-247800-00
87-152000-10	08-152000-00	87-179300-05	08-179300-10	87-206617-10	08-206617-00	87-247800-10	08-247800-00
87-152007-10	08-152007-00	87-179300-10	08-179300-10	87-206800-00	08-206800-00	87-247808-00	08-247808-00
87-152010-10	08-152010-00	87-179300-15	08-179300-10	87-206800-10	08-206800-00	87-247808-10	08-247808-00
87-152700-00	08-152700-00	87-179300-16	08-179300-10	87-206808-00	08-206808-00	87-248000-00	08-248000-10
87-152707-00	08-152707-00	87-179300-20	08-179300-10	87-206808-10	08-206808-00	87-248000-10	08-248000-10
87-154200-00	08-154200-00	87-179300-25	08-179300-10	87-207200-00	08-207200-00	87-252500-10	08-252500-00
87-154200-10	08-154200-00	87-179300-30	08-179300-10	87-207208-00	08-207208-00	87-252507-10	08-252507-00
87-154200-30	08-154200-00	87-179300-40	08-179300-10	87-207500-00	08-207500-00	87-252800-00	08-252800-00
87-154206-00	08-154206-00	87-179300-50	08-179300-10	87-207500-10	08-207500-00	87-263100-00	08-263100-00
87-154206-10	08-154206-00	87-179300-55	08-179300-10	87-207500-30	08-207500-00	87-263100-10	08-263100-00
87-154206-30	08-154206-00	87-179300-60	08-179300-10	87-207700-00	08-207700-00	87-263107-00	08-263107-00
87-154208-00	08-154208-00	87-179300-65	08-179300-10	87-207800-00	08-207800-30	87-263107-10	08-263107-00
87-154208-10	08-154208-00	87-179300-70	08-179300-10	87-207800-10	08-207800-10	87-269900-00	08-269900-00
87-154208-30	08-154208-00	87-179300-80	08-179300-10	87-208100-10	08-208100-00	87-274800-00	08-274800-10
87-154300-00	08-154300-00	87-179300-85	08-179300-10	87-208800-00	08-208800-00	87-274800-30	08-274800-10
87-154400-00	08-154400-00	87-179300-90	08-179300-10	87-208807-00	08-208807-00	87-279600-10	08-279600-00
87-154600-00	08-154600-00	87-179400-00	08-179400-00	87-208811-00	08-208811-00	87-280000-00	08-280000-10
87-154608-00	08-154608-00	87-179500-10	08-179500-00	87-209800-00	08-209800-00	87-280200-10	08-280200-00
87-167600-00	08-167600-10	87-179507-10	08-179507-00	87-209800-10	08-209800-00	87-280400-00	08-280400-10
87-167611-00	08-167611-10	87-179511-10	08-179511-00	87-209800-30	08-209800-00	87-283100-00	08-283100-00
87-172500-00	08-172500-00	87-179700-10	08-179700-00	87-209806-00	08-209806-00	87-283100-01	08-283100-00
87-172507-00	08-172507-00	87-179707-10	08-179707-00	87-209806-10	08-209806-00	87-283100-10	08-283100-00
87-172511-00	08-172511-00	87-179711-10	08-179711-00	87-209806-30	08-209806-00	87-283100-30	08-283100-00
87-173800-10	08-173800-00	87-181100-10	08-181100-00	87-209808-00	08-209808-00	87-283100-40	08-283100-00
87-173807-10	08-173807-00	87-181100-20	08-181100-00	87-209808-10	08-209808-00	87-283100-60	08-283100-00
87-174100-00	08-174100-10	87-181100-30	08-181100-00	87-214100-10	08-214100-00	87-283100-70	08-283100-00
87-174100-30	08-174100-10	87-181700-00	08-181700-00	87-214107-00	08-214107-00	87-283100-80	08-283100-00
87-174300-00	08-174300-10	87-181800-00	08-181800-00	87-214107-10	08-214107-00	87-283100-85	08-283100-00
87-174307-00	08-174307-10	87-181800-10	08-181800-00	87-214111-00	08-214111-00	87-283100-86	08-283100-00
87-174311-00	08-174311-10	87-183000-00	08-183000-00	87-214111-10	08-214111-00	87-283300-00	08-283300-00
87-174600-00	08-174600-10	87-183007-00	08-183007-00	87-214500-00	08-214500-10	87-283600-00	08-283600-00
87-174600-10	08-174600-10	87-183100-00	08-183100-00	87-214508-00	08-214508-10	87-283607-00	08-283607-00
87-174600-30	08-174600-10	87-183107-00	08-183107-00	87-214800-10	08-214800-10	87-283611-00	08-283611-00
87-174607-00	08-174607-10	87-183300-00	08-183300-00	87-214807-10	08-214807-10	87-285800-00	08-285800-00
87-174607-10	08-174607-10	87-183307-00	08-183307-00	87-214809-10	08-214809-10	87-285900-00	08-285900-00
87-174607-30	08-174607-10	87-202400-00	08-202400-10	87-214811-10	08-214811-10	87-285900-05	08-285900-00
87-176000-00	08-176000-00	87-202400-10	08-202400-10	87-215100-10	08-215100-10	87-285900-06	08-285900-00
87-176000-01	08-176000-00	87-202400-30	08-202400-10	87-215108-10	08-215108-10	87-285900-10	08-285900-00
87-176000-10	08-176000-00	87-202407-00	08-202407-10	87-215200-00	08-215200-10	87-285900-15	08-285900-00
87-176400-00	08-176400-10	87-202407-10	08-202407-10	87-215208-00	08-215208-10	87-285900-16	08-285900-00

Nüral Kolben ausgestattet mit Goetze Kolbenringsätzen
 Pistons Nüral équipés de jeux de segments Goetze
 Pistones Nüral equipados con conjuntos de segmentos Goetze

Tłoki Nüral z zamontowanymi zestawami pierścieni Goetze
 Поршни Nüral, оснащаемые кольцами Goetze
 Goetze يتم تركيب كباسات Nüral باستخدام مجموعات حلقات









 Nüral Piston	 GOETZE Rings set	 Nüral Piston	 GOETZE Rings set	 Nüral Piston	 GOETZE Rings set	 Nüral Piston	 GOETZE Rings set
87-285900-30	08-285900-00	87-307207-00	08-307207-00	87-335900-00	08-335900-00	87-425008-00	08-425008-00
87-285900-40	08-285900-00	87-307600-10	08-307600-00	87-335900-10	08-335900-00	87-425008-10	08-425008-00
87-287100-00	08-287100-00	87-307600-20	08-307600-00	87-335900-30	08-335900-00	87-425200-00	08-425200-00
87-287100-10	08-287100-00	87-307600-30	08-307600-00	87-336500-00	08-336500-00	87-425300-00	08-425300-00
87-287100-30	08-287100-00	87-307600-40	08-307600-00	87-336500-10	08-336500-00	87-425307-00	08-425307-00
87-287107-10	08-287107-00	87-307607-20	08-307607-00	87-336505-00	08-336505-00	87-425400-00	08-425400-00
87-287107-30	08-287107-00	87-307607-30	08-307607-00	87-336507-00	08-336507-00	87-425600-00	08-425600-00
87-287500-00	08-287500-00	87-307607-40	08-307607-00	87-336507-10	08-336507-00	87-425606-00	08-425606-00
87-287500-10	08-287500-00	87-307700-00	08-307700-00	87-336510-00	08-336510-00	87-425700-00	08-425700-00
87-287500-20	08-287500-00	87-307700-10	08-307700-00	87-336600-00	08-336600-00	87-425707-00	08-425707-00
87-287500-30	08-287500-00	87-307707-00	08-307707-00	87-337300-00	08-337300-00	87-426100-00	08-426100-00
87-287500-40	08-287500-00	87-307707-10	08-307707-00	87-337500-00	08-337500-00	87-426107-00	08-426107-00
87-287505-10	08-287505-00	87-307800-10	08-307800-00	87-337500-10	08-337500-00	87-426200-00	08-426200-00
87-287505-30	08-287505-00	87-307807-10	08-307807-00	87-337500-30	08-337500-00	87-426300-00	08-426300-00
87-287507-20	08-287507-00	87-313400-00	08-313400-00	87-337500-50	08-337500-00	87-426600-00	08-426600-00
87-287507-30	08-287507-00	87-314600-00	08-314600-00	87-337500-70	08-337500-00	87-426700-00	08-426700-00
87-287507-40	08-287507-00	87-314600-10	08-314600-00	87-373800-00	08-373800-00	87-426707-00	08-426707-00
87-288000-00	08-288000-10	87-315200-00	08-315200-00	87-373800-10	08-373800-00	87-427000-00	08-427000-00
87-288000-10	08-288000-10	87-318000-00	08-318000-10	87-373807-00	08-373807-00	87-427100-00	08-427100-00
87-288007-00	08-288007-10	87-318700-00	08-318700-00	87-374407-00	08-374407-00	87-427105-00	08-427105-00
87-288007-10	08-288007-10	87-318700-10	08-318700-10	87-396300-00	08-396300-10	87-427107-00	08-427107-00
87-288300-10	08-288300-00	87-318700-30	08-318700-10	87-404500-00	08-404500-00	87-427400-00	08-427400-00
87-288307-10	08-288307-00	87-318706-00	08-318706-10	87-404507-00	08-404507-00	87-427400-10	08-427400-00
87-288800-00	08-288800-00	87-318706-10	08-318706-10	87-404511-00	08-404511-00	87-427400-20	08-427400-00
87-288807-00	08-288807-00	87-318706-30	08-318706-10	87-405500-10	08-405500-10	87-427400-30	08-427400-00
87-289300-00	08-289300-00	87-318708-00	08-318708-10	87-405600-60	08-405600-10	87-427407-00	08-427407-00
87-289300-10	08-289300-00	87-318708-10	08-318708-10	87-405600-70	08-405600-10	87-427407-10	08-427407-00
87-289600-00	08-289600-00	87-318708-30	08-318708-10	87-407000-00	08-407000-10	87-427500-00	08-427500-00
87-289600-20	08-289600-00	87-318710-10	08-318710-10	87-407100-00	08-407100-10	87-427507-00	08-427507-00
87-295400-00	08-295400-00	87-318710-30	08-318710-10	87-407100-10	08-407100-10	87-427600-10	08-427600-10
87-304207-00	08-304207-00	87-318711-00	08-318711-10	87-420100-00	08-420100-00	87-427700-10	08-427700-00
87-305607-10	08-305607-00	87-318900-10	08-318900-10	87-420108-00	08-420108-00	87-427700-30	08-427700-00
87-305900-00	08-305900-10	87-319000-00	08-319000-10	87-420200-00	08-420200-00	87-427700-40	08-427700-00
87-305907-00	08-305907-10	87-319000-10	08-319000-10	87-420900-00	08-420900-00	87-427700-50	08-427700-00
87-305911-00	08-305911-10	87-321500-10	08-321500-00	87-420900-10	08-420900-00	87-427707-10	08-427707-00
87-306307-00	08-306307-00	87-321507-10	08-321507-00	87-420900-50	08-420900-00	87-427707-30	08-427707-00
87-306311-00	08-306311-00	87-321510-10	08-321510-00	87-421000-10	08-421000-00	87-427707-40	08-427707-00
87-306700-00	08-306700-00	87-322000-00	08-322000-00	87-421000-20	08-421000-00	87-427707-50	08-427707-00
87-306700-10	08-306700-00	87-322700-00	08-322700-00	87-421000-30	08-421000-00	87-427900-00	08-427900-00
87-306707-00	08-306707-00	87-323600-00	08-323600-00	87-421007-10	08-421007-00	87-428000-00	08-428000-00
87-306707-10	08-306707-00	87-323607-00	08-323607-00	87-421007-20	08-421007-00	87-428600-00	08-428600-00
87-306711-00	08-306711-00	87-324300-10	08-324300-00	87-421007-30	08-421007-00	87-428700-00	08-428700-00
87-306711-10	08-306711-00	87-325600-00	08-325600-00	87-421600-00	08-421600-00	87-428707-00	08-428707-00
87-306800-10	08-306800-00	87-325600-10	08-325600-00	87-422000-00	08-422000-00	87-428800-00	08-428800-00
87-306800-20	08-306800-00	87-325800-00	08-325800-00	87-422007-00	08-422007-00	87-428900-00	08-428900-00
87-306800-30	08-306800-00	87-325806-00	08-325806-00	87-422100-00	08-422100-00	87-429100-00	08-429100-00
87-306807-10	08-306807-00	87-326300-00	08-326300-00	87-422200-10	08-422200-00	87-429200-00	08-429200-00
87-306807-20	08-306807-00	87-326307-00	08-326307-00	87-422207-10	08-422207-00	87-429400-00	08-429400-00
87-306807-30	08-306807-00	87-333300-00	08-333300-00	87-422300-00	08-422300-00	87-429407-00	08-429407-00
87-306811-30	08-306811-00	87-333400-00	08-333400-10	87-422307-00	08-422307-00	87-429500-00	08-429500-00
87-306900-00	08-306900-00	87-333500-00	08-333500-00	87-422400-00	08-422400-00	87-429507-00	08-429507-00
87-306900-10	08-306900-00	87-334300-00	08-334300-00	87-422407-00	08-422407-00	87-429600-00	08-429600-00
87-306900-20	08-306900-00	87-334400-00	08-334400-00	87-423000-00	08-423000-00	87-429900-00	08-429900-00
87-306907-00	08-306907-00	87-335000-00	08-335000-10	87-423000-10	08-423000-00	87-429907-00	08-429907-00
87-306907-10	08-306907-00	87-335000-10	08-335000-10	87-423400-00	08-423400-00	87-430000-00	08-430000-00
87-307100-20	08-307100-00	87-335007-00	08-335007-10	87-423407-00	08-423407-00	87-431000-00	08-431000-00
87-307100-30	08-307100-00	87-335007-10	08-335007-10	87-424000-00	08-424000-00	87-431000-10	08-431000-00
87-307107-20	08-307107-00	87-335100-10	08-335100-00	87-424008-00	08-424008-00	87-431300-00	08-431300-00
87-307107-30	08-307107-00	87-335107-10	08-335107-00	87-425000-00	08-425000-00	87-431600-00	08-431600-00
87-307200-00	08-307200-00	87-335300-00	08-335300-00	87-425000-10	08-425000-00	87-431700-00	08-431700-00

NÜRAL PISTONS FITTED WITH GOETZE RING SETS

 Nüral Piston	 GOETZE Rings set	 Nüral Piston	 GOETZE Rings set	 Nüral Piston	 GOETZE Rings set	 Nüral Piston	 GOETZE Rings set
87-431707-00	08-431707-00	87-501500-10	08-501500-00	87-522411-00	08-522411-00	87-525507-00	08-525507-00
87-431800-00	08-431800-00	87-501500-20	08-501500-00	87-522414-00	08-522414-00	87-525509-00	08-525509-00
87-431900-00	08-431900-00	87-501500-30	08-501500-00	87-522600-00	08-522600-00	87-525700-00	08-525700-00
87-431907-00	08-431907-00	87-501500-40	08-501500-00	87-522607-00	08-522607-00	87-525707-00	08-525707-00
87-432200-00	08-432200-00	87-501507-00	08-501507-00	87-522700-00	08-522700-00	87-525709-00	08-525709-00
87-432300-00	08-432300-00	87-501507-10	08-501507-00	87-522700-10	08-522700-00	87-525711-00	08-525711-00
87-432300-10	08-432300-10	87-501507-20	08-501507-00	87-522900-00	08-522900-00	87-525900-00	08-525900-00
87-432400-00	08-432400-00	87-501507-30	08-501507-00	87-522900-10	08-522900-00	87-525907-00	08-525907-00
87-433300-00	08-433300-00	87-501507-40	08-501507-00	87-522900-30	08-522900-00	87-525909-00	08-525909-00
87-433400-00	08-433400-00	87-501800-20	08-501800-00	87-522900-40	08-522900-00	87-525911-00	08-525911-00
87-433405-00	08-433405-00	87-501800-40	08-501800-00	87-523000-00	08-523000-00	87-525914-00	08-525914-00
87-433407-00	08-433407-00	87-501807-10	08-501807-00	87-523000-10	08-523000-00	87-526300-00	08-526300-00
87-433500-00	08-433500-00	87-501807-20	08-501807-00	87-523100-00	08-523100-00	87-526400-00	08-526400-00
87-433505-00	08-433505-00	87-501900-00	08-501900-00	87-523108-00	08-523108-00	87-526411-00	08-526411-00
87-433507-00	08-433507-00	87-501907-00	08-501907-00	87-523300-00	08-523300-00	87-526600-00	08-526600-00
87-433600-00	08-433600-00	87-502600-00	08-502600-00	87-523307-00	08-523307-00	87-526900-00	08-526900-00
87-433607-00	08-433607-00	87-502700-00	08-502700-00	87-523311-00	08-523311-00	87-527200-00	08-527200-00
87-433700-00	08-433700-00	87-502800-00	08-502800-00	87-523500-00	08-523500-00	87-527300-00	08-527300-00
87-433707-00	08-433707-00	87-502800-10	08-502800-00	87-523600-00	08-523600-00	87-527600-00	08-527600-00
87-433800-00	08-433800-00	87-502807-00	08-502807-00	87-523800-00	08-523800-00	87-527606-00	08-527606-00
87-434300-00	08-434300-00	87-502807-10	08-502807-00	87-523807-00	08-523807-00	87-527608-00	08-527608-00
87-434307-00	08-434307-00	87-502900-00	08-502900-00	87-523811-00	08-523811-00	87-527800-00	08-527800-00
87-434400-00	08-434400-00	87-502900-10	08-502900-00	87-524000-00	08-524000-00	87-527808-00	08-527808-00
87-434600-00	08-434600-00	87-502905-10	08-502905-00	87-524000-10	08-524000-00	87-527900-00	08-527900-00
87-434600-10	08-434600-00	87-502907-00	08-502907-00	87-524007-00	08-524007-00	87-528100-00	08-528100-00
87-435000-00	08-435000-00	87-502907-10	08-502907-00	87-524007-10	08-524007-00	87-528200-00	08-528200-00
87-435000-10	08-435000-00	87-520100-00	08-520100-00	87-524009-00	08-524009-00	87-528300-00	08-528300-00
87-435100-00	08-435100-10	87-520100-10	08-520100-00	87-524100-00	08-524100-00	87-528306-00	08-528306-00
87-435300-00	08-435300-00	87-520107-00	08-520107-00	87-524107-00	08-524107-00	87-528400-00	08-528400-00
87-435307-00	08-435307-00	87-520107-10	08-520107-00	87-524111-00	08-524111-00	87-528406-00	08-528406-00
87-435400-00	08-435400-00	87-520200-00	08-520200-00	87-524114-00	08-524114-00	87-528408-00	08-528408-00
87-435407-00	08-435407-00	87-520500-00	08-520500-00	87-524200-00	08-524200-00	87-528500-00	08-528500-00
87-435500-00	08-435500-00	87-520600-00	08-520600-00	87-524207-00	08-524207-00	87-528600-00	08-528600-00
87-435507-00	08-435507-00	87-520607-00	08-520607-00	87-524211-00	08-524211-00	87-528607-00	08-528607-00
87-436500-00	08-436500-00	87-520611-00	08-520611-00	87-524307-10	08-524307-10	87-528700-00	08-528700-00
87-436506-00	08-436506-00	87-520900-00	08-520900-00	87-524311-10	08-524311-10	87-528707-00	08-528707-00
87-436700-00	08-436700-00	87-521000-00	08-521000-00	87-524314-10	08-524314-10	87-528800-00	08-528800-00
87-436700-10	08-436700-00	87-521100-00	08-521100-00	87-524400-00	08-524400-00	87-528807-00	08-528807-00
87-436708-00	08-436708-00	87-521300-00	08-521300-00	87-524407-00	08-524407-00	87-529000-00	08-529000-00
87-436708-10	08-436708-00	87-521300-10	08-521300-00	87-524800-00	08-524800-00	87-529007-00	08-529007-00
87-436800-00	08-436800-00	87-521307-00	08-521307-00	87-524800-10	08-524800-00	87-529200-00	08-529200-00
87-436806-00	08-436806-00	87-521307-10	08-521307-00	87-524804-00	08-524804-00	87-529300-00	08-529300-00
87-436900-00	08-436900-00	87-521400-00	08-521400-00	87-524807-00	08-524807-00	87-529306-00	08-529306-00
87-437000-00	08-437000-00	87-521407-00	08-521407-00	87-524807-10	08-524807-00	87-529907-00	08-529907-00
87-437000-10	08-437000-00	87-521500-00	08-521500-00	87-524811-00	08-524811-00	87-529909-00	08-529909-00
87-437007-00	08-437007-00	87-521500-10	08-521500-00	87-525000-00	08-525000-00	87-529911-00	08-529911-00
87-437007-10	08-437007-00	87-521600-00	08-521600-00	87-525007-00	08-525007-00	87-530100-00	08-530100-00
87-437400-00	08-437400-00	87-521700-00	08-521700-00	87-525011-00	08-525011-00	87-530107-00	08-530107-00
87-437600-00	08-437600-00	87-521707-00	08-521707-00	87-525014-00	08-525014-00	87-530109-00	08-530109-00
87-438800-00	08-438800-00	87-521711-00	08-521711-00	87-525100-00	08-525100-00	87-530400-00	08-530400-00
87-440600-00	08-440600-00	87-521714-00	08-521714-00	87-525100-10	08-525100-00	87-704200-10	08-704200-00
87-440900-00	08-440900-00	87-521800-20	08-521800-20	87-525200-00	08-525200-00	87-704207-10	08-704207-00
87-441300-00	08-441300-00	87-521807-20	08-521807-20	87-525209-00	08-525209-00	87-704500-00	08-704500-00
87-449000-00	08-449000-00	87-521811-20	08-521811-20	87-525211-00	08-525211-00	87-704507-00	08-704507-00
87-449007-00	08-449007-00	87-522307-00	08-522307-00	87-525300-00	08-525300-00	87-705000-00	08-705000-00
87-450000-00	08-450000-10	87-522309-00	08-522309-00	87-525400-00	08-525400-00	87-705007-00	08-705007-00
87-450007-00	08-450007-10	87-522311-00	08-522311-00	87-525407-00	08-525407-00	87-714400-00	08-714400-00
87-501300-00	08-501300-00	87-522314-00	08-522314-00	87-525411-00	08-525411-00	87-714407-00	08-714407-00
87-501400-00	08-501400-00	87-522400-00	08-522400-00	87-525414-00	08-525414-00	87-714411-00	08-714411-00
87-501500-00	08-501500-00	87-522407-00	08-522407-00	87-525500-00	08-525500-00	87-740000-00	08-740000-00

Nüral Kolben ausgestattet mit Goetze Kolbenringsätzen
 Pistons Nüral équipés de jeux de segments Goetze
 Pistones Nüral equipados con conjuntos de segmentos Goetze

Tłoki Nüral z zamontowanymi zestawami pierścieni Goetze
 Поршни Nüral, оснащаемые кольцами Goetze
 Goetze يتم تركيب كياسات Nüral باستخدام مجموعات حلقات

 Nüral Piston	 GOETZE Rings set	 Nüral Piston	 GOETZE Rings set	 Nüral Piston	 GOETZE Rings set	 Nüral Piston	 GOETZE Rings set
87-740000-01	08-740000-00	87-780314-10	08-780314-00	87-784100-10	08-784100-00	87-962000-30	08-962000-00
87-740000-10	08-740000-00	87-780314-30	08-780314-00	87-784107-00	08-784107-00	87-962000-40	08-962000-00
87-740000-20	08-740000-00	87-780600-10	08-780600-10	87-784107-10	08-784107-00	87-962000-50	08-962000-00
87-740000-40	08-740000-00	87-780600-20	08-780600-10	87-784200-00	08-784200-00	87-962000-80	08-962000-00
87-740000-41	08-740000-00	87-780607-00	08-780607-10	87-784200-10	08-784200-00	87-990100-10	08-990100-00
87-740000-50	08-740000-00	87-780607-10	08-780607-10	87-784207-00	08-784207-00	87-990100-40	08-990100-00
87-740000-51	08-740000-00	87-780607-20	08-780607-10	87-784207-10	08-784207-00	87-990105-10	08-990105-00
87-740007-10	08-740007-00	87-780609-00	08-780609-10	87-784600-00	08-784600-00	87-990105-40	08-990105-00
87-740007-20	08-740007-00	87-780609-10	08-780609-10	87-784607-00	08-784607-00	87-990107-10	08-990107-00
87-740007-40	08-740007-00	87-780609-20	08-780609-10	87-784611-00	08-784611-00	87-990107-40	08-990107-00
87-740007-50	08-740007-00	87-780611-10	08-780611-10	87-784800-00	08-784800-00	87-990111-10	08-990111-00
87-740300-00	08-740300-00	87-780611-20	08-780611-10	87-784811-00	08-784811-00	87-990111-40	08-990111-00
87-740900-00	08-740900-00	87-780614-00	08-780614-10	87-784821-00	08-784821-00	87-990500-00	08-990500-00
87-740900-10	08-740900-00	87-780614-10	08-780614-10	87-785000-00	08-785000-00	87-990700-00	08-990700-00
87-740900-20	08-740900-00	87-780614-20	08-780614-10	87-785000-10	08-785000-00	87-990705-00	08-990705-00
87-740900-30	08-740900-00	87-780617-00	08-780617-10	87-785007-00	08-785007-00	87-990707-00	08-990707-00
87-740907-00	08-740907-00	87-780617-10	08-780617-10	87-785007-10	08-785007-00	87-101100-00	08-101100-00
87-740907-10	08-740907-00	87-781000-00	08-781000-00	87-785011-00	08-785011-00	87-101700-10	08-101700-00
87-740907-20	08-740907-00	87-781900-10	08-781900-00	87-785011-10	08-785011-00	87-334600-00	08-334600-00
87-741200-10	08-741200-00	87-781900-30	08-781900-00	87-785107-00	08-785107-00	87-425407-00	08-425407-00
87-741207-10	08-741207-00	87-781908-10	08-781908-00	87-785200-00	08-785200-00	87-425411-00	08-425411-00
87-741600-00	08-741600-00	87-781908-30	08-781908-00	87-785207-00	08-785207-00	87-434400-10	08-434400-00
87-741800-00	08-741800-00	87-782000-00	08-782000-00	87-785300-00	08-785300-00	87-740907-30	08-740907-00
87-741800-20	08-741800-00	87-782000-10	08-782000-00	87-785300-10	08-785300-00		
87-741807-00	08-741807-00	87-782008-00	08-782008-00	87-785400-00	08-785400-00		
87-741807-20	08-741807-00	87-782100-00	08-782100-00	87-785408-00	08-785408-00		
87-741811-20	08-741811-00	87-782100-30	08-782100-00	87-785500-00	08-785500-00		
87-743100-00	08-743100-00	87-782100-40	08-782100-00	87-785506-00	08-785506-00		
87-743100-10	08-743100-00	87-782300-00	08-782300-00	87-785508-00	08-785508-00		
87-743100-30	08-743100-00	87-782308-00	08-782308-00	87-786300-00	08-786300-00		
87-743100-40	08-743100-00	87-782606-00	08-782606-00	87-786307-00	08-786307-00		
87-743107-00	08-743107-00	87-782608-00	08-782608-00	87-786400-00	08-786400-00		
87-743107-10	08-743107-00	87-782900-00	08-782900-00	87-786407-00	08-786407-00		
87-743107-30	08-743107-00	87-782906-00	08-782906-00	87-786500-00	08-786500-00		
87-743107-40	08-743107-00	87-782910-00	08-782910-00	87-786507-00	08-786507-00		
87-743107-50	08-743107-00	87-783000-00	08-783000-00	87-786800-00	08-786800-00		
87-743120-10	08-743120-00	87-783000-10	08-783000-00	87-786806-00	08-786806-00		
87-743120-20	08-743120-00	87-783000-15	08-783000-00	87-787000-00	08-787000-00		
87-743200-00	08-743200-00	87-783000-30	08-783000-00	87-787000-10	08-787000-00		
87-743400-00	08-743400-00	87-783300-00	08-783300-00	87-787000-30	08-787000-00		
87-743400-10	08-743400-00	87-783308-00	08-783308-00	87-787006-00	08-787006-00		
87-743400-30	08-743400-00	87-783400-00	08-783400-00	87-787006-10	08-787006-00		
87-743400-40	08-743400-00	87-783500-10	08-783500-00	87-787006-30	08-787006-00		
87-743400-50	08-743400-00	87-783507-10	08-783507-00	87-849000-00	08-849000-00		
87-743600-00	08-743600-00	87-783511-10	08-783511-00	87-849007-00	08-849007-00		
87-743600-10	08-743600-00	87-783600-00	08-783600-00	87-849200-00	08-849200-50		
87-743607-00	08-743607-00	87-783606-00	08-783606-00	87-849207-00	08-849207-50		
87-743607-10	08-743607-00	87-783608-00	08-783608-00	87-854700-00	08-854700-00		
87-744100-00	08-744100-00	87-783700-00	08-783700-00	87-854708-00	08-854708-00		
87-744107-00	08-744107-00	87-783706-00	08-783706-00	87-879200-00	08-879200-00		
87-744600-00	08-744600-00	87-783708-00	08-783708-00	87-879207-00	08-879207-00		
87-744607-00	08-744607-00	87-783800-00	08-783800-00	87-960200-00	08-960200-00		
87-744611-00	08-744611-00	87-783800-10	08-783800-00	87-960207-00	08-960207-00		
87-780300-10	08-780300-00	87-783800-30	08-783800-00	87-960800-10	08-960800-00		
87-780300-30	08-780300-00	87-783808-00	08-783808-00	87-960900-00	08-960900-00		
87-780307-10	08-780307-00	87-783808-10	08-783808-00	87-960900-10	08-960900-00		
87-780307-30	08-780307-00	87-783808-30	08-783808-00	87-961000-00	08-961000-00		
87-780309-30	08-780309-00	87-783900-00	08-783900-00	87-961000-10	08-961000-00		
87-780311-10	08-780311-00	87-783900-10	08-783900-00	87-962000-00	08-962000-00		
87-780311-30	08-780311-00	87-784100-00	08-784100-00	87-962000-10	08-962000-00		

PISTON CLEARANCE & PROTRUSION DATA



FBP	From base of piston
FPC	From piston crown
ABP	At base of piston
PCL	At pin centre line
FOC	From flat of crown
MP (D)	Measurement point (Datum)
BD	Bore diameter
PD	Piston diameter



FBP	Desde la base del pistón
FPC	Desde la corona del pistón
ABP	En la base del pistón
PCL	En el centro del bulón
FOC	Desde la base de la corona
MP (D)	Punto de medida (dato)
BD	Diámetro de cilindro
PD	Diámetro de pistón



FBP	Vom unteren Ende des Kolbenschafts
FPC	Vom Kolbenboden
ABP	Am unteren Ende des Kolbenschafts
PCL	Maß Kolbenblozen-Mitte
FOC	Flach vom Kolbenboden
MP (D)	Messepunkte
BD	Durchmesser Bohrung
PD	Durchmesser Kolben



FBP	Od bazy tłoka
FPC	Od korony tłoka
ABP	W bazie tłoka
PCL	W osi centralnej sworznia
FOC	Od płaszczyzny korony
MP (D)	Punkt pomiarowy (Datum)
BD	Średnica cylindra
PD	Średnica tłoka



FBP	Dalla base del pistone
FPC	Dalla testa del pistone
ABP	Alla base del pistone
PCL	All'asse foro spinotto
FOC	Dal piano testa
MP (D)	Punto di misurazione (dati)
BD	Alesaggio
PD	Diametro pistone



FBP	От основания поршня
FPC	От головки поршня
ABP	У основания поршня
PCL	У оси поршневого пальца
FOC	От плоскости головки поршня
MP (D)	Точка измерения (начало отсчета)
BD	Диаметр цилиндра
PD	Диаметр поршня





FBP	De la base du piston
FPC	De la tête du piston
ABP	À la base du piston
PCL	Au centre de l'axe
FOC	Du plat de la tête
MP (D)	Point de mesure (Système géodésique)
BD	Diamètre d'alésage
PD	Diamètre de piston



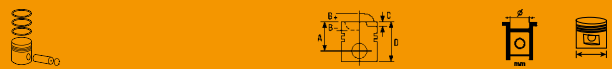

FBP	من قاعدة المكبس
FPC	من تاج المكبس
ABP	على قاعدة المكبس
PCL	الخط المركزي للمسمار
FOC	من مسطح من التاج
MP (D)	نقطة القياس (بالمرجع)
BD	قطر الثقب
PD	قطر المكبس

PISTON CLEARANCE DATA



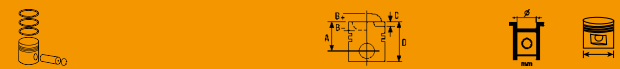





Kolbenpiel • Dato de holgura del pistón
Jeu de piston • Dati di tolleranza pistone



											
86-136000-00	0.203		64.00mm FBP	130.000	129.797	87-114400-60	0.055		12.75mm FBP	84.000	83.945
87-100100-00	0.160		30.00mm FBP	111.770	111.610	87-114400-65	0.055		12.75mm FBP	84.000	83.945
87-101100-00	0.140		27.00mm FBP	144.000	143.860	87-114700-00	0.090		20.00mm FBP	85.000	84.910
87-101100-10	0.140		27.00mm FBP	144.000	143.860	87-114700-10	0.065		10.00mm FBP	85.000	84.935
87-101300-00	0.010		44.00mm FPC	67.105	67.095	87-114700-30	0.075		15.00mm FBP	85.000	84.925
87-101500-00	0.060		17.00mm FBP	80.000	79.940	87-114700-40	0.056		15.00mm FBP	85.000	84.944
87-101600-00	0.030		12.00mm FBP	87.000	86.970	87-114708-40	0.056		15.00mm FBP	85.600	85.544
87-101700-00	0.050		3.00mm FBP	100.000	99.950	87-114900-05	0.050		10.00mm FBP	79.510	79.460
87-102300-00	0.040		14.00mm FBP	76.000	75.960	87-114900-15	0.050		10.00mm FBP	79.510	79.460
87-102700-00	0.022		37.00mm FPC	72.500	72.478	87-114900-20	0.050		10.50mm FBP	79.510	79.460
87-102700-10	0.022		39.00mm FPC	72.500	72.478	87-114900-25	0.050		10.00mm FBP	79.510	79.460
87-102800-10	0.046		6.80mm FBP	83.975	83.929	87-114900-30	0.050		10.50mm FBP	79.510	79.460
87-102900-10	0.046		6.80mm FBP	83.975	83.929	87-114900-35	0.050		10.00mm FBP	79.510	79.460
87-103200-00	0.070		13.50mm FBP	91.000	90.930	87-114900-40	0.040		10.00mm FBP	79.510	79.470
87-103500-00	0.025		15.00mm FBP	80.000	79.975	87-114900-45	0.050		10.00mm FBP	79.510	79.460
87-103800-00	0.040		10.00mm FBP	78.500	78.460	87-114900-46	0.050		10.00mm FBP	79.510	79.460
87-103900-00	0.140		12.00mm FBP	104.000	103.860	87-114900-50	0.040		10.00mm FBP	79.510	79.470
87-103900-10	0.140		12.00mm FBP	104.000	103.860	87-114900-55	0.050		10.00mm FBP	79.510	79.460
87-103900-30	0.140		12.00mm FBP	104.000	103.860	87-114900-56	0.050		10.00mm FBP	79.510	79.460
87-103900-40	0.140		14.50mm FBP	104.000	103.860	87-114900-60	0.050		10.00mm FBP	79.510	79.460
87-104000-00	0.070		12.00mm FBP	82.200	82.130	87-114900-65	0.050		10.00mm FBP	79.510	79.460
87-104100-00	0.040		10.00mm FBP	69.000	68.960	87-114900-66	0.050		10.00mm FBP	79.510	79.460
87-104200-00	0.043		12.25mm FBP	79.500	79.457	87-114900-70	0.050		10.00mm FBP	79.510	79.460
87-104200-10	0.043		12.25mm FBP	79.500	79.457	87-114900-80	0.050		10.00mm FBP	79.510	79.460
87-104200-30	0.030		12.50mm FBP	79.510	79.480	87-114900-85	0.070		10.00mm FBP	79.510	79.440
87-104300-00	0.140		27.00mm FBP	128.000	127.860	87-114900-90	0.070		10.00mm FBP	79.510	79.440
87-104300-10	0.140		27.00mm FBP	128.000	127.860	87-114900-95	0.070		10.00mm FBP	79.510	79.440
87-105500-00	0.050		14.00mm FBP	83.000	82.950	87-115800-00	0.150		15.00mm FBP	128.000	127.850
87-105900-00	0.045		9.00mm FBP	81.010	80.965	87-116100-00	0.035		12.00mm FBP	76.510	76.475
87-107000-00	0.043		62.50mm FPC	82.500	82.457	87-117900-00	0.040		10.50mm FBP	88.009	87.969
87-107000-10	0.080		12.00mm FBP	82.500	82.420	87-117900-10	0.031		9.50mm FBP	88.000	87.969
87-107100-40	0.050		17.00mm FBP	84.000	83.950	87-117900-20	0.040		10.50mm FBP	88.009	87.969
87-107200-00	0.099		98.20mm FPC	98.425	98.326	87-118000-00	0.045		12.50mm FBP	82.000	81.955
87-107200-10	0.160		31.00mm FBP	98.480	98.320	87-118000-10	0.032		12.50mm FBP	82.000	81.968
87-107600-00	0.030		39.00mm FPC	89.600	89.570	87-118000-30	0.038		12.50mm FBP	82.000	81.962
87-107900-00	0.078		13.00mm FBP	82.000	81.922	87-119000-00	0.018		7.50mm FBP	89.905	89.887
87-108000-00	0.070		8.00mm FBP	82.000	81.930	87-119800-00	0.100		0.00mm ABP	84.450	84.350
87-108200-00	0.087		13.00mm FBP	94.400	94.313	87-121800-00	0.120		18.00mm FBP	115.000	114.880
87-109100-00	0.036		19.00mm FBP	90.900	90.864	87-121800-10	0.100		18.00mm FBP	115.000	114.900
87-109100-10	0.036		19.00mm FBP	90.900	90.864	87-121900-00	0.110		18.00mm FBP	125.000	124.890
87-109200-00	0.090		109.00mm FPC	115.000	114.910	87-122000-00	0.100		21.00mm FBP	135.000	134.900
87-109400-50	0.025		12.00mm FBP	81.010	80.985	87-122200-00	0.090		12.00mm FBP	94.400	94.310
87-109500-00	0.030		10.00mm FBP	76.510	76.480	87-122200-10	0.090		12.00mm FBP	94.400	94.310
87-109700-00	0.025		12.00mm FBP	81.010	80.985	87-123200-00	0.140		12.00mm FBP	131.000	130.860
87-109700-10	0.025		10.00mm FBP	81.010	80.985	87-123200-10	0.055		36.00mm FBP	131.000	130.945
87-109700-20	0.025		13.00mm FBP	81.010	80.985	87-123400-00	0.055		10.00mm FBP	76.000	75.945
87-109700-30	0.025		10.00mm FBP	81.010	80.985	87-123400-10	0.051		56.00mm FPC	76.000	75.949
87-109800-10	0.030		12.00mm FBP	76.510	76.480	87-123400-20	0.048		10.00mm FBP	76.000	75.952
87-110100-00	0.075		17.00mm FBP	92.000	91.925	87-123400-30	0.048		10.00mm FBP	76.000	75.952
87-110200-40	0.060		15.00mm FBP	84.000	83.940	87-123400-40	0.055		10.00mm FBP	76.000	75.945
87-110500-30	0.035		12.00mm FBP	87.990	87.955	87-123400-50	0.051		10.00mm FBP	76.000	75.949
87-110900-00	0.038		12.50mm FBP	83.000	82.962	87-123700-00	0.037		15.45mm FBP	93.660	93.623
87-111200-00	0.040		70.00mm FPC	96.000	95.960	87-123700-10	0.037		15.45mm FBP	93.660	93.623
87-111900-00	0.050		27.00mm FBP	100.000	99.950	87-123700-30	0.037		15.50mm FBP	93.660	93.623
87-112400-00	0.060		12.00mm FBP	92.000	91.940	87-123900-10	0.137		22.00mm FBP	132.010	131.873
87-113500-00	0.040		12.50mm FBP	89.910	89.870	87-124000-00	0.060		15.50mm FBP	82.000	81.940
87-113500-10	0.068		12.50mm FBP	89.910	89.842	87-124000-10	0.078		8.00mm FBP	82.000	81.922
87-114400-00	0.045		12.00mm FBP	84.000	83.955	87-124000-30	0.070		9.00mm FBP	82.000	81.930
87-114400-10	0.050		12.00mm FBP	84.000	83.950	87-124500-00	0.145		20.00mm FBP	128.000	127.855
87-114400-30	0.050		12.75mm FBP	84.000	83.950	87-124500-10	0.145		20.00mm FBP	128.000	127.855
87-114400-40	0.055		12.75mm FBP	84.000	83.945	87-124500-20	0.145		20.00mm FBP	128.000	127.855

											
87-124500-30	0.150		18.00mm FBP	128.000	127.850	87-14050-00	0.070		12.00mm FBP	100.000	99.930
87-124500-40	0.150		18.00mm FBP	128.000	127.850	87-140800-00	0.055		12.00mm FBP	86.000	85.945
87-124800-00	0.038		10.00mm FBP	80.500	80.462	87-140800-10	0.055		12.00mm FBP	86.000	85.945
87-125600-00	0.025		14.50mm FBP	79.000	78.975	87-141200-00	0.040		10.00mm FBP	80.500	80.460
87-126000-00	0.045		14.00mm FBP	84.000	83.955	87-141300-00	0.030		10.00mm FBP	79.000	78.970
87-126000-10	0.045		14.00mm FBP	84.000	83.955	87-141300-10	0.030		10.00mm FBP	79.000	78.970
87-126300-10	0.195		7.62mm FBP	103.190	102.995	87-141300-20	0.020		15.00mm FBP	79.000	78.980
87-126600-00	0.080		15.00mm FBP	85.000	84.920	87-141800-00	0.115		30.00mm FBP	128.000	127.885
87-127400-00	0.080		20.00mm FBP	87.000	86.920	87-141900-00	0.081		120.00mm FPC	106.990	106.909
87-127400-10	0.090		25.00mm FBP	87.000	86.910	87-142000-00	0.110		28.00mm FBP	120.000	119.890
87-127800-00	0.090		16.00mm FBP	98.000	97.910	87-142100-00	0.110		18.00mm FBP	94.000	93.890
87-127900-00	0.090		16.00mm FBP	101.000	100.910	87-142300-00	0.035		12.50mm FBP	70.000	69.965
87-131500-00	0.115		20.00mm FBP	120.030	119.915	87-142400-00	0.070		15.00mm FBP	84.000	83.930
87-133100-00	0.035		16.00mm FBP	80.000	79.965	87-142500-00	0.115		25.00mm FBP	98.430	98.315
87-135300-00	0.060		13.00mm FBP	73.700	73.640	87-142800-00	0.111		0.00mm ABP	104.780	104.669
87-135500-00	0.030		0.00mm ABP	123.000	122.970	87-142900-00	0.140		22.00mm FBP	112.000	111.860
87-135800-00	0.100		18.00mm FBP	92.000	91.900	87-143200-00	0.040		12.00mm FBP	75.000	74.960
87-136000-00	0.123		15.00mm FBP	130.000	129.877	87-143300-00	0.040		10.00mm FBP	80.000	79.960
87-136000-10	0.123		15.00mm FBP	130.000	129.877	87-143400-00	0.020		17.00mm FBP	90.000	89.980
87-136400-00	0.031		9.50mm FBP	88.000	87.969	87-143500-00	0.075		3.00mm FBP	108.000	107.925
87-136500-00	0.100		17.00mm FBP	108.000	107.900	87-143600-00	0.055		3.60mm FBP	131.000	130.945
87-136500-10	0.100		17.00mm FBP	108.000	107.900	87-143600-10	0.115		119.00mm FPC	127.000	126.885
87-136500-30	0.115		17.00mm FBP	108.000	107.885	87-143600-30	0.140		20.00mm FBP	127.000	126.860
87-136500-40	0.115		17.00mm FBP	108.000	107.885	87-143600-40	0.150		20.00mm FBP	127.000	126.850
87-136500-50	0.115		17.00mm FBP	108.000	107.885	87-143600-50	0.140		20.00mm FBP	127.000	126.860
87-136500-50	0.115		17.00mm FBP	108.000	107.885	87-143800-00	0.150		27.00mm FBP	128.000	127.850
87-136500-60	0.091		17.00mm FBP	108.000	107.909	87-143800-10	0.150		27.00mm FBP	128.000	127.850
87-136500-65	0.116		17.00mm FBP	108.000	107.884	87-143800-20	0.150		27.00mm FBP	128.000	127.850
87-136500-70	0.091		17.00mm FBP	108.000	107.909	87-143800-30	0.150		27.00mm FBP	128.000	127.850
87-136500-75	0.116		17.00mm FBP	108.000	107.884	87-143800-40	0.150		27.00mm FBP	128.000	127.850
87-136500-80	0.091		17.00mm FBP	108.000	107.909	87-143800-50	0.120		19.50mm FBP	128.000	127.880
87-136500-85	0.116		17.00mm FBP	108.000	107.884	87-143800-60	0.120		19.50mm FBP	128.000	127.880
87-136500-90	0.140		19.00mm FBP	108.000	107.860	87-143800-70	0.120		19.50mm FBP	128.000	127.880
87-136500-91	0.140		19.00mm FBP	108.000	107.860	87-145000-00	0.100		13.00mm FBP	102.000	101.900
87-136600-00	0.030		7.00mm FBP	80.600	80.570	87-145100-00	0.040		14.00mm FBP	65.000	64.960
87-136700-00	0.030		23.00mm FBP	64.000	63.970	87-145200-00	0.037		10.00mm FBP	83.000	82.963
87-136800-10	0.120		28.00mm FBP	120.640	120.520	87-145200-30	0.020		15.00mm FBP	70.000	69.980
87-136800-30	0.120		28.00mm FBP	120.640	120.520	87-145300-00	0.045		11.00mm FBP	83.000	82.955
87-136800-40	0.150		28.00mm FBP	120.640	120.490	87-145400-00	0.046		11.00mm FBP	82.000	81.954
87-136900-00	0.100		18.00mm FBP	108.000	107.900	87-145400-10	0.038		11.00mm FBP	82.000	81.962
87-136900-10	0.110		18.00mm FBP	108.000	107.890	87-145400-30	0.038		11.00mm FBP	82.000	81.962
87-137500-10	0.100		0.00mm ABP	89.000	88.900	87-145900-00	0.150		15.00mm FBP	130.000	129.850
87-137500-30	0.120		25.00mm FBP	89.000	88.880	87-146100-00	0.045		10.00mm FBP	82.000	81.955
87-137600-00	0.070		12.00mm FBP	69.600	69.530	87-146100-10	0.055		10.00mm FBP	82.000	81.945
87-138000-00	0.092		15.00mm FBP	88.005	87.913	87-146500-00	0.100		21.00mm FBP	94.000	93.900
87-138000-10	0.092		15.00mm FBP	88.002	87.910	87-148100-00	0.060		12.50mm FBP	89.905	89.845
87-138400-00	0.038		10.00mm FBP	70.800	70.762	87-148100-10	0.030		12.50mm FBP	89.900	89.870
87-138400-10	0.030		8.50mm FBP	70.800	70.770	87-148100-30	0.030		12.50mm FBP	89.900	89.870
87-138400-30	0.040		15.00mm FBP	70.800	70.760	87-148100-40	0.030		12.50mm FBP	89.900	89.870
87-138400-40	0.100		9.00mm FBP	70.800	70.700	87-148100-80	0.060		12.50mm FBP	89.905	89.845
87-138900-10	0.030		10.00mm FBP	75.000	74.970	87-148100-85	0.050		12.50mm FBP	89.900	89.850
87-138900-30	0.020		41.50mm FPC	75.000	74.980	87-148300-00	0.025		9.00mm FBP	81.000	80.975
87-139400-00	0.030		8.00mm FBP	78.500	78.470	87-152000-10	0.070		25.00mm FBP	83.000	82.930
87-139500-00	0.060		10.00mm FBP	81.010	80.950	87-154200-00	0.030		12.00mm FBP	70.000	69.970
87-139500-10	0.050		10.00mm FBP	81.010	80.960	87-154200-10	0.030		12.00mm FBP	70.000	69.970
87-139500-20	0.050		10.00mm FBP	81.010	80.960	87-154200-30	0.020		15.00mm FBP	70.000	69.980
87-139500-30	0.075		10.50mm FBP	81.010	80.935	87-154300-00	0.056		9.00mm FBP	72.000	71.944
87-139500-40	0.075		10.50mm FBP	81.010	80.935	87-154400-00	0.040		10.00mm FBP	75.000	74.960
87-139900-00	0.085		7.00mm FBP	82.000	81.915	87-154600-00	0.040		18.00mm FBP	86.000	85.960
87-140000-00	0.082		14.00mm FBP	84.442	84.360	87-167600-00	0.110		14.50mm FBP	120.000	119.890
87-140200-00	0.105		20.00mm FBP	118.000	117.895	87-170700-00	0.030		18.00mm FBP	87.000	86.970

PISTON CLEARANCE DATA

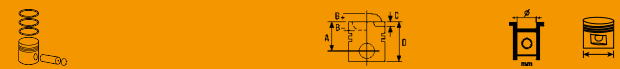

Kolbenspiel • Dato de holgura del pistón
Jeu de piston • Dati di tolleranza pistone



   					   						
87-172500-00	0.110		17.00mm FBP	100.000	99.890	87-206800-00	0.110		15.00mm FBP	100.000	99.890
87-173800-10	0.025		13.50mm FBP	91.000	90.975	87-206800-10	0.092		0.00mm ABP	100.000	99.908
87-174100-00	0.140		14.00mm FBP	130.000	129.860	87-207200-00	0.090		15.00mm FBP	95.000	94.910
87-174100-30	0.140		0.00mm ABP	130.000	129.860	87-207300-00	0.110		10.00mm FBP	93.650	93.540
87-174300-00	0.100		14.00mm FBP	97.000	96.900	87-207500-00	0.150		25.00mm FBP	110.000	109.850
87-174300-10	0.100		14.00mm FBP	97.000	96.900	87-207500-10	0.140		40.00mm FBP	110.000	109.860
87-174600-00	0.105		15.00mm FBP	102.005	101.900	87-207500-30	0.140		40.00mm FBP	110.000	109.860
87-174600-10	0.105		15.00mm FBP	102.005	101.900	87-207800-00	0.230		35.00mm FBP	137.000	136.770
87-174600-30	0.110		0.00mm ABP	102.000	101.890	87-207800-10	0.145		30.50mm FBP	137.000	136.855
87-176000-00	0.150		33.00mm FBP	125.000	124.850	87-208100-10	0.178		22.31mm FBP	106.698	106.520
87-176000-00	0.150		33.00mm FBP	125.000	124.850	87-208800-00	0.020		0.00mm APC	73.940	73.920
87-176000-01	0.150		33.00mm FBP	125.000	124.850	87-209800-00	0.020		16.00mm FBP	65.000	64.980
87-176000-10	0.153		15.00mm FBP	125.000	124.847	87-209800-10	0.020		16.00mm FBP	65.000	64.980
87-176400-00	0.150		22.50mm FBP	115.000	114.850	87-209800-30	0.040		6.50mm FBP	65.000	64.960
87-176700-00	0.025		13.50mm FBP	90.900	90.875	87-214100-00	0.020		20.50mm FBP	79.985	79.965
87-176700-10	0.050		12.00mm FBP	90.900	90.850	87-214100-10	0.012		9.10mm FBP	79.965	79.953
87-176800-00	0.150		25.00mm FBP	125.000	124.850	87-214500-00	0.051		12.00mm FBP	93.000	92.949
87-176900-00	0.100		45.00mm FBP	128.000	127.900	87-214800-10	0.129		26.42mm FBP	107.213	107.084
87-176900-10	0.130		21.00mm FBP	128.000	127.870	87-215100-10	0.060		18.00mm FBP	83.000	82.940
87-178200-20	0.100		15.00mm FBP	97.000	96.900	87-215200-00	0.040		14.00mm FBP	76.000	75.960
87-178300-10	0.025		13.50mm FBP	91.000	90.975	87-215300-00	0.040		13.00mm FBP	84.000	83.960
87-178400-00	0.130		15.00mm FBP	102.005	101.875	87-215300-10	0.050		25.00mm FBP	84.000	83.950
87-178800-00	0.100		14.00mm FBP	97.000	96.900	87-215500-00	0.025		67.00mm FPC	80.000	79.975
87-179000-10	0.130		0.00mm ABP	104.175	104.045	87-243300-00	0.098		4.00mm FBP	98.425	98.327
87-179300-05	0.150		15.00mm FBP	128.000	127.850	87-243600-00	0.088		9.50mm FBP	98.425	98.337
87-179300-10	0.155		15.00mm FBP	128.000	127.845	87-244500-10	0.139		12.00mm FBP	104.000	103.861
87-179300-15	0.150		12.00mm FBP	128.000	127.850	87-244500-30	0.140		12.00mm FBP	104.000	103.860
87-179300-16	0.150		12.00mm FBP	128.000	127.850	87-244500-40	0.129		12.00mm FBP	104.000	103.871
87-179300-20	0.150		21.00mm FBP	128.000	127.850	87-245200-00	0.045		12.00mm FBP	93.000	92.955
87-179300-25	0.140		15.00mm FBP	128.000	127.860	87-245200-30	0.040		30.00mm FBP	93.000	92.960
87-179300-30	0.150		0.00mm ABP	128.000	127.850	87-245200-40	0.080		15.00mm FBP	93.000	92.920
87-179300-40	0.160		0.00mm ABP	128.000	127.840	87-245200-50	0.080		15.00mm FBP	93.000	92.920
87-179300-50	0.170		21.50mm FBP	128.000	127.830	87-245500-00	0.180		35.00mm FBP	115.000	114.820
87-179300-55	0.170		21.50mm FBP	128.000	127.830	87-245500-10	0.180		35.00mm FBP	115.000	114.820
87-179300-60	0.170		26.30mm FBP	128.000	127.830	87-247200-00	0.080		17.50mm FBP	86.000	85.920
87-179300-65	0.160		27.00mm FBP	128.000	127.840	87-247600-00	0.040		18.00mm FBP	88.000	87.960
87-179300-66	0.160		27.00mm FBP	128.000	127.840	87-247600-10	0.050		20.00mm FBP	88.000	87.950
87-179300-70	0.140		15.00mm FBP	128.000	127.860	87-247800-00	0.129		17.00mm FBP	104.000	103.871
87-179300-80	0.160		27.00mm FBP	128.000	127.840	87-247800-10	0.129		0.00mm ABP	104.000	103.871
87-179300-85	0.150		27.00mm FBP	128.000	127.850	87-248000-00	0.015		73.00mm FPC	93.000	92.985
87-179300-86	0.150		27.00mm FBP	128.000	127.850	87-248000-10	0.010		72.00mm FPC	93.000	92.990
87-179300-90	0.150		15.00mm FBP	128.000	127.850	87-248000-30	0.015		73.00mm FPC	93.000	92.985
87-179500-00	0.025		21.00mm FBP	89.000	88.975	87-252500-10	0.070		13.50mm FBP	91.000	90.930
87-179500-10	0.025		9.00mm FBP	89.000	88.975	87-252800-00	0.090		18.00mm FBP	94.000	93.910
87-179700-00	0.020		21.00mm FBP	95.500	95.480	87-263100-00	0.060		0.00mm ABP	90.475	90.415
87-179700-10	0.030		16.50mm FBP	95.500	95.470	87-263100-10	0.060		0.00mm ABP	90.475	90.415
87-181100-10	0.120		18.00mm FBP	106.500	106.380	87-269700-00	0.040		24.00mm FBP	76.000	75.960
87-181100-20	0.100		18.00mm FBP	106.500	106.400	87-269800-00	0.040		15.00mm FBP	79.000	78.960
87-181100-30	0.110		28.00mm FBP	106.500	106.390	87-269900-00	0.030		12.00mm FBP	82.000	81.970
87-181700-30	0.140		15.00mm FBP	128.000	127.860	87-274800-00	0.130		5.00mm FBP	121.000	120.870
87-181800-10	0.120		21.00mm FBP	102.000	101.880	87-274800-10	0.130		5.00mm FBP	121.000	120.870
87-183100-00	0.045		12.00mm FBP	82.900	82.855	87-274800-30	0.130		5.00mm FBP	121.000	120.870
87-202400-00	0.180		22.35mm FBP	111.760	111.580	87-279600-10	0.050		20.00mm FBP	105.000	104.950
87-202400-10	0.192		22.40mm FBP	111.778	111.586	87-280000-00	0.311		21.50mm FBP	108.000	107.689
87-202400-30	0.184		22.35mm FBP	111.784	111.600	87-280200-10	0.140		19.00mm FBP	125.000	124.860
87-202800-00	0.153		24.13mm FBP	104.775	104.622	87-280400-00	0.130		27.50mm FBP	125.000	124.870
87-203100-00	0.040		20.00mm FBP	80.000	79.960	87-283100-00	0.140		27.00mm FBP	128.000	127.860
87-203500-00	0.100		24.00mm FBP	100.000	99.900	87-283100-01	0.140		27.00mm FBP	128.000	127.860
87-205800-00	0.030		11.37mm FBP	87.650	87.620	87-283100-10	0.150		14.50mm FBP	128.000	127.850
87-206600-00	0.040		17.65mm FBP	90.810	90.770	87-283100-30	0.150		25.00mm FBP	128.000	127.850
87-206600-10	0.030		10.30mm FBP	90.800	90.770	87-283100-40	0.150		25.00mm FBP	128.000	127.850

											
87-283100-60	0.150		25.00mm FBP	128.000	127.850	87-315000-00	0.150		10.00mm FBP	98.480	98.330
87-283100-70	0.150		25.00mm FBP	128.000	127.850	87-315200-00	0.089		1.60mm FBP	79.375	79.286
87-283100-80	0.140		27.00mm FBP	128.000	127.860	87-316900-00	0.050		14.00mm FBP	88.000	87.950
87-283100-85	0.140		27.00mm FBP	128.000	127.860	87-316900-10	0.050		14.00mm FBP	88.000	87.950
87-283100-86	0.140		27.00mm FBP	128.000	127.860	87-318000-00	0.070		27.00mm FBP	101.054	100.984
87-283300-00	0.130		19.00mm FBP	102.000	101.870	87-318700-00	0.090		15.00mm FBP	94.000	93.910
87-283600-00	0.041		67.30mm FPC	86.000	85.959	87-318700-10	0.120		15.80mm FBP	94.000	93.880
87-285800-00	0.136		19.00mm FBP	108.000	107.864	87-318700-30	0.115		79.42mm FPC	94.022	93.907
87-285900-00	0.113		19.00mm FBP	108.000	107.887	87-318900-10	0.060		10.00mm FBP	98.480	98.420
87-285900-05	0.113		19.00mm FBP	108.000	107.887	87-319000-00	0.080		24.00mm FBP	98.480	98.400
87-285900-06	0.113		19.00mm FBP	108.000	107.887	87-319000-10	0.050		40.00mm FBP	98.480	98.430
87-285900-10	0.126		19.00mm FBP	108.000	107.874	87-321500-10	0.070		20.00mm FBP	80.000	79.930
87-285900-15	0.126		19.00mm FBP	108.000	107.874	87-322000-00	0.140		5.00mm FBP	91.480	91.340
87-285900-16	0.126		19.00mm FBP	108.000	107.874	87-322000-10	0.114		2.90mm FBP	91.491	91.377
87-285900-30	0.113		13.50mm FBP	108.000	107.887	87-322100-00	0.150		9.00mm FBP	98.480	98.330
87-285900-40	0.113		13.50mm FBP	108.000	107.887	87-322700-00	0.096		10.00mm FBP	101.054	100.958
87-287100-00	0.020		68.70mm FPC	91.100	91.080	87-323600-00	0.080		21.00mm FBP	80.000	79.920
87-287100-10	0.020		68.70mm FPC	91.100	91.080	87-325600-00	0.110		14.00mm FBP	100.000	99.890
87-287100-30	0.040		19.00mm FBP	91.100	91.060	87-325600-10	0.102		7.50mm FBP	100.000	99.898
87-287500-00	0.046		19.00mm FBP	89.900	89.854	87-325600-20	0.110		14.00mm FBP	100.000	99.890
87-287500-10	0.046		16.50mm FBP	89.900	89.854	87-325800-00	0.070		12.00mm FBP	77.000	76.930
87-287500-20	0.046		3.00mm FBP	89.900	89.854	87-326300-00	0.090		12.00mm FBP	92.010	91.920
87-287500-30	0.046		3.00mm FBP	89.900	89.854	87-333300-00	0.043		46.50mm FPC	58.008	57.965
87-287500-40	0.046		16.00mm FBP	89.900	89.854	87-334400-00	0.060		10.50mm FBP	88.000	87.940
87-288200-00	0.100		50.00mm FBP	100.000	99.900	87-334600-00	0.040		11.00mm FBP	70.000	69.960
87-288200-10	0.046		70.70mm FPC	100.000	99.954	87-335000-00	0.060		14.50mm FBP	78.000	77.940
87-288800-00	0.110		12.80mm FBP	97.500	97.390	87-335000-10	0.060		14.50mm FBP	78.000	77.940
87-289300-00	0.130		17.00mm FBP	102.000	101.870	87-335000-20	0.060		14.50mm FBP	78.000	77.940
87-289300-10	0.130		17.50mm FBP	102.000	101.870	87-335300-00	0.140		0.00mm ABP	135.030	134.890
87-289600-00	0.130		15.00mm FBP	130.000	129.870	87-335900-00	0.140		17.00mm FBP	135.030	134.890
87-289600-20	0.130		15.00mm FBP	130.000	129.870	87-335900-10	0.100		29.00mm FBP	135.000	134.900
87-295400-00	0.015		64.00mm FPC	85.000	84.985	87-335900-30	0.100		29.00mm FBP	135.000	134.900
87-304200-00	0.020		27.00mm FBP	79.000	78.980	87-336500-00	0.025		12.00mm FBP	80.000	79.975
87-305600-00	0.030		60.00mm FPC	80.000	79.970	87-336500-10	0.040		12.50mm FBP	80.000	79.960
87-305600-10	0.030		12.00mm FBP	80.000	79.970	87-336600-00	0.025		6.00mm FBP	82.000	81.975
87-305900-00	0.030		12.00mm FBP	80.000	79.970	87-337300-00	0.030		14.00mm FBP	74.000	73.970
87-306300-00	0.020		10.00mm FBP	75.000	74.980	87-337500-00	0.030		35.00mm FBP	120.000	119.970
87-306700-00	0.030		10.00mm FBP	82.500	82.470	87-337500-10	0.055		20.00mm FBP	120.000	119.945
87-306700-10	0.030		15.00mm FBP	82.500	82.470	87-337500-30	0.070		30.00mm FBP	120.000	119.930
87-306800-10	0.030		10.00mm FBP	86.000	85.970	87-337500-50	0.122		24.00mm FBP	120.024	119.902
87-306800-20	0.030		45.50mm FPC	86.000	85.970	87-337600-00	0.150		28.00mm FBP	121.000	120.850
87-306800-30	0.020		11.00mm FBP	86.000	85.980	87-346500-00	0.085		27.00mm FBP	102.000	101.915
87-306800-40	0.020		42.50mm FPC	86.000	85.980	87-361900-00	0.080		8.00mm FBP	100.000	99.920
87-306900-00	0.011		42.45mm FPC	79.000	78.989	87-373700-00	0.045		35.00mm FBP	90.000	89.955
87-306900-10	0.030		14.00mm FBP	79.000	78.970	87-373800-00	0.030		15.00mm FBP	92.000	91.970
87-306900-20	0.018		42.45mm FPC	79.000	78.982	87-373800-10	0.040		18.00mm FBP	92.000	91.960
87-307000-20	0.015		57.00mm FPC	76.000	75.985	87-373800-30	0.040		15.00mm FBP	92.000	91.960
87-307100-20	0.020		9.00mm FBP	77.600	77.580	87-373800-40	0.040		10.00mm FBP	92.000	91.960
87-307100-30	0.023		48.10mm FPC	77.600	77.577	87-374400-00	0.040		8.00mm FBP	73.000	72.960
87-307200-00	0.020		6.68mm FBP	84.800	84.780	87-396300-00	0.160		35.70mm FBP	120.640	120.480
87-307200-10	0.015		45.50mm FPC	84.800	84.785	87-404500-00	0.080		5.70mm FBP	90.000	89.920
87-307600-10	0.020		64.00mm FPC	78.975	78.955	87-404500-20	0.080		10.00mm FBP	90.000	89.920
87-307600-20	0.020		64.00mm FPC	78.975	78.955	87-405500-10	0.100		21.30mm FBP	98.400	98.300
87-307600-30	0.030		0.00mm ABP	79.000	78.970	87-405600-60	0.150		21.00mm FBP	130.180	130.030
87-307600-40	0.040		30.00mm FBP	79.000	78.960	87-405600-70	0.135		21.00mm FBP	130.165	130.030
87-307700-00	0.030		16.00mm FBP	81.580	81.550	87-407000-00	0.110		12.00mm FBP	104.770	104.660
87-307700-10	0.035		16.00mm FBP	81.580	81.545	87-407100-00	0.160		25.00mm FBP	120.640	120.480
87-307800-10	0.030		6.00mm FBP	79.000	78.970	87-407100-10	0.160		25.00mm FBP	120.640	120.480
87-313400-00	0.095		17.50mm FBP	79.375	79.280	87-420100-00	0.170		50.00mm FBP	130.000	129.830
87-314600-00	0.100		3.00mm FBP	91.480	91.380	87-420200-00	0.100		0.00mm ABP	130.000	129.900
87-314600-10	0.140		2.87mm FBP	91.480	91.340	87-420900-00	0.130		15.00mm FBP	130.000	129.870

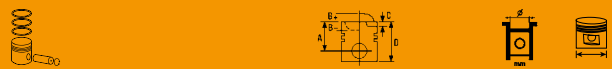
PISTON CLEARANCE DATA

Kolbenspiel • Dato de holgura del pistón
 Jeu de piston • Dati di tolleranza pistone

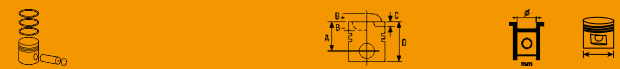
											
87-420900-10	0.123		15.00mm FBP	130.000	129.877	87-432300-00	0.060		10.00mm FBP	81.010	80.950
87-420900-50	0.103		15.00mm FBP	130.000	129.897	87-432300-10	0.060		10.00mm FBP	81.010	80.950
87-421000-10	0.040		15.00mm FBP	81.000	80.960	87-432900-00	0.147		35.00mm FBP	79.510	79.363
87-421000-20	0.040		15.00mm FBP	81.000	80.960	87-433200-00	0.030		9.00mm FBP	72.000	71.970
87-421000-30	0.060		13.00mm FBP	81.010	80.950	87-433300-00	0.160		30.00mm FBP	130.000	129.840
87-422000-00	0.070		13.50mm FBP	84.000	83.930	87-433400-00	0.054		19.00mm FBP	83.000	82.946
87-422000-10	0.090		13.50mm FBP	84.000	83.910	87-433500-00	0.035		10.00mm FBP	77.000	76.965
87-422100-00	0.100		14.00mm FBP	100.000	99.900	87-433600-00	0.060		12.00mm FBP	75.000	74.940
87-422200-10	0.050		8.00mm FBP	80.000	79.950	87-433700-00	0.015		14.00mm FBP	75.000	74.985
87-422300-00	0.080		22.50mm FBP	80.000	79.920	87-433800-00	0.122		27.00mm FBP	128.000	127.878
87-422400-00	0.040		10.00mm FBP	96.000	95.960	87-433900-00	0.045		10.00mm FBP	76.500	76.455
87-423000-00	0.120		16.00mm FBP	120.000	119.880	87-433900-10	0.050		9.50mm FBP	77.000	76.950
87-423000-01	0.120		16.00mm FBP	120.000	119.880	87-434300-00	0.060		9.00mm FBP	83.000	82.940
87-423000-10	0.120		16.00mm FBP	120.000	119.880	87-434400-00	0.150		40.00mm FBP	131.000	130.850
87-423000-11	0.200		16.00mm FBP	120.000	119.800	87-434400-10	0.070		0.00mm APC	131.010	130.940
87-423000-30	0.120		16.00mm FBP	120.000	119.880	87-434600-00	0.033		11.50mm FBP	84.000	83.967
87-424000-00	0.055		12.00mm FBP	75.000	74.945	87-434600-10	0.033		11.50mm FBP	84.000	83.967
87-425000-00	0.075		12.00mm FBP	93.000	92.925	87-435000-00	0.040		24.00mm FBP	102.000	101.960
87-425000-10	0.070		13.00mm FBP	93.000	92.930	87-435000-10	0.040		24.00mm FBP	102.000	101.960
87-425200-00	0.015		10.00mm FBP	82.000	81.985	87-435100-00	0.040		8.00mm FBP	82.510	82.470
87-425300-00	0.045		9.00mm FBP	84.000	83.955	87-435300-00	0.040		15.00mm FBP	79.010	78.970
87-425400-00	0.175		24.00mm FBP	103.000	102.825	87-435400-00	1.030		9.00mm FBP	75.500	74.470
87-425600-00	0.054		7.00mm FBP	69.615	69.561	87-435700-10	0.354		7.00mm FBP	69.905	69.551
87-425700-00	0.015		10.00mm FBP	85.000	84.985	87-436500-00	0.045		10.00mm FBP	83.000	82.955
87-425900-00	0.091		17.00mm FBP	108.000	107.909	87-436600-00	0.080		8.00mm FBP	85.000	84.920
87-426100-00	0.035		15.00mm FBP	76.010	75.975	87-436700-00	0.052		17.00mm FBP	85.000	84.948
87-426200-00	0.080		14.00mm FBP	105.000	104.920	87-436700-10	0.067		17.00mm FBP	85.000	84.933
87-426300-00	0.030		8.50mm FBP	72.000	71.970	87-436800-00	0.030		9.00mm FBP	72.000	71.970
87-426600-00	0.040		5.00mm FBP	82.200	82.160	87-436900-00	0.050		12.00mm FBP	76.510	76.460
87-426700-00	0.040		0.00mm ABP	79.000	78.960	87-437000-10	0.055		12.00mm FBP	82.500	82.445
87-427000-00	0.130		30.00mm FBP	128.000	127.870	87-437400-00	0.025		10.30mm FBP	72.492	72.467
87-427100-00	0.020		6.00mm FBP	66.500	66.480	87-437600-00	0.060		33.00mm FBP	127.000	126.940
87-427400-00	0.041		16.50mm FBP	83.000	82.959	87-438500-00	0.500		10.00mm FBP	83.000	82.500
87-427400-10	0.041		16.50mm FBP	83.000	82.959	87-438800-00	0.060		0.00mm APC	123.010	122.950
87-427400-20	0.034		16.50mm FBP	83.000	82.966	87-438900-00	0.110		30.00mm FBP	120.010	119.900
87-427400-30	0.034		16.50mm FBP	83.000	82.966	87-440500-00	0.052		15.00mm FBP	83.008	82.956
87-427500-00	0.031		14.50mm FBP	83.000	82.969	87-440600-00	0.040		78.00mm FPC	132.000	131.960
87-427600-00	0.047		10.00mm FBP	82.000	81.953	87-440800-00	0.100		17.00mm FBP	108.000	107.900
87-427600-10	0.030		15.00mm FBP	82.000	81.970	87-440900-00	0.020		14.40mm FBP	88.008	87.988
87-427700-00	0.030		12.00mm FBP	86.000	85.970	87-441100-00	0.130		15.00mm FBP	111.000	110.870
87-427700-10	0.030		12.00mm FBP	86.000	85.970	87-441300-00	0.150		14.00mm FBP	105.000	104.850
87-427700-30	0.030		12.00mm FBP	86.000	85.970	87-441900-00	0.055		14.50mm FBP	83.565	83.510
87-427700-40	0.030		12.00mm FBP	86.000	85.970	87-442300-00	0.090		11.00mm FBP	71.010	70.920
87-427700-50	0.050		12.00mm FBP	86.000	85.950	87-443100-00	0.544		17.00mm FBP	85.544	85.000
87-427900-00	0.115		12.00mm FBP	102.000	101.885	87-449000-00	0.040		11.00mm FBP	73.960	73.920
87-428000-00	0.116		18.00mm FBP	135.000	134.884	87-450000-00	0.025		8.00mm FBP	69.000	68.975
87-428600-00	0.120		16.00mm FBP	120.000	119.880	87-501300-00	0.140		25.00mm FBP	130.180	130.040
87-428600-01	0.120		16.00mm FBP	120.000	119.880	87-501400-00	0.110		12.00mm FBP	104.770	104.660
87-428600-10	0.120		16.00mm FBP	120.000	119.880	87-501500-00	0.050		60.50mm FPC	81.010	80.960
87-428700-00	0.031		9.50mm FBP	88.000	87.969	87-501500-10	0.050		60.50mm FPC	81.010	80.960
87-428800-00	0.084		15.00mm FBP	117.000	116.916	87-501500-20	0.050		60.50mm FPC	81.010	80.960
87-428900-00	0.130		17.50mm FBP	102.000	101.870	87-501500-30	0.050		60.50mm FPC	81.010	80.960
87-429100-00	0.091		17.00mm FBP	108.000	107.909	87-501800-10	0.035		12.00mm FBP	82.510	82.475
87-429200-00	0.080		16.00mm FBP	92.000	91.920	87-501800-20	0.040		12.00mm FBP	82.510	82.470
87-429500-10	0.360		10.00mm FBP	73.760	73.400	87-501800-40	0.035		12.00mm FBP	82.510	82.475
87-429900-00	0.045		10.00mm FBP	76.500	76.455	87-501800-50	0.040		12.00mm FBP	82.510	82.470
87-430000-00	0.140		21.00mm FBP	108.000	107.860	87-501800-60	0.025		16.00mm FBP	82.510	82.485
87-431000-00	0.130		16.00mm FBP	126.000	125.870	87-502600-00	0.120		35.00mm FBP	120.640	120.520
87-431000-10	0.130		16.00mm FBP	126.000	125.870	87-502700-00	0.100		23.00mm FBP	104.775	104.675
87-432000-00	0.040		18.00mm FBP	91.100	91.060	87-502800-00	0.020		9.00mm FBP	76.500	76.480
87-432200-00	0.050		15.00mm FBP	84.000	83.950	87-502800-10	0.020		16.00mm FBP	76.500	76.480

											
87-502900-00	0.035		15.00mm FBP	81.010	80.975	87-526100-00	0.015		0.00mm ABP	73.647	73.632
87-502900-10	0.060		0.00mm ABP	81.010	80.950	87-526300-00	0.110		20.00mm FBP	95.000	94.890
87-502900-20	0.035		12.00mm FBP	81.010	80.975	87-526300-10	0.050		20.00mm FBP	95.000	94.950
87-502900-30	0.060		12.00mm FBP	81.010	80.950	87-526400-00	0.130		17.00mm FBP	90.470	90.340
87-520100-00	0.030		0.00mm ABP	88.860	88.830	87-526600-00	0.048		0.00mm ABP	73.500	73.452
87-520100-10	0.030		0.00mm ABP	88.860	88.830	87-526800-00	0.050		10.00mm FBP	91.000	90.950
87-520200-00	0.110		21.00mm FBP	93.000	92.890	87-526800-10	0.050		20.00mm FBP	91.000	90.950
87-520400-00	0.105		70.65mm FPC	100.000	99.895	87-526900-00	0.151		138.00mm FPC	127.000	126.849
87-520500-00	0.020		35.50mm FPC	74.970	74.950	87-527100-00	0.020		15.00mm FBP	102.000	101.980
87-520600-00	0.183		35.71mm FBP	100.050	99.867	87-527100-10	0.060		10.00mm FBP	102.000	101.940
87-520900-00	0.153		25.00mm FBP	104.770	104.617	87-527300-00	0.050		10.00mm FBP	78.000	77.950
87-521000-00	0.203		34.60mm FBP	127.028	126.825	87-527600-00	0.040		22.00mm FBP	67.400	67.360
87-521100-00	0.150		16.80mm FBP	93.000	92.850	87-527800-00	0.090		6.00mm FBP	85.000	84.910
87-521200-00	0.030		2.00mm FBP	91.100	91.070	87-527900-00	0.175		30.00mm FBP	125.000	124.825
87-521300-00	0.160		0.00mm ABP	111.760	111.600	87-528000-00	0.130		2.00mm FBP	115.000	114.870
87-521300-10	0.135		29.30mm FBP	111.760	111.625	87-528300-00	0.050		15.00mm FBP	70.000	69.950
87-521400-00	0.180		29.00mm FBP	111.770	111.590	87-528400-00	0.055		57.25mm FPC	73.500	73.445
87-521500-00	0.015		49.00mm FPC	94.000	93.985	87-528500-00	0.040		15.00mm FBP	80.000	79.960
87-521500-10	0.010		0.00mm ABP	94.000	93.990	87-528600-00	0.060		7.00mm FBP	65.000	64.940
87-521600-00	0.028		0.03mm FPC	80.000	79.972	87-528800-00	0.050		64.00mm FPC	96.000	95.950
87-521700-00	0.030		7.00mm FBP	70.625	70.595	87-528900-00	0.060		20.00mm FBP	95.000	94.940
87-521700-10	0.030		50.75mm FPC	70.625	70.595	87-528900-10	0.140		10.00mm FBP	95.000	94.860
87-521800-20	0.080		15.00mm FBP	90.475	90.395	87-529000-00	0.060		16.00mm FBP	95.000	94.940
87-521900-00	0.015		0.00mm ABP	80.251	80.236	87-529200-00	0.080		7.00mm FBP	82.000	81.920
87-522200-00	0.067		0.00mm ABP	66.675	66.608	87-529300-00	0.055		10.00mm FBP	82.000	81.945
87-522300-00	0.013		0.00mm ABP	64.554	64.541	87-529400-00	0.030		15.00mm FBP	91.000	90.970
87-522400-00	0.010		5.10mm FBP	64.567	64.557	87-529500-00	0.030		10.00mm FBP	94.000	93.970
87-522500-00	0.017		3.20mm FBP	86.990	86.973	87-529500-10	0.030		10.00mm FBP	94.000	93.970
87-522600-00	0.100		77.75mm FOC	86.990	86.890	87-529600-00	0.040		20.00mm FBP	96.000	95.960
87-522700-00	0.010		35.50mm FPC	80.000	79.990	87-529600-10	0.080		15.00mm FBP	96.000	95.920
87-522700-10	0.030		10.00mm FBP	80.000	79.970	87-529900-00	0.010		0.00mm ABP	82.994	82.984
87-522800-00	0.076		58.50mm FPC	82.550	82.474	87-530100-00	0.061		0.00mm ABP	83.343	83.282
87-522900-00	0.010		0.00mm ABP	82.994	82.984	87-530200-00	0.116		0.00mm ABP	70.988	70.872
87-522900-10	0.070		12.00mm FBP	102.021	101.951	87-530300-00	0.060		0.00mm ABP	82.000	81.940
87-522900-30	0.055		12.00mm FBP	102.000	101.945	87-530400-00	0.040		16.00mm FBP	74.000	73.960
87-522900-40	0.080		108.20mm FPC	102.015	101.935	87-702600-00	0.015		15.00mm FBP	84.000	83.985
87-523000-00	0.160		30.00mm FBP	115.000	114.840	87-704200-10	0.015		12.00mm FBP	84.000	83.985
87-523000-10	0.123		16.00mm FBP	115.000	114.877	87-704500-00	0.040		7.00mm FBP	80.000	79.960
87-523300-00	0.100		25.00mm FBP	105.000	104.900	87-705000-00	0.020		9.00mm FBP	80.000	79.980
87-523500-00	0.140		8.60mm FBP	104.775	104.635	87-714400-00	0.040		9.00mm FBP	90.475	90.435
87-523600-00	0.021		68.50mm FPC	90.000	89.979	87-740000-00	0.120		18.00mm FBP	97.500	97.380
87-523800-00	0.185		2.20mm FBP	95.250	95.065	87-740000-01	0.120		18.00mm FBP	97.500	97.380
87-524000-00	0.018		65.00mm FOC	92.075	92.057	87-740000-10	0.120		13.00mm FBP	97.500	97.380
87-524000-10	0.026		65.00mm FOC	92.075	92.049	87-740000-20	0.110		20.00mm FBP	97.500	97.390
87-524100-00	0.030		6.00mm FBP	70.625	70.595	87-740000-40	0.110		16.00mm FBP	97.500	97.390
87-524200-00	0.025		2.87mm FBP	90.475	90.450	87-740000-41	0.110		16.00mm FBP	97.500	97.390
87-524300-00	0.025		48.63mm FPC	64.567	64.542	87-740000-50	0.110		16.00mm FBP	97.500	97.390
87-524400-00	0.013		72.00mm FPC	90.475	90.462	87-740000-51	0.110		18.00mm FBP	97.500	97.390
87-524500-00	0.025		0.00mm ABP	94.000	93.975	87-740300-00	0.120		13.00mm FBP	125.000	124.880
87-524500-10	0.025		0.00mm ABP	94.000	93.975	87-740300-10	0.150		18.00mm FBP	125.000	124.850
87-524800-00	0.110		17.00mm FBP	80.000	79.890	87-740900-00	0.105		16.00mm FBP	102.000	101.895
87-524800-10	0.080		15.00mm FBP	80.000	79.920	87-740900-10	0.105		17.00mm FBP	102.000	101.895
87-525000-00	0.095		0.00mm ABP	87.312	87.217	87-740900-20	0.090		9.50mm FBP	102.000	101.910
87-525100-00	0.140		10.00mm FBP	91.480	91.340	87-740900-30	0.110		21.50mm FBP	102.000	101.890
87-525100-10	0.110		6.00mm FBP	91.480	91.370	87-741200-10	0.050		12.00mm FBP	85.000	84.950
87-525200-00	0.150		10.00mm FBP	98.480	98.330	87-741600-00	0.060		15.00mm FBP	104.175	104.115
87-525300-00	0.160		3.00mm FBP	98.000	97.840	87-741800-00	0.110		16.00mm FBP	100.000	99.890
87-525400-00	0.129		0.00mm ABP	71.000	70.871	87-741800-20	0.040		13.00mm FBP	100.000	99.960
87-525500-00	0.017		86.50mm FOC	86.990	86.973	87-743100-00	0.031		9.50mm FBP	89.000	88.969
87-525700-00	0.031		12.00mm FBP	74.688	74.657	87-743100-10	0.030		10.50mm FBP	89.000	88.970
87-525900-00	0.020		0.00mm ABP	80.251	80.231	87-743100-20	0.030		15.00mm FBP	89.000	88.970

PISTON CLEARANCE DATA











Kolbenspiel • Dato de holgura del pistón
Jeu de piston • Dati di tolleranza pistone



87-743100-30	0.021		9.50mm FBP	89.000	88.979
87-743100-40	0.031		9.50mm FBP	89.000	88.969
87-743200-00	0.141		15.00mm FBP	130.000	129.859
87-743400-00	0.140		14.00mm FBP	130.000	129.860
87-743400-10	0.140		20.00mm FBP	130.000	129.860
87-743400-30	0.140		33.00mm FBP	130.000	129.860
87-743400-40	0.150		21.00mm FBP	130.000	129.850
87-743400-50	0.150		21.00mm FBP	130.000	129.850
87-743600-10	0.030		18.00mm FBP	87.000	86.970
87-744600-00	0.105		16.20mm FBP	100.000	99.895
87-780100-10	0.015		81.50mm FPC	93.648	93.633
87-780300-10	0.040		0.00mm ABP	90.800	90.760
87-780300-30	0.040		25.00mm FBP	90.800	90.760
87-780600-00	0.035		30.00mm FBP	80.980	80.945
87-780600-10	0.060		10.00mm FBP	80.980	80.920
87-780600-20	0.035		25.00mm FBP	80.985	80.950
87-781800-00	0.140		21.00mm FBP	125.000	124.860
87-781900-10	0.119		17.00mm FBP	100.000	99.881
87-781900-30	0.108		0.00mm ABP	100.000	99.892
87-782000-00	0.130		15.00mm FBP	103.000	102.870
87-782000-10	0.133		0.00mm ABP	103.000	102.867
87-782100-00	0.173		21.00mm FBP	145.000	144.827
87-782100-10	0.170		21.50mm FBP	145.000	144.830
87-782100-30	0.180		18.00mm FBP	145.000	144.820
87-782100-40	0.180		21.00mm FBP	145.000	144.820
87-782600-00	0.060		14.00mm FBP	67.200	67.140
87-782700-00	0.020		16.50mm FBP	65.000	64.980
87-782900-00	0.050		8.00mm FBP	107.185	107.135
87-783000-00	0.180		33.00mm FBP	137.000	136.820
87-783000-10	0.180		33.00mm FBP	137.035	136.855
87-783000-15	0.180		42.50mm FBP	137.000	136.820
87-783000-30	0.180		33.00mm FBP	137.000	136.820
87-783500-10	0.030		60.00mm FPC	82.500	82.470
87-783600-00	0.030		8.00mm FBP	69.500	69.470
87-783800-00	0.075		15.00mm FBP	82.600	82.525
87-783800-10	0.080		15.00mm FBP	82.600	82.520
87-783800-30	0.030		15.00mm FBP	82.600	82.570
87-783900-10	0.120		25.50mm FBP	103.000	102.880
87-784100-00	0.030		16.50mm FBP	68.700	68.670
87-784100-10	0.030		0.00mm ABP	68.700	68.670
87-784200-00	0.030		0.00mm ABP	86.000	85.970
87-784200-10	0.010		45.00mm FPC	86.000	85.990
87-784600-00	0.025		4.00mm FBP	81.300	81.275
87-784800-00	0.040		15.50mm FBP	93.670	93.630
87-785000-00	0.030		15.00mm FBP	74.000	73.970
87-785000-10	0.035		15.00mm FBP	73.975	73.940
87-785100-00	0.025		42.00mm FPC	79.945	79.920
87-785200-00	0.030		66.00mm FPC	82.500	82.470
87-785300-10	0.168		19.70mm FBP	120.000	119.832
87-785400-00	0.060		15.00mm FBP	82.600	82.540
87-785500-00	0.070		57.25mm FPC	77.000	76.930
87-786300-00	0.015		46.40mm FPC	76.000	75.985
87-786400-00	0.030		9.00mm FBP	84.800	84.770
87-786500-00	0.040		10.00mm FBP	80.600	80.560
87-787000-10	0.035		45.46mm FPC	82.000	81.965
87-787000-30	0.029		12.50mm FBP	82.000	81.971
87-848300-02	0.050		15.00mm FBP	76.500	76.450
87-849000-02	0.060		15.00mm FBP	75.000	74.940
87-849200-02	0.030		9.00mm FBP	75.500	75.470
87-854700-00	0.077		17.00mm FBP	94.400	94.323
87-873400-02	0.050		12.00mm FBP	91.100	91.050























87-873400-12	0.050		12.00mm FBP	91.100	91.050
87-879200-02	0.120		10.00mm FBP	83.000	82.880
87-898400-02	0.057		10.50mm FBP	73.000	72.943
87-960200-00	0.075		30.45mm FBP	65.500	65.425
87-960900-00	0.120		24.40mm FBP	115.000	114.880
87-960900-10	0.120		115.00mm FPC	115.000	114.880
87-961000-00	0.140		10.10mm FBP	115.000	114.860
87-961000-10	0.120		24.40mm FBP	115.000	114.880
87-962000-00	0.120		24.26mm FBP	127.000	126.880
87-962000-30	0.140		12.00mm FBP	127.000	126.860
87-962000-40	0.133		128.00mm FPC	127.000	126.867
87-962000-50	0.140		30.67mm FBP	127.000	126.860
87-962000-60	0.140		27.00mm FBP	127.000	126.860
87-962000-70	0.140		27.00mm FBP	127.000	126.860
87-962000-80	0.120		27.00mm FBP	127.000	126.880
87-990100-10	0.030		15.00mm FBP	79.510	79.480
87-990100-40	0.030		10.00mm FBP	79.510	79.480
87-990700-10	0.100		3.00mm FBP	75.000	74.900
87-990700-00	0.100		3.00mm FBP	75.000	74.900
87-433400-10	0.123		37.80mm FBP	83.007	82.884
87-433100-10	0.056		17.00mm FBP	85.000	84.944
87-435200-00	0.085		14.00mm FBP	85.010	84.925

											
87-102800-10	OPEL 84 MM STD		+0.40	+0.50		STD gasket					
87-102800-10	OPEL 84 MM STD		+0.51	+0.60		1 notch gasket					
87-102800-10	OPEL 84 MM STD		+0.61	+0.70		2 notch gasket					
87-102900-10	OPEL 83,975 MM STD		+0.40	+0.50		STD gasket					
87-102900-10	OPEL 83,975 MM STD		+0.69	+0.76		2 notch gasket					
87-102900-10	OPEL 83,975 MM STD		+0.76	+0.83		3 notch gasket					
87-103200-00	KHD 91 MM STD		+0.59	+0.69		1 notch gasket					
87-103200-00	KHD 91 MM STD		+0.69	+0.76		2 notch gasket					
87-103200-00	KHD 91 MM STD		+0.76	+0.83		3 notch gasket					
87-103900-00	IVECO 104 MM STD		+0.53	+0.72							
87-103900-30	IVECO-TRK 104 MM STD		+0.48	+0.79							
87-104000-00	PEUGEOT 82,2 MM STD		+0.51	+0.55		1.26mm gasket					
87-104000-00	PEUGEOT 82,2 MM STD		+0.55	+0.59		1.30mm gasket					
87-104000-00	PEUGEOT 82,2 MM STD		+0.59	+0.63		1.34mm gasket					
87-104300-00	MAN 128 MM STD		+0.01	+0.33							
87-104300-10	MAN 128 MM STD KH-0,20		+0.01	+0.33							
87-105500-00	PEUGEOT 83 MM STD		+0.56	+0.67		1.36mm gasket					
87-105500-00	PEUGEOT 83 MM STD		+0.68	+0.71		1.40mm gasket					
87-105500-00	PEUGEOT 83 MM STD		+0.72	+0.75		1.44mm gasket					
87-105500-00	PEUGEOT 83 MM STD		+0.76	+0.79		1.48mm gasket					
87-105500-00	PEUGEOT 83 MM STD		+0.80	+0.83		1.52mm gasket					
87-105900-00	VAG 81 MM STD		+0.66	+0.86		1 notch gasket					
87-105900-00	VAG 81 MM STD		+0.81	+0.90		2 notch gasket					
87-105900-00	VAG 81 MM STD		+0.91	+1.02		3 notch gasket					
87-107000-00	FORD 82.50 MM STD		+0.50	+0.60							
87-109500-00	AUDI 76,5 MM STD		+0.67	+0.80		1 notch gasket					
87-109500-00	AUDI 76,5 MM STD		+0.81	+0.90		2 notch gasket					
87-109500-00	AUDI 76,5 MM STD		+0.91	+1.02		3 notch gasket					
87-109800-10	VAG 76,51 MM STD		+0.65	+0.80		1 notch gasket					
87-109800-10	VAG 76,51 MM STD		+0.81	+0.90		2 notch gasket					
87-109800-10	VAG 76,51 MM STD		+0.91	+1.02		3 notch gasket					
87-113500-00	FORD 89,91 MM STD		+0.45	+0.53		1 hole gasket					
87-113500-00	FORD 89,91 MM STD		+0.53	+0.65		2 hole gasket					
87-113500-00	FORD 89,91 MM STD		+0.65	+0.70		3 hole gasket					
87-113500-10	FORD 89.9 MM STD		+0.45	+0.53		1 hole gasket					
87-113500-10	FORD 89.9 MM STD		+0.53	+0.65		2 hole gasket					
87-113500-10	FORD 89.9 MM STD		+0.65	+0.70		3 hole gasket					
87-114400-00	BMW 84 MM STD		+0.80	+0.90		1 notch gasket					
87-114400-00	BMW 84 MM STD		+0.90	+1.00		2 notch gasket					
87-114400-10	BMW 84 MM STD		+0.80	+0.90		1 notch gasket					
87-114400-10	BMW 84 MM STD		+0.90	+1.00		2 notch gasket					
87-114400-30	BMW 84 MM STD		+0.85	+0.90		1 notch gasket					
87-114400-30	BMW 84 MM STD		+0.90	+1.00		2 notch gasket					
87-114400-30	BMW 84 MM STD		+1.00	+1.10		3 notch gasket					
87-114700-00	PEUGEOT 85 MM STD		+0.55	+0.60		1.25mm gasket					
87-114700-00	PEUGEOT 85 MM STD		+0.61	+0.65		1.30mm gasket					
87-114700-00	PEUGEOT 85 MM STD		+0.66	+0.70		1.35mm gasket					
87-114700-00	PEUGEOT 85 MM STD		+0.71	+0.75		1.40mm gasket					
87-114900-80	VAG 79,51 MM STD		+0.81	+0.96		1.53mm gasket					
87-114900-80	VAG 79,51 MM STD		+0.96	+1.01		1.57mm gasket					
87-114900-80	VAG 79,51 MM STD		+1.01	+1.03		1.61mm gasket					
87-114900-85	VAG 79,51 MM STD		+0.81	+0.96		1.53mm gasket					
87-114900-85	VAG 79,51 MM STD		+0.96	+1.01		1.57mm gasket					
87-114900-85	VAG 79,51 MM STD		+1.01	+1.03		1.61mm gasket					
87-114900-90	VAG 79,51 MM STD		+0.91	+1.00		1 notch gasket					
87-114900-90	VAG 79,51 MM STD		+1.01	+1.10		2 notch gasket					
87-114900-90	VAG 79,51 MM STD		+1.10	+1.20		3 notch gasket					
87-114900-95	VAG 79,51 MM STD		+0.91	+1.00		1 notch gasket					
87-114900-95	VAG 79,51 MM STD		+1.01	+1.10		2 notch gasket					
87-114900-95	VAG 79,51 MM STD		+1.10	+1.20		3 notch gasket					
87-117900-00	M.BENZ-PKW 88 MM STD		+0.38	+0.62							
87-117900-00	M.BENZ-PKW 88 MM STD		+0.38	+0.62							
87-121900-00	IVECO LKW 125 MM STD		+0.20	+0.25							
87-122200-00	IVECO 94,4 MM STD		+0.45	+0.50		1.20mm gasket					
87-122200-00	IVECO 94,4 MM STD		+0.51	+0.60		1.30mm gasket					
87-122200-00	IVECO 94,4 MM STD		+0.61	+0.70		1.40mm gasket					
87-122200-00	IVECO 94,4 MM STD		+0.71	+0.80		1.50mm gasket					
87-122200-10	IVECO 94,4 MM STD		+0.40	+0.50		1.20mm gasket					
87-122200-10	IVECO 94,4 MM STD		+0.51	+0.60		1.30mm gasket					
87-122200-10	IVECO 94,4 MM STD		+0.61	+0.70		1.40mm gasket					
87-122200-10	IVECO 94,4 MM STD		+0.71	+0.80		1.50mm gasket					
87-123400-10	RENAULT 76 MM STD		+0.25	+0.30							
87-123700-30	FORD 93.67 MM STD		+0.25	+0.40							
87-124000-30	FIAT-PKW 82 MM STD		+0.79	+0.88		STD gasket					
87-124000-30	FIAT-PKW 82 MM STD		+0.88	+0.96		1 notch gasket					
87-124000-30	FIAT-PKW 82 MM STD		+0.96	+1.05		2 notch gasket					
87-124500-00	MAN 128 MM STD		+0.10	+0.33							
87-124500-10	MAN 128 MM STD KH 0,20 MM		+0.10	+0.33							
87-126600-00	PEUGEOT 85.00 MM STD		+0.65	+0.75		1.52mm gasket					
87-126600-00	PEUGEOT 85.00 MM STD		+0.77	+0.81		1.57mm gasket					
87-126600-00	PEUGEOT 85.00 MM STD		+0.82	+0.86		1.62mm gasket					
87-135800-00	PEUGEOT 92 MM STD		+0.50	+0.60		1.30mm gasket					
87-136400-00	M.BENZ 88 MM STD		+0.38	+0.60							
87-136500-10	MAN 108 MM STD		+0.09	+0.39							
87-140800-00	FORD-PKW 86 MM STD		+0.43	+0.52		1.10mm gasket					
87-140800-00	FORD-PKW 86 MM STD		+0.52	+0.57		1.15mm gasket					
87-140800-00	FORD-PKW 86 MM STD		+0.57	+0.62		1.20mm gasket					
87-140800-10	FORD 86,01 MM FORD		+0.43	+0.52		1.10mm gasket					
87-140800-10	FORD 86,01 MM FORD		+0.52	+0.57		1.15mm gasket					
87-140800-10	FORD 86,01 MM FORD		+0.57	+0.62		1.20mm gasket					
87-141300-00	FORD 79 MM STD		-1.40	-1.60							
87-141800-00	M.BENZ-LKW 128 MM STD		+0.22	+0.71							
87-143200-00	HATZ 75 MM STD		+0.65	+0.75		Together with gasket					
87-143300-00	HATZ 80 MM STD		+0.80	+0.90		Together with gasket					
87-143500-00	HATZ 108 MM STD		+1.10	+1.30							
87-143800-00	MAN 128 MM STD		+0.01	+0.33							
87-143800-10	MAN 128 MM STD KH 0,20 MM		+0.01	+0.33							
87-143800-20	MAN 128 MM STD KH 0,40 MM		+0.01	+0.33							
87-143800-30	MAN 128 MM STD		+0.01	+0.33							
87-143800-40	MAN 128 MM STD		+0.01	+0.33							
87-144000-00	LAND-ROVER 90,47 MM STD		+0.10	+0.15		1.10mm gasket					
87-152000-10	PEUGEOT 83 MM STD		+0.35	+0.54		1.49mm gasket					
87-152000-10	PEUGEOT 83 MM STD		+0.65	+0.77		1.60mm gasket					
87-152000-10	PEUGEOT 83 MM STD		+0.77	+0.83		1.73mm gasket					
87-167600-00	KHD 120 MM STD		+1.10	+1.30		Together with gasket					
87-172500-00	KHD 100 MM STD		+1.00	+1.20		Together with gasket					
87-174100-00	DAF 130 MM STD		-0.25	+0.25							
87-174100-30	DAF 130 MM STD		-0.25	+0.25							
87-174300-00	MERCEDES 97 MM STD		-0.70	+0.30							
87-174300-10	MERCEDES 97 MM STD		-0.70	+0.30							
87-176000-00	M.BENZ-LKW 125 MM STD		+0.07	+0.43							
87-176400-00	M.BENZ-LKW 115 MM STD		+0.08	+0.41							
87-176700-00	M.BENZ 90.9 MM STD		+0.50	+0.90							
87-176800-00	M.BENZ-LKW 125 MM STD		+0.07	+0.43							
87-176900-00	M.BENZ 128 MM STD		+0.09	+0.30							
87-176900-10	MERCEDES 128 MM STD		-0.10	+0.22							
87-178200-20	MERCEDES 97 MM STD		-0.70	+0.30							
87-178400-00	KHD 102 MM STD		+1.00	+1.20		Together with gasket					
87-178800-00	MERCEDES PKW 97 MM STD		-0.08	+0.30							
87-179300-10	M.BENZ-LKW 128 MM STD		+0.17	+0.53							
87-179300-15	M.BENZ-LKW 128 MM STD		+0.17	+0.53							
87-179300-50	M.BENZ-LKW 128 MM STD		+0.07	+0.43							

PISTON PROTRUSION DATA

Kolbenüberstands-Daten • Altura del pistón en PMS
Données de dépassement de piston • Dati di tolleranza pistone

												
87-179300-65	M.BENZ-LKW	128 MM STD	-0.10	+0.32			87-307600-20	OPEL	79 MM STD	+0.58	+0.64	STD gasket
87-179300-70	M.BENZ-LKW	128 MM STD	-0.07	+0.43			87-307600-20	OPEL	79 MM STD	+0.65	+0.70	1 hole gasket
87-179300-80	M.BENZ-LKW	128 MM STD	+0.07	+0.43			87-307600-20	OPEL	79 MM STD	+0.70	+0.78	2 hole gasket
87-179300-85	M.BENZ-LKW	128 MM STD	+0.17	+0.53			87-307600-40	OPEL	79 MM STD	+0.63	+0.70	1.45mm gasket
87-179300-86	M.BENZ-LKW	128 MM STD	+0.17	+0.53			87-307600-40	OPEL	79 MM STD	+0.70	+0.76	1.50mm gasket
87-179700-00	M.BENZ	95,5 MM STD	+0.50	+0.90			87-307600-40	OPEL	79 MM STD	+0.76	+0.83	1.55mm gasket
87-181100-10	JOHN DEERE	106,5 MM STD	+0.10	+0.30			87-314600-00	PERKINS TRK	91,48 MM STD	0.00	-0.13	
87-181700-00	M.BENZ-LKW	128 MM STD	+0.17	+0.53			87-314600-10	PERKINS	91,48 MM STD	0.00	-0.13	
87-181800-00	J.DEERE	102 MM STD	-0.07	0.00			87-315000-00	PERKINS-TRK	98,48 MM STD	+0.28	+0.48	
87-181800-10	J.DEERE	102 MM STD	-0.07	0.00			87-318000-00	PERKINS	101,054 MM STD KH-0,30MM	+0.08	+0.25	
87-181800-20	J.DEERE	106.5 MM STD	+0.14	+0.20			87-318700-10	PEUGEOT	94 MM STD	0.00	+0.84	
87-183300-00	M.BENZ	87 MM STD	+0.73	+0.96			87-321500-00	PEUGEOT	80 MM STD	+0.54	+0.77	1.61mm gasket
87-202400-00	FORD-TRK	111,76 MM STD	+0.18	+0.61			87-321500-00	PEUGEOT	80 MM STD	+0.77	+0.82	1.73mm gasket
87-202400-10	FORD-TRK	111,76 MM STD	+0.28	+0.58			87-321500-10	PEUGEOT	80 MM STD	+0.54	+0.77	1.61mm gasket
87-202400-30	FORD-TRK	111,76 MM STD	+0.28	+0.58			87-321500-10	PEUGEOT	80 MM STD	+0.77	+0.82	1.73mm gasket
87-202800-00	FORD-LKW	104,775 MM STD	-0.15	+0.40			87-322100-00	PERKINS	98,48 MM STD	+0.38	+0.53	
87-203500-00	FORDSON	100 MM STD	-0.700	+0.127			87-322700-00	PERKINS TRK	101.054 MM STD	+0.08	+0.25	
87-206800-00	IVECO	100 MM STD	+0.46	+0.79			87-325600-00	PERKINS LKW	100 MM STD	+0.382	+0.504	
87-207200-00	IVECO	95 MM STD	+0.46	+0.79			87-325800-00	FORD	73,7 MM STD	+0.618	+0.725	1.252mm gasket
87-207300-00	FORD PKW	93,67 MM STD	-0.114	+0.213			87-326300-00	PEUGEOT	92 MM STD	+0.64	+0.74	
87-207800-00	IVECO	137 MM STD	-0.27	+0.22			87-326500-00	PERKINS-LKW	100 MM STD	+0.382	+0.504	
87-207800-10	IVECO-LKW	137 MM STD	-0.275	+0.225			87-335000-00	RENAULT	78 MM STD	0.00	+0.885	1.65mm gasket
87-208100-10	FORD TRK	106,68 MM STD	-0.05	-0.15			87-335000-00	RENAULT	78 MM STD	+0.885	+0.985	1.75mm gasket
87-214800-10	FORD	107,21 MM STD	-0.15	+0.40			87-335000-00	RENAULT	78 MM STD	+0.985	+1.085	1.85mm gasket
87-214900-10	IVECO	115 MM STD	-0.29	+0.10			87-335000-10	RENAULT	78 MM STD	0.00	+0.885	1.65mm gasket
87-215500-00	FORD 80 MM STD		+0.43	+0.62	1 notch gasket		87-335000-10	RENAULT	78 MM STD	+0.885	+0.985	1.75mm gasket
87-215500-00	FORD 80 MM STD		+0.62	+0.68	2 notch gasket		87-335000-10	RENAULT	78 MM STD	+0.985	+1.085	1.85mm gasket
87-215500-00	FORD 80 MM STD		+0.68	+0.74	3 notch gasket		87-336500-00	RENAULT	80 MM STD	0.00	+0.87	1.65mm gasket
87-243300-00	IHC LKW	98,425 MM STD	+0.46	+0.77			87-336500-00	RENAULT	80 MM STD	+0.87	+1.00	1.75mm gasket
87-243600-00	IHC LKW	98,425 MM STD	-0.40	-0.55			87-336500-00	RENAULT	80 MM STD	+1.00	+...	1.85mm gasket
87-244500-10	IVECO	104 MM STD	+0.46	+0.79			87-336500-10	RENAULT	80 MM STD	+0.55	+0.65	1.40mm gasket
87-247800-00	IVECO	104 MM STD	+0.355	+0.761			87-336500-10	RENAULT	80 MM STD	+0.65	+0.75	1.50mm gasket
87-247800-10	IVECO	104 MM STD	+0.46	+0.79			87-336500-10	RENAULT	80 MM STD	+0.75	+0.85	1.60mm gasket
87-248000-10	ISUZU	93 MM STD	0.00	+0.70			87-335000-00	RENAULT	78 MM STD	0.00	+0.885	1.65mm gasket
87-252800-00	KHD	94 MM STD	+0.43	+0.64	1 notch gasket		87-335000-00	RENAULT	78 MM STD	+0.885	+0.985	1.75mm gasket
87-252800-00	KHD	94 MM STD	+0.64	+0.74	2 notch gasket		87-335000-00	RENAULT	78 MM STD	+0.985	+1.085	1.85mm gasket
87-252800-00	KHD	94 MM STD	+0.74	+0.84	3 notch gasket		87-335000-10	RENAULT	78 MM STD	0.00	+0.885	1.65mm gasket
87-274800-00	MAN	121 MM STD	+0.05	+0.35			87-335000-10	RENAULT	78 MM STD	+0.885	+0.985	1.75mm gasket
87-274800-10	MAN	121 MM STD	+0.05	+0.35			87-335000-10	RENAULT	78 MM STD	+0.985	+1.085	1.85mm gasket
87-274800-20	MAN	121 MM STD KH -0,20	+0.05	+0.35			87-336500-00	RENAULT	80 MM STD	0.00	+0.87	1.65mm gasket
87-274800-30	MAN	121 MM STD KH -0,40	+0.05	+0.35			87-336500-00	RENAULT	80 MM STD	+0.87	+1.00	1.75mm gasket
87-279600-10	MWM	105 MM STD	-0.28	-0.60			87-336500-00	RENAULT	80 MM STD	+1.00	+...	1.85mm gasket
87-280200-10	MAN	125 MM STD	0.00	+0.32			87-336500-10	RENAULT	80 MM STD	+0.55	+0.65	1.40mm gasket
87-283100-00	MAN	128 MM STD	+0.010	+0.038			87-336500-10	RENAULT	80 MM STD	+0.65	+0.75	1.50mm gasket
87-283100-30	MAN	128 MM STD	0.00	+0.20			87-336500-10	RENAULT	80 MM STD	+0.75	+0.85	1.60mm gasket
87-283100-80	MAN	128 MM STD	+0.01	+0.38			87-361900-00	STEYR	100 MM STD	+0.25	+0.28	
87-283100-85	MAN	128 MM STD KH 0,20 MM	+0.01	+0.38			87-373800-10	TOYOTA	92 MM STD	+0.68	+0.77	B gasket
87-283100-86	MAN	128 MM STD KH 0,40 MM	+0.01	+0.38			87-373800-10	TOYOTA	92 MM STD	+0.78	+0.87	D gasket
87-285900-20	MAN	108 MM STD	+0.15	+0.32			87-373800-10	TOYOTA	92 MM STD	+0.88	+0.97	F gasket
87-285900-40	MAN	108 MM STD	+0.15	+0.32			87-396300-00	VOLVO	120,65 MM STD	-0.50	+0.20	
87-288000-10	MINIBUSHI	91.10 MM STD	+0.55	+0.65			87-405600-60	VOLVO	130,18 MM STD	-0.50	+0.45	
87-288300-00	MINIBUSHI	104 MM STD	+0.60	+0.70			87-405600-70	VOLVO	130,18 MM STD	-0.05	+0.45	
87-288300-10	MINIBUSHI	104 MM STD	+0.60	+0.70			87-421000-10	VAG	81 MM STD	0.00	+0.75	
87-289300-10	M.BENZ-LKW	102 MM STD	+0.28	+0.50			87-421000-20	VAG	81 MM STD	0.00	+0.75	
87-289600-00	M.BENZ-LKW	130 MM STD	+0.27	+0.61			87-421900-00	M.BENZ-PKW	93,75 MM STD	+0.50	+0.90	
87-305900-00	OPEL	80 MM STD	0.00	+0.75	1.30mm gasket		87-424000-00	PEUGEOT	75 MM STD	+0.53	+0.63	1.25mm gasket
87-305900-00	OPEL	80 MM STD	+0.75	+0.85	1.40mm gasket		87-424000-00	PEUGEOT	75 MM STD	+0.63	+0.68	1.30mm gasket
87-305900-00	OPEL	80 MM STD	+0.85	+1.05	1.50mm gasket		87-424000-00	PEUGEOT	75 MM STD	+0.68	+0.73	1.35mm gasket
87-306700-10	OPEL	82,5 MM STD	0.00	+0.75	1.30mm gasket		87-424000-00	PEUGEOT	75 MM STD	+0.73	+0.78	1.40mm gasket
87-306700-10	OPEL	82,5 MM STD	+0.75	+0.85	1.40mm gasket		87-424000-00	PEUGEOT	75 MM STD	+0.78	+0.88	1.45mm gasket
87-306700-10	OPEL	82,5 MM STD	+0.85	+1.05	1.50mm gasket		87-425000-00	PERKINS-TRK	103 MM STD	+0.35	+0.55	1.70mm gasket

											
87-425400-00	PERKINS-TRK	103 MM STD	+0.35	+0.55	1.70mm gasket		87-990100-40	VAG 79,51 MM STD	+0.87	+0.90	2 notch gasket
87-426200-00	PERKINS-TRK	105 MM STD	+0.36	+0.50			87-990100-40	VAG 79,51 MM STD	+0.91	+1.02	3 notch gasket
87-427700-10	FORD-PKW	86,01 MM STD	+0.43	+0.52	1.10mm gasket		88-103200-00	KHD 91 MM STD	+0.59	+0.69	1 notch gasket
87-427700-10	FORD-PKW	86,01 MM STD	+0.52	+0.57	1.15mm gasket		88-103200-00	KHD 91 MM STD	+0.69	+0.76	2 notch gasket
87-427700-10	FORD-PKW	86,01 MM STD	+0.57	+0.62	1.20mm gasket		88-103200-00	KHD 91 MM STD	+0.76	+0.83	3 notch gasket
87-427700-30	FORD-PKW	86.01 MM STD	+0.43	+0.52	1.10mm gasket		88-104300-00	MAN 128 MM STD	+0.01	+0.33	
87-427700-30	FORD-PKW	86.01 MM STD	+0.52	+0.57	1.15mm gasket		88-136500-10	MAN 108 MM STD	+0.09	+0.39	
87-427700-30	FORD-PKW	86.01 MM STD	+0.57	+0.62	1.20mm gasket		88-141800-00	M.BENZ-LKW 128 MM STD	+0.22	+0.71	
87-431700-00	KIA	91 MM STD	+0.06	+0.24			88-152000-30	PEUGEOT 83 MM STD	+0.35	+0.54	1.49mm gasket
87-431800-00	KIA	94.545 MM STD	+0.30	+0.40			88-172500-00	KHD 100 MM STD	+1.00	+1.20	Together with gasket
87-431900-00	HYUNDAI	83 MM STD	+0.30	+0.39			88-174100-30	DAF 130 MM STD	0.25	+0.25	
87-432000-00	HYUNDAI	91.1 MM STD	+0.45	+0.60			88-176800-00	M.BENZ-LKW 125 MM STD	-0.07	+0.43	
87-501400-00	VOLVO	104,77 MM STD	+0.20	+0.70			88-179300-10	M.BENZ-LKW 128 MM STD	+0.17	+0.53	
87-520900-00	FORD	104,775 MM STD	+0.152	+0.380			88-181100-10	J.DEERE 106,5 MM STD	+0.10	+0.30	
87-521100-00	NISSAN	93 MM STD	+0.11	+0.16			88-181100-20	J.DEERE 106,5 MM STD	+0.14	+0.20	
87-521200-00	MITSUBISHI	91.10 MM STD	+0.65	+0.90			88-181700-00	M.BENZ-LKW 128 MM STD	+0.17	+0.53	
87-521400-00	FORD-TRK	111,76 MM STD	0.00	+0.50			88-181800-00	J.DEERE 102 MM STD	-0.07	0.00	
87-521800-20	LAND ROVER	90.47 MM STD	+0.50	+0.60	1 notch gasket		88-181800-10	J.DEERE 102 MM STD	-0.07	0.00	
87-521800-20	LAND ROVER	90.47 MM STD	+0.61	+0.70	2 notch gasket		88-203500-00	FORD LKW 100 MM STD	+0.700	+0.127	
87-521800-20	LAND ROVER	90.47 MM STD	+0.71	+0.80	3 notch gasket		88-243300-00	IHC LKW 98,425 MM STD	+0.45	+0.77	
87-525300-00	BMC	98 MM STD	0.00	+0.20			88-243600-00	IHC LKW 98,425 MM STD	-0.40	-0.55	
87-714400-00	LAND ROVER	90.47 MM STD	+0.10	+0.15	1.10mm Gasket		88-252800-00	KHD 94 MM STD	+0.43	+0.64	1 notch gasket
87-714800-20	KHD	100 MM STD	+1.00	+1.20	Together with gasket		88-274800-00	MAN 121 MM STD	+0.05	+0.35	
87-740000-20	M.BENZ-LKW	97,5 MM STD	+0.38	+0.62			88-743400-10	DAF 130 MM STD	0.00	+0.25	
87-740000-40	MERCEDES	97.5 MM STD	+0.38	+0.62			88-743400-30	DAF 130 MM STD	0.00	+0.25	
87-740000-50	MERCEDES	97.5 MM STD	+0.38	+0.62			88-960900-00	SCANIA 115 MM STD	+0.07	+0.50	
87-740300-00	KHD	125 MM STD	+1.15	+1.30	Together with gasket		89-124500-00	MAN 128 MM STD	+0.10	+0.33	
87-740300-10	KHD	125 MM STD	+1.15	+1.30	Together with gasket		89-143800-00	MAN 128 MM STD	+0.01	+0.33	
87-741800-00	KHD	100 MM STD	+1.00	+1.20	Together with gasket		89-143800-10	MAN 128 MM STD KH: 0,20MM	+0.01	+0.33	
87-741800-20	KHD	100 MM STD	+1.00	+1.20	Together with gasket		89-143800-20	MAN 128 MM STD KH: 0,40MM	+0.01	+0.33	
87-743100-00	M.BENZ	89 MM STD	+0.83	+1.06			89-143800-30	MAN 128 MM STD	+0.01	+0.33	
87-743100-10	M.BENZ	89 MM STD	+0.84	+1.06	1.80mm gasket		89-179300-05	M.BENZ-LKW 128 MM STD	-0.07	+0.43	
87-743100-10	M.BENZ	89 MM STD	+1.03	+1.06	2.00mm gasket		89-179300-15	M.BENZ-LKW 128 MM STD	+0.17	+0.53	
87-743100-30	M.BENZ	89 MM STD	+0.73	+0.97			89-179300-18	M.BENZ-LKW 128 MM STD	+0.17	+0.53	
87-743100-40	M.BENZ	89 MM STD	+0.83	+1.06	1.74mm gasket		89-179300-60	M.BENZ LKW 128 MM STD	+0.17	+0.53	
87-743100-40	M.BENZ	89 MM STD	+1.03	+1.26	1.97mm gasket		89-179300-65	M.BENZ-LKW 128 MM STD	-0.10	+0.32	
87-743200-00	M.BENZ-LKW	130 MM STD	+0.07	+0.43			89-179300-66	M.BENZ-LKW 128 MM STD	-0.10	+0.32	
87-743400-10	DAF	130 MM STD	0.00	+0.25			89-179300-70	M.BENZ-LKW 128 MM STD	-0.07	+0.43	
87-743400-30	DAF	130 MM STD	0.00	+0.25			89-179300-71	M.BENZ-LKW 128 MM STD	-0.07	+0.43	
87-743400-40	DAF	130 MM STD	0.00	+0.25			89-179300-80	M.BENZ-LKW 128 MM STD	+0.07	+0.43	
87-743400-50	DAF	130 MM STD	0.00	+0.25			89-179300-85	M.BENZ-LKW 128 MM STD	+0.17	+0.53	
87-743600-10	M.BENZ	87,00 MM STD	+0.735	+0.965			89-179300-86	M.BENZ-LKW 128 MM STD	+0.17	+0.53	
87-744600-00	KHD	100 MM STD	+1.00	+1.20	Together with gasket		89-181700-00	M.BENZ-LKW 128 MM STD	+0.17	+0.53	
87-781900-10	FIAT	100 MM STD	+0.365	+0.761			89-181700-60	M.BENZ-LKW 128 MM STD	+0.17	+0.53	
87-781900-30	IVECO	100 MM STD	+0.365	+0.761			89-289600-00	M.BENZ-LKW 130 MM STD	+0.27	+0.61	
87-782000-00	IVECO-TRK	103 MM STD	+0.465	+0.785			89-243300-10	IHC LKW 98,425 MM STD	+0.45	+0.77	
87-782900-00	FORD	107,21 MM STD	+0.152	+0.380			89-243600-10	IHC LKW 98,425 MM STD	-0.40	-0.55	
87-783000-30	IVECO	137 MM STD	-0.27	+0.22			89-280200-10	MAN 125 MM STD	0.00	+0.32	
87-784800-00	FORD	93,67 MM STD	+0.30	+0.40			89-283100-00	MAN 128 MM STD	+0.010	+0.038	
87-784800-10	FORD	93,67 MM STD	+0.35	+0.45			89-283100-30	MAN 128 MM STD	0.00	+0.20	
87-854700-00	IVECO	94,4 MM STD	+0.40	+0.50	1.20mm gasket		89-283100-80	MAN 128 MM STD	+0.01	+0.33	
87-854700-00	IVECO	94,4 MM STD	+0.51	+0.60	1.30mm gasket		89-283100-85	MAN 128 MM STD KH:0,20MM	+0.01	+0.33	
87-854700-00	IVECO	94,4 MM STD	+0.61	+0.70	1.40mm gasket		89-283100-86	MAN 128 MM STD KH:0,40MM	+0.01	+0.33	
87-854700-00	IVECO	94,4 MM STD	+0.71	+0.80	1.50mm gasket		89-289600-30	M.BENZ-LKW 130 MM STD	+0.27	+0.61	
87-960900-00	SCANIA	115 MM STD	+0.07	+0.50			89-396300-00	VOLVO 120,65 MM STD	-0.50	+0.20	
87-962000-10	SCANIA	127 MM STD	+0.95	+1.35	Together with gasket		89-405600-00	VOLVO 130,18 MM STD	-0.50	+0.45	
87-962000-40	SCANIA	127 MM STD	+0.95	+1.35	Together with gasket		89-405600-60	VOLVO 130,18 MM STD	-0.50	+0.45	
87-990100-10	AUDI	79,5 MM STD	+0.66	+0.86	1 notch gasket		89-405600-70	VOLVO-LKW 130,18 MM STD	-0.05	+0.45	
87-990100-10	AUDI	79,5 MM STD	+0.87	+0.90	2 notch gasket		89-405600-80	VOLVO-LKW 130,18 MM STD	-0.05	+0.45	
87-990100-10	AUDI	79,5 MM STD	+0.91	+1.02	3 notch gasket		89-743200-00	M.BENZ-LKW 130 MM STD	+0.07	+0.43	
87-990100-40	VAG	79,51 MM STD	+0.66	+0.86	1 notch gasket		89-960900-00	SCANIA 115 MM STD	+0.07	+0.50	
							89-962000-10	SCANIA 127 MM STD	+0.95	+1.35	Together with gasket



CHECK OUT OUR CATALOGUES



CATAE902 - Belts and Timing Belt kits

CATAE130I - Valves and Components

CATAE150I - Camshaft, Kits and Components

CATPA110I - Gaskets, Oil Seals and Cylinder Headbolts

CATPA120I - Cylinder Headbolts

CATPA140I - Gaskets, Oil Seals and Cylinder Headbolts



CATGY160I
Engine Bearings



CATGT140I
Piston Rings



CATGT150I
Liners



Combined E&S catalogues per vehicle makes:

CATMX130I - Audi / Seat / Skoda / Volkswagen

CATMX140I - PSA Renault

CATMX1403 - BMW / Mini / Mercedes-Benz / Smart / Porsche

CATMX150I - Alfa / Fiat / Lancia / Iveco

CATMX160I - Ford - Jaguar - Land Rover - Opel - Saab

Visit www.fmmotorparts.eu
Online catalogue website. Available 24/7

You can obtain these catalogues through your Federal-Mogul sales representative
or through your local distributor

Federal-Mogul Global Aftermarket EMEA bvba

Prins Boudewijnlaan 5 • B-2550 Kontich • Belgium

Central Distribution Centre

Prins Boudewijnlaan 7 • B-2550 Kontich • Belgium

Phone +32 (0) 3450 83 10 • Fax +32 (0) 3450 83 38

Federal-Mogul Italy Srl**Aftermarket Division**

Via Enrico Fermi 8 • 37135 Verona • Italy

Phone +39 045 828 13 11 • Fax +39 045 828 14 00

Federal-Mogul Germany GmbH

Albert-Ruprecht-Strasse 2 • 71636 Ludwigsburg • Germany

Phone +49 (0) 7141-64865-8230 • Fax +49 (0) 7141-64865-8390

Federal-Mogul Aftermarket UK Limited

Greyhound Drive • Bradford BD7 1NQ • England

Phone +44 (0) 1274 723481 • Fax: +44 (0) 1274 848282

Federal-Mogul Ibérica, S.L.**Federal-Mogul Aftermarket España, S.A.**

Calle Alcarria, nº 2 • 28823 Coslada • Madrid • Spain

Phone: + 34 91 746 1900 • Fax: + 34 91 746 18 90

Federal-Mogul Aftermarket France

60-62, rue Danjou • 92517 Boulogne-Billancourt Cedex • France

Phone +33 (0) 1 46 94 27 00 • Fax +33 (0) 1 46 94 27 01

Service Commande de stock :

Phone +33 (0) 810 000 029 • Fax +32 34 50 80 26

Service Commande express :

Phone +33 (0) 810 000 029 • Fax +32 34 50 80 26

Federal-Mogul Aftermarket**Southern Africa (PTY) Ltd**

33 Western Boulevard • City West • Johannesburg • South Africa

Phone +27 11 630 3000 • Fax +27 11 630 3040

Federal-Mogul Aftermarket Turkey

Meclis-i Mebusan Cad. No: 53 Dereli İş Merkezi 34427 • Fındıklı / İstanbul • Türkiye

Phone +90 212 292 6313 • Fax +90 212 292 6260

Federal-Mogul Aftermarket Russia Ltd

Smolnaya street 24D, 13th floor • 125445 Moscow • Russia

Phone +7 495 221 50 60 • Fax +7 495 221 50 64



