

# Land Rover

Spare parts for passenger cars



DRIVER'S BEST FRIEND

**MEYLE**

## Sophisticated technology - considerably longer service life.



The MEYLE range of products features a wide variety of components. Spare parts from A to Z, from Alfa Romeo to Volvo, from minicars to top-of-the-range luxury models.



### Steering & suspension

Control arms, Stabilizer links, Tie rod assemblies, and many more



### Brakes

Brake discs, MEYLE PD, Brake pad sets, Brake drums, and many more



### Drive components

C.V. joint kits, Wheel bearings, Belt drives, and many more



### Damping parts

Shock absorbers, Strut mounts, Coil springs, and many more



### Filters

Oil filters, Air filters, Cabin air filters, Fuel filters, and many more



### Cooling components

Water pumps, Expansion tanks, Radiator hoses, and many more



### Rubber-to-metal parts

Flex discs, Cardan shaft bearings, Engine mounts, and many more



### Electrics and sensors

Crank position sensor, Control units, Glow plugs, and many more



### Engine and transmission parts

Oil change kits, V-ribbed belts, Idlers/guide pulleys, and many more



### Fluids

Coolant additives, Hydraulic oil, Engine oil, and many more



### Complementary product range

Wiper blades, Gas springs, Window lifters, and many more

# ORIGINAL, PD and HD – The MEYLE product lines



## **MEYLE-ORIGINAL: Fit as snugly as the original.**

More than 21,000 spare parts for passenger cars, vans and trucks, quality-tested, robust, durable and tried and tested a thousand times over on the roads across the world – that's MEYLE-ORIGINAL. Relying on our comprehensive product portfolio – offering everything from A for axial joint to Z for zinc-coated screw – customers can be sure that they will always have safety on their side.

## **MEYLE-PD: Safety to the power of two.**

Thinking outside the box to make our products better: MEYLE-PD stands for brake discs and pads delivering maximum braking performance and setting new standards in terms of durability, comfort, aesthetics, and ease of installation. Look for the „/PD“ part number extension.

## **MEYLE-HD: Better than originals.**

MEYLE-HD parts simply last longer. Their technically optimised and reinforced designs make them more durable and reliable than OE components. So it is only natural for us to offer extended warranty protection for our MEYLE-HD parts: All parts of the HD range come with a full four-year guarantee. Look for the „/HD“ part number extension.



**4-year guarantee on all MEYLE-HD parts!**

Robust, high mileage, reliable and better than the original. MEYLE-HD parts simply last longer!

## Our three success factors.

### **The success of the MEYLE brand is based on competence, quality and service.**

The development of quality-approved automotive spare parts for the independent aftermarket is our trademark. And MEYLE-HD parts are our specialty: improved parts, developed by our team of engineers at our headquarters in Hamburg. We give a 4-year guarantee on our MEYLE-HD parts which have a far longer service life. Based on information from TÜV (Technical control board), from recall statistics as well as media and market information from workshops and other technical partners, MEYLE engineers identify parts in vehicles which become conspicuous on account of frequent, early wear. On the basis of their findings, they develop technical improvements for the respective weakness. In the end, this work is a

large benefit for all MEYLE parts. Something all reputable automotive manufacturers highly appreciate: MEYLE also develops customized products, for example for Morgan, the legendary sports car manufacturer.

Passing on our know-how to staff and customers is just as much a part of our service as high parts availability and swift delivery. Modern warehouse logistics with space covering 29,000 m<sup>2</sup> and 56,000 pallet places ensure the reliable supply of our partners.

We have now won the "Top Job Employer" award for the fifth time which confirms our outstanding internal business approach and excellent Human Resources policy. We have been one of Germany's leading SME employers for many years.

# MEYLE

## Guarantee certificate



A distinguishing feature of MEYLE is our high level of precision, achieved by the application of the most modern manufacturing methods. Our MEYLE articles meet highest quality standards and our supply plants are certified in accordance with ISO 9001:2008 and ISO/TS 16949.

We guarantee perfect material and faultless processing of all our MEYLE articles for a period of 24 months as of the date of installation. For MEYLE-HD articles, this guarantee applies for 48 months as of the date of installation.

Complementing this guarantee, we give an additional 100,000 miles (160,934 kilometres) performance guarantee against defects of material and workmanship for MEYLE passenger car water pumps purchased from 01 May 2016. The guarantee given for MEYLE passenger car water pumps terminates upon expiration of the guarantee period or the guaranteed mileage, whichever occurs later: if the guaranteed mileage has not been reached at the end of the guarantee period of 24 or 48 months respectively, the performance guarantee continues to be valid. Respectively, the guarantee period of 24 or 48 months continues to be valid also in any case where the guaranteed mileage was already exceeded.

During the guarantee period, we perform repair work on claimed MEYLE articles or provide a replacement. The MEYLE guarantee does not apply for normal wear and damage caused by inappropriate handling or inappropriate installation. The guarantee expires if the respective part is modified by third parties or via installation of parts from third parties, or if the part, or vehicle, is used in excess of the appropriate use and purpose. The MEYLE guarantee also expires if MEYLE instructions or vehicle manufacturer instructions, e.g. concerning maintenance and replacement intervals, are not observed. The guarantee only applies for MEYLE water pumps, if the cooling circuit has been flushed prior to installation of the MEYLE water pump. Rights granted by law continue to apply unrestrictedly, irrespective of this guarantee.

The customer must submit a written guarantee claim immediately, or at the latest 30 days after identifying an error in material or processing. This claim is to be submitted to the dealer from which he acquired the MEYLE article part. The customer should return the article, carefully packed. He must enclose the original sales receipt and a description of the error. The customer must also verify the date of installation and the mileage of the vehicle by means of respective documents.

Last amended January 2017

A handwritten signature in white ink, appearing to read 'M. Wunder', set against a dark blue background.

Director Quality Assurance  
Manfred Wunder



## Body/Cabin

1

### Body, Interior fittings

Cabin air filter  
Wiper Blade

## Brakes

6

### Disc brake, Drum brake

|               |                                 |
|---------------|---------------------------------|
| Brake disc    | Brake shoe set, parking brake   |
| Brake pad set | Guide sleeve kit, brake caliper |

## Drive train/Transmission

26

### Drive shafts, Joints, Transmission

|                      |                           |   |
|----------------------|---------------------------|---|
| A/T oil pan          | Drive shaft               | Joint, propeller shaft                  |
| Boot kit, C.V. joint | Hydraulic filter kit, A/T | Parts kit, automatic transm. oil change |
| C.V. joint kit       |                           |   |

## Electrics

31

### Brakes, Engine

|                  |                           |                      |
|------------------|---------------------------|----------------------|
| ABS wheel sensor | Ignition coil             | Spark plug connector |
| Glow plug        | Sensor, camshaft position | Wear sensor          |

## Engine/Cooling/Clutch

44

### Belt drive / Engine control, Cooling system, Crankshaft drive, Fuel system, Lubrication system

|                |                               |                    |
|----------------|-------------------------------|--------------------|
| Air filter     | Oil filter                    | Timing belt roller |
| Breather valve | Oil pressure switch           | V-ribbed belt      |
| Expansion tank | Oil trap                      | Water pump         |
| Fuel filter    | Tensioner pulley, timing belt |                    |

## Steering

69

### Hydraulics, Mounting parts, Tie rod assemblies

|                     |                   |             |
|---------------------|-------------------|-------------|
| Axial rod           | P/S hose          | Tie rod end |
| Hydraulic pump, P/S | Steering boot kit |             |

## Suspension

81

### Control arms, Stabilizer, Suspension / damping, Wheel hubs / Wheel bearings

|                                |                    |                   |
|--------------------------------|--------------------|-------------------|
| Ball joint                     | Mount, control arm | Wheel bearing kit |
| Control arm                    | Mount, stabilizer  | Wheel hub         |
| Control arm bushing            | Shock absorber     |                   |
| Dust cover kit, shock absorber | Stabilizer link    |                   |







### Wiper Blade

029 330 1300 | MBL0008

#### Notes

Observe service information  
Length [in]  
Length [mm]

Flat wiper blade  
Flat bar wiper blade  
13  
330  
Front



#### Application info

90/110 (09/83-07/90)

### Wiper Blade

029 350 1410 | MBL0014

#### Notes

Length [in]  
Length [mm]

Bracket wiper blade  
Beam wiper blade  
14  
350  
Rear



#### Application info

Discovery II (11/98-06/04)

### Wiper Blade

029 425 1710 | MBL0061

#### Notes

Length [in]  
Length [mm]

Bracket wiper blade  
Beam wiper blade  
17  
425  
Rear



#### Application info

Range Rover I (07/70-07/94)

029 450 1800 | MBL0027

Wiper Blade



Notes

Observe service information  
Length [in]  
Length [mm]

Flat wiper blade  
Flat bar wiper blade  
18  
450  
Front

Application info

Discovery I [10/89-10/98]

Range Rover I [07/70-07/94]

029 475 1900 | MBL0028

Wiper Blade



Notes

Observe service information  
Length [in]  
Length [mm]

Flat bar wiper blade  
Flat wiper blade  
19  
475  
Front

Application info

Freelander II [10/06--]

029 500 2000 | MBL0029

Wiper Blade



Notes

Observe service information  
Length [in]  
Length [mm]

Flat bar wiper blade  
Flat wiper blade  
20  
500  
Front

Application info

Freelander I [02/98-10/06]

**Wiper Blade**

**029 530 2100 | MBL0030**

**Notes**

Observe service information  
Length [in]  
Length [mm]

Flat bar wiper blade  
Flat wiper blade  
21  
530  
Front



**Application info**

Discovery III (07/04-09/09)  
Discovery IV (09/09--)  
Range Rover Evoque (06/11--)

Range Rover II (07/94-03/02)  
Range Rover Sport (02/05--)

**Wiper Blade**

**029 550 2200 | MBL0032**

**Notes**

Observe service information  
Length [in]  
Length [mm]

Flat bar wiper blade  
Flat wiper blade  
22  
550  
Front



**Application info**

Discovery III (07/04-09/09)  
Discovery IV (09/09--)  
Freelander I (02/98-10/06)

Range Rover II (07/94-03/02)  
Range Rover Sport (02/05--)

**Wiper Blade**

**029 600 2400 | MBL0034**

**Notes**

Observe service information  
Length [in]  
Length [mm]

Flat bar wiper blade  
Flat wiper blade  
24  
600  
Front



**Application info**

Freelander II (10/06--)

Range Rover Evoque (06/11--)

512 320 0006 | MCF0378

Cabin air filter



Notes

Height [mm] 34  
Width [mm] 194  
Length [mm] 275  
Filter Insert  
Activated Carbon Filter

References

6G9N19N619BA LR019589  
LR000901

Application info

Freelander II [10/06--]

Range Rover Evoque [06/11--]

53-12 319 0002 | MCF0380

Cabin air filter

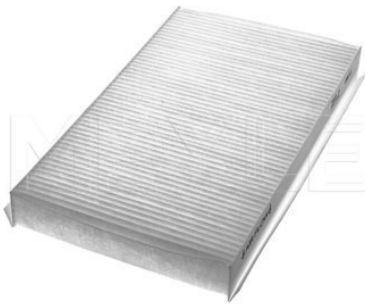

Notes

Height [mm] 30  
Width [mm] 158  
Length [mm] 270  
Filter Insert  
Particulate Filter

References

JKR500010

Application info

Discovery III [07/04-09/09]  
Discovery IV [09/09--]

Range Rover III [03/02-08/12]  
Range Rover Sport [02/05--]

53-12 320 0002 | MCF0381

Cabin air filter



Notes

Height [mm] 30  
Width [mm] 158  
Length [mm] 270  
Filter Insert  
Activated Carbon Filter

References

JKR500020

Application info

Discovery III [07/04-09/09]  
Discovery IV [09/09--]

Range Rover III [03/02-08/12]  
Range Rover Sport [02/05--]

**Cabin air filter**

**312 320 0013 | MCF0257**

**Notes**

Height [mm] 30  
 Width [mm] 256  
 Length [mm] 541  
 Filter Insert  
 Activated Carbon Filter

**References**

JM0000010



**Application info**

Range Rover III (03/02-08/12)

**Cabin air filter**

**512 320 0005 | MCF0377**

**Notes**

Height [mm] 35  
 Width [mm] 196  
 Length [mm] 272  
 Filter Insert  
 Particulate Filter

**References**

6G9N180543BA LR019192  
 LR008899 LR039612



**Application info**

Freelander II (10/06--)

Range Rover Evoque (06/11--)

**Cabin air filter**

**30-12 320 0006 | MCF0216**

**Notes**

Height [mm] 30  
 Width [mm] 194  
 Length [mm] 215  
 Filter Insert  
 Activated Carbon Filter

**References**

LR036369

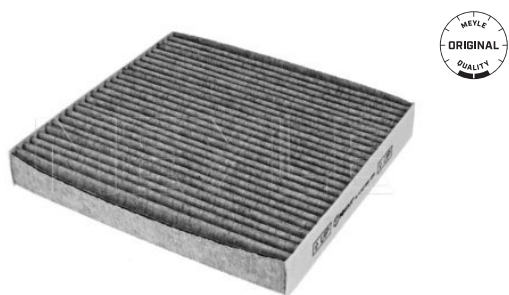

**Application info**

Range Rover IV (08/12--)

Range Rover Sport (LW) (04/13--)

53-15 521 0014/PD | MBD2105PD

Brake disc



Notes

|                           |                   |
|---------------------------|-------------------|
| Wheel Bolt Bore Ø [mm]    | 12.6              |
|                           | Zink flake coated |
|                           | Solid             |
| Centering Diameter [mm]   | 66                |
| Minimum thickness [mm]    | 11                |
| Outer diameter [mm]       | 262               |
| Height [mm]               | 51                |
| Bolt Hole Circle Ø [mm]   | 114               |
| Brake Disc Thickness [mm] | 14                |
| Required quantity         | 2                 |
| Number of Holes           | 5                 |
|                           | Front Axle        |

References

|         |           |
|---------|-----------|
| ANR4983 | SDB100830 |
|---------|-----------|

Application info

Freelander I (02/98-10/06)

45-15 521 0002/PD | MBD1133PD

Brake disc



Notes

|                           |                               |
|---------------------------|-------------------------------|
| Wheel Bolt Bore Ø [mm]    | 10                            |
|                           | Chrome-(VI)- free passivation |
|                           | Solid                         |
| Centering Diameter [mm]   | 101.6                         |
| Minimum thickness [mm]    | 13                            |
| Outer diameter [mm]       | 298.5                         |
| Height [mm]               | 70                            |
| Bolt Hole Circle Ø [mm]   | 127                           |
| Brake Disc Thickness [mm] | 14                            |
| Required quantity         | 2                             |
| Number of Holes           | 5                             |
|                           | Front Axle                    |

References

|          |          |
|----------|----------|
| 571762   | LR017951 |
| FRC 7329 |          |

Application info

90/110 (09/83-07/90)  
Defender (09/90-09/03)

Discovery I (10/89-10/98)



### Brake disc

### 45-15 521 0004/PD | MBD1135PD

#### Notes

|                           |                               |
|---------------------------|-------------------------------|
|                           | Chrome-(VI)- free passivation |
|                           | Vented                        |
| Centering Diameter [mm]   | 101.6                         |
| Minimum thickness [mm]    | 22                            |
| Outer diameter [mm]       | 298.5                         |
| Height [mm]               | 70                            |
| Bolt Hole Circle Ø [mm]   | 127                           |
| Brake Disc Thickness [mm] | 24                            |
| Required quantity         | 2                             |
| Number of Holes           | 5                             |
|                           | Front Axle                    |



#### References

|        |          |
|--------|----------|
| FTC902 | LR017952 |
|--------|----------|

#### Application info

Defender (09/90-09/03)

Discovery I (10/89-10/98)

### Brake disc

### 583 521 0004/PD | MBD1654PD

#### Notes

|                           |                   |
|---------------------------|-------------------|
| Wheel Bolt Bore Ø [mm]    | 16                |
|                           | Zink flake coated |
|                           | High-carbon       |
|                           | Vented            |
| Centering Diameter [mm]   | 63.5              |
| Minimum thickness [mm]    | 26                |
| Outer diameter [mm]       | 316               |
| Height [mm]               | 52                |
| Bolt Hole Circle Ø [mm]   | 108               |
| Brake Disc Thickness [mm] | 28                |
| Required quantity         | 2                 |
| Number of Holes           | 5                 |
|                           | Front Axle        |



#### References

|          |          |
|----------|----------|
| LR000470 | LR027107 |
|----------|----------|

#### Application info

Freelander II (10/06--)

2

53-15 523 0013/PD | MBD2032PD

Brake disc



Notes

|                           |                   |
|---------------------------|-------------------|
| Wheel Bolt Bore Ø [mm]    | 15.7              |
|                           | Zink flake coated |
|                           | Solid             |
| Centering Diameter [mm]   | 63.5              |
| Minimum thickness [mm]    | 10                |
| Outer diameter [mm]       | 302               |
| Height [mm]               | 66                |
| Bolt Hole Circle Ø [mm]   | 108               |
| Brake Disc Thickness [mm] | 12                |
| Required quantity         | 2                 |
| Number of Holes           | 5                 |
|                           | Rear Axle         |

References

LR001018

Application info

Freelander II [10/06--]

53-15 523 0004/PD | MBD1196PD

Brake disc



Notes

|                           |                               |
|---------------------------|-------------------------------|
|                           | Chrome-(VI)- free passivation |
|                           | Vented                        |
| Centering Diameter [mm]   | 63.5                          |
| Minimum thickness [mm]    | 18                            |
| Outer diameter [mm]       | 302                           |
| Height [mm]               | 66                            |
| Bolt Hole Circle Ø [mm]   | 108                           |
| Brake Disc Thickness [mm] | 20                            |
| Required quantity         | 2                             |
| Number of Holes           | 5                             |
|                           | Rear Axle                     |

References

LR001019

Application info

Freelander II [10/06--]



### Brake disc

783 521 0026/PD | MBD1657PD

#### Notes

|                           |                   |
|---------------------------|-------------------|
| Wheel Bolt Bore Ø [mm]    | 15.9              |
|                           | Zink flake coated |
|                           | High-carbon       |
|                           | Vented            |
| Centering Diameter [mm]   | 63.5              |
| Minimum thickness [mm]    | 26                |
| Outer diameter [mm]       | 300               |
| Height [mm]               | 52                |
| Bolt Hole Circle Ø [mm]   | 108               |
| Brake Disc Thickness [mm] | 28                |
| Required quantity         | 2                 |
| Number of Holes           | 5                 |
|                           | Front Axle        |



#### References

|          |          |
|----------|----------|
| LR000571 | LR007055 |
|----------|----------|

#### Application info

Discovery Sport (09/14--)  
Freelander II (10/06--)

Range Rover Evoque (06/11--)  
Range Rover Evoque II (11/15--)

### Brake disc

53-15 523 0014/PD | MBD2033PD

#### Notes

|                           |                   |
|---------------------------|-------------------|
|                           | Zink flake coated |
|                           | Vented            |
| Centering Diameter [mm]   | 79                |
| Minimum thickness [mm]    | 17                |
| Outer diameter [mm]       | 365               |
| Height [mm]               | 58.9              |
| Bolt Hole Circle Ø [mm]   | 120               |
| Brake Disc Thickness [mm] | 20                |
| Required quantity         | 2                 |
| Number of Holes           | 5                 |
|                           | Rear Axle         |



#### References

|          |
|----------|
| LR016192 |
|----------|

#### Application info

Range Rover Sport (02/05--)

45-15 523 0003/PD | MBD1138PD

Brake disc



Notes

|                           |                   |
|---------------------------|-------------------|
| Wheel Bolt Bore Ø [mm]    | 10                |
|                           | Zink flake coated |
|                           | Solid             |
| Centering Diameter [mm]   | 101.6             |
| Minimum thickness [mm]    | 11.7              |
| Outer diameter [mm]       | 290               |
| Height [mm]               | 61.5              |
| Bolt Hole Circle Ø [mm]   | 127               |
| Brake Disc Thickness [mm] | 12.5              |
| Required quantity         | 2                 |
| Number of Holes           | 5                 |
|                           | Rear Axle         |

References

|         |           |
|---------|-----------|
| 571912  | LR017953  |
| FRC9831 | LR018026  |
| FTC1381 | SDB000330 |
| FTC3846 | SDB100980 |
| FTC461  |           |

Application info

Defender (09/90-09/03)

Discovery I (10/89-10/98)

715 523 0021/PD | MBD2068PD

Brake disc



Notes

|                           |                   |
|---------------------------|-------------------|
| Wheel Bolt Bore Ø [mm]    | 15.8              |
|                           | Zink flake coated |
|                           | Solid             |
| Centering Diameter [mm]   | 63.5              |
| Minimum thickness [mm]    | 9                 |
| Outer diameter [mm]       | 302               |
| Height [mm]               | 50.8              |
| Bolt Hole Circle Ø [mm]   | 108               |
| Brake Disc Thickness [mm] | 10.9              |
| Required quantity         | 2                 |
| Number of Holes           | 5                 |
|                           | Rear Axle         |

References

LR027123

Application info

Range Rover Evoque (06/11--)

Range Rover Evoque II (11/15--)



### Brake disc

53-83 523 0015/PD | MBD2035PD

#### Notes

|                           |                 |
|---------------------------|-----------------|
|                           | UV paint coated |
|                           | High-carbon     |
|                           | Solid           |
| Centering Diameter [mm]   | 63.6            |
| Minimum thickness [mm]    | 9               |
| Outer diameter [mm]       | 302             |
| Height [mm]               | 64.2            |
| Bolt Hole Circle Ø [mm]   | 108             |
| Brake Disc Thickness [mm] | 11              |
| Required quantity         | 2               |
| Number of Holes           | 5               |
|                           | Rear Axle       |



#### References

LR039935

#### Application info

Freelander II [10/06--]

### Brake disc

45-15 521 0005/PD | MBD1136PD

#### Notes

|                           |                               |
|---------------------------|-------------------------------|
|                           | Chrome-(VI)- free passivation |
|                           | Vented                        |
| Centering Diameter [mm]   | 70                            |
| Minimum thickness [mm]    | 22                            |
| Outer diameter [mm]       | 297                           |
| Height [mm]               | 64.7                          |
| Bolt Hole Circle Ø [mm]   | 120                           |
| Brake Disc Thickness [mm] | 25                            |
| Required quantity         | 2                             |
| Number of Holes           | 5                             |
|                           | Front Axle                    |



#### References

NTC 8780

#### Application info

Range Rover II [07/94-03/02]

45-15 523 0006/PD | MBD1139PD

Brake disc



Notes

|                           |                               |
|---------------------------|-------------------------------|
| Wheel Bolt Bore Ø [mm]    | 14.3                          |
|                           | Chrome-(VI)- free passivation |
|                           | Solid                         |
| Centering Diameter [mm]   | 70                            |
| Minimum thickness [mm]    | 11.7                          |
| Outer diameter [mm]       | 304                           |
| Height [mm]               | 62.8                          |
| Bolt Hole Circle Ø [mm]   | 120                           |
| Brake Disc Thickness [mm] | 12.6                          |
| Required quantity         | 2                             |
| Number of Holes           | 5                             |
|                           | Rear Axle                     |

References

|           |           |
|-----------|-----------|
| NTC 8781  | SDB000470 |
| SDB000210 |           |

Application info

Discovery II [11/98-06/04]  
Range Rover II [07/94-03/02]

Range Rover III [03/02-08/12]

53-15 521 0012/PD | MBD2028PD

Brake disc



Notes

|                           |                   |
|---------------------------|-------------------|
| Wheel Bolt Bore Ø [mm]    | 16.6              |
|                           | Zink flake coated |
|                           | Vented            |
| Centering Diameter [mm]   | 79                |
| Minimum thickness [mm]    | 28.4              |
| Outer diameter [mm]       | 344               |
| Height [mm]               | 75.9              |
| Bolt Hole Circle Ø [mm]   | 120               |
| Brake Disc Thickness [mm] | 29.9              |
| Required quantity         | 2                 |
| Number of Holes           | 5                 |
|                           | Front Axle        |

References

|           |           |
|-----------|-----------|
| SDB000200 | SDB000201 |
|-----------|-----------|

Application info

Range Rover III [03/02-08/12]



### Brake disc

53-15 521 0013/PD | MBD2029PD

#### Notes

|                           |                   |
|---------------------------|-------------------|
| Wheel Bolt Bore Ø [mm]    | 15                |
|                           | Zink flake coated |
|                           | Vented            |
| Centering Diameter [mm]   | 79                |
| Minimum thickness [mm]    | 27                |
| Outer diameter [mm]       | 317               |
| Height [mm]               | 62                |
| Bolt Hole Circle Ø [mm]   | 120               |
| Brake Disc Thickness [mm] | 30                |
| Required quantity         | 2                 |
| Number of Holes           | 5                 |
|                           | Front Axle        |



#### References

|           |           |
|-----------|-----------|
| SDB000602 | SDB000604 |
| SDB000603 | SDB500120 |

#### Application info

Discovery III [07/04-09/09]  
Discovery IV [09/09--]

Range Rover Sport [02/05--]

### Brake disc

53-83 521 0005/PD | MBD1609PD

#### Notes

|                           |                   |
|---------------------------|-------------------|
| Wheel Bolt Bore Ø [mm]    | 15                |
|                           | Zink flake coated |
|                           | High-carbon       |
|                           | Vented            |
| Centering Diameter [mm]   | 79                |
| Minimum thickness [mm]    | 27                |
| Outer diameter [mm]       | 360               |
| Height [mm]               | 62                |
| Bolt Hole Circle Ø [mm]   | 120               |
| Brake Disc Thickness [mm] | 30                |
| Required quantity         | 2                 |
| Number of Holes           | 5                 |
|                           | Front Axle        |



#### References

|           |           |
|-----------|-----------|
| SDB000622 | SDB000624 |
| SDB000623 |           |

#### Application info

Discovery IV [09/09--]

Range Rover Sport [02/05--]

53-15 523 0011/PD | MBD2030PD

Brake disc



Notes

|                           |                   |
|---------------------------|-------------------|
| Wheel Bolt Bore Ø [mm]    | 15                |
|                           | Zink flake coated |
|                           | Vented            |
| Centering Diameter [mm]   | 79                |
| Minimum thickness [mm]    | 17                |
| Outer diameter [mm]       | 325               |
| Height [mm]               | 59                |
| Bolt Hole Circle Ø [mm]   | 120               |
| Brake Disc Thickness [mm] | 20                |
| Required quantity         | 2                 |
| Number of Holes           | 5                 |
|                           | Rear Axle         |

References

|           |           |
|-----------|-----------|
| SDB000634 | SDB000636 |
| SDB000635 |           |

Application info

Discovery III [07/04-09/09]  
Discovery IV [09/09--]

Range Rover Sport [02/05--]

53-15 523 0016/PD | MBD2034PD

Brake disc



Notes

|                           |                   |
|---------------------------|-------------------|
| Wheel Bolt Bore Ø [mm]    | 15                |
|                           | Zink flake coated |
|                           | Vented            |
| Centering Diameter [mm]   | 79                |
| Minimum thickness [mm]    | 17                |
| Outer diameter [mm]       | 350               |
| Height [mm]               | 59                |
| Bolt Hole Circle Ø [mm]   | 120               |
| Brake Disc Thickness [mm] | 20                |
| Required quantity         | 2                 |
| Number of Holes           | 5                 |
|                           | Rear Axle         |

References

|           |           |
|-----------|-----------|
| SDB000644 | SDB000646 |
| SDB000645 |           |

Application info

Discovery IV [09/09--]

Range Rover Sport [02/05--]



### Brake disc

53-15 521 0008/PD | MBD1189PD

#### Notes

|                           |            |
|---------------------------|------------|
|                           | Vented     |
| Centering Diameter [mm]   | 66.1       |
| Minimum thickness [mm]    | 18         |
| Outer diameter [mm]       | 277        |
| Height [mm]               | 51         |
| Bolt Hole Circle Ø [mm]   | 114.3      |
| Brake Disc Thickness [mm] | 21         |
| Required quantity         | 2          |
| Number of Holes           | 5          |
|                           | Front Axle |



#### References

|           |           |
|-----------|-----------|
| SDB000080 | SDB101070 |
|-----------|-----------|

#### Application info

Freelander I [02/98-10/06]

### Brake disc

53-83 521 0007/PD | MBD1611PD

#### Notes

|                           |                   |
|---------------------------|-------------------|
| Wheel Bolt Bore Ø [mm]    | 16.6              |
|                           | Zink flake coated |
|                           | High-carbon       |
|                           | Vented            |
| Centering Diameter [mm]   | 79                |
| Minimum thickness [mm]    | 27                |
| Outer diameter [mm]       | 360               |
| Height [mm]               | 81                |
| Bolt Hole Circle Ø [mm]   | 120               |
| Brake Disc Thickness [mm] | 30                |
| Required quantity         | 2                 |
| Number of Holes           | 5                 |
|                           | Front Axle        |



#### References

|           |           |
|-----------|-----------|
| LR031843  | SDB500193 |
| SDB500192 |           |

#### Application info

Range Rover III [03/02-08/12]

2

53-15 523 0012/PD | MBD2031PD

Brake disc



Notes

|                           |                   |
|---------------------------|-------------------|
| Wheel Bolt Bore Ø [mm]    | 16.7              |
|                           | Zink flake coated |
|                           | Vented            |
| Centering Diameter [mm]   | 79                |
| Minimum thickness [mm]    | 17                |
| Outer diameter [mm]       | 354               |
| Height [mm]               | 75                |
| Bolt Hole Circle Ø [mm]   | 120               |
| Brake Disc Thickness [mm] | 20                |
| Required quantity         | 2                 |
| Number of Holes           | 5                 |
|                           | Rear Axle         |

References

|           |           |
|-----------|-----------|
| LR017804  | S08500202 |
| LR031844  | S08500230 |
| S08500201 |           |

Application info

Range Rover III (03/02-08/12)

025 245 3715 | MBP0617

Brake pad set

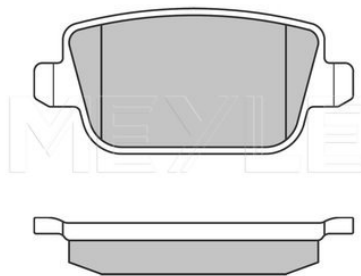

Notes

|                |                                 |
|----------------|---------------------------------|
|                | not prepared for wear indicator |
| Thickness [mm] | 15.8                            |
| Height [mm]    | 43.2                            |
| Width [mm]     | 95.1                            |
| Brake System   | TRW                             |
|                | with anti-squeak plate          |
|                | Rear Axle                       |

References

|          |          |
|----------|----------|
| LR003655 | LR023888 |
| LR003657 |          |

Application info

Freelander II (10/06--)



### Brake pad set

025 245 3715/PD | MBP0617PD

#### Notes

Quality  
Thickness [mm]  
Height [mm]  
Width [mm]  
Brake System

not prepared for wear indicator  
PREMIUM  
15.8  
43.2  
95.1  
TRW  
with anti-squeak plate  
Rear Axle

#### References

LR003655                      LR023888  
LR003657

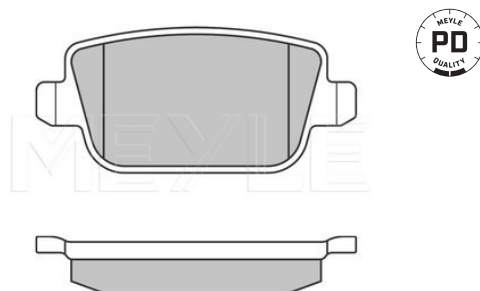

#### Application info

Freelander II [10/06--]

### Brake pad set

025 241 2319 | MBP0527

#### Notes

Thickness/Strength 2 [mm]  
Thickness/Strength 1 [mm]  
Height 2 [mm]  
Height 1 [mm]  
Width 2 [mm]  
Width 1 [mm]

not prepared for wear indicator  
20.3  
19.3  
66.6  
72  
155.1  
156.3  
with anti-squeak plate  
Front Axle

#### References

LR004936                      LR027309

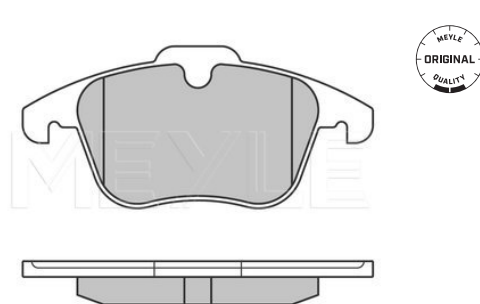

#### Application info

Discovery Sport [09/14--]  
Freelander II [10/06--]

Range Rover Evoque [06/11--]  
Range Rover Evoque II [11/15--]

2

025 241 2319/PD | MBP0527PD

Brake pad set

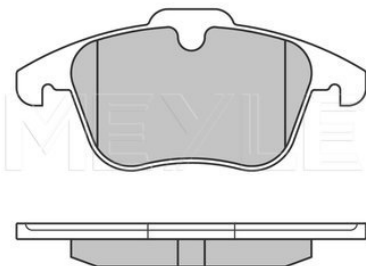

Notes

Quality  
Thickness/Strength 2 [mm]  
Thickness/Strength 1 [mm]  
Height 2 [mm]  
Height 1 [mm]  
Width 2 [mm]  
Width 1 [mm]

not prepared for wear indicator  
PREMIUM  
20.3  
19.3  
66.6  
72  
155.1  
156.3  
with anti-squeak plate  
Front Axle

References

LR004936

LR027309

Application info

Discovery Sport [09/14--]  
Freelander II [10/06--]

Range Rover Evoque [06/11--]  
Range Rover Evoque II [11/15--]

025 241 9217 | MBP1260

Brake pad set

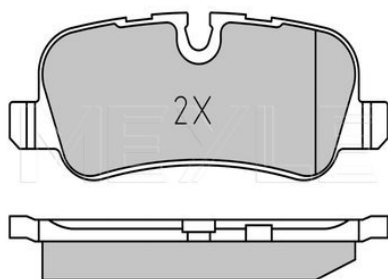

Notes

Thickness [mm]  
Height [mm]  
Width [mm]  
Brake System

with accessories  
prepared for wear indicator  
17.4  
46.5  
116.7  
TRW  
with screws  
with anti-squeak plate  
Rear Axle

References

LR015519  
LR016808  
LR019627  
LR021316  
LR032377  
LR055454

LR055455  
SFP500020  
SFP500021  
SFP500022  
SFP500040  
SFP500140

Application info

Discovery III [07/04-09/09]  
Discovery IV [09/09--]

Range Rover III [03/02-06/12]  
Range Rover Sport [02/05--]

**Brake pad set**

**025 241 9118 | MBP1259**

**Notes**

Thickness [mm] 18.2  
 Height [mm] 58.7  
 Width [mm] 162.6  
 Brake System TRW  
 with anti-squeak plate  
 Front Axle

**References**

LR019618 SFP500010

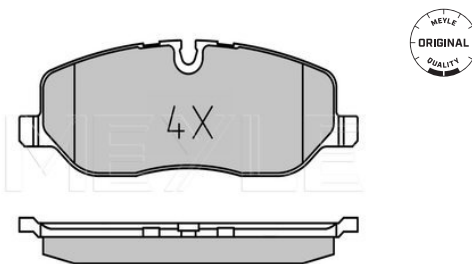

**Application info**

Discovery III (07/04-09/09)  
 Discovery IV (09/09--)

Range Rover III (03/02-08/12)  
 Range Rover Sport (02/05--)

**Brake pad set**

**025 246 5916 | MBP1673**

**Notes**

Thickness [mm] 16.2  
 Height [mm] 95  
 Width [mm] 189.6  
 Brake System BREMBO  
 with anti-squeak plate  
 Front Axle

**References**

LR016684 LR064181  
 LR020362

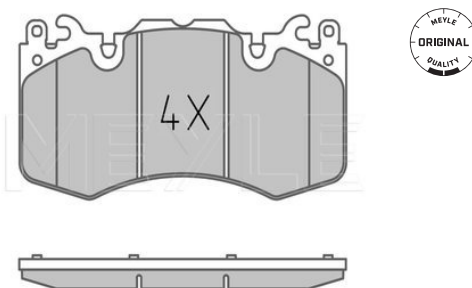

**Application info**

Range Rover III (03/02-08/12)  
 Range Rover IV (08/12--)

Range Rover Sport (02/05--)  
 Range Rover Sport (LW) (04/13--)

**Brake pad set**

**025 250 8517 | MBP1733**

**Notes**

Thickness [mm] 17  
 Height [mm] 63  
 Width [mm] 116.6  
 Brake System TRW  
 with anti-squeak plate

**References**

LR015577 LR025739



**Application info**

Range Rover III (03/02-08/12)

Range Rover Sport (02/05--)

025 257 2016 | MBP0849

Brake pad set

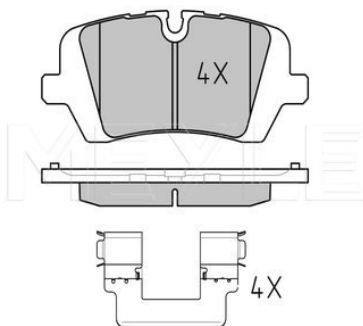

Notes

Thickness [mm]  
Height [mm]  
Width [mm]  
Brake System

with accessories  
prepared for wear indicator  
16.4  
58.4  
131.3  
TRW  
with anti-squeak plate  
Rear Axle

References

LR036574  
LR065492  
LR068303

LR079910  
LR079935

Application info

Range Rover IV (08/12--)

Range Rover Sport (LW) (04/13--)

025 250 2119 | MBP1659

Brake pad set



Notes

Thickness [mm]  
Height [mm]  
Width [mm]  
Brake System

prepared for wear indicator  
18.7  
72.2  
192.6  
TRW  
with anti-squeak plate  
Front Axle

References

LR016962  
LR021253  
LR026220  
LR026221

LR032063  
LR047859  
LR051626  
LR057725

Application info

Discovery IV (09/09--)  
Range Rover III (03/02-08/12)  
Range Rover IV (08/12--)

Range Rover Sport (02/05--)  
Range Rover Sport (LW) (04/13--)

025 233 9719 | MBP1729

Brake pad set



Notes

Thickness [mm]  
Height [mm]  
Width 2 [mm]  
Width 1 [mm]  
Brake System

prepared for wear indicator  
18.9  
73.5  
156.6  
155.4  
ATE  
with anti-squeak plate  
Front Axle

References

SFC000010  
SFC500050

SFC500070  
SFC500080

**Brake pad set**

**025 233 9719 | MBP1729**

**Application info**

Range Rover III (03/02-08/12)

**Brake pad set**

**025 236 1517 | MBP0406**

**Notes**

|                |   |
|----------------|---|
| Thickness [mm] | 17.4  |
| Height [mm]    | 62.2  |
| Width [mm]     | 131.6                                       |
| Brake System   | TRW<br>with anti-squeak plate<br>Front Axle |

**References**

|           |           |
|-----------|-----------|
| LR021899  | SFP000020 |
| SFP000010 | SFP500100 |

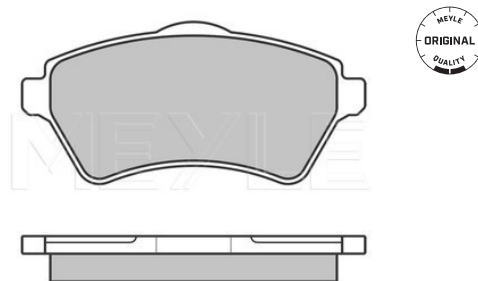

**Application info**

Freelander I (02/98-10/06)

**Brake pad set**

**025 202 1717 | MBP1632**

**Notes**

|                |  |
|----------------|--|
| Thickness [mm] | 17.3   |
| Height [mm]    | 77.3   |
| Width [mm]     | 131.8  |
| Brake System   | BREMBO<br>with anti-squeak plate<br>Front Axle |

**References**

SFP500070



**Application info**

Range Rover III (03/02-08/12)

Range Rover Sport (02/05--)

**Brake pad set**

**025 214 8717 | MBP0143**

**Notes**

|                |  |
|----------------|--|
| Thickness [mm] | 17   |
| Height [mm]    | 59.4                                       |
| Width [mm]     | 123.2                                      |
| Brake System   | ATE<br>with anti-squeak plate<br>Rear Axle |

**References**

|           |           |
|-----------|-----------|
| SFP000120 | SFP500210 |
|-----------|-----------|

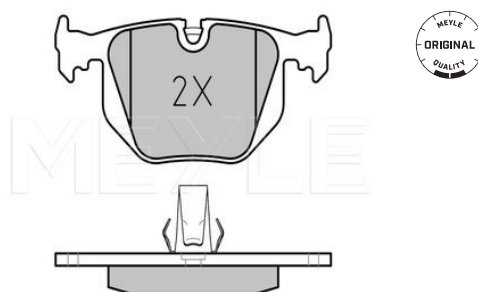

025 214 8717 | MBP0143

Brake pad set

Application info

Range Rover III [03/02-08/12]

025 214 8717/PD | MBP0143PD

Brake pad set

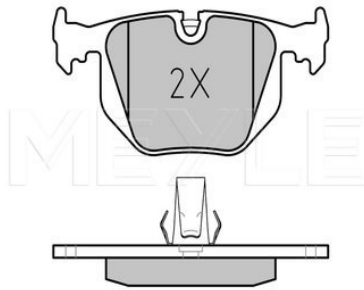

Notes

Quality  
Thickness [mm]  
Height [mm]  
Width [mm]  
Brake System

prepared for wear indicator  
PREMIUM  
17  
59.4  
123.2  
ATE  
with anti-squeak plate  
Rear Axle

References

SFP000120

SFP500210

Application info

Range Rover III [03/02-08/12]

025 215 1918 | MBP0150

Brake pad set

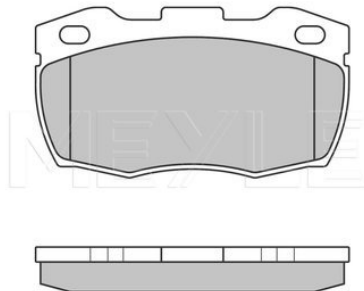

Notes

Thickness [mm]  
Height [mm]  
Width [mm]  
Brake System

excl. wear warning contact  
18  
68.6  
126.5  
Lockheed  
with anti-squeak plate  
Front Axle

References

RTC5574  
SFP000140  
SFP000260

STC1275  
STC2952

Application info

Defender [09/90-09/03]

**Brake pad set**

**025 234 5816 | MBP0355**

**Notes**

not prepared for wear indicator  
 Thickness [mm] 16.3  
 Height [mm] 52.4  
 Width [mm] 94.7  
 with anti-squeak plate  
 Rear Axle

**References**

SFP100470 STC1879  
 SFP100490 STC3684  
 SFP500130

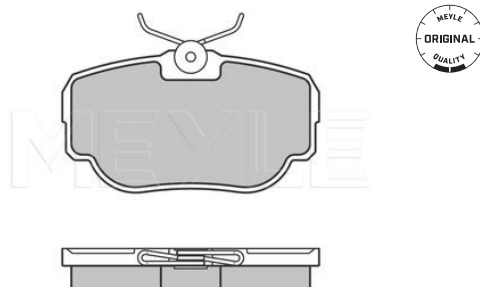

**Application info**

Discovery II [11/98-06/04]

Range Rover II [07/94-03/02]

**Brake pad set**

**025 234 5219 | MBP0352**

**Notes**

not prepared for wear indicator  
 Thickness [mm] 19  
 Height [mm] 66.4  
 Width [mm] 144.9  
 with anti-squeak plate  
 Front Axle

**References**

SFP000210 SFP500150  
 SFP100460 STC1880  
 SFP100480 STC3195  
 SFP100580 STC3685  
 SFP100590

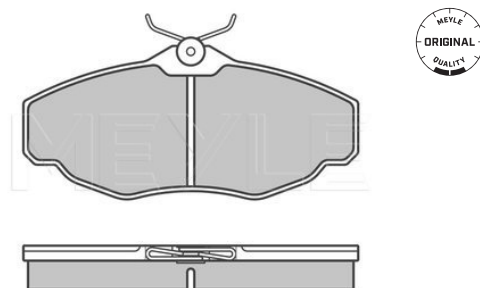

**Application info**

Discovery II [11/98-06/04]

Range Rover II [07/94-03/02]

**Brake pad set**

**025 214 5918/W | MBP0133**

**Notes**

incl. wear warning contact  
 Thickness [mm] 17.8  
 Height [mm] 72.4  
 Width [mm] 104.8  
 Number of wear indicators [per axle] 1  
 Brake System Lockheed  
 with anti-squeak plate  
 Front Axle

**References**

RTC6781 STC9149  
 SFP500160 STC9150  
 STC8571 STC9190  
 STC8572 STC9191

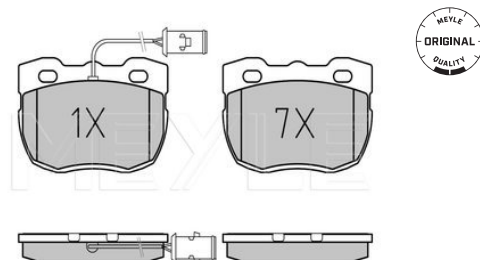

025 214 5918/W | MBP0133

Brake pad set

Application info

Discovery I (10/89-10/98)

025 203 5918 | MBP0017

Brake pad set

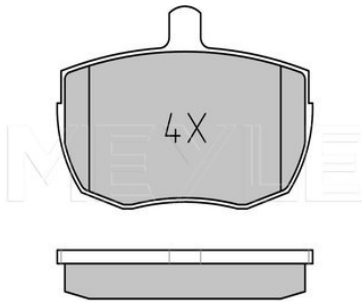

Notes

Thickness [mm]  
Height [mm]  
Width [mm]  
Brake System

excl. wear warning contact  
18.1  
74.8  
105  
Lockheed  
with anti-squeak plate  
Front Axle

References

GBP267  
GBP270

RTC3163  
STC2956

Application info

90/110 (09/83-07/90)

Defender (09/90-09/03)

025 244 9617 | MBP0609

Brake pad set

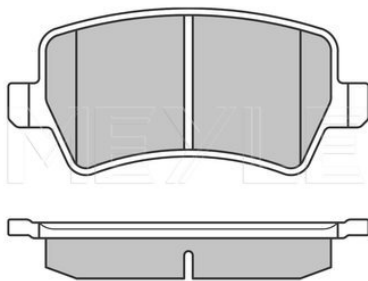

Notes

Thickness [mm]  
Height [mm]  
Width [mm]  
Brake System

not prepared for wear indicator  
17.3  
48.7  
106.1  
TRW  
with anti-squeak plate  
Rear Axle

References

LR027129  
LR043285

LR043714

Application info

Freelander II (10/06--)  
Range Rover Evoque (06/11--)

Range Rover Evoque II (11/15--)



**Guide sleeve kit, brake caliper**

**014 698 0006 | MBX0010**

**Notes**

Brake System

without guide bolts  
ATE  
Front Axle



**Application info**

Freelander II [10/06--]

**Guide sleeve kit, brake caliper**

**014 698 0006/S | MBX0011**

**Notes**

Brake System

with guide pin  
ATE  
Front Axle

**Parts list**

014 698 0006 | MBX0010  
100 698 0008 | MBX0156

Guide sleeve kit, brake caliper  
Guide bolt, brake caliper



**Application info**

Freelander II [10/06--]

**Brake shoe set, parking brake**

**114 042 1201 | MPB0021**

**Notes**

Diameter [mm]  
Width [mm]

without spring  
210  
30  
Rear Axle

**References**

SFS000050

SFS000051



**Application info**

Range Rover III [03/02-08/12]

53-14 495 0000 | MBK0232

Boot kit, C.V. joint



Notes

|                       |             |
|-----------------------|-------------|
| Inner diameter 2 [mm] | Thermoplast |
| Inner diameter 1 [mm] | 89          |
| Length [mm]           | 25          |
|                       | 138         |

References

TDR100750

Application info

Freelander I [02/98-10/06]

53-14 498 0000 | MDS0050

Drive shaft



Notes

|                                  |                  |
|----------------------------------|------------------|
| Number of Teeth, ABS ring        | 60               |
| Seal Diameter [mm]               | 55.6             |
| Length [mm]                      | 611              |
| Outer teething differential side | 25               |
| Outer gearing wheel side         | 28               |
|                                  | Front Axle Right |
|                                  | Front Axle Left  |

References

TOB000360

TOB000500

Application info

Freelander I [02/98-10/06]

53-14 498 0001 | MCV0329

C.V. joint kit



Notes

|                            |               |
|----------------------------|---------------|
| Number of Teeth, ABS ring  | CV Joint      |
|                            | 48            |
|                            | with ABS ring |
| Seal Diameter [mm]         | 74            |
| Length [mm]                | 163.5         |
| Internal Teeth, wheel side | 27            |
| Outer gearing wheel side   | 29            |
|                            | Wheel Side    |

References

TDJ500040

Application info

Discovery III [07/04-09/09]

Range Rover Sport [02/05--]

**Joint, propeller shaft**

**514 814 0002 | MPJ0090**

**Notes**

Piece with accessories  
Universal Joint

Diameter [mm] 27  
Outer diameter [mm] 27  
Length [mm] 74.6  
Centre  
Front

**References**

FRC8387



**Application info**

Defender [09/90-09/03]  
Discovery I [10/89-10/98]

Discovery III [07/04-09/09]  
Range Rover I [07/70-07/94]

**A/T oil pan**

**300 325 0000 | MTX0067**

**Notes**

Number of mounting bores 24  
with seal  
with filter

**References**

LR007474



**Application info**

Discovery III [07/04-09/09]  
Discovery IV [09/09--]

Range Rover III [03/02-08/12]  
Range Rover Sport [02/05--]

**Hydraulic filter kit, A/T**

**314 137 0002 | MHK0037**

**Notes**

Number of mounting bores 20  
Kit with seal

Transmission Type 5L40E  
Automatic Transmission,  
5-speed

Manufacturer Restriction gasket: rubber/metal  
with fastening material

**References**

THE500030

THE500031

**Parts list**

314 139 0001 | MMX0965

A/T oil pan gasket

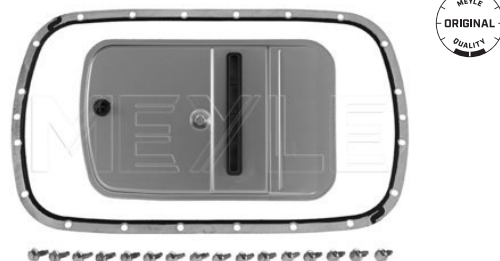

3

+

**314 137 0002 | MHK0037**

**Hydraulic filter kit, A/T**

**Application info**

Range Rover III (03/02-08/12)

**300 135 0002 | MOK0020**

**Parts kit, automatic transm. oil change**

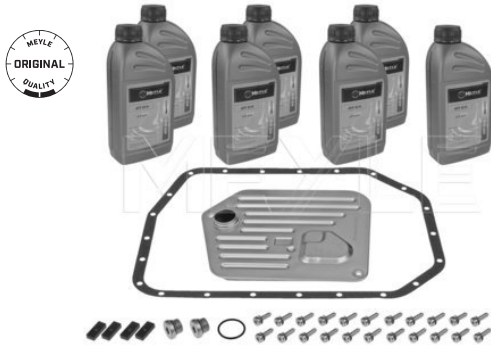

**Notes**

Alternative Repair Kit

Transmission Type

Manufacturer Restriction

**Parts list**

014 019 2300 | MAX0015  
314 137 0001 | MHK0036

Kit  
300 135 0002/SK  
with accessories  
5HP24  
Automatic Transmission,  
5-speed  
ZF

Transmission fluid  
Hydraulic filter kit, A/T

**Application info**

Range Rover III (03/02-08/12)

**300 135 0002/SK | MOK0043**

**Parts kit, automatic transm. oil change**



**Notes**

Consult accessories list for recommended additional repairs

Alternative Repair Kit

Transmission Type

Manufacturer Restriction  
Slim Set

**Parts list**

314 137 0001 | MHK0036

Kit  
300 135 0002  
with accessories  
5HP24  
Automatic Transmission,  
5-speed  
ZF

Hydraulic filter kit, A/T

**Application info**

Range Rover III (03/02-08/12)

3



### Parts kit, automatic transm. oil change

300 135 0401 | MOK0048

#### Notes

Transmission Type  
 Manufacturer Restriction

Kit with accessories  
 5L40E  
 Automatic Transmission,  
 5-speed  
 GM

#### Parts list

014 019 2300 | MAX0015  
 314 137 0002 | MHK0037

Transmission fluid  
 Hydraulic filter kit, A/T



#### Application info

Range Rover III [03/02-08/12]

### Parts kit, automatic transm. oil change

300 135 1005 | MOK0035

#### Notes

Alternative Repair Kit

Transmission Type  
 Transmission Type  
 Transmission Type  
 Transmission Type  
 Transmission Type

Manufacturer Restriction

Kit with accessories  
 Plastic  
 6HP32  
 6HP28 X  
 6HP28  
 6HP26 X  
 6HP26  
 Automatic Transmission,  
 6-speed  
 ZF

#### Parts list

014 019 2900 | MAX0033  
 300 325 0000 | MTX0067  
 300 930 0001/S | MEX0484

Transmission fluid  
 A/T oil pan  
 Keine Bezeichnung: GA 4743



#### Application info

Discovery III [07/04-09/09]  
 Discovery IV [09/09--]

Range Rover III [03/02-08/12]  
 Range Rover Sport [02/05--]

3

300 135 1005/SK | MOK0045

Parts kit, automatic transm. oil change



Notes

Consult accessories list for recommended additional repairs

Alternative Repair Kit

Transmission Type  
Transmission Type  
Transmission Type  
Transmission Type

Manufacturer Restriction  
Slim Set

Parts list

300 325 0000 | MTX0067  
300 930 0001/S | MEX0484

Kit  
300 135 1005  
with accessories  
Plastic  
6HP26  
6HP26 X  
6HP28  
6HP28 X  
6HP32  
Automatic Transmission,  
6-speed  
ZF

A/T oil pan  
Keine Bezeichnung: GA 4743

Application info

Discovery III [07/04-09/09]  
Discovery IV [09/09--]

Range Rover III [03/02-08/12]  
Range Rover Sport [02/05--]

3



### ABS wheel sensor

53-14 899 0006 | MAS0399

#### Notes

|                       |            |
|-----------------------|------------|
| Cable Length [mm]     | 981        |
| Operating voltage [V] | 12         |
| Number of Poles       | 2          |
| Required quantity     | 1          |
|                       | Front Axle |

#### References

|               |          |
|---------------|----------|
| AH22 9E731 AB | LR013783 |
|---------------|----------|



#### Application info

Discovery IV [09/09--]

### ABS wheel sensor

53-14 899 0001 | MAS0394

#### Notes

|                   |            |
|-------------------|------------|
| Cable Length [mm] | 940        |
| Resistance [Ohm]  | 1800       |
|                   | Front Axle |

#### References

LR023690



#### Application info

Defender [09/90-09/03]

### ABS wheel sensor

53-14 899 0002 | MAS0395

#### Notes

|                       |           |
|-----------------------|-----------|
| Operating voltage [V] | 12        |
| Cable Length [mm]     | 1905      |
| Number of Poles       | 2         |
| Required quantity     | 1         |
| Resistance [Ohm]      | 1800      |
|                       | Rear Axle |

#### References

|               |          |
|---------------|----------|
| BH12 2B372 BC | LR023691 |
| BH12 3B372 BB |          |



#### Application info

Defender [09/90-09/03]

4

53-14 899 0003 | MAS0396

ABS wheel sensor



Notes

Cable Length [mm]  
Operating voltage [V]  
Number of Poles  
Required quantity

Active sensor  
1200  
12  
2  
1  
Front Axle

References

SSB 5000 90

SSB 5000 92

Application info

Discovery III [07/04-09/09]

53-14 899 0005 | MAS0398

ABS wheel sensor



Notes

Cable Length [mm]  
Operating voltage [V]  
Number of Poles  
Required quantity

Active sensor  
1250  
12  
2  
1  
Rear Axle

References

SSB 5001 00

SSB 5001 02

Application info

Discovery III [07/04-09/09]  
Discovery IV [09/09--]

Range Rover Sport [02/05--]

53-14 899 0004 | MAS0397

ABS wheel sensor



Notes

Cable Length [mm]  
Operating voltage [V]  
Number of Poles  
Required quantity

Active sensor  
1200  
12  
2  
1  
Front Axle

References

SSB 5001 33

Application info

Range Rover Sport [02/05--]





### Wear sensor

53-14 527 0000 | MWS0098

#### Notes

Warning Contact Length [mm]  
Required quantity

Disc Brake  
830  
1  
Front Axle

#### References

LR012824



#### Application info

Range Rover III [03/02-08/12]

### Wear sensor

53-14 527 0001 | MWS0099

#### Notes

Warning Contact Length [mm]  
Required quantity

Disc Brake  
1213  
1  
Front Axle

#### References

LR014568

LR019401



#### Application info

Range Rover Sport [02/05--]

### Wear sensor

53-14 527 0003 | MWS0125

#### Notes

Warning Contact Length [mm]  
Required quantity

Disc Brake  
1425  
1  
Front Axle

#### References

LR033275



#### Application info

Range Rover IV [08/12--]

Range Rover Sport (LW) [04/13--]

4

53-14 527 0004 | MWS0126

Wear sensor



Notes

Warning Contact Length [mm]  
Required quantity

Disc Brake  
951  
1  
Rear Axle

References

LR033295

Application info

Range Rover IV (08/12--)

Range Rover Sport (LW) (04/13--)

53-14 527 0002 | MWS0124

Wear sensor



Notes

Warning Contact Length [mm]  
Required quantity

Disc Brake  
1380  
1  
Front Axle

References

LR045959

Application info

Range Rover Sport (LW) (04/13--)

53-14 000 0000 | MWS0089

Wear sensor



Notes

Warning Contact Length [mm]  
Required quantity

Disc Brake  
780  
1  
Rear Axle

References

SEM000012

Application info

Range Rover III (03/02-08/12)

### Wear sensor

53-14 000 0004 | MWS0092

#### Notes

Warning Contact Length [mm] 1147  
Required quantity 1  
Front Axle

#### References

SEM000024 SEM500070



#### Application info

Discovery III [07/04-09/09] Range Rover Sport [02/05--]  
Discovery IV [09/09--]

### Wear sensor

53-14 000 0006 | MWS0094

#### Notes

Warning Contact Length [mm] 1185  
Required quantity 1  
Front Axle

#### References

SEM500026 SEM500090



#### Application info

Range Rover Sport [02/05--]

### Wear sensor

53-14 500 0002 | MWS0097

#### Notes

Warning Contact Length [mm] 845  
Required quantity 1  
Front Axle

#### References

SEM500050



#### Application info

Range Rover III [03/02-08/12]

4

53-14 500 0001 | MWS0096

Wear sensor



Notes

Warning Contact Length [mm]  
Required quantity

Disc Brake  
1230  
1  
Front Axle

References

SEM500062

SEM500080

Application info

Range Rover Sport [02/05--]

53-14 000 0003 | MWS0091

Wear sensor



Notes

Warning Contact Length [mm]  
Required quantity

Drum Brake  
1118  
1  
Rear Axle

References

SOE000010

SOE000011

Application info

Range Rover III [03/02-08/12]

53-14 000 0001 | MWS0090

Wear sensor



Notes

Warning Contact Length [mm]  
Required quantity

Disc Brake  
1156  
1  
Rear Axle

References

SOE000025

Application info

Discovery III [07/04-09/09]  
Discovery IV [09/09--]

Range Rover Sport [02/05--]



### Wear sensor

53-14 000 0005 | MWS0093

#### Notes

Warning Contact Length [mm]  
Required quantity

Disc Brake  
1184  
1  
Rear Axle

#### References

SOE500030



#### Application info

Range Rover III (03/02-08/12)

### Glow plug

514 860 0001 | MGP0098

#### Notes

Rated current [A]

10  
after-glow capable  
Pencil-type Glow Plug

Spanner Size  
Diameter [mm]  
Thread Size  
Overall Length [mm]  
Cone Pitch  
Fitting Depth [mm]  
Connector type  
Voltage [V]

8  
4  
M8 x 1  
126  
93°  
25  
Ø 4 mm  
11

#### References

1354289



#### Application info

Discovery III (07/04-09/09)  
Range Rover III (03/02-08/12)

Range Rover Sport (02/05--)

### Glow plug

014 020 1039 | MGP0007

#### Notes

Rated current [A]

16  
Pencil-type Glow Plug

Spanner Size  
Diameter [mm]  
Thread Size  
Overall Length [mm]  
Cone Pitch  
Fitting Depth [mm]  
Connector type  
Voltage [V]

12  
6.1  
M12 x 1,25  
71  
63°  
24.5  
M5  
11

#### References

ERC 8450



4



014 020 1039 | MGP0007

Glow plug

Application info

88/109 [09/61-12/86]

90/110 [09/83-07/90]

53-14 860 0000 | MGP0070

Glow plug



Notes

|                     |                       |
|---------------------|-----------------------|
| Rated current [A]   | 15                    |
|                     | Pencil-type Glow Plug |
| Spanner Size        | 10                    |
| Diameter [mm]       | 5                     |
| Thread Size         | M10 x 1               |
| Overall Length [mm] | 125                   |
| Cone Pitch          | 90°                   |
| Fitting Depth [mm]  | 26                    |
| Connector type      | M4                    |
| Voltage [V]         | 11.5                  |

References

ETC8847

Application info

Defender [09/90-09/03]

Discovery I [10/89-10/98]

40-14 860 0002 | MGP0069

Glow plug



Notes

|                     |                       |
|---------------------|-----------------------|
| Rated current [A]   | 10                    |
|                     | after-glow capable    |
|                     | Pencil-type Glow Plug |
| Spanner Size        | 8                     |
| Diameter [mm]       | 4.4                   |
| Thread Size         | M8 x 1                |
| Overall Length [mm] | 97                    |
| Cone Pitch          | 123°                  |
| Fitting Depth [mm]  | 28                    |
| Connector type      | Ø 4 mm                |
| Voltage [V]         | 11                    |

References

LR001302

Application info

Freelander II [10/06--]



### Glow plug

53-14 860 0002 | MGP0116

#### Notes

|                     |   |
|---------------------|---|
|                     | after-glow capable<br>Pencil-type Glow Plug |
| Spanner Size        | 10  |
| Diameter [mm]       | 4   |
| Thread Size         | M10 x 1                                     |
| Overall Length [mm] | 124   |
| Connector type      | Ø 4 mm                                      |
| Cone Pitch          | 93°   |
| Fitting Depth [mm]  | 26  |
| Voltage [V]         | 7   |

#### References

LR013275



#### Application info

Discovery IV (09/09--)  
 Range Rover III (03/02-08/12)  
 Range Rover IV (08/12--)

Range Rover Sport (02/05--)  
 Range Rover Sport (LW) (04/13--)

### Glow plug

40-14 860 0003 | MGP0102

#### Notes

|                     |                       |
|---------------------|-----------------------|
|                     | Pencil-type Glow Plug |
| Spanner Size        | 10                    |
| Diameter [mm]       | 4                     |
| Thread Size         | M8 x 1                |
| Overall Length [mm] | 99.5                  |
| Cone Pitch          | 123°                  |
| Fitting Depth [mm]  | 30.8                  |
| Connector type      | Ø 4 mm                |
| Voltage [V]         | 5                     |

#### References

LR022300



#### Application info

Discovery Sport (09/14--)  
 Freelander II (10/06--)

Range Rover Evoque (06/11--)

4

16-14 860 0001 | MGP0027

Glow plug



Notes

|                     |   |
|---------------------|---|
| Rated current [A]   | 15<br>after-glow capable<br>Pencil-type Glow Plug |
| Spanner Size        | 10  |
| Diameter [mm]       | 5   |
| Thread Size         | M10 x 1   |
| Overall Length [mm] | 83  |
| Cone Pitch          | 63°   |
| Fitting Depth [mm]  | 25  |
| Connector type      | M4  |
| Voltage [V]         | 11  |

References

|           |            |
|-----------|------------|
| NCC100050 | NCC100050L |
|-----------|------------|

Application info

Freelander I [02/98-10/06]

314 023 0000 | MGP0051

Glow plug



Notes

|                     |   |
|---------------------|---|
| Rated current [A]   | 15<br>after-glow capable<br>Pencil-type Glow Plug |
| Spanner Size        | 10  |
| Diameter [mm]       | 5   |
| Thread Size         | M10 x 1   |
| Overall Length [mm] | 107   |
| Cone Pitch          | 63°   |
| Fitting Depth [mm]  | 33  |
| Connector type      | Ø 4 mm  |
| Voltage [V]         | 11  |

References

|            |
|------------|
| NCC100120L |
|------------|

Application info

Freelander I [02/98-10/06]

Range Rover III [03/02-08/12]





### Glow plug

300 022 0163 | MGP0050

#### Notes

|                     |                       |
|---------------------|-----------------------|
| Rated current [A]   | 16                    |
|                     | Pencil-type Glow Plug |
| Spanner Size        | 12                    |
| Diameter [mm]       | 6.1                   |
| Thread Size         | M12 x 1,25            |
| Overall Length [mm] | 71                    |
| Cone Pitch          | 63°                   |
| Fitting Depth [mm]  | 25                    |
| Connector type      | M5                    |
| Voltage [V]         | 11                    |

#### References

STC3103



#### Application info

Range Rover II [07/94-03/02]

### Glow plug

53-14 860 0001 | MGP0071

#### Notes

|                     |   |
|---------------------|---|
| Rated current [A]   | 15.5  |
|                     | after-glow capable<br>Pencil-type Glow Plug |
| Spanner Size        | 10  |
| Diameter [mm]       | 5   |
| Thread Size         | M10 x 1                                     |
| Overall Length [mm] | 105   |
| Cone Pitch          | 63°   |
| Fitting Depth [mm]  | 25  |
| Connector type      | Ø 4 mm                                      |
| Voltage [V]         | 11  |

#### References

ERR 6066



#### Application info

Defender [09/90-09/03]

Discovery II [11/98-06/04]

### Glow plug

714 020 0001 | MGP0087

#### Notes

|                     |   |
|---------------------|---|
| Rated current [A]   | 15  |
|                     | after-glow capable<br>Pencil-type Glow Plug |
| Spanner Size        | 10  |
| Diameter [mm]       | 5.1   |
| Thread Size         | M10 x 1                                     |
| Overall Length [mm] | 147   |
| Cone Pitch          | 93°   |
| Fitting Depth [mm]  | 35  |
| Connector type      | M4  |
| Voltage [V]         | 11.5  |



714 020 0001 | MGP0087

Glow plug

Application info

Defender [09/90-09/03]

314 131 0000 | MIC0058

Ignition coil



Notes

Operating voltage [V]  
Number of Poles  
Required quantity

for fully electronic ignition (FI)  
incl. spark plug connector  
Coupling Type SAE  
12  
3  
12  
for vehicles without distributor

References

LR022494

Parts list

314 131 0001 | MIC0059  
314 862 0000 | MEX0400

Ignition coil  
Spark plug connector

Application info

Range Rover III [03/02-08/12]

314 131 0001 | MIC0059

Ignition coil



Notes

Operating voltage [V]  
Number of Poles

for fully electronic ignition (FI)  
without spark plug connector  
Coupling Type SAE  
12  
3  
for vehicles without distributor

References

LR022494

Application info

Range Rover III [03/02-08/12]



### Sensor, camshaft position

314 899 0069 | MEX0412

#### Notes

Cable Length [mm]  
Fitting Depth [mm]  
Operating voltage [V]  
Number of Poles

Active sensor  
355  
28  
12  
3  
with seal



#### Application info

Discovery III [07/04-09/09]

Discovery IV [09/09--]

### Spark plug connector

314 862 0000 | MEX0400

#### Notes

only in connection with  
Operating voltage [V]  
Length [mm]  
Number of Poles

Interference Suppression  
Coupling Type M4  
Coupling Type SAE  
314 131 0001  
12  
93  
1



#### References

LR022494

#### Application info

Range Rover III [03/02-08/12]

4

45-51 902 1001 | MMX1647

Tensioner pulley, timing belt



Notes

|                     |       |
|---------------------|-------|
| Inner diameter [mm] | Piece |
| Outer diameter [mm] | 10    |
| Width [mm]          | 55    |
|                     | 32    |

References

LHP10015L

Application info

Freelander I [02/98-10/06]

45-51 902 1002 | MMX1648

Tensioner pulley, timing belt



Notes

|                     |       |
|---------------------|-------|
| Outer diameter [mm] | Piece |
| Width [mm]          | 60    |
|                     | 26    |

References

LHP100550L

Application info

Freelander I [02/98-10/06]

11-51 902 1013 | MMX1602

Tensioner pulley, timing belt



Notes

|                     |       |
|---------------------|-------|
| Inner diameter [mm] | Piece |
| Outer diameter [mm] | 8     |
| Width [mm]          | 60    |
|                     | 29.5  |

References

LR005362 LR009395  
LR006671

Application info

Discovery Sport [09/14--]  
Freelander II [10/06--]

Range Rover Evoque [06/11--]



### Timing belt roller

53-51 902 2000 | MMX1695

#### Notes

|                     |    |
|---------------------|----|
| Inner diameter [mm] | 25 |
| Outer diameter [mm] | 60 |
| Width [mm]          | 34 |

#### References

LHV100160



#### Application info

Freelander I [02/98-10/06]

### Timing belt roller

11-51 902 2004 | MMX1611

#### Notes

|                     |    |
|---------------------|----|
| Inner diameter [mm] | 10 |
| Outer diameter [mm] | 60 |
| Width [mm]          | 30 |

#### References

LR000660



#### Application info

Discovery Sport [09/14--]  
Freelander II [10/06--]

Range Rover Evoque [06/11--]

### V-ribbed belt

050 006 1205 | MRB0379

#### Notes

|                |      |
|----------------|------|
| Number of Ribs | 6    |
| Length [mm]    | 1205 |

#### References

BJ328620BA                      LR028881

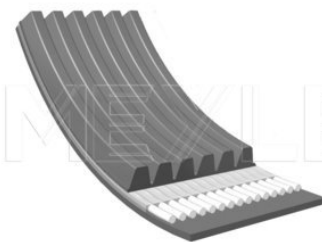

#### Application info

Range Rover Evoque [06/11--]

5

050 003 0750 | MRB0023

V-ribbed belt

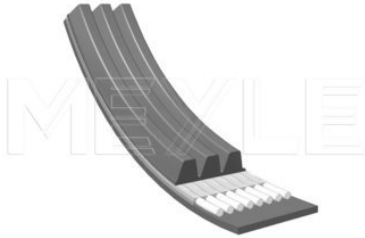

Notes

|                |     |
|----------------|-----|
| Number of Ribs | 3   |
| Length [mm]    | 750 |

References

COU2160

Application info

Freelander I [02/98-10/06]

050 004 1325 | MRB0157

V-ribbed belt

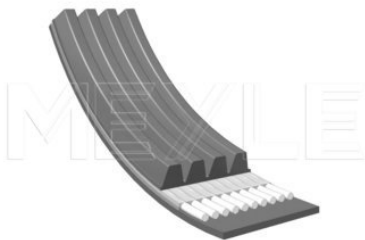

Notes

|                |      |
|----------------|------|
| Number of Ribs | 4    |
| Length [mm]    | 1325 |

References

ERR2215

Application info

Defender [09/90-09/03]

050 007 1593 | MRB0604

V-ribbed belt

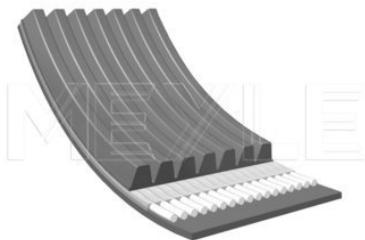

Notes

|                |      |
|----------------|------|
| Number of Ribs | 7    |
| Length [mm]    | 1593 |

References

ERR3287

Application info

Defender [09/90-09/03]



### V-ribbed belt

050 007 1870 | MRB0619

#### Notes

Number of Ribs 7  
Length [mm] 1870

#### References

ERR4461

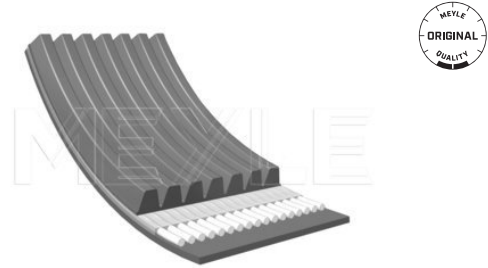

#### Application info

Discovery I [10/89-10/98]  
Discovery II [11/98-06/04]

Range Rover II [07/94-03/02]

### V-ribbed belt

050 007 2250 | MRB0630

#### Notes

Number of Ribs 7  
Length [mm] 2250

#### References

ERR4623

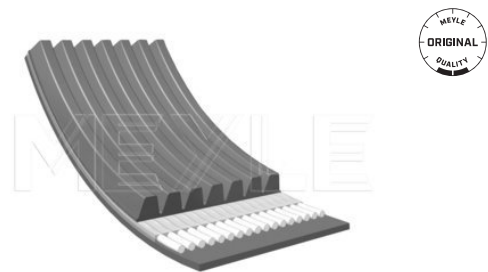

#### Application info

Discovery I [10/89-10/98]  
Discovery II [11/98-06/04]

Range Rover I [07/70-07/94]

### V-ribbed belt

050 007 1580 | MRB0603

#### Notes

Number of Ribs 7  
Length [mm] 1580

#### References

ERR5911

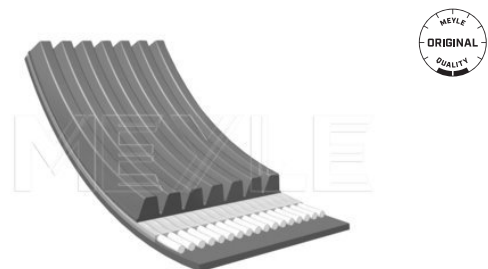

#### Application info

Defender [09/90-09/03]

050 007 1855 | MRB0766

V-ribbed belt

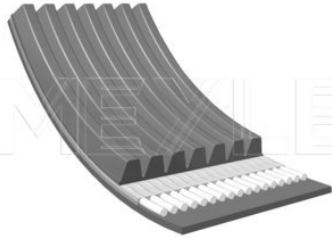

Notes

Number of Ribs 7  
Length [mm] 1855

References

ERR6191

Application info

Discovery I [10/89-10/98]

Discovery II [11/98-06/04]

050 007 2620 | MRB0636

V-ribbed belt

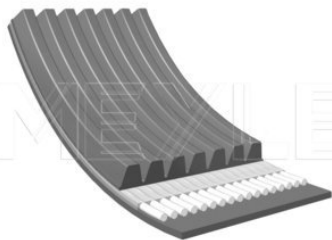

Notes

Number of Ribs 7  
Length [mm] 2620

References

ERR6897

Application info

Discovery II [11/98-06/04]

Range Rover II [07/94-03/02]

050 007 1775 | MRB0615

V-ribbed belt

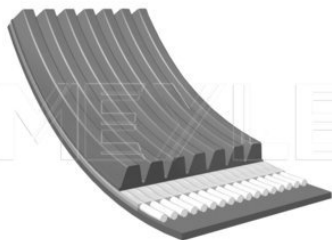

Notes

Number of Ribs 7  
Length [mm] 1775

References

ERR6899

Application info

Discovery II [11/98-06/04]





### V-ribbed belt

050 006 1750 | MRB0460

#### Notes

Number of Ribs 6  
Length [mm] 1750

#### References

GFB101750

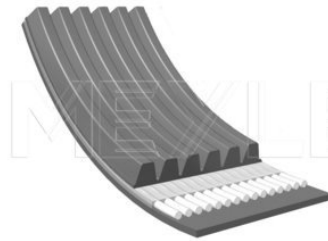

#### Application info

Discovery I [10/89-10/98]

### V-ribbed belt

050 006 1743 | MRB0459

#### Notes

Number of Ribs 6  
Length [mm] 1743

#### References

LR000996

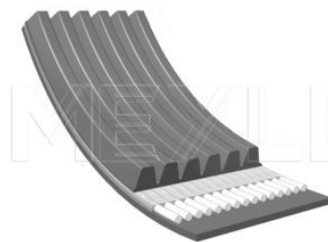

#### Application info

Freelander II [10/06--]

### V-ribbed belt

050 006 1200 | MRB0377

#### Notes

Number of Ribs 6  
Length [mm] 1200

#### References

LR003570

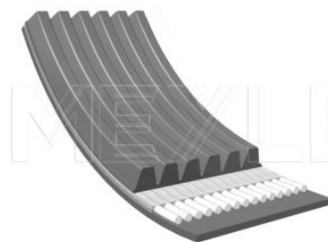

#### Application info

Freelander II [10/06--]

5

050 006 2498 | MRB0563

V-ribbed belt

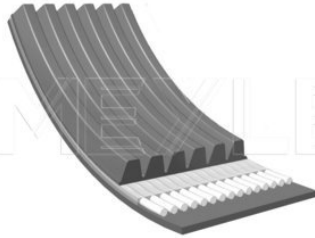

Notes

|                |      |
|----------------|------|
| Number of Ribs | 6    |
| Length [mm]    | 2498 |

References

LR018312

Application info

Range Rover Sport (02/05--)

050 007 1635 | MRB0607

V-ribbed belt

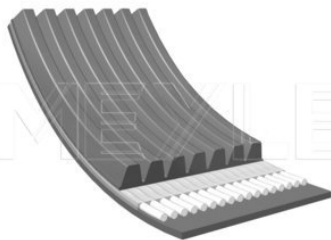

Notes

|                |      |
|----------------|------|
| Number of Ribs | 7    |
| Length [mm]    | 1635 |

References

PQS000100

Application info

Range Rover III (03/02-08/12)

050 005 0812 | MRB0185

V-ribbed belt

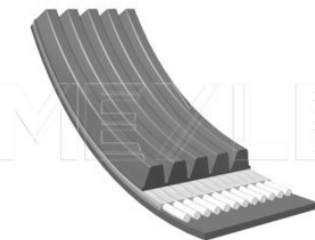

Notes

|                |     |
|----------------|-----|
| Number of Ribs | 5   |
| Length [mm]    | 812 |

References

PQS000190

Application info

Range Rover III (03/02-08/12)



### V-ribbed belt

050 005 2020 | MRB0294

#### Notes

Number of Ribs 5  
Length [mm] 2020

#### References

PQS000200

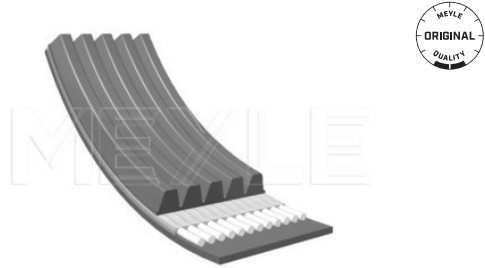

#### Application info

Range Rover III (03/02-08/12)

### V-ribbed belt

050 005 1005 | MRB0217

#### Notes

Number of Ribs 5  
Length [mm] 1005

#### References

PQS000220

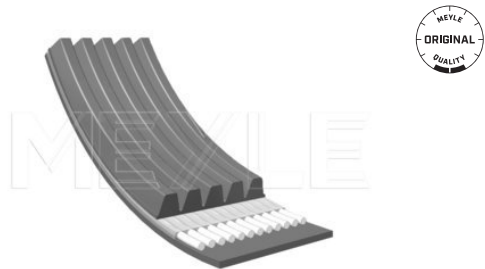

#### Application info

Range Rover III (03/02-08/12)

### V-ribbed belt

050 006 1460 | MRB0417

#### Notes

Number of Ribs 6  
Length [mm] 1460

#### References

PQS100851

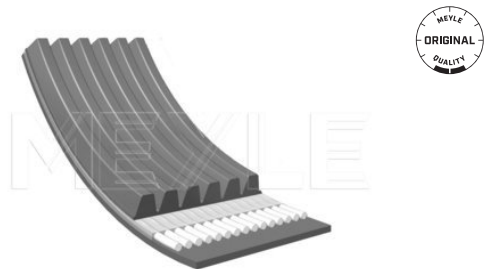

#### Application info

Freelander I (02/98-10/06)

5

050 006 1370 | MRB0406

V-ribbed belt

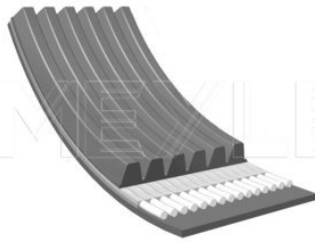

Notes

|                |      |
|----------------|------|
| Number of Ribs | 6    |
| Length [mm]    | 1370 |

References

PQS100900

Application info

Discovery I [10/89-10/98]

050 006 1185 | MRB0373

V-ribbed belt

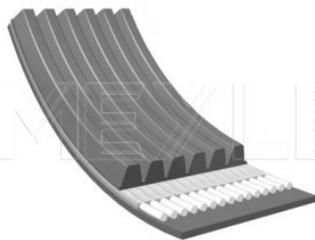

Notes

|                |      |
|----------------|------|
| Number of Ribs | 6    |
| Length [mm]    | 1185 |

References

PQS101030

Application info

Freelander I [02/98-10/06]

050 005 1188 | MRB0246

V-ribbed belt

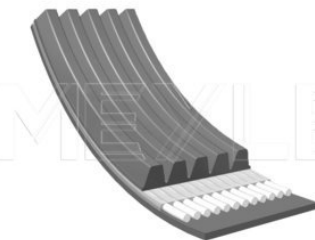

Notes

|                |      |
|----------------|------|
| Number of Ribs | 5    |
| Length [mm]    | 1188 |

References

|          |           |
|----------|-----------|
| GMB51190 | PQS101130 |
|----------|-----------|

Application info

Freelander I [02/98-10/06]



### V-ribbed belt

050 005 1195 | MRB0247

#### Notes

Number of Ribs 5  
Length [mm] 1195

#### References

GMB51190 PQS101130

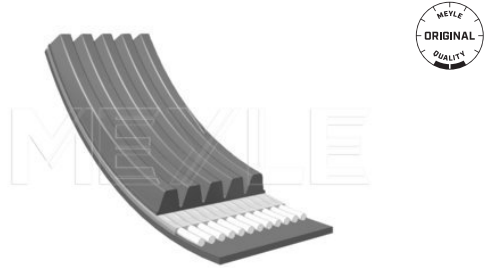

#### Application info

Freelander I [02/98-10/06]

### V-ribbed belt

050 006 1560 | MRB0427

#### Notes

Number of Ribs 6  
Length [mm] 1560

#### References

PQS101272

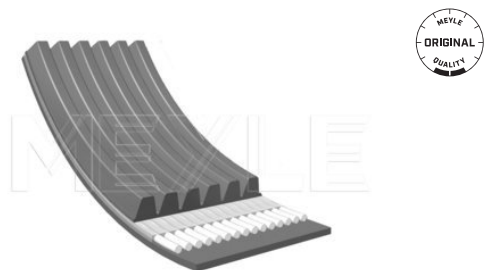

#### Application info

Freelander I [02/98-10/06]

### V-ribbed belt

050 007 1713 | MRB0610

#### Notes

Number of Ribs 7  
Length [mm] 1713

#### References

PQS101490

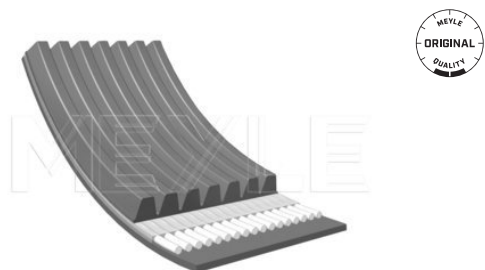

#### Application info

Defender [09/90-09/03]

Discovery II [11/98-06/04]

050 004 0855 | MRB0090

V-ribbed belt

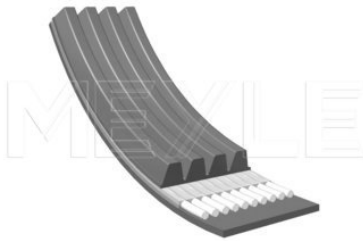

Notes

|                |     |
|----------------|-----|
| Number of Ribs | 4   |
| Length [mm]    | 855 |

References

STC2326

Application info

Range Rover II [07/94-03/02]

050 005 1815 | MRB0292

V-ribbed belt

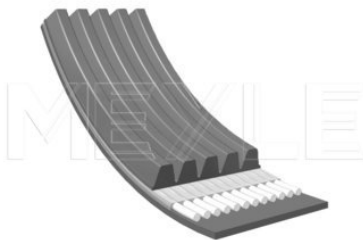

Notes

|                |      |
|----------------|------|
| Number of Ribs | 5    |
| Length [mm]    | 1815 |

References

|         |         |
|---------|---------|
| STC2134 | STC4455 |
|---------|---------|

Application info

Range Rover II [07/94-03/02]

050 005 0735 | MRB0180

V-ribbed belt

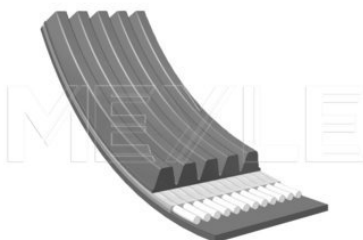

Notes

|                |     |
|----------------|-----|
| Number of Ribs | 5   |
| Length [mm]    | 735 |

Application info

Freelander I [02/98-10/06]



### V-ribbed belt

050 005 0875 | MRB0195

#### Notes

|                |     |
|----------------|-----|
| Number of Ribs | 5   |
| Length [mm]    | 875 |

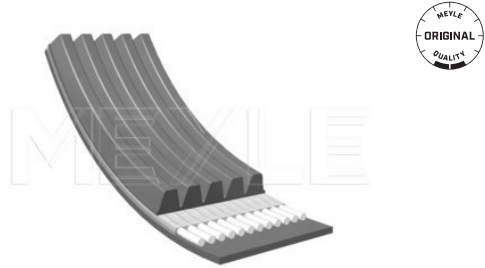

#### Application info

Freelander I (02/98-10/06)

### V-ribbed belt

050 005 1200 | MRB0248

#### Notes

|                |      |
|----------------|------|
| Number of Ribs | 5    |
| Length [mm]    | 1200 |

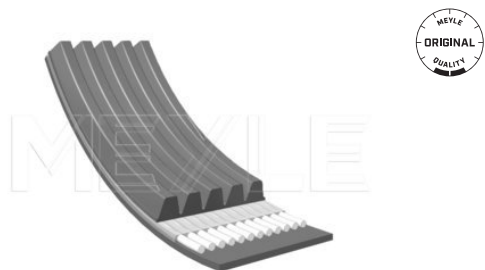

#### Application info

Freelander I (02/98-10/06)

### V-ribbed belt

050 005 2030 | MRB0295

#### Notes

|                |      |
|----------------|------|
| Number of Ribs | 5    |
| Length [mm]    | 2030 |

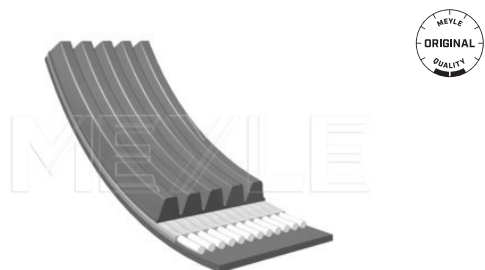

#### Application info

Freelander I (02/98-10/06)

5

050 007 2713 | MRB0639

V-ribbed belt

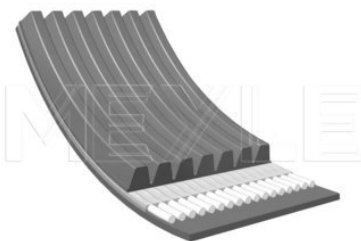

Notes

Number of Ribs 7  
Length [mm] 2713

References

ERR6896

Application info

Discovery II [11/98-06/04]

53-14 223 0001 | MET0091

Expansion tank



Notes

with sensor  
with filler cap

References

LR020367

Application info

Discovery III [07/04-09/09]  
Discovery IV [09/09--]

Range Rover Sport [02/05--]

53-14 223 0000 | MET0086

Expansion tank



Notes

without filler cap

References

ESR2935                      PCF101410

Application info

Discovery II [11/98-06/04]

Range Rover II [07/94-03/02]





### Water pump

313 011 4300 | MWP0330

#### Notes

Quality

with seal  
Sealed with SiC/SiC

#### References

8510324

PEB000030



#### Application info

Range Rover III [03/02-08/12]

### Water pump

313 011 3800 | MWP0328

#### Notes

Quality

with seal  
Sealed with SiC/SiC

#### References

8510325

STC3342

STC2192

STC3343E



#### Application info

Range Rover II [07/94-03/02]

### Water pump

45-13 220 0002 | MWP0423

#### Notes

Quality  
Number of Teeth

for toothed belt drive  
with seal  
Sealed with SiC/SiC  
24

#### References

GWP333



#### Application info

Freelander I [02/98-10/06]

11-13 220 0021 | MWP0094

Water pump



Notes

Quality  
Number of Teeth

for toothed belt drive  
with seal  
Sealed with SiC/SiC  
19

References

LR001309  
LR009392

LR011694

Application info

Discovery Sport [09/14--]  
Freelander II [10/06--]

Range Rover Evoque [06/11--]

713 220 0010 | MWP0500

Water pump



Notes

Quality  
Number of Ribs

for v-ribbed belt use  
with seal  
with housing  
Sealed with SiC/SiC  
7

References

LR004514

LR004799

Application info

Defender [09/90-09/03]

53-13 220 0007 | MWP0574

Water pump



Notes

Quality

with seal  
Sealed with SiC/SiC

References

1311325  
LR005764

LR007602  
LR009324

Application info

Discovery III [07/04-09/09]  
Discovery IV [09/09--]

Range Rover Sport [02/05--]



### Water pump

713 220 0005 | MWP0496

#### Notes

with seal

#### References

LR025302

LR053310



#### Application info

Freelander II [10/06--]

Range Rover Evoque [06/11--]

### Water pump

313 220 0004 | MWP0333

#### Notes

for v-ribbed belt use  
with seal  
Sealed with SiC/SiC  
5

Quality  
Number of Ribs

#### References

PEB000050

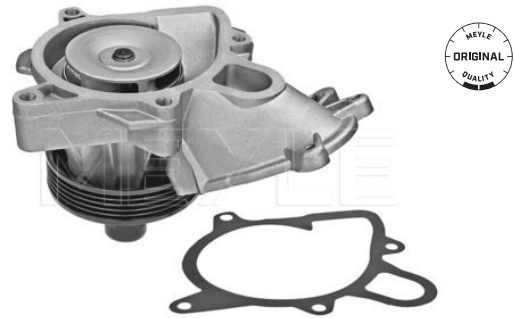

#### Application info

Range Rover III [03/02-08/12]

### Water pump

45-13 220 0001 | MWP0422

#### Notes

for toothed belt drive  
with seal

#### References

PEB102240

PEB102240L



#### Application info

Freelander I [02/98-10/06]

31-13 220 0003 | MWP0297

Water pump



Notes

with seal

References

GWP193  
GWP347  
PEB10095

PEB102010  
PEB102420

Application info

Discovery I [10/89-10/98]

Freelander I [02/98-10/06]

53-13 220 0002 | MWP0435

Water pump

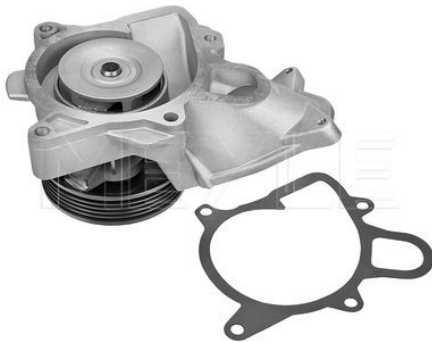

Notes

Quality  
Number of Ribs

for v-ribbed belt use  
with seal  
Sealed with SiC/SiC  
5

References

GWP2604  
PEB102270

PEB102440  
PEB102470

Application info

Freelander I [02/98-10/06]

53-13 220 0003 | MWP0436

Water pump



Notes

Number of Teeth

for toothed belt drive  
with seal  
24

References

PEB102510L

Application info

Freelander I [02/98-10/06]



### Water pump

53-13 220 0005 | MWP0438

#### Notes

Quality

with seal  
Sealed with SiC/SiC

#### References

ERR6505

PEM500040



#### Application info

Defender [09/90-09/03]

### Water pump

53-13 220 0001 | MWP0434

#### Notes

Quality

with seal  
Sealed with SiC/SiC

#### References

ERR3290

PEB500090

STC1086



#### Application info

Defender [09/90-09/03]

Discovery I [10/89-10/98]

### Water pump

53-13 043 0001 | MWP0433

#### Notes

Quality

with seal  
Sealed with SiC/SiC

#### References

STC 4378



#### Application info

Defender [09/90-09/03]

Discovery I [10/89-10/98]

Discovery II [11/98-06/04]

Range Rover I [07/70-07/94]

Range Rover II [07/94-03/02]

**314 036 0014 | MMX1514**

**Breather valve**



**Notes**

with seal

**References**

8510298

**Parts list**

314 038 0002 | MMX0957

Oil trap

**Application info**

Freelander I [02/98-10/06]

Range Rover III [03/02-08/12]

**45-12 410 0001 | MAF0552**

**Air filter**



**Notes**

Height [mm]  
Width [mm]  
Length [mm]

58  
118  
272  
Filter Insert

**References**

ESR4103

**Application info**

Freelander I [02/98-10/06]

**53-12 321 0002 | MAF0684**

**Air filter**

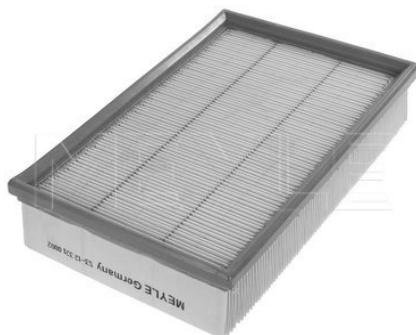

**Notes**

Height [mm]  
Width [mm]  
Length [mm]

57  
182  
270  
Filter Insert

**References**

LR003011

LR005816

**Application info**

Freelander II [10/06--]

### Air filter

**53-12 321 0003 | MAF0685**

**Notes**

|              |               |
|--------------|---------------|
| Height [mm]  | 59            |
| Width [mm]   | 213           |
| Width 2 [mm] | 180           |
| Length [mm]  | 290           |
|              | Filter Insert |

**References**

|            |          |
|------------|----------|
| BJ329601AA | LR029078 |
|------------|----------|

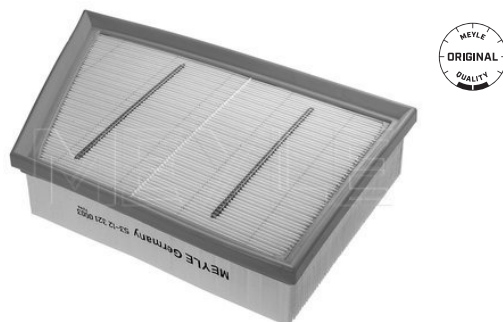

**Application info**

Discovery Sport [09/14--]  
Freelander II [10/06--]

Range Rover Evoque [06/11--]

### Air filter

**312 321 0001 | MAF0415**

**Notes**

|                     |               |
|---------------------|---------------|
| Inner diameter [mm] | 108           |
| Outer diameter [mm] | 155           |
| Height [mm]         | 498           |
|                     | Filter Insert |

**References**

PHE000040



**Application info**

Range Rover III [03/02-08/12]

### Air filter

**312 321 0000 | MAF0414**

**Notes**

|                     |               |
|---------------------|---------------|
| Inner diameter [mm] | 108           |
| Outer diameter [mm] | 145           |
| Height [mm]         | 377           |
|                     | Filter Insert |

**References**

|           |            |
|-----------|------------|
| LR007478  | PHE100500L |
| PHE100500 |            |



**Application info**

Freelander I [02/98-10/06]

**53-12 321 0001 | MAF0569**

**Air filter**



**Notes**

|             |               |
|-------------|---------------|
| Height [mm] | 71            |
| Width [mm]  | 198           |
| Length [mm] | 244           |
|             | Filter Insert |

**References**

PHE500060

**Application info**

Defender [09/90-09/03]

**314 323 0003 | MFF0151**

**Fuel filter**



**Notes**

|               |                |
|---------------|----------------|
| Diameter [mm] | 30             |
| Height [mm]   | 97             |
|               | In-Line Filter |

**References**

PHB000450

STC4202

**Application info**

Freelander I [02/98-10/06]

Range Rover III [03/02-06/12]

**100 323 0007 | MFF0056**

**Fuel filter**



**Notes**

|               |                            |
|---------------|----------------------------|
| Diameter [mm] | 84                         |
| Height [mm]   | 71.3                       |
|               | with seal<br>Filter Insert |

**References**

90517711

RTC6079

**Application info**

88/109 [09/61-12/86]

90/110 [09/83-07/90]



**Fuel filter**

**314 323 0008 | MFF0154**

**Notes**

Diameter [mm]                    Steel  
70  
Diameter 1 [mm]                55  
Height [mm]                      207  
In-Line Filter

**References**

WFL000020                      WFL000021



**Application info**

Range Rover III (03/02-08/12)

**Fuel filter**

**314 323 0000 | MFF0148**

**Notes**

Diameter [mm]                    Zinc-coated  
Steel  
83.5  
Height [mm]                      177  
In-Line Filter

**References**

WFL000070                      WFL4070



**Application info**

Range Rover III (03/02-08/12)

**Fuel filter**

**100 127 0006 | MFF0030**

**Notes**

Diameter [mm]                    without holder  
Steel  
88  
Height [mm]                      170  
In-Line Filter

**References**

WJN000130



**Application info**

Freelander I (02/98-10/06)

**314 114 0004 | MOF0125**

**Oil filter**



**Notes**

|                       |               |
|-----------------------|---------------|
| Inner diameter 2 [mm] | with seal     |
| Inner diameter [mm]   | 39.5          |
| Outer diameter [mm]   | 24.5          |
| Outer diameter [mm]   | 83            |
| Height [mm]           | 161           |
|                       | Filter Insert |

**References**

|           |           |
|-----------|-----------|
| LPW000010 | LPW500030 |
|-----------|-----------|

**Application info**

Range Rover III [03/02-08/12]

**300 114 2200 | MOF0114**

**Oil filter**



**Notes**

|                     |               |
|---------------------|---------------|
| Inner diameter [mm] | with seal     |
| Inner diameter [mm] | 29            |
| Outer diameter [mm] | 68            |
| Outer diameter [mm] | 79            |
| Height [mm]         | Filter Insert |

**References**

LPZ000020

**Application info**

Range Rover III [03/02-08/12]

**714 322 0011 | MOF0205**

**Oil filter**



**Notes**

|                     |               |
|---------------------|---------------|
| Inner diameter [mm] | with seal     |
| Inner diameter [mm] | 24            |
| Outer diameter [mm] | 65            |
| Outer diameter [mm] | 69            |
| Height [mm]         | Filter Insert |

**References**

|          |          |
|----------|----------|
| LR001247 | LR030778 |
| LR004459 |          |

**Application info**

Defender [09/90-09/03]  
Discovery Sport [09/14--]

Freelander II [10/06--]  
Range Rover Evoque [06/11--]

**Oil filter**

**714 322 0014 | MOF0207**

**Notes**

Bypass Valve Opening Pressure [bar] 1  
Outer diameter [mm] 75  
Height [mm] 86  
Thread Size 3/4"-16 UNF  
Screw-on Filter with one anti-return valve

**References**

LR025306



**Application info**

Discovery Sport (09/14--)  
Freelander II (10/06--)

Range Rover Evoque (06/11--)  
Range Rover Evoque II (11/15--)

**Oil filter**

**314 114 0001 | MOF0122**

**Notes**

Inner diameter [mm] with seal 31.5  
Outer diameter [mm] 65  
Height [mm] 115  
Filter Insert

**References**

LRF100150



**Application info**

Freelander I (02/98-10/06)

**Oil filter**

**314 114 0008 | MOF0129**

**Notes**

Inner diameter [mm] with seal 28  
Outer diameter [mm] 88.5  
Height [mm] 157  
Filter Insert

**References**

STC2180

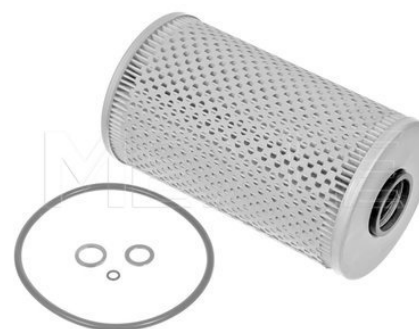

**Application info**

Range Rover II (07/94-03/02)

314 322 0001 | MOF0131

Oil filter



Notes

Inner diameter [mm]  
Outer diameter [mm]  
Height [mm]

with seal  
37  
83  
159,5  
Filter Insert

References

STC3350

Application info

Range Rover II [07/94-03/02]

314 126 1101 | MMX0964

Oil pressure switch



Notes

Pressure to [bar]  
Pressure from [bar]  
Spanner Size  
Thread Size  
Number of Poles

Brown  
Opener  
0,5  
0,2  
24  
M12 x 1,5  
1

References

1730160

Application info

Defender [09/90-09/03]  
Discovery II [11/98-06/04]  
Freelander I [02/98-10/06]

Range Rover II [07/94-03/02]  
Range Rover III [03/02-08/12]

314 038 0002 | MMX0957

Oil trap



Notes

with seal

References

LLJ500010

Application info

Freelander I [02/98-10/06]

Range Rover III [03/02-08/12]



### Hydraulic pump, P/S

714 631 0030 | MHP0158

#### Notes

Operating Pressure [bar]

Hydraulic  
110

#### References

6G91-3A696-EF  
LR001106  
LR005658

LR006462  
LR007500



#### Application info

Freelander II [10/06--]

### P/S hose

53-59 202 0001 | MHH0103

#### Notes

for foreflow

#### References

ANR3133



#### Application info

Discovery I [10/89-10/98]

### P/S hose

53-59 202 0003 | MHH0105

#### Notes

for foreflow

#### References

ANR6974



#### Application info

Discovery II [11/98-06/04]

53-59 202 0006 | MHH0108

P/S hose



Notes

for foreflow

References

NTC9989

Application info

Range Rover I [07/70-07/94]

53-59 202 0000 | MHH0102

P/S hose



Notes

for foreflow

References

QEH000100  
QEH000101

QEH000102  
QEH000103

Application info

Range Rover III [03/02-08/12]

53-59 203 0000 | MHH0110

P/S hose



Notes

for backflow

References

QEH000160

Application info

Range Rover III [03/02-08/12]



### P/S hose

53-59 202 0005 | MHH0107

#### Notes

for foreflow

#### References

QE000294



#### Application info

Discovery III [07/04-09/09]

### P/S hose

53-59 202 0002 | MHH0104

#### Notes

for foreflow

#### References

QE02080



#### Application info

Freelander I [02/98-10/06]

### P/S hose

53-59 202 0007 | MHH0109

#### Notes

for foreflow

#### References

QE02570



#### Application info

Defender [09/90-09/03]

53-59 202 0004 | MHH0106

P/S hose



Notes

for foreflow

References

ANR6680

QEH102790

Application info

Discovery II [11/98-06/04]

714 620 0004 | MSK0029

Steering boot kit



Notes

Inner diameter 2 [mm]  
Inner diameter 1 [mm]  
Height [mm]

with accessories  
52  
16.5  
195  
Front Axle Right  
Front Axle Left

References

LR0 02682

Application info

Freelander II [10/06--]

300 321 3601 | MSK0017

Steering boot kit



Notes

Inner diameter 2 [mm]  
Inner diameter 1 [mm]  
Height [mm]

with accessories  
Thermoplast  
67  
16  
200  
Front Axle Right  
Front Axle Left

References

QFW 000010

Application info

Range Rover III [03/02-08/12]





### Axial rod

716 031 0010 | MAR0351

#### Notes

Thread Measurement 2  
Thread Measurement 1  
Length [mm]

M18x1,5  
M16x1,5  
315  
Front Axle Right  
Front Axle Left

#### References

LR016869



#### Application info

Freelander II [10/06--]

### Axial rod

53-16 031 0004 | MAR0392

#### Notes

Thread Measurement 2  
Thread Measurement 1  
Length [mm]

M18x1,5  
M16x1,5  
298  
Front Axle Right  
Front Axle Left

#### References

LR026271



#### Application info

Discovery Sport [09/14--]

Range Rover Evoque [06/11--]

### Axial rod

53-16 031 0008 | MAR0547

#### Notes

Thread Measurement 2  
Thread Measurement 1  
Length [mm]

M14x1,5  
M16x1,5  
329  
Front Axle Right  
Front Axle Left

#### References

LR033529



#### Application info

Range Rover IV [08/12--]

Range Rover Sport [LW] [04/13--]

53-16 031 0006/HD | MAR0528HD

Axial rod



Notes

Thread Measurement 2  
Thread Measurement 1  
Length [mm]

M16x1,5  
M16x1,5  
375  
Front Axle  
inner

Reinforced Version

References

QFK500010

Counterpart

53-16 031 0005/HD | MAR0527HD

Application info

Discovery III (07/04-09/09)

Discovery IV (09/09--)

53-16 031 0005/HD | MAR0527HD

Axial rod



Notes

Thread Measurement 2  
Thread Measurement 1  
Length [mm]

M16x1,5  
M20x1,5  
375  
Front Axle  
inner

Reinforced Version

References

QFK500020

Counterpart

53-16 031 0006/HD | MAR0528HD

Application info

Discovery III (07/04-09/09)

Discovery IV (09/09--)

53-16 031 0003 | MAR0303

Axial rod



Notes

Thread Measurement 2  
Thread Measurement 1  
Length [mm]

M16x1,5  
M16x1,5  
365  
Front Axle Right  
Front Axle Left

References

QFK500030

Application info

Range Rover Sport (02/05--)



### Axial rod

53-16 031 0002 | MAR0302

#### Notes

Thread Measurement 2  
Thread Measurement 1  
Length [mm]

M18x1,5  
M18x1,5  
230  
Front Axle Right  
Front Axle Left

#### References

QJB500060

TIQ000040



#### Application info

Range Rover III (03/02-08/12)

### Tie rod end

53-16 020 0003 | MTE0463

#### Notes

Thread Measurement 2  
Thread Measurement 1  
Length [mm]

M18x1,5  
M12x1,25  
85  
Front Axle Left

#### References

ANR3826  
QFS000010  
QFS100060

QHG000050  
STC1871  
TIQ000020



#### Application info

Discovery I (10/89-10/98)  
Discovery II (11/98-06/04)

Range Rover II (07/94-03/02)

### Tie rod end

716 020 0021 | MTE0516

#### Notes

Thread Measurement 2  
Thread Measurement 1  
Length [mm]

M18x1,5  
M14x2  
113  
Front Axle Right

#### References

LR002609

#### Counterpart

716 020 0020 | MTE0515



#### Application info

Freelander II (10/06--)

716 020 0020 | MTE0515

Tie rod end



Notes

Thread Measurement 2  
Thread Measurement 1  
Length [mm]

M18x1,5  
M14x2  
113  
Front Axle Left

References

LR002610

Counterpart

716 020 0021 | MTE0516

Application info

Freelander II [10/06--]

53-16 020 0004 | MTE0464

Tie rod end



Notes

Thread Measurement 2  
Thread Measurement 1  
Length [mm]

M16x1,5  
M12x1,75  
89  
Front Axle Right  
Front Axle Left

References

LR010671

QJB500010

Application info

Discovery III [07/04-09/09]

53-16 020 0002 | MTE0462

Tie rod end



Notes

Thread Measurement 2  
Thread Measurement 1  
Length [mm]

M16x1,5  
M14x2,0  
87  
Front Axle Right  
Front Axle Left

References

LR010672

QJB500080

Application info

Discovery III [07/04-09/09]

Discovery IV [09/09--]



### Tie rod end

53-16 020 0012 | MTE0560

#### Notes

|                      |                  |
|----------------------|------------------|
| Thread Measurement 2 | M18x1,5          |
| Thread Measurement 1 | M14x2            |
| Length [mm]          | 116              |
|                      | Front Axle Right |

#### References

LR026267

#### Counterpart

53-16 020 0013 | MTE0561



#### Application info

Range Rover Evoque [06/11--]

### Tie rod end

53-16 020 0013 | MTE0561

#### Notes

|                      |                 |
|----------------------|-----------------|
| Thread Measurement 2 | 18x1,5          |
| Thread Measurement 1 | 14x2            |
| Length [mm]          | 116             |
|                      | Front Axle Left |

#### References

LR027570

#### Counterpart

53-16 020 0012 | MTE0560



#### Application info

Range Rover Evoque [06/11--]

### Tie rod end

53-16 020 0017/HD | MTE0756HD

#### Notes

|                      |                  |
|----------------------|------------------|
| Thread Measurement 2 | M14x1,5          |
| Thread Measurement 1 | M14              |
| Length [mm]          | 102.5            |
|                      | Front Axle Right |
|                      | Front Axle Left  |

#### References

LR033534



#### Application info

Range Rover IV [08/12--]

Range Rover Sport [LW] [04/13--]

53-16 020 0011 | MTE0469

Tie rod end



Notes

Thread Measurement 2  
Thread Measurement 1  
Length [mm]

with right-hand thread  
W11/16"-16RH  
M12x1,25  
86  
Front Axle Right

References

NTC1886D

RTC5869

Counterpart

53-16 020 0010 | MTE0468

Application info

Defender [09/90-09/03]

Discovery I [10/89-10/98]

53-16 020 0010 | MTE0468

Tie rod end



Notes

Thread Measurement 2  
Thread Measurement 1  
Length [mm]

with left-hand thread  
W11/16"-16LH  
M12x1,75  
86  
Front Axle Left

References

NTC1887D

RTC5870

Counterpart

53-16 020 0011 | MTE0469

Application info

Defender [09/90-09/03]

Discovery I [10/89-10/98]

53-16 020 0001 | MTE0461

Tie rod end



Notes

Thread Measurement 2  
Thread Measurement 1  
Length [mm]

M16x1,5  
M12x1,5  
70  
Front Axle Right

References

QJB100220

Counterpart

53-16 020 0000 | MTE0460

Application info

Freelander I [02/98-10/06]



### Tie rod end

53-16 020 0000 | MTE0460

#### Notes

|                      |                 |
|----------------------|-----------------|
| Thread Measurement 2 | M16x1,5         |
| Thread Measurement 1 | M12x1,5         |
| Length [mm]          | 70              |
|                      | Front Axle Left |

#### References

QJB100230

#### Counterpart

53-16 020 0001 | MTE0461



#### Application info

Freelander I (02/98-10/06)

### Tie rod end

53-16 020 0008 | MTE0466

#### Notes

|                      |                  |
|----------------------|------------------|
| Thread Measurement 2 | M16x1,5          |
| Thread Measurement 1 | M12x1,75         |
| Length [mm]          | 105              |
|                      | Front Axle Right |
|                      | Front Axle Left  |

#### References

QJB500040



#### Application info

Range Rover Sport (02/05--)

### Tie rod end

53-16 020 0009 | MTE0467

#### Notes

|                      |                  |
|----------------------|------------------|
| Thread Measurement 2 | M16x1,5          |
| Thread Measurement 1 | M14x1,5          |
| Length [mm]          | 210              |
|                      | Front Axle Right |
|                      | Front Axle Left  |

#### References

QJB500050

TIQ000030



#### Application info

Range Rover III (03/02-08/12)



**53-16 020 0007 | MTE0465**

**Tie rod end**



MEYLE

**Notes**

Thread Measurement 2  
Thread Measurement 1  
Length [mm]

M16x1,5  
M14x2,0  
105  
Front Axle Right  
Front Axle Left

**References**

QJB500070

**Application info**

Range Rover Sport (02/05--)





### Ball joint

53-16 010 0005 | MBJ0267

#### Notes

Thread Measurement 1

M16x1,5  
Lower  
Front Axle Right  
Front Axle Left

#### References

FTC3571



#### Application info

Discovery II [11/98-06/04]

Range Rover II [07/94-03/02]

### Ball joint

53-16 010 0006 | MBJ0340

#### Notes

Front Axle Right  
Front Axle Left

#### References

LR002624\*  
LR002625\*

LR007205\*  
LR007206\*



#### Application info

Freelander II [10/06--]

### Ball joint

53-16 010 0000 | MBJ0264

#### Notes

Outer diameter [mm]  
Height [mm]  
Thread Size

42  
95  
M12x1,75  
Upper  
Front Axle Right  
Front Axle Left

#### References

RBJ500221  
RBJ500222  
RBJ500231

RBJ500232  
RBK500030  
RBK500170



#### Application info

Discovery III [07/04-09/09]  
Discovery IV [09/09--]

Range Rover Sport [02/05--]

7

53-16 010 0004 | MBJ0266

Ball joint



Notes

|                      |                  |
|----------------------|------------------|
| Outer diameter [mm]  | 42               |
| Height [mm]          | 103              |
| Thread Measurement 1 | M12x1,75         |
|                      | Upper            |
|                      | Front Axle Right |
|                      | Front Axle Left  |

References

|           |           |
|-----------|-----------|
| RBK500161 | RBK500170 |
|-----------|-----------|

Application info

Discovery III [07/04-09/09]  
Discovery IV [09/09--]

Range Rover Sport [02/05--]

53-16 010 0002 | MBJ0339

Ball joint



Notes

|                     |                  |
|---------------------|------------------|
| Outer diameter [mm] | 44.5             |
| Thread Size         | M14x1,5          |
|                     | Upper            |
|                     | Front Axle Right |
|                     | Front Axle Left  |

References

|           |           |
|-----------|-----------|
| RBK000010 | RBK500150 |
| RBK000011 | RBK500210 |
| RBK000012 |           |

Application info

Range Rover III [03/02-08/12]

53-16 010 0001 | MBJ0265

Ball joint



Notes

|                     |                  |
|---------------------|------------------|
| Outer diameter [mm] | 45               |
| Thread Size         | M12x2,0          |
|                     | Lower            |
|                     | Front Axle Right |
|                     | Front Axle Left  |

References

|           |           |
|-----------|-----------|
| RBK500040 | RBK500240 |
| RBK500180 | RBK500280 |
| RBK500230 | RBK500300 |

Application info

Discovery III [07/04-09/09]  
Discovery IV [09/09--]

Range Rover Sport [02/05--]



### Control arm

53-16 050 0034 | MCA1131

#### Notes

Steel  
Control Arm  
Rear  
Rear Axle Right  
Rear Axle Left



#### References

LR002576

#### Application info

Freelander II [10/06--]  
Range Rover Evoque [06/11--]

Range Rover Evoque II [11/15--]

### Control arm

53-16 050 0016 | MCA0996

#### Notes

Sheet Steel  
with ball joint  
with rubber mounting  
Control Arm  
Upper  
Front Axle Right



#### References

LR014132

LR051614

#### Counterpart

53-16 050 0017 | MCA0997



#### Application info

Discovery IV [09/09--]

### Control arm

53-16 050 0017 | MCA0997

#### Notes

Sheet Steel  
with ball joint  
with rubber mounting  
Control Arm  
Upper  
Front Axle Left



#### References

LR014133

LR051615

#### Parts list

53-16 010 0004 | MBJ0266

Ball joint

#### Counterpart

53-16 050 0016 | MCA0996



7



53-16 050 0017 | MCA0997

Control arm

Application info

Discovery IV (09/09--)

53-16 050 0003 | MCA0834

Control arm



Notes

Steel  
with rubber mounting  
Control Arm  
Rear  
Upper  
Front Axle Right

References

LR018343

RBJ000120

Parts list

53-14 610 0007 | MCB0373

Control arm bushing

Counterpart

53-16 050 0002 | MCA0833

Application info

Range Rover III (03/02-08/12)

53-16 050 0002 | MCA0833

Control arm



Notes

Steel  
with rubber mounting  
Control Arm  
Upper  
Rear  
Front Axle Left

References

LR018344

RBJ000130

Parts list

53-14 610 0007 | MCB0373

Control arm bushing

Counterpart

53-16 050 0003 | MCA0834

Application info

Range Rover III (03/02-08/12)



### Control arm

53-16 050 0011/HD | MCA1020HD

#### Notes

Reinforced Version

Sheet Steel  
Control Arm  
Lower  
Front Axle Left

#### References

LR028250  
RBJ500194  
RBJ501330

RBJ501370  
RBJ501570

#### Parts list

53-16 010 0001 | MBJ0265  
53-14 610 0000/HD |  
MCB0405HD  
53-14 610 0001 | MCB0372

Ball joint  
Control arm bushing  
Control arm bushing

#### Counterpart

53-16 050 0012/HD | MCA1021HD



#### Application info

Discovery III (07/04-09/09)

### Control arm

53-16 050 0001/HD | MCA1017HD

#### Notes

Reinforced Version

Sheet Steel  
with ball joint  
with rubber mounting  
Control Arm  
Lower  
Front Axle Right

#### References

LR028248  
LR029304  
RBJ500446  
RBJ501280

RBJ501380  
RBJ501500  
RBJ501600

#### Parts list

53-16 010 0001 | MBJ0265  
53-14 610 0000/HD |  
MCB0405HD

Ball joint  
Control arm bushing

#### Counterpart

53-16 050 0000/HD | MCA1016HD



#### Application info

Range Rover Sport (02/05--)

53-16 050 0000/HD | MCA1016HD

Control arm



Notes

Sheet Steel  
with ball joint  
with rubber mounting  
Control Arm  
Lower  
Front Axle Left

Reinforced Version

References

|           |           |
|-----------|-----------|
| LR028252  | RBJ501390 |
| LR029306  | RBJ501510 |
| RBJ500456 | RBJ501610 |
| RBJ501290 |           |

Parts list

|                                  |                     |
|----------------------------------|---------------------|
| 53-16 010 0001   MBJ0265         | Ball joint          |
| 53-14 610 0000/HD  <br>MCB0405HD | Control arm bushing |

Counterpart

53-16 050 0001/HD | MCA1017HD

Application info

Range Rover Sport [02/05--]

53-16 050 0033 | MCA1130

Control arm



Notes

Steel  
Control Arm  
Rear Axle Right  
Rear Axle Left

References

|          |          |
|----------|----------|
| LR002575 | LR032308 |
|----------|----------|

Application info

Freelander II [10/06--]



### Control arm

### 53-16 050 0009/HD | MCA1018HD

#### Notes

Sheet Steel  
Control Arm  
Lower  
Front Axle Left

Reinforced Version

#### References

LR014138  
LR025613  
LR028249  
LR051584  
LR071929  
LR073369

LR075995  
RBJ500193  
RBJ501250  
RBJ501350  
RBJ501550

#### Parts list

|                               |                     |
|-------------------------------|---------------------|
| 53-16 010 0001   MBJ0265      | Ball joint          |
| 53-14 610 0000/HD   MCB0405HD | Control arm bushing |
| 53-14 610 0001   MCB0372      | Control arm bushing |

#### Counterpart

53-16 050 0010/HD | MCA1019HD



#### Application info

Discovery III [07/04-09/09]

Discovery IV [09/09--]

### Control arm

### 53-16 050 0010/HD | MCA1019HD

#### Notes

Sheet Steel  
Control Arm  
Lower  
Front Axle Right

Reinforced Version

#### References

LR014136  
LR025610  
LR028245  
LR051583  
LR071166  
LR073367

LR075993  
RBJ500183  
RBJ501240  
RBJ501340  
RBJ501540

#### Parts list

|                               |                     |
|-------------------------------|---------------------|
| 53-16 010 0001   MBJ0265      | Ball joint          |
| 53-14 610 0000/HD   MCB0405HD | Control arm bushing |
| 53-14 610 0001   MCB0372      | Control arm bushing |

#### Counterpart

53-16 050 0009/HD | MCA1018HD



#### Application info

Discovery III [07/04-09/09]

Discovery IV [09/09--]

53-16 050 0012/HD | MCA1021HD

Control arm



Notes

Sheet Steel  
Control Arm  
Lower  
Front Axle Right

Reinforced Version

References

LR028246  
LR075994  
RBJ500184

RBJ501320  
RBJ501360  
RBJ501560

Parts list

53-16 010 0001 | MBJ0265  
53-14 610 0000/HD |  
MCB0405HD  
53-14 610 0001 | MCB0372

Ball joint  
Control arm bushing  
Control arm bushing

Counterpart

53-16 050 0011/HD | MCA1020HD

Application info

Discovery III [07/04-09/09]

53-16 050 0018 | MCA0998

Control arm



Notes

Sheet Steel  
with ball joint  
with rubber mounting  
Control Arm  
Upper  
Front Axle Right

References

RBJ500221

RBJ500222

Parts list

53-16 010 0000 | MBJ0264

Ball joint

Counterpart

53-16 050 0019 | MCA0999

Application info

Discovery III [07/04-09/09]





### Control arm

53-16 050 0019 | MCA0999

#### Notes

Sheet Steel  
with ball joint  
with rubber mounting  
Control Arm  
Upper  
Front Axle Left

#### References

RBJ500231

RBJ500232

#### Parts list

53-16 010 0000 | MBJ0264

Ball joint

#### Counterpart

53-16 050 0018 | MCA0998



#### Application info

Discovery III [07/04-09/09]

### Control arm

53-16 050 0008 | MCA0872

#### Notes

Cast Steel  
Control Arm  
Upper  
Front Axle Right

#### References

LR026095

RBJ500840

#### Parts list

53-16 010 0004 | MBJ0266

53-14 610 0006 | MCB0374

Ball joint

Control arm bushing

#### Counterpart

53-16 050 0007 | MCA0871



#### Application info

Discovery III [07/04-09/09]

Discovery IV [09/09--]

Range Rover Sport [02/05--]

53-16 050 0007 | MCA0871

Control arm



Notes

Cast Steel  
Control Arm  
Upper  
Front Axle Left

References

RBJ500850

Parts list

53-16 010 0004 | MBJ0266  
53-14 610 0006 | MCB0374

Ball joint  
Control arm bushing

Counterpart

53-16 050 0008 | MCA0872

Application info

Discovery III [07/04-09/09]  
Discovery IV [09/09--]

Range Rover Sport [02/05--]

53-16 050 0004 | MCA0832

Control arm



Notes

Thread Size

Steel  
M14x1,5  
with ball joint  
with rubber mounting  
Control Arm  
Front  
Lower  
Front Axle Right  
Front Axle Left

References

RBJ000062  
RBJ000710

RBJ500710  
RBJ500920

Application info

Range Rover III [03/02-08/12]

53-14 610 0000/HD | MCB0405HD

Control arm bushing



Notes

Inner diameter [mm]  
Outer diameter [mm]  
Height [mm]

16  
70  
83  
Rear  
Front Axle Right  
Front Axle Left

Reinforced Version

References

LR023715  
LR025159  
LR025986

LR051586  
RBX500291  
RBX500531

### Control arm bushing

53-14 610 0000/HD | MCB0405HD

#### Application info

Discovery III (07/04-09/09)  
Discovery IV (09/09--)

Range Rover Sport (02/05--)

### Control arm bushing

53-14 610 0001 | MCB0372

#### Notes

|                     |                  |
|---------------------|------------------|
| Inner diameter [mm] | 16               |
| Outer diameter [mm] | 53               |
| Height [mm]         | 77               |
|                     | Front            |
|                     | Lower            |
|                     | Front Axle Right |
|                     | Front Axle Left  |

#### References

LR051585                      RBX500311



#### Application info

Discovery III (07/04-09/09)

Discovery IV (09/09--)

### Control arm bushing

53-14 610 0006 | MCB0374

#### Notes

|                     |                  |
|---------------------|------------------|
| Inner diameter [mm] | 14.5             |
| Outer diameter [mm] | 44               |
| Height [mm]         | 53               |
|                     | for control arm  |
|                     | Front Axle Right |
|                     | Front Axle Left  |

#### References

LR051625                      RBX500443



#### Application info

Discovery III (07/04-09/09)  
Discovery IV (09/09--)

Range Rover Sport (02/05--)

### Control arm bushing

53-14 610 0007 | MCB0373

#### Notes

|                     |                  |
|---------------------|------------------|
| Inner diameter [mm] | 14               |
| Outer diameter [mm] | 66               |
| Height [mm]         | 76               |
|                     | Front Axle Right |
|                     | Front Axle Left  |

#### References

LR018345                      RBX000200



53-14 610 0007 | MCB0373

Control arm bushing

Application info

Range Rover III (03/02-08/12)

714 610 0011 | MCB0331

Control arm bushing



Notes

|                     |                  |
|---------------------|------------------|
| Inner diameter [mm] | 14               |
| Outer diameter [mm] | 60               |
| Height [mm]         | 60               |
|                     | Front            |
|                     | Front Axle Right |
|                     | Front Axle Left  |

References

|           |           |
|-----------|-----------|
| LR002624* | LR007205* |
| LR002625* | LR007206* |

Application info

Freelander II (10/06--)

53-14 710 0000 | MCM0124

Mount, control arm



Notes

|                     |                 |
|---------------------|-----------------|
| Inner diameter [mm] | 13              |
| Outer diameter [mm] | 47              |
| Height [mm]         | 62              |
|                     | Upper           |
|                     | Rear Axle Left  |
|                     | Rear Axle Right |

References

|           |           |
|-----------|-----------|
| RHF500031 | RHF500100 |
|-----------|-----------|

Application info

Discovery III (07/04-09/09)  
Discovery IV (09/09--)

Range Rover Sport (02/05--)

53-14 715 0007 | MSB0471

Mount, stabilizer



Notes

|                     |                 |
|---------------------|-----------------|
| Inner diameter [mm] | 18              |
| Required quantity   | 2               |
|                     | Rear Axle Left  |
|                     | Rear Axle Right |

References

EGP1889

7



### Mount, stabilizer

53-14 715 0007 | MSB0471

#### Application info

Defender [09/90-09/03]

### Mount, stabilizer

53-14 615 0006 | MSB0462

#### Notes

|                     |                  |
|---------------------|------------------|
| Inner diameter [mm] | 18               |
| Required quantity   | 2                |
|                     | Front Axle Left  |
|                     | Front Axle Right |

#### References

LR005649



#### Application info

Freelander II [10/06--]

### Mount, stabilizer

53-14 715 0000 | MSB0465

#### Notes

|                     |                 |
|---------------------|-----------------|
| Inner diameter [mm] | 22              |
| Required quantity   | 2               |
|                     | Rear Axle Left  |
|                     | Rear Axle Right |

#### References

LR015336

RGX500060



#### Application info

Discovery III [07/04-09/09]

Discovery IV [09/09--]

### Mount, stabilizer

53-14 615 0000 | MSB0456

#### Notes

|                     |                  |
|---------------------|------------------|
| Inner diameter [mm] | 27               |
| Required quantity   | 2                |
|                     | Front Axle Left  |
|                     | Front Axle Right |

#### References

LR015339

RBX000571



53-14 615 0000 | MSB0456

Mount, stabilizer

Application info

Discovery III (07/04-09/09)

53-14 615 0007 | MSB0463

Mount, stabilizer



Notes

|                     |                  |
|---------------------|------------------|
| Inner diameter [mm] | 29               |
| Required quantity   | 2                |
|                     | Front Axle Left  |
|                     | Front Axle Right |

References

LR018346

Application info

Discovery IV (09/09--)

53-14 615 0001 | MSB0457

Mount, stabilizer



Notes

|                     |                  |
|---------------------|------------------|
| Inner diameter [mm] | 30.5             |
| Required quantity   | 2                |
|                     | Front Axle Left  |
|                     | Front Axle Right |

References

|          |           |
|----------|-----------|
| LR018347 | RBX500280 |
|----------|-----------|

Application info

Range Rover Sport (02/05--)

53-14 715 0002 | MSB0467

Mount, stabilizer



Notes

|                     |                 |
|---------------------|-----------------|
| Inner diameter [mm] | 22              |
| Required quantity   | 2               |
|                     | Rear Axle Left  |
|                     | Rear Axle Right |

References

LR018354

**Mount, stabilizer**

**53-14 715 0002 | MSB0467**

**Application info**

Range Rover Sport [02/05--]

**Mount, stabilizer**

**514 715 0001 | MSB0455**

**Notes**

Inner diameter [mm] 19.5  
Required quantity 2

**References**

LR030743



**Application info**

Discovery Sport [09/14--]  
Freelander II [10/06--]

Range Rover Evoque [06/11--]  
Range Rover Evoque II [11/15--]

**Mount, stabilizer**

**53-14 715 0008 | MSB0472**

**Notes**

Inner diameter [mm] 19  
Required quantity 2  
Rear Axle Left  
Rear Axle Right

**References**

NRC5674



**Application info**

Defender [09/90-09/03]

**Mount, stabilizer**

**53-14 615 0005 | MSB0461**

**Notes**

Inner diameter [mm] 23  
Required quantity 2  
Front Axle Left  
Front Axle Right

**References**

NTC6828



53-14 615 0005 | MSB0461

Mount, stabilizer

Application info

Defender [09/90-09/03]  
Discovery I [10/89-10/98]

Range Rover I [07/70-07/94]  
Range Rover II [07/94-03/02]

53-14 715 0009 | MSB0473

Mount, stabilizer



Notes

Inner diameter [mm]  
Required quantity

18  
2  
Rear Axle Left  
Rear Axle Right

References

NTC7394

Application info

Defender [09/90-09/03]  
Discovery I [10/89-10/98]

Range Rover I [07/70-07/94]

53-14 615 0008 | MSB0464

Mount, stabilizer



Notes

Inner diameter [mm]  
Required quantity

21  
2  
Front Axle Right  
Front Axle Left

References

RBX000010

Application info

Freelander I [02/98-10/06]

53-14 715 0005 | MSB0470

Mount, stabilizer



Notes

Inner diameter [mm]  
Required quantity

35  
2  
Rear Axle Left  
Rear Axle Right

References

RBX101181





### Mount, stabilizer

53-14 715 0005 | MSB0470

#### Application info

Discovery II [11/98-06/04]

### Mount, stabilizer

53-14 615 0004 | MSB0460

#### Notes

|                     |                  |
|---------------------|------------------|
| Inner diameter [mm] | 30               |
| Required quantity   | 2                |
|                     | Front Axle Left  |
|                     | Front Axle Right |

#### References

RBX101690



#### Application info

Discovery II [11/98-06/04]

### Mount, stabilizer

53-14 715 0004 | MSB0469

#### Notes

|                     |                 |
|---------------------|-----------------|
| Inner diameter [mm] | 29              |
| Required quantity   | 2               |
|                     | Rear Axle Left  |
|                     | Rear Axle Right |

#### References

RBX101700



#### Application info

Discovery II [11/98-06/04]

### Mount, stabilizer

53-14 715 0006 | MSB0494

#### Notes

|                     |                 |
|---------------------|-----------------|
| Inner diameter [mm] | 19              |
| Required quantity   | 2               |
|                     | Rear Axle Left  |
|                     | Rear Axle Right |

#### References

RBX101710



7

53-14 715 0006 | MSB0494

Mount, stabilizer

Application info

Discovery II [11/98-06/04]

53-14 715 0003 | MSB0468

Mount, stabilizer



Notes

|                     |                 |
|---------------------|-----------------|
| Inner diameter [mm] | 28              |
| Required quantity   | 2               |
|                     | Rear Axle Left  |
|                     | Rear Axle Right |

References

RBX500040

Application info

Range Rover III [03/02-08/12]

53-14 615 0003 | MSB0459

Mount, stabilizer



Notes

|                     |                  |
|---------------------|------------------|
| Inner diameter [mm] | 31               |
| Required quantity   | 2                |
|                     | Front Axle Left  |
|                     | Front Axle Right |

References

RBX500160

Application info

Range Rover III [03/02-08/12]

53-14 715 0001 | MSB0466

Mount, stabilizer



Notes

|                     |                 |
|---------------------|-----------------|
| Inner diameter [mm] | 33              |
| Required quantity   | 2               |
|                     | Rear Axle Left  |
|                     | Rear Axle Right |

References

|           |           |
|-----------|-----------|
| RGX500070 | RVU000022 |
|-----------|-----------|

**Mount, stabilizer**

**53-14 715 0001 | MSB0466**

**Application info**

Range Rover Sport [02/05--]

**Mount, stabilizer**

**53-14 615 0002 | MSB0458**

**Notes**

Inner diameter [mm] 33  
 Required quantity 2  
 Front Axle Left  
 Front Axle Right

**References**

RVU500010 RVU500011



**Application info**

Range Rover Sport [02/05--]

**Stabilizer link**

**53-16 060 0004/HD | MSL0499HD**

**Notes**

with spanner attachment  
 Coupling Rod  
 Thread Measurement 2 M12X1,5  
 Thread Measurement 1 M12X1,5  
 Length [mm] 100  
 Front Axle Right  
 Front Axle Left

Reinforced Version

**References**

ANR3304



**Application info**

Range Rover II [07/94-03/02]

**Stabilizer link**

**53-16 060 0020 | MSL0873**

**Notes**

with spanner attachment  
 Coupling Rod  
 Thread Measurement 2 M12X1,5  
 Thread Measurement 1 M12X1,5  
 Length [mm] 100  
 Front Axle Right  
 Front Axle Left

**References**

ANR3304



7

53-16 060 0020 | MSL0873

Stabilizer link

Application info

Range Rover II (07/94-03/02)

53-16 060 0014/HD | MSL0509HD

Stabilizer link



Notes

Thread Measurement 2  
Thread Measurement 1  
Length [mm]

Reinforced Version

References

LR002826

with spanner attachment  
Coupling Rod  
M10x1,5  
M10x1,5  
350  
Front Axle Right  
Front Axle Left

Application info

Freelander II (10/06--)

316 060 0001/HD | MSL0306HD

Stabilizer link



Notes

Thread Measurement 2  
Thread Measurement 1  
Length [mm]

Reinforced Version

References

LR002876

with spanner attachment  
Coupling Rod  
M10x1,5  
M10x1,5  
231  
Right  
Left

Application info

Freelander II (10/06--)  
Range Rover Evoque (06/11--)

Range Rover Evoque II (11/15--)

### Stabilizer link

53-16 060 0008/HD | MSL0503HD

#### Notes

Thread Measurement 2  
Thread Measurement 1  
Length [mm]

with spanner attachment  
Coupling Rod  
M12x1,75  
M12x1,75  
310  
Front Axle Right  
Front Axle Left

Reinforced Version

#### References

LR014145



#### Application info

Discovery IV [09/09--]

### Stabilizer link

53-16 060 0019/HD | MSL0581HD

#### Notes

Thread Measurement 2  
Thread Measurement 1  
Length [mm]

with spanner attachment  
Coupling Rod  
M10x1,5  
M10x1,5  
320  
Front Axle Left  
Front Axle Right

Reinforced Version

#### References

LR024474



#### Application info

Discovery Sport [09/14--]

Range Rover Evoque [06/11--]

### Stabilizer link

53-16 060 0007/HD | MSL0502HD

#### Notes

Thread Measurement 2  
Thread Measurement 1  
Length [mm]

with spanner attachment  
Coupling Rod  
M12x1,5  
M12x1,5  
380  
Front Axle Right  
Front Axle Left

Reinforced Version

#### References

LR030047  
RBM000011

RBM500200



#### Application info

Range Rover III [03/02-08/12]

53-16 060 0023 | MSL0876

Stabilizer link



Notes

Thread Measurement 2  
Thread Measurement 1  
Length [mm]

with spanner attachment  
Coupling Rod  
M12X1,5  
M12X1,5  
380  
Front Axle Right  
Front Axle Left

References

LR030047  
RBM000011

RBM500200

Application info

Range Rover III [03/02-08/12]

53-16 060 0015/HD | MSL0510HD

Stabilizer link



Notes

Thread Measurement 2  
Thread Measurement 1  
Length [mm]

Coupling Rod  
M12x1,5  
M12x1,5  
120  
Rear Axle Right  
Rear Axle Left

Reinforced Version

References

LR030048  
RGD000130

RGD000131  
RGD500150

Application info

Range Rover III [03/02-08/12]

53-16 060 0013 | MSL0508

Stabilizer link



Notes

Thread Measurement 1  
Length [mm]

Coupling Rod  
M12x1,75  
65  
Rear Axle Right  
Rear Axle Left  
Front Axle Right  
Front Axle Left

References

NTC1888

Application info

Defender [09/90-09/03]  
Discovery I [10/89-10/98]

Range Rover I [07/70-07/94]

7

### Stabilizer link

53-16 060 0016/HD | MSL0511HD

#### Notes

Thread Measurement 2  
Thread Measurement 1  
Length [mm]

with spanner attachment  
Coupling Rod  
M10x1,5  
M12x1,5  
203  
Front Axle Right  
Front Axle Left

Reinforced Version

#### References

RBM100170  
RBM100171

RBM100172



#### Application info

Freelander I [02/98-10/06]

### Stabilizer link

53-16 060 0005/HD | MSL0500HD

#### Notes

Thread Measurement 2  
Thread Measurement 1  
Length [mm]

with spanner attachment  
Coupling Rod  
M12x1,25  
M12x1,5  
246  
Front Axle Right  
Front Axle Left

Reinforced Version

#### References

RBM100223



#### Application info

Discovery II [11/98-06/04]

### Stabilizer link

53-16 060 0011 | MSL0506

#### Notes

Thread Measurement 2  
Thread Measurement 1  
Length [mm]

Coupling Rod  
M14x2,0  
M14x2,0  
345  
Front Axle Right

#### References

RBM500140

#### Counterpart

53-16 060 0012 | MSL0507



#### Application info

Discovery III [07/04-09/09]  
Discovery IV [09/09--]

Range Rover Sport [02/05--]

53-16 060 0012 | MSL0507

Stabilizer link



Notes

Thread Measurement 2  
Thread Measurement 1  
Length [mm]

Coupling Rod  
M14x2,0  
M14x2,0  
345  
Front Axle Left

References

RBM500150

Counterpart

53-16 060 0011 | MSL0506

Application info

Discovery III [07/04-09/09]  
Discovery IV [09/09--]

Range Rover Sport [02/05--]

53-16 060 0009/HD | MSL0504HD

Stabilizer link



Notes

Thread Measurement 2  
Thread Measurement 1  
Length [mm]

with spanner attachment  
Coupling Rod  
M12x1,75  
M12x1,75  
300  
Front Axle Right  
Front Axle Left

Reinforced Version

References

RBM500110  
RBM500180

RBM500190

Application info

Discovery III [07/04-09/09]

53-16 060 0010/HD | MSL0505HD

Stabilizer link



Notes

Thread Measurement 2  
Thread Measurement 1  
Length [mm]

Coupling Rod  
M12x1,75  
M12x1,75  
120  
Rear Axle Right  
Rear Axle Left

Reinforced Version

References

RG0000311

RG0000312

Application info

Discovery III [07/04-09/09]  
Discovery IV [09/09--]

Range Rover Sport [02/05--]

7





### Stabilizer link

53-16 060 0006/HD | MSL0501HD

#### Notes

Thread Measurement 2  
Thread Measurement 1  
Length [mm]

with spanner attachment  
Coupling Rod  
M12x1,25  
M12x1,5  
159  
Rear Axle Right  
Rear Axle Left

Reinforced Version

#### References

RGD100682



#### Application info

Discovery II [11/98-06/04]

### Stabilizer link

53-16 060 0017/HD | MSL0512HD

#### Notes

Thread Measurement 2  
Thread Measurement 1  
Length [mm]

Coupling Rod  
M12x1,75  
M12x1,75  
135  
Rear Axle Right  
Rear Axle Left

Reinforced Version

#### References

RGD500140



#### Application info

Range Rover Sport [02/05--]

### Dust cover kit, shock absorber

53-14 640 0000 | MSC0087

#### Notes

Kit  
Front Axle



#### Application info

Freelander I [02/98-10/06]

53-14 740 0000 | MSC0088

Dust cover kit, shock absorber



Notes

Kit  
Rear Axle

Application info

Freelander I (02/98-10/06)

53-26 723 0000 | MSA0453

Shock absorber



Notes

Suspension Strut  
Gas Pressure  
Twin-Tube  
Rear Axle Right

References

RPD102180

RPM000020

Counterpart

53-26 723 0001 | MSA0454

Application info

Freelander I (02/98-10/06)

53-26 723 0001 | MSA0454

Shock absorber



Notes

Suspension Strut  
Gas Pressure  
Twin-Tube  
Rear Axle Left

References

RPD102190

RPM000030

Counterpart

53-26 723 0000 | MSA0453

Application info

Freelander I (02/98-10/06)

7



### Shock absorber

53-26 623 0000 | MSA0451

#### Notes

Suspension Strut  
Gas Pressure  
Twin-Tube  
Front Axle Right

#### References

RSC000020

RSC000040

#### Counterpart

53-26 623 0001 | MSA0452



#### Application info

Freelander I [02/98-10/06]

### Shock absorber

53-26 623 0001 | MSA0452

#### Notes

Suspension Strut  
Gas Pressure  
Twin-Tube  
Front Axle Left

#### References

RSC000030

RSC000050

#### Counterpart

53-26 623 0000 | MSA0451



#### Application info

Freelander I [02/98-10/06]

### Wheel bearing kit

53-14 650 0001 | MWK0232

#### Notes

Number of Teeth, ABS ring  
Inner diameter [mm]  
Outer diameter [mm]  
Height [mm]

with accessories  
48  
51  
96  
50  
Rear Axle  
Front Axle

#### References

LR024267  
LR070453

LR078387  
RLB000011



#### Application info

Range Rover Evoque [06/11--]  
Range Rover III [03/02-08/12]

Range Rover IV [08/12--]  
Range Rover Sport [LW] [04/13--]

714 651 0006 | MWH0244

Wheel hub



Notes

Inner diameter [mm]  
Outer diameter [mm]  
Bolt Hole Circle Ø [mm]  
Rim Hole Number

with add-on material

30

136

108

5

with wheel studs

with integrated sensor ring

with integrated wheel bearing

Front Axle left and right

References

LR 003 157

Application info

Freelander II (10/06--)

| MEYLE no.         | Ref. no.  | Page |
|-------------------|---|------|
| <b>Land Rover</b> |   |      |
| 014 020 1039      | ERC 8450  | 37   |
| 014 698 0006      | -   | 25   |
| 014 698 0006/S    | -   | 25   |
| 025 202 1717      | SFP500070   | 21   |
| 025 203 5918      | GBP267<br>GBP270<br>RTC3163<br>STC2956  | 24   |
| 025 214 5918/W    | RTC6781<br>SFP500160<br>STC8571<br>STC8572<br>STC9149<br>STC9150<br>STC9190<br>STC9191                      | 23   |
| 025 214 8717      | SFP000120<br>SFP500210  | 21   |
| 025 214 8717/PD   | SFP000120<br>SFP500210  | 22   |
| 025 215 1918      | RTC5574<br>SFP000140<br>SFP000260<br>STC1275<br>STC2952   | 22   |
| 025 233 9719      | SFC000010<br>SFC500050<br>SFC500070<br>SFC500080  | 20   |
| 025 234 5219      | SFP000210<br>SFP100460<br>SFP100480<br>SFP100580<br>SFP100590<br>SFP500150<br>STC1880<br>STC3195<br>STC3685 | 23   |
| 025 234 5816      | SFP100470<br>SFP100490<br>SFP500130<br>STC1879<br>STC3684   | 23   |
| 025 236 1517      | LR021899<br>SFP000010<br>SFP000020  | 21   |

| MEYLE no.         | Ref. no.  | Page |
|-------------------|---|------|
| <b>Land Rover</b> |   |      |
|                   | SFP500100   |      |
| 025 241 2319      | LR004936<br>LR027309  | 17   |
| 025 241 2319/PD   | LR004936<br>LR027309  | 18   |
| 025 241 9118      | LR019618<br>SFP500010   | 19   |
| 025 241 9217      | LR015519<br>LR016808<br>LR019627<br>LR021316<br>LR032377<br>LR055454<br>LR055455<br>SFP500020<br>SFP500021<br>SFP500022<br>SFP500040<br>SFP500140 | 18   |
| 025 244 9617      | LR027129<br>LR043285<br>LR043714  | 24   |
| 025 245 3715      | LR003655<br>LR003657<br>LR023888  | 16   |
| 025 245 3715/PD   | LR003655<br>LR003657<br>LR023888  | 17   |
| 025 246 5916      | LR016684<br>LR020362<br>LR064181  | 19   |
| 025 250 2119      | LR016962<br>LR021253<br>LR026220<br>LR026221<br>LR032063<br>LR047859<br>LR051626<br>LR057725  | 20   |
| 025 250 8517      | LR015577<br>LR025739  | 19   |
| 025 257 2016      | LR036574<br>LR065492<br>LR068303<br>LR079910<br>LR079935  | 20   |

| MEYLE no.         | Ref. no.               | Page |
|-------------------|------------------------|------|
| <b>Land Rover</b> |                        |      |
| 029 330 1300      | -                      | 1    |
| 029 350 1410      | -                      | 1    |
| 029 425 1710      | -                      | 1    |
| 029 450 1800      | -                      | 2    |
| 029 475 1900      | -                      | 2    |
| 029 500 2000      | -                      | 2    |
| 029 530 2100      | -                      | 3    |
| 029 550 2200      | -                      | 3    |
| 029 600 2400      | -                      | 3    |
| 050 003 0750      | CDU2160                | 46   |
| 050 004 0855      | STC2326                | 54   |
| 050 004 1325      | ERR2215                | 46   |
| 050 005 0735      | -                      | 54   |
| 050 005 0812      | PQS000190              | 50   |
| 050 005 0875      | -                      | 55   |
| 050 005 1005      | PQS000220              | 51   |
| 050 005 1188      | GMB51190<br>PQS101130  | 52   |
| 050 005 1195      | GMB51190<br>PQS101130  | 53   |
| 050 005 1200      | -                      | 55   |
| 050 005 1815      | STC2134<br>STC4455     | 54   |
| 050 005 2020      | PQS000200              | 51   |
| 050 005 2030      | -                      | 55   |
| 050 006 1185      | PQS101030              | 52   |
| 050 006 1200      | LR003570               | 49   |
| 050 006 1205      | BJ3286208A<br>LR028881 | 45   |
| 050 006 1370      | PQS100900              | 52   |
| 050 006 1460      | PQS100851              | 51   |
| 050 006 1560      | PQS101272              | 53   |
| 050 006 1743      | LR000996               | 49   |
| 050 006 1750      | GFB101750              | 49   |
| 050 006 2498      | LR018312               | 50   |
| 050 007 1580      | ERR5911                | 47   |
| 050 007 1593      | ERR3287                | 46   |
| 050 007 1635      | PQS000100              | 50   |
| 050 007 1713      | PQS101490              | 53   |
| 050 007 1775      | ERR6899                | 48   |
| 050 007 1855      | ERR6191                | 48   |
| 050 007 1870      | ERR4461                | 47   |
| 050 007 2250      | ERR4623                | 47   |
| 050 007 2620      | ERR6897                | 48   |
| 050 007 2713      | ERR6896                | 56   |
| 100 127 0006      | WJN000130              | 65   |

| MEYLE no.         | Ref. no.   | Page |
|-------------------|--|------|
| <b>Land Rover</b> |  |      |
| 100 323 0007      | 90517711<br>RTC6079                                    | 64   |
| 11-13 220 0021    | LR001309<br>LR009392<br>LR011694                       | 58   |
| 11-51 902 1013    | LR005362<br>LR006671<br>LR009395                       | 44   |
| 11-51 902 2004    | LR000660   | 45   |
| 114 042 1201      | SFS000050<br>SFS000051                                 | 25   |
| 16-14 860 0001    | NCC100050<br>NCC100050L                                | 40   |
| 30-12 320 0006    | LR036369   | 5    |
| 300 022 0163      | STC3103  | 41   |
| 300 114 2200      | LPZ000020  | 66   |
| 300 135 0002      | -  | 28   |
| 300 135 0002/SK   | -  | 28   |
| 300 135 0401      | -  | 29   |
| 300 135 1005      | -  | 29   |
| 300 135 1005/SK   | -  | 30   |
| 300 321 3601      | QFW 000010   | 72   |
| 300 325 0000      | LR007474   | 27   |
| 31-13 220 0003    | GWP193<br>GWP347<br>PEB10095<br>PEB102010<br>PEB102420 | 60   |
| 312 320 0013      | JM0000010  | 5    |
| 312 321 0000      | LR007478<br>PHE100500<br>PHE100500L                    | 63   |
| 312 321 0001      | PHE000040  | 63   |
| 313 011 3800      | 8510325<br>STC2192<br>STC3342<br>STC3343E              | 57   |
| 313 011 4300      | 8510324<br>PEB000030                                   | 57   |
| 313 220 0004      | PEB000050  | 59   |
| 314 023 0000      | NCC100120L   | 40   |
| 314 036 0014      | 8510298  | 62   |
| 314 038 0002      | LLJ500010  | 68   |
| 314 114 0001      | LRF100150  | 67   |
| 314 114 0004      | LPW000010<br>LPW500030                                 | 66   |

| MEYLE no.         | Ref. no.  | Page |
|-------------------|---|------|
| <b>Land Rover</b> |   |      |
| 314 114 0008      | STC2180   | 67   |
| 314 126 1101      | 1730160   | 68   |
| 314 131 0000      | LR022494  | 42   |
| 314 131 0001      | LR022494  | 42   |
| 314 137 0002      | THE500030<br>THE500031  | 27   |
| 314 322 0001      | STC3350   | 68   |
| 314 323 0000      | WFL000070<br>WFL4070  | 65   |
| 314 323 0003      | PHB000450<br>STC4202  | 64   |
| 314 323 0008      | WFL000020<br>WFL000021  | 65   |
| 314 862 0000      | LR022494  | 43   |
| 314 899 0069      | -   | 43   |
| 316 060 0001/HD   | LR002876  | 100  |
| 40-14 860 0002    | LR001302  | 38   |
| 40-14 860 0003    | LR022300  | 39   |
| 45-12 410 0001    | ESR4103   | 62   |
| 45-13 220 0001    | PEB102240<br>PEB102240L   | 59   |
| 45-13 220 0002    | GWP333  | 57   |
| 45-15 521 0002/PD | 571762<br>FRC 7329<br>LR017951  | 6    |
| 45-15 521 0004/PD | FTC902<br>LR017952  | 7    |
| 45-15 521 0005/PD | NTC 8780  | 11   |
| 45-15 523 0003/PD | 571912<br>FRC9831<br>FTC1381<br>FTC3846<br>FTC461<br>LR017953<br>LR018026<br>SDB000330<br>SDB100980 | 10   |
| 45-15 523 0006/PD | NTC 8781<br>SDB000210<br>SDB000470  | 12   |
| 45-51 902 1001    | LHP10015L   | 44   |
| 45-51 902 1002    | LHP100550L  | 44   |
| 512 320 0005      | 6G9N180543BA<br>LR000899<br>LR019192<br>LR039612  | 5    |

| MEYLE no.         | Ref. no.                                       | Page |
|-------------------|--|------|
| <b>Land Rover</b> |  |      |
| 512 320 0006      | 6G9N19N619BA<br>LR000901<br>LR019589           | 4    |
| 514 715 0001      | LR030743                                       | 95   |
| 514 814 0002      | FRC8387  | 27   |
| 514 860 0001      | 1354289  | 37   |
| 53-12 319 0002    | JKR500010                                      | 4    |
| 53-12 320 0002    | JKR500020                                      | 4    |
| 53-12 321 0001    | PHE500060                                      | 64   |
| 53-12 321 0002    | LR003011<br>LR005816                           | 62   |
| 53-12 321 0003    | BJ329601AA<br>LR029078                         | 63   |
| 53-13 043 0001    | STC 4378                                       | 61   |
| 53-13 220 0001    | ERR3290<br>PEB500090<br>STC1086                | 61   |
| 53-13 220 0002    | GWP2604<br>PEB102270<br>PEB102440<br>PEB102470 | 60   |
| 53-13 220 0003    | PEB102510L                                     | 60   |
| 53-13 220 0005    | ERR6505<br>PEM500040                           | 61   |
| 53-13 220 0007    | 1311325<br>LR005764<br>LR007602<br>LR009324    | 58   |
| 53-14 000 0000    | SEM000012                                      | 34   |
| 53-14 000 0001    | SOE000025                                      | 36   |
| 53-14 000 0003    | SOE000010<br>SOE000011                         | 36   |
| 53-14 000 0004    | SEM000024<br>SEM500070                         | 35   |
| 53-14 000 0005    | SOE500030                                      | 37   |
| 53-14 000 0006    | SEM500026<br>SEM500090                         | 35   |
| 53-14 223 0000    | ESR2935<br>PCF101410                           | 56   |
| 53-14 223 0001    | LR020367                                       | 56   |
| 53-14 495 0000    | TDR100750                                      | 26   |
| 53-14 498 0000    | TDB000360<br>TDB000500                         | 26   |
| 53-14 498 0001    | TDJ500040                                      | 26   |
| 53-14 500 0001    | SEM500062<br>SEM500080                         | 36   |

| MEYLE no.         | Ref. no.   | Page |
|-------------------|--|------|
| <b>Land Rover</b> |  |      |
| 53-14 500 0002    | SEM500050  | 35   |
| 53-14 527 0000    | LR012824   | 33   |
| 53-14 527 0001    | LR014568<br>LR019401   | 33   |
| 53-14 527 0002    | LR045959   | 34   |
| 53-14 527 0003    | LR033275   | 33   |
| 53-14 527 0004    | LR033295   | 34   |
| 53-14 610 0000/HD | LR023715<br>LR025159<br>LR025986<br>LR051586<br>RBX500291<br>RBX500531 | 90   |
| 53-14 610 0001    | LR051585<br>RBX500311  | 91   |
| 53-14 610 0006    | LR051625<br>RBX500443  | 91   |
| 53-14 610 0007    | LR018345<br>RBX000200  | 91   |
| 53-14 615 0000    | LR015339<br>RBX000571  | 93   |
| 53-14 615 0001    | LR018347<br>RBX500280  | 94   |
| 53-14 615 0002    | RVU500010<br>RVU500011   | 99   |
| 53-14 615 0003    | RBX500160  | 98   |
| 53-14 615 0004    | RBX101690  | 97   |
| 53-14 615 0005    | NTC6828  | 95   |
| 53-14 615 0006    | LR005649   | 93   |
| 53-14 615 0007    | LR018346   | 94   |
| 53-14 615 0008    | RBX000010  | 96   |
| 53-14 640 0000    | -  | 105  |
| 53-14 650 0001    | LR024267<br>LR070453<br>LR078387<br>RLB000011                          | 107  |
| 53-14 710 0000    | RHF500031<br>RHF500100   | 92   |
| 53-14 715 0000    | LR015336<br>RGX500060  | 93   |
| 53-14 715 0001    | RGX500070<br>RVU000022   | 98   |
| 53-14 715 0002    | LR018354   | 94   |
| 53-14 715 0003    | RBX500040  | 98   |
| 53-14 715 0004    | RBX101700  | 97   |
| 53-14 715 0005    | RBX101181  | 96   |

| MEYLE no.         | Ref. no.  | Page |
|-------------------|---|------|
| <b>Land Rover</b> |   |      |
| 53-14 715 0006    | RBX101710   | 97   |
| 53-14 715 0007    | EGP1889   | 92   |
| 53-14 715 0008    | NRC5674   | 95   |
| 53-14 715 0009    | NTC7394   | 96   |
| 53-14 740 0000    | -   | 106  |
| 53-14 860 0000    | ETC8847   | 38   |
| 53-14 860 0001    | ERR 6066  | 41   |
| 53-14 860 0002    | LR013275  | 39   |
| 53-14 899 0001    | LR023690  | 31   |
| 53-14 899 0002    | BH12 28372 BC<br>BH12 38372 BB<br>LR023691                  | 31   |
| 53-14 899 0003    | SSB 5000 90<br>SSB 5000 92                                  | 32   |
| 53-14 899 0004    | SSB 5001 33   | 32   |
| 53-14 899 0005    | SSB 5001 00<br>SSB 5001 02                                  | 32   |
| 53-14 899 0006    | AH22 9E731 AB<br>LR013783                                   | 31   |
| 53-15 521 0008/PD | SDB000080<br>SDB101070                                      | 15   |
| 53-15 521 0012/PD | SDB000200<br>SDB000201                                      | 12   |
| 53-15 521 0013/PD | SDB000602<br>SDB000603<br>SDB000604<br>SDB500120            | 13   |
| 53-15 521 0014/PD | ANR4983<br>SDB100830  | 6    |
| 53-15 523 0004/PD | LR001019  | 8    |
| 53-15 523 0011/PD | SDB000634<br>SDB000635<br>SDB000636                         | 14   |
| 53-15 523 0012/PD | LR017804<br>LR031844<br>SDB500201<br>SDB500202<br>SDB500230 | 16   |
| 53-15 523 0013/PD | LR001018  | 8    |
| 53-15 523 0014/PD | LR016192  | 9    |
| 53-15 523 0016/PD | SDB000644<br>SDB000645<br>SDB000646                         | 14   |
| 53-16 010 0000    | RBJ500221<br>RBJ500222<br>RBJ500231                         | 81   |



| MEYLE no.         | Ref. no.   | Page |
|-------------------|--|------|
| <b>Land Rover</b> |  |      |
|                   | RBJ500232<br>RBK500030<br>RBK500170  |      |
| 53-16 010 0001    | RBK500040<br>RBK500180<br>RBK500230<br>RBK500240<br>RBK500280<br>RBK500300 | 82   |
| 53-16 010 0002    | RBK000010<br>RBK000011<br>RBK000012<br>RBK500150<br>RBK500210              | 82   |
| 53-16 010 0004    | RBK500161<br>RBK500170   | 82   |
| 53-16 010 0005    | FTC3571  | 81   |
| 53-16 010 0006    | LR002624*<br>LR002625*<br>LR007205*<br>LR007206*                           | 81   |
| 53-16 020 0000    | QJB100230  | 79   |
| 53-16 020 0001    | QJB100220  | 78   |
| 53-16 020 0002    | LR010672<br>QJB500080  | 76   |
| 53-16 020 0003    | ANR3826<br>QFS000010<br>QFS100060<br>QH6000050<br>STC1871<br>TIQ000020     | 75   |
| 53-16 020 0004    | LR010671<br>QJB500010  | 76   |
| 53-16 020 0007    | QJB500070  | 80   |
| 53-16 020 0008    | QJB500040  | 79   |
| 53-16 020 0009    | QJB500050<br>TIQ000030   | 79   |
| 53-16 020 0010    | NTC18870<br>RTC5870  | 78   |
| 53-16 020 0011    | NTC18860<br>RTC5869  | 78   |
| 53-16 020 0012    | LR026267   | 77   |
| 53-16 020 0013    | LR027570   | 77   |
| 53-16 020 0017/HD | LR033534   | 77   |
| 53-16 031 0002    | QJB500060<br>TIQ000040   | 75   |

| MEYLE no.         | Ref. no.   | Page |
|-------------------|--|------|
| <b>Land Rover</b> |  |      |
| 53-16 031 0003    | QFK500030  | 74   |
| 53-16 031 0004    | LR026271   | 73   |
| 53-16 031 0005/HD | QFK500020  | 74   |
| 53-16 031 0006/HD | QFK500010  | 74   |
| 53-16 031 0008    | LR033529   | 73   |
| 53-16 050 0000/HD | LR028252<br>LR029306<br>RBJ500456<br>RBJ501290<br>RBJ501390<br>RBJ501510<br>RBJ501610  | 86   |
| 53-16 050 0001/HD | LR028248<br>LR029304<br>RBJ500446<br>RBJ501280<br>RBJ501380<br>RBJ501500<br>RBJ501600  | 85   |
| 53-16 050 0002    | LR018344<br>RBJ000130  | 84   |
| 53-16 050 0003    | LR018343<br>RBJ000120  | 84   |
| 53-16 050 0004    | RBJ000062<br>RBJ000710<br>RBJ500710<br>RBJ500920   | 90   |
| 53-16 050 0007    | RBJ500850  | 90   |
| 53-16 050 0008    | LR026095<br>RBJ500840  | 89   |
| 53-16 050 0009/HD | LR014138<br>LR025613<br>LR028249<br>LR051584<br>LR071929<br>LR073369<br>LR075995<br>RBJ500193<br>RBJ501250<br>RBJ501350<br>RBJ501550 | 87   |
| 53-16 050 0010/HD | LR014136<br>LR025610<br>LR028245<br>LR051583<br>LR071166   | 87   |

| MEYLE no.         | Ref. no.   | Page |
|-------------------|--|------|
| <b>Land Rover</b> |  |      |
|                   | LR073367<br>LR075993<br>RBJ500183<br>RBJ501240<br>RBJ501340<br>RBJ501540 |      |
| 53-16 050 0011/HD | LR028250<br>RBJ500194<br>RBJ501330<br>RBJ501370<br>RBJ501570             | 85   |
| 53-16 050 0012/HD | LR028246<br>LR075994<br>RBJ500184<br>RBJ501320<br>RBJ501360<br>RBJ501560 | 88   |
| 53-16 050 0016    | LR014132<br>LR051614   | 83   |
| 53-16 050 0017    | LR014133<br>LR051615   | 83   |
| 53-16 050 0018    | RBJ500221<br>RBJ500222   | 88   |
| 53-16 050 0019    | RBJ500231<br>RBJ500232   | 89   |
| 53-16 050 0033    | LR002575<br>LR032308   | 86   |
| 53-16 050 0034    | LR002576   | 83   |
| 53-16 060 0004/HD | ANR3304  | 99   |
| 53-16 060 0005/HD | RBM100223  | 103  |
| 53-16 060 0006/HD | RGD100682  | 105  |
| 53-16 060 0007/HD | LR030047<br>RBM000011<br>RBM500200                                       | 101  |
| 53-16 060 0008/HD | LR014145   | 101  |
| 53-16 060 0009/HD | RBM500110<br>RBM500180<br>RBM500190                                      | 104  |
| 53-16 060 0010/HD | RGD000311<br>RGD000312   | 104  |
| 53-16 060 0011    | RBM500140  | 103  |
| 53-16 060 0012    | RBM500150  | 104  |
| 53-16 060 0013    | NTC1888  | 102  |
| 53-16 060 0014/HD | LR002626   | 100  |
| 53-16 060 0015/HD | LR030048<br>RGD000130  | 102  |

| MEYLE no.         | Ref. no.   | Page |
|-------------------|--|------|
| <b>Land Rover</b> |  |      |
|                   | RGD000131<br>RGD500150                           |      |
| 53-16 060 0016/HD | RBM100170<br>RBM100171<br>RBM100172              | 103  |
| 53-16 060 0017/HD | RGD500140  | 105  |
| 53-16 060 0019/HD | LR024474   | 101  |
| 53-16 060 0020    | ANR3304  | 99   |
| 53-16 060 0023    | LR030047<br>RBM000011<br>RBM500200               | 102  |
| 53-26 623 0000    | RSC000020<br>RSC000040                           | 107  |
| 53-26 623 0001    | RSC000030<br>RSC000050                           | 107  |
| 53-26 723 0000    | RPD102180<br>RPM000020                           | 106  |
| 53-26 723 0001    | RPD102190<br>RPM000030                           | 106  |
| 53-51 902 2000    | LHV100160  | 45   |
| 53-59 202 0000    | QEH000100<br>QEH000101<br>QEH000102<br>QEH000103 | 70   |
| 53-59 202 0001    | ANR3133  | 69   |
| 53-59 202 0002    | QEH102080  | 71   |
| 53-59 202 0003    | ANR6974  | 69   |
| 53-59 202 0004    | ANR6680<br>QEH102790                             | 72   |
| 53-59 202 0005    | QEH000294  | 71   |
| 53-59 202 0006    | NTC9989  | 70   |
| 53-59 202 0007    | QEH102570  | 71   |
| 53-59 203 0000    | QEH000160  | 70   |
| 53-83 521 0005/PD | SDB000622<br>SDB000623<br>SDB000624              | 13   |
| 53-83 521 0007/PD | LR031843<br>SDB500192<br>SDB500193               | 15   |
| 53-83 523 0015/PD | LR039935   | 11   |
| 583 521 0004/PD   | LR000470<br>LR027107                             | 7    |
| 713 220 0005      | LR025302<br>LR053310                             | 59   |
| 713 220 0010      | LR004514<br>LR004799                             | 58   |

| MEYLE no.         | Ref. no.  | Page |
|-------------------|---|------|
| <b>Land Rover</b> |   |      |
| 714 020 0001      | -   | 41   |
| 714 322 0011      | LR001247<br>LR004459<br>LR030778                              | 66   |
| 714 322 0014      | LR025306  | 67   |
| 714 610 0011      | LR002624*<br>LR002625*<br>LR007205*<br>LR007206*              | 92   |
| 714 620 0004      | LR0 02682   | 72   |
| 714 631 0030      | 6G91-3A696-EF<br>LR001106<br>LR005658<br>LR006462<br>LR007500 | 69   |
| 714 651 0006      | LR 003 157  | 108  |
| 715 523 0021/PD   | LR027123  | 10   |
| 716 020 0020      | LR002610  | 76   |
| 716 020 0021      | LR002609  | 75   |
| 716 031 0010      | LR016869  | 73   |
| 783 521 0026/PD   | LR000571<br>LR007055  | 9    |



| Ref. no.          | MEYLE no.                           | Page |
|-------------------|-------------------------------------|------|
| <b>Land Rover</b> |                                     |      |
| 1311325           | 53-13 220 0007                      | 58   |
| 1354289           | 514 860 0001                        | 37   |
| 1730160           | 314 126 1101                        | 68   |
| 571762            | 45-15 521 0002/PD                   | 6    |
| 571912            | 45-15 523 0003/PD                   | 10   |
| 6G91-3A696-EF     | 714 631 0030                        | 69   |
| 6G9N180543BA      | 512 320 0005                        | 5    |
| 6G9N19N619BA      | 512 320 0006                        | 4    |
| 8510298           | 314 036 0014                        | 62   |
| 8510324           | 313 011 4300                        | 57   |
| 8510325           | 313 011 3800                        | 57   |
| 90517711          | 100 323 0007                        | 64   |
| AH22 9E731 AB     | 53-14 899 0006                      | 31   |
| ANR3133           | 53-59 202 0001                      | 69   |
| ANR3304           | 53-16 060 0004/HD<br>53-16 060 0020 | 99   |
| ANR3826           | 53-16 020 0003                      | 75   |
| ANR4983           | 53-15 521 0014/PD                   | 6    |
| ANR6680           | 53-59 202 0004                      | 72   |
| ANR6974           | 53-59 202 0003                      | 69   |
| BH12 2B372 BC     | 53-14 899 0002                      | 31   |
| BH12 3B372 BB     | 53-14 899 0002                      | 31   |
| BJ328620BA        | 050 006 1205                        | 45   |
| BJ329601AA        | 53-12 321 0003                      | 63   |
| CDU2160           | 050 003 0750                        | 46   |
| EGP1889           | 53-14 715 0007                      | 92   |
| ERC 8450          | 014 020 1039                        | 37   |
| ERR2215           | 050 004 1325                        | 46   |
| ERR3287           | 050 007 1593                        | 46   |
| ERR3290           | 53-13 220 0001                      | 61   |
| ERR4461           | 050 007 1870                        | 47   |
| ERR4623           | 050 007 2250                        | 47   |
| ERR5911           | 050 007 1580                        | 47   |
| ERR 6066          | 53-14 860 0001                      | 41   |
| ERR6191           | 050 007 1855                        | 48   |
| ERR6505           | 53-13 220 0005                      | 61   |
| ERR6896           | 050 007 2713                        | 56   |
| ERR6897           | 050 007 2620                        | 48   |
| ERR6899           | 050 007 1775                        | 48   |
| ESR2935           | 53-14 223 0000                      | 56   |
| ESR4103           | 45-12 410 0001                      | 62   |
| ETC8847           | 53-14 860 0000                      | 38   |
| FRC 7329          | 45-15 521 0002/PD                   | 6    |
| FRC8387           | 514 814 0002                        | 27   |
| FRC9831           | 45-15 523 0003/PD                   | 10   |
| FTC1381           | 45-15 523 0003/PD                   | 10   |

| Ref. no.          | MEYLE no.                      | Page   |
|-------------------|--------------------------------|--------|
| <b>Land Rover</b> |                                |        |
| FTC3571           | 53-16 010 0005                 | 81     |
| FTC3846           | 45-15 523 0003/PD              | 10     |
| FTC461            | 45-15 523 0003/PD              | 10     |
| FTC902            | 45-15 521 0004/PD              | 7      |
| GBP267            | 025 203 5918                   | 24     |
| GBP270            | 025 203 5918                   | 24     |
| GFB101750         | 050 006 1750                   | 49     |
| GMB51190          | 050 005 1188<br>050 005 1195   | 52-53  |
| GWP193            | 31-13 220 0003                 | 60     |
| GWP2604           | 53-13 220 0002                 | 60     |
| GWP333            | 45-13 220 0002                 | 57     |
| GWP347            | 31-13 220 0003                 | 60     |
| JKR500010         | 53-12 319 0002                 | 4      |
| JKR500020         | 53-12 320 0002                 | 4      |
| JM0000010         | 312 320 0013                   | 5      |
| LHP10015L         | 45-51 902 1001                 | 44     |
| LHP100550L        | 45-51 902 1002                 | 44     |
| LHV100160         | 53-51 902 2000                 | 45     |
| LLJ500010         | 314 038 0002                   | 68     |
| LPW000010         | 314 114 0004                   | 66     |
| LPW500030         | 314 114 0004                   | 66     |
| LPZ000020         | 300 114 2200                   | 66     |
| LR000470          | 583 521 0004/PD                | 7      |
| LR000571          | 783 521 0026/PD                | 9      |
| LR000660          | 11-51 902 2004                 | 45     |
| LR000899          | 512 320 0005                   | 5      |
| LR000901          | 512 320 0006                   | 4      |
| LR000996          | 050 006 1743                   | 49     |
| LR001018          | 53-15 523 0013/PD              | 8      |
| LR001019          | 53-15 523 0004/PD              | 8      |
| LR001106          | 714 631 0030                   | 69     |
| LR001247          | 714 322 0011                   | 66     |
| LR001302          | 40-14 860 0002                 | 38     |
| LR001309          | 11-13 220 0021                 | 58     |
| LR002575          | 53-16 050 0033                 | 86     |
| LR002576          | 53-16 050 0034                 | 83     |
| LR002609          | 716 020 0021                   | 75     |
| LR002610          | 716 020 0020                   | 76     |
| LR002624*         | 53-16 010 0006<br>714 610 0011 | 81, 92 |
| LR002625*         | 53-16 010 0006<br>714 610 0011 | 81, 92 |
| LR002626          | 53-16 060 0014/HD              | 100    |
| LR0 02682         | 714 620 0004                   | 72     |
| LR002876          | 316 060 0001/HD                | 100    |

| Ref. no.          | MEYLE no.                       | Page   |
|-------------------|---------------------------------|--------|
| <b>Land Rover</b> |                                 |        |
| LR003011          | 53-12 321 0002                  | 62     |
| LR 003 157        | 714 651 0006                    | 108    |
| LR003570          | 050 006 1200                    | 49     |
| LR003655          | 025 245 3715<br>025 245 3715/PD | 16-17  |
| LR003657          | 025 245 3715<br>025 245 3715/PD | 16-17  |
| LR004459          | 714 322 0011                    | 66     |
| LR004514          | 713 220 0010                    | 58     |
| LR004799          | 713 220 0010                    | 58     |
| LR004936          | 025 241 2319<br>025 241 2319/PD | 17-18  |
| LR005362          | 11-51 902 1013                  | 44     |
| LR005649          | 53-14 615 0006                  | 93     |
| LR005658          | 714 631 0030                    | 69     |
| LR005764          | 53-13 220 0007                  | 58     |
| LR005816          | 53-12 321 0002                  | 62     |
| LR006462          | 714 631 0030                    | 69     |
| LR006671          | 11-51 902 1013                  | 44     |
| LR007055          | 783 521 0026/PD                 | 9      |
| LR007205*         | 53-16 010 0006<br>714 610 0011  | 81, 92 |
| LR007206*         | 53-16 010 0006<br>714 610 0011  | 81, 92 |
| LR007474          | 300 325 0000                    | 27     |
| LR007478          | 312 321 0000                    | 63     |
| LR007500          | 714 631 0030                    | 69     |
| LR007602          | 53-13 220 0007                  | 58     |
| LR009324          | 53-13 220 0007                  | 58     |
| LR009392          | 11-13 220 0021                  | 58     |
| LR009395          | 11-51 902 1013                  | 44     |
| LR010671          | 53-16 020 0004                  | 76     |
| LR010672          | 53-16 020 0002                  | 76     |
| LR011694          | 11-13 220 0021                  | 58     |
| LR012824          | 53-14 527 0000                  | 33     |
| LR013275          | 53-14 860 0002                  | 39     |
| LR013783          | 53-14 899 0006                  | 31     |
| LR014132          | 53-16 050 0016                  | 83     |
| LR014133          | 53-16 050 0017                  | 83     |
| LR014136          | 53-16 050 0010/HD               | 87     |
| LR014138          | 53-16 050 0009/HD               | 87     |
| LR014145          | 53-16 060 0008/HD               | 101    |
| LR014568          | 53-14 527 0001                  | 33     |
| LR015336          | 53-14 715 0000                  | 93     |
| LR015339          | 53-14 615 0000                  | 93     |
| LR015519          | 025 241 9217                    | 18     |

| Ref. no.          | MEYLE no.                                    | Page  |
|-------------------|--|-------|
| <b>Land Rover</b> |  |       |
| LR015577          | 025 250 8517                                 | 19    |
| LR016192          | 53-15 523 0014/PD                            | 9     |
| LR016684          | 025 246 5916                                 | 19    |
| LR016808          | 025 241 9217                                 | 18    |
| LR016869          | 716 031 0010                                 | 73    |
| LR016962          | 025 250 2119                                 | 20    |
| LR017804          | 53-15 523 0012/PD                            | 16    |
| LR017951          | 45-15 521 0002/PD                            | 6     |
| LR017952          | 45-15 521 0004/PD                            | 7     |
| LR017953          | 45-15 523 0003/PD                            | 10    |
| LR018026          | 45-15 523 0003/PD                            | 10    |
| LR018312          | 050 006 2498                                 | 50    |
| LR018343          | 53-16 050 0003                               | 84    |
| LR018344          | 53-16 050 0002                               | 84    |
| LR018345          | 53-14 610 0007                               | 91    |
| LR018346          | 53-14 615 0007                               | 94    |
| LR018347          | 53-14 615 0001                               | 94    |
| LR018354          | 53-14 715 0002                               | 94    |
| LR019192          | 512 320 0005                                 | 5     |
| LR019401          | 53-14 527 0001                               | 33    |
| LR019589          | 512 320 0006                                 | 4     |
| LR019618          | 025 241 9118                                 | 19    |
| LR019627          | 025 241 9217                                 | 18    |
| LR020362          | 025 246 5916                                 | 19    |
| LR020367          | 53-14 223 0001                               | 56    |
| LR021253          | 025 250 2119                                 | 20    |
| LR021316          | 025 241 9217                                 | 18    |
| LR021899          | 025 236 1517                                 | 21    |
| LR022300          | 40-14 860 0003                               | 39    |
| LR022494          | 314 131 0000<br>314 131 0001<br>314 862 0000 | 42-43 |
| LR023690          | 53-14 899 0001                               | 31    |
| LR023691          | 53-14 899 0002                               | 31    |
| LR023715          | 53-14 610 0000/HD                            | 90    |
| LR023888          | 025 245 3715<br>025 245 3715/PD              | 16-17 |
| LR024267          | 53-14 650 0001                               | 107   |
| LR024474          | 53-16 060 0019/HD                            | 101   |
| LR025159          | 53-14 610 0000/HD                            | 90    |
| LR025302          | 713 220 0005                                 | 59    |
| LR025306          | 714 322 0014                                 | 67    |
| LR025610          | 53-16 050 0010/HD                            | 87    |
| LR025613          | 53-16 050 0009/HD                            | 87    |
| LR025739          | 025 250 8517                                 | 19    |
| LR025986          | 53-14 610 0000/HD                            | 90    |

| Ref. no.          | MEYLE no.                           | Page    |
|-------------------|-------------------------------------|---------|
| <b>Land Rover</b> |                                     |         |
| LR026095          | 53-16 050 0008                      | 89      |
| LR026220          | 025 250 2119                        | 20      |
| LR026221          | 025 250 2119                        | 20      |
| LR026267          | 53-16 020 0012                      | 77      |
| LR026271          | 53-16 031 0004                      | 73      |
| LR027107          | 583 521 0004/PD                     | 7       |
| LR027123          | 715 523 0021/PD                     | 10      |
| LR027129          | 025 244 9617                        | 24      |
| LR027309          | 025 241 2319<br>025 241 2319/PD     | 17-18   |
| LR027570          | 53-16 020 0013                      | 77      |
| LR028245          | 53-16 050 0010/HD                   | 87      |
| LR028246          | 53-16 050 0012/HD                   | 88      |
| LR028248          | 53-16 050 0001/HD                   | 85      |
| LR028249          | 53-16 050 0009/HD                   | 87      |
| LR028250          | 53-16 050 0011/HD                   | 85      |
| LR028252          | 53-16 050 0000/HD                   | 86      |
| LR028881          | 050 006 1205                        | 45      |
| LR029078          | 53-12 321 0003                      | 63      |
| LR029304          | 53-16 050 0001/HD                   | 85      |
| LR029306          | 53-16 050 0000/HD                   | 86      |
| LR030047          | 53-16 060 0007/HD<br>53-16 060 0023 | 101-102 |
| LR030048          | 53-16 060 0015/HD                   | 102     |
| LR030743          | 514 715 0001                        | 95      |
| LR030778          | 714 322 0011                        | 66      |
| LR031843          | 53-83 521 0007/PD                   | 15      |
| LR031844          | 53-15 523 0012/PD                   | 16      |
| LR032063          | 025 250 2119                        | 20      |
| LR032308          | 53-16 050 0033                      | 86      |
| LR032377          | 025 241 9217                        | 18      |
| LR033275          | 53-14 527 0003                      | 33      |
| LR033295          | 53-14 527 0004                      | 34      |
| LR033529          | 53-16 031 0008                      | 73      |
| LR033534          | 53-16 020 0017/HD                   | 77      |
| LR036369          | 30-12 320 0006                      | 5       |
| LR036574          | 025 257 2016                        | 20      |
| LR039612          | 512 320 0005                        | 5       |
| LR039935          | 53-83 523 0015/PD                   | 11      |
| LR043285          | 025 244 9617                        | 24      |
| LR043714          | 025 244 9617                        | 24      |
| LR045959          | 53-14 527 0002                      | 34      |
| LR047859          | 025 250 2119                        | 20      |
| LR051583          | 53-16 050 0010/HD                   | 87      |
| LR051584          | 53-16 050 0009/HD                   | 87      |
| LR051585          | 53-14 610 0001                      | 91      |

| Ref. no.          | MEYLE no.         | Page |
|-------------------|-------------------|------|
| <b>Land Rover</b> |                   |      |
| LR051586          | 53-14 610 0000/HD | 90   |
| LR051614          | 53-16 050 0016    | 83   |
| LR051615          | 53-16 050 0017    | 83   |
| LR051625          | 53-14 610 0006    | 91   |
| LR051626          | 025 250 2119      | 20   |
| LR053310          | 713 220 0005      | 59   |
| LR055454          | 025 241 9217      | 18   |
| LR055455          | 025 241 9217      | 18   |
| LR057725          | 025 250 2119      | 20   |
| LR064181          | 025 246 5916      | 19   |
| LR065492          | 025 257 2016      | 20   |
| LR068303          | 025 257 2016      | 20   |
| LR070453          | 53-14 650 0001    | 107  |
| LR071166          | 53-16 050 0010/HD | 87   |
| LR071929          | 53-16 050 0009/HD | 87   |
| LR073367          | 53-16 050 0010/HD | 87   |
| LR073369          | 53-16 050 0009/HD | 87   |
| LR075993          | 53-16 050 0010/HD | 87   |
| LR075994          | 53-16 050 0012/HD | 88   |
| LR075995          | 53-16 050 0009/HD | 87   |
| LR078387          | 53-14 650 0001    | 107  |
| LR079910          | 025 257 2016      | 20   |
| LR079935          | 025 257 2016      | 20   |
| LRF100150         | 314 114 0001      | 67   |
| NCC100050         | 16-14 860 0001    | 40   |
| NCC100050L        | 16-14 860 0001    | 40   |
| NCC100120L        | 314 023 0000      | 40   |
| NRC5674           | 53-14 715 0008    | 95   |
| NTC18860          | 53-16 020 0011    | 78   |
| NTC18870          | 53-16 020 0010    | 78   |
| NTC1888           | 53-16 060 0013    | 102  |
| NTC6828           | 53-14 615 0005    | 95   |
| NTC7394           | 53-14 715 0009    | 96   |
| NTC 8780          | 45-15 521 0005/PD | 11   |
| NTC 8781          | 45-15 523 0006/PD | 12   |
| NTC9989           | 53-59 202 0006    | 70   |
| PCF101410         | 53-14 223 0000    | 56   |
| PEB000030         | 313 011 4300      | 57   |
| PEB000050         | 313 220 0004      | 59   |
| PEB10095          | 31-13 220 0003    | 60   |
| PEB102010         | 31-13 220 0003    | 60   |
| PEB102240         | 45-13 220 0001    | 59   |
| PEB102240L        | 45-13 220 0001    | 59   |
| PEB102270         | 53-13 220 0002    | 60   |
| PEB102420         | 31-13 220 0003    | 60   |
| PEB102440         | 53-13 220 0002    | 60   |

| Ref. no.          | MEYLE no.                    | Page  |
|-------------------|------------------------------|-------|
| <b>Land Rover</b> |                              |       |
| PEB102470         | 53-13 220 0002               | 60    |
| PEB102510L        | 53-13 220 0003               | 60    |
| PEB500090         | 53-13 220 0001               | 61    |
| PEM500040         | 53-13 220 0005               | 61    |
| PHB000450         | 314 323 0003                 | 64    |
| PHE000040         | 312 321 0001                 | 63    |
| PHE100500         | 312 321 0000                 | 63    |
| PHE100500L        | 312 321 0000                 | 63    |
| PHE500060         | 53-12 321 0001               | 64    |
| PQS000100         | 050 007 1635                 | 50    |
| PQS000190         | 050 005 0812                 | 50    |
| PQS000200         | 050 005 2020                 | 51    |
| PQS000220         | 050 005 1005                 | 51    |
| PQS100851         | 050 006 1460                 | 51    |
| PQS100900         | 050 006 1370                 | 52    |
| PQS101030         | 050 006 1185                 | 52    |
| PQS101130         | 050 005 1188<br>050 005 1195 | 52-53 |
| PQS101272         | 050 006 1560                 | 53    |
| PQS101490         | 050 007 1713                 | 53    |
| QEH000100         | 53-59 202 0000               | 70    |
| QEH000101         | 53-59 202 0000               | 70    |
| QEH000102         | 53-59 202 0000               | 70    |
| QEH000103         | 53-59 202 0000               | 70    |
| QEH000160         | 53-59 203 0000               | 70    |
| QEH000294         | 53-59 202 0005               | 71    |
| QEH102080         | 53-59 202 0002               | 71    |
| QEH102570         | 53-59 202 0007               | 71    |
| QEH102790         | 53-59 202 0004               | 72    |
| QFK500010         | 53-16 031 0006/HD            | 74    |
| QFK500020         | 53-16 031 0005/HD            | 74    |
| QFK500030         | 53-16 031 0003               | 74    |
| QFS000010         | 53-16 020 0003               | 75    |
| QFS100060         | 53-16 020 0003               | 75    |
| QFW 000010        | 300 321 3601                 | 72    |
| QH6000050         | 53-16 020 0003               | 75    |
| QJB100220         | 53-16 020 0001               | 78    |
| QJB100230         | 53-16 020 0000               | 79    |
| QJB500010         | 53-16 020 0004               | 76    |
| QJB500040         | 53-16 020 0008               | 79    |
| QJB500050         | 53-16 020 0009               | 79    |
| QJB500060         | 53-16 031 0002               | 75    |
| QJB500070         | 53-16 020 0007               | 80    |
| QJB500080         | 53-16 020 0002               | 76    |
| RBJ000062         | 53-16 050 0004               | 90    |
| RBJ000120         | 53-16 050 0003               | 84    |

| Ref. no.          | MEYLE no.                        | Page   |
|-------------------|----------------------------------|--------|
| <b>Land Rover</b> |                                  |        |
| RBJ000130         | 53-16 050 0002                   | 84     |
| RBJ000710         | 53-16 050 0004                   | 90     |
| RBJ500183         | 53-16 050 0010/HD                | 87     |
| RBJ500184         | 53-16 050 0012/HD                | 88     |
| RBJ500193         | 53-16 050 0009/HD                | 87     |
| RBJ500194         | 53-16 050 0011/HD                | 85     |
| RBJ500221         | 53-16 010 0000<br>53-16 050 0018 | 81, 88 |
| RBJ500222         | 53-16 010 0000<br>53-16 050 0018 | 81, 88 |
| RBJ500231         | 53-16 010 0000<br>53-16 050 0019 | 81, 89 |
| RBJ500232         | 53-16 010 0000<br>53-16 050 0019 | 81, 89 |
| RBJ500446         | 53-16 050 0001/HD                | 85     |
| RBJ500456         | 53-16 050 0000/HD                | 86     |
| RBJ500710         | 53-16 050 0004                   | 90     |
| RBJ500840         | 53-16 050 0008                   | 89     |
| RBJ500850         | 53-16 050 0007                   | 90     |
| RBJ500920         | 53-16 050 0004                   | 90     |
| RBJ501240         | 53-16 050 0010/HD                | 87     |
| RBJ501250         | 53-16 050 0009/HD                | 87     |
| RBJ501280         | 53-16 050 0001/HD                | 85     |
| RBJ501290         | 53-16 050 0000/HD                | 86     |
| RBJ501320         | 53-16 050 0012/HD                | 88     |
| RBJ501330         | 53-16 050 0011/HD                | 85     |
| RBJ501340         | 53-16 050 0010/HD                | 87     |
| RBJ501350         | 53-16 050 0009/HD                | 87     |
| RBJ501360         | 53-16 050 0012/HD                | 88     |
| RBJ501370         | 53-16 050 0011/HD                | 85     |
| RBJ501380         | 53-16 050 0001/HD                | 85     |
| RBJ501390         | 53-16 050 0000/HD                | 86     |
| RBJ501500         | 53-16 050 0001/HD                | 85     |
| RBJ501510         | 53-16 050 0000/HD                | 86     |
| RBJ501540         | 53-16 050 0010/HD                | 87     |
| RBJ501550         | 53-16 050 0009/HD                | 87     |
| RBJ501560         | 53-16 050 0012/HD                | 88     |
| RBJ501570         | 53-16 050 0011/HD                | 85     |
| RBJ501600         | 53-16 050 0001/HD                | 85     |
| RBJ501610         | 53-16 050 0000/HD                | 86     |
| RBK000010         | 53-16 010 0002                   | 82     |
| RBK000011         | 53-16 010 0002                   | 82     |
| RBK000012         | 53-16 010 0002                   | 82     |
| RBK500030         | 53-16 010 0000                   | 81     |
| RBK500040         | 53-16 010 0001                   | 82     |
| RBK500150         | 53-16 010 0002                   | 82     |

| Ref. no.          | MEYLE no.                           | Page    |
|-------------------|-------------------------------------|---------|
| <b>Land Rover</b> |                                     |         |
| RBK500161         | 53-16 010 0004                      | 82      |
| RBK500170         | 53-16 010 0000<br>53-16 010 0004    | 81-82   |
| RBK500180         | 53-16 010 0001                      | 82      |
| RBK500210         | 53-16 010 0002                      | 82      |
| RBK500230         | 53-16 010 0001                      | 82      |
| RBK500240         | 53-16 010 0001                      | 82      |
| RBK500280         | 53-16 010 0001                      | 82      |
| RBK500300         | 53-16 010 0001                      | 82      |
| RBM000011         | 53-16 060 0007/HD<br>53-16 060 0023 | 101-102 |
| RBM100170         | 53-16 060 0016/HD                   | 103     |
| RBM100171         | 53-16 060 0016/HD                   | 103     |
| RBM100172         | 53-16 060 0016/HD                   | 103     |
| RBM100223         | 53-16 060 0005/HD                   | 103     |
| RBM500110         | 53-16 060 0009/HD                   | 104     |
| RBM500140         | 53-16 060 0011                      | 103     |
| RBM500150         | 53-16 060 0012                      | 104     |
| RBM500180         | 53-16 060 0009/HD                   | 104     |
| RBM500190         | 53-16 060 0009/HD                   | 104     |
| RBM500200         | 53-16 060 0007/HD<br>53-16 060 0023 | 101-102 |
| RBX000010         | 53-14 615 0008                      | 96      |
| RBX000200         | 53-14 610 0007                      | 91      |
| RBX000571         | 53-14 615 0000                      | 93      |
| RBX101181         | 53-14 715 0005                      | 96      |
| RBX101690         | 53-14 615 0004                      | 97      |
| RBX101700         | 53-14 715 0004                      | 97      |
| RBX101710         | 53-14 715 0006                      | 97      |
| RBX500040         | 53-14 715 0003                      | 98      |
| RBX500160         | 53-14 615 0003                      | 98      |
| RBX500280         | 53-14 615 0001                      | 94      |
| RBX500291         | 53-14 610 0000/HD                   | 90      |
| RBX500311         | 53-14 610 0001                      | 91      |
| RBX500443         | 53-14 610 0006                      | 91      |
| RBX500531         | 53-14 610 0000/HD                   | 90      |
| RGD000130         | 53-16 060 0015/HD                   | 102     |
| RGD000131         | 53-16 060 0015/HD                   | 102     |
| RGD000311         | 53-16 060 0010/HD                   | 104     |
| RGD000312         | 53-16 060 0010/HD                   | 104     |
| RGD100682         | 53-16 060 0006/HD                   | 105     |
| RGD500140         | 53-16 060 0017/HD                   | 105     |
| RGD500150         | 53-16 060 0015/HD                   | 102     |
| RGX500060         | 53-14 715 0000                      | 93      |
| RGX500070         | 53-14 715 0001                      | 98      |
| RHF500031         | 53-14 710 0000                      | 92      |

| Ref. no.          | MEYLE no.         | Page |
|-------------------|-------------------|------|
| <b>Land Rover</b> |                   |      |
| RHF500100         | 53-14 710 0000    | 92   |
| RLB000011         | 53-14 650 0001    | 107  |
| RPD102180         | 53-26 723 0000    | 106  |
| RPD102190         | 53-26 723 0001    | 106  |
| RPM000020         | 53-26 723 0000    | 106  |
| RPM000030         | 53-26 723 0001    | 106  |
| RSC000020         | 53-26 623 0000    | 107  |
| RSC000030         | 53-26 623 0001    | 107  |
| RSC000040         | 53-26 623 0000    | 107  |
| RSC000050         | 53-26 623 0001    | 107  |
| RTC3163           | 025 203 5918      | 24   |
| RTC5574           | 025 215 1918      | 22   |
| RTC5869           | 53-16 020 0011    | 78   |
| RTC5870           | 53-16 020 0010    | 78   |
| RTC6079           | 100 323 0007      | 64   |
| RTC6781           | 025 214 5918/W    | 23   |
| RVU000022         | 53-14 715 0001    | 98   |
| RVU500010         | 53-14 615 0002    | 99   |
| RVU500011         | 53-14 615 0002    | 99   |
| SDB000080         | 53-15 521 0008/PD | 15   |
| SDB000200         | 53-15 521 0012/PD | 12   |
| SDB000201         | 53-15 521 0012/PD | 12   |
| SDB000210         | 45-15 523 0006/PD | 12   |
| SDB000330         | 45-15 523 0003/PD | 10   |
| SDB000470         | 45-15 523 0006/PD | 12   |
| SDB000602         | 53-15 521 0013/PD | 13   |
| SDB000603         | 53-15 521 0013/PD | 13   |
| SDB000604         | 53-15 521 0013/PD | 13   |
| SDB000622         | 53-83 521 0005/PD | 13   |
| SDB000623         | 53-83 521 0005/PD | 13   |
| SDB000624         | 53-83 521 0005/PD | 13   |
| SDB000634         | 53-15 523 0011/PD | 14   |
| SDB000635         | 53-15 523 0011/PD | 14   |
| SDB000636         | 53-15 523 0011/PD | 14   |
| SDB000644         | 53-15 523 0016/PD | 14   |
| SDB000645         | 53-15 523 0016/PD | 14   |
| SDB000646         | 53-15 523 0016/PD | 14   |
| SDB100830         | 53-15 521 0014/PD | 6    |
| SDB100980         | 45-15 523 0003/PD | 10   |
| SDB101070         | 53-15 521 0008/PD | 15   |
| SDB500120         | 53-15 521 0013/PD | 13   |
| SDB500192         | 53-83 521 0007/PD | 15   |
| SDB500193         | 53-83 521 0007/PD | 15   |
| SDB500201         | 53-15 523 0012/PD | 16   |
| SDB500202         | 53-15 523 0012/PD | 16   |
| SDB500230         | 53-15 523 0012/PD | 16   |



| Ref. no.          | MEYLE no.                       | Page  |
|-------------------|---------------------------------|-------|
| <b>Land Rover</b> |                                 |       |
| SEM000012         | 53-14 000 0000                  | 34    |
| SEM000024         | 53-14 000 0004                  | 35    |
| SEM500026         | 53-14 000 0006                  | 35    |
| SEM500050         | 53-14 500 0002                  | 35    |
| SEM500062         | 53-14 500 0001                  | 36    |
| SEM500070         | 53-14 000 0004                  | 35    |
| SEM500080         | 53-14 500 0001                  | 36    |
| SEM500090         | 53-14 000 0006                  | 35    |
| SFC000010         | 025 233 9719                    | 20    |
| SFC500050         | 025 233 9719                    | 20    |
| SFC500070         | 025 233 9719                    | 20    |
| SFC500080         | 025 233 9719                    | 20    |
| SFP000010         | 025 236 1517                    | 21    |
| SFP000020         | 025 236 1517                    | 21    |
| SFP000120         | 025 214 8717<br>025 214 8717/PD | 21-22 |
| SFP000140         | 025 215 1918                    | 22    |
| SFP000210         | 025 234 5219                    | 23    |
| SFP000260         | 025 215 1918                    | 22    |
| SFP100460         | 025 234 5219                    | 23    |
| SFP100470         | 025 234 5816                    | 23    |
| SFP100480         | 025 234 5219                    | 23    |
| SFP100490         | 025 234 5816                    | 23    |
| SFP100580         | 025 234 5219                    | 23    |
| SFP100590         | 025 234 5219                    | 23    |
| SFP500010         | 025 241 9118                    | 19    |
| SFP500020         | 025 241 9217                    | 18    |
| SFP500021         | 025 241 9217                    | 18    |
| SFP500022         | 025 241 9217                    | 18    |
| SFP500040         | 025 241 9217                    | 18    |
| SFP500070         | 025 202 1717                    | 21    |
| SFP500100         | 025 236 1517                    | 21    |
| SFP500130         | 025 234 5816                    | 23    |
| SFP500140         | 025 241 9217                    | 18    |
| SFP500150         | 025 234 5219                    | 23    |
| SFP500160         | 025 214 5918/W                  | 23    |
| SFP500210         | 025 214 8717<br>025 214 8717/PD | 21-22 |
| SFS000050         | 114 042 1201                    | 25    |
| SFS000051         | 114 042 1201                    | 25    |
| SOE000010         | 53-14 000 0003                  | 36    |
| SOE000011         | 53-14 000 0003                  | 36    |
| SOE000025         | 53-14 000 0001                  | 36    |
| SOE500030         | 53-14 000 0005                  | 37    |
| SSB 5000 90       | 53-14 899 0003                  | 32    |
| SSB 5000 92       | 53-14 899 0003                  | 32    |

| Ref. no.          | MEYLE no.      | Page |
|-------------------|----------------|------|
| <b>Land Rover</b> |                |      |
| SSB 5001 00       | 53-14 899 0005 | 32   |
| SSB 5001 02       | 53-14 899 0005 | 32   |
| SSB 5001 33       | 53-14 899 0004 | 32   |
| STC1086           | 53-13 220 0001 | 61   |
| STC1275           | 025 215 1918   | 22   |
| STC1871           | 53-16 020 0003 | 75   |
| STC1879           | 025 234 5816   | 23   |
| STC1880           | 025 234 5219   | 23   |
| STC2134           | 050 005 1815   | 54   |
| STC2180           | 314 114 0008   | 67   |
| STC2192           | 313 011 3800   | 57   |
| STC2326           | 050 004 0855   | 54   |
| STC2952           | 025 215 1918   | 22   |
| STC2956           | 025 203 5918   | 24   |
| STC3103           | 300 022 0163   | 41   |
| STC3195           | 025 234 5219   | 23   |
| STC3342           | 313 011 3800   | 57   |
| STC3343E          | 313 011 3800   | 57   |
| STC3350           | 314 322 0001   | 68   |
| STC3684           | 025 234 5816   | 23   |
| STC3685           | 025 234 5219   | 23   |
| STC4202           | 314 323 0003   | 64   |
| STC 4378          | 53-13 043 0001 | 61   |
| STC4455           | 050 005 1815   | 54   |
| STC8571           | 025 214 5918/W | 23   |
| STC8572           | 025 214 5918/W | 23   |
| STC9149           | 025 214 5918/W | 23   |
| STC9150           | 025 214 5918/W | 23   |
| STC9190           | 025 214 5918/W | 23   |
| STC9191           | 025 214 5918/W | 23   |
| TDB000360         | 53-14 498 0000 | 26   |
| TDB000500         | 53-14 498 0000 | 26   |
| TDJ500040         | 53-14 498 0001 | 26   |
| TDR100750         | 53-14 495 0000 | 26   |
| THE500030         | 314 137 0002   | 27   |
| THE500031         | 314 137 0002   | 27   |
| TIQ000020         | 53-16 020 0003 | 75   |
| TIQ000030         | 53-16 020 0009 | 79   |
| TIQ000040         | 53-16 031 0002 | 75   |
| WFL000020         | 314 323 0008   | 65   |
| WFL000021         | 314 323 0008   | 65   |
| WFL000070         | 314 323 0000   | 65   |
| WFL4070           | 314 323 0000   | 65   |
| WJN000130         | 100 127 0006   | 65   |

| Short no.         | MEYLE no.         | Page |
|-------------------|-------------------|------|
| <b>Land Rover</b> |                   |      |
| MAF0414           | 312 321 0000      | 63   |
| MAF0415           | 312 321 0001      | 63   |
| MAF0552           | 45-12 410 0001    | 62   |
| MAF0569           | 53-12 321 0001    | 64   |
| MAF0684           | 53-12 321 0002    | 62   |
| MAF0685           | 53-12 321 0003    | 63   |
| MAR0302           | 53-16 031 0002    | 75   |
| MAR0303           | 53-16 031 0003    | 74   |
| MAR0351           | 716 031 0010      | 73   |
| MAR0392           | 53-16 031 0004    | 73   |
| MAR0527HD         | 53-16 031 0005/HD | 74   |
| MAR0528HD         | 53-16 031 0006/HD | 74   |
| MAR0547           | 53-16 031 0008    | 73   |
| MAS0394           | 53-14 899 0001    | 31   |
| MAS0395           | 53-14 899 0002    | 31   |
| MAS0396           | 53-14 899 0003    | 32   |
| MAS0397           | 53-14 899 0004    | 32   |
| MAS0398           | 53-14 899 0005    | 32   |
| MAS0399           | 53-14 899 0006    | 31   |
| MBD1133PD         | 45-15 521 0002/PD | 6    |
| MBD1135PD         | 45-15 521 0004/PD | 7    |
| MBD1136PD         | 45-15 521 0005/PD | 11   |
| MBD1138PD         | 45-15 523 0003/PD | 10   |
| MBD1139PD         | 45-15 523 0006/PD | 12   |
| MBD1189PD         | 53-15 521 0008/PD | 15   |
| MBD1196PD         | 53-15 523 0004/PD | 8    |
| MBD1609PD         | 53-83 521 0005/PD | 13   |
| MBD1611PD         | 53-83 521 0007/PD | 15   |
| MBD1654PD         | 583 521 0004/PD   | 7    |
| MBD1657PD         | 783 521 0026/PD   | 9    |
| MBD2028PD         | 53-15 521 0012/PD | 12   |
| MBD2029PD         | 53-15 521 0013/PD | 13   |
| MBD2030PD         | 53-15 523 0011/PD | 14   |
| MBD2031PD         | 53-15 523 0012/PD | 16   |
| MBD2032PD         | 53-15 523 0013/PD | 8    |
| MBD2033PD         | 53-15 523 0014/PD | 9    |
| MBD2034PD         | 53-15 523 0016/PD | 14   |
| MBD2035PD         | 53-83 523 0015/PD | 11   |
| MBD2068PD         | 715 523 0021/PD   | 10   |
| MBD2105PD         | 53-15 521 0014/PD | 6    |
| MBJ0264           | 53-16 010 0000    | 81   |
| MBJ0265           | 53-16 010 0001    | 82   |
| MBJ0266           | 53-16 010 0004    | 82   |
| MBJ0267           | 53-16 010 0005    | 81   |
| MBJ0339           | 53-16 010 0002    | 82   |
| MBJ0340           | 53-16 010 0006    | 81   |

| Short no.         | MEYLE no.         | Page |
|-------------------|-------------------|------|
| <b>Land Rover</b> |                   |      |
| MBK0232           | 53-14 495 0000    | 26   |
| MBL0008           | 029 330 1300      | 1    |
| MBL0014           | 029 350 1410      | 1    |
| MBL0027           | 029 450 1800      | 2    |
| MBL0028           | 029 475 1900      | 2    |
| MBL0029           | 029 500 2000      | 2    |
| MBL0030           | 029 530 2100      | 3    |
| MBL0032           | 029 550 2200      | 3    |
| MBL0034           | 029 600 2400      | 3    |
| MBL0061           | 029 425 1710      | 1    |
| MBP0017           | 025 203 5918      | 24   |
| MBP0133           | 025 214 5918/W    | 23   |
| MBP0143           | 025 214 8717      | 21   |
| MBP0143PD         | 025 214 8717/PD   | 22   |
| MBP0150           | 025 215 1918      | 22   |
| MBP0352           | 025 234 5219      | 23   |
| MBP0355           | 025 234 5816      | 23   |
| MBP0406           | 025 236 1517      | 21   |
| MBP0527           | 025 241 2319      | 17   |
| MBP0527PD         | 025 241 2319/PD   | 18   |
| MBP0609           | 025 244 9617      | 24   |
| MBP0617           | 025 245 3715      | 16   |
| MBP0617PD         | 025 245 3715/PD   | 17   |
| MBP0849           | 025 257 2016      | 20   |
| MBP1259           | 025 241 9118      | 19   |
| MBP1260           | 025 241 9217      | 18   |
| MBP1632           | 025 202 1717      | 21   |
| MBP1659           | 025 250 2119      | 20   |
| MBP1673           | 025 246 5916      | 19   |
| MBP1729           | 025 233 9719      | 20   |
| MBP1733           | 025 250 8517      | 19   |
| MBX0010           | 014 698 0006      | 25   |
| MBX0011           | 014 698 0006/S    | 25   |
| MCA0832           | 53-16 050 0004    | 90   |
| MCA0833           | 53-16 050 0002    | 84   |
| MCA0834           | 53-16 050 0003    | 84   |
| MCA0871           | 53-16 050 0007    | 90   |
| MCA0872           | 53-16 050 0008    | 89   |
| MCA0996           | 53-16 050 0016    | 83   |
| MCA0997           | 53-16 050 0017    | 83   |
| MCA0998           | 53-16 050 0018    | 88   |
| MCA0999           | 53-16 050 0019    | 89   |
| MCA1016HD         | 53-16 050 0000/HD | 86   |
| MCA1017HD         | 53-16 050 0001/HD | 85   |
| MCA1018HD         | 53-16 050 0009/HD | 87   |
| MCA1019HD         | 53-16 050 0010/HD | 87   |

| Short no.         | MEYLE no.         | Page |
|-------------------|-------------------|------|
| <b>Land Rover</b> |                   |      |
| MCA1020HD         | 53-16 050 0011/HD | 85   |
| MCA1021HD         | 53-16 050 0012/HD | 88   |
| MCA1130           | 53-16 050 0033    | 86   |
| MCA1131           | 53-16 050 0034    | 83   |
| MCB0331           | 714 610 0011      | 92   |
| MCB0372           | 53-14 610 0001    | 91   |
| MCB0373           | 53-14 610 0007    | 91   |
| MCB0374           | 53-14 610 0006    | 91   |
| MCB0405HD         | 53-14 610 0000/HD | 90   |
| MCF0216           | 30-12 320 0006    | 5    |
| MCF0257           | 312 320 0013      | 5    |
| MCF0377           | 512 320 0005      | 5    |
| MCF0378           | 512 320 0006      | 4    |
| MCF0380           | 53-12 319 0002    | 4    |
| MCF0381           | 53-12 320 0002    | 4    |
| MCM0124           | 53-14 710 0000    | 92   |
| MCV0329           | 53-14 498 0001    | 26   |
| MDS0050           | 53-14 498 0000    | 26   |
| MET0086           | 53-14 223 0000    | 56   |
| MET0091           | 53-14 223 0001    | 56   |
| MEX0400           | 314 862 0000      | 43   |
| MEX0412           | 314 899 0069      | 43   |
| MFF0030           | 100 127 0006      | 65   |
| MFF0056           | 100 323 0007      | 64   |
| MFF0148           | 314 323 0000      | 65   |
| MFF0151           | 314 323 0003      | 64   |
| MFF0154           | 314 323 0008      | 65   |
| MGP0007           | 014 020 1039      | 37   |
| MGP0027           | 16-14 860 0001    | 40   |
| MGP0050           | 300 022 0163      | 41   |
| MGP0051           | 314 023 0000      | 40   |
| MGP0069           | 40-14 860 0002    | 38   |
| MGP0070           | 53-14 860 0000    | 38   |
| MGP0071           | 53-14 860 0001    | 41   |
| MGP0087           | 714 020 0001      | 41   |
| MGP0098           | 514 860 0001      | 37   |
| MGP0102           | 40-14 860 0003    | 39   |
| MGP0116           | 53-14 860 0002    | 39   |
| MHH0102           | 53-59 202 0000    | 70   |
| MHH0103           | 53-59 202 0001    | 69   |
| MHH0104           | 53-59 202 0002    | 71   |
| MHH0105           | 53-59 202 0003    | 69   |
| MHH0106           | 53-59 202 0004    | 72   |
| MHH0107           | 53-59 202 0005    | 71   |
| MHH0108           | 53-59 202 0006    | 70   |
| MHH0109           | 53-59 202 0007    | 71   |

| Short no.         | MEYLE no.       | Page |
|-------------------|-----------------|------|
| <b>Land Rover</b> |                 |      |
| MHH0110           | 53-59 203 0000  | 70   |
| MHK0037           | 314 137 0002    | 27   |
| MHP0158           | 714 631 0030    | 69   |
| MIC0058           | 314 131 0000    | 42   |
| MIC0059           | 314 131 0001    | 42   |
| MMX0957           | 314 038 0002    | 68   |
| MMX0964           | 314 126 1101    | 68   |
| MMX1514           | 314 036 0014    | 62   |
| MMX1602           | 11-51 902 1013  | 44   |
| MMX1611           | 11-51 902 2004  | 45   |
| MMX1647           | 45-51 902 1001  | 44   |
| MMX1648           | 45-51 902 1002  | 44   |
| MMX1695           | 53-51 902 2000  | 45   |
| MOF0114           | 300 114 2200    | 66   |
| MOF0122           | 314 114 0001    | 67   |
| MOF0125           | 314 114 0004    | 66   |
| MOF0129           | 314 114 0008    | 67   |
| MOF0131           | 314 322 0001    | 68   |
| MOF0205           | 714 322 0011    | 66   |
| MOF0207           | 714 322 0014    | 67   |
| MOK0020           | 300 135 0002    | 28   |
| MOK0035           | 300 135 1005    | 29   |
| MOK0043           | 300 135 0002/SK | 28   |
| MOK0045           | 300 135 1005/SK | 30   |
| MOK0048           | 300 135 0401    | 29   |
| MPB0021           | 114 042 1201    | 25   |
| MPJ0090           | 514 814 0002    | 27   |
| MRB0023           | 050 003 0750    | 46   |
| MRB0090           | 050 004 0855    | 54   |
| MRB0157           | 050 004 1325    | 46   |
| MRB0180           | 050 005 0735    | 54   |
| MRB0185           | 050 005 0812    | 50   |
| MRB0195           | 050 005 0875    | 55   |
| MRB0217           | 050 005 1005    | 51   |
| MRB0246           | 050 005 1188    | 52   |
| MRB0247           | 050 005 1195    | 53   |
| MRB0248           | 050 005 1200    | 55   |
| MRB0292           | 050 005 1815    | 54   |
| MRB0294           | 050 005 2020    | 51   |
| MRB0295           | 050 005 2030    | 55   |
| MRB0373           | 050 006 1185    | 52   |
| MRB0377           | 050 006 1200    | 49   |
| MRB0379           | 050 006 1205    | 45   |
| MRB0406           | 050 006 1370    | 52   |
| MRB0417           | 050 006 1460    | 51   |
| MRB0427           | 050 006 1560    | 53   |

| Short no.         | MEYLE no.         | Page |
|-------------------|-------------------|------|
| <b>Land Rover</b> |                   |      |
| MRB0459           | 050 006 1743      | 49   |
| MRB0460           | 050 006 1750      | 49   |
| MRB0563           | 050 006 2498      | 50   |
| MRB0603           | 050 007 1580      | 47   |
| MRB0604           | 050 007 1593      | 46   |
| MRB0607           | 050 007 1635      | 50   |
| MRB0610           | 050 007 1713      | 53   |
| MRB0615           | 050 007 1775      | 48   |
| MRB0619           | 050 007 1870      | 47   |
| MRB0630           | 050 007 2250      | 47   |
| MRB0636           | 050 007 2620      | 48   |
| MRB0639           | 050 007 2713      | 56   |
| MRB0766           | 050 007 1855      | 48   |
| MSA0451           | 53-26 623 0000    | 107  |
| MSA0452           | 53-26 623 0001    | 107  |
| MSA0453           | 53-26 723 0000    | 106  |
| MSA0454           | 53-26 723 0001    | 106  |
| MSB0455           | 514 715 0001      | 95   |
| MSB0456           | 53-14 615 0000    | 93   |
| MSB0457           | 53-14 615 0001    | 94   |
| MSB0458           | 53-14 615 0002    | 99   |
| MSB0459           | 53-14 615 0003    | 98   |
| MSB0460           | 53-14 615 0004    | 97   |
| MSB0461           | 53-14 615 0005    | 95   |
| MSB0462           | 53-14 615 0006    | 93   |
| MSB0463           | 53-14 615 0007    | 94   |
| MSB0464           | 53-14 615 0008    | 96   |
| MSB0465           | 53-14 715 0000    | 93   |
| MSB0466           | 53-14 715 0001    | 98   |
| MSB0467           | 53-14 715 0002    | 94   |
| MSB0468           | 53-14 715 0003    | 98   |
| MSB0469           | 53-14 715 0004    | 97   |
| MSB0470           | 53-14 715 0005    | 96   |
| MSB0471           | 53-14 715 0007    | 92   |
| MSB0472           | 53-14 715 0008    | 95   |
| MSB0473           | 53-14 715 0009    | 96   |
| MSB0494           | 53-14 715 0006    | 97   |
| MSC0087           | 53-14 640 0000    | 105  |
| MSC0088           | 53-14 740 0000    | 106  |
| MSK0017           | 300 321 3601      | 72   |
| MSK0029           | 714 620 0004      | 72   |
| MSL0306HD         | 316 060 0001/HD   | 100  |
| MSL0499HD         | 53-16 060 0004/HD | 99   |
| MSL0500HD         | 53-16 060 0005/HD | 103  |
| MSL0501HD         | 53-16 060 0006/HD | 105  |
| MSL0502HD         | 53-16 060 0007/HD | 101  |

| Short no.         | MEYLE no.         | Page |
|-------------------|-------------------|------|
| <b>Land Rover</b> |                   |      |
| MSL0503HD         | 53-16 060 0008/HD | 101  |
| MSL0504HD         | 53-16 060 0009/HD | 104  |
| MSL0505HD         | 53-16 060 0010/HD | 104  |
| MSL0506           | 53-16 060 0011    | 103  |
| MSL0507           | 53-16 060 0012    | 104  |
| MSL0508           | 53-16 060 0013    | 102  |
| MSL0509HD         | 53-16 060 0014/HD | 100  |
| MSL0510HD         | 53-16 060 0015/HD | 102  |
| MSL0511HD         | 53-16 060 0016/HD | 103  |
| MSL0512HD         | 53-16 060 0017/HD | 105  |
| MSL0581HD         | 53-16 060 0019/HD | 101  |
| MSL0873           | 53-16 060 0020    | 99   |
| MSL0876           | 53-16 060 0023    | 102  |
| MTE0460           | 53-16 020 0000    | 79   |
| MTE0461           | 53-16 020 0001    | 78   |
| MTE0462           | 53-16 020 0002    | 76   |
| MTE0463           | 53-16 020 0003    | 75   |
| MTE0464           | 53-16 020 0004    | 76   |
| MTE0465           | 53-16 020 0007    | 80   |
| MTE0466           | 53-16 020 0008    | 79   |
| MTE0467           | 53-16 020 0009    | 79   |
| MTE0468           | 53-16 020 0010    | 78   |
| MTE0469           | 53-16 020 0011    | 78   |
| MTE0515           | 716 020 0020      | 76   |
| MTE0516           | 716 020 0021      | 75   |
| MTE0560           | 53-16 020 0012    | 77   |
| MTE0561           | 53-16 020 0013    | 77   |
| MTE0756HD         | 53-16 020 0017/HD | 77   |
| MTX0067           | 300 325 0000      | 27   |
| MWH0244           | 714 651 0006      | 108  |
| MWK0232           | 53-14 650 0001    | 107  |
| MWP0094           | 11-13 220 0021    | 58   |
| MWP0297           | 31-13 220 0003    | 60   |
| MWP0328           | 313 011 3800      | 57   |
| MWP0330           | 313 011 4300      | 57   |
| MWP0333           | 313 220 0004      | 59   |
| MWP0422           | 45-13 220 0001    | 59   |
| MWP0423           | 45-13 220 0002    | 57   |
| MWP0433           | 53-13 043 0001    | 61   |
| MWP0434           | 53-13 220 0001    | 61   |
| MWP0435           | 53-13 220 0002    | 60   |
| MWP0436           | 53-13 220 0003    | 60   |
| MWP0438           | 53-13 220 0005    | 61   |
| MWP0496           | 713 220 0005      | 59   |
| MWP0500           | 713 220 0010      | 58   |
| MWP0574           | 53-13 220 0007    | 58   |

| Short no.         | MEYLE no.      | Page |
|-------------------|----------------|------|
| <b>Land Rover</b> |                |      |
| MWS0089           | 53-14 000 0000 | 34   |
| MWS0090           | 53-14 000 0001 | 36   |
| MWS0091           | 53-14 000 0003 | 36   |
| MWS0092           | 53-14 000 0004 | 35   |
| MWS0093           | 53-14 000 0005 | 37   |
| MWS0094           | 53-14 000 0006 | 35   |
| MWS0096           | 53-14 500 0001 | 36   |
| MWS0097           | 53-14 500 0002 | 35   |
| MWS0098           | 53-14 527 0000 | 33   |
| MWS0099           | 53-14 527 0001 | 33   |
| MWS0124           | 53-14 527 0002 | 34   |
| MWS0125           | 53-14 527 0003 | 33   |
| MWS0126           | 53-14 527 0004 | 34   |





# MEYLE

**You see the pretty  
curves, underneath  
is what counts.**



**The MEYLE brand supplies its customers with more than 21,000 extremely reliable and durable spare parts manufactured at our own production facilities or by trusted production partners. MEYLE boasts a highly diversified product range.**

Whether steering and suspension components, rubber-to-metal parts, brakes, damping components, cooling systems, filters, drive components, electric and sensors MEYLE is synonymous with top-grade quality-tested spare parts.

#### **Notes**

This catalogue is protected by copyright. Reproduction of text, graphic elements, photographs and/or data, even in part, is prohibited. MEYLE, **MEYLE**, or parts thereof, are registered trademarks of MEYLE AG.

All supplies and services are subject to our General Terms and Conditions. The original spare part numbers shown in this catalogue are for cross-reference purposes only and shall not be disclosed to third parties on invoices and delivery notes. While the information in this catalogue was compiled and edited with utmost care we do not assume responsibility or accept claims arising from errors or inconsistencies. Subject to technical and/or design changes.

This issue of the catalogue supersedes all previous issues.  
All rights reserved. © 2017 MEYLE AG



MEYLE parts are available through:

**MEYLE AG**

Merkurring 111, 22143 Hamburg, Germany  
Tel. +49 40 67506 510, Fax +49 40 67506 506  
[contact@meyle.com](mailto:contact@meyle.com)

[www.meyle.com](http://www.meyle.com)

**MEYLE**