

WATER PUMPS TRUCKS & BUSES

2016

INDICE - INDEX - INDEX - INHALT - INDICE

Abbreviazioni - Abbreviations - Abréviations - Zeichenerklärung - Abreviaturas	pag. IV
Simbologia - Symbols - Symbologie - Symbole - Simbologia	pag. V
Indice marca e modello - Make and model Index	
Index marque et modèle - Inhalt Marke und Modell - Índice marca y modelo	pag. 1
Applicazioni - Applications - Applications - Anwendungen - Aplicaciones	pag. 1
Lista dei riferimenti - Cross References List	
Table equivalences - Vergleichsliste - Lista de equivalencias	pag. 295
Lista numerica - Numerical list - Liste numérique - Teilnummerliste - Lista numerica	pag. 297
Condizioni di vendita - Conditions of sale	
Conditions de vente - Verkaufsbedingungen - Condiciones de venta	pag. 299



La Metelli nasce il 1° Agosto 1962 quale officina per lavorazioni meccaniche. Nel 1970 prende avvio la produzione delle parti motore e già nel 1975 inizia la fabbricazione delle parti freno e frizione idrauliche. Un ulteriore impulso all'espansione giunge nel 1991 con l'installazione della linea per la produzione dei giunti omocineticici a cui si aggiungono i semiassi nel 1999. Nel luglio del 2001 la Metelli S.p.A. acquista il 100% della società GRAF S.p.A., produttrice di pompe acqua e dischi freno. Nel 2008 vengono introdotte le pastiglie freno e nel 2010 le ganasce freno a completamento della gamma frenante. Nel 2012 vengono lanciati il Kit distribuzione con pompa acqua e il kit cuffia. A fine 2014 il gruppo Metelli acquisisce le società Fri.Tech. e Trusting, aziende italiane produttrici di pastiglie e ganasce freno.





Metelli was established on 1st August 1962 as a mechanical engineering workshop. In 1970, the company started producing engine parts and, in 1975, began manufacturing hydraulic brake and clutch parts. A further boost to expansion came in 1991 with the installation of the line for the production of constant velocity joints, later expanded in 1999 to include driveshafts. In July 2001, Metelli Co. acquired 100% of GRAF Co., a leading manufacturer of water pumps and brake discs. In order to complete the brake parts range Metelli introduced brake pads in 2008 and brake shoes in 2010. In 2012 Metelli introduced the timing belt Kit with water pump and boot kit. At the end of 2014, Metelli Group acquires Fri.Tech. and Trusting companies, Italian manufacturers of brake pads and brake shoes

La société Metelli a été créée le 1er août 1962 comme atelier d'usinage. En 1970, l'entreprise a démarré la production de composants pour l'industrie des moteurs et a lancé en 1975 la fabrication de pièces de freinage et d'embrayage hydrauliques. En 1991, dans le cadre de sa politique d'expansion, la société a installé une nouvelle ligne pour la production de joints homocinétiques, à laquelle s'est ajoutée en 1999 celle des transmissions. En juillet 2001, Metelli S.p.A. a racheté la totalité de la société GRAF S.p.A., producteur leader de pompes à eau et de disques de frein. En 2008 nous avons introduits dans notre gamme les Plaquettes de Freins et en 2010 les Mâchoires de Frein à complètement de notre programme de freinage. En 2012 nous avons introduits les kit distribution avec pompe à eau et les kit de soufflet de transmission. Fin 2014 Metelli Group reprend les sociétés Fri.Tech. et Trusting qui sont des sociétés italiennes qui fabriquent plaquettes de frein et mâchoires de frein.

Die Firma Metelli wurde am 1. August 1962 als mechanische Werkstätte gegründet. 1970 beginnt die Produktion von Motorteilen und bereits 1975 die Fertigung von hydraulischen Bremsenteilen und Kupplungsteilen. Einen weiteren Impuls zur Expansion erhält die Firma im 1991 durch die neue Produktionslinie Radgelenke und im Jahre im 1999 kommen dann Antriebswellen hinzu. Im Juli 2001 aquiriert die Metelli S.p.A. zu 100% die Gesellschaft GRAF S.p.A. auf, eine leitende Herstellerfirma von Wasserpumpen und Bremsscheiben. Im 2008 haben wir Bremsbelaege und im 2010 Bremsbacken in unserem Produktpalette eingefuehrt um unser Bremshydraulikprogramm zu vollstaendingen. Im Jahr 2012 hat Metelli Zusaetzlich Spannrollen Kit mit Wasserpumpe und Faltenbalg-Satz im Programm vorgestellt. Am Ende 2014 hat die Firma Metelli zwei italienische Firmen erworben: Die Firma Fri.Tech. Hersteller von Bremsbelaege und die Firma Trusting Hersteller von Bremsbacken.

La firma Metelli nasce el 1 de Agosto de 1962 como taller para mecanizaciones. En 1970 comienza la realización de piezas para motores y ya en 1975 inicia la fabricación de piezas para frenos y embragues hidráulicos. Un mayor impulso a la expansión llega en 1991 con la instalación de una línea para la producción de juntas homocinéticas a las que se añadirán los semiejes en 1999. En el mes de Julio de 2001 Metelli S.p.A. adquiere el 100% de la firma GRAF S.p.A., fabricante líder de bombas de agua y discos de freno. En 2008 se introduce la gama de pastillas de freno y en 2010 la de zapatas de freno para completar la gama de frenos. Los kit distribución con bomba de agua y los fuele se introdujeron en 2012. En el año 2014 el Grupo Metelli adquirió las empresas Fri.Tech. y Trusting, empresas italianas productoras de pastillas y zapatas de freno.



					
	ABBREVIAZIONI	ABBREVIATIONS	ABRÉVIATIONS	ZEICHENERKLÄRUNG	ABREVIATURAS
16v	16 Valvole	16 Valves	16 Soupapes	16 Ventile	16 Válvulas
AF	Ventilatore automatico	Automatic fan	Ventilateur automat.	Autom. Luefter	Ventilador autom.
Air	Con condizionatore	With air conditioning	Avec climatiseur	Mit Klimaanlage	Con aire acondicionado
A/T	Cambio automatico	Automatic transmission	Automatique	Schaltgetriebe	Cambio automático
BH	Coperchio	Back Housing	Carter	Gegengehäuse	Cárter
-Ch	Fino telaio N.	To chassis No.	Jusqu'au chassis N.	Bis Fahrgestell Nr.	Hasta bastidor
Ch-	Dal telaio N.	From chassis No.	Depuis chassis N.	Ab Fahrgestell Nr.	Desde bastidor N.
CM	Contagiri meccanico	Mecan.revol.counter	Compte tours méc.	Mech.Drehzahlm.	Cuenta revoluc. mee.
Dynamo	Con dinamo	With dynamo	Avec dynamo	Drehstrom-Lichtmasch.	Con dinamo
-Eng.	Fino a motore N.	To engine No.	Jusqu'au moteur N.	Bis Motor Nr.	Hasta motor N.
Eng.-	Dal motore N.	From engine No.	Depuis moteur N.	Ab Motor Nr.	Desde motor N.
-G.Box	Fino a cambio N.	To gear box No.	Jusqu'à boîte vit. N.	Bis Getriebe Nr.	Hasta cambio N.
G.Box-	Dal cambio N.	From gear box No.	Depuis boîte vit. N.	Ab Getriebe Nr.	Desde cambio N.
Impeller	Girante	Impeller	Turbine	Flügelrad	Rodete
Mod.	Modello	Model	Modèle	Model	Modelo
PS	Servosterzo	Power-steering	Direction assistée	Servolenkung	Servo dirección
Pulley	Puleggia	Pulley	Poulie	Riemenscheibe	Polea
RB	Cuscinetto rinforz.	Reinforced bearing	Roulement renforcé	Verstaerkt. Lager	Rodamiento reforzado
Teeth	Denti	Teeth	Dents	Zähne	Dientes
Thermo	Con termocontatto	With thermo contact	Avec thermo contact	Mit thermo Kontakt	Con termo contacto
T.T.	Tutti i tipi	All models	Tous les types	Alle Typen	Todos los tipos
-Vett.	Fino a produz. N.	To production No.	Jusqu'à production N.	Bis Produktion Nr.	Hasta producción N.
Vett.-	Da produz. N.	From production No.	Depuis production N.	Ab Produktion Nr.	Desde producción N.
w/	Con	With	Avec	Mit	Con

					
	SIMBOLOGIA	SYMBOLS	SYMBOLOGIE	SYMBOLE	SIMBOLOGIA
	Marca e modello	Make and model	Marque et modèle	Marke und Modell	Marca y modelo
	Anno	Year	Année	Baujahr	Año
GRAF réf.	GRAF ref.	GRAF part n°	Réf. GRAF	GRAF NR	Ref. GRAF
	Ricambio	Repair kit	Nécessaire	Teilpumpe	Recambio
	Cinghia distribuzione	Timing belt system	Courroie de distribution	Steuerriemen	Correa de distribución
NOTE	Note	Note	Note	Noten	Notas
Ad. OE	Adattabile a OE	Adaptable to OE	Adaptable au OE	Passend zur OE	Adaptable al OE

MAKE - MODEL	PAGE	MAKE - MODEL	PAGE	MAKE - MODEL	PAGE
DAF		P / PA '12/79-'12/93.....	38	Integro (O 550) '1/01-.....	208
65 CF '2/98-'12/00.....	2	Stralis '1/02-.....	40	Intouro '1/05-.....	208
85 '7/92-'2/98.....	2	Trakker '1/04-.....	40	LP-LPK-LPS-LPO '1/67-'3/77.....	208
85 CF '2/98-'12/00.....	4	Turbostar '7/84-'12/93.....	40	O 301 '2/86-'5/87.....	208
95 '9/87-'1/98.....	6	TurboTech '1/90-'1/93.....	40	O 302 '11/64-'11/75.....	210
95 XF '1/97-'9/02.....	10	MAN BUS		O 303 '1/74-'12/92.....	210
CF 65 '1/01-.....	16	Hocl '1/96-.....	40	O 305 '1/69-'12/87.....	212
CF 85 '1/01-.....	16	LION'S COACH '9/95-.....	42	O 307 '1/73-'12/77.....	212
F 2800 '1/74-'9/91.....	20	LION'S STAR '1/93-.....	42	O 309 '1/68-'2/89.....	212
LF 45 '1/01-.....	24	LIONS CITY '8/96-.....	42	O 330 '1/90-.....	212
LF 55 '1/01-.....	24	LIONS COMFORT '9/96-.....	42	O 340 '1/91-'8/95.....	212
XF 105 '10/05-.....	24	Low entry '7/86-'5/94.....	42	O 350 Turismo '8/95-.....	214
XF 95 '9/02-'12/06.....	24	NG '8/92-.....	46	O 355 '1/68-.....	214
IRIS BUS		NL '9/89-.....	48	O 402 '2/86-'12/91.....	214
Arway '1/06-'12/13.....	26	NM '8/87-.....	48	O 403 '9/03-.....	214
Domino '10/03-'12/13.....	26	SD '4/74-'4/94.....	50	O 404 '9/91-'11/92.....	216
Evadys '10/03-'12/13.....	26	SG '1/69-'12/98.....	50	O 405 '1/84-.....	216
Magelys '8/08-'12/13.....	26	SL '1/63-'12/73.....	52	O 407 '1/85-.....	216
IVECO BUS		SL II '1/76-'12/80.....	52	O 408 '1/91-'12/98.....	218
Autobus.....	26	SM '11/87-'2/95.....	52	OH Series '1/70-.....	218
CityClass '1/92-'12/08.....	26	SR '1/76-.....	52	Serie LK-LN2 '1/84-'12/98.....	218
EuroRider '1/92-.....	26	SU '10/76-.....	52	Serie MK '12/87-'9/96.....	218
IVECO TRUCK		UL '9/89-.....	56	Serie NG '8/73-'9/96.....	220
100 '1/73-.....	26	MAN TRUCK		Serie PK '1/77-'12/84.....	224
109 '1/83-'12/91.....	26	E 2000 '5/00-.....	56	Serie SK '1/81-'9/96.....	224
110 '1/73-.....	26	EL '1/93-.....	64	Tourino (O 510) '10/03-.....	226
115.....	28	EM '10/93-.....	64	Touro (O 500) '10/01-.....	228
135.....	28	F 2000 '1/94-.....	64	Travego (O 580) '10/99-.....	228
145 '1/87-.....	28	F 9 '1/83-'12/86.....	84	Unimog '1/73-'12/00.....	228
150 '1/75-.....	28	F 90 '1/87-'6/96.....	84	Zetros '9/08-.....	236
175.....	28	G 90 '9/87-'5/95.....	114	RENAULT TRUCK	
300 '1/74-.....	28	Industrial '1/76-'12/81.....	114	Agora Bus '1/95-.....	236
40/35 '1/66-'12/71.....	28	L 2000 '10/93-.....	114	C '10/80-'6/97.....	236
50 '1/66-'12/86.....	28	M 2000 L '8/95-.....	118	G '10/80-'10/96.....	236
55 '1/70-.....	28	M 2000 M '8/95-.....	120	Kerax '4/96-.....	238
60 '1/79-'12/91.....	28	M 90 '8/88-'6/96.....	124	Magnum '4/87-'12/13.....	240
616 '1/65-'12/71.....	28	NU '9/96-.....	130	Major '10/80-'10/96.....	244
625 '1/71-.....	28	R '5/85-'1/93.....	130	Manager '10/80-'6/97.....	244
645 '1/60-'12/73.....	28	Serie 11000 '1/73-'12/81.....	130	Maxity '5/06-.....	246
65 '1/70-'12/91.....	28	Serie 12000 '1/73-'12/81.....	130	Maxter '5/90-.....	246
653.....	28	Serie 13000 '1/69-'12/81.....	130	Premium I '10/92-'9/05.....	246
655 '1/66-'12/71.....	28	Serie 14000 '1/73-'12/81.....	130	Premium II '10/05-'12/13.....	248
662 '1/60-'12/71.....	28	Serie 15000 '1/69-'12/81.....	132	R '10/80-'10/92.....	250
672 '1/69-.....	30	Serie 16000 '11/69-'12/81.....	132	R312 Bus '1/88-'12/98.....	250
684 '1/70-.....	30	Serie 19000 '1/72-'12/81.....	132	SCANIA TRUCK	
690 '1/62-.....	30	TGA '4/00-'7/16.....	132	112 H '1/81-'12/86.....	250
691 '1/69-.....	30	TGL '5/16-.....	154	112 M '1/81-'12/86.....	250
697 '1/70-.....	30	TGM '5/16-.....	156	113 E '11/91-.....	250
79 '1/83-'12/91.....	30	TGS '7/16-.....	160	113 H '5/88-.....	250
90 '1/70-.....	30	TGX '7/16-.....	164	113 M '11/91-.....	252
95 '1/83-'12/91.....	30	MERCEDES BENZ TRUCK		114 C '5/96-.....	254
Daily - Grinta '1/79-'12/90.....	30	Accelo '5/03-.....	166	114 G '5/96-.....	254
Daily I '1/91-'1/99.....	30	Actros I '4/96-'10/02.....	166	114 L '5/96-.....	254
Daily II '2/99-'4/06.....	32	Actros II/ III '1/03-.....	170	124 C '9/96-.....	254
Daily III '5/06-'12/10.....	34	Atego I '1/98-'10/04.....	176	124 G '5/96-.....	256
Daily IV '1/11-'2/14.....	34	Atego II '10/04-.....	186	124 L '9/96-.....	256
EuroCargo '1/91-'12/11.....	34	Axor I '1/02-'10/04.....	192	143 E '1/91-.....	256
EuroStar '1/93-'12/02.....	36	Axor II '10/04-.....	194	143 H '5/88-.....	256
EuroTech MH '1/98-'12/03.....	36	CapaCity (O 530 GL) '4/07-.....	202	143 M '1/91-.....	256
EuroTech MP '1/92-'12/03.....	36	Citaro (O 530) '1/98-.....	204	164 C '5/00-.....	256
EuroTech MT '1/92-'12/98.....	38	Cito (O 520) '1/98-.....	204	164 G '5/00-.....	258
EuroTrakker '1/93-'12/04.....	38	Conecto (O 345) '11/01-.....	204	164 L '5/00-.....	258
Massif '7/08-'12/11.....	38	Econic '3/98-.....	206	93 H '3/88-.....	258
		Industrial '1/72-.....	206	93 M '3/88-.....	258
				94 C '12/96-.....	258
				94 D '12/96-.....	258
				94 G '8/96-.....	260

MAKE - MODEL	PAGE	MAKE - MODEL	PAGE	MAKE - MODEL	PAGE
94 L '4/97-.....	260				
BR 112DH.....	260				
G II '3/04-.....	260				
K III '11/90-.....	260				
K-Serie '1/06-.....	260				
P II '9/04-.....	262				
R II '3/04-.....	264				
T 113 E '11/91-.....	266				
T 113 H '11/91-.....	266				
T 114 C '3/98-.....	266				
T 114 G '5/96-.....	266				
T 114 L '5/96-.....	268				
T 124 C '9/95-.....	268				
T 124 G '3/97-.....	268				
T 124 L '9/95-.....	268				
T 143 E '1/91-.....	268				
T 143 H '1/91-.....	270				
T 93 H '1/90-.....	270				
T 94 C '9/96-.....	270				
T 94 G '8/96-.....	270				
VOLVO TRUCK					
7700 '6/06-.....	272				
8500 '1/99-.....	272				
8700 '1/99-.....	272				
9700 '10/07-.....	272				
9900 '10/07-.....	272				
A-Serie '1/99-.....	272				
B 12 '1/92-.....	274				
B 54 '1/65-'12/75.....	274				
B 6 '11/91-.....	274				
B 7 '1/99-.....	274				
B 9 '9/05-.....	274				
F 10 '8/77-'12/94.....	274				
F 12 '1/79-'12/94.....	276				
F 16 '1/88-'12/94.....	276				
F 80 '1/65-'12/85.....	276				
FE '5/06-.....	276				
FE II '5/12-.....	278				
FH '5/05-.....	278				
FH 12 '9/01-.....	280				
FH 13 '1/05-.....	282				
FH 16 '8/93-.....	282				
FH 16 II '5/12-.....	284				
FH II '5/12-.....	284				
FL 10 '1/88-'9/98.....	284				
FL 12 '9/95-'9/98.....	284				
FL 7 '9/85-'9/98.....	286				
FL II '5/06-.....	286				
FL III '5/13-.....	288				
FM '9/05-.....	288				
FM 12 '8/98-'9/05.....	290				
FM 7 '9/98-'12/01.....	292				
FM 9 '12/01-'9/05.....	292				
FMX '4/10-.....	292				
FS 7 '9/94-'3/96.....	294				
L.....	294				
N '1/65-.....	294				
N 10 '10/83-'12/89.....	294				
NH 12 '5/99-.....	294				



PA1060

PA1307





--	--	--	--



--	--	--	--

--	--	--	--





--	--	--	--

		GRAF ref.			NOTE	Adaptable for OES
65 CF '2/98-'12/00						
FA65CF180 (133 kW) Eng.NS133M	98-00	PA1060				1399689
FA65CF210 (156 kW) Eng.NS156M	98-00	PA1060				1399689
FA65CF240 (177 kW) Eng.NS177M	98-00	PA1060				1399689
FAV65CF210 (156 kW) Eng.NS156M	98-00	PA1060				1399689
85 '7/92-'2/98						
FA85.330 (242 kW) Eng.WS242	92-98	PA1307				0681653,0682258,372896,681653,682258/ R 682968/ R
FA85.330 (242 kW) Eng.WS242L	92-98	PA1307				0681653,0682258,372896,681653,682258/ R 682968/ R
FA85.330 (242 kW) Eng.WS242M	92-98	PA1307				0681653,0682258,372896,681653,682258/ R 682968/ R
FA85.360 (268 kW) Eng.WS268	92-98	PA1307				0681653,0682258,372896,681653,682258/ R 682968/ R
FA85.360 (268 kW) Eng.WS268L	92-98	PA1307				0681653,0682258,372896,681653,682258/ R 682968/ R
FA85.360 (268 kW) Eng.WS268M	92-98	PA1307				0681653,0682258,372896,681653,682258/ R 682968/ R
FA85.400 (295 kW) Eng.WS295M	95-98	PA1307				0681653,0682258,372896,681653,682258/ R 682968/ R
FAD85.330 (242 kW) Eng.WS242L	92-98	PA1307				0681653,0682258,372896,681653,682258/ R 682968/ R
FAD85.330 (242 kW) Eng.WS242M	92-98	PA1307				0681653,0682258,372896,681653,682258/ R 682968/ R
FAD85.360 (268 kW) Eng.WS268L	92-98	PA1307				0681653,0682258,372896,681653,682258/ R 682968/ R
FAD85.360 (268 kW) Eng.WS268M	92-98	PA1307				0681653,0682258,372896,681653,682258/ R 682968/ R
FAD85.400 (295 kW) Eng.WS295M	95-98	PA1307				0681653,0682258,372896,681653,682258/ R 682968/ R
FAG/FAR/FAS85.330 (242 kW) Eng.WS242L	92-98	PA1307				0681653,0682258,372896,681653,682258/ R 682968/ R
FAG/FAR/FAS85.330 (242 kW) Eng.WS242M	92-98	PA1307				0681653,0682258,372896,681653,682258/ R 682968/ R
FAG/FAR/FAS85.360 (268 kW) Eng.WS268L	92-98	PA1307				0681653,0682258,372896,681653,682258/ R 682968/ R
FAG/FAR/FAS85.360 (268 kW) Eng.WS268M	92-98	PA1307				0681653,0682258,372896,681653,682258/ R 682968/ R
FAG/FAR/FAS85.400 (295 kW) Eng.WS295M	95-98	PA1307				0681653,0682258,372896,681653,682258/ R 682968/ R
FAT85.330 (242 kW) Eng.WS242L	92-98	PA1307				0681653,0682258,372896,681653,682258/ R 682968/ R
FAT85.330 (242 kW) Eng.WS242M	92-98	PA1307				0681653,0682258,372896,681653,682258/ R 682968/ R
FAT85.360 (268 kW) Eng.WS268L	92-98	PA1307				0681653,0682258,372896,681653,682258/ R 682968/ R
FAT85.360 (268 kW) Eng.WS268M	92-98	PA1307				0681653,0682258,372896,681653,682258/ R 682968/ R
FAT85.400 (295 kW) Eng.WS295M	95-98	PA1307				0681653,0682258,372896,681653,682258/ R 682968/ R
FT85.330 (242 kW) Eng.WS242	92-98	PA1307				0681653,0682258,372896,681653,682258/ R 682968/ R
FT85.330 (242 kW) Eng.WS242L	92-98	PA1307				0681653,0682258,372896,681653,682258/ R 682968/ R
FT85.330 (242 kW) Eng.WS242M	92-98	PA1307				0681653,0682258,372896,681653,682258/ R 682968/ R
FT85.360 (268 kW) Eng.WS268L	92-98	PA1307				0681653,0682258,372896,681653,682258/ R 682968/ R
FT85.360 (268 kW) Eng.WS268M	92-98	PA1307				0681653,0682258,372896,681653,682258/ R 682968/ R
FT85.400 (295 kW) Eng.WS295M	95-98	PA1307				0681653,0682258,372896,681653,682258/ R 682968/ R
FTG85.330 (242 kW) Eng.WS242L	92-98	PA1307				0681653,0682258,372896,681653,682258/ R 682968/ R



		GRAF ref.			NOTE	Adaptable for OES
FTG85.330 (242 kW) Eng.WS242M	92-98	PA1307				0681653,0682258,372896,681653,682258/ R 682968/ R
FTG85.360 (268 kW) Eng.WS268L	92-98	PA1307				0681653,0682258,372896,681653,682258/ R 682968/ R
FTG85.360 (268 kW) Eng.WS268M	92-98	PA1307				0681653,0682258,372896,681653,682258/ R 682968/ R
FTG85.400 (295 kW) Eng.WS295M	95-98	PA1307				0681653,0682258,372896,681653,682258/ R 682968/ R
FTT85.330 (242 kW) Eng.WS242L	92-98	PA1307				0681653,0682258,372896,681653,682258/ R 682968/ R
FTT85.330 (242 kW) Eng.WS242M	92-98	PA1307				0681653,0682258,372896,681653,682258/ R 682968/ R
FTT85.360 (268 kW) Eng.WS268L	92-98	PA1307				0681653,0682258,372896,681653,682258/ R 682968/ R
FTT85.360 (268 kW) Eng.WS268M	92-98	PA1307				0681653,0682258,372896,681653,682258/ R 682968/ R
FTT85.400 (295 kW) Eng.WS295M	95-98	PA1307				0681653,0682258,372896,681653,682258/ R 682968/ R
85 CF '2/98-'12/00						
FA85CF340 (250 kW) Eng.XF250M	98-00	PA1317			Impeller Ø 135mm	0063225,0683225/ R,0683386/ R,1262683 1609871,683225R,683386/ 586
FA85CF380 (280 kW) Eng.XF280M	98-00	PA1317			Impeller Ø 135mm	0063225,0683225/ R,0683386/ R,1262683 1609871,683225R,683386/ 586
FA85CF430 (315 kW) Eng.XF315M	98-00	PA1317			Impeller Ø 135mm	0063225,0683225/ R,0683386/ R,1262683 1609871,683225R,683386/ 586
FAC85CF340 (250 kW) Eng.XF250M	98-00	PA1317			Impeller Ø 135mm	0063225,0683225/ R,0683386/ R,1262683 1609871,683225R,683386/ 586
FAC85CF380 (280 kW) Eng.XF280M	98-00	PA1317			Impeller Ø 135mm	0063225,0683225/ R,0683386/ R,1262683 1609871,683225R,683386/ 586
FAC85CF430 (315 kW) Eng.XF315M	98-00	PA1317			Impeller Ø 135mm	0063225,0683225/ R,0683386/ R,1262683 1609871,683225R,683386/ 586
FAD85CF340 (250 kW) Eng.XF250M	98-00	PA1317			Impeller Ø 135mm	0063225,0683225/ R,0683386/ R,1262683 1609871,683225R,683386/ 586
FAD85CF380 (280 kW) Eng.XF280M	98-00	PA1317			Impeller Ø 135mm	0063225,0683225/ R,0683386/ R,1262683 1609871,683225R,683386/ 586
FAD85CF430 (315 kW) Eng.XF315M	98-00	PA1317			Impeller Ø 135mm	0063225,0683225/ R,0683386/ R,1262683 1609871,683225R,683386/ 586
FAG/FAN85CF340 (250 kW) Eng.XF250M	98-00	PA1317			Impeller Ø 135mm	0063225,0683225/ R,0683386/ R,1262683 1609871,683225R,683386/ 586
FAG/FAN85CF380 (280 kW) Eng.XF280M	98-00	PA1317			Impeller Ø 135mm	0063225,0683225/ R,0683386/ R,1262683 1609871,683225R,683386/ 586
FAG/FAN85CF430 (315 kW) Eng.XF315M	98-00	PA1317			Impeller Ø 135mm	0063225,0683225/ R,0683386/ R,1262683 1609871,683225R,683386/ 586
FAR85CF340 (250 kW) Eng.XF250M	98-00	PA1317			Impeller Ø 135mm	0063225,0683225/ R,0683386/ R,1262683 1609871,683225R,683386/ 586
FAR85CF380 (280 kW) Eng.XF280M	98-00	PA1317			Impeller Ø 135mm	0063225,0683225/ R,0683386/ R,1262683 1609871,683225R,683386/ 586
FAR85CF430 (315 kW) Eng.XF315M	98-00	PA1317			Impeller Ø 135mm	0063225,0683225/ R,0683386/ R,1262683 1609871,683225R,683386/ 586
FAS85CF340 (250 kW) Eng.XF250M	98-00	PA1317			Impeller Ø 135mm	0063225,0683225/ R,0683386/ R,1262683 1609871,683225R,683386/ 586
FAS85CF380 (280 kW) Eng.XF280M	98-00	PA1317			Impeller Ø 135mm	0063225,0683225/ R,0683386/ R,1262683 1609871,683225R,683386/ 586
FAS85CF430 (315 kW) Eng.XF315M	98-00	PA1317			Impeller Ø 135mm	0063225,0683225/ R,0683386/ R,1262683 1609871,683225R,683386/ 586
FAT85CF340 (250 kW) Eng.XF250M	98-00	PA1317			Impeller Ø 135mm	0063225,0683225/ R,0683386/ R,1262683 1609871,683225R,683386/ 586
FAT85CF380 (280 kW) Eng.XF280M	98-00	PA1317			Impeller Ø 135mm	0063225,0683225/ R,0683386/ R,1262683 1609871,683225R,683386/ 586
FAT85CF430 (315 kW) Eng.XF315M	98-00	PA1317			Impeller Ø 135mm	0063225,0683225/ R,0683386/ R,1262683 1609871,683225R,683386/ 586
FT85CF340 (250 kW) Eng.XF250M	98-00	PA1317			Impeller Ø 135mm	0063225,0683225/ R,0683386/ R,1262683 1609871,683225R,683386/ 586
FT85CF380 (280 kW) Eng.XF280M	98-00	PA1317			Impeller Ø 135mm	0063225,0683225/ R,0683386/ R,1262683 1609871,683225R,683386/ 586

			
<p>PA1307</p>	<p>PA1317</p>		



		GRAF ref.			NOTE	Adaptable for OES
FT85CF430 (315 kW) Eng.XF315M	98-00	PA1317			Impeller Ø 135mm	0063225,0683225/ R,0683386/ R,1262683 1609871,683225R,683386/ 586
FTG85CF340 (250 kW) Eng.XF250M	98-00	PA1317			Impeller Ø 135mm	0063225,0683225/ R,0683386/ R,1262683 1609871,683225R,683386/ 586
FTG85CF380 (280 kW) Eng.XF280M	98-00	PA1317			Impeller Ø 135mm	0063225,0683225/ R,0683386/ R,1262683 1609871,683225R,683386/ 586
FTG85CF430 (315 kW) Eng.XF315M	98-00	PA1317			Impeller Ø 135mm	0063225,0683225/ R,0683386/ R,1262683 1609871,683225R,683386/ 586
FTT85CF340 (250 kW) Eng.XF250M	98-00	PA1317			Impeller Ø 135mm	0063225,0683225/ R,0683386/ R,1262683 1609871,683225R,683386/ 586
FTT85CF430 (315 kW) Eng.XF315M	98-00	PA1317			Impeller Ø 135mm	0063225,0683225/ R,0683386/ R,1262683 1609871,683225R,683386/ 586
95 '9/87-'1/98						
FA95.330 (242 kW) Eng.WS242	90-98	PA1307				0681653,0682258,372896,681653,682258/ R 682968/ R
FA95.360 (268 kW) Eng.WS268	90-98	PA1307				0681653,0682258,372896,681653,682258/ R 682968/ R
FA95.360 (268 kW) Eng.WS268G	90-98	PA1307				0681653,0682258,372896,681653,682258/ R 682968/ R
FA95.360 (268 kW) Eng.WS268L	90-98	PA1307				0681653,0682258,372896,681653,682258/ R 682968/ R
FA95.360 (268 kW) Eng.WS268M	90-98	PA1307				0681653,0682258,372896,681653,682258/ R 682968/ R
FA95.400 (295 kW) Eng.WS295	90-98	PA1307				0681653,0682258,372896,681653,682258/ R 682968/ R
FA95.400 (295 kW) Eng.WS295G	90-98	PA1307				0681653,0682258,372896,681653,682258/ R 682968/ R
FA95.400 (295 kW) Eng.WS295L	90-98	PA1307				0681653,0682258,372896,681653,682258/ R 682968/ R
FA95.400 (295 kW) Eng.WS295M	90-98	PA1307				0681653,0682258,372896,681653,682258/ R 682968/ R
FA95.430 (315 kW) Eng.WS315	92-98	PA1307				0681653,0682258,372896,681653,682258/ R 682968/ R
FA95.430 (315 kW) Eng.WS315G	92-98	PA1307				0681653,0682258,372896,681653,682258/ R 682968/ R
FA95.430 (315 kW) Eng.WS315L	92-98	PA1307				0681653,0682258,372896,681653,682258/ R 682968/ R
FA95.430 (315 kW) Eng.WS315M	92-98	PA1307				0681653,0682258,372896,681653,682258/ R 682968/ R
FAD95.360 (268 kW) Eng.WS268	90-98	PA1307				0681653,0682258,372896,681653,682258/ R 682968/ R
FAD95.360 (268 kW) Eng.WS268G	90-98	PA1307				0681653,0682258,372896,681653,682258/ R 682968/ R
FAD95.360 (268 kW) Eng.WS268L	90-98	PA1307				0681653,0682258,372896,681653,682258/ R 682968/ R
FAD95.360 (268 kW) Eng.WS268M	90-98	PA1307				0681653,0682258,372896,681653,682258/ R 682968/ R
FAD95.400 (295 kW) Eng.WS295	90-98	PA1307				0681653,0682258,372896,681653,682258/ R 682968/ R
FAD95.400 (295 kW) Eng.WS295G	90-98	PA1307				0681653,0682258,372896,681653,682258/ R 682968/ R
FAD95.400 (295 kW) Eng.WS295L	90-98	PA1307				0681653,0682258,372896,681653,682258/ R 682968/ R
FAD95.400 (295 kW) Eng.WS295M	90-98	PA1307				0681653,0682258,372896,681653,682258/ R 682968/ R
FAD95.430 (315 kW) Eng.WS315	92-98	PA1307				0681653,0682258,372896,681653,682258/ R 682968/ R
FAD95.430 (315 kW) Eng.WS315L	92-98	PA1307				0681653,0682258,372896,681653,682258/ R 682968/ R
FAD95.430 (315 kW) Eng.WS315M	92-98	PA1307				0681653,0682258,372896,681653,682258/ R 682968/ R
FAG/FAR/FAS95.360 (268 kW) Eng.WS268	90-98	PA1307				0681653,0682258,372896,681653,682258/ R 682968/ R
FAG/FAR/FAS95.360 (268 kW) Eng.WS268G	90-98	PA1307				0681653,0682258,372896,681653,682258/ R 682968/ R



		GRAF ref.			NOTE	Adaptable for OES
FAG/FAR/FAS95.360 (268 kW) Eng.WS268L	90-98	PA1307				0681653,0682258,372896,681653,682258/ R 682968/ R
FAG/FAR/FAS95.360 (268 kW) Eng.WS268M	90-98	PA1307				0681653,0682258,372896,681653,682258/ R 682968/ R
FAG/FAR/FAS95.400 (295 kW) Eng.WS295	90-98	PA1307				0681653,0682258,372896,681653,682258/ R 682968/ R
FAG/FAR/FAS95.400 (295 kW) Eng.WS295G	90-98	PA1307				0681653,0682258,372896,681653,682258/ R 682968/ R
FAG/FAR/FAS95.400 (295 kW) Eng.WS295L	90-98	PA1307				0681653,0682258,372896,681653,682258/ R 682968/ R
FAG/FAR/FAS95.400 (295 kW) Eng.WS295M	90-98	PA1307				0681653,0682258,372896,681653,682258/ R 682968/ R
FAG/FAR/FAS95.430 (315 kW) Eng.WS315	92-98	PA1307				0681653,0682258,372896,681653,682258/ R 682968/ R
FAG/FAR/FAS95.430 (315 kW) Eng.WS315L	92-98	PA1307				0681653,0682258,372896,681653,682258/ R 682968/ R
FAG/FAR/FAS95.430 (315 kW) Eng.WS315M	92-98	PA1307				0681653,0682258,372896,681653,682258/ R 682968/ R
FAK95.360 (268 kW) Eng.WS268	90-98	PA1307				0681653,0682258,372896,681653,682258/ R 682968/ R
FAK95.360 (268 kW) Eng.WS268L	90-98	PA1307				0681653,0682258,372896,681653,682258/ R 682968/ R
FAK95.360 (268 kW) Eng.WS268M	90-98	PA1307				0681653,0682258,372896,681653,682258/ R 682968/ R
FAK95.400 (295 kW) Eng.WS295	90-98	PA1307				0681653,0682258,372896,681653,682258/ R 682968/ R
FAK95.400 (295 kW) Eng.WS295L	90-98	PA1307				0681653,0682258,372896,681653,682258/ R 682968/ R
FAK95.400 (295 kW) Eng.WS295M	90-98	PA1307				0681653,0682258,372896,681653,682258/ R 682968/ R
FAK95.430 (315 kW) Eng.WS315	92-98	PA1307				0681653,0682258,372896,681653,682258/ R 682968/ R
FAK95.430 (315 kW) Eng.WS315L	92-98	PA1307				0681653,0682258,372896,681653,682258/ R 682968/ R
FAK95.430 (315 kW) Eng.WS315M	92-98	PA1307				0681653,0682258,372896,681653,682258/ R 682968/ R
FAR/FAS95.330 (242 kW) Eng.WS242	90-98	PA1307				0681653,0682258,372896,681653,682258/ R 682968/ R
FAT95.360 (268 kW) Eng.WS268	90-98	PA1307				0681653,0682258,372896,681653,682258/ R 682968/ R
FAT95.360 (268 kW) Eng.WS268G	90-98	PA1307				0681653,0682258,372896,681653,682258/ R 682968/ R
FAT95.360 (268 kW) Eng.WS268L	90-98	PA1307				0681653,0682258,372896,681653,682258/ R 682968/ R
FAT95.360 (268 kW) Eng.WS268M	90-98	PA1307				0681653,0682258,372896,681653,682258/ R 682968/ R
FAT95.400 (295 kW) Eng.WS295	90-98	PA1307				0681653,0682258,372896,681653,682258/ R 682968/ R
FAT95.400 (295 kW) Eng.WS295G	90-98	PA1307				0681653,0682258,372896,681653,682258/ R 682968/ R
FAT95.400 (295 kW) Eng.WS295L	90-98	PA1307				0681653,0682258,372896,681653,682258/ R 682968/ R
FAT95.400 (295 kW) Eng.WS295M	90-98	PA1307				0681653,0682258,372896,681653,682258/ R 682968/ R
FAT95.430 (315 kW) Eng.WS315	92-98	PA1307				0681653,0682258,372896,681653,682258/ R 682968/ R
FAT95.430 (315 kW) Eng.WS315L	92-98	PA1307				0681653,0682258,372896,681653,682258/ R 682968/ R
FAT95.430 (315 kW) Eng.WS315M	92-98	PA1307				0681653,0682258,372896,681653,682258/ R 682968/ R
FT95.330 (242 kW) Eng.WS242	90-93	PA1307				0681653,0682258,372896,681653,682258/ R 682968/ R
FT95.360 (268 kW) Eng.WS268	90-98	PA1307				0681653,0682258,372896,681653,682258/ R 682968/ R
FT95.360 (268 kW) Eng.WS268G	90-98	PA1307				0681653,0682258,372896,681653,682258/ R 682968/ R

		GRAF ref.			NOTE	Adaptable for OES
FT95.360 (268 kW) Eng.WS268L	90-98	PA1307				0681653,0682258,372896,681653,682258/ R 682968/ R
FT95.360 (268 kW) Eng.WS268M	90-98	PA1307				0681653,0682258,372896,681653,682258/ R 682968/ R
FT95.400 (295 kW) Eng.WS295	90-98	PA1307				0681653,0682258,372896,681653,682258/ R 682968/ R
FT95.400 (295 kW) Eng.WS295G	90-98	PA1307				0681653,0682258,372896,681653,682258/ R 682968/ R
FT95.400 (295 kW) Eng.WS295L	90-98	PA1307				0681653,0682258,372896,681653,682258/ R 682968/ R
FT95.400 (295 kW) Eng.WS295M	90-98	PA1307				0681653,0682258,372896,681653,682258/ R 682968/ R
FT95.430 (315 kW) Eng.WS315	92-98	PA1307				0681653,0682258,372896,681653,682258/ R 682968/ R
FT95.430 (315 kW) Eng.WS315L	92-98	PA1307				0681653,0682258,372896,681653,682258/ R 682968/ R
FT95.430 (315 kW) Eng.WS315M	92-98	PA1307				0681653,0682258,372896,681653,682258/ R 682968/ R
FTG/FTR/FTS95.360 (268 kW) Eng.WS268	90-98	PA1307				0681653,0682258,372896,681653,682258/ R 682968/ R
FTG/FTR/FTS95.360 (268 kW) Eng.WS268L	90-98	PA1307				0681653,0682258,372896,681653,682258/ R 682968/ R
FTG/FTR/FTS95.360 (268 kW) Eng.WS268M	90-98	PA1307				0681653,0682258,372896,681653,682258/ R 682968/ R
FTG/FTR/FTS95.400 (295 kW) Eng.WS295	90-98	PA1307				0681653,0682258,372896,681653,682258/ R 682968/ R
FTG/FTR/FTS95.400 (295 kW) Eng.WS295G	90-98	PA1307				0681653,0682258,372896,681653,682258/ R 682968/ R
FTG/FTR/FTS95.400 (295 kW) Eng.WS295L	90-98	PA1307				0681653,0682258,372896,681653,682258/ R 682968/ R
FTG/FTR/FTS95.400 (295 kW) Eng.WS295M	90-98	PA1307				0681653,0682258,372896,681653,682258/ R 682968/ R
FTG/FTR/FTS95.430 (315 kW) Eng.WS315	92-98	PA1307				0681653,0682258,372896,681653,682258/ R 682968/ R
FTG/FTR/FTS95.430 (315 kW) Eng.WS315L	92-98	PA1307				0681653,0682258,372896,681653,682258/ R 682968/ R
FTG/FTR/FTS95.430 (315 kW) Eng.WS315M	92-98	PA1307				0681653,0682258,372896,681653,682258/ R 682968/ R
FTT95.360 (268 kW) Eng.WS268	90-98	PA1307				0681653,0682258,372896,681653,682258/ R 682968/ R
FTT95.360 (268 kW) Eng.WS268L	90-98	PA1307				0681653,0682258,372896,681653,682258/ R 682968/ R
FTT95.360 (268 kW) Eng.WS268M	90-98	PA1307				0681653,0682258,372896,681653,682258/ R 682968/ R
FTT95.400 (295 kW) Eng.WS295	90-98	PA1307				0681653,0682258,372896,681653,682258/ R 682968/ R
FTT95.400 (295 kW) Eng.WS295G	90-98	PA1307				0681653,0682258,372896,681653,682258/ R 682968/ R
FTT95.400 (295 kW) Eng.WS295L	90-98	PA1307				0681653,0682258,372896,681653,682258/ R 682968/ R
FTT95.400 (295 kW) Eng.WS295M	90-98	PA1307				0681653,0682258,372896,681653,682258/ R 682968/ R
FTT95.430 (315 kW) Eng.WS315	92-98	PA1307				0681653,0682258,372896,681653,682258/ R 682968/ R
FTT95.430 (315 kW) Eng.WS315L	92-98	PA1307				0681653,0682258,372896,681653,682258/ R 682968/ R
FTT95.430 (315 kW) Eng.WS315M	92-98	PA1307				0681653,0682258,372896,681653,682258/ R 682968/ R
95 XF '1/97-'9/02						
FA95XF380 (280 kW) Eng.XF280M	97-02	PA1317			Impeller Ø 135mm	0063225,0683225/ R,0683386/ R,1262683 1609871,683225R,683386/ 586
	97-02	PA1338			Impeller Ø 120mm	1653974,1664762,1738991,1742258/ 59 1747962/ 63,1778280,1828141/ 42/ 62 93103402,931147

			
<p>PA1317</p>	<p>PA1338</p>		

		GRAF ref.			NOTE	Adaptable for OES
FA95XF430 (315 kW) Eng.XF315M	97-02	PA1317			Impeller Ø 135mm	0063225,0683225/ R,0683386/ R,1262683 1609871,683225R,683386/ 586
	97-02	PA1338			Impeller Ø 120mm	1653974,1664762,1738991,1742258/ 59 1747962/ 63,1778280,1828141/ 42/ 62 93103402,931147
FA95XF480 (355 kW) Eng.XF355M	97-02	PA1317			Impeller Ø 135mm	0063225,0683225/ R,0683386/ R,1262683 1609871,683225R,683386/ 586
	97-02	PA1338			Impeller Ø 120mm	1653974,1664762,1738991,1742258/ 59 1747962/ 63,1778280,1828141/ 42/ 62 93103402,931147
FA95XF530 (390 kW) Eng.VF390M	97-02	PA1338			Impeller Ø 120mm	1653974,1664762,1738991,1742258/ 59 1747962/ 63,1778280,1828141/ 42/ 62 93103402,931147
FAC95XF380 (280 kW) Eng.XF280M	97-02	PA1317			Impeller Ø 135mm	0063225,0683225/ R,0683386/ R,1262683 1609871,683225R,683386/ 586
	97-02	PA1338			Impeller Ø 120mm	1653974,1664762,1738991,1742258/ 59 1747962/ 63,1778280,1828141/ 42/ 62 93103402,931147
FAC95XF430 (315 kW) Eng.XF315M	97-02	PA1317			Impeller Ø 135mm	0063225,0683225/ R,0683386/ R,1262683 1609871,683225R,683386/ 586
	97-02	PA1338			Impeller Ø 120mm	1653974,1664762,1738991,1742258/ 59 1747962/ 63,1778280,1828141/ 42/ 62 93103402,931147
FAC95XF480 (355 kW) Eng.XF355M	97-02	PA1317			Impeller Ø 135mm	0063225,0683225/ R,0683386/ R,1262683 1609871,683225R,683386/ 586
	97-02	PA1338			Impeller Ø 120mm	1653974,1664762,1738991,1742258/ 59 1747962/ 63,1778280,1828141/ 42/ 62 93103402,931147
FAD95XF380 (280 kW) Eng.XF280M	97-02	PA1317			Impeller Ø 135mm	0063225,0683225/ R,0683386/ R,1262683 1609871,683225R,683386/ 586
	97-02	PA1338			Impeller Ø 120mm	1653974,1664762,1738991,1742258/ 59 1747962/ 63,1778280,1828141/ 42/ 62 93103402,931147
FAD95XF430 (315 kW) Eng.XF315M	97-02	PA1317			Impeller Ø 135mm	0063225,0683225/ R,0683386/ R,1262683 1609871,683225R,683386/ 586
	97-02	PA1338			Impeller Ø 120mm	1653974,1664762,1738991,1742258/ 59 1747962/ 63,1778280,1828141/ 42/ 62 93103402,931147
FAD95XF480 (355 kW) Eng.XF355M	97-02	PA1317			Impeller Ø 135mm	0063225,0683225/ R,0683386/ R,1262683 1609871,683225R,683386/ 586
	97-02	PA1338			Impeller Ø 120mm	1653974,1664762,1738991,1742258/ 59 1747962/ 63,1778280,1828141/ 42/ 62 93103402,931147
FAR95XF380 (280 kW) Eng.XF280M	97-02	PA1317			Impeller Ø 135mm	0063225,0683225/ R,0683386/ R,1262683 1609871,683225R,683386/ 586
	97-02	PA1338			Impeller Ø 120mm	1653974,1664762,1738991,1742258/ 59 1747962/ 63,1778280,1828141/ 42/ 62 93103402,931147
FAR95XF430 (315 kW) Eng.XF315M	97-02	PA1317			Impeller Ø 135mm	0063225,0683225/ R,0683386/ R,1262683 1609871,683225R,683386/ 586
	97-02	PA1338			Impeller Ø 120mm	1653974,1664762,1738991,1742258/ 59 1747962/ 63,1778280,1828141/ 42/ 62 93103402,931147
FAR95XF480 (355 kW) Eng.XF355M	97-02	PA1317			Impeller Ø 135mm	0063225,0683225/ R,0683386/ R,1262683 1609871,683225R,683386/ 586
	97-02	PA1338			Impeller Ø 120mm	1653974,1664762,1738991,1742258/ 59 1747962/ 63,1778280,1828141/ 42/ 62 93103402,931147
FAR95XF530 (390 kW) Eng.VF390M	97-02	PA1338			Impeller Ø 120mm	1653974,1664762,1738991,1742258/ 59 1747962/ 63,1778280,1828141/ 42/ 62 93103402,931147
FAS95XF380 (280 kW) Eng.XF280M	97-02	PA1317			Impeller Ø 135mm	0063225,0683225/ R,0683386/ R,1262683 1609871,683225R,683386/ 586
	97-02	PA1338			Impeller Ø 120mm	1653974,1664762,1738991,1742258/ 59 1747962/ 63,1778280,1828141/ 42/ 62 93103402,931147

			
<p>PA1317</p>	<p>PA1335</p>	<p>PA1338</p>	

		GRAF ref.		NOTE	Adaptable for OES
FAS95XF430 (315 kW) Eng.XF315M	97-02	PA1317		Impeller Ø 135mm	0063225,0683225/ R,0683386/ R,1262683 1609871,683225R,683386/ 586
	97-02	PA1338		Impeller Ø 120mm	1653974,1664762,1738991,1742258/ 59 1747962/ 63,1778280,1828141/ 42/ 62 93103402,931147
FAS95XF480 (355 kW) Eng.XF355M	97-02	PA1317		Impeller Ø 135mm	0063225,0683225/ R,0683386/ R,1262683 1609871,683225R,683386/ 586
	97-02	PA1338		Impeller Ø 120mm	1653974,1664762,1738991,1742258/ 59 1747962/ 63,1778280,1828141/ 42/ 62 93103402,931147
FAS95XF530 (390 kW) Eng.VF390M	97-02	PA1338		Impeller Ø 120mm	1653974,1664762,1738991,1742258/ 59 1747962/ 63,1778280,1828141/ 42/ 62 93103402,931147
FAT95XF380 (280 kW) Eng.XF280M	97-02	PA1317		Impeller Ø 135mm	0063225,0683225/ R,0683386/ R,1262683 1609871,683225R,683386/ 586
	97-02	PA1338		Impeller Ø 120mm	1653974,1664762,1738991,1742258/ 59 1747962/ 63,1778280,1828141/ 42/ 62 93103402,931147
FAT95XF430 (315 kW) Eng.XF315M	97-02	PA1317		Impeller Ø 135mm	0063225,0683225/ R,0683386/ R,1262683 1609871,683225R,683386/ 586
	97-02	PA1338		Impeller Ø 120mm	1653974,1664762,1738991,1742258/ 59 1747962/ 63,1778280,1828141/ 42/ 62 93103402,931147
FAT95XF480 (355 kW) Eng.XF355M	97-02	PA1317		Impeller Ø 135mm	0063225,0683225/ R,0683386/ R,1262683 1609871,683225R,683386/ 586
	97-02	PA1338		Impeller Ø 120mm	1653974,1664762,1738991,1742258/ 59 1747962/ 63,1778280,1828141/ 42/ 62 93103402,931147
FT95XF380 (280 kW) Eng.XF280M	97-02	PA1317		Impeller Ø 135mm	0063225,0683225/ R,0683386/ R,1262683 1609871,683225R,683386/ 586
	97-02	PA1338		Impeller Ø 120mm	1653974,1664762,1738991,1742258/ 59 1747962/ 63,1778280,1828141/ 42/ 62 93103402,931147
FT95XF430 (315 kW) Eng.XF315M	97-02	PA1317		Impeller Ø 135mm	0063225,0683225/ R,0683386/ R,1262683 1609871,683225R,683386/ 586
	97-02	PA1338		Impeller Ø 120mm	1653974,1664762,1738991,1742258/ 59 1747962/ 63,1778280,1828141/ 42/ 62 93103402,931147
FT95XF480 (355 kW) Eng.XF355M	97-02	PA1317		Impeller Ø 135mm	0063225,0683225/ R,0683386/ R,1262683 1609871,683225R,683386/ 586
	97-02	PA1338		Impeller Ø 120mm	1653974,1664762,1738991,1742258/ 59 1747962/ 63,1778280,1828141/ 42/ 62 93103402,931147
FT95XF530 (390 kW) Eng.VF390M	97-02	PA1338		Impeller Ø 120mm	1653974,1664762,1738991,1742258/ 59 1747962/ 63,1778280,1828141/ 42/ 62 93103402,931147
FT95XF530 (390 kW) Eng.XE390C	01-02	PA1335		Impeller Ø 135mm	1282029,1399150/ 336,1609853,683579
	97-02	PA1338		Impeller Ø 120mm	1653974,1664762,1738991,1742258/ 59 1747962/ 63,1778280,1828141/ 42/ 62 93103402,931147
FTG95XF380 (280 kW) Eng.XF280M	97-02	PA1317		Impeller Ø 135mm	0063225,0683225/ R,0683386/ R,1262683 1609871,683225R,683386/ 586
	97-02	PA1338		Impeller Ø 120mm	1653974,1664762,1738991,1742258/ 59 1747962/ 63,1778280,1828141/ 42/ 62 93103402,931147
FTG95XF430 (315 kW) Eng.XF315M	97-02	PA1317		Impeller Ø 135mm	0063225,0683225/ R,0683386/ R,1262683 1609871,683225R,683386/ 586
	97-02	PA1338		Impeller Ø 120mm	1653974,1664762,1738991,1742258/ 59 1747962/ 63,1778280,1828141/ 42/ 62 93103402,931147
FTG95XF480 (355 kW) Eng.XF355M	97-02	PA1317		Impeller Ø 135mm	0063225,0683225/ R,0683386/ R,1262683 1609871,683225R,683386/ 586
	97-02	PA1338		Impeller Ø 120mm	1653974,1664762,1738991,1742258/ 59 1747962/ 63,1778280,1828141/ 42/ 62 93103402,931147

		GRAF ref.			NOTE	Adaptable for OES
FTR95XF380 (280 kW) Eng.XF280M	97-02	PA1317			Impeller Ø 135mm	0063225,0683225/ R,0683386/ R,1262683 1609871,683225R,683386/ 586
	97-02	PA1338			Impeller Ø 120mm	1653974,1664762,1738991,1742258/ 59 1747962/ 63,1778280,1828141/ 42/ 62 93103402,931147
FTR95XF430 (315 kW) Eng.XF315M	97-02	PA1317			Impeller Ø 135mm	0063225,0683225/ R,0683386/ R,1262683 1609871,683225R,683386/ 586
	97-02	PA1338			Impeller Ø 120mm	1653974,1664762,1738991,1742258/ 59 1747962/ 63,1778280,1828141/ 42/ 62 93103402,931147
FTR95XF480 (355 kW) Eng.XF355M	97-02	PA1317			Impeller Ø 135mm	0063225,0683225/ R,0683386/ R,1262683 1609871,683225R,683386/ 586
	97-02	PA1338			Impeller Ø 120mm	1653974,1664762,1738991,1742258/ 59 1747962/ 63,1778280,1828141/ 42/ 62 93103402,931147
FTS95XF380 (280 kW) Eng.XF280M	97-02	PA1317			Impeller Ø 135mm	0063225,0683225/ R,0683386/ R,1262683 1609871,683225R,683386/ 586
	97-02	PA1338			Impeller Ø 120mm	1653974,1664762,1738991,1742258/ 59 1747962/ 63,1778280,1828141/ 42/ 62 93103402,931147
FTS95XF430 (315 kW) Eng.XF315M	97-02	PA1317			Impeller Ø 135mm	0063225,0683225/ R,0683386/ R,1262683 1609871,683225R,683386/ 586
	97-02	PA1338			Impeller Ø 120mm	1653974,1664762,1738991,1742258/ 59 1747962/ 63,1778280,1828141/ 42/ 62 93103402,931147
FTS95XF480 (355 kW) Eng.XF355M	97-02	PA1317			Impeller Ø 135mm	0063225,0683225/ R,0683386/ R,1262683 1609871,683225R,683386/ 586
	97-02	PA1338			Impeller Ø 120mm	1653974,1664762,1738991,1742258/ 59 1747962/ 63,1778280,1828141/ 42/ 62 93103402,931147
FTT95XF430 (315 kW) Eng.XF315M	97-02	PA1317			Impeller Ø 135mm	0063225,0683225/ R,0683386/ R,1262683 1609871,683225R,683386/ 586
	97-02	PA1338			Impeller Ø 120mm	1653974,1664762,1738991,1742258/ 59 1747962/ 63,1778280,1828141/ 42/ 62 93103402,931147
FTT95XF480 (355 kW) Eng.XF355M	97-02	PA1317			Impeller Ø 135mm	0063225,0683225/ R,0683386/ R,1262683 1609871,683225R,683386/ 586
	97-02	PA1338			Impeller Ø 120mm	1653974,1664762,1738991,1742258/ 59 1747962/ 63,1778280,1828141/ 42/ 62 93103402,931147
FTT95XF530 (390 kW) Eng.VF390M	97-02	PA1338			Impeller Ø 120mm	1653974,1664762,1738991,1742258/ 59 1747962/ 63,1778280,1828141/ 42/ 62 93103402,931147
CF 65 '1/01-						
FA 65.300 (220 kW) Eng.GR220	09-	PA1060				1399689
FA65.180 (136 kW) Eng.CE136C	01-	PA1060				1399689
FA65.220 (162 kW) Eng.CE162C	01-	PA1060				1399689
FA65.250 (184 kW) Eng.CE184C	01-	PA1060				1399689
CF 85 '1/01-						
FA/FT85.360 (265 kW) Eng.MX265	06-	PA1338			Impeller Ø 120mm	1653974,1664762,1738991,1742258/ 59 1747962/ 63,1778280,1828141/ 42/ 62 93103402,931147
FA/FT85.380 (280 kW) Eng.XE280C	01-	PA1335			Impeller Ø 135mm	1282029,1399150/ 336,1609853,683579
	01-	PA1338			Impeller Ø 120mm	1653974,1664762,1738991,1742258/ 59 1747962/ 63,1778280,1828141/ 42/ 62 93103402,931147
FA/FT85.410 (300 kW) Eng.MX300	05-	PA1338			Impeller Ø 120mm	1653974,1664762,1738991,1742258/ 59 1747962/ 63,1778280,1828141/ 42/ 62 93103402,931147
FA/FT85.430 (315 kW) Eng.XE315C	01-	PA1335			Impeller Ø 135mm	1282029,1399150/ 336,1609853,683579
	01-	PA1338			Impeller Ø 120mm	1653974,1664762,1738991,1742258/ 59 1747962/ 63,1778280,1828141/ 42/ 62 93103402,931147







PA1335





PA1338

		GRAF ref.			NOTE	Adaptable for OES
FA/FT85.460 (340 kW) Eng.MX340	05-	PA1338			Impeller Ø 120mm	1653974,1664762,1738991,1742258/ 59 1747962/ 63,1778280,1828141/ 42/ 62 93103402,931147
FA/FT85.480 (355 kW) Eng.XE355C	01-	PA1335			Impeller Ø 135mm	1282029,1399150/ 336,1609853,683579
	01-	PA1338			Impeller Ø 120mm	1653974,1664762,1738991,1742258/ 59 1747962/ 63,1778280,1828141/ 42/ 62 93103402,931147
FA/FT85.510 (375 kW) Eng.MX375	05-	PA1338			Impeller Ø 120mm	1653974,1664762,1738991,1742258/ 59 1747962/ 63,1778280,1828141/ 42/ 62 93103402,931147
FA85.340 (250 kW) Eng.XE250C	01-	PA1335			Impeller Ø 135mm	1282029,1399150/ 336,1609853,683579
	01-	PA1338			Impeller Ø 120mm	1653974,1664762,1738991,1742258/ 59 1747962/ 63,1778280,1828141/ 42/ 62 93103402,931147
FAC/FAD/FAX85.360 (265 kW) Eng.MX265	06-	PA1338			Impeller Ø 120mm	1653974,1664762,1738991,1742258/ 59 1747962/ 63,1778280,1828141/ 42/ 62 93103402,931147
FAC/FAG/FAN/FAX85.460 (340 kW) Eng.MX340	05-	PA1338			Impeller Ø 120mm	1653974,1664762,1738991,1742258/ 59 1747962/ 63,1778280,1828141/ 42/ 62 93103402,931147
FAC/FAX85.410 (300 kW) Eng.MX300	05-	PA1338			Impeller Ø 120mm	1653974,1664762,1738991,1742258/ 59 1747962/ 63,1778280,1828141/ 42/ 62 93103402,931147
FAC/FAX85.510 (375 kW) Eng.MX375	05-	PA1338			Impeller Ø 120mm	1653974,1664762,1738991,1742258/ 59 1747962/ 63,1778280,1828141/ 42/ 62 93103402,931147
FAD/FAG/FAN/FAR/FAS/FAT85.380 (280 kW) Eng.XE280C	01-	PA1335			Impeller Ø 135mm	1282029,1399150/ 336,1609853,683579
	01-	PA1338			Impeller Ø 120mm	1653974,1664762,1738991,1742258/ 59 1747962/ 63,1778280,1828141/ 42/ 62 93103402,931147
FAD/FAG/FAN/FAR/FAS/FAT85.410 (300 kW) Eng.MX300	05-	PA1338			Impeller Ø 120mm	1653974,1664762,1738991,1742258/ 59 1747962/ 63,1778280,1828141/ 42/ 62 93103402,931147
FAD/FAG/FAN/FAR/FAS/FAT85.430 (315 kW) Eng.XE315C	01-	PA1335			Impeller Ø 135mm	1282029,1399150/ 336,1609853,683579
	01-	PA1338			Impeller Ø 120mm	1653974,1664762,1738991,1742258/ 59 1747962/ 63,1778280,1828141/ 42/ 62 93103402,931147
FAD/FAG/FAN/FAR/FAS/FAT85.510 (375 kW) Eng.MX375	05-	PA1338			Impeller Ø 120mm	1653974,1664762,1738991,1742258/ 59 1747962/ 63,1778280,1828141/ 42/ 62 93103402,931147
FAD/FAG/FAN/FAT85.480 (355 kW) Eng.XE355C	01-	PA1335			Impeller Ø 135mm	1282029,1399150/ 336,1609853,683579
	01-	PA1338			Impeller Ø 120mm	1653974,1664762,1738991,1742258/ 59 1747962/ 63,1778280,1828141/ 42/ 62 93103402,931147
FAD/FAR/FAS/FAT85.460 (340 kW) Eng.MX340	05-	PA1338			Impeller Ø 120mm	1653974,1664762,1738991,1742258/ 59 1747962/ 63,1778280,1828141/ 42/ 62 93103402,931147
FAD85.340 (250 kW) Eng.XE250C	01-	PA1335			Impeller Ø 135mm	1282029,1399150/ 336,1609853,683579
	01-	PA1338			Impeller Ø 120mm	1653974,1664762,1738991,1742258/ 59 1747962/ 63,1778280,1828141/ 42/ 62 93103402,931147
FAG/FAN/FAR/FAS/FAT85.340 (250 kW) Eng.XE250C	01-	PA1335			Impeller Ø 135mm	1282029,1399150/ 336,1609853,683579
	01-	PA1338			Impeller Ø 120mm	1653974,1664762,1738991,1742258/ 59 1747962/ 63,1778280,1828141/ 42/ 62 93103402,931147
FAG/FAN85.360 (265 kW) Eng.MX265	06-	PA1338			Impeller Ø 120mm	1653974,1664762,1738991,1742258/ 59 1747962/ 63,1778280,1828141/ 42/ 62 93103402,931147
FAR/FAS/FAT85.360 (265 kW) Eng.MX265	06-	PA1338			Impeller Ø 120mm	1653974,1664762,1738991,1742258/ 59 1747962/ 63,1778280,1828141/ 42/ 62 93103402,931147
FTG/FTP/FTS85.360 (265 kW) Eng.MX265	06-	PA1338			Impeller Ø 120mm	1653974,1664762,1738991,1742258/ 59 1747962/ 63,1778280,1828141/ 42/ 62 93103402,931147

			
PA1293	PA1305	PA1335	PA1338







		GRAF ref.			NOTE	Adaptable for OES
FTG/FTS/FTP/FTT85.510 (375 kW) Eng.MX375	05-	PA1338			Impeller Ø 120mm	1653974,1664762,1738991,1742258/ 59 1747962/ 63,1778280,1828141/ 42/ 62 93103402,931147
FTG/FTS/FTT85.460 (340 kW) Eng.MX340	05-	PA1338			Impeller Ø 120mm	1653974,1664762,1738991,1742258/ 59 1747962/ 63,1778280,1828141/ 42/ 62 93103402,931147
FTG/FTT85.340 (250 kW) Eng.XE250C	01-	PA1335			Impeller Ø 135mm	1282029,1399150/ 336,1609853,683579
	01-	PA1338			Impeller Ø 120mm	1653974,1664762,1738991,1742258/ 59 1747962/ 63,1778280,1828141/ 42/ 62 93103402,931147
FTG/FTT85.380 (280 kW) Eng.XE280C	01-	PA1335			Impeller Ø 135mm	1282029,1399150/ 336,1609853,683579
	01-	PA1338			Impeller Ø 120mm	1653974,1664762,1738991,1742258/ 59 1747962/ 63,1778280,1828141/ 42/ 62 93103402,931147
FTG/FTT85.410 (300 kW) Eng.MX300	05-	PA1338			Impeller Ø 120mm	1653974,1664762,1738991,1742258/ 59 1747962/ 63,1778280,1828141/ 42/ 62 93103402,931147
FTG/FTT85.480 (355 kW) Eng.XE355C	01-	PA1335			Impeller Ø 135mm	1282029,1399150/ 336,1609853,683579
	01-	PA1338			Impeller Ø 120mm	1653974,1664762,1738991,1742258/ 59 1747962/ 63,1778280,1828141/ 42/ 62 93103402,931147
FTS85.410 (300 kW) Eng.MX300	05-	PA1338			Impeller Ø 120mm	1653974,1664762,1738991,1742258/ 59 1747962/ 63,1778280,1828141/ 42/ 62 93103402,931147
FTT85.430 (315 kW) Eng.XE315C	01-	PA1335			Impeller Ø 135mm	1282029,1399150/ 336,1609853,683579
	01-	PA1338			Impeller Ø 120mm	1653974,1664762,1738991,1742258/ 59 1747962/ 63,1778280,1828141/ 42/ 62 93103402,931147
F 2800 '1/74-'9/91						
FA2800DKS (228 kW) Eng.DKS1160	74-86	PA1293			For vehicles without retarder	0506109,0517097,0682260,288619,516724 517097,682260
	74-86	PA1305			With viscous-static fan	0680156R,0682262R,680156,682262
FA2800DKSE (206 kW) Eng.DKS1160E	80-86	PA1293			For vehicles without retarder	0506109,0517097,0682260,288619,516724 517097,682260
	83-91	PA1293			For vehicles without retarder	0506109,0517097,0682260,288619,516724 517097,682260
	83-91	PA1305			With viscous-static fan	0680156R,0682262R,680156,682262
FA2800DKSE (206 kW) Eng.DKV1160	83-91	PA1305			With viscous-static fan	0680156R,0682262R,680156,682262
FA2800DKTD (188 kW) Eng.DKTD1160	74-86	PA1293			For vehicles without retarder	0506109,0517097,0682260,288619,516724 517097,682260
	86-91	PA1293			For vehicles without retarder	0506109,0517097,0682260,288619,516724 517097,682260
	74-86	PA1305			With viscous-static fan	0680156R,0682262R,680156,682262
	86-91	PA1305			With viscous-static fan	0680156R,0682262R,680156,682262
FAB/FAR/FAS2805DKS (228 kW) Eng.DKS1160	74-86	PA1293			For vehicles without retarder	0506109,0517097,0682260,288619,516724 517097,682260
	74-86	PA1305			With viscous-static fan	0680156R,0682262R,680156,682262
FAB2805DKTD,FAS2800DKTD (188 kW) Eng.DKTD1160	74-86	PA1293			For vehicles without retarder	0506109,0517097,0682260,288619,516724 517097,682260
	74-86	PA1305			With viscous-static fan	0680156R,0682262R,680156,682262
FAC2803DKS (228 kW) Eng.DKS1160	74-86	PA1293			For vehicles without retarder	0506109,0517097,0682260,288619,516724 517097,682260
	74-86	PA1305			With viscous-static fan	0680156R,0682262R,680156,682262
FAC2803DKSE (206 kW) Eng.DKS1160E	80-90	PA1293			For vehicles without retarder	0506109,0517097,0682260,288619,516724 517097,682260
	80-90	PA1305			With viscous-static fan	0680156R,0682262R,680156,682262
FAC2803DKTD (188 kW) Eng.DKTD1160	74-91	PA1293			For vehicles without retarder	0506109,0517097,0682260,288619,516724 517097,682260
	74-91	PA1305			With viscous-static fan	0680156R,0682262R,680156,682262
FAD2805DKS (228 kW) Eng.DKS1160	74-86	PA1293			For vehicles without retarder	0506109,0517097,0682260,288619,516724 517097,682260
	74-86	PA1305			With viscous-static fan	0680156R,0682262R,680156,682262
FAD2805DKTD (188 kW) Eng.DKTD1160	74-86	PA1293			For vehicles without retarder	0506109,0517097,0682260,288619,516724 517097,682260
	74-86	PA1305			With viscous-static fan	0680156R,0682262R,680156,682262

			
<p>PA1293</p>	<p>PA1305</p>		

		GRAF ref.			NOTE	Adaptable for OES
FAD2825DKTD (188 kW) Eng.DKTD1160	74-91	PA1293			For vehicles without retarder	0506109,0517097,0682260,288619,516724 517097,682260
	86-91	PA1293			For vehicles without retarder	0506109,0517097,0682260,288619,516724 517097,682260
	74-91	PA1305			With viscous-static fan	0680156R,0682262R,680156,682262
	86-91	PA1305			With viscous-static fan	0680156R,0682262R,680156,682262
FAG/FAR/FAS2800DKV (212 kW) Eng.DKS1160E	83-91	PA1305			With viscous-static fan	0680156R,0682262R,680156,682262
FAG/FAR/FAS2800DKV (212 kW) Eng.DKV1160	83-91	PA1305			With viscous-static fan	0680156R,0682262R,680156,682262
FAR2804DKSE,FAS2800DKT (206 kW) Eng.DKS1160E	80-86	PA1293			For vehicles without retarder	0506109,0517097,0682260,288619,516724 517097,682260
	80-86	PA1305			With viscous-static fan	0680156R,0682262R,680156,682262
FAS2803DKS (228 kW) Eng.DKS1160	86-91	PA1293			For vehicles without retarder	0506109,0517097,0682260,288619,516724 517097,682260
	86-91	PA1305			With viscous-static fan	0680156R,0682262R,680156,682262
FAS2803DKTD (188 kW) Eng.DKTD1160	86-91	PA1293			For vehicles without retarder	0506109,0517097,0682260,288619,516724 517097,682260
	86-91	PA1305			With viscous-static fan	0680156R,0682262R,680156,682262
FAT2800DKS (228 kW) Eng.DKS1160	74-86	PA1293			For vehicles without retarder	0506109,0517097,0682260,288619,516724 517097,682260
	74-86	PA1305			With viscous-static fan	0680156R,0682262R,680156,682262
FAT2800DKTD (188 kW) Eng.DKTD1160	74-86	PA1293			For vehicles without retarder	0506109,0517097,0682260,288619,516724 517097,682260
	74-86	PA1305			With viscous-static fan	0680156R,0682262R,680156,682262
FAT2805DKS,2825DKS (228 kW) Eng.DKTD1160	86-91	PA1293			For vehicles without retarder	0506109,0517097,0682260,288619,516724 517097,682260
	86-91	PA1305			With viscous-static fan	0680156R,0682262R,680156,682262
FAT2805DKTD,2825DKTD (188 kW) Eng.DKTD1160	86-91	PA1293			For vehicles without retarder	0506109,0517097,0682260,288619,516724 517097,682260
	86-91	PA1305			With viscous-static fan	0680156R,0682262R,680156,682262
FMD2805DKTD,2825DKTD (188 kW) Eng.DKTD1160	74-86	PA1293			For vehicles without retarder	0506109,0517097,0682260,288619,516724 517097,682260
	86-91	PA1293			For vehicles without retarder	0506109,0517097,0682260,288619,516724 517097,682260
	74-86	PA1305			With viscous-static fan	0680156R,0682262R,680156,682262
	86-91	PA1305			With viscous-static fan	0680156R,0682262R,680156,682262
FMD2825DKV (212 kW) Eng.DKV1160	83-91	PA1305			With viscous-static fan	0680156R,0682262R,680156,682262
FT2800DK (206 kW) Eng.DKS1160E	80-91	PA1293			For vehicles without retarder	0506109,0517097,0682260,288619,516724 517097,682260
	80-91	PA1305			With viscous-static fan	0680156R,0682262R,680156,682262
FT2800DKS (228 kW) Eng.DKS1160	74-86	PA1293			For vehicles without retarder	0506109,0517097,0682260,288619,516724 517097,682260
	74-86	PA1305			With viscous-static fan	0680156R,0682262R,680156,682262
FT2800DKTD (188 kW) Eng.DKTD1160	74-86	PA1293			For vehicles without retarder	0506109,0517097,0682260,288619,516724 517097,682260
	74-86	PA1305			With viscous-static fan	0680156R,0682262R,680156,682262
FT2805DKS (228 kW) Eng.DKS1160	86-91	PA1293			For vehicles without retarder	0506109,0517097,0682260,288619,516724 517097,682260
	86-91	PA1305			With viscous-static fan	0680156R,0682262R,680156,682262
FT2805DKTD (188 kW) Eng.DKTD1160	86-91	PA1293			For vehicles without retarder	0506109,0517097,0682260,288619,516724 517097,682260
	86-91	PA1305			With viscous-static fan	0680156R,0682262R,680156,682262
FTS2800DKS (228 kW) Eng.DKS1160	74-86	PA1293			For vehicles without retarder	0506109,0517097,0682260,288619,516724 517097,682260
	74-86	PA1305			With viscous-static fan	0680156R,0682262R,680156,682262
FTS2800DKTD (188 kW) Eng.DKTD1160	74-86	PA1293			For vehicles without retarder	0506109,0517097,0682260,288619,516724 517097,682260
	74-86	PA1305			With viscous-static fan	0680156R,0682262R,680156,682262
FTS2803DKS (228 kW) Eng.DKS1160	86-91	PA1293			For vehicles without retarder	0506109,0517097,0682260,288619,516724 517097,682260
	86-91	PA1305			With viscous-static fan	0680156R,0682262R,680156,682262
FTS2803DKTD (188 kW) Eng.DKTD1160	86-91	PA1293			For vehicles without retarder	0506109,0517097,0682260,288619,516724 517097,682260
	86-91	PA1305			With viscous-static fan	0680156R,0682262R,680156,682262
FTT2800DKS (228 kW) Eng.DKS1160	74-86	PA1293			For vehicles without retarder	0506109,0517097,0682260,288619,516724 517097,682260
	74-86	PA1305			With viscous-static fan	0680156R,0682262R,680156,682262

			
<p>PA1060</p>	<p>PA1293</p>	<p>PA1305</p>	<p>PA1335</p>
			
<p>PA1338</p>			

		GRAF ref.			NOTE	Adaptable for OES
FTT2800DKTD (188 kW) Eng.DKTD1160	74-86	PA1293			For vehicles without retarder	0506109,0517097,0682260,288619,516724 517097,682260
	74-86	PA1305			With viscous-static fan	0680156R,0682262R,680156,682262
FTT2805DKS,2815DKS,2825DKS (225 kW) Eng.DKS1160	86-91	PA1293			For vehicles without retarder	0506109,0517097,0682260,288619,516724 517097,682260
	86-91	PA1305			With viscous-static fan	0680156R,0682262R,680156,682262
FTT2805DKTD (188 kW) Eng.DKTD1160	86-91	PA1293			For vehicles without retarder	0506109,0517097,0682260,288619,516724 517097,682260
	86-91	PA1305			With viscous-static fan	0680156R,0682262R,680156,682262
LF 45 '1/01-						
FA45.150 (110 kW) Eng.BE110C	01-	PA1060				1399689
FA45.170 (123 kW) Eng.BE123C	01-	PA1060				1399689
FA45.180 (136 kW) Eng.CE136C	01-	PA1060				1399689
FA45.180 (136 kW) Eng.FR136S1	06-	PA1060				1399689
FA45.220 (162 kW) Eng.CE162C	01-	PA1060				1399689
FA45.220 (165 kW) Eng.GR165S1	06-	PA1060				1399689
LF 55 '1/01-						
FA 55.210 (152 kW) Eng.FR152	09-	PA1060				1399689
FA 55.300 (220 kW) Eng.GR220	09-	PA1060				1399689
FA55.160 (118 kW) Eng.FR118S1	06-	PA1060				1399689
FA55.170 (123 kW) Eng.BE123C	01-	PA1060				1399689
FA55.180 (136 kW) Eng.CE136C	01-	PA1060				1399689
FA55.180 (136 kW) Eng.FR136S1	06-	PA1060				1399689
FA55.220 (162 kW) Eng.CE162C	01-	PA1060				1399689
FA55.220 (165 kW) Eng.GR165S1	01-	PA1060				1399689
FA55.250 (184 kW) Eng.CE184C	01-	PA1060				1399689
FA55.250 (184 kW) Eng.GR184S1	06-	PA1060				1399689
FA55.290 (210 kW) Eng.GR210S1	06-	PA1060				1399689
FAN55.220 (165 kW) Eng.GR165S1	06-	PA1060				1399689
FAN55.250 (184 kW) Eng.GR184S1	06-	PA1060				1399689
FAN55.290 (210 kW) Eng.GR210S1	06-	PA1060				1399689
FT55.220 (162 kW) Eng.CE162C	01-	PA1060				1399689
FT55.220 (165 kW) Eng.GR165S1	06-	PA1060				1399689
FT55.250 (184 kW) Eng.CE184C	01-	PA1060				1399689
FT55.250 (184 kW) Eng.GR184S1	06-	PA1060				1399689
FT55.290 (210 kW) Eng.GR210S1	06-	PA1060				1399689
XF 105 '10/05-						
FA/FTXF105.410 (300 kW) Eng.MX300	05-	PA1338			Impeller Ø 120mm	1653974,1664762,1738991,1742258/ 59 1747962/ 63,1778280,1828141/ 42/ 62 93103402,931147
FA/FTXF105.460 (340 kW) Eng.MX340	05-	PA1338			Impeller Ø 120mm	1653974,1664762,1738991,1742258/ 59 1747962/ 63,1778280,1828141/ 42/ 62 93103402,931147
FA/FTXF105.510 (375 kW) Eng.MX375	05-	PA1338			Impeller Ø 120mm	1653974,1664762,1738991,1742258/ 59 1747962/ 63,1778280,1828141/ 42/ 62 93103402,931147
FAS/FAR/FANXF105.410 (300 kW) Eng.MX300	05-	PA1338			Impeller Ø 120mm	1653974,1664762,1738991,1742258/ 59 1747962/ 63,1778280,1828141/ 42/ 62 93103402,931147
FAS/FAR/FANXF105.460 (340 kW) Eng.MX340	05-	PA1338			Impeller Ø 120mm	1653974,1664762,1738991,1742258/ 59 1747962/ 63,1778280,1828141/ 42/ 62 93103402,931147
FAS/FAR/FANXF105.510 (375 kW) Eng.MX375	05-	PA1338			Impeller Ø 120mm	1653974,1664762,1738991,1742258/ 59 1747962/ 63,1778280,1828141/ 42/ 62 93103402,931147
XF 95 '9/02-'12/06						
FA/FT95.380 (280 kW) Eng.XE280C	02-	PA1335			Impeller Ø 135mm	1282029,1399150/ 336,1609853,683579
	02-	PA1338			Impeller Ø 120mm	1653974,1664762,1738991,1742258/ 59 1747962/ 63,1778280,1828141/ 42/ 62 93103402,931147
FA/FT95.430 (315 kW) Eng.XE315C	02-	PA1335			Impeller Ø 135mm	1282029,1399150/ 336,1609853,683579

			
PA031	PA842	PA1198	PA1199
			
PA1335	PA1338		

		GRAF ref.		NOTE	Adaptable for OES
FA/FT95.430 (315 kW) Eng.XE315C	02-	PA1338		Impeller Ø 120mm	1653974,1664762,1738991,1742258/ 59 1747962/ 63,1778280,1828141/ 42/ 62 93103402,931147
FA/FT95.480 (355 kW) Eng.XE355C	02-	PA1335		Impeller Ø 135mm	1282029,1399150/ 336,1609853,683579
	02-	PA1338		Impeller Ø 120mm	1653974,1664762,1738991,1742258/ 59 1747962/ 63,1778280,1828141/ 42/ 62 93103402,931147
FA/FT95.530 (390 kW) Eng.XE390C	02-	PA1335		Impeller Ø 135mm	1282029,1399150/ 336,1609853,683579
	02-	PA1338		Impeller Ø 120mm	1653974,1664762,1738991,1742258/ 59 1747962/ 63,1778280,1828141/ 42/ 62 93103402,931147
FTG95.380 (250 kW) Eng.XE250C	02-	PA1335		Impeller Ø 135mm	1282029,1399150/ 336,1609853,683579
	02-	PA1338		Impeller Ø 120mm	1653974,1664762,1738991,1742258/ 59 1747962/ 63,1778280,1828141/ 42/ 62 93103402,931147

IRIS BUS

Arway '1/06-'12/13					
10.6M, 12M, 12.8M (243 kW) Eng.F2BE3681B	06-	PA1198			504093706
Domino '10/03-'12/13					
HD (280 kW)	06-	PA1198			504093706
HD, HDH (330 kW)	06-	PA1198			504093706
Evadys '10/03-'12/13					
12m (280 kW)	03-	PA1198			504093706
12m (330 kW)	03-	PA1198			504093706
Magelys '8/08-'12/13					
HD (280 kW)	08-13	PA1198			504093706
HD (330 kW)	08-13	PA1198			504093706

IVECO BUS











Autobus					
314/3 Eng.8060.12		PA031			4639182,4655010/ 54,4679242,93191101
315.13 (96-99-101 kW) Eng.8060.04		PA031			4639182,4655010/ 54,4679242,93191101
315.17 (124 kW) Eng.8060.24		PA031			4639182,4655010/ 54,4679242,93191101
316.13 (96-99-101 kW) Eng.8060.04		PA031			4639182,4655010/ 54,4679242,93191101
CityClass '1/92-'12/08					
491.10 (180-200-213 kW) Eng.F2BE0681	92-	PA1199			504029280
491.12/.22/.27 (165-177-200-213 kW) Eng.F2BE0681C	92-	PA1199			504029280
591.10/.22/.27 (180-196-213 kW) Eng.F2BE0681	92-	PA1199			504029280
591.12 (196-213 kW) Eng.F2BE0681	92-	PA1199			504029280
591.18 (259 kW) Eng.F2BE0681A	92-	PA1199			504029280
EuroRider '1/92-					
35	92-	PA1199			504029280
38	92-	PA1198			504093706
43	92-	PA1198			504093706

IVECO TRUCK





100 '1/73-					
F13, OM13, EC (90 kW) Eng.8060.02		PA031			4639182,4655010/ 54,4679242,93191101
NC (90 kW) Eng.8060.02		PA031			4639182,4655010/ 54,4679242,93191101
109 '1/83-'12/91					
109.14 Zeta (96-99-101 kW) Eng.8060.04/.05		PA842			98497115
110 '1/73-					
110.14, NC, 130 NC (96-99-101 kW) Eng.8060.04		PA842			98497115

			
<p>PA031</p>	<p>PA077</p>	<p>PA840</p>	<p>PA841</p>
			
<p>PA842</p>			

		GRAF ref.			NOTE	Adaptable for OES
115						
115.14 - 115.17 (96 kW) Eng.8060.04/.24		PA842				98497115
135						
135.14 - 135.17 (101 kW) Eng.8060.05		PA842				98497115
145 '1/87-						
145.17 (105-130 kW) Eng.8060.25		PA842				98497115
150 '1/75-						
150.20NC, NR, NT Eng.8220.02		PA842				98497115
F14, OM14, 150.16A, 150.17 (105-130 kW) Eng.8060.25		PA842				98497115
175						
175.17 (105-130 kW) Eng.8060.25	92-	PA842				98497115
300 '1/74-						
300 PC, PT, TC (192 kW) Eng.8210.02		PA077				4606023,4952496
40/35 '1/66-'12/71						
OM 40 - 40/35 NC (60 kW) Eng.8040.02		PA031				4639182,4655010/ 54,4679242,93191101
50 '1/66-'12/86						
50 - NC/ F8, 0M8 (60 kW) Eng.8040.02		PA031				4639182,4655010/ 54,4679242,93191101
50.9 Zeta (65 kW) Eng.8040.05	1/87-12/91	PA840				4813370
	92-	PA841				98497117
NC, OM (60 kW) Eng.8040.02		PA031				4639182,4655010/ 54,4679242,93191101
55 '1/70-						
55NC (60 kW) Eng.8040.02		PA031				4639182,4655010/ 54,4679242,93191101
60 '1/79-'12/91						
60.10 Zeta (73-74 kW) Eng.8340.04	1/87-12/91	PA840				4813370
60.11 Zeta (75-85 kW) Eng.8040.25B/X		PA842				98497115
60.8 Zeta (63 kW) Eng.8040.04	1/87-12/91	PA840				4813370
616 '1/65-'12/71						
616N2 (33 kW) Eng.803A(8030.01)		PA031				4639182,4655010/ 54,4679242,93191101
616N3 (46 kW) Eng.8030.02		PA031				4639182,4655010/ 54,4679242,93191101
616N4 (60 kW) Eng.803A(8040.01)		PA031				4639182,4655010/ 54,4679242,93191101
625 '1/71-						
N2, N2P Eng.804A		PA031				4639182,4655010/ 54,4679242,93191101
N3 (60 kW) Eng.8040.02		PA031				4639182,4655010/ 54,4679242,93191101
645 '1/60-'12/73						
N1, N2 (81 kW) Eng.806A		PA031				4639182,4655010/ 54,4679242,93191101
N3 (90 kW) Eng.8060.02		PA031				4639182,4655010/ 54,4679242,93191101
65 '1/70-'12/91						
65.10NC (60 kW) Eng.8040.02		PA031				4639182,4655010/ 54,4679242,93191101
65.9 Zeta (65 kW) Eng.8040.05	1/87-12/91	PA840				4813370
653						
N - N1 - N2 - N3		PA031				4639182,4655010/ 54,4679242,93191101
655 '1/66-'12/71						
N (81 kW) Eng.8060.01(806A)		PA031				4639182,4655010/ 54,4679242,93191101
N, N1 (90 kW) Eng.8060.02		PA031				4639182,4655010/ 54,4679242,93191101
662 '1/60-'12/71						
N1 (81 kW) Eng.8060.01(806A)		PA031				4639182,4655010/ 54,4679242,93191101
N2 (81 kW) Eng.8060.01(806A)		PA031				4639182,4655010/ 54,4679242,93191101
N2, N3 T (90 kW) Eng.8060.02		PA031				4639182,4655010/ 54,4679242,93191101

			
PA031	PA077	PA161	PA178
			
PA317	PA498	PA499	PA840
			
PA842	PA914	PA1161	

		GRAF ref.			NOTE	Adaptable for OES
672 '1/69-						
N (90 kW) Eng.8060.02		PA031				4639182,4655010/ 54,4679242,93191101
684 '1/70-						
N, NP (147 kW) Eng.8200.02		PA077				4606023,4952496
T (147 kW) Eng.8200.03		PA077				4606023,4952496
690 '1/62-						
N4 (147 kW) Eng.8200.02		PA077				4606023,4952496
N4, T4 (192 kW) Eng.8210.02		PA077				4606023,4952496
691 '1/69-						
N, T, TS (192 kW) Eng.8210.02		PA077				4606023,4952496
697 '1/70-						
N, NP, NT, T, TP (192 kW) Eng.8210.02		PA077				4606023,4952496
79 '1/83-'12/91						
79.10 Zeta (73-74 kW) Eng.8340.04	1/87-12/91	PA840				4813370
79.12 T. Zeta (75-85 kW) Eng.8060.25B/X	1/87-12/91	PA840				4813370
79.14, 79.13 Zeta (96-99-101 kW) Eng.8040.04/.05		PA842				98497115
90 '1/70-						
NC, OM, F13, OM13 (96-99-101 kW) Eng.8060.04		PA031				4639182,4655010/ 54,4679242,93191101
OM14 (96-99-101 kW) Eng.8060.04		PA031				4639182,4655010/ 54,4679242,93191101
95 '1/83-'12/91						
95.14 Zeta (96-99-101 kW) Eng.8060.04		PA842				98497115
Daily - Grinta '1/79-'12/90						
30.8 (53 kW) Eng.8140.61	79-90	PA178				4714636,4754850,4764761,7303009
32.8 (53 kW) Eng.8140.61	79-90	PA178				4714636,4754850,4764761,7303009
35.10 (68 kW) Eng.8140.21	79-90	PA317				2995627,7303056,99459755
35.10 T. (68 kW) Eng.8140.21	79-90	PA317				2995627,7303056,99459755
35.12 T. (53 kW) Eng.8140.61	79-90	PA498			Vett 12675-12679, +AF	2995629,98435994,99459757
35.8 (53 kW) Eng.8140.61	79-90	PA178				4714636,4754850,4764761,7303009
40.10 (68 kW) Eng.8140.21	79-90	PA317				2995627,7303056,99459755
40.8 (53 kW) Eng.8140.61	79-90	PA178				4714636,4754850,4764761,7303009
45.10 (68 kW) Eng.8140.21	79-90	PA317				2995627,7303056,99459755
49.10 T. (68 kW) Eng.8140.21	79-90	PA317				2995627,7303056,99459755
Daily I '1/91-'1/99						
30.10 (76 kW) Eng.8140.23	96-99	PA1161				99476298
30.8 (53 kW) Eng.8140.61	91-99	PA161			+AF	5001833230,7303050
	91-99	PA178				4714636,4754850,4764761,7303009
	91-95	PA499			Vett 12497-12674, +AF	98437726,99440728
	96-99	PA914				5001849884,500300476,500361203 500361919,98438356,98439407,99438900 99448068
30.8 (62 kW) Eng.8140.63	98-99	PA914				5001849884,500300476,500361203 500361919,98438356,98439407,99438900 99448068
35.10 (68 kW) Eng.8140.21	91-95	PA161			+AF	5001833230,7303050
	91-95	PA178				4714636,4754850,4764761,7303009
	96-99	PA914				5001849884,500300476,500361203 500361919,98438356,98439407,99438900 99448068
35.10 (76 kW) Eng.8140.23	96-99	PA914				5001849884,500300476,500361203 500361919,98438356,98439407,99438900 99448068
	96-99	PA1161				99476298
35.10 (76 kW) Eng.8140.47R	89-96	PA914				5001849884,500300476,500361203 500361919,98438356,98439407,99438900 99448068

			
PA161	PA178	PA499	PA900
			
PA913	PA914	PA915	PA916
			
PA1156	PA1161		

		GRAF ref.			NOTE	Adaptable for OES
35.12 (85 kW) Eng.8140.47	90-96	PA914				5001849884,500300476,500361203 500361919,98438356,98439407,99438900 99448068
35.12 V, C (53 kW) Eng.8140.61	91-99	PA914			Vett 12680-, +AF	5001849884,500300476,500361203 500361919,98438356,98439407,99438900 99448068
35.8 (53 kW) Eng.8140.61	91-95	PA161			+AF	5001833230,7303050
	91-95	PA178				4714636,4754850,4764761,7303009
	91-95	PA499			Vett 12497-12674, +AF	98437726,99440728
	96-99	PA914				5001849884,500300476,500361203 500361919,98438356,98439407,99438900 99448068
35.8 (62 kW) Eng.8140.63	98-99	PA914				5001849884,500300476,500361203 500361919,98438356,98439407,99438900 99448068
	96-98	PA916				2995624,500361455
40.10 (68 kW) Eng.8140.21	91-95	PA161			+AF	5001833230,7303050
	91-95	PA178				4714636,4754850,4764761,7303009
40.10 (76 kW) Eng.8140.23	96-99	PA914				5001849884,500300476,500361203 500361919,98438356,98439407,99438900 99448068
	96-99	PA1161				99476298
40.8 (53 kW) Eng.8140.61	91-95	PA161			+AF	5001833230,7303050
	91-95	PA178				4714636,4754850,4764761,7303009
45.10 (76 kW) Eng.8140.23	96-99	PA914				5001849884,500300476,500361203 500361919,98438356,98439407,99438900 99448068
	96-99	PA1161				99476298
45.10 TD (68 kW) Eng.8140.21	91-95	PA161			+AF	5001833230,7303050
	91-95	PA178				4714636,4754850,4764761,7303009
45.12 (85 kW) Eng.8140.47	90-	PA914				5001849884,500300476,500361203 500361919,98438356,98439407,99438900 99448068
	91-99	PA914				5001849884,500300476,500361203 500361919,98438356,98439407,99438900 99448068
49.10 (76 kW) Eng.8140.23	96-99	PA914				5001849884,500300476,500361203 500361919,98438356,98439407,99438900 99448068
	96-99	PA1161				99476298
49.10 (76 kW) Eng.8140.47R	89-96	PA914				5001849884,500300476,500361203 500361919,98438356,98439407,99438900 99448068
49.10 TD (68 kW) Eng.8140.21	91-95	PA161			+AF	5001833230,7303050
	91-95	PA178				4714636,4754850,4764761,7303009
	96-99	PA914				5001849884,500300476,500361203 500361919,98438356,98439407,99438900 99448068
49.12 TD (68 kW) Eng.8140.21	96-99	PA914				5001849884,500300476,500361203 500361919,98438356,98439407,99438900 99448068
59.12 TD (85 kW) Eng.8140.21/.47	96-99	PA914				5001849884,500300476,500361203 500361919,98438356,98439407,99438900 99448068

Daily II '2/99-'4/06

29L11 2.8 D (62-78 kW) Eng.8140.43C/B	99-	PA915				500362859
29L12 2.3JTD (70 kW) Eng.F1AE0481C	99-	PA900		•		504033770
35C11V 2.8 D (78 kW) Eng.8140.43C/B	99-	PA913				500316451,500362834
35C13V 2.8 D (92-94 kW) Eng.8140.43S	99-	PA915				500362859
35C14 3.0JTD (96 kW) Eng.F1CE0481A	05-	PA1156				504113544,504360207,504369725
35C15V (107 kW) Eng.8140.43N	99-06	PA915				500362859
35S11 2.8 D (78 kW) Eng.8140.43C	99-	PA913				500316451,500362834
35S13 2.8 D (92 kW) Eng.8140.43S	99-	PA915				500362859
35S15 2.8 D (107 kW) Eng.8140.43N	99-06	PA915				500362859
40C15 (107 kW) Eng.8140.43N	01-	PA915				500362859

		<p>N° denti / teeth = 21 Ø 57</p> 	<p>N° denti / teeth = 21 Ø 57</p> 
<p>PA843</p>	<p>PA844</p>	<p>PA845</p>	<p>PA846</p>
			
<p>PA900</p>	<p>PA915</p>	<p>PA1026</p>	<p>PA1060</p>
			
<p>PA1156</p>			





		GRAF ref.			NOTE	Adaptable for OES
50C11 2.8 D (78 kW) Eng.8140.43C/B	99-	PA915				500362859
50C13 2.8 D (92-94 kW) Eng.8140.43S	99-	PA915				500362859
50C14 3.0JTD (136 kW) Eng.F1CE0481A	05-	PA1156				504113544,504360207,504369725
50C15 (107 kW) Eng.8140.43N	01-06	PA915				500362859
65C14 3.0JTD (100 kW) Eng.F1CE0481A	04-	PA1156				504113544,504360207,504369725
65C15 2.8 TD (107-90 kW) Eng.8140.43N	99-06	PA915				500362859
Daily III '5/06-'12/10						
2.3 HPI (100 kW) Eng.F1AE0481HA	06-	PA900		•		504033770
2.3 HPI (71-78 kW) Eng.F1AE0481FA	06-	PA900		•		504033770
2.3 HPI (78-93 kW) Eng.F1AE0481FA	09-	PA900		•		504033770
3.0 HPI (108-130 kW) Eng.F1CE0481FA	06-	PA1156				504113544,504360207,504369725
3.0 HPT (130 kW) Eng.F1CE0481HC	07-	PA1156				504113544,504360207,504369725
3.0 Nat. Power (100 kW) Eng.F1CE0441A	10-	PA1156				504113544,504360207,504369725
3.0 TT (103 kW) Eng.F1CE3481LC	10-	PA1156				504113544,504360207,504369725
3.0 TT (125 kW) Eng.F1CE0481HA	10-	PA1156				504113544,504360207,504369725
Daily IV '1/11-'2/14						
2.3 HPI (78 kW) Eng.F1AE3481A	11-	PA900		•		504033770
2.3 HPI (93 kW) Eng.F1AE3481B	11-	PA900		•		504033770
3.0 HPI (100 kW)	11-	PA1026				504102572,504248581
3.0 HPI (107 kW) Eng.F1CE3481J/F1CE3481L	11-	PA1026				504102572,504248581
3.0 HPT (125 kW) Eng.F1CE3481C/F1CE3481K	11-	PA1026				504102572,504248581
3.0 HPT (130 kW)	11-	PA1026				504102572,504248581
3.0 HPT (150 kW) Eng.F1CE3481D	11-	PA1026				504102572,504248581
EuroCargo '1/91-'12/11						
100 E 15 (105-130 kW) Eng.8060.25R	91-	PA843				98415831
100 E 15 (105-130 kW) Eng.8060.45R	91-	PA843				98415831
100 E 17 (125 kW) Eng.F4AE0481A	00-	PA1060				504062854
100 E 18 (130 kW) Eng.8060.25V	91-00	PA843				98415831
100 E 18 (134 kW) Eng.F4AE0681E	00-	PA1060				504062854
100 E 21 (152-105 kW) Eng.8060.45	91-	PA843				98415831
100 E 21 (154 kW) Eng.F4AE0681D	00-	PA1060				504062854
120 E 15 (105-130 kW) Eng.8060.25R	91-	PA843				98415831
120 E 18 (130 kW) Eng.8060.25V	92-	PA843				98415831
120 E 18 (134 kW) Eng.F4AE0681E	00-	PA1060				504062854
120 E 23 (167 kW) Eng.8060.45S/.6090	91-	PA844				4838676
120 E 24 (176 kW) Eng.F4AE0681B	00-	PA1060				504062854
120 E 28 (202 kW) Eng.F4AE0681A	00-	PA1060				504062854
120 EL 17 (125 kW) Eng.F4AE0481A	00-	PA1060				504062854
120 EL 21 (154 kW) Eng.F4AE0681D	00-	PA1060				504062854
130 E 15 (105-130 kW) Eng.8060.25R	94-	PA843				98415831
130 E 18 (130-105 kW) Eng.8060.25V	92-	PA843				98415831
130 E 18 (134 kW) Eng.F4AE0681E	00-	PA1060				504062854
130 E 23 (167 kW) Eng.8060.45S/.6090	92-	PA844				4838676
130 E 24 (176 kW) Eng.F4AE0681B	00-	PA1060				504062854
130 E 28 (202 kW) Eng.F4AE0681A	00-	PA1060				504062854
140 E 18 (134 kW) Eng.F4AE0681E	00-	PA1060				504062854
140 E 24 (176 kW) Eng.F4AE0681B	00-	PA1060				504062854
150 E 18 (134 kW) Eng.F4AE0681E	00-	PA1060				504062854
150 E 23 (167 kW) Eng.8060.45S/.6090	92-	PA844				4838676
150 E 24 (176 kW) Eng.F4AE0681B	00-	PA1060				504062854
150 E 27, 170 E 27, 180 E 27 (196-176 kW) Eng.8360.46/R	92-	PA845				42532083,98439476
	92-	PA846	•			42532082,42535615
150 E 28 (202 kW) Eng.F4AE0681A	00-	PA1060				504062854
180 E 21 (154 kW) Eng.F4AE0681D	00-	PA1060				504062854
180 E 24 (176 kW) Eng.F4AE0681B	00-	PA1060				504062854
180 E 28 (202 kW) Eng.F4AE0681A	00-	PA1060				504062854
320 E 27 (196-176 kW) Eng.8360.46/R	92-	PA845				42532083,98439476
	92-	PA846	•			42532082,42535615

	<p>N° denti / teeth = 23 Ø 62,5</p> 	<p>N° denti / teeth = 23 Ø 62,5</p> 	<p>N° denti / teeth = 19 Ø 65</p> 
<p>PA843</p>	<p>PA849</p>	<p>PA850</p>	<p>PA852</p>
			
<p>PA942</p>	<p>PA968</p>	<p>PA969</p>	<p>PA1060</p>

		GRAF ref.			NOTE	Adaptable for OES
320 E 28 (202 kW) Eng.F4AE0681A	00-	PA1060				504062854
60 E 12 (75-85 kW) Eng.8040.25B/X	91-96	PA843				98415831
65 E 12 (75-85 kW) Eng.8040.25B/X	91-	PA843				98415831
65 E 13 (95 kW) Eng.F4AE0481D	00-	PA1060				504062854
65 E 14 (100 kW) Eng.8040.45	91-	PA843				98415831
65 E 15 (110 kW) Eng.F4AE0481C	00-	PA1060				504062854
75 E 12 (75-85 kW) Eng.8040.25B/X	91-	PA843				98415831
75 E 13 (95 kW) Eng.F4AE0481D	00-	PA1060				504062854
75 E 14 (100 kW) Eng.8040.45	91-	PA843				98415831
75 E 15 (105-130 kW) Eng.8060.25R	91-00	PA843				98415831
75 E 15 (110 kW) Eng.F4AE0481C	00-	PA1060				504062854
75 E 17 (125 kW) Eng.F4AE0481A	00-	PA1060				504062854
75 E 18 (134 kW) Eng.F4AE0681E	00-	PA1060				504062854
80 E 15 (105-130 kW) Eng.8060.25R	91-	PA843				98415831
80 E 17 (125 kW) Eng.F4AE0481A	00-	PA1060				504062854
80 E 18 (105-130 kW) Eng.8060.25V	91-	PA843				98415831
80 E 18 (134 kW) Eng.F4AE0681E	00-	PA1060				504062854
80 E 21 (105-152 kW) Eng.8060.45	91-	PA843				98415831
80 E 21 (154 kW) Eng.F4AE0681D	00-	PA1060				504062854
80 EL 15 (110 kW) Eng.F4AE0481C	00-	PA1060				504062854
90 E 17 (125 kW) Eng.F4AE0481A	00-	PA1060				504062854
90 E 18 (134 kW) Eng.F4AE0681E	00-	PA1060				504062854
90 E 21 (154 kW) Eng.F4AE0681D	00-	PA1060				504062854
EuroStar '1/93-'12/02						
LD 190 E 42 (243-265-272-277-309 kW) Eng.8210.42/K/L	93-95	PA852	•			98479675,99445447
	96-	PA969				500350785,93190285
LD 190 E 47 (345 kW) Eng.8210.42M	93-95	PA852	•			98479675,99445447
	96-	PA969				500350785,93190285
LD 240 E 42 (243-265-272-277-309 kW) Eng.8210.42/K/L	93-95	PA852	•			98479675,99445447
	96-	PA969				500350785,93190285
LD 240 E 47 (345 kW) Eng.8210.42M	93-95	PA852	•			98479675,99445447
	96-	PA969				500350785,93190285
LD 440 E 42 (243-265-272-277-309 kW) Eng.8210.42/K/L	93-95	PA852	•			98479675,99445447
	96-	PA969				500350785,93190285
LD 440 E 47 (345 kW) Eng.8210.42M	93-95	PA852	•			98479675,99445447
	96-	PA969				500350785,93190285
LD 440 E 48 (353 kW) Eng.F3BE0681E	01-02	PA942				500356553,5801807827
EuroTech MH '1/98-'12/03						
190 E 24 (180 kW) Eng.F2BE0681D	98-	PA968				99483937
190 E 27 (200 kW) Eng.F2BE0681C	98-	PA968				99483937
190 E 27 (200 kW) Eng.F2BE0681F	98-	PA968				99483937
190 E 31 (228 kW) Eng.F2BE0681B	98-	PA968				99483937
190 E 35 (259 kW) Eng.F2BE0681A	98-	PA968				99483937
260 E 24 (180 kW) Eng.F2BE0681D	99-	PA968				99483937
260 E 27 (200 kW) Eng.F2BE0681C	99-	PA968				99483937
260 E 27 (200 kW) Eng.F2BE0681F	99-	PA968				99483937
260 E 31 (228 kW) Eng.F2BE0681B	99-	PA968				99483937
260 E 35 (259 kW) Eng.F2BE0681A	99-	PA968				99483937
400/440 E 31 (228 kW) Eng.F2BE0681B	98-	PA968				99483937
400/440 E 35 (259 kW) Eng.F2BE0681A	98-	PA968				99483937
EuroTech MP '1/92-'12/03						
180 E 34, 190 E 34, 190 E 38, 240 E 38 (221-234-254-276 kW) Eng.8460.41	92-93	PA849			+BH	500350797,61318939
	92-93	PA850	•			500350798,93190284
180 E 42 (243-265-272-277-309 kW) Eng.8210.42/K/L	92-93	PA852	•			98479675,99445447
190 E 42 (243-265-272-277-309 kW) Eng.8210.42/K/L	93-95	PA852	•			98479675,99445447
	96-	PA969				500350785,93190285
240 E 42 (243-265-272-277-309 kW) Eng.8210.42/K/L	92-95	PA852	•			98479675,99445447

<p>N° denti / teeth = 23 Ø 62,5</p> 	<p>N° denti / teeth = 23 Ø 62,5</p> 	<p>N° denti / teeth = 19 Ø 65</p> 	<p>N° denti / teeth = 24 Ø 63</p> 
<p>PA849</p>	<p>PA850</p>	<p>PA852</p>	<p>PA853</p>
<p>12 Ribs</p> 	<p>10 Ribs</p> 		
<p>PA942</p>	<p>PA968</p>	<p>PA969</p>	<p>PA1156</p>

		GRAF ref.			NOTE	Adaptable for OES
240 E 42 (243-265-272-277-309 kW) Eng.8210.42/K/L	96-	PA969				500350785,93190285
260 E 42 (243-265-272-277-309 kW) Eng.8210.42/K/L	94-95	PA852	•			98479675,99445447
	96-	PA969				500350785,93190285
400 E 38 (221-234-254-276 kW) Eng.8460.41L	92-	PA849			+BH	500350797,61318939
	92-	PA850	•			500350798,93190284
400 E 38 (221-234-254-276 kW) Eng.8460.41N	92-	PA849			+BH	500350797,61318939
	92-	PA850	•			500350798,93190284
400 E 42 (309 kW) Eng.8210.42L	92-95	PA852	•			98479675,99445447
	96-	PA969				500350785,93190285
400/440 E 34 (221-234-254-276 kW) Eng.8460.41	92-	PA849			+BH	500350797,61318939
	92-	PA850	•			500350798,93190284
440 E 38 (221-234-254-276 kW) Eng.8460.41	93-	PA849			+BH	500350797,61318939
	93-	PA850	•			500350798,93190284
440 E 42 (243-265-272-277-309 kW) Eng.8210.42/K/L	93-95	PA852	•			98479675,99445447
	96-	PA969				500350785,93190285
EuroTech MT '1/92-'12/98						
180 E 30 (221-234-254-276 kW) Eng.8460.41	92-	PA849			+BH	500350797,61318939
	92-	PA850	•			500350798,93190284
180 E 34 (221-234-254-276 kW) Eng.8460.41	92-93	PA849			+BH	500350797,61318939
	92-93	PA850	•			500350798,93190284
190 E 30 (221-234-254-276 kW) Eng.8460.41	97-98	PA849			+BH	500350797,61318939
	97-98	PA850	•			500350798,93190284
400 E 34 (221-234-254-276 kW) Eng.8460.41	92-	PA849			+BH	500350797,61318939
	92-	PA850	•			500350798,93190284
EuroTrakker '1/93-'12/04						
MP 190 E 31 (228 kW) Eng.F2BE0681B	99-04	PA968				99483937
MP 190 E 34 (221-234-254-276 kW) Eng.8460.41	93-	PA849			+BH	500350797,61318939
	93-	PA850	•			500350798,93190284
MP 190 E 35 (259 kW) Eng.F2BE0681A	99-04	PA968				99483937
MP 190 E 37 (243-265-272-277-309 kW) Eng.8210.42/K/L	93-95	PA852	•			98479675,99445447
	96-	PA969				500350785,93190285
MP 190 E 38 (280 kW) Eng.F3BE0681G	01-04	PA942				500356553,5801807827
MP 190 E 42 (243-265-272-277-309 kW) Eng.8210.42/K/L	93-	PA969				500350785,93190285
MP 190 E 44 (324 kW) Eng.F3BE0681C	00-04	PA942				500356553,5801807827
MP 260 E 31 (228 kW) Eng.F2BE0681B	99-04	PA968				99483937
MP 260 E 35 (259 kW) Eng.F2BE0681A	99-04	PA968				99483937
MP 260 E 38 (280 kW) Eng.F3BE0681G	01-04	PA942				500356553,5801807827
MP 260 E 44 (324 kW) Eng.F3BE0681C	00-04	PA942				500356553,5801807827
MP 340 E 35 (259 kW) Eng.F2BE0681A	99-04	PA968				99483937
MP 340 E 38 (280 kW) Eng.F3BE0681G	01-04	PA942				500356553,5801807827
MP 340 E 44 (324 kW) Eng.F3BE0681C	01-04	PA942				500356553,5801807827
MP 380 E 34 (221-234-254-276 kW) Eng.8460.41	93-	PA849			+BH	500350797,61318939
	93-	PA850	•			500350798,93190284
MP 380 E 37, MP 380 E 42, MP 410 E 37, MP 410 E 42 (243-265-272-277-309 kW) Eng.8210.42/K/L	93-95	PA852	•			98479675,99445447
	96-	PA969				500350785,93190285
MP 380 E 38 (280 kW) Eng.F3BE0681G	01-04	PA942				500356553,5801807827
MP 380 E 44 (324 kW) Eng.F3BE0681C	01-04	PA942				500356553,5801807827
MP 410 E 38 (280 kW) Eng.F3BE0681G	01-04	PA942				500356553,5801807827
MP 720 E 37 (243-265-272-277-309 kW) Eng.8210.42/K/L	93-	PA969				500350785,93190285
MP 720 E 42 (243-265-272-277-309 kW) Eng.8210.42/K/L	93-95	PA852	•			98479675,99445447
	96-	PA969				500350785,93190285
Massif '7/08-'12/11						
3.0 HPI (107 kW) Eng.F1CE0481FA	08-	PA1156				504113544,504360207,504369725
3.0 HPT (130 kW) Eng.F1CE0481HA	08-	PA1156				504113544,504360207,504369725
P / PA '12/79-'12/93						
330.36 (243-265-272-277-309 kW) Eng.8210.42/K/L	89-92	PA853			+BH	98468830,99458098

<p>N° denti / teeth = 19 Ø 65</p> 	<p>N° denti / teeth = 19 Ø 65 ~14</p> 	<p>N° denti / teeth = 24 Ø 63</p> 	<p>N° denti / teeth = 24 Ø 63</p> 
<p>PA847</p>	<p>PA848</p>	<p>PA853</p>	<p>PA854</p>
<p>12 Ribs</p> 	<p>10 Ribs</p> 		
<p>PA942</p>	<p>PA968</p>	<p>PA1224</p>	<p>PA1235</p>
			
<p>PA1331</p>			

		GRAF ref.			NOTE	Adaptable for OES
330.36 (243-265-272-277-309 kW) Eng.8210.42/K/L	89-92	PA854	•			42530032,93190286
Stralis '1/02-						
AD/AT 190S27 (200 kW) Eng.F2BE0681F	04-	PA968				99483937
AD/AT 190S30 (218 kW) Eng.F2BE0681E	04-	PA968				99483937
AD/AT 190S31 (228 kW) Eng.F2BE0681B	03-	PA968				99483937
AD/AT 190S35 (259 kW) Eng.F2BE0681A	03-	PA968				99483937
AD/AT 260S27 (200 kW) Eng.F2BE0681F	04-	PA968				99483937
AD/AT 260S30 (218 kW) Eng.F2BE0681E	04-	PA968				99483937
AD/AT 260S31 (228 kW) Eng.F2BE0681B	03-	PA968				99483937
AD/AT 260S35 (259 kW) Eng.F2BE0681A	03-	PA968				99483937
AD/AT 260S36 (265 kW) Eng.F2BE3681A	07-	PA968				99483937
AD/AT 440S35 (259 kW) Eng.F2BE0681A	03-	PA968				99483937
AS 260S48 (353 kW) Eng.F3BE0681E	02-	PA942				500356553,5801807827
AS 260S54 (397 kW) Eng.F3BE0681A	02-	PA942				500356553,5801807827
AS 440S48 (353 kW) Eng.F3BE0681E	02-	PA942				500356553,5801807827
AS 440S54 (397 kW) Eng.F3BE0681A	02-	PA942				500356553,5801807827
Trakker '1/04-						
AD/AT 180T27 (200 kW) Eng.F2BE0681F	05-	PA968				99483937
AD/AT 190T27 (200 kW) Eng.F2BE0681F	05-	PA968				99483937
AD/AT 190T31 (228 kW) Eng.F2BE0681B	04-	PA968				99483937
AD/AT 190T35 (259 kW) Eng.F2BE0681A	04-	PA968				99483937
AD/AT 190T38 (280 kW) Eng.F3BE0681G	05-	PA942				500356553,5801807827
AD/AT 190T44 (324 kW) Eng.F3BE0681C	05-	PA942			ZF	500356553,5801807827
AD/AT 260T31 (228 kW) Eng.F2BE0681B	04-	PA968				99483937
AD/AT 260T35 (259 kW) Eng.F2BE0681A	04-	PA968				99483937
AD/AT 260T38 (280 kW) Eng.F3BE0681G	04-	PA942				500356553,5801807827
AD/AT 400T35 (259 kW) Eng.F2BE0681A	05-	PA968				99483937
Turbostar '7/84-'12/93						
190.36 (243-265-272-277-309 kW) Eng.8210.42/K/L	87-93	PA847			+BH	98468832,99458099
	87-93	PA848	•			42530033
	87-93	PA853			+BH	98468830,99458098
	87-93	PA854	•			42530032,93190286
TurboTech '1/90-'1/93						
190.36 (243-265-272-277-309 kW) Eng.8210.42/K/L	90-92	PA847			+BH	98468832,99458099
	90-92	PA848	•			42530033
	90-92	PA853			+BH	98468830,99458098
	90-92	PA854	•			42530032,93190286
220.36 (243-265-272-277-309 kW) Eng.8210.42/K/L	90-93	PA847			+BH	98468832,99458099
	90-93	PA848	•			42530033
	90-93	PA853			+BH	98468830,99458098
	90-93	PA854	•			42530032,93190286
240.36 (243-265-272-277-309 kW) Eng.8210.42/K/L	90-92	PA847			+BH	98468832,99458099
	90-92	PA848	•			42530033
	90-92	PA853			+BH	98468830,99458098
	90-92	PA854	•			42530032,93190286
MAN BUS						
Hocl '1/96-						
11.220 (162 kW) Eng.DO826LOH15	96-	PA1331			Impeller Ø 125mm	51065006575/ 6606/ 6612 51065006669/ 9575/ 9606/ 9612
14.280 (206 kW) Eng.DO836LOH02	96-	PA1331			Impeller Ø 125mm	51065006575/ 6606/ 6612 51065006669/ 9575/ 9606/ 9612
18.360 (265 kW) Eng.D2066LOH02/06/27	06-14	PA1224			+Retarder	51065006642/ 6675/ 6694/ 9642/ 9675/ 9694
	06-14	PA1235				51065006646/ 6676/ 6695/ 7050 51065009050/ 9646/ 9676/ 9695
18.400 (294 kW) Eng.D2066LOH03,28	06-14	PA1224			+Retarder	51065006642/ 6675/ 6694/ 9642/ 9675/ 9694
	06-14	PA1235				51065006646/ 6676/ 6695/ 7050 51065009050/ 9646/ 9676/ 9695

			
<p>PA1224</p>	<p>PA1235</p>	<p>PA1294</p>	<p>PA1298</p>
			
<p>PA1302</p>	<p>PA1319</p>	<p>PA1321</p>	<p>PA1336</p>

		GRAF ref.			NOTE	Adaptable for OES
18.440 (324 kW) Eng.D2066LOH04,08	06-09	PA1224			+Retarder	51065006642/ 6675/ 6694/ 9642/ 9675/ 9694
	06-09	PA1235				51065006646/ 6676/ 6695/ 7050 51065009050/ 9646/ 9676/ 9695
24.440 (324 kW) Eng.D2066LOH04,08	06-09	PA1224			+Retarder	51065006642/ 6675/ 6694/ 9642/ 9675/ 9694
	06-09	PA1235				51065006646/ 6676/ 6695/ 7050 51065009050/ 9646/ 9676/ 9695
LION'S COACH '9/95-						
FRH 352,RH 353 (257 kW) Eng.D2866LOH26 FRH 402,RH 403 (294 kW) Eng.D2866LOH23	95-	PA1294			For vehicles without retarder; Impeller Ø 125mm	51065006282/ 6387/ 9282/ 9387
	95-	PA1298			For vehicles without retarder, w/o pulley; Impeller Ø 135mm, Incl Eletronic fuel Injection pump	51065006408/ 6492/ 9492
	95-	PA1302			For vehicles with retarder, w/o pulley	51065006426/ 6490/ 9426/ 9490
RH 413 (301 kW) Eng.D2866LOH29	00-	PA1294			For vehicles without retarder; Impeller Ø 125mm	51065006282/ 6387/ 9282/ 9387
	00-	PA1298			For vehicles without retarder, w/o pulley; Impeller Ø 135mm, Incl Eletronic fuel Injection pump	51065006408/ 6492/ 9492
	00-	PA1302			For vehicles with retarder, w/o pulley	51065006426/ 6490/ 9426/ 9490
RH 463, RHC 464 (338 kW) Eng.D2876LOH03/02	00-	PA1298			For vehicles without retarder, w/o pulley; Impeller Ø 135mm, Incl Eletronic fuel Injection pump	51065006408/ 6492/ 9492
	00-	PA1302			For vehicles with retarder, w/o pulley	51065006426/ 6490/ 9426/ 9490
RHC 414 (301 kW) Eng.D2866LOH34	02-	PA1294			For vehicles without retarder; Impeller Ø 125mm	51065006282/ 6387/ 9282/ 9387
	02-	PA1298			For vehicles without retarder, w/o pulley; Impeller Ø 135mm, Incl Eletronic fuel Injection pump	51065006408/ 6492/ 9492
	02-	PA1302			For vehicles with retarder, w/o pulley	51065006426/ 6490/ 9426/ 9490
LION'S STAR '1/93-						
FRH 352,RH 353 (257 kW) Eng.D2866LOH26	95-	PA1294			For vehicles without retarder; Impeller Ø 125mm	51065006282/ 6387/ 9282/ 9387
	95-	PA1298			For vehicles without retarder, w/o pulley; Impeller Ø 135mm, Incl Eletronic fuel Injection pump	51065006408/ 6492/ 9492
	95-	PA1302			For vehicles with retarder, w/o pulley	51065006426/ 6490/ 9426/ 9490
FRH 402,RH 403 (294 kW) Eng.D2866LOH23	95-	PA1294			For vehicles without retarder; Impeller Ø 125mm	51065006282/ 6387/ 9282/ 9387
	95-	PA1298			For vehicles without retarder, w/o pulley; Impeller Ø 135mm, Incl Eletronic fuel Injection pump	51065006408/ 6492/ 9492
	95-	PA1302			For vehicles with retarder, w/o pulley	51065006426/ 6490/ 9426/ 9490
FRH 422 (309 kW) Eng.D2866LOH20	93-96	PA1294			For vehicles without retarder; Impeller Ø 125mm	51065006282/ 6387/ 9282/ 9387
	93-96	PA1298			For vehicles without retarder, w/o pulley; Impeller Ø 135mm, Incl Eletronic fuel Injection pump	51065006408/ 6492/ 9492
	93-96	PA1302			For vehicles with retarder, w/o pulley	51065006426/ 6490/ 9426/ 9490
RH 414, RHS 414 (301 kW) Eng.D2866LOH39/34	00-	PA1294			For vehicles without retarder; Impeller Ø 125mm	51065006282/ 6387/ 9282/ 9387
	00-	PA1298			For vehicles without retarder, w/o pulley; Impeller Ø 135mm, Incl Eletronic fuel Injection pump	51065006408/ 6492/ 9492
	00-	PA1302			For vehicles with retarder, w/o pulley	51065006426/ 6490/ 9426/ 9490
RH 464, RHS 464 (338 kW) Eng.D2876LOH03	00-	PA1298			For vehicles without retarder, w/o pulley; Impeller Ø 135mm, Incl Eletronic fuel Injection pump	51065006408/ 6492/ 9492
	00-	PA1302			For vehicles with retarder, w/o pulley	51065006426/ 6490/ 9426/ 9490
LIONS CITY '8/96-						
A 23 (191 kW) Eng.D2866LUH22	94-	PA1294			For vehicles without retarder; Impeller Ø 125mm	51065006282/ 6387/ 9282/ 9387
	96-	PA1302			For vehicles with retarder, w/o pulley	51065006426/ 6490/ 9426/ 9490
LIONS COMFORT '9/96-						
RN 313 (228 kW) Eng.D2866LUH20	96-	PA1294			For vehicles without retarder; Impeller Ø 125mm	51065006282/ 6387/ 9282/ 9387
	96-	PA1298			For vehicles without retarder, w/o pulley; Impeller Ø 135mm, Incl Eletronic fuel Injection pump	51065006408/ 6492/ 9492
	96-	PA1302			For vehicles with retarder, w/o pulley	51065006426/ 6490/ 9426/ 9490
RN 313 (228 kW) Eng.D2866LUH26	96-	PA1294			For vehicles without retarder; Impeller Ø 125mm	51065006282/ 6387/ 9282/ 9387
	96-	PA1298			For vehicles without retarder, w/o pulley; Impeller Ø 135mm, Incl Eletronic fuel Injection pump	51065006408/ 6492/ 9492
	96-	PA1302			For vehicles with retarder, w/o pulley	51065006426/ 6490/ 9426/ 9490
RN 353 (257 kW) Eng.D2866LUH21	97-	PA1294			For vehicles without retarder; Impeller Ø 125mm	51065006282/ 6387/ 9282/ 9387
	97-	PA1298			For vehicles without retarder, w/o pulley; Impeller Ø 135mm, Incl Eletronic fuel Injection pump	51065006408/ 6492/ 9492
	97-	PA1302			For vehicles with retarder, w/o pulley	51065006426/ 6490/ 9426/ 9490
Low entry '7/86-'5/94						
19.322 (235 kW) Eng.D2865LF03	90-94	PA1298			For vehicles without retarder, w/o pulley; Impeller Ø 135mm, Incl Eletronic fuel Injection pump	51065006408/ 6492/ 9492
	90-94	PA1302			For vehicles with retarder, w/o pulley	51065006426/ 6490/ 9426/ 9490
	90-94	PA1319			For vehicles with retarder, w pulley	51065006546/ 9546
	90-94	PA1321			For vehicles without retarder, w pulley	51065006545/ 6547/ 9545/ 9547
	90-94	PA1336			w/ Pulley	51065006548/ 9548
19.322 (235 kW) Eng.D2865LF06	90-94	PA1298			For vehicles without retarder, w/o pulley; Impeller Ø 135mm, Incl Eletronic fuel Injection pump	51065006408/ 6492/ 9492

			
PA1298	PA1302	PA1319	PA1321
			
PA1336			

			
PA1235	PA1294	PA1298	PA1302
			
PA1308	PA1319	PA1321	PA1323
			
PA1324	PA1336		

		GRAF ref.			NOTE	Adaptable for OES
25.372 (272 kW) Eng.D2866LF05	90-92	PA1336			w/ Pulley	51065006548/ 9548
25.422 (309 kW) Eng.D2866LF06	90-92	PA1298			For vehicles without retarder, w/o pulley; Impeller Ø 135mm, Incl Electronic fuel Injection pump	51065006408/ 6492/ 9492
	90-92	PA1302			For vehicles with retarder, w/o pulley	51065006426/ 6490/ 9426/ 9490
	90-92	PA1319			For vehicles with retarder, w pulley	51065006546/ 9546
	90-92	PA1321			For vehicles without retarder, w pulley	51065006545/ 6547/ 9545/ 9547
	90-92	PA1336			w/ Pulley	51065006548/ 9548
25.422 (309 kW) Eng.D2866LF09	90-92	PA1302			For vehicles with retarder, w/o pulley	51065006426/ 6490/ 9426/ 9490
	90-92	PA1319			For vehicles with retarder, w pulley	51065006546/ 9546
	90-92	PA1321			For vehicles without retarder, w pulley	51065006545/ 6547/ 9545/ 9547
	90-92	PA1336			w/ Pulley	51065006548/ 9548
26.322 (235 kW) Eng.D2865LF03/ LF06	90-94	PA1298			For vehicles without retarder, w/o pulley; Impeller Ø 135mm, Incl Electronic fuel Injection pump	51065006408/ 6492/ 9492
	90-94	PA1302			For vehicles with retarder, w/o pulley	51065006426/ 6490/ 9426/ 9490
	90-94	PA1319			For vehicles with retarder, w pulley	51065006546/ 9546
	90-94	PA1321			For vehicles without retarder, w pulley	51065006545/ 6547/ 9545/ 9547
26.372 (272 kW) Eng.D2866LF03	90-94	PA1298			For vehicles without retarder, w/o pulley; Impeller Ø 135mm, Incl Electronic fuel Injection pump	51065006408/ 6492/ 9492
	90-94	PA1302			For vehicles with retarder, w/o pulley	51065006426/ 6490/ 9426/ 9490
	90-94	PA1319			For vehicles with retarder, w pulley	51065006546/ 9546
	90-94	PA1321			For vehicles without retarder, w pulley	51065006545/ 6547/ 9545/ 9547
26.372 (272 kW) Eng.D2866LF05	90-94	PA1298			For vehicles without retarder, w/o pulley; Impeller Ø 135mm, Incl Electronic fuel Injection pump	51065006408/ 6492/ 9492
	90-94	PA1302			For vehicles with retarder, w/o pulley	51065006426/ 6490/ 9426/ 9490
	90-94	PA1319			For vehicles with retarder, w pulley	51065006546/ 9546
	90-94	PA1321			For vehicles without retarder, w pulley	51065006545/ 6547/ 9545/ 9547
26.422 (309 kW) Eng.D2866LF06	90-94	PA1298			For vehicles without retarder, w/o pulley; Impeller Ø 135mm, Incl Electronic fuel Injection pump	51065006408/ 6492/ 9492
	90-94	PA1302			For vehicles with retarder, w/o pulley	51065006426/ 6490/ 9426/ 9490
	90-94	PA1319			For vehicles with retarder, w pulley	51065006546/ 9546
	90-94	PA1321			For vehicles without retarder, w pulley	51065006545/ 6547/ 9545/ 9547
26.422 (309 kW) Eng.D2866LF09	90-94	PA1298			For vehicles without retarder, w/o pulley; Impeller Ø 135mm, Incl Electronic fuel Injection pump	51065006408/ 6492/ 9492
	90-94	PA1302			For vehicles with retarder, w/o pulley	51065006426/ 6490/ 9426/ 9490
	90-94	PA1319			For vehicles with retarder, w pulley	51065006546/ 9546
	90-94	PA1321			For vehicles without retarder, w pulley	51065006545/ 6547/ 9545/ 9547
NG '8/92-						
NG 262 (191 kW) Eng.D2865LUH09	97-98	PA1298			For vehicles without retarder, w/o pulley; Impeller Ø 135mm, Incl Electronic fuel Injection pump	51065006408/ 6492/ 9492
	97-98	PA1302			For vehicles with retarder, w/o pulley	51065006426/ 6490/ 9426/ 9490
NG 262/272 (191-198 kW) Eng.D0826LUH01	92-98	PA1308			w/ Pulley; Installation height 79,5 mm	51065006480/ 9480,51065063043
	92-98	PA1323			Impeller Ø 125mm	51065006537/ 9537
	92-98	PA1324			w/ Pulley; Installation height 90,0 mm	51065006543/ 6569/ 9543/ 9569
NG 312 (228-235 kW) Eng.D2865LUH07	95-98	PA1298			For vehicles without retarder, w/o pulley; Impeller Ø 135mm, Incl Electronic fuel Injection pump	51065006408/ 6492/ 9492
	95-98	PA1302			For vehicles with retarder, w/o pulley	51065006426/ 6490/ 9426/ 9490
NG 312/313 (228-231 kW) Eng.D2866LUH26	98-	PA1294			For vehicles without retarder; Impeller Ø 125mm	51065006282/ 6387/ 9282/ 9387
	98-	PA1298			For vehicles without retarder, w/o pulley; Impeller Ø 135mm, Incl Electronic fuel Injection pump	51065006408/ 6492/ 9492
	98-	PA1302			For vehicles with retarder, w/o pulley	51065006426/ 6490/ 9426/ 9490
NG 313 (228 kW) Eng.D2066LUH12	06-09	PA1235				51065006646/ 6676/ 6695/ 7050 51065009050/ 9646/ 9676/ 9695
NG 313 (228 kW) Eng.D2066LUH22	06-09	PA1235				51065006646/ 6676/ 6695/ 7050 51065009050/ 9646/ 9676/ 9695
NG 323 (235 kW) Eng.D2066LUH42	07-14	PA1235				51065006646/ 6676/ 6695/ 7050 51065009050/ 9646/ 9676/ 9695
NG 353 (257 kW) Eng.D2066LUH13	07-14	PA1235				51065006646/ 6676/ 6695/ 7050 51065009050/ 9646/ 9676/ 9695
NG 353 (257 kW) Eng.D2066LUH23	07-14	PA1235				51065006646/ 6676/ 6695/ 7050 51065009050/ 9646/ 9676/ 9695
NG 363 (264 kW) Eng.D2066LUH48	07-14	PA1235				51065006646/ 6676/ 6695/ 7050 51065009050/ 9646/ 9676/ 9695





			
PA1227	PA1234	PA1235	PA1294
			
PA1298	PA1302	PA1308	PA1310
			
PA1323	PA1324		

		GRAF ref.			NOTE	Adaptable for OES
NL '9/89-						
NL 202 (157 kW) Eng.D0826LUH/213	92-	PA1308			w/ Pulley; Installation height 79,5 mm	51065006480/ 9480,51065063043
	89-94	PA1323			Impeller Ø 125mm	51065006537/ 9537
	89-94	PA1324			w/ Pulley; Installation height 90,0 mm	51065006543/ 6569/ 9543/ 9569
NL 202/222/223 (157-162 kW) Eng.D0826LUH03	92-	PA1308			w/ Pulley; Installation height 79,5 mm	51065006480/ 9480,51065063043
	92-	PA1323			Impeller Ø 125mm	51065006537/ 9537
	89-94	PA1324			w/ Pulley; Installation height 90,0 mm	51065006543/ 6569/ 9543/ 9569
NL 202/222/223 (157-162 kW) Eng.D0826LUH12	91-	PA1308			w/ Pulley; Installation height 79,5 mm	51065006480/ 9480,51065063043
	92-	PA1323			Impeller Ø 125mm	51065006537/ 9537
	89-94	PA1324			w/ Pulley; Installation height 90,0 mm	51065006543/ 6569/ 9543/ 9569
NL 202/262/263 (184 kW) Eng.D0826LUH	90-93	PA1308			w/ Pulley; Installation height 79,5 mm	51065006480/ 9480,51065063043
	91-	PA1323			Impeller Ø 125mm	51065006537/ 9537
	89-94	PA1324			w/ Pulley; Installation height 90,0 mm	51065006543/ 6569/ 9543/ 9569
NL 243 (180 kW) Eng.E2866DUH03/04	07-14	PA1294			For vehicles without retarder; Impeller Ø 125mm	51065006282/ 6387/ 9282/ 9387
	07-14	PA1298			For vehicles without retarder, w/o pulley; Impeller Ø 135mm, Incl Electronic fuel Injection pump	51065006408/ 6492/ 9492
	07-14	PA1302			For vehicles with retarder, w/o pulley	51065006426/ 6490/ 9426/ 9490
NL 262 (191 kW) Eng.D2865LUH09	97-	PA1298			For vehicles without retarder, w/o pulley; Impeller Ø 135mm, Incl Electronic fuel Injection pump	51065006408/ 6492/ 9492
	97-	PA1302			For vehicles with retarder, w/o pulley	51065006426/ 6490/ 9426/ 9490
NL 262/263 (191 kW) Eng.D2866LUH22	98-	PA1294			For vehicles without retarder; Impeller Ø 125mm	51065006282/ 6387/ 9282/ 9387
	98-	PA1298			For vehicles without retarder, w/o pulley; Impeller Ø 135mm, Incl Electronic fuel Injection pump	51065006408/ 6492/ 9492
	98-	PA1302			For vehicles with retarder, w/o pulley	51065006426/ 6490/ 9426/ 9490
NL 273 (199 kW) Eng.D2066LUH11/ LUH21	06-09	PA1235				51065006646/ 6676/ 6695/ 7050 51065009050/ 9646/ 9676/ 9695
NL 283 (206 kW) Eng.D2066LUH41	06-09	PA1235				51065006646/ 6676/ 6695/ 7050 51065009050/ 9646/ 9676/ 9695
NL 312 (228-235 kW) Eng.D2865LUH07	95-98	PA1298			For vehicles without retarder, w/o pulley; Impeller Ø 135mm, Incl Electronic fuel Injection pump	51065006408/ 6492/ 9492
	95-98	PA1302			For vehicles with retarder, w/o pulley	51065006426/ 6490/ 9426/ 9490
NL 313 (228 kW) Eng.D2066LUH12	06-09	PA1235				51065006646/ 6676/ 6695/ 7050 51065009050/ 9646/ 9676/ 9695
NL 313 (228 kW) Eng.D2066LUH22	06-09	PA1235				51065006646/ 6676/ 6695/ 7050 51065009050/ 9646/ 9676/ 9695
	98-	PA1294			For vehicles without retarder; Impeller Ø 125mm	51065006282/ 6387/ 9282/ 9387
	98-	PA1298			For vehicles without retarder, w/o pulley; Impeller Ø 135mm, Incl Electronic fuel Injection pump	51065006408/ 6492/ 9492
NL 313 (228 kW) Eng.D2866LUH26	98-	PA1298			For vehicles without retarder, w/o pulley; Impeller Ø 135mm, Incl Electronic fuel Injection pump	51065006408/ 6492/ 9492
	98-	PA1302			For vehicles with retarder, w/o pulley	51065006426/ 6490/ 9426/ 9490
NL 313 (228 kW) Eng.E2876LUH02	07-14	PA1298			For vehicles without retarder, w/o pulley; Impeller Ø 135mm, Incl Electronic fuel Injection pump	51065006408/ 6492/ 9492
NL 323 (235 kW) Eng.D2066LUH42	06-09	PA1235				51065006646/ 6676/ 6695/ 7050 51065009050/ 9646/ 9676/ 9695
NM '8/87-						
NM 152 (110 kW) Eng.D0826OH02	90-93	PA1310			Impeller Ø 135mm	51065003178/ 6463/ 6495/ 9463/ 9495
	90-93	PA1323			Impeller Ø 125mm	51065006537/ 9537
NM 152 (114 kW) Eng.D0824LOH01	92-97	PA1323			Impeller Ø 125mm	51065006537/ 9537
NM 182/192 (130-140 kW) Eng.D0826LOH01	90-97	PA1310			Impeller Ø 135mm	51065003178/ 6463/ 6495/ 9463/ 9495
	90-97	PA1323			Impeller Ø 125mm	51065006537/ 9537
NM 182/192 (130-140 kW) Eng.D0826TOH	90-97	PA1310			Impeller Ø 135mm	51065003178/ 6463/ 6495/ 9463/ 9495
	90-97	PA1323			Impeller Ø 125mm	51065006537/ 9537
NM 222/223 (162 kW) Eng.D0826LUH12	87-	PA1308			w/ Pulley; Installation height 79,5 mm	51065006480/ 9480,51065063043
	96-	PA1310			Impeller Ø 135mm	51065003178/ 6463/ 6495/ 9463/ 9495
	96-	PA1323			Impeller Ø 125mm	51065006537/ 9537
	96-	PA1324			w/ Pulley; Installation height 90,0 mm	51065006543/ 6569/ 9543/ 9569
NM 223 (162 kW) Eng.D0826LOH15	87-	PA1310			Impeller Ø 135mm	51065003178/ 6463/ 6495/ 9463/ 9495
	87-	PA1323			Impeller Ø 125mm	51065006537/ 9537
NM 243 (176 kW) Eng.D0836LOH52	87-	PA1227			M16x1,5	51065006651/ 6680/ 7079/ 9079 51065009651/ 9680/ 9700
	87-	PA1234			Impeller Ø 135mm, M14x1,5	51065006679/ 6699/ 7064/ 7078 51065009064/ 9078/ 9679/ 9699
NM 243 (176 kW) Eng.D0836LOH56	87-	PA1227			M16x1,5	51065006651/ 6680/ 7079/ 9079 51065009651/ 9680/ 9700
	87-	PA1234			Impeller Ø 135mm, M14x1,5	51065006679/ 6699/ 7064/ 7078 51065009064/ 9078/ 9679/ 9699
NM 253 (184 kW) Eng.D0836LOH61	87-	PA1227			M16x1,5	51065006651/ 6680/ 7079/ 9079 51065009651/ 9680/ 9700

			
<p>PA1227</p>	<p>PA1234</p>	<p>PA1294</p>	<p>PA1298</p>
			
<p>PA1302</p>			

		GRAF ref.			NOTE	Adaptable for OES
NM 253 (184 kW) Eng.D0836LOH61	87-	PA1234			Impeller Ø 135mm, M14x1,5	51065006679/ 6699/ 7064/ 7078 51065009064/ 9078/ 9679/ 9699
NM 283 (206 kW) Eng.D0836LOH51/ LOH55	87-	PA1227			M16x1,5	51065006651/ 6680/ 7079/ 9079 51065009651/ 9680/ 9700
	87-	PA1234			Impeller Ø 135mm, M14x1,5	51065006679/ 6699/ 7064/ 7078 51065009064/ 9078/ 9679/ 9699
NM 293 (213 kW) Eng.D0836LOH60	87-	PA1227			M16x1,5	51065006651/ 6680/ 7079/ 9079 51065009651/ 9680/ 9700
	87-	PA1234			Impeller Ø 135mm, M14x1,5	51065006679/ 6699/ 7064/ 7078 51065009064/ 9078/ 9679/ 9699
SD '4/74-'4/94						
SD 200 (125-144-177 kW) Eng.D2566HM/M/ME/MH/MR/MU	76-80	PA1294			For vehicles without retarder, Impeller Ø 125mm	51065006282/ 6387/ 9282/ 9387
	76-80	PA1298			For vehicles without retarder, w/o pulley; Impeller Ø 135mm, Incl Eletronic fuel Injection pump	51065006408/ 6492/ 9492
	76-80	PA1302			For vehicles with retarder, w/o pulley	51065006426/ 6490/ 9426/ 9490
SD 200 (128 kW) Eng.D2566MUH/175	75-80	PA1294			For vehicles without retarder, Impeller Ø 125mm	51065006282/ 6387/ 9282/ 9387
	75-80	PA1298			For vehicles without retarder, w/o pulley; Impeller Ø 135mm, Incl Eletronic fuel Injection pump	51065006408/ 6492/ 9492
	75-80	PA1302			For vehicles with retarder, w/o pulley	51065006426/ 6490/ 9426/ 9490
SD 200 (141-147 kW) Eng.D2566MUH/192/200	75-86	PA1294			For vehicles without retarder, Impeller Ø 125mm	51065006282/ 6387/ 9282/ 9387
	75-86	PA1298			For vehicles without retarder, w/o pulley; Impeller Ø 135mm, Incl Eletronic fuel Injection pump	51065006408/ 6492/ 9492
	75-86	PA1302			For vehicles with retarder, w/o pulley	51065006426/ 6490/ 9426/ 9490
SD 200 (162 kW) Eng.D2566MUH/220	75-86	PA1294			For vehicles without retarder, Impeller Ø 125mm	51065006282/ 6387/ 9282/ 9387
	79-86	PA1298			For vehicles without retarder, w/o pulley; Impeller Ø 135mm, Incl Eletronic fuel Injection pump	51065006408/ 6492/ 9492
	79-86	PA1302			For vehicles with retarder, w/o pulley	51065006426/ 6490/ 9426/ 9490
SD 202 (125-144-177 kW) Eng.D2566HM/M/ME/MH/MR/MU	76-80	PA1294			For vehicles without retarder, Impeller Ø 125mm	51065006282/ 6387/ 9282/ 9387
	76-80	PA1298			For vehicles without retarder, w/o pulley; Impeller Ø 135mm, Incl Eletronic fuel Injection pump	51065006408/ 6492/ 9492
	76-80	PA1302			For vehicles with retarder, w/o pulley	51065006426/ 6490/ 9426/ 9490
SD 202 (155 kW) Eng.D2566UH	79-86	PA1294			For vehicles without retarder, Impeller Ø 125mm	51065006282/ 6387/ 9282/ 9387
	85-94	PA1298			For vehicles without retarder, w/o pulley; Impeller Ø 135mm, Incl Eletronic fuel Injection pump	51065006408/ 6492/ 9492
	85-94	PA1302			For vehicles with retarder, w/o pulley	51065006426/ 6490/ 9426/ 9490
SG '1/69-'12/98						
SG 12.0 (176-265 kW) Eng.D2866	83-98	PA1294			For vehicles without retarder, Impeller Ø 125mm	51065006282/ 6387/ 9282/ 9387
	83-98	PA1298			For vehicles without retarder, w/o pulley; Impeller Ø 135mm, Incl Eletronic fuel Injection pump	51065006408/ 6492/ 9492
	83-98	PA1302			For vehicles with retarder, w/o pulley	51065006426/ 6490/ 9426/ 9490
SG 15-9 T. (223-294 kW) Eng.D2566MK/ML/MT	76-98	PA1294			For vehicles without retarder, Impeller Ø 125mm	51065006282/ 6387/ 9282/ 9387
	76-98	PA1298			For vehicles without retarder, w/o pulley; Impeller Ø 135mm, Incl Eletronic fuel Injection pump	51065006408/ 6492/ 9492
	76-98	PA1302			For vehicles with retarder, w/o pulley	51065006426/ 6490/ 9426/ 9490
SG 220 (147-162 kW) Eng.D2566MUM/200	80-85	PA1294			For vehicles without retarder, Impeller Ø 125mm	51065006282/ 6387/ 9282/ 9387
	80-85	PA1298			For vehicles without retarder, w/o pulley; Impeller Ø 135mm, Incl Eletronic fuel Injection pump	51065006408/ 6492/ 9492
	80-85	PA1302			For vehicles with retarder, w/o pulley	51065006426/ 6490/ 9426/ 9490
SG 220/240/242 (177 kW) Eng.D2566MUH/240	80-86	PA1294			For vehicles without retarder, Impeller Ø 125mm	51065006282/ 6387/ 9282/ 9387
	80-86	PA1298			For vehicles without retarder, w/o pulley; Impeller Ø 135mm, Incl Eletronic fuel Injection pump	51065006408/ 6492/ 9492
	80-86	PA1302			For vehicles with retarder, w/o pulley	51065006426/ 6490/ 9426/ 9490
SG 240 HÜ (206 kW) Eng.D2566MTUH/280	81-86	PA1294			For vehicles without retarder, Impeller Ø 125mm	51065006282/ 6387/ 9282/ 9387
	81-86	PA1298			For vehicles without retarder, w/o pulley; Impeller Ø 135mm, Incl Eletronic fuel Injection pump	51065006408/ 6492/ 9492
	81-86	PA1302			For vehicles with retarder, w/o pulley	51065006426/ 6490/ 9426/ 9490
SG 240/242 (177-180 kW) Eng.D2866UH/240	85-94	PA1294			For vehicles without retarder, Impeller Ø 125mm	51065006282/ 6387/ 9282/ 9387
	85-94	PA1298			For vehicles without retarder, w/o pulley; Impeller Ø 135mm, Incl Eletronic fuel Injection pump	51065006408/ 6492/ 9492
	85-94	PA1302			For vehicles with retarder, w/o pulley	51065006426/ 6490/ 9426/ 9490
SG 240/292 (213 kW) Eng.D2866TUH/290	84-89	PA1294			For vehicles without retarder, Impeller Ø 125mm	51065006282/ 6387/ 9282/ 9387
	84-89	PA1298			For vehicles without retarder, w/o pulley; Impeller Ø 135mm, Incl Eletronic fuel Injection pump	51065006408/ 6492/ 9492
	84-89	PA1302			For vehicles with retarder, w/o pulley	51065006426/ 6490/ 9426/ 9490
SG 242/292 (224-229 kW) Eng.D2866TOH/310	85-94	PA1294			For vehicles without retarder, Impeller Ø 125mm	51065006282/ 6387/ 9282/ 9387
	85-94	PA1298			For vehicles without retarder, w/o pulley; Impeller Ø 135mm, Incl Eletronic fuel Injection pump	51065006408/ 6492/ 9492
	85-94	PA1302			For vehicles with retarder, w/o pulley	51065006426/ 6490/ 9426/ 9490

		GRAF ref.			NOTE	Adaptable for OES
SG 242/292 (224-229 kW) Eng.D2866TUH/290	85-94	PA1294			For vehicles without retarder, Impeller Ø 125mm	51065006282/ 6387/ 9282/ 9387
	85-94	PA1298			For vehicles without retarder, w/o pulley; Impeller Ø 135mm, Incl Eletronic fuel Injection pump	51065006408/ 6492/ 9492
	85-94	PA1302			For vehicles with retarder, w/o pulley	51065006426/ 6490/ 9426/ 9490
SG 312/322 (228-235 kW) Eng.D2865LUH08	94-97	PA1298			For vehicles without retarder, w/o pulley; Impeller Ø 135mm, Incl Eletronic fuel Injection pump	51065006408/ 6492/ 9492
SL '1/63-'12/73						
SL 11.4 (125-144-177 kW) Eng.D2566HM/M/ME/MH/MR/MU	76-80	PA1294			For vehicles without retarder, Impeller Ø 125mm	51065006282/ 6387/ 9282/ 9387
	76-80	PA1298			For vehicles without retarder, w/o pulley; Impeller Ø 135mm, Incl Eletronic fuel Injection pump	51065006408/ 6492/ 9492
	76-80	PA1302			For vehicles with retarder, w/o pulley	51065006426/ 6490/ 9426/ 9490
SL 200 (125-144-177 kW) Eng.D2566MUH/240	80-86	PA1294			For vehicles without retarder, Impeller Ø 125mm	51065006282/ 6387/ 9282/ 9387
	80-86	PA1298			For vehicles without retarder, w/o pulley; Impeller Ø 135mm, Incl Eletronic fuel Injection pump	51065006408/ 6492/ 9492
	80-86	PA1302			For vehicles with retarder, w/o pulley	51065006426/ 6490/ 9426/ 9490
SL 200 (147-150 kW) Eng.D2566UH/205 SL 200 (177 kW) Eng.D2866UH/240	80-87	PA1294			For vehicles without retarder, Impeller Ø 125mm	51065006282/ 6387/ 9282/ 9387
	80-87	PA1298			For vehicles without retarder, w/o pulley; Impeller Ø 135mm, Incl Eletronic fuel Injection pump	51065006408/ 6492/ 9492
	80-87	PA1302			For vehicles with retarder, w/o pulley	51065006426/ 6490/ 9426/ 9490
SL II '1/76-'12/80						
SL 202 (147-155 kW) Eng.D2566UH	84-93	PA1294			For vehicles without retarder, Impeller Ø 125mm	51065006282/ 6387/ 9282/ 9387
	84-93	PA1302			For vehicles with retarder, w/o pulley	51065006426/ 6490/ 9426/ 9490
SL 202 (176-180-265 kW) Eng.D2866UH/240	84-94	PA1294			For vehicles without retarder, Impeller Ø 125mm	51065006282/ 6387/ 9282/ 9387
	84-94	PA1298			For vehicles without retarder, w/o pulley; Impeller Ø 135mm, Incl Eletronic fuel Injection pump	51065006408/ 6492/ 9492
	84-94	PA1302			For vehicles with retarder, w/o pulley	51065006426/ 6490/ 9426/ 9490
SL 283 (206 kW) Eng.D0836LOH55	76-80	PA1227			M16x1,5	51065006651/ 6680/ 7079/ 9079 51065009651/ 9680/ 9700
	76-80	PA1234			Impeller Ø 135mm, M14x1,5	51065006679/ 6699/ 7064/ 7078 51065009064/ 9078/ 9679/ 9699
SL 353 (257 kW) Eng.D2066LOH12/13	76-80	PA1224			+Retarder	51065006642/ 6675/ 6694/ 9642/ 9675/ 9694
SL 363 (264 kW) Eng.D2066LOH27	76-80	PA1224			+Retarder	51065006642/ 6675/ 6694/ 9642/ 9675/ 9694
SM '11/87-'2/95						
SM 152 (110-114 kW) Eng.D0826OH02	87-94	PA1310			Impeller Ø 135mm	51065003178/ 6463/ 6495/ 9463/ 9495
	87-94	PA1323			Impeller Ø 125mm	51065006537/ 9537
SM 182/192 (130-140 kW) Eng.D0826LOH01/TOH	87-95	PA1310			Impeller Ø 135mm	51065003178/ 6463/ 6495/ 9463/ 9495
	87-95	PA1323			Impeller Ø 125mm	51065006537/ 9537
SR '1/76-						
SR 11.4 (125-144-177 kW) Eng.D2566HM/M/ME/MH/MR/MU	76-80	PA1294			For vehicles without retarder, Impeller Ø 125mm	51065006282/ 6387/ 9282/ 9387
	76-80	PA1298			For vehicles without retarder, w/o pulley; Impeller Ø 135mm, Incl Eletronic fuel Injection pump	51065006408/ 6492/ 9492
	76-80	PA1302			For vehicles with retarder, w/o pulley	51065006426/ 6490/ 9426/ 9490
SR 15.9 T. (223-294 kW) Eng.D2566MK/ML/MT	76-	PA1294			For vehicles without retarder, Impeller Ø 125mm	51065006282/ 6387/ 9282/ 9387
	76-	PA1298			For vehicles without retarder, w/o pulley; Impeller Ø 135mm, Incl Eletronic fuel Injection pump	51065006408/ 6492/ 9492
	76-	PA1302			For vehicles with retarder, w/o pulley	51065006426/ 6490/ 9426/ 9490
SR 240 (177 kW) Eng.D2566MUH/240	75-83	PA1294			For vehicles without retarder, Impeller Ø 125mm	51065006282/ 6387/ 9282/ 9387
	75-83	PA1298			For vehicles without retarder, w/o pulley; Impeller Ø 135mm, Incl Eletronic fuel Injection pump	51065006408/ 6492/ 9492
	75-83	PA1302			For vehicles with retarder, w/o pulley	51065006426/ 6490/ 9426/ 9490
SR 280 (206 kW) Eng.D2566MTUH/280	77-86	PA1294			For vehicles without retarder, Impeller Ø 125mm	51065006282/ 6387/ 9282/ 9387
	77-86	PA1298			For vehicles without retarder, w/o pulley; Impeller Ø 135mm, Incl Eletronic fuel Injection pump	51065006408/ 6492/ 9492
	77-86	PA1302			For vehicles with retarder, w/o pulley	51065006426/ 6490/ 9426/ 9490
SR 321 H (235 kW) Eng.D2566MKUH/320	82-86	PA1294			For vehicles without retarder, Impeller Ø 125mm	51065006282/ 6387/ 9282/ 9387
	82-86	PA1298			For vehicles without retarder, w/o pulley; Impeller Ø 135mm, Incl Eletronic fuel Injection pump	51065006408/ 6492/ 9492
	82-86	PA1302			For vehicles with retarder, w/o pulley	51065006426/ 6490/ 9426/ 9490
SU '10/76-						
SU 11.4 (125-144-177 kW) Eng.D2566HM	76-80	PA1294			For vehicles without retarder, Impeller Ø 125mm	51065006282/ 6387/ 9282/ 9387
	76-80	PA1298			For vehicles without retarder, w/o pulley; Impeller Ø 135mm, Incl Eletronic fuel Injection pump	51065006408/ 6492/ 9492
	76-80	PA1302			For vehicles with retarder, w/o pulley	51065006426/ 6490/ 9426/ 9490
SU 12.0 (176-265 kW) Eng.D2866	83-	PA1294			For vehicles without retarder, Impeller Ø 125mm	51065006282/ 6387/ 9282/ 9387

		GRAF ref.			NOTE	Adaptable for OES
SU 12.0 (176-265 kW) Eng.D2866	83-	PA1298			For vehicles without retarder, w/o pulley; Impeller Ø 135mm, Incl Electronic fuel Injection pump	51065006408/ 6492/ 9492
	83-	PA1302			For vehicles with retarder, w/o pulley	51065006426/ 6490/ 9426/ 9490
SU 15.9 T. (223-294 kW) Eng.D2566MK/ML/MT	76-	PA1294			For vehicles without retarder, Impeller Ø 125mm	51065006282/ 6387/ 9282/ 9387
	76-	PA1298			For vehicles without retarder, w/o pulley; Impeller Ø 135mm, Incl Electronic fuel Injection pump	51065006408/ 6492/ 9492
	76-	PA1302			For vehicles with retarder, w/o pulley	51065006426/ 6490/ 9426/ 9490
SU 240 (147-150 kW) Eng.D2566MUH/200/ UH/205	80-89	PA1294			For vehicles without retarder, Impeller Ø 125mm	51065006282/ 6387/ 9282/ 9387
	80-89	PA1298			For vehicles without retarder, w/o pulley; Impeller Ø 135mm, Incl Electronic fuel Injection pump	51065006408/ 6492/ 9492
	80-89	PA1302			For vehicles with retarder, w/o pulley	51065006426/ 6490/ 9426/ 9490
SU 240 (177 kW) Eng.D2566MUH/240	75-86	PA1294			For vehicles without retarder, Impeller Ø 125mm	51065006282/ 6387/ 9282/ 9387
	75-86	PA1298			For vehicles without retarder, w/o pulley; Impeller Ø 135mm, Incl Electronic fuel Injection pump	51065006408/ 6492/ 9492
	75-86	PA1302			For vehicles with retarder, w/o pulley	51065006426/ 6490/ 9426/ 9490
SU 240 (177 kW) Eng.D2866UH/240	86-89	PA1294			For vehicles without retarder, Impeller Ø 125mm	51065006282/ 6387/ 9282/ 9387
	86-89	PA1298			For vehicles without retarder, w/o pulley; Impeller Ø 135mm, Incl Electronic fuel Injection pump	51065006408/ 6492/ 9492
	86-89	PA1302			For vehicles with retarder, w/o pulley	51065006426/ 6490/ 9426/ 9490
SU 240 (206 kW) Eng.D2566MTUH/280	82-86	PA1294			For vehicles without retarder, Impeller Ø 125mm	51065006282/ 6387/ 9282/ 9387
	82-86	PA1298			For vehicles without retarder, w/o pulley; Impeller Ø 135mm, Incl Electronic fuel Injection pump	51065006408/ 6492/ 9492
	82-86	PA1302			For vehicles with retarder, w/o pulley	51065006426/ 6490/ 9426/ 9490
SU 240 (213 kW) Eng.D2866TOH/290	86-89	PA1294			For vehicles without retarder, Impeller Ø 125mm	51065006282/ 6387/ 9282/ 9387
	86-89	PA1298			For vehicles without retarder, w/o pulley; Impeller Ø 135mm, Incl Electronic fuel Injection pump	51065006408/ 6492/ 9492
	86-89	PA1302			For vehicles with retarder, w/o pulley	51065006426/ 6490/ 9426/ 9490
SU 242 (180 kW) Eng.D2866UH/240	87-93	PA1294			For vehicles without retarder, Impeller Ø 125mm	51065006282/ 6387/ 9282/ 9387
	87-93	PA1298			For vehicles without retarder, w/o pulley; Impeller Ø 135mm, Incl Electronic fuel Injection pump	51065006408/ 6492/ 9492
	87-93	PA1302			For vehicles with retarder, w/o pulley	51065006426/ 6490/ 9426/ 9490
SU 243 (176 kW) Eng.D0836LOH56	05-09	PA1227			M16x1,5	51065006651/ 6680/ 7079/ 9079 51065009651/ 9680/ 9700
	05-09	PA1234			Impeller Ø 135mm, M14x1,5	51065006679/ 6699/ 7064/ 7078 51065009064/ 9078/ 9679/ 9699
	05-09	PA1234			Impeller Ø 135mm, M14x1,5	51065006651/ 6680/ 7079/ 9079 51065009651/ 9680/ 9700
SU 263 (191 kW) Eng.D0836LOH62	03-	PA1294			For vehicles without retarder, Impeller Ø 125mm	51065006282/ 6387/ 9282/ 9387
	03-	PA1298			For vehicles without retarder, w/o pulley; Impeller Ø 135mm, Incl Electronic fuel Injection pump	51065006408/ 6492/ 9492
	03-	PA1302			For vehicles with retarder, w/o pulley	51065006426/ 6490/ 9426/ 9490
SU 272 (198 kW) Eng.D2865LUH02	93-95	PA1298			For vehicles without retarder, w/o pulley; Impeller Ø 135mm, Incl Electronic fuel Injection pump	51065006408/ 6492/ 9492
SU 273 (198 kW) Eng.D2066LUH11	06-09	PA1235				51065006646/ 6676/ 6695/ 7050 51065009050/ 9646/ 9676/ 9695
SU 273 (198 kW) Eng.D2066LUH21	06-09	PA1235				51065006646/ 6676/ 6695/ 7050 51065009050/ 9646/ 9676/ 9695
SU 283 (206 kW) Eng.D0836LOH02	03-	PA1227			M16x1,5	51065006651/ 6680/ 7079/ 9079 51065009651/ 9680/ 9700
	03-	PA1234			Impeller Ø 135mm, M14x1,5	51065006679/ 6699/ 7064/ 7078 51065009064/ 9078/ 9679/ 9699
	03-	PA1331			Impeller Ø 125mm	51065006575/ 6606/ 6612 51065006669/ 9575/ 9606/ 9612
SU 292 (229 kW) Eng.D2866TOH/310	92-93	PA1294			For vehicles without retarder, Impeller Ø 125mm	51065006282/ 6387/ 9282/ 9387
	92-93	PA1298			For vehicles without retarder, w/o pulley; Impeller Ø 135mm, Incl Electronic fuel Injection pump	51065006408/ 6492/ 9492
	92-93	PA1302			For vehicles with retarder, w/o pulley	51065006426/ 6490/ 9426/ 9490
SU 293 (213 kW) Eng.D0836LOH60	03-	PA1227			M16x1,5	51065006651/ 6680/ 7079/ 9079 51065009651/ 9680/ 9700
	03-	PA1234			Impeller Ø 135mm, M14x1,5	51065006679/ 6699/ 7064/ 7078 51065009064/ 9078/ 9679/ 9699
SU 313 (228 kW) Eng.D2066LUH12	06-09	PA1235				51065006646/ 6676/ 6695/ 7050 51065009050/ 9646/ 9676/ 9695
SU 313 (228 kW) Eng.D2066LUH22	06-09	PA1235				51065006646/ 6676/ 6695/ 7050 51065009050/ 9646/ 9676/ 9695
SU 313 (228 kW) Eng.D2866LUH24	03-	PA1294			For vehicles without retarder, Impeller Ø 125mm	51065006282/ 6387/ 9282/ 9387
	03-	PA1298			For vehicles without retarder, w/o pulley; Impeller Ø 135mm, Incl Electronic fuel Injection pump	51065006408/ 6492/ 9492
	03-	PA1302			For vehicles with retarder, w/o pulley	51065006426/ 6490/ 9426/ 9490
SU 320 (235 kW) Eng.D2066LUH32	03-	PA1235				51065006646/ 6676/ 6695/ 7050 51065009050/ 9646/ 9676/ 9695
SU 322 (198-235 kW) Eng.D2865LUH08	95-97	PA1298			For vehicles without retarder, w/o pulley; Impeller Ø 135mm, Incl Electronic fuel Injection pump	51065006408/ 6492/ 9492



		GRAF ref.			NOTE	Adaptable for OES
SU 353 (257 kW) Eng.D2066LUH13	06-09	PA1235				51065006646/ 6676/ 6695/ 7050 51065009050/ 9646/ 9676/ 9695
SU 353 (257 kW) Eng.D2066LUH23	06-09	PA1235				51065006646/ 6676/ 6695/ 7050 51065009050/ 9646/ 9676/ 9695
SU 360 (264 kW) Eng.D2066LUH33	07-	PA1235				51065006646/ 6676/ 6695/ 7050 51065009050/ 9646/ 9676/ 9695
SU 9.9 (228-235 kW) Eng.D2865LUH08	95-97	PA1298			For vehicles without retarder, w/o pulley; Impeller Ø 135mm, Incl Eletronic fuel Injection pump	51065006408/ 6492/ 9492
UL '9/89-						
UL 242 (177 kW) Eng.D2866UH/240	89-93	PA1294			For vehicles without retarder, Impeller Ø 125mm	51065006282/ 6387/ 9282/ 9387
	89-93	PA1298			For vehicles without retarder, w/o pulley; Impeller Ø 135mm, Incl Eletronic fuel Injection pump	51065006408/ 6492/ 9492
	89-93	PA1302			For vehicles with retarder, w/o pulley	51065006426/ 6490/ 9426/ 9490
UL 272 (198 kW) Eng.D2865LUH05	93-	PA1298			For vehicles without retarder, w/o pulley; Impeller Ø 135mm, Incl Eletronic fuel Injection pump	51065006408/ 6492/ 9492
	93-	PA1302			For vehicles with retarder, w/o pulley	51065006426/ 6490/ 9426/ 9490
UL 272 (198-235 kW) Eng.D2865LUH02	93-	PA1298			For vehicles without retarder, w/o pulley; Impeller Ø 135mm, Incl Eletronic fuel Injection pump	51065006408/ 6492/ 9492
	93-	PA1302			For vehicles with retarder, w/o pulley	51065006426/ 6490/ 9426/ 9490
UL 292 (213 kW) Eng.D2866TUH01	89-93	PA1294			For vehicles without retarder, Impeller Ø 125mm	51065006282/ 6387/ 9282/ 9387
	89-93	PA1298			For vehicles without retarder, w/o pulley; Impeller Ø 135mm, Incl Eletronic fuel Injection pump	51065006408/ 6492/ 9492
	89-93	PA1302			For vehicles with retarder, w/o pulley	51065006426/ 6490/ 9426/ 9490
UL 312/322 (228-235 kW) Eng.D2865LUH07/LUH08	92-96	PA1298			For vehicles without retarder, w/o pulley; Impeller Ø 135mm, Incl Eletronic fuel Injection pump	51065006408/ 6492/ 9492
	92-96	PA1302			For vehicles with retarder, w/o pulley	51065006426/ 6490/ 9426/ 9490
UL 313 (228 kW) Eng.D2866LUH26	96-	PA1294			For vehicles without retarder, Impeller Ø 125mm	51065006282/ 6387/ 9282/ 9387
	96-	PA1298			For vehicles without retarder, w/o pulley; Impeller Ø 135mm, Incl Eletronic fuel Injection pump	51065006408/ 6492/ 9492
	96-	PA1302			For vehicles with retarder, w/o pulley	51065006426/ 6490/ 9426/ 9490
UL 353 (257 kW) Eng.D2866LUH21	97-	PA1294			For vehicles without retarder, Impeller Ø 125mm	51065006282/ 6387/ 9282/ 9387
	97-	PA1298			For vehicles without retarder, w/o pulley; Impeller Ø 135mm, Incl Eletronic fuel Injection pump	51065006408/ 6492/ 9492
	97-	PA1302			For vehicles with retarder, w/o pulley	51065006426/ 6490/ 9426/ 9490
UL 9.9 (191 kW) Eng.D2865LUH09	96-98	PA1298			For vehicles without retarder, w/o pulley; Impeller Ø 135mm, Incl Eletronic fuel Injection pump	51065006408/ 6492/ 9492
	96-98	PA1302			For vehicles with retarder, w/o pulley	51065006426/ 6490/ 9426/ 9490

MAN TRUCK
E 2000 '5/00-



19.310 (228 kW) Eng.D2866LF23	00-	PA1298			For vehicles without retarder, w/o pulley; Impeller Ø 135mm, Incl Eletronic fuel Injection pump	51065006408/ 6492/ 9492
	00-	PA1302			For vehicles with retarder, w/o pulley	51065006426/ 6490/ 9426/ 9490
	00-	PA1319			For vehicles with retarder, w pulley	51065006546/ 9546
	00-	PA1321			For vehicles without retarder, w pulley	51065006545/ 6547/ 9545/ 9547
	00-	PA1330		•		51065000298,51065006066/ 7033/ 7036 51065007043/ 7045/ 7047/ 7048/ 7051 51065007052/ 7065/ 7066/ 7088/ 7089 51065009045/ 9047/ 9048/ 9052/ 9066
19.360 (265 kW) Eng.D2866LF24	00-	PA1298			For vehicles without retarder, w/o pulley; Impeller Ø 135mm, Incl Eletronic fuel Injection pump	51065006408/ 6492/ 9492
	00-	PA1302			For vehicles with retarder, w/o pulley	51065006426/ 6490/ 9426/ 9490
	00-	PA1319			For vehicles with retarder, w pulley	51065006546/ 9546
	00-	PA1321			For vehicles without retarder, w pulley	51065006545/ 6547/ 9545/ 9547
	00-	PA1330		•		51065000298,51065006066/ 7033/ 7036 51065007043/ 7045/ 7047/ 7048/ 7051 51065007052/ 7065/ 7066/ 7088/ 7089 51065009045/ 9047/ 9048/ 9052/ 9066
19.410 (301 kW) Eng.D2866LF25	00-	PA1298			For vehicles without retarder, w/o pulley; Impeller Ø 135mm, Incl Eletronic fuel Injection pump	51065006408/ 6492/ 9492
	00-	PA1302			For vehicles with retarder, w/o pulley	51065006426/ 6490/ 9426/ 9490
	00-	PA1319			For vehicles with retarder, w pulley	51065006546/ 9546
	00-	PA1321			For vehicles without retarder, w pulley	51065006545/ 6547/ 9545/ 9547
	00-	PA1330		•		51065000298,51065006066/ 7033/ 7036 51065007043/ 7045/ 7047/ 7048/ 7051 51065007052/ 7065/ 7066/ 7088/ 7089 51065009045/ 9047/ 9048/ 9052/ 9066
19.460 (338 kW) Eng.D2876LF03	00-	PA1298			For vehicles without retarder, w/o pulley; Impeller Ø 135mm, Incl Eletronic fuel Injection pump	51065006408/ 6492/ 9492
	00-	PA1302			For vehicles with retarder, w/o pulley	51065006426/ 6490/ 9426/ 9490
	00-	PA1319			For vehicles with retarder, w pulley	51065006546/ 9546
	00-	PA1321			For vehicles without retarder, w pulley	51065006545/ 6547/ 9545/ 9547

			
<p>PA1298</p>	<p>PA1302</p>	<p>PA1319</p>	<p>PA1321</p>
			
<p>PA1330</p>			

		GRAF ref.			NOTE	Adaptable for OES
19.460 (338 kW) Eng.D2876LF03	00-	PA1330		•		51065000298,51065006066/ 7033/ 7036 51065007043/ 7045/ 7047/ 7048/ 7051 51065007052/ 7065/ 7066/ 7088/ 7089 51065009045/ 9047/ 9048/ 9052/ 9066
26.310 (228 kW) Eng.D2866LF23 26.360 (265 kW) Eng.D2866LF24 26.410 (301 kW) Eng.D2866LF25	00-	PA1298			For vehicles without retarder, w/o pulley; Impeller Ø 135mm, Incl Eletronic fuel Injection pump	51065006408/ 6492/ 9492
	00-	PA1302			For vehicles with retarder, w/o pulley	51065006426/ 6490/ 9426/ 9490
	00-	PA1319			For vehicles with retarder, w pulley	51065006546/ 9546
	00-	PA1321			For vehicles without retarder, w pulley	51065006545/ 6547/ 9545/ 9547
	00-	PA1330		•		51065000298,51065006066/ 7033/ 7036 51065007043/ 7045/ 7047/ 7048/ 7051 51065007052/ 7065/ 7066/ 7088/ 7089 51065009045/ 9047/ 9048/ 9052/ 9066
26.460 (338 kW) Eng.D2876LF03	00-	PA1298			For vehicles without retarder, w/o pulley; Impeller Ø 135mm, Incl Eletronic fuel Injection pump	51065006408/ 6492/ 9492
	00-	PA1302			For vehicles with retarder, w/o pulley	51065006426/ 6490/ 9426/ 9490
	00-	PA1319			For vehicles with retarder, w pulley	51065006546/ 9546
	00-	PA1330		•		51065000298,51065006066/ 7033/ 7036 51065007043/ 7045/ 7047/ 7048/ 7051 51065007052/ 7065/ 7066/ 7088/ 7089 51065009045/ 9047/ 9048/ 9052/ 9066
28.230 (170 kW) Eng.E2866DF01	00-	PA1298			For vehicles without retarder, w/o pulley; Impeller Ø 135mm, Incl Eletronic fuel Injection pump	51065006408/ 6492/ 9492
	00-	PA1302			For vehicles with retarder, w/o pulley	51065006426/ 6490/ 9426/ 9490
	00-	PA1319			For vehicles with retarder, w pulley	51065006546/ 9546
28.310 (228 kW) Eng.D2866LF23	00-	PA1298			For vehicles without retarder, w/o pulley; Impeller Ø 135mm, Incl Eletronic fuel Injection pump	51065006408/ 6492/ 9492
	00-	PA1302			For vehicles with retarder, w/o pulley	51065006426/ 6490/ 9426/ 9490
	00-	PA1319			For vehicles with retarder, w pulley	51065006546/ 9546
	00-	PA1321			For vehicles without retarder, w pulley	51065006545/ 6547/ 9545/ 9547
	00-	PA1330		•		51065000298,51065006066/ 7033/ 7036 51065007043/ 7045/ 7047/ 7048/ 7051 51065007052/ 7065/ 7066/ 7088/ 7089 51065009045/ 9047/ 9048/ 9052/ 9066
28.360 (265 kW) Eng.D2866LF24	00-	PA1298			For vehicles without retarder, w/o pulley; Impeller Ø 135mm, Incl Eletronic fuel Injection pump	51065006408/ 6492/ 9492
	00-	PA1302			For vehicles with retarder, w/o pulley	51065006426/ 6490/ 9426/ 9490
	00-	PA1319			For vehicles with retarder, w pulley	51065006546/ 9546
	00-	PA1321			For vehicles without retarder, w pulley	51065006545/ 6547/ 9545/ 9547
	00-	PA1330		•		51065000298,51065006066/ 7033/ 7036 51065007043/ 7045/ 7047/ 7048/ 7051 51065007052/ 7065/ 7066/ 7088/ 7089 51065009045/ 9047/ 9048/ 9052/ 9066
28.410 (301 kW) Eng.D2866LF25	00-	PA1298			For vehicles without retarder, w/o pulley; Impeller Ø 135mm, Incl Eletronic fuel Injection pump	51065006408/ 6492/ 9492
	00-	PA1302			For vehicles with retarder, w/o pulley	51065006426/ 6490/ 9426/ 9490
	00-	PA1319			For vehicles with retarder, w pulley	51065006546/ 9546
	00-	PA1321			For vehicles without retarder, w pulley	51065006545/ 6547/ 9545/ 9547
	00-	PA1330		•		51065000298,51065006066/ 7033/ 7036 51065007043/ 7045/ 7047/ 7048/ 7051 51065007052/ 7065/ 7066/ 7088/ 7089 51065009045/ 9047/ 9048/ 9052/ 9066
28.460 (338 kW) Eng.D2876LF03	00-	PA1298			For vehicles without retarder, w/o pulley; Impeller Ø 135mm, Incl Eletronic fuel Injection pump	51065006408/ 6492/ 9492
	00-	PA1302			For vehicles with retarder, w/o pulley	51065006426/ 6490/ 9426/ 9490
	00-	PA1319			For vehicles with retarder, w pulley	51065006546/ 9546
	00-	PA1321			For vehicles without retarder, w pulley	51065006545/ 6547/ 9545/ 9547

			
PA1298	PA1302	PA1319	PA1321
			
PA1330			

		GRAF ref.			NOTE	Adaptable for OES
28.460 (338 kW) Eng.D2876LF03	00-	PA1330		•		51065000298,51065006066/ 7033/ 7036 51065007043/ 7045/ 7047/ 7048/ 7051 51065007052/ 7065/ 7066/ 7088/ 7089 51065009045/ 9047/ 9048/ 9052/ 9066
29.460 (338 kW) Eng.D2876LF03	00-	PA1298			For vehicles without retarder, w/o pulley; Impeller Ø 135mm, Incl Eletronic fuel Injection pump	51065006408/ 6492/ 9492
	00-	PA1302			For vehicles with retarder, w/o pulley	51065006426/ 6490/ 9426/ 9490
	00-	PA1319			For vehicles with retarder, w pulley	51065006546/ 9546
	00-	PA1321			For vehicles without retarder, w pulley	51065006545/ 6547/ 9545/ 9547
30.310 (228 kW) Eng.D2866LF23 30.360 (265 kW) Eng.D2866LF24	00-	PA1298			For vehicles without retarder, w/o pulley; Impeller Ø 135mm, Incl Eletronic fuel Injection pump	51065006408/ 6492/ 9492
	00-	PA1302			For vehicles with retarder, w/o pulley	51065006426/ 6490/ 9426/ 9490
	00-	PA1319			For vehicles with retarder, w pulley	51065006546/ 9546
	00-	PA1321			For vehicles without retarder, w pulley	51065006545/ 6547/ 9545/ 9547
30.410 (301 kW) Eng.D2866LF25	00-	PA1298			For vehicles without retarder, w/o pulley; Impeller Ø 135mm, Incl Eletronic fuel Injection pump	51065006408/ 6492/ 9492
	00-	PA1302			For vehicles with retarder, w/o pulley	51065006426/ 6490/ 9426/ 9490
	00-	PA1319			For vehicles with retarder, w pulley	51065006546/ 9546
	00-	PA1321			For vehicles without retarder, w pulley	51065006545/ 6547/ 9545/ 9547
30.460 (338 kW) Eng.D2876LF03	00-	PA1298			For vehicles without retarder, w/o pulley; Impeller Ø 135mm, Incl Eletronic fuel Injection pump	51065006408/ 6492/ 9492
	00-	PA1302			For vehicles with retarder, w/o pulley	51065006426/ 6490/ 9426/ 9490
	00-	PA1319			For vehicles with retarder, w pulley	51065006546/ 9546
	00-	PA1321			For vehicles without retarder, w pulley	51065006545/ 6547/ 9545/ 9547
32.310 (228 kW) Eng.D2866LF23	00-	PA1298			For vehicles without retarder, w/o pulley; Impeller Ø 135mm, Incl Eletronic fuel Injection pump	51065006408/ 6492/ 9492
	00-	PA1302			For vehicles with retarder, w/o pulley	51065006426/ 6490/ 9426/ 9490
	00-	PA1319			For vehicles with retarder, w pulley	51065006546/ 9546
	00-	PA1330		•		51065000298,51065006066/ 7033/ 7036 51065007043/ 7045/ 7047/ 7048/ 7051 51065007052/ 7065/ 7066/ 7088/ 7089 51065009045/ 9047/ 9048/ 9052/ 9066
32.360 (265 kW) Eng.D2866LF24	00-	PA1298			For vehicles without retarder, w/o pulley; Impeller Ø 135mm, Incl Eletronic fuel Injection pump	51065006408/ 6492/ 9492
	00-	PA1302			For vehicles with retarder, w/o pulley	51065006426/ 6490/ 9426/ 9490
	00-	PA1319			For vehicles with retarder, w pulley	51065006546/ 9546
	00-	PA1321			For vehicles without retarder, w pulley	51065006545/ 6547/ 9545/ 9547
	00-	PA1330		•		51065000298,51065006066/ 7033/ 7036 51065007043/ 7045/ 7047/ 7048/ 7051 51065007052/ 7065/ 7066/ 7088/ 7089 51065009045/ 9047/ 9048/ 9052/ 9066
32.410 (301 kW) Eng.D2866LF25	00-	PA1298			For vehicles without retarder, w/o pulley; Impeller Ø 135mm, Incl Eletronic fuel Injection pump	51065006408/ 6492/ 9492
	00-	PA1302			For vehicles with retarder, w/o pulley	51065006426/ 6490/ 9426/ 9490
	00-	PA1319			For vehicles with retarder, w pulley	51065006546/ 9546
	00-	PA1321			For vehicles without retarder, w pulley	51065006545/ 6547/ 9545/ 9547
	00-	PA1330		•		51065000298,51065006066/ 7033/ 7036 51065007043/ 7045/ 7047/ 7048/ 7051 51065007052/ 7065/ 7066/ 7088/ 7089 51065009045/ 9047/ 9048/ 9052/ 9066
32.460 (338 kW) Eng.D2876LF03	00-	PA1298			For vehicles without retarder, w/o pulley; Impeller Ø 135mm, Incl Eletronic fuel Injection pump	51065006408/ 6492/ 9492
	00-	PA1302			For vehicles with retarder, w/o pulley	51065006426/ 6490/ 9426/ 9490
	00-	PA1319			For vehicles with retarder, w pulley	51065006546/ 9546
	00-	PA1321			For vehicles without retarder, w pulley	51065006545/ 6547/ 9545/ 9547
33.360 (265 kW) Eng.D2876LF03	00-	PA1298			For vehicles without retarder, w/o pulley; Impeller Ø 135mm, Incl Eletronic fuel Injection pump	51065006408/ 6492/ 9492
	00-	PA1302			For vehicles with retarder, w/o pulley	51065006426/ 6490/ 9426/ 9490
	00-	PA1319			For vehicles with retarder, w pulley	51065006546/ 9546

			
<p>PA1298</p>	<p>PA1302</p>	<p>PA1319</p>	<p>PA1321</p>
			
<p>PA1330</p>			

			
PA1294	PA1298	PA1301	PA1302
			
PA1308	PA1310	PA1319	PA1321
			
PA1323	PA1324	PA1330	PA1336

		GRAF ref.			NOTE	Adaptable for OES
50.460 (338 kW) Eng.D2876LF03	00-	PA1302			For vehicles with retarder, w/o pulley	51065006426/ 6490/ 9426/ 9490
	00-	PA1319			For vehicles with retarder, w pulley	51065006546/ 9546
	00-	PA1321			For vehicles without retarder, w pulley	51065006545/ 6547/ 9545/ 9547
50.600 (441 kW) Eng.D2840LF21	00-	PA1298			For vehicles without retarder, w/o pulley; Impeller Ø 135mm, Incl Electronic fuel Injection pump	51065006408/ 6492/ 9492
	00-	PA1302			For vehicles with retarder, w/o pulley	51065006426/ 6490/ 9426/ 9490
EL '1/93-						
EL 202/262 (157-162 kW) Eng.D0826LUH	94-97	PA1323			Impeller Ø 125mm	51065006537/ 9537
	94-97	PA1324			w/ Pulley; Installation height 90,0 mm	51065006543/ 6569/ 9543/ 9569
EL 262 (191 kW) Eng.D2866LUH	98-	PA1294			For vehicles without retarder; Impeller Ø 125mm	51065006282/ 6387/ 9282/ 9387
	98-	PA1298			For vehicles without retarder, w/o pulley; Impeller Ø 135mm, Incl Electronic fuel Injection pump	51065006408/ 6492/ 9492
	98-	PA1302			For vehicles with retarder, w/o pulley	51065006426/ 6490/ 9426/ 9490
EM '10/93-						
EM 192 (140 kW) Eng.D0826LOH06	93-97	PA1310			Impeller Ø 135mm	51065003178/ 6463/ 6495/ 9463/ 9495
	93-97	PA1323			Impeller Ø 125mm	51065006537/ 9537
EM 222/223 (157-162 kW) Eng.D0826LUH	96-	PA1308			w/ Pulley; Installation height 79,5 mm	51065006480/ 9480,51065063043
	96-	PA1323			Impeller Ø 125mm	51065006537/ 9537
	96-	PA1324			w/ Pulley; Installation height 90,0 mm	51065006543/ 6569/ 9543/ 9569
EM 223 (162 kW) Eng.D0826LOH15	97-	PA1310			Impeller Ø 135mm	51065003178/ 6463/ 6495/ 9463/ 9495
	97-	PA1323			Impeller Ø 125mm	51065006537/ 9537
F 2000 '1/94-						
12.8 (338 kW) Eng.D2876LF03	98-	PA1298			For vehicles without retarder, w/o pulley; Impeller Ø 135mm, Incl Electronic fuel Injection pump	51065006408/ 6492/ 9492
	98-	PA1301			For vehicles with retarder; w/o pulley; Injection Pump with electronic control unit	51065006479/ 9479
	98-	PA1302			For vehicles with retarder, w/o pulley	51065006426/ 6490/ 9426/ 9490
	98-	PA1319			For vehicles with retarder, w pulley	51065006546/ 9546
	98-	PA1321			For vehicles without retarder, w pulley	51065006545/ 6547/ 9545/ 9547
	98-	PA1330		•		51065000298,51065006066/ 7033/ 7036 51065007043/ 7045/ 7047/ 7048/ 7051 51065007052/ 7065/ 7066/ 7088/ 7089 51065009045/ 9047/ 9048/ 9052/ 9066
18.273 (198-235 kW) Eng.D2865LOH/LUH/LF	89-	PA1298			For vehicles without retarder, w/o pulley; Impeller Ø 135mm, Incl Electronic fuel Injection pump	51065006408/ 6492/ 9492
	89-	PA1301			For vehicles with retarder; w/o pulley; Injection Pump with electronic control unit	51065006479/ 9479
	89-	PA1302			For vehicles with retarder, w/o pulley	51065006426/ 6490/ 9426/ 9490
19.233 (170 kW) Eng.E2866DF01	96-	PA1298			For vehicles without retarder, w/o pulley; Impeller Ø 135mm, Incl Electronic fuel Injection pump	51065006408/ 6492/ 9492
	96-	PA1301			For vehicles with retarder; w/o pulley; Injection Pump with electronic control unit	51065006479/ 9479
	96-	PA1302			For vehicles with retarder, w/o pulley	51065006426/ 6490/ 9426/ 9490
	96-	PA1319			For vehicles with retarder, w pulley	51065006546/ 9546
19.273 (198 kW) Eng.D2865LF22 9.293 (213 kW) Eng.D2865LF20/LF24	94-95	PA1298			For vehicles without retarder, w/o pulley; Impeller Ø 135mm, Incl Electronic fuel Injection pump	51065006408/ 6492/ 9492
	94-95	PA1301			For vehicles with retarder; w/o pulley; Injection Pump with electronic control unit	51065006479/ 9479
	94-95	PA1302			For vehicles with retarder, w/o pulley	51065006426/ 6490/ 9426/ 9490
	94-95	PA1319			For vehicles with retarder, w pulley	51065006546/ 9546
	94-95	PA1321			For vehicles without retarder, w pulley	51065006545/ 6547/ 9545/ 9547
19.314 (228 kW) Eng.D2866LF34	94-95	PA1336			w/ Pulley	51065006548/ 9548
	98-	PA1298			For vehicles without retarder, w/o pulley; Impeller Ø 135mm, Incl Electronic fuel Injection pump	51065006408/ 6492/ 9492
	98-	PA1301			For vehicles with retarder; w/o pulley; Injection Pump with electronic control unit	51065006479/ 9479
	98-	PA1302			For vehicles with retarder, w/o pulley	51065006426/ 6490/ 9426/ 9490
	98-	PA1319			For vehicles with retarder, w pulley	51065006546/ 9546
	98-	PA1321			For vehicles without retarder, w pulley	51065006545/ 6547/ 9545/ 9547
19.314 (228 kW) Eng.D2866LF34	98-	PA1330		•		51065000298,51065006066/ 7033/ 7036 51065007043/ 7045/ 7047/ 7048/ 7051 51065007052/ 7065/ 7066/ 7088/ 7089 51065009045/ 9047/ 9048/ 9052/ 9066

		GRAF ref.		NOTE	Adaptable for OES
19.323 (235 kW) Eng.D2865LF23	94-95	PA1298		For vehicles without retarder, w/o pulley; Impeller Ø 135mm, Incl Electronic fuel Injection pump	51065006408/ 6492/ 9492
	94-95	PA1301		For vehicles with retarder; w/o pulley; Injection Pump with electronic control unit	51065006479/ 9479
	94-95	PA1302		For vehicles with retarder, w/o pulley	51065006426/ 6490/ 9426/ 9490
	94-95	PA1319		For vehicles with retarder, w pulley	51065006546/ 9546
	94-95	PA1321		For vehicles without retarder, w pulley	51065006545/ 6547/ 9545/ 9547
	94-95	PA1336		w/ Pulley	51065006548/ 9548
19.343 (250 kW) Eng.D2865LF21	94-	PA1298		For vehicles without retarder, w/o pulley; Impeller Ø 135mm, Incl Electronic fuel Injection pump	51065006408/ 6492/ 9492
	94-	PA1301		For vehicles with retarder; w/o pulley; Injection Pump with electronic control unit	51065006479/ 9479
	94-	PA1302		For vehicles with retarder, w/o pulley	51065006426/ 6490/ 9426/ 9490
	94-	PA1319		For vehicles with retarder, w pulley	51065006546/ 9546
	94-	PA1321		For vehicles without retarder, w pulley	51065006545/ 6547/ 9545/ 9547
	94-	PA1336		w/ Pulley	51065006548/ 9548
19.364 (265 kW) Eng.D2866LF35	98-	PA1298		For vehicles without retarder, w/o pulley; Impeller Ø 135mm, Incl Electronic fuel Injection pump	51065006408/ 6492/ 9492
	98-	PA1301		For vehicles with retarder; w/o pulley; Injection Pump with electronic control unit	51065006479/ 9479
	98-	PA1302		For vehicles with retarder, w/o pulley	51065006426/ 6490/ 9426/ 9490
	98-	PA1319		For vehicles with retarder, w pulley	51065006546/ 9546
	98-	PA1321		For vehicles without retarder, w pulley	51065006545/ 6547/ 9545/ 9547
	98-	PA1330	•		51065000298,51065006066/ 7033/ 7036 51065007043/ 7045/ 7047/ 7048/ 7051 51065007052/ 7065/ 7066/ 7088/ 7089 51065009045/ 9047/ 9048/ 9052/ 9066
19.373 (272 kW) Eng.D2866LF21 19.403 (294 kW) Eng.D2866LF20	94-95	PA1298		For vehicles without retarder, w/o pulley; Impeller Ø 135mm, Incl Electronic fuel Injection pump	51065006408/ 6492/ 9492
	94-95	PA1301		For vehicles with retarder; w/o pulley; Injection Pump with electronic control unit	51065006479/ 9479
	94-95	PA1302		For vehicles with retarder, w/o pulley	51065006426/ 6490/ 9426/ 9490
	94-95	PA1319		For vehicles with retarder, w pulley	51065006546/ 9546
	94-95	PA1321		For vehicles without retarder, w pulley	51065006545/ 6547/ 9545/ 9547
	94-95	PA1330	•		51065000298,51065006066/ 7033/ 7036 51065007043/ 7045/ 7047/ 7048/ 7051 51065007052/ 7065/ 7066/ 7088/ 7089 51065009045/ 9047/ 9048/ 9052/ 9066
19.414 (228-301 kW) Eng.D2866LF31	98-	PA1298		For vehicles without retarder, w/o pulley; Impeller Ø 135mm, Incl Electronic fuel Injection pump	51065006408/ 6492/ 9492
	98-	PA1301		For vehicles with retarder; w/o pulley; Injection Pump with electronic control unit	51065006479/ 9479
	98-	PA1302		For vehicles with retarder, w/o pulley	51065006426/ 6490/ 9426/ 9490
	98-	PA1319		For vehicles with retarder, w pulley	51065006546/ 9546
	98-	PA1321		For vehicles without retarder, w pulley	51065006545/ 6547/ 9545/ 9547
	98-	PA1330	•		51065000298,51065006066/ 7033/ 7036 51065007043/ 7045/ 7047/ 7048/ 7051 51065007052/ 7065/ 7066/ 7088/ 7089 51065009045/ 9047/ 9048/ 9052/ 9066
19.423 (309 kW) Eng.D2866LF22	94-95	PA1298		For vehicles without retarder, w/o pulley; Impeller Ø 135mm, Incl Electronic fuel Injection pump	51065006408/ 6492/ 9492
	94-95	PA1301		For vehicles with retarder; w/o pulley; Injection Pump with electronic control unit	51065006479/ 9479
	94-95	PA1302		For vehicles with retarder, w/o pulley	51065006426/ 6490/ 9426/ 9490
	94-95	PA1319		For vehicles with retarder, w pulley	51065006546/ 9546
	94-95	PA1321		For vehicles without retarder, w pulley	51065006545/ 6547/ 9545/ 9547
	94-95	PA1330	•		51065000298,51065006066/ 7033/ 7036 51065007043/ 7045/ 7047/ 7048/ 7051 51065007052/ 7065/ 7066/ 7088/ 7089 51065009045/ 9047/ 9048/ 9052/ 9066
19.463 (338 kW) Eng.D2876LF02	94-	PA1298		For vehicles without retarder, w/o pulley; Impeller Ø 135mm, Incl Electronic fuel Injection pump	51065006408/ 6492/ 9492
	94-	PA1301		For vehicles with retarder; w/o pulley; Injection Pump with electronic control unit	51065006479/ 9479
	94-	PA1302		For vehicles with retarder, w/o pulley	51065006426/ 6490/ 9426/ 9490
	94-	PA1319		For vehicles with retarder, w pulley	51065006546/ 9546
	94-	PA1321		For vehicles without retarder, w pulley	51065006545/ 6547/ 9545/ 9547
	94-	PA1330	•		51065000298,51065006066/ 7033/ 7036 51065007043/ 7045/ 7047/ 7048/ 7051 51065007052/ 7065/ 7066/ 7088/ 7089 51065009045/ 9047/ 9048/ 9052/ 9066

		GRAF ref.			NOTE	Adaptable for OES
19.464 (338 kW) Eng.D2876LF06	98-	PA1298			For vehicles without retarder, w/o pulley; Impeller Ø 135mm, Incl Eletronic fuel Injection pump	51065006408/ 6492/ 9492
	98-	PA1301			For vehicles with retarder; w/o pulley; Injection Pump with electronic control unit	51065006479/ 9479
	98-	PA1302			For vehicles with retarder, w/o pulley	51065006426/ 6490/ 9426/ 9490
	98-	PA1319			For vehicles with retarder, w pulley	51065006546/ 9546
	98-	PA1321			For vehicles without retarder, w pulley	51065006545/ 6547/ 9545/ 9547
	98-	PA1330		•		51065000298,51065006066/ 7033/ 7036 51065007043/ 7045/ 7047/ 7048/ 7051 51065007052/ 7065/ 7066/ 7088/ 7089 51065009045/ 9047/ 9048/ 9052/ 9066
19.603 (441 kW) Eng.D2840LF20	96-	PA1298			For vehicles without retarder, w/o pulley; Impeller Ø 135mm, Incl Eletronic fuel Injection pump	51065006408/ 6492/ 9492
23.293 (213 kW) Eng.D2865LF20	94-	PA1298			For vehicles without retarder, w/o pulley; Impeller Ø 135mm, Incl Eletronic fuel Injection pump	51065006408/ 6492/ 9492
	94-	PA1301			For vehicles with retarder; w/o pulley; Injection Pump with electronic control unit	51065006479/ 9479
	94-	PA1302			For vehicles with retarder, w/o pulley	51065006426/ 6490/ 9426/ 9490
	94-	PA1319			For vehicles with retarder, w pulley	51065006546/ 9546
	94-	PA1336			w/ Pulley	51065006548/ 9548
23.293 (213 kW) Eng.D2865LF24 23.343 (250 kW) Eng.D2865LF21	94-	PA1298			For vehicles without retarder, w/o pulley; Impeller Ø 135mm, Incl Eletronic fuel Injection pump	51065006408/ 6492/ 9492
	94-	PA1301			For vehicles with retarder; w/o pulley; Injection Pump with electronic control unit	51065006479/ 9479
	94-	PA1302			For vehicles with retarder, w/o pulley	51065006426/ 6490/ 9426/ 9490
	94-	PA1319			For vehicles with retarder, w pulley	51065006546/ 9546
	94-	PA1321			For vehicles without retarder, w pulley	51065006545/ 6547/ 9545/ 9547
23.403 (294 kW) Eng.D2866LF20	94-	PA1298			For vehicles without retarder, w/o pulley; Impeller Ø 135mm, Incl Eletronic fuel Injection pump	51065006408/ 6492/ 9492
	94-	PA1301			For vehicles with retarder; w/o pulley; Injection Pump with electronic control unit	51065006479/ 9479
	94-	PA1302			For vehicles with retarder, w/o pulley	51065006426/ 6490/ 9426/ 9490
	94-	PA1319			For vehicles with retarder, w pulley	51065006546/ 9546
	94-	PA1321			For vehicles without retarder, w pulley	51065006545/ 6547/ 9545/ 9547
23.463 (338 kW) Eng.D2876LF02	94-	PA1298			For vehicles without retarder, w/o pulley; Impeller Ø 135mm, Incl Eletronic fuel Injection pump	51065006408/ 6492/ 9492
	94-	PA1301			For vehicles with retarder; w/o pulley; Injection Pump with electronic control unit	51065006479/ 9479
	94-	PA1302			For vehicles with retarder, w/o pulley	51065006426/ 6490/ 9426/ 9490
	94-	PA1319			For vehicles with retarder, w pulley	51065006546/ 9546
	94-	PA1321			For vehicles without retarder, w pulley	51065006545/ 6547/ 9545/ 9547
24.273 (198 kW) Eng.D2865LF22 24.293 (213 kW) Eng.D2865LF24	94-	PA1298			For vehicles without retarder, w/o pulley; Impeller Ø 135mm, Incl Eletronic fuel Injection pump	51065006408/ 6492/ 9492
	94-	PA1301			For vehicles with retarder; w/o pulley; Injection Pump with electronic control unit	51065006479/ 9479
	94-	PA1302			For vehicles with retarder, w/o pulley	51065006426/ 6490/ 9426/ 9490
	94-	PA1319			For vehicles with retarder, w pulley	51065006546/ 9546
	94-	PA1321			For vehicles without retarder, w pulley	51065006545/ 6547/ 9545/ 9547
	94-	PA1336			w/ Pulley	51065006548/ 9548
24.323 (235 kW) Eng.D2865LF23	94-95	PA1298			For vehicles without retarder, w/o pulley; Impeller Ø 135mm, Incl Eletronic fuel Injection pump	51065006408/ 6492/ 9492
	94-95	PA1301			For vehicles with retarder; w/o pulley; Injection Pump with electronic control unit	51065006479/ 9479
	94-95	PA1302			For vehicles with retarder, w/o pulley	51065006426/ 6490/ 9426/ 9490
	94-95	PA1319			For vehicles with retarder, w pulley	51065006546/ 9546
	94-95	PA1321			For vehicles without retarder, w pulley	51065006545/ 6547/ 9545/ 9547
	94-95	PA1336			w/ Pulley	51065006548/ 9548
24.343 (250 kW) Eng.D2865LF21	94-	PA1298			For vehicles without retarder, w/o pulley; Impeller Ø 135mm, Incl Eletronic fuel Injection pump	51065006408/ 6492/ 9492
	94-	PA1301			For vehicles with retarder; w/o pulley; Injection Pump with electronic control unit	51065006479/ 9479
	94-	PA1302			For vehicles with retarder, w/o pulley	51065006426/ 6490/ 9426/ 9490





			
<p>PA1298</p>	<p>PA1301</p>	<p>PA1302</p>	<p>PA1319</p>
			
<p>PA1321</p>	<p>PA1330</p>	<p>PA1336</p>	

		GRAF ref.			NOTE	Adaptable for OES
24.343 (250 kW) Eng.D2865LF21	94-	PA1319			For vehicles with retarder, w pulley	51065006546/ 9546
	94-	PA1321			For vehicles without retarder, w pulley	51065006545/ 6547/ 9545/ 9547
	94-	PA1336			w/ Pulley	51065006548/ 9548
24.373 (272 kW) Eng.D2866LF21 24.403 (294 kW) Eng.D2866LF20	94-95	PA1298			For vehicles without retarder, w/o pulley; Impeller Ø 135mm, Incl Eletronic fuel Injection pump	51065006408/ 6492/ 9492
	94-95	PA1301			For vehicles with retarder; w/o pulley; Injection Pump with electronic control unit	51065006479/ 9479
	94-95	PA1302			For vehicles with retarder, w/o pulley	51065006426/ 6490/ 9426/ 9490
	94-95	PA1319			For vehicles with retarder, w pulley	51065006546/ 9546
	94-95	PA1321			For vehicles without retarder, w pulley	51065006545/ 6547/ 9545/ 9547
	94-95	PA1330		•		51065000298,51065006066/ 7033/ 7036 51065007043/ 7045/ 7047/ 7048/ 7051 51065007052/ 7065/ 7066/ 7088/ 7089 51065009045/ 9047/ 9048/ 9052/ 9066
	94-95	PA1298			For vehicles without retarder, w/o pulley; Impeller Ø 135mm, Incl Eletronic fuel Injection pump	51065006408/ 6492/ 9492
24.423 (309 kW) Eng.D2866LF22	94-95	PA1301			For vehicles with retarder; w/o pulley; Injection Pump with electronic control unit	51065006479/ 9479
	94-95	PA1302			For vehicles with retarder, w/o pulley	51065006426/ 6490/ 9426/ 9490
	94-95	PA1319			For vehicles with retarder, w pulley	51065006546/ 9546
	94-95	PA1321			For vehicles without retarder, w pulley	51065006545/ 6547/ 9545/ 9547
	94-95	PA1330		•		51065000298,51065006066/ 7033/ 7036 51065007043/ 7045/ 7047/ 7048/ 7051 51065007052/ 7065/ 7066/ 7088/ 7089 51065009045/ 9047/ 9048/ 9052/ 9066
24.463 (338 kW) Eng.D2876LF02	94-	PA1298			For vehicles without retarder, w/o pulley; Impeller Ø 135mm, Incl Eletronic fuel Injection pump	51065006408/ 6492/ 9492
	94-	PA1301			For vehicles with retarder; w/o pulley; Injection Pump with electronic control unit	51065006479/ 9479
	94-	PA1302			For vehicles with retarder, w/o pulley	51065006426/ 6490/ 9426/ 9490
	94-	PA1319			For vehicles with retarder, w pulley	51065006546/ 9546
	94-	PA1321			For vehicles without retarder, w pulley	51065006545/ 6547/ 9545/ 9547
26.233 (170 kW) Eng.E2866DF01	94-	PA1330		•		51065000298,51065006066/ 7033/ 7036 51065007043/ 7045/ 7047/ 7048/ 7051 51065007052/ 7065/ 7066/ 7088/ 7089 51065009045/ 9047/ 9048/ 9052/ 9066
	96-	PA1298			For vehicles without retarder, w/o pulley; Impeller Ø 135mm, Incl Eletronic fuel Injection pump	51065006408/ 6492/ 9492
	96-	PA1301			For vehicles with retarder; w/o pulley; Injection Pump with electronic control unit	51065006479/ 9479
	96-	PA1302			For vehicles with retarder, w/o pulley	51065006426/ 6490/ 9426/ 9490
	96-	PA1319			For vehicles with retarder, w pulley	51065006546/ 9546
26.273 (198 kW) Eng.D2865LF22	94-95	PA1298			For vehicles without retarder, w/o pulley; Impeller Ø 135mm, Incl Eletronic fuel Injection pump	51065006408/ 6492/ 9492
	94-95	PA1301			For vehicles with retarder; w/o pulley; Injection Pump with electronic control unit	51065006479/ 9479
	94-95	PA1302			For vehicles with retarder, w/o pulley	51065006426/ 6490/ 9426/ 9490
	94-95	PA1319			For vehicles with retarder, w pulley	51065006546/ 9546
	94-95	PA1321			For vehicles without retarder, w pulley	51065006545/ 6547/ 9545/ 9547
	94-95	PA1336			w/ Pulley	51065006548/ 9548
	94-95	PA1298			For vehicles without retarder, w/o pulley; Impeller Ø 135mm, Incl Eletronic fuel Injection pump	51065006408/ 6492/ 9492
26.293 (213 kW) Eng.D2865LF20	94-	PA1301			For vehicles with retarder; w/o pulley; Injection Pump with electronic control unit	51065006479/ 9479
	94-	PA1302			For vehicles with retarder, w/o pulley	51065006426/ 6490/ 9426/ 9490
	94-	PA1319			For vehicles with retarder, w pulley	51065006546/ 9546
	94-	PA1321			For vehicles without retarder, w pulley	51065006545/ 6547/ 9545/ 9547
	94-	PA1336			w/ Pulley	51065006548/ 9548
	94-	PA1298			For vehicles without retarder, w/o pulley; Impeller Ø 135mm, Incl Eletronic fuel Injection pump	51065006408/ 6492/ 9492
26.293 (213 kW) Eng.D2865LF24	94-	PA1301			For vehicles with retarder; w/o pulley; Injection Pump with electronic control unit	51065006479/ 9479
	94-	PA1302			For vehicles with retarder, w/o pulley	51065006426/ 6490/ 9426/ 9490
	94-	PA1319			For vehicles with retarder, w pulley	51065006546/ 9546
	94-	PA1321			For vehicles without retarder, w pulley	51065006545/ 6547/ 9545/ 9547
	94-	PA1336			w/ Pulley	51065006548/ 9548
26.314 (228 kW) Eng.D2866LF23	01-	PA1298			For vehicles without retarder, w/o pulley; Impeller Ø 135mm, Incl Eletronic fuel Injection pump	51065006408/ 6492/ 9492
	01-	PA1301			For vehicles with retarder; w/o pulley; Injection Pump with electronic control unit	51065006479/ 9479
	01-	PA1302			For vehicles with retarder, w/o pulley	51065006426/ 6490/ 9426/ 9490
	01-	PA1319			For vehicles with retarder, w pulley	51065006546/ 9546
	01-	PA1321			For vehicles without retarder, w pulley	51065006545/ 6547/ 9545/ 9547

			
<p>PA1298</p>	<p>PA1301</p>	<p>PA1302</p>	<p>PA1319</p>
			
<p>PA1321</p>	<p>PA1330</p>	<p>PA1336</p>	

		GRAF ref.			NOTE	Adaptable for OES
26.314 (228 kW) Eng.D2866LF23	01-	PA1330		•		51065000298,51065006066/ 7033/ 7036 51065007043/ 7045/ 7047/ 7048/ 7051 51065007052/ 7065/ 7066/ 7088/ 7089 51065009045/ 9047/ 9048/ 9052/ 9066
26.323 (235 kW) Eng.D2865LF23 26.343 (250 kW) Eng.D2865LF21	94-95	PA1298			For vehicles without retarder, w/o pulley; Impeller Ø 135mm, Incl Electronic fuel Injection pump	51065006408/ 6492/ 9492
	94-95	PA1301			For vehicles with retarder; w/o pulley; Injection Pump with electronic control unit	51065006479/ 9479
	94-95	PA1302			For vehicles with retarder, w/o pulley	51065006426/ 6490/ 9426/ 9490
	94-95	PA1319			For vehicles with retarder, w pulley	51065006546/ 9546
	94-95	PA1321			For vehicles without retarder, w pulley	51065006545/ 6547/ 9545/ 9547
26.364 (265 kW) Eng.D2866LF24	94-95	PA1336			w/ Pulley	51065006548/ 9548
	01-	PA1298			For vehicles without retarder, w/o pulley; Impeller Ø 135mm, Incl Electronic fuel Injection pump	51065006408/ 6492/ 9492
	01-	PA1301			For vehicles with retarder; w/o pulley; Injection Pump with electronic control unit	51065006479/ 9479
	01-	PA1302			For vehicles with retarder, w/o pulley	51065006426/ 6490/ 9426/ 9490
	01-	PA1319			For vehicles with retarder, w pulley	51065006546/ 9546
26.373 (272 kW) Eng.D2866LF21	01-	PA1321			For vehicles without retarder, w pulley	51065006545/ 6547/ 9545/ 9547
	01-	PA1330		•		51065000298,51065006066/ 7033/ 7036 51065007043/ 7045/ 7047/ 7048/ 7051 51065007052/ 7065/ 7066/ 7088/ 7089 51065009045/ 9047/ 9048/ 9052/ 9066
	94-95	PA1298			For vehicles without retarder, w/o pulley; Impeller Ø 135mm, Incl Electronic fuel Injection pump	51065006408/ 6492/ 9492
	94-95	PA1301			For vehicles with retarder; w/o pulley; Injection Pump with electronic control unit	51065006479/ 9479
	94-95	PA1302			For vehicles with retarder, w/o pulley	51065006426/ 6490/ 9426/ 9490
26.403 (294 kW) Eng.D2866LF20	94-95	PA1319			For vehicles with retarder, w pulley	51065006546/ 9546
	94-95	PA1321			For vehicles without retarder, w pulley	51065006545/ 6547/ 9545/ 9547
	94-95	PA1330		•		51065000298,51065006066/ 7033/ 7036 51065007043/ 7045/ 7047/ 7048/ 7051 51065007052/ 7065/ 7066/ 7088/ 7089 51065009045/ 9047/ 9048/ 9052/ 9066
	94-	PA1298			For vehicles without retarder, w/o pulley; Impeller Ø 135mm, Incl Electronic fuel Injection pump	51065006408/ 6492/ 9492
	94-	PA1301			For vehicles with retarder; w/o pulley; Injection Pump with electronic control unit	51065006479/ 9479
26.414 (301 kW) Eng.D2866LF25	94-	PA1302			For vehicles with retarder, w/o pulley	51065006426/ 6490/ 9426/ 9490
	94-	PA1319			For vehicles with retarder, w pulley	51065006546/ 9546
	94-	PA1321			For vehicles without retarder, w pulley	51065006545/ 6547/ 9545/ 9547
	01-	PA1298			For vehicles without retarder, w/o pulley; Impeller Ø 135mm, Incl Electronic fuel Injection pump	51065006408/ 6492/ 9492
	01-	PA1301			For vehicles with retarder; w/o pulley; Injection Pump with electronic control unit	51065006479/ 9479
26.423 (309 kW) Eng.D2866LF22	01-	PA1302			For vehicles with retarder, w/o pulley	51065006426/ 6490/ 9426/ 9490
	01-	PA1319			For vehicles with retarder, w pulley	51065006546/ 9546
	01-	PA1321			For vehicles without retarder, w pulley	51065006545/ 6547/ 9545/ 9547
	01-	PA1330		•		51065000298,51065006066/ 7033/ 7036 51065007043/ 7045/ 7047/ 7048/ 7051 51065007052/ 7065/ 7066/ 7088/ 7089 51065009045/ 9047/ 9048/ 9052/ 9066
	94-95	PA1298			For vehicles without retarder, w/o pulley; Impeller Ø 135mm, Incl Electronic fuel Injection pump	51065006408/ 6492/ 9492
26.463 (338 kW) Eng.D2876LF02 26.464 (338 kW) Eng.D2876LF03	94-95	PA1301			For vehicles with retarder; w/o pulley; Injection Pump with electronic control unit	51065006479/ 9479
	94-	PA1302			For vehicles with retarder, w/o pulley	51065006426/ 6490/ 9426/ 9490
	94-	PA1319			For vehicles with retarder, w pulley	51065006546/ 9546
	94-	PA1321			For vehicles without retarder, w pulley	51065006545/ 6547/ 9545/ 9547
	94-	PA1298			For vehicles without retarder, w/o pulley; Impeller Ø 135mm, Incl Electronic fuel Injection pump	51065006408/ 6492/ 9492

			
<p>PA1298</p>	<p>PA1301</p>	<p>PA1302</p>	<p>PA1319</p>
			
<p>PA1321</p>	<p>PA1330</p>	<p>PA1336</p>	

		GRAF ref.			NOTE	Adaptable for OES
26.463 (338 kW) Eng.D2876LF02 26.464 (338 kW) Eng.D2876LF03	94-	PA1330		•		51065000298,51065006066/ 7033/ 7036 51065007043/ 7045/ 7047/ 7048/ 7051 51065007052/ 7065/ 7066/ 7088/ 7089 51065009045/ 9047/ 9048/ 9052/ 9066
26.603 (441 kW) Eng.D2840LF20	96-	PA1298			For vehicles without retarder, w/o pulley; Impeller Ø 135mm, Incl Eletronic fuel Injection pump	51065006408/ 6492/ 9492
27.273 (198 kW) Eng.D2865LF22	94-95	PA1298			For vehicles without retarder, w/o pulley; Impeller Ø 135mm, Incl Eletronic fuel Injection pump	51065006408/ 6492/ 9492
	94-95	PA1301			For vehicles with retarder; w/o pulley; Injection Pump with electronic control unit	51065006479/ 9479
	94-95	PA1302			For vehicles with retarder, w/o pulley	51065006426/ 6490/ 9426/ 9490
	94-95	PA1319			For vehicles with retarder, w pulley	51065006546/ 9546
	94-95	PA1321			For vehicles without retarder, w pulley	51065006545/ 6547/ 9545/ 9547
	94-95	PA1336			w/ Pulley	51065006548/ 9548
27.293 (213 kW) Eng.D2865LF20/LF24	94-	PA1298			For vehicles without retarder, w/o pulley; Impeller Ø 135mm, Incl Eletronic fuel Injection pump	51065006408/ 6492/ 9492
	94-	PA1301			For vehicles with retarder; w/o pulley; Injection Pump with electronic control unit	51065006479/ 9479
	94-	PA1302			For vehicles with retarder, w/o pulley	51065006426/ 6490/ 9426/ 9490
	94-	PA1319			For vehicles with retarder, w pulley	51065006546/ 9546
	94-	PA1321			For vehicles without retarder, w pulley	51065006545/ 6547/ 9545/ 9547
	94-	PA1336			w/ Pulley	51065006548/ 9548
27.314 (228 kW) Eng.D2866LF23	98-	PA1298			For vehicles without retarder, w/o pulley; Impeller Ø 135mm, Incl Eletronic fuel Injection pump	51065006408/ 6492/ 9492
	98-	PA1301			For vehicles with retarder; w/o pulley; Injection Pump with electronic control unit	51065006479/ 9479
	98-	PA1302			For vehicles with retarder, w/o pulley	51065006426/ 6490/ 9426/ 9490
	98-	PA1319			For vehicles with retarder, w pulley	51065006546/ 9546
	98-	PA1321			For vehicles without retarder, w pulley	51065006545/ 6547/ 9545/ 9547
	98-	PA1330		•		51065000298,51065006066/ 7033/ 7036 51065007043/ 7045/ 7047/ 7048/ 7051 51065007052/ 7065/ 7066/ 7088/ 7089 51065009045/ 9047/ 9048/ 9052/ 9066
27.323 (235 kW) Eng.D2865LF23	94-95	PA1298			For vehicles without retarder, w/o pulley; Impeller Ø 135mm, Incl Eletronic fuel Injection pump	51065006408/ 6492/ 9492
	94-95	PA1301			For vehicles with retarder; w/o pulley; Injection Pump with electronic control unit	51065006479/ 9479
	94-95	PA1302			For vehicles with retarder, w/o pulley	51065006426/ 6490/ 9426/ 9490
	94-95	PA1319			For vehicles with retarder, w pulley	51065006546/ 9546
	94-95	PA1321			For vehicles without retarder, w pulley	51065006545/ 6547/ 9545/ 9547
	94-95	PA1336			w/ Pulley	51065006548/ 9548
27.343 (250 kW) Eng.D2865LF21	94-	PA1298			For vehicles without retarder, w/o pulley; Impeller Ø 135mm, Incl Eletronic fuel Injection pump	51065006408/ 6492/ 9492
	94-	PA1301			For vehicles with retarder; w/o pulley; Injection Pump with electronic control unit	51065006479/ 9479
	94-	PA1302			For vehicles with retarder, w/o pulley	51065006426/ 6490/ 9426/ 9490
	94-	PA1319			For vehicles with retarder, w pulley	51065006546/ 9546
	94-	PA1321			For vehicles without retarder, w pulley	51065006545/ 6547/ 9545/ 9547
	94-	PA1336			w/ Pulley	51065006548/ 9548
27.364 (265 kW) Eng.D2866LF24	01-	PA1298			For vehicles without retarder, w/o pulley; Impeller Ø 135mm, Incl Eletronic fuel Injection pump	51065006408/ 6492/ 9492
	01-	PA1301			For vehicles with retarder; w/o pulley; Injection Pump with electronic control unit	51065006479/ 9479
	01-	PA1302			For vehicles with retarder, w/o pulley	51065006426/ 6490/ 9426/ 9490
	01-	PA1319			For vehicles with retarder, w pulley	51065006546/ 9546
	01-	PA1321			For vehicles without retarder, w pulley	51065006545/ 6547/ 9545/ 9547
	01-	PA1330		•		51065000298,51065006066/ 7033/ 7036 51065007043/ 7045/ 7047/ 7048/ 7051 51065007052/ 7065/ 7066/ 7088/ 7089 51065009045/ 9047/ 9048/ 9052/ 9066
27.373 (272 kW) Eng.D2866LF21	94-95	PA1298			For vehicles without retarder, w/o pulley; Impeller Ø 135mm, Incl Eletronic fuel Injection pump	51065006408/ 6492/ 9492
	94-95	PA1301			For vehicles with retarder; w/o pulley; Injection Pump with electronic control unit	51065006479/ 9479
	94-95	PA1302			For vehicles with retarder, w/o pulley	51065006426/ 6490/ 9426/ 9490
	94-95	PA1319			For vehicles with retarder, w pulley	51065006546/ 9546

		GRAF ref.			NOTE	Adaptable for OES
27.373 (272 kW) Eng.D2866LF21	94-95	PA1321			For vehicles without retarder, w pulley	51065006545/ 6547/ 9545/ 9547
	94-95	PA1330		•		51065000298,51065006066/ 7033/ 7036 51065007043/ 7045/ 7047/ 7048/ 7051 51065007052/ 7065/ 7066/ 7088/ 7089 51065009045/ 9047/ 9048/ 9052/ 9066
27.403 (294 kW) Eng.D2866LF20	94-	PA1298			For vehicles without retarder, w/o pulley; Impeller Ø 135mm, Incl Eletronic fuel Injection pump	51065006408/ 6492/ 9492
	94-	PA1301			For vehicles with retarder; w/o pulley; Injection Pump with electronic control unit	51065006479/ 9479
	94-	PA1302			For vehicles with retarder, w/o pulley	51065006426/ 6490/ 9426/ 9490
	94-	PA1319			For vehicles with retarder, w pulley	51065006546/ 9546
	94-	PA1321			For vehicles without retarder, w pulley	51065006545/ 6547/ 9545/ 9547
	94-	PA1330		•		51065000298,51065006066/ 7033/ 7036 51065007043/ 7045/ 7047/ 7048/ 7051 51065007052/ 7065/ 7066/ 7088/ 7089 51065009045/ 9047/ 9048/ 9052/ 9066
27.414 (301 kW) Eng.D2866LF25	01-	PA1298			For vehicles without retarder, w/o pulley; Impeller Ø 135mm, Incl Eletronic fuel Injection pump	51065006408/ 6492/ 9492
	01-	PA1301			For vehicles with retarder; w/o pulley; Injection Pump with electronic control unit	51065006479/ 9479
	01-	PA1302			For vehicles with retarder, w/o pulley	51065006426/ 6490/ 9426/ 9490
	01-	PA1319			For vehicles with retarder, w pulley	51065006546/ 9546
	01-	PA1321			For vehicles without retarder, w pulley	51065006545/ 6547/ 9545/ 9547
	01-	PA1330		•		51065000298,51065006066/ 7033/ 7036 51065007043/ 7045/ 7047/ 7048/ 7051 51065007052/ 7065/ 7066/ 7088/ 7089 51065009045/ 9047/ 9048/ 9052/ 9066
27.423 (309 kW) Eng.D2866LF22	94-95	PA1298			For vehicles without retarder, w/o pulley; Impeller Ø 135mm, Incl Eletronic fuel Injection pump	51065006408/ 6492/ 9492
	94-95	PA1301			For vehicles with retarder; w/o pulley; Injection Pump with electronic control unit	51065006479/ 9479
	94-95	PA1302			For vehicles with retarder, w/o pulley	51065006426/ 6490/ 9426/ 9490
	94-95	PA1319			For vehicles with retarder, w pulley	51065006546/ 9546
	94-95	PA1321			For vehicles without retarder, w pulley	51065006545/ 6547/ 9545/ 9547
	94-95	PA1330		•		51065000298,51065006066/ 7033/ 7036 51065007043/ 7045/ 7047/ 7048/ 7051 51065007052/ 7065/ 7066/ 7088/ 7089 51065009045/ 9047/ 9048/ 9052/ 9066
27.463 (338 kW) Eng.D2876LF02 27.464 (338 kW) Eng.D2876LF03	94-	PA1298			For vehicles without retarder, w/o pulley; Impeller Ø 135mm, Incl Eletronic fuel Injection pump	51065006408/ 6492/ 9492
	94-	PA1301			For vehicles with retarder; w/o pulley; Injection Pump with electronic control unit	51065006479/ 9479
	94-	PA1302			For vehicles with retarder, w/o pulley	51065006426/ 6490/ 9426/ 9490
	94-	PA1319			For vehicles with retarder, w pulley	51065006546/ 9546
	94-	PA1321			For vehicles without retarder, w pulley	51065006545/ 6547/ 9545/ 9547
	94-	PA1330		•		51065000298,51065006066/ 7033/ 7036 51065007043/ 7045/ 7047/ 7048/ 7051 51065007052/ 7065/ 7066/ 7088/ 7089 51065009045/ 9047/ 9048/ 9052/ 9066
27.603 (441 kW) Eng.D2840LF20	96-	PA1298			For vehicles without retarder, w/o pulley; Impeller Ø 135mm, Incl Eletronic fuel Injection pump	51065006408/ 6492/ 9492
32.293 (213 kW) Eng.D2865LF24	95-	PA1298			For vehicles without retarder, w/o pulley; Impeller Ø 135mm, Incl Eletronic fuel Injection pump	51065006408/ 6492/ 9492
	95-	PA1301			For vehicles with retarder; w/o pulley; Injection Pump with electronic control unit	51065006479/ 9479
	95-	PA1302			For vehicles with retarder, w/o pulley	51065006426/ 6490/ 9426/ 9490
	95-	PA1319			For vehicles with retarder, w pulley	51065006546/ 9546
	95-	PA1321			For vehicles without retarder, w pulley	51065006545/ 6547/ 9545/ 9547
	95-	PA1336			w/ Pulley	51065006548/ 9548
32.314 (228 kW) Eng.D2866LF23	01-	PA1298			For vehicles without retarder, w/o pulley; Impeller Ø 135mm, Incl Eletronic fuel Injection pump	51065006408/ 6492/ 9492
	01-	PA1301			For vehicles with retarder; w/o pulley; Injection Pump with electronic control unit	51065006479/ 9479
	01-	PA1302			For vehicles with retarder, w/o pulley	51065006426/ 6490/ 9426/ 9490
	01-	PA1319			For vehicles with retarder, w pulley	51065006546/ 9546
	01-	PA1321			For vehicles without retarder, w pulley	51065006545/ 6547/ 9545/ 9547
	01-	PA1330		•		51065000298,51065006066/ 7033/ 7036 51065007043/ 7045/ 7047/ 7048/ 7051 51065007052/ 7065/ 7066/ 7088/ 7089 51065009045/ 9047/ 9048/ 9052/ 9066

			
<p>PA1298</p>	<p>PA1301</p>	<p>PA1302</p>	<p>PA1319</p>
			
<p>PA1321</p>	<p>PA1330</p>	<p>PA1336</p>	

		GRAF ref.			NOTE	Adaptable for OES
32.343 (250 kW) Eng.D2865LF21	95-	PA1298			For vehicles without retarder, w/o pulley; Impeller Ø 135mm, Incl Eletronic fuel Injection pump	51065006408/ 6492/ 9492
	95-	PA1301			For vehicles with retarder; w/o pulley; Injection Pump with electronic control unit	51065006479/ 9479
	95-	PA1302			For vehicles with retarder, w/o pulley	51065006426/ 6490/ 9426/ 9490
	95-	PA1319			For vehicles with retarder, w pulley	51065006546/ 9546
	95-	PA1321			For vehicles without retarder, w pulley	51065006545/ 6547/ 9545/ 9547
	95-	PA1336			w/ Pulley	51065006548/ 9548
32.364 (265 kW) Eng.D2866LF24	01-	PA1298			For vehicles without retarder, w/o pulley; Impeller Ø 135mm, Incl Eletronic fuel Injection pump	51065006408/ 6492/ 9492
	01-	PA1301			For vehicles with retarder; w/o pulley; Injection Pump with electronic control unit	51065006479/ 9479
	01-	PA1302			For vehicles with retarder, w/o pulley	51065006426/ 6490/ 9426/ 9490
	01-	PA1319			For vehicles with retarder, w pulley	51065006546/ 9546
	01-	PA1321			For vehicles without retarder, w pulley	51065006545/ 6547/ 9545/ 9547
	01-	PA1330		•		51065000298,51065006066/ 7033/ 7036 51065007043/ 7045/ 7047/ 7048/ 7051 51065007052/ 7065/ 7066/ 7088/ 7089 51065009045/ 9047/ 9048/ 9052/ 9066
32.403 (294 kW) Eng.D2866LF20	95-	PA1298			For vehicles without retarder, w/o pulley; Impeller Ø 135mm, Incl Eletronic fuel Injection pump	51065006408/ 6492/ 9492
	95-	PA1301			For vehicles with retarder; w/o pulley; Injection Pump with electronic control unit	51065006479/ 9479
	95-	PA1302			For vehicles with retarder, w/o pulley	51065006426/ 6490/ 9426/ 9490
	95-	PA1319			For vehicles with retarder, w pulley	51065006546/ 9546
	95-	PA1321			For vehicles without retarder, w pulley	51065006545/ 6547/ 9545/ 9547
	95-	PA1330		•		51065000298,51065006066/ 7033/ 7036 51065007043/ 7045/ 7047/ 7048/ 7051 51065007052/ 7065/ 7066/ 7088/ 7089 51065009045/ 9047/ 9048/ 9052/ 9066
32.414 (301 kW) Eng.D2866LF25	01-	PA1298			For vehicles without retarder, w/o pulley; Impeller Ø 135mm, Incl Eletronic fuel Injection pump	51065006408/ 6492/ 9492
	01-	PA1301			For vehicles with retarder; w/o pulley; Injection Pump with electronic control unit	51065006479/ 9479
	01-	PA1302			For vehicles with retarder, w/o pulley	51065006426/ 6490/ 9426/ 9490
	01-	PA1319			For vehicles with retarder, w pulley	51065006546/ 9546
	01-	PA1330		•		51065000298,51065006066/ 7033/ 7036 51065007043/ 7045/ 7047/ 7048/ 7051 51065007052/ 7065/ 7066/ 7088/ 7089 51065009045/ 9047/ 9048/ 9052/ 9066
32.463 (338 kW) Eng.D2876LF02 32.464 (338 kW) Eng.D2876LF03	95-	PA1298			For vehicles without retarder, w/o pulley; Impeller Ø 135mm, Incl Eletronic fuel Injection pump	51065006408/ 6492/ 9492
	95-	PA1301			For vehicles with retarder; w/o pulley; Injection Pump with electronic control unit	51065006479/ 9479
	95-	PA1302			For vehicles with retarder, w/o pulley	51065006426/ 6490/ 9426/ 9490
	95-	PA1319			For vehicles with retarder, w pulley	51065006546/ 9546
	95-	PA1321			For vehicles without retarder, w pulley	51065006545/ 6547/ 9545/ 9547
	95-	PA1330		•		51065000298,51065006066/ 7033/ 7036 51065007043/ 7045/ 7047/ 7048/ 7051 51065007052/ 7065/ 7066/ 7088/ 7089 51065009045/ 9047/ 9048/ 9052/ 9066
33.323 (235 kW) Eng.D2865LF23	94-95	PA1298			For vehicles without retarder, w/o pulley; Impeller Ø 135mm, Incl Eletronic fuel Injection pump	51065006408/ 6492/ 9492
	94-95	PA1301			For vehicles with retarder; w/o pulley; Injection Pump with electronic control unit	51065006479/ 9479
	94-95	PA1302			For vehicles with retarder, w/o pulley	51065006426/ 6490/ 9426/ 9490
	94-95	PA1319			For vehicles with retarder, w pulley	51065006546/ 9546
	94-95	PA1321			For vehicles without retarder, w pulley	51065006545/ 6547/ 9545/ 9547
	94-95	PA1336			w/ Pulley	51065006548/ 9548
33.343 (250 kW) Eng.D2865LF21	94-	PA1298			For vehicles without retarder, w/o pulley; Impeller Ø 135mm, Incl Eletronic fuel Injection pump	51065006408/ 6492/ 9492
	94-	PA1301			For vehicles with retarder; w/o pulley; Injection Pump with electronic control unit	51065006479/ 9479
	94-	PA1302			For vehicles with retarder, w/o pulley	51065006426/ 6490/ 9426/ 9490
	94-	PA1319			For vehicles with retarder, w pulley	51065006546/ 9546
	94-	PA1321			For vehicles without retarder, w pulley	51065006545/ 6547/ 9545/ 9547
	94-	PA1336			w/ Pulley	51065006548/ 9548
33.373 (272 kW) Eng.D2866LF21	94-95	PA1298			For vehicles without retarder, w/o pulley; Impeller Ø 135mm, Incl Eletronic fuel Injection pump	51065006408/ 6492/ 9492
	94-95	PA1301			For vehicles with retarder; w/o pulley; Injection Pump with electronic control unit	51065006479/ 9479
	94-95	PA1302			For vehicles with retarder, w/o pulley	51065006426/ 6490/ 9426/ 9490
	94-95	PA1319			For vehicles with retarder, w pulley	51065006546/ 9546
	94-95	PA1321			For vehicles without retarder, w pulley	51065006545/ 6547/ 9545/ 9547

			
<p>PA1298</p>	<p>PA1301</p>	<p>PA1302</p>	<p>PA1319</p>
			
<p>PA1321</p>	<p>PA1330</p>	<p>PA1336</p>	

		GRAF ref.			NOTE	Adaptable for OES
33.373 (272 kW) Eng.D2866LF21	94-95	PA1330		•		51065000298,51065006066/ 7033/ 7036 51065007043/ 7045/ 7047/ 7048/ 7051 51065007052/ 7065/ 7066/ 7088/ 7089 51065009045/ 9047/ 9048/ 9052/ 9066
33.403 (294 kW) Eng.D2866LF20	94-	PA1298			For vehicles without retarder, w/o pulley; Impeller Ø 135mm, Incl Eletronic fuel Injection pump	51065006408/ 6492/ 9492
	94-	PA1301			For vehicles with retarder; w/o pulley; Injection Pump with electronic control unit	51065006479/ 9479
	94-	PA1302			For vehicles with retarder, w/o pulley	51065006426/ 6490/ 9426/ 9490
	94-	PA1319			For vehicles with retarder, w pulley	51065006546/ 9546
	94-	PA1321			For vehicles without retarder, w pulley	51065006545/ 6547/ 9545/ 9547
33.423 (309 kW) Eng.D2866LF22 33.463 (338 kW) Eng.D2876LF02	94-95	PA1298			For vehicles without retarder, w/o pulley; Impeller Ø 135mm, Incl Eletronic fuel Injection pump	51065006408/ 6492/ 9492
	94-95	PA1301			For vehicles with retarder; w/o pulley; Injection Pump with electronic control unit	51065006479/ 9479
	94-95	PA1302			For vehicles with retarder, w/o pulley	51065006426/ 6490/ 9426/ 9490
	94-95	PA1319			For vehicles with retarder, w pulley	51065006546/ 9546
	94-95	PA1321			For vehicles without retarder, w pulley	51065006545/ 6547/ 9545/ 9547
33.603 (441 kW) Eng.D2840LF20	96-	PA1298			For vehicles without retarder, w/o pulley; Impeller Ø 135mm, Incl Eletronic fuel Injection pump	51065006408/ 6492/ 9492
	95-	PA1298			For vehicles without retarder, w/o pulley; Impeller Ø 135mm, Incl Eletronic fuel Injection pump	51065006408/ 6492/ 9492
	95-	PA1301			For vehicles with retarder; w/o pulley; Injection Pump with electronic control unit	51065006479/ 9479
	95-	PA1302			For vehicles with retarder, w/o pulley	51065006426/ 6490/ 9426/ 9490
	95-	PA1319			For vehicles with retarder, w pulley	51065006546/ 9546
35.343 (250 kW) Eng.D2865LF21	95-	PA1298			For vehicles without retarder, w/o pulley; Impeller Ø 135mm, Incl Eletronic fuel Injection pump	51065006408/ 6492/ 9492
	95-	PA1301			For vehicles with retarder; w/o pulley; Injection Pump with electronic control unit	51065006479/ 9479
	95-	PA1302			For vehicles with retarder, w/o pulley	51065006426/ 6490/ 9426/ 9490
	95-	PA1319			For vehicles with retarder, w pulley	51065006546/ 9546
	95-	PA1321			For vehicles without retarder, w pulley	51065006545/ 6547/ 9545/ 9547
35.364 (265 kW) Eng.D2866LF24	95-	PA1336			w/ Pulley	51065006548/ 9548
	01-	PA1298			For vehicles without retarder, w/o pulley; Impeller Ø 135mm, Incl Eletronic fuel Injection pump	51065006408/ 6492/ 9492
	01-	PA1301			For vehicles with retarder; w/o pulley; Injection Pump with electronic control unit	51065006479/ 9479
	01-	PA1302			For vehicles with retarder, w/o pulley	51065006426/ 6490/ 9426/ 9490
	01-	PA1319			For vehicles with retarder, w pulley	51065006546/ 9546
35.403 (294 kW) Eng.D2866LF20	01-	PA1321			For vehicles without retarder, w pulley	51065006545/ 6547/ 9545/ 9547
	01-	PA1330		•		51065000298,51065006066/ 7033/ 7036 51065007043/ 7045/ 7047/ 7048/ 7051 51065007052/ 7065/ 7066/ 7088/ 7089 51065009045/ 9047/ 9048/ 9052/ 9066
	95-	PA1298			For vehicles without retarder, w/o pulley; Impeller Ø 135mm, Incl Eletronic fuel Injection pump	51065006408/ 6492/ 9492
	95-	PA1301			For vehicles with retarder; w/o pulley; Injection Pump with electronic control unit	51065006479/ 9479
	95-	PA1302			For vehicles with retarder, w/o pulley	51065006426/ 6490/ 9426/ 9490
35.414 (301 kW) Eng.D2866LF25	95-	PA1319			For vehicles with retarder, w pulley	51065006546/ 9546
	95-	PA1321			For vehicles without retarder, w pulley	51065006545/ 6547/ 9545/ 9547
	01-	PA1298			For vehicles without retarder, w/o pulley; Impeller Ø 135mm, Incl Eletronic fuel Injection pump	51065006408/ 6492/ 9492
	01-	PA1301			For vehicles with retarder; w/o pulley; Injection Pump with electronic control unit	51065006479/ 9479
	01-	PA1302			For vehicles with retarder, w/o pulley	51065006426/ 6490/ 9426/ 9490
35.463 (338 kW) Eng.D2876LF02 35.464 (338 kW) Eng.D2876LF03	01-	PA1319			For vehicles with retarder, w pulley	51065006546/ 9546
	01-	PA1321			For vehicles without retarder, w pulley	51065006545/ 6547/ 9545/ 9547
	01-	PA1330		•		51065000298,51065006066/ 7033/ 7036 51065007043/ 7045/ 7047/ 7048/ 7051 51065007052/ 7065/ 7066/ 7088/ 7089 51065009045/ 9047/ 9048/ 9052/ 9066
	95-	PA1298			For vehicles without retarder, w/o pulley; Impeller Ø 135mm, Incl Eletronic fuel Injection pump	51065006408/ 6492/ 9492





			
<p>PA1298</p>	<p>PA1301</p>	<p>PA1302</p>	<p>PA1319</p>
			
<p>PA1321</p>	<p>PA1330</p>	<p>PA1336</p>	

		GRAF ref.		NOTE	Adaptable for OES
35.463 (338 kW) Eng.D2876LF02 35.464 (338 kW) Eng.D2876LF03	95-	PA1301		For vehicles with retarder; w/o pulley; Injection Pump with electronic control unit	51065006479/ 9479
	95-	PA1302		For vehicles with retarder, w/o pulley	51065006426/ 6490/ 9426/ 9490
	95-	PA1319		For vehicles with retarder, w pulley	51065006546/ 9546
	95-	PA1321		For vehicles without retarder, w pulley	51065006545/ 6547/ 9545/ 9547
	95-	PA1330	•		51065000298,51065006066/ 7033/ 7036 51065007043/ 7045/ 7047/ 7048/ 7051 51065007052/ 7065/ 7066/ 7088/ 7089 51065009045/ 9047/ 9048/ 9052/ 9066
37.414 (301 kW) Eng.D2866LF25	98-	PA1298		For vehicles without retarder, w/o pulley; Impeller Ø 135mm, Incl Eletronic fuel Injection pump	51065006408/ 6492/ 9492
	98-	PA1301		For vehicles with retarder; w/o pulley; Injection Pump with electronic control unit	51065006479/ 9479
	98-	PA1302		For vehicles with retarder, w/o pulley	51065006426/ 6490/ 9426/ 9490
	98-	PA1319		For vehicles with retarder, w pulley	51065006546/ 9546
	98-	PA1321		For vehicles without retarder, w pulley	51065006545/ 6547/ 9545/ 9547
	98-	PA1330	•		51065000298,51065006066/ 7033/ 7036 51065007043/ 7045/ 7047/ 7048/ 7051 51065007052/ 7065/ 7066/ 7088/ 7089 51065009045/ 9047/ 9048/ 9052/ 9066
37.464 (338 kW) Eng.D2876LF03	98-	PA1298		For vehicles without retarder, w/o pulley; Impeller Ø 135mm, Incl Eletronic fuel Injection pump	51065006408/ 6492/ 9492
	98-	PA1301		For vehicles with retarder; w/o pulley; Injection Pump with electronic control unit	51065006479/ 9479
	98-	PA1302		For vehicles with retarder, w/o pulley	51065006426/ 6490/ 9426/ 9490
	98-	PA1319		For vehicles with retarder, w pulley	51065006546/ 9546
	98-	PA1321		For vehicles without retarder, w pulley	51065006545/ 6547/ 9545/ 9547
	98-	PA1330	•		51065000298,51065006066/ 7033/ 7036 51065007043/ 7045/ 7047/ 7048/ 7051 51065007052/ 7065/ 7066/ 7088/ 7089 51065009045/ 9047/ 9048/ 9052/ 9066
40.273 (198 kW) Eng.D2865LF22	94-	PA1298		For vehicles without retarder, w/o pulley; Impeller Ø 135mm, Incl Eletronic fuel Injection pump	51065006408/ 6492/ 9492
	94-	PA1301		For vehicles with retarder; w/o pulley; Injection Pump with electronic control unit	51065006479/ 9479
	94-	PA1302		For vehicles with retarder, w/o pulley	51065006426/ 6490/ 9426/ 9490
	94-	PA1319		For vehicles with retarder, w pulley	51065006546/ 9546
	94-	PA1321		For vehicles without retarder, w pulley	51065006545/ 6547/ 9545/ 9547
	94-	PA1336		w/ Pulley	51065006548/ 9548
40.403 (294 kW) Eng.D2866LF20	94-	PA1298		For vehicles without retarder, w/o pulley; Impeller Ø 135mm, Incl Eletronic fuel Injection pump	51065006408/ 6492/ 9492
	94-	PA1301		For vehicles with retarder; w/o pulley; Injection Pump with electronic control unit	51065006479/ 9479
	94-	PA1302		For vehicles with retarder, w/o pulley	51065006426/ 6490/ 9426/ 9490
	94-	PA1319		For vehicles with retarder, w pulley	51065006546/ 9546
	94-	PA1321		For vehicles without retarder, w pulley	51065006545/ 6547/ 9545/ 9547
	94-	PA1330	•		51065000298,51065006066/ 7033/ 7036 51065007043/ 7045/ 7047/ 7048/ 7051 51065007052/ 7065/ 7066/ 7088/ 7089 51065009045/ 9047/ 9048/ 9052/ 9066
40.463 (338 kW) Eng.D2876LF01	94-	PA1298		For vehicles without retarder, w/o pulley; Impeller Ø 135mm, Incl Eletronic fuel Injection pump	51065006408/ 6492/ 9492
	94-	PA1301		For vehicles with retarder; w/o pulley; Injection Pump with electronic control unit	51065006479/ 9479
	94-	PA1302		For vehicles with retarder, w/o pulley	51065006426/ 6490/ 9426/ 9490
	94-	PA1319		For vehicles with retarder, w pulley	51065006546/ 9546
	94-	PA1321		For vehicles without retarder, w pulley	51065006545/ 6547/ 9545/ 9547
	94-	PA1330	•		51065000298,51065006066/ 7033/ 7036 51065007043/ 7045/ 7047/ 7048/ 7051 51065007052/ 7065/ 7066/ 7088/ 7089 51065009045/ 9047/ 9048/ 9052/ 9066
41.343 (250 kW) Eng.D2865LF21	95-	PA1298		For vehicles without retarder, w/o pulley; Impeller Ø 135mm, Incl Eletronic fuel Injection pump	51065006408/ 6492/ 9492
	95-	PA1301		For vehicles with retarder; w/o pulley; Injection Pump with electronic control unit	51065006479/ 9479
	95-	PA1302		For vehicles with retarder, w/o pulley	51065006426/ 6490/ 9426/ 9490
	95-	PA1319		For vehicles with retarder, w pulley	51065006546/ 9546
	95-	PA1321		For vehicles without retarder, w pulley	51065006545/ 6547/ 9545/ 9547
	95-	PA1336		w/ Pulley	51065006548/ 9548
41.403 (294 kW) Eng.D2866LF20	95-	PA1298		For vehicles without retarder, w/o pulley; Impeller Ø 135mm, Incl Eletronic fuel Injection pump	51065006408/ 6492/ 9492

			
<p>PA1292</p>	<p>PA1294</p>	<p>PA1298</p>	<p>PA1301</p>
			
<p>PA1302</p>	<p>PA1319</p>	<p>PA1321</p>	<p>PA1330</p>
			
<p>PA1336</p>			

		GRAF ref.			NOTE	Adaptable for OES
41.403 (294 kW) Eng.D2866LF20	95-	PA1301			For vehicles with retarder; w/o pulley; Injection Pump with electronic control unit	51065006479/ 9479
	95-	PA1302			For vehicles with retarder, w/o pulley	51065006426/ 6490/ 9426/ 9490
	95-	PA1319			For vehicles with retarder, w pulley	51065006546/ 9546
	95-	PA1321			For vehicles without retarder, w pulley	51065006545/ 6547/ 9545/ 9547
	95-	PA1330		•		51065000298,51065006066/ 7033/ 7036 51065007043/ 7045/ 7047/ 7048/ 7051 51065007052/ 7065/ 7066/ 7088/ 7089 51065009045/ 9047/ 9048/ 9052/ 9066
41.463 (338 kW) Eng.D2876LF02 41.464 (338 kW) Eng.D2876LF06	95-	PA1298			For vehicles without retarder, w/o pulley; Impeller Ø 135mm, Incl Eletronic fuel Injection pump	51065006408/ 6492/ 9492
	95-	PA1301			For vehicles with retarder; w/o pulley; Injection Pump with electronic control unit	51065006479/ 9479
	95-	PA1302			For vehicles with retarder, w/o pulley	51065006426/ 6490/ 9426/ 9490
	95-	PA1319			For vehicles with retarder, w pulley	51065006546/ 9546
	95-	PA1321			For vehicles without retarder, w pulley	51065006545/ 6547/ 9545/ 9547
	95-	PA1330		•		51065000298,51065006066/ 7033/ 7036 51065007043/ 7045/ 7047/ 7048/ 7051 51065007052/ 7065/ 7066/ 7088/ 7089 51065009045/ 9047/ 9048/ 9052/ 9066
F 9 '1/83-'12/86						
15.192 (141 kW) Eng.D2565MF	83-86	PA1292			For vehicles without retarder	51065006204/ 6213/ 6214/ 6215/ 6216/ 6218 51065006219/ 6221/ 6222/ 6223/ 6224/ 6225 51065006228/ 6229/ 9228
F 90 '1/87-'6/96						
18.3 (245-268 kW) Eng.D2840ME/MF/MH	80-96	PA1298			For vehicles without retarder, w/o pulley; Impeller Ø 135mm, Incl Eletronic fuel Injection pump	51065006408/ 6492/ 9492
	80-96	PA1302			For vehicles with retarder, w/o pulley	51065006426/ 6490/ 9426/ 9490
19.242 (177 kW) Eng.D2866F/240	88-89	PA1294			For vehicles without retarder; Impeller Ø 125mm	51065006282/ 6387/ 9282/ 9387
	88-89	PA1298			For vehicles without retarder, w/o pulley; Impeller Ø 135mm, Incl Eletronic fuel Injection pump	51065006408/ 6492/ 9492
	88-89	PA1301			For vehicles with retarder; w/o pulley; Injection Pump with electronic control unit	51065006479/ 9479
	88-89	PA1302			For vehicles with retarder, w/o pulley	51065006426/ 6490/ 9426/ 9490
	88-89	PA1319			For vehicles with retarder, w pulley	51065006546/ 9546
	88-89	PA1321			For vehicles without retarder, w pulley	51065006545/ 6547/ 9545/ 9547
19.262 (191 kW) Eng.D2865LF/260	89-90	PA1298			For vehicles without retarder, w/o pulley; Impeller Ø 135mm, Incl Eletronic fuel Injection pump	51065006408/ 6492/ 9492
	89-90	PA1301			For vehicles with retarder; w/o pulley; Injection Pump with electronic control unit	51065006479/ 9479
	89-90	PA1302			For vehicles with retarder, w/o pulley	51065006426/ 6490/ 9426/ 9490
	89-90	PA1319			For vehicles with retarder, w pulley	51065006546/ 9546
	89-90	PA1321			For vehicles without retarder, w pulley	51065006545/ 6547/ 9545/ 9547
	89-90	PA1336			w/ Pulley	51065006548/ 9548
19.272 (198 kW) Eng.D2865LF02	90-95	PA1298			For vehicles without retarder, w/o pulley; Impeller Ø 135mm, Incl Eletronic fuel Injection pump	51065006408/ 6492/ 9492
	90-95	PA1301			For vehicles with retarder; w/o pulley; Injection Pump with electronic control unit	51065006479/ 9479
	90-95	PA1302			For vehicles with retarder, w/o pulley	51065006426/ 6490/ 9426/ 9490
	90-95	PA1319			For vehicles with retarder, w pulley	51065006546/ 9546
	90-95	PA1321			For vehicles without retarder, w pulley	51065006545/ 6547/ 9545/ 9547
	90-95	PA1336			w/ Pulley	51065006548/ 9548
19.272 (198 kW) Eng.D2865LF05	86-90	PA1298			For vehicles without retarder, w/o pulley; Impeller Ø 135mm, Incl Eletronic fuel Injection pump	51065006408/ 6492/ 9492
	90-95	PA1301			For vehicles with retarder; w/o pulley; Injection Pump with electronic control unit	51065006479/ 9479
	90-95	PA1302			For vehicles with retarder, w/o pulley	51065006426/ 6490/ 9426/ 9490
	90-95	PA1319			For vehicles with retarder, w pulley	51065006546/ 9546
	90-95	PA1321			For vehicles without retarder, w pulley	51065006545/ 6547/ 9545/ 9547
	90-95	PA1336			w/ Pulley	51065006548/ 9548
19.292 (213 kW) Eng.D2866LF/290	86-90	PA1294			For vehicles without retarder; Impeller Ø 125mm	51065006282/ 6387/ 9282/ 9387
	90-96	PA1298			For vehicles without retarder, w/o pulley; Impeller Ø 135mm, Incl Eletronic fuel Injection pump	51065006408/ 6492/ 9492
	86-90	PA1301			For vehicles with retarder; w/o pulley; Injection Pump with electronic control unit	51065006479/ 9479
	86-90	PA1302			For vehicles with retarder, w/o pulley	51065006426/ 6490/ 9426/ 9490
	86-90	PA1319			For vehicles with retarder, w pulley	51065006546/ 9546
	86-90	PA1321			For vehicles without retarder, w pulley	51065006545/ 6547/ 9545/ 9547

			
<p>PA1294</p>	<p>PA1298</p>	<p>PA1301</p>	<p>PA1302</p>
			
<p>PA1319</p>	<p>PA1321</p>	<p>PA1336</p>	

		GRAF ref.			NOTE	Adaptable for OES
19.292 (213 kW) Eng.D2866LF/290	86-90	PA1336			w/ Pulley	51065006548/ 9548
19.322 (235 kW) Eng.D2865LF03/LF06	90-96	PA1298			For vehicles without retarder, w/o pulley; Impeller Ø 135mm, Incl Eletronic fuel Injection pump	51065006408/ 6492/ 9492
	90-96	PA1301			For vehicles with retarder; w/o pulley; Injection Pump with electronic control unit	51065006479/ 9479
	90-96	PA1302			For vehicles with retarder, w/o pulley	51065006426/ 6490/ 9426/ 9490
	90-96	PA1319			For vehicles with retarder, w pulley	51065006546/ 9546
	90-96	PA1321			For vehicles without retarder, w pulley	51065006545/ 6547/ 9545/ 9547
	90-96	PA1336			w/ Pulley	51065006548/ 9548
19.332 (243 kW) Eng.D2866LF/330	86-90	PA1294			For vehicles without retarder; Impeller Ø 125mm	51065006282/ 6387/ 9282/ 9387
	86-90	PA1298			For vehicles without retarder, w/o pulley; Impeller Ø 135mm, Incl Eletronic fuel Injection pump	51065006408/ 6492/ 9492
	86-90	PA1301			For vehicles with retarder; w/o pulley; Injection Pump with electronic control unit	51065006479/ 9479
	86-90	PA1302			For vehicles with retarder, w/o pulley	51065006426/ 6490/ 9426/ 9490
	86-90	PA1319			For vehicles with retarder, w pulley	51065006546/ 9546
	94-96	PA1321			For vehicles without retarder, w pulley	51065006545/ 6547/ 9545/ 9547
	86-90	PA1336			w/ Pulley	51065006548/ 9548
19.342 (250-213 kW) Eng.D2865LF09	94-96	PA1298			For vehicles without retarder, w/o pulley; Impeller Ø 135mm, Incl Eletronic fuel Injection pump	51065006408/ 6492/ 9492
	94-96	PA1301			For vehicles with retarder; w/o pulley; Injection Pump with electronic control unit	51065006479/ 9479
	94-96	PA1302			For vehicles with retarder, w/o pulley	51065006426/ 6490/ 9426/ 9490
	94-96	PA1319			For vehicles with retarder, w pulley	51065006546/ 9546
	86-90	PA1321			For vehicles without retarder, w pulley	51065006545/ 6547/ 9545/ 9547
	94-96	PA1336			w/ Pulley	51065006548/ 9548
19.362 (265 kW) Eng.D2866KF/LXF	86-90	PA1294			For vehicles without retarder; Impeller Ø 125mm	51065006282/ 6387/ 9282/ 9387
	86-90	PA1298			For vehicles without retarder, w/o pulley; Impeller Ø 135mm, Incl Eletronic fuel Injection pump	51065006408/ 6492/ 9492
	86-90	PA1301			For vehicles with retarder; w/o pulley; Injection Pump with electronic control unit	51065006479/ 9479
	86-90	PA1302			For vehicles with retarder, w/o pulley	51065006426/ 6490/ 9426/ 9490
	86-90	PA1319			For vehicles with retarder, w pulley	51065006546/ 9546
	94-96	PA1321			For vehicles without retarder, w pulley	51065006545/ 6547/ 9545/ 9547
	86-90	PA1336			w/ Pulley	51065006548/ 9548
19.372 (249-265 kW) Eng.D2866LXF	90-95	PA1294			For vehicles without retarder; Impeller Ø 125mm	51065006282/ 6387/ 9282/ 9387
	90-95	PA1298			For vehicles without retarder, w/o pulley; Impeller Ø 135mm, Incl Eletronic fuel Injection pump	51065006408/ 6492/ 9492
	90-95	PA1301			For vehicles with retarder; w/o pulley; Injection Pump with electronic control unit	51065006479/ 9479
	90-95	PA1302			For vehicles with retarder, w/o pulley	51065006426/ 6490/ 9426/ 9490
	90-95	PA1319			For vehicles with retarder, w pulley	51065006546/ 9546
	90-95	PA1321			For vehicles without retarder, w pulley	51065006545/ 6547/ 9545/ 9547
	90-95	PA1336			w/ Pulley	51065006548/ 9548
19.372 (272 kW) Eng.D2866LF03	90-96	PA1294			For vehicles without retarder; Impeller Ø 125mm	51065006282/ 6387/ 9282/ 9387
	90-96	PA1298			For vehicles without retarder, w/o pulley; Impeller Ø 135mm, Incl Eletronic fuel Injection pump	51065006408/ 6492/ 9492
	90-96	PA1301			For vehicles with retarder; w/o pulley; Injection Pump with electronic control unit	51065006479/ 9479
	90-96	PA1302			For vehicles with retarder, w/o pulley	51065006426/ 6490/ 9426/ 9490
	90-96	PA1319			For vehicles with retarder, w pulley	51065006546/ 9546
	90-96	PA1321			For vehicles without retarder, w pulley	51065006545/ 6547/ 9545/ 9547
	90-96	PA1336			w/ Pulley	51065006548/ 9548
19.372 (272 kW) Eng.D2866LF05	90-96	PA1294			For vehicles without retarder; Impeller Ø 125mm	51065006282/ 6387/ 9282/ 9387
	90-96	PA1298			For vehicles without retarder, w/o pulley; Impeller Ø 135mm, Incl Eletronic fuel Injection pump	51065006408/ 6492/ 9492
	90-96	PA1301			For vehicles with retarder; w/o pulley; Injection Pump with electronic control unit	51065006479/ 9479
	90-96	PA1302			For vehicles with retarder, w/o pulley	51065006426/ 6490/ 9426/ 9490
	90-96	PA1319			For vehicles with retarder, w pulley	51065006546/ 9546
	90-96	PA1321			For vehicles without retarder, w pulley	51065006545/ 6547/ 9545/ 9547
	90-96	PA1336			w/ Pulley	51065006548/ 9548
19.372 (272 kW) Eng.D2866LF15	90-96	PA1294			For vehicles without retarder; Impeller Ø 125mm	51065006282/ 6387/ 9282/ 9387
	94-96	PA1298			For vehicles without retarder, w/o pulley; Impeller Ø 135mm, Incl Eletronic fuel Injection pump	51065006408/ 6492/ 9492
	90-96	PA1301			For vehicles with retarder; w/o pulley; Injection Pump with electronic control unit	51065006479/ 9479
	90-96	PA1302			For vehicles with retarder, w/o pulley	51065006426/ 6490/ 9426/ 9490
	90-96	PA1319			For vehicles with retarder, w pulley	51065006546/ 9546

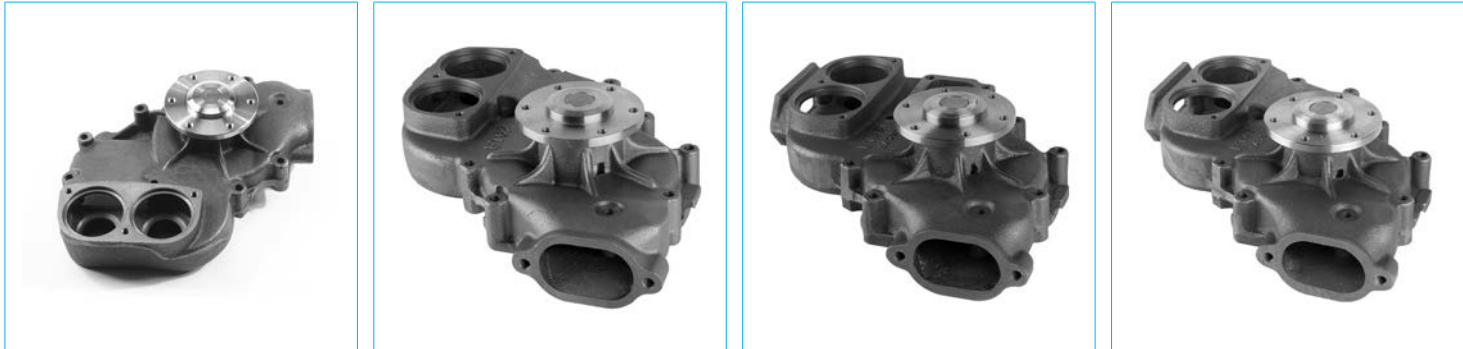

PA1294

PA1298

PA1301

PA1302



PA1319



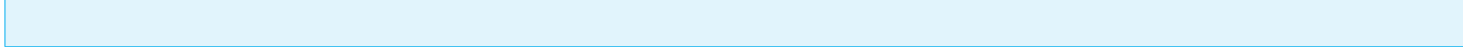
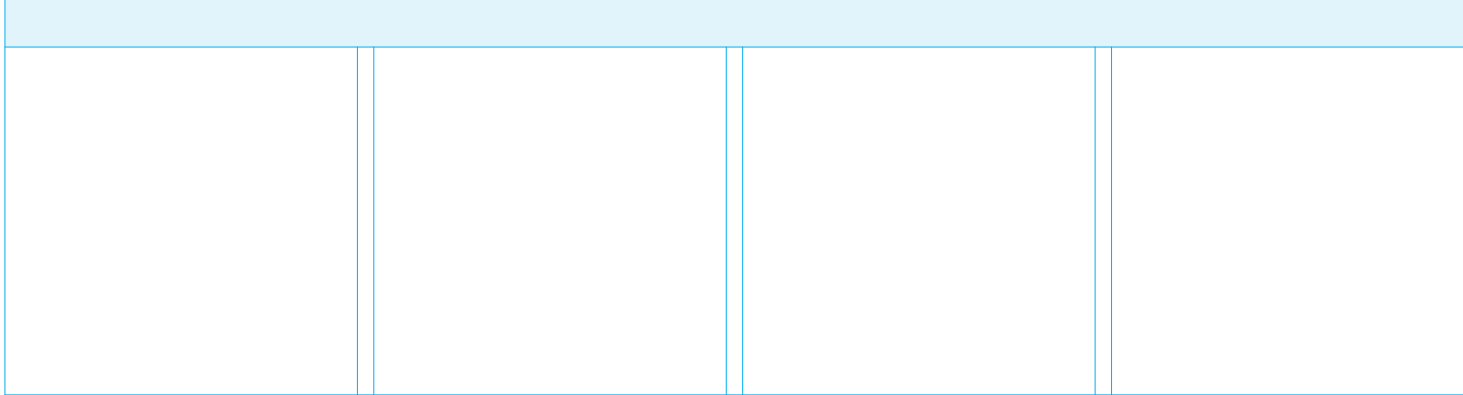
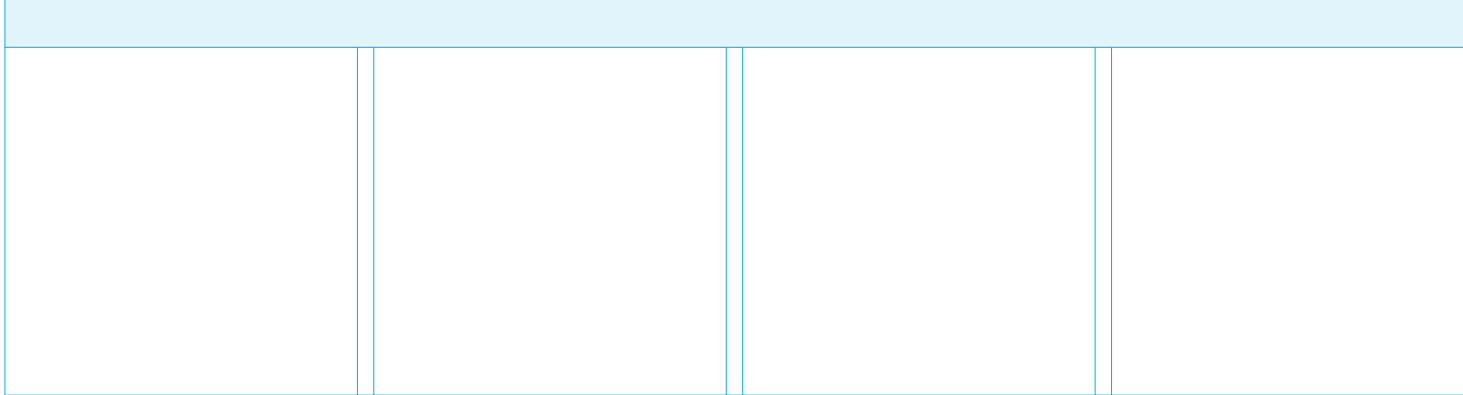
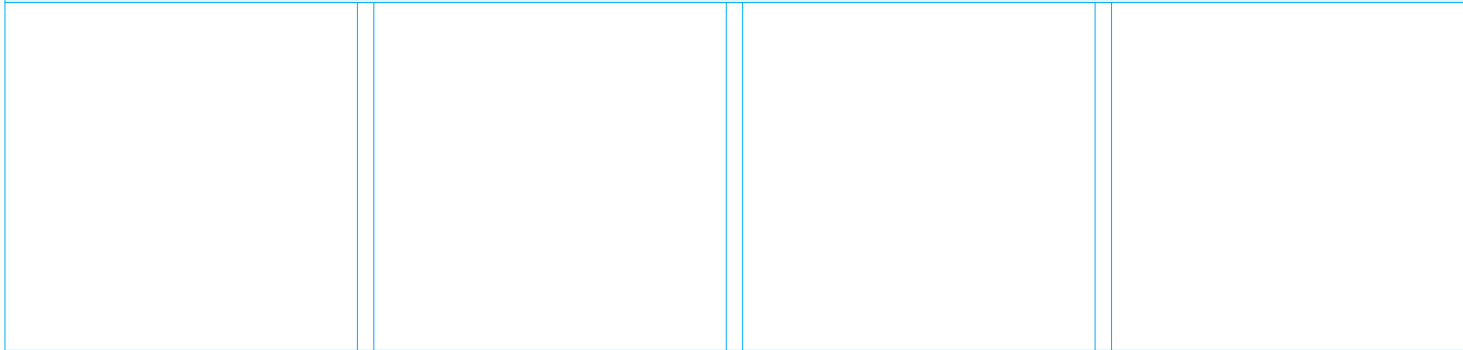

PA1321

PA1336



		GRAF ref.			NOTE	Adaptable for OES
19.372 (272 kW) Eng.D2866LF15	90-96	PA1321			For vehicles without retarder, w pulley	51065006545/ 6547/ 9545/ 9547
	90-96	PA1336			w/ Pulley	51065006548/ 9548
19.402 (294 kW) Eng.D2866LF16	90-96	PA1294			For vehicles without retarder; Impeller Ø 125mm	51065006282/ 6387/ 9282/ 9387
	90-96	PA1298			For vehicles without retarder, w/o pulley; Impeller Ø 135mm, Incl Eletronic fuel Injection pump	51065006408/ 6492/ 9492
	94-96	PA1301			For vehicles with retarder; w/o pulley; Injection Pump with electronic control unit	51065006479/ 9479
	94-96	PA1302			For vehicles with retarder, w/o pulley	51065006426/ 6490/ 9426/ 9490
	94-96	PA1319			For vehicles with retarder, w pulley	51065006546/ 9546
	94-96	PA1321			For vehicles without retarder, w pulley	51065006545/ 6547/ 9545/ 9547
	94-96	PA1336			w/ Pulley	51065006548/ 9548
19.422 (309 kW) Eng.D2866LF06/LF09	90-96	PA1294			For vehicles without retarder; Impeller Ø 125mm	51065006282/ 6387/ 9282/ 9387
	90-96	PA1298			For vehicles without retarder, w/o pulley; Impeller Ø 135mm, Incl Eletronic fuel Injection pump	51065006408/ 6492/ 9492
	90-96	PA1301			For vehicles with retarder; w/o pulley; Injection Pump with electronic control unit	51065006479/ 9479
	90-96	PA1302			For vehicles with retarder, w/o pulley	51065006426/ 6490/ 9426/ 9490
	90-96	PA1319			For vehicles with retarder, w pulley	51065006546/ 9546
	90-96	PA1321			For vehicles without retarder, w pulley	51065006545/ 6547/ 9545/ 9547
	90-96	PA1336			w/ Pulley	51065006548/ 9548
19.422 (309 kW) Eng.D2866LF10	90-95	PA1294			For vehicles without retarder; Impeller Ø 125mm	51065006282/ 6387/ 9282/ 9387
	87-90	PA1298			For vehicles without retarder, w/o pulley; Impeller Ø 135mm, Incl Eletronic fuel Injection pump	51065006408/ 6492/ 9492
	90-95	PA1301			For vehicles with retarder; w/o pulley; Injection Pump with electronic control unit	51065006479/ 9479
	90-95	PA1302			For vehicles with retarder, w/o pulley	51065006426/ 6490/ 9426/ 9490
	90-95	PA1319			For vehicles with retarder, w pulley	51065006546/ 9546
	90-95	PA1321			For vehicles without retarder, w pulley	51065006545/ 6547/ 9545/ 9547
	90-95	PA1336			w/ Pulley	51065006548/ 9548
19.462 (338-382 kW) Eng.D2840LF/460	90-96	PA1298			For vehicles without retarder, w/o pulley; Impeller Ø 135mm, Incl Eletronic fuel Injection pump	51065006408/ 6492/ 9492
	87-90	PA1302			For vehicles with retarder, w/o pulley	51065006426/ 6490/ 9426/ 9490
19.502 (368 kW) Eng.D2840LF01	90-96	PA1298			For vehicles without retarder, w/o pulley; Impeller Ø 135mm, Incl Eletronic fuel Injection pump	51065006408/ 6492/ 9492
	90-96	PA1302			For vehicles with retarder, w/o pulley	51065006426/ 6490/ 9426/ 9490
19.502 (368 kW) Eng.D2840LF04/LF06	90-96	PA1298			For vehicles without retarder, w/o pulley; Impeller Ø 135mm, Incl Eletronic fuel Injection pump	51065006408/ 6492/ 9492
	90-96	PA1302			For vehicles with retarder, w/o pulley	51065006426/ 6490/ 9426/ 9490
21.9 T. (530-735 kW) Eng.D2840LF/LFX	90-96	PA1298			For vehicles without retarder, w/o pulley; Impeller Ø 135mm, Incl Eletronic fuel Injection pump	51065006408/ 6492/ 9492
	90-96	PA1302			For vehicles with retarder, w/o pulley	51065006426/ 6490/ 9426/ 9490
24.242 (177 kW) Eng.D2866F/240	88-90	PA1294			For vehicles without retarder; Impeller Ø 125mm	51065006282/ 6387/ 9282/ 9387
	88-90	PA1298			For vehicles without retarder, w/o pulley; Impeller Ø 135mm, Incl Eletronic fuel Injection pump	51065006408/ 6492/ 9492
	88-90	PA1301			For vehicles with retarder; w/o pulley; Injection Pump with electronic control unit	51065006479/ 9479
	88-90	PA1302			For vehicles with retarder, w/o pulley	51065006426/ 6490/ 9426/ 9490
	88-90	PA1319			For vehicles with retarder, w pulley	51065006546/ 9546
	88-90	PA1321			For vehicles without retarder, w pulley	51065006545/ 6547/ 9545/ 9547
24.262 (191 kW) Eng.D2865LF/260	88-90	PA1298			For vehicles without retarder, w/o pulley; Impeller Ø 135mm, Incl Eletronic fuel Injection pump	51065006408/ 6492/ 9492
	88-90	PA1301			For vehicles with retarder; w/o pulley; Injection Pump with electronic control unit	51065006479/ 9479
	88-90	PA1302			For vehicles with retarder, w/o pulley	51065006426/ 6490/ 9426/ 9490
	88-90	PA1319			For vehicles with retarder, w pulley	51065006546/ 9546
	88-90	PA1321			For vehicles without retarder, w pulley	51065006545/ 6547/ 9545/ 9547
	88-90	PA1336			w/ Pulley	51065006548/ 9548
24.272 (198 kW) Eng.D2865LF02/LF05	90-95	PA1298			For vehicles without retarder, w/o pulley; Impeller Ø 135mm, Incl Eletronic fuel Injection pump	51065006408/ 6492/ 9492
	90-95	PA1301			For vehicles with retarder; w/o pulley; Injection Pump with electronic control unit	51065006479/ 9479
	90-95	PA1302			For vehicles with retarder, w/o pulley	51065006426/ 6490/ 9426/ 9490
	90-95	PA1319			For vehicles with retarder, w pulley	51065006546/ 9546
	90-95	PA1321			For vehicles without retarder, w pulley	51065006545/ 6547/ 9545/ 9547
	90-95	PA1336			w/ Pulley	51065006548/ 9548
24.292 (213 kW) Eng.D2866LF/290	86-90	PA1294			For vehicles without retarder; Impeller Ø 125mm	51065006282/ 6387/ 9282/ 9387
	86-90	PA1298			For vehicles without retarder, w/o pulley; Impeller Ø 135mm, Incl Eletronic fuel Injection pump	51065006408/ 6492/ 9492

			
<p>PA1294</p>	<p>PA1298</p>	<p>PA1301</p>	<p>PA1302</p>
			
<p>PA1319</p>	<p>PA1321</p>	<p>PA1336</p>	

		GRAF ref.	 	NOTE	Adaptable for OES
24.292 (213 kW) Eng.D2866LF/290	86-90	PA1301		For vehicles with retarder; w/o pulley; Injection Pump with electronic control unit	51065006479/ 9479
	86-90	PA1302		For vehicles with retarder, w/o pulley	51065006426/ 6490/ 9426/ 9490
	86-90	PA1319		For vehicles with retarder, w pulley	51065006546/ 9546
	86-90	PA1321		For vehicles without retarder, w pulley	51065006545/ 6547/ 9545/ 9547
	86-90	PA1336		w/ Pulley	51065006548/ 9548
24.302 (220 kW) Eng.D2866LF04	90-95	PA1294		For vehicles without retarder; Impeller Ø 125mm	51065006282/ 6387/ 9282/ 9387
	90-95	PA1298		For vehicles without retarder, w/o pulley; Impeller Ø 135mm, Incl Eletronic fuel Injection pump	51065006408/ 6492/ 9492
	90-95	PA1301		For vehicles with retarder; w/o pulley; Injection Pump with electronic control unit	51065006479/ 9479
	90-95	PA1302		For vehicles with retarder, w/o pulley	51065006426/ 6490/ 9426/ 9490
	90-95	PA1319		For vehicles with retarder, w pulley	51065006546/ 9546
	90-95	PA1321		For vehicles without retarder, w pulley	51065006545/ 6547/ 9545/ 9547
	90-95	PA1336		w/ Pulley	51065006548/ 9548
24.322 (235 kW) Eng.D2865LF03/LF06	90-95	PA1298		For vehicles without retarder, w/o pulley; Impeller Ø 135mm, Incl Eletronic fuel Injection pump	51065006408/ 6492/ 9492
	90-95	PA1301		For vehicles with retarder; w/o pulley; Injection Pump with electronic control unit	51065006479/ 9479
	90-95	PA1302		For vehicles with retarder, w/o pulley	51065006426/ 6490/ 9426/ 9490
	90-95	PA1319		For vehicles with retarder, w pulley	51065006546/ 9546
	90-95	PA1321		For vehicles without retarder, w pulley	51065006545/ 6547/ 9545/ 9547
	90-95	PA1336		w/ Pulley	51065006548/ 9548
24.332 (243 kW) Eng.D2866LF/330	86-90	PA1294		For vehicles without retarder; Impeller Ø 125mm	51065006282/ 6387/ 9282/ 9387
	86-90	PA1298		For vehicles without retarder, w/o pulley; Impeller Ø 135mm, Incl Eletronic fuel Injection pump	51065006408/ 6492/ 9492
	86-90	PA1301		For vehicles with retarder; w/o pulley; Injection Pump with electronic control unit	51065006479/ 9479
	86-90	PA1302		For vehicles with retarder, w/o pulley	51065006426/ 6490/ 9426/ 9490
	86-90	PA1319		For vehicles with retarder, w pulley	51065006546/ 9546
	86-90	PA1321		For vehicles without retarder, w pulley	51065006545/ 6547/ 9545/ 9547
	86-90	PA1336		w/ Pulley	51065006548/ 9548
	86-90	PA1336		w/ Pulley	51065006548/ 9548
24.342 (250-213 kW) Eng.D2865LF09	94-95	PA1298		For vehicles without retarder, w/o pulley; Impeller Ø 135mm, Incl Eletronic fuel Injection pump	51065006408/ 6492/ 9492
	94-95	PA1301		For vehicles with retarder; w/o pulley; Injection Pump with electronic control unit	51065006479/ 9479
	94-95	PA1302		For vehicles with retarder, w/o pulley	51065006426/ 6490/ 9426/ 9490
	94-95	PA1319		For vehicles with retarder, w pulley	51065006546/ 9546
	94-95	PA1321		For vehicles without retarder, w pulley	51065006545/ 6547/ 9545/ 9547
	94-95	PA1336		w/ Pulley	51065006548/ 9548
24.362 (265 kW) Eng.D2866KF/LXF	86-90	PA1294		For vehicles without retarder; Impeller Ø 125mm	51065006282/ 6387/ 9282/ 9387
	86-90	PA1298		For vehicles without retarder, w/o pulley; Impeller Ø 135mm, Incl Eletronic fuel Injection pump	51065006408/ 6492/ 9492
	86-90	PA1301		For vehicles with retarder; w/o pulley; Injection Pump with electronic control unit	51065006479/ 9479
	86-90	PA1302		For vehicles with retarder, w/o pulley	51065006426/ 6490/ 9426/ 9490
	86-90	PA1319		For vehicles with retarder, w pulley	51065006546/ 9546
	86-90	PA1321		For vehicles without retarder, w pulley	51065006545/ 6547/ 9545/ 9547
	86-90	PA1336		w/ Pulley	51065006548/ 9548
	86-90	PA1336		w/ Pulley	51065006548/ 9548
24.372 (249-265 kW) Eng.D2866LXF	05/90-12/90	PA1294		For vehicles without retarder; Impeller Ø 125mm	51065006282/ 6387/ 9282/ 9387
	05/90-12/90	PA1298		For vehicles without retarder, w/o pulley; Impeller Ø 135mm, Incl Eletronic fuel Injection pump	51065006408/ 6492/ 9492
	86-90	PA1301		For vehicles with retarder; w/o pulley; Injection Pump with electronic control unit	51065006479/ 9479
	05/90-12/90	PA1302		For vehicles with retarder, w/o pulley	51065006426/ 6490/ 9426/ 9490
	05/90-12/90	PA1319		For vehicles with retarder, w pulley	51065006546/ 9546
	05/90-12/90	PA1321		For vehicles without retarder, w pulley	51065006545/ 6547/ 9545/ 9547
	05/90-12/90	PA1336		w/ Pulley	51065006548/ 9548
	05/90-12/90	PA1336		w/ Pulley	51065006548/ 9548
24.372 (272 kW) Eng.D2866LF03	90-95	PA1294		For vehicles without retarder; Impeller Ø 125mm	51065006282/ 6387/ 9282/ 9387
	90-95	PA1298		For vehicles without retarder, w/o pulley; Impeller Ø 135mm, Incl Eletronic fuel Injection pump	51065006408/ 6492/ 9492
	86-90	PA1301		For vehicles with retarder; w/o pulley; Injection Pump with electronic control unit	51065006479/ 9479
	90-95	PA1302		For vehicles with retarder, w/o pulley	51065006426/ 6490/ 9426/ 9490
	90-95	PA1319		For vehicles with retarder, w pulley	51065006546/ 9546
	90-95	PA1321		For vehicles without retarder, w pulley	51065006545/ 6547/ 9545/ 9547
	90-95	PA1336		w/ Pulley	51065006548/ 9548
	90-95	PA1336		w/ Pulley	51065006548/ 9548
24.372 (272 kW) Eng.D2866LF15	90-95	PA1294		For vehicles without retarder; Impeller Ø 125mm	51065006282/ 6387/ 9282/ 9387



PA1294

PA1298

PA1301

PA1302



PA1319

PA1321

PA1336

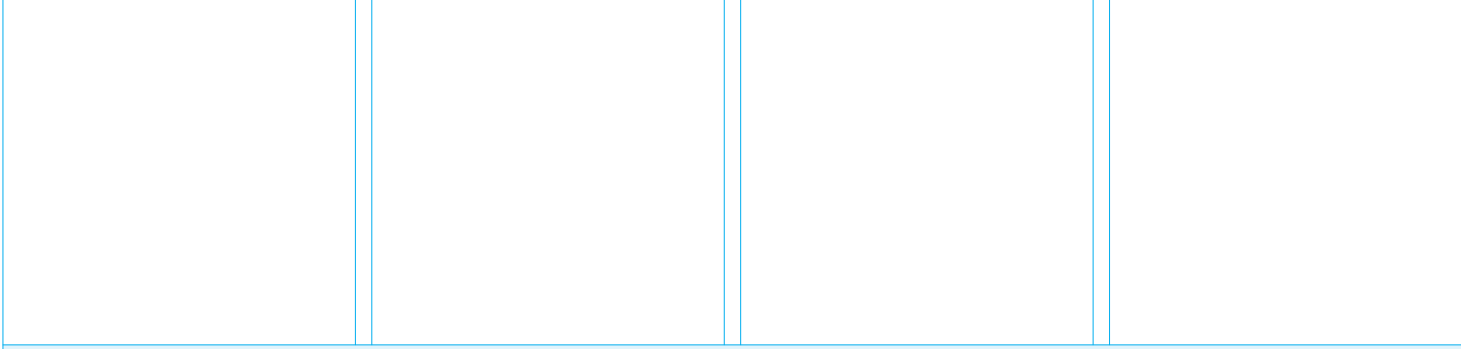
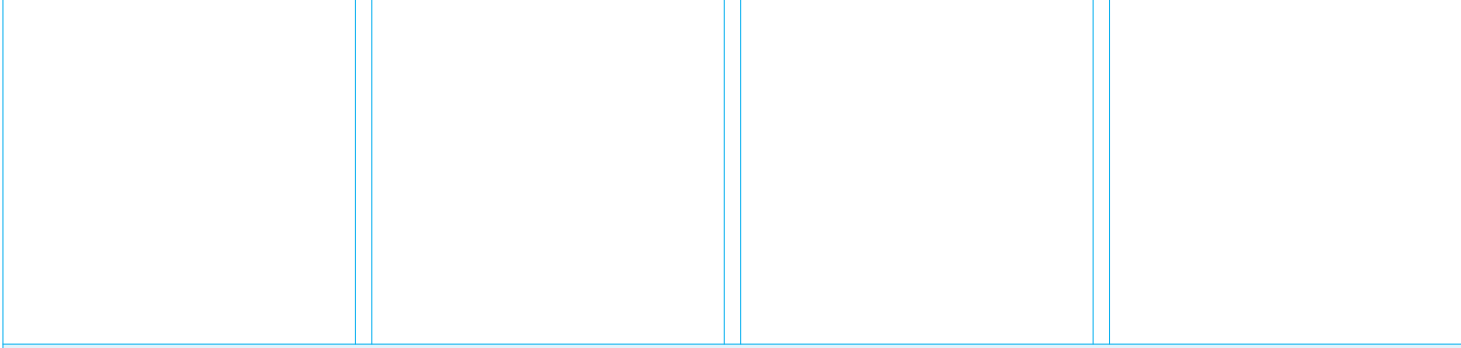
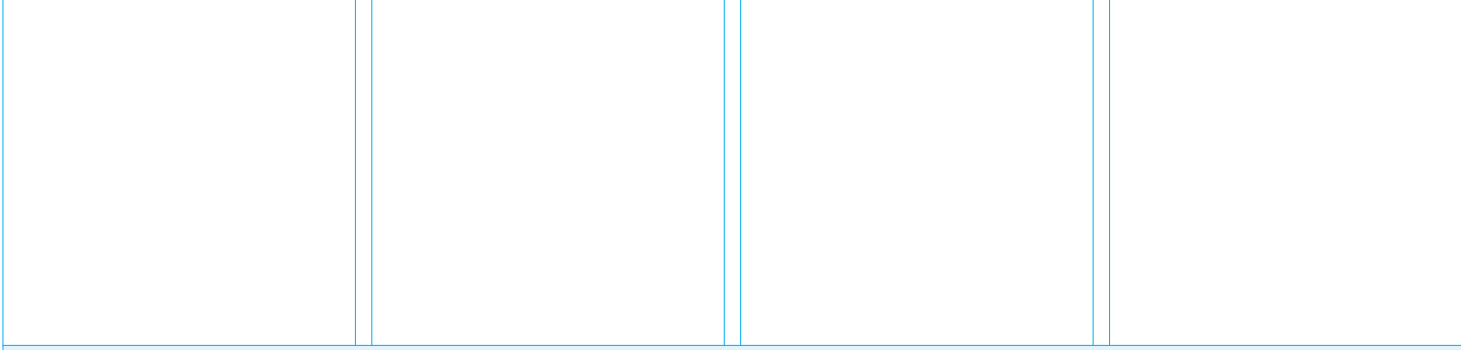

		GRAF ref.			NOTE	Adaptable for OES	
24.372 (272 kW) Eng.D2866LF15	90-95	PA1298			For vehicles without retarder, w/o pulley; Impeller Ø 135mm, Incl Eletronic fuel Injection pump	51065006408/ 6492/ 9492	
	05/90-12/90	PA1301			For vehicles with retarder; w/o pulley; Injection Pump with electronic control unit	51065006479/ 9479	
	90-95	PA1302			For vehicles with retarder, w/o pulley	51065006426/ 6490/ 9426/ 9490	
	90-95	PA1319			For vehicles with retarder, w pulley	51065006546/ 9546	
	90-95	PA1321			For vehicles without retarder, w pulley	51065006545/ 6547/ 9545/ 9547	
	90-95	PA1336			w/ Pulley	51065006548/ 9548	
24.402 (294 kW) Eng.D2866LF16	94-95	PA1294			For vehicles without retarder; Impeller Ø 125mm	51065006282/ 6387/ 9282/ 9387	
	94-95	PA1298			For vehicles without retarder, w/o pulley; Impeller Ø 135mm, Incl Eletronic fuel Injection pump	51065006408/ 6492/ 9492	
	90-95	PA1301			For vehicles with retarder; w/o pulley; Injection Pump with electronic control unit	51065006479/ 9479	
	94-95	PA1302			For vehicles with retarder, w/o pulley	51065006426/ 6490/ 9426/ 9490	
	94-95	PA1319			For vehicles with retarder, w pulley	51065006546/ 9546	
	94-95	PA1321			For vehicles without retarder, w pulley	51065006545/ 6547/ 9545/ 9547	
24.422 (309 kW) Eng.D2866LF06/LF09	90-95	PA1294			For vehicles without retarder; Impeller Ø 125mm	51065006282/ 6387/ 9282/ 9387	
	90-95	PA1298			For vehicles without retarder, w/o pulley; Impeller Ø 135mm, Incl Eletronic fuel Injection pump	51065006408/ 6492/ 9492	
	90-95	PA1301			For vehicles with retarder; w/o pulley; Injection Pump with electronic control unit	51065006479/ 9479	
	90-95	PA1302			For vehicles with retarder, w/o pulley	51065006426/ 6490/ 9426/ 9490	
	90-95	PA1319			For vehicles with retarder, w pulley	51065006546/ 9546	
	90-95	PA1321			For vehicles without retarder, w pulley	51065006545/ 6547/ 9545/ 9547	
24.462 (338-382 kW) Eng.D2840LF/460	89-90	PA1298			For vehicles without retarder, w/o pulley; Impeller Ø 135mm, Incl Eletronic fuel Injection pump	51065006408/ 6492/ 9492	
	89-90	PA1302			For vehicles with retarder, w/o pulley	51065006426/ 6490/ 9426/ 9490	
	24.502 (368 kW) Eng.D2840LF01	02/90-12/90	PA1298			For vehicles without retarder, w/o pulley; Impeller Ø 135mm, Incl Eletronic fuel Injection pump	51065006408/ 6492/ 9492
		02/90-12/90	PA1302			For vehicles with retarder, w/o pulley	51065006426/ 6490/ 9426/ 9490
	25.272 (198 kW) Eng.D2865LF02/LF05	90-93	PA1298			For vehicles without retarder, w/o pulley; Impeller Ø 135mm, Incl Eletronic fuel Injection pump	51065006408/ 6492/ 9492
		90-93	PA1301			For vehicles with retarder; w/o pulley; Injection Pump with electronic control unit	51065006479/ 9479
90-93		PA1302			For vehicles with retarder, w/o pulley	51065006426/ 6490/ 9426/ 9490	
90-93		PA1319			For vehicles with retarder, w pulley	51065006546/ 9546	
90-93		PA1321			For vehicles without retarder, w pulley	51065006545/ 6547/ 9545/ 9547	
90-93		PA1336			w/ Pulley	51065006548/ 9548	
25.302 (220 kW) Eng.D2866LF04	90-91	PA1294			For vehicles without retarder; Impeller Ø 125mm	51065006282/ 6387/ 9282/ 9387	
	90-91	PA1298			For vehicles without retarder, w/o pulley; Impeller Ø 135mm, Incl Eletronic fuel Injection pump	51065006408/ 6492/ 9492	
	90-91	PA1301			For vehicles with retarder; w/o pulley; Injection Pump with electronic control unit	51065006479/ 9479	
	90-91	PA1302			For vehicles with retarder, w/o pulley	51065006426/ 6490/ 9426/ 9490	
	90-91	PA1319			For vehicles with retarder, w pulley	51065006546/ 9546	
	90-91	PA1321			For vehicles without retarder, w pulley	51065006545/ 6547/ 9545/ 9547	
25.322 (235 kW) Eng.D2865LF03	90-92	PA1298			For vehicles without retarder, w/o pulley; Impeller Ø 135mm, Incl Eletronic fuel Injection pump	51065006408/ 6492/ 9492	
	90-92	PA1301			For vehicles with retarder; w/o pulley; Injection Pump with electronic control unit	51065006479/ 9479	
	90-92	PA1302			For vehicles with retarder, w/o pulley	51065006426/ 6490/ 9426/ 9490	
	90-92	PA1319			For vehicles with retarder, w pulley	51065006546/ 9546	
	90-92	PA1321			For vehicles without retarder, w pulley	51065006545/ 6547/ 9545/ 9547	
	90-92	PA1336			w/ Pulley	51065006548/ 9548	
25.322 (235 kW) Eng.D2865LF06	90-92	PA1298			For vehicles without retarder, w/o pulley; Impeller Ø 135mm, Incl Eletronic fuel Injection pump	51065006408/ 6492/ 9492	
	90-92	PA1301			For vehicles with retarder; w/o pulley; Injection Pump with electronic control unit	51065006479/ 9479	
	90-92	PA1302			For vehicles with retarder, w/o pulley	51065006426/ 6490/ 9426/ 9490	
	90-92	PA1319			For vehicles with retarder, w pulley	51065006546/ 9546	
	90-92	PA1321			For vehicles without retarder, w pulley	51065006545/ 6547/ 9545/ 9547	
	90-92	PA1336			w/ Pulley	51065006548/ 9548	
25.372 (249-265 kW) Eng.D2866LXF	90-93	PA1294			For vehicles without retarder; Impeller Ø 125mm	51065006282/ 6387/ 9282/ 9387	
	90-93	PA1298			For vehicles without retarder, w/o pulley; Impeller Ø 135mm, Incl Eletronic fuel Injection pump	51065006408/ 6492/ 9492	
	90-93	PA1301			For vehicles with retarder; w/o pulley; Injection Pump with electronic control unit	51065006479/ 9479	
	90-93	PA1302			For vehicles with retarder, w/o pulley	51065006426/ 6490/ 9426/ 9490	

			
<p>PA1294</p>	<p>PA1298</p>	<p>PA1301</p>	<p>PA1302</p>
			
<p>PA1319</p>	<p>PA1321</p>	<p>PA1336</p>	

		GRAF ref.			NOTE	Adaptable for OES
25.372 (249-265 kW) Eng.D2866LXF	90-93	PA1319			For vehicles with retarder, w pulley	51065006546/ 9546
	90-93	PA1321			For vehicles without retarder, w pulley	51065006545/ 6547/ 9545/ 9547
	90-93	PA1336			w/ Pulley	51065006548/ 9548
25.372 (272 kW) Eng.D2866LF03/LF05	90-93	PA1294			For vehicles without retarder; Impeller Ø 125mm	51065006282/ 6387/ 9282/ 9387
	90-93	PA1298			For vehicles without retarder, w/o pulley; Impeller Ø 135mm, Incl Eletronic fuel Injection pump	51065006408/ 6492/ 9492
	90-93	PA1301			For vehicles with retarder; w/o pulley; Injection Pump with electronic control unit	51065006479/ 9479
	90-93	PA1302			For vehicles with retarder, w/o pulley	51065006426/ 6490/ 9426/ 9490
	90-93	PA1319			For vehicles with retarder, w pulley	51065006546/ 9546
	90-93	PA1321			For vehicles without retarder, w pulley	51065006545/ 6547/ 9545/ 9547
	90-93	PA1336			w/ Pulley	51065006548/ 9548
25.422 (309 kW) Eng.D2866LF06/LF09	90-92	PA1294			For vehicles without retarder; Impeller Ø 125mm	51065006282/ 6387/ 9282/ 9387
	90-92	PA1298			For vehicles without retarder, w/o pulley; Impeller Ø 135mm, Incl Eletronic fuel Injection pump	51065006408/ 6492/ 9492
	90-92	PA1301			For vehicles with retarder; w/o pulley; Injection Pump with electronic control unit	51065006479/ 9479
	90-92	PA1302			For vehicles with retarder, w/o pulley	51065006426/ 6490/ 9426/ 9490
	90-92	PA1319			For vehicles with retarder, w pulley	51065006546/ 9546
	90-92	PA1321			For vehicles without retarder, w pulley	51065006545/ 6547/ 9545/ 9547
25.502 (368 kW) Eng.D2840LF01	90-92	PA1298			For vehicles without retarder, w/o pulley; Impeller Ø 135mm, Incl Eletronic fuel Injection pump	51065006408/ 6492/ 9492
	90-92	PA1302			For vehicles with retarder, w/o pulley	51065006426/ 6490/ 9426/ 9490
	90-92	PA1298			For vehicles without retarder, w/o pulley; Impeller Ø 135mm, Incl Eletronic fuel Injection pump	51065006408/ 6492/ 9492
25.502 (368 kW) Eng.D2840LF04	90-92	PA1298			For vehicles without retarder, w/o pulley; Impeller Ø 135mm, Incl Eletronic fuel Injection pump	51065006408/ 6492/ 9492
	90-92	PA1302			For vehicles with retarder, w/o pulley	51065006426/ 6490/ 9426/ 9490
26.242 (177 kW) Eng.D2866F/240	88-89	PA1294			For vehicles without retarder; Impeller Ø 125mm	51065006282/ 6387/ 9282/ 9387
	88-89	PA1298			For vehicles without retarder, w/o pulley; Impeller Ø 135mm, Incl Eletronic fuel Injection pump	51065006408/ 6492/ 9492
	88-89	PA1301			For vehicles with retarder; w/o pulley; Injection Pump with electronic control unit	51065006479/ 9479
	88-89	PA1302			For vehicles with retarder, w/o pulley	51065006426/ 6490/ 9426/ 9490
	88-89	PA1319			For vehicles with retarder, w pulley	51065006546/ 9546
	88-89	PA1321			For vehicles without retarder, w pulley	51065006545/ 6547/ 9545/ 9547
26.262 (191 kW) Eng.D2865LF/260	88-90	PA1298			For vehicles without retarder, w/o pulley; Impeller Ø 135mm, Incl Eletronic fuel Injection pump	51065006408/ 6492/ 9492
	88-90	PA1301			For vehicles with retarder; w/o pulley; Injection Pump with electronic control unit	51065006479/ 9479
	88-90	PA1302			For vehicles with retarder, w/o pulley	51065006426/ 6490/ 9426/ 9490
	88-90	PA1319			For vehicles with retarder, w pulley	51065006546/ 9546
	88-90	PA1321			For vehicles without retarder, w pulley	51065006545/ 6547/ 9545/ 9547
	88-90	PA1336			w/ Pulley	51065006548/ 9548
26.272 (198 kW) Eng.D2865LF02	90-96	PA1298			For vehicles without retarder, w/o pulley; Impeller Ø 135mm, Incl Eletronic fuel Injection pump	51065006408/ 6492/ 9492
	90-96	PA1301			For vehicles with retarder; w/o pulley; Injection Pump with electronic control unit	51065006479/ 9479
	90-96	PA1302			For vehicles with retarder, w/o pulley	51065006426/ 6490/ 9426/ 9490
	90-96	PA1319			For vehicles with retarder, w pulley	51065006546/ 9546
	90-96	PA1321			For vehicles without retarder, w pulley	51065006545/ 6547/ 9545/ 9547
	90-96	PA1336			w/ Pulley	51065006548/ 9548
26.272 (198 kW) Eng.D2865LF05	90-96	PA1298			For vehicles without retarder, w/o pulley; Impeller Ø 135mm, Incl Eletronic fuel Injection pump	51065006408/ 6492/ 9492
	90-96	PA1301			For vehicles with retarder; w/o pulley; Injection Pump with electronic control unit	51065006479/ 9479
	90-96	PA1302			For vehicles with retarder, w/o pulley	51065006426/ 6490/ 9426/ 9490
	90-96	PA1319			For vehicles with retarder, w pulley	51065006546/ 9546
	90-96	PA1321			For vehicles without retarder, w pulley	51065006545/ 6547/ 9545/ 9547
	90-96	PA1336			w/ Pulley	51065006548/ 9548
26.292 (213 kW) Eng.D2866LF/290	87-90	PA1294			For vehicles without retarder; Impeller Ø 125mm	51065006282/ 6387/ 9282/ 9387
	87-90	PA1298			For vehicles without retarder, w/o pulley; Impeller Ø 135mm, Incl Eletronic fuel Injection pump	51065006408/ 6492/ 9492
	87-90	PA1301			For vehicles with retarder; w/o pulley; Injection Pump with electronic control unit	51065006479/ 9479
	87-90	PA1302			For vehicles with retarder, w/o pulley	51065006426/ 6490/ 9426/ 9490
	87-90	PA1319			For vehicles with retarder, w pulley	51065006546/ 9546
	87-90	PA1321			For vehicles without retarder, w pulley	51065006545/ 6547/ 9545/ 9547
87-90	PA1336			w/ Pulley	51065006548/ 9548	

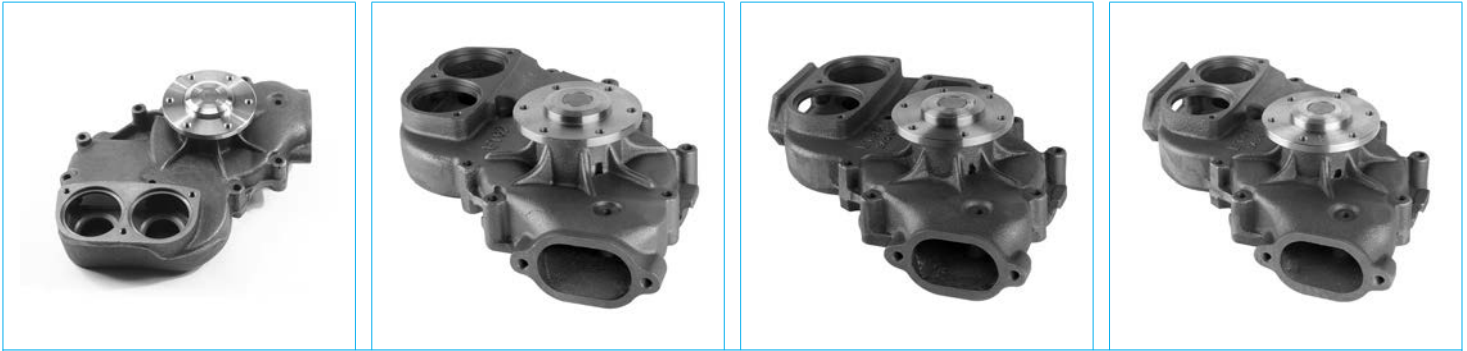

PA1294

PA1298

PA1301

PA1302

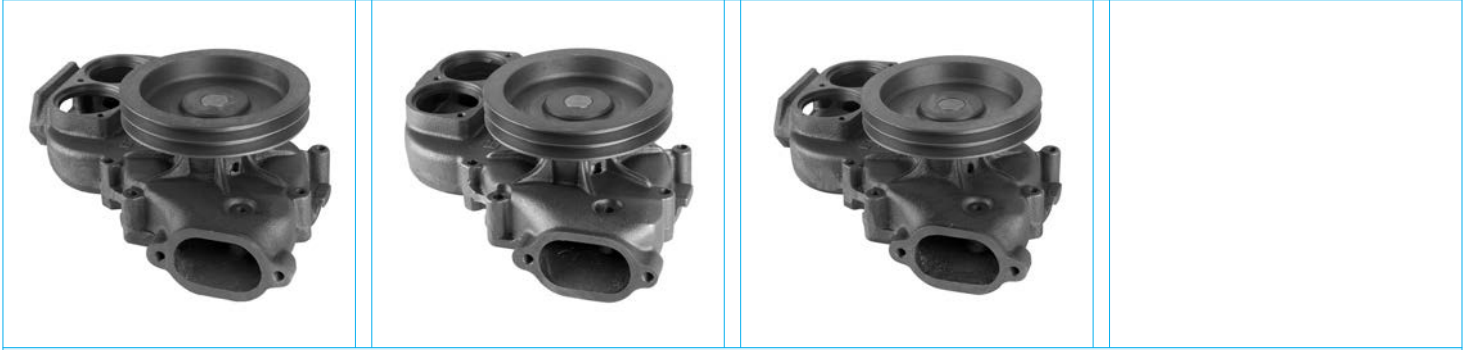



PA1319

PA1321

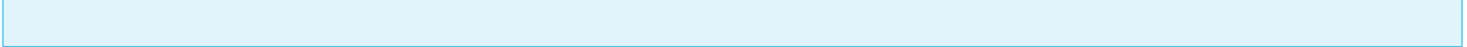
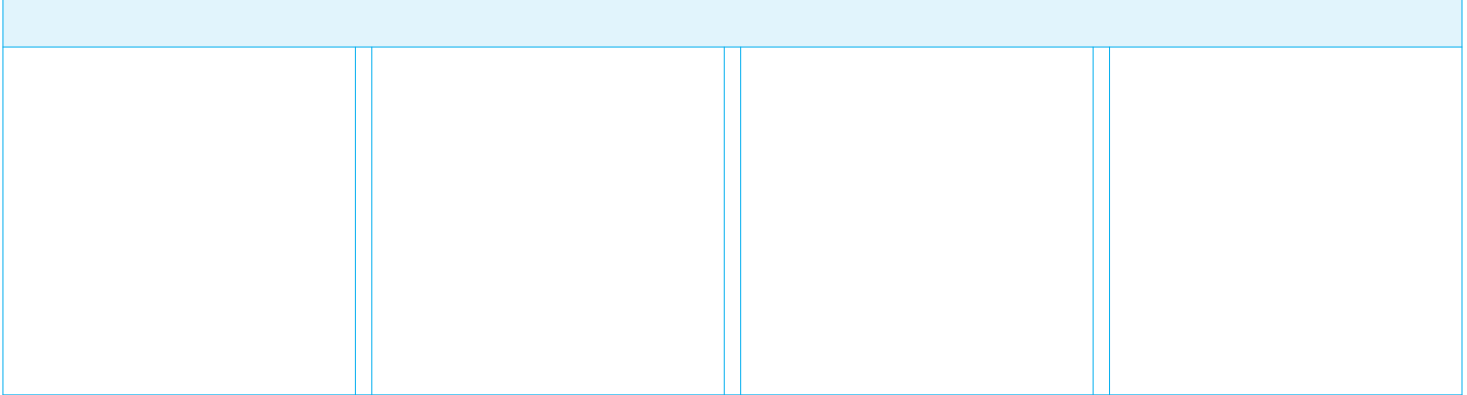
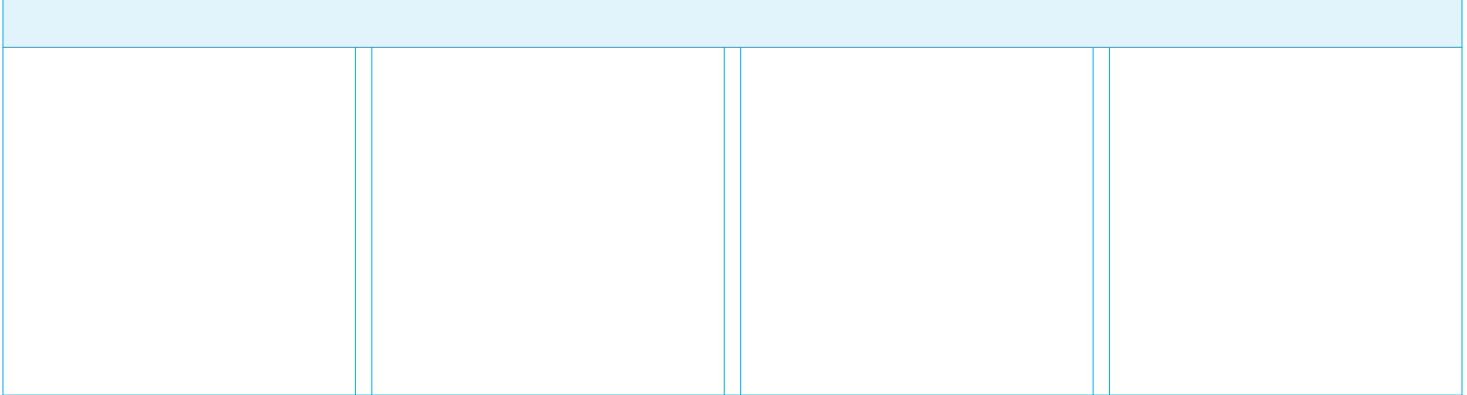
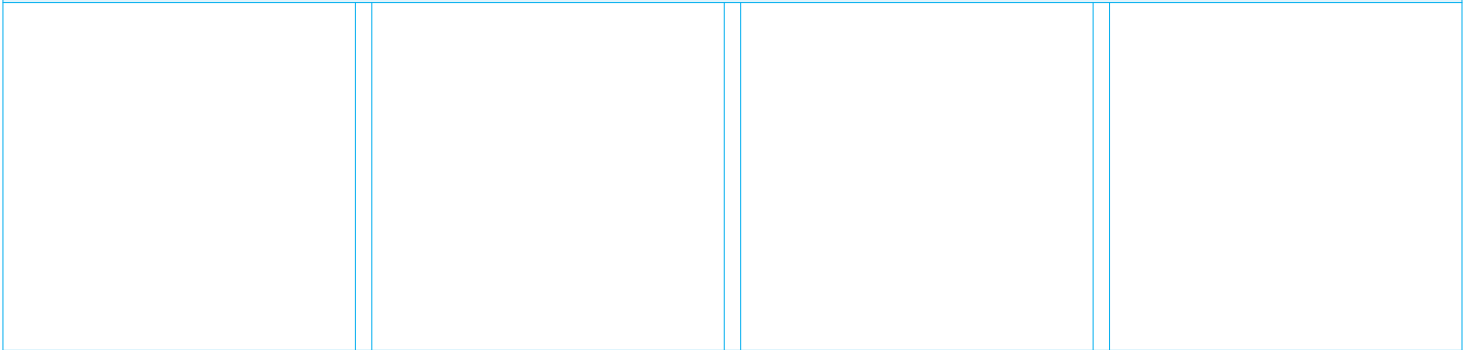
PA1336



		GRAF ref.		NOTE	Adaptable for OES
26.302 (220 kW) Eng.D2866LF04	90-91	PA1294		For vehicles without retarder; Impeller Ø 125mm	51065006282/ 6387/ 9282/ 9387
	90-91	PA1298		For vehicles without retarder, w/o pulley; Impeller Ø 135mm, Incl Electronic fuel Injection pump	51065006408/ 6492/ 9492
	90-91	PA1301		For vehicles with retarder; w/o pulley; Injection Pump with electronic control unit	51065006479/ 9479
	90-91	PA1302		For vehicles with retarder, w/o pulley	51065006426/ 6490/ 9426/ 9490
	90-91	PA1319		For vehicles with retarder, w pulley	51065006546/ 9546
	90-91	PA1321		For vehicles without retarder, w pulley	51065006545/ 6547/ 9545/ 9547
	90-91	PA1336		w/ Pulley	51065006548/ 9548
26.322 (235 kW) Eng.D2865LF03/LF06	90-96	PA1298		For vehicles without retarder, w/o pulley; Impeller Ø 135mm, Incl Electronic fuel Injection pump	51065006408/ 6492/ 9492
	90-96	PA1301		For vehicles with retarder; w/o pulley; Injection Pump with electronic control unit	51065006479/ 9479
	90-96	PA1302		For vehicles with retarder, w/o pulley	51065006426/ 6490/ 9426/ 9490
	90-96	PA1319		For vehicles with retarder, w pulley	51065006546/ 9546
	90-96	PA1321		For vehicles without retarder, w pulley	51065006545/ 6547/ 9545/ 9547
	90-96	PA1336		w/ Pulley	51065006548/ 9548
26.332 (243 kW) Eng.D2865LF/330	87-90	PA1294		For vehicles without retarder; Impeller Ø 125mm	51065006282/ 6387/ 9282/ 9387
	87-90	PA1298		For vehicles without retarder, w/o pulley; Impeller Ø 135mm, Incl Electronic fuel Injection pump	51065006408/ 6492/ 9492
	87-90	PA1301		For vehicles with retarder; w/o pulley; Injection Pump with electronic control unit	51065006479/ 9479
	87-90	PA1302		For vehicles with retarder, w/o pulley	51065006426/ 6490/ 9426/ 9490
	87-90	PA1319		For vehicles with retarder, w pulley	51065006546/ 9546
	87-90	PA1321		For vehicles without retarder, w pulley	51065006545/ 6547/ 9545/ 9547
	87-90	PA1336		w/ Pulley	51065006548/ 9548
26.342 (250-213 kW) Eng.D2865LF09	94-96	PA1298		For vehicles without retarder, w/o pulley; Impeller Ø 135mm, Incl Electronic fuel Injection pump	51065006408/ 6492/ 9492
	94-96	PA1301		For vehicles with retarder; w/o pulley; Injection Pump with electronic control unit	51065006479/ 9479
	94-96	PA1302		For vehicles with retarder, w/o pulley	51065006426/ 6490/ 9426/ 9490
	94-96	PA1319		For vehicles with retarder, w pulley	51065006546/ 9546
	94-96	PA1321		For vehicles without retarder, w pulley	51065006545/ 6547/ 9545/ 9547
	94-96	PA1336		w/ Pulley	51065006548/ 9548
26.362 (265 kW) Eng.D2866KF/LXF	87-90	PA1294		For vehicles without retarder; Impeller Ø 125mm	51065006282/ 6387/ 9282/ 9387
	87-90	PA1298		For vehicles without retarder, w/o pulley; Impeller Ø 135mm, Incl Electronic fuel Injection pump	51065006408/ 6492/ 9492
	87-90	PA1301		For vehicles with retarder; w/o pulley; Injection Pump with electronic control unit	51065006479/ 9479
	87-90	PA1302		For vehicles with retarder, w/o pulley	51065006426/ 6490/ 9426/ 9490
	87-90	PA1319		For vehicles with retarder, w pulley	51065006546/ 9546
	87-90	PA1321		For vehicles without retarder, w pulley	51065006545/ 6547/ 9545/ 9547
	87-90	PA1336		w/ Pulley	51065006548/ 9548
26.372 (272 kW) Eng.D2866LF03	90-96	PA1294		For vehicles without retarder; Impeller Ø 125mm	51065006282/ 6387/ 9282/ 9387
	90-96	PA1298		For vehicles without retarder, w/o pulley; Impeller Ø 135mm, Incl Electronic fuel Injection pump	51065006408/ 6492/ 9492
	90-96	PA1301		For vehicles with retarder; w/o pulley; Injection Pump with electronic control unit	51065006479/ 9479
	90-96	PA1302		For vehicles with retarder, w/o pulley	51065006426/ 6490/ 9426/ 9490
	90-96	PA1319		For vehicles with retarder, w pulley	51065006546/ 9546
	90-96	PA1321		For vehicles without retarder, w pulley	51065006545/ 6547/ 9545/ 9547
	90-96	PA1336		w/ Pulley	51065006548/ 9548
26.372 (272 kW) Eng.D2866LF05	90-96	PA1294		For vehicles without retarder; Impeller Ø 125mm	51065006282/ 6387/ 9282/ 9387
	90-96	PA1298		For vehicles without retarder, w/o pulley; Impeller Ø 135mm, Incl Electronic fuel Injection pump	51065006408/ 6492/ 9492
	90-96	PA1301		For vehicles with retarder; w/o pulley; Injection Pump with electronic control unit	51065006479/ 9479
	90-96	PA1302		For vehicles with retarder, w/o pulley	51065006426/ 6490/ 9426/ 9490
	90-96	PA1319		For vehicles with retarder, w pulley	51065006546/ 9546
	90-96	PA1321		For vehicles without retarder, w pulley	51065006545/ 6547/ 9545/ 9547
	90-96	PA1336		w/ Pulley	51065006548/ 9548
26.372 (272 kW) Eng.D2866LF15	90-96	PA1294		For vehicles without retarder; Impeller Ø 125mm	51065006282/ 6387/ 9282/ 9387
	90-96	PA1298		For vehicles without retarder, w/o pulley; Impeller Ø 135mm, Incl Electronic fuel Injection pump	51065006408/ 6492/ 9492
	90-96	PA1301		For vehicles with retarder; w/o pulley; Injection Pump with electronic control unit	51065006479/ 9479
	90-96	PA1302		For vehicles with retarder, w/o pulley	51065006426/ 6490/ 9426/ 9490
	90-96	PA1319		For vehicles with retarder, w pulley	51065006546/ 9546
	90-96	PA1321		For vehicles without retarder, w pulley	51065006545/ 6547/ 9545/ 9547

			
<p>PA1294</p>	<p>PA1298</p>	<p>PA1301</p>	<p>PA1302</p>
			
<p>PA1319</p>	<p>PA1321</p>	<p>PA1336</p>	

		GRAF ref.			NOTE	Adaptable for OES
26.372 (272 kW) Eng.D2866LF15	90-96	PA1336			w/ Pulley	51065006548/ 9548
26.402 (294 kW) Eng.D2866LF16	94-96	PA1294			For vehicles without retarder; Impeller Ø 125mm	51065006282/ 6387/ 9282/ 9387
	94-96	PA1298			For vehicles without retarder, w/o pulley; Impeller Ø 135mm, Incl Electronic fuel Injection pump	51065006408/ 6492/ 9492
	94-96	PA1301			For vehicles with retarder; w/o pulley; Injection Pump with electronic control unit	51065006479/ 9479
	94-96	PA1302			For vehicles with retarder, w/o pulley	51065006426/ 6490/ 9426/ 9490
	94-96	PA1319			For vehicles with retarder, w pulley	51065006546/ 9546
	94-96	PA1321			For vehicles without retarder, w pulley	51065006545/ 6547/ 9545/ 9547
	94-96	PA1336			w/ Pulley	51065006548/ 9548
26.422 (309 kW) Eng.D2866LF06/LF09	90-96	PA1294			For vehicles without retarder; Impeller Ø 125mm	51065006282/ 6387/ 9282/ 9387
	90-96	PA1298			For vehicles without retarder, w/o pulley; Impeller Ø 135mm, Incl Electronic fuel Injection pump	51065006408/ 6492/ 9492
	90-96	PA1301			For vehicles with retarder; w/o pulley; Injection Pump with electronic control unit	51065006479/ 9479
	90-96	PA1302			For vehicles with retarder, w/o pulley	51065006426/ 6490/ 9426/ 9490
	90-96	PA1319			For vehicles with retarder, w pulley	51065006546/ 9546
	90-96	PA1321			For vehicles without retarder, w pulley	51065006545/ 6547/ 9545/ 9547
	90-96	PA1336			w/ Pulley	51065006548/ 9548
26.462 (338-382 kW) Eng.D2840LF/460	89-90	PA1298			For vehicles without retarder, w/o pulley; Impeller Ø 135mm, Incl Electronic fuel Injection pump	51065006408/ 6492/ 9492
	89-90	PA1302			For vehicles with retarder, w/o pulley	51065006426/ 6490/ 9426/ 9490
26.502 (368 kW) Eng.D2840LF01	90-96	PA1298			For vehicles without retarder, w/o pulley; Impeller Ø 135mm, Incl Electronic fuel Injection pump	51065006408/ 6492/ 9492
	90-96	PA1302			For vehicles with retarder, w/o pulley	51065006426/ 6490/ 9426/ 9490
26.502 (368 kW) Eng.D2840LF04/LF06	90-96	PA1298			For vehicles without retarder, w/o pulley; Impeller Ø 135mm, Incl Electronic fuel Injection pump	51065006408/ 6492/ 9492
	90-96	PA1302			For vehicles with retarder, w/o pulley	51065006426/ 6490/ 9426/ 9490
32.262 (191 kW) Eng.D2865LF/260	89-90	PA1298			For vehicles without retarder, w/o pulley; Impeller Ø 135mm, Incl Electronic fuel Injection pump	51065006408/ 6492/ 9492
	89-90	PA1301			For vehicles with retarder; w/o pulley; Injection Pump with electronic control unit	51065006479/ 9479
	89-90	PA1302			For vehicles with retarder, w/o pulley	51065006426/ 6490/ 9426/ 9490
	89-90	PA1319			For vehicles with retarder, w pulley	51065006546/ 9546
	89-90	PA1321			For vehicles without retarder, w pulley	51065006545/ 6547/ 9545/ 9547
	89-90	PA1336			w/ Pulley	51065006548/ 9548
32.272 (198 kW) Eng.D2865LF02/LF05	90-95	PA1298			For vehicles without retarder, w/o pulley; Impeller Ø 135mm, Incl Electronic fuel Injection pump	51065006408/ 6492/ 9492
	90-95	PA1301			For vehicles with retarder; w/o pulley; Injection Pump with electronic control unit	51065006479/ 9479
	90-95	PA1302			For vehicles with retarder, w/o pulley	51065006426/ 6490/ 9426/ 9490
	90-95	PA1319			For vehicles with retarder, w pulley	51065006546/ 9546
	90-95	PA1321			For vehicles without retarder, w pulley	51065006545/ 6547/ 9545/ 9547
	90-95	PA1336			w/ Pulley	51065006548/ 9548
32.292 (213 kW) Eng.D2866LF/290	88-90	PA1294			For vehicles without retarder; Impeller Ø 125mm	51065006282/ 6387/ 9282/ 9387
	88-90	PA1298			For vehicles without retarder, w/o pulley; Impeller Ø 135mm, Incl Electronic fuel Injection pump	51065006408/ 6492/ 9492
	88-90	PA1301			For vehicles with retarder; w/o pulley; Injection Pump with electronic control unit	51065006479/ 9479
	88-90	PA1302			For vehicles with retarder, w/o pulley	51065006426/ 6490/ 9426/ 9490
	88-90	PA1319			For vehicles with retarder, w pulley	51065006546/ 9546
	88-90	PA1321			For vehicles without retarder, w pulley	51065006545/ 6547/ 9545/ 9547
	88-90	PA1336			w/ Pulley	51065006548/ 9548
32.302 (220 kW) Eng.D2866LF04	90-91	PA1294			For vehicles without retarder; Impeller Ø 125mm	51065006282/ 6387/ 9282/ 9387
	90-91	PA1298			For vehicles without retarder, w/o pulley; Impeller Ø 135mm, Incl Electronic fuel Injection pump	51065006408/ 6492/ 9492
	90-91	PA1301			For vehicles with retarder; w/o pulley; Injection Pump with electronic control unit	51065006479/ 9479
	90-91	PA1302			For vehicles with retarder, w/o pulley	51065006426/ 6490/ 9426/ 9490
	90-91	PA1319			For vehicles with retarder, w pulley	51065006546/ 9546
	90-91	PA1321			For vehicles without retarder, w pulley	51065006545/ 6547/ 9545/ 9547
	90-91	PA1336			w/ Pulley	51065006548/ 9548
32.322 (235 kW) Eng.D2865LF03/LF06	90-96	PA1298			For vehicles without retarder, w/o pulley; Impeller Ø 135mm, Incl Electronic fuel Injection pump	51065006408/ 6492/ 9492
	90-96	PA1301			For vehicles with retarder; w/o pulley; Injection Pump with electronic control unit	51065006479/ 9479
	90-96	PA1302			For vehicles with retarder, w/o pulley	51065006426/ 6490/ 9426/ 9490
	90-96	PA1319			For vehicles with retarder, w pulley	51065006546/ 9546

			
<p>PA1294</p>	<p>PA1298</p>	<p>PA1301</p>	<p>PA1302</p>
			
<p>PA1319</p>	<p>PA1321</p>	<p>PA1336</p>	

		GRAF ref.			NOTE	Adaptable for OES
32.322 (235 kW) Eng.D2865LF03/LF06	90-96	PA1321			For vehicles without retarder, w pulley	51065006545/ 6547/ 9545/ 9547
	90-96	PA1336			w/ Pulley	51065006548/ 9548
32.332 (243 kW) Eng.D2866LF/330	88-90	PA1294			For vehicles without retarder; Impeller Ø 125mm	51065006282/ 6387/ 9282/ 9387
	88-90	PA1298			For vehicles without retarder, w/o pulley; Impeller Ø 135mm, Incl Eletronic fuel Injection pump	51065006408/ 6492/ 9492
	88-90	PA1301			For vehicles with retarder; w/o pulley; Injection Pump with electronic control unit	51065006479/ 9479
	88-90	PA1302			For vehicles with retarder, w/o pulley	51065006426/ 6490/ 9426/ 9490
	88-90	PA1319			For vehicles with retarder, w pulley	51065006546/ 9546
	88-90	PA1321			For vehicles without retarder, w pulley	51065006545/ 6547/ 9545/ 9547
	88-90	PA1336			w/ Pulley	51065006548/ 9548
32.342 (250-213 kW) Eng.D2865LF09	94-96	PA1298			For vehicles without retarder, w/o pulley; Impeller Ø 135mm, Incl Eletronic fuel Injection pump	51065006408/ 6492/ 9492
	94-96	PA1301			For vehicles with retarder; w/o pulley; Injection Pump with electronic control unit	51065006479/ 9479
	94-96	PA1302			For vehicles with retarder, w/o pulley	51065006426/ 6490/ 9426/ 9490
	94-96	PA1319			For vehicles with retarder, w pulley	51065006546/ 9546
	94-96	PA1321			For vehicles without retarder, w pulley	51065006545/ 6547/ 9545/ 9547
	94-96	PA1336			w/ Pulley	51065006548/ 9548
32.362 (265 kW) Eng.D2866LXF	88-90	PA1294			For vehicles without retarder; Impeller Ø 125mm	51065006282/ 6387/ 9282/ 9387
	88-90	PA1298			For vehicles without retarder, w/o pulley; Impeller Ø 135mm, Incl Eletronic fuel Injection pump	51065006408/ 6492/ 9492
	88-90	PA1301			For vehicles with retarder; w/o pulley; Injection Pump with electronic control unit	51065006479/ 9479
	88-90	PA1302			For vehicles with retarder, w/o pulley	51065006426/ 6490/ 9426/ 9490
	88-90	PA1319			For vehicles with retarder, w pulley	51065006546/ 9546
	88-90	PA1321			For vehicles without retarder, w pulley	51065006545/ 6547/ 9545/ 9547
	88-90	PA1336			w/ Pulley	51065006548/ 9548
32.372 (249-265 kW) Eng.D2866LXF	88-90	PA1294			For vehicles without retarder; Impeller Ø 125mm	51065006282/ 6387/ 9282/ 9387
	90-96	PA1298			For vehicles without retarder, w/o pulley; Impeller Ø 135mm, Incl Eletronic fuel Injection pump	51065006408/ 6492/ 9492
	90-96	PA1301			For vehicles with retarder; w/o pulley; Injection Pump with electronic control unit	51065006479/ 9479
	90-96	PA1302			For vehicles with retarder, w/o pulley	51065006426/ 6490/ 9426/ 9490
	90-96	PA1319			For vehicles with retarder, w pulley	51065006546/ 9546
	90-96	PA1321			For vehicles without retarder, w pulley	51065006545/ 6547/ 9545/ 9547
	90-96	PA1336			w/ Pulley	51065006548/ 9548
32.372 (272 kW) Eng.D2866LF03/LF05	90-96	PA1294			For vehicles without retarder; Impeller Ø 125mm	51065006282/ 6387/ 9282/ 9387
	90-96	PA1298			For vehicles without retarder, w/o pulley; Impeller Ø 135mm, Incl Eletronic fuel Injection pump	51065006408/ 6492/ 9492
	90-96	PA1301			For vehicles with retarder; w/o pulley; Injection Pump with electronic control unit	51065006479/ 9479
	90-96	PA1302			For vehicles with retarder, w/o pulley	51065006426/ 6490/ 9426/ 9490
	90-96	PA1319			For vehicles with retarder, w pulley	51065006546/ 9546
	90-96	PA1321			For vehicles without retarder, w pulley	51065006545/ 6547/ 9545/ 9547
	90-96	PA1336			w/ Pulley	51065006548/ 9548
32.372 (272 kW) Eng.D2866LF15	90-96	PA1294			For vehicles without retarder; Impeller Ø 125mm	51065006282/ 6387/ 9282/ 9387
	90-96	PA1298			For vehicles without retarder, w/o pulley; Impeller Ø 135mm, Incl Eletronic fuel Injection pump	51065006408/ 6492/ 9492
	90-96	PA1301			For vehicles with retarder; w/o pulley; Injection Pump with electronic control unit	51065006479/ 9479
	90-96	PA1302			For vehicles with retarder, w/o pulley	51065006426/ 6490/ 9426/ 9490
	90-96	PA1319			For vehicles with retarder, w pulley	51065006546/ 9546
	90-96	PA1321			For vehicles without retarder, w pulley	51065006545/ 6547/ 9545/ 9547
	90-96	PA1336			w/ Pulley	51065006548/ 9548
32.402 (294 kW) Eng.D2866LF16	94-96	PA1294			For vehicles without retarder; Impeller Ø 125mm	51065006282/ 6387/ 9282/ 9387
	94-96	PA1298			For vehicles without retarder, w/o pulley; Impeller Ø 135mm, Incl Eletronic fuel Injection pump	51065006408/ 6492/ 9492
	94-96	PA1301			For vehicles with retarder; w/o pulley; Injection Pump with electronic control unit	51065006479/ 9479
	94-96	PA1302			For vehicles with retarder, w/o pulley	51065006426/ 6490/ 9426/ 9490
	94-96	PA1319			For vehicles with retarder, w pulley	51065006546/ 9546
	94-96	PA1321			For vehicles without retarder, w pulley	51065006545/ 6547/ 9545/ 9547
	94-96	PA1336			w/ Pulley	51065006548/ 9548
32.422 (309 kW) Eng.D2866LF06/LF09	90-96	PA1294			For vehicles without retarder; Impeller Ø 125mm	51065006282/ 6387/ 9282/ 9387
	90-96	PA1298			For vehicles without retarder, w/o pulley; Impeller Ø 135mm, Incl Eletronic fuel Injection pump	51065006408/ 6492/ 9492
	90-96	PA1301			For vehicles with retarder; w/o pulley; Injection Pump with electronic control unit	51065006479/ 9479

			
<p>PA1294</p>	<p>PA1298</p>	<p>PA1301</p>	<p>PA1302</p>
			
<p>PA1319</p>	<p>PA1321</p>	<p>PA1336</p>	

		GRAF ref.			NOTE	Adaptable for OES
32.422 (309 kW) Eng.D2866LF06/LF09	90-96	PA1302			For vehicles with retarder, w/o pulley	51065006426/ 6490/ 9426/ 9490
	90-96	PA1319			For vehicles with retarder, w pulley	51065006546/ 9546
	90-96	PA1321			For vehicles without retarder, w pulley	51065006545/ 6547/ 9545/ 9547
	90-96	PA1336			w/ Pulley	51065006548/ 9548
33.242 (177 kW) Eng.D2866F/240	01/88-08/88	PA1294			For vehicles without retarder; Impeller Ø 125mm	51065006282/ 6387/ 9282/ 9387
	01/88-08/88	PA1298			For vehicles without retarder, w/o pulley; Impeller Ø 135mm, Incl Eletronic fuel Injection pump	51065006408/ 6492/ 9492
	01/88-08/88	PA1301			For vehicles with retarder; w/o pulley; Injection Pump with electronic control unit	51065006479/ 9479
	01/88-08/88	PA1302			For vehicles with retarder, w/o pulley	51065006426/ 6490/ 9426/ 9490
	01/88-08/88	PA1319			For vehicles with retarder, w pulley	51065006546/ 9546
	01/88-08/88	PA1321			For vehicles without retarder, w pulley	51065006545/ 6547/ 9545/ 9547
33.262 (191 kW) Eng.D2865LF/260	89-90	PA1298			For vehicles without retarder, w/o pulley; Impeller Ø 135mm, Incl Eletronic fuel Injection pump	51065006408/ 6492/ 9492
	89-90	PA1301			For vehicles with retarder; w/o pulley; Injection Pump with electronic control unit	51065006479/ 9479
	89-90	PA1302			For vehicles with retarder, w/o pulley	51065006426/ 6490/ 9426/ 9490
	89-90	PA1319			For vehicles with retarder, w pulley	51065006546/ 9546
	89-90	PA1321			For vehicles without retarder, w pulley	51065006545/ 6547/ 9545/ 9547
	89-90	PA1336			w/ Pulley	51065006548/ 9548
33.272 (191-198 kW) Eng.D2865LF05	92-95	PA1298			For vehicles without retarder, w/o pulley; Impeller Ø 135mm, Incl Eletronic fuel Injection pump	51065006408/ 6492/ 9492
	92-95	PA1301			For vehicles with retarder; w/o pulley; Injection Pump with electronic control unit	51065006479/ 9479
	92-95	PA1302			For vehicles with retarder, w/o pulley	51065006426/ 6490/ 9426/ 9490
	92-95	PA1319			For vehicles with retarder, w pulley	51065006546/ 9546
	92-95	PA1321			For vehicles without retarder, w pulley	51065006545/ 6547/ 9545/ 9547
	92-95	PA1336			w/ Pulley	51065006548/ 9548
33.292 (213 kW) Eng.D2866LF/290	88-90	PA1294			For vehicles without retarder; Impeller Ø 125mm	51065006282/ 6387/ 9282/ 9387
	88-90	PA1298			For vehicles without retarder, w/o pulley; Impeller Ø 135mm, Incl Eletronic fuel Injection pump	51065006408/ 6492/ 9492
	88-90	PA1301			For vehicles with retarder; w/o pulley; Injection Pump with electronic control unit	51065006479/ 9479
	88-90	PA1302			For vehicles with retarder, w/o pulley	51065006426/ 6490/ 9426/ 9490
	88-90	PA1319			For vehicles with retarder, w pulley	51065006546/ 9546
	88-90	PA1321			For vehicles without retarder, w pulley	51065006545/ 6547/ 9545/ 9547
	88-90	PA1336			w/ Pulley	51065006548/ 9548
33.322 (235 kW) Eng.D2865LF03/LF06	91-96	PA1298			For vehicles without retarder, w/o pulley; Impeller Ø 135mm, Incl Eletronic fuel Injection pump	51065006408/ 6492/ 9492
	91-96	PA1301			For vehicles with retarder; w/o pulley; Injection Pump with electronic control unit	51065006479/ 9479
	91-96	PA1302			For vehicles with retarder, w/o pulley	51065006426/ 6490/ 9426/ 9490
	91-96	PA1319			For vehicles with retarder, w pulley	51065006546/ 9546
	91-96	PA1321			For vehicles without retarder, w pulley	51065006545/ 6547/ 9545/ 9547
	91-96	PA1336			w/ Pulley	51065006548/ 9548
33.332 (243 kW) Eng.D2866LF/330	87-90	PA1294			For vehicles without retarder; Impeller Ø 125mm	51065006282/ 6387/ 9282/ 9387
	87-90	PA1298			For vehicles without retarder, w/o pulley; Impeller Ø 135mm, Incl Eletronic fuel Injection pump	51065006408/ 6492/ 9492
	87-90	PA1301			For vehicles with retarder; w/o pulley; Injection Pump with electronic control unit	51065006479/ 9479
	87-90	PA1302			For vehicles with retarder, w/o pulley	51065006426/ 6490/ 9426/ 9490
	87-90	PA1319			For vehicles with retarder, w pulley	51065006546/ 9546
	87-90	PA1321			For vehicles without retarder, w pulley	51065006545/ 6547/ 9545/ 9547
	87-90	PA1336			w/ Pulley	51065006548/ 9548
33.342 (250-213 kW) Eng.D2865LF09	94-96	PA1298			For vehicles without retarder, w/o pulley; Impeller Ø 135mm, Incl Eletronic fuel Injection pump	51065006408/ 6492/ 9492
	94-96	PA1301			For vehicles with retarder; w/o pulley; Injection Pump with electronic control unit	51065006479/ 9479
	94-96	PA1302			For vehicles with retarder, w/o pulley	51065006426/ 6490/ 9426/ 9490
	94-96	PA1319			For vehicles with retarder, w pulley	51065006546/ 9546
	94-96	PA1321			For vehicles without retarder, w pulley	51065006545/ 6547/ 9545/ 9547
	94-96	PA1336			w/ Pulley	51065006548/ 9548
33.362 (265 kW) Eng.D2866KF	88-90	PA1294			For vehicles without retarder; Impeller Ø 125mm	51065006282/ 6387/ 9282/ 9387
	87-90	PA1298			For vehicles without retarder, w/o pulley; Impeller Ø 135mm, Incl Eletronic fuel Injection pump	51065006408/ 6492/ 9492
	87-90	PA1301			For vehicles with retarder; w/o pulley; Injection Pump with electronic control unit	51065006479/ 9479
	87-90	PA1302			For vehicles with retarder, w/o pulley	51065006426/ 6490/ 9426/ 9490
	87-90	PA1319			For vehicles with retarder, w pulley	51065006546/ 9546

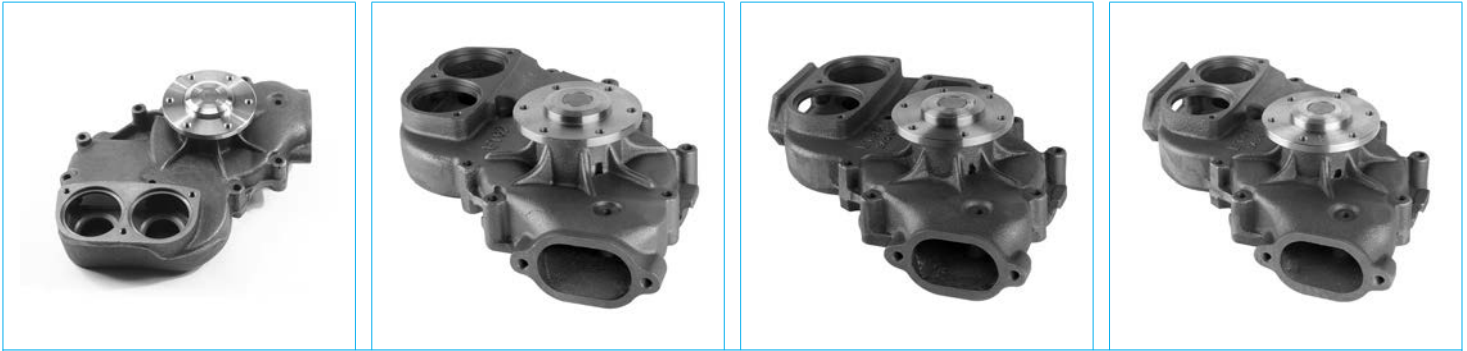

PA1294

PA1298

PA1301

PA1302

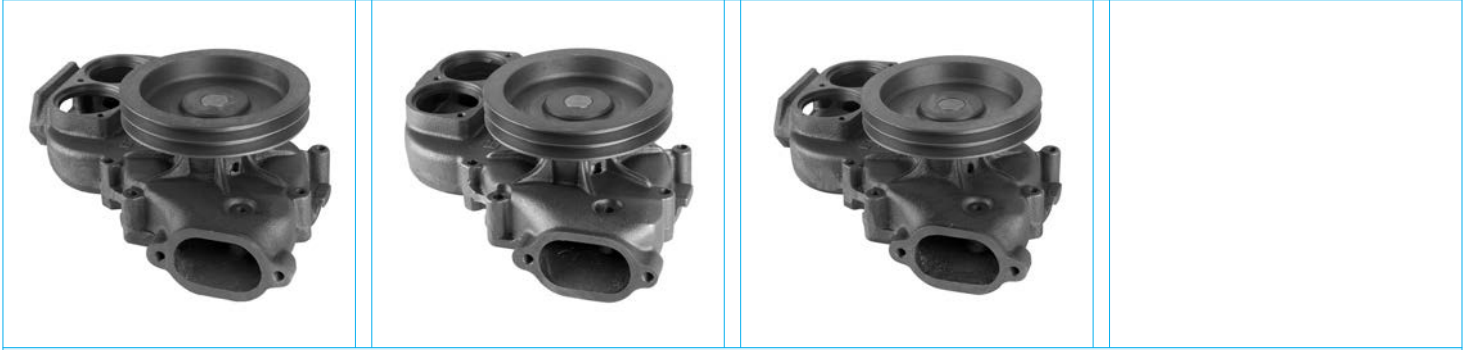

PA1319

PA1321

PA1336

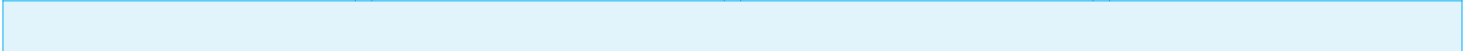
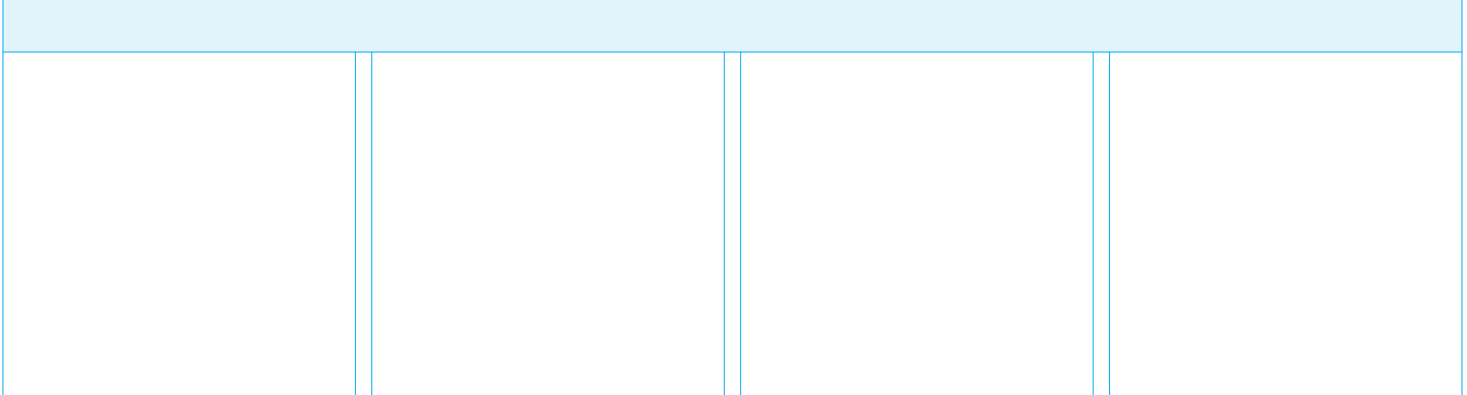
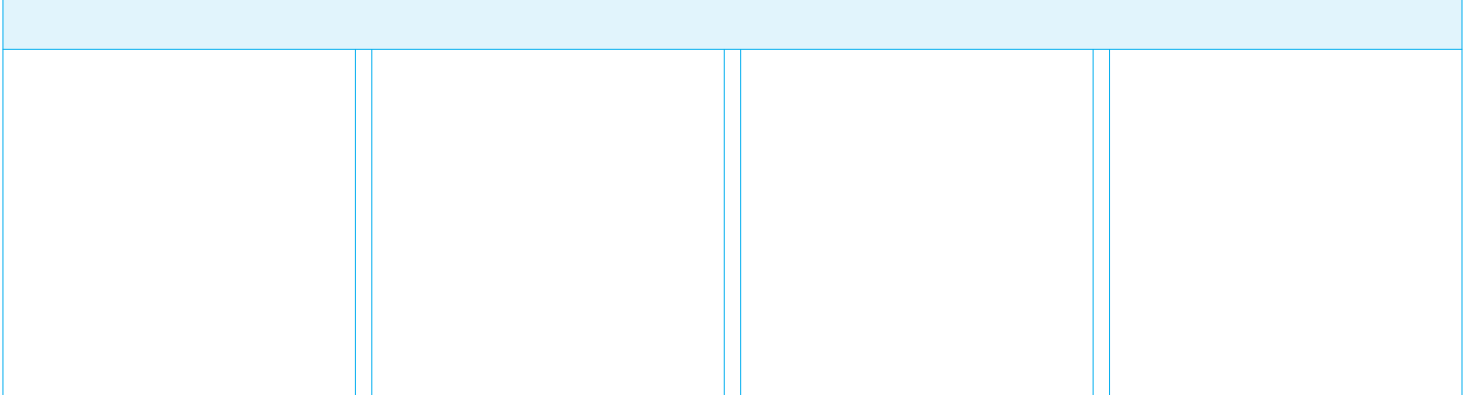
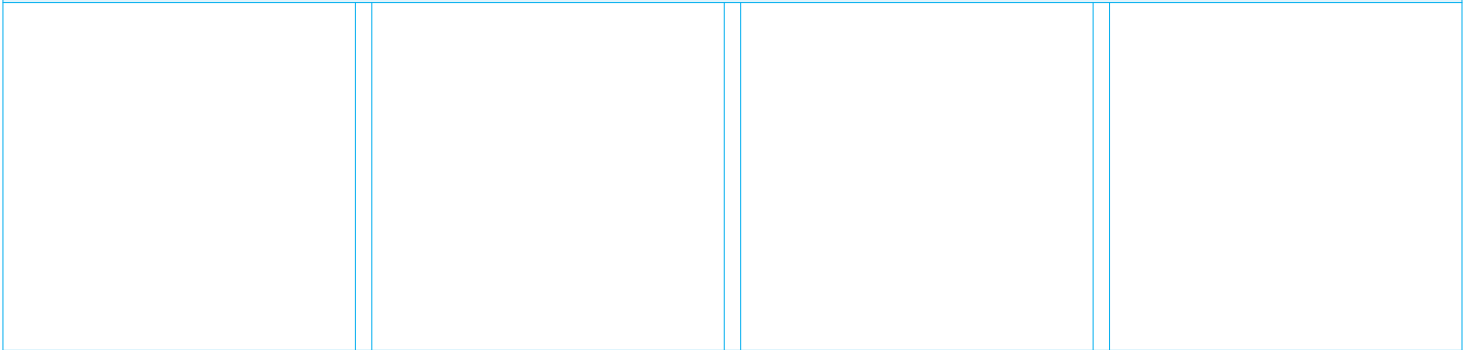

		GRAF ref.			NOTE	Adaptable for OES
33.362 (265 kW) Eng.D2866KF	87-90	PA1321			For vehicles without retarder, w pulley	51065006545/ 6547/ 9545/ 9547
	87-90	PA1336			w/ Pulley	51065006548/ 9548
33.362 (265 kW) Eng.D2866LXF	91-96	PA1294			For vehicles without retarder; Impeller Ø 125mm	51065006282/ 6387/ 9282/ 9387
	88-90	PA1298			For vehicles without retarder, w/o pulley; Impeller Ø 135mm, Incl Eletronic fuel Injection pump	51065006408/ 6492/ 9492
	88-90	PA1301			For vehicles with retarder; w/o pulley; Injection Pump with electronic control unit	51065006479/ 9479
	88-90	PA1302			For vehicles with retarder, w/o pulley	51065006426/ 6490/ 9426/ 9490
	88-90	PA1319			For vehicles with retarder, w pulley	51065006546/ 9546
	88-90	PA1321			For vehicles without retarder, w pulley	51065006545/ 6547/ 9545/ 9547
	88-90	PA1336			w/ Pulley	51065006548/ 9548
33.372 (272 kW) Eng.D2866LF03/LF05	91-96	PA1294			For vehicles without retarder; Impeller Ø 125mm	51065006282/ 6387/ 9282/ 9387
	91-96	PA1298			For vehicles without retarder, w/o pulley; Impeller Ø 135mm, Incl Eletronic fuel Injection pump	51065006408/ 6492/ 9492
	91-96	PA1301			For vehicles with retarder; w/o pulley; Injection Pump with electronic control unit	51065006479/ 9479
	91-96	PA1302			For vehicles with retarder, w/o pulley	51065006426/ 6490/ 9426/ 9490
	91-96	PA1319			For vehicles with retarder, w pulley	51065006546/ 9546
	91-96	PA1321			For vehicles without retarder, w pulley	51065006545/ 6547/ 9545/ 9547
	91-96	PA1336			w/ Pulley	51065006548/ 9548
33.372 (272 kW) Eng.D2866LF15	91-96	PA1294			For vehicles without retarder; Impeller Ø 125mm	51065006282/ 6387/ 9282/ 9387
	91-96	PA1298			For vehicles without retarder, w/o pulley; Impeller Ø 135mm, Incl Eletronic fuel Injection pump	51065006408/ 6492/ 9492
	91-96	PA1301			For vehicles with retarder; w/o pulley; Injection Pump with electronic control unit	51065006479/ 9479
	91-96	PA1302			For vehicles with retarder, w/o pulley	51065006426/ 6490/ 9426/ 9490
	91-96	PA1319			For vehicles with retarder, w pulley	51065006546/ 9546
	91-96	PA1321			For vehicles without retarder, w pulley	51065006545/ 6547/ 9545/ 9547
	91-96	PA1336			w/ Pulley	51065006548/ 9548
33.402 (294 kW) Eng.D2866LF16	94-96	PA1294			For vehicles without retarder; Impeller Ø 125mm	51065006282/ 6387/ 9282/ 9387
	94-96	PA1298			For vehicles without retarder, w/o pulley; Impeller Ø 135mm, Incl Eletronic fuel Injection pump	51065006408/ 6492/ 9492
	94-96	PA1301			For vehicles with retarder; w/o pulley; Injection Pump with electronic control unit	51065006479/ 9479
	94-96	PA1302			For vehicles with retarder, w/o pulley	51065006426/ 6490/ 9426/ 9490
	94-96	PA1319			For vehicles with retarder, w pulley	51065006546/ 9546
	94-96	PA1321			For vehicles without retarder, w pulley	51065006545/ 6547/ 9545/ 9547
	94-96	PA1336			w/ Pulley	51065006548/ 9548
33.422 (309 kW) Eng.D2866LF06/LF09	94-96	PA1294			For vehicles without retarder; Impeller Ø 125mm	51065006282/ 6387/ 9282/ 9387
	94-96	PA1298			For vehicles without retarder, w/o pulley; Impeller Ø 135mm, Incl Eletronic fuel Injection pump	51065006408/ 6492/ 9492
	94-96	PA1301			For vehicles with retarder; w/o pulley; Injection Pump with electronic control unit	51065006479/ 9479
	94-96	PA1302			For vehicles with retarder, w/o pulley	51065006426/ 6490/ 9426/ 9490
	92-96	PA1319			For vehicles with retarder, w pulley	51065006546/ 9546
	94-96	PA1321			For vehicles without retarder, w pulley	51065006545/ 6547/ 9545/ 9547
	94-96	PA1336			w/ Pulley	51065006548/ 9548
33.462 (338-382 kW) Eng.D2840LF/460	89-90	PA1298			For vehicles without retarder, w/o pulley; Impeller Ø 135mm, Incl Eletronic fuel Injection pump	51065006408/ 6492/ 9492
	89-90	PA1302			For vehicles with retarder, w/o pulley	51065006426/ 6490/ 9426/ 9490
33.502 (368 kW) Eng.D2840LF01	91-96	PA1298			For vehicles without retarder, w/o pulley; Impeller Ø 135mm, Incl Eletronic fuel Injection pump	51065006408/ 6492/ 9492
	91-96	PA1302			For vehicles with retarder, w/o pulley	51065006426/ 6490/ 9426/ 9490
33.502 (368 kW) Eng.D2840LF04	91-96	PA1298			For vehicles without retarder, w/o pulley; Impeller Ø 135mm, Incl Eletronic fuel Injection pump	51065006408/ 6492/ 9492
	91-96	PA1302			For vehicles with retarder, w/o pulley	51065006426/ 6490/ 9426/ 9490
33.502 (368 kW) Eng.D2840LF06	91-96	PA1298			For vehicles without retarder, w/o pulley; Impeller Ø 135mm, Incl Eletronic fuel Injection pump	51065006408/ 6492/ 9492
	91-96	PA1302			For vehicles with retarder, w/o pulley	51065006426/ 6490/ 9426/ 9490
35.262 (191 kW) Eng.D2865LF/260	89-90	PA1298			For vehicles without retarder, w/o pulley; Impeller Ø 135mm, Incl Eletronic fuel Injection pump	51065006408/ 6492/ 9492
	89-90	PA1301			For vehicles with retarder; w/o pulley; Injection Pump with electronic control unit	51065006479/ 9479
	89-90	PA1302			For vehicles with retarder, w/o pulley	51065006426/ 6490/ 9426/ 9490
	89-90	PA1319			For vehicles with retarder, w pulley	51065006546/ 9546
	89-90	PA1321			For vehicles without retarder, w pulley	51065006545/ 6547/ 9545/ 9547
35.272 (198 kW) Eng.D2865LF02	89-90	PA1336			w/ Pulley	51065006548/ 9548
	90-92	PA1298			For vehicles without retarder, w/o pulley; Impeller Ø 135mm, Incl Eletronic fuel Injection pump	51065006408/ 6492/ 9492

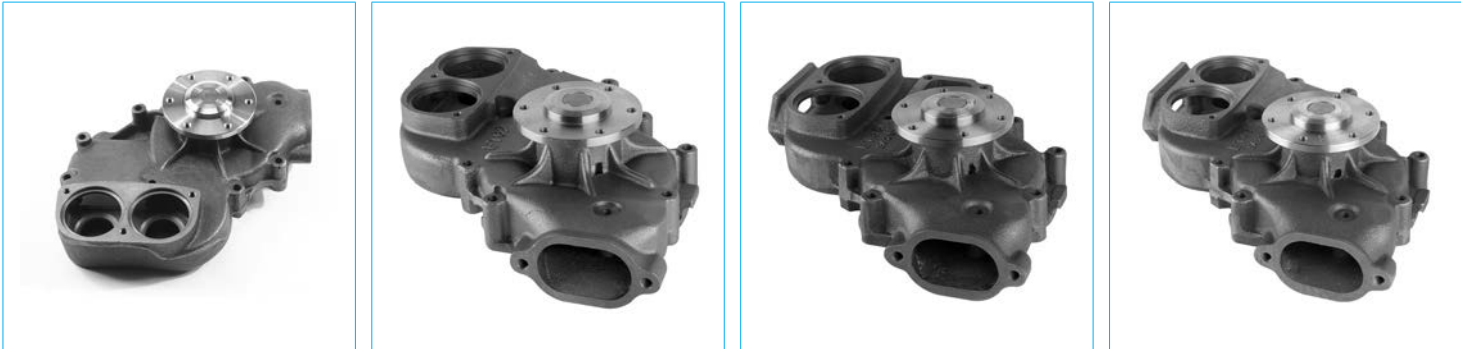

PA1294

PA1298

PA1301

PA1302



PA1319

PA1321

PA1336

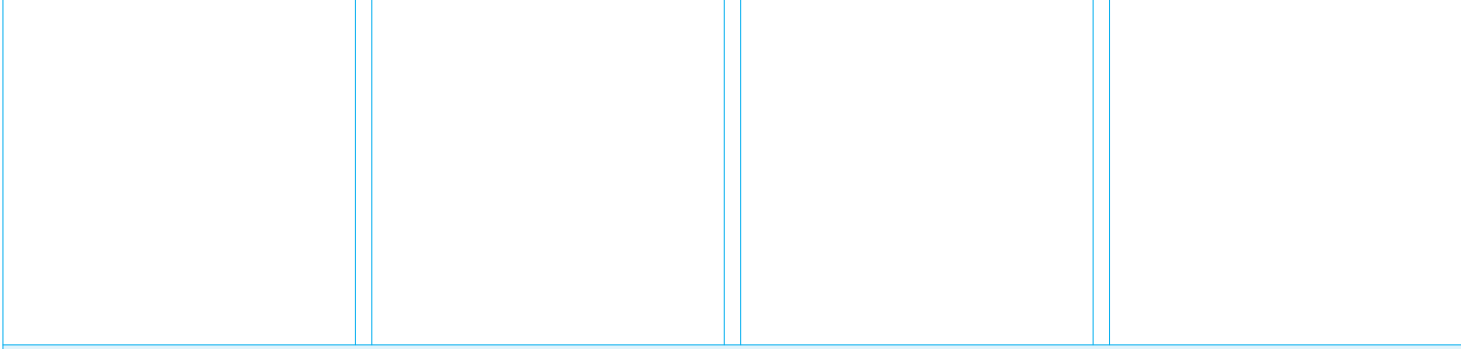
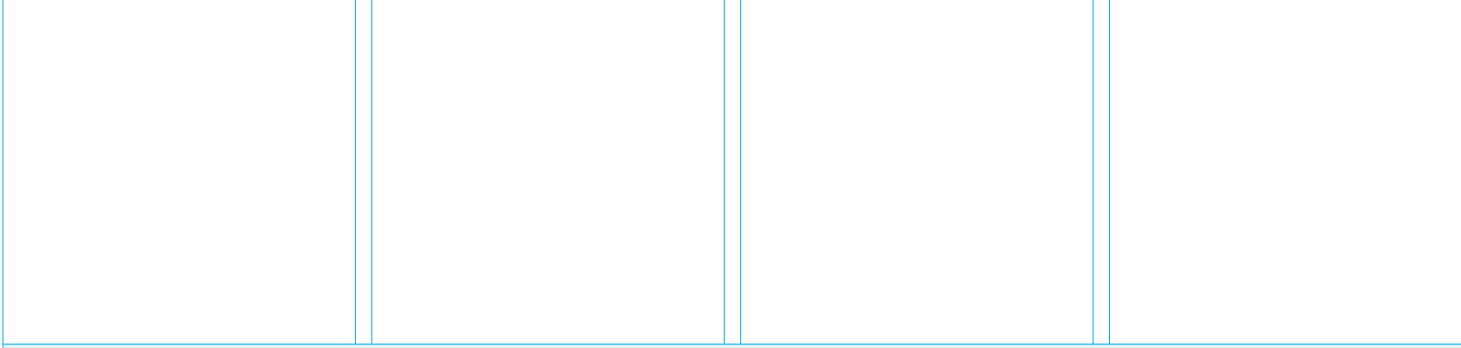
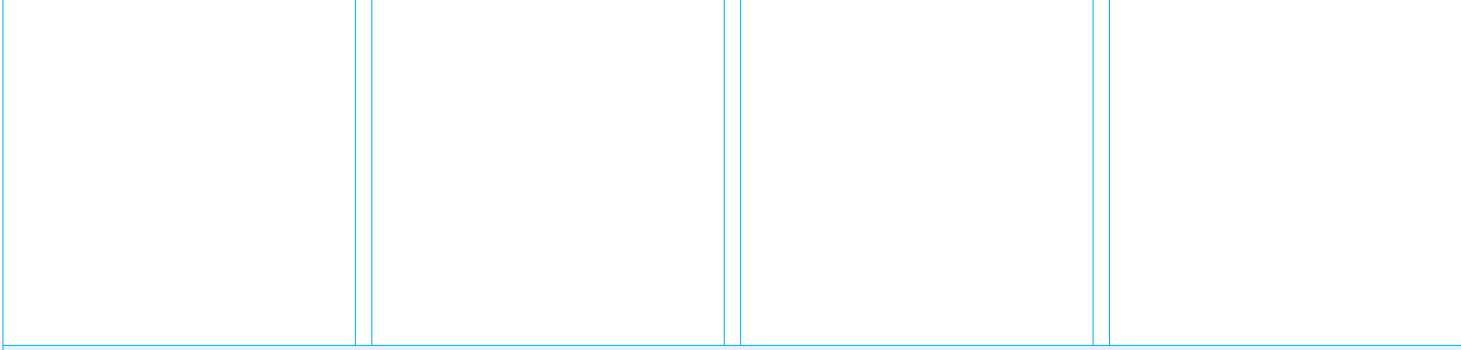

		GRAF ref.		NOTE	Adaptable for OES
35.272 (198 kW) Eng.D2865LF02	90-92	PA1301		For vehicles with retarder; w/o pulley; Injection Pump with electronic control unit	51065006479/ 9479
	90-92	PA1302		For vehicles with retarder, w/o pulley	51065006426/ 6490/ 9426/ 9490
	90-92	PA1319		For vehicles with retarder, w pulley	51065006546/ 9546
	90-92	PA1321		For vehicles without retarder, w pulley	51065006545/ 6547/ 9545/ 9547
	90-92	PA1336		w/ Pulley	51065006548/ 9548
35.292 (213 kW) Eng.D2866LFZ/290 35.302 (220 kW) Eng.D2866LF04	88-95	PA1294		For vehicles without retarder; Impeller Ø 125mm	51065006282/ 6387/ 9282/ 9387
	88-95	PA1298		For vehicles without retarder, w/o pulley; Impeller Ø 135mm, Incl Eletronic fuel Injection pump	51065006408/ 6492/ 9492
	88-95	PA1301		For vehicles with retarder; w/o pulley; Injection Pump with electronic control unit	51065006479/ 9479
	88-95	PA1302		For vehicles with retarder, w/o pulley	51065006426/ 6490/ 9426/ 9490
	88-95	PA1319		For vehicles with retarder, w pulley	51065006546/ 9546
	88-95	PA1321		For vehicles without retarder, w pulley	51065006545/ 6547/ 9545/ 9547
35.322 (235 kW) Eng.D2865LF03/LF06	90-96	PA1298		For vehicles without retarder, w/o pulley; Impeller Ø 135mm, Incl Eletronic fuel Injection pump	51065006408/ 6492/ 9492
	90-96	PA1301		For vehicles with retarder; w/o pulley; Injection Pump with electronic control unit	51065006479/ 9479
	90-96	PA1302		For vehicles with retarder, w/o pulley	51065006426/ 6490/ 9426/ 9490
	90-96	PA1319		For vehicles with retarder, w pulley	51065006546/ 9546
	90-96	PA1321		For vehicles without retarder, w pulley	51065006545/ 6547/ 9545/ 9547
35.332 (243 kW) Eng.D2866LFZ/330	88-95	PA1294		For vehicles without retarder; Impeller Ø 125mm	51065006282/ 6387/ 9282/ 9387
	88-95	PA1298		For vehicles without retarder, w/o pulley; Impeller Ø 135mm, Incl Eletronic fuel Injection pump	51065006408/ 6492/ 9492
	94-96	PA1301		For vehicles with retarder; w/o pulley; Injection Pump with electronic control unit	51065006479/ 9479
	88-95	PA1302		For vehicles with retarder, w/o pulley	51065006426/ 6490/ 9426/ 9490
	88-95	PA1319		For vehicles with retarder, w pulley	51065006546/ 9546
	88-95	PA1321		For vehicles without retarder, w pulley	51065006545/ 6547/ 9545/ 9547
	88-95	PA1336		w/ Pulley	51065006548/ 9548
35.342 (250-213 kW) Eng.D2865LF09	94-96	PA1298		For vehicles without retarder, w/o pulley; Impeller Ø 135mm, Incl Eletronic fuel Injection pump	51065006408/ 6492/ 9492
	88-90	PA1301		For vehicles with retarder; w/o pulley; Injection Pump with electronic control unit	51065006479/ 9479
	94-96	PA1302		For vehicles with retarder, w/o pulley	51065006426/ 6490/ 9426/ 9490
	94-96	PA1319		For vehicles with retarder, w pulley	51065006546/ 9546
	94-96	PA1321		For vehicles without retarder, w pulley	51065006545/ 6547/ 9545/ 9547
35.362 (265 kW) Eng.D2866LXF	88-90	PA1294		For vehicles without retarder; Impeller Ø 125mm	51065006282/ 6387/ 9282/ 9387
	88-90	PA1298		For vehicles without retarder, w/o pulley; Impeller Ø 135mm, Incl Eletronic fuel Injection pump	51065006408/ 6492/ 9492
	90-95	PA1301		For vehicles with retarder; w/o pulley; Injection Pump with electronic control unit	51065006479/ 9479
	88-90	PA1302		For vehicles with retarder, w/o pulley	51065006426/ 6490/ 9426/ 9490
	88-90	PA1319		For vehicles with retarder, w pulley	51065006546/ 9546
	88-90	PA1321		For vehicles without retarder, w pulley	51065006545/ 6547/ 9545/ 9547
35.372 (249-265 kW) Eng.D2866LXF	90-95	PA1294		For vehicles without retarder; Impeller Ø 125mm	51065006282/ 6387/ 9282/ 9387
	90-95	PA1298		For vehicles without retarder, w/o pulley; Impeller Ø 135mm, Incl Eletronic fuel Injection pump	51065006408/ 6492/ 9492
	90-97	PA1301		For vehicles with retarder; w/o pulley; Injection Pump with electronic control unit	51065006479/ 9479
	90-95	PA1302		For vehicles with retarder, w/o pulley	51065006426/ 6490/ 9426/ 9490
	90-95	PA1319		For vehicles with retarder, w pulley	51065006546/ 9546
	94-96	PA1321		For vehicles without retarder, w pulley	51065006545/ 6547/ 9545/ 9547
	90-95	PA1336		w/ Pulley	51065006548/ 9548
35.372 (272 kW) Eng.D2866LF03	90-97	PA1294		For vehicles without retarder; Impeller Ø 125mm	51065006282/ 6387/ 9282/ 9387
	90-97	PA1298		For vehicles without retarder, w/o pulley; Impeller Ø 135mm, Incl Eletronic fuel Injection pump	51065006408/ 6492/ 9492
	90-97	PA1301		For vehicles with retarder; w/o pulley; Injection Pump with electronic control unit	51065006479/ 9479
	90-97	PA1302		For vehicles with retarder, w/o pulley	51065006426/ 6490/ 9426/ 9490
	90-97	PA1319		For vehicles with retarder, w pulley	51065006546/ 9546
	88-90	PA1321		For vehicles without retarder, w pulley	51065006545/ 6547/ 9545/ 9547
	90-97	PA1336		w/ Pulley	51065006548/ 9548
35.372 (272 kW) Eng.D2866LF05/LF15	90-97	PA1294		For vehicles without retarder; Impeller Ø 125mm	51065006282/ 6387/ 9282/ 9387

			
<p>PA1294</p>	<p>PA1298</p>	<p>PA1301</p>	<p>PA1302</p>
			
<p>PA1319</p>	<p>PA1321</p>	<p>PA1336</p>	

		GRAF ref.		NOTE	Adaptable for OES
35.372 (272 kW) Eng.D2866LF05/LF15	90-97	PA1298		For vehicles without retarder, w/o pulley; Impeller Ø 135mm, Incl Electronic fuel Injection pump	51065006408/ 6492/ 9492
	90-97	PA1301		For vehicles with retarder; w/o pulley; Injection Pump with electronic control unit	51065006479/ 9479
	90-97	PA1302		For vehicles with retarder, w/o pulley	51065006426/ 6490/ 9426/ 9490
	90-97	PA1319		For vehicles with retarder, w pulley	51065006546/ 9546
	90-95	PA1321		For vehicles without retarder, w pulley	51065006545/ 6547/ 9545/ 9547
	90-97	PA1336		w/ Pulley	51065006548/ 9548
35.402 (294 kW) Eng.D2866LF16	94-97	PA1294		For vehicles without retarder; Impeller Ø 125mm	51065006282/ 6387/ 9282/ 9387
	94-97	PA1298		For vehicles without retarder, w/o pulley; Impeller Ø 135mm, Incl Electronic fuel Injection pump	51065006408/ 6492/ 9492
	94-97	PA1301		For vehicles with retarder; w/o pulley; Injection Pump with electronic control unit	51065006479/ 9479
	94-97	PA1302		For vehicles with retarder, w/o pulley	51065006426/ 6490/ 9426/ 9490
	94-97	PA1319		For vehicles with retarder, w pulley	51065006546/ 9546
	90-97	PA1321		For vehicles without retarder, w pulley	51065006545/ 6547/ 9545/ 9547
94-97	PA1336		w/ Pulley	51065006548/ 9548	
35.422 (309 kW) Eng.D2866LF06/LF09	90-97	PA1294		For vehicles without retarder; Impeller Ø 125mm	51065006282/ 6387/ 9282/ 9387
	90-97	PA1298		For vehicles without retarder, w/o pulley; Impeller Ø 135mm, Incl Electronic fuel Injection pump	51065006408/ 6492/ 9492
	90-97	PA1301		For vehicles with retarder; w/o pulley; Injection Pump with electronic control unit	51065006479/ 9479
	90-97	PA1302		For vehicles with retarder, w/o pulley	51065006426/ 6490/ 9426/ 9490
	90-97	PA1319		For vehicles with retarder, w pulley	51065006546/ 9546
	90-97	PA1321		For vehicles without retarder, w pulley	51065006545/ 6547/ 9545/ 9547
90-97	PA1336		w/ Pulley	51065006548/ 9548	
40.372 (272 kW) Eng.D2866LF03	91-96	PA1294		For vehicles without retarder; Impeller Ø 125mm	51065006282/ 6387/ 9282/ 9387
	91-96	PA1298		For vehicles without retarder, w/o pulley; Impeller Ø 135mm, Incl Electronic fuel Injection pump	51065006408/ 6492/ 9492
	91-96	PA1301		For vehicles with retarder; w/o pulley; Injection Pump with electronic control unit	51065006479/ 9479
	91-96	PA1302		For vehicles with retarder, w/o pulley	51065006426/ 6490/ 9426/ 9490
	91-96	PA1319		For vehicles with retarder, w pulley	51065006546/ 9546
	91-96	PA1321		For vehicles without retarder, w pulley	51065006545/ 6547/ 9545/ 9547
91-96	PA1336		w/ Pulley	51065006548/ 9548	
40.372 (272 kW) Eng.D2866LF05	91-96	PA1294		For vehicles without retarder; Impeller Ø 125mm	51065006282/ 6387/ 9282/ 9387
	91-96	PA1298		For vehicles without retarder, w/o pulley; Impeller Ø 135mm, Incl Electronic fuel Injection pump	51065006408/ 6492/ 9492
	91-96	PA1301		For vehicles with retarder; w/o pulley; Injection Pump with electronic control unit	51065006479/ 9479
	91-96	PA1302		For vehicles with retarder, w/o pulley	51065006426/ 6490/ 9426/ 9490
	91-96	PA1319		For vehicles with retarder, w pulley	51065006546/ 9546
	91-96	PA1321		For vehicles without retarder, w pulley	51065006545/ 6547/ 9545/ 9547
91-96	PA1336		w/ Pulley	51065006548/ 9548	
40.372 (272 kW) Eng.D2866LF15	91-96	PA1294		For vehicles without retarder; Impeller Ø 125mm	51065006282/ 6387/ 9282/ 9387
	91-96	PA1298		For vehicles without retarder, w/o pulley; Impeller Ø 135mm, Incl Electronic fuel Injection pump	51065006408/ 6492/ 9492
	91-96	PA1301		For vehicles with retarder; w/o pulley; Injection Pump with electronic control unit	51065006479/ 9479
	91-96	PA1302		For vehicles with retarder, w/o pulley	51065006426/ 6490/ 9426/ 9490
	91-96	PA1319		For vehicles with retarder, w pulley	51065006546/ 9546
	91-96	PA1321		For vehicles without retarder, w pulley	51065006545/ 6547/ 9545/ 9547
91-96	PA1336		w/ Pulley	51065006548/ 9548	
40.402 (294 kW) Eng.D2866LF16	95-96	PA1294		For vehicles without retarder; Impeller Ø 125mm	51065006282/ 6387/ 9282/ 9387
	95-96	PA1298		For vehicles without retarder, w/o pulley; Impeller Ø 135mm, Incl Electronic fuel Injection pump	51065006408/ 6492/ 9492
	95-96	PA1301		For vehicles with retarder; w/o pulley; Injection Pump with electronic control unit	51065006479/ 9479
	95-96	PA1302		For vehicles with retarder, w/o pulley	51065006426/ 6490/ 9426/ 9490
	95-96	PA1319		For vehicles with retarder, w pulley	51065006546/ 9546
	95-96	PA1321		For vehicles without retarder, w pulley	51065006545/ 6547/ 9545/ 9547
95-96	PA1336		w/ Pulley	51065006548/ 9548	
40.422 (309 kW) Eng.D2866LF06	91-96	PA1294		For vehicles without retarder; Impeller Ø 125mm	51065006282/ 6387/ 9282/ 9387
	91-96	PA1298		For vehicles without retarder, w/o pulley; Impeller Ø 135mm, Incl Electronic fuel Injection pump	51065006408/ 6492/ 9492
	91-96	PA1301		For vehicles with retarder; w/o pulley; Injection Pump with electronic control unit	51065006479/ 9479
	91-96	PA1302		For vehicles with retarder, w/o pulley	51065006426/ 6490/ 9426/ 9490



PA1294

PA1298

PA1301

PA1302





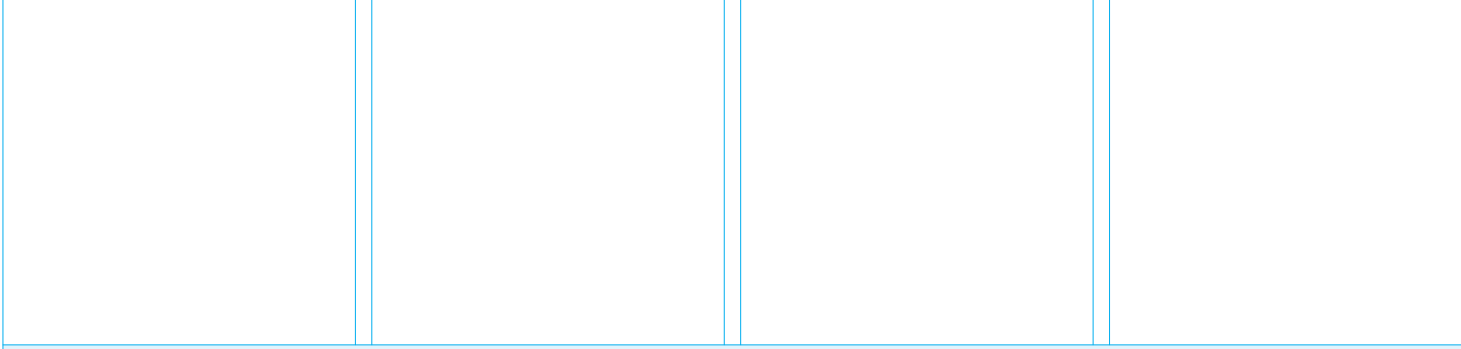
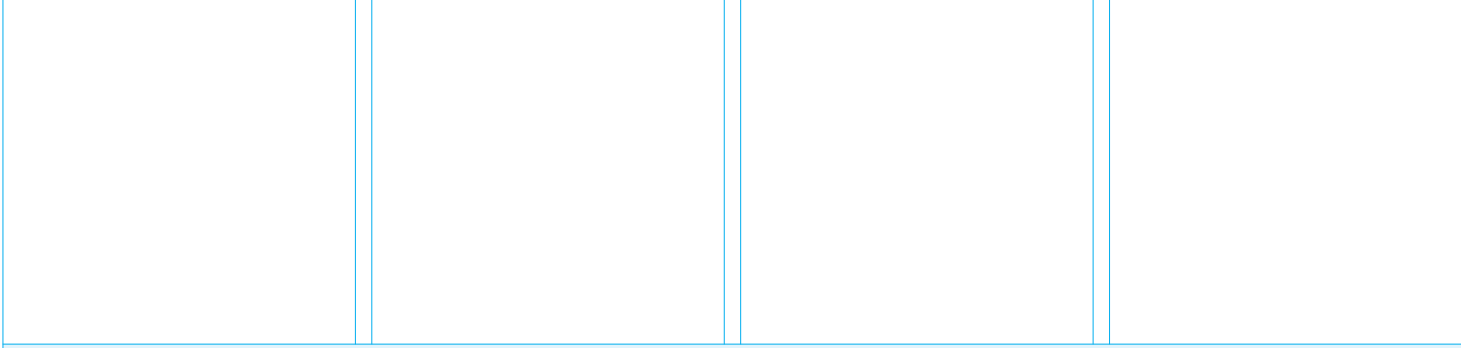
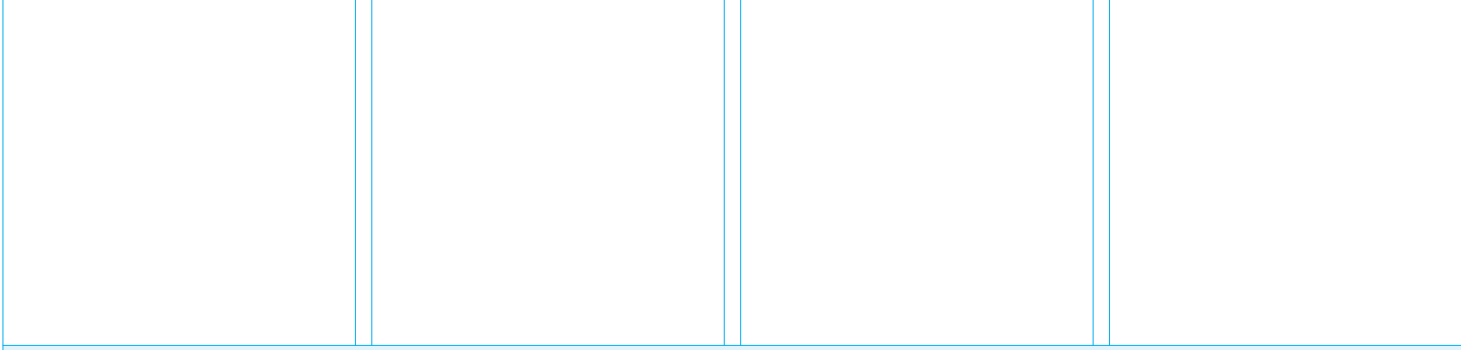

PA1319

PA1321

PA1336









		GRAF ref.			NOTE	Adaptable for OES
40.422 (309 kW) Eng.D2866LF06	91-96	PA1319			For vehicles with retarder, w pulley	51065006546/ 9546
	91-96	PA1321			For vehicles without retarder, w pulley	51065006545/ 6547/ 9545/ 9547
	91-96	PA1336			w/ Pulley	51065006548/ 9548
40.422 (309 kW) Eng.D2866LF09	91-96	PA1294			For vehicles without retarder; Impeller Ø 125mm	51065006282/ 6387/ 9282/ 9387
	91-96	PA1298			For vehicles without retarder, w/o pulley; Impeller Ø 135mm, Incl Eletronic fuel Injection pump	51065006408/ 6492/ 9492
	91-96	PA1301			For vehicles with retarder; w/o pulley; Injection Pump with electronic control unit	51065006479/ 9479
	91-96	PA1302			For vehicles with retarder, w/o pulley	51065006426/ 6490/ 9426/ 9490
	91-96	PA1319			For vehicles with retarder, w pulley	51065006546/ 9546
	91-96	PA1321			For vehicles without retarder, w pulley	51065006545/ 6547/ 9545/ 9547
	91-96	PA1336			w/ Pulley	51065006548/ 9548
40.462 (338-382 kW) Eng.D2840LF/460	89-90	PA1298			For vehicles without retarder, w/o pulley; Impeller Ø 135mm, Incl Eletronic fuel Injection pump	51065006408/ 6492/ 9492
	89-90	PA1302			For vehicles with retarder, w/o pulley	51065006426/ 6490/ 9426/ 9490
40.502 (368 kW) Eng.D2840LF01/LF04/LF06	90-96	PA1298			For vehicles without retarder, w/o pulley; Impeller Ø 135mm, Incl Eletronic fuel Injection pump	51065006408/ 6492/ 9492
	90-96	PA1302			For vehicles with retarder, w/o pulley	51065006426/ 6490/ 9426/ 9490
41.262 (191 kW) Eng.D2865LF/260	89-90	PA1298			For vehicles without retarder, w/o pulley; Impeller Ø 135mm, Incl Eletronic fuel Injection pump	51065006408/ 6492/ 9492
	89-90	PA1301			For vehicles with retarder; w/o pulley; Injection Pump with electronic control unit	51065006479/ 9479
	89-90	PA1302			For vehicles with retarder, w/o pulley	51065006426/ 6490/ 9426/ 9490
	89-90	PA1319			For vehicles with retarder, w pulley	51065006546/ 9546
	89-90	PA1321			For vehicles without retarder, w pulley	51065006545/ 6547/ 9545/ 9547
	89-90	PA1336			w/ Pulley	51065006548/ 9548
41.272 (198 kW) Eng.D2865LF02	90-91	PA1298			For vehicles without retarder, w/o pulley; Impeller Ø 135mm, Incl Eletronic fuel Injection pump	51065006408/ 6492/ 9492
	90-91	PA1301			For vehicles with retarder; w/o pulley; Injection Pump with electronic control unit	51065006479/ 9479
	90-91	PA1302			For vehicles with retarder, w/o pulley	51065006426/ 6490/ 9426/ 9490
	90-91	PA1319			For vehicles with retarder, w pulley	51065006546/ 9546
	90-91	PA1321			For vehicles without retarder, w pulley	51065006545/ 6547/ 9545/ 9547
	90-91	PA1336			w/ Pulley	51065006548/ 9548
41.292 (213 kW) Eng.D2866LF/290 41.332 (243 kW) Eng.D2866LF/330	88-90	PA1294			For vehicles without retarder; Impeller Ø 125mm	51065006282/ 6387/ 9282/ 9387
	88-90	PA1298			For vehicles without retarder, w/o pulley; Impeller Ø 135mm, Incl Eletronic fuel Injection pump	51065006408/ 6492/ 9492
	88-90	PA1301			For vehicles with retarder; w/o pulley; Injection Pump with electronic control unit	51065006479/ 9479
	88-90	PA1302			For vehicles with retarder, w/o pulley	51065006426/ 6490/ 9426/ 9490
	88-90	PA1319			For vehicles with retarder, w pulley	51065006546/ 9546
	88-90	PA1321			For vehicles without retarder, w pulley	51065006545/ 6547/ 9545/ 9547
	88-90	PA1336			w/ Pulley	51065006548/ 9548
41.322 (235 kW) Eng.D2865LF03/LF06	90-96	PA1298			For vehicles without retarder, w/o pulley; Impeller Ø 135mm, Incl Eletronic fuel Injection pump	51065006408/ 6492/ 9492
	90-96	PA1301			For vehicles with retarder; w/o pulley; Injection Pump with electronic control unit	51065006479/ 9479
	90-96	PA1302			For vehicles with retarder, w/o pulley	51065006426/ 6490/ 9426/ 9490
	90-96	PA1319			For vehicles with retarder, w pulley	51065006546/ 9546
	90-96	PA1321			For vehicles without retarder, w pulley	51065006545/ 6547/ 9545/ 9547
	90-96	PA1336			w/ Pulley	51065006548/ 9548
41.342 (250-213 kW) Eng.D2865LF09	94-96	PA1298			For vehicles without retarder, w/o pulley; Impeller Ø 135mm, Incl Eletronic fuel Injection pump	51065006408/ 6492/ 9492
	94-96	PA1301			For vehicles with retarder; w/o pulley; Injection Pump with electronic control unit	51065006479/ 9479
	94-96	PA1302			For vehicles with retarder, w/o pulley	51065006426/ 6490/ 9426/ 9490
	94-96	PA1319			For vehicles with retarder, w pulley	51065006546/ 9546
	90-96	PA1321			For vehicles without retarder, w pulley	51065006545/ 6547/ 9545/ 9547
	94-96	PA1336			w/ Pulley	51065006548/ 9548
41.362 (265 kW) Eng.D2866LXF	88-90	PA1294			For vehicles without retarder; Impeller Ø 125mm	51065006282/ 6387/ 9282/ 9387
	88-90	PA1298			For vehicles without retarder, w/o pulley; Impeller Ø 135mm, Incl Eletronic fuel Injection pump	51065006408/ 6492/ 9492
	88-90	PA1301			For vehicles with retarder; w/o pulley; Injection Pump with electronic control unit	51065006479/ 9479
	88-90	PA1302			For vehicles with retarder, w/o pulley	51065006426/ 6490/ 9426/ 9490





			
<p>PA1294</p>	<p>PA1298</p>	<p>PA1301</p>	<p>PA1302</p>
			
<p>PA1319</p>	<p>PA1321</p>	<p>PA1336</p>	

		GRAF ref.			NOTE	Adaptable for OES
41.362 (265 kW) Eng.D2866LXF	88-90	PA1319			For vehicles with retarder, w pulley	51065006546/ 9546
	90-96	PA1321			For vehicles without retarder, w pulley	51065006545/ 6547/ 9545/ 9547
	88-90	PA1336			w/ Pulley	51065006548/ 9548
41.372 (272 kW) Eng.D2866LF03/LF05	90-96	PA1294			For vehicles without retarder; Impeller Ø 125mm	51065006282/ 6387/ 9282/ 9387
	90-96	PA1298			For vehicles without retarder, w/o pulley; Impeller Ø 135mm, Incl Eletronic fuel Injection pump	51065006408/ 6492/ 9492
	90-96	PA1301			For vehicles with retarder; w/o pulley; Injection Pump with electronic control unit	51065006479/ 9479
	90-96	PA1302			For vehicles with retarder, w/o pulley	51065006426/ 6490/ 9426/ 9490
	90-96	PA1319			For vehicles with retarder, w pulley	51065006546/ 9546
	90-96	PA1321			For vehicles without retarder, w pulley	51065006545/ 6547/ 9545/ 9547
	90-96	PA1336			w/ Pulley	51065006548/ 9548
	90-96	PA1294			For vehicles without retarder; Impeller Ø 125mm	51065006282/ 6387/ 9282/ 9387
41.372 (272 kW) Eng.D2866LF15	90-96	PA1298			For vehicles without retarder, w/o pulley; Impeller Ø 135mm, Incl Eletronic fuel Injection pump	51065006408/ 6492/ 9492
	90-96	PA1301			For vehicles with retarder; w/o pulley; Injection Pump with electronic control unit	51065006479/ 9479
	90-96	PA1302			For vehicles with retarder, w/o pulley	51065006426/ 6490/ 9426/ 9490
	90-96	PA1319			For vehicles with retarder, w pulley	51065006546/ 9546
	90-96	PA1321			For vehicles without retarder, w pulley	51065006545/ 6547/ 9545/ 9547
	90-96	PA1336			w/ Pulley	51065006548/ 9548
	90-96	PA1294			For vehicles without retarder; Impeller Ø 125mm	51065006282/ 6387/ 9282/ 9387
	90-96	PA1298			For vehicles without retarder, w/o pulley; Impeller Ø 135mm, Incl Eletronic fuel Injection pump	51065006408/ 6492/ 9492
41.402 (294 kW) Eng.D2866LF16	94-96	PA1301			For vehicles with retarder; w/o pulley; Injection Pump with electronic control unit	51065006479/ 9479
	94-96	PA1302			For vehicles with retarder, w/o pulley	51065006426/ 6490/ 9426/ 9490
	94-96	PA1319			For vehicles with retarder, w pulley	51065006546/ 9546
	94-96	PA1321			For vehicles without retarder, w pulley	51065006545/ 6547/ 9545/ 9547
	94-96	PA1336			w/ Pulley	51065006548/ 9548
	90-96	PA1294			For vehicles without retarder; Impeller Ø 125mm	51065006282/ 6387/ 9282/ 9387
	90-96	PA1298			For vehicles without retarder, w/o pulley; Impeller Ø 135mm, Incl Eletronic fuel Injection pump	51065006408/ 6492/ 9492
	90-96	PA1301			For vehicles with retarder; w/o pulley; Injection Pump with electronic control unit	51065006479/ 9479
41.422 (309 kW) Eng.D2866LF06/LF09	90-96	PA1302			For vehicles with retarder, w/o pulley	51065006426/ 6490/ 9426/ 9490
	90-96	PA1319			For vehicles with retarder, w pulley	51065006546/ 9546
	90-96	PA1321			For vehicles without retarder, w pulley	51065006545/ 6547/ 9545/ 9547
	90-96	PA1336			w/ Pulley	51065006548/ 9548
	90-96	PA1294			For vehicles without retarder; Impeller Ø 125mm	51065006282/ 6387/ 9282/ 9387
	90-96	PA1298			For vehicles without retarder, w/o pulley; Impeller Ø 135mm, Incl Eletronic fuel Injection pump	51065006408/ 6492/ 9492
	90-96	PA1301			For vehicles with retarder; w/o pulley; Injection Pump with electronic control unit	51065006479/ 9479
	90-96	PA1302			For vehicles with retarder, w/o pulley	51065006426/ 6490/ 9426/ 9490
48.292 (213 kW) Eng.D2866LF/290	89-90	PA1319			For vehicles with retarder, w pulley	51065006546/ 9546
	89-90	PA1321			For vehicles without retarder, w pulley	51065006545/ 6547/ 9545/ 9547
	89-90	PA1336			w/ Pulley	51065006548/ 9548
	89-90	PA1294			For vehicles without retarder; Impeller Ø 125mm	51065006282/ 6387/ 9282/ 9387
	89-90	PA1298			For vehicles without retarder, w/o pulley; Impeller Ø 135mm, Incl Eletronic fuel Injection pump	51065006408/ 6492/ 9492
	89-90	PA1301			For vehicles with retarder; w/o pulley; Injection Pump with electronic control unit	51065006479/ 9479
	89-90	PA1302			For vehicles with retarder, w/o pulley	51065006426/ 6490/ 9426/ 9490
	89-90	PA1319			For vehicles with retarder, w pulley	51065006546/ 9546
48.332 (243 kW) Eng.D2866LF/330	89-90	PA1321			For vehicles without retarder, w pulley	51065006545/ 6547/ 9545/ 9547
	89-90	PA1336			w/ Pulley	51065006548/ 9548
	89-90	PA1294			For vehicles without retarder; Impeller Ø 125mm	51065006282/ 6387/ 9282/ 9387
	89-90	PA1298			For vehicles without retarder, w/o pulley; Impeller Ø 135mm, Incl Eletronic fuel Injection pump	51065006408/ 6492/ 9492
	89-90	PA1301			For vehicles with retarder; w/o pulley; Injection Pump with electronic control unit	51065006479/ 9479
	89-90	PA1302			For vehicles with retarder, w/o pulley	51065006426/ 6490/ 9426/ 9490
	89-90	PA1319			For vehicles with retarder, w pulley	51065006546/ 9546
	89-90	PA1321			For vehicles without retarder, w pulley	51065006545/ 6547/ 9545/ 9547
48.362 (265 kW) Eng.D2866LXF	89-90	PA1336			w/ Pulley	51065006548/ 9548
	89-90	PA1321			For vehicles without retarder, w pulley	51065006545/ 6547/ 9545/ 9547
	89-90	PA1319			For vehicles with retarder, w pulley	51065006546/ 9546
	89-90	PA1302			For vehicles with retarder, w/o pulley	51065006426/ 6490/ 9426/ 9490
	89-90	PA1301			For vehicles with retarder; w/o pulley; Injection Pump with electronic control unit	51065006479/ 9479
	89-90	PA1298			For vehicles without retarder, w/o pulley; Impeller Ø 135mm, Incl Eletronic fuel Injection pump	51065006408/ 6492/ 9492
	89-90	PA1294			For vehicles without retarder; Impeller Ø 125mm	51065006282/ 6387/ 9282/ 9387
	89-90	PA1336			w/ Pulley	51065006548/ 9548

			
PA1234	PA1292	PA1294	PA1298
			
PA1302	PA1306	PA1310	PA1322
			
PA1323	PA1331		





		GRAF ref.			NOTE	Adaptable for OES
48.462 (338-382 kW) Eng.D2840LF/460	89-90	PA1298			For vehicles without retarder, w/o pulley; Impeller Ø 135mm, Incl Electronic fuel Injection pump	51065006408/ 6492/ 9492
	89-90	PA1302			For vehicles with retarder, w/o pulley	51065006426/ 6490/ 9426/ 9490
G 90 '9/87-'5/95						
10.150 (110-114 kW) Eng.D0826GF01	87-93	PA1310			Impeller Ø 135mm	51065003178/ 6463/ 6495/ 9463/ 9495
	87-93	PA1323			Impeller Ø 125mm	51065006537/ 9537
10.150 (110-114 kW) Eng.D0826GF03	87-93	PA1310			Impeller Ø 135mm	51065003178/ 6463/ 6495/ 9463/ 9495
	87-93	PA1323			Impeller Ø 125mm	51065006537/ 9537
6.100 (75 kW) Eng.D0824GF01	87-93	PA1323			Impeller Ø 125mm	51065006537/ 9537
6.100 (75 kW) Eng.D0824GF02	87-93	PA1323			Impeller Ø 125mm	51065006537/ 9537
8.100 (75 kW) Eng.D0824GF01	87-93	PA1323			Impeller Ø 125mm	51065006537/ 9537
8.100 (75 kW) Eng.D0824GF02	87-93	PA1323			Impeller Ø 125mm	51065006537/ 9537
8.150 (110-114 kW) Eng.D0826GF	87-95	PA1310			Impeller Ø 135mm	51065003178/ 6463/ 6495/ 9463/ 9495
	87-95	PA1323			Impeller Ø 125mm	51065006537/ 9537
8.150 (110-114 kW) Eng.D0826GF01	88-93	PA1310			Impeller Ø 135mm	51065003178/ 6463/ 6495/ 9463/ 9495
	88-93	PA1323			Impeller Ø 125mm	51065006537/ 9537
8.150 (110-114 kW) Eng.D0826GF03	88-95	PA1310			Impeller Ø 135mm	51065003178/ 6463/ 6495/ 9463/ 9495
	88-95	PA1323			Impeller Ø 125mm	51065006537/ 9537
9.150 (110-114 kW) Eng.D0826GF	87-93	PA1310			Impeller Ø 135mm	51065003178/ 6463/ 6495/ 9463/ 9495
	87-93	PA1323			Impeller Ø 125mm	51065006537/ 9537
9.150 (110-114 kW) Eng.D0826GF01	88-93	PA1310			Impeller Ø 135mm	51065003178/ 6463/ 6495/ 9463/ 9495
	88-93	PA1323			Impeller Ø 125mm	51065006537/ 9537
9.150 (110-114 kW) Eng.D0826GF03	88-93	PA1310			Impeller Ø 135mm	51065003178/ 6463/ 6495/ 9463/ 9495
	88-93	PA1323			Impeller Ø 125mm	51065006537/ 9537
Industrial '1/76-'12/81						
9.5 T. (169 kW) Eng.D2565MT/MK	76-81	PA1292			For vehicles without retarder	51065006204/ 6213/ 6214/ 6215/ 6216/ 6218 51065006219/ 6221/ 6222/ 6223/ 6224/ 6225 51065006228/ 6229/ 9228
	76-81	PA1294			For vehicles without retarder; Impeller Ø 125mm	51065006282/ 6387/ 9282/ 9387
L 2000 '10/93-						
10.150 (114-118 kW) Eng.D0824LFO	95-96	PA1306			For vehicles without retarder, Impeller Ø 125mm	51065006462/ 6476/ 9462/ 9476
	95-96	PA1322			For vehicles without retarder, Impeller Ø 110mm	51065006515/ 6532/ 9515/ 9532
	95-96	PA1323			Impeller Ø 125mm	51065006537/ 9537
10.153 (114 kW) Eng.D0824LFL01/5	93-96	PA1306			For vehicles without retarder, Impeller Ø 125mm	51065006462/ 6476/ 9462/ 9476
	93-96	PA1322			For vehicles without retarder, Impeller Ø 110mm	51065006515/ 6532/ 9515/ 9532
	93-96	PA1323			Impeller Ø 125mm	51065006537/ 9537
10.163 (114-118 kW) Eng.D0824LFL02/6/9	94-	PA1306			For vehicles without retarder, Impeller Ø 125mm	51065006462/ 6476/ 9462/ 9476
	94-	PA1322			For vehicles without retarder, Impeller Ø 110mm	51065006515/ 6532/ 9515/ 9532
	94-	PA1323			Impeller Ø 125mm	51065006537/ 9537
10.185 (132 kW) Eng.D0834LFL03	00-	PA1234			Impeller Ø 135mm, M14x1,5	51065006679/ 6699/ 7064/ 7078 51065009064/ 9078/ 9679/ 9699
	00-	PA1331			Impeller Ø 125mm	51065006575/ 6606/ 6612 51065006669/ 9575/ 9606/ 9612
10.220 (162 kW) Eng.D0826LFL03	95-	PA1306			For vehicles without retarder, Impeller Ø 125mm	51065006462/ 6476/ 9462/ 9476
	95-	PA1310			Impeller Ø 135mm	51065003178/ 6463/ 6495/ 9463/ 9495
	95-	PA1322			For vehicles without retarder, Impeller Ø 110mm	51065006515/ 6532/ 9515/ 9532
	95-	PA1323			Impeller Ø 125mm	51065006537/ 9537
10.223 (162-169 kW) Eng.D0826LFL02/6	93-96	PA1306			For vehicles without retarder, Impeller Ø 125mm	51065006462/ 6476/ 9462/ 9476
	93-96	PA1310			Impeller Ø 135mm	51065003178/ 6463/ 6495/ 9463/ 9495
	93-96	PA1322			For vehicles without retarder, Impeller Ø 110mm	51065006515/ 6532/ 9515/ 9532
	93-96	PA1323			Impeller Ø 125mm	51065006537/ 9537
10.224 (162 kW) Eng.D0826LFL03	94-	PA1306			For vehicles without retarder, Impeller Ø 125mm	51065006462/ 6476/ 9462/ 9476
	94-	PA1310			Impeller Ø 135mm	51065003178/ 6463/ 6495/ 9463/ 9495
	94-	PA1322			For vehicles without retarder, Impeller Ø 110mm	51065006515/ 6532/ 9515/ 9532
	94-	PA1323			Impeller Ø 125mm	51065006537/ 9537
10.225 (162-206 kW) Eng.D0836LFL02	00-	PA1234			Impeller Ø 135mm, M14x1,5	51065006679/ 6699/ 7064/ 7078 51065009064/ 9078/ 9679/ 9699
	00-	PA1322			For vehicles without retarder, Impeller Ø 110mm	51065006515/ 6532/ 9515/ 9532
	00-	PA1331			Impeller Ø 125mm	51065006575/ 6606/ 6612 51065006669/ 9575/ 9606/ 9612
12.185 (132 kW) Eng.D0834LFL03	99-	PA1331			Impeller Ø 125mm	51065006575/ 6606/ 6612 51065006669/ 9575/ 9606/ 9612

			
<p>PA1234</p>	<p>PA1306</p>	<p>PA1310</p>	<p>PA1322</p>
			
<p>PA1323</p>	<p>PA1331</p>		

		GRAF ref.			NOTE	Adaptable for OES
12.225 (162-206 kW) Eng.D0836LFL02	99-	PA1234			Impeller Ø 135mm, M14x1,5	51065006679/ 6699/ 7064/ 7078 51065009064/ 9078/ 9679/ 9699
	99-	PA1322			For vehicles without retarder, Impeller Ø 110mm	51065006515/ 6532/ 9515/ 9532
	99-	PA1331			Impeller Ø 125mm	51065006575/ 6606/ 6612 51065006669/ 9575/ 9606/ 9612
8.103 (75 kW) Eng.D0824FL01	93-96	PA1306			For vehicles without retarder, Impeller Ø 125mm	51065006462/ 6476/ 9462/ 9476
	93-96	PA1322			For vehicles without retarder, Impeller Ø 110mm	51065006515/ 6532/ 9515/ 9532
	93-96	PA1323			Impeller Ø 125mm	51065006537/ 9537
8.113 (81 kW) Eng.D0824LFL04	95-	PA1306			For vehicles without retarder, Impeller Ø 125mm	51065006462/ 6476/ 9462/ 9476
	95-	PA1322			For vehicles without retarder, Impeller Ø 110mm	51065006515/ 6532/ 9515/ 9532
	95-	PA1323			Impeller Ø 125mm	51065006537/ 9537
8.113 (83 kW) Eng.D0824LFL08	00-	PA1306			For vehicles without retarder, Impeller Ø 125mm	51065006462/ 6476/ 9462/ 9476
	00-	PA1322			For vehicles without retarder, Impeller Ø 110mm	51065006515/ 6532/ 9515/ 9532
	00-	PA1323			Impeller Ø 125mm	51065006537/ 9537
8.145 (103 kW) Eng.D0834LFL02	00-	PA1323			Impeller Ø 125mm	51065006537/ 9537
8.150 (114-118 kW) Eng.D0824LFO	95-	PA1306			For vehicles without retarder, Impeller Ø 125mm	51065006462/ 6476/ 9462/ 9476
	95-	PA1322			For vehicles without retarder, Impeller Ø 110mm	51065006515/ 6532/ 9515/ 9532
	95-	PA1323			Impeller Ø 125mm	51065006537/ 9537
8.153 (114 kW) Eng.D0824LFL01/5	93-96	PA1306			For vehicles without retarder, Impeller Ø 125mm	51065006462/ 6476/ 9462/ 9476
	93-96	PA1322			For vehicles without retarder, Impeller Ø 110mm	51065006515/ 6532/ 9515/ 9532
	93-96	PA1323			Impeller Ø 125mm	51065006537/ 9537
8.163 (104 kW) Eng.D0824LFL07	95-	PA1306			For vehicles without retarder, Impeller Ø 125mm	51065006462/ 6476/ 9462/ 9476
	95-	PA1322			For vehicles without retarder, Impeller Ø 110mm	51065006515/ 6532/ 9515/ 9532
	95-	PA1323			Impeller Ø 125mm	51065006537/ 9537
8.163 (114-118 kW) Eng.D0824LFL02/6/9	95-	PA1306			For vehicles without retarder, Impeller Ø 125mm	51065006462/ 6476/ 9462/ 9476
	95-	PA1322			For vehicles without retarder, Impeller Ø 110mm	51065006515/ 6532/ 9515/ 9532
	95-	PA1323			Impeller Ø 125mm	51065006537/ 9537
8.185 (132 kW) Eng.D0834LFL03	00-	PA1234			Impeller Ø 135mm, M14x1,5	51065006679/ 6699/ 7064/ 7078 51065009064/ 9078/ 9679/ 9699
	00-	PA1331			Impeller Ø 125mm	51065006575/ 6606/ 6612 51065006669/ 9575/ 9606/ 9612
8.220 (162 kW) Eng.D0826LFL03	95-	PA1306			For vehicles without retarder, Impeller Ø 125mm	51065006462/ 6476/ 9462/ 9476
	95-	PA1310			Impeller Ø 135mm	51065003178/ 6463/ 6495/ 9463/ 9495
	95-	PA1322			For vehicles without retarder, Impeller Ø 110mm	51065006515/ 6532/ 9515/ 9532
	95-	PA1323			Impeller Ø 125mm	51065006537/ 9537
8.223 (162-169 kW) Eng.D0826LFL02/6	93-96	PA1306			For vehicles without retarder, Impeller Ø 125mm	51065006462/ 6476/ 9462/ 9476
	93-96	PA1310			Impeller Ø 135mm	51065003178/ 6463/ 6495/ 9463/ 9495
	93-96	PA1322			For vehicles without retarder, Impeller Ø 110mm	51065006515/ 6532/ 9515/ 9532
	93-96	PA1323			Impeller Ø 125mm	51065006537/ 9537
8.224 (162 kW) Eng.D0826LFL03 8.225 (162 kW) Eng.D0826LFL10	94-	PA1306			For vehicles without retarder, Impeller Ø 125mm	51065006462/ 6476/ 9462/ 9476
	94-	PA1310			Impeller Ø 135mm	51065003178/ 6463/ 6495/ 9463/ 9495
	94-	PA1322			For vehicles without retarder, Impeller Ø 110mm	51065006515/ 6532/ 9515/ 9532
	94-	PA1323			Impeller Ø 125mm	51065006537/ 9537
8.225 (162-206 kW) Eng.D0836LFL02	00-	PA1234			Impeller Ø 135mm, M14x1,5	51065006679/ 6699/ 7064/ 7078 51065009064/ 9078/ 9679/ 9699
	00-	PA1322			For vehicles without retarder, Impeller Ø 110mm	51065006515/ 6532/ 9515/ 9532
	00-	PA1331			Impeller Ø 125mm	51065006575/ 6606/ 6612 51065006669/ 9575/ 9606/ 9612
9.145 (103 kW) Eng.D0834LFL02	00-	PA1323			Impeller Ø 125mm	51065006537/ 9537
9.153 (114 kW) Eng.D0824LFL01/5	93-96	PA1306			For vehicles without retarder, Impeller Ø 125mm	51065006462/ 6476/ 9462/ 9476
	93-96	PA1322			For vehicles without retarder, Impeller Ø 110mm	51065006515/ 6532/ 9515/ 9532
	93-96	PA1323			Impeller Ø 125mm	51065006537/ 9537
9.163 (104 kW) Eng.D0824LFL07	95-97	PA1306			For vehicles without retarder, Impeller Ø 125mm	51065006462/ 6476/ 9462/ 9476
	95-97	PA1322			For vehicles without retarder, Impeller Ø 110mm	51065006515/ 6532/ 9515/ 9532
	95-97	PA1323			Impeller Ø 125mm	51065006537/ 9537
9.163 (114-118 kW) Eng.D0824LFL02/6/9	94-	PA1306			For vehicles without retarder, Impeller Ø 125mm	51065006462/ 6476/ 9462/ 9476
	94-	PA1322			For vehicles without retarder, Impeller Ø 110mm	51065006515/ 6532/ 9515/ 9532
	94-	PA1323			Impeller Ø 125mm	51065006537/ 9537
9.185 (132 kW) Eng.D0834LFL03	00-	PA1234			Impeller Ø 135mm, M14x1,5	51065006679/ 6699/ 7064/ 7078 51065009064/ 9078/ 9679/ 9699
	00-	PA1331			Impeller Ø 125mm	51065006575/ 6606/ 6612 51065006669/ 9575/ 9606/ 9612

		GRAF ref.			NOTE	Adaptable for OES
9.223 (162 kW) Eng.D0826LFL02/6	93-96	PA1306			For vehicles without retarder, Impeller Ø 125mm	51065006462/ 6476/ 9462/ 9476
	93-96	PA1310			Impeller Ø 135mm	51065003178/ 6463/ 6495/ 9463/ 9495
	93-96	PA1322			For vehicles without retarder, Impeller Ø 110mm	51065006515/ 6532/ 9515/ 9532
	93-96	PA1323			Impeller Ø 125mm	51065006537/ 9537
9.224 (162 kW) Eng.D0826LFL03	94-	PA1306			For vehicles without retarder, Impeller Ø 125mm	51065006462/ 6476/ 9462/ 9476
	94-	PA1310			Impeller Ø 135mm	51065003178/ 6463/ 6495/ 9463/ 9495
	94-	PA1322			For vehicles without retarder, Impeller Ø 110mm	51065006515/ 6532/ 9515/ 9532
	94-	PA1323			Impeller Ø 125mm	51065006537/ 9537
9.225 (162-206 kW) Eng.D0836LFL02	00-	PA1234			Impeller Ø 135mm, M14x1,5	51065006679/ 6699/ 7064/ 7078 51065009064/ 9078/ 9679/ 9699
	00-	PA1322			For vehicles without retarder, Impeller Ø 110mm	51065006515/ 6532/ 9515/ 9532
	00-	PA1331			Impeller Ø 125mm	51065006575/ 6606/ 6612 51065006669/ 9575/ 9606/ 9612
M 2000 L '8/95-						
12.163 (114 kW) Eng.D0824LFL06/LF09	95-	PA1306			For vehicles without retarder, Impeller Ø 125mm	51065006462/ 6476/ 9462/ 9476
	95-	PA1322			For vehicles without retarder, Impeller Ø 110mm	51065006515/ 6532/ 9515/ 9532
	95-	PA1323			Impeller Ø 125mm	51065006537/ 9537
12.224 (162 kW) Eng.D0826LFL03	95-	PA1306			For vehicles without retarder, Impeller Ø 125mm	51065006462/ 6476/ 9462/ 9476
	95-	PA1310			Impeller Ø 135mm	51065003178/ 6463/ 6495/ 9463/ 9495
	95-	PA1322			For vehicles without retarder, Impeller Ø 110mm	51065006515/ 6532/ 9515/ 9532
	95-	PA1323			Impeller Ø 125mm	51065006537/ 9537
12.224 (162 kW) Eng.D0826LFL10	95-	PA1306			For vehicles without retarder, Impeller Ø 125mm	51065006462/ 6476/ 9462/ 9476
	95-	PA1310			Impeller Ø 135mm	51065003178/ 6463/ 6495/ 9463/ 9495
	95-	PA1322			For vehicles without retarder, Impeller Ø 110mm	51065006515/ 6532/ 9515/ 9532
	95-	PA1323			Impeller Ø 125mm	51065006537/ 9537
14.163 (114 kW) Eng.D0824LFL06	95-	PA1306			For vehicles without retarder, Impeller Ø 125mm	51065006462/ 6476/ 9462/ 9476
	95-	PA1322			For vehicles without retarder, Impeller Ø 110mm	51065006515/ 6532/ 9515/ 9532
	95-	PA1323			Impeller Ø 125mm	51065006537/ 9537
14.163 (114 kW) Eng.D0824LFL09	95-	PA1306			For vehicles without retarder, Impeller Ø 125mm	51065006462/ 6476/ 9462/ 9476
	95-	PA1322			For vehicles without retarder, Impeller Ø 110mm	51065006515/ 6532/ 9515/ 9532
	95-	PA1323			Impeller Ø 125mm	51065006537/ 9537
14.224 (162 kW) Eng.D0826LFL03	95-	PA1306			For vehicles without retarder, Impeller Ø 125mm	51065006462/ 6476/ 9462/ 9476
	95-	PA1310			Impeller Ø 135mm	51065003178/ 6463/ 6495/ 9463/ 9495
	95-	PA1322			For vehicles without retarder, Impeller Ø 110mm	51065006515/ 6532/ 9515/ 9532
	95-	PA1323			Impeller Ø 125mm	51065006537/ 9537
14.224 (162 kW) Eng.D0826LFL10	95-	PA1306			For vehicles without retarder, Impeller Ø 125mm	51065006462/ 6476/ 9462/ 9476
	95-	PA1310			Impeller Ø 135mm	51065003178/ 6463/ 6495/ 9463/ 9495
	95-	PA1322			For vehicles without retarder, Impeller Ø 110mm	51065006515/ 6532/ 9515/ 9532
	95-	PA1323			Impeller Ø 125mm	51065006537/ 9537
14.225 (162 kW) Eng.D0836LFL02	00-	PA1234			Impeller Ø 135mm, M14x1,5	51065006679/ 6699/ 7064/ 7078 51065009064/ 9078/ 9679/ 9699
	00-	PA1322			For vehicles without retarder, Impeller Ø 110mm	51065006515/ 6532/ 9515/ 9532
	00-	PA1331			Impeller Ø 125mm	51065006575/ 6606/ 6612 51065006669/ 9575/ 9606/ 9612
14.255 (180 kW) Eng.D0836LFL05	00-	PA1234			Impeller Ø 135mm, M14x1,5	51065006679/ 6699/ 7064/ 7078 51065009064/ 9078/ 9679/ 9699
	00-	PA1322			For vehicles without retarder, Impeller Ø 110mm	51065006515/ 6532/ 9515/ 9532
	00-	PA1331			Impeller Ø 125mm	51065006575/ 6606/ 6612 51065006669/ 9575/ 9606/ 9612
14.264 (191 kW) Eng.D0826LFL09	95-	PA1306			For vehicles without retarder, Impeller Ø 125mm	51065006462/ 6476/ 9462/ 9476
	95-	PA1310			Impeller Ø 135mm	51065003178/ 6463/ 6495/ 9463/ 9495
	95-	PA1322			For vehicles without retarder, Impeller Ø 110mm	51065006515/ 6532/ 9515/ 9532
	95-	PA1323			Impeller Ø 125mm	51065006537/ 9537
14.284 (206 kW) Eng.D0836LF01	98-	PA1234			Impeller Ø 135mm, M14x1,5	51065006679/ 6699/ 7064/ 7078 51065009064/ 9078/ 9679/ 9699
	98-	PA1322			For vehicles without retarder, Impeller Ø 110mm	51065006515/ 6532/ 9515/ 9532
	98-	PA1331			Impeller Ø 125mm	51065006575/ 6606/ 6612 51065006669/ 9575/ 9606/ 9612
14.285 (206 kW) Eng.D0836LFL03	00-	PA1322			For vehicles without retarder, Impeller Ø 110mm	51065006515/ 6532/ 9515/ 9532
	00-	PA1331			Impeller Ø 125mm	51065006575/ 6606/ 6612 51065006669/ 9575/ 9606/ 9612
15.163 (114 kW) Eng.D0824LFL06	95-	PA1306			For vehicles without retarder, Impeller Ø 125mm	51065006462/ 6476/ 9462/ 9476



		GRAF ref.			NOTE	Adaptable for OES
15.163 (114 kW) Eng.D0824LFL06	95-	PA1322			For vehicles without retarder, Impeller Ø 110mm	51065006515/ 6532/ 9515/ 9532
	95-	PA1323			Impeller Ø 125mm	51065006537/ 9537
15.163 (114 kW) Eng.D0824LFL09	95-	PA1306			For vehicles without retarder, Impeller Ø 125mm	51065006462/ 6476/ 9462/ 9476
	95-	PA1322			For vehicles without retarder, Impeller Ø 110mm	51065006515/ 6532/ 9515/ 9532
15.224 (162 kW) Eng.D0826LFL03	95-	PA1323			Impeller Ø 125mm	51065006537/ 9537
	95-	PA1306			For vehicles without retarder, Impeller Ø 125mm	51065006462/ 6476/ 9462/ 9476
15.224 (162 kW) Eng.D0826LFL10	95-	PA1310			Impeller Ø 135mm	51065003178/ 6463/ 6495/ 9463/ 9495
	95-	PA1322			For vehicles without retarder, Impeller Ø 110mm	51065006515/ 6532/ 9515/ 9532
	95-	PA1323			Impeller Ø 125mm	51065006537/ 9537
15.224 (162 kW) Eng.D0826LFL10	95-	PA1306			For vehicles without retarder, Impeller Ø 125mm	51065006462/ 6476/ 9462/ 9476
	95-	PA1310			Impeller Ø 135mm	51065003178/ 6463/ 6495/ 9463/ 9495
	95-	PA1322			For vehicles without retarder, Impeller Ø 110mm	51065006515/ 6532/ 9515/ 9532
	95-	PA1323			Impeller Ø 125mm	51065006537/ 9537
15.225 (162 kW) Eng.D0836LFL02	99-	PA1234			Impeller Ø 135mm, M14x1,5	51065006679/ 6699/ 7064/ 7078 51065009064/ 9078/ 9679/ 9699
	99-	PA1322			For vehicles without retarder, Impeller Ø 110mm	51065006515/ 6532/ 9515/ 9532
	99-	PA1331			Impeller Ø 125mm	51065006575/ 6606/ 6612 51065006669/ 9575/ 9606/ 9612
15.255 (180 kW) Eng.D0836LFL05	99-	PA1234			Impeller Ø 135mm, M14x1,5	51065006679/ 6699/ 7064/ 7078 51065009064/ 9078/ 9679/ 9699
	99-	PA1322			For vehicles without retarder, Impeller Ø 110mm	51065006515/ 6532/ 9515/ 9532
	99-	PA1331			Impeller Ø 125mm	51065006575/ 6606/ 6612 51065006669/ 9575/ 9606/ 9612
15.264 (191 kW) Eng.D0826LFL09	95-	PA1306			For vehicles without retarder, Impeller Ø 125mm	51065006462/ 6476/ 9462/ 9476
	95-	PA1310			Impeller Ø 135mm	51065003178/ 6463/ 6495/ 9463/ 9495
	95-	PA1322			For vehicles without retarder, Impeller Ø 110mm	51065006515/ 6532/ 9515/ 9532
	95-	PA1323			Impeller Ø 125mm	51065006537/ 9537
15.284 (206 kW) Eng.D0836LF01	98-	PA1234			Impeller Ø 135mm, M14x1,5	51065006679/ 6699/ 7064/ 7078 51065009064/ 9078/ 9679/ 9699
	98-	PA1322			For vehicles without retarder, Impeller Ø 110mm	51065006515/ 6532/ 9515/ 9532
	98-	PA1331			Impeller Ø 125mm	51065006575/ 6606/ 6612 51065006669/ 9575/ 9606/ 9612
15.285 (206 kW) Eng.D0836LFL03	99-	PA1322			For vehicles without retarder, Impeller Ø 110mm	51065006515/ 6532/ 9515/ 9532
	99-	PA1331			Impeller Ø 125mm	51065006575/ 6606/ 6612 51065006669/ 9575/ 9606/ 9612
18.224 (162 kW) Eng.D0826LFL03	95-	PA1306			For vehicles without retarder, Impeller Ø 125mm	51065006462/ 6476/ 9462/ 9476
	95-	PA1310			Impeller Ø 135mm	51065003178/ 6463/ 6495/ 9463/ 9495
	95-	PA1322			For vehicles without retarder, Impeller Ø 110mm	51065006515/ 6532/ 9515/ 9532
	95-	PA1323			Impeller Ø 125mm	51065006537/ 9537
18.224 (162 kW) Eng.D0826LFL10	95-	PA1306			For vehicles without retarder, Impeller Ø 125mm	51065006462/ 6476/ 9462/ 9476
	95-	PA1310			Impeller Ø 135mm	51065003178/ 6463/ 6495/ 9463/ 9495
	95-	PA1322			For vehicles without retarder, Impeller Ø 110mm	51065006515/ 6532/ 9515/ 9532
	95-	PA1323			Impeller Ø 125mm	51065006537/ 9537
18.255 (180 kW) Eng.D0836LFL05	99-	PA1234			Impeller Ø 135mm, M14x1,5	51065006679/ 6699/ 7064/ 7078 51065009064/ 9078/ 9679/ 9699
	99-	PA1322			For vehicles without retarder, Impeller Ø 110mm	51065006515/ 6532/ 9515/ 9532
	99-	PA1331			Impeller Ø 125mm	51065006575/ 6606/ 6612 51065006669/ 9575/ 9606/ 9612
18.264 (191 kW) Eng.D0826LFL09	95-	PA1306			For vehicles without retarder, Impeller Ø 125mm	51065006462/ 6476/ 9462/ 9476
	95-	PA1310			Impeller Ø 135mm	51065003178/ 6463/ 6495/ 9463/ 9495
	95-	PA1322			For vehicles without retarder, Impeller Ø 110mm	51065006515/ 6532/ 9515/ 9532
	95-	PA1323			Impeller Ø 125mm	51065006537/ 9537
18.284 (206 kW) Eng.D0836LF01	98-	PA1234			Impeller Ø 135mm, M14x1,5	51065006679/ 6699/ 7064/ 7078 51065009064/ 9078/ 9679/ 9699
	98-	PA1322			For vehicles without retarder, Impeller Ø 110mm	51065006515/ 6532/ 9515/ 9532
	98-	PA1331			Impeller Ø 125mm	51065006575/ 6606/ 6612 51065006669/ 9575/ 9606/ 9612
18.285 (206 kW) Eng.D0836LFL03	99-	PA1322			For vehicles without retarder, Impeller Ø 110mm	51065006515/ 6532/ 9515/ 9532
	99-	PA1331			Impeller Ø 125mm	51065006575/ 6606/ 6612 51065006669/ 9575/ 9606/ 9612
7.3 (93-118 kW) Eng.D0836M/HM/HM/U	69-73	PA1322			For vehicles without retarder, Impeller Ø 110mm	51065006515/ 6532/ 9515/ 9532
M 2000 M '8/95-						
12.225 (162 kW) Eng.D0836LF04	03-	PA1322			For vehicles without retarder, Impeller Ø 110mm	51065006515/ 6532/ 9515/ 9532
	03-	PA1331			Impeller Ø 125mm	51065006575/ 6606/ 6612 51065006669/ 9575/ 9606/ 9612

			
<p>PA1306</p>	<p>PA1310</p>	<p>PA1322</p>	<p>PA1323</p>
			
<p>PA1331</p>			





			
<p>PA1298</p>	<p>PA1302</p>	<p>PA1306</p>	<p>PA1310</p>
			
<p>PA1319</p>	<p>PA1321</p>	<p>PA1322</p>	<p>PA1323</p>
			
<p>PA1331</p>			

		GRAF ref.			NOTE	Adaptable for OES
25.225 (162 kW) Eng.D0836LF02	03-	PA1322			For vehicles without retarder, Impeller Ø 110mm	51065006515/ 6532/ 9515/ 9532
	03-	PA1331			Impeller Ø 125mm	51065006575/ 6606/ 6612 51065006669/ 9575/ 9606/ 9612
25.225 (162 kW) Eng.D0836LF04	03-	PA1322			For vehicles without retarder, Impeller Ø 110mm	51065006515/ 6532/ 9515/ 9532
	03-	PA1331			Impeller Ø 125mm	51065006575/ 6606/ 6612 51065006669/ 9575/ 9606/ 9612
25.264 (191 kW) Eng.D0826LF17	95-	PA1306			For vehicles without retarder, Impeller Ø 125mm	51065006462/ 6476/ 9462/ 9476
	95-	PA1310			Impeller Ø 135mm	51065003178/ 6463/ 6495/ 9463/ 9495
	95-	PA1322			For vehicles without retarder, Impeller Ø 110mm	51065006515/ 6532/ 9515/ 9532
25.285 (206 kW) Eng.D0836LF03	03-	PA1322			For vehicles without retarder, Impeller Ø 110mm	51065006515/ 6532/ 9515/ 9532
	03-	PA1331			Impeller Ø 125mm	51065006575/ 6606/ 6612 51065006669/ 9575/ 9606/ 9612
M 90 '8/88-'6/96						
12.152 (110-114 kW) Eng.D0826F01	88-94	PA1306			For vehicles without retarder, Impeller Ø 125mm	51065006462/ 6476/ 9462/ 9476
	88-94	PA1310			Impeller Ø 135mm	51065003178/ 6463/ 6495/ 9463/ 9495
	88-94	PA1323			Impeller Ø 125mm	51065006537/ 9537
12.152 (110-114 kW) Eng.D0826F02	88-94	PA1306			For vehicles without retarder, Impeller Ø 125mm	51065006462/ 6476/ 9462/ 9476
	88-94	PA1310			Impeller Ø 135mm	51065003178/ 6463/ 6495/ 9463/ 9495
	88-94	PA1323			Impeller Ø 125mm	51065006537/ 9537
12.192 (140 kW) Eng.D0826LF01/LF05	90-96	PA1306			For vehicles without retarder, Impeller Ø 125mm	51065006462/ 6476/ 9462/ 9476
	90-96	PA1310			Impeller Ø 135mm	51065003178/ 6463/ 6495/ 9463/ 9495
	90-96	PA1323			Impeller Ø 125mm	51065006537/ 9537
12.192 (140 kW) Eng.D0826LF07	90-96	PA1306			For vehicles without retarder, Impeller Ø 125mm	51065006462/ 6476/ 9462/ 9476
	90-96	PA1310			Impeller Ø 135mm	51065003178/ 6463/ 6495/ 9463/ 9495
	90-96	PA1323			Impeller Ø 125mm	51065006537/ 9537
12.222 (162 kW) Eng.D0826LF11	94-96	PA1306			For vehicles without retarder, Impeller Ø 125mm	51065006462/ 6476/ 9462/ 9476
	94-96	PA1310			Impeller Ø 135mm	51065003178/ 6463/ 6495/ 9463/ 9495
	94-96	PA1323			Impeller Ø 125mm	51065006537/ 9537
12.232 (169 kW) Eng.D0826LF02/LF06/LF08	88-96	PA1306			For vehicles without retarder, Impeller Ø 125mm	51065006462/ 6476/ 9462/ 9476
	88-96	PA1310			Impeller Ø 135mm	51065003178/ 6463/ 6495/ 9463/ 9495
	88-96	PA1323			Impeller Ø 125mm	51065006537/ 9537
12.262 (191 kW) Eng.D0826LF13	95-96	PA1306			For vehicles without retarder, Impeller Ø 125mm	51065006462/ 6476/ 9462/ 9476
	95-96	PA1310			Impeller Ø 135mm	51065003178/ 6463/ 6495/ 9463/ 9495
	95-96	PA1323			Impeller Ø 125mm	51065006537/ 9537
12.272 (198 kW) Eng.D0826LF04	92-96	PA1306			For vehicles without retarder, Impeller Ø 125mm	51065006462/ 6476/ 9462/ 9476
	92-96	PA1310			Impeller Ø 135mm	51065003178/ 6463/ 6495/ 9463/ 9495
	92-96	PA1323			Impeller Ø 125mm	51065006537/ 9537
12.272 (198-235 kW) Eng.D2865LF02	91-92	PA1298			For vehicles without retarder, w/o pulley; Impeller Ø 135mm, Incl Electronic fuel Injection pump	51065006408/ 6492/ 9492
	91-92	PA1302			For vehicles with retarder, w/o pulley	51065006426/ 6490/ 9426/ 9490
	91-92	PA1319			For vehicles with retarder, w pulley	51065006546/ 9546
	91-92	PA1321			For vehicles without retarder, w pulley	51065006545/ 6547/ 9545/ 9547
14.152 (110-114 kW) Eng.D0826F01	88-94	PA1306			For vehicles without retarder, Impeller Ø 125mm	51065006462/ 6476/ 9462/ 9476
	88-94	PA1310			Impeller Ø 135mm	51065003178/ 6463/ 6495/ 9463/ 9495
	88-94	PA1323			Impeller Ø 125mm	51065006537/ 9537
14.152 (110-114 kW) Eng.D0826F02	88-94	PA1306			For vehicles without retarder, Impeller Ø 125mm	51065006462/ 6476/ 9462/ 9476
	88-94	PA1310			Impeller Ø 135mm	51065003178/ 6463/ 6495/ 9463/ 9495
	88-94	PA1323			Impeller Ø 125mm	51065006537/ 9537
14.152 (114 kW) Eng.D0824LF01	94-96	PA1306			For vehicles without retarder, Impeller Ø 125mm	51065006462/ 6476/ 9462/ 9476
	94-96	PA1323			Impeller Ø 125mm	51065006537/ 9537
14.162 (118 kW) Eng.D0824LF02	95-96	PA1306			For vehicles without retarder, Impeller Ø 125mm	51065006462/ 6476/ 9462/ 9476
	95-96	PA1323			Impeller Ø 125mm	51065006537/ 9537
14.192 (137 kW) Eng.D0826TF	88-90	PA1306			For vehicles without retarder, Impeller Ø 125mm; w/o Pulley	51065006462/ 6476/ 9462/ 9476
	88-90	PA1310			Impeller Ø 135mm; w/o Pulley	51065003178/ 6463/ 6495/ 9463/ 9495
	88-90	PA1323			Impeller Ø 125mm; w/o Pulley	51065006537/ 9537
14.192 (140 kW) Eng.D0826LF01	90-96	PA1306			For vehicles without retarder, Impeller Ø 125mm	51065006462/ 6476/ 9462/ 9476
	90-96	PA1310			Impeller Ø 135mm	51065003178/ 6463/ 6495/ 9463/ 9495

			
<p>PA1298</p>	<p>PA1302</p>	<p>PA1306</p>	<p>PA1310</p>
			
<p>PA1319</p>	<p>PA1321</p>	<p>PA1323</p>	<p>PA1336</p>

		GRAF ref.		NOTE	Adaptable for OES
14.192 (140 kW) Eng.D0826LF01	90-96	PA1323		Impeller Ø 125mm	51065006537/ 9537
14.192 (140 kW) Eng.D0826LF05	90-96	PA1306		For vehicles without retarder, Impeller Ø 125mm	51065006462/ 6476/ 9462/ 9476
	90-96	PA1310		Impeller Ø 135mm	51065003178/ 6463/ 6495/ 9463/ 9495
	90-96	PA1323		Impeller Ø 125mm	51065006537/ 9537
14.192 (140 kW) Eng.D0826LF07	90-96	PA1306		For vehicles without retarder, Impeller Ø 125mm	51065006462/ 6476/ 9462/ 9476
	90-96	PA1310		Impeller Ø 135mm	51065003178/ 6463/ 6495/ 9463/ 9495
	90-96	PA1323		Impeller Ø 125mm	51065006537/ 9537
14.222 (162 kW) Eng.D0826LF11	94-96	PA1306		For vehicles without retarder, Impeller Ø 125mm	51065006462/ 6476/ 9462/ 9476
	94-96	PA1310		Impeller Ø 135mm	51065003178/ 6463/ 6495/ 9463/ 9495
	94-96	PA1323		Impeller Ø 125mm	51065006537/ 9537
14.232 (160 kW) Eng.D0826LF/217/Silent	90-95	PA1306		For vehicles without retarder, Impeller Ø 125mm	51065006462/ 6476/ 9462/ 9476
	90-95	PA1310		Impeller Ø 135mm	51065003178/ 6463/ 6495/ 9463/ 9495
	90-95	PA1323		Impeller Ø 125mm	51065006537/ 9537
14.232 (169 kW) Eng.D0826LF02/LF06/LF08	88-96	PA1306		For vehicles without retarder, Impeller Ø 125mm	51065006462/ 6476/ 9462/ 9476
	88-96	PA1310		Impeller Ø 135mm	51065003178/ 6463/ 6495/ 9463/ 9495
	88-96	PA1323		Impeller Ø 125mm	51065006537/ 9537
14.262 (191 kW) Eng.D0826LF13	95-96	PA1306		For vehicles without retarder, Impeller Ø 125mm	51065006462/ 6476/ 9462/ 9476
	95-96	PA1310		Impeller Ø 135mm	51065003178/ 6463/ 6495/ 9463/ 9495
	95-96	PA1323		Impeller Ø 125mm	51065006537/ 9537
14.272 (198 kW) Eng.D0826LF04	92-96	PA1306		For vehicles without retarder, Impeller Ø 125mm	51065006462/ 6476/ 9462/ 9476
	92-96	PA1310		Impeller Ø 135mm	51065003178/ 6463/ 6495/ 9463/ 9495
	92-96	PA1323		Impeller Ø 125mm	51065006537/ 9537
14.272 (198-235 kW) Eng.D2865LF02	91-92	PA1298		For vehicles without retarder, w/o pulley; Impeller Ø 135mm, Incl Electronic fuel Injection pump	51065006408/ 6492/ 9492
	91-92	PA1302		For vehicles with retarder, w/o pulley	51065006426/ 6490/ 9426/ 9490
	91-92	PA1319		For vehicles with retarder, w pulley	51065006546/ 9546
	91-92	PA1321		For vehicles without retarder, w pulley	51065006545/ 6547/ 9545/ 9547
	91-92	PA1336		w/ Pulley	51065006548/ 9548
17.192 (137 kW) Eng.D0826TF	88-90	PA1306		For vehicles without retarder, Impeller Ø 125mm	51065006462/ 6476/ 9462/ 9476
	88-90	PA1310		Impeller Ø 135mm	51065003178/ 6463/ 6495/ 9463/ 9495
	88-90	PA1323		Impeller Ø 125mm	51065006537/ 9537
17.192 (140 kW) Eng.D0826LF01	90-96	PA1306		For vehicles without retarder, Impeller Ø 125mm	51065006462/ 6476/ 9462/ 9476
	90-96	PA1310		Impeller Ø 135mm	51065003178/ 6463/ 6495/ 9463/ 9495
	90-96	PA1323		Impeller Ø 125mm	51065006537/ 9537
17.192 (140 kW) Eng.D0826LF05	90-96	PA1306		For vehicles without retarder, Impeller Ø 125mm	51065006462/ 6476/ 9462/ 9476
	90-96	PA1310		Impeller Ø 135mm	51065003178/ 6463/ 6495/ 9463/ 9495
	90-96	PA1323		Impeller Ø 125mm	51065006537/ 9537
17.192 (140 kW) Eng.D0826LF07	90-96	PA1306		For vehicles without retarder, Impeller Ø 125mm	51065006462/ 6476/ 9462/ 9476
	90-96	PA1310		Impeller Ø 135mm	51065003178/ 6463/ 6495/ 9463/ 9495
	90-96	PA1323		Impeller Ø 125mm	51065006537/ 9537
17.222 (162 kW) Eng.D0826LF11	94-96	PA1306		For vehicles without retarder, Impeller Ø 125mm	51065006462/ 6476/ 9462/ 9476
	94-96	PA1310		Impeller Ø 135mm	51065003178/ 6463/ 6495/ 9463/ 9495
	94-96	PA1323		Impeller Ø 125mm	51065006537/ 9537
17.232 (160 kW) Eng.D0826LF/217/Silent	90-95	PA1306		For vehicles without retarder, Impeller Ø 125mm	51065006462/ 6476/ 9462/ 9476
	90-95	PA1310		Impeller Ø 135mm	51065003178/ 6463/ 6495/ 9463/ 9495
	90-95	PA1323		Impeller Ø 125mm	51065006537/ 9537
17.232 (169 kW) Eng.D0826LF06	88-96	PA1306		For vehicles without retarder, Impeller Ø 125mm	51065006462/ 6476/ 9462/ 9476
	88-96	PA1310		Impeller Ø 135mm	51065003178/ 6463/ 6495/ 9463/ 9495
	88-96	PA1323		Impeller Ø 125mm	51065006537/ 9537
17.232 (169 kW) Eng.D0826LF08	88-96	PA1306		For vehicles without retarder, Impeller Ø 125mm	51065006462/ 6476/ 9462/ 9476
	88-96	PA1310		Impeller Ø 135mm	51065003178/ 6463/ 6495/ 9463/ 9495
	88-96	PA1323		Impeller Ø 125mm	51065006537/ 9537
17.272 (198 kW) Eng.D0826LF04	92-95	PA1306		For vehicles without retarder, Impeller Ø 125mm	51065006462/ 6476/ 9462/ 9476
	92-95	PA1310		Impeller Ø 135mm	51065003178/ 6463/ 6495/ 9463/ 9495
	92-95	PA1323		Impeller Ø 125mm	51065006537/ 9537
17.272 (198-235 kW) Eng.D2865LF02	91-95	PA1298		For vehicles without retarder, w/o pulley; Impeller Ø 135mm, Incl Electronic fuel Injection pump	51065006408/ 6492/ 9492
	91-95	PA1302		For vehicles with retarder, w/o pulley	51065006426/ 6490/ 9426/ 9490
	91-95	PA1319		For vehicles with retarder, w pulley	51065006546/ 9546
	91-95	PA1321		For vehicles without retarder, w pulley	51065006545/ 6547/ 9545/ 9547
	91-95	PA1336		w/ Pulley	51065006548/ 9548
18.192 (140 kW) Eng.D0826LF01	90-96	PA1306		For vehicles without retarder, Impeller Ø 125mm	51065006462/ 6476/ 9462/ 9476

			
<p>PA1298</p>	<p>PA1302</p>	<p>PA1306</p>	<p>PA1310</p>
			
<p>PA1319</p>	<p>PA1321</p>	<p>PA1323</p>	<p>PA1336</p>

		GRAF ref.			NOTE	Adaptable for OES
18.192 (140 kW) Eng.D0826LF01	90-96	PA1310			Impeller Ø 135mm	51065003178/ 6463/ 6495/ 9463/ 9495
	90-96	PA1323			Impeller Ø 125mm	51065006537/ 9537
18.192 (140 kW) Eng.D0826LF05	90-96	PA1306			For vehicles without retarder, Impeller Ø 125mm	51065006462/ 6476/ 9462/ 9476
	90-96	PA1310			Impeller Ø 135mm	51065003178/ 6463/ 6495/ 9463/ 9495
	90-96	PA1323			Impeller Ø 125mm	51065006537/ 9537
18.192 (140 kW) Eng.D0826LF07	90-96	PA1306			For vehicles without retarder, Impeller Ø 125mm	51065006462/ 6476/ 9462/ 9476
	90-96	PA1310			Impeller Ø 135mm	51065003178/ 6463/ 6495/ 9463/ 9495
	90-96	PA1323			Impeller Ø 125mm	51065006537/ 9537
18.222 (162 kW) Eng.D0826LF11	94-96	PA1306			For vehicles without retarder, Impeller Ø 125mm	51065006462/ 6476/ 9462/ 9476
	94-96	PA1310			Impeller Ø 135mm	51065003178/ 6463/ 6495/ 9463/ 9495
	94-96	PA1323			Impeller Ø 125mm	51065006537/ 9537
18.232 (169 kW) Eng.D0826LF02/LF06/LF08	90-96	PA1306			For vehicles without retarder, Impeller Ø 125mm	51065006462/ 6476/ 9462/ 9476
	90-96	PA1310			Impeller Ø 135mm	51065003178/ 6463/ 6495/ 9463/ 9495
	90-96	PA1323			Impeller Ø 125mm	51065006537/ 9537
18.262 (191 kW) Eng.D0826LF13	95-96	PA1306			For vehicles without retarder, Impeller Ø 125mm	51065006462/ 6476/ 9462/ 9476
	95-96	PA1310			Impeller Ø 135mm	51065003178/ 6463/ 6495/ 9463/ 9495
	95-96	PA1323			Impeller Ø 125mm	51065006537/ 9537
18.272 (198 kW) Eng.D0826LF04	92-96	PA1306			For vehicles without retarder, Impeller Ø 125mm	51065006462/ 6476/ 9462/ 9476
	92-96	PA1310			Impeller Ø 135mm	51065003178/ 6463/ 6495/ 9463/ 9495
	92-96	PA1323			Impeller Ø 125mm	51065006537/ 9537
18.272 (198-235 kW) Eng.D2865LF02	91-94	PA1298			For vehicles without retarder, w/o pulley, Impeller Ø 135mm, Incl Electronic fuel Injection pump	51065006408/ 6492/ 9492
	91-94	PA1302			For vehicles with retarder, w/o pulley	51065006426/ 6490/ 9426/ 9490
	91-94	PA1319			For vehicles with retarder, w pulley	51065006546/ 9546
	91-94	PA1321			For vehicles without retarder, w pulley	51065006545/ 6547/ 9545/ 9547
	91-94	PA1336			w/ Pulley	51065006548/ 9548
24.192 (140 kW) Eng.D0826LF01	89-96	PA1306			For vehicles without retarder, Impeller Ø 125mm	51065006462/ 6476/ 9462/ 9476
	89-96	PA1310			Impeller Ø 135mm	51065003178/ 6463/ 6495/ 9463/ 9495
	89-96	PA1323			Impeller Ø 125mm	51065006537/ 9537
24.192 (140 kW) Eng.D0826LF05	89-96	PA1306			For vehicles without retarder, Impeller Ø 125mm	51065006462/ 6476/ 9462/ 9476
	89-96	PA1310			Impeller Ø 135mm	51065003178/ 6463/ 6495/ 9463/ 9495
	89-96	PA1323			Impeller Ø 125mm	51065006537/ 9537
24.192 (140 kW) Eng.D0826LF07	89-96	PA1306			For vehicles without retarder, Impeller Ø 125mm	51065006462/ 6476/ 9462/ 9476
	89-96	PA1310			Impeller Ø 135mm	51065003178/ 6463/ 6495/ 9463/ 9495
	89-96	PA1323			Impeller Ø 125mm	51065006537/ 9537
24.222 (162 kW) Eng.D0826LF11	94-96	PA1306			For vehicles without retarder, Impeller Ø 125mm	51065006462/ 6476/ 9462/ 9476
	94-96	PA1310			Impeller Ø 135mm	51065003178/ 6463/ 6495/ 9463/ 9495
	94-96	PA1323			Impeller Ø 125mm	51065006537/ 9537
24.232 (160 kW) Eng.D0826LF/217/Silent	90-95	PA1306			For vehicles without retarder, Impeller Ø 125mm	51065006462/ 6476/ 9462/ 9476
	90-95	PA1310			Impeller Ø 135mm	51065003178/ 6463/ 6495/ 9463/ 9495
	90-95	PA1323			Impeller Ø 125mm	51065006537/ 9537
24.232 (169 kW) Eng.D0826LF02	89-96	PA1306			For vehicles without retarder, Impeller Ø 125mm	51065006462/ 6476/ 9462/ 9476
	89-96	PA1310			Impeller Ø 135mm	51065003178/ 6463/ 6495/ 9463/ 9495
	89-96	PA1323			Impeller Ø 125mm	51065006537/ 9537
24.232 (169 kW) Eng.D0826LF06	89-96	PA1306			For vehicles without retarder, Impeller Ø 125mm	51065006462/ 6476/ 9462/ 9476
	89-96	PA1310			Impeller Ø 135mm	51065003178/ 6463/ 6495/ 9463/ 9495
	89-96	PA1323			Impeller Ø 125mm	51065006537/ 9537
24.232 (169 kW) Eng.D0826LF08	89-96	PA1306			For vehicles without retarder, Impeller Ø 125mm	51065006462/ 6476/ 9462/ 9476
	89-96	PA1310			Impeller Ø 135mm	51065003178/ 6463/ 6495/ 9463/ 9495
	89-96	PA1323			Impeller Ø 125mm	51065006537/ 9537
24.262 (191 kW) Eng.D0826LF13	95-96	PA1306			For vehicles without retarder, Impeller Ø 125mm	51065006462/ 6476/ 9462/ 9476
	95-96	PA1310			Impeller Ø 135mm	51065003178/ 6463/ 6495/ 9463/ 9495
	95-96	PA1323			Impeller Ø 125mm	51065006537/ 9537
24.272 (198 kW) Eng.D0826LF04	92-96	PA1306			For vehicles without retarder, Impeller Ø 125mm	51065006462/ 6476/ 9462/ 9476
	92-96	PA1310			Impeller Ø 135mm	51065003178/ 6463/ 6495/ 9463/ 9495
	92-96	PA1323			Impeller Ø 125mm	51065006537/ 9537
24.272 (198-235 kW) Eng.D2865LF02	91-94	PA1298			For vehicles without retarder, w/o pulley, Impeller Ø 135mm, Incl Electronic fuel Injection pump	51065006408/ 6492/ 9492
	91-94	PA1302			For vehicles with retarder, w/o pulley	51065006426/ 6490/ 9426/ 9490
	91-94	PA1319			For vehicles with retarder, w pulley	51065006546/ 9546
	91-94	PA1321			For vehicles without retarder, w pulley	51065006545/ 6547/ 9545/ 9547
	91-94	PA1336			w/ Pulley	51065006548/ 9548

			
<p>PA1292</p>	<p>PA1294</p>	<p>PA1298</p>	<p>PA1302</p>
			
<p>PA1308</p>	<p>PA1323</p>	<p>PA1324</p>	

		GRAF ref.			NOTE	Adaptable for OES
NU '9/96-						
NU 263 (191 kW) Eng.D0826LUH13	87-94	PA1308			w/ Pulley; Installation height 79,5 mm	51065006480/ 9480,51065063043
	98-	PA1323			Impeller Ø 125mm	51065006537/ 9537
	98-	PA1324			w/ Pulley; Installation height 90,0 mm	51065006543/ 6569/ 9543/ 9569
NU 263 (191 kW) Eng.D2865LUH09	96-98	PA1298			For vehicles without retarder, w/o pulley; Impeller Ø 135mm, Incl Eletronic fuel Injection pump	51065006408/ 6492/ 9492
	96-98	PA1302			For vehicles with retarder, w/o pulley	51065006426/ 6490/ 9426/ 9490
NU 263 (191 kW) Eng.D2866LUH22	98-	PA1294			For vehicles without retarder; Impeller Ø 125mm	51065006282/ 6387/ 9282/ 9387
	98-	PA1298			For vehicles without retarder, w/o pulley; Impeller Ø 135mm, Incl Eletronic fuel Injection pump	51065006408/ 6492/ 9492
	98-	PA1302			For vehicles with retarder, w/o pulley	51065006426/ 6490/ 9426/ 9490
NU 313 (228 kW) Eng.D2866LUH26	98-	PA1294			For vehicles without retarder; Impeller Ø 125mm	51065006282/ 6387/ 9282/ 9387
	98-	PA1298			For vehicles without retarder, w/o pulley; Impeller Ø 135mm, Incl Eletronic fuel Injection pump	51065006408/ 6492/ 9492
	98-	PA1302			For vehicles with retarder, w/o pulley	51065006426/ 6490/ 9426/ 9490
NU 313 15M (228 kW) Eng.D2866LUH26	98-	PA1294			For vehicles without retarder; Impeller Ø 125mm	51065006282/ 6387/ 9282/ 9387
	98-	PA1298			For vehicles without retarder, w/o pulley; Impeller Ø 135mm, Incl Eletronic fuel Injection pump	51065006408/ 6492/ 9492
	98-	PA1302			For vehicles with retarder, w/o pulley	51065006426/ 6490/ 9426/ 9490
NU 353 15M (257 kW) Eng.D2866LUH21	98-	PA1294			For vehicles without retarder; Impeller Ø 125mm	51065006282/ 6387/ 9282/ 9387
	98-	PA1298			For vehicles without retarder, w/o pulley; Impeller Ø 135mm, Incl Eletronic fuel Injection pump	51065006408/ 6492/ 9492
	98-	PA1302			For vehicles with retarder, w/o pulley	51065006426/ 6490/ 9426/ 9490
R '5/85-'1/93						
FRH 362 (265-274-176 kW) Eng.D2866KUH/360	85-92	PA1294			For vehicles without retarder; Impeller Ø 125mm	51065006282/ 6387/ 9282/ 9387
	85-92	PA1298			For vehicles without retarder, w/o pulley; Impeller Ø 135mm, Incl Eletronic fuel Injection pump	51065006408/ 6492/ 9492
	85-92	PA1302			For vehicles with retarder, w/o pulley	51065006426/ 6490/ 9426/ 9490
R 292,FR 292,FRH 292 (213-229 kW) Eng.D2866TOH/310	85-93	PA1294			For vehicles without retarder; Impeller Ø 125mm	51065006282/ 6387/ 9282/ 9387
	95-93	PA1298			For vehicles without retarder, w/o pulley; Impeller Ø 135mm, Incl Eletronic fuel Injection pump	51065006408/ 6492/ 9492
	85-93	PA1302			For vehicles with retarder, w/o pulley	51065006426/ 6490/ 9426/ 9490
R 292,FR 292,FRH 292 (213-229 kW) Eng.D2866TUH/290	85-93	PA1294			For vehicles without retarder; Impeller Ø 125mm	51065006282/ 6387/ 9282/ 9387
	85-93	PA1298			For vehicles without retarder, w/o pulley; Impeller Ø 135mm, Incl Eletronic fuel Injection pump	51065006408/ 6492/ 9492
	85-93	PA1302			For vehicles with retarder, w/o pulley	51065006426/ 6490/ 9426/ 9490
Serie 11000 '1/73-'12/81						
11168 9.5 (92-141 kW) Eng.D2565HM/M/ME/MF/MH/MR	76-81	PA1292			For vehicles without retarder	51065006204/ 6213/ 6214/ 6215/ 6216/ 6218 51065006219/ 6221/ 6222/ 6223/ 6224/ 6225 51065006228/ 6229/ 9228
	76-81	PA1294			For vehicles without retarder; Impeller Ø 125mm	51065006282/ 6387/ 9282/ 9387
Serie 12000 '1/73-'12/81						
12168 9.5 (92-141 kW) Eng.D2565HM/M/ME/MF/MH/MR	76-81	PA1292			For vehicles without retarder	51065006204/ 6213/ 6214/ 6215/ 6216/ 6218 51065006219/ 6221/ 6222/ 6223/ 6224/ 6225 51065006228/ 6229/ 9228
	76-81	PA1294			For vehicles without retarder; Impeller Ø 125mm	51065006282/ 6387/ 9282/ 9387
Serie 13000 '1/69-'12/81						
13168 9.5 (92-141 kW) Eng.D2565HM/M/ME/MF/MH/MR	76-81	PA1292			For vehicles without retarder	51065006204/ 6213/ 6214/ 6215/ 6216/ 6218 51065006219/ 6221/ 6222/ 6223/ 6224/ 6225 51065006228/ 6229/ 9228
	76-81	PA1294			For vehicles without retarder; Impeller Ø 125mm	51065006282/ 6387/ 9282/ 9387
Serie 14000 '1/73-'12/81						
14168 9.5 (92-141 kW) Eng.D2565HM/M/ME/MF/MH/MR	76-81	PA1292			For vehicles without retarder	51065006204/ 6213/ 6214/ 6215/ 6216/ 6218 51065006219/ 6221/ 6222/ 6223/ 6224/ 6225 51065006228/ 6229/ 9228
	76-81	PA1294			For vehicles without retarder; Impeller Ø 125mm	51065006282/ 6387/ 9282/ 9387
14192 9.5 (92-141 kW) Eng.D2565HM/M/ME/MF/MH/MR	76-81	PA1292			For vehicles without retarder	51065006204/ 6213/ 6214/ 6215/ 6216/ 6218 51065006219/ 6221/ 6222/ 6223/ 6224/ 6225 51065006228/ 6229/ 9228
	76-81	PA1294			For vehicles without retarder; Impeller Ø 125mm	51065006282/ 6387/ 9282/ 9387

			
<p>PA1224</p>	<p>PA1225</p>	<p>PA1292</p>	<p>PA1294</p>
			
<p>PA1298</p>	<p>PA1302</p>	<p>PA1319</p>	<p>PA1321</p>
			
<p>PA1330</p>			

		GRAF ref.			NOTE	Adaptable for OES
Serie 15000 '1/69-'12/81						
15168 9.5 (92-141 kW) Eng.D2565HM/M/ME/MF/MH/MR	76-81	PA1292			For vehicles without retarder	51065006204/ 6213/ 6214/ 6215/ 6216/ 6218 51065006219/ 6221/ 6222/ 6223/ 6224/ 6225 51065006228/ 6229/ 9228
	76-81	PA1294			For vehicles without retarder; Impeller Ø 125mm	51065006282/ 6387/ 9282/ 9387
15192 9.5 (92-141 kW) Eng.D2565HM/M/ME/MF/MH/MR	76-81	PA1292			For vehicles without retarder	51065006204/ 6213/ 6214/ 6215/ 6216/ 6218 51065006219/ 6221/ 6222/ 6223/ 6224/ 6225 51065006228/ 6229/ 9228
	76-81	PA1294			For vehicles without retarder; Impeller Ø 125mm	51065006282/ 6387/ 9282/ 9387
Serie 16000 '11/69-'12/81						
16168 9.5 (92-141 kW) Eng.D2565HM/M/ME/MF/MH/MR	76-81	PA1292			For vehicles without retarder	51065006204/ 6213/ 6214/ 6215/ 6216/ 6218 51065006219/ 6221/ 6222/ 6223/ 6224/ 6225 51065006228/ 6229/ 9228
	76-81	PA1294			For vehicles without retarder; Impeller Ø 125mm	51065006282/ 6387/ 9282/ 9387
Serie 19000 '1/72-'12/81						
19168 9.5 (92-141 kW) Eng.D2565HM/M/ME/MF/MH/MR	76-81	PA1292			For vehicles without retarder	51065006204/ 6213/ 6214/ 6215/ 6216/ 6218 51065006219/ 6221/ 6222/ 6223/ 6224/ 6225 51065006228/ 6229/ 9228
	76-81	PA1294			For vehicles without retarder; Impeller Ø 125mm	51065006282/ 6387/ 9282/ 9387
TGA '4/00-'7/16						
18.310 (228 kW) Eng.D2866LF36/26	00-	PA1298			For vehicles without retarder, w/o pulley; Impeller Ø 135mm, Incl Eletronic fuel Injection pump	51065006408/ 6492/ 9492
	00-	PA1302			For vehicles with retarder, w/o pulley	51065006426/ 6490/ 9426/ 9490
	00-	PA1319			For vehicles with retarder, w pulley	51065006546/ 9546
	00-	PA1321			For vehicles without retarder, w pulley	51065006545/ 6547/ 9545/ 9547
	00-	PA1330		•		51065000298,51065006066/ 7033/ 7036 51065007043/ 7045/ 7047/ 7048/ 7051 51065007052/ 7065/ 7066/ 7088/ 7089 51065009045/ 9047/ 9048/ 9052/ 9066
18.310, 18.320 (228 kW) Eng.D2066LF04	04-	PA1224			+Retarder	51065006642/ 6675/ 6694/ 9642/ 9675/ 9694
	04-	PA1225			-Retarder	51065006637/ 7049/ 9049
18.310, 18.320 (228-235 kW) Eng.D2066LF14	04-	PA1224			+Retarder	51065006642/ 6675/ 6694/ 9642/ 9675/ 9694
	04-	PA1225			-Retarder	51065006637/ 7049/ 9049
18.310, 18.320 (228-235 kW) Eng.D2066LF35	04-	PA1224			+Retarder	51065006642/ 6675/ 6694/ 9642/ 9675/ 9694
	04-	PA1225			-Retarder	51065006637/ 7049/ 9049
18.350, 18.360 (257-265 kW) Eng.D2066LF03	04-	PA1224			+Retarder	51065006642/ 6675/ 6694/ 9642/ 9675/ 9694
	04-	PA1225			-Retarder	51065006637/ 7049/ 9049
18.350, 18.360 (257-265 kW) Eng.D2066LF33	04-	PA1224			+Retarder	51065006642/ 6675/ 6694/ 9642/ 9675/ 9694
	04-	PA1225			-Retarder	51065006637/ 7049/ 9049
18.360 (265-176 kW) Eng.D2866LF37/27	00-	PA1298			For vehicles without retarder, w/o pulley; Impeller Ø 135mm, Incl Eletronic fuel Injection pump	51065006408/ 6492/ 9492
	00-	PA1302			For vehicles with retarder, w/o pulley	51065006426/ 6490/ 9426/ 9490
	00-	PA1319			For vehicles with retarder, w pulley	51065006546/ 9546
	00-	PA1321			For vehicles without retarder, w pulley	51065006545/ 6547/ 9545/ 9547
	00-	PA1330		•		51065000298,51065006066/ 7033/ 7036 51065007043/ 7045/ 7047/ 7048/ 7051 51065007052/ 7065/ 7066/ 7088/ 7089 51065009045/ 9047/ 9048/ 9052/ 9066
18.390 (287 kW) Eng.D2066LF02	04-	PA1224			+Retarder	51065006642/ 6675/ 6694/ 9642/ 9675/ 9694
	04-	PA1225			-Retarder	51065006637/ 7049/ 9049
18.390, 18.400 (287-294 kW) Eng.D2066LF02,LF12,LF32,LF37	04-	PA1224			+Retarder	51065006642/ 6675/ 6694/ 9642/ 9675/ 9694
	04-	PA1225			-Retarder	51065006637/ 7049/ 9049
18.410 (301 kW) Eng.D2866LF28	00-	PA1298			For vehicles without retarder, w/o pulley; Impeller Ø 135mm, Incl Eletronic fuel Injection pump	51065006408/ 6492/ 9492

			
<p>PA1224</p>	<p>PA1225</p>	<p>PA1298</p>	<p>PA1302</p>
			
<p>PA1319</p>	<p>PA1321</p>	<p>PA1330</p>	

		GRAF ref.			NOTE	Adaptable for OES
18.410 (301 kW) Eng.D2866LF28	00-	PA1302			For vehicles with retarder, w/o pulley	51065006426/ 6490/ 9426/ 9490
	00-	PA1319			For vehicles with retarder, w pulley	51065006546/ 9546
	00-	PA1321			For vehicles without retarder, w pulley	51065006545/ 6547/ 9545/ 9547
	00-	PA1330		•		51065000298,51065006066/ 7033/ 7036 51065007043/ 7045/ 7047/ 7048/ 7051 51065007052/ 7065/ 7066/ 7088/ 7089 51065009045/ 9047/ 9048/ 9052/ 9066
18.410 (301 kW) Eng.D2866LF32	00-	PA1298			For vehicles without retarder, w/o pulley; Impeller Ø 135mm, Incl Eletronic fuel Injection pump	51065006408/ 6492/ 9492
	00-	PA1302			For vehicles with retarder, w/o pulley	51065006426/ 6490/ 9426/ 9490
	00-	PA1319			For vehicles with retarder, w pulley	51065006546/ 9546
	00-	PA1321			For vehicles without retarder, w pulley	51065006545/ 6547/ 9545/ 9547
	00-	PA1330		•		51065000298,51065006066/ 7033/ 7036 51065007043/ 7045/ 7047/ 7048/ 7051 51065007052/ 7065/ 7066/ 7088/ 7089 51065009045/ 9047/ 9048/ 9052/ 9066
18.430, 18.440 (316-324 kW) Eng.D2066LF01	04-	PA1224			+Retarder	51065006642/ 6675/ 6694/ 9642/ 9675/ 9694
	04-	PA1225			-Retarder	51065006637/ 7049/ 9049
18.430, 18.440 (316-324 kW) Eng.D2066LF11	04-	PA1224			+Retarder	51065006642/ 6675/ 6694/ 9642/ 9675/ 9694
	04-	PA1225			-Retarder	51065006637/ 7049/ 9049
18.430, 18.440 (316-324 kW) Eng.D2066LF31	06-	PA1224			+Retarder	51065006642/ 6675/ 6694/ 9642/ 9675/ 9694
	06-	PA1225			-Retarder	51065006637/ 7049/ 9049
18.460 (338 kW) Eng.D2876LF04	00-	PA1298			For vehicles without retarder, w/o pulley; Impeller Ø 135mm, Incl Eletronic fuel Injection pump	51065006408/ 6492/ 9492
	00-	PA1302			For vehicles with retarder, w/o pulley	51065006426/ 6490/ 9426/ 9490
	00-	PA1319			For vehicles with retarder, w pulley	51065006546/ 9546
	00-	PA1321			For vehicles without retarder, w pulley	51065006545/ 6547/ 9545/ 9547
	00-	PA1330		•		51065000298,51065006066/ 7033/ 7036 51065007043/ 7045/ 7047/ 7048/ 7051 51065007052/ 7065/ 7066/ 7088/ 7089 51065009045/ 9047/ 9048/ 9052/ 9066
18.460 (338 kW) Eng.D2876LF07	00-	PA1298			For vehicles without retarder, w/o pulley; Impeller Ø 135mm, Incl Eletronic fuel Injection pump	51065006408/ 6492/ 9492
	00-	PA1302			For vehicles with retarder, w/o pulley	51065006426/ 6490/ 9426/ 9490
	00-	PA1319			For vehicles with retarder, w pulley	51065006546/ 9546
	00-	PA1321			For vehicles without retarder, w pulley	51065006545/ 6547/ 9545/ 9547
	00-	PA1330		•		51065000298,51065006066/ 7033/ 7036 51065007043/ 7045/ 7047/ 7048/ 7051 51065007052/ 7065/ 7066/ 7088/ 7089 51065009045/ 9047/ 9048/ 9052/ 9066
18.480 (353 kW) Eng.D2876LF01	06-	PA1298			For vehicles without retarder, w/o pulley; Impeller Ø 135mm, Incl Eletronic fuel Injection pump	51065006408/ 6492/ 9492
	06-	PA1302			For vehicles with retarder, w/o pulley	51065006426/ 6490/ 9426/ 9490
	06-	PA1319			For vehicles with retarder, w pulley	51065006546/ 9546
	06-	PA1321			For vehicles without retarder, w pulley	51065006545/ 6547/ 9545/ 9547
	06-	PA1330		•		51065000298,51065006066/ 7033/ 7036 51065007043/ 7045/ 7047/ 7048/ 7051 51065007052/ 7065/ 7066/ 7088/ 7089 51065009045/ 9047/ 9048/ 9052/ 9066
18.480 (353 kW) Eng.D2876LF12	02-	PA1298			For vehicles without retarder, w/o pulley; Impeller Ø 135mm, Incl Eletronic fuel Injection pump	51065006408/ 6492/ 9492
	02-	PA1302			For vehicles with retarder, w/o pulley	51065006426/ 6490/ 9426/ 9490
	02-	PA1319			For vehicles with retarder, w pulley	51065006546/ 9546
	02-	PA1321			For vehicles without retarder, w pulley	51065006545/ 6547/ 9545/ 9547
	02-	PA1330		•		51065000298,51065006066/ 7033/ 7036 51065007043/ 7045/ 7047/ 7048/ 7051 51065007052/ 7065/ 7066/ 7088/ 7089 51065009045/ 9047/ 9048/ 9052/ 9066
18.510 (375 kW) Eng.D2876LF05	00-	PA1298			For vehicles without retarder, w/o pulley; Impeller Ø 135mm, Incl Eletronic fuel Injection pump	51065006408/ 6492/ 9492
	00-	PA1302			For vehicles with retarder, w/o pulley	51065006426/ 6490/ 9426/ 9490
	00-	PA1319			For vehicles with retarder, w pulley	51065006546/ 9546
	00-	PA1321			For vehicles without retarder, w pulley	51065006545/ 6547/ 9545/ 9547
	00-	PA1330		•		51065000298,51065006066/ 7033/ 7036 51065007043/ 7045/ 7047/ 7048/ 7051 51065007052/ 7065/ 7066/ 7088/ 7089 51065009045/ 9047/ 9048/ 9052/ 9066
18.530 (390 kW) Eng.D2876LF13	02-	PA1298			For vehicles without retarder, w/o pulley; Impeller Ø 135mm, Incl Eletronic fuel Injection pump	51065006408/ 6492/ 9492
	02-	PA1302			For vehicles with retarder, w/o pulley	51065006426/ 6490/ 9426/ 9490

			
<p>PA1224</p>	<p>PA1225</p>	<p>PA1298</p>	<p>PA1302</p>
			
<p>PA1319</p>	<p>PA1321</p>	<p>PA1330</p>	

		GRAF ref.			NOTE	Adaptable for OES
18.530 (390 kW) Eng.D2876LF13	02-	PA1319			For vehicles with retarder, w pulley	51065006546/ 9546
	02-	PA1321			For vehicles without retarder, w pulley	51065006545/ 6547/ 9545/ 9547
	02-	PA1330		•		51065000298,51065006066/ 7033/ 7036 51065007043/ 7045/ 7047/ 7048/ 7051 51065007052/ 7065/ 7066/ 7088/ 7089 51065009045/ 9047/ 9048/ 9052/ 9066
19.350 (257 kW) Eng.D2066LF03	04-	PA1224			+Retarder	51065006642/ 6675/ 6694/ 9642/ 9675/ 9694
19.390 (287 kW) Eng.D2066LF02	04-	PA1224			+Retarder	51065006642/ 6675/ 6694/ 9642/ 9675/ 9694
24.350 (257-265 kW) Eng.D2066LF03	04-	PA1224			+Retarder	51065006642/ 6675/ 6694/ 9642/ 9675/ 9694
	04-	PA1225			-Retarder	51065006637/ 7049/ 9049
24.350 (257-265 kW) Eng.D2066LF13	04-	PA1224			+Retarder	51065006642/ 6675/ 6694/ 9642/ 9675/ 9694
	04-	PA1225			-Retarder	51065006637/ 7049/ 9049
24.350 (257-265 kW) Eng.D2066LF33	04-	PA1224			+Retarder	51065006642/ 6675/ 6694/ 9642/ 9675/ 9694
	04-	PA1225			-Retarder	51065006637/ 7049/ 9049
	04-	PA1302			For vehicles with retarder, w/o pulley	51065006426/ 6490/ 9426/ 9490
24.360 (265-176 kW) Eng.D2866LF27	01-	PA1298			For vehicles without retarder, w/o pulley; Impeller Ø 135mm, Incl Electronic fuel Injection pump	51065006408/ 6492/ 9492
	01-	PA1302			For vehicles with retarder, w/o pulley	51065006426/ 6490/ 9426/ 9490
	01-	PA1319			For vehicles with retarder, w pulley	51065006546/ 9546
	01-	PA1321			For vehicles without retarder, w pulley	51065006545/ 6547/ 9545/ 9547
24.390 (287-294 kW) Eng.D2066LF02	04-	PA1224			+Retarder	51065006642/ 6675/ 6694/ 9642/ 9675/ 9694
	04-	PA1225			-Retarder	51065006637/ 7049/ 9049
24.390 (287-294 kW) Eng.D2066LF12	06-14	PA1224			+Retarder	51065006642/ 6675/ 6694/ 9642/ 9675/ 9694
	04-	PA1225			-Retarder	51065006637/ 7049/ 9049
24.390 (287-294 kW) Eng.D2066LF32	06-14	PA1224			+Retarder	51065006642/ 6675/ 6694/ 9642/ 9675/ 9694
	04-	PA1225			-Retarder	51065006637/ 7049/ 9049
24.410 (301 kW) Eng.D2866LF28	01-	PA1298			For vehicles without retarder, w/o pulley; Impeller Ø 135mm, Incl Electronic fuel Injection pump	51065006408/ 6492/ 9492
	01-	PA1302			For vehicles with retarder, w/o pulley	51065006426/ 6490/ 9426/ 9490
	01-	PA1319			For vehicles with retarder, w pulley	51065006546/ 9546
	01-	PA1321			For vehicles without retarder, w pulley	51065006545/ 6547/ 9545/ 9547
	01-	PA1330		•		51065000298,51065006066/ 7033/ 7036 51065007043/ 7045/ 7047/ 7048/ 7051 51065007052/ 7065/ 7066/ 7088/ 7089 51065009045/ 9047/ 9048/ 9052/ 9066
24.430 (316-324 kW) Eng.D2066LF01	04-	PA1224			+Retarder	51065006642/ 6675/ 6694/ 9642/ 9675/ 9694
	04-	PA1225			-Retarder	51065006637/ 7049/ 9049
24.430 (316-324 kW) Eng.D2066LF11	04-	PA1224			+Retarder	51065006642/ 6675/ 6694/ 9642/ 9675/ 9694
	04-	PA1225			-Retarder	51065006637/ 7049/ 9049
24.430 (316-324 kW) Eng.D2066LF23	04-	PA1224			+Retarder	51065006642/ 6675/ 6694/ 9642/ 9675/ 9694
	04-	PA1225			-Retarder	51065006637/ 7049/ 9049
24.430 (316-324 kW) Eng.D2066LF31	04-	PA1224			+Retarder	51065006642/ 6675/ 6694/ 9642/ 9675/ 9694
	04-	PA1225			-Retarder	51065006637/ 7049/ 9049
24.460 (338 kW) Eng.D2876LF04	01-	PA1298			For vehicles without retarder, w/o pulley; Impeller Ø 135mm, Incl Electronic fuel Injection pump	51065006408/ 6492/ 9492
	01-	PA1302			For vehicles with retarder, w/o pulley	51065006426/ 6490/ 9426/ 9490
	01-	PA1319			For vehicles with retarder, w pulley	51065006546/ 9546
	01-	PA1321			For vehicles without retarder, w pulley	51065006545/ 6547/ 9545/ 9547
	01-	PA1330		•		51065000298,51065006066/ 7033/ 7036 51065007043/ 7045/ 7047/ 7048/ 7051 51065007052/ 7065/ 7066/ 7088/ 7089 51065009045/ 9047/ 9048/ 9052/ 9066

			
<p>PA1224</p>	<p>PA1225</p>	<p>PA1234</p>	<p>PA1298</p>
			
<p>PA1302</p>	<p>PA1319</p>	<p>PA1321</p>	<p>PA1330</p>

		GRAF ref.			NOTE	Adaptable for OES
24.480 (353 kW) Eng.D2676LF01	06-	PA1224			+Retarder	51065006642/ 6675/ 6694/ 9642/ 9675/ 9694
24.480 (353 kW) Eng.D2876LF12	02-	PA1298			For vehicles without retarder, w/o pulley; Impeller Ø 135mm, Incl Electronic fuel Injection pump	51065006408/ 6492/ 9492
	02-	PA1302			For vehicles with retarder, w/o pulley	51065006426/ 6490/ 9426/ 9490
	02-	PA1319			For vehicles with retarder, w pulley	51065006546/ 9546
	02-	PA1321			For vehicles without retarder, w pulley	51065006545/ 6547/ 9545/ 9547
	02-	PA1330		•		51065000298,51065006066/ 7033/ 7036 51065007043/ 7045/ 7047/ 7048/ 7051 51065007052/ 7065/ 7066/ 7088/ 7089 51065009045/ 9047/ 9048/ 9052/ 9066
24.510 (375 kW) Eng.D2876LF05	01-	PA1298			For vehicles without retarder, w/o pulley; Impeller Ø 135mm, Incl Electronic fuel Injection pump	51065006408/ 6492/ 9492
	01-	PA1302			For vehicles with retarder, w/o pulley	51065006426/ 6490/ 9426/ 9490
	01-	PA1319			For vehicles with retarder, w pulley	51065006546/ 9546
	01-	PA1321			For vehicles without retarder, w pulley	51065006545/ 6547/ 9545/ 9547
	01-	PA1330		•		51065000298,51065006066/ 7033/ 7036 51065007043/ 7045/ 7047/ 7048/ 7051 51065007052/ 7065/ 7066/ 7088/ 7089 51065009045/ 9047/ 9048/ 9052/ 9066
24.530 (390 kW) Eng.D2876LF13	01-	PA1298			For vehicles without retarder, w/o pulley; Impeller Ø 135mm, Incl Electronic fuel Injection pump	51065006408/ 6492/ 9492
	01-	PA1302			For vehicles with retarder, w/o pulley	51065006426/ 6490/ 9426/ 9490
	01-	PA1319			For vehicles with retarder, w pulley	51065006546/ 9546
	01-	PA1321			For vehicles without retarder, w pulley	51065006545/ 6547/ 9545/ 9547
	01-	PA1330		•		51065000298,51065006066/ 7033/ 7036 51065007043/ 7045/ 7047/ 7048/ 7051 51065007052/ 7065/ 7066/ 7088/ 7089 51065009045/ 9047/ 9048/ 9052/ 9066
26.280 (206 kW) Eng.D0836LF41	02-	PA1234			Impeller Ø 135mm, M14x1,5	51065006679/ 6699/ 7064/ 7078 51065009064/ 9078/ 9679/ 9699
26.310 (228 kW) Eng.D2866LF36/26	00-	PA1298			For vehicles without retarder, w/o pulley; Impeller Ø 135mm, Incl Electronic fuel Injection pump	51065006408/ 6492/ 9492
	00-	PA1302			For vehicles with retarder, w/o pulley	51065006426/ 6490/ 9426/ 9490
	00-	PA1319			For vehicles with retarder, w pulley	51065006546/ 9546
	00-	PA1321			For vehicles without retarder, w pulley	51065006545/ 6547/ 9545/ 9547
	00-	PA1330		•		51065000298,51065006066/ 7033/ 7036 51065007043/ 7045/ 7047/ 7048/ 7051 51065007052/ 7065/ 7066/ 7088/ 7089 51065009045/ 9047/ 9048/ 9052/ 9066
26.310, 26.320 (228-235 kW) Eng.D2066LF04	04-	PA1224			+Retarder	51065006642/ 6675/ 6694/ 9642/ 9675/ 9694
	04-	PA1225			-Retarder	51065006637/ 7049/ 9049
26.310, 26.320 (228-235 kW) Eng.D2066LF35	06-14	PA1224			+Retarder	51065006642/ 6675/ 6694/ 9642/ 9675/ 9694
	04-	PA1225			-Retarder	51065006637/ 7049/ 9049
26.330 (240 kW) Eng.D0836LF44	02-	PA1234			Impeller Ø 135mm, M14x1,5	51065006679/ 6699/ 7064/ 7078 51065009064/ 9078/ 9679/ 9699
26.350, 24.360 (257-265 kW) Eng.D2066LF03	04-	PA1224			+Retarder	51065006642/ 6675/ 6694/ 9642/ 9675/ 9694
	04-	PA1225			-Retarder	51065006637/ 7049/ 9049
26.350, 24.360 (257-265 kW) Eng.D2066LF13	06-14	PA1224			+Retarder	51065006642/ 6675/ 6694/ 9642/ 9675/ 9694
	04-	PA1225			-Retarder	51065006637/ 7049/ 9049
26.350, 24.360 (257-265 kW) Eng.D2066LF33	04-	PA1224			+Retarder	51065006642/ 6675/ 6694/ 9642/ 9675/ 9694
	04-	PA1225			-Retarder	51065006637/ 7049/ 9049
26.360 (265-176 kW) Eng.D2866LF27	01-	PA1298			For vehicles without retarder, w/o pulley; Impeller Ø 135mm, Incl Electronic fuel Injection pump	51065006408/ 6492/ 9492
	01-	PA1302			For vehicles with retarder, w/o pulley	51065006426/ 6490/ 9426/ 9490
	01-	PA1319			For vehicles with retarder, w pulley	51065006546/ 9546
	01-	PA1321			For vehicles without retarder, w pulley	51065006545/ 6547/ 9545/ 9547
	01-	PA1330		•		51065000298,51065006066/ 7033/ 7036 51065007043/ 7045/ 7047/ 7048/ 7051 51065007052/ 7065/ 7066/ 7088/ 7089 51065009045/ 9047/ 9048/ 9052/ 9066
26.360 (265-176 kW) Eng.D2866LF37	00-	PA1298			For vehicles without retarder, w/o pulley; Impeller Ø 135mm, Incl Electronic fuel Injection pump	51065006408/ 6492/ 9492
	00-	PA1302			For vehicles with retarder, w/o pulley	51065006426/ 6490/ 9426/ 9490
	00-	PA1319			For vehicles with retarder, w pulley	51065006546/ 9546
	00-	PA1321			For vehicles without retarder, w pulley	51065006545/ 6547/ 9545/ 9547

			
<p>PA1224</p>	<p>PA1225</p>	<p>PA1298</p>	<p>PA1302</p>
			
<p>PA1319</p>	<p>PA1321</p>	<p>PA1330</p>	

		GRAF ref.			NOTE	Adaptable for OES
26.360 (265-176 kW) Eng.D2866LF37	00-	PA1330		•		51065000298,51065006066/ 7033/ 7036 51065007043/ 7045/ 7047/ 7048/ 7051 51065007052/ 7065/ 7066/ 7088/ 7089 51065009045/ 9047/ 9048/ 9052/ 9066
26.390 (287-294 kW) Eng.D2066LF12	04-	PA1225			-Retarder	51065006637/ 7049/ 9049
26.390 (287-294 kW) Eng.D2066LF24	06-14	PA1224			+Retarder	51065006642/ 6675/ 6694/ 9642/ 9675/ 9694
	04-	PA1225			-Retarder	51065006637/ 7049/ 9049
26.390 (287-294 kW) Eng.D2066LF32	04-	PA1224			+Retarder	51065006642/ 6675/ 6694/ 9642/ 9675/ 9694
	04-	PA1225			-Retarder	51065006637/ 7049/ 9049
26.390, 26.400 (287-294 kW) Eng.D2066LF02	06-14	PA1224			+Retarder	51065006642/ 6675/ 6694/ 9642/ 9675/ 9694
	04-	PA1225			-Retarder	51065006637/ 7049/ 9049
26.410 (301 kW) Eng.D2866LF28	00-	PA1298			For vehicles without retarder, w/o pulley; Impeller Ø 135mm, Incl Electronic fuel Injection pump	51065006408/ 6492/ 9492
	00-	PA1302			For vehicles with retarder, w/o pulley	51065006426/ 6490/ 9426/ 9490
	00-	PA1319			For vehicles with retarder, w pulley	51065006546/ 9546
	00-	PA1321			For vehicles without retarder, w pulley	51065006545/ 6547/ 9545/ 9547
26.410 (301 kW) Eng.D2866LF32	00-	PA1330		•		51065000298,51065006066/ 7033/ 7036 51065007043/ 7045/ 7047/ 7048/ 7051 51065007052/ 7065/ 7066/ 7088/ 7089 51065009045/ 9047/ 9048/ 9052/ 9066
	02-	PA1298			For vehicles without retarder, w/o pulley; Impeller Ø 135mm, Incl Electronic fuel Injection pump	51065006408/ 6492/ 9492
	02-	PA1302			For vehicles with retarder, w/o pulley	51065006426/ 6490/ 9426/ 9490
	02-	PA1319			For vehicles with retarder, w pulley	51065006546/ 9546
	02-	PA1321			For vehicles without retarder, w pulley	51065006545/ 6547/ 9545/ 9547
26.410 (301 kW) Eng.D2866LF32	02-	PA1330		•		51065000298,51065006066/ 7033/ 7036 51065007043/ 7045/ 7047/ 7048/ 7051 51065007052/ 7065/ 7066/ 7088/ 7089 51065009045/ 9047/ 9048/ 9052/ 9066
	04-	PA1224			+Retarder	51065006642/ 6675/ 6694/ 9642/ 9675/ 9694
	04-	PA1225			-Retarder	51065006637/ 7049/ 9049
	04-	PA1224			+Retarder	51065006642/ 6675/ 6694/ 9642/ 9675/ 9694
	04-	PA1225			-Retarder	51065006637/ 7049/ 9049
26.430, 26.440 (316-324 kW) Eng.D2066LF01	04-	PA1224			+Retarder	51065006642/ 6675/ 6694/ 9642/ 9675/ 9694
26.430, 26.440 (316-324 kW) Eng.D2066LF11	04-	PA1225			-Retarder	51065006637/ 7049/ 9049
	04-	PA1224			+Retarder	51065006642/ 6675/ 6694/ 9642/ 9675/ 9694
26.430, 26.440 (316-324 kW) Eng.D2066LF31	04-	PA1225			-Retarder	51065006637/ 7049/ 9049
	04-	PA1302			For vehicles with retarder, w/o pulley	51065006426/ 6490/ 9426/ 9490
	04-	PA1298			For vehicles without retarder, w/o pulley; Impeller Ø 135mm, Incl Electronic fuel Injection pump	51065006408/ 6492/ 9492
26.460 (338 kW) Eng.D2876LF04	01-	PA1302			For vehicles with retarder, w/o pulley	51065006426/ 6490/ 9426/ 9490
	01-	PA1319			For vehicles with retarder, w pulley	51065006546/ 9546
	01-	PA1321			For vehicles without retarder, w pulley	51065006545/ 6547/ 9545/ 9547
	01-	PA1330		•		51065000298,51065006066/ 7033/ 7036 51065007043/ 7045/ 7047/ 7048/ 7051 51065007052/ 7065/ 7066/ 7088/ 7089 51065009045/ 9047/ 9048/ 9052/ 9066
	01-	PA1298			For vehicles without retarder, w/o pulley; Impeller Ø 135mm, Incl Electronic fuel Injection pump	51065006408/ 6492/ 9492
26.460 (338 kW) Eng.D2876LF07	01-	PA1302			For vehicles with retarder, w/o pulley	51065006426/ 6490/ 9426/ 9490
	01-	PA1319			For vehicles with retarder, w pulley	51065006546/ 9546
	01-	PA1321			For vehicles without retarder, w pulley	51065006545/ 6547/ 9545/ 9547
	01-	PA1330		•		51065000298,51065006066/ 7033/ 7036 51065007043/ 7045/ 7047/ 7048/ 7051 51065007052/ 7065/ 7066/ 7088/ 7089 51065009045/ 9047/ 9048/ 9052/ 9066
26.480 (353 kW) Eng.D2676LF01	06-	PA1224			+Retarder	51065006642/ 6675/ 6694/ 9642/ 9675/ 9694
26.480 (353 kW) Eng.D2876LF12	02-	PA1298			For vehicles without retarder, w/o pulley; Impeller Ø 135mm, Incl Electronic fuel Injection pump	51065006408/ 6492/ 9492
	02-	PA1302			For vehicles with retarder, w/o pulley	51065006426/ 6490/ 9426/ 9490
	02-	PA1319			For vehicles with retarder, w pulley	51065006546/ 9546
	02-	PA1321			For vehicles without retarder, w pulley	51065006545/ 6547/ 9545/ 9547





			
<p>PA1224</p>	<p>PA1225</p>	<p>PA1298</p>	<p>PA1302</p>
			
<p>PA1319</p>	<p>PA1321</p>	<p>PA1330</p>	

		GRAF ref.			NOTE	Adaptable for OES
26.480 (353 kW) Eng.D2876LF12	02-	PA1330		•		51065000298,51065006066/ 7033/ 7036 51065007043/ 7045/ 7047/ 7048/ 7051 51065007052/ 7065/ 7066/ 7088/ 7089 51065009045/ 9047/ 9048/ 9052/ 9066
26.510 (375 kW) Eng.D2876LF05	00-	PA1298			For vehicles without retarder, w/o pulley; Impeller Ø 135mm, Incl Electronic fuel Injection pump	51065006408/ 6492/ 9492
	00-	PA1302			For vehicles with retarder, w/o pulley	51065006426/ 6490/ 9426/ 9490
	00-	PA1319			For vehicles with retarder, w pulley	51065006546/ 9546
	00-	PA1321			For vehicles without retarder, w pulley	51065006545/ 6547/ 9545/ 9547
	00-	PA1330		•		51065000298,51065006066/ 7033/ 7036 51065007043/ 7045/ 7047/ 7048/ 7051 51065007052/ 7065/ 7066/ 7088/ 7089 51065009045/ 9047/ 9048/ 9052/ 9066
26.530 (390 kW) Eng.D2876LF13	01-	PA1298			For vehicles without retarder, w/o pulley; Impeller Ø 135mm, Incl Electronic fuel Injection pump	51065006408/ 6492/ 9492
	01-	PA1302			For vehicles with retarder, w/o pulley	51065006426/ 6490/ 9426/ 9490
	01-	PA1319			For vehicles with retarder, w pulley	51065006546/ 9546
	01-	PA1321			For vehicles without retarder, w pulley	51065006545/ 6547/ 9545/ 9547
	01-	PA1330		•		51065000298,51065006066/ 7033/ 7036 51065007043/ 7045/ 7047/ 7048/ 7051 51065007052/ 7065/ 7066/ 7088/ 7089 51065009045/ 9047/ 9048/ 9052/ 9066
28.310 (228 kW) Eng.D2866LF26	02-	PA1298			For vehicles without retarder, w/o pulley; Impeller Ø 135mm, Incl Electronic fuel Injection pump	51065006408/ 6492/ 9492
	02-	PA1302			For vehicles with retarder, w/o pulley	51065006426/ 6490/ 9426/ 9490
	02-	PA1319			For vehicles with retarder, w pulley	51065006546/ 9546
	02-	PA1321			For vehicles without retarder, w pulley	51065006545/ 6547/ 9545/ 9547
	02-	PA1330		•		51065000298,51065006066/ 7033/ 7036 51065007043/ 7045/ 7047/ 7048/ 7051 51065007052/ 7065/ 7066/ 7088/ 7089 51065009045/ 9047/ 9048/ 9052/ 9066
28.320 (228-235 kW) Eng.D2066LF04,LF14,LF28,LF39	06-	PA1224			+Retarder	51065006642/ 6675/ 6694/ 9642/ 9675/ 9694
	06-	PA1225			-Retarder	51065006637/ 7049/ 9049
28.350, 28.360 (257-265 kW) Eng.D2066LF03,LF13,LF27,LF38	04-	PA1225			-Retarder	51065006637/ 7049/ 9049
28.360 (265-176 kW) Eng.D2866LF27	02-	PA1298			For vehicles without retarder, w/o pulley; Impeller Ø 135mm, Incl Electronic fuel Injection pump	51065006408/ 6492/ 9492
	02-	PA1302			For vehicles with retarder, w/o pulley	51065006426/ 6490/ 9426/ 9490
	02-	PA1319			For vehicles with retarder, w pulley	51065006546/ 9546
	02-	PA1321			For vehicles without retarder, w pulley	51065006545/ 6547/ 9545/ 9547
	02-	PA1330		•		51065000298,51065006066/ 7033/ 7036 51065007043/ 7045/ 7047/ 7048/ 7051 51065007052/ 7065/ 7066/ 7088/ 7089 51065009045/ 9047/ 9048/ 9052/ 9066
28.390, 28.400 (287-294 kW) Eng.D2066LF02	07-	PA1224			+Retarder	51065006642/ 6675/ 6694/ 9642/ 9675/ 9694
	07-	PA1225			-Retarder	51065006637/ 7049/ 9049
28.390, 28.400 (287-294 kW) Eng.D2066LF26	05-	PA1224			+Retarder	51065006642/ 6675/ 6694/ 9642/ 9675/ 9694
	05-	PA1225			-Retarder	51065006637/ 7049/ 9049
28.410 (301 kW) Eng.D2866LF28	02-	PA1298			For vehicles without retarder, w/o pulley; Impeller Ø 135mm, Incl Electronic fuel Injection pump	51065006408/ 6492/ 9492
	02-	PA1302			For vehicles with retarder, w/o pulley	51065006426/ 6490/ 9426/ 9490
	02-	PA1319			For vehicles with retarder, w pulley	51065006546/ 9546
	02-	PA1321			For vehicles without retarder, w pulley	51065006545/ 6547/ 9545/ 9547
	02-	PA1330		•		51065000298,51065006066/ 7033/ 7036 51065007043/ 7045/ 7047/ 7048/ 7051 51065007052/ 7065/ 7066/ 7088/ 7089 51065009045/ 9047/ 9048/ 9052/ 9066
28.430, 28.440 (316-324 kW) Eng.D2066LF11	04-	PA1224			+Retarder	51065006642/ 6675/ 6694/ 9642/ 9675/ 9694
	04-	PA1225			-Retarder	51065006637/ 7049/ 9049
28.460 (338 kW) Eng.D2876LF04	02-	PA1298			For vehicles without retarder, w/o pulley; Impeller Ø 135mm, Incl Electronic fuel Injection pump	51065006408/ 6492/ 9492
	02-	PA1302			For vehicles with retarder, w/o pulley	51065006426/ 6490/ 9426/ 9490
	02-	PA1319			For vehicles with retarder, w pulley	51065006546/ 9546
	02-	PA1321			For vehicles without retarder, w pulley	51065006545/ 6547/ 9545/ 9547
	02-	PA1330		•		51065000298,51065006066/ 7033/ 7036 51065007043/ 7045/ 7047/ 7048/ 7051 51065007052/ 7065/ 7066/ 7088/ 7089 51065009045/ 9047/ 9048/ 9052/ 9066
28.480 (353 kW) Eng.D2876LF12	02-	PA1298			For vehicles without retarder, w/o pulley; Impeller Ø 135mm, Incl Electronic fuel Injection pump	51065006408/ 6492/ 9492

			
<p>PA1224</p>	<p>PA1225</p>	<p>PA1298</p>	<p>PA1302</p>
			
<p>PA1319</p>	<p>PA1321</p>	<p>PA1330</p>	

		GRAF ref.			NOTE	Adaptable for OES
28.480 (353 kW) Eng.D2876LF12	02-	PA1302			For vehicles with retarder, w/o pulley	51065006426/ 6490/ 9426/ 9490
	02-	PA1319			For vehicles with retarder, w pulley	51065006546/ 9546
	02-	PA1321			For vehicles without retarder, w pulley	51065006545/ 6547/ 9545/ 9547
	02-	PA1330		•		51065000298,51065006066/ 7033/ 7036 51065007043/ 7045/ 7047/ 7048/ 7051 51065007052/ 7065/ 7066/ 7088/ 7089 51065009045/ 9047/ 9048/ 9052/ 9066
28.510 (375 kW) Eng.D2876LF05	02-	PA1298			For vehicles without retarder, w/o pulley; Impeller Ø 135mm, Incl Electronic fuel Injection pump	51065006408/ 6492/ 9492
	02-	PA1302			For vehicles with retarder, w/o pulley	51065006426/ 6490/ 9426/ 9490
	02-	PA1319			For vehicles with retarder, w pulley	51065006546/ 9546
	02-	PA1321			For vehicles without retarder, w pulley	51065006545/ 6547/ 9545/ 9547
	02-	PA1330		•		51065000298,51065006066/ 7033/ 7036 51065007043/ 7045/ 7047/ 7048/ 7051 51065007052/ 7065/ 7066/ 7088/ 7089 51065009045/ 9047/ 9048/ 9052/ 9066
28.530 (390 kW) Eng.D2876LF13	02-	PA1298			For vehicles without retarder, w/o pulley; Impeller Ø 135mm, Incl Electronic fuel Injection pump	51065006408/ 6492/ 9492
	02-	PA1302			For vehicles with retarder, w/o pulley	51065006426/ 6490/ 9426/ 9490
	02-	PA1319			For vehicles with retarder, w pulley	51065006546/ 9546
	02-	PA1321			For vehicles without retarder, w pulley	51065006545/ 6547/ 9545/ 9547
	02-	PA1330		•		51065000298,51065006066/ 7033/ 7036 51065007043/ 7045/ 7047/ 7048/ 7051 51065007052/ 7065/ 7066/ 7088/ 7089 51065009045/ 9047/ 9048/ 9052/ 9066
32,350, 32,360 (257-265 kW) Eng.D2066LF03,LF13,LF27,LF38	04-	PA1224			+Retarder	51065006642/ 6675/ 6694/ 9642/ 9675/ 9694
	04-	PA1225			-Retarder	51065006637/ 7049/ 9049
32.310 (228 kW) Eng.D2866LF26	02-	PA1298			For vehicles without retarder, w/o pulley; Impeller Ø 135mm, Incl Electronic fuel Injection pump	51065006408/ 6492/ 9492
	02-	PA1302			For vehicles with retarder, w/o pulley	51065006426/ 6490/ 9426/ 9490
	02-	PA1319			For vehicles with retarder, w pulley	51065006546/ 9546
	02-	PA1321			For vehicles without retarder, w pulley	51065006545/ 6547/ 9545/ 9547
	02-	PA1330		•		51065000298,51065006066/ 7033/ 7036 51065007043/ 7045/ 7047/ 7048/ 7051 51065007052/ 7065/ 7066/ 7088/ 7089 51065009045/ 9047/ 9048/ 9052/ 9066
32.360 (265-176 kW) Eng.D2866LF27	02-	PA1298			For vehicles without retarder, w/o pulley; Impeller Ø 135mm, Incl Electronic fuel Injection pump	51065006408/ 6492/ 9492
	02-	PA1302			For vehicles with retarder, w/o pulley	51065006426/ 6490/ 9426/ 9490
	02-	PA1319			For vehicles with retarder, w pulley	51065006546/ 9546
	02-	PA1321			For vehicles without retarder, w pulley	51065006545/ 6547/ 9545/ 9547
	02-	PA1330		•		51065000298,51065006066/ 7033/ 7036 51065007043/ 7045/ 7047/ 7048/ 7051 51065007052/ 7065/ 7066/ 7088/ 7089 51065009045/ 9047/ 9048/ 9052/ 9066
32.410 (301 kW) Eng.D2866LF28	02-	PA1298			For vehicles without retarder, w/o pulley; Impeller Ø 135mm, Incl Electronic fuel Injection pump	51065006408/ 6492/ 9492
	02-	PA1302			For vehicles with retarder, w/o pulley	51065006426/ 6490/ 9426/ 9490
	02-	PA1319			For vehicles with retarder, w pulley	51065006546/ 9546
	02-	PA1321			For vehicles without retarder, w pulley	51065006545/ 6547/ 9545/ 9547
	02-	PA1330		•		51065000298,51065006066/ 7033/ 7036 51065007043/ 7045/ 7047/ 7048/ 7051 51065007052/ 7065/ 7066/ 7088/ 7089 51065009045/ 9047/ 9048/ 9052/ 9066
32.430, 32.440 (316-324 kW) Eng.D2066LF11	05-	PA1224			+Retarder	51065006642/ 6675/ 6694/ 9642/ 9675/ 9694
	05-	PA1225			-Retarder	51065006637/ 7049/ 9049
32.430, 32.440 (316-324 kW) Eng.D2066LF31	04-	PA1224			+Retarder	51065006642/ 6675/ 6694/ 9642/ 9675/ 9694
	04-	PA1225			-Retarder	51065006637/ 7049/ 9049
32.460 (338 kW) Eng.D2876LF04	02-	PA1298			For vehicles without retarder, w/o pulley; Impeller Ø 135mm, Incl Electronic fuel Injection pump	51065006408/ 6492/ 9492
	02-	PA1302			For vehicles with retarder, w/o pulley	51065006426/ 6490/ 9426/ 9490
	02-	PA1319			For vehicles with retarder, w pulley	51065006546/ 9546
	02-	PA1321			For vehicles without retarder, w pulley	51065006545/ 6547/ 9545/ 9547
	02-	PA1330		•		51065000298,51065006066/ 7033/ 7036 51065007043/ 7045/ 7047/ 7048/ 7051 51065007052/ 7065/ 7066/ 7088/ 7089 51065009045/ 9047/ 9048/ 9052/ 9066
32.480 (353 kW) Eng.D2876LF12	02-	PA1298			For vehicles without retarder, w/o pulley; Impeller Ø 135mm, Incl Electronic fuel Injection pump	51065006408/ 6492/ 9492
	02-	PA1302			For vehicles with retarder, w/o pulley	51065006426/ 6490/ 9426/ 9490

			
<p>PA1224</p>	<p>PA1225</p>	<p>PA1298</p>	<p>PA1302</p>
			
<p>PA1319</p>	<p>PA1321</p>	<p>PA1330</p>	

		GRAF ref.			NOTE	Adaptable for OES
32.480 (353 kW) Eng.D2876LF12	02-	PA1319			For vehicles with retarder, w pulley	51065006546/ 9546
	02-	PA1321			For vehicles without retarder, w pulley	51065006545/ 6547/ 9545/ 9547
	02-	PA1330		•		51065000298,51065006066/ 7033/ 7036 51065007043/ 7045/ 7047/ 7048/ 7051 51065007052/ 7065/ 7066/ 7088/ 7089 51065009045/ 9047/ 9048/ 9052/ 9066
33.350, 33.360 (257-265 kW) Eng.D2066LF03	05-	PA1224			+Retarder	51065006642/ 6675/ 6694/ 9642/ 9675/ 9694
	05-	PA1225			-Retarder	51065006637/ 7049/ 9049
33.350, 33.360 (257-265 kW) Eng.D2066LF13	05-	PA1224			+Retarder	51065006642/ 6675/ 6694/ 9642/ 9675/ 9694
	05-	PA1225			-Retarder	51065006637/ 7049/ 9049
33.350, 33.360 (257-265 kW) Eng.D2066LF33	05-	PA1224			+Retarder	51065006642/ 6675/ 6694/ 9642/ 9675/ 9694
	05-	PA1225			-Retarder	51065006637/ 7049/ 9049
33.360 (265-176 kW) Eng.D2866LF27	00-	PA1298			For vehicles without retarder, w/o pulley; Impeller Ø 135mm, Incl Eletronic fuel Injection pump	51065006408/ 6492/ 9492
	00-	PA1302			For vehicles with retarder, w/o pulley	51065006426/ 6490/ 9426/ 9490
	02-	PA1319			For vehicles with retarder, w pulley	51065006546/ 9546
	00-	PA1321			For vehicles without retarder, w pulley	51065006545/ 6547/ 9545/ 9547
	00-	PA1330		•		51065000298,51065006066/ 7033/ 7036 51065007043/ 7045/ 7047/ 7048/ 7051 51065007052/ 7065/ 7066/ 7088/ 7089 51065009045/ 9047/ 9048/ 9052/ 9066
33.390, 33.400 (287-294 kW) Eng.D2066LF02	04-	PA1224			+Retarder	51065006642/ 6675/ 6694/ 9642/ 9675/ 9694
	04-	PA1225			-Retarder	51065006637/ 7049/ 9049
33.390, 33.400 (287-294 kW) Eng.D2066LF12	04-	PA1224			+Retarder	51065006642/ 6675/ 6694/ 9642/ 9675/ 9694
	04-	PA1225			-Retarder	51065006637/ 7049/ 9049
33.390, 33.400 (287-294 kW) Eng.D2066LF32	05-	PA1224			+Retarder	51065006642/ 6675/ 6694/ 9642/ 9675/ 9694
	05-	PA1225			-Retarder	51065006637/ 7049/ 9049
33.410 (301 kW) Eng.D2866LF28	02-	PA1298			For vehicles without retarder, w/o pulley; Impeller Ø 135mm, Incl Eletronic fuel Injection pump	51065006408/ 6492/ 9492
	02-	PA1302			For vehicles with retarder, w/o pulley	51065006426/ 6490/ 9426/ 9490
	02-	PA1319			For vehicles with retarder, w pulley	51065006546/ 9546
	02-	PA1321			For vehicles without retarder, w pulley	51065006545/ 6547/ 9545/ 9547
	02-	PA1330		•		51065000298,51065006066/ 7033/ 7036 51065007043/ 7045/ 7047/ 7048/ 7051 51065007052/ 7065/ 7066/ 7088/ 7089 51065009045/ 9047/ 9048/ 9052/ 9066
33.410 (301 kW) Eng.D2866LF32	00-	PA1298			For vehicles without retarder, w/o pulley; Impeller Ø 135mm, Incl Eletronic fuel Injection pump	51065006408/ 6492/ 9492
	00-	PA1302			For vehicles with retarder, w/o pulley	51065006426/ 6490/ 9426/ 9490
	00-	PA1319			For vehicles with retarder, w pulley	51065006546/ 9546
	00-	PA1321			For vehicles without retarder, w pulley	51065006545/ 6547/ 9545/ 9547
	00-	PA1330		•		51065000298,51065006066/ 7033/ 7036 51065007043/ 7045/ 7047/ 7048/ 7051 51065007052/ 7065/ 7066/ 7088/ 7089 51065009045/ 9047/ 9048/ 9052/ 9066
33.430, 33.440 (316-324 kW) Eng.D2066LF01	05-	PA1224			+Retarder	51065006642/ 6675/ 6694/ 9642/ 9675/ 9694
	05-	PA1225			-Retarder	51065006637/ 7049/ 9049
33.430, 33.440 (316-324 kW) Eng.D2066LF11	06-	PA1224			+Retarder	51065006642/ 6675/ 6694/ 9642/ 9675/ 9694
	06-	PA1225			-Retarder	51065006637/ 7049/ 9049
33.430, 33.440 (316-324 kW) Eng.D2066LF31	05-	PA1225			-Retarder	51065006637/ 7049/ 9049
33.460 (338 kW) Eng.D2876LF04	02-	PA1298			For vehicles without retarder, w/o pulley; Impeller Ø 135mm, Incl Eletronic fuel Injection pump	51065006408/ 6492/ 9492
	02-	PA1302			For vehicles with retarder, w/o pulley	51065006426/ 6490/ 9426/ 9490
	02-	PA1319			For vehicles with retarder, w pulley	51065006546/ 9546
	02-	PA1321			For vehicles without retarder, w pulley	51065006545/ 6547/ 9545/ 9547
	02-	PA1330		•		51065000298,51065006066/ 7033/ 7036 51065007043/ 7045/ 7047/ 7048/ 7051 51065007052/ 7065/ 7066/ 7088/ 7089 51065009045/ 9047/ 9048/ 9052/ 9066
33.460 (338 kW) Eng.D2876LF07	02-	PA1298			For vehicles without retarder, w/o pulley; Impeller Ø 135mm, Incl Eletronic fuel Injection pump	51065006408/ 6492/ 9492
	02-	PA1302			For vehicles with retarder, w/o pulley	51065006426/ 6490/ 9426/ 9490
	02-	PA1319			For vehicles with retarder, w pulley	51065006546/ 9546





			
<p>PA1224</p>	<p>PA1225</p>	<p>PA1298</p>	<p>PA1302</p>
			
<p>PA1319</p>	<p>PA1321</p>	<p>PA1330</p>	

		GRAF ref.			NOTE	Adaptable for OES
33.460 (338 kW) Eng.D2876LF07	02-	PA1321			For vehicles without retarder, w pulley	51065006545/ 6547/ 9545/ 9547
	02-	PA1330		•		51065000298,51065006066/ 7033/ 7036 51065007043/ 7045/ 7047/ 7048/ 7051 51065007052/ 7065/ 7066/ 7088/ 7089 51065009045/ 9047/ 9048/ 9052/ 9066
33.480 (353 kW) Eng.D2676LF05	06-	PA1224			+Retarder	51065006642/ 6675/ 6694/ 9642/ 9675/ 9694
33.480 (353 kW) Eng.D2876LF12	02-	PA1298			For vehicles without retarder, w/o pulley; Impeller Ø 135mm, Incl Eletronic fuel Injection pump	51065006408/ 6492/ 9492
	02-	PA1302			For vehicles with retarder, w/o pulley	51065006426/ 6490/ 9426/ 9490
	02-	PA1319			For vehicles with retarder, w pulley	51065006546/ 9546
	02-	PA1321			For vehicles without retarder, w pulley	51065006545/ 6547/ 9545/ 9547
	02-	PA1330		•		51065000298,51065006066/ 7033/ 7036 51065007043/ 7045/ 7047/ 7048/ 7051 51065007052/ 7065/ 7066/ 7088/ 7089 51065009045/ 9047/ 9048/ 9052/ 9066
33.510 (375 kW) Eng.D2876LF05	02-	PA1298			For vehicles without retarder, w/o pulley; Impeller Ø 135mm, Incl Eletronic fuel Injection pump	51065006408/ 6492/ 9492
	02-	PA1302			For vehicles with retarder, w/o pulley	51065006426/ 6490/ 9426/ 9490
	02-	PA1319			For vehicles with retarder, w pulley	51065006546/ 9546
	02-	PA1321			For vehicles without retarder, w pulley	51065006545/ 6547/ 9545/ 9547
	02-	PA1330		•		51065000298,51065006066/ 7033/ 7036 51065007043/ 7045/ 7047/ 7048/ 7051 51065007052/ 7065/ 7066/ 7088/ 7089 51065009045/ 9047/ 9048/ 9052/ 9066
33.530 (390 kW) Eng.D2876LF13	02-	PA1298			For vehicles without retarder, w/o pulley; Impeller Ø 135mm, Incl Eletronic fuel Injection pump	51065006408/ 6492/ 9492
	02-	PA1302			For vehicles with retarder, w/o pulley	51065006426/ 6490/ 9426/ 9490
	02-	PA1319			For vehicles with retarder, w pulley	51065006546/ 9546
	02-	PA1321			For vehicles without retarder, w pulley	51065006545/ 6547/ 9545/ 9547
	02-	PA1330		•		51065000298,51065006066/ 7033/ 7036 51065007043/ 7045/ 7047/ 7048/ 7051 51065007052/ 7065/ 7066/ 7088/ 7089 51065009045/ 9047/ 9048/ 9052/ 9066
35.310, 35.320 (228-235 kW) Eng.D2066LF04,LF35,LF39	04-	PA1224			+Retarder	51065006642/ 6675/ 6694/ 9642/ 9675/ 9694
	04-	PA1225			-Retarder	51065006637/ 7049/ 9049
35.350, 35.360 (257-265 kW) Eng.D2066LF03,LF13,LF33,LF38	04-	PA1224			+Retarder	51065006642/ 6675/ 6694/ 9642/ 9675/ 9694
	04-	PA1225			-Retarder	51065006637/ 7049/ 9049
35.360 (265 kW) Eng.DF2866LF27	06-	PA1298			For vehicles without retarder, w/o pulley; Impeller Ø 135mm, Incl Eletronic fuel Injection pump	51065006408/ 6492/ 9492
	06-	PA1302			For vehicles with retarder, w/o pulley	51065006426/ 6490/ 9426/ 9490
	06-	PA1319			For vehicles with retarder, w pulley	51065006546/ 9546
	06-	PA1321			For vehicles without retarder, w pulley	51065006545/ 6547/ 9545/ 9547
35.390, 35.400 (287-294 kW) Eng.D2066LF02,LF12,LF32,LF37	04-	PA1224			+Retarder	51065006642/ 6675/ 6694/ 9642/ 9675/ 9694
	04-	PA1225			-Retarder	51065006637/ 7049/ 9049
35.410 (301 kW) Eng.D2866LF28	06-	PA1298			For vehicles without retarder, w/o pulley; Impeller Ø 135mm, Incl Eletronic fuel Injection pump	51065006408/ 6492/ 9492
	06-	PA1302			For vehicles with retarder, w/o pulley	51065006426/ 6490/ 9426/ 9490
	06-	PA1319			For vehicles with retarder, w pulley	51065006546/ 9546
	06-	PA1321			For vehicles without retarder, w pulley	51065006545/ 6547/ 9545/ 9547
	06-	PA1330		•		51065000298,51065006066/ 7033/ 7036 51065007043/ 7045/ 7047/ 7048/ 7051 51065007052/ 7065/ 7066/ 7088/ 7089 51065009045/ 9047/ 9048/ 9052/ 9066
35.430, 35.440 (316-324 kW) Eng.D2066LF01,LF11,LF31,LF36	04-	PA1224			+Retarder	51065006642/ 6675/ 6694/ 9642/ 9675/ 9694
	04-	PA1225			-Retarder	51065006637/ 7049/ 9049
35.460 (338 kW) Eng.D2876LF04	02-	PA1298			For vehicles without retarder, w/o pulley; Impeller Ø 135mm, Incl Eletronic fuel Injection pump	51065006408/ 6492/ 9492
	02-	PA1302			For vehicles with retarder, w/o pulley	51065006426/ 6490/ 9426/ 9490
	02-	PA1319			For vehicles with retarder, w pulley	51065006546/ 9546
	02-	PA1321			For vehicles without retarder, w pulley	51065006545/ 6547/ 9545/ 9547
	02-	PA1330		•		51065000298,51065006066/ 7033/ 7036 51065007043/ 7045/ 7047/ 7048/ 7051 51065007052/ 7065/ 7066/ 7088/ 7089 51065009045/ 9047/ 9048/ 9052/ 9066
35.480 (353 kW) Eng.D2676LF01	04-	PA1224			+Retarder	51065006642/ 6675/ 6694/ 9642/ 9675/ 9694
35.480 (353 kW) Eng.D2876LF12	06-	PA1298			For vehicles without retarder, w/o pulley; Impeller Ø 135mm, Incl Eletronic fuel Injection pump	51065006408/ 6492/ 9492

			
<p>PA1224</p>	<p>PA1225</p>	<p>PA1298</p>	<p>PA1302</p>
			
<p>PA1319</p>	<p>PA1321</p>	<p>PA1330</p>	

		GRAF ref.			NOTE	Adaptable for OES
35.480 (353 kW) Eng.D2876LF12	06-	PA1302			For vehicles with retarder, w/o pulley	51065006426/ 6490/ 9426/ 9490
	06-	PA1319			For vehicles with retarder, w pulley	51065006546/ 9546
	06-	PA1321			For vehicles without retarder, w pulley	51065006545/ 6547/ 9545/ 9547
	06-	PA1330		•		51065000298,51065006066/ 7033/ 7036 51065007043/ 7045/ 7047/ 7048/ 7051 51065007052/ 7065/ 7066/ 7088/ 7089 51065009045/ 9047/ 9048/ 9052/ 9066
37.310, 37.320 (228-235 kW) Eng.D2066LF04	04-	PA1224			+Retarder	51065006642/ 6675/ 6694/ 9642/ 9675/ 9694
	04-	PA1225			-Retarder	51065006637/ 7049/ 9049
37.310, 37.320 (228-235 kW) Eng.D2066LF35	04-	PA1225			-Retarder	51065006637/ 7049/ 9049
37.350, 37.360 (257-265 kW) Eng.D2066LF13	04-	PA1224			+Retarder	51065006642/ 6675/ 6694/ 9642/ 9675/ 9694
	04-	PA1225			-Retarder	51065006637/ 7049/ 9049
40.390, 40.400 (287-294 kW) Eng.D2066LF02	05-	PA1224			+Retarder	51065006642/ 6675/ 6694/ 9642/ 9675/ 9694
	05-	PA1225			-Retarder	51065006637/ 7049/ 9049
40.390, 40.400 (287-294 kW) Eng.D2066LF06	05-	PA1224			+Retarder	51065006642/ 6675/ 6694/ 9642/ 9675/ 9694
	05-	PA1225			-Retarder	51065006637/ 7049/ 9049
40.390, 40.400 (287-294 kW) Eng.D2066LF37	05-	PA1224			+Retarder	51065006642/ 6675/ 6694/ 9642/ 9675/ 9694
	05-	PA1225			-Retarder	51065006637/ 7049/ 9049
40.410 (301 kW) Eng.D2866LF28	04-	PA1298			For vehicles without retarder, w/o pulley; Impeller Ø 135mm, Incl Electronic fuel Injection pump	51065006408/ 6492/ 9492
	04-	PA1302			For vehicles with retarder, w/o pulley	51065006426/ 6490/ 9426/ 9490
	04-	PA1319			For vehicles with retarder, w pulley	51065006546/ 9546
	04-	PA1321			For vehicles without retarder, w pulley	51065006545/ 6547/ 9545/ 9547
40.410 (301 kW) Eng.D2866LF32	04-	PA1330		•		51065000298,51065006066/ 7033/ 7036 51065007043/ 7045/ 7047/ 7048/ 7051 51065007052/ 7065/ 7066/ 7088/ 7089 51065009045/ 9047/ 9048/ 9052/ 9066
	04-	PA1298			For vehicles without retarder, w/o pulley; Impeller Ø 135mm, Incl Electronic fuel Injection pump	51065006408/ 6492/ 9492
	04-	PA1302			For vehicles with retarder, w/o pulley	51065006426/ 6490/ 9426/ 9490
	04-	PA1319			For vehicles with retarder, w pulley	51065006546/ 9546
40.410 (301 kW) Eng.D2866LF32	04-	PA1321			For vehicles without retarder, w pulley	51065006545/ 6547/ 9545/ 9547
	04-	PA1330		•		51065000298,51065006066/ 7033/ 7036 51065007043/ 7045/ 7047/ 7048/ 7051 51065007052/ 7065/ 7066/ 7088/ 7089 51065009045/ 9047/ 9048/ 9052/ 9066
	04-	PA1298			For vehicles without retarder, w/o pulley; Impeller Ø 135mm, Incl Electronic fuel Injection pump	51065006408/ 6492/ 9492
	04-	PA1302			For vehicles with retarder, w/o pulley	51065006426/ 6490/ 9426/ 9490
40.430, 40.440 (316-324 kW) Eng.D2066LF01	05-	PA1224			+Retarder	51065006642/ 6675/ 6694/ 9642/ 9675/ 9694
	05-	PA1225			-Retarder	51065006637/ 7049/ 9049
	04-	PA1298			For vehicles without retarder, w/o pulley; Impeller Ø 135mm, Incl Electronic fuel Injection pump	51065006408/ 6492/ 9492
	04-	PA1302			For vehicles with retarder, w/o pulley	51065006426/ 6490/ 9426/ 9490
40.460 (338 kW) Eng.D2876LF07	04-	PA1319			For vehicles with retarder, w pulley	51065006546/ 9546
	04-	PA1321			For vehicles without retarder, w pulley	51065006545/ 6547/ 9545/ 9547
	04-	PA1330		•		51065000298,51065006066/ 7033/ 7036 51065007043/ 7045/ 7047/ 7048/ 7051 51065007052/ 7065/ 7066/ 7088/ 7089 51065009045/ 9047/ 9048/ 9052/ 9066
	04-	PA1298			For vehicles without retarder, w/o pulley; Impeller Ø 135mm, Incl Electronic fuel Injection pump	51065006408/ 6492/ 9492
40.480 (353 kW) Eng.D2876LF12	04-	PA1302			For vehicles with retarder, w/o pulley	51065006426/ 6490/ 9426/ 9490
	04-	PA1319			For vehicles with retarder, w pulley	51065006546/ 9546
	04-	PA1321			For vehicles without retarder, w pulley	51065006545/ 6547/ 9545/ 9547
	04-	PA1330		•		51065000298,51065006066/ 7033/ 7036 51065007043/ 7045/ 7047/ 7048/ 7051 51065007052/ 7065/ 7066/ 7088/ 7089 51065009045/ 9047/ 9048/ 9052/ 9066
40.480 (353 kW) Eng.D2876LF25	04-	PA1298			For vehicles without retarder, w/o pulley; Impeller Ø 135mm, Incl Electronic fuel Injection pump	51065006408/ 6492/ 9492
	04-	PA1302			For vehicles with retarder, w/o pulley	51065006426/ 6490/ 9426/ 9490
	04-	PA1319			For vehicles with retarder, w pulley	51065006546/ 9546
	04-	PA1321			For vehicles without retarder, w pulley	51065006545/ 6547/ 9545/ 9547
40.480 (353 kW) Eng.D2876LF25	04-	PA1330		•		51065000298,51065006066/ 7033/ 7036 51065007043/ 7045/ 7047/ 7048/ 7051 51065007052/ 7065/ 7066/ 7088/ 7089 51065009045/ 9047/ 9048/ 9052/ 9066

		GRAF ref.			NOTE	Adaptable for OES
41.350, 41.360 (257-265 kW) Eng.D2066LF03,LF07,LF13,LF33,LF38	04-	PA1224			+Retarder	51065006642/ 6675/ 6694/ 9642/ 9675/ 9694
	04-	PA1225			-Retarder	51065006637/ 7049/ 9049
41.360 (265-176 kW) Eng.D2866LF27/37	03-	PA1298			For vehicles without retarder, w/o pulley; Impeller Ø 135mm, Incl Eletronic fuel Injection pump	51065006408/ 6492/ 9492
	03-	PA1302			For vehicles with retarder, w/o pulley	51065006426/ 6490/ 9426/ 9490
	03-	PA1319			For vehicles with retarder, w pulley	51065006546/ 9546
	03-	PA1321			For vehicles without retarder, w pulley	51065006545/ 6547/ 9545/ 9547
	03-	PA1330		•		51065000298,51065006066/ 7033/ 7036 51065007043/ 7045/ 7047/ 7048/ 7051 51065007052/ 7065/ 7066/ 7088/ 7089 51065009045/ 9047/ 9048/ 9052/ 9066
	04-	PA1224			+Retarder	51065006642/ 6675/ 6694/ 9642/ 9675/ 9694
41.390, 41.400 (287-294 kW) Eng.D2066LF12	04-	PA1225			-Retarder	51065006637/ 7049/ 9049
	06-	PA1298			For vehicles without retarder, w/o pulley; Impeller Ø 135mm, Incl Eletronic fuel Injection pump	51065006408/ 6492/ 9492
41.410 (301 kW) Eng.D2866LF28	06-	PA1302			For vehicles with retarder, w/o pulley	51065006426/ 6490/ 9426/ 9490
	06-	PA1319			For vehicles with retarder, w pulley	51065006546/ 9546
	06-	PA1321			For vehicles without retarder, w pulley	51065006545/ 6547/ 9545/ 9547
	06-	PA1330		•		51065000298,51065006066/ 7033/ 7036 51065007043/ 7045/ 7047/ 7048/ 7051 51065007052/ 7065/ 7066/ 7088/ 7089 51065009045/ 9047/ 9048/ 9052/ 9066
	04-	PA1224			+Retarder	51065006642/ 6675/ 6694/ 9642/ 9675/ 9694
41.430, 41.440 (316-324 kW) Eng.D2066LF01	04-	PA1225			-Retarder	51065006637/ 7049/ 9049
	04-	PA1224			+Retarder	51065006642/ 6675/ 6694/ 9642/ 9675/ 9694
41.430, 41.440 (316-324 kW) Eng.D2066LF31	04-	PA1225			-Retarder	51065006637/ 7049/ 9049
	03-	PA1298			For vehicles without retarder, w/o pulley; Impeller Ø 135mm, Incl Eletronic fuel Injection pump	51065006408/ 6492/ 9492
41.460 (338 kW) Eng.D2876LF07	03-	PA1302			For vehicles with retarder, w/o pulley	51065006426/ 6490/ 9426/ 9490
	03-	PA1319			For vehicles with retarder, w pulley	51065006546/ 9546
	03-	PA1321			For vehicles without retarder, w pulley	51065006545/ 6547/ 9545/ 9547
	03-	PA1330		•		51065000298,51065006066/ 7033/ 7036 51065007043/ 7045/ 7047/ 7048/ 7051 51065007052/ 7065/ 7066/ 7088/ 7089 51065009045/ 9047/ 9048/ 9052/ 9066
	06-	PA1224			+Retarder	51065006642/ 6675/ 6694/ 9642/ 9675/ 9694
41.480 (353 kW) Eng.D2676LF01	06-	PA1298			For vehicles without retarder, w/o pulley; Impeller Ø 135mm, Incl Eletronic fuel Injection pump	51065006408/ 6492/ 9492
	06-	PA1302			For vehicles with retarder, w/o pulley	51065006426/ 6490/ 9426/ 9490
	06-	PA1319			For vehicles with retarder, w pulley	51065006546/ 9546
	06-	PA1321			For vehicles without retarder, w pulley	51065006545/ 6547/ 9545/ 9547
	06-	PA1330		•		51065000298,51065006066/ 7033/ 7036 51065007043/ 7045/ 7047/ 7048/ 7051 51065007052/ 7065/ 7066/ 7088/ 7089 51065009045/ 9047/ 9048/ 9052/ 9066
	06-	PA1298			For vehicles without retarder, w/o pulley; Impeller Ø 135mm, Incl Eletronic fuel Injection pump	51065006408/ 6492/ 9492
41.480 (353 kW) Eng.D2876LF12	06-	PA1302			For vehicles with retarder, w/o pulley	51065006426/ 6490/ 9426/ 9490
	06-	PA1319			For vehicles with retarder, w pulley	51065006546/ 9546
	06-	PA1321			For vehicles without retarder, w pulley	51065006545/ 6547/ 9545/ 9547
	06-	PA1330		•		51065000298,51065006066/ 7033/ 7036 51065007043/ 7045/ 7047/ 7048/ 7051 51065007052/ 7065/ 7066/ 7088/ 7089 51065009045/ 9047/ 9048/ 9052/ 9066
	06-	PA1298			For vehicles without retarder, w/o pulley; Impeller Ø 135mm, Incl Eletronic fuel Injection pump	51065006408/ 6492/ 9492
41.530 (353 kW) Eng.D2876LF12	06-	PA1302			For vehicles with retarder, w/o pulley	51065006426/ 6490/ 9426/ 9490
	06-	PA1319			For vehicles with retarder, w pulley	51065006546/ 9546
	06-	PA1321			For vehicles without retarder, w pulley	51065006545/ 6547/ 9545/ 9547
	06-	PA1330		•		51065000298,51065006066/ 7033/ 7036 51065007043/ 7045/ 7047/ 7048/ 7051 51065007052/ 7065/ 7066/ 7088/ 7089 51065009045/ 9047/ 9048/ 9052/ 9066
	02-	PA1298			For vehicles without retarder, w/o pulley; Impeller Ø 135mm, Incl Eletronic fuel Injection pump	51065006408/ 6492/ 9492
41.530 (390 kW) Eng.D2876LF13	02-	PA1302			For vehicles with retarder, w/o pulley	51065006426/ 6490/ 9426/ 9490
	02-	PA1319			For vehicles with retarder, w pulley	51065006546/ 9546
	02-	PA1321			For vehicles without retarder, w pulley	51065006545/ 6547/ 9545/ 9547
	02-	PA1330		•		51065000298,51065006066/ 7033/ 7036 51065007043/ 7045/ 7047/ 7048/ 7051 51065007052/ 7065/ 7066/ 7088/ 7089 51065009045/ 9047/ 9048/ 9052/ 9066
	02-	PA1298			For vehicles without retarder, w/o pulley; Impeller Ø 135mm, Incl Eletronic fuel Injection pump	51065006408/ 6492/ 9492
41.660 (485 kW) Eng.D2840LF25	02-	PA1302			For vehicles with retarder, w/o pulley	51065006426/ 6490/ 9426/ 9490
	83-	PA1298			For vehicles without retarder, w/o pulley; Impeller Ø 135mm, Incl Eletronic fuel Injection pump	51065006408/ 6492/ 9492
TG 12.0 (176-265 kW) Eng.D2866	83-	PA1302			For vehicles with retarder, w/o pulley	51065006426/ 6490/ 9426/ 9490

			
<p>PA1227</p>	<p>PA1234</p>	<p>PA1319</p>	<p>PA1321</p>
			
<p>PA1330</p>			

		GRAF ref.			NOTE	Adaptable for OES
TG 12.0 (176-265 kW) Eng.D2866	83-	PA1319			For vehicles with retarder, w pulley	51065006546/ 9546
	83-	PA1321			For vehicles without retarder, w pulley	51065006545/ 6547/ 9545/ 9547
	83-	PA1330		•		51065000298,51065006066/ 7033/ 7036 51065007043/ 7045/ 7047/ 7048/ 7051 51065007052/ 7065/ 7066/ 7088/ 7089 51065009045/ 9047/ 9048/ 9052/ 9066
TGL '5/16-						
10.180 (132 kW) Eng.D0834LFL41	05-	PA1227			M16x1,5	51065006651/ 6680/ 7079/ 9079 51065009651/ 9680/ 9700
	05-	PA1234			Impeller Ø 135mm, M14x1,5	51065006679/ 6699/ 7064/ 7078 51065009064/ 9078/ 9679/ 9699
10.210 (151 kW) Eng.D0834LFL42	05-	PA1227			M16x1,5	51065006651/ 6680/ 7079/ 9079 51065009651/ 9680/ 9700
	05-	PA1234			Impeller Ø 135mm, M14x1,5	51065006679/ 6699/ 7064/ 7078 51065009064/ 9078/ 9679/ 9699
10.220 (162 kW) Eng.D0834LFL65/68	05-	PA1227			M16x1,5	51065006651/ 6680/ 7079/ 9079 51065009651/ 9680/ 9700
	05-	PA1234			Impeller Ø 135mm, M14x1,5	51065006679/ 6699/ 7064/ 7078 51065009064/ 9078/ 9679/ 9699
10.240 (176 kW) Eng.D0836LFL40	05-	PA1227			M16x1,5	51065006651/ 6680/ 7079/ 9079 51065009651/ 9680/ 9700
	05-	PA1234			Impeller Ø 135mm, M14x1,5	51065006679/ 6699/ 7064/ 7078 51065009064/ 9078/ 9679/ 9699
10.250 (184 kW) Eng.D0836LFL63/66	05-	PA1227			M16x1,5	51065006651/ 6680/ 7079/ 9079 51065009651/ 9680/ 9700
	05-	PA1234			Impeller Ø 135mm, M14x1,5	51065006679/ 6699/ 7064/ 7078 51065009064/ 9078/ 9679/ 9699
12.180 (132 kW) Eng.D0834LFL41	05-	PA1227			M16x1,5	51065006651/ 6680/ 7079/ 9079 51065009651/ 9680/ 9700
	05-	PA1234			Impeller Ø 135mm, M14x1,5	51065006679/ 6699/ 7064/ 7078 51065009064/ 9078/ 9679/ 9699
12.210 (151 kW) Eng.D0834LFL42	05-	PA1227			M16x1,5	51065006651/ 6680/ 7079/ 9079 51065009651/ 9680/ 9700
	05-	PA1234			Impeller Ø 135mm, M14x1,5	51065006679/ 6699/ 7064/ 7078 51065009064/ 9078/ 9679/ 9699
12.220 (162 kW) Eng.D0834LFL65/68	05-	PA1227			M16x1,5	51065006651/ 6680/ 7079/ 9079 51065009651/ 9680/ 9700
	05-	PA1234			Impeller Ø 135mm, M14x1,5	51065006679/ 6699/ 7064/ 7078 51065009064/ 9078/ 9679/ 9699
12.240 (176 kW) Eng.D0836LFL40	05-	PA1227			M16x1,5	51065006651/ 6680/ 7079/ 9079 51065009651/ 9680/ 9700
	05-	PA1234			Impeller Ø 135mm, M14x1,5	51065006679/ 6699/ 7064/ 7078 51065009064/ 9078/ 9679/ 9699
12.250 (184 kW) Eng.D0836LFL63/66	05-	PA1227			M16x1,5	51065006651/ 6680/ 7079/ 9079 51065009651/ 9680/ 9700
	05-	PA1234			Impeller Ø 135mm, M14x1,5	51065006679/ 6699/ 7064/ 7078 51065009064/ 9078/ 9679/ 9699
7.150 (110 kW) Eng.D0834LFL40	05-	PA1227			M16x1,5	51065006651/ 6680/ 7079/ 9079 51065009651/ 9680/ 9700
	05-	PA1234			Impeller Ø 135mm, M14x1,5	51065006679/ 6699/ 7064/ 7078 51065009064/ 9078/ 9679/ 9699
7.180 (132 kW) Eng.D0834LFL41	05-	PA1227			M16x1,5	51065006651/ 6680/ 7079/ 9079 51065009651/ 9680/ 9700
	05-	PA1234			Impeller Ø 135mm, M14x1,5	51065006679/ 6699/ 7064/ 7078 51065009064/ 9078/ 9679/ 9699
7.220 (162 kW) Eng.D0834LFL65/62	05-	PA1227			M16x1,5	51065006651/ 6680/ 7079/ 9079 51065009651/ 9680/ 9700
	05-	PA1234			Impeller Ø 135mm, M14x1,5	51065006679/ 6699/ 7064/ 7078 51065009064/ 9078/ 9679/ 9699
7.250 (184 kW) Eng.D0836LFL60/63	05-	PA1227			M16x1,5	51065006651/ 6680/ 7079/ 9079 51065009651/ 9680/ 9700
	05-	PA1234			Impeller Ø 135mm, M14x1,5	51065006679/ 6699/ 7064/ 7078 51065009064/ 9078/ 9679/ 9699
8.180 (132 kW) Eng.D0834LFL41	05-	PA1227			M16x1,5	51065006651/ 6680/ 7079/ 9079 51065009651/ 9680/ 9700

		GRAF ref.			NOTE	Adaptable for OES
8.180 (132 kW) Eng.D0834LFL41	05-	PA1234			Impeller Ø 135mm, M14x1,5	51065006679/ 6699/ 7064/ 7078 51065009064/ 9078/ 9679/ 9699
8.210 (151 kW) Eng.D0834LFL42	05-	PA1227			M16x1,5	51065006651/ 6680/ 7079/ 9079 51065009651/ 9680/ 9700
	05-	PA1234			Impeller Ø 135mm, M14x1,5	51065006679/ 6699/ 7064/ 7078 51065009064/ 9078/ 9679/ 9699
8.220 (162 kW) Eng.D0834LFL65/68	05-	PA1227			M16x1,5	51065006651/ 6680/ 7079/ 9079 51065009651/ 9680/ 9700
	05-	PA1234			Impeller Ø 135mm, M14x1,5	51065006679/ 6699/ 7064/ 7078 51065009064/ 9078/ 9679/ 9699
8.240 (176 kW) Eng.D0836LFL40	05-	PA1227			M16x1,5	51065006651/ 6680/ 7079/ 9079 51065009651/ 9680/ 9700
	05-	PA1234			Impeller Ø 135mm, M14x1,5	51065006679/ 6699/ 7064/ 7078 51065009064/ 9078/ 9679/ 9699
8.250 (184 kW) Eng.D0836LFL66/63	05-	PA1234			Impeller Ø 135mm, M14x1,5	51065006679/ 6699/ 7064/ 7078 51065009064/ 9078/ 9679/ 9699
TGM '5/16-						
12.240 (176 kW) Eng.D0836LFL50	05-	PA1227			M16x1,5	51065006651/ 6680/ 7079/ 9079 51065009651/ 9680/ 9700
	05-	PA1234			Impeller Ø 135mm, M14x1,5	51065006679/ 6699/ 7064/ 7078 51065009064/ 9078/ 9679/ 9699
12.250 (184 kW) Eng.D0836LFL63/66	05-	PA1227			M16x1,5	51065006651/ 6680/ 7079/ 9079 51065009651/ 9680/ 9700
	05-	PA1234			Impeller Ø 135mm, M14x1,5	51065006679/ 6699/ 7064/ 7078 51065009064/ 9078/ 9679/ 9699
12.280 (206 kW) Eng.D0836LFL51	05-	PA1227			M16x1,5	51065006651/ 6680/ 7079/ 9079 51065009651/ 9680/ 9700
	05-	PA1234			Impeller Ø 135mm, M14x1,5	51065006679/ 6699/ 7064/ 7078 51065009064/ 9078/ 9679/ 9699
12.290 (213 kW) Eng.D0836LFL64/67	05-	PA1227			M16x1,5	51065006651/ 6680/ 7079/ 9079 51065009651/ 9680/ 9700
	05-	PA1234			Impeller Ø 135mm, M14x1,5	51065006679/ 6699/ 7064/ 7078 51065009064/ 9078/ 9679/ 9699
13.240 (176 kW) Eng.D0836LFL40	06-	PA1227			M16x1,5	51065006651/ 6680/ 7079/ 9079 51065009651/ 9680/ 9700
	06-	PA1234			Impeller Ø 135mm, M14x1,5	51065006679/ 6699/ 7064/ 7078 51065009064/ 9078/ 9679/ 9699
13.240 (176 kW) Eng.D0836LFL50	06-	PA1227			M16x1,5	51065006651/ 6680/ 7079/ 9079 51065009651/ 9680/ 9700
	06-	PA1234			Impeller Ø 135mm, M14x1,5	51065006679/ 6699/ 7064/ 7078 51065009064/ 9078/ 9679/ 9699
13.250 (184 kW) Eng.D0836LFL63/66	05-	PA1227			M16x1,5	51065006651/ 6680/ 7079/ 9079 51065009651/ 9680/ 9700
	05-	PA1234			Impeller Ø 135mm, M14x1,5	51065006679/ 6699/ 7064/ 7078 51065009064/ 9078/ 9679/ 9699
13.280 (206 kW) Eng.D0836LFL51	06-	PA1227			M16x1,5	51065006651/ 6680/ 7079/ 9079 51065009651/ 9680/ 9700
	06-	PA1234			Impeller Ø 135mm, M14x1,5	51065006679/ 6699/ 7064/ 7078 51065009064/ 9078/ 9679/ 9699
13.280 (206 kW) Eng.D0836LFL54	05-	PA1227			M16x1,5	51065006651/ 6680/ 7079/ 9079 51065009651/ 9680/ 9700
	05-	PA1234			Impeller Ø 135mm, M14x1,5	51065006679/ 6699/ 7064/ 7078 51065009064/ 9078/ 9679/ 9699
13.290 (213 kW) Eng.D0836LFL64/67	05-	PA1227			M16x1,5	51065006651/ 6680/ 7079/ 9079 51065009651/ 9680/ 9700
	05-	PA1234			Impeller Ø 135mm, M14x1,5	51065006679/ 6699/ 7064/ 7078 51065009064/ 9078/ 9679/ 9699
15.240 (176 kW) Eng.D0836LFL50	05-	PA1227			M16x1,5	51065006651/ 6680/ 7079/ 9079 51065009651/ 9680/ 9700
	05-	PA1234			Impeller Ø 135mm, M14x1,5	51065006679/ 6699/ 7064/ 7078 51065009064/ 9078/ 9679/ 9699
15.250 (184 kW) Eng.D0836LFL63/66	05-	PA1227			M16x1,5	51065006651/ 6680/ 7079/ 9079 51065009651/ 9680/ 9700
	05-	PA1234			Impeller Ø 135mm, M14x1,5	51065006679/ 6699/ 7064/ 7078 51065009064/ 9078/ 9679/ 9699



PA1227





PA1234

--	--	--	--



--	--	--	--

--	--	--	--



--	--	--	--

			
<p>PA1224</p>	<p>PA1225</p>	<p>PA1227</p>	<p>PA1234</p>

		GRAF ref.			NOTE	Adaptable for OES
22.280 (206 kW) Eng.D0836LFL54	05-	PA1234			Impeller Ø 135mm, M14x1,5	51065006679/ 6699/ 7064/ 7078 51065009064/ 9078/ 9679/ 9699
22.290 (213 kW) Eng.D0836LFL64/67	05-	PA1227			M16x1,5	51065006651/ 6680/ 7079/ 9079 51065009651/ 9680/ 9700
	05-	PA1234			Impeller Ø 135mm, M14x1,5	51065006679/ 6699/ 7064/ 7078 51065009064/ 9078/ 9679/ 9699
26.280 (206 kW) Eng.D0836LFL51	06-	PA1227			M16x1,5	51065006651/ 6680/ 7079/ 9079 51065009651/ 9680/ 9700
	06-	PA1234			Impeller Ø 135mm, M14x1,5	51065006679/ 6699/ 7064/ 7078 51065009064/ 9078/ 9679/ 9699
26.280 (206 kW) Eng.D0836LFL54	05-	PA1227			M16x1,5	51065006651/ 6680/ 7079/ 9079 51065009651/ 9680/ 9700
	05-	PA1234			Impeller Ø 135mm, M14x1,5	51065006679/ 6699/ 7064/ 7078 51065009064/ 9078/ 9679/ 9699
26.290 (213 kW) Eng.D0836LFL64/67	05-	PA1227			M16x1,5	51065006651/ 6680/ 7079/ 9079 51065009651/ 9680/ 9700
	05-	PA1234			Impeller Ø 135mm, M14x1,5	51065006679/ 6699/ 7064/ 7078 51065009064/ 9078/ 9679/ 9699
26.330 (240 kW) Eng.D0836LFL52	06-	PA1227			M16x1,5	51065006651/ 6680/ 7079/ 9079 51065009651/ 9680/ 9700
	06-	PA1234			Impeller Ø 135mm, M14x1,5	51065006679/ 6699/ 7064/ 7078 51065009064/ 9078/ 9679/ 9699
26.330 (240 kW) Eng.D0836LFL55	05-	PA1227			M16x1,5	51065006651/ 6680/ 7079/ 9079 51065009651/ 9680/ 9700
	05-	PA1234			Impeller Ø 135mm, M14x1,5	51065006679/ 6699/ 7064/ 7078 51065009064/ 9078/ 9679/ 9699
26.340 (250 kW) Eng.D0836LFL65/68	05-	PA1227			M16x1,5	51065006651/ 6680/ 7079/ 9079 51065009651/ 9680/ 9700
	05-	PA1234			Impeller Ø 135mm, M14x1,5	51065006679/ 6699/ 7064/ 7078 51065009064/ 9078/ 9679/ 9699
TGS '7/16-						
18.320 (235 kW) Eng.D2066LF28	07-	PA1224			+Retarder	51065006642/ 6675/ 6694/ 9642/ 9675/ 9694
	07-	PA1225			-Retarder	51065006637/ 7049/ 9049
18.320 (235 kW) Eng.D2066LF39	07-	PA1224			+Retarder	51065006642/ 6675/ 6694/ 9642/ 9675/ 9694
	07-	PA1225			-Retarder	51065006637/ 7049/ 9049
18.350 (257 kW) Eng.D2066LF03	07-	PA1225			-Retarder	51065006637/ 7049/ 9049
18.360 (265 kW) Eng.D2066LF27	07-	PA1224			+Retarder	51065006642/ 6675/ 6694/ 9642/ 9675/ 9694
	07-	PA1225			-Retarder	51065006637/ 7049/ 9049
18.360 (265 kW) Eng.D2066LF38	07-	PA1224			+Retarder	51065006642/ 6675/ 6694/ 9642/ 9675/ 9694
	07-	PA1225			-Retarder	51065006637/ 7049/ 9049
18.390 (287 kW) Eng.D2066LF02	08-	PA1225			-Retarder	51065006637/ 7049/ 9049
18.400 (294 kW) Eng.D2066LF26	07-	PA1224			+Retarder	51065006642/ 6675/ 6694/ 9642/ 9675/ 9694
	07-	PA1225			-Retarder	51065006637/ 7049/ 9049
18.430 (316 kW) Eng.D2066LF01	07-	PA1225			-Retarder	51065006637/ 7049/ 9049
18.440 (324 kW) Eng.D2066LF25/26	07-	PA1224			+Retarder	51065006642/ 6675/ 6694/ 9642/ 9675/ 9694
	07-	PA1225			-Retarder	51065006637/ 7049/ 9049
18.480 (353 kW) Eng.D2676LF05	07-	PA1224			+Retarder	51065006642/ 6675/ 6694/ 9642/ 9675/ 9694
18.480 (353 kW) Eng.D2676LF14	07-	PA1224			+Retarder	51065006642/ 6675/ 6694/ 9642/ 9675/ 9694
18.540 (397 kW) Eng.D2676LF13	07-	PA1224			+Retarder	51065006642/ 6675/ 6694/ 9642/ 9675/ 9694
19.350 (257 kW) Eng.D2066LF03	07-	PA1225			-Retarder	51065006637/ 7049/ 9049
19.360 (265 kW) Eng.D2066LF07/48/64	11-	PA1225			-Retarder	51065006637/ 7049/ 9049
19.390 (287 kW) Eng.D2066LF02	08-	PA1225			-Retarder	51065006637/ 7049/ 9049
19.400 (294 kW) Eng.D2066LF06/49/63	11-	PA1225			-Retarder	51065006637/ 7049/ 9049
19.430 (316 kW) Eng.D2066LF01	07-	PA1225			-Retarder	51065006637/ 7049/ 9049
19.440 (324 kW) Eng.D2066LF50/62	11-	PA1225			-Retarder	51065006637/ 7049/ 9049
21.360 (265 kW) Eng.D2066LF07/48/64	07-	PA1225			-Retarder	51065006637/ 7049/ 9049

			
PA1224	PA1225		

		GRAF ref.			NOTE	Adaptable for OES
21.400 (294 kW) Eng.D2066LF06/49/63	07-	PA1225			-Retarder	51065006637/ 7049/ 9049
21.440 (324 kW) Eng.D2066LF50/62	07-	PA1225			-Retarder	51065006637/ 7049/ 9049
24.320 (235 kW) Eng.D2066LF28/39/43/53/68	07-	PA1225			-Retarder	51065006637/ 7049/ 9049
24.400 (294 kW) Eng.D2066LF26	07-	PA1224			+Retarder	51065006642/ 6675/ 6694/ 9642/ 9675/ 9694
	07-	PA1225			-Retarder	51065006637/ 7049/ 9049
24.440 (324 kW) Eng.D2066LF25/26	07-	PA1224			+Retarder	51065006642/ 6675/ 6694/ 9642/ 9675/ 9694
	07-	PA1225			-Retarder	51065006637/ 7049/ 9049
24.480 (353 kW) Eng.D2676LF05/LF14	07-	PA1224			+Retarder	51065006642/ 6675/ 6694/ 9642/ 9675/ 9694
24.540 (397 kW) Eng.D2676LF13	07-	PA1224			+Retarder	51065006642/ 6675/ 6694/ 9642/ 9675/ 9694
26.320 (235 kW) Eng.D2066LF28/39/43/53/68	08-	PA1225			-Retarder	51065006637/ 7049/ 9049
26.350 (257 kW) Eng.D2066LF03	07-	PA1225			-Retarder	51065006637/ 7049/ 9049
26.360 (265 kW) Eng.D2066LF67/38/42/27/48/07/64/52	08-	PA1225			-Retarder	51065006637/ 7049/ 9049
26.390 (287 kW) Eng.D2066LF02	08-	PA1225			-Retarder	51065006637/ 7049/ 9049
26.400 (294 kW) Eng.D2066LF06/26/37/41/49/51/61/63	08-	PA1225			-Retarder	51065006637/ 7049/ 9049
26.430 (316 kW) Eng.D2066LF01	07-	PA1225			-Retarder	51065006637/ 7049/ 9049
26.440 (324 kW) Eng.D2066LF25/36/40/50/62	07-	PA1225			-Retarder	51065006637/ 7049/ 9049
28.320 (235 kW) Eng.D2066LF39/43/68	08-	PA1225			-Retarder	51065006637/ 7049/ 9049
28.350 (257 kW) Eng.D2066LF03	08-	PA1225			-Retarder	51065006637/ 7049/ 9049
28.360 (265 kW) Eng.D2066LF38/48/67/42/64	08-	PA1225			-Retarder	51065006637/ 7049/ 9049
28.390 (287 kW) Eng.D2066LF02	08-	PA1225			-Retarder	51065006637/ 7049/ 9049
28.400 (294 kW) Eng.D2066LF37/41/49/61/63	08-	PA1225			-Retarder	51065006637/ 7049/ 9049
28.430 (316 kW) Eng.D2066LF01	08-	PA1225			-Retarder	51065006637/ 7049/ 9049
28.440 (324 kW) Eng.D2066LF36/40/50/62	08-	PA1225			-Retarder	51065006637/ 7049/ 9049
32.320 (235 kW) Eng.D2066LF28/39/43/53/68	09-	PA1225			-Retarder	51065006637/ 7049/ 9049
32.350 (257 kW) Eng.D2066LF03	08-	PA1225			-Retarder	51065006637/ 7049/ 9049
32.360 (265 kW) Eng.D2066LF38/42/67/27	07-	PA1225			-Retarder	51065006637/ 7049/ 9049
32.390 (287 kW) Eng.D2066LF02	08-	PA1225			-Retarder	51065006637/ 7049/ 9049
32.400 (294 kW) Eng.D2066LF26/37/41/61/49/51	07-	PA1225			-Retarder	51065006637/ 7049/ 9049
32.440 (324 kW) Eng.D2066LF25/36/40	07-	PA1225			-Retarder	51065006637/ 7049/ 9049
33.320 (235 kW) Eng.D2066LF39/43/68	08-	PA1225			-Retarder	51065006637/ 7049/ 9049
33.350 (257 kW) Eng.D2066LF03	08-	PA1225			-Retarder	51065006637/ 7049/ 9049
33.360 (265 kW) Eng.D2066LF07/38/42/48/64/67	07-	PA1225			-Retarder	51065006637/ 7049/ 9049
33.390 (287 kW) Eng.D2066LF02	08-	PA1225			-Retarder	51065006637/ 7049/ 9049
33.400 (294 kW) Eng.D2066LF06/26/37/41/49/61/63	08-	PA1225			-Retarder	51065006637/ 7049/ 9049
33.430 (316 kW) Eng.D2066LF01	08-	PA1225			-Retarder	51065006637/ 7049/ 9049
33.440 (324 kW) Eng.D2066LF25/36/40/50/62	07-	PA1225			-Retarder	51065006637/ 7049/ 9049
35.320 (235 kW) Eng.D2066LF28/39/43/53/68	07-	PA1225			-Retarder	51065006637/ 7049/ 9049
35.350 (257 kW) Eng.D2066LF03	08-	PA1225			-Retarder	51065006637/ 7049/ 9049
35.360 (265 kW) Eng.D2066LF27/38/42/48/52/64/67	07-	PA1225			-Retarder	51065006637/ 7049/ 9049
35.390 (287 kW) Eng.D2066LF02	08-	PA1225			-Retarder	51065006637/ 7049/ 9049
35.400 (294 kW) Eng.D2066LF41/61/26/37/49/51/63	07-	PA1225			-Retarder	51065006637/ 7049/ 9049
35.430 (316 kW) Eng.D2066LF01	08-	PA1225			-Retarder	51065006637/ 7049/ 9049
35.440 (324 kW) Eng.D2066LF25/36/40/50/62	07-	PA1225			-Retarder	51065006637/ 7049/ 9049
37.320 (235 kW) Eng.D2066LF28/39/43/53/68	07-	PA1225			-Retarder	51065006637/ 7049/ 9049
37.360 (265 kW) Eng.D2066LF27/38/42/67	07-	PA1225			-Retarder	51065006637/ 7049/ 9049
37.400 (294 kW) Eng.D2066LF26/37/41/61	07-	PA1225			-Retarder	51065006637/ 7049/ 9049
37.440 (324 kW) Eng.D2066LF25/36/40	07-	PA1225			-Retarder	51065006637/ 7049/ 9049
40.360 (265 kW) Eng.D2066LF48/07/64	08-	PA1225			-Retarder	51065006637/ 7049/ 9049
40.390 (287 kW) Eng.D2066LF02	08-	PA1225			-Retarder	51065006637/ 7049/ 9049
40.400 (294 kW) Eng.D2066LF06/49/63	11-	PA1225			-Retarder	51065006637/ 7049/ 9049
40.430 (316 kW) Eng.D2066LF01	08-	PA1225			-Retarder	51065006637/ 7049/ 9049
40.440 (324 kW) Eng.D2066LF50/62	11-	PA1225			-Retarder	51065006637/ 7049/ 9049
41.320 (235 kW) Eng.D2066LF39/43/68	08-	PA1225			-Retarder	51065006637/ 7049/ 9049
41.350 (257 kW) Eng.D2066LF03	08-	PA1225			-Retarder	51065006637/ 7049/ 9049
41.360 (265 kW) Eng.D2066LF07/27/38/42/48/64/67	08-	PA1225			-Retarder	51065006637/ 7049/ 9049
41.390 (287 kW) Eng.D2066LF02	08-	PA1225			-Retarder	51065006637/ 7049/ 9049
41.400 (294 kW) Eng.D2066LF06/26/37/41/49/51/61/63	07-	PA1225			-Retarder	51065006637/ 7049/ 9049
41.430 (316 kW) Eng.D2066LF01	07-	PA1225			-Retarder	51065006637/ 7049/ 9049
41.440 (324 kW) Eng.D2066LF25/36/40/50/62	07-	PA1225			-Retarder	51065006637/ 7049/ 9049

			
PA1224	PA1225		

		GRAF ref.		NOTE	Adaptable for OES
TGX '7/16-					
18.360 (265 kW) Eng.D2066LF38	07-	PA1224		+Retarder	51065006642/ 6675/ 6694/ 9642/ 9675/ 9694
	07-	PA1225		-Retarder	51065006637/ 7049/ 9049
18.400 (294 kW) Eng.D2066LF26	07-	PA1224		+Retarder	51065006642/ 6675/ 6694/ 9642/ 9675/ 9694
	07-	PA1225		-Retarder	51065006637/ 7049/ 9049
18.440 (324 kW) Eng.D2066LF25	07-	PA1224		+Retarder	51065006642/ 6675/ 6694/ 9642/ 9675/ 9694
	07-	PA1225		-Retarder	51065006637/ 7049/ 9049
18.480 (353 kW) Eng.D2676LF14	07-	PA1224		+Retarder	51065006642/ 6675/ 6694/ 9642/ 9675/ 9694
18.540 (397 kW) Eng.D2676LF13	07-	PA1224		+Retarder	51065006642/ 6675/ 6694/ 9642/ 9675/ 9694
24.360 (265 kW) Eng.D2066LF38	07-	PA1224		+Retarder	51065006642/ 6675/ 6694/ 9642/ 9675/ 9694
	07-	PA1225		-Retarder	51065006637/ 7049/ 9049
24.400 (294 kW) Eng.D2066LF26	07-	PA1224		+Retarder	51065006642/ 6675/ 6694/ 9642/ 9675/ 9694
	07-	PA1225		-Retarder	51065006637/ 7049/ 9049
24.440 (324 kW) Eng.D2066LF25	07-	PA1224		+Retarder	51065006642/ 6675/ 6694/ 9642/ 9675/ 9694
	07-	PA1225		-Retarder	51065006637/ 7049/ 9049
24.480 (353 kW) Eng.D2676LF14	07-	PA1224		+Retarder	51065006642/ 6675/ 6694/ 9642/ 9675/ 9694
26.320 (235 kW) Eng.D2066LF28	07-	PA1224		+Retarder	51065006642/ 6675/ 6694/ 9642/ 9675/ 9694
	07-	PA1225		-Retarder	51065006637/ 7049/ 9049
26.360 (265 kW) Eng.D2066LF38	07-	PA1224		+Retarder	51065006642/ 6675/ 6694/ 9642/ 9675/ 9694
	07-	PA1225		-Retarder	51065006637/ 7049/ 9049
26.360 (265 kW) Eng.D2066LF38/42/67	07-	PA1225		-Retarder	51065006637/ 7049/ 9049
26.400 (294 kW) Eng.D2066LF37/41/61	07-	PA1225		-Retarder	51065006637/ 7049/ 9049
26.440 (324 kW) Eng.D2066LF25	07-	PA1224		+Retarder	51065006642/ 6675/ 6694/ 9642/ 9675/ 9694
	07-	PA1225		-Retarder	51065006637/ 7049/ 9049
26.440 (324 kW) Eng.D2066LF36	07-	PA1224		+Retarder	51065006642/ 6675/ 6694/ 9642/ 9675/ 9694
	07-	PA1225		-Retarder	51065006637/ 7049/ 9049
26.440 (324 kW) Eng.D2066LF36/40	07-	PA1225		-Retarder	51065006637/ 7049/ 9049
26.480 (353 kW) Eng.D2676LF05	07-	PA1224		+Retarder	51065006642/ 6675/ 6694/ 9642/ 9675/ 9694
26.480 (353 kW) Eng.D2676LF14	07-	PA1224		+Retarder	51065006642/ 6675/ 6694/ 9642/ 9675/ 9694
26.540 (397 kW) Eng.D2676LF13	07-	PA1224		+Retarder	51065006642/ 6675/ 6694/ 9642/ 9675/ 9694
28.360 (265 kW) Eng.D2066LF38	07-	PA1224		+Retarder	51065006642/ 6675/ 6694/ 9642/ 9675/ 9694
	07-	PA1225		-Retarder	51065006637/ 7049/ 9049
28.400 (294 kW) Eng.D2066LF26	07-	PA1224		+Retarder	51065006642/ 6675/ 6694/ 9642/ 9675/ 9694
	07-	PA1225		-Retarder	51065006637/ 7049/ 9049
28.400 (294 kW) Eng.D2066LF37	07-	PA1224		+Retarder	51065006642/ 6675/ 6694/ 9642/ 9675/ 9694
	07-	PA1225		-Retarder	51065006637/ 7049/ 9049
28.440 (324 kW) Eng.D2066LF36	07-	PA1224		+Retarder	51065006642/ 6675/ 6694/ 9642/ 9675/ 9694
	07-	PA1225		-Retarder	51065006637/ 7049/ 9049
28.480 (353 kW) Eng.D2676LF05	07-	PA1224		+Retarder	51065006642/ 6675/ 6694/ 9642/ 9675/ 9694
32.360 (265 kW) Eng.D2066LF38	07-	PA1224		+Retarder	51065006642/ 6675/ 6694/ 9642/ 9675/ 9694
	07-	PA1225		-Retarder	51065006637/ 7049/ 9049
32.440 (265 kW) Eng.D2066LF38/42/67	07-	PA1225		-Retarder	51065006637/ 7049/ 9049

			
<p>PA1224</p>	<p>PA1225</p>	<p>PA1312</p>	<p>PA1320</p>
			
<p>PA1341</p>	<p>PA1342</p>		



		GRAF ref.		NOTE	Adaptable for OES
33.400 (294 kW) Eng.D2066LF26	07-	PA1224		+Retarder	51065006642/ 6675/ 6694/ 9642/ 9675/ 9694
	07-	PA1225		-Retarder	51065006637/ 7049/ 9049
33.440 (324 kW) Eng.D2066LF36	07-	PA1224		+Retarder	51065006642/ 6675/ 6694/ 9642/ 9675/ 9694
	07-	PA1225		-Retarder	51065006637/ 7049/ 9049
33.540 (397 kW) Eng.D2676LF13	07-	PA1224		+Retarder	51065006642/ 6675/ 6694/ 9642/ 9675/ 9694



MERCEDES BENZ TRUCK
Accelo '5/03-

915 (110 kW) Eng.OM904.965/.966	03-	PA1320		For vehicles without retarder	904 200 02 01/ 04 01/ 06 01/ 07 01/ 08 01 904 200 19 01/ 20 01/ 22 01/ 25 01/ 26 01 904 200 27 01/ 28 01/ 29 01/ 32 01/ 38 01 904 200 43 01/ 49 01/ 50 01
---------------------------------	-----	---------------	--	-------------------------------	--

Actros I '4/96-'10/02

1831 (230 kW) Eng.OM541.920/.926/.941	96-02	PA1312		For vehicles with retarder; Without fastening eyes for axial fan	541 200 10 01 542 200 06 01/ 16 01/ 20 01
1835 (260 kW) Eng.OM541.922/.927	96-02	PA1312		For vehicles with retarder; Without fastening eyes for axial fan	541 200 10 01 542 200 06 01/ 16 01/ 20 01
1840 (290 kW) Eng.OM541.923/.924	96-02	PA1312		For vehicles with retarder; Without fastening eyes for axial fan	541 200 10 01 542 200 06 01/ 16 01/ 20 01
1843 (315 kW) Eng.OM541.925/.921/.947	96-02	PA1312		For vehicles with retarder; Without fastening eyes for axial fan	541 200 10 01 542 200 06 01/ 16 01/ 20 01
1848 (350 kW) Eng.OM542.921/.925	96-02	PA1312		For vehicles with retarder; Without fastening eyes for axial fan	541 200 10 01 542 200 06 01/ 16 01/ 20 01
	96-02	PA1341		For vehicles without retarder; With fastening eyes for axial fan	542 200 25 01
	96-02	PA1342		For vehicles with retarder; With fastening eyes for axial fan	542 200 26 01
1853 (390 kW) Eng.OM542.920	96-02	PA1312		For vehicles with retarder; Without fastening eyes for axial fan	541 200 10 01 542 200 06 01/ 16 01/ 20 01
	96-02	PA1341		For vehicles without retarder; With fastening eyes for axial fan	542 200 25 01
	96-02	PA1342		For vehicles with retarder; With fastening eyes for axial fan	542 200 26 01
1857 (420 kW) Eng.OM542.922	97-02	PA1312		For vehicles with retarder; Without fastening eyes for axial fan	541 200 10 01 542 200 06 01/ 16 01/ 20 01
	97-02	PA1341		For vehicles without retarder; With fastening eyes for axial fan	542 200 25 01
	97-02	PA1342		For vehicles with retarder; With fastening eyes for axial fan	542 200 26 01
2031 (230 kW) Eng.OM541.920/.926	97-02	PA1312		For vehicles with retarder; Without fastening eyes for axial fan	541 200 10 01 542 200 06 01/ 16 01/ 20 01
2035 (260 kW) Eng.OM541.922/.927/.943	96-02	PA1312		For vehicles with retarder; Without fastening eyes for axial fan	541 200 10 01 542 200 06 01/ 16 01/ 20 01
2040 (290 kW) Eng.OM541.923/.924	96-02	PA1312		For vehicles with retarder; Without fastening eyes for axial fan	541 200 10 01 542 200 06 01/ 16 01/ 20 01
2043 (315 kW) Eng.OM541.925	96-02	PA1312		For vehicles with retarder; Without fastening eyes for axial fan	541 200 10 01 542 200 06 01/ 16 01/ 20 01
2048 (350 kW) Eng.OM542.925	96-02	PA1312		For vehicles with retarder; Without fastening eyes for axial fan	541 200 10 01 542 200 06 01/ 16 01/ 20 01
	96-02	PA1341		For vehicles without retarder; With fastening eyes for axial fan	542 200 25 01
	96-02	PA1342		For vehicles with retarder; With fastening eyes for axial fan	542 200 26 01
2053 (390 kW) Eng.OM542.920	96-02	PA1312		For vehicles with retarder; Without fastening eyes for axial fan	541 200 10 01 542 200 06 01/ 16 01/ 20 01
	96-02	PA1341		For vehicles without retarder; With fastening eyes for axial fan	542 200 25 01
	96-02	PA1342		For vehicles with retarder; With fastening eyes for axial fan	542 200 26 01
2531 (230 kW) Eng.OM541.920/.940	96-02	PA1312		For vehicles with retarder; Without fastening eyes for axial fan	541 200 10 01 542 200 06 01/ 16 01/ 20 01
2535 (260 kW) Eng.OM541.922/.942	96-02	PA1312		For vehicles with retarder; Without fastening eyes for axial fan	541 200 10 01 542 200 06 01/ 16 01/ 20 01
2540 (290 kW) Eng.OM541.923/.944	96-02	PA1312		For vehicles with retarder; Without fastening eyes for axial fan	541 200 10 01 542 200 06 01/ 16 01/ 20 01
2543 (315 kW) Eng.OM541.925/.946	96-02	PA1312		For vehicles with retarder; Without fastening eyes for axial fan	541 200 10 01 542 200 06 01/ 16 01/ 20 01
2548 (350 kW) Eng.OM542.921	96-02	PA1312		For vehicles with retarder; Without fastening eyes for axial fan	541 200 10 01 542 200 06 01/ 16 01/ 20 01
	96-02	PA1341		For vehicles without retarder; With fastening eyes for axial fan	542 200 25 01

			
<p>PA1312</p>	<p>PA1341</p>	<p>PA1342</p>	

			
PA1312	PA1341	PA1342	

		GRAF ref.			NOTE	Adaptable for OES
3357 (420 kW) Eng.OM542.922	97-02	PA1312			For vehicles with retarder; Without fastening eyes for axial fan	541 200 10 01 542 200 06 01/ 16 01/ 20 01
	97-02	PA1341			For vehicles without retarder; With fastening eyes for axial fan	542 200 25 01
	97-02	PA1342			For vehicles with retarder; With fastening eyes for axial fan	542 200 26 01
4140 (290 kW) Eng.OM541.923	97-02	PA1312			For vehicles with retarder; Without fastening eyes for axial fan	541 200 10 01 542 200 06 01/ 16 01/ 20 01
4140 (290 kW) Eng.OM541.924	97-02	PA1312			For vehicles with retarder; Without fastening eyes for axial fan	541 200 10 01 542 200 06 01/ 16 01/ 20 01
4143 (315 kW) Eng.OM541.921	97-02	PA1312			For vehicles with retarder; Without fastening eyes for axial fan	541 200 10 01 542 200 06 01/ 16 01/ 20 01
4143 (315 kW) Eng.OM541.925	97-02	PA1312			For vehicles with retarder; Without fastening eyes for axial fan	541 200 10 01 542 200 06 01/ 16 01/ 20 01
4148 (350 kW) Eng.OM542.921	97-02	PA1312			For vehicles with retarder; Without fastening eyes for axial fan	541 200 10 01 542 200 06 01/ 16 01/ 20 01
	97-02	PA1341			For vehicles without retarder; With fastening eyes for axial fan	542 200 25 01
	97-02	PA1342			For vehicles with retarder; With fastening eyes for axial fan	542 200 26 01
4148 (350 kW) Eng.OM542.925	97-02	PA1312			For vehicles with retarder; Without fastening eyes for axial fan	541 200 10 01 542 200 06 01/ 16 01/ 20 01
	97-02	PA1341			For vehicles without retarder; With fastening eyes for axial fan	542 200 25 01
	97-02	PA1342			For vehicles with retarder; With fastening eyes for axial fan	542 200 26 01
Actros II/ III '1/03-						
1831 AK (230 kW) Eng.OM541.926/.941	03-	PA1312			For vehicles with retarder; Without fastening eyes for axial fan	541 200 10 01 542 200 06 01/ 16 01/ 20 01
1831 K (230 kW) Eng.OM541.920/.940	03-	PA1312			For vehicles with retarder; Without fastening eyes for axial fan	541 200 10 01 542 200 06 01/ 16 01/ 20 01
1832 (235 kW) Eng.OM541.940/.970	03-	PA1312			For vehicles with retarder; Without fastening eyes for axial fan	541 200 10 01 542 200 06 01/ 16 01/ 20 01
1832 (235 kW) Eng.OM541.971	03-	PA1312			For vehicles with retarder; Without fastening eyes for axial fan	541 200 10 01 542 200 06 01/ 16 01/ 20 01
1835 AK (260 kW) Eng.OM541.927/.943	03-	PA1312			For vehicles with retarder; Without fastening eyes for axial fan	541 200 10 01 542 200 06 01/ 16 01/ 20 01
1835 K (260 kW) Eng.OM541.922/.942	03-	PA1312			For vehicles with retarder; Without fastening eyes for axial fan	541 200 10 01 542 200 06 01/ 16 01/ 20 01
1836 (265 kW) Eng.OM541.942	03-	PA1312			For vehicles with retarder; Without fastening eyes for axial fan	541 200 10 01 542 200 06 01/ 16 01/ 20 01
1840 AK (290 kW) Eng.OM541.924/.945	03-	PA1312			For vehicles with retarder; Without fastening eyes for axial fan	541 200 10 01 542 200 06 01/ 16 01/ 20 01
1840 K (290 kW) Eng.OM541.923/.944	03-	PA1312			For vehicles with retarder; Without fastening eyes for axial fan	541 200 10 01 542 200 06 01/ 16 01/ 20 01
1841 (300 kW) Eng.OM541.944/.974	03-	PA1312			For vehicles with retarder; Without fastening eyes for axial fan	541 200 10 01 542 200 06 01/ 16 01/ 20 01
1844 (315-320 kW) Eng.OM541.921/.946	03-	PA1312			For vehicles with retarder; Without fastening eyes for axial fan	541 200 10 01 542 200 06 01/ 16 01/ 20 01
1844 (320 kW) Eng.OM541.946/.976	03-	PA1312			For vehicles with retarder; Without fastening eyes for axial fan	541 200 10 01 542 200 06 01/ 16 01/ 20 01
1846 (335 kW) Eng.OM541.948/.980	03-	PA1312			For vehicles with retarder; Without fastening eyes for axial fan	541 200 10 01 542 200 06 01/ 16 01/ 20 01
1846 (335 kW) Eng.OM541.981	03-	PA1312			For vehicles with retarder; Without fastening eyes for axial fan	541 200 10 01 542 200 06 01/ 16 01/ 20 01
1848 (350 kW) Eng.OM541.948/.978	03-	PA1312			For vehicles with retarder; Without fastening eyes for axial fan	541 200 10 01 542 200 06 01/ 16 01/ 20 01
	03-	PA1312			For vehicles with retarder; Without fastening eyes for axial fan	541 200 10 01 542 200 06 01/ 16 01/ 20 01
	03-	PA1341			For vehicles without retarder; With fastening eyes for axial fan	542 200 25 01
1850/1851 (370-375 kW) Eng.OM542.940/.960	03-	PA1342			For vehicles with retarder; With fastening eyes for axial fan	542 200 26 01
	03-	PA1312			For vehicles with retarder; Without fastening eyes for axial fan	541 200 10 01 542 200 06 01/ 16 01/ 20 01
	03-	PA1341			For vehicles without retarder; With fastening eyes for axial fan	542 200 25 01
1854 (395 kW) Eng.OM542.942	03-	PA1342			For vehicles with retarder; With fastening eyes for axial fan	542 200 26 01
	03-	PA1312			For vehicles with retarder; Without fastening eyes for axial fan	541 200 10 01 542 200 06 01/ 16 01/ 20 01
	03-	PA1341			For vehicles without retarder; With fastening eyes for axial fan	542 200 25 01
1854 (395-405 kW) Eng.OM542.942/.962	03-	PA1342			For vehicles with retarder; With fastening eyes for axial fan	542 200 26 01
	03-	PA1312			For vehicles with retarder; Without fastening eyes for axial fan	541 200 10 01 542 200 06 01/ 16 01/ 20 01





PA1312



PA1341



PA1342

			
PA1312	PA1341	PA1342	

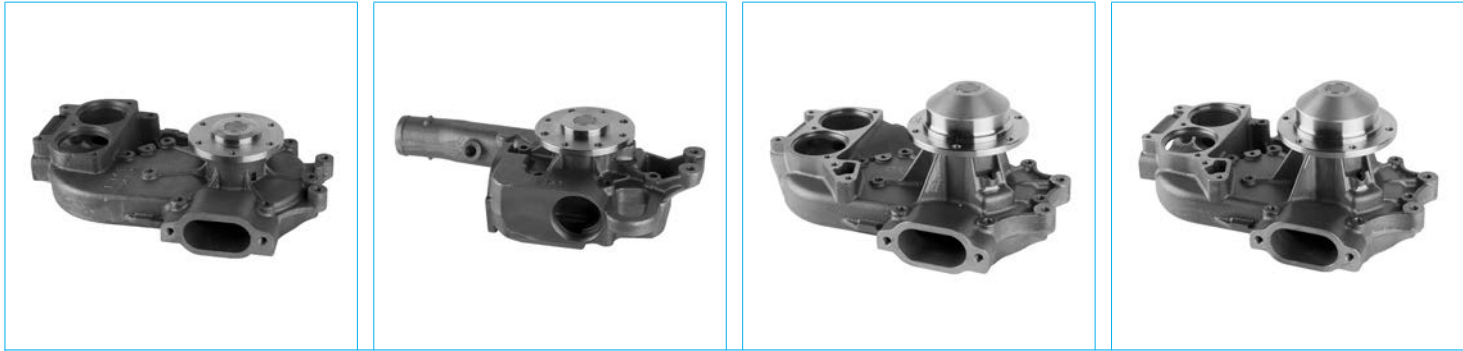

PA1312

PA1320

PA1341

PA1342

--	--	--	--

--	--	--	--

--	--	--	--

--	--	--	--

		GRAF ref.			NOTE	Adaptable for OES
3344 (315-320 kW) Eng.OM541.921	03-	PA1312			For vehicles with retarder; Without fastening eyes for axial fan	541 200 10 01 542 200 06 01/ 16 01/ 20 01
3344 (315-320 kW) Eng.OM541.946/.947	03-	PA1312			For vehicles with retarder; Without fastening eyes for axial fan	541 200 10 01 542 200 06 01/ 16 01/ 20 01
3344 (320 kW) Eng.OM541.946/.976	03-	PA1312			For vehicles with retarder; Without fastening eyes for axial fan	541 200 10 01 542 200 06 01/ 16 01/ 20 01
3344 (320 kW) Eng.OM541.947	03-	PA1312			For vehicles with retarder; Without fastening eyes for axial fan	541 200 10 01 542 200 06 01/ 16 01/ 20 01
3346 (335 kW) Eng.OM541.948	03-	PA1312			For vehicles with retarder; Without fastening eyes for axial fan	541 200 10 01 542 200 06 01/ 16 01/ 20 01
3346 (335 kW) Eng.OM541.949	03-	PA1312			For vehicles with retarder; Without fastening eyes for axial fan	541 200 10 01 542 200 06 01/ 16 01/ 20 01
3348 (350 kW) Eng.OM541.948	03-	PA1312			For vehicles with retarder; Without fastening eyes for axial fan	541 200 10 01 542 200 06 01/ 16 01/ 20 01
3348 (350 kW) Eng.OM542.921	03-	PA1312			For vehicles with retarder; Without fastening eyes for axial fan	541 200 10 01 542 200 06 01/ 16 01/ 20 01
	03-	PA1341			For vehicles without retarder; With fastening eyes for axial fan	542 200 25 01
	03-	PA1342			For vehicles with retarder; With fastening eyes for axial fan	542 200 26 01
3350/3351 (370-375 kW) Eng.OM542.940	03-	PA1312			For vehicles with retarder; Without fastening eyes for axial fan	541 200 10 01 542 200 06 01/ 16 01/ 20 01
	03-	PA1341			For vehicles without retarder; With fastening eyes for axial fan	542 200 25 01
	03-	PA1342			For vehicles with retarder; With fastening eyes for axial fan	542 200 26 01
3351 (370-375 kW) Eng.OM542.941	03-	PA1312			For vehicles with retarder; Without fastening eyes for axial fan	541 200 10 01 542 200 06 01/ 16 01/ 20 01
	03-	PA1341			For vehicles without retarder; With fastening eyes for axial fan	542 200 25 01
	03-	PA1342			For vehicles with retarder; With fastening eyes for axial fan	542 200 26 01
3351 (375 kW) Eng.OM542.940	03-	PA1312			For vehicles with retarder; Without fastening eyes for axial fan	541 200 10 01 542 200 06 01/ 16 01/ 20 01
	03-	PA1341			For vehicles without retarder; With fastening eyes for axial fan	542 200 25 01
	03-	PA1342			For vehicles with retarder; With fastening eyes for axial fan	542 200 26 01
3354/3355 (395-405 kW) Eng.OM542.942/.962	03-	PA1312			For vehicles with retarder; Without fastening eyes for axial fan	541 200 10 01 542 200 06 01/ 16 01/ 20 01
	03-	PA1341			For vehicles without retarder; With fastening eyes for axial fan	542 200 25 01
	03-	PA1342			For vehicles with retarder; With fastening eyes for axial fan	542 200 26 01
3355 (405 kW) Eng.OM542.962	03-	PA1312			For vehicles with retarder; Without fastening eyes for axial fan	541 200 10 01 542 200 06 01/ 16 01/ 20 01
	03-	PA1341			For vehicles without retarder; With fastening eyes for axial fan	542 200 25 01
	03-	PA1342			For vehicles with retarder; With fastening eyes for axial fan	542 200 26 01
4140 (290-300 kW) Eng.OM541.923/.944	03-	PA1312			For vehicles with retarder; Without fastening eyes for axial fan	541 200 10 01 542 200 06 01/ 16 01/ 20 01
4141 (300 kW) Eng.OM541.974	03-	PA1312			For vehicles with retarder; Without fastening eyes for axial fan	541 200 10 01 542 200 06 01/ 16 01/ 20 01
4144 (315-320 kW) Eng.OM541.925/.946/.976	03-	PA1312			For vehicles with retarder; Without fastening eyes for axial fan	541 200 10 01 542 200 06 01/ 16 01/ 20 01
4144 (320 kW) Eng.OM541.976	03-	PA1312			For vehicles with retarder; Without fastening eyes for axial fan	541 200 10 01 542 200 06 01/ 16 01/ 20 01
4146 (335 kW) Eng.OM541.948	03-	PA1312			For vehicles with retarder; Without fastening eyes for axial fan	541 200 10 01 542 200 06 01/ 16 01/ 20 01
4148 (350 kW) Eng.OM541.948	03-	PA1312			For vehicles with retarder; Without fastening eyes for axial fan	541 200 10 01 542 200 06 01/ 16 01/ 20 01
4151 (375 kW) Eng.OM542.960	03-	PA1312			For vehicles with retarder; Without fastening eyes for axial fan	541 200 10 01 542 200 06 01/ 16 01/ 20 01
	05-	PA1341			For vehicles without retarder; With fastening eyes for axial fan	542 200 25 01
	05-	PA1342			For vehicles with retarder; With fastening eyes for axial fan	542 200 26 01
Atego I '1/98-'10/04						
1017 (125 kW) Eng.OM904.911	98-04	PA1320			For vehicles without retarder	904 200 02 01/ 04 01/ 06 01/ 07 01/ 08 01 904 200 19 01/ 20 01/ 22 01/ 25 01/ 26 01 904 200 27 01/ 28 01/ 29 01/ 32 01/ 38 01 904 200 43 01/ 49 01/ 50 01
1017/1018 (125-130 kW) Eng.OM904.911/.913/.917	98-04	PA1320			For vehicles without retarder	904 200 02 01/ 04 01/ 06 01/ 07 01/ 08 01 904 200 19 01/ 20 01/ 22 01/ 25 01/ 26 01 904 200 27 01/ 28 01/ 29 01/ 32 01/ 38 01 904 200 43 01/ 49 01/ 50 01



PA1320



PA1333

		GRAF ref.			NOTE	Adaptable for OES
1023 (170 kW) Eng.OM906.910	98-04	PA1320			For vehicles without retarder	904 200 02 01/ 04 01/ 06 01/ 07 01/ 08 01 904 200 19 01/ 20 01/ 22 01/ 25 01/ 26 01 904 200 27 01/ 28 01/ 29 01/ 32 01/ 38 01 904 200 43 01/ 49 01/ 50 01
	98-04	PA1333				906 200 09 01/ 12 01/ 13 01/ 14 01/ 18 01 906 200 20 01/ 22 01/ 24 01/ 29 01/ 32 01 906 200 38 01/ 42 01/ 45 01/ 48 01/ 54 01 906 200 57 01/ 65 01
1214 (100 kW) Eng.OM904.910/.916	98-04	PA1320			For vehicles without retarder	904 200 02 01/ 04 01/ 06 01/ 07 01/ 08 01 904 200 19 01/ 20 01/ 22 01/ 25 01/ 26 01 904 200 27 01/ 28 01/ 29 01/ 32 01/ 38 01 904 200 43 01/ 49 01/ 50 01
1215 (112 kW) Eng.OM904.922	98-04	PA1320			For vehicles without retarder	904 200 02 01/ 04 01/ 06 01/ 07 01/ 08 01 904 200 19 01/ 20 01/ 22 01/ 25 01/ 26 01 904 200 27 01/ 28 01/ 29 01/ 32 01/ 38 01 904 200 43 01/ 49 01/ 50 01
1217 (125 kW) Eng.OM904.911	98-04	PA1320			For vehicles without retarder	904 200 02 01/ 04 01/ 06 01/ 07 01/ 08 01 904 200 19 01/ 20 01/ 22 01/ 25 01/ 26 01 904 200 27 01/ 28 01/ 29 01/ 32 01/ 38 01 904 200 43 01/ 49 01/ 50 01
1223 (170 kW) Eng.OM906.910	98-04	PA1320			For vehicles without retarder	904 200 02 01/ 04 01/ 06 01/ 07 01/ 08 01 904 200 19 01/ 20 01/ 22 01/ 25 01/ 26 01 904 200 27 01/ 28 01/ 29 01/ 32 01/ 38 01 904 200 43 01/ 49 01/ 50 01
	98-04	PA1333				906 200 09 01/ 12 01/ 13 01/ 14 01/ 18 01 906 200 20 01/ 22 01/ 24 01/ 29 01/ 32 01 906 200 38 01/ 42 01/ 45 01/ 48 01/ 54 01 906 200 57 01/ 65 01
1225 (180 kW) Eng.OM906.919	98-04	PA1320			For vehicles without retarder	904 200 02 01/ 04 01/ 06 01/ 07 01/ 08 01 904 200 19 01/ 20 01/ 22 01/ 25 01/ 26 01 904 200 27 01/ 28 01/ 29 01/ 32 01/ 38 01 904 200 43 01/ 49 01/ 50 01
	98-04	PA1333				906 200 09 01/ 12 01/ 13 01/ 14 01/ 18 01 906 200 20 01/ 22 01/ 24 01/ 29 01/ 32 01 906 200 38 01/ 42 01/ 45 01/ 48 01/ 54 01 906 200 57 01/ 65 01
1228 (205 kW) Eng.OM906.911	98-04	PA1320			For vehicles without retarder	904 200 02 01/ 04 01/ 06 01/ 07 01/ 08 01 904 200 19 01/ 20 01/ 22 01/ 25 01/ 26 01 904 200 27 01/ 28 01/ 29 01/ 32 01/ 38 01 904 200 43 01/ 49 01/ 50 01
	98-04	PA1333				906 200 09 01/ 12 01/ 13 01/ 14 01/ 18 01 906 200 20 01/ 22 01/ 24 01/ 29 01/ 32 01 906 200 38 01/ 42 01/ 45 01/ 48 01/ 54 01 906 200 57 01/ 65 01
1317 (125 kW) Eng.OM904.911	98-04	PA1320			For vehicles without retarder	904 200 02 01/ 04 01/ 06 01/ 07 01/ 08 01 904 200 19 01/ 20 01/ 22 01/ 25 01/ 26 01 904 200 27 01/ 28 01/ 29 01/ 32 01/ 38 01 904 200 43 01/ 49 01/ 50 01
1317/1318 (125-130 kW) Eng.OM904.911/.913	98-04	PA1320			For vehicles without retarder	904 200 02 01/ 04 01/ 06 01/ 07 01/ 08 01 904 200 19 01/ 20 01/ 22 01/ 25 01/ 26 01 904 200 27 01/ 28 01/ 29 01/ 32 01/ 38 01 904 200 43 01/ 49 01/ 50 01



PA1320



PA1333

		GRAF ref.			NOTE	Adaptable for OES
1323 (170 kW) Eng.OM906.910	98-04	PA1320			For vehicles without retarder	904 200 02 01/ 04 01/ 06 01/ 07 01/ 08 01 904 200 19 01/ 20 01/ 22 01/ 25 01/ 26 01 904 200 27 01/ 28 01/ 29 01/ 32 01/ 38 01 904 200 43 01/ 49 01/ 50 01
	98-04	PA1333				906 200 09 01/ 12 01/ 13 01/ 14 01/ 18 01 906 200 20 01/ 22 01/ 24 01/ 29 01/ 32 01 906 200 38 01/ 42 01/ 45 01/ 48 01/ 54 01 906 200 57 01/ 65 01
1325 (180 kW) Eng.OM906.919	98-04	PA1320			For vehicles without retarder	904 200 02 01/ 04 01/ 06 01/ 07 01/ 08 01 904 200 19 01/ 20 01/ 22 01/ 25 01/ 26 01 904 200 27 01/ 28 01/ 29 01/ 32 01/ 38 01 904 200 43 01/ 49 01/ 50 01
	98-04	PA1333				906 200 09 01/ 12 01/ 13 01/ 14 01/ 18 01 906 200 20 01/ 22 01/ 24 01/ 29 01/ 32 01 906 200 38 01/ 42 01/ 45 01/ 48 01/ 54 01 906 200 57 01/ 65 01
1328 (205 kW) Eng.OM906.911	98-04	PA1320			For vehicles without retarder	904 200 02 01/ 04 01/ 06 01/ 07 01/ 08 01 904 200 19 01/ 20 01/ 22 01/ 25 01/ 26 01 904 200 27 01/ 28 01/ 29 01/ 32 01/ 38 01 904 200 43 01/ 49 01/ 50 01
	98-04	PA1333				906 200 09 01/ 12 01/ 13 01/ 14 01/ 18 01 906 200 20 01/ 22 01/ 24 01/ 29 01/ 32 01 906 200 38 01/ 42 01/ 45 01/ 48 01/ 54 01 906 200 57 01/ 65 01
1517 (125 kW) Eng.OM904.911	98-04	PA1320			For vehicles without retarder	904 200 02 01/ 04 01/ 06 01/ 07 01/ 08 01 904 200 19 01/ 20 01/ 22 01/ 25 01/ 26 01 904 200 27 01/ 28 01/ 29 01/ 32 01/ 38 01 904 200 43 01/ 49 01/ 50 01
1523 (170 kW) Eng.OM906.910	98-04	PA1320			For vehicles without retarder	904 200 02 01/ 04 01/ 06 01/ 07 01/ 08 01 904 200 19 01/ 20 01/ 22 01/ 25 01/ 26 01 904 200 27 01/ 28 01/ 29 01/ 32 01/ 38 01 904 200 43 01/ 49 01/ 50 01
	98-04	PA1333				906 200 09 01/ 12 01/ 13 01/ 14 01/ 18 01 906 200 20 01/ 22 01/ 24 01/ 29 01/ 32 01 906 200 38 01/ 42 01/ 45 01/ 48 01/ 54 01 906 200 57 01/ 65 01
1525 (180 kW) Eng.OM906.919	98-04	PA1320			For vehicles without retarder	904 200 02 01/ 04 01/ 06 01/ 07 01/ 08 01 904 200 19 01/ 20 01/ 22 01/ 25 01/ 26 01 904 200 27 01/ 28 01/ 29 01/ 32 01/ 38 01 904 200 43 01/ 49 01/ 50 01
	98-04	PA1333				906 200 09 01/ 12 01/ 13 01/ 14 01/ 18 01 906 200 20 01/ 22 01/ 24 01/ 29 01/ 32 01 906 200 38 01/ 42 01/ 45 01/ 48 01/ 54 01 906 200 57 01/ 65 01
1528 (205 kW) Eng.OM906.911	98-04	PA1320			For vehicles without retarder	904 200 02 01/ 04 01/ 06 01/ 07 01/ 08 01 904 200 19 01/ 20 01/ 22 01/ 25 01/ 26 01 904 200 27 01/ 28 01/ 29 01/ 32 01/ 38 01 904 200 43 01/ 49 01/ 50 01
	98-04	PA1333				906 200 09 01/ 12 01/ 13 01/ 14 01/ 18 01 906 200 20 01/ 22 01/ 24 01/ 29 01/ 32 01 906 200 38 01/ 42 01/ 45 01/ 48 01/ 54 01 906 200 57 01/ 65 01



PA1320



PA1333

		GRAF ref.			NOTE	Adaptable for OES
1823 (170 kW) Eng.OM906.920	98-04	PA1320			For vehicles without retarder	904 200 02 01/ 04 01/ 06 01/ 07 01/ 08 01 904 200 19 01/ 20 01/ 22 01/ 25 01/ 26 01 904 200 27 01/ 28 01/ 29 01/ 32 01/ 38 01 904 200 43 01/ 49 01/ 50 01
	98-04	PA1333				906 200 09 01/ 12 01/ 13 01/ 14 01/ 18 01 906 200 20 01/ 22 01/ 24 01/ 29 01/ 32 01 906 200 38 01/ 42 01/ 45 01/ 48 01/ 54 01 906 200 57 01/ 65 01
1823 (170 kW) Eng.OM906.920/.925	98-04	PA1320			For vehicles without retarder	904 200 02 01/ 04 01/ 06 01/ 07 01/ 08 01 904 200 19 01/ 20 01/ 22 01/ 25 01/ 26 01 904 200 27 01/ 28 01/ 29 01/ 32 01/ 38 01 904 200 43 01/ 49 01/ 50 01
	98-04	PA1333				906 200 09 01/ 12 01/ 13 01/ 14 01/ 18 01 906 200 20 01/ 22 01/ 24 01/ 29 01/ 32 01 906 200 38 01/ 42 01/ 45 01/ 48 01/ 54 01 906 200 57 01/ 65 01
1823 (170 kW) Eng.OM906.922	98-04	PA1320			For vehicles without retarder	904 200 02 01/ 04 01/ 06 01/ 07 01/ 08 01 904 200 19 01/ 20 01/ 22 01/ 25 01/ 26 01 904 200 27 01/ 28 01/ 29 01/ 32 01/ 38 01 904 200 43 01/ 49 01/ 50 01
	98-04	PA1333				906 200 09 01/ 12 01/ 13 01/ 14 01/ 18 01 906 200 20 01/ 22 01/ 24 01/ 29 01/ 32 01 906 200 38 01/ 42 01/ 45 01/ 48 01/ 54 01 906 200 57 01/ 65 01
1828 (205 kW) Eng.OM906.921/.926	98-04	PA1320			For vehicles without retarder	904 200 02 01/ 04 01/ 06 01/ 07 01/ 08 01 904 200 19 01/ 20 01/ 22 01/ 25 01/ 26 01 904 200 27 01/ 28 01/ 29 01/ 32 01/ 38 01 904 200 43 01/ 49 01/ 50 01
	98-04	PA1333				906 200 09 01/ 12 01/ 13 01/ 14 01/ 18 01 906 200 20 01/ 22 01/ 24 01/ 29 01/ 32 01 906 200 38 01/ 42 01/ 45 01/ 48 01/ 54 01 906 200 57 01/ 65 01
1828 (205 kW) Eng.OM906.923	98-04	PA1320			For vehicles without retarder	904 200 02 01/ 04 01/ 06 01/ 07 01/ 08 01 904 200 19 01/ 20 01/ 22 01/ 25 01/ 26 01 904 200 27 01/ 28 01/ 29 01/ 32 01/ 38 01 904 200 43 01/ 49 01/ 50 01
	98-04	PA1333				906 200 09 01/ 12 01/ 13 01/ 14 01/ 18 01 906 200 20 01/ 22 01/ 24 01/ 29 01/ 32 01 906 200 38 01/ 42 01/ 45 01/ 48 01/ 54 01 906 200 57 01/ 65 01
2523 (205 kW) Eng.OM906.920	98-04	PA1320			For vehicles without retarder	904 200 02 01/ 04 01/ 06 01/ 07 01/ 08 01 904 200 19 01/ 20 01/ 22 01/ 25 01/ 26 01 904 200 27 01/ 28 01/ 29 01/ 32 01/ 38 01 904 200 43 01/ 49 01/ 50 01
	98-04	PA1333				906 200 09 01/ 12 01/ 13 01/ 14 01/ 18 01 906 200 20 01/ 22 01/ 24 01/ 29 01/ 32 01 906 200 38 01/ 42 01/ 45 01/ 48 01/ 54 01 906 200 57 01/ 65 01
2528 (205 kW) Eng.OM906.921/.926	98-04	PA1320			For vehicles without retarder	904 200 02 01/ 04 01/ 06 01/ 07 01/ 08 01 904 200 19 01/ 20 01/ 22 01/ 25 01/ 26 01 904 200 27 01/ 28 01/ 29 01/ 32 01/ 38 01 904 200 43 01/ 49 01/ 50 01



PA1320



PA1333

		GRAF ref.			NOTE	Adaptable for OES
2528 (205 kW) Eng.OM906.921/.926	98-04	PA1333				906 200 09 01/ 12 01/ 13 01/ 14 01/ 18 01 906 200 20 01/ 22 01/ 24 01/ 29 01/ 32 01 906 200 38 01/ 42 01/ 45 01/ 48 01/ 54 01 906 200 57 01/ 65 01
2628 (205 kW) Eng.OM906.921	98-04	PA1320			For vehicles without retarder	904 200 02 01/ 04 01/ 06 01/ 07 01/ 08 01 904 200 19 01/ 20 01/ 22 01/ 25 01/ 26 01 904 200 27 01/ 28 01/ 29 01/ 32 01/ 38 01 904 200 43 01/ 49 01/ 50 01
	98-04	PA1333				906 200 09 01/ 12 01/ 13 01/ 14 01/ 18 01 906 200 20 01/ 22 01/ 24 01/ 29 01/ 32 01 906 200 38 01/ 42 01/ 45 01/ 48 01/ 54 01 906 200 57 01/ 65 01
712 (90 kW) Eng.OM904.909	98-04	PA1320			For vehicles without retarder	904 200 02 01/ 04 01/ 06 01/ 07 01/ 08 01 904 200 19 01/ 20 01/ 22 01/ 25 01/ 26 01 904 200 27 01/ 28 01/ 29 01/ 32 01/ 38 01 904 200 43 01/ 49 01/ 50 01
714 (100 kW) Eng.OM904.910/.916	98-04	PA1320			For vehicles without retarder	904 200 02 01/ 04 01/ 06 01/ 07 01/ 08 01 904 200 19 01/ 20 01/ 22 01/ 25 01/ 26 01 904 200 27 01/ 28 01/ 29 01/ 32 01/ 38 01 904 200 43 01/ 49 01/ 50 01
715 (112 kW) Eng.OM904.922	98-04	PA1320			For vehicles without retarder	904 200 02 01/ 04 01/ 06 01/ 07 01/ 08 01 904 200 19 01/ 20 01/ 22 01/ 25 01/ 26 01 904 200 27 01/ 28 01/ 29 01/ 32 01/ 38 01 904 200 43 01/ 49 01/ 50 01
717 (125 kW) Eng.OM904.911/.917	98-04	PA1320			For vehicles without retarder	904 200 02 01/ 04 01/ 06 01/ 07 01/ 08 01 904 200 19 01/ 20 01/ 22 01/ 25 01/ 26 01 904 200 27 01/ 28 01/ 29 01/ 32 01/ 38 01 904 200 43 01/ 49 01/ 50 01
812 (90 kW) Eng.OM904.909	98-04	PA1320			For vehicles without retarder	904 200 02 01/ 04 01/ 06 01/ 07 01/ 08 01 904 200 19 01/ 20 01/ 22 01/ 25 01/ 26 01 904 200 27 01/ 28 01/ 29 01/ 32 01/ 38 01 904 200 43 01/ 49 01/ 50 01
814 (100 kW) Eng.OM904.910/.916	98-04	PA1320			For vehicles without retarder	904 200 02 01/ 04 01/ 06 01/ 07 01/ 08 01 904 200 19 01/ 20 01/ 22 01/ 25 01/ 26 01 904 200 27 01/ 28 01/ 29 01/ 32 01/ 38 01 904 200 43 01/ 49 01/ 50 01
815 (112 kW) Eng.OM904.922	98-04	PA1320			For vehicles without retarder	904 200 02 01/ 04 01/ 06 01/ 07 01/ 08 01 904 200 19 01/ 20 01/ 22 01/ 25 01/ 26 01 904 200 27 01/ 28 01/ 29 01/ 32 01/ 38 01 904 200 43 01/ 49 01/ 50 01
815 (112 kW) Eng.OM906.922	98-04	PA1320			For vehicles without retarder	904 200 02 01/ 04 01/ 06 01/ 07 01/ 08 01 904 200 19 01/ 20 01/ 22 01/ 25 01/ 26 01 904 200 27 01/ 28 01/ 29 01/ 32 01/ 38 01 904 200 43 01/ 49 01/ 50 01
	98-04	PA1333				906 200 09 01/ 12 01/ 13 01/ 14 01/ 18 01 906 200 20 01/ 22 01/ 24 01/ 29 01/ 32 01 906 200 38 01/ 42 01/ 45 01/ 48 01/ 54 01 906 200 57 01/ 65 01
817 (125 kW) Eng.OM904.911	98-04	PA1320			For vehicles without retarder	904 200 02 01/ 04 01/ 06 01/ 07 01/ 08 01 904 200 19 01/ 20 01/ 22 01/ 25 01/ 26 01 904 200 27 01/ 28 01/ 29 01/ 32 01/ 38 01 904 200 43 01/ 49 01/ 50 01



PA1320



PA1333

		GRAF ref.			NOTE	Adaptable for OES
823 (170 kW) Eng.OM906.910	98-04	PA1320			For vehicles without retarder	904 200 02 01/ 04 01/ 06 01/ 07 01/ 08 01 904 200 19 01/ 20 01/ 22 01/ 25 01/ 26 01 904 200 27 01/ 28 01/ 29 01/ 32 01/ 38 01 904 200 43 01/ 49 01/ 50 01
	98-04	PA1333				906 200 09 01/ 12 01/ 13 01/ 14 01/ 18 01 906 200 20 01/ 22 01/ 24 01/ 29 01/ 32 01 906 200 38 01/ 42 01/ 45 01/ 48 01/ 54 01 906 200 57 01/ 65 01
917 (125 kW) Eng.OM904.911	98-04	PA1320			For vehicles without retarder	904 200 02 01/ 04 01/ 06 01/ 07 01/ 08 01 904 200 19 01/ 20 01/ 22 01/ 25 01/ 26 01 904 200 27 01/ 28 01/ 29 01/ 32 01/ 38 01 904 200 43 01/ 49 01/ 50 01
917 (125 kW) Eng.OM904.917	98-04	PA1320			For vehicles without retarder	904 200 02 01/ 04 01/ 06 01/ 07 01/ 08 01 904 200 19 01/ 20 01/ 22 01/ 25 01/ 26 01 904 200 27 01/ 28 01/ 29 01/ 32 01/ 38 01 904 200 43 01/ 49 01/ 50 01
923 (170 kW) Eng.OM906.910	98-04	PA1320			For vehicles without retarder	904 200 02 01/ 04 01/ 06 01/ 07 01/ 08 01 904 200 19 01/ 20 01/ 22 01/ 25 01/ 26 01 904 200 27 01/ 28 01/ 29 01/ 32 01/ 38 01 904 200 43 01/ 49 01/ 50 01
	98-04	PA1333				906 200 09 01/ 12 01/ 13 01/ 14 01/ 18 01 906 200 20 01/ 22 01/ 24 01/ 29 01/ 32 01 906 200 38 01/ 42 01/ 45 01/ 48 01/ 54 01 906 200 57 01/ 65 01
925 (205 kW) Eng.OM906.919	98-04	PA1320			For vehicles without retarder	904 200 02 01/ 04 01/ 06 01/ 07 01/ 08 01 904 200 19 01/ 20 01/ 22 01/ 25 01/ 26 01 904 200 27 01/ 28 01/ 29 01/ 32 01/ 38 01 904 200 43 01/ 49 01/ 50 01
	98-04	PA1333				906 200 09 01/ 12 01/ 13 01/ 14 01/ 18 01 906 200 20 01/ 22 01/ 24 01/ 29 01/ 32 01 906 200 38 01/ 42 01/ 45 01/ 48 01/ 54 01 906 200 57 01/ 65 01
Atego II '10/04-						
1022 (160 kW) Eng.OM924.920	04-	PA1320			For vehicles without retarder	904 200 02 01/ 04 01/ 06 01/ 07 01/ 08 01 904 200 19 01/ 20 01/ 22 01/ 25 01/ 26 01 904 200 27 01/ 28 01/ 29 01/ 32 01/ 38 01 904 200 43 01/ 49 01/ 50 01
1023/1024 (170-175 kW) Eng.OM902.916	04-	PA1320			For vehicles without retarder	904 200 02 01/ 04 01/ 06 01/ 07 01/ 08 01 904 200 19 01/ 20 01/ 22 01/ 25 01/ 26 01 904 200 27 01/ 28 01/ 29 01/ 32 01/ 38 01 904 200 43 01/ 49 01/ 50 01
1023/1024 (170-175 kW) Eng.OM906.910/.915	04-	PA1320			For vehicles without retarder	904 200 02 01/ 04 01/ 06 01/ 07 01/ 08 01 904 200 19 01/ 20 01/ 22 01/ 25 01/ 26 01 904 200 27 01/ 28 01/ 29 01/ 32 01/ 38 01 904 200 43 01/ 49 01/ 50 01
	04-	PA1333				906 200 09 01/ 12 01/ 13 01/ 14 01/ 18 01 906 200 20 01/ 22 01/ 24 01/ 29 01/ 32 01 906 200 38 01/ 42 01/ 45 01/ 48 01/ 54 01 906 200 57 01/ 65 01



PA1320



PA1333

		GRAF ref.			NOTE	Adaptable for OES
1222 (160 kW) Eng.OM924.920	04-	PA1320			For vehicles without retarder	904 200 02 01/ 04 01/ 06 01/ 07 01/ 08 01 904 200 19 01/ 20 01/ 22 01/ 25 01/ 26 01 904 200 27 01/ 28 01/ 29 01/ 32 01/ 38 01 904 200 43 01/ 49 01/ 50 01
1223/1224 (170-175 kW) Eng.OM902.916	04-	PA1320			For vehicles without retarder	904 200 02 01/ 04 01/ 06 01/ 07 01/ 08 01 904 200 19 01/ 20 01/ 22 01/ 25 01/ 26 01 904 200 27 01/ 28 01/ 29 01/ 32 01/ 38 01 904 200 43 01/ 49 01/ 50 01
1223/1224 (170-175 kW) Eng.OM906.910/.915	04-	PA1320			For vehicles without retarder	904 200 02 01/ 04 01/ 06 01/ 07 01/ 08 01 904 200 19 01/ 20 01/ 22 01/ 25 01/ 26 01 904 200 27 01/ 28 01/ 29 01/ 32 01/ 38 01 904 200 43 01/ 49 01/ 50 01
	04-	PA1333				906 200 09 01/ 12 01/ 13 01/ 14 01/ 18 01 906 200 20 01/ 22 01/ 24 01/ 29 01/ 32 01 906 200 38 01/ 42 01/ 45 01/ 48 01/ 54 01 906 200 57 01/ 65 01
1228/1229 (205-210 kW) Eng.OM906.911/.916	04-	PA1320			For vehicles without retarder	904 200 02 01/ 04 01/ 06 01/ 07 01/ 08 01 904 200 19 01/ 20 01/ 22 01/ 25 01/ 26 01 904 200 27 01/ 28 01/ 29 01/ 32 01/ 38 01 904 200 43 01/ 49 01/ 50 01
	04-	PA1333				906 200 09 01/ 12 01/ 13 01/ 14 01/ 18 01 906 200 20 01/ 22 01/ 24 01/ 29 01/ 32 01 906 200 38 01/ 42 01/ 45 01/ 48 01/ 54 01 906 200 57 01/ 65 01
1322 (160 kW) Eng.OM924.920	04-	PA1320			For vehicles without retarder	904 200 02 01/ 04 01/ 06 01/ 07 01/ 08 01 904 200 19 01/ 20 01/ 22 01/ 25 01/ 26 01 904 200 27 01/ 28 01/ 29 01/ 32 01/ 38 01 904 200 43 01/ 49 01/ 50 01
1323/1324 (170-175 kW) Eng.OM906.910/.915	04-	PA1320			For vehicles without retarder	904 200 02 01/ 04 01/ 06 01/ 07 01/ 08 01 904 200 19 01/ 20 01/ 22 01/ 25 01/ 26 01 904 200 27 01/ 28 01/ 29 01/ 32 01/ 38 01 904 200 43 01/ 49 01/ 50 01
	04-	PA1333				906 200 09 01/ 12 01/ 13 01/ 14 01/ 18 01 906 200 20 01/ 22 01/ 24 01/ 29 01/ 32 01 906 200 38 01/ 42 01/ 45 01/ 48 01/ 54 01 906 200 57 01/ 65 01
1328/1329 (205-210 kW) Eng.OM906.911/.916	04-	PA1320			For vehicles without retarder	904 200 02 01/ 04 01/ 06 01/ 07 01/ 08 01 904 200 19 01/ 20 01/ 22 01/ 25 01/ 26 01 904 200 27 01/ 28 01/ 29 01/ 32 01/ 38 01 904 200 43 01/ 49 01/ 50 01
	04-	PA1333				906 200 09 01/ 12 01/ 13 01/ 14 01/ 18 01 906 200 20 01/ 22 01/ 24 01/ 29 01/ 32 01 906 200 38 01/ 42 01/ 45 01/ 48 01/ 54 01 906 200 57 01/ 65 01
1418/1718 (130 kW) Eng.OM904.962/967/968	11-	PA1320			For vehicles without retarder	904 200 02 01/ 04 01/ 06 01/ 07 01/ 08 01 904 200 19 01/ 20 01/ 22 01/ 25 01/ 26 01 904 200 27 01/ 28 01/ 29 01/ 32 01/ 38 01 904 200 43 01/ 49 01/ 50 01
1418/1718 (130 kW) Eng.OM904.972/973/976	11-	PA1320			For vehicles without retarder	904 200 02 01/ 04 01/ 06 01/ 07 01/ 08 01 904 200 19 01/ 20 01/ 22 01/ 25 01/ 26 01 904 200 27 01/ 28 01/ 29 01/ 32 01/ 38 01 904 200 43 01/ 49 01/ 50 01



PA1320





PA1333

		GRAF ref.		NOTE	Adaptable for OES
1522 (160 kW) Eng.OM924.920	04-	PA1320		For vehicles without retarder	904 200 02 01/ 04 01/ 06 01/ 07 01/ 08 01 904 200 19 01/ 20 01/ 22 01/ 25 01/ 26 01 904 200 27 01/ 28 01/ 29 01/ 32 01/ 38 01 904 200 43 01/ 49 01/ 50 01
1523/1524 (170-175 kW) Eng.OM906.910/.915	04-	PA1320		For vehicles without retarder	904 200 02 01/ 04 01/ 06 01/ 07 01/ 08 01 904 200 19 01/ 20 01/ 22 01/ 25 01/ 26 01 904 200 27 01/ 28 01/ 29 01/ 32 01/ 38 01 904 200 43 01/ 49 01/ 50 01
	04-	PA1333			906 200 09 01/ 12 01/ 13 01/ 14 01/ 18 01 906 200 20 01/ 22 01/ 24 01/ 29 01/ 32 01 906 200 38 01/ 42 01/ 45 01/ 48 01/ 54 01 906 200 57 01/ 65 01
1528/1529 (205-210 kW) Eng.OM906.911/.916	04-	PA1320		For vehicles without retarder	904 200 02 01/ 04 01/ 06 01/ 07 01/ 08 01 904 200 19 01/ 20 01/ 22 01/ 25 01/ 26 01 904 200 27 01/ 28 01/ 29 01/ 32 01/ 38 01 904 200 43 01/ 49 01/ 50 01
	04-	PA1333			906 200 09 01/ 12 01/ 13 01/ 14 01/ 18 01 906 200 20 01/ 22 01/ 24 01/ 29 01/ 32 01 906 200 38 01/ 42 01/ 45 01/ 48 01/ 54 01 906 200 57 01/ 65 01
1725 K (180 kW) Eng.OM906.983/985/988	11-	PA1320		For vehicles without retarder	904 200 02 01/ 04 01/ 06 01/ 07 01/ 08 01 904 200 19 01/ 20 01/ 22 01/ 25 01/ 26 01 904 200 27 01/ 28 01/ 29 01/ 32 01/ 38 01 904 200 43 01/ 49 01/ 50 01
	11-	PA1333			906 200 09 01/ 12 01/ 13 01/ 14 01/ 18 01 906 200 20 01/ 22 01/ 24 01/ 29 01/ 32 01 906 200 38 01/ 42 01/ 45 01/ 48 01/ 54 01 906 200 57 01/ 65 01
1725 K (180 kW) Eng.OM906.990	11-	PA1320		For vehicles without retarder	904 200 02 01/ 04 01/ 06 01/ 07 01/ 08 01 904 200 19 01/ 20 01/ 22 01/ 25 01/ 26 01 904 200 27 01/ 28 01/ 29 01/ 32 01/ 38 01 904 200 43 01/ 49 01/ 50 01
	11-	PA1333			906 200 09 01/ 12 01/ 13 01/ 14 01/ 18 01 906 200 20 01/ 22 01/ 24 01/ 29 01/ 32 01 906 200 38 01/ 42 01/ 45 01/ 48 01/ 54 01 906 200 57 01/ 65 01
712/713 (90-95 kW) Eng.OM904.909/.911/.915/.917	04-	PA1320		For vehicles without retarder	904 200 02 01/ 04 01/ 06 01/ 07 01/ 08 01 904 200 19 01/ 20 01/ 22 01/ 25 01/ 26 01 904 200 27 01/ 28 01/ 29 01/ 32 01/ 38 01 904 200 43 01/ 49 01/ 50 01
812/813 (90-95 kW) Eng.OM904.909/.911/.917	04-	PA1320		For vehicles without retarder	904 200 02 01/ 04 01/ 06 01/ 07 01/ 08 01 904 200 19 01/ 20 01/ 22 01/ 25 01/ 26 01 904 200 27 01/ 28 01/ 29 01/ 32 01/ 38 01 904 200 43 01/ 49 01/ 50 01
822 (160 kW) Eng.OM924.920	04-	PA1320		For vehicles without retarder	904 200 02 01/ 04 01/ 06 01/ 07 01/ 08 01 904 200 19 01/ 20 01/ 22 01/ 25 01/ 26 01 904 200 27 01/ 28 01/ 29 01/ 32 01/ 38 01 904 200 43 01/ 49 01/ 50 01
823/824 (170-175 kW) Eng.OM906.910/.915	04-	PA1320		For vehicles without retarder	904 200 02 01/ 04 01/ 06 01/ 07 01/ 08 01 904 200 19 01/ 20 01/ 22 01/ 25 01/ 26 01 904 200 27 01/ 28 01/ 29 01/ 32 01/ 38 01 904 200 43 01/ 49 01/ 50 01

			
<p>PA1320</p>	<p>PA1326</p>	<p>PA1327</p>	<p>PA1329</p>
			
<p>PA1333</p>			

		GRAF ref.			NOTE	Adaptable for OES
823/824 (170-175 kW) Eng.OM906.910/.915	04-	PA1333				906 200 09 01/ 12 01/ 13 01/ 14 01/ 18 01 906 200 20 01/ 22 01/ 24 01/ 29 01/ 32 01 906 200 38 01/ 42 01/ 45 01/ 48 01/ 54 01 906 200 57 01/ 65 01
922 (160 kW) Eng.OM924.920	04-	PA1320			For vehicles without retarder	904 200 02 01/ 04 01/ 06 01/ 07 01/ 08 01 904 200 19 01/ 20 01/ 22 01/ 25 01/ 26 01 904 200 27 01/ 28 01/ 29 01/ 32 01/ 38 01 904 200 43 01/ 49 01/ 50 01
923/924 (170-175 kW) Eng.OM906.910/.915	04-	PA1320			For vehicles without retarder	904 200 02 01/ 04 01/ 06 01/ 07 01/ 08 01 904 200 19 01/ 20 01/ 22 01/ 25 01/ 26 01 904 200 27 01/ 28 01/ 29 01/ 32 01/ 38 01 904 200 43 01/ 49 01/ 50 01
	04-	PA1333				906 200 09 01/ 12 01/ 13 01/ 14 01/ 18 01 906 200 20 01/ 22 01/ 24 01/ 29 01/ 32 01 906 200 38 01/ 42 01/ 45 01/ 48 01/ 54 01 906 200 57 01/ 65 01
Axor I '1/02-'10/04						
1823 (170 kW) Eng.OM906.920	02-04	PA1320			For vehicles without retarder	904 200 02 01/ 04 01/ 06 01/ 07 01/ 08 01 904 200 19 01/ 20 01/ 22 01/ 25 01/ 26 01 904 200 27 01/ 28 01/ 29 01/ 32 01/ 38 01 904 200 43 01/ 49 01/ 50 01
1835 (260 kW) Eng.OM457.937	02-04	PA1326			For vehicles with retarder; Open hole	457 200 02 01/ 05 01/ 11 01/ 25 01/ 27 01
	02-04	PA1327			For vehicles with retarder; Close hole	442 200 04 01/ 06 01/ 07 01/ 09 01 457 200 10 01/ 24 01/ 28 01
	02-04	PA1329			For vehicles without retarder	457 200 08 01/ 19 01/ 23 01/ 29 01
1840 (295 kW) Eng.OM457.937	02-04	PA1326			For vehicles with retarder; Open hole	457 200 02 01/ 05 01/ 11 01/ 25 01/ 27 01
	02-04	PA1327			For vehicles with retarder; Close hole	442 200 04 01/ 06 01/ 07 01/ 09 01 457 200 10 01/ 24 01/ 28 01
	02-04	PA1329			For vehicles without retarder	457 200 08 01/ 19 01/ 23 01/ 29 01
1843 (315 kW) Eng.OM457.937	02-04	PA1326			For vehicles with retarder; Open hole	457 200 02 01/ 05 01/ 11 01/ 25 01/ 27 01
	02-04	PA1327			For vehicles with retarder; Close hole	442 200 04 01/ 06 01/ 07 01/ 09 01 457 200 10 01/ 24 01/ 28 01
	02-04	PA1329			For vehicles without retarder	457 200 08 01/ 19 01/ 23 01/ 29 01
2523 (170 kW) Eng.OM906.920	02-04	PA1320			For vehicles without retarder	904 200 02 01/ 04 01/ 06 01/ 07 01/ 08 01 904 200 19 01/ 20 01/ 22 01/ 25 01/ 26 01 904 200 27 01/ 28 01/ 29 01/ 32 01/ 38 01 904 200 43 01/ 49 01/ 50 01
2528 (205 kW) Eng.OM906.921	02-04	PA1320			For vehicles without retarder	904 200 02 01/ 04 01/ 06 01/ 07 01/ 08 01 904 200 19 01/ 20 01/ 22 01/ 25 01/ 26 01 904 200 27 01/ 28 01/ 29 01/ 32 01/ 38 01 904 200 43 01/ 49 01/ 50 01
2535 (260 kW) Eng.OM457.937	02-04	PA1326			For vehicles with retarder; Open hole	457 200 02 01/ 05 01/ 11 01/ 25 01/ 27 01
	02-04	PA1327			For vehicles with retarder; Close hole	442 200 04 01/ 06 01/ 07 01/ 09 01 457 200 10 01/ 24 01/ 28 01
	02-04	PA1329			For vehicles without retarder	457 200 08 01/ 19 01/ 23 01/ 29 01
2540 (295 kW) Eng.OM457.937	02-04	PA1326			For vehicles with retarder; Open hole	457 200 02 01/ 05 01/ 11 01/ 25 01/ 27 01
	02-04	PA1327			For vehicles with retarder; Close hole	442 200 04 01/ 06 01/ 07 01/ 09 01 457 200 10 01/ 24 01/ 28 01
	02-04	PA1329			For vehicles without retarder	457 200 08 01/ 19 01/ 23 01/ 29 01
2543 (315 kW) Eng.OM457.937	02-04	PA1326			For vehicles with retarder; Open hole	457 200 02 01/ 05 01/ 11 01/ 25 01/ 27 01
	02-04	PA1327			For vehicles with retarder; Close hole	442 200 04 01/ 06 01/ 07 01/ 09 01 457 200 10 01/ 24 01/ 28 01

			
PA1320	PA1329	PA1333	

		GRAF ref.			NOTE	Adaptable for OES
2543 (315 kW) Eng.OM457.937	02-04	PA1329			For vehicles without retarder	457 200 08 01/ 19 01/ 23 01/ 29 01
2623 (170 kW) Eng.OM906.920	02-04	PA1320			For vehicles without retarder	904 200 02 01/ 04 01/ 06 01/ 07 01/ 08 01 904 200 19 01/ 20 01/ 22 01/ 25 01/ 26 01 904 200 27 01/ 28 01/ 29 01/ 32 01/ 38 01 904 200 43 01/ 49 01/ 50 01
2628 (205 kW) Eng.OM906.921	02-04	PA1320			For vehicles without retarder	904 200 02 01/ 04 01/ 06 01/ 07 01/ 08 01 904 200 19 01/ 20 01/ 22 01/ 25 01/ 26 01 904 200 27 01/ 28 01/ 29 01/ 32 01/ 38 01 904 200 43 01/ 49 01/ 50 01
3228 (205 kW) Eng.OM906.921	02-04	PA1320			For vehicles without retarder	904 200 02 01/ 04 01/ 06 01/ 07 01/ 08 01 904 200 19 01/ 20 01/ 22 01/ 25 01/ 26 01 904 200 27 01/ 28 01/ 29 01/ 32 01/ 38 01 904 200 43 01/ 49 01/ 50 01
Axor II '10/04-						
1824 (175 kW) Eng.OM906.920	04-	PA1320			For vehicles without retarder	904 200 02 01/ 04 01/ 06 01/ 07 01/ 08 01 904 200 19 01/ 20 01/ 22 01/ 25 01/ 26 01 904 200 27 01/ 28 01/ 29 01/ 32 01/ 38 01 904 200 43 01/ 49 01/ 50 01
	04-	PA1333				906 200 09 01/ 12 01/ 13 01/ 14 01/ 18 01 906 200 20 01/ 22 01/ 24 01/ 29 01/ 32 01 906 200 38 01/ 42 01/ 45 01/ 48 01/ 54 01 906 200 57 01/ 65 01
1824 (175 kW) Eng.OM906.922	04-	PA1320			For vehicles without retarder	904 200 02 01/ 04 01/ 06 01/ 07 01/ 08 01 904 200 19 01/ 20 01/ 22 01/ 25 01/ 26 01 904 200 27 01/ 28 01/ 29 01/ 32 01/ 38 01 904 200 43 01/ 49 01/ 50 01
	04-	PA1333				906 200 09 01/ 12 01/ 13 01/ 14 01/ 18 01 906 200 20 01/ 22 01/ 24 01/ 29 01/ 32 01 906 200 38 01/ 42 01/ 45 01/ 48 01/ 54 01 906 200 57 01/ 65 01
1828/1829 (205-210 kW) Eng.OM906.921/.926	04-	PA1320			For vehicles without retarder	904 200 02 01/ 04 01/ 06 01/ 07 01/ 08 01 904 200 19 01/ 20 01/ 22 01/ 25 01/ 26 01 904 200 27 01/ 28 01/ 29 01/ 32 01/ 38 01 904 200 43 01/ 49 01/ 50 01
	04-	PA1333				906 200 09 01/ 12 01/ 13 01/ 14 01/ 18 01 906 200 20 01/ 22 01/ 24 01/ 29 01/ 32 01 906 200 38 01/ 42 01/ 45 01/ 48 01/ 54 01 906 200 57 01/ 65 01
1828/1829 (205-210 kW) Eng.OM906.923/.928	04-	PA1320			For vehicles without retarder	904 200 02 01/ 04 01/ 06 01/ 07 01/ 08 01 904 200 19 01/ 20 01/ 22 01/ 25 01/ 26 01 904 200 27 01/ 28 01/ 29 01/ 32 01/ 38 01 904 200 43 01/ 49 01/ 50 01
	04-	PA1333				906 200 09 01/ 12 01/ 13 01/ 14 01/ 18 01 906 200 20 01/ 22 01/ 24 01/ 29 01/ 32 01 906 200 38 01/ 42 01/ 45 01/ 48 01/ 54 01 906 200 57 01/ 65 01
1833 (240 kW) Eng.OM926.913	04-	PA1320			For vehicles without retarder	904 200 02 01/ 04 01/ 06 01/ 07 01/ 08 01 904 200 19 01/ 20 01/ 22 01/ 25 01/ 26 01 904 200 27 01/ 28 01/ 29 01/ 32 01/ 38 01 904 200 43 01/ 49 01/ 50 01

			
<p>PA1320</p>	<p>PA1326</p>	<p>PA1327</p>	<p>PA1329</p>
			
<p>PA1333</p>			



		GRAF ref.		NOTE	Adaptable for OES
1833 (240 kW) Eng.OM926.913	04-	PA1333			906 200 09 01/ 12 01/ 13 01/ 14 01/ 18 01 906 200 20 01/ 22 01/ 24 01/ 29 01/ 32 01 906 200 38 01/ 42 01/ 45 01/ 48 01/ 54 01 906 200 57 01/ 65 01
1835/3535 (260 kW) Eng.OM457.937	09-	PA1326		For vehicles with retarder; Open hole	457 200 02 01/ 05 01/ 11 01/ 25 01/ 27 01
	09-	PA1327		For vehicles with retarder; Close hole	442 200 04 01/ 06 01/ 07 01/ 09 01 457 200 10 01/ 24 01/ 28 01
	09-	PA1329		For vehicles without retarder	457 200 08 01/ 19 01/ 23 01/ 29 01
1836 (265 kW) Eng.OM457.937/.948	04-	PA1326		For vehicles with retarder; Open hole	457 200 02 01/ 05 01/ 11 01/ 25 01/ 27 01
	04-	PA1327		For vehicles with retarder; Close hole	442 200 04 01/ 06 01/ 07 01/ 09 01 457 200 10 01/ 24 01/ 28 01
	04-	PA1329		For vehicles without retarder	457 200 08 01/ 19 01/ 23 01/ 29 01
1840 (295 kW) Eng.OM457.937/.948	04-	PA1326		For vehicles with retarder; Open hole	457 200 02 01/ 05 01/ 11 01/ 25 01/ 27 01
	04-	PA1327		For vehicles with retarder; Close hole	442 200 04 01/ 06 01/ 07 01/ 09 01 457 200 10 01/ 24 01/ 28 01
	04-	PA1329		For vehicles without retarder	457 200 08 01/ 19 01/ 23 01/ 29 01
1843 (315 kW) Eng.OM457.948	04-	PA1326		For vehicles with retarder; Open hole	457 200 02 01/ 05 01/ 11 01/ 25 01/ 27 01
	04-	PA1327		For vehicles with retarder; Close hole	442 200 04 01/ 06 01/ 07 01/ 09 01 457 200 10 01/ 24 01/ 28 01
	04-	PA1329		For vehicles without retarder	457 200 08 01/ 19 01/ 23 01/ 29 01
1933 S (240 kW) Eng.OM926.921	11-	PA1320		For vehicles without retarder	904 200 02 01/ 04 01/ 06 01/ 07 01/ 08 01 904 200 19 01/ 20 01/ 22 01/ 25 01/ 26 01 904 200 27 01/ 28 01/ 29 01/ 32 01/ 38 01 904 200 43 01/ 49 01/ 50 01
	11-	PA1333			906 200 09 01/ 12 01/ 13 01/ 14 01/ 18 01 906 200 20 01/ 22 01/ 24 01/ 29 01/ 32 01 906 200 38 01/ 42 01/ 45 01/ 48 01/ 54 01 906 200 57 01/ 65 01
1933 S (240 kW) Eng.OM926.990	11-	PA1320		For vehicles without retarder	904 200 02 01/ 04 01/ 06 01/ 07 01/ 08 01 904 200 19 01/ 20 01/ 22 01/ 25 01/ 26 01 904 200 27 01/ 28 01/ 29 01/ 32 01/ 38 01 904 200 43 01/ 49 01/ 50 01
	11-	PA1333			906 200 09 01/ 12 01/ 13 01/ 14 01/ 18 01 906 200 20 01/ 22 01/ 24 01/ 29 01/ 32 01 906 200 38 01/ 42 01/ 45 01/ 48 01/ 54 01 906 200 57 01/ 65 01
2035 (260 kW) Eng.OM457.910/.917/.918	11-	PA1326		For vehicles with retarder; Open hole	457 200 02 01/ 05 01/ 11 01/ 25 01/ 27 01
	11-	PA1327		For vehicles with retarder; Close hole	442 200 04 01/ 06 01/ 07 01/ 09 01 457 200 10 01/ 24 01/ 28 01
	11-	PA1329		For vehicles without retarder	457 200 08 01/ 19 01/ 23 01/ 29 01
2035/2036 (260 kW) Eng.OM457.910/917/918	11-	PA1326		For vehicles with retarder; Open hole	457 200 02 01/ 05 01/ 11 01/ 25 01/ 27 01
	11-	PA1327		For vehicles with retarder; Close hole	442 200 04 01/ 06 01/ 07 01/ 09 01 457 200 10 01/ 24 01/ 28 01
	11-	PA1329		For vehicles without retarder	457 200 08 01/ 19 01/ 23 01/ 29 01
2040 (295 kW) Eng.OM457.910/.917/.918	11-	PA1326		For vehicles with retarder; Open hole	457 200 02 01/ 05 01/ 11 01/ 25 01/ 27 01
	11-	PA1327		For vehicles with retarder; Close hole	442 200 04 01/ 06 01/ 07 01/ 09 01 457 200 10 01/ 24 01/ 28 01
	11-	PA1329		For vehicles without retarder	457 200 08 01/ 19 01/ 23 01/ 29 01
2040/2041 (295 kW) Eng.OM457.910/917/918	11-	PA1326		For vehicles with retarder; Open hole	457 200 02 01/ 05 01/ 11 01/ 25 01/ 27 01
	11-	PA1327		For vehicles with retarder; Close hole	442 200 04 01/ 06 01/ 07 01/ 09 01 457 200 10 01/ 24 01/ 28 01
	11-	PA1329		For vehicles without retarder	457 200 08 01/ 19 01/ 23 01/ 29 01

			
<p>PA1320</p>	<p>PA1326</p>	<p>PA1327</p>	<p>PA1329</p>
			
<p>PA1333</p>			

		GRAF ref.			NOTE	Adaptable for OES
2044 (315 kW) Eng.OM457.910/.917/.918	11-	PA1326			For vehicles with retarder; Open hole	457 200 02 01/ 05 01/ 11 01/ 25 01/ 27 01
	11-	PA1327			For vehicles with retarder; Close hole	442 200 04 01/ 06 01/ 07 01/ 09 01 457 200 10 01/ 24 01/ 28 01
	11-	PA1329			For vehicles without retarder	457 200 08 01/ 19 01/ 23 01/ 29 01
2044/3343/3344/4144 (315 kW) Eng.OM457.910/917/918	11-	PA1326			For vehicles with retarder; Open hole	457 200 02 01/ 05 01/ 11 01/ 25 01/ 27 01
	11-	PA1327			For vehicles with retarder; Close hole	442 200 04 01/ 06 01/ 07 01/ 09 01 457 200 10 01/ 24 01/ 28 01
	11-	PA1329			For vehicles without retarder	457 200 08 01/ 19 01/ 23 01/ 29 01
2523 (170 kW) Eng.OM906.920	11-	PA1333				906 200 09 01/ 12 01/ 13 01/ 14 01/ 18 01 906 200 20 01/ 22 01/ 24 01/ 29 01/ 32 01 906 200 38 01/ 42 01/ 45 01/ 48 01/ 54 01 906 200 57 01/ 65 01
2528/2529 (205-210 kW) Eng.OM906.921/.926	04-	PA1320			For vehicles without retarder	904 200 02 01/ 04 01/ 06 01/ 07 01/ 08 01 904 200 19 01/ 20 01/ 22 01/ 25 01/ 26 01 904 200 27 01/ 28 01/ 29 01/ 32 01/ 38 01 904 200 43 01/ 49 01/ 50 01
	04-	PA1333				906 200 09 01/ 12 01/ 13 01/ 14 01/ 18 01 906 200 20 01/ 22 01/ 24 01/ 29 01/ 32 01 906 200 38 01/ 42 01/ 45 01/ 48 01/ 54 01 906 200 57 01/ 65 01
2528/3028/3228 (205 kW) Eng.OM906.921	11-	PA1320			For vehicles without retarder	904 200 02 01/ 04 01/ 06 01/ 07 01/ 08 01 904 200 19 01/ 20 01/ 22 01/ 25 01/ 26 01 904 200 27 01/ 28 01/ 29 01/ 32 01/ 38 01 904 200 43 01/ 49 01/ 50 01
	11-	PA1333				906 200 09 01/ 12 01/ 13 01/ 14 01/ 18 01 906 200 20 01/ 22 01/ 24 01/ 29 01/ 32 01 906 200 38 01/ 42 01/ 45 01/ 48 01/ 54 01 906 200 57 01/ 65 01
2533 (240 kW) Eng.OM926.913	04-	PA1320			For vehicles without retarder	904 200 02 01/ 04 01/ 06 01/ 07 01/ 08 01 904 200 19 01/ 20 01/ 22 01/ 25 01/ 26 01 904 200 27 01/ 28 01/ 29 01/ 32 01/ 38 01 904 200 43 01/ 49 01/ 50 01
	04-	PA1333				906 200 09 01/ 12 01/ 13 01/ 14 01/ 18 01 906 200 20 01/ 22 01/ 24 01/ 29 01/ 32 01 906 200 38 01/ 42 01/ 45 01/ 48 01/ 54 01 906 200 57 01/ 65 01
2536 (265 kW) Eng.OM457.937/.948	04-	PA1326			For vehicles with retarder; Open hole	457 200 02 01/ 05 01/ 11 01/ 25 01/ 27 01
	04-	PA1327			For vehicles with retarder; Close hole	442 200 04 01/ 06 01/ 07 01/ 09 01 457 200 10 01/ 24 01/ 28 01
	04-	PA1329			For vehicles without retarder	457 200 08 01/ 19 01/ 23 01/ 29 01
2540 (295 kW) Eng.OM457.937/.948	04-	PA1326			For vehicles with retarder; Open hole	457 200 02 01/ 05 01/ 11 01/ 25 01/ 27 01
	04-	PA1327			For vehicles with retarder; Close hole	442 200 04 01/ 06 01/ 07 01/ 09 01 457 200 10 01/ 24 01/ 28 01
	04-	PA1329			For vehicles without retarder	457 200 08 01/ 19 01/ 23 01/ 29 01
2543 (315 kW) Eng.OM457.937/.948	04-	PA1326			For vehicles with retarder; Open hole	457 200 02 01/ 05 01/ 11 01/ 25 01/ 27 01
	04-	PA1327			For vehicles with retarder; Close hole	442 200 04 01/ 06 01/ 07 01/ 09 01 457 200 10 01/ 24 01/ 28 01
	04-	PA1329			For vehicles without retarder	457 200 08 01/ 19 01/ 23 01/ 29 01
2628 (205-210 kW) Eng.OM906.921/.926	04-	PA1320			For vehicles without retarder	904 200 02 01/ 04 01/ 06 01/ 07 01/ 08 01 904 200 19 01/ 20 01/ 22 01/ 25 01/ 26 01 904 200 27 01/ 28 01/ 29 01/ 32 01/ 38 01 904 200 43 01/ 49 01/ 50 01

			
<p>PA1320</p>	<p>PA1326</p>	<p>PA1327</p>	<p>PA1329</p>
			
<p>PA1333</p>			

		GRAF ref.		NOTE	Adaptable for OES
2628 (205-210 kW) Eng.OM906.921/.926	04-	PA1333			906 200 09 01/ 12 01/ 13 01/ 14 01/ 18 01 906 200 20 01/ 22 01/ 24 01/ 29 01/ 32 01 906 200 38 01/ 42 01/ 45 01/ 48 01/ 54 01 906 200 57 01/ 65 01
2633 (240 kW) Eng.OM926.913	04-	PA1320		For vehicles without retarder	904 200 02 01/ 04 01/ 06 01/ 07 01/ 08 01 904 200 19 01/ 20 01/ 22 01/ 25 01/ 26 01 904 200 27 01/ 28 01/ 29 01/ 32 01/ 38 01 904 200 43 01/ 49 01/ 50 01
	04-	PA1333			906 200 09 01/ 12 01/ 13 01/ 14 01/ 18 01 906 200 20 01/ 22 01/ 24 01/ 29 01/ 32 01 906 200 38 01/ 42 01/ 45 01/ 48 01/ 54 01 906 200 57 01/ 65 01
2636 (265 kW) Eng.OM457.937/.948	04-	PA1326		For vehicles with retarder; Open hole	457 200 02 01/ 05 01/ 11 01/ 25 01/ 27 01
	04-	PA1327		For vehicles with retarder; Close hole	442 200 04 01/ 06 01/ 07 01/ 09 01 457 200 10 01/ 24 01/ 28 01
	04-	PA1329		For vehicles without retarder	457 200 08 01/ 19 01/ 23 01/ 29 01
2640 (295 kW) Eng.OM457.956/.957	04-	PA1326		For vehicles with retarder; Open hole	457 200 02 01/ 05 01/ 11 01/ 25 01/ 27 01
	04-	PA1327		For vehicles with retarder; Close hole	442 200 04 01/ 06 01/ 07 01/ 09 01 457 200 10 01/ 24 01/ 28 01
	04-	PA1329		For vehicles without retarder	457 200 08 01/ 19 01/ 23 01/ 29 01
2643 (315 kW) Eng.OM457.956/.957	04-	PA1326		For vehicles with retarder; Open hole	457 200 02 01/ 05 01/ 11 01/ 25 01/ 27 01
	04-	PA1327		For vehicles with retarder; Close hole	442 200 04 01/ 06 01/ 07 01/ 09 01 457 200 10 01/ 24 01/ 28 01
	04-	PA1329		For vehicles without retarder	457 200 08 01/ 19 01/ 23 01/ 29 01
2644 (315 kW) Eng.OM457.918	11-	PA1326		For vehicles with retarder; Open hole	457 200 02 01/ 05 01/ 11 01/ 25 01/ 27 01
	11-	PA1327		For vehicles with retarder; Close hole	442 200 04 01/ 06 01/ 07 01/ 09 01 457 200 10 01/ 24 01/ 28 01
	11-	PA1329		For vehicles without retarder	457 200 08 01/ 19 01/ 23 01/ 29 01
2644 (315 kW) Eng.OM457.937	11-	PA1326		For vehicles with retarder; Open hole	457 200 02 01/ 05 01/ 11 01/ 25 01/ 27 01
	11-	PA1327		For vehicles with retarder; Close hole	442 200 04 01/ 06 01/ 07 01/ 09 01 457 200 10 01/ 24 01/ 28 01
	11-	PA1329		For vehicles without retarder	457 200 08 01/ 19 01/ 23 01/ 29 01
2644 (315 kW) Eng.OM457.948	11-	PA1326		For vehicles with retarder; Open hole	457 200 02 01/ 05 01/ 11 01/ 25 01/ 27 01
	11-	PA1327		For vehicles with retarder; Close hole	442 200 04 01/ 06 01/ 07 01/ 09 01 457 200 10 01/ 24 01/ 28 01
	11-	PA1329		For vehicles without retarder	457 200 08 01/ 19 01/ 23 01/ 29 01
2831 (225 kW) Eng.OM926.926/930/932	11-	PA1320		For vehicles without retarder	904 200 02 01/ 04 01/ 06 01/ 07 01/ 08 01 904 200 19 01/ 20 01/ 22 01/ 25 01/ 26 01 904 200 27 01/ 28 01/ 29 01/ 32 01/ 38 01 904 200 43 01/ 49 01/ 50 01
	11-	PA1333			906 200 09 01/ 12 01/ 13 01/ 14 01/ 18 01 906 200 20 01/ 22 01/ 24 01/ 29 01/ 32 01 906 200 38 01/ 42 01/ 45 01/ 48 01/ 54 01 906 200 57 01/ 65 01
3236 (265 kW) Eng.OM457.956/.957	04-	PA1326		For vehicles with retarder; Open hole	457 200 02 01/ 05 01/ 11 01/ 25 01/ 27 01
	04-	PA1327		For vehicles with retarder; Close hole	442 200 04 01/ 06 01/ 07 01/ 09 01 457 200 10 01/ 24 01/ 28 01
	04-	PA1329		For vehicles without retarder	457 200 08 01/ 19 01/ 23 01/ 29 01
3240 (295 kW) Eng.OM457.937/.948	04-	PA1326		For vehicles with retarder; Open hole	457 200 02 01/ 05 01/ 11 01/ 25 01/ 27 01
	05-	PA1327		For vehicles with retarder; Close hole	442 200 04 01/ 06 01/ 07 01/ 09 01 457 200 10 01/ 24 01/ 28 01
	05-	PA1329		For vehicles without retarder	457 200 08 01/ 19 01/ 23 01/ 29 01

			
<p>PA1326</p>	<p>PA1327</p>	<p>PA1329</p>	

		GRAF ref.			NOTE	Adaptable for OES
3240 (295 kW) Eng.OM457.956/957	04-	PA1326			For vehicles with retarder; Open hole	457 200 02 01/ 05 01/ 11 01/ 25 01/ 27 01
	04-	PA1327			For vehicles with retarder; Close hole	442 200 04 01/ 06 01/ 07 01/ 09 01 457 200 10 01/ 24 01/ 28 01
	04-	PA1329			For vehicles without retarder	457 200 08 01/ 19 01/ 23 01/ 29 01
3243 (315 kW) Eng.OM457.956/957	04-	PA1326			For vehicles with retarder; Open hole	457 200 02 01/ 05 01/ 11 01/ 25 01/ 27 01
	04-	PA1327			For vehicles with retarder; Close hole	442 200 04 01/ 06 01/ 07 01/ 09 01 457 200 10 01/ 24 01/ 28 01
	04-	PA1329			For vehicles without retarder	457 200 08 01/ 19 01/ 23 01/ 29 01
3335 (260 kW) Eng.OM457.937	04-	PA1326			For vehicles with retarder; Open hole	457 200 02 01/ 05 01/ 11 01/ 25 01/ 27 01
	04-	PA1327			For vehicles with retarder; Close hole	442 200 04 01/ 06 01/ 07 01/ 09 01 457 200 10 01/ 24 01/ 28 01
	04-	PA1329			For vehicles without retarder	457 200 08 01/ 19 01/ 23 01/ 29 01
3335 (260 kW) Eng.OM457.962	08-	PA1326			For vehicles with retarder; Open hole	457 200 02 01/ 05 01/ 11 01/ 25 01/ 27 01
	08-	PA1327			For vehicles with retarder; Close hole	442 200 04 01/ 06 01/ 07 01/ 09 01 457 200 10 01/ 24 01/ 28 01
	08-	PA1329			For vehicles without retarder	457 200 08 01/ 19 01/ 23 01/ 29 01
3335/4135 (260 kW) Eng.OM457.956/957	09-	PA1326			For vehicles with retarder; Open hole	457 200 02 01/ 05 01/ 11 01/ 25 01/ 27 01
	09-	PA1327			For vehicles with retarder; Close hole	442 200 04 01/ 06 01/ 07 01/ 09 01 457 200 10 01/ 24 01/ 28 01
	09-	PA1329			For vehicles without retarder	457 200 08 01/ 19 01/ 23 01/ 29 01
3340 (295 kW) Eng.OM457.937	04-	PA1326			For vehicles with retarder; Open hole	457 200 02 01/ 05 01/ 11 01/ 25 01/ 27 01
	04-	PA1327			For vehicles with retarder; Close hole	442 200 04 01/ 06 01/ 07 01/ 09 01 457 200 10 01/ 24 01/ 28 01
	04-	PA1329			For vehicles without retarder	457 200 08 01/ 19 01/ 23 01/ 29 01
3340/3341 (295 kW) Eng.OM457.962	09-	PA1326			For vehicles with retarder; Open hole	457 200 02 01/ 05 01/ 11 01/ 25 01/ 27 01
	09-	PA1327			For vehicles with retarder; Close hole	442 200 04 01/ 06 01/ 07 01/ 09 01 457 200 10 01/ 24 01/ 28 01
	09-	PA1329			For vehicles without retarder	457 200 08 01/ 19 01/ 23 01/ 29 01
3340/3341/4140 (295 kW) Eng.OM457.910/917/918	09-	PA1326			For vehicles with retarder; Open hole	457 200 02 01/ 05 01/ 11 01/ 25 01/ 27 01
	09-	PA1327			For vehicles with retarder; Close hole	442 200 04 01/ 06 01/ 07 01/ 09 01 457 200 10 01/ 24 01/ 28 01
	09-	PA1329			For vehicles without retarder	457 200 08 01/ 19 01/ 23 01/ 29 01
3343 (315 kW) Eng.OM457.937	04-	PA1326			For vehicles with retarder; Open hole	457 200 02 01/ 05 01/ 11 01/ 25 01/ 27 01
	04-	PA1327			For vehicles with retarder; Close hole	442 200 04 01/ 06 01/ 07 01/ 09 01 457 200 10 01/ 24 01/ 28 01
	04-	PA1329			For vehicles without retarder	457 200 08 01/ 19 01/ 23 01/ 29 01
3344/4143 (315 kW) Eng.OM457.956/957	09-	PA1326			For vehicles with retarder; Open hole	457 200 02 01/ 05 01/ 11 01/ 25 01/ 27 01
	09-	PA1327			For vehicles with retarder; Close hole	442 200 04 01/ 06 01/ 07 01/ 09 01 457 200 10 01/ 24 01/ 28 01
	09-	PA1329			For vehicles without retarder	457 200 08 01/ 19 01/ 23 01/ 29 01
4140 (295 kW) Eng.OM457.956/957	09-	PA1326			For vehicles with retarder; Open hole	457 200 02 01/ 05 01/ 11 01/ 25 01/ 27 01
	09-	PA1327			For vehicles with retarder; Close hole	442 200 04 01/ 06 01/ 07 01/ 09 01 457 200 10 01/ 24 01/ 28 01
	09-	PA1329			For vehicles without retarder	457 200 08 01/ 19 01/ 23 01/ 29 01

CapaCity (O 530 GL) '4/07-















CapaCity (354 kW) Eng.OM457.950/973	07-	PA1326			For vehicles with retarder; Open hole	457 200 02 01/ 05 01/ 11 01/ 25 01/ 27 01
	07-	PA1327			For vehicles with retarder; Close hole	442 200 04 01/ 06 01/ 07 01/ 09 01 457 200 10 01/ 24 01/ 28 01
	07-	PA1329			For vehicles without retarder	457 200 08 01/ 19 01/ 23 01/ 29 01

			
<p>PA1320</p>	<p>PA1326</p>	<p>PA1327</p>	<p>PA1329</p>
			
<p>PA1333</p>			

		GRAF ref.			NOTE	Adaptable for OES
Citaro (O 530) '1/98-						
Citaro G (205 kW) Eng.OM906.960/.930/.961	99-	PA1333				906 200 09 01/ 12 01/ 13 01/ 14 01/ 18 01 906 200 20 01/ 22 01/ 24 01/ 29 01/ 32 01 906 200 38 01/ 42 01/ 45 01/ 48 01/ 54 01 906 200 57 01/ 65 01
Citaro L (205 kW) Eng.OM906.930/.960	99-	PA1333				906 200 09 01/ 12 01/ 13 01/ 14 01/ 18 01 906 200 20 01/ 22 01/ 24 01/ 29 01/ 32 01 906 200 38 01/ 42 01/ 45 01/ 48 01/ 54 01 906 200 57 01/ 65 01
Citaro N (180 kW) Eng.OM906.962/.963	99-	PA1333				906 200 09 01/ 12 01/ 13 01/ 14 01/ 18 01 906 200 20 01/ 22 01/ 24 01/ 29 01/ 32 01 906 200 38 01/ 42 01/ 45 01/ 48 01/ 54 01 906 200 57 01/ 65 01
Citaro N (185 kW) Eng.OM457.942	04-	PA1326			For vehicles with retarder; Open hole	457 200 02 01/ 05 01/ 11 01/ 25 01/ 27 01
	98-	PA1327			For vehicles with retarder; Close hole	442 200 04 01/ 06 01/ 07 01/ 09 01 457 200 10 01/ 24 01/ 28 01
	98-	PA1329			For vehicles without retarder	457 200 08 01/ 19 01/ 23 01/ 29 01
Citaro N (205 kW) Eng.OM906.930	98-	PA1333				906 200 09 01/ 12 01/ 13 01/ 14 01/ 18 01 906 200 20 01/ 22 01/ 24 01/ 29 01/ 32 01 906 200 38 01/ 42 01/ 45 01/ 48 01/ 54 01 906 200 57 01/ 65 01
Citaro N (205 kW) Eng.OM906.960/.961	98-	PA1333				906 200 09 01/ 12 01/ 13 01/ 14 01/ 18 01 906 200 20 01/ 22 01/ 24 01/ 29 01/ 32 01 906 200 38 01/ 42 01/ 45 01/ 48 01/ 54 01 906 200 57 01/ 65 01
Citaro N (220 kW) Eng.OM457.934/.942	98-	PA1326			For vehicles with retarder; Open hole	457 200 02 01/ 05 01/ 11 01/ 25 01/ 27 01
	98-	PA1327			For vehicles with retarder; Close hole	442 200 04 01/ 06 01/ 07 01/ 09 01 457 200 10 01/ 24 01/ 28 01
	98-	PA1329			For vehicles without retarder	457 200 08 01/ 19 01/ 23 01/ 29 01
Citaro N (260 kW) Eng.OM457.942	98-	PA1326			For vehicles with retarder; Open hole	457 200 02 01/ 05 01/ 11 01/ 25 01/ 27 01
	98-	PA1327			For vehicles with retarder; Close hole	442 200 04 01/ 06 01/ 07 01/ 09 01 457 200 10 01/ 24 01/ 28 01
	98-	PA1329			For vehicles without retarder	457 200 08 01/ 19 01/ 23 01/ 29 01
Cito (O 520) '1/98-						
4.2 (130 kW) Eng.OM904.942	98-	PA1320			For vehicles without retarder	904 200 02 01/ 04 01/ 06 01/ 07 01/ 08 01 904 200 19 01/ 20 01/ 22 01/ 25 01/ 26 01 904 200 27 01/ 28 01/ 29 01/ 32 01/ 38 01 904 200 43 01/ 49 01/ 50 01
Conecto (O 345) '11/01-						
C, H, M, UE (185-220-260 kW) Eng.OM457.942	01-	PA1327			For vehicles with retarder; Close hole	442 200 04 01/ 06 01/ 07 01/ 09 01 457 200 10 01/ 24 01/ 28 01
	01-	PA1329			For vehicles without retarder	457 200 08 01/ 19 01/ 23 01/ 29 01
C, H, UE (205 kW) Eng.OM906.960	01-	PA1320			For vehicles without retarder	904 200 02 01/ 04 01/ 06 01/ 07 01/ 08 01 904 200 19 01/ 20 01/ 22 01/ 25 01/ 26 01 904 200 27 01/ 28 01/ 29 01/ 32 01/ 38 01 904 200 43 01/ 49 01/ 50 01
	01-	PA1333				906 200 09 01/ 12 01/ 13 01/ 14 01/ 18 01 906 200 20 01/ 22 01/ 24 01/ 29 01/ 32 01 906 200 38 01/ 42 01/ 45 01/ 48 01/ 54 01 906 200 57 01/ 65 01

			
<p>PA1292</p>	<p>PA1298</p>	<p>PA1302</p>	<p>PA1309</p>
			
<p>PA1320</p>	<p>PA1333</p>		

		GRAF ref.		NOTE	Adaptable for OES
Econic '3/98-					
1823 (170 kW) Eng.OM906.940	98-	PA1320		For vehicles without retarder	904 200 02 01/ 04 01/ 06 01/ 07 01/ 08 01 904 200 19 01/ 20 01/ 22 01/ 25 01/ 26 01 904 200 27 01/ 28 01/ 29 01/ 32 01/ 38 01 904 200 43 01/ 49 01/ 50 01
	98-	PA1333			906 200 09 01/ 12 01/ 13 01/ 14 01/ 18 01 906 200 20 01/ 22 01/ 24 01/ 29 01/ 32 01 906 200 38 01/ 42 01/ 45 01/ 48 01/ 54 01 906 200 57 01/ 65 01
1828/2628 (205 kW) Eng.OM906.900	00-	PA1333			906 200 09 01/ 12 01/ 13 01/ 14 01/ 18 01 906 200 20 01/ 22 01/ 24 01/ 29 01/ 32 01 906 200 38 01/ 42 01/ 45 01/ 48 01/ 54 01 906 200 57 01/ 65 01
1833/2633 (240 kW) Eng.OM926.924	06-	PA1320		For vehicles without retarder	904 200 02 01/ 04 01/ 06 01/ 07 01/ 08 01 904 200 19 01/ 20 01/ 22 01/ 25 01/ 26 01 904 200 27 01/ 28 01/ 29 01/ 32 01/ 38 01 904 200 43 01/ 49 01/ 50 01
	06-	PA1333			906 200 09 01/ 12 01/ 13 01/ 14 01/ 18 01 906 200 20 01/ 22 01/ 24 01/ 29 01/ 32 01 906 200 38 01/ 42 01/ 45 01/ 48 01/ 54 01 906 200 57 01/ 65 01
1833/2633/3233 (240 kW) Eng.OM926.934	01-	PA1320		For vehicles without retarder	904 200 02 01/ 04 01/ 06 01/ 07 01/ 08 01 904 200 19 01/ 20 01/ 22 01/ 25 01/ 26 01 904 200 27 01/ 28 01/ 29 01/ 32 01/ 38 01 904 200 43 01/ 49 01/ 50 01
	01-	PA1333			906 200 09 01/ 12 01/ 13 01/ 14 01/ 18 01 906 200 20 01/ 22 01/ 24 01/ 29 01/ 32 01 906 200 38 01/ 42 01/ 45 01/ 48 01/ 54 01 906 200 57 01/ 65 01
2628 (205 kW) Eng.OM906.941/.952	98-	PA1320		For vehicles without retarder	904 200 02 01/ 04 01/ 06 01/ 07 01/ 08 01 904 200 19 01/ 20 01/ 22 01/ 25 01/ 26 01 904 200 27 01/ 28 01/ 29 01/ 32 01/ 38 01 904 200 43 01/ 49 01/ 50 01
	98-	PA1333			906 200 09 01/ 12 01/ 13 01/ 14 01/ 18 01 906 200 20 01/ 22 01/ 24 01/ 29 01/ 32 01 906 200 38 01/ 42 01/ 45 01/ 48 01/ 54 01 906 200 57 01/ 65 01
2633 (240 kW) Eng.OM926.921	01-	PA1320		For vehicles without retarder	904 200 02 01/ 04 01/ 06 01/ 07 01/ 08 01 904 200 19 01/ 20 01/ 22 01/ 25 01/ 26 01 904 200 27 01/ 28 01/ 29 01/ 32 01/ 38 01 904 200 43 01/ 49 01/ 50 01
	01-	PA1333			906 200 09 01/ 12 01/ 13 01/ 14 01/ 18 01 906 200 20 01/ 22 01/ 24 01/ 29 01/ 32 01 906 200 38 01/ 42 01/ 45 01/ 48 01/ 54 01 906 200 57 01/ 65 01
Industrial '1/72-					
11.9 TD (206 kW) Eng.OM447A/LA	86-	PA1302		For vehicles with retarder, w/o pulley	422 200 06 01
	86-	PA1309		For vehicles without retarder; Eng. -744215	403 200 76 01/ 77 01 422 200 13 01/ 14 01,441 200 03 01
20.6 D (184-236 kW) Eng.OM404	72-	PA1292		For vehicles without retarder; Eng. 744216-	403 200 27 01/ 32 01/ 34 01 403 200 35 01/ 49 01/ 70 01
	72-	PA1298		For vehicles without retarder, w/o pulley; Impeller Ø 135mm, Incl Electronic fuel Injection pump	403 200 57 01,422 200 05 01/ 10 01
	72-	PA1302		For vehicles with retarder, w/o pulley	422 200 06 01

			
PA870	PA871	PA1295	PA1296
			
PA1298	PA1299	PA1300	PA1302
			
PA1309	PA1320	PA1325	PA1326
			
PA1327	PA1329	PA1333	

		GRAF ref.			NOTE	Adaptable for OES
21.9 D (309-390-404-452 kW) Eng.OM424A/LA	81-	PA1309			For vehicles without retarder; Eng. -744215	403 200 76 01/ 77 01 422 200 13 01/ 14 01,441 200 03 01
21.9 D (392-478-610 kW) Eng.OM444A/LA	86-	PA1298			For vehicles without retarder, w/o pulley; Impeller Ø 135mm, Incl Electronic fuel Injection pump	403 200 57 01,422 200 05 01/ 10 01
	86-	PA1302			For vehicles with retarder, w/o pulley	422 200 06 01
	86-	PA1309			For vehicles without retarder; Eng. -744215	403 200 76 01/ 77 01 422 200 13 01/ 14 01,441 200 03 01
Integro (O 550) '1/01-						
O 550 (210 kW) Eng.OM926.939	06-	PA1320			For vehicles without retarder	904 200 02 01/ 04 01/ 06 01/ 07 01/ 08 01 904 200 19 01/ 20 01/ 22 01/ 25 01/ 26 01 904 200 27 01/ 28 01/ 29 01/ 32 01/ 38 01 904 200 43 01/ 49 01/ 50 01
	06-	PA1333				906 200 09 01/ 12 01/ 13 01/ 14 01/ 18 01 906 200 20 01/ 22 01/ 24 01/ 29 01/ 32 01 906 200 38 01/ 42 01/ 45 01/ 48 01/ 54 01 906 200 57 01/ 65 01
O 550 (220-260-300 kW) Eng.OM457.952/.964/.965	01-	PA1326			For vehicles with retarder; Open hole	457 200 02 01/ 05 01/ 11 01/ 25 01/ 27 01
	01-	PA1327			For vehicles with retarder; Close hole	442 200 04 01/ 06 01/ 07 01/ 09 01 457 200 10 01/ 24 01/ 28 01
	01-	PA1329			For vehicles without retarder	457 200 08 01/ 19 01/ 23 01/ 29 01
Intouro '1/05-						
Intouro, E, M, EM (210 kW) Eng.OM926.939	05-	PA1320			For vehicles without retarder	904 200 02 01/ 04 01/ 06 01/ 07 01/ 08 01 904 200 19 01/ 20 01/ 22 01/ 25 01/ 26 01 904 200 27 01/ 28 01/ 29 01/ 32 01/ 38 01 904 200 43 01/ 49 01/ 50 01
	05-	PA1333				906 200 09 01/ 12 01/ 13 01/ 14 01/ 18 01 906 200 20 01/ 22 01/ 24 01/ 29 01/ 32 01 906 200 38 01/ 42 01/ 45 01/ 48 01/ 54 01 906 200 57 01/ 65 01
Intouro, E, M, EM (220 kW) Eng.OM457.965	05-	PA1326			For vehicles with retarder; Open hole	457 200 02 01/ 05 01/ 11 01/ 25 01/ 27 01
	05-	PA1327			For vehicles with retarder; Close hole	442 200 04 01/ 06 01/ 07 01/ 09 01 457 200 10 01/ 24 01/ 28 01
	05-	PA1329			For vehicles without retarder	457 200 08 01/ 19 01/ 23 01/ 29 01
Intouro, E, M, EM (260 kW) Eng.OM457.965	05-	PA1326			For vehicles with retarder; Open hole	457 200 02 01/ 05 01/ 11 01/ 25 01/ 27 01
	05-	PA1327			For vehicles with retarder; Close hole	442 200 04 01/ 06 01/ 07 01/ 09 01 457 200 10 01/ 24 01/ 28 01
	05-	PA1329			For vehicles without retarder	457 200 08 01/ 19 01/ 23 01/ 29 01
Intouro, E, M, EM (300 kW) Eng.OM457.965	05-	PA1326			For vehicles with retarder; Open hole	457 200 02 01/ 05 01/ 11 01/ 25 01/ 27 01
	05-	PA1327			For vehicles with retarder; Close hole	442 200 04 01/ 06 01/ 07 01/ 09 01 457 200 10 01/ 24 01/ 28 01
	05-	PA1329			For vehicles without retarder	457 200 08 01/ 19 01/ 23 01/ 29 01
LP-LPK-LPS-LPO '1/67-'3/77						
608,709,808,809 (63 kW) Eng.OM314.910/944	69-84	PA1296			Eng -456936	
	69-84	PA1300			Eng 456937-	314 200 35 01/ 41 01/ 47 01
811 (81 kW) Eng.OM352	69-73	PA1295			Impeller Ø 88mm	352 200 38 01/ 74 01/ 84 01/ 94 01/ 353 200 03 01/ 04 01/ 36 01/ 29 01/ 42 01
	69-73	PA1299			Impeller Ø 94,5mm	353 200 21 01/ 37 01
911 (81 kW) Eng.OM352.907/986/911/353.909	67-77	PA870				353 200 56 01
	67-77	PA1295			Impeller Ø 88mm	352 200 38 01/ 74 01/ 84 01/ 94 01/ 353 200 03 01/ 04 01/ 36 01/ 29 01/ 42 01
	67-77	PA1299			Impeller Ø 94,5mm	353 200 21 01/ 37 01
O 301 '2/86-'5/87						
O 301 (100 kW) Eng.OM366.917	86-91	PA871				366 200 59 01
	86-87	PA1325				366 200 54 01/ 67 01/ 68 01 390 200 00 01

			
PA871	PA872	PA1292	PA1295
			
PA1299	PA1301	PA1302	PA1309
			
PA1325	PA1328		

		GRAF ref.			NOTE	Adaptable for OES
O 301 (125 kW) Eng.OM366.965	86-91	PA871				366 200 59 01
	86-87	PA1325				366 200 54 01/ 67 01/ 68 01 390 200 00 01
O 302 '11/64-'11/75						
O 302 (130 kW) Eng.OM353.906	67-77	PA1295			Impeller Ø 88mm	352 200 38 01/ 74 01/ 84 01/ 94 01/ 353 200 03 01/ 04 01/ 36 01/ 29 01/ 42 01
	68-	PA1299			Impeller Ø 94,5mm	353 200 21 01/ 37 01
O 302 (159 kW) Eng.OM421.908/.904	87-96	PA1328			Eng. 744216-	422 200 11 01/ 16 01
O 302 (96 kW) Eng.OM352.980/.993	64-74	PA1295			Impeller Ø 88mm	352 200 38 01/ 74 01/ 84 01/ 94 01/ 353 200 03 01/ 04 01/ 36 01/ 29 01/ 42 01
	64-74	PA1299			Impeller Ø 94,5mm	353 200 21 01/ 37 01
O 303 '1/74-'12/92						
11.0 D (159 kW) Eng.OM421.908/OM441.908/.909/.911	85-99	PA872				403 200 73 01
	80-92	PA1302			For vehicles with retarder, w/o pulley	422 200 06 01
	80-92	PA1309			For vehicles without retarder; Eng. -744215	403 200 76 01/ 77 01 422 200 13 01/ 14 01,441 200 03 01
	80-92	PA1328			Eng. 744216-	422 200 11 01/ 16 01
	80-89	PA1302			For vehicles with retarder, w/o pulley	422 200 06 01
	80-89	PA1328			Eng. 744216-	422 200 11 01/ 16 01
11.0 D (184 kW) Eng.OM421.951/.950	85-99	PA872				403 200 73 01
	85-89	PA1302			For vehicles with retarder, w/o pulley	422 200 06 01
	85-89	PA1309			For vehicles without retarder; Eng. -744215	403 200 76 01/ 77 01 422 200 13 01/ 14 01,441 200 03 01
	85-89	PA1328			Eng. 744216-	422 200 11 01/ 16 01
11.0 D (200 kW) Eng.OM441.950/.953	87-92	PA1328			Eng. 744216-	422 200 11 01/ 16 01
11.3 D (165 kW) Eng.OM441.918	87-	PA1328			Eng. 744216-	422 200 11 01/ 16 01
12.7 D (188 kW) Eng.OM402.907	75-99	PA872				403 200 73 01
	75-83	PA1292			For vehicles without retarder; Eng. 744216-	403 200 27 01/ 32 01/ 34 01 403 200 35 01/ 49 01/ 70 01
	75-83	PA1302			For vehicles with retarder, w/o pulley	422 200 06 01
	75-83	PA1309			For vehicles without retarder; Eng. -744215	403 200 76 01/ 77 01 422 200 13 01/ 14 01,441 200 03 01
	75-83	PA1328			Eng. 744216-	422 200 11 01/ 16 01
14.6 D (206 kW) Eng.OM422.908/.917	87-99	PA872				403 200 73 01
	80-87	PA1301			For vehicles with retarder	403 200 64 01/ 75 01 422 200 07 01/ 12 01,442 200 12 01
	80-87	PA1302			For vehicles with retarder, w/o pulley	422 200 06 01
	80-87	PA1309			For vehicles without retarder; Eng. -744215	403 200 76 01/ 77 01 422 200 13 01/ 14 01,441 200 03 01
	80-87	PA1328			Eng. 744216-	422 200 11 01/ 16 01
14.6 D (243 kW) Eng.OM422.951/.963	87-99	PA872				403 200 73 01
	80-87	PA1301			For vehicles with retarder	403 200 64 01/ 75 01 422 200 07 01/ 12 01,442 200 12 01
	80-87	PA1302			For vehicles with retarder, w/o pulley	422 200 06 01
	80-87	PA1309			For vehicles without retarder; Eng. -744215	403 200 76 01/ 77 01 422 200 13 01/ 14 01,441 200 03 01
	80-87	PA1328			Eng. 744216-	422 200 11 01/ 16 01
14.6 D (260 kW) Eng.OM442.954/955/960/961	87-92	PA872				403 200 73 01
	87-92	PA1302			For vehicles with retarder, w/o pulley	422 200 06 01
	87-92	PA1309			For vehicles without retarder; Eng. -744215	403 200 76 01/ 77 01 422 200 13 01/ 14 01,441 200 03 01
	87-92	PA1328			Eng. 744216-	422 200 11 01/ 16 01
16.0 D (235 kW) Eng.OM403.918	75-83	PA1292			For vehicles without retarder; Eng. 744216-	403 200 27 01/ 32 01/ 34 01 403 200 35 01/ 49 01/ 70 01
	75-83	PA1302			For vehicles with retarder, w/o pulley	422 200 06 01
	75-83	PA1309			For vehicles without retarder; Eng. -744215	403 200 76 01/ 77 01 422 200 13 01/ 14 01,441 200 03 01
	75-83	PA1328			Eng. 744216-	422 200 11 01/ 16 01
9.6 D (141 kW) Eng.OM401.907/.908/.912	74-99	PA872				403 200 73 01
	74-83	PA1292			For vehicles without retarder; Eng. 744216-	403 200 27 01/ 32 01/ 34 01 403 200 35 01/ 49 01/ 70 01
	74-83	PA1302			For vehicles with retarder, w/o pulley	422 200 06 01
	74-83	PA1309			For vehicles without retarder; Eng. -744215	403 200 76 01/ 77 01 422 200 13 01/ 14 01,441 200 03 01

				
<p>PA872</p>	<p>PA1292</p>	<p>PA1295</p>	<p>PA1296</p>	
				
<p>PA1299</p>	<p>PA1300</p>	<p>PA1302</p>	<p>PA1309</p>	
				
<p>PA1328</p>				











		GRAF ref.			NOTE	Adaptable for OES
9.6 D (141 kW) Eng.OM401.907/.908/.912	74-83	PA1328			Eng. 744216-	422 200 11 01/ 16 01
O 305 '1/69-'12/87						
11.0 D (132 kW) Eng.OM407.905/908	73-77	PA872				403 200 73 01
	73-77	PA1292			For vehicles without retarder; Eng. 744216-	403 200 27 01/ 32 01/ 34 01 403 200 35 01/ 49 01/ 70 01
	73-77	PA1302			For vehicles with retarder, w/o pulley	422 200 06 01
	73-77	PA1309			For vehicles without retarder; Eng. -744215	403 200 76 01/ 77 01 422 200 13 01/ 14 01,441 200 03 01
	73-77	PA1328			Eng. 744216-	422 200 11 01/ 16 01
11.0 D (155 kW) Eng.OM407.909/.910/.911	73-77	PA1292			For vehicles without retarder; Eng. 744216-	403 200 27 01/ 32 01/ 34 01 403 200 35 01/ 49 01/ 70 01
	73-77	PA1328			Eng. 744216-	422 200 11 01/ 16 01
11.0 D (206 kW) Eng.OM407.951/955	73-77	PA872				403 200 73 01
	79-87	PA1292			For vehicles without retarder; Eng. 744216-	403 200 27 01/ 32 01/ 34 01 403 200 35 01/ 49 01/ 70 01
	79-87	PA1302			For vehicles with retarder, w/o pulley	422 200 06 01
	79-87	PA1309			For vehicles without retarder; Eng. -744215	403 200 76 01/ 77 01 422 200 13 01/ 14 01,441 200 03 01
	79-87	PA1328			Eng. 744216-	422 200 11 01/ 16 01
11.4 D (147 kW) Eng.OM407.913/.914	76-87	PA1292			For vehicles without retarder; Eng. 744216-	403 200 27 01/ 32 01/ 34 01 403 200 35 01/ 49 01/ 70 01
	76-87	PA1328			Eng. 744216-	422 200 11 01/ 16 01
11.4 D (177 kW) Eng.OM407.917	76-87	PA1292			For vehicles without retarder; Eng. 744216-	403 200 27 01/ 32 01/ 34 01 403 200 35 01/ 49 01/ 70 01
	76-87	PA1328			Eng. 744216-	422 200 11 01/ 16 01
11.4 D (177 kW) Eng.OM407.919	78-87	PA1292			For vehicles without retarder; Eng. 744216-	403 200 27 01/ 32 01/ 34 01 403 200 35 01/ 49 01/ 70 01
	78-87	PA1328			Eng. 744216-	422 200 11 01/ 16 01
8.7 D (125-141 kW) Eng.OM360.911	73-77	PA872				403 200 73 01
	69-73	PA1328			Eng. 744216-	422 200 11 01/ 16 01
O 307 '1/73-'12/77						
11.0 D (132 kW) Eng.OM407.905	73-77	PA872				403 200 73 01
	73-77	PA1292			For vehicles without retarder; Eng. 744216-	403 200 27 01/ 32 01/ 34 01 403 200 35 01/ 49 01/ 70 01
	73-77	PA1302			For vehicles with retarder, w/o pulley	422 200 06 01
	73-77	PA1309			For vehicles without retarder; Eng. -744215	403 200 76 01/ 77 01 422 200 13 01/ 14 01,441 200 03 01
	73-77	PA1328			Eng. 744216-	422 200 11 01/ 16 01
11.0 D (155 kW) Eng.OM407.907/.911	73-77	PA1292			For vehicles without retarder; Eng. 744216-	403 200 27 01/ 32 01/ 34 01 403 200 35 01/ 49 01/ 70 01
	73-77	PA1328			Eng. 744216-	422 200 11 01/ 16 01
11.4 D (147 kW) Eng.OM407.915	76-87	PA1292			For vehicles without retarder; Eng. 744216-	403 200 27 01/ 32 01/ 34 01 403 200 35 01/ 49 01/ 70 01
	76-87	PA1328			Eng. 744216-	422 200 11 01/ 16 01
11.4 D (177 kW) Eng.OM407.916/.918	73-77	PA1292			For vehicles without retarder; Eng. 744216-	403 200 27 01/ 32 01/ 34 01 403 200 35 01/ 49 01/ 70 01
	73-77	PA1328			Eng. 744216-	422 200 11 01/ 16 01
11.4 D (206 kW) Eng.OM407.955	76-87	PA1292			For vehicles without retarder; Eng. 744216-	403 200 27 01/ 32 01/ 34 01 403 200 35 01/ 49 01/ 70 01
O 309 '1/68-'2/89						
O 309 (63 kW) Eng.OM314.948/.946/.959/.962/963	70-89	PA1296			Eng -456936	
	70-89	PA1300			Eng 456937-	314 200 35 01/ 41 01/ 47 01
O 309 (96 kW) Eng.OM353.963/.966/.968/.969	77-89	PA1295			Impeller Ø 88mm	352 200 38 01/ 74 01/ 84 01/ 94 01/ 353 200 03 01/ 04 01/ 36 01/ 29 01/ 42 01
	77-89	PA1299			Impeller Ø 94,5mm	353 200 21 01/ 37 01
O 330 '1/90-						
330 (260 kW) Eng.OM442.955/.961	90-	PA1328			Eng. 744216-	422 200 11 01/ 16 01
O 340 '1/91-'8/95						
Tourismo (250 kW) Eng.OM441.994/.995	85-	PA1309			For vehicles without retarder; Eng. -744215	403 200 76 01/ 77 01 422 200 13 01/ 14 01,441 200 03 01
Tourismo (280 kW) Eng.OM402.984/.995	75-99	PA872				403 200 73 01

			
PA872	PA1292	PA1297	PA1302
			
PA1309	PA1325	PA1326	PA1327
			
PA1328	PA1329	PA1341	PA1342











		GRAF ref.			NOTE	Adaptable for OES
Tourismo (280 kW) Eng.OM402.984/.995	92-95	PA1292			For vehicles without retarder; Eng. 744216-	403 200 27 01/ 32 01/ 34 01 403 200 35 01/ 49 01/ 70 01
	85-	PA1309			For vehicles without retarder; Eng. -744215	403 200 76 01/ 77 01 422 200 13 01/ 14 01,441 200 03 01
	92-95	PA1328			Eng. 744216-	422 200 11 01/ 16 01
O 350 Tourismo '8/95-						
Tourismo (185-220-300 kW) Eng.OM457.941/.952/.965	03-	PA1326			For vehicles with retarder; Open hole	457 200 02 01/ 05 01/ 11 01/ 25 01/ 27 01
	03-	PA1329			For vehicles without retarder	457 200 08 01/ 19 01/ 23 01/ 29 01
Tourismo (220-260-310 kW) Eng.OM457.944/.952/.961/.965	03-	PA1326			For vehicles with retarder; Open hole	457 200 02 01/ 05 01/ 11 01/ 25 01/ 27 01
	03-	PA1329			For vehicles without retarder	457 200 08 01/ 19 01/ 23 01/ 29 01
Tourismo (250 kW) Eng.OM441.980	95-	PA1302			For vehicles with retarder, w/o pulley	422 200 06 01
	84-	PA1309			For vehicles without retarder; Eng. -744215	403 200 76 01/ 77 01 422 200 13 01/ 14 01,441 200 03 01
	95-	PA1328			Eng. 744216-	422 200 11 01/ 16 01
Tourismo (250 kW) Eng.OM445.934	95-	PA1328			Eng. 744216-	422 200 11 01/ 16 01
Tourismo (260 kW) Eng.OM457.941/.953/.961/.965	03-	PA1326			For vehicles with retarder; Open hole	457 200 02 01/ 05 01/ 11 01/ 25 01/ 27 01
	03-	PA1329			For vehicles without retarder	457 200 08 01/ 19 01/ 23 01/ 29 01
Tourismo (260 kW) Eng.OM457.944/.953/.961	03-	PA1326			For vehicles with retarder; Open hole	457 200 02 01/ 05 01/ 11 01/ 25 01/ 27 01
	03-	PA1329			For vehicles without retarder	457 200 08 01/ 19 01/ 23 01/ 29 01
Tourismo (260-310 kW) Eng.OM457.944	03-	PA1326			For vehicles with retarder; Open hole	457 200 02 01/ 05 01/ 11 01/ 25 01/ 27 01
	03-	PA1327			For vehicles with retarder; Close hole	442 200 04 01/ 06 01/ 07 01/ 09 01 457 200 10 01/ 24 01/ 28 01
	03-	PA1329			For vehicles without retarder	457 200 08 01/ 19 01/ 23 01/ 29 01
Tourismo (280 kW) Eng.OM402.970	75-99	PA872				403 200 73 01
	95-	PA1292			For vehicles without retarder; Eng. 744216-	403 200 27 01/ 32 01/ 34 01 403 200 35 01/ 49 01/ 70 01
	85-	PA1309			For vehicles without retarder; Eng. -744215	403 200 76 01/ 77 01 422 200 13 01/ 14 01,441 200 03 01
	95-	PA1328			Eng. 744216-	422 200 11 01/ 16 01
Tourismo (280 kW) Eng.OM446.938	95-	PA1328			Eng. 744216-	422 200 11 01/ 16 01
Tourismo (310 kW) Eng.OM457.944	03-	PA1326			For vehicles with retarder; Open hole	457 200 02 01/ 05 01/ 11 01/ 25 01/ 27 01
	03-	PA1329			For vehicles without retarder	457 200 08 01/ 19 01/ 23 01/ 29 01
Tourismo (315-335 kW) Eng.OM457.953/.961	03-	PA1326			For vehicles with retarder; Open hole	457 200 02 01/ 05 01/ 11 01/ 25 01/ 27 01
	03-	PA1329			For vehicles without retarder	457 200 08 01/ 19 01/ 23 01/ 29 01
Tourismo (320 kW) Eng.OM542.948	03-	PA1341			For vehicles without retarder; With fastening eyes for axial fan	542 200 25 01
	03-	PA1342			For vehicles with retarder; With fastening eyes for axial fan	542 200 26 01
Tourismo (350-370 kW) Eng.OM542.948/.966	03-	PA1341			For vehicles without retarder; With fastening eyes for axial fan	542 200 25 01
	03-	PA1342			For vehicles with retarder; With fastening eyes for axial fan	542 200 26 01
Tourismo (350-370 kW) Eng.OM542.966	03-	PA1341			For vehicles without retarder; With fastening eyes for axial fan	542 200 25 01
	03-	PA1342			For vehicles with retarder; With fastening eyes for axial fan	542 200 26 01
O 355 '1/68-						
11.6 TD (136-155-177-191-205 kW) Eng.OM355/H/A	68-	PA1297				
O 402 '2/86-'12/91						
O 402 (100 kW) Eng.OM366.917	86-91	PA1325				366 200 54 01/ 67 01/ 68 01 390 200 00 01
O 402 (125 kW) Eng.OM366.965	86-91	PA1325				366 200 54 01/ 67 01/ 68 01 390 200 00 01
O 403 '9/03-						
O 403 (250 kW) Eng.OM441.980/.934	03-	PA1328			Eng. 744216-	422 200 11 01/ 16 01
O 403 (260 kW) Eng.OM457.944	03-	PA1326			For vehicles with retarder; Open hole	457 200 02 01/ 05 01/ 11 01/ 25 01/ 27 01
	03-	PA1327			For vehicles with retarder; Close hole	442 200 04 01/ 06 01/ 07 01/ 09 01 457 200 10 01/ 24 01/ 28 01
	03-	PA1329			For vehicles without retarder	457 200 08 01/ 19 01/ 23 01/ 29 01

			
<p>PA872</p>	<p>PA1292</p>	<p>PA1302</p>	<p>PA1309</p>
			
<p>PA1326</p>	<p>PA1327</p>	<p>PA1328</p>	<p>PA1329</p>





		GRAF ref.			NOTE	Adaptable for OES
O 403 (280 kW) Eng.OM402.970	03-	PA1292			For vehicles without retarder; Eng. 744216-	403 200 27 01/ 32 01/ 34 01 403 200 35 01/ 49 01/ 70 01
	03-	PA1328			Eng. 744216-	422 200 11 01/ 16 01
O 403 (280 kW)	03-	PA1328			Eng. 744216-	422 200 11 01/ 16 01
O 403 (310 kW) Eng.OM457.944	03-	PA1326			For vehicles with retarder; Open hole	457 200 02 01/ 05 01/ 11 01/ 25 01/ 27 01
	03-	PA1327			For vehicles with retarder; Close hole	442 200 04 01/ 06 01/ 07 01/ 09 01 457 200 10 01/ 24 01/ 28 01
	03-	PA1329			For vehicles without retarder	457 200 08 01/ 19 01/ 23 01/ 29 01
O 404 '9/91-'11/92						
10.9 D (213 kW) Eng.OM445.935	94-99	PA1328			Eng. 744216-	422 200 11 01/ 16 01
10.9 D (250 kW) Eng.OM441.980/OM445.934	91-99	PA1328			Eng. 744216-	422 200 11 01/ 16 01
11.3 D (151 kW) Eng.OM441.922	73-77	PA872				403 200 73 01
	91-92	PA1302			For vehicles with retarder, w/o pulley	422 200 06 01
	91-92	PA1309			For vehicles without retarder; Eng. -744215	403 200 76 01/ 77 01 422 200 13 01/ 14 01,441 200 03 01
	91-92	PA1328			Eng. 744216-	422 200 11 01/ 16 01
11.3 D (165 kW) Eng.OM441.921	91-92	PA1328			Eng. 744216-	422 200 11 01/ 16 01
12.7 D (280 kW) Eng.OM402.970/.974	91-99	PA1292			For vehicles without retarder; Eng. 744216-	403 200 27 01/ 32 01/ 34 01 403 200 35 01/ 49 01/ 70 01
	91-99	PA1328			Eng. 744216-	422 200 11 01/ 16 01
14.6 D (280 kW) Eng.OM446.938	94-99	PA1328			Eng. 744216-	422 200 11 01/ 16 01
15.1 D (213 kW) Eng.OM442.930	91-92	PA1328			Eng. 744216-	422 200 11 01/ 16 01
9.5 D (200 kW) Eng.OM401.974	91-	PA1292			For vehicles without retarder; Eng. 744216-	403 200 27 01/ 32 01/ 34 01 403 200 35 01/ 49 01/ 70 01
	91-	PA1328			Eng. 744216-	422 200 11 01/ 16 01
9.5 D (213 kW) Eng.OM401.970	91-99	PA1292			For vehicles without retarder; Eng. 744216-	403 200 27 01/ 32 01/ 34 01 403 200 35 01/ 49 01/ 70 01
	91-99	PA1328			Eng. 744216-	422 200 11 01/ 16 01
9.8 D (200 kW) Eng.OM401.974	91-99	PA1292			For vehicles without retarder; Eng. 744216-	403 200 27 01/ 32 01/ 34 01 403 200 35 01/ 49 01/ 70 01
	91-99	PA1328			Eng. 744216-	422 200 11 01/ 16 01
O 405 '1/84-						
12.0 D (150 kW) Eng.OM447.905/911/913/914/970/973	84-01	PA872				403 200 73 01
	84-	PA1302			For vehicles with retarder, w/o pulley	422 200 06 01
	84-	PA1309			For vehicles without retarder; Eng. -744215	403 200 76 01/ 77 01 422 200 13 01/ 14 01,441 200 03 01
12.0 D (150-170 kW) Eng.OM427H	84-01	PA872				403 200 73 01
	85-	PA1302			For vehicles with retarder, w/o pulley	422 200 06 01
	85-	PA1309			For vehicles without retarder; Eng. -744215	403 200 76 01/ 77 01 422 200 13 01/ 14 01,441 200 03 01
12.0 D (177 kW) Eng.OM447.907/908/910/956/957/971/974	84-01	PA872				403 200 73 01
	85-	PA1302			For vehicles with retarder, w/o pulley	422 200 06 01
	85-	PA1309			For vehicles without retarder; Eng. -744215	403 200 76 01/ 77 01 422 200 13 01/ 14 01,441 200 03 01
	85-	PA1328			Eng. 744216-	422 200 11 01/ 16 01
12.0 D (177 kW) Eng.OM447.955/959/976/978	84-01	PA872				403 200 73 01
	85-	PA1302			For vehicles with retarder, w/o pulley	422 200 06 01
	85-	PA1309			For vehicles without retarder; Eng. -744215	403 200 76 01/ 77 01 422 200 13 01/ 14 01,441 200 03 01
	85-	PA1328			Eng. 744216-	422 200 11 01/ 16 01
12.0 D (206 kW) Eng.OM447.950	84-01	PA872				403 200 73 01
	85-	PA1309			For vehicles without retarder; Eng. -744215	403 200 76 01/ 77 01 422 200 13 01/ 14 01,441 200 03 01
O 407 '1/85-						
12.0 D (177 kW) Eng.OM447.906/954/990	84-01	PA872				403 200 73 01
	87-	PA1302			For vehicles with retarder, w/o pulley	422 200 06 01
	87-	PA1309			For vehicles without retarder; Eng. -744215	403 200 76 01/ 77 01 422 200 13 01/ 14 01,441 200 03 01
	87-	PA1328			Eng. 744216-	422 200 11 01/ 16 01
12.0 D (220 kW) Eng.OM447.985/.991	91-01	PA1328			Eng. 744216-	422 200 11 01/ 16 01

			
PA871	PA872	PA873	PA1292
			
PA1301	PA1302	PA1303	PA1309
			
PA1320	PA1325	PA1328	













		GRAF ref.			NOTE	Adaptable for OES
O 408 '1/91-'12/98						
O 408 (177 kW) Eng.OM447.908/.912/.958/.992	84-01	PA872				403 200 73 01
	91-98	PA1302			For vehicles with retarder, w/o pulley	422 200 06 01
	86-	PA1309			For vehicles without retarder; Eng. -744215	403 200 76 01/ 77 01 422 200 13 01/ 14 01,441 200 03 01
	91-98	PA1328			Eng. 744216-	422 200 11 01/ 16 01
O 408 (220 kW) Eng.OM447.987/.993	84-01	PA872				403 200 73 01
	92-98	PA1302			For vehicles with retarder, w/o pulley	422 200 06 01
	86-	PA1309			For vehicles without retarder; Eng. -744215	403 200 76 01/ 77 01 422 200 13 01/ 14 01,441 200 03 01
	92-98	PA1328			Eng. 744216-	422 200 11 01/ 16 01
OH Series '1/70-						
1417 (125 kW) Eng.OM366.957	70-	PA1325				366 200 54 01/ 67 01/ 68 01 390 200 00 01
1625, 1625L (184 kW) Eng.OM422.915	70-	PA1301			For vehicles with retarder	403 200 64 01/ 75 01 422 200 07 01/ 12 01,442 200 12 01
1628, 1628L (206 kW) Eng.OM422.918	70-	PA1301			For vehicles with retarder	403 200 64 01/ 75 01 422 200 07 01/ 12 01,442 200 12 01
1634L (250 kW) Eng.OM445.934	70-	PA1328			Eng. 744216-	422 200 11 01/ 16 01
1829L (213 kW) Eng.OM445.935	70-	PA1328			Eng. 744216-	422 200 11 01/ 16 01
Serie LK-LN2 '1/84-'12/98						
1114,1117 Eng.OM356/357	84-98	PA871				366 200 59 01
1114,L,K,S,1117,1120,1314,1317,1320,814, (100-116-125-148 kW) Eng.OM366.905/914/962/988	84-98	PA1325				366 200 54 01/ 67 01/ 68 01 390 200 00 01
1120,1124 Eng.OM356/357	84-98	PA871				366 200 59 01
1217 Eng.OM356/357	84-98	PA871				366 200 59 01
1314,1317,1320,1324 Eng.OM356/357	84-98	PA871				366 200 59 01
1514,1517,1520,1524 Eng.OM356/357	84-98	PA871				366 200 59 01
609/709/809 D (63-66 kW) Eng.OM364.906/907/911/912/918/919/920/921	84-98	PA1303				364 200 01 01/ 09 01/ 14 01/ 20 01
611/711/811 D (85 kW) Eng.OM364.950/952/954	86-94	PA1303				364 200 01 01/ 09 01/ 14 01/ 20 01
711,811,814,1117,1317,1517,817,917 (77-90-100-125 kW) Eng.OM904.905/906/907	96-98	PA1320			For vehicles without retarder	904 200 02 01/ 04 01/ 06 01/ 07 01/ 08 01 904 200 19 01/ 20 01/ 22 01/ 25 01/ 26 01 904 200 27 01/ 28 01/ 29 01/ 32 01/ 38 01 904 200 43 01/ 49 01/ 50 01
814,817,914,917 Eng.OM356/357	84-98	PA871				366 200 59 01
Serie MK '12/87-'9/96						
1222 A (151-160 kW) Eng.OM441.905/913/914/923/926	88-94	PA1309			For vehicles without retarder; Eng. -744215	403 200 76 01/ 77 01 422 200 13 01/ 14 01,441 200 03 01
	88-94	PA1328			Eng. 744216-	422 200 11 01/ 16 01
1222,1226,1234 Eng.OM445/441	89-96	PA873				403 200 71 01
	89-96	PA1328			Eng. 744216-	422 200 11 01/ 16 01
1224 AF,1226,1227,1422,1424,1722,1726,1824 (180-200-230 kW) Eng.OM401	87-96	PA873				403 200 71 01
	87-96	PA1292			For vehicles without retarder; Eng. 744216-	403 200 27 01/ 32 01/ 34 01 403 200 35 01/ 49 01/ 70 01
	87-96	PA1302			For vehicles with retarder, w/o pulley	422 200 06 01
	86-	PA1309			For vehicles without retarder; Eng. -744215	403 200 76 01/ 77 01 422 200 13 01/ 14 01,441 200 03 01
	87-96	PA1328			Eng. 744216-	422 200 11 01/ 16 01
1224,1417,1420 Eng.OM356/357	87-96	PA871				366 200 59 01
	87-96	PA1328			Eng. 744216-	422 200 11 01/ 16 01
1226,1426,1722,1726,2426,2527 Eng.OM442/440	87-96	PA873				403 200 71 01
	87-96	PA1302			For vehicles with retarder, w/o pulley	422 200 06 01
	87-96	PA1309			For vehicles without retarder; Eng. -744215	403 200 76 01/ 77 01 422 200 13 01/ 14 01,441 200 03 01
	87-96	PA1328			Eng. 744216-	422 200 11 01/ 16 01
1422 F,1722,1726,1733,2422,2426,2433 (151-160-243-250 kW) Eng.OM441	88-94	PA1309			For vehicles without retarder; Eng. -744215	403 200 76 01/ 77 01 422 200 13 01/ 14 01,441 200 03 01
	88-94	PA1328			Eng. 744216-	422 200 11 01/ 16 01
1422,1722,1726,1824,1827,1831 Eng.OM401	87-96	PA873				403 200 71 01
	87-96	PA1292			For vehicles without retarder; Eng. 744216-	403 200 27 01/ 32 01/ 34 01 403 200 35 01/ 49 01/ 70 01

			
PA870	PA871	PA873	PA1292
			
PA1294	PA1295	PA1299	PA1302
			
PA1309	PA1325	PA1328	

		GRAF ref.			NOTE	Adaptable for OES
1422,1722,1726,1824,1827,1831 Eng.OM401	87-96	PA1302			For vehicles with retarder, w/o pulley	422 200 06 01
	86-	PA1309			For vehicles without retarder; Eng. -744215	403 200 76 01/ 77 01 422 200 13 01/ 14 01,441 200 03 01
	87-96	PA1328			Eng. 744216-	422 200 11 01/ 16 01
1422,1722,2422 Eng.OM441	87-96	PA873				403 200 71 01
	87-96	PA1309			For vehicles without retarder; Eng. -744215	403 200 76 01/ 77 01 422 200 13 01/ 14 01,441 200 03 01
	87-96	PA1328			Eng. 744216-	422 200 11 01/ 16 01
1717,1720,1722,1820,2420 Eng.OM356/357	87-96	PA871				366 200 59 01
	87-96	PA1328			Eng. 744216-	422 200 11 01/ 16 01
1733,1824,1827,1831,1834 Eng.OM445/441	87-96	PA873				403 200 71 01
1824 AK,2024 (180 kW) Eng.OM401.984	93-96	PA1292			For vehicles without retarder; Eng. 744216-	403 200 27 01/ 32 01/ 34 01 403 200 35 01/ 49 01/ 70 01
	93-96	PA1302			For vehicles with retarder, w/o pulley	422 200 06 01
	93-96	PA1309			For vehicles without retarder; Eng. -744215	403 200 76 01/ 77 01 422 200 13 01/ 14 01,441 200 03 01
	93-96	PA1328			Eng. 744216-	422 200 11 01/ 16 01
2426,2524,2527,2531 Eng.OM401	87-96	PA873				403 200 71 01
	87-96	PA1292			For vehicles without retarder; Eng. 744216-	403 200 27 01/ 32 01/ 34 01 403 200 35 01/ 49 01/ 70 01
	87-96	PA1302			For vehicles with retarder, w/o pulley	422 200 06 01
	86-	PA1309			For vehicles without retarder; Eng. -744215	403 200 76 01/ 77 01 422 200 13 01/ 14 01,441 200 03 01
	87-96	PA1328			Eng. 744216-	422 200 11 01/ 16 01
2524,2527,2531,2534,2426,2433 Eng.OM445/441	87-96	PA873				403 200 71 01
	87-96	PA1328			Eng. 744216-	422 200 11 01/ 16 01
2631,S,B (180-200-230 kW) Eng.OM401.979	92-96	PA1292			For vehicles without retarder; Eng. 744216-	403 200 27 01/ 32 01/ 34 01 403 200 35 01/ 49 01/ 70 01
	92-96	PA1309			For vehicles without retarder; Eng. -744215	403 200 76 01/ 77 01 422 200 13 01/ 14 01,441 200 03 01
Serie NG '8/73-'9/96						
1017,1217,1617 (124 kW) Eng.OM353.950/951/952/953/954/970/971/975	75-91	PA1294			For vehicles without retarder; Impeller Ø 125mm	403 200 06 01/ 36 01/ 44 01/ 51 01 403 200 71 01/ 01 01/ 02 01/
	75-91	PA1295			Impeller Ø 88mm	352 200 38 01/ 74 01/ 84 01/ 94 01/ 353 200 03 01/ 04 01/ 36 01/ 29 01/ 42 01
	75-91	PA1299			Impeller Ø 94,5mm	353 200 21 01/ 37 01
1219 A,K,1419,1619,1719,1919,2219 (141 kW) Eng.OM401.906/905/915/918/919/914	89-96	PA873				403 200 71 01
	75-96	PA1292			For vehicles without retarder; Eng. 744216-	403 200 27 01/ 32 01/ 34 01 403 200 35 01/ 49 01/ 70 01
	75-96	PA1294			For vehicles without retarder; Impeller Ø 125mm	403 200 06 01/ 36 01/ 44 01/ 51 01 403 200 71 01/ 01 01/ 02 01/
	75-96	PA1309			For vehicles without retarder; Eng. -744215	403 200 76 01/ 77 01 422 200 13 01/ 14 01,441 200 03 01
	75-96	PA1328			Eng. 744216-	422 200 11 01/ 16 01
1219 A,K,1419,1619,1719,1919,2219 (141 kW) Eng.OM401.909/916/923/925/926	89-96	PA873				403 200 71 01
	75-96	PA1292			For vehicles without retarder; Eng. 744216-	403 200 27 01/ 32 01/ 34 01 403 200 35 01/ 49 01/ 70 01
	75-96	PA1294			For vehicles without retarder; Impeller Ø 125mm	403 200 06 01/ 36 01/ 44 01/ 51 01 403 200 71 01/ 01 01/ 02 01/
	75-96	PA1309			For vehicles without retarder; Eng. -744215	403 200 76 01/ 77 01 422 200 13 01/ 14 01,441 200 03 01
	75-96	PA1328			Eng. 744216-	422 200 11 01/ 16 01
1222,2222,1422,1622,1922 (141-159 kW) Eng.OM421.905/906	82-90	PA1294			For vehicles without retarder; Impeller Ø 125mm	403 200 06 01/ 36 01/ 44 01/ 51 01 403 200 71 01/ 01 01/ 02 01/
	82-90	PA1309			For vehicles without retarder; Eng. -744215	403 200 76 01/ 77 01 422 200 13 01/ 14 01,441 200 03 01
	82-90	PA1328			Eng. 744216-	422 200 11 01/ 16 01
1414,1420,1614,1620,2220 Eng.OM366	84-91	PA871				366 200 59 01
	73-96	PA1294			For vehicles without retarder; Impeller Ø 125mm	403 200 06 01/ 36 01/ 44 01/ 51 01 403 200 71 01/ 01 01/ 02 01/
	73-96	PA1325				366 200 54 01/ 67 01/ 68 01 390 200 00 01
	73-96	PA1328			Eng. 744216-	422 200 11 01/ 16 01
1417 Eng.OM353	75-84	PA870				353 200 56 01

			
PA871	PA873	PA1292	PA1294
			
PA1295	PA1298	PA1299	PA1301
			
PA1309	PA1325	PA1328	

		GRAF ref.			NOTE	Adaptable for OES
1417 Eng.OM353	73-96	PA1294			For vehicles without retarder; Impeller Ø 125mm	403 200 06 01/ 36 01/ 44 01/ 51 01 403 200 71 01/ 01 01/ 02 01/
	73-96	PA1295			Impeller Ø 88mm	352 200 38 01/ 74 01/ 84 01/ 94 01/ 353 200 03 01/ 04 01/ 36 01/ 29 01/ 42 01
	73-96	PA1299			Impeller Ø 94,5mm	353 200 21 01/ 37 01
1417 C,CA,CK,CAK,1617 (125 kW) Eng.OM366.951	84-91	PA871				366 200 59 01
	84-91	PA1294			For vehicles without retarder; Impeller Ø 125mm	403 200 06 01/ 36 01/ 44 01/ 51 01 403 200 71 01/ 01 01/ 02 01/
	84-91	PA1325				366 200 54 01/ 67 01/ 68 01 390 200 00 01
1419 C,CL,1619,2219 (141 kW) Eng.OM362.906/909	83-85	PA1294			For vehicles without retarder; Impeller Ø 125mm	403 200 06 01/ 36 01/ 44 01/ 51 01 403 200 71 01/ 01 01/ 02 01/
	83-85	PA1328			Eng. 744216-	422 200 11 01/ 16 01
1424 F,1624,2224 (176 kW) Eng.OM402.911/910/914/919/923/927/928	75-87	PA873				403 200 71 01
	75-87	PA1292			For vehicles without retarder; Eng. 744216-	403 200 27 01/ 32 01/ 34 01 403 200 35 01/ 49 01/ 70 01
	75-87	PA1294			For vehicles without retarder; Impeller Ø 125mm	403 200 06 01/ 36 01/ 44 01/ 51 01 403 200 71 01/ 01 01/ 02 01/
	75-96	PA1309			For vehicles without retarder; Eng. -744215	403 200 76 01/ 77 01 422 200 13 01/ 14 01,441 200 03 01
	75-87	PA1328			Eng. 744216-	422 200 11 01/ 16 01
1622,L,2222 (150 kW) Eng.OM441.906/907	82-91	PA1294			For vehicles without retarder; Impeller Ø 125mm	403 200 06 01/ 36 01/ 44 01/ 51 01 403 200 71 01/ 01 01/ 02 01/
	82-91	PA1309			For vehicles without retarder; Eng. -744215	403 200 76 01/ 77 01 422 200 13 01/ 14 01,441 200 03 01
	82-91	PA1328			Eng. 744216-	422 200 11 01/ 16 01
1626,1926,2026,2226,2626 (188 kW) Eng.OM402.906/910/911/912/916	74-87	PA873				403 200 71 01
	74-87	PA1292			For vehicles without retarder; Eng. 744216-	403 200 27 01/ 32 01/ 34 01 403 200 35 01/ 49 01/ 70 01
	74-87	PA1294			For vehicles without retarder; Impeller Ø 125mm	403 200 06 01/ 36 01/ 44 01/ 51 01 403 200 71 01/ 01 01/ 02 01/
	74-87	PA1309			For vehicles without retarder; Eng. -744215	403 200 76 01/ 77 01 422 200 13 01/ 14 01,441 200 03 01
	74-87	PA1328			Eng. 744216-	422 200 11 01/ 16 01
1632,1932,2032,2232,2632 (235 kW) Eng.OM403.916/932/931/935	74-83	PA873				403 200 71 01
	74-83	PA1292			For vehicles without retarder; Eng. 744216-	403 200 27 01/ 32 01/ 34 01 403 200 35 01/ 49 01/ 70 01
	74-83	PA1294			For vehicles without retarder; Impeller Ø 125mm	403 200 06 01/ 36 01/ 44 01/ 51 01 403 200 71 01/ 01 01/ 02 01/
	86-	PA1309			For vehicles without retarder; Eng. -744215	403 200 76 01/ 77 01 422 200 13 01/ 14 01,441 200 03 01
	74-83	PA1328			Eng. 744216-	422 200 11 01/ 16 01
1644,S,LS,1944,2244,2644 (320 kW) Eng.OM442.951/953/980	86-89	PA1294			For vehicles without retarder; Impeller Ø 125mm	403 200 06 01/ 36 01/ 44 01/ 51 01 403 200 71 01/ 01 01/ 02 01/
	86-	PA1309			For vehicles without retarder; Eng. -744215	403 200 76 01/ 77 01 422 200 13 01/ 14 01,441 200 03 01
	86-89	PA1328			Eng. 744216-	422 200 11 01/ 16 01
1928,1933,1425,1938,2025,2028,2033 (206-243-184-276 kW) Eng.OM422	80-91	PA873				403 200 71 01
	80-91	PA1294			For vehicles without retarder; Impeller Ø 125mm	403 200 06 01/ 36 01/ 44 01/ 51 01 403 200 71 01/ 01 01/ 02 01/
	80-91	PA1301			For vehicles with retarder	403 200 64 01/ 75 01 422 200 07 01/ 12 01,442 200 12 01
	80-91	PA1309			For vehicles without retarder; Eng. -744215	403 200 76 01/ 77 01 422 200 13 01/ 14 01,441 200 03 01
	80-91	PA1328			Eng. 744216-	422 200 11 01/ 16 01
1935 AK,2035,2036,1635,2235,2635,3535 (260-269 kW) Eng.OM442.950/952/958/962	86-91	PA1294			For vehicles without retarder; Impeller Ø 125mm	403 200 06 01/ 36 01/ 44 01/ 51 01 403 200 71 01/ 01 01/ 02 01/
	86-91	PA1309			For vehicles without retarder; Eng. -744215	403 200 76 01/ 77 01 422 200 13 01/ 14 01,441 200 03 01
	86-91	PA1328			Eng. 744216-	422 200 11 01/ 16 01
1936 AS,AK,2036,1636,2236,2636,3250,3 (261-368 kW) Eng.OM423.905/906/907/908	81-96	PA873				403 200 71 01
	81-96	PA1298			For vehicles without retarder, w/o pulley; Impeller Ø 135mm, Incl Electronic fuel Injection pump	403 200 57 01,422 200 05 01/ 10 01
	81-96	PA1328			Eng. 744216-	422 200 11 01/ 16 01
2226,L,S,LS,2626 (188 kW) Eng.OM402.924/926	74-80	PA873				403 200 71 01
	74-80	PA1292			For vehicles without retarder; Eng. 744216-	403 200 27 01/ 32 01/ 34 01 403 200 35 01/ 49 01/ 70 01

			
PA870	PA873	PA874	PA1294
			
PA1295	PA1296	PA1298	PA1299
			
PA1300	PA1301	PA1309	PA1328

		GRAF ref.			NOTE	Adaptable for OES
2226,L,S,LS,2626 (188 kW) Eng.OM402.924/926	74-80	PA1294			For vehicles without retarder; Impeller Ø 125mm	403 200 06 01/ 36 01/ 44 01/ 51 01 403 200 71 01/ 01 01/ 02 01/
	74-80	PA1309			For vehicles without retarder; Eng. -744215	403 200 76 01/ 77 01 422 200 13 01/ 14 01,441 200 03 01
	74-80	PA1328			Eng. 744216-	422 200 11 01/ 16 01
2228,2233,2238,2628,2633,2638 (206-243-184-276 kW) Eng.OM422	80-91	PA873				403 200 71 01
	80-91	PA1294			For vehicles without retarder; Impeller Ø 125mm	403 200 06 01/ 36 01/ 44 01/ 51 01 403 200 71 01/ 01 01/ 02 01/
	80-91	PA1301			For vehicles with retarder	403 200 64 01/ 75 01 422 200 07 01/ 12 01,442 200 12 01
	80-91	PA1309			For vehicles without retarder; Eng. -744215	403 200 76 01/ 77 01 422 200 13 01/ 14 01,441 200 03 01
	80-91	PA1328			Eng. 744216-	422 200 11 01/ 16 01
3025 B (184 kW) Eng.OM422.920	85-91	PA873				403 200 71 01
	85-91	PA1294			For vehicles without retarder; Impeller Ø 125mm	403 200 06 01/ 36 01/ 44 01/ 51 01 403 200 71 01/ 01 01/ 02 01/
	85-91	PA1301			For vehicles with retarder	403 200 64 01/ 75 01 422 200 07 01/ 12 01,442 200 12 01
	85-91	PA1309			For vehicles without retarder; Eng. -744215	403 200 76 01/ 77 01 422 200 13 01/ 14 01,441 200 03 01
	85-91	PA1328			Eng. 744216-	422 200 11 01/ 16 01
3025 B,3028,3228,3328,3528 (184-206 kW) Eng.OM422.919/921	85-91	PA873				403 200 71 01
	85-91	PA1294			For vehicles without retarder; Impeller Ø 125mm	403 200 06 01/ 36 01/ 44 01/ 51 01 403 200 71 01/ 01 01/ 02 01/
	85-91	PA1301			For vehicles with retarder	403 200 64 01/ 75 01 422 200 07 01/ 12 01,442 200 12 01
	85-91	PA1309			For vehicles without retarder; Eng. -744215	403 200 76 01/ 77 01 422 200 13 01/ 14 01,441 200 03 01
	85-91	PA1328			Eng. 744216-	422 200 11 01/ 16 01
3250 A,AF,3850 (368 kW) Eng.OM423.950/951	85-94	PA874				422 200 10 01
	85-94	PA1298			For vehicles without retarder, w/o pulley; Impeller Ø 135mm, Incl Electronic fuel Injection pump	403 200 57 01,422 200 05 01/ 10 01
3328 K,B (206 kW) Eng.OM422.914	82-87	PA873				403 200 71 01
	82-87	PA1294			For vehicles without retarder; Impeller Ø 125mm	403 200 06 01/ 36 01/ 44 01/ 51 01 403 200 71 01/ 01 01/ 02 01/
	82-87	PA1301			For vehicles with retarder	403 200 64 01/ 75 01 422 200 07 01/ 12 01,442 200 12 01
	82-87	PA1309			For vehicles without retarder; Eng. -744215	403 200 76 01/ 77 01 422 200 13 01/ 14 01,441 200 03 01
	82-87	PA1328			Eng. 744216-	422 200 11 01/ 16 01
3333,B,K (243 kW) Eng.OM422.954	80-91	PA873				403 200 71 01
	80-91	PA1294			For vehicles without retarder; Impeller Ø 125mm	403 200 06 01/ 36 01/ 44 01/ 51 01 403 200 71 01/ 01 01/ 02 01/
	80-91	PA1301			For vehicles with retarder	403 200 64 01/ 75 01 422 200 07 01/ 12 01,442 200 12 01
	80-91	PA1309			For vehicles without retarder; Eng. -744215	403 200 76 01/ 77 01 422 200 13 01/ 14 01,441 200 03 01
	80-91	PA1328			Eng. 744216-	422 200 11 01/ 16 01
3535 K (260-269 kW) Eng.OM442.959	87-94	PA1294			For vehicles without retarder; Impeller Ø 125mm	403 200 06 01/ 36 01/ 44 01/ 51 01 403 200 71 01/ 01 01/ 02 01/
	87-94	PA1309			For vehicles without retarder; Eng. -744215	403 200 76 01/ 77 01 422 200 13 01/ 14 01,441 200 03 01
	87-94	PA1328			Eng. 744216-	422 200 11 01/ 16 01
813,911,913 Eng.OM352/353	73-96	PA870				353 200 56 01
	73-96	PA1294			For vehicles without retarder; Impeller Ø 125mm	403 200 06 01/ 36 01/ 44 01/ 51 01 403 200 71 01/ 01 01/ 02 01/
	73-96	PA1295			Impeller Ø 88mm	352 200 38 01/ 74 01/ 84 01/ 94 01/ 353 200 03 01/ 04 01/ 36 01/ 29 01/ 42 01
	73-96	PA1299			Impeller Ø 94,5mm	353 200 21 01/ 37 01
Serie PK '1/77-'12/84						
3.8 D (63 kW) Eng.OM314.910	77-84	PA1296			Eng -456936	
	77-84	PA1300			Eng 456937-	314 200 35 01/ 41 01/ 47 01
Serie SK '1/81-'9/96						
1224,1226,2024 (180-200-230 kW) Eng.OM401.975/979/984	93-	PA873				403 200 71 01

			
<p>PA873</p>	<p>PA1292</p>	<p>PA1298</p>	<p>PA1302</p>
			
<p>PA1309</p>	<p>PA1320</p>	<p>PA1328</p>	





		GRAF ref.			NOTE	Adaptable for OES
1224,1226,2024 (180-200-230 kW) Eng.OM401.975/979/984	93-96	PA1292			For vehicles without retarder; Eng. 744216-	403 200 27 01/ 32 01/ 34 01 403 200 35 01/ 49 01/ 70 01
	86-	PA1309			For vehicles without retarder; Eng. -744215	403 200 76 01/ 77 01 422 200 13 01/ 14 01,441 200 03 01
1735,1748,1838,1844,1935,1948 Eng.OM440/446	87-96	PA1328			Eng. 744216-	422 200 11 01/ 16 01
1735,1935,2435,2635,3235,3535 (250-260-269 kW) Eng.OM442	88-94	PA873				403 200 71 01
	86-	PA1309			For vehicles without retarder; Eng. -744215	403 200 76 01/ 77 01 422 200 13 01/ 14 01,441 200 03 01
	88-94	PA1328			Eng. 744216-	422 200 11 01/ 16 01
1831,1834 Eng.OM445/441	89-96	PA873				403 200 71 01
	87-96	PA1328			Eng. 744216-	422 200 11 01/ 16 01
1831,2024,2031,2629,2631 Eng.OM401	87-96	PA873				403 200 71 01
	87-96	PA1292			For vehicles without retarder; Eng. 744216-	403 200 27 01/ 32 01/ 34 01 403 200 35 01/ 49 01/ 70 01
	87-96	PA1309			For vehicles without retarder; Eng. -744215	403 200 76 01/ 77 01 422 200 13 01/ 14 01,441 200 03 01
	87-96	PA1328			Eng. 744216-	422 200 11 01/ 16 01
1838,1840 Eng.OM402/440	91-96	PA873				403 200 71 01
	87-96	PA1292			For vehicles without retarder; Eng. 744216-	403 200 27 01/ 32 01/ 34 01 403 200 35 01/ 49 01/ 70 01
	86-	PA1309			For vehicles without retarder; Eng. -744215	403 200 76 01/ 77 01 422 200 13 01/ 14 01,441 200 03 01
	87-96	PA1328			Eng. 744216-	422 200 11 01/ 16 01
1922 (151-160 kW) Eng.OM441.905/914/923/926	89-94	PA873				403 200 71 01
	89-94	PA1302			For vehicles with retarder, w/o pulley	422 200 06 01
	86-	PA1309			For vehicles without retarder; Eng. -744215	403 200 76 01/ 77 01 422 200 13 01/ 14 01,441 200 03 01
	89-94	PA1328			Eng. 744216-	422 200 11 01/ 16 01
1935 S,K,AS,AK (250-260-269 kW) Eng.OM442.942,944,963,964,976	89-94	PA873				403 200 71 01
	89-94	PA1302			For vehicles with retarder, w/o pulley	422 200 06 01
	86-	PA1309			For vehicles without retarder; Eng. -744215	403 200 76 01/ 77 01 422 200 13 01/ 14 01,441 200 03 01
	89-94	PA1328			Eng. 744216-	422 200 11 01/ 16 01
2024,2031,2631 Eng.OM445/441	89-96	PA873				403 200 71 01
	87-96	PA1302			For vehicles with retarder, w/o pulley	422 200 06 01
	87-96	PA1328			Eng. 744216-	422 200 11 01/ 16 01
2031,2038,2044,2050 Eng.OM440/446	87-96	PA1328			Eng. 744216-	422 200 11 01/ 16 01
2031,2038,2538,2629,2635,2638 Eng.OM402/440	91-96	PA873				403 200 71 01
	87-96	PA1292			For vehicles without retarder; Eng. 744216-	403 200 27 01/ 32 01/ 34 01 403 200 35 01/ 49 01/ 70 01
	86-	PA1309			For vehicles without retarder; Eng. -744215	403 200 76 01/ 77 01 422 200 13 01/ 14 01,441 200 03 01
	87-96	PA1328			Eng. 744216-	422 200 11 01/ 16 01
2435,2448,2538,2544,2550,2553 Eng.OM440/446	87-96	PA1328			Eng. 744216-	422 200 11 01/ 16 01
2629,2635,2638,2644,2650 Eng.OM440/446	87-96	PA1328			Eng. 744216-	422 200 11 01/ 16 01
3233,3234,3534 Eng.OM445/441	89-96	PA873				403 200 71 01
	87-96	PA1302			For vehicles with retarder, w/o pulley	422 200 06 01
	87-96	PA1328			Eng. 744216-	422 200 11 01/ 16 01
3235,3238,3253,3535,3538,3550 Eng.OM440/446	87-96	PA1328			Eng. 744216-	422 200 11 01/ 16 01
3238,3535 Eng.OM402/440	91-96	PA873				403 200 71 01
	87-96	PA1292			For vehicles without retarder; Eng. 744216-	403 200 27 01/ 32 01/ 34 01 403 200 35 01/ 49 01/ 70 01
	86-	PA1309			For vehicles without retarder; Eng. -744215	403 200 76 01/ 77 01 422 200 13 01/ 14 01,441 200 03 01
	87-96	PA1328			Eng. 744216-	422 200 11 01/ 16 01
3336 (261 kW) Eng.OM423.905	81-91	PA1298			For vehicles without retarder, w/o pulley; Impeller Ø 135mm, Incl Electronic fuel Injection pump	403 200 57 01,422 200 05 01/ 10 01

Tourino (O 510) '10/03-

TOURINO (180 kW) Eng.OM906.962	03-	PA1320			For vehicles without retarder	904 200 02 01/ 04 01/ 06 01/ 07 01/ 08 01 904 200 19 01/ 20 01/ 22 01/ 25 01/ 26 01 904 200 27 01/ 28 01/ 29 01/ 32 01/ 38 01 904 200 43 01/ 49 01/ 50 01

			
PA1295	PA1299	PA1303	PA1320
			
PA1326	PA1327	PA1329	PA1333
			
PA1341	PA1342		

		GRAF ref.			NOTE	Adaptable for OES
TOURINO (180 kW) Eng.OM906.962	03-	PA1333				906 200 09 01/ 12 01/ 13 01/ 14 01/ 18 01 906 200 20 01/ 22 01/ 24 01/ 29 01/ 32 01 906 200 38 01/ 42 01/ 45 01/ 48 01/ 54 01 906 200 57 01/ 65 01
TOURINO (205 kW) Eng.OM906.961	03-	PA1320			For vehicles without retarder	904 200 02 01/ 04 01/ 06 01/ 07 01/ 08 01 904 200 19 01/ 20 01/ 22 01/ 25 01/ 26 01 904 200 27 01/ 28 01/ 29 01/ 32 01/ 38 01 904 200 43 01/ 49 01/ 50 01
	03-	PA1333				906 200 09 01/ 12 01/ 13 01/ 14 01/ 18 01 906 200 20 01/ 22 01/ 24 01/ 29 01/ 32 01 906 200 38 01/ 42 01/ 45 01/ 48 01/ 54 01 906 200 57 01/ 65 01
Touro (O 500) '10/01-						
Touro (260 kW) Eng.OM457.944	01-	PA1326			For vehicles with retarder; Open hole	457 200 02 01/ 05 01/ 11 01/ 25 01/ 27 01
	01-	PA1327			For vehicles with retarder; Close hole	442 200 04 01/ 06 01/ 07 01/ 09 01 457 200 10 01/ 24 01/ 28 01
	01-	PA1329			For vehicles without retarder	457 200 08 01/ 19 01/ 23 01/ 29 01
Touro (310 kW) Eng.OM457.944	01-	PA1326			For vehicles with retarder; Open hole	457 200 02 01/ 05 01/ 11 01/ 25 01/ 27 01
	01-	PA1327			For vehicles with retarder; Close hole	442 200 04 01/ 06 01/ 07 01/ 09 01 457 200 10 01/ 24 01/ 28 01
	01-	PA1329			For vehicles without retarder	457 200 08 01/ 19 01/ 23 01/ 29 01
Travego (O 580) '10/99-						
O 580-15 (260 kW) Eng.OM457.940	99-	PA1326			For vehicles with retarder; Open hole	457 200 02 01/ 05 01/ 11 01/ 25 01/ 27 01
	99-	PA1327			For vehicles with retarder; Close hole	442 200 04 01/ 06 01/ 07 01/ 09 01 457 200 10 01/ 24 01/ 28 01
	99-	PA1329			For vehicles without retarder	457 200 08 01/ 19 01/ 23 01/ 29 01
O 580-15 (300 kW) Eng.OM457.936/.938	99-	PA1326			For vehicles with retarder; Open hole	457 200 02 01/ 05 01/ 11 01/ 25 01/ 27 01
	99-	PA1327			For vehicles with retarder; Close hole	442 200 04 01/ 06 01/ 07 01/ 09 01 457 200 10 01/ 24 01/ 28 01
	99-	PA1329			For vehicles without retarder	457 200 08 01/ 19 01/ 23 01/ 29 01
O 580-17 (310 kW) Eng.OM457.944	99-	PA1326			For vehicles with retarder; Open hole	457 200 02 01/ 05 01/ 11 01/ 25 01/ 27 01
	99-	PA1327			For vehicles with retarder; Close hole	442 200 04 01/ 06 01/ 07 01/ 09 01 457 200 10 01/ 24 01/ 28 01
	99-	PA1329			For vehicles without retarder	457 200 08 01/ 19 01/ 23 01/ 29 01
O 580-17 (320 kW) Eng.OM542.948	99-	PA1341			For vehicles without retarder; With fastening eyes for axial fan	542 200 25 01
	99-	PA1342			For vehicles with retarder; With fastening eyes for axial fan	542 200 26 01
O 580-17 (350 kW) Eng.OM542.948	99-	PA1341			For vehicles without retarder; With fastening eyes for axial fan	542 200 25 01
	99-	PA1342			For vehicles with retarder; With fastening eyes for axial fan	542 200 26 01
Unimog '1/73-'12/00						
100,110,1100L (74-81 kW) Eng.OM353.901/.940/.980	77-88	PA1295			Impeller Ø 88mm	352 200 38 01/ 74 01/ 84 01/ 94 01/ 353 200 03 01/ 04 01/ 36 01/ 29 01/ 42 01
	77-88	PA1299			Impeller Ø 94,5mm	353 200 21 01/ 37 01
100,110T,1100T (74-81 kW) Eng.OM353.901/.940/.980	77-88	PA1295			Impeller Ø 88mm	352 200 38 01/ 74 01/ 84 01/ 94 01/ 353 200 03 01/ 04 01/ 36 01/ 29 01/ 42 01
	77-88	PA1299			Impeller Ø 94,5mm	353 200 21 01/ 37 01
1000 (70 kW) Eng.OM353.962	77-88	PA1295			Impeller Ø 88mm	352 200 38 01/ 74 01/ 84 01/ 94 01/ 353 200 03 01/ 04 01/ 36 01/ 29 01/ 42 01
	77-88	PA1299			Impeller Ø 94,5mm	353 200 21 01/ 37 01
1000T (81 kW) Eng.OM353.940/.980	77-82	PA1295			Impeller Ø 88mm	352 200 38 01/ 74 01/ 84 01/ 94 01/ 353 200 03 01/ 04 01/ 36 01/ 29 01/ 42 01
	77-82	PA1299			Impeller Ø 94,5mm	353 200 21 01/ 37 01
110,110L (75-77 kW) Eng.OM364.955/.958	92-00	PA1303				364 200 01 01/ 09 01/ 14 01/ 20 01
1150,1150L (81 kW) Eng.OM353.940	88-00	PA1295			Impeller Ø 88mm	352 200 38 01/ 74 01/ 84 01/ 94 01/ 353 200 03 01/ 04 01/ 36 01/ 29 01/ 42 01
	88-00	PA1299			Impeller Ø 94,5mm	353 200 21 01/ 37 01

			
<p>PA870</p>	<p>PA1295</p>	<p>PA1299</p>	<p>PA1303</p>
			
<p>PA1325</p>			

		GRAF ref.			NOTE	Adaptable for OES
1150L (92 kW) Eng.OM353.907	77-88	PA870				353 200 56 01
	88-00	PA1295			Impeller Ø 88mm	352 200 38 01/ 74 01/ 84 01/ 94 01/ 353 200 03 01/ 04 01/ 36 01/ 29 01/ 42 01
	88-00	PA1299			Impeller Ø 94,5mm	353 200 21 01/ 37 01
1200 (92 kW) Eng.OM353.973/.995	77-88	PA870				353 200 56 01
	82-84	PA1295			Impeller Ø 88mm	352 200 38 01/ 74 01/ 84 01/ 94 01/ 353 200 03 01/ 04 01/ 36 01/ 29 01/ 42 01
	82-84	PA1299			Impeller Ø 94,5mm	353 200 21 01/ 37 01
1200 (92 kW) Eng.OM356.950/.954	92-00	PA1325				366 200 54 01/ 67 01/ 68 01 390 200 00 01
1200 (92 kW) Eng.OM366.949	88-00	PA1325				366 200 54 01/ 67 01/ 68 01 390 200 00 01
1200T (92 kW) Eng.OM353.973/.995	77-88	PA870				353 200 56 01
	83-84	PA1295			Impeller Ø 88mm	352 200 38 01/ 74 01/ 84 01/ 94 01/ 353 200 03 01/ 04 01/ 36 01/ 29 01/ 42 01
	83-84	PA1299			Impeller Ø 94,5mm	353 200 21 01/ 37 01
1200T (92 kW) Eng.OM356.954	91-00	PA1325				366 200 54 01/ 67 01/ 68 01 390 200 00 01
1200T (92 kW) Eng.OM366.949	88-00	PA1325				366 200 54 01/ 67 01/ 68 01 390 200 00 01
125,1100L (92 kW) Eng.OM353.907	77-88	PA870				353 200 56 01
	77-88	PA1295			Impeller Ø 88mm	352 200 38 01/ 74 01/ 84 01/ 94 01/ 353 200 03 01/ 04 01/ 36 01/ 29 01/ 42 01
	77-88	PA1299			Impeller Ø 94,5mm	353 200 21 01/ 37 01
1250 (92 kW) Eng.OM353.973/.995	77-88	PA870				353 200 56 01
	84-	PA1295			Impeller Ø 88mm	352 200 38 01/ 74 01/ 84 01/ 94 01/ 353 200 03 01/ 04 01/ 36 01/ 29 01/ 42 01
	84-	PA1299			Impeller Ø 94,5mm	353 200 21 01/ 37 01
1250,1250L (92 kW) Eng.OM356.950/.954	92-00	PA1325				366 200 54 01/ 67 01/ 68 01 390 200 00 01
1250,1250L (92 kW) Eng.OM366.949	88-00	PA1325				366 200 54 01/ 67 01/ 68 01 390 200 00 01
1250L (100 kW) Eng.OM366.955	88-00	PA1325				366 200 54 01/ 67 01/ 68 01 390 200 00 01
130,140 (98-103 kW) Eng.OM364.982/.985	92-00	PA1303				364 200 01 01/ 09 01/ 14 01/ 20 01
1300 (92 kW) Eng.OM353.973/.995	77-88	PA870				353 200 56 01
	77-84	PA1295			Impeller Ø 88mm	352 200 38 01/ 74 01/ 84 01/ 94 01/ 353 200 03 01/ 04 01/ 36 01/ 29 01/ 42 01
	77-84	PA1299			Impeller Ø 94,5mm	353 200 21 01/ 37 01
1300,1300L (92-96 kW) Eng.OM353.961/.973	77-88	PA870				353 200 56 01
	77-88	PA1295			Impeller Ø 88mm	352 200 38 01/ 74 01/ 84 01/ 94 01/ 353 200 03 01/ 04 01/ 36 01/ 29 01/ 42 01
	77-88	PA1299			Impeller Ø 94,5mm	353 200 21 01/ 37 01
1350L (100 kW) Eng.OM366.955	88-00	PA1325				366 200 54 01/ 67 01/ 68 01 390 200 00 01
1400 (100 kW) Eng.OM366.947/.948	88-00	PA1325				366 200 54 01/ 67 01/ 68 01 390 200 00 01
1400 (100 kW) Eng.OM366.955/.956	88-00	PA1325				366 200 54 01/ 67 01/ 68 01 390 200 00 01
140L (100-103 kW) Eng.OM364.985	93-00	PA1303				364 200 01 01/ 09 01/ 14 01/ 20 01
140T (98 kW) Eng.OM364.982	92-00	PA1303				364 200 01 01/ 09 01/ 14 01/ 20 01
1450,1450L (100 kW) Eng.OM366.947/.948	88-00	PA1325				366 200 54 01/ 67 01/ 68 01 390 200 00 01
1450,1450L (100 kW) Eng.OM366.955/.956	88-00	PA1325				366 200 54 01/ 67 01/ 68 01 390 200 00 01
1500 (110 kW) Eng.OM353.958	77-88	PA1295			Impeller Ø 88mm	352 200 38 01/ 74 01/ 84 01/ 94 01/ 353 200 03 01/ 04 01/ 36 01/ 29 01/ 42 01
	77-88	PA1299			Impeller Ø 94,5mm	353 200 21 01/ 37 01
1500T (110 kW) Eng.OM353.958	77-88	PA1295			Impeller Ø 88mm	352 200 38 01/ 74 01/ 84 01/ 94 01/ 353 200 03 01/ 04 01/ 36 01/ 29 01/ 42 01
	77-88	PA1299			Impeller Ø 94,5mm	353 200 21 01/ 37 01
1550 (110 kW) Eng.OM353.958	86-88	PA1295			Impeller Ø 88mm	352 200 38 01/ 74 01/ 84 01/ 94 01/ 353 200 03 01/ 04 01/ 36 01/ 29 01/ 42 01
	86-88	PA1299			Impeller Ø 94,5mm	353 200 21 01/ 37 01
1550L (100 kW) Eng.OM366.955/.956	88-00	PA1325				366 200 54 01/ 67 01/ 68 01 390 200 00 01

			
<p>PA870</p>	<p>PA1295</p>	<p>PA1299</p>	<p>PA1320</p>
			
<p>PA1325</p>	<p>PA1333</p>		

		GRAF ref.			NOTE	Adaptable for OES
1550L (125 kW) Eng.OM366.963	92-00	PA1325				366 200 54 01/ 67 01/ 68 01 390 200 00 01
1550L (150-157 kW) Eng.OM366.984	88-00	PA1325				366 200 54 01/ 67 01/ 68 01 390 200 00 01
1550L (92-96 kW) Eng.OM353.961/.995	77-88	PA870				353 200 56 01
	86-88	PA1295			Impeller Ø 88mm	352 200 38 01/ 74 01/ 84 01/ 94 01/ 353 200 03 01/ 04 01/ 36 01/ 29 01/ 42 01
	86-88	PA1299			Impeller Ø 94,5mm	353 200 21 01/ 37 01
1600 (115 kW) Eng.OM366.949	88-00	PA1325				366 200 54 01/ 67 01/ 68 01 390 200 00 01
1600 (150-157 kW) Eng.OM366.984	89-00	PA1325				366 200 54 01/ 67 01/ 68 01 390 200 00 01
1650,1650L (115 kW) Eng.OM366.948/.949	88-00	PA1325				366 200 54 01/ 67 01/ 68 01 390 200 00 01
1650,1650L (150-157 kW) Eng.OM366.984	89-00	PA1325				366 200 54 01/ 67 01/ 68 01 390 200 00 01
1700,1700L (122-125 kW) Eng.OM366.963	88-00	PA1325				366 200 54 01/ 67 01/ 68 01 390 200 00 01
1700,1700L (124 kW) Eng.OM353.959	78-88	PA1295			Impeller Ø 88mm	352 200 38 01/ 74 01/ 84 01/ 94 01/ 353 200 03 01/ 04 01/ 36 01/ 29 01/ 42 01
	78-88	PA1299			Impeller Ø 94,5mm	353 200 21 01/ 37 01
1700L (124 kW) Eng.OM353.959	78-88	PA1295			Impeller Ø 88mm	352 200 38 01/ 74 01/ 84 01/ 94 01/ 353 200 03 01/ 04 01/ 36 01/ 29 01/ 42 01
	78-88	PA1299			Impeller Ø 94,5mm	353 200 21 01/ 37 01
1700T (122-125 kW) Eng.OM366.963	88-00	PA1325				366 200 54 01/ 67 01/ 68 01 390 200 00 01
2100 (155-157 kW) Eng.OM366.984	89-00	PA1325				366 200 54 01/ 67 01/ 68 01 390 200 00 01
2100T (155-157 kW) Eng.OM366.984	89-00	PA1325				366 200 54 01/ 67 01/ 68 01 390 200 00 01
2150 (155-157 kW) Eng.OM366.984	89-00	PA1325				366 200 54 01/ 67 01/ 68 01 390 200 00 01
2150,2150L (155-157 kW) Eng.OM366.984	89-00	PA1325				366 200 54 01/ 67 01/ 68 01 390 200 00 01
300 (110 kW) Eng.OM904.927	03/00-12/00	PA1320			For vehicles without retarder	904 200 02 01/ 04 01/ 06 01/ 07 01/ 08 01 904 200 19 01/ 20 01/ 22 01/ 25 01/ 26 01 904 200 27 01/ 28 01/ 29 01/ 32 01/ 38 01 904 200 43 01/ 49 01/ 50 01
300 (130 kW) Eng.OM904.928	03/00-12/00	PA1320			For vehicles without retarder	904 200 02 01/ 04 01/ 06 01/ 07 01/ 08 01 904 200 19 01/ 20 01/ 22 01/ 25 01/ 26 01 904 200 27 01/ 28 01/ 29 01/ 32 01/ 38 01 904 200 43 01/ 49 01/ 50 01
3000 (110 kW) Eng.OM904.953	03/00-12/00	PA1320			For vehicles without retarder	904 200 02 01/ 04 01/ 06 01/ 07 01/ 08 01 904 200 19 01/ 20 01/ 22 01/ 25 01/ 26 01 904 200 27 01/ 28 01/ 29 01/ 32 01/ 38 01 904 200 43 01/ 49 01/ 50 01
3000 (130 kW) Eng.OM904.952	03/00-12/00	PA1320			For vehicles without retarder	904 200 02 01/ 04 01/ 06 01/ 07 01/ 08 01 904 200 19 01/ 20 01/ 22 01/ 25 01/ 26 01 904 200 27 01/ 28 01/ 29 01/ 32 01/ 38 01 904 200 43 01/ 49 01/ 50 01
400 (130 kW) Eng.OM904.928	03/00-12/00	PA1320			For vehicles without retarder	904 200 02 01/ 04 01/ 06 01/ 07 01/ 08 01 904 200 19 01/ 20 01/ 22 01/ 25 01/ 26 01 904 200 27 01/ 28 01/ 29 01/ 32 01/ 38 01 904 200 43 01/ 49 01/ 50 01
400 (170 kW) Eng.OM906.935	03/00-12/00	PA1333				906 200 09 01/ 12 01/ 13 01/ 14 01/ 18 01 906 200 20 01/ 22 01/ 24 01/ 29 01/ 32 01 906 200 38 01/ 42 01/ 45 01/ 48 01/ 54 01 906 200 57 01/ 65 01

			
<p>PA1295</p>	<p>PA1296</p>	<p>PA1299</p>	<p>PA1300</p>
			
<p>PA1320</p>	<p>PA1333</p>		

		GRAF ref.			NOTE	Adaptable for OES
4000 (110 kW) Eng.OM904.953	03/00-12/00	PA1320			For vehicles without retarder	904 200 02 01/ 04 01/ 06 01/ 07 01/ 08 01 904 200 19 01/ 20 01/ 22 01/ 25 01/ 26 01 904 200 27 01/ 28 01/ 29 01/ 32 01/ 38 01 904 200 43 01/ 49 01/ 50 01
4000 (130 kW) Eng.OM904.952	03/00-12/00	PA1320			For vehicles without retarder	904 200 02 01/ 04 01/ 06 01/ 07 01/ 08 01 904 200 19 01/ 20 01/ 22 01/ 25 01/ 26 01 904 200 27 01/ 28 01/ 29 01/ 32 01/ 38 01 904 200 43 01/ 49 01/ 50 01
500,GNNA (170-172 kW) Eng.OM906.935	03/00-12/00	PA1320			For vehicles without retarder	904 200 02 01/ 04 01/ 06 01/ 07 01/ 08 01 904 200 19 01/ 20 01/ 22 01/ 25 01/ 26 01 904 200 27 01/ 28 01/ 29 01/ 32 01/ 38 01 904 200 43 01/ 49 01/ 50 01
	10/00-12/00	PA1333				906 200 09 01/ 12 01/ 13 01/ 14 01/ 18 01 906 200 20 01/ 22 01/ 24 01/ 29 01/ 32 01 906 200 38 01/ 42 01/ 45 01/ 48 01/ 54 01 906 200 57 01/ 65 01
500,GNNA (205-209 kW) Eng.OM906.955/.967	03/00-12/00	PA1320			For vehicles without retarder	904 200 02 01/ 04 01/ 06 01/ 07 01/ 08 01 904 200 19 01/ 20 01/ 22 01/ 25 01/ 26 01 904 200 27 01/ 28 01/ 29 01/ 32 01/ 38 01 904 200 43 01/ 49 01/ 50 01
	10/00-12/00	PA1333				906 200 09 01/ 12 01/ 13 01/ 14 01/ 18 01 906 200 20 01/ 22 01/ 24 01/ 29 01/ 32 01 906 200 38 01/ 42 01/ 45 01/ 48 01/ 54 01 906 200 57 01/ 65 01
54 (40 kW) Eng.OM314.916	66-72	PA1296			Eng -456936	
	66-72	PA1300			Eng 456937-	314 200 35 01/ 41 01/ 47 01
65,70 (48 kW) Eng.OM352.919	65-66	PA1295			Impeller Ø 88mm	352 200 38 01/ 74 01/ 84 01/ 94 01/ 353 200 03 01/ 04 01/ 36 01/ 29 01/ 42 01
	65-66	PA1299			Impeller Ø 94,5mm	353 200 21 01/ 37 01
65T,70T (48 kW) Eng.OM352.919	65-66	PA1295			Impeller Ø 88mm	352 200 38 01/ 74 01/ 84 01/ 94 01/ 353 200 03 01/ 04 01/ 36 01/ 29 01/ 42 01
	69-88	PA1299			Impeller Ø 94,5mm	353 200 21 01/ 37 01
66,72 (55 kW) Eng.OM314.917	69-88	PA1296			Eng -456936	
	69-88	PA1300			Eng 456937-	314 200 35 01/ 41 01/ 47 01
72,80 (48-55 kW) Eng.OM314.917	69-77	PA1296			Eng -456936	
	69-77	PA1300			Eng 456937-	314 200 35 01/ 41 01/ 47 01
80,84,90 (62-66 kW) Eng.OM352.903	69-76	PA1295			Impeller Ø 88mm	352 200 38 01/ 74 01/ 84 01/ 94 01/ 353 200 03 01/ 04 01/ 36 01/ 29 01/ 42 01
	69-00	PA1299			Impeller Ø 94,5mm	353 200 21 01/ 37 01
80,84,90 (62-66 kW) Eng.OM353.902	69-88	PA1295			Impeller Ø 88mm	352 200 38 01/ 74 01/ 84 01/ 94 01/ 353 200 03 01/ 04 01/ 36 01/ 29 01/ 42 01
	69-76	PA1299			Impeller Ø 94,5mm	353 200 21 01/ 37 01
800 (53-55 kW) Eng.OM314.917	05/88-12/88	PA1296			Eng -456936	
	77-88	PA1296			Eng -456936	
	05/88-12/88	PA1300			Eng 456937-	314 200 35 01/ 41 01/ 47 01
	77-88	PA1300			Eng 456937-	314 200 35 01/ 41 01/ 47 01
800L (53-55 kW) Eng.OM314.917	77-88	PA1296			Eng -456936	
	77-88	PA1300			Eng 456937-	314 200 35 01/ 41 01/ 47 01
80T,90T (59-66 kW) Eng.OM352.903/.984	69-00	PA1295			Impeller Ø 88mm	352 200 38 01/ 74 01/ 84 01/ 94 01/ 353 200 03 01/ 04 01/ 36 01/ 29 01/ 42 01
	77-00	PA1299			Impeller Ø 94,5mm	353 200 21 01/ 37 01
900 (62 kW) Eng.OM353.902	77-00	PA1295			Impeller Ø 88mm	352 200 38 01/ 74 01/ 84 01/ 94 01/ 353 200 03 01/ 04 01/ 36 01/ 29 01/ 42 01
	77-88	PA1299			Impeller Ø 94,5mm	353 200 21 01/ 37 01
900 (81 kW) Eng.OM353.940	77-88	PA1295			Impeller Ø 88mm	352 200 38 01/ 74 01/ 84 01/ 94 01/ 353 200 03 01/ 04 01/ 36 01/ 29 01/ 42 01
	67-77	PA1299			Impeller Ø 94,5mm	353 200 21 01/ 37 01



PA1320



PA1333



PA1343



		GRAF ref.			NOTE	Adaptable for OES
Zetros '9/08-						
1833A (240 kW) Eng.OM926.935/.936/.947	08-	PA1320			For vehicles without retarder	904 200 02 01/ 04 01/ 06 01/ 07 01/ 08 01 904 200 19 01/ 20 01/ 22 01/ 25 01/ 26 01 904 200 27 01/ 28 01/ 29 01/ 32 01/ 38 01 904 200 43 01/ 49 01/ 50 01
	08-	PA1333				906 200 09 01/ 12 01/ 13 01/ 14 01/ 18 01 906 200 20 01/ 22 01/ 24 01/ 29 01/ 32 01 906 200 38 01/ 42 01/ 45 01/ 48 01/ 54 01 906 200 57 01/ 65 01
2733A (240 kW) Eng.OM926.935/.936/.947	08-	PA1320			For vehicles without retarder	904 200 02 01/ 04 01/ 06 01/ 07 01/ 08 01 904 200 19 01/ 20 01/ 22 01/ 25 01/ 26 01 904 200 27 01/ 28 01/ 29 01/ 32 01/ 38 01 904 200 43 01/ 49 01/ 50 01
	08-	PA1333				906 200 09 01/ 12 01/ 13 01/ 14 01/ 18 01 906 200 20 01/ 22 01/ 24 01/ 29 01/ 32 01 906 200 38 01/ 42 01/ 45 01/ 48 01/ 54 01 906 200 57 01/ 65 01

RENAULT TRUCK





Agora Bus '1/95-						
Agora (186-188 kW) Eng.MIDR0620.45	95-	PA1343		•		50 01 837 309,50 10 330 029
C '10/80-'6/97						
C 260.19 (192 kW) Eng.MIDS0620.45	80-89	PA1343		•		50 01 837 309,50 10 330 029
C 260.26 (192 kW) Eng.MIDS0620.45	85-89	PA1343		•		50 01 837 309,50 10 330 029
C 280.19 (202 kW) Eng.MIDS0620.45	92-96	PA1343		•		50 01 837 309,50 10 330 029
C 290.19,C 300.19 (214-222 kW) Eng.MIDR0620.45	90-91	PA1343		•		50 01 837 309,50 10 330 029
	92-	PA1343		•		50 01 837 309,50 10 330 029
C 290.19/T (214 kW) Eng.MIDR0620.45	90-91	PA1343		•		50 01 837 309,50 10 330 029
C 290.26,C 300.26 (214-222 kW) Eng.MIDR0620.45	90-91	PA1343		•		50 01 837 309,50 10 330 029
	92-	PA1343		•		50 01 837 309,50 10 330 029
	92-97	PA1343		•		50 01 837 309,50 10 330 029
C 300.19 (222 kW) Eng.MIDR0620.45	90-91	PA1343		•		50 01 837 309,50 10 330 029
C 300.24 (222 kW) Eng.MIDR0620.45	90-91	PA1343		•		50 01 837 309,50 10 330 029
C 300.26 (222 kW) Eng.MIDR0620.45	90-91	PA1343		•		50 01 837 309,50 10 330 029
C 340.19/T (249 kW) Eng.MIDR0620.45	91-96	PA1343		•		50 01 837 309,50 10 330 029
C 340ti.17/T (249 kW) Eng.MIDR0620.45	91-96	PA1343		•		50 01 837 309,50 10 330 029
C 340ti.19/T (249 kW) Eng.MIDR0620.45	91-96	PA1343		•		50 01 837 309,50 10 330 029
CCH 300.26 (222 kW) Eng.MIDR0620.45	91-92	PA1343		•		50 01 837 309,50 10 330 029
CCH 300.30 (222 kW) Eng.MIDR0620.45	91-92	PA1343		•		50 01 837 309,50 10 330 029

G '10/80-'10/96

G 220.17 (161 kW) Eng.MIDS0620.45	91-92	PA1343		•		50 01 837 309,50 10 330 029
G 220.19 (161 kW) Eng.MIDS0620.45	91-92	PA1343		•		50 01 837 309,50 10 330 029
G 260.15 (192-202 kW) Eng.MIDS0620.45	80-89	PA1343		•		50 01 837 309,50 10 330 029
G 260.16 (192-202 kW) Eng.MIDS0620.45	85-89	PA1343		•		50 01 837 309,50 10 330 029
G 260.17 (192-202 kW) Eng.MIDS0620.45	80-89	PA1343		•		50 01 837 309,50 10 330 029
G 260.17 (202 kW) Eng.MIDS0620.45	90-91	PA1343		•		50 01 837 309,50 10 330 029
G 260.19 (192-202 kW) Eng.MIDS0620.45	80-89	PA1343		•		50 01 837 309,50 10 330 029
G 260.22 (192-202 kW) Eng.MIDS0620.45	87-89	PA1343		•		50 01 837 309,50 10 330 029
G 260.24 (192-202 kW) Eng.MIDS0620.45	87-89	PA1343		•		50 01 837 309,50 10 330 029
G 280.13 (202 kW) Eng.MIDS0620.45	90-91	PA1343		•		50 01 837 309,50 10 330 029
G 280.15 (202 kW) Eng.MIDS0620.45	90-91	PA1343		•		50 01 837 309,50 10 330 029
G 280.16 (202 kW) Eng.MIDS0620.45	90-91	PA1343		•		50 01 837 309,50 10 330 029
G 280.18 (202 kW) Eng.MIDS0620.45	90-91	PA1343		•		50 01 837 309,50 10 330 029
G 280.19 (202 kW) Eng.MIDS0620.45	90-91	PA1343		•		50 01 837 309,50 10 330 029
G 280.24 (202 kW) Eng.MIDS0620.45	90-91	PA1343		•		50 01 837 309,50 10 330 029
G 280.26 (202 kW) Eng.MIDS0620.45	90-91	PA1343		•		50 01 837 309,50 10 330 029
G 290.17 (214-222 kW) Eng.MIDR0620.45	85-90	PA1343		•		50 01 837 309,50 10 330 029
G 290.19 (214-222 kW) Eng.MIDR0620.45	85-90	PA1343		•		50 01 837 309,50 10 330 029

			
PA1204	PA1340	PA1343	



		GRAF ref.			NOTE	Adaptable for OES
G 290.22 (214-222 kW) Eng.MIDR0620.45	85-90	PA1343		•		50 01 837 309,50 10 330 029
G 290.24 (214-222 kW) Eng.MIDR0620.45	85-90	PA1343		•		50 01 837 309,50 10 330 029
G 290.26 (214-222 kW) Eng.MIDR0620.45	85-90	PA1343		•		50 01 837 309,50 10 330 029
G 300.13 (222 kW) Eng.MIDR0620.45	90-91	PA1343		•		50 01 837 309,50 10 330 029
G 300.15 (222 kW) Eng.MIDR0620.45	90-91	PA1343		•		50 01 837 309,50 10 330 029
G 300.16 (222 kW) Eng.MIDR0620.45	90-91	PA1343		•		50 01 837 309,50 10 330 029
G 300.17 (222 kW) Eng.MIDR0620.45	3/91-10/91	PA1343		•		50 01 837 309,50 10 330 029
G 300.19 (222 kW) Eng.MIDR0620.45	86-91	PA1343		•		50 01 837 309,50 10 330 029
G 300.24 (222 kW) Eng.MIDR0620.45	88-91	PA1343		•		50 01 837 309,50 10 330 029
G 300.25 (222 kW) Eng.MIDR0620.45	88-91	PA1343		•		50 01 837 309,50 10 330 029
G 300.26 (222 kW) Eng.MIDR0620.45	88-91	PA1343		•		50 01 837 309,50 10 330 029
G 320.19 (240 kW) Eng.MIDR0620.45	91-92	PA1343		•		50 01 837 309,50 10 330 029
G 320.24 (240 kW) Eng.MIDR0620.45	91-92	PA1343		•		50 01 837 309,50 10 330 029
G 330.13 (240 kW) Eng.MIDR0620.45	90-92	PA1343		•		50 01 837 309,50 10 330 029
G 330.15 (240 kW) Eng.MIDR0620.45	91-92	PA1343		•		50 01 837 309,50 10 330 029
G 330.16 (240 kW) Eng.MIDR0620.45	91-92	PA1343		•		50 01 837 309,50 10 330 029
G 330.17 (240 kW) Eng.MIDR0620.45	91-92	PA1343		•		50 01 837 309,50 10 330 029
G 330.24 (240 kW) Eng.MIDR0620.45	91-92	PA1343		•		50 01 837 309,50 10 330 029
G 330.26 (240 kW) Eng.MIDR0620.45	91-92	PA1343		•		50 01 837 309,50 10 330 029
G 340ti.19/T,G 330.19/T (240-249 kW) Eng.MIDR0620.45	92-96	PA1343		•		50 01 837 309,50 10 330 029
Kerax '4/96-						
260.18 (188 kW) Eng.MIDR0620.45	96-	PA1343		•		50 01 837 309,50 10 330 029
260.18/B (188 kW) Eng.MIDR0620.45	96-	PA1343		•		50 01 837 309,50 10 330 029
270.18 (195 kW) Eng.dCi11-270	96-	PA1340		•		50 01 857 427,50 01 858 484 50 10 477 005/ 162/ 321/ 734 50 10 550 549/ 550/ 551/ 552 74 22 189 466
300.18/B (219 kW) Eng.MIDR0620.45	96-	PA1343		•		50 01 837 309,50 10 330 029
300.26/A (219 kW) Eng.MIDR0620.45	96-	PA1343		•		50 01 837 309,50 10 330 029
300.26/B (219 kW) Eng.MIDR0620.45	96-	PA1343		•		50 01 837 309,50 10 330 029
320.18 (230 kW) Eng.dCi11G	96-	PA1340		•		50 01 857 427,50 01 858 484 50 10 477 005/ 162/ 321/ 734 50 10 550 549/ 550/ 551/ 552 74 22 189 466
320.26 (230 kW) Eng.dCi11G	96-	PA1340		•		50 01 857 427,50 01 858 484 50 10 477 005/ 162/ 321/ 734 50 10 550 549/ 550/ 551/ 552 74 22 189 466
340.18 (249 kW) Eng.MIDR0620.45	96-	PA1343		•		50 01 837 309,50 10 330 029
340.18/B (249 kW) Eng.MIDR0620.45	96-	PA1343		•		50 01 837 309,50 10 330 029
340.26 (249 kW) Eng.MIDR0620.45	96-	PA1343		•		50 01 837 309,50 10 330 029
340.26/A (249 kW) Eng.MIDR0620.45	96-	PA1343		•		50 01 837 309,50 10 330 029
340.26/B (249 kW) Eng.MIDR0620.45	96-	PA1343		•		50 01 837 309,50 10 330 029
340.32/A (249 kW) Eng.MIDR0620.45	96-	PA1343		•		50 01 837 309,50 10 330 029
370.18 (266 kW) Eng.dCi11E	96-	PA1340		•		50 01 857 427,50 01 858 484 50 10 477 005/ 162/ 321/ 734 50 10 550 549/ 550/ 551/ 552 74 22 189 466
370.18 (272 kW) Eng.DXi11	96-	PA1204			w/o pulley	74 20 744 939/ 940,74 85 000 763 74 85 013 068
370.26 (266 kW) Eng.dCi11E	96-	PA1340		•		50 01 857 427,50 01 858 484 50 10 477 005/ 162/ 321/ 734 50 10 550 549/ 550/ 551/ 552 74 22 189 466
370.26 (272 kW) Eng.DXi11	96-	PA1204			w/o pulley	74 20 744 939/ 940,74 85 000 763 74 85 013 068
370.32 (266 kW) Eng.dCi11E	96-	PA1340		•		50 01 857 427,50 01 858 484 50 10 477 005/ 162/ 321/ 734 50 10 550 549/ 550/ 551/ 552 74 22 189 466
370.32 (272 kW) Eng.DXi11	96-	PA1204			w/o pulley	74 20 744 939/ 940,74 85 000 763 74 85 013 068
410.18 (302 kW) Eng.DXi11	96-	PA1204			w/o pulley	74 20 744 939/ 940,74 85 000 763 74 85 013 068

			
<p>PA1204</p>	<p>PA1332</p>	<p>PA1340</p>	<p>PA1344</p>



		GRAF ref.			NOTE	Adaptable for OES
410.26 (302 kW) Eng.DXi11	96-	PA1204			w/o pulley	74 20 744 939/ 940,74 85 000 763 74 85 013 068
410.32 (302 kW) Eng.DXi11	96-	PA1204			w/o pulley	74 20 744 939/ 940,74 85 000 763 74 85 013 068
420.18 (303 kW) Eng.dCi11C	96-	PA1340		•		50 01 857 427,50 01 858 484 50 10 477 005/ 162/ 321/ 734 50 10 550 549/ 550/ 551/ 552 74 22 189 466
420.26 (303 kW) Eng.dCi11C	96-	PA1340		•		50 01 857 427,50 01 858 484 50 10 477 005/ 162/ 321/ 734 50 10 550 549/ 550/ 551/ 552 74 22 189 466
420.32 (303 kW) Eng.dCi11C	96-	PA1340		•		50 01 857 427,50 01 858 484 50 10 477 005/ 162/ 321/ 734 50 10 550 549/ 550/ 551/ 552 74 22 189 466
420.34 (303 kW) Eng.dCi11C	96-	PA1340		•		50 01 857 427,50 01 858 484 50 10 477 005/ 162/ 321/ 734 50 10 550 549/ 550/ 551/ 552 74 22 189 466
450.18 (331 kW) Eng.DXi11	96-	PA1204			w/o pulley	74 20 744 939/ 940,74 85 000 763 74 85 013 068
450.26 (331 kW) Eng.DXi11	96-	PA1204			w/o pulley	74 20 744 939/ 940,74 85 000 763 74 85 013 068
450.32 (331 kW) Eng.DXi11	96-	PA1204			w/o pulley	74 20 744 939/ 940,74 85 000 763 74 85 013 068
460.32 (339 kW) Eng.DXi13	05-	PA1204			w/o pulley	74 20 744 939/ 940,74 85 000 763 74 85 013 068
	05-	PA1332		•		50 01 866 278,74 20 734 268
500.32 (368 kW) Eng.DXi13	05-	PA1332		•		50 01 866 278,74 20 734 268

Magnum '4/87-'12/13

AE 390.18 (287 kW) Eng.MIDR0624.65	92-	PA1344				50 01 863 728/ 754,50 01 875 237 52 00 537 899,52 00 551 856
AE 390.18T (287 kW) Eng.MIDR0624.65	92-	PA1344				50 01 863 728/ 754,50 01 875 237 52 00 537 899,52 00 551 856
AE 390.19 (287 kW) Eng.MIDR0624.65	92-	PA1344				50 01 863 728/ 754,50 01 875 237 52 00 537 899,52 00 551 856
AE 390.19T (287 kW) Eng.MIDR0624.65	92-	PA1344				50 01 863 728/ 754,50 01 875 237 52 00 537 899,52 00 551 856
AE 390.26 (287 kW) Eng.MIDR0624.65	92-	PA1344				50 01 863 728/ 754,50 01 875 237 52 00 537 899,52 00 551 856
AE 420ti.18 (305 kW) Eng.MIDR0635.40	92-	PA1344				50 01 863 728/ 754,50 01 875 237 52 00 537 899,52 00 551 856
AE 420ti.18T (305 kW) Eng.MIDR0635.40	92-	PA1344				50 01 863 728/ 754,50 01 875 237 52 00 537 899,52 00 551 856
AE 420ti.19 (305 kW) Eng.MIDR0635.40	92-	PA1344				50 01 863 728/ 754,50 01 875 237 52 00 537 899,52 00 551 856
AE 420ti.19T (305 kW) Eng.MIDR0635.40	92-	PA1344				50 01 863 728/ 754,50 01 875 237 52 00 537 899,52 00 551 856
AE 420ti.22T (305 kW) Eng.MIDR0635.40	92-	PA1344				50 01 863 728/ 754,50 01 875 237 52 00 537 899,52 00 551 856
AE 420ti.24 (305 kW) Eng.MIDR0635.40	92-	PA1344				50 01 863 728/ 754,50 01 875 237 52 00 537 899,52 00 551 856
AE 420ti.24T (305 kW) Eng.MIDR0635.40	92-	PA1344				50 01 863 728/ 754,50 01 875 237 52 00 537 899,52 00 551 856
AE 420ti.26 (305 kW) Eng.MIDR0635.40	92-	PA1344				50 01 863 728/ 754,50 01 875 237 52 00 537 899,52 00 551 856
AE 420ti.26T (305 kW) Eng.MIDR0635.40	92-	PA1344				50 01 863 728/ 754,50 01 875 237 52 00 537 899,52 00 551 856
AE 430.18 (316 kW) Eng.MIDR0624.65	92-	PA1344				50 01 863 728/ 754,50 01 875 237 52 00 537 899,52 00 551 856
AE 430.18T (316 kW) Eng.MIDR0624.65	92-	PA1344				50 01 863 728/ 754,50 01 875 237 52 00 537 899,52 00 551 856
AE 430.19 (316 kW) Eng.MIDR0624.65	92-	PA1344				50 01 863 728/ 754,50 01 875 237 52 00 537 899,52 00 551 856

			
<p>PA1332</p>	<p>PA1344</p>		

		GRAF ref.			NOTE	Adaptable for OES
AE 430.19T (316 kW) Eng.MIDR0624.65	92-	PA1344				50 01 863 728/ 754,50 01 875 237 52 00 537 899,52 00 551 856
AE 430.26 (316 kW) Eng.MIDR0624.65	94-	PA1344				50 01 863 728/ 754,50 01 875 237 52 00 537 899,52 00 551 856
AE 430.26T (316 kW) Eng.MIDR0624.65	96-	PA1344				50 01 863 728/ 754,50 01 875 237 52 00 537 899,52 00 551 856
AE 470.18 (346 kW) Eng.MIDR0624.65	92-	PA1344				50 01 863 728/ 754,50 01 875 237 52 00 537 899,52 00 551 856
AE 470.18T (346 kW) Eng.MIDR0624.65	92-	PA1344				50 01 863 728/ 754,50 01 875 237 52 00 537 899,52 00 551 856
AE 470.19 (346 kW) Eng.MIDR0624.65	92-	PA1344				50 01 863 728/ 754,50 01 875 237 52 00 537 899,52 00 551 856
AE 470.19T (346 kW) Eng.MIDR0624.65	92-	PA1344				50 01 863 728/ 754,50 01 875 237 52 00 537 899,52 00 551 856
AE 470.26 (346 kW) Eng.MIDR0624.65	92-	PA1344				50 01 863 728/ 754,50 01 875 237 52 00 537 899,52 00 551 856
AE 470.26T (346 kW) Eng.MIDR0624.65	92-	PA1344				50 01 863 728/ 754,50 01 875 237 52 00 537 899,52 00 551 856
AE 520.18 (390 kW) Eng.Mack-EE9-530	91-	PA1344				50 01 863 728/ 754,50 01 875 237 52 00 537 899,52 00 551 856
AE 520.18T (390 kW) Eng.Mack-EE9-530	92-	PA1344				50 01 863 728/ 754,50 01 875 237 52 00 537 899,52 00 551 856
AE 520.19 (390 kW) Eng.Mack-EE9-530	91-	PA1344				50 01 863 728/ 754,50 01 875 237 52 00 537 899,52 00 551 856
AE 520.19T (390 kW) Eng.Mack-EE9-530	92-	PA1344				50 01 863 728/ 754,50 01 875 237 52 00 537 899,52 00 551 856
AE 520.22T (390 kW) Eng.Mack-EE9-530	92-	PA1344				50 01 863 728/ 754,50 01 875 237 52 00 537 899,52 00 551 856
AE 520.24 (390 kW) Eng.Mack-EE9-530	92-	PA1344				50 01 863 728/ 754,50 01 875 237 52 00 537 899,52 00 551 856
AE 520.24T (390 kW) Eng.Mack-EE9-530	92-	PA1344				50 01 863 728/ 754,50 01 875 237 52 00 537 899,52 00 551 856
AE 520.26 (390 kW) Eng.Mack-EE9-530	92-	PA1344				50 01 863 728/ 754,50 01 875 237 52 00 537 899,52 00 551 856
AE 520.26T (390 kW) Eng.Mack-EE9-530	87-	PA1344				50 01 863 728/ 754,50 01 875 237 52 00 537 899,52 00 551 856
AE 560.18 (412 kW) Eng.Mack-EE9-560	92-	PA1344				50 01 863 728/ 754,50 01 875 237 52 00 537 899,52 00 551 856
AE 560.18T (412 kW) Eng.Mack-EE9-560	92-	PA1344				50 01 863 728/ 754,50 01 875 237 52 00 537 899,52 00 551 856
AE 560.19 (412 kW) Eng.Mack-EE9-560	92-	PA1344				50 01 863 728/ 754,50 01 875 237 52 00 537 899,52 00 551 856
AE 560.19T (412 kW) Eng.Mack-EE9-560	92-	PA1344				50 01 863 728/ 754,50 01 875 237 52 00 537 899,52 00 551 856
AE 560.26 (412 kW) Eng.Mack-EE9-560	92-	PA1344				50 01 863 728/ 754,50 01 875 237 52 00 537 899,52 00 551 856
AE 560.26T (412 kW) Eng.Mack-EE9-560	96-	PA1344				50 01 863 728/ 754,50 01 875 237 52 00 537 899,52 00 551 856
DXi 12 440.18 (324 kW) Eng.DXi12	01-	PA1332		•		50 01 866 278,74 20 734 268
DXi 12 440.18 T (324 kW) Eng.DXi12	01-	PA1332		•		50 01 866 278,74 20 734 268
DXi 12 440.24 (324 kW) Eng.DXi12	01-	PA1332		•		50 01 866 278,74 20 734 268
DXi 12 440.26 (324 kW) Eng.DXi12	01-	PA1332		•		50 01 866 278,74 20 734 268
DXi 12 440.26 T (324 kW) Eng.DXi12	01-	PA1332		•		50 01 866 278,74 20 734 268
DXi 12 480.18 (353 kW) Eng.DXi12	01-	PA1332		•		50 01 866 278,74 20 734 268
DXi 12 480.18 T (353 kW) Eng.DXi12	01-	PA1332		•		50 01 866 278,74 20 734 268
DXi 12 480.24 (353 kW) Eng.DXi12	01-	PA1332		•		50 01 866 278,74 20 734 268
DXi 12 480.26 (353 kW) Eng.DXi12	01-	PA1332		•		50 01 866 278,74 20 734 268
DXi 12 480.26 T (353 kW) Eng.DXi12	01-	PA1332		•		50 01 866 278,74 20 734 268
DXi 13 460.18 T (339 kW) Eng.DXi13	05-	PA1332		•		50 01 866 278,74 20 734 268
DXi 13 460.24 (339 kW) Eng.DXi13	05-	PA1332		•		50 01 866 278,74 20 734 268
DXi 13 460.25 (339 kW) Eng.DXi13	05-	PA1332		•		50 01 866 278,74 20 734 268
DXi 13 460.26 (339 kW) Eng.DXi13	05-	PA1332		•		50 01 866 278,74 20 734 268
DXi 13 460.26 T (339 kW) Eng.DXi13	05-	PA1332		•		50 01 866 278,74 20 734 268
DXi 13 500.18 T (368 kW) Eng.DXi13	05-	PA1332		•		50 01 866 278,74 20 734 268
DXi 13 500.24 (368 kW) Eng.DXi13	05-	PA1332		•		50 01 866 278,74 20 734 268
DXi 13 500.25 (368 kW) Eng.DXi13	05-	PA1332		•		50 01 866 278,74 20 734 268

			
<p>PA1332</p>	<p>PA1343</p>	<p>PA1344</p>	

		GRAF ref.			NOTE	Adaptable for OES
DXi 13 500.26 (368 kW) Eng.DXi13	05-	PA1332		•		50 01 866 278,74 20 734 268
DXi 13 500.26 T (368 kW) Eng.DXi13	05-	PA1332		•		50 01 866 278,74 20 734 268
DXi 13 520.19 (382 kW) Eng.DXi13	09-	PA1332		•		50 01 866 278,74 20 734 268
DXi 13 520.24 (382 kW) Eng.DXi13	09-	PA1332		•		50 01 866 278,74 20 734 268
DXi 13 520.25 (382 kW) Eng.DXi13	09-	PA1332		•		50 01 866 278,74 20 734 268
DXi 13 520.26 (382 kW) Eng.DXi13	09-	PA1332		•		50 01 866 278,74 20 734 268
E.TECH 400.18 (295 kW) Eng.MACKE.TECHA/46	00-	PA1344				50 01 863 728/ 754,50 01 875 237 52 00 537 899,52 00 551 856
E.TECH 400.18T (295 kW) Eng.MACKE.TECHA/46	00-	PA1344				50 01 863 728/ 754,50 01 875 237 52 00 537 899,52 00 551 856
E.TECH 400.24 (295 kW) Eng.MACKE.TECHA/46	00-	PA1344				50 01 863 728/ 754,50 01 875 237 52 00 537 899,52 00 551 856
E.TECH 400.26 (295 kW) Eng.MACKE.TECHA/46	00-	PA1344				50 01 863 728/ 754,50 01 875 237 52 00 537 899,52 00 551 856
E.TECH 440.18 (324 kW) Eng.MACKE.TECHB/46	00-	PA1344				50 01 863 728/ 754,50 01 875 237 52 00 537 899,52 00 551 856
E.TECH 440.18T (324 kW) Eng.MACKE.TECHB/46	00-	PA1344				50 01 863 728/ 754,50 01 875 237 52 00 537 899,52 00 551 856
E.TECH 440.24 (324 kW) Eng.MACKE.TECHB/46	00-	PA1344				50 01 863 728/ 754,50 01 875 237 52 00 537 899,52 00 551 856
E.TECH 440.26 (324 kW) Eng.MACKE.TECHB/46	00-	PA1344				50 01 863 728/ 754,50 01 875 237 52 00 537 899,52 00 551 856
E.TECH 440.26T (324 kW) Eng.MACKE.TECHB/46	00-	PA1344				50 01 863 728/ 754,50 01 875 237 52 00 537 899,52 00 551 856
E.TECH 480.18 (347-353 kW) Eng.MACKE.TECHC/46	00-	PA1344				50 01 863 728/ 754,50 01 875 237 52 00 537 899,52 00 551 856
E.TECH 480.18T (347-353 kW) Eng.MACKE.TECHC/46	00-	PA1344				50 01 863 728/ 754,50 01 875 237 52 00 537 899,52 00 551 856
E.TECH 480.24 (347-353 kW) Eng.MACKE.TECHC/46	00-	PA1344				50 01 863 728/ 754,50 01 875 237 52 00 537 899,52 00 551 856
E.TECH 480.26 (347-353 kW) Eng.MACKE.TECHC/46	00-	PA1344				50 01 863 728/ 754,50 01 875 237 52 00 537 899,52 00 551 856
E.TECH 480.26T (347-353 kW) Eng.MACKE.TECHC/46	00-	PA1344				50 01 863 728/ 754,50 01 875 237 52 00 537 899,52 00 551 856
Major '10/80-'10/96						
R 340ti.16/T (249 kW) Eng.MIDR0620.45	92-96	PA1343		•		50 01 837 309,50 10 330 029
R 340ti.17 (249 kW) Eng.MIDR0620.45	91-96	PA1343		•		50 01 837 309,50 10 330 029
R 340ti.18 (249 kW) Eng.MIDR0620.45	91-96	PA1343		•		50 01 837 309,50 10 330 029
R 340ti.18/T (249 kW) Eng.MIDR0620.45	92-96	PA1343		•		50 01 837 309,50 10 330 029
R 340ti.19 (249 kW) Eng.MIDR0620.45	91-96	PA1343		•		50 01 837 309,50 10 330 029
R 340ti.19/T (249 kW) Eng.MIDR0620.45	91-96	PA1343		•		50 01 837 309,50 10 330 029
R 340ti.24 (249 kW) Eng.MIDR0620.45	91-96	PA1343		•		50 01 837 309,50 10 330 029
R 340ti.26 (249 kW) Eng.MIDR0620.45	91-96	PA1343		•		50 01 837 309,50 10 330 029
Manager '10/80-'6/97						
G 220.17 BOM (161-168 kW) Eng.MIDS0620.45	92-96	PA1343		•		50 01 837 309,50 10 330 029
G 220.19 BOM (161-168 kW) Eng.MIDS0620.45	92-96	PA1343		•		50 01 837 309,50 10 330 029
G 270.13 SP (195 kW) Eng.MIDR0620.45	80-97	PA1343		•		50 01 837 309,50 10 330 029
G 270.14 SP (195 kW) Eng.MIDR0620.45	80-97	PA1343		•		50 01 837 309,50 10 330 029
G 280.13,G 270.13 (195-202 kW) Eng.MIDR0620.45	80-97	PA1343		•		50 01 837 309,50 10 330 029
G 280.15,G 270.15 (195-202 kW) Eng.MIDR0620.45	80-97	PA1343		•		50 01 837 309,50 10 330 029
G 280.16 (202 kW) Eng.MIDS0620.45	87-93	PA1343		•		50 01 837 309,50 10 330 029
G 280.16,G 270.16 (195-202 kW) Eng.MIDR0620.45	80-97	PA1343		•		50 01 837 309,50 10 330 029
G 280.17,G 270.18 (195-202 kW) Eng.MIDR0620.45	80-97	PA1343		•		50 01 837 309,50 10 330 029
G 280.19 (202 kW) Eng.MIDS0620.45	92-93	PA1343		•		50 01 837 309,50 10 330 029
G 280.19,G 270.19 (195-202 kW) Eng.MIDR0620.45	80-97	PA1343		•		50 01 837 309,50 10 330 029
G 280.24 (202 kW) Eng.MIDS0620.45	91-93	PA1343		•		50 01 837 309,50 10 330 029
G 280.26,G 270.26 (195-202 kW) Eng.MIDR0620.45	80-97	PA1343		•		50 01 837 309,50 10 330 029
G 300.13 (222 kW) Eng.MIDR0620.45	80-96	PA1343		•		50 01 837 309,50 10 330 029
G 300.15 (222 kW) Eng.MIDR0620.45	80-96	PA1343		•		50 01 837 309,50 10 330 029
G 300.16 (222 kW) Eng.MIDR0620.45	91-93	PA1343		•		50 01 837 309,50 10 330 029
G 300.17 (222 kW) Eng.MIDR0620.45	87-96	PA1343		•		50 01 837 309,50 10 330 029
G 300.18 (222 kW) Eng.MIDR0620.45	90-96	PA1343		•		50 01 837 309,50 10 330 029
G 300.19 (222 kW) Eng.MIDR0620.45	87-96	PA1343		•		50 01 837 309,50 10 330 029
G 300.24 (222 kW) Eng.MIDR0620.45	80-96	PA1343		•		50 01 837 309,50 10 330 029



PA1066









PA1340







PA1343

		GRAF ref.			NOTE	Adaptable for OES
G 300.25 (222 kW) Eng.MIDR0620.45	91-96	PA1343		•		50 01 837 309,50 10 330 029
G 300.26 (222 kW) Eng.MIDR0620.45	87-96	PA1343		•		50 01 837 309,50 10 330 029
G 330.13 (240 kW) Eng.MIDR0620.45	92-93	PA1343		•		50 01 837 309,50 10 330 029
G 330.15 (240 kW) Eng.MIDR0620.45	92-93	PA1343		•		50 01 837 309,50 10 330 029
G 330.17 (240 kW) Eng.MIDR0620.45	92-93	PA1343		•		50 01 837 309,50 10 330 029
G 330.18 (240 kW) Eng.MIDR0620.45	92-96	PA1343		•		50 01 837 309,50 10 330 029
G 330.19 (240 kW) Eng.MIDR0620.45	91-93	PA1343		•		50 01 837 309,50 10 330 029
G 330.24 (240 kW) Eng.MIDR0620.45	92-96	PA1343		•		50 01 837 309,50 10 330 029
G 330.26 (240 kW) Eng.MIDR0620.45	91-93	PA1343		•		50 01 837 309,50 10 330 029
G 340ti.16,G 330.16 (240-249 kW) Eng.MIDR0620.45	91-96	PA1343		•		50 01 837 309,50 10 330 029
G 340ti.17,G 330.19 (240-249 kW) Eng.MIDR0620.45	91-96	PA1343		•		50 01 837 309,50 10 330 029
G 340ti.18,G 330.18 (240-249 kW) Eng.MIDR0620.45	91-96	PA1343		•		50 01 837 309,50 10 330 029
G 340ti.18/T (249 kW) Eng.MIDR0620.45	92-96	PA1343		•		50 01 837 309,50 10 330 029
G 340ti.19,G 330.19 (240-249 kW) Eng.MIDR0620.45	92-96	PA1343		•		50 01 837 309,50 10 330 029
G 340ti.26,G 330.26 (240-249 kW) Eng.MIDR0620.45	91-96	PA1343		•		50 01 837 309,50 10 330 029
Maxity '5/06-						
110.28 (81 kW) Eng.DXi2,5	06-	PA1066				-
110.32 (81 kW) Eng.DXi2,5	06-	PA1066				-
110.35 (81 kW) Eng.DXi2,5	06-	PA1066				-
130.35 (96 kW) Eng.DXi2,5	06-	PA1066				-
130.45 (96 kW) Eng.DXi2,5	06-	PA1066				-
Maxter '5/90-						
G 270.19 (195 kW) Eng.MIDR0620.45	90-	PA1343		•		50 01 837 309,50 10 330 029
G 280.18 (202 kW) Eng.MIDS0620.45	92-96	PA1343		•		50 01 837 309,50 10 330 029
G 300.18 (222 kW) Eng.MIDR0620.45	92-96	PA1343		•		50 01 837 309,50 10 330 029
G 300.19 (219 kW) Eng.MIDR0620.45	92-	PA1343		•		50 01 837 309,50 10 330 029
G 300.19 (222 kW) Eng.MIDR0620.45	92-96	PA1343		•		50 01 837 309,50 10 330 029
G 300.26 (219 kW) Eng.MIDR0620.45	92-	PA1343		•		50 01 837 309,50 10 330 029
G 300.26 (222 kW) Eng.MIDR0620.45	92-96	PA1343		•		50 01 837 309,50 10 330 029
G 340ti.18/T (249 kW) Eng.MIDR0620.45	92-	PA1343		•		50 01 837 309,50 10 330 029
G 340ti.19 (249 kW) Eng.MIDR0620.45	92-96	PA1343		•		50 01 837 309,50 10 330 029
G 340ti.25/A,B (249 kW) Eng.MIDR0620.45	91-96	PA1343		•		50 01 837 309,50 10 330 029
G 340ti.26/B,C (249 kW) Eng.MIDR0620.45	91-96	PA1343		•		50 01 837 309,50 10 330 029
G 340ti.32/A,B,C (249 kW) Eng.MIDR0620.45	91-96	PA1343		•		50 01 837 309,50 10 330 029
G 340ti.34 (249 kW) Eng.MIDR0620.45	92-	PA1343		•		50 01 837 309,50 10 330 029
G 340ti.40 (249 kW) Eng.MIDR0620.45	92-	PA1343		•		50 01 837 309,50 10 330 029
Premium I '10/92-'9/05						
Distribution 260.16 (188 kW) Eng.MIDR0620.45	92-	PA1343		•		50 01 837 309,50 10 330 029
Distribution 260.18 (188 kW) Eng.MIDR0620.45	92-	PA1343		•		50 01 837 309,50 10 330 029
Distribution 260.19 (188 kW) Eng.MIDR0620.45	92-	PA1343		•		50 01 837 309,50 10 330 029
Distribution 300.16 (219 kW) Eng.MIDR0620.45	92-	PA1343		•		50 01 837 309,50 10 330 029
Distribution 300.18 (219 kW) Eng.MIDR0620.45	92-	PA1343		•		50 01 837 309,50 10 330 029
Distribution 300.19 (219 kW) Eng.MIDR0620.45	92-	PA1343		•		50 01 837 309,50 10 330 029
Distribution 300.26 (219 kW) Eng.MIDR0620.45	92-	PA1343		•		50 01 837 309,50 10 330 029
Distribution 320.18, 320.24, 320.26 (230 kW) Eng.dCi11G	92-	PA1340		•		50 01 857 427,50 01 858 484 50 10 477 005/ 162/ 321/ 734 50 10 550 549/ 550/ 551/ 552 74 22 189 466
Distribution 340.18 (249 kW) Eng.MIDR0620.45	92-	PA1343		•		50 01 837 309,50 10 330 029
Distribution 340.19 (249 kW) Eng.MIDR0620.45	92-	PA1343		•		50 01 837 309,50 10 330 029
Distribution 340.26 (249 kW) Eng.MIDR0620.45	92-	PA1343		•		50 01 837 309,50 10 330 029
Distribution 370.18 (266 kW) Eng.dCi11E	92-	PA1340		•		50 01 857 427,50 01 858 484 50 10 477 005/ 162/ 321/ 734 50 10 550 549/ 550/ 551/ 552 74 22 189 466

			
<p>PA1204</p>	<p>PA1340</p>	<p>PA1343</p>	

		GRAF ref.			NOTE	Adaptable for OES
Distribution 370.24 (266 kW) Eng.dCi11E	92-	PA1340		•		50 01 857 427,50 01 858 484 50 10 477 005/ 162/ 321/ 734 50 10 550 549/ 550/ 551/ 552 74 22 189 466
Distribution 370.26 (266 kW) Eng.dCi11E	92-	PA1340		•		50 01 857 427,50 01 858 484 50 10 477 005/ 162/ 321/ 734 50 10 550 549/ 550/ 551/ 552 74 22 189 466
Distribution 420.18 (303 kW) Eng.dCi11C	92-	PA1340		•		50 01 857 427,50 01 858 484 50 10 477 005/ 162/ 321/ 734 50 10 550 549/ 550/ 551/ 552 74 22 189 466
Route 300.16 (219 kW) Eng.MIDR0620.45	96-	PA1343		•		50 01 837 309,50 10 330 029
Route 300.18 (219 kW) Eng.MIDR0620.45	96-	PA1343		•		50 01 837 309,50 10 330 029
Route 300.19 (219 kW) Eng.MIDR0620.45	96-	PA1343		•		50 01 837 309,50 10 330 029
Route 320.18 (230 kW) Eng.dCi11G	92-	PA1340		•		50 01 857 427,50 01 858 484 50 10 477 005/ 162/ 321/ 734 50 10 550 549/ 550/ 551/ 552 74 22 189 466
Route 340.18 (249 kW) Eng.MIDR0620.45	92-	PA1343		•		50 01 837 309,50 10 330 029
Route 340.19 (249 kW) Eng.MIDR0620.45	92-	PA1343		•		50 01 837 309,50 10 330 029
Route 340.24 (249 kW) Eng.MIDR0620.45	92-	PA1343		•		50 01 837 309,50 10 330 029
Route 340.26 (249 kW) Eng.MIDR0620.45	92-	PA1343		•		50 01 837 309,50 10 330 029
Route 370.18 (266 kW) Eng.dCi11E	92-	PA1340		•		50 01 857 427,50 01 858 484 50 10 477 005/ 162/ 321/ 734 50 10 550 549/ 550/ 551/ 552 74 22 189 466
Route 370.24 (266 kW) Eng.dCi11E	92-	PA1340		•		50 01 857 427,50 01 858 484 50 10 477 005/ 162/ 321/ 734 50 10 550 549/ 550/ 551/ 552 74 22 189 466
Route 370.26 (266 kW) Eng.dCi11E	92-	PA1340		•		50 01 857 427,50 01 858 484 50 10 477 005/ 162/ 321/ 734 50 10 550 549/ 550/ 551/ 552 74 22 189 466
Route 420.18 (303 kW) Eng.dCi11C	92-	PA1340		•		50 01 857 427,50 01 858 484 50 10 477 005/ 162/ 321/ 734 50 10 550 549/ 550/ 551/ 552 74 22 189 466
Route 420.24 (303 kW) Eng.dCi11C	92-	PA1340		•		50 01 857 427,50 01 858 484 50 10 477 005/ 162/ 321/ 734 50 10 550 549/ 550/ 551/ 552 74 22 189 466
Route 420.25 (303 kW) Eng.dCi11C	92-	PA1340		•		50 01 857 427,50 01 858 484 50 10 477 005/ 162/ 321/ 734 50 10 550 549/ 550/ 551/ 552 74 22 189 466
Route 420.26 (303 kW) Eng.dCi11C	92-	PA1340		•		50 01 857 427,50 01 858 484 50 10 477 005/ 162/ 321/ 734 50 10 550 549/ 550/ 551/ 552 74 22 189 466
Premium II '10/05-'12/13						
370.18/.26 (272 kW) Eng.DXi11	05-	PA1204			w/o pulley	74 20 744 939/ 940,74 85 000 763 74 85 013 068
380.18/.19/.26/.32 (280 kW) Eng.DXi11	06-	PA1204			w/o pulley	74 20 744 939/ 940,74 85 000 763 74 85 013 068
410.18/.24/.25/.26 (302 kW) Eng.DXi11	06-	PA1204			w/o pulley	74 20 744 939/ 940,74 85 000 763 74 85 013 068
430.18/.19/.26/.32 (316 kW) Eng.DXi11	06-	PA1204			w/o pulley	74 20 744 939/ 940,74 85 000 763 74 85 013 068
440.18/.19/.26/.32 (324 kW) Eng.DXi11	05-	PA1204			w/o pulley	74 20 744 939/ 940,74 85 000 763 74 85 013 068
450.18/.24/.25/.26 (331 kW) Eng.DXi11	06-	PA1204			w/o pulley	74 20 744 939/ 940,74 85 000 763 74 85 013 068

			
<p>PA869</p>	<p>PA1201</p>	<p>PA1204</p>	<p>PA1343</p>

		GRAF ref.			NOTE	Adaptable for OES
460.18/.19/.26/.32 (339 kW) Eng.DXi11	06-	PA1204			w/o pulley	74 20 744 939/ 940,74 85 000 763 74 85 013 068
R '10/80-'10/92						
R 330.17 (240-249 kW) Eng.MIDR0620.45	90-91	PA1343		•		50 01 837 309,50 10 330 029
R 330.19 (240-249 kW) Eng.MIDR0620.45	90-91	PA1343		•		50 01 837 309,50 10 330 029
R 330.24 (240-249 kW) Eng.MIDR0620.45	90-91	PA1343		•		50 01 837 309,50 10 330 029
R 340ti.16 (249 kW) Eng.MIDR0620.45	88-91	PA1343		•		50 01 837 309,50 10 330 029
R 340ti.17 (249 kW) Eng.MIDR0620.45	88-91	PA1343		•		50 01 837 309,50 10 330 029
R 340ti.18 (249 kW) Eng.MIDR0620.45	88-91	PA1343		•		50 01 837 309,50 10 330 029
R 340ti.19 (249 kW) Eng.MIDR0620.45	88-91	PA1343		•		50 01 837 309,50 10 330 029
R 340ti.24 (249 kW) Eng.MIDR0620.45	88-91	PA1343		•		50 01 837 309,50 10 330 029
R 340ti.26 (249 kW) Eng.MIDR0620.45	88-91	PA1343		•		50 01 837 309,50 10 330 029
R312 Bus '1/88-'12/98						
R312 (145 kW) Eng.MIDR0620.45	88-98	PA1343		•		50 01 837 309,50 10 330 029
SCANIA TRUCK						
112 H '1/81-'12/86						
280 (206 kW) Eng.DS11.14	81-86	PA869				1314406
305 (224 kW) Eng.DS11.15	81-86	PA869				1314406
112 M '1/81-'12/86						
305 (224-232 kW) Eng.DS11.15	81-86	PA869				1314406
113 E '11/91-						
320 (235-239 kW) Eng.DSC11.16	91-	PA869				1314406
	91-	PA1201			Impeller Ø 105mm	0570951/ 5,10570951/ 5,1353072,1372365 1508533/ 6,1570951/ 5,1896752,508533 570951/ 55/ 62
320 (235-239 kW) Eng.DSC11.17	91-	PA869				1314406
	91-	PA1201			Impeller Ø 105mm	0570951/ 5,10570951/ 5,1353072,1372365 1508533/ 6,1570951/ 5,1896752,508533 570951/ 55/ 62
320 (235-239 kW) Eng.DSC11.21	91-	PA869				1314406
	91-	PA1201			Impeller Ø 105mm	0570951/ 5,10570951/ 5,1353072,1372365 1508533/ 6,1570951/ 5,1896752,508533 570951/ 55/ 62
360 (265-267 kW) Eng.DSC11.13	91-	PA869				1314406
	91-	PA1201			Impeller Ø 105mm	0570951/ 5,10570951/ 5,1353072,1372365 1508533/ 6,1570951/ 5,1896752,508533 570951/ 55/ 62
360 (265-267 kW) Eng.DSC11.18	91-	PA869				1314406
	91-	PA1201			Impeller Ø 105mm	0570951/ 5,10570951/ 5,1353072,1372365 1508533/ 6,1570951/ 5,1896752,508533 570951/ 55/ 62
360 (265-267 kW) Eng.DSC11.23	91-	PA869				1314406
	91-	PA1201			Impeller Ø 105mm	0570951/ 5,10570951/ 5,1353072,1372365 1508533/ 6,1570951/ 5,1896752,508533 570951/ 55/ 62
360 (265-267 kW) Eng.DSC11.30	91-	PA869				1314406
	91-	PA1201			Impeller Ø 105mm	0570951/ 5,10570951/ 5,1353072,1372365 1508533/ 6,1570951/ 5,1896752,508533 570951/ 55/ 62
380 (280 kW) Eng.DSC11.22	94-	PA869				1314406
	94-	PA1201			Impeller Ø 105mm	0570951/ 5,10570951/ 5,1353072,1372365 1508533/ 6,1570951/ 5,1896752,508533 570951/ 55/ 62
380 (280 kW) Eng.DSC11.70	91-	PA869				1314406
	91-	PA1201			Impeller Ø 105mm	0570951/ 5,10570951/ 5,1353072,1372365 1508533/ 6,1570951/ 5,1896752,508533 570951/ 55/ 62
113 H '5/88-						
310 (228-229 kW) Eng.DSC11.06	88-	PA869				1314406



PA869



PA1201

		GRAF ref.			NOTE	Adaptable for OES
310 (228-229 kW) Eng.DSC11.06	88-	PA1201			Impeller Ø 105mm	0570951/ 5,10570951/ 5,1353072,1372365 1508533/ 6,1570951/ 5,1896752,508533 570951/ 55/ 62
310 (228-229 kW) Eng.DSC11.08	90-	PA869				1314406
	90-	PA1201			Impeller Ø 105mm	0570951/ 5,10570951/ 5,1353072,1372365 1508533/ 6,1570951/ 5,1896752,508533 570951/ 55/ 62
320 (235-239 kW) Eng.DSC11.16	91-	PA869				1314406
	91-	PA1201			Impeller Ø 105mm	0570951/ 5,10570951/ 5,1353072,1372365 1508533/ 6,1570951/ 5,1896752,508533 570951/ 55/ 62
320 (235-239 kW) Eng.DSC11.17	91-	PA869				1314406
	91-	PA1201			Impeller Ø 105mm	0570951/ 5,10570951/ 5,1353072,1372365 1508533/ 6,1570951/ 5,1896752,508533 570951/ 55/ 62
320 (235-239 kW) Eng.DSC11.21	91-	PA869				1314406
	91-	PA1201			Impeller Ø 105mm	0570951/ 5,10570951/ 5,1353072,1372365 1508533/ 6,1570951/ 5,1896752,508533 570951/ 55/ 62
360 (265-267 kW) Eng.DSC11.13	91-	PA869				1314406
	91-	PA1201			Impeller Ø 105mm	0570951/ 5,10570951/ 5,1353072,1372365 1508533/ 6,1570951/ 5,1896752,508533 570951/ 55/ 62
360 (265-267 kW) Eng.DSC11.18	91-	PA869				1314406
	91-	PA1201			Impeller Ø 105mm	0570951/ 5,10570951/ 5,1353072,1372365 1508533/ 6,1570951/ 5,1896752,508533 570951/ 55/ 62
360 (265-267 kW) Eng.DSC11.23	91-	PA869				1314406
	91-	PA1201			Impeller Ø 105mm	0570951/ 5,10570951/ 5,1353072,1372365 1508533/ 6,1570951/ 5,1896752,508533 570951/ 55/ 62
360 (265-267 kW) Eng.DSC11.30	91-	PA869				1314406
	91-	PA1201			Impeller Ø 105mm	0570951/ 5,10570951/ 5,1353072,1372365 1508533/ 6,1570951/ 5,1896752,508533 570951/ 55/ 62
380 (280 kW) Eng.DSC11.22	94-	PA869				1314406
	94-	PA1201			Impeller Ø 105mm	0570951/ 5,10570951/ 5,1353072,1372365 1508533/ 6,1570951/ 5,1896752,508533 570951/ 55/ 62
380 (280 kW) Eng.DSC11.70	91-	PA869				1314406
	91-	PA1201			Impeller Ø 105mm	0570951/ 5,10570951/ 5,1353072,1372365 1508533/ 6,1570951/ 5,1896752,508533 570951/ 55/ 62
113 M '11/91-						
320 (235-239 kW) Eng.DSC11.16	91-	PA869				1314406
	91-	PA1201			Impeller Ø 105mm	0570951/ 5,10570951/ 5,1353072,1372365 1508533/ 6,1570951/ 5,1896752,508533 570951/ 55/ 62
320 (235-239 kW) Eng.DSC11.17	91-	PA869				1314406
	91-	PA1201			Impeller Ø 105mm	0570951/ 5,10570951/ 5,1353072,1372365 1508533/ 6,1570951/ 5,1896752,508533 570951/ 55/ 62
320 (235-239 kW) Eng.DSC11.21	91-	PA869				1314406
	91-	PA1201			Impeller Ø 105mm	0570951/ 5,10570951/ 5,1353072,1372365 1508533/ 6,1570951/ 5,1896752,508533 570951/ 55/ 62
360 (265-267 kW) Eng.DSC11.13	91-	PA869				1314406
	91-	PA1201			Impeller Ø 105mm	0570951/ 5,10570951/ 5,1353072,1372365 1508533/ 6,1570951/ 5,1896752,508533 570951/ 55/ 62
360 (265-267 kW) Eng.DSC11.18	91-	PA869				1314406
	91-	PA1201			Impeller Ø 105mm	0570951/ 5,10570951/ 5,1353072,1372365 1508533/ 6,1570951/ 5,1896752,508533 570951/ 55/ 62
360 (265-267 kW) Eng.DSC11.23	91-	PA869				1314406





PA869



PA1201

		GRAF ref.			NOTE	Adaptable for OES
360 (265-267 kW) Eng.DSC11.23	91-	PA1201			Impeller Ø 105mm	0570951/ 5,10570951/ 5,1353072,1372365 1508533/ 6,1570951/ 5,1896752,508533 570951/ 55/ 62
360 (265-267 kW) Eng.DSC11.30	91-	PA869				1314406
	91-	PA1201			Impeller Ø 105mm	0570951/ 5,10570951/ 5,1353072,1372365 1508533/ 6,1570951/ 5,1896752,508533 570951/ 55/ 62
380 (280 kW) Eng.DSC11.22	94-	PA869				1314406
	94-	PA1201			Impeller Ø 105mm	0570951/ 5,10570951/ 5,1353072,1372365 1508533/ 6,1570951/ 5,1896752,508533 570951/ 55/ 62
380 (280 kW) Eng.DSC11.70	91-	PA869				1314406
	91-	PA1201			Impeller Ø 105mm	0570951/ 5,10570951/ 5,1353072,1372365 1508533/ 6,1570951/ 5,1896752,508533 570951/ 55/ 62
114 C '5/96-						
340 (250 kW) Eng.DC11.01	98-	PA1201			Impeller Ø 105mm	0570951/ 5,10570951/ 5,1353072,1372365 1508533/ 6,1570951/ 5,1896752,508533 570951/ 55/ 62
340 (250 kW) Eng.DC11.03	99-	PA1201			Impeller Ø 105mm	0570951/ 5,10570951/ 5,1353072,1372365 1508533/ 6,1570951/ 5,1896752,508533 570951/ 55/ 62
340 (250 kW) Eng.DSC11.79	96-	PA1201			Impeller Ø 105mm	0570951/ 5,10570951/ 5,1353072,1372365 1508533/ 6,1570951/ 5,1896752,508533 570951/ 55/ 62
380 (280 kW) Eng.DC11.02	98-	PA1201			Impeller Ø 105mm	0570951/ 5,10570951/ 5,1353072,1372365 1508533/ 6,1570951/ 5,1896752,508533 570951/ 55/ 62
114 G '5/96-						
340 (250 kW) Eng.DC11.01	98-	PA1201			Impeller Ø 105mm	0570951/ 5,10570951/ 5,1353072,1372365 1508533/ 6,1570951/ 5,1896752,508533 570951/ 55/ 62
340 (250 kW) Eng.DC11.03	99-	PA1201			Impeller Ø 105mm	0570951/ 5,10570951/ 5,1353072,1372365 1508533/ 6,1570951/ 5,1896752,508533 570951/ 55/ 62
340 (250 kW) Eng.DSC11.79	96-	PA1201			Impeller Ø 105mm	0570951/ 5,10570951/ 5,1353072,1372365 1508533/ 6,1570951/ 5,1896752,508533 570951/ 55/ 62
380 (280 kW) Eng.DC11.02	98-	PA1201			Impeller Ø 105mm	0570951/ 5,10570951/ 5,1353072,1372365 1508533/ 6,1570951/ 5,1896752,508533 570951/ 55/ 62
114 L '5/96-						
340 (250 kW) Eng.DC11.01	98-	PA1201			Impeller Ø 105mm	0570951/ 5,10570951/ 5,1353072,1372365 1508533/ 6,1570951/ 5,1896752,508533 570951/ 55/ 62
340 (250 kW) Eng.DC11.03	99-	PA1201			Impeller Ø 105mm	0570951/ 5,10570951/ 5,1353072,1372365 1508533/ 6,1570951/ 5,1896752,508533 570951/ 55/ 62
340 (250 kW) Eng.DSC11.79	96-	PA1201			Impeller Ø 105mm	0570951/ 5,10570951/ 5,1353072,1372365 1508533/ 6,1570951/ 5,1896752,508533 570951/ 55/ 62
380 (280 kW) Eng.DC11.02	98-	PA1201			Impeller Ø 105mm	0570951/ 5,10570951/ 5,1353072,1372365 1508533/ 6,1570951/ 5,1896752,508533 570951/ 55/ 62
380 (280 kW) Eng.DC11.04	99-	PA1201			Impeller Ø 105mm	0570951/ 5,10570951/ 5,1353072,1372365 1508533/ 6,1570951/ 5,1896752,508533 570951/ 55/ 62
124 C '9/96-						
360 (265 kW) Eng.DSC12.02	96-	PA1201			Impeller Ø 105mm	0570951/ 5,10570951/ 5,1353072,1372365 1508533/ 6,1570951/ 5,1896752,508533 570951/ 55/ 62

			
<p>PA1201</p>	<p>PA1207</p>	<p>PA1212</p>	

		GRAF ref.			NOTE	Adaptable for OES
400 (294 kW) Eng.DSC12.01	96-	PA1201			Impeller Ø 105mm	0570951/ 5,10570951/ 5,1353072,1372365 1508533/ 6,1570951/ 5,1896752,508533 570951/ 55/ 62
124 G '5/96-						
360 (265 kW) Eng.DSC12.02	96-	PA1201			Impeller Ø 105mm	0570951/ 5,10570951/ 5,1353072,1372365 1508533/ 6,1570951/ 5,1896752,508533 570951/ 55/ 62
400 (294 kW) Eng.DSC12.01	96-	PA1201			Impeller Ø 105mm	0570951/ 5,10570951/ 5,1353072,1372365 1508533/ 6,1570951/ 5,1896752,508533 570951/ 55/ 62
124 L '9/96-						
360 (265 kW) Eng.DSC12.02	96-	PA1201			Impeller Ø 105mm	0570951/ 5,10570951/ 5,1353072,1372365 1508533/ 6,1570951/ 5,1896752,508533 570951/ 55/ 62
400 (294 kW) Eng.DSC12.01	96-	PA1201			Impeller Ø 105mm	0570951/ 5,10570951/ 5,1353072,1372365 1508533/ 6,1570951/ 5,1896752,508533 570951/ 55/ 62
420 (309 kW) Eng.DSC12.05	97-	PA1201			Impeller Ø 105mm	0570951/ 5,10570951/ 5,1353072,1372365 1508533/ 6,1570951/ 5,1896752,508533 570951/ 55/ 62
143 E '1/91-						
420 (309 kW) Eng.DSC14.08	91-	PA1212				0570952,10570952/ 6,1365481/ 841 1508534,1570956,570952/ 6
450 (331-333 kW) Eng.DSC14.03	91-	PA1212				0570952,10570952/ 6,1365481/ 841 1508534,1570956,570952/ 6
450 (331-333 kW) Eng.DSC14.10	91-	PA1212				0570952,10570952/ 6,1365481/ 841 1508534,1570956,570952/ 6
500 (368 kW) Eng.DSC14.09	91-	PA1212				0570952,10570952/ 6,1365481/ 841 1508534,1570956,570952/ 6
500 (368 kW) Eng.DSC14.16	91-	PA1212				0570952,10570952/ 6,1365481/ 841 1508534,1570956,570952/ 6
143 H '5/88-						
400 (297 kW) Eng.DSC14.06	91-	PA1212				0570952,10570952/ 6,1365481/ 841 1508534,1570956,570952/ 6
420 (309 kW) Eng.DSC14.08	91-	PA1212				0570952,10570952/ 6,1365481/ 841 1508534,1570956,570952/ 6
450 (331-333 kW) Eng.DSC14.03	91-	PA1212				0570952,10570952/ 6,1365481/ 841 1508534,1570956,570952/ 6
450 (331-333 kW) Eng.DSC14.10	91-	PA1212				0570952,10570952/ 6,1365481/ 841 1508534,1570956,570952/ 6
500 (368 kW) Eng.DSC14.09	91-	PA1212				0570952,10570952/ 6,1365481/ 841 1508534,1570956,570952/ 6
500 (368 kW) Eng.DSC14.16	91-	PA1212				0570952,10570952/ 6,1365481/ 841 1508534,1570956,570952/ 6
143 M '1/91-						
420 (309 kW) Eng.DSC14.08	91-	PA1212				0570952,10570952/ 6,1365481/ 841 1508534,1570956,570952/ 6
450 (331-333 kW) Eng.DSC14.03	91-	PA1212				0570952,10570952/ 6,1365481/ 841 1508534,1570956,570952/ 6
450 (331-333 kW) Eng.DSC14.10	91-	PA1212				0570952,10570952/ 6,1365481/ 841 1508534,1570956,570952/ 6
500 (368 kW) Eng.DSC14.09	91-	PA1212				0570952,10570952/ 6,1365481/ 841 1508534,1570956,570952/ 6
500 (368 kW) Eng.DSC14.16	91-	PA1212				0570952,10570952/ 6,1365481/ 841 1508534,1570956,570952/ 6
164 C '5/00-						
480 (353 kW) Eng.DC16.02	00-	PA1207				10570954/ 958,1433792,1510404 1549481/ 2,1570954,1793989,570954/ 8
580 (426 kW) Eng.DC16.01	00-	PA1207				10570954/ 958,1433792,1510404 1549481/ 2,1570954,1793989,570954/ 8

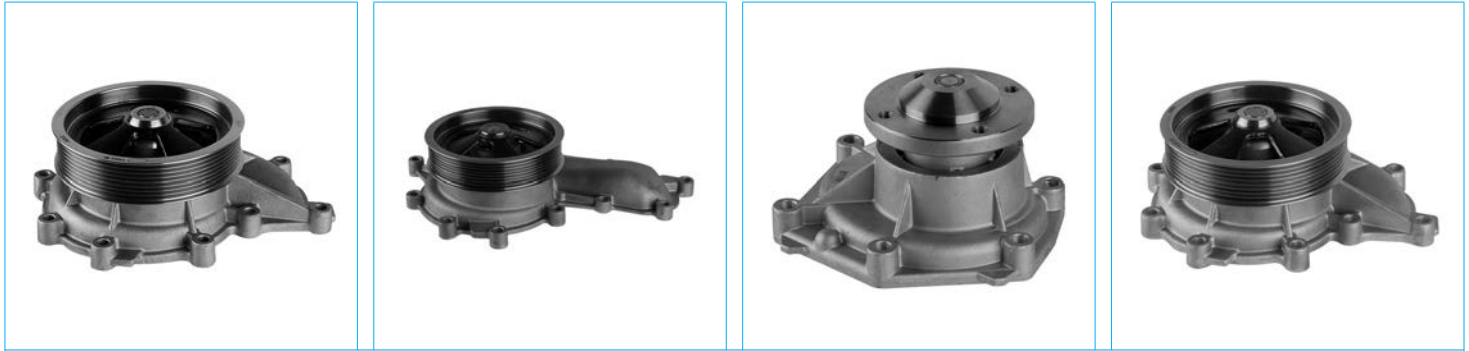



PA1201

PA1207



PA1334

PA1339



		GRAF ref.			NOTE	Adaptable for OES
164 G '5/00-						
480 (353 kW) Eng.DC16.02	00-	PA1207				10570954/ 958,1433792,1510404 1549481/ 2,1570954,1793989,570954/ 8
580 (426 kW) Eng.DC16.01	00-	PA1207				10570954/ 958,1433792,1510404 1549481/ 2,1570954,1793989,570954/ 8
164 L '5/00-						
480 (353 kW) Eng.DC16.02	00-	PA1207				10570954/ 958,1433792,1510404 1549481/ 2,1570954,1793989,570954/ 8
580 (426 kW) Eng.DC16.01	00-	PA1207				10570954/ 958,1433792,1510404 1549481/ 2,1570954,1793989,570954/ 8
93 H '3/88-						
220 (162 kW) Eng.DSC9.10	91-	PA1334			Impeller Ø 88mm	0570953/ 957,1380897,1486098,1510490 570953/ 57/ 61,571157
250 (185 kW) Eng.DSC9.07	91-	PA1334			Impeller Ø 88mm	0570953/ 957,1380897,1486098,1510490 570953/ 57/ 61,571157
280 (207-208 kW) Eng.DSC9.02	91-95	PA1334			Impeller Ø 88mm	0570953/ 957,1380897,1486098,1510490 570953/ 57/ 61,571157
280 (207-208 kW) Eng.DSC9.08	91-	PA1334			Impeller Ø 88mm	0570953/ 957,1380897,1486098,1510490 570953/ 57/ 61,571157
93 M '3/88-						
220 (162 kW) Eng.DSC9.10	91-	PA1334			Impeller Ø 88mm	0570953/ 957,1380897,1486098,1510490 570953/ 57/ 61,571157
250 (185 kW) Eng.DSC9.07	91-	PA1334			Impeller Ø 88mm	0570953/ 957,1380897,1486098,1510490 570953/ 57/ 61,571157
280 (207 kW) Eng.DSC9.02	88-95	PA1334			Impeller Ø 88mm	0570953/ 957,1380897,1486098,1510490 570953/ 57/ 61,571157
280 (207-208 kW) Eng.DSC9.08	91-	PA1334			Impeller Ø 88mm	0570953/ 957,1380897,1486098,1510490 570953/ 57/ 61,571157
94 C '12/96-						
260 (191 kW) Eng.DSC9.12	96-	PA1334			Impeller Ø 88mm	0570953/ 957,1380897,1486098,1510490 570953/ 57/ 61,571157
310 (228 kW) Eng.DSC9.13	97-	PA1334			Impeller Ø 88mm	0570953/ 957,1380897,1486098,1510490 570953/ 57/ 61,571157
310 (228 kW) Eng.DSC9.15	97-	PA1334			Impeller Ø 88mm	0570953/ 957,1380897,1486098,1510490 570953/ 57/ 61,571157
94 D '12/96-						
220 (162 kW) Eng.DSC9.11	96-	PA1334			Impeller Ø 88mm	0570953/ 957,1380897,1486098,1510490 570953/ 57/ 61,571157
230 (169 kW) Eng.DC9.01	99-	PA1201			Impeller Ø 105mm	0570951/ 5,10570951/ 5,1353072,1372365 1508533/ 6,1570951/ 5,1896752,508533 570951/ 55/ 62
	99-	PA1334			Impeller Ø 88mm	0570953/ 957,1380897,1486098,1510490 570953/ 57/ 61,571157
	99-	PA1339			Impeller Ø 112mm	0570959/ 964/ 965,10570959/ 64,1546188 1570959,1787120/ 23,1789522,546188 570959/ 64/ 65
230 (169 kW) Eng.DC9.04	00-	PA1201			Impeller Ø 105mm	0570951/ 5,10570951/ 5,1353072,1372365 1508533/ 6,1570951/ 5,1896752,508533 570951/ 55/ 62
	00-	PA1334			Impeller Ø 88mm	0570953/ 957,1380897,1486098,1510490 570953/ 57/ 61,571157
	00-	PA1339			Impeller Ø 112mm	0570959/ 964/ 965,10570959/ 64,1546188 1570959,1787120/ 23,1789522,546188 570959/ 64/ 65
260 (191 kW) Eng.DSC9.12	96-	PA1334			Impeller Ø 88mm	0570953/ 957,1380897,1486098,1510490 570953/ 57/ 61,571157
310 (228 kW) Eng.DSC9.13	97-	PA1334			Impeller Ø 88mm	0570953/ 957,1380897,1486098,1510490 570953/ 57/ 61,571157
310 (228 kW) Eng.DSC9.15	97-	PA1334			Impeller Ø 88mm	0570953/ 957,1380897,1486098,1510490 570953/ 57/ 61,571157

			
<p>PA1201</p>	<p>PA1334</p>	<p>PA1339</p>	

		GRAF ref.		NOTE	Adaptable for OES
94 G '8/96-					
220 (162 kW) Eng.DSC9.11	96-	PA1334		Impeller Ø 88mm	0570953/ 957,1380897,1486098,1510490 570953/ 57/ 61,571157
260 (191 kW) Eng.DSC9.12	96-	PA1334		Impeller Ø 88mm	0570953/ 957,1380897,1486098,1510490 570953/ 57/ 61,571157
310 (228 kW) Eng.DSC9.13	97-	PA1334		Impeller Ø 88mm	0570953/ 957,1380897,1486098,1510490 570953/ 57/ 61,571157
310 (228 kW) Eng.DSC9.15	97-	PA1334		Impeller Ø 88mm	0570953/ 957,1380897,1486098,1510490 570953/ 57/ 61,571157
94 L '4/97-					
310 (228 kW) Eng.DSC9.13	97-	PA1334		Impeller Ø 88mm	0570953/ 957,1380897,1486098,1510490 570953/ 57/ 61,571157
310 (228 kW) Eng.DSC9.15	97-	PA1334		Impeller Ø 88mm	0570953/ 957,1380897,1486098,1510490 570953/ 57/ 61,571157
BR 112DH					
11.0 Eng.D11	99-	PA1339		Impeller Ø 112mm	0570959/ 964/ 965,10570959/ 64,1546188 1570959,1787120/ 23,1789522,546188 570959/ 64/ 65
G II '3/04-					
230 (169 kW) Eng.DC9.13/DC9.16	04-	PA1201		Impeller Ø 105mm	0570951/ 5,10570951/ 5,1353072,1372365 1508533/ 6,1570951/ 5,1896752,508533 570951/ 55/ 62
	04-	PA1339		Impeller Ø 112mm	0570959/ 964/ 965,10570959/ 64,1546188 1570959,1787120/ 23,1789522,546188 570959/ 64/ 65
230 (169 kW) Eng.DC9.30/DC9.35	07-	PA1201		Impeller Ø 105mm	0570951/ 5,10570951/ 5,1353072,1372365 1508533/ 6,1570951/ 5,1896752,508533 570951/ 55/ 62
	07-	PA1339		Impeller Ø 112mm	0570959/ 964/ 965,10570959/ 64,1546188 1570959,1787120/ 23,1789522,546188 570959/ 64/ 65
270 (198 kW) Eng.DC9.12/DC9.17	04-	PA1201		Impeller Ø 105mm	0570951/ 5,10570951/ 5,1353072,1372365 1508533/ 6,1570951/ 5,1896752,508533 570951/ 55/ 62
	04-	PA1339		Impeller Ø 112mm	0570959/ 964/ 965,10570959/ 64,1546188 1570959,1787120/ 23,1789522,546188 570959/ 64/ 65
310 (228 kW) Eng.DC9.11/DC9.18	04-	PA1201		Impeller Ø 105mm	0570951/ 5,10570951/ 5,1353072,1372365 1508533/ 6,1570951/ 5,1896752,508533 570951/ 55/ 62
	04-	PA1339		Impeller Ø 112mm	0570959/ 964/ 965,10570959/ 64,1546188 1570959,1787120/ 23,1789522,546188 570959/ 64/ 65
K III '11/90-					
113 (228 kW) Eng.DSC11.08	90-	PA1201		Impeller Ø 105mm	0570951/ 5,10570951/ 5,1353072,1372365 1508533/ 6,1570951/ 5,1896752,508533 570951/ 55/ 62
113 CLB (280 kW) Eng.DSC11.22	92-	PA1201		Impeller Ø 105mm	0570951/ 5,10570951/ 5,1353072,1372365 1508533/ 6,1570951/ 5,1896752,508533 570951/ 55/ 62
93 CL (208 kW) Eng.DSC9.08	91-	PA1334		Impeller Ø 88mm	0570953/ 957,1380897,1486098,1510490 570953/ 57/ 61,571157
K-Serie '1/06-					
230 (169 kW) Eng.DC9.16	09-	PA1201		Impeller Ø 105mm	0570951/ 5,10570951/ 5,1353072,1372365 1508533/ 6,1570951/ 5,1896752,508533 570951/ 55/ 62
	09-	PA1339		Impeller Ø 112mm	0570959/ 964/ 965,10570959/ 64,1546188 1570959,1787120/ 23,1789522,546188 570959/ 64/ 65

			
PA1201	PA1339		

		GRAF ref.			NOTE	Adaptable for OES
250 (184 kW) Eng.DC9.109/114	06-	PA1201			Impeller Ø 105mm	0570951/ 5,10570951/ 5,1353072,1372365 1508533/ 6,1570951/ 5,1896752,508533 570951/ 55/ 62
	06-	PA1339			Impeller Ø 112mm	0570959/ 964/ 965,10570959/ 64,1546188 1570959,1787120/ 23,1789522,546188 570959/ 64/ 65
270 (198 kW) Eng.DC9E.02	06-	PA1339			Impeller Ø 112mm	0570959/ 964/ 965,10570959/ 64,1546188 1570959,1787120/ 23,1789522,546188 570959/ 64/ 65
280 (206 kW) Eng.DC9.29	09-	PA1201			Impeller Ø 105mm	0570951/ 5,10570951/ 5,1353072,1372365 1508533/ 6,1570951/ 5,1896752,508533 570951/ 55/ 62
	09-	PA1339			Impeller Ø 112mm	0570959/ 964/ 965,10570959/ 64,1546188 1570959,1787120/ 23,1789522,546188 570959/ 64/ 65
310 (228 kW) Eng.DC9.110	06-	PA1201			Impeller Ø 105mm	0570951/ 5,10570951/ 5,1353072,1372365 1508533/ 6,1570951/ 5,1896752,508533 570951/ 55/ 62
	06-	PA1339			Impeller Ø 112mm	0570959/ 964/ 965,10570959/ 64,1546188 1570959,1787120/ 23,1789522,546188 570959/ 64/ 65
320 (235 kW) Eng.DC9.32	11-	PA1201			Impeller Ø 105mm	0570951/ 5,10570951/ 5,1353072,1372365 1508533/ 6,1570951/ 5,1896752,508533 570951/ 55/ 62
	11-	PA1339			Impeller Ø 112mm	0570959/ 964/ 965,10570959/ 64,1546188 1570959,1787120/ 23,1789522,546188 570959/ 64/ 65
P II '9/04-						
230 (169 kW) Eng.DC9.01/DC9.04	04-	PA1201			Impeller Ø 105mm	0570951/ 5,10570951/ 5,1353072,1372365 1508533/ 6,1570951/ 5,1896752,508533 570951/ 55/ 62
	04-	PA1339			Impeller Ø 112mm	0570959/ 964/ 965,10570959/ 64,1546188 1570959,1787120/ 23,1789522,546188 570959/ 64/ 65
230 (169 kW) Eng.DC9.13	04-	PA1201			Impeller Ø 105mm	0570951/ 5,10570951/ 5,1353072,1372365 1508533/ 6,1570951/ 5,1896752,508533 570951/ 55/ 62
	04-	PA1339			Impeller Ø 112mm	0570959/ 964/ 965,10570959/ 64,1546188 1570959,1787120/ 23,1789522,546188 570959/ 64/ 65
230 (169 kW) Eng.DC9.16	04-	PA1201			Impeller Ø 105mm	0570951/ 5,10570951/ 5,1353072,1372365 1508533/ 6,1570951/ 5,1896752,508533 570951/ 55/ 62
	04-	PA1339			Impeller Ø 112mm	0570959/ 964/ 965,10570959/ 64,1546188 1570959,1787120/ 23,1789522,546188 570959/ 64/ 65
230 (169 kW) Eng.DC9.30/DC9.35	07-	PA1201			Impeller Ø 105mm	0570951/ 5,10570951/ 5,1353072,1372365 1508533/ 6,1570951/ 5,1896752,508533 570951/ 55/ 62
	07-	PA1339			Impeller Ø 112mm	0570959/ 964/ 965,10570959/ 64,1546188 1570959,1787120/ 23,1789522,546188 570959/ 64/ 65
250 (184 kW) Eng.DC09.109/DC09.111	13-	PA1201			Impeller Ø 105mm	0570951/ 5,10570951/ 5,1353072,1372365 1508533/ 6,1570951/ 5,1896752,508533 570951/ 55/ 62
260 (191 kW) Eng.DC9.02/DC9.05	04-	PA1201			Impeller Ø 105mm	0570951/ 5,10570951/ 5,1353072,1372365 1508533/ 6,1570951/ 5,1896752,508533 570951/ 55/ 62
	04-	PA1339			Impeller Ø 112mm	0570959/ 964/ 965,10570959/ 64,1546188 1570959,1787120/ 23,1789522,546188 570959/ 64/ 65
270 (198 kW) Eng.DC9.12	04-	PA1201			Impeller Ø 105mm	0570951/ 5,10570951/ 5,1353072,1372365 1508533/ 6,1570951/ 5,1896752,508533 570951/ 55/ 62

			
PA1201	PA1207	PA1339	

		GRAF ref.			NOTE	Adaptable for OES
270 (198 kW) Eng.DC9.12	04-	PA1339			Impeller Ø 112mm	0570959/ 964/ 965,10570959/ 64,1546188 1570959,1787120/ 23,1789522,546188 570959/ 64/ 65
280 (206 kW) Eng.DC9.29	04-	PA1201			Impeller Ø 105mm	0570951/ 5,10570951/ 5,1353072,1372365 1508533/ 6,1570951/ 5,1896752,508533 570951/ 55/ 62
	04-	PA1339			Impeller Ø 112mm	0570959/ 964/ 965,10570959/ 64,1546188 1570959,1787120/ 23,1789522,546188 570959/ 64/ 65
300 (220 kW) Eng.DC9.03/DC9.06	04-	PA1201			Impeller Ø 105mm	0570951/ 5,10570951/ 5,1353072,1372365 1508533/ 6,1570951/ 5,1896752,508533 570951/ 55/ 62
	04-	PA1339			Impeller Ø 112mm	0570959/ 964/ 965,10570959/ 64,1546188 1570959,1787120/ 23,1789522,546188 570959/ 64/ 65
310 (228 kW) Eng.DC9.11	04-	PA1201			Impeller Ø 105mm	0570951/ 5,10570951/ 5,1353072,1372365 1508533/ 6,1570951/ 5,1896752,508533 570951/ 55/ 62
	04-	PA1339			Impeller Ø 112mm	0570959/ 964/ 965,10570959/ 64,1546188 1570959,1787120/ 23,1789522,546188 570959/ 64/ 65
310 (228 kW) Eng.DC9.18	04-	PA1201			Impeller Ø 105mm	0570951/ 5,10570951/ 5,1353072,1372365 1508533/ 6,1570951/ 5,1896752,508533 570951/ 55/ 62
	04-	PA1339			Impeller Ø 112mm	0570959/ 964/ 965,10570959/ 64,1546188 1570959,1787120/ 23,1789522,546188 570959/ 64/ 65
320 (235 kW) Eng.DC09.108/DC09.22/.32/.37	13-	PA1201			Impeller Ø 105mm	0570951/ 5,10570951/ 5,1353072,1372365 1508533/ 6,1570951/ 5,1896752,508533 570951/ 55/ 62
500 (368 kW) Eng.DC16.04/DC16.06/DC16.09	00-	PA1207				10570954/ 958,1433792,1510404 1549481/ 2,1570954,1793989,570954/ 8
560 (412 kW) Eng.DC16.05/DC16.18	00-	PA1207				10570954/ 958,1433792,1510404 1549481/ 2,1570954,1793989,570954/ 8
580 (426 kW) Eng.DC16.03	00-	PA1207				10570954/ 958,1433792,1510404 1549481/ 2,1570954,1793989,570954/ 8
620 (456 kW) Eng.DC16.08/DC16.17	00-	PA1207				10570954/ 958,1433792,1510404 1549481/ 2,1570954,1793989,570954/ 8
R II '3/04-						
230 (169 kW) Eng.DC9.13/DC9.16	04-	PA1201			Impeller Ø 105mm	0570951/ 5,10570951/ 5,1353072,1372365 1508533/ 6,1570951/ 5,1896752,508533 570951/ 55/ 62
	04-	PA1339			Impeller Ø 112mm	0570959/ 964/ 965,10570959/ 64,1546188 1570959,1787120/ 23,1789522,546188 570959/ 64/ 65
270 (198 kW) Eng.DC9.12/DC9.17	04-	PA1201			Impeller Ø 105mm	0570951/ 5,10570951/ 5,1353072,1372365 1508533/ 6,1570951/ 5,1896752,508533 570951/ 55/ 62
	04-	PA1339			Impeller Ø 112mm	0570959/ 964/ 965,10570959/ 64,1546188 1570959,1787120/ 23,1789522,546188 570959/ 64/ 65
310 (228 kW) Eng.DC9.11/DC9.18	04-	PA1201			Impeller Ø 105mm	0570951/ 5,10570951/ 5,1353072,1372365 1508533/ 6,1570951/ 5,1896752,508533 570951/ 55/ 62
	04-	PA1339			Impeller Ø 112mm	0570959/ 964/ 965,10570959/ 64,1546188 1570959,1787120/ 23,1789522,546188 570959/ 64/ 65
500 (368 kW) Eng.DC16.04/.06/.09/.19/.22	00-	PA1207				10570954/ 958,1433792,1510404 1549481/ 2,1570954,1793989,570954/ 8
520 (382 kW) Eng.DC16.101	00-	PA1207				10570954/ 958,1433792,1510404 1549481/ 2,1570954,1793989,570954/ 8
560 (412 kW) Eng.DC16.05/DC16.18	00-	PA1207				10570954/ 958,1433792,1510404 1549481/ 2,1570954,1793989,570954/ 8
580 (426 kW) Eng.DC16.03	00-	PA1207				10570954/ 958,1433792,1510404 1549481/ 2,1570954,1793989,570954/ 8



PA1201

PA1207



--	--	--	--

--	--	--	--

--	--	--	--

--	--	--	--

		GRAF ref.			NOTE	Adaptable for OES
580 (426 kW) Eng.DC16.102	00-	PA1207				10570954/ 958,1433792,1510404 1549481/ 2,1570954,1793989,570954/ 8
620 (456 kW) Eng.DC16.08/17	00-	PA1207				10570954/ 958,1433792,1510404 1549481/ 2,1570954,1793989,570954/ 8
730 (537 kW) Eng.DC16.21	00-	PA1207				10570954/ 958,1433792,1510404 1549481/ 2,1570954,1793989,570954/ 8
T 113 E '11/91-						
320 (235-239 kW) Eng.DSC11.16	91-	PA1201			Impeller Ø 105mm	0570951/ 5,10570951/ 5,1353072,1372365 1508533/ 6,1570951/ 5,1896752,508533 570951/ 55/ 62
320 (235-239 kW) Eng.DSC11.17	91-	PA1201			Impeller Ø 105mm	0570951/ 5,10570951/ 5,1353072,1372365 1508533/ 6,1570951/ 5,1896752,508533 570951/ 55/ 62
320 (235-239 kW) Eng.DSC11.21	91-	PA1201			Impeller Ø 105mm	0570951/ 5,10570951/ 5,1353072,1372365 1508533/ 6,1570951/ 5,1896752,508533 570951/ 55/ 62
360 (266-267 kW) Eng.DSC11.13	91-	PA1201			Impeller Ø 105mm	0570951/ 5,10570951/ 5,1353072,1372365 1508533/ 6,1570951/ 5,1896752,508533 570951/ 55/ 62
360 (266-267 kW) Eng.DSC11.18	91-	PA1201			Impeller Ø 105mm	0570951/ 5,10570951/ 5,1353072,1372365 1508533/ 6,1570951/ 5,1896752,508533 570951/ 55/ 62
360 (266-267 kW) Eng.DSC11.23	91-	PA1201			Impeller Ø 105mm	0570951/ 5,10570951/ 5,1353072,1372365 1508533/ 6,1570951/ 5,1896752,508533 570951/ 55/ 62
T 113 H '11/91-						
320 (235-239 kW) Eng.DSC11.16	91-	PA1201			Impeller Ø 105mm	0570951/ 5,10570951/ 5,1353072,1372365 1508533/ 6,1570951/ 5,1896752,508533 570951/ 55/ 62
320 (235-239 kW) Eng.DSC11.17	91-	PA1201			Impeller Ø 105mm	0570951/ 5,10570951/ 5,1353072,1372365 1508533/ 6,1570951/ 5,1896752,508533 570951/ 55/ 62
320 (235-239 kW) Eng.DSC11.21	91-	PA1201			Impeller Ø 105mm	0570951/ 5,10570951/ 5,1353072,1372365 1508533/ 6,1570951/ 5,1896752,508533 570951/ 55/ 62
360 (266-267 kW) Eng.DSC11.13	91-	PA1201			Impeller Ø 105mm	0570951/ 5,10570951/ 5,1353072,1372365 1508533/ 6,1570951/ 5,1896752,508533 570951/ 55/ 62
360 (266-267 kW) Eng.DSC11.18	91-	PA1201			Impeller Ø 105mm	0570951/ 5,10570951/ 5,1353072,1372365 1508533/ 6,1570951/ 5,1896752,508533 570951/ 55/ 62
360 (266-267 kW) Eng.DSC11.23	91-	PA1201			Impeller Ø 105mm	0570951/ 5,10570951/ 5,1353072,1372365 1508533/ 6,1570951/ 5,1896752,508533 570951/ 55/ 62
T 114 C '3/98-						
340 (250 kW) Eng.DC11.01	98-	PA1201			Impeller Ø 105mm	0570951/ 5,10570951/ 5,1353072,1372365 1508533/ 6,1570951/ 5,1896752,508533 570951/ 55/ 62
340 (250 kW) Eng.DC11.03	99-	PA1201			Impeller Ø 105mm	0570951/ 5,10570951/ 5,1353072,1372365 1508533/ 6,1570951/ 5,1896752,508533 570951/ 55/ 62
380 (280 kW) Eng.DC11.02	98-	PA1201			Impeller Ø 105mm	0570951/ 5,10570951/ 5,1353072,1372365 1508533/ 6,1570951/ 5,1896752,508533 570951/ 55/ 62
T 114 G '5/96-						
340 (250 kW) Eng.DC11.01	98-	PA1201			Impeller Ø 105mm	0570951/ 5,10570951/ 5,1353072,1372365 1508533/ 6,1570951/ 5,1896752,508533 570951/ 55/ 62
340 (250 kW) Eng.DC11.03	99-	PA1201			Impeller Ø 105mm	0570951/ 5,10570951/ 5,1353072,1372365 1508533/ 6,1570951/ 5,1896752,508533 570951/ 55/ 62

			
PA1201	PA1212		

		GRAF ref.			NOTE	Adaptable for OES
340 (250 kW) Eng.DSC11.79	96-	PA1201			Impeller Ø 105mm	0570951/ 5,10570951/ 5,1353072,1372365 1508533/ 6,1570951/ 5,1896752,508533 570951/ 55/ 62
380 (280 kW) Eng.DC11.02	98-	PA1201			Impeller Ø 105mm	0570951/ 5,10570951/ 5,1353072,1372365 1508533/ 6,1570951/ 5,1896752,508533 570951/ 55/ 62
T 114 L '5/96-						
340 (250 kW) Eng.DC11.01	98-	PA1201			Impeller Ø 105mm	0570951/ 5,10570951/ 5,1353072,1372365 1508533/ 6,1570951/ 5,1896752,508533 570951/ 55/ 62
340 (250 kW) Eng.DC11.03	99-	PA1201			Impeller Ø 105mm	0570951/ 5,10570951/ 5,1353072,1372365 1508533/ 6,1570951/ 5,1896752,508533 570951/ 55/ 62
340 (250 kW) Eng.DSC11.79	96-	PA1201			Impeller Ø 105mm	0570951/ 5,10570951/ 5,1353072,1372365 1508533/ 6,1570951/ 5,1896752,508533 570951/ 55/ 62
380 (280 kW) Eng.DC11.02	98-	PA1201			Impeller Ø 105mm	0570951/ 5,10570951/ 5,1353072,1372365 1508533/ 6,1570951/ 5,1896752,508533 570951/ 55/ 62
T 124 C '9/95-						
360 (265 kW) Eng.DSC12.02	95-	PA1201			Impeller Ø 105mm	0570951/ 5,10570951/ 5,1353072,1372365 1508533/ 6,1570951/ 5,1896752,508533 570951/ 55/ 62
400 (294 kW) Eng.DSC12.01	96-	PA1201			Impeller Ø 105mm	0570951/ 5,10570951/ 5,1353072,1372365 1508533/ 6,1570951/ 5,1896752,508533 570951/ 55/ 62
420 (309 kW) Eng.DC12.01	98-	PA1201			Impeller Ø 105mm	0570951/ 5,10570951/ 5,1353072,1372365 1508533/ 6,1570951/ 5,1896752,508533 570951/ 55/ 62
420 (309 kW) Eng.DSC12.05	97-	PA1201			Impeller Ø 105mm	0570951/ 5,10570951/ 5,1353072,1372365 1508533/ 6,1570951/ 5,1896752,508533 570951/ 55/ 62
T 124 G '3/97-						
360 (265 kW) Eng.DSC12.02	97-	PA1201			Impeller Ø 105mm	0570951/ 5,10570951/ 5,1353072,1372365 1508533/ 6,1570951/ 5,1896752,508533 570951/ 55/ 62
400 (294 kW) Eng.DSC12.01	97-	PA1201			Impeller Ø 105mm	0570951/ 5,10570951/ 5,1353072,1372365 1508533/ 6,1570951/ 5,1896752,508533 570951/ 55/ 62
420 (309 kW) Eng.DC12.01	98-	PA1201			Impeller Ø 105mm	0570951/ 5,10570951/ 5,1353072,1372365 1508533/ 6,1570951/ 5,1896752,508533 570951/ 55/ 62
420 (309 kW) Eng.DSC12.05	97-	PA1201			Impeller Ø 105mm	0570951/ 5,10570951/ 5,1353072,1372365 1508533/ 6,1570951/ 5,1896752,508533 570951/ 55/ 62
T 124 L '9/95-						
360 (265 kW) Eng.DSC12.02	95-	PA1201			Impeller Ø 105mm	0570951/ 5,10570951/ 5,1353072,1372365 1508533/ 6,1570951/ 5,1896752,508533 570951/ 55/ 62
400 (294 kW) Eng.DSC12.01	96-	PA1201			Impeller Ø 105mm	0570951/ 5,10570951/ 5,1353072,1372365 1508533/ 6,1570951/ 5,1896752,508533 570951/ 55/ 62
420 (309 kW) Eng.DSC12.05	97-	PA1201			Impeller Ø 105mm	0570951/ 5,10570951/ 5,1353072,1372365 1508533/ 6,1570951/ 5,1896752,508533 570951/ 55/ 62
T 143 E '1/91-						
420 (309 kW) Eng.DSC14.08	91-	PA1212				0570952,10570952/ 6,1365481/ 841 1508534,1570956,570952/ 6
450 (331-333 kW) Eng.DSC14.03	91-	PA1212				0570952,10570952/ 6,1365481/ 841 1508534,1570956,570952/ 6



PA1201



PA1212









PA1334









PA1339



		GRAF ref.			NOTE	Adaptable for OES
450 (331-333 kW) Eng.DSC14.10	91-	PA1212				0570952,10570952/ 6,1365481/ 841 1508534,1570956,570952/ 6
500 (368 kW) Eng.DSC14.09	91-	PA1212				0570952,10570952/ 6,1365481/ 841 1508534,1570956,570952/ 6
500 (368 kW) Eng.DSC14.16	91-	PA1212				0570952,10570952/ 6,1365481/ 841 1508534,1570956,570952/ 6
T 143 H '1/91-						
420 (309 kW) Eng.DSC14.08	91-	PA1212				0570952,10570952/ 6,1365481/ 841 1508534,1570956,570952/ 6
450 (331-333 kW) Eng.DSC14.03	91-	PA1212				0570952,10570952/ 6,1365481/ 841 1508534,1570956,570952/ 6
450 (331-333 kW) Eng.DSC14.10	91-	PA1212				0570952,10570952/ 6,1365481/ 841 1508534,1570956,570952/ 6
500 (368 kW) Eng.DSC14.09	91-	PA1212				0570952,10570952/ 6,1365481/ 841 1508534,1570956,570952/ 6
500 (368 kW) Eng.DSC14.16	91-	PA1212				0570952,10570952/ 6,1365481/ 841 1508534,1570956,570952/ 6
T 93 H '1/90-						
250 (185 kW) Eng.DSC9.07	91-	PA1334			Impeller Ø 88mm	0570953/ 957,1380897,1486098,1510490 570953/ 57/ 61,571157
280 (207-208 kW) Eng.DSC9.02	91-95	PA1334			Impeller Ø 88mm	0570953/ 957,1380897,1486098,1510490 570953/ 57/ 61,571157
280 (207-208 kW) Eng.DSC9.08	91-	PA1334			Impeller Ø 88mm	0570953/ 957,1380897,1486098,1510490 570953/ 57/ 61,571157
T 94 C '9/96-						
260 (191 kW) Eng.DSC9.12	96-	PA1334			Impeller Ø 88mm	0570953/ 957,1380897,1486098,1510490 570953/ 57/ 61,571157
310 (228 kW) Eng.DSC9.13	96-	PA1334			Impeller Ø 88mm	0570953/ 957,1380897,1486098,1510490 570953/ 57/ 61,571157
T 94 G '8/96-						
220 (162 kW) Eng.DSC9.11	96-	PA1334			Impeller Ø 88mm	0570953/ 957,1380897,1486098,1510490 570953/ 57/ 61,571157
230 (169 kW) Eng.DC9.01	99-	PA1201			Impeller Ø 105mm	0570951/ 5,10570951/ 5,1353072,1372365 1508533/ 6,1570951/ 5,1896752,508533 570951/ 55/ 62
	99-	PA1339			Impeller Ø 112mm	0570959/ 964/ 965,10570959/ 64,1546188 1570959,1787120/ 23,1789522,546188 570959/ 64/ 65
260 (191 kW) Eng.DSC9.12	96-	PA1334			Impeller Ø 88mm	0570953/ 957,1380897,1486098,1510490 570953/ 57/ 61,571157
310 (221-228 kW) Eng.DC9.03	99-	PA1201			Impeller Ø 105mm	0570951/ 5,10570951/ 5,1353072,1372365 1508533/ 6,1570951/ 5,1896752,508533 570951/ 55/ 62
	99-	PA1339			Impeller Ø 112mm	0570959/ 964/ 965,10570959/ 64,1546188 1570959,1787120/ 23,1789522,546188 570959/ 64/ 65
310 (221-228 kW) Eng.DSC9.13	96-	PA1334			Impeller Ø 88mm	0570953/ 957,1380897,1486098,1510490 570953/ 57/ 61,571157
310 (221-228 kW) Eng.DSC9.15	97-	PA1334			Impeller Ø 88mm	0570953/ 957,1380897,1486098,1510490 570953/ 57/ 61,571157
T 94 L '9/96-						
310 (228 kW) Eng.DSC9.13	96-	PA1334			Impeller Ø 88mm	0570953/ 957,1380897,1486098,1510490 570953/ 57/ 61,571157
310 (228 kW) Eng.DSC9.15	97-	PA1334			Impeller Ø 88mm	0570953/ 957,1380897,1486098,1510490 570953/ 57/ 61,571157

			
<p>PA1204</p>	<p>PA1211</p>	<p>PA1316</p>	<p>PA1318</p>
			
<p>PA1332</p>	<p>PA1337</p>		



		GRAF ref.			NOTE	Adaptable for OES
7700 '6/06-						
7700 (191 kW) Eng.D9B260	06-	PA1204			w/o pulley	20538845,20744939/ 940,20761306 21228793,21468471,3161436,85000486 85020085
	06-	PA1211			w/ pulley	20411880,20857085,85000214
7700 (228 kW) Eng.D9B310	06-	PA1204			w/o pulley	20538845,20744939/ 940,20761306 21228793,21468471,3161436,85000486 85020085
	06-	PA1211			w/ pulley	20411880,20857085,85000214
7700 (265 kW) Eng.D9B360	06-	PA1204			w/o pulley	20538845,20744939/ 940,20761306 21228793,21468471,3161436,85000486 85020085
	06-	PA1211			w/ pulley	20411880,20857085,85000214
8500 '1/99-						
8500 (265 kW) Eng.D9B360	99-	PA1204			w/o pulley	20538845,20744939/ 940,20761306 21228793,21468471,3161436,85000486 85020085
	06-	PA1211			w/ pulley	20411880,20857085,85000214
8700 '1/99-						
8700 (213 kW) Eng.D7E290	99-	PA1318		•		1675750,20575653,3183908/ 9,420759 465884,471500,477397/ 770,8112184/ 5 8113522/ 3,8192050,85000387
8700 (250 kW) Eng.D7F340	99-	PA1318		•		1675750,20575653,3183908/ 9,420759 465884,471500,477397/ 770,8112184/ 5 8113522/ 3,8192050,85000387
9700 '10/07-						
9700 (309 kW) Eng.D13C420	09-	PA1204			w/o pulley	20538845,20744939/ 940,20761306 21228793,21468471,3161436,85000486 85020085
	06-	PA1211			w/ pulley	20411880,20857085,85000214
9700 (338 kW) Eng.D13C460	09-	PA1204			w/o pulley	20538845,20744939/ 940,20761306 21228793,21468471,3161436,85000486 85020085
	06-	PA1211			w/ pulley	20411880,20857085,85000214
9900 '10/07-						
9900 (309 kW) Eng.D13C420	09-	PA1204			w/o pulley	20538845,20744939/ 940,20761306 21228793,21468471,3161436,85000486 85020085
	06-	PA1211			w/ pulley	20411880,20857085,85000214
9900 (338 kW) Eng.D13C460	09-	PA1204			w/o pulley	20538845,20744939/ 940,20761306 21228793,21468471,3161436,85000486 85020085
	06-	PA1211			w/ pulley	20411880,20857085,85000214
A-Serie '1/99-						
A25D (224 kW) Eng.D9A300	05-	PA1204			w/o pulley	20538845,20744939/ 940,20761306 21228793,21468471,3161436,85000486 85020085
	06-	PA1211			w/ pulley	20411880,20857085,85000214
A30D (251 kW) Eng.D9A340	05-	PA1204			w/o pulley	20538845,20744939/ 940,20761306 21228793,21468471,3161436,85000486 85020085
	06-	PA1211			w/ pulley	20411880,20857085,85000214
A35D (289 kW) Eng.D12C390/D390	03-	PA1332		•		20431135/ 51,20713787,20734268,3803909 81070305,8113274/ 75,8170305/ 833 85000076/ 452
A40D (309 kW) Eng.D12A420/C420/D420	03-	PA1316		•	M/T	1001698,1547155,8112275,8113117,8148460 8149941
	03-	PA1337		•	For vehicles with retarder	1676713,8112889/ 3155,8149882

			
<p>PA1204</p>	<p>PA1211</p>	<p>PA1304</p>	<p>PA1316</p>
			
<p>PA1318</p>	<p>PA1332</p>	<p>PA1337</p>	

		GRAF ref.			NOTE	Adaptable for OES
B 12 '1/92-						
B 12 (262 kW) Eng.TD122FH	92-94	PA1304			• +BH	1545261,1675945,1698616/ 20,1699786/ 90 20431484,3184802,422791,468250/ 937 470232,478405,478845,479164,479931 8112520/ 683,8113157/ 431,8121802 8149937
B 12 (291-298 kW) Eng.TD122FL	92-94	PA1304			• +BH	1545261,1675945,1698616/ 20,1699786/ 90 20431484,3184802,422791,468250/ 937 470232,478405,478845,479164,479931 8112520/ 683,8113157/ 431,8121802 8149937
B 12 (291-298 kW) Eng.TD123ES	92-94	PA1304			• +BH	1545261,1675945,1698616/ 20,1699786/ 90 20431484,3184802,422791,468250/ 937 470232,478405,478845,479164,479931 8112520/ 683,8113157/ 431,8121802 8149937
B 12 (309 kW) Eng.D12A420	92-	PA1316			• M/T	1001698,1547155,8112275,8113117,8148460 8149941
	92-	PA1337			• For vehicles with retarder	1676713,8112889/ 3155,8149882
B 12 (309 kW) Eng.D12C420/D420	09-	PA1332			•	20431135/ 51,20713787,20734268,3803909 81070305,8113274/ 75,8170305/ 833 85000076/ 452
B 54 '1/65-'12/75						
6.7 TD (110-152 kW) Eng.TD70A/B/C	99-	PA1318			•	1675750,20575653,3183908/ 9,420759 465884,471500,477397/ 770,8112184/ 5 8113522/ 3,8192050,85000387
B 6 '11/91-						
B6R, LE (132 kW) Eng.TD63E	99-	PA1318			•	1675750,20575653,3183908/ 9,420759 465884,471500,477397/ 770,8112184/ 5 8113522/ 3,8192050,85000387
B6R, LE (154 kW) Eng.TD63ES	99-	PA1318			•	1675750,20575653,3183908/ 9,420759 465884,471500,477397/ 770,8112184/ 5 8113522/ 3,8192050,85000387
B 7 '1/99-						
7.1D (213 kW) Eng.D7	99-	PA1318			•	1675750,20575653,3183908/ 9,420759 465884,471500,477397/ 770,8112184/ 5 8113522/ 3,8192050,85000387
B 9 '9/05-						
9.4 D (191-228-265 kW) Eng.D9B	05-	PA1204			w/o pulley	20538845,20744939/ 940,20761306 21228793,21468471,3161436,85000486 85020085
	06-	PA1211			w/ pulley	20411880,20857085,85000214
F 10 '8/77-'12/94						
300 (215-220 kW) Eng.TD101F/FA	85-87	PA1304			• +BH	1545261,1675945,1698616/ 20,1699786/ 90 20431484,3184802,422791,468250/ 937 470232,478405,478845,479164,479931 8112520/ 683,8113157/ 431,8121802 8149937
320 (228-235 kW) Eng.TD102FM	91-94	PA1304			• +BH	1545261,1675945,1698616/ 20,1699786/ 90 20431484,3184802,422791,468250/ 937 470232,478405,478845,479164,479931 8112520/ 683,8113157/ 431,8121802 8149937
320 (228-235 kW) Eng.TD103E/ES	91-94	PA1304			• +BH	1545261,1675945,1698616/ 20,1699786/ 90 20431484,3184802,422791,468250/ 937 470232,478405,478845,479164,479931 8112520/ 683,8113157/ 431,8121802 8149937

			
<p>PA1204</p>	<p>PA1304</p>	<p>PA1318</p>	

		GRAF ref.			NOTE	Adaptable for OES
F 12 '1/79-'12/94						
320, 330 (235-243 kW) Eng.TD121G	79-87	PA1304			• +BH	1545261,1675945,1698616/ 20,1699786/ 90 20431484,3184802,422791,468250/ 937 470232,478405,478845,479164,479931 8112520/ 683,8113157/ 431,8121802 8149937
360 (262 kW) Eng.TD122F	88-94	PA1304			• +BH	1545261,1675945,1698616/ 20,1699786/ 90 20431484,3184802,422791,468250/ 937 470232,478405,478845,479164,479931 8112520/ 683,8113157/ 431,8121802 8149937
370 (272 kW) Eng.TD121F	83-86	PA1304			• +BH	1545261,1675945,1698616/ 20,1699786/ 90 20431484,3184802,422791,468250/ 937 470232,478405,478845,479164,479931 8112520/ 683,8113157/ 431,8121802 8149937
400 (291 kW) Eng.TD122FL/FS	89-94	PA1304			• +BH	1545261,1675945,1698616/ 20,1699786/ 90 20431484,3184802,422791,468250/ 937 470232,478405,478845,479164,479931 8112520/ 683,8113157/ 431,8121802 8149937
400 (291-298 kW) Eng.TD123ES	92-94	PA1304			• +BH	1545261,1675945,1698616/ 20,1699786/ 90 20431484,3184802,422791,468250/ 937 470232,478405,478845,479164,479931 8112520/ 683,8113157/ 431,8121802 8149937
410 (291-298 kW) Eng.TD122FL/FS	89-94	PA1304			• +BH	1545261,1675945,1698616/ 20,1699786/ 90 20431484,3184802,422791,468250/ 937 470232,478405,478845,479164,479931 8112520/ 683,8113157/ 431,8121802 8149937
410 (291-298 kW) Eng.TD123ES	92-94	PA1304			• +BH	1545261,1675945,1698616/ 20,1699786/ 90 20431484,3184802,422791,468250/ 937 470232,478405,478845,479164,479931 8112520/ 683,8113157/ 431,8121802 8149937
F 16 '1/88-'12/94						
470 (342 kW) Eng.TD162F	88-89	PA1204			w/o pulley	20538845,20744939/ 940,20761306 21228793,21468471,3161436,85000486 85020085
485 (357 kW) Eng.TD162F	90-92	PA1204			w/o pulley	20538845,20744939/ 940,20761306 21228793,21468471,3161436,85000486 85020085
500 (368 kW) Eng.TD163ES	92-94	PA1204			w/o pulley	20538845,20744939/ 940,20761306 21228793,21468471,3161436,85000486 85020085
F 80 '1/65-'12/85						
86 (106-110 kW) Eng.D70	99-	PA1318			•	1675750,20575653,3183908/ 9,420759 465884,471500,477397/ 770,8112184/ 5 8113522/ 3,8192050,85000387
86 (110-152 kW) Eng.TD70A/B/C	99-	PA1318			•	1675750,20575653,3183908/ 9,420759 465884,471500,477397/ 770,8112184/ 5 8113522/ 3,8192050,85000387
86 (162 kW) Eng.TD70E/F/G/H	99-	PA1318			•	1675750,20575653,3183908/ 9,420759 465884,471500,477397/ 770,8112184/ 5 8113522/ 3,8192050,85000387
FE '5/06-						
240-18 (177 kW) Eng.D7E240	99-	PA1318			•	1675750,20575653,3183908/ 9,420759 465884,471500,477397/ 770,8112184/ 5 8113522/ 3,8192050,85000387

			
<p>PA1204</p>	<p>PA1211</p>	<p>PA1318</p>	

		GRAF ref.			NOTE	Adaptable for OES
240-22 (177 kW) Eng.D7E240	99-	PA1318		•		1675750,20575653,3183908/ 9,420759 465884,471500,477397/ 770,8112184/ 5 8113522/ 3,8192050,85000387
240-26 (177 kW) Eng.D7E240	99-	PA1318		•		1675750,20575653,3183908/ 9,420759 465884,471500,477397/ 770,8112184/ 5 8113522/ 3,8192050,85000387
240-26 (177 kW) Eng.D7E240/F240	99-	PA1318		•		1675750,20575653,3183908/ 9,420759 465884,471500,477397/ 770,8112184/ 5 8113522/ 3,8192050,85000387
260-18/-26 (191 kW) Eng.D7F260	99-	PA1318		•		1675750,20575653,3183908/ 9,420759 465884,471500,477397/ 770,8112184/ 5 8113522/ 3,8192050,85000387
280-18 (206 kW) Eng.D7E280	99-	PA1318		•		1675750,20575653,3183908/ 9,420759 465884,471500,477397/ 770,8112184/ 5 8113522/ 3,8192050,85000387
280-22 (206 kW) Eng.D7E280	99-	PA1318		•		1675750,20575653,3183908/ 9,420759 465884,471500,477397/ 770,8112184/ 5 8113522/ 3,8192050,85000387
280-26 (206 kW) Eng.D7E280	99-	PA1318		•		1675750,20575653,3183908/ 9,420759 465884,471500,477397/ 770,8112184/ 5 8113522/ 3,8192050,85000387
300-18/-26 (221 kW) Eng.D7F300	99-	PA1318		•		1675750,20575653,3183908/ 9,420759 465884,471500,477397/ 770,8112184/ 5 8113522/ 3,8192050,85000387
320-18 (235 kW) Eng.D7E320	99-	PA1318		•		1675750,20575653,3183908/ 9,420759 465884,471500,477397/ 770,8112184/ 5 8113522/ 3,8192050,85000387
320-22 (235 kW) Eng.D7E320	99-	PA1318		•		1675750,20575653,3183908/ 9,420759 465884,471500,477397/ 770,8112184/ 5 8113522/ 3,8192050,85000387
320-26 (235 kW) Eng.D7E320	99-	PA1318		•		1675750,20575653,3183908/ 9,420759 465884,471500,477397/ 770,8112184/ 5 8113522/ 3,8192050,85000387
340-18/-26 (250 kW) Eng.D7F340	99-	PA1318		•		1675750,20575653,3183908/ 9,420759 465884,471500,477397/ 770,8112184/ 5 8113522/ 3,8192050,85000387
FE II '5/12-						
240 (177 kW) Eng.D7E240	99-	PA1318		•		1675750,20575653,3183908/ 9,420759 465884,471500,477397/ 770,8112184/ 5 8113522/ 3,8192050,85000387
240 (177 kW) Eng.D7F240	99-	PA1318		•		1675750,20575653,3183908/ 9,420759 465884,471500,477397/ 770,8112184/ 5 8113522/ 3,8192050,85000387
260 (191 kW) Eng.D7F260	99-	PA1318		•		1675750,20575653,3183908/ 9,420759 465884,471500,477397/ 770,8112184/ 5 8113522/ 3,8192050,85000387
280 (206 kW) Eng.D7E280	99-	PA1318		•		1675750,20575653,3183908/ 9,420759 465884,471500,477397/ 770,8112184/ 5 8113522/ 3,8192050,85000387
300 (221 kW) Eng.D7F300	99-	PA1318		•		1675750,20575653,3183908/ 9,420759 465884,471500,477397/ 770,8112184/ 5 8113522/ 3,8192050,85000387
320 (235 kW) Eng.D7E320	99-	PA1318		•		1675750,20575653,3183908/ 9,420759 465884,471500,477397/ 770,8112184/ 5 8113522/ 3,8192050,85000387
340 (250 kW) Eng.D7F340	99-	PA1318		•		1675750,20575653,3183908/ 9,420759 465884,471500,477397/ 770,8112184/ 5 8113522/ 3,8192050,85000387
FH '5/05-						
400 (294 kW) Eng.D13A400	05-	PA1204			w/o pulley	20538845,20744939/ 940,20761306 21228793,21468471,3161436,85000486 85020085
	06-	PA1211			w/ pulley	20411880,20857085,85000214

			
<p>PA1204</p>	<p>PA1211</p>	<p>PA1316</p>	<p>PA1332</p>
			
<p>PA1337</p>			



		GRAF ref.			NOTE	Adaptable for OES
400 (294 kW) Eng.D13B400/A400	05-	PA1204			w/o pulley	20538845,20744939/ 940,20761306 21228793,21468471,3161436,85000486 85020085
	06-	PA1211			w/ pulley	20411880,20857085,85000214
420 (309 kW) Eng.D13C420	09-	PA1204			w/o pulley	20538845,20744939/ 940,20761306 21228793,21468471,3161436,85000486 85020085
	06-	PA1211			w/ pulley	20411880,20857085,85000214
440 (324 kW) Eng.D13A440	05-	PA1204			w/o pulley	20538845,20744939/ 940,20761306 21228793,21468471,3161436,85000486 85020085
	06-	PA1211			w/ pulley	20411880,20857085,85000214
440 (324 kW) Eng.D13B440/A440	05-	PA1204			w/o pulley	20538845,20744939/ 940,20761306 21228793,21468471,3161436,85000486 85020085
	06-	PA1211			w/ pulley	20411880,20857085,85000214
460 (338 kW) Eng.D13C460	09-	PA1204			w/o pulley	20538845,20744939/ 940,20761306 21228793,21468471,3161436,85000486 85020085
	06-	PA1211			w/ pulley	20411880,20857085,85000214
480 (353 kW) Eng.D13A480	05-	PA1204			w/o pulley	20538845,20744939/ 940,20761306 21228793,21468471,3161436,85000486 85020085
	06-	PA1211			w/ pulley	20411880,20857085,85000214
500 (368 kW) Eng.D13B500	07-	PA1204			w/o pulley	20538845,20744939/ 940,20761306 21228793,21468471,3161436,85000486 85020085
	06-	PA1211			w/ pulley	20411880,20857085,85000214
500 (368 kW) Eng.D13B500/C500/K500	07-	PA1204			w/o pulley	20538845,20744939/ 940,20761306 21228793,21468471,3161436,85000486 85020085
	06-	PA1211			w/ pulley	20411880,20857085,85000214
520 (382 kW) Eng.D13A520	05-	PA1204			w/o pulley	20538845,20744939/ 940,20761306 21228793,21468471,3161436,85000486 85020085
	06-	PA1211			w/ pulley	20411880,20857085,85000214
540 (397 kW) Eng.D13C540	09-	PA1204			w/o pulley	20538845,20744939/ 940,20761306 21228793,21468471,3161436,85000486 85020085
	06-	PA1211			w/ pulley	20411880,20857085,85000214
550 (404 kW) Eng.D16C550	05-	PA1204			w/o pulley	20538845,20744939/ 940,20761306 21228793,21468471,3161436,85000486 85020085
	06-	PA1211			w/ pulley	20411880,20857085,85000214
610 (449 kW) Eng.D16C610	05-	PA1204			w/o pulley	20538845,20744939/ 940,20761306 21228793,21468471,3161436,85000486 85020085
	06-	PA1211			w/ pulley	20411880,20857085,85000214
FH 12 '9/01-						
340 (250 kW) Eng.D12A340	93-	PA1316			• M/T	1001698,1547155,8112275,8113117,8148460 8149941
	93-	PA1337			• For vehicles with retarder	1676713,8112889/ 3155,8149882
340 (250 kW) Eng.D12C340	98-	PA1332			•	20431135/ 51,20713787,20734268,3803909 81070305,8113274/ 75,8170305/ 833 85000076/ 452
340 (250 kW) Eng.D12D340	01-	PA1332			•	20431135/ 51,20713787,20734268,3803909 81070305,8113274/ 75,8170305/ 833 85000076/ 452
380 (279 kW) Eng.D12A380	93-	PA1316			• M/T	1001698,1547155,8112275,8113117,8148460 8149941
	93-	PA1337			• For vehicles with retarder	1676713,8112889/ 3155,8149882
380 (279 kW) Eng.D12C380	98-	PA1332			•	20431135/ 51,20713787,20734268,3803909 81070305,8113274/ 75,8170305/ 833 85000076/ 452

			
<p>PA1204</p>	<p>PA1211</p>	<p>PA1316</p>	<p>PA1332</p>
			
<p>PA1337</p>			



		GRAF ref.			NOTE	Adaptable for OES
380 (279 kW) Eng.D12D380	01-	PA1332		•		20431135/ 51,20713787,20734268,3803909 81070305,8113274/ 75,8170305/ 833 85000076/ 452
420 (309 kW) Eng.D12A420	95-	PA1316		•	M/T	1001698,1547155,8112275,8113117,8148460 8149941
	95-	PA1337		•	For vehicles with retarder	1676713,8112889/ 3155,8149882
420 (309 kW) Eng.D12C420	98-	PA1332		•		20431135/ 51,20713787,20734268,3803909 81070305,8113274/ 75,8170305/ 833 85000076/ 452
420 (309 kW) Eng.D12D420	01-	PA1332		•		20431135/ 51,20713787,20734268,3803909 81070305,8113274/ 75,8170305/ 833 85000076/ 452
460 (338 kW) Eng.D12C460	98-	PA1332		•		20431135/ 51,20713787,20734268,3803909 81070305,8113274/ 75,8170305/ 833 85000076/ 452
460 (338 kW) Eng.D12D460	01-	PA1332		•		20431135/ 51,20713787,20734268,3803909 81070305,8113274/ 75,8170305/ 833 85000076/ 452
FH 13 '1/05-						
400 (294 kW) Eng.D13A400	05-	PA1204			w/o pulley	20538845,20744939/ 940,20761306 21228793,21468471,3161436,85000486 85020085
	06-	PA1211			w/ pulley	20411880,20857085,85000214
440 (324 kW) Eng.D13A440	05-	PA1204			w/o pulley	20538845,20744939/ 940,20761306 21228793,21468471,3161436,85000486 85020085
	06-	PA1211			w/ pulley	20411880,20857085,85000214
480 (353 kW) Eng.D13A480	05-	PA1204			w/o pulley	20538845,20744939/ 940,20761306 21228793,21468471,3161436,85000486 85020085
	06-	PA1211			w/ pulley	20411880,20857085,85000214
520 (382 kW) Eng.D13A520	05-	PA1204			w/o pulley	20538845,20744939/ 940,20761306 21228793,21468471,3161436,85000486 85020085
	06-	PA1211			w/ pulley	20411880,20857085,85000214
FH 16 '8/93-						
470 (346 kW) Eng.D16A470	93-99	PA1204			w/o pulley	20538845,20744939/ 940,20761306 21228793,21468471,3161436,85000486 85020085
	06-	PA1211			w/ pulley	20411880,20857085,85000214
520 (382 kW) Eng.D16A520	93-02	PA1204			w/o pulley	20538845,20744939/ 940,20761306 21228793,21468471,3161436,85000486 85020085
	06-	PA1211			w/ pulley	20411880,20857085,85000214
520 (382 kW) Eng.D16B520	98-	PA1204			w/o pulley	20538845,20744939/ 940,20761306 21228793,21468471,3161436,85000486 85020085
	06-	PA1211			w/ pulley	20411880,20857085,85000214
540 (396-404 kW) Eng.D16E540	03-	PA1204			w/o pulley	20538845,20744939/ 940,20761306 21228793,21468471,3161436,85000486 85020085
	06-	PA1211			w/ pulley	20411880,20857085,85000214
540/ 550 Eng.D16C550	07-	PA1204			w/o pulley	20538845,20744939/ 940,20761306 21228793,21468471,3161436,85000486 85020085
	06-	PA1211			w/ pulley	20411880,20857085,85000214
540/ 550 Eng.D16G540/E540	07-	PA1204			w/o pulley	20538845,20744939/ 940,20761306 21228793,21468471,3161436,85000486 85020085
	06-	PA1211			w/ pulley	20411880,20857085,85000214
550 (396-404 kW) Eng.D16C550	03-	PA1204			w/o pulley	20538845,20744939/ 940,20761306 21228793,21468471,3161436,85000486 85020085
	06-	PA1211			w/ pulley	20411880,20857085,85000214

			
<p>PA1204</p>	<p>PA1211</p>	<p>PA1304</p>	<p>PA1316</p>
			
<p>PA1337</p>			



		GRAF ref.			NOTE	Adaptable for OES
580 (426 kW) Eng.D16E580	03-	PA1204			w/o pulley	20538845,20744939/ 940,20761306 21228793,21468471,3161436,85000486 85020085
	09-	PA1204			w/o pulley	20538845,20744939/ 940,20761306 21228793,21468471,3161436,85000486 85020085
	06-	PA1211			w/ pulley	20411880,20857085,85000214
600 (441 kW) Eng.D16G600	06-	PA1204			w/o pulley	20538845,20744939/ 940,20761306 21228793,21468471,3161436,85000486 85020085
	06-	PA1211			w/ pulley	20411880,20857085,85000214
610 (449 kW) Eng.D16C610	03-	PA1204			w/o pulley	20538845,20744939/ 940,20761306 21228793,21468471,3161436,85000486 85020085
	07-	PA1204			w/o pulley	20538845,20744939/ 940,20761306 21228793,21468471,3161436,85000486 85020085
	06-	PA1211			w/ pulley	20411880,20857085,85000214
660 (485 kW) Eng.D16E660	06-	PA1204			w/o pulley	20538845,20744939/ 940,20761306 21228793,21468471,3161436,85000486 85020085
	07-	PA1204			w/o pulley	20538845,20744939/ 940,20761306 21228793,21468471,3161436,85000486 85020085
	06-	PA1211			w/ pulley	20411880,20857085,85000214
700 (515 kW) Eng.D16G700	09-	PA1204			w/o pulley	20538845,20744939/ 940,20761306 21228793,21468471,3161436,85000486 85020085
	06-	PA1211			w/ pulley	20411880,20857085,85000214
FH 16 II '5/12-						
540 (396 kW) Eng.D16G540	06-	PA1211			w/ pulley	20411880,20857085,85000214
600 (441 kW) Eng.D16G600	06-	PA1211			w/ pulley	20411880,20857085,85000214
700 (515 kW) Eng.D16G700	06-	PA1211			w/ pulley	20411880,20857085,85000214
750 (551 kW) Eng.D16G750	06-	PA1211			w/ pulley	20411880,20857085,85000214
FH II '5/12-						
420 (309 kW) Eng.D13C420/K420	12-	PA1204			w/o pulley	20538845,20744939/ 940,20761306 21228793,21468471,3161436,85000486 85020085
	06-	PA1211			w/ pulley	20411880,20857085,85000214
460 (338 kW) Eng.D13C460/K460	12-	PA1204			w/o pulley	20538845,20744939/ 940,20761306 21228793,21468471,3161436,85000486 85020085
	06-	PA1211			w/ pulley	20411880,20857085,85000214
500 (368 kW) Eng.D13C500/K500	12-	PA1204			w/o pulley	20538845,20744939/ 940,20761306 21228793,21468471,3161436,85000486 85020085
	06-	PA1211			w/ pulley	20411880,20857085,85000214
540 (397 kW) Eng.D13C540/K540	12-	PA1204			w/o pulley	20538845,20744939/ 940,20761306 21228793,21468471,3161436,85000486 85020085
	06-	PA1211			w/ pulley	20411880,20857085,85000214
FL 10 '1/88-'9/98						
280 (202-209 kW) Eng.TD101G	01/88-05/88	PA1304			• +BH	1545261,1675945,1698616/ 20,1699786/ 90 20431484,3184802,422791,468250/ 937 470232,478405,478845,479164,479931 8112520/ 683,8113157/ 431,8121802 8149937
FL 12 '9/95-'9/98						
380 (279 kW) Eng.D12A380	95-98	PA1316			• M/T	1001698,1547155,8112275,8113117,8148460 8149941
	95-98	PA1337			• For vehicles with retarder	1676713,8112889/ 3155,8149882

			
<p>PA1316</p>	<p>PA1318</p>	<p>PA1337</p>	





		GRAF ref.			NOTE	Adaptable for OES
420 (279 kW) Eng.D12A420	95-98	PA1316		•	M/T	1001698,1547155,8112275,8113117,8148460 8149941
	95-98	PA1337		•	For vehicles with retarder	1676713,8112889/ 3155,8149882
420 (309 kW) Eng.D12A420	95-98	PA1316		•	M/T	1001698,1547155,8112275,8113117,8148460 8149941
	95-98	PA1337		•	For vehicles with retarder	1676713,8112889/ 3155,8149882
FL 7 '9/85-'9/98						
230 (169-173 kW) Eng.D7B230	99-	PA1318		•		1675750,20575653,3183908/ 9,420759 465884,471500,477397/ 770,8112184/ 5 8113522/ 3,8192050,85000387
230 (169-173 kW) Eng.TD71F	99-	PA1318		•		1675750,20575653,3183908/ 9,420759 465884,471500,477397/ 770,8112184/ 5 8113522/ 3,8192050,85000387
230 (169-173 kW) Eng.TD73E	99-	PA1318		•		1675750,20575653,3183908/ 9,420759 465884,471500,477397/ 770,8112184/ 5 8113522/ 3,8192050,85000387
260 (191 kW) Eng.D7B260	99-	PA1318		•		1675750,20575653,3183908/ 9,420759 465884,471500,477397/ 770,8112184/ 5 8113522/ 3,8192050,85000387
260 (191 kW) Eng.TD73ES	99-	PA1318		•		1675750,20575653,3183908/ 9,420759 465884,471500,477397/ 770,8112184/ 5 8113522/ 3,8192050,85000387
290 (210 kW) Eng.D7A285	99-	PA1318		•		1675750,20575653,3183908/ 9,420759 465884,471500,477397/ 770,8112184/ 5 8113522/ 3,8192050,85000387
FL II '5/06-						
240-12 (177 kW) Eng.D7E240	99-	PA1318		•		1675750,20575653,3183908/ 9,420759 465884,471500,477397/ 770,8112184/ 5 8113522/ 3,8192050,85000387
240-14 (177 kW) Eng.D7F240/E240	99-	PA1318		•		1675750,20575653,3183908/ 9,420759 465884,471500,477397/ 770,8112184/ 5 8113522/ 3,8192050,85000387
240-15 (177 kW) Eng.D7E240	99-	PA1318		•		1675750,20575653,3183908/ 9,420759 465884,471500,477397/ 770,8112184/ 5 8113522/ 3,8192050,85000387
240-16 (177 kW) Eng.D7E240	99-	PA1318		•		1675750,20575653,3183908/ 9,420759 465884,471500,477397/ 770,8112184/ 5 8113522/ 3,8192050,85000387
240-16 (177 kW) Eng.D7F240/E240	99-	PA1318		•		1675750,20575653,3183908/ 9,420759 465884,471500,477397/ 770,8112184/ 5 8113522/ 3,8192050,85000387
240-18 (177 kW) Eng.D7E240	99-	PA1318		•		1675750,20575653,3183908/ 9,420759 465884,471500,477397/ 770,8112184/ 5 8113522/ 3,8192050,85000387
260-12 (191 kW) Eng.D7F260	99-	PA1318		•		1675750,20575653,3183908/ 9,420759 465884,471500,477397/ 770,8112184/ 5 8113522/ 3,8192050,85000387
260-12/-14/-15/-16/-18 (191 kW) Eng.D7F260	99-	PA1318		•		1675750,20575653,3183908/ 9,420759 465884,471500,477397/ 770,8112184/ 5 8113522/ 3,8192050,85000387
260-14 (191 kW) Eng.D7D260	99-	PA1318		•		1675750,20575653,3183908/ 9,420759 465884,471500,477397/ 770,8112184/ 5 8113522/ 3,8192050,85000387
260-15 (191 kW) Eng.D7F260	99-	PA1318		•		1675750,20575653,3183908/ 9,420759 465884,471500,477397/ 770,8112184/ 5 8113522/ 3,8192050,85000387
260-16 (191 kW) Eng.D7F260	99-	PA1318		•		1675750,20575653,3183908/ 9,420759 465884,471500,477397/ 770,8112184/ 5 8113522/ 3,8192050,85000387
260-18 (191 kW) Eng.D7F260	99-	PA1318		•		1675750,20575653,3183908/ 9,420759 465884,471500,477397/ 770,8112184/ 5 8113522/ 3,8192050,85000387

			
<p>PA1204</p>	<p>PA1211</p>	<p>PA1318</p>	





		GRAF ref.			NOTE	Adaptable for OES
280-12 (206 kW) Eng.D7E280	99-	PA1318		•		1675750,20575653,3183908/ 9,420759 465884,471500,477397/ 770,8112184/ 5 8113522/ 3,8192050,85000387
280-14 (206 kW) Eng.D7E280	99-	PA1318		•		1675750,20575653,3183908/ 9,420759 465884,471500,477397/ 770,8112184/ 5 8113522/ 3,8192050,85000387
280-15 (206 kW) Eng.D7E280	99-	PA1318		•		1675750,20575653,3183908/ 9,420759 465884,471500,477397/ 770,8112184/ 5 8113522/ 3,8192050,85000387
280-16 (206 kW) Eng.D7E280	99-	PA1318		•		1675750,20575653,3183908/ 9,420759 465884,471500,477397/ 770,8112184/ 5 8113522/ 3,8192050,85000387
280-18 (206 kW) Eng.D7E280	99-	PA1318		•		1675750,20575653,3183908/ 9,420759 465884,471500,477397/ 770,8112184/ 5 8113522/ 3,8192050,85000387
290-12 (213 kW) Eng.D7F290	99-	PA1318		•		1675750,20575653,3183908/ 9,420759 465884,471500,477397/ 770,8112184/ 5 8113522/ 3,8192050,85000387
290-12/-14/-16/-18 (213 kW) Eng.D7F290	99-	PA1318		•		1675750,20575653,3183908/ 9,420759 465884,471500,477397/ 770,8112184/ 5 8113522/ 3,8192050,85000387
290-14 (213 kW) Eng.D7F290	99-	PA1318		•		1675750,20575653,3183908/ 9,420759 465884,471500,477397/ 770,8112184/ 5 8113522/ 3,8192050,85000387
290-16 (213 kW) Eng.D7F290	99-	PA1318		•		1675750,20575653,3183908/ 9,420759 465884,471500,477397/ 770,8112184/ 5 8113522/ 3,8192050,85000387
290-18 (213 kW) Eng.D7F290	99-	PA1318		•		1675750,20575653,3183908/ 9,420759 465884,471500,477397/ 770,8112184/ 5 8113522/ 3,8192050,85000387
FL III '5/13-						
240 (177 kW) Eng.D7F240/D7E240	99-	PA1318		•		1675750,20575653,3183908/ 9,420759 465884,471500,477397/ 770,8112184/ 5 8113522/ 3,8192050,85000387
260 (191 kW) Eng.D7F260	99-	PA1318		•		1675750,20575653,3183908/ 9,420759 465884,471500,477397/ 770,8112184/ 5 8113522/ 3,8192050,85000387
280 (206 kW) Eng.D7E280	99-	PA1318		•		1675750,20575653,3183908/ 9,420759 465884,471500,477397/ 770,8112184/ 5 8113522/ 3,8192050,85000387
290 (213 kW) Eng.D7F290	99-	PA1318		•		1675750,20575653,3183908/ 9,420759 465884,471500,477397/ 770,8112184/ 5 8113522/ 3,8192050,85000387
FM '9/05-						
300 (221 kW) Eng.D9B300	05-	PA1204			w/o pulley	20538845,20744939/ 940,20761306 21228793,21468471,3161436,85000486 85020085
	06-	PA1211			w/ pulley	20411880,20857085,85000214
330 (243 kW) Eng.D11C330/K330	06-	PA1211			w/ pulley	20411880,20857085,85000214
340 (250 kW) Eng.D9B340	05-	PA1204			w/o pulley	20538845,20744939/ 940,20761306 21228793,21468471,3161436,85000486 85020085
	06-	PA1211			w/ pulley	20411880,20857085,85000214
360 (264 kW) Eng.D13A360	05-	PA1204			w/o pulley	20538845,20744939/ 940,20761306 21228793,21468471,3161436,85000486 85020085
	06-	PA1211			w/ pulley	20411880,20857085,85000214
360 (264 kW) Eng.D13B360	07-	PA1204			w/o pulley	20538845,20744939/ 940,20761306 21228793,21468471,3161436,85000486 85020085
	06-	PA1211			w/ pulley	20411880,20857085,85000214
370 (272 kW) Eng.D11C370/K370	06-	PA1211			w/ pulley	20411880,20857085,85000214

			
<p>PA1204</p>	<p>PA1211</p>	<p>PA1332</p>	

		GRAF ref.			NOTE	Adaptable for OES
380 (280 kW) Eng.D13C380	12-	PA1204			w/o pulley	20538845,20744939/ 940,20761306 21228793,21468471,3161436,85000486 85020085
	06-	PA1211			w/ pulley	20411880,20857085,85000214
380 (280 kW) Eng.D9B380	05-	PA1204			w/o pulley	20538845,20744939/ 940,20761306 21228793,21468471,3161436,85000486 85020085
	06-	PA1211			w/ pulley	20411880,20857085,85000214
390 (287 kW) Eng.D11B390	06-	PA1211			w/ pulley	20411880,20857085,85000214
400 (294 kW) Eng.D13A400	05-	PA1204			w/o pulley	20538845,20744939/ 940,20761306 21228793,21468471,3161436,85000486 85020085
	06-	PA1211			w/ pulley	20411880,20857085,85000214
400 (294 kW) Eng.D13B400	07-	PA1204			w/o pulley	20538845,20744939/ 940,20761306 21228793,21468471,3161436,85000486 85020085
	06-	PA1211			w/ pulley	20411880,20857085,85000214
410 (302 kW) Eng.D11C410/K410	06-	PA1211			w/ pulley	20411880,20857085,85000214
420 (309 kW) Eng.D13C420/K420	12-	PA1204			w/o pulley	20538845,20744939/ 940,20761306 21228793,21468471,3161436,85000486 85020085
	06-	PA1211			w/ pulley	20411880,20857085,85000214
430 (243 kW) Eng.D11A430	06-	PA1211			w/ pulley	20411880,20857085,85000214
440 (324 kW) Eng.D13A440	05-	PA1204			w/o pulley	20538845,20744939/ 940,20761306 21228793,21468471,3161436,85000486 85020085
	06-	PA1211			w/ pulley	20411880,20857085,85000214
440 (324 kW) Eng.D13B440	07-	PA1204			w/o pulley	20538845,20744939/ 940,20761306 21228793,21468471,3161436,85000486 85020085
	06-	PA1211			w/ pulley	20411880,20857085,85000214
450 (332 kW) Eng.D11C450/K450	06-	PA1211			w/ pulley	20411880,20857085,85000214
460 (338 kW) Eng.D13C460/K460	12-	PA1204			w/o pulley	20538845,20744939/ 940,20761306 21228793,21468471,3161436,85000486 85020085
	06-	PA1211			w/ pulley	20411880,20857085,85000214
480 (353 kW) Eng.D13A480	05-	PA1204			w/o pulley	20538845,20744939/ 940,20761306 21228793,21468471,3161436,85000486 85020085
	06-	PA1211			w/ pulley	20411880,20857085,85000214
500 (368 kW) Eng.D13B500	07-	PA1204			w/o pulley	20538845,20744939/ 940,20761306 21228793,21468471,3161436,85000486 85020085
	06-	PA1211			w/ pulley	20411880,20857085,85000214
500 (368 kW) Eng.D13C500/K500	12-	PA1204			w/o pulley	20538845,20744939/ 940,20761306 21228793,21468471,3161436,85000486 85020085
	06-	PA1211			w/ pulley	20411880,20857085,85000214
FM 12 '8/98-'9/05						
340 (250 kW) Eng.D12C340	98-05	PA1332		•		20431135/ 51,20713787,20734268,3803909 81070305,8113274/ 75,8170305/ 833 85000076/ 452
340 (250 kW) Eng.D12D340	01-05	PA1332		•		20431135/ 51,20713787,20734268,3803909 81070305,8113274/ 75,8170305/ 833 85000076/ 452
380 (279 kW) Eng.D12C380	98-05	PA1332		•		20431135/ 51,20713787,20734268,3803909 81070305,8113274/ 75,8170305/ 833 85000076/ 452
380 (279 kW) Eng.D12D380	01-05	PA1332		•		20431135/ 51,20713787,20734268,3803909 81070305,8113274/ 75,8170305/ 833 85000076/ 452
420 (309 kW) Eng.D12C420	98-05	PA1332		•		20431135/ 51,20713787,20734268,3803909 81070305,8113274/ 75,8170305/ 833 85000076/ 452

			
<p>PA1204</p>	<p>PA1211</p>	<p>PA1318</p>	<p>PA1332</p>

		GRAF ref.			NOTE	Adaptable for OES
420 (309 kW) Eng.D12D420	01-05	PA1332		•		20431135/ 51,20713787,20734268,3803909 81070305,8113274/ 75,8170305/ 833 85000076/ 452
460 (338 kW) Eng.D12C460	98-05	PA1332		•		20431135/ 51,20713787,20734268,3803909 81070305,8113274/ 75,8170305/ 833 85000076/ 452
FM 7 '9/98-'12/01						
250 (184 kW) Eng.D7C250	99-	PA1318		•		1675750,20575653,3183908/ 9,420759 465884,471500,477397/ 770,8112184/ 5 8113522/ 3,8192050,85000387
290 (213 kW) Eng.D7C290	99-	PA1318		•		1675750,20575653,3183908/ 9,420759 465884,471500,477397/ 770,8112184/ 5 8113522/ 3,8192050,85000387
FM 9 '12/01-'9/05						
260 (191 kW) Eng.D9A260	01-05	PA1204			w/o pulley	20538845,20744939/ 940,20761306 21228793,21468471,3161436,85000486 85020085
	06-	PA1211			w/ pulley	20411880,20857085,85000214
300 (221 kW) Eng.D9A300	01-05	PA1204			w/o pulley	20538845,20744939/ 940,20761306 21228793,21468471,3161436,85000486 85020085
	06-	PA1211			w/ pulley	20411880,20857085,85000214
340 (250 kW) Eng.D9A340	01-05	PA1204			w/o pulley	20538845,20744939/ 940,20761306 21228793,21468471,3161436,85000486 85020085
	06-	PA1211			w/ pulley	20411880,20857085,85000214
380 (279 kW) Eng.D9A380	01-05	PA1204			w/o pulley	20538845,20744939/ 940,20761306 21228793,21468471,3161436,85000486 85020085
	06-	PA1211			w/ pulley	20411880,20857085,85000214
FMX '4/10-						
330 (243 kW) Eng.D11C330	06-	PA1211			w/ pulley	20411880,20857085,85000214
330 (243 kW) Eng.D11C330/K330	06-	PA1211			w/ pulley	20411880,20857085,85000214
370 (272 kW) Eng.D11C370/K370	06-	PA1211			w/ pulley	20411880,20857085,85000214
380 (280 kW) Eng.D13C380	13-	PA1204			w/o pulley	20538845,20744939/ 940,20761306 21228793,21468471,3161436,85000486 85020085
	06-	PA1211			w/ pulley	20411880,20857085,85000214
380 (285 kW) Eng.D13C380	10-	PA1204			w/o pulley	20538845,20744939/ 940,20761306 21228793,21468471,3161436,85000486 85020085
	06-	PA1211			w/ pulley	20411880,20857085,85000214
380 Eng.D13C380	13-	PA1204			w/o pulley	20538845,20744939/ 940,20761306 21228793,21468471,3161436,85000486 85020085
	06-	PA1211			w/ pulley	20411880,20857085,85000214
400 (294 kW) Eng.D13B400	12-	PA1204			w/o pulley	20538845,20744939/ 940,20761306 21228793,21468471,3161436,85000486 85020085
	06-	PA1211			w/ pulley	20411880,20857085,85000214
410 (302 kW) Eng.D11C410/K410	06-	PA1211			w/ pulley	20411880,20857085,85000214
420 (309 kW) Eng.D13C420/K420	13-	PA1204			w/o pulley	20538845,20744939/ 940,20761306 21228793,21468471,3161436,85000486 85020085
	06-	PA1211			w/ pulley	20411880,20857085,85000214
430 (316 kW) Eng.D11A430	06-	PA1211			w/ pulley	20411880,20857085,85000214
440 (324 kW) Eng.D13A440	12-	PA1204			w/o pulley	20538845,20744939/ 940,20761306 21228793,21468471,3161436,85000486 85020085
	06-	PA1211			w/ pulley	20411880,20857085,85000214
450 (332 kW) Eng.D11C450/K450	06-	PA1211			w/ pulley	20411880,20857085,85000214

			
<p>PA1204</p>	<p>PA1211</p>	<p>PA1304</p>	<p>PA1318</p>
			
<p>PA1332</p>			

		GRAF ref.			NOTE	Adaptable for OES
460 (338 kW) Eng.D13C460/K460	13-	PA1204			w/o pulley	20538845,20744939/ 940,20761306 21228793,21468471,3161436,85000486 85020085
	06-	PA1211			w/ pulley	20411880,20857085,85000214
480 (353 kW) Eng.D13A480	12-	PA1204			w/o pulley	20538845,20744939/ 940,20761306 21228793,21468471,3161436,85000486 85020085
	06-	PA1211			w/ pulley	20411880,20857085,85000214
500 (368 kW) Eng.D13C500/K500	13-	PA1204			w/o pulley	20538845,20744939/ 940,20761306 21228793,21468471,3161436,85000486 85020085
	06-	PA1211			w/ pulley	20411880,20857085,85000214
FS 7 '9/94-'3/96						
230 (169 kW) Eng.D7B230	99-	PA1318		•		1675750,20575653,3183908/ 9,420759 465884,471500,477397/ 770,8112184/ 5 8113522/ 3,8192050,85000387
260 (191 kW) Eng.D7B260	99-	PA1318		•		1675750,20575653,3183908/ 9,420759 465884,471500,477397/ 770,8112184/ 5 8113522/ 3,8192050,85000387
L						
495 Eng.D96B/TD96B	05-	PA1204			w/o pulley	20538845,20744939/ 940,20761306 21228793,21468471,3161436,85000486 85020085
N '1/65-						
86 (106-110 kW) Eng.D70	99-	PA1318		•		1675750,20575653,3183908/ 9,420759 465884,471500,477397/ 770,8112184/ 5 8113522/ 3,8192050,85000387
N 10 '10/83-'12/89						
270 (202 kW) Eng.TD101G	83-88	PA1304		•	+BH	1545261,1675945,1698616/ 20,1699786/ 90 20431484,3184802,422791,468250/ 937 470232,478405,478845,479164,479931 8112520/ 683,8113157/ 431,8121802 8149937
300 (220 kW) Eng.TD101F	85-89	PA1304		•	+BH	1545261,1675945,1698616/ 20,1699786/ 90 20431484,3184802,422791,468250/ 937 470232,478405,478845,479164,479931 8112520/ 683,8113157/ 431,8121802 8149937
NH 12 '5/99-						
380 (279 kW) Eng.D12C380	99-	PA1332		•		20431135/ 51,20713787,20734268,3803909 81070305,8113274/ 75,8170305/ 833 85000076/ 452
420 (309 kW) Eng.D12C420	00-	PA1332		•		20431135/ 51,20713787,20734268,3803909 81070305,8113274/ 75,8170305/ 833 85000076/ 452

Adaptable to	GRAF ref.	Adaptable to	GRAF ref.	Adaptable to	GRAF ref.	Adaptable to	GRAF ref.	Adaptable to	GRAF ref.	
DAF TRUCK		4639182	PA031	51065006426	PA1302	51065009646	PA1235	51065007052	PA1330	
		4655010	PA031	51065006462	PA1306	51065009651	PA1227	51065007064	PA1234	
		4655054	PA031	51065006463	PA1310	51065009675	PA1224	51065007065	PA1330	
63225	PA1317	4679242	PA031	51065006476	PA1306	51065009676	PA1235	51065007066	PA1330	
288619	PA1293	4714636	PA178	51065006480	PA1308	51065009679	PA1234	51065007078	PA1234	
372896	PA1307	4754850	PA178	51065006490	PA1302	51065009680	PA1227	51065007079	PA1227	
506109	PA1293	4764761	PA178	51065006492	PA1298	51065009694	PA1224	51065007088	PA1330	
516724	PA1293	4813370	PA840	51065006495	PA1310	51065009695	PA1235	51065007089	PA1330	
517097	PA1293	4838676	PA844	51065006537	PA1323	51065009699	PA1234	51065009045	PA1330	
517097	PA1293	4952496	PA077	51065006543	PA1324	51065009700	PA1227	51065009047	PA1330	
680156	PA1305	7303009	PA178	51065006545	PA1321	51065063043	PA1308	51065009048	PA1330	
681653	PA1307	7303050	PA161	51065006546	PA1319			51065009049	PA1225	
681653	PA1307	7303056	PA317	51065006547	PA1321			51065009050	PA1235	
682258	PA1307	42530032	PA854	51065006548	PA1336	MAN TRUCK				
682258	PA1307	42530033	PA848	51065006569	PA1324					
682260	PA1293	42532082	PA846	51065006575	PA1331			51065009066	PA1330	
682260	PA1293	42532083	PA845	51065006606	PA1331	51065000298	PA1330	51065009078	PA1234	
682262	PA1305	42535615	PA846	51065006612	PA1331	51065003178	PA1310	51065009079	PA1227	
682968	PA1307	61318939	PA849	51065006637	PA1225	51065006066	PA1330	51065009228	PA1292	
683225	PA1317	93190284	PA850	51065006642	PA1224	51065006204	PA1292	51065009282	PA1294	
683386	PA1317	93190285	PA969	51065006646	PA1235	51065006213	PA1292	51065009387	PA1294	
683386	PA1317	93190286	PA854	51065006651	PA1227	51065006214	PA1292	51065009426	PA1302	
683579	PA1335	93191101	PA031	51065006669	PA1331	51065006215	PA1292	51065009462	PA1306	
683586	PA1317	98415831	PA843	51065006675	PA1224	51065006216	PA1292	51065009463	PA1310	
931147	PA1338	98435994	PA498	51065006676	PA1235	51065006218	PA1292	51065009476	PA1306	
1262683	PA1317	98437726	PA499	51065006679	PA1234	51065006219	PA1292	51065009479	PA1301	
1282029	PA1335	98438356	PA914	51065006680	PA1227	51065006221	PA1292	51065009480	PA1308	
1399150	PA1335	98439407	PA914	51065006694	PA1224	51065006222	PA1292	51065009490	PA1302	
1399336	PA1335	98439476	PA845	51065006695	PA1235	51065006223	PA1292	51065009492	PA1298	
1399689	PA1060	98468830	PA853	51065006699	PA1234	51065006224	PA1292	51065009495	PA1310	
1609853	PA1335	98468832	PA847	51065007033	PA1330	51065006225	PA1292	51065009515	PA1322	
1609871	PA1317	98479675	PA852	51065007036	PA1330	51065006228	PA1292	51065009532	PA1322	
1653974	PA1338	98497115	PA842	51065007043	PA1330	51065006229	PA1292	51065009537	PA1323	
1664762	PA1338	98497117	PA841	51065007045	PA1330	51065006282	PA1294	51065009543	PA1324	
1738991	PA1338	99438900	PA914	51065007047	PA1330	51065006387	PA1294	51065009545	PA1321	
1742258	PA1338	99440728	PA499	51065007048	PA1330	51065006408	PA1298	51065009546	PA1319	
1742259	PA1338	99445447	PA852	51065007049	PA1225	51065006426	PA1302	51065009547	PA1321	
1747962	PA1338	99448068	PA914	51065007050	PA1235	51065006462	PA1306	51065009548	PA1336	
1747963	PA1338	99458098	PA853	51065007051	PA1330	51065006463	PA1310	51065009569	PA1324	
1778280	PA1338	99458099	PA847	51065007052	PA1330	51065006476	PA1306	51065009575	PA1331	
1828141	PA1338	99459755	PA317	51065007064	PA1234	51065006479	PA1301	51065009606	PA1331	
1828142	PA1338	99459757	PA498	51065007065	PA1330	51065006480	PA1308	51065009612	PA1331	
1828162	PA1338	99476298	PA1161	51065007066	PA1330	51065006490	PA1302	51065009642	PA1224	
93103402	PA1338	99483937	PA968	51065007078	PA1234	51065006492	PA1298	51065009646	PA1235	
0680156R	PA1305	500300476	PA914	51065007079	PA1227	51065006495	PA1310	51065009651	PA1227	
0682262R	PA1305	500316451	PA913	51065007088	PA1330	51065006515	PA1322	51065009675	PA1224	
0683225R	PA1317	500350785	PA969	51065007089	PA1330	51065006532	PA1322	51065009676	PA1235	
0683586R	PA1317	500350797	PA849	51065009045	PA1330	51065006537	PA1323	51065009679	PA1234	
682258R	PA1307	500350798	PA850	51065009047	PA1330	51065006543	PA1324	51065009680	PA1227	
682968R	PA1307	500356553	PA942	51065009048	PA1330	51065006545	PA1321	51065009694	PA1224	
683225R	PA1317	500361203	PA914	51065009049	PA1225	51065006546	PA1319	51065009695	PA1235	
		500361455	PA916	51065009050	PA1235	51065006547	PA1321	51065009699	PA1234	
		500361919	PA914	51065009052	PA1330	51065006548	PA1336	51065009700	PA1227	
IRIS BUS		500362834	PA913	51065009064	PA1234	51065006569	PA1324	51065063043	PA1308	
		500362859	PA915	51065009066	PA1330	51065006575	PA1331			
		504029280	PA1199	51065009078	PA1234	51065006606	PA1331			
504093706	PA1198	504033770	PA900	51065009079	PA1227	51065006612	PA1331	MERCEDES BENZ TRUCK		
		504062854	PA1060	51065009282	PA1294	51065006637	PA1225			
		504093706	PA1198	51065009387	PA1294	51065006642	PA1224			
IVECO BUS		504102572	PA1026	51065009426	PA1302	51065006646	PA1235	314 200 29 01	PA1296	
		504113544	PA1156	51065009462	PA1306	51065006651	PA1227	314 200 35 01	PA1300	
		504248581	PA1026	51065009463	PA1310	51065006669	PA1331	314 200 41 01	PA1300	
4639182	PA031	504360207	PA1156	51065009476	PA1306	51065006675	PA1224	314 200 42 01	PA1296	
4655010	PA031	504369725	PA1156	51065009480	PA1308	51065006676	PA1235	314 200 47 01	PA1300	
4655054	PA031	5001833230	PA161	51065009490	PA1302	51065006679	PA1234	352 200 38 01	PA1295	
4679242	PA031	5001849884	PA914	51065009492	PA1298	51065006680	PA1227	352 200 74 01	PA1295	
93191101	PA031	5801807827	PA942	51065009495	PA1310	51065006694	PA1224	352 200 84 01	PA1295	
504029280	PA1199			51065009537	PA1323	51065006695	PA1235	352 200 94 01	PA1295	
504093706	PA1198			51065009543	PA1324	51065006699	PA1234	353 200 03 01	PA1295	
		MAN BUS			51065009545	PA1321	51065007033	PA1330	353 200 04 01	PA1295
				51065009546	PA1319	51065007036	PA1330	353 200 21 01	PA1299	
				51065009547	PA1321	51065007043	PA1330	353 200 36 01	PA1295	
IVECO TRUCK		51065000298	PA1330	51065009548	PA1336	51065007045	PA1330	353 200 37 01	PA1299	
		51065003178	PA1310	51065009569	PA1324	51065007047	PA1330	353 200 56 01	PA870	
2995624	PA916	51065006066	PA1330	51065009575	PA1331	51065007048	PA1330	355 200 01 01	PA1297	
2995627	PA317	51065006282	PA1294	51065009606	PA1331	51065007049	PA1225	355 200 15 01	PA1297	
2995629	PA498	51065006387	PA1294	51065009612	PA1331	51065007050	PA1235	364 200 01 01	PA1303	
4606023	PA077	51065006408	PA1298	51065009642	PA1224	51065007051	PA1330	364 200 09 01	PA1303	

Adaptable to	GRAF ref.	Adaptable to	GRAF ref.	Adaptable to	GRAF ref.	Adaptable to	GRAF ref.	Adaptable to	GRAF ref.
MERCEDES BENZ TRUCK		904 200 38 01	PA1320	570965	PA1339	8113157	PA1304		
		904 200 43 01	PA1320	570965	PA1339	8113274	PA1332		
		904 200 49 01	PA1320	571157	PA1334	8113275	PA1332		
364 200 14 01	PA1303	904 200 50 01	PA1320	1314406	PA869	8113431	PA1304		
364 200 20 01	PA1303	906 200 09 01	PA1333	1353072	PA1201	8113522	PA1318		
366 200 54 01	PA1325	906 200 12 01	PA1333	1365481	PA1212	8113523	PA1318		
366 200 59 01	PA871	906 200 13 01	PA1333	1365841	PA1212	8121802	PA1304		
366 200 67 01	PA1325	906 200 14 01	PA1333	1372365	PA1201	8148460	PA1316		
366 200 68 01	PA1325	906 200 18 01	PA1333	1380897	PA1334	8149882	PA1337		
390 200 00 01	PA1325	906 200 20 01	PA1333	1433792	PA1207	8149937	PA1304		
403 200 06 01	PA1294	906 200 22 01	PA1333	1486098	PA1334	8149941	PA1316		
403 200 27 01	PA1292	906 200 24 01	PA1333	1508533	PA1201	8170305	PA1332		
403 200 32 01	PA1292	906 200 29 01	PA1333	1508534	PA1212	8170833	PA1332		
403 200 34 01	PA1292	906 200 32 01	PA1333	1508536	PA1201	8192050	PA1318		
403 200 35 01	PA1292	906 200 38 01	PA1333	1510404	PA1207	20411880	PA1211		
403 200 36 01	PA1294	906 200 42 01	PA1333	1510490	PA1334	20431135	PA1332		
403 200 44 01	PA1294	906 200 45 01	PA1333	1546188	PA1339	20431151	PA1332		
403 200 49 01	PA1292	906 200 48 01	PA1333	1549481	PA1207	20431484	PA1304		
403 200 51 01	PA1294	906 200 54 01	PA1333	1549482	PA1207	20538845	PA1204		
403 200 57 01	PA1298	906 200 57 01	PA1333	1570951	PA1201	20575653	PA1318		
403 200 64 01	PA1301	906 200 65 01	PA1333	1570954	PA1207	20713787	PA1332		
403 200 70 01	PA1292			1570955	PA1201	20734268	PA1332		
403 200 71 01	PA1294			1570956	PA1212	20744939	PA1204		
403 200 71 01	PA1294	RENAULT TRUCK		1570959	PA1339	20744940	PA1204		
403 200 73 01	PA1326			1787120	PA1339	20761306	PA1204		
403 200 75 01	PA1301			1787123	PA1339	20857085	PA1211		
403 200 76 01	PA1309	-	PA1066	1789522	PA1339	21228793	PA1204		
403 200 77 01	PA1309	50 01 837 309	PA1343	1793989	PA1207	21468471	PA1204		
422 200 05 01	PA1298	50 01 857 427	PA1340	1896752	PA1201	81070305	PA1332		
422 200 06 01	PA1302	50 01 858 484	PA1340	10570951	PA1201	85000076	PA1332		
422 200 07 01	PA1301	50 01 863 728	PA1344	10570952	PA1212	85000214	PA1211		
422 200 10 01	PA1298	50 01 863 754	PA1344	10570954	PA1207	85000387	PA1318		
422 200 10 01	PA1298	50 01 866 278	PA1332	10570955	PA1201	85000452	PA1332		
422 200 11 01	PA1328	50 01 875 237	PA1344	10570956	PA1212	85000486	PA1204		
422 200 12 01	PA1301	50 10 330 029	PA1343	10570958	PA1207	85020085	PA1204		
422 200 13 01	PA1309	50 10 477 005	PA1340	10570959	PA1339				
422 200 14 01	PA1309	50 10 477 162	PA1340	10570964	PA1339				
422 200 16 01	PA1328	50 10 477 321	PA1340						
441 200 01 01	PA1294	50 10 477 734	PA1340						
441 200 02 01	PA1294	50 10 550 549	PA1340	VOLVO TRUCK					
441 200 03 01	PA1309	50 10 550 550	PA1340						
442 200 04 01	PA1327	50 10 550 551	PA1340						
442 200 06 01	PA1327	50 10 550 552	PA1340	420759	PA1318				
442 200 07 01	PA1327	52 00 537 899	PA1344	422791	PA1304				
442 200 12 01	PA1301	52 00 551 856	PA1344	465884	PA1318				
457 200 02 01	PA1326	74 20 734 268	PA1332	468250	PA1304				
457 200 05 01	PA1326	74 20 744 939	PA1204	468937	PA1304				
457 200 08 01	PA1329	74 20 744 940	PA1204	470232	PA1304				
457 200 09 01	PA1327	74 22 189 466	PA1340	471500	PA1318				
457 200 10 01	PA1327	74 85 000 763	PA1204	477397	PA1318				
457 200 11 01	PA1326	74 85 003 149	PA1344	477770	PA1318				
457 200 19 01	PA1329	74 85 013 068	PA1204	478405	PA1304				
457 200 23 01	PA1329			478845	PA1304				
457 200 24 01	PA1327			479164	PA1304				
457 200 25 01	PA1326			479931	PA1304				
457 200 27 01	PA1326	SCANIA TRUCK		1001698	PA1316				
457 200 28 01	PA1327			1545261	PA1304				
457 200 29 01	PA1329	508533	PA1201	1547155	PA1316				
541 200 10 01	PA1312	546188	PA1339	1675750	PA1318				
542 200 06 01	PA1312	570951	PA1201	1675945	PA1304				
542 200 16 01	PA1312	570951	PA1201	1676713	PA1337				
542 200 20 01	PA1312	570952	PA1212	1698616	PA1304				
542 200 25 01	PA1341	570952	PA1212	1698620	PA1304				
542 200 26 01	PA1342	570953	PA1334	1699786	PA1304				
904 200 02 01	PA1320	570953	PA1334	1699790	PA1304				
904 200 04 01	PA1320	570954	PA1207	3161436	PA1204				
904 200 06 01	PA1320	570955	PA1201	3183908	PA1318				
904 200 07 01	PA1320	570955	PA1201	3183909	PA1318				
904 200 08 01	PA1320	570956	PA1212	3184802	PA1304				
904 200 19 01	PA1320	570957	PA1334	3803909	PA1332				
904 200 20 01	PA1320	570957	PA1334	8112184	PA1318				
904 200 22 01	PA1320	570958	PA1207	8112185	PA1318				
904 200 25 01	PA1320	570959	PA1339	8112275	PA1316				
904 200 26 01	PA1320	570959	PA1339	8112520	PA1304				
904 200 27 01	PA1320	570961	PA1334	8112683	PA1304				
904 200 28 01	PA1320	570962	PA1201	8112889	PA1337				
904 200 29 01	PA1320	570964	PA1339	8113117	PA1316				
904 200 32 01	PA1320	570964	PA1339	8113155	PA1337				

GRAF ref.	MARCA MAKE	PAGINA PAGE	GRAF ref.	MARCA MAKE	PAGINA PAGE	GRAF ref.	MARCA MAKE	PAGINA PAGE			
PA031	Iveco Bus / Iveco Truck	26, 28, 30	PA1212	Scania Truck	256, 268, 270	PA1302	Man Bus / Man Truck / Mercedes Benz Truck	42, 44, 46, 48, 50, 52, 54, 56, 58, 60, 62, 64, 66, 68, 70, 72, 74, 76, 78, 80, 82, 84, 86, 88, 90, 92, 94, 96, 98, 100, 102, 104, 106, 108, 110, 112, 114, 124, 126, 128, 130, 132, 134, 136, 138, 140, 142, 144, 146, 148, 150, 152, 206, 208, 210, 212, 214, 216, 218, 220, 226			
PA077	Iveco Truck	28, 30	PA1224	Man Bus / Man Truck	40, 42, 52, 132, 134, 136, 138, 140, 142, 144, 146, 148, 150, 152, 160, 162, 164, 166						
PA161	Iveco Truck	30, 32									
PA178	Iveco Truck	30, 32									
PA317	Iveco Truck	30									
PA498	Iveco Truck	30									
PA499	Iveco Truck	30, 32	PA1225	Man Bus / Man Truck	132, 134, 136, 138, 140, 142, 144, 146, 148, 150, 152, 160, 162, 164, 166						
PA840	Iveco Truck	28, 30	PA1227	Man Bus / Man Truck	48, 50, 52, 54, 154, 156, 158, 160						
PA841	Iveco Truck	28									
PA842	Iveco Truck	26, 28, 30									
PA843	Iveco Truck	34, 36									
PA844	Iveco Truck	34									
PA845	Iveco Truck	34	PA1234	Man Bus / Man Truck	48, 50, 52, 54, 114, 116, 118, 120, 138, 154, 156, 158, 160						
PA846	Iveco Truck	34	PA1235	Man Bus / Man Truck	40, 42, 46, 48, 54, 56	PA1303	Mercedes Benz Truck	218, 228, 230			
PA847	Iveco Truck	40				PA1304	Volvo Truck	274, 276, 284, 294			
PA848	Iveco Truck	40				PA1292	Man Truck / Mercedes Benz Truck	84, 114, 130, 132, 206, 210, 212, 214, 216, 218, 220, 222, 226	PA1305	Daf Truck	20, 22, 24
PA849	Iveco Truck	36, 38				PA1293	Daf Truck	20, 22, 24	PA1306	Man Bus / Man Truck	114, 116, 118, 120, 122, 124, 126, 128
PA850	Iveco Truck	36, 38									
PA852	Iveco Truck	36, 38									
PA853	Iveco Truck	38, 40	PA1307	Daf Truck	2, 4, 6, 8, 10						
PA854	Iveco Truck	40	PA1308	Man Bus / Man Truck	46, 48, 64, 130						
PA869	Scania Truck	250, 252, 254	PA1294	Man Bus / Man Truck / Mercedes Benz Truck	42, 46, 48, 50, 52, 54, 56, 64, 84, 86, 88, 90, 92, 94, 96, 98, 100, 102, 104, 106, 108, 110, 112, 114, 130, 132, 220, 222, 224	PA1309	Mercedes Benz Truck	206, 208, 210, 212, 214, 216, 218, 220, 222, 224, 226			
PA870	Mercedes Benz Truck	208, 220, 224, 230, 232	PA1295	Mercedes Benz Truck	208, 210, 212, 220, 222, 224, 228, 230, 232, 234	PA1310	Man Bus / Man Truck	48, 52, 64, 114, 116, 118, 120, 122, 124, 126, 128			
PA871	Mercedes Benz Truck	208, 210, 218, 220, 222									
PA872	Mercedes Benz Truck	210, 212, 214, 216, 218				PA1312	Mercedes Benz Truck	166, 168, 170, 172, 174, 176			
PA873	Mercedes Benz Truck	218, 220, 222, 224, 226				PA1316	Volvo Truck	272, 274, 280, 282, 284, 286			
PA874	Mercedes Benz Truck	224				PA1296	Mercedes Benz Truck	208, 212, 224, 234	PA1317	Daf Truck	4, 6, 10, 12, 14, 16
PA900	Iveco Truck	32, 34	PA1297	Mercedes Benz Truck	214	PA1318	Volvo Truck	272, 274, 276, 278, 286, 288, 292, 294			
PA913	Iveco Truck	32	PA1298	Man Bus / Man Truck / Mercedes Benz Truck	42, 44, 46, 48, 50, 52, 54, 56, 58, 60, 62, 64, 66, 68, 70, 72, 74, 76, 78, 80, 82, 84, 86, 88, 90, 92, 94, 96, 98, 100, 102, 104, 106, 108, 110, 112, 114, 124, 126, 128, 130, 132, 134, 136, 138, 140, 142, 144, 146, 148, 150, 152, 206, 208, 222, 224, 226	PA1319	Man Bus / Man Truck	42, 44, 46, 56, 58, 60, 62, 64, 66, 68, 70, 72, 74, 76, 78, 80, 82, 84, 86, 88, 90, 92, 94, 96, 98, 100, 102, 104, 106, 108, 110, 112, 124, 126, 128, 132, 134, 136, 138, 140, 142, 144, 146, 148, 150, 152, 154			
PA914	Iveco Truck	30, 32									
PA915	Iveco Truck	32, 34									
PA916	Iveco Truck	32									
PA942	Iveco Truck	36, 38, 40									
PA968	Iveco Truck	36, 38, 40									
PA969	Iveco Truck	36, 38									
PA1026	Iveco Truck	34									
PA1060	Daf Truck / Iveco Truck	2, 16, 24, 34, 36									
PA1066	Renault Truck	246									
PA1156	Iveco Truck	32, 34, 38									
PA1161	Iveco Truck	30, 32									
PA1198	Iris Bus / Iveco Bus / Iveco Truck	26	PA1299	Mercedes Benz Truck	208, 210, 212, 220, 222, 224, 228, 230, 232, 234	PA1320	Mercedes Benz Truck	166, 176, 178, 180, 182, 184, 186, 188, 190, 192, 194, 196, 198, 200, 204, 206, 208, 218, 226, 228, 232, 234, 236			
PA1199	Iveco Bus / Iveco Truck	26	PA1300	Mercedes Benz Truck	208, 212, 224, 234						
PA1201	Scania Truck	250, 252, 254, 256, 258, 260, 262, 264, 266, 268, 270	PA1301	Man Truck / Mercedes Benz Truck	64, 66, 68, 70, 72, 74, 76, 78, 80, 82, 84, 86, 88, 90, 92, 94, 96, 98, 100, 102, 104, 106, 108, 110, 112, 210, 218, 222, 224						
PA1204	Renault Truck / Volvo Truck	238, 240, 248, 250, 272, 274, 276, 278, 280, 282, 284, 288, 290, 292, 294									
PA1207	Scania Truck	256, 258, 264, 266									
PA1211	Volvo Truck	272, 274, 278, 280, 282, 284, 288, 290, 292, 294									

GRAF ref.	MARCA MAKE	PAGINA PAGE	GRAF ref.	MARCA MAKE	PAGINA PAGE	GRAF ref.	MARCA MAKE	PAGINA PAGE
PA1321	Man Bus / Man Truck	42, 44, 46, 56, 58, 60, 62, 64, 66, 68, 70, 72, 74, 76, 78, 80, 82, 84, 86, 88, 90, 92, 94, 96, 98, 100, 102, 104, 106, 108, 110, 112, 124, 126, 128, 132, 134, 136, 138, 140, 142, 144, 146, 148, 150, 152, 154	PA1339	Scania Truck	258, 260, 262, 264, 270			
			PA1340	Renault Truck	238, 240, 246, 248			
			PA1341	Mercedes Benz Truck	166, 168, 170, 172, 174, 176, 214, 228			
			PA1342	Mercedes Benz Truck	166, 168, 170, 172, 174, 176, 214, 228			
			PA1343	Renault Truck	236, 238, 244, 246, 248, 250			
			PA1344	Renault Truck	240, 242, 244			
PA1322	Man Truck	114, 116, 118, 120, 122, 124						
PA1323	Man Bus / Man Truck	46, 48, 52, 64, 114, 116, 118, 120, 122, 124, 126, 128, 130						
PA1324	Man Bus / Man Truck	46, 48, 64, 130						
PA1325	Mercedes Benz Truck	208, 210, 214, 218, 220, 222, 230, 232						
PA1326	Mercedes Benz Truck	192, 196, 198, 200, 202, 204, 208, 214, 216, 228						
PA1327	Mercedes Benz Truck	192, 196, 198, 200, 202, 204, 208, 214, 216, 228						
PA1328	Mercedes Benz Truck	210, 212, 214, 216, 218, 220, 222, 224, 226						
PA1329	Mercedes Benz Truck	192, 194, 196, 198, 200, 202, 204, 208, 214, 216, 228						
PA1330	Man Bus / Man Truck	56, 58, 60, 62, 64, 66, 68, 70, 72, 74, 76, 78, 80, 82, 84, 132, 134, 136, 138, 140, 142, 144, 146, 148, 150, 152, 154						
PA1331	Man Bus / Man Truck	40, 54, 114, 116, 118, 120, 122, 124						
PA1332	Renault Truck / Volvo Truck	240, 242, 244, 272, 274, 280, 282, 290, 292, 294						
PA1333	Mercedes Benz Truck	178, 180, 182, 184, 186, 188, 190, 192, 194, 196, 198, 200, 204, 206, 208, 228, 232, 234, 236						
PA1334	Scania Truck	258, 260, 270						
PA1335	Daf Truck	14, 16, 18, 20, 24, 26						
PA1336	Man Bus / Man Truck	42, 44, 46, 64, 66, 68, 70, 72, 74, 76, 78, 80, 82, 84, 86, 88, 90, 92, 94, 96, 98, 100, 102, 104, 106, 108, 110, 112, 126, 128						
PA1337	Volvo Truck	272, 274, 280, 282, 284, 286						
PA1338	Daf Truck	10, 12, 14, 16, 18, 20, 24, 26						