



Professionally tested!

Quickly repaired
and replaced!



Satisfied customers!

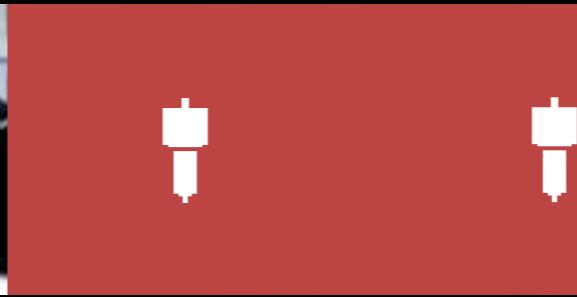

Reliable diagnosis. Time saving repairs.
Bosch diagnostics and service parts.

Everything from one single source.
Bosch has a complete program available
which increases efficiency and quality
in the work-shop's daily work.
The service parts from the globally active
development expert and leading manu-
facturer of automotive system technology
are in renowned Bosch OE quality.

Bosch Diagnostics			
ESI[tronic] Software	Test Equipment	Service Training	Technical Hotline



2008 | 2009

2008 | 2009



BOSCH

☎ 1 987 720 219/200801

AA/MKV3 - 01.2008 - int

© 2008 Robert Bosch GmbH
Automotive Aftermarket
Postfach 41 09 60
76225 Karlsruhe

Token fee: € 10,00

www.bosch.de/aa

Editorial closing: 15.11.2007

Subject to change without notice.
Please direct questions and
comments to our Authorized
Representative in your country.
This edition supersedes all
previous editions.



BOSCH



BOSCH



4 047 023 038 05 0

ZEXEL

de

Bosch-Diesel-Einspritztechnik – Know-how des weltweit führenden Zulieferers für Diesel-Erstausrüstung.

en

Bosch Diesel Injection Technology – Know-how from the world's leading supplier of original-equipment diesel systems.

fr

Systèmes d'injection Diesel Bosch – Tout le savoir-faire du plus important fournisseur mondial d'équipements Diesel de première monte.

it

Sistemi iniezione diesel Bosch – know-how dal fornitore di sistemi iniezione diesel leader a livello mondiale per il primo equipaggiamento diesel.

es

Inyección Diesel Bosch – Los conocimientos y la experiencia del principal proveedor de equipos Diesel de origen del mundo.



► Technologievorsprung nutzen
Bosch-Diesel-Einspritzsysteme bieten stets die aktuellen Vorteile der führenden Entwicklungen aus der Fahrzeug-Erstausrüstung

► Benefit from cutting-edge technology
Bosch diesel injection systems incorporate all the latest innovations in the motor-vehicle original-equipment sector

► Profiter de l'avance technologique
Les systèmes d'injection Diesel Bosch offrent toujours les avantages des plus récentes innovations issues de la première monte

► Beneficiare di una tecnologia d'avanguardia
I sistemi di iniezione diesel Bosch offrono sempre i vantaggi degli ultimi sviluppi raggiunti nell'ambito del primo equipaggiamento di autoveicoli

► Aproveche el adelanto tecnológico
Los sistemas de inyección Diesel de Bosch ofrecen siempre las ventajas actuales de los desarrollos más importantes de los equipos de origen para vehículos

► Dieselsystem integriert
Das komplette Bosch-System Know-how fließt in die Entwicklung einzelner Komponenten ein und macht aus Einzelteilen das perfekte Dieselsystem

► Integrated diesel system
All the wealth of Bosch system expertise goes into the development of individual components and the creation of a perfect diesel system

► Système Diesel intégré
Tout le savoir-faire de Bosch en matière de systèmes rejaillit sur le développement de chaque composant qui constitue la base d'un système Diesel parfait

► Integrazione perfetta nel sistema diesel
Tutto il know-how acquisito da Bosch nell'ambito dei sistemi diesel viene utilizzato per la progettazione dei singoli componenti, questo fa sì che tutti gli elementi si integrino in un sistema diesel perfetto

► Sistema Diesel integrado
Todos los conocimientos y la experiencia que tiene Bosch en materia de sistemas se aplican en el desarrollo de los distintos componentes y hacen de las piezas aisladas el sistema Diesel perfecto

► Weltweit Nr. 1 bei Diesel
Seit der ersten Serienfertigung von Diesel-Einspritzpumpen 1927 ist Bosch weltweit führender Anbieter innovativer Diesel-System-technologie

► The world's leading diesel specialist
Bosch has been the world's no. 1 supplier of innovative diesel-system technology ever since the series launch of diesel injection pumps in 1927

► N° 1 mondial dans le domaine du Diesel
Depuis la première fabrication en série de pompes d'injection Diesel en 1927, Bosch est le plus important fournisseur mondial de systèmes Diesel novateurs

► N. 1 al mondo nel diesel
Dalla prima produzione in serie di pompe di iniezione diesel nel 1927, Bosch è il fornitore leader a livello mondiale per la tecnologia dei sistemi diesel

► El N° 1 mundial en Diesel
Desde la primera fabricación en serie de bombas de inyección Diesel, que se remonta a 1927, Bosch es el principal proveedor mundial de tecnología innovadora de sistemas Diesel

de

Die Startprofis: Düse und Glühkerze von Bosch

en

Starting the professional way: The Bosch nozzle and glow plug

fr

Les pros du démarrage: injecteur et bougie de préchauffage Bosch

it

I professionisti dell'avviamento: polverizzatore e candele ad incandescenza di Bosch

es

Los profesionales del arranque: inyector y bujías de incandescencia de Bosch



Optimales Zusammenspiel für härteste Startbedingungen: Eine raffinierte Technologie der Strahlauslegung sorgt für gebündelte Funktion von Einspritzdüse und Glühkerze. Düsenstrahlage, ausgerichtet auf die spezifischen Brennraum- und Komponentengeometrien, als wesentliches Element moderner Düsenauslegung.

The best combination for even the toughest starting conditions: Sophisticated jet technology ensures the optimal interaction of nozzle and glow plug. Adaption of the spray position to the specific combustion chamber and component geometry is an essential element of modern nozzle design.

Une synergie parfaite pour faire face aux plus rudes conditions de démarrage: la technologie sophistiquée de formation du jet assure un fonctionnement conjoint optimal de l'injecteur et de la bougie de préchauffage. Adapté aux géométries spécifiques de la chambre de combustion et des composants, la précision du jet constitue un élément essentiel de conception des injecteurs modernes.

Sinergia perfetta per far fronte anche alle più severe condizioni di avviamento: una tecnologia molto sofisticata consente di ottenere un effetto sinergico tra polverizzatore e candele ad incandescenza. Un approccio fondamentale nella progettazione moderna di polverizzatori è rappresentato dalla taratura su misura della direzione del getto del polverizzatore in base alle geometrie specifiche della camera di combustione e dei singoli componenti.

Una acción conjunta óptima para dominar las más duras condiciones de arranque: la refinada tecnología aplicada en la formación del chorro cuida de un funcionamiento concertado del inyector y la bujía. La posición del chorro del inyector, orientada a la geometría específica de la cámara de combustión y los componentes, es un elemento esencial del diseño de los inyectores modernos.

Für neuen Fortschritt in der Strahlagenoptimierung setzt Bosch auf exakte brennraum-spezifische Zuordnung von Einspritzstrahl und Glühkerzenposition. Damit verbessern sich künftig Kaltstartverhalten und Motorleistung im Kaltleerlauf.

Bosch takes spray position optimization one step further with an injection jet and glow-plug location perfectly matched to specific combustion-chamber conditions. This will pave the way to enhanced cold starting and cold idling performance in the future.

Pour faire progresser encore l'optimisation du jet, Bosch mise sur une adaptation précise et spécifique du jet et de la position des bougies de préchauffage. Le démarrage à froid et les performances du moteur au ralenti à froid s'en trouveront améliorés à l'avenir.

Per proseguire nell'ottimizzazione della traiettoria del getto, Bosch opta anche in futuro per una configurazione su misura del getto di iniezione e della posizione della candele per la relativa camera di combustione. Una scelta che permetterà di migliorare ulteriormente le caratteristiche di avviamento a freddo e le prestazioni del motore con il funzionamento al minimo a freddo.

Con el fin de lograr un nuevo avance en la optimización de la posición del chorro, Bosch apuesta por una correspondencia exacta, específica de la cámara de combustión, entre el chorro de inyección y la posición de la bujía de incandescencia. Con esto mejorarán en el futuro el comportamiento de arranque en frío y la potencia del motor en el régimen de ralenti en frío.

de

Inhalt

en

Content

fr

Contenu

it

Contenuto

es

Contenido

Angebot	Offer	Offre	Offerta	Oferta	
Düsen-Bestellnummer → Typformel Bosch	Part number → Type designation Bosch	Référence injecteur → Formule de type Bosch	Numero d'ordine → Sigla Bosch	Número de pedido de los inyectores → Designación de tipo Bosch	A 2
Typformel Bosch → Düsen-Bestellnummer	Type designation → Part number	Formule de type Bosch → Référence injecteur	Sigla Bosch → Numero d'ordine	Designación de tipo Bosch → Número de pedido de los inyectores	A 35
Düsen-Bestellnummer → Typformel Zexel	Part number → Type designation Zexel	Référence injecteur → Formule de type Zexel	Numero d'ordine → Sigla Zexel	Número de pedido de los inyectores → Designación de tipo Zexel	A 68
Typformel Zexel → Düsen-Bestellnummer	Type designation Zexel → Part number	Formule de type Zexel → Référence injecteur	Sigla Zexel → Numero d'ordine	Designación de tipo Zexel → Número de pedido de los inyectores	A 97
Düsen für 1-Feder-Düsenhalter, Zexel	Nozzles for single-spring nozzle-holders, Zexel	Injecteurs pour les principaux porte-injecteurs à 1 ressort, Zexel	Polverizzatori per portapolverizzatori a 1 molla, Zexel	Inyectores para los portainyectores de 1 resorte, Zexel	A 129
Verschleißteile für die wichtigsten 1-Feder-Düsenhalter	Wear parts for the most important 1-spring nozzle-holders	Pièces d'usure pour les principaux porte-injecteurs à 1 ressort,	Parti soggette a usura per i principali portapolverizzatori a 1 molla	Piezas de desgaste para los portainyectores de 1 resorte más importantes	A 208
Teile für Düsenhalter, Zexel	Parts for nozzle holder, Zexel	Pièces pour porte-injecteurs, Zexel	Parti per portapolverizzatori, Zexel	Piezas para portainyectores, Zexel	A 211
Typformel Düsenhalter → Typformel Düse → DHK	Type designation nozzle holder → Type designation nozzle → Nozzle-and-holder assemblies	Formule de type principaux porte-injecteurs → Formule de type injecteur → Ensembles porte-injecteurs	Sigla pulverizzatori → Sigla portapolverizzatori → Sigla combinazione portapolverizzatori	Designación de tipo portainyectores → Designación de tipo inyectores → Conjuntos portainyectores	A 218
Ersatzteile für Düsenhalter- Kombinationen	Spare parts for nozzle-and-holder assemblies	Pièces de rechange pour ensembles porte-injecteurs	Ricambi per combinazione portapolverizzatori	Piezas de repuesto para conjuntos portainyectores	A 274
Teile für Düsenhalter, Bosch – Zwischenscheiben	Parts for nozzle holder, Bosch – Shims	Pièces pour porte-injecteurs, Bosch – Disques intermédiaires	Parti per portapolverizzatori, Bosch – Rosette intermedia	Piezas para portainyectores, Bosch – Arandelas intermedias	A 386
Druckausgleichsscheiben für Düsenhalterkombinationen	Pressure-compensation discs for nozzle-and-holder assemblies	Cales de réglage de pression pour ensembles porte-injecteurs	Rosette di compensazione della pressione per combinazione portapolverizzatori	Arandelas de compensación de presión para conjuntos portainyectores	A 388
Druckstifte für Düsenhalterkombinationen	Pressure pins for nozzle-and-holder assemblies	Poussoirs pour ensembles porte-injecteurs	Spine di pressione per combinazione portapolverizzatori	Espigas de presión para conjuntos portainyectores	A 392
Teile für Düsenhalter, Bosch – Anschluss, Dichtungen	Parts for nozzle holder, Bosch – Connection, seals	Pièces pour porte-injecteurs, Bosch – Raccords, joints	Parti per portapol-verizzatori, Bosch – Collegamento, guarnizioni	Piezas para portainyectores, Bosch – Empalme, Juntas	A 394
Wärmeschutz für Düsen	Thermal protection for nozzles	Protection thermique pour injecteurs	Isolamento termico per pulverizzatori	Arandelas de protección antitérmica	A 400
Ersatzteile für Common Rail Injektoren	Spare parts for Common Rail Injectors	Pièces de rechange pour injecteurs Common Rail	Ricambi per iniettori Common Rail	Piezas de repuesto para inyectores Common Rail	A 402
Ersatzteile für Unit Injektoren (Pkw)	Repair parts for Unit Injectors (PV)	Pièces de rechange pour Unit Injecteurs (VP)	Ricambi per unità pompa-iniettore (Autovetture)	Piezas de repuesto para unidad de bomba-inyector (Turismos)	A 424
Ersatzteile für Unit Injektoren (Nkw)	Repair parts for Unit Injectors (CV)	Pièces de rechange pour Unit Injecteurs (PL)	Ricambi per unità pompa-iniettore (Autocarri)	Piezas de repuesto para unidad de bomba-inyector (Vehículos industriales)	A 428
Hinweise zur Benutzung	Instructions on use	Remarques sur l'utilisation	Istruzioni per l'uso	Indicaciones de uso	B 1.1
Verwendung	Application	Application	Impiego	Aplicaciones	
Personenkraftwagen, Kleintransporter	Passenger cars, passenger-car engines	Voitures particulières, véhicules utilitaires légers	Autovetture, motori per autovetture	Turismos, motores de vehículos turismos	B 2
Transporter, Lastkraftwagen, Omnibusse	Vans, trucks, buses, commercial-vehicle engines	Poids lourds, camionettes	Furgoni, autocarri, autobus	Vehículos de transporte, camiones, autobuses	B 120
Land- und Baumaschinen	Agricultural and construction machinery	Machines agricoles, machines de travaux publics	Trattori e macchine per l'edilizia	Máquinas agrícola máuinas de construcción	B 376
Stationärmotoren, Einbaumotoren	Stationary engines, built-in-engines	Moteurs stationnaires, moteurs à incorporer	Motori stazionari, motori incorporati	Motores estacionares, motores para montaje incorporado	B 484
Motorräder, Bootsmotoren	Motorcycles, inboard engines	Motocyclettes, moteurs à bord	Motociclettas, motori entrobordo	Motocicletas, motores intrabordo	B 494
Gegenüberstellung	Cross-references	Table de correspondance	Comparazione	Equivalencias	
Bestellnummer Fremd → Bosch	Part numbers External → Bosch	Références Autre marque → Bosch	Numero d'ordine Altro → Bosch	Numero de pedido Externas → Bosch	C 2
Piktogramm- und Sonderfallrklärungen	Pictogram and special cases explanations	Signification des pictogrammes et des codes spécifiques	Significato dei pittogrammi e dei casi particolari	Aclaraciones sobre pictogramas y casos especiales	D 1



de

Bestellnummer →
Typformel

en

Part number →
Type designation

fr

Référence →
Formule de type

it

Numero d'ordina-
zione → Sigla

es

Número de pedido →
Designación del tipo

0 433 171 001 ...



0 433 171 ...

0 433 171 001	DLLA 150 P 1
0 433 171 002	DLLA 150 P 2
0 433 171 003	DLLA 150 P 3

0 433 171 004	DLLZ 155 P 4
0 433 171 005	DLLZ 155 P 41
0 433 171 006	DLLA 155 P 5
0 433 171 007	DLLZ 160 P 6
0 433 171 008	DLLA 150 P 7

0 433 171 009	DLLA 150 P 8
0 433 171 010	DLLA 160 P 9
0 433 171 011	DLLA 150 P 10
0 433 171 012	DLLA 150 P 11
0 433 171 013	DLLA 150 P 12

0 433 171 014	DLLA 150 P 13
0 433 171 015	DLLA 142 P 14
0 433 171 016	DLLA 144 P 15
0 433 171 017	DLLA 142 P 16
0 433 171 018	DLLA 150 P 17

0 433 171 020	DLLA 150 P 19
0 433 171 021	DLLA 150 P 20
0 433 171 022	DLLA 150 P 21
0 433 171 023	DLLA 150 P 22
0 433 171 024	DLLA 150 P 23

0 433 171 025	DLLA 150 P 24
0 433 171 026	DLLA 150 P 25
0 433 171 027	DLLA 150 P 26
0 433 171 029	DLLA 150 P 28
0 433 171 030	DLLA 150 P 29

0 433 171 031	DLLA 150 P 30
0 433 171 032	DLLA 150 P 31
0 433 171 033	DLLA 150 P 32
0 433 171 034	DLLA 150 P 33
0 433 171 035	DLLA 150 P 34

0 433 171 036	DLLA 160 P 35
0 433 171 037	DLLA 150 P 36
0 433 171 038	DLLA 150 P 37
0 433 171 039	DLLA 148 P 38
0 433 171 040	DLLA 150 P 39

0 433 171 041	DLLA 143 P 40
0 433 171 042	DLLA 150 P 42
0 433 171 043	DLLA 150 P 43
0 433 171 044	DLLA 140 P 44
0 433 171 046	DLLA 150 P 46



0 433 171 047	DLLA 150 P 47
0 433 171 048	DLLA 150 P 48
0 433 171 049	DLLA 150 P 49
0 433 171 050	DLLA 150 P 50
0 433 171 051	DLLA 155 P 51

0 433 171 052	DLLA 150 P 52
0 433 171 053	DLLA 150 P 53
0 433 171 054	DLLA 160 P 54
0 433 171 055	DLLA 143 P 55
0 433 171 056	DLLA 150 P 56

0 433 171 057	DLLA 160 P 57
0 433 171 058	DLLA 160 P 58
0 433 171 059	DLLA 150 P 59
0 433 171 060	DLLA 150 P 60
0 433 171 061	DLLA 150 P 61

0 433 171 062	DLLA 130 P 62
0 433 171 063	DLLA 160 P 63
0 433 171 064	DLLA 150 P 64
0 433 171 065	DLLA 150 P 65
0 433 171 066	DLLA 155 P 66

0 433 171 067	DLLA 155 P 67
0 433 171 069	DLLA 136 P 69
0 433 171 070	DLLA 155 P 70
0 433 171 071	DLLA 150 P 71
0 433 171 072	DLLA 150 P 72

0 433 171 073	DLLA 152 P 73
0 433 171 074	DLLA 155 P 74
0 433 171 076	DLLA 150 P 76
0 433 171 077	DLLA 150 P 77
0 433 171 078	DLLA 150 P 78

0 433 171 079	DLLA 140 P 79
0 433 171 080	DLLA 155 P 82
0 433 171 081	DLLA 150 P 83
0 433 171 082	DLLA 160 P 85
0 433 171 083	DLLA 113 P 86

0 433 171 084	DLLA 142 P 87
0 433 171 085	DLLA 150 P 89
0 433 171 086	DLLA 160 P 90
0 433 171 087	DLLA 150 P 91
0 433 171 088	DLLA 143 P 88

0 433 171 089	DLLA 143 P 93
0 433 171 090	DLLA 143 P 94
0 433 171 091	DLLA 143 P 95
0 433 171 092	DLLA 143 P 96
0 433 171 093	DLLA 148 P 97



0 433 171 094	DLLA 148 P 98
0 433 171 095	DLLA 150 P 99
0 433 171 096	DLLA 155 P 101
0 433 171 097	DLLA 150 P 102
0 433 171 098	DLLA 150 P 105

0 433 171 099	DLLA 152 P 107
0 433 171 100	DLLA 150 P 110
0 433 171 101	DLLA 155 P 111
0 433 171 102	DLLA 150 P 113
0 433 171 103	DLLA 155 P 114

0 433 171 104	DLLA 150 P 115
0 433 171 105	DLLA 150 P 116
0 433 171 106	DLLA 150 P 117
0 433 171 107	DLLA 144 P 118
0 433 171 108	DLLA 150 P 119

0 433 171 109	DLLA 155 P 120
0 433 171 110	DLLA 143 P 121
0 433 171 111	DLLA 143 P 122
0 433 171 112	DLLA 143 P 123
0 433 171 113	DLLA 155 P 125

0 433 171 114	DLLA 143 P 126
0 433 171 115	DLLA 143 P 127
0 433 171 116	DLLA 143 P 128
0 433 171 117	DLLA 150 P 91/
0 433 171 118	DLLA 150 P 130

0 433 171 119	DLLA 150 P 131
0 433 171 120	DLLA 151 P 132
0 433 171 121	DLLA 150 P 133
0 433 171 122	DLLA 144 P 134
0 433 171 123	DLLA 155 P 135

0 433 171 124	DLLA 150 P 136
0 433 171 125	DLLA 150 P 137
0 433 171 126	DLLA 144 P 138
0 433 171 127	DLLA 146 P 139
0 433 171 128	DLLA 146 P 140

0 433 171 129	DLLA 155 P 141
0 433 171 130	DLLA 144 P 144
0 433 171 131	DLLA 150 P 145
0 433 171 132	DLLA 155 P 146
0 433 171 133	DLLA 150 P 147

0 433 171 134	DLLA 148 P 149
0 433 171 135	DLLA 148 P 150
0 433 171 136	DLLA 152 P 152
0 433 171 137	DLLA 146 P 154
0 433 171 138	DLLA 155 P 156

... 0 433 171 274



0 433 171 139	DLLA 143 P 151
0 433 171 140	DLLA 155 P 157
0 433 171 141	DLLA 149 P 158
0 433 171 142	DLLA 150 P 159
0 433 171 143	DLLA 143 P 160
0 433 171 144	DLLA 158 P 161
0 433 171 145	DLLA 150 P 162
0 433 171 146	DLLA 148 P 163
0 433 171 147	DLLA 148 P 164
0 433 171 148	DLLA 158 P 165
0 433 171 149	DLLA 146 P 166
0 433 171 150	DLLA 150 P 167
0 433 171 151	DLLA 158 P 168
0 433 171 152	DLLA 155 P 172
0 433 171 153	DLLA 160 P 171
0 433 171 154	DLLA 140 P 175
0 433 171 155	DLLA 142 P 176
0 433 171 156	DLLA 150 P 177
0 433 171 157	DLLA 150 P 178
0 433 171 158	DLLA 155 P 179
0 433 171 159	DLLA 134 P 180
0 433 171 160	DLLA 140 P 182
0 433 171 161	DLLA 144 P 184
0 433 171 162	DLLA 134 P 186
0 433 171 163	DLLA 146 P 190
0 433 171 164	DLLA 150 P 91/+
0 433 171 165	DLLA 146 P 154-
0 433 171 166	DLLA 140 P 196
0 433 171 167	DLLA 146 P 197
0 433 171 168	DLLA 150 P 199
0 433 171 169	DLLA 146 P 203
0 433 171 170	DLLA 155 P 223
0 433 171 171	DLLA 150 P 205
0 433 171 172	DLLA 154 P 206
0 433 171 173	DLLA 160 P 209
0 433 171 174	DLLA 144 P 184/
0 433 171 175	DLLA 150 P 213
0 433 171 176	DLLA 150 P 214
0 433 171 177	DLLA 155 P 215
0 433 171 178	DLLA 150 P 216
0 433 171 179	DLLA 150 P 217
0 433 171 180	DLLA 142 P 221
0 433 171 181	DLLA 150 P 222
0 433 171 182	DLLA 146 P 224
0 433 171 183	DLLA 150 P 225/TR



0 433 171 185	DLLA 124 P 227
0 433 171 186	DLLA 150 P 228
0 433 171 187	DLLA 148 P 229
0 433 171 188	DLLA 155 P 230
0 433 171 189	DLLA 155 P 231
0 433 171 190	DLLA 150 P 232
0 433 171 191	DLLA 140 P 233
0 433 171 192	DLLA 144 P 234
0 433 171 193	DLLA 150 P 235
0 433 171 194	DLLA 148 P 240
0 433 171 195	DLLA 148 P 241
0 433 171 196	DLLA 150 P 242
0 433 171 197	DLLA 146 P 244
0 433 171 198	DLLA 143 P 247
0 433 171 199	DLLA 155 P 248
0 433 171 200	DLLA 135 P 250
0 433 171 201	DLLA 134 P 204
0 433 171 202	DLLA 140 P 257
0 433 171 203	DLLA 170 P 260
0 433 171 204	DLLA 155 P 270
0 433 171 205	DLLA 155 P 273
0 433 171 206	DLLA 155 P 274
0 433 171 207	DLLA 155 P 275
0 433 171 208	DLLA 155 P 277
0 433 171 209	DLLA 155 P 283
0 433 171 210	DLLA 152 P 285
0 433 171 211	DLLA 145 P 286
0 433 171 212	DLLA 140 P 290
0 433 171 213	DLLA 150 P 291
0 433 171 214	DLLA 146 P 166/
0 433 171 215	DLLA 134 P 296
0 433 171 216	DLLA 150 P 299
0 433 171 217	DLLA 134 P 301
0 433 171 218	DLLA 155 P 302
0 433 171 219	DLLA 155 P 304
0 433 171 220	DLLA 140 P 305
0 433 171 221	DLLA 155 P 306
0 433 171 222	DLLA 155 P 307
0 433 171 223	DLLA 142 P 312
0 433 171 224	DLLA 152 P 313
0 433 171 225	DLLA 150 P 315
0 433 171 226	DLLA 154 P 316
0 433 171 227	DLLA 160 P 317
0 433 171 228	DLLA 145 P 319
0 433 171 229	DLLA 150 P 324



0 433 171 230	DLLA 148 P 325
0 433 171 231	DLLA 150 P 326
0 433 171 232	DLLA 145 P 328
0 433 171 233	DLLA 148 P 329
0 433 171 234	DLLA 145 P 331
0 433 171 235	DLLA 143 P 333
0 433 171 236	DLLA 143 P 334
0 433 171 237	DLLA 152 P 335
0 433 171 238	DLLA 152 P 336
0 433 171 239	DLLA 145 P 337
0 433 171 240	DLLA 170 P 338
0 433 171 241	DLLA 152 P 339
0 433 171 242	DLLA 152 P 340
0 433 171 243	DLLA 148 P 341
0 433 171 244	DLLA 155 P 343
0 433 171 245	DLLA 147 P 344
0 433 171 246	DLLA 150 P 345
0 433 171 247	DLLA 152 P 347
0 433 171 248	DLLA 153 P 352
0 433 171 249	DLLA 148 P 350
0 433 171 250	DLLA 140 P 351
0 433 171 251	DLLA 144 P 354
0 433 171 252	DLLA 144 P 353
0 433 171 253	DLLA 153 P 355
0 433 171 254	DLLA 153 P 356
0 433 171 255	DLLA 155 P 358
0 433 171 256	DLLA 155 P 359
0 433 171 257	DLLA 147 P 360
0 433 171 258	DLLA 147 P 361
0 433 171 259	DLLA 148 P 363
0 433 171 260	DLLA 150 P 364
0 433 171 261	DLLA 135 P 367
0 433 171 262	DLLA 149 P 369
0 433 171 263	DLLA 147 P 370
0 433 171 264	DLLA 134 P 371
0 433 171 265	DLLA 134 P 372
0 433 171 266	DLLA 135 P 373
0 433 171 267	DLLA 135 P 374
0 433 171 268	DLLA 152 P 378
0 433 171 269	DLLA 160 P 382
0 433 171 270	DLLA 155 P 383
0 433 171 271	DLLA 140 P 384
0 433 171 272	DLLA 147 P 385
0 433 171 273	DLLA 155 P 386
0 433 171 274	DLLA 155 P 387



de

**Bestellnummer →
Typformel**
(Fortsetzung)

en

**Part number →
Type designation**
(continued)

fr

**Référence →
Formule de type**
(suite)







it

**Numero d'ordina-
zione → Sigla**
(seguito)

es

**Número de pedido →
Designación del tipo**
(continuación)

0 433 171 275 ...

  		 		 	
0 433 171 275	DLLA 155 P 388	0 433 171 322	DLLA 155 P 447	0 433 171 367	DLLA 155 P 511
0 433 171 276	DLLA 140 P 389	0 433 171 323	DLLA 144 P 449	0 433 171 368	DLLA 134 P 512
0 433 171 277	DLLA 140 P 390	0 433 171 324	DLLA 144 P 450	0 433 171 369	DLLA 148 P 513
0 433 171 278	DLLA 146 P 391	0 433 171 325	DLLA 155 P 451	0 433 171 370	DLLA 149 P 514
0 433 171 279	DLLA 145 P 393	0 433 171 326	DLLA 152 P 452	0 433 171 371	DLLA 140 P 517
0 433 171 280	DLLA 145 P 392	0 433 171 327	DLLA 158 P 454	0 433 171 372	DLLA 140 P 518
0 433 171 281	DLLA 145 P 394	0 433 171 328	DLLA 158 P 455	0 433 171 385	DLLA 144 P 521
0 433 171 282	DLLA 154 P 397	0 433 171 329	DLLA 158 P 456/	0 433 171 386	DLLA 148 P 522
0 433 171 283	DLLA 152 P 398	0 433 171 330	DLLA 158 P 457	0 433 171 387	DLLA 150 P 524
0 433 171 284	DLLA 140 P 399	0 433 171 331	DLLA 154 P 458	0 433 171 388	DLLA 154 P 525
0 433 171 285	DLLA 138 P 401	0 433 171 332	DLLA 134 P 459	0 433 171 389	DLLA 153 P 526
0 433 171 286	DLLA 138 P 402	0 433 171 333	DLLA 149 P 460	0 433 171 390	DLLA 144 P 527
0 433 171 287	DLLA 138 P 403	0 433 171 334	DLLA 148 P 461	0 433 171 391	DLLA 149 P 528
0 433 171 288	DLLA 147 P 404	0 433 171 335	DLLA 145 P 466	0 433 171 392	DLLA 125 P 529
0 433 171 290	DLLA 150 P 407	0 433 171 336	DLLA 148 P 465	0 433 171 393	DLLA 135 P 530
0 433 171 291	DLLA 148 P 408	0 433 171 337	DLLA 144 P 467	0 433 171 394	DLLA 152 P 531
0 433 171 292	DLLA 150 P 409	0 433 171 338	DLLA 160 P 469	0 433 171 395	DLLA 160 P 532
0 433 171 293	DLLA 144 P 410	0 433 171 339	DLLA 143 P 470	0 433 171 396	DLLA 155 P 534
0 433 171 294	DLLA 140 P 411	0 433 171 340	DLLA 143 P 471	0 433 171 397	DLLA 145 P 536
0 433 171 295	DLLA 145 P 412	0 433 171 341	DLLA 160 P 473	0 433 171 398	DLLA 147 P 538
0 433 171 296	DLLA 153 P 413	0 433 171 342	DLLA 154 P 474	0 433 171 399	DLLA 135 P 539
0 433 171 297	DLLA 142 P 417	0 433 171 343	DLLA 150 P 476+	0 433 171 400	DLLA 149 P 541
0 433 171 298	DLLA 142 P 418	0 433 171 344	DLLA 145 P 478	0 433 171 401	DLLA 145 P 542
0 433 171 299	DLLA 142 P 419	0 433 171 345	DLLA 142 P 479	0 433 171 402	DLLA 142 P 544
0 433 171 300	DLLA 150 P 421	0 433 171 346	DLLA 150 P 481+	0 433 171 403	DLLA 150 P 545/
0 433 171 302	DLLA 145 P 420	0 433 171 347	DLLA 140 P 483	0 433 171 404	DLLA 150 P 550
0 433 171 303	DLLA 134 P 422	0 433 171 348	DLLA 158 P 484	0 433 171 405	DLLA 150 P 552
0 433 171 304	DLLA 134 P 423	0 433 171 349	DLLA 143 P 485	0 433 171 406	DLLA 149 P 554
0 433 171 305	DLLA 134 P 424	0 433 171 350	DLLA 152 P 486/	0 433 171 407	DLLA 150 P 555
0 433 171 306	DLLA 168 P 426	0 433 171 351	DLLA 150 P 487	0 433 171 408	DLLA 155 P 556
0 433 171 307	DLLA 143 P 428	0 433 171 352	DLLA 150 P 488	0 433 171 409	DLLA 154 P 557
0 433 171 308	DLLA 150 P 429	0 433 171 353	DLLA 146 P 489	0 433 171 410	DLLA 150 P 558
0 433 171 309	DLLA 134 P 430	0 433 171 354	DLLA 144 P 490	0 433 171 411	DLLA 150 P 559
0 433 171 310	DLLA 134 P 431	0 433 171 355	DLLA 148 P 493	0 433 171 412	DLLA 138 P 563
0 433 171 311	DLLA 145 P 433	0 433 171 356	DLLA 157 P 494	0 433 171 413	DLLA 155 P 564
0 433 171 312	DLLA 150 P 434	0 433 171 357	DLLA 143 P 495	0 433 171 414	DLLA 152 P 566
0 433 171 313	DLLA 134 P 435	0 433 171 358	DLLA 152 P 496	0 433 171 415	DLLA 144 P 568
0 433 171 314	DLLA 150 P 436	0 433 171 359	DLLA 150 P 497	0 433 171 430	DLLA 147 P 569
0 433 171 315	DLLA 135 P 437	0 433 171 360	DLLA 146 P 499	0 433 171 431	DLLA 155 P 570
0 433 171 316	DLLA 145 P 438	0 433 171 361	DLLA 148 P 500	0 433 171 432	DLLA 152 P 571
0 433 171 317	DLLA 145 P 439	0 433 171 362	DLLA 151 P 503	0 433 171 433	DLLA 155 P 572
0 433 171 318	DLLA 155 P 440	0 433 171 363	DLLA 145 P 504	0 433 171 434	DLLA 150 P 573
0 433 171 319	DLLA 155 P 441	0 433 171 364	DLLA 138 P 505	0 433 171 435	DLLA 145 P 574
0 433 171 320	DLLA 155 P 444	0 433 171 365	DLLA 150 P 509	0 433 171 436	DLLA 160 P 577
0 433 171 321	DLLA 155 P 445	0 433 171 366	DLLA 144 P 510	0 433 171 437	DLLA 148 P 578

... 0 433 171 593



0 433 171 438	DLLA 155 P 579+
0 433 171 439	DLLA 140 P 580
0 433 171 440	DLLA 146 P 581
0 433 171 441	DLLA 151 P 582
0 433 171 442	DLLA 140 P 583
0 433 171 443	DLLA 158 P 584
0 433 171 444	DLLA 150 P 585
0 433 171 445	DLLA 148 P 586
0 433 171 446	DLLA 158 P 587
0 433 171 447	DLLA 150 P 589
0 433 171 449	DLLA 160 P 595
0 433 171 450	DLLA 154 P 596
0 433 171 452	DLLA 149 P 602
0 433 171 453	DLLA 145 P 605
0 433 171 454	DLLA 145 P 606
0 433 171 455	DLLA 145 P 607
0 433 171 457	DLLA 148 P 610
0 433 171 458	DLLA 148 P 611
0 433 171 459	DLLA 148 P 612
0 433 171 460	DLLA 150 P 613
0 433 171 461	DLLA 155 P 614
0 433 171 462	DLLA 150 P 615+
0 433 171 463	DLLA 149 P 622
0 433 171 464	DLLA 145 P 624
0 433 171 465	DLLA 155 P 657
0 433 171 467	DLLA 140 P 629
0 433 171 468	DLLA 145 P 632
0 433 171 469	DLLA 160 P 634
0 433 171 470	DLLA 150 P 635
0 433 171 471	DLLA 159 P 636
0 433 171 472	DLLA 140 P 637
0 433 171 473	DLLA 159 P 638
0 433 171 474	DLLA 148 P 650
0 433 171 475	DLLA 158 P 651
0 433 171 476	DLLA 150 P 652
0 433 171 477	DLLA 0 P 653
0 433 171 478	DLLA 147 P 658
0 433 171 479	DLLA 145 P 659
0 433 171 480	DLLA 152 P 660
0 433 171 481	DLLA 140 P 662
0 433 171 482	DLLA 148 P 663
0 433 171 483	DLLA 160 P 664
0 433 171 484	DLLA 155 P 665
0 433 171 485	DLLA 144 P 666
0 433 171 486	DLLA 145 P 669



0 433 171 487	DLLA 155 P 670
0 433 171 488	DLLA 150 P 673
0 433 171 489	DLLA 150 P 674
0 433 171 490	DLLA 150 P 675
0 433 171 491	DLLA 150 P 676
0 433 171 492	DLLA 150 P 677
0 433 171 493	DLLA 158 P 678
0 433 171 494	DLLA 150 P 679
0 433 171 495	DLLA 147 P 680
0 433 171 496	DLLA 158 P 684
0 433 171 501	DLLA 152 P 685
0 433 171 502	DLLA 155 P 686
0 433 171 503	DLLA 140 P 688
0 433 171 504	DLLA 140 P 689
0 433 171 505	DLLA 140 P 690
0 433 171 506	DLLA 158 P 691
0 433 171 507	DLLA 160 P 692
0 433 171 508	DLLA 146 P 693
0 433 171 510	DLLA 145 P 695
0 433 171 511	DLLA 142 P 696
0 433 171 512	DLLA 149 P 697
0 433 171 513	DLLA 155 P 699
0 433 171 514	DLLA 153 P 700
0 433 171 517	DLLA 134 P 703
0 433 171 518	DLLA 140 P 705
0 433 171 519	DLLA 146 P 708
0 433 171 520	DLLA 154 P 709
0 433 171 521	DLLA 150 P 711
0 433 171 522	DLLA 150 P 717
0 433 171 523	DLLA 150 P 718
0 433 171 524	DLLA 150 P 719
0 433 171 525	DLLA 150 P 722
0 433 171 526	DLLA 150 P 723
0 433 171 527	DLLA 150 P 724
0 433 171 528	DLLA 158 P 728
0 433 171 529	DLLA 158 P 729
0 433 171 530	DLLA 158 P 730
0 433 171 531	DLLA 142 P 732
0 433 171 533	DLLA 147 P 734
0 433 171 534	DLLA 155 P 742
0 433 171 535	DLLA 153 P 743
0 433 171 537	DLLA 156 P 750
0 433 171 538	DLLA 168 P 751
0 433 171 539	DLLA 147 P 752
0 433 171 540	DLLA 147 P 753



0 433 171 541	DLLA 147 P 754
0 433 171 542	DLLA 145 P 758
0 433 171 543	DLLA 134 P 760
0 433 171 545	DLLA 155 P 765
0 433 171 546	DLLA 155 P 767
0 433 171 547	DLLA 135 P 769+
0 433 171 548	DLLA 154 P 771
0 433 171 549	DLLA 135 P 782
0 433 171 550	DLLA 145 P 785
0 433 171 551	DLLA 145 P 787
0 433 171 552	DLLA 145 P 788
0 433 171 553	DLLA 152 P 790
0 433 171 554	DLLA 155 P 796
0 433 171 555	DLLA 147 P 799
0 433 171 556	DLLA 145 P 809
0 433 171 557	DLLA 153 P 810
0 433 171 558	DLLA 155 P 811
0 433 171 559	DLLA 150 P 812
0 433 171 560	DLLA 145 P 818
0 433 171 561	DLLA 156 P 819
0 433 171 562	DLLA 155 P 822
0 433 171 564	DLLA 140 P 826
0 433 171 566	DLLA 156 P 828+
0 433 171 568	DLLA 145 P 832
0 433 171 569	DLLA 146 P 834
0 433 171 570	DLLA 148 P 836
0 433 171 573	DLLA 145 P 842
0 433 171 574	DLLA 134 P 846
0 433 171 575	DLLA 150 P 847
0 433 171 576	DLLA 150 P 848
0 433 171 577	DLLA 145 P 849
0 433 171 578	DLLA 156 P 850
0 433 171 579	DLLA 147 P 854
0 433 171 580	DLLA 154 P 857
0 433 171 581	DLLA 155 P 859
0 433 171 582	DLLA 147 P 861
0 433 171 583	DLLA 154 P 866
0 433 171 584	DLLA 155 P 872
0 433 171 585	DLLA 147 P 875
0 433 171 586	DLLA 152 P 876
0 433 171 587	DLLA 152 P 877
0 433 171 590	DLLA 147 P 880
0 433 171 591	DLLA 147 P 884
0 433 171 592	DLLA 155 P 885
0 433 171 593	DLLA 157 P 888



de

**Bestellnummer →
Typformel**
(Fortsetzung)

en

**Part number →
Type designation**
(continued)

fr

**Référence →
Formule de type**
(suite)

it

**Numero d'ordina-
zione → Sigla**
(seguito)

es

**Número de pedido →
Designación del tipo**
(continuación)

0 433 171 594 ...

Ref.	Typ
0 433 171 594	DLLA 156 P 889
0 433 171 595	DLLA 150 P 892
0 433 171 596	DLLA 143 P 894
0 433 171 597	DLLA 156 P 897+
0 433 171 598	DLLA 150 P 898
0 433 171 599	DLLA 150 P 901
0 433 171 600	DLLA 152 P 903
0 433 171 601	DLLA 145 P 905
0 433 171 602	DLLA 145 P 906
0 433 171 603	DLLA 145 P 907
0 433 171 605	DLLA 148 P 911
0 433 171 606	DLLA 148 P 912
0 433 171 607	DLLA 150 P 913
0 433 171 608	DLLA 158 P 914
0 433 171 609	DLLA 148 P 915
0 433 171 610	DLLA 150 P 916
0 433 171 612	DLLA 148 P 923
0 433 171 615	DLLA 148 P 924
0 433 171 616	DLLA 145 P 926
0 433 171 617	DLLA 145 P 927
0 433 171 618	DLLA 145 P 928
0 433 171 620	DLLA 150 P 930
0 433 171 621	DLLA 152 P 932
0 433 171 622	DLLA 151 P 939
0 433 171 623	DLLA 151 P 940
0 433 171 624	DLLA 151 P 941
0 433 171 625	DLLA 151 P 942
0 433 171 628	DLLA 150 P 943
0 433 171 629	DLLA 147 P 944
0 433 171 630	DLLA 147 P 945
0 433 171 631	DLLA 140 P 947
0 433 171 632	DLLA 150 P 952
0 433 171 633	DLLA 142 P 956
0 433 171 634	DLLA 150 P 957
0 433 171 636	DLLA 145 P 961
0 433 171 637	DLLA 156 P 963+
0 433 171 638	DLLZ 157 P 964
0 433 171 639	DLLA 154 P 965
0 433 171 640	DLLA 152 P 967
0 433 171 641	DLLA 145 P 978
0 433 171 642	DLLA 156 P 980
0 433 171 643	DLLA 150 P 983
0 433 171 644	DLLA 148 P 984
0 433 171 645	DLLA 142 P 985
0 433 171 646	DLLA 152 P 996

Ref.	Typ
0 433 171 647	DLLA 145 P 998
0 433 171 648	DLLA 145 P 999
0 433 171 649	DLLA 166 P 1005
0 433 171 650	DLLA 168 P 1006
0 433 171 651	DLLA 150 P 1008
0 433 171 652	DLLA 141 P 1009
0 433 171 653	DLLA 148 P 1010
0 433 171 654	DLLA 150 P 1011
0 433 171 655	DLLA 150 P 1012
0 433 171 656	DLLA 148 P 1013
0 433 171 657	DLLA 145 P 1014
0 433 171 658	DLLA 145 P 1015
0 433 171 673	DLLA 148 P 1022
0 433 171 674	DLLA 150 P 1023
0 433 171 676	DLLA 160 P 1032+
0 433 171 677	DLLA 166 P 1036
0 433 171 678	DLLA 158 P 1039
0 433 171 679	DLLA 147 P 1048
0 433 171 680	DLLA 147 P 1049
0 433 171 681	DLLA 144 P 1050
0 433 171 682	DLLA 140 P 1051
0 433 171 683	DLLA 155 P 1052
0 433 171 684	DLLA 150 P 1053
0 433 171 685	DLLA 150 P 1054
0 433 171 686	DLLA 144 P 1056
0 433 171 687	DLLA 150 P 1057
0 433 171 688	DLLA 156 P 1059
0 433 171 689	DLLA 145 P 1062
0 433 171 690	DLLA 155 P 1063+
0 433 171 691	DLLA 150 P 1064
0 433 171 692	DLLA 150 P 1065
0 433 171 693	DLLA 148 P 1067
0 433 171 695	DLLA 143 P 1069
0 433 171 696	DLLA 142 P 1070
0 433 171 698	DLLA 152 P 1075
0 433 171 699	DLLA 150 P 1076
0 433 171 700	DLLA 152 P 1077
0 433 171 701	DLLA 155 P 1078
0 433 171 702	DLLA 153 P 1080
0 433 171 703	DLLA 152 P 1081
0 433 171 704	DLLA 148 P 1083
0 433 171 705	DLLA 152 P 1084
0 433 171 706	DLLA 153 P 1090+
0 433 171 707	DLLA 152 P 1094
0 433 171 708	DLLA 140 P 1098

Ref.	Typ
0 433 171 709	DLLA 152 P 1104
0 433 171 710	DLLA 144 P 1105
0 433 171 711	DLLA 150 P 1110
0 433 171 712	DLLA 156 P 1107
0 433 171 713	DLLA 155 P 1108
0 433 171 717	DLLA 158 P 1106
0 433 171 718	DLLA 156 P 1111
0 433 171 719	DLLA 156 P 1114
0 433 171 720	DLLA 158 P 1116
0 433 171 721	DLLA 158 P 1117
0 433 171 722	DLLA 158 P 1118
0 433 171 723	DLLA 142 P 1119
0 433 171 724	DLLA 150 P 1120
0 433 171 725	DLLA 147 P 1121
0 433 171 726	DLLA 146 P 1122
0 433 171 727	DLLA 158 P 1128
0 433 171 728	DLLA 144 P 1132
0 433 171 729	DLLA 142 P 1135
0 433 171 730	DLLA 154 P 1137
0 433 171 731	DLLA 155 P 1138
0 433 171 732	DLLA 145 P 1139
0 433 171 733	DLLA 144 P 1140
0 433 171 734	DLLA 140 P 1144
0 433 171 735	DLLA 153 P 1146
0 433 171 737	DLLA 155 P 1152
0 433 171 738	DLLA 143 P 1153
0 433 171 739	DLLA 155 P 1159
0 433 171 740	DLLA 150 P 1163
0 433 171 741	DLLA 150 P 1164
0 433 171 742	DLLA 153 P 1165
0 433 171 743	DLLA 151 P 1169
0 433 171 744	DLLA 144 P 1170
0 433 171 745	DLLA 150 P 1171
0 433 171 746	DLLA 144 P 1175
0 433 171 747	DLLA 140 P 1179
0 433 171 748	DLLA 140 P 1181
0 433 171 749	DLLA 145 P 1182
0 433 171 750	DLLA 140 P 1187
0 433 171 751	DLLA 145 P 1189
0 433 171 752	DLLA 148 P 1193
0 433 171 753	DLLA 144 P 1194
0 433 171 754	DLLA 145 P 1195
0 433 171 755	DLLA 150 P 1197
0 433 171 756	DLLA 140 P 1199
0 433 171 757	DLLA 148 P 1200

... 0 433 171 902



0 433 171 758	DLLA 146 P 1203
0 433 171 759	DLLA 154 P 1204
0 433 171 760	DLLA 150 P 1205
0 433 171 761	DLLA 154 P 1206
0 433 171 762	DLLA 150 P 1207
0 433 171 763	DLLA 146 P 1210
0 433 171 764	DLLA 152 P 1215
0 433 171 765	DLLA 146 P 1214
0 433 171 766	DLLA 158 P 1216
0 433 171 767	DLLA 166 P 1217
0 433 171 768	DLLA 146 P 1218
0 433 171 769	DLLA 145 P 1219
0 433 171 770	DLLA 144 P 1220
0 433 171 771	DLLA 148 P 1221
0 433 171 772	DLLA 153 P 1222
0 433 171 773	DLLA 145 P 1223
0 433 171 774	DLLA 150 P 1224
0 433 171 775	DLLA 154 P 1225
0 433 171 776	DLLA 158 P 1226
0 433 171 777	DLLA 158 P 1227
0 433 171 779	DLLA 147 P 1229
0 433 171 780	DLLA 147 P 1230
0 433 171 781	DLLA 152 P 1231
0 433 171 782	DLLA 142 P 1233
0 433 171 783	DLLA 158 P 1234
0 433 171 784	DLLA 148 P 1237
0 433 171 785	DLLA 148 P 1238
0 433 171 786	DLLA 150 P 1239
0 433 171 787	DLLA 145 P 1240
0 433 171 788	DLLA 153 P 1246
0 433 171 789	DLLA 150 P 1244
0 433 171 790	DLLA 150 P 1245
0 433 171 791	DLLA 144 P 1249
0 433 171 792	DLLA 146 P 1257
0 433 171 793	DLLA 155 P 1258
0 433 171 796	DLLA 160 P 1262
0 433 171 797	DLLA 144 P 1264
0 433 171 798	DLLA 156 P 1265
0 433 171 799	DLLA 150 P 1269
0 433 171 800	DLLA 153 P 1270
0 433 171 801	DLLA 150 P 1274
0 433 171 802	DLLA 140 P 1278
0 433 171 803	DLLA 140 P 1279
0 433 171 804	DLLA 142 P 1280
0 433 171 805	DLLA 158 P 1281



0 433 171 806	DLLA 142 P 1283
0 433 171 807	DLLA 142 P 1284
0 433 171 808	DLLA 150 P 1285
0 433 171 809	DLLA 152 P 1286
0 433 171 810	DLLA 140 P 1294
0 433 171 811	DLLA 146 P 1296
0 433 171 812	DLLA 146 P 1297
0 433 171 813	DLLA 150 P 1298
0 433 171 814	DLLA 155 P 1301
0 433 171 815	DLLA 158 P 1305
0 433 171 816	DLLA 160 P 1307
0 433 171 817	DLLA 160 P 1308
0 433 171 818	DLLA 146 P 1311/
0 433 171 819	DLLA 148 P 1312
0 433 171 820	DLLA 148 P 1313
0 433 171 821	DLLA 154 P 1319
0 433 171 822	DLLA 142 P 1321
0 433 171 823	DLLA 153 P 1322
0 433 171 824	DLLA 154 P 1324
0 433 171 825	DLLA 150 P 1325
0 433 171 826	DLLA 154 P 1326
0 433 171 827	DLLA 142 P 1333
0 433 171 828	DLLA 148 P 1334
0 433 171 830	DLLA 145 P 1338
0 433 171 831	DLLA 146 P 1339
0 433 171 832	DLLA 140 P 1340
0 433 171 833	DLLA 140 P 1341
0 433 171 834	DLLA 140 P 1342
0 433 171 835	DLLA 140 P 1343
0 433 171 836	DLLA 150 P 1345
0 433 171 837	DLLA 154 P 1346
0 433 171 838	DLLA 148 P 1347
0 433 171 839	DLLA 145 P 1348
0 433 171 840	DLLA 152 P 1349
0 433 171 841	DLLA 150 P 1351
0 433 171 842	DLLA 150 P 1352
0 433 171 843	DLLA 118 P 1357
0 433 171 844	DLLA 118 P 1358
0 433 171 845	DLLA 148 P 1350
0 433 171 846	DLLA 142 P 1363
0 433 171 847	DLLA 156 P 1367
0 433 171 848	DLLA 156 P 1368
0 433 171 849	DLLA 144 P 1369
0 433 171 853	DLLA 150 P 1373
0 433 171 855	DLLA 140 P 1377



0 433 171 856	DLLA 153 P 1378
0 433 171 857	DLLA 160 P 1384
0 433 171 860	DLLA 158 P 1385
0 433 171 861	DLLA 145 P 1386
0 433 171 862	DLLA 144 P 1387
0 433 171 863	DLLA 145 P 1391
0 433 171 864	DLLA 158 P 1392
0 433 171 865	DLLA 160 P 1395
0 433 171 866	DLLA 135 P 1399
0 433 171 867	DLLA 135 P 1400
0 433 171 868	DLLA 135 P 1401
0 433 171 869	DLLA 149 P 1402
0 433 171 870	DLLA 143 P 1404
0 433 171 871	DLLA 146 P 1405
0 433 171 872	DLLA 146 P 1406
0 433 171 873	DLLA 148 P 1407
0 433 171 874	DLLA 162 P 1408
0 433 171 875	DLLA 144 P 1413
0 433 171 876	DLLA 143 P 1414
0 433 171 877	DLLA 160 P 1415
0 433 171 878	DLLA 144 P 1417
0 433 171 879	DLLA 154 P 1418
0 433 171 880	DLLA 156 P 1419
0 433 171 881	DLLA 140 P 1420
0 433 171 882	DLLA 140 P 1421
0 433 171 883	DLLA 135 P 1422
0 433 171 884	DLLA 150 P 1410
0 433 171 885	DLLA 144 P 1423
0 433 171 886	DLLA 157 P 1424
0 433 171 887	DLLA 157 P 1425
0 433 171 888	DLLA 145 P 1430
0 433 171 889	DLLA 150 P 1437
0 433 171 890	DLLA 146 P 1439
0 433 171 891	DLLA 162 P 1443
0 433 171 892	DLLA 140 P 1444
0 433 171 893	DLLA 140 P 1445
0 433 171 894	DLLA 140 P 1446
0 433 171 895	DLLA 146 P 1447
0 433 171 896	DLLA 143 P 1448
0 433 171 897	DLLA 145 P 1449
0 433 171 898	DLLA 153 P 1450
0 433 171 899	DLLA 150 P 1451
0 433 171 900	DLLA 146 P 1453
0 433 171 901	DLLA 152 P 1454
0 433 171 902	DLLA 153 P 1455



de

**Bestellnummer →
Typformel**
(Fortsetzung)

en

**Part number →
Type designation**
(continued)

fr

**Référence →
Formule de type**
(suite)

it

**Numero d'ordina-
zione → Sigla**
(seguito)

es

**Número de pedido →
Designación del tipo**
(continuación)

0 433 171 903 ...

Ref.	Typ
0 433 171 903	DLLA 152 P 1459
0 433 171 904	DLLA 148 P 1460
0 433 171 905	DLLA 148 P 1461
0 433 171 906	DLLA 148 P 1462
0 433 171 907	DLLA 153 P 1463
0 433 171 908	DLLA 150 P 1464
0 433 171 909	DLLA 152 P 1466
0 433 171 910	DLLA 150 P 1467
0 433 171 911	DLLA 154 P 1469
0 433 171 913	DLLA 156 P 1473
0 433 171 914	DLLA 150 P 1471
0 433 171 916	DLLA 142 P 1481
0 433 171 917	DLLA 144 P 1483
0 433 171 918	DLLA 146 P 1484
0 433 171 919	DLLA 150 P 1487
0 433 171 920	DLLA 155 P 1492
0 433 171 921	DLLA 155 P 1493
0 433 171 922	DLLA 153 P 1494
0 433 171 923	DLLA 139 P 1497
0 433 171 924	DLLA 158 P 1500
0 433 171 926	DLLA 145 P 1503
0 433 171 927	DLLA 151 P 1504
0 433 171 928	DLLA 148 P 1506
0 433 171 929	DLLA 152 P 1507/
0 433 171 930	DLLA 143 P 879/
0 433 171 931	DLLA 156 P 1509
0 433 171 932	DLLA 150 P 1511
0 433 171 933	DLLA 150 P 1512
0 433 171 934	DLLA 152 P 1513
0 433 171 935	DLLA 155 P 1514
0 433 171 936	DLLA 149 P 1515/
0 433 171 937	DLLA 145 P 1517
0 433 171 938	DLLA 146 P 1522
0 433 171 939	DLLA 148 P 1524/
0 433 171 940	DLLA 152 P 1525
0 433 171 942	DLLA 143 P 1528
0 433 171 943	DLLA 145 P 1529
0 433 171 944	DLLA 143 P 1532
0 433 171 945	DLLA 138 P 1533
0 433 171 946	DLLA 145 P 1534
0 433 171 947	DLLA 143 P 1536
0 433 171 948	DLLA 154 P 1538
0 433 171 949	DLLA 144 P 1539
0 433 171 950	DLLA 145 P 1540
0 433 171 951	DLLA 143 P 1541

Ref.	Typ
0 433 171 952	DLLA 145 P 1543
0 433 171 953	DLLA 146 P 1545
0 433 171 954	DLLA 152 P 1546
0 433 171 955	DLLA 145 P 1547
0 433 171 956	DLLA 147 P 1548
0 433 171 957	DLLA 140 P 1551
0 433 171 958	DLLA 145 P 1552
0 433 171 959	DLLA 145 P 1556
0 433 171 960	DLLA 150 P 1557
0 433 171 961	DLLA 149 P 1562
0 433 171 962	DLLA 152 P 1563
0 433 171 963	DLLA 150 P 1564
0 433 171 964	DLLA 144 P 1565
0 433 171 965	DLLA 150 P 1566
0 433 171 966	DLLA 137 P 1577
0 433 171 968	DLLA 146 P 1581
0 433 171 969	DLLA 146 P 1583
0 433 171 970	DLLA 145 P 1589
0 433 171 971	DLLA 145 P 1590
0 433 171 972	DLLA 145 P 1591
0 433 171 973	DLLA 149 P 1594
0 433 171 974	DLLA 142 P 1595
0 433 171 976	DLLA 153 P 1600
0 433 171 977	DLLA 143 P 1601
0 433 171 978	DLLA 122 P 1602
0 433 171 979	DLLA 152 P 1605
0 433 171 980	DLLA 150 P 1606
0 433 171 981	DLLA 142 P 1607
0 433 171 982	DLLA 153 P 1608
0 433 171 983	DLLA 153 P 1609
0 433 171 985	DLLA 159 P 1611
0 433 171 986	DLLA 150 P 1614
0 433 171 987	DLLA 145 P 1617
0 433 171 988	DLLA 143 P 1619
0 433 171 989	DLLA 88 P 1620
0 433 171 990	DLLA 149 P 1621
0 433 171 992	DLLA 148 P 1623
0 433 171 993	DLLA 149 P 1625
0 433 171 994	DLLA 156 P 1626
0 433 171 995	DLLA 156 P 1627
0 433 171 996	DLLA 150 P 49+SCH
0 433 171 997	DLLA 150 P 48+SCH
0 433 171 998	DLLA 150 P 47+SCH
0 433 171 999	DLLA 150 P 46+SCH

Ref.	Typ
0 433 172 ...	
0 433 172 000	DLLA 118 P 1630
0 433 172 001	DLLA 128 P 1635
0 433 172 002	DLLA 148 P 1638
0 433 172 008	DLLA 145 P 1645
0 433 172 009	DLLA 144 P 1646
0 433 172 010	DLLA 145 P 1647
0 433 172 011	DLLA 137 P 1648
0 433 172 012	DLLA 160 P 1650
0 433 172 013	DLLA 146 P 1652
0 433 172 015	DLLA 142 P 1654
0 433 172 016	DLLA 145 P 1655
0 433 172 019	DLLA 148 P 1660
0 433 172 020	DLLA 152 P 1661
0 433 172 022	DLLA 150 P 1666
0 433 172 024	DLLA 82 P 1668
0 433 172 025	DLLA 148 P 1671
0 433 172 026	DLLA 155 P 1674
0 433 172 027	DLLA 118 P 1677
0 433 172 028	DLLA 154 P 1680
0 433 172 029	DLLA 152 P 1681
0 433 172 036	DLLA 152 P 1690
0 433 172 041	DLLA 149 P 1699
0 433 172 045	DLLA 144 P 1707
0 433 172 046	DLLA 136 P 1708
0 433 172 047	DLLA 142 P 1709
0 433 172 049	DLLA 150 P 1712
0 433 172 051	DLLA 145 P 1714
0 433 172 052	DLLA 145 P 1715
0 433 172 056	
0 433 172 058	
0 433 172 059	
0 433 175 ...	
0 433 175 001	DSLA 155 P 75
0 433 175 002	DSLA 150 P 78
0 433 175 003	DSLA 140 P 79
0 433 175 004	DSLA 155 P 84
0 433 175 005	DSLA 155 P 104
0 433 175 006	DSLA 150 P 143
0 433 175 007	DSLA 155 P 170
0 433 175 008	DSLA 140 P 173

... 0 433 175 184



0 433 175 009	DSLA 138 P 181
0 433 175 010	DSLA 155 P 185
0 433 175 011	DSLA 150 P 188
0 433 175 014	DSLA 160 P 192
0 433 175 015	DSLA 150 P 194
0 433 175 016	DSLA 124 P 198
0 433 175 018	DSLA 150 P 211
0 433 175 019	DSLA 150 P 218
0 433 175 020	DSLA 148 P 219
0 433 175 022	DSLA 148 P 243
0 433 175 023	DSLA 124 P 245
0 433 175 024	DSLA 150 P 246
0 433 175 025	DSLA 150 P 249
0 433 175 026	DSLA 145 P 251
0 433 175 027	DSLA 149 P 252
0 433 175 028	DSLA 135 P 259
0 433 175 030	DSLA 148 P 262
0 433 175 031	DSLA 145 P 263
0 433 175 032	DSLA 145 P 264
0 433 175 033	DSLA 145 P 265
0 433 175 034	DSLA 148 P 266
0 433 175 035	DSLA 145 P 267
0 433 175 036	DSLA 145 P 268
0 433 175 037	DSLA 145 P 269
0 433 175 038	DSLA 142 P 272
0 433 175 039	DSLA 155 P 276
0 433 175 040	DSLA 155 P 278
0 433 175 041	DSLA 140 P 279
0 433 175 042	DSLA 150 P 280-
0 433 175 043	DSLA 155 P 298
0 433 175 044	DSLA 140 P 292
0 433 175 045	DSLA 145 P 293
0 433 175 046	DSLA 150 P 294
0 433 175 047	DSLA 140 P 297
0 433 175 048	DSLA 145 P 300
0 433 175 049	DSLA 145 P 311
0 433 175 050	DSLA 150 P 318
0 433 175 051	DSLA 130 P 320
0 433 175 052	DSLA 130 P 321
0 433 175 053	DSLA 78 P 322
0 433 175 054	DSLA 145 P 330
0 433 175 055	DSLA 149 P 342
0 433 175 056	DSLA 150 P 346
0 433 175 057	DSLA 148 P 348
0 433 175 062	DSLA 145 P 379



0 433 175 063	DSLA 145 P 380
0 433 175 064	DSLA 140 P 381
0 433 175 065	DSLA 145 P 395
0 433 175 066	DSLA 145 P 396
0 433 175 067	DSLA 140 P 400
0 433 175 068	DSLA 141 P 405
0 433 175 069	DSLA 145 P 414
0 433 175 070	DSLA 140 P 425
0 433 175 071	DSLA 149 P 427
0 433 175 074	DSLA 150 P 448
0 433 175 075	DSLA 140 P 453
0 433 175 076	DSLA 145 P 462
0 433 175 077	DSLA 145 P 463
0 433 175 078	DSLA 145 P 464
0 433 175 079	DSLA 135 P 468
0 433 175 080	DSLA 140 P 472
0 433 175 081	DSLA 145 P 477
0 433 175 082	DSLA 88 P 480
0 433 175 083	DSLA 148 P 482
0 433 175 084	DSLA 145 P 491
0 433 175 085	DSLA 154 P 492/
0 433 175 086	DSLA 155 P 498
0 433 175 088	DSLA 137 P 506
0 433 175 089	DSLA 137 P 507
0 433 175 090	DSLA 137 P 508
0 433 175 091	DSLA 148 P 516
0 433 175 094	DSLA 128 P 523
0 433 175 096	DSLA 145 P 537
0 433 175 097	DSLA 149 P 540
0 433 175 098	DSLA 150 P 543
0 433 175 099	DSLA 134 P 546
0 433 175 100	DSLA 144 P 547
0 433 175 101	DSLA 146 P 548
0 433 175 102	DSLA 140 P 562
0 433 175 103	DSLA 146 P 565
0 433 175 108	DSLA 140 P 576
0 433 175 109	DSLA 148 P 590
0 433 175 111	DSLA 145 P 598
0 433 175 112	DSLA 145 P 599
0 433 175 113	DSLA 145 P 603
0 433 175 114	DSLA 134 P 604
0 433 175 115	DSLA 140 P 616
0 433 175 118	DSLA 154 P 620
0 433 175 119	DSLA 154 P 625
0 433 175 120	DSLA 152 P 630



0 433 175 122	DSLA 135 P 633
0 433 175 123	DSLA 145 P 639
0 433 175 125	DSLA 145 P 626
0 433 175 126	DSLA 150 P 641
0 433 175 127	DSLA 145 P 642
0 433 175 128	DSLA 145 P 643
0 433 175 129	DSLA 145 P 644
0 433 175 130	DSLA 150 P 645
0 433 175 132	DSLA 150 P 648
0 433 175 133	DSLA 155 P 654
0 433 175 134	DSLA 155 P 655
0 433 175 135	DSLA 155 P 656
0 433 175 137	DSLA 145 P 668
0 433 175 138	DSLA 140 P 671
0 433 175 140	DSLA 145 P 681
0 433 175 146	DSLA 157 P 687
0 433 175 147	DSLA 145 P 311 M
0 433 175 148	DSLA 138 P 698
0 433 175 149	DSLA 145 P 704
0 433 175 151	DSLA 140 P 707
0 433 175 157	DSLA 150 P 720
0 433 175 158	DSLA 150 P 721
0 433 175 159	DSLA 145 P 725
0 433 175 160	DSLA 150 P 726
0 433 175 161	DSLA 150 P 727+
0 433 175 162	DSLA 140 P 735
0 433 175 163	DSLA 156 P 736
0 433 175 164	DSLA 156 P 737
0 433 175 165	DSLA 140 P 739
0 433 175 166	DSLA 140 P 740
0 433 175 167	DSLA 140 P 741
0 433 175 169	DSLA 140 P 746
0 433 175 170	DSLA 150 P 755
0 433 175 171	DSLA 150 P 756
0 433 175 172	DSLA 138 P 757
0 433 175 173	DSLA 147 P 759
0 433 175 174	DSLA 150 P 761
0 433 175 175	DSLA 145 P 763
0 433 175 177	DSLA 145 P 768
0 433 175 178	DSLA 142 P 770/
0 433 175 180	DSLA 150 P 773
0 433 175 181	DSLA 145 P 774
0 433 175 182	DSLA 150 P 775
0 433 175 183	DSLA 150 P 776
0 433 175 184	DSLA 150 P 777



A10

de	en	fr	it	es
Bestellnummer → Typformel (Fortsetzung)	Part number → Type designation (continued)	Référence → Formule de type (suite)	Numero d'ordina- zione → Sigla (seguito)	Número de pedido → Designación del tipo (continuación)

0 433 175 185 ...



Ref.	Typ	Ref.	Typ	Ref.	Typ
0 433 175 185	DSLA 145 P 778	0 433 175 250	DSLA 144 P 890	0 433 175 311	DSLA 145 P 1066
0 433 175 186	DSLA 150 P 779	0 433 175 251	DSLA 145 P 891	0 433 175 312	DSLA 140 P 1071
0 433 175 187	DSLA 142 P 780	0 433 175 252	DSLA 142 P 893	0 433 175 313	DSLA 150 P 1072
0 433 175 188	DSLA 134 P 781	0 433 175 253	DSLA 145 P 896	0 433 175 314	DSLA 156 P 1079/+
0 433 175 189	DSLA 150 P 783	0 433 175 254	DSLA 158 P 902	0 433 175 315	DSLA 140 P 1085
0 433 175 191	DSLA 147 P 786	0 433 175 255	DSLA 160 P 904	0 433 175 316	DSLA 140 P 1086
0 433 175 192	DSLA 155 P 789	0 433 175 256	DSLA 143 P 909	0 433 175 317	DSLA 152 P 1087
0 433 175 193	DSLA 152 P 790	0 433 175 265	DSLA 160 P 937	0 433 175 318	DSLA 145 P 1091
0 433 175 194	DSLA 142 P 792	0 433 175 266	DSLA 160 P 938	0 433 175 319	DSLA 145 P 1097
0 433 175 196	DSLA 142 P 795	0 433 175 267	DSLA 157 P 955	0 433 175 320	DSLA 143 P 1099
0 433 175 197	DSLA 153 P 797	0 433 175 268	DSLA 140 P 959	0 433 175 321	DSLA 140 P 1100
0 433 175 198	DSLA 153 P 798	0 433 175 269	DSLA 154 P 960	0 433 175 324	DSLA 145 P 1109
0 433 175 199	DSLA 150 P 800	0 433 175 270	DSLA 156 P 969	0 433 175 326	DSLA 156 P 1113
0 433 175 200	DSLA 153 P 801	0 433 175 271	DSLA 143 P 970	0 433 175 327	DSLA 145 P 1115
0 433 175 201	DSLA 153 P 802	0 433 175 272	DSLA 144 P 971+	0 433 175 328	DSLA 158 P 1123
0 433 175 202	DSLA 153 P 803	0 433 175 273	DSLA 160 P 972	0 433 175 329	DSLA 140 P 1124
0 433 175 203	DSLA 136 P 804	0 433 175 274	DSLA 144 P 973+	0 433 175 330	DSLA 140 P 1125
0 433 175 204	DSLA 150 P 805	0 433 175 275	DSLA 158 P 974	0 433 175 331	DSLA 140 P 1126
0 433 175 205	DSLA 160 P 807	0 433 175 278	DSLA 145 P 979	0 433 175 332	DSLA 140 P 1127
0 433 175 207	DSLA 147 P 814	0 433 175 279	DSLA 145 P 986	0 433 175 333	DSLA 154 P 1129
0 433 175 208	DSLA 134 P 816	0 433 175 281	DSLA 142 P 988	0 433 175 334	DSLA 140 P 1131
0 433 175 210	DSLA 153 P 820	0 433 175 282	DSLA 150 P 989	0 433 175 335	DSLA 150 P 1134
0 433 175 211	DSLA 145 P 821	0 433 175 283	DSLA 150 P 990	0 433 175 336	DSLA 144 P 1141
0 433 175 212	DSLA 152 P 829	0 433 175 284	DSLA 141 P 991	0 433 175 337	DSLA 140 P 1142
0 433 175 215	DSLA 152 P 830	0 433 175 285	DSLA 160 P 992	0 433 175 338	DSLA 158 P 1143
0 433 175 216	DSLA 145 P 833	0 433 175 286	DSLA 150 P 1000	0 433 175 341	DSLA 143 P 1154
0 433 175 220	DSLA 155 P 839	0 433 175 287	DSLA 150 P 1001	0 433 175 342	DSLA 156 P 1155+
0 433 175 225	DSLA 154 P 852	0 433 175 288	DSLA 144 P 1021	0 433 175 343	DSLA 150 P 1156
0 433 175 226	DSLA 154 P 853	0 433 175 289	DSLA 155 P 1003	0 433 175 345	DSLA 150 P 1166
0 433 175 227	DSLA 150 P 855	0 433 175 290	DSLA 160 P 1016	0 433 175 346	DSLA 148 P 1168
0 433 175 228	DSLA 156 P 856	0 433 175 292	DSLA 150 P 1020	0 433 175 347	DSLA 140 P 1173
0 433 175 229	DSLA 144 P 860	0 433 175 295	DSLA 155 P 1029	0 433 175 348	DSLA 145 P 1174
0 433 175 230	DSLA 140 P 862	0 433 175 297	DSLA 140 P 1033	0 433 175 349	DSLA 156 P 1176
0 433 175 231	DSLA 155 P 863	0 433 175 298	DSLA 154 P 1034	0 433 175 350	DSLA 156 P 1177
0 433 175 232	DSLA 145 P 864	0 433 175 299	DSLA 156 P 1035	0 433 175 351	DSLA 142 P 1178
0 433 175 233	DSLA 160 P 865	0 433 175 300	DSLA 144 P 1037	0 433 175 352	DSLA 152 P 1184
0 433 175 234	DSLA 145 P 867	0 433 175 301	DSLA 150 P 1040	0 433 175 353	DSLA 156 P 1190
0 433 175 235	DSLA 145 P 868	0 433 175 302	DSLA 156 P 1041	0 433 175 355	DSLA 162 P 1192
0 433 175 236	DSLA 144 P 869	0 433 175 303	DSLA 150 P 1042	0 433 175 356	DSLA 140 P 1196
0 433 175 238	DSLA 157 P 871	0 433 175 304	DSLA 150 P 1043	0 433 175 357	DSLA 128 P 1198
0 433 175 240	DSLA 150 P 874	0 433 175 306	DSLA 150 P 1045	0 433 175 358	DSLA 140 P 1201
0 433 175 241	DSLA 145 P 879+	0 433 175 307	DSLA 150 P 1046	0 433 175 359	DSLA 140 P 1202
0 433 175 245	DSLA 150 P 881	0 433 175 308	DSLA 146 P 1055	0 433 175 361	DSLA 150 P 1211
0 433 175 248	DSLA 150 P 886	0 433 175 309	DSLA 143 P 1058	0 433 175 363	DSLA 144 P 1213
0 433 175 249	DSLA 152 P 887	0 433 175 310	DSLA 140 P 1061	0 433 175 366	DSLA 154 P 1242

... 0 433 200 042



0 433 175 367	DSLA 150 P 1247
0 433 175 368	DSLA 150 P 1248
0 433 175 370	DSLA 145 P 1253
0 433 175 371	DSLA 145 P 1255
0 433 175 372	DSLA 145 P 1259
0 433 175 373	DSLA 150 P 1263
0 433 175 374	DSLA 140 P 1266
0 433 175 375	DSLA 140 P 1267
0 433 175 376	DSLA 150 P 1268
0 433 175 377	DSLA 144 P 1271
0 433 175 378	DSLA 150 P 1272
0 433 175 379	DSLA 152 P 1287++
0 433 175 380	DSLA 145 P 1288
0 433 175 381	DSLA 150 P 1289
0 433 175 382	DSLA 148 P 1290
0 433 175 383	DSLA 135 P 1291
0 433 175 384	DSLA 135 P 1292
0 433 175 385	DSLA 135 P 1293
0 433 175 386	DSLA 144 P 1295
0 433 175 387	DSLA 151 P 1302
0 433 175 388	DSLA 145 P 1303
0 433 175 389	DSLA 145 P 1304
0 433 175 390	DSLA 124 P 1309
0 433 175 395	DSLA 154 P 1320
0 433 175 396	DSLA 145 P 1299
0 433 175 397	DSLA 140 P 1328
0 433 175 398	DSLA 140 P 1329
0 433 175 399	DSLA 150 P 1330
0 433 175 400	DSLA 150 P 1331
0 433 175 402	DSLA 156 P 1336
0 433 175 403	DSLA 150 P 1355
0 433 175 404	DSLA 140 P 1359
0 433 175 405	DSLA 154 P 1360
0 433 175 406	DSLA 140 P 1361
0 433 175 407	DSLA 150 P 1362
0 433 175 408	DSLA 143 P 1364
0 433 175 409	DSLA 153 P 1376
0 433 175 410	DSLA 153 P 1375
0 433 175 411	DSLA 156 P 1381
0 433 175 412	DSLA 150 P 1383
0 433 175 413	DSLA 146 P 1398
0 433 175 414	DSLA 146 P 1409
0 433 175 416	DSLA 156 P 1411
0 433 175 417	DSLA 156 P 1412
0 433 175 418	DSLA 150 P 1426



0 433 175 419	DSLA 150 P 1431
0 433 175 425	DSLA 150 P 1438
0 433 175 426	DSLA 145 P 1441
0 433 175 427	DSLA 145 P 1442
0 433 175 428	DSLA 150 P 1452
0 433 175 429	DSLA 148 P 1468
0 433 175 430	DSLA 156 P 1472
0 433 175 431	DSLA 142 P 1474
0 433 175 434	DSLA 156 P 1475
0 433 175 435	DSLA 156 P 1476
0 433 175 436	DSLA 156 P 1477
0 433 175 437	DSLA 150 P 1485
0 433 175 438	DSLA 145 P 1479
0 433 175 439	DSLA 153 P 1376+
0 433 175 440	DSLA 153 P 1375+
0 433 175 441	DSLA 150 P 1489
0 433 175 442	DSLA 150 P 1490
0 433 175 443	DSLA 146 P 1465
0 433 175 444	DSLA 150 P 1491
0 433 175 446	DSLA 150 P 1498
0 433 175 447	DSLA 150 P 1499
0 433 175 448	DSLA 150 P 1508
0 433 175 449	DSLA 128 P 1510
0 433 175 450	DSLA 143 P 1523
0 433 175 451	DSLA 142 P 1501
0 433 175 452	DSLA 138 P 1505
0 433 175 453	DSLA 146 P 1527
0 433 175 454	DSLA 146 P 1530
0 433 175 455	DSLA 146 P 1531
0 433 175 456	DSLA 143 P 1535
0 433 175 457	DSLA 146 P 1488
0 433 175 459	DSLA 128 P 1560
0 433 175 460	DSLA 150 P 1585
0 433 175 461	DSLA 150 P 1586
0 433 175 462	DSLA 152 P 1603
0 433 175 463	DSLA 142 P 1519
0 433 175 465	DSLA 140 P 1613
0 433 175 466	DLLA 147 P 1628
0 433 175 467	DSLA 144 P 1629
0 433 175 468	DSLA 152 P 1633
0 433 175 469	DSLA 152 P 1634
0 433 175 470	DSLA 124 P 1659
0 433 175 471	DSLA 146 P 1675
0 433 175 472	DSLA 145 P 1679
0 433 175 481	DSLA 140 P 1723



0 433 175 779	DLLA 175 P 270
0 433 200 ...	
0 433 200 001	DL 0 S 47
0 433 200 002	DL 0 S 64
0 433 200 004	DL 0 S 171
0 433 200 005	DL 0 S 184
0 433 200 006	DL 0 S 242
0 433 200 007	DL 0 S 288
0 433 200 008	DL 0 S 316
0 433 200 010	DL 0 S 421
0 433 200 011	DL 0 S 470
0 433 200 012	DL 0 S 482
0 433 200 013	DL 0 S 770
0 433 200 014	DL 0 S 869
0 433 200 015	DL 0 S 872
0 433 200 016	DL 0 S 959
0 433 200 017	DL 0 S 984
0 433 200 018	DL 15 S 14
0 433 200 019	DL 30 S 327
0 433 200 020	DL 35 S 325
0 433 200 021	DL 40 S 325
0 433 200 022	DL 45 S 408
0 433 200 024	DL 45 S 735
0 433 200 025	DL 50 S 5
0 433 200 026	DL 50 S 25
0 433 200 027	DL 50 S 45
0 433 200 028	DL 60 S 5
0 433 200 029	DL 60 S 6
0 433 200 031	DL 60 S 28
0 433 200 032	DL 60 S 36
0 433 200 033	DL 60 S 68
0 433 200 034	DL 60 S 86
0 433 200 035	DL 60 S 848
0 433 200 036	DL 60 S 879
0 433 200 037	DL 60 S 880
0 433 200 038	DL 60 S 928
0 433 200 039	DL 60 S 933
0 433 200 040	DL 60 S 971
0 433 200 041	DL 65 S 405
0 433 200 042	DL 70 S 2



A12

de	en	fr	it	es
Bestellnummer → Typformel (Fortsetzung)	Part number → Type designation (continued)	Référence → Formule de type (suite)	Numero d'ordina- zione → Sigla (seguito)	Número de pedido → Designación del tipo (continuación)

0 433 200 043 ...



Ref.	Typ
------	-----

0 433 200 043	DL 70 S 130
0 433 200 044	DL 70 S 790
0 433 200 045	DL 70 S 971
0 433 200 046	DL 70 S 972
0 433 200 047	DL 80 S 5

0 433 200 048	DL 80 S 28
0 433 200 049	DL 80 S 130
0 433 200 050	DL 80 S 164
0 433 200 051	DL 80 S 333
0 433 200 052	DL 80 S 743

0 433 200 053	DL 90 S 78
0 433 200 054	DL 90 S 818
0 433 200 055	DL 90 S 1008
0 433 200 056	DL 100 S 16
0 433 200 057	DL 100 S 86

0 433 200 058	DL 100 S 973
0 433 200 059	DL 105 S 16
0 433 200 060	DL 105 S 86
0 433 200 061	DL 105 S 94
0 433 200 062	DL 110 S 30

0 433 200 063	DL 120 S 2
0 433 200 064	DL 120 S 5
0 433 200 065	DL 120 S 16
0 433 200 066	DL 120 S 25
0 433 200 067	DL 120 S 30

0 433 200 068	DL 120 S 36
0 433 200 069	DL 120 S 91
0 433 200 070	DL 120 S 94
0 433 200 071	DL 120 S 239
0 433 200 073	DL 120 S 332

0 433 200 074	DL 120 S 454
0 433 200 075	DL 120 S 805
0 433 200 076	DL 120 S 847
0 433 200 077	DL 120 S 999
0 433 200 078	DL 120 S 1011

0 433 200 079	DL 130 S 5
0 433 200 080	DL 130 S 850
0 433 200 081	DL 132 S 942
0 433 200 082	DL 135 S 94
0 433 200 083	DL 140 S 5

0 433 200 084	DL 140 S 78
0 433 200 085	DL 140 S 92
0 433 200 086	DL 140 S 204
0 433 200 087	DL 140 S 218
0 433 200 088	DL 140 S 301

Ref.	Typ
------	-----

0 433 200 089	DL 140 S 333
0 433 200 090	DL 140 S 349
0 433 200 091	DL 140 S 384
0 433 200 092	DL 140 S 863
0 433 200 093	DL 140 S 895

0 433 200 094	DL 140 S 914
0 433 200 095	DL 140 S 1006
0 433 200 096	DL 145 S 16
0 433 200 097	DL 145 S 30
0 433 200 098	DL 148 S 878

0 433 200 099	DL 150 S 25
0 433 200 100	DL 150 S 92
0 433 200 102	DL 150 S 499
0 433 200 103	DL 150 S 846
0 433 200 104	DL 150 S 864

0 433 200 105	DL 150 S 875
0 433 200 106	DL 150 S 894
0 433 200 107	DL 150 S 917
0 433 200 108	DL 150 S 936
0 433 200 109	DL 150 S 948

0 433 200 110	DL 150 S 990
0 433 200 111	DL 160 S 91
0 433 200 112	DL 160 S 301
0 433 200 113	DL 160 S 859
0 433 200 114	DL 160 S 860

0 433 200 115	DL 160 S 931
0 433 200 116	DL 160 S 1650
0 433 200 117	DL 60 S 1013
0 433 200 118	DL 90 S 1018
0 433 200 119	DL 0 S 920

0 433 200 120	DL 120 S 9990
0 433 200 121	DL 140 S 9990
0 433 200 122	DL 50 S 1056
0 433 200 123	DL 120 S 1076
0 433 200 124	DL 40 S 1078

0 433 200 125	DL 0 S 909
0 433 200 126	DL 100 S 1053
0 433 200 127	DL 90 S 1086
0 433 200 128	DL 150 S 1101
0 433 200 129	DL 130 S 1104

0 433 200 130	DL 0 S 1107
0 433 200 131	DL 90 S 1106
0 433 200 132	DL 170 S 1128
0 433 200 133	DL 140 S 1159
0 433 200 135	DL 150 S 1234

Ref.	Typ
------	-----

0 433 220 ...	
0 433 220 001	DLL 60 S 59
0 433 220 002	DLL 85 S 28
0 433 220 003	DLL 110 S 96

0 433 220 004	DLL 110 S 97
0 433 220 005	DLL 120 S 18
0 433 220 006	DLL 120 S 47
0 433 220 007	DLL 120 S 73
0 433 220 008	DLL 120 S 117

0 433 220 009	DLL 130 S 5
0 433 220 010	DLL 130 S 54
0 433 220 011	DLL 130 S 56
0 433 220 012	DLL 130 S 121
0 433 220 013	DLL 132 S 1

0 433 220 014	DLL 132 S 16
0 433 220 015	DLL 132 S 34
0 433 220 016	DLL 140 S 37
0 433 220 017	DLL 140 S 44
0 433 220 018	DLL 140 S 58

0 433 220 019	DLL 140 S 129
0 433 220 020	DLL 140 S 162
0 433 220 021	DLL 140 S 370
0 433 220 022	DLL 145 S 16
0 433 220 023	DLL 145 S 22

0 433 220 024	DLL 145 S 27
0 433 220 025	DLL 145 S 29
0 433 220 026	DLL 145 S 36
0 433 220 027	DLL 145 S 46
0 433 220 028	DLL 145 S 79

0 433 220 029	DLL 145 S 100
0 433 220 030	DLL 145 S 157
0 433 220 031	DLL 150 S 25
0 433 220 032	DLL 150 S 26
0 433 220 033	DLL 150 S 60

0 433 220 034	DLL 150 S 83
0 433 220 035	DLL 150 S 84
0 433 220 036	DLL 150 S 106
0 433 220 037	DLL 150 S 122
0 433 220 038	DLL 150 S 123

0 433 220 039	DLL 150 S 124
0 433 220 040	DLL 150 S 128
0 433 220 041	DLL 150 S 141
0 433 220 042	DLL 150 S 142
0 433 220 043	DLL 155 S 113

... 0 433 220 185



0 433 220 044	DLL 160 S 22
0 433 220 045	DLL 160 S 65
0 433 220 046	DLL 160 S 67
0 433 220 047	DLL 180 S 11
0 433 220 048	DLL 180 S 15
0 433 220 049	DLL 180 S 23
0 433 220 050	DLL 180 S 24
0 433 220 051	DLL 180 S 45
0 433 220 052	DLL 180 S 147
0 433 220 053	DLL 180 S 148
0 433 220 054	DLL 140 S 167
0 433 220 055	DLL 145 S 166
0 433 220 056	DLL 145 S 172
0 433 220 057	DLL 140 S 176
0 433 220 058	DLL 150 S 184
0 433 220 059	DLL 140 S 185
0 433 220 060	DLL 150 S 188
0 433 220 061	DLL 132 S 193
0 433 220 062	DLL 160 S 210
0 433 220 063	DLL 150 S 211
0 433 220 064	DLL 150 S 219
0 433 220 065	DLL 140 S 217
0 433 220 066	DLL 50 S 226
0 433 220 067	DLL 160 S 202
0 433 220 068	DLL 140 S 229
0 433 220 069	DLL 50 S 232
0 433 220 071	DLL 140 S 215
0 433 220 072	DLL 150 S 243
0 433 220 073	DLL 140 S 248
0 433 220 074	DLL 145 S 250
0 433 220 075	DLL 150 S 253
0 433 220 076	DLL 160 S 270
0 433 220 077	DLL 140 S 282
0 433 220 078	DLL 50 S 278
0 433 220 079	DLL 120 S 285
0 433 220 080	DLL 140 S 287
0 433 220 081	DLL 150 S 304
0 433 220 082	DLL 50 S 309
0 433 220 085	DLL 85 S 326
0 433 220 086	DLL 145 S 327
0 433 220 087	DLL 160 S 336
0 433 220 088	DLL 135 S 339
0 433 220 089	DLL 160 S 340
0 433 220 090	DLL 170 S 342
0 433 220 091	DLL 160 S 343



0 433 220 092	DLL 150 S 344
0 433 220 093	DLL 160 S 346
0 433 220 094	DLL 160 S 347
0 433 220 095	DLL 150 S 348
0 433 220 096	DLL 130 S 349
0 433 220 097	DLL 120 S 352
0 433 220 098	DLL 145 S 366
0 433 220 099	DLL 145 S 369
0 433 220 100	DLL 145 S 372
0 433 220 101	DLL 145 S 371
0 433 220 102	DLL 160 S 410
0 433 220 103	DLL 159 S 411
0 433 220 104	DLL 155 S 426
0 433 220 106	DLL 145 S 432
0 433 220 107	DLL 150 S 434
0 433 220 108	DLL 150 S 438
0 433 220 109	DLL 140 S 446
0 433 220 110	DLL 150 S 450
0 433 220 111	DLL 150 S 463
0 433 220 112	DLL 156 S 411
0 433 220 113	DLL 150 S 464
0 433 220 114	DLL 150 S 472
0 433 220 115	DLL 150 S 476
0 433 220 117	DLL 155 S 487
0 433 220 118	DLL 150 S 491
0 433 220 119	DLL 150 S 492
0 433 220 120	DLL 160 S 498
0 433 220 121	DLL 155 S 502
0 433 220 122	DLL 153 S 528
0 433 220 123	DLL 153 S 529
0 433 220 124	DLL 150 S 530
0 433 220 126	DLL 150 S 535
0 433 220 127	DLL 155 S 538
0 433 220 128	DLL 150 S 545
0 433 220 129	DLL 23 S 553
0 433 220 130	DLL 35 S 559
0 433 220 131	DLL 38 S 560
0 433 220 132	DLL 35 S 561
0 433 220 133	DLL 35 S 562
0 433 220 134	DLL 160 S 564
0 433 220 135	DLL 130 S 566
0 433 220 136	DLL 155 S 571
0 433 220 137	DLL 160 S 577
0 433 220 138	DLL 150 S 578
0 433 220 139	DLL 35 S 585



0 433 220 140	DLL 140 S 586
0 433 220 141	DLL 16 S 592
0 433 220 142	DLL 160 S 599
0 433 220 143	DLL 150 S 606
0 433 220 144	DLL 150 S 617
0 433 220 145	DLL 155 S 623
0 433 220 146	DLL 140 S 625
0 433 220 147	DLL 150 S 631
0 433 220 148	DLL 140 S 632
0 433 220 149	DLL 145 S 644
0 433 220 150	DLL 140 S 645
0 433 220 151	DLL 130 S 649
0 433 220 152	DLL 30 S 652
0 433 220 153	DLL 150 S 670
0 433 220 154	DLL 155 S 676
0 433 220 155	DLL 160 S 721
0 433 220 156	DLL 150 S 730
0 433 220 157	DLL 120 S 736
0 433 220 158	DLL 130 S 740
0 433 220 159	DLL 120 S 755
0 433 220 160	DLL 152 S 756
0 433 220 162	DLL 150 S 930
0 433 220 163	DLL 152 S 780
0 433 220 164	IBMD 5121
0 433 220 165	IBMD 5320 AB
0 433 220 166	DLL 155 S 802
0 433 220 167	DLL 150 S 805
0 433 220 168	DLL 140 S 819
0 433 220 169	DLL 135 S 844
0 433 220 170	DLL 152 S 864
0 433 220 171	DLL 150 S 869
0 433 220 172	DLL 151 S 939
0 433 220 173	DLL 155 S 942
0 433 220 174	DLL 150 S 946
0 433 220 175	DLL 150 S 949
0 433 220 176	DLL 150 S 950
0 433 220 177	DLL 145 S 951
0 433 220 178	DLL 145 S 954
0 433 220 179	DLL 138 S 956
0 433 220 180	DLL 150 S 961
0 433 220 181	DLL 130 S 962
0 433 220 182	DLL 150 S 979
0 433 220 183	DLL 30 S 987
0 433 220 184	DLL 145 S 988
0 433 220 185	DLL 145 S 989



A14

de	en	fr	it	es
Bestellnummer → Typformel (Fortsetzung)	Part number → Type designation (continued)	Référence → Formule de type (suite)	Numero d'ordina- zione → Sigla (seguito)	Número de pedido → Designación del tipo (continuación)

0 433 220 186 ...



Ref.	Typ
------	-----

0 433 220 186	DLL 150 S 997
0 433 220 187	DLL 30 S 1004
0 433 220 188	DLL 140 S 1040
0 433 220 189	DLL 140 S 1041/TR
0 433 220 190	DLL 155 S 1057

0 433 220 191	DLL 140 S 1071
0 433 220 192	DLL 155 S 1073
0 433 220 193	DLL 140 S 1077
0 433 220 194	DLL 120 S 1078
0 433 220 195	DLL 150 S 1093

0 433 220 196	DLL 76 S 1114
0 433 220 197	DLL 150 S 1126
0 433 220 198	DLL 160 S 1194
0 433 220 199	DLL 150 S 1195
0 433 220 200	DLL 140 S 1210

0 433 220 201	DLL 155 S 1276
0 433 220 202	DLL 155 S 1300

0 433 240 ...

0 433 240 001	DLP 0 S 1
0 433 240 002	DLP 0 S 5
0 433 240 003	DLP 0 S 6

0 433 240 004	DLP 0 S 7
----------------------	-----------

0 433 250 ...

0 433 250 001	DL 27 S 742
0 433 250 002	DL 27 S 819
0 433 250 003	DL 30 S 3

0 433 250 004	DL 30 S 46
0 433 250 005	DL 30 S 54
0 433 250 006	DL 30 S 406
0 433 250 007	DL 30 S 808
0 433 250 008	DL 30 S 856

0 433 250 009	DL 30 S 986
0 433 250 010	DL 35 S 347
0 433 250 011	DL 40 S 925
0 433 250 012	DL 45 S 319
0 433 250 013	DL 45 S 804

Ref.	Typ
------	-----

0 433 250 014	DL 50 S 348
0 433 250 015	DL 55 S 862
0 433 250 016	DL 55 S 923
0 433 250 017	DL 55 S 926
0 433 250 018	DL 55 S 927

0 433 250 019	DL 60 S 110
0 433 250 020	DL 87 S 824
0 433 250 021	DL 70 S 212
0 433 250 022	DL 70 S 450
0 433 250 023	DL 70 S 900

0 433 250 024	DL 72 S 366
0 433 250 025	DL 75 S 410
0 433 250 026	DL 80 S 731
0 433 250 027	DL 80 S 803
0 433 250 028	DL 80 S 809

0 433 250 029	DL 80 S 861
0 433 250 030	DL 84 S 912
0 433 250 031	DL 85 S 949
0 433 250 032	DL 90 S 209
0 433 250 033	DL 90 S 966

0 433 250 034	DL 100 S 836
0 433 250 035	DL 105 S 939
0 433 250 036	DL 106 S 994
0 433 250 037	DL 110 S 916
0 433 250 038	DL 110 S 954

0 433 250 039	DL 120 S 3
0 433 250 040	DL 130 S 946
0 433 250 041	DL 132 S 992
0 433 250 042	DL 140 S 752
0 433 250 043	DL 148 S 866

0 433 250 044	DL 150 S 798
0 433 250 045	DL 154 S 922
0 433 250 046	DL 160 S 747
0 433 250 047	DL 15 S 1017
0 433 250 048	DL 84 S 1027

0 433 250 049	DL 110 S 1028
0 433 250 050	DL 12 S 1043
0 433 250 051	DL 68 S 066
0 433 250 052	DL 110 S 1067
0 433 250 053	DL 68 S 1074

0 433 250 054	DL 80 S 1075
0 433 250 055	DL 110 S 1030
0 433 250 056	DL 50 S 1082
0 433 250 057	DL 110 S 1084
0 433 250 058	DL 95 S 1009

Ref.	Typ
------	-----

0 433 250 059	DL 55 S 1049
0 433 250 060	DL 55 S 1050
0 433 250 061	DL 50 S 1089
0 433 250 062	DL 40 S 1090
0 433 250 063	DL 125 S 1091

0 433 250 064	DL 90 S 1042
0 433 250 066	DL 50 S 1115
0 433 250 067	DL 50 S 1132
0 433 250 068	DL 12 S 1212

0 433 251 ...

0 433 251 001	DLA 0 S 1
0 433 251 002	DLA 0 S 2

0 433 270 ...

0 433 270 001	DLL 10 S 119
0 433 270 002	DLL 30 S 35
0 433 270 003	DLL 90 S 30

0 433 270 004	DLL 110 S 103
0 433 270 005	DLL 110 S 149
0 433 270 007	DLL 130 S 62
0 433 270 008	DLL 130 S 150
0 433 270 009	DLL 135 S 57

0 433 270 010	DLL 140 S 78
0 433 270 011	DLL 140 S 118
0 433 270 012	DLL 140 S 146
0 433 270 013	DLL 145 S 49
0 433 270 014	DLL 145 S 101

0 433 270 015	DLL 145 S 159
0 433 270 016	DLL 150 S 2
0 433 270 017	DLL 150 S 17
0 433 270 018	DLL 150 S 38
0 433 270 019	DLL 150 S 39

0 433 270 020	DLL 150 S 53
0 433 270 021	DLL 150 S 77
0 433 270 022	DLL 150 S 87
0 433 270 023	DLL 150 S 89
0 433 270 024	DLL 150 S 90

0 433 270 025	DLL 150 S 104
0 433 270 026	DLL 150 S 115
0 433 270 027	DLL 150 S 126
0 433 270 028	DLL 150 S 130
0 433 270 029	DLL 150 S 135

... 0 433 270 169



0 433 270 030	DLL 150 S 143
0 433 270 031	DLL 150 S 145
0 433 270 032	DLL 150 S 156
0 433 270 033	DLL 150 S 158
0 433 270 034	DLL 150 S 471
0 433 270 035	DLL 152 S 31
0 433 270 036	DLL 160 S 2
0 433 270 037	DLL 160 S 3
0 433 270 038	DLL 160 S 91
0 433 270 039	DLL 160 S 136
0 433 270 040	DLL 160 S 137
0 433 270 041	DLL 160 S 154
0 433 270 042	DLL 165 S 48
0 433 270 043	DLL 165 S 144
0 433 270 044	DLL 180 S 68
0 433 270 046	DLL 180 S 125
0 433 270 047	DLL 180 S 151
0 433 270 048	DLL 150 S 168
0 433 270 049	DLL 150 S 171
0 433 270 050	DLL 145 S 173
0 433 270 051	DLL 150 S 180
0 433 270 052	DLL 160 S 177
0 433 270 053	DLL 140 S 181
0 433 270 054	DLL 145 S 182
0 433 270 055	DLL 150 S 192
0 433 270 056	DLL 130 S 163
0 433 270 057	DLL 145 S 205
0 433 270 058	DLL 150 S 209
0 433 270 059	DLL 140 S 213
0 433 270 060	DLL 180 S 222
0 433 270 061	DLL 145 S 224
0 433 270 062	DLL 160 S 227
0 433 270 063	DLL 120 S 230
0 433 270 064	DLL 140 S 231
0 433 270 065	DLL 140 S 237
0 433 270 066	DLL 150 S 238
0 433 270 067	DLL 145 S 240
0 433 270 068	DLL 150 S 235
0 433 270 069	DLL 140 S 242
0 433 270 070	DLL 150 S 252
0 433 270 071	DLL 145 S 258
0 433 270 072	DLL 145 S 259
0 433 270 073	DLL 150 S 260
0 433 270 074	DLL 145 S 261
0 433 270 076	DLL 160 S 267



0 433 270 077	DLL 150 S 264
0 433 270 078	DLL 150 S 281
0 433 270 079	DLL 150 S 283
0 433 270 080	DLL 150 S 291
0 433 270 081	DLL 160 S 295
0 433 270 082	DLL 150 S 296
0 433 270 083	DLL 140 S 306
0 433 270 084	DLL 150 S 315
0 433 270 085	DLL 150 S 316
0 433 270 086	DLL 145 S 317
0 433 270 087	DLL 145 S 318
0 433 270 088	DLL 150 S 319
0 433 270 089	DLL 145 S 320
0 433 270 090	DLL 150 S 321
0 433 270 091	DLL 150 S 324
0 433 270 092	DLL 150 S 325
0 433 270 093	DLL 150 S 2810
0 433 270 094	DLL 150 S 2811
0 433 270 096	DLL 150 S 241
0 433 270 097	DLL 34 S 331
0 433 270 098	DLL 150 S 332
0 433 270 099	DLL 150 S 333
0 433 270 100	DLL 150 S 334
0 433 270 101	DLL 150 S 350
0 433 270 102	DLL 18 S 353
0 433 270 103	DLL 150 S 354
0 433 270 104	DLL 150 S 2640
0 433 270 105	DLL 150 S 356
0 433 270 106	DLL 35 S 364
0 433 270 107	DLL 155 S 368
0 433 270 108	DLL 150 S 373
0 433 270 109	DLL 140 S 380
0 433 270 110	DLL 140 S 382
0 433 270 111	DLL 140 S 385
0 433 270 112	DLL 165 S 388
0 433 270 113	DLL 150 S 389
0 433 270 114	DLL 150 S 393
0 433 270 115	DLL 140 S 403
0 433 270 116	DLL 150 S 405
0 433 270 117	DLL 150 S 406
0 433 270 118	DLL 155 S 412
0 433 270 119	DLL 145 S 416
0 433 270 120	DLL 150 S 2641
0 433 270 121	DLL 18 S 418
0 433 270 122	DLL 150 S 424



0 433 270 123	DLL 160 S 431
0 433 270 124	DLL 35 S 433
0 433 270 125	DLL 22 S 435
0 433 270 126	DLL 25 S 444
0 433 270 127	DLL 150 S 452
0 433 270 128	DLL 160 S 453
0 433 270 129	DLL 150 S 454
0 433 270 130	DLL 150 S 457
0 433 270 131	DLL 155 S 466
0 433 270 132	DLL 160 S 473
0 433 270 133	DLL 150 S 480
0 433 270 134	DLL 150 S 481
0 433 270 135	DLL 155 S 482
0 433 270 136	DLL 150 S 484
0 433 270 137	DLL 18 S 486
0 433 270 138	DLL 150 S 489
0 433 270 139	DLL 180 S 497
0 433 270 140	DLL 140 S 504
0 433 270 141	DLL 150 S 493
0 433 270 142	DLL 150 S 508
0 433 270 143	DLL 160 S 510
0 433 270 144	DLL 150 S 511
0 433 270 145	DLL 150 S 518
0 433 270 146	DLL 140 S 522
0 433 270 148	DLL 180 S 540
0 433 270 149	DLL 145 S 558
0 433 270 150	DLL 18 S 572
0 433 270 151	DLL 140 S 591
0 433 270 152	DLL 150 S 596
0 433 270 153	DLL 18 S 603
0 433 270 154	DLL 150 S 604
0 433 270 155	DLL 150 S 605
0 433 270 157	DLL 140 S 610
0 433 270 158	DLL 140 S 611
0 433 270 159	DLL 150 S 612
0 433 270 160	DLL 145 S 620
0 433 270 161	DLL 155 S 4820
0 433 270 162	DLL 18 S 629
0 433 270 163	DLL 160 S 642
0 433 270 164	DLL 160 S 534
0 433 270 165	DLL 10 S 647
0 433 270 166	DLL 165 S 657
0 433 270 167	DLL 150 S 665
0 433 270 168	DLL 25 S 680
0 433 270 169	DLL 150 S 697



A16

de	en	fr	it	es
Bestellnummer → Typformel (Fortsetzung)	Part number → Type designation (continued)	Référence → Formule de type (suite)	Numero d'ordina- zione → Sigla (seguito)	Número de pedido → Designación del tipo (continuación)

0 433 270 170 ...



Ref.	Typ
------	-----

0 433 270 170	DLL 160 S 705
0 433 270 172	IBMDB 1035 C
0 433 270 174	DLL 150 S 790/TR
0 433 270 175	IBMD 5750 A 3
0 433 270 176	DLL 25 S 834

0 433 270 177	IBMDB 5330
0 433 270 178	DLL 150 S 859
0 433 270 179	DLL 30 S 880
0 433 270 180	DLL 150 S 882
0 433 270 181	DLL 150 S 919/

0 433 270 182	DLL 28 S 932
0 433 270 183	DLL 35 S 965
0 433 270 184	IBMD 5753
0 433 270 185	DLL 16 S 966
0 433 270 186	DLL 16 S 971

0 433 270 187	DLL 150 S 1027
0 433 270 188	DLL 28 S 1056
0 433 270 189	DLL 154 S 1136
0 433 270 190	DLL 148 S 1149
0 433 270 191	DLL 155 S 1271

0 433 270 998	DLL 160 S 642
0 433 270 999	DLL 150 S 90

0 433 271 ...

0 433 271 001	DLLA 10 S 134
0 433 271 002	DLLA 19 S 132
0 433 271 003	DLLA 20 S 81

0 433 271 004	DLLA 20 S 99
0 433 271 005	DLLA 20 S 102
0 433 271 006	DLLA 20 S 110
0 433 271 007	DLLA 20 S 131
0 433 271 008	DLLA 23 S 155

0 433 271 009	DLLA 25 S 64
0 433 271 010	DLLA 25 S 86
0 433 271 011	DLLA 25 S 109
0 433 271 012	DLLA 25 S 116
0 433 271 013	DLLA 27 S 50

0 433 271 014	DLLA 27 S 51
0 433 271 015	DLLA 27 S 74
0 433 271 016	DLLA 27 S 88
0 433 271 017	DLLA 30 S 50
0 433 271 018	DLLA 30 S 51

Ref.	Typ
------	-----

0 433 271 019	DLLA 30 S 69
0 433 271 020	DLLA 30 S 98
0 433 271 021	DLLA 35 S 161
0 433 271 022	DLLA 38 S 133
0 433 271 023	DLLA 135 S 76

0 433 271 024	DLLA 150 S 52
0 433 271 025	DLLA 150 S 80
0 433 271 026	DLLA 150 S 85
0 433 271 027	DLLA 150 S 111
0 433 271 028	DLLA 150 S 112

0 433 271 029	DLLA 150 S 120
0 433 271 030	DLLA 150 S 138
0 433 271 031	DLLA 150 S 139
0 433 271 032	DLLA 150 S 140
0 433 271 033	DLLA 150 S 160

0 433 271 034	DLLA 150 S 164
0 433 271 035	DLLA 150 S 165
0 433 271 036	DLLA 150 S 720
0 433 271 037	DLLA 150 S 153
0 433 271 038	DLLB 25 S 169

0 433 271 039	DLLA 145 S 170
0 433 271 040	DLLA 150 S 1600
0 433 271 041	DLLA 35 S 175
0 433 271 042	DLLA 23 S 179
0 433 271 043	DLLA 150 S 178

0 433 271 044	DLLA 150 S 183
0 433 271 045	DLLA 150 S 186
0 433 271 046	DLLA 150 S 187
0 433 271 047	DLLA 35 S 189
0 433 271 048	DLLA 150 S 190

0 433 271 049	DLLA 23 S 191
0 433 271 050	DLLA 160 S 194
0 433 271 051	DLLA 23 S 195
0 433 271 052	DLLA 87 S 196
0 433 271 053	DLLA 27 S 198

0 433 271 054	DLLA 165 S 200
0 433 271 055	DLLA 145 S 199
0 433 271 056	DLLA 150 S 201
0 433 271 057	DLLA 150 S 203
0 433 271 058	DLLA 150 S 204

0 433 271 059	DLLA 150 S 207
0 433 271 060	DLLA 38 S 208
0 433 271 061	DLLA 150 S 212
0 433 271 062	DLLA 160 S 214
0 433 271 063	DLLA 150 S 216

Ref.	Typ
------	-----

0 433 271 064	DLLA 35 S 218
0 433 271 065	DLLA 150 S 220
0 433 271 066	DLLA 160 S 221
0 433 271 067	DLLA 150 S 223
0 433 271 068	DLLA 150 S 225

0 433 271 069	DLLA 140 S 233
0 433 271 070	DLLA 145 S 234
0 433 271 071	DLLA 150 S 236
0 433 271 072	DLLA 150 S 239
0 433 271 073	DLLA 35 S 244

0 433 271 074	DLLA 150 S 245
0 433 271 075	DLLA 79 S 246
0 433 271 076	DLLA 22 S 247
0 433 271 077	DLLA 150 S 249
0 433 271 078	DLLA 35 S 2180

0 433 271 079	DLLA 160 S 255
0 433 271 080	DLLA 130 S 233
0 433 271 081	DLLA 35 S 262
0 433 271 082	DLLA 26 S 263
0 433 271 083	DLLA 150 S 265

0 433 271 085	DLLA 150 S 266
0 433 271 086	DLLA 150 S 269
0 433 271 087	DLLA 110 S 271
0 433 271 088	DLLA 165 S 272
0 433 271 089	DLLA 150 S 268

0 433 271 090	DLLA 150 S 273
0 433 271 091	DLLA 160 S 275
0 433 271 092	DLLA 150 S 274
0 433 271 093	DLLA 150 S 254
0 433 271 094	DLLA 36 S 276

0 433 271 095	DLLA 145 S 277
0 433 271 096	DLLA 28 S 279
0 433 271 097	DLLA 150 S 280
0 433 271 098	DLLA 22 S 284
0 433 271 099	DLLA 10 S 286

0 433 271 100	DLLA 150 S 288
0 433 271 101	DLLA 140 S 289
0 433 271 102	DLLA 150 S 290
0 433 271 103	DLLA 150 S 292
0 433 271 104	DLLA 38 S 293

0 433 271 105	DLLA 125 S 294
0 433 271 106	DLLA 28 S 297
0 433 271 107	DLLA 150 S 298
0 433 271 108	DLLA 82 S 299
0 433 271 109	DLLA 18 S 300

... 0 433 271 249



0 433 271 110	DLLA 160 S 302
0 433 271 111	DLLA 160 S 303
0 433 271 112	DLLA 140 S 305
0 433 271 113	DLLA 140 S 307
0 433 271 114	DLLA 153 S 308
0 433 271 115	DLLA 17 S 301
0 433 271 116	DLLA 140 S 242
0 433 271 117	DLLA 28 S 310
0 433 271 118	DLLA 28 S 312
0 433 271 119	DLLA 160 S 311
0 433 271 120	DLLA 145 S 322
0 433 271 121	DLLA 145 S 314
0 433 271 122	DLLA 54 S 228
0 433 271 123	DLLA 150 S 323
0 433 271 124	DLLA 140 S 328
0 433 271 125	DLLA 150 S 329
0 433 271 126	DLLA 32 S 330
0 433 271 127	DLLA 150 S 257
0 433 271 128	DLLA 110 S 335
0 433 271 129	DLLA 150 S 337
0 433 271 130	DLLA 150 S 338
0 433 271 131	DLLA 18 S 341
0 433 271 132	DLLA 150 S 345
0 433 271 133	DLLA 150 S 351
0 433 271 134	DLLA 150 S 355
0 433 271 135	DLLA 150 S 357
0 433 271 136	DLLA 153 S 358
0 433 271 137	DLLA 145 S 359
0 433 271 138	DLLA 140 S 360
0 433 271 139	DLLA 160 S 361
0 433 271 140	DLLA 145 S 362
0 433 271 141	DLLA 23 S 363
0 433 271 142	DLLA 32 S 365
0 433 271 143	DLLA 160 S 227
0 433 271 144	DLLA 38 S 367
0 433 271 145	DLLA 145 S 224
0 433 271 146	DLLA 145 S 240
0 433 271 147	DLLA 145 S 101
0 433 271 148	DLLA 145 S 374
0 433 271 149	DLLA 150 S 375
0 433 271 150	DLLA 35 S 376
0 433 271 151	DLLA 35 S 377
0 433 271 152	DLLA 160 S 378
0 433 271 153	DLLA 140 S 379
0 433 271 154	DLLA 150 S 381



0 433 271 155	DLLA 23 S 383
0 433 271 156	DLLA 18 S 384
0 433 271 157	DLLA 150 S 386
0 433 271 158	DLLA 35 S 387
0 433 271 159	DLLA 82 S 391
0 433 271 160	DLLA 79 S 390
0 433 271 161	DLLA 150 S 392
0 433 271 162	DLLA 149 S 394
0 433 271 163	DLLA 150 S 395
0 433 271 164	DLLA 150 S 396
0 433 271 165	DLLA 160 S 397
0 433 271 166	DLLA 146 S 398
0 433 271 167	DLLA 160 S 399
0 433 271 168	DLLA 10 S 400
0 433 271 169	DLLA 150 S 402
0 433 271 170	DLLA 150 S 2661
0 433 271 171	DLLA 146 S 404
0 433 271 172	DLLA 140 S 254
0 433 271 173	DLLA 150 S 407
0 433 271 174	DLLA 27 S 408
0 433 271 175	DLLA 110 S 409
0 433 271 176	DLLA 150 S 413
0 433 271 177	DLLA 28 S 414
0 433 271 178	DLLA 28 S 415
0 433 271 179	DLLA 150 S 2660
0 433 271 180	DLLA 150 S 417
0 433 271 181	DLLA 150 S 419
0 433 271 182	DLLA 27 S 420
0 433 271 183	DLLA 150 S 421
0 433 271 184	DLLA 150 S 422
0 433 271 185	DLLA 150 S 423
0 433 271 186	DLLA 28 S 425
0 433 271 187	DLLA 150 S 427
0 433 271 188	DLLA 150 S 428
0 433 271 189	DLLA 150 S 429
0 433 271 190	DLLA 150 S 430
0 433 271 191	DLLA 150 S 436
0 433 271 192	DLLA 150 S 437
0 433 271 194	DLLA 176 S 440
0 433 271 195	DLLA 150 S 442
0 433 271 196	DLLA 160 S 443
0 433 271 197	DLLA 145 S 445
0 433 271 198	DLLA 63 S 447
0 433 271 199	DLLA 145 S 448
0 433 271 200	DLLA 147 S 449





0 433 271 201	DLLA 28 S 441
0 433 271 202	DLLA 28 S 451
0 433 271 203	DLLA 150 S 455
0 433 271 204	DLLA 140 S 338
0 433 271 205	DLLA 150 S 456
0 433 271 206	DLLA 150 S 458
0 433 271 207	DLLA 150 S 459
0 433 271 208	DLLA 140 S 460
0 433 271 210	DLLA 17 S 462
0 433 271 211	DLLA 150 S 465
0 433 271 212	DLLA 150 S 467
0 433 271 213	DLLA 150 S 468
0 433 271 214	DLLA 150 S 469
0 433 271 215	DLLA 148 S 470
0 433 271 216	DLLA 27 S 474
0 433 271 217	DLLA 150 S 475
0 433 271 219	DLLA 160 S 479
0 433 271 220	DLLA 180 S 483
0 433 271 221	DLLA 144 S 485
0 433 271 222	DLLA 144 S 488
0 433 271 223	DLLA 149 S 490
0 433 271 224	DLLA 150 S 494
0 433 271 225	DLLA 150 S 495
0 433 271 226	DLLA 150 S 496
0 433 271 227	DLLA 140 S 499
0 433 271 229	DLLA 150 S 501
0 433 271 230	DLLA 150 S 506
0 433 271 231	DLLA 145 S 507
0 433 271 232	DLLA 160 S 509
0 433 271 233	DLLA 27 S 512
0 433 271 234	DLLA 150 S 513
0 433 271 235	DLLA 150 S 514
0 433 271 236	DLLA 150 S 515
0 433 271 237	DLLA 28 S 516
0 433 271 238	DLLA 27 S 517
0 433 271 239	DLLA 155 S 520
0 433 271 240	DLLA 150 S 521
0 433 271 241	DLLA 150 S 523
0 433 271 242	DLLA 160 S 524
0 433 271 243	DLLA 145 S 525
0 433 271 244	DLLA 160 S 526
0 433 271 245	DLLA 150 S 527
0 433 271 246	DLLA 152 S 533
0 433 271 247	DLLC 150 S 532
0 433 271 249	DLLA 155 S 536



A18

de	en	fr	it	es
Bestellnummer → Typformel (Fortsetzung)	Part number → Type designation (continued)	Référence → Formule de type (suite)	Numero d'ordina- zione → Sigla (seguito)	Número de pedido → Designación del tipo (continuación)

0 433 271 250 ...

 Ref.	Typ	 Ref.	Typ	 Ref.	Typ
0 433 271 250	DLLA 155 S 537	0 433 271 295	DLLA 160 S 608	0 433 271 340	DLLB 150 S 688
0 433 271 251	DLLC 155 S 539	0 433 271 296	DLLA 27 S 613	0 433 271 341	DLLA 140 S 694/EE
0 433 271 252	DLLA 38 S 541	0 433 271 297	DLLA 25 S 614	0 433 271 343	DLLA 160 S 699
0 433 271 253	DLLC 150 S 542	0 433 271 298	DLLA 150 S 615	0 433 271 344	DLLA 160 S 707
0 433 271 254	DLLC 150 S 543	0 433 271 299	DLLA 150 S 616	0 433 271 345	DLLA 150 S 708
0 433 271 255	DLLB 160 S 544	0 433 271 300	DLLA 150 S 618	0 433 271 346	DLLB 150 S 711
0 433 271 256	DLLA 160 S 546	0 433 271 301	DLLA 140 S 619	0 433 271 347	DLLA 165 S 712
0 433 271 257	DLLA 150 S 547	0 433 271 302	DLLA 16 S 621	0 433 271 348	DLLA 150 S 714
0 433 271 258	DLLA 150 S 548	0 433 271 303	TR-DLLA 75 S 622	0 433 271 349	DLLA 149 S 715
0 433 271 259	DLLA 150 S 549	0 433 271 304	DLLC 150 S 624	0 433 271 352	DLLA 155 S 723
0 433 271 260	DLLA 150 S 550	0 433 271 305	DLLA 160 S 626	0 433 271 353	DLLA 150 S 718
0 433 271 261	DLLA 155 S 551	0 433 271 306	DLLA 25 S 627	0 433 271 354	DLLA 150 S 709
0 433 271 262	DLLA 150 S 552	0 433 271 307	DLLA 150 S 628	0 433 271 355	DLLA 25 S 722
0 433 271 263	DLLA 160 S 555	0 433 271 308	DLLA 160 S 630	0 433 271 356	DLLA 150 S 724
0 433 271 264	DLLA 145 S 556	0 433 271 309	DLLA 150 S 633	0 433 271 357	DLLA 140 S 726
0 433 271 265	DLLA 160 S 557	0 433 271 310	DLLA 150 S 634	0 433 271 358	DLLA 165 S 727
0 433 271 266	DLLA 140 S 563	0 433 271 311	DLLA 140 S 635	0 433 271 359	DLLA 155 S 733
0 433 271 267	DLLA 150 S 565	0 433 271 312	DLLA 155 S 636	0 433 271 360	DLLA 140 S 738
0 433 271 268	DLLA 150 S 2120	0 433 271 313	DLLA 140 S 637	0 433 271 361	DLLA 160 S 734
0 433 271 269	DLLA 140 S 567	0 433 271 314	DLLA 140 S 638	0 433 271 362	DLLA 26 S 743
0 433 271 270	DLLA 155 S 568	0 433 271 315	DLLA 160 S 641	0 433 271 363	DLLA 24 S 745
0 433 271 271	DLLA 150 S 569	0 433 271 316	DLLC 150 S 646	0 433 271 364	DLLZ 150 S 746
0 433 271 272	DLLA 150 S 570	0 433 271 317	DLLA 150 S 650	0 433 271 365	DLLA 34 S 749
0 433 271 273	DLLA 22 S 573	0 433 271 318	DLLA 155 S 651	0 433 271 366	DLLA 144 S 747
0 433 271 274	DLLA 155 S 574	0 433 271 319	DLLA 150 S 653	0 433 271 367	DLLA 140 S 752
0 433 271 275	DLLA 160 S 575	0 433 271 320	DLLA 160 S 654	0 433 271 368	DLLA 30 S 757
0 433 271 276	DLLA 149 S 576	0 433 271 321	DLLA 142 S 655	0 433 271 369	DLLA 150 S 758
0 433 271 277	DLLB 155 S 579	0 433 271 322	DLLA 28 S 656	0 433 271 370	DLLA 32 S 759
0 433 271 278	DLLB 155 S 580	0 433 271 323	DLLC 150 S 660	0 433 271 371	DLLA 150 S 761
0 433 271 279	DLLC 157 S 581	0 433 271 324	DLLA 160 S 661	0 433 271 372	DLLA 30 S 763
0 433 271 280	DLLA 150 S 582	0 433 271 325	DLLA 141 S 662	0 433 271 373	DLLA 150 S 764
0 433 271 281	DLLA 150 S 583	0 433 271 326	DLLA 135 S 664	0 433 271 374	DLLB 150 S 765
0 433 271 282	DLLA 24 S 584	0 433 271 327	DLLA 150 S 666	0 433 271 375	DLLA 145 S 770
0 433 271 283	DLLC 157 S 587	0 433 271 328	DLLA 150 S 669	0 433 271 376	DLLA 149 S 774
0 433 271 284	DLLA 150 S 588	0 433 271 329	DLLA 150 S 671	0 433 271 377	DLLA 149 S 775
0 433 271 285	DLLA 28 S 589	0 433 271 330	DLLA 150 S 673	0 433 271 378	DLLA 34 S 776
0 433 271 286	DLLA 155 S 590	0 433 271 331	DLLA 160 S 674	0 433 271 379	DLLA 150 S 777
0 433 271 287	DLLA 155 S 593	0 433 271 332	DLLB 155 S 675	0 433 271 380	IBMDB 5492
0 433 271 288	DLLA 170 S 594	0 433 271 333	DLLA 140 S 677	0 433 271 381	IBMD 5767
0 433 271 289	DLLC 155 S 595	0 433 271 334	DLLA 30 S 678	0 433 271 383	IBMDB 5777
0 433 271 290	DLLA 140 S 597	0 433 271 335	DLLA 150 S 679	0 433 271 384	IBMDB 5221
0 433 271 291	DLLB 155 S 598	0 433 271 336	DLLA 150 S 682/	0 433 271 385	IBMDB 5299
0 433 271 292	DLLA 28 S 600	0 433 271 337	DLLA 150 S 683	0 433 271 386	IBMDB 5301
0 433 271 293	DLLA 25 S 601	0 433 271 338	DLLA 160 S 684	0 433 271 388	IBMDB 5392
0 433 271 294	DLLA 150 S 607	0 433 271 339	DLLA 135 S 685	0 433 271 389	IBMDB 5434

... 0 433 271 533



0 433 271 391	IBMB 5587 A
0 433 271 392	IBMD 5719
0 433 271 393	DLLZ 140 S 784
0 433 271 394	DLLA 150 S 781
0 433 271 395	DLLA 140 S 786
0 433 271 396	DLLA 160 S 787
0 433 271 397	DLLA 150 S 788/
0 433 271 398	DLLA 150 S 793
0 433 271 399	IBMD 5626
0 433 271 400	DLLB 150 S 794
0 433 271 401	DLLA 160 S 795
0 433 271 402	DLLA 150 S 796
0 433 271 403	DLLA 142 S 791
0 433 271 404	DLLA 142 S 792
0 433 271 406	SIGMA-IBMD 5826
0 433 271 407	DLLA 150 S 394
0 433 271 408	DLLA 79 S 800
0 433 271 409	DLLB 150 S 803
0 433 271 410	DLLA 144 S 808
0 433 271 411	DLLA 150 S 809
0 433 271 412	DLLA 26 S 810
0 433 271 413	DLLA 35 S 812
0 433 271 414	DLLA 144 S 820
0 433 271 415	DLLA 150 S 823
0 433 271 417	DLLA 150 S 824
0 433 271 418	DLLA 150 S 825
0 433 271 419	IBMD 5707
0 433 271 421	DLLA 34 S 837
0 433 271 422	DLLA 150 S 841
0 433 271 423	DLLA 144 S 829
0 433 271 424	DLLA 145 S 847
0 433 271 425	DLLA 150 S 852
0 433 271 426	DLLA 35 S 855
0 433 271 427	DLLZ 154 S 860
0 433 271 428	DLLA 148 S 862
0 433 271 429	DLLA 28 S 863
0 433 271 430	DLLA 150 S 866
0 433 271 431	DLLA 150 S 867
0 433 271 432	DLLA 150 S 871
0 433 271 433	DLLA 150 S 872
0 433 271 434	DLLA 150 S 873
0 433 271 435	DLLA 34 S 876
0 433 271 436	DLLA 30 S 877
0 433 271 439	DLLA 30 S 888
0 433 271 440	DLLA 150 S 891/TR



0 433 271 441	DLLA 150 S 893
0 433 271 442	DLLA 28 S 892
0 433 271 443	DLLA 33 S 894
0 433 271 445	DLLA 32 S 900
0 433 271 446	DLLA 150 S 902
0 433 271 447	DLLA 144 S 8200
0 433 271 448	DLLA 148 S 909
0 433 271 449	DLLA 146 S 910
0 433 271 450	DLLA 156 S 911
0 433 271 451	DLLA 150 S 913
0 433 271 452	DLLA 31 S 915
0 433 271 453	DLLA 35 S 918
0 433 271 454	DLLA 31 S 921
0 433 271 455	DLLZ 154 S 923
0 433 271 456	DLLA 144 S 747
0 433 271 457	DLLA 35 S 941
0 433 271 458	DLLA 145 S 944/
0 433 271 459	DLLA 145 S 945
0 433 271 460	DLLZ 156 S 948
0 433 271 461	DLLA 30 S 931
0 433 271 462	DLLA 150 S 935
0 433 271 463	DLLA 31 S 955
0 433 271 464	DLLZ 156 S 957
0 433 271 465	DLLA 150 S 975
0 433 271 466	DLLA 142 S 926
0 433 271 467	DLLA 144 S 982
0 433 271 468	DLLA 150 S 996/
0 433 271 469	DLLA 144 S 829/
0 433 271 471	DLLA 134 S 999
0 433 271 472	DLLA 146 S 1007
0 433 271 473	DLLA 150 S 1008
0 433 271 474	DLLA 30 S 1009
0 433 271 475	DLLZ 165 S 1010
0 433 271 476	DLLA 31 S 1014
0 433 271 478	DLLA 140 S 1003
0 433 271 479	DLLA 150 S 1016
0 433 271 480	DLLA 140 S 1017
0 433 271 481	DLLA 145 S 1018
0 433 271 482	DLLA 145 S 1019
0 433 271 483	DLLA 142 S 926
0 433 271 484	DLLA 148 S 1026
0 433 271 485	DLLA 128 S 1028
0 433 271 486	DLLA 131 S 1035
0 433 271 487	DLLA 136 S 1034
0 433 271 488	DLLA 150 S 1036



0 433 271 489	DLLA 144 S 1037
0 433 271 490	DLLA 144 S 1037/
0 433 271 491	DLLA 150 S 1042
0 433 271 492	DLLZ 156 S 1048
0 433 271 493	DLLA 165 S 1051
0 433 271 494	DLLA 150 S 1052
0 433 271 495	DLLA 136 S 1043
0 433 271 496	DLLA 150 S 1072
0 433 271 497	DLLA 31 S 1079
0 433 271 498	DLLA 145 S 1090
0 433 271 499	DLLA 136 S 1094
0 433 271 500	DLLZ 160 S 1095
0 433 271 501	DLLA 140 S 1100
0 433 271 502	DLLA 142 S 1096
0 433 271 503	DLLA 134 S 1119
0 433 271 504	DLLA 156 S 1123
0 433 271 505	DLLA 24 S 1127
0 433 271 506	DLLZ 160 S 1128
0 433 271 507	DLLA 131 S 1131
0 433 271 508	DLLZ 156 S 1134
0 433 271 509	DLLA 31 S 1138
0 433 271 510	DLLA 134 S 1143
0 433 271 511	DLLA 136 S 1147
0 433 271 512	DLLA 150 S 1148/TR
0 433 271 513	DLLA 134 S 1150
0 433 271 514	DLLA 163 S 1156
0 433 271 515	DLLA 137 S 1157
0 433 271 516	DLLA 150 S 1159
0 433 271 517	DLLZ 150 S 1170
0 433 271 518	DLLA 142 S 1173
0 433 271 519	DLLA 136 S 1182
0 433 271 520	DLLA 35 S 1190
0 433 271 521	DLLA 138 S 1191
0 433 271 522	DLLA 148 S 1196
0 433 271 523	DLLA 134 S 1197
0 433 271 524	DLLA 134 S 1199
0 433 271 525	DLLA 155 S 1202
0 433 271 526	DLLA 155 S 1223
0 433 271 527	DLLA 142 S 1224
0 433 271 528	DLLA 156 S 1233
0 433 271 529	DLLA 139 S 1235
0 433 271 530	DLLA 140 S 1236
0 433 271 531	DLLA 146 S 1239
0 433 271 532	DLLA 160 S 1241
0 433 271 533	DLLA 150 S 1251



A20

de	en	fr	it	es
Bestellnummer → Typformel (Fortsetzung)	Part number → Type designation (continued)	Référence → Formule de type (suite)	Numero d'ordina- zione → Sigla (seguito)	Número de pedido → Designación del tipo (continuación)

0 433 271 534 ...

Ref.	Typ	Ref.	Typ	Ref.	Typ
0 433 271 534	DLLA 142 S 1257	0 433 271 649	DLLA 150 S 1248	0 433 271 694	DLLA 146 S 1175
0 433 271 535	DLLA 150 S 1267	0 433 271 650	DLLZ 152 S 1247	0 433 271 695	DLLA 137 S 1174
0 433 271 536	DLLA 142 S 1269	0 433 271 651	DLLZ 150 S 1246	0 433 271 696	DLLA 145 S 1172
0 433 271 567	DLLA 150 S 1270	0 433 271 652	DLLA 146 S 1245	0 433 271 697	DLLA 137 S 1171
0 433 271 569	DLLA 150 S 1283	0 433 271 653	DLLA 145 S 1244	0 433 271 698	DLLA 145 S 1169
0 433 271 571	DLLA 134 S 1284	0 433 271 654	DLLA 140 S 1242	0 433 271 699	DLLZ 140 S 1168
0 433 271 576	DLLA 150 S 1304	0 433 271 655	DLLA 150 S 1238	0 433 271 700	DLLA 144 S 1167
0 433 271 587	DLLA 138 S 1191+/ 0 433 271 588	0 433 271 656	DLLA 150 S 1237	0 433 271 701	DLLA 155 S 1163
0 433 271 588	DLLA 134 S 1199+/ 0 433 271 589	0 433 271 657	DLLA 150 S 1234	0 433 271 702	DLLA 145 S 1161
0 433 271 589	DLLA 134 S 999+/ 0 433 271 590	0 433 271 658	DLLA 140 S 1232	0 433 271 703	DLLA 145 S 1160
0 433 271 590	DLLA 134 S 1284+/ 0 433 271 591	0 433 271 659	DLLA 150 S 1231	0 433 271 704	DLLA 150 S 1158
0 433 271 591	DLLA 136 S 1034+/ 0 433 271 592	0 433 271 660	DLLZ 152 S 1229	0 433 271 705	DLLA 134 S 1155
0 433 271 592	DLLA 144 S 829+/ 0 433 271 593	0 433 271 661	DLLA 148 S 1228	0 433 271 706	DLLA 137 S 1154
0 433 271 593	DLLA 140 S 1003+/ 0 433 271 594	0 433 271 662	DLLA 132 S 1227	0 433 271 708	DLLA 149 S 1152
0 433 271 594	DLLA 144 S 485+/ 0 433 271 595	0 433 271 663	DLLA 148 S 1226	0 433 271 709	DLLA 150 S 1151
0 433 271 595	DLLA 150 S 1316 0 433 271 600	0 433 271 664	DLLA 149 S 1225	0 433 271 710	DLLA 158 S 1146
0 433 271 600	DLLA 150 S 1311 0 433 271 601	0 433 271 665	DLLA 155 S 1221	0 433 271 711	DLLA 148 S 1145
0 433 271 601	DLLA 146 S 1310 0 433 271 602	0 433 271 666	DLLA 150 S 1220	0 433 271 712	DLLA 159 S 1141
0 433 271 602	DLLA 135 S 1309 0 433 271 603	0 433 271 667	DLLA 145 S 1218	0 433 271 713	DLLA 140 S 1140
0 433 271 603	DLLA 155 S 1308 0 433 271 604	0 433 271 668	DLLA 140 S 1217	0 433 271 714	DLLA 150 S 1137
0 433 271 604	DLLA 155 S 1307 0 433 271 614	0 433 271 669	DLLA 150 S 1216	0 433 271 715	DLLZ 155 S 1133
0 433 271 614	DLLA 160 S 1305 0 433 271 615	0 433 271 670	DLLA 155 S 1215	0 433 271 716	DLLA 140 S 1121
0 433 271 615	DLLA 155 S 1303 0 433 271 616	0 433 271 671	DLLA 148 S 1214	0 433 271 717	DLLA 140 S 1117
0 433 271 616	DLLA 143 S 1302 0 433 271 624	0 433 271 672	DLLA 150 S 1213	0 433 271 718	DLLA 140 S 1116
0 433 271 624	DLLA 148 S 1298 0 433 271 625	0 433 271 673	DLLA 149 S 1209	0 433 271 719	DLLA 134 S 1113
0 433 271 625	DLLA 150 S 1295 0 433 271 626	0 433 271 674	DLLA 137 S 1208	0 433 271 720	DLLA 138 S 1112
0 433 271 626	DLLA 143 S 1292 0 433 271 627	0 433 271 675	DLLA 149 S 1207	0 433 271 721	DLLA 140 S 1110
0 433 271 627	DLLA 136 S 1289 0 433 271 628	0 433 271 676	DLLA 145 S 1206	0 433 271 722	DLLA 140 S 1109
0 433 271 628	DLLZ 150 S 1287 0 433 271 629	0 433 271 677	DLLA 155 S 1205	0 433 271 723	DLLA 150 S 1105
0 433 271 629	DLLA 160 S 1285 0 433 271 630	0 433 271 678	DLLA 148 S 1204	0 433 271 724	DLLA 150 S 1104
0 433 271 630	DLLA 140 S 1282 0 433 271 631	0 433 271 679	DLLA 148 S 1203	0 433 271 725	DLLA 136 S 1102
0 433 271 631	DLLZ 155 S 1281 0 433 271 632	0 433 271 680	DLLA 134 S 1201	0 433 271 726	DLLA 145 S 1101
0 433 271 632	DLLA 152 S 1280 0 433 271 633	0 433 271 681	DLLA 140 S 1198	0 433 271 727	DLLA 140 S 1099
0 433 271 633	DLLA 125 S 1279 0 433 271 634	0 433 271 682	DLLA 140 S 1193	0 433 271 728	DLLA 148 S 1098
0 433 271 634	DLLA 125 S 1278 0 433 271 635	0 433 271 683	DLLA 150 S 1192	0 433 271 729	DLLA 145 S 1097
0 433 271 635	DLLA 152 S 1277 0 433 271 636	0 433 271 684	DLLA 142 S 1189	0 433 271 730	DLLA 150 S 851/ 0 433 271 731
0 433 271 636	DLLA 144 S 1275 0 433 271 637	0 433 271 685	DLLA 142 S 1188	0 433 271 731	DLLA 150 S 1091
0 433 271 637	DLLZ 150 S 1274 0 433 271 638	0 433 271 686	DLLA 140 S 1187	0 433 271 732	DLLA 148 S 1089
0 433 271 638	DLLA 148 S 1272 0 433 271 643	0 433 271 687	DLLA 140 S 1186	0 433 271 733	DLLA 154 S 1088
0 433 271 643	DLLA 136 S 1268 0 433 271 644	0 433 271 688	DLLA 152 S 1184	0 433 271 734	DLLA 150 S 1087
0 433 271 644	DLLA 148 S 1263 0 433 271 645	0 433 271 689	DLLA 130 S 1183	0 433 271 735	DLLA 154 S 1086
0 433 271 645	DLLA 144 S 1262 0 433 271 646	0 433 271 690	DLLA 160 S 1181	0 433 271 736	DLLA 160 S 1084
0 433 271 646	DLLA 140 S 1252 0 433 271 647	0 433 271 691	DLLA 152 S 1180	0 433 271 737	DLLZ 147 S 1083
0 433 271 647	DLLA 146 S 1250 0 433 271 648	0 433 271 692	DLLA 145 S 1179	0 433 271 738	DLLA 159 S 1082
0 433 271 648	DLLA 143 S 1249	0 433 271 693	DLLA 145 S 1176	0 433 271 739	DLLA 148 S 1076

... 0 433 271 874



0 433 271 740	DLLA 136 S 943
0 433 271 741	DLLA 140 S 1075
0 433 271 742	DLLA 150 S 1074
0 433 271 743	DLLA 140 S 1069
0 433 271 744	DLLA 140 S 1068
0 433 271 745	DLLA 150 S 1067
0 433 271 746	DLLA 150 S 1066
0 433 271 747	DLLA 150 S 1065
0 433 271 748	DLLA 150 S 1064
0 433 271 749	DLLA 150 S 1063
0 433 271 750	DLLA 150 S 1062
0 433 271 751	DLLA 150 S 1061
0 433 271 752	DLLA 150 S 1060
0 433 271 753	DLLA 145 S 1059
0 433 271 754	DLLA 148 S 1058
0 433 271 755	DLLA 150 S 1055
0 433 271 756	DLLA 140 S 1054
0 433 271 757	DLLZ 147 S 1050
0 433 271 758	DLLA 150 S 1044
0 433 271 759	DLLA 140 S 1039
0 433 271 760	DLLA 140 S 1038
0 433 271 761	DLLA 155 S 1032
0 433 271 762	DLLA 136 S 1031
0 433 271 763	DLLA 160 S 1030
0 433 271 764	DLLA 150 S 1029
0 433 271 765	DLLA 145 S 1023
0 433 271 766	DLLZ 147 S 1022
0 433 271 767	DLLA 140 S 1021
0 433 271 768	DLLA 136 S 1020
0 433 271 769	DLLA 150 S 1015
0 433 271 770	DLLA 160 S 1012
0 433 271 771	DLLA 150 S 1006
0 433 271 772	DLLA 145 S 1005
0 433 271 773	DLLA 136 S 1002
0 433 271 774	DLLA 124 S 1001
0 433 271 775	DLLA 136 S 1000
0 433 271 776	DLLA 132 S 999
0 433 271 777	DLLA 150 S 998
0 433 271 778	DLLA 160 S 995
0 433 271 779	DLLA 150 S 994
0 433 271 780	DLLA 150 S 993
0 433 271 781	DLLA 144 S 992
0 433 271 782	DLLA 151 S 985
0 433 271 783	DLLA 138 S 983
0 433 271 784	DLLA 132 S 981



0 433 271 785	DLLA 142 S 980
0 433 271 786	DLLA 150 S 978
0 433 271 787	DLLA 150 S 977
0 433 271 788	DLLA 140 S 976
0 433 271 789	DLLA 150 S 974/TR
0 433 271 790	DLLA 151 S 972
0 433 271 791	DLLA 154 S 970
0 433 271 792	DLLA 147 S 969
0 433 271 793	DLLA 150 S 968
0 433 271 794	DLLA 150 S 967
0 433 271 795	DLLA 136 S 964
0 433 271 796	DLLA 124 S 963
0 433 271 797	DLLA 150 S 960/
0 433 271 798	DLLZ 147 S 958
0 433 271 799	DLLA 160 S 952
0 433 271 800	DLLA 142 S 947
0 433 271 801	DLLA 136 S 943
0 433 271 802	DLLA 160 S 938
0 433 271 803	DLLA 151 S 928
0 433 271 804	DLLA 150 S 925
0 433 271 805	DLLA 142 S 924
0 433 271 806	DLLA 158 S 920
0 433 271 807	DLLA 150 S 916
0 433 271 808	DLLA 150 S 914
0 433 271 809	DLLA 160 S 908
0 433 271 810	DLLA 150 S 904
0 433 271 811	DLLA 150 S 903
0 433 271 812	DLLA 152 S 899
0 433 271 813	DLLA 142 S 897
0 433 271 814	DLLA 150 S 896
0 433 271 815	DLLA 155 S 895
0 433 271 816	DLLA 146 S 890
0 433 271 817	DLLA 144 S 889
0 433 271 818	DLLA 145 S 886
0 433 271 819	DLLA 148 S 885
0 433 271 820	DLLA 150 S 883
0 433 271 821	DLLA 150 S 881
0 433 271 822	DLLA 155 S 879
0 433 271 823	DLLA 150 S 870
0 433 271 824	DLLA 150 S 868
0 433 271 825	DLLA 155 S 858
0 433 271 826	DLLA 160 S 857
0 433 271 827	DLLA 160 S 856
0 433 271 828	DLLB 151 S 854
0 433 271 829	DLLA 150 S 853



0 433 271 830	DLLA 150 S 851
0 433 271 831	DLLA 150 S 850
0 433 271 832	DLLA 150 S 849
0 433 271 833	TR-DLLA 160 S 846
0 433 271 834	DLLA 150 S 843
0 433 271 835	DLLA 144 S 842
0 433 271 836	DLLA 150 S 839
0 433 271 837	DLLA 150 S 838/
0 433 271 838	DLLA 150 S 836
0 433 271 839	DLLA 155 S 835
0 433 271 840	DLLA 155 S 831
0 433 271 841	DLLA 150 S 830
0 433 271 842	DLLA 150 S 828
0 433 271 843	DLLA 140 S 827
0 433 271 844	DLLA 150 S 826
0 433 271 845	DLLA 156 S 822
0 433 271 846	DLLB 150 S 821
0 433 271 847	DLLA 160 S 817
0 433 271 848	DLLA 150 S 816
0 433 271 849	DLLA 150 S 815
0 433 271 850	DLLA 151 S 813
0 433 271 851	DLLA 160 S 811
0 433 271 852	IBMD 5837
0 433 271 853	SIGMA-IBMD 5823
0 433 271 854	DLLA 160 S 807
0 433 271 855	DLLA 150 S 806
0 433 271 856	DLLA 150 S 804
0 433 271 857	DLLA 150 S 798
0 433 271 858	EE-DLLA 150 S 797
0 433 271 859	DLLA 150 S 789
0 433 271 860	DLLA 145 S 785
0 433 271 861	DLLA 152 S 783
0 433 271 862	DLLA 145 S 768
0 433 271 863	DLLA 150 S 767
0 433 271 864	DLLA 158 S 766
0 433 271 865	DLLA 150 S 762
0 433 271 866	DLLA 160 S 760
0 433 271 867	DLLA 150 S 754
0 433 271 868	DLLA 150 S 753
0 433 271 869	DLLA 152 S 751
0 433 271 870	DLLA 150 S 750
0 433 271 871	DLLA 150 S 748
0 433 271 872	DLLZ 150 S 744
0 433 271 873	DLLA 150 S 741
0 433 271 874	DLLA 150 S 739



de

**Bestellnummer →
Typformel**
(Fortsetzung)

en

**Part number →
Type designation**
(continued)

fr

**Référence →
Formule de type**
(suite)

it

**Numero d'ordina-
zione → Sigla**
(seguito)

es

**Número de pedido →
Designación del tipo**
(continuación)

0 433 271 875 ...

Ref.	Typ
------	-----

0 433 271 875	DLLA 150 S 737
0 433 271 876	DLLA 155 S 732
0 433 271 877	DLLA 150 S 731
0 433 271 878	DLLA 155 S 729
0 433 271 879	DLLA 150 S 728

0 433 271 880	DLLA 150 S 725
0 433 271 881	DLLA 150 S 717
0 433 271 882	DLLA 150 S 716
0 433 271 883	DLLA 155 S 713
0 433 271 884	DLLA 155 S 710

0 433 271 885	DLLA 150 S 704
0 433 271 886	DLLA 152 S 703
0 433 271 887	DLLA 150 S 700
0 433 271 888	DLLA 150 S 702
0 433 271 889	DLLA 140 S 696

0 433 271 890	DLLA 155 S 695
0 433 271 891	DLLA 150 S 690
0 433 271 892	DLLA 150 S 689
0 433 271 893	DLLA 155 S 687
0 433 271 894	DLLA 151 S 686

0 433 271 895	DLLA 155 S 681
0 433 271 897	DLLA 155 S 659
0 433 271 898	DLLA 155 S 658
0 433 271 998	DLLC 155 S 595
0 433 271 999	DLLC 150 S 624

0 433 272 ...

0 433 272 004	DLLA 145 S 1330
0 433 272 005	DLLA 148 S 1337
0 433 272 012	DLLA 131 S 1035+/ /

0 433 272 036	DLLA 148 S 1379
0 433 272 037	DLLA 148 S 1380
0 433 272 038	DLL 155 S 1383
0 433 272 959	DLLA 144 S 5457
0 433 272 960	DLLA 132 S 1400

0 433 272 961	DLLA 132 S 1398
0 433 272 963	DLLA 132 S 1384
0 433 272 964	DLLA 146 S 1378
0 433 272 965	DLLA 123 S 1372
0 433 272 966	DLLA 145 S 1368

0 433 272 967	DLLA 145 S 1367
0 433 272 968	DLLA 124 S 1365
0 433 272 969	DLLZ 140 S 1361
0 433 272 980	DLLA 155 S 1351
0 433 272 985	DLLA 155 S 1348

Ref.	Typ
------	-----

0 433 272 986	DLLA 150 S 1340
0 433 272 987	DLLA 132 S 1335
0 433 272 989	DLLA 150 S 1324
0 433 272 994	DLLA 155 S 1323
0 433 272 995	DLLA 150 S 1322

0 433 272 996	DLLA 150 S 1321
0 433 272 997	DLLA 132 S 1320
0 433 272 998	DLLA 150 S 1314
0 433 272 999	DLLA 150 S 1313

0 433 300 ...

0 433 300 001	DL 0 T 64
0 433 300 002	DL 0 T 178
0 433 300 003	DL 0 T 247

0 433 300 004	DL 0 T 258
0 433 300 005	DL 0 T 722
0 433 300 006	DL 0 T 843
0 433 300 007	DL 0 T 924
0 433 300 008	DL 0 T 993

0 433 300 009	DL 0 T 1004
0 433 300 010	DL 0 T 1007
0 433 300 011	DL 30 T 2
0 433 300 012	DL 30 T 122
0 433 300 013	DL 35 T 486

0 433 300 014	DL 50 T 884
0 433 300 015	DL 60 T 200
0 433 300 016	DL 80 T 844
0 433 300 017	DL 86 T 183
0 433 300 018	DL 86 T 245

0 433 300 019	DL 90 T 2
0 433 300 020	DL 90 T 16
0 433 300 021	DL 90 T 433
0 433 300 022	DL 90 T 748
0 433 300 023	DL 90 T 812

0 433 300 024	DL 100 T 30
0 433 300 025	DL 100 T 86
0 433 300 026	DL 100 T 183
0 433 300 027	DL 100 T 728
0 433 300 028	DL 100 T 826

0 433 300 029	DL 100 T 968
0 433 300 030	DL 105 T 86
0 433 300 031	DL 105 T 1000
0 433 300 032	DL 105 T 1001
0 433 300 033	DL 108 T 938

Ref.	Typ
------	-----

0 433 300 034	DL 110 T 5
0 433 300 035	DL 110 T 28
0 433 300 036	DL 110 T 30
0 433 300 037	DL 110 T 36
0 433 300 038	DL 110 T 86

0 433 300 039	DL 110 T 91
0 433 300 040	DL 110 T 92
0 433 300 041	DL 110 T 94
0 433 300 042	DL 110 T 139
0 433 300 043	DL 110 T 183

0 433 300 044	DL 110 T 188
0 433 300 045	DL 110 T 333
0 433 300 046	DL 110 T 769
0 433 300 047	DL 110 T 896
0 433 300 048	DL 110 T 897

0 433 300 049	DL 110 T 903
0 433 300 050	DL 110 T 906
0 433 300 051	DL 110 T 907
0 433 300 052	DL 110 T 918
0 433 300 053	DL 110 T 919

0 433 300 054	DL 110 T 947
0 433 300 055	DL 110 T 950
0 433 300 056	DL 110 T 957
0 433 300 057	DL 110 T 958
0 433 300 058	DL 110 T 963

0 433 300 059	DL 115 T 255
0 433 300 060	DL 115 T 272
0 433 300 061	DL 115 T 867
0 433 300 062	DL 115 T 997
0 433 300 063	DL 120 T 2

0 433 300 064	DL 120 T 16
0 433 300 065	DL 120 T 20
0 433 300 066	DL 120 T 28
0 433 300 067	DL 120 T 30
0 433 300 068	DL 120 T 45

0 433 300 069	DL 120 T 86
0 433 300 070	DL 120 T 91
0 433 300 071	DL 120 T 164
0 433 300 072	DL 120 T 165
0 433 300 073	DL 120 T 182

0 433 300 074	DL 120 T 183
0 433 300 075	DL 120 T 196
0 433 300 076	DL 120 T 255
0 433 300 077	DL 120 T 262
0 433 300 078	DL 120 T 271

... 0 433 300 216



0 433 300 079	DL 120 T 333
0 433 300 080	DL 120 T 398
0 433 300 081	DL 120 T 435
0 433 300 082	DL 120 T 464
0 433 300 083	DL 120 T 876
0 433 300 084	DL 120 T 945
0 433 300 085	DL 120 T 985
0 433 300 086	DL 125 T 20
0 433 300 087	DL 125 T 86
0 433 300 088	DL 125 T 91
0 433 300 089	DL 125 T 183
0 433 300 090	DL 125 T 771
0 433 300 091	DL 125 T 957
0 433 300 092	DL 130 T 20
0 433 300 093	DL 130 T 30
0 433 300 094	DL 130 T 86
0 433 300 095	DL 130 T 91
0 433 300 097	DL 130 T 114
0 433 300 098	DL 130 T 182
0 433 300 099	DL 130 T 183
0 433 300 100	DL 130 T 196
0 433 300 101	DL 130 T 204
0 433 300 102	DL 130 T 205
0 433 300 103	DL 130 T 232
0 433 300 104	DL 130 T 387
0 433 300 105	DL 130 T 388
0 433 300 106	DL 130 T 465
0 433 300 107	DL 130 T 725
0 433 300 108	DL 130 T 871
0 433 300 109	DL 130 T 955
0 433 300 110	DL 130 T 956
0 433 300 111	DL 130 T 982
0 433 300 112	DL 132 T 226
0 433 300 113	DL 132 T 911
0 433 300 114	DL 134 T 182
0 433 300 115	DL 134 T 196
0 433 300 116	DL 134 T 225
0 433 300 117	DL 135 T 20
0 433 300 118	DL 135 T 91
0 433 300 119	DL 135 T 181
0 433 300 120	DL 135 T 204
0 433 300 121	DL 135 T 226
0 433 300 122	DL 135 T 236
0 433 300 123	DL 135 T 882
0 433 300 124	DL 135 T 891



0 433 300 125	DL 135 T 975
0 433 300 126	DL 138 T 729
0 433 300 127	DL 140 T 16
0 433 300 128	DL 140 T 18
0 433 300 129	DL 140 T 20
0 433 300 130	DL 140 T 30
0 433 300 131	DL 140 T 91
0 433 300 132	DL 140 T 92
0 433 300 133	DL 140 T 183
0 433 300 134	DL 140 T 205
0 433 300 135	DL 140 T 218
0 433 300 136	DL 140 T 226
0 433 300 137	DL 140 T 232
0 433 300 138	DL 140 T 260
0 433 300 139	DL 140 T 262
0 433 300 140	DL 140 T 272
0 433 300 141	DL 140 T 333
0 433 300 142	DL 140 T 769
0 433 300 143	DL 140 T 848
0 433 300 144	DL 140 T 849
0 433 300 145	DL 140 T 855
0 433 300 146	DL 140 T 877
0 433 300 147	DL 140 T 890
0 433 300 148	DL 140 T 929
0 433 300 149	DL 140 T 965
0 433 300 150	DL 145 T 30
0 433 300 151	DL 145 T 204
0 433 300 152	DL 145 T 301
0 433 300 153	DL 145 T 385
0 433 300 154	DL 145 T 431
0 433 300 155	DL 145 T 479
0 433 300 156	DL 145 T 769
0 433 300 157	DL 145 T 870
0 433 300 158	DL 145 T 940
0 433 300 159	DL 145 T 960
0 433 300 160	DL 145 T 991
0 433 300 161	DL 150 T 16
0 433 300 162	DL 150 T 20
0 433 300 163	DL 150 T 30
0 433 300 164	DL 150 T 91
0 433 300 165	DL 150 T 147
0 433 300 166	DL 150 T 182
0 433 300 167	DL 150 T 183
0 433 300 168	DL 150 T 204
0 433 300 169	DL 150 T 205



0 433 300 170	DL 150 T 232
0 433 300 171	DL 150 T 390
0 433 300 172	DL 150 T 418
0 433 300 173	DL 150 T 477
0 433 300 174	DL 150 T 874
0 433 300 175	DL 150 T 885
0 433 300 176	DL 150 T 886
0 433 300 177	DL 150 T 910
0 433 300 178	DL 150 T 937
0 433 300 179	DL 150 T 952
0 433 300 180	DL 150 T 957
0 433 300 181	DL 150 T 958
0 433 300 182	DL 150 T 997
0 433 300 183	DL 155 T 86
0 433 300 184	DL 155 T 92
0 433 300 185	DL 155 T 205
0 433 300 186	DL 155 T 271
0 433 300 187	DL 155 T 952
0 433 300 188	DL 150 T 962
0 433 300 189	DL 150 T 970
0 433 300 190	DL 150 T 995
0 433 300 191	DL 160 T 398
0 433 300 192	DL 160 T 477
0 433 300 193	DL 160 T 857
0 433 300 194	DL 165 T 841
0 433 300 195	DL 165 T 930
0 433 300 196	DL 165 T 981
0 433 300 197	DL 170 T 468
0 433 300 198	DL 170 T 490
0 433 300 199	DL 170 T 773
0 433 300 200	DL 170 T 885
0 433 300 201	DL 170 T 921
0 433 300 202	DL 0 T 1014
0 433 300 203	DL 130 T 1016
0 433 300 204	DL 140 T 390
0 433 300 205	DL 145 T 1012
0 433 300 206	DL 160 T 1015
0 433 300 207	DL 150 T 1024
0 433 300 208	DL 170 T 1021
0 433 300 210	DL 150 T 1023
0 433 300 212	DL 150 T 1022
0 433 300 213	DL 90 T 1025
0 433 300 214	DL 160 T 147
0 433 300 215	DL 140 T 1026
0 433 300 216	DL 140 T 1034



A24

de

**Bestellnummer →
Typformel**
(Fortsetzung)

en

**Part number →
Type designation**
(continued)

fr

**Référence →
Formule de type**
(suite)

it

**Numero d'ordina-
zione → Sigla**
(seguito)

es

**Número de pedido →
Designación del tipo**
(continuación)

0 433 300 217 ...



Ref.	Typ
------	-----

0 433 300 217	DL 145 T 1035
0 433 300 218	DL 0 T 1037
0 433 300 219	DL 140 T 1038
0 433 300 220	DL 145 T 1040
0 433 300 221	DL 160 T 1041

0 433 300 222	DL 150 T 239
0 433 300 223	DL 110 T 1044
0 433 300 224	DL 150 T 1045
0 433 300 225	DL 150 T 1047
0 433 300 226	DL 165 T 1048

0 433 300 227	DL 120 T 1052
0 433 300 228	DL 140 T 1051
0 433 300 229	DL 150 T 1054
0 433 300 230	DL 160 T 1057
0 433 300 231	DL 145 T 1058

0 433 300 232	DL 140 T 1060
0 433 300 233	DL 165 T 1063
0 433 300 235	DL 145 T 1068
0 433 300 236	DL 157 T 1069
0 433 300 237	DL 125 T 1071

0 433 300 238	DL 130 T 1072
0 433 300 239	DL 150 T 1073
0 433 300 240	DL 160 T 1077
0 433 300 241	DL 157 T 1080
0 433 300 242	DL 140 T 1081

0 433 300 243	DL 145 T 970
0 433 300 244	DL 130 T 1085
0 433 300 245	DL 160 T 1088
0 433 300 246	DL 120 T 1092
0 433 300 247	DL 120 T 1093

0 433 300 248	DL 140 T 1094
0 433 300 249	DL 132 T 91
0 433 300 250	DL 150 T 1097
0 433 300 251	DL 150 T 1100
0 433 300 252	DL 150 T 1102

0 433 300 253	DL 155 T 1108
0 433 300 254	DL 0 T 1109
0 433 300 255	DL 164 T 1110
0 433 300 256	DL 135 T 1111
0 433 300 257	DL 155 T 1112

0 433 300 258	DL 145 T 1113
0 433 300 259	DL 140 T 1119
0 433 300 260	DL 145 T 1121
0 433 300 261	DL 145 T 1122
0 433 300 262	DL 157 T 1123

Ref.	Typ
------	-----

0 433 300 263	DL 140 T 1124
0 433 300 264	DL 110 T 1125
0 433 300 265	DL 120 T 188
0 433 300 266	DL 140 T 1129
0 433 300 267	DL 160 T 1131

0 433 300 268	DL 160 T 1133
0 433 300 269	DL 110 T 1138
0 433 300 270	DL 150 T 1139
0 433 300 271	DL 155 T 1140
0 433 300 272	DL 155 T 1143

0 433 300 273	DL 140 T 1144
0 433 300 274	DL 105 T 1145
0 433 300 275	DL 145 T 1146
0 433 300 276	DL 150 T 1147
0 433 300 277	DL 160 T 1148

0 433 300 278	DL 140 T 1149
0 433 300 279	DL 130 T 1150
0 433 300 280	DL 160 T 1151
0 433 300 281	DL 130 T 1152
0 433 300 282	DL 140 T 1153

0 433 300 283	DL 0 T 1154
0 433 300 285	DL 145 T 1156
0 433 300 286	DL 140 T 1155
0 433 300 287	DL 150 T 1158
0 433 300 288	DL 150 T 1160

0 433 300 289	DL 130 T 1161
0 433 300 290	DL 140 T 1162
0 433 300 291	DL 140 T 1163
0 433 300 292	DL 150 T 1164
0 433 300 293	DL 130 T 1165

0 433 300 294	DL 110 T 1167
0 433 300 295	DL 140 T 1168
0 433 300 296	DL 145 T 1169
0 433 300 298	DL 130 T 1170
0 433 300 299	DL 155 T 1171

0 433 300 300	DL 140 T 1172
0 433 300 301	DL 150 T 1173
0 433 300 302	DL 155 T 1175
0 433 300 303	DL 0 T 1181
0 433 300 304	DL 140 T 1182

0 433 300 305	DL 140 T 1183
0 433 300 306	DL 150 T 1185
0 433 300 307	DL 155 T 1186
0 433 300 308	DL 145 T 1187
0 433 300 309	DL 155 T 1188

Ref.	Typ
------	-----

0 433 300 310	DL 130 T 1189
0 433 300 311	DL 110 T 1190
0 433 300 312	DL 135 T 1191
0 433 300 313	DL 145 T 1192
0 433 300 314	DL 155 T 1193

0 433 300 315	DL 160 T 1194
0 433 300 316	DL 150 T 1195
0 433 300 317	DL 140 T 1196
0 433 300 319	DL 145 T 1198
0 433 300 320	DL 150 T 1197

0 433 300 321	DL 170 T 1200
0 433 300 322	DL 145 T 1201
0 433 300 323	DL 145 T 1203
0 433 300 324	DL 145 T 1204
0 433 300 325	DL 145 T 1205

0 433 300 326	DL 155 T 1206
0 433 300 327	DL 145 T 1207
0 433 300 328	DL 150 T 1208
0 433 300 329	DL 120 T 1209
0 433 300 330	DL 150 T 1210

0 433 300 331	DL 165 T 1211
0 433 300 332	DL 150 T 1213
0 433 300 333	DL 154 T 1214
0 433 300 334	DL 130 T 1215
0 433 300 335	DL 145 T 1217

0 433 300 336	DL 150 T 1218
0 433 300 337	DL 140 T 1223
0 433 300 338	DL 140 T 1224
0 433 300 339	DL 130 T 1225
0 433 300 340	DL 120 T 1226

0 433 300 341	DL 155 T 1228
0 433 300 342	DL 155 T 1229
0 433 300 343	DL 140 T 1230
0 433 300 344	DL 155 T 1236
0 433 300 345	DL 120 T 1241

0 433 300 346	DL 155 T 1243
0 433 300 347	DL 155 T 1248
0 433 300 348	DL 155 T 1249
0 433 300 983	DL 145 T 1205+SH
0 433 300 984	DL 145 T 1217+SH

0 433 300 985	DL 145 T 1156+SH
0 433 300 986	DL 145 T 1201+SH
0 433 300 987	DL 145 T 1121+SH
0 433 300 988	DL 165 T 1211+SH
0 433 300 989	DL 155 T 1193+SH

... 0 433 371 013



0 433 300 990	DL 155 T 1188+SH
0 433 300 991	DL 155 T 271+SH
0 433 300 995	DL 150 T 957+SH
0 433 300 996	DL 155 T 1112+SH
0 433 300 999	DL 115 T 1140+SH

0 433 350 ...

0 433 350 001	DL 27 T 712
0 433 350 002	DL 30 T 3/HB
0 433 350 003	DL 30 T 853

0 433 350 004	DL 30 T 858
0 433 350 005	DL 65 T 944
0 433 350 006	DL 75 T 817
0 433 350 007	DN 6 TD 119
0 433 350 008	DL 150 T 1033

0 433 350 009	DL 30 T 1059
0 433 350 010	DL 150 T 1105
0 433 350 011	DLZ 140 T 1157
0 433 350 012	DLZ 154 T 1235
0 433 350 013	DLZ 125 T 1237

0 433 350 014	DLZ 125 T 1247
0 433 350 015	DLZ 130 T 1250

0 433 351 ...

0 433 351 001	DLF 100 T 4
0 433 351 002	DLF 110 T 5
0 433 351 003	DLF 110 T 6

0 433 351 004	DLF 130 T 7
0 433 351 005	DLF 132 T 1
0 433 351 006	DLF 140 T 2
0 433 351 007	DLF 152 T 3
0 433 351 008	DLF 150 T 8

0 433 351 010	DLF 155 T 3
0 433 351 011	DLF 130 T 70
0 433 351 012	DLF 150 T 10
0 433 351 013	DLF 145 T 11
0 433 351 014	DLF 150 T 12

0 433 351 015	DLF 150 T 13
0 433 351 016	DLF 140 T 14
0 433 351 017	DLF 155 T 11
0 433 351 018	DLF 140 T 15
0 433 351 019	DLF 170 T 16



0 433 351 020	DLF 150 T 17
0 433 351 021	DLF 160 T 18
0 433 351 022	DLF 140 T 19
0 433 351 023	DLF 140 T 20
0 433 351 024	DLF 145 T 21

0 433 351 025	DLF 135 T 22
0 433 351 026	DLF 145 T 23
0 433 351 027	DLF 160 T 24
0 433 351 028	DLF 155 T 25
0 433 351 029	DLF 155 T 26

0 433 351 030	DLF 130 T 27
0 433 351 031	DLF 150 T 28
0 433 351 032	DLF 135 T 29
0 433 351 033	DLF 160 T 30
0 433 351 034	DLLF 150 T 6

0 433 351 035	DLF 120 T 32
0 433 351 036	DLF 150 T 33
0 433 351 037	DLF 140 T 34
0 433 351 038	DLF 140 T 35
0 433 351 039	DLLF 140 T 7

0 433 351 040	DLLF 145 T 8
0 433 351 041	DLF 145 T 38
0 433 351 042	DLF 120 T 39
0 433 351 043	DLF 130 T 40
0 433 351 044	DLF 130 T 41

0 433 351 045	DLF 140 T 42
0 433 351 046	DLF 155 T 43
0 433 351 047	DLF 145 T 44
0 433 351 048	DLF 140 T 45
0 433 351 049	DLLF 150 T 11

0 433 351 050	DLF 130 T 47
0 433 351 051	DLLF 145 T 9
0 433 351 052	DLF 145 T 49
0 433 351 053	DLLF 145 T 1
0 433 351 054	DLLF 155 T 2

0 433 351 055	DLLF 155 T 3
0 433 351 056	DLLF 120 T 4
0 433 351 057	DLLF 140 T 5
0 433 351 058	DLLF 145 T 10
0 433 351 059	DLLF 150 T 12

0 433 351 060	DLLF 145 T 13
0 433 351 061	DLLF 156 T 14
0 433 351 062	DLLF 156 T 16
0 433 351 063	DLLF 156 T 17
0 433 351 064	DLLF 150 T 18



0 433 351 065	DLLF 156 T 19
0 433 351 066	DLLF 155 T 20
0 433 351 067	DLLF 140 T 21
0 433 351 068	DLLF 145 T 22
0 433 351 069	DLLF 156 T 23

0 433 351 070	DLLF 150 T 24
0 433 351 071	DLLF 150 T 37
0 433 351 072	DLLF 155 T 38
0 433 351 073	DLLF 155 T 39
0 433 351 074	DLLF 150 T 40

0 433 351 982	DLLF 150 T 40
0 433 351 983	DLLF 155 T 39+SH
0 433 351 984	DLLF 155 T 38+SH
0 433 351 985	DLLF 150 T 37+SH
0 433 351 986	DLLF 150 T 24+SH

0 433 351 987	DLLF 145 T 22+RG
0 433 351 988	DLLF 150 T 18+RG
0 433 351 989	DLLF 150 T 12+RG
0 433 351 991	DLF 140 T 34+SH
0 433 351 992	DLF 150 T 17+SH

0 433 351 993	DLF 140 T 19+SH
0 433 351 994	DLF 140 T 42+SH
0 433 351 995	DLF 140 T 14+SH
0 433 351 999	DLF 155 T 25

0 433 352 ...

0 433 352 001	DLF 150 T 50
----------------------	--------------

0 433 371 ...

0 433 371 001	DLLA 160 T 1
0 433 371 002	DLLA 160 T 2
0 433 371 003	DLLA 160 T 3

0 433 371 004	DLLA 160 T 4
0 433 371 005	DLLB 145 T 5
0 433 371 006	DLLB 145 T 6
0 433 371 007	DLLB 145 T 7
0 433 371 008	DLLZ 150 T 8

0 433 371 009	DLLZ 150 T 9
0 433 371 010	DLLZ 150 T 10
0 433 371 011	DLLZ 150 T 11
0 433 371 012	DLLZ 150 T 12
0 433 371 013	DLLZ 150 T 13



de

**Bestellnummer →
Typformel**
(Fortsetzung)

en

**Part number →
Type designation**
(continued)

fr

**Référence →
Formule de type**
(suite)

it

**Numero d'ordina-
zione → Sigla**
(seguito)

es

**Número de pedido →
Designación del tipo**
(continuación)

0 433 371 995 ...

Ref.	Typ
0 433 371 995	DLLZ 150 T 10+SH
0 433 371 996	DLLZ 150 T 12+SH
0 433 371 997	DLLZ 150 T 11+SH
0 433 371 998	DLLZ 150 T 9+SH
0 433 371 999	DLLZ 150 T 8+SH

Ref.	Typ
0 433 400 039	DL 125 U 259
0 433 400 040	DL 125 U 260
0 433 400 041	DL 125 U 317
0 433 400 042	DL 125 U 987
0 433 400 043	DL 130 U 196

Ref.	Typ
0 433 400 084	DL 60 U 979
0 433 400 085	DL 60 U 1020
0 433 400 087	DL 130 U 182
0 433 400 088	DL 150 U 1029
0 433 400 089	DL 140 U 188

0 433 400 ...

0 433 400 001	DL 0 U 404
0 433 400 002	DL 0 U 779
0 433 400 003	DL 0 U 840

0 433 400 044	DL 130 U 232
0 433 400 045	DL 130 U 245
0 433 400 046	DL 130 U 246
0 433 400 047	DL 130 U 263
0 433 400 048	DL 130 U 380

0 433 400 090	DL 140 U 225
0 433 400 091	DL 150 U 246
0 433 400 092	DL 150 U 1032
0 433 400 093	DL 130 U 237
0 433 400 094	DL 140 U 237

0 433 400 004	DL 0 U 887
0 433 400 005	DL 0 U 8870
0 433 400 006	DL 50 U 979
0 433 400 007	DL 50 U 980
0 433 400 008	DL 70 U 139

0 433 400 049	DL 130 U 446
0 433 400 050	DL 130 U 899
0 433 400 051	DL 130 U 901
0 433 400 052	DL 130 U 935
0 433 400 053	DL 130 U 989

0 433 400 095	DL 55 U 980
0 433 400 096	DL 135 U 1039
0 433 400 097	DL 150 U 821
0 433 400 098	DL 160 U 2560
0 433 400 099	DL 160 U 1055

0 433 400 009	DL 90 U 703
0 433 400 010	DL 110 U 86
0 433 400 011	DL 110 U 139
0 433 400 012	DL 110 U 196
0 433 400 013	DL 110 U 225

0 433 400 054	DL 140 U 204
0 433 400 055	DL 140 U 205
0 433 400 056	DL 140 U 232
0 433 400 057	DL 140 U 255
0 433 400 058	DL 140 U 259

0 433 400 100	DL 160 U 1061
0 433 400 101	DL 130 U 1062
0 433 400 102	DL 140 U 1064
0 433 400 104	DL 140 U 1070
0 433 400 105	DL 145 U 226

0 433 400 014	DL 110 U 226
0 433 400 015	DL 110 U 237
0 433 400 016	DL 110 U 256
0 433 400 017	DL 110 U 868
0 433 400 018	DL 110 U 893

0 433 400 059	DL 140 U 263
0 433 400 060	DL 140 U 271
0 433 400 061	DL 140 U 375
0 433 400 062	DL 140 U 386
0 433 400 063	DL 140 U 392

0 433 400 106	DL 135 U 1079
0 433 400 107	DL 140 U 1083
0 433 400 108	DL 160 U 1087
0 433 400 109	DL 110 U 1098
0 433 400 110	DL 135 U 1099

0 433 400 019	DL 115 U 249
0 433 400 020	DL 115 U 260
0 433 400 021	DL 115 U 364
0 433 400 022	DL 120 U 20
0 433 400 023	DL 120 U 86

0 433 400 064	DL 140 U 785
0 433 400 065	DL 140 U 816
0 433 400 066	DL 140 U 842
0 433 400 067	DL 140 U 904
0 433 400 068	DL 140 U 978

0 433 400 111	DL 130 U 1103
0 433 400 112	DL 140 U 114
0 433 400 113	DL 135 U 1114
0 433 400 114	DL 120 U 1116
0 433 400 115	DL 160 U 1118

0 433 400 024	DL 120 U 114
0 433 400 025	DL 120 U 147
0 433 400 026	DL 120 U 181
0 433 400 027	DL 120 U 211
0 433 400 028	DL 120 U 232

0 433 400 069	DL 140 U 996
0 433 400 070	DL 145 U 232
0 433 400 071	DL 145 U 364
0 433 400 072	DL 145 U 873
0 433 400 073	DL 145 U 974

0 433 400 116	DL 115 U 1120
0 433 400 117	DL 140 U 1137
0 433 400 118	DL 155 U 1118
0 433 400 119	DL 150 U 1142
0 433 400 120	DL 110 U 147

0 433 400 029	DL 120 U 236
0 433 400 030	DL 120 U 256
0 433 400 031	DL 120 U 260
0 433 400 032	DL 120 U 276
0 433 400 033	DL 120 U 314

0 433 400 074	DL 145 U 1003
0 433 400 075	DL 150 U 183
0 433 400 076	DL 150 U 256
0 433 400 077	DL 150 U 364
0 433 400 078	DL 150 U 390

0 433 400 121	DL 125 U 1039
0 433 400 122	DL 155 U 1087
0 433 400 123	DL 140 U 1216
0 433 400 124	DL 160 U 1221
0 433 400 403	DL 70 U 225

0 433 400 034	DL 120 U 443
0 433 400 035	DL 120 U 792
0 433 400 036	DL 120 U 905
0 433 400 037	DL 120 U 978
0 433 400 038	DL 125 U 255

0 433 400 079	DL 150 U 888
0 433 400 080	DL 155 U 390
0 433 400 081	DL 160 U 256
0 433 400 082	DL 160 U 1002
0 433 400 083	DL 120 U 1019

0 433 421 ...

0 433 421 001	DLLA 145 U 2
0 433 421 002	DLLA 152 U 1
0 433 421 003	DLLA 140 U 3

... 0 433 600 003



0 433 421 004	DLA 132 U 3
0 433 421 005	DLA 132 U 4
0 433 421 006	DLA 132 U 5
0 433 421 007	DLA 155 U 6
0 433 421 008	DLA 144 U 7

0 433 450 ...

0 433 450 001	DL 80 U 881
0 433 450 002	DL 80 U 983
0 433 450 003	DLZ 150 U 1222

0 433 450 004	DLZ 150 U 1227
0 433 450 005	DLZ 150 U 1233
0 433 450 006	DLZ 150 U 1234
0 433 450 007	DLZ 155 U 1238
0 433 450 008	DLZ 155 U 1239

0 433 450 009	DLZ 150 U 1240
0 433 450 010	DLA 155 U 1242
0 433 450 011	DLZ 155 U 1244

0 433 451 ...

0 433 451 001	DLF 110 U 1
0 433 451 002	DLF 110 U 18
0 433 451 003	DLF 110 U 28

0 433 451 004	DLF 115 U 13
0 433 451 005	DLF 115 U 190
0 433 451 006	DLF 125 U 1
0 433 451 007	DLF 130 U 5
0 433 451 008	DLF 130 U 15

0 433 451 009	DLF 132 U 15
0 433 451 010	DLF 132 U 30
0 433 451 011	DLF 132 U 35
0 433 451 012	DLF 132 U 36
0 433 451 013	DLF 135 U 1

0 433 451 014	DLF 135 U 16
0 433 451 015	DLF 140 U 1
0 433 451 016	DLF 140 U 3
0 433 451 017	DLF 140 U 4 -
0 433 451 018	DLF 140 U 6

0 433 451 019	DLF 140 U 9
0 433 451 020	DLF 140 U 17
0 433 451 021	DLF 140 U 20
0 433 451 022	DLF 140 U 21
0 433 451 023	DLF 140 U 22



0 433 451 024	DLF 140 U 24
0 433 451 025	DLF 140 U 25
0 433 451 026	DLF 140 U 26
0 433 451 027	DLF 140 U 27
0 433 451 028	DLF 140 U 29

0 433 451 029	DLF 140 U 32
0 433 451 030	DLF 145 U 10
0 433 451 031	DLF 145 U 11
0 433 451 032	DLF 145 U 23
0 433 451 033	DLF 145 U 31

0 433 451 034	DLF 145 U 34
0 433 451 035	DLF 150 U 10
0 433 451 036	DLF 150 U 12
0 433 451 037	DLF 132 U 26
0 433 451 038	DLF 140 U 37

0 433 451 039	DLF 108 U 38
0 433 451 040	DLF 150 U 1
0 433 451 041	DLF 150 U 6
0 433 451 042	DLF 145 U 39
0 433 451 043	DLF 140 U 36

0 433 451 044	DLF 140 U 40
0 433 451 045	DLF 145 U 41
0 433 451 046	DLF 120 U 42
0 433 451 047	DLF 132 U 24
0 433 451 048	DLF 132 U 25

0 433 451 049	DLF 120 U 43
0 433 451 050	DLF 120 U 2
0 433 451 051	DLF 150 U 44
0 433 451 052	DLF 145 U 45
0 433 451 053	DLF 120 U 46

0 433 451 054	DLF 150 U 47
0 433 451 055	DLF 150 U 48
0 433 451 056	DLF 140 U 49
0 433 451 057	DLF 155 U 50
0 433 451 058	DLF 150 U 51

0 433 451 059	DLF 140 U 53
0 433 451 060	DLF 150 U 54
0 433 451 200	DLF 155 U 52

0 433 490 ...

0 433 490 001	DLP 80 U 1 E
0 433 490 002	DLP 80 U 2 E

**0 433 491 ...**

0 433 491 001	DLPF 80 U 1
----------------------	-------------

0 433 500 ...

0 433 500 001	DL 0 V 851
0 433 500 002	DL 0 V 892
0 433 500 003	DL 0 V 8920

0 433 500 004	DL 0 V 8921
0 433 500 005	DL 110 V 8921
0 433 500 006	DL 110 V 865
0 433 500 007	DL 110 V 969
0 433 500 008	DL 110 V 976

0 433 500 009	DL 124 V 428
0 433 500 010	DL 124 V 732
0 433 500 011	DL 124 V 767
0 433 500 012	DL 124 V 902
0 433 500 013	DL 124 V 988

0 433 500 014	DL 124 V 889
0 433 500 015	DL 125 V 969
0 433 500 016	DL 125 V 976
0 433 500 017	DL 130 V 274
0 433 500 018	DL 130 V 286

0 433 500 019	DL 135 V 976
0 433 500 020	DL 0 V 8922
0 433 500 021	DL 110 V 8650
0 433 500 022	DL 125 V 1046
0 433 500 023	DL 130 V 1095

0 433 500 024	DL 130 V 1096
----------------------	---------------

0 433 551 ...

0 433 551 002	DLF 155 V 2
----------------------	-------------

0 433 600 ...

0 433 600 001	DL 0 W 839
0 433 600 002	DL 0 W 883
0 433 600 003	DL 0 W 8830



de	en	fr	it	es
Bestellnummer → Typformel (Fortsetzung)	Part number → Type designation (continued)	Référence → Formule de type (suite)	Numero d'ordina- zione → Sigla (seguito)	Número de pedido → Designación del tipo (continuación)

0 433 600 004 ...

Ref.	Typ
------	-----

0 433 600 004	DL 0 W 8831
0 433 600 005	DL 110 W 967
0 433 600 006	DL 124 W 761
0 433 600 007	DL 135 W 707
0 433 600 008	DL 0 W 8832
0 433 600 009	DL 120 W 1010
0 433 600 010	DL 100 W 967

0 433 920 ...

0 433 920 001	DLL 160 X 3
0 433 920 002	DLL 160 X 6
0 433 920 003	DLL 180 X 1
0 433 920 004	DLL 180 X 2
0 433 920 005	DLL 180 X 4
0 433 920 006	DLL 180 X 5
0 433 920 007	DLL 160 X 7
0 433 920 008	DLL 160 X 8

0 434 100 ...

0 434 100 001	DN 4 R 102
0 434 100 002	DN 8 R 48
0 434 100 003	DN 8 R 101
0 434 100 007	DN 8 R 191

0 434 150 ...

0 434 150 001	DN 4 RD 122
0 434 150 003	DN 12 RD 124
0 434 150 005	DN 0 PD 1
0 434 150 006	DN 0 PD 2

0 434 200 ...

0 434 200 001	DN 4 S 1
0 434 200 002	DN 4 S 2
0 434 200 003	DN 4 S 3

Ref.	Typ
------	-----

0 434 200 006	DN 4 S 144
0 434 200 009	DN 6 S 1
0 434 200 010	DN 6 S 2
0 434 200 011	DN 8 S 1
0 434 200 012	DN 8 S 2
0 434 200 013	DN 8 S 3
0 434 200 014	DN 8 S 129
0 434 200 015	DN 8 S 138
0 434 200 016	DN 8 S 139
0 434 200 017	DN 8 S 142

0 434 200 018	DN 15 S 2
0 434 200 019	DN 15 S 3
0 434 200 021	DN 15 S 156
0 434 200 022	DN 18 S 152
0 434 200 023	DN 30 S 2

0 434 200 024	DN 30 S 3
0 434 200 025	DN 40 S 2
0 434 200 026	DN 45 S 3
0 434 200 028	DN 4 S 162
0 434 200 030	DN 4 S 176

0 434 200 032	DN 4 S 183
0 434 200 034	DN 6 S 197
0 434 200 035	DN 6 S 198
0 434 200 038	DN 4 S 206
0 434 200 041	DN 0 S 209

0 434 200 042	DN 0 S 225
0 434 200 043	DN 0 S 227
0 434 200 044	TR-DN 8 S 229
0 434 200 045	DN 0 S 231
0 434 200 046	DN 6 S 233

0 434 200 047	DN 8 S 234/
0 434 200 049	DN 0 S 235
0 434 200 052	DN 6 S 241
0 434 200 053	DN 10 S 242
0 434 200 054	DN 0 S 243

0 434 200 996	DN 4 S 3+SH
0 434 200 998	DN 8 S 138+SH
0 434 200 999	DN 4 S 2+SH

0 434 220 ...

0 434 220 898	DNL 0 S 3
---------------	-----------

Ref.	Typ
------	-----

0 434 240 ...	
0 434 240 002	DN 8 S 143
0 434 240 005	DN 0 S 226

0 434 250 ...

0 434 250 001	DN 0 SD 21
0 434 250 002	DN 0 SD 126
0 434 250 003	DN 0 SD 127

0 434 250 004	DN 0 SD 130
0 434 250 005	DN 0 SD 137
0 434 250 006	DN 0 SD 150
0 434 250 007	DN 0 SD 151
0 434 250 009	DN 0 SD 211

0 434 250 010	DN 0 SD 212
0 434 250 011	DN 0 SD 1510
0 434 250 012	DN 0 SD 2110
0 434 250 013	DN 4 SD 20
0 434 250 014	DN 4 SD 24

0 434 250 015	DN 4 SD 42
0 434 250 016	DN 4 SD 51
0 434 250 017	DN 4 SD 118
0 434 250 018	DN 4 SD 128
0 434 250 019	DN 4 SD 136

0 434 250 020	DN 4 SD 140
0 434 250 021	DN 4 SD 141
0 434 250 022	DN 4 SD 147
0 434 250 025	DN 4 SD 303
0 434 250 026	DN 8 SD 32

0 434 250 027	DN 12 SD 12
0 434 250 030	DN 12 SD 145
0 434 250 032	DN 12 SD 160
0 434 250 033	DN 15 SD 35
0 434 250 034	DN 30 SD 158

0 434 250 035	DN 4 SD 163
0 434 250 036	DN 4 SD 166
0 434 250 037	DN 0 SD 165
0 434 250 039	DN 12 SD 167
0 434 250 041	DN 4 SD 169

0 434 250 045	DN 12 SD 175
0 434 250 046	DN 0 SD 174
0 434 250 047	DNA 0 SD 178
0 434 250 048	DN 0 SD 210
0 434 250 049	DNA 4 SD 180

... 0 434 250 248



0 434 250 050	DN 4 SD 1660
0 434 250 052	DN 12 SD 182
0 434 250 053	DN 0 SD 184
0 434 250 054	DN 0 SD 185
0 434 250 055	DNA 12 SD 186
0 434 250 056	DN 4 SD 187
0 434 250 057	DN 0 SD 213
0 434 250 058	DNA 0 SD 188
0 434 250 060	DN 0 SD 189
0 434 250 062	DN 0 SD 192
0 434 250 063	DN 0 SD 193
0 434 250 065	DN 0 SD 195
0 434 250 066	DN 0 SD 199
0 434 250 067	DN 0 SD 203
0 434 250 071	DN 0 SD 216
0 434 250 072	DN 0 SD 220
0 434 250 073	DN 12 SD 221
0 434 250 075	DN 0 SD 228
0 434 250 076	DN 0 ZSD 211
0 434 250 077	DN 0 SD 230
0 434 250 078	DN 4 SD 24
0 434 250 079	DN 0 SD 1510
0 434 250 080	DN 12 SD 12
0 434 250 081	DN 0 ZSD 21
0 434 250 082	DN ZSD 0 6209
0 434 250 083	DN 0 ZSD 126
0 434 250 085	DN 0 ZSD 212
0 434 250 086	DN 4 SD 187
0 434 250 087	DN 12 SD 175
0 434 250 089	TR-DNA 0 SD 238
0 434 250 090	DN 12 SD 221
0 434 250 092	DN 0 SD 1930
0 434 250 093	DN 0 ZSD 220
0 434 250 094	DN 0 SD 239
0 434 250 095	DN 0 SD 240
0 434 250 096	DN 0 SD 2400
0 434 250 097	DN 0 ZSD 165
0 434 250 100	DN 0 SD 15100
0 434 250 102	DN 0 SD 240-
0 434 250 103	DN 0 SD 293
0 434 250 105	DN 0 SD 248
0 434 250 106	DN 0 ZSD 189
0 434 250 107	DN 4 SD 249
0 434 250 108	DN 0 SD 251
0 434 250 109	DN 0 SD 252



0 434 250 110	DN 0 SD 240/
0 434 250 111	DN 0 SD 253
0 434 250 112	DN 0 SD 254
0 434 250 113	DN 0 ZSD 193
0 434 250 114	DN 0 SD 256
0 434 250 115	DN 0 SD 257
0 434 250 116	DN 0 SD 258
0 434 250 117	DN 0 SD 259
0 434 250 118	DN 0 SD 260
0 434 250 119	DN 12 SD 1750
0 434 250 120	DN 0 SD 261
0 434 250 121	DN 0 SD 262/
0 434 250 122	DN 0 SD 189/
0 434 250 123	KP-DN 0 SD 126 FD
0 434 250 124	KP-DN 0 SD 193
0 434 250 125	DN 0 SD 263
0 434 250 126	DN 0 SD 193/
0 434 250 127	DN 0 SD 264
0 434 250 128	DN 0 SD 265
0 434 250 129	DN 0 SD 266/
0 434 250 130	DN 0 SD 267
0 434 250 131	DN 0 SD 268
0 434 250 132	DN 0 SD 269
0 434 250 134	DN 0 SD 252+
0 434 250 135	DN 0 SD 256/
0 434 250 136	DN 0 SD 271
0 434 250 137	DN 0 SD 272
0 434 250 138	DN 0 SD 273
0 434 250 139	DN 0 SD 274
0 434 250 141	DN 0 SD 276
0 434 250 142	DN 0 SD 280
0 434 250 143	DN 0 SD 281
0 434 250 144	DN 0 SD 282
0 434 250 145	DN 12 SD 283
0 434 250 146	DN 0 SD 284
0 434 250 147	DN 0 SD 285
0 434 250 148	DN 0 SD 286
0 434 250 149	DN 0 SD 287
0 434 250 150	DN 0 SD 288
0 434 250 151	DN 0 SD 276/
0 434 250 153	DN 12 SD 290
0 434 250 154	DN 0 SD 292
0 434 250 155	DN 0 SD 294
0 434 250 156	DN 0 SD 289
0 434 250 157	DN 0 SD 287+



0 434 250 158	DN 12 SD 296
0 434 250 159	DN 0 SD 297
0 434 250 160	DN 0 SD 299
0 434 250 161	DN 0 SD 300
0 434 250 162	DN 0 SD 301
0 434 250 163	DN 0 SD 302
0 434 250 164	DN 0 SD 252+/ DN 0 SD 305
0 434 250 165	DN 0 SD 305
0 434 250 166	DN 0 SD 289/
0 434 250 167	DN 0 SD 306
0 434 250 168	DN 0 SD 307
0 434 250 169	DN 0 SD 308
0 434 250 170	DN 0 SD 309
0 434 250 171	DN 0 SD 299 A
0 434 250 172	DN 0 SD 302/
0 434 250 173	DN 0 SD 299 B
0 434 250 174	DN 0 SD 313
0 434 250 175	DN 0 SD 302 A
0 434 250 176	DN 0 SD 314
0 434 250 177	DN 0 SD 315
0 434 250 190	DN 0 SD 317
0 434 250 191	DN 0 SD 318
0 434 250 192	DN 0 SD 319
0 434 250 193	DN 0 SD 299 C
0 434 250 223	DN 0 SD 302 B
0 434 250 224	DN 0 SD 320
0 434 250 225	DN 0 SD 321
0 434 250 226	DN 0 SD 322
0 434 250 231	DN 0 SD 324
0 434 250 232	DN 0 SD 325
0 434 250 233	DN 0 SD 326
0 434 250 234	DN 0 SD 327
0 434 250 235	DN 12 SD 328
0 434 250 236	DN 12 SD 329
0 434 250 237	DN 0 SD 330
0 434 250 238	DN 0 SD 331
0 434 250 240	DN 0 SD 334
0 434 250 241	DN 0 SD 335
0 434 250 242	DN 12 SD 336
0 434 250 243	DN 0 SD 337
0 434 250 244	DN 12 SD 338
0 434 250 245	DN 4 SD 339
0 434 250 246	DN 4 SD 340
0 434 250 247	DN 0 SD 341
0 434 250 248	DN 0 SD 342



A30

de	en	fr	it	es
Bestellnummer → Typformel (Fortsetzung)	Part number → Type designation (continued)	Référence → Formule de type (suite)	Numero d'ordina- zione → Sigla (seguito)	Número de pedido → Designación del tipo (continuación)

0 434 250 249 ...



Ref.	Typ
------	-----

0 434 250 249	DN 4 SD 343
0 434 250 250	DN 0 SD 344
0 434 250 251	DN 12 SD 345
0 434 250 252	DN 12 SD 346
0 434 250 253	DN 12 SD 347

0 434 250 254	DN 0 SD 348
0 434 250 894	DN 0 SD 316
0 434 250 895	DN 0 SD 312
0 434 250 896	DN 0 SD 311
0 434 250 897	DN 0 SD 310

0 434 250 898	DN 0 SD 304
0 434 250 899	DN 12 SD 236
0 434 250 990	DN 4 SD 118+SH
0 434 250 991	DNA 12 SD 186
0 434 250 992	DN 12 SD 12+SH

0 434 250 993	DN 4 SD 140+SH
0 434 250 994	DN 4 SD 42+SH
0 434 250 995	DN 4 SD 24+SH
0 434 250 996	DN 4 SD 20+SH
0 434 250 997	DN 0 SD 2110+SH

0 434 250 998	DN 0 SD 137+SH
0 434 250 999	DN 0 SD 21+SH

0 434 270 ...

0 434 270 001	DNL 0 SD 4
0 434 270 002	DNL 0 SD 5

0 434 290 ...

0 434 290 002	DN 0 SD 52
0 434 290 003	DN 0 SD 131
0 434 290 005	DN 0 SD 149

0 434 290 006	DN 0 SD 155
0 434 290 008	DN 4 SD 33
0 434 290 009	DN 4 SD 44
0 434 290 010	DN 4 SD 161
0 434 290 011	DN 12 SD 43

0 434 290 014	DN 0 SD 1550
0 434 290 015	DN 4 SD 177
0 434 290 016	DN 0 SD 219

Ref.	Typ
------	-----

0 434 300 ...

0 434 300 001	DN 4 T 2
0 434 300 002	DN 4 T 4
0 434 300 006	DN 6 T 2

0 434 300 007	DN 6 T 4
0 434 300 008	DN 6 T 49
0 434 300 009	DN 8 T 2
0 434 300 014	DN 60 T 2
0 434 300 015	DN 4 T 170

0 434 300 017	DN 4 T 208
0 434 300 999	DN 6 T 4+SH

0 434 350 ...

0 434 350 002	DN 0 TD 119
0 434 350 004	DN 4 TD 117
0 434 350 005	DN 6 TD 109

0 434 350 006	DN 6 TD 116
0 434 350 007	DN 6 TD 119

2 437 010 ...

2 437 010 051	DLLA 145 P 593
2 437 010 052	DLLA 145 P 627
2 437 010 053	DLLA 149 P 601

2 437 010 054	DLLA 142 P 406
2 437 010 055	DSLA 142 P 683
2 437 010 056	DSLA 150 P 362
2 437 010 057	DLLA 145 P 748
2 437 010 059	DSLA 150 P 706

2 437 010 060	DSLA 150 P 764
2 437 010 062	DSLA 150 P 745
2 437 010 063	DSLA 147 P 535
2 437 010 064	DSLA 147 P 716
2 437 010 065	DSLA 147 P 715

2 437 010 066	DSLA 140 P 713
2 437 010 067	DSLA 145 P 712
2 437 010 068	DSLA 139 P 710
2 437 010 070	DSLA 145 P 682
2 437 010 071	DSLA 150 P 672

Ref.	Typ
------	-----

2 437 010 072	DSLA 150 P 661
2 437 010 073	DSLA 150 P 646
2 437 010 074	DSLA 140 P 640
2 437 010 075	DSLA 145 P 631
2 437 010 076	DSLA 150 P 442

2 437 010 077	DSLA 150 P 520
2 437 010 079	DSLA 155 P 617
2 437 010 080	DSLA 148 P 591
2 437 010 081	DSLA 148 P 575
2 437 010 082	DSLA 150 P 502

2 437 010 083	DSLA 150 P 357
2 437 010 085	DSLA 145 P 446
2 437 010 086	DSLA 145 P 365
2 437 010 087	DSLA 145 P 366
2 437 010 088	DSLA 150 P 261

2 437 010 089	DSLA 150 P 191
2 437 010 090	DSLA 145 P 208
2 437 010 091	DSLA 134 P 772
2 437 010 093	DSLA 150 P 784
2 437 010 094	DSLA 147 P 794

2 437 010 095	DSLA 145 P 808
2 437 010 097	DSLA 158 P 817
2 437 010 098	DLLA 144 P 825
2 437 010 099	DLLA 147 P 827
2 437 010 101	DSLA 149 P 824

2 437 010 102	DSLA 147 P 823
2 437 010 103	DLLA 149 P 831
2 437 010 104	DSLA 145 P 835
2 437 010 106	DSLA 93 P 838
2 437 010 107	DSLA 148 P 837

2 437 010 108	DSLA 145 P 619
2 437 010 109	DSLA 145 P 870
2 437 010 110	DSLA 142 P 851
2 437 010 111	DSLA 150 P 873
2 437 010 112	DSLA 142 P 843

2 437 010 113	DSLA 145 P 882
2 437 010 114	DSLA 145 P 883
2 437 010 116	DLLA 144 P 908
2 437 010 117	DSLA 142 P 925
2 437 010 118	DSLA 147 P 919

2 437 010 119	DSLA 147 P 918
2 437 010 120	DSLA 145 P 975
2 437 010 121	DSLA 139 P 976
2 437 010 123	DSLA 145 P 987
2 437 010 126	DSLA 150 P 1019

... 9 430 034 261



2 437 010 127	DSLA 145 P 1024
2 437 010 128	DSLA 150 P 934
2 437 010 129	DSLA 150 P 933
2 437 010 130	DSLA 142 P 1025
2 437 010 131	DLLA 145 P 1031
2 437 010 132	DLLA 145 P 1068
2 437 010 133	DSLA 150 P 1102
2 437 010 134	DSLA 150 P 1103
2 437 010 135	DSLA 140 P 1112
2 437 010 136	DSLA 140 P 1145
2 437 010 137	DLLA 150 P 1151
2 437 010 138	DSLA 147 P 1147
2 437 010 139	DSLA 142 P 1191
2 437 010 140	DSLA 150 P 672-
2 437 010 141	DSLA 147 P 1243
2 437 010 142	DSLA 157 P 1241
2 437 010 143	DSLA 150 P 1250
2 437 010 144	DLLA 147 P 1374
2 437 010 145	DSLA 150 P 1434
2 437 010 146	DSLA 146 P 1433
2 437 010 147	DSLA 148 P 1432
2 437 010 148	DSLA 146 P 1436
2 437 010 149	DSLA 148 P 1435
2 437 010 150	DSLA 150 P 1495
2 437 010 151	DLLA 147 P 1521
2 437 010 151	DLLA 147 P 1521
2 437 010 152	DSLA 150 P 1559

9 430 033 ...

9 430 033 200	HB-DL 120 S
9 430 033 201	HB-DL 130 S
9 430 033 202	HB-DL 110 S 9160
9 430 033 203	HB-DLA 110 S 1166
9 430 033 204	HB-DL 90 S 4
9 430 033 205	HB-DL 90 D 3
9 430 033 206	HB-DL 30 S 1176
9 430 033 207	HB-DL 55 S 1177
9 430 033 208	HB-DL 55 S 1178
9 430 033 209	HB-DL 30 S 1180
9 430 033 210	HB-DL 30 S 1184
9 430 033 211	HB-DL 30 S 1199
9 430 033 212	HB-DL 30 S 1202



9 430 033 213	HB-DL 100 S 1212
9 430 033 214	DL 30 S 46
9 430 033 215	DL 30 S 54
9 430 033 216	DL 100 S 1053 HB-4
9 430 033 218	HB-DL 30 S 1232
9 430 033 221	DL 55 S 406
9 430 033 222	DL 55 S 923
9 430 033 226	HB-DL 80 S 861
9 430 033 228	HB DL 30 S 3
9 430 033 230	DL 138 S 1235
9 430 033 300	HB-DL 157 T
9 430 033 301	HB-DL 157 T
9 430 033 302	HB-DL 130 T 1179
9 430 033 303	HB-DL 145 T 1219
9 430 033 304	HB-DL 145 T 1220
9 430 033 306	HB-DL 144 T 1231
9 430 034 100	HB-DLLA 154 P 202

9 430 034 ...

9 430 034 101	HB-DLLA 160 P 201
9 430 034 102	DLLA 160 P 3
9 430 034 105	HB DLLA 154 P 005 HB
9 430 034 107	DLLA 160 P 50
9 430 034 108	HB-DLLA 150 P 376
9 430 034 110	DLLA 154 PN 58
9 430 034 113	HB-DLLA 150 P 475
9 430 034 114	HB-DLLA 140 P 501
9 430 034 116	HB-DLLA 130 P 549
9 430 034 117	DLLA 150 P 27
9 430 034 118	DLLA 150 P 39
9 430 034 119	DLLA 154 PN 067
9 430 034 120	DLLA 157 PN 069
9 430 034 121	HB-DLLA 150 P 59
9 430 034 122	DLLA 145 P 621
9 430 034 123	HB-DLLA 150 P 623
9 430 034 201	HB-DLL 150 S 519
9 430 034 204	HB-DLL 140 S 2150
9 430 034 205	DLL 110 S 1030
9 430 034 206	HB-DLLA 150 S 2390
9 430 034 208	HB DLLA 150 S 643
9 430 034 209	HB DLLA 150 S 663
9 430 034 210	DLLA 149 S 668



9 430 034 212	DLLA 150 S 693
9 430 034 213	HB DLLA 150 S 692
9 430 034 214	HB-DLLA 150 S 698
9 430 034 215	HB-DLLA 150 S 691
9 430 034 216	DLL 110 S 639
9 430 034 217	HB-DLLA 150 S 719
9 430 034 219	HB-DLLA 155 S 772
9 430 034 220	DLLA 158 S 769
9 430 034 221	DLLA 160 S 778
9 430 034 222	HB-DLLA 138 S 782
9 430 034 224	HB-DLLA 135 S 799
9 430 034 225	HB-DLL 150 S 814
9 430 034 226	HB-DLL 150 S 840
9 430 034 227	HB-DLLA 155 S 833
9 430 034 228	HB-DLLA 150 S 875
9 430 034 229	HB-DLLA 142 S 878
9 430 034 230	HB-DLL 140 S 884
9 430 034 231	HB-DLLA 140 S 874
9 430 034 232	HB-DLLA 160 S 905
9 430 034 233	HB-DLLA 150 S 901
9 430 034 235	HB-DLLA 138 S 940
9 430 034 236	HB-DLL 140 S 922
9 430 034 237	HB-DLLA 142 S 959
9 430 034 238	HB-DLL 140 S 973
9 430 034 239	HB-DLLA 142 S 1011
9 430 034 240	HB DLLA 124 S 6152
9 430 034 242	DLL 150 S 241 HB-20
9 430 034 243	DLLA 150 S 187 HB-21
9 430 034 244	DLL 160 S 1024
9 430 034 245	DLLA 142 S 1025
9 430 034 246	DLLA 142 S 1033
9 430 034 247	HB-DLL 160 S 1053
9 430 034 248	HB-DLLA 150 S 384 HB-1
9 430 034 249	HB-DLLA 150 S 384 HB-2
9 430 034 250	HB-DLLA 150 S 344 HB-3
9 430 034 251	HB-DLLA 150 S 334 HB-1
9 430 034 252	HB-DLLA 160 S 354 HB-5
9 430 034 253	HB-DLL 140 S 256 HB-6
9 430 034 254	HB-DLLA 166 S 414 HB-7
9 430 034 255	HB-DLLA 145 S 701 HB-8
9 430 034 257	HB-DLL 16 S 561 HB-9
9 430 034 258	HB-DLLA 166 S 374 HB-15
9 430 034 259	HB-DLLA 168 S 304 HB-16
9 430 034 260	HB-DLLA 171 S 374 HB-10
9 430 034 261	HB-DLLA 158 S 325 HB-11



de

**Bestellnummer →
Typformel**
(Fortsetzung)

en

**Part number →
Type designation**
(continued)

fr

**Référence →
Formule de type**
(suite)

it

**Numero d'ordina-
zione → Sigla**
(seguito)

es

**Número de pedido →
Designación del tipo**
(continuación)

9 430 034 262 ...

Ref.	Typ
------	-----

9 430 034 262	HB-DLLA 160 S 354 HB-12
9 430 034 263	HB-DLLA 152 S 324 HB-13
9 430 034 264	HB-DLLA 154 S 324 HB-14
9 430 034 265	DLL 150 S 691
9 430 034 266	HB-DLL 140 S 282

9 430 034 270	HB-DLLA 150 S 257
9 430 034 271	DLLA 150 S 2120
9 430 034 272	HB-DLLA 146 S 1085
9 430 034 273	HB-DLLA 150 S 990
9 430 034 274	HB-DLL 160 S 1045

9 430 034 275	HB-DLLA 135 S 1106
9 430 034 276	HB-DLLA 145 S 1107
9 430 034 277	HB-DLL 140 S 1115
9 430 034 278	HB-DLLA 152 S 1108
9 430 034 279	HB-DLL 157 S 1118

9 430 034 280	HB-DLLB 160 S 1125
9 430 034 281	HB-DLLA 150 S 1124
9 430 034 282	HB-DLLA 146 S 1129
9 430 034 283	HB-DLL 145 S 1139
9 430 034 284	HB-DLLA 142 S 1142

9 430 034 285	HB-DLLA 160 S 1144
9 430 034 286	DLLA 160 S 1165
9 430 034 287	HB-DLLA 160 S 1164
9 430 034 290	DLLA 160 S 1166
9 430 034 291	DLLA 142 S 897

9 430 034 292	HB DLLA 151 S 354 HB 86
9 430 034 293	HB-DLLA 150 S 402
9 430 034 294	DLLA 23 S 155
9 430 034 295	HB DLL 150 S 6571
9 430 034 297	HB DLLA 160 S 295 HB 422

9 430 034 298	HB DLL 150 S 6395
9 430 034 299	HB-DLLA 146 S 1177
9 430 034 700	HB-DLL 150 S 405
9 430 034 701	HB-DLLA 155 S 833
9 430 034 702	DLLA 156 S 344

9 430 034 703	DLLA 150 S 374
9 430 034 704	DLLA 146 S 1212
9 430 034 705	DLLA 150 S 1211
9 430 034 707	DLLA 160 S 1222
9 430 034 708	DLLA 160 S 1230

9 430 034 709	HB-DLLA 136 S 1240
9 430 034 710	HB-DLL 155 S 1312
9 430 034 711	DLLA 160 S 171 HB
9 430 034 712	DLLA 146 S 1243
9 430 034 713	HB-DLLA 146 S 774

Ref.	Typ
------	-----

9 430 034 714	HB DLLA 150 S 424 HB 470
9 430 034 716	HB-DLL 152 S 1255
9 430 034 717	DLLA 142 S 1256
9 430 034 718	HB-DLLA 140 S 1261
9 430 034 719	HB-DLLA 137 S 1273

9 430 034 720	HB-DLLA 160 S 1297
9 430 034 721	DLLA 155 S 199 HB
9 430 034 722	DLLA 154 S HB 606

9 430 036 ...

9 430 036 204	DN 4 S 1
9 430 036 205	HB-DN 4 S 2 HB-6
9 430 036 206	HB DN 6 S 1

9 430 036 207	DN 8 S 2
9 430 036 208	DN 15 S 2
9 430 036 209	HB-DN 15 S 3
9 430 036 210	HB DN 4 S 3
9 430 036 211	DN 8 S 1

9 430 036 214	HB DN 30 S 2
9 430 037 205	DN 0 SD 245

9 430 037 ...

9 430 037 206	HB-DN 0 SD 255
9 430 037 207	HB-DN 0 SD 21 HB 17
9 430 037 208	DN 0 SD 130

9 430 037 209	DN 0 SD 211
9 430 037 210	HB-DN 0 SD 212
9 430 037 211	DNA 0 SD 1510
9 430 037 212	DN 4 SD 24
9 430 037 213	DN 112 SD 12

9 430 037 214	DN 0 SD 2110
9 430 037 215	DN 0 SD 193
9 430 037 216	HB-DN 4 SD 90 HB-17
9 430 037 217	HB-DN 40 SD 32 HB-18
9 430 037 218	HB-DN 0 SD 177 HB-16

9 430 037 219	HB-DN 15 SD HB-1
9 430 037 220	HB-DN 4 SD 139 HB-2
9 430 037 221	HB-DN 4 SD 62 HB-3
9 430 037 222	HB-DN 0 SD 126 HB-4
9 430 037 223	DN 0 SD 151 HB-5

Ref.	Typ
------	-----

9 430 037 224	HB DN 12 SD 148
9 430 037 226	HB DN 12 SD 160
9 430 037 227	HB DNA 4 SD 180
9 430 037 228	HB-DNA 12 SD 186
9 430 037 229	HB-DN 4 SD 187

9 430 037 231	HB-DNA 0 SD 298
9 430 037 232	HB-DN 0 SD 287
9 430 037 234	HB-DN 0 SD 252

9 430 083 ...

9 430 083 000	DL 95 S 1136
9 430 083 001	DL 110 S 1126
9 430 083 002	DL 110 S 1130

9 430 083 003	DL 95 S 1117
9 430 083 004	DL 70 S 1137
9 430 083 202	DL 110 S 1130
9 430 083 204	DL 70 S 1137

9 430 087 ...

9 430 087 201	DN 15 SD 12
9 430 087 203	DN 0 SD 247
9 430 087 204	DN 12 SD 1750

9 430 093 ...

9 430 093 000	DL 110 S 1231
---------------	---------------

9 430 394 ...

9 430 394 100	DLLA 150 S 1070
9 430 394 400	DLLA 148 P 187
9 430 394 401	DLLA 150 P 212

9 430 394 402	DLLA 152 P 200
---------------	----------------

9 433 391 ...

9 433 391 000	DLLA 124 S 1293
---------------	-----------------



... F 002 C40 550

**F 000 430 ...**

F 000 430 300	DLLA 142 P 731
F 000 430 301	DLLA 136 P 738
F 000 430 302	DLLA 145 P 749

F 000 430 304	DLLA 138 P 820
F 000 430 305	DLLA 143 P 813
F 000 430 306	DLLA 142 P 815
F 000 430 307	DLLA 150 P 878
F 000 430 308	DLLA 147 P 936

F 000 430 309	DLLA 134 P 1314
F 000 430 310	DLLA 140 P 1335
F 000 430 311	DLLA 157 P 1649
F 000 430 900	DSLA 137 P 793
F 000 430 901	DSLA 145 P 917

F 000 430 902	DSLA 137 P 981
F 000 430 903	DSLA 139 P 982
F 000 430 904	DSLA 140 P 1002
F 000 430 906	DSLA141P1096
F 000 430 907	DSLA 145 P 1160

F 000 430 908	DSLA 145 P 1167
F 000 430 910	DSLA 145 P 1300
F 000 430 911	DSLA 145 P 1275
F 000 430 912	DSLA 140 P 1344
F 000 430 913	DSLA 140 P 1624

F 000 430 914	DSLA 128 P 1672
----------------------	-----------------

F 002 030 ...

F 002 030 005	DLLA 150 S 1336
----------------------	-----------------

F 002 C10 ...

F 002 C10 161	DN 0 SD 333
F 002 C10 600	DN 0 SD 332
F 002 C10 601	DN 0 SD 333

F 002 C10 602	DN 0 SD 354
F 002 C10 603	HB-DN 0 SD 299
F 002 C10 604	DN 0 SD 355
F 002 C10 605	DN 12 SD 290

**F 002 C30 ...**

F 002 C30 002	HB-DLLA 150 S 1318
F 002 C30 003	DLLA 150 S 1329
F 002 C30 004	DLLA 142 S 1333

F 002 C30 005	HB-DLLA 150 S 1336
F 002 C30 006	HB-DLLA 142 S 1334
F 002 C30 007	DLLA 150 S 1339
F 002 C30 008	HB-DLLA 150 S 1338
F 002 C30 009	HB-DLLA 150 S 1353

F 002 C30 010	DLLA 150 S 1362
F 002 C30 011	HB-DLLA144S1381
F 002 C30 014	DLLA 152 S 1390
F 002 C30 016	DLLA 150 S 1394
F 002 C30 100	DLLA 142 S 1317

F 002 C30 101	HB-DLL 140 S 1319
F 002 C30 105	HB-DLLA 150 S 1326
F 002 C30 106	DLLA 150 S 1331
F 002 C30 107	HB-DLLA 142 S 1332
F 002 C30 110	DLLA 142 S 1350

F 002 C30 111	HB-DLL 157 S 1352
F 002 C30 112	HB-DLL 160 S 1354
F 002 C30 113	HB-DLL 157 S 1355
F 002 C30 114	DLLA 160 S 1356
F 002 C30 115	DLLA 146 S 1357

F 002 C30 117	DLLA 145 S 1360
F 002 C30 118	HB-DLLA 150 S 1359
F 002 C30 119	DLLA 150 S 1363
F 002 C30 120	HB-DLLA 158 S 1364
F 002 C30 121	HB-DLLA 150 S 1366

F 002 C30 122	DLLA 148 S 1369
F 002 C30 126	DLLA 150 S 1373
F 002 C30 127	DLLA 148 S 1376
F 002 C30 128	DLLA 150 S 1377
F 002 C30 130	HB-DLLA 150 S 1375

F 002 C30 131	DLLA 150 S 1374
F 002 C30 134	DLLA 140 S 1386
F 002 C30 137	DLLA 160 S 1387
F 002 C30 140	DLLA 150 S 1393

F 002 C40 ...

F 002 C40 001	HB-DLLA 148 P 667
F 002 C40 002	DLLA 148 P 714
F 002 C40 003	HB-DLL 130 P 766



F 002 C40 004	HB-DLLA 148 P 791
F 002 C40 005	HB-DLLA 130 P 858
F 002 C40 006	DLLA 147 P 900
F 002 C40 007	DLLA 152 P 966
F 002 C40 008	DLLA 145 P 574

F 002 C40 010	DLLA 148 P 1185
F 002 C40 500	HB-DSLA 144 P 931
F 002 C40 501	DSLA 147 P 899
F 002 C40 502	DSLA 152 P 922
F 002 C40 503	DSLA 142 P 993

F 002 C40 504	DSLA 142 P 921
F 002 C40 507	DSLA 142 P 935
F 002 C40 509	HB-DSLA 144 P 949
F 002 C40 510	DSLA 146 P 954
F 002 C40 511	HB-DSLA 146 P 977

F 002 C40 512	DSLA 145 P 265
F 002 C40 513	HB-DSLA 128 P 962
F 002 C40 515	HB-DSLA 128 P 997
F 002 C40 518	HB-DSLA 146 P 1007
F 002 C40 519	DSLA 142 P 1018

F 002 C40 520	DSLA 142 P 1017
F 002 C40 521	DSLA 154 P 1028
F 002 C40 522	DSLA 148 P 1026
F 002 C40 523	DSLA 145 P 1027
F 002 C40 524	DSLA 155 P 1038

F 002 C40 525	HB-DLLA 150 P 1047
F 002 C40 526	HB-DSLA 150 P 1060
F 002 C40 529	DSLA 142 P 1074
F 002 C40 530	HB-DSLA 147 P 1082
F 002 C40 531	DSLA 142 P 1088

F 002 C40 533	HB-DSLA 138 P 1092
F 002 C40 535	DSLA 152 P 1101
F 002 C40 536	DSLA 148 P 1133
F 002 C40 537	HB-DSLA 142 P 1130
F 002 C40 538	DSLA 145 P 1136

F 002 C40 539	HB-DSLA 147 P 1149
F 002 C40 540	HB-DSLA 147 P 1150
F 002 C40 542	DSLA 144 P 1158
F 002 C40 543	DSLA 144 P 1161
F 002 C40 544	DSLA 142 P 1162

F 002 C40 545	HB-DSLA 150 P 1172
F 002 C40 546	DSLA 146 P 1180
F 002 C40 548	DSLA 140 P 1188
F 002 C40 549	DSLA 152 P 1208
F 002 C40 550	HB-DSLA 155 P 1235



de

Typformel →
Bestellnummer

en

Type designation →
Part number

fr

Formule de type →
Référence

it

Sigla → Numero
d'ordinazione

es

Designación del tipo
→ Número de pedido

DL 0 S 47 ...

... DL 110 S 1030

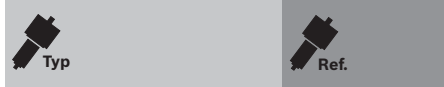

DL ... S ...

DL 0 S 47	0 433 200 001
DL 0 S 64	0 433 200 002
DL 0 S 171	0 433 200 004

DL 0 S 184	0 433 200 005
DL 0 S 242	0 433 200 006
DL 0 S 288	0 433 200 007
DL 0 S 316	0 433 200 008
DL 0 S 421	0 433 200 010

DL 0 S 470	0 433 200 011
DL 0 S 482	0 433 200 012
DL 0 S 770	0 433 200 013
DL 0 S 869	0 433 200 014
DL 0 S 872	0 433 200 015

DL 0 S 909	0 433 200 125
DL 0 S 920	0 433 200 119
DL 0 S 959	0 433 200 016
DL 0 S 984	0 433 200 017
DL 0 S 1107	0 433 200 130

DL 12 S 1043	0 433 250 050
DL 12 S 1212	0 433 250 068
DL 15 S 14	0 433 200 018
DL 15 S 1017	0 433 250 047
DL 27 S 742	0 433 250 001

DL 27 S 819	0 433 250 002
DL 30 S 3	0 433 250 003
DL 30 S 46	0 433 250 004
DL 30 S 46	9 430 033 214
DL 30 S 54	0 433 250 005

DL 30 S 54	9 430 033 215
DL 30 S 327	0 433 200 019
DL 30 S 406	0 433 250 006
DL 30 S 808	0 433 250 007
DL 30 S 856	0 433 250 008

DL 30 S 986	0 433 250 009
DL 35 S 325	0 433 200 020
DL 35 S 347	0 433 250 010
DL 40 S 325	0 433 200 021
DL 40 S 925	0 433 250 011

DL 40 S 1078	0 433 200 124
DL 40 S 1090	0 433 250 062
DL 45 S 319	0 433 250 012
DL 45 S 408	0 433 200 022
DL 45 S 735	0 433 200 024

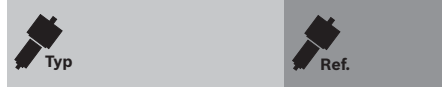

DL 45 S 804	0 433 250 013
DL 50 S 5	0 433 200 025
DL 50 S 25	0 433 200 026
DL 50 S 45	0 433 200 027
DL 50 S 348	0 433 250 014

DL 50 S 1056	0 433 200 122
DL 50 S 1082	0 433 250 056
DL 50 S 1089	0 433 250 061
DL 50 S 1115	0 433 250 066
DL 50 S 1132	0 433 250 067

DL 55 S 406	9 430 033 221
DL 55 S 862	0 433 250 015
DL 55 S 923	0 433 250 016
DL 55 S 923	9 430 033 222
DL 55 S 926	0 433 250 017

DL 55 S 927	0 433 250 018
DL 55 S 1049	0 433 250 059
DL 55 S 1050	0 433 250 060
DL 60 S 5	0 433 200 028
DL 60 S 6	0 433 200 029

DL 60 S 28	0 433 200 031
DL 60 S 36	0 433 200 032
DL 60 S 68	0 433 200 033
DL 60 S 86	0 433 200 034
DL 60 S 110	0 433 250 019

DL 60 S 848	0 433 200 035
DL 60 S 879	0 433 200 036
DL 60 S 880	0 433 200 037
DL 60 S 928	0 433 200 038
DL 60 S 933	0 433 200 039

DL 60 S 971	0 433 200 040
DL 60 S 1013	0 433 200 117
DL 65 S 405	0 433 200 041
DL 68 S 066	0 433 250 051
DL 68 S 1074	0 433 250 053

DL 70 S 2	0 433 200 042
DL 70 S 130	0 433 200 043
DL 70 S 212	0 433 250 021
DL 70 S 450	0 433 250 022
DL 70 S 790	0 433 200 044

DL 70 S 900	0 433 250 023
DL 70 S 971	0 433 200 045
DL 70 S 972	0 433 200 046
DL 70 S 1137	9 430 083 004
DL 70 S 1137	9 430 083 204

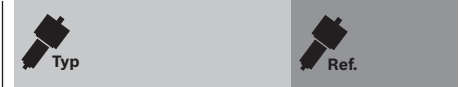

DL 72 S 366	0 433 250 024
DL 75 S 410	0 433 250 025
DL 80 S 5	0 433 200 047
DL 80 S 28	0 433 200 048
DL 80 S 130	0 433 200 049

DL 80 S 164	0 433 200 050
DL 80 S 333	0 433 200 051
DL 80 S 731	0 433 250 026
DL 80 S 743	0 433 200 052
DL 80 S 803	0 433 250 027

DL 80 S 809	0 433 250 028
DL 80 S 861	0 433 250 029
DL 80 S 1075	0 433 250 054
DL 84 S 912	0 433 250 030
DL 84 S 1027	0 433 250 048

DL 85 S 949	0 433 250 031
DL 87 S 824	0 433 250 020
DL 90 S 78	0 433 200 053
DL 90 S 209	0 433 250 032
DL 90 S 818	0 433 200 054

DL 90 S 966	0 433 250 033
DL 90 S 1008	0 433 200 055
DL 90 S 1018	0 433 200 118
DL 90 S 1042	0 433 250 064
DL 90 S 1086	0 433 200 127

DL 90 S 1106	0 433 200 131
DL 95 S 1009	0 433 250 058
DL 95 S 1117	9 430 083 003
DL 95 S 1136	9 430 083 000
DL 100 S 16	0 433 200 056

DL 100 S 86	0 433 200 057
DL 100 S 836	0 433 250 034
DL 100 S 973	0 433 200 058
DL 100 S 1053	0 433 200 126
DL 100 S 1053 HB-4	9 430 033 216

DL 105 S 16	0 433 200 059
DL 105 S 86	0 433 200 060
DL 105 S 94	0 433 200 061
DL 105 S 939	0 433 250 035
DL 106 S 994	0 433 250 036

DL 110 S 30	0 433 200 062
DL 110 S 916	0 433 250 037
DL 110 S 954	0 433 250 038
DL 110 S 1028	0 433 250 049
DL 110 S 1030	0 433 250 055



de

Typformel →
Bestellnummer
(Fortsetzung)

en

Type designation →
Part number
(continued)

fr

Formule de type →
Référence
(suite)

it

Sigla → Numero
d'ordinazione
(seguito)

es

Designación del tipo
→ Número de pedido
(continuación)

DL 110 S 1067 ...



Typ	Ref.
DL 110 S 1067	0 433 250 052
DL 110 S 1084	0 433 250 057
DL 110 S 1126	9 430 083 001
DL 110 S 1130	9 430 083 002
DL 110 S 1130	9 430 083 202
DL 110 S 1231	9 430 093 000
DL 120 S 2	0 433 200 063
DL 120 S 3	0 433 250 039
DL 120 S 5	0 433 200 064
DL 120 S 16	0 433 200 065
DL 120 S 25	0 433 200 066
DL 120 S 30	0 433 200 067
DL 120 S 36	0 433 200 068
DL 120 S 91	0 433 200 069
DL 120 S 94	0 433 200 070
DL 120 S 239	0 433 200 071
DL 120 S 332	0 433 200 073
DL 120 S 454	0 433 200 074
DL 120 S 805	0 433 200 075
DL 120 S 847	0 433 200 076
DL 120 S 999	0 433 200 077
DL 120 S 1011	0 433 200 078
DL 120 S 1076	0 433 200 123
DL 120 S 9990	0 433 200 120
DL 125 S 1091	0 433 250 063
DL 130 S 5	0 433 200 079
DL 130 S 850	0 433 200 080
DL 130 S 946	0 433 250 040
DL 130 S 1104	0 433 200 129
DL 132 S 942	0 433 200 081
DL 132 S 992	0 433 250 041
DL 135 S 94	0 433 200 082
DL 138 S 1235	9 430 033 230
DL 140 S 5	0 433 200 083
DL 140 S 78	0 433 200 084
DL 140 S 92	0 433 200 085
DL 140 S 204	0 433 200 086
DL 140 S 218	0 433 200 087
DL 140 S 301	0 433 200 088
DL 140 S 333	0 433 200 089
DL 140 S 349	0 433 200 090
DL 140 S 384	0 433 200 091
DL 140 S 752	0 433 250 042
DL 140 S 863	0 433 200 092
DL 140 S 895	0 433 200 093

Typ	Ref.
DL 140 S 914	0 433 200 094
DL 140 S 1006	0 433 200 095
DL 140 S 1159	0 433 200 133
DL 140 S 9990	0 433 200 121
DL 145 S 16	0 433 200 096
DL 145 S 30	0 433 200 097
DL 148 S 866	0 433 250 043
DL 148 S 878	0 433 200 098
DL 150 S 25	0 433 200 099
DL 150 S 92	0 433 200 100
DL 150 S 499	0 433 200 102
DL 150 S 798	0 433 250 044
DL 150 S 846	0 433 200 103
DL 150 S 864	0 433 200 104
DL 150 S 875	0 433 200 105
DL 150 S 894	0 433 200 106
DL 150 S 917	0 433 200 107
DL 150 S 936	0 433 200 108
DL 150 S 948	0 433 200 109
DL 150 S 990	0 433 200 110
DL 150 S 1101	0 433 200 128
DL 150 S 1234	0 433 200 135
DL 154 S 922	0 433 250 045
DL 160 S 91	0 433 200 111
DL 160 S 301	0 433 200 112
DL 160 S 747	0 433 250 046
DL 160 S 859	0 433 200 113
DL 160 S 860	0 433 200 114
DL 160 S 931	0 433 200 115
DL 160 S 1650	0 433 200 116
DL 170 S 1128	0 433 200 132
DL ... T ...	
DL 0 T 64	0 433 300 001
DL 0 T 178	0 433 300 002
DL 0 T 247	0 433 300 003
DL 0 T 258	0 433 300 004
DL 0 T 722	0 433 300 005
DL 0 T 843	0 433 300 006
DL 0 T 924	0 433 300 007
DL 0 T 993	0 433 300 008

Typ	Ref.
DL 0 T 1004	0 433 300 009
DL 0 T 1007	0 433 300 010
DL 0 T 1014	0 433 300 202
DL 0 T 1037	0 433 300 218
DL 0 T 1109	0 433 300 254
DL 0 T 1154	0 433 300 283
DL 0 T 1181	0 433 300 303
DL 27 T 712	0 433 350 001
DL 30 T 2	0 433 300 011
DL 30 T 3/HB	0 433 350 002
DL 30 T 122	0 433 300 012
DL 30 T 853	0 433 350 003
DL 30 T 858	0 433 350 004
DL 30 T 1059	0 433 350 009
DL 35 T 486	0 433 300 013
DL 50 T 884	0 433 300 014
DL 60 T 200	0 433 300 015
DL 65 T 944	0 433 350 005
DL 75 T 817	0 433 350 006
DL 80 T 844	0 433 300 016
DL 86 T 183	0 433 300 017
DL 86 T 245	0 433 300 018
DL 90 T 2	0 433 300 019
DL 90 T 16	0 433 300 020
DL 90 T 433	0 433 300 021
DL 90 T 748	0 433 300 022
DL 90 T 812	0 433 300 023
DL 90 T 1025	0 433 300 213
DL 100 T 30	0 433 300 024
DL 100 T 86	0 433 300 025
DL 100 T 183	0 433 300 026
DL 100 T 728	0 433 300 027
DL 100 T 826	0 433 300 028
DL 100 T 968	0 433 300 029
DL 105 T 86	0 433 300 030
DL 105 T 1000	0 433 300 031
DL 105 T 1001	0 433 300 032
DL 105 T 1145	0 433 300 274
DL 108 T 938	0 433 300 033
DL 110 T 5	0 433 300 034
DL 110 T 28	0 433 300 035
DL 110 T 30	0 433 300 036
DL 110 T 36	0 433 300 037
DL 110 T 86	0 433 300 038
DL 110 T 91	0 433 300 039

... DL 140 T 877

 Typ	 Ref.
---	--

DL 110 T 92	0 433 300 040
DL 110 T 94	0 433 300 041
DL 110 T 139	0 433 300 042
DL 110 T 183	0 433 300 043
DL 110 T 188	0 433 300 044

DL 110 T 333	0 433 300 045
DL 110 T 769	0 433 300 046
DL 110 T 896	0 433 300 047
DL 110 T 897	0 433 300 048
DL 110 T 903	0 433 300 049

DL 110 T 906	0 433 300 050
DL 110 T 907	0 433 300 051
DL 110 T 918	0 433 300 052
DL 110 T 919	0 433 300 053
DL 110 T 947	0 433 300 054

DL 110 T 950	0 433 300 055
DL 110 T 957	0 433 300 056
DL 110 T 958	0 433 300 057
DL 110 T 963	0 433 300 058
DL 110 T 1044	0 433 300 223

DL 110 T 1125	0 433 300 264
DL 110 T 1138	0 433 300 269
DL 110 T 1167	0 433 300 294
DL 110 T 1190	0 433 300 311
DL 115 T 255	0 433 300 059

DL 115 T 272	0 433 300 060
DL 115 T 867	0 433 300 061
DL 115 T 997	0 433 300 062
DL 115 T 1140+SH	0 433 300 999
DL 120 T 2	0 433 300 063

DL 120 T 16	0 433 300 064
DL 120 T 20	0 433 300 065
DL 120 T 28	0 433 300 066
DL 120 T 30	0 433 300 067
DL 120 T 45	0 433 300 068

DL 120 T 86	0 433 300 069
DL 120 T 91	0 433 300 070
DL 120 T 164	0 433 300 071
DL 120 T 165	0 433 300 072
DL 120 T 182	0 433 300 073

DL 120 T 183	0 433 300 074
DL 120 T 188	0 433 300 265
DL 120 T 196	0 433 300 075
DL 120 T 255	0 433 300 076
DL 120 T 262	0 433 300 077

 Typ	 Ref.
---	--

DL 120 T 271	0 433 300 078
DL 120 T 333	0 433 300 079
DL 120 T 398	0 433 300 080
DL 120 T 435	0 433 300 081
DL 120 T 464	0 433 300 082

DL 120 T 876	0 433 300 083
DL 120 T 945	0 433 300 084
DL 120 T 985	0 433 300 085
DL 120 T 1052	0 433 300 227
DL 120 T 1092	0 433 300 246

DL 120 T 1093	0 433 300 247
DL 120 T 1209	0 433 300 329
DL 120 T 1226	0 433 300 340
DL 120 T 1241	0 433 300 345
DL 125 T 20	0 433 300 086

DL 125 T 86	0 433 300 087
DL 125 T 91	0 433 300 088
DL 125 T 183	0 433 300 089
DL 125 T 771	0 433 300 090
DL 125 T 957	0 433 300 091

DL 125 T 1071	0 433 300 237
DL 130 T 20	0 433 300 092
DL 130 T 30	0 433 300 093
DL 130 T 86	0 433 300 094
DL 130 T 91	0 433 300 095

DL 130 T 114	0 433 300 097
DL 130 T 182	0 433 300 098
DL 130 T 183	0 433 300 099
DL 130 T 196	0 433 300 100
DL 130 T 204	0 433 300 101

DL 130 T 205	0 433 300 102
DL 130 T 232	0 433 300 103
DL 130 T 387	0 433 300 104
DL 130 T 388	0 433 300 105
DL 130 T 465	0 433 300 106

DL 130 T 725	0 433 300 107
DL 130 T 871	0 433 300 108
DL 130 T 955	0 433 300 109
DL 130 T 956	0 433 300 110
DL 130 T 982	0 433 300 111

DL 130 T 1016	0 433 300 203
DL 130 T 1072	0 433 300 238
DL 130 T 1085	0 433 300 244
DL 130 T 1150	0 433 300 279
DL 130 T 1152	0 433 300 281

 Typ	 Ref.
---	--

DL 130 T 1161	0 433 300 289
DL 130 T 1165	0 433 300 293
DL 130 T 1170	0 433 300 298
DL 130 T 1189	0 433 300 310
DL 130 T 1215	0 433 300 334

DL 130 T 1225	0 433 300 339
DL 132 T 91	0 433 300 249
DL 132 T 226	0 433 300 112
DL 132 T 911	0 433 300 113
DL 134 T 182	0 433 300 114

DL 134 T 196	0 433 300 115
DL 134 T 225	0 433 300 116
DL 135 T 20	0 433 300 117
DL 135 T 91	0 433 300 118
DL 135 T 181	0 433 300 119

DL 135 T 204	0 433 300 120
DL 135 T 226	0 433 300 121
DL 135 T 236	0 433 300 122
DL 135 T 882	0 433 300 123
DL 135 T 891	0 433 300 124

DL 135 T 975	0 433 300 125
DL 135 T 1111	0 433 300 256
DL 135 T 1191	0 433 300 312
DL 138 T 729	0 433 300 126
DL 140 T 16	0 433 300 127

DL 140 T 18	0 433 300 128
DL 140 T 20	0 433 300 129
DL 140 T 30	0 433 300 130
DL 140 T 91	0 433 300 131
DL 140 T 92	0 433 300 132

DL 140 T 183	0 433 300 133
DL 140 T 205	0 433 300 134
DL 140 T 218	0 433 300 135
DL 140 T 226	0 433 300 136
DL 140 T 232	0 433 300 137

DL 140 T 260	0 433 300 138
DL 140 T 262	0 433 300 139
DL 140 T 272	0 433 300 140
DL 140 T 333	0 433 300 141
DL 140 T 390	0 433 300 204







DL 140 T 769	0 433 300 142
DL 140 T 848	0 433 300 143
DL 140 T 849	0 433 300 144
DL 140 T 855	0 433 300 145
DL 140 T 877	0 433 300 146



A38

de	en	fr	it	es
Typformel → Bestellnummer (Fortsetzung)	Type designation → Part number (continued)	Formule de type → Référence (suite)	Sigla → Numero d'ordinazione (seguito)	Designación del tipo → Número de pedido (continuación)

DL 140 T 890 ...

 Typ	 Ref.	 Typ	 Ref.	 Typ	 Ref.
DL 140 T 890	0 433 300 147	DL 145 T 1121	0 433 300 260	DL 150 T 997	0 433 300 182
DL 140 T 929	0 433 300 148	DL 145 T 1121+SH	0 433 300 987	DL 150 T 1022	0 433 300 212
DL 140 T 965	0 433 300 149	DL 145 T 1122	0 433 300 261	DL 150 T 1023	0 433 300 210
DL 140 T 1026	0 433 300 215	DL 145 T 1146	0 433 300 275	DL 150 T 1024	0 433 300 207
DL 140 T 1034	0 433 300 216	DL 145 T 1156	0 433 300 285	DL 150 T 1033	0 433 350 008
DL 140 T 1038	0 433 300 219	DL 145 T 1156+SH	0 433 300 985	DL 150 T 1045	0 433 300 224
DL 140 T 1051	0 433 300 228	DL 145 T 1169	0 433 300 296	DL 150 T 1047	0 433 300 225
DL 140 T 1060	0 433 300 232	DL 145 T 1187	0 433 300 308	DL 150 T 1054	0 433 300 229
DL 140 T 1081	0 433 300 242	DL 145 T 1192	0 433 300 313	DL 150 T 1073	0 433 300 239
DL 140 T 1094	0 433 300 248	DL 145 T 1198	0 433 300 319	DL 150 T 1097	0 433 300 250
DL 140 T 1119	0 433 300 259	DL 145 T 1201	0 433 300 322	DL 150 T 1100	0 433 300 251
DL 140 T 1124	0 433 300 263	DL 145 T 1201+SH	0 433 300 986	DL 150 T 1102	0 433 300 252
DL 140 T 1129	0 433 300 266	DL 145 T 1203	0 433 300 323	DL 150 T 1105	0 433 350 010
DL 140 T 1144	0 433 300 273	DL 145 T 1204	0 433 300 324	DL 150 T 1139	0 433 300 270
DL 140 T 1149	0 433 300 278	DL 145 T 1205	0 433 300 325	DL 150 T 1147	0 433 300 276
DL 140 T 1153	0 433 300 282	DL 145 T 1205+SH	0 433 300 983	DL 150 T 1158	0 433 300 287
DL 140 T 1155	0 433 300 286	DL 145 T 1207	0 433 300 327	DL 150 T 1160	0 433 300 288
DL 140 T 1162	0 433 300 290	DL 145 T 1217	0 433 300 335	DL 150 T 1164	0 433 300 292
DL 140 T 1163	0 433 300 291	DL 145 T 1217+SH	0 433 300 984	DL 150 T 1173	0 433 300 301
DL 140 T 1168	0 433 300 295	DL 150 T 16	0 433 300 161	DL 150 T 1185	0 433 300 306
DL 140 T 1172	0 433 300 300	DL 150 T 20	0 433 300 162	DL 150 T 1195	0 433 300 316
DL 140 T 1182	0 433 300 304	DL 150 T 30	0 433 300 163	DL 150 T 1197	0 433 300 320
DL 140 T 1183	0 433 300 305	DL 150 T 91	0 433 300 164	DL 150 T 1208	0 433 300 328
DL 140 T 1196	0 433 300 317	DL 150 T 147	0 433 300 165	DL 150 T 1210	0 433 300 330
DL 140 T 1223	0 433 300 337	DL 150 T 182	0 433 300 166	DL 150 T 1213	0 433 300 332
DL 140 T 1224	0 433 300 338	DL 150 T 183	0 433 300 167	DL 150 T 1218	0 433 300 336
DL 140 T 1230	0 433 300 343	DL 150 T 204	0 433 300 168	DL 154 T 1214	0 433 300 333
DL 145 T 30	0 433 300 150	DL 150 T 205	0 433 300 169	DL 155 T 86	0 433 300 183
DL 145 T 204	0 433 300 151	DL 150 T 232	0 433 300 170	DL 155 T 92	0 433 300 184
DL 145 T 301	0 433 300 152	DL 150 T 239	0 433 300 222	DL 155 T 205	0 433 300 185
DL 145 T 385	0 433 300 153	DL 150 T 390	0 433 300 171	DL 155 T 271	0 433 300 186
DL 145 T 431	0 433 300 154	DL 150 T 418	0 433 300 172	DL 155 T 271+SH	0 433 300 991
DL 145 T 479	0 433 300 155	DL 150 T 477	0 433 300 173	DL 155 T 952	0 433 300 187
DL 145 T 769	0 433 300 156	DL 150 T 874	0 433 300 174	DL 155 T 1108	0 433 300 253
DL 145 T 870	0 433 300 157	DL 150 T 885	0 433 300 175	DL 155 T 1112	0 433 300 257
DL 145 T 940	0 433 300 158	DL 150 T 886	0 433 300 176	DL 155 T 1112+SH	0 433 300 996
DL 145 T 960	0 433 300 159	DL 150 T 910	0 433 300 177	DL 155 T 1140	0 433 300 271
DL 145 T 970	0 433 300 243	DL 150 T 937	0 433 300 178	DL 155 T 1143	0 433 300 272
DL 145 T 991	0 433 300 160	DL 150 T 952	0 433 300 179	DL 155 T 1171	0 433 300 299
DL 145 T 1012	0 433 300 205	DL 150 T 957	0 433 300 180	DL 155 T 1175	0 433 300 302
DL 145 T 1035	0 433 300 217	DL 150 T 957+SH	0 433 300 995	DL 155 T 1186	0 433 300 307
DL 145 T 1040	0 433 300 220	DL 150 T 958	0 433 300 181	DL 155 T 1188	0 433 300 309
DL 145 T 1058	0 433 300 231	DL 150 T 962	0 433 300 188	DL 155 T 1188+SH	0 433 300 990
DL 145 T 1068	0 433 300 235	DL 150 T 970	0 433 300 189	DL 155 T 1193	0 433 300 314
DL 145 T 1113	0 433 300 258	DL 150 T 995	0 433 300 190	DL 155 T 1193+SH	0 433 300 989

... DL 140 U 996



DL 155 T 1206	0 433 300 326
DL 155 T 1228	0 433 300 341
DL 155 T 1229	0 433 300 342
DL 155 T 1236	0 433 300 344
DL 155 T 1243	0 433 300 346

DL 155 T 1248	0 433 300 347
DL 155 T 1249	0 433 300 348
DL 157 T 1069	0 433 300 236
DL 157 T 1080	0 433 300 241
DL 157 T 1123	0 433 300 262

DL 160 T 147	0 433 300 214
DL 160 T 398	0 433 300 191
DL 160 T 477	0 433 300 192
DL 160 T 857	0 433 300 193
DL 160 T 1015	0 433 300 206

DL 160 T 1041	0 433 300 221
DL 160 T 1057	0 433 300 230
DL 160 T 1077	0 433 300 240
DL 160 T 1088	0 433 300 245
DL 160 T 1131	0 433 300 267

DL 160 T 1133	0 433 300 268
DL 160 T 1148	0 433 300 277
DL 160 T 1151	0 433 300 280
DL 160 T 1194	0 433 300 315
DL 164 T 1110	0 433 300 255

DL 165 T 841	0 433 300 194
DL 165 T 930	0 433 300 195
DL 165 T 981	0 433 300 196
DL 165 T 1048	0 433 300 226
DL 165 T 1063	0 433 300 233

DL 165 T 1211	0 433 300 331
DL 165 T 1211+SH	0 433 300 988
DL 170 T 468	0 433 300 197
DL 170 T 490	0 433 300 198
DL 170 T 773	0 433 300 199

DL 170 T 885	0 433 300 200
DL 170 T 921	0 433 300 201
DL 170 T 1021	0 433 300 208
DL 170 T 1200	0 433 300 321

DL ... U ...

DL 0 U 404	0 433 400 001
DL 0 U 779	0 433 400 002
DL 0 U 840	0 433 400 003



DL 0 U 887	0 433 400 004
DL 0 U 8870	0 433 400 005
DL 50 U 979	0 433 400 006
DL 50 U 980	0 433 400 007
DL 55 U 980	0 433 400 095

DL 60 U 979	0 433 400 084
DL 60 U 1020	0 433 400 085
DL 70 U 139	0 433 400 008
DL 70 U 225	0 433 400 403
DL 80 U 881	0 433 450 001

DL 80 U 983	0 433 450 002
DL 90 U 703	0 433 400 009
DL 110 U 86	0 433 400 010
DL 110 U 139	0 433 400 011
DL 110 U 147	0 433 400 120

DL 110 U 196	0 433 400 012
DL 110 U 225	0 433 400 013
DL 110 U 226	0 433 400 014
DL 110 U 237	0 433 400 015
DL 110 U 256	0 433 400 016

DL 110 U 868	0 433 400 017
DL 110 U 893	0 433 400 018
DL 110 U 1098	0 433 400 109
DL 115 U 249	0 433 400 019
DL 115 U 260	0 433 400 020

DL 115 U 364	0 433 400 021
DL 115 U 1120	0 433 400 116
DL 120 U 20	0 433 400 022
DL 120 U 86	0 433 400 023
DL 120 U 114	0 433 400 024

DL 120 U 147	0 433 400 025
DL 120 U 181	0 433 400 026
DL 120 U 211	0 433 400 027
DL 120 U 232	0 433 400 028
DL 120 U 236	0 433 400 029

DL 120 U 256	0 433 400 030
DL 120 U 260	0 433 400 031
DL 120 U 276	0 433 400 032
DL 120 U 314	0 433 400 033
DL 120 U 443	0 433 400 034

DL 120 U 792	0 433 400 035
DL 120 U 905	0 433 400 036
DL 120 U 978	0 433 400 037
DL 120 U 1019	0 433 400 083
DL 120 U 1116	0 433 400 114



DL 125 U 255	0 433 400 038
DL 125 U 259	0 433 400 039
DL 125 U 260	0 433 400 040
DL 125 U 317	0 433 400 041
DL 125 U 987	0 433 400 042

DL 125 U 1039	0 433 400 121
DL 130 U 182	0 433 400 087
DL 130 U 196	0 433 400 043
DL 130 U 232	0 433 400 044
DL 130 U 237	0 433 400 093

DL 130 U 245	0 433 400 045
DL 130 U 246	0 433 400 046
DL 130 U 263	0 433 400 047
DL 130 U 380	0 433 400 048
DL 130 U 446	0 433 400 049

DL 130 U 899	0 433 400 050
DL 130 U 901	0 433 400 051
DL 130 U 935	0 433 400 052
DL 130 U 989	0 433 400 053
DL 130 U 1062	0 433 400 101

DL 130 U 1103	0 433 400 111
DL 135 U 1039	0 433 400 096
DL 135 U 1079	0 433 400 106
DL 135 U 1099	0 433 400 110
DL 135 U 1114	0 433 400 113

DL 140 U 114	0 433 400 112
DL 140 U 188	0 433 400 089
DL 140 U 204	0 433 400 054
DL 140 U 205	0 433 400 055
DL 140 U 225	0 433 400 090

DL 140 U 232	0 433 400 056
DL 140 U 237	0 433 400 094
DL 140 U 255	0 433 400 057
DL 140 U 259	0 433 400 058
DL 140 U 263	0 433 400 059

DL 140 U 271	0 433 400 060
DL 140 U 375	0 433 400 061
DL 140 U 386	0 433 400 062
DL 140 U 392	0 433 400 063
DL 140 U 785	0 433 400 064

DL 140 U 816	0 433 400 065
DL 140 U 842	0 433 400 066
DL 140 U 904	0 433 400 067
DL 140 U 978	0 433 400 068
DL 140 U 996	0 433 400 069



A40

de	en	fr	it	es
Typformel → Bestellnummer (Fortsetzung)	Type designation → Part number (continued)	Formule de type → Référence (suite)	Sigla → Numero d'ordinazione (seguito)	Designación del tipo → Número de pedido (continuación)

DL 140 U 1064 ...



Typ	Ref.
-----	------

DL 140 U 1064	0 433 400 102
DL 140 U 1070	0 433 400 104
DL 140 U 1083	0 433 400 107
DL 140 U 1137	0 433 400 117
DL 140 U 1216	0 433 400 123

DL 145 U 226	0 433 400 105
DL 145 U 232	0 433 400 070
DL 145 U 364	0 433 400 071
DL 145 U 873	0 433 400 072
DL 145 U 974	0 433 400 073

DL 145 U 1003	0 433 400 074
DL 150 U 183	0 433 400 075
DL 150 U 246	0 433 400 091
DL 150 U 256	0 433 400 076
DL 150 U 364	0 433 400 077

DL 150 U 390	0 433 400 078
DL 150 U 821	0 433 400 097
DL 150 U 888	0 433 400 079
DL 150 U 1029	0 433 400 088
DL 150 U 1032	0 433 400 092

DL 150 U 1142	0 433 400 119
DL 155 U 390	0 433 400 080
DL 155 U 1087	0 433 400 122
DL 155 U 1118	0 433 400 118
DL 160 U 256	0 433 400 081

DL 160 U 1002	0 433 400 082
DL 160 U 1055	0 433 400 099
DL 160 U 1061	0 433 400 100
DL 160 U 1087	0 433 400 108
DL 160 U 1118	0 433 400 115

DL 160 U 1221	0 433 400 124
DL 160 U 2560	0 433 400 098

DL ... V ...

DL 0 V 851	0 433 500 001
DL 0 V 892	0 433 500 002
DL 0 V 8920	0 433 500 003

DL 0 V 8921	0 433 500 004
DL 0 V 8922	0 433 500 020
DL 110 V 865	0 433 500 006
DL 110 V 969	0 433 500 007
DL 110 V 976	0 433 500 008

Typ	Ref.
-----	------

DL 110 V 8650	0 433 500 021
DL 110 V 8921	0 433 500 005
DL 124 V 428	0 433 500 009
DL 124 V 732	0 433 500 010
DL 124 V 767	0 433 500 011

DL 124 V 889	0 433 500 014
DL 124 V 902	0 433 500 012
DL 124 V 988	0 433 500 013
DL 125 V 969	0 433 500 015
DL 125 V 976	0 433 500 016

DL 125 V 1046	0 433 500 022
DL 130 V 274	0 433 500 017
DL 130 V 286	0 433 500 018
DL 130 V 1095	0 433 500 023
DL 130 V 1096	0 433 500 024

DL 135 V 976	0 433 500 019
--------------	----------------------

DL ... W ...

DL 0 W 839	0 433 600 001
DL 0 W 883	0 433 600 002
DL 0 W 8830	0 433 600 003

DL 0 W 8831	0 433 600 004
DL 0 W 8832	0 433 600 008
DL 100 W 967	0 433 600 010
DL 110 W 967	0 433 600 005
DL 120 W 1010	0 433 600 009

DL 124 W 761	0 433 600 006
DL 135 W 707	0 433 600 007

DLA ... S ...

DLA 0 S 1	0 433 251 001
DLA 0 S 2	0 433 251 002

DLA ... U ...

DLA 155 U 1242	0 433 450 010
----------------	----------------------

Typ	Ref.
-----	------

DLF ... T ...

DLF 100 T 4	0 433 351 001
DLF 110 T 5	0 433 351 002
DLF 110 T 6	0 433 351 003

DLF 120 T 32	0 433 351 035
DLF 120 T 39	0 433 351 042
DLF 130 T 7	0 433 351 004
DLF 130 T 27	0 433 351 030
DLF 130 T 40	0 433 351 043

DLF 130 T 41	0 433 351 044
DLF 130 T 47	0 433 351 050
DLF 130 T 70	0 433 351 011
DLF 132 T 1	0 433 351 005
DLF 135 T 22	0 433 351 025

DLF 135 T 29	0 433 351 032
DLF 140 T 2	0 433 351 006
DLF 140 T 14	0 433 351 016
DLF 140 T 14+SH	0 433 351 995
DLF 140 T 15	0 433 351 018

DLF 140 T 19	0 433 351 022
DLF 140 T 19+SH	0 433 351 993
DLF 140 T 20	0 433 351 023
DLF 140 T 34	0 433 351 037
DLF 140 T 34+SH	0 433 351 991

DLF 140 T 35	0 433 351 038
DLF 140 T 42	0 433 351 045
DLF 140 T 42+SH	0 433 351 994
DLF 140 T 45	0 433 351 048
DLF 145 T 11	0 433 351 013

DLF 145 T 21	0 433 351 024
DLF 145 T 23	0 433 351 026
DLF 145 T 38	0 433 351 041
DLF 145 T 44	0 433 351 047
DLF 145 T 49	0 433 351 052

DLF 150 T 8	0 433 351 008
DLF 150 T 10	0 433 351 012
DLF 150 T 12	0 433 351 014
DLF 150 T 13	0 433 351 015
DLF 150 T 17	0 433 351 020

DLF 150 T 17+SH	0 433 351 992
DLF 150 T 28	0 433 351 031
DLF 150 T 33	0 433 351 036
DLF 150 T 50	0 433 352 001
DLF 152 T 3	0 433 351 007

... DLL 120 S 285

 Typ	 Ref.
---	--

DLF 155 T 3	0 433 351 010
DLF 155 T 11	0 433 351 017
DLF 155 T 25	0 433 351 028
DLF 155 T 25	0 433 351 999
DLF 155 T 26	0 433 351 029

DLF 155 T 43	0 433 351 046
DLF 160 T 18	0 433 351 021
DLF 160 T 24	0 433 351 027
DLF 160 T 30	0 433 351 033
DLF 170 T 16	0 433 351 019

DLF ... U ...

DLF 108 U 38	0 433 451 039
DLF 110 U 1	0 433 451 001
DLF 110 U 18	0 433 451 002

DLF 110 U 28	0 433 451 003
DLF 115 U 13	0 433 451 004
DLF 115 U 190	0 433 451 005
DLF 120 U 2	0 433 451 050
DLF 120 U 42	0 433 451 046

DLF 120 U 43	0 433 451 049
DLF 120 U 46	0 433 451 053
DLF 125 U 1	0 433 451 006
DLF 130 U 5	0 433 451 007
DLF 130 U 15	0 433 451 008

DLF 132 U 15	0 433 451 009
DLF 132 U 24	0 433 451 047
DLF 132 U 25	0 433 451 048
DLF 132 U 26	0 433 451 037
DLF 132 U 30	0 433 451 010

DLF 132 U 35	0 433 451 011
DLF 132 U 36	0 433 451 012
DLF 135 U 1	0 433 451 013
DLF 135 U 16	0 433 451 014
DLF 140 U 1	0 433 451 015

DLF 140 U 3	0 433 451 016
DLF 140 U 4 -	0 433 451 017
DLF 140 U 6	0 433 451 018
DLF 140 U 9	0 433 451 019
DLF 140 U 17	0 433 451 020

DLF 140 U 20	0 433 451 021
DLF 140 U 21	0 433 451 022
DLF 140 U 22	0 433 451 023
DLF 140 U 24	0 433 451 024
DLF 140 U 25	0 433 451 025

 Typ	 Ref.
---	--

DLF 140 U 26	0 433 451 026
DLF 140 U 27	0 433 451 027
DLF 140 U 29	0 433 451 028
DLF 140 U 32	0 433 451 029
DLF 140 U 36	0 433 451 043

DLF 140 U 37	0 433 451 038
DLF 140 U 40	0 433 451 044
DLF 140 U 49	0 433 451 056
DLF 140 U 53	0 433 451 059
DLF 145 U 10	0 433 451 030

DLF 145 U 11	0 433 451 031
DLF 145 U 23	0 433 451 032
DLF 145 U 31	0 433 451 033
DLF 145 U 34	0 433 451 034
DLF 145 U 39	0 433 451 042

DLF 145 U 41	0 433 451 045
DLF 145 U 45	0 433 451 052
DLF 150 U 1	0 433 451 040
DLF 150 U 6	0 433 451 041
DLF 150 U 10	0 433 451 035

DLF 150 U 12	0 433 451 036
DLF 150 U 44	0 433 451 051
DLF 150 U 47	0 433 451 054
DLF 150 U 48	0 433 451 055
DLF 150 U 51	0 433 451 058

DLF 150 U 54	0 433 451 060
DLF 155 U 50	0 433 451 057
DLF 155 U 52	0 433 451 200

DLF ... V ...

DLF 155 V 2	0 433 551 002
-------------	----------------------

DLL ... S ...

DLL 10 S 119	0 433 270 001
DLL 10 S 647	0 433 270 165
DLL 16 S 592	0 433 220 141

DLL 16 S 966	0 433 270 185
DLL 16 S 971	0 433 270 186
DLL 18 S 353	0 433 270 102
DLL 18 S 418	0 433 270 121
DLL 18 S 486	0 433 270 137

 Typ	 Ref.
---	--

DLL 18 S 572	0 433 270 150
DLL 18 S 603	0 433 270 153
DLL 18 S 629	0 433 270 162
DLL 22 S 435	0 433 270 125
DLL 23 S 553	0 433 220 129

DLL 25 S 444	0 433 270 126
DLL 25 S 680	0 433 270 168
DLL 25 S 834	0 433 270 176
DLL 28 S 932	0 433 270 182
DLL 28 S 1056	0 433 270 188

DLL 30 S 35	0 433 270 002
DLL 30 S 652	0 433 220 152
DLL 30 S 880	0 433 270 179
DLL 30 S 987	0 433 220 183
DLL 30 S 1004	0 433 220 187

DLL 34 S 331	0 433 270 097
DLL 35 S 364	0 433 270 106
DLL 35 S 433	0 433 270 124
DLL 35 S 559	0 433 220 130
DLL 35 S 561	0 433 220 132

DLL 35 S 562	0 433 220 133
DLL 35 S 585	0 433 220 139
DLL 35 S 965	0 433 270 183
DLL 38 S 560	0 433 220 131
DLL 50 S 226	0 433 220 066

DLL 50 S 232	0 433 220 069
DLL 50 S 278	0 433 220 078
DLL 50 S 309	0 433 220 082
DLL 60 S 59	0 433 220 001
DLL 76 S 1114	0 433 220 196

DLL 85 S 28	0 433 220 002
DLL 85 S 326	0 433 220 085
DLL 90 S 30	0 433 270 003
DLL 110 S 96	0 433 220 003
DLL 110 S 97	0 433 220 004

DLL 110 S 103	0 433 270 004
DLL 110 S 149	0 433 270 005
DLL 110 S 639	9 430 034 216
DLL 110 S 1030	9 430 034 205
DLL 120 S 18	0 433 220 005

DLL 120 S 47	0 433 220 006
DLL 120 S 73	0 433 220 007
DLL 120 S 117	0 433 220 008
DLL 120 S 230	0 433 270 063
DLL 120 S 285	0 433 220 079



A42

de

**Typformel →
Bestellnummer**
(Fortsetzung)

en

**Type designation →
Part number**
(continued)

fr

**Formule de type →
Référence**
(suite)

it



**Sigla → Numero
d'ordinazione**
(seguito)



es



**Designación del tipo
→ Número de pedido**
(continuación)

DLL 120 S 352 ...



 Typ	 Ref.
DLL 120 S 352	0 433 220 097
DLL 120 S 736	0 433 220 157
DLL 120 S 755	0 433 220 159
DLL 120 S 1078	0 433 220 194
DLL 130 S 5	0 433 220 009
DLL 130 S 54	0 433 220 010
DLL 130 S 56	0 433 220 011
DLL 130 S 62	0 433 270 007
DLL 130 S 121	0 433 220 012
DLL 130 S 150	0 433 270 008
DLL 130 S 163	0 433 270 056
DLL 130 S 349	0 433 220 096
DLL 130 S 566	0 433 220 135
DLL 130 S 649	0 433 220 151
DLL 130 S 740	0 433 220 158
DLL 130 S 962	0 433 220 181
DLL 132 S 1	0 433 220 013
DLL 132 S 16	0 433 220 014
DLL 132 S 34	0 433 220 015
DLL 132 S 193	0 433 220 061
DLL 135 S 57	0 433 270 009
DLL 135 S 339	0 433 220 088
DLL 135 S 844	0 433 220 169
DLL 138 S 956	0 433 220 179
DLL 140 S 37	0 433 220 016
DLL 140 S 44	0 433 220 017
DLL 140 S 58	0 433 220 018
DLL 140 S 78	0 433 270 010
DLL 140 S 118	0 433 270 011
DLL 140 S 129	0 433 220 019
DLL 140 S 146	0 433 270 012
DLL 140 S 162	0 433 220 020
DLL 140 S 167	0 433 220 054
DLL 140 S 176	0 433 220 057
DLL 140 S 181	0 433 270 053
DLL 140 S 185	0 433 220 059
DLL 140 S 213	0 433 270 059
DLL 140 S 215	0 433 220 071
DLL 140 S 217	0 433 220 065
DLL 140 S 229	0 433 220 068
DLL 140 S 231	0 433 270 064
DLL 140 S 237	0 433 270 065
DLL 140 S 242	0 433 270 069
DLL 140 S 248	0 433 220 073
DLL 140 S 282	0 433 220 077

 Typ	 Ref.
DLL 140 S 287	0 433 220 080
DLL 140 S 306	0 433 270 083
DLL 140 S 370	0 433 220 021
DLL 140 S 380	0 433 270 109
DLL 140 S 382	0 433 270 110
DLL 140 S 385	0 433 270 111
DLL 140 S 403	0 433 270 115
DLL 140 S 446	0 433 220 109
DLL 140 S 504	0 433 270 140
DLL 140 S 522	0 433 270 146
DLL 140 S 586	0 433 220 140
DLL 140 S 591	0 433 270 151
DLL 140 S 610	0 433 270 157
DLL 140 S 611	0 433 270 158
DLL 140 S 625	0 433 220 146
DLL 140 S 632	0 433 220 148
DLL 140 S 645	0 433 220 150
DLL 140 S 819	0 433 220 168
DLL 140 S 1040	0 433 220 188
DLL 140 S 1071	0 433 220 191
DLL 140 S 1077	0 433 220 193
DLL 140 S 1210	0 433 220 200
DLL 140 S 1041/TR	0 433 220 189
DLL 145 S 16	0 433 220 022
DLL 145 S 22	0 433 220 023
DLL 145 S 27	0 433 220 024
DLL 145 S 29	0 433 220 025
DLL 145 S 36	0 433 220 026
DLL 145 S 46	0 433 220 027
DLL 145 S 49	0 433 270 013
DLL 145 S 79	0 433 220 028
DLL 145 S 100	0 433 220 029
DLL 145 S 101	0 433 270 014
DLL 145 S 157	0 433 220 030
DLL 145 S 159	0 433 270 015
DLL 145 S 166	0 433 220 055
DLL 145 S 172	0 433 220 056
DLL 145 S 173	0 433 270 050
DLL 145 S 182	0 433 270 054
DLL 145 S 205	0 433 270 057
DLL 145 S 224	0 433 270 061
DLL 145 S 240	0 433 270 067
DLL 145 S 250	0 433 220 074
DLL 145 S 258	0 433 270 071
DLL 145 S 259	0 433 270 072

 Typ	 Ref.
DLL 145 S 261	0 433 270 074
DLL 145 S 317	0 433 270 086
DLL 145 S 318	0 433 270 087
DLL 145 S 320	0 433 270 089
DLL 145 S 327	0 433 220 086
DLL 145 S 366	0 433 220 098
DLL 145 S 369	0 433 220 099
DLL 145 S 371	0 433 220 101
DLL 145 S 372	0 433 220 100
DLL 145 S 416	0 433 270 119
DLL 145 S 432	0 433 220 106
DLL 145 S 558	0 433 270 149
DLL 145 S 620	0 433 270 160
DLL 145 S 644	0 433 220 149
DLL 145 S 951	0 433 220 177
DLL 145 S 954	0 433 220 178
DLL 145 S 988	0 433 220 184
DLL 145 S 989	0 433 220 185
DLL 148 S 1149	0 433 270 190
DLL 150 S 2	0 433 270 016
DLL 150 S 17	0 433 270 017
DLL 150 S 25	0 433 220 031
DLL 150 S 26	0 433 220 032
DLL 150 S 38	0 433 270 018
DLL 150 S 39	0 433 270 019
DLL 150 S 53	0 433 270 020
DLL 150 S 60	0 433 220 033
DLL 150 S 77	0 433 270 021
DLL 150 S 83	0 433 220 034
DLL 150 S 84	0 433 220 035
DLL 150 S 87	0 433 270 022
DLL 150 S 89	0 433 270 023
DLL 150 S 90	0 433 270 024
DLL 150 S 90	0 433 270 999
DLL 150 S 104	0 433 270 025
DLL 150 S 106	0 433 220 036
DLL 150 S 115	0 433 270 026
DLL 150 S 122	0 433 220 037
DLL 150 S 123	0 433 220 038
DLL 150 S 124	0 433 220 039
DLL 150 S 126	0 433 270 027
DLL 150 S 128	0 433 220 040
DLL 150 S 130	0 433 270 028
DLL 150 S 135	0 433 270 029
DLL 150 S 141	0 433 220 041

... DLL 155 S 4820



DLL 150 S 142	0 433 220 042
DLL 150 S 143	0 433 270 030
DLL 150 S 145	0 433 270 031
DLL 150 S 156	0 433 270 032
DLL 150 S 158	0 433 270 033

DLL 150 S 168	0 433 270 048
DLL 150 S 171	0 433 270 049
DLL 150 S 180	0 433 270 051
DLL 150 S 184	0 433 220 058
DLL 150 S 188	0 433 220 060

DLL 150 S 192	0 433 270 055
DLL 150 S 209	0 433 270 058
DLL 150 S 211	0 433 220 063
DLL 150 S 219	0 433 220 064
DLL 150 S 235	0 433 270 068

DLL 150 S 238	0 433 270 066
DLL 150 S 241	0 433 270 096
DLL 150 S 241 HB-20	9 430 034 242
DLL 150 S 243	0 433 220 072
DLL 150 S 252	0 433 270 070

DLL 150 S 253	0 433 220 075
DLL 150 S 260	0 433 270 073
DLL 150 S 264	0 433 270 077
DLL 150 S 281	0 433 270 078
DLL 150 S 283	0 433 270 079

DLL 150 S 291	0 433 270 080
DLL 150 S 296	0 433 270 082
DLL 150 S 304	0 433 220 081
DLL 150 S 315	0 433 270 084
DLL 150 S 316	0 433 270 085

DLL 150 S 319	0 433 270 088
DLL 150 S 321	0 433 270 090
DLL 150 S 324	0 433 270 091
DLL 150 S 325	0 433 270 092
DLL 150 S 332	0 433 270 098

DLL 150 S 333	0 433 270 099
DLL 150 S 334	0 433 270 100
DLL 150 S 344	0 433 220 092
DLL 150 S 348	0 433 220 095
DLL 150 S 350	0 433 270 101

DLL 150 S 354	0 433 270 103
DLL 150 S 356	0 433 270 105
DLL 150 S 373	0 433 270 108
DLL 150 S 389	0 433 270 113
DLL 150 S 393	0 433 270 114



DLL 150 S 405	0 433 270 116
DLL 150 S 406	0 433 270 117
DLL 150 S 424	0 433 270 122
DLL 150 S 434	0 433 220 107
DLL 150 S 438	0 433 220 108

DLL 150 S 450	0 433 220 110
DLL 150 S 452	0 433 270 127
DLL 150 S 454	0 433 270 129
DLL 150 S 457	0 433 270 130
DLL 150 S 463	0 433 220 111

DLL 150 S 464	0 433 220 113
DLL 150 S 471	0 433 270 034
DLL 150 S 472	0 433 220 114
DLL 150 S 476	0 433 220 115
DLL 150 S 480	0 433 270 133

DLL 150 S 481	0 433 270 134
DLL 150 S 484	0 433 270 136
DLL 150 S 489	0 433 270 138
DLL 150 S 491	0 433 220 118
DLL 150 S 492	0 433 220 119

DLL 150 S 493	0 433 270 141
DLL 150 S 508	0 433 270 142
DLL 150 S 511	0 433 270 144
DLL 150 S 518	0 433 270 145
DLL 150 S 530	0 433 220 124

DLL 150 S 535	0 433 220 126
DLL 150 S 545	0 433 220 128
DLL 150 S 578	0 433 220 138
DLL 150 S 596	0 433 270 152
DLL 150 S 604	0 433 270 154

DLL 150 S 605	0 433 270 155
DLL 150 S 606	0 433 220 143
DLL 150 S 612	0 433 270 159
DLL 150 S 617	0 433 220 144
DLL 150 S 631	0 433 220 147

DLL 150 S 665	0 433 270 167
DLL 150 S 670	0 433 220 153
DLL 150 S 691	9 430 034 265
DLL 150 S 697	0 433 270 169
DLL 150 S 730	0 433 220 156

DLL 150 S 805	0 433 220 167
DLL 150 S 859	0 433 270 178
DLL 150 S 869	0 433 220 171
DLL 150 S 882	0 433 270 180
DLL 150 S 930	0 433 220 162



DLL 150 S 946	0 433 220 174
DLL 150 S 949	0 433 220 175
DLL 150 S 950	0 433 220 176
DLL 150 S 961	0 433 220 180
DLL 150 S 979	0 433 220 182

DLL 150 S 997	0 433 220 186
DLL 150 S 1027	0 433 270 187
DLL 150 S 1093	0 433 220 195
DLL 150 S 1126	0 433 220 197
DLL 150 S 1195	0 433 220 199

DLL 150 S 2640	0 433 270 104
DLL 150 S 2641	0 433 270 120
DLL 150 S 2810	0 433 270 093
DLL 150 S 2811	0 433 270 094
DLL 150 S 790/TR	0 433 270 174

DLL 150 S 919/	0 433 270 181
DLL 151 S 939	0 433 220 172
DLL 152 S 31	0 433 270 035
DLL 152 S 756	0 433 220 160
DLL 152 S 780	0 433 220 163

DLL 152 S 864	0 433 220 170
DLL 153 S 528	0 433 220 122
DLL 153 S 529	0 433 220 123
DLL 154 S 1136	0 433 270 189
DLL 155 S 113	0 433 220 043

DLL 155 S 368	0 433 270 107
DLL 155 S 412	0 433 270 118
DLL 155 S 426	0 433 220 104
DLL 155 S 466	0 433 270 131
DLL 155 S 482	0 433 270 135

DLL 155 S 487	0 433 220 117
DLL 155 S 502	0 433 220 121
DLL 155 S 538	0 433 220 127
DLL 155 S 571	0 433 220 136
DLL 155 S 623	0 433 220 145

DLL 155 S 676	0 433 220 154
DLL 155 S 802	0 433 220 166
DLL 155 S 942	0 433 220 173
DLL 155 S 1057	0 433 220 190
DLL 155 S 1073	0 433 220 192

DLL 155 S 1271	0 433 270 191
DLL 155 S 1276	0 433 220 201
DLL 155 S 1300	0 433 220 202
DLL 155 S 1383	0 433 272 038
DLL 155 S 4820	0 433 270 161



de

Typformel →
Bestellnummer
(Fortsetzung)

en

Type designation →
Part number
(continued)

fr

Formule de type →
Référence
(suite)

it

Sigla → Numero
d'ordinazione
(seguito)

es

Designación del tipo
→ Número de pedido
(continuación)

DLL 156 S 411 ...



DLL 156 S 411	0 433 220 112
DLL 159 S 411	0 433 220 103
DLL 160 S 2	0 433 270 036
DLL 160 S 3	0 433 270 037
DLL 160 S 22	0 433 220 044

DLL 160 S 65	0 433 220 045
DLL 160 S 67	0 433 220 046
DLL 160 S 91	0 433 270 038
DLL 160 S 136	0 433 270 039
DLL 160 S 137	0 433 270 040

DLL 160 S 154	0 433 270 041
DLL 160 S 177	0 433 270 052
DLL 160 S 202	0 433 220 067
DLL 160 S 210	0 433 220 062
DLL 160 S 227	0 433 270 062

DLL 160 S 267	0 433 270 076
DLL 160 S 270	0 433 220 076
DLL 160 S 295	0 433 270 081
DLL 160 S 336	0 433 220 087
DLL 160 S 340	0 433 220 089

DLL 160 S 343	0 433 220 091
DLL 160 S 346	0 433 220 093
DLL 160 S 347	0 433 220 094
DLL 160 S 410	0 433 220 102
DLL 160 S 431	0 433 270 123

DLL 160 S 453	0 433 270 128
DLL 160 S 473	0 433 270 132
DLL 160 S 498	0 433 220 120
DLL 160 S 510	0 433 270 143
DLL 160 S 534	0 433 270 164

DLL 160 S 564	0 433 220 134
DLL 160 S 577	0 433 220 137
DLL 160 S 599	0 433 220 142
DLL 160 S 642	0 433 270 163
DLL 160 S 642	0 433 270 998

DLL 160 S 705	0 433 270 170
DLL 160 S 721	0 433 220 155
DLL 160 S 1024	9 430 034 244
DLL 160 S 1194	0 433 220 198
DLL 165 S 48	0 433 270 042

DLL 165 S 144	0 433 270 043
DLL 165 S 388	0 433 270 112
DLL 165 S 657	0 433 270 166
DLL 170 S 342	0 433 220 090
DLL 180 S 11	0 433 220 047



DLL 180 S 15	0 433 220 048
DLL 180 S 23	0 433 220 049
DLL 180 S 24	0 433 220 050
DLL 180 S 45	0 433 220 051
DLL 180 S 68	0 433 270 044

DLL 180 S 125	0 433 270 046
DLL 180 S 147	0 433 220 052
DLL 180 S 148	0 433 220 053
DLL 180 S 151	0 433 270 047
DLL 180 S 222	0 433 270 060

DLL 180 S 497	0 433 270 139
DLL 180 S 540	0 433 270 148

DLL ... X ...

DLL 160 X 3	0 433 920 001
DLL 160 X 6	0 433 920 002
DLL 160 X 7	0 433 920 007

DLL 160 X 8	0 433 920 008
DLL 180 X 1	0 433 920 003
DLL 180 X 2	0 433 920 004
DLL 180 X 4	0 433 920 005
DLL 180 X 5	0 433 920 006

DLLA ... P ...

DLLA 0 P 653	0 433 171 477
DLLA 82 P 1668	0 433 172 024
DLLA 88 P 1620	0 433 171 989

DLLA 113 P 86	0 433 171 083
DLLA 118 P 1357	0 433 171 843
DLLA 118 P 1358	0 433 171 844
DLLA 118 P 1630	0 433 172 000
DLLA 118 P 1677	0 433 172 027

DLLA 122 P 1602	0 433 171 978
DLLA 124 P 227	0 433 171 185
DLLA 125 P 529	0 433 171 392
DLLA 128 P 1635	0 433 172 001
DLLA 130 P 62	0 433 171 062

DLLA 134 P 180	0 433 171 159
DLLA 134 P 186	0 433 171 162
DLLA 134 P 204	0 433 171 201
DLLA 134 P 296	0 433 171 215
DLLA 134 P 301	0 433 171 217



DLLA 134 P 371	0 433 171 264
DLLA 134 P 372	0 433 171 265
DLLA 134 P 422	0 433 171 303
DLLA 134 P 423	0 433 171 304
DLLA 134 P 424	0 433 171 305

DLLA 134 P 430	0 433 171 309
DLLA 134 P 431	0 433 171 310
DLLA 134 P 435	0 433 171 313
DLLA 134 P 459	0 433 171 332
DLLA 134 P 512	0 433 171 368

DLLA 134 P 703	0 433 171 517
DLLA 134 P 760	0 433 171 543
DLLA 134 P 846	0 433 171 574
DLLA 134 P 1314	F 000 430 309
DLLA 135 P 250	0 433 171 200

DLLA 135 P 367	0 433 171 261
DLLA 135 P 373	0 433 171 266
DLLA 135 P 374	0 433 171 267
DLLA 135 P 437	0 433 171 315
DLLA 135 P 530	0 433 171 393

DLLA 135 P 539	0 433 171 399
DLLA 135 P 769+	0 433 171 547
DLLA 135 P 782	0 433 171 549
DLLA 135 P 1399	0 433 171 866
DLLA 135 P 1400	0 433 171 867

DLLA 135 P 1401	0 433 171 868
DLLA 135 P 1422	0 433 171 883
DLLA 136 P 69	0 433 171 069
DLLA 136 P 738	F 000 430 301
DLLA 136 P 1708	0 433 172 046

DLLA 137 P 1577	0 433 171 966
DLLA 137 P 1648	0 433 172 011
DLLA 138 P 401	0 433 171 285
DLLA 138 P 402	0 433 171 286
DLLA 138 P 403	0 433 171 287

DLLA 138 P 505	0 433 171 364
DLLA 138 P 563	0 433 171 412
DLLA 138 P 820	F 000 430 304
DLLA 138 P 1533	0 433 171 945
DLLA 139 P 1497	0 433 171 923

DLLA 140 P 44	0 433 171 044
DLLA 140 P 79	0 433 171 079
DLLA 140 P 175	0 433 171 154
DLLA 140 P 182	0 433 171 160
DLLA 140 P 196	0 433 171 166

... DLLA 144 P 527



DLLA 140 P 233	0 433 171 191
DLLA 140 P 257	0 433 171 202
DLLA 140 P 290	0 433 171 212
DLLA 140 P 305	0 433 171 220
DLLA 140 P 351	0 433 171 250

DLLA 140 P 384	0 433 171 271
DLLA 140 P 389	0 433 171 276
DLLA 140 P 390	0 433 171 277
DLLA 140 P 399	0 433 171 284
DLLA 140 P 411	0 433 171 294

DLLA 140 P 483	0 433 171 347
DLLA 140 P 517	0 433 171 371
DLLA 140 P 518	0 433 171 372
DLLA 140 P 580	0 433 171 439
DLLA 140 P 583	0 433 171 442

DLLA 140 P 629	0 433 171 467
DLLA 140 P 637	0 433 171 472
DLLA 140 P 662	0 433 171 481
DLLA 140 P 688	0 433 171 503
DLLA 140 P 689	0 433 171 504

DLLA 140 P 690	0 433 171 505
DLLA 140 P 705	0 433 171 518
DLLA 140 P 826	0 433 171 564
DLLA 140 P 947	0 433 171 631
DLLA 140 P 1051	0 433 171 682

DLLA 140 P 1098	0 433 171 708
DLLA 140 P 1144	0 433 171 734
DLLA 140 P 1179	0 433 171 747
DLLA 140 P 1181	0 433 171 748
DLLA 140 P 1187	0 433 171 750

DLLA 140 P 1199	0 433 171 756
DLLA 140 P 1278	0 433 171 802
DLLA 140 P 1279	0 433 171 803
DLLA 140 P 1294	0 433 171 810
DLLA 140 P 1335	F 000 430 310

DLLA 140 P 1340	0 433 171 832
DLLA 140 P 1341	0 433 171 833
DLLA 140 P 1342	0 433 171 834
DLLA 140 P 1343	0 433 171 835
DLLA 140 P 1377	0 433 171 855

DLLA 140 P 1420	0 433 171 881
DLLA 140 P 1421	0 433 171 882
DLLA 140 P 1444	0 433 171 892
DLLA 140 P 1445	0 433 171 893
DLLA 140 P 1446	0 433 171 894



DLLA 140 P 1551	0 433 171 957
DLLA 141 P 1009	0 433 171 652
DLLA 142 P 14	0 433 171 015
DLLA 142 P 16	0 433 171 017
DLLA 142 P 87	0 433 171 084

DLLA 142 P 176	0 433 171 155
DLLA 142 P 221	0 433 171 180
DLLA 142 P 312	0 433 171 223
DLLA 142 P 406	2 437 010 054
DLLA 142 P 417	0 433 171 297

DLLA 142 P 418	0 433 171 298
DLLA 142 P 419	0 433 171 299
DLLA 142 P 479	0 433 171 345
DLLA 142 P 544	0 433 171 402
DLLA 142 P 696	0 433 171 511

DLLA 142 P 731	F 000 430 300
DLLA 142 P 732	0 433 171 531
DLLA 142 P 815	F 000 430 306
DLLA 142 P 956	0 433 171 633
DLLA 142 P 985	0 433 171 645

DLLA 142 P 1070	0 433 171 696
DLLA 142 P 1119	0 433 171 723
DLLA 142 P 1135	0 433 171 729
DLLA 142 P 1233	0 433 171 782
DLLA 142 P 1280	0 433 171 804

DLLA 142 P 1283	0 433 171 806
DLLA 142 P 1284	0 433 171 807
DLLA 142 P 1321	0 433 171 822
DLLA 142 P 1333	0 433 171 827
DLLA 142 P 1363	0 433 171 846

DLLA 142 P 1481	0 433 171 916
DLLA 142 P 1595	0 433 171 974
DLLA 142 P 1607	0 433 171 981
DLLA 142 P 1654	0 433 172 015
DLLA 142 P 1709	0 433 172 047

DLLA 143 P 40	0 433 171 041
DLLA 143 P 55	0 433 171 055
DLLA 143 P 88	0 433 171 088
DLLA 143 P 93	0 433 171 089
DLLA 143 P 94	0 433 171 090

DLLA 143 P 95	0 433 171 091
DLLA 143 P 96	0 433 171 092
DLLA 143 P 121	0 433 171 110
DLLA 143 P 122	0 433 171 111
DLLA 143 P 123	0 433 171 112



DLLA 143 P 126	0 433 171 114
DLLA 143 P 127	0 433 171 115
DLLA 143 P 128	0 433 171 116
DLLA 143 P 151	0 433 171 139
DLLA 143 P 160	0 433 171 143

DLLA 143 P 247	0 433 171 198
DLLA 143 P 333	0 433 171 235
DLLA 143 P 334	0 433 171 236
DLLA 143 P 428	0 433 171 307
DLLA 143 P 470	0 433 171 339

DLLA 143 P 471	0 433 171 340
DLLA 143 P 485	0 433 171 349
DLLA 143 P 495	0 433 171 357
DLLA 143 P 813	F 000 430 305
DLLA 143 P 879/	0 433 171 930

DLLA 143 P 894	0 433 171 596
DLLA 143 P 1069	0 433 171 695
DLLA 143 P 1153	0 433 171 738
DLLA 143 P 1404	0 433 171 870
DLLA 143 P 1414	0 433 171 876

DLLA 143 P 1448	0 433 171 896
DLLA 143 P 1528	0 433 171 942
DLLA 143 P 1532	0 433 171 944
DLLA 143 P 1536	0 433 171 947
DLLA 143 P 1541	0 433 171 951

DLLA 143 P 1601	0 433 171 977
DLLA 143 P 1619	0 433 171 988
DLLA 144 P 15	0 433 171 016
DLLA 144 P 118	0 433 171 107
DLLA 144 P 134	0 433 171 122

DLLA 144 P 138	0 433 171 126
DLLA 144 P 144	0 433 171 130
DLLA 144 P 184	0 433 171 161
DLLA 144 P 184/	0 433 171 174
DLLA 144 P 234	0 433 171 192

DLLA 144 P 353	0 433 171 252
DLLA 144 P 354	0 433 171 251
DLLA 144 P 410	0 433 171 293
DLLA 144 P 449	0 433 171 323
DLLA 144 P 450	0 433 171 324

DLLA 144 P 467	0 433 171 337
DLLA 144 P 490	0 433 171 354
DLLA 144 P 510	0 433 171 366
DLLA 144 P 521	0 433 171 385
DLLA 144 P 527	0 433 171 390



de

Typformel →
Bestellnummer
(Fortsetzung)

en

Type designation →
Part number
(continued)

fr

Formule de type →
Référence
(suite)







it

Sigla → Numero
d'ordinazione
(seguito)

es

Designación del tipo
→ Número de pedido
(continuación)

DLLA 144 P 568 ...

 Typ	 Ref.	 Typ	 Ref.	 Typ	 Ref.
DLLA 144 P 568	0 433 171 415	DLLA 145 P 593	2 437 010 051	DLLA 145 P 1348	0 433 171 839
DLLA 144 P 666	0 433 171 485	DLLA 145 P 605	0 433 171 453	DLLA 145 P 1386	0 433 171 861
DLLA 144 P 825	2 437 010 098	DLLA 145 P 606	0 433 171 454	DLLA 145 P 1391	0 433 171 863
DLLA 144 P 908	2 437 010 116	DLLA 145 P 607	0 433 171 455	DLLA 145 P 1430	0 433 171 888
DLLA 144 P 1050	0 433 171 681	DLLA 145 P 621	9 430 034 122	DLLA 145 P 1449	0 433 171 897
DLLA 144 P 1056	0 433 171 686	DLLA 145 P 624	0 433 171 464	DLLA 145 P 1503	0 433 171 926
DLLA 144 P 1105	0 433 171 710	DLLA 145 P 627	2 437 010 052	DLLA 145 P 1517	0 433 171 937
DLLA 144 P 1132	0 433 171 728	DLLA 145 P 632	0 433 171 468	DLLA 145 P 1529	0 433 171 943
DLLA 144 P 1140	0 433 171 733	DLLA 145 P 659	0 433 171 479	DLLA 145 P 1534	0 433 171 946
DLLA 144 P 1170	0 433 171 744	DLLA 145 P 669	0 433 171 486	DLLA 145 P 1540	0 433 171 950
DLLA 144 P 1175	0 433 171 746	DLLA 145 P 695	0 433 171 510	DLLA 145 P 1543	0 433 171 952
DLLA 144 P 1194	0 433 171 753	DLLA 145 P 748	2 437 010 057	DLLA 145 P 1547	0 433 171 955
DLLA 144 P 1220	0 433 171 770	DLLA 145 P 749	F 000 430 302	DLLA 145 P 1552	0 433 171 958
DLLA 144 P 1249	0 433 171 791	DLLA 145 P 758	0 433 171 542	DLLA 145 P 1556	0 433 171 959
DLLA 144 P 1264	0 433 171 797	DLLA 145 P 785	0 433 171 550	DLLA 145 P 1589	0 433 171 970
DLLA 144 P 1369	0 433 171 849	DLLA 145 P 787	0 433 171 551	DLLA 145 P 1590	0 433 171 971
DLLA 144 P 1387	0 433 171 862	DLLA 145 P 788	0 433 171 552	DLLA 145 P 1591	0 433 171 972
DLLA 144 P 1413	0 433 171 875	DLLA 145 P 809	0 433 171 556	DLLA 145 P 1617	0 433 171 987
DLLA 144 P 1417	0 433 171 878	DLLA 145 P 818	0 433 171 560	DLLA 145 P 1645	0 433 172 008
DLLA 144 P 1423	0 433 171 885	DLLA 145 P 832	0 433 171 568	DLLA 145 P 1647	0 433 172 010
DLLA 144 P 1483	0 433 171 917	DLLA 145 P 842	0 433 171 573	DLLA 145 P 1655	0 433 172 016
DLLA 144 P 1539	0 433 171 949	DLLA 145 P 849	0 433 171 577	DLLA 145 P 1714	0 433 172 051
DLLA 144 P 1565	0 433 171 964	DLLA 145 P 905	0 433 171 601	DLLA 145 P 1715	0 433 172 052
DLLA 144 P 1646	0 433 172 009	DLLA 145 P 906	0 433 171 602	DLLA 146 P 139	0 433 171 127
DLLA 144 P 1707	0 433 172 045	DLLA 145 P 907	0 433 171 603	DLLA 146 P 140	0 433 171 128
DLLA 145 P 286	0 433 171 211	DLLA 145 P 926	0 433 171 616	DLLA 146 P 154	0 433 171 137
DLLA 145 P 319	0 433 171 228	DLLA 145 P 927	0 433 171 617	DLLA 146 P 154-	0 433 171 165
DLLA 145 P 328	0 433 171 232	DLLA 145 P 928	0 433 171 618	DLLA 146 P 166	0 433 171 149
DLLA 145 P 331	0 433 171 234	DLLA 145 P 961	0 433 171 636	DLLA 146 P 166/	0 433 171 214
DLLA 145 P 337	0 433 171 239	DLLA 145 P 978	0 433 171 641	DLLA 146 P 190	0 433 171 163
DLLA 145 P 392	0 433 171 280	DLLA 145 P 998	0 433 171 647	DLLA 146 P 197	0 433 171 167
DLLA 145 P 393	0 433 171 279	DLLA 145 P 999	0 433 171 648	DLLA 146 P 203	0 433 171 169
DLLA 145 P 394	0 433 171 281	DLLA 145 P 1014	0 433 171 657	DLLA 146 P 224	0 433 171 182
DLLA 145 P 412	0 433 171 295	DLLA 145 P 1015	0 433 171 658	DLLA 146 P 244	0 433 171 197
DLLA 145 P 420	0 433 171 302	DLLA 145 P 1031	2 437 010 131	DLLA 146 P 391	0 433 171 278
DLLA 145 P 433	0 433 171 311	DLLA 145 P 1062	0 433 171 689	DLLA 146 P 489	0 433 171 353
DLLA 145 P 438	0 433 171 316	DLLA 145 P 1068	2 437 010 132	DLLA 146 P 499	0 433 171 360
DLLA 145 P 439	0 433 171 317	DLLA 145 P 1139	0 433 171 732	DLLA 146 P 581	0 433 171 440
DLLA 145 P 466	0 433 171 335	DLLA 145 P 1182	0 433 171 749	DLLA 146 P 693	0 433 171 508
DLLA 145 P 478	0 433 171 344	DLLA 145 P 1189	0 433 171 751	DLLA 146 P 708	0 433 171 519
DLLA 145 P 504	0 433 171 363	DLLA 145 P 1195	0 433 171 754	DLLA 146 P 834	0 433 171 569
DLLA 145 P 536	0 433 171 397	DLLA 145 P 1219	0 433 171 769	DLLA 146 P 1122	0 433 171 726
DLLA 145 P 542	0 433 171 401	DLLA 145 P 1223	0 433 171 773	DLLA 146 P 1203	0 433 171 758
DLLA 145 P 574	0 433 171 435	DLLA 145 P 1240	0 433 171 787	DLLA 146 P 1210	0 433 171 763
DLLA 145 P 574	F 002 C40 008	DLLA 145 P 1338	0 433 171 830	DLLA 146 P 1214	0 433 171 765

... DLLA 149 P 1621



DLLA 146 P 1218	0 433 171 768
DLLA 146 P 1257	0 433 171 792
DLLA 146 P 1296	0 433 171 811
DLLA 146 P 1297	0 433 171 812
DLLA 146 P 1311/	0 433 171 818

DLLA 146 P 1339	0 433 171 831
DLLA 146 P 1405	0 433 171 871
DLLA 146 P 1406	0 433 171 872
DLLA 146 P 1439	0 433 171 890
DLLA 146 P 1447	0 433 171 895

DLLA 146 P 1453	0 433 171 900
DLLA 146 P 1484	0 433 171 918
DLLA 146 P 1522	0 433 171 938
DLLA 146 P 1545	0 433 171 953
DLLA 146 P 1581	0 433 171 968

DLLA 146 P 1583	0 433 171 969
DLLA 146 P 1652	0 433 172 013
DLLA 146 P 1725	0 433 172 059
DLLA 147 P 344	0 433 171 245
DLLA 147 P 360	0 433 171 257

DLLA 147 P 361	0 433 171 258
DLLA 147 P 370	0 433 171 263
DLLA 147 P 385	0 433 171 272
DLLA 147 P 404	0 433 171 288
DLLA 147 P 538	0 433 171 398

DLLA 147 P 569	0 433 171 430
DLLA 147 P 658	0 433 171 478
DLLA 147 P 680	0 433 171 495
DLLA 147 P 734	0 433 171 533
DLLA 147 P 752	0 433 171 539

DLLA 147 P 753	0 433 171 540
DLLA 147 P 754	0 433 171 541
DLLA 147 P 799	0 433 171 555
DLLA 147 P 827	2 437 010 099
DLLA 147 P 854	0 433 171 579

DLLA 147 P 861	0 433 171 582
DLLA 147 P 875	0 433 171 585
DLLA 147 P 880	0 433 171 590
DLLA 147 P 884	0 433 171 591
DLLA 147 P 900	F 002 C40 006

DLLA 147 P 936	F 000 430 308
DLLA 147 P 944	0 433 171 629
DLLA 147 P 945	0 433 171 630
DLLA 147 P 1048	0 433 171 679
DLLA 147 P 1049	0 433 171 680



DLLA 147 P 1121	0 433 171 725
DLLA 147 P 1229	0 433 171 779
DLLA 147 P 1230	0 433 171 780
DLLA 147 P 1374	2 437 010 144
DLLA 147 P 1521	2 437 010 151

DLLA 147 P 1521	2 437 010 151
DLLA 147 P 1548	0 433 171 956
DLLA 147 P 1628	0 433 175 466
DLLA 148 P 38	0 433 171 039
DLLA 148 P 97	0 433 171 093

DLLA 148 P 98	0 433 171 094
DLLA 148 P 149	0 433 171 134
DLLA 148 P 150	0 433 171 135
DLLA 148 P 163	0 433 171 146
DLLA 148 P 164	0 433 171 147

DLLA 148 P 187	9 430 394 400
DLLA 148 P 229	0 433 171 187
DLLA 148 P 240	0 433 171 194
DLLA 148 P 241	0 433 171 195
DLLA 148 P 325	0 433 171 230

DLLA 148 P 329	0 433 171 233
DLLA 148 P 341	0 433 171 243
DLLA 148 P 350	0 433 171 249
DLLA 148 P 363	0 433 171 259
DLLA 148 P 408	0 433 171 291

DLLA 148 P 461	0 433 171 334
DLLA 148 P 465	0 433 171 336
DLLA 148 P 493	0 433 171 355
DLLA 148 P 500	0 433 171 361
DLLA 148 P 513	0 433 171 369

DLLA 148 P 522	0 433 171 386
DLLA 148 P 578	0 433 171 437
DLLA 148 P 586	0 433 171 445
DLLA 148 P 610	0 433 171 457
DLLA 148 P 611	0 433 171 458

DLLA 148 P 612	0 433 171 459
DLLA 148 P 650	0 433 171 474
DLLA 148 P 663	0 433 171 482
DLLA 148 P 694	F 00Z 220 000
DLLA 148 P 714	F 002 C40 002

DLLA 148 P 836	0 433 171 570
DLLA 148 P 911	0 433 171 605
DLLA 148 P 912	0 433 171 606
DLLA 148 P 915	0 433 171 609
DLLA 148 P 923	0 433 171 612



DLLA 148 P 924	0 433 171 615
DLLA 148 P 984	0 433 171 644
DLLA 148 P 1010	0 433 171 653
DLLA 148 P 1013	0 433 171 656
DLLA 148 P 1022	0 433 171 673

DLLA 148 P 1067	0 433 171 693
DLLA 148 P 1083	0 433 171 704
DLLA 148 P 1185	F 002 C40 010
DLLA 148 P 1193	0 433 171 752
DLLA 148 P 1200	0 433 171 757

DLLA 148 P 1221	0 433 171 771
DLLA 148 P 1237	0 433 171 784
DLLA 148 P 1238	0 433 171 785
DLLA 148 P 1312	0 433 171 819
DLLA 148 P 1313	0 433 171 820

DLLA 148 P 1334	0 433 171 828
DLLA 148 P 1347	0 433 171 838
DLLA 148 P 1350	0 433 171 845
DLLA 148 P 1407	0 433 171 873
DLLA 148 P 1460	0 433 171 904

DLLA 148 P 1461	0 433 171 905
DLLA 148 P 1462	0 433 171 906
DLLA 148 P 1506	0 433 171 928
DLLA 148 P 1524/	0 433 171 939
DLLA 148 P 1623	0 433 171 992

DLLA 148 P 1638	0 433 172 002
DLLA 148 P 1660	0 433 172 019
DLLA 148 P 1671	0 433 172 025
DLLA 149 P 158	0 433 171 141
DLLA 149 P 369	0 433 171 262

DLLA 149 P 460	0 433 171 333
DLLA 149 P 514	0 433 171 370
DLLA 149 P 528	0 433 171 391
DLLA 149 P 541	0 433 171 400
DLLA 149 P 554	0 433 171 406

DLLA 149 P 601	2 437 010 053
DLLA 149 P 602	0 433 171 452
DLLA 149 P 622	0 433 171 463
DLLA 149 P 697	0 433 171 512
DLLA 149 P 831	2 437 010 103

DLLA 149 P 1402	0 433 171 869
DLLA 149 P 1515/	0 433 171 936
DLLA 149 P 1562	0 433 171 961
DLLA 149 P 1594	0 433 171 973
DLLA 149 P 1621	0 433 171 990



de

**Typformel →
Bestellnummer**
(Fortsetzung)

en

**Type designation →
Part number**
(continued)

fr

**Formule de type →
Référence**
(suite)

it

**Sigla → Numero
d'ordinazione**
(seguito)

es

**Designación del tipo
→ Número de pedido**
(continuación)

DLLA 149 P 1625 ...

Typ	Ref.
DLLA 149 P 1625	0 433 171 993
DLLA 149 P 1699	0 433 172 041
DLLA 149 P 1724	0 433 172 058
DLLA 150 P 1	0 433 171 001
DLLA 150 P 2	0 433 171 002
DLLA 150 P 3	0 433 171 003
DLLA 150 P 7	0 433 171 008
DLLA 150 P 8	0 433 171 009
DLLA 150 P 10	0 433 171 011
DLLA 150 P 11	0 433 171 012
DLLA 150 P 12	0 433 171 013
DLLA 150 P 13	0 433 171 014
DLLA 150 P 17	0 433 171 018
DLLA 150 P 19	0 433 171 020
DLLA 150 P 20	0 433 171 021
DLLA 150 P 21	0 433 171 022
DLLA 150 P 22	0 433 171 023
DLLA 150 P 23	0 433 171 024
DLLA 150 P 24	0 433 171 025
DLLA 150 P 25	0 433 171 026
DLLA 150 P 26	0 433 171 027
DLLA 150 P 27	9 430 034 117
DLLA 150 P 28	0 433 171 029
DLLA 150 P 29	0 433 171 030
DLLA 150 P 30	0 433 171 031
DLLA 150 P 31	0 433 171 032
DLLA 150 P 32	0 433 171 033
DLLA 150 P 33	0 433 171 034
DLLA 150 P 34	0 433 171 035
DLLA 150 P 36	0 433 171 037
DLLA 150 P 37	0 433 171 038
DLLA 150 P 39	0 433 171 040
DLLA 150 P 39	9 430 034 118
DLLA 150 P 42	0 433 171 042
DLLA 150 P 43	0 433 171 043
DLLA 150 P 46	0 433 171 046
DLLA 150 P 46+SCH	0 433 171 999
DLLA 150 P 47	0 433 171 047
DLLA 150 P 47+SCH	0 433 171 998
DLLA 150 P 48	0 433 171 048
DLLA 150 P 48+SCH	0 433 171 997
DLLA 150 P 49	0 433 171 049
DLLA 150 P 49+SCH	0 433 171 996
DLLA 150 P 50	0 433 171 050
DLLA 150 P 52	0 433 171 052

Typ	Ref.
DLLA 150 P 53	0 433 171 053
DLLA 150 P 56	0 433 171 056
DLLA 150 P 59	0 433 171 059
DLLA 150 P 60	0 433 171 060
DLLA 150 P 61	0 433 171 061
DLLA 150 P 64	0 433 171 064
DLLA 150 P 65	0 433 171 065
DLLA 150 P 71	0 433 171 071
DLLA 150 P 72	0 433 171 072
DLLA 150 P 76	0 433 171 076
DLLA 150 P 77	0 433 171 077
DLLA 150 P 78	0 433 171 078
DLLA 150 P 83	0 433 171 081
DLLA 150 P 89	0 433 171 085
DLLA 150 P 91	0 433 171 087
DLLA 150 P 91/+	0 433 171 164
DLLA 150 P 99	0 433 171 095
DLLA 150 P 102	0 433 171 097
DLLA 150 P 105	0 433 171 098
DLLA 150 P 110	0 433 171 100
DLLA 150 P 113	0 433 171 102
DLLA 150 P 115	0 433 171 104
DLLA 150 P 116	0 433 171 105
DLLA 150 P 117	0 433 171 106
DLLA 150 P 119	0 433 171 108
DLLA 150 P 130	0 433 171 118
DLLA 150 P 131	0 433 171 119
DLLA 150 P 133	0 433 171 121
DLLA 150 P 136	0 433 171 124
DLLA 150 P 137	0 433 171 125
DLLA 150 P 145	0 433 171 131
DLLA 150 P 147	0 433 171 133
DLLA 150 P 159	0 433 171 142
DLLA 150 P 162	0 433 171 145
DLLA 150 P 167	0 433 171 150
DLLA 150 P 177	0 433 171 156
DLLA 150 P 178	0 433 171 157
DLLA 150 P 199	0 433 171 168
DLLA 150 P 205	0 433 171 171
DLLA 150 P 212	9 430 394 401
DLLA 150 P 213	0 433 171 175
DLLA 150 P 214	0 433 171 176
DLLA 150 P 216	0 433 171 178
DLLA 150 P 217	0 433 171 179
DLLA 150 P 222	0 433 171 181

Typ	Ref.
DLLA 150 P 225/TR	0 433 171 183
DLLA 150 P 228	0 433 171 186
DLLA 150 P 232	0 433 171 190
DLLA 150 P 235	0 433 171 193
DLLA 150 P 242	0 433 171 196
DLLA 150 P 291	0 433 171 213
DLLA 150 P 299	0 433 171 216
DLLA 150 P 315	0 433 171 225
DLLA 150 P 324	0 433 171 229
DLLA 150 P 326	0 433 171 231
DLLA 150 P 345	0 433 171 246
DLLA 150 P 364	0 433 171 260
DLLA 150 P 407	0 433 171 290
DLLA 150 P 409	0 433 171 292
DLLA 150 P 421	0 433 171 300
DLLA 150 P 429	0 433 171 308
DLLA 150 P 434	0 433 171 312
DLLA 150 P 436	0 433 171 314
DLLA 150 P 476+	0 433 171 343
DLLA 150 P 481+	0 433 171 346
DLLA 150 P 487	0 433 171 351
DLLA 150 P 488	0 433 171 352
DLLA 150 P 497	0 433 171 359
DLLA 150 P 509	0 433 171 365
DLLA 150 P 524	0 433 171 387
DLLA 150 P 545/	0 433 171 403
DLLA 150 P 550	0 433 171 404
DLLA 150 P 552	0 433 171 405
DLLA 150 P 555	0 433 171 407
DLLA 150 P 558	0 433 171 410
DLLA 150 P 559	0 433 171 411
DLLA 150 P 573	0 433 171 434
DLLA 150 P 585	0 433 171 444
DLLA 150 P 589	0 433 171 447
DLLA 150 P 613	0 433 171 460
DLLA 150 P 615+	0 433 171 462
DLLA 150 P 635	0 433 171 470
DLLA 150 P 652	0 433 171 476
DLLA 150 P 673	0 433 171 488
DLLA 150 P 674	0 433 171 489
DLLA 150 P 675	0 433 171 490
DLLA 150 P 676	0 433 171 491
DLLA 150 P 677	0 433 171 492
DLLA 150 P 679	0 433 171 494
DLLA 150 P 711	0 433 171 521

... DLLA 153 P 700



DLLA 150 P 717	0 433 171 522
DLLA 150 P 718	0 433 171 523
DLLA 150 P 719	0 433 171 524
DLLA 150 P 722	0 433 171 525
DLLA 150 P 723	0 433 171 526

DLLA 150 P 724	0 433 171 527
DLLA 150 P 812	0 433 171 559
DLLA 150 P 847	0 433 171 575
DLLA 150 P 848	0 433 171 576
DLLA 150 P 878	F 000 430 307

DLLA 150 P 892	0 433 171 595
DLLA 150 P 898	0 433 171 598
DLLA 150 P 901	0 433 171 599
DLLA 150 P 913	0 433 171 607
DLLA 150 P 916	0 433 171 610

DLLA 150 P 930	0 433 171 620
DLLA 150 P 943	0 433 171 628
DLLA 150 P 952	0 433 171 632
DLLA 150 P 957	0 433 171 634
DLLA 150 P 983	0 433 171 643

DLLA 150 P 1008	0 433 171 651
DLLA 150 P 1011	0 433 171 654
DLLA 150 P 1012	0 433 171 655
DLLA 150 P 1023	0 433 171 674
DLLA 150 P 1053	0 433 171 684

DLLA 150 P 1054	0 433 171 685
DLLA 150 P 1057	0 433 171 687
DLLA 150 P 1064	0 433 171 691
DLLA 150 P 1065	0 433 171 692
DLLA 150 P 1076	0 433 171 699

DLLA 150 P 1110	0 433 171 711
DLLA 150 P 1120	0 433 171 724
DLLA 150 P 1151	2 437 010 137
DLLA 150 P 1163	0 433 171 740
DLLA 150 P 1164	0 433 171 741

DLLA 150 P 1171	0 433 171 745
DLLA 150 P 1197	0 433 171 755
DLLA 150 P 1205	0 433 171 760
DLLA 150 P 1207	0 433 171 762
DLLA 150 P 1224	0 433 171 774

DLLA 150 P 1239	0 433 171 786
DLLA 150 P 1244	0 433 171 789
DLLA 150 P 1245	0 433 171 790
DLLA 150 P 1269	0 433 171 799
DLLA 150 P 1274	0 433 171 801



DLLA 150 P 1285	0 433 171 808
DLLA 150 P 1298	0 433 171 813
DLLA 150 P 1325	0 433 171 825
DLLA 150 P 1345	0 433 171 836
DLLA 150 P 1351	0 433 171 841

DLLA 150 P 1352	0 433 171 842
DLLA 150 P 1373	0 433 171 853
DLLA 150 P 1410	0 433 171 884
DLLA 150 P 1437	0 433 171 889
DLLA 150 P 1451	0 433 171 899

DLLA 150 P 1464	0 433 171 908
DLLA 150 P 1467	0 433 171 910
DLLA 150 P 1471	0 433 171 914
DLLA 150 P 1487	0 433 171 919
DLLA 150 P 1511	0 433 171 932

DLLA 150 P 1512	0 433 171 933
DLLA 150 P 1557	0 433 171 960
DLLA 150 P 1564	0 433 171 963
DLLA 150 P 1566	0 433 171 965
DLLA 150 P 1606	0 433 171 980

DLLA 150 P 1614	0 433 171 986
DLLA 150 P 1666	0 433 172 022
DLLA 150 P 1712	0 433 172 049
DLLA 150 P 91/	0 433 171 117
DLLA 151 P 132	0 433 171 120

DLLA 151 P 503	0 433 171 362
DLLA 151 P 582	0 433 171 441
DLLA 151 P 939	0 433 171 622
DLLA 151 P 940	0 433 171 623
DLLA 151 P 941	0 433 171 624

DLLA 151 P 942	0 433 171 625
DLLA 151 P 1169	0 433 171 743
DLLA 151 P 1504	0 433 171 927
DLLA 152 P 73	0 433 171 073
DLLA 152 P 107	0 433 171 099

DLLA 152 P 152	0 433 171 136
DLLA 152 P 200	9 430 394 402
DLLA 152 P 285	0 433 171 210
DLLA 152 P 313	0 433 171 224
DLLA 152 P 335	0 433 171 237

DLLA 152 P 336	0 433 171 238
DLLA 152 P 339	0 433 171 241
DLLA 152 P 340	0 433 171 242
DLLA 152 P 347	0 433 171 247
DLLA 152 P 378	0 433 171 268



DLLA 152 P 398	0 433 171 283
DLLA 152 P 452	0 433 171 326
DLLA 152 P 486/	0 433 171 350
DLLA 152 P 496	0 433 171 358
DLLA 152 P 531	0 433 171 394

DLLA 152 P 566	0 433 171 414
DLLA 152 P 571	0 433 171 432
DLLA 152 P 660	0 433 171 480
DLLA 152 P 685	0 433 171 501
DLLA 152 P 790	0 433 171 553

DLLA 152 P 876	0 433 171 586
DLLA 152 P 877	0 433 171 587
DLLA 152 P 903	0 433 171 600
DLLA 152 P 932	0 433 171 621
DLLA 152 P 966	F 002 C40 007

DLLA 152 P 967	0 433 171 640
DLLA 152 P 996	0 433 171 646
DLLA 152 P 1075	0 433 171 698
DLLA 152 P 1077	0 433 171 700
DLLA 152 P 1081	0 433 171 703

DLLA 152 P 1084	0 433 171 705
DLLA 152 P 1094	0 433 171 707
DLLA 152 P 1104	0 433 171 709
DLLA 152 P 1215	0 433 171 764
DLLA 152 P 1231	0 433 171 781

DLLA 152 P 1286	0 433 171 809
DLLA 152 P 1349	0 433 171 840
DLLA 152 P 1454	0 433 171 901
DLLA 152 P 1459	0 433 171 903
DLLA 152 P 1466	0 433 171 909

DLLA 152 P 1507/	0 433 171 929
DLLA 152 P 1513	0 433 171 934
DLLA 152 P 1525	0 433 171 940
DLLA 152 P 1546	0 433 171 954
DLLA 152 P 1563	0 433 171 962

DLLA 152 P 1605	0 433 171 979
DLLA 152 P 1661	0 433 172 020
DLLA 152 P 1681	0 433 172 029
DLLA 152 P 1690	0 433 172 036
DLLA 153 P 352	0 433 171 248

DLLA 153 P 355	0 433 171 253
DLLA 153 P 356	0 433 171 254
DLLA 153 P 413	0 433 171 296
DLLA 153 P 526	0 433 171 389
DLLA 153 P 700	0 433 171 514



A50

de	en	fr	it	es
Typformel → Bestellnummer (Fortsetzung)	Type designation → Part number (continued)	Formule de type → Référence (suite)	Sigla → Numero d'ordinazione (seguito)	Designación del tipo → Número de pedido (continuación)

DLLA 153 P 743 ...



Typ	Ref.	Typ	Ref.	Typ	Ref.
DLLA 153 P 743	0 433 171 535	DLLA 155 P 51	0 433 171 051	DLLA 155 P 451	0 433 171 325
DLLA 153 P 810	0 433 171 557	DLLA 155 P 66	0 433 171 066	DLLA 155 P 511	0 433 171 367
DLLA 153 P 1080	0 433 171 702	DLLA 155 P 67	0 433 171 067	DLLA 155 P 534	0 433 171 396
DLLA 153 P 1090+	0 433 171 706	DLLA 155 P 70	0 433 171 070	DLLA 155 P 556	0 433 171 408
DLLA 153 P 1146	0 433 171 735	DLLA 155 P 74	0 433 171 074	DLLA 155 P 564	0 433 171 413
DLLA 153 P 1165	0 433 171 742	DLLA 155 P 82	0 433 171 080	DLLA 155 P 570	0 433 171 431
DLLA 153 P 1222	0 433 171 772	DLLA 155 P 101	0 433 171 096	DLLA 155 P 572	0 433 171 433
DLLA 153 P 1246	0 433 171 788	DLLA 155 P 111	0 433 171 101	DLLA 155 P 579+	0 433 171 438
DLLA 153 P 1270	0 433 171 800	DLLA 155 P 114	0 433 171 103	DLLA 155 P 614	0 433 171 461
DLLA 153 P 1322	0 433 171 823	DLLA 155 P 120	0 433 171 109	DLLA 155 P 657	0 433 171 465
DLLA 153 P 1378	0 433 171 856	DLLA 155 P 125	0 433 171 113	DLLA 155 P 665	0 433 171 484
DLLA 153 P 1450	0 433 171 898	DLLA 155 P 135	0 433 171 123	DLLA 155 P 670	0 433 171 487
DLLA 153 P 1455	0 433 171 902	DLLA 155 P 141	0 433 171 129	DLLA 155 P 686	0 433 171 502
DLLA 153 P 1463	0 433 171 907	DLLA 155 P 146	0 433 171 132	DLLA 155 P 699	0 433 171 513
DLLA 153 P 1494	0 433 171 922	DLLA 155 P 156	0 433 171 138	DLLA 155 P 742	0 433 171 534
DLLA 153 P 1600	0 433 171 976	DLLA 155 P 157	0 433 171 140	DLLA 155 P 765	0 433 171 545
DLLA 153 P 1608	0 433 171 982	DLLA 155 P 172	0 433 171 152	DLLA 155 P 767	0 433 171 546
DLLA 153 P 1609	0 433 171 983	DLLA 155 P 179	0 433 171 158	DLLA 155 P 796	0 433 171 554
DLLA 153 P 1721	0 433 172 056	DLLA 155 P 215	0 433 171 177	DLLA 155 P 811	0 433 171 558
DLLA 154 P 206	0 433 171 172	DLLA 155 P 223	0 433 171 170	DLLA 155 P 822	0 433 171 562
DLLA 154 P 316	0 433 171 226	DLLA 155 P 230	0 433 171 188	DLLA 155 P 859	0 433 171 581
DLLA 154 P 397	0 433 171 282	DLLA 155 P 231	0 433 171 189	DLLA 155 P 872	0 433 171 584
DLLA 154 P 458	0 433 171 331	DLLA 155 P 248	0 433 171 199	DLLA 155 P 885	0 433 171 592
DLLA 154 P 474	0 433 171 342	DLLA 155 P 270	0 433 171 204	DLLA 155 P 1052	0 433 171 683
DLLA 154 P 525	0 433 171 388	DLLA 155 P 273	0 433 171 205	DLLA 155 P 1063+	0 433 171 690
DLLA 154 P 557	0 433 171 409	DLLA 155 P 274	0 433 171 206	DLLA 155 P 1078	0 433 171 701
DLLA 154 P 596	0 433 171 450	DLLA 155 P 275	0 433 171 207	DLLA 155 P 1108	0 433 171 713
DLLA 154 P 709	0 433 171 520	DLLA 155 P 277	0 433 171 208	DLLA 155 P 1138	0 433 171 731
DLLA 154 P 771	0 433 171 548	DLLA 155 P 283	0 433 171 209	DLLA 155 P 1152	0 433 171 737
DLLA 154 P 857	0 433 171 580	DLLA 155 P 302	0 433 171 218	DLLA 155 P 1159	0 433 171 739
DLLA 154 P 866	0 433 171 583	DLLA 155 P 304	0 433 171 219	DLLA 155 P 1258	0 433 171 793
DLLA 154 P 965	0 433 171 639	DLLA 155 P 306	0 433 171 221	DLLA 155 P 1301	0 433 171 814
DLLA 154 P 1137	0 433 171 730	DLLA 155 P 307	0 433 171 222	DLLA 155 P 1492	0 433 171 920
DLLA 154 P 1204	0 433 171 759	DLLA 155 P 343	0 433 171 244	DLLA 155 P 1493	0 433 171 921
DLLA 154 P 1206	0 433 171 761	DLLA 155 P 358	0 433 171 255	DLLA 155 P 1514	0 433 171 935
DLLA 154 P 1225	0 433 171 775	DLLA 155 P 359	0 433 171 256	DLLA 155 P 1674	0 433 172 026
DLLA 154 P 1319	0 433 171 821	DLLA 155 P 383	0 433 171 270	DLLA 156 P 750	0 433 171 537
DLLA 154 P 1324	0 433 171 824	DLLA 155 P 386	0 433 171 273	DLLA 156 P 819	0 433 171 561
DLLA 154 P 1326	0 433 171 826	DLLA 155 P 387	0 433 171 274	DLLA 156 P 828+	0 433 171 566
DLLA 154 P 1346	0 433 171 837	DLLA 155 P 388	0 433 171 275	DLLA 156 P 850	0 433 171 578
DLLA 154 P 1418	0 433 171 879	DLLA 155 P 440	0 433 171 318	DLLA 156 P 889	0 433 171 594
DLLA 154 P 1469	0 433 171 911	DLLA 155 P 441	0 433 171 319	DLLA 156 P 897+	0 433 171 597
DLLA 154 P 1538	0 433 171 948	DLLA 155 P 444	0 433 171 320	DLLA 156 P 963+	0 433 171 637
DLLA 154 P 1680	0 433 172 028	DLLA 155 P 445	0 433 171 321	DLLA 156 P 980	0 433 171 642
DLLA 155 P 5	0 433 171 006	DLLA 155 P 447	0 433 171 322	DLLA 156 P 1059	0 433 171 688

... DLLA 25 S 601



DLLA 156 P 1107	0 433 171 712
DLLA 156 P 1111	0 433 171 718
DLLA 156 P 1114	0 433 171 719
DLLA 156 P 1265	0 433 171 798
DLLA 156 P 1367	0 433 171 847

DLLA 156 P 1368	0 433 171 848
DLLA 156 P 1419	0 433 171 880
DLLA 156 P 1473	0 433 171 913
DLLA 156 P 1509	0 433 171 931
DLLA 156 P 1626	0 433 171 994

DLLA 156 P 1627	0 433 171 995
DLLA 157 P 494	0 433 171 356
DLLA 157 P 888	0 433 171 593
DLLA 157 P 1424	0 433 171 886
DLLA 157 P 1425	0 433 171 887

DLLA 157 P 1649	F 000 430 311
DLLA 158 P 161	0 433 171 144
DLLA 158 P 165	0 433 171 148
DLLA 158 P 168	0 433 171 151
DLLA 158 P 454	0 433 171 327

DLLA 158 P 455	0 433 171 328
DLLA 158 P 456/	0 433 171 329
DLLA 158 P 457	0 433 171 330
DLLA 158 P 484	0 433 171 348
DLLA 158 P 584	0 433 171 443

DLLA 158 P 587	0 433 171 446
DLLA 158 P 651	0 433 171 475
DLLA 158 P 678	0 433 171 493
DLLA 158 P 684	0 433 171 496
DLLA 158 P 691	0 433 171 506

DLLA 158 P 728	0 433 171 528
DLLA 158 P 729	0 433 171 529
DLLA 158 P 730	0 433 171 530
DLLA 158 P 914	0 433 171 608
DLLA 158 P 1039	0 433 171 678

DLLA 158 P 1106	0 433 171 717
DLLA 158 P 1116	0 433 171 720
DLLA 158 P 1117	0 433 171 721
DLLA 158 P 1118	0 433 171 722
DLLA 158 P 1128	0 433 171 727

DLLA 158 P 1216	0 433 171 766
DLLA 158 P 1226	0 433 171 776
DLLA 158 P 1227	0 433 171 777
DLLA 158 P 1234	0 433 171 783
DLLA 158 P 1281	0 433 171 805



DLLA 158 P 1305	0 433 171 815
DLLA 158 P 1385	0 433 171 860
DLLA 158 P 1392	0 433 171 864
DLLA 158 P 1500	0 433 171 924
DLLA 159 P 636	0 433 171 471

DLLA 159 P 638	0 433 171 473
DLLA 159 P 1611	0 433 171 985
DLLA 160 P 3	9 430 034 102
DLLA 160 P 9	0 433 171 010
DLLA 160 P 35	0 433 171 036

DLLA 160 P 50	9 430 034 107
DLLA 160 P 54	0 433 171 054
DLLA 160 P 57	0 433 171 057
DLLA 160 P 58	0 433 171 058
DLLA 160 P 63	0 433 171 063

DLLA 160 P 85	0 433 171 082
DLLA 160 P 90	0 433 171 086
DLLA 160 P 171	0 433 171 153
DLLA 160 P 209	0 433 171 173
DLLA 160 P 317	0 433 171 227

DLLA 160 P 382	0 433 171 269
DLLA 160 P 469	0 433 171 338
DLLA 160 P 473	0 433 171 341
DLLA 160 P 532	0 433 171 395
DLLA 160 P 577	0 433 171 436

DLLA 160 P 595	0 433 171 449
DLLA 160 P 634	0 433 171 469
DLLA 160 P 664	0 433 171 483
DLLA 160 P 692	0 433 171 507
DLLA 160 P 1032+	0 433 171 676

DLLA 160 P 1262	0 433 171 796
DLLA 160 P 1307	0 433 171 816
DLLA 160 P 1308	0 433 171 817
DLLA 160 P 1384	0 433 171 857
DLLA 160 P 1395	0 433 171 865

DLLA 160 P 1415	0 433 171 877
DLLA 160 P 1650	0 433 172 012
DLLA 162 P 1408	0 433 171 874
DLLA 162 P 1443	0 433 171 891
DLLA 166 P 1005	0 433 171 649

DLLA 166 P 1036	0 433 171 677
DLLA 166 P 1217	0 433 171 767
DLLA 168 P 426	0 433 171 306
DLLA 168 P 751	0 433 171 538
DLLA 168 P 1006	0 433 171 650



DLLA 170 P 260	0 433 171 203
DLLA 170 P 338	0 433 171 240
DLLA 175 P 270	0 433 175 779

DLLA ... PN ...

DLLA 154 PN 58	9 430 034 110
DLLA 154 PN 067	9 430 034 119
DLLA 157 PN 069	9 430 034 120

DLLA ... S ...

DLLA 10 S 134	0 433 271 001
DLLA 10 S 286	0 433 271 099
DLLA 10 S 400	0 433 271 168

DLLA 16 S 621	0 433 271 302
DLLA 17 S 301	0 433 271 115
DLLA 17 S 462	0 433 271 210
DLLA 18 S 300	0 433 271 109
DLLA 18 S 341	0 433 271 131

DLLA 18 S 384	0 433 271 156
DLLA 19 S 132	0 433 271 002
DLLA 20 S 81	0 433 271 003
DLLA 20 S 99	0 433 271 004
DLLA 20 S 102	0 433 271 005

DLLA 20 S 110	0 433 271 006
DLLA 20 S 131	0 433 271 007
DLLA 22 S 247	0 433 271 076
DLLA 22 S 284	0 433 271 098
DLLA 22 S 573	0 433 271 273

DLLA 23 S 155	0 433 271 008
DLLA 23 S 155	9 430 034 294
DLLA 23 S 179	0 433 271 042
DLLA 23 S 191	0 433 271 049
DLLA 23 S 195	0 433 271 051

DLLA 23 S 363	0 433 271 141
DLLA 23 S 383	0 433 271 155
DLLA 24 S 584	0 433 271 282
DLLA 24 S 745	0 433 271 363
DLLA 24 S 1127	0 433 271 505

DLLA 25 S 64	0 433 271 009
DLLA 25 S 86	0 433 271 010
DLLA 25 S 109	0 433 271 011
DLLA 25 S 116	0 433 271 012
DLLA 25 S 601	0 433 271 293









A52

de	en	fr	it	es
Typformel → Bestellnummer (Fortsetzung)	Type designation → Part number (continued)	Formule de type → Référence (suite)	Sigla → Numero d'ordinazione (seguito)	Designación del tipo → Número de pedido (continuación)

DLLA 25 S 614 ...



 Typ	 Ref.	 Typ	 Ref.	 Typ	 Ref.
DLLA 25 S 614	0 433 271 297	DLLA 31 S 955	0 433 271 463	DLLA 123 S 1372	0 433 272 965
DLLA 25 S 627	0 433 271 306	DLLA 31 S 1014	0 433 271 476	DLLA 124 S 963	0 433 271 796
DLLA 25 S 722	0 433 271 355	DLLA 31 S 1079	0 433 271 497	DLLA 124 S 1001	0 433 271 774
DLLA 26 S 263	0 433 271 082	DLLA 31 S 1138	0 433 271 509	DLLA 124 S 1293	9 433 391 000
DLLA 26 S 743	0 433 271 362	DLLA 32 S 330	0 433 271 126	DLLA 124 S 1365	0 433 272 968
DLLA 26 S 810	0 433 271 412	DLLA 32 S 365	0 433 271 142	DLLA 125 S 294	0 433 271 105
DLLA 27 S 50	0 433 271 013	DLLA 32 S 759	0 433 271 370	DLLA 125 S 1278	0 433 271 634
DLLA 27 S 51	0 433 271 014	DLLA 32 S 900	0 433 271 445	DLLA 125 S 1279	0 433 271 633
DLLA 27 S 74	0 433 271 015	DLLA 33 S 894	0 433 271 443	DLLA 128 S 1028	0 433 271 485
DLLA 27 S 88	0 433 271 016	DLLA 34 S 749	0 433 271 365	DLLA 130 S 233	0 433 271 080
DLLA 27 S 198	0 433 271 053	DLLA 34 S 776	0 433 271 378	DLLA 130 S 1183	0 433 271 689
DLLA 27 S 408	0 433 271 174	DLLA 34 S 837	0 433 271 421	DLLA 131 S 1035	0 433 271 486
DLLA 27 S 420	0 433 271 182	DLLA 34 S 876	0 433 271 435	DLLA 131 S 1035+/ D	0 433 272 012
DLLA 27 S 474	0 433 271 216	DLLA 35 S 161	0 433 271 021	DLLA 131 S 1131	0 433 271 507
DLLA 27 S 512	0 433 271 233	DLLA 35 S 175	0 433 271 041	DLLA 132 S 981	0 433 271 784
DLLA 27 S 517	0 433 271 238	DLLA 35 S 189	0 433 271 047	DLLA 132 S 999	0 433 271 776
DLLA 27 S 613	0 433 271 296	DLLA 35 S 218	0 433 271 064	DLLA 132 S 1227	0 433 271 662
DLLA 28 S 279	0 433 271 096	DLLA 35 S 244	0 433 271 073	DLLA 132 S 1320	0 433 272 997
DLLA 28 S 297	0 433 271 106	DLLA 35 S 262	0 433 271 081	DLLA 132 S 1335	0 433 272 987
DLLA 28 S 310	0 433 271 117	DLLA 35 S 376	0 433 271 150	DLLA 132 S 1384	0 433 272 963
DLLA 28 S 312	0 433 271 118	DLLA 35 S 377	0 433 271 151	DLLA 132 S 1398	0 433 272 961
DLLA 28 S 414	0 433 271 177	DLLA 35 S 387	0 433 271 158	DLLA 132 S 1400	0 433 272 960
DLLA 28 S 415	0 433 271 178	DLLA 35 S 812	0 433 271 413	DLLA 134 S 999	0 433 271 471
DLLA 28 S 425	0 433 271 186	DLLA 35 S 855	0 433 271 426	DLLA 134 S 999+/ D	0 433 271 589
DLLA 28 S 441	0 433 271 201	DLLA 35 S 918	0 433 271 453	DLLA 134 S 1113	0 433 271 719
DLLA 28 S 451	0 433 271 202	DLLA 35 S 941	0 433 271 457	DLLA 134 S 1119	0 433 271 503
DLLA 28 S 516	0 433 271 237	DLLA 35 S 1190	0 433 271 520	DLLA 134 S 1143	0 433 271 510
DLLA 28 S 589	0 433 271 285	DLLA 35 S 2180	0 433 271 078	DLLA 134 S 1150	0 433 271 513
DLLA 28 S 600	0 433 271 292	DLLA 36 S 276	0 433 271 094	DLLA 134 S 1155	0 433 271 705
DLLA 28 S 656	0 433 271 322	DLLA 38 S 133	0 433 271 022	DLLA 134 S 1197	0 433 271 523
DLLA 28 S 863	0 433 271 429	DLLA 38 S 208	0 433 271 060	DLLA 134 S 1199	0 433 271 524
DLLA 28 S 892	0 433 271 442	DLLA 38 S 293	0 433 271 104	DLLA 134 S 1199+/ D	0 433 271 588
DLLA 30 S 50	0 433 271 017	DLLA 38 S 367	0 433 271 144	DLLA 134 S 1201	0 433 271 680
DLLA 30 S 51	0 433 271 018	DLLA 38 S 541	0 433 271 252	DLLA 134 S 1284	0 433 271 571
DLLA 30 S 69	0 433 271 019	DLLA 54 S 228	0 433 271 122	DLLA 134 S 1284+/ D	0 433 271 590
DLLA 30 S 98	0 433 271 020	DLLA 63 S 447	0 433 271 198	DLLA 135 S 76	0 433 271 023
DLLA 30 S 678	0 433 271 334	DLLA 79 S 246	0 433 271 075	DLLA 135 S 664	0 433 271 326
DLLA 30 S 757	0 433 271 368	DLLA 79 S 390	0 433 271 160	DLLA 135 S 685	0 433 271 339
DLLA 30 S 763	0 433 271 372	DLLA 79 S 800	0 433 271 408	DLLA 135 S 1309	0 433 271 602
DLLA 30 S 877	0 433 271 436	DLLA 82 S 299	0 433 271 108	DLLA 136 S 943	0 433 271 740
DLLA 30 S 888	0 433 271 439	DLLA 82 S 391	0 433 271 159	DLLA 136 S 943	0 433 271 801
DLLA 30 S 931	0 433 271 461	DLLA 87 S 196	0 433 271 052	DLLA 136 S 964	0 433 271 795
DLLA 30 S 1009	0 433 271 474	DLLA 110 S 271	0 433 271 087	DLLA 136 S 1000	0 433 271 775
DLLA 31 S 915	0 433 271 452	DLLA 110 S 335	0 433 271 128	DLLA 136 S 1002	0 433 271 773
DLLA 31 S 921	0 433 271 454	DLLA 110 S 409	0 433 271 175	DLLA 136 S 1020	0 433 271 768

... DLLA 145 S 359



DLLA 136 S 1031	0 433 271 762
DLLA 136 S 1034	0 433 271 487
DLLA 136 S 1034+/ /	0 433 271 591
DLLA 136 S 1043	0 433 271 495
DLLA 136 S 1094	0 433 271 499

DLLA 136 S 1102	0 433 271 725
DLLA 136 S 1147	0 433 271 511
DLLA 136 S 1182	0 433 271 519
DLLA 136 S 1268	0 433 271 643
DLLA 136 S 1289	0 433 271 627

DLLA 137 S 1154	0 433 271 706
DLLA 137 S 1157	0 433 271 515
DLLA 137 S 1171	0 433 271 697
DLLA 137 S 1174	0 433 271 695
DLLA 137 S 1208	0 433 271 674

DLLA 138 S 983	0 433 271 783
DLLA 138 S 1112	0 433 271 720
DLLA 138 S 1191	0 433 271 521
DLLA 138 S 1191+/ /	0 433 271 587
DLLA 139 S 1235	0 433 271 529

DLLA 140 S 233	0 433 271 069
DLLA 140 S 242	0 433 271 116
DLLA 140 S 254	0 433 271 172
DLLA 140 S 289	0 433 271 101
DLLA 140 S 305	0 433 271 112

DLLA 140 S 307	0 433 271 113
DLLA 140 S 328	0 433 271 124
DLLA 140 S 338	0 433 271 204
DLLA 140 S 360	0 433 271 138
DLLA 140 S 379	0 433 271 153

DLLA 140 S 460	0 433 271 208
DLLA 140 S 499	0 433 271 227
DLLA 140 S 563	0 433 271 266
DLLA 140 S 567	0 433 271 269
DLLA 140 S 597	0 433 271 290

DLLA 140 S 619	0 433 271 301
DLLA 140 S 635	0 433 271 311
DLLA 140 S 637	0 433 271 313
DLLA 140 S 638	0 433 271 314
DLLA 140 S 677	0 433 271 333

DLLA 140 S 694/EE	0 433 271 341
DLLA 140 S 696	0 433 271 889
DLLA 140 S 726	0 433 271 357
DLLA 140 S 738	0 433 271 360
DLLA 140 S 752	0 433 271 367



DLLA 140 S 786	0 433 271 395
DLLA 140 S 827	0 433 271 843
DLLA 140 S 976	0 433 271 788
DLLA 140 S 1003	0 433 271 478
DLLA 140 S 1003+/ /	0 433 271 593

DLLA 140 S 1017	0 433 271 480
DLLA 140 S 1021	0 433 271 767
DLLA 140 S 1038	0 433 271 760
DLLA 140 S 1039	0 433 271 759
DLLA 140 S 1054	0 433 271 756

DLLA 140 S 1068	0 433 271 744
DLLA 140 S 1069	0 433 271 743
DLLA 140 S 1075	0 433 271 741
DLLA 140 S 1099	0 433 271 727
DLLA 140 S 1100	0 433 271 501

DLLA 140 S 1109	0 433 271 722
DLLA 140 S 1110	0 433 271 721
DLLA 140 S 1116	0 433 271 718
DLLA 140 S 1117	0 433 271 717
DLLA 140 S 1121	0 433 271 716

DLLA 140 S 1140	0 433 271 713
DLLA 140 S 1186	0 433 271 687
DLLA 140 S 1187	0 433 271 686
DLLA 140 S 1193	0 433 271 682
DLLA 140 S 1198	0 433 271 681

DLLA 140 S 1217	0 433 271 668
DLLA 140 S 1232	0 433 271 658
DLLA 140 S 1236	0 433 271 530
DLLA 140 S 1242	0 433 271 654
DLLA 140 S 1252	0 433 271 646

DLLA 140 S 1282	0 433 271 630
DLLA 140 S 1386	F 002 C30 134
DLLA 141 S 662	0 433 271 325
DLLA 142 S 655	0 433 271 321
DLLA 142 S 791	0 433 271 403

DLLA 142 S 792	0 433 271 404
DLLA 142 S 897	0 433 271 813
DLLA 142 S 897	9 430 034 291
DLLA 142 S 924	0 433 271 805
DLLA 142 S 926	0 433 271 466

DLLA 142 S 926	0 433 271 483
DLLA 142 S 947	0 433 271 800
DLLA 142 S 980	0 433 271 785
DLLA 142 S 1025	9 430 034 245
DLLA 142 S 1033	9 430 034 246



DLLA 142 S 1096	0 433 271 502
DLLA 142 S 1173	0 433 271 518
DLLA 142 S 1188	0 433 271 685
DLLA 142 S 1189	0 433 271 684
DLLA 142 S 1224	0 433 271 527

DLLA 142 S 1256	9 430 034 717
DLLA 142 S 1257	0 433 271 534
DLLA 142 S 1269	0 433 271 536
DLLA 142 S 1317	F 002 C30 100
DLLA 142 S 1333	F 002 C30 004

DLLA 142 S 1350	F 002 C30 110
DLLA 143 S 1249	0 433 271 648
DLLA 143 S 1292	0 433 271 626
DLLA 143 S 1302	0 433 271 616
DLLA 144 S 485	0 433 271 221

DLLA 144 S 485+/ /	0 433 271 594
DLLA 144 S 488	0 433 271 222
DLLA 144 S 747	0 433 271 366
DLLA 144 S 747	0 433 271 456
DLLA 144 S 808	0 433 271 410

DLLA 144 S 820	0 433 271 414
DLLA 144 S 829	0 433 271 423
DLLA 144 S 829/ /	0 433 271 469
DLLA 144 S 829+/ /	0 433 271 592
DLLA 144 S 842	0 433 271 835

DLLA 144 S 889	0 433 271 817
DLLA 144 S 982	0 433 271 467
DLLA 144 S 992	0 433 271 781
DLLA 144 S 1037	0 433 271 489
DLLA 144 S 1037/ /	0 433 271 490

DLLA 144 S 1167	0 433 271 700
DLLA 144 S 1262	0 433 271 645
DLLA 144 S 1275	0 433 271 636
DLLA 144 S 5457	0 433 272 959
DLLA 144 S 8200	0 433 271 447

DLLA 145 S 101	0 433 271 147
DLLA 145 S 170	0 433 271 039
DLLA 145 S 199	0 433 271 055
DLLA 145 S 224	0 433 271 145
DLLA 145 S 234	0 433 271 070

DLLA 145 S 240	0 433 271 146
DLLA 145 S 277	0 433 271 095
DLLA 145 S 314	0 433 271 121
DLLA 145 S 322	0 433 271 120
DLLA 145 S 359	0 433 271 137



A54

de

**Typformel →
Bestellnummer**
(Fortsetzung)

en

**Type designation →
Part number**
(continued)

fr

**Formule de type →
Référence**
(suite)

it

**Sigla → Numero
d'ordinazione**
(seguito)

es

**Designación del tipo
→ Número de pedido**
(continuación)

DLLA 145 S 362 ...



Typ	Ref.
-----	------

DLLA 145 S 362	0 433 271 140
DLLA 145 S 374	0 433 271 148
DLLA 145 S 445	0 433 271 197
DLLA 145 S 448	0 433 271 199
DLLA 145 S 507	0 433 271 231
DLLA 145 S 525	0 433 271 243
DLLA 145 S 556	0 433 271 264
DLLA 145 S 768	0 433 271 862
DLLA 145 S 770	0 433 271 375
DLLA 145 S 785	0 433 271 860
DLLA 145 S 847	0 433 271 424
DLLA 145 S 886	0 433 271 818
DLLA 145 S 944/	0 433 271 458
DLLA 145 S 945	0 433 271 459
DLLA 145 S 1005	0 433 271 772
DLLA 145 S 1018	0 433 271 481
DLLA 145 S 1019	0 433 271 482
DLLA 145 S 1023	0 433 271 765
DLLA 145 S 1059	0 433 271 753
DLLA 145 S 1090	0 433 271 498
DLLA 145 S 1097	0 433 271 729
DLLA 145 S 1101	0 433 271 726
DLLA 145 S 1160	0 433 271 703
DLLA 145 S 1161	0 433 271 702
DLLA 145 S 1169	0 433 271 698
DLLA 145 S 1172	0 433 271 696
DLLA 145 S 1176	0 433 271 693
DLLA 145 S 1179	0 433 271 692
DLLA 145 S 1206	0 433 271 676
DLLA 145 S 1218	0 433 271 667
DLLA 145 S 1244	0 433 271 653
DLLA 145 S 1330	0 433 272 004
DLLA 145 S 1360	F 002 C30 117
DLLA 145 S 1367	0 433 272 967
DLLA 145 S 1368	0 433 272 966
DLLA 146 S 398	0 433 271 166
DLLA 146 S 404	0 433 271 171
DLLA 146 S 890	0 433 271 816
DLLA 146 S 910	0 433 271 449
DLLA 146 S 1007	0 433 271 472
DLLA 146 S 1175	0 433 271 694
DLLA 146 S 1212	9 430 034 704
DLLA 146 S 1239	0 433 271 531
DLLA 146 S 1243	9 430 034 712
DLLA 146 S 1245	0 433 271 652

Typ	Ref.
-----	------

DLLA 146 S 1250	0 433 271 647
DLLA 146 S 1310	0 433 271 601
DLLA 146 S 1357	F 002 C30 115
DLLA 146 S 1378	0 433 272 964
DLLA 147 S 449	0 433 271 200
DLLA 147 S 969	0 433 271 792
DLLA 148 S 470	0 433 271 215
DLLA 148 S 862	0 433 271 428
DLLA 148 S 885	0 433 271 819
DLLA 148 S 909	0 433 271 448
DLLA 148 S 1026	0 433 271 484
DLLA 148 S 1058	0 433 271 754
DLLA 148 S 1076	0 433 271 739
DLLA 148 S 1089	0 433 271 732
DLLA 148 S 1098	0 433 271 728
DLLA 148 S 1145	0 433 271 711
DLLA 148 S 1196	0 433 271 522
DLLA 148 S 1203	0 433 271 679
DLLA 148 S 1204	0 433 271 678
DLLA 148 S 1214	0 433 271 671
DLLA 148 S 1226	0 433 271 663
DLLA 148 S 1228	0 433 271 661
DLLA 148 S 1263	0 433 271 644
DLLA 148 S 1272	0 433 271 638
DLLA 148 S 1298	0 433 271 624
DLLA 148 S 1337	0 433 272 005
DLLA 148 S 1369	F 002 C30 122
DLLA 148 S 1376	F 002 C30 127
DLLA 148 S 1379	0 433 272 036
DLLA 148 S 1380	0 433 272 037
DLLA 149 S 394	0 433 271 162
DLLA 149 S 490	0 433 271 223
DLLA 149 S 576	0 433 271 276
DLLA 149 S 668	9 430 034 210
DLLA 149 S 715	0 433 271 349
DLLA 149 S 774	0 433 271 376
DLLA 149 S 775	0 433 271 377
DLLA 149 S 1152	0 433 271 708
DLLA 149 S 1207	0 433 271 675
DLLA 149 S 1209	0 433 271 673
DLLA 149 S 1225	0 433 271 664
DLLA 150 S 52	0 433 271 024
DLLA 150 S 80	0 433 271 025
DLLA 150 S 85	0 433 271 026
DLLA 150 S 111	0 433 271 027

Typ	Ref.
-----	------

DLLA 150 S 112	0 433 271 028
DLLA 150 S 120	0 433 271 029
DLLA 150 S 138	0 433 271 030
DLLA 150 S 139	0 433 271 031
DLLA 150 S 140	0 433 271 032
DLLA 150 S 153	0 433 271 037
DLLA 150 S 160	0 433 271 033
DLLA 150 S 164	0 433 271 034
DLLA 150 S 165	0 433 271 035
DLLA 150 S 178	0 433 271 043
DLLA 150 S 183	0 433 271 044
DLLA 150 S 186	0 433 271 045
DLLA 150 S 187	0 433 271 046
DLLA 150 S 187 HB-21	9 430 034 243
DLLA 150 S 190	0 433 271 048
DLLA 150 S 201	0 433 271 056
DLLA 150 S 203	0 433 271 057
DLLA 150 S 204	0 433 271 058
DLLA 150 S 207	0 433 271 059
DLLA 150 S 212	0 433 271 061
DLLA 150 S 216	0 433 271 063
DLLA 150 S 220	0 433 271 065
DLLA 150 S 223	0 433 271 067
DLLA 150 S 225	0 433 271 068
DLLA 150 S 236	0 433 271 071
DLLA 150 S 239	0 433 271 072
DLLA 150 S 245	0 433 271 074
DLLA 150 S 249	0 433 271 077
DLLA 150 S 254	0 433 271 093
DLLA 150 S 257	0 433 271 127
DLLA 150 S 265	0 433 271 083
DLLA 150 S 266	0 433 271 085
DLLA 150 S 268	0 433 271 089
DLLA 150 S 269	0 433 271 086
DLLA 150 S 273	0 433 271 090
DLLA 150 S 274	0 433 271 092
DLLA 150 S 280	0 433 271 097
DLLA 150 S 288	0 433 271 100
DLLA 150 S 290	0 433 271 102
DLLA 150 S 292	0 433 271 103
DLLA 150 S 298	0 433 271 107
DLLA 150 S 323	0 433 271 123
DLLA 150 S 329	0 433 271 125
DLLA 150 S 337	0 433 271 129
DLLA 150 S 338	0 433 271 130

... DLLA 150 S 868



DLLA 150 S 345	0 433 271 132
DLLA 150 S 351	0 433 271 133
DLLA 150 S 355	0 433 271 134
DLLA 150 S 357	0 433 271 135
DLLA 150 S 374	9 430 034 703

DLLA 150 S 375	0 433 271 149
DLLA 150 S 381	0 433 271 154
DLLA 150 S 386	0 433 271 157
DLLA 150 S 392	0 433 271 161
DLLA 150 S 394	0 433 271 407

DLLA 150 S 395	0 433 271 163
DLLA 150 S 396	0 433 271 164
DLLA 150 S 402	0 433 271 169
DLLA 150 S 407	0 433 271 173
DLLA 150 S 413	0 433 271 176

DLLA 150 S 417	0 433 271 180
DLLA 150 S 419	0 433 271 181
DLLA 150 S 421	0 433 271 183
DLLA 150 S 422	0 433 271 184
DLLA 150 S 423	0 433 271 185

DLLA 150 S 427	0 433 271 187
DLLA 150 S 428	0 433 271 188
DLLA 150 S 429	0 433 271 189
DLLA 150 S 430	0 433 271 190
DLLA 150 S 436	0 433 271 191

DLLA 150 S 437	0 433 271 192
DLLA 150 S 442	0 433 271 195
DLLA 150 S 455	0 433 271 203
DLLA 150 S 456	0 433 271 205
DLLA 150 S 458	0 433 271 206

DLLA 150 S 459	0 433 271 207
DLLA 150 S 465	0 433 271 211
DLLA 150 S 467	0 433 271 212
DLLA 150 S 468	0 433 271 213
DLLA 150 S 469	0 433 271 214

DLLA 150 S 475	0 433 271 217
DLLA 150 S 494	0 433 271 224
DLLA 150 S 495	0 433 271 225
DLLA 150 S 496	0 433 271 226
DLLA 150 S 501	0 433 271 229

DLLA 150 S 506	0 433 271 230
DLLA 150 S 513	0 433 271 234
DLLA 150 S 514	0 433 271 235
DLLA 150 S 515	0 433 271 236
DLLA 150 S 521	0 433 271 240



DLLA 150 S 523	0 433 271 241
DLLA 150 S 527	0 433 271 245
DLLA 150 S 547	0 433 271 257
DLLA 150 S 548	0 433 271 258
DLLA 150 S 549	0 433 271 259

DLLA 150 S 550	0 433 271 260
DLLA 150 S 552	0 433 271 262
DLLA 150 S 565	0 433 271 267
DLLA 150 S 569	0 433 271 271
DLLA 150 S 570	0 433 271 272

DLLA 150 S 582	0 433 271 280
DLLA 150 S 583	0 433 271 281
DLLA 150 S 588	0 433 271 284
DLLA 150 S 607	0 433 271 294
DLLA 150 S 615	0 433 271 298

DLLA 150 S 616	0 433 271 299
DLLA 150 S 618	0 433 271 300
DLLA 150 S 628	0 433 271 307
DLLA 150 S 633	0 433 271 309
DLLA 150 S 634	0 433 271 310

DLLA 150 S 650	0 433 271 317
DLLA 150 S 653	0 433 271 319
DLLA 150 S 666	0 433 271 327
DLLA 150 S 669	0 433 271 328
DLLA 150 S 671	0 433 271 329

DLLA 150 S 673	0 433 271 330
DLLA 150 S 679	0 433 271 335
DLLA 150 S 682/	0 433 271 336
DLLA 150 S 683	0 433 271 337
DLLA 150 S 689	0 433 271 892

DLLA 150 S 690	0 433 271 891
DLLA 150 S 693	9 430 034 212
DLLA 150 S 700	0 433 271 887
DLLA 150 S 702	0 433 271 888
DLLA 150 S 704	0 433 271 885

DLLA 150 S 708	0 433 271 345
DLLA 150 S 709	0 433 271 354
DLLA 150 S 714	0 433 271 348
DLLA 150 S 716	0 433 271 882
DLLA 150 S 717	0 433 271 881

DLLA 150 S 718	0 433 271 353
DLLA 150 S 720	0 433 271 036
DLLA 150 S 724	0 433 271 356
DLLA 150 S 725	0 433 271 880
DLLA 150 S 728	0 433 271 879



DLLA 150 S 731	0 433 271 877
DLLA 150 S 737	0 433 271 875
DLLA 150 S 739	0 433 271 874
DLLA 150 S 741	0 433 271 873
DLLA 150 S 748	0 433 271 871

DLLA 150 S 750	0 433 271 870
DLLA 150 S 753	0 433 271 868
DLLA 150 S 754	0 433 271 867
DLLA 150 S 758	0 433 271 369
DLLA 150 S 761	0 433 271 371

DLLA 150 S 762	0 433 271 865
DLLA 150 S 764	0 433 271 373
DLLA 150 S 767	0 433 271 863
DLLA 150 S 777	0 433 271 379
DLLA 150 S 781	0 433 271 394

DLLA 150 S 788/	0 433 271 397
DLLA 150 S 789	0 433 271 859
DLLA 150 S 793	0 433 271 398
DLLA 150 S 796	0 433 271 402
DLLA 150 S 798	0 433 271 857

DLLA 150 S 804	0 433 271 856
DLLA 150 S 806	0 433 271 855
DLLA 150 S 809	0 433 271 411
DLLA 150 S 815	0 433 271 849
DLLA 150 S 816	0 433 271 848

DLLA 150 S 823	0 433 271 415
DLLA 150 S 824	0 433 271 417
DLLA 150 S 825	0 433 271 418
DLLA 150 S 826	0 433 271 844
DLLA 150 S 828	0 433 271 842

DLLA 150 S 830	0 433 271 841
DLLA 150 S 836	0 433 271 838
DLLA 150 S 838/	0 433 271 837
DLLA 150 S 839	0 433 271 836
DLLA 150 S 841	0 433 271 422

DLLA 150 S 843	0 433 271 834
DLLA 150 S 849	0 433 271 832
DLLA 150 S 850	0 433 271 831
DLLA 150 S 851/	0 433 271 730
DLLA 150 S 851	0 433 271 830







DLLA 150 S 852	0 433 271 425
DLLA 150 S 853	0 433 271 829
DLLA 150 S 866	0 433 271 430
DLLA 150 S 867	0 433 271 431
DLLA 150 S 868	0 433 271 824



A56

de	en	fr	it	es
Typformel → Bestellnummer (Fortsetzung)	Type designation → Part number (continued)	Formule de type → Référence (suite)	Sigla → Numero d'ordinazione (seguito)	Designación del tipo → Número de pedido (continuación)

DLLA 150 S 870 ...

 Typ	 Ref.	 Typ	 Ref.	 Typ	 Ref.
DLLA 150 S 870	0 433 271 823	DLLA 150 S 1067	0 433 271 745	DLLA 150 S 1377	F 002 C30 128
DLLA 150 S 871	0 433 271 432	DLLA 150 S 1070	9 430 394 100	DLLA 150 S 1393	F 002 C30 140
DLLA 150 S 872	0 433 271 433	DLLA 150 S 1072	0 433 271 496	DLLA 150 S 1394	F 002 C30 016
DLLA 150 S 873	0 433 271 434	DLLA 150 S 1074	0 433 271 742	DLLA 150 S 1600	0 433 271 040
DLLA 150 S 881	0 433 271 821	DLLA 150 S 1087	0 433 271 734	DLLA 150 S 2120	0 433 271 268
DLLA 150 S 883	0 433 271 820	DLLA 150 S 1091	0 433 271 731	DLLA 150 S 2120	9 430 034 271
DLLA 150 S 891/TR	0 433 271 440	DLLA 150 S 1104	0 433 271 724	DLLA 150 S 2660	0 433 271 179
DLLA 150 S 893	0 433 271 441	DLLA 150 S 1105	0 433 271 723	DLLA 150 S 2661	0 433 271 170
DLLA 150 S 896	0 433 271 814	DLLA 150 S 1137	0 433 271 714	DLLA 151 S 686	0 433 271 894
DLLA 150 S 902	0 433 271 446	DLLA 150 S 1148/TR	0 433 271 512	DLLA 151 S 813	0 433 271 850
DLLA 150 S 903	0 433 271 811	DLLA 150 S 1151	0 433 271 709	DLLA 151 S 928	0 433 271 803
DLLA 150 S 904	0 433 271 810	DLLA 150 S 1158	0 433 271 704	DLLA 151 S 972	0 433 271 790
DLLA 150 S 913	0 433 271 451	DLLA 150 S 1159	0 433 271 516	DLLA 151 S 985	0 433 271 782
DLLA 150 S 914	0 433 271 808	DLLA 150 S 1192	0 433 271 683	DLLA 152 S 533	0 433 271 246
DLLA 150 S 916	0 433 271 807	DLLA 150 S 1211	9 430 034 705	DLLA 152 S 703	0 433 271 886
DLLA 150 S 925	0 433 271 804	DLLA 150 S 1213	0 433 271 672	DLLA 152 S 751	0 433 271 869
DLLA 150 S 935	0 433 271 462	DLLA 150 S 1216	0 433 271 669	DLLA 152 S 783	0 433 271 861
DLLA 150 S 960/	0 433 271 797	DLLA 150 S 1220	0 433 271 666	DLLA 152 S 899	0 433 271 812
DLLA 150 S 967	0 433 271 794	DLLA 150 S 1231	0 433 271 659	DLLA 152 S 1180	0 433 271 691
DLLA 150 S 968	0 433 271 793	DLLA 150 S 1234	0 433 271 657	DLLA 152 S 1184	0 433 271 688
DLLA 150 S 974/TR	0 433 271 789	DLLA 150 S 1237	0 433 271 656	DLLA 152 S 1277	0 433 271 635
DLLA 150 S 975	0 433 271 465	DLLA 150 S 1238	0 433 271 655	DLLA 152 S 1280	0 433 271 632
DLLA 150 S 977	0 433 271 787	DLLA 150 S 1248	0 433 271 649	DLLA 152 S 1390	F 002 C30 014
DLLA 150 S 978	0 433 271 786	DLLA 150 S 1251	0 433 271 533	DLLA 153 S 308	0 433 271 114
DLLA 150 S 993	0 433 271 780	DLLA 150 S 1267	0 433 271 535	DLLA 153 S 358	0 433 271 136
DLLA 150 S 994	0 433 271 779	DLLA 150 S 1270	0 433 271 567	DLLA 154 S 970	0 433 271 791
DLLA 150 S 996/	0 433 271 468	DLLA 150 S 1283	0 433 271 569	DLLA 154 S 1086	0 433 271 735
DLLA 150 S 998	0 433 271 777	DLLA 150 S 1295	0 433 271 625	DLLA 154 S 1088	0 433 271 733
DLLA 150 S 1006	0 433 271 771	DLLA 150 S 1304	0 433 271 576	DLLA 154 S HB-606	9 430 034 722
DLLA 150 S 1008	0 433 271 473	DLLA 150 S 1311	0 433 271 600	DLLA 155 S 199 HB	9 430 034 721
DLLA 150 S 1015	0 433 271 769	DLLA 150 S 1313	0 433 272 999	DLLA 155 S 520	0 433 271 239
DLLA 150 S 1016	0 433 271 479	DLLA 150 S 1314	0 433 272 998	DLLA 155 S 536	0 433 271 249
DLLA 150 S 1029	0 433 271 764	DLLA 150 S 1316	0 433 271 595	DLLA 155 S 537	0 433 271 250
DLLA 150 S 1036	0 433 271 488	DLLA 150 S 1321	0 433 272 996	DLLA 155 S 551	0 433 271 261
DLLA 150 S 1042	0 433 271 491	DLLA 150 S 1322	0 433 272 995	DLLA 155 S 568	0 433 271 270
DLLA 150 S 1044	0 433 271 758	DLLA 150 S 1324	0 433 272 989	DLLA 155 S 574	0 433 271 274
DLLA 150 S 1052	0 433 271 494	DLLA 150 S 1329	F 002 C30 003	DLLA 155 S 590	0 433 271 286
DLLA 150 S 1055	0 433 271 755	DLLA 150 S 1331	F 002 C30 106	DLLA 155 S 593	0 433 271 287
DLLA 150 S 1060	0 433 271 752	DLLA 150 S 1336	F 002 030 005	DLLA 155 S 636	0 433 271 312
DLLA 150 S 1061	0 433 271 751	DLLA 150 S 1339	F 002 C30 007	DLLA 155 S 651	0 433 271 318
DLLA 150 S 1062	0 433 271 750	DLLA 150 S 1340	0 433 272 986	DLLA 155 S 658	0 433 271 898
DLLA 150 S 1063	0 433 271 749	DLLA 150 S 1362	F 002 C30 010	DLLA 155 S 659	0 433 271 897
DLLA 150 S 1064	0 433 271 748	DLLA 150 S 1363	F 002 C30 119	DLLA 155 S 681	0 433 271 895
DLLA 150 S 1065	0 433 271 747	DLLA 150 S 1373	F 002 C30 126	DLLA 155 S 687	0 433 271 893
DLLA 150 S 1066	0 433 271 746	DLLA 150 S 1374	F 002 C30 131	DLLA 155 S 695	0 433 271 890

... DLLB 151 S 854



DLLA 155 S 710	0 433 271 884
DLLA 155 S 713	0 433 271 883
DLLA 155 S 723	0 433 271 352
DLLA 155 S 729	0 433 271 878
DLLA 155 S 732	0 433 271 876

DLLA 155 S 733	0 433 271 359
DLLA 155 S 831	0 433 271 840
DLLA 155 S 835	0 433 271 839
DLLA 155 S 858	0 433 271 825
DLLA 155 S 879	0 433 271 822

DLLA 155 S 895	0 433 271 815
DLLA 155 S 1032	0 433 271 761
DLLA 155 S 1163	0 433 271 701
DLLA 155 S 1202	0 433 271 525
DLLA 155 S 1205	0 433 271 677

DLLA 155 S 1215	0 433 271 670
DLLA 155 S 1221	0 433 271 665
DLLA 155 S 1223	0 433 271 526
DLLA 155 S 1303	0 433 271 615
DLLA 155 S 1307	0 433 271 604

DLLA 155 S 1308	0 433 271 603
DLLA 155 S 1323	0 433 272 994
DLLA 155 S 1348	0 433 272 985
DLLA 155 S 1351	0 433 272 980
DLLA 156 S 344	9 430 034 702

DLLA 156 S 822	0 433 271 845
DLLA 156 S 911	0 433 271 450
DLLA 156 S 1123	0 433 271 504
DLLA 156 S 1233	0 433 271 528
DLLA 158 S 766	0 433 271 864

DLLA 158 S 769	9 430 034 220
DLLA 158 S 920	0 433 271 806
DLLA 158 S 1146	0 433 271 710
DLLA 159 S 1082	0 433 271 738
DLLA 159 S 1141	0 433 271 712

DLLA 160 S 171 HB	9 430 034 711
DLLA 160 S 194	0 433 271 050
DLLA 160 S 214	0 433 271 062
DLLA 160 S 221	0 433 271 066
DLLA 160 S 227	0 433 271 143

DLLA 160 S 255	0 433 271 079
DLLA 160 S 275	0 433 271 091
DLLA 160 S 302	0 433 271 110
DLLA 160 S 303	0 433 271 111
DLLA 160 S 311	0 433 271 119



DLLA 160 S 361	0 433 271 139
DLLA 160 S 378	0 433 271 152
DLLA 160 S 397	0 433 271 165
DLLA 160 S 399	0 433 271 167
DLLA 160 S 443	0 433 271 196

DLLA 160 S 479	0 433 271 219
DLLA 160 S 509	0 433 271 232
DLLA 160 S 524	0 433 271 242
DLLA 160 S 526	0 433 271 244
DLLA 160 S 546	0 433 271 256

DLLA 160 S 555	0 433 271 263
DLLA 160 S 557	0 433 271 265
DLLA 160 S 575	0 433 271 275
DLLA 160 S 608	0 433 271 295
DLLA 160 S 626	0 433 271 305

DLLA 160 S 630	0 433 271 308
DLLA 160 S 641	0 433 271 315
DLLA 160 S 654	0 433 271 320
DLLA 160 S 661	0 433 271 324
DLLA 160 S 674	0 433 271 331

DLLA 160 S 684	0 433 271 338
DLLA 160 S 699	0 433 271 343
DLLA 160 S 707	0 433 271 344
DLLA 160 S 734	0 433 271 361
DLLA 160 S 760	0 433 271 866

DLLA 160 S 778	9 430 034 221
DLLA 160 S 787	0 433 271 396
DLLA 160 S 795	0 433 271 401
DLLA 160 S 807	0 433 271 854
DLLA 160 S 811	0 433 271 851

DLLA 160 S 817	0 433 271 847
DLLA 160 S 856	0 433 271 827
DLLA 160 S 857	0 433 271 826
DLLA 160 S 908	0 433 271 809
DLLA 160 S 938	0 433 271 802

DLLA 160 S 952	0 433 271 799
DLLA 160 S 995	0 433 271 778
DLLA 160 S 1012	0 433 271 770
DLLA 160 S 1030	0 433 271 763
DLLA 160 S 1084	0 433 271 736

DLLA 160 S 1165	9 430 034 286
DLLA 160 S 1166	9 430 034 290
DLLA 160 S 1181	0 433 271 690
DLLA 160 S 1222	9 430 034 707
DLLA 160 S 1230	9 430 034 708



DLLA 160 S 1241	0 433 271 532
DLLA 160 S 1285	0 433 271 629
DLLA 160 S 1305	0 433 271 614
DLLA 160 S 1356	F 002 C30 114
DLLA 160 S 1387	F 002 C30 137

DLLA 163 S 1156	0 433 271 514
DLLA 165 S 200	0 433 271 054
DLLA 165 S 272	0 433 271 088
DLLA 165 S 712	0 433 271 347
DLLA 165 S 727	0 433 271 358

DLLA 165 S 1051	0 433 271 493
DLLA 170 S 594	0 433 271 288
DLLA 176 S 440	0 433 271 194
DLLA 180 S 483	0 433 271 220

DLLA ... T ...

DLLA 160 T 1	0 433 371 001
DLLA 160 T 2	0 433 371 002
DLLA 160 T 3	0 433 371 003

DLLA 160 T 4	0 433 371 004
--------------	----------------------

DLLA ... U ...

DLLA 132 U 3	0 433 421 004
DLLA 132 U 4	0 433 421 005
DLLA 132 U 5	0 433 421 006

DLLA 140 U 3	0 433 421 003
DLLA 145 U 2	0 433 421 001
DLLA 152 U 1	0 433 421 002
DLLA 155 U 6	0 433 421 007

DLLB ... S ...

DLLB 25 S 169	0 433 271 038
DLLB 150 S 688	0 433 271 340
DLLB 150 S 711	0 433 271 346

DLLB 150 S 765	0 433 271 374
DLLB 150 S 794	0 433 271 400
DLLB 150 S 803	0 433 271 409
DLLB 150 S 821	0 433 271 846
DLLB 151 S 854	0 433 271 828



de

Typformel →
Bestellnummer
(Fortsetzung)

en

Type designation →
Part number
(continued)

fr

Formule de type →
Référence
(suite)

it

Sigla → Numero
d'ordinazione
(seguito)

es

Designación del tipo
→ Número de pedido
(continuación)

DLLB 155 S 579 ...



Typ	Ref.
-----	------

DLLB 155 S 579	0 433 271 277
DLLB 155 S 580	0 433 271 278
DLLB 155 S 598	0 433 271 291
DLLB 155 S 675	0 433 271 332
DLLB 160 S 544	0 433 271 255

DLLB ... T ...

DLLB 145 T 5	0 433 371 005
DLLB 145 T 6	0 433 371 006
DLLB 145 T 7	0 433 371 007

DLLC ... S ...

DLLC 150 S 532	0 433 271 247
DLLC 150 S 542	0 433 271 253
DLLC 150 S 543	0 433 271 254

DLLC 150 S 624	0 433 271 304
DLLC 150 S 624	0 433 271 999
DLLC 150 S 646	0 433 271 316
DLLC 150 S 660	0 433 271 323
DLLC 155 S 539	0 433 271 251

DLLC 155 S 595	0 433 271 289
DLLC 155 S 595	0 433 271 998
DLLC 157 S 581	0 433 271 279
DLLC 157 S 587	0 433 271 283

DLLC ... U ...

DLLC 144 U 7	0 433 421 008
--------------	---------------

DLLF ... T ...

DLLF 120 T 4	0 433 351 056
DLLF 140 T 5	0 433 351 057
DLLF 140 T 7	0 433 351 039

DLLF 140 T 21	0 433 351 067
DLLF 145 T 1	0 433 351 053
DLLF 145 T 8	0 433 351 040
DLLF 145 T 9	0 433 351 051
DLLF 145 T 10	0 433 351 058

DLLF 145 T 13	0 433 351 060
DLLF 145 T 22	0 433 351 068
DLLF 145 T 22+RG	0 433 351 987
DLLF 150 T 6	0 433 351 034
DLLF 150 T 11	0 433 351 049

Typ	Ref.
-----	------

DLLF 150 T 12	0 433 351 059
DLLF 150 T 12+RG	0 433 351 989
DLLF 150 T 18	0 433 351 064
DLLF 150 T 18+RG	0 433 351 988
DLLF 150 T 24	0 433 351 070

DLLF 150 T 24+SH	0 433 351 986
DLLF 150 T 37	0 433 351 071
DLLF 150 T 37+SH	0 433 351 985
DLLF 150 T 40	0 433 351 074
DLLF 150 T 40	0 433 351 982

DLLF 155 T 2	0 433 351 054
DLLF 155 T 3	0 433 351 055
DLLF 155 T 20	0 433 351 066
DLLF 155 T 38	0 433 351 072
DLLF 155 T 38+SH	0 433 351 984

DLLF 155 T 39	0 433 351 073
DLLF 155 T 39+SH	0 433 351 983
DLLF 156 T 14	0 433 351 061
DLLF 156 T 16	0 433 351 062
DLLF 156 T 17	0 433 351 063

DLLF 156 T 19	0 433 351 065
DLLF 156 T 23	0 433 351 069

DLLZ ... P ...

DLLZ 155 P 4	0 433 171 004
DLLZ 155 P 41	0 433 171 005
DLLZ 157 P 964	0 433 171 638

DLLZ 160 P 6	0 433 171 007
--------------	---------------

DLLZ ... S ...

DLLZ 140 S 784	0 433 271 393
DLLZ 140 S 1168	0 433 271 699
DLLZ 140 S 1361	0 433 272 969

DLLZ 147 S 958	0 433 271 798
DLLZ 147 S 1022	0 433 271 766
DLLZ 147 S 1050	0 433 271 757
DLLZ 147 S 1083	0 433 271 737
DLLZ 150 S 744	0 433 271 872

Typ	Ref.
-----	------

DLLZ 150 S 746	0 433 271 364
DLLZ 150 S 1170	0 433 271 517
DLLZ 150 S 1246	0 433 271 651
DLLZ 150 S 1274	0 433 271 637
DLLZ 150 S 1287	0 433 271 628

DLLZ 152 S 1229	0 433 271 660
DLLZ 152 S 1247	0 433 271 650
DLLZ 154 S 860	0 433 271 427
DLLZ 154 S 923	0 433 271 455
DLLZ 155 S 1133	0 433 271 715

DLLZ 155 S 1281	0 433 271 631
DLLZ 156 S 948	0 433 271 460
DLLZ 156 S 957	0 433 271 464
DLLZ 156 S 1048	0 433 271 492
DLLZ 156 S 1134	0 433 271 508

DLLZ 160 S 1095	0 433 271 500
DLLZ 160 S 1128	0 433 271 506
DLLZ 165 S 1010	0 433 271 475

DLLZ ... T ...

DLLZ 150 T 8	0 433 371 008
DLLZ 150 T 8+SH	0 433 371 999
DLLZ 150 T 9	0 433 371 009

DLLZ 150 T 9+SH	0 433 371 998
DLLZ 150 T 10	0 433 371 010
DLLZ 150 T 10+SH	0 433 371 995
DLLZ 150 T 11	0 433 371 011
DLLZ 150 T 11+SH	0 433 371 997

DLLZ 150 T 12	0 433 371 012
DLLZ 150 T 12+SH	0 433 371 996
DLLZ 150 T 13	0 433 371 013

DLP ... S ...

DLP 0 S 1	0 433 240 001
DLP 0 S 5	0 433 240 002
DLP 0 S 6	0 433 240 003

DLP 0 S 7	0 433 240 004
-----------	---------------

... DN 0 SD 213

 Typ	 Ref.
---	--

DLP ... U ...

DLP 80 U 1 E	0 433 490 001
DLP 80 U 2 E	0 433 490 002

DLPF ... U ...

DLPF 80 U 1	0 433 491 001
-------------	----------------------

DLZ ... T ...

DLZ 125 T 1237	0 433 350 013
DLZ 125 T 1247	0 433 350 014
DLZ 130 T 1250	0 433 350 015

DLZ 140 T 1157	0 433 350 011
DLZ 154 T 1235	0 433 350 012

DLZ ... U ...

DLZ 150 U 1222	0 433 450 003
DLZ 150 U 1227	0 433 450 004
DLZ 150 U 1233	0 433 450 005

DLZ 150 U 1234	0 433 450 006
DLZ 150 U 1240	0 433 450 009
DLZ 155 U 1238	0 433 450 007
DLZ 155 U 1239	0 433 450 008
DLZ 155 U 1244	0 433 450 011

DN ... PD ...

DN 0 PD 1	0 434 150 005
DN 0 PD 2	0 434 150 006

DN ... R ...

DN 4 R 102	0 434 100 001
DN 8 R 48	0 434 100 002
DN 8 R 101	0 434 100 003

DN 8 R 191	0 434 100 007
------------	----------------------

 Typ	 Ref.
---	--

DN ... RD ...

DN 4 RD 122	0 434 150 001
DN 12 RD 124	0 434 150 003

DN ... S ...

DN 0 S 209	0 434 200 041
DN 0 S 225	0 434 200 042
DN 0 S 226	0 434 240 005

DN 0 S 227	0 434 200 043
DN 0 S 231	0 434 200 045
DN 0 S 235	0 434 200 049
DN 0 S 243	0 434 200 054
DN 4 S 1	0 434 200 001

DN 4 S 1	9 430 036 204
DN 4 S 2	0 434 200 002
DN 4 S 2+SH	0 434 200 999
DN 4 S 3	0 434 200 003
DN 4 S 3+SH	0 434 200 996

DN 4 S 144	0 434 200 006
DN 4 S 162	0 434 200 028
DN 4 S 176	0 434 200 030
DN 4 S 183	0 434 200 032
DN 4 S 206	0 434 200 038

DN 6 S 1	0 434 200 009
DN 6 S 2	0 434 200 010
DN 6 S 197	0 434 200 034
DN 6 S 198	0 434 200 035
DN 6 S 233	0 434 200 046

DN 6 S 241	0 434 200 052
DN 8 S 1	0 434 200 011
DN 8 S 1	9 430 036 211
DN 8 S 2	0 434 200 012
DN 8 S 2	9 430 036 207

DN 8 S 3	0 434 200 013
DN 8 S 129	0 434 200 014
DN 8 S 138	0 434 200 015
DN 8 S 138+SH	0 434 200 998
DN 8 S 139	0 434 200 016

DN 8 S 142	0 434 200 017
DN 8 S 143	0 434 240 002
DN 8 S 234/	0 434 200 047
DN 10 S 242	0 434 200 053
DN 15 S 2	0 434 200 018

 Typ	 Ref.
---	--

DN 15 S 2	9 430 036 208
DN 15 S 3	0 434 200 019
DN 15 S 156	0 434 200 021
DN 18 S 152	0 434 200 022
DN 30 S 2	0 434 200 023

DN 30 S 3	0 434 200 024
DN 40 S 2	0 434 200 025
DN 45 S 3	0 434 200 026

DN ... SD ...

DN 0 SD 21	0 434 250 001
DN 0 SD 21+SH	0 434 250 999
DN 0 SD 52	0 434 290 002

DN 0 SD 126	0 434 250 002
DN 0 SD 127	0 434 250 003
DN 0 SD 130	0 434 250 004
DN 0 SD 130	9 430 037 208
DN 0 SD 131	0 434 290 003

DN 0 SD 137	0 434 250 005
DN 0 SD 137+SH	0 434 250 998
DN 0 SD 149	0 434 290 005
DN 0 SD 150	0 434 250 006
DN 0 SD 151	0 434 250 007

DN 0 SD 151 HB-5	9 430 037 223
DN 0 SD 155	0 434 290 006
DN 0 SD 165	0 434 250 037
DN 0 SD 174	0 434 250 046
DN 0 SD 184	0 434 250 053

DN 0 SD 185	0 434 250 054
DN 0 SD 189	0 434 250 060
DN 0 SD 189/	0 434 250 122
DN 0 SD 192	0 434 250 062
DN 0 SD 193	0 434 250 063

DN 0 SD 193/	0 434 250 126
DN 0 SD 193	9 430 037 215
DN 0 SD 195	0 434 250 065
DN 0 SD 199	0 434 250 066
DN 0 SD 203	0 434 250 067

DN 0 SD 210	0 434 250 048
DN 0 SD 211	0 434 250 009
DN 0 SD 211	9 430 037 209
DN 0 SD 212	0 434 250 010
DN 0 SD 213	0 434 250 057



A60

de

**Typformel →
Bestellnummer**
(Fortsetzung)

en

**Type designation →
Part number**
(continued)

fr

**Formule de type →
Référence**
(suite)

it

**Sigla → Numero
d'ordinazione**
(seguito)

es

**Designación del tipo
→ Número de pedido**
(continuación)

DN 0 SD 216 ...



 Typ	 Ref.
---	--

DN 0 SD 216	0 434 250 071
DN 0 SD 219	0 434 290 016
DN 0 SD 220	0 434 250 072
DN 0 SD 228	0 434 250 075
DN 0 SD 230	0 434 250 077

DN 0 SD 239	0 434 250 094
DN 0 SD 240	0 434 250 095
DN 0 SD 240-	0 434 250 102
DN 0 SD 240/	0 434 250 110
DN 0 SD 245	9 430 037 205

DN 0 SD 247	9 430 087 203
DN 0 SD 248	0 434 250 105
DN 0 SD 251	0 434 250 108
DN 0 SD 252	0 434 250 109
DN 0 SD 252+	0 434 250 134

DN 0 SD 252+/ DN 0 SD 253	0 434 250 164
DN 0 SD 254	0 434 250 111
DN 0 SD 254	0 434 250 112
DN 0 SD 256	0 434 250 114
DN 0 SD 256/	0 434 250 135

DN 0 SD 257	0 434 250 115
DN 0 SD 258	0 434 250 116
DN 0 SD 259	0 434 250 117
DN 0 SD 260	0 434 250 118
DN 0 SD 261	0 434 250 120

DN 0 SD 262/ DN 0 SD 263	0 434 250 121
DN 0 SD 264	0 434 250 125
DN 0 SD 264	0 434 250 127
DN 0 SD 265	0 434 250 128
DN 0 SD 266/	0 434 250 129

DN 0 SD 267	0 434 250 130
DN 0 SD 268	0 434 250 131
DN 0 SD 269	0 434 250 132
DN 0 SD 271	0 434 250 136
DN 0 SD 272	0 434 250 137

DN 0 SD 273	0 434 250 138
DN 0 SD 274	0 434 250 139
DN 0 SD 276	0 434 250 141
DN 0 SD 276/	0 434 250 151
DN 0 SD 280	0 434 250 142

DN 0 SD 281	0 434 250 143
DN 0 SD 282	0 434 250 144
DN 0 SD 284	0 434 250 146
DN 0 SD 285	0 434 250 147
DN 0 SD 286	0 434 250 148

 Typ	 Ref.
---	--

DN 0 SD 287	0 434 250 149
DN 0 SD 287+	0 434 250 157
DN 0 SD 288	0 434 250 150
DN 0 SD 289	0 434 250 156
DN 0 SD 289/	0 434 250 166

DN 0 SD 292	0 434 250 154
DN 0 SD 293	0 434 250 103
DN 0 SD 294	0 434 250 155
DN 0 SD 297	0 434 250 159
DN 0 SD 299	0 434 250 160

DN 0 SD 299 A	0 434 250 171
DN 0 SD 299 B	0 434 250 173
DN 0 SD 299 C	0 434 250 193
DN 0 SD 300	0 434 250 161
DN 0 SD 301	0 434 250 162

DN 0 SD 302	0 434 250 163
DN 0 SD 302/ DN 0 SD 302 A	0 434 250 172
DN 0 SD 302 B	0 434 250 175
DN 0 SD 304	0 434 250 223
DN 0 SD 304	0 434 250 898

DN 0 SD 305	0 434 250 165
DN 0 SD 306	0 434 250 167
DN 0 SD 307	0 434 250 168
DN 0 SD 308	0 434 250 169
DN 0 SD 309	0 434 250 170

DN 0 SD 310	0 434 250 897
DN 0 SD 311	0 434 250 896
DN 0 SD 312	0 434 250 895
DN 0 SD 313	0 434 250 174
DN 0 SD 314	0 434 250 176

DN 0 SD 315	0 434 250 177
DN 0 SD 316	0 434 250 894
DN 0 SD 317	0 434 250 190
DN 0 SD 318	0 434 250 191
DN 0 SD 319	0 434 250 192

DN 0 SD 320	0 434 250 224
DN 0 SD 321	0 434 250 225
DN 0 SD 322	0 434 250 226
DN 0 SD 324	0 434 250 231
DN 0 SD 325	0 434 250 232

DN 0 SD 326	0 434 250 233
DN 0 SD 327	0 434 250 234
DN 0 SD 330	0 434 250 237
DN 0 SD 331	0 434 250 238
DN 0 SD 332	F 002 C10 600

 Typ	 Ref.
---	--

DN 0 SD 333	F 002 C10 161
DN 0 SD 333	F 002 C10 601
DN 0 SD 334	0 434 250 240
DN 0 SD 335	0 434 250 241
DN 0 SD 337	0 434 250 243

DN 0 SD 341	0 434 250 247
DN 0 SD 342	0 434 250 248
DN 0 SD 344	0 434 250 250
DN 0 SD 348	0 434 250 254
DN 0 SD 354	F 002 C10 602

DN 0 SD 355	F 002 C10 604
DN 0 SD 1510	0 434 250 011
DN 0 SD 1510	0 434 250 079
DN 0 SD 1550	0 434 290 014
DN 0 SD 1930	0 434 250 092

DN 0 SD 2110	0 434 250 012
DN 0 SD 2110+SH	0 434 250 997
DN 0 SD 2110	9 430 037 214
DN 0 SD 2400	0 434 250 096
DN 0 SD 15100	0 434 250 100

DN 4 SD 20	0 434 250 013
DN 4 SD 20+SH	0 434 250 996
DN 4 SD 24	0 434 250 014
DN 4 SD 24	0 434 250 078
DN 4 SD 24+SH	0 434 250 995

DN 4 SD 24	9 430 037 212
DN 4 SD 33	0 434 290 008
DN 4 SD 42	0 434 250 015
DN 4 SD 42+SH	0 434 250 994
DN 4 SD 44	0 434 290 009

DN 4 SD 51	0 434 250 016
DN 4 SD 118	0 434 250 017
DN 4 SD 118+SH	0 434 250 990
DN 4 SD 128	0 434 250 018
DN 4 SD 136	0 434 250 019

DN 4 SD 140	0 434 250 020
DN 4 SD 140+SH	0 434 250 993
DN 4 SD 141	0 434 250 021
DN 4 SD 147	0 434 250 022
DN 4 SD 161	0 434 290 010

DN 4 SD 163	0 434 250 035
DN 4 SD 166	0 434 250 036
DN 4 SD 169	0 434 250 041
DN 4 SD 177	0 434 290 015
DN 4 SD 187	0 434 250 056

... DSLA 138 P 698

 Typ	 Ref.
---	--

DN 4 SD 187	0 434 250 086
DN 4 SD 249	0 434 250 107
DN 4 SD 303	0 434 250 025
DN 4 SD 339	0 434 250 245
DN 4 SD 340	0 434 250 246

DN 4 SD 343	0 434 250 249
DN 4 SD 1660	0 434 250 050
DN 8 SD 32	0 434 250 026
DN 12 SD 12	0 434 250 027
DN 12 SD 12	0 434 250 080

DN 12 SD 12+SH	0 434 250 992
DN 12 SD 43	0 434 290 011
DN 12 SD 145	0 434 250 030
DN 12 SD 160	0 434 250 032
DN 12 SD 167	0 434 250 039

DN 12 SD 175	0 434 250 045
DN 12 SD 175	0 434 250 087
DN 12 SD 182	0 434 250 052
DN 12 SD 221	0 434 250 073
DN 12 SD 221	0 434 250 090

DN 12 SD 236	0 434 250 899
DN 12 SD 283	0 434 250 145
DN 12 SD 290	0 434 250 153
DN 12 SD 290	F 002 C10 605
DN 12 SD 296	0 434 250 158

DN 12 SD 328	0 434 250 235
DN 12 SD 329	0 434 250 236
DN 12 SD 336	0 434 250 242
DN 12 SD 338	0 434 250 244
DN 12 SD 345	0 434 250 251

DN 12 SD 346	0 434 250 252
DN 12 SD 347	0 434 250 253
DN 12 SD 1750	0 434 250 119
DN 12 SD 1750	9 430 087 204
DN 15 SD 12	9 430 087 201

DN 15 SD 35	0 434 250 033
DN 30 SD 158	0 434 250 034
DN 112 SD 12	9 430 037 213

DN ... T ...

DN 4 T 2	0 434 300 001
DN 4 T 4	0 434 300 002
DN 4 T 170	0 434 300 015

 Typ	 Ref.
---	--

DN 4 T 208	0 434 300 017
DN 6 T 2	0 434 300 006
DN 6 T 4	0 434 300 007
DN 6 T 4+SH	0 434 300 999
DN 6 T 49	0 434 300 008

DN 8 T 2	0 434 300 009
DN 60 T 2	0 434 300 014

DN ... TD ...

DN 0 TD 119	0 434 350 002
DN 4 TD 117	0 434 350 004
DN 6 TD 109	0 434 350 005

DN 6 TD 116	0 434 350 006
DN 6 TD 119	0 433 350 007
DN 6 TD 119	0 434 350 007

DN ... ZSD ...

DN 0 ZSD 21	0 434 250 081
DN 0 ZSD 126	0 434 250 083
DN 0 ZSD 165	0 434 250 097

DN 0 ZSD 189	0 434 250 106
DN 0 ZSD 193	0 434 250 113
DN 0 ZSD 211	0 434 250 076
DN 0 ZSD 212	0 434 250 085
DN 0 ZSD 220	0 434 250 093

DN 0 ZSD 6209	0 434 250 082
---------------	----------------------

DNA ... SD ...

DNA 0 SD 178	0 434 250 047
DNA 0 SD 188	0 434 250 058
DNA 0 SD 1510	9 430 037 211

DNA 4 SD 180	0 434 250 049
DNA 12 SD 186	0 434 250 055
DNA 12 SD 186	0 434 250 991

 Typ	 Ref.
---	--

DNL ... S ...

DNL 0 S 3	0 434 220 898
-----------	----------------------

DNL ... SD ...

DNL 0 SD 4	0 434 270 001
DNL 0 SD 5	0 434 270 002

DSLA ... P ...

DSLA 78 P 322	0 433 175 053
DSLA 88 P 480	0 433 175 082
DSLA 93 P 838	2 437 010 106

DSLA 124 P 198	0 433 175 016
DSLA 124 P 245	0 433 175 023
DSLA 124 P 1309	0 433 175 390
DSLA 124 P 1659	0 433 175 470
DSLA 128 P 523	0 433 175 094

DSLA 128 P 1198	0 433 175 357
DSLA 128 P 1510	0 433 175 449
DSLA 128 P 1560	0 433 175 459
DSLA 128 P 1672	F 000 430 914
DSLA 130 P 320	0 433 175 051

DSLA 130 P 321	0 433 175 052
DSLA 134 P 546	0 433 175 099
DSLA 134 P 604	0 433 175 114
DSLA 134 P 772	2 437 010 091
DSLA 134 P 781	0 433 175 188

DSLA 134 P 816	0 433 175 208
DSLA 135 P 259	0 433 175 028
DSLA 135 P 468	0 433 175 079
DSLA 135 P 633	0 433 175 122
DSLA 135 P 1291	0 433 175 383

DSLA 135 P 1292	0 433 175 384
DSLA 135 P 1293	0 433 175 385
DSLA 136 P 804	0 433 175 203
DSLA 137 P 506	0 433 175 088
DSLA 137 P 507	0 433 175 089

DSLA 137 P 508	0 433 175 090
DSLA 137 P 793	F 000 430 900
DSLA 137 P 981	F 000 430 902
DSLA 138 P 181	0 433 175 009
DSLA 138 P 698	0 433 175 148



A62

de

**Typformel →
Bestellnummer**
(Fortsetzung)

en

**Type designation →
Part number**
(continued)

fr

**Formule de type →
Référence**
(suite)

it

**Sigla → Numero
d'ordinazione**
(seguito)

es

**Designación del tipo
→ Número de pedido**
(continuación)

DSLA 138 P 757 ...



Typ	Ref.
-----	------

DSLA 138 P 757	0 433 175 172
DSLA 138 P 1505	0 433 175 452
DSLA 139 P 710	2 437 010 068
DSLA 139 P 976	2 437 010 121
DSLA 139 P 982	F 000 430 903
DSLA 140 P 79	0 433 175 003
DSLA 140 P 173	0 433 175 008
DSLA 140 P 279	0 433 175 041
DSLA 140 P 292	0 433 175 044
DSLA 140 P 297	0 433 175 047
DSLA 140 P 381	0 433 175 064
DSLA 140 P 400	0 433 175 067
DSLA 140 P 425	0 433 175 070
DSLA 140 P 453	0 433 175 075
DSLA 140 P 472	0 433 175 080
DSLA 140 P 562	0 433 175 102
DSLA 140 P 576	0 433 175 108
DSLA 140 P 616	0 433 175 115
DSLA 140 P 640	2 437 010 074
DSLA 140 P 671	0 433 175 138
DSLA 140 P 707	0 433 175 151
DSLA 140 P 713	2 437 010 066
DSLA 140 P 735	0 433 175 162
DSLA 140 P 739	0 433 175 165
DSLA 140 P 740	0 433 175 166
DSLA 140 P 741	0 433 175 167
DSLA 140 P 746	0 433 175 169
DSLA 140 P 862	0 433 175 230
DSLA 140 P 959	0 433 175 268
DSLA 140 P 1002	F 000 430 904
DSLA 140 P 1033	0 433 175 297
DSLA 140 P 1061	0 433 175 310
DSLA 140 P 1071	0 433 175 312
DSLA 140 P 1085	0 433 175 315
DSLA 140 P 1086	0 433 175 316
DSLA 140 P 1100	0 433 175 321
DSLA 140 P 1112	2 437 010 135
DSLA 140 P 1124	0 433 175 329
DSLA 140 P 1125	0 433 175 330
DSLA 140 P 1126	0 433 175 331
DSLA 140 P 1127	0 433 175 332
DSLA 140 P 1131	0 433 175 334
DSLA 140 P 1142	0 433 175 337
DSLA 140 P 1145	2 437 010 136
DSLA 140 P 1173	0 433 175 347

Typ	Ref.
-----	------

DSLA 140 P 1188	F 002 C40 548
DSLA 140 P 1196	0 433 175 356
DSLA 140 P 1201	0 433 175 358
DSLA 140 P 1202	0 433 175 359
DSLA 140 P 1266	0 433 175 374
DSLA 140 P 1267	0 433 175 375
DSLA 140 P 1328	0 433 175 397
DSLA 140 P 1329	0 433 175 398
DSLA 140 P 1344	F 000 430 912
DSLA 140 P 1359	0 433 175 404
DSLA 140 P 1361	0 433 175 406
DSLA 140 P 1613	0 433 175 465
DSLA 140 P 1624	F 000 430 913
DSLA 140 P 1723	0 433 175 481
DSLA 141 P 405	0 433 175 068
DSLA 141 P 991	0 433 175 284
DSLA 141 P 1096	F 000 430 906
DSLA 142 P 272	0 433 175 038
DSLA 142 P 683	2 437 010 055
DSLA 142 P 780	0 433 175 187
DSLA 142 P 792	0 433 175 194
DSLA 142 P 795	0 433 175 196
DSLA 142 P 843	2 437 010 112
DSLA 142 P 851	2 437 010 110
DSLA 142 P 893	0 433 175 252
DSLA 142 P 921	F 002 C40 504
DSLA 142 P 925	2 437 010 117
DSLA 142 P 935	F 002 C40 507
DSLA 142 P 935	F 002 C40 901
DSLA 142 P 988	0 433 175 281
DSLA 142 P 993	F 002 C40 503
DSLA 142 P 1017	F 002 C40 520
DSLA 142 P 1018	F 002 C40 519
DSLA 142 P 1018	F 002 C40 902
DSLA 142 P 1025	2 437 010 130
DSLA 142 P 1074	F 002 C40 529
DSLA 142 P 1088	F 002 C40 531
DSLA 142 P 1162	F 002 C40 544
DSLA 142 P 1178	0 433 175 351
DSLA 142 P 1191	2 437 010 139
DSLA 142 P 1277	F 002 C40 559
DSLA 142 P 1353	F 002 C40 565
DSLA 142 P 1390	F 002 C40 575
DSLA 142 P 1474	0 433 175 431
DSLA 142 P 1501	0 433 175 451

Typ	Ref.
-----	------

DSLA 142 P 1519	0 433 175 463
DSLA 142 P 770/	0 433 175 178
DSLA 143 P 909	0 433 175 256
DSLA 143 P 970	0 433 175 271
DSLA 143 P 1058	0 433 175 309
DSLA 143 P 1099	0 433 175 320
DSLA 143 P 1154	0 433 175 341
DSLA 143 P 1364	0 433 175 408
DSLA 143 P 1523	0 433 175 450
DSLA 143 P 1535	0 433 175 456
DSLA 144 P 547	0 433 175 100
DSLA 144 P 860	0 433 175 229
DSLA 144 P 869	0 433 175 236
DSLA 144 P 890	0 433 175 250
DSLA 144 P 1021	0 433 175 288
DSLA 144 P 1037	0 433 175 300
DSLA 144 P 1141	0 433 175 336
DSLA 144 P 1158	F 002 C40 542
DSLA 144 P 1161	F 002 C40 543
DSLA 144 P 1213	0 433 175 363
DSLA 144 P 1271	0 433 175 377
DSLA 144 P 1295	0 433 175 386
DSLA 144 P 1416	F 002 C40 582
DSLA 144 P 1629	0 433 175 467
DSLA 144 P 971+	0 433 175 272
DSLA 144 P 973+	0 433 175 274
DSLA 145 P 208	2 437 010 090
DSLA 145 P 251	0 433 175 026
DSLA 145 P 263	0 433 175 031
DSLA 145 P 264	0 433 175 032
DSLA 145 P 265	0 433 175 033
DSLA 145 P 265	F 002 C40 512
DSLA 145 P 267	0 433 175 035
DSLA 145 P 268	0 433 175 036
DSLA 145 P 269	0 433 175 037
DSLA 145 P 293	0 433 175 045
DSLA 145 P 300	0 433 175 048
DSLA 145 P 311	0 433 175 049
DSLA 145 P 311 M	0 433 175 147
DSLA 145 P 330	0 433 175 054
DSLA 145 P 365	2 437 010 086
DSLA 145 P 366	2 437 010 087
DSLA 145 P 379	0 433 175 062
DSLA 145 P 380	0 433 175 063
DSLA 145 P 395	0 433 175 065

... DSLA 150 P 211



DSLA 145 P 396	0 433 175 066
DSLA 145 P 414	0 433 175 069
DSLA 145 P 446	2 437 010 085
DSLA 145 P 462	0 433 175 076
DSLA 145 P 463	0 433 175 077

DSLA 145 P 464	0 433 175 078
DSLA 145 P 477	0 433 175 081
DSLA 145 P 491	0 433 175 084
DSLA 145 P 537	0 433 175 096
DSLA 145 P 598	0 433 175 111

DSLA 145 P 599	0 433 175 112
DSLA 145 P 603	0 433 175 113
DSLA 145 P 619	2 437 010 108
DSLA 145 P 626	0 433 175 125
DSLA 145 P 631	2 437 010 075

DSLA 145 P 639	0 433 175 123
DSLA 145 P 642	0 433 175 127
DSLA 145 P 643	0 433 175 128
DSLA 145 P 644	0 433 175 129
DSLA 145 P 668	0 433 175 137

DSLA 145 P 681	0 433 175 140
DSLA 145 P 682	2 437 010 070
DSLA 145 P 704	0 433 175 149
DSLA 145 P 712	2 437 010 067
DSLA 145 P 725	0 433 175 159

DSLA 145 P 763	0 433 175 175
DSLA 145 P 768	0 433 175 177
DSLA 145 P 774	0 433 175 181
DSLA 145 P 778	0 433 175 185
DSLA 145 P 808	2 437 010 095

DSLA 145 P 821	0 433 175 211
DSLA 145 P 833	0 433 175 216
DSLA 145 P 835	2 437 010 104
DSLA 145 P 864	0 433 175 232
DSLA 145 P 867	0 433 175 234

DSLA 145 P 868	0 433 175 235
DSLA 145 P 870	2 437 010 109
DSLA 145 P 882	2 437 010 113
DSLA 145 P 883	2 437 010 114
DSLA 145 P 891	0 433 175 251

DSLA 145 P 896	0 433 175 253
DSLA 145 P 917	F 000 430 901
DSLA 145 P 975	2 437 010 120
DSLA 145 P 979	0 433 175 278
DSLA 145 P 986	0 433 175 279



DSLA 145 P 987	2 437 010 123
DSLA 145 P 1024	2 437 010 127
DSLA 145 P 1027	F 002 C40 523
DSLA 145 P 1066	0 433 175 311
DSLA 145 P 1091	0 433 175 318

DSLA 145 P 1097	0 433 175 319
DSLA 145 P 1109	0 433 175 324
DSLA 145 P 1115	0 433 175 327
DSLA 145 P 1136	F 002 C40 538
DSLA 145 P 1160	F 000 430 907

DSLA 145 P 1167	F 000 430 908
DSLA 145 P 1174	0 433 175 348
DSLA 145 P 1253	0 433 175 370
DSLA 145 P 1255	0 433 175 371
DSLA 145 P 1259	0 433 175 372

DSLA 145 P 1273	F 002 C40 558
DSLA 145 P 1275	F 000 430 911
DSLA 145 P 1288	0 433 175 380
DSLA 145 P 1299	0 433 175 396
DSLA 145 P 1300	F 000 430 910

DSLA 145 P 1303	0 433 175 388
DSLA 145 P 1304	0 433 175 389
DSLA 145 P 1310	F 002 C40 561
DSLA 145 P 1441	0 433 175 426
DSLA 145 P 1442	0 433 175 427

DSLA 145 P 1479	0 433 175 438
DSLA 145 P 1679	0 433 175 472
DSLA 145 P 879+	0 433 175 241
DSLA 146 P 548	0 433 175 101
DSLA 146 P 565	0 433 175 103

DSLA 146 P 954	F 002 C40 510
DSLA 146 P 1055	0 433 175 308
DSLA 146 P 1180	F 002 C40 546
DSLA 146 P 1306	F 002 C40 562
DSLA 146 P 1398	0 433 175 413

DSLA 146 P 1409	0 433 175 414
DSLA 146 P 1433	2 437 010 146
DSLA 146 P 1436	2 437 010 148
DSLA 146 P 1457	F 002 C40 587
DSLA 146 P 1465	0 433 175 443

DSLA 146 P 1488	0 433 175 457
DSLA 146 P 1527	0 433 175 453
DSLA 146 P 1530	0 433 175 454
DSLA 146 P 1531	0 433 175 455
DSLA 146 P 1675	0 433 175 471



DSLA 147 P 535	2 437 010 063
DSLA 147 P 715	2 437 010 065
DSLA 147 P 716	2 437 010 064
DSLA 147 P 759	0 433 175 173
DSLA 147 P 786	0 433 175 191

DSLA 147 P 794	2 437 010 094
DSLA 147 P 814	0 433 175 207
DSLA 147 P 823	2 437 010 102
DSLA 147 P 899	F 002 C40 501
DSLA 147 P 918	2 437 010 119

DSLA 147 P 919	2 437 010 118
DSLA 147 P 1147	2 437 010 138
DSLA 147 P 1243	2 437 010 141
DSLA 147 P 1276	F 002 C40 557
DSLA 147 P 1379	F 002 C40 571

DSLA 148 P 219	0 433 175 020
DSLA 148 P 243	0 433 175 022
DSLA 148 P 262	0 433 175 030
DSLA 148 P 266	0 433 175 034
DSLA 148 P 348	0 433 175 057

DSLA 148 P 482	0 433 175 083
DSLA 148 P 516	0 433 175 091
DSLA 148 P 575	2 437 010 081
DSLA 148 P 590	0 433 175 109
DSLA 148 P 591	2 437 010 080

DSLA 148 P 837	2 437 010 107
DSLA 148 P 1026	F 002 C40 522
DSLA 148 P 1133	F 002 C40 536
DSLA 148 P 1168	0 433 175 346
DSLA 148 P 1290	0 433 175 382

DSLA 148 P 1356	F 002 C40 567
DSLA 148 P 1432	2 437 010 147
DSLA 148 P 1435	2 437 010 149
DSLA 148 P 1468	0 433 175 429
DSLA 149 P 252	0 433 175 027

DSLA 149 P 342	0 433 175 055
DSLA 149 P 427	0 433 175 071
DSLA 149 P 540	0 433 175 097
DSLA 149 P 824	2 437 010 101
DSLA 150 P 78	0 433 175 002

DSLA 150 P 143	0 433 175 006
DSLA 150 P 188	0 433 175 011
DSLA 150 P 191	2 437 010 089
DSLA 150 P 194	0 433 175 015
DSLA 150 P 211	0 433 175 018



A64

de	en	fr	it	es
Typformel → Bestellnummer (Fortsetzung)	Type designation → Part number (continued)	Formule de type → Référence (suite)	Sigla → Numero d'ordinazione (seguito)	Designación del tipo → Número de pedido (continuación)

DSLA 150 P 218 ...



Typ	Ref.	Typ	Ref.	Typ	Ref.
DSLA 150 P 218	0 433 175 019	DSLA 150 P 934	2 437 010 128	DSLA 150 P 1508	0 433 175 448
DSLA 150 P 246	0 433 175 024	DSLA 150 P 989	0 433 175 282	DSLA 150 P 1559	2 437 010 152
DSLA 150 P 249	0 433 175 025	DSLA 150 P 990	0 433 175 283	DSLA 150 P 1585	0 433 175 460
DSLA 150 P 261	2 437 010 088	DSLA 150 P 1000	0 433 175 286	DSLA 150 P 1586	0 433 175 461
DSLA 150 P 280-	0 433 175 042	DSLA 150 P 1001	0 433 175 287	DSLA 150 P 672-	2 437 010 140
DSLA 150 P 294	0 433 175 046	DSLA 150 P 1019	2 437 010 126	DSLA 150 P 727+	0 433 175 161
DSLA 150 P 318	0 433 175 050	DSLA 150 P 1020	0 433 175 292	DSLA 151 P 1302	0 433 175 387
DSLA 150 P 346	0 433 175 056	DSLA 150 P 1040	0 433 175 301	DSLA 152 P 630	0 433 175 120
DSLA 150 P 357	2 437 010 083	DSLA 150 P 1042	0 433 175 303	DSLA 152 P 790	0 433 175 193
DSLA 150 P 362	2 437 010 056	DSLA 150 P 1043	0 433 175 304	DSLA 152 P 829	0 433 175 212
DSLA 150 P 442	2 437 010 076	DSLA 150 P 1045	0 433 175 306	DSLA 152 P 830	0 433 175 215
DSLA 150 P 448	0 433 175 074	DSLA 150 P 1046	0 433 175 307	DSLA 152 P 887	0 433 175 249
DSLA 150 P 502	2 437 010 082	DSLA 150 P 1072	0 433 175 313	DSLA 152 P 922	F 002 C40 502
DSLA 150 P 520	2 437 010 077	DSLA 150 P 1102	2 437 010 133	DSLA 152 P 1087	0 433 175 317
DSLA 150 P 543	0 433 175 098	DSLA 150 P 1103	2 437 010 134	DSLA 152 P 1101	F 002 C40 535
DSLA 150 P 641	0 433 175 126	DSLA 150 P 1134	0 433 175 335	DSLA 152 P 1184	0 433 175 352
DSLA 150 P 645	0 433 175 130	DSLA 150 P 1156	0 433 175 343	DSLA 152 P 1208	F 002 C40 549
DSLA 150 P 646	2 437 010 073	DSLA 150 P 1166	0 433 175 345	DSLA 152 P 1282	F 002 C40 560
DSLA 150 P 648	0 433 175 132	DSLA 150 P 1211	0 433 175 361	DSLA 152 P 1323	F 002 C40 563
DSLA 150 P 661	2 437 010 072	DSLA 150 P 1247	0 433 175 367	DSLA 152 P 1603	0 433 175 462
DSLA 150 P 672	2 437 010 071	DSLA 150 P 1248	0 433 175 368	DSLA 152 P 1633	0 433 175 468
DSLA 150 P 706	2 437 010 059	DSLA 150 P 1250	2 437 010 143	DSLA 152 P 1634	0 433 175 469
DSLA 150 P 720	0 433 175 157	DSLA 150 P 1263	0 433 175 373	DSLA 152 P 1287++	0 433 175 379
DSLA 150 P 721	0 433 175 158	DSLA 150 P 1268	0 433 175 376	DSLA 153 P 797	0 433 175 197
DSLA 150 P 726	0 433 175 160	DSLA 150 P 1272	0 433 175 378	DSLA 153 P 798	0 433 175 198
DSLA 150 P 745	2 437 010 062	DSLA 150 P 1289	0 433 175 381	DSLA 153 P 801	0 433 175 200
DSLA 150 P 755	0 433 175 170	DSLA 150 P 1330	0 433 175 399	DSLA 153 P 802	0 433 175 201
DSLA 150 P 756	0 433 175 171	DSLA 150 P 1331	0 433 175 400	DSLA 153 P 803	0 433 175 202
DSLA 150 P 761	0 433 175 174	DSLA 150 P 1355	0 433 175 403	DSLA 153 P 820	0 433 175 210
DSLA 150 P 764	2 437 010 060	DSLA 150 P 1362	0 433 175 407	DSLA 153 P 1375	0 433 175 410
DSLA 150 P 773	0 433 175 180	DSLA 150 P 1383	0 433 175 412	DSLA 153 P 1376	0 433 175 409
DSLA 150 P 775	0 433 175 182	DSLA 150 P 1388	F 002 C40 574	DSLA 153 P 1375+	0 433 175 440
DSLA 150 P 776	0 433 175 183	DSLA 150 P 1397	F 002 C40 578	DSLA 153 P 1376+	0 433 175 439
DSLA 150 P 777	0 433 175 184	DSLA 150 P 1426	0 433 175 418	DSLA 154 P 492/	0 433 175 085
DSLA 150 P 779	0 433 175 186	DSLA 150 P 1431	0 433 175 419	DSLA 154 P 620	0 433 175 118
DSLA 150 P 783	0 433 175 189	DSLA 150 P 1434	2 437 010 145	DSLA 154 P 625	0 433 175 119
DSLA 150 P 784	2 437 010 093	DSLA 150 P 1438	0 433 175 425	DSLA 154 P 852	0 433 175 225
DSLA 150 P 800	0 433 175 199	DSLA 150 P 1452	0 433 175 428	DSLA 154 P 853	0 433 175 226
DSLA 150 P 805	0 433 175 204	DSLA 150 P 1485	0 433 175 437	DSLA 154 P 960	0 433 175 269
DSLA 150 P 855	0 433 175 227	DSLA 150 P 1489	0 433 175 441	DSLA 154 P 1028	F 002 C40 521
DSLA 150 P 873	2 437 010 111	DSLA 150 P 1490	0 433 175 442	DSLA 154 P 1034	0 433 175 298
DSLA 150 P 874	0 433 175 240	DSLA 150 P 1491	0 433 175 444	DSLA 154 P 1129	0 433 175 333
DSLA 150 P 881	0 433 175 245	DSLA 150 P 1495	2 437 010 150	DSLA 154 P 1242	0 433 175 366
DSLA 150 P 886	0 433 175 248	DSLA 150 P 1498	0 433 175 446	DSLA 154 P 1320	0 433 175 395
DSLA 150 P 933	2 437 010 129	DSLA 150 P 1499	0 433 175 447	DSLA 154 P 1360	0 433 175 405

... HB-DLL 160 S 1053

 Typ	 Ref.
---	--

DSLA 155 P 75	0 433 175 001
DSLA 155 P 84	0 433 175 004
DSLA 155 P 104	0 433 175 005
DSLA 155 P 170	0 433 175 007
DSLA 155 P 185	0 433 175 010

DSLA 155 P 276	0 433 175 039
DSLA 155 P 278	0 433 175 040
DSLA 155 P 298	0 433 175 043
DSLA 155 P 498	0 433 175 086
DSLA 155 P 617	2 437 010 079

DSLA 155 P 654	0 433 175 133
DSLA 155 P 655	0 433 175 134
DSLA 155 P 656	0 433 175 135
DSLA 155 P 789	0 433 175 192
DSLA 155 P 839	0 433 175 220

DSLA 155 P 863	0 433 175 231
DSLA 155 P 1003	0 433 175 289
DSLA 155 P 1029	0 433 175 295
DSLA 155 P 1038	F 002 C40 524
DSLA 155 P 1327	F 002 C40 564

DSLA 156 P 736	0 433 175 163
DSLA 156 P 737	0 433 175 164
DSLA 156 P 856	0 433 175 228
DSLA 156 P 969	0 433 175 270
DSLA 156 P 1035	0 433 175 299

DSLA 156 P 1041	0 433 175 302
DSLA 156 P 1113	0 433 175 326
DSLA 156 P 1176	0 433 175 349
DSLA 156 P 1177	0 433 175 350
DSLA 156 P 1190	0 433 175 353

DSLA 156 P 1336	0 433 175 402
DSLA 156 P 1381	0 433 175 411
DSLA 156 P 1411	0 433 175 416
DSLA 156 P 1412	0 433 175 417
DSLA 156 P 1472	0 433 175 430

DSLA 156 P 1475	0 433 175 434
DSLA 156 P 1476	0 433 175 435
DSLA 156 P 1477	0 433 175 436
DSLA 156 P 1079/+	0 433 175 314
DSLA 156 P 1155+	0 433 175 342

DSLA 157 P 687	0 433 175 146
DSLA 157 P 871	0 433 175 238
DSLA 157 P 955	0 433 175 267
DSLA 157 P 1241	2 437 010 142
DSLA 158 P 817	2 437 010 097

 Typ	 Ref.
---	--

DSLA 158 P 902	0 433 175 254
DSLA 158 P 974	0 433 175 275
DSLA 158 P 1123	0 433 175 328
DSLA 158 P 1143	0 433 175 338
DSLA 160 P 192	0 433 175 014

DSLA 160 P 807	0 433 175 205
DSLA 160 P 865	0 433 175 233
DSLA 160 P 904	0 433 175 255
DSLA 160 P 937	0 433 175 265
DSLA 160 P 938	0 433 175 266

DSLA 160 P 972	0 433 175 273
DSLA 160 P 992	0 433 175 285
DSLA 160 P 1016	0 433 175 290
DSLA 162 P 1192	0 433 175 355

EE-DLLA ... S ...

EE-DLLA 150 S 797	0 433 271 858
-------------------	----------------------

HB-DL ... D ...

HB-DL 90 D 3	9 430 033 205
--------------	----------------------

HB-DL ... S ...

HB-DL 30 S 3	9 430 033 228
HB-DL 30 S 1176	9 430 033 206
HB-DL 30 S 1180	9 430 033 209

HB-DL 30 S 1184	9 430 033 210
HB-DL 30 S 1199	9 430 033 211
HB-DL 30 S 1202	9 430 033 212
HB-DL 30 S 1232	9 430 033 218
HB-DL 55 S 1177	9 430 033 207

HB-DL 55 S 1178	9 430 033 208
HB-DL 80 S 861	9 430 033 226
HB-DL 90 S 4	9 430 033 204
HB-DL 100 S 1212	9 430 033 213
HB-DL 110 S 9160	9 430 033 202

HB-DL 120 S	9 430 033 200
HB-DL 130 S	9 430 033 201

 Typ	 Ref.
---	--

HB-DL ... T ...

HB-DL 130 T 1179	9 430 033 302
HB-DL 144 T 1231	9 430 033 306
HB-DL 145 T 1219	9 430 033 303

HB-DL 145 T 1220	9 430 033 304
HB-DL 157 T	9 430 033 300
HB-DL 157 T	9 430 033 301

HB-DLA ... S ...

HB-DLA 110 S 1166	9 430 033 203
-------------------	----------------------

HB-DLL ... P ...

HB-DLL 130 P 766	F 002 C40 003
------------------	----------------------

HB-DLL ... S ...

HB-DLL 16 S 561 HB-9	9 430 034 257
HB-DLL 140 S 256 HB-6	9 430 034 253
HB-DLL 140 S 282	9 430 034 266

HB-DLL 140 S 884	9 430 034 230
HB-DLL 140 S 922	9 430 034 236
HB-DLL 140 S 973	9 430 034 238
HB-DLL 140 S 1115	9 430 034 277
HB-DLL 140 S 1319	F 002 C30 101

HB-DLL 140 S 2150	9 430 034 204
HB-DLL 145 S 1139	9 430 034 283
HB-DLL 150 S 405	9 430 034 700
HB-DLL 150 S 519	9 430 034 201
HB-DLL 150 S 814	9 430 034 225

HB-DLL 150 S 840	9 430 034 226
HB-DLL 150 S 6395	9 430 034 298
HB-DLL 150 S 6571	9 430 034 295
HB-DLL 152 S 1255	9 430 034 716
HB-DLL 155 S 1312	9 430 034 710

HB-DLL 157 S 1118	9 430 034 279
HB-DLL 157 S 1352	F 002 C30 111
HB-DLL 157 S 1355	F 002 C30 113
HB-DLL 160 S 1045	9 430 034 274
HB-DLL 160 S 1053	9 430 034 247



de

Typformel →
Bestellnummer
(Fortsetzung)

en

Type designation →
Part number
(continued)

fr

Formule de type →
Référence
(suite)

it

Sigla → Numero
d'ordinazione
(seguito)

es

Designación del tipo
→ Número de pedido
(continuación)

HB-DLL 160 S 1354 ...



HB-DLL 160 S 1354	F 002 C30 112
-------------------	----------------------

HB-DLLA ... P ...

HB-DLLA 130 P 549	9 430 034 116
HB-DLLA 130 P 858	F 002 C40 005
HB-DLLA 140 P 501	9 430 034 114

HB-DLLA 148 P 667	F 002 C40 001
HB-DLLA 148 P 791	F 002 C40 004
HB-DLLA 150 P 59	9 430 034 121
HB-DLLA 150 P 376	9 430 034 108
HB-DLLA 150 P 475	9 430 034 113

HB-DLLA 150 P 623	9 430 034 123
HB-DLLA 150 P 1047	F 002 C40 525
HB-DLLA 154 P 005 HB	9 430 034 105
HB-DLLA 154 P 202	9 430 034 100
HB-DLLA 160 P 201	9 430 034 101

HB-DLLA ... S ...

HB-DLLA 124 S 6152	9 430 034 240
HB-DLLA 135 S 799	9 430 034 224
HB-DLLA 135 S 1106	9 430 034 275

HB-DLLA 136 S 1240	9 430 034 709
HB-DLLA 137 S 1273	9 430 034 719
HB-DLLA 138 S 782	9 430 034 222
HB-DLLA 138 S 940	9 430 034 235
HB-DLLA 140 S 874	9 430 034 231

HB-DLLA 140 S 1261	9 430 034 718
HB-DLLA 142 S 878	9 430 034 229
HB-DLLA 142 S 959	9 430 034 237
HB-DLLA 142 S 1011	9 430 034 239
HB-DLLA 142 S 1142	9 430 034 284

HB-DLLA 142 S 1332	F 002 C30 107
HB-DLLA 142 S 1334	F 002 C30 006
HB-DLLA 144 S 1381	F 002 C30 011
HB-DLLA 145 S 701 HB-8	9 430 034 255
HB-DLLA 145 S 1107	9 430 034 276

HB-DLLA 146 S 774	9 430 034 713
HB-DLLA 146 S 1085	9 430 034 272
HB-DLLA 146 S 1129	9 430 034 282
HB-DLLA 146 S 1177	9 430 034 299
HB-DLLA 150 S 257	9 430 034 270



HB-DLLA 150 S 334 HB-1	9 430 034 251
HB-DLLA 150 S 344 HB-3	9 430 034 250
HB-DLLA 150 S 384 HB-1	9 430 034 248
HB-DLLA 150 S 384 HB-2	9 430 034 249
HB-DLLA 150 S 402	9 430 034 293

HB-DLLA 150 S 424 HB-470	9 430 034 714
HB-DLLA 150 S 643	9 430 034 208
HB-DLLA 150 S 663	9 430 034 209
HB-DLLA 150 S 691	9 430 034 215
HB-DLLA 150 S 692	9 430 034 213

HB-DLLA 150 S 698	9 430 034 214
HB-DLLA 150 S 719	9 430 034 217
HB-DLLA 150 S 875	9 430 034 228
HB-DLLA 150 S 901	9 430 034 233
HB-DLLA 150 S 990	9 430 034 273

HB-DLLA 150 S 1124	9 430 034 281
HB-DLLA 150 S 1318	F 002 C30 002
HB-DLLA 150 S 1326	F 002 C30 105
HB-DLLA 150 S 1336	F 002 C30 005
HB-DLLA 150 S 1338	F 002 C30 008

HB-DLLA 150 S 1353	F 002 C30 009
HB-DLLA 150 S 1359	F 002 C30 118
HB-DLLA 150 S 1366	F 002 C30 121
HB-DLLA 150 S 1375	F 002 C30 130
HB-DLLA 150 S 2390	9 430 034 206

HB-DLLA 151 S 354 HB-86	9 430 034 292
HB-DLLA 152 S 324 HB-13	9 430 034 263
HB-DLLA 152 S 1108	9 430 034 278
HB-DLLA 154 S 324 HB-14	9 430 034 264
HB-DLLA 155 S 772	9 430 034 219

HB-DLLA 155 S 833	9 430 034 227
HB-DLLA 155 S 833	9 430 034 701
HB-DLLA 158 S 325 HB-11	9 430 034 261
HB-DLLA 158 S 1364	F 002 C30 120
HB-DLLA 160 S 295 HB-422	9 430 034 297

HB-DLLA 160 S 354 HB-5	9 430 034 252
HB-DLLA 160 S 354 HB-12	9 430 034 262
HB-DLLA 160 S 905	9 430 034 232
HB-DLLA 160 S 1144	9 430 034 285
HB-DLLA 160 S 1164	9 430 034 287

HB-DLLA 160 S 1297	9 430 034 720
HB-DLLA 166 S 374 HB-15	9 430 034 258
HB-DLLA 166 S 414 HB-7	9 430 034 254
HB-DLLA 168 S 304 HB-16	9 430 034 259
HB-DLLA 171 S 374 HB-10	9 430 034 260



HB-DLLB ... S ...

HB-DLLB 160 S 1125	9 430 034 280
--------------------	----------------------

HB-DN ... S ...

HB-DN 4 S 2 HB-6	9 430 036 205
HB-DN 4 S 3	9 430 036 210
HB-DN 6 S 1	9 430 036 206

HB-DN 15 S 3	9 430 036 209
HB-DN 30 S 2	9 430 036 214

HB-DN ... SD ...

HB-DN 0 SD 21 HB-17	9 430 037 207
HB-DN 0 SD 126 HB-4	9 430 037 222
HB-DN 0 SD 177 HB-16	9 430 037 218

HB-DN 0 SD 212	9 430 037 210
HB-DN 0 SD 252	9 430 037 234
HB-DN 0 SD 255	9 430 037 206
HB-DN 0 SD 287	9 430 037 232
HB-DN 0 SD 299	F 002 C10 603

HB-DN 4 SD 62 HB-3	9 430 037 221
HB-DN 4 SD 90 HB-17	9 430 037 216
HB-DN 4 SD 139 HB-2	9 430 037 220
HB-DN 4 SD 187	9 430 037 229
HB-DN 12 SD 148	9 430 037 224

HB-DN 12 SD 160	9 430 037 226
HB-DN 15 SD HB-1	9 430 037 219
HB-DN 40 SD 32 HB-18	9 430 037 217

HB-DNA ... SD ...

HB-DNA 0 SD 298	9 430 037 231
HB-DNA 4 SD 180	9 430 037 227
HB-DNA 12 SD 186	9 430 037 228

HB-DSLA ... P ...

HB-DSLA 128 P 962	F 002 C40 513
HB-DSLA 128 P 997	F 002 C40 515
HB-DSLA 138 P 1092	F 002 C40 533

... TR-DNA 0 SD 238

 Typ	 Ref.
---	--

HB-DSLA 142 P 1130	F 002 C40 537
HB-DSLA 144 P 931	F 002 C40 500
HB-DSLA 144 P 949	F 002 C40 509
HB-DSLA 146 P 977	F 002 C40 511
HB-DSLA 146 P 1007	F 002 C40 518

HB-DSLA 146 P 1254	F 002 C40 555
HB-DSLA 147 P 1082	F 002 C40 530
HB-DSLA 147 P 1149	F 002 C40 539
HB-DSLA 147 P 1150	F 002 C40 540
HB-DSLA 150 P 1060	F 002 C40 526

HB-DSLA 150 P 1172	F 002 C40 545
HB-DSLA 150 P 1232	F 002 C40 551
HB-DSLA 150 P 1236	F 002 C40 552
HB-DSLA 150 P 1252	F 002 C40 554
HB-DSLA 155 P 1235	F 002 C40 550

IBMB ...

IBMB 5587 A	0 433 271 391
-------------	----------------------

IBMD ...

IBMD 5750 A 3	0 433 270 175
IBMD 5320 AB	0 433 220 165
IBMD 5121	0 433 220 164

IBMD 5626	0 433 271 399
IBMD 5707	0 433 271 419
IBMD 5719	0 433 271 392
IBMD 5753	0 433 270 184
IBMD 5767	0 433 271 381

IBMD 5837	0 433 271 852
-----------	----------------------

IBMDB ...

IBMDB 1035 C	0 433 270 172
IBMDB 5221	0 433 271 384
IBMDB 5299	0 433 271 385

IBMDB 5301	0 433 271 386
IBMDB 5330	0 433 270 177
IBMDB 5392	0 433 271 388
IBMDB 5434	0 433 271 389
IBMDB 5492	0 433 271 380

 Typ	 Ref.
---	--

IBMDB 5777	0 433 271 383
------------	----------------------

KP-DN ... SD ...

KP-DN 0 SD 126 FD	0 434 250 123
KP-DN 0 SD 193	0 434 250 124

SIGMA-IBMD ...

SIGMA-IBMD 5823	0 433 271 853
SIGMA-IBMD 5826	0 433 271 406

TR-DLLA ... S ...

TR-DLLA 75 S 622	0 433 271 303
TR-DLLA 160 S 846	0 433 271 833

TR-DN ... S ...

TR-DN 8 S 229	0 434 200 044
---------------	----------------------

TR-DNA ... SD ...

TR-DNA 0 SD 238	0 434 250 089
-----------------	----------------------



de

Bestellnummer →
Typformel
für Zexel-Düsen

en

Part number →
Type designation
for Zexel nozzles

fr

Référence →
Formule de type
pour injecteurs Zexel

it

Numero d'ordina-
zione → Sigla per
polverizzatori Zexel

es

Número de pedido →
Designación del tipo
para inyectoros Zexel

9 430 611 790 ...



9 430 611 ...

9 430 611 790	NP-DLL 155 S 288 N431
---------------	-----------------------

9 430 612 ...

9 430 612 727	NP-DLLA 155 PN 118
---------------	--------------------

9 432 610 ...

9 432 610 000	NP-DN 4 S 1
---------------	-------------

9 432 610 001	NP-DN 0 SD 21
---------------	---------------

9 432 610 002	NP-DN 0 SD 211
---------------	----------------

9 432 610 003	NP-DN 0 SD 193
---------------	----------------

9 432 610 004	NP-DN 0 SD 193 NP 1
---------------	---------------------

9 432 610 005	NP-DN 30 SDN 180
---------------	------------------

9 432 610 006	NP-DN 15 PDN 100
---------------	------------------

9 432 610 007	NP-DN 0 SD 2110
---------------	-----------------

9 432 610 008	NP-DN 0 SD 126
---------------	----------------

9 432 610 009	NP-DN 7 SD 64
---------------	---------------

9 432 610 010	NP-DN 0 SD 126 A
---------------	------------------

9 432 610 011	NP-DN 0 SDN 187
---------------	-----------------

9 432 610 012	NP-DN 4 SD 24
---------------	---------------

9 432 610 013	NP-DN 1830
---------------	------------

9 432 610 014	NP-DN 0 SDN 184
---------------	-----------------

9 432 610 015	NP-DLLA 166 S 374 NP 6
---------------	------------------------

9 432 610 016	NP-DLL 150 S 328 NP 52
---------------	------------------------

9 432 610 017	NP-DLLA 150 S 414 NP 83
---------------	-------------------------

9 432 610 018	NP-DLLA 154 S 324 N413
---------------	------------------------

9 432 610 019	NP-DLLA 151 S 354 NP 86
---------------	-------------------------

9 432 610 020	NP-DL 130 T 328 NP 20
---------------	-----------------------

9 432 610 021	NP-DN 0 SDN 177
---------------	-----------------

9 432 610 022	NP-DLLA 150 PN 000
---------------	--------------------

9 432 610 023	NP-DN 0 SDN 187
---------------	-----------------

9 432 610 024	NP-DLLA 154 S 334 N 419
---------------	-------------------------

9 432 610 025	NP-DLLA 154 S 304 N474
---------------	------------------------

9 432 610 026	NP-DN 0 SD 193 NP 2
---------------	---------------------

9 432 610 027	NP-DLLA 154 PN 007
---------------	--------------------

9 432 610 028	NP-DL 150 T 348 NP 20
---------------	-----------------------

9 432 610 029	NP-DLLA 150 S 344 NP 82
---------------	-------------------------

9 432 610 030	NP-DLLA 160 S 354 NP 88
---------------	-------------------------

9 432 610 031	NP-DN 4 SDNP 90
---------------	-----------------

9 432 610 032	NP-DL 150 T 268 NP 22
---------------	-----------------------



9 432 610 033	NP-DLLA 150 S 384 NP 13
---------------	-------------------------

9 432 610 034	NP-DN 4 SD 24 NP 80
---------------	---------------------

9 432 610 035	NP-DLLA 186 S 334 NP 8
---------------	------------------------

9 432 610 036	NP-DN 4 S 1
---------------	-------------

9 432 610 037	NP-DN 4 SD 24+
---------------	----------------

9 432 610 038	NP-DN 12 SD 12-
---------------	-----------------

9 432 610 039	NP-DN 4 SDNP 62
---------------	-----------------

9 432 610 040	NP-DN 0 SD 193 NP 1
---------------	---------------------

9 432 610 043	NP-DN 0 SD 193 NP 1
---------------	---------------------

9 432 610 044	NP-DN 4 SNP 3
---------------	---------------

9 432 610 045	NP-DLLA 150 S 344 NP70
---------------	------------------------

9 432 610 046	NP-DLLA 160 S 295 N 422
---------------	-------------------------

9 432 610 047	NP-DL 150 T 308 NP 22
---------------	-----------------------

9 432 610 048	NP-DN 12 SDN 189
---------------	------------------

9 432 610 049	NP-DLLA 154 SN 607
---------------	--------------------

9 432 610 050	NP-DLLA 154 PN 006
---------------	--------------------

9 432 610 051	NP-DLLA 154 S 284 N 393
---------------	-------------------------

9 432 610 052	NP-DLF 150 TB 288 N 23
---------------	------------------------

9 432 610 053	NP-DLF 125 U 509 NP 7
---------------	-----------------------

9 432 610 054	NP-DLL 155 S 288 N 431
---------------	------------------------

9 432 610 055	NP-DLLA 142 S 354 N 502
---------------	-------------------------

9 432 610 056	NP-DLLA 154 SN 667
---------------	--------------------

9 432 610 057	NP-DN 15 SDNP 2
---------------	-----------------

9 432 610 058	NP-DN 6 S 197
---------------	---------------

9 432 610 059	NP-DN 4 PDN 101
---------------	-----------------

9 432 610 060	NP-DN 4 SD 65
---------------	---------------

9 432 610 061	NP-DLLA 186 S 324 NP 8
---------------	------------------------

9 432 610 062	NP-DN 0 PDN 112
---------------	-----------------

9 432 610 063	NP-DN 0 PDN 102
---------------	-----------------

9 432 610 064	NP-DLLA 144 S 354 N 403
---------------	-------------------------

9 432 610 065	NP-DLLA 152 S 354 N 406
---------------	-------------------------

9 432 610 067	NP-DN 0 SD 193 NP 1
---------------	---------------------

9 432 610 069	NP-DN 8 SD 24 N 6
---------------	-------------------

9 432 610 070	NP-DLLA 162 S 384 N 457
---------------	-------------------------

9 432 610 071	NP-DLF 130 U 5810 NP 9
---------------	------------------------

9 432 610 072	NP-DLLA 142 S 344 N 547
---------------	-------------------------

9 432 610 073	NP-DLLA 158 SN 638
---------------	--------------------

9 432 610 074	NP-DN 0 PDN 108
---------------	-----------------

9 432 610 075	NP-DLL 150 S 328 NP 33
---------------	------------------------

9 432 610 076	NP-DN 0 SD 211 NP 2
---------------	---------------------

9 432 610 077	NP-DN 0 PDN 113
---------------	-----------------

9 432 610 078	NP-DLLA 160 PN 010
---------------	--------------------

9 432 610 079	NP-DLLA 150 PN 021
---------------	--------------------

9 432 610 080	NP-DN 15 PDN 111
---------------	------------------

9 432 610 081	NP-DLL 160 S 307 N 435
---------------	------------------------

... 9 432 610 171



9 432 610 082	NP-DLF 150 TB 388 N 17
9 432 610 083	NP-DLLA 176 S 324 N
9 432 610 084	NP-DLLA 155 SN 536
9 432 610 085	NP-DN 0 SD 21
9 432 610 086	NP-DLF 144 T 388 NP 9
9 432 610 087	NP-DL 155 T 358 NP 26
9 432 610 088	NP-DL 155 T 358 NP 1
9 432 610 089	NP-DLLA 154 S 374 N 438
9 432 610 090	NP-DN 0 SDN 186
9 432 610 091	NP-DLLA 154 S 284 N 386
9 432 610 092	NP-DLLA 171 S 374 NP 58
9 432 610 093	NP-DLLA 145 S 701 NP 15
9 432 610 094	NP-DLLA 150 PN 050
9 432 610 095	NP-DLLA 154 SN 606
9 432 610 096	NP-DN 12 SD 175
9 432 610 097	NP-DLLA 154 S 364 N476
9 432 610 098	NP-DLLA 150 PN 044
9 432 610 099	NP-DLLA 154 PN 005
9 432 610 100	NP-DLLA 150 S 394 NP 76
9 432 610 101	NP-DLLA 160 S 385 NP50
9 432 610 102	NP-DLLA 171 S 334 NP 84
9 432 610 103	NP-DLF 123 U 408 NP 10
9 432 610 104	NP-DN 15 SDNK 1
9 432 610 105	NP-DNZ 0 SDN 202
9 432 610 106	NP-DL 120 T 306 NP
9 432 610 107	NP-DL 115 T 305 NP
9 432 610 108	NP-DL 130 T 328 NP 1
9 432 610 109	NP-DL 150 T 258 NP 1
9 432 610 110	NP-DN 0 PDN 105
9 432 610 111	NP-DLLA 154 SN 533
9 432 610 112	NP-DN 0 SDN 10
9 432 610 113	NP-DN 40 SDNP 32
9 432 610 114	NP-DN 0 SDNP 136
9 432 610 115	NP-DLLA 168 S 304 NP 59
9 432 610 116	NP-DN 0 PDN 107
9 432 610 117	NP-DLF 150 TB 288 N 22
9 432 610 118	NP-DLF 150 TB 258 N22
9 432 610 119	NP-DLF 150 TB 2810 N 23
9 432 610 120	NP-DLF 150 TB 308 N 23
9 432 610 121	NP-DLF 155 TB 3010 N 23
9 432 610 122	NP-DLF 155 TB 358 N 23
9 432 610 123	NP-DLF 150 TB 288 N 25
9 432 610 124	NP-DLF 150 TB 328 N 25 C
9 432 610 125	NP-DLF 150 TB 308 N 25
9 432 610 126	NP-DLF 150 TB 288 N 29







9 432 610 127	NP-DLF 150 TB 258 N 29
9 432 610 128	NP-DLF 150 TB 288 N 30
9 432 610 129	NP-DLF 150 TB 358 N 23 C
9 432 610 130	NP-DLF 140 TB 328 N 23
9 432 610 131	NP-DLF 140 TB 358 N 23
9 432 610 132	NP-DLF 150 TB 258 N 23
9 432 610 133	NP-DLF 150 TB 388 N 32
9 432 610 134	NP-DLF 150 TB 366 N 23
9 432 610 135	NP-DLF 150 TB 358 N 23 C
9 432 610 136	NP-DLF 150 UB 408 N 11
9 432 610 137	NP-DLF 135 UB 409 N 11
9 432 610 138	NP-DLL 150 TA 288 N 6
9 432 610 139	NP-DLL 150 TA 2510 N 6
9 432 610 140	NP-DLL 150 TA 258 N 6
9 432 610 141	NP-DLF 130 TB 408 N 33
9 432 610 142	NP-DLLA 150 S 384 NP 73
9 432 610 143	NP-DLLA 166 S 384 NP 97
9 432 610 144	NP-DLL 155 SN 521
9 432 610 145	NP-DLLA 150 S 404 NP 13
9 432 610 146	NP-DLLA 155 PN 079
9 432 610 147	NP-DLLA 142 S 394 NP 66
9 432 610 148	NP-DN 4 SD 24 NP 1
9 432 610 149	NP-DL 150 T 378 NP 15
9 432 610 150	NP-DLL 158 SN 701
9 432 610 151	NP-DN 0 SD 130 NP 3
9 432 610 152	NP-DLL 16 S 561 N 389
9 432 610 153	NP-DLLA 152 PN 014
9 432 610 154	NP-DLLA 150 SN 742
9 432 610 155	NP-DL 150 T 388 NP 20
9 432 610 156	NP-DN 0 S 34
9 432 610 157	NP-DN 0 PDN 110
9 432 610 158	NP-DLLA 150 S 334 N 385
9 432 610 159	NP-DLSLA 154 PN 082
9 432 610 160	NP-DN 0 SDN 196
9 432 610 161	NP-DLLA 154 PN 005
9 432 610 162	NP-DN 0 PDN 108
9 432 610 163	NP-DLLA 154 PN 068
9 432 610 164	NP-DLLA 144 S 304 N 481
9 432 610 165	NP-DLLA 150 S 345 N 492
9 432 610 166	NP-DLLA 142 SN 581
9 432 610 167	NP-DLLA 142 SN 613
9 432 610 168	NP-DLLA 160 PN 004
9 432 610 169	NP-DL 160 T 306 NP 1
9 432 610 170	NP-DLLA 160 SN 731
9 432 610 171	NP-DLLA 154 PN 018





A70



de	en	fr	it	es
Bestellnummer → Typformel für Zexel-Düsen (Fortsetzung)	Part number → Type designation for Zexel nozzles (continued)	Référence → Formule de type pour injecteurs Zexel (suite)	Numero d'ordina- zione → Sigla per polverizzatori Zexel (seguito)	Número de pedido → Designación del tipo para inyectoros Zexel (continuación)

9 432 610 172 ...

 Ref.	 Typ	 Ref.	 Typ
9 432 610 172	NP-DLLA 150 S 344 NP 51	9 432 610 218	NP-DLLA 138 S 364 N 409
9 432 610 173	NP-DLLA 150 S 344 N 489	9 432 610 219	NP-DN 4 SDN 2
9 432 610 174	NP-DLLA 160 SN 566	9 432 610 220	NP-DN 4 SDNP 135
9 432 610 175	NP-DLLA 152 PN 009	9 432 610 221	NP-DN 4 PD 1
9 432 610 176	NP-DLLA 160 S 324 N 486	9 432 610 222	NP-DN 4 PDN 117
9 432 610 177	NP-DLLA 142 SN 718	9 432 610 223	NP-DLLA 150 SN 615
9 432 610 178	NP-DLLA 156 PN 110	9 432 610 224	NP-DLL 155 SN 639
9 432 610 179	NP-DLLA 150 S 374 N 464	9 432 610 225	NP-DLLA 148 S 365 N 388
9 432 610 180	NP-DL 155 S 258 NP 12	9 432 610 226	NP-DLF 145 T 308 NP 8
9 432 610 181	NP-DLLA 154 PN 058	9 432 610 227	NP-DLLA 160 PN 036
9 432 610 182	NP-DLLA 160 S 354 NP 49	9 432 610 228	NP-DL 155 U 408 NP 1
9 432 610 183	NP-DLLA 160 S 354 NP 49	9 432 610 229	NP-DLLA 155 PN 089
9 432 610 184	NP-DLLA 137 S 374 N 417	9 432 610 230	NP-DN 0 SDN 187
9 432 610 185	NP-DLLA 150 SN 623	9 432 610 231	NP-DLLA 154 S 424 N 459
9 432 610 186	NP-DL 160 T 3510 NP 34	9 432 610 232	NP-DLLA 158 PN 108
9 432 610 187	NP-DLLA 151 SN 517	9 432 610 233	NP-DLLA 155 PN 080
9 432 610 189	NP-DN 0 PDN 1061	9 432 610 234	NP-DN 4 SDNP 146
9 432 610 190	NP-DLLA 158 S 325 N 437	9 432 610 235	NP-DLLA 160 SN 539
9 432 610 191	NP-DLL 155 SN 595	9 432 610 236	NP-DN 0 PDN 114
9 432 610 192	NP-DN 4 SDNP 133	9 432 610 237	NP-DN 0 PDN 122
9 432 610 193	NP-DLLA 155 SN 707	9 432 610 238	NP-DLLA 150 SN 722
9 432 610 194	NP-DL 150 U 428 NP 9	9 432 610 239	NP-DN 0 PD 4
9 432 610 195	NP-DLLA 145 S 344 N 453	9 432 610 240	NP-DLF 150 TB 348 N17
9 432 610 196	NP-DLLA 150 PN 044	9 432 610 241	NP-DLLA 155 S 334 NP96
9 432 610 197	NP-DL 140 T 358 NP 1	9 432 610 242	NP-DLLA 160 S 325 N507
9 432 610 198	NP-DLLA 150 SN 624	9 432 610 243	NP-DLLA 154 SN 661
9 432 610 199	NP-DN 0 PDN 121	9 432 610 244	NP-DLLA 150 P 9
9 432 610 200	NP-DLLA 148 SN 545	9 432 610 245	NP-DLLA 154 SN 586
9 432 610 201	NP-DLLA 154 PN 067	9 432 610 246	NP-DLF 150 TB 368 N 27
9 432 610 202	NP-DLSLA 154 PN 098	9 432 610 247	NP-DLF 150 TB 368 N 31
9 432 610 203	NP-DLLA 157 SN 778	9 432 610 248	NP-DLF 150 TB 368 N 39
9 432 610 204	NP-DLLA 148 S 324 N 473	9 432 610 249	NP-DN 0 PD 55
9 432 610 205	NP-DN 0 SDN 220	9 432 610 250	NP-DLLA 152 PN 097
9 432 610 206	NP-DLL 160 SN 647	9 432 610 251	NP-DN 0 SDN 224
9 432 610 207	NP-DLLA 160 SN 670	9 432 610 252	NP-DLLA 160 SN 644
9 432 610 208	NP-DLLA 157 PN 102	9 432 610 253	NP-DLLA 146 PN 055
9 432 610 209	NP-DLF 150 UB 479 N9	9 432 610 254	NP-DLLA 154 SN 640
9 432 610 210	NP-DLLA 150 PN 052	9 432 610 255	NP-DLLA 150 PN 047
9 432 610 211	NP-DLLA 153 SN 7131	9 432 610 256	NP-DLLA 154 PN 049
9 432 610 212	NP-DLLA 152 SN 681	9 432 610 257	NP-DL 150 T 308 NP 1
9 432 610 213	NP-DLLA 144 SN 649	9 432 610 258	NP-DLF 160 TB 306 N8
9 432 610 214	NP-DLLA 150 SN 708	9 432 610 259	NP-DLF 150 TB 308 N13
9 432 610 215	NP-DLLA 160 S 385 N 426	9 432 610 260	NP-DLF 150 TB 328 N35
9 432 610 216	NP-DLL 160 SN 538	9 432 610 261	NP-DLF 150 TB 348 N35
9 432 610 217	NP-DLLA 154 PN 093	9 432 610 262	NP-DLF 145 TB 348 N34

... 9 432 610 352

 Ref.	 Typ
9 432 610 263	NP-DLF 145 TE 328 N3
9 432 610 264	NP-DL 150 T 308 NP15
9 432 610 265	NP-DLLA 155 SN 710
9 432 610 266	NP-DLLA 158 SN 869
9 432 610 267	NP-DN 0 PDN 122
9 432 610 268	NP-DLLA 154 DN 006
9 432 610 269	NP-DN 4 SDN 223
9 432 610 270	NP-DL 145 S 268 NP 1
9 432 610 271	NP-DN 0 PDN 124
9 432 610 272	NP-DL 155 T 378 NP 1
9 432 610 273	NP-DLLA 154 PN 062
9 432 610 274	NP-DN 6 TD 119 NP 1 T
9 432 610 275	NP-DLL 160 SN 664
9 432 610 276	NP-DLF 145 TE 248 N 6 C
9 432 610 277	NP-DLL 155 SN 807
9 432 610 278	NP-DLLA 143 SN 553
9 432 610 279	NP-DLLA 154 PN 025
9 432 610 280	NP-DLLA 154 PN 064
9 432 610 281	NP-DN 0 PDN 127
9 432 610 282	NP-DLLA 154 PN 042
9 432 610 283	NP-DLLA 154 PN 061
9 432 610 284	NP-DN 4 PD 57
9 432 610 285	NP-DLLA 160 SN 567
9 432 610 286	NP-DLLA 142 S 344 N 501
9 432 610 287	NP-DLF 130 TB 328 N 17
9 432 610 288	NP-DLLA 157 PN 090
9 432 610 289	NP-DLLA 154 PN 116
9 432 610 290	NP-DLL 155 S 268 N 485
9 432 610 291	NP-DLLA 153 SN 736
9 432 610 292	NP-DN 0 SDN 199
9 432 610 293	NP-DLLA 150 SN 666
9 432 610 294	NP-DN 10 PDN 129
9 432 610 295	NP-DN 10 PDN 130
9 432 610 296	NP-DL 160 U 388 NP 2
9 432 610 297	NP-DL 160 T 3310 NP 34
9 432 610 298	NP-DL 130 T 306 NP 1
9 432 610 299	NP-DLF 150 TB 328 N 23 C
9 432 610 300	NP-DLLA 154 PN 161
9 432 610 301	NP-DL 150 T 288 NP 22
9 432 610 302	NP-DLLA 142 S 374 N 461
9 432 610 303	NP-DL 168 S 384 NP 14
9 432 610 304	NP-DLLA 158 SN 821
9 432 610 305	NP-DLLA 158 SN 852
9 432 610 306	NP-DLLA 154 PN 0171
9 432 610 307	NP-DLLA 154 PN 094

 Ref.	 Typ
9 432 610 308	NP-DN 4 SDNP 139
9 432 610 309	NP-DLLA 155 PN 123
9 432 610 310	NP-DN 0 PDN 131
9 432 610 311	NP-DLLA 150 SN 702
9 432 610 312	NP-DLLA 154 SN 578
9 432 610 313	NP-DLLA 155 SN 635
9 432 610 314	NP-DLLA 150 S 414 N 380
9 432 610 315	NP-DLLA 160 SN 833
9 432 610 316	NP-DLLA 150 S 394 N 404
9 432 610 317	NP-DN 0 PD 20
9 432 610 318	NP-DLLA 160 SN 564
9 432 610 319	NP-DLLA 154 SN 625
9 432 610 320	NP-DLLA 155 PN 107
9 432 610 321	NP-DLF 145 TE 348 N3
9 432 610 322	NP-DL 145 S 258 NP 1
9 432 610 323	NP-DLLA 160 P 3
9 432 610 324	NP-DLLA 144 S 364 N 497
9 432 610 325	NP-DLF 145 T 408 NP 13
9 432 610 326	NP-DLLA 154 PN 155
9 432 610 327	NP-DN 0 PDN 133
9 432 610 328	NP-DLLA 157 SN 829
9 432 610 329	NP-DSLA 149 PN 901
9 432 610 330	NP-DLLA 155 SN 532
9 432 610 331	NP-DLF 144 T 388 NP 10
9 432 610 332	NP-DLLA 154 PN 148
9 432 610 333	NP-DLLA 152 PN 112
9 432 610 334	NP-DLLA 160 PN 024
9 432 610 335	NP-DLL 160 SN 879
9 432 610 336	NP-DLL 160 SN 614
9 432 610 337	NP DN 0 PDN 123
9 432 610 338	NP-DLF 140 TB 368 N 34
9 432 610 339	NP-DLLA 146 S 344 N 439
9 432 610 340	NP-DLLA 150 S 334 NP 89
9 432 610 341	NP-DLLA 160 PN 085
9 432 610 342	NP-DLLA 150 SN 660
9 432 610 343	NP-DLLA 150 PN 056
9 432 610 344	NP-DLLA 154 SN 791
9 432 610 345	NP-DLLA 155 S 365 N 458
9 432 610 346	NP-DL 160 T 32510 NP 40
9 432 610 347	NP-DLLA 142 SN 582
9 432 610 348	NP-DLLA 166 S 414 NP 46
9 432 610 349	NP-DLLA 105 S 304 N433
9 432 610 350	NP-DLLA 150 SN 941
9 432 610 351	NP-DLLA 154 PN 173
9 432 610 352	NP-DL 150 U 408 NP 9





A72



de	en	fr	it	es
Bestellnummer → Typformel für Zexel-Düsen (Fortsetzung)	Part number → Type designation for Zexel nozzles (continued)	Référence → Formule de type pour injecteurs Zexel (suite)	Numero d'ordina- zione → Sigla per polverizzatori Zexel (seguito)	Número de pedido → Designación del tipo para inyectoros Zexel (continuación)

9 432 610 353 ...

Ref.	Typ	Ref.	Typ
9 432 610 353	NP-DLLA 151 PN 086	9 432 610 400	NP-DLLA 154 PN 154
9 432 610 354	NP-DLLA 157 PN 130	9 432 610 401	NP-DLLA 160 SN 706
9 432 610 355	NP-DN 0 SDN 220 S	9 432 610 402	NP-DSLA 154 PN 011
9 432 610 356	NP-DLLA 157 PN 069	9 432 610 403	NP-DLLA 150 SN 868
9 432 610 357	NP-DL 155 T 3110 NP 40	9 432 610 404	NP-DSLA 154 PN 114
9 432 610 358	NP-DL 160 T 3510 NP 40	9 432 610 405	NP-DLLA 154 S 324 NP81
9 432 610 359	NP-DLLA 150 PN 021	9 432 610 406	NP-DLLA 152 SN 645
9 432 610 360	NP-DLLA 155 PN 157	9 432 610 407	NP-DN 0 SDN 228
9 432 610 361	NP-DLLA 160 PN 140	9 432 610 408	NP-DLLA 146 PN 122
9 432 610 362	NP-DLLA 152 PN 063	9 432 610 409	NP-DLLA 149 SN 679
9 432 610 363	NP-DN 0 SDN 221	9 432 610 410	NP-DLLA 160 S 424 N427
9 432 610 364	NP-DL 155 T 308 NP 26	9 432 610 411	NP-DLLA 150 S 325 NP60
9 432 610 365	NP-DN 4 SDNP 142	9 432 610 412	NP-DLLA 160 S 354 NP77
9 432 610 366	NP-DLLA 153 PN 164	9 432 610 413	NP-DLLA 155 PN 182
9 432 610 367	NP-DLLA 158 SN 949	9 432 610 414	NP-DLLA 148 S 354 NP98
9 432 610 368	NP-DLLA 150 S 374 N 414	9 432 610 415	NP-DLLA 146 S 315 N460
9 432 610 369	NP-DLLA 150 PN 035	9 432 610 416	NP-DLL 16 S 601 NP 93
9 432 610 370	NP-DLF 130 UJ 388 N 1	9 432 610 417	NP-DLLA 160 SN 671
9 432 610 371	NP-DLLA 154 PN 186	9 432 610 418	NP-DLLA 148 SN 841
9 432 610 372	NP-DLLA 169 SN 588	9 432 610 419	NP-DN 40 SDN 4
9 432 610 373	NP-DL 120 T 306 NP 2	9 432 610 420	NP-DLLA 150 SN 877
9 432 610 374	NP-DLLA 160 PN 141	9 432 610 421	NP-DN 0 PDN 136
9 432 610 375	NP-DLLA 150 SN 737	9 432 610 422	NP-DLLA 158 SN 885
9 432 610 376	NP-DLLA 141 PN 136	9 432 610 423	NP-DN 4 SD 128
9 432 610 377	NP-DLLA 158 PN 209	9 432 610 424	NP-DLLA 156 PN 121
9 432 610 378	NP-DSLA 157 PN 902	9 432 610 425	NP-DN 4 PD 57
9 432 610 379	NP-DLLA 154 SN 907	9 432 610 426	NP-DN 4 PD 98
9 432 610 380	NP-DLLA 140 PN 204	9 432 610 427	NP-DN 0 PD 600
9 432 610 382	NP-DLLA 149 SN 809	9 432 610 436	NP-DN 20 PD 32
9 432 610 383	NP-DLLA 154 PN 162	9 432 610 437	NP-DN 0 PD 650
9 432 610 384	NP-DLLA 160 SN 698	9 432 610 438	NP-DN 0 SD 212
9 432 610 385	NP-DN 0 SDN 226	9 432 610 439	NP-DLLA 150 S 424 N470
9 432 610 386	NP-DLLA 150 SNP 173	9 432 610 440	NP-DLLA 148 S 334 N472
9 432 610 387	NP-DLLA 150 S 3840 NP 16	9 432 610 441	NP-DLLA 143 SN 580
9 432 610 388	NP-DLLA 160 SN 570	9 432 610 442	NP-DLLA 157 SN 584
9 432 610 389	NP-DLLA 158 SN 878	9 432 610 444	NP-DN 4 SN 8
9 432 610 390	NP-DL 125 U 5310 NP 5	9 432 610 445	NP-DLLA 154 PN 051
9 432 610 391	NP-DN 0 SDN 229	9 432 610 446	NP-DLLA 151 SM 103
9 432 610 392	NP-DLLA 150 SN 933	9 432 610 448	NP-DLLA 160 PN 224
9 432 610 393	NP-DLLA 150 SN 927	9 432 610 449	NP-DLLA 155 SM 166
9 432 610 394	NP-DLLA 154 PN 208	9 432 610 450	NP-DLLA 153 SM 029
9 432 610 395	NP-DLLA 140 S 274 NP 12	9 432 610 451	NP-DLLA 160 SN 860
9 432 610 396	NP-DLLA 150 SN 763	9 432 610 452	NP-DLLA 153 PN 177
9 432 610 397	NP-DLLA 155 PN 179	9 432 610 453	NP-DLLA 156 SM 139
9 432 610 399	NP-DLLA 155 SN 711	9 432 610 454	NP-DN 0 PDN 137

... 9 432 610 588

 Ref.	 Typ
9 432 610 455	NP-DLLA 152 PN 184
9 432 610 456	NP-DLLA 140 SN 634
9 432 610 457	NP-DLLA 155 SM 096
9 432 610 458	NP-DLLA 150 PN 088
9 432 610 459	NP-DLLA 160 PN 135
9 432 610 460	NP-DLLA 141 SN 714
9 432 610 461	NP-DLLA 153 PN 238
9 432 610 462	NP-DLLA 152 PN 266
9 432 610 463	NP-DLLA 152 PN 258
9 432 610 464	NP-DLLA 152 PN 267
9 432 610 465	NP-DLL 140 S 256 NP38
9 432 610 466	NP-DN 0 S 26
9 432 610 467	NP-DN 0 SD 131
9 432 610 468	NP-DN 4 SD 20
9 432 610 469	NP-DN 4 SD 24 N181
9 432 610 470	NP-DN 12 SDN 188
9 432 610 471	NP-DN 0 SDN 222
9 432 610 472	NP-DN 4 SDN 230
9 432 610 473	NP-DN 0 PDN 104
9 432 610 474	NP-DN 0 PDN 109
9 432 610 475	NP-DN 0 PDN 127
9 432 610 476	NP-DN 0 PDN 128
9 432 610 477	NP-DN 0 PDN 134
9 432 610 478	NP-DN 10 PDN 135
9 432 610 479	NP-DN 0 PDN 147
9 432 610 480	NP-DLF 145 TB 348 NP9
9 432 610 481	NP-DLF 145 T 328 NP8
9 432 610 482	NP-DLF 145 T 428 NP12
9 432 610 483	NP-DLF 160 TB 328 N17
9 432 610 484	NP-DLF 150 TB 268 N28
9 432 610 485	NP-DLF 140 TB 324284 N3
9 432 610 486	NP-DLF 140 TB 348 N34
9 432 610 487	NP-DLF 150 TB 248 N28
9 432 610 488	NP-DLF 145 TB 388 N38
9 432 610 489	NP-DLF 140 TB 304264 N3
9 432 610 490	NP-DLF 145 TB 368 N38
9 432 610 491	NP-DLF 145 TB 304264 N3
9 432 610 492	NP-DLF 145 TB 324284 N3
9 432 610 493	NP-DLF 140 TE 328 N1 %
9 432 610 494	NP-DLF 140 TE 348 N1 %
9 432 610 495	NP-DLF 140 TE 368 N1 %
9 432 610 496	NP-DL 145 T 428 ANP1
9 432 610 497	NP-DL 150 T 368 NP20
9 432 610 498	NP-DL 140 T 368 NP32
9 432 610 499	NP-DL 140 T 348 NP32





 Ref.	 Typ
9 432 610 500	NP-DL 145 T 388 AN3
9 432 610 501	NP-DLF 150 UB 428 N12
9 432 610 502	NP-DLF 150 UB 408 N13
9 432 610 503	NP-DLF 150 UB 509 N9
9 432 610 504	NP-DLF 120 UE 4210 N3 C
9 432 610 505	NP-DLF 156 VV 5110 NP1
9 432 610 506	NP-DLL 165 S 306 NP1
9 432 610 507	NP-DLL 35 S 6 71 NP92
9 432 610 508	NP-DLL 30 S 7 01 N465
9 432 610 509	NP-DLLA 155 SN 515
9 432 610 510	NP-DLLA 160 SN 827
9 432 610 511	NP-DLLA 157 SN 848
9 432 610 512	NP-DLLA 160 SN 922
9 432 610 513	NP-DLLA 155 SN 967
9 432 610 514	NP-DLLA 155 SN 975
9 432 610 515	NP-DLLA 140 SN 982
9 432 610 516	NP-DLLA 160 SN 983
9 432 610 517	NP-DLLA 161 SN 984
9 432 610 518	NP-DLLA 145 SN 988
9 432 610 519	NP-DLLA 145 SN 989
9 432 610 520	NP-DLLA 155 SN 991
9 432 610 521	NP-DLLA 158 SN 995
9 432 610 522	NP-DLLA 150 SN 998
9 432 610 523	NP-DLLA 150 SN 999
9 432 610 526	NP-DLF 154 UM 428 N2
9 432 610 527	NP-DLF 115 UM 328 N4
9 432 610 528	NP-DLF 140 TM 308 N1
9 432 610 529	NP-DLF 154 UM 348 N8
9 432 610 530	NP-DLF 130 UM 388 N6
9 432 610 531	NP-DLF 140 UM 358 N12
9 432 610 532	NP-DLF 140 TM 308 N18
9 432 610 533	NP-DLF 140 TM 309 N18
9 432 610 534	NP-DLF 140 TM 308 N20
9 432 610 550	NP-DLF 140 TM 2710 N18
9 432 610 567	NP-DLF 130 UM 388 N22
9 432 610 579	NP-DLLA 155 PN 198
9 432 610 580	NP-DLLA 162 PN 216
9 432 610 581	NP-DLLA 148 PN 223
9 432 610 582	NP-DLLA 148 PN 226
9 432 610 583	NP-DLLA 149 PN 231
9 432 610 584	NP-DLLA 152 PN 232
9 432 610 585	NP-DLLA 152 PN 233
9 432 610 586	NP-DLLA 153 PN 234
9 432 610 587	NP-DLLA 158 PN 237
9 432 610 588	NP-DLLA 155 PN 239



A74

de	en	fr	it	es
Bestellnummer → Typformel für Zexel-Düsen (Fortsetzung)	Part number → Type designation for Zexel nozzles (continued)	Référence → Formule de type pour injecteurs Zexel (suite)	Numero d'ordina- zione → Sigla per polverizzatori Zexel (seguito)	Número de pedido → Designación del tipo para inyectoros Zexel (continuación)

9 432 610 589 ...

 Ref.	 Typ	 Ref.	 Typ
9 432 610 589	NP-DLLA 155 PN 240	9 432 610 643	NP-DLLA 160 SM 057
9 432 610 590	NP-DLLA 155 PN 241	9 432 610 644	NP-DLLA 156 SM 058
9 432 610 591	NP-DLLA 150 PN 242	9 432 610 645	NP-DLLA 155 SM 061
9 432 610 592	NP-DLLA 146 PN 245	9 432 610 646	NP-DLLA 148 SM 063
9 432 610 593	NP-DLLA 147 PN 246	9 432 610 647	NP-DLLA 155 SM 067
9 432 610 594	NP-DLLA 152 PN 247	9 432 610 648	NP-DLLA 150 SM 078
9 432 610 595	NP-DLLA 152 PN 248	9 432 610 649	NP-DLLA 160 SM 080
9 432 610 596	NP-DLLA 142 PN 249	9 432 610 650	NP-DLLA 161 SM 085
9 432 610 597	NP-DLLA 143 PN 250	9 432 610 651	NP-DLLA 160 SM 092
9 432 610 598	NP-DLLA 147 PN 252	9 432 610 652	NP-DLLA 148 SM 098
9 432 610 599	NP-DLLA 155 PN 256	9 432 610 653	NP-DLLA 158 SM 100
9 432 610 600	NP-DLLA 155 PN 257	9 432 610 654	NP-DLLA 155 SM 102
9 432 610 601	MP-DLLA 156 PN 262	9 432 610 655	NP-DLLA 150 SM 122
9 432 610 602	NP-DLLA 152 PN 640	9 432 610 656	NP-DLLA 155 SM 126
9 432 610 603	NP-DLLA 143 PN 265	9 432 610 657	NP-DLLA 152 SM 127
9 432 610 604	NP-DLLA 157 PN 268	9 432 610 658	NP-DLLA 156 SM 138
9 432 610 605	NP-DLLA 154 PN 270	9 432 610 659	NP-DLLA 155 SM 140
9 432 610 606	NP-DLLA 155 PN 271	9 432 610 660	NP-DLLA 157 SM 143
9 432 610 607	NP-DLLA 152 PN 274	9 432 610 661	NP-DLLA 165 SM 148
9 432 610 608	NP-DLLA 152 PN 275	9 432 610 662	NP-DLLA 155 SM 158
9 432 610 609	NP-DLLA 157 PN 278	9 432 610 663	NP-DLLA 150 SM 160
9 432 610 610	NP-DLLA 151 PN 279	9 432 610 664	NP-DLLA 155 SM 164
9 432 610 611	NP-DLLA 150 PN 281	9 432 610 665	NP-DLLA 157 SM 177
9 432 610 612	NP-DLLA 150 PN 282	9 432 610 666	NP-DLLA 157 SM 180
9 432 610 613	NP-DSLA 155 PN 908	9 432 610 667	NP-DLLA 155 SM 182
9 432 610 614	NP-DSLA 150 PN 909	9 432 610 668	NP-DLLA 157 SM 187
9 432 610 615	NP-DSLA 155 PN 910	9 432 610 669	NP-DLLA 145 SM 198
9 432 610 616	NP-DSLA 150 PN 911	9 432 610 670	NP-DLLA 146 SM 203
9 432 610 617	NP-DSLA 154 PN 913	9 432 610 671	NP-DLLA 150 SM 206
9 432 610 618	NP-DSLA 155 PN 916	9 432 610 672	NP-DLLA 140 SM 218
9 432 610 619	NP-DSLA 151 PN 917	9 432 610 673	NP-DLLA 160 SM 220
9 432 610 620	NP-DSLA 152 PN 918	9 432 610 674	NP-DLLA 150 SM 221
9 432 610 621	NP-DSLA 147 PN 919	9 432 610 675	NP-DLLA 155 SM 225
9 432 610 622	NP-DL 150 TE 378 N1	9 432 610 676	NP-DLLA 150 SM 234
9 432 610 623	NP-DL 150 T 348 NP15	9 432 610 677	NP-DLLA 158 SM 241
9 432 610 624	NP-DL 155 TE 4010 N5	9 432 610 678	NP-DLLA 157 SM 242
9 432 610 634	NP-DLLA 150 SM 000	9 432 610 679	NP-DLLA 155 SM 243
9 432 610 635	NP-DLLA 150 SM 000	9 432 610 680	NP-DLLA 160 SM 244
9 432 610 636	NP-DLLA 145 SM 013	9 432 610 681	NP-DLLA 160 SM 245
9 432 610 637	NP-DLLA 160 SM 032	9 432 610 682	NP-DLLA 160 SM 246
9 432 610 638	NP-DLLA 160 SM 037	9 432 610 683	NP-DLLA 160 SM 247
9 432 610 639	NP-DLLA 158 SM 039	9 432 610 684	NP-DLLA 160 SM 248
9 432 610 640	NP-DLLA 155 SM 050	9 432 610 685	NP-DLLA 155 SM 267
9 432 610 641	NP-DLLA 158 SM 053	9 432 610 686	NP-DLLA 145 SM 276
9 432 610 642	NP-DLLA 149 SM 055	9 432 610 687	NP-DLLA 145 SM 277

... 9 432 610 782



9 432 610 688	KP-DLLA 155 SM 067
9 432 610 689	KP-DLLA 155 SM 061
9 432 610 690	KP-DLLA 155 SN 458
9 432 610 691	NP-DLLA 154 S 1 44W
9 432 610 692	NP-DLLA 155 PN 202
9 432 610 693	NP-DLLA 140 SN 510
9 432 610 694	NP-DLF 145 TE 324284 N3
9 432 610 695	NP-DLF 130 UJ 608 N2
9 432 610 696	NP-DLLA 160 SM 087
9 432 610 697	NP-DLLA 150 S 315 NP145
9 432 610 698	NP-DLLA 142 SN P15
9 432 610 699	NP-DLLA 155 SNP 189
9 432 610 700	NP-DLLA 155 SM 230
9 432 610 701	NP-DLLA 155 PN 200
9 432 610 702	NP-DLLA 154 SN 847
9 432 610 703	NP-DLLA 155 SN 745
9 432 610 704	NP-DLLA 150 SN 876
9 432 610 705	NP-DLLA 155 S 324 N468
9 432 610 706	NP-DLLA 154 PN 087
9 432 610 707	NP-DLLA 154 PN 040
9 432 610 708	NP-DLLA 154 PN 125
9 432 610 709	NP-DLLA 160 SN 659
9 432 610 710	NP-DLLA 160 PN 159
9 432 610 711	NP-DLLA 158 PN 104
9 432 610 712	NP-DLLA 154 PN 207
9 432 610 713	NP-DN 0 SD 151
9 432 610 714	NP-DLL 155 S 289 N434
9 432 610 715	NP-DLLA 155 S 324 N456
9 432 610 716	NP-DLLA 156 SN 820
9 432 610 717	NP-DLLA 145 SN 891
9 432 610 718	NP-DLLA 160 PN 039
9 432 610 719	NP-DLLA 152 PN 077
9 432 610 720	NP-DLLA 161 PN 109
9 432 610 721	NP-DLF 130 TB 388 N1
9 432 610 722	NP-DLLA 154 SN 903
9 432 610 723	NP-DLLA 152 SN 529
9 432 610 724	NP-DLLA 139 PN 119
9 432 610 725	NP-DLL 155 SN 979
9 432 610 726	NP-DLLA 154 SM 119
9 432 610 727	NP-DLLA 160 SN 744
9 432 610 728	NP-DLLA 154 SM 025
9 432 610 729	NP-DLLA 154 SM 178
9 432 610 730	NP-DLLA 153 PN 178
9 432 610 731	NP-DLLA 149 PN 151
9 432 610 732	NP-DLLA 160 PN 070



9 432 610 733	NP-DLLA 155 PN 060
9 432 610 734	NP-DLLA 155 PN 057
9 432 610 735	NP-DLLA 160 PN 031
9 432 610 736	NP-DLLA 146 PN 028
9 432 610 737	NP-DLLA 158 SN 971
9 432 610 738	NP-DLLA 155 SN 926
9 432 610 739	NP-DLLA 150 SN 917
9 432 610 740	NP-DLLA 150 SN 836
9 432 610 741	NP-DLLA 150 SN 826
9 432 610 742	NP-DLLA 150 SN 818
9 432 610 743	NP-DLLA 153 SN 786
9 432 610 744	NP-DLLA 150 SN 775
9 432 610 745	NP-DLLA 153 SN 768
9 432 610 746	NP-DLLA 150 SN 758
9 432 610 747	NP-DLLA 155 SN 755
9 432 610 748	NP-DLLA 154 SN 750
9 432 610 749	NP-DLLA 155 SN 743
9 432 610 750	NP-DLLA 150 SN 728
9 432 610 751	NP-DLLA 157 SN 725
9 432 610 752	NP-DLLA 147 SN 703
9 432 610 753	NP-DLLA 160 SN 676
9 432 610 754	NP-DLLA 138 SN 612
9 432 610 755	NP-DLLA 142 SN 568
9 432 610 756	NP-DLLA 150 SN 555
9 432 610 757	NP-DLLA 150 SN 548
9 432 610 758	NP-DLLA 154 SN 503
9 432 610 759	NP-DLLA 151 S 354 N425
9 432 610 760	NP-DLLA 166 S 384 NP72
9 432 610 761	NP-DL 125 T 407 NP1
9 432 610 762	NP-DLLA 140 PN 003
9 432 610 763	NP-DL 130 S 228 NP1
9 432 610 764	NP-DLLA 149 SM 304
9 432 610 765	NP-DLLA 152 PN 269
9 432 610 766	NP-DLLA 155 SN 824
9 432 610 767	NP-DLLA 157 SM 273
9 432 610 769	NP-DLLA 150 SM 303
9 432 610 770	NP-DLLA 150 SN 930
9 432 610 771	NP-DLLA 155 PN 276
9 432 610 772	NP-DLLA 147 SM 327
9 432 610 774	NP-DLLA 150 SN 912
9 432 610 777	NP-DLLA 133 SM 257
9 432 610 778	NP-DLLA 150 SM 271
9 432 610 779	NP-DLLA 145 SM 033
9 432 610 781	NP-DLLA 146 PN 218?
9 432 610 782	NP-DLLA 155 SM 194



A76

de

**Bestellnummer →
Typformel
für Zexel-Düsen**
(Fortsetzung)

en

**Part number →
Type designation
for Zexel nozzles**
(continued)

fr

**Référence →
Formule de type
pour injecteurs Zexel**
(suite)

it

**Numero d'ordina-
zione → Sigla per
polverizzatori Zexel**
(seguito)

es

**Número de pedido →
Designación del tipo
para inyectoros Zexel**
(continuación)

9 432 610 784 ...



Ref.



Typ

9 432 610 784	NP-DLLA 153 SM 215
9 432 610 786	NP-DLLA 155 SM 045
9 432 610 788	NP-DLLA 156 SM 146
9 432 610 789	NP-DLLA 160 SM 309
9 432 610 791	NP-DLLA 150 SM 034
9 432 610 793	NP-DLLA 150 SM 105
9 432 610 795	NP-DLLA 155 SM 157
9 432 610 797	NP-DLLA 155 SM 156
9 432 610 799	NP-DLLA 146 SM 224
9 432 610 801	NP-DLLA 156 SM 317
9 432 610 803	NP-DLLA 155 SM 295
9 432 610 805	NP-DLLA 155 SM 324
9 432 610 807	NP-DLLA 156 SM 263
9 432 610 809	NP-DLLA 150 SM 018
9 432 610 811	NP-DLLA 160 PN 059
9 432 610 812	NP-DLLA 148 PN 066
9 432 610 813	NP-DLLA 160 PN 100
9 432 610 814	NP-DLLA 150 PN 106
9 432 610 815	NP-DLLA 157 PN 115
9 432 610 816	NP-DN 0 SD 130 NP4
9 432 610 817	NP-DLLA 160 PN 168
9 432 610 819	NP-DLLA 155 PN 181
9 432 610 820	NP-DLL 140 S 256 NP38M
9 432 610 821	NP-DLLA 145 SM 012
9 432 610 822	NP-DLLA 154 S 344 NP54
9 432 610 823	NP-DLLA 154 SN 641
9 432 610 824	NP-DLLA 166 S 374 N379
9 432 610 825	NP-DLLA 140 SM 088
9 432 610 826	NP-DLLA 146 S 394 N455
9 432 610 827	NP-DLLA 142 SM 095
9 432 610 828	NP-DLLA 155 SN 687
9 432 610 829	NP-DLLA 150 S 334 N462
9 432 610 830	NP-DLLA 160 SM 217
9 432 610 831	NP-DLL 153 S 295 N475
9 432 610 832	NP-DLLA 148 SN 693
9 432 610 833	NP-DLLA 133 SN 504
9 432 610 834	NP-DLLA 149 SN 699
9 432 610 835	NP-DLL 145 SN 506
9 432 610 836	NP-DLLA 150 SN 549
9 432 610 837	NP-DLLA 135 SN 721
9 432 610 838	NP-DLLA 154 SN 572
9 432 610 839	NP-DLLA 142 SN 575
9 432 610 840	NP-DLLA 155 SN 727
9 432 610 841	NP-DLLA 153 SN 753
9 432 610 842	NP-DLLA 134 SN 759



Ref.



Typ

9 432 610 843	NP-DLLA 146 SN 765
9 432 610 844	NP-DLLA 159 SN 792
9 432 610 845	NP-DLLA 160 SN 822
9 432 610 846	NP-DLLA 146 SN 886
9 432 610 847	NP-DLLA 142 SN 890
9 432 610 848	NP-DLLA 140 PN 013
9 432 610 849	NP-DLLA 146 PN 032
9 432 610 850	NP-DLLA 155 SM 066
9 432 610 851	NP-DLLA 154 PN 185
9 432 610 852	NP-DLLA 156 SM 008
9 432 610 853	NP-DLLA 155 PN 053
9 432 610 854	NP-DLLA 160 SM 183
9 432 610 855	NP-DLLA 156 SM 328
9 432 610 856	NP-DLL 155 SN 790
9 432 610 857	NP-DLL 143 SM 229
9 432 610 858	NP-DLL 155 SN 596
9 432 610 859	NP-DLLA 150 SM 292
9 432 610 861	NP-DL 145 T 4010 NP8
9 432 610 862	NP-DLLA 153 SM 211
9 432 610 864	NP-DLLA 144 SM 209
9 432 610 866	NP-DLL 156 SM 286
9 432 610 868	NP-DLL 156 SM 287
9 432 610 870	NP-DLLA 151 SM 145
9 432 610 871	NP-DLLA 150 SM 041
9 432 610 873	NP-DLLA 155 SM 274
9 432 610 875	NP-DLLA 156 SM 318
9 432 610 877	NP-DLLA 150 SM 255
9 432 610 879	NP-DLLA 157 SM 280
9 432 610 881	NP-DLLA 160 SM 301
9 432 610 882	NP-DLLA 147 PN 288
9 432 610 883	NP-DLLA 153 PN 203
9 432 610 884	NP-DLLA 157 SM 036
9 432 610 886	NP-DLLA 150 SM 170
9 432 610 888	NP-DLLA 155 SN 815
9 432 610 889	NP-DLLA 160 SM 185
9 432 610 890	NP-DSLA 149 PN 903
9 432 610 891	NP-DLLA 150 PN 228
9 432 610 892	NP-DLL 155 SN 882
9 432 610 893	NP-DLLA 157 SN 944
9 432 610 894	NP-DLLA 155 SM 316
9 432 610 895	NP-DLLA 155 SM 326
9 432 610 897	NP-DLLA 155 SM 297
9 432 610 899	NP-DLLA 142 SN 569
9 432 610 900	NP-DSLA 155 SN 697
9 432 610 901	NP-DLLA 150 SN 748

... 9 432 610 997



9 432 610 902	NP-DLLA 155 SN 760
9 432 610 903	NP-DLLA 150 SN 862
9 432 610 904	NP-DLLA 160 PN 137
9 432 610 905	NP-DSLA 147 PN 900
9 432 610 906	NP-DLLA 154 SN 972
9 432 610 907	NP-DLLA 148 PN 285
9 432 610 908	NP-DLLA 154 SN 643
9 432 610 909	NP-DSLA 140 PN 915
9 432 610 910	NP-DL 145 TE 308 N1
9 432 610 913	NP-DSLA 145 PN 905
9 432 610 914	NP-DSLA 150 PN 906
9 432 610 916	NP-DSLA 145 PN 912
9 432 610 918	NP-DSLA 153 PN 920
9 432 610 919	NP-DSLA 147 PN 921
9 432 610 920	NP-DSLA 150 PN 923
9 432 610 921	NP-DSLA 150 PN 924
9 432 610 922	NP-DSLA 150 PN 925
9 432 610 923	NP-DSLA 150 PN 927
9 432 610 924	NP-DSLA 148 PN 928
9 432 610 925	NP-DL 145 TE 368 N1 %
9 432 610 926	NP-DL 145 TE 388 N1 %
9 432 610 927	NP-DSLA 147 PN 907
9 432 610 928	NP-DLLA 152 PN 273
9 432 610 929	NP-DLLA 160 PN 131
9 432 610 930	NP-DLLA 150 PN 235
9 432 610 931	NP-DLLA 158 PN 236
9 432 610 932	NP-DLLA 145 PN 243
9 432 610 933	NP-DLLA 150 PN 244
9 432 610 934	NP-DLLA 152 PN 251
9 432 610 936	NP-DLLA 153 PN 255
9 432 610 937	NP-DL 145 TE 368 N1
9 432 610 938	NP-DLLA 149 PN 277
9 432 610 939	NP-DLLA 148 PN 283
9 432 610 940	NP-DLLA 152 PN 284
9 432 610 941	NP-DLLA 158 PN 286
9 432 610 942	NP-DLLA 158 PN 287
9 432 610 944	NP-DLLA 150 PN 292
9 432 610 945	NP-DLLA 157 PN 253
9 432 610 946	NP-DL 145 TE 408 N1 %
9 432 610 947	NP-DL 145 TE 348 N1
9 432 610 948	NP-DL 150 T 284244 NP37
9 432 610 949	NP-DL 150 T 304244 NP35
9 432 610 950	NP-DL 150 T 304244 NP37
9 432 610 951	NP-DL 150 T 304244 NP37
9 432 610 952	NP-DL 145 TE 324284 N1



9 432 610 953	NP-DL 150 T 324264 NP35
9 432 610 954	NP-DL 150 T 324264 NP37
9 432 610 955	NP-DL 150 T 324264 NP37
9 432 610 956	NP-DL 150 T 284244 NP37
9 432 610 957	NP-DL 155 T 3410 NP36
9 432 610 958	NP-DL 150 T 284244 NP35
9 432 610 959	NP-DL 150 T 344304 NP35
9 432 610 960	NP-DL 150 T 344304 NP37
9 432 610 961	NP-DL 150 T 344304 NP37
9 432 610 962	NP-DL 160 T 3410 NP34
9 432 610 963	NP-DL 145 TE 304,265 N5
9 432 610 964	NP-DL 145 TE 428 N1 %
9 432 610 965	NP-DL 140 T 348 NP20
9 432 610 966	NP-DL 140 T 328 NP20
9 432 610 967	NP-DL 145 T 248 NP3
9 432 610 968	NP-DL 115 T 338 NP1
9 432 610 969	NP-DL 145 TE 408 N2
9 432 610 970	NP-DL 160 T 348 NP20
9 432 610 971	NP-DL 115 T 388 NP15
9 432 610 972	NP-DL 145 T 278 NP35
9 432 610 973	NP-DL 145 T 278 NP37
9 432 610 974	NP-DL 145 T 278 NP37 -
9 432 610 975	NP-DL 155 T 3110 NP34
9 432 610 976	NP-DL 145 T 248 NP3
9 432 610 977	NP-DL 145 T 248 NP37 -
9 432 610 978	NP-DL 145 TE 428 N2
9 432 610 979	NP-DL 150 T 304264 NP37
9 432 610 980	NP-DL 150 T 304264 NP37
9 432 610 981	NP-DL 145 TE 448 N2
9 432 610 982	NP-DLLA 160 PN 175
9 432 610 983	NP-DLLA 157 PN 165
9 432 610 984	NP-DLLA 154 PN 166
9 432 610 985	NP-DLLA 152 PN 169
9 432 610 986	NP-DLLA 160 PN 170
9 432 610 987	NP-DLLA 160 PN 171
9 432 610 988	NP-DLLA 158 PN 172
9 432 610 989	NP-DLLA 155 PN 174
9 432 610 990	NP-DLLA 150 PN 160
9 432 610 991	NP-DLLA 162 PN 176
9 432 610 992	NP-DLLA 157 PN 180
9 432 610 993	NP-DLLA 152 PN 143
9 432 610 994	NP-DLL 160 SN 690
9 432 610 995	NP-DLLA 157 PN 133
9 432 610 996	NP-DLLA 141 PN 134
9 432 610 997	NP-DLLA 157 PN 138



de

**Bestellnummer →
Typformel
für Zexel-Düsen**
(Fortsetzung)

en

**Part number →
Type designation
for Zexel nozzles**
(continued)

fr

**Référence →
Formule de type
pour injecteurs Zexel**
(suite)

it

**Numero d'ordina-
zione → Sigla per
polverizzatori Zexel**
(seguito)

es

**Número de pedido →
Designación del tipo
para inyectoros Zexel**
(continuación)

9 432 610 998 ...



Ref.



Typ

9 432 610 998	NP-DLLA 156 PN 163
9 432 610 999	NP-DLLA 137 PN 142
9 432 611 000	NP-DLLA 152 PN 145
9 432 611 001	NP-DLLA 160 PN 146
9 432 611 002	NP-DLLA 154 PN 147
9 432 611 003	NP-DLLA 160 PN 149
9 432 611 004	NP-DLLA 153 PN 152
9 432 611 005	NP-DLLA 152 PN 153
9 432 611 006	NP-DLLA 153 PN 139
9 432 611 007	NP-DLLA 146 PN 220
9 432 611 008	NP-DLLA 148 PN 221
9 432 611 009	NP-DLLA 152 PN 222
9 432 611 010	NP-DLLA 145 PN 225
9 432 611 011	NP-DLLA 146 PN 218
9 432 611 012	NP-DLLA 155 PN 217
9 432 611 013	NP-DLLA 154 PN 227
9 432 611 014	NP-DLLA 146 PN 229
9 432 611 015	NP-DLLA 153 PN 230
9 432 611 016	NP-DLLA 149 PN 197
9 432 611 017	NP-DLLA 160 PN 187
9 432 611 018	NP-DLLA 155 PN 188
9 432 611 019	NP-DLLA 154 PN 189
9 432 611 020	NP-DLLA 157 PN 190
9 432 611 021	NP-DLLA 162 PN 191
9 432 611 022	NP-DLLA 155 PN 192
9 432 611 023	NP-DLLA 149 PN 193
9 432 611 024	NP-DLLA 161 PN 194
9 432 611 025	NP-DLLA 155 PN 195
9 432 611 026	NP-DLLA 157 PN 219
9 432 611 027	NP-DLLA 140 PN 196
9 432 611 028	NP-DLLA 155 PN 199
9 432 611 029	NP-DLLA 157 PN 201
9 432 611 030	NP-DLLA 154 PN 205
9 432 611 031	NP-DLLA 160 PN 206
9 432 611 032	NP-DLLA 160 PN 212
9 432 611 033	NP-DLLA 152 PN 213
9 432 611 034	NP-DLLA 161 PN 214
9 432 611 035	NP-DLLA 157 PN 215
9 432 611 044	NP-DLLA 155 SM 124
9 432 611 045	NP-DL 140 T 368 NP20
9 432 611 047	NP-DLLA 150 SM 026
9 432 611 056	NP-DLLA 156 SM 019
9 432 611 062	NP-DLLA 152 SM 043
9 432 611 063	NP-DLLA 153 SM 205
9 432 611 067	NP-DLLA 150 SM 233





Ref.





Typ

9 432 611 068	NP-DLLA 157 SM 197
9 432 611 082	NP-DLLA 162 PN 176
9 432 611 093	NP-DLLA 158 SM 193
9 432 611 095	NP-DL 145 TE 308 N3
9 432 611 096	NP-DL 130 TN 081
9 432 611 097	NP-DL 130 TN 082
9 432 611 098	NP-DL 115 TN 083
9 432 611 099	NP-DL 150 T 278 NP37
9 432 611 104	NP-DL 160 TE 3510 N6
9 432 611 106	NP-DL 145 TE 344304 N4
9 432 611 114	NP-DLLA 155 SN 913
9 432 611 116	NP-DLLA 156 SN 921
9 432 611 118	NP-DL 120 T 358 NP1
9 432 611 119	NP-DL 125 T 306 NP1
9 432 611 120	NP-DL 160 T 326 NP1
9 432 611 121	NP-DL 140 TE 3010 N1
9 432 611 122	NP-DL 145 T 324284 NP37
9 432 611 123	NP-DL 145 T 324284 NP37
9 432 611 124	NP-DL 155 TE 3710 N6
9 432 611 125	NP-DL 140 TE 2810 N7
9 432 611 126	NP-DL 140 TE 2810 N7
9 432 611 127	NP-DL 145 TE 288 N3
9 432 611 128	NP-DL 140 TE 2610 N7
9 432 611 130	NP-DL 140 TE 3210 N1
9 432 611 131	NP-DL 160 T 3110 NP40
9 432 611 132	NP-DL 130 T 3610 NP41
9 432 611 133	NP-DL 130 T 368 NP41
9 432 611 134	NP-DL 130 T 3610 NP43
9 432 611 135	NP-DL 160 T 2910 NP40
9 432 611 136	NP-DL 140 TE 348 N1 %
9 432 611 137	NP-DL 140 TE 268 N3
9 432 611 138	NP-DL 160 TE 3710N6
9 432 611 139	NP-DL 130 T 3610 NP42
9 432 611 153	NP-DLLA 160 SN 961
9 432 611 170	NP-DLLA 160 SN 863
9 432 611 171	NP-DLLA 160 SN 844
9 432 611 172	NP-DLLA 160 SN 845
9 432 611 173	NP-DLLA 150 SN 846
9 432 611 174	NP-DLLA 160 SN 850
9 432 611 175	NP-DLLA 160 SN 851
9 432 611 176	NP-DLLA 150 SN 854
9 432 611 177	NP-DLLA 150 SN 855
9 432 611 178	NP-DLLA 154 SN 856
9 432 611 179	NP-DLLA 155 SN 857
9 432 611 180	NP-DLLA 155 SN 858

... 9 432 611 271

 Ref.	 Typ
9 432 611 181	NP-DLLA 150 SN 859
9 432 611 182	NP-DLLA 154 SN 861
9 432 611 184	NP-DLLA 151 SN 839
9 432 611 185	NP-DLLA 161 PN 132
9 432 611 186	NP-DLLA 163 SN 823
9 432 611 187	NP-DLLA 160 SN 828
9 432 611 188	NP-DLLA 163 SN 831
9 432 611 189	NP-DLLA 150 SN 832
9 432 611 190	NP-DLLA 154 SN 834
9 432 611 191	NP-DLLA 150 SN 835
9 432 611 192	NP-DLLA 150 SN 837
9 432 611 193	NP-DLLA 155 SN 864
9 432 611 194	NP-DLLA 150 SN 840
9 432 611 195	NP-DLLA 153 SN 842
9 432 611 196	NP-DLLA 150 SN 843
9 432 611 197	NP-DLLA 160 SN 838
9 432 611 198	NP-DLLA 160 SN 905
9 432 611 199	NP-DLL 155 SN 897
9 432 611 200	NP-DLLA 155 SN 898
9 432 611 201	NP-DLLA 144 SN 899
9 432 611 202	NP-DLLA 150 SN 900
9 432 611 203	NP-DLLA 150 SN 902
9 432 611 204	NP-DLLA 150 SN 904
9 432 611 205	NP-DLLA 160 SN 896
9 432 611 206	NP-DLLA 150 SN 906
9 432 611 207	NP-DLLA 154 SN 907
9 432 611 208	NP-DLLA 156 SN 908
9 432 611 209	NP-DLLA 152 SN 909
9 432 611 210	NP-DLLA 160 SN 910
9 432 611 211	NP-DLLA 156 SN 911
9 432 611 212	NP-DLLA 155 SN 913
9 432 611 213	NP-DLLA 154 SN 903
9 432 611 214	NP-DLLA 150 SN 883
9 432 611 215	NP-DLL 155 SN 865
9 432 611 216	NP-DLLA 150 SN 866
9 432 611 217	NP-DLLA 150 SN 867
9 432 611 218	NP-DLLA 150 SN 870
9 432 611 219	NP-DLLA 150 SN 871
9 432 611 220	NP-DLLA 155 SN 873
9 432 611 221	NP-DLLA 150 SN 874
9 432 611 222	NP-DLLA 160 SN 875
9 432 611 223	NP-DLLA 160 SN 896
9 432 611 224	NP-DLLA 151 SN 817
9 432 611 225	NP-DLLA 143 SN 884
9 432 611 226	NP-DLLA 140 SN 887

 Ref.	 Typ
9 432 611 227	NP-DLLA 145 SN 888
9 432 611 228	NP-DLLA 160 SN 889
9 432 611 229	NP-DLLA 150 SN 892
9 432 611 230	NP-DLLA 160 SN 893
9 432 611 231	NP-DLLA 149 SN 894
9 432 611 232	NP-DLLA 160 SN 895
9 432 611 233	NP-DLLA 160 SN 880
9 432 611 234	NP-DLLA 157 SN 741
9 432 611 235	NP-DLL 155 SN 729
9 432 611 236	NP-DLLA 150 SN 730
9 432 611 237	NP-DLLA 146 SN 733
9 432 611 238	NP-DLLA 149 SN 734
9 432 611 239	NP-DLLA 143 SN 735
9 432 611 240	NP-DLLA 142 SN 738
9 432 611 241	NP-DLLA 150 SN 739
9 432 611 242	NP-DLLA 149 SN 724
9 432 611 243	NP-DLLA 150 SN 740
9 432 611 244	NP-DLLA 160 SN 747
9 432 611 245	NP-DLLA 153 SN 749
9 432 611 246	NP-DLLA 154 SN 751
9 432 611 247	NP-DLLA 154 SN 752
9 432 611 248	NP-DLLA 160 SN 754
9 432 611 249	NP-DLLA 149 SN 819
9 432 611 250	NP-DLLA 155 SN 709
9 432 611 251	NP-DLLA 148 SN 691
9 432 611 252	NP-DLL 155 SN 692
9 432 611 253	NP-DLLA 140 SN 694
9 432 611 254	NP-DLLA 150 SN 695
9 432 611 255	NP-DLLA 153 SN 696
9 432 611 256	NP-DLLA 153 SN 700
9 432 611 257	NP-DLLA 150 SN 704
9 432 611 258	NP-DLLA 153 SN 726
9 432 611 259	NP-DLLA 150 SN 705
9 432 611 260	NP-DLLA 148 SN 756
9 432 611 261	NP-DLL 160 SN 716
9 432 611 262	NP-DLLA 135 SN 717
9 432 611 263	NP-DLLA 138 SN 719
9 432 611 264	NP-DLLA 160 SN 720
9 432 611 265	NP-DLLA 150 SN 723
9 432 611 266	NP-DLLA 143 SN 803
9 432 611 267	NP-DLLA 150 SN 779
9 432 611 268	NP-DLLA 155 SN 780
9 432 611 269	NP-DLLA 150 SN 781
9 432 611 270	NP-DLLA 149 SN 783
9 432 611 271	NP-DLLA 155 SN 784



A80

de

**Bestellnummer →
Typformel
für Zexel-Düsen**
(Fortsetzung)

en

**Part number →
Type designation
for Zexel nozzles**
(continued)

fr

**Référence →
Formule de type
pour injecteurs Zexel**
(suite)

it

**Numero d'ordina-
zione → Sigla per
polverizzatori Zexel**
(seguito)

es

**Número de pedido →
Designación del tipo
para inyectoros Zexel**
(continuación)

9 432 611 272 ...



Ref.



Typ

9 432 611 272	NP-DLLA 155 SN 787
9 432 611 273	NP-DLLA 155 SN 788
9 432 611 274	NP-DLLA 155 SN 789
9 432 611 275	NP-DLLA 155 SN 774
9 432 611 276	NP-DLLA 150 SN 802
9 432 611 277	NP-DLLA 155 SN 773
9 432 611 278	NP-DLLA 149 SN 804
9 432 611 279	NP-DLLA 143 SN 805
9 432 611 280	NP-DLL 160 SN 806
9 432 611 281	NP-DLLA 149 SN 810
9 432 611 282	NP-DLLA 150 SN 811
9 432 611 283	NP-DLLA 150 SN 812
9 432 611 284	NP-DLLA 160 SN 813
9 432 611 285	NP-DLLA 150 SN 814
9 432 611 286	NP-DLLA 157 SN 816
9 432 611 287	NP-DLL 155 SN 767
9 432 611 288	NP-DLLA 150 SN 761
9 432 611 289	NP-DLLA 150 SN 762
9 432 611 290	NP-DLLA 145 SN 764
9 432 611 291	NP-DLLA 149 SN 776
9 432 611 292	NP-DLLA 144 SN 766
9 432 611 293	NP-DLLA 150 SN 769
9 432 611 294	NP-DLLA 150 SN 770
9 432 611 295	NP-DLLA 156 SN 771
9 432 611 296	NP-DLLA 160 SN 772
9 432 611 297	NP-DL 140 TC 359 N3
9 432 611 298	NP-DLF 145 TU 458 N6 C
9 432 611 299	NP-DLF 145 TU 428 N6 C
9 432 611 300	NP-DL 140 TC 309 N3
9 432 611 301	NP-DLF 145 TU 428 N4
9 432 611 304	NP-DLF 145 TU 1508 N4
9 432 611 309	NP-DLF 120 UJ 429 N5
9 432 611 310	NP-DLLA 140 PN 002
9 432 611 311	NP-DLLA 152 PN 012
9 432 611 313	NP-DLF 145 TU 408 N1
9 432 611 314	NP-DLF 145 TU 428 N2
9 432 611 315	NP-DLF 145 TU 458 N4
9 432 611 316	NP-DLF 145 TU 408 N2
9 432 611 317	NP-DSLA 154 PN 016
9 432 611 318	NP-DLLA 161 PN 124
9 432 611 320	NP-DLLA 156 PN 099
9 432 611 321	NP-DLLA 154 PN 101
9 432 611 322	NP-DLLA 154 PN 103
9 432 611 323	NP-DLLA 154 PN 105
9 432 611 324	NP-DLLA 155 PN 111



Ref.



Typ

9 432 611 325	NP-DLLA 158 PN 113
9 432 611 326	NP-DLLA 157 PN 096
9 432 611 327	NP-DLLA 143 PN 117
9 432 611 328	NP-DLLA 160 PN 126
9 432 611 329	NP-DLLA 160 PN 127
9 432 611 330	NP-DLLA 162 PN 128
9 432 611 331	NP-DLLA 160 PN 129
9 432 611 332	NP-DLLA 150 PN 033
9 432 611 333	NP-DLLA 154 PN 018
9 432 611 334	NP-DLLA 154 PN 019
9 432 611 335	NP-DLLA 157 PN 020
9 432 611 336	NP-DLLA 160 PN 022
9 432 611 337	NP-DLLA 132 PN 023
9 432 611 338	NP-DLLA 160 PN 026
9 432 611 339	NP-DLLA 139 PN 030
9 432 611 340	NP-DLL 140 TE 3210 N1
9 432 611 341	NP-DLLA 154 PN 041
9 432 611 342	NP-DLLA 152 PN 043
9 432 611 343	NP-DLLA 152 PN 065
9 432 611 344	NP-DLLA 157 PN 072
9 432 611 345	NP-DLLA 154 PN 084
9 432 611 346	NP-DLLA 155 PN 091
9 432 611 347	NP-DLLA 154 PN 095
9 432 611 348	NP-DLLA 150 SN 960
9 432 611 349	NP-DLF 145 TU 454424 N1
9 432 611 350	NP-DLLA 151 SN 950
9 432 611 351	NP-DLLA 161 SN 951
9 432 611 352	NP-DLLA 163 SN 952
9 432 611 353	NP-DLLA 150 SN 953
9 432 611 354	NP-DLLA 150 SN 954
9 432 611 355	NP-DLLA 155 SN 955
9 432 611 356	NP-DLLA 150 SN 956
9 432 611 357	NP-DLLA 157 SN 957
9 432 611 358	NP-DLLA 155 SN 946
9 432 611 359	NP-DLLA 154 SN 959
9 432 611 360	NP-DLLA 160 SN 961
9 432 611 361	NP-DLLA 160 SN 962
9 432 611 362	NP-DLLA 161 SN 963
9 432 611 363	NP-DLLA 161 SN 963
9 432 611 364	NP-DLLA 160 SN 964
9 432 611 365	NP-DLLA 157 SN 965
9 432 611 366	NP-DLLA 157 SN 966
9 432 611 367	NP-DLLA 154 SN 958
9 432 611 368	NP-DLLA 150 SN 929
9 432 611 369	NP-DLLA 160 SN 915

... 9 432 611 466



9 432 611 370	NP-DLL 155 SN 916
9 432 611 371	NP-DLLA 160 SN 918
9 432 611 372	NP-DLLA 156 SN 919
9 432 611 373	NP-DLLA 157 SN 920
9 432 611 374	NP-DLLA 156 SN 921
9 432 611 375	NP-DLLA 150 SN 923
9 432 611 376	NP-DLLA 152 SN 924
9 432 611 377	NP-DLLA 152 SN 925
9 432 611 378	NP-DLLA 160 SN 947
9 432 611 379	NP-DLLA 156 SN 928
9 432 611 381	NP-DLLA 152 SN 931
9 432 611 382	NP-DLLA 154 SN 932
9 432 611 383	NP-DLL 160 SN 934
9 432 611 384	NP-DLLA 155 SN 935
9 432 611 385	NP-DLLA 152 SN 936
9 432 611 386	NP-DLLA 160 SN 937
9 432 611 387	NP-DLLA 150 SN 938
9 432 611 388	NP-DLLA 157 SN 940
9 432 611 389	NP-DLLA 150 SN 942
9 432 611 390	NP-DLLA 155 SN 943
9 432 611 392	NP-DLLA 150 SN 993
9 432 611 393	NP-DLLA 150 SN 994
9 432 611 394	NP-DLLA 157 SN 996
9 432 611 395	NP-DLLA 157 SN 997
9 432 611 396	NP-DL 145 TU 458 N2
9 432 611 397	NP-DL 145 TU 508 N2
9 432 611 398	NP-DLLA 154 SN 990
9 432 611 404	NP-DLL 140 TE 3010 N1
9 432 611 405	NP-DLL 140 TE 2810 N1
9 432 611 406	NP-DLLA 149 SN 914
9 432 611 407	NP-DLL 155 SN 978
9 432 611 408	NP-DF 145 TU 428 N1
9 432 611 409	NP-DLLA 160 SN 969
9 432 611 410	NP-DLLA 152 SN 970
9 432 611 411	NP-DLLA 152 SN 970
9 432 611 412	NP-DLL S
9 432 611 413	NP-DLLA 150 SN 973
9 432 611 414	NP-DLLA 157 SN 974
9 432 611 415	NP-DLLA 150 SN 992
9 432 611 416	NP-DLLA 160 SN 977
9 432 611 417	NP-DLLA 157 SN 980
9 432 611 418	NP-DLLA 160 SN 981
9 432 611 419	NP-DLLA 161 SN 984
9 432 611 420	NP-DLLA 145 SN 986
9 432 611 421	NP-DLLA 150 SN 987



9 432 611 422	NP-DLLA 156 SN 968
9 432 611 423	NP-DLLA 160 SN 976
9 432 611 424	NP-DLLA 148 SM 144
9 432 611 425	NP-DLLA 158 SM 129
9 432 611 426	NP-DLLA 150 SM 130
9 432 611 427	NP-DLLA 146 SM 132
9 432 611 428	NP-DLLA 154 SM 133
9 432 611 429	NP-DLLA 155 SM 134
9 432 611 430	NP-DLLA 155 SM 135
9 432 611 431	NP-DLLA 155 SN 136
9 432 611 432	NP-DLLA 157 SM 137
9 432 611 433	NP-DLL 130 SM 128
9 432 611 434	NP-DLLA 155 SM 147
9 432 611 435	NP-DLLA 142 SM 149
9 432 611 436	NP-DLLA 154 SM 150
9 432 611 437	NP-DLLA 155 SM 151
9 432 611 438	NP-DLLA 156 SM 152
9 432 611 439	NP-DLLA 160 SM 153
9 432 611 440	NP-DLLA 156 SM 154
9 432 611 441	NP-DLLA 155 SM 228
9 432 611 442	NP-DLLA 140 SM 141
9 432 611 443	NP-DLLA 158 SM 112
9 432 611 444	NP-DLL 160 SM 090
9 432 611 445	NP-DLLA 160 SM 091
9 432 611 446	NP-DLL 140 SM 093
9 432 611 447	NP-DLL 143 SM 094
9 432 611 448	NP-DLL 160 SM 099
9 432 611 449	NP-DLLA 150 SM 101
9 432 611 450	NP-DLLA 152 SM 104
9 432 611 451	NP-DLLA 155 SM 106
9 432 611 452	NP-DLLA 157 SM 107
9 432 611 453	NP-DLLA 140 SM 109
9 432 611 454	NP-DLLA 156 SM 111
9 432 611 455	NP-DLLA 156 SM 114
9 432 611 456	NP-DLLA 160 SM 115
9 432 611 457	NP-DLLA 150 SM 116
9 432 611 458	NP-DLLA 158 SM 120
9 432 611 459	NP-DLLA 150 SM 121
9 432 611 460	NP-DLLA 152 SM 123
9 432 611 461	NP-DLLA 155 SM 124
9 432 611 462	NP-DLL 140 SM 125
9 432 611 463	NP-DLLA 160 SM 110
9 432 611 464	NP-DLLA 158 SM 155
9 432 611 465	NP-DLLA 158 SM 193
9 432 611 466	NP-DLLA 160 SM 195



A82

de

**Bestellnummer →
Typformel
für Zexel-Düsen**
(Fortsetzung)

en

**Part number →
Type designation
for Zexel nozzles**
(continued)

fr

**Référence →
Formule de type
pour injecteurs Zexel**
(suite)

it



**Numero d'ordina-
zione → Sigla per
polverizzatori Zexel**
(seguito)



es

**Número de pedido →
Designación del tipo
para inyectoros Zexel**
(continuación)

9 432 611 467 ...



 Ref.	 Typ
9 432 611 467	NP-DLLA 157 SM 197
9 432 611 468	NP-DLLA 157 SM 197 B
9 432 611 469	NP-DLLA 158 SM 199
9 432 611 470	NP-DLLA 156 SM 200
9 432 611 471	NP-DLLA 150 SM 201
9 432 611 472	NP-DLLA 155 SM 202
9 432 611 473	NP-DLLA 153 SM 205
9 432 611 474	NP-DLLA 152 SM 191
9 432 611 475	NP-DLLA 133 SM 208
9 432 611 476	NP-DLLA 157 SM 210
9 432 611 477	NP-DLLA 150 SM 212
9 432 611 478	NP-DLLA 156 SM 213
9 432 611 479	NP-DLL 148 SM 214
9 432 611 480	NP-DLLA 158 SM 216
9 432 611 481	NP-DLLA 145 SM 219
9 432 611 482	NP-DLLA 160 SM 222
9 432 611 483	NP-DLLA 160 SM 223
9 432 611 484	NP-DLLA 150 SM 207
9 432 611 485	NP-DLLA 165 SM 181
9 432 611 486	NP-DLLA 155 SM 159
9 432 611 487	NP-DLLA 160 SM 163
9 432 611 488	NP-DLLA 145 SM 167
9 432 611 489	NP-DLLA 156 SM 168
9 432 611 490	NP-DLLA 155 SM 169
9 432 611 491	NP-DLLA 156 SM 171
9 432 611 492	NP-DLLA 150 SM 172
9 432 611 493	NP-DLLA 151 SM 175
9 432 611 494	NP-DLLA 155 SM 192
9 432 611 495	NP-DLL 138 SM 079
9 432 611 496	NP-DLLA 156 SM 184
9 432 611 497	NP-DLLA 151 SM 186
9 432 611 498	NP-DLLA 158 SM 188
9 432 611 499	NP-DLLA 158 SM 189
9 432 611 500	NP-DLLA 154 SM 190
9 432 611 501	NP-DLLA 160 SM 179
9 432 611 502	NP-DLLA 157 SM 014
9 432 611 503	NP-DLLA 156 SM 089
9 432 611 504	NP-DLLA 154 SM 006
9 432 611 505	NP-DLLA 154 SM 009
9 432 611 506	NP-DLLA 160 SM 010
9 432 611 507	NP-DLLA 160 SM 011
9 432 611 508	NP-DLLA 160 SM 004
9 432 611 509	NP-DLLA 153 SM 015
9 432 611 510	NP-DLLA 157 SM 016
9 432 611 511	NP-DLLA 152 SM 017

 Ref.	 Typ
9 432 611 512	NP-DLLA 156 SM 019
9 432 611 513	NP-DLLA 154 SM 020
9 432 611 514	NP-DLLA 160 SM 021
9 432 611 515	NP-DLLA 157 SM 022
9 432 611 516	NP-DLLA 157 SM 023
9 432 611 517	NP-DLLA 150 SM 026
9 432 611 518	NP-DLL 155 SN 825
9 432 611 521	NP-DLLA 152 SM 005
9 432 611 522	NP-DLLA 158 SM 028
9 432 611 528	NP-DLLA 155 SM 001
9 432 611 529	NP-DLLA 160 SM 002
9 432 611 530	NP-DLLA 156 SM 003
9 432 611 531	NP-DLLA 158 SM 283
9 432 611 532	NP-DLLA 160 SM 056
9 432 611 533	NP-DLLA 155 SM 059
9 432 611 534	NP-DLLA 155 SM 062
9 432 611 535	NP-DLLA 155 SM 064
9 432 611 536	NP-DLLA 140 SM 068
9 432 611 537	NP-DLLA 140 SM 069
9 432 611 538	NP-DLL 155 SM 071
9 432 611 539	NP-DLLA 157 SM 054
9 432 611 540	NP-DLLA 160 SM 072
9 432 611 541	NP-DLLA 158 SM 073
9 432 611 542	NP-DLLA 156 SM 074
9 432 611 543	NP-DLLA 155 SM 075
9 432 611 544	NP-DLLA 142 SM 076
9 432 611 545	NP-DLL 155 SM 077
9 432 611 546	NP-DLLA 152 SM 070
9 432 611 547	NP-DLLA 150 SM 040
9 432 611 548	NP-DLLA 157 SM 081
9 432 611 549	NP-DLLA 152 SM 035
9 432 611 550	NP-DLLA 152 SM 043
9 432 611 551	NP-DLLA 155 SM 044
9 432 611 552	NP-DLLA 158 SM 046
9 432 611 553	NP-DLLA 158 SM 047
9 432 611 554	NP-DLLA 158 SM 048
9 432 611 555	NP-DLLA 155 SM 049
9 432 611 556	NP-DLLA 157 SM 051
9 432 611 557	NP-DLLA 155 SM 052
9 432 611 558	NP-DLLA 157 SM 027
9 432 611 559	NP-DLLA 155 SM 038
9 432 611 560	NP-DLLA 156 SM 227
9 432 611 562	NP-DLLA 155 SM 284
9 432 611 563	NP-DLLA 158 SM 268
9 432 611 564	NP-DLLA 158 SM 269

... 9 432 611 661



9 432 611 565	NP-DLL 148 SM 272
9 432 611 566	NP-DLLA 158 SM 275
9 432 611 567	NP-DLLA 155 SM 278
9 432 611 568	NP-DLLA 155 SM 279
9 432 611 569	NP-DLLA 154 SM 281
9 432 611 570	NP-DLLA 158 SM 283
9 432 611 571	NP-DLLA 158 SM 288
9 432 611 572	NP-DLLA 158 SM 289
9 432 611 573	NP-DLLA 158 SM 290
9 432 611 574	NP-DLLA 150 SM 293
9 432 611 575	NP-DLLA 160 SM 294
9 432 611 576	NP-DLLA 155 SM 296
9 432 611 577	NP-DLLA 158 SM 282
9 432 611 578	NP-DLLA 160 SM 254
9 432 611 579	NP-DLL S
9 432 611 580	NP-DLLA 150 SM 233
9 432 611 581	NP-DLLA 148 SM 235
9 432 611 582	NP-DLLA 148 SM 236
9 432 611 583	NP-DLLA 165 SM 237
9 432 611 584	NP-DLLA 150 SM 238
9 432 611 585	NP-DLLA 156 SM 249
9 432 611 586	NP-DLLA 156 SM 250
9 432 611 587	NP-DLLA 157 SM 251
9 432 611 588	NP-DLLA 142 SM 266
9 432 611 589	NP-DLLA 156 SM 253
9 432 611 590	NP-DLLA 160 SM 256
9 432 611 591	NP-DLLA 158 SM 258
9 432 611 592	NP-DLLA 158 SM 259
9 432 611 593	NP-DLLA 158 SM 260
9 432 611 594	NP-DLLA 155 SM 261
9 432 611 595	NP-DLLA 143 SM 262
9 432 611 596	NP-DLLA 158 SM 264
9 432 611 597	NP-DLLA 156 SM 252
9 432 611 598	NP-DLLA 158 SM 330
9 432 611 599	NP-DLLA 153 SM 331
9 432 611 600	NP-DLL 140 SM 332
9 432 611 601	NP-DLLA 158 SM 333
9 432 611 602	NP-DLL 140 SM 334
9 432 611 603	NP-DLLA 140 SM 335
9 432 611 604	NP-DLLA 155 SM 336
9 432 611 605	NP-DLLA 158 SM 337
9 432 611 606	NP-DLLA 158 SM 340
9 432 611 607	NP-DLLA 158 SM 341
9 432 611 608	NP-DLL 143 SM 342
9 432 611 609	NP-DLLA 148 SM 344







9 432 611 610	NP-DLLA 141 SM 346
9 432 611 611	NP-DLLA 158 SM 339
9 432 611 612	NP-DLLA 154 SM 313
9 432 611 613	NP-DLLA 165 SM 298
9 432 611 614	NP-DLLA 158 SM 300
9 432 611 615	NP-DLLA 160 SM 302
9 432 611 616	NP-DLLA 155 SM 305
9 432 611 617	NP-DLLA 140 SM 306
9 432 611 618	NP-DLLA 142 SM 307
9 432 611 619	NP-DLLA 158 SM 308
9 432 611 620	NP-DLLA 151 SM 329
9 432 611 621	NP-DLLA 155 SM 311
9 432 611 622	NP-DLLA 158 SM 315
9 432 611 623	NP-DLLA 157 SM 319
9 432 611 624	NP-DLLA 155 SM 320
9 432 611 625	NP-DLLA 154 SM 321
9 432 611 626	NP-DLLA 133 SM 322
9 432 611 627	NP-DLLA 150 SM 323
9 432 611 628	NP-DLLA 151 SM 325
9 432 611 629	NP-DLLA 150 SM 310
9 432 611 630	NP-DN 0 SD 130 NP5
9 432 611 631	NP-DN 4 SDN 225
9 432 611 632	NP-DN 7 SD 64 NP4
9 432 611 637	NP-DN 0 SDN 203
9 432 611 640	NP-DN 0 PDN 149
9 432 611 642	NP-DN 12 TN 2
9 432 611 643	NP-DN 0 TDNP 1
9 432 611 644	NP-DN 20 SN 9
9 432 611 645	NP-DN 4 S 2
9 432 611 646	NP-DN 4 S 3
9 432 611 647	NP-DLF 140 TB 387 N19
9 432 611 648	NP-DL 150 T 278 NP1
9 432 611 649	NP-DLF 145 TE 348 N1
9 432 611 650	NP-DLF 145 TE 368 N1.].
9 432 611 651	NP-DLF 150 TB 508 N40
9 432 611 652	NP-DLF 145 TB 308 N37
9 432 611 653	NP-DLF 145 TE 348 N1.].
9 432 611 654	NP-DLF 155 TB 308 N36
9 432 611 655	NP-DLF 155 TB 2810 N13
9 432 611 656	NP-DLF 145 TB 258 N8
9 432 611 657	NP-DLF 130 TB 358 N1
9 432 611 658	NP-DLF 145 TB 288 N8
9 432 611 659	NP-DL 140 T 388 NP1
9 432 611 660	NP-DL 160 T 328 NP1
9 432 611 661	NP-DL 145 S 286 NP1



de	en	fr	it	es
Bestellnummer → Typformel für Zexel-Düsen (Fortsetzung)	Part number → Type designation for Zexel nozzles (continued)	Référence → Formule de type pour injecteurs Zexel (suite)	Numero d'ordina- zione → Sigla per polverizzatori Zexel (seguito)	Número de pedido → Designación del tipo para inyectoros Zexel (continuación)

9 432 611 662 ...

 Ref.	 Typ	 Ref.	 Typ
9 432 611 662	NP-DLF 145 TB 328 N1	9 432 611 710	NP-DLL 145 S 308 N482
9 432 611 663	NP-DLF 145 TE 388 N4	9 432 611 711	NP-DLL 140 S 366 N483
9 432 611 664	NP-DLF 145 TE 408 N4 C	9 432 611 712	NP-DLLA 150 S 285 N484
9 432 611 665	NP-DLF 145 TE 428 N4 C	9 432 611 713	NP-DLL 150 S 366 N488
9 432 611 666	NP-DLF 145 TE 368 N4C	9 432 611 714	NP-DLLA 150 S 355 N490
9 432 611 667	NP-DL 160 T 286 NP1	9 432 611 715	NP-DLL 150 S 386 N479
9 432 611 668	NP-DLF 145 TE 368 N3	9 432 611 716	NP-DLLA 103 S 314 N495
9 432 611 669	NP-DLF 145 TE 388 N3	9 432 611 717	NP-DLLA 144 S 324 N478
9 432 611 670	NP-DLF 145 TE 388 N1	9 432 611 718	NP-DLLA 150 S 424 N477
9 432 611 671	NP-DLF 145 TE 308 N3	9 432 611 719	NP-DLLA 160 S 315 N471
9 432 611 672	NP-DL 145 T 288 NP1	9 432 611 720	NP-DLLA 150 S 394 NP68
9 432 611 674	NP-DL 160 S 258 NP1	9 432 611 721	NP-DLLA 154 S 324 N451
9 432 611 675	NP-DL 155 S 228 NP1	9 432 611 722	NP-DLLA 150 S 394 N452
9 432 611 676	NP-DL 150 S 20 S 208 NP1	9 432 611 723	NP-DLLA 142 S 354 N454
9 432 611 677	NP-DL 162 S 384 NP11	9 432 611 724	NP-DLLA 154 S 344 N463
9 432 611 678	NP-DL 125 S 303 NP6	9 432 611 725	NP-DLLA 150 S 355 N467
9 432 611 679	NP-DL 160 S 258 N236	9 432 611 726	NP-DLLA 160 S 295 N469
9 432 611 680	NP-DL 130 T 258 NP1	9 432 611 727	NP-DLLA 160 SN 516
9 432 611 681	NP-DL 130 T 308 NP1	9 432 611 728	NP-DLLA 145 SN 523
9 432 611 682	NP-DL 145 T 358 NP1	9 432 611 729	NP-DLLA 145 SN 522
9 432 611 683	NP-DL 130 T 206 NP1	9 432 611 730	NP-DLL 155 SN 520
9 432 611 684	NP-DL 145 T 258 NP1	9 432 611 731	NP-DLLA 160 SN 519
9 432 611 686	NP-DL 160 S 2710 N239	9 432 611 732	NP-DLLA 155 SN 513
9 432 611 687	NP-DL 155 S 308 N238	9 432 611 733	NP-DLL 155 SN 514
9 432 611 688	NP-DL 160 S 268 N237	9 432 611 734	NP-DLLA 155 SN 512
9 432 611 689	NP-DL 160 S 258 N236	9 432 611 735	NP-DLLA 151 S 354 N381
9 432 611 690	NP-DL 140 S 386 N23	9 432 611 736	NP-DLL 165 S 288 N392
9 432 611 691	NP-DL 160 S 2810 N233	9 432 611 737	NP-DLLA 150 S 315 N450
9 432 611 693	NP-DL 150 S 308 NP15	9 432 611 738	NP-DLLA 146 S 284 N496
9 432 611 694	NP-DL 155 S 348 NP15	9 432 611 739	NP-DLLA 162 S 285 N498
9 432 611 695	NP-DL 150 S 248 NP15	9 432 611 740	NP-DLLA 133 SN 500
9 432 611 696	NP-DL 160 S 268 N237	9 432 611 741	NP-DLLA 140 SN 505
9 432 611 697	NP-DN 6 S 197 NP1	9 432 611 742	NP-DLLA 155 SN 508
9 432 611 698	NP-DN 4 S 1.M	9 432 611 743	NP-DLLA 151 SN 509
9 432 611 699	NP-DN 0 SN 8	9 432 611 744	NP-DLLA 160 SN 518
9 432 611 700	NP-DLLA 150 SN 830	9 432 611 745	NP-DLLA 160 S 424 N390
9 432 611 701	NP-DN 7 SD 64 N2	9 432 611 746	NP-DLLA 146 S 394 N387
9 432 611 702	NP-DN S	9 432 611 747	NP-DLLA 160 S 295 N394
9 432 611 703	NP-DN 0 SD 21 NP1	9 432 611 748	NP-DLLA 154 S 364 N382
9 432 611 704	NP-DLLA 138 SN 686	9 432 611 749	NP-DLLA 160 S 354 N405
9 432 611 705	NP-DN 15 S 156	9 432 611 750	NP-DLLA 154 S 365 NP91
9 432 611 706	NP-DLF 145 TB 278 N41	9 432 611 751	NP-DLLA 155 S 324 NP90
9 432 611 707	NP-DLLA 160 S 335 N494	9 432 611 753	NP-DLLA 150 S 394 NP69
9 432 611 708	NP-DLLA 150 S 424 N493	9 432 611 754	NP-DLLA 154 S 344 N424
9 432 611 709	NP-DLLA 157 S 385 N480	9 432 611 755	NP-DLLA 151 S 384 N449

... 9 432 611 848



9 432 611 756	NP-DLLA 144 S 325 N441
9 432 611 757	NP-DLLA 155 S 324 N440
9 432 611 758	NP-DLLA 150 S 384 N436
9 432 611 759	NP-DLLA 146 S 394 N430
9 432 611 760	NP-DLLA 154 S 344 N428
9 432 611 761	NP-DLLA 143 S 384 N418
9 432 611 762	NP-DLLA 150 S 394 N416
9 432 611 763	NP-DLLA 150 S 394 N412
9 432 611 764	NP-DLLA 150 S 394 N411
9 432 611 765	NP-DLLA 158 S 325 N407
9 432 611 766	NP-DLLA 166 S 364 N408
9 432 611 767	NP-DLLA 148 S 354 N429
9 432 611 768	NP-DLLA 142 SN 627
9 432 611 769	NP-DLLA 160 SN 524
9 432 611 770	NP-DLL 155 SN 636
9 432 611 771	NP-DLL 160 SN 633
9 432 611 772	NP-DLLA 143 SN 632
9 432 611 773	NP-DLLA 160 SN 629
9 432 611 774	NP-DLLA 142 SN 630
9 432 611 775	NP-DLLA 154 SN 631
9 432 611 776	NP-DLLA 150 SN 605
9 432 611 777	NP-DLL 160 SN 609
9 432 611 778	NP-DLL 160 SN 616
9 432 611 779	NP-DLLA 157 SN 617
9 432 611 780	NP-DLLA 150 SN 618
9 432 611 781	NP-DLL 155 SN 619
9 432 611 782	NP-DLLA 160 SN 620
9 432 611 783	NP-DLLA 160 SN 621
9 432 611 784	NP-DLLA 146 SN 622
9 432 611 785	NP-DLL 160 SN 626
9 432 611 786	NP-DLLA 144 SN 648
9 432 611 787	NP-DLLA 146 SN 662
9 432 611 788	NP-DLL 155 SN 675
9 432 611 789	NP-DLLA 155 SN 677
9 432 611 790	NP-DLLA 145 SN 680
9 432 611 791	NP-DLL 160 SN 683
9 432 611 792	NP-DLL 155 SN 672
9 432 611 794	NP-DLLA 150 SN 604
9 432 611 795	NP-DLLA 150 SN 637
9 432 611 796	NP-DLLA 160 SN 658
9 432 611 797	NP-DLLA 154 SN 663
9 432 611 798	NP-DLLA 154 SN 665
9 432 611 799	NP-DLLA 152 SN 668
9 432 611 800	NP-DLLA 144 SN 657
9 432 611 801	NP-DLLA 151 SN 656



9 432 611 802	NP-DLLA 152 SN 655
9 432 611 803	NP-DLLA 155 SN 650
9 432 611 804	NP-DLLA 148 SN 651
9 432 611 805	NP-DLLA 156 SN 652
9 432 611 806	NP-DLLA 156 SN 653
9 432 611 807	NP-DLLA 152 SN 654
9 432 611 809	NP-DLL 155 SN 550
9 432 611 810	NP-DLLA 157 SN 551
9 432 611 811	NP-DLLA 149 SN 552
9 432 611 812	NP-DLLA 150 SN 554
9 432 611 813	NP-DLL 155 SN 556
9 432 611 814	NP-DLLA 150 SN 557
9 432 611 815	NP-DLLA 149 SN 558
9 432 611 816	NP-DLL 155 SN 559
9 432 611 817	NP-DLL 155 SN 542
9 432 611 818	NP-DLL 150 SN 543
9 432 611 819	NP-DLLA 157 SN 544
9 432 611 820	NP-DLLA 155 SN 546
9 432 611 821	NP-DLLA 174 S 334 NP75
9 432 611 822	NP-DLL 160 SN 531
9 432 611 823	NP-DLLA 150 SN 534
9 432 611 824	NP-DLL 160 SN 535
9 432 611 825	NP-DLL 160 SN 537
9 432 611 826	NP-DLLA 150 SN 541
9 432 611 827	NP-DLL 1155 SN 560
9 432 611 828	NP-DLL 160 SN 530
9 432 611 829	NP-DLLA 160 SN 602
9 432 611 830	NP-DLL 155 SN 576
9 432 611 831	NP-DLLA 160 SN 577
9 432 611 832	NP-DLLA 142 SN 579
9 432 611 833	NP-DLLA 146 SN 585
9 432 611 834	NP-DLLA 154 SN 587
9 432 611 835	NP-DLLA 156 SN 589
9 432 611 836	NP-DLLA 154 SN 593
9 432 611 837	NP-DLLA 154 SN 599
9 432 611 838	NP-DLLA 154 SN 573
9 432 611 840	NP-DLLA 160 SN 565
9 432 611 841	NP-DLLA 149 SN 563
9 432 611 842	NP-DLL 155 SN 562
9 432 611 843	NP-DLL 1155 SN 561
9 432 611 844	NP-DLL 155 SN 574
9 432 611 845	NP-DL 145 U 479 AN1
9 432 611 846	NP-DL 145 T 304264 NP32
9 432 611 847	NP-DL 140 UC 659 N1
9 432 611 848	NP-DL 145 UE 509 N3



A86

de

**Bestellnummer →
Typformel
für Zexel-Düsen**
(Fortsetzung)

en

**Part number →
Type designation
for Zexel nozzles**
(continued)

fr

**Référence →
Formule de type
pour injecteurs Zexel**
(suite)

it

**Numero d'ordina-
zione → Sigla per
polverizzatori Zexel**
(seguito)

es

**Número de pedido →
Designación del tipo
para inyectoros Zexel**
(continuación)

9 432 611 849 ...



Ref.



Typ

9 432 611 849	NP-DL 150 UE 559 N1
9 432 611 850	NP-DL 135 U 4810 NP18
9 432 611 851	NP-DL 150 U 479 NP5
9 432 611 852	NP-DL 150 U 428 NP7
9 432 611 853	NP-DL 150 U 408 NP9A
9 432 611 854	NP-DL 145 U 479 NP10
9 432 611 855	NP-DL 150 U 509 NP5
9 432 611 856	NP-DL 135 UF 408 8N1
9 432 611 857	NP-DL 156 U 629 NP15
9 432 611 858	NP-DL 130 U 508 NP5
9 432 611 859	NP-DL 140 U 4810 AN3
9 432 611 860	NP-DL 145 UE 559 N1
9 432 611 861	NP-DL 145 TE 328 N1
9 432 611 862	NP-DL 155 T 3010 NP28
9 432 611 863	NP-DL 145 U 509 AN1
9 432 611 864	NP-DL 145 UE 4410 N1
9 432 611 865	NP-DLF 150 UB 408 N1
9 432 611 866	NP-DLF 160 U 388 NP8
9 432 611 868	NP-DL 150 UE 4010 N1
9 432 611 869	NP-DL 140 U 4610 AN3
9 432 611 870	NP-DL 140 U 4610 AN3
9 432 611 871	NP-DL 140 U 4810 AN3
9 432 611 872	NP-DL 150 UE 4410 N1
9 432 611 873	NP-DL 150 T 248 NP32
9 432 611 874	NP-DL 145 UE 4010 N1
9 432 611 875	NP-DL 140 U 4810 AN3
9 432 611 876	NP-DL 140 U 5210 AN3
9 432 611 877	NP-DL 156 UE 609 N2 R
9 432 611 878	NP-DL 140 U 529 AN3
9 432 611 879	NP-DL 140 U 529 AN3
9 432 611 880	NP-DL 150 UE 4410 N1
9 432 611 881	NP-DL 145 UE 509 N4 A
9 432 611 882	NP-DLF 145 TE 304,264 N3
9 432 611 883	NP-DL 145 T 324284 NP32
9 432 611 884	NP-DLF 140 TE 3210 N3 C
9 432 611 885	NP-DLF 140 TE 3210 N3 C
9 432 611 886	NP-DLF 140 TE 2810 N6 C
9 432 611 887	NP-DLF 140 TE 3010 N3 C
9 432 611 888	NP-DLF 140 TE 3010 N3 C
9 432 611 889	NP-DLF 140 TE 2810 N6 C
9 432 611 890	NP-DLF 145 TE 368 N3 C
9 432 611 891	NP-DLF 145 TB 248 N41
9 432 611 892	NP-DLF 145 TE 448 N4 C
9 432 611 893	NP-DLF 145 TE 268 N6 C
9 432 611 894	NP-DLF 140 TE 2610 N6 C



Ref.



Typ

9 432 611 895	NP-DL 150 T 328 NP15
9 432 611 896	NP-DLF 160 TB 286 N26
9 432 611 897	NP-DL 155 T 288 NP30
9 432 611 898	NP-DL 155 T 308 NP15
9 432 611 899	NP-DL 155 T 2610 NP30
9 432 611 900	NP-DL 155 T 268 NP30
9 432 611 901	NP-DL 155 T 308 NP30
9 432 611 902	NP-DL 155 T 2410 NP30
9 432 611 903	NP-DL 140 T 324284 NP32
9 432 611 904	NP-DL 155 T 328 NP26
9 432 611 905	NP-DL 150 T 338 NP1
9 432 611 906	NP-DL 140 T 304264 NP32
9 432 611 907	NP-DLF 145 UB 479 N19
9 432 611 908	NP-DL 155 T 288 NP15
9 432 611 909	NP-DL 160 T 328 NP20
9 432 611 910	NP-DL 135 T 388 NP15
9 432 611 911	NP-DL 140 T 387 NP2
9 432 611 912	NP-DLF 150 UE 3810 N1 C
9 432 611 913	NP-DLL 150 S 206 NP3
9 432 611 914	NP-DLL 155 S 256 NP3
9 432 611 915	NP-DLF 151 VE 5811 N1 C
9 432 611 916	NP-DLF 145 VE 5610 N1 C
9 432 611 917	DN-PDLF 151 VE 6010 N1 C
9 432 611 918	NP-DL 151 VE 6011 N1
9 432 611 919	NP-DL 151 VE 5811 N1
9 432 611 920	NP-DL 151 VE 6010 N1
9 432 611 921	NP-DLF 125 VB 538 N3
9 432 611 922	NP-DLF 151 VE 5411 N1 C
9 432 611 923	NP-DLF 151 VE 5411 N1 C
9 432 611 924	NP-DLF 151 VE 6011 N1 C
9 432 611 925	NP-DLL 150 S 256 NP3
9 432 611 927	NP-DL 151 VE 5411 N1
9 432 611 928	NP-DLLA 180 S 374 NP57
9 432 611 929	NP-DLLA 150 S 324 NP65
9 432 611 930	NP-DLL 155 S 206 NP3
9 432 611 931	NP-DLLA 160 S 344 NP11
9 432 611 932	NP-DLLA 156 S 344 NP55
9 432 611 933	NP-DL 130 U 488 NP5
9 432 611 934	NP-DLF 140 UB 4810 N27 C
9 432 611 935	NP-DL 151 VE 5411 N1
9 432 611 936	NP-DLL 150 S 308 NP33
9 432 611 937	NP-DLLA 150 S 334 NP3
9 432 611 938	NP-DLLA 176 S 334 NP4
9 432 611 939	NP-DLLA 160 S 324 NP9
9 432 611 940	NP-DLLA 152 S 324 NP48

... 9 432 612 038



9 432 611 941	NP-DLF 145 UC 629 N2 C
9 432 611 942	NP-DLF 140 UB 529 N27 C
9 432 611 943	NP-DLF 140 UB 529 N27 C
9 432 611 945	NP-DLF 140 UC 6010 N2 C
9 432 611 946	NP-DLF 140 UB 5210 N27 C
9 432 611 947	NP-DLF 145 UE 4010 N3 C
9 432 611 948	NP-DLF 145 UE 4010 N3 C
9 432 611 949	NP-DLF 145 UE 4410 N3 C
9 432 611 950	NP-DLF 140 UB 5210 N27 C
9 432 611 951	NP-DLF 156 UE 649 N5 R
9 432 611 952	NP-DLF 140 UC 569 N2 C
9 432 611 953	NP-DLF 150 UE 4410 N3 C
9 432 611 954	NP-DLF 150 UE 4410 N3 C
9 432 611 955	NP-DLF 150 UE 4010 N3 C
9 432 611 956	DN-PDLF 150 UE 4010 N3 C
9 432 611 957	NP-DLF 130 UB 538 N9
9 432 611 958	NP-DLF 120 UB 508 N21
9 432 611 959	NP-DLF 145 UB 488 N1
9 432 611 960	NP-DLF 145 UB 459 N26
9 432 611 961	NP-DLF 145 UC 589 N2 C
9 432 611 962	NP-DLF 145 UC 659 N2 C
9 432 611 963	NP-DLF 145 UB 509 N19
9 432 611 964	NP-DLF 150 UE 559 N3 C
9 432 611 965	NP-DLF 140 UB 4810 N27 C
9 432 611 968	NP-DL 145 UE 529 N3
9 432 611 969	NP-DLF 145 UE 4210 N3 C
9 432 611 970	NP-DLF 145 UE 3810 N3 C
9 432 611 971	NP-DN 12 SD 12T
9 432 611 972	NP-DN 8 S 1
9 432 611 973	NP-DN 15 S 2
9 432 611 974	NP-DN 30 S 1
9 432 611 975	NP-DN 30 S 2
9 432 611 976	NP-DN 8 S 2
9 432 611 977	NP-DN 8 S 142
9 432 611 978	NP-DN 40 S 2
9 432 611 979	NP-DN 4 S 162
9 432 611 980	NP-DN 0 SN 9
9 432 611 981	NP-DN 0 SN 11
9 432 611 982	NP-DN 0 SN 12
9 432 611 983	NP-DN 6 S 241
9 432 611 984	NP-DN 0 SN 059
9 432 611 985	NP-DN 0 SD 130
9 432 611 986	NP-DN 0 SD 131-1
9 432 611 987	NP-DN 4 SD 24 NP2
9 432 611 988	NP-DN 0 SD 1550



9 432 611 989	NP-DN 4 SD 20 NP1
9 432 611 990	NP-DN 7 SD 64 NP3
9 432 611 991	NP-DN 4 SD 24 NP4
9 432 611 993	NP-DN 0 SDNP 184
9 432 611 994	NP-DN 12 TN 1
9 432 611 995	NP-DN 4 T 208
9 432 611 996	NP-DN 12 TN 052
9 432 611 997	NP-DN 12 TN 053 C
9 432 611 998	NP-DN 6 TD 119 NP2
9 432 611 999	NP-DN 4 PDN 103
9 432 612 002	NP-DL 140 S 254 NP1
9 432 612 003	NP-DL 155 S 258 NP1
9 432 612 004	NP-DL 150 S 256 NP1
9 432 612 005	NP-DL 145 S 2758 NP1
9 432 612 006	NP-DL 145 S 27510 NP1
9 432 612 007	NP-DL 145 S 228 NP1
9 432 612 008	NP-DL 155 S 326 NP1
9 432 612 009	NP-DL 140 S 357 NP1
9 432 612 010	NP-DL 130 S 276 NP1
9 432 612 011	NP-DL 130 S 278 NP1
9 432 612 012	NP-DL 160 S 288 NP1
9 432 612 013	NP-DLA 110 S 602 NP10
9 432 612 014	NP-DLA 110 S 802 NP10
9 432 612 015	NP-DLA 110 S 902 NP10
9 432 612 018	NP-DL 145 S 268 NP19
9 432 612 019	NP-DL 160 S 278 N235
9 432 612 020	NP-DL 160 S 278 N235
9 432 612 021	NP-DL 160 S 248 N240
9 432 612 022	NP-DL 160 S 248 N240
9 432 612 023	NP-DL 160 S 238 N241
9 432 612 024	NP-DL 160 S 238 N241
9 432 612 025	NP-DL 160 S 268 N242 C
9 432 612 026	NP-DL 160 S 268 N242 C
9 432 612 027	NP-DL 130 S 348 N243
9 432 612 028	NP-DL 110 T 306 NP1
9 432 612 029	NP-DL 110 T 287 NP1
9 432 612 030	NP-DL 120 T 305 NP1
9 432 612 031	NP-DL 135 T 306 NP1
9 432 612 032	NP-DL 140 T 306 NP1
9 432 612 033	NP-DL 140 T 356 NP1
9 432 612 034	NP-DL 110 T 326 NP1
9 432 612 035	NP-DL 120 T 326 NP1
9 432 612 036	NP-DL 140 T 308 NP1
9 432 612 037	NP-DL 140 T 327 NP1
9 432 612 038	NP-DL 150 T 306 NP1



A88

de

**Bestellnummer →
Typformel
für Zexel-Düsen**
(Fortsetzung)

en

**Part number →
Type designation
for Zexel nozzles**
(continued)

fr

**Référence →
Formule de type
pour injecteurs Zexel**
(suite)

it

**Numero d'ordina-
zione → Sigla per
polverizzatori Zexel**
(seguito)

es

**Número de pedido →
Designación del tipo
para inyectoros Zexel**
(continuación)

9 432 612 039 ...



Ref.



Typ

9 432 612 039	NP-DL 130 T 326 NP1
9 432 612 040	NP-DL 150 T 288 NP1
9 432 612 041	NP-DL 150 T 287 NP1
9 432 612 042	NP-DL 140 T 387 NP1
9 432 612 043	NP-DL 140 T 3758 NP1
9 432 612 044	NP-DL 130 T 246 NP1
9 432 612 045	NP-DL 123 T 346 NP1
9 432 612 047	NP-DL 135 T 305 NP1
9 432 612 048	NP-DL 120 T 328 NP1
9 432 612 049	NP-DL 130 T 356 NP1
9 432 612 050	NP-DL 115 T 286 NP1
9 432 612 051	NP-DL 125 T 326 NP1
9 432 612 052	NP-DL 150 T 237 NP1
9 432 612 053	NP-DL 120 T 286 NP1
9 432 612 054	NP-DL 125 T 285 NP1
9 432 612 055	NP-DL 135 T 285 NP1
9 432 612 057	NP-DL 120 T 287 NP1
9 432 612 058	NP-DL 150 T 328 NP1
9 432 612 059	NP-DL 115 T 356 NP1
9 432 612 060	NP-DL 120 T 368 NP1
9 432 612 061	NP-DL 145 T 408 NP1
9 432 612 062	NP-DL 120 T 356 NP1
9 432 612 063	NP-DL 145 T 368 NP1
9 432 612 064	NP-DL 130 T 326 N2
9 432 612 065	NP-DL 118 T 306 N2
9 432 612 066	NP-DL 120 T 306 N2
9 432 612 067	NP-DL 115 T 306 NP3
9 432 612 068	NP-DL 120 T 367 NP1
9 432 612 069	NP-DL 140 T 408 NP1
9 432 612 070	NP-DL 110 T 346 NP1
9 432 612 071	NP-DL 130 T 327 NP1
9 432 612 072	NP-DL 150 T 388 NP1
9 432 612 073	NP-DL 130 T 387 NP1
9 432 612 074	NP-DL 120 T 307 NP1
9 432 612 075	NP-DL 120 T 308 NP1
9 432 612 076	NP-DL 130 T 357 NP1
9 432 612 077	NP-DL 130 T 286 NP1
9 432 612 078	NP-DL 150 T 327 NP1
9 432 612 079	NP-DL 120 T 256 NP1
9 432 612 080	NP-DL 145 T 428 NP1
9 432 612 081	NP-DL 145 T 356 NP1
9 432 612 082	NP-DL 140 T 328 NP1
9 432 612 083	NP-DL 160 T 358 NP1
9 432 612 084	NP-DL 130 T 388 NP1
9 432 612 085	NP-DL 130 T 358 NP1



Ref.



Typ

9 432 612 086	NP-DL 125 T 356 NP1
9 432 612 087	NP-DL 145 T 458 NP11
9 432 612 088	NP-DL 140 T 228 NP7
9 432 612 089	NP-DL 125 T 357 NP6
9 432 612 090	NP-DL 130 T 309 NP1
9 432 612 091	NP-DL 120 T 408 NP8
9 432 612 092	NP-DL 125 T 408 NP8
9 432 612 093	NP-DL 150 T 207 NP2
9 432 612 094	NP-DLF 120 T 326 NP1
9 432 612 095	NP-DLF 140 T 328 N11
9 432 612 096	NP-DLF 130 T 387 N11
9 432 612 097	NP-DLF 123 TB 346 N10
9 432 612 098	NP-DLF 140 TB 358 N10
9 432 612 099	NP-DLF 135 TB 326 N1
9 432 612 100	NP-DLF 115 TB 328 N1
9 432 612 101	NP-DLF 120 TB 368 N10
9 432 612 102	NP-DLF 120 TB 328 N1
9 432 612 103	NP-DLF 130 TB 357 N10
9 432 612 104	NP-DLF 120 TB 358 N10
9 432 612 105	NP-DLF 130 TB 387 N1
9 432 612 106	NP-DLF 120 TB 306 N1
9 432 612 107	NP-DLF 125 T 4 08 NP4
9 432 612 108	NP-DLF 140 TB 387 N1
9 432 612 109	NP-DLF 145 TB 328 N3
9 432 612 110	NP-DLF 145 TB 308 N8
9 432 612 111	NP-DLF 125 TB 408 N9
9 432 612 112	NP-DLF 125 TB 407 N5
9 432 612 113	NP-DLF 140 TB 407 N1
9 432 612 114	NP-DLF 144 TB 388 N7
9 432 612 115	NP-DLF 145 TB 4010 N9
9 432 612 116	NP-DLF 150 TB 2810 N13
9 432 612 117	NP-DLF 155 TB 3010 N13
9 432 612 118	NP-DLF 140 TB 358 N1
9 432 612 119	NP-DLF 140 TB 3010 N1
9 432 612 120	NP-DLF 140 TB 2810 N1
9 432 612 121	NP-DLF 135 TB 387 N10
9 432 612 122	NP-DLF 130 TB 356 N10
9 432 612 123	NP-DLF 150 TB 288 N15
9 432 612 124	NP-DLF 130 TB 3410 AN3
9 432 612 125	NP-DLF 130 TB 3610 AN3
9 432 612 126	NP-DLF 130 TB 3410 N16
9 432 612 127	NP-DLF 118 TB 349 AN3
9 432 612 128	NP-DLF 120 TB 408 N10
9 432 612 129	NP-DLF 130 TB 368 N16
9 432 612 130	NP-DLF 140 TB 2610 N1

... 9 432 612 229



9 432 612 131	NP-DLF 120 TB 357 N28
9 432 612 132	NP-DLF 115 TB 358 N28
9 432 612 133	NP-DLF 140 TB 408 N1
9 432 612 134	NP-DLF 150 TB 288 N28
9 432 612 135	NP-DLF 150 TB 328 N27
9 432 612 136	NP-DLF 125 TB 228 N28
9 432 612 137	NP-DLF 120 TB 327 N28
9 432 612 138	NP-DLF 115 TB 338 N28
9 432 612 139	NP-DLF 140 TB 368 N27
9 432 612 141	NP-DLF 150 TB 348 N32
9 432 612 142	NP-DLF 140 TB 364324 N3
9 432 612 143	NP-DLF 145 TE 368 N1
9 432 612 144	NP-DLF 130 TB 358 N28
9 432 612 147	NP-DLF 150 TB 348 N39
9 432 612 148	NP-DLF 145 TE 248 N5
9 432 612 149	NP-DLF 145 TE 268 N5
9 432 612 151	NP-DLF 150 TB 304244 N3
9 432 612 152	NP-DLF 115 TB 388 N28
9 432 612 153	NP-DLF 150 TE 454 N7
9 432 612 154	NP-DLF 115 TB 408 N40
9 432 612 156	NP-DLF 155 TE 3710 N8
9 432 612 157	NP-DLF 140 TE 2610 N6 C
9 432 612 158	NP-DL 160 T 328 NP12
9 432 612 159	NP-DL 155 T 2810 NP15
9 432 612 160	NP-DL 144 T 368 NP1
9 432 612 161	NP-DL 155 T 387 NP1
9 432 612 162	NP-DL 160 T 2810 NP15
9 432 612 163	NP-DL 125 T 438 NP17
9 432 612 164	NP-DL 155 T 2810 NP18
9 432 612 165	NP-DL 155 T 388 NP19
9 432 612 166	NP-DL 155 T 3210 NP12
9 432 612 167	NP-DL 130 T 3410 AN1
9 432 612 168	NP-DL 130 T 3610 AN1
9 432 612 169	NP-DL 150 T 288 NP23
9 432 612 170	NP-DL 155 T 3410 NP19
9 432 612 171	NP-DL 115 T 358 NP15
9 432 612 172	NP-DL 42 T 1 501 NP24
9 432 612 174	NP-DL 120 T 357 NP1
9 432 612 176	NP-DL 155 T 288 NP27
9 432 612 178	NP-DL 45T 3 601 NP29
9 432 612 179	NP-DL 150 T 348 NP31
9 432 612 180	NP-DL 160 T 288 NP15
9 432 612 181	NP-DL 118 T 349 AN1
9 432 612 182	NP-DL 130 T 3410 A N2
9 432 612 183	NP-DL 130 T 368 A N2



9 432 612 184	NP-DL 120 T 3410 A N2
9 432 612 185	NP-DL 115 T 328 A N2
9 432 612 186	NP-DL 130 T 358 AN1
9 432 612 187	NP-DL 110 T 338 NP1
9 432 612 188	NP-DL 130 T 3010 A N2
9 432 612 189	NP-DL 145 T 368 AN3
9 432 612 190	NP-DL 150 T 368 AN3
9 432 612 191	NP-DL 118 T 348 AN1
9 432 612 192	NP-DL 150 T 328 NP33
9 432 612 193	NP-DL 110 T 368 A N2
9 432 612 194	NP-DL 155 T 2810 NP28
9 432 612 195	NP-DL 150 T 248 NP22
9 432 612 196	NP-DL 150 T 268 NP32
9 432 612 197	NP-DL 150 U 428 NP1
9 432 612 198	NP-DL 125 U 458 NP4
9 432 612 199	NP-DL 145 U 428 NP4
9 432 612 200	NP-DL 145 U 308 NP1
9 432 612 201	NP-DL 145 U 428 NP8
9 432 612 202	NP-DL 140 U 458 NP4
9 432 612 203	NP-DL 145 U 458 NP4
9 432 612 204	NP-DL 145 U 488 NP4
9 432 612 205	NP-DL 130 U 5710 NP5
9 432 612 206	NP-DL 145 UC 589 N1
9 432 612 207	NP-DL 130 U 5810 NP5
9 432 612 208	NP-DL 130 U 6010 NP5
9 432 612 209	NP-DL 135 U 5010 NP9
9 432 612 210	NP-DL 135 U 6010 NP11
9 432 612 211	NP-DL 135 U 6210 NP11
9 432 612 212	NP-DL 135 U 6410 NP11
9 432 612 213	NP-DL 135 U 7010 NP11
9 432 612 214	NP-DL 135 U 6010 NP12
9 432 612 215	NP-DL 135 U 6510 NP12
9 432 612 216	NP-DL 135 U 6510 NP13
9 432 612 217	NP-DL 135 U 6510 NP14
9 432 612 218	NP-DL 156 U 609 NP15
9 432 612 219	NP-DL 130 U 488 NP5
9 432 612 220	NP-DL 150 UE 559 N1
9 432 612 221	NP-DL 140 U 408 NP4
9 432 612 222	NP-DL 156 U 609 NP16
9 432 612 223	NP-DL 156 UE 609 N2
9 432 612 224	NP-DL 140 U 458 NP4R
9 432 612 225	NP-DL 140 U 529 A N2R
9 432 612 226	NP-DL 135 U 5310 NP18
9 432 612 228	NP-DL 145 UE 509 N3
9 432 612 229	NP-DL 145 UE 559 N1



A90

de

**Bestellnummer →
Typformel
für Zexel-Düsen**
(Fortsetzung)

en

**Part number →
Type designation
for Zexel nozzles**
(continued)

fr

**Référence →
Formule de type
pour injecteurs Zexel**
(suite)

it

**Numero d'ordina-
zione → Sigla per
polverizzatori Zexel**
(seguito)

es

**Número de pedido →
Designación del tipo
para inyectoros Zexel**
(continuación)

9 432 612 230 ...



Ref.



Typ

9 432 612 230	NP-DL 140 U 4510 NP5
9 432 612 231	NP-DL 120 UE 4210 N1
9 432 612 232	NP-DL 120 UE 4410 N1
9 432 612 233	NP-DL 110 UE 449 N1
9 432 612 234	NP-DL 145 UE 509 N4
9 432 612 235	NP-DL 145 UE 3810 N1
9 432 612 236	NP-DL 145 UE 4010 N1
9 432 612 237	NP-DL 145 UE 4210 N1
9 432 612 238	NP-DL 145 UE 4410 N1
9 432 612 239	NP-DL 155 UE 4410 N1
9 432 612 240	NP-DLF 128 U 210 NP1
9 432 612 241	NP-DLF 123 U 367 NP10
9 432 612 242	NP-DLF 120 U 387 NP1
9 432 612 243	NP-DLF 125 U 488 NP10
9 432 612 244	NP-DLF 125 U 458 NP10
9 432 612 245	NP-DLF 125 U 428 NP10
9 432 612 246	NP-DLF 125 U 387 NP1
9 432 612 247	NP-DLF 140 UB 408 N8
9 432 612 248	NP-DLF 125 UB 358 N8
9 432 612 249	NP-DLF 128 U 310 NP9
9 432 612 250	NP-DLF 125 U 010 NP10
9 432 612 251	NP-DLF 130 UB 488 N1
9 432 612 252	NP-DLF 125 U 010 NP7
9 432 612 253	NP-DLF 125 UB 5310 N1
9 432 612 254	NP-DLF 125 UB 458 N1
9 432 612 255	NP-DLF 140 UB 458 N7
9 432 612 256	NP-DLF 145 UB 428 N8
9 432 612 257	NP-DLF 150 UB 408 N8
9 432 612 258	NP-DLF 140 UB 488 N7
9 432 612 259	NP-DLF 125 UB 408 N8
9 432 612 260	NP-DLF 145 UB 408 N8
9 432 612 261	NP-DLF 125 UB 5310 N8
9 432 612 262	NP-DLF 150 UB 459 N9
9 432 612 263	NP-DLF 120 UB 388 N14
9 432 612 264	NP-DLF 120 UB 408 N14
9 432 612 265	NP-DLF 124 UB 458 N15
9 432 612 266	NP-DLF 120 UB 508 N15
9 432 612 267	NP-DLF 150 UB 428 N16
9 432 612 268	NP-DLF 150 UB 408 N17
9 432 612 269	NP-DLF 145 UB 479 N18
9 432 612 270	NP-DLF 135 UB 5310 N1
9 432 612 271	NP-DLF 120 UB 388 N20
9 432 612 272	NP-DLF 120 UB 428 N20
9 432 612 273	NP-DLF 145 UB 4510 N1
9 432 612 274	NP-DLF 140 UB 488 N1



Ref.



Typ

9 432 612 275	NP-DLF 140 UB 4510 N1
9 432 612 276	NP-DLF 145 UB 479 N22C
9 432 612 277	NP-DLF 135 UB 459 N1
9 432 612 278	NP-DLF 140 UB 459 N1
9 432 612 279	NP-DLF 145 UB 459 N1
9 432 612 280	NP-DLF 140 UB 489 N1
9 432 612 281	NP-DLF 135 UB 5310 N24 C
9 432 612 282	NP-DLF 156 UE 649 N1
9 432 612 283	NP-DLF 150 UE 559 N3 C
9 432 612 285	NP-DLF 150 UE 466 N4
9 432 612 286	NP-DLF 156 UE 649 N5
9 432 612 287	NP-DLF 140 UB 559 N27 C
9 432 612 288	NP-DLLA 150 SN 867
9 432 612 289	NP-DLF 140 UC 659 N2 C
9 432 612 290	NP-DLF 140 UC 589 N2 C
9 432 612 291	NP-DLF 140 UC 629 N2 C
9 432 612 293	NP-DLF 156 UE 5013 N5
9 432 612 294	NP-DLF 145 UE 4410 N3 C
9 432 612 295	NP-DLF 155 UE 4410 N3 C
9 432 612 296	NP-DLF 120 UE 4010 N3 C
9 432 612 297	NP-DLF 120 UE 4410 N3 C
9 432 612 298	NP-DLF 140 UB 4610 B27 C
9 432 612 300	NP-DLF 156 UE 789 N6
9 432 612 301	NP-DLF 140 UC 6210 N2 C
9 432 612 302	NP-DL 148 VE 5611 N1
9 432 612 303	NP-DL 148 VE 5411 N1
9 432 612 304	NP-DL 151 VE 5611 N1
9 432 612 305	NP-DLF 125 VB 558 N2
9 432 612 306	NP-DLF 151 VE 6011 N1 C
9 432 612 307	NP-DLF 148 VE 5611 N1 C
9 432 612 308	NP-DLF 148 VE 5411 N1 C
9 432 612 309	NP-DLL 120 S 354 NP39
9 432 612 311	NP-DLL 145 S 254 NP43
9 432 612 312	NP-DLLA 150 S 255 NP14
9 432 612 313	NP-DLL 150 S 308 N396
9 432 612 314	NP-DLLA 160 S 354 N420
9 432 612 315	NP-DLL 31 S 7 01 N466
9 432 612 316	NP-DLLA 150 SN 487
9 432 612 317	NP-DLLA 162 S 265 N491
9 432 612 318	NP-DLLA 145 SN 511
9 432 612 319	NP-DLLA 160 SN 525
9 432 612 320	NP-DLLA 154 SN 526
9 432 612 321	NP-DLL 155 SN 527
9 432 612 322	NP-DLL 155 SN 528
9 432 612 323	NP-DLLA 154 SN 583

... 9 432 612 425



9 432 612 324	NP-DLL 150 SN 590
9 432 612 325	NP-DLL S
9 432 612 326	NP-DLL 150 SN 592
9 432 612 327	NP-DLL 25 SN 594
9 432 612 328	NP-DLL 160 SN 597
9 432 612 329	NP-DLL 160 SN 598
9 432 612 330	NP-DLLA 155 SN 600
9 432 612 331	NP-DLLA 155 SN 601
9 432 612 332	NP-DLL 160 SN 608
9 432 612 333	NP-DLL 150 SN 628
9 432 612 334	NP-DLLA 144 SN 642
9 432 612 335	NP-DLLA 103 SN 646
9 432 612 336	NP-DLLA 150 SN 673
9 432 612 337	NP-DLL 30 SN 674
9 432 612 338	NP-DLLA 150 SN 682
9 432 612 339	NP-DLLA 155 SN 684
9 432 612 340	NP-DLLA 155 SN 685
9 432 612 341	NP-DLL 30 SN 689
9 432 612 343	NP-DLLA 149 SN 712
9 432 612 344	NP-DLLA 160 SN 732
9 432 612 345	NP-DLLA 155 SN 746
9 432 612 346	NP-DLLA 138 SN 757
9 432 612 347	NP-DLLA 157 SN 777
9 432 612 348	NP-DLLA 153 SN 782
9 432 612 349	NP-DLL 160 SN 785
9 432 612 350	NP-DLLA 150 SN P20
9 432 612 351	NP-DLLA 155 SNP 187
9 432 612 352	NP-DLLA 150 S 344 NP103
9 432 612 353	NP-DLLA 150 S 344 NP108
9 432 612 354	NP-DLLA 150 SN P18
9 432 612 355	NP-DLLA 150 SN 808
9 432 612 357	NP-DLLA 160 SN 822
9 432 612 358	NP-DLLA 155 SN 872
9 432 612 359	NP-DLLA 160 SN 881
9 432 612 360	NP-DLLA 150 SN 901
9 432 612 361	NP-DLLA 160 SN 915
9 432 612 362	NP-DLL 155 SN 939
9 432 612 363	NP-DLLA 160 SN 945
9 432 612 364	NP-DLLA 150 SN 948
9 432 612 365	NP-DLLA 155 SN 955
9 432 612 366	NP-DLLA 160 SN 961
9 432 612 367	NP-DLLA 160 SN 961
9 432 612 368	NP-DLLA 161 SN 963
9 432 612 369	NP-DLLA 157 SN 966
9 432 612 370	NP-DLLA 140 SN 982



9 432 612 371	NP-DLLA 150 SN 985
9 432 612 372	NP-DL 130 U J408 N3
9 432 612 373	NP-DL 130 U J608 N3
9 432 612 374	NP-DLL 150 TA 258 N2
9 432 612 375	NP-DLL 130 TA 286
9 432 612 376	NP-DLL 150 TA 288
9 432 612 377	NP-DL 145 TU 428 N1
9 432 612 378	NP-DL 145 TU 428 N2
9 432 612 380	NP-DL 140 TC 329 N3R
9 432 612 383	NP-DL 140 TU 458 N2
9 432 612 384	NP-DLF 118 TJ 348 N1
9 432 612 385	NP-DLF 135 TJ 348 N1
9 432 612 386	NP-DLF 140 UJ 4210 N1
9 432 612 387	NP-DLF 140 UM 328 N6
9 432 612 388	NP-DLF 145 TJ 309 N1
9 432 612 390	NP-DLF 130 UJ 708 N2
9 432 612 392	NP-DLF 125 TJ 357 N2
9 432 612 393	NP-DLF 130 TJ 358 N3
9 432 612 394	NP-DLF 120 TJ 357 N2
9 432 612 395	NP-DLF 132 TJ 357 N2
9 432 612 396	NP-DLF 120 TJ 357 N4
9 432 612 397	NP-DLF 130 TJ 358 N4
9 432 612 398	NP-DLF 125 TJ 357 N4
9 432 612 399	NP-DLF 130 TJ 3410 N1
9 432 612 401	NP-DLF 140 TM 318 N20
9 432 612 402	NP-DLF 120 TJ 358 N4
9 432 612 403	NP-DLF 130 UJ 408 N4
9 432 612 404	NP-DLF 130 UJ 458 N4
9 432 612 405	NP-DLF 130 UJ 488 N4
9 432 612 406	NP-DLF 130 UJ 4610 N1
9 432 612 408	NP-DLF 140 UJ 3510 N4
9 432 612 409	NP-DLF 140 UJ 3810 N4
9 432 612 410	NP-DLF 140 UJ 4210 N4
9 432 612 411	NP-DLF 140 VJ 4810 N2
9 432 612 412	NP-DLF 140 VJ 5210 N2
9 432 612 414	NP-DLF 130 UJ 4210 N1
9 432 612 415	NP-DLF 130 UJ 568 N2
9 432 612 417	NP-DLF 120 UJ 3510 N6
9 432 612 418	NP-DLF 130 UJ 3510 N6
9 432 612 419	NP-DLF 120 UJ 3810 N6
9 432 612 420	NP-DLF 130 UJ 3810 N6
9 432 612 421	NP-DLF 130 UJ 4010 N5
9 432 612 423	NP-DLF 130 VJ 6210 N1
9 432 612 424	NP-DLF 130 UJ 4210 N6
9 432 612 425	NP-DLF 130 UJ 4010 N6



A92

de

**Bestellnummer →
Typformel
für Zexel-Düsen**
(Fortsetzung)

en

**Part number →
Type designation
for Zexel nozzles**
(continued)

fr

**Référence →
Formule de type
pour injecteurs Zexel**
(suite)

it

**Numero d'ordina-
zione → Sigla per
polverizzatori Zexel**
(seguito)

es

**Número de pedido →
Designación del tipo
para inyectoros Zexel**
(continuación)

9 432 612 426 ...



Ref.



Typ

9 432 612 426	NP-DLF 130 UJ 4410 N6
9 432 612 429	NP-DLF 130 UJ 5510 N7
9 432 612 430	NP-DLF 130 UJ 5010 N7
9 432 612 431	NP-DLF 145 TU 424384 N1
9 432 612 432	NP-DLF 130 UJ 5210 N7
9 432 612 438	NP-DLF 145 TU 458 N3
9 432 612 439	NP-DLF 145 TU 428 N5 C
9 432 612 466	NP-DLF 120 UJ 4210 N6
9 432 612 467	NP-DLF 120 UJ 5310 N7
9 432 612 468	NP-DLF 120 UJ 4410 N6
9 432 612 469	NP-DLLA 150 PN 001
9 432 612 470	NP-DLLA 160 PN 008
9 432 612 471	NP-DLLA 150 PN 027
9 432 612 472	NP-DLLA 159 PN 029
9 432 612 473	NP-DLLA 155 PN 034
9 432 612 474	NP-DLLA 155 PN 037
9 432 612 475	NP-DLLA 155 PN 038
9 432 612 476	NP-DLLA 155 PN 045
9 432 612 477	NP-DLLA 155 PN 046
9 432 612 478	NP-DLLA 155 PN 048
9 432 612 479	NP-DLLA 150 PN 054
9 432 612 480	NP-DLLA 154 PN 073
9 432 612 481	NP-DLLA 160 P 36
9 432 612 482	NP-DLLA 152 PN 081
9 432 612 483	NP-DLLA 155 PN 083
9 432 612 484	NP-DLLA 155 PN 092
9 432 612 485	NP-DLLA 139 PN 120
9 432 612 486	NP-DLLA 146 PN 122
9 432 612 487	NP-DLLA 150 PN 144
9 432 612 488	NP-DLLA 150 PN 150
9 432 612 489	NP-DLLA 160 PN 156
9 432 612 490	NP-DLLA 151 PN 158
9 432 612 491	NP-DLLA 158 PN 167
9 432 612 492	NP-DLLA 150 PN 183
9 432 612 493	NP-DLLA 150 PN 211
9 432 612 494	NP-DLLA 140 PN 254
9 432 612 495	NP-DLLA 145 PN 263
9 432 612 496	NP-DLLA 153 P 272W
9 432 612 497	NP-DLLA 156 PN 280
9 432 612 498	NP-DLLA 140 PN 289
9 432 612 499	NP-DLLA 140 PN 290
9 432 612 500	NP-DLLA 149 PN 293
9 432 612 501	NP-DLLA 141 PN 294
9 432 612 502	NP-DLLA 148 PN 295
9 432 612 503	NP-DLLA 146 P N296



Ref.



Typ

9 432 612 504	NP-DLLA 146 PN 296
9 432 612 505	NP-DLLA 152 PN 297
9 432 612 506	NP-DLLA 152 PN 298
9 432 612 507	NP-DLLA 147 PN 300
9 432 612 514	NP-DSLA 145 PN 904
9 432 612 517	NP-DL 130 T 3410 AN4
9 432 612 518	NP-DL 150 T 3010 NP15
9 432 612 519	NP-DL 130 T 308 NP20
9 432 612 520	NP-DL 145 T 248 NP3
9 432 612 521	NP-DL 130 T 328 NP20L
9 432 612 522	NP-DL 120 T 438 NP8
9 432 612 523	NP-DL 145 T 408 AN3
9 432 612 524	NP-DL 145 TE 248 N3
9 432 612 525	NP-DL 145 TE 268 N3
9 432 612 526	NP-DL 150 T 304264 NP35
9 432 612 527	NP-DL 115 T 408 NP19
9 432 612 528	NP-DL 115 T 428 NP19
9 432 612 529	NP-DL 130 T 3610 A N2
9 432 612 530	NP-DL 150 T 4110 NP38
9 432 612 531	NP-DL 115 T 328 NP41
9 432 612 532	NP-DL 130 T 3410 NP41
9 432 612 533	NP-DL 145 TE 348 N4
9 432 612 534	NP-DL 140 TE 2610 N7
9 432 612 535	NP-DL 140 TE 3010 N1
9 432 612 536	NP-DL 140 TE 3210 N1
9 432 612 537	NP-DL 155 TE 3510 N6
9 432 612 538	NP-DL 130 T 3210 NP41
9 432 612 539	NP-DL 140 TE 368 N1 %
9 432 612 540	NP-DL 130 T 3210 NP44
9 432 612 541	NP-DL 150 T 366 NP15
9 432 612 542	NP-DL 130 T 387 NP45
9 432 612 543	NP-DL 150110 T 3014 NP46
9 432 612 544	NP-DL 150110 T 3214 NP46
9 432 612 545	NP-DL 150110 T 3414 NP46
9 432 612 546	NP-DL 140100 T 3214 NP46
9 432 612 556	NP-DLLA 156 SM 003
9 432 612 568	NP-DLLA 150 SM 130
9 432 612 586	NP-DLLA 146 PN 296
9 432 612 603	NP-DLLA 157 SM 319
9 432 612 612	NP-DLLA 156 SM 003
9 432 612 613	NP-DLLA 156 SM 003
9 432 612 614	NP-DLLA 152 SM 005
9 432 612 615	NP-DLLA 153 SM 007
9 432 612 616	NP-DLLA 156 SM 019
9 432 612 617	NP-DLLA 156 SM 019

... 9 432 612 718



9 432 612 618	NP-DLLA 150 SM 024
9 432 612 619	NP-DLLA 158 SM 039
9 432 612 620	NP-DLLA 150 SM 042
9 432 612 621	NP-DLLA 158 SM 060
9 432 612 622	NP-DLLA 150 SM 065
9 432 612 623	NP-DLLA 150 SM 082
9 432 612 624	NP-DLLA 155 SM 083
9 432 612 625	NP-DLLA 160 SM 084
9 432 612 626	NP-DLLA 150 SM 086
9 432 612 627	NP-DLLA 152 SM 097
9 432 612 628	NP-DLLA 152 SM 108
9 432 612 629	NP-DLLA 150 SM 113
9 432 612 630	NP-DLLA 150 SM 117
9 432 612 631	NP-DLLA 155 SM 118
9 432 612 632	NP-DLLA 157 SM 131
9 432 612 633	NP-DLLA 155 SM 142
9 432 612 634	NP-DLLA 150 SM 161
9 432 612 635	NP-DLLA 155 SM 162
9 432 612 636	NP-DLLA 150 SM 165
9 432 612 637	NP-DLLA 150 SM 173
9 432 612 638	NP-DLLA 150 SM 174
9 432 612 639	NP-DLLA 150 SM 176
9 432 612 640	NP-DLL 125 SM 196
9 432 612 641	NP-DLLA 133 SM 208
9 432 612 642	NP-DLL 125 SM 226
9 432 612 643	NP-DLLA 155 SM 232
9 432 612 644	NP-DLLA 155 SM 239
9 432 612 645	NP-DLLA 150 SM 240
9 432 612 646	NP-DLLA 160 SM 265
9 432 612 647	NP-DLLA 155 SM 270
9 432 612 648	NP-DLLA 146 SM 285
9 432 612 649	NP-DLLA 146 SM 291
9 432 612 650	NP-DLLA 155 SM 312
9 432 612 651	NP-DLLA 160 SM 314
9 432 612 652	NP-DLLA 151 SM 338
9 432 612 653	NP-DLLA 150 SM 343
9 432 612 654	NP-DLLA 148 SM 345
9 432 612 655	NP-DLLA 155 SM 347
9 432 612 656	NP-DLLA 160 SM 348
9 432 612 657	NP-DLLA 156 SM 349
9 432 612 658	NP-DLLA 140 SM 350
9 432 612 659	NP-DLLA 158 SM 351
9 432 612 660	NP-DLLA 140 SM 353
9 432 612 661	NP-DLLA 151 SM 354
9 432 612 662	KP-DN 0 SDN 226



9 432 612 670	KP-DLLA 136 SH 120
9 432 612 671	KP-DLLA 150 SH 122
9 432 612 672	KP-DLLA 150 SH 123
9 432 612 673	KP-DLLA 150 SH 124
9 432 612 674	KP-DLLA 150 SH 125
9 432 612 675	KP-DLLA 150 SN 762
9 432 612 677	KP-DLLA 150 SN 902
9 432 612 678	KP-DLLA 156 SN 921
9 432 612 679	KP-DLLA 152 SN 681
9 432 612 680	KP-DLLA 152 SN 924
9 432 612 681	KP-DLLA 155 SM 066
9 432 612 682	KP-DLLA 154 SN 533
9 432 612 683	KP-DLLA 150 SM 082
9 432 612 684	KP-DLLA 155 SM 083
9 432 612 685	KP-DLLA 160 SM 084
9 432 612 686	KP-DLLA 152 SM 097
9 432 612 687	KP-DLLA 152 SM 108
9 432 612 688	KP-DLLA 150 SM 117
9 432 612 689	KP-DLLA 155 SM 118
9 432 612 690	KP-DLLA 150 SN 615
9 432 612 691	KP-DLLA 150 SM 161
9 432 612 692	KP-DLLA 155 SM 162
9 432 612 693	KP-DLLA 150 SM 165
9 432 612 694	KP-DLLA 150 SM 173
9 432 612 695	KP-DLLA 155 SM 239
9 432 612 696	KP-DLLA 150 SM 240
9 432 612 697	KP-DLLA 155 PN 179
9 432 612 698	KP-DLLA 154 PN 148
9 432 612 699	KP-DLLA 155 PN 200
9 432 612 700	KP-DLLA 155 PN 202
9 432 612 701	NP-DLLA 154 P 2 04W
9 432 612 702	KP-DLLA 150 PN 211
9 432 612 703	NP-DLLA 153 P 206 W
9 432 612 704	KP-DLLA 156 PN 280
9 432 612 705	KP-DN 0 PDN 112
9 432 612 706	KP-DN 10 PDN 130
9 432 612 707	NP-DLLA 145 SM 357
9 432 612 711	NP-DLLA 141 SM 373
9 432 612 712	NP-DN 4 PDN 154
9 432 612 713	NP-DN 5 PDN 155
9 432 612 714	NP-DLL 150 UE 4010 N1
9 432 612 715	NP-DL 156 UE 5611 N5
9 432 612 716	NP-DLLA 140 PN 302
9 432 612 717	NP-DLLA 140 PN 303
9 432 612 718	NP-DLLA 150 PN 304







A94

de	en	fr	it	es
Bestellnummer → Typformel für Zexel-Düsen (Fortsetzung)	Part number → Type designation for Zexel nozzles (continued)	Référence → Formule de type pour injecteurs Zexel (suite)	Numero d'ordina- zione → Sigla per polverizzatori Zexel (seguito)	Número de pedido → Designación del tipo para inyectoros Zexel (continuación)

9 432 612 719 ...



 Ref.	 Typ
9 432 612 719	NP-DLLA 155 PN 310
9 432 612 720	NP-DLLA 152 PN 311
9 432 612 721	NP-DLLA 158 PN 312
9 432 612 722	NP-DLLA 158 PN 313
9 432 612 723	NP-DLLA 158 PN 314
9 432 612 724	NP-DLL 140 SM 352
9 432 612 725	NP-DLLA 140 SM 355
9 432 612 726	NP-DLLA 152 SM 358
9 432 612 727	NP-DLLA 156 SM 359
9 432 612 728	NP-DLLA 142 SM 360
9 432 612 729	NP-DLLA 141 SM 361
9 432 612 730	NP-DLLA 152 SM 362
9 432 612 731	NP-DLLA 157 SM 363
9 432 612 732	NP-DLLA 146 SM 364
9 432 612 733	NP-DLLA 158 SM 365
9 432 612 734	NP-DLLA 158 SM 366
9 432 612 735	NP-DLLA 158 SM 367
9 432 612 736	NP-DLLA 158 SM 368
9 432 612 737	NP-DLLA 152 SM 369
9 432 612 738	NP-DLLA 150 SM 370
9 432 612 739	NP-DLLA 155 SM 371
9 432 612 740	NP-DLLA 155 SM 372
9 432 612 741	NP-DLLA 156 SM 374
9 432 612 742	NP-DLLA 156 SM 375
9 432 612 743	NP-DLLA 155 SM 376
9 432 612 744	NP-DLLA 158 SM 378
9 432 612 745	NP-DLLA 155 SM 379
9 432 612 755	NP-DLLA 158 SM 384
9 432 612 756	NP-DLLA 150 SM 385
9 432 612 757	NP-DLLA 155 SM 386
9 432 612 759	NP-DLLA 145 SM 387
9 432 612 760	NP-DLLA 155 SM 391
9 432 612 761	NP-DLLA 150 PN 316
9 432 612 762	NP-DLLA 158 SM 388
9 432 612 763	NP-DLLA 150 PN 315
9 432 612 764	NP-DSLA 152 PN 929
9 432 612 766	NP-DLLA 157 SM 389
9 432 612 769	NP-DLLA 160 PN 317
9 432 612 770	NP-DLLA 160 SM 382
9 432 612 772	NP-DLF 156 UE 789 N6
9 432 612 773	NP-DLLA 148 PN 306
9 432 612 774	NP-DLL 145 UE 4810 N1
9 432 612 775	NP-DLLA 151 SM 397
9 432 612 777	NP-DLLA 153 PN 318
9 432 612 778	NP-DLLA 158 SM 392

 Ref.	 Typ
9 432 612 779	NP-DLLA 157 SM 396
9 432 612 781	NP-DLLA 155 SM 393
9 432 612 785	NP-DLLA 158 SM 390
9 432 612 786	NP-DLLA 158 SM 401
9 432 612 788	NP-DLLA 156 SM 394
9 432 612 790	NP-DLLA 156 SM 395
9 432 612 791	NP-DLLA 158 PN 332
9 432 612 792	NP-DLLA 145 PN 331
9 432 612 793	NP-DLLA 157 SM 402
9 432 612 794	NP-DLLA 137 SM 406
9 432 612 795	NP-DN 0 PDN 158
9 432 612 796	NP-DLLA 152 SM 400
9 432 612 797	NP-DLLA 152 SM 399
9 432 612 798	NP-DLLA 160 SM 404
9 432 612 800	NP-DLLA 141 SM 403
9 432 612 802	NP-DLLA 154 PN 327
9 432 612 804	NP-DLLA 161 PN 328
9 432 612 806	NP-DLLA 154 PN 319
9 432 612 808	NP-DLLA 157 PN 329
9 432 612 810	NP-DLLA 152 PN 320
9 432 612 812	NP-DLLA 143 PN 325
9 432 612 814	NP-DLLA 142 PN 324
9 432 612 816	NP-DLLA 146 PN 322
9 432 612 818	NP-DLLA 147 PN 323
9 432 612 821	NP-DLLA 158 PN 341
9 432 612 822	NP-DN 15 PDN 157
9 432 612 823	NP-DLLA 152 SM 411
9 432 612 826	NP-DLLA 150 SM 412
9 432 612 828	NP-DSLA 153 PN 934
9 432 612 829	NP-DLLA 158 SM 383
9 432 612 830	NP-DLLA 15 PN 343
9 432 612 831	NP-DLLA 140 SM 413
9 432 612 832	NP-DLLA 152 PN 342
9 432 612 833	NP-DLLA 150 PN 344
9 432 612 835	NP-DLLA 157 SM 415
9 432 612 837	NP-DLLA 152 SM 414
9 432 612 838	NP-DLLA 158 SM 417
9 432 612 839	NP-DSLA 140 PN 935
9 432 612 843	NP-DLLA 144 PN 309
9 432 612 844	NP-DSLA 140 PN 936
9 432 612 846	NP-DLLA 148 PN 307
9 432 612 847	NP-DLLA 165 SM 419
9 432 612 848	NP-DLLA 130 SM 418
9 432 612 849	NP-DLLA 156 SM 420
9 432 612 850	NP-DLLA 145 PN 346

... 9 432 610 612



9 432 612 852	NP-DL 160 TE 3510 N8
9 432 612 853	NP-DLLA 160 SM 381
9 432 612 854	NP-DLLA 147 SM 380
9 432 612 855	NP-DLLA 136 PN 326
9 432 612 856	NP-DLLA 150 SM 407
9 432 612 857	NP-DL 155 TE 3710 N8
9 432 612 858	NP-DL 155 TE 3510 N8
9 432 612 859	NP-DLLA 148 PN 345
9 432 612 860	NP-DLLA 148 PN 330
9 432 612 861	NP-DSLA 147 PN 933
9 432 612 862	NP-DL 160 TE 3710 N8
9 432 612 863	NP-DN 0 PD 628
9 432 612 864	NP-DLLA 146 SM 424
9 432 612 866	NP-DLLA 142 SM 425
9 432 612 867	NP-DLLA 145 PN 349
9 432 612 869	NP-DLLA 140 PN 348
9 432 612 871	NP-DSLA 138 PN 938
9 432 612 872	NP-DSLA 147 PN 937
9 432 612 873	NP-DN 4 PDN 160
9 432 612 874	NP-DLLA 147 PN 351
9 432 612 875	NP-DN 0 PDN 161
9 432 612 876	NP-DN 0 PDN 159
9 432 612 890	NP-DLLA 140 SM 421
9 432 612 891	NP-DSLA 150 PN 930
9 432 612 892	NP-DSLA 150 PN 939
9 432 612 893	NP-DLLA 155 SM 427
9 432 612 895	NP-DLL 155 SM 426
9 432 612 896	NP-DSLA 150 PN 931
9 432 612 897	NP-DL 150 UE 3810 N1
9 432 612 898	NP-DLL 150 UE 4410 N1
9 432 612 899	NP-DLF 151 VE 6211 N1 C
9 432 612 900	NP-DLL 150 TE 288 N1
9 432 612 901	NP-DL 145 TU 484454 N2
9 432 612 902	NP-DLLA 154 PN 350
9 432 612 903	NP-DLLA 150 PN 352
9 432 612 907	NP-DSLA 150 PN 932
9 432 612 908	NP-DL 155 TE 3710 N8
9 432 612 909	NP-DL 155 TE 3510 N8
9 432 612 910	NP-DL 160 TE 3710 N8
9 432 612 911	NP-DL 160 TE 3510 N8
9 432 612 912	NP-DL 160 T 32510 NP40E
9 432 612 913	NP-DL 160 T 3110 NP40E
9 432 612 914	NP-DL 160 T 2910 NP47E
9 432 612 915	NP-DL 160 T 3110 NP47E
9 432 612 916	NP-DL 160 T 3010 NP47



9 432 612 917	NP-DL 160 T 32510 NP47
9 432 612 918	NP-DL 160 T 2510 NP47E
9 432 612 919	NP-DL 160 T 2610 NP47E
9 432 612 920	NP-DL 160 T 2710 NP47E
9 432 612 921	NP-DL 160 T 2810 NP47E
9 432 612 922	NP-DL 160 T 2710 NP48E
9 432 612 923	NP-DL 160 T 2610 NP49E
9 432 612 924	NP-DL 160 T 2510 NP49E
9 432 612 925	NP-DL 160 T 2410 NP49E
9 432 612 927	NP-DLLA 158 SM 408
9 432 612 928	NP-DLLA 158 SM 409
9 432 612 929	NP-DLLA 157 SM 410
9 432 612 930	NP-DLLA 158 SM 416
9 432 612 931	NP-DLLA 140 SM 422
9 432 612 932	NP-DLLA 140 SM 423
9 432 612 933	NP-DLLA 155 SM 431
9 432 612 934	NP-DLLA 133 SM 433
9 432 612 935	NP-DLLA 133 SM 434
9 432 612 937	NP-DLLA 140 PN 359
9 432 612 938	NP-DLLA 155 SM 435
9 432 612 939	NP-DLLA 157 SM 437
9 432 612 943	NP-DLL 150 TE 288 N2
9 432 612 944	NP-DLLA 160 SM 436
9 432 612 945	NP-DLLA 148 PN 363
9 432 612 946	NP-DLLA 157 SM 438
9 432 612 949	NP-DLLA 140 PN 361
9 432 612 950	NP-DLLA 152 P 69
9 432 612 951	NP-DLLA 150 P 602
9 432 612 952	NP-DLLA 140 P 643
9 432 612 953	NP-DLLA 150 S 325 ND117
9 432 612 954	NP-DLLA 155 SND 160
9 432 612 955	NP-DLLA 155 SND 199
9 432 612 956	NP-DSLA 149 PN 941
9 432 612 957	NP-DLLA 162 SM 441
9 432 612 960	NP-DSLA 148 PN 942
9 432 612 961	NP-DLLA 160 SM 445
9 432 612 964	NP-DLLA 160 SM 448
9 432 612 965	NP-DN 0 PDN 156
9 432 612 966	NP-DLL 140 SM 432
9 432 612 967	NP-DLF 151 VE 5811 N2 C
9 432 612 968	NP-DLLA 160 SM 447
9 432 612 970	NP-DSLA 140 PN 940
9 443 610 366	NP-DLF 145 TB 308 N20
9 432 610 417	NP-DLLA 160 SN 671
9 432 610 612	NP-DLLA 150 P N282



de

**Bestellnummer →
Typformel
für Zexel-Düsen**
(Fortsetzung)

en

**Part number →
Type designation
for Zexel nozzles**
(continued)

fr

**Référence →
Formule de type
pour injecteurs Zexel**
(suite)

it

**Numero d'ordina-
zione → Sigla per
polverizzatori Zexel**
(seguito)

es

**Número de pedido →
Designación del tipo
para inyectoros Zexel**
(continuación)

9 432 610 948 ...

... F 01G 0V5 000



Ref.	Typ
------	-----

9 432 610 948	NP-DL 150 T 284.244 NP37
9 432 610 951	NP-DL 150 T 304.244 NP37
9 432 610 955	NP-DL 150 T 324.264 NP37
9 432 610 961	NP-DL 150 T 344.304 NP37
9 432 610 974	NP-DL 145 T 278 NP37 %
9 432 610 977	NP-DL 145 T 248 NP37 %
9 432 610 980	NP-DL 150 T 304.264 NP37

9 432 611 ...

9 432 611 123	NP-DL 145 T 324.284NP37
9 432 611 475	NP-DLLA 133 SM 208
9 432 611 620	NP-DLLA 151 SM 329
9 432 611 884	NP-DLF 140 TE 3210N3 C
9 432 611 886	NP-DLF 140 TE 2810N6 C
9 432 611 888	NP-DLF 140 TE 3010N3 C
9 432 611 894	NP-DLF 140 TE 2610N6 C
9 432 611 917	NP-DLF 151 VE 6010 N1 C
9 432 611 947	NP-DLF 145 UE 4010N3 C
9 432 611 948	NP-DLF 145 UE 4010N3 C
9 432 611 954	NP-DLF 150 UE 4410N3 C
9 432 611 956	NP-DLF 150 UE 4010N3 C

9 432 612 ...

9 432 612 220	NP-DL 150 UE 559N1
9 432 612 228	NP-DL 145 UE 509N3
9 432 612 229	NP-DL 145 UE 559N1
9 432 612 238	NP-DL 145 UE 4410N1
9 432 612 283	NP-DLF 150 UE 559N3 C
9 432 612 288	NP-DLF 140 UB 559 N27 C
9 432 612 722	NP-DLLA 158 PN 313
9 432 612 723	NP-DLLA 158 PN 314
9 432 612 821	NP-DLLA 158 PN 341
9 432 612 838	NP-DLLA 158 SM 417
9 432 612 948	NP-DLLA 148 PN 360
9 432 612 979	NP-DL 151 VE 5411 N2
9 432 612 980	NP-DL 151 VE 6011 N2
9 432 612 981	NP-DL 151 VE 5811 N2
9 432 612 982	NP-DL 151 VE 6010 N2
9 432 612 983	NP-DL 148 VE 5611 N2
9 432 612 984	NP-DL 148 VE 5411 N2
9 432 612 985	NP-DL 151 VE 5611 N2

Ref.	Typ
------	-----

9 432 612 986	NP-DLF 151 VE 5411 N2 C
9 432 612 987	NP-DLF 151 VE 6011 N2 C
9 432 612 988	NP-DLF 151 VE 6010 N2 C
9 432 612 989	NP-DLF 145 VE 5610 N2 C
9 432 612 990	NP-DLF 151 VE 5611 N2 C
9 432 612 991	NP-DLF 148 VE 5611 N2 C
9 432 612 992	NP-DLF 148 VE 5411 N1 C
9 432 612 993	NP-DLF 151 VE 6211 N2 C

9 432 613 ...

9 432 613 006	NP-DLL 145 TE 288 N3
9 432 613 009	NP-DLL 145 UC 5010 N2
9 432 613 010	NP-DLL 140 UE 4010 N1
9 432 613 011	NP-DLL 140 UE 4410 N1
9 432 613 012	NP-DL 140 UE 4010 N1
9 432 613 013	NP-DL 140 UE 4410 N1
9 432 613 014	NP-DLF 140 UE 4010 N3 C
9 432 613 015	NP-DLF 140 UE 4410 N3 C
9 432 613 016	NP-DL 140 VE 5611 N2
9 432 613 017	NP-DL 145 VE 5611 N2
9 432 613 018	NP-DL 140 VE 5411 N2
9 432 613 019	NP-DLF 140 VE 5611 N2 C
9 432 613 020	NP-DLF 145 VE 5611 N2 C
9 432 613 021	NP-DLF 140 VE 5411 N2 C
9 432 613 022	NP-DLL 150 TE 288 N3
9 432 613 023	NP-DLL 140 TE 288 N3
9 432 613 024	NP-DLLA 140 PN 369
9 443 616 020	NP-DL 150 T 288 NP37

F 01G 0V5 000	NP-DLLA 140 PN 291
---------------	--------------------

de

Typformel →
Bestellnummer
für Zexel-Düsen

en

Type designation →
Part number
for Zexel nozzles

fr

Formule de type →
Référence
pour injecteurs Zexel

it

Sigla → Numero
d'ordinazione per
polverizzatori Zexel

es

Designación del tipo
→ Número de pedido
para inyectoros Zexel

DN-PDLF 150 UE 4010 N3C ...

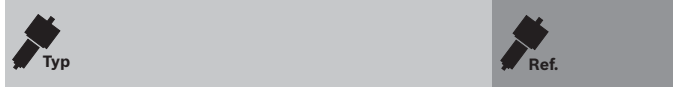

DN-PDLF ... UE ...

DN-PDLF 150 UE 4010 N3C	9 432 611 956
-------------------------	---------------

DN-PDLF ... VE ...

DN-PDLF 151 VE 6010 N1C	9 432 611 917
-------------------------	---------------

KP-DLLA ... PN ...

KP-DLLA 150 PN 211	9 432 612 702
KP-DLLA 154 PN 148	9 432 612 698
KP-DLLA 155 PN 179	9 432 612 697

KP-DLLA 155 PN 200	9 432 612 699
KP-DLLA 155 PN 202	9 432 612 700
KP-DLLA 156 PN 280	9 432 612 704

KP-DLLA ... SH ...

KP-DLLA 136 SH 120	9 432 612 670
KP-DLLA 150 SH 122	9 432 612 671
KP-DLLA 150 SH 123	9 432 612 672

KP-DLLA 150 SH 124	9 432 612 673
KP-DLLA 150 SH 125	9 432 612 674

KP-DLLA ... SM ...

KP-DLLA 150 SM 082	9 432 612 683
KP-DLLA 150 SM 117	9 432 612 688
KP-DLLA 150 SM 161	9 432 612 691

KP-DLLA 150 SM 165	9 432 612 693
KP-DLLA 150 SM 173	9 432 612 694
KP-DLLA 150 SM 240	9 432 612 696
KP-DLLA 152 SM 097	9 432 612 686
KP-DLLA 152 SM 108	9 432 612 687

KP-DLLA 155 SM 061	9 432 610 689
KP-DLLA 155 SM 066	9 432 612 681
KP-DLLA 155 SM 067	9 432 610 688
KP-DLLA 155 SM 083	9 432 612 684
KP-DLLA 155 SM 118	9 432 612 689

... NP-DL 145 S 286 NP1

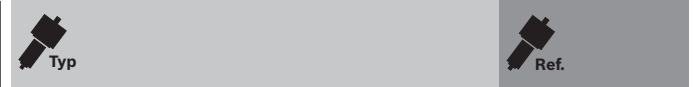

KP-DLLA 155 SM 162	9 432 612 692
KP-DLLA 155 SM 239	9 432 612 695
KP-DLLA 160 SM 084	9 432 612 685

KP-DLLA ... SN ...

KP-DLLA 150 SN 615	9 432 612 690
KP-DLLA 150 SN 762	9 432 612 675
KP-DLLA 150 SN 902	9 432 612 677

KP-DLLA 152 SN 681	9 432 612 679
KP-DLLA 152 SN 924	9 432 612 680
KP-DLLA 154 SN 533	9 432 612 682
KP-DLLA 155 SN 458	9 432 610 690
KP-DLLA 156 SN 921	9 432 612 678

KP-DN ... PDN ...

KP-DN 0 PDN 112	9 432 612 705
KP-DN 10 PDN 130	9 432 612 706

KP-DN ... SDN ...

KP-DN 0 SDN 226	9 432 612 662
-----------------	---------------

MP-DLLA ... PN ...

MP-DLLA 156 PN 262	9 432 610 601
--------------------	---------------

NP-DL ... S ...





NP-DL 125 S 303 NP6	9 432 611 678
NP-DL 130 S 228 NP1	9 432 610 763
NP-DL 130 S 276 NP1	9 432 612 010

NP-DL 130 S 278 NP1	9 432 612 011
NP-DL 130 S 348 N243	9 432 612 027
NP-DL 140 S 254 NP1	9 432 612 002
NP-DL 140 S 357 NP1	9 432 612 009
NP-DL 140 S 386 N23	9 432 611 690



NP-DL 145 S 228 NP1	9 432 612 007
NP-DL 145 S 258 NP1	9 432 610 322
NP-DL 145 S 268 NP19	9 432 612 018
NP-DL 145 S 268 NP1	9 432 610 270
NP-DL 145 S 286 NP1	9 432 611 661



de	en	fr	it	es
Typformel → Bestellnummer für Zexel-Düsen (Fortsetzung)	Type designation → Part number for Zexel nozzles (continued)	Formule de type → Référence pour injecteurs Zexel (suite)	Sigla → Numero d'ordinazione per polverizzatori Zexel (seguito)	Designación del tipo → Número de pedido para inyectoros Zexel (continuación)

NP-DL 145 S 2758 NP1 ...

 Typ	 Ref.	 Typ	 Ref.
NP-DL 145 S 2758 NP1	9 432 612 005	NP-DL 115 T 338 NP1	9 432 610 968
NP-DL 145 S 27510 NP1	9 432 612 006	NP-DL 115 T 356 NP1	9 432 612 059
NP-DL 150 S 248 NP15	9 432 611 695	NP-DL 115 T 358 NP15	9 432 612 171
NP-DL 150 S 256 NP1	9 432 612 004	NP-DL 115 T 388 NP15	9 432 610 971
NP-DL 150 S 308 NP15	9 432 611 693	NP-DL 115 T 408 NP19	9 432 612 527
NP-DL 155 S 228 NP1	9 432 611 675	NP-DL 115 T 428 NP19	9 432 612 528
NP-DL 155 S 258 NP12	9 432 610 180	NP-DL 118 T 306 N2	9 432 612 065
NP-DL 155 S 258 NP1	9 432 612 003	NP-DL 118 T 348 AN1	9 432 612 191
NP-DL 155 S 308 N238	9 432 611 687	NP-DL 118 T 349 AN1	9 432 612 181
NP-DL 155 S 326 NP1	9 432 612 008	NP-DL 120 T 256 NP1	9 432 612 079
NP-DL 155 S 348 NP15	9 432 611 694	NP-DL 120 T 286 NP1	9 432 612 053
NP-DL 160 S 238 N241	9 432 612 023	NP-DL 120 T 287 NP1	9 432 612 057
NP-DL 160 S 238 N241	9 432 612 024	NP-DL 120 T 305 NP1	9 432 612 030
NP-DL 160 S 248 N240	9 432 612 021	NP-DL 120 T 306 NP2	9 432 610 373
NP-DL 160 S 248 N240	9 432 612 022	NP-DL 120 T 306 NP	9 432 610 106
NP-DL 160 S 258 NP1	9 432 611 674	NP-DL 120 T 306 N2	9 432 612 066
NP-DL 160 S 258 N236	9 432 611 679	NP-DL 120 T 307 NP1	9 432 612 074
NP-DL 160 S 258 N236	9 432 611 689	NP-DL 120 T 308 NP1	9 432 612 075
NP-DL 160 S 268 N242C	9 432 612 025	NP-DL 120 T 326 NP1	9 432 612 035
NP-DL 160 S 268 N242C	9 432 612 026	NP-DL 120 T 328 NP1	9 432 612 048
NP-DL 160 S 268 N237	9 432 611 688	NP-DL 120 T 356 NP1	9 432 612 062
NP-DL 160 S 268 N237	9 432 611 696	NP-DL 120 T 357 NP1	9 432 612 174
NP-DL 160 S 278 N235	9 432 612 019	NP-DL 120 T 358 NP1	9 432 611 118
NP-DL 160 S 278 N235	9 432 612 020	NP-DL 120 T 367 NP1	9 432 612 068
NP-DL 160 S 288 NP1	9 432 612 012	NP-DL 120 T 368 NP1	9 432 612 060
NP-DL 160 S 2710 N239	9 432 611 686	NP-DL 120 T 408 NP8	9 432 612 091
NP-DL 160 S 2810 N233	9 432 611 691	NP-DL 120 T 438 NP8	9 432 612 522
NP-DL 162 S 384 NP11	9 432 611 677	NP-DL 120 T 3410 AN2	9 432 612 184
NP-DL 168 S 384 NP14	9 432 610 303	NP-DL 123 T 346 NP1	9 432 612 045
NP-DL 150S20 S 208 NP1	9 432 611 676	NP-DL 125 T 285 NP1	9 432 612 054
NP-DL ... T ...		NP-DL 125 T 306 NP1	9 432 611 119
NP-DL 42 T 1501 NP24	9 432 612 172	NP-DL 125 T 326 NP1	9 432 612 051
NP-DL 45 T 3601 NP29	9 432 612 178	NP-DL 125 T 356 NP1	9 432 612 086
NP-DL 110 T 287 NP1	9 432 612 029	NP-DL 125 T 357 NP6	9 432 612 089
NP-DL 110 T 306 NP1	9 432 612 028	NP-DL 125 T 407 NP1	9 432 610 761
NP-DL 110 T 326 NP1	9 432 612 034	NP-DL 125 T 408 NP8	9 432 612 092
NP-DL 110 T 338 NP1	9 432 612 187	NP-DL 125 T 438 NP17	9 432 612 163
NP-DL 110 T 346 NP1	9 432 612 070	NP-DL 130 T 206 NP1	9 432 611 683
NP-DL 110 T 368 AN2	9 432 612 193	NP-DL 130 T 246 NP1	9 432 612 044
NP-DL 115 T 286 NP1	9 432 612 050	NP-DL 130 T 258 NP1	9 432 611 680
NP-DL 115 T 305 NP	9 432 610 107	NP-DL 130 T 286 NP1	9 432 612 077
NP-DL 115 T 306 NP3	9 432 612 067	NP-DL 130 T 306 NP1	9 432 610 298
NP-DL 115 T 328 NP41	9 432 612 531	NP-DL 130 T 308 NP20	9 432 612 519
NP-DL 115 T 328 AN2	9 432 612 185	NP-DL 130 T 308 NP1	9 432 611 681
		NP-DL 130 T 309 NP1	9 432 612 090

... NP-DL 150 T 288 NP22

 Typ	 Ref.
NP-DL 130 T 326 NP1	9 432 612 039
NP-DL 130 T 326 N2	9 432 612 064
NP-DL 130 T 327 NP1	9 432 612 071
NP-DL 130 T 328 NP20L	9 432 612 521
NP-DL 130 T 328 NP20	9 432 610 020
NP-DL 130 T 328 NP1	9 432 610 108
NP-DL 130 T 356 NP1	9 432 612 049
NP-DL 130 T 357 NP1	9 432 612 076
NP-DL 130 T 358 NP1	9 432 612 085
NP-DL 130 T 358 AN1	9 432 612 186
NP-DL 130 T 368 NP41	9 432 611 133
NP-DL 130 T 368 AN2	9 432 612 183
NP-DL 130 T 387 NP45	9 432 612 542
NP-DL 130 T 387 NP1	9 432 612 073
NP-DL 130 T 388 NP1	9 432 612 084
NP-DL 130 T 3010 AN2	9 432 612 188
NP-DL 130 T 3210 NP44	9 432 612 540
NP-DL 130 T 3210 NP41	9 432 612 538
NP-DL 130 T 3410 NP41	9 432 612 532
NP-DL 130 T 3410 AN4	9 432 612 517
NP-DL 130 T 3410 AN2	9 432 612 182
NP-DL 130 T 3410 AN1	9 432 612 167
NP-DL 130 T 3610 NP43	9 432 611 134
NP-DL 130 T 3610 NP42	9 432 611 139
NP-DL 130 T 3610 NP41	9 432 611 132
NP-DL 130 T 3610 AN2	9 432 612 529
NP-DL 130 T 3610 AN1	9 432 612 168
NP-DL 135 T 285 NP1	9 432 612 055
NP-DL 135 T 305 NP1	9 432 612 047
NP-DL 135 T 306 NP1	9 432 612 031
NP-DL 135 T 388 NP15	9 432 611 910
NP-DL 140 T 228 NP7	9 432 612 088
NP-DL 140 T 306 NP1	9 432 612 032
NP-DL 140 T 308 NP1	9 432 612 036
NP-DL 140 T 324,284 NP32	9 432 611 903
NP-DL 140 T 327 NP1	9 432 612 037
NP-DL 140 T 328 NP20	9 432 610 966
NP-DL 140 T 328 NP1	9 432 612 082
NP-DL 140 T 348 NP32	9 432 610 499
NP-DL 140 T 348 NP20	9 432 610 965
NP-DL 140 T 356 NP1	9 432 612 033
NP-DL 140 T 358 NP1	9 432 610 197
NP-DL 140 T 368 NP32	9 432 610 498
NP-DL 140 T 368 NP20	9 432 611 045
NP-DL 140 T 387 NP2	9 432 611 911





 Typ	 Ref.
NP-DL 140 T 387 NP1	9 432 612 042
NP-DL 140 T 388 NP1	9 432 611 659
NP-DL 140 T 408 NP1	9 432 612 069
NP-DL 140 T 3758 NP1	9 432 612 043
NP-DL 140 T 304.264 NP32	9 432 611 906
NP-DL 144 T 368 NP1	9 432 612 160
NP-DL 145 T 248 NP37-	9 432 610 977
NP-DL 145 T 248 NP37	9 432 610 976
NP-DL 145 T 248 NP35	9 432 610 967
NP-DL 145 T 248 NP32	9 432 612 520
NP-DL 145 T 258 NP1	9 432 611 684
NP-DL 145 T 278 NP37-	9 432 610 974
NP-DL 145 T 278 NP37	9 432 610 973
NP-DL 145 T 278 NP35	9 432 610 972
NP-DL 145 T 288 NP1	9 432 611 672
NP-DL 145 T 324,284 NP37	9 432 611 122
NP-DL 145 T 356 NP1	9 432 612 081
NP-DL 145 T 358 NP1	9 432 611 682
NP-DL 145 T 368 NP1	9 432 612 063
NP-DL 145 T 368 AN3	9 432 612 189
NP-DL 145 T 388 AN3	9 432 610 500
NP-DL 145 T 408 NP1	9 432 612 061
NP-DL 145 T 408 AN3	9 432 612 523
NP-DL 145 T 428 NP1	9 432 612 080
NP-DL 145 T 428 ANP1	9 432 610 496
NP-DL 145 T 458 NP11	9 432 612 087
NP-DL 145 T 4010 NP8	9 432 610 861
NP-DL 145 T 304.264 NP32	9 432 611 846
NP-DL 145 T 324.284 NP37	9 432 611 123
NP-DL 145 T 324.284 NP32	9 432 611 883
NP-DL 150 T 207 NP2	9 432 612 093
NP-DL 150 T 237 NP1	9 432 612 052
NP-DL 150 T 248 NP32	9 432 611 873
NP-DL 150 T 248 NP22	9 432 612 195
NP-DL 150 T 258 NP1	9 432 610 109
NP-DL 150 T 268 NP32	9 432 612 196
NP-DL 150 T 268 NP22	9 432 610 032
NP-DL 150 T 278 NP37	9 432 611 099
NP-DL 150 T 278 NP1	9 432 611 648
NP-DL 150 T 284,244 NP37	9 432 610 956
NP-DL 150 T 284,244 NP35	9 432 610 958
NP-DL 150 T 287 NP1	9 432 612 041
NP-DL 150 T 288 NP37	9 443 616 020
NP-DL 150 T 288 NP23	9 432 612 169
NP-DL 150 T 288 NP22	9 432 610 301



A100

de	en	fr	it	es
Typformel → Bestellnummer für Zexel-Düsen (Fortsetzung)	Type designation → Part number for Zexel nozzles (continued)	Formule de type → Référence pour injecteurs Zexel (suite)	Sigla → Numero d'ordinazione per polverizzatori Zexel (seguito)	Designación del tipo → Número de pedido para inyectoros Zexel (continuación)

NP-DL 150 T 288 NP1 ...

 Typ	 Ref.	 Typ	 Ref.
NP-DL 150 T 288 NP1	9 432 612 040	NP-DL 155 T 387 NP1	9 432 612 161
NP-DL 150 T 304,244 NP37	9 432 610 950	NP-DL 155 T 388 NP19	9 432 612 165
NP-DL 150 T 304,244 NP35	9 432 610 949	NP-DL 155 T 2410 NP30	9 432 611 902
NP-DL 150 T 304,264 NP37	9 432 610 979	NP-DL 155 T 2610 NP30	9 432 611 899
NP-DL 150 T 304,264 NP35	9 432 612 526	NP-DL 155 T 2810 NP28	9 432 612 194
NP-DL 150 T 306 NP1	9 432 612 038	NP-DL 155 T 2810 NP18	9 432 612 164
NP-DL 150 T 308 NP22	9 432 610 047	NP-DL 155 T 2810 NP15	9 432 612 159
NP-DL 150 T 308 NP15	9 432 610 264	NP-DL 155 T 3010 NP28	9 432 611 862
NP-DL 150 T 308 NP1	9 432 610 257	NP-DL 155 T 3110 NP40	9 432 610 357
NP-DL 150 T 324,264 NP37	9 432 610 954	NP-DL 155 T 3110 NP34	9 432 610 975
NP-DL 150 T 324,264 NP35	9 432 610 953	NP-DL 155 T 3210 NP12	9 432 612 166
NP-DL 150 T 327 NP1	9 432 612 078	NP-DL 155 T 3410 NP36	9 432 610 957
NP-DL 150 T 328 NP33	9 432 612 192	NP-DL 155 T 3410 NP19	9 432 612 170
NP-DL 150 T 328 NP15	9 432 611 895	NP-DL 160 T 286 NP1	9 432 611 667
NP-DL 150 T 328 NP1	9 432 612 058	NP-DL 160 T 288 NP15	9 432 612 180
NP-DL 150 T 338 NP1	9 432 611 905	NP-DL 160 T 306 NP1	9 432 610 169
NP-DL 150 T 344,304 NP37	9 432 610 960	NP-DL 160 T 326 NP1	9 432 611 120
NP-DL 150 T 344,304 NP35	9 432 610 959	NP-DL 160 T 328 NP20	9 432 611 909
NP-DL 150 T 348 NP31	9 432 612 179	NP-DL 160 T 328 NP12	9 432 612 158
NP-DL 150 T 348 NP20	9 432 610 028	NP-DL 160 T 328 NP1	9 432 611 660
NP-DL 150 T 348 NP15	9 432 610 623	NP-DL 160 T 348 NP20	9 432 610 970
NP-DL 150 T 366 NP15	9 432 612 541	NP-DL 160 T 358 NP1	9 432 612 083
NP-DL 150 T 368 NP20	9 432 610 497	NP-DL 160 T 2410 NP49E	9 432 612 925
NP-DL 150 T 368 AN3	9 432 612 190	NP-DL 160 T 2510 NP49E	9 432 612 924
NP-DL 150 T 378 NP15	9 432 610 149	NP-DL 160 T 2510 NP47E	9 432 612 918
NP-DL 150 T 388 NP20	9 432 610 155	NP-DL 160 T 2610 NP49E	9 432 612 923
NP-DL 150 T 388 NP1	9 432 612 072	NP-DL 160 T 2610 NP47E	9 432 612 919
NP-DL 150 T 3010 NP15	9 432 612 518	NP-DL 160 T 2710 NP48E	9 432 612 922
NP-DL 150 T 4110 NP38	9 432 612 530	NP-DL 160 T 2710 NP47E	9 432 612 920
NP-DL 150 T 284.244 NP37	9 432 610 948	NP-DL 160 T 2810 NP47E	9 432 612 921
NP-DL 150 T 304.244 NP37	9 432 610 951	NP-DL 160 T 2810 NP15	9 432 612 162
NP-DL 150 T 304.264 NP37	9 432 610 980	NP-DL 160 T 2910 NP47E	9 432 612 914
NP-DL 150 T 324.264 NP37	9 432 610 955	NP-DL 160 T 2910 NP40	9 432 611 135
NP-DL 150 T 344.304 NP37	9 432 610 961	NP-DL 160 T 3010 NP47	9 432 612 916
NP-DL 155 T 268 NP30	9 432 611 900	NP-DL 160 T 3110 NP47E	9 432 612 915
NP-DL 155 T 288 NP30	9 432 611 897	NP-DL 160 T 3110 NP40E	9 432 612 913
NP-DL 155 T 288 NP27	9 432 612 176	NP-DL 160 T 3110 NP40	9 432 611 131
NP-DL 155 T 288 NP15	9 432 611 908	NP-DL 160 T 3310 NP34	9 432 610 297
NP-DL 155 T 308 NP30	9 432 611 901	NP-DL 160 T 3410 NP34	9 432 610 962
NP-DL 155 T 308 NP26	9 432 610 364	NP-DL 160 T 3510 NP40	9 432 610 358
NP-DL 155 T 308 NP15	9 432 611 898	NP-DL 160 T 3510 NP34	9 432 610 186
NP-DL 155 T 328 NP26	9 432 611 904	NP-DL 160 T 32510 NP47	9 432 612 917
NP-DL 155 T 358 NP26	9 432 610 087	NP-DL 160 T 32510 NP40E	9 432 612 912
NP-DL 155 T 358 NP1	9 432 610 088	NP-DL 160 T 32510 NP40	9 432 610 346
NP-DL 155 T 378 NP1	9 432 610 272	NP-DL 140100 T 3214 NP46	9 432 612 546

... NP-DL 135 U 6010 NP11

Typ	
-----	---

NP-DL 150110 T 3014 NP46	9 432 612 543
NP-DL 150110 T 3214 NP46	9 432 612 544
NP-DL 150110 T 3414 NP46	9 432 612 545

NP-DL ... TC ...

NP-DL 140 TC 309 N3	9 432 611 300
NP-DL 140 TC 329 N3R	9 432 612 380
NP-DL 140 TC 359 N3	9 432 611 297

NP-DL ... TE ...

NP-DL 140 TE 268 N3	9 432 611 137
NP-DL 140 TE 2610 N7	9 432 611 128
NP-DL 140 TE 2610 N7	9 432 612 534

NP-DL 140 TE 2610 N7	9 432 611 128
NP-DL 140 TE 2810 N7	9 432 611 125
NP-DL 140 TE 2810 N7	9 432 611 126
NP-DL 140 TE 3010 N1	9 432 611 121
NP-DL 140 TE 3010 N1	9 432 612 535

NP-DL 140 TE 3010 N1	9 432 611 121
NP-DL 140 TE 3210 N1	9 432 611 130
NP-DL 140 TE 3210 N1	9 432 612 536
NP-DL 140 TE 3210 N1	9 432 611 130
NP-DL 145 TE 248 N3	9 432 612 524

NP-DL 145 TE 268 N3	9 432 612 525
NP-DL 145 TE 288 N3	9 432 611 127
NP-DL 145 TE 304,265 N5	9 432 610 963
NP-DL 145 TE 308 N3	9 432 611 095
NP-DL 145 TE 308 N1	9 432 610 910

NP-DL 145 TE 324,284 N1	9 432 610 952
NP-DL 145 TE 328 N1	9 432 611 861
NP-DL 145 TE 344,304 N4	9 432 611 106
NP-DL 145 TE 348 N4	9 432 612 533
NP-DL 145 TE 348 N1	9 432 610 947

NP-DL 145 TE 368 N1	9 432 610 937
NP-DL 145 TE 368 N1	9 432 610 925
NP-DL 145 TE 388 N1	9 432 610 926
NP-DL 145 TE 408 N2	9 432 610 969
NP-DL 145 TE 408 N1	9 432 610 946

NP-DL 145 TE 428 N2	9 432 610 978
NP-DL 145 TE 428 N1	9 432 610 964
NP-DL 145 TE 448 N2	9 432 610 981
NP-DL 150 TE 378 N1	9 432 610 622
NP-DL 155 TE 3510 N8	9 432 612 858

Typ	Ref.
-----	------

NP-DL 155 TE 3510 N8	9 432 612 909
NP-DL 155 TE 3510 N6	9 432 612 537
NP-DL 155 TE 3710 N8	9 432 612 857
NP-DL 155 TE 3710 N8	9 432 612 908
NP-DL 155 TE 3710 N6	9 432 611 124

NP-DL 155 TE 4010 N5	9 432 610 624
NP-DL 160 TE 3510 N8	9 432 612 852
NP-DL 160 TE 3510 N8	9 432 612 911
NP-DL 160 TE 3510 N6	9 432 611 104
NP-DL 160 TE 3710 N8	9 432 612 862

NP-DL 160 TE 3710 N8	9 432 612 910
NP-DL 160 TE 3710 N6	9 432 611 138

NP-DL ... TN ...

NP-DL 115 TN 083	9 432 611 098
NP-DL 130 TN 081	9 432 611 096
NP-DL 130 TN 082	9 432 611 097

NP-DL ... TU ...

NP-DL 140 TU 458 N2	9 432 612 383
NP-DL 145 TU 428 N2	9 432 612 378
NP-DL 145 TU 428 N1	9 432 612 377

NP-DL 145 TU 458 N2	9 432 611 396
NP-DL 145 TU 484,454 N2	9 432 612 901
NP-DL 145 TU 508 N2	9 432 611 397

NP-DL ... U ...

NP-DL 125 U 458 NP4	9 432 612 198
NP-DL 125 U 5310 NP5	9 432 610 390
NP-DL 130 U 488 NP5	9 432 611 933

NP-DL 130 U 488 NP5	9 432 612 219
NP-DL 130 U 508 NP5	9 432 611 858
NP-DL 130 U 5710 NP5	9 432 612 205
NP-DL 130 U 5810 NP5	9 432 612 207
NP-DL 130 U 6010 NP5	9 432 612 208

NP-DL 135 U 4810 NP18	9 432 611 850
NP-DL 135 U 5010 NP9	9 432 612 209
NP-DL 135 U 5310 NP18	9 432 612 226
NP-DL 135 U 6010 NP12	9 432 612 214
NP-DL 135 U 6010 NP11	9 432 612 210

de

**Typformel →
Bestellnummer
für Zexel-Düsen**
(Fortsetzung)

en

**Type designation →
Part number
for Zexel nozzles**
(continued)

fr

**Formule de type →
Référence
pour injecteurs Zexel**
(suite)

it



**Sigla → Numero
d'ordinazione per
polverizzatori Zexel**
(seguito)

es

**Designación del tipo
→ Número de pedido
para inyectoros Zexel**
(continuación)

NP-DL 135 U 6210 NP11 ...



 Typ	 Ref.
---	--

NP-DL 135 U 6210 NP11	9 432 612 211
NP-DL 135 U 6410 NP11	9 432 612 212
NP-DL 135 U 6510 NP14	9 432 612 217
NP-DL 135 U 6510 NP13	9 432 612 216
NP-DL 135 U 6510 NP12	9 432 612 215
NP-DL 135 U 7010 NP11	9 432 612 213
NP-DL 140 U 408 NP4	9 432 612 221
NP-DL 140 U 458 NP4R	9 432 612 224
NP-DL 140 U 458 NP4	9 432 612 202
NP-DL 140 U 529 AN3	9 432 611 878
NP-DL 140 U 529 AN3	9 432 611 879
NP-DL 140 U 529 AN2R	9 432 612 225
NP-DL 140 U 4510 NP5	9 432 612 230
NP-DL 140 U 4610 AN3	9 432 611 869
NP-DL 140 U 4810 AN3	9 432 611 859
NP-DL 140 U 4810 AN3	9 432 611 871
NP-DL 140 U 4810 AN3	9 432 611 875
NP-DL 140 U 5210 AN3	9 432 611 876
NP-DL 140 U 4610A N3	9 432 611 870
NP-DL 140 U 4810A N3	9 432 611 859
NP-DL 140 U 4810A N3	9 432 611 875
NP-DL 145 U 308 NP1	9 432 612 200
NP-DL 145 U 428 NP8	9 432 612 201
NP-DL 145 U 428 NP4	9 432 612 199
NP-DL 145 U 458 NP4	9 432 612 203
NP-DL 145 U 479 NP10	9 432 611 854
NP-DL 145 U 479 AN1	9 432 611 845
NP-DL 145 U 488 NP4	9 432 612 204
NP-DL 145 U 509 AN1	9 432 611 863
NP-DL 150 U 408 NP9A	9 432 611 853
NP-DL 150 U 408 NP9	9 432 610 352
NP-DL 150 U 428 NP9	9 432 610 194
NP-DL 150 U 428 NP7	9 432 611 852
NP-DL 150 U 428 NP1	9 432 612 197
NP-DL 150 U 479 NP5	9 432 611 851
NP-DL 150 U 509 NP5	9 432 611 855
NP-DL 155 U 408 NP1	9 432 610 228
NP-DL 156 U 609 NP16	9 432 612 222
NP-DL 156 U 609 NP15	9 432 612 218
NP-DL 156 U 629 NP15	9 432 611 857
NP-DL 160 U 388 NP2	9 432 610 296

Typ



NP-DL ... UC ...

NP-DL 140 UC 659 N1	9 432 611 847
NP-DL 145 UC 589 N1	9 432 612 206

NP-DL ... UE ...

NP-DL 110 UE 449 N1	9 432 612 233
NP-DL 120 UE 4210 N1	9 432 612 231
NP-DL 120 UE 4410 N1	9 432 612 232
NP-DL 140 UE 4010 N1	9 432 613 012
NP-DL 140 UE 4410 N1	9 432 613 013
NP-DL 145 UE 509 N4A	9 432 611 881
NP-DL 145 UE 509 N4	9 432 612 234
NP-DL 145 UE 509 N3	9 432 611 848
NP-DL 145 UE 509 N3	9 432 612 228
NP-DL 145 UE 529 N3	9 432 611 968
NP-DL 145 UE 559 N1	9 432 611 860
NP-DL 145 UE 559 N1	9 432 612 229
NP-DL 145 UE 3810 N1	9 432 612 235
NP-DL 145 UE 4010 N1	9 432 611 874
NP-DL 145 UE 4210 N1	9 432 612 237
NP-DL 145 UE 4410 N1	9 432 611 864
NP-DL 145 UE 4410 N1	9 432 612 238
NP-DL 150 UE 559 N1	9 432 611 849
NP-DL 150 UE 559 N1	9 432 612 220
NP-DL 150 UE 3810 N1	9 432 612 897
NP-DL 150 UE 4010 N1	9 432 611 868
NP-DL 150 UE 4410 N1	9 432 611 872
NP-DL 150 UE 4410 N1	9 432 611 880
NP-DL 155 UE 4410 N1	9 432 612 236
NP-DL 155 UE 4410 N1	9 432 612 239
NP-DL 156 UE 609 N2R	9 432 611 877
NP-DL 156 UE 609 N2	9 432 612 223
NP-DL 156 UE 5611 N5	9 432 612 715

NP-DL ... UF ...

NP-DL 135 UF 408 8N1	9 432 611 856
----------------------	---------------

NP-DL ... UJ ...

NP-DL 130 UJ 408 N3	9 432 612 372
NP-DL 130 UJ 608 N3	9 432 612 373

... NP-DLF 140 TB 3010 N1

**NP-DL ... VE ...**

NP-DL 140 VE 5411 N2	9 432 613 018
NP-DL 140 VE 5611 N2	9 432 613 016
NP-DL 145 VE 5611 N2	9 432 613 017

NP-DL 148 VE 5411 N2	9 432 612 984
NP-DL 148 VE 5411 N1	9 432 612 303
NP-DL 148 VE 5611 N2	9 432 612 983
NP-DL 148 VE 5611 N1	9 432 612 302
NP-DL 151 VE 5411 N2	9 432 612 979

NP-DL 151 VE 5411 N1	9 432 611 927
NP-DL 151 VE 5411 N1	9 432 611 935
NP-DL 151 VE 5611 N2	9 432 612 985
NP-DL 151 VE 5611 N1	9 432 612 304
NP-DL 151 VE 5811 N2	9 432 612 981

NP-DL 151 VE 5811 N1	9 432 611 919
NP-DL 151 VE 6010 N2	9 432 612 982
NP-DL 151 VE 6010 N1	9 432 611 920
NP-DL 151 VE 6011 N2	9 432 612 980
NP-DL 151 VE 6011 N1	9 432 611 918

NP-DLA ... S ...

NP-DLA 110 S 602 NP10	9 432 612 013
NP-DLA 110 S 802 NP10	9 432 612 014
NP-DLA 110 S 902 NP10	9 432 612 015

NP-DLF ... T ...

NP-DLF 120 T 326 NP1	9 432 612 094
NP-DLF 125 T 408 NP4	9 432 612 107
NP-DLF 130 T 387 N11	9 432 612 096

NP-DLF 140 T 328 N11	9 432 612 095
NP-DLF 144 T 388 NP9	9 432 610 086
NP-DLF 144 T 388 NP10	9 432 610 331
NP-DLF 145 T 308 NP8	9 432 610 226
NP-DLF 145 T 328 NP8	9 432 610 481

NP-DLF 145 T 408 NP13	9 432 610 325
NP-DLF 145 T 428 NP12	9 432 610 482

NP-DLF ... TB ...

NP-DLF 115 TB 328 N1	9 432 612 100
NP-DLF 115 TB 338 N28	9 432 612 138
NP-DLF 115 TB 358 N28	9 432 612 132



NP-DLF 115 TB 388 N28	9 432 612 152
NP-DLF 115 TB 408 N40	9 432 612 154
NP-DLF 118 TB 349 AN3	9 432 612 127
NP-DLF 120 TB 306 N1	9 432 612 106
NP-DLF 120 TB 327 N28	9 432 612 137

NP-DLF 120 TB 328 N1	9 432 612 102
NP-DLF 120 TB 357 N28	9 432 612 131
NP-DLF 120 TB 358 N10	9 432 612 104
NP-DLF 120 TB 368 N10	9 432 612 101
NP-DLF 120 TB 408 N10	9 432 612 128

NP-DLF 123 TB 346 N10	9 432 612 097
NP-DLF 125 TB 228 N28	9 432 612 136
NP-DLF 125 TB 407 N5	9 432 612 112
NP-DLF 125 TB 408 N9	9 432 612 111
NP-DLF 130 TB 328 N17	9 432 610 287

NP-DLF 130 TB 356 N10	9 432 612 122
NP-DLF 130 TB 357 N10	9 432 612 103
NP-DLF 130 TB 358 N28	9 432 612 144
NP-DLF 130 TB 358 N1	9 432 611 657
NP-DLF 130 TB 368 N16	9 432 612 129

NP-DLF 130 TB 387 N1	9 432 612 105
NP-DLF 130 TB 388 N1	9 432 610 721
NP-DLF 130 TB 408 N33	9 432 610 141
NP-DLF 130 TB 3410 N16	9 432 612 126
NP-DLF 130 TB 3410 AN3	9 432 612 124

NP-DLF 130 TB 3610 AN3	9 432 612 125
NP-DLF 135 TB 326 N1	9 432 612 099
NP-DLF 135 TB 387 N10	9 432 612 121
NP-DLF 140 TB 304,264 N3	9 432 610 489
NP-DLF 140 TB 324,284 N3	9 432 610 485

NP-DLF 140 TB 328 N23	9 432 610 130
NP-DLF 140 TB 348 N34	9 432 610 486
NP-DLF 140 TB 358 N23	9 432 610 131
NP-DLF 140 TB 358 N10	9 432 612 098
NP-DLF 140 TB 358 N1	9 432 612 118



NP-DLF 140 TB 364,324 N3	9 432 612 142
NP-DLF 140 TB 368 N34	9 432 610 338
NP-DLF 140 TB 368 N27	9 432 612 139
NP-DLF 140 TB 387 N19	9 432 611 647
NP-DLF 140 TB 387 N1	9 432 612 108



NP-DLF 140 TB 407 N1	9 432 612 113
NP-DLF 140 TB 408 N1	9 432 612 133
NP-DLF 140 TB 2610 N1	9 432 612 130
NP-DLF 140 TB 2810 N1	9 432 612 120
NP-DLF 140 TB 3010 N1	9 432 612 119

A104



de	en	fr	it	es
Typformel → Bestellnummer für Zexel-Düsen (Fortsetzung)	Type designation → Part number for Zexel nozzles (continued)	Formule de type → Référence pour injecteurs Zexel (suite)	Sigla → Numero d'ordinazione per polverizzatori Zexel (seguito)	Designación del tipo → Número de pedido para inyectoros Zexel (continuación)

NP-DLF 144 TB 388 N7 ...

 Typ	 Ref.
NP-DLF 144 TB 388 N7	9 432 612 114
NP-DLF 145 TB 248 N41	9 432 611 891
NP-DLF 145 TB 258 N8	9 432 611 656
NP-DLF 145 TB 278 N41	9 432 611 706
NP-DLF 145 TB 288 N8	9 432 611 658
NP-DLF 145 TB 304,264 N3	9 432 610 491
NP-DLF 145 TB 308 N8	9 432 612 110
NP-DLF 145 TB 308 N37	9 432 611 652
NP-DLF 145 TB 308 N20	9 443 610 366
NP-DLF 145 TB 324,284 N3	9 432 610 492
NP-DLF 145 TB 328 N3	9 432 612 109
NP-DLF 145 TB 328 N1	9 432 611 662
NP-DLF 145 TB 348 NP9	9 432 610 480
NP-DLF 145 TB 348 N34	9 432 610 262
NP-DLF 145 TB 368 N38	9 432 610 490
NP-DLF 145 TB 388 N38	9 432 610 488
NP-DLF 145 TB 4010 N9	9 432 612 115
NP-DLF 150 TB 248 N28	9 432 610 487
NP-DLF 150 TB 258 N29	9 432 610 127
NP-DLF 150 TB 258 N23	9 432 610 132
NP-DLF 150 TB 258 N22	9 432 610 118
NP-DLF 150 TB 268 N28	9 432 610 484
NP-DLF 150 TB 288 N30	9 432 610 128
NP-DLF 150 TB 288 N29	9 432 610 126
NP-DLF 150 TB 288 N28	9 432 612 134
NP-DLF 150 TB 288 N25	9 432 610 123
NP-DLF 150 TB 288 N23	9 432 610 052
NP-DLF 150 TB 288 N22	9 432 610 117
NP-DLF 150 TB 288 N15	9 432 612 123
NP-DLF 150 TB 308 N25	9 432 610 125
NP-DLF 150 TB 308 N23	9 432 610 120
NP-DLF 150 TB 308 N13	9 432 610 259
NP-DLF 150 TB 328 N35	9 432 610 260
NP-DLF 150 TB 328 N27	9 432 612 135
NP-DLF 150 TB 328 N25C	9 432 610 124
NP-DLF 150 TB 328 N23C	9 432 610 299
NP-DLF 150 TB 348 N39	9 432 612 147
NP-DLF 150 TB 348 N35	9 432 610 261
NP-DLF 150 TB 348 N32	9 432 612 141
NP-DLF 150 TB 348 N17	9 432 610 240
NP-DLF 150 TB 358 N23C	9 432 610 129
NP-DLF 150 TB 358 N23C	9 432 610 135
NP-DLF 150 TB 366 N23	9 432 610 134
NP-DLF 150 TB 368 N39	9 432 610 248
NP-DLF 150 TB 368 N31	9 432 610 247

 Typ	 Ref.
NP-DLF 150 TB 368 N27	9 432 610 246
NP-DLF 150 TB 388 N32	9 432 610 133
NP-DLF 150 TB 388 N17	9 432 610 082
NP-DLF 150 TB 508 N40	9 432 611 651
NP-DLF 150 TB 2810 N23	9 432 610 119
NP-DLF 150 TB 2810 N13	9 432 612 116
NP-DLF 150 TB 304244 N3	9 432 612 151
NP-DLF 155 TB 308 N36	9 432 611 654
NP-DLF 155 TB 358 N23	9 432 610 122
NP-DLF 155 TB 2810 N13	9 432 611 655
NP-DLF 155 TB 3010 N23	9 432 610 121
NP-DLF 155 TB 3010 N13	9 432 612 117
NP-DLF 160 TB 286 N26	9 432 611 896
NP-DLF 160 TB 306 N8	9 432 610 258
NP-DLF 160 TB 328 N17	9 432 610 483
NP-DLF ... TE ...	
NP-DLF 140 TE 328 N1	9 432 610 493
NP-DLF 140 TE 348 N1	9 432 610 494
NP-DLF 140 TE 368 N1	9 432 610 495
NP-DLF 140 TE 2610 N6C	9 432 612 157
NP-DLF 140 TE 2610 N6C	9 432 611 894
NP-DLF 140 TE 2810 N6C	9 432 611 886
NP-DLF 140 TE 2810 N6C	9 432 611 889
NP-DLF 140 TE 3010 N3C	9 432 611 887
NP-DLF 140 TE 3010 N3C	9 432 611 888
NP-DLF 140 TE 3210 N3C	9 432 611 884
NP-DLF 140 TE 3210 N3C	9 432 611 885
NP-DLF 145 TE 248 N6C	9 432 610 276
NP-DLF 145 TE 248 N5	9 432 612 148
NP-DLF 145 TE 268 N6C	9 432 611 893
NP-DLF 145 TE 268 N5	9 432 612 149
NP-DLF 145 TE 304,264 N3	9 432 611 882
NP-DLF 145 TE 308 N3	9 432 611 671
NP-DLF 145 TE 324,284 N3	9 432 610 694
NP-DLF 145 TE 328 N3	9 432 610 263
NP-DLF 145 TE 348 N3	9 432 610 321
NP-DLF 145 TE 348 N1.].	9 432 611 653
NP-DLF 145 TE 348 N1	9 432 611 649
NP-DLF 145 TE 368 N4C	9 432 611 666
NP-DLF 145 TE 368 N3C	9 432 611 890
NP-DLF 145 TE 368 N3	9 432 611 668
NP-DLF 145 TE 368 N1.].	9 432 611 650
NP-DLF 145 TE 368 N1	9 432 612 143
NP-DLF 145 TE 388 N4	9 432 611 663

... NP-DLF 135 UB 5310 N1

 Typ	 Ref.
---	--

NP-DLF 145 TE 388 N3	9 432 611 669
NP-DLF 145 TE 388 N1	9 432 611 670
NP-DLF 145 TE 408 N4C	9 432 611 664
NP-DLF 145 TE 428 N4C	9 432 611 665
NP-DLF 145 TE 448 N4C	9 432 611 892

NP-DLF 150 TE 454 N7	9 432 612 153
NP-DLF 155 TE 3710 N8	9 432 612 156

NP-DLF ... TJ ...

NP-DLF 118 TJ 348 N1	9 432 612 384
NP-DLF 120 TJ 357 N4	9 432 612 396
NP-DLF 120 TJ 357 N2	9 432 612 394

NP-DLF 120 TJ 358 N4	9 432 612 402
NP-DLF 125 TJ 357 N4	9 432 612 398
NP-DLF 125 TJ 357 N2	9 432 612 392
NP-DLF 130 TJ 358 N4	9 432 612 397
NP-DLF 130 TJ 358 N3	9 432 612 393

NP-DLF 130 TJ 3410 N1	9 432 612 399
NP-DLF 132 TJ 357 N2	9 432 612 395
NP-DLF 135 TJ 348 N1	9 432 612 385
NP-DLF 145 TJ 309 N1	9 432 612 388

NP-DLF ... TM ...

NP-DLF 140 TM 308 N20	9 432 610 534
NP-DLF 140 TM 308 N18	9 432 610 532
NP-DLF 140 TM 308 N1	9 432 610 528

NP-DLF 140 TM 309 N18	9 432 610 533
NP-DLF 140 TM 318 N20	9 432 612 401
NP-DLF 140 TM 2710 N18	9 432 610 550

NP-DLF ... TU ...

NP-DLF 145 TU 408 N2	9 432 611 316
NP-DLF 145 TU 408 N1	9 432 611 313
NP-DLF 145 TU 424,384 N1	9 432 612 431

NP-DLF 145 TU 428 N6C	9 432 611 299
NP-DLF 145 TU 428 N5C	9 432 612 439
NP-DLF 145 TU 428 N4	9 432 611 301
NP-DLF 145 TU 428 N2	9 432 611 314
NP-DLF 145 TU 428 N1	9 432 611 408

 Typ	 Ref.
---	--

NP-DLF 145 TU 454,424 N1	9 432 611 349
NP-DLF 145 TU 458 N6C	9 432 611 298
NP-DLF 145 TU 458 N4	9 432 611 315
NP-DLF 145 TU 458 N3	9 432 612 438
NP-DLF 145 TU 1508 N4	9 432 611 304

NP-DLF ... U ...

NP-DLF 120 U 387 NP1	9 432 612 242
NP-DLF 123 U 367 NP10	9 432 612 241
NP-DLF 123 U 408 NP10	9 432 610 103

NP-DLF 125 U 010 NP7	9 432 612 252
NP-DLF 125 U 010 NP10	9 432 612 250
NP-DLF 125 U 387 NP1	9 432 612 246
NP-DLF 125 U 428 NP10	9 432 612 245
NP-DLF 125 U 458 NP10	9 432 612 244

NP-DLF 125 U 488 NP10	9 432 612 243
NP-DLF 125 U 509 NP7	9 432 610 053
NP-DLF 128 U 210 NP1	9 432 612 240
NP-DLF 128 U 310 NP9	9 432 612 249
NP-DLF 130 U 5810 NP9	9 432 610 071

NP-DLF 160 U 388 NP8	9 432 611 866
----------------------	----------------------

NP-DLF ... UB ...

NP-DLF 120 UB 388 N20	9 432 612 271
NP-DLF 120 UB 388 N14	9 432 612 263
NP-DLF 120 UB 408 N14	9 432 612 264

NP-DLF 120 UB 428 N20	9 432 612 272
NP-DLF 120 UB 508 N21	9 432 611 958
NP-DLF 120 UB 508 N15	9 432 612 266
NP-DLF 124 UB 458 N15	9 432 612 265
NP-DLF 125 UB 358 N8	9 432 612 248

NP-DLF 125 UB 408 N8	9 432 612 259
NP-DLF 125 UB 458 N1	9 432 612 254
NP-DLF 125 UB 5310 N8	9 432 612 261
NP-DLF 125 UB 5310 N1	9 432 612 253
NP-DLF 130 UB 488 N1	9 432 612 251

NP-DLF 130 UB 538 N9	9 432 611 957
NP-DLF 135 UB 409 N11	9 432 610 137
NP-DLF 135 UB 459 N1	9 432 612 277
NP-DLF 135 UB 5310 N24C	9 432 612 281
NP-DLF 135 UB 5310 N1	9 432 612 270

de

Typformel →
Bestellnummer
für Zexel-Düsen
(Fortsetzung)

en

Type designation →
Part number
for Zexel nozzles
(continued)

fr

Formule de type →
Référence
pour injecteurs Zexel
(suite)

it

Sigla → Numero
d'ordinazione per
polverizzatori Zexel
(seguito)

es

Designación del tipo
→ Número de pedido
para inyectoros Zexel
(continuación)

NP-DLF 140 UB 408 N8 ...

 Typ	 Ref.
---	--

NP-DLF 140 UB 408 N8	9 432 612 247
NP-DLF 140 UB 458 N7	9 432 612 255
NP-DLF 140 UB 459 N1	9 432 612 278
NP-DLF 140 UB 488 N7	9 432 612 258
NP-DLF 140 UB 488 N1	9 432 612 274

NP-DLF 140 UB 489 N1	9 432 612 280
NP-DLF 140 UB 529 N27C	9 432 611 942
NP-DLF 140 UB 529 N27C	9 432 611 943
NP-DLF 140 UB 559 N27C	9 432 612 287
NP-DLF 140 UB 559 N27C	9 432 612 288

NP-DLF 140 UB 4510 N1	9 432 612 275
NP-DLF 140 UB 4610 B27C	9 432 612 298
NP-DLF 140 UB 4810 N27C	9 432 611 934
NP-DLF 140 UB 4810 N27C	9 432 611 965
NP-DLF 140 UB 5210 N27C	9 432 611 946

NP-DLF 140 UB 5210 N27C	9 432 611 950
NP-DLF 145 UB 408 N8	9 432 612 260
NP-DLF 145 UB 428 N8	9 432 612 256
NP-DLF 145 UB 459 N26	9 432 611 960
NP-DLF 145 UB 459 N1	9 432 612 279

NP-DLF 145 UB 479 N22C	9 432 612 276
NP-DLF 145 UB 479 N19	9 432 611 907
NP-DLF 145 UB 479 N18	9 432 612 269
NP-DLF 145 UB 488 N1	9 432 611 959
NP-DLF 145 UB 509 N19	9 432 611 963

NP-DLF 145 UB 4510 N1	9 432 612 273
NP-DLF 150 UB 408 N8	9 432 612 257
NP-DLF 150 UB 408 N17	9 432 612 268
NP-DLF 150 UB 408 N13	9 432 610 502
NP-DLF 150 UB 408 N11	9 432 610 136

NP-DLF 150 UB 408 N1	9 432 611 865
NP-DLF 150 UB 428 N16	9 432 612 267
NP-DLF 150 UB 428 N12	9 432 610 501
NP-DLF 150 UB 459 N9	9 432 612 262
NP-DLF 150 UB 479 N9	9 432 610 209

NP-DLF 150 UB 509 N9	9 432 610 503
----------------------	---------------

NP-DLF ... UC ...

NP-DLF 140 UC 569 N2C	9 432 611 952
NP-DLF 140 UC 589 N2C	9 432 612 290
NP-DLF 140 UC 629 N2C	9 432 612 291

 Typ	 Ref.
---	--

NP-DLF 140 UC 659 N2C	9 432 612 289
NP-DLF 140 UC 6010 N2C	9 432 611 945
NP-DLF 140 UC 6210 N2C	9 432 612 301
NP-DLF 145 UC 589 N2C	9 432 611 961
NP-DLF 145 UC 629 N2C	9 432 611 941

NP-DLF 145 UC 659 N2C	9 432 611 962
-----------------------	---------------

NP-DLF ... UE ...

NP-DLF 120 UE 4010 N3C	9 432 612 296
NP-DLF 120 UE 4210 N3C	9 432 610 504
NP-DLF 120 UE 4410 N3C	9 432 612 297

NP-DLF 140 UE 4010 N3C	9 432 613 014
NP-DLF 140 UE 4410 N3C	9 432 613 015
NP-DLF 145 UE 3810 N3C	9 432 611 970
NP-DLF 145 UE 4010 N3C	9 432 611 947
NP-DLF 145 UE 4010 N3C	9 432 611 948

NP-DLF 145 UE 4010 N3C	9 432 611 947
NP-DLF 145 UE 4210 N3C	9 432 611 969
NP-DLF 145 UE 4410 N3C	9 432 611 949
NP-DLF 145 UE 4410 N3C	9 432 612 294
NP-DLF 150 UE 466 N4	9 432 612 285

NP-DLF 150 UE 559 N3C	9 432 611 964
NP-DLF 150 UE 559 N3C	9 432 612 283
NP-DLF 150 UE 3810 N1C	9 432 611 912
NP-DLF 150 UE 4010 N3C	9 432 611 955
NP-DLF 150 UE 4010 N3C	9 432 611 956

NP-DLF 150 UE 4410 N3C	9 432 611 953
NP-DLF 150 UE 4410 N3C	9 432 611 954
NP-DLF 155 UE 4410 N3C	9 432 612 295
NP-DLF 156 UE 649 N5R	9 432 611 951
NP-DLF 156 UE 649 N5	9 432 612 286

NP-DLF 156 UE 649 N1	9 432 612 282
NP-DLF 156 UE 5013 N5	9 432 612 293

NP-DLF ... UJ ...

NP-DLF 120 UJ 429 N5	9 432 611 309
NP-DLF 120 UJ 3510 N6	9 432 612 417
NP-DLF 120 UJ 3810 N6	9 432 612 419

... NP-DLL 140 S 366 N483

 Typ	 Ref.
---	--

NP-DLF 120 UJ 4210 N6	9 432 612 466
NP-DLF 120 UJ 4410 N6	9 432 612 468
NP-DLF 120 UJ 5310 N7	9 432 612 467
NP-DLF 130 UJ 388 N1	9 432 610 370
NP-DLF 130 UJ 408 N4	9 432 612 403

NP-DLF 130 UJ 458 N4	9 432 612 404
NP-DLF 130 UJ 488 N4	9 432 612 405
NP-DLF 130 UJ 568 N2	9 432 612 415
NP-DLF 130 UJ 608 N2	9 432 610 695
NP-DLF 130 UJ 708 N2	9 432 612 390

NP-DLF 130 UJ 3510 N6	9 432 612 418
NP-DLF 130 UJ 3810 N6	9 432 612 420
NP-DLF 130 UJ 4010 N6	9 432 612 425
NP-DLF 130 UJ 4010 N5	9 432 612 421
NP-DLF 130 UJ 4210 N6	9 432 612 424

NP-DLF 130 UJ 4210 N1	9 432 612 414
NP-DLF 130 UJ 4410 N6	9 432 612 426
NP-DLF 130 UJ 4610 N1	9 432 612 406
NP-DLF 130 UJ 5010 N7	9 432 612 430
NP-DLF 130 UJ 5210 N7	9 432 612 432

NP-DLF 130 UJ 5510 N7	9 432 612 429
NP-DLF 140 UJ 3510 N4	9 432 612 408
NP-DLF 140 UJ 3810 N4	9 432 612 409
NP-DLF 140 UJ 4210 N4	9 432 612 410
NP-DLF 140 UJ 4210 N1	9 432 612 386

NP-DLF ... UM ...

NP-DLF 115 UM 328 N4	9 432 610 527
NP-DLF 130 UM 388 N6	9 432 610 530
NP-DLF 130 UM 388 N22	9 432 610 567

NP-DLF 140 UM 328 N6	9 432 612 387
NP-DLF 140 UM 358 N12	9 432 610 531
NP-DLF 154 UM 348 N8	9 432 610 529
NP-DLF 154 UM 428 N2	9 432 610 526

NP-DLF ... VB ...

NP-DLF 125 VB 538 N3	9 432 611 921
NP-DLF 125 VB 558 N2	9 432 612 305

NP-DLF ... VE ...

NP-DLF 140 VE 5411 N2C	9 432 613 021
NP-DLF 140 VE 5611 N2C	9 432 613 019
NP-DLF 145 VE 5610 N2C	9 432 612 989

 Typ	 Ref.
---	--

NP-DLF 145 VE 5610 N1C	9 432 611 916
NP-DLF 145 VE 5611 N2C	9 432 613 020
NP-DLF 148 VE 5411 N1C	9 432 612 308
NP-DLF 148 VE 5411 N1C	9 432 612 992
NP-DLF 148 VE 5611 N2C	9 432 612 991

NP-DLF 148 VE 5611 N1C	9 432 612 307
NP-DLF 151 VE 5411 N2C	9 432 612 986
NP-DLF 151 VE 5411 N1C	9 432 611 922
NP-DLF 151 VE 5411 N1C	9 432 611 923
NP-DLF 151 VE 5611 N2C	9 432 612 990

NP-DLF 151 VE 5811 N2C	9 432 612 967
NP-DLF 151 VE 5811 N1C	9 432 611 915
NP-DLF 151 VE 6010 N2C	9 432 612 988
NP-DLF 151 VE 6010 N1C	9 432 611 917
NP-DLF 151 VE 6011 N2C	9 432 612 987

NP-DLF 151 VE 6011 N1C	9 432 611 924
NP-DLF 151 VE 6011 N1C	9 432 612 306
NP-DLF 151 VE 6011 N1C	9 432 611 924
NP-DLF 151 VE 6011 N1C	9 432 612 306
NP-DLF 151 VE 6211 N2C	9 432 612 993

NP-DLF 151 VE 6211 N1C	9 432 612 899
------------------------	---------------

NP-DLF ... VJ ...

NP-DLF 130 VJ 6210 N1	9 432 612 423
NP-DLF 140 VJ 4810 N2	9 432 612 411
NP-DLF 140 VJ 5210 N2	9 432 612 412

NP-DLF ... VV ...

NP-DLF 156 VV 5110 NP1	9 432 610 505
------------------------	---------------

NP-DLL ... S ...

NP-DLL 16 S 561 N389	9 432 610 152
NP-DLL 16 S 601 NP93	9 432 610 416
NP-DLL 31 S 701 N466	9 432 612 315

NP-DLL 35 S 671 NP92	9 432 610 507
NP-DLL 120 S 354 NP39	9 432 612 309
NP-DLL 140 S 256 NP38M	9 432 610 820
NP-DLL 140 S 256 NP38	9 432 610 465
NP-DLL 140 S 366 N483	9 432 611 711

de

Typformel →
Bestellnummer
für Zexel-Düsen
(Fortsetzung)

en

Type designation →
Part number
for Zexel nozzles
(continued)

fr

Formule de type →
Référence
pour injecteurs Zexel
(suite)

it

Sigla → Numero
d'ordinazione per
polverizzatori Zexel
(seguito)

es

Designación del tipo
→ Número de pedido
para inyectoros Zexel
(continuación)

NP-DLL 145 S 254 NP43 ...

 Typ	 Ref.
---	--

NP-DLL 145 S 254 NP43	9 432 612 311
NP-DLL 145 S 308 N482	9 432 611 710
NP-DLL 150 S 206 NP3	9 432 611 913
NP-DLL 150 S 256 NP3	9 432 611 925
NP-DLL 150 S 308 NP33	9 432 611 936

NP-DLL 150 S 308 N396	9 432 612 313
NP-DLL 150 S 328 NP52	9 432 610 016
NP-DLL 150 S 328 NP33	9 432 610 075
NP-DLL 150 S 366 N488	9 432 611 713
NP-DLL 150 S 386 N479	9 432 611 715

NP-DLL 153 S 295 N475	9 432 610 831
NP-DLL 155 S 206 NP3	9 432 611 930
NP-DLL 155 S 256 NP3	9 432 611 914
NP-DLL 155 S 268 N485	9 432 610 290
NP-DLL 155 S 288 N431	9 432 610 054

NP-DLL 155 S 288 N431	9 430 611 790
NP-DLL 155 S 289 N434	9 432 610 714
NP-DLL 160 S 307 N435	9 432 610 081
NP-DLL 165 S 288 N392	9 432 611 736
NP-DLL 165 S 306 NP1	9 432 610 506

NP-DLL ... SM ...

NP-DLL 125 SM 196	9 432 612 640
NP-DLL 125 SM 226	9 432 612 642
NP-DLL 130 SM 128	9 432 611 433

NP-DLL 138 SM 079	9 432 611 495
NP-DLL 140 SM 093	9 432 611 446
NP-DLL 140 SM 125	9 432 611 462
NP-DLL 140 SM 332	9 432 611 600
NP-DLL 140 SM 334	9 432 611 602

NP-DLL 140 SM 352	9 432 612 724
NP-DLL 140 SM 432	9 432 612 966
NP-DLL 143 SM 094	9 432 611 447
NP-DLL 143 SM 229	9 432 610 857
NP-DLL 143 SM 342	9 432 611 608

NP-DLL 148 SM 214	9 432 611 479
NP-DLL 148 SM 272	9 432 611 565
NP-DLL 155 SM 071	9 432 611 538
NP-DLL 155 SM 077	9 432 611 545
NP-DLL 155 SM 426	9 432 612 895

NP-DLL 156 SM 286	9 432 610 866
NP-DLL 156 SM 287	9 432 610 868
NP-DLL 160 SM 090	9 432 611 444
NP-DLL 160 SM 099	9 432 611 448

 Typ	 Ref.
---	--

NP-DLL ... SN ...

NP-DLL 25 SN 594	9 432 612 327
NP-DLL 30 SN 674	9 432 612 337
NP-DLL 30 SN 689	9 432 612 341

NP-DLL 30 SN 701 N465	9 432 610 508
NP-DLL 145 SN 506	9 432 610 835
NP-DLL 150 SN 543	9 432 611 818
NP-DLL 150 SN 590	9 432 612 324
NP-DLL 150 SN 592	9 432 612 326

NP-DLL 150 SN 628	9 432 612 333
NP-DLL 155 SN 514	9 432 611 733
NP-DLL 155 SN 520	9 432 611 730
NP-DLL 155 SN 521	9 432 610 144
NP-DLL 155 SN 527	9 432 612 321

NP-DLL 155 SN 528	9 432 612 322
NP-DLL 155 SN 542	9 432 611 817
NP-DLL 155 SN 550	9 432 611 809
NP-DLL 155 SN 556	9 432 611 813
NP-DLL 155 SN 559	9 432 611 816

NP-DLL 155 SN 562	9 432 611 842
NP-DLL 155 SN 574	9 432 611 844
NP-DLL 155 SN 576	9 432 611 830
NP-DLL 155 SN 595	9 432 610 191
NP-DLL 155 SN 596	9 432 610 858

NP-DLL 155 SN 619	9 432 611 781
NP-DLL 155 SN 636	9 432 611 770
NP-DLL 155 SN 639	9 432 610 224
NP-DLL 155 SN 672	9 432 611 792
NP-DLL 155 SN 675	9 432 611 788

NP-DLL 155 SN 692	9 432 611 252
NP-DLL 155 SN 729	9 432 611 235
NP-DLL 155 SN 767	9 432 611 287
NP-DLL 155 SN 790	9 432 610 856
NP-DLL 155 SN 807	9 432 610 277

NP-DLL 155 SN 825	9 432 611 518
NP-DLL 155 SN 865	9 432 611 215
NP-DLL 155 SN 882	9 432 610 892
NP-DLL 155 SN 897	9 432 611 199
NP-DLL 155 SN 916	9 432 611 370

NP-DLL 155 SN 939	9 432 612 362
NP-DLL 155 SN 978	9 432 611 407
NP-DLL 155 SN 979	9 432 610 725
NP-DLL 158 SN 701	9 432 610 150
NP-DLL 160 SN 530	9 432 611 828

... NP-DLLA 140 PN 002

 Typ	 Ref.
---	--

NP-DLL 160 SN 531	9 432 611 822
NP-DLL 160 SN 535	9 432 611 824
NP-DLL 160 SN 537	9 432 611 825
NP-DLL 160 SN 538	9 432 610 216
NP-DLL 160 SN 597	9 432 612 328

NP-DLL 160 SN 598	9 432 612 329
NP-DLL 160 SN 608	9 432 612 332
NP-DLL 160 SN 609	9 432 611 777
NP-DLL 160 SN 614	9 432 610 336
NP-DLL 160 SN 616	9 432 611 778

NP-DLL 160 SN 626	9 432 611 785
NP-DLL 160 SN 633	9 432 611 771
NP-DLL 160 SN 647	9 432 610 206
NP-DLL 160 SN 664	9 432 610 275
NP-DLL 160 SN 683	9 432 611 791

NP-DLL 160 SN 690	9 432 610 994
NP-DLL 160 SN 716	9 432 611 261
NP-DLL 160 SN 785	9 432 612 349
NP-DLL 160 SN 806	9 432 611 280
NP-DLL 160 SN 879	9 432 610 335

NP-DLL 160 SN 934	9 432 611 383
NP-DLL 1155 SN 560	9 432 611 827
NP-DLL 1155 SN 561	9 432 611 843

NP-DLL ... TA ...

NP-DLL 130 TA 286	9 432 612 375
NP-DLL 150 TA 258 N6	9 432 610 140
NP-DLL 150 TA 258 N2	9 432 612 374

NP-DLL 150 TA 288 N6	9 432 610 138
NP-DLL 150 TA 288	9 432 612 376
NP-DLL 150 TA 2510 N6	9 432 610 139

NP-DLL ... TE ...

NP-DLL 140 TE 288 N3	9 432 613 023
NP-DLL 140 TE 2810 N1	9 432 611 405
NP-DLL 140 TE 3010 N1	9 432 611 404

NP-DLL 140 TE 3210 N1	9 432 611 340
NP-DLL 145 TE 288 N3	9 432 613 006
NP-DLL 150 TE 288 N3	9 432 613 022
NP-DLL 150 TE 288 N2	9 432 612 943
NP-DLL 150 TE 288 N1	9 432 612 900

 Typ	 Ref.
---	--

NP-DLL ... UC ...

NP-DLL 145 UC 5010 N2	9 432 613 009
-----------------------	---------------

NP-DLL ... UE ...

NP-DLL 140 UE 4010 N1	9 432 613 010
NP-DLL 140 UE 4410 N1	9 432 613 011
NP-DLL 145 UE 4810 N1	9 432 612 774

NP-DLL 150 UE 4010 N1	9 432 612 714
NP-DLL 150 UE 4410 N1	9 432 612 898
NP-DLL S	9 432 611 412
NP-DLL S	9 432 611 579
NP-DLL S	9 432 612 325

NP-DLLA ... DN ...

NP-DLLA 154 DN 006	9 432 610 268
--------------------	---------------

NP-DLLA ... P ...

NP-DLLA 140 P 643	9 432 612 952
NP-DLLA 150 P 9	9 432 610 244
NP-DLLA 150 P 602	9 432 612 951

NP-DLLA 152 P 69	9 432 612 950
NP-DLLA 153 P 206 W	9 432 612 703
NP-DLLA 153 P 272 W	9 432 612 496
NP-DLLA 154 P 204 W	9 432 612 701
NP-DLLA 160 P 3	9 432 610 323

NP-DLLA 160 P 36	9 432 612 481
------------------	---------------

NP-DLLA ... PN ...





NP-DLLA 15 PN 343	9 432 612 830
NP-DLLA 132 PN 023	9 432 611 337
NP-DLLA 136 PN 326	9 432 612 855

NP-DLLA 137 PN 142	9 432 610 999
NP-DLLA 139 PN 030	9 432 611 339
NP-DLLA 139 PN 119	9 432 610 724
NP-DLLA 139 PN 120	9 432 612 485
NP-DLLA 140 PN 002	9 432 611 310



A110



de	en	fr	it	es
Typformel → Bestellnummer für Zexel-Düsen (Fortsetzung)	Type designation → Part number for Zexel nozzles (continued)	Formule de type → Référence pour injecteurs Zexel (suite)	Sigla → Numero d'ordinazione per polverizzatori Zexel (seguito)	Designación del tipo → Número de pedido para inyectoros Zexel (continuación)

NP-DLLA 140 PN 003 ...

 Typ	 Ref.	 Typ	 Ref.
NP-DLLA 140 PN 003	9 432 610 762	NP-DLLA 147 PN 252	9 432 610 598
NP-DLLA 140 PN 013	9 432 610 848	NP-DLLA 147 PN 288	9 432 610 882
NP-DLLA 140 PN 196	9 432 611 027	NP-DLLA 147 PN 300	9 432 612 507
NP-DLLA 140 PN 204	9 432 610 380	NP-DLLA 147 PN 323	9 432 612 818
NP-DLLA 140 PN 254	9 432 612 494	NP-DLLA 147 PN 351	9 432 612 874
NP-DLLA 140 PN 289	9 432 612 498	NP-DLLA 148 PN 066	9 432 610 812
NP-DLLA 140 PN 290	9 432 612 499	NP-DLLA 148 PN 221	9 432 611 008
NP-DLLA 140 PN 291	F 01G 0V5 000	NP-DLLA 148 PN 223	9 432 610 581
NP-DLLA 140 PN 302	9 432 612 716	NP-DLLA 148 PN 226	9 432 610 582
NP-DLLA 140 PN 303	9 432 612 717	NP-DLLA 148 PN 283	9 432 610 939
NP-DLLA 140 PN 348	9 432 612 869	NP-DLLA 148 PN 285	9 432 610 907
NP-DLLA 140 PN 359	9 432 612 937	NP-DLLA 148 PN 295	9 432 612 502
NP-DLLA 140 PN 361	9 432 612 949	NP-DLLA 148 PN 306	9 432 612 773
NP-DLLA 140 PN 369	9 432 613 024	NP-DLLA 148 PN 307	9 432 612 846
NP-DLLA 141 PN 134	9 432 610 996	NP-DLLA 148 PN 330	9 432 612 860
NP-DLLA 141 PN 136	9 432 610 376	NP-DLLA 148 PN 345	9 432 612 859
NP-DLLA 141 PN 294	9 432 612 501	NP-DLLA 148 PN 360	9 432 612 948
NP-DLLA 142 PN 249	9 432 610 596	NP-DLLA 148 PN 363	9 432 612 945
NP-DLLA 142 PN 324	9 432 612 814	NP-DLLA 149 PN 151	9 432 610 731
NP-DLLA 143 PN 117	9 432 611 327	NP-DLLA 149 PN 193	9 432 611 023
NP-DLLA 143 PN 250	9 432 610 597	NP-DLLA 149 PN 197	9 432 611 016
NP-DLLA 143 PN 265	9 432 610 603	NP-DLLA 149 PN 231	9 432 610 583
NP-DLLA 143 PN 325	9 432 612 812	NP-DLLA 149 PN 277	9 432 610 938
NP-DLLA 144 PN 309	9 432 612 843	NP-DLLA 149 PN 293	9 432 612 500
NP-DLLA 145 PN 225	9 432 611 010	NP-DLLA 150 PN 000	9 432 610 022
NP-DLLA 145 PN 243	9 432 610 932	NP-DLLA 150 PN 001	9 432 612 469
NP-DLLA 145 PN 263	9 432 612 495	NP-DLLA 150 PN 021	9 432 610 079
NP-DLLA 145 PN 331	9 432 612 792	NP-DLLA 150 PN 021	9 432 610 359
NP-DLLA 145 PN 346	9 432 612 850	NP-DLLA 150 PN 027	9 432 612 471
NP-DLLA 145 PN 349	9 432 612 867	NP-DLLA 150 PN 033	9 432 611 332
NP-DLLA 146 PN 028	9 432 610 736	NP-DLLA 150 PN 035	9 432 610 369
NP-DLLA 146 PN 032	9 432 610 849	NP-DLLA 150 PN 044	9 432 610 098
NP-DLLA 146 PN 055	9 432 610 253	NP-DLLA 150 PN 044	9 432 610 196
NP-DLLA 146 PN 122	9 432 610 408	NP-DLLA 150 PN 047	9 432 610 255
NP-DLLA 146 PN 122	9 432 612 486	NP-DLLA 150 PN 050	9 432 610 094
NP-DLLA 146 PN 218	9 432 611 011	NP-DLLA 150 PN 052	9 432 610 210
NP-DLLA 146 PN 218	9 432 610 781	NP-DLLA 150 PN 054	9 432 612 479
NP-DLLA 146 PN 220	9 432 611 007	NP-DLLA 150 PN 056	9 432 610 343
NP-DLLA 146 PN 229	9 432 611 014	NP-DLLA 150 PN 088	9 432 610 458
NP-DLLA 146 PN 245	9 432 610 592	NP-DLLA 150 PN 106	9 432 610 814
NP-DLLA 146 PN 296	9 432 612 504	NP-DLLA 150 PN 144	9 432 612 487
NP-DLLA 146 PN 296	9 432 612 586	NP-DLLA 150 PN 150	9 432 612 488
NP-DLLA 146 PN 296	9 432 612 503	NP-DLLA 150 PN 160	9 432 610 990
NP-DLLA 146 PN 322	9 432 612 816	NP-DLLA 150 PN 183	9 432 612 492
NP-DLLA 147 PN 246	9 432 610 593	NP-DLLA 150 PN 211	9 432 612 493

... NP-DLLA 154 PN 105

 Typ	 Ref.
NP-DLLA 150 PN 228	9 432 610 891
NP-DLLA 150 PN 235	9 432 610 930
NP-DLLA 150 PN 242	9 432 610 591
NP-DLLA 150 PN 244	9 432 610 933
NP-DLLA 150 PN 281	9 432 610 611
NP-DLLA 150 PN 282	9 432 610 612
NP-DLLA 150 PN 292	9 432 610 944
NP-DLLA 150 PN 304	9 432 612 718
NP-DLLA 150 PN 315	9 432 612 763
NP-DLLA 150 PN 316	9 432 612 761
NP-DLLA 150 PN 344	9 432 612 833
NP-DLLA 150 PN 352	9 432 612 903
NP-DLLA 151 PN 086	9 432 610 353
NP-DLLA 151 PN 158	9 432 612 490
NP-DLLA 151 PN 279	9 432 610 610
NP-DLLA 152 PN 009	9 432 610 175
NP-DLLA 152 PN 012	9 432 611 311
NP-DLLA 152 PN 014	9 432 610 153
NP-DLLA 152 PN 043	9 432 611 342
NP-DLLA 152 PN 063	9 432 610 362
NP-DLLA 152 PN 065	9 432 611 343
NP-DLLA 152 PN 077	9 432 610 719
NP-DLLA 152 PN 081	9 432 612 482
NP-DLLA 152 PN 097	9 432 610 250
NP-DLLA 152 PN 112	9 432 610 333
NP-DLLA 152 PN 143	9 432 610 993
NP-DLLA 152 PN 145	9 432 611 000
NP-DLLA 152 PN 153	9 432 611 005
NP-DLLA 152 PN 169	9 432 610 985
NP-DLLA 152 PN 184	9 432 610 455
NP-DLLA 152 PN 213	9 432 611 033
NP-DLLA 152 PN 222	9 432 611 009
NP-DLLA 152 PN 232	9 432 610 584
NP-DLLA 152 PN 233	9 432 610 585
NP-DLLA 152 PN 247	9 432 610 594
NP-DLLA 152 PN 248	9 432 610 595
NP-DLLA 152 PN 251	9 432 610 934
NP-DLLA 152 PN 258	9 432 610 463
NP-DLLA 152 PN 266	9 432 610 462
NP-DLLA 152 PN 267	9 432 610 464
NP-DLLA 152 PN 269	9 432 610 765
NP-DLLA 152 PN 273	9 432 610 928
NP-DLLA 152 PN 274	9 432 610 607
NP-DLLA 152 PN 275	9 432 610 608
NP-DLLA 152 PN 284	9 432 610 940





 Typ	 Ref.
NP-DLLA 152 PN 297	9 432 612 505
NP-DLLA 152 PN 298	9 432 612 506
NP-DLLA 152 PN 311	9 432 612 720
NP-DLLA 152 PN 320	9 432 612 810
NP-DLLA 152 PN 342	9 432 612 832
NP-DLLA 152 PN 640	9 432 610 602
NP-DLLA 153 PN 139	9 432 611 006
NP-DLLA 153 PN 152	9 432 611 004
NP-DLLA 153 PN 164	9 432 610 366
NP-DLLA 153 PN 177	9 432 610 452
NP-DLLA 153 PN 178	9 432 610 730
NP-DLLA 153 PN 203	9 432 610 883
NP-DLLA 153 PN 230	9 432 611 015
NP-DLLA 153 PN 234	9 432 610 586
NP-DLLA 153 PN 238	9 432 610 461
NP-DLLA 153 PN 255	9 432 610 936
NP-DLLA 153 PN 318	9 432 612 777
NP-DLLA 154 PN 005	9 432 610 161
NP-DLLA 154 PN 005	9 432 610 099
NP-DLLA 154 PN 006	9 432 610 050
NP-DLLA 154 PN 007	9 432 610 027
NP-DLLA 154 PN 018	9 432 610 171
NP-DLLA 154 PN 018	9 432 611 333
NP-DLLA 154 PN 019	9 432 611 334
NP-DLLA 154 PN 025	9 432 610 279
NP-DLLA 154 PN 040	9 432 610 707
NP-DLLA 154 PN 041	9 432 611 341
NP-DLLA 154 PN 042	9 432 610 282
NP-DLLA 154 PN 049	9 432 610 256
NP-DLLA 154 PN 051	9 432 610 445
NP-DLLA 154 PN 058	9 432 610 181
NP-DLLA 154 PN 061	9 432 610 283
NP-DLLA 154 PN 062	9 432 610 273
NP-DLLA 154 PN 064	9 432 610 280
NP-DLLA 154 PN 067	9 432 610 201
NP-DLLA 154 PN 068	9 432 610 163
NP-DLLA 154 PN 073	9 432 612 480
NP-DLLA 154 PN 084	9 432 611 345
NP-DLLA 154 PN 087	9 432 610 706
NP-DLLA 154 PN 093	9 432 610 217
NP-DLLA 154 PN 094	9 432 610 307
NP-DLLA 154 PN 095	9 432 611 347
NP-DLLA 154 PN 101	9 432 611 321
NP-DLLA 154 PN 103	9 432 611 322
NP-DLLA 154 PN 105	9 432 611 323



A112

de	en	fr	it	es
Typformel → Bestellnummer für Zexel-Düsen (Fortsetzung)	Type designation → Part number for Zexel nozzles (continued)	Formule de type → Référence pour injecteurs Zexel (suite)	Sigla → Numero d'ordinazione per polverizzatori Zexel (seguito)	Designación del tipo → Número de pedido para inyectoros Zexel (continuación)

NP-DLLA 154 PN 116 ...

 Typ	 Ref.	 Typ	 Ref.
NP-DLLA 154 PN 116	9 432 610 289	NP-DLLA 155 PN 182	9 432 610 413
NP-DLLA 154 PN 125	9 432 610 708	NP-DLLA 155 PN 188	9 432 611 018
NP-DLLA 154 PN 147	9 432 611 002	NP-DLLA 155 PN 192	9 432 611 022
NP-DLLA 154 PN 148	9 432 610 332	NP-DLLA 155 PN 195	9 432 611 025
NP-DLLA 154 PN 154	9 432 610 400	NP-DLLA 155 PN 198	9 432 610 579
NP-DLLA 154 PN 155	9 432 610 326	NP-DLLA 155 PN 199	9 432 611 028
NP-DLLA 154 PN 161	9 432 610 300	NP-DLLA 155 PN 200	9 432 610 701
NP-DLLA 154 PN 162	9 432 610 383	NP-DLLA 155 PN 202	9 432 610 692
NP-DLLA 154 PN 166	9 432 610 984	NP-DLLA 155 PN 217	9 432 611 012
NP-DLLA 154 PN 0171	9 432 610 306	NP-DLLA 155 PN 239	9 432 610 588
NP-DLLA 154 PN 173	9 432 610 351	NP-DLLA 155 PN 240	9 432 610 589
NP-DLLA 154 PN 185	9 432 610 851	NP-DLLA 155 PN 241	9 432 610 590
NP-DLLA 154 PN 186	9 432 610 371	NP-DLLA 155 PN 256	9 432 610 599
NP-DLLA 154 PN 189	9 432 611 019	NP-DLLA 155 PN 257	9 432 610 600
NP-DLLA 154 PN 205	9 432 611 030	NP-DLLA 155 PN 271	9 432 610 606
NP-DLLA 154 PN 207	9 432 610 712	NP-DLLA 155 PN 276	9 432 610 771
NP-DLLA 154 PN 208	9 432 610 394	NP-DLLA 155 PN 310	9 432 612 719
NP-DLLA 154 PN 227	9 432 611 013	NP-DLLA 156 PN 099	9 432 611 320
NP-DLLA 154 PN 270	9 432 610 605	NP-DLLA 156 PN 110	9 432 610 178
NP-DLLA 154 PN 319	9 432 612 806	NP-DLLA 156 PN 121	9 432 610 424
NP-DLLA 154 PN 327	9 432 612 802	NP-DLLA 156 PN 163	9 432 610 998
NP-DLLA 154 PN 350	9 432 612 902	NP-DLLA 156 PN 280	9 432 612 497
NP-DLLA 155 PN 034	9 432 612 473	NP-DLLA 157 PN 020	9 432 611 335
NP-DLLA 155 PN 037	9 432 612 474	NP-DLLA 157 PN 069	9 432 610 356
NP-DLLA 155 PN 038	9 432 612 475	NP-DLLA 157 PN 072	9 432 611 344
NP-DLLA 155 PN 045	9 432 612 476	NP-DLLA 157 PN 090	9 432 610 288
NP-DLLA 155 PN 046	9 432 612 477	NP-DLLA 157 PN 096	9 432 611 326
NP-DLLA 155 PN 048	9 432 612 478	NP-DLLA 157 PN 102	9 432 610 208
NP-DLLA 155 PN 053	9 432 610 853	NP-DLLA 157 PN 115	9 432 610 815
NP-DLLA 155 PN 057	9 432 610 734	NP-DLLA 157 PN 130	9 432 610 354
NP-DLLA 155 PN 060	9 432 610 733	NP-DLLA 157 PN 133	9 432 610 995
NP-DLLA 155 PN 079	9 432 610 146	NP-DLLA 157 PN 138	9 432 610 997
NP-DLLA 155 PN 080	9 432 610 233	NP-DLLA 157 PN 165	9 432 610 983
NP-DLLA 155 PN 083	9 432 612 483	NP-DLLA 157 PN 180	9 432 610 992
NP-DLLA 155 PN 089	9 432 610 229	NP-DLLA 157 PN 190	9 432 611 020
NP-DLLA 155 PN 091	9 432 611 346	NP-DLLA 157 PN 201	9 432 611 029
NP-DLLA 155 PN 092	9 432 612 484	NP-DLLA 157 PN 215	9 432 611 035
NP-DLLA 155 PN 107	9 432 610 320	NP-DLLA 157 PN 219	9 432 611 026
NP-DLLA 155 PN 111	9 432 611 324	NP-DLLA 157 PN 253	9 432 610 945
NP-DLLA 155 PN 118	9 430 612 727	NP-DLLA 157 PN 268	9 432 610 604
NP-DLLA 155 PN 123	9 432 610 309	NP-DLLA 157 PN 278	9 432 610 609
NP-DLLA 155 PN 157	9 432 610 360	NP-DLLA 157 PN 329	9 432 612 808
NP-DLLA 155 PN 174	9 432 610 989	NP-DLLA 158 PN 104	9 432 610 711
NP-DLLA 155 PN 179	9 432 610 397	NP-DLLA 158 PN 108	9 432 610 232
NP-DLLA 155 PN 181	9 432 610 819	NP-DLLA 158 PN 113	9 432 611 325

... NP-DLLA 148 S 354 NP98

 Typ	 Ref.
---	--

NP-DLLA 158 PN 167	9 432 612 491
NP-DLLA 158 PN 172	9 432 610 988
NP-DLLA 158 PN 209	9 432 610 377
NP-DLLA 158 PN 236	9 432 610 931
NP-DLLA 158 PN 237	9 432 610 587

NP-DLLA 158 PN 286	9 432 610 941
NP-DLLA 158 PN 287	9 432 610 942
NP-DLLA 158 PN 312	9 432 612 721
NP-DLLA 158 PN 313	9 432 612 722
NP-DLLA 158 PN 314	9 432 612 723

NP-DLLA 158 PN 332	9 432 612 791
NP-DLLA 158 PN 341	9 432 612 821
NP-DLLA 159 PN 029	9 432 612 472
NP-DLLA 160 PN 004	9 432 610 168
NP-DLLA 160 PN 008	9 432 612 470

NP-DLLA 160 PN 010	9 432 610 078
NP-DLLA 160 PN 022	9 432 611 336
NP-DLLA 160 PN 024	9 432 610 334
NP-DLLA 160 PN 026	9 432 611 338
NP-DLLA 160 PN 031	9 432 610 735

NP-DLLA 160 PN 036	9 432 610 227
NP-DLLA 160 PN 039	9 432 610 718
NP-DLLA 160 PN 059	9 432 610 811
NP-DLLA 160 PN 070	9 432 610 732
NP-DLLA 160 PN 085	9 432 610 341

NP-DLLA 160 PN 100	9 432 610 813
NP-DLLA 160 PN 126	9 432 611 328
NP-DLLA 160 PN 127	9 432 611 329
NP-DLLA 160 PN 129	9 432 611 331
NP-DLLA 160 PN 131	9 432 610 929

NP-DLLA 160 PN 135	9 432 610 459
NP-DLLA 160 PN 137	9 432 610 904
NP-DLLA 160 PN 140	9 432 610 361
NP-DLLA 160 PN 141	9 432 610 374
NP-DLLA 160 PN 146	9 432 611 001

NP-DLLA 160 PN 149	9 432 611 003
NP-DLLA 160 PN 156	9 432 612 489
NP-DLLA 160 PN 159	9 432 610 710
NP-DLLA 160 PN 168	9 432 610 817
NP-DLLA 160 PN 170	9 432 610 986

NP-DLLA 160 PN 171	9 432 610 987
NP-DLLA 160 PN 175	9 432 610 982
NP-DLLA 160 PN 187	9 432 611 017
NP-DLLA 160 PN 206	9 432 611 031
NP-DLLA 160 PN 212	9 432 611 032

 Typ	 Ref.
---	--

NP-DLLA 160 PN 224	9 432 610 448
NP-DLLA 160 PN 317	9 432 612 769
NP-DLLA 161 PN 109	9 432 610 720
NP-DLLA 161 PN 124	9 432 611 318
NP-DLLA 161 PN 132	9 432 611 185

NP-DLLA 161 PN 194	9 432 611 024
NP-DLLA 161 PN 214	9 432 611 034
NP-DLLA 161 PN 328	9 432 612 804
NP-DLLA 162 PN 128	9 432 611 330
NP-DLLA 162 PN 176	9 432 610 991

NP-DLLA 162 PN 176	9 432 611 082
NP-DLLA 162 PN 191	9 432 611 021
NP-DLLA 162 PN 216	9 432 610 580

NP-DLLA ... S ...

NP-DLLA 103 S 314 N495	9 432 611 716
NP-DLLA 105 S 304 N433	9 432 610 349
NP-DLLA 137 S 374 N417	9 432 610 184

NP-DLLA 138 S 364 N409	9 432 610 218
NP-DLLA 140 S 274 NP12	9 432 610 395
NP-DLLA 142 S 344 N547	9 432 610 072
NP-DLLA 142 S 344 N501	9 432 610 286
NP-DLLA 142 S 354 N502	9 432 610 055

NP-DLLA 142 S 354 N454	9 432 611 723
NP-DLLA 142 S 374 N461	9 432 610 302
NP-DLLA 142 S 394 NP66	9 432 610 147
NP-DLLA 143 S 384 N418	9 432 611 761
NP-DLLA 144 S 304 N481	9 432 610 164

NP-DLLA 144 S 324 N478	9 432 611 717
NP-DLLA 144 S 325 N441	9 432 611 756
NP-DLLA 144 S 354 N403	9 432 610 064
NP-DLLA 144 S 364 N497	9 432 610 324
NP-DLLA 145 S 344 N453	9 432 610 195

NP-DLLA 145 S 701 NP15	9 432 610 093
NP-DLLA 146 S 284 N496	9 432 611 738
NP-DLLA 146 S 315 N460	9 432 610 415
NP-DLLA 146 S 344 N439	9 432 610 339
NP-DLLA 146 S 394 N455	9 432 610 826





NP-DLLA 146 S 394 N430	9 432 611 759
NP-DLLA 146 S 394 N387	9 432 611 746
NP-DLLA 148 S 324 N473	9 432 610 204
NP-DLLA 148 S 334 N472	9 432 610 440
NP-DLLA 148 S 354 NP98	9 432 610 414



A114

de	en	fr	it	es
Typformel → Bestellnummer für Zexel-Düsen (Fortsetzung)	Type designation → Part number for Zexel nozzles (continued)	Formule de type → Référence pour injecteurs Zexel (suite)	Sigla → Numero d'ordinazione per polverizzatori Zexel (seguito)	Designación del tipo → Número de pedido para inyectoros Zexel (continuación)

NP-DLLA 148 S 354 N429 ...

 Typ	 Ref.	 Typ	 Ref.
NP-DLLA 148 S 354 N429	9 432 611 767	NP-DLLA 151 S 384 N449	9 432 611 755
NP-DLLA 148 S 365 N388	9 432 610 225	NP-DLLA 152 S 324 NP48	9 432 611 940
NP-DLLA 150 S 255 NP14	9 432 612 312	NP-DLLA 152 S 354 N406	9 432 610 065
NP-DLLA 150 S 285 N484	9 432 611 712	NP-DLLA 154 S 144 W	9 432 610 691
NP-DLLA 150 S 315 NP145	9 432 610 697	NP-DLLA 154 S 284 N393	9 432 610 051
NP-DLLA 150 S 315 N450	9 432 611 737	NP-DLLA 154 S 284 N386	9 432 610 091
NP-DLLA 150 S 324 NP65	9 432 611 929	NP-DLLA 154 S 304 N474	9 432 610 025
NP-DLLA 150 S 325 NP60	9 432 610 411	NP-DLLA 154 S 324 NP81	9 432 610 405
NP-DLLA 150 S 325 ND117	9 432 612 953	NP-DLLA 154 S 324 N451	9 432 611 721
NP-DLLA 150 S 334 NP89	9 432 610 340	NP-DLLA 154 S 324 N413	9 432 610 018
NP-DLLA 150 S 334 NP3	9 432 611 937	NP-DLLA 154 S 334 N419	9 432 610 024
NP-DLLA 150 S 334 N462	9 432 610 829	NP-DLLA 154 S 344 NP54	9 432 610 822
NP-DLLA 150 S 334 N385	9 432 610 158	NP-DLLA 154 S 344 N463	9 432 611 724
NP-DLLA 150 S 344 NP82	9 432 610 029	NP-DLLA 154 S 344 N428	9 432 611 760
NP-DLLA 150 S 344 NP70	9 432 610 045	NP-DLLA 154 S 344 N424	9 432 611 754
NP-DLLA 150 S 344 NP51	9 432 610 172	NP-DLLA 154 S 364 N476	9 432 610 097
NP-DLLA 150 S 344 NP108	9 432 612 353	NP-DLLA 154 S 364 N382	9 432 611 748
NP-DLLA 150 S 344 NP103	9 432 612 352	NP-DLLA 154 S 365 NP91	9 432 611 750
NP-DLLA 150 S 344 N489	9 432 610 173	NP-DLLA 154 S 374 N438	9 432 610 089
NP-DLLA 150 S 345 N492	9 432 610 165	NP-DLLA 154 S 424 N459	9 432 610 231
NP-DLLA 150 S 355 N490	9 432 611 714	NP-DLLA 155 S 324 NP90	9 432 611 751
NP-DLLA 150 S 355 N467	9 432 611 725	NP-DLLA 155 S 324 N468	9 432 610 705
NP-DLLA 150 S 374 N464	9 432 610 179	NP-DLLA 155 S 324 N456	9 432 610 715
NP-DLLA 150 S 374 N414	9 432 610 368	NP-DLLA 155 S 324 N440	9 432 611 757
NP-DLLA 150 S 384 NP73	9 432 610 142	NP-DLLA 155 S 334 NP96	9 432 610 241
NP-DLLA 150 S 384 NP13	9 432 610 033	NP-DLLA 155 S 365 N458	9 432 610 345
NP-DLLA 150 S 384 N436	9 432 611 758	NP-DLLA 156 S 344 NP55	9 432 611 932
NP-DLLA 150 S 394 NP76	9 432 610 100	NP-DLLA 157 S 385 N480	9 432 611 709
NP-DLLA 150 S 394 NP69	9 432 611 753	NP-DLLA 158 S 325 N437	9 432 610 190
NP-DLLA 150 S 394 NP68	9 432 611 720	NP-DLLA 158 S 325 N407	9 432 611 765
NP-DLLA 150 S 394 N452	9 432 611 722	NP-DLLA 160 S 295 N469	9 432 611 726
NP-DLLA 150 S 394 N416	9 432 611 762	NP-DLLA 160 S 295 N422	9 432 610 046
NP-DLLA 150 S 394 N412	9 432 611 763	NP-DLLA 160 S 295 N394	9 432 611 747
NP-DLLA 150 S 394 N411	9 432 611 764	NP-DLLA 160 S 315 N471	9 432 611 719
NP-DLLA 150 S 394 N404	9 432 610 316	NP-DLLA 160 S 324 NP9	9 432 611 939
NP-DLLA 150 S 404 NP13	9 432 610 145	NP-DLLA 160 S 324 N486	9 432 610 176
NP-DLLA 150 S 414 NP83	9 432 610 017	NP-DLLA 160 S 325 N507	9 432 610 242
NP-DLLA 150 S 414 N380	9 432 610 314	NP-DLLA 160 S 335 N494	9 432 611 707
NP-DLLA 150 S 424 N493	9 432 611 708	NP-DLLA 160 S 344 NP11	9 432 611 931
NP-DLLA 150 S 424 N477	9 432 611 718	NP-DLLA 160 S 354 NP88	9 432 610 030
NP-DLLA 150 S 424 N470	9 432 610 439	NP-DLLA 160 S 354 NP77	9 432 610 412
NP-DLLA 150 S 3840 NP16	9 432 610 387	NP-DLLA 160 S 354 NP49	9 432 610 182
NP-DLLA 151 S 354 NP86	9 432 610 019	NP-DLLA 160 S 354 NP49	9 432 610 183
NP-DLLA 151 S 354 N425	9 432 610 759	NP-DLLA 160 S 354 N420	9 432 612 314
NP-DLLA 151 S 354 N381	9 432 611 735	NP-DLLA 160 S 354 N405	9 432 611 749

... NP-DLLA 148 SM 345

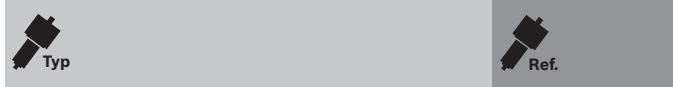

NP-DLLA 160 S 385 NP50	9 432 610 101
NP-DLLA 160 S 385 N426	9 432 610 215
NP-DLLA 160 S 424 N427	9 432 610 410
NP-DLLA 160 S 424 N390	9 432 611 745
NP-DLLA 162 S 265 N491	9 432 612 317

NP-DLLA 162 S 285 N498	9 432 611 739
NP-DLLA 162 S 384 N457	9 432 610 070
NP-DLLA 166 S 364 N408	9 432 611 766
NP-DLLA 166 S 374 NP6	9 432 610 015
NP-DLLA 166 S 374 N379	9 432 610 824

NP-DLLA 166 S 384 NP97	9 432 610 143
NP-DLLA 166 S 384 NP72	9 432 610 760
NP-DLLA 166 S 414 NP46	9 432 610 348
NP-DLLA 168 S 304 NP59	9 432 610 115
NP-DLLA 171 S 334 NP84	9 432 610 102

NP-DLLA 171 S 374 NP58	9 432 610 092
NP-DLLA 174 S 334 NP75	9 432 611 821
NP-DLLA 176 S 324 N	9 432 610 083
NP-DLLA 176 S 334 NP4	9 432 611 938
NP-DLLA 180 S 374 NP57	9 432 611 928

NP-DLLA 186 S 324 NP8	9 432 610 061
NP-DLLA 186 S 334 NP8	9 432 610 035

NP-DLLA ... SM ...

NP-DLLA 130 SM 418	9 432 612 848
NP-DLLA 133 SM 208	9 432 611 475
NP-DLLA 133 SM 208	9 432 612 641

NP-DLLA 133 SM 208	9 432 611 475
NP-DLLA 133 SM 257	9 432 610 777
NP-DLLA 133 SM 322	9 432 611 626
NP-DLLA 133 SM 433	9 432 612 934
NP-DLLA 133 SM 434	9 432 612 935

NP-DLLA 137 SM 406	9 432 612 794
NP-DLLA 140 SM 068	9 432 611 536
NP-DLLA 140 SM 069	9 432 611 537
NP-DLLA 140 SM 088	9 432 610 825
NP-DLLA 140 SM 109	9 432 611 453

NP-DLLA 140 SM 141	9 432 611 442
NP-DLLA 140 SM 218	9 432 610 672
NP-DLLA 140 SM 306	9 432 611 617
NP-DLLA 140 SM 335	9 432 611 603
NP-DLLA 140 SM 350	9 432 612 658

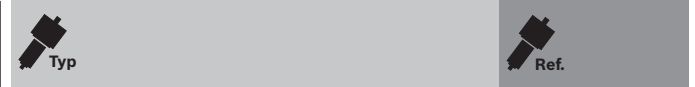

NP-DLLA 140 SM 353	9 432 612 660
NP-DLLA 140 SM 355	9 432 612 725
NP-DLLA 140 SM 413	9 432 612 831
NP-DLLA 140 SM 421	9 432 612 890
NP-DLLA 140 SM 422	9 432 612 931

NP-DLLA 140 SM 423	9 432 612 932
NP-DLLA 141 SM 346	9 432 611 610
NP-DLLA 141 SM 361	9 432 612 729
NP-DLLA 141 SM 373	9 432 612 711
NP-DLLA 141 SM 403	9 432 612 800

NP-DLLA 142 SM 076	9 432 611 544
NP-DLLA 142 SM 095	9 432 610 827
NP-DLLA 142 SM 149	9 432 611 435
NP-DLLA 142 SM 266	9 432 611 588
NP-DLLA 142 SM 307	9 432 611 618

NP-DLLA 142 SM 360	9 432 612 728
NP-DLLA 142 SM 425	9 432 612 866
NP-DLLA 143 SM 262	9 432 611 595
NP-DLLA 144 SM 209	9 432 610 864
NP-DLLA 145 SM 012	9 432 610 821

NP-DLLA 145 SM 013	9 432 610 636
NP-DLLA 145 SM 033	9 432 610 779
NP-DLLA 145 SM 167	9 432 611 488
NP-DLLA 145 SM 198	9 432 610 669
NP-DLLA 145 SM 219	9 432 611 481

NP-DLLA 145 SM 276	9 432 610 686
NP-DLLA 145 SM 277	9 432 610 687
NP-DLLA 145 SM 357	9 432 612 707
NP-DLLA 145 SM 387	9 432 612 759
NP-DLLA 146 SM 132	9 432 611 427

NP-DLLA 146 SM 203	9 432 610 670
NP-DLLA 146 SM 224	9 432 610 799
NP-DLLA 146 SM 285	9 432 612 648
NP-DLLA 146 SM 291	9 432 612 649
NP-DLLA 146 SM 364	9 432 612 732

NP-DLLA 146 SM 424	9 432 612 864
NP-DLLA 147 SM 327	9 432 610 772
NP-DLLA 147 SM 380	9 432 612 854
NP-DLLA 148 SM 063	9 432 610 646
NP-DLLA 148 SM 098	9 432 610 652





NP-DLLA 148 SM 144	9 432 611 424
NP-DLLA 148 SM 235	9 432 611 581
NP-DLLA 148 SM 236	9 432 611 582
NP-DLLA 148 SM 344	9 432 611 609
NP-DLLA 148 SM 345	9 432 612 654





A116



de	en	fr	it	es
Typformel → Bestellnummer für Zexel-Düsen (Fortsetzung)	Type designation → Part number for Zexel nozzles (continued)	Formule de type → Référence pour injecteurs Zexel (suite)	Sigla → Numero d'ordinazione per polverizzatori Zexel (seguito)	Designación del tipo → Número de pedido para inyectoros Zexel (continuación)

NP-DLLA 149 SM 055 ...

 Typ	 Ref.	 Typ	 Ref.
NP-DLLA 149 SM 055	9 432 610 642	NP-DLLA 150 SM 292	9 432 610 859
NP-DLLA 149 SM 304	9 432 610 764	NP-DLLA 150 SM 293	9 432 611 574
NP-DLLA 150 SM 000	9 432 610 634	NP-DLLA 150 SM 303	9 432 610 769
NP-DLLA 150 SM 000	9 432 610 635	NP-DLLA 150 SM 310	9 432 611 629
NP-DLLA 150 SM 018	9 432 610 809	NP-DLLA 150 SM 323	9 432 611 627
NP-DLLA 150 SM 024	9 432 612 618	NP-DLLA 150 SM 343	9 432 612 653
NP-DLLA 150 SM 026	9 432 611 047	NP-DLLA 150 SM 370	9 432 612 738
NP-DLLA 150 SM 026	9 432 611 517	NP-DLLA 150 SM 385	9 432 612 756
NP-DLLA 150 SM 034	9 432 610 791	NP-DLLA 150 SM 407	9 432 612 856
NP-DLLA 150 SM 040	9 432 611 547	NP-DLLA 150 SM 412	9 432 612 826
NP-DLLA 150 SM 041	9 432 610 871	NP-DLLA 151 SM 103	9 432 610 446
NP-DLLA 150 SM 042	9 432 612 620	NP-DLLA 151 SM 145	9 432 610 870
NP-DLLA 150 SM 065	9 432 612 622	NP-DLLA 151 SM 175	9 432 611 493
NP-DLLA 150 SM 078	9 432 610 648	NP-DLLA 151 SM 186	9 432 611 497
NP-DLLA 150 SM 082	9 432 612 623	NP-DLLA 151 SM 325	9 432 611 628
NP-DLLA 150 SM 086	9 432 612 626	NP-DLLA 151 SM 329	9 432 611 620
NP-DLLA 150 SM 101	9 432 611 449	NP-DLLA 151 SM 338	9 432 612 652
NP-DLLA 150 SM 105	9 432 610 793	NP-DLLA 151 SM 354	9 432 612 661
NP-DLLA 150 SM 113	9 432 612 629	NP-DLLA 151 SM 397	9 432 612 775
NP-DLLA 150 SM 116	9 432 611 457	NP-DLLA 152 SM 005	9 432 611 521
NP-DLLA 150 SM 117	9 432 612 630	NP-DLLA 152 SM 005	9 432 612 614
NP-DLLA 150 SM 121	9 432 611 459	NP-DLLA 152 SM 017	9 432 611 511
NP-DLLA 150 SM 122	9 432 610 655	NP-DLLA 152 SM 035	9 432 611 549
NP-DLLA 150 SM 130	9 432 611 426	NP-DLLA 152 SM 043	9 432 611 062
NP-DLLA 150 SM 130	9 432 612 568	NP-DLLA 152 SM 043	9 432 611 550
NP-DLLA 150 SM 160	9 432 610 663	NP-DLLA 152 SM 070	9 432 611 546
NP-DLLA 150 SM 161	9 432 612 634	NP-DLLA 152 SM 097	9 432 612 627
NP-DLLA 150 SM 165	9 432 612 636	NP-DLLA 152 SM 104	9 432 611 450
NP-DLLA 150 SM 170	9 432 610 886	NP-DLLA 152 SM 108	9 432 612 628
NP-DLLA 150 SM 172	9 432 611 492	NP-DLLA 152 SM 123	9 432 611 460
NP-DLLA 150 SM 173	9 432 612 637	NP-DLLA 152 SM 127	9 432 610 657
NP-DLLA 150 SM 174	9 432 612 638	NP-DLLA 152 SM 191	9 432 611 474
NP-DLLA 150 SM 176	9 432 612 639	NP-DLLA 152 SM 358	9 432 612 726
NP-DLLA 150 SM 201	9 432 611 471	NP-DLLA 152 SM 362	9 432 612 730
NP-DLLA 150 SM 206	9 432 610 671	NP-DLLA 152 SM 369	9 432 612 737
NP-DLLA 150 SM 207	9 432 611 484	NP-DLLA 152 SM 399	9 432 612 797
NP-DLLA 150 SM 212	9 432 611 477	NP-DLLA 152 SM 400	9 432 612 796
NP-DLLA 150 SM 221	9 432 610 674	NP-DLLA 152 SM 411	9 432 612 823
NP-DLLA 150 SM 233	9 432 611 067	NP-DLLA 152 SM 414	9 432 612 837
NP-DLLA 150 SM 233	9 432 611 580	NP-DLLA 153 SM 007	9 432 612 615
NP-DLLA 150 SM 234	9 432 610 676	NP-DLLA 153 SM 015	9 432 611 509
NP-DLLA 150 SM 238	9 432 611 584	NP-DLLA 153 SM 029	9 432 610 450
NP-DLLA 150 SM 240	9 432 612 645	NP-DLLA 153 SM 205	9 432 611 063
NP-DLLA 150 SM 255	9 432 610 877	NP-DLLA 153 SM 205	9 432 611 473
NP-DLLA 150 SM 271	9 432 610 778	NP-DLLA 153 SM 211	9 432 610 862

... NP-DLLA 156 SM 003

 Typ	 Ref.
NP-DLLA 153 SM 215	9 432 610 784
NP-DLLA 153 SM 331	9 432 611 599
NP-DLLA 154 SM 006	9 432 611 504
NP-DLLA 154 SM 009	9 432 611 505
NP-DLLA 154 SM 020	9 432 611 513
NP-DLLA 154 SM 025	9 432 610 728
NP-DLLA 154 SM 119	9 432 610 726
NP-DLLA 154 SM 133	9 432 611 428
NP-DLLA 154 SM 150	9 432 611 436
NP-DLLA 154 SM 178	9 432 610 729
NP-DLLA 154 SM 190	9 432 611 500
NP-DLLA 154 SM 281	9 432 611 569
NP-DLLA 154 SM 313	9 432 611 612
NP-DLLA 154 SM 321	9 432 611 625
NP-DLLA 155 SM 001	9 432 611 528
NP-DLLA 155 SM 038	9 432 611 559
NP-DLLA 155 SM 044	9 432 611 551
NP-DLLA 155 SM 045	9 432 610 786
NP-DLLA 155 SM 049	9 432 611 555
NP-DLLA 155 SM 050	9 432 610 640
NP-DLLA 155 SM 052	9 432 611 557
NP-DLLA 155 SM 059	9 432 611 533
NP-DLLA 155 SM 061	9 432 610 645
NP-DLLA 155 SM 062	9 432 611 534
NP-DLLA 155 SM 064	9 432 611 535
NP-DLLA 155 SM 066	9 432 610 850
NP-DLLA 155 SM 067	9 432 610 647
NP-DLLA 155 SM 075	9 432 611 543
NP-DLLA 155 SM 083	9 432 612 624
NP-DLLA 155 SM 096	9 432 610 457
NP-DLLA 155 SM 102	9 432 610 654
NP-DLLA 155 SM 106	9 432 611 451
NP-DLLA 155 SM 118	9 432 612 631
NP-DLLA 155 SM 124	9 432 611 044
NP-DLLA 155 SM 124	9 432 611 461
NP-DLLA 155 SM 126	9 432 610 656
NP-DLLA 155 SM 134	9 432 611 429
NP-DLLA 155 SM 135	9 432 611 430
NP-DLLA 155 SM 140	9 432 610 659
NP-DLLA 155 SM 142	9 432 612 633
NP-DLLA 155 SM 147	9 432 611 434
NP-DLLA 155 SM 151	9 432 611 437
NP-DLLA 155 SM 156	9 432 610 797
NP-DLLA 155 SM 157	9 432 610 795
NP-DLLA 155 SM 158	9 432 610 662





 Typ	 Ref.
NP-DLLA 155 SM 159	9 432 611 486
NP-DLLA 155 SM 162	9 432 612 635
NP-DLLA 155 SM 164	9 432 610 664
NP-DLLA 155 SM 166	9 432 610 449
NP-DLLA 155 SM 169	9 432 611 490
NP-DLLA 155 SM 182	9 432 610 667
NP-DLLA 155 SM 192	9 432 611 494
NP-DLLA 155 SM 194	9 432 610 782
NP-DLLA 155 SM 202	9 432 611 472
NP-DLLA 155 SM 225	9 432 610 675
NP-DLLA 155 SM 228	9 432 611 441
NP-DLLA 155 SM 230	9 432 610 700
NP-DLLA 155 SM 232	9 432 612 643
NP-DLLA 155 SM 239	9 432 612 644
NP-DLLA 155 SM 243	9 432 610 679
NP-DLLA 155 SM 261	9 432 611 594
NP-DLLA 155 SM 267	9 432 610 685
NP-DLLA 155 SM 270	9 432 612 647
NP-DLLA 155 SM 274	9 432 610 873
NP-DLLA 155 SM 278	9 432 611 567
NP-DLLA 155 SM 279	9 432 611 568
NP-DLLA 155 SM 284	9 432 611 562
NP-DLLA 155 SM 295	9 432 610 803
NP-DLLA 155 SM 296	9 432 611 576
NP-DLLA 155 SM 297	9 432 610 897
NP-DLLA 155 SM 305	9 432 611 616
NP-DLLA 155 SM 311	9 432 611 621
NP-DLLA 155 SM 312	9 432 612 650
NP-DLLA 155 SM 316	9 432 610 894
NP-DLLA 155 SM 320	9 432 611 624
NP-DLLA 155 SM 324	9 432 610 805
NP-DLLA 155 SM 326	9 432 610 895
NP-DLLA 155 SM 336	9 432 611 604
NP-DLLA 155 SM 347	9 432 612 655
NP-DLLA 155 SM 371	9 432 612 739
NP-DLLA 155 SM 372	9 432 612 740
NP-DLLA 155 SM 376	9 432 612 743
NP-DLLA 155 SM 379	9 432 612 745
NP-DLLA 155 SM 386	9 432 612 757
NP-DLLA 155 SM 391	9 432 612 760
NP-DLLA 155 SM 393	9 432 612 781
NP-DLLA 155 SM 427	9 432 612 893
NP-DLLA 155 SM 431	9 432 612 933
NP-DLLA 155 SM 435	9 432 612 938
NP-DLLA 156 SM 003	9 432 611 530





A118



de	en	fr	it	es
Typformel → Bestellnummer für Zexel-Düsen (Fortsetzung)	Type designation → Part number for Zexel nozzles (continued)	Formule de type → Référence pour injecteurs Zexel (suite)	Sigla → Numero d'ordinazione per polverizzatori Zexel (seguito)	Designación del tipo → Número de pedido para inyectoros Zexel (continuación)

NP-DLLA 156 SM 003 ...

 Typ	 Ref.	 Typ	 Ref.
NP-DLLA 156 SM 003	9 432 612 556	NP-DLLA 157 SM 051	9 432 611 556
NP-DLLA 156 SM 003	9 432 612 612	NP-DLLA 157 SM 054	9 432 611 539
NP-DLLA 156 SM 003	9 432 612 613	NP-DLLA 157 SM 081	9 432 611 548
NP-DLLA 156 SM 008	9 432 610 852	NP-DLLA 157 SM 107	9 432 611 452
NP-DLLA 156 SM 019	9 432 611 512	NP-DLLA 157 SM 131	9 432 612 632
NP-DLLA 156 SM 019	9 432 612 616	NP-DLLA 157 SM 137	9 432 611 432
NP-DLLA 156 SM 019	9 432 612 617	NP-DLLA 157 SM 143	9 432 610 660
NP-DLLA 156 SM 019	9 432 611 056	NP-DLLA 157 SM 177	9 432 610 665
NP-DLLA 156 SM 058	9 432 610 644	NP-DLLA 157 SM 180	9 432 610 666
NP-DLLA 156 SM 074	9 432 611 542	NP-DLLA 157 SM 187	9 432 610 668
NP-DLLA 156 SM 089	9 432 611 503	NP-DLLA 157 SM 197 B	9 432 611 468
NP-DLLA 156 SM 111	9 432 611 454	NP-DLLA 157 SM 197	9 432 611 068
NP-DLLA 156 SM 114	9 432 611 455	NP-DLLA 157 SM 197	9 432 611 467
NP-DLLA 156 SM 138	9 432 610 658	NP-DLLA 157 SM 210	9 432 611 476
NP-DLLA 156 SM 139	9 432 610 453	NP-DLLA 157 SM 242	9 432 610 678
NP-DLLA 156 SM 146	9 432 610 788	NP-DLLA 157 SM 251	9 432 611 587
NP-DLLA 156 SM 152	9 432 611 438	NP-DLLA 157 SM 273	9 432 610 767
NP-DLLA 156 SM 154	9 432 611 440	NP-DLLA 157 SM 280	9 432 610 879
NP-DLLA 156 SM 168	9 432 611 489	NP-DLLA 157 SM 319	9 432 611 623
NP-DLLA 156 SM 171	9 432 611 491	NP-DLLA 157 SM 319	9 432 612 603
NP-DLLA 156 SM 184	9 432 611 496	NP-DLLA 157 SM 363	9 432 612 731
NP-DLLA 156 SM 200	9 432 611 470	NP-DLLA 157 SM 389	9 432 612 766
NP-DLLA 156 SM 213	9 432 611 478	NP-DLLA 157 SM 396	9 432 612 779
NP-DLLA 156 SM 227	9 432 611 560	NP-DLLA 157 SM 402	9 432 612 793
NP-DLLA 156 SM 249	9 432 611 585	NP-DLLA 157 SM 410	9 432 612 929
NP-DLLA 156 SM 250	9 432 611 586	NP-DLLA 157 SM 415	9 432 612 835
NP-DLLA 156 SM 252	9 432 611 597	NP-DLLA 157 SM 437	9 432 612 939
NP-DLLA 156 SM 253	9 432 611 589	NP-DLLA 157 SM 438	9 432 612 946
NP-DLLA 156 SM 263	9 432 610 807	NP-DLLA 158 SM 028	9 432 611 522
NP-DLLA 156 SM 317	9 432 610 801	NP-DLLA 158 SM 039	9 432 610 639
NP-DLLA 156 SM 318	9 432 610 875	NP-DLLA 158 SM 039	9 432 612 619
NP-DLLA 156 SM 328	9 432 610 855	NP-DLLA 158 SM 046	9 432 611 552
NP-DLLA 156 SM 349	9 432 612 657	NP-DLLA 158 SM 047	9 432 611 553
NP-DLLA 156 SM 359	9 432 612 727	NP-DLLA 158 SM 048	9 432 611 554
NP-DLLA 156 SM 374	9 432 612 741	NP-DLLA 158 SM 053	9 432 610 641
NP-DLLA 156 SM 375	9 432 612 742	NP-DLLA 158 SM 060	9 432 612 621
NP-DLLA 156 SM 394	9 432 612 788	NP-DLLA 158 SM 073	9 432 611 541
NP-DLLA 156 SM 395	9 432 612 790	NP-DLLA 158 SM 100	9 432 610 653
NP-DLLA 156 SM 420	9 432 612 849	NP-DLLA 158 SM 112	9 432 611 443
NP-DLLA 157 SM 014	9 432 611 502	NP-DLLA 158 SM 120	9 432 611 458
NP-DLLA 157 SM 016	9 432 611 510	NP-DLLA 158 SM 129	9 432 611 425
NP-DLLA 157 SM 022	9 432 611 515	NP-DLLA 158 SM 155	9 432 611 464
NP-DLLA 157 SM 023	9 432 611 516	NP-DLLA 158 SM 188	9 432 611 498
NP-DLLA 157 SM 027	9 432 611 558	NP-DLLA 158 SM 189	9 432 611 499
NP-DLLA 157 SM 036	9 432 610 884	NP-DLLA 158 SM 193	9 432 611 093

... NP-DLLA 160 SM 448

 Typ	 Ref.
NP-DLLA 158 SM 193	9 432 611 465
NP-DLLA 158 SM 199	9 432 611 469
NP-DLLA 158 SM 216	9 432 611 480
NP-DLLA 158 SM 241	9 432 610 677
NP-DLLA 158 SM 258	9 432 611 591
NP-DLLA 158 SM 259	9 432 611 592
NP-DLLA 158 SM 260	9 432 611 593
NP-DLLA 158 SM 264	9 432 611 596
NP-DLLA 158 SM 268	9 432 611 563
NP-DLLA 158 SM 269	9 432 611 564
NP-DLLA 158 SM 275	9 432 611 566
NP-DLLA 158 SM 282	9 432 611 577
NP-DLLA 158 SM 283	9 432 611 531
NP-DLLA 158 SM 283	9 432 611 570
NP-DLLA 158 SM 288	9 432 611 571
NP-DLLA 158 SM 289	9 432 611 572
NP-DLLA 158 SM 290	9 432 611 573
NP-DLLA 158 SM 300	9 432 611 614
NP-DLLA 158 SM 308	9 432 611 619
NP-DLLA 158 SM 315	9 432 611 622
NP-DLLA 158 SM 330	9 432 611 598
NP-DLLA 158 SM 333	9 432 611 601
NP-DLLA 158 SM 337	9 432 611 605
NP-DLLA 158 SM 339	9 432 611 611
NP-DLLA 158 SM 340	9 432 611 606
NP-DLLA 158 SM 341	9 432 611 607
NP-DLLA 158 SM 351	9 432 612 659
NP-DLLA 158 SM 365	9 432 612 733
NP-DLLA 158 SM 366	9 432 612 734
NP-DLLA 158 SM 367	9 432 612 735
NP-DLLA 158 SM 368	9 432 612 736
NP-DLLA 158 SM 378	9 432 612 744
NP-DLLA 158 SM 383	9 432 612 829
NP-DLLA 158 SM 384	9 432 612 755
NP-DLLA 158 SM 388	9 432 612 762
NP-DLLA 158 SM 390	9 432 612 785
NP-DLLA 158 SM 392	9 432 612 778
NP-DLLA 158 SM 401	9 432 612 786
NP-DLLA 158 SM 408	9 432 612 927
NP-DLLA 158 SM 409	9 432 612 928
NP-DLLA 158 SM 416	9 432 612 930
NP-DLLA 158 SM 417	9 432 612 838
NP-DLLA 160 SM 002	9 432 611 529
NP-DLLA 160 SM 004	9 432 611 508
NP-DLLA 160 SM 010	9 432 611 506

 Typ	 Ref.
NP-DLLA 160 SM 011	9 432 611 507
NP-DLLA 160 SM 021	9 432 611 514
NP-DLLA 160 SM 032	9 432 610 637
NP-DLLA 160 SM 037	9 432 610 638
NP-DLLA 160 SM 056	9 432 611 532
NP-DLLA 160 SM 057	9 432 610 643
NP-DLLA 160 SM 072	9 432 611 540
NP-DLLA 160 SM 080	9 432 610 649
NP-DLLA 160 SM 084	9 432 612 625
NP-DLLA 160 SM 087	9 432 610 696
NP-DLLA 160 SM 091	9 432 611 445
NP-DLLA 160 SM 092	9 432 610 651
NP-DLLA 160 SM 110	9 432 611 463
NP-DLLA 160 SM 115	9 432 611 456
NP-DLLA 160 SM 153	9 432 611 439
NP-DLLA 160 SM 163	9 432 611 487
NP-DLLA 160 SM 179	9 432 611 501
NP-DLLA 160 SM 183	9 432 610 854
NP-DLLA 160 SM 185	9 432 610 889
NP-DLLA 160 SM 195	9 432 611 466
NP-DLLA 160 SM 217	9 432 610 830
NP-DLLA 160 SM 220	9 432 610 673
NP-DLLA 160 SM 222	9 432 611 482
NP-DLLA 160 SM 223	9 432 611 483
NP-DLLA 160 SM 244	9 432 610 680
NP-DLLA 160 SM 245	9 432 610 681
NP-DLLA 160 SM 246	9 432 610 682
NP-DLLA 160 SM 247	9 432 610 683
NP-DLLA 160 SM 248	9 432 610 684
NP-DLLA 160 SM 254	9 432 611 578
NP-DLLA 160 SM 256	9 432 611 590
NP-DLLA 160 SM 265	9 432 612 646
NP-DLLA 160 SM 294	9 432 611 575
NP-DLLA 160 SM 301	9 432 610 881
NP-DLLA 160 SM 302	9 432 611 615
NP-DLLA 160 SM 309	9 432 610 789
NP-DLLA 160 SM 314	9 432 612 651
NP-DLLA 160 SM 348	9 432 612 656
NP-DLLA 160 SM 381	9 432 612 853
NP-DLLA 160 SM 382	9 432 612 770
NP-DLLA 160 SM 404	9 432 612 798
NP-DLLA 160 SM 436	9 432 612 944
NP-DLLA 160 SM 445	9 432 612 961
NP-DLLA 160 SM 447	9 432 612 968
NP-DLLA 160 SM 448	9 432 612 964



A120

de

**Typformel →
Bestellnummer
für Zexel-Düsen**
(Fortsetzung)

en

**Type designation →
Part number
for Zexel nozzles**
(continued)

fr

**Formule de type →
Référence
pour injecteurs Zexel**
(suite)

it

**Sigla → Numero
d'ordinazione per
polverizzatori Zexel**
(seguito)

es

**Designación del tipo
→ Número de pedido
para inyectoros Zexel**
(continuación)

NP-DLLA 161 SM 085 ...



Typ



Ref.

NP-DLLA 161 SM 085	9 432 610 650
NP-DLLA 162 SM 441	9 432 612 957
NP-DLLA 165 SM 148	9 432 610 661
NP-DLLA 165 SM 181	9 432 611 485
NP-DLLA 165 SM 237	9 432 611 583
NP-DLLA 165 SM 298	9 432 611 613
NP-DLLA 165 SM 419	9 432 612 847

NP-DLLA ... SN ...

NP-DLLA 103 SN 646	9 432 612 335
NP-DLLA 133 SN 500	9 432 611 740
NP-DLLA 133 SN 504	9 432 610 833
NP-DLLA 134 SN 759	9 432 610 842
NP-DLLA 135 SN 717	9 432 611 262
NP-DLLA 135 SN 721	9 432 610 837
NP-DLLA 138 SN 612	9 432 610 754
NP-DLLA 138 SN 686	9 432 611 704
NP-DLLA 138 SN 719	9 432 611 263
NP-DLLA 138 SN 757	9 432 612 346
NP-DLLA 140 SN 505	9 432 611 741
NP-DLLA 140 SN 510	9 432 610 693
NP-DLLA 140 SN 634	9 432 610 456
NP-DLLA 140 SN 694	9 432 611 253
NP-DLLA 140 SN 887	9 432 611 226
NP-DLLA 140 SN 982	9 432 610 515
NP-DLLA 140 SN 982	9 432 612 370
NP-DLLA 141 SN 714	9 432 610 460
NP-DLLA 142 SN 568	9 432 610 755
NP-DLLA 142 SN 569	9 432 610 899
NP-DLLA 142 SN 575	9 432 610 839
NP-DLLA 142 SN 579	9 432 611 832
NP-DLLA 142 SN 581	9 432 610 166
NP-DLLA 142 SN 582	9 432 610 347
NP-DLLA 142 SN 613	9 432 610 167
NP-DLLA 142 SN 627	9 432 611 768
NP-DLLA 142 SN 630	9 432 611 774
NP-DLLA 142 SN 718	9 432 610 177
NP-DLLA 142 SN 738	9 432 611 240
NP-DLLA 142 SN 890	9 432 610 847
NP-DLLA 143 SN 553	9 432 610 278
NP-DLLA 143 SN 580	9 432 610 441
NP-DLLA 143 SN 632	9 432 611 772



Typ



Ref.

NP-DLLA 143 SN 735	9 432 611 239
NP-DLLA 143 SN 803	9 432 611 266
NP-DLLA 143 SN 805	9 432 611 279
NP-DLLA 143 SN 884	9 432 611 225
NP-DLLA 144 SN 642	9 432 612 334
NP-DLLA 144 SN 648	9 432 611 786
NP-DLLA 144 SN 649	9 432 610 213
NP-DLLA 144 SN 657	9 432 611 800
NP-DLLA 144 SN 766	9 432 611 292
NP-DLLA 144 SN 899	9 432 611 201
NP-DLLA 145 SN 511	9 432 612 318
NP-DLLA 145 SN 522	9 432 611 729
NP-DLLA 145 SN 523	9 432 611 728
NP-DLLA 145 SN 680	9 432 611 790
NP-DLLA 145 SN 764	9 432 611 290
NP-DLLA 145 SN 888	9 432 611 227
NP-DLLA 145 SN 891	9 432 610 717
NP-DLLA 145 SN 986	9 432 611 420
NP-DLLA 145 SN 988	9 432 610 518
NP-DLLA 145 SN 989	9 432 610 519
NP-DLLA 146 SN 585	9 432 611 833
NP-DLLA 146 SN 622	9 432 611 784
NP-DLLA 146 SN 662	9 432 611 787
NP-DLLA 146 SN 733	9 432 611 237
NP-DLLA 146 SN 765	9 432 610 843
NP-DLLA 146 SN 886	9 432 610 846
NP-DLLA 147 SN 703	9 432 610 752
NP-DLLA 148 SN 545	9 432 610 200
NP-DLLA 148 SN 651	9 432 611 804
NP-DLLA 148 SN 691	9 432 611 251
NP-DLLA 148 SN 693	9 432 610 832
NP-DLLA 148 SN 756	9 432 611 260
NP-DLLA 148 SN 841	9 432 610 418
NP-DLLA 149 SN 552	9 432 611 811
NP-DLLA 149 SN 558	9 432 611 815
NP-DLLA 149 SN 563	9 432 611 841
NP-DLLA 149 SN 679	9 432 610 409
NP-DLLA 149 SN 699	9 432 610 834
NP-DLLA 149 SN 712	9 432 612 343
NP-DLLA 149 SN 724	9 432 611 242
NP-DLLA 149 SN 734	9 432 611 238
NP-DLLA 149 SN 776	9 432 611 291
NP-DLLA 149 SN 783	9 432 611 270
NP-DLLA 149 SN 804	9 432 611 278
NP-DLLA 149 SN 809	9 432 610 382

... NP-DLLA 150 SN 942



NP-DLLA 149 SN 810	9 432 611 281
NP-DLLA 149 SN 819	9 432 611 249
NP-DLLA 149 SN 894	9 432 611 231
NP-DLLA 149 SN 914	9 432 611 406
NP-DLLA 150 SN 487	9 432 612 316
NP-DLLA 150 SN 534	9 432 611 823
NP-DLLA 150 SN 541	9 432 611 826
NP-DLLA 150 SN 548	9 432 610 757
NP-DLLA 150 SN 549	9 432 610 836
NP-DLLA 150 SN 554	9 432 611 812
NP-DLLA 150 SN 555	9 432 610 756
NP-DLLA 150 SN 557	9 432 611 814
NP-DLLA 150 SN 604	9 432 611 794
NP-DLLA 150 SN 605	9 432 611 776
NP-DLLA 150 SN 615	9 432 610 223
NP-DLLA 150 SN 618	9 432 611 780
NP-DLLA 150 SN 623	9 432 610 185
NP-DLLA 150 SN 624	9 432 610 198
NP-DLLA 150 SN 637	9 432 611 795
NP-DLLA 150 SN 660	9 432 610 342
NP-DLLA 150 SN 666	9 432 610 293
NP-DLLA 150 SN 673	9 432 612 336
NP-DLLA 150 SN 682	9 432 612 338
NP-DLLA 150 SN 695	9 432 611 254
NP-DLLA 150 SN 702	9 432 610 311
NP-DLLA 150 SN 704	9 432 611 257
NP-DLLA 150 SN 705	9 432 611 259
NP-DLLA 150 SN 708	9 432 610 214
NP-DLLA 150 SN 722	9 432 610 238
NP-DLLA 150 SN 723	9 432 611 265
NP-DLLA 150 SN 728	9 432 610 750
NP-DLLA 150 SN 730	9 432 611 236
NP-DLLA 150 SN 737	9 432 610 375
NP-DLLA 150 SN 739	9 432 611 241
NP-DLLA 150 SN 740	9 432 611 243
NP-DLLA 150 SN 742	9 432 610 154
NP-DLLA 150 SN 748	9 432 610 901
NP-DLLA 150 SN 758	9 432 610 746
NP-DLLA 150 SN 761	9 432 611 288
NP-DLLA 150 SN 762	9 432 611 289
NP-DLLA 150 SN 763	9 432 610 396
NP-DLLA 150 SN 769	9 432 611 293
NP-DLLA 150 SN 770	9 432 611 294
NP-DLLA 150 SN 775	9 432 610 744
NP-DLLA 150 SN 779	9 432 611 267



NP-DLLA 150 SN 781	9 432 611 269
NP-DLLA 150 SN 802	9 432 611 276
NP-DLLA 150 SN 808	9 432 612 355
NP-DLLA 150 SN 811	9 432 611 282
NP-DLLA 150 SN 812	9 432 611 283
NP-DLLA 150 SN 814	9 432 611 285
NP-DLLA 150 SN 818	9 432 610 742
NP-DLLA 150 SN 826	9 432 610 741
NP-DLLA 150 SN 830	9 432 611 700
NP-DLLA 150 SN 832	9 432 611 189
NP-DLLA 150 SN 835	9 432 611 191
NP-DLLA 150 SN 836	9 432 610 740
NP-DLLA 150 SN 837	9 432 611 192
NP-DLLA 150 SN 840	9 432 611 194
NP-DLLA 150 SN 843	9 432 611 196
NP-DLLA 150 SN 846	9 432 611 173
NP-DLLA 150 SN 854	9 432 611 176
NP-DLLA 150 SN 855	9 432 611 177
NP-DLLA 150 SN 859	9 432 611 181
NP-DLLA 150 SN 862	9 432 610 903
NP-DLLA 150 SN 866	9 432 611 216
NP-DLLA 150 SN 867	9 432 611 217
NP-DLLA 150 SN 868	9 432 610 403
NP-DLLA 150 SN 870	9 432 611 218
NP-DLLA 150 SN 871	9 432 611 219
NP-DLLA 150 SN 874	9 432 611 221
NP-DLLA 150 SN 876	9 432 610 704
NP-DLLA 150 SN 877	9 432 610 420
NP-DLLA 150 SN 883	9 432 611 214
NP-DLLA 150 SN 892	9 432 611 229
NP-DLLA 150 SN 900	9 432 611 202
NP-DLLA 150 SN 901	9 432 612 360
NP-DLLA 150 SN 902	9 432 611 203
NP-DLLA 150 SN 904	9 432 611 204
NP-DLLA 150 SN 906	9 432 611 206
NP-DLLA 150 SN 912	9 432 610 774
NP-DLLA 150 SN 917	9 432 610 739
NP-DLLA 150 SN 923	9 432 611 375
NP-DLLA 150 SN 927	9 432 610 393
NP-DLLA 150 SN 929	9 432 611 368
NP-DLLA 150 SN 930	9 432 610 770
NP-DLLA 150 SN 933	9 432 610 392
NP-DLLA 150 SN 938	9 432 611 387
NP-DLLA 150 SN 941	9 432 610 350
NP-DLLA 150 SN 942	9 432 611 389



A122

de

**Typformel →
Bestellnummer
für Zexel-Düsen**
(Fortsetzung)

en

**Type designation →
Part number
for Zexel nozzles**
(continued)

fr

**Formule de type →
Référence
pour injecteurs Zexel**
(suite)

it

**Sigla → Numero
d'ordinazione per
polverizzatori Zexel**
(seguito)

es

**Designación del tipo
→ Número de pedido
para inyectoros Zexel**
(continuación)

NP-DLLA 150 SN 948 ...



Typ



Ref.

NP-DLLA 150 SN 948	9 432 612 364
NP-DLLA 150 SN 953	9 432 611 353
NP-DLLA 150 SN 954	9 432 611 354
NP-DLLA 150 SN 956	9 432 611 356
NP-DLLA 150 SN 960	9 432 611 348
NP-DLLA 150 SN 973	9 432 611 413
NP-DLLA 150 SN 985	9 432 612 371
NP-DLLA 150 SN 987	9 432 611 421
NP-DLLA 150 SN 992	9 432 611 415
NP-DLLA 150 SN 993	9 432 611 392
NP-DLLA 150 SN 994	9 432 611 393
NP-DLLA 150 SN 998	9 432 610 522
NP-DLLA 150 SN 999	9 432 610 523
NP-DLLA 151 SN 509	9 432 611 743
NP-DLLA 151 SN 517	9 432 610 187
NP-DLLA 151 SN 656	9 432 611 801
NP-DLLA 151 SN 817	9 432 611 224
NP-DLLA 151 SN 839	9 432 611 184
NP-DLLA 151 SN 950	9 432 611 350
NP-DLLA 152 SN 529	9 432 610 723
NP-DLLA 152 SN 645	9 432 610 406
NP-DLLA 152 SN 654	9 432 611 807
NP-DLLA 152 SN 655	9 432 611 802
NP-DLLA 152 SN 668	9 432 611 799
NP-DLLA 152 SN 681	9 432 610 212
NP-DLLA 152 SN 909	9 432 611 209
NP-DLLA 152 SN 924	9 432 611 376
NP-DLLA 152 SN 925	9 432 611 377
NP-DLLA 152 SN 931	9 432 611 381
NP-DLLA 152 SN 936	9 432 611 385
NP-DLLA 152 SN 970	9 432 611 410
NP-DLLA 152 SN 970	9 432 611 411
NP-DLLA 153 SN 696	9 432 611 255
NP-DLLA 153 SN 700	9 432 611 256
NP-DLLA 153 SN 726	9 432 611 258
NP-DLLA 153 SN 736	9 432 610 291
NP-DLLA 153 SN 749	9 432 611 245
NP-DLLA 153 SN 753	9 432 610 841
NP-DLLA 153 SN 768	9 432 610 745
NP-DLLA 153 SN 782	9 432 612 348
NP-DLLA 153 SN 786	9 432 610 743
NP-DLLA 153 SN 842	9 432 611 195
NP-DLLA 153 SN 7131	9 432 610 211
NP-DLLA 154 SN 503	9 432 610 758
NP-DLLA 154 SN 526	9 432 612 320





Typ





Ref.

NP-DLLA 154 SN 533	9 432 610 111
NP-DLLA 154 SN 572	9 432 610 838
NP-DLLA 154 SN 573	9 432 611 838
NP-DLLA 154 SN 578	9 432 610 312
NP-DLLA 154 SN 583	9 432 612 323
NP-DLLA 154 SN 586	9 432 610 245
NP-DLLA 154 SN 587	9 432 611 834
NP-DLLA 154 SN 593	9 432 611 836
NP-DLLA 154 SN 599	9 432 611 837
NP-DLLA 154 SN 606	9 432 610 095
NP-DLLA 154 SN 607	9 432 610 049
NP-DLLA 154 SN 625	9 432 610 319
NP-DLLA 154 SN 631	9 432 611 775
NP-DLLA 154 SN 640	9 432 610 254
NP-DLLA 154 SN 641	9 432 610 823
NP-DLLA 154 SN 643	9 432 610 908
NP-DLLA 154 SN 661	9 432 610 243
NP-DLLA 154 SN 663	9 432 611 797
NP-DLLA 154 SN 665	9 432 611 798
NP-DLLA 154 SN 667	9 432 610 056
NP-DLLA 154 SN 750	9 432 610 748
NP-DLLA 154 SN 751	9 432 611 246
NP-DLLA 154 SN 752	9 432 611 247
NP-DLLA 154 SN 791	9 432 610 344
NP-DLLA 154 SN 834	9 432 611 190
NP-DLLA 154 SN 847	9 432 610 702
NP-DLLA 154 SN 856	9 432 611 178
NP-DLLA 154 SN 861	9 432 611 182
NP-DLLA 154 SN 903	9 432 610 722
NP-DLLA 154 SN 903	9 432 611 213
NP-DLLA 154 SN 907	9 432 610 379
NP-DLLA 154 SN 907	9 432 611 207
NP-DLLA 154 SN 932	9 432 611 382
NP-DLLA 154 SN 958	9 432 611 367
NP-DLLA 154 SN 959	9 432 611 359
NP-DLLA 154 SN 972	9 432 610 906
NP-DLLA 154 SN 990	9 432 611 398
NP-DLLA 155 SN 508	9 432 611 742
NP-DLLA 155 SN 512	9 432 611 734
NP-DLLA 155 SN 513	9 432 611 732
NP-DLLA 155 SN 515	9 432 610 509
NP-DLLA 155 SN 532	9 432 610 330
NP-DLLA 155 SN 536	9 432 610 084
NP-DLLA 155 SN 546	9 432 611 820
NP-DLLA 155 SN 600	9 432 612 330

... NP-DLLA 160 SN 524

 Typ	 Ref.
NP-DLLA 155 SN 601	9 432 612 331
NP-DLLA 155 SN 635	9 432 610 313
NP-DLLA 155 SN 650	9 432 611 803
NP-DLLA 155 SN 677	9 432 611 789
NP-DLLA 155 SN 684	9 432 612 339
NP-DLLA 155 SN 685	9 432 612 340
NP-DLLA 155 SN 687	9 432 610 828
NP-DLLA 155 SN 707	9 432 610 193
NP-DLLA 155 SN 709	9 432 611 250
NP-DLLA 155 SN 710	9 432 610 265
NP-DLLA 155 SN 711	9 432 610 399
NP-DLLA 155 SN 727	9 432 610 840
NP-DLLA 155 SN 743	9 432 610 749
NP-DLLA 155 SN 745	9 432 610 703
NP-DLLA 155 SN 746	9 432 612 345
NP-DLLA 155 SN 755	9 432 610 747
NP-DLLA 155 SN 760	9 432 610 902
NP-DLLA 155 SN 773	9 432 611 277
NP-DLLA 155 SN 774	9 432 611 275
NP-DLLA 155 SN 780	9 432 611 268
NP-DLLA 155 SN 784	9 432 611 271
NP-DLLA 155 SN 787	9 432 611 272
NP-DLLA 155 SN 788	9 432 611 273
NP-DLLA 155 SN 789	9 432 611 274
NP-DLLA 155 SN 815	9 432 610 888
NP-DLLA 155 SN 824	9 432 610 766
NP-DLLA 155 SN 857	9 432 611 179
NP-DLLA 155 SN 858	9 432 611 180
NP-DLLA 155 SN 864	9 432 611 193
NP-DLLA 155 SN 872	9 432 612 358
NP-DLLA 155 SN 873	9 432 611 220
NP-DLLA 155 SN 898	9 432 611 200
NP-DLLA 155 SN 913	9 432 611 114
NP-DLLA 155 SN 913	9 432 611 212
NP-DLLA 155 SN 926	9 432 610 738
NP-DLLA 155 SN 935	9 432 611 384
NP-DLLA 155 SN 943	9 432 611 390
NP-DLLA 155 SN 946	9 432 611 358
NP-DLLA 155 SN 955	9 432 611 355
NP-DLLA 155 SN 955	9 432 612 365
NP-DLLA 155 SN 967	9 432 610 513
NP-DLLA 155 SN 975	9 432 610 514
NP-DLLA 155 SN 991	9 432 610 520
NP-DLLA 156 SN 589	9 432 611 835
NP-DLLA 156 SN 771	9 432 611 295

 Typ	 Ref.
NP-DLLA 156 SN 820	9 432 610 716
NP-DLLA 156 SN 908	9 432 611 208
NP-DLLA 156 SN 911	9 432 611 211
NP-DLLA 156 SN 919	9 432 611 372
NP-DLLA 156 SN 921	9 432 611 116
NP-DLLA 156 SN 921	9 432 611 374
NP-DLLA 156 SN 928	9 432 611 379
NP-DLLA 156 SN 968	9 432 611 422
NP-DLLA 157 SN 544	9 432 611 819
NP-DLLA 157 SN 551	9 432 611 870
NP-DLLA 157 SN 551	9 432 611 810
NP-DLLA 157 SN 584	9 432 610 442
NP-DLLA 157 SN 617	9 432 611 779
NP-DLLA 157 SN 725	9 432 610 751
NP-DLLA 157 SN 741	9 432 611 234
NP-DLLA 157 SN 777	9 432 612 347
NP-DLLA 157 SN 778	9 432 610 203
NP-DLLA 157 SN 816	9 432 611 286
NP-DLLA 157 SN 829	9 432 610 328
NP-DLLA 157 SN 848	9 432 610 511
NP-DLLA 157 SN 920	9 432 611 373
NP-DLLA 157 SN 940	9 432 611 388
NP-DLLA 157 SN 944	9 432 610 893
NP-DLLA 157 SN 957	9 432 611 357
NP-DLLA 157 SN 965	9 432 611 365
NP-DLLA 157 SN 966	9 432 611 366
NP-DLLA 157 SN 966	9 432 612 369
NP-DLLA 157 SN 974	9 432 611 414
NP-DLLA 157 SN 980	9 432 611 417
NP-DLLA 157 SN 996	9 432 611 394
NP-DLLA 157 SN 997	9 432 611 395
NP-DLLA 158 SN 638	9 432 610 073
NP-DLLA 158 SN 821	9 432 610 304
NP-DLLA 158 SN 852	9 432 610 305
NP-DLLA 158 SN 869	9 432 610 266
NP-DLLA 158 SN 878	9 432 610 389
NP-DLLA 158 SN 885	9 432 610 422
NP-DLLA 158 SN 949	9 432 610 367
NP-DLLA 158 SN 971	9 432 610 737
NP-DLLA 158 SN 995	9 432 610 521
NP-DLLA 159 SN 792	9 432 610 844
NP-DLLA 160 SN 516	9 432 611 727
NP-DLLA 160 SN 518	9 432 611 744
NP-DLLA 160 SN 519	9 432 611 731
NP-DLLA 160 SN 524	9 432 611 769



A124

de

**Typformel →
Bestellnummer
für Zexel-Düsen**
(Fortsetzung)

en

**Type designation →
Part number
for Zexel nozzles**
(continued)

fr

**Formule de type →
Référence
pour injecteurs Zexel**
(suite)

it

**Sigla → Numero
d'ordinazione per
polverizzatori Zexel**
(seguito)

es

**Designación del tipo
→ Número de pedido
para inyectoros Zexel**
(continuación)

NP-DLLA 160 SN 525 ...



 Typ	 Ref.
---	--

NP-DLLA 160 SN 525	9 432 612 319
NP-DLLA 160 SN 539	9 432 610 235
NP-DLLA 160 SN 564	9 432 610 318
NP-DLLA 160 SN 565	9 432 611 840
NP-DLLA 160 SN 566	9 432 610 174
NP-DLLA 160 SN 567	9 432 610 285
NP-DLLA 160 SN 570	9 432 610 388
NP-DLLA 160 SN 577	9 432 611 831
NP-DLLA 160 SN 602	9 432 611 829
NP-DLLA 160 SN 620	9 432 611 782
NP-DLLA 160 SN 621	9 432 611 783
NP-DLLA 160 SN 629	9 432 611 773
NP-DLLA 160 SN 644	9 432 610 252
NP-DLLA 160 SN 658	9 432 611 796
NP-DLLA 160 SN 659	9 432 610 709
NP-DLLA 160 SN 670	9 432 610 207
NP-DLLA 160 SN 671	9 432 610 417
NP-DLLA 160 SN 676	9 432 610 753
NP-DLLA 160 SN 698	9 432 610 384
NP-DLLA 160 SN 706	9 432 610 401
NP-DLLA 160 SN 720	9 432 611 264
NP-DLLA 160 SN 731	9 432 610 170
NP-DLLA 160 SN 732	9 432 612 344
NP-DLLA 160 SN 744	9 432 610 727
NP-DLLA 160 SN 747	9 432 611 244
NP-DLLA 160 SN 754	9 432 611 248
NP-DLLA 160 SN 772	9 432 611 296
NP-DLLA 160 SN 813	9 432 611 284
NP-DLLA 160 SN 822	9 432 610 845
NP-DLLA 160 SN 822	9 432 612 357
NP-DLLA 160 SN 827	9 432 610 510
NP-DLLA 160 SN 828	9 432 611 187
NP-DLLA 160 SN 833	9 432 610 315
NP-DLLA 160 SN 838	9 432 611 197
NP-DLLA 160 SN 844	9 432 611 171
NP-DLLA 160 SN 845	9 432 611 172
NP-DLLA 160 SN 850	9 432 611 174
NP-DLLA 160 SN 851	9 432 611 175
NP-DLLA 160 SN 860	9 432 610 451
NP-DLLA 160 SN 863	9 432 611 170
NP-DLLA 160 SN 875	9 432 611 222
NP-DLLA 160 SN 880	9 432 611 233
NP-DLLA 160 SN 881	9 432 612 359
NP-DLLA 160 SN 889	9 432 611 228
NP-DLLA 160 SN 893	9 432 611 230

 Typ	 Ref.
---	--

NP-DLLA 160 SN 895	9 432 611 232
NP-DLLA 160 SN 896	9 432 611 205
NP-DLLA 160 SN 896	9 432 611 223
NP-DLLA 160 SN 905	9 432 611 198
NP-DLLA 160 SN 910	9 432 611 210
NP-DLLA 160 SN 915	9 432 611 369
NP-DLLA 160 SN 915	9 432 612 361
NP-DLLA 160 SN 918	9 432 611 371
NP-DLLA 160 SN 922	9 432 610 512
NP-DLLA 160 SN 937	9 432 611 386
NP-DLLA 160 SN 945	9 432 612 363
NP-DLLA 160 SN 947	9 432 611 378
NP-DLLA 160 SN 961	9 432 611 153
NP-DLLA 160 SN 961	9 432 611 360
NP-DLLA 160 SN 961	9 432 612 366
NP-DLLA 160 SN 961	9 432 612 367
NP-DLLA 160 SN 962	9 432 611 361
NP-DLLA 160 SN 964	9 432 611 364
NP-DLLA 160 SN 969	9 432 611 409
NP-DLLA 160 SN 976	9 432 611 423
NP-DLLA 160 SN 977	9 432 611 416
NP-DLLA 160 SN 981	9 432 611 418
NP-DLLA 160 SN 983	9 432 610 516
NP-DLLA 161 SN 951	9 432 611 351
NP-DLLA 161 SN 963	9 432 611 362
NP-DLLA 161 SN 963	9 432 611 363
NP-DLLA 161 SN 963	9 432 612 368
NP-DLLA 161 SN 984	9 432 610 517
NP-DLLA 161 SN 984	9 432 611 419
NP-DLLA 163 SN 823	9 432 611 186
NP-DLLA 163 SN 831	9 432 611 188
NP-DLLA 163 SN 952	9 432 611 352
NP-DLLA 169 SN 588	9 432 610 372
NP-DLLA ... SND ...	
NP-DLLA 155 SND 160	9 432 612 954
NP-DLLA 155 SND 199	9 432 612 955
NP-DLLA ... SNP ...	
NP-DLLA 142 SNP 15	9 432 610 698
NP-DLLA 150 SNP 18	9 432 612 354
NP-DLLA 150 SNP 20	9 432 612 350

... NP-DN 40 S 2

 Typ	 Ref.
---	--

NP-DLLA 150 SNP 173	9 432 610 386
NP-DLLA 155 SNP 187	9 432 612 351
NP-DLLA 155 SNP 189	9 432 610 699

NP-DN ... PD ...

NP-DN 0 PD 4	9 432 610 239
NP-DN 0 PD 20	9 432 610 317
NP-DN 0 PD 55	9 432 610 249

NP-DN 0 PD 600	9 432 610 427
NP-DN 0 PD 628	9 432 612 863
NP-DN 0 PD 650	9 432 610 437
NP-DN 4 PD 1	9 432 610 221
NP-DN 4 PD 57	9 432 610 284

NP-DN 4 PD 57	9 432 610 425
NP-DN 4 PD 98	9 432 610 426
NP-DN 20 PD 32	9 432 610 436

NP-DN ... PDN ...

NP-DN 0 PDN 102	9 432 610 063
NP-DN 0 PDN 104	9 432 610 473
NP-DN 0 PDN 105	9 432 610 110

NP-DN 0 PDN 107	9 432 610 116
NP-DN 0 PDN 108	9 432 610 074
NP-DN 0 PDN 108	9 432 610 162
NP-DN 0 PDN 109	9 432 610 474
NP-DN 0 PDN 110	9 432 610 157

NP-DN 0 PDN 112	9 432 610 062
NP-DN 0 PDN 113	9 432 610 077
NP-DN 0 PDN 114	9 432 610 236
NP-DN 0 PDN 121	9 432 610 199
NP-DN 0 PDN 122	9 432 610 237

NP-DN 0 PDN 122	9 432 610 267
NP-DN 0 PDN 123	9 432 610 337
NP-DN 0 PDN 124	9 432 610 271
NP-DN 0 PDN 127	9 432 610 281
NP-DN 0 PDN 127	9 432 610 475

NP-DN 0 PDN 128	9 432 610 476
NP-DN 0 PDN 131	9 432 610 310
NP-DN 0 PDN 133	9 432 610 327
NP-DN 0 PDN 134	9 432 610 477
NP-DN 0 PDN 136	9 432 610 421

 Typ	 Ref.
---	--

NP-DN 0 PDN 137	9 432 610 454
NP-DN 0 PDN 147	9 432 610 479
NP-DN 0 PDN 149	9 432 611 640
NP-DN 0 PDN 156	9 432 612 965
NP-DN 0 PDN 158	9 432 612 795

NP-DN 0 PDN 159	9 432 612 876
NP-DN 0 PDN 161	9 432 612 875
NP-DN 0 PDN 1061	9 432 610 189
NP-DN 4 PDN 101	9 432 610 059
NP-DN 4 PDN 103	9 432 611 999

NP-DN 4 PDN 117	9 432 610 222
NP-DN 4 PDN 154	9 432 612 712
NP-DN 4 PDN 160	9 432 612 873
NP-DN 5 PDN 155	9 432 612 713
NP-DN 10 PDN 129	9 432 610 294

NP-DN 10 PDN 130	9 432 610 295
NP-DN 10 PDN 135	9 432 610 478
NP-DN 15 PDN 100	9 432 610 006
NP-DN 15 PDN 111	9 432 610 080
NP-DN 15 PDN 157	9 432 612 822

NP-DN ... S ...

NP-DN 0 S 26	9 432 610 466
NP-DN 0 S 34	9 432 610 156
NP-DN 4 S 1 .M	9 432 611 698

NP-DN 4 S 1	9 432 610 036
NP-DN 4 S 2	9 432 611 645
NP-DN 4 S 3	9 432 611 646
NP-DN 4 S 162	9 432 611 979
NP-DN 4 S	9 432 610 000

NP-DN 6 S 197 NP1	9 432 611 697
NP-DN 6 S 197	9 432 610 058
NP-DN 6 S 241	9 432 611 983
NP-DN 8 S 1	9 432 611 972
NP-DN 8 S 2	9 432 611 976

NP-DN 8 S 142	9 432 611 977
NP-DN 15 S 2	9 432 611 973
NP-DN 15 S 156	9 432 611 705
NP-DN 30 S 1	9 432 611 974
NP-DN 30 S 2	9 432 611 975

NP-DN 40 S 2	9 432 611 978
--------------	----------------------



de

**Typformel →
Bestellnummer
für Zexel-Düsen**
(Fortsetzung)

en

**Type designation →
Part number
for Zexel nozzles**
(continued)

fr

**Formule de type →
Référence
pour injecteurs Zexel**
(suite)

it

**Sigla → Numero
d'ordinazione per
polverizzatori Zexel**
(seguito)

es

**Designación del tipo
→ Número de pedido
para inyectoros Zexel**
(continuación)

NP-DN 0 SD 21 NP1 ...



Typ



Ref.

NP-DN ... SD ...

NP-DN 0 SD 21 NP1	9 432 611 703
NP-DN 0 SD 21	9 432 610 001
NP-DN 0 SD 21	9 432 610 085

NP-DN 0 SD 126 A	9 432 610 010
NP-DN 0 SD 126	9 432 610 008
NP-DN 0 SD 130 NP3	9 432 610 151
NP-DN 0 SD 130 NP4	9 432 610 816
NP-DN 0 SD 130 NP5	9 432 611 630

NP-DN 0 SD 130	9 432 611 985
NP-DN 0 SD 131	9 432 610 467
NP-DN 0 SD 151	9 432 610 713
NP-DN 0 SD 193 NP2	9 432 610 026
NP-DN 0 SD 193 NP1	9 432 610 004

NP-DN 0 SD 193 NP1	9 432 610 040
NP-DN 0 SD 193 NP1	9 432 610 043
NP-DN 0 SD 193 NP1	9 432 610 067
NP-DN 0 SD 193	9 432 610 003
NP-DN 0 SD 211 NP2	9 432 610 076

NP-DN 0 SD 211	9 432 610 002
NP-DN 0 SD 212	9 432 610 438
NP-DN 0 SD 1550	9 432 611 988
NP-DN 0 SD 2110	9 432 610 007
NP-DN 0 SD 131-1	9 432 611 986

NP-DN 4 SD 20 NP1	9 432 611 989
NP-DN 4 SD 20	9 432 610 468
NP-DN 4 SD 24 NP80	9 432 610 034
NP-DN 4 SD 24 NP4	9 432 611 991
NP-DN 4 SD 24 NP2	9 432 611 987

NP-DN 4 SD 24 NP1	9 432 610 148
NP-DN 4 SD 24 N181	9 432 610 469
NP-DN 4 SD 24 +	9 432 610 037
NP-DN 4 SD 24	9 432 610 012
NP-DN 4 SD 65	9 432 610 060

NP-DN 4 SD 128	9 432 610 423
NP-DN 7 SD 64 NP4	9 432 611 632
NP-DN 7 SD 64 NP3	9 432 611 990
NP-DN 7 SD 64 N2	9 432 611 701
NP-DN 7 SD 64	9 432 610 009

NP-DN 8 SD 24 N6	9 432 610 069
NP-DN 12 SD 12 T	9 432 611 971
NP-DN 12 SD 175	9 432 610 096
NP-DN 12 SD 12-	9 432 610 038



Typ



Ref.

NP-DN ... SDN ...

NP-DN 0 SDN 10	9 432 610 112
NP-DN 0 SDN 177	9 432 610 021
NP-DN 0 SDN 184	9 432 610 014

NP-DN 0 SDN 186	9 432 610 090
NP-DN 0 SDN 187 -	9 432 610 230
NP-DN 0 SDN 187	9 432 610 011
NP-DN 0 SDN 187	9 432 610 023
NP-DN 0 SDN 196	9 432 610 160

NP-DN 0 SDN 199	9 432 610 292
NP-DN 0 SDN 203	9 432 611 637
NP-DN 0 SDN 220 S	9 432 610 355
NP-DN 0 SDN 220	9 432 610 205
NP-DN 0 SDN 221	9 432 610 363

NP-DN 0 SDN 222	9 432 610 471
NP-DN 0 SDN 224	9 432 610 251
NP-DN 0 SDN 226	9 432 610 385
NP-DN 0 SDN 228	9 432 610 407
NP-DN 0 SDN 229	9 432 610 391

NP-DN 4 SDN 2	9 432 610 219
NP-DN 4 SDN 223	9 432 610 269
NP-DN 4 SDN 225	9 432 611 631
NP-DN 4 SDN 230	9 432 610 472
NP-DN 12 SDN 188	9 432 610 470

NP-DN 12 SDN 189	9 432 610 048
NP-DN 30 SDN 180	9 432 610 005
NP-DN 40 SDN 4	9 432 610 419

NP-DN ... SDNK ...

NP-DN 15 SDNK 1	9 432 610 104
-----------------	---------------

NP-DN ... SDNP ...

NP-DN 0 SDNP 136	9 432 610 114
NP-DN 0 SDNP 184	9 432 611 993
NP-DN 4 SDNP 62	9 432 610 039

NP-DN 4 SDNP 90	9 432 610 031
NP-DN 4 SDNP 133	9 432 610 192
NP-DN 4 SDNP 135	9 432 610 220
NP-DN 4 SDNP 139	9 432 610 308
NP-DN 4 SDNP 142	9 432 610 365

... NP-DSL A 154 PN 082

 Typ	 Ref.
---	--

NP-DN 4 SDNP 146	9 432 610 234
NP-DN 15 SDNP 2	9 432 610 057
NP-DN 40 SDNP 32	9 432 610 113

NP-DN ... SN ...

NP-DN 0 SN 8	9 432 611 699
NP-DN 0 SN 9	9 432 611 980
NP-DN 0 SN 11	9 432 611 981

NP-DN 0 SN 12	9 432 611 982
NP-DN 0 SN 059	9 432 611 984
NP-DN 4 SN 8	9 432 610 444
NP-DN 20 SN 9	9 432 611 644

NP-DN ... SNP ...

NP-DN 4 SNP 3	9 432 610 044
---------------	----------------------

NP-DN ... T ...

NP-DN 4 T 208	9 432 611 995
---------------	----------------------

NP-DN ... TD ...

NP-DN 6 TD 119 NP2	9 432 611 998
NP-DN 6 TD 119 NP1T	9 432 610 274

NP-DN ... TDNP ...

NP-DN 0 TDNP 1	9 432 611 643
----------------	----------------------

NP-DN ... TN ...

NP-DN 12 TN 1	9 432 611 994
NP-DN 12 TN 2	9 432 611 642
NP-DN 12 TN 052	9 432 611 996

NP-DN 12 TN 053 C	9 432 611 997
NP-DN 1830	9 432 610 013
NP-DN S	9 432 611 702

 Typ	 Ref.
---	--

NP-DNZ ... SDN ...

NP-DNZ 0 SDN 202	9 432 610 105
------------------	----------------------

NP-DSL A ... PN ...

NP-DSL A 138 PN 938	9 432 612 871
NP-DSL A 140 PN 915	9 432 610 909
NP-DSL A 140 PN 935	9 432 612 839

NP-DSL A 140 PN 936	9 432 612 844
NP-DSL A 140 PN 940	9 432 612 970
NP-DSL A 145 PN 904	9 432 612 514
NP-DSL A 145 PN 905	9 432 610 913
NP-DSL A 145 PN 912	9 432 610 916

NP-DSL A 147 PN 900	9 432 610 905
NP-DSL A 147 PN 907	9 432 610 927
NP-DSL A 147 PN 919	9 432 610 621
NP-DSL A 147 PN 921	9 432 610 919
NP-DSL A 147 PN 933	9 432 612 861

NP-DSL A 147 PN 937	9 432 612 872
NP-DSL A 148 PN 928	9 432 610 924
NP-DSL A 148 PN 942	9 432 612 960
NP-DSL A 149 PN 901	9 432 610 329
NP-DSL A 149 PN 903	9 432 610 890

NP-DSL A 149 PN 941	9 432 612 956
NP-DSL A 150 PN 906	9 432 610 914
NP-DSL A 150 PN 909	9 432 610 614
NP-DSL A 150 PN 911	9 432 610 616
NP-DSL A 150 PN 923	9 432 610 920

NP-DSL A 150 PN 924	9 432 610 921
NP-DSL A 150 PN 925	9 432 610 922
NP-DSL A 150 PN 927	9 432 610 923
NP-DSL A 150 PN 930	9 432 612 891
NP-DSL A 150 PN 931	9 432 612 896

NP-DSL A 150 PN 932	9 432 612 907
NP-DSL A 150 PN 939	9 432 612 892
NP-DSL A 151 PN 917	9 432 610 619
NP-DSL A 152 PN 918	9 432 610 620
NP-DSL A 152 PN 929	9 432 612 764

NP-DSL A 153 PN 920	9 432 610 918
NP-DSL A 153 PN 934	9 432 612 828
NP-DSL A 154 PN 011	9 432 610 402
NP-DSL A 154 PN 016	9 432 611 317
NP-DSL A 154 PN 082	9 432 610 159



de

**Düsen für
1-Feder-Düsenhalter
von Zexel**

en

**Nozzles for the most
important single-
spring nozzle-holders
Zexel**

fr







**Injecteurs pour
les principaux porte-
injecteurs à 1 ressort
Zexel**

it

**Polvrizzatori per
i principali porta-
polverizzatori
a 1 molla, Zexel**

es

**Inyectores para
los portainyectores
de 1 muelle más
importantes, Zexel**







 Typ	 Ref.	 Zexel	 Ref.	 Typ	 Ref.
0001	9 430 615 051	105078-0001	9 430 610 061	NP-DN4PDN101	9 432 610 059
0002	9 430 615 644	105078-0002	9 430 610 397	NP-DN4PDN101	9 432 610 059
0002 J	9 430 615 644	105078-0002	9 430 610 401	NP-DN0PDN101	9 432 610 063
0003		105079-0003		NP-DN0PDN121	
0003	9 443 610 789	105079-0003	9 443 611 769	NP-DN0PDN121	9 432 610 199
0010	9 430 615 009	105078-0010	9 430 610 009	NP-DN15PDN100	9 432 610 006
0010	9 443 612 075	105079-0010	9 443 610 385	NP-DN0PDN121	9 432 610 199
0010 1	9 430 615 009	105078-0010	9 430 610 113	NP-DN0PDN112	9 432 610 062
0011	9 430 615 645	105078-0011	9 430 610 398	NP-DN15PDN100	9 432 610 006
0011 1	9 430 615 645	105078-0011	9 430 610 406	NP-DN0PDN112	9 432 610 062
0011 1	9 430 615 645	105078-0011	9 430 610 417	NP-DN0PDN112	9 432 610 062
0012	9 430 615 121	105078-0012	9 430 610 399	NP-DN15PDN100	9 432 610 006
0012 1	9 430 615 121	105078-0012	9 430 610 154	NP-DN0PDN112	9 432 610 062
0012 1	9 430 615 121	105078-0012	9 430 610 407	NP-DN0PDN112	9 432 610 062
0040		105078-0040		NP-DN0PDN102	9 432 610 063
0040		105078-0040		NP-DN0PDN102	9 432 610 063
0041	9 430 615 646	105078-0041		NP-DN0PDN102	
0041	9 430 615 646	105078-0041	9 430 610 402	NP-DN0PDN102	
0041	9 430 615 646	105078-0041	9 430 610 404	NP-DN0PDN102	
0041	9 430 615 646	105078-0041		NP-DN0PDN102	9 432 610 063
0041	9 430 615 646	105078-0041		NP-DN0PDN102	9 432 610 063
0050	9 430 615 042	105078-0050	9 430 610 405	NP-DN0PDN109	9 432 610 474
0050 T	9 430 615 042	105078-0050	9 430 613 540	NP-DN0PDN121	9 432 610 199
0050 A	9 430 615 042	105078-0050	9 430 610 432	NP-DN0PDN121	9 432 610 199
0050 A	9 430 615 042	105078-0050	9 430 610 433	NP-DN0PDN121	9 432 610 199
0050 B	9 430 615 042	105078-0050	9 430 610 048	NP-DN0PDN113	9 432 610 077
0050 B	9 430 615 042	105078-0050	9 430 610 065	NP-DN0PDN113	9 432 610 077
0050 B	9 430 615 042	105078-0050	9 430 613 538	NP-DN0PDN113	9 432 610 077
0050 B	9 430 615 042	105078-0050	9 430 613 539	NP-DN0PDN113	9 432 610 077
0050 C	9 430 615 042	105078-0050	9 430 610 425	NP-DN0PDN113	9 432 610 077
0050 L		105078-0050		NP-DN0PDN158	
0050 M	9 430 615 042	105078-0050	9 430 610 411	NP-DN0PDN121	9 432 610 199
0050 T	9 430 615 042	105078-0050		NP-DN0PDN121	9 432 610 199
0050 T	9 430 615 042	105078-0050	9 430 610 112	NP-DN0PDN121	9 432 610 199
0050 T	9 430 615 042	105078-0050	9 430 610 125	NP-DN0PDN121	9 432 610 199
0050 T	9 430 615 042	105078-0050	9 430 610 135	NP-DN0PDN121	9 432 610 199
0050 T	9 430 615 042	105078-0050	9 430 610 170	NP-DN0PDN121	9 432 610 199
0060		105078-0060		NP-DN0PDN114	9 432 610 236
0061	9 430 615 189	105078-0061	9 430 610 408	NP-DN0PDN114	9 432 610 236
0062	9 430 615 322	105078-0062	9 430 610 409	NP-DN0PDN114	9 432 610 236
0070	9 430 615 045	105078-0070	9 430 610 051	NP-DN15PDN111	9 432 610 080
0080	9 430 615 043	105078-0080	9 430 610 049	NP-DN0PDN102	9 432 610 063
0100		105078-0100			
0100		105078-0100		NP-DN4PDN117	
0100	9 430 615 105	105078-0100	9 430 610 172	NP-DN4PDN117	9 432 610 222









A130

de	en	fr	it	es
Düsen für 1-Feder-Düsenhalter von Zexel (Fortsetzung)	Nozzles for the most important single- spring nozzle-holders Zexel (continued)	Injecteurs pour les principaux porte- injecteurs à 1 ressort Zexel (suite)	Polvrizzatori per i principali porta- polverizzatori a 1 molla, Zexel (seguito)	Inyectores para los portainyectores de 1 muelle más importantes, Zexel (continuación)



						
0100 H		9 430 615 105	105078-0100	9 430 610 412	NP-DN4PDN117	9 432 610 222
0100 H			105078-0100		NP-DN4PDN117	
0110		9 430 615 077	105078-0110	9 430 610 088	NP-DN8SD32	9 432 610 199
0111		9 430 615 119	105078-0111	9 430 610 157	NP-DN0PDN121	9 432 610 199
0111		9 430 615 119	105078-0111	9 430 610 158	NP-DN0PDN121	9 432 610 199
0111		9 430 615 119	105078-0111	9 430 610 159	NP-DN0PDN121	9 432 610 199
0111		9 430 615 119	105078-0111	9 430 610 160	NP-DN0PDN121	9 432 610 199
0111		9 430 615 119	105078-0111	9 430 610 441	NP-DN0PDN121	9 432 610 199
0111 T		9 430 615 119	105078-0111	9 430 610 439	NP-DN0PDN137	9 432 610 454
0111 T		9 430 615 119	105078-0111	9 430 610 440	NP-DN0PDN137	9 432 610 454
0120		9 430 615 647	105078-0120	9 430 610 410	NP-DN4SD128	9 432 610 222
0140		9 430 615 648	105078-0140	9 430 610 414	NP-DN0PDN121	9 432 610 199
0150			105088-1130		NP-DN0PDN127	9 432 610 281
0150			105088-1130		NP-DN0PDN127	9 432 610 281
0150		9 430 615 097	105078-0150	9 430 610 123	NP-DN0PDN127	9 432 610 281
0150		9 430 615 102	105088-1130	9 430 610 140	NP-DN0PDN127	9 432 610 281
0150		9 430 615 097	105078-0150	9 430 610 418	NP-DN0PDN127	9 432 610 281
0150		9 430 615 097	105078-0150	9 430 610 419	NP-DN0PDN127	9 432 610 281
0150		9 430 615 097	105078-0150	9 430 610 415	NP-DN0PDN127	9 432 610 475
0160 A		9 430 615 377	105078-0160	9 430 610 403	NP-DN0PDN102	9 432 610 063
0171		9 430 615 190	105078-0171	9 430 610 416	NP-DN4PDN101	9 432 610 059
0180		9 430 615 116	105078-0180	9 430 610 120	NP-DN10PDN130	9 432 610 295
0180		9 430 615 116	105078-0180	9 430 610 423	NP-DN10PDN130	9 432 610 295
0180 04		9 430 615 116	105078-0180	9 430 610 119	NP-DN10PDN129	9 432 610 294
0180 27		9 430 615 116	105078-0180	9 430 610 421	NP-DN0PDN112	9 432 610 062
0180 A		9 430 615 116	105078-0180	9 430 610 429	NP-DN0PDN134	9 432 610 477
0181		9 430 615 127	105078-0181	9 430 610 179	NP-DN10PDN130	9 432 610 295
0181		9 430 615 127	105078-0181	9 430 610 424	NP-DN10PDN130	9 432 610 295
0181 P			105078-0181		NP-DN15PDN157	9 432 612 822
0181 98		9 430 615 127	105078-0181	9 430 613 543	NP-DN5PDN155	9 432 612 713
0181 44			105078-0181		NP-DN10PDN135	9 432 610 478
0181 04		9 430 615 127	105078-0181	9 430 610 420	NP-DN10PDN129	9 432 610 294
0181 04		9 430 615 127	105078-0181	9 430 610 445	NP-DN10PDN129	9 432 610 294
0181 27		9 430 615 127	105078-0181	9 430 610 422	NP-DN0PDN112	9 432 610 062
0181 44		9 430 615 127	105078-0181	9 430 610 435	NP-DN10PDN135	9 432 610 478
0181 A		9 430 615 127	105078-0181	9 430 610 430	NP-DN0PDN134	9 432 610 477
0181 A		9 430 615 127	105078-0181	9 430 613 149	NP-DN0PDN134	9 432 610 477
0181 G		9 430 615 127	105078-0181	9 430 610 444	NP-DN0PDN112	9 432 610 062
0181 G			105078-0181		NP-DN0PDN112	
0200		9 430 615 123	105078-0200	9 430 610 426	NP-DN0PDN133	9 432 610 327
0200 R			105078-0200		NP-DN4PDN154	
0210 B		9 430 615 523	105078-0210	9 430 610 427	NP-DN0PDN133	9 432 610 327
0211 V		9 430 615 191	105078-0211	9 430 613 154	NP-DN0PDN133	9 432 610 327
0211 W		9 430 615 191	105078-0211	9 430 613 148	NP-DN0PDN114	9 432 610 236
0211 B		9 430 615 191	105078-0211	9 430 610 428	NP-DN0PDN133	9 432 610 327

 Typ	 Ref.	 Zexel	 Ref.	 Typ	 Ref.
0211 R	9 430 615 191	105078-0211	9 430 613 428	NP-DN0PDN112	9 432 610 062
0211 S	9 430 615 191	105078-0211	9 430 610 443	NP-DN0PDN114	9 432 610 236
0211 V		105078-0211		NP-DN0PDN133	
0211 W		105078-0211		NP-DN0PDN114	
0211 X	9 430 615 191	105078-0211	9 430 610 446	NP-DN0PDN147	9 432 610 479
0211 V		105078-0211		NP-DN0PDN133	
0220 A	9 430 615 649	105078-0220	9 430 613 150	NP-DN0PDN149	9 432 611 640
0230	9 430 615 451	105078-0230	9 430 610 436	NP-DN0PDN133	9 432 610 327
0230 B		105078-0230		NP-DN4PDN154	
0230 B		105078-0230		NP-DN4PDN160	
0240		105078-0240		NP-DN0PDN131	9 432 610 310
0240		105078-0240		NP-DN0PDN131	9 432 610 310
0240	9 430 615 650	105078-0240	9 430 610 437	NP-DN0PDN131	9 432 610 310
0250		105078-0250		NP-DN0PDN131	9 432 610 310
0250		105078-0250		NP-DN0PDN131	9 432 610 310
0250	9 430 615 651	105078-0250	9 430 610 438	NP-DN0PDN131	9 432 610 310
0260 R	9 430 616 182	105078-0260	9 430 610 442	NP-DN0PDN112	9 432 610 062
0280	9 430 616 273	105078-0280	9 430 613 541	NP-DN4PDN154	9 432 612 712
0280	9 430 616 273	105078-0280	9 430 613 542	NP-DN4PDN154	9 432 612 712
0281 A		105078-0281		NP-DN4PDN154	9 432 612 712
0290		105078-0290		NP-DN0PDN121	9 432 610 199
0290		105078-0290		NP-DN0PDN158	9 432 612 795
0290 A		105078-0290		NP-DN0PDN158	
0290 A		105078-0290		NP-DN0PDN158	
0290 C		105078-0290		NP-DN0PDN159	
0290 C		105078-0290		NP-DN0PDN159	
0290 C		105078-0290		NP-DN0PDN159	
0290 E		105078-0290		NP-DN0PDN161	
0290 E		105078-0290		NP-DN0PDN161	
0290 E		105078-0290		NP-DN0PDN161	
0300 B		105078-0300		NP-DN4PDN117	
0300 B		105078-0300		NP-DN4PDN117	
0300 B		105078-0300		NP-DN4PDN117	
0300 B		105078-0300		NP-DN4PDN117	
1032 A		105079-1032	9 443 610 384	NP-DN0SDN221	9 432 610 363
1032 A	9 443 611 764	105079-1033	9 443 611 288	NP-DN0SDN221	9 432 610 363
1032 A	9 443 611 764	105079-1033	9 443 611 765	NP-DN0SDN221	9 432 610 363
1032 A	9 443 611 764	105079-1033	9 443 611 768	NP-DN0SDN221	9 432 610 363
1040	9 443 610 423	105079-1040	9 443 611 766	NP-DN0SDN221	9 432 610 363
1040 A		105079-1040		NP-DN0SDN229	
1040 A	9 443 610 423	105079-1040	9 443 611 767	NP-DN0SDN229	9 432 610 391
30-2000	9 430 616 116	105030-2000	9 430 610 729	NP-DN4SNP3	9 432 610 044
30-2010	9 430 615 443	105030-2010	9 430 610 577	NP-DLLA157SM177	9 432 610 665
30-2010 A	9 430 615 443	105030-2010	9 430 610 576	NP-DLLA157SM180	9 432 610 666
30-2010 B		105030-2010		NP-DLLA157SM319	9 432 611 623

A132

de

**Düsen für
1-Feder-Düsenhalter
von Zexel**

(Fortsetzung)

en

**Nozzles for the most
important single-
spring nozzle-holders
Zexel**

(continued)

fr

**Injecteurs pour
les principaux porte-
injecteurs à 1 ressort
Zexel**

(suite)

it

**Polvrizzatori per
i principali porta-
polverizzatori
a 1 molla, Zexel**







(seguito)







es

**Inyectores para
los portainyectores
de 1 muelle más
importantes, Zexel**

(continuación)



 Typ	 Ref.	 Zexel	 Ref.	 Typ	 Ref.
30-2010 C		105030-2010		NP-DLLA157SM438	
30-3000	9 430 616 110	105030-3000	9 430 611 050	NP-DLLA154S324N413	9 432 610 018
30-3010	9 430 616 111	105030-3010	9 430 611 052	NP-DLLA154S334N419	9 432 610 024
30-3020	9 430 616 112	105030-3020	9 430 611 054	NP-DLLA154S344N463	9 432 611 724
30-3030	9 430 616 101	105030-3030	9 430 611 056	NP-DLLA154SN641	9 432 610 823
30-3040	9 430 616 113	105030-3040	9 430 611 061	NP-DLLA154SN663	9 432 611 797
30-3080 A	9 430 615 762	105030-3080	9 430 611 352	NP-DLLA153SN707	9 432 610 193
30-3080 B	9 430 615 762	105030-3080	9 430 610 950	NP-DLLA154S304N474	9 432 610 025
30-3110	9 430 616 197	105030-3110	9 430 611 325	NP-DLLA154SN667	9 432 610 056
30-3120	9 430 615 317	105030-3120	9 430 610 825	NP-DLLA154S324N413	9 432 610 018
30-3120 A	9 430 615 317	105030-3120	9 430 611 349	NP-DLLA154S324N413	9 432 610 018
30-3130	9 430 616 063	105030-3130	9 430 610 856	NP-DLLA154S344N463	9 432 611 724
30-3140	9 430 616 064	105030-3140	9 430 610 858	NP-DLLA154S334N419	9 432 610 024
30-3160	9 430 616 198	105030-3160	9 430 611 022	NP-DLLA154SN631	9 432 611 775
30-3170	9 430 616 199	105030-3170	9 430 611 094	NP-DLLA150SN682	9 432 612 338
30-3170 A	9 430 616 199	105030-3170	9 430 611 098	NP-DLLA150SN695	9 432 611 254
30-3180	9 430 616 140	105030-3180	9 430 611 332	NP-DLLA155SN684	9 432 612 339
30-3180 A	9 430 616 140	105030-3180	9 430 611 333	NP-DLLA155SN685	9 432 612 340
30-3180 C	9 430 616 140	105030-3180	9 430 611 377	NP-DLLA155SN746	9 432 612 345
30-3200 J	9 430 616 065	105030-3200	9 430 611 410	NP-DLLA159SN792	9 432 610 844
30-3200 X	9 430 616 065	105030-3200	9 430 611 447	NP-DLLA156SN771	9 432 611 295
30-3201	9 430 615 106	105030-3201	9 430 611 051	NP-DLLA154S324N413	9 432 610 018
30-3201 2A	9 430 615 106	105030-3201	9 430 611 350	NP-DLLA154SN413	9 432 610 018
30-3201 2C	9 430 615 106	105030-3201	9 430 611 055	NP-DLLA154S344N463	9 432 611 724
30-3201 2J	9 430 615 106	105030-3201	9 430 611 326	NP-DLLA154SN667	9 432 610 056
30-3201 2N	9 430 615 106	105030-3201	9 430 610 871	NP-DLLA154S304N474	9 432 610 025
30-3201 2P	9 430 615 106	105030-3201	9 430 610 977	NP-DLLA154SN572	9 432 610 838
30-3201 2U	9 430 615 106	105030-3201	9 430 611 411	NP-DLLA159SN792	9 432 610 844
30-3201 2Z	9 430 615 106	105030-3201	9 430 611 381	NP-DLLA154SN586	9 432 610 245
30-3201 3	9 430 615 106	105030-3201	9 430 611 483	NP-DLLA149SN894	9 432 611 231
30-3201 3A	9 430 615 106	105030-3201	9 430 610 574	NP-DLLA150SM160	9 432 610 663
30-3201 3B	9 430 615 106	105030-3201	9 430 613 102	NP-DLLA155SM225	9 432 610 675
30-3201 4	9 430 615 106	105030-3201	9 430 611 495	NP-DLLA154SN903	9 432 610 722
30-3201 9	9 430 615 106	105030-3201	9 430 611 427	NP-DLLA150SN826	9 432 610 741
30-3201 A	9 430 615 106	105030-3201	9 430 610 996	NP-DLLA154SN586	9 432 610 245
30-3201 B	9 430 615 106	105030-3201	9 430 611 498	NP-DLLA154SN907	9 432 610 379
30-3201 C.	9 430 615 106	105030-3201	9 430 610 565	NP-DLLA154SN6060	9 432 610 095
30-3201 D	9 430 615 106	105030-3201	9 430 611 053	NP-DLLA154S334N419	9 432 610 024
30-3201 E	9 430 615 106	105030-3201	9 430 610 539	NP-DLLA148SM063	9 432 610 646
30-3201 G	9 430 615 106	105030-3201	9 430 611 385	NP-DLLA154SN752	9 432 611 247
30-3201 H	9 430 615 106	105030-3201	9 430 613 441	NP-DLLA151SM354	9 432 612 661
30-3201 K	9 430 615 106	105030-3201	9 430 611 409	NP-DLLA154SN791	9 432 610 344
30-3201 L	9 430 615 106	105030-3201	9 430 610 575	NP-DLLA155SM164	9 432 610 664
30-3201 M	9 430 615 106	105030-3201	9 430 610 530	NP-DLLA149SM055	9 432 610 642
30-3201 N	9 430 615 106	105030-3201	9 430 611 422	NP-DLLA158SN821	9 432 610 304

 Typ	 Ref.	 Zexel	 Ref.	 Typ	 Ref.
30-3201 R		105030-3201		NP-DLLA154SM178	
30-3201 S	9 430 615 106	105030-3201	9 430 610 588	NP-DLLA155SM225	9 432 610 675
30-3201 T	9 430 615 106	105030-3201	9 430 610 859	NP-DLLA154S334N419	9 432 610 024
30-3201 V	9 430 615 106	105030-3201	9 430 611 442	NP-DLLA151SN839	9 432 611 184
30-3201 W	9 430 615 106	105030-3201	9 430 610 826	NP-DLLA154S324N413	9 432 610 018
30-3201 X	9 430 615 106	105030-3201	9 430 611 448	NP-DLLA156SN771	9 432 611 295
30-3201 Z	9 430 615 106	105030-3201	9 430 610 986	NP-DLLA154S334N419	9 432 610 024
30-3210 3	9 430 615 752	105030-3210	9 430 611 482	NP-DLLA149SN894	9 432 611 231
30-3210 4	9 430 615 752	105030-3210	9 430 611 494	NP-DLLA154SN903	9 432 611 213
30-3210 5	9 430 615 752	105030-3210	9 430 611 497	NP-DLLA154SN907	9 432 611 207
30-3210 C	9 430 615 752	105030-3210	9 430 611 379	NP-DLLA150SN748	9 432 610 901
30-3210 E	9 430 615 752	105030-3210	9 430 611 380	NP-DLLA154SN586	9 432 610 245
30-3210 F	9 430 615 752	105030-3210	9 430 611 383	NP-DLLA154SN751	9 432 611 246
30-3210 G	9 430 615 752	105030-3210	9 430 611 384	NP-DLLA154SN752	9 432 611 247
30-3210 K	9 430 615 752	105030-3210	9 430 611 408	NP-DLLA154SN791	9 432 610 344
30-3210 N	9 430 615 752	105030-3210	9 430 611 421	NP-DLLA158SN821	9 432 610 304
30-3210 P	9 430 615 752	105030-3210	9 430 611 426	NP-DLLA150SN826	9 432 610 741
30-3210 V	9 430 615 752	105030-3210	9 430 611 441	NP-DLLA151SN839	9 432 611 184
30-3220 2	9 430 615 259	105030-3220	9 430 611 496	NP-DLLA160SN827	9 432 610 510
30-3220 E	9 430 615 259	105030-3220	9 430 611 387	NP-DLLA160S325N507	9 432 610 242
30-3221 2		105030-3221		NP-DLLA160SN827	9 432 610 510
30-3221 E		105030-3221		NP-DLLAS325N507	9 432 610 242
30-3231 2G	9 430 615 355	105030-3231	9 430 611 099	NP-DLLA150SN695	9 432 611 254
30-3231 2M	9 430 615 355	105030-3231	9 430 611 136	NP-DLLA156SN771	9 432 611 295
30-3231 M	9 430 615 355	105030-3231	9 430 611 602	NP-DLLA149SN914	9 432 611 406
30-3240	9 430 615 367	105030-3240	9 430 611 391	NP-DLLA160SN629	9 432 611 773
30-3240 B	9 430 615 367	105030-3240	9 430 611 434	NP-DLLA160SN838	9 432 611 197
30-3240 F		105030-3240		NP-DLLA160SM436	
30-3240 C		105030-3240		NP-DLLA160SM381	9 432 612 853
30-3240 G		105030-3240		NP-DLLA160SM445	
30-3250 H	9 430 616 067	105030-3250	9 430 611 397	NP-DLLA147SN703	9 432 610 752
30-3250 L	9 430 616 067	105030-3250	9 430 611 412	NP-DLLA149SN783	9 432 611 270
30-3250 M	9 430 616 067	105030-3250	9 430 611 419	NP-DLLA149SN819	9 432 611 249
30-3251 3B	9 430 615 284	105030-3251	9 430 611 420	NP-DLLA149SN819	9 432 611 249
30-3251 4E		105030-3251		NP-DLLA165SM419	9 432 612 847
30-3251 H	9 430 615 284	105030-3251	9 430 611 398	NP-DLLA147SN703	9 432 610 752
30-3251 L	9 430 615 284	105030-3251	9 430 611 413	NP-DLLA149SN783	9 432 611 270
30-3251 R	9 430 615 284	105030-3251	9 430 610 571	NP-DLLA165SM148	9 432 610 661
30-3260	9 430 615 369	105030-3260	9 430 611 407	NP-DLLA155SN787	9 432 611 272
30-3260 A	9 430 615 369	105030-3260	9 430 611 446	NP-DLLA155SN857	9 432 611 179
30-3270	9 430 616 200	105030-3270	9 430 611 431	NP-DLLA154SN834	9 432 611 190
30-3280 B	9 430 616 078	105030-3280	9 430 611 424	NP-DLLA158SN821	9 432 610 304
30-3290	9 430 616 069	105030-3290	9 430 611 443	NP-DLLA150SN855	9 432 611 177
30-3291 219	9 430 615 192	105030-3291	9 430 613 038	NP-DLLA150SN855	9 432 611 177
30-3291 A	9 430 615 192	105030-3291	9 430 611 444	NP-DLLA150SN855	9 432 611 177

A134

de

**Düsen für
1-Feder-Düsenhalter
von Zexel**

(Fortsetzung)

en

**Nozzles for the most
important single-
spring nozzle-holders
Zexel**

(continued)

fr

**Injecteurs pour
les principaux porte-
injecteurs à 1 ressort
Zexel**

(suite)

it

**Polvrizzatori per
i principali porta-
polverizzatori
a 1 molla, Zexel**







(seguito)







es

**Inyectores para
los portainyectores
de 1 muelle más
importantes, Zexel**

(continuación)



 Typ	 Ref.	 Zexel	 Ref.	 Typ	 Ref.
30-3300	9 430 616 062	105030-3300	9 430 611 537	NP-DLLA154SN861	9 432 611 182
30-3301 H	9 430 615 356	105030-3301	9 430 611 538	NP-DLLA154SN861	9 432 611 182
30-3330	9 430 615 193	105030-3330	9 430 611 543	NP-DLLA150SN866	9 432 611 216
30-3330 Y	9 430 615 193	105030-3330	9 430 611 580	NP-DLLA150SN904	9 432 611 204
30-3340	9 430 616 071	105030-3340	9 430 611 556	NP-DLLA150SN871	9 432 611 219
30-3340 P	9 430 616 071	105030-3340	9 430 611 575	NP-DLLA150SN901	9 432 612 360
30-3340 T	9 430 616 071	105030-3340	9 430 611 582	NP-DLLA160SN905	9 432 611 198
30-3350 2C	9 430 615 260	105030-3350	9 430 611 465	NP-DLLA160SN644	9 432 610 252
30-3350 2D	9 430 615 260	105030-3350	9 430 611 461	NP-DLLA157SN848	9 432 610 511
30-3350 4A	9 430 615 260	105030-3350	9 430 611 464	NP-DLLA160SN567	9 432 610 285
30-3350 5A	9 430 615 260	105030-3350	9 430 611 466	NP-DLLA150SN623	9 432 610 185
30-3350 5B	9 430 615 260	105030-3350	9 430 611 511	NP-DLLA150SN930	9 432 610 770
30-3350 5D	9 430 615 260	105030-3350	9 430 610 523	NP-DLLA157SN848	9 432 610 511
30-3350 5J	9 430 615 260	105030-3350	9 430 610 526	NP-DLLA160SM037	9 432 610 638
30-3350 5K	9 430 615 260	105030-3350	9 430 610 549	NP-DLLA160SM080	9 432 610 649
30-3350 5N	9 430 615 260	105030-3350	9 430 610 579	NP-DLLA157SM187	9 432 610 668
30-3350 6A	9 430 615 260	105030-3350	9 430 611 467	NP-DLLA157SN778	9 432 610 203
30-3350 6B	9 430 615 260	105030-3350	9 430 611 517	NP-DLLA154SN932	9 432 611 382
30-3351 A	9 430 615 133	105030-3531	9 430 611 710	NP-DLLA150SM292	9 432 610 859
30-3370	9 430 616 072	105030-3370	9 430 611 563	NP-DLLA150SN855	9 432 611 177
30-3380 4B	9 430 616 073	105030-3380	9 430 611 471	NP-DLLA160S324N486	9 432 610 176
30-3390 C	9 430 616 074	105030-3390	9 430 611 472	NP-DLLA160SN889	9 432 611 228
30-3390 E	9 430 616 074	105030-3390	9 430 611 478	NP-DLLA155SN707	9 432 610 193
30-3391 2V	9 430 615 178	105030-3391	9 430 610 951	NP-DLLA154S304N474	9 432 610 025
30-3391 3A	9 430 615 178	105030-3391	9 430 610 174	NP-DLLA154S284N393	9 432 610 051
30-3391 C	9 430 615 178	105030-3391	9 430 611 473	NP-DLLA160SN889	9 432 611 228
30-3391 E	9 430 615 178	105030-3391	9 430 611 479	NP-DLLA155SN707	9 432 610 193
30-3391 J	9 430 615 178	105030-3391	9 430 611 353	NP-DLLA155SN707	9 432 610 193
30-3400	9 430 616 075	105030-3400	9 430 611 567	NP-DLLA150SN871	9 432 611 219
30-3402	9 430 616 201	105030-3402	9 430 611 568	NP-DLLA150SN871	9 432 611 219
30-3420 1C	9 430 615 352	105030-3420	9 430 611 588	NP-DLLA160SN915	9 432 612 361
30-3420 2E	9 430 615 352	105030-3420	9 430 611 571	NP-DLLA160SN893	9 432 611 230
30-3431 A	9 430 615 332	105030-3431	9 430 611 487	NP-DLLA157SN920	9 432 611 373
30-3440	9 430 616 077	105030-3440	9 430 611 490	NP-DLLA144SN899	9 432 611 201
30-3441 D	9 430 615 373	105030-3441	9 430 611 491	NP-DLLA144SN899	9 432 611 201
30-3451 A	9 430 615 769	105030-3451	9 430 611 579	NP-DLLA150SN904	9 432 611 204
30-3460 A	9 430 616 052	105030-3460	9 430 611 596	NP-DLLA156SN919	9 432 611 372
30-3461	9 430 616 068	105030-3461	9 430 611 587	NP-DLLA156SN908	9 432 611 208
30-3461 A	9 430 616 068	105030-3461	9 430 611 597	NP-DLLA156SN919	9 432 611 372
30-3462 A	9 430 615 357	105030-3462	9 430 611 598	NP-DLLA156SN919	9 432 611 372
30-3471 C	9 430 616 045	105030-3471	9 430 611 599	NP-DLLA156SN921	9 432 611 374
30-3472 C	9 430 616 046	105030-3472	9 430 611 600	NP-DLLA156SN921	9 432 611 374
30-3473 A	9 430 615 770	105030-3473	9 430 611 601	NP-DLLA156SN921	9 432 611 374
30-3480	9 430 615 771	105030-3480	9 430 611 583	NP-DLLA155SN913	9 432 611 212
30-3480 B	9 430 615 771	105030-3480	9 430 611 557	NP-DLLA150SN871	9 432 611 219

 Typ	 Ref.	 Zexel	 Ref.	 Typ	 Ref.
30-3481 B	9 430 615 195	105030-3481	9 430 611 558	NP-DLLA150SN871	9 432 611 219
30-3481 L	9 430 615 195	105030-3481	9 430 611 584	NP-DLLA155SN913	9 432 611 212
30-3481 L	9 430 615 195	105030-3481	9 430 611 585	NP-DLLA155SN913	9 432 611 212
30-3482 241	9 430 615 196	105030-3482	9 430 613 025	NP-DLLA155SM913	9 432 611 212
30-3490	9 430 615 225	105030-3490	9 430 611 505	NP-DLLA160SN918	9 432 611 371
30-3490 A	9 430 615 225	105030-3490	9 430 611 510	NP-DLLA155SN926	9 432 610 738
30-3490 B	9 430 615 225	105030-3490	9 430 611 522	NP-DLLA155SN946	9 432 611 358
30-3500	9 430 615 431	105030-3500	9 430 611 603	NP-DLLA156SN928	9 432 611 379
30-3511	9 430 616 048	105030-3511	9 430 611 607	NP-DLLA155SN935	9 432 611 384
30-3520	9 430 615 197	105030-3520	9 430 611 523	NP-DLLA160SN947	9 432 611 378
30-3530	9 430 615 828	105030-3530	9 430 611 618	NP-DLLA150SN953	9 432 611 353
30-3530 C	9 430 615 828	105030-3530	9 430 611 646	NP-DLLA150SM034	9 432 610 791
30-3531 289	9 430 615 133	105030-3531	9 430 612 810	NP-DLLA150SM105	9 432 610 793
30-3531 308	9 430 615 133	105030-3531	9 430 612 826	NP-DLLA150SM176	9 432 612 639
30-3531 314	9 430 615 133	105030-3531	9 430 612 855	NP-DLLA158SM188	9 432 611 498
30-3531 315	9 430 615 133	105030-3531	9 430 612 854	NP-DLLA158SM189	9 432 611 499
30-3531 335	9 430 615 133	105030-3531	9 430 612 746	NP-DLLA150SM292	9 432 610 859
30-3531 336	9 430 615 133	105030-3531	9 430 612 860	NP-DLLA150SM293	9 432 611 574
30-3531 50	9 430 615 133	105030-3531	9 430 611 700	NP-DLLA153SM205	9 432 611 473
30-3531 B	9 430 615 133	105030-3531	9 430 611 711	NP-DLLA150SM293	9 432 611 574
30-3531 H	9 430 615 133	105030-3531	9 430 611 669	NP-DLLA150SM101	9 432 611 449
30-3531 K	9 430 615 133	105030-3531	9 430 611 647	NP-DLLA150SM034	9 432 610 791
30-3531 M	9 430 615 133	105030-3531	9 430 611 619	NP-DLLA150SN953	9 432 611 353
30-3531 Z	9 430 615 133	105030-3531	9 430 611 667	NP-DLLA150SM105	9 432 610 793
30-3540 A	9 430 615 285	105030-3540	9 430 611 698	NP-DLLA156SM200	9 432 611 470
30-3540 E	9 430 615 285	105030-3540	9 430 611 704	NP-DLLA156SM213	9 432 611 478
30-3540 R	9 430 615 285	105030-3540	9 430 611 623	NP-DLLA154SN972	9 432 610 906
30-3540 U	9 430 615 285	105030-3540	9 430 611 631	NP-DLLA154SM009	9 432 611 505
30-3550 5E	9 430 615 261	105030-3550	9 430 610 510	NP-DLLA145SN988	9 432 610 518
30-3550 5F	9 430 615 261	105030-3550	9 430 610 512	NP-DLLA145SN989	9 432 610 519
30-3550 6E	9 430 615 261	105030-3550	9 430 610 511	NP-DLLA145SM276	9 432 610 686
30-3550 6F	9 430 615 261	105030-3550	9 430 610 513	NP-DLLA145SM277	9 432 610 687
30-3560 C2	9 430 615 578	105030-3560	9 430 610 519	NP-DLLA155SN975	9 432 610 514
30-3570 H	9 430 616 049	105030-3570	9 430 611 626	NP-DLLA157SM014	9 432 611 502
30-3580 A	9 430 616 050	105030-3580	9 430 611 635	NP-DLLA152SM043	9 432 611 550
30-3581 J	9 430 615 198	105030-3581	9 430 611 636	NP-DLLA152SM043	9 432 611 550
30-3581 T	9 430 615 198	105030-3581	9 430 611 671	NP-DLLA152SM123	9 432 611 460
30-3590 C		105030-3590	9 430 611 637	NP-DLLA150SM018	9 432 610 809
30-3591 C	9 430 615 199	105030-3591	9 430 611 638	NP-DLLA150SM018	9 432 610 809
30-3601	9 430 615 200	105030-3601	9 430 611 627	NP-DLLA157SM036	9 432 610 884
30-3601 A	9 430 615 200	105030-3601	9 430 611 660	NP-DLLA155SM059	9 432 611 533
30-3611 E		105030-3611	9 430 611 648	NP-DLLA155SM062	9 432 611 534
30-3612 306	9 430 615 201	105030-3612	9 430 612 823	NP-DLLA155SM156	9 432 610 797
30-3612 E	9 430 615 201	105030-3612	9 430 611 649	NP-DLLA155SN062	9 432 611 534
30-3612 L1	9 430 615 201	105030-3612	9 430 611 689	NP-DLLA155SM156	9 432 610 797

de

**Düsen für
1-Feder-Düsenhalter
von Zexel**

(Fortsetzung)

en

**Nozzles for the most
important single-
spring nozzle-holders
Zexel**

(continued)

fr

**Injecteurs pour
les principaux porte-
injecteurs à 1 ressort
Zexel**

(suite)

it

**Polvrizzatori per
i principali porta-
polverizzatori
a 1 molla, Zexel**







(seguito)







es

**Inyectores para
los portainyectores
de 1 muelle más
importantes, Zexel**

(continuación)



 Typ	 Ref.	 Zexel	 Ref.	 Typ	 Ref.
30-3620 B	9 430 615 396	105030-3620	9 430 611 608	NP-DLLA155SN935	9 432 611 384
30-3630 D		105030-3630	9 430 611 658	NP-DLLA155SM052	9 432 611 557
30-3631 D	9 430 615 202	105030-3631	9 430 611 659	NP-DLLA155SM052	9 432 611 557
30-3660 4E	9 430 615 262	105030-3660	9 430 613 097	NP-DLLA154SM313	9 432 611 612
30-3660 4F	9 430 615 262	105030-3660	9 430 613 100	NP-DLLA151SM325	9 432 611 628
30-3660 4G		105030-3660		NP-DLLA157SM396	9 432 612 779
30-3660 4H		105030-3660		NP-DLLA157SM402	9 432 612 793
30-3660 4J		105030-3660		NP-DLLA157SM396	9 432 612 779
30-3660 4K		105030-3660		NP-DLLA157SM415	9 432 612 835
30-3660 5L	9 430 615 262	105030-3660	9 430 610 552	NP-DLLA160SM092	9 432 610 651
30-3670 296	9 430 615 203	105030-3670	9 430 612 754	NP-DLLA155SM157	9 432 610 795
30-3670 A2	9 430 615 203	105030-3670	9 430 611 672	NP-DLLA155SM124	9 432 611 461
30-3670 A3	9 430 615 203	105030-3670	9 430 611 673	NP-DLLA155SM135	9 432 611 430
30-3670 A4	9 430 615 203	105030-3670	9 430 611 674	NP-DLLA155SM157	9 432 610 795
30-3670 E	9 430 615 203	105030-3670	9 430 611 678	NP-DLLA155SM147	9 432 611 434
30-3670 E1	9 430 615 203	105030-3670	9 430 611 679	NP-DLLA150SM034	9 432 610 791
30-3680	9 430 615 204	105030-3680	9 430 610 562	NP-DLLA155SM126	9 432 610 656
30-3680	9 430 615 204	105030-3680	9 430 613 085	NP-DLLA155SM126	9 432 610 656
30-3680 C	9 430 615 204	105030-3680	9 430 612 738	NP-DLLA155SM194	9 432 610 782
30-3680 C	9 430 615 204	105030-3680	9 430 612 752	NP-DLLA155SM194	9 432 610 782
30-3690	9 430 615 579	105030-3690	9 430 610 564	NP-DLLA154S144W	9 432 610 691
30-3700	9 430 615 205	105030-3700	9 430 611 676	NP-DLLA157SM036	9 432 610 884
30-3700 A	9 430 615 205	105030-3700	9 430 611 694	NP-DLLA158SM193	9 432 611 465
30-3700 BA	9 430 615 205	105030-3700	9 430 611 695	NP-DLLA157SM197	9 432 611 467
30-3700 C	9 430 615 205	105030-3700	9 430 611 701	NP-DLLA155SM194	9 432 610 782
30-3700 E	9 430 615 205	105030-3700	9 430 611 696	NP-DLLA157SM197	9 432 611 467
30-3700 F	9 430 615 205	105030-3700	9 430 611 702	NP-DLLA155SM194	9 432 610 782
30-3700 F	9 430 615 205	105030-3700	9 430 612 737	NP-DLLA155SM194	9 432 610 782
30-3700 G	9 430 615 205	105030-3700	9 430 611 706	NP-DLLA157SM177	9 432 610 665
30-3700 J	9 430 615 205	105030-3700	9 430 611 697	NP-DLLA157SM273	9 432 610 767
30-3700 J	9 430 615 205	105030-3700	9 430 612 733	NP-DLLA157SM273	9 432 610 767
30-3700 K	9 430 615 205	105030-3700	9 430 612 857	NP-DLLA157SM319	9 432 611 623
30-3700 N		105030-3700		NP-DLLA157SM437	
30-3700 P		105030-3700		NP-DLLA157SM438	
30-3710	9 430 616 061	105030-3710	9 430 611 683	NP-DLLA150SM034	9 432 610 791
30-3711 218	9 430 615 402	105030-3711	9 430 612 859	NP-DLLA150SM310	9 432 611 629
30-3711 3	9 430 615 402	105030-3711	9 430 611 707	NP-DLLA150SM233	9 432 611 580
30-3711 300	9 430 615 402	105030-3711	9 430 612 824	NP-DLLA150SM034	9 432 610 791
30-3711 344	9 430 615 402	105030-3711	9 430 613 463	NP-DLLA152SM358	9 432 612 726
30-3711 361		105030-3711		NP-DLLA152SM414	9 432 612 837
30-3711 K	9 430 615 402	105030-3711	9 430 611 684	NP-DLLA150SM034	9 432 610 791
30-3720	9 430 615 403	105030-3720	9 430 611 686	NP-DLLA152SM043	9 432 611 550
30-3720 J	9 430 615 403	105030-3720	9 430 611 693	NP-DLLA152SM191	9 432 611 474
30-3730 2	9 430 615 404	105030-3730	9 430 611 712	NP-DLLA156SM295	9 432 610 803
30-3730 C	9 430 615 404	105030-3730	9 430 611 687	NP-DLLA150SM018	9 432 610 809







 Typ	 Ref.	 Zexel	 Ref.	 Typ	 Ref.
30-3740 D	9 430 615 444	105030-3740	9 430 611 699	NP-DLLA155SM052	9 432 611 557
30-3750 327	9 430 615 763	105030-3750	9 430 612 850	NP-DLLA150SM105	9 432 610 793
30-3760 A		105030-3760		NP-DLLA155SM427	
30-3770 332	9 430 615 831	105030-3770	9 430 612 751	NP-DLLA155SM316	9 432 610 894
30-3780 348	9 430 616 202	105030-3780	9 430 613 547	NP-DLLA157SM363	9 432 612 731
30-3790	9 430 616 203	105030-3790	9 430 613 464	NP-DLLA152SM369	9 432 612 737
30-4030	9 430 615 772	105030-4030	9 430 611 272	NP-DLLA160S354NP49	9 432 610 182
30-4040		105030-4040	9 430 611 114	NP-DLLA160SN715	
30-4041	9 430 616 042	105030-4041	9 430 611 115	NP-DLLA160SN720	9 432 611 264
30-4050		105030-4050	9 430 611 357	NP-DLLA160SN716	9 432 611 261
30-4051	9 430 615 254	105030-4051	9 430 611 358	NP-DLL160SN716	9 432 611 261
30-4051 A	9 430 615 254	105030-4051	9 430 611 403	NP-DLL160SN785	9 432 612 349
30-4051 B	9 430 615 254	105030-4051	9 430 611 331	NP-DLLA160SN683	9 432 611 791
30-4060	9 430 615 118	105030-4060	9 430 610 153	NP-DLLA142SN718	9 432 610 177
30-4070	9 430 616 054	105030-4070	9 430 611 359	NP-DLLA138SN719	9 432 611 263
30-4080 B	9 430 616 055	105030-4080	9 430 611 116	NP-DLLA160SN671	9 432 610 417
30-4090 G3	9 430 616 056	105030-4090	9 430 611 117	NP-DLLA149SN724	9 432 611 242
30-4100	9 430 615 134	105030-4100	9 430 611 360	NP-DLLA150SN722	9 432 610 238
30-4100 187	9 430 615 134	105030-4100	9 430 613 035	NP-DLLA150SN722	9 432 610 238
30-4100 C	9 430 615 345	105030-4110	9 430 611 151	NP-DLLA157SN617	9 432 611 779
30-4110 G	9 430 615 345	105030-4110	9 430 611 130	NP-DLLA155SN755	9 432 610 747
30-4110 K	9 430 615 345	105030-4110	9 430 611 126	NP-DLLA160SN744	9 432 610 727
30-4110 L	9 430 615 345	105030-4110	9 430 611 127	NP-DLLA155SN745	9 432 610 703
30-4110 T	9 430 615 345	105030-4110	9 430 611 132	NP-DLLA150SN761	9 432 611 288
30-4110 V	9 430 615 345	105030-4110	9 430 611 118	NP-DLLA150SN723	9 432 611 265
30-4120	9 430 615 773	105030-4120	9 430 611 110	NP-DLLA155SN727	9 432 610 840
30-4120 G	9 430 615 773	105030-4120	9 430 611 134	NP-DLLA145SN764	9 432 611 290
30-4130	9 430 615 263	105030-4130	9 430 611 124	NP-DLLA157SN741	9 432 611 234
30-4140 A	9 430 615 226	105030-4140	9 430 611 125	NP-DLLA155SN743	9 432 610 749
30-4140 A1	9 430 615 226	105030-4140	9 430 611 157	NP-DLLA155SN815	9 432 610 888
30-4140 A3	9 430 615 226	105030-4140	9 430 611 549	NP-DLLA150SN868	9 432 610 403
30-4140 A7	9 430 615 226	105030-4140	9 430 612 858	NP-DLLA155SM312	9 432 612 650
30-4140 C	9 430 615 226	105030-4140	9 430 611 565	NP-DLLA145SN888	9 432 611 227
30-4140 E	9 430 615 226	105030-4140	9 430 611 566	NP-DLLA145SN891	9 432 610 717
30-4140 E2	9 430 615 226	105030-4140	9 430 611 666	NP-DLLA150SM868	9 432 610 403
30-4150	9 430 616 057	105030-4150	9 430 611 128	NP-DLLA160SN747	9 432 611 244
30-4160	9 430 615 774	105030-4160	9 430 611 131	NP-DLLA150SN758	9 432 610 746
30-4170	9 430 615 397	105030-4170	9 430 611 144	NP-DLLA150SN758	9 432 610 746
30-4170 E	9 430 615 397	105030-4170	9 430 611 177	NP-DLLA150SN846	9 432 611 173
30-4180 A	9 430 615 438	105030-4180	9 430 611 404	NP-DLLA160S335N494	9 432 611 707
30-4180 I	9 430 615 438	105030-4180	9 430 611 450	NP-DLLA160SN863	9 432 611 170
30-4180 J	9 430 615 438	105030-4180	9 430 610 585	NP-DLLA160SM220	9 432 610 673
30-4180 K		105030-4180		NP-DLLA160SM404	9 432 612 798
30-4180 L		105030-4180		NP-DLLA160SM448	
30-4190 E2	9 430 615 323	105030-4190	9 430 611 147	NP-DLLA155SN789	9 432 611 274

A138

de	en	fr	it	es
Düsen für 1-Feder-Düsenhalter von Zexel (Fortsetzung)	Nozzles for the most important single- spring nozzle-holders Zexel (continued)	Injecteurs pour les principaux porte- injecteurs à 1 ressort Zexel (suite)	Polvrizzatori per i principali porta- polverizzatori a 1 molla, Zexel (seguito)	Inyectoros para los portainyectoros de 1 muelle más importantes, Zexel (continuación)



Typ	Ref.	Zexel	Ref.	Typ	Ref.
30-4190 E3	9 430 615 323	105030-4190	9 430 611 146	NP-DLLA155SN788	9 432 611 273
30-4190 E4	9 430 615 323	105030-4190	9 430 611 536	NP-DLLA155SN858	9 432 611 180
30-4190 E9	9 430 615 323	105030-4190	9 430 611 620	NP-DLLA155SN955	9 432 612 365
30-4190 N1	9 430 615 323	105030-4190	9 430 611 158	NP-DLLA157SN816	9 432 611 286
30-4200	9 430 616 058	105030-4200	9 430 611 150	NP-DLLA150SN802	9 432 611 276
30-4210	9 430 615 227	105030-4210	9 430 611 172	NP-DLLA148SN841	9 432 610 418
30-4210 F1	9 430 615 227	105030-4210	9 430 611 152	NP-DLLA143SN803	9 432 611 266
30-4210 F2	9 430 615 227	105030-4210	9 430 611 153	NP-DLLA149SN804	9 432 611 278
30-4210 F3	9 430 615 227	105030-4210	9 430 611 154	NP-DLLA143SN805	9 432 611 279
30-4210 F4	9 430 615 227	105030-4210	9 430 611 159	NP-DLLA151SN817	9 432 611 224
30-4210 F5	9 430 615 227	105030-4210	9 430 611 171	NP-DLLA150SN840	9 432 611 194
30-4210 F8	9 430 615 227	105030-4210	9 430 611 173	NP-DLLA153SN842	9 432 611 195
30-4210 F9	9 430 615 227	105030-4210	9 430 611 535	NP-DLLA150SN854	9 432 611 176
30-4210 H1	9 430 615 227	105030-4210	9 430 611 555	NP-DLLA153SN842	9 432 611 195
30-4210 H3	9 430 615 227	105030-4210	9 430 611 562	NP-DLLA143SN884	9 432 611 225
30-4210 H9	9 430 615 227	105030-4210	9 430 611 657	NP-DLLA150SN877	9 432 610 420
30-4220 F5	9 430 616 059	105030-4220	9 430 611 414	NP-DLLA149SN809	9 432 610 382
30-4230	9 430 616 060	105030-4230	9 430 611 416	NP-DLLA150SN811	9 432 611 282
30-4240	9 430 616 079	105030-4240	9 430 611 160	NP-DLLA150SN818	9 432 610 742
30-4250 6	9 430 615 346	105030-4250	9 430 611 574	NP-DLLA160SN895	9 432 611 232
30-4250 F	9 430 615 346	105030-4250	9 430 611 164	NP-DLLA160SN822	9 432 610 845
30-4250 F	9 430 615 346	105030-4250	9 430 611 163	NP-DLLA160SN822	9 432 612 357
30-4250 X	9 430 615 346	105030-4250	9 430 611 534	NP-DLLA160SN851	9 432 611 175
30-4260	9 430 616 043	105030-4260	9 430 611 423	NP-DLLA150SN818	9 432 610 742
30-4270		105030-4270	9 430 611 429	NP-DLLA150SN830	9 432 611 700
30-4271	9 430 615 179	105030-4271	9 430 611 430	NP-DLLA150SN830	9 432 611 700
30-4271 A	9 430 615 179	105030-4271	9 430 611 417	NP-DLLA150SN811	9 432 611 282
30-4271 B	9 430 615 179	105030-4271	9 430 610 925	NP-DLLA150S384NP73	9 432 610 142
30-4271 C	9 430 615 179	105030-4271	9 430 611 509	NP-DLLA150SN923	9 432 611 375
30-4271 E	9 430 615 179	105030-4271	9 430 611 063	NP-DLLA150SN666	9 432 610 293
30-4271 G	9 430 615 179	105030-4271	9 430 611 436	NP-DLLA150SN705	9 432 611 259
30-4280	9 430 616 204	105030-4280	9 430 611 432	NP-DLLA150SN835	9 432 611 191
30-4290 1A	9 430 615 347	105030-4290	9 430 611 178	NP-DLLA154SN847	9 432 610 702
30-4290 1B	9 430 615 347	105030-4290	9 430 611 550	NP-DLLA154SN847	9 432 610 702
30-4290 2A	9 430 615 347	105030-4290	9 430 611 532	NP-DLLA157SN848	9 432 610 511
30-4290 2B	9 430 615 347	105030-4290	9 430 611 551	NP-DLLA157SN848	9 432 610 511
30-4290 5C	9 430 615 347	105030-4290	9 430 611 612	NP-DLLA150SN623	9 432 610 185
30-4300	9 430 615 206	105030-4300	9 430 611 438	NP-DLLA150SN818	9 432 610 742
30-4300 C	9 430 615 206	105030-4300	9 430 611 449	NP-DLLA150SN859	9 432 611 181
30-4310 N2	9 430 615 324	105030-4310	9 430 611 439	NP-DLLA157SN816	9 432 611 286
30-4310 N3	9 430 615 324	105030-4310	9 430 611 468	NP-DLLA150SN883	9 432 611 214
30-4320	9 430 615 165	105030-4320	9 430 611 440	NP-DLLA158SN852	9 432 610 305
30-4320 B	9 430 615 165	105030-4320	9 430 610 558	NP-DLLA158SN995	9 432 610 521
30-4320 E	9 430 615 165	105030-4320	9 430 611 460	NP-DLLA158SN878	9 432 610 389
30-4320 F	9 430 615 165	105030-4320	9 430 611 524	NP-DLLA158SN949	9 432 610 367

 Typ	 Ref.	 Zexel	 Ref.	 Typ	 Ref.
30-4320 R	9 430 615 165	105030-4320	9 430 613 080	NP-DLLA158SM289	9 432 611 572
30-4320 S	9 430 615 165	105030-4320	9 430 613 109	NP-DLLA158SM290	9 432 611 573
30-4320 T	9 430 615 165	105030-4320	9 430 613 110	NP-DLLA158SM333	9 432 611 601
30-4320 U		105030-4320		NP-DLLA158SM241	9 432 610 677
30-4320 V		105030-4320		NP-DLLA158SM392	9 432 612 778
30-4320 W		105030-4320		NP-DLLA158SM417	9 432 612 838
30-4320 X		105030-4320		NP-DLLA158SM378	
30-4320 Y		105030-4320		NP-DLLA158SM392	
30-4330 A	9 430 616 141	105030-4330	9 430 611 393	NP-DLLA150SN775	9 432 610 744
30-4340	9 430 616 070	105030-4340	9 430 611 539	NP-DLLA150SN862	9 432 610 903
30-4340 A	9 430 616 070	105030-4340	9 430 611 552	NP-DLLA150SN870	9 432 611 218
30-4341	9 430 615 358	105030-4341	9 430 611 540	NP-DLLA150SN862	9 432 610 903
30-4341 A	9 430 615 358	105030-4341	9 430 611 553	NP-DLLA150SN870	9 432 611 218
30-4341 B	9 430 615 358	105030-4341	9 430 611 106	NP-DLLA150SN705	9 432 611 259
30-4341 C	9 430 615 358	105030-4341	9 430 611 632	NP-DLLA156SN919	9 432 611 372
30-4350 Y	9 430 616 092	105030-4350	9 430 611 451	NP-DLLA155SN864	9 432 611 193
30-4351 2W	9 430 615 286	105030-4351	9 430 611 452	NP-DLLA155SN864	9 432 611 193
30-4360 1	9 430 615 825	105030-4360	9 430 611 476	NP-DLLA154S284N393	9 432 610 051
30-4360 2	9 430 615 825	105030-4360	9 430 611 480	NP-DLLA154S334N419	9 432 610 024
30-4360 3	9 430 615 825	105030-4360	9 430 611 499	NP-DLLA154S304N474	9 432 610 025
30-4360 7	9 430 615 825	105030-4360	9 430 611 501	NP-DLLA155SN707	9 432 610 193
30-4360 S	9 430 615 825	105030-4360	9 430 611 453	NP-DLLA158SN869	9 432 610 266
30-4360 U	9 430 615 825	105030-4360	9 430 611 469	NP-DLLA158SN885	9 432 610 422
30-4361 1	9 430 615 287	105030-4361	9 430 611 477	NP-DLLA154S284N393	9 432 610 051
30-4361 2	9 430 615 287	105030-4361	9 430 611 481	NP-DLLA154S334N419	9 432 610 024
30-4361 6	9 430 615 287	105030-4361	9 430 610 181	NP-DLLA154S304N474	9 432 610 025
30-4361 6	9 430 615 287	105030-4361	9 430 611 500	NP-DLLA154S304N474	9 432 610 025
30-4361 7	9 430 615 287	105030-4361	9 430 611 502	NP-DLLA155SN707	9 432 610 193
30-4361 8	9 430 615 287	105030-4361	9 430 610 587	NP-DLLA154S304N474	9 432 610 025
30-4361 A	9 430 615 287	105030-4361	9 430 610 525	NP-DLLA153SM029	9 432 610 450
30-4361 S	9 430 615 287	105030-4361	9 430 611 454	NP-DLLA158SN869	9 432 610 266
30-4361 U	9 430 615 287	105030-4361	9 430 611 470	NP-DLLA158SN885	9 432 610 422
30-4370 0	9 430 616 093	105030-4370	9 430 611 544	NP-DLLA160SN822	9 432 612 357
30-4371 0	9 430 616 094	105030-4371	9 430 611 545	NP-DLLA160SN822	9 432 610 845
30-4380 A3	9 430 616 095	105030-4380	9 430 611 541	NP-DLLA150SN868	9 432 610 403
30-4380 A3	9 430 616 095	105030-4380	9 430 611 542	NP-DLLA150SN868	9 432 610 403
30-4390 K	9 430 615 793	105030-4390	9 430 611 564	NP-DLLA140SN887	9 432 611 226
30-4400	9 430 615 398	105030-4400	9 430 611 474	NP-DLLA142SN890	9 432 610 847
30-4410	9 430 615 207	105030-4410	9 430 611 489	NP-DLLA155SN898	9 432 611 200
30-4420	9 430 615 399	105030-4420	9 430 611 492	NP-DLLA150SN900	9 432 611 202
30-4430	9 430 615 333	105030-4430	9 430 611 581	NP-DLLA150SN859	9 432 611 181
30-4440	9 430 615 208	105030-4440	9 430 611 507	NP-DLLA160SN922	9 432 610 512
30-4440 B	9 430 615 208	105030-4440	9 430 610 520	NP-DLLA160SN922	9 432 610 512
30-4440 C	9 430 615 208	105030-4440	9 430 610 531	NP-DLLA160SM057	9 432 610 643
30-4450 3		105030-4450	9 430 611 591	NP-DLLA160SN895	9 432 611 232

A140

de

**Düsen für
1-Feder-Düsenhalter
von Zexel**

(Fortsetzung)

en

**Nozzles for the most
important single-
spring nozzle-holders
Zexel**
(continued)

fr

**Injecteurs pour
les principaux porte-
injecteurs à 1 ressort
Zexel**
(suite)







it







**Polvrizzatori per
i principali porta-
polverizzatori
a 1 molla, Zexel**
(seguito)

es

**Inyectores para
los portainyectores
de 1 muelle más
importantes, Zexel**
(continuación)



 Typ	 Ref.	 Zexel	 Ref.	 Typ	 Ref.
30-4451	9 430 615 348	105030-4451	9 430 611 621	NP-DLLA157SN940	9 432 611 388
30-4451	9 430 615 348	105030-4451	9 430 611 622	NP-DLLA157SN940	9 432 611 388
30-4451 3	9 430 615 348	105030-4451	9 430 611 592	NP-DLLA157SN940	9 432 611 388
30-4461 4	9 430 615 349	105030-4461	9 430 611 593	NP-DLLA160SN822	9 432 610 845
30-4470 2N	9 430 616 097	105030-4470	9 430 611 503	NP-DLLA157SN816	9 432 611 286
30-4480 F6	9 430 616 098	105030-4480	9 430 611 504	NP-DLLA150SN843	9 432 611 196
30-4490		105030-4490	9 430 611 515	NP-DLLA150SN705	9 432 611 259
30-4492	9 430 615 359	105030-4492	9 430 611 516	NP-DLLA150SN705	9 432 611 259
30-4492 A	9 430 615 359	105030-4492	9 430 613 094	NP-DLLA153SM331	9 432 611 599
30-4500	9 430 615 433	105030-4500	9 430 611 521	NP-DLLA155SN939	9 432 612 362
30-4510 9	9 430 615 264	105030-4510	9 430 611 624	NP-DLLA157SN980	9 432 611 417
30-4510 R	9 430 615 264	105030-4510	9 430 611 176	NP-DLLA157SN944	9 432 610 893
30-4520	9 430 615 379	105030-4520	9 430 611 613	NP-DLLA142S344N547	9 432 610 072
30-4530	9 430 615 432	105030-4530	9 430 611 614	NP-DLLA150SN948	9 432 612 364
30-4540 H4	9 430 615 228	105030-4540	9 430 611 529	NP-DLLA146SN886	9 432 610 846
30-4540 H5	9 430 615 228	105030-4540	9 430 611 525	NP-DLLA161SN951	9 432 611 351
30-4540 H7	9 430 615 228	105030-4540	9 430 610 509	NP-DLLA161SN984	9 432 610 517
30-4540 H8	9 430 615 228	105030-4540	9 430 610 527	NP-DLLA158SM039	9 432 610 639
30-4540 K1	9 430 615 228	105030-4540	9 430 610 550	NP-DLLA161SM085	9 432 610 650
30-4540 K3	9 430 615 228	105030-4540	9 430 610 568	NP-DLLA155SM140	9 432 610 659
30-4550	9 430 616 108	105030-4550	9 430 611 527	NP-DLLA155SN967	9 432 610 513
30-4551	9 430 615 580	105030-4551	9 430 611 528	NP-DLLA155SN967	9 432 610 513
30-4551 A	9 430 615 580	105030-4551	9 430 610 560	NP-DLLA155SN967	9 432 610 513
30-4560 C1	9 430 615 229	105030-4560	9 430 611 531	NP-DLLA140SN982	9 432 610 515
30-4560 C1	9 430 615 229	105030-4560	9 430 611 530	NP-DLLA140SN982	9 432 612 370
30-4560 F4	9 430 615 229	105030-4560	9 430 610 580	NP-DLLA145SM198	9 432 610 669
30-4571 J5	9 430 615 230	105030-4571	9 430 610 508	NP-DLLA160SN983	9 432 610 516
30-4571 U8	9 430 615 230	105030-4571	9 430 610 563	NP-DLLA152SM127	9 432 610 657
30-4580 Z	9 430 615 410	105030-4580	9 430 611 625	NP-DLLA150SN987	9 432 611 421
30-4581 Z		105030-4581		NP-DLLA150SN987	
30-4591 4M	9 430 615 209	105030-4591	9 430 610 514	NP-DLLA150SN998	9 432 610 522
30-4601 6T	9 430 615 210	105030-4601	9 430 610 516	NP-DDLA150SM000	9 432 610 634
30-4601 6T	9 430 615 210	105030-4601	9 430 610 517	NP-DLLA150SM000	9 432 610 635
30-4601 6V	9 430 615 210	105030-4601	9 430 610 515	NP-DDLA150SN999	9 432 610 523
30-4610	9 430 615 288	105030-4610	9 430 611 628	NP-DLLA152SM005	9 432 612 614
30-4610 A	9 430 615 288	105030-4610	9 430 611 629	NP-DLLA153SM007	9 432 612 615
30-4610 B	9 430 615 288	105030-4610	9 430 611 630	NP-DLLA156SM008	9 432 610 852
30-4620	9 430 615 255	105030-4620	9 430 610 518	NP-DLLA158SN995	9 432 610 521
30-4620 A	9 430 615 255	105030-4620	9 430 610 561	NP-DLLA158SN852	9 432 610 305
30-4640	9 430 615 441	105030-4640	9 430 610 524	NP-DLLA160SM032	9 432 610 637
30-4650	9 430 615 381	105030-4650	9 430 611 640	NP-DLLA156SM008	9 432 610 852
30-4650 C	9 430 615 381	105030-4650	9 430 611 680	NP-DLLA154SM150	9 432 611 436
30-4650 C	9 430 615 381	105030-4650	9 430 611 681	NP-DLLA154SM150	9 432 611 436
30-4650 L	9 430 615 381	105030-4650	9 430 611 641	NP-DLLA156SM008	9 432 610 852
30-4650 L	9 430 615 381	105030-4650	9 430 611 642	NP-DLLA156SM008	9 432 610 852

 Typ	 Ref.	 Zexel	 Ref.	 Typ	 Ref.
30-4651 C	9 430 615 382	105030-4651	9 430 611 682	NP-DLLA154SM150	9 432 611 436
30-4651 L	9 430 615 382	105030-4651	9 430 611 643	NP-DLLA156SM008	9 432 610 852
30-4660	9 430 615 289	105030-4660	9 430 611 644	NP-DLLA152SM005	9 432 611 521
30-4660 H	9 430 615 289	105030-4660	9 430 611 645	NP-DLLA152SM005	9 432 611 521
30-4670 A	9 430 615 452	105030-4670	9 430 610 528	NP-DLLA155SM050	9 432 610 640
30-4680		105030-4680	9 430 611 650	NP-DLLA150SM040	9 432 611 547
30-4680 A		105030-4680	9 430 611 651	NP-DLLA155SM045	9 432 610 786
30-4681 A	9 430 615 211	105030-4681	9 430 611 652	NP-DLLA155SM045	9 432 610 786
30-4682 279	9 430 616 103	105030-4682	9 430 612 844	NP-DLLA155SM045	9 432 610 786
30-4682 A	9 430 616 103	105030-4682	9 430 611 653	NP-DLLA155SM045	9 432 610 786
30-4700	9 430 615 290	105030-4700	9 430 610 532	NP-DLLA158SM053	9 432 610 641
30-4700 B	9 430 615 290	105030-4700	9 430 610 553	NP-DLLA148SM098	9 432 610 652
30-4700 B	9 430 615 290	105030-4700	9 430 610 554	NP-DLLA148SM098	9 432 610 652
30-4700 P	9 430 615 290	105030-4700	9 430 610 535	NP-DLLA156SM058	9 432 610 644
30-4700 P	9 430 615 290	105030-4700	9 430 610 536	NP-DLLA156SM058	9 432 610 644
30-4700 R	9 430 615 290	105030-4700	9 430 610 533	NP-DLLA158SM053	9 432 610 641
30-4700 R	9 430 615 290	105030-4700	9 430 610 534	NP-DLLA158SM053	9 432 610 641
30-4700 X	9 430 615 290	105030-4700	9 430 610 555	NP-DLLA158SM100	9 432 610 653
30-4700 X	9 430 615 290	105030-4700	9 430 610 556	NP-DLLA158SM100	9 432 610 653
30-4710		105030-4710	9 430 611 661	NP-DLLA155SM066	9 432 610 850
30-4710 A		105030-4710	9 430 611 663	KP-DLLA155SM066	9 432 612 681
30-4711 B	9 430 615 442	105030-4711	9 430 611 662	NP-DLLA155SM066	9 432 610 850
30-4711 B	9 430 615 442	105030-4711	9 430 611 664	NP-DLLA155SM066	9 432 612 681
30-4711 C	9 430 615 442	105030-4711	9 430 611 705	NP-DLLA146SM224	9 432 610 799
30-4711 E	9 430 615 442	105030-4711	9 430 611 708	NP-DLLA146SM285	9 432 612 648
30-4711 F	9 430 615 442	105030-4711	9 430 611 709	NP-DLLA146SM291	9 432 612 649
30-4711 G		105030-4711		NP-DLLA146SM424	
30-4720	9 430 615 581	105030-4720	9 430 610 537	NP-DLLA155SM061	9 432 610 645
30-4720 A	9 430 615 581	105030-4720	9 430 610 540	NP-DLLA155SM067	9 432 610 647
30-4721	9 430 615 425	105030-4721	9 430 610 538	NP-DLLA155SM061	9 432 610 645
30-4721	9 430 615 425	105030-4721	9 430 610 543	KP-DLLA155SM061	9 432 610 689
30-4721 A	9 430 615 425	105030-4721	9 430 610 541	NP-DLLA155SM067	9 432 610 647
30-4721 A	9 430 615 425	105030-4721	9 430 610 542	KP-DLLA155SM067	9 432 610 688
30-4730	9 430 615 212	105030-4730	9 430 610 548	NP-DLLA150SM078	9 432 610 648
30-4750	9 430 615 291	105030-4750	9 430 610 551	NP-DLLA153SM029	9 432 610 450
30-4750 J	9 430 615 291	105030-4750	9 430 612 732	NP-DLLA149SM304	9 432 610 764
30-4750 L	9 430 615 291	105030-4750	9 430 613 098	NP-DLLA150SM323	9 432 611 627
30-4750 M	9 430 615 291	105030-4750	9 430 613 099	NP-DLLA150SM323	9 432 611 627
30-4750 N	9 430 615 291	105030-4750	9 430 613 104	NP-DLLA141SM346	9 432 611 610
30-4750 N	9 430 615 291	105030-4750	9 430 613 462	NP-DLLA141SM373	9 432 612 711
30-4750 P	9 430 615 291	105030-4750	9 430 613 548	NP-DLLA155SM372	9 432 612 740
30-4750 R		105030-4750		NP-DLLA155SM386	9 432 612 757
30-4790	9 430 615 213	105030-4790	9 430 611 668	NP-DLLA155SM106	9 432 611 451
30-4810 E7	9 430 616 104	105030-4810	9 430 611 677	NP-DSLA155SN136	9 432 611 431
30-4820 E4	9 430 615 386	105030-4820	9 430 610 572	NP-DLLA155SM102	9 432 610 654

A142

de

**Düsen für
1-Feder-Düsenhalter
von Zexel**

(Fortsetzung)

en

**Nozzles for the most
important single-
spring nozzle-holders
Zexel**

(continued)

fr

**Injecteurs pour
les principaux porte-
injecteurs à 1 ressort
Zexel**

(suite)

it

**Polvrizzatori per
i principali porta-
polverizzatori
a 1 molla, Zexel**







(seguito)







es

**Inyectoros para
los portainyectoros
de 1 muelle más
importantes, Zexel**

(continuación)



						
30-4830	E8	9 430 615 231	105030-4830	9 430 611 688	NP-DLLA155SM151	9 432 611 437
30-4840		9 430 615 405	105030-4840	9 430 610 573	NP-DLLA155SM158	9 432 610 662
30-4840	347		105030-4840		NP-DLLA155SM158	9 432 610 662
30-4850		9 430 615 406	105030-4850	9 430 611 690	NP-DLLA150SM170	9 432 610 886
30-4850	A	9 430 615 406	105030-4850	9 430 611 691	NP-DLLA150SM170	9 432 610 886
30-4860	F5	9 430 615 387	105030-4860	9 430 610 582	NP-DLLA150SM206	9 432 610 671
30-4860	G1	9 430 615 387	105030-4860	9 430 610 586	NP-DLLA150SM221	9 432 610 674
30-4870	F7	9 430 615 582	105030-4870	9 430 610 583	NP-DLLA140SM218	9 432 610 672
30-4880	F6	9 430 615 388	105030-4880	9 430 610 584	NP-DLLA140SN982	9 432 610 515
30-4890	G5	9 430 615 389	105030-4890	9 430 610 589	NP-DLLA150SM234	9 432 610 676
30-4900		9 430 615 583	105030-4900	9 430 610 590	NP-DLLA158SM241	9 432 610 677
30-4900	A	9 430 615 583	105030-4900	9 430 610 591	NP-DLLA157SM242	9 432 610 678
30-4900	B	9 430 615 583	105030-4900	9 430 610 592	NP-DLLA155SM243	9 432 610 679
30-4910		9 430 615 584	105030-4910	9 430 610 593	NP-DLLA160SM244	9 432 610 680
30-4920		9 430 615 585	105030-4920	9 430 610 594	NP-DLLA160SM245	9 432 610 681
30-4930		9 430 615 586	105030-4930	9 430 610 595	NP-DLLA160SM248	9 432 610 682
30-4930	A	9 430 615 586	105030-4930	9 430 610 596	NP-DLLA160SM247	9 432 610 683
30-4930	B	9 430 615 586	105030-4930	9 430 610 597	NP-DLLA160SM248	9 432 610 684
30-4960		9 430 616 187	105030-4960	9 430 613 103	NP-DLLA155SM336	9 432 611 604
30-4980	6D		105030-4980		NP-DLLA150SM122	9 432 610 655
30-4980	A		105030-4980		NP-DLLAS325N507	9 432 610 242
30-4980	C		105030-4980		NP-DLLA160SN731	9 432 610 170
30-4980	H		105030-4980		NP-DLLA160SN827	9 432 610 510
30-4980	N		105030-4980		NP-DLLA160SN844	9 432 611 171
30-4980	Q		105030-4980		NP-DLLA160SN658	9 432 611 796
30-4980	S		105030-4980		NP-DLLA160SN850	9 432 611 174
30-4980	T		105030-4980		NP-DLLA157SN544	9 432 611 819
30-4980	Y		105030-4980		NP-DLLA157SN551	9 432 611 810
30-4990			105030-4990		NP-DLLA150S344NP82	
30-4990	4		105030-4990		NP-DLLA160S325N507	9 432 610 242
30-4990	5C		105030-4990		NP-DLLA160SN827	9 432 610 510
30-4990	6C		105030-4990		NP-DLLA150SM122	9 432 610 655
30-4990	A		105030-4990		NP-DLLA160S354NP88	
30-4990	F		105030-4990		NP-DLLA160S324N486	
30-4990	K		105030-4990		NP-DLLA158S325N437	9 432 610 190
30-4990	M		105030-4990		NP-DLLA160S325N507	
30-4990	N		105030-4990		NP-DLLA158S325N407	
30-4990	P		105030-4990		NP-DLLA154S374N438	
30-4990	Q		105030-4990		NP-DLLA160S295N422	
30-4990	W		105030-4990		NP-DLLA155S365N458	9 432 610 345
30-4990	Z		105030-4990		NP-DLLA160S324N486	
30-5000	9		105030-5000		NP-DLLA157SN980	9 432 611 417
30-5000	R		105030-5000		NP-DLLA157SN944	9 432 610 893
30-5010	1D		105030-5010		NP-DLLA157SM143	
30-5010	D		105030-5010		NP-DLLA154SN533	

 Typ	 Ref.	 Zexel	 Ref.	 Typ	 Ref.
30-5010 I		105030-5010		NP-DLLA160SN539	
30-5020 2C		105030-5020		NP-DLLA160SM056	
30-5020 L		105030-5020		NP-DLLA150SN637	
30-5020 N		105030-5020		NP-DLLA150SN615	
30-5020 V		105030-5020		NP-DLLA157SN584	
30-5030 C		105030-5030		NP-DLLA160SM381	
30-5040 K		105030-5040		NP-DLLA160SM404	
30-5050 A		105030-5050		NP-DLLA155SM435	
31-1050	9 430 616 205	105031-1050	9 430 611 202	NP-DN7SD64	9 432 610 009
31-1050 M	9 430 616 205	105031-1050	9 430 611 191	NP-DN7SD64N2	9 432 611 701
31-1120	9 430 616 107	105031-1120	9 430 611 229	NP-DN0SD130NP3	9 432 610 151
31-1120 A	9 430 616 107	105031-1120	9 430 611 225	NP-DN7SD64NP4	9 432 611 632
31-1270		105031-1270	9 430 611 179	NP-DN4S1	9 432 610 036
31-1330	9 430 615 000	105031-1330	9 430 610 000	NP-DN481	9 432 610 000
31-1330 A	9 430 615 000	105031-1330	9 430 611 193	NP-DN0SD126	9 432 610 008
31-1380		105031-1380	9 430 611 180	NP-DN4S1	9 432 610 036
31-1400 J22	9 430 616 136	105031-1400	9 430 611 241	NP-DLA110S602NP10	9 432 612 013
31-1400 J34	9 430 616 136	105031-1400	9 430 611 242	NP-DLA110S802NP10	9 432 612 014
31-1400 J40	9 430 616 136	105031-1400	9 430 611 243	NP-DLA110S902NP10	9 432 612 015
31-1420	9 430 615 799	105031-1420	9 430 611 209	NP-DN7SD64NP4	9 432 611 632
31-1460	9 430 615 794	105031-1460	9 430 611 274	NP-DLLA120S354NP39	9 432 612 309
31-1470		105031-1470	9 430 611 275	NP-DLLA150S344NP51	9 432 610 172
31-1470 10		105031-1470	9 430 611 279	NP-DLLA158S305NP53	
31-1480		105031-1480	9 430 611 244	NP-DLA110S602NP10	9 432 612 013
31-1490 J23	9 430 615 546	105031-1490	9 430 611 245	NP-DLA110S602NP10	9 432 612 013
31-1490 J34	9 430 615 546	105031-1490	9 430 611 246	NP-DLA110S802NP10	9 432 612 014
31-1490 J40	9 430 615 546	105031-1490	9 430 611 247	NP-DLA110S902NP10	9 432 612 015
31-1500	9 430 616 130	105031-1500	9 430 611 183	NP-DN4S1	9 432 611 698
31-1510	9 430 616 131	105031-1510	9 430 611 185	NP-DN4SL	9 432 611 698
31-1520	9 430 616 086	105031-1520	9 430 611 207	NP-DN0SD21	9 432 610 001
31-1530	9 430 616 134	105031-1530	9 430 611 208	NP-DN7SD64NP4	9 432 611 632
31-1540	9 430 615 800	105031-1540	9 430 611 211	NP-DN7SD64NP4	9 432 611 632
31-1540 A	9 430 615 800	105031-1540	9 430 611 210	NP-DN7SD64	9 432 610 009
31-1550	9 430 616 100	105031-1550	9 430 611 213	NP-DN0SD126	9 432 610 008
31-1560		105031-1560	9 430 611 304	NP-DLLA156S344NP55	9 432 611 932
31-1580	9 430 616 080	105031-1580	9 430 611 214	NP-DN7SD64NP4	9 432 611 632
31-1580 A	9 430 616 080	105031-1580	9 430 611 220	NP-DN7SD64N2	9 432 611 701
31-1590		105031-1590	9 430 611 215	NP-DN0S34	9 432 610 156
31-1600		105031-1600	9 430 611 217	NP-DN0S34	9 432 610 156
31-1610	9 430 615 015	105031-1610	9 430 610 011	NP-DN0SD126	9 432 610 008
31-1620		105031-1620	9 430 611 219	NP-DN0S34	9 432 610 156
31-1630 L		105031-1630	9 430 610 748	NP-DLLA154S344NP95	
31-1630 LA		105031-1630	9 430 610 795	NP-DLLA154S344N421	
31-1630 LB		105031-1630	9 430 610 800	NP-DLLA154S344N424	9 432 611 754
31-1630 TA		105031-1630	9 430 610 756	NP-DLLA154S364N382	9 432 611 748

A144

de

**Düsen für
1-Feder-Düsenhalter
von Zexel**

(Fortsetzung)

en

**Nozzles for the most
important single-
spring nozzle-holders
Zexel**

(continued)

fr

**Injecteurs pour
les principaux porte-
injecteurs à 1 ressort
Zexel**

(suite)

it

**Polvrizzatori per
i principali porta-
polverizzatori
a 1 molla, Zexel**







(seguito)







es

**Inyectores para
los portainyectores
de 1 muelle más
importantes, Zexel**

(continuación)



 Typ	 Ref.	 Zexel	 Ref.	 Typ	 Ref.
31-1640		105031-1640	9 430 611 282	NP-DLLA156S344NP55	9 432 611 932
31-1660		105031-1660	9 430 611 222	NP-DN12SD175	9 432 610 096
31-1670		105031-1670	9 430 610 805	NP-DLLA154S344N428	9 432 611 760
31-1680	9 430 615 090	105031-1680	9 430 610 103	NP-DN12SD175	9 432 610 096
31-1690	9 430 615 801	105031-1690	9 430 611 226	NP-DN7SD64NP4	9 432 611 632
31-1700	9 430 616 081	105031-1700	9 430 611 227	NP-DN0SD130NP3	9 432 610 151
31-1710		105031-1710	9 430 610 873	NP-DLLA154S364N476	9 432 610 097
31-1720		105031-1720	9 430 610 918	NP-DLLA154S364N476	9 432 610 097
31-1740	9 430 615 775	105031-1740	9 430 611 001	NP-DLLA154SN625	9 432 610 319
31-1740 A	9 430 615 775	105031-1740	9 430 611 014	NP-DLLA154S344N424	9 432 611 754
31-1741 N	9 430 615 292	105031-1741	9 430 611 002	NP-DLLA154SN625	9 432 610 319
31-1741 P	9 430 615 292	105031-1741	9 430 611 395	NP-DLLA154SN665	9 432 611 798
31-1750 A	9 430 616 082	105031-1750	9 430 611 276	NP-DLLA150S344NP51	9 432 610 172
31-1751 B	9 430 616 083	105031-1751	9 430 610 875	NP-DLLA154S364N476	9 432 610 097
31-1751 L	9 430 616 083	105031-1751	9 430 611 277	NP-DLLA150S344NP51	9 432 610 172
31-1751 M	9 430 616 083	105031-1751	9 430 610 919	NP-DLLA154S364N476	9 432 610 097
31-1770	9 430 616 206	105031-1770	9 430 611 305	NP-DLLA156S344NP55	9 432 611 932
31-1780 A	9 430 616 085	105031-1780	9 430 610 943	NP-DLLA160SN518	9 432 611 744
31-1780 LB	9 430 616 085	105031-1780	9 430 610 801	NP-DLLA154S344N424	9 432 611 754
31-1780 TA	9 430 616 085	105031-1780	9 430 610 757	NP-DLLA154S364N382	9 432 611 748
31-1790	9 430 616 090	105031-1790	9 430 610 806	NP-DLLA154S344N428	9 432 611 760
31-1791 J	9 430 615 420	105031-1791	9 430 610 807	NP-DLLA154S344N428	9 432 611 760
31-1791 S	9 430 615 420	105031-1791	9 430 610 802	NP-DLLA154S344N424	9 432 611 754
31-1791 T	9 430 615 420	105031-1791	9 430 610 758	NP-DLLA154S364N382	9 432 611 748
31-1800	9 430 616 207	105031-1800	9 430 610 874	NP-DLLA154S364N476	9 432 610 097
31-1820	9 430 616 208	105031-1820	9 430 611 394	NP-DLLA154SN665	9 432 611 798
31-2050	9 430 616 209	105031-2050	9 430 611 189	NP-DN4SD24NP1	9 432 610 148
31-2060	9 430 615 453	105031-2060	9 430 611 188	NP-DN4SD24	9 432 610 012
31-2070		105031-2070	9 430 611 187	NP-DN4SD128	9 432 610 423
31-2130		105031-2130	9 430 611 232	NP-DL125S303NP6	9 432 611 678
31-2160	9 430 615 454	105031-2160	9 430 611 231	NP-DL125S303NP6	9 432 611 678
31-2160	9 430 615 454	105031-2160	9 430 611 233	NP-DL125S303NP6	9 432 611 678
31-2220	9 430 615 016	105031-2220	9 430 610 012	NP-DN7SD64	9 432 610 009
31-2260	9 430 616 133	105031-2260	9 430 611 196	NP-DN4SD24NP2	9 432 611 987
31-2390	9 430 616 089	105031-2390	9 430 611 190	NP-DN4SD24	9 432 610 012
31-2460		105031-2460	9 430 611 194	NP-DN7SD64	9 432 610 009
31-2480		105031-2480	9 430 611 195	NP-DN4SD24	9 432 610 012
31-2520	9 430 615 802	105031-2520	9 430 611 198	NP-DN4SD65	9 432 610 060
31-2520	9 430 615 802	105031-2520	9 430 611 201	NP-DN7SD94NP3	9 432 611 990
31-2530		105031-2530	9 430 611 197	NP-DN4SD24NP2	9 432 611 987
31-2530		105031-2530	9 430 611 203	NP-DN4SD24NP4	9 432 611 991
31-2550		105031-2550	9 430 611 204	NP-DN0SD21	9 432 610 001
31-2550		105031-2550	9 430 611 181	NP-DN4SNP3	9 432 610 044
31-2550		105031-2550	9 430 611 200	NP-DN4SD128	9 432 610 423
31-2570 A	9 430 615 455	105031-2570	9 430 611 206	NP-DN4SD128	9 432 610 423

 Typ	 Ref.	 Zexel	 Ref.	 Typ	 Ref.
31-2570 D	9 430 615 455	105031-2570	9 430 611 182	NP-DN4SNP3	9 432 610 044
31-2570 H	9 430 615 455	105031-2570	9 430 611 184	NP-DN4S1	9 432 610 036
31-2570 HB	9 430 615 455	105031-2570	9 430 611 205	NP-DN0SD21	9 432 610 001
31-2590	9 430 615 803	105031-2590	9 430 611 221	NP-DN4SNP3	9 432 610 044
31-2600	9 430 615 079	105031-2600	9 430 610 093	NP-DN4SD24	9 432 610 012
31-3120	9 430 615 804	105031-3120	9 430 611 192	NP-DN0SD130NP3	9 432 610 151
31-3240	9 430 615 908	105031-3240	9 430 611 256	NP-DLL140S256NP38	9 432 610 465
31-3240 M	9 430 615 908	105031-3240	9 430 611 258	NP-DLL140S256NP38M	9 432 610 820
31-3280	9 430 615 909	105031-3280	9 430 611 199	NP-DN0SD130NP3	9 432 610 151
31-3300	9 430 615 915	105031-3300	9 430 611 257	NP-DLL140S256NP38	9 432 610 465
31-3300 M	9 430 615 915	105031-3300	9 430 611 259	NP-DLL140S256NP38M	9 432 610 820
31-3340		105031-3340	9 430 611 263	NP-DLLA150S325NP10	
31-3350	9 430 615 911	105031-3350	9 430 611 212	NP-DN0SD130NP3	9 432 610 151
31-3350 A	9 430 615 911	105031-3350	9 430 611 223	NP-DN0SN056	
31-3390	9 430 615 149	105031-3390	9 430 611 290	NP-DLLA186S324NP8	9 432 610 061
31-3390 A	9 430 615 149	105031-3390	9 430 611 283	NP-DLLA180S374NP57	9 432 611 928
31-3390 C	9 430 615 149	105031-3390	9 430 611 306	NP-DLLA176S324NP80	9 432 610 083
31-3390 D	9 430 615 149	105031-3390	9 430 611 302	NP-DLLA174S334NP75	9 432 611 821
31-3390 G	9 430 615 149	105031-3390	9 430 610 732	NP-DLLA171S334NP84	9 432 610 102
31-3390 S	9 430 615 149	105031-3390	9 430 611 270	NP-DLLA186S334NP8	9 432 610 035
31-3400		105031-3400	9 430 611 262	NP-DLLA160S284NP9	
31-3400		105031-3400	9 430 611 261	NP-DLLA160S324NP9	9 432 611 939
31-3410	9 430 615 805	105031-3410	9 430 611 265	NP-DLLA140S274NP12	9 432 610 395
31-3420	9 430 615 912	105031-3420	9 430 611 267	NP-DLLA150S325NP10	
31-3420	9 430 615 912	105031-3420	9 430 611 286	NP-DLLA150S325NP60	9 432 610 411
31-3431 4	9 430 616 210	105031-3431	9 430 611 271	NP-DLLA152S324NP48	9 432 611 940
31-3431 6	9 430 616 210	105031-3431	9 430 611 280	NP-DLLA154S324N413	9 432 610 018
31-3450	9 430 615 913	105031-3450	9 430 611 273	NP-DLLA160S385NP50	9 432 610 101
31-3450 B	9 430 615 913	105031-3450	9 430 610 813	NP-DLLA160S385N426	9 432 610 215
31-3450 C	9 430 615 913	105031-3450	9 430 610 828	NP-DLLA160S424N427	9 432 610 410
31-3450 M	9 430 615 913	105031-3450	9 430 610 766	NP-DLLA160S424N390	9 432 611 745
31-3471	9 430 615 021	105031-3471	9 430 611 036	NP-DLLA154SN640	9 432 610 254
31-3471 E	9 430 615 021	105031-3471	9 430 611 307	NP-DLLA154S324NP81	9 432 610 405
31-3471 G	9 430 615 021	105031-3471	9 430 611 005	NP-DLLA155SN601	9 432 612 331
31-3471 K	9 430 615 021	105031-3471	9 430 610 023	NP-DLLA154S324N413	9 432 610 018
31-3471 M	9 430 615 021	105031-3471	9 430 611 518	NP-DLLA154S324N413	9 432 610 018
31-3480	9 430 615 914	105031-3480	9 430 611 299	NP-DLLA160S354NP77	9 432 610 412
31-3490	9 430 615 475	105031-3490	9 430 611 216	NP-DN0SN8	9 432 611 699
31-3510 A	9 430 615 080	105031-3510	9 430 610 781	NP-DLLA166S364N408	9 432 611 766
31-3510 E	9 430 615 080	105031-3510	9 430 611 308	NP-DLLA176S324NP80	9 432 610 083
31-3510 F	9 430 615 080	105031-3510	9 430 610 731	NP-DLLA174S334NP75	9 432 611 821
31-3510 H	9 430 615 080	105031-3510	9 430 610 090	NP-DLLA171S334NP84	9 432 610 102
31-3521 A	9 430 615 266	105031-3521	9 430 610 738	NP-DLLA160S354NP88	9 432 610 030
31-3521 B	9 430 615 266	105031-3521	9 430 610 744	NP-DLLA154S365NP91	9 432 611 750
31-3521 C	9 430 615 266	105031-3521	9 430 610 764	NP-DLLA148S365N388	9 432 610 225

A146

de
Düsen für
1-Feder-Düsenhalter
von Zexel
 (Fortsetzung)







en
Nozzles for the most
important single-
spring nozzle-holders
Zexel
 (continued)







fr
Injecteurs pour
les principaux porte-
injecteurs à 1 ressort
Zexel
 (suite)

it
Polvrizzatori per
i principali porta-
polverizzatori
a 1 molla, Zexel
 (seguito)

es
Inyectoros para
los portainyectoros
de 1 muelle más
importantes, Zexel
 (continuación)



						
31-3521	H	9 430 615 266	105031-3521	9 430 610 769	NP-DLLA160S295N394	9 432 611 747
31-3521	I	9 430 615 266	105031-3521	9 430 610 864	NP-DLLA160S295N469	9 432 611 726
31-3521	K	9 430 615 266	105031-3521	9 430 610 816	NP-DLLA158S325N437	9 432 610 190
31-3521	N	9 430 615 266	105031-3521	9 430 610 779	NP-DLLA158S325N407	9 432 611 765
31-3521	P	9 430 615 266	105031-3521	9 430 610 818	NP-DLLA154S374N438	9 432 610 089
31-3521	Q	9 430 615 266	105031-3521	9 430 610 796	NP-DLLA160S295N422	9 432 610 046
31-3521	W	9 430 615 266	105031-3521	9 430 610 846	NP-DLLA155S365N458	9 432 610 345
31-3521	X	9 430 615 266	105031-3521	9 430 610 830	NP-DLLA150S315N450	9 432 611 737
31-3522		9 430 615 094	105031-3522	9 430 611 309	NP-DLLA150S344NP82	9 432 610 029
31-3522	10	9 430 615 094	105031-3522	9 430 611 526	NP-DLLA155S365N458	9 432 610 345
31-3522	13	9 430 615 094	105031-3522	9 430 610 545	NP-DLLA155SN515	9 432 610 509
31-3522	14	9 430 615 094	105031-3522	9 430 610 546	NP-DLLA155SN710	9 432 610 265
31-3522	15	9 430 615 094	105031-3522	9 430 610 547	NP-DLLA155SN711	9 432 610 399
31-3522	4	9 430 615 094	105031-3522	9 430 611 041	NP-DLLA160S325N507	9 432 610 242
31-3522	5	9 430 615 094	105031-3522	9 430 610 892	NP-DLLA162S265N491	9 432 612 317
31-3522	5C	9 430 615 094	105031-3522	9 430 610 559	NP-DLLA160SN827	9 432 610 510
31-3522	6	9 430 615 094	105031-3522	9 430 610 903	NP-DLLA162S285N498	9 432 611 739
31-3522	6C	9 430 615 094	105031-3522	9 430 610 557	NP-DLLA150SM122	9 432 610 655
31-3522	8	9 430 615 094	105031-3522	9 430 610 169	NP-DLLA155SN711	9 432 610 399
31-3522	9	9 430 615 094	105031-3522	9 430 610 927	NP-DLLA155SN515	9 432 610 509
31-3522	A	9 430 615 094	105031-3522	9 430 610 739	NP-DLLA160S354NP88	9 432 610 030
31-3522	A1	9 430 615 094	105031-3522	9 430 610 598	NP-DLLA155SM267	9 432 610 685
31-3522	B	9 430 615 094	105031-3522	9 430 610 745	NP-DLLA154S365NP91	9 432 611 750
31-3522	C	9 430 615 094	105031-3522	9 430 610 765	NP-DLLA148S365N388	9 432 610 225
31-3522	F	9 430 615 094	105031-3522	9 430 610 885	NP-DLLA160S324N486	9 432 610 176
31-3522	G	9 430 615 094	105031-3522	9 430 610 544	KP-DLLA155SN458	9 432 610 690
31-3522	H	9 430 615 094	105031-3522	9 430 610 770	NP-DLLA160S295N394	9 432 611 747
31-3522	I	9 430 615 094	105031-3522	9 430 610 865	NP-DLLA160S295N469	9 432 611 726
31-3522	K	9 430 615 094	105031-3522	9 430 610 817	NP-DLLA158S325N437	9 432 610 190
31-3522	L	9 430 615 094	105031-3522	9 430 610 108	NP-DLLA155SN710	9 432 610 265
31-3522	M	9 430 615 094	105031-3522	9 430 610 907	NP-DLLA160S325N507	9 432 610 242
31-3522	N	9 430 615 094	105031-3522	9 430 610 780	NP-DLLA158S325N407	9 432 611 765
31-3522	P	9 430 615 094	105031-3522	9 430 610 819	NP-DLLA154S374N438	9 432 610 089
31-3522	Q	9 430 615 094	105031-3522	9 430 610 797	NP-DLLA160S295N422	9 432 610 046
31-3522	W	9 430 615 094	105031-3522	9 430 610 847	NP-DLLA155S365N458	9 432 610 345
31-3522	X	9 430 615 094	105031-3522	9 430 610 831	NP-DLLA150S315N450	9 432 611 737
31-3522	Z	9 430 615 094	105031-3522	9 430 610 118	NP-DLLA160S324N486	9 432 610 176
31-3530		9 430 615 476	105031-3530	9 430 611 218	NP-DN0S130NP3	
31-3540		9 430 616 211	105031-3540	9 430 610 751	NP-DLLA150S325NP60	9 432 610 411
31-3551	A	9 430 615 395	105031-3551	9 430 610 173	NP-DLLA154S284N393	9 432 610 051
31-3551	B	9 430 615 395	105031-3551	9 430 610 949	NP-DLLA154S304N474	9 432 610 025
31-3551	C	9 430 615 395	105031-3551	9 430 611 519	NP-DLLA154S284N393	9 432 610 051
31-3560			105031-3560	9 430 610 771	NP-DLLA150S356N395	
31-3570		9 430 615 439	105031-3570	9 430 611 224	NP-DN0SD130NP3	9 432 610 151
31-3581		9 430 616 212	105031-3581	9 430 610 793	NP-DLLA154S334N419	9 432 610 024

 Typ	 Ref.	 Zexel	 Ref.	 Typ	 Ref.
31-3590	9 430 616 122	105031-3590	9 430 610 809	NP-DLLA105S304N433	9 432 610 349
31-3591	9 430 616 213	105031-3591	9 430 610 810	NP-DLLA105S304N433	9 432 610 349
31-3592	9 430 616 214	105031-3592	9 430 610 811	NP-DLLA105S304N433	9 432 610 349
31-3600	9 430 615 903	105031-3600	9 430 610 820	NP-DLLA146S344N439	9 432 610 339
31-3610	9 430 615 830	105031-3610	9 430 610 823	NP-DLLA154S324N413	9 432 610 018
31-3611	9 430 615 426	105031-3611	9 430 610 824	NP-DLLA154S324N413	9 432 610 018
31-3620	9 430 615 181	105031-3620	9 430 610 829	NP-DLLA146S344N439	9 432 610 339
31-3630	9 430 615 898	105031-3630	9 430 610 840	NP-DLLA154S324N451	9 432 611 721
31-3640 A		105031-3640	9 430 610 868	NP-DLLA160S315N471	9 432 611 719
31-3640 Z		105031-3640	9 430 610 848	NP-DLLA154S424N459	9 432 610 231
31-3641 A	9 430 615 776	105031-3641	9 430 610 869	NP-DLLA160S315N471	9 432 611 719
31-3641 E	9 430 615 776	105031-3641	9 430 610 882	NP-DLLA157S385N480	9 432 611 709
31-3641 G	9 430 615 776	105031-3641	9 430 610 896	NP-DLLA150S424N493	9 432 611 708
31-3641 H	9 430 615 776	105031-3641	9 430 610 897	NP-DLLA160S335N494	9 432 611 707
31-3641 R	9 430 615 776	105031-3641	9 430 610 939	NP-DLLA154SN526	9 432 612 320
31-3641 Z	9 430 615 776	105031-3641	9 430 610 849	NP-DLLA154S424N459	9 432 610 231
31-3642 G		105031-3642		NP-DLLA150S424N493	
31-3642 Z		105031-3642		NP-DLLA154S424N459	
31-3650		105031-3650	9 430 610 842	NP-DLLA160S295N422	9 432 610 046
31-3651		105031-3651	9 430 610 843	NP-DLLA160S295N422	9 432 610 046
31-3660		105031-3660	9 430 610 854	NP-DLLA154S344N463	9 432 611 724
31-3661	9 430 615 899	105031-3661	9 430 610 855	NP-DLLA154S344N463	9 432 611 724
31-3670	9 430 616 121	105031-3670	9 430 610 799	NP-DLLA30S701N466	9 432 612 315
31-3681	9 430 615 022	105031-3681	9 430 610 024	NP-DLLA154S334N419	9 432 610 024
31-3690	9 430 615 557	105031-3690	9 430 610 862	NP-DLLA155S324N468	9 432 610 705
31-3690 N	9 430 615 557	105031-3690	9 430 610 933	NP-DLLA145SN522	9 432 611 729
31-3690 P	9 430 615 557	105031-3690	9 430 610 935	NP-DLLA145SN523	9 432 611 728
31-3690 U	9 430 615 557	105031-3690	9 430 611 045	NP-DLLA155SN650	9 432 611 803
31-3691 N	9 430 615 456	105031-3691	9 430 610 934	NP-DLLA145SN522	9 432 611 729
31-3691 P	9 430 615 456	105031-3691	9 430 610 936	NP-DLLA145SN523	9 432 611 728
31-3691 Q	9 430 615 456	105031-3691	9 430 610 863	NP-DLLA155S324N468	9 432 610 705
31-3691 Q	9 430 615 456	105031-3691	9 430 611 512	NP-DLLA155S324N468	9 432 610 705
31-3691 S	9 430 615 456	105031-3691	9 430 611 008	NP-DLLA103S314N495	9 432 611 716
31-3691 U	9 430 615 456	105031-3691	9 430 611 046	NP-DLLA155SN650	9 432 611 803
31-3691 U	9 430 615 456	105031-3691	9 430 611 514	NP-DLLA155SN650	9 432 611 803
31-3700	9 430 615 023	105031-3700	9 430 610 025	NP-DLLA154S304N474	9 432 610 025
31-3710	9 430 616 123	105031-3710	9 430 610 878	NP-DLLA160S354NP77	9 432 610 412
31-3720	9 430 615 900	105031-3720	9 430 610 884	NP-DLLA150S285N484	9 432 611 712
31-3730	9 430 615 901	105031-3730	9 430 610 890	NP-DLLA154S344N424	9 432 611 754
31-3740	9 430 616 125	105031-3740	9 430 610 894	NP-DLLA105S304N433	9 432 610 349
31-3741	9 430 615 466	105031-3741	9 430 610 895	NP-DLLA105S304N433	9 432 610 349
31-3750	9 430 616 126	105031-3750	9 430 610 929	NP-DLLA140S256NP38M	9 432 610 820
31-3760	9 430 615 806	105031-3760	9 430 610 906	NP-DLLA146S384N496	9 432 611 738
31-3770		105031-3770	9 430 610 899	NP-DLLA103S314N495	9 432 611 716
31-3771	9 430 615 457	105031-3771	9 430 610 901	NP-DLLA103S314N495	9 432 611 716

A148

de

**Düsen für
1-Feder-Düsenhalter
von Zexel**

(Fortsetzung)

en

**Nozzles for the most
important single-
spring nozzle-holders
Zexel**

(continued)

fr

**Injecteurs pour
les principaux porte-
injecteurs à 1 ressort
Zexel**

(suite)

it

**Polvrizzatori per
i principali porta-
polverizzatori
a 1 molla, Zexel**







(seguito)







es

**Inyectoros para
los portainyectoros
de 1 muelle más
importantes, Zexel**

(continuación)



 Typ	 Ref.	 Zexel	 Ref.	 Typ	 Ref.
31-3771	9 430 615 457	105031-3771	9 430 611 513	NP-DLLA103S314N495	9 432 611 716
31-3771 A	9 430 615 457	105031-3771	9 430 611 415	NP-DLLA103SN646	9 432 612 335
31-3780	9 430 615 902	105031-3780	9 430 610 909	NP-DLLA146S344N439	9 432 610 339
31-3781	9 430 615 907	105031-3781	9 430 610 910	NP-DLLA146S344N439	9 432 610 339
31-3782 A	9 430 615 182	105031-3782	9 430 610 914	NP-DLLA150S285N484	9 432 611 712
31-3782 C	9 430 615 182	105031-3782	9 430 610 911	NP-DLLA146S344N439	9 432 610 339
31-3790		105031-3790	9 430 610 912	NP-DLLA150S285N484	9 432 611 712
31-3791	9 430 616 215	105031-3791	9 430 610 913	NP-DLLA150S285N484	9 432 611 712
31-3800	9 430 615 743	105031-3800	9 430 610 926	NP-DLLA154S304N474	9 432 610 025
31-3810	9 430 615 795	105031-3810	9 430 610 904	NP-DLLA162S285N498	9 432 611 739
31-3810 1	9 430 615 795	105031-3810	9 430 610 866	NP-DLLA160S295N469	9 432 611 726
31-3810 5	9 430 615 795	105031-3810	9 430 610 893	NP-DLLA162S265N491	9 432 612 317
31-3810 X	9 430 615 795	105031-3810	9 430 610 832	NP-DLLA150S315N450	9 432 611 737
31-3820 A	9 430 615 370	105031-3820	9 430 610 870	NP-DLLA160S315N471	9 432 611 719
31-3820 B	9 430 615 370	105031-3820	9 430 610 959	NP-DLLA155SN546	9 432 611 820
31-3820 D	9 430 615 370	105031-3820	9 430 611 019	NP-DLLA160SN629	9 432 611 773
31-3820 H	9 430 615 370	105031-3820	9 430 610 898	NP-DLLA160S335N494	9 432 611 707
31-3830	9 430 615 904	105031-3830	9 430 610 930	NP-DLLA160SN518	9 432 611 744
31-3830 B	9 430 615 904	105031-3830	9 430 610 937	NP-DLLA160SN518	9 432 611 744
31-3831 H	9 430 616 216	105031-3831	9 430 611 064	NP-DLLA154SN625	9 432 610 319
31-3840		105031-3840	9 430 610 931	NP-DLLA154S364N476	9 432 610 097
31-3840 B		105031-3840	9 430 610 938	NP-DLLA154S364N476	9 432 610 097
31-3841 H	9 430 615 897	105031-3841	9 430 611 066	NP-DLLA154SN578	9 432 610 312
31-3842 H	9 430 615 293	105031-3842	9 430 611 067	NP-DLLA154SN578	9 432 610 312
31-3850	9 430 615 905	105031-3850	9 430 610 932	NP-DLLA160SN519	9 432 611 731
31-3860		105031-3860	9 430 610 944	NP-DLLA154S334N419	9 432 610 024
31-3861	9 430 615 083	105031-3861	9 430 610 095	NP-DLLA154S334N419	9 432 610 024
31-3862 2B	9 430 615 183	105031-3862	9 430 611 425	NP-DLLA158SN821	9 432 610 304
31-3862 2R	9 430 615 183	105031-3862	9 430 610 945	NP-DLLA154S334N419	9 432 610 024
31-3862 J	9 430 615 183	105031-3862	9 430 610 566	NP-DLLA156SM138	9 432 610 658
31-3862 K	9 430 615 183	105031-3862	9 430 610 567	NP-DLLA156SM139	9 432 610 453
31-3862 L		105031-3862		NP-DLLA152SM400	9 432 612 796
31-3862 M		105031-3862		NP-DLLA152SM399	9 432 612 797
31-3862 N		105031-3862		NP-DLLA156SM420	9 432 612 849
31-3870 U	9 430 615 777	105031-3870	9 430 610 946	NP-DLLA160SN539	9 432 610 235
31-3871 U		105031-3871		NP-DLLA160SN539	
31-3880	9 430 615 906	105031-3880	9 430 610 956	NP-DLLA160SN519	9 432 611 731
31-3881	9 430 615 910	105031-3881	9 430 610 957	NP-DLLA160SN519	9 432 611 731
31-3882	9 430 615 294	105031-3882	9 430 610 958	NP-DLLA160SN519	9 432 611 731
31-3890	9 430 616 127	105031-3890	9 430 610 966	NP-DLL140S256NP38	9 432 610 465
31-3900	9 430 615 140	105031-3900	9 430 611 017	NP-DLLA150SN623	9 432 610 185
31-3900 0	9 430 615 140	105031-3900	9 430 610 971	NP-DLLA160SN567	9 432 610 285
31-3900 A	9 430 615 140	105031-3900	9 430 611 402	NP-DLLA150SN761	9 432 611 288
31-3900 B	9 430 615 140	105031-3900	9 430 611 040	NP-DLLA160SN644	9 432 610 252
31-3900 H	9 430 615 140	105031-3900	9 430 610 969	NP-DLLA160SN565	9 432 611 840

 Typ	 Ref.	 Zexel	 Ref.	 Typ	 Ref.
31-3900 L	9 430 615 140	105031-3900	9 430 610 975	NP-DLLA160SN570	9 432 610 388
31-3900 M	9 430 615 140	105031-3900	9 430 611 362	NP-DLLA157SN725	9 432 610 751
31-3900 N	9 430 615 140	105031-3900	9 430 611 013	NP-DLLA157SN617	9 432 611 779
31-3900 P	9 430 615 140	105031-3900	9 430 611 396	NP-DLLA157SN778	9 432 610 203
31-3900 Q	9 430 615 140	105031-3900	9 430 611 376	NP-DLLA160SN644	9 432 610 252
31-3900 R	9 430 615 140	105031-3900	9 430 611 374	NP-DLLA160SN567	9 432 610 285
31-3900 S	9 430 615 140	105031-3900	9 430 610 970	NP-DLLA160SN566	9 432 610 174
31-3900 X	9 430 615 140	105031-3900	9 430 611 361	NP-DLLA150SN623	9 432 610 185
31-3900 Y	9 430 615 140	105031-3900	9 430 611 335	NP-DLLA160SN566	9 432 610 174
31-3910 1D	9 430 615 092	105031-3910	9 430 610 569	NP-DLLA157SM143	9 432 610 660
31-3910 D	9 430 615 092	105031-3910	9 430 610 106	NP-DLLA154SN533	9 432 610 111
31-3910 I	9 430 615 092	105031-3910	9 430 610 974	NP-DLLA160SN539	9 432 610 235
31-3920	9 430 615 798	105031-3920	9 430 610 976	NP-DLLA154SN572	9 432 610 838
31-3930	9 430 615 934	105031-3930	9 430 610 978	NP-DLLA154SN573	9 432 611 838
31-3930 A	9 430 615 934	105031-3930	9 430 610 995	NP-DLLA154SN586	9 432 610 245
31-3940	9 430 615 024	105031-3940	9 430 610 026	NP-DLLA154S304N474	9 432 610 025
31-3941 C	9 430 615 093	105031-3941	9 430 611 009	NP-DLLA154SN606	9 432 610 095
31-3950		105031-3950	9 430 610 984	NP-DLLA154S324N413	9 432 610 018
31-3951	9 430 615 032	105031-3951	9 430 611 010	NP-DLLA154SN607	9 432 610 049
31-3952 H	9 430 615 184	105031-3952	9 430 610 841	NP-DLLA154S324N451	9 432 611 721
31-3952 K	9 430 615 184	105031-3952	9 430 610 791	NP-DLLA154S324N413	9 432 610 018
31-3952 L	9 430 615 184	105031-3952	9 430 611 011	NP-DLLA154SN607	9 432 610 049
31-3961	9 430 615 935	105031-3961	9 430 610 985	NP-DLLA154S334N419	9 432 610 024
31-3970 L	9 430 615 120	105031-3970	9 430 611 030	NP-DLLA150SN637	9 432 611 795
31-3970 N	9 430 615 120	105031-3970	9 430 610 162	NP-DLLA150SN615	9 432 610 223
31-3970 P	9 430 615 120	105031-3970	9 430 610 529	NP-DLLA150SN615	9 432 610 223
31-3970 V	9 430 615 120	105031-3970	9 430 610 992	NP-DLLA157SN584	9 432 610 442
31-3980	9 430 616 128	105031-3980	9 430 611 000	NP-DLLA25SN594	9 432 612 327
31-3990	9 430 615 936	105031-3990	9 430 611 003	NP-DLLA154S364N476	9 432 610 097
31-4130	9 430 616 137	105031-4130	9 430 611 281	NP-DLLA169S324NP5	
31-4130 N	9 430 616 137	105031-4130	9 430 611 253	NP-DLLA168S304NP59	9 432 610 115
31-4130 T	9 430 616 137	105031-4130	9 430 611 293	NP-DLLA168S304NP59	9 432 610 115
31-4140 P		105031-4140	9 430 611 255	NP-DLLA166S374NP6	9 432 610 015
31-4140 T		105031-4140	9 430 611 266	NP-DLLA166S414NP46	9 432 610 348
31-4150	9 430 615 937	105031-4150	9 430 611 264	NP-DLLA160S414NP11	9 432 611 931
31-4170	9 430 615 124	105031-4170	9 430 611 268	NP-DLLA150S384NP13	9 432 610 033
31-4170 3	9 430 615 124	105031-4170	9 430 610 164	NP-DLLA150S404NP13	9 432 610 145
31-4170 B	9 430 615 124	105031-4170	9 430 611 300	NP-DLLA150S834NP73	9 432 610 142
31-4171 B	9 430 615 185	105031-4171	9 430 611 301	NP-DLLA150S384NP73	9 432 610 142
31-4190		105031-4190	9 430 611 269	NP-DLLA166S374NP17	
31-4190 A		105031-4190	9 430 611 285	NP-DLLA171S374NP58	9 432 610 092
31-4210	9 430 615 072	105031-4210	9 430 611 284	NP-DLLA171S374NP58	9 432 610 092
31-4210 A	9 430 615 072	105031-4210	9 430 610 792	NP-DLLA143S384N418	9 432 611 761
31-4210 B	9 430 615 072	105031-4210	9 430 611 298	NP-DLLA166S384NP72	9 432 610 760
31-4210 B1	9 430 615 072	105031-4210	9 430 610 902	NP-DLLA144S364N497	9 432 610 324

A150

de

**Düsen für
1-Feder-Düsenhalter
von Zexel**

(Fortsetzung)

en

**Nozzles for the most
important single-
spring nozzle-holders
Zexel**

(continued)

fr

**Injecteurs pour
les principaux porte-
injecteurs à 1 ressort
Zexel**

(suite)

it

**Polvrizzatori per
i principali porta-
polverizzatori
a 1 molla, Zexel**







(seguito)







es

**Inyectores para
los portainyectores
de 1 muelle más
importantes, Zexel**

(continuación)



						
31-4210	B2	9 430 615 072	105031-4210	9 430 610 083	NP-DLLA148SN545	9 432 610 200
31-4210	B2	9 430 615 072	105031-4210	9 430 611 023	NP-DLLA148SN545	9 432 610 200
31-4210	B3	9 430 615 072	105031-4210	9 430 611 042	NP-DLLA152N645	9 432 610 406
31-4210	B4	9 430 615 072	105031-4210	9 430 611 049	NP-DLLA148SN545	9 432 610 200
31-4210	B6	9 430 615 072	105031-4210	9 430 611 388	NP-DLLA152SN6810	9 432 610 212
31-4210	B7	9 430 615 072	105031-4210	9 430 611 344	NP-DLLA148SN693	9 432 610 832
31-4210	B8	9 430 615 072	105031-4210	9 430 611 372	NP-DLLA142SN738	9 432 611 240
31-4210	E8	9 430 615 072	105031-4210	9 430 611 520	NP-DLLA152SN936	9 432 611 385
31-4210	R-2	9 430 615 072	105031-4210	9 430 610 737	NP-DLLA151S354NP86	
31-4210	R-3	9 430 615 072	105031-4210	9 430 610 753	NP-DLLA148S354NP98	9 432 610 414
31-4210	R5	9 430 615 072	105031-4210	9 430 610 783	NP-DLLA146S344N410	
31-4210	R6	9 430 615 072	105031-4210	9 430 610 788	NP-DLLA151S354N425	9 432 610 759
31-4210	R7	9 430 615 072	105031-4210	9 430 610 814	NP-DLLA148S354N429	9 432 611 767
31-4210	R8	9 430 615 072	105031-4210	9 430 610 834	NP-DLLA145S344N453	9 432 610 195
31-4210	R9	9 430 615 072	105031-4210	9 430 610 850	NP-DLLA146S315N460	9 432 610 415
31-4210	T	9 430 615 072	105031-4210	9 430 611 289	NP-DLLA142S394NP66	9 432 610 147
31-4220		9 430 615 365	105031-4220	9 430 611 295	NP-DLLA150S344NP65	
31-4220		9 430 615 365	105031-4220	9 430 611 288	NP-DLLA150S324NP65	9 432 611 929
31-4230		9 430 615 778	105031-4230	9 430 611 287	NP-DLLA160S354NP49	9 432 610 182
31-4230	A	9 430 615 778	105031-4230	9 430 610 742	NP-DLLA160S354NP49	9 432 610 183
31-4230	B	9 430 615 778	105031-4230	9 430 610 761	NP-DLLA160S354N383	
31-4250		9 430 615 948	105031-4250	9 430 611 296	NP-DLLA150S344NP70	9 432 610 045
31-4260		9 430 615 232	105031-4260	9 430 610 733	NP-DLLA168S304NP59	9 432 610 115
31-4260	T	9 430 615 232	105031-4260	9 430 610 734	NP-DLLA168S304NP59	9 432 610 115
31-4270		9 430 615 158	105031-4270	9 430 610 735	NP-DLLA166S374NP6	9 432 610 015
31-4270	P2	9 430 615 158	105031-4270	9 430 610 767	NP-DLLA166S374N379	9 432 610 824
31-4270	T	9 430 615 158	105031-4270	9 430 610 736	NP-DLLA166S414NP46	9 432 610 348
31-4270	T1	9 430 615 158	105031-4270	9 430 610 752	NP-DLLA166S384NP97	9 432 610 143
31-4270	T2	9 430 615 158	105031-4270	9 430 610 987	NP-DLLA142SN579	9 432 611 832
31-4280			105031-4280	9 430 610 740	NP-DLLA150S334NP89	9 432 610 340
31-4281		9 430 615 334	105031-4281	9 430 610 741	NP-DLLA150S334NP89	9 432 610 340
31-4290		9 430 615 325	105031-4290	9 430 610 743	NP-DLLA155S324N90	9 432 611 751
31-4290	B	9 430 615 325	105031-4290	9 430 610 915	NP-DLLA154SN503	9 432 610 758
31-4290	FT	9 430 615 325	105031-4290	9 430 610 821	NP-DLLA155S324N440	9 432 611 757
31-4290	H	9 430 615 325	105031-4290	9 430 611 348	NP-DLLA153SN700	9 432 611 256
31-4290	T	9 430 615 325	105031-4290	9 430 610 808	NP-DLLA155S324NP90	9 432 611 751
31-4290	TL	9 430 615 325	105031-4290	9 430 610 839	NP-DLLA155S324N456	9 432 610 715
31-4300		9 430 615 938	105031-4300	9 430 610 750	NP-DLLA160S354NP49	9 432 610 183
31-4300	B	9 430 615 938	105031-4300	9 430 610 768	NP-DLLA160S354N383	
31-4300	C	9 430 615 938	105031-4300	9 430 610 777	NP-DLLA160S354N405	9 432 611 749
31-4310		9 430 615 326	105031-4310	9 430 611 390	NP-DLLA153SN768	9 432 610 745
31-4310	4	9 430 615 326	105031-4310	9 430 611 356	NP-DLLA153SN7131	9 432 610 211
31-4310	M	9 430 615 326	105031-4310	9 430 611 363	NP-DLLA153SN726	9 432 611 258
31-4310	N	9 430 615 326	105031-4310	9 430 610 749	NP-DLLA155S334NP96	9 432 610 241
31-4330	R4	9 430 615 940	105031-4330	9 430 610 755	NP-DLLA151S354N381	9 432 611 735

 Typ	 Ref.	 Zexel	 Ref.	 Typ	 Ref.
31-4340	9 430 615 435	105031-4340	9 430 610 759	NP-DLLA150S334N385	9 432 610 158
31-4341	9 430 615 135	105031-4341	9 430 610 760	NP-DLLA150S334N385	9 432 610 158
31-4341 117	9 430 615 135	105031-4341	9 430 612 967	NP-DLLA150S334N385	9 432 610 158
31-4350	9 430 616 119	105031-4350	9 430 610 762	NP-DLLA146S394N387	9 432 611 746
31-4350 A	9 430 616 119	105031-4350	9 430 610 803	NP-DLLA146S394N430	9 432 611 759
31-4350 B	9 430 616 119	105031-4350	9 430 610 836	NP-DLLA146S394N455	9 432 610 826
31-4351	9 430 615 941	105031-4351	9 430 610 763	NP-DLLA146S394N387	9 432 611 746
31-4351 A	9 430 615 941	105031-4351	9 430 610 804	NP-DLLA146S394N430	9 432 611 759
31-4351 B	9 430 615 941	105031-4351	9 430 610 837	NP-DLLA146S394N455	9 432 610 826
31-4351 C	9 430 615 941	105031-4351	9 430 610 993	NP-DLLA146SN585	9 432 611 833
31-4352 B	9 430 615 779	105031-4352	9 430 610 838	NP-DLLA146S394N455	9 432 610 826
31-4352 C	9 430 615 779	105031-4352	9 430 610 994	NP-DLLA146SN585	9 432 611 833
31-4360	9 430 615 150	105031-4360	9 430 610 775	NP-DLLA144S354N403	9 432 610 064
31-4360 A	9 430 615 150	105031-4360	9 430 610 778	NP-DLLA152S354N406	9 432 610 065
31-4360 B	9 430 615 150	105031-4360	9 430 610 827	NP-DLLA151S384N449	9 432 611 755
31-4360 D	9 430 615 150	105031-4360	9 430 610 835	NP-DLLA142S354N454	9 432 611 723
31-4360 E	9 430 615 150	105031-4360	9 430 610 851	NP-DLLA142S374N461	9 432 610 302
31-4360 H	9 430 615 150	105031-4360	9 430 610 844	NP-DLLA162S384N457	9 432 610 070
31-4370	9 430 615 159	105031-4370	9 430 611 031	NP-DLLA166S374NP6	9 432 610 015
31-4370 A	9 430 615 159	105031-4370	9 430 610 782	NP-DLLA138S364N409	9 432 610 218
31-4370 A1	9 430 615 159	105031-4370	9 430 610 905	NP-DLLA133SN500	9 432 611 740
31-4370 A3	9 430 615 159	105031-4370	9 430 610 916	NP-DLLA133SN504	9 432 610 833
31-4370 A4	9 430 615 159	105031-4370	9 430 610 917	NP-DLLA140SN505	9 432 611 741
31-4370 A5	9 430 615 159	105031-4370	9 430 610 922	NP-DLLA140SN510	9 432 610 693
31-4370 A6	9 430 615 159	105031-4370	9 430 610 940	NP-DLLA152SN529	9 432 610 723
31-4370 A7	9 430 615 159	105031-4370	9 430 610 963	NP-DLLA146SN553	9 432 610 278
31-4370 A8	9 430 615 159	105031-4370	9 430 610 967	NP-DLLA149SN558	9 432 611 815
31-4370 A9	9 430 615 159	105031-4370	9 430 610 989	NP-DLLA143SN580	9 432 610 441
31-4370 C3	9 430 615 159	105031-4370	9 430 611 327	NP-DLLA149SN679	9 432 610 409
31-4370 C4	9 430 615 159	105031-4370	9 430 611 340	NP-DLLA140SN694	9 432 611 253
31-4370 C6	9 430 615 159	105031-4370	9 430 611 389	NP-DLLA138SN757	9 432 612 346
31-4370 ET	9 430 615 159	105031-4370	9 430 610 790	NP-DLLA137S374N417	9 432 610 184
31-4370 F6	9 430 615 159	105031-4370	9 430 611 433	NP-DLLA150SN843	9 432 611 196
31-4370 H2	9 430 615 159	105031-4370	9 430 611 459	NP-DLLA150SN877	9 432 610 420
31-4370 H4	9 430 615 159	105031-4370	9 430 611 462	NP-DLLA146SN886	9 432 610 846
31-4370 J	9 430 615 159	105031-4370	9 430 611 369	NP-DLLA140SN634	9 432 610 456
31-4370 M	9 430 615 159	105031-4370	9 430 611 475	NP-DLLA153SN842	9 432 611 195
31-4370 P2	9 430 615 159	105031-4370	9 430 611 034	NP-DLLA166S374N379	9 432 610 824
31-4370 T	9 430 615 159	105031-4370	9 430 611 032	NP-DLLA166S414NP46	9 432 610 348
31-4370 T1	9 430 615 159	105031-4370	9 430 611 033	NP-DLLA166S384NP97	9 432 610 143
31-4370 T2	9 430 615 159	105031-4370	9 430 611 035	NP-DLLA142SN579	9 432 611 832
31-4380 D	9 430 615 141	105031-4380	9 430 610 794	NP-DLLA160S354N420	9 432 612 314
31-4391		105031-4391	9 430 610 798	NP-DLLA160S307N423	
31-4391 A		105031-4391	9 430 610 812	NP-DLLA160S307N435	9 432 610 081
31-4400	9 430 615 942	105031-4400	9 430 610 852	NP-DLLA150S334N462	9 432 610 829

A152

de

**Düsen für
1-Feder-Düsenhalter
von Zexel**

(Fortsetzung)

en

**Nozzles for the most
important single-
spring nozzle-holders
Zexel**

(continued)

fr

**Injecteurs pour
les principaux porte-
injecteurs à 1 ressort
Zexel**

(suite)

it

**Polvrizzatori per
i principali porta-
polverizzatori
a 1 molla, Zexel**







(seguito)







es

**Inyectoros para
los portainyectoros
de 1 muelle más
importantes, Zexel**

(continuación)









 Typ	 Ref.	 Zexel	 Ref.	 Typ	 Ref.
31-4401	9 430 615 943	105031-4401	9 430 610 853	NP-DLLA150S334N462	9 432 610 829
31-4410 A	9 430 615 944	105031-4410	9 430 610 879	NP-DLLA152S354N406	9 432 610 065
31-4410 D	9 430 615 944	105031-4410	9 430 610 861	NP-DLLA162S384N457	9 432 610 070
31-4420 TC	9 430 615 233	105031-4420	9 430 610 171	NP-DLLA148S324N473	9 432 610 204
31-4430 T	9 430 615 081	105031-4430	9 430 610 091	NP-DLLA148S324N473	9 432 610 204
31-4440	9 430 615 945	105031-4440	9 430 610 876	NP-DLLA160S307N435	9 432 610 081
31-4440 B	9 430 615 945	105031-4440	9 430 610 941	NP-DLLA160SN530	9 432 611 828
31-4441	9 430 615 166	105031-4441	9 430 610 877	NP-DLLA160S307N435	9 432 610 081
31-4450	9 430 615 136	105031-4450	9 430 610 886	NP-DLLA150S355N490	9 432 611 714
31-4450 A	9 430 615 136	105031-4450	9 430 610 887	NP-DLLA150S345N492	9 432 610 165
31-4451 156	9 430 615 073	105031-4451	9 430 612 745	NP-DLLA150S345N492	9 432 610 165
31-4451 A	9 430 615 073	105031-4451	9 430 610 082	NP-DLLA150S345N492	9 432 610 165
31-4451 E	9 430 615 073	105031-4451	9 430 611 373	NP-DLLA150SN742	9 432 610 154
31-4460	9 430 616 124	105031-4460	9 430 610 889	NP-DLLA150SN344N489	9 432 610 173
31-4460 B	9 430 616 124	105031-4460	9 430 611 006	NP-DLLA155SN600	9 432 612 330
31-4460 G	9 430 616 124	105031-4460	9 430 611 456	NP-DLLA155SN872	9 432 612 358
31-4470 A	9 430 615 160	105031-4470	9 430 610 872	NP-DLLA148S334N472	9 432 610 440
31-4470 Z	9 430 615 160	105031-4470	9 430 611 047	NP-DLLA148SN651	9 432 611 804
31-4480	9 430 615 069	105031-4480	9 430 610 908	NP-DLLA142S344N501	9 432 610 286
31-4480 A	9 430 615 069	105031-4480	9 430 610 097	NP-DLLA142S354N502	9 432 610 055
31-4480 B	9 430 615 069	105031-4480	9 430 610 080	NP-DLLA142S344N547	9 432 610 072
31-4480 C	9 430 615 069	105031-4480	9 430 610 972	NP-DLLA142SN568	9 432 610 755
31-4480 E	9 430 615 069	105031-4480	9 430 610 990	NP-DLLA142SN581	9 432 610 166
31-4480 F	9 430 615 069	105031-4480	9 430 610 092	NP-DLLA142SN613	9 432 610 167
31-4480 G	9 430 615 069	105031-4480	9 430 611 018	NP-DLLA412SN627	9 432 611 768
31-4480 H	9 430 615 069	105031-4480	9 430 610 973	NP-DLLA142SN569	9 432 610 899
31-4480 J	9 430 615 069	105031-4480	9 430 611 020	NP-DLLA142SN630	9 432 611 774
31-4480 K	9 430 615 069	105031-4480	9 430 611 366	NP-DLLA142SN569	9 432 610 899
31-4490	9 430 615 161	105031-4490	9 430 610 920	NP-DLLA155SN532	9 432 610 330
31-4500 4Q	9 430 615 063	105031-4500	9 430 611 119	NP-DLLA160SN732	9 432 612 344
31-4500 5	9 430 615 063	105031-4500	9 430 611 611	NP-DLLA157SN944	9 432 610 893
31-4500 6D	9 430 615 063	105031-4500	9 430 611 675	NP-DLLA150SM122	9 432 610 655
31-4500 A	9 430 615 063	105031-4500	9 430 610 923	NP-DLLA160S325N507	9 432 610 242
31-4500 C	9 430 615 063	105031-4500	9 430 610 928	NP-DLLA160S325N507	9 432 610 242
31-4500 C 4	9 430 615 063	105031-4500	9 430 610 075	NP-DLLA160SN731	9 432 610 170
31-4500 H	9 430 615 063	105031-4500	9 430 611 167	NP-DLLA160SN827	9 432 610 510
31-4500 L	9 430 615 063	105031-4500	9 430 611 168	NP-DLLA160SN828	9 432 611 187
31-4500 N	9 430 615 063	105031-4500	9 430 611 174	NP-DLLA160SN844	9 432 611 171
31-4500 Q	9 430 615 063	105031-4500	9 430 611 082	NP-DLLA160SN658	9 432 611 796
31-4500 R	9 430 615 063	105031-4500	9 430 611 175	NP-DLLA160SN845	9 432 611 172
31-4500 S	9 430 615 063	105031-4500	9 430 611 533	NP-DLLA160SN850	9 432 611 174
31-4500 T	9 430 615 063	105031-4500	9 430 610 955	NP-DLLA157SN544	9 432 611 819
31-4500 Y	9 430 615 063	105031-4500	9 430 610 961	NP-DLLA157SN551	9 432 611 810
31-4500 YY	9 430 615 063	105031-4500	9 430 611 139	NP-DLLA157SN777	9 432 612 347
31-4510	9 430 616 217	105031-4510	9 430 610 924	NP-DLLA150S384NP73	9 432 610 142







 Typ	 Ref.	 Zexel	 Ref.	 Typ	 Ref.
31-4510 G	9 430 616 217	105031-4510	9 430 611 508	NP-DLLA150SN923	9 432 611 375
31-4520	9 430 615 046	105031-4520	9 430 610 921	NP-DLLA151S517	9 432 610 187
31-4520 D6	9 430 615 046	105031-4520	9 430 611 437	NP-DLLA151SN517	9 432 610 187
31-4520 G	9 430 615 046	105031-4520	9 430 610 052	NP-DLLA155SN536	9 432 610 084
31-4530		105031-4530			
31-4530 8	9 430 615 061	105031-4530	9 430 611 617	NP-DLLA163SN952	9 432 611 352
31-4530 B	9 430 615 061	105031-4530	9 430 611 092	NP-DLLA160SN671	9 432 610 417
31-4530 F	9 430 615 061	105031-4530	9 430 611 140	NP-DLLA150SN779	9 432 611 267
31-4530 G	9 430 615 061	105031-4530	9 430 611 148	NP-DLLA150SN615	9 432 610 223
31-4530 J	9 430 615 061	105031-4530	9 430 610 070	NP-DLLA154SN533	9 432 610 111
31-4530 K	9 430 615 061	105031-4530	9 430 611 165	NP-DLLA163SN823	9 432 611 186
31-4530 L	9 430 615 061	105031-4530	9 430 610 942	NP-DLLA150SN534	9 432 611 823
31-4530 M	9 430 615 061	105031-4530	9 430 610 176	NP-DLLA150SN615	9 432 610 223
31-4530 N	9 430 615 061	105031-4530	9 430 611 169	NP-DLLA163SN831	9 432 611 188
31-4530 P	9 430 615 061	105031-4530	9 430 611 149	NP-DLLA150SN779	9 432 611 267
31-4530 R	9 430 615 061	105031-4530	9 430 611 166	NP-DLLA150SN779	9 432 611 267
31-4530 S	9 430 615 061	105031-4530	9 430 611 107	NP-DLLA150SN637	9 432 611 795
31-4530 U	9 430 615 061	105031-4530	9 430 610 954	NP-DLLA160SN539	9 432 610 235
31-4530 U4	9 430 615 061	105031-4530	9 430 611 137	NP-DLLA155SN780	9 432 611 268
31-4530 V	9 430 615 061	105031-4530	9 430 611 170	NP-DLLA150SN832	9 432 611 189
31-4530 X	9 430 615 061	105031-4530	9 430 610 960	NP-DLLA150SN548	9 432 610 757
31-4530 "49"		105031-4530			
31-4530 "50"		105031-4530			
31-4530 "80"		105031-4530			
31-4540	9 430 615 946	105031-4540	9 430 610 947	NP-DLLA160S307N435	9 432 610 081
31-4540 B	9 430 615 946	105031-4540	9 430 611 024	NP-DLL160SN633	9 432 611 771
31-4541	9 430 615 947	105031-4541	9 430 610 948	NP-DLLA160S307N435	9 432 610 081
31-4541 B	9 430 615 947	105031-4541	9 430 611 025	NP-DLL160SN633	9 432 611 771
31-4550 G1	9 430 615 327	105031-4550	9 430 610 962	NP-DLLA149SN552	9 432 611 811
31-4550 G2	9 430 615 327	105031-4550	9 430 611 016	NP-DLLA146SN622	9 432 611 784
31-4560	9 430 615 371	105031-4560	9 430 610 981	NP-DLL155SN559	9 432 611 816
31-4560 A	9 430 615 371	105031-4560	9 430 611 328	NP-DLL155SN576	9 432 611 830
31-4560 B	9 430 615 371	105031-4560	9 430 611 488	NP-DLL155SN897	9 432 611 199
31-4570	9 430 615 234	105031-4570	9 430 610 968	NP-DLLA149SN563	9 432 611 841
31-4570 1	9 430 615 234	105031-4570	9 430 610 997	NP-DLLA169SN588	9 432 610 372
31-4580 A	9 430 615 780	105031-4580	9 430 610 980	NP-DLLA150S345N492	9 432 610 165
31-4580 B	9 430 615 780	105031-4580	9 430 611 072	NP-DLLA150S345N492	9 432 610 165
31-4580 C	9 430 615 780	105031-4580	9 430 611 076	NP-DLLA138SN612	9 432 610 754
31-4580 J	9 430 615 780	105031-4580	9 430 611 077	NP-DLLA150SN742	9 432 610 154
31-4590	9 430 615 781	105031-4590	9 430 610 982	NP-DLLA142SN575	9 432 610 839
31-4590 A	9 430 615 781	105031-4590	9 430 610 991	NP-DLLA142SN582	9 432 610 347
31-4600 1	9 430 615 162	105031-4600	9 430 611 355	NP-DLLA149SN699	9 432 610 834
31-4600 7	9 430 615 162	105031-4600	9 430 611 367	NP-DLLA153SN7131	9 432 610 211
31-4600 7A	9 430 615 162	105031-4600	9 430 611 386	NP-DLLA153SN753	9 432 610 841
31-4600 8	9 430 615 162	105031-4600	9 430 611 368	NP-DLLA153SN7131	9 432 610 211

A154

de	en	fr	it	es
Düsen für 1-Feder-Düsenhalter von Zexel (Fortsetzung)	Nozzles for the most important single-spring nozzle-holders Zexel (continued)	Injecteurs pour les principaux porte-injecteurs à 1 ressort Zexel (suite)	Polvrizzatori per i principali porta-polverizzatori a 1 molla, Zexel (seguito)	Inyectoros para los portainyectoros de 1 muelle más importantes, Zexel (continuación)



 Typ	 Ref.	 Zexel	 Ref.	 Typ	 Ref.
31-4600 9S	9 430 615 162	105031-4600	9 430 611 375	NP-DLLA153SN7131	9 432 610 211
31-4600 C	9 430 615 162	105031-4600	9 430 610 988	NP-DLLA154SN503	9 432 610 758
31-4600 D	9 430 615 162	105031-4600	9 430 610 999	NP-DLLA154SN593	9 432 611 836
31-4600 F	9 430 615 162	105031-4600	9 430 611 007	NP-DLLA154SN603	
31-4600 F	9 430 615 162	105031-4600	9 430 611 044	NP-DLLA144SN649	9 432 610 213
31-4600 F1	9 430 615 162	105031-4600	9 430 611 043	NP-DLLA144SN648	9 432 611 786
31-4600 F4	9 430 615 162	105031-4600	9 430 611 324	NP-DLLA144SN649	9 432 610 213
31-4600 F5	9 430 615 162	105031-4600	9 430 611 493	NP-DLLA144SN649	9 432 610 213
31-4600 G	9 430 615 162	105031-4600	9 430 611 347	NP-DLLA149SN699	9 432 610 834
31-4610	9 430 616 129	105031-4610	9 430 611 069	NP-DLLA154SN503	9 432 610 758
31-4620	9 430 615 163	105031-4620	9 430 610 998	NP-DLLA149SN563	9 432 611 841
31-4620 A	9 430 615 163	105031-4620	9 430 611 343	NP-DLLA160SN698	9 432 610 384
31-4620 A	9 430 615 163	105031-4620	9 430 611 484	NP-DLLA160SN698	9 432 610 384
31-4620 B	9 430 615 163	105031-4620	9 430 611 354	NP-DLLA155SN709	9 432 611 250
31-4620 N	9 430 615 163	105031-4620	9 430 611 059	NP-DSLA160SN659	9 432 610 709
31-4620 T	9 430 615 163	105031-4620	9 430 611 026	NP-DLLA155SN635	9 432 610 313
31-4620 T	9 430 615 163	105031-4620	9 430 611 060	NP-DLLA150SN660	9 432 610 342
31-4620 T	9 430 615 163	105031-4620	9 430 611 048	NP-DSLA156SN653	9 432 611 806
31-4620 T1	9 430 615 163	105031-4620	9 430 611 370	NP-DLLA153SN736	9 432 610 291
31-4620 T1	9 430 615 163	105031-4620	9 430 611 485	NP-DLLA153SN736	9 432 610 291
31-4620 T3	9 430 615 163	105031-4620	9 430 610 522	NP-DLLA145SM013	9 432 610 636
31-4630	9 430 615 235	105031-4630	9 430 611 012	NP-DLLA143SN580	9 432 610 441
31-4630 C1	9 430 615 235	105031-4630	9 430 611 079	NP-DLLA143SN632	9 432 611 772
31-4630 C2	9 430 615 235	105031-4630	9 430 611 080	NP-DLLA140SN634	9 432 610 456
31-4630 C5	9 430 615 235	105031-4630	9 430 611 129	NP-DLLA153SN749	9 432 611 245
31-4630 C7	9 430 615 235	105031-4630	9 430 611 141	NP-DLLA150SN781	9 432 611 269
31-4630 D	9 430 615 235	105031-4630	9 430 611 088	NP-DLLA152SN529	9 432 610 723
31-4630 FA	9 430 615 235	105031-4630	9 430 611 121	NP-DLLA149SN734	9 432 611 238
31-4630 FB	9 430 615 235	105031-4630	9 430 611 122	NP-DLLA143SN735	9 432 611 239
31-4630 FT	9 430 615 235	105031-4630	9 430 611 120	NP-DLLA146SN733	9 432 611 237
31-4650	9 430 615 039	105031-4650	9 430 610 044	NP-DLLA158SN638	9 432 610 073
31-4650 A2	9 430 615 039	105031-4650	9 430 611 445	NP-DLLA154SN856	9 432 611 178
31-4650 A4	9 430 615 039	105031-4650	9 430 611 457	NP-DLLA160SN875	9 432 611 222
31-4650 A5	9 430 615 039	105031-4650	9 430 611 458	NP-DLLA150SN876	9 432 610 704
31-4650 A6	9 430 615 039	105031-4650	9 430 611 506	NP-DLLA150SN917	9 432 610 739
31-4650 D1	9 430 615 039	105031-4650	9 430 611 341	NP-DLLA153SN696	9 432 611 255
31-4650 D3	9 430 615 039	105031-4650	9 430 611 371	NP-DLLA150SN737	9 432 610 375
31-4650 D4	9 430 615 039	105031-4650	9 430 611 382	NP-DLLA154SN750	9 432 610 748
31-4650 D5	9 430 615 039	105031-4650	9 430 611 401	NP-DLLA155SN784	9 432 611 271
31-4650 E3	9 430 615 039	105031-4650	9 430 610 521	NP-DLLA155SM102	9 432 610 654
31-4650 F1	9 430 615 039	105031-4650	9 430 610 178	NP-DLLA155SM166	9 432 610 449
31-4650 F2	9 430 615 039	105031-4650	9 430 610 578	NP-DLLA155SM182	9 432 610 667
31-4650 Z	9 430 615 039	105031-4650	9 430 611 486	NP-DLLA158SN638	9 432 610 073
31-4660 H	9 430 616 218	105031-4660	9 430 611 015	NP-DLLA150SN548	9 432 610 757
31-4750	9 430 616 219	105031-4750	9 430 611 021	NP-DLLA154SN631	9 432 611 775

 Typ	 Ref.	 Zexel	 Ref.	 Typ	 Ref.
31-4760		105031-4760	9 430 611 027	NP-DLL155S268N485	9 432 610 290
31-4760 E		105031-4760	9 430 611 329	NP-DLL155SN675	9 432 611 788
31-4760 F		105031-4760	9 430 611 345	NP-DLL158SN701	9 432 610 150
31-4761	9 430 615 122	105031-4761	9 430 611 028	NP-DLL155S268N485	9 432 610 290
31-4761 A		105031-4761		NP-DLL155S288N431	
31-4761 C	9 430 615 122	105031-4761	9 430 611 428	NP-DLL157SN829	9 432 610 328
31-4761 E	9 430 615 122	105031-4761	9 430 610 570	NP-DLLA155SN991	9 432 610 520
31-4761 E	9 430 615 122	105031-4761	9 430 611 330	NP-DLL155SN675	9 432 611 788
31-4761 F	9 430 615 122	105031-4761	9 430 611 346	NP-DLL158SN701	9 432 610 150
31-4770	9 430 615 918	105031-4770	9 430 611 037	NP-DLLA154SN641	9 432 610 823
31-4770 A	9 430 615 918	105031-4770	9 430 611 057	NP-DLLA154S364N476	9 432 610 097
31-4771 2	9 430 615 374	105031-4771	9 430 610 891	NP-DLLA154S344N424	9 432 611 754
31-4771 3	9 430 615 374	105031-4771	9 430 611 058	NP-DLLA154S364N476	9 432 610 097
31-4780	9 430 615 759	105031-4780	9 430 611 038	NP-DLLA154SN643	9 432 610 908
31-4781 5	9 430 615 295	105031-4781	9 430 611 039	NP-DLLA154SN643	9 432 610 908
31-4781 P	9 430 615 295	105031-4781	9 430 611 004	NP-DLLA154S364N476	9 432 610 097
31-4790 B2	9 430 615 328	105031-4790	9 430 611 081	NP-DLLA148SN545	9 432 610 200
31-4790 B5	9 430 615 328	105031-4790	9 430 611 089	NP-DLLA155SN669	9 432 610 200
31-4790 B6	9 430 615 328	105031-4790	9 430 611 093	NP-DLLA152SN681	9 432 610 212
31-4790 B7	9 430 615 328	105031-4790	9 430 611 097	NP-DLLA148SN693	9 432 610 832
31-4790 B9	9 430 615 328	105031-4790	9 430 611 135	NP-DLLA152SN6810	9 432 610 212
31-4790 E1	9 430 615 328	105031-4790	9 430 611 145	NP-DLLA152SN6810	9 432 610 212
31-4800	9 430 615 919	105031-4800	9 430 611 084	NP-DLLA154SN661	9 432 610 243
31-4800 C	9 430 615 919	105031-4800	9 430 611 112	NP-DLLA147SN703	9 432 610 752
31-4800 F	9 430 615 919	105031-4800	9 430 611 138	NP-DLLA149SN776	9 432 611 291
31-4801 2N	9 430 615 296	105031-4801	9 430 611 091	NP-DLLA154SN667	9 432 610 056
31-4801 2S	9 430 615 296	105031-4801	9 430 611 143	NP-DLLA149SN783	9 432 611 270
31-4801 2T	9 430 615 296	105031-4801	9 430 611 113	NP-DLLA147SN703	9 432 610 752
31-4801 2X	9 430 615 296	105031-4801	9 430 611 085	NP-DLLA154SN661	9 432 610 243
31-4801 2Y	9 430 615 296	105031-4801	9 430 611 103	NP-DLLA147SN703	9 432 610 752
31-4801 3C	9 430 615 296	105031-4801	9 430 611 156	NP-DLLA149SN810	9 432 611 281
31-4801 3D	9 430 615 296	105031-4801	9 430 611 665	NP-DLLA152SM070	9 432 611 546
31-4820	9 430 615 920	105031-4820	9 430 611 062	NP-DLLA150SN665	9 432 610 293
31-4820 G	9 430 615 920	105031-4820	9 430 611 435	NP-DLLA150SN705	9 432 611 259
31-4830	9 430 615 921	105031-4830	9 430 611 086	NP-DLLA154SN665	9 432 611 798
31-4830 A	9 430 615 921	105031-4830	9 430 611 161	NP-DLLA156SN820	9 432 610 716
31-4830 C	9 430 615 921	105031-4830	9 430 611 594	NP-DLLA144SN899	9 432 611 201
31-4830 F	9 430 615 921	105031-4830	9 430 611 615	NP-DLLA151SN950	9 432 611 350
31-4831 A	9 430 615 297	105031-4831	9 430 611 162	NP-DLLA156SN820	9 432 610 716
31-4831 C	9 430 615 297	105031-4831	9 430 611 595	NP-DLLA144SN899	9 432 611 201
31-4831 E	9 430 615 297	105031-4831	9 430 611 087	NP-DLLA154SN665	9 432 611 798
31-4831 F	9 430 615 297	105031-4831	9 430 611 616	NP-DLLA151SN950	9 432 611 350
31-4831 K	9 430 615 297	105031-4831	9 430 611 065	NP-DLLA154SN625	9 432 610 319
31-4840	9 430 615 428	105031-4840	9 430 611 311	NP-DLLA155SN601	9 432 612 331
31-4840 A	9 430 615 428	105031-4840	9 430 611 310	NP-DLLA154SN640	9 432 610 254

A156

de

**Düsen für
1-Feder-Düsenhalter
von Zexel**

(Fortsetzung)

en

**Nozzles for the most
important single-
spring nozzle-holders
Zexel**

(continued)

fr

**Injecteurs pour
les principaux porte-
injecteurs à 1 ressort
Zexel**

(suite)

it

**Polvrizzatori per
i principali porta-
polverizzatori
a 1 molla, Zexel**







(seguito)







es

**Inyectores para
los portainyectores
de 1 muelle más
importantes, Zexel**

(continuación)



 Typ	 Ref.	 Zexel	 Ref.	 Typ	 Ref.
31-4850	9 430 616 138	105031-4850	9 430 611 312	NP-DLLA25SN594	9 432 612 327
31-4860	9 430 615 458	105031-4860	9 430 611 313	NP-DLLA155S324N468	9 432 610 705
31-4860 A	9 430 615 458	105031-4860	9 430 611 315	NP-DLLA145SN522	9 432 611 729
31-4860 B	9 430 615 458	105031-4860	9 430 611 316	NP-DLLA145SN523	9 432 611 728
31-4860 C	9 430 615 458	105031-4860	9 430 611 317	NP-DLLA103S314N495	9 432 611 716
31-4860 E	9 430 615 458	105031-4860	9 430 611 318	NP-DLLA103SN646	9 432 612 335
31-4860 F	9 430 615 458	105031-4860	9 430 611 319	NP-DLLA155SN650	9 432 611 803
31-4870	9 430 615 922	105031-4870	9 430 611 090	NP-DLLA154SN667	9 432 610 056
31-4870 E	9 430 615 922	105031-4870	9 430 611 102	NP-DLLA147SN703	9 432 610 752
31-4870 N	9 430 615 922	105031-4870	9 430 611 142	NP-DLLA149SN783	9 432 611 270
31-4870 X	9 430 615 922	105031-4870	9 430 611 155	NP-DLLA149SN810	9 432 611 281
31-4880	9 430 616 139	105031-4880	9 430 611 314	NP-DLLA103S314N495	9 432 611 716
31-4890	9 430 615 335	105031-4890	9 430 611 095	NP-DLLA138SN686	9 432 611 704
31-4890 B	9 430 615 335	105031-4890	9 430 611 096	NP-DLLA134SN759	9 432 610 842
31-4900	9 430 615 923	105031-4900	9 430 611 334	NP-DLLA155SN687	9 432 610 828
31-4910 N	9 430 615 924	105031-4910	9 430 611 336	NP-DLLA155S334NP96	9 432 610 241
31-4920	9 430 615 933	105031-4920	9 430 611 337	NP-DLLA148S334N472	9 432 610 440
31-4930 TC	9 430 615 925	105031-4930	9 430 611 338	NP-DLLA148S324N473	9 432 610 204
31-4940 A2	9 430 615 916	105031-4940	9 430 611 455	NP-DLLA154SN856	9 432 611 178
31-4940 A5	9 430 615 916	105031-4940	9 430 611 463	NP-DLLA150SN876	9 432 610 704
31-4940 Z	9 430 615 916	105031-4940	9 430 611 339	NP-DLLA158SN638	9 432 610 073
31-4950	9 430 615 329	105031-4950	9 430 611 342	NP-DLLA155SN697	9 432 610 900
31-4960	9 430 615 926	105031-4960	9 430 611 101	NP-DLLA155SN687	9 432 610 828
31-4970	9 430 615 927	105031-4970	9 430 611 105	NP-DLLA150SN705	9 432 611 259
31-4980	9 430 615 928	105031-4980	9 430 611 109	NP-DLLA155SN687	9 432 610 828
31-4990	9 430 615 364	105031-4990	9 430 611 111	NP-DLLA141SN714	9 432 610 460
31-4990 K	9 430 615 364	105031-4990	9 430 611 703	NP-DLLA150SM212	9 432 611 477
31-4990 L	9 430 615 364	105031-4990	9 430 613 343	NP-DLLA140SM350	9 432 612 658
31-5010		105031-5010	9 430 611 250	NP-DL150S208NP1	9 432 611 676
31-5110	9 430 615 480	105031-5110	9 430 611 249	NP-DL145S268NP1	9 432 610 270
31-5170	9 430 615 929	105031-5170	9 430 611 254	NP-DLL150S328NP33	9 432 610 075
31-5170	9 430 615 929	105031-5170	9 430 611 260	NP-DLL150S308NP33	9 432 611 936
31-5180	9 430 616 132	105031-5180	9 430 611 186	NP-DN30S1	9 432 611 974
31-5190	9 430 615 151	105031-5190	9 430 611 278	NP-DLL150S328NP52	9 432 610 016
31-5230	9 430 615 930	105031-5230	9 430 611 291	NP-DLLA150S38,40N016	9 432 610 387
31-5240	9 430 615 931	105031-5240	9 430 611 292	NP-DLLA150S394NP68	9 432 611 758
31-5250	9 430 615 932	105031-5250	9 430 611 294	NP-DLLA150S394NP69	9 432 611 753
31-5250 A	9 430 615 932	105031-5250	9 430 611 297	NP-DLLA150S394NP71	
31-5270	9 430 615 887	105031-5270	9 430 610 730	NP-DLLA150S414NP83	9 432 610 017
31-5280	9 430 615 782	105031-5280	9 430 611 303	NP-DLLA150S394NP76	9 432 610 100
31-5300	9 430 615 066	105031-5300	9 430 610 746	NP-DLLA150S394NP76	9 432 610 100
31-5300 122	9 430 615 066	105031-5300	9 430 612 972	NP-DLLA150S374N464	9 432 610 179
31-5300 A	9 430 615 066	105031-5300	9 430 610 776	NP-DLLA150S394N404	9 432 610 316
31-5300 C	9 430 615 066	105031-5300	9 430 610 787	NP-DLLA150S374N414	9 432 610 368
31-5300 D	9 430 615 066	105031-5300	9 430 610 786	NP-DLLA150S394N412	9 432 611 763

 Typ	 Ref.	 Zexel	 Ref.	 Typ	 Ref.
31-5300 F	9 430 615 066	105031-5300	9 430 610 078	NP-DLLA150S374N464	9 432 610 179
31-5310	9 430 615 850	105031-5310	9 430 610 747	NP-DLLA150S414NP83	9 432 610 017
31-5310 D	9 430 615 850	105031-5310	9 430 610 784	NP-DLLA150S394N411	9 432 611 764
31-5320	9 430 615 783	105031-5320	9 430 610 754	NP-DLLA150S414N380	9 432 610 314
31-5320 C	9 430 615 783	105031-5320	9 430 610 789	NP-DLLA150S394N416	9 432 611 762
31-5320 D	9 430 615 783	105031-5320	9 430 610 833	NP-DLLA150S394N452	9 432 611 722
31-5330	9 430 616 120	105031-5330	9 430 610 774	NP-DLLA150S404N397	
31-5340	9 430 615 851	105031-5340	9 430 610 822	NP-DLLA144S325N441	9 432 611 756
31-5340	9 430 615 851	105031-5340	9 430 610 815	NP-DLLA150S384N436	9 432 611 758
31-5340 A	9 430 615 851	105031-5340	9 430 610 881	NP-DLLA144S324N478	9 432 611 717
31-5340 B	9 430 615 851	105031-5340	9 430 610 883	NP-DLLA144S304N481	9 432 610 164
31-5350 A	9 430 615 336	105031-5350	9 430 611 418	NP-DLLA150SN812	9 432 611 283
31-5350 D	9 430 615 336	105031-5350	9 430 610 785	NP-DLLA150S394N411	9 432 611 764
31-5360	9 430 615 852	105031-5360	9 430 610 845	NP-DLL150S328NP52	9 432 610 016
31-5370	9 430 615 350	105031-5370	9 430 610 857	NP-DLLA150S355N467	9 432 611 725
31-5370 A	9 430 615 350	105031-5370	9 430 610 888	NP-DLLA150S424N470	9 432 610 439
31-5380		105031-5380	9 430 610 860	NP-DLLA144S325N441	9 432 611 756
31-5390	9 430 615 853	105031-5390	9 430 611 228	NP-DN4SD65	9 432 610 060
31-5400	9 430 615 214	105031-5400	9 430 610 867	NP-DLLA150S424N470	9 432 610 439
31-5410	9 430 615 784	105031-5410	9 430 610 880	NP-DLLA150S424N477	9 432 611 718
31-5420	9 430 615 337	105031-5420	9 430 610 952	NP-DLLA142S344N501	9 432 610 286
31-5420 161	9 430 615 337	105031-5420	9 430 612 966	NP-DLLA150SN549	9 432 610 836
31-5430 A	9 430 615 400	105031-5430	9 430 610 983	NP-DLLA150SN557	9 432 611 814
31-5430 B	9 430 615 400	105031-5430	9 430 611 405	NP-DLLA150SN704	9 432 611 257
31-5440	9 430 615 785	105031-5440	9 430 611 068	NP-DLLA150S394N452	9 432 611 722
31-5440 A	9 430 615 785	105031-5440	9 430 611 074	NP-DLLA150SN605	9 432 611 776
31-5440 H	9 430 615 785	105031-5440	9 430 611 075	NP-DLLA150SN730	9 432 611 236
31-5450	9 430 615 854	105031-5450	9 430 611 323	NP-DLLA144S325N441	9 432 611 756
31-5450 A	9 430 615 854	105031-5450	9 430 611 320	NP-DLLA144S324N478	9 432 611 717
31-5450 B	9 430 615 854	105031-5450	9 430 611 321	NP-DLLA144S304N481	9 432 610 164
31-5450 C	9 430 615 854	105031-5450	9 430 611 322	NP-DLLA156SN589	9 432 611 835
31-5450 E	9 430 615 854	105031-5450	9 430 611 351	NP-DLLA152SN668	9 432 611 799
31-5460	9 430 615 855	105031-5460	9 430 611 364	NP-DLLA150SN702	9 432 610 311
31-5461	9 430 615 215	105031-5461	9 430 611 365	NP-DLLA150SN702	9 432 610 311
31-5461 186	9 430 615 215	105031-5461	9 430 613 034	NP-DLLA150SN702	9 432 610 311
31-5470	9 430 615 216	105031-5470	9 430 611 378	NP-DLLA150SN702	9 432 610 311
31-5470 197	9 430 615 216	105031-5470	9 430 613 045	NP-DLLA150SN702	9 432 610 311
31-5470 324	9 430 615 216	105031-5470	9 430 613 101	NP-DLLA146SM203	9 432 610 670
31-5470 D	9 430 615 216	105031-5470	9 430 610 581	NP-DLLA146SM203	9 432 610 670
31-5480	9 430 615 217	105031-5480	9 430 611 392	NP-DLLA150SN769	9 432 611 293
31-5480 203	9 430 615 217	105031-5480	9 430 613 041	NP-DLLA150SN769	9 432 611 293
31-5490 4B	9 430 615 383	105031-5490	9 430 611 400	NP-DLLA153SN782	9 432 612 348
31-5490 4D	9 430 615 383	105031-5490	9 430 611 406	NP-DLLA153SN786	9 432 610 743
31-6070		105031-6070	9 430 611 248	NP-DL160S258NP1	9 432 611 674
31-6110		105031-6110	9 430 610 772	NP-DLLA38S602N398	

A158

de

**Düsen für
1-Feder-Düsenhalter
von Zexel**

(Fortsetzung)

en

**Nozzles for the most
important single-
spring nozzle-holders
Zexel**

(continued)

fr

**Injecteurs pour
les principaux porte-
injecteurs à 1 ressort
Zexel**

(suite)

it

**Polvizzatori per
i principali porta-
polverizzatori
a 1 molla, Zexel**







(seguito)







es

**Inyectores para
los portainyectores
de 1 muelle más
importantes, Zexel**

(continuación)



 Typ	 Ref.	 Zexel	 Ref.	 Typ	 Ref.
31-6110 A		105031-6110	9 430 610 773	NP-DLLA38S552N399	
31-6120	9 430 615 338	105031-6120	9 430 611 133	NP-DLLA150SN762	9 432 611 289
31-6120 G	9 430 615 338	105031-6120	9 430 611 548	NP-DLLA150SN762	9 432 611 289
31-6130	9 430 615 372	105031-6130	9 430 611 399	NP-DLLA155SN773	9 432 611 277
31-7020		105031-7020	9 430 611 234	NP-DL145S2210NP1	
31-7020		105031-7020	9 430 611 237	NP-DL145S308NP1	
31-7020		105031-7020	9 430 611 238	NP-DL145S258NP1	9 432 610 322
31-7020		105031-7020	9 430 611 240	NP-DL155S228NP1	9 432 611 675
31-7020		105031-7020	9 430 611 239	NP-DL155S258NP1	9 432 612 003
31-7020		105031-7020	9 430 611 230	NP-DL145S228NP1	9 432 612 007
31-7120		105031-7120	9 430 611 252	NP-DL145S258NP1	9 432 610 322
31-7120		105031-7120	9 430 611 251	NP-DL145S2758NP1	9 432 612 005
31-7140	9 430 615 330	105031-7140	9 430 610 953	NP-DLLA150SN541	9 432 611 826
31-7140 C	9 430 615 330	105031-7140	9 430 610 964	NP-DLLA150SN554	9 432 611 812
31-7140 E	9 430 615 330	105031-7140	9 430 611 070	NP-DLLA150S424N470	9 432 610 439
31-7150 E	9 430 615 786	105031-7150	9 430 610 965	NP-DLLA150SN555	9 432 610 756
31-7150 F	9 430 615 786	105031-7150	9 430 611 071	NP-DLLA150SN555	9 432 610 756
31-7160	9 430 615 787	105031-7160	9 430 610 979	NP-DLLA150S424N470	9 432 610 439
31-7160 D	9 430 615 787	105031-7160	9 430 611 073	NP-DLLA150S424N470	9 432 610 439
31-7160 H	9 430 615 787	105031-7160	9 430 611 104	NP-DLLA150SN704	9 432 611 257
31-7170	9 430 615 339	105031-7170	9 430 611 078	NP-DLLA150SN555	9 432 610 756
31-7180	9 430 615 860	105031-7180	9 430 611 083	NP-DLLA150SN555	9 432 610 756
31-7190	9 430 615 788	105031-7190	9 430 611 100	NP-DLLA150SN702	9 432 610 311
31-7200	9 430 615 353	105031-7200	9 430 611 108	NP-DLLA150SN702	9 432 610 311
31-7200 G	9 430 615 353	105031-7200	9 430 611 123	NP-DLLA150SN739	9 432 611 241
31-7230	9 430 615 137	105031-7230	9 430 611 554	NP-DLLA150SN762	9 432 611 289
31-7230 G	9 430 615 137	105031-7230	9 430 611 578	NP-DLLA150SN902	9 432 611 203
31-7230 H	9 430 615 137	105031-7230	9 430 611 576	NP-DLLA150SN902	9 432 611 203
31-7230 K	9 430 615 137	105031-7230	9 430 611 570	NP-DLLA150SN762	9 432 611 289
31-7230 R	9 430 615 137	105031-7230	9 430 611 577	NP-DLLA150SN902	9 432 611 203
31-7240	9 430 615 340	105031-7240	9 430 611 546	NP-DLLA150SN867	9 432 611 217
31-7240	9 430 615 340	105031-7240	9 430 611 572	NP-DLLA150SN867	9 432 611 217
31-7240 L	9 430 615 340	105031-7240	9 430 611 589	NP-DLLA150SN912	9 432 610 774
31-7240 S	9 430 615 340	105031-7240	9 430 611 604	NP-DLLA150SN929	9 432 611 368
31-7241	9 430 615 218	105031-7241	9 430 611 547	NP-DLLA150SN867	9 432 611 217
31-7241 247	9 430 615 218	105031-7241	9 430 613 018	NP-DLLA150SN912	9 432 610 774
31-7241 252	9 430 615 218	105031-7241	9 430 612 999	NP-DLLA150SN929	9 432 611 368
31-7241 255	9 430 615 218	105031-7241	9 430 613 012	NP-DLLA150SN938	
31-7241 P	9 430 615 218	105031-7241	9 430 611 606	NP-DLLA150SN929	9 432 611 368
31-7241 R	9 430 615 218	105031-7241	9 430 611 610	NP-DLLA150SN938	9 432 611 387
31-7241 S	9 430 615 218	105031-7241	9 430 611 590	NP-DLLA150SN912	9 432 610 774
31-7241 X	9 430 615 218	105031-7241	9 430 611 573	NP-DLLA150SN867	9 432 611 217
31-7250	9 430 615 319	105031-7250	9 430 611 559	NP-DLLA150SN702	9 432 610 311
31-7251	9 430 615 341	105031-7251	9 430 611 560	NP-DLLA150SN702	9 432 610 311
31-7260 A	9 430 615 861	105031-7260	9 430 611 561	NP-DLLA150SN874	9 432 611 221

 Typ	 Ref.	 Zexel	 Ref.	 Typ	 Ref.
31-7270	9 430 615 862	105031-7270	9 430 611 569	NP-DLLA150SN892	9 432 611 229
31-7270 F	9 430 615 862	105031-7270	9 430 611 586	NP-DLLA150SN906	9 432 611 206
31-7310	9 430 615 125	105031-7310	9 430 610 166	NP-DLLA150SN933	9 432 610 392
31-7310 A	9 430 615 125	105031-7310	9 430 612 856	NP-DLLA155SM320	9 432 611 624
31-7310 B		105031-7310		NP-DLLA155SM393	9 432 612 781
31-7320 A	9 430 615 836	105031-7320	9 430 611 609	NP-DLLA150SN938	9 432 611 387
31-7331		105031-7331	9 430 611 633	NP-DLLA153SM015	9 432 611 509
31-7332 F	9 430 615 219	105031-7332	9 430 611 634	NP-DLLA153SM015	9 432 611 509
31-7360 B		105031-7360	9 430 611 639	NP-DLLA150SM026	9 432 611 517
31-7360 E		105031-7360	9 430 611 654	NP-DLLA150SM041	9 432 610 871
31-7361 E		105031-7361	9 430 611 655	NP-DLLA150SM041	9 432 610 871
31-7363 I	9 430 615 220	105031-7363	9 430 611 670	NP-DLLA150SM121	9 432 611 459
31-7363 N	9 430 615 220	105031-7363	9 430 611 656	NP-DLLA150SM041	9 432 610 871
31-7370	9 430 615 838	105031-7370	9 430 611 605	NP-DLLA150SN929	9 432 611 368
31-7390 F	9 430 615 408	105031-7390	9 430 611 685	NP-DLLA153SM015	9 432 611 509
31-7410 305	9 430 615 409	105031-7410	9 430 612 853	NP-DLLA150SM041	9 432 610 871
31-7410 N	9 430 615 409	105031-7410	9 430 611 692	NP-DLLA150SM041	9 432 610 871
31-7420	9 430 615 839	105031-7420	9 430 610 189	NP-DLLA150SN702	9 432 610 311
31-7430	9 430 616 196	105031-7430	9 430 613 465	NP-DLLA150SM370	9 432 612 738
31-7430 C		105031-7430		NP-DLLA150SM412	9 432 612 826
31-8020	9 430 615 524	105031-8020	9 430 611 236	NP-DL130S278NP1	9 432 612 011
31-8020 A	9 430 615 524	105031-8020	9 430 611 235	NP-DL130S276NP1	9 432 612 010
31-8021 A	9 430 616 220	105031-8021	9 430 612 957	NP-DL130S276NP1	9 432 612 010
3200		105088-2002		NP-DSLA140PN935	9 432 612 839
3212	9 430 616 193	105088-2001		NP-DLLA140PN291	F 01G 0V5 000
3212	9 430 616 183	105088-2000	9 430 613 190	NP-DLLA140PN291	F 01G 0V5 000
3212	F 000 430 201	105088-2002	F 01G 0V4 000	NP-DLLA140PN291	F 01G 0V5 000
3269	9 430 616 193	105088-2001		NP-DLLA140PN291	F 01G 0V5 000
3269	9 430 616 183	105088-2000	9 430 613 435	NP-DLLA140PN291	F 01G 0V5 000
3269	F 000 430 201	105088-2002	F 01G 0V4 001	NP-DLLA140PN291	F 01G 0V5 000
33-1010		105033-1010	9 430 611 716	NP-DN0TDNP1	9 432 611 643
33-1011	9 430 615 840	105033-1011	9 430 611 717	NP-DN0TDNP1	9 432 611 643
33-1030 A	9 430 615 807	105033-1030	9 430 611 728	NP-DL42T1251NP24	
33-1030 B	9 430 615 807	105033-1030	9 430 611 730	NP-DL42T1501NP24	9 432 612 172
33-1030 C	9 430 615 807	105033-1030	9 430 611 731	NP-DL42T801NP24	
33-1030 D	9 430 615 807	105033-1030	9 430 611 735	NP-DL45T3601NP29	9 432 612 178
33-1040	9 430 615 808	105033-1040	9 430 611 729	NP-DL45T2051NP25	
33-1040 A	9 430 615 808	105033-1040	9 430 611 733	NP-DL155T358NP1	9 432 612 178
33-1050 A	9 430 616 221	105033-1050	9 430 611 713	NP-DN12TN2	9 432 611 642
33-1060 A	9 430 616 222	105033-1060	9 430 611 714	NP-DN12TN052	9 432 611 996
33-1070	9 430 616 223	105033-1070	9 430 611 715	NP-DN12TN053C	9 432 611 997
33-3020	9 430 615 047	105033-3020	9 430 611 718	NP-DL155T358NP1	9 432 610 088
33-3030	9 430 615 809	105033-3030	9 430 611 734	NP-DL45T3601NP29	9 432 612 178
33-5240	9 430 615 482	105033-5240	9 430 611 723	NP-DL150T348NP20	9 432 610 028
33-5240 A	9 430 615 482	105033-5240	9 430 611 726	NP-DL160T328NP20	9 432 611 909

A160

de

**Düsen für
1-Feder-Düsenhalter
von Zexel**

(Fortsetzung)

en

**Nozzles for the most
important single-
spring nozzle-holders
Zexel**

(continued)

fr

**Injecteurs pour
les principaux porte-
injecteurs à 1 ressort
Zexel**

(suite)

it

**Polvrizzatori per
i principali porta-
polverizzatori
a 1 molla, Zexel**







(seguito)







es

**Inyectores para
los portainyectores
de 1 muelle más
importantes, Zexel**

(continuación)



						
33-5240	B	9 430 615 482	105033-5240	9 430 611 736	NP-DL150T328NP15	9 432 611 895
33-5240	C	9 430 615 482	105033-5240	9 430 611 746	NP-DL160T348NP20	9 432 610 970
33-5260		9 430 615 841	105033-5260	9 430 611 721	NP-DL150T308NP22	9 432 610 047
33-5260	A	9 430 615 841	105033-5260	9 430 611 722	NP-DL150T288NP22	9 432 610 301
33-5260	D	9 430 615 841	105033-5260	9 430 611 732	NP-DL150T278NP22	
33-5280		9 430 616 224	105033-5280	9 430 611 724	NP-DL155T288NP15	9 432 611 908
33-5310	A	9 430 616 225	105033-5310	9 430 611 725	NP-DL150T268NP22	9 432 610 032
33-5310	B	9 430 616 225	105033-5310	9 430 611 740	NP-DL150T248NP22	9 432 612 195
33-5310	C	9 430 616 225	105033-5310	9 430 611 744	NP-DL150T248NP32	9 432 611 873
33-5310	D	9 430 616 225	105033-5310	9 430 611 745	NP-DL150T268NP32	9 432 612 196
33-6020	A	9 430 615 483	105033-6020	9 430 611 720	NP-DL130T328NP20	9 432 610 020
33-6020	B	9 430 615 483	105033-6020	9 430 611 727	NP-DL150T348NP20	9 432 610 028
33-6020	C	9 430 615 483	105033-6020	9 430 611 737	NP-DL150T368NP20	9 432 610 497
33-6020	D	9 430 615 483	105033-6020	9 430 611 741	NP-DL130T308NP20	9 432 612 519
33-6020	E	9 430 615 483	105033-6020	9 430 611 742	NP-DL130T328NP20	9 432 612 521
33-6020	F	9 430 615 483	105033-6020	9 430 611 747	NP-DL140T328NP20	9 432 610 966
33-6020	G	9 430 615 483	105033-6020	9 430 611 748	NP-DL140T348NP20	9 432 610 965
33-6020	H	9 430 615 483	105033-6020	9 430 611 749	NP-DL140T368NP20	9 432 611 045
33-6360	A	9 430 615 467	105033-6360	9 430 611 743	NP-DL150T308NP1	9 432 610 257
33-6380		9 430 615 070	105033-6380	9 430 611 738	NP-DL140T388NP1	9 432 611 659
33-6380	A	9 430 615 070	105033-6380	9 430 611 739	NP-DL135T388NP15	9 432 611 910
33-6390		9 430 615 547	105033-6390	9 430 611 719	NP-DL155T387NP1	9 432 612 161
34-2010		9 430 615 484	105034-2010	9 430 611 750	NP-DL150U428NP7	9 432 611 852
34-2010	A	9 430 615 484	105034-2010	9 430 611 752	NP-DL150U408NP9	9 432 611 853
34-2010	B	9 430 615 484	105034-2010	9 430 611 753	NP-DL150U428NP9	9 432 610 194
34-4020		9 430 615 485	105034-4020	9 430 611 751	NP-DL150U479NP5	9 432 611 851
34-4020	A	9 430 615 485	105034-4020	9 430 611 754	NP-DL150U509NP5	9 432 611 855
34-6010	B		105034-6010			
34-6010	B		105034-6010		D NP-DLL145UC5010N2	
34-6011	A		105034-6011		NP-DLL145UC5010N2	
3630			105088-2002		NP-DSLA140PN935	
3630			105088-2002		NP-DSLA140PN935	9 432 612 839
3630			105088-2002		NP-DSLA140PN936	9 432 612 844
3797			105088-2002		NP-DSLA140PN935	9 432 612 839
38-2010		9 430 616 226	105038-2010	9 430 611 757	NP-DLLA150PN044	9 432 610 196
38-4000			105038-4000	9 430 612 445	NP-DLLA154PN040	9 432 610 707
38-4001	H	9 430 615 360	105038-4001	9 430 612 446	NP-DLLA154PN040	9 432 610 707
38-4001	W	9 430 615 360	105038-4001	9 430 611 755	NP-DLLA154PN103	9 432 611 322
38-4001	Z	9 430 615 360	105038-4001	9 430 611 756	NP-DLLA156PN110	9 432 610 178
38-4010			105038-4010	9 430 612 447	NP-DLLA154NP041	9 432 611 341
38-4011	J	9 430 615 361	105038-4011	9 430 612 448	NP-DLLA154PN051	9 432 610 445
3858			105088-2010		NP-DSLA138PN938	
3858			105088-2010		NP-DSLA138PN938	
3919			105088-2002		NP-DSLA140PN940	
40-1030			105040-1030	9 430 611 758	NP-DN4SN8	9 432 610 444

 Typ	 Ref.	 Zexel	 Ref.	 Typ	 Ref.
40-1200		105040-1200	9 430 611 764	NP-DN12SD12	9 432 610 038
40-1200		105040-1200	9 430 611 759	NP-DN15S2	9 432 611 973
40-1220	9 430 616 147	105040-1220	9 430 611 760	NP-DN4S1	9 432 610 036
40-1320		105040-1320	9 430 611 770	NP-DL50S255NP3	
40-1320		105040-1320	9 430 611 765	NP-DN12SD12	9 432 610 038
40-1320		105040-1320	9 430 611 768	NP-DN12SD12	9 432 610 038
40-1320		105040-1320	9 430 611 761	NP-DN15S156	9 432 611 705
40-1321	9 430 615 459	105040-1321	9 430 611 766	NP-DN12SD12	9 432 610 038
40-1321	9 430 615 459	105040-1321	9 430 611 769	NP-DN12SD12	9 432 610 038
40-1322	9 430 616 148	105040-1322	9 430 611 767	NP-DN12SD12-	9 432 610 038
40-2120	9 430 615 812	105040-2120	9 430 611 762	NP-DN4S1	9 432 610 036
40-2130		105040-2130	9 430 611 763	NP-DN4S1	9 432 610 036
40-2140		105040-2140	9 430 611 771	NP-DLL165S288NP85	9 432 611 720
40-2150		105040-2150	9 430 611 772	NP-DLLA165S288N384	
40-2160	9 430 615 848	105040-2160	9 430 611 773	NP-DLL165S288N392	9 432 611 736
40-2170 A	9 430 615 368	105040-2170	9 430 611 774	NP-DLL155S288N431	9 432 610 054
40-2180	9 430 615 107	105040-2180	9 430 611 776	NP-DLL155S288N431	9 432 610 054
40-2180 A	9 430 615 107	105040-2180	9 430 611 778	NP-DLL155S268N485	9 432 610 290
40-2180 AB	9 430 615 107	105040-2180	9 430 611 779	NP-DLL155S268N485	9 432 610 290
40-2180 B	9 430 615 107	105040-2180	9 430 611 777	NP-DLL155S288N431	9 430 611 790
40-2190	9 430 615 849	105040-2190	9 430 611 789	NP-DLL155SN574	9 432 611 844
40-2190 A	9 430 615 849	105040-2190	9 430 611 792	NP-DLL155SN636	9 432 611 770
40-2200 A	9 430 615 424	105040-2200	9 430 611 799	NP-DLL155SN636	9 432 611 770
40-4040 C	9 430 615 315	105048-4040	9 430 612 649	NP-DLLA149PN151	9 432 610 731
40-5010	9 430 615 865	105040-5010	9 430 611 775	NP-DLL155S289N434	9 432 610 714
40-5020	9 430 615 256	105040-5020	9 430 611 817	NP-DLLA158SM047	9 432 611 553
40-5020 A	9 430 615 256	105040-5020	9 430 611 818	NP-DLLA158SM060	9 432 612 621
40-5020 G	9 430 615 256	105040-5020	9 430 611 835	NP-DLLA158SM199	9 432 611 469
40-5020 H	9 430 615 256	105040-5020	9 430 612 799	NP-DLLA158SM288	9 432 611 571
40-5020 J	9 430 615 256	105040-5020	9 430 613 550	NP-DLLA158SM268	9 432 611 563
40-5020 K	9 430 615 256	105040-5020	9 430 613 474	NP-DLLA158SM368	9 432 612 736
40-5020 L		105040-5020		NP-DLLA158SM384	9 432 612 755
40-5020 M		105040-5020		NP-DLLA158SM392	
40-5030	9 430 615 257	105040-5030	9 430 611 822	NP-DLLA158SM060	9 432 612 621
40-5030 A	9 430 615 257	105040-5030	9 430 611 828	NP-DLLA158SM120	9 432 611 458
40-5030 B	9 430 615 257	105040-5030	9 430 611 836	NP-DLLA158SM216	9 432 611 480
40-5030 C	9 430 615 257	105040-5030	9 430 611 850	NP-DLLA158SM275	9 432 611 566
40-5030 D	9 430 615 257	105040-5030	9 430 613 347	NP-DLLA158SM351	9 432 612 659
40-5030 E		105040-5030		NP-DLLA158SM268	9 432 611 563
40-5030 F		105040-5030		NP-DLLA158SM384	
40-5040	9 430 616 150	105040-5040	9 430 611 840	NP-DLLA158SM216	9 432 611 480
40-5040 A	9 430 616 150	105040-5040	9 430 611 846	NP-DLLA158SM260	9 432 611 593
40-5040 B	9 430 616 150	105040-5040	9 430 611 847	NP-DLLA158SM264	9 432 611 596
40-5040 C	9 430 616 150	105040-5040	9 430 612 797	NP-DLLA158SM308	9 432 611 619
40-5050	9 430 616 151	105040-5050	9 430 612 796	NP-DLLA158SM288	9 432 611 571

A162

de

**Düsen für
1-Feder-Düsenhalter
von Zexel**

(Fortsetzung)

en

**Nozzles for the most
important single-
spring nozzle-holders
Zexel**

(continued)

fr

**Injecteurs pour
les principaux porte-
injecteurs à 1 ressort
Zexel**

(suite)

it

**Polvrizzatori per
i principali porta-
polverizzatori
a 1 molla, Zexel**







(seguito)







es

**Inyectores para
los portainyectores
de 1 muelle más
importantes, Zexel**

(continuación)



						
40-5050	A	9 430 616 151	105040-5050	9 430 613 471	NP-DLLA158SM365	9 432 612 733
40-5050	B	9 430 616 151	105040-5050	9 430 613 472	NP-DLLA158SM366	9 432 612 734
40-5050	C	9 430 616 151	105040-5050	9 430 613 473	NP-DLLA158SM367	9 432 612 735
40-5050	E		105040-5050		NP-DLLA158SM390	9 432 612 785
40-5050	F		105040-5050		NP-DLLA158SM384	9 432 612 755
40-5050	G		105040-5050		NP-DLLA158SM268	
40-5060		9 430 616 115	105040-5060	9 430 612 795	NP-DLLA158SM330	9 432 611 598
40-5060			105040-5060		NP-DLLA158SM388	9 432 612 762
40-5060	A	9 430 616 115	105040-5060	9 430 612 794	NP-DLLA158SM337	9 432 611 605
40-5060	B	9 430 616 115	105040-5060	9 430 613 475	NP-DLLA158SM378	9 432 612 744
40-5060	C		105040-5060		NP-DLLA158SM383	9 432 612 829
40-5080			105040-5080		NP-DLLA158SM390	9 432 612 785
40-5080	A		105040-5080		NP-DLLA158SM401	9 432 612 786
40-5090			105040-5090		NP-DLLA158SM268	9 432 611 563
40-5090	A		105040-5090		NP-DLLA158SM384	9 432 612 755
40-5100			105040-5100		NP-DLLA158SM351	9 432 612 659
40-5110			105040-5110		NP-DLLA158SM383	
40-5120			105040-5120		NP-DLLA158SM390	
40-5130	J		105040-5130		NP-DLLA158SM268	
40-5130	M		105040-5130		NP-DLLA158SM392	
40-5130	N		105040-5130			
40-5130	N		105040-5130		NP-DLLA158SM417	
40-5140			105040-5140		NP-DLLA158SM330	
40-5140	E		105040-5140		NP-DLLA158SM388	
40-5150			105040-5150		NP-DLLA158SM390	
40-5170	G		105040-5170		NP-DLLA158SM451	
40-8000	A	9 430 615 835	105040-8000	9 430 612 073	NP-DLL160SN647	9 432 610 206
40-8001	A	9 430 615 858	105040-8001	9 430 612 074	NP-DLL160SN647	9 432 610 206
40-8002	A		105040-8002		NP-DLL160SN647	9 432 610 206
40-8011		9 430 615 881	105040-8011	9 430 612 108	NP-DLLA160SN860	9 432 610 451
40-8012			105048-8012		NP-DLLA160SN860	9 432 610 451
41-1040			105041-1040	9 430 611 996	NP-DN4SD24	9 432 610 012
41-1040			105041-1040	9 430 611 991	NP-DN15SDNK1	9 432 610 104
41-1041		9 430 615 460	105041-1041	9 430 611 997	NP-DN4SD24	9 432 610 012
41-1041		9 430 615 460	105041-1041	9 430 611 992	NP-DN15SDNK1	9 432 610 104
41-1042			105041-1042		NP-DN4SD24	
41-1042		9 430 615 882	105041-1042	9 430 611 998	NP-DN4SD24	9 432 610 012
41-1042		9 430 615 882	105041-1042	9 430 612 014	NP-DN4SD24	9 432 610 012
41-1042		9 430 615 882	105041-1042	9 430 611 993	NP-DN15SDNK1	9 432 610 104
41-1042	A		105041-1042		NP-DN4SDN231	
41-1060		9 430 615 461	105041-1060	9 430 611 994	NP-DN12SD12	9 432 610 038
41-1061		9 430 615 126	105041-1061	9 430 611 995	NP-DN12SD12-	9 432 610 038
41-1080		9 430 616 160	105041-1080	9 430 611 999	NP-DN15SDNK1	9 432 610 104
41-1090		9 430 615 813	105041-1090	9 430 612 001	NP-DN4S162	9 432 611 979
41-1100		9 430 615 017	105041-1100	9 430 610 013	NP-DN0SD2110	9 432 610 007

 Typ	 Ref.	 Zexel	 Ref.	 Typ	 Ref.
41-1100 C	9 430 615 017	105041-1100	9 430 612 013	NP-DN0SDN187	9 432 610 023
41-1110	9 430 615 001	105041-1110	9 430 610 015	NP-DN0SDN187	9 432 610 011
41-1111	9 430 615 013	105041-1111	9 430 612 010	NP-DN0SDN187	9 432 610 023
41-1111 A	9 430 615 013	105041-1111	9 430 612 009	NP-DN0SD187	9 432 610 011
41-1111 A	9 430 615 013	105041-1111	9 430 610 035	NP-DN0SDN187	9 432 610 023
41-1111 B	9 430 615 013	105041-1111	9 430 612 011	NP-DN0SDN187	9 432 610 023
41-1111 K	9 430 615 013	105041-1111	9 430 610 071	NP-DN0SD196	9 432 610 160
41-1111 S	9 430 615 013	105041-1111	9 430 612 008	NP-DN0SD187	9 432 610 011
41-1120	9 430 615 002	105041-1120	9 430 610 001	NP-DN0SD193NP1	9 432 610 004
41-1120 N	9 430 615 002	105041-1120	9 430 612 002	NP-DN1830	9 432 610 013
41-1120 P	9 430 615 002	105041-1120	9 430 612 004	NP-DN0SDN184	9 432 610 014
41-1121	9 430 615 014	105041-1121	9 430 610 014	NP-DN0SD193NP1	9 432 610 004
41-1121 B	9 430 615 014	105041-1121	9 430 612 006	NP-DN0SD187	9 432 610 023
41-1121 N	9 430 615 014	105041-1121	9 430 612 003	NP-DN1830	9 432 610 013
41-1121 P	9 430 615 014	105041-1121	9 430 612 005	NP-DN0SD184	9 432 610 014
41-1121 S	9 430 615 014	105041-1121	9 430 610 027	NP-DN0SD193NP1	9 432 610 004
41-1121 T	9 430 615 014	105041-1121	9 430 612 007	NP-DN1830	9 432 610 013
41-2030	9 430 615 883	105041-2030	9 430 611 990	NP-DN0SD21	9 432 610 001
41-2040	9 430 616 159	105041-2040	9 430 611 989	NP-DN4S1	9 432 610 036
41-2080	9 430 615 411	105041-2080	9 430 611 957	NP-DLLA157SM210	9 432 611 476
41-2080 A	9 430 615 411	105041-2080	9 430 611 959	NP-DLLA153SM211	9 432 610 862
41-2080 B	9 430 615 411	105041-2080	9 430 611 961	NP-DLLA153SM215	9 432 610 784
41-2081	9 430 615 744	105041-2081	9 430 611 958	NP-DLLA157SM210	9 432 611 476
41-2081	9 430 615 744	105041-2081	9 430 612 935	NP-DLLA157SM210	9 432 611 476
41-2081 E	9 430 615 744	105041-2081	9 430 612 923	NP-DLLA142SM307	9 432 611 618
41-2081 G	9 430 615 744	105041-2081	9 430 612 736	NP-DLLA147SM327	9 432 610 772
41-2081 G	9 430 615 744	105041-2081	9 430 612 913	NP-DLLA147SM327	9 432 610 772
41-2081 H	9 430 615 744	105041-2081	9 430 612 916	NP-DLLA151SM338	9 432 612 652
41-2081 J	9 430 615 744	105041-2081	9 430 613 446	NP-DLLA145SM357	9 432 612 707
41-2081 K	9 430 615 744	105041-2081	9 430 613 512	NP-DLLA141SM361	9 432 612 729
41-2082	9 430 616 227	105041-2082	9 430 613 485	NP-DLLA157SM210	9 432 611 476
41-2082 E	9 430 616 227	105041-2082	9 430 613 497	NP-DLLA142SM307	9 432 611 618
41-2082 G	9 430 616 227	105041-2082	9 430 613 505	NP-DLLA147SM327	9 432 610 772
41-2082 H	9 430 616 227	105041-2082	9 430 613 507	NP-DLLA151SM338	9 432 612 652
41-2082 J	9 430 616 227	105041-2082	9 430 613 510	NP-DLLA145SM357	9 432 612 707
41-2082 K	9 430 616 227	105041-2082	9 430 613 513	NP-DLLA141SM361	9 432 612 729
41-2082 M		105041-2082		NP-DLLA141SM403	9 432 612 800
41-2100	9 430 615 412	105041-2100	9 430 611 964	NP-DLLA160SM222	9 432 611 482
41-2101 U	9 430 615 413	105041-2101	9 430 611 965	NP-DLLA160SM222	9 432 611 482
41-2102 W	9 430 615 884	105041-2102	9 430 611 966	NP-DLLA160SM254	9 432 611 578
41-2110	9 430 615 885	105041-2110	9 430 611 967	NP-DLLA154SM150	9 432 611 436
41-2111	9 430 616 228	105041-2111	9 430 613 488	NP-DLLA154SM150	9 432 611 436
41-2120 A		105041-2120		NP-DLLA157SM251	
41-2120 B		105041-2120		NP-DLLA160SM254	
41-2120 C		105041-2120		NP-DLLA154SM321	

A164

de

**Düsen für
1-Feder-Düsenhalter
von Zexel**

(Fortsetzung)

en

**Nozzles for the most
important single-
spring nozzle-holders
Zexel**

(continued)

fr

**Injecteurs pour
les principaux porte-
injecteurs à 1 ressort
Zexel**

(suite)

it

**Polvrizzatori per
i principali porta-
polverizzatori
a 1 molla, Zexel**







(seguito)







es

**Inyectores para
los portainyectores
de 1 muelle más
importantes, Zexel**

(continuación)



						
41-2120	E		105041-2120		NP-DLLA157SM389	
41-2120	R		105041-2120		NP-DLLA157SM389	9 432 612 766
41-2120	S	9 430 615 745	105041-2120	9 430 612 910	NP-DLLA154SM321	9 432 611 625
41-2120	T	9 430 615 745	105041-2120	9 430 611 981	NP-DLLA160SM254	9 432 611 578
41-2120	V	9 430 615 745	105041-2120	9 430 611 974	NP-DLLA157SM251	9 432 611 587
41-2130	A	9 430 615 746	105041-2130	9 430 611 960	NP-DLLA153SM211	9 432 610 862
41-2130	A	9 430 615 746	105041-2130	9 430 612 934	NP-DLLA153SM211	9 432 610 862
41-2130	B	9 430 615 746	105041-2130	9 430 611 962	NP-DLLA153SM215	9 432 610 784
41-2130	B	9 430 615 746	105041-2130	9 430 612 933	NP-DLLA153SM215	9 432 610 784
41-2130	C	9 430 615 746	105041-2130	9 430 612 918	NP-DLLA153SM211	9 432 610 862
41-2130	C	9 430 615 746	105041-2130	9 430 612 919	NP-DLLA153SM211	9 432 610 862
41-2131	A	9 430 616 229	105041-2131	9 430 613 486	NP-DLLA153SM211	9 432 610 862
41-2131	B	9 430 616 229	105041-2131	9 430 613 487	NP-DLLA153SM215	9 432 610 784
41-2131	C	9 430 616 229	105041-2131	9 430 613 498	NP-DLLA153SM211	9 432 610 862
41-2140	A	9 430 616 192	105041-2140	9 430 613 468	NP-DLLA142SM360	9 432 612 728
41-3000		9 430 615 886	105041-3000	9 430 612 000	NP-DN0SD130NP3	9 432 610 151
41-3010	H	9 430 615 298	105041-3010	9 430 611 798	NP-DLLA152SN931	9 432 611 381
41-3010	P	9 430 615 298	105041-3010	9 430 611 813	NP-DLLA152SM035	9 432 611 549
41-3011	P	9 430 615 896	105041-3011	9 430 611 814	NP-DLLA152SM025	9 432 611 549
41-3012	P	9 430 615 362	105041-3012	9 430 611 815	NP-DLLA152SM025	9 432 611 549
41-3013	P	9 430 615 879	105041-3013	9 430 611 816	NP-DLLA152SM035	9 432 611 549
41-3020	1C	9 430 615 888	105041-3020	9 430 611 884	NP-DLLA160SN915	9 432 612 361
41-3030	1D	9 430 615 267	105041-3030	9 430 611 886	NP-DLLA160SN915	9 432 611 369
41-3030	1D	9 430 615 267	105041-3030	9 430 611 885	NP-DLLA160SN915	9 432 612 361
41-3030	2G	9 430 615 267	105041-3030	9 430 611 887	NP-DLLA160SN893	9 432 611 230
41-3030	2I	9 430 615 267	105041-3030	9 430 611 898	NP-DLLA157SN965	9 432 611 365
41-3030	2J	9 430 615 267	105041-3030	9 430 611 931	NP-DLLA157SM054	9 432 611 539
41-3030	2L	9 430 615 267	105041-3030	9 430 611 899	NP-DLLA157SM051	9 432 611 556
41-3030	2M	9 430 615 267	105041-3030	9 430 611 942	NP-DLLA154SM133	9 432 611 428
41-3030	5M	9 430 615 267	105041-3030	9 430 611 934	NP-DLLA150SM116	9 432 611 457
41-3031	2G	9 430 615 757	105041-3031	9 430 612 785	NP-DLLA160SN893	9 432 611 230
41-3031	2J	9 430 615 757	105041-3031	9 430 612 928	NP-DLLA157SM054	9 432 611 539
41-3031	2L	9 430 615 757	105041-3031	9 430 612 792	NP-DLLA157SM051	9 432 611 556
41-3031	2M	9 430 615 757	105041-3031	9 430 612 936	NP-DLLA154SM133	9 432 611 428
41-3031	5M	9 430 615 757	105041-3031	9 430 612 932	NP-DLLA150SM116	9 432 611 457
41-3040	X	9 430 615 889	105041-3040	9 430 611 893	NP-DLLA154SN959	9 432 611 359
41-3040	Y	9 430 615 889	105041-3040	9 430 611 913	NP-DLLA160SM004	9 432 611 508
41-3051	J3	9 430 615 236	105041-3051	9 430 611 900	NP-DLLA156SN968	9 432 611 422
41-3051	U3	9 430 615 236	105041-3051	9 430 611 901	NP-DLLA158SM073	9 432 611 541
41-3060	G	9 430 615 299	105041-3060	9 430 611 903	NP-DLLA154SN972	9 432 610 906
41-3060	H	9 430 615 299	105041-3060	9 430 611 980	NP-DLLA156SM263	9 432 610 807
41-3060	J	9 430 615 299	105041-3060	9 430 612 907	NP-DLLA156SM263	9 432 610 807
41-3061	G	9 430 616 230	105041-3061	9 430 613 477	NP-DLLA154SN972	9 432 610 906
41-3061	J		105041-3061		NP-DLLA156SM263	9 432 610 807
41-3070	K	9 430 615 300	105041-3070	9 430 611 819	NP-DLLA156SM111	9 432 611 454

 Typ	 Ref.	 Zexel	 Ref.	 Typ	 Ref.
41-3070 N	9 430 615 300	105041-3070	9 430 611 800	NP-DLLA152SN970	9 432 611 410
41-3070 N	9 430 615 300	105041-3070	9 430 611 801	NP-DLLA152SN970	9 432 611 411
41-3071 K	9 430 615 301	105041-3071	9 430 611 820	NP-DLLA156SM111	9 432 611 454
41-3071 N	9 430 615 301	105041-3071	9 430 611 802	NP-DLLA152SN970	9 432 611 411
41-3071 P	9 430 615 301	105041-3071	9 430 611 838	NP-DLLA156SM227	9 432 611 560
41-3072 K	9 430 615 890	105041-3072	9 430 611 821	NP-DLLA156SM111	9 432 611 454
41-3072 L	9 430 615 890	105041-3072	9 430 613 467	NP-DLLA156SM359	9 432 612 727
41-3072 N	9 430 615 890	105041-3072	9 430 611 803	NP-DLLA152SN970	9 432 611 411
41-3072 P	9 430 615 890	105041-3072	9 430 611 839	NP-DLLA156SM227	9 432 611 560
41-3080 A	9 430 615 417	105041-3080	9 430 611 810	NP-DLLA158SM028	9 432 611 522
41-3080 C	9 430 615 417	105041-3080	9 430 611 804	NP-DLLA158SN971	9 432 610 737
41-3081 A	9 430 615 302	105041-3081	9 430 611 811	NP-DLLA158SM028	9 432 611 522
41-3081 B	9 430 615 302	105041-3081	9 430 611 823	NP-DLLA158SM112	9 432 611 443
41-3081 E	9 430 615 302	105041-3081	9 430 611 829	NP-DLLA158SM129	9 432 611 425
41-3082 A	9 430 615 764	105041-3082	9 430 611 812	NP-DLLA158SM028	9 432 611 522
41-3082 B	9 430 615 764	105041-3082	9 430 611 824	NP-DLLA158SM112	9 432 611 443
41-3082 E	9 430 615 764	105041-3082	9 430 611 830	NP-DLLA158SM129	9 432 611 425
41-3090 Z	9 430 615 891	105041-3090	9 430 611 904	NP-DLLA157SN974	9 432 611 414
41-3100 J4	9 430 616 191	105041-3100	9 430 611 807	NP-DLLA156SN968	9 432 611 422
41-3101 J4	9 430 615 384	105041-3101	9 430 611 808	NP-DLLA156SN968	9 432 611 422
41-3101 J7	9 430 615 384	105041-3101	9 430 611 809	NP-DLLA156SN968	9 432 611 422
41-3101 J7	9 430 615 384	105041-3101	9 430 613 466	NP-DLLA156SN968	9 432 611 422
41-3110 W	9 430 615 268	105041-3110	9 430 611 920	NP-DLLA160SM004	9 432 611 508
41-3120 5G	9 430 615 892	105041-3120	9 430 611 927	NP-DLLA145SN988	9 432 610 518
41-3120 5H	9 430 615 892	105041-3120	9 430 611 928	NP-DLLA145SN989	9 432 610 519
41-3130 D		105041-3130	9 430 611 825	NP-DLLA156SM114	9 432 611 455
41-3131 D	9 430 615 303	105041-3131	9 430 611 826	NP-DLLA156SM114	9 432 611 455
41-3132 C	9 430 615 563	105041-3132	9 430 611 834	NP-DLLA156SM171	9 432 611 491
41-3132 D	9 430 615 563	105041-3132	9 430 611 827	NP-DLLA156SM114	9 432 611 455
41-3132 E	9 430 615 563	105041-3132	9 430 611 843	NP-DLLA165SM237	9 432 611 583
41-3132 H		105041-3132	9 430 613 640	NP-DLLA165SM237	9 432 611 583
41-3132 N	9 430 615 563	105041-3132	9 430 612 798	NP-DLL165SM298	9 432 611 613
41-3132 P	9 430 615 563	105041-3132	9 430 613 346	NP-DLLA156SM349	9 432 612 657
41-3132 T		105041-3132		NP-DLLA150SM452	
41-3132 S		105041-3132		NP-DLLA156SM450	
41-3140 C	9 430 615 418	105041-3140	9 430 611 832	NP-DLLA156SM146	9 432 610 788
41-3140 C	9 430 615 418	105041-3140	9 430 611 833	NP-DLLA156SM171	9 432 611 491
41-3150 U6	9 430 615 237	105041-3150	9 430 611 947	NP-DLLA158SM073	9 432 611 541
41-3150 U6	9 430 615 237	105041-3150	9 430 613 481	NP-DLLA158SM073	9 432 611 541
41-3150 U7	9 430 615 237	105041-3150	9 430 611 948	NP-DLLA158SM155	9 432 611 464
41-3150 U7 A	9 430 615 237	105041-3150	9 430 611 949	NP-DLLA158SM155	9 432 611 464
41-3150 U7 A	9 430 615 237	105041-3150	9 430 613 482	NP-DLLA158SM155	9 432 611 464
41-3150 X5 D	9 430 615 237	105041-3150	9 430 612 909	NP-DLLA158SM300	9 432 611 614
41-3150 X5 D	9 430 615 237	105041-3150	9 430 613 494	NP-DLLA158SM300	9 432 611 614
41-3160 G	9 430 615 564	105041-3160	9 430 611 968	NP-DLLA156SM249	9 432 611 585

A166

de

**Düsen für
1-Feder-Düsenhalter
von Zexel**

(Fortsetzung)

en

**Nozzles for the most
important single-
spring nozzle-holders
Zexel**

(continued)

fr

**Injecteurs pour
les principaux porte-
injecteurs à 1 ressort
Zexel**

(suite)

it

**Polvrizzatori per
i principali porta-
polverizzatori
a 1 molla, Zexel**







(seguito)







es

**Inyectores para
los portainyectores
de 1 muelle más
importantes, Zexel**

(continuación)



						
41-3160	H	9 430 615 564	105041-3160	9 430 611 971	NP-DLLA156SM250	9 432 611 586
41-3161	G	9 430 615 565	105041-3161	9 430 611 969	NP-DLLA156SM249	9 432 611 585
41-3161	H	9 430 615 565	105041-3161	9 430 611 972	NP-DLLA156SM250	9 432 611 586
41-3162	G	9 430 615 747	105041-3162	9 430 611 970	NP-DLLA156SM286	9 432 610 866
41-3162	H	9 430 615 747	105041-3162	9 430 611 973	NP-DLLA156SM287	9 432 610 868
41-3163	G		105041-3163		NP-DLLA156SM286	9 432 610 866
41-3163	H		105041-3163		NP-DLLA156SM287	9 432 610 868
41-3163	J		105041-3163		NP-DLLA156SM394	9 432 612 788
41-3163	K		105041-3163		NP-DLLA156SM395	9 432 612 790
41-3170	L	9 430 615 753	105041-3170	9 430 611 844	NP-DLLA156SM252	9 432 611 597
41-3170	M	9 430 615 753	105041-3170	9 430 611 845	NP-DLLA156SM253	9 432 611 589
41-3180	V5 B	9 430 615 748	105041-3180	9 430 611 977	NP-DLLA158SM258	9 432 611 591
41-3180	V5 B	9 430 615 748	105041-3180	9 430 613 489	NP-DLLA158SM258	9 432 611 591
41-3180	X1 B	9 430 615 748	105041-3180	9 430 611 986	NP-DLLA158SM258	9 432 611 591
41-3180	X1 B	9 430 615 748	105041-3180	9 430 613 492	NP-DLLA158SM258	9 432 611 591
41-3180	X2 C	9 430 615 748	105041-3180	9 430 611 987	NP-DLLA158SM283	9 432 611 570
41-3180	X2 E	9 430 615 748	105041-3180	9 430 613 493	NP-DLLA158SM283	9 432 611 570
41-3180	X4 C	9 430 615 748	105041-3180	9 430 611 982	NP-DLLA158SM269	9 432 611 564
41-3180	X4 C	9 430 615 748	105041-3180	9 430 613 491	NP-DLLA158SM269	9 432 611 564
41-3180	X6 E	9 430 615 748	105041-3180	9 430 612 921	NP-DLLA155SM305	9 432 611 616
41-3180	X6 E	9 430 615 748	105041-3180	9 430 613 496	NP-DLLA155SM305	9 432 611 616
41-3180	X7 C	9 430 615 748	105041-3180	9 430 613 495	NP-DLLA158SM269	9 432 611 564
41-3180	X8 B	9 430 615 748	105041-3180	9 430 612 741	NP-DLLA156SM317	9 432 610 801
41-3180	X8 B	9 430 615 748	105041-3180	9 430 613 499	NP-DLLA156SM317	9 432 610 801
41-3180	X9 C	9 430 615 748	105041-3180	9 430 612 747	NP-DLLA156SM318	9 432 610 875
41-3180	X9 C	9 430 615 748	105041-3180	9 430 613 501	NP-DLLA156SM318	9 432 610 875
41-3180	Y1 E	9 430 615 748	105041-3180	9 430 612 743	NP-DLLA155SM324	9 432 610 805
41-3180	Y1 E	9 430 615 748	105041-3180	9 430 613 503	NP-DLLA155SM324	9 432 610 805
41-3180	Y2 B	9 430 615 748	105041-3180	9 430 613 500	NP-DLLA156SM374	9 432 612 741
41-3180	Y3 C	9 430 615 748	105041-3180	9 430 613 502	NP-DLLA156SM375	9 432 612 742
41-3180	Y4 E	9 430 615 748	105041-3180	9 430 613 504	NP-DLLA155SM376	9 432 612 743
41-3190	V6 C	9 430 615 893	105041-3190	9 430 611 978	NP-DLLA158SM259	9 432 611 592
41-3190	V6 C	9 430 615 893	105041-3190	9 430 613 490	NP-DLLA158SM259	9 432 611 592
41-3200	A	9 430 615 827	105041-3200	9 430 612 739	NP-DLLA160SM309	9 432 610 789
41-3200	B		105041-3200		NP-DLLA160SM309	
41-3210	S	9 430 615 829	105041-3210	9 430 612 744	NP-DLLA156SM328	9 432 610 855
41-3220	A		105041-3220		NP-DLLA156SM394	9 432 612 788
41-3220	B		105041-3220		NP-DLLA156SM395	9 432 612 790
41-4020	A	9 430 615 238	105041-4020	9 430 611 937	NP-DLLA152SN924	9 432 611 376
41-4020	E6	9 430 615 238	105041-4020	9 430 611 883	NP-DLLA152SN924	9 432 611 376
41-4020	E7	9 430 615 238	105041-4020	9 430 611 888	NP-DLLA152SN925	9 432 611 377
41-4020	J8	9 430 615 238	105041-4020	9 430 611 929	NP-DLLA156SM019	9 432 611 512
41-4020	N5	9 430 615 238	105041-4020	9 430 611 912	NP-DLLA156SM003	9 432 611 530
41-4020	U1	9 430 615 238	105041-4020	9 430 611 895	NP-DLLA160SN961	9 432 611 360
41-4020	U2	9 430 615 238	105041-4020	9 430 611 911	NP-DLLA160SM002	9 432 611 529

 Typ	 Ref.	 Zexel	 Ref.	 Typ	 Ref.
41-4030 6	9 430 615 789	105041-4030	9 430 611 889	NP-DLLA150SN954	9 432 611 354
41-4040 R	9 430 615 304	105041-4040	9 430 611 891	NP-DLLA150SN956	9 432 611 356
41-4041 R	9 430 616 231	105041-4041	9 430 613 476	NP-DLLA150SN956	9 432 611 356
41-4050 6A	9 430 615 351	105041-4050	9 430 611 914	NP-DLLA154SM006	9 432 611 504
41-4050 7	9 430 615 351	105041-4050	9 430 611 894	NP-DLLA154SN958	9 432 611 367
41-4060 H6	9 430 615 796	105041-4060	9 430 611 896	NP-DLLA161SN963	9 432 611 362
41-4060 H6	9 430 615 796	105041-4060	9 430 611 897	NP-DLLA161SN963	9 432 611 363
41-4070 A	9 430 615 269	105041-4070	9 430 611 902	NP-DLLA160SN969	9 432 611 409
41-4070 B	9 430 615 269	105041-4070	9 430 611 905	NP-DLLA160SN976	9 432 611 423
41-4070 C	9 430 615 269	105041-4070	9 430 611 906	NP-DLLA160SN977	9 432 611 416
41-4070 D	9 430 615 269	105041-4070	9 430 611 909	NP-DLLA160SN969	9 432 611 409
41-4080 1A	9 430 615 872	105041-4080	9 430 611 910	NP-DLLA157SN996	9 432 611 394
41-4080 2A	9 430 615 872	105041-4080	9 430 611 907	NP-DLLA154SN990	9 432 611 398
41-4080 5	9 430 615 872	105041-4080	9 430 611 892	NP-DLLA157SN957	9 432 611 357
41-4090 Y	9 430 615 305	105041-4090	9 430 611 805	NP-DLLA150SN973	9 432 611 412
41-4090 Y	9 430 615 305	105041-4090	9 430 611 806	NP-DLLA150SN973	9 432 611 413
41-4100 A	9 430 615 270	105041-4100	9 430 611 923	NP-DLLA160SM021	9 432 611 514
41-4100 D	9 430 615 270	105041-4100	9 430 611 925	NP-DLLA160SM021	9 432 611 514
41-4100 E	9 430 615 270	105041-4100	9 430 611 916	NP-DLLA160SM010	9 432 611 506
41-4100 F	9 430 615 270	105041-4100	9 430 611 918	NP-DLLA160SM011	9 432 611 507
41-4101 A	9 430 615 271	105041-4101	9 430 611 924	NP-DLLA160SM021	9 432 611 514
41-4101 C	9 430 615 271	105041-4101	9 430 612 087	NP-DLLA160SN833	9 432 610 315
41-4101 E	9 430 615 271	105041-4101	9 430 611 917	NP-DLLA160SM010	9 432 611 506
41-4101 F	9 430 615 271	105041-4101	9 430 611 919	NP-DLLA160SM011	9 432 611 507
41-4110 1A	9 430 615 272	105041-4110	9 430 611 926	NP-DLLA157SM023	9 432 611 516
41-4110 2A	9 430 615 272	105041-4110	9 430 611 908	NP-DLLA154SN990	9 432 611 398
41-4110 2B	9 430 615 272	105041-4110	9 430 611 921	NP-DLLA157SM016	9 432 611 510
41-4110 2J	9 430 615 272	105041-4110	9 430 613 360	NP-DLLA151SM329	9 432 611 620
41-4110 P	9 430 615 272	105041-4110	9 430 612 914	NP-DLLA151SM329	9 432 611 620
41-4111 1A		105041-4111		NP-DLLA157SM023	
41-4111 1C		105041-4111		NP-DLLA157SM121	
41-4111 2A		105041-4111		NP-DLLA154SN990	
41-4111 2B		105041-4111		NP-DLLA157SM016	
41-4111 2J		105041-4111		,m,0-,c,k,k,`151,r,l329	
41-4120 5A	9 430 615 273	105041-4120	9 430 611 922	NP-DLLA154SM025	9 432 610 728
41-4120 5B	9 430 615 273	105041-4120	9 430 611 930	NP-DLLA154SM025	9 432 610 728
41-4120 5D	9 430 615 273	105041-4120	9 430 611 943	NP-DLLA157SM137	9 432 611 432
41-4120 6A	9 430 615 273	105041-4120	9 430 611 915	NP-DLLA154SM006	9 432 611 504
41-4120 6D	9 430 615 273	105041-4120	9 430 611 954	NP-DLLA151SM186	9 432 611 497
41-4120 6E	9 430 615 273	105041-4120	9 430 611 944	NP-DLLA148SM144	9 432 611 424
41-4120 6H	9 430 615 273	105041-4120	9 430 613 483	NP-DLLA151SM186	9 432 611 497
41-4120 D7	9 430 615 273	105041-4120	9 430 610 175	NP-DLLA151SM103	9 432 610 446
41-4121 5A		105041-4121		NP-DLLA154SM025	9 432 610 728
41-4121 5B		105041-4121		NP-DLLA154SM025	9 432 610 728
41-4121 5D		105041-4121		NP-DLLA157SM137	9 432 611 432

A168

de
**Düsen für
 1-Feder-Düsenhalter
 von Zexel**
 (Fortsetzung)







en
**Nozzles for the most
 important single-
 spring nozzle-holders
 Zexel**
 (continued)







fr
**Injecteurs pour
 les principaux porte-
 injecteurs à 1 ressort
 Zexel**
 (suite)

it
**Polvrizzatori per
 i principali porta-
 polverizzatori
 a 1 molla, Zexel**
 (seguito)

es
**Inyectores para
 los portainyectores
 de 1 muelle más
 importantes, Zexel**
 (continuación)



	 Typ	 Ref.	 Zexel	 Ref.	 Typ	 Ref.
41-4121	6A		105041-4121		NP-DLLA154SM006	9 432 611 504
41-4121	6E		105041-4121		NP-DLLA148SM144	9 432 611 424
41-4121	6H		105041-4121		NP-DLLA151SM186	9 432 611 497
41-4121	D7		105041-4121		NP-DLLA151SM103	9 432 610 446
41-4130	1B	9 430 615 274	105041-4130	9 430 611 933	NP-DLLA157SM107	9 432 611 452
41-4130	2E	9 430 615 274	105041-4130	9 430 611 932	NP-DLLA157SM081	9 432 611 548
41-4130	2F	9 430 615 274	105041-4130	9 430 611 938	NP-DLLA154SM119	9 432 610 726
41-4130	6	9 430 615 274	105041-4130	9 430 611 890	NP-DLLA150SN954	9 432 611 354
41-4131	1B		105041-4131		NP-DLLA157SM107	
41-4131	2D		105041-4131		NP-DLLA160SM056	
41-4131	2E		105041-4131		NP-DLLA157SM081	
41-4131	2F		105041-4131		NP-DLLA154SM119	
41-4131	6		105041-4131		NP-DLLA150SN954	
41-4140		9 430 615 306	105041-4140	9 430 611 935	NP-DLLA152SM104	9 432 611 450
41-4140		9 430 615 306	105041-4140	9 430 611 936	NP-DLLA152SM104	9 432 611 450
41-4141		9 430 616 232	105041-4141	9 430 613 478	NP-DLLA152SM104	9 432 611 450
41-4150	2	9 430 615 307	105041-4150	9 430 611 939	NP-DLLA150SM130	9 432 611 426
41-4150	A	9 430 615 307	105041-4150	9 430 611 940	NP-DLLA150SM201	9 432 611 471
41-4151	C	9 430 615 871	105041-4151	9 430 612 926	NP-DLLA150SM201	9 432 611 471
41-4152	C	9 430 616 233	105041-4152	9 430 613 479	NP-DLLA150SM201	9 432 611 471
41-4160	3E	9 430 615 308	105041-4160	9 430 611 941	NP-DLLA146SM132	9 432 611 427
41-4160	B	9 430 615 308	105041-4160	9 430 611 956	NP-DLLA144SM209	9 432 610 864
41-4161	3E	9 430 616 234	105041-4161	9 430 613 480	NP-DLLA146SM132	9 432 611 427
41-4161	B	9 430 616 234	105041-4161	9 430 613 484	NP-DLLA144SM209	9 432 610 864
41-4170	2G	9 430 615 750	105041-4170	9 430 611 831	NP-DLLA151SM145	9 432 610 870
41-4170	2H	9 430 615 750	105041-4170	9 430 611 841	NP-DLLA148SM235	9 432 611 581
41-4170	2K		105041-4170		NP-DLLA151SM397	9 432 612 775
41-4170	2L		105041-4170		NP-DLLA151SM329	9 432 611 620
41-4171	2G		105041-4171		NP-DLLA151SM145	
41-4171	2H		105041-4171		NP-DLLA148SM235	
41-4171	2K		105041-4171		NP-DLLA151SM397	
41-4171	2L		105041-4171		NP-DLLA151SM329	
41-4171	2M		105041-4171		NP-DLLA148SM449	
41-4180	N6	9 430 615 239	105041-4180	9 430 611 946	NP-DLLA156SM154	9 432 611 440
41-4180	U4	9 430 615 239	105041-4180	9 430 611 951	NP-DLLA160SM163	9 432 611 487
41-4180	U5	9 430 615 239	105041-4180	9 430 611 945	NP-DLLA160SM153	9 432 611 439
41-4180	U9	9 430 615 239	105041-4180	9 430 611 953	NP-DLLA156SM184	9 432 611 496
41-4190	K2	9 430 615 240	105041-4190	9 430 611 950	NP-DLLA161SN963	9 432 611 363
41-4190	K5	9 430 615 240	105041-4190	9 430 611 955	NP-DLLA161SN963	9 432 611 363
41-4190	L1	9 430 615 240	105041-4190	9 430 612 922	NP-DLLA160SM217	9 432 610 830
41-4200	E9	9 430 615 241	105041-4200	9 430 611 952	NP-DLLA145SM167	9 432 611 488
41-4200	F8	9 430 615 241	105041-4200	9 430 611 963	NP-DLLA145SM219	9 432 611 481
41-4210	K6	9 430 615 242	105041-4210	9 430 611 837	NP-DLLA160SM217	9 432 610 830
41-4210	K7	9 430 615 242	105041-4210	9 430 611 848	NP-DLLA160SM265	9 432 612 646
41-4210	K8	9 430 615 242	105041-4210	9 430 611 849	NP-DLLA155SM278	9 432 611 567

 Typ	 Ref.	 Zexel	 Ref.	 Typ	 Ref.
41-4210 L2	9 430 615 242	105041-4210	9 430 612 804	NP-DLLA155SM311	9 432 611 621
41-4210 L5		105041-4210		NP-DLLA155SM391	9 432 612 760
41-4210 L6		105041-4210		NP-DLLA152SM411	9 432 612 823
41-4210 L7		105041-4210		NP-DLLA155SM431	
41-4220 6G	9 430 615 758	105041-4220	9 430 611 842	NP-DLLA142SM266	9 432 611 588
41-4221 6G		105041-4221		NP-DLLA142SM266	9 432 611 588
41-4270 B	9 430 615 566	105041-4270	9 430 611 975	NP-DLLA150SM255	9 432 610 877
41-4280 V4	9 430 615 766	105041-4280	9 430 611 976	NP-DLLA160SM256	9 432 611 590
41-4280 V7	9 430 615 766	105041-4280	9 430 611 979	NP-DLLA155SM261	9 432 611 594
41-4280 X3	9 430 615 766	105041-4280	9 430 611 983	NP-DLLA155SM274	9 432 610 873
41-4290 G	9 430 615 574	105041-4290	9 430 611 984	NP-DLLA157SM280	9 432 610 879
41-4300 5E	9 430 615 575	105041-4300	9 430 611 985	NP-DLLA154SM281	9 432 611 569
41-4301 5E		105041-4301		NP-DLLA154SM281	9 432 611 569
41-4310 K9	9 430 615 832	105041-4310	9 430 611 988	NP-DLLA160SM294	9 432 611 575
41-4310 L4	9 430 615 832	105041-4310	9 430 612 753	NP-DLLA155SM326	9 432 610 895
41-4310 LO	9 430 615 832	105041-4310	9 430 612 908	NP-DLLA155SM296	9 432 611 576
41-4320 E	9 430 616 154	105041-4320	9 430 612 915	NP-DLLA150SM255	9 432 610 877
41-4321 E	9 430 616 235	105041-4321	9 430 613 506	NP-DLLA150SM255	9 432 610 877
41-4330	9 430 616 155	105041-4330	9 430 612 912	NP-DLLA148SM344	9 432 611 609
41-4340	9 430 616 156	105041-4340	9 430 612 911	NP-DLLA148SM345	9 432 612 654
41-4341 A	9 430 616 236	105041-4341	9 430 613 508	NP-DLLA146SM364	9 432 612 732
41-4341 B		105041-4341		NP-DLLA147SM380	9 432 612 854
41-4350	9 430 616 117	105041-4350	9 430 612 917	NP-DLLA150SM343	9 432 612 653
41-4360	9 430 616 157	105041-4360	9 430 613 361	NP-DLLA156SM349	9 432 612 657
41-4360 F		105041-4360		NP-DLLA152SM362	
41-4361 A	9 430 616 261	105041-4361	9 430 613 509	NP-DLLA156SM349	9 432 612 657
41-4361 B		105041-4361		NP-DLLA156SM349	9 432 612 657
41-4361 F	9 430 616 261	105041-4361	9 430 613 514	NP-DLLA152SM362	9 432 612 730
41-4370	9 430 616 158	105041-4370	9 430 613 362	NP-DLLA156SM328	9 432 610 855
41-4371	9 430 616 237	105041-4371	9 430 613 511	NP-DLLA156SM328	9 432 610 855
41-4390		105041-4390		NP-DLLA150SM343	
41-4390 A		105041-4390		NP-DLLA150SM407	9 432 612 856
41-4390 B		105041-4390		NP-DLLA145SM443	
41-4400		105041-4400		NP-DLLA145SM387	9 432 612 759
41-4410 A		105041-4410		NP-DLLA150SM323	9 432 611 627
41-4410 B		105041-4410		NP-DLLA150SM323	9 432 611 627
41-4410 C		105041-4410		NP-DLLA141SM346	9 432 611 610
41-4410 E		105041-4410		NP-DLLA150SM303	9 432 610 769
41-4420 8		105041-4420		NP-DLLA163SN952	
41-4420 B		105041-4420		NP-DLLA160SN671	
41-4420 F		105041-4420		NP-DLLA150SN779	
41-4420 G		105041-4420		NP-DLLA150SN615	
41-4420 J		105041-4420		NP-DLLA154SN533	
41-4420 K		105041-4420		NP-DLLA163SN823	
41-4420 L		105041-4420		NP-DLLA150SN534	

A170

de

**Düsen für
1-Feder-Düsenhalter
von Zexel**

(Fortsetzung)

en

**Nozzles for the most
important single-
spring nozzle-holders
Zexel**

(continued)

fr

**Injecteurs pour
les principaux porte-
injecteurs à 1 ressort
Zexel**

(suite)

it

**Polvrizzatori per
i principali porta-
polverizzatori
a 1 molla, Zexel**







(seguito)







es

**Inyectores para
los portainyectores
de 1 muelle más
importantes, Zexel**

(continuación)



						
41-4420	M		105041-4420		NP-DLLA150SN615	
41-4420	N		105041-4420		NP-DLLA163SN831	
41-4420	P		105041-4420		NP-DLLA150SN779	
41-4420	R		105041-4420		NP-DLLA150SN779	
41-4420	S		105041-4420		NP-DLLA150SN637	
41-4420	U		105041-4420		NP-DLLA160SN539	
41-4420	U4		105041-4420		NP-DLLA155SN780	
41-4420	V		105041-4420		NP-DLLA150SN832	
41-4420	X		105041-4420		NP-DLLA150SN548	
41-5010		9 430 616 238	105041-5010	9 430 611 851	NP-DLLA145SN511	9 432 612 318
41-5020		9 430 615 814	105041-5020	9 430 611 780	NP-DLL155SN512	9 432 611 734
41-5020	A	9 430 615 814	105041-5020	9 430 611 781	NP-DLL155SN513	9 432 611 732
41-5020	B	9 430 615 814	105041-5020	9 430 611 784	NP-DLL155SN520	9 432 611 730
41-5020	C	9 430 615 814	105041-5020	9 430 611 785	NP-DLL160SN535	9 432 611 824
41-5020	D	9 430 615 814	105041-5020	9 430 611 786	NP-DLL155SN542	9 432 611 817
41-5020	E	9 430 615 814	105041-5020	9 430 611 790	NP-DLL155SN619	9 432 611 781
41-5020	F	9 430 615 814	105041-5020	9 430 611 791	NP-DLL160SN626	9 432 611 785
41-5020	G	9 430 615 814	105041-5020	9 430 611 794	NP-DLL155SN556	9 432 611 813
41-5030		9 430 615 138	105041-5030	9 430 611 782	NP-DLLA160SN516	9 432 611 727
41-5030	A	9 430 615 138	105041-5030	9 430 611 783	NP-DLLA160SN525	9 432 612 319
41-5041		9 430 615 071	105041-5041	9 430 611 787	NP-DLLA160SN564	9 432 610 318
41-5041	B	9 430 615 071	105041-5041	9 430 611 788	NP-DLLA155SM049	9 432 611 555
41-5041	C	9 430 615 071	105041-5041	9 430 610 081	NP-DLLA150SN624	9 432 610 198
41-5041	E	9 430 615 071	105041-5041	9 430 611 877	NP-DLLA150SN942	9 432 611 389
41-5041	F	9 430 615 071	105041-5041	9 430 611 865	NP-DLLA150SN837	9 432 611 192
41-5041	H	9 430 615 071	105041-5041	9 430 611 861	NP-DLLA150SN814	9 432 611 285
41-5041	J	9 430 615 071	105041-5041	9 430 611 867	NP-DLLA155SN824	
41-5041	K	9 430 615 071	105041-5041	9 430 611 868	NP-DLLA155SN824	9 432 610 766
41-5041	M	9 430 615 071	105041-5041	9 430 611 859	NP-DLLA160SN813	9 432 611 284
41-5041	P	9 430 615 071	105041-5041	9 430 611 880	NP-DLLA155SM230	9 432 610 700
41-5041	P1	9 430 615 071	105041-5041	9 430 611 881	NP-DLLA155SM284	9 432 611 562
41-5041	P1	9 430 615 071	105041-5041	9 430 612 783	NP-DLLA155SM284	9 432 611 562
41-5041	R	9 430 615 071	105041-5041	9 430 612 781	NP-DLLA150SM238	9 432 611 584
41-5041	Y	9 430 615 071	105041-5041	9 430 611 855	NP-DLLA150SN728	9 432 610 750
41-5050		9 430 615 342	105041-5050	9 430 611 853	NP-DLLA150SN618	9 432 611 780
41-5060		9 430 616 161	105041-5060	9 430 612 012	NP-DN0SD2110	9 432 610 007
41-5070		9 430 615 866	105041-5070	9 430 611 793	NP-DLLA160SN676	9 432 610 753
41-5080		9 430 616 149	105041-5080	9 430 611 795	NP-DLLA160SN564	9 432 610 318
41-5090		9 430 615 086	105041-5090	9 430 611 796	NP-DLLA150SN708	9 432 610 214
41-5090	C	9 430 615 086	105041-5090	9 430 611 864	NP-DLLA150SN836	9 432 610 740
41-5090	L	9 430 615 086	105041-5090	9 430 611 869	NP-DLLA150SN927	9 432 610 393
41-5090	M	9 430 615 086	105041-5090	9 430 611 870	NP-DLLA150SN941	9 432 610 350
41-5100		9 430 615 343	105041-5100	9 430 611 856	NP-DLLA150SN763	9 432 610 396
41-5110		9 430 615 221	105041-5110	9 430 611 857	NP-DLLA146SN765	9 432 610 843
41-5120		9 430 615 867	105041-5120	9 430 611 858	NP-DLLA150SN770	9 432 611 294

 Typ	 Ref.	 Zexel	 Ref.	 Typ	 Ref.
41-5130	9 430 615 344	105041-5130	9 430 611 860	NP-DLLA160SN564	9 432 610 318
41-5130 A1	9 430 615 344	105041-5130	9 430 611 882	NP-DLLA155SM279	9 432 611 568
41-5140	9 430 615 222	105041-5140	9 430 611 862	NP-DLLA150SN814	9 432 611 285
41-5140 B	9 430 615 222	105041-5140	9 430 611 871	NP-DLLA150SN942	9 432 611 389
41-5140 C	9 430 615 222	105041-5140	9 430 611 873	NP-DLLA155SN943	9 432 611 390
41-5140 E	9 430 615 222	105041-5140	9 430 611 872	NP-DLLA150SN942	9 432 611 389
41-5140 G	9 430 615 222	105041-5140	9 430 611 874	NP-DLLA155SN943	9 432 611 390
41-5140 H	9 430 615 222	105041-5140	9 430 611 876	NP-DLLA150SN942	9 432 611 389
41-5150	9 430 615 868	105041-5150	9 430 611 863	NP-DLLA155SN824	
41-5160	9 430 615 223	105041-5160	9 430 611 866	NP-DLLA150SN837	9 432 611 192
41-5160 C	9 430 615 223	105041-5160	9 430 613 469	NP-DLLA155SM371	9 432 612 739
41-5160 E	9 430 615 223	105041-5160	9 430 613 470	NP-DLLA155SM379	9 432 612 745
41-5160 F		105041-5160		NP-DLLA155SM371	9 432 612 739
41-5171	9 430 615 224	105041-5171	9 430 611 875	NP-DLLA150SN624	9 432 610 198
41-5190	9 430 615 445	105041-5190	9 430 611 878	NP-DLLA150SN624	9 432 610 198
41-5190 A		105041-5190		NP-DLLA150SM385	9 432 612 756
41-5200	9 430 616 152	105041-5200	9 430 611 879	NP-DLLA150SM207	9 432 611 484
41-6000	9 430 615 815	105041-6000	9 430 612 015	NP-DLLA160S258NP1	9 432 611 674
41-6010	9 430 615 870	105041-6010	9 430 612 019	NP-DLLA140S386N234	9 432 611 690
41-6020	9 430 615 864	105041-6020	9 430 612 021	NP-DL140S386N234	9 432 611 690
41-6030	9 430 615 816	105041-6030	9 430 612 024	NP-DLL150S386N479	9 432 611 715
41-6030 A	9 430 615 816	105041-6030	9 430 612 025	NP-DLL145S308N482	9 432 611 710
41-6030 B	9 430 615 816	105041-6030	9 430 612 026	NP-DLL140S366N483	9 432 611 711
41-6030 C	9 430 615 816	105041-6030	9 430 612 027	NP-DLL150S366N488	9 432 611 713
41-6030 D	9 430 615 816	105041-6030	9 430 612 028	NP-DLL145SN506	9 432 610 835
41-6030 E	9 430 615 816	105041-6030	9 430 612 029	NP-DLL155SN513	9 432 611 732
41-6040	9 430 615 873	105041-6040	9 430 611 852	NP-DLLA150SN604	9 432 611 794
41-6040 A	9 430 615 873	105041-6040	9 430 611 854	NP-DLLA135SN721	9 432 610 837
4166	F 000 430 201	105088-2002	9 430 613 546	NP-DLLA145PN225	9 432 611 010
41-7000 A	9 430 615 462	105041-7000	9 430 612 016	NP-DL150S308NP15	9 432 611 693
41-7000 B	9 430 615 462	105041-7000	9 430 612 017	NP-DL155S348NP15	9 432 611 694
41-7000 C	9 430 615 462	105041-7000	9 430 612 018	NP-DL150S248NP15	9 432 611 695
41-7000 H	9 430 615 462	105041-7000	9 430 612 020	NP-DL160S2810N233	9 432 611 691
41-7000 I	9 430 615 462	105041-7000	9 430 612 022	NP-DL155S308N238	9 432 611 687
41-7000 J	9 430 615 462	105041-7000	9 430 612 023	NP-DL160S2710N239	9 432 611 686
41-7020	9 430 615 354	105041-7020	9 430 612 030	NP-DLL155SN514	9 432 611 733
41-7020 A	9 430 615 354	105041-7020	9 430 612 036	NP-DLL155SN550	9 432 611 809
41-7020 C	9 430 615 354	105041-7020	9 430 612 032	NP-DLL155SN521	9 432 610 144
41-7020 D	9 430 615 354	105041-7020	9 430 612 041	NP-DLL160SN616	9 432 611 778
41-7020 E	9 430 615 354	105041-7020	9 430 612 040	NP-DLL160SN614	9 432 610 336
41-7020 F	9 430 615 354	105041-7020	9 430 612 048	NP-DLL160SN647	9 432 610 206
41-7020 G	9 430 615 354	105041-7020	9 430 612 049	NP-DLL160SN664	9 432 610 275
41-7020 H	9 430 615 354	105041-7020	9 430 612 059	NP-DLL160SN690	9 432 610 994
41-7020 J	9 430 615 354	105041-7020	9 430 612 075	NP-DLL155SN672	9 432 611 792
41-7020 K	9 430 615 354	105041-7020	9 430 612 076	NP-DLL160SN647	9 432 610 206

A172

de

**Düsen für
1-Feder-Düsenhalter
von Zexel**

(Fortsetzung)

en

**Nozzles for the most
important single-
spring nozzle-holders
Zexel**
(continued)

fr

**Injecteurs pour
les principaux porte-
injecteurs à 1 ressort
Zexel**
(suite)







it







**Polvrizzatori per
i principali porta-
polverizzatori
a 1 molla, Zexel**
(seguito)

es

**Inyectores para
los portainyectores
de 1 muelle más
importantes, Zexel**
(continuación)



						
41-7020	L	9 430 615 354	105041-7020	9 430 612 080	NP-DLL160SN806	9 432 611 280
41-7020	M	9 430 615 354	105041-7020	9 430 612 083	NP-DLL155SN825	9 432 611 518
41-7020	N	9 430 615 354	105041-7020	9 430 612 092	NP-DLL160SN879	9 432 610 335
41-7030	A	9 430 615 152	105041-7030	9 430 612 035	NP-DLL160SN538	9 432 610 216
41-7030	B	9 430 615 152	105041-7030	9 430 612 034	NP-DLL160SN537	9 432 611 825
41-7040	B	9 430 615 095	105041-7040	9 430 610 110	NP-DLL155SN595	9 432 610 191
41-7040	B	9 430 615 095	105041-7040	9 430 612 039	NP-DLL155SN596	9 432 610 858
41-7040	F	9 430 615 095	105041-7040	9 430 612 088	NP-DLL155SN865	9 432 611 215
41-7050			105041-7050	9 430 612 044	NP-DLL155SN639	9 432 610 224
41-7051		9 430 615 567	105041-7051	9 430 612 045	NP-DLL155SN639	9 432 610 224
41-7051	C	9 430 615 567	105041-7051	9 430 612 061	NP-DLL155SN692	9 432 611 252
41-7051	D	9 430 615 567	105041-7051	9 430 612 068	NP-DLL155SN729	9 432 611 235
41-7051	G	9 430 615 567	105041-7051	9 430 612 071	NP-DLL155SN767	9 432 611 287
41-7051	H	9 430 615 567	105041-7051	9 430 612 077	NP-DLL155SN790	9 432 610 856
41-7060		9 430 615 874	105041-7060	9 430 612 052	NP-DLLA160SN670	9 432 610 207
41-7060	A	9 430 615 874	105041-7060	9 430 612 057	NP-DLLA160SN670A	
41-7060	C	9 430 615 874	105041-7060	9 430 612 063	NP-DLLA160SN706	9 432 610 401
41-7060	E	9 430 615 874	105041-7060	9 430 612 066	NP-DLLA160SN706	9 432 610 401
41-7060	F	9 430 615 874	105041-7060	9 430 612 085	NP-DLLA160SN833	9 432 610 315
41-7060	G	9 430 615 874	105041-7060	9 430 612 089	NP-DLLA160SN860	9 432 610 451
41-7070		9 430 615 875	105041-7070	9 430 612 055	NP-DLL155SN672	9 432 611 792
41-7070	B	9 430 615 875	105041-7070	9 430 612 082	NP-DLL155SN807	9 432 610 277
41-7080		9 430 615 320	105041-7080	9 430 612 056	NP-DLLA155SN677	9 432 611 789
41-7080	A	9 430 615 320	105041-7080	9 430 612 058	NP-DLLA154SN680	9 432 611 790
41-7080	C	9 430 615 320	105041-7080	9 430 612 060	NP-DLLA148SN691	9 432 611 251
41-7080	F	9 430 615 320	105041-7080	9 430 611 797	NP-DLLA155SN760	9 432 610 902
41-7080	G	9 430 615 320	105041-7080	9 430 612 072	NP-DLLA155SN774	9 432 611 275
41-7100			105041-7100	9 430 612 053	NP-DLLA160SN670	9 432 610 207
41-7100	A		105041-7100	9 430 612 064	NP-DLLA160SN706	9 432 610 401
41-7100	B		105041-7100	9 430 612 067	NP-DLLA160SN706	9 432 610 401
41-7100	C		105041-7100	9 430 612 086	NP-DLLA160SN833	9 432 610 315
41-7100	E		105041-7100	9 430 612 090	NP-DLLA160SN860	9 432 610 451
41-7100	G		105041-7100	9 430 612 104	NP-DLLA160SN860	9 432 610 451
41-7100	H		105041-7100	9 430 612 106	NP-DLLA160SN910	9 432 611 210
41-7101		9 430 615 153	105041-7101	9 430 612 054	NP-DLLA160SN670	9 432 610 207
41-7101	A	9 430 615 153	105041-7101	9 430 612 065	NP-DLLA160SN706	9 432 610 401
41-7101	E	9 430 615 153	105041-7101	9 430 612 091	NP-DLLA160SN860	9 432 610 451
41-7101	G	9 430 615 153	105041-7101	9 430 612 105	NP-DLLA160SN860	9 432 610 451
41-7101	H	9 430 615 153	105041-7101	9 430 612 107	NP-DLLA160SN910	9 432 611 210
41-7101	J	9 430 615 153	105041-7101	9 430 612 112	NP-DLLA160SN937	9 432 611 386
41-7101	L	9 430 615 153	105041-7101	9 430 612 118	NP-DLLA160SM072	9 432 611 540
41-7101	N	9 430 615 153	105041-7101	9 430 612 132	NP-DLLA160SM115	9 432 611 456
41-7101	R	9 430 615 153	105041-7101	9 430 612 138	NP-DLLA160SM183	9 432 610 854
41-7101	S	9 430 615 153	105041-7101	9 430 612 140	NP-DLLA155SM202	9 432 611 472
41-7101	T	9 430 615 153	105041-7101	9 430 612 485	NP-DLLA160SM223	9 432 611 483

 Typ	 Ref.	 Zexel	 Ref.	 Typ	 Ref.
41-7101 U	9 430 615 153	105041-7101	9 430 612 870	NP-DLA160SM301	9 432 610 881
41-7101 W	9 430 615 153	105041-7101	9 430 612 876	NP-DLLA155SM347	9 432 612 655
41-7102		105041-7102		NP-DLLA160SN670	9 432 610 207
41-7102 A		105041-7102		NP-DLLA160SN706	9 432 610 401
41-7102 B		105041-7102		NP-DLLA160SN706	9 432 610 401
41-7102 C		105041-7102		NP-DLLA160SN833	9 432 610 315
41-7102 E		105041-7102		NP-DLLA160SN860	9 432 610 451
41-7102 G	9 430 616 239	105041-7102	9 430 613 515	NP-DLLA160SN860	9 432 610 451
41-7102 J		105041-7102		NP-DLLA160SN937	9 432 611 386
41-7102 L		105041-7102		NP-DLLA160SM072	9 432 611 540
41-7102 M		105041-7102		NP-DLLA160SM091	9 432 611 445
41-7102 T		105041-7102		NP-DLLA160SM223	9 432 611 483
41-7102 U		105041-7102		NP-DLLA160SM301	9 432 610 881
41-7102 V		105041-7102		NP-DLLA160SM302	9 432 611 615
41-7102 W		105041-7102		NP-DLLA155SM347	9 432 612 655
41-7102 X		105041-7102		NP-DLLA162SM441	
41-7110	9 430 615 082	105041-7110	9 430 612 031	NP-DLL155SN514	9 432 611 733
41-7110 A	9 430 615 082	105041-7110	9 430 610 094	NP-DLL155SN521	9 432 610 144
41-7110 B	9 430 615 082	105041-7110	9 430 612 037	NP-DLL155SN550	9 432 611 809
41-7110 E	9 430 615 082	105041-7110	9 430 612 042	NP-DLL160SN616	9 432 611 778
41-7110 F	9 430 615 082	105041-7110	9 430 612 050	NP-DLL160SN664	9 432 610 275
41-7110 G	9 430 615 082	105041-7110	9 430 612 081	NP-DLL160SN806	9 432 611 280
41-7110 H	9 430 615 082	105041-7110	9 430 612 084	NP-DLL155SN825	9 432 611 518
41-7110 J	9 430 615 082	105041-7110	9 430 612 093	NP-DLL160SN879	9 432 610 335
41-7110 K	9 430 615 082	105041-7110	9 430 612 103	NP-DLL160SN879	9 432 610 335
41-7111 A	9 430 615 154	105041-7111	9 430 612 033	NP-DLLA155SN521	9 432 610 144
41-7111 B	9 430 615 154	105041-7111	9 430 612 038	NP-DLL155SN550	9 432 611 809
41-7111 E	9 430 615 154	105041-7111	9 430 612 043	NP-DLL160SN616	9 432 611 778
41-7111 F	9 430 615 154	105041-7111	9 430 612 051	NP-DLL160SN664	9 432 610 275
41-7111 L	9 430 615 154	105041-7111	9 430 612 111	NP-DLL160SN934	9 432 611 383
41-7111 M	9 430 615 154	105041-7111	9 430 612 129	NP-DLL160SM099	9 432 611 448
41-7111 N	9 430 615 154	105041-7111	9 430 612 130	NP-DLL160SM099	9 432 611 448
41-7111 P	9 430 615 154	105041-7111	9 430 612 139	NP-DLL160SM185	9 432 610 889
41-7112		105041-7112		NP-DLL155SN514	9 432 611 733
41-7112 A		105041-7112		NP-DLL155SN521	9 432 610 144
41-7112 B		105041-7112		NP-DLL155SN550	9 432 611 809
41-7112 E		105041-7112		NP-DLL160SN616	9 432 611 778
41-7112 F		105041-7112		NP-DLL160SN664	9 432 610 275
41-7112 G		105041-7112		NP-DLL160SN806	9 432 611 280
41-7112 H		105041-7112		NP-DLL155SN825	9 432 611 518
41-7112 J		105041-7112		NP-DLL160SM090	9 432 611 444
41-7112 K		105041-7112		NP-DLL160SM090	9 432 611 444
41-7112 L		105041-7112		NP-DLL160SN934	9 432 611 383
41-7112 M		105041-7112		NP-DLL160SM099	9 432 611 448
41-7112 N		105041-7112		NP-DLL160SM099	9 432 611 448

A174

de

**Düsen für
1-Feder-Düsenhalter
von Zexel**

(Fortsetzung)

en

**Nozzles for the most
important single-
spring nozzle-holders
Zexel**

(continued)

fr

**Injecteurs pour
les principaux porte-
injecteurs à 1 ressort
Zexel**

(suite)

it

**Polvrizzatori per
i principali porta-
polverizzatori
a 1 molla, Zexel**

(seguito)







es

**Inyectores para
los portainyectores
de 1 muelle más
importantes, Zexel**

(continuación)



41-7112 P		105041-7112		NP-DLL160SM185	9 432 610 889
41-7120	9 430 615 876	105041-7120	9 430 612 094	NP-DLL155SN807	9 432 610 277
41-7120 A	9 430 615 876	105041-7120	9 430 612 097	NP-DLL155SN807	9 432 610 277
41-7120 B	9 430 615 876	105041-7120	9 430 612 100	NP-DLL155SN882	9 432 610 892
41-7121	9 430 615 385	105041-7121	9 430 612 095	NP-DLL155SN807	9 432 610 277
41-7121 A	9 430 615 385	105041-7121	9 430 612 098	NP-DLL155SN807	9 432 610 277
41-7121 B	9 430 615 385	105041-7121	9 430 612 101	NP-DLL155SN882	9 432 610 892
41-7121 E	9 430 615 385	105041-7121	9 430 612 109	NP-DLL155SN916	9 432 611 370
41-7121 F	9 430 615 385	105041-7121	9 430 612 046	NP-DLL155SN639	9 432 610 224
41-7121 H	9 430 615 385	105041-7121	9 430 612 069	NP-DLL155SN729	9 432 611 235
41-7121 J	9 430 615 385	105041-7121	9 430 612 078	NP-DLL155SN790	9 432 610 856
41-7122	9 430 615 155	105041-7122	9 430 612 096	NP-DLL155SN807	9 432 610 277
41-7122 A	9 430 615 155	105041-7122	9 430 612 099	NP-DLL155SN807	9 432 610 277
41-7122 A2	9 430 615 155	105041-7122	9 430 612 145	NP-DLL143SM229	9 432 610 857
41-7122 B	9 430 615 155	105041-7122	9 430 612 102	NP-DLL155SN882	9 432 610 892
41-7122 B1		105041-7122		NP-DLL155SM426	
41-7122 C1	9 430 615 155	105041-7122	9 430 612 146	NP-DLL155SM231	9 432 611 579
41-7122 E	9 430 615 155	105041-7122	9 430 612 110	NP-DLL155SN916	9 432 611 370
41-7122 E1	9 430 615 155	105041-7122	9 430 612 869	NP-DLL140SM332	9 432 611 600
41-7122 F	9 430 615 155	105041-7122	9 430 612 047	NP-DLL155SN639	9 432 610 224
41-7122 F1	9 430 615 155	105041-7122	9 430 612 873	NP-DLL140SM334	9 432 611 602
41-7122 F2		105041-7122		NP-DLL140SM432	
41-7122 G	9 430 615 155	105041-7122	9 430 612 062	NP-DLL155SN692	9 432 611 252
41-7122 G1	9 430 615 155	105041-7122	9 430 612 875	NP-DLL143SM342	9 432 611 608
41-7122 H	9 430 615 155	105041-7122	9 430 612 070	NP-DLL155SN729	9 432 611 235
41-7122 H1	9 430 615 155	105041-7122	9 430 613 517	NP-DLL140SM352	9 432 612 724
41-7122 J	9 430 615 155	105041-7122	9 430 612 079	NP-DLL155SN790	9 432 610 856
41-7122 J1		105041-7122		NP-DLL155SM444	
41-7122 K	9 430 615 155	105041-7122	9 430 612 113	NP-DLL155SN979	9 432 610 725
41-7122 L1	9 430 615 155	105041-7122	9 430 612 150	NP-DLL148SM272	9 432 611 565
41-7122 M	9 430 615 155	105041-7122	9 430 612 126	NP-DLL143SM094	9 432 611 447
41-7122 N	9 430 615 155	105041-7122	9 430 612 125	NP-DLL140SM093	9 432 611 446
41-7122 T	9 430 615 155	105041-7122	9 430 612 121	NP-DLL155SM077	9 432 611 545
41-7122 U	9 430 615 155	105041-7122	9 430 612 122	NP-DLL138SM079	9 432 611 495
41-7122 V	9 430 615 155	105041-7122	9 430 612 133	NP-DLL140SM125	9 432 611 462
41-7122 W	9 430 615 155	105041-7122	9 430 612 134	NP-DLL130SM128	9 432 611 433
41-7122 Y	9 430 615 155	105041-7122	9 430 612 142	NP-DLL148SM214	9 432 611 479
41-7130	9 430 615 249	105041-7130	9 430 612 114	NP-DLLA145SM012	9 432 610 821
41-7130 A	9 430 615 249	105041-7130	9 430 612 119	NP-DLLA155SM075	9 432 611 543
41-7130 B	9 430 615 249	105041-7130	9 430 612 116	NP-DLLA140SM068	9 432 611 536
41-7130 C	9 430 615 249	105041-7130	9 430 612 117	NP-DLLA140SM069	9 432 611 537
41-7130 E	9 430 615 249	105041-7130	9 430 612 120	NP-DLLA142SM076	9 432 611 544
41-7130 F	9 430 615 249	105041-7130	9 430 612 131	NP-DLLA140SM109	9 432 611 453
41-7130 G	9 430 615 249	105041-7130	9 430 612 135	NP-DLLA155SM134	9 432 611 429
41-7130 H	9 430 615 249	105041-7130	9 430 612 149	NP-DLLA150SM271	9 432 610 778

 Typ	 Ref.	 Zexel	 Ref.	 Typ	 Ref.
41-7130 J	9 430 615 249	105041-7130	9 430 612 866	NP-DLLA140SM306	9 432 611 617
41-7130 K	9 430 615 249	105041-7130	9 430 612 874	NP-DLLA140SM335	9 432 611 603
41-7130 M	9 430 615 249	105041-7130	9 430 612 115	NP-DLLA145SM033	9 432 610 779
41-7130 R	9 430 615 249	105041-7130	9 430 612 136	NP-DLLA142SM149	9 432 611 435
41-7130 S	9 430 615 249	105041-7130	9 430 613 370	NP-DLLA140SM353	9 432 612 660
41-7130 T	9 430 615 249	105041-7130	9 430 613 518	NP-DLLA140SM355	9 432 612 725
41-7130 U		105041-7130		NP-DLLA137SM406	9 432 612 794
41-7130 V		105041-7130		NP-DLLA140SM421	
41-7130 W		105041-7130		NP-DLLA140SM422	
41-7130 X		105041-7130		NP-DLLA140SM423	
41-7130 Y		105041-7130		NP-DLLA142SM425	
41-7140	9 430 615 250	105041-7140	9 430 612 123	NP-DLLA160SM087	9 432 610 696
41-7140 A	9 430 615 250	105041-7140	9 430 612 128	NP-DLLA155SM096	9 432 610 457
41-7140 B	9 430 615 250	105041-7140	9 430 612 137	NP-DLLA155SM159	9 432 611 486
41-7140 E	9 430 615 250	105041-7140	9 430 612 872	NP-DLLA160SM314	9 432 612 651
41-7140 F	9 430 615 250	105041-7140	9 430 612 877	NP-DLLA160SM348	9 432 612 656
41-7141		105041-7141		NP-DLLA160SM087	9 432 610 696
41-7141 A		105041-7141		NP-DLLA155SM096	9 432 610 457
41-7141 B		105041-7141		NP-DLLA155SM159	9 432 611 486
41-7141 C		105041-7141		NP-DLLA160SM195	9 432 611 466
41-7141 F	9 430 616 240	105041-7141	9 430 613 516	NP-DLLA160SM348	9 432 612 656
41-7150	9 430 615 251	105041-7150	9 430 612 124	NP-DLLA140SM088	9 432 610 825
41-7150 B	9 430 615 251	105041-7150	9 430 612 127	NP-DLLA142SM095	9 432 610 827
41-7150 E		105041-7150		,m,0-,c,k,k,`133,r,l208	
41-7150 E	9 430 615 251	105041-7150	9 430 612 141	NP-DLLA133SM208	9 432 612 641
41-7150 F	9 430 615 251	105041-7150	9 430 612 144	NP-DLLA155SM228	9 432 611 441
41-7150 H	9 430 615 251	105041-7150	9 430 612 147	NP-DLLA133SM257	9 432 610 777
41-7150 J	9 430 615 251	105041-7150	9 430 612 148	NP-DLLA143SM262	9 432 611 595
41-7150 K	9 430 615 251	105041-7150	9 430 612 868	NP-DLLA133SM322	9 432 611 626
41-7150 L		105041-7150		NP-DLLA160SM382	9 432 612 770
41-7150 L		105041-7150		NP-DLLA160SM382	9 432 612 770
41-7150 M		105041-7150		NP-DLLA160SM382	9 432 612 770
41-7150 N		105041-7150		NP-DLLA140SM413	9 432 612 831
41-7150 P		105041-7150		NP-DLLA130SM418	9 432 612 848
41-7150 R		105041-7150		NP-DLLA133SM433	
41-7150 S		105041-7150		NP-DLLA133SM434	
41-7150 T		105041-7150		NP-DLLA155SM439	
41-7150 V		105041-7150		NP-DLLA133SM453	
41-7160	9 430 616 162	105041-7160	9 430 612 143	NP-DLL125SM196	9 432 612 640
43-1000	9 430 616 241	105043-1000	9 430 612 152	NP-DN6TD119NP2	9 432 611 998
43-1020 A		105043-1020		D NP-DLL150TE288N2	
43-1021 D		105043-1021		D NP-DLL150TE288N3	
43-1022 C		105043-1022		NP-DLL145TE288N3	
43-1022 D		105043-1022		NP-DLL150TE288N3	
43-1030 A		105043-1030		D NP-DLL150TE288N3	

A176

de

**Düsen für
1-Feder-Düsenhalter
von Zexel**
(Fortsetzung)

en

**Nozzles for the most
important single-
spring nozzle-holders
Zexel**
(continued)

fr

**Injecteurs pour
les principaux porte-
injecteurs à 1 ressort
Zexel**
(suite)







it







**Polvrizzatori per
i principali porta-
polverizzatori
a 1 molla, Zexel**
(seguito)

es

**Inyectoros para
los portainyectoros
de 1 muelle más
importantes, Zexel**
(continuación)



	 Typ	 Ref.	 Zexel	 Ref.	 Typ	 Ref.
43-1030	B		105043-1030		D NP-DLL145TE288N3	
43-1031	A		105043-1031		NP-DLL150TE288N3	
43-1031	C		105043-1031		D NP-DLL140TE288N3	
43-1031	B		105043-1031		D NP-DLL145TE288N3	
43-2000	A	9 430 615 877	105043-2000	9 430 612 290	NP-DLF140TE2610N6C	9 432 612 157
43-2000	B	9 430 615 877	105043-2000	9 430 612 292	NP-DLF140TE2810N6C	9 432 611 889
43-2000	C	9 430 615 877	105043-2000	9 430 612 294	NP-DLF140TE3010N3C	9 432 611 887
43-2000	D	9 430 615 877	105043-2000	9 430 612 296	NP-DLF140TE3210N3 C	9 432 611 885
43-2001	A	9 430 616 242	105043-2001	9 430 612 291	D NP-DLF140TE2610N6 C	9 432 611 894
43-2001	B	9 430 616 242	105043-2001	9 430 612 293	D NP-DLF140TE2810N6 C	9 432 611 886
43-2001	C	9 430 616 242	105043-2001	9 430 612 295	D NP-DLF140TE3010N3 C	9 432 611 888
43-2001	D	9 430 616 242	105043-2001	9 430 612 297	D,NP-DLF140TE3210N3	9 432 611 884
43-2002	A	9 430 616 243	105043-2002	9 430 613 521	D NP-DLF140TE2610N6 C	9 432 611 894
43-2010		9 430 615 878	105043-2010	9 430 612 217	NP-DL140TE3010N1	9 432 612 535
43-2010	A	9 430 615 878	105043-2010	9 430 612 214	NP-DL140TE2810N7	9 432 611 125
43-2011	A	9 430 616 244	105043-2011	9 430 612 215	D NP-DL140TE2810N7	9 432 611 126
43-2011	B	9 430 616 244	105043-2011	9 430 612 216	D NP-DL140TE2610N7	9 432 611 128
43-2011	C	9 430 616 244	105043-2011	9 430 612 218	D NP-DL140TE3010N1	9 432 611 121
43-2011	D	9 430 616 244	105043-2011	9 430 612 219	D NP-DL140TE3210N1	9 432 611 130
43-2012	B	9 430 616 245	105043-2012	9 430 613 519	D NP-DL140TE2610N7	9 432 611 128
43-2020	A	9 430 616 025	105043-2020	9 430 612 898	D NP-DLL140TSN143	9 432 611 404
43-2020	B	9 430 616 025	105043-2020	9 430 612 897	D NP-DLL140TSN144	9 432 611 405
43-2020	C	9 430 616 025	105043-2020	9 430 612 896	D NP-DLL140TE3210N1	9 432 611 340
43-2021	A	9 430 616 246	105043-2021	9 430 613 520	D NP-DLL140TE3010N1	9 432 611 404
43-3020		9 430 615 468	105043-3020	9 430 612 153	NP-DL155T288NP30	9 432 611 897
43-3020	A	9 430 615 468	105043-3020	9 430 612 154	NP-DL155T288NP28	
43-3020	C	9 430 615 468	105043-3020	9 430 612 157	NP-DL155T2610NP30	9 432 611 899
43-3020	D	9 430 615 468	105043-3020	9 430 612 158	NP-DL155T268NP30	9 432 611 900
43-3020	F	9 430 615 468	105043-3020	9 430 612 160	NP-DL155T308NP30	9 432 611 901
43-3020	G	9 430 615 468	105043-3020	9 430 612 161	NP-DL155T2410NP30	9 432 611 902
43-3050	A		105043-3050	9 430 612 211	NP-DL155TE3710N6	9 432 611 124
43-3051		9 430 615 939	105043-3051	9 430 612 220	NP-DL155TE3510N6	9 432 612 537
43-3051	A	9 430 615 939	105043-3051	9 430 612 212	NP-DL155TE3710N6	9 432 611 124
43-3051	C	9 430 615 939	105043-3051	9 430 612 221	NP-DL160TE3710N6	9 432 611 138
43-3051	D	9 430 615 939	105043-3051	9 430 612 222	NP-DL160TE3510N6	9 432 611 104
43-3051	E		105043-3051		NP-DL155TE3710N8	9 432 612 857
43-3051	F		105043-3051		NP-DL155TE3510N8	9 432 612 858
43-3051	G		105043-3051		NP-DL160TE3710N8	9 432 612 862
43-3051	H		105043-3051		NP-DL160TE3510N8	9 432 612 852
43-3051	J		105043-3051		NP-DL155TE3710N8	
43-3051	K		105043-3051		NP-DL155TE3510N8	
43-3051	L		105043-3051		NP-DL160TE3710N8	
43-3051	M		105043-3051		NP-DL160TE3510N8	
43-3060	A		105043-3060	9 430 612 288	NP-DLF155TE3710N8	9 432 612 156
43-3061	A	9 430 616 247	105043-3061	9 430 612 289	NP-DLF155TE3710N8	9 432 612 156

 Typ	 Ref.	 Zexel	 Ref.	 Typ	 Ref.
43-3061 B		105043-3061		NP-DLF155TE3710N9	
43-4021 A	9 430 615 996	105043-4021	9 430 612 199	NP-DL145T248NP37 %	9 432 610 976
43-4021 B	9 430 615 996	105043-4021	9 430 612 200	NP-DL150T304,264NP37	9 432 610 979
43-4021 C	9 430 615 996	105043-4021	9 430 612 201	NP-DL150T304,244NP37	9 432 610 950
43-4021 D	9 430 615 996	105043-4021	9 430 612 202	NP-DL150T284,244NP37	9 432 610 956
43-4021 E	9 430 615 996	105043-4021	9 430 612 203	NP-DL150T324,264NP37	9 432 610 954
43-4021 F	9 430 615 996	105043-4021	9 430 612 204	NP-DL150T344,304NP37	9 432 610 960
43-4021 G	9 430 615 996	105043-4021	9 430 612 205	NP-DL145T278NP37%	9 432 610 973
43-4021 H	9 430 615 996	105043-4021	9 430 612 208	NP-DL145T324,284NP37	9 432 611 122
43-4021 H	9 430 615 996	105043-4021	9 430 612 895	NP-DL145T324,284NP37	9 432 611 122
43-4030 A	9 430 615 997	105043-4030	9 430 612 279	NP-DLF145TB248N41	9 432 611 891
43-4030 B	9 430 615 997	105043-4030	9 430 612 280	NP-DLF150TB304244N34	9 432 612 151
43-4030 C	9 430 615 997	105043-4030	9 430 612 283	NP-DLF145TB278N41	9 432 611 706
43-4040 A	9 430 616 006	105043-4040	9 430 612 900	D NP-DL150T304,244NP37	9 432 610 951
43-4040 B	9 430 616 006	105043-4040	9 430 612 903	D NP-DL145T248NP37 %	9 432 610 977
43-4040 C	9 430 616 006	105043-4040	9 430 612 904	D NP-DL150T304,264NP37	9 432 610 980
43-4040 D	9 430 616 006	105043-4040	9 430 612 899	D NP-DL150T284,244NP37	9 432 610 948
43-4040 E	9 430 616 006	105043-4040	9 430 612 889	D NP-DL150T324,264NP37	9 432 610 955
43-4040 F	9 430 616 006	105043-4040	9 430 612 894	D NP-DL150T344,304NP37	9 432 610 961
43-4040 G	9 430 616 006	105043-4040	9 430 612 893	D NP-DL145T278NP37	9 432 610 974
43-4040 H	9 430 616 006	105043-4040	9 430 612 891	D NP-DL145T324,284NP37	9 432 611 123
43-4040 K		105043-4040		D NP-DL150T288NP37	
43-4040 K		105043-4040		NP-DL150T288NP37	
43-5000	9 430 615 469	105043-5000	9 430 612 155	NP-DL155T288NP15	9 432 611 908
43-5000 A	9 430 615 469	105043-5000	9 430 612 156	NP-DL155T308NP15	9 432 611 898
43-5010 A	9 430 615 486	105043-5010	9 430 612 223	NP-DLF150TB348N17	9 432 610 240
43-5010 B	9 430 615 486	105043-5010	9 430 612 224	NP-DLF150TB328N35	9 432 610 260
43-5010 C	9 430 615 486	105043-5010	9 430 612 225	NP-DLF150TB348N35	9 432 610 261
43-5020 A		105043-5020	9 430 612 226	NP-DLF145TB328N37	9 432 611 662
43-5020 B		105043-5020	9 430 612 228	NP-DLF145TE308N1	9 432 611 652
43-5020 C		105043-5020	9 430 612 248	NP-DLF145TE348N1	9 432 611 649
43-5020 D		105043-5020	9 430 612 253	NP-DLF145TE308N1	9 432 611 671
43-5020 F		105043-5020	9 430 612 255	NP-DLF145TE328N3	9 432 610 263
43-5023 A	9 430 615 487	105043-5023	9 430 612 227	NP-DLF145TE328N1	9 432 611 662
43-5023 B	9 430 615 487	105043-5023	9 430 612 229	NP-DLF145TB308N37	9 432 611 652
43-5023 C	9 430 615 487	105043-5023	9 430 612 249	NP-DLF145TE348N1	9 432 611 649
43-5023 D	9 430 615 487	105043-5023	9 430 612 254	NP-DLF145TE308N3	9 432 611 671
43-5023 E	9 430 615 487	105043-5023	9 430 612 256	NP-DLF145TE328N3	9 432 610 263
43-5023 F	9 430 615 487	105043-5023	9 430 612 278	NP-DLF145TE348N3	9 432 610 321
43-5023 G	9 430 615 487	105043-5023	9 430 612 282	NP-DLF145TE368N1	9 432 612 143
43-5023 H	9 430 615 487	105043-5023	9 430 612 286	NP-DLF145TE368N3	9 432 611 890
43-5030 A		105043-5030	9 430 612 175	NP-DL145TE328N1	9 432 611 861
43-5030 B		105043-5030	9 430 612 183	NP-DL145TE348N1	9 432 610 947
43-5030 C		105043-5030	9 430 612 187	NP-DL145TE308N1	9 432 610 910
43-5030 D		105043-5030	9 430 612 189	NP-DL145TE368N1	9 432 610 937

A178

de

**Düsen für
1-Feder-Düsenhalter
von Zexel**
(Fortsetzung)

en

**Nozzles for the most
important single-
spring nozzle-holders
Zexel**
(continued)

fr

**Injecteurs pour
les principaux porte-
injecteurs à 1 ressort
Zexel**
(suite)







it







**Polvrizzatori per
i principali porta-
polverizzatori
a 1 molla, Zexel**
(seguito)

es

**Inyectoros para
los portainyectoros
de 1 muelle más
importantes, Zexel**
(continuación)



						
43-5031	A		105043-5031	9 430 612 176	NP-DL145TE328N1	9 432 611 861
43-5033	B	9 430 615 488	105043-5033	9 430 612 184	NP-DL145TE348N1	9 432 610 947
43-5033	C	9 430 615 488	105043-5033	9 430 612 188	NP-DL145TE308N1	9 432 610 910
43-5033	D	9 430 615 488	105043-5033	9 430 612 190	NP-DL145TE368N1	9 432 610 937
43-5040	A	9 430 616 248	105043-5040	9 430 612 234	NP-DLF155TB308N36	9 432 611 654
43-5050		9 430 615 992	105043-5050	9 430 612 235	NP-DLF145TE368N1..	9 432 611 650
43-5050	A	9 430 615 992	105043-5050	9 430 612 250	NP-DLF145TE348N1...	9 432 611 653
43-5050	C	9 430 615 992	105043-5050	9 430 612 259	NP-DLF145TE368N3	9 432 611 668
43-5051	24C		105043-5051	9 430 612 236	NP-DLF145TE368N1..	9 432 611 650
43-5051	A		105043-5051	9 430 612 251	NP-DLF145TE348N1..	9 432 611 653
43-5051	B		105043-5051	9 430 612 257	NP-DLF145TE388N1	9 432 611 670
43-5051	C		105043-5051	9 430 612 260	NP-DLF145TE368N3	9 432 611 668
43-5051	D		105043-5051	9 430 612 262	NP-DLF145TE388N3	9 432 611 669
43-5054	A	9 430 615 489	105043-5054	9 430 612 252	NP-DLF145TE348N1.1	9 432 611 653
43-5054	B	9 430 615 489	105043-5054	9 430 612 258	NP-DLF145TE388N1%	9 432 611 670
43-5054	C	9 430 615 489	105043-5054	9 430 612 261	NP-DLF145TE368N3C%	9 432 611 668
43-5054	D	9 430 615 489	105043-5054	9 430 612 263	NP-DLF145TE388N3C%	9 432 611 669
43-5054	E	9 430 615 489	105043-5054	9 430 612 237	NP-DLF145TE368N1%	9 432 611 650
43-6000		9 430 615 463	105043-6000	9 430 612 159	NP-DL160T328NP12	9 432 612 158
43-6010	A	9 430 615 555	105043-6010	9 430 612 162	NP-DL140T324,284NP32	9 432 611 903
43-6010	B	9 430 615 555	105043-6010	9 430 612 163	NP-DL140T304,264NP32	9 432 611 906
43-6010	C	9 430 615 555	105043-6010	9 430 612 167	NP-DL145T324,284NP32	9 432 611 883
43-6010	D	9 430 615 555	105043-6010	9 430 612 168	NP-DL145T324,264NP32	9 432 611 846
43-6020	A	9 430 615 490	105043-6020	9 430 612 232	NP-DLF150TB268N28	9 432 610 484
43-6020	B	9 430 615 490	105043-6020	9 430 612 233	NP-DLF150TB248N28	9 432 610 487
43-6030	A	9 430 615 491	105043-6030	9 430 612 165	NP-DL150T248NP32	9 432 611 873
43-6030	A	9 430 615 491	105043-6030	9 430 612 166	NP-DL150T268NP32	9 432 612 196
43-6040	A	9 430 615 492	105043-6040	9 430 612 240	NP-DLF150TB268N28	9 432 610 484
43-6040	B	9 430 615 492	105043-6040	9 430 612 241	NP-DLF150TB248N28	9 432 610 487
43-6040	E	9 430 615 492	105043-6040	9 430 612 276	NP-DLF145TE248N6C	9 432 610 276
43-6040	F	9 430 615 492	105043-6040	9 430 612 277	NP-DLF145TE268N6C	9 432 611 893
43-6050	A	9 430 615 493	105043-6050	9 430 612 169	NP-DL150T248NP32	9 432 611 873
43-6050	B	9 430 615 493	105043-6050	9 430 612 170	NP-DLL150T268NP32	9 432 612 196
43-6050	C	9 430 615 493	105043-6050	9 430 612 193	NP-DL145TE248N3	9 432 612 524
43-6050	D	9 430 615 493	105043-6050	9 430 612 194	NP-DL145TE268N3	9 432 612 525
43-6060		9 430 615 999	105043-6060	9 430 612 213	NP-DL145TE348N4	9 432 612 533
43-6060	A	9 430 615 999	105043-6060	9 430 612 171	NP-DL140T324,284NP32	9 432 611 903
43-6060	B	9 430 615 999	105043-6060	9 430 612 172	NP-DL140T304,264NP32	9 432 611 906
43-6060	C	9 430 615 999	105043-6060	9 430 612 185	NP-DL140T324,284NP32	9 432 611 883
43-6060	D	9 430 615 999	105043-6060	9 430 612 186	NP-DL145T304,264NP32	9 432 611 846
43-6060	E	9 430 615 999	105043-6060	9 430 612 197	NP-DL145TE324,284N1	9 432 610 952
43-6060	F	9 430 615 999	105043-6060	9 430 612 206	NP-DL145TE304,265N5	9 432 610 963
43-6070	A	9 430 616 000	105043-6070	9 430 612 242	NP-DLF140TB324,284N34	9 432 610 485
43-6070	B	9 430 616 000	105043-6070	9 430 612 243	NP-DLF140TB304,264N34	9 432 610 489
43-6070	C	9 430 616 000	105043-6070	9 430 612 268	NP-DLF145TB324,284NP38	9 432 610 492

 Typ	 Ref.	 Zexel	 Ref.	 Typ	 Ref.
43-6070 D	9 430 616 000	105043-6070	9 430 612 269	NP-DLF145TB304,264NP38	9 432 610 491
43-6070 E	9 430 616 000	105043-6070	9 430 612 271	NP-DLF145TE324,284N3	9 432 610 694
43-6070 F	9 430 616 000	105043-6070	9 430 612 284	NP-DLF145TE304,264N3	9 432 611 882
43-7000 A	9 430 616 001	105043-7000	9 430 612 177	NP-DL145TE368N1	9 432 610 925
43-7000 B	9 430 616 001	105043-7000	9 430 612 180	NP-DL145TE388N1	9 432 610 926
43-7001 A		105043-7001	9 430 612 178	NP-DL145TE368N1	9 432 610 925
43-7001 B		105043-7001	9 430 612 181	NP-DL145TE388N1	9 432 610 926
43-7004 A	9 430 616 002	105043-7004	9 430 612 179	NP-DL145TE368N1%	9 432 610 925
43-7004 B	9 430 616 002	105043-7004	9 430 612 182	NP-DL145TE388N1%	9 432 610 926
43-7004 C	9 430 616 002	105043-7004	9 430 612 198	NP-DL145TE408N1%	9 432 610 946
43-7004 D	9 430 616 002	105043-7004	9 430 612 207	NP-DL145TE428N1%	9 432 610 964
43-8000	9 430 616 249	105043-8000	9 430 612 151	NP-DN4T208	9 432 611 995
43-8020 A	9 430 616 003	105043-8020	9 430 612 230	NP-DLF145TU428N1	9 432 611 408
43-8020 B	9 430 616 003	105043-8020	9 430 612 231	NP-DLF145TU408N1	9 432 611 313
43-8040 A	9 430 615 494	105043-8040	9 430 612 164	NP-DL145TU428N1	9 432 612 377
43-8050 A	9 430 615 495	105043-8050	9 430 612 238	NP-DLF145TU428N1	9 432 611 408
43-8050 B	9 430 615 495	105043-8050	9 430 612 239	NP-DLF145TU408N1	9 432 611 313
43-8061 A	9 430 615 496	105043-8061	9 430 612 173	NP-DL145T388AN3	9 432 610 500
43-8071 A	9 430 615 497	105043-8071	9 430 612 244	NP-DLF145TB388N38	9 432 610 488
43-8071 B	9 430 615 497	105043-8071	9 430 612 245	NP-DLF145TB368N38	9 432 610 490
43-8080 A	9 430 616 004	105043-8080	9 430 612 174	NP-DL145TU428N1	9 432 612 377
43-8080 B	9 430 616 004	105043-8080	9 430 612 191	NP-DL145TU458N2	9 432 611 396
43-8110 A	9 430 615 498	105043-8110	9 430 612 246	NP-DLF145TU428N1	9 432 611 408
43-8110 B	9 430 615 498	105043-8110	9 430 612 247	NP-DLF145TU408N1	9 432 611 313
43-8110 C	9 430 615 498	105043-8110	9 430 612 270	NP-DLF145TU458N4	9 432 611 315
43-8110 D	9 430 615 498	105043-8110	9 430 612 274	NP-DLF145TU458N6C	9 432 611 298
43-8110 E	9 430 615 498	105043-8110	9 430 612 281	NP-DLF145TU428N6C	9 432 611 299
43-8110 F	9 430 615 498	105043-8110	9 430 612 285	NP-DLF145TU428N4	9 432 611 301
43-8130 A		105043-8130	9 430 612 264	NP-DLF145TE388N4	9 432 611 663
43-8130 B		105043-8130	9 430 612 266	NP-DLF145TE368N4C	9 432 611 666
43-8133 A	9 430 616 005	105043-8133	9 430 612 265	NP-DLF145TE388N4	9 432 611 663
43-8133 B	9 430 616 005	105043-8133	9 430 612 267	NP-DLF145TE368N4C	9 432 611 666
43-8143 A	9 430 615 499	105043-8143	9 430 612 192	NP-DL145TE408N2	9 432 610 969
43-8143 B	9 430 615 499	105043-8143	9 430 612 195	NP-DL145TE428N2	9 432 610 978
43-8143 C	9 430 615 499	105043-8143	9 430 612 196	NP-DL145TE448N2	9 432 610 981
43-8143 D	9 430 615 499	105043-8143	9 430 612 209	NP-DL145T388AN3	9 432 610 500
43-8151 A		105043-8151	9 430 612 272	NP-DLF145TE408N4C	9 432 611 664
43-8151 C		105043-8151	9 430 612 275	NP-DLF145TE448N4	9 432 611 892
43-8152 B	9 430 615 500	105043-8153	9 430 612 273	NP-DLF145TE428N4C	9 432 611 665
4385		105088-2010		NP-DLLA140PN361	
43-9000 A	9 430 615 986	105043-9000	9 430 612 287	NP-DLF145TU1508N4	9 432 611 304
43-9010 A	9 430 615 984	105043-9010	9 430 612 210	NP-DL145TU508N2	9 432 611 397
44-1003 A	9 430 615 188	105044-1003	9 430 612 338	158X8X0.42X1.2	9 432 612 447
44-1003 B	9 430 615 188	105044-1003	9 430 612 349	158X8X0.42X0.8	9 432 612 461
44-1003 B	9 430 615 188	105044-1003	9 430 613 267	158x8x0.42x0.8	9 432 612 464

A180

de

**Düsen für
1-Feder-Düsenhalter
von Zexel**

(Fortsetzung)

en

**Nozzles for the most
important single-
spring nozzle-holders
Zexel**

(continued)

fr

**Injecteurs pour
les principaux porte-
injecteurs à 1 ressort
Zexel**

(suite)

it

**Polvrizzatori per
i principali porta-
polverizzatori
a 1 molla, Zexel**







(seguito)







es

**Inyectores para
los portainyectores
de 1 muelle más
importantes, Zexel**

(continuación)



						
44-1003	C		105044-1003		158x8x0.42x0.8	
44-1010	A	9 430 615 979	105044-1010	9 430 612 352	NP-DLF140UB4810N27C	9 432 611 934
44-1010	A	9 430 615 979	105044-1010	9 430 612 353	D NP-DLF140UB4810N27 C	9 432 611 965
44-1010	B	9 430 615 979	105044-1010	9 430 612 355	NP-DLF140UB529N27 C	9 432 611 942
44-1010	B	9 430 615 979	105044-1010	9 430 612 356	D NP-DLF140UB529N27 C	9 432 611 943
44-1010	C	9 430 615 979	105044-1010	9 430 612 357	NP-DLF140UB521N27 C	9 432 611 946
44-1010	C	9 430 615 979	105044-1010	9 430 612 358	D NP-DLF140UB521N27 C	9 432 611 950
44-1020	A	9 430 615 980	105044-1020	9 430 612 311	NP-DL140U4810AN3	9 432 611 871
44-1021	A	9 430 615 981	105044-1021	9 430 612 313	D NP-DL140U4810AN3	9 432 611 859
44-1021	A	9 430 615 981	105044-1021	9 430 612 312	NP-DL140U4810AN3	9 432 611 871
44-1021	B	9 430 615 981	105044-1021	9 430 612 317	NP-DL140U529AN3	9 432 611 878
44-1021	B	9 430 615 981	105044-1021	9 430 612 318	D NP-DL140U529AN3	9 432 611 879
44-1021	C	9 430 615 981	105044-1021	9 430 612 320	D NP-DL140U5210AN3	9 432 611 875
44-1021	C	9 430 615 981	105044-1021	9 430 612 319	NP-DL140U5210AN3	9 432 611 876
44-1021	D	9 430 615 981	105044-1021	9 430 612 326	D NP-DL140U4610AN3	9 432 611 870
44-1022	F		105044-1022		NP-DL0U1641AN3	
44-1030	C	9 430 615 982	105044-1030	9 430 612 359	D NP-DLF145UE4010N3 C	9 432 611 947
44-1031	A	9 430 616 250	105044-1031	9 430 612 361	D NP-DLF145UE4410N3 C	9 432 612 294
44-1031	C	9 430 616 250	105044-1031	9 430 612 360	D NP-DLF145UE4010N3 C	9 432 611 948
44-1031	D	9 430 616 250	105044-1031	9 430 612 362	D NP-DLF150UE4410N3 C	9 432 611 954
44-1031	E	9 430 616 250	105044-1031	9 430 612 363	D NP-DLF150UE4010N3 C	9 432 611 956
44-1031	F	9 430 616 250	105044-1031	9 430 612 364	D NP-DLF150UE3810N1 C	9 432 611 912
44-1031	G		105044-1031		D NP-DLF140UE4010N3 C	
44-1031	H		105044-1031		D NP-DLL140UE4410N3 C	
44-1040	A	9 430 615 983	105044-1040	9 430 612 322	D NP-DL145UE4010N1	9 432 611 874
44-1040	A	9 430 615 983	105044-1040	9 430 612 321	NP-DL145UE4010N1	9 432 612 236
44-1040	B	9 430 615 983	105044-1040	9 430 612 323	D NP-DL145UE4410N1	9 432 612 238
44-1040	C	9 430 615 983	105044-1040	9 430 612 324	NP-DL150UE4410N1	9 432 611 872
44-1040	C	9 430 615 983	105044-1040	9 430 612 325	D NP-DL150UE4410N1	9 432 611 880
44-1040	D	9 430 615 983	105044-1040	9 430 612 327	D NP-DL150UE4010N1	9 432 611 868
44-1041	K		105044-1041		D NP-DL150UE3810N1	
44-1041	M		105044-1041		D NP-DL140UE4410N1	
44-1041	L		105044-1041		D NP-DL 140UE4010N1	
44-1050	A	9 430 615 251	105044-1050	9 430 613 522	D NP-DLL150UE4010N1	9 432 612 714
44-1050	C		105044-1050		D NP-DLL140UE4010N1	
44-1050	D		105044-1050		D NP-DLL140UE4410N1	
44-1060	A		105044-1060		NP-DLL145UE4810N1	9 432 612 774
44-2000	A	9 430 616 252	105044-2000	9 430 612 351	NP-DLF156UE5013N5	9 432 612 293
44-2000	B	9 430 616 252	105044-2000	9 430 612 354	NP-DLF156UE649N5 R	9 432 611 951
44-2010	A	9 430 616 253	105044-2010	9 430 612 316	NP-DL156UE609N2R	9 432 611 877
44-3002		9 430 615 985	105044-3002	9 430 612 305	NP-DL150UE559N1	9 432 611 849
44-3002	A	9 430 615 985	105044-3002	9 430 612 308	NP-DL145UE509N3	9 432 611 848
44-3002	B	9 430 615 985	105044-3002	9 430 612 314	NP-DL145UE559N1	9 432 611 860
44-3003		9 430 616 254	105044-3003	9 430 612 306	D NP-DL150UE559N1	9 432 612 220
44-3003	A	9 430 616 254	105044-3003	9 430 612 309	D NP-DL145UE509N3	9 432 612 228

 Typ	 Ref.	 Zexel	 Ref.	 Typ	 Ref.
44-3003 B	9 430 616 254	105044-3003	9 430 612 315	D NP-DL145UE559N1	9 432 612 229
44-3012	9 430 615 987	105044-3012	9 430 612 339	NP-DLF150UE559N3C	9 432 611 964
44-3012 A	9 430 615 987	105044-3012	9 430 612 344	NP-DLF140UB559N27C	9 432 612 287
44-3014	9 430 616 114	105044-3014	9 430 612 340	D NP-DLF150UE559N3 C	9 432 612 283
44-3014 A	9 430 616 114	105044-3014	9 430 612 345	D NP-DLF140UB559N27 C	9 432 612 288
44-3020 B	9 430 616 255	105044-3020	9 430 613 264	NP-DLF156UE789N6	9 432 612 300
44-3020 B	9 430 616 255	105044-3020		NP-DLF156UE789N6	9 432 612 772
44-3030 A	9 430 616 256	105044-3030	9 430 613 523	NP-DL156UE5611N51	9 432 612 715
44-4000		105044-4000	9 430 612 328	NP-DLF145UB479N18	9 432 612 269
44-4001 B	9 430 615 501	105044-4001	9 430 612 329	NP-DLF145UB479N19	9 432 611 907
44-4010 A		105044-4010	9 430 612 298	NP-DL145U479NP10	9 432 611 854
44-4010 B		105044-4010	9 430 612 299	NP-DL145U479AN1	9 432 611 845
44-4011 B	9 430 615 502	105044-4011	9 430 612 300	NP-DL145U479AN1	9 432 611 845
44-4021 B	9 430 615 503	105044-4021	9 430 612 301	NP-DL145U479AN1	9 432 611 845
44-4021 C	9 430 615 503	105044-4021	9 430 612 303	NP-DL145U509AN1	9 432 611 863
44-4031 B	9 430 615 504	105044-4031	9 430 612 330	NP-DLF145UB479N19	9 432 611 907
44-4031 C	9 430 615 504	105044-4031	9 430 612 333	NP-DLF145UB479N23	9 432 611 960
44-4031 E	9 430 615 504	105044-4031	9 430 612 331	NP-DLF145UB479N22C	9 432 612 276
44-4044 A	9 430 615 988	105044-4044	9 430 612 302	NP-DL145UC589N1	9 432 612 206
44-4044 B	9 430 615 988	105044-4044	9 430 612 310	NP-DL140UC659N1	9 432 611 847
44-4052 A	9 430 616 257	105044-4052	9 430 612 332	NP-DLF145UB479N22C	9 432 612 276
44-4064 A	9 430 615 989	105044-4064	9 430 612 334	NP-DLF145UC589N2C	9 432 611 961
44-4064 A	9 430 615 989	105044-4064	9 430 612 335	NP-DLF145UC659N2C	9 432 611 962
44-4064 C	9 430 615 989	105044-4064	9 430 612 343	NP-DLF145UC629N2C	9 432 611 941
44-4064 D	9 430 615 989	105044-4064	9 430 612 346	NP-DLF140UC659N2C	9 432 612 289
44-4064 E	9 430 615 989	105044-4064	9 430 612 347	NP-DLF140UC589N2C	9 432 612 290
44-4064 F	9 430 615 989	105044-4064	9 430 612 348	NP-DLF140UC629N2C	9 432 612 291
44-6000 A		105044-6000	9 430 612 336	NP-DLF156UE649N1	9 432 612 282
44-6001 A	9 430 615 470	105044-6001	9 430 612 337	NP-DLF156UE649N1	9 432 612 282
44-6011 A	9 430 615 471	105044-6011	9 430 612 304	NP-DL156U609NP15	9 432 612 218
44-6020	9 430 616 258	105044-6020	9 430 612 341	NP-DLF150UE466N4	9 432 612 285
44-6030 A	9 430 616 259	105044-6030	9 430 612 307	NP-DL156UE609N2	9 432 612 223
44-6040 A	9 430 616 260	105044-6040	9 430 612 342	NP-DLF156UE649N5	9 432 612 286
45-3000 B		105045-3000	9 430 612 371	D NP-DLF151VE6011N1 C	9 432 612 306
45-3001 A		105045-3001	9 430 612 370	D NP-DLF151VE5411N1 C	9 432 611 923
45-3001 B		105045-3001	9 430 612 372	D NP-DLF151VE6011N1 C	9 432 611 924
45-3001 C		105045-3001	9 430 612 373	D NP-DLF151VE6010N1 C	9 432 611 917
45-3001 D		105045-3001	9 430 612 374	D NP-DLF145VE5610N1 C	9 432 611 916
45-3001 E		105045-3001	9 430 613 378	D NP-DLF148VE5611N1 C	9 432 612 307
45-3001 F		105045-3001	9 430 613 379	D NP-DLF148VE5411N1 C	9 432 612 308
45-3002 J		105045-3002		D NP-DLF151VE5411N2 C	
45-3002 K		105045-3002		D NP-DLF151VE6011N2 C	
45-3002 L		105045-3002		D NP-DLF151VE6010N2 C	
45-3002 M		105045-3002		D NP-DLF145VE5610N2 C	
45-3002 N		105045-3002		D NP-DLF151VE5611N2 C	

A182

de

**Düsen für
1-Feder-Düsenhalter
von Zexel**

(Fortsetzung)

en

**Nozzles for the most
important single-
spring nozzle-holders
Zexel**

(continued)

fr

**Injecteurs pour
les principaux porte-
injecteurs à 1 ressort
Zexel**

(suite)

it

**Polvrizzatori per
i principali porta-
polverizzatori
a 1 molla, Zexel**







(seguito)







es

**Inyectoros para
los portainyectoros
de 1 muelle más
importantes, Zexel**

(continuación)



						
45-3002	P		105045-3002		D NP-DLF148VE5611N2 C	
45-3002	Q		105045-3002		D NP-DLF148VE5411N2 C	
45-3002	R		105045-3002		D NP-DLF151VE6211N2 C	
45-3002	S		105045-3002		D NP-DLF151VE5811N2 C	
45-3002	S		105045-3002			
45-3002	U		105045-3002			
45-3002	V		105045-3002			
45-3010	A		105045-3010	9 430 612 365	NP-DL151VE5411N1	9 432 611 927
45-3011	A		105045-3011	9 430 612 366	D NP-DL151VE5411N1	9 432 611 935
45-3011	B		105045-3011	9 430 612 367	D NP-DL151VE6011N1	9 432 611 918
45-3011	C		105045-3011	9 430 612 368	D NP-DL151VE5811N1	9 432 611 919
45-3011	D		105045-3011	9 430 612 369	D NP-DL151VE6010N1	9 432 611 920
45-3011	E		105045-3011	9 430 613 374	D NP-DL148VE5611N1	9 432 612 302
45-3011	F		105045-3011	9 430 613 375	D NP-DL148VE5411N1	9 432 612 303
45-3011	G		105045-3011	9 430 613 376	D NP-DL151VE5611N1	9 432 612 304
45-3012	J		105045-3012		D NP-DL151VE5411N2	
45-3012	K		105045-3012		D NP-DL151VE6011N2	
45-3012	L		105045-3012		D NP-DL151VE5811N2	
45-3012	M		105045-3012		D NP-DL151VE6010N2	
45-3012	N		105045-3012		D NP-DL148VE5611N2	
45-3012	P		105045-3012		D NP-DL148VE5411N2	
45-3012	Q		105045-3012		D NP-DL151VE5611N2	
45-3012	R		105045-3012			
45-3012	S		105045-3012			
45-3012	T		105045-3012			
48-2000	C	9 430 615 036	105048-2000	9 430 610 040	NP-DLLA150PN000	9 432 610 022
48-2000	K	9 430 615 036	105048-2000	9 430 612 376	NP-DLLA150PN001	9 432 612 469
48-2001		9 430 615 091	105048-2001	9 430 610 104	NP-DLLA150PN000	9 432 610 022
48-2002		9 430 615 754	105048-2002	9 430 612 375	NP-DLLA150PN000	9 432 610 022
48-2010		9 430 615 464	105048-2010	9 430 612 377	NP-DLLA140PN002	9 432 611 310
48-2010		9 430 615 464	105048-2010	9 430 612 583	NP-DLLA140PN002	9 432 611 310
48-2010	1	9 430 615 464	105048-2010	9 430 612 395	NP-DLLA140PN013	9 432 610 848
48-2010	1	9 430 615 464	105048-2010	9 430 612 585	NP-DLLA140PN013	9 432 610 848
48-2010	A	9 430 615 464	105048-2010	9 430 612 378	NP-DLLA140PN003	9 432 610 762
48-2010	A	9 430 615 464	105048-2010	9 430 612 584	NP-DLLA140PN003	9 432 610 762
48-2010	A1		105048-2010			
48-2020		9 430 615 532	105048-2020	9 430 612 465	NP-DLLA155PN60	9 432 610 733
48-2020		9 430 615 532	105048-2020	9 430 612 452	NP-DLLA155PN045	9 432 612 476
48-2030	B	9 430 615 053	105048-2030	9 430 612 699	NP-DLLA155PN092	9 432 612 484
48-2030	C	9 430 615 053	105048-2030	9 430 610 062	NP-DLLA150PN044	9 432 610 098
48-2030	E	9 430 615 053	105048-2030	9 430 612 698	NP-DLLA155PN083	9 432 612 483
48-2031	C	9 430 615 104	105048-2031	9 430 612 696	NP-DLLA150PN044	9 432 610 098
48-2031	H	9 430 615 104	105048-2031	9 430 610 151	NP-DSLA154PN082	9 432 610 159
48-2031	J	9 430 615 104	105048-2031	9 430 612 703	NP-DSLA154PN114	9 432 610 404
48-2040		9 430 615 755	105048-2040	9 430 612 458	NP-DLLA150PN052	9 432 610 210

 Typ	 Ref.	 Zexel	 Ref.	 Typ	 Ref.
48-2040 E		105048-2040		NP-DLLA150PN316	9 432 612 761
48-2050	9 430 615 756	105048-2050	9 430 612 464	NP-DLLA150PN052	9 432 610 210
48-2050 H		105048-2050		NP-DLLA150PN316	9 432 612 761
48-2080 A	9 430 615 057	105048-2080	9 430 612 700	NP-DLLA155PN093	9 432 610 217
48-2080 G3	9 430 615 057	105048-2080	9 430 610 067	NP-DLLA155PN079	9 432 610 146
48-2080 G5	9 430 615 057	105048-2080	9 430 612 697	NP-DLLA155PN080	9 432 610 233
48-2081 A	9 430 615 060	105048-2081	9 430 610 099	NP-DLLA155PN093	9 432 610 217
48-2081 E3	9 430 615 060	105048-2081	9 430 610 100	NP-DLLA157PN102	9 432 610 208
48-2081 G3	9 430 615 060	105048-2081	9 430 610 072	NP-DLLA155PN079	9 432 610 146
48-2081 Q	9 430 615 060	105048-2081	9 430 612 716	NP-DLLA155PN157	9 432 610 360
48-2081 T	9 430 615 060	105048-2081	9 430 612 724	NP-DLLA155PN199	9 432 611 028
48-2090	9 430 615 059	105048-2090	9 430 610 069	NP-DLSA154PN82	9 432 610 159
48-2100	9 430 615 990	105048-2100	9 430 612 701	NP-DLLA150PN106	9 432 610 814
48-2110	9 430 615 280	105048-2110	9 430 612 702	NP-DLSA154PN114	9 432 610 404
48-2120	9 430 615 519	105048-2120	9 430 612 561	NP-DLLA160PN126	9 432 611 328
48-2120 A	9 430 615 519	105048-2120	9 430 612 562	NP-DLLA160PN127	9 432 611 329
48-2130	9 430 615 520	105048-2130	9 430 612 707	NP-DLLA160PN129	9 432 611 331
48-2140	9 430 615 521	105048-2140	9 430 612 576	NP-DLLA160PN126	9 432 611 328
48-2150	9 430 615 522	105048-2150	9 430 612 712	NP-DLLA160PN149	9 432 611 003
48-2151	9 430 615 991	105048-2151	9 430 612 713	NP-DLLA160PN149	9 432 611 003
48-2151 A	9 430 615 991	105048-2151	9 430 612 720	NP-DLLA160PN187	9 432 611 017
48-2152 B		105048-2152		NP-DLLA160PN317	9 432 612 769
48-2170	9 430 615 111	105048-2170	9 430 610 156	NP-DLLA140PN204	9 432 610 380
48-2190	9 430 615 587	105048-2190	9 430 610 197	NP-DLLA153PN234	9 432 610 586
48-2200	9 430 615 573	105048-2200	9 430 610 183	NP-DLLA145PN238	9 432 610 461
48-2201		105048-2201		NP-DLLA145PN238	
48-2201		105048-2201		NP-DLLA145PN238	9 432 610 461
48-2210	9 430 616 174	105048-2210	9 430 612 685	NP-DLLA152PN251	9 432 610 934
48-2210	9 430 616 174	105048-2210	9 430 613 135	NP-DLLA152PN251	9 432 610 934
48-2220 B1	9 430 615 559	105048-2220	9 430 613 532	NP-DLLA145PN263	9 432 612 495
48-2220 J	9 430 615 559	105048-2220	9 430 613 534	NP-DLLA140PN302	9 432 612 716
48-2220 L	9 430 615 559	105048-2220	9 430 613 535	NP-DLLA140PN303	9 432 612 717
48-2220 T	9 430 615 559	105048-2220	9 430 613 227	NP-DLLA140PN290	9 432 612 499
48-2220 Z	9 430 615 559	105048-2220	9 430 613 070	NP-DLLA145PN263	9 432 612 495
48-2221 A4		105048-2221		NP-DLLA140PN359	
48-2221 A5		105048-2221		NP-DLLA145PN357	
48-2221 A6		105048-2221		NP-DLLA140PN358	
48-2221 A8		105048-2221		NP-DLLA140PN364	
48-2221 A9		105048-2221		NP-DLLA145PN365	
48-2221 B1		105048-2221		NP-DLLA145PN263	
48-2221 J		105048-2221		NP-DLLA140PN302	
48-2221 L		105048-2221		NP-DLLA140PN303	
48-2221 T		105048-2221		NP-DLLA140PN290	
48-2222 A4		105048-2222		NP-DLLA140PN359	
48-2222 A5		105048-2222		NP-DLLA145PN357	

A184

de

**Düsen für
1-Feder-Düsenhalter
von Zexel**
(Fortsetzung)

en

**Nozzles for the most
important single-
spring nozzle-holders
Zexel**
(continued)

fr

**Injecteurs pour
les principaux porte-
injecteurs à 1 ressort
Zexel**
(suite)







it







**Polvrizzatori per
i principali porta-
polverizzatori
a 1 molla, Zexel**
(seguito)

es

**Inyectores para
los portainyectores
de 1 muelle más
importantes, Zexel**
(continuación)



 Typ		 Ref.		 Zexel		 Ref.		 Typ		 Ref.	
48-2222	A6			105048-2222				NP-DLLA140PN358			
48-2222	A7			105048-2222				NP-DLLA140PN367			
48-2222	A8			105048-2222				NP-DLLA140PN364			
48-2222	A9			105048-2222				NP-DLLA145PN365			
48-2222	B1			105048-2222				NP-DLLA145PN263			
48-2222	J			105048-2222				NP-DLLA140PN302			
48-2222	J			105048-2222				NP-DLLA140PN302			
48-2222	L			105048-2222				NP-DLLA140PN303			
48-2222	T			105048-2222				NP-DLLA140PN290			
48-2230	A	9 430 615 588		105048-2230		9 430 610 233		NP-DLLA154PN270		9 432 610 605	
48-2231	A			105048-2231				NP-DLLA154PN270			
48-2231	A			105048-2231				NP-DLLA154PN270			
48-2240	B	9 430 615 589		105048-2240		9 430 610 234		NP-DLLA154PN270		9 432 610 605	
48-2250	E			105048-2250				NP-DLLA152PN342		9 432 612 832	
48-2260				105048-2260				NP-DLLA152PN284		9 432 610 940	
48-2260	A	9 430 616 176		105048-2260		9 430 613 402		NP-DLLA152PN297		9 432 612 505	
48-2260	B	9 430 616 176		105048-2260		9 430 613 403		NP-DLLA152PN298		9 432 612 506	
48-2260	C	9 430 616 176		105048-2260		9 430 613 529		NP-DLLA152PN311		9 432 612 720	
48-2260	E			105048-2260				NP-DLLA152PN284		9 432 610 940	
48-2260	E	9 430 616 176		105048-2260				NP-DLLA152PN284		9 432 610 940	
48-2270		9 430 616 180		105048-2270		9 430 613 217		NP-DLLA141PN294		9 432 612 501	
48-2270	A			105048-2270				NP-DLLA147PN300			
48-2270	A			105048-2270				NP-DLLA147PN300			
48-2270	A			105048-2270				NP-DLLA147PN300		9 432 612 507	
48-2270	A	9 430 616 180		105048-2270		9 430 613 415		NP-DLLA147PN300		9 432 612 507	
48-2270	B			105048-2270				NP-DLLA144PN309		9 432 612 843	
48-2270	F			105048-2270				NP-DLLA136PN326			
48-2270	F			105048-2270				NP-DLLA136PN326			
48-2270	G			105048-2270				NP-DLLA144PN309			
48-2270	G			105048-2270				NP-DLLA144PN309			
48-2270	C or E			105048-2270				NP-DLLA136PN326		9 432 612 855	
48-2270	F			105048-2270				NP-DLLA136PN326			
48-2280	K1	9 430 616 195		105048-2280		9 430 613 525		NP-DLLA150PN304		9 432 612 718	
48-2300				105048-2300				NP-DLLA141PN294			
48-2300				105048-2300				NP-DLLA141PN294		9 432 612 501	
48-2310	B4			105048-2310				NP-DLLA140PN371			
48-2310	C			105048-2310				NP-DLLA140PN374			
48-2310	B2			105048-2310				NP-DLLA140PN370			
48-2310	B3			105048-2310				NP-DLLA140PN371			
48-3000	1	9 430 615 275		105048-3000		9 430 612 416		NP-DLLA160PN024		9 432 610 334	
48-3000	K	9 430 615 275		105048-3000		9 430 612 410		NP-DLLA160PN022		9 432 611 336	
48-3000	T	9 430 615 275		105048-3000		9 430 612 379		NP-DLLA160PN004		9 432 610 168	
48-3010		9 430 615 142		105048-3010		9 430 612 380		NP-DLLA160PN004		9 432 610 168	
48-3010	9	9 430 615 142		105048-3010		9 430 612 389		NP-DLLA160PN008		9 432 612 470	
48-3020		9 430 616 028		105048-3020		9 430 612 381		NP-DLLA154PN005		9 432 610 099	

 Typ	 Ref.	 Zexel	 Ref.	 Typ	 Ref.
48-3021	9 430 615 074	105048-3021	9 430 610 084	NP-DLLA154PN005	9 432 610 099
48-3022	9 430 615 817	105048-3022	9 430 612 382	NP-DLLA154PN005	9 432 610 161
48-3030	9 430 616 029	105048-3030	9 430 612 384	NP-DLLA154PN006	9 432 610 050
48-3031	9 430 615 054	105048-3031	9 430 610 063	NP-DLLA154PN006	9 432 610 050
48-3032	9 430 615 818	105048-3032	9 430 612 385	NP-DLLA154PN006	9 432 610 268
48-3040	9 430 616 030	105048-3040	9 430 612 387	NP-DLLA160PN004	9 432 610 168
48-3050	9 430 615 030	105048-3050	9 430 610 034	NP-DLLA154PN007	9 432 610 027
48-3060	9 430 615 058	105048-3060	9 430 612 390	NP-DLLA152PN009	9 432 610 175
48-3060 A	9 430 615 058	105048-3060	9 430 610 068	NP-DLLA152PN014	9 432 610 153
48-3060 B	9 430 615 058	105048-3060	9 430 612 415	NP-DLLA152PN014	9 432 610 153
48-3070	9 430 615 041	105048-3070	9 430 610 046	NP-DLLA160PN010	9 432 610 078
48-3080	9 430 616 031	105048-3080	9 430 612 391	NP-DSL154PN011	9 432 610 402
48-3090		105048-3090	9 430 612 392	NP-DLLA152PN012	9 432 611 311
48-3090 A		105048-3090	9 430 612 393	NP-DLLA154PN019	9 432 611 334
48-3091 A	9 430 615 819	105048-3091	9 430 612 394	NP-DLLA154PN019	9 432 611 334
48-3100	9 430 615 087	105048-3100	9 430 612 401	NP-DLLA154PN006	9 432 610 050
48-3100 A	9 430 615 087	105048-3100	9 430 612 396	NP-DSL154PN011	9 432 610 402
48-3100 E	9 430 615 087	105048-3100	9 430 612 397	NP-DSL154PN016	9 432 611 317
48-3100 H	9 430 615 087	105048-3100	9 430 612 400	NP-DLLA154PN018	9 432 611 333
48-3100 J	9 430 615 087	105048-3100	9 430 612 405	NP-DLLA154PN005	9 432 610 099
48-3101 J	9 430 616 032	105048-3101	9 430 612 406	NP-DLLA154PN005	9 432 610 099
48-3110	9 430 616 026	105048-3110	9 430 612 403	NP-DLLA157PN020	9 432 611 335
48-3111	9 430 615 820	105048-3111	9 430 612 404	NP-DLLA157PN020	9 432 611 335
48-3120	9 430 615 033	105048-3120	9 430 612 408	NP-DLLA150PN021	9 432 610 359
48-3121	9 430 615 313	105048-3121	9 430 612 409	NP-DLLA150PN021	9 432 610 359
48-3121 A	9 430 615 313	105048-3121	9 430 612 420	NP-DLLA146PN028	9 432 610 736
48-3121 B	9 430 615 313	105048-3121	9 430 612 495	NP-DLLA154PN087	9 432 610 706
48-3121 C	9 430 615 313	105048-3121	9 430 612 539	NP-DLLA154PN087	9 432 610 706
48-3121 E	9 430 615 313	105048-3121	9 430 612 569	NP-DLLA141PN134	9 432 610 996
48-3121 H	9 430 615 313	105048-3121	9 430 612 388	NP-DLLA154PN207	9 432 610 712
48-3121 J	9 430 615 313	105048-3121	9 430 612 644	NP-DLLA141PN136	9 432 610 376
48-3130	9 430 615 414	105048-3130	9 430 612 411	NP-DLLA160PN010	9 432 610 078
48-3131	9 430 615 143	105048-3131	9 430 612 412	NP-DLLA160PN010	9 432 610 078
48-3140	9 430 616 033	105048-3140	9 430 612 413	NP-DLLA132PN023	9 432 611 337
48-3150	9 430 616 034	105048-3150	9 430 612 414	NP-DLLA160PN004	9 432 610 168
48-3160	9 430 615 429	105048-3160	9 430 612 419	NP-DLLA146PN028	9 432 610 736
48-3170	9 430 616 035	105048-3170	9 430 612 421	NP-DLLA160PN010	9 432 610 078
48-3180	9 430 616 163	105048-3180	9 430 612 422	NP-DLLA159PN029	9 432 612 472
48-3190	9 430 616 164	105048-3190	9 430 612 423	NP-DLLA139PN030	9 432 611 339
48-3200	9 430 616 036	105048-3200	9 430 612 427	NP-DLLA152PN009	9 432 610 175
48-3210	9 430 615 144	105048-3210	9 430 612 424	NP-DLLA160PN031	9 432 610 735
48-3210 E	9 430 615 144	105048-3210	9 430 612 441	NP-DLLA160PN36	9 432 610 227
48-3211	9 430 615 089	105048-3211	9 430 612 425	NP-DLLA160PN031	9 432 610 735
48-3211	9 430 615 089	105048-3211	9 430 612 426	NP-DLLA160PN137	9 432 610 904
48-3211 A	9 430 615 089	105048-3211	9 430 610 102	NP-DLLA160PN036	9 432 610 227

A186

de

**Düsen für
1-Feder-Düsenhalter
von Zexel**

(Fortsetzung)

en

**Nozzles for the most
important single-
spring nozzle-holders
Zexel**

(continued)

fr

**Injecteurs pour
les principaux porte-
injecteurs à 1 ressort
Zexel**

(suite)

it

**Polvizzatori per
i principali porta-
polverizzatori
a 1 molla, Zexel**







(seguito)







es

**Inyectores para
los portainyectores
de 1 muelle más
importantes, Zexel**

(continuación)



						
48-3220		9 430 615 110	105048-3220	9 430 612 428	NP-DLLA146PN032	9 432 610 849
48-3220 B		9 430 615 110	105048-3220		NP-DLLA146PN055	9 432 610 253
48-3220 B		9 430 615 110	105048-3220	9 430 612 429	NP-DLLA146PN055	9 432 610 253
48-3220 B		9 430 615 110	105048-3220	9 430 612 430	NP-DLLA146PN055	9 432 610 253
48-3220 B		9 430 615 110	105048-3220	9 430 612 431	NP-DLLA146PN055	9 432 610 253
48-3220 G		9 430 615 110	105048-3220	9 430 610 130	NP-DSLA149PN901	9 432 610 329
48-3220 G			105048-3220	9 430 613 679	NP-DSLA149PN901	9 432 610 329
48-3220 J			105048-3220	9 430 613 664	NP-DLLA153PN178	9 432 610 730
48-3220 K			105048-3220		NP-DLLA153PN177	9 432 610 452
48-3220 K		9 430 615 110	105048-3220	9 430 612 621	NP-DLLA153PN177	9 432 610 452
48-3220 L			105048-3220		NP-DLLA153PN255	9 432 610 936
48-3220 L		9 430 615 110	105048-3220	9 430 612 686	NP-DLLA153PN255	9 432 610 936
48-3230		9 430 615 075	105048-3230	9 430 612 432	NP-DLLA150PN033	9 432 611 332
48-3230 A		9 430 615 075	105048-3230	9 430 612 434	NP-DLLA155PN034	9 432 612 473
48-3230 A		9 430 615 075	105048-3230	9 430 613 668	NP-DLLA155PN034	9 432 612 473
48-3230 B		9 430 615 075	105048-3230	9 430 612 443	NP-DLLA155PN037	9 432 612 474
48-3230 C		9 430 615 075	105048-3230	9 430 612 444	NP-DLLA155PN038	9 432 612 475
48-3230 E		9 430 615 075	105048-3230		NP-DLLA154PN042	9 432 610 282
48-3230 E		9 430 615 075	105048-3230	9 430 612 449	NP-DLLA154PN042	9 432 610 282
48-3230 F		9 430 615 075	105048-3230		NP-DSLA154PN098	9 432 610 202
48-3230 F		9 430 615 075	105048-3230	9 430 610 087	NP-DSLA154PN098	9 432 610 202
48-3230 G		9 430 615 075	105048-3230	9 430 612 557	NP-DLLA154PN125	9 432 610 708
48-3230 G		9 430 615 075	105048-3230	9 430 612 558	NP-DLLA154PN125	9 432 610 708
48-3230 G		9 430 615 075	105048-3230	9 430 613 682	NP-DLLA154PN125	9 432 610 708
48-3230 H		9 430 615 075	105048-3230	9 430 612 601	NP-DLLA153PN152	9 432 611 004
48-3230 H			105048-3230	9 430 613 681	NP-DLLA153PN152	9 432 611 004
48-3230 J		9 430 615 075	105048-3230	9 430 612 402	NP-DLLA154PN155	9 432 610 326
48-3230 J		9 430 615 075	105048-3230	9 430 613 671	NP-DLLA154PN155	9 432 610 326
48-3230 K		9 430 615 075	105048-3230	9 430 612 456	NP-DLLA154PN049	9 432 610 256
48-3230 K		9 430 615 075	105048-3230	9 430 612 457	NP-DLLA154PN049	9 432 610 256
48-3230 K			105048-3230	9 430 613 665	NP-DLLA154PN049	9 432 610 256
48-3230 L		9 430 615 075	105048-3230	9 430 612 487	NP-DLLA157PN072	9 432 611 344
48-3230 L		9 430 615 075	105048-3230	9 430 613 676	NP-DLLA157PN072	9 432 611 344
48-3230 M		9 430 615 075	105048-3230	9 430 612 433	NP-DLLA150PN056	9 432 610 343
48-3230 M		9 430 615 075	105048-3230	9 430 613 669	NP-DLLA150PN056	9 432 610 343
48-3230 N		9 430 615 075	105048-3230	9 430 610 126	NP-DLLA154PN161	9 432 610 300
48-3230 N		9 430 615 075	105048-3230	9 430 613 672	NP-DLLA154PN161	9 432 610 300
48-3230 N1			105048-3230		NP-DLLA154PN161	9 432 610 300
48-3230 N1			105048-3230		NP-DLLA154PN161	9 432 610 300
48-3230 N1		9 430 615 075	105048-3230	9 430 612 692	NP-DLLA154PN161	9 432 610 300
48-3230 P		9 430 615 075	105048-3230	9 430 610 138	NP-DLLA154PN067	9 432 610 201
48-3230 P		9 430 615 075	105048-3230	9 430 613 678	NP-DLLA154PN067	9 432 610 201
48-3230 R		9 430 615 075	105048-3230	9 430 612 537	NP-DLLA154PN116	9 432 610 289
48-3230 R		9 430 615 075	105048-3230	9 430 613 683	NP-DLLA154PN116	9 432 610 289
48-3230 S		9 430 615 075	105048-3230	9 430 610 139	NP-DLLA154PN173	9 432 610 351

 Typ	 Ref.	 Zexel	 Ref.	 Typ	 Ref.
48-3230 S		105048-3230	9 430 613 680	NP-DLLA154PN173	9 432 610 351
48-3230 T		105048-3230		NP-DLLA153PN203	9 432 610 883
48-3230 T	9 430 615 075	105048-3230	9 430 612 639	NP-DLLA153PN203	9 432 610 883
48-3230 T1		105048-3230		NP-DLLA152PN269	9 432 610 765
48-3230 T1	9 430 615 075	105048-3230	9 430 612 693	NP-DLLA152PN269	9 432 610 765
48-3230 T2		105048-3230		NP-DLLA147PN288	9 432 610 882
48-3230 T2	9 430 615 075	105048-3230	9 430 612 749	NP-DLLA147PN288	9 432 610 882
48-3230 T3		105048-3230		NP-DLLA147PN351	
48-3230 U		105048-3230		NP-DLLA158PN209	9 432 610 377
48-3230 U	9 430 615 075	105048-3230	9 430 610 155	NP-DLLA158PN209	9 432 610 377
48-3230 U2		105048-3230		NP-DLLA150PN228	9 432 610 891
48-3230 U2	9 430 615 075	105048-3230	9 430 612 672	NP-DLLA150PN228	9 432 610 891
48-3230 U2		105048-3230	9 430 613 687	NP-DLLA150PN228	9 432 610 891
48-3230 U3		105048-3230		NP-DLLA150PN235	9 432 610 930
48-3230 U3	9 430 615 075	105048-3230	9 430 612 679	NP-DLLA150PN235	9 432 610 930
48-3230 U5		105048-3230		NP-DLLA158PN236	9 432 610 931
48-3230 U5	9 430 615 075	105048-3230	9 430 612 682	NP-DLLA158PN236	9 432 610 931
48-3230 W	9 430 615 075	105048-3230	9 430 612 482	NP-DLLA154PN068	9 432 610 163
48-3230 W	9 430 615 075	105048-3230	9 430 612 483	NP-DLLA154PN068	9 432 610 163
48-3230 W	9 430 615 075	105048-3230	9 430 613 677	NP-DLLA154PN068	9 432 610 163
48-3240		105048-3240	9 430 612 435	NP-DLLA160PN024	9 432 610 334
48-3241	9 430 616 037	105048-3241	9 430 612 436	NP-DLLA160PN024	9 432 610 334
48-3250	9 430 616 038	105048-3250	9 430 612 437	NP-DLLA150PN035	9 432 610 369
48-3250 B	9 430 616 038	105048-3250	9 430 612 438	NP-DLLA150PN035	9 432 610 369
48-3251 B	9 430 615 281	105048-3251	9 430 612 439	NP-DLLA150PN160	9 432 610 990
48-3251 B	9 430 615 281	105048-3251	9 430 613 667	NP-DLLA150PN160	9 432 610 990
48-3251 C		105048-3251		NP-DLLA153PN178	9 432 610 730
48-3251 C	9 430 615 281	105048-3251	9 430 612 628	NP-DLLA153PN178	9 432 610 730
48-3251 E		105048-3251		NP-DSLA149PN903	9 432 610 890
48-3251 E	9 430 615 281	105048-3251	9 430 610 163	NP-DSLA149PN903	9 432 610 890
48-3251 F		105048-3251		NP-DLLA148PN221	9 432 611 008
48-3251 F	9 430 615 281	105048-3251	9 430 612 668	NP-DLLA148PN221	9 432 611 008
48-3251 G		105048-3251		NP-DLLA153PN178	9 432 610 730
48-3260	9 430 616 039	105048-3260	9 430 612 440	NP-DLLA152PN009	9 432 610 175
48-3260 A	9 430 616 039	105048-3260	9 430 612 567	NP-DLLA152PN014	9 432 610 153
48-3270	9 430 616 016	105048-3270	9 430 612 442	NP-DLLA160PN010	9 432 610 078
48-3300 C	9 430 615 112	105048-3300	9 430 612 479	NP-DLLA152PN065	9 432 611 343
48-3300 E	9 430 615 112	105048-3300	9 430 612 450	NP-DLLA152PN043	9 432 611 342
48-3300 F	9 430 615 112	105048-3300	9 430 612 451	NP-DLLA152PN043	9 432 611 342
48-3300 G	9 430 615 112	105048-3300	9 430 612 480	NP-DLLA148PN066	9 432 610 812
48-3300 J	9 430 615 112	105048-3300	9 430 612 488	NP-DLLA152PN081	9 432 612 482
48-3300 K	9 430 615 112	105048-3300	9 430 612 489	NP-DLLA154PN084	9 432 611 345
48-3300 L	9 430 615 112	105048-3300	9 430 612 474	NP-DLLA152PN063	9 432 610 362
48-3300 M	9 430 615 112	105048-3300	9 430 612 496	NP-DLLA150PN088	9 432 610 458
48-3300 N	9 430 615 112	105048-3300	9 430 610 142	NP-DLLA152PN097	9 432 610 250

A188

de

**Düsen für
1-Feder-Düsenhalter
von Zexel**

(Fortsetzung)

en

**Nozzles for the most
important single-
spring nozzle-holders
Zexel**

(continued)

fr

**Injecteurs pour
les principaux porte-
injecteurs à 1 ressort
Zexel**

(suite)

it

**Polvrizzatori per
i principali porta-
polverizzatori
a 1 molla, Zexel**







(seguito)







es

**Inyectores para
los portainyectores
de 1 muelle más
importantes, Zexel**

(continuación)



						
48-3300 R		9 430 615 112	105048-3300	9 430 612 582	NP-DLLA150PN088	9 432 610 458
48-3300 T		9 430 615 112	105048-3300	9 430 612 586	NP-DLLA152PN145	9 432 611 000
48-3300 U		9 430 615 112	105048-3300	9 430 612 658	NP-DLLA152PN213	9 432 611 033
48-3300 V		9 430 615 112	105048-3300	9 430 610 185	NP-DLLA152PN258	9 432 610 463
48-3300 W		9 430 615 112	105048-3300	9 430 610 184	NP-DLLA148PN266	9 432 610 462
48-3300 X		9 430 615 112	105048-3300	9 430 610 186	NP-DLLA152PN267	9 432 610 464
48-3310 A		9 430 615 530	105048-3310	9 430 612 453	NP-DLLA155PN046	9 432 612 477
48-3320		9 430 615 168	105048-3320	9 430 612 454	NP-DLLA150PN047	9 432 610 255
48-3330		9 430 615 258	105048-3330	9 430 612 455	NP-DLLA155PN048	9 432 612 478
48-3330 A		9 430 615 258	105048-3330	9 430 612 459	NP-DLLA155PN053	9 432 610 853
48-3330 AZ		9 430 615 258	105048-3330	9 430 612 735	NP-DLLA155PN276	9 432 610 771
48-3330 C		9 430 615 258	105048-3330	9 430 612 499	NP-DLLA155PN091	9 432 611 346
48-3330 C		9 430 615 258	105048-3330	9 430 612 500	NP-DLLA155PN091	9 432 611 346
48-3330 N		9 430 615 258	105048-3330	9 430 612 541	NP-DLLA155PN118	9 430 612 727
48-3330 P		9 430 615 258	105048-3330	9 430 612 553	NP-DLLA155PN123	9 432 610 309
48-3330 P		9 430 615 258	105048-3330	9 430 612 554	NP-DLLA155PN123	9 432 610 309
48-3330 S		9 430 615 258	105048-3330	9 430 612 623	NP-DLLA155PN182	9 432 610 413
48-3330 T		9 430 615 258	105048-3330	9 430 612 663	NP-DLLA155PN217	9 432 611 012
48-3330 U			105048-3330		NP-DLLA150PN315	9 432 612 763
48-3340		9 430 616 166	105048-3340	9 430 612 460	NP-DLLA155PN057	9 432 610 734
48-3341		9 430 615 169	105048-3341	9 430 612 461	NP-DLLA155PN057	9 432 610 734
48-3341 A		9 430 615 169	105048-3341	9 430 612 463	NP-DLLA160PN059	9 432 610 811
48-3341 B		9 430 615 169	105048-3341	9 430 612 577	NP-DLLA160PN141	9 432 610 374
48-3350		9 430 616 008	105048-3350	9 430 612 466	NP-DLLA154PN061	9 432 610 283
48-3350 M		9 430 616 008	105048-3350	9 430 612 470	NP-DLLA154PN062	9 432 610 273
48-3350 N		9 430 616 008	105048-3350	9 430 612 475	NP-DLLA154PN064	9 432 610 280
48-3350 W		9 430 616 008	105048-3350	9 430 612 588	NP-DLLA154PN062	9 432 610 273
48-3351		9 430 615 790	105048-3351	9 430 612 468	NP-DLLA154PN061	9 432 610 283
48-3351 A		9 430 615 790	105048-3351	9 430 612 471	NP-DLLA154PN062	9 432 610 273
48-3351 B		9 430 615 790	105048-3351	9 430 612 477	NP-DLLA154PN064	9 432 610 280
48-3351 C		9 430 615 790	105048-3351	9 430 612 520	NP-DLLA158PN108	9 432 610 232
48-3351 E		9 430 615 790	105048-3351	9 430 612 528	NP-DLLA154PN061	9 432 610 283
48-3351 W		9 430 615 790	105048-3351	9 430 612 589	NP-DLLA154PN062	9 432 610 273
48-3352		9 430 615 282	105048-3352	9 430 612 469	NP-DLLA154PN060	9 432 610 283
48-3352 A		9 430 615 282	105048-3352	9 430 612 472	NP-DLLA154PN062	9 432 610 273
48-3352 B		9 430 615 282	105048-3352	9 430 612 478	NP-DLLA154PN064	9 432 610 280
48-3352 C		9 430 615 282	105048-3352	9 430 612 521	NP-DLLA158PN108	9 432 610 232
48-3352 E		9 430 615 282	105048-3352	9 430 612 529	NP-DLLA154PN061	9 432 610 283
48-3352 F		9 430 615 282	105048-3352	9 430 612 695	NP-DLLA156PN280	9 432 612 497
48-3352 W		9 430 615 282	105048-3352	9 430 612 590	NP-DLLA154PN062	9 432 610 273
48-3361		9 430 616 009	105048-3361	9 430 612 473	NP-DLLA160PN059	9 432 610 811
48-3380		9 430 615 076	105048-3380	9 430 610 086	NP-DLLA154PN067	9 432 610 201
48-3380		9 430 615 076	105048-3380	9 430 612 481	NP-DLLA154PN067	9 432 610 201
48-3380 H		9 430 615 076	105048-3380	9 430 612 536	NP-DLLA154PN116	9 432 610 289
48-3390		9 430 615 130	105048-3390	9 430 612 484	NP-DLLA157PN069	9 432 610 356

 Typ	 Ref.	 Zexel	 Ref.	 Typ	 Ref.
48-3390 A	9 430 615 130	105048-3390	9 430 612 498	NP-DLLA157PN090	9 432 610 288
48-3390 A9	9 430 615 130	105048-3390	9 430 612 681	NP-DLLA157PN090	9 432 610 288
48-3390 AA	9 430 615 130	105048-3390	9 430 612 671	NP-DLLA154PN227	9 432 611 013
48-3390 B	9 430 615 130	105048-3390	9 430 612 637	NP-DLSA157PN902	9 432 610 378
48-3390 B1		105048-3390		NP-DLLA158PN332	9 432 612 791
48-3390 B2		105048-3390		NP-DLLA149PN362	
48-3390 BB		105048-3390		NP-DLLA153PN318	9 432 612 777
48-3390 X	9 430 615 130	105048-3390	9 430 612 602	NP-DLLA157PN090	9 432 610 288
48-3390 Z	9 430 615 130	105048-3390	9 430 612 605	NP-DLLA157PN090	9 432 610 288
48-3410	9 430 615 064	105048-3410	9 430 610 076	NP-DLLA154PN018	9 432 610 171
48-3410 A	9 430 615 064	105048-3410	9 430 610 085	NP-DLLA154PN006	9 432 610 268
48-3420	9 430 615 821	105048-3420	9 430 612 467	NP-DLLA154PN061	9 432 610 283
48-3420 F	9 430 615 821	105048-3420	9 430 612 519	NP-DLLA158PN108	9 432 610 232
48-3430	9 430 616 011	105048-3430	9 430 612 476	NP-DLLA154PN064	9 432 610 280
48-3440	9 430 616 167	105048-3440	9 430 612 490	NP-DLLA160PN085	9 432 610 341
48-3441	9 430 616 012	105048-3441	9 430 612 491	NP-DLLA160PN085	9 432 610 341
48-3450 A	9 430 615 314	105048-3450	9 430 612 493	NP-DLLA151PN086	9 432 610 353
48-3450 E	9 430 615 314	105048-3450	9 430 612 580	NP-DLLA141PN136	9 432 610 376
48-3450 F	9 430 615 314	105048-3450	9 430 612 600	NP-DLLA149PN151	9 432 610 731
48-3450 H	9 430 615 314	105048-3450	9 430 612 633	NP-DLLA149PN193	9 432 611 023
48-3450 J	9 430 615 314	105048-3450	9 430 612 632	NP-DLLA149PN197	9 432 611 016
48-3460	9 430 615 276	105048-3460	9 430 612 494	NP-DLLA154PN087	9 432 610 706
48-3470	9 430 615 145	105048-3470	9 430 612 497	NP-DLLA155PN089	9 432 610 229
48-3480	9 430 615 421	105048-3480	9 430 612 503	NP-DLLA154PN095	9 432 611 347
48-3490	9 430 615 422	105048-3490	9 430 612 504	NP-DLLA157PN096	9 432 611 326
48-3500	9 430 616 013	105048-3500	9 430 612 507	NP-DLLA160PN100	9 432 610 813
48-3500 E	9 430 616 013	105048-3500	9 430 612 530	NP-DLLA160PN085	9 432 610 341
48-3501	9 430 615 146	105048-3501	9 430 612 508	NP-DLLA160PN100	9 432 610 813
48-3501 A	9 430 615 146	105048-3501	9 430 612 531	NP-DLLA160PN085	9 432 610 341
48-3501 B	9 430 615 146	105048-3501	9 430 612 579	NP-DLLA160PN059	9 432 610 811
48-3501 F	9 430 615 146	105048-3501	9 430 612 604	NP-DLLA160PN156	9 432 612 489
48-3501 G	9 430 615 146	105048-3501	9 430 612 614	NP-DLLA160PN100	9 432 610 813
48-3501 H	9 430 615 146	105048-3501	9 430 612 492	NP-DLLA160PN085	9 432 610 341
48-3501 L	9 430 615 146	105048-3501	9 430 612 641	NP-DLLA160PN206	9 432 611 031
48-3510	9 430 616 014	105048-3510	9 430 612 509	NP-DLLA154PN101	9 432 611 321
48-3520	9 430 616 015	105048-3520	9 430 612 510	NP-DLLA154PN040	9 432 610 707
48-3520 A	9 430 616 015	105048-3520	9 430 612 513	NP-DLLA154PN051	9 432 610 445
48-3520 H	9 430 616 015	105048-3520	9 430 612 518	NP-DLLA154PN105	9 432 611 323
48-3520 K	9 430 616 015	105048-3520	9 430 612 523	NP-DLLA155PN111	9 432 611 324
48-3520 M	9 430 616 015	105048-3520	9 430 612 555	NP-DLLA156PN110	9 432 610 178
48-3530	9 430 616 007	105048-3530	9 430 612 515	NP-DLLA158PN104	9 432 610 711
48-3540	9 430 616 017	105048-3540	9 430 612 517	NP-DLLA157PN069	9 432 610 356
48-3540	9 430 616 017	105048-3540	9 430 612 552	NP-DLLA157PN069	9 432 610 356
48-3550	9 430 615 375	105048-3550	9 430 612 526	NP-DLLA158PN113	9 432 611 325
48-3560	9 430 615 252	105048-3560	9 430 612 525	NP-DLLA152PN112	9 432 610 333

A190

de

**Düsen für
1-Feder-Düsenhalter
von Zexel**

(Fortsetzung)

en

**Nozzles for the most
important single-
spring nozzle-holders
Zexel**

(continued)

fr

**Injecteurs pour
les principaux porte-
injecteurs à 1 ressort
Zexel**

(suite)

it

**Polvizzatori per
i principali porta-
polverizzatori
a 1 molla, Zexel**







(seguito)







es

**Inyectores para
los portainyectores
de 1 muelle más
importantes, Zexel**

(continuación)



						
48-3560	A	9 430 615 252	105048-3560	9 430 612 549	NP-DLLA152PN112	9 432 610 333
48-3560	E	9 430 615 252	105048-3560	9 430 612 603	NP-DLLA152PN153	9 432 611 005
48-3560	K	9 430 615 252	105048-3560	9 430 612 635	NP-DLLA140PN196	9 432 611 027
48-3560	N	9 430 615 252	105048-3560	9 430 612 636	NP-DLLA140PN196	9 432 611 027
48-3560	P	9 430 615 252	105048-3560	9 430 612 643	NP-DLLA140PN196	9 432 611 027
48-3571			105048-3571	9 430 612 522	NP-DLLA161PN109	9 432 610 720
48-3580	P	9 430 616 018	105048-3580	9 430 612 527	NP-DLLA154PN061	9 432 610 283
48-3590		9 430 615 108	105048-3590	9 430 612 532	NP-DLLA157PN115	9 432 610 815
48-3590	A	9 430 615 108	105048-3590	9 430 610 127	NP-DLLA155PN089	9 432 610 229
48-3590	B	9 430 615 108	105048-3590	9 430 612 516	NP-DLLA158PN104	9 432 610 711
48-3590	C	9 430 615 108	105048-3590	9 430 612 575	NP-DLLA160PN140	9 432 610 361
48-3590	F	9 430 615 108	105048-3590	9 430 613 524	NP-DLLA158PN104	9 432 610 711
48-3590	F		105048-3590		NP-DLLA158PN343	9 432 612 830
48-3590	G	9 430 615 108	105048-3590	9 430 613 530	NP-DLLA158PN312	9 432 612 721
48-3590	H		105048-3590		NP-DLLA154PN350	
48-3600		9 430 615 749	105048-3600	9 430 612 533	NP-DLLA161PN109	9 432 610 720
48-3610			105048-3610	9 430 612 534	NP-DLLA158PN113	9 432 611 325
48-3620		9 430 616 019	105048-3620	9 430 612 535	NP-DLLA160PN085	9 432 610 341
48-3630		9 430 615 826	105048-3630	9 430 612 538	NP-DLLA154PN087	9 432 610 706
48-3640		9 430 616 020	105048-3640	9 430 612 542	NP-DLLA139PN119	9 432 610 724
48-3642			105048-3642	9 430 612 543	NP-DLLA139PN119	9 432 610 724
48-3643			105048-3643	9 430 612 544	NP-DLLA139PN119	9 432 610 724
48-3644		9 430 616 022	105048-3644	9 430 612 545	NP-DLLA139PN119	9 432 610 724
48-3650		9 430 616 023	105048-3650	9 430 612 540	NP-DLLA143PN117	9 432 611 327
48-3650	A	9 430 616 023	105048-3650	9 430 612 551	NP-DLLA146PN122	9 432 612 486
48-3660		9 430 615 253	105048-3660	9 430 612 547	NP-DLLA139PN120	9 432 612 485
48-3660	A	9 430 615 253	105048-3660	9 430 612 640	NP-DLLA154PN205	9 432 611 030
48-3670		9 430 616 024	105048-3670	9 430 612 548	NP-DLLA156PN121	9 432 610 424
48-3671	E		105048-3671	9 430 612 591	NP-DLLA160PN146	9 432 611 001
48-3672	A	9 430 615 751	105048-3672	9 430 612 624	NP-DLLA154PN185	9 432 610 851
48-3672	B	9 430 615 751	105048-3672	9 430 612 626	NP-DLLA154PN186	9 432 610 371
48-3672	C	9 430 615 751	105048-3672	9 430 612 629	NP-DLLA154PN189	9 432 611 019
48-3672	U	9 430 615 751	105048-3672	9 430 612 606	NP-DLLA160PN159	9 432 610 710
48-3672	W	9 430 615 751	105048-3672	9 430 612 617	NP-DLLA150PN172	9 432 610 988
48-3672	X	9 430 615 751	105048-3672	9 430 612 616	NP-DLLA160PN170	9 432 610 986
48-3673			105048-3673		NP-DLLA156PN121	
48-3673	A	9 430 615 117	105048-3673	9 430 612 625	NP-DLLA154PN185	9 432 610 851
48-3673	B	9 430 615 117	105048-3673	9 430 610 152	NP-DLLA154PN186	9 432 610 371
48-3673	E		105048-3673		NP-DLLA160PN146	
48-3673	G	9 430 615 117	105048-3673	9 430 612 656	NP-DLLA160PN212	9 432 611 032
48-3673	H	9 430 615 117	105048-3673	9 430 612 664	NP-DLLA146PN218	9 432 611 011
48-3673	J		105048-3673		NP-DLLA160PN171	
48-3673	J	9 430 615 117	105048-3673	9 430 612 667	NP-DLLA146PN220	9 432 611 007
48-3673	L	9 430 615 117	105048-3673	9 430 612 657	NP-DLLA152PN222	9 432 611 009
48-3673	M	9 430 615 117	105048-3673	9 430 612 665	NP-DLLA146PN218	9 432 610 781

 Typ	 Ref.	 Zexel	 Ref.	 Typ	 Ref.
48-3673 T		105048-3673		NP-DLLA160PN168	
48-3673 U	9 430 615 117	105048-3673	9 430 612 607	NP-DLLA160PN159	9 432 610 710
48-3673 W		105048-3673		NP-DLLA158PN172	
48-3673 X		105048-3673		NP-DLLA160PN170	
48-3680	9 430 615 415	105048-3680	9 430 612 546	NP-DLLA160PN070	9 432 610 732
48-3680 A	9 430 615 415	105048-3680	9 430 612 550	NP-DLLA160PN010	9 432 610 078
48-3691 C	9 430 615 243	105048-3691	9 430 612 556	NP-DLLA161PN124	9 432 611 318
48-3691 E	9 430 615 243	105048-3691	9 430 612 564	NP-DLLA162PN128	9 432 611 330
48-3691 H	9 430 615 243	105048-3691	9 430 612 634	NP-DLLA161PN194	9 432 611 024
48-3691 J	9 430 615 243	105048-3691	9 430 612 638	NP-DLLA157PN201	9 432 611 029
48-3700	9 430 616 168	105048-3700	9 430 612 559	NP-DLLA160PN070	9 432 610 732
48-3710	9 430 616 169	105048-3710	9 430 612 560	NP-DLLA160PN010	9 432 610 078
48-3720	9 430 616 027	105048-3720	9 430 612 704	NP-DLLA154PN040	9 432 610 707
48-3721		105048-3721	9 430 612 705	NP-DLLA154PN040	9 432 610 707
48-3721 Z		105048-3721	9 430 612 706	NP-DLLA161PN109	9 432 610 720
48-3730 A	9 430 615 147	105048-3730	9 430 612 563	NP-DLLA146PN122	9 432 610 408
48-3730 F	9 430 615 147	105048-3730	9 430 612 676	NP-DLLA146PN229	9 432 611 014
48-3750	9 430 615 100	105048-3750	9 430 612 565	NP-DLLA157PN130	9 432 610 354
48-3750	9 430 615 100	105048-3750	9 430 612 566	NP-DLLA157PN130	9 432 610 354
48-3750	9 430 615 100	105048-3750	9 430 612 595	NP-DLLA157PN130	9 432 610 354
48-3750 A	9 430 615 100	105048-3750	9 430 610 116	NP-DLLA157PN090	9 432 610 288
48-3750 A	9 430 615 100	105048-3750	9 430 612 608	NP-DLLA157PN165	9 432 610 983
48-3750 B	9 430 615 100	105048-3750	9 430 612 677	NP-DLLA153PN230	9 432 611 015
48-3760 B	9 430 615 244	105048-3760	9 430 612 573	NP-DLLA161PN132	9 432 611 185
48-3760 B	9 430 615 244	105048-3760	9 430 612 574	NP-DLLA161PN132	9 432 611 185
48-3760 L	9 430 615 244	105048-3760	9 430 612 581	NP-DLLA157PN133	9 432 610 995
48-3760 P	9 430 615 244	105048-3760	9 430 612 661	NP-DLLA161PN214	9 432 611 034
48-3770	9 430 615 955	105048-3770	9 430 612 568	NP-DLLA141PN134	9 432 610 996
48-3780	9 430 615 797	105048-3780	9 430 612 570	NP-DLLA141PN136	9 432 610 376
48-3781	9 430 615 186	105048-3781	9 430 612 571	NP-DLLA141PN136	9 432 610 376
48-3790 Z	9 430 615 956	105048-3790	9 430 612 708	NP-DLLA157PN138	9 432 610 997
48-3800	9 430 615 957	105048-3800	9 430 612 578	NP-DLLA139PN120	9 432 612 485
48-3820	9 430 616 170	105048-3820	9 430 612 587	NP-DLLA150PN144	9 432 612 487
48-3830	9 430 615 791	105048-3830	9 430 612 709	NP-DLLA154PN147	9 432 611 002
48-3831	9 430 615 309	105048-3831	9 430 612 710	NP-DLLA154PN147	9 432 611 002
48-3831	9 430 615 309	105048-3831	9 430 612 711	NP-DLLA154PN147	9 432 611 002
48-3831 A	9 430 615 309	105048-3831	9 430 610 180	NP-DLLA152PN184	9 432 610 455
48-3831 A	9 430 615 309	105048-3831	9 430 612 719	NP-DLLA152PN184	9 432 610 455
48-3831 H	9 430 615 309	105048-3831	9 430 610 194	NP-DLLA149PN231	9 432 610 583
48-3832		105048-3832		NP-DLLA154PN319	9 432 612 806
48-3832 A		105048-3832		NP-DLLA152PN320	9 432 612 810
48-3832 A		105048-3832		NP-DLLA146PN322	9 432 612 816
48-3832 C		105048-3832		NP-DLLA142PN324	9 432 612 814
48-3832 F		105048-3832		NP-DLLA143PN325	9 432 612 812
48-3832 G or H		105048-3832		NP-DLLA143PN325	

A192

de
Düsen für
1-Feder-Düsenhalter
von Zexel
 (Fortsetzung)







en
Nozzles for the most
important single-
spring nozzle-holders
Zexel
 (continued)







fr
Injecteurs pour
les principaux porte-
injecteurs à 1 ressort
Zexel
 (suite)

it
Polvrizzatori per
i principali porta-
polverizzatori
a 1 molla, Zexel
 (seguito)

es
Inyectores para
los portainyectores
de 1 muelle más
importantes, Zexel
 (continuación)



						
48-3840	A	9 430 615 131	105048-3840	9 430 612 660	NP-DLLA154PN208	9 432 610 394
48-3840	B	9 430 615 131	105048-3840	9 430 612 662	NP-DLLA157PN090	9 432 610 288
48-3840	F	9 430 615 131	105048-3840	9 430 612 592	NP-DLLA154PN148	9 432 610 332
48-3840	G	9 430 615 131	105048-3840	9 430 612 593	NP-DLLA154PN208	9 432 610 394
48-3840	H	9 430 615 131	105048-3840	9 430 612 594	NP-DLLA154PN208	9 432 610 394
48-3840	K		105048-3840		NP-DSLA149PN941	
48-3860		9 430 615 792	105048-3860	9 430 612 596	NP-DLLA161PN109	9 432 610 720
48-3860	F	9 430 615 792	105048-3860	9 430 612 524	NP-DLLA155PN111	9 432 611 324
48-3861	B		105048-3861	9 430 612 511	NP-DLLA154PN040	9 432 610 707
48-3861	C		105048-3861	9 430 612 514	NP-DLLA154PN051	9 432 610 445
48-3862		9 430 615 310	105048-3862	9 430 612 597	NP-DLLA161PN109	9 432 610 720
48-3862		9 430 615 310	105048-3862	9 430 612 598	NP-DLLA161PN109	9 432 610 720
48-3862	B	9 430 615 310	105048-3862	9 430 612 512	NP-DLLA154PN040	9 432 610 707
48-3862	H	9 430 615 310	105048-3862	9 430 612 630	NP-DLLA157PN190	9 432 611 020
48-3862	H	9 430 615 310	105048-3862	9 430 612 631	NP-DLLA157PN190	9 432 611 020
48-3862	J	9 430 615 310	105048-3862	9 430 613 528	NP-DLLA155PN310	9 432 612 719
48-3870		9 430 615 430	105048-3870	9 430 612 599	NP-DLLA150PN150	9 432 612 488
48-3880			105048-3880	9 430 612 714	NP-DLLA157PN138	9 432 610 997
48-3882		9 430 615 401	105048-3882	9 430 612 715	NP-DLLA157PN138	9 432 610 997
48-3882	B	9 430 616 296	105048-3832		NP-DLLA147PN323	9 432 612 818
48-3883			105048-3883		NP-DLLA157PN329	9 432 612 808
48-3883	Y		105048-3883		NP-DLLA154PN327	9 432 612 802
48-3883	Z		105048-3883		NP-DLLA161PN328	9 432 612 804
48-3890		9 430 615 187	105048-3890	9 430 612 383	NP-DLLA154PN154	9 432 610 400
48-3890		9 430 615 187	105048-3890	9 430 613 674	NP-DLLA154PN154	9 432 610 400
48-3890	A	9 430 615 187	105048-3890	9 430 612 386	NP-DLLA154PN155	9 432 610 326
48-3890	A	9 430 615 187	105048-3890	9 430 613 673	NP-DLLA154PN155	9 432 610 326
48-3900		9 430 615 376	105048-3900	9 430 612 407	NP-DLLA154PN154	9 432 610 400
48-3900			105048-3900	9 430 613 670	NP-DLLA154PN154	9 432 610 400
48-3910		9 430 616 171	105048-3910	9 430 612 609	NP-DSLA146PN900	9 432 610 905
48-3911			105048-3911	9 430 612 610	NP-DSLA146PN900	9 432 610 905
48-3912			105048-3912	9 430 613 391	NP-DSLA146PN900	9 432 610 905
48-3913			105048-3913	9 430 613 301	NP-DSLA146PN900	9 432 610 905
48-3914		9 430 615 568	105048-3914	9 430 612 611	NP-DSLA146PN900	9 432 610 905
48-3915		9 430 615 311	105048-3915	9 430 612 612	NP-DSLA146PN900	9 432 610 905
48-3915		9 430 615 311	105048-3915	9 430 612 613	NP-DSLA146PN900	9 432 610 905
48-3920		9 430 615 958	105048-3920	9 430 612 717	NP-DLLA146PN122	9 432 610 408
48-3930		9 430 616 172	105048-3930	9 430 612 615	NP-DLLA152PN112	9 432 610 333
48-3930	A		105048-3930		NP-DLLA152PN153	9 432 611 005
48-3940	C3		105048-3940	9 430 612 618	NP-DLLA155PN174	9 432 610 989
48-3950		9 430 615 959	105048-3950	9 430 612 622	NP-DLLA155PN181	9 432 610 819
48-3970		9 430 615 245	105048-3970	9 430 612 718	NP-DLLA155PN174	9 432 610 989
48-3970	E1	9 430 615 245	105048-3970	9 430 612 723	NP-DLLA155PN198	9 432 610 579
48-3980	C5	9 430 615 960	105048-3980	9 430 612 627	NP-DLLA155PN188	9 432 611 018
48-4000	M1	9 430 615 961	105048-4000	9 430 612 619	NP-DLLA162PN176	9 432 610 991

 Typ	 Ref.	 Zexel	 Ref.	 Typ	 Ref.
48-4001 M1	9 430 615 962	105048-4001	9 430 612 620	NP-DLLA162PN176	9 432 610 991
48-4020 M3	9 430 615 246	105048-4020	9 430 612 721	NP-DLLA162PN176	9 432 610 991
48-4020 M4	9 430 615 246	105048-4020	9 430 612 722	NP-DLLA162PN176	9 432 610 991
48-4020 M5	9 430 615 246	105048-4020	9 430 612 725	NP-DLLA162PN216	9 432 610 580
48-4030	9 430 616 173	105048-4030	9 430 612 642	NP-DLLA154P204W	9 432 612 701
48-4040 A	9 430 615 315	105048-4040	9 430 612 645	NP-DLLA151PN086	9 432 610 353
48-4040 B	9 430 615 315	105048-4040	9 430 612 647	NP-DLLA141PN136	9 432 610 376
48-4040 E	9 430 615 315	105048-4040	9 430 612 651	NP-DLLA149PN193	9 432 611 023
48-4040 F	9 430 615 315	105048-4040	9 430 612 653	NP-DLLA149PN197	9 432 611 016
48-4041 A	9 430 615 434	105048-4041	9 430 612 646	NP-DLLA151PN086	9 432 610 353
48-4041 B	9 430 615 434	105048-4041	9 430 612 648	NP-DLLA141PN136	9 432 610 376
48-4041 C	9 430 615 434	105048-4041	9 430 612 650	NP-DLLA149PN151	9 432 610 731
48-4041 E	9 430 615 434	105048-4041	9 430 612 652	NP-DLLA149PN193	9 432 611 023
48-4041 F	9 430 615 434	105048-4041	9 430 612 654	NP-DLLA149PN197	9 432 611 016
48-4050	9 430 615 954	105048-4050	9 430 612 655	NP-DLLA157PN090	9 432 610 288
48-4050 B	9 430 615 954	105048-4050	9 430 612 678	NP-DLLA154PN227	9 432 611 013
48-4060	9 430 615 247	105048-4060	9 430 612 659	NP-DLLA157PN215	9 432 611 035
48-4060 A	9 430 615 247	105048-4060	9 430 612 666	NP-DLLA157PN219	9 432 611 026
48-4060 C	9 430 615 247	105048-4060	9 430 612 684	NP-DLLA145PN243	9 432 610 932
48-4070 E5	9 430 615 248	105048-4070	9 430 612 726	NP-DLLA155PN198	9 432 610 579
48-4071 E5	9 430 615 590	105048-4071	9 430 610 187	NP-DLLA155PN198	9 432 610 579
48-4080 M6	9 430 615 391	105048-4080	9 430 610 188	NP-DLLA162PN216	9 432 610 580
48-4090	9 430 615 965	105048-4090	9 430 612 669	NP-DLLA158PN104	9 432 610 711
48-4100	9 430 615 592	105048-4100	9 430 613 407	NP-DLLA150PN282	9 432 610 612
48-4100 1	9 430 615 592	105048-4100	9 430 610 225	NP-DLLA148PN223	9 432 610 581
48-4100 A	9 430 615 592	105048-4100	9 430 613 405	NP-DLLA148PN223	9 432 610 581
48-4100 B	9 430 615 592	105048-4100	9 430 610 190	NP-DLLA148PN223	9 432 610 581
48-4100 B	9 430 615 592	105048-4100	9 430 610 205	NP-DLLA148PN223	9 432 610 581
48-4100 J	9 430 615 592	105048-4100	9 430 610 213	NP-DLLA152PN247	9 432 610 594
48-4100 M		105048-4100		NP-DLLA148PN295	9 432 612 502
48-4100 N	9 430 615 592	105048-4100	9 430 610 246	NP-DLLA150PN282	9 432 610 612
48-4100 P		105048-4100		NP-DLLA148PN307	9 432 612 846
48-4100 P		105048-4100		NP-DLLA148PN307	9 432 612 846
48-4100 R	9 430 615 592	105048-4100	9 430 610 214	NP-DLLA152PN248	9 432 610 595
48-4100 S	9 430 615 592	105048-4100	9 430 610 191	NP-DLLA148PN223	9 432 610 581
48-4100 G or H	9 430 615 592	105048-4100	9 430 610 235	NP-DLLA156PN248	9 432 610 595
48-4111 GO	9 430 615 392	105048-4111	9 430 612 670	NP-DSLA150PN906	9 432 610 914
48-4120 E		105048-4120		NP-DLLA156PN262	
48-4120 E		105048-4120		NP-DLLA156PN262	
48-4120 E	9 430 615 593	105048-4120	9 430 610 224	NP-DLLA156PN262	9 432 610 601
48-4120 F	9 430 615 593	105048-4120	9 430 610 192	NP-DLLA148PN226	9 432 610 582
48-4120 G	9 430 615 593	105048-4120	9 430 612 757	NP-DLLA148PN285	9 432 610 907
48-4120 S		105048-4120		NP-DLLA148PN226	
48-4120 W		105048-4120		NP-DLLA148PN360	
48-4120 V or Z		105048-4120		NP-DLLA148PN3330	

A194

de

**Düsen für
1-Feder-Düsenhalter
von Zexel**

(Fortsetzung)

en

**Nozzles for the most
important single-
spring nozzle-holders
Zexel**

(continued)

fr

**Injecteurs pour
les principaux porte-
injecteurs à 1 ressort
Zexel**

(suite)

it

**Polvrizzatori per
i principali porta-
polverizzatori
a 1 molla, Zexel**







(seguito)







es

**Inyectores para
los portainyectores
de 1 muelle más
importantes, Zexel**

(continuación)



 Typ	 Ref.	 Zexel	 Ref.	 Typ	 Ref.
48-4120 V or Z		105048-4120		NP-DLLA148PN330	9 432 612 860
48-4120 W or X		105048-4120			
48-4120 G or H		105048-4120		NP-DLLA148PN306	9 432 612 773
48-4120 S or L	9 430 615 593	105048-4120	9 430 610 236	NP-DLLA148PN226	9 432 610 582
48-4120 T or U		105048-4120		NP-DLLA148PN306	9 432 612 773
48-4130 B	9 430 615 393	105048-4130	9 430 612 673	NP-DSLA145PN905	9 432 610 913
48-4130 C	9 430 615 393	105048-4130	9 430 612 675	NP-DSLA145PN912	9 432 610 916
48-4130 C	9 430 615 393	105048-4130	9 430 612 689	NP-DSLA145PN912	9 432 610 916
48-4130 C	9 430 615 393	105048-4130	9 430 613 146	NP-DSLA145PN912	9 432 610 916
48-4130 C	9 430 615 393	105048-4130	9 430 612 674	NP-DSLA147PN907	9 432 610 927
48-4130 C	9 430 615 393	105048-4130	9 430 612 688	NP-DSLA147PN907	9 432 610 927
48-4140	9 430 615 594	105048-4140	9 430 610 195	NP-DLLA152PN232	9 432 610 584
48-4140 A	9 430 615 594	105048-4140	9 430 610 196	NP-DLLA152PN233	9 432 610 585
48-4160	9 430 615 966	105048-4160	9 430 612 680	NP-DLLA146PN122	9 432 610 408
48-4170 A	9 430 615 595	105048-4170	9 430 610 199	NP-DLLA158PN237	9 432 610 587
48-4170 A	9 430 615 595	105048-4170	9 430 610 200	NP-DLLA158PN237	9 432 610 587
48-4170 A	9 430 615 595	105048-4170	9 430 613 531	NP-DLLA158PN237	9 432 610 587
48-4180 G2	9 430 615 447	105048-4180	9 430 610 201	NP-DSLA155PN908	9 432 610 613
48-4180 H1	9 430 615 447	105048-4180	9 430 610 220	NP-DSLA155PN910	9 432 610 615
48-4190 G3	9 430 615 394	105048-4190	9 430 610 202	NP-DLLA155PN239	9 432 610 588
48-4190 G4	9 430 615 394	105048-4190	9 430 610 203	NP-DLLA155PN240	9 432 610 589
48-4190 H2	9 430 615 394	105048-4190	9 430 610 221	NP-DLLA155PN256	9 432 610 463
48-4190 H3	9 430 615 394	105048-4190	9 430 610 222	NP-DSLA150PN911	9 432 610 616
48-4190 HO	9 430 615 394	105048-4190	9 430 610 219	NP-DSLA150PN909	9 432 610 614
48-4200 M7	9 430 615 569	105048-4200	9 430 610 204	NP-DLLA155PN241	9 432 610 590
48-4200 M8	9 430 615 569	105048-4200	9 430 610 223	NP-DLLA155PN257	9 432 610 600
48-4210	9 430 615 596	105048-4210	9 430 610 198	NP-DLLA150PN242	9 432 610 591
48-4260 B	9 430 615 967	105048-4260	9 430 613 207	NP-DLLA158PN287	9 432 610 942
48-4260 C	9 430 615 967	105048-4260	9 430 613 537		9 432 612 723
48-4260 E		105048-4260			9 432 612 821
48-4270	9 430 615 570	105048-4270	9 430 612 683	NP-DLLA150PN244	9 432 610 933
48-4280	9 430 615 554	105048-4280	9 430 610 206	NP-DLLA149PN231	9 432 610 583
48-4280 E	9 430 615 554	105048-4280	9 430 610 216	NP-DLLA143PN250	9 432 610 597
48-4280 F	9 430 615 554	105048-4280	9 430 610 217	NP-DLLA143PN265	9 432 610 603
48-4290	9 430 615 597	105048-4290	9 430 610 209	NP-DLLA152PN232	9 432 610 584
48-4290 A	9 430 615 597	105048-4290	9 430 610 211	NP-DLLA152PN233	9 432 610 585
48-4300	9 430 615 598	105048-4300	9 430 610 210	NP-DLLA152PN232	9 432 610 584
48-4300 B	9 430 615 598	105048-4300	9 430 610 218	NP-DLLA147PN252	9 432 610 598
48-4300 C		105048-4300		NP-DLLA152PN264	9 432 610 602
48-4300 C	9 430 615 598	105048-4300	9 430 610 212	NP-DLLA152PN264	9 432 610 602
48-4300 E	9 430 615 598	105048-4300	9 430 610 239	NP-DLLA152PN274	9 432 610 607
48-4300 F	9 430 615 598	105048-4300	9 430 610 240	NP-DLLA152PN275	9 432 610 608
48-4300 G	9 430 615 598	105048-4300	9 430 613 203	NP-DLLA149PN277	9 432 610 938
48-4300 H	9 430 615 598	105048-4300	9 430 613 208	NP-DLLA152PN232	9 432 610 584
48-4300 J	9 430 615 598	105048-4300	9 430 613 209	NP-DLLA152PN264	9 432 610 602

 Typ	 Ref.	 Zexel	 Ref.	 Typ	 Ref.
48-4300 K	9 430 615 598	105048-4300	9 430 613 210	NP-DLLA147PN252	9 432 610 598
48-4300 L	9 430 615 598	105048-4300	9 430 613 204	NP-DLLA149PN277	9 432 610 938
48-4310 51	9 430 615 599	105048-4310	9 430 610 227	NP-DLLA157PN268	9 432 610 604
48-4310 91	9 430 615 599	105048-4310	9 430 610 241	NP-DLLA157PN278	9 432 610 609
48-4320 12	9 430 615 600	105048-4320	9 430 610 242	NP-DLLA151PN279	9 432 610 610
48-4320 37	9 430 615 600	105048-4320	9 430 610 237	NP-DSLA151PN917	9 432 610 619
48-4320 96	9 430 615 600	105048-4320	9 430 610 228	NP-DSLA154PN913	9 432 610 617
48-4321 96		105048-4321		NP-DSLA154PN913	
48-4330 H4	9 430 615 761	105048-4330	9 430 612 694	NP-DSLA140PN915	9 432 610 909
48-4330 H4	9 430 615 761	105048-4330	9 430 613 134	NP-DSLA150PN927	9 432 610 923
48-4350 H5	9 430 615 601	105048-4350	9 430 610 229	NP-DSLA155PN910	9 432 610 615
48-4350 K3		105048-4350		NP-DSLA153PN934	9 432 612 828
48-4350 KO	9 430 615 601	105048-4350	9 430 613 145	NP-DSLA153PN920	9 432 610 918
48-4360 H6	9 430 615 571	105048-4360	9 430 610 230	NP-DLLA155PN256	9 432 610 599
48-4360 H7	9 430 615 571	105048-4360	9 430 610 231	NP-DSLA155PN916	9 432 610 618
48-4360 H8		105048-4360		NP-DLLA150PN352	
48-4360 H8	9 430 615 571	105048-4360	9 430 610 245	NP-DLLA150PN281	9 432 610 611
48-4360 H9	9 430 615 571	105048-4360	9 430 610 243	NP-DSLA152PN918	9 432 610 620
48-4360 K2		105048-4360		NP-DSLA152PN929	
48-4370 M9	9 430 615 572	105048-4370	9 430 610 232	NP-DLLA155PN271	9 432 610 606
48-4390 G	9 430 615 602	105048-4390	9 430 613 205	NP-DLLA152PN248	9 432 610 595
48-4390 G or H	9 430 615 602	105048-4390	9 430 610 238	NP-DLLA156PN248	9 432 610 595
48-4391 E		105048-4391		NP-DLLA150PN282	
48-4391 E		105048-4391			
48-4391 E		105048-4391		NP-DLLA150PN282	9 432 610 612
48-4391 X		105048-4391			
48-4391 X Y	9 430 616 177	105048-4391	9 430 613 206	NP-DLLA150PN282	9 432 610 612
48-4391 G or H	9 430 616 177	105048-4391	9 430 613 083	NP-DLLA156PN248	9 432 610 595
48-4400 AO	9 430 615 603	105048-4400	9 430 610 244	NP-DSLA147PN919	9 432 610 621
48-4410 61	9 430 615 968	105048-4410	9 430 613 088	NP-DLLA148PN283	9 432 610 939
48-4410 61	9 430 615 968	105048-4410	9 430 613 406	NP-DLLA148PN283	9 432 610 939
48-4410 62	9 430 615 968	105048-4410	9 430 613 215	NP-DSLA148PN928	9 432 610 924
48-4410 71	9 430 615 968	105048-4410	9 430 613 413	NP-DLLA146PN296	9 432 612 503
48-4410 99	9 430 615 968	105048-4410	9 430 613 214	NP-DLLA150PN292	9 432 610 944
48-4411 61		105048-4411		NP-DLLA148PN283	
48-4420 A2	9 430 615 760	105048-4420	9 430 613 137	NP-DSLA147PN921	9 432 610 919
48-4430	9 430 616 118	105048-4430	9 430 613 139	NP-DLLA149PN293	9 432 612 500
48-4430	9 430 616 118	105048-4430	9 430 613 447	NP-DLLA1490N293	9 432 612 500
48-4440 72	9 430 616 179	105048-4440	9 430 613 409	NP-DLLA146PN296	9 432 612 504
48-4441 73		105048-4441	9 430 613 533	NP-DLLA146PN296	9 432 612 504
48-4450		105048-4450	9 430 613 526	NP-DLLA148PN266	9 432 610 462
48-4450 A		105048-4450	9 430 613 527	NP-DLLA152PN267	9 432 610 464
48-4450 B	9 430 616 269	105048-4450		NP-DLLA152PN258	9 432 610 463
48-4450 C		105048-4450		NP-DLLA148PN345	9 432 612 859
48-4450 E		105048-4450		NP-DLLA145PN346	9 432 612 850

A196

de

**Düsen für
1-Feder-Düsenhalter
von Zexel**
(Fortsetzung)

en

**Nozzles for the most
important single-
spring nozzle-holders
Zexel**
(continued)

fr

**Injecteurs pour
les principaux porte-
injecteurs à 1 ressort
Zexel**
(suite)

it







**Polvrizzatori per
i principali porta-
polverizzatori
a 1 molla, Zexel**
(seguito)

es

**Inyectores para
los portainyectores
de 1 muelle más
importantes, Zexel**
(continuación)



48-4450	F			105048-4450				NP-DLLA148PN363			
48-4450	G			105048-4450				NP-DSLA148PN942			
48-4450	H			105048-4450				NP-DSLA148PN943			
48-4450	J			105048-4450				NP-DSLA148PN944			
48-4460	A			105048-4460	9 430 613 536						9 432 612 722
48-4470	C			105048-4470				NP-DSLA147PN933			9 432 612 861
48-4480	A			105048-4480				NP-DLLA150PN315			9 432 612 763
48-4480	A			105048-4480				NP-DLLA150PN315			9 432 612 763
48-4480	B			105048-4480				NP-DLLA145PN331			9 432 612 792
48-4480	C			105048-4480				NP-DLLA150PN373			
48-4500				105048-4500				NP-DLLA161PN109			9 432 610 720
48-4500	H			105048-4500				NP-DLLA157PN190			9 432 611 020
48-4510	M			105048-4510				NP-DLLA146PN218			9 432 610 781
48-4520	A			105048-4520				NP-DLLA150PN344			9 432 612 833
48-4520	A			105048-4520				NP-DLLA150PN344			9 432 612 833
48-4520	B			105048-4520				NP-DLLA150PN344			
48-4530	C			105048-4530				NP-DSLA147PN937			
48-4530	E			105048-4530				NP-DSLA150PN939			
48-4540				105048-4540				NP-DSLA147PN937			
48-4540	A			105048-4540				NP-DSLA150PN939			
48-5000		9 430 615 822		105048-5000	9 430 612 398			NP-DLLA154PN017			
48-5000	A	9 430 615 822		105048-5000	9 430 612 399			NP-DLLA154PN0171			9 432 610 306
48-5010		9 430 615 969		105048-5010	9 430 612 417			NP-DLLA154PN025			9 432 610 279
48-5011		9 430 615 312		105048-5011	9 430 612 418			NP-DLLA154PN166			9 432 610 984
48-5011	B	9 430 615 312		105048-5011	9 430 612 462			NP-DLLA154PN058			9 432 610 181
48-5020	A	9 430 615 067		105048-5020	9 430 612 486			NP-DLLA154PN073			9 432 612 480
48-5020	B	9 430 615 067		105048-5020	9 430 610 079			NP-DLLA154PN058			9 432 610 181
48-5030		9 430 615 449		105048-5030	9 430 612 501			NP-DLLA154PN094			9 432 610 307
48-5030	A	9 430 615 449		105048-5030	9 430 612 505			NP-DLLA156PN099			9 432 611 320
48-5031		9 430 615 970		105048-5031				NP-DLLA154PN162			9 432 610 383
48-5031		9 430 615 970		105048-5031	9 430 612 502			NP-DLLA154PN162			9 432 610 383
48-5031	A	9 430 615 970		105048-5031				NP-DLLA156PN163			9 432 610 998
48-5031	A	9 430 615 970		105048-5031	9 430 612 506			NP-DLLA156PN163			9 432 610 998
48-5031	C	9 430 615 970		105048-5031				NP-DLLA153PN164			9 432 610 366
48-5031	C	9 430 615 970		105048-5031	9 430 612 572			NP-DLLA153PN164			9 432 610 366
5031-428				105031-4280				NP-DLLA150S334NP87			
53-5010		9 430 615 506		105053-5010	9 430 610 257			NP-DLF150TB348N17			9 432 610 240
53-5010	A	9 430 615 506		105053-5010	9 430 610 259			NP-DLF160TB328N17			9 432 610 483
53-6030	A	9 430 615 507		105053-6030	9 430 610 253			NP-DLF130TB328N17			9 432 610 287
53-6030	B	9 430 615 507		105053-6030	9 430 610 258			NP-DLF150TB348N17			9 432 610 240
53-6030	D	9 430 615 507		105053-6030	9 430 610 262			NP-DLF150TB368N27			9 432 610 246
53-6030	E	9 430 615 507		105053-6030	9 430 610 263			NP-DLF150TB368N31			9 432 610 247
53-6030	F	9 430 615 507		105053-6030	9 430 610 265			NP-DLF140TE328N1			9 432 610 493
53-6030	G	9 430 615 507		105053-6030	9 430 610 266			NP-DLF140TE348N1 %			9 432 610 494
53-6030	H	9 430 615 507		105053-6030	9 430 610 267			NP-DLF140TE368N1 %			9 432 610 495

 Typ	 Ref.	 Zexel	 Ref.	 Typ	 Ref.
53-6110	9 430 615 604	105053-6110	9 430 610 248	NP-DLF145T328NP8	9 432 610 481
53-6180	9 430 615 605	105053-6180	9 430 610 249	NP-DLF145TB348NP9	9 432 610 480
53-6190	9 430 615 606	105053-6190	9 430 610 250	NP-DLF145T348NP9	9 432 610 480
53-6230	9 430 615 607	105053-6230	9 430 610 254	NP-DLF145TB348NP9	9 432 610 480
53-6240	9 430 615 608	105053-6240	9 430 610 256	NP-DLF145TB308N20	9 443 610 366
53-6280	9 430 615 508	105053-6280	9 430 610 261	NP-DLF150TB268N28	9 432 610 484
53-6280 A	9 430 615 508	105053-6280	9 430 610 264	NP-DLF150TB248N28	9 432 610 487
53-6300	9 430 615 609	105053-6300	9 430 610 632	NP-DLF140TB324,284N34	9 432 610 485
53-6300 B	9 430 615 609	105053-6300	9 430 610 637	NP-DLF140TB304,264N34	9 432 610 489
53-6300 C	9 430 615 609	105053-6300	9 430 610 638	NP-DLF145TB324,284N34	9 432 610 492
53-6300 D	9 430 615 609	105053-6300	9 430 610 639	NP-DLF145TB304,264N34	9 432 610 491
53-7090	9 430 615 610	105053-7090	9 430 610 251	NP-DLF144T388NP10	9 432 610 331
53-7100	9 430 615 611	105053-7100	9 430 610 252	NP-DLF144T388NP10	9 432 610 331
53-7140	9 430 615 612	105053-7140	9 430 610 247	NP-DL145T428ANP1	9 432 610 496
53-7150	9 430 615 613	105053-7150	9 430 610 260	NP-DLF145T408NP13	9 432 610 325
53-8100	9 430 615 614	105053-8100	9 430 610 255	NP-DLF145T428NP12	9 432 610 482
54-2000	9 430 615 509	105054-2000	9 430 610 268	NP-DLF150UB428N12	9 432 610 501
54-2000 A	9 430 615 509	105054-2000	9 430 610 270	NP-DLF150UB408N13	9 432 610 502
54-4160	9 430 615 510	105054-4160	9 430 610 269	NP-DLF150UB479N9	9 432 610 209
54-4160 A	9 430 615 510	105054-4160	9 430 610 271	NP-DLF150UB509N9	9 432 610 503
54-4230 A	9 430 615 615	105054-4230	9 430 610 272	NP-DLF120UE4210N3 C	9 432 610 504
55-5000	9 430 615 616	105055-5000	9 430 610 273	NP-DLF156VV5110NP1	9 432 610 505
60-1010	9 430 615 617	105060-1010	9 430 610 274	NP-DN4SD20	9 432 610 468
60-1090	9 430 615 170	105060-1090	9 430 610 275	NP-DN0SD130NP3	9 432 610 151
60-1090 A	9 430 615 170	105060-1090	9 430 610 276	NP-DN4SD128	9 432 610 423
60-1100	9 430 615 618	105060-1100	9 430 610 277	NP-DN4SD128	9 432 610 423
61-2090		105061-2090		NP-DN0SD131	9 432 611 986
61-2130	9 430 615 619	105061-2130	9 430 610 278	NP-DN0SD131	9 432 610 467
61-2130 A	9 430 615 619	105061-2130	9 430 610 279	NP-DN0S226	9 432 610 466
61-4010	9 430 615 620	105061-4010	9 430 610 280	NP-DLL165S306NP1	9 432 610 506
71-0360	9 430 615 621	105071-0360	9 430 610 302	NP-DN0SD212	9 432 610 438
71-0400	9 430 616 271	105071-0400		NP-DN0SD21	9 432 610 001
71-0470	9 430 615 622	105071-0470	9 430 610 303	NP-DN4SD24P1	9 432 610 148
71-0480	9 430 615 035	105071-0480	9 430 610 041	NP-DN8SD24N6	9 432 610 069
71-0480 A	9 430 615 035	105071-0480	9 430 610 324	NP-DN0SD2110	9 432 610 007
71-0500		105071-0500		NP-DN0SD21	9 432 610 001
71-0500		105071-0500		NP-DN4SN8	9 432 610 444
71-0501		105071-0501		NP-DN12SD12	9 432 610 038
71-0502	9 430 615 099	105071-0502	9 430 610 306	NP-DN12SD12-	9 432 610 038
71-0530	9 430 615 623	105071-0530		NP-DN15SDNK1	9 432 610 104
71-0530 A	9 430 615 623	105071-0530	9 430 610 311	NP-DN9SD211	9 432 610 002
71-0530 D	9 430 615 623	105071-0530		NP-DN9SD211	9 432 610 002
71-0540		105071-0540		NP-DN0SD21	9 432 610 001
71-0540		105071-0540		NP-DN12SD12	9 432 610 038
71-0540		105071-0540		NP-DN4SN8	9 432 610 444

A198

de

**Düsen für
1-Feder-Düsenhalter
von Zexel**

(Fortsetzung)

en

**Nozzles for the most
important single-
spring nozzle-holders
Zexel**

(continued)

fr

**Injecteurs pour
les principaux porte-
injecteurs à 1 ressort
Zexel**

(suite)

it

**Polvizzatori per
i principali porta-
polverizzatori
a 1 molla, Zexel**







(seguito)







es

**Inyectores para
los portainyectores
de 1 muelle más
importantes, Zexel**

(continuación)



 Typ	 Ref.	 Zexel	 Ref.	 Typ	 Ref.
71-0541	9 430 615 098	105071-0541		NP-DN12SD12	9 432 610 038
71-0541 B	9 430 615 098	105071-0541	9 430 610 300	NP-DN4SN8	9 432 610 444
71-0542	9 430 615 171	105071-0542	9 430 610 310	NP-DN12SD12-	9 432 610 038
71-0560		105071-0560		NP-DN12SD12	9 432 610 038
71-0570	9 430 615 172	105071-0570		NP-DN12SD12	9 432 610 038
71-0570 A	9 430 615 172	105071-0570	9 430 610 319	NP-DN0SD21	9 432 610 001
71-0570 B	9 430 615 172	105071-0570	9 430 610 301	NP-DN4S1	9 432 610 036
71-0570 C	9 430 615 172	105071-0570	9 430 610 307	NP-DN0SD21	9 432 610 001
71-0570 E	9 430 615 172	105071-0570	9 430 610 314	NP-DN0SD2110	9 432 610 007
71-0570 F	9 430 615 172	105071-0570	9 430 610 317	NP-DN4SD24	9 432 610 012
71-0570 G	9 430 615 172	105071-0570	9 430 610 334	NP-DN0SD2110	9 432 610 007
71-0570 H	9 430 615 172	105071-0570	9 430 610 343	NP-DN0SD211	9 432 610 002
71-0580	9 430 615 624	105071-0580	9 430 610 321	NP-DN0SD126	9 432 610 008
71-0590	9 430 615 003	105071-0590	9 430 610 017	NP-DN0SD126	9 432 610 008
71-0590 B	9 430 615 003	105071-0590	9 430 610 019	NP-DN0SD126A	9 432 610 010
71-0600	9 430 615 625	105071-0600	9 430 610 332	NP-DN0SD211	9 432 610 002
71-0610	9 430 615 626	105071-0610	9 430 610 333	NP-DN0SD21	9 432 610 001
71-0620	9 430 615 173	105071-0620	9 430 610 335	NP-DN4SD24	9 432 610 012
71-0630		105071-0630		NP-DN0SD21	9 432 610 001
71-0630 A		105071-0630		NP-DN12SD12	9 432 610 038
71-0631		105071-0631		NP-DN12SD12	9 432 610 038
71-0632	9 430 615 627	105071-0632	9 430 610 336	NP-DN12SD12-	9 432 610 038
71-0640	9 430 615 533	105071-0640	9 430 610 337	NP-DN0SD21	9 432 610 001
71-0650	9 430 615 628	105071-0650	9 430 610 338	NP-DN0SD21	9 432 610 001
71-0660	9 430 615 629	105071-0660	9 430 610 339	NP-DN0SD21	9 432 610 001
71-0670	9 430 615 630	105071-0670	9 430 610 340	NP-DN0SD193	9 432 610 003
71-0680		105071-0680		NP-0SD193NP1	9 432 610 004
71-0680 A		105071-0680		NP-DN0SD187	9 432 610 011
71-0681	9 430 615 031	105071-0681	9 430 610 352	NP-DS0SD193NP1	9 432 610 004
71-0681 A	9 430 615 031	105071-0681	9 430 610 036	NP-DS0SD193NP1	9 432 610 004
71-0681 A	9 430 615 029	105071-0721	9 430 610 033	NP-DN0SDN187	9 432 610 023
71-0681 B	9 430 615 029	105071-0721	9 430 610 037	NP-DN0SDN187	9 432 610 023
71-0681 C	9 430 615 031	105071-0681	9 430 610 182	NP-DN0SDN220	9 432 610 205
71-0681 C	9 430 615 031	105071-0681	9 430 610 285	NP-DN0SDN220	9 432 610 205
71-0681 C	9 430 615 031	105071-0681	9 430 610 298	NP-DN0SDN220	9 432 610 205
71-0681 C	9 430 615 031	105071-0681	9 430 610 392	NP-DN0SDN220	9 432 610 205
71-0681 C	9 430 615 031	105071-0681	9 430 610 393	NP-DN0SDN220	9 432 610 205
71-0681 E	9 430 615 031	105071-0681	9 430 610 289	NP-DN0SDN221	9 432 610 363
71-0681 E	9 430 615 031	105071-0681	9 430 610 290	NP-DN0SDN221	9 432 610 363
71-0681 E	9 430 615 031	105071-0681	9 430 610 295	NP-DN0SDN221	9 432 610 363
71-0681 H	9 430 615 031	105071-0681	9 430 610 297	NP-DN0SDN229	9 432 610 391
71-0681 J	9 430 615 031	105071-0681	9 430 610 291	NP-DN0SDN220	9 432 610 205
71-0691		105071-0691		NP-DN0SD21	9 432 610 001
71-0692	9 430 615 113	105071-0692	9 430 610 114	NP-DN0SD21	9 432 610 001
71-0701		105071-0701		NP-DN0SD21	9 432 610 001

 Typ	 Ref.	 Zexel	 Ref.	 Typ	 Ref.
71-0702	9 430 615 114	105071-0702	9 430 610 115	NP-DN0SD21	9 432 610 001
71-0710	9 430 615 037	105071-0710	9 430 610 055	NP-DN0SD193	9 432 610 003
71-0721 A	9 430 615 029	105071-0721	9 430 610 059	NP-DN0SDN187	9 432 610 023
71-0721 A	9 430 615 029	105071-0721	9 430 610 096	NP-DN0SDN187	9 432 610 023
71-0721 B	9 430 615 029	105071-0721	9 430 610 370	NP-DN0SDN187	9 432 610 023
71-0730	9 430 615 534	105071-0730	9 430 610 359	NP-DN0SD21	9 432 610 001
71-0740	9 430 615 631	105071-0740	9 430 610 360	NP-DN4SD24	9 432 610 012
71-0740 A	9 430 615 631	105071-0740	9 430 610 362	NP-DN0SD211	9 432 610 002
71-0750	9 430 615 549	105071-0750	9 430 610 366	NP-DN12SDN188	9 432 610 470
71-1080	9 430 615 004	105071-1080	9 430 610 002	NP-DN0SD21	9 432 610 001
71-1080	9 430 615 004	105071-1080		NP-DN0SD212	9 432 610 438
71-1081	9 430 616 272	105071-1081		NP-DN0SD21	9 432 610 001
71-1160	9 430 615 139	105071-1160	9 430 610 304	NP-DN4SD24	9 432 610 012
71-1160	9 430 615 139	105071-1160	9 430 610 305	NP-DN0SD212	9 432 610 023
71-1220	9 430 615 632	105071-1220	9 430 610 308	NP-DN0SD21	9 432 610 001
71-1220 A	9 430 615 632	105071-1220	9 430 610 313	NP-DN0SD211	9 432 610 002
71-1230	9 430 615 633	105071-1230	9 430 610 309	NP-DN0SD21	9 432 610 001
71-1240 B	9 430 615 005	105071-1240	9 430 610 003	NP-DN0SD211	9 432 610 002
71-1240 G	9 430 615 005	105071-1240		NP-DN0SD21	9 432 610 001
71-1240 H	9 430 615 005	105071-1240	9 430 610 315	NP-DN0SD211	9 432 610 002
71-1240 P	9 430 615 005	105071-1240	9 430 610 053	NP-DN0SD21	9 432 610 001
71-1240 U	9 430 615 005	105071-1240	9 430 610 038	NP-DN9SD193	9 432 610 003
71-1241 U	9 430 615 048	105071-1241	9 430 610 058	NP-DN0SD193	9 432 610 003
71-1251	9 430 615 634	105071-1251	9 430 610 312	NP-DN0SD21	9 432 610 001
71-1260	9 430 615 174	105071-1260	9 430 610 316	NP-DN0SD2110	9 432 610 007
71-1260	9 430 615 174	105071-1260		NP-DN0SD21	9 432 610 085
71-1261	9 430 615 176	105071-1261	9 430 610 320	NP-DN0SD21	9 432 610 085
71-1270	9 430 615 088	105071-1270	9 430 610 318	NP-DN0SD211	9 432 610 002
71-1270 A	9 430 615 088	105071-1270	9 430 610 322	NP-DN0SD21	9 432 610 001
71-1270 B	9 430 615 088	105071-1270	9 430 610 323	NP-DN0SD211	9 432 610 002
71-1271 O	9 430 615 006	105071-1271	9 430 610 356	NP-DN0SDN199	9 432 610 292
71-1271 O	9 430 615 006	105071-1271	9 430 610 365	NP-DN0SDN199	9 432 610 292
71-1271 C		105071-1271		NP-DN0SD211	
71-1271 D	9 430 615 006	105071-1271	9 430 610 344	NP-DN0SD21	9 432 610 001
71-1271 F	9 430 615 006	105071-1271	9 430 610 054	NP-DN0SDN187	9 432 610 023
71-1271 F	9 430 615 006	105071-1271	9 430 610 056	NP-DN0SDN187	9 432 610 023
71-1271 I	9 430 615 006	105071-1271	9 430 610 354	NP-DN0SDN187-	9 432 610 230
71-1271 I	9 430 615 006	105071-1271	9 430 610 376	NP-DN0SDN187	9 432 610 230
71-1271 N	9 430 615 006	105071-1271	9 430 610 355	NP-DN0SDN187-	9 432 610 230
71-1271 N	9 430 615 006	105071-1271	9 430 610 364	NP-DN0SDN187-	9 432 610 230
71-1271 U	9 430 615 006	105071-1271	9 430 610 006	NP-DN0SD193	9 432 610 003
71-1271 U	9 430 615 006	105071-1271	9 430 610 363	NP-DN0SD193	9 432 610 003
71-1271 V	9 430 615 006	105071-1271	9 430 610 361	NP-DN0SD211	9 432 610 002
71-1271 W	9 430 615 006	105071-1271	9 430 610 375	NP-DN12SDN189	9 432 610 048
71-1271 W	9 430 615 006	105071-1271	9 430 610 380	NP-DN12SDN189	9 432 610 048

A200

de
Düsen für
1-Feder-Düsenhalter
von Zexel
 (Fortsetzung)







en
Nozzles for the most
important single-
spring nozzle-holders
Zexel
 (continued)







fr
Injecteurs pour
les principaux porte-
injecteurs à 1 ressort
Zexel
 (suite)

it
Polvrizzatori per
i principali porta-
polverizzatori
a 1 molla, Zexel
 (seguito)

es
Inyectores para
los portainyectores
de 1 muelle más
importantes, Zexel
 (continuación)



 Typ	 Ref.	 Zexel	 Ref.	 Typ	 Ref.
71-1280	9 430 615 025	105071-1280	9 430 610 028	NP-DN0SD177	9 432 610 021
71-1280 F	9 430 615 025	105071-1280	9 430 610 149	NP-DN0SD193	9 432 610 003
71-1290		105071-1290		NP-DN4SD128	9 432 610 423
71-1300	9 430 615 007	105071-1300	9 430 610 005	NP-DN30SDN180	9 432 610 005
71-1310	9 430 615 536	105071-1310	9 430 610 325	NP-DN12SD12	9 432 610 038
71-1320	9 430 615 635	105071-1320	9 430 610 326	NP-DN4SD128	9 432 610 423
71-1330	9 430 615 103	105071-1330	9 430 610 327	NP-DN12SD12	9 432 610 038
71-1331	9 430 615 109	105071-1331	9 430 610 281	NP-DN12SD12-	9 432 610 038
71-1331	9 430 615 109	105071-1331	9 430 610 328	NP-DN12SD12	9 432 610 038
71-1331 B	9 430 615 109	105071-1331	9 430 610 124	NP-DN12SD12-	9 432 610 038
71-1331 B	9 430 615 109	105071-1331	9 430 610 282	NP-DN12SD12-	9 432 610 038
71-1340	9 430 615 636	105071-1340	9 430 610 329	NP-DN12SD12	9 432 610 038
71-1341	9 430 615 465	105071-1341	9 430 610 283	NP-DN12SD12-	9 432 610 038
71-1341	9 430 615 465	105071-1341	9 430 610 330	NP-DN12SD12	9 432 610 038
71-1341 A	9 430 615 465	105071-1341	9 430 610 284	NP-DN12SD12-	9 432 610 038
71-1341 A	9 430 615 465	105071-1341	9 430 610 331	NP-DN12SD12-	9 432 610 038
71-1350		105071-1350		NP-DN4SD128	9 432 610 423
71-1360	9 430 615 008	105071-1360	9 430 610 008	NP-DN0SD193NP1	9 432 610 004
71-1361	9 430 615 018	105071-1361	9 430 610 018	NP-DN0SD193NP1	9 432 610 004
71-1361 A		105071-1361		NP-DN0SDN221	
71-1361 A		105071-1361		NP-DN0SDN221	
71-1361 A	9 430 615 018	105071-1361	9 430 610 147	NP-DN0SDN221	9 432 610 363
71-1361 A	9 430 615 018	105071-1361	9 430 610 293	NP-DN0SDN221	9 432 610 363
71-1361 A	9 430 615 018	105071-1361	9 430 610 294	NP-DN0SDN221	9 432 610 363
71-1361 A	9 430 615 018	105071-1361	9 430 610 296	NP-DN0SDN221	9 432 610 363
71-1361 A	9 430 615 018	105071-1361	9 430 610 386	NP-DN0SDN221	9 432 610 363
71-1361 B	9 430 615 018	105071-1361	9 430 610 105	NP-DN0SDN220	9 432 610 205
71-1361 E	9 430 615 018	105071-1361	9 430 610 287	NP-DN0SDN220S	9 432 610 355
71-1361 F	9 430 615 018	105071-1361	9 430 610 288	NP-DN0SDN220S	9 432 610 355
71-1361 H	9 430 615 018	105071-1361	9 430 610 132	NP-DN0SDN220S	9 432 610 355
71-1361 J	9 430 615 018	105071-1361		NP-DN0SDN220	9 432 610 205
71-1361 J	9 430 615 018	105071-1361	9 430 610 098	NP-DN0SDN220	9 432 610 205
71-1361 J	9 430 615 018	105071-1361	9 430 610 383	NP-DN0SDN220	9 432 610 205
71-1361 J	9 430 615 018	105071-1361	9 430 610 391	NP-DN0SDN220	9 432 610 205
71-1361 S	9 430 615 018	105071-1361	9 430 610 029	NP-DN0SD193NP1	9 432 610 004
71-1370	9 430 615 637	105071-1370	9 430 610 341	NP-DN0SD186	9 432 610 090
71-1370 A	9 430 615 637	105071-1370	9 430 610 369	NP-DN0SDN186	9 432 610 090
71-1370 B	9 430 615 637	105071-1370	9 430 610 372	NP-DN0SDN177	9 432 610 021
71-1380	9 430 615 034	105071-1380	9 430 610 042	NP-DN0SD177	9 432 610 021
71-1380 C	9 430 615 034	105071-1380	9 430 610 385	NP-DN0SDN187	9 432 610 023
71-1380 C	9 430 615 034	105071-1380	9 430 610 389	NP-DN0SDN187	9 432 610 023
71-1380 E	9 430 615 034	105071-1380	9 430 610 390	NP-DN0SDN228	9 432 610 407
71-1380 P	9 430 615 034	105071-1380	9 430 610 150	NP-DN0SD177	9 432 610 021
71-1380 T	9 430 615 034	105071-1380	9 430 610 342	NP-DN0SDN186	9 432 610 090
71-1390	9 430 615 638	105071-1390	9 430 610 346	NP-DN0SD193	9 432 610 003

 Typ	 Ref.	 Zexel	 Ref.	 Typ	 Ref.
71-1390 A	9 430 615 638	105071-1390	9 430 610 382	NP-DN0SD21	9 432 610 001
71-1400		105071-1400		NP-DN12SDN188	9 432 610 470
71-1401	9 430 615 639	105071-1401	9 430 610 349	NP-DN12SDN188	9 432 610 470
71-1410		105071-1410		NP-DN12SDN188	9 432 610 470
71-1411	9 430 615 640	105071-1411	9 430 610 350	NP-DN12SDN188	9 432 610 470
71-1421	9 430 615 537	105071-1421	9 430 610 351	NP-DN12SD12	9 432 610 038
71-1430	9 430 615 641	105071-1430	9 430 610 353	NP-DN12SDN189	9 432 610 048
71-1440		105071-1440		NP-DN0SDN187	9 432 610 011
71-1440 A		105071-1440		NP-DN0SDN187	9 432 610 011
71-1441	9 430 615 026	105071-1441	9 430 610 030	NP-DN0SDN187	9 432 610 023
71-1441	9 430 615 026	105071-1441	9 430 610 357	NP-DN0SDN187	9 432 610 023
71-1450 C	9 430 615 156	105071-1450	9 430 610 358	NP-DN0SD177	9 432 610 021
71-1460	9 430 615 642	105071-1460	9 430 610 347	NP-DN0SDN177	9 432 610 021
71-1461	9 430 615 366	105071-1461	9 430 610 348	NP-DN0SDN177	9 432 610 021
71-1470	9 430 615 363	105071-1470	9 430 610 345	NP-DN0SD193	9 432 610 003
71-1470 A	9 430 615 363	105071-1470	9 430 610 381	NP-DN0SD21	9 432 610 001
71-1480		105071-1480		NP-DN0SD211	9 432 610 002
71-1480 A		105071-1480		NP-DN4SD24	9 432 610 012
71-1481	9 430 615 531	105071-1481	9 430 610 367	NP-DN0SD211	9 432 610 002
71-1481 A	9 430 615 531	105071-1481	9 430 610 371	NP-DN4SD24	9 432 610 012
71-1481 B	9 430 615 531	105071-1481	9 430 610 373	NP-DN0SD2110	9 432 610 007
71-1481 C	9 430 615 531	105071-1481	9 430 610 374	NP-DN0SD21	9 432 610 001
71-1490	9 430 615 643	105071-1490	9 430 610 368	NP-DN12SDN188	9 432 610 470
71-1500	9 430 615 055	105071-1500	9 430 610 064	NP-DN20SD202	9 432 610 105
71-1510	9 430 615 129	105071-1510	9 430 610 378	NP-DN0SDN199	9 432 610 292
71-1510	9 430 615 129	105071-1510	9 430 610 384	NP-DN0SDN199	9 432 610 292
71-1530	9 430 615 085	105071-1530	9 430 610 007	NP-DN0SD193	9 432 610 003
71-1530	9 430 615 085	105071-1530	9 430 610 387	NP-DN0SDN222	9 432 610 471
71-1530 L	9 430 615 085	105071-1530	9 430 610 109	NP-DN0SDN224	9 432 610 251
71-1530 M	9 430 615 085	105071-1530	9 430 610 377	NP-DN20SDN202	9 432 610 105
71-1530 P	9 430 615 085	105071-1530	9 430 610 379	NP-DN0SDN199	9 432 610 292
71-1530 R	9 430 615 085	105071-1530	9 430 610 286	NP-DN0SDN226	9 432 610 385
71-1530 W	9 430 615 085	105071-1530	9 430 610 292	NP-DN0SDN224	9 432 610 251
71-1540	9 430 615 164	105071-1540	9 430 610 388	NP-DN4SDN223	9 432 610 269
71-1560 A	9 430 615 561	105071-1560	9 430 610 299	NP-DN4SDN230	9 432 610 472
71-2030	9 430 615 175	105071-2030		NP-DN0SD211	9 432 610 002
78-0000	9 430 615 049	105078-0000		NP-DN4PDN101	9 432 610 059
78-0010 1	9 430 615 009	105078-0010	9 430 610 039	NP-DN0PDN112	9 432 610 062
78-0010 3	9 430 615 009	105078-0010	9 430 610 050	NP-DN15PDN111	9 432 610 080
78-0020	9 430 615 044	105078-0020	9 430 610 400	NP-DN0PDN104	9 432 610 473
78-0030	9 430 615 038	105078-0030	9 430 610 043	NP-DN0PDN102	9 432 610 063
78-0160	9 430 615 377	105078-0160	9 430 610 413	NP-DN4PDN101	9 432 610 059
78-0180 44	9 430 615 116	105078-0180	9 430 610 434	NP-DN10PDN135	9 432 610 478
78-0220	9 430 615 649	105078-0220	9 430 610 431	NP-DN0PDN1120	9 432 610 062
780-2250		105780-2250	9 430 613 549		9 430 613 445



A202

de

**Düsen für
1-Feder-Düsenhalter
von Zexel**

(Fortsetzung)

en

**Nozzles for the most
important single-
spring nozzle-holders
Zexel**

(continued)

fr

**Injecteurs pour
les principaux porte-
injecteurs à 1 ressort
Zexel**

(suite)

it

**Polvrizzatori per
i principali porta-
polverizzatori
a 1 molla, Zexel**







(seguito)







es

**Inyectores para
los portainyectores
de 1 muelle más
importantes, Zexel**

(continuación)



 Typ	 Ref.	 Zexel	 Ref.	 Typ	 Ref.
79-1000	9 430 615 652	105079-1000	9 430 610 394	NP-DN0SDN187	9 432 610 023
79-1010		105079-1010		NP-DN0SDN187	9 432 610 230
79-1011	9 430 615 653	105079-1011	9 430 610 395	NP-DN0SDN187	9 432 610 230
79-1020	9 430 615 654	105079-1020	9 430 610 396	NP-DN0SDN187	9 432 610 023
81-1050	9 430 615 655	105081-1050	9 430 610 448	NP-DN4SD24NP1	9 432 610 148
81-1060	9 430 615 656	105081-1060	9 430 610 449	NP-DN4SD24NP1	9 432 610 148
81-1110	9 430 615 157	105081-1110	9 430 610 456	NP-DN15SDNP2	9 432 610 057
81-1120	9 430 615 657	105081-1120	9 430 610 455	NP-DN4SD24	9 432 610 012
81-2030		105081-2030		NP-DN0SD21	9 432 610 001
81-2050	9 430 615 974	105081-2050		NP-DN4SD24	9 432 610 012
81-2110	9 430 615 658	105081-2110	9 430 610 450	NP-DN4SD24	9 432 610 012
81-2140	9 430 615 148	105081-2140	9 430 610 451	NP-DN4SD24	9 432 610 012
81-2150	9 430 615 279	105081-2150	9 430 610 452	NP-DN4SD24	9 432 610 012
81-2180	9 430 615 659	105081-2180	9 430 610 453	NP-DN0SD211	9 432 610 002
81-2190	9 430 615 660	105081-2190	9 430 610 447	NP-DN4S1	9 432 610 036
81-2190 A	9 430 615 660	105081-2190	9 430 610 459	NP-DN4SD24	9 432 610 012
81-2200	9 430 615 661	105081-2200	9 430 610 460	NP-DN4SD24N181	9 432 610 469
81-2210		105081-2210		NP-DN0SD21	9 432 610 085
81-3030	9 430 615 050	105081-3030		NP-DN0SD211	9 432 610 002
81-3060	9 430 615 662	105081-3060	9 430 610 463	NP-DLL16S306NP1	9 432 610 506
81-3070	9 430 615 663	105081-3070	9 430 610 465	NP-DLLA150S38,40NP16	9 432 610 387
81-3080		105081-3080		NP-DN0SD211	9 432 610 002
81-3081	9 430 615 065	105081-3081	9 430 610 077	NP-DN0SD211	9 432 610 002
81-3090	9 430 615 664	105081-3090	9 430 610 467	NP-DLLA150S38,40NP16	9 432 610 387
81-3120		105081-3120		NP-DN0SD2110	9 432 610 007
81-3130		105081-3130		NP-DN0SD2110	9 432 610 007
81-3140		105081-3140		NP-DN0SD2110	9 432 610 007
81-3141	9 430 615 011	105081-3141	9 430 610 020	NP-DN0SD2110	9 432 610 007
81-3160		105081-3160		NP-DN0SD2110	9 432 610 007
81-3161	9 430 615 665	105081-3161	9 430 610 454	NP-DN0SD2110	9 432 610 007
81-3170		105081-3170		NP-DN0SD2110	9 432 610 007
81-3171	9 430 615 019	105081-3171	9 430 610 021	NP-DN0SD2110	9 432 610 007
81-3180	9 430 615 084	105081-3180	9 430 610 457	NP-DN4SD24	9 432 610 012
81-3190	9 430 615 576	105081-3190	9 430 610 470	NP-DLLA16S561N389	9 432 610 152
81-3190	9 430 615 576	105081-3190	9 430 610 469	NP-DLL16S601NP93	9 432 610 416
81-3190	9 430 615 576	105081-3190	9 430 610 471	NP-DLL30S701N465	9 432 610 508
81-3200	9 430 615 010	105081-3200	9 430 610 458	NP-DN0SDN10	9 432 610 112
81-3201		105081-3201		NP-DN0SD193	
81-3201	9 430 615 012	105081-3201	9 430 610 145	NP-DN0SD193	9 432 610 003
81-3210	9 430 615 027	105081-3210	9 430 610 031	NP-DN0SD193	9 432 610 003
81-3210 C	9 430 615 027	105081-3210	9 430 610 462	NP-DN0SDN187	9 432 610 023
81-3220	9 430 615 028	105081-3220	9 430 610 032	NP-DN0SD193	9 432 610 003
81-3230	9 430 615 068	105081-3230	9 430 610 461	NP-DN0SD193	9 432 610 003
81-4010	9 430 615 666	105081-4010	9 430 610 464	NP-DLLA145S701NP15	9 432 610 093
81-4020	9 430 615 972	105081-4020		NP-DLLA14.5S701NP15	9 432 610 093

 Typ	 Ref.	 Zexel	 Ref.	 Typ	 Ref.
81-4030		105081-4030		NP-DLLA14.5S701NP15	9 432 610 093
81-4030		105081-4030		NP-DLLA14.5S701NP15	9 432 610 093
81-4031	9 430 615 052	105081-4031	9 430 610 466	NP-DLLA14.5S701NP15	9 432 610 093
81-4050	9 430 615 427	105081-4050		NP-DLL38S721NP94	
81-4050	9 430 615 427	105081-4050	9 430 610 468	NP-DLL35S671NP92	9 432 610 507
88-1032	9 430 615 667	105088-1032	9 430 610 472	NP-DN0PDN105	9 432 610 110
88-1032	9 430 615 667	105088-1032	9 430 610 475	NP-DN0PDN105	9 432 610 110
88-1042	9 430 615 378	105088-1042	9 430 610 474	NP-DN0PDN1061	9 432 610 189
88-1042	9 430 615 378	105088-1042	9 430 610 476	NP-DN0PDN1061	9 432 610 189
88-1051	9 430 615 056	105088-1051		NP-DN0PDN107	9 432 610 116
88-1051	9 430 615 056	105088-1051		NP-DN0PDN107	9 432 610 116
88-1051	9 430 615 056	105088-1051	9 430 610 473	NP-DN0PDN107	9 432 610 116
88-1061	9 430 615 040	105088-1061	9 430 610 045	NP-DN0PDN108	9 432 610 074
88-1061	9 430 615 040	105088-1061	9 430 610 060	NP-DN0PDN108	9 432 610 074
88-1070	9 430 615 668	105088-1070	9 430 610 477	NP-DN0PDN110	9 432 610 157
88-1070	9 430 615 668	105088-1070	9 430 610 478	NP-DN0PDN110	9 432 610 157
88-1090		105088-1090		NP-DN0PDN108	9 432 610 074
88-1090		105088-1090		NP-DN0PDN108	9 432 610 074
88-1090	9 430 615 062	105088-1090	9 430 610 101	NP-DN0PDN108	9 432 610 074
88-1090	9 430 615 062	105088-1090	9 430 610 136	NP-DN0PDN108	9 432 610 074
88-1090	9 430 615 062	105088-1090	9 430 610 137	NP-DN0PDN108	9 432 610 074
88-1090 A	9 430 615 062	105088-1090	9 430 610 073	NP-DN0PDN108	9 432 610 074
88-1090 A	9 430 615 062	105088-1090	9 430 610 074	NP-DN0PDN108	9 432 610 162
88-1090 A	9 430 615 062	105088-1090	9 430 610 484	NP-DN0PDN108	9 432 610 162
88-1090 A	9 430 615 062	105088-1090	9 430 610 128	NP-DN0PDN122	9 432 610 237
88-1090 A	9 430 615 062	105088-1090	9 430 610 129	NP-DN0PDN122	9 432 610 237
88-1090 A	9 430 615 062	105088-1090	9 430 610 486	NP-DN0PDN122	9 432 610 237
88-1090 A	9 430 615 062	105088-1090	9 430 610 485	NP-DN0PDN122	9 432 610 267
88-1090 A	9 430 615 062	105088-1090	9 430 610 487	NP-DN0PDN122	9 432 610 267
88-1090 C	9 430 615 062	105088-1090	9 430 610 479	NP-DN0PDN110	9 432 610 157
88-1090 C	9 430 615 062	105088-1090	9 430 610 481	NP-DN0PDN110	9 432 610 157
88-1090 P	9 430 615 062	105088-1090	9 430 610 148	NP-DN0PDN123	9 432 610 337
88-1090 P	9 430 615 062	105088-1090	9 430 610 488	NP-DN0PDN123	9 432 610 337
88-1090 P	9 430 615 062	105088-1090	9 430 610 489	NP-DN0PDN123	9 432 610 337
88-1090 P	9 430 615 062	105088-1090	9 430 610 502	NP-DN0PDN123	9 432 610 337
88-1100	9 430 615 078	105088-1100	9 430 610 089	NP-DN0PDN110	9 432 610 157
88-1100 A	9 430 615 078	105088-1100	9 430 610 480	NP-DN0PDN110	9 432 610 157
88-1110	9 430 615 669	105088-1110	9 430 610 482	NP-DN0PDN110	9 432 610 157
88-1110	9 430 615 669	105088-1110	9 430 610 483	NP-DN0PDN110	9 432 610 157
88-1120		105088-1120		NP-DN0PDN124	9 432 610 271
88-1120		105088-1120		NP-DN0PDN124	9 432 610 271
88-1120	9 430 615 096	105088-1120	9 430 610 161	NP-DN0PDN124	9 432 610 271
88-1120	9 430 615 096	105088-1120	9 430 610 490	NP-DN0PDN124	9 432 610 271
88-1120	9 430 615 096	105088-1120	9 430 610 491	NP-DN0PDN124	9 432 610 271
88-1120	9 430 615 096	105088-1120	9 430 610 492	NP-DN0PDN124	9 432 610 271

A204

de

**Düsen für
1-Feder-Düsenhalter
von Zexel**

(Fortsetzung)

en

**Nozzles for the most
important single-
spring nozzle-holders
Zexel**

(continued)

fr

**Injecteurs pour
les principaux porte-
injecteurs à 1 ressort
Zexel**

(suite)

it

**Polvizzatori per
i principali porta-
polverizzatori
a 1 molla, Zexel**







(seguito)







es

**Inyectores para
los portainyectores
de 1 muelle más
importantes, Zexel**

(continuación)



						
88-1120	H	9 430 615 096	105088-1120	9 430 610 493	NP-DN0PDN128	9 432 610 476
88-1120	H	9 430 615 096	105088-1120	9 430 610 494	NP-DN0PDN128	9 432 610 476
88-1120	H	9 430 615 096	105088-1120	9 430 610 495	NP-DN0PDN128	9 432 610 476
88-1120	H	9 430 615 096	105088-1120	9 430 610 496	NP-DN0PDN128	9 432 610 476
88-1120	L	9 430 615 096	105088-1120	9 430 610 504	NP-DN0PDN136	9 432 610 421
88-1120	L	9 430 615 096	105088-1120	9 430 610 505	NP-DN0PDN136	9 432 610 421
88-1130		9 430 615 102	105088-1130	9 430 610 497	NP-DN0PDN127	9 432 610 281
88-1140			105088-1140		NP-DN0PDN131	9 432 610 310
88-1140		9 430 615 283	105088-1140	9 430 610 498	NP-DN0PDN131	9 432 610 310
88-1140		9 430 615 283	105088-1140	9 430 610 499	NP-DN0PDN131	9 432 610 310
88-1140		9 430 615 283	105088-1140	9 430 610 500	NP-DN0PDN131	9 432 610 310
88-1140		9 430 615 283	105088-1140	9 430 610 501	NP-DN0PDN131	9 432 610 310
88-1150			105088-1150		NP-DN0PDN131	9 432 610 310
88-1150		9 430 615 670	105088-1150	9 430 610 503	NP-DN0PDN131	9 432 610 310
88-1160			105088-1160		NP-DN0PDN127	9 432 610 281
88-1160			105088-1160		NP-DN0PDN127	9 432 610 281
88-1160		9 430 615 671	105088-1160	9 430 610 506	NP-DN0PDN127	9 432 610 281
88-1160		9 430 615 671	105088-1160	9 430 610 507	NP-DN0PDN127	9 432 610 281
90-1050		9 430 615 672	105090-1050	9 430 610 599	NP-DN4SNP3	9 432 610 044
90-1070		9 430 616 274	105090-1070		NP-DN4SNP3	9 432 610 044
90-1100			105090-1100		NP-DN4SNP3	9 432 610 044
90-1120		9 430 615 673	105090-1120	9 430 610 600	NP-DN4SNP3	9 432 610 044
90-1130		9 430 615 674	105090-1130	9 430 610 601	NP-DN4SNP3	9 432 610 044
90-1130	A	9 430 615 674	105090-1130	9 430 610 605	NP-DN4SNP3	9 432 610 044
90-1140		9 430 616 275	105090-1140		NP-DN4SNP3	9 432 610 044
90-1150		9 430 615 472	105090-1150	9 430 610 602	NP-DN4SNP3	9 432 610 044
90-1160		9 430 615 675	105090-1160	9 430 610 603	NP-DN4SNP3	9 432 610 044
90-5000 KE1235		9 430 615 676	105090-5000	9 430 610 604	NP-DN0S226	9 432 610 466
91-1040		9 430 615 677	105091-1040	9 430 610 606	NP-DN4SD24	9 432 610 037
91-1090			105091-1090		NP-DN0SD211	9 432 610 002
91-1140		9 430 615 020	105091-1140	9 430 610 022	NP-DN0SD211	9 432 610 002
91-1150		9 430 615 678	105091-1150	9 430 610 608	NP-DN0SD211	9 432 610 002
91-1150	B	9 430 615 678	105091-1150	9 430 610 609	NP-DN0SD193	9 432 610 003
91-1160			105091-1160		NP-DN4SD24	9 432 610 012
91-2030		9 430 615 679	105091-2030	9 430 610 607	NP-DN4SD24	9 432 610 012
91-2040		9 430 615 680	105091-2040	9 430 610 610	NP-DN4SD24	9 432 610 012
92-1000		9 430 615 681	105092-1000	9 430 610 611	NP-DLF140TM308N18	9 432 610 532
92-1030		9 430 615 538	105092-1030	9 430 610 612	NP-DLF140TM308N20	9 432 610 534
92-1030	F	9 430 615 538	105092-1030	9 430 610 613	NP-DLF140TM2710N18	9 432 610 550
93-6000	A		105093-6000		NP-DL150T378NP15	9 432 610 149
93-6002	A		105093-6002		NP-DL150T378NP15	9 432 610 149
93-6003	B		105093-6003	9 430 610 625	NP-DL150T348NP15	9 432 610 623
93-6004	A	9 430 615 473	105093-6004	9 430 610 616	NP-DL150T378NP15	9 432 610 149
93-6005	A	9 430 615 682	105093-6005	9 430 610 617	NP-DL150T378NP15	9 432 610 149
93-6005	B	9 430 615 682	105093-6005	9 430 610 626	NP-DL150T348NP15	9 432 610 623

 Typ	 Ref.	 Zexel	 Ref.	 Typ	 Ref.
93-7000 B	9 430 615 478	105093-7000	9 430 610 631	NP-DLF140TB368N33	9 432 610 338
93-7000 D	9 430 615 478	105093-7000	9 430 610 640	NP-DLF140TB348N34	9 432 610 486
93-7010	9 430 615 556	105093-7010	9 430 610 614	NP-DL150T388NP20	9 432 610 155
93-7020	9 430 615 512	105093-7020	9 430 610 615	NP-DL150T388NP20	9 432 610 155
93-7020 A	9 430 615 512	105093-7020	9 430 610 618	NP-DL150T368NP20	9 432 610 497
93-7030	9 430 615 513	105093-7030	9 430 610 629	NP-DLF150TB388N17	9 432 610 082
93-7030 C	9 430 615 513	105093-7030	9 430 610 630	NP-DLF150TB368N27	9 432 610 246
93-7060	9 430 615 683	105093-7060	9 430 610 619	NP-DL140T368NP32	9 432 610 498
93-7060 A	9 430 615 683	105093-7060	9 430 610 620	NP-DL140T348NP32	9 432 610 499
93-7070 A	9 430 615 514	105093-7070	9 430 610 633	NP-DLF140TB348N34	9 432 610 486
93-7070 B	9 430 615 514	105093-7070	9 430 610 641	NP-DLF140TB368N34	9 432 610 338
93-8000 A	9 430 615 684	105093-8000	9 430 610 634	NP-DLF145TB388N38	9 432 610 488
93-8010 A	9 430 615 515	105093-8010	9 430 610 621	NP-DL145T388AN3	9 432 610 500
93-8020 A	9 430 615 685	105093-8020	9 430 610 622	NP-DL145T388AN3	9 432 610 500
93-8030 A	9 430 615 516	105093-8030	9 430 610 635	NP-DLF145TB388N38	9 432 610 488
93-8030 B	9 430 615 516	105093-8030	9 430 610 636	NP-DLF145TB368N38	9 432 610 490
93-8040 A		105093-8040		NP-DL150TE378N1	9 432 610 622
93-8041 A		105093-8041	9 430 610 623	NP-DL150TE378N1	9 432 610 622
93-8042 B	9 430 615 686	105093-8042	9 430 610 627	NP-DL155TE4010N5	9 432 610 624
93-8043 A	9 430 615 687	105093-8043	9 430 610 624	NP-DL150TE378N1	9 432 610 622
93-8043 B	9 430 615 687	105093-8043	9 430 610 628	NP-DL155TE4010N5	9 432 610 624
94-1040 A	9 430 615 688	105094-1040	9 430 610 646	NP-DLF140TM308N1	9 432 610 528
94-1040 B	9 430 615 688	105094-1040	9 430 610 647	NP-DLF140TM309N18	9 432 610 533
94-1040 C	9 430 615 688	105094-1040	9 430 610 650	NP-DLF140TM308N20	9 432 610 534
94-2060	9 430 615 689	105094-2060	9 430 610 643	NP-DLF140UM358N12	9 432 610 531
94-2070	9 430 615 690	105094-2070	9 430 610 644	NP-DLF154UM348N8	9 432 610 529
94-2080	9 430 615 691	105094-2080	9 430 610 649	NP-DLF115UM328N4	9 432 610 527
94-2110	9 430 615 440	105094-2110	9 430 610 648	NP-DLF154UM428N2	9 432 610 526
94-4050	9 430 615 692	105094-4050	9 430 610 645	NP-DLF130UM388N6	9 432 610 530
94-4110	9 430 615 693	105094-4110	9 430 610 642	*****	9 432 610 564
94-4120	9 430 615 694	105094-4120	9 430 610 651	NP-DLF130UM388N22	9 432 610 567
94-5070		105094-5070		*****	
95-1000	9 430 615 695	105095-1000	9 430 610 662	*****	9 432 610 539
95-1010	9 430 615 479	105095-1010	9 430 610 710	*****	9 432 610 524
95-1010 A	9 430 615 479	105095-1010	9 430 610 711	(STAMPING ON)	9 432 610 525
95-1020	9 430 615 535	105095-1020	9 430 610 665	*****	9 432 610 542
95-3050	9 430 615 696	105095-3050	9 430 610 655	10-06-140	9 432 610 536
95-3060		105095-3060		10-06-140	9 432 610 536
95-3070	9 430 615 697	105095-3070	9 430 610 658	10-06-140	9 432 610 536
95-3080 A	9 430 615 698	105095-3080	9 430 610 695	10-0.65-140	9 432 610 538
95-3080 B	9 430 615 698	105095-3080	9 430 610 698	10-06-140	9 432 610 536
95-3090 A	9 430 615 699	105095-3090	9 430 610 697	9-0.68-140	9 432 610 562
95-3090 B	9 430 615 699	105095-3090	9 430 610 705	10-06-140	9 432 610 536
95-3090 C	9 430 615 699	105095-3090	9 430 610 707	10-0.65-140	9 432 610 538
95-5040	9 430 615 700	105095-5040	9 430 610 652	10-0.60-140-X	9 432 610 546

A 206

de

**Düsen für
1-Feder-Düsenhalter
von Zexel**

(Fortsetzung)

en

**Nozzles for the most
important single-
spring nozzle-holders
Zexel**

(continued)

fr

**Injecteurs pour
les principaux porte-
injecteurs à 1 ressort
Zexel**

(suite)

it

**Polvrizzatori per
i principali porta-
polverizzatori
a 1 molla, Zexel**







(seguito)







es

**Inyectores para
los portainyectores
de 1 muelle más
importantes, Zexel**

(continuación)



						
95-5080		9 430 615 701	105095-5080	9 430 610 657	10-0.77-145	9 432 610 537
95-5090		9 430 615 702	105095-5090	9 430 610 663	10-0.77-144	9 432 610 540
95-5100		9 430 615 703	105095-5100	9 430 610 664	10-0.77-144	9 432 610 541
95-5110		9 430 615 704	105095-5110	9 430 610 667	10-0.60-140-X	9 432 610 546
95-5120		9 430 615 705	105095-5120	9 430 610 668	10-0.60-140-X	9 432 610 546
95-6030		9 430 615 706	105095-6030	9 430 610 656	10-0.77-145	9 432 610 537
95-9010		9 430 616 276	105095-9010	9 430 613 105	9-0.85-154A	9 432 610 535
95-9020		9 430 615 707	105095-9020	9 430 610 653	9-0.85-154A	9 432 610 535
95-9021 B		9 430 615 708	105095-9021	9 430 610 670	9-0.78-154A	9 432 610 544
95-9021 C		9 430 615 708	105095-9021	9 430 610 672	10-0.74-154A	9 432 610 547
95-9021 D		9 430 615 708	105095-9021	9 430 610 660	9-0.85-154	9 432 610 545
95-9021 E		9 430 615 708	105095-9021	9 430 610 654	9-0.85-154A	9 432 610 535
95-9030			105095-9030		9-0.85-154A	9 432 610 535
95-9040		9 430 615 709	105095-9040	9 430 610 659	9-0.85-154	9 432 610 545
95-9040 A		9 430 615 709	105095-9040		9-0.78-154A	9 432 612 413
95-9040 B		9 430 615 709	105095-9040	9 430 610 669	9-0.78-154A	9 432 610 544
95-9040 C		9 430 615 709	105095-9040	9 430 610 671	10-0.74-154A	9 432 610 547
95-9050		9 430 615 710	105095-9050	9 430 610 661	9-0.85-154A	9 432 610 545
95-9050 A		9 430 615 710	105095-9050		9-0.78-154A	9 432 612 413
95-9050 B		9 430 615 710	105095-9050	9 430 610 673	10-0.74-154A	9 432 610 547
95-9052 B		9 430 615 711	105095-9052	9 430 610 674	10-0.74-154A	9 432 610 547
95-9060			105095-9060		9-0.78-154	9 432 610 543
95-9060 A			105095-9060		9-0.85-154A	9 432 610 535
95-9070			105095-9070		9-0.85-154A	9 432 610 548
95-9080		9 430 615 712	105095-9080	9 430 610 676	10-0.74-154A	9 432 610 549
95-9080 A		9 430 615 712	105095-9080	9 430 610 681	10-0.78-154A	9 432 610 555
95-9090		9 430 615 713	105095-9090	9 430 610 677	10-0.74-154A	9 432 610 549
95-9090 A		9 430 615 713	105095-9090	9 430 610 680	10-0.78-154A	9 432 610 555
95-9100		9 430 615 714	105095-9100	9 430 610 678	9-0.78-154A	9 432 610 553
95-9101 A		9 430 615 715	105095-9101	9 430 610 679	9-0.78-154A	9 432 610 553
95-9110			105095-9110		10X0.82X154X0.2R	9 432 612 422
95-9111			105095-9111		10X0.82X154X0.2R	9 432 612 422
95-9120		9 430 615 716	105095-9120	9 430 610 682	10-0.74-154A	9 432 610 549
95-9120 A		9 430 615 716	105095-9120	9 430 610 686	10-0.78-154A	9 432 610 555
95-9121 A		9 430 615 717	105095-9121	9 430 610 687	10-0.78-154A	9 432 610 555
95-9121 B		9 430 615 717	105095-9121	9 430 610 683	10-0.74-154A	9 432 610 549
95-9130		9 430 615 718	105095-9130	9 430 610 684	10-0.74-154A	9 432 610 549
95-9130 A		9 430 615 718	105095-9130	9 430 610 688	10-0.78-154A	9 432 610 555
95-9131 B		9 430 615 719	105095-9131	9 430 610 685	10-0.74-154A	9 432 610 549
95-9140		9 430 615 720	105095-9140	9 430 610 689	10X0.78X154-0.2R S	9 432 610 557
95-9141 A		9 430 615 721	105095-9141	9 430 610 704	11X0.68X78X0.2R A	9 432 610 574
95-9142 B		9 430 615 722	105095-9142	9 430 610 690	10X0.78X154-0.2R S	9 432 610 557
95-9142 C		9 430 615 722	105095-9142	9 430 610 708	11X0.68X78-0.2R	9 432 610 577
95-9150		9 430 615 723	105095-9150	9 430 610 691	10X0.78X154-0.2R S	9 432 610 557
95-9152 A		9 430 615 724	105095-9152	9 430 610 692	10X0.78X154-0.2R S	9 432 610 557

 Typ	 Ref.	 Zexel	 Ref.	 Typ	 Ref.
95-9160	9 430 615 725	105095-9160	9 430 610 693	0.4416.9A02.00 IN-1 1-10	9 432 610 552
95-9170		105095-9170		12X0.74X154	9 432 610 559
95-9170 A		105095-9170		10X0.82X154X0.2R	9 432 612 422
95-9170 B		105095-9170		10X0.82X154-R	9 432 610 563
95-9172 A	9 430 615 726	105095-9172	9 430 610 694	12X0.74X154	9 432 610 559
95-9172 B	9 430 615 726	105095-9172	9 430 610 696	10X0.82X154-R	9 432 610 563
95-9201 A	9 430 615 727	105095-9201	9 430 613 318	10X0.82X154-R	9 432 610 563
95-9201 D	9 430 615 727	105095-9201	9 430 610 702	10X0.76X77X0.2R	9 432 610 573
95-9202 A	9 430 615 728	105095-9202	9 430 610 699	10X0.82X154-R	9 432 610 563
95-9202 B	9 430 615 728	105095-9202	9 430 610 666	9-0.78-154	9 432 610 543
95-9202 C	9 430 615 728	105095-9202	9 430 610 675	9X0.85-154-0.2R A	9 432 610 548
95-9202 D	9 430 615 728	105095-9202	9 430 610 703	10X0.76X77X0.2R	9 432 610 573
95-9220 A	9 430 615 729	105095-9220	9 430 610 700	11X0.76X78X0.2R	9 432 610 570
95-9220 B	9 430 615 729	105095-9220	9 430 610 701	12X0.72X78X0.2R	9 432 610 572
95-9230 A	9 430 615 730	105095-9230	9 430 610 706	11X0.68X78-R B	9 432 610 576
95-9230 E	9 430 615 730	105095-9230	9 430 610 709	11X0.68X78-R-Z B	9 432 610 578
96-4000	9 430 615 731	105096-4000	9 430 610 713	60H-53-0.92X4X23X10.24.10	9 432 610 554
96-4010	9 430 615 732	105096-4010	9 430 610 714	0.8X4X23X10.20.10	9 432 610 556
96-6000	9 430 615 733	105096-6000	9 430 610 712	10-0.62-157	9 432 610 551
96-6010	9 430 615 734	105096-6010	9 430 610 715	10X0.62X152	9 432 610 558
96-6011	9 430 615 735	105096-6011	9 430 610 716	10X0.62X152	9 432 610 558
96-6020	9 430 615 736	105096-6020	9 430 610 717	10X0.62X152	9 432 610 560
96-6020 A	9 430 615 736	105096-6020	9 430 610 719	10X0.62X152-0.2RD	9 432 610 561
96-6021	9 430 615 737	105096-6021	9 430 610 718	10X0.62X152	9 432 610 560
96-6021 A	9 430 615 737	105096-6021	9 430 610 720	10X0.62X152-0.2RD	9 432 610 561
96-9001 A	9 430 615 738	105096-9001	9 430 610 721	10X0.82X81.5X0.45X65	9 432 610 565
96-9011 A	9 430 615 739	105096-9011	9 430 610 722	10X0.82X81.5X0.45X65	9 432 610 565
96-9021 B	9 430 615 740	105096-9021	9 430 610 723	10X0.835X81.5X0.50X66	9 432 610 566
96-9021 C	9 430 615 740	105096-9021	9 430 610 724	10X0.82X81.5X0.45X65	9 432 610 565
96-9030 C	9 430 615 474	105096-9030	9 430 610 725	14X0.86X81 A	9 432 610 569
96-9030 D	9 430 615 474	105096-9030	9 430 610 726	10X0.85X81.5X0.55X66 A	9 432 610 568
96-9040 A	9 430 615 741	105096-9040	9 430 610 727	14X0.82X81X0.2RAN	9 432 610 571
96-9040 B	9 430 615 741	105096-9040	9 430 610 728	14X0.79X81X0.2RA	9 432 610 575
C88-1090		105088-1090		NP-DN0PDN110	9 432 610 157
C88-1090		105088-1090		NP-DN0PDN110	9 432 610 157
H88-1120		105088-1120		NP-DN0PDN128	9 432 610 476
H88-1120		105088-1120		NP-DN0PDN128	9 432 610 476
L88-1120		105088-1120		NP-DN0PDN136	9 432 610 421
L88-1120		105088-1120		NP-DN0PDN136	9 432 610 421

A208

de

Verschleißteile
für die wichtigsten
1-Feder-Düsenhalter
Zexel

en

Wear parts for
the most important
single-spring nozzle-
holders
Zexel

fr

Pièces d'usure
pour les principaux
porte-injecteurs
à 1 ressort
Zexel

it

Pezzi soggetti
ad usura per i prin-
cipali portapolveriz-
zatori a 1 molla
Zexel

es

Piezas de desgaste
para los porta-
inyectores de
1 resorte más impor-
tantes
Zexel

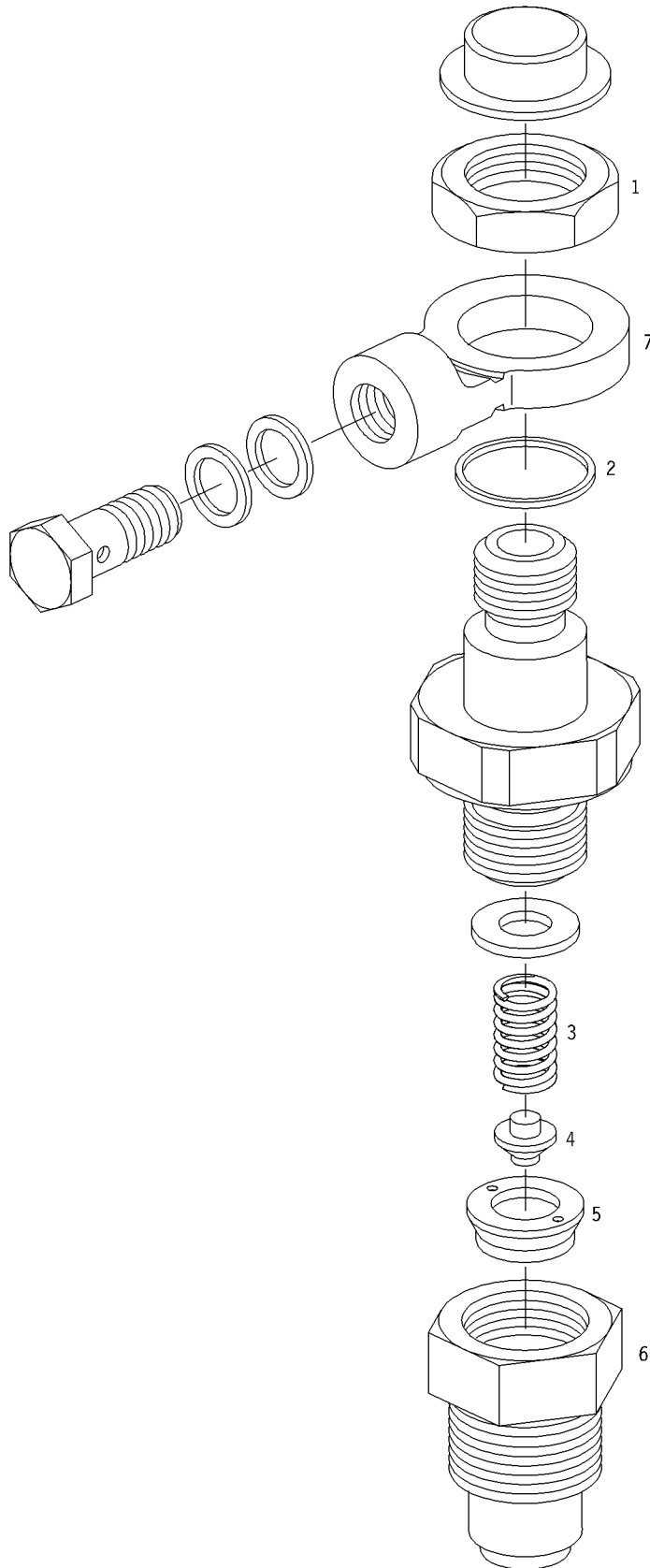

de

**Verschleißteile
für die wichtigsten
1-Feder-Düsenhalter
Zexel**

en

**Wear parts for
the most important
single-spring nozzle-
holders
Zexel**

fr











**Pièces d'usure
pour les principaux
porte-injecteurs
à 1 ressort
Zexel**

it

**Pezzi soggetti
ad usura per i prin-
cipali portapolveriz-
zatori a 1 molla
Zexel**

es









**Piezas de desgaste
para los porta-
inyectores de
1 resorte más impor-
tantes
Zexel**

										
	①	②	③	④	⑤	⑥	⑦	⑧		
30-3201	9 431 610 269	9 442 610 263	9 431 610 263	9 431 610 261		9 431 610 985	9 431 610 277	9 442 610 356		
31-1330	9 431 610 143	9 442 610 122	9 431 610 139	9 431 610 002		9 431 610 158	9 431 610 159	9 442 610 064		
31-1610	9 431 610 143	9 442 610 122	9 431 610 139	9 431 610 002		9 431 610 158	9 431 610 238	9 442 610 064		
31-2220	9 431 610 177	9 442 610 122	9 431 610 139	9 431 610 169		9 431 610 233	9 431 610 235	9 442 610 063		
31-2600	9 431 610 882	9 442 610 122	9 431 610 243	9 431 610 169		9 431 610 889	9 431 610 892	9 442 610 063		
31-3471	9 431 610 271	9 442 610 122	9 431 610 243	9 431 610 242		9 431 610 244	9 431 610 277	9 442 610 263		
31-3510	9 431 610 883	9 442 610 122	9 431 610 243	9 431 610 885		9 431 610 893	9 431 610 890			
31-3522	9 431 610 919	9 442 610 356	9 431 610 338	9 431 610 261		9 431 610 768	9 431 610 160	9 442 610 063		
31-3700	9 431 610 269	9 442 610 356	9 431 610 263	9 431 610 259		9 431 610 280	9 431 610 277	9 442 610 263		
31-3861	9 431 610 896	9 442 610 356	9 431 610 263	9 431 610 261		9 431 610 280	9 431 610 277	9 442 610 263		
31-3910	9 431 610 916	9 442 610 356	9 431 610 338	9 431 610 261		9 431 610 768	9 431 610 160	9 442 610 063		
31-3940	9 431 610 272		9 431 610 263	9 431 610 261		9 431 610 280	9 431 610 277	9 442 610 263		
31-4451	9 431 610 861	9 442 610 356	9 431 610 338	9 431 610 259		9 431 610 879	9 431 610 878	9 442 610 063		
31-4480	9 431 610 861	9 442 610 356	9 431 610 338	9 431 610 259		9 431 610 865				
31-4500	9 431 610 764	9 442 610 122	9 431 610 762	9 431 610 767		9 431 610 768	9 431 610 160	9 442 610 063		
31-4520	9 431 610 340	9 442 610 356	9 431 610 338	9 431 610 259		9 431 610 363	9 431 610 362	9 431 610 234		
31-4530	9 431 610 764	9 442 610 122	9 431 610 762	9 431 610 767		9 431 610 768	9 431 610 160	9 442 610 063		
31-4650	9 431 610 340	9 442 610 356	9 431 610 338	9 431 610 259		9 431 610 342	9 431 610 341	9 431 610 234		
31-5300	9 431 610 787	9 442 610 822	9 431 610 784	9 431 610 785		9 431 610 790	9 431 610 789	9 442 610 063		
41-1100	9 431 610 178	9 442 610 121	9 431 610 172	9 431 610 000	9 431 610 057	9 431 610 236	9 431 610 239	9 431 610 234		
41-1121			9 431 610 140	9 431 610 000	9 431 610 057	9 431 610 168	9 431 610 160	9 442 610 063		
41-7040			9 431 610 922	9 431 610 858	9 431 610 923	9 431 610 920	9 431 610 924	9 442 610 063		
48-2000			9 431 610 328	9 431 610 285	9 431 610 286	9 431 610 329	9 431 610 336	9 442 610 263		
48-2001			9 431 610 328	9 431 610 285	9 431 610 286	9 431 610 329	9 431 610 336	9 442 610 263		
48-2030	9 431 610 585	9 431 610 591	9 431 610 328	9 431 610 589	9 431 610 463	9 431 610 329	9 431 610 593	9 442 610 263		
48-2031	9 431 610 585	9 442 610 263	9 431 610 583	9 431 610 589	9 431 610 463	9 431 610 329	9 431 610 593	9 431 610 591		
48-2090	9 431 610 585	9 431 610 591	9 431 610 328	9 431 610 589	9 431 610 463	9 431 610 329	9 431 610 706	9 442 610 263		
48-2170	9 431 610 152	9 431 610 241	9 431 610 140	9 431 610 000	9 431 610 057					
48-3021			9 431 610 328	9 431 610 285	9 431 610 463	9 431 610 329				
48-3031			9 431 610 328	9 431 610 285	9 431 610 463	9 431 610 329				
48-3050			9 431 610 328	9 431 610 285	9 431 610 286	9 431 610 928	9 431 610 925			
48-3060			9 431 610 328	9 431 610 285	9 431 610 463	9 431 610 329				
48-3070			9 431 610 328	9 431 610 285	9 431 610 286	9 431 610 329				
48-3211			9 431 610 328	9 431 610 285	9 431 610 286	9 431 610 329				
48-3220			9 431 610 328	9 431 610 333	9 431 610 463	9 431 610 329				
48-3230			9 431 610 328	9 431 610 333	9 431 610 286	9 431 610 329				
48-3410			9 431 610 328	9 431 610 285	9 431 610 463	9 431 610 329				
48-3590			9 431 610 328	9 431 610 333	9 431 610 286	9 431 610 329				
48-3750			9 431 610 328	9 431 610 333	9 431 610 286	9 431 610 329				
48-5020			9 431 610 328	9 431 610 333	9 431 610 057	9 431 610 329	9 431 610 793	9 442 610 263		
71-0480	9 431 610 152	9 431 610 156	9 431 610 243	9 431 610 000	9 431 610 057	9 431 610 335	9 431 610 904			
71-0590	9 431 610 153		9 431 610 140	9 431 610 000	9 431 610 057	9 431 610 146				
71-0681	9 431 610 152	9 431 610 156	9 431 610 140	9 431 610 000	9 431 610 057	9 431 610 283				
71-0710	9 431 610 152		9 431 610 243	9 431 610 000	9 431 610 057	9 431 610 146				
71-1080	9 431 610 152		9 431 610 140	9 431 610 000	9 431 610 057	9 431 610 145	9 431 610 150			

A210

<p>de</p> <p>Verschleißteile für die wichtigsten 1-Feder-Düsenhalter Zexel (Fortsetzung)</p>	<p>en</p> <p>Wear parts for the most important single-spring nozzle-holders Zexel (continued)</p>	<p>fr</p> <p>Pièces d'usure pour les principaux porte-injecteurs à 1 ressort Zexel (suite)</p>	<p>it</p> <p>Pezzi soggetti ad usura per i principali portapolverizzatori a 1 molla Zexel (seguito)</p>	<p>es</p> <p>Piezas de desgaste para los portainyectores de 1 resorte más importantes Zexel (continuación)</p>
--	---	--	---	--



								
71-1240	9 431 610 152		9 431 610 140	9 431 610 000	9 431 610 057	9 431 610 145	9 431 610 904	
71-1241	9 431 610 152		9 431 610 140	9 431 610 000	9 431 610 057	9 431 610 146	9 431 610 904	
71-1271			9 431 610 140	9 431 610 000	9 431 610 057	9 431 610 146		
71-1280	9 431 610 152	9 431 610 241	9 431 610 004	9 431 610 000	9 431 610 057	9 431 610 279		
71-1300			9 431 610 140	9 431 610 000	9 431 610 057	9 431 610 145		
71-1361	9 431 610 152	9 431 610 156	9 431 610 140	9 431 610 000	9 431 610 057	9 431 610 240		
71-1380			9 431 610 140	9 431 610 000	9 431 610 057	9 431 610 334		
71-1500	9 431 610 152		9 431 610 140	9 431 610 000	9 431 610 057	9 431 610 594		
71-1530	9 431 610 152		9 431 610 140	9 431 610 000	9 431 610 057	9 431 610 146		
78-0001	9 431 610 152	9 431 610 358	9 431 610 141	9 431 610 138	9 431 610 058	9 431 610 451		
78-0010			9 431 610 141	9 431 610 138	9 431 610 058	9 431 610 164		
78-0030	9 431 610 153		9 431 610 141	9 431 610 138	9 431 610 058	9 431 610 337		
78-0050			9 431 610 141	9 431 610 138	9 431 610 058	9 431 610 337		
78-0070			9 431 610 141	9 431 610 138	9 431 610 346	9 431 610 349		
78-0080	9 431 610 152		9 431 610 141	9 431 610 138	9 431 610 058	9 431 610 164		
78-0100	9 431 610 152	9 431 610 241	9 431 610 140	9 431 610 000	9 431 610 057		9 431 610 150	
78-0110	9 431 610 152		9 431 610 141	9 431 610 138	9 431 610 346	9 431 610 349		
80-2080	9 431 610 152	9 431 610 241	9 431 610 140	9 431 610 000	9 431 610 057		9 431 610 150	
81-3081	9 431 610 165	9 442 610 122	9 431 610 783	9 431 610 003		9 431 610 157	9 431 610 167	9 431 610 148
81-3141	9 431 610 165	9 442 610 122	9 431 610 139	9 431 610 003		9 431 610 157	9 431 610 167	9 431 610 148
81-3171	9 431 610 165	9 442 610 122	9 431 610 231	9 431 610 003		9 431 610 157	9 431 610 161	9 431 610 148
81-3200	9 431 610 006	9 442 610 122	9 431 610 139	9 431 610 003		9 431 610 157	9 431 610 161	9 442 610 122
81-3210	9 431 610 270	9 442 610 356	9 431 610 264	9 431 610 260		9 431 610 281	9 431 610 161	9 431 610 148
81-3220	9 431 610 270	9 442 610 356	9 431 610 264	9 431 610 260		9 431 610 281	9 431 610 167	9 431 610 148
88-1051			9 431 610 141	9 431 610 138	9 431 610 343	9 431 610 345		
88-1061			9 431 610 141	9 431 610 138	9 431 610 343	9 431 610 345		
88-1090			9 431 610 141	9 431 610 138	9 431 610 769	9 431 610 770		
88-1100			9 431 610 141	9 431 610 138	9 431 610 769	9 431 610 770		
88-1130			9 431 610 141	9 431 610 138	9 431 610 346	9 431 610 770		
91-1140	9 431 610 178	9 442 610 121	9 431 610 172	9 431 610 000	9 431 610 057	9 431 610 236	9 431 610 237	9 442 610 063

de

Teile für
Zexel-Düsenhalter

en

Parts for
Zexel nozzle-holders

fr

Pièces pour
porte-injecteurs
Zexel

it

Ricambi per
portapolverizzatori
Zexel

es

Piezas para
portainyectoros
Zexel

Zwischenscheiben (ohne Spannstifte)
Shims (without locating pin)
Disques intermédiaires (sans goupilles élastiques)
Rosette intermedia (senza spine di serraggio)
Arandelas intermedias (sin pasadores de fijación)

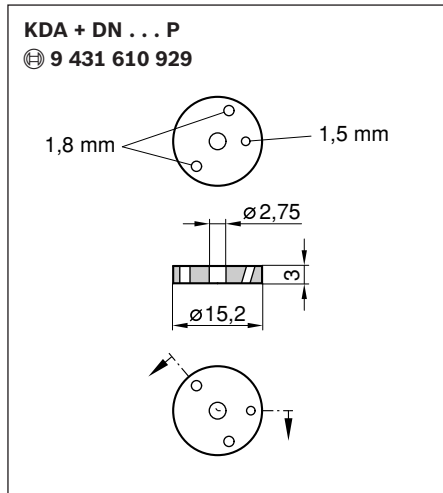
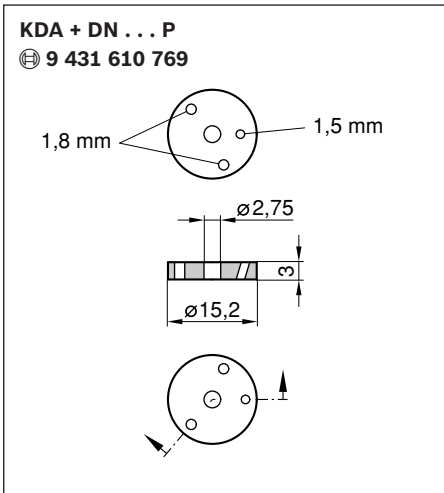
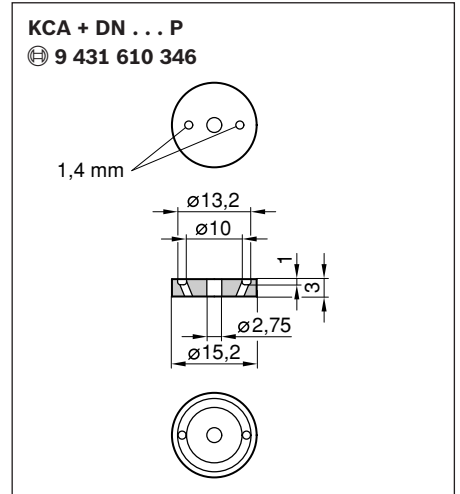
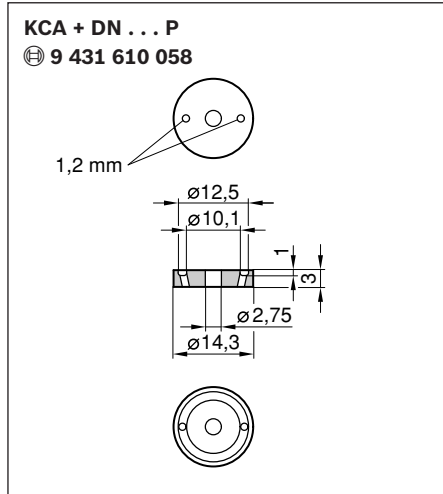
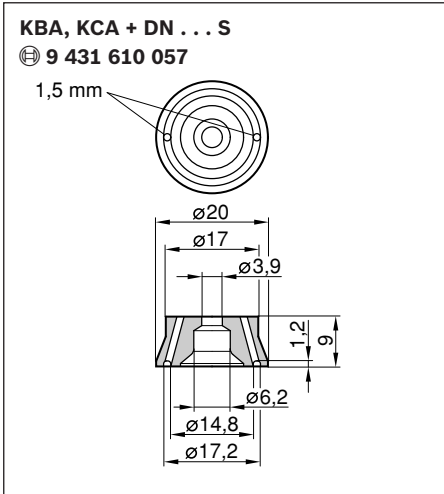

A212

de

**Teile für
Zexel-Düsenhalter**
(Fortsetzung)

en

**Parts for
Zexel nozzle-holders**
(continued)

fr

**Pièces pour
porte-injecteurs
Zexel**
(suite)

it

**Ricambi per
portapolverizzatori
Zexel**
(seguito)

es

**Piezas para
portainyectoros
Zexel**
(continuación)



Leckölddichtscheibe
Leak-fuel sealing disc
Joint pour huile de fuite
Rosetta di tenuta olio di trafilemento
Arandela estanqueizante de aceite de fugas

Druckbolzen
Pressure pin
Tige-poussoir
Perno di pressione
Perno de presión

Federteller
Spring seat
Cuvette de ressort
Piattello molla
Platillo elástico

KCA + DN . . . S
⊕ 9 431 610 156

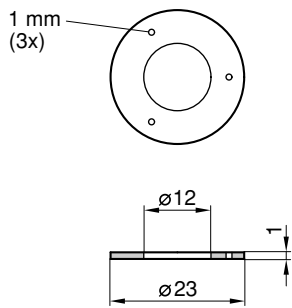

KBA, KCA + DN . . . S
⊕ 9 431 610 000

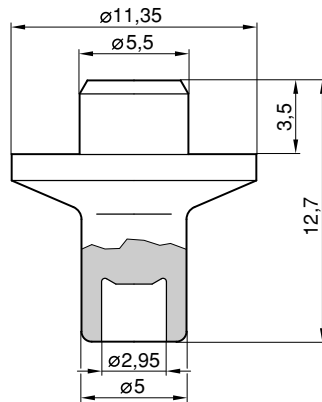

KCA + DN . . . P
⊕ 9 431 610 138

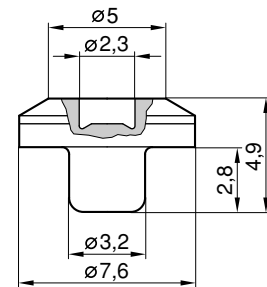

de

**Teile für
Zexel-Düsenhalter**
Druckausgleich-
scheiben*

en

**Parts for
Zexel nozzle-holders**
Pressure-compen-
sation discs*

fr

**Pièces pour
porte-injecteurs
Zexel**
Cales de réglage
de pression*

it

**Ricambi per
portapolverizzatori
Zexel**
Rosette di compen-
sazione della
pressione*

es

**Piezas para
portainyectoros
Zexel**
Arandelas de compen-
sación de presión*

**KCA-P**

① 7,7 mm, ③

0,10	9 431 610 245	150534-2600
0,20	9 431 610 246	150534-2700
0,30	9 431 610 247	150534-2800
0,40	9 431 610 248	150534-2900
0,50	9 431 610 249	150534-3000
0,52	9 431 610 250	150534-3100
0,54	9 431 610 251	150534-3200
0,56	9 431 610 252	150534-3300
0,58	9 431 610 253	150534-3400
0,80	9 431 610 254	150534-3500
1,00	9 431 610 113	150533-5000
1,02	9 431 610 115	150533-5200
1,04	9 431 610 117	150533-5400
1,06	9 431 610 119	150533-5600
1,08	9 431 610 121	150533-5800
1,10	9 431 610 123	150533-6000
1,12	9 431 610 125	150533-6200
1,14	9 431 610 127	150533-6400
1,16	9 431 610 129	150533-6600
1,18	9 431 610 131	150533-6800
1,20	9 431 610 133	150533-7000
1,22	9 431 610 135	150533-7200
1,24	9 431 610 137	150533-7400
1,26	9 431 610 180	150533-7600
1,28	9 431 610 182	150533-7800
1,30	9 431 610 184	150533-8000
1,32	9 431 610 186	150533-8200
1,34	9 431 610 188	150533-8400
1,36	9 431 610 190	150533-8600
1,38	9 431 610 192	150533-8800
1,40	9 431 610 194	150533-9000
1,42	9 431 610 196	150533-9200
1,44	9 431 610 198	150533-9400

1,48	9 431 610 202	150533-9800
1,50	9 431 610 204	150534-0000
1,52	9 431 610 206	150534-0200
1,54	9 431 610 208	150534-0400
1,56	9 431 610 210	150534-0600
1,58	9 431 610 212	150534-0800
1,60	9 431 610 214	150534-1000
1,62	9 431 610 216	150534-1200
1,64	9 431 610 218	150534-1400
1,66	9 431 610 220	150534-1600
1,68	9 431 610 222	150534-1800
1,70	9 431 610 224	150534-2000
1,72	9 431 610 226	150534-2200
1,74	9 431 610 228	150534-2400

KCA-S

① 11,5 mm, ② 4,5 mm

0,50	9 431 610 007	150523-5000
0,54	9 431 610 009	150523-5200
0,58	9 431 610 011	150523-5400
0,62	9 431 610 013	150523-5600
0,66	9 431 610 015	150523-5800
0,70	9 431 610 017	150523-6000
0,74	9 431 610 019	150523-6200
0,78	9 431 610 021	150523-6400
0,82	9 431 610 023	150523-6600
0,86	9 431 610 025	150523-6800
0,90	9 431 610 027	150523-7000
0,94	9 431 610 029	150523-7200
0,98	9 431 610 031	150523-7400
1,00	9 431 610 032	150523-7500

KDA-P

① 7,7 mm, ③

0,10	9 431 610 245	150534-2600
0,20	9 431 610 246	150534-2700
0,30	9 431 610 247	150534-2800
0,40	9 431 610 248	150534-2900
0,50	9 431 610 249	150534-3000
0,52	9 431 610 250	150534-3100
0,54	9 431 610 251	150534-3200
0,56	9 431 610 252	150534-3300
0,58	9 431 610 253	150534-3400
0,80	9 431 610 254	150534-3500
0,50	9 431 610 007	150523-5000
0,52	9 431 610 008	150523-5100
0,54	9 431 610 009	150523-5200
0,56	9 431 610 010	150523-5300
0,58	9 431 610 011	150523-5400
0,60	9 431 610 012	150523-5500
0,70	9 431 610 017	150523-6000
0,80	9 431 610 022	150523-6500
0,90	9 431 610 027	150523-7000
1,00	9 431 610 032	150523-7500
0,10	9 431 610 354	150532-6700
0,20	9 431 610 355	150532-6800
0,30	9 431 610 356	150532-6900
0,40	9 431 610 357	150532-7000

KBL2.1-S

① 11,5 mm, ② 4,5 mm

* Einbau zwischen Haltekörper des Düsenhalters und der Druckfeder.

Installed between nozzle-holder retainer and spring.

Montage entre le corps du porte-injecteur et le ressort de compression.

Montaggio tra corpo di fissaggio del portapolverizzatore e della molla di compressione.

Montaje entre le cuerpo de sujeción del portainyector y el resorte de compresión.

① Außen-Ø

① External dia.

① Ø ext.

① Diametro esterno

① Ø exterior

② Innen-Ø

② Internal dia.

② Ø int.

② Diametro interno

② Ø interior

③ innen ohne Loch

③ Internal without hole

③ int. sans trou

③ Interno senza foro

③ interior sin agujero

A214

de
Teile für
Zexel-Düsenhalter
 (Fortsetzung)
 Druckausgleichs-
 scheiben*

en
Parts for
Zexel nozzle-holders
 (continued)
 Pressure-compen-
 sation discs*

fr
Pièces pour
porte-injecteurs
Zexel
 (suite)
 Cales de réglage
 de pression*

it
Ricambi per
portapolverizzatori
Zexel
 (seguito)
 Rosette di compen-
 sazione della
 pressione*

es
Piezas para
portainyectoros
Zexel
 (continuación)
 Arandelas de compen-
 sación de presión*

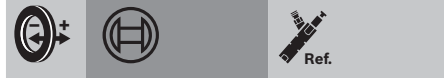

KBL2.1-P; KBDL2.1-P

① 7,2 mm, ② 3,6 mm

0,10	9 431 610 968	150591-1000
0,20	9 431 610 969	150591-2000
0,30	9 431 610 970	150591-3000

0,40	9 431 610 971	150591-4000
0,50	9 431 610 972	150591-5000
0,51	9 431 610 973	150591-5100
0,52	9 431 610 974	150591-5200
0,53	9 431 610 975	150591-5300

0,54	9 431 610 976	150591-5400
0,55	9 431 610 977	150591-5500
0,56	9 431 610 927	150591-5600
0,57	9 431 610 978	150591-5700
0,58	9 431 610 979	150591-5800

0,59	9 431 610 980	150591-5900
------	----------------------	-------------

KBL2.2-P; KBDL2.2-P

① 7,2 mm, ② 3,6 mm

0,10	9 431 610 968	150591-1000
0,20	9 431 610 969	150591-2000
0,30	9 431 610 970	150591-3000

0,40	9 431 610 971	150591-4000
0,50	9 431 610 972	150591-5000
0,51	9 431 610 973	150591-5100
0,52	9 431 610 974	150591-5200
0,53	9 431 610 975	150591-5300

0,54	9 431 610 976	150591-5400
0,55	9 431 610 977	150591-5500
0,56	9 431 610 927	150591-5600
0,57	9 431 610 978	150591-5700
0,58	9 431 610 979	150591-5800

0,59	9 431 610 980	150591-5900
------	----------------------	-------------

KBL2.3-S

① 9,5 mm, ② 4,5 mm

0,40	9 431 610 934	150538-4900
0,50	9 431 610 935	150538-5000
0,52	9 431 610 936	150538-5100



0,54	9 431 610 937	150538-5200
0,56	9 431 610 938	150538-5300
0,58	9 431 610 939	150538-5400
0,60	9 431 610 940	150538-5500
0,70	9 431 610 941	150538-5600

KBL2.4-P

① 6,2 mm, ② 2,6 mm

0,40	9 431 611 011	150538-9800
0,50	9 431 611 012	150538-9900
0,52	9 431 611 013	150539-0000

0,54	9 431 611 014	150539-0100
0,56	9 431 611 015	150539-0200
0,58	9 431 611 016	150539-0300
0,60	9 431 611 017	150539-0400
0,70	9 431 611 018	150539-0500

1,20	9 431 611 033	150539-0600
------	----------------------	-------------

KBL2.4-P

① 7,2 mm, ② 3,6 mm

0,10	9 431 610 968	150591-1000
0,20	9 431 610 969	150591-2000
0,30	9 431 610 970	150591-3000

0,40	9 431 610 971	150591-4000
0,50	9 431 610 972	150591-5000
0,51	9 431 610 973	150591-5100
0,52	9 431 610 974	150591-5200
0,53	9 431 610 975	150591-5300

0,54	9 431 610 976	150591-5400
0,55	9 431 610 977	150591-5500
0,56	9 431 610 927	150591-5600
0,57	9 431 610 978	150591-5700
0,58	9 431 610 979	150591-5800

0,59	9 431 610 980	150591-5900
------	----------------------	-------------

KBL2.4-S

① 8,9mm, ② 3,8 mm

0,40	9 431 611 274	150539-0700
0,50	9 431 611 275	150539-0800
0,52	9 431 611 276	150539-0900



0,54	9 431 611 277	150539-1000
0,56	9 431 611 278	150539-1100
0,58	9 431 611 279	150539-1200
0,60	9 430 615 316	150539-1300
0,70	9 431 611 280	150539-1400

KBL2.4-S

① 9,9 mm, ② 4,8 mm

0,40	9 431 611 313	150590-0600
0,50	9 431 611 314	150590-0700
0,52	9 431 611 315	150590-0800

0,54	9 431 611 316	150590-0900
0,56	9 431 611 317	150590-1000
0,58	9 431 611 318	150590-1100
0,60	9 431 611 319	150590-1200
0,70	9 431 611 320	150590-1300

KBL2.5-P

① 7,2 mm, ② 3,6 mm

0,10	9 431 610 968	150591-1000
0,20	9 431 610 969	150591-2000
0,30	9 431 610 970	150591-3000

0,40	9 431 610 971	150591-4000
0,50	9 431 610 972	150591-5000
0,51	9 431 610 973	150591-5100
0,52	9 431 610 974	150591-5200
0,53	9 431 610 975	150591-5300

0,54	9 431 610 976	150591-5400
0,55	9 431 610 977	150591-5500
0,56	9 431 610 927	150591-5600
0,57	9 431 610 978	150591-5700
0,58	9 431 610 979	150591-5800

0,59	9 431 610 980	150591-5900
------	----------------------	-------------

KBL2.5-P

① 8,9 mm, ② 4,4 mm

0,50	9 431 612 106	150594-0000
0,52	9 431 612 107	150594-0100
0,54	9 431 612 108	150594-0200

0,56	9 431 612 109	150594-0300
0,58	9 431 612 110	150594-0400
0,60	9 431 612 111	150594-0500
0,62	9 431 612 112	150594-0600
0,64	9 431 612 113	150594-0700



0,66	9 431 612 114	150594-0800
0,68	9 431 612 115	150594-0900
0,70	9 431 612 116	150594-1000
0,72	9 431 612 117	150594-1100
0,74	9 431 612 118	150594-1200
<hr/>		
0,76	9 431 612 119	150594-1300
0,78	9 431 612 120	150594-1400
0,80	9 431 612 121	150594-1500
0,82	9 431 612 122	150594-1600
0,84	9 431 612 123	150594-1700
<hr/>		
0,86	9 431 612 124	150594-1800
0,88	9 431 612 125	150594-1900
0,90	9 431 612 126	150594-2000
0,92	9 431 612 127	150594-2100
0,94	9 431 612 128	150594-2200
<hr/>		
0,96	9 431 612 129	150594-2300
0,98	9 431 612 130	150594-2400
1,00	9 431 612 131	150594-2500
1,02	9 431 612 132	150594-2600
1,04	9 431 612 133	150594-2700
<hr/>		
1,06	9 431 612 134	150594-2800
1,08	9 431 612 135	150594-2900
1,12	9 431 612 136	150594-3100
1,14	9 431 612 137	150594-3200
1,16	9 431 612 138	150594-3300
<hr/>		
1,18	9 431 612 139	150594-3400
1,20	9 431 612 140	150594-3500
1,22	9 431 612 141	150594-3600
1,24	9 431 612 142	150594-3700
1,26	9 431 612 143	150594-3800
<hr/>		
1,28	9 431 612 144	150594-3900
1,30	9 431 612 145	150594-4000
1,32	9 431 612 146	150594-4100
1,34	9 431 612 147	150594-4200
1,36	9 431 612 148	150594-4300



1,38	9 431 612 149	150594-4400
1,40	9 431 612 150	150594-4500
1,42	9 431 612 151	150594-4600
1,44	9 431 612 152	150594-4700
1,46	9 431 612 153	150594-4800
<hr/>		
1,48	9 431 612 154	150594-4900
1,50	9 431 612 155	150594-5000
1,52	9 431 612 156	150594-5100
1,54	9 431 612 157	150594-5200
1,56	9 431 612 158	150594-5300
<hr/>		
1,58	9 431 612 159	150594-5400
1,60	9 431 612 160	150594-5500
1,62	9 431 612 161	150594-5600
1,64	9 431 612 162	150594-5700
1,66	9 431 612 163	150594-5800
<hr/>		
1,68	9 431 612 164	150594-5900
1,70	9 431 612 165	150594-6000
1,72	9 431 612 166	150594-6100
1,74	9 431 612 167	150594-6200
1,76	9 431 612 168	150594-6300
<hr/>		
1,78	9 431 612 169	150594-6400
1,80	9 431 612 170	150594-6500
1,82	9 431 612 171	150594-6600
1,84	9 431 612 172	150594-6700
1,86	9 431 612 173	150594-6800
<hr/>		
1,88	9 431 612 174	150594-6900
1,90	9 431 612 175	150594-7000
1,92	9 431 612 176	150594-7100
1,94	9 431 612 177	150594-7200
1,96	9 431 612 178	150594-7300
<hr/>		
1,98	9 431 612 179	150594-7400

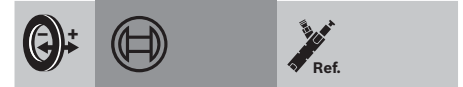

KBAL-P		
① 7,2 mm, ② 3,6 mm		
0,10	9 431 610 968	150591-1000
0,20	9 431 610 969	150591-2000
0,30	9 431 610 970	150591-3000
<hr/>		
0,40	9 431 610 971	150591-4000
0,50	9 431 610 972	150591-5000
0,51	9 431 610 973	150591-5100
0,52	9 431 610 974	150591-5200
0,53	9 431 610 975	150591-5300
<hr/>		
0,54	9 431 610 976	150591-5400
0,55	9 431 610 977	150591-5500
0,56	9 431 610 927	150591-5600
0,57	9 431 610 978	150591-5700
0,58	9 431 610 979	150591-5800
<hr/>		
0,59	9 431 610 980	150591-5900
<hr/>		
KBALS		
① 9,9 mm, ② 4,8 mm		
0,40	9 431 611 313	150590-0600
0,50	9 431 611 314	150590-0700
0,52	9 431 611 315	150590-0800
<hr/>		
0,54	9 431 611 316	150590-0900
0,56	9 431 611 317	150590-1000
0,58	9 431 611 318	150590-1100
0,60	9 431 611 319	150590-1200
0,70	9 431 611 320	150590-1300
<hr/>		
KBDL-P		
① 7,2 mm, ② 3,6 mm		
0,10	9 431 610 968	150591-1000
0,20	9 431 610 969	150591-2000
0,30	9 431 610 970	150591-3000



* Einbau zwischen Haltekörper des Düsenhalters und der Druckfeder.
 Installed between nozzle-holder retainer and spring.
 Montage entre le corps du porte-injecteur et le ressort de compression.
 Montaggio tra corpo di fissaggio del portapolverizzatore e della molla di compressione.
 Montaje entre el cuerpo de sujeción del portainyector y el resorte de compresión.

① Außen-Ø
 ② Innen-Ø
 ③ innen ohne Loch

① External dia.
 ② Internal dia.
 ③ Internal without hole

① Ø ext.
 ② Ø int.
 ③ int. sans trou

① Diametro esterno
 ② Diametro interno
 ③ Interno senza foro

① Ø exterior
 ② Ø interior
 ③ interior sin agujero

de

Wärmeschutz-
scheiben

en

Thermal-protection
discs

fr







Rondelles
calorifuges

it

Rosette di
isolamento termico

es







Arandelas de protec-
ción antitérmica







						
9 430 610 161	Opel, Vauxhall	9 430 615 096	88-1120	9 432 610 271	DN 0 PDN 124	9 431 610 358
9 430 610 140	Opel, Vauxhall	9 430 615 102	0150	9 432 610 281	DN 0 PDN 127	9 431 610 358
9 430 610 128	Opel, Vauxhall	9 430 615 062	A88-1090	9 432 610 237	DN 0 PDN 122	9 431 610 358
9 430 610 136	Opel, Vauxhall	9 430 615 062	88-1090	9 432 610 074	DN 0 PDN 108	9 431 610 358
9 430 610 033	Nissan	9 430 615 031	71-A0681	9 432 610 023	DN 0 SDN 187	9 431 610 358
9 430 610 037	Nissan	9 430 615 031	71-B0681	9 432 610 023	DN 0 SDN 187	9 431 610 282
9 430 610 029	Nissan	9 430 615 018	71-S1361	9 432 610 004	DN 0 SD 193 NP 1	9 431 610 276



A218







de	en	fr	it	es
Typformel Düsenhalter → Typformel Düse → DHK	Type designation nozzle holder → Type designation nozzle → Nozzle-and-holder assemblies	Formule de type principaux porte-injecteurs → Formule de type injecteur → Ensembles porte-injecteurs	Sigla polverizzatori → Sigla portapolverizzatori → Sigla combinazione portapolverizzatori	Designación de tipo portainyectoros → Designación de tipo inyectoros → Conjuntos portainyectoros

						
		DLLA 151 P 582	295-303		0 432 131 746	
HB-KBL 80 S 192/4		HB-DLLA 150 S 719			9 430 032 153	
HB-KCA 17 S 38/4		HB-DN 0 SD 287			9 430 032 266	
HB-KDAL 74 S 3/19		HB-DLLA 142 S 1142			9 430 032 264	
KB 107 SA 581/13		DN 0 SD 2110	135-143		0 432 287 035	
KB 107 SA 581/13		DN 4 SD 24	140-148		0 432 287 036	
KB 125 TA 818/13		DL 155 T 1112	245-253		0 432 380 005	
KB 125 TA 818/13		DL 155 T 271	240-248		0 432 380 004	
KB 125 TA 836/13		DL 155 T 271	295-303		0 432 380 006	
KB 125 TA 839/13		DL 155 T 1112			0 432 380 009	
KB 125 TA 840/13		DL 155 T 1188	245-253		0 432 380 011	
KB 125 TA 840/13		DL 155 T 1193			0 432 380 012	
KB 125 TA 840/13		DL 155 T 271			0 432 380 010	
KB 125 TA 840/13		DL 165 T 1211			0 432 380 015	
KB 175 T 845/13		DL 145 T 1201			0 432 380 014	
KB 175 T 845/13		DL 145 T 1205			0 432 380 013	
KB 175 T 852		DL 145 T 1201			0 432 380 016	
KB 175 T 852		DL 145 T 1205			0 432 380 017	
KB 175 TA 838/13		DL 145 T 1121	300-308		0 432 380 008	
KB 175 TA 838/13		DL 145 T 1169	300-308		0 432 380 007	
KB 178 U 906		DLLC 144 U 7	380-388		0 432 480 002	
KB 35 S 565/4		DN 0 SD 189	115-120		0 432 287 024	
KB 35 S 565/4		DN 0 SD 193	140-148		0 432 287 031	
KB 35 S 565/4		DN 0 SD 230	130-138		0 432 287 047	
KB 35 S 619/13		DNA 0 SD 178	135-143		0 432 287 051	
KB 35 S 635		DN 4 SD 187	180-188		0 432 287 050	
KB 35 SA 253/13		DN 15 S 156	160-168		0 432 286 014	
KB 35 SA 485/13		DN 4 SD 140			0 432 287 002	
KB 35 SA 485/13		DN 4 SD 20			0 432 287 001	
KB 35 SA 524/4		DN 8 S 3	85-93		0 432 286 008	
KB 35 SA 542/4		DN 4 SD 20			0 432 287 004	
KB 35 SA 600/4		TR-DN 8 S 229	210-218		0 432 286 018	
KB 35 SD 535/4		DN 0 SD 210	120-128		0 432 287 005	
KB 35 SD 571/4		DN 0 SD 189	115-120		0 432 287 028	
KB 35 SD 571/4		DN 0 SD 211	180-188		0 432 287 034	
KB 35 SD 593/4		DN 0 SD 228	120-128		0 432 287 041	
KB 35 SD 593/4		DN 0 SD 230	120-128		0 432 287 042	
KB 37 SA 590/4		DN 0 SD 193	145-153		0 432 287 045	
KB 37 SA 590/4		DN 0 SD 1930	145-153		0 432 287 049	
KB 37 SA 590/4		DN 0 SD 21	145-153		0 432 287 038	
KB 40 S 643		DN 0 SD 126	125-133		0 432 287 052	
KB 40 SD 533/4		DN 0 SD 126	125-133		0 432 287 007	
KB 40 SD 533/4		DN 4 SD 169	125-133		0 432 287 008	
KB 40 SD 533/4		DN 4 SD 169	150-158		0 432 287 020	
KB 47 SA 539/4		DN 4 S 162	115-120		0 432 286 005	

 Typ	 Typ	 1st/bar	 2nd/bar	 Ref.		
KB 50 S 592/13	DN 0 SD 189	130–138		0 432 287 039		
KB 50 S 621/13	DN 0 SD 189	130–138		0 432 287 048		
KB 50 SA 564/4	DL 50 S 1082	185–193		0 432 280 006		
KB 50 TA 448/13	DN 6 T 4			0 432 386 001		
KB 55 SA 566/4	DL 125 T 1091	200–208		9 430 082 211		
KB 65 SA 442	DN 4 SD 24	140–148		0 432 287 023		
KB 65 SDA 456/13	DN 0 SD 21	137–145		0 432 287 026		
KB 80 SA 390/4	DN 0 SD 137			0 432 287 011		
KB 80 TA 312/4	DN 6 T 49	150–158		0 432 386 002		
KB 95 SA 485/13	DN 0 SD 2110	140–148		0 432 287 021		
KB 95 SA 485/13	DN 0 SD 2110	125–133		0 432 287 022		
KB 95 SA 485/13	DN 0 SD 2110	135–143		0 432 287 027		
KB 95 SA 485/13	DN 4 SD 24			0 432 287 016		
KBA 137 U 5	DLZ 150 U 1227			0 432 490 002		
KBA 137 U 5	DLZ 150 U 1233			0 432 490 003		
KBA 142 T 18	DL 155 T 1175			0 432 390 016		
KBA 142 T 18	DL 155 T 1236			0 432 390 019		
KBA 142 T 7/13	DL 155 T 1243			0 432 390 021		
KBA 142 T 7/13	DL 155 T 1248			0 432 390 023		
KBA 142 T 7/13	DL 150 T 1164	280–288		0 432 390 002		
KBA 142 T 7/13	DL 150 T 1208			0 432 390 007		
KBA 142 T 7/13	DL 155 T 1171			0 432 390 003		
KBA 142 T 7/13	DL 155 T 1175			0 432 390 004		
KBA 142 T 7/13	DL 155 T 1228			0 432 390 015		
KBA 142 T 7/13	DL 155 T 1229			0 432 390 017		
KBA 142 T 8/4	HB-DL 130 T 1179			9 430 032 141		
KBA 208 T 14	DL 150 T 1210			0 432 390 010		
KBA 38 S 1/13	DN 0 SD 21			0 432 297 001		
KBA 38 S 1/13	DN 0 SD 21			0 432 297 002		
KBA 38 S 1/13	DN 0 SD 21	135–143		0 432 297 011		
KBA 38 S 1/13	DN 0 SD 211	100–108		0 432 297 025		
KBA 38 S 1/13	DN 12 SD 12			0 432 297 004		
KBA 38 S 1/13	DN 15 S 156			0 432 296 001		
KBA 38 S 1/13	DN 4 SD 128			0 432 297 003		
KBA 38 S 16/13	DN 0 SD 211	150–158		0 432 297 013		
KBA 38 S 16/13	DN 8 S 129	125–133		0 432 296 004		
KBA 38 S 36/4	DN 10 S 242	110–118		0 432 296 011		
KBA 38 S 36/4	DN 15 S 156	110–118		0 432 296 009		
KBA 38 SD 22/4	DN 0 SD 21			0 432 297 007		
KBA 38 SD 22/4	DN 15 S 156			0 432 296 002		
KBA 38 SD 22/4	DN 15 S 156	110–118		0 432 296 005		
KBA 38 SD 25/4	DN 0 SD 21	135–143		0 432 297 016		
KBA 38 SD 25/4	DN 0 SD 21	110–118		0 432 297 023		
KBA 38 SD 25/4	DN 10 S 242	150–158		0 432 296 010		
KBA 38 SD 25/4	DN 15 S 156	110–118		0 432 296 007		

A220

de	en	fr	it	es
Typformel Düsenhalter → Typformel Düse → DHK (Fortsetzung)	Type designation nozzle holder → Type designation nozzle → Nozzle-and-holder assemblies (continued)	Formule de type principaux porte-injecteurs → Formule de type injecteur → Ensembles porte-injecteurs (suite)	Sigla polverizzatori → Sigla portapolverizzatori → Sigla combinazione portapolverizzatori (seguito)	Designación de tipo portainyectoros → Designación de tipo inyectoros → Conjuntos portainyectoros (continuación)

					
KBA 42 S 37	DN 0 SD 21	135-143		0 432 297 043	
KBA 42 SD 30/4	DN 0 SD 21	135-143		0 432 297 022	
KBA 42 SD 32/4	DN 0 SD 21	135-143		0 432 297 026	
KBA 42 SD 33/4	DN 0 SD 21	145-153		0 432 297 028	
KBA 43 S 21/4	DN 0 SD 21			0 432 297 008	
KBA 50 SD 26/4	DN 0 SD 21	135-143		0 432 297 017	
KBA 50 SD 26/4	DN 0 SD 21	110-118		0 432 297 024	
KBA 50 SD 28/4	DN 0 SD 21	135-143		0 432 297 019	
KBA 50 SD 28/4	DN 0 SD 21	110-118		0 432 297 027	
KBA 55 S 9/13	DN 0 SD 21	135-143		0 432 297 012	
KBA 55 S 9/13	DN 12 SD 12	150-158		0 432 297 014	
KBA 86 S 34/13	DN 0 SD 137	140-148		0 432 297 029	
KBAF 157 T 1	DLLF 150 T 18			0 432 392 005	
KBAF 157 T 3	DLLF 150 T 12			0 432 392 001	
KBAF 262 T 2	DLLF 156 T 14			0 432 392 002	
KBAF 262 T 2	DLLF 156 T 16			0 432 392 003	
KBAF 262 T 2	DLLF 156 T 17	300-308		0 432 392 004	
KBAF 262 T 2	DLLF 156 T 19	300-308		0 432 392 006	
KBAF 262 T 2	DLLF 156 T 23			0 432 392 007	
KBAL 100 S 24/4	DLLA 150 S 138	205-213		0 432 291 814	
KBAL 100 S 24/4	DLLA 150 S 138	175-183		0 432 291 862	
KBAL 100 S 24/4	DLLA 150 S 140	155-163		0 432 291 830	
KBAL 100 S 24/4	DLLA 150 S 178	175-183		0 432 291 825	
KBAL 100 S 24/4	DLLA 150 S 633	180-188		0 432 291 818	
KBAL 100 S 24/4	DLLA 150 S 748	275-283		0 432 291 763	
KBAL 100 S 33/4	DLL 150 S 606	180-188		0 432 291 033	
KBAL 100 S 52	DLLA 144 S 842	230-238		0 432 291 718	0 986 430 141
KBAL 100 S 52	DLLA 144 S 992	230-238		0 432 291 661	0 986 430 203
KBAL 100 S 52	DLLA 149 S 1209	230-238		0 432 291 558	0 986 430 337
KBAL 100 S 52	DLLA 149 S 1225	220-228		0 432 291 548	
KBAL 100 S 52	DLLA 154 S 1086	230-238		0 432 291 621	0 986 430 338
KBAL 100 S 52	DLLA 154 S 1088	230-238		0 432 291 618	
KBAL 100 S 52	DLLA 154 S 970	230-238		0 432 291 672	0 986 430 336
KBAL 100 S 52	DLLA 155 S 835	230-238		0 432 291 710	0 986 430 333
KBAL 100 S 52	DLLA 155 S 835	220-228		0 432 292 884	
KBAL 100 S 77	DLLA 149 S 1207	260-268		0 432 291 557	
KBAL 100 S 77	DLLA 149 S 1209	250-258		0 432 291 551	
KBAL 100 SC 2/13	DLL 25 S 444	230-238		0 432 291 010	
KBAL 101 P 67	DLLA 147 P 658	255-269		0 432 191 582	
KBAL 101 P 67	DLLA 147 P 854	255-269		0 432 191 487	
KBAL 101 P 67	DLLA 147 P 875	255-269		0 432 191 479	
KBAL 101 P 67	DLLA 147 P 884	255-269		0 432 191 471	
KBAL 101 P 67	DSLA 147 P 786	255-269	301-315	0 432 193 654	
KBAL 101 P 67	DSLA 147 P 814	255-269		0 432 193 642	
KBAL 103 S 24/4	DLLA 150 S 140	205-213		0 432 291 751	















KBAL 103 S 24/4	DLLA 150 S 204	205-213		0 432 291 797	
KBAL 103 S 24/4	DLLA 150 S 204	175-183		0 432 291 854	
KBAL 103 S 24/4	DLLA 150 S 583	200-208		0 432 291 795	
KBAL 103 S 24/4	DLLA 150 S 583	155-163		0 432 291 837	
KBAL 103 S 24/4	DLLA 150 S 633	205-213		0 432 291 766	
KBAL 103 S 24/4	DLLA 150 S 720	180-188		0 432 291 785	
KBAL 103 S 24/4	DLLA 150 S 720	155-163		0 432 291 855	
KBAL 104 P 134	DLLA 145 P 1240	180-188		0 432 191 322	
KBAL 104 P 134	DLLA 150 P 1351	180-188		0 432 191 295	
KBAL 104 P 134	DLLA 150 P 1352	180-188		0 432 191 294	
KBAL 105 P 18	DLLA 150 P 155			9 430 082 715	
KBAL 105 P 18	DLLA 150 P 115	205-219		0 432 191 812	
KBAL 105 P 18	DLLA 150 P 130	205-219		0 432 191 799	
KBAL 105 P 18	DLLA 150 P 133	205-219		0 432 191 796	
KBAL 105 P 18	DLLA 150 P 213	300-314		0 432 191 756	
KBAL 105 P 18	DLLA 150 P 216	205-213		0 432 191 754	
KBAL 105 P 18	DLLA 155 P 125	205-219		0 432 191 804	
KBAL 105 P 18	DLLA 155 P 135	205-219		0 432 191 794	
KBAL 105 P 27	DLLA 150 P 242	300-308		0 432 191 744	
KBAL 105 P 29	DLLA 140 P 1144	300-314		0 432 191 341	
KBAL 105 P 29	DLLA 140 P 1144	300-314		0 432 191 354	
KBAL 105 P 29	DLLA 140 P 1179	300-314		0 432 191 343	
KBAL 105 P 29	DLLA 140 P 1181	300-314		0 432 191 338	
KBAL 105 P 29	DLLA 140 P 1181	300-314		0 432 191 342	
KBAL 105 P 29	DLLA 140 P 1199	300-314		0 432 191 335	
KBAL 105 P 29	DLLA 140 P 1294	260-274		0 432 191 314	
KBAL 105 P 29	DLLA 140 P 1340	300-314		0 432 191 300	
KBAL 105 P 29	DLLA 140 P 1341	300-314		0 432 191 299	
KBAL 105 P 29	DLLA 140 P 1342	300-314		0 432 191 298	
KBAL 105 P 29	DLLA 140 P 1343	300-314		0 432 191 297	
KBAL 105 P 29	DLLA 140 P 257	300-314		0 432 191 740	
KBAL 105 P 29	DLLA 140 P 290	300-314		0 432 191 735	
KBAL 105 P 29	DLLA 140 P 351	245-259		0 432 191 707	
KBAL 105 P 29	DLLA 140 P 399	300-314		0 432 191 682	
KBAL 105 P 29	DLLA 140 P 483	300-314		0 432 191 642	
KBAL 105 P 29	DLLA 140 P 517	300-314		0 432 191 629	
KBAL 105 P 29	DLLA 140 P 518	300-314		0 432 191 628	
KBAL 105 P 29	DLLA 140 P 637	300-314		0 432 191 588	
KBAL 105 P 29	DLLA 150 P 242	300-314		0 432 191 718	
KBAL 105 P 29	DLLA 150 P 409	205-219		0 432 191 720	
KBAL 105 P 29	DLLA 150 P 497	300-308		0 432 191 636	
KBAL 105 P 29	DLLA 150 P 585	260-274		0 432 191 595	
KBAL 105 P 29	DLLA 155 P 270	300-314		0 432 191 531	
KBAL 105 P 29	DLLA 155 P 270	300-314		0 432 191 632	
KBAL 105 P 29	DLLA 155 P 270	205-219		0 432 191 738	

A222

de	en	fr	it	es
Typformel Düsenhalter → Typformel Düse → DHK (Fortsetzung)	Type designation nozzle holder → Type designation nozzle → Nozzle-and-holder assemblies (continued)	Formule de type principaux porte-injecteurs → Formule de type injecteur → Ensembles porte-injecteurs (suite)	Sigla polverizzatori → Sigla portapolverizzatori → Sigla combinazione portapolverizzatori (seguito)	Designación de tipo portainyectores → Designación de tipo inyectores → Conjuntos portainyectores (continuación)









 Typ	 Typ	 1st/bar	 2nd/bar	 Ref.	
KBAL 105 P 29	DLLA 155 P 534	210-220		0 432 191 619	
KBAL 105 P 29	DLLA 155 P 614	300-314		0 432 191 594	
KBAL 105 P 29	DLLA 155 P 670	300-314		0 432 191 576	
KBAL 105 P 30	DLLA 155 P 282			9 430 082 743	
KBAL 105 P 40	DLLA 140 P 384	300-314		0 432 191 690	
KBAL 105 P 51	DLLA 140 P 384	300-314		0 432 191 643	
KBAL 105 P 51	DLLA 140 P 483	300-308		0 432 191 637	
KBAL 105 P 51	DLLA 140 P 629	300-314		0 432 191 592	
KBAL 105 P 51	DLLA 150 P 679	260-274		0 432 191 569	
KBAL 105 P 51	DLLA 155 P 1078	260-274		0 432 191 383	
KBAL 105 P 51	DLLA 155 P 1108	260-274		0 432 191 365	
KBAL 105 P 51	DLLA 155 P 1138	260-274		0 432 191 356	
KBAL 105 P 51	DLLA 155 P 1152	260-274		0 432 191 352	
KBAL 105 P 51	DSLA 140 P 1361	300-314		0 432 193 485	
KBAL 105 P 62	DLLA 150 P 585	260-274		0 432 191 601	
KBAL 107 S 10/4	DLLA 150 S 523	200-208		0 432 291 858	
KBAL 107 S 10/4	DLLA 160 S 397	175-183		0 432 291 881	
KBAL 107 S 23/4	DLLA 160 S 397	200-208		0 432 291 843	
KBAL 107 S 23/4	DLLA 160 S 397	200-208		0 432 291 861	
KBAL 107 S 23/4	DLLA 160 S 575	200-208		0 432 291 844	
KBAL 107 S 9/13	DLLA 150 S 506	180-188		0 432 291 865	
KBAL 107 S 9/13	DLLA 156 S 822	250-258		0 432 291 728	
KBAL 107 S 9/4	DLLA 150 S 392	200-208		0 432 291 883	
KBAL 107 S 9/4	DLLA 150 S 515	190-198		0 432 291 859	
KBAL 107 S 9/4	DLLA 160 S 397	200-208		0 432 291 874	
KBAL 107 S 9/4	DLLA 160 S 397	180-188		0 432 291 879	
KBAL 112 S 28/4	DLLA 150 S 138	200-208		0 432 291 828	
KBAL 112 S 28/4	DLLA 150 S 140	155-163		0 432 291 826	
KBAL 112 S 28/4	DLLA 150 S 178	175-183		0 432 291 853	
KBAL 112 S 28/4	DLLA 150 S 204	195-203		0 432 291 768	
KBAL 112 S 28/4	DLLA 150 S 582	195-203		0 432 291 777	
KBAL 112 S 35/4	DLLA 150 S 178	180-188		0 432 291 804	
KBAL 112 S 35/4	DLLA 150 S 748	245-253		0 432 291 727	
KBAL 112 S 45/4	DLLA 150 S 762	245-253		0 432 291 760	
KBAL 112 S 50/13	DLL 150 S 805	240-248		0 432 291 039	
KBAL 112 S 69	DLL 150 S 805	240-248		0 432 291 044	
KBAL 115 P 108	DSLA 141 P 991	211-219		0 432 193 556	
KBAL 115 P 109	DSLA 141 P 991	211-223	341-357	0 432 193 555	
KBAL 115 P 71	DSLA 157 P 687	270-284		0 432 193 699	
KBAL 115 P 95	DSLA 145 P 835	211-223	341-357	0 432 193 628	
KBAL 115 P 95	DSLA 157 P 1241	211-223	341-357	0 432 193 513	
KBAL 115 P 96	DSLA 145 P 835	211-223	341-357	0 432 193 627	
KBAL 115 P 96	DSLA 157 P 1241	211-223	341-357	0 432 193 514	
KBAL 116 P 146	DLLA 152 P 1513	296-302		0 432 191 244	
KBAL 116 S 095	DLLA 146 S 1378	235-259		0 432 291 496	







 Typ	 Typ	 1st/bar	 2nd/bar	 Ref.	
KBAL 116 S 66	DLLA 140 S 1054	265-273		0 432 291 635	0 986 430 169
KBAL 116 S 66	DLLA 140 S 1140	265-273		0 432 291 594	
KBAL 116 S 75	DLLA 146 S 1310	240-248		0 432 291 513	
KBAL 116 S 75	DLLA 148 S 1204	240-248		0 432 291 562	
KBAL 116 S 75	DLLA 148 S 1263	265-273		0 432 291 531	
KBAL 116 S 75	DLLA 148 S 1272	240-248		0 432 291 534	0 986 430 301
KBAL 116 S 75	DLLA 148 S 1298	290-298		0 432 291 517	
KBAL 117 S 46/4	DLLA 150 S 762	230-238		0 432 291 759	
KBAL 118 S 12/4	DLL 153 S 529	250-258		0 432 291 024	
KBAL 118 S 12/4	DLL 159 S 411	245-253		0 432 291 006	
KBAL 122 S 70	DLLA 140 S 1100	240-248		0 432 292 870	
KBAL 122 S 70	DLLA 140 S 1109	240-248		0 432 292 869	
KBAL 122 S 70	DLLA 140 S 1110	240-252		0 432 292 868	
KBAL 125 S 38/4	DLLA 165 S 712	200-208		0 432 291 783	
KBAL 125 S 38/4	DLLA 165 S 727	230-238		0 432 291 770	
KBAL 125 S 60	DLLA 165 S 1051			0 432 291 636	
KBAL 125 S 60	DLLA 165 S 712	200-208		0 432 291 601	
KBAL 125 S 60	DLLA 165 S 712	245-253		0 432 291 666	
KBAL 125 S 60	DLLA 165 S 727	245-253		0 432 291 673	
KBAL 125 S 72	DLLA 155 S 1202	250-258		0 432 291 563	
KBAL 125 S 72	DLLA 155 S 1223	250-258		0 432 291 550	
KBAL 125 S 72	DLLA 156 S 1123	250-258		0 432 291 599	
KBAL 125 S 83	DLLA 160 S 1241	250-258		0 432 291 539	
KBAL 127 S 34	DLLA 145 S 1330	250-258		0 432 231 655	
KBAL 135 S 26/4	DLL 160 S 721	220-228		0 432 291 036	
KBAL 135 S 58	DLL 150 S 997	240-248		0 432 291 041	
KBAL 135 S 58	DLL 155 S 942	240-248		0 432 291 040	
KBAL 137 P 14	DLLA 148 P 229	250-264		0 432 191 750	
KBAL 137 P 14	DLLA 155 P 111	300-308		0 432 191 814	
KBAL 137 P 14	DLLA 155 P 156	295-309		0 432 191 786	
KBAL 137 P 14	DLLA 155 P 172	295-303		0 432 191 772	
KBAL 137 P 14	DLLA 155 P 179	270-284		0 432 191 762	
KBAL 137 P 14	DLLA 155 P 179	250-264		0 432 191 769	
KBAL 137 P 14	DLLA 155 P 82	300-308		0 432 191 830	
KBAL 137 P 14	DSLA 155 P 185	250-264		0 432 191 767	
KBAL 137 P 26	DLLA 160 P 209	250-264		0 432 191 757	
KBAL 137 P 26	DLLA 160 P 473	300-314		0 432 191 649	
KBAL 137 P 26	DLLA 160 P 692	290-304		0 432 191 560	
KBAL 137 P 26	DSLA 137 P 506	260-274		0 432 193 805	
KBAL 137 P 26	DSLA 137 P 507	260-274		0 432 193 804	
KBAL 137 P 26	DSLA 137 P 508	260-274		0 432 193 803	
KBAL 137 P 26	DSLA 140 P 562	260-274		0 432 193 770	
KBAL 137 P 26	DSLA 145 P 267	260-274		0 432 193 864	
KBAL 137 P 26	DSLA 145 P 268	260-274		0 432 193 863	
KBAL 137 P 26	DSLA 145 P 269	260-274		0 432 193 862	

A224

de	en	fr	it	es
Typformel Düsenhalter → Typformel Düse → DHK (Fortsetzung)	Type designation nozzle holder → Type designation nozzle → Nozzle-and-holder assemblies (continued)	Formule de type principaux porte-injecteurs → Formule de type injecteur → Ensembles porte-injecteurs (suite)	Sigla polverizzatori → Sigla portapolverizzatori → Sigla combinazione portapolverizzatori (seguito)	Designación de tipo portainyectoros → Designación de tipo inyectoros → Conjuntos portainyectoros (continuación)



 Typ	 Typ	 1st/bar	 2nd/bar	 Ref.	
KBAL 137 P 26	DSLA 145 P 537	260-274		0 432 193 796	
KBAL 137 P 26	DSLA 148 P 219	260-274		0 432 193 873	
KBAL 137 P 28	DSLA 140 P 381	260-274		0 432 193 831	
KBAL 137 P 28	DSLA 145 P 379	260-274		0 432 193 833	
KBAL 137 P 28	DSLA 145 P 380	260-274		0 432 193 832	
KBAL 139 P 113	DSLA 145 P 1024	191-203	301-317	0 432 193 549	
KBAL 140 P 74	DLLA 145 P 1031	210-222	410-426	0 432 191 398	
KBAL 140 P 74	DLLA 145 P 748	204-216	402-418	0 432 191 528	
KBAL 140 P 75	DLLA 145 P 1031	210-222	410-426	0 432 191 401	
KBAL 140 P 75	DLLA 145 P 748	204-216	402-418	0 432 191 527	
KBAL 140 S 63	DLLA 150 S 883	240-248		0 432 291 662	
KBAL 140 S 74	DLLA 140 S 1099	230-238		0 432 291 614	
KBAL 140 S 74	DLLA 144 S 1167	230-238		0 432 291 582	
KBAL 140 S 74	DLLA 145 S 1059	230-238		0 432 291 632	
KBAL 140 S 74	DLLA 145 S 1097	260-268		0 432 291 565	
KBAL 140 S 74	DLLA 145 S 1097	260-272		0 432 291 615	
KBAL 140 S 74	DLLA 145 S 1179	230-238		0 432 291 574	
KBAL 140 S 74	DLLA 150 S 1104	230-238		0 432 291 608	
KBAL 140 S 74	DLLA 150 S 1105	230-238		0 432 291 607	
KBAL 140 S 74	DLLA 150 S 883	230-238		0 432 291 625	
KBAL 150 P 47	DLLA 140 P 594	300-308		9 430 082 762	
KBAL 150 P 47	DLLA 150 P 878	260-274		F 000 439 010	
KBAL 150 P 47	DLLA 155 P 282			9 430 082 753	
KBAL 150 P 47	DSLA 140 P 1002	300-314		F 000 439 015	
KBAL 150 P 47	DSLA 140 P 1361	300-314		F 000 439 028	
KBAL 150 S 87	DLL 155 S 1300	240-248		0 432 292 001	
KBAL 154 SB 1/13	DLLB 155 S 580	215-223		0 432 291 839	
KBAL 154 SB 1/13	DLLB 155 S 598	235-243		0 432 291 827	
KBAL 154 SB 1/13	DLLB 155 S 675	200-208		0 432 291 802	
KBAL 40 P 104	DSLA 147 P 1147	221-233	381-397	0 432 193 525	
KBAL 40 P 104	DSLA 147 P 1243	221-233	381-397	0 432 193 512	
KBAL 40 P 104	DSLA 147 P 918	221-233	381-397	0 432 193 570	
KBAL 40 P 104	DSLA 147 P 919	221-233	381-397	0 432 193 569	
KBAL 40 P 54	DSLA 152 P 535	181-193	366-382	0 432 193 797	
KBAL 40 P 79	DSLA 147 P 535	181-193	366-382	0 432 193 686	
KBAL 40 P 79	DSLA 147 P 715	181-193	366-382	0 432 193 688	
KBAL 40 P 79	DSLA 147 P 716	181-193	366-382	0 432 193 687	
KBAL 40 P 79	DSLA 147 P 794	181-193	366-382	0 432 193 650	
KBAL 40 P 91	DSLA 147 P 823	221-233	381-397	0 432 193 634	
KBAL 40 P 91	DSLA 149 P 824	221-233	381-397	0 432 193 633	
KBAL 52 P 21	DLLA 144 P 353	210-220		0 432 191 696	
KBAL 52 P 21	DLLA 144 P 353	250-260		0 432 191 705	
KBAL 52 P 21	DLLA 144 P 354	210-220		0 432 191 697	
KBAL 52 P 21	DLLA 144 P 354	250-260		0 432 191 706	
KBAL 52 P 21	DLLA 144 P 410	250-260		0 432 191 676	

 Typ	 Typ	 1st/bar	 2nd/bar	 Ref.		
KBAL 55 S 1/4	DLLA 150 S 273	180–188		0 432 291 739		
KBAL 59 P 7	DLLA 145 P 695	250–258		0 432 131 708		
KBAL 60 S 64	DLLA 151 S 1200	230–238		9 430 082 310		
KBAL 60 S 64	DLLA 151 S 991	200–208		9 430 082 288		
KBAL 61 S 27/4	DLLA 152 S 533	180–188		0 432 291 857		
KBAL 62 P 10	DLLA 150 P 53	212–222		0 432 191 847		
KBAL 62 S 29/13	HB-DLLA 155 S 772			9 430 032 177		
KBAL 62 S 29/13	DLLA 155 S 551	190–198		0 432 291 847		
KBAL 62 S 29/13	DLLA 160 S 1030	190–198		0 432 291 643		
KBAL 65 P 1/4	DLLA 150 P 8			0 432 191 882		
KBAL 65 P 22	DSLA 155 P 298	215–225		0 432 193 855		
KBAL 65 P 3/13	DLLA 150 P 3	200–208		0 432 191 887		
KBAL 65 P 9/4	DLLA 150 P 1	180–190		0 432 191 889		
KBAL 65 P 9/4	DLLA 150 P 117	205–215		0 432 191 810		
KBAL 65 P 9/4	DLLA 150 P 33	180–190		0 432 191 861		
KBAL 65 P 9/4	DLLA 150 P 65	185–195		0 432 191 839		
KBAL 65 S 13/13	DLL 140 S 591	175–183		0 432 291 030		
KBAL 65 S 13/13	DLLA 142 S 655	180–188		0 432 291 808		
KBAL 65 S 13/13	DLLA 149 S 394	180–188		0 432 291 836		
KBAL 65 S 13/13	DLLA 149 S 490	180–188		0 432 291 835		
KBAL 65 S 13/13	DLLA 149 S 576	180–188		0 432 291 829		
KBAL 65 S 13/13	DLLA 149 S 715	180–188		0 432 291 782		
KBAL 65 S 13/13	DLLA 149 S 774	180–188		0 432 291 753	0 986 430 067	
KBAL 65 S 13/13	DLLA 149 S 775	180–188		0 432 291 752		
KBAL 65 S 13/13	DLLA 150 S 708	175–183		0 432 291 786		
KBAL 65 S 13/13	DLLA 150 S 764	185–193		0 432 291 758		
KBAL 65 S 13/13	DLLA 156 S 911	185–193		0 432 291 689		
KBAL 65 S 13/13	DLLA 28 S 414	180–188		0 432 291 832		
KBAL 65 S 13/13	DLLA 28 S 415	180–188		0 432 291 834		
KBAL 65 S 13/13	DLLA 28 S 425	180–188		0 432 291 833		
KBAL 65 S 13/13	DLLA 28 S 656	180–188		0 432 291 807	0 986 430 124	
KBAL 65 S 13/4	DLLA 28 S 414	180–188		0 432 291 878		
KBAL 65 S 13/4	DLLA 28 S 415	200–208		0 432 291 877		
KBAL 65 S 13/4	DLLA 28 S 425	200–208		0 432 291 869		
KBAL 65 S 55	DLLA 145 S 1023	240–248		0 432 291 644		
KBAL 65 S 55	DLLA 145 S 1244	240–248		0 432 291 537		
KBAL 65 S 55	DLLA 145 S 886	240–248		0 432 291 698		
KBAL 65 S 55	DLLA 148 S 1058	275–283		0 432 291 633		
KBAL 65 S 55	DLLA 148 S 1145	275–283		0 432 291 591		
KBAL 65 S 55	DLLA 148 S 885	275–283		0 432 291 699	0 986 430 180	
KBAL 65 S 61	DLLA 149 S 775	225–233		0 432 291 669		
KBAL 65 S 79	DLLA 145 S 1218	240–248		0 432 291 553		
KBAL 65 S 79	DLLA 145 S 1367	270–278		0 432 291 498		
KBAL 65 S 79	DLLA 145 S 1368	270–278		0 432 291 497		
KBAL 67 P 31	DSLA 140 P 297	195–205		0 432 193 849		

A226

de

Typformel Düsenhalter → Typformel Düse → DHK
(Fortsetzung)

en

Type designation nozzle holder → Type designation nozzle → Nozzle-and-holder assemblies
(continued)

fr

Formule de type principaux porte-injecteurs → Formule de type injecteur → Ensembles porte-injecteurs
(suite)







it

Sigla polverizzatori → Sigla portapolverizzatori → Sigla combinazione portapolverizzatori
(seguito)

es

Designación de tipo portainyectoros → Designación de tipo inyectoros → Conjuntos portainyectoros
(continuación)



 Typ	 Typ	 1st/bar	 2nd/bar	 Ref.	
KBAL 70 P 45	DSLA 145 P 446	201-211	312-335	0 432 193 820	
KBAL 70 P 46	DSLA 145 P 446	201-211	312-335	0 432 193 819	
KBAL 70 P 69	DSLA 145 P 682	201-211	321-335	0 432 193 701	
KBAL 70 P 70	DSLA 145 P 682	201-211	321-335	0 432 193 700	
KBAL 70 P 70	DSLA 145 P 870	211-223	381-397	0 432 193 571	
KBAL 70 P 93	DSLA 158 P 817	226-236	351-365	0 432 193 636	
KBAL 70 P 99	DSLA 145 P 870	211-223	381-397	0 432 193 601	
KBAL 72 P 19	DLLA 144 P 118	255-265		0 432 191 809	
KBAL 72 P 19	DLLA 144 P 138	255-265		0 432 191 793	
KBAL 72 P 19	DLLA 150 P 137	255-265		0 432 191 795	
KBAL 72 P 23	DLLA 140 P 196	265-275		0 432 191 765	
KBAL 72 P 23	DLLA 145 P 394	270-280		0 432 191 684	
KBAL 72 P 23	DSLA 142 P 272	270-280		0 432 193 861	
KBAL 72 P 76	DSLA 145 P 712	261-273	391-407	0 432 193 690	
KBAL 72 P 83	DLLA 145 P 394	270-280		0 432 191 515	
KBAL 73 S 41/13	DLLA 160 S 1030	210-218		0 432 291 642	
KBAL 73 S 41/13	DLLA 160 S 1084	210-218		0 432 291 624	
KBAL 75 P 65	DSLA 140 P 616	270-280		0 432 193 756	
KBAL 75 P 77	DSLA 140 P 1145	241-253	381-397	0 432 193 527	
KBAL 75 P 77	DSLA 140 P 713	241-253	361-377	0 432 193 689	
KBAL 75 P 92	DSLA 140 P 1145	241-253	381-397	0 432 193 526	
KBAL 75 P 92	DSLA 140 P 713	241-253	361-377	0 432 193 632	
KBAL 75 S 71	DLLA 160 S 1122	200-208		9 430 082 302	
KBAL 77 S 54	DLLA 148 S 862	240-248		0 432 291 704	
KBAL 77 S 54	DLLA 148 S 909	250-258		0 432 291 691	
KBAL 77 S 54	DLLA 150 S 501	260-268		0 432 291 687	
KBAL 77 S 9/13	DLLA 140 S 567	180-188		0 432 291 838	
KBAL 77 S 9/13	DLLA 150 S 475	200-208		0 432 291 868	
KBAL 77 S 9/13	DLLA 150 S 501	200-208		0 432 291 864	
KBAL 77 S 9/13	DLLA 150 S 501	180-188		0 432 291 867	
KBAL 77 S 9/13	DLLA 150 S 977	260-268		0 432 291 667	
KBAL 77 S 9/13	DLLA 160 S 1012	250-258		0 432 291 650	
KBAL 78 P 49	DSLA 148 P 482	265-275		0 432 193 557	
KBAL 78 P 49	DSLA 148 P 482	265-275		0 432 193 813	
KBAL 78 P 50	DSLA 148 P 482	265-275		0 432 193 558	
KBAL 78 P 50	DSLA 148 P 482	265-275		0 432 193 812	
KBAL 78 P 59	DSLA 148 P 591	191-201	301-315	0 432 193 769	
KBAL 78 P 59	DSLA 148 P 591	191-201	301-315	0 432 193 768	
KBAL 78 P 64	DSLA 148 P 591	191-203	301-315	0 432 193 758	
KBAL 78 P 64	DSLA 148 P 591	191-201	301-315	0 432 193 790	
KBAL 78 P 87	DSLA 148 P 591	191-201	301-315	0 432 193 640	
KBAL 78 P 87	DSLA 148 P 837	191-201	301-315	0 432 193 626	
KBAL 78 P 87	DSLA 148 P 591	191-201	301-315	0 432 193 639	
KBAL 78 P 87	DSLA 148 P 837	191-201	301-315	0 432 193 625	
KBAL 78 P 88	DSLA 148 P 591	191-201	301-315	0 432 193 638	









KBAL 78 P 88	DSLA 148 P 837	191-201	301-315	0 432 193 624	
KBAL 78 P 88	DSLA 148 P 591	191-201	301-315	0 432 193 637	
KBAL 78 P 88	DSLA 148 P 837	191-201	301-315	0 432 193 623	
KBAL 80 P 142	DSLA 146 P 1433	221-233	311-327	0 432 193 471	
KBAL 80 P 142	DSLA 146 P 1436	221-233	311-327	0 432 193 468	
KBAL 80 P 142	DSLA 148 P 1432	221-233	311-327	0 432 193 472	
KBAL 80 P 142	DSLA 148 P 1435	221-233	331-347	0 432 193 469	
KBAL 80 P 142	DSLA 150 P 1434	201-213	351-367	0 432 193 470	
KBAL 80 P 58	DLLA 150 P 552	225-233		0 432 191 613	
KBAL 82 P 131	DLLA 146 P 1210	200-210		0 432 191 330	
KBAL 82 P 131	DLLA 146 P 1297	200-210		0 432 191 312	
KBAL 84 S 30	DLLA 140 S 619	190-198		0 432 291 821	
KBAL 84 S 30	DLLA 150 S 618	175-183		0 432 291 820	
KBAL 84 S 39	DLLA 150 S 724	225-233		0 432 291 778	
KBAL 85 P 148	DSLA 142 P 1501	260-268		0 432 193 462	
KBAL 85 P 48	DSLA 145 P 626	190-200		0 432 193 727	
KBAL 85 P 48	DSLA 88 P 480	190-200		0 432 193 814	
KBAL 85 P 63	DSLA 139 P 710	221-231	301-315	0 432 193 691	
KBAL 85 P 63	DSLA 139 P 976	221-231	301-315	0 432 193 565	
KBAL 85 P 63	DSLA 145 P 631	221-231	301-315	0 432 193 731	
KBAL 85 P 63	DSLA 145 P 975	221-231	301-315	0 432 193 566	
KBAL 85 P 81	DLLA 136 P 738			F 000 439 001	
KBAL 85 P 81	DLLA 145 P 749	250-260		F 000 439 002	
KBAL 85 P 81	DSLA 139 P 982	250-260		F 000 439 014	
KBAL 89 S 8/13	DLLA 149 S 576	180-188		0 432 291 842	
KBAL 90 P 11	DLLA 140 P 182	225-233		0 432 191 768	
KBAL 90 P 11	DLLA 150 P 147	212-220		0 432 191 783	
KBAL 90 P 11	DLLA 152 P 73	250-258		0 432 191 838	
KBAL 90 P 20	DLLA 151 P 132	215-223		0 432 191 797	
KBAL 90 P 36	DSLA 145 P 365	201-211	301-315	0 432 193 836	
KBAL 90 P 37	DSLA 140 P 1112	201-211	345-359	0 432 193 532	
KBAL 90 P 37	DSLA 145 P 366	226-236	281-295	0 432 193 631	
KBAL 90 P 37	DSLA 145 P 366	201-211	281-295	0 432 193 835	
KBAL 90 P 37	DSLA 145 P 882	231-241	301-315	0 432 193 583	
KBAL 90 P 37	DSLA 145 P 883	231-241	301-315	0 432 193 582	
KBAL 90 P 37	DSLA 148 P 575	201-211	281-295	0 432 193 766	
KBAL 93 P 85	DSLA 150 P 784	241-253	301-317	0 432 193 541	
KBAL 93 P 85	DSLA 150 P 784	201-213	301-317	0 432 193 655	
KBAL 95 P 111	DLLA 145 P 1014	185-199		0 432 191 413	
KBAL 95 P 130	DLLA 145 P 1195	180-188		0 432 191 336	
KBAL 95 P 43	DLLA 140 P 411	250-260		0 432 191 675	
KBAL 95 P 43	DLLA 145 P 412	250-260		0 432 191 674	
KBAL 95 P 53	DLLA 144 P 521	250-260		0 432 191 625	
KBAL 95 P 53	DLLA 144 P 521	210-220		0 432 191 627	
KBAL 95 P 53	DLLA 144 P 527	250-260		0 432 191 623	0 986 430 488

A228

<div style="border: 1px solid black; padding: 2px; display: inline-block; margin-bottom: 5px;">de</div> <p>Typformel Düsenhalter → Typformel Düse → DHK (Fortsetzung)</p>	<div style="border: 1px solid black; padding: 2px; display: inline-block; margin-bottom: 5px;">en</div> <p>Type designation nozzle holder → Type designation nozzle → Nozzle-and-holder assemblies (continued)</p>	<div style="border: 1px solid black; padding: 2px; display: inline-block; margin-bottom: 5px;">fr</div> <p>Formule de type principaux porte-injecteurs → Formule de type injecteur → Ensembles porte-injecteurs (suite)</p>	<div style="border: 1px solid black; padding: 2px; display: inline-block; margin-bottom: 5px;">it</div> <p>Sigla polverizzatori → Sigla portapolverizzatori → Sigla combinazione portapolverizzatori (seguito)</p>	<div style="border: 1px solid black; padding: 2px; display: inline-block; margin-bottom: 5px;">es</div> <p>Designación de tipo portainyectoros → Designación de tipo inyectoros → Conjuntos portainyectoros (continuación)</p>
--	---	--	---	---



KBAL 95 P 53	DLLA 144 P 527	210–220		0 432 191 624	
KBAL 95 P 53	DLLA 144 P 568	250–260		0 432 191 605	
KBAL 95 P 53	DSLA 144 P 547	210–220		0 432 193 791	
KBAL 95 P 53	DSLA 144 P 860	210–222		0 432 193 596	
KBAL 95 P 60	DSLA 140 P 576	280–290		0 432 193 765	
KBAL 95 P 97	DLLA 145 P 849	180–194		0 432 191 490	
KBAL 95 S 34/4	DLLA 155 S 733	220–228		0 432 291 767	
KBAL 95 S 34/4	DLLA 160 S 626	230–238		0 432 291 819	
KBAL 95 S 56	DLLA 146 S 1007	225–233		0 432 291 652	
KBAL 96 P 101	DLLA 151 P 941	275–287		0 432 191 450	
KBAL 96 P 101	DLLA 151 P 942	275–287		0 432 191 449	
KBAL 96 P 101	DLLA 158 P 587	250–262		0 432 191 474	
KBAL 96 P 101	DLLA 158 P 691	275–287		0 432 191 475	
KBAL 96 P 102	DLLA 158 P 456/	250–262		0 432 191 472	
KBAL 96 P 112	DLLA 147 P 360	250–262		0 432 191 411	
KBAL 96 P 112	DLLA 147 P 361	250–262		0 432 191 406	
KBAL 96 P 112	DLLA 147 P 370	250–262		0 432 191 412	
KBAL 96 P 112	DLLA 147 P 734	250–262		0 432 191 408	
KBAL 96 P 117	DLLA 144 P 1369	250–262		0 432 191 292	
KBAL 96 P 117	DLLA 148 P 1083	220–232		0 432 191 324	
KBAL 96 P 117	DLLA 148 P 1083	250–262		0 432 191 380	
KBAL 96 P 117	DLLA 151 P 1169	220–228		0 432 191 346	
KBAL 96 P 118	DLLA 147 P 360	250–262		0 432 191 374	
KBAL 96 P 118	DLLA 147 P 361	250–262		0 432 191 373	
KBAL 96 P 118	DLLA 147 P 370	250–262		0 432 191 375	
KBAL 96 P 118	DLLA 147 P 734	250–262		0 432 191 369	
KBAL 96 P 118	DLLA 158 P 456/	250–262		0 432 191 377	
KBAL 96 P 118	DLLA 158 P 729	275–287		0 432 191 378	
KBAL 96 P 118	DLLA 158 P 730	275–287		0 432 191 379	
KBAL 96 P 119	DLLA 151 P 939	250–262		0 432 191 252	
KBAL 96 P 119	DLLA 151 P 940	250–262		0 432 191 325	
KBAL 96 P 119	DLLA 151 P 941	275–287		0 432 191 376	
KBAL 96 P 119	DLLA 151 P 942	275–287		0 432 191 368	
KBAL 96 P 120	DLLA 152 P 1104	250–262		0 432 191 367	
KBAL 96 P 123	DLLA 151 P 940	250–262		0 432 191 353	
KBAL 96 P 125	DLLA 144 P 1170	250–262		0 432 191 345	
KBAL 96 P 125	DLLA 144 P 1194	220–232		0 432 191 337	
KBAL 96 P 125	DLLA 147 P 1230	220–232		0 432 191 326	
KBAL 96 P 132	DLLA 144 P 1220	250–262		0 432 191 328	
KBAL 96 P 132	DLLA 147 P 1229	250–262		0 432 191 327	
KBAL 96 P 137	DLLA 148 P 1083	220–232		0 432 191 287	
KBAL 96 P 137	DLLA 151 P 1169	220–232		0 432 191 313	
KBAL 96 P 35	DLLA 147 P 360	260–270		0 432 191 700	
KBAL 96 P 35	DLLA 147 P 361	260–270		0 432 191 699	
KBAL 96 P 35	DLLA 147 P 370	260–270		0 432 191 693	

 Typ	 Typ	 1st/bar	 2nd/bar	 Ref.		
KBAL 96 P 35	DLLA 147 P 734	250–262			0 432 191 535	
KBAL 96 P 35	DLLA 147 P 752				0 432 191 525	
KBAL 96 P 35	DLLA 147 P 753				0 432 191 524	
KBAL 96 P 35	DLLA 147 P 754				0 432 191 523	
KBAL 96 P 35	DLLA 158 P 454	260–270			0 432 191 657	
KBAL 96 P 35	DLLA 158 P 455	275–287			0 432 191 656	
KBAL 96 P 35	DLLA 158 P 456/	260–270			0 432 191 655	0 986 430 490
KBAL 96 P 35	DLLA 158 P 457	260–270			0 432 191 654	
KBAL 96 P 35	DLLA 158 P 729	275–287			0 432 191 539	
KBAL 96 P 35	DLLA 158 P 730	275–287			0 432 191 538	
KBAL 96 P 41	DLLA 147 P 385	250–260			0 432 191 689	
KBAL 96 P 41	DLLA 147 P 880	250–262			0 432 191 473	
KBAL 96 P 41	DLLA 158 P 584	250–260			0 432 191 602	
KBAL 96 P 41	DLLA 158 P 587	250–260			0 432 191 599	
KBAL 96 P 41	DLLA 158 P 684	275–287			0 432 191 566	
KBAL 96 P 41	DLLA 158 P 691	275–287			0 432 191 561	
KBAL 96 P 80	DLLA 151 P 939	250–262			0 432 191 452	
KBAL 96 P 80	DLLA 151 P 940	250–262			0 432 191 451	
KBAL 96 P 80	DLLA 152 P 876	250–262			0 432 191 480	
KBAL 96 P 80	DLLA 152 P 877	250–262			0 432 191 481	
KBAL 96 P 80	DLLA 158 P 584	250–262			0 432 191 510	
KBAL 96 P 80	DLLA 158 P 587	250–262			0 432 191 530	
KBAL 96 P 80	DLLA 158 P 728	250–262			0 432 191 540	
KBAL 97 S 19/4	DLLA 150 S 494	250–258			0 432 291 866	
KBAL 97 S 19/4	DLLA 150 S 607	205–213			0 432 291 822	
KBAL 97 S 62	DLLA 140 S 1068	210–218			0 432 291 630	
KBAL 97 S 62	DLLA 140 S 1193	230–238			0 432 291 567	
KBAL 97 S 62	DLLA 140 S 1198	230–238			0 432 291 564	
KBAL 97 S 62	DLLA 140 S 1232	230–238			0 432 291 545	
KBAL 97 S 62	DLLA 140 S 1242	230–238			0 432 291 538	
KBAL 97 S 62	DLLA 140 S 1282	230–238			0 432 291 523	
KBAL 97 S 62	DLLA 140 S 976	230–238			0 432 291 668	
KBAL 97 S 9/4	DLLA 140 S 694/EE	200–208			0 432 291 791	
KBAL 97 S 9/4	DLLA 140 S 635	180–188			0 432 291 816	
KBAL 97 S 9/4	DLLA 140 S 677	190–198			0 432 291 801	
KBAL 97 S 9/4	DLLA 140 S 726	235–247			0 432 291 750	
KBAL 97 S 9/4	DLLA 140 S 726	210–218			0 432 291 776	
KBAL 97 S 9/4	DLLA 150 S 437	200–208			0 432 291 875	
KBAL 97 SC 1/13	DLL 145 S 258	220–228			0 432 291 001	
KBAL 97 SC 1/13	DLL 145 S 259	220–228			0 432 291 002	
KBAL 97 SC 1/13	DLL 145 S 261	220–228			0 432 291 004	
KBAL 97 SC 1/13	DLL 145 S 416	220–228			0 432 291 007	
KBAL 97 SC 1/13	DLL 150 S 454	215–223			0 432 291 011	
KBAL 97 SC 1/13	DLLC 150 S 532	165–173			0 432 291 856	
KBAL 97 SC 4/13	DLLC 150 S 542	220–228			0 432 291 851	

A230

de

Typformel Düsenhalter → Typformel Düse → DHK
(Fortsetzung)

en

Type designation nozzle holder → Type designation nozzle → Nozzle-and-holder assemblies
(continued)

fr

Formule de type principaux porte-injecteurs → Formule de type injecteur → Ensembles porte-injecteurs
(suite)

it

Sigla polverizzatori → Sigla portapolverizzatori → Sigla combinazione portapolverizzatori
(seguito)

es

Designación de tipo portainyectoros → Designación de tipo inyectoros → Conjuntos portainyectoros
(continuación)



KBAL 97 SC 4/13	DLLC 150 S 543	237–245		0 432 291 849	
KBAL 97 SC 4/13	DLLC 150 S 543	218–226		0 432 291 850	
KBAL 98 S 8/13	DLLA 149 S 394	180–188		0 432 291 882	
KBAL 98 S 8/13	DLLA 149 S 774	175–183		0 432 291 745	
KBAL 98 S 8/13	DLLA 149 S 775	180–188		0 432 291 744	
KBAL 98 S 8/13	DLLA 153 S 308	175–183		0 432 291 886	
KBAL 98 S 8/4	DLLA 153 S 308	180–188		0 432 291 887	
KBALB 87 S 2/4	DLL 150 S 296	190–198		0 432 291 032	
KBALB 87 S 2/4	DLL 150 S 393	190–198		0 432 291 029	
KBALB 87 S 2/4	DLLB 150 S 688	180–188		0 432 291 794	
KBALB 87 S 2/4	DLLB 150 S 711	190–198		0 432 291 784	
KBALB 87 S 2/4	DLLB 150 S 765	180–188		0 432 291 756	
KBALB 87 S 2/4	DLLB 150 S 794	220–228		0 432 291 742	
KBALB 87 S 3	DLLB 150 S 821	190–198		0 432 291 731	
KBALB 87 S 3	DLLB 151 S 854	190–198		0 432 291 711	
KBALC 100 S 7/13	DLL 25 S 680	195–203		0 432 291 035	
KBALC 118 S 6/4	DLLC 150 S 646	250–258		0 432 291 813	
KBALC 118 S 6/4	DLLC 150 S 660	250–258		0 432 291 806	
KBALZ 123 S 73	DLLZ 150 S 1170	250–258		0 432 291 579	
KBALZ 123 S 73	DLLZ 150 S 1274	300–308		0 432 291 530	
KBALZ 127 S 84	DLL 155 S 1271	250–258		0 432 291 047	
KBALZ 127 S 84	DLL 155 S 1383	250–275		0 432 291 493	
KBALZ 128 S 80	DLL 120 S 352	250–258		0 432 291 046	
KBALZ 150 S 67	DLL 155 S 1057	240–248		0 432 291 042	
KBALZ 150 S 67	DLL 155 S 1276	240–248		0 432 291 048	
KBALZ 150 S 67	DLL 155 S 1300	240–248		0 432 291 049	
KBALZ 153 S 53	DLLZ 154 S 923	240–248		0 432 291 679	
KBALZ 153 S 53	DLLZ 156 S 1048	240–248		0 432 291 637	
KBALZ 153 S 53	DLLZ 156 S 1134	240–248		0 432 291 596	
KBALZ 153 S 53	DLLZ 156 S 948	240–248		0 432 291 683	
KBALZ 153 S 53	DLLZ 156 S 957	240–248		0 432 291 681	
KBALZ 335 T 24	DLLZ 150 T 13			0 432 391 001	
KBALZ 83 S 85	DLLZ 155 S 1281	370–408		0 432 291 510	
KBALZ 83 S 85	DLLZ 155 S 1281	325–358		0 432 291 524	
KBAZ 150 T 2/12	DL 120 T 1209			0 432 390 009	
KBAZ 150 T 2/12	DL 120 T 1226			0 432 390 014	
KBAZ 150 T 2/12	DL 120 T 1226			0 432 390 018	
KBAZ 150 T 2/12	DL 130 T 1189			0 432 390 005	
KBAZ 150 T 2/12	DL 130 T 1189			0 432 390 006	
KBAZ 150 T 2/12	DL 130 T 1189			0 432 390 008	
KBAZ 150 T 2/12	DL 130 T 1225			0 432 390 011	
KBAZ 150 T 2/12	DL 130 T 1225			0 432 390 012	
KBAZ 150 T 2/12	DL 130 T 1225			0 432 390 013	
KBAZ 228 T 1/4	DLZ 140 T 1157			0 432 390 001	
KBE 36 S 2/13	DN 0 SD 193	180–188		0 432 297 032	















KBE 45 S 6	DN 0 SD 1930	145-153		0 432 297 039	
KBE 48 S 5/4	DN 0 SD 189	131-137		0 432 297 035	
KBE 48 S 5/4	DN 0 SD 189/	131-137		0 432 297 051	
KBE 48 S 5/4	DN 0 SD 254	131-137		0 432 297 045	
KBE 48 S 7	DN 0 SD 193	131-137		0 432 297 044	
KBE 48 S 7	DN 0 SD 193/	130-138		0 432 297 049	0 986 430 147
KBE 48 S 7	DN 0 SD 264	131-137		0 432 297 050	0 986 430 147
KBE 53 S 11	DN 0 SD 294	165-173		0 432 297 056	
KBE 58 S 4/4	DN 0 SD 1510	155-163		0 432 297 041	
KBE 58 S 4/4	DN 0 SD 193	125-133		0 432 297 034	0 986 430 144
KBE 58 S 4/4	DN 0 SD 193	120-128		0 432 297 038	
KBE 58 S 4/4	DN 0 SD 193	135-143		0 432 297 040	
KBE 58 S 4/4	DN 0 SD 1930	135-143		0 432 297 042	
KBE 58 S 4/4	DN 0 SD 216	150-158		0 432 297 036	
KBE 58 S 4/4	DN 0 SD 216	150-158		0 432 297 053	
KBE 58 S 4/4	DN 0 SD 230	140-148		0 432 297 037	
KBE 58 S 4/4	DN 0 SD 263	155-163		0 432 297 047	
KBE 58 S 8	DN 0 SD 193	165-173		0 432 297 046	
KBE 58 S 8	DN 0 SD 259	155-163		0 432 297 048	
KBE 58 S 8	DN 0 SD 259	120-128		0 432 297 054	
KBE 58 S 8	DN 0 SD 299	120-128		0 432 297 058	
KBE 58 S 8	DN 0 SD 301	120-128		0 432 297 057	0 986 430 532
KBE 58 S 8	DN 0 SD 307	145-153		0 432 297 055	
KBEL 100 P 118	DLLA 152 P 685	250-258		0 432 191 565	
KBEL 100 P 123	DLLA 144 P 510	320-328		0 432 191 633	0 986 430 352
KBEL 100 P 123	DSLA 149 P 540	310-324		0 432 193 793	
KBEL 100 P 126	DLLA 148 P 650	320-328		0 432 191 586	
KBEL 100 P 126	DLLA 149 P 528	320-328		0 432 191 622	
KBEL 100 P 127	DLLA 150 P 652	300-312		0 432 191 584	
KBEL 100 P 127	DLLA 154 P 596	300-308		0 432 191 596	
KBEL 100 P 127	DLLA 160 P 577	320-328		0 432 191 620	
KBEL 100 P 141	DLLA 142 P 1070	290-298		0 432 191 385	
KBEL 100 P 141	DLLA 142 P 1283	290-302		0 432 191 317	
KBEL 100 P 141	DLLA 142 P 1284	290-302		0 432 191 316	
KBEL 100 P 141	DLLA 144 P 1105	320-332		0 432 191 366	
KBEL 100 P 141	DLLA 147 P 1121	320-332		0 432 191 362	
KBEL 100 P 141	DLLA 148 P 915	290-300		0 432 191 457	
KBEL 100 P 141	DLLA 150 P 1012	320-332		0 432 191 423	
KBEL 100 P 141	DLLA 150 P 1064	290-302		0 432 191 387	
KBEL 100 P 141	DLLA 150 P 1120	290-300		0 432 191 363	
KBEL 100 P 141	DLLA 150 P 724	320-332		0 432 191 543	
KBEL 100 P 141	DLLA 150 P 812	320-332		0 432 191 503	
KBEL 100 P 141	DLLA 150 P 892	320-332		0 432 191 469	
KBEL 100 P 141	DLLA 150 P 901	320-332		0 432 191 467	
KBEL 100 P 141	DLLA 150 P 913	290-300		0 432 191 370	

A232

<div style="border: 1px solid black; padding: 2px; display: inline-block; margin-bottom: 5px;">de</div> <p>Typformel Düsenhalter → Typformel Düse → DHK (Fortsetzung)</p>	<div style="border: 1px solid black; padding: 2px; display: inline-block; margin-bottom: 5px;">en</div> <p>Type designation nozzle holder → Type designation nozzle → Nozzle-and-holder assemblies (continued)</p>	<div style="border: 1px solid black; padding: 2px; display: inline-block; margin-bottom: 5px;">fr</div> <p>Formule de type principaux porte-injecteurs → Formule de type injecteur → Ensembles porte-injecteurs (suite)</p>	<div style="border: 1px solid black; padding: 2px; display: inline-block; margin-bottom: 5px;">it</div> <p>Sigla polverizzatori → Sigla portapolverizzatori → Sigla combinazione portapolverizzatori (seguito)</p>	<div style="border: 1px solid black; padding: 2px; display: inline-block; margin-bottom: 5px;">es</div> <p>Designación de tipo portainyectores → Designación de tipo inyector → Conjuntos portainyectores (continuación)</p>
--	---	--	---	---



 Typ	 Typ	 1st/bar	 2nd/bar	 Ref.	
KBEL 100 P 141	DLLA 150 P 913	290–300		0 432 191 459	
KBEL 100 P 141	DLLA 150 P 916	290–300		0 432 191 372	
KBEL 100 P 141	DLLA 150 P 916	290–300		0 432 191 456	
KBEL 100 P 141	DLLA 150 P 930	290–302		0 432 191 453	
KBEL 100 P 141	DLLA 150 P 943	290–300		0 432 191 384	
KBEL 100 P 141	DLLA 150 P 943	290–298		0 432 191 446	
KBEL 100 P 141	DLLA 150 P 957	325–333		0 432 191 359	
KBEL 100 P 141	DLLA 150 P 983	320–332		0 432 191 427	
KBEL 100 P 141	DLLA 154 P 596	325–333		0 432 191 360	
KBEL 100 P 141	DLLA 154 P 596	325–333		0 432 191 589	
KBEL 100 P 141	DLLA 154 P 709	320–332		0 432 191 553	
KBEL 100 P 141	DLLA 159 P 636	270–278		0 432 191 590	
KBEL 100 P 141	DLLA 160 P 1032+	290–302		0 432 191 400	
KBEL 100 P 141	DLLA 160 P 577	280–292		0 432 191 407	
KBEL 100 P 141	DLLA 160 P 577	325–337		0 432 191 551	
KBEL 100 P 141	DLLA 162 P 1408	280–290		0 432 191 286	
KBEL 100 P 150	DLLA 159 P 638	261–273	361–377	0 432 191 587	
KBEL 100 P 166	DLLA 159 P 638	261–273	361–377	0 432 191 554	
KBEL 100 P 169	DLLA 144 P 1175	245–257		0 432 191 344	
KBEL 100 P 169	DLLA 144 P 1264	245–259		0 432 191 303	
KBEL 100 P 169	DLLA 144 P 1264	245–259		0 432 191 321	
KBEL 100 P 169	DLLA 147 P 1048	245–259		0 432 191 302	
KBEL 100 P 169	DLLA 147 P 1048	245–257		0 432 191 395	
KBEL 100 P 169	DLLA 147 P 1048	245–259		0 432 191 396	
KBEL 100 P 169	DLLA 147 P 1049	245–259		0 432 191 301	
KBEL 100 P 169	DLLA 147 P 1049	245–257		0 432 191 393	
KBEL 100 P 169	DLLA 147 P 1049	245–259		0 432 191 394	
KBEL 100 P 169	DLLA 156 P 1059	245–259		0 432 191 304	
KBEL 100 P 169	DLLA 156 P 1059	245–257		0 432 191 489	
KBEL 100 P 169	DLLA 156 P 1059	245–257		0 432 191 526	
KBEL 100 P 169	DLLA 156 P 828+	245–259		0 432 191 305	
KBEL 100 P 169	DLLA 156 P 828+	245–257		0 432 191 463	
KBEL 100 P 169	DLLA 156 P 828+	245–257		0 432 191 488	
KBEL 100 P 169	DLLA 156 P 897+	245–259		0 432 191 306	
KBEL 100 P 169	DSLA 156 P 1412	245–259		0 432 193 479	
KBEL 100 P 184	DLLA 156 P 897+	245–257		0 432 191 468	
KBEL 100 P 184	DSLA 156 P 1411	245–259		0 432 193 480	
KBEL 100 P 184	DSLA 156 P 1411	245–259		0 432 193 481	
KBEL 100 P 202	DLLA 149 P 541	320–328		0 432 191 616	0 986 430 348
KBEL 100 P 236	DLLA 150 P 1163	290–298		0 432 191 348	
KBEL 100 P 236	DLLA 150 P 1164	290–300		0 432 191 347	
KBEL 100 P 251	DSLA 156 P 1411	245–259		0 432 193 477	
KBEL 100 P 252	DLLA 156 P 1626	245–259		0 432 191 237	
KBEL 100 P 253	DLLA 144 P 1264	245–259		0 432 191 282	
KBEL 100 P 253	DSLA 144 P 1629	245–259		0 432 193 455	





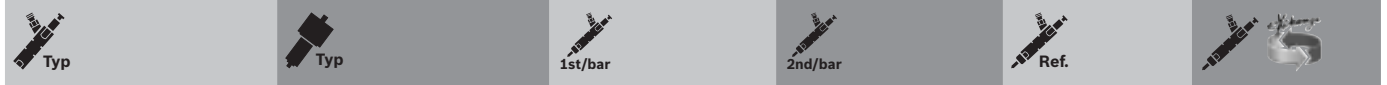

 Typ	 Typ	 1st/bar	 2nd/bar	 Ref.		
KBEL 100 P 253	DLLA 147 P 1048	245-259			0 432 191 280	
KBEL 100 P 253	DLLA 147 P 1048	245-259			0 432 191 281	
KBEL 100 P 253	DLLA 147 P 1049	245-259			0 432 191 279	
KBEL 100 P 253	DLLA 147 P 1628	245-259			0 432 193 456	
KBEL 100 P 253	DLLA 156 P 1059	245-259			0 432 191 278	
KBEL 100 P 253	DLLA 156 P 1627	245-259			0 432 191 236	
KBEL 100 P 253	DLLA 156 P 828+	245-259			0 432 191 276	
KBEL 100 P 253	DLLA 156 P 897+	245-259			0 432 191 277	
KBEL 100 P 253	DSLA 156 P 1412	245-259			0 432 193 478	
KBEL 100 P 254	DLLA 142 P 1481	270-284			0 432 191 248	
KBEL 100 P 254	DLLA 144 P 1413	270-284			0 432 191 285	
KBEL 100 P 254	DLLA 146 P 1439	270-284			0 432 191 275	
KBEL 100 P 254	DLLA 146 P 1447	270-284			0 432 191 271	
KBEL 100 P 254	DLLA 154 P 1538	270-284			0 432 191 242	
KBEL 100 P 256	DLLA 142 P 1283	290-302			0 432 191 270	
KBEL 100 P 256	DLLA 150 P 1120	290-302			0 432 191 265	
KBEL 100 P 256	DLLA 150 P 913	290-302			0 432 191 262	
KBEL 100 P 256	DLLA 150 P 957	325-337			0 432 191 267	
KBEL 100 P 256	DLLA 154 P 596	325-337			0 432 191 266	
KBEL 100 P 257	DLLA 150 P 1163	290-302			0 432 191 268	
KBEL 100 P 257	DLLA 150 P 1164	290-302			0 432 191 269	
KBEL 100 P 257	DLLA 150 P 916	290-302			0 432 191 263	
KBEL 100 P 257	DLLA 160 P 1032+	290-302			0 432 191 260	
KBEL 100 P 258	DLLA 142 P 1283	290-302			0 432 191 259	
KBEL 100 P 259	DLLA 150 P 1164	290-302			0 432 191 258	
KBEL 100 P 259	DLLA 160 P 1032+	290-302			0 432 191 256	
KBEL 100 P 263	DLLA 150 P 1464	320-332			0 432 191 251	
KBEL 100 P 266	DLLA 145 P 1503	330-340			0 432 191 247	
KBEL 100 P 266	DLLA 145 P 1645	330-340			0 432 191 233	
KBEL 100 P 271	DLLA 122 P 1602	270-284			0 432 191 240	
KBEL 100 P 271	DLLA 150 P 1614	270-284			0 432 191 238	
KBEL 100 P 272	DLLA 150 P 1285	260-272			0 432 191 239	
KBEL 100 P 64	DLLA 148 P 513	320-328			0 432 191 630	0 986 430 349
KBEL 100 P 64	DLLA 149 P 369	320-328			0 432 191 694	0 986 430 447
KBEL 100 P 64	DLLA 154 P 397	320-328			0 432 191 683	
KBEL 100 P 64	DSLA 149 P 252	300-308			0 432 193 867	
KBEL 100 P 943	DLLA 150 P 943	290-302			0 432 191 261	
KBEL 100 P 967	DLLA 150 P 957	325-333			0 432 191 437	
KBEL 100 S 11/4	DLLA 145 S 768	190-198			0 432 291 754	
KBEL 100 S 29	DLLA 150 S 870	210-218			0 432 291 702	
KBEL 100 S 29	DLLA 150 S 903	210-218			0 432 291 694	
KBEL 100 S 29	DLLA 150 S 914	210-218			0 432 291 688	
KBEL 100 S 31	DLLA 150 S 1158	180-188			0 432 291 584	
KBEL 100 S 31	DLLA 150 S 1322	180-188			0 432 291 507	
KBEL 100 S 31	DLLA 150 S 925	180-188			0 432 291 685	

A234

<p>de</p> <p>Typformel Düsenhalter → Typformel Düse → DHK (Fortsetzung)</p>	<p>en</p> <p>Type designation nozzle holder → Type designation nozzle → Nozzle-and-holder assemblies (continued)</p>	<p>fr</p> <p>Formule de type principaux porte-injecteurs → Formule de type injecteur → Ensembles porte-injecteurs (suite)</p>	<p>it</p> <p>Sigla polverizzatori → Sigla portapolverizzatori → Sigla combinazione portapolverizzatori (seguito)</p>	<p>es</p> <p>Designación de tipo portainyectores → Designación de tipo inyectores → Conjuntos portainyectores (continuación)</p>
---	--	---	--	--









KBEL 100 S 31	DLLA 155 S 1323	180–188		0 432 291 506	
KBEL 101 P 185	DLLA 144 P 825	271–281	361–375	0 432 191 495	
KBEL 101 P 185	DLLA 144 P 908	271–281	361–375	0 432 191 465	
KBEL 101 P 186	DLLA 144 P 825	271–281	361–375	0 432 191 494	
KBEL 101 P 186	DLLA 144 P 908	271–281	361–375	0 432 191 464	
KBEL 101 P 67	DLLA 147 P 680	255–269		0 432 191 568	
KBEL 101 S 76	DLLA 149 S 1207	260–268		0 432 291 560	
KBEL 103 P 21	DLLA 150 P 64	210–222		0 432 191 840	
KBEL 104 P 12/13	DLLA 150 P 59	210–222		0 432 191 844	
KBEL 105 S 40	DLLA 150 S 998	220–228		0 432 291 656	
KBEL 105 S 5/4	DLLA 140 S 696	205–213		0 432 291 790	
KBEL 106 P 135	DLLA 153 P 810	300–310		0 432 191 504	
KBEL 106 P 135	DLLA 155 P 579+	230–238		0 432 191 604	
KBEL 106 P 135	DLLA 155 P 657	230–240		0 432 191 583	
KBEL 106 P 135	DLLA 157 P 888	300–310		0 432 191 470	
KBEL 106 P 135	DLLA 158 P 678	230–238		0 432 191 570	
KBEL 106 P 228	DLLA 152 P 1081	300–310		0 432 191 381	
KBEL 106 P 228	DLLA 152 P 1286	300–310		0 432 191 315	
KBEL 106 P 228	DLLA 153 P 1080	300–310		0 432 191 382	
KBEL 106 P 261	DLLA 152 P 1454	300–310		0 432 191 253	
KBEL 106 P 261	DLLA 153 P 1455	300–310		0 432 191 254	
KBEL 108 P 25	DLLA 160 P 85	231–243		0 432 191 829	0 986 430 231
KBEL 108 P 51	DLLA 150 P 205	240–252		0 432 191 760	
KBEL 108 P 51	DLLA 150 P 235	240–252		0 432 191 747	
KBEL 108 P 51	DLLA 150 P 299	240–252		0 432 191 733	
KBEL 108 P 51	DLLA 150 P 315	240–252		0 432 191 729	
KBEL 108 P 51	DLLA 150 P 324	240–252		0 432 191 726	
KBEL 108 P 51	DLLA 150 P 326	240–252		0 432 191 725	0 986 430 215
KBEL 108 P 51	DLLA 154 P 206	240–252		0 432 191 759	0 986 430 332
KBEL 108 P 51	DLLA 154 P 316	240–252		0 432 191 728	
KBEL 108 P 51	DSLA 145 P 300	240–252		0 432 193 854	
KBEL 108 P 51	DSLA 150 P 211	240–252		0 432 193 876	
KBEL 108 P 51	DSLA 150 P 318	240–252		0 432 193 848	
KBEL 108 P 60	DLLA 148 P 240	230–238		0 432 191 746	
KBEL 108 P 60	DLLA 148 P 241	230–238		0 432 191 745	
KBEL 108 P 82	DSLA 145 P 330	240–252		0 432 193 843	
KBEL 108 P 85	DLLA 148 P 341	230–238		0 432 191 713	
KBEL 108 P 85	DLLA 153 P 352	230–238		0 432 191 709	
KBEL 108 P 85	DLLA 153 P 355	230–238		0 432 191 704	
KBEL 108 P 85	DLLA 153 P 356	230–238		0 432 191 703	
KBEL 108 P 85	DLLA 153 P 413	230–238		0 432 191 673	
KBEL 108 P 85	DLLA 153 P 526	230–240		0 432 191 626	
KBEL 108 P 85	DLLA 155 P 564	230–240		0 432 191 606	
KBEL 109 P 11/13	DLLA 150 P 29	205–213		0 432 192 885	
KBEL 109 P 11/13	DLLA 150 P 29	205–213		0 432 192 889	

 Typ	 Typ	 1st/bar	 2nd/bar	 Ref.	
KBEL 109 P 11/13	DLLA 150 P 91/	305-313		0 432 192 881	0 986 430 034
KBEL 109 P 128	DSLA 134 P 781	280-292		0 432 193 656	
KBEL 109 P 128	DSLA 134 P 816	280-292		0 432 193 641	
KBEL 109 P 44	DLLA 150 P 91/+	255-263		0 432 192 876	
KBEL 109 P 81	DLLA 142 P 732	240-252		0 432 191 537	
KBEL 109 P 81	DSLA 141 P 405	240-252		0 432 193 827	
KBEL 109 P 81	DSLA 145 P 300	240-252		0 432 193 845	0 986 430 256
KBEL 109 P 81	DSLA 150 P 448	240-252		0 432 193 818	
KBEL 109 S 15/13	DLLA 150 S 1066	225-233		0 432 292 874	
KBEL 109 S 15/13	DLLA 150 S 1067	225-233		0 432 292 873	
KBEL 109 S 15/13	DLLA 150 S 798	230-238		0 432 292 885	
KBEL 109 S 6/13	DLLA 150 S 700			0 432 291 788	
KBEL 109 S 6/13	DLLA 150 S 739	235-243		0 432 292 887	
KBEL 109 S 6/13	DLLA 150 S 754	215-223		0 432 292 886	
KBEL 109 S 6/13	DLLA 150 S 851/	235-243		0 432 292 882	
KBEL 109 S 6/13	DLLA 150 S 853	255-263		0 432 292 881	0 986 430 074
KBEL 109 S 6/13	DLLA 150 S 896	235-243		0 432 292 880	
KBEL 109 S 6/13	DLLA 150 S 916	235-243		0 432 292 879	
KBEL 109 S6 / 13	DLLA 150 S 700	205-213		0 432 292 889	
KBEL 110 P 118	DLLA 144 P 490	250-258		0 432 191 639	
KBEL 110 P 118	DLLA 152 P 660	250-258		0 432 191 580	
KBEL 110 P 121	DLLA 157 P 494	300-308		0 432 191 638	
KBEL 110 P 132	DLLA 154 P 557	250-258		0 432 191 609	
KBEL 110 P 140	DSLA 134 P 604	240-252		0 432 193 757	0 986 430 522
KBEL 110 P 172	DLLA 144 P 449	250-262		0 432 191 521	
KBEL 110 P 172	DLLA 144 P 450	250-262		0 432 191 522	
KBEL 110 P 172	DLLA 144 P 490	250-262		0 432 191 518	
KBEL 110 P 172	DLLA 152 P 660	250-262		0 432 191 520	
KBEL 110 P 172	DLLA 152 P 685	250-262		0 432 191 519	
KBEL 110 P 176	DSLA 134 P 772	181-193	301-317	0 432 193 666	
KBEL 110 P 233	DLLA 152 P 1094	250-262		0 432 191 371	
KBEL 110 S 42	DLLA 150 S 1015	225-233		0 432 291 649	
KBEL 110 S 42	DLLA 150 S 1091	225-233		0 432 291 617	
KBEL 110 S 42	DLLA 150 S 1313	225-233		0 432 291 512	
KBEL 110 S 42	DLLA 155 S 1032	225-233		0 432 291 640	
KBEL 110 S 43	DLLA 140 S 1021	230-238		0 432 291 647	
KBEL 110 S 43	DLLA 140 S 1075	230-238		0 432 291 627	
KBEL 110 S 43	DLLA 140 S 1116	230-238		0 432 291 603	
KBEL 110 S 43	DLLA 140 S 1117	230-238		0 432 291 602	
KBEL 110 S 43	DLLA 145 S 1160	230-238		0 432 291 588	
KBEL 110 S 43	DLLA 145 S 1161	230-238		0 432 291 587	
KBEL 110 S 73	DLLA 145 S 1206	230-238		0 432 291 561	
KBEL 110 S 83	DLLA 150 S 1237	230-238		0 432 291 521	
KBEL 110 S 83	DLLA 150 S 1237	230-238		0 432 291 543	
KBEL 110 S 83	DLLA 150 S 1238	230-238		0 432 291 542	

A236

de	en	fr	it	es
Typformel Düsenhalter → Typformel Düse → DHK (Fortsetzung)	Type designation nozzle holder → Type designation nozzle → Nozzle-and-holder assemblies (continued)	Formule de type principaux porte-injecteurs → Formule de type injecteur → Ensembles porte-injecteurs (suite)	Sigla polverizzatori → Sigla portapolverizzatori → Sigla combinazione portapolverizzatori (seguito)	Designación de tipo portainyectoros → Designación de tipo inyectoros → Conjuntos portainyectoros (continuación)



					
KBEL 110 S 83	DLLA 152 S 1277	230-238		0 432 291 528	
KBEL 110 S 83	DLLA 152 S 1280	230-238		0 432 291 525	
KBEL 111 P 109	DLLA 144 P 449	250-258		0 432 191 661	
KBEL 111 P 109	DLLA 144 P 450	250-258		0 432 191 660	
KBEL 111 S 36	DLLA 144 S 1262	250-258		0 432 291 532	
KBEL 111 S 36	DLLA 144 S 1275	250-258		0 432 291 529	
KBEL 111 S 36	DLLA 147 S 969	210-218		0 432 291 674	
KBEL 111 S 36	DLLA 150 S 968	210-218		0 432 291 675	
KBEL 111 S 75	DLLA 140 S 1252	250-262		0 432 291 533	
KBEL 111 S 75	DLLA 143 S 1249	250-262		0 432 291 535	
KBEL 111 S 75	DLLA 143 S 1292	250-262		0 432 291 519	
KBEL 111 S 75	DLLA 143 S 1302	250-262		0 432 291 516	
KBEL 111 S 75	DLLA 145 S 1169	250-262		0 432 291 555	0 986 430 258
KBEL 115 P 28	DLLA 150 P 113	245-253		0 432 191 813	
KBEL 115 P 28	DLLA 150 P 60	245-253		0 432 191 821	
KBEL 117 P 122	DLLA 150 P 555	260-268		0 432 191 611	0 986 430 370
KBEL 117 P 122	DLLA 151 P 503	260-268		0 432 191 635	0 986 430 367
KBEL 117 P 122	DLLA 152 P 571	260-268		0 432 191 612	0 986 430 369
KBEL 117 P 163	DLLA 150 P 550	280-288		0 432 191 567	
KBEL 117 P 227	DLLA 152 P 571	260-268		0 432 191 386	
KBEL 117 P 7/4	DLLA 148 P 149	260-268		0 432 191 788	0 986 430 167
KBEL 117 P 7/4	DLLA 150 P 110	265-273		0 432 191 815	0 986 430 164
KBEL 117 P 7/4	DLLA 150 P 113	245-253		0 432 191 800	0 986 430 493
KBEL 117 P 7/4	DLLA 150 P 119	275-283		0 432 191 808	
KBEL 117 P 7/4	DLLA 150 P 177	260-268		0 432 191 771	0 986 430 166
KBEL 117 P 7/4	DLLA 150 P 178	260-268		0 432 191 770	0 986 430 165
KBEL 117 P 7/4	DLLA 150 P 31	275-283		0 432 191 863	0 986 430 032
KBEL 117 P 7/4	DLLA 150 P 43	275-283		0 432 191 852	
KBEL 117 P 7/4	DLLA 150 P 52	265-277		0 432 191 848	0 986 430 000
KBEL 117 P 7/4	DLLA 150 P 60	225-233		0 432 191 758	
KBEL 117 P 7/4	DLLA 150 P 60	245-253		0 432 191 842	
KBEL 117 P 7/4	DLLA 150 P 61	245-253		0 432 191 841	0 986 430 497
KBEL 117 P 7/4	DLLA 150 P 72	275-283		0 432 191 835	
KBEL 117 P 7/4	DLLA 150 P 76	255-263		0 432 191 834	
KBEL 117 P 73	DLLA 143 P 333	245-253		0 432 191 723	
KBEL 117 P 73	DLLA 143 P 334	245-253		0 432 191 722	
KBEL 117 P 73	DLLA 148 P 350	260-268		0 432 191 708	
KBEL 117 P 73	DLLA 150 P 407	260-268		0 432 191 677	
KBEL 117 P 73	DLLA 150 P 429	260-268		0 432 191 670	
KBEL 117 P 73	DLLA 150 P 550	280-288		0 432 191 614	
KBEL 117 P 73	DLLA 150 P 711	260-268		0 432 191 552	
KBEL 117 P 73	DLLA 152 P 285	260-268		0 432 191 737	0 986 430 353
KBEL 117 P 73	DLLA 152 P 313	260-268		0 432 191 730	0 986 430 263
KBEL 117 P 73	DLLA 152 P 335	260-268		0 432 191 721	0 986 430 250
KBEL 117 P 73	DLLA 152 P 336	260-268		0 432 191 719	0 986 430 359









KBEL 117 P 73	DLLA 152 P 339	260–268		0 432 191 715	0 986 430 354
KBEL 117 P 73	DLLA 152 P 340	260–268		0 432 191 714	
KBEL 117 P 73	DLLA 152 P 347	260–268		0 432 191 710	0 986 430 366
KBEL 120 S 67	DLLA 145 S 1169	250–262		0 432 291 580	
KBEL 123 S 59	DLLA 150 S 1137	250–258		0 432 291 595	
KBEL 123 S 80	DLLA 150 S 1137	250–262		0 432 291 549	
KBEL 123 S 80	DLLA 150 S 1321	250–262		0 432 291 508	
KBEL 132 P 108	DLLA 155 P 447	250–258		0 432 191 662	
KBEL 132 P 110	DLLA 155 P 451	300–308		0 432 191 659	
KBEL 132 P 110	DLLA 155 P 556	300–310		0 432 191 610	
KBEL 132 P 31	DLLA 150 P 105	225–233		0 432 191 817	
KBEL 132 P 31	DLLA 150 P 167	225–233		0 432 191 773	
KBEL 132 P 89	DLLA 150 P 364	225–233		0 432 191 698	
KBEL 137 P 161	DSLA 140 P 739	221–229		0 432 193 567	
KBEL 137 P 161	DSLA 140 P 741	300–314		0 432 193 568	
KBEL 137 P 174	DLLA 140 P 1278	300–314		0 432 191 319	
KBEL 137 P 230	DLLA 135 P 1399	240–260		0 432 191 289	
KBEL 137 P 230	DLLA 135 P 1401	240–260		0 432 191 291	
KBEL 137 P 230	DLLA 135 P 1400	240–260		0 432 191 290	
KBEL 137 P 230	DLLA 140 P 1420	200–220		0 432 191 283	
KBEL 137 P 230	DLLA 140 P 1421	200–220		0 432 191 284	
KBEL 137 P 230	DLLA 140 P 1444	240–260		0 432 191 274	
KBEL 137 P 230	DLLA 140 P 1445	240–260		0 432 191 273	
KBEL 137 P 230	DLLA 140 P 1446	240–260		0 432 191 272	
KBEL 162 P 164	DLLA 155 P 742	300–314		0 432 191 534	
KBEL 162 P 209	DLLA 145 P 1015	300–314		0 432 191 410	
KBEL 162 P 209	DLLA 155 P 742	300–314		0 432 191 448	
KBEL 162 P 210	DLLA 145 P 1015	300–314		0 432 191 409	
KBEL 162 P 210	DLLA 155 P 742	300–314		0 432 191 447	
KBEL 162 S 93	DLLA 141 S 1404			0 432 292 858	
KBEL 162 S 93	DLLA 144 S 5457	300–314		0 432 292 859	
KBEL 162 S 93	DLLA 150 S 1324	300–308		0 432 292 862	
KBEL 162 S 93	DLLA 155 S 1307	280–288		0 432 292 864	
KBEL 162 S 93	DLLA 155 S 1308	300–314		0 432 292 863	
KBEL 162 S 93	DLLA 155 S 1348	300–314		0 432 292 861	
KBEL 162 S 93	DLLA 155 S 1351	300–314		0 432 292 860	
KBEL 48 P 13/13	DLLA 150 P 11	200–208		0 432 191 857	
KBEL 48 P 38	DSLA 150 P 294	247–254		0 432 193 851	0 986 430 253
KBEL 48 P 38	DSLA 150 P 294	246–254		0 432 193 850	0 986 430 253
KBEL 53 P 103	DLLA 150 P 436	200–208		0 432 191 668	
KBEL 53 P 117	DLLA 144 P 354	220–228		0 432 191 640	
KBEL 53 P 2/13	DLLA 150 P 11	200–208		0 432 191 878	
KBEL 53 P 43	DSLA 150 P 191	181–189	331–345	0 432 193 878	
KBEL 53 P 43	DSLA 150 P 191	181–189	331–345	0 432 193 877	
KBEL 53 P 71	DSLA 150 P 280-	191–201	301–315	0 432 193 859	

A238

de	en	fr	it	es
Typformel Düsenhalter → Typformel Düse → DHK (Fortsetzung)	Type designation nozzle holder → Type designation nozzle → Nozzle-and-holder assemblies (continued)	Formule de type principaux porte-injecteurs → Formule de type injecteur → Ensembles porte-injecteurs (suite)	Sigla polverizzatori → Sigla portapolverizzatori → Sigla combinazione portapolverizzatori (seguito)	Designación de tipo portainyectoros → Designación de tipo inyectoros → Conjuntos portainyectoros (continuación)



 Typ	 Typ	 1st/bar	 2nd/bar	 Ref.	
KBEL 53 P 71	DSLA 150 P 280-	191-201	301-315	0 432 193 858	
KBEL 53 P 72	DSLA 150 P 280-	191-201	301-315	0 432 193 857	
KBEL 53 P 72	DSLA 150 P 280-	191-201	301-315	0 432 193 856	
KBEL 56 S 27	DLLA 144 S 889	205-213		0 432 291 697	
KBEL 56 S 27	DLLA 144 S 889	205-213		0 432 291 713	
KBEL 56 S 27	DLLA 146 S 890	205-213		0 432 291 696	
KBEL 56 S 27	DLLA 146 S 890	205-213		0 432 291 712	
KBEL 56 S 27	DLLA 150 S 1234	250-260		0 432 291 544	
KBEL 58 P 119	DSLA 150 P 1019	221-231	301-315	0 432 193 553	
KBEL 58 P 119	DSLA 150 P 280-	191-201	301-315	0 432 193 809	
KBEL 58 P 119	DSLA 150 P 442	191-201	301-315	0 432 193 824	
KBEL 58 P 119	DSLA 150 P 502	191-201	301-315	0 432 193 807	
KBEL 58 P 119	DSLA 150 P 646	190-198		0 432 193 721	
KBEL 58 P 119	DSLA 150 P 706	221-231	301-315	0 432 193 663	
KBEL 58 P 119	DSLA 150 P 764	221-231	301-315	0 432 193 670	
KBEL 58 P 119	DSLA 150 P 1019	221-231	301-315	0 432 193 552	
KBEL 58 P 119	DSLA 150 P 280-	191-201	301-315	0 432 193 785	
KBEL 58 P 119	DSLA 150 P 442	191-201	301-315	0 432 193 823	
KBEL 58 P 119	DSLA 150 P 502	191-201	301-315	0 432 193 786	
KBEL 58 P 119	DSLA 150 P 646	190-198		0 432 193 720	
KBEL 58 P 119	DSLA 150 P 706	221-231	301-315	0 432 193 662	
KBEL 58 P 119	DSLA 150 P 764	221-231	301-315	0 432 193 669	
KBEL 58 P 120	DSLA 150 P 280-	191-201	301-315	0 432 193 808	
KBEL 58 P 120	DSLA 150 P 502	191-201	301-315	0 432 193 806	
KBEL 58 P 120	DSLA 150 P 502	191-201	301-315	0 432 193 788	
KBEL 58 P 131	DSLA 150 P 502	191-201	301-315	0 432 193 784	
KBEL 58 P 131	DSLA 150 P 502	191-201	301-315	0 432 193 771	
KBEL 58 P 133	DSLA 150 P 357	190-198		0 432 193 783	
KBEL 58 P 133	DSLA 150 P 357	190-198		0 432 193 777	
KBEL 58 P 142	DSLA 150 P 442	191-201	301-315	0 432 193 735	
KBEL 58 P 142	DSLA 150 P 520	191-201	301-315	0 432 193 745	
KBEL 58 P 142	DSLA 150 P 672-	221-231	301-315	0 432 193 705	
KBEL 58 P 142	DSLA 150 P 706	221-231	301-315	0 432 193 694	
KBEL 58 P 142	DSLA 150 P 873	221-231	301-315	0 432 193 593	
KBEL 58 P 142	DSLA 150 P 442	191-201	301-315	0 432 193 734	
KBEL 58 P 142	DSLA 150 P 520	191-201	301-315	0 432 193 744	
KBEL 58 P 142	DSLA 150 P 672-	221-231	301-315	0 432 193 704	
KBEL 58 P 142	DSLA 150 P 706	221-231	301-315	0 432 193 693	
KBEL 58 P 142	DSLA 150 P 873	221-231	301-315	0 432 193 592	
KBEL 58 P 144	DSLA 150 P 442	191-201	301-315	0 432 193 733	
KBEL 58 P 144	DSLA 150 P 520	191-201	301-315	0 432 193 747	
KBEL 58 P 144	DSLA 150 P 672-	221-231	301-315	0 432 193 703	
KBEL 58 P 144	DSLA 150 P 706	221-231	301-315	0 432 193 696	
KBEL 58 P 144	DSLA 150 P 873	221-231	301-315	0 432 193 595	
KBEL 58 P 144	DSLA 150 P 442	191-201	301-315	0 432 193 732	









KBEL 58 P 144	DSLA 150 P 520	191-201	301-315	0 432 193 746	
KBEL 58 P 144	DSLA 150 P 672-	221-231	301-315	0 432 193 702	
KBEL 58 P 144	DSLA 150 P 706	221-231	301-315	0 432 193 695	
KBEL 58 P 144	DSLA 150 P 873	221-231	301-315	0 432 193 594	
KBEL 58 P 145	DSLA 150 P 442	190-198		0 432 193 743	
KBEL 58 P 145	DSLA 150 P 442	190-198		0 432 193 781	
KBEL 58 P 145	DSLA 150 P 520	190-198		0 432 193 739	
KBEL 58 P 145	DSLA 150 P 520	190-198		0 432 193 779	
KBEL 58 P 145	DSLA 150 P 442	190-198		0 432 193 742	
KBEL 58 P 145	DSLA 150 P 442	190-198		0 432 193 775	
KBEL 58 P 145	DSLA 150 P 520	190-198		0 432 193 738	
KBEL 58 P 145	DSLA 150 P 520	190-198		0 432 193 773	
KBEL 58 P 146	DSLA 145 P 619	201-211	381-395	0 432 193 754	
KBEL 58 P 147	DSLA 145 P 619	201-211	381-395	0 432 193 753	
KBEL 58 P 157	DSLA 150 P 646	191-201	301-315	0 432 193 717	
KBEL 58 P 157	DSLA 150 P 646	191-201	301-315	0 432 193 716	
KBEL 58 P 170	DSLA 150 P 745	191-201	301-315	0 432 193 683	
KBEL 58 P 170	DSLA 150 P 745	191-201	301-315	0 432 193 682	
KBEL 58 P 171	DSLA 150 P 745	191-201	301-315	0 432 193 681	
KBEL 58 P 171	DSLA 150 P 745	191-201	301-315	0 432 193 680	
KBEL 58 P 182	DSLA 145 P 808	201-211	381-397	0 432 193 643	
KBEL 58 P 183	DSLA 145 P 808	201-211	381-395	0 432 193 644	
KBEL 58 P 189	DSLA 150 P 1019	221-231	301-315	0 432 193 551	
KBEL 58 P 189	DSLA 150 P 442	191-201	301-315	0 432 193 622	
KBEL 58 P 189	DSLA 150 P 706	221-231	301-315	0 432 193 620	
KBEL 58 P 189	DSLA 150 P 764	221-231	301-315	0 432 193 609	
KBEL 58 P 189	DSLA 150 P 1019	221-231	301-315	0 432 193 550	
KBEL 58 P 189	DSLA 150 P 442	191-201	301-315	0 432 193 621	
KBEL 58 P 189	DSLA 150 P 706	221-231	301-315	0 432 193 619	
KBEL 58 P 189	DSLA 150 P 764	221-231	301-315	0 432 193 608	
KBEL 58 P 190	DSLA 150 P 646	191-201	301-315	0 432 193 618	
KBEL 58 P 190	DSLA 150 P 646	191-201	301-315	0 432 193 617	
KBEL 58 P 194	DSLA 145 P 619	191-201	386-400	0 432 193 611	
KBEL 58 P 195	DSLA 145 P 619	191-201	386-400	0 432 193 610	
KBEL 58 P 202	DSLA 150 P 442	191-201	301-315	0 432 193 576	
KBEL 58 P 202	DSLA 150 P 520	191-201	301-315	0 432 193 578	
KBEL 58 P 202	DSLA 150 P 672	221-231	301-315	0 432 193 585	
KBEL 58 P 202	DSLA 150 P 706	221-231	301-315	0 432 193 580	
KBEL 58 P 202	DSLA 150 P 873	221-231	301-315	0 432 193 543	
KBEL 58 P 202	DSLA 150 P 442	191-201	301-315	0 432 193 575	
KBEL 58 P 202	DSLA 150 P 520	191-201	301-315	0 432 193 577	
KBEL 58 P 202	DSLA 150 P 672	221-231	301-315	0 432 193 584	
KBEL 58 P 202	DSLA 150 P 706	221-231	301-315	0 432 193 579	
KBEL 58 P 202	DSLA 150 P 873	221-231	301-315	0 432 193 542	
KBEL 58 P 213	DSLA 145 P 987	206-216	386-400	0 432 193 563	

A240

<div style="border: 1px solid black; padding: 2px; display: inline-block;">de</div> Typformel Düsenhalter → Typformel Düse → DHK (Fortsetzung)	<div style="border: 1px solid black; padding: 2px; display: inline-block;">en</div> Type designation nozzle holder → Type designation nozzle → Nozzle-and-holder assemblies (continued)	<div style="border: 1px solid black; padding: 2px; display: inline-block;">fr</div> Formule de type principaux porte-injecteurs → Formule de type injecteur → Ensembles porte-injecteurs (suite)	<div style="border: 1px solid black; padding: 2px; display: inline-block;">it</div> Sigla polverizzatori → Sigla portapolverizzatori → Sigla combinazione portapolverizzatori (seguito)	<div style="border: 1px solid black; padding: 2px; display: inline-block;">es</div> Designación de tipo portainyectoros → Designación de tipo inyectoros → Conjuntos portainyectoros (continuación)
---	--	---	--	--



KBEL 58 P 214	DSLA 145 P 987	206-216	386-400	0 432 193 564	
KBEL 58 P 241	DSLA 150 P 1250	221-231	301-315	0 432 193 511	
KBEL 58 P 241	DSLA 150 P 1250	221-231	301-315	0 432 193 510	
KBEL 58 P 242	DSLA 150 P 1250	221-231	301-315	0 432 193 509	
KBEL 58 P 242	DSLA 150 P 1250	221-231	301-315	0 432 193 508	
KBEL 58 P 87	DSLA 150 P 357	191-201	301-315	0 432 193 840	
KBEL 58 P 87	DSLA 150 P 442	191-201	301-315	0 432 193 811	
KBEL 58 P 87	DSLA 150 P 661	191-201	301-315	0 432 193 710	
KBEL 58 P 87	DSLA 150 P 357	191-201	301-315	0 432 193 838	
KBEL 58 P 87	DSLA 150 P 442	191-201	301-315	0 432 193 794	
KBEL 58 P 87	DSLA 150 P 661	191-201	301-315	0 432 193 709	
KBEL 58 P 88	DSLA 150 P 357	191-201	301-315	0 432 193 839	
KBEL 58 P 88	DSLA 150 P 357	191-201	301-315	0 432 193 837	
KBEL 58 P 94	DSLA 150 P 357	191-201	301-315	0 432 193 830	
KBEL 58 P 94	DSLA 150 P 442	191-201	301-315	0 432 193 810	
KBEL 58 P 94	DSLA 150 P 661	191-201	301-315	0 432 193 708	
KBEL 58 P 94	DSLA 150 P 357	191-201	301-315	0 432 193 829	
KBEL 58 P 94	DSLA 150 P 442	191-201	301-315	0 432 193 795	
KBEL 58 P 94	DSLA 150 P 661	191-201	301-315	0 432 193 707	
KBEL 59 P 191	DSLA 93 P 838	191-201	301-315	0 432 193 616	
KBEL 59 P 191	DSLA 93 P 838	191-201	301-315	0 432 193 615	
KBEL 59 P 192	DSLA 93 P 838	191-201	301-315	0 432 193 614	
KBEL 59 P 192	DSLA 93 P 838	191-201	301-315	0 432 193 613	
KBEL 59 P 197	DSLA 150 P 672	221-231	301-315	0 432 193 600	
KBEL 59 P 197	DSLA 150 P 672	221-231	301-315	0 432 193 599	
KBEL 59 P 198	DSLA 150 P 672	221-231	301-315	0 432 193 598	
KBEL 59 P 198	DSLA 150 P 672	221-231	301-315	0 432 193 597	
KBEL 59 P 200	DSLA 142 P 851	221-231	301-315	0 432 193 605	
KBEL 59 P 200	DSLA 142 P 851	221-231	301-315	0 432 193 604	
KBEL 59 P 201	DSLA 142 P 851	221-231	301-315	0 432 193 603	
KBEL 59 P 201	DSLA 142 P 851	221-231	301-315	0 432 193 602	
KBEL 59 P 204	DSLA 150 P 672	221-231	301-315	0 432 193 574	
KBEL 59 P 204	DSLA 150 P 672	221-231	301-315	0 432 193 573	
KBEL 59 P 226	DSLA 150 P 745	191-201	301-315	0 432 193 545	
KBEL 59 P 226	DSLA 150 P 745	191-201	301-315	0 432 193 544	
KBEL 62 P 20	DLLA 130 P 62	250-258		0 432 191 843	
KBEL 62 S 78	DLLA 144 S 1162	220-228		9 430 082 313	
KBEL 62 S 78	DLLA 144 S 1162	245-253		9 430 082 314	
KBEL 62 S 9/13	DLLA 150 S 741	280-288		0 432 291 762	
KBEL 63 P 193	DSLA 155 P 1003	225-233		0 432 193 554	
KBEL 63 P 37	DSLA 150 P 143	210-218		0 432 193 887	
KBEL 63 P 37	DSLA 150 P 1498	230-237		0 432 193 463	
KBEL 63 P 56/TR	DLLA 150 P 225/TR	210-218		0 432 191 761	
KBEL 63 P 62	DSLA 150 P 194	190-198		0 432 193 844	
KBEL 63 P 62	DSLA 150 P 194	230-238		0 432 193 883	







 Typ	 Typ	 1st/bar	 2nd/bar	 Ref.	
KBEL 63 P 62	DSLA 150 P 246	280–288		0 432 193 870	
KBEL 63 P 66	DLLA 160 P 469	200–208		0 432 191 652	
KBEL 63 P 66	DLLA 160 P 664	200–208		0 432 191 578	
KBEL 63 P 66	DLLA 170 P 260	200–208		0 432 191 739	
KBEL 63 P 84	DLLA 170 P 338	200–208		0 432 191 716	
KBEL 64 P 16	DLLA 140 P 44	250–258		0 432 191 851	
KBEL 64 P 53	DLLA 140 P 44	200–208		9 430 082 723	
KBEL 64 P 53	DLLA 150 X 4	200–208		9 430 082 763	
KBEL 64 S 21	DLLA 140 S 827	250–258		0 432 291 726	
KBEL 65 P 113	DSLA 140 P 472	250–258		0 432 193 815	
KBEL 65 S 1/13	DLLA 151 S 686	200–208		0 432 291 789	
KBEL 65 S 34	DLLA 150 S 960/	245–253		0 432 291 680	
KBEL 65 S 34/TR	DLLA 150 S 1148/TR	175–183		0 432 291 589	
KBEL 65 S 34/TR	DLLA 150 S 974/TR	240–248		0 432 291 592	
KBEL 65 S 46/TR	DLLA 150 S 974/TR	240–248		0 432 291 670	
KBEL 65 S 49	DLLA 159 S 1082	250–258		0 432 291 626	
KBEL 65 S 60	DLLA 159 S 1141	250–258		0 432 291 593	
KBEL 66 P 111	DSLA 140 P 453	250–258		0 432 193 817	
KBEL 66 P 137	DSLA 140 P 472	250–258		0 432 193 762	
KBEL 66 P 69	DSLA 140 P 292	250–258		0 432 193 860	
KBEL 66 P 69	DSLA 140 P 400	250–258		0 432 193 828	
KBEL 66 S 45	DLLA 140 S 1039	250–258		0 432 291 638	
KBEL 66 S 45	DLLA 140 S 1069	250–258		0 432 291 629	
KBEL 66 S 47	DLLA 145 S 1172	270–278		0 432 291 577	
KBEL 66 S 47	DLLA 150 S 1055	250–258		0 432 291 634	
KBEL 66 S 47	DLLA 150 S 1087	250–258		0 432 291 620	
KBEL 66 S 91	DLLA 145 S 1172	250–258		0 432 291 518	
KBEL 67 S 38	DLLA 160 S 995	220–228		0 432 291 658	
KBEL 68 P 100	DSLA 135 P 468	250–258		0 432 193 816	
KBEL 68 P 100	DSLA 140 P 425	250–258		0 432 193 826	
KBEL 68 P 152	DSLA 140 P 640	201–213	321–337	0 432 193 728	
KBEL 68 P 40	DLLA 150 P 159	225–233		0 432 191 779	
KBEL 68 P 40	DLLA 150 P 214	225–233		0 432 191 755	
KBEL 68 P 67	DSLA 150 P 261	201–211	371–385	0 432 193 866	
KBEL 68 P 67	DSLA 155 P 617	221–231	371–385	0 432 193 755	
KBEL 69 P 99	DSLA 140 P 292	250–258		0 432 193 825	
KBEL 70 P 139	DSLA 140 P 425	250–258		0 432 193 759	
KBEL 70 S 33	DLLA 150 S 741	213–221		0 432 291 646	
KBEL 70 S 33	DLLA 150 S 741	275–283		0 432 291 682	
KBEL 70 S 55	DLLA 140 S 1121	250–258		0 432 291 600	
KBEL 70 S 55	DLLA 140 S 1187	250–258		0 432 291 570	
KBEL 75 S 12/4	DLLA 151 S 686	215–223		0 432 291 749	
KBEL 75 S 12/4	DLLA 151 S 813	250–258		0 432 291 734	
KBEL 75 S 22	DLLA 150 S 828	245–253		0 432 291 725	
KBEL 75 S 22	DLLA 150 S 993	200–208		0 432 291 660	

A242

<p>de</p> <p>Typformel Düsenhalter → Typformel Düse → DHK (Fortsetzung)</p>	<p>en</p> <p>Type designation nozzle holder → Type designation nozzle → Nozzle-and-holder assemblies (continued)</p>	<p>fr</p> <p>Formule de type principaux porte-injecteurs → Formule de type injecteur → Ensembles porte-injecteurs (suite)</p>	<p>it</p> <p>Sigla polverizzatori → Sigla portapolverizzatori → Sigla combinazione portapolverizzatori (seguito)</p>	<p>es</p> <p>Designación de tipo portainyectores → Designación de tipo inyectores → Conjuntos portainyectores (continuación)</p>
---	--	---	--	--



KBEL 75 S 39	DLLA 160 S 995	220-228		0 432 291 657	
KBEL 75 S 62	DLLA 134 S 1155	225-233		0 432 291 585	
KBEL 75 S 62	DLLA 137 S 1154	225-233		0 432 291 586	
KBEL 75 S 84	DLLA 134 S 1155	225-233		0 432 291 541	
KBEL 78 P 10/13	DLLA 150 P 34	180-188		0 432 191 860	
KBEL 78 P 114	DLLA 154 P 474	235-243		0 432 191 648	
KBEL 78 P 114	DSLA 154 P 620	235-243		0 432 193 752	
KBEL 78 P 23	DLLA 150 P 71	250-258		0 432 191 836	
KBEL 78 P 98	DLLA 150 P 421	250-258		0 432 191 672	
KBEL 80 P 58	DLLA 142 P 731	300-310		F 000 439 000	
KBEL 80 P 58	DLLA 146 P 600			9 430 082 768	
KBEL 80 S 61	DLLA 158 S 1146	250-258		0 432 291 590	
KBEL 80 S 61	DLLA 160 S 1181	250-258		0 432 291 572	
KBEL 81 P 22	DLLA 136 P 69	230-242		0 432 191 837	
KBEL 81 S 94	DLLA 132 S 1320	260-272		0 432 291 505	
KBEL 82 P 125	DSLA 128 P 523	260-272		0 432 193 798	
KBEL 82 P 149	DSLA 135 P 633	260-272		0 432 193 730	
KBEL 82 P 23	DLLA 134 P 703	265-273		0 432 131 702	
KBEL 82 P 235	DLLA 155 P 1159	310-318		0 432 191 350	
KBEL 82 P 63	DLLA 135 P 250	240-252		0 432 191 741	
KBEL 82 P 76	DLLA 140 P 305	260-272		0 432 191 732	
KBEL 82 P 90	DLLA 135 P 367	260-272		0 432 191 695	
KBEL 82 P 90	DLLA 135 P 373	260-272		0 432 191 692	
KBEL 83 P 105	DLLA 145 P 439	225-233		0 432 191 665	
KBEL 83 P 105	DLLA 145 P 536	225-233		0 432 191 618	
KBEL 83 P 78	DLLA 135 P 782	270-282		0 432 191 511	
KBEL 83 P 78	DSLA 130 P 320	260-272		0 432 193 847	
KBEL 83 P 79	DSLA 130 P 321	260-272		0 432 193 846	
KBEL 83 S 35	DLLA 124 S 1001	230-242		0 432 291 654	
KBEL 83 S 35	DLLA 124 S 1365	230-242		0 432 291 499	
KBEL 83 S 35	DLLA 124 S 963	230-242		0 432 291 678	
KBEL 83 S 35	DLLA 132 S 1320	260-272		0 432 291 509	
KBEL 83 S 35	DLLA 132 S 1335	260-272		0 432 291 504	
KBEL 83 S 35	DLLA 134 S 1113	260-272		0 432 291 604	
KBEL 83 S 35	DLLA 136 S 1000	230-242		0 432 291 655	
KBEL 83 S 35	DLLA 136 S 1020	230-242		0 432 291 648	
KBEL 83 S 35	DLLA 136 S 1031	230-242		0 432 291 641	
KBEL 83 S 35	DLLA 136 S 964	230-242		0 432 291 677	
KBEL 83 S 35	DLLA 137 S 1171	260-272		0 432 291 578	
KBEL 83 S 35	DLLA 138 S 1112	260-272		0 432 291 605	
KBEL 83 S 68	DLLA 137 S 1174	240-252		0 432 291 576	
KBEL 83 S 68	DLLA 137 S 1208	240-252		0 432 291 559	
KBEL 84 P 148	DLLA 145 P 439	225-233		0 432 191 541	
KBEL 84 P 148	DLLA 145 P 536	300-308		0 432 191 502	
KBEL 84 P 148	DLLA 145 P 536	225-233		0 432 191 542	

 Typ					
KBEL 84 P 148	DLLA 145 P 632	225-233		0 432 191 591	
KBEL 84 P 148	DLLA 145 P 669	225-233		0 432 191 577	
KBEL 84 P 162	DLLA 140 P 583	260-274		0 432 191 571	
KBEL 84 P 162	DLLA 150 P 722	300-308		0 432 191 546	
KBEL 84 P 162	DLLA 153 P 1146	300-314		0 432 191 355	
KBEL 84 P 162	DLLA 153 P 1165	300-314		0 432 191 349	
KBEL 84 P 162	DLLA 153 P 700	300-314		0 432 191 484	
KBEL 84 P 162	DLLA 153 P 700	300-308		0 432 191 556	
KBEL 84 P 162	DSLA 150 P 755	300-308		0 432 193 665	
KBEL 84 P 162	DSLA 150 P 755	300-308		0 432 193 678	
KBEL 84 P 162	DSLA 150 P 773	300-308		0 432 193 664	
KBEL 84 P 162	DSLA 150 P 775	300-314		0 432 193 659	
KBEL 84 P 162	DSLA 152 P 829	300-314		0 432 193 630	
KBEL 84 P 162	DSLA 152 P 830	300-314		0 432 193 629	
KBEL 84 P 162	DSLA 152 P 887	300-314		0 432 193 581	
KBEL 84 P 162	DSLA 153 P 820	300-314		0 432 193 635	
KBEL 84 P 178	DSLA 150 P 755	300-314		0 432 193 653	
KBEL 84 P 178	DSLA 150 P 773	300-314		0 432 193 652	
KBEL 84 P 178	DSLA 153 P 797	300-314		0 432 193 649	
KBEL 84 P 178	DSLA 153 P 798	300-314		0 432 193 648	
KBEL 84 P 178	DSLA 153 P 801	300-314		0 432 193 647	
KBEL 84 P 178	DSLA 153 P 802	300-314		0 432 193 646	
KBEL 84 P 178	DSLA 153 P 803	300-314		0 432 193 645	
KBEL 84 P 223	DLLA 145 P 669	225-233		0 432 191 403	
KBEL 84 P 225	DLLA 145 P 536	300-308		0 432 191 397	
KBEL 84 P 234	DLLA 145 P 669	225-233		0 432 191 358	
KBEL 84 P 26	DLLA 142 P 169	214-222		9 430 082 716	
KBEL 84 P 26	DLLA 150 P 106	220-228		9 430 082 703	
KBEL 84 P 26	DLLA 150 P 112	254-262		9 430 082 708	
KBEL 84 P 26	DLLA 150 P 129	254-262		9 430 082 711	
KBEL 84 P 26	DLLA 150 P 183	214-222		9 430 082 718	
KBEL 84 P 26	DLLA 150 P 194	214-222		9 430 082 719	
KBEL 84 P 26	DLLA 150 P 236	270-278		9 430 082 727	
KBEL 84 P 26	DLLA 150 P 281	230-238		9 430 082 739	
KBEL 84 P 26	DLLA 153 P 142	214-222		9 430 082 713	
KBEL 84 P 26	DLLA 155 P 153	220-228		9 430 082 714	
KBEL 84 P 46	DSLA 124 P 198	230-242		0 432 193 882	
KBEL 84 P 48	DLLA 150 P 129	254-262		9 430 082 722	
KBEL 84 P 48	DLLA 150 P 174	254-262		9 430 082 717	
KBEL 84 P 48	DLLA 150 P 226	254-262		9 430 082 726	
KBEL 84 P 93	DLLA 135 P 530	255-265		0 432 191 621	
KBEL 84 P 93	DLLA 135 P 539	240-252		0 432 191 617	
KBEL 84 P 93	DLLA 140 P 389	255-267		0 432 191 688	
KBEL 84 P 93	DLLA 140 P 390	240-252		0 432 191 687	
KBEL 84 P 93	DLLA 143 P 471	270-282		0 432 191 650	

A244

de

Typformel Düsenhalter → Typformel Düse → DHK
(Fortsetzung)

en

Type designation nozzle holder → Type designation nozzle → Nozzle-and-holder assemblies
(continued)

fr

Formule de type principaux porte-injecteurs → Formule de type injecteur → Ensembles porte-injecteurs
(suite)

it

Sigla polverizzatori → Sigla portapolverizzatori → Sigla combinazione portapolverizzatori
(seguito)

es

Designación de tipo portainyectores → Designación de tipo inyectores → Conjuntos portainyectores
(continuación)



KBEL 84 P 93	DLLA 143 P 485	270–282		0 432 191 641	
KBEL 84 P 93	DLLA 150 P 1110	300–312		0 432 191 364	
KBEL 84 P 93	DLLA 150 P 952	300–312		0 432 191 440	
KBEL 84 P 93	DSLA 143 P 1154	270–282		0 432 193 524	
KBEL 84 P 93	DSLA 143 P 1364	270–282		0 432 191 351	
KBEL 84 S 4/13	DLLA 150 S 690	240–248		0 432 291 773	
KBEL 84 S 4/13	DLLA 150 S 690	225–233		0 432 291 774	
KBEL 84 S 4/13	DLLA 150 S 690	225–233		0 432 291 792	
KBEL 84 S 4/13	DLLA 150 S 716	240–248		0 432 291 771	
KBEL 84 S 4/13	DLLA 150 S 716	225–233		0 432 291 775	
KBEL 84 S 4/13	DLLA 150 S 716	225–233		0 432 291 781	
KBEL 84 S 4/13	DLLA 150 S 728	240–248		0 432 291 755	
KBEL 84 S 4/13	DLLA 150 S 728	225–233		0 432 291 772	
KBEL 84 S 4/13	DLLA 150 S 815	240–248		0 432 291 714	
KBEL 84 S 4/13	DLLA 150 S 815	240–248		0 432 291 723	
KBEL 84 S 4/13	DLLA 150 S 815	225–233		0 432 291 724	
KBEL 84 S 4/13	DLLA 150 S 815	225–233		0 432 291 733	
KBEL 84 S 4/13	DLLA 150 S 836	240–248		0 432 291 715	
KBEL 84 S 4/13	DLLA 150 S 836	225–233		0 432 291 719	
KBEL 84 S 4/13	DLLA 150 S 836	240–248		0 432 291 720	
KBEL 84 S 4/13	DLLA 150 S 843	240–248		0 432 291 598	
KBEL 84 S 4/13	DLLA 150 S 843	240–248		0 432 291 716	
KBEL 84 S 4/13	DLLA 150 S 843	225–233		0 432 291 717	
KBEL 84 S 4/13	DLLA 150 S 868	200–208		0 432 291 703	
KBEL 84 S 82	DLLA 150 S 1231	240–248		0 432 291 546	
KBEL 84 S 82	DLLA 150 S 1314	275–283		0 432 291 511	
KBEL 85 P 104	DLLA 135 P 437	255–267		0 432 191 667	
KBEL 85 P 68	DLLA 139 P 288	270–278		9 430 082 742	
KBEL 85 P 68	DLLA 139 P 288	270–278		9 430 082 755	
KBEL 85 P 68	DLLA 139 P 289	270–278		9 430 082 740	
KBEL 85 P 68	DLLA 139 P 289	270–278		9 430 082 754	
KBEL 85 P 68	DLLA 139 P 303			9 430 082 744	
KBEL 85 P 68	DLLA 140 P 271	254–262		9 430 082 735	
KBEL 85 S 28	DLLA 160 S 856	265–273		0 432 291 708	
KBEL 85 S 28	DLLA 160 S 857	240–248		0 432 291 707	
KBEL 88 P 1/4	DLLA 150 P 10	185–193		0 432 191 880	
KBEL 88 P 115	DLLA 150 P 476+	210–218		0 432 191 647	
KBEL 88 P 115	DLLA 150 P 481+	210–218		0 432 191 644	
KBEL 88 P 115	DLLA 150 P 615+	210–218		0 432 191 593	
KBEL 88 P 29	DLLA 148 P 97	210–218		0 432 191 820	
KBEL 88 P 29	DLLA 148 P 98	210–218		0 432 191 819	
KBEL 88 P 33	DLLA 150 P 207	250–258		9 430 082 721	
KBEL 88 P 34	DLLA 150 P 131	180–188		0 432 191 785	
KBEL 88 P 34	DLLA 150 P 131	250–258		0 432 191 798	
KBEL 88 P 34	DLLA 150 P 145	180–188		0 432 191 787	















KBEL 88 P 55	DLLA 147 P 344	225-233		0 432 191 712	
KBEL 88 P 55	DLLA 147 P 404	255-263		0 432 191 678	
KBEL 88 P 55	DLLA 150 P 228	225-233		0 432 191 752	
KBEL 88 P 55	DLLA 150 P 232	255-263		0 432 191 749	
KBEL 88 P 55	DLLA 150 P 291	225-233		0 432 191 734	
KBEL 88 P 55	DLLA 150 P 345	185-193		0 432 191 711	
KBEL 88 P 70	DLLA 148 P 163	210-218		0 432 191 776	
KBEL 88 P 70	DLLA 148 P 164	210-218		0 432 191 775	
KBEL 88 P 70	DLLA 152 P 378	210-218		0 432 191 702	
KBEL 88 P 70	DLLA 155 P 440	210-218		0 432 191 664	
KBEL 88 S 20	DLLA 160 S 817	265-273		0 432 291 732	
KBEL 88 S 20	DLLA 160 S 856	265-273		0 432 291 709	
KBEL 89 S 16/4	DLLA 150 S 804	220-228		0 432 291 740	
KBEL 90 P 124	DLLA 134 P 760	250-258		0 432 191 517	
KBEL 90 P 124	DLLA 142 P 956	210-218		0 432 191 438	
KBEL 90 P 124	DLLA 143 P 495	250-258		0 432 191 631	
KBEL 90 P 154	DSLA 150 P 645	230-242		0 432 193 722	
KBEL 90 P 18	DLLA 160 P 57	300-308		9 430 233 006	
KBEL 90 P 18	DLLA 160 P 57	270-278		9 430 233 009	
KBEL 90 P 18	DLLA 160 P 57	210-218		9 430 233 010	
KBEL 90 P 18	DLLA 160 P 58	300-308		9 430 233 016	
KBEL 90 P 18	DLLA 160 P 58	270-278		9 430 233 007	
KBEL 90 P 18	DLLA 160 P 63	300-308		9 430 233 008	
KBEL 90 P 18	DLLA 160 P 90	300-308		9 430 233 015	
KBEL 90 P 18	DSLA 160 P 192	250-258		0 432 193 884	
KBEL 90 P 35	DLLA 168 P 751	290-298		0 432 131 699	
KBEL 90 P 5/13	DLLA 155 P 5	300-308		0 432 191 879	
KBEL 90 P 5/13	DLLA 160 P 9	270-278		0 432 191 881	
KBEL 90 P 5/13	DLLA 160 P 9	300-308		9 430 233 001	
KBEL 90 P 5/13	DLLA 160 P 9	210-218		9 430 233 005	
KBEL 90 P 51	DLLA 150 P 545/	310-320		0 432 131 666	
KBEL 90 S 14/4	DLLA 150 S 789	200-208		0 432 291 743	
KBEL 90 S 17/4	DLLA 150 S 806	200-208		0 432 291 737	
KBEL 90 S 23	DLLA 150 S 1029	230-238		0 432 292 876	
KBEL 90 S 23	DLLA 150 S 1044	230-238		0 432 292 875	
KBEL 90 S 23	DLLA 150 S 804	205-213		0 432 292 878	
KBEL 90 S 23	DLLA 150 S 830	200-208		0 432 291 721	
KBEL 90 S 23	DLLA 150 S 994	200-208		0 432 291 659	
KBEL 90 S 3/13	DLLA 132 S 981	225-233		0 432 291 664	
KBEL 90 S 3/13	DLLA 142 S 1188	230-238		0 432 291 569	
KBEL 90 S 3/13	DLLA 142 S 1189	225-233		0 432 291 568	
KBEL 90 S 3/13	DLLA 142 S 897	240-248		0 432 291 695	
KBEL 90 S 3/13	DLLA 142 S 924	220-228		0 432 291 686	
KBEL 90 S 3/13	DLLA 142 S 980	260-268		0 432 291 606	
KBEL 90 S 3/13	DLLA 142 S 980	225-233		0 432 291 665	

A246

de	en	fr	it	es
Typformel Düsenhalter → Typformel Düse → DHK (Fortsetzung)	Type designation nozzle holder → Type designation nozzle → Nozzle-and-holder assemblies (continued)	Formule de type principaux porte-injecteurs → Formule de type injecteur → Ensembles porte-injecteurs (suite)	Sigla polverizzatori → Sigla portapolverizzatori → Sigla combinazione portapolverizzatori (seguito)	Designación de tipo portainyectoros → Designación de tipo inyectoros → Conjuntos portainyectoros (continuación)



 Typ	 Typ	 1st/bar	 2nd/bar	 Ref.	
KBEL 90 S 3/13	DLLA 150 S 1060	255-263		0 432 291 631	
KBEL 90 S 3/13	DLLA 150 S 881	190-198		0 432 291 701	
KBEL 90 S 3/13	DLLA 150 S 904	220-228		0 432 291 693	
KBEL 90 S 3/13	DLLA 151 S 928	230-238		0 432 291 684	
KBEL 90 S 3/13	DLLA 151 S 972	230-238		0 432 291 671	
KBEL 90 S 3/13	DLLA 151 S 985	230-238		0 432 291 663	
KBEL 90 S 3/13	DLLA 152 S 1180	230-238		0 432 291 573	
KBEL 90 S 3/13	DLLA 152 S 1184	230-238		0 432 291 552	
KBEL 90 S 3/13	DLLA 160 S 760	250-258		0 432 291 761	
KBEL 90 S 3/13	DLLA 160 S 908	250-258		0 432 291 692	
KBEL 90 S 44	DLLA 142 S 1188	220-228		0 432 291 520	
KBEL 90 S 44	DLLA 142 S 1189	225-233		0 432 291 540	
KBEL 90 S 44	DLLA 142 S 924	220-228		0 432 291 645	
KBEL 90 S 48/TR	DLLA 150 S 1066	225-233		0 432 291 623	
KBEL 90 S 48/TR	DLLA 150 S 1066	225-233		0 432 292 872	
KBEL 90 S 48/TR	DLLA 150 S 1067	225-233		0 432 291 619	
KBEL 90 S 48/TR	DLLA 150 S 798	225-233		0 432 291 622	
KBEL 90 S 48/TR	DLLA 150 S 798	225-233		0 432 292 871	
KBEL 90 S 69	DLLA 145 S 1176	240-252		0 432 291 575	
KBEL 90 S 71	DLLA 150 S 1029	230-238		0 432 292 866	
KBEL 90 S 71	DLLA 150 S 1044	230-238		0 432 292 867	
KBEL 90 S 71	DLLA 150 S 804	205-213		0 432 292 865	
KBEL 90 S 76	DLLA 135 S 1309	240-252		0 432 291 514	
KBEL 90 S 76	DLLA 140 S 1217	240-252		0 432 291 554	
KBEL 92 P 250	DLLA 149 P 1402	260-272		0 432 191 288	
KBEL 93 P 167	DLLA 150 P 723	300-308		0 432 191 544	
KBEL 93 P 177	DLLA 148 P 924	300-314		0 432 191 454	
KBEL 93 P 177	DLLA 150 P 722	300-314		0 432 191 498	
KBEL 93 P 177	DLLA 150 P 723	300-308		0 432 191 512	
KBEL 93 P 216	DLLA 144 P 1056	300-314		0 432 191 390	
KBEL 93 P 216	DLLA 144 P 1132	300-314		0 432 191 357	
KBEL 93 P 216	DLLA 148 P 1013	300-314		0 432 191 422	
KBEL 93 P 216	DLLA 150 P 1008	300-314		0 432 191 426	
KBEL 93 P 216	DLLA 150 P 1053	300-314		0 432 191 392	
KBEL 93 P 216	DLLA 150 P 1054	300-314		0 432 191 391	
KBEL 93 P 216	DLLA 150 P 1057	300-314		0 432 191 389	
KBEL 94 P 156	DLLA 158 P 651	250-262		0 432 191 585	
KBEL 94 P 180	DLLA 154 P 866	320-328		0 432 191 482	
KBEL 94 P 218	DLLA 152 P 1349	320-328		0 432 191 296	
KBEL 94 P 218	DLLA 152 P 1466	300-308		0 432 191 250	
KBEL 94 P 218	DLLA 152 P 967	300-308		0 432 191 419	
KBEL 94 P 218	DLLA 154 P 1319	320-328		0 432 191 310	
KBEL 94 P 218	DLLA 154 P 866	320-328		0 432 191 416	
KBEL 94 P 218	DLLA 154 P 965	320-328		0 432 191 421	
KBEL 94 P 219	DLLA 152 P 1466	300-308		0 432 191 249	





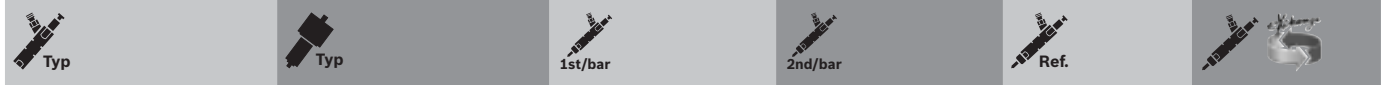

 Typ	 Typ	 1st/bar	 2nd/bar	 Ref.	
KBEL 94 P 219	DLLA 152 P 967	300–308		0 432 191 418	
KBEL 94 P 219	DLLA 154 P 1319	320–328		0 432 191 309	
KBEL 94 P 219	DLLA 154 P 866	320–328		0 432 191 415	
KBEL 94 P 219	DLLA 154 P 965	320–328		0 432 191 420	
KBEL 94 P 220	DLLA 152 P 967	300–308		0 432 191 417	
KBEL 94 P 220	DLLA 154 P 866	320–328		0 432 191 414	
KBEL 95 P 175	DLLA 135 P 769+	260–270		0 432 191 513	
KBEL 95 P 30	DLLA 150 P 99	255–267		0 432 191 818	
KBEL 95 P 42	DLLA 134 P 186	250–262		0 432 191 766	
KBEL 95 P 42	DLLA 150 P 199	260–272		0 432 191 763	
KBEL 95 P 9/4	DLLA 143 P 40	275–283		0 432 191 854	0 986 430 002
KBEL 95 P 9/4	DLLA 143 P 45	250–258		0 432 191 850	
KBEL 95 P 9/4	DLLA 143 P 88	275–283		0 432 191 827	
KBEL 95 P 9/4	DLLA 148 P 38	265–273		0 432 191 855	
KBEL 95 P 9/4	DLLA 150 P 20	275–283		0 432 191 872	
KBEL 95 P 9/4	DLLA 150 P 22	275–283		0 432 191 870	
KBEL 95 P 9/4	DLLA 150 P 24	275–283		0 432 191 868	
KBEL 95 P 9/4	DLLA 150 P 28	245–253		0 432 191 865	
KBEL 95 P 9/4	DLLA 150 P 30	245–253		0 432 191 864	
KBEL 95 P 9/4	DLLA 150 P 32	275–283		0 432 191 862	
KBEL 95 P 9/4	DLLA 150 P 37	250–258		0 432 191 856	
KBEL 95 S 10/13	DLLA 150 S 422	175–183		0 432 291 757	
KBEL 95 S 19	DLLA 160 S 811	265–273		0 432 291 735	
KBEL 95 S 19	DLLA 160 S 938	265–273		9 430 233 014	
KBEL 95 S 52	DLLA 145 S 1023	200–208		0 432 291 611	
KBEL 95 S 70	DLLA 140 S 1186	240–248		0 432 291 571	
KBEL 96 P 116	DLLA 138 P 403	260–272		0 432 191 646	
KBEL 96 P 6/13	DLLA 155 P 51			9 430 233 011	
KBEL 96 P 77	DLLA 142 P 312	260–272		0 432 191 731	
KBEL 97 P 136	DLLA 140 P 583	250–258		0 432 191 603	
KBEL 97 P 206	DLLA 140 P 583	250–258		0 432 191 458	
KBEL 97 P 35	DLLA 146 P 139	250–258		0 432 191 789	
KBEL 97 P 35	DLLA 146 P 140	250–258		0 432 191 790	
KBEL 97 P 35	DLLA 146 P 197	250–258		0 432 191 764	
KBEL 97 P 35	DLLA 146 P 244	250–258		0 432 191 743	
KBEL 97 P 91	DLLA 135 P 374	250–258		0 432 191 691	
KBEL 97 P 96	DLLA 138 P 403	260–272		0 432 191 679	
KBEL 97 P 97	DLLA 138 P 401	260–272		0 432 191 681	
KBEL 97 P 97	DLLA 138 P 402	260–272		0 432 191 680	
KBEL 98 P 101	DLLA 143 P 428	245–253		0 432 191 671	
KBEL 98 P 101	DLLA 145 P 466	245–253		0 432 191 658	0 986 430 498
KBEL 98 P 102	DLLA 145 P 286	255–267		0 432 191 529	
KBEL 98 P 102	DLLA 145 P 433	260–268		0 432 191 669	0 986 430 364
KBEL 98 P 102	DLLA 145 P 438	260–268		0 432 191 666	0 986 430 365
KBEL 98 P 102	DLLA 145 P 504	260–268		0 432 191 634	0 986 430 368

A248

<p>de</p> <p>Typformel Düsenhalter → Typformel Düse → DHK (Fortsetzung)</p>	<p>en</p> <p>Type designation nozzle holder → Type designation nozzle → Nozzle-and-holder assemblies (continued)</p>	<p>fr</p> <p>Formule de type principaux porte-injecteurs → Formule de type injecteur → Ensembles porte-injecteurs (suite)</p>	<p>it</p> <p>Sigla polverizzatori → Sigla portapolverizzatori → Sigla combinazione portapolverizzatori (seguito)</p>	<p>es</p> <p>Designación de tipo portainyectores → Designación de tipo inyectores → Conjuntos portainyectores (continuación)</p>
---	--	---	--	--



KBEL 98 P 102	DLLA 145 P 809	260–268		0 432 191 506	
KBEL 98 P 102	DLLA 146 P 1122	260–274		0 432 191 361	
KBEL 98 P 102	DLLA 148 P 911	260–274		0 432 191 461	
KBEL 98 P 102	DLLA 148 P 912	260–274		0 432 191 460	
KBEL 98 P 102	DSLA 147 P 759	260–268		0 432 193 676	
KBEL 98 P 15	DLLA 150 P 39	230–238		0 432 192 884	
KBEL 98 P 15	DLLA 150 P 42	230–238		0 432 191 853	
KBEL 98 P 15	DLLA 150 P 42	230–238		0 432 192 883	
KBEL 98 P 160	DLLA 141 P 1009	305–317		0 432 191 425	
KBEL 98 P 160	DLLA 145 P 1062	295–307		0 432 191 388	
KBEL 98 P 160	DLLA 145 P 659	305–317		0 432 191 581	
KBEL 98 P 173	DLLA 145 P 809	260–268		0 432 191 505	
KBEL 98 P 205	DLLA 145 P 809	260–268		0 432 191 466	
KBEL 98 P 205	DLLA 148 P 911	260–274		0 432 191 439	
KBEL 98 P 221	DLLA 148 P 1022	260–274		0 432 191 402	
KBEL 98 P 221	DLLA 148 P 911	260–274		0 432 191 405	
KBEL 98 P 222	DLLA 148 P 1022	260–274		0 432 191 404	
KBEL 98 P 238	DLLA 145 P 1189	290–302		0 432 191 339	
KBEL 98 P 27	DLLA 143 P 121	255–263		0 432 191 807	
KBEL 98 P 27	DLLA 143 P 122	255–263		0 432 191 806	
KBEL 98 P 27	DLLA 143 P 123	255–263		0 432 191 805	
KBEL 98 P 27	DLLA 143 P 126	245–253		0 432 191 803	
KBEL 98 P 27	DLLA 143 P 127	245–253		0 432 191 802	0 986 430 495
KBEL 98 P 27	DLLA 143 P 128	245–253		0 432 191 801	0 986 430 494
KBEL 98 P 27	DLLA 143 P 151	235–243		0 432 191 782	
KBEL 98 P 27	DLLA 143 P 160	255–263		0 432 191 778	0 986 430 492
KBEL 98 P 27	DLLA 143 P 93	255–263		0 432 191 825	0 986 430 163
KBEL 98 P 27	DLLA 143 P 94	255–263		0 432 191 824	
KBEL 98 P 27	DLLA 143 P 96	265–273		0 432 191 822	0 986 430 162
KBEL 98 P 27	DLLA 150 P 43	275–283		0 432 191 792	
KBEL 98 P 52	DSLA 145 P 208	201–209	281–293	0 432 193 879	
KBEL 98 P 54	DLLA 150 P 217	305–313		0 432 191 753	
KBEL 98 P 74	DLLA 145 P 286	260–268		0 432 191 736	0 986 430 363
KBEL 98 P 74	DLLA 145 P 328	260–268		0 432 191 724	0 986 430 311
KBEL 98 P 74	DLLA 145 P 331	295–303		0 432 191 727	
KBEL 98 P 74	DLLA 145 P 337	245–253		0 432 191 717	
KBEL 98 P 74	DLLA 145 P 392	305–313		0 432 191 685	
KBEL 98 P 74	DLLA 145 P 393	305–313		0 432 191 686	
KBEL 98 P 74	DLLA 145 P 478	260–268		0 432 191 645	
KBEL 98 P 74	DLLA 145 P 785	295–303		0 432 191 509	
KBEL 98 P 74	DLLA 145 P 832	295–303		0 432 191 492	
KBEL 98 P 74	DLLA 145 P 961	295–303		0 432 191 435	
KBEL 98 P 74	DLLA 148 P 586	260–268		0 432 191 600	
KBEL 98 P 74	DSLA 143 P 1099	290–302		0 432 193 535	
KBEL 99 P 188	DLLA 148 P 1010	250–262		0 432 191 424	

 Typ	 Typ	 1st/bar	 2nd/bar	 Ref.	
KBEL 99 P 188	DLLA 148 P 1237	250–262		0 432 191 323	
KBEL 99 P 188	DLLA 148 P 923	250–262		0 432 191 491	
KBEL 99 P 243	DLLA 150 P 1285	260–272		0 432 191 318	
KBEL 99 P 248	DLLA 148 P 1506	250–262		0 432 191 245	
KBEL 99 P 269	DLLA 146 P 1583	280–292		0 432 191 241	
KBEL 99 P 57	DLLA 124 P 227	250–262		0 432 191 751	
KBELZ 114 S 50	DLLZ 160 S 1095	220–228		0 432 291 616	
KBELZ 124 S 66	DLLZ 140 S 1168	250–262		0 432 291 581	
KBELZ 124 S 66	DLLZ 140 S 1361	260–272		0 432 291 500	
KBELZ 90 P 4/13	DLLZ 155 P 4	300–308		0 432 191 885	
KBF 175 T 23	DLLF 145 T 10			0 432 382 007	
KBF 175 T 23	DLLF 145 T 13			0 432 382 008	
KBF 178 T 5/20	DLF 145 T 21			0 432 382 001	
KBF 178 T 5/20	DLF 145 T 21			0 432 382 002	
KBF 178 T 5/20	DLLF 145 T 8			0 432 382 005	
KBF 230 T 16/20	DLF 145 T 38			0 432 382 004	
KBF 230 T 16/20	DLF 145 T 44	250–258		0 432 382 006	
KBF 230 T 18/20	DLLF 145 T 9			0 432 382 009	
KBF 280 V 50	DLF 155 V 2			0 432 582 001	
KBL 103 S 21/13	DLLA 150 S 112			0 432 281 884	
KBL 103 S 21/13	DLLA 150 S 140			0 432 281 885	
KBL 103 S 21/13	DLLA 150 S 178			0 432 281 886	
KBL 103 S 21/13	DLLA 150 S 720			0 432 281 887	
KBL 106 S 168/4	DLLA 155 S 520	175–183		0 432 281 737	
KBL 106 S 168/4	DLLA 155 S 636	230–238		0 432 281 739	
KBL 108 S 178/4	DLLA 140 S 1017	250–262		0 432 281 687	
KBL 108 S 178/4	DLLA 140 S 1236	250–262		0 432 281 686	
KBL 108 S 178/4	DLLA 140 S 563	200–208		0 432 281 732	
KBL 108 S 178/4	DLLA 160 S 641	200–208		0 432 281 731	
KBL 108 S 178/4	DLLA 160 S 699	200–208		0 432 281 724	
KBL 112 S 164/13	DLLA 150 S 549	205–213		0 432 281 723	
KBL 112 S 164/13	DLLA 150 S 615	205–213		0 432 281 748	
KBL 112 S 164/13	DLLA 150 S 616	205–213		0 432 281 747	
KBL 112 S 21/13	DLLA 150 S 140	165–173		0 432 281 874	
KBL 112 S 21/13	DLLA 150 S 178	205–213		0 432 281 802	
KBL 112 S 21/13	DLLA 150 S 178	180–188		0 432 281 873	
KBL 112 S 21/13	DLLA 150 S 467	215–223		0 432 281 711	
KBL 112 S 21/13	DLLA 150 S 467	185–193		0 432 281 728	
KBL 112 S 21/13	DLLA 150 S 467	145–153		0 432 281 807	
KBL 112 S 21/13	DLLA 150 S 521	215–223		0 432 281 777	
KBL 112 S 21/13	DLLA 150 S 521	175–183		0 432 281 783	
KBL 112 S 21/13	DLLA 150 S 714	216–224		0 432 281 720	
KBL 112 S 21/13	DLLA 150 S 816	255–263		0 432 281 707	
KBL 112 S 28/13	DLL 150 S 484	200–208		0 432 281 058	
KBL 112 S 28/13	DLL 150 S 489	200–208		0 432 281 059	

A250

de

Typformel Düsenhalter → Typformel Düse → DHK
(Fortsetzung)

en

Type designation nozzle holder → Type designation nozzle → Nozzle-and-holder assemblies
(continued)

fr

Formule de type principaux porte-injecteurs → Formule de type injecteur → Ensembles porte-injecteurs
(suite)

it







Sigla polverizzatori → Sigla portapolverizzatori → Sigla combinazione portapolverizzatori
(seguito)

es

Designación de tipo portainyectoros → Designación de tipo inyectoros → Conjuntos portainyectoros
(continuación)









KBL 112 S 28/13	DLLA 150 S 138			0 432 281 888	
KBL 112 S 28/13	DLLA 150 S 204			0 432 281 889	
KBL 112 S 28/13	DLLA 150 S 548	205-213		0 432 281 772	
KBL 112 S 28/13	DLLA 150 S 549	205-213		0 432 281 773	
KBL 112 S 28/13	DLLA 150 S 569	205-213		0 432 281 765	
KBL 112 S 28/13	DLLA 150 S 570	205-213		0 432 281 764	
KBL 112 S 28/13	DLLA 150 S 616	205-213		0 432 281 722	
KBL 112 S 82/13	DLLA 150 S 138	210-218		0 432 281 715	
KBL 112 S 82/13	DLLA 150 S 140	165-173		0 432 281 872	
KBL 112 S 82/13	DLLA 150 S 178	200-208		0 432 281 800	
KBL 112 S 82/13	DLLA 150 S 178	185-193		0 432 281 871	
KBL 112 S 82/13	DLLA 150 S 720	145-153		0 432 281 870	
KBL 114 S 106/4	DLLA 24 S 584	175-183		0 432 281 759	
KBL 114 S 106/4	DLLA 27 S 517	175-183		0 432 281 785	
KBL 117 S 21/13	DLLA 150 S 178	175-183		0 432 281 789	
KBL 117 S 21/13	DLLA 150 S 178	185-193		0 432 281 853	
KBL 117 S 21/13	DLLA 150 S 582	190-198		0 432 281 761	
KBL 117 S 82/13	DLLA 150 S 582	190-198		0 432 281 760	
KBL 122 S 117/4	DLLA 150 S 204	200-208		0 432 281 827	
KBL 128 S 47/4	DLL 150 S 184	200-208		0 432 281 005	
KBL 128 S 47/4	DLL 150 S 188	200-208		0 432 281 006	
KBL 128 S 92/4	DLLA 150 S 396	225-233		0 432 281 843	
KBL 128 S 92/4	DLLA 150 S 421	237-245		0 432 281 832	
KBL 128 S 92/4	DLLA 150 S 456	222-230		0 432 281 812	
KBL 128 S 92/4	DLLA 150 S 550	220-228		0 432 281 771	
KBL 128 S 92/4	DLLA 150 S 777	225-233		0 432 281 709	
KBL 128 S 92/4	DLLA 150 S 852	224-232		0 432 281 703	
KBL 128 S 92/4	DLLA 150 S 891/TR	225-233		0 432 281 691	
KBL 128 S 92/4	DLLA 150 S 891/TR	220-228		0 432 281 700	
KBL 128 S 92/4	DLLA 150 S 902	225-233		0 432 281 699	
KBL 64 S 194/4	DLLA 160 S 707	205-213		0 432 281 717	
KBL 64 SE 193/4	DLL 160 S 705	205-213		0 432 281 112	
KBL 67 S 162/13	DLLA 150 S 682/	180-188		0 432 281 726	
KBL 67 S 201/13	DLL 150 S 790/TR	170-178		0 432 281 116	
KBL 67 S 201/13	DLL 150 S 919/	175-183		0 432 281 117	
KBL 67 S 201/13	DLLA 150 S 1008	190-198		0 432 281 694	
KBL 67 S 201/13	DLLA 150 S 1052	175-183		0 432 281 692	
KBL 67 S 201/13	DLLA 150 S 469	175-183		0 432 281 696	
KBL 67 S 201/13	DLL 150 S 612	170-178		0 432 281 113	
KBL 67 S 75	DLL 150 S 171	175-183		0 432 281 037	
KBL 70 S 177/4	DLLA 141 S 662	230-238		0 432 281 718	
KBL 70 S 177/4	DLLA 145 S 448	220-228		0 432 281 716	
KBL 73 S 111/4	DLLA 150 S 236	200-208		0 432 281 830	
KBL 73 S 111/4	DLLA 150 S 469	200-208		0 432 281 763	
KBL 73 S 111/4	DLLA 150 S 671	180-188		0 432 281 729	







 Typ		 1st/bar	 2nd/bar	 Ref.	
KBL 74 S 107/4	DLLA 160 S 255	220–228		0 432 281 705	
KBL 74 S 107/4	DLLA 160 S 255	200–208		0 432 281 838	
KBL 76 S 120/4	DLLA 160 S 1084	190–198		0 432 281 688	
KBL 76 S 120/4	DLLA 160 S 378	220–228		0 432 281 814	
KBL 76 S 120/4	DLLA 160 S 378	190–198		0 432 281 817	
KBL 76 S 120/4	DLLA 160 S 555	190–198		0 432 281 751	
KBL 76 S 148/4	DLL 18 S 629	230–238		0 432 281 093	
KBL 76 S 211/4	DLLA 144 S 808	250–258		0 432 281 708	
KBL 76 S 211/4	DLLA 144 S 982	255–263		0 432 281 695	0 986 430 342
KBL 76 S 225	DLLA 160 S 555	190–198		0 432 281 690	
KBL 76 S 79/4	DLL 18 S 353	175–183		0 432 281 025	
KBL 76 S 79/4	DLL 18 S 418	180–188		0 432 281 040	
KBL 76 S 79/4	DLL 18 S 418	190–198		0 432 281 066	0 986 430 135
KBL 76 S 79/4	DLL 18 S 418	230–238		0 432 281 115	
KBL 76 S 79/4	DLLA 18 S 384	180–188		0 432 281 844	
KBL 76 S 79/4	DLLA 25 S 614	175–183		0 432 281 733	
KBL 82 S 166/4	DLLA 145 S 507	200–208		0 432 281 743	
KBL 82 S 166/4	DLLA 150 S 527	200–208		0 432 281 740	
KBL 84 S 109/4	DLL 120 S 285	210–218		0 432 281 094	
KBL 84 S 109/4	DLL 120 S 352	210–218		0 432 281 103	
KBL 85 S 105/4	DLL 150 S 389	190–198		0 432 281 029	
KBL 85 S 105/4	DLL 150 S 405	180–188		0 432 281 035	
KBL 85 S 105/4	DLLA 150 S 402	180–188		0 432 281 837	
KBL 86 S 121/4	DLLA 160 S 1084	190–198		0 432 281 689	
KBL 86 S 121/4	DLLA 160 S 378	190–198		0 432 281 818	
KBL 86 S 121/4	DLLA 160 S 555	190–198		0 432 281 769	
KBL 86 S 121/4	DLLA 160 S 557	210–218		0 432 281 768	
KBL 87 S 78/4	DLLA 110 S 335	175–183		0 432 281 854	
KBL 87 S 78/4	DLLA 150 S 245	170–178		0 432 281 749	
KBL 87 S 78/4	DLLA 150 S 245			0 432 281 881	
KBL 87 S 78/4	DLLA 150 S 422	175–183		0 432 281 831	
KBL 87 S 78/4	DLLA 150 S 436	175–183		0 432 281 820	
KBL 87 S 78/4	DLLA 150 S 552	175–183		0 432 281 770	
KBL 87 S 78/4	DLLA 150 S 720	170–178		0 432 281 779	
KBL 87 S 87/4	DLL 150 S 296	190–198		0 432 281 016	
KBL 87 S 87/4	DLL 150 S 393	190–198		0 432 281 030	
KBL 87 S 87/4	DLL 150 S 406	190–198		0 432 281 036	
KBL 88 S 203/4	DLLA 145 S 770	200–208		0 432 281 710	
KBL 88 S 203/4	DLLA 145 S 847	215–227		0 432 281 704	
KBL 89 S 132/4	DLLA 160 S 509	210–218		0 432 281 791	
KBL 89 S 217	DLLA 150 S 893	210–218		0 432 281 701	
KBL 90 S 104/4	DLL 150 S 2641	205–213		0 432 281 039	
KBL 90 S 104/4	DLL 150 S 2641	205–213		0 432 281 052	
KBL 90 S 104/4	DLLA 150 S 417	205–213		0 432 281 828	
KBL 90 S 104/4	DLLA 150 S 417	205–213		0 432 281 833	

A252

de	en	fr	it	es
Typformel Düsenhalter → Typformel Düse → DHK (Fortsetzung)	Type designation nozzle holder → Type designation nozzle → Nozzle-and-holder assemblies (continued)	Formule de type principaux porte-injecteurs → Formule de type injecteur → Ensembles porte-injecteurs (suite)	Sigla polverizzatori → Sigla portapolverizzatori → Sigla combinazione portapolverizzatori (seguito)	Designación de tipo portainyectores → Designación de tipo inyectores → Conjuntos portainyectores (continuación)









					
KBL 90 S 104/4	DLLA 150 S 429	205-213		0 432 281 824	
KBL 90 S 104/4	DLLA 150 S 430	205-213		0 432 281 822	
KBL 90 S 104/4	DLLA 150 S 442	205-213		0 432 281 816	
KBL 90 S 128/4	DLL 150 S 2641	205-213		0 432 281 062	
KBL 90 S 128/4	DLL 150 S 2641	205-213		0 432 281 063	
KBL 90 S 128/4	DLLA 150 S 417	205-213		0 432 281 797	
KBL 90 S 128/4	DLLA 150 S 417	205-213		0 432 281 798	
KBL 90 S 128/4	DLLA 150 S 442	205-213		0 432 281 796	
KBL 90 S 145/13	DLLA 155 S 651	230-238		0 432 281 735	
KBL 90 S 176/4	DLLA 150 S 417	240-248		0 432 281 736	
KBL 91 S 146/13	DLLA 150 S 547	180-188		0 432 281 775	
KBL 91 S 146/13	DLLA 150 S 548	205-213		0 432 281 774	
KBL 95 S 149/13	DLL 150 S 211	165-173		0 432 281 088	
KBL 95 S 149/13	DLL 150 S 211	180-188		0 432 281 102	
KBL 95 S 149/13	DLL 150 S 211	165-173		0 432 281 107	
KBL 95 S 149/13	DLL 150 S 211	185-193		0 432 281 111	
KBL 95 S 149/13	DLL 150 S 450	190-198		0 432 281 089	
KBL 95 S 149/13	DLL 150 S 450	216-224		0 432 281 106	
KBL 95 S 149/13	DLL 150 S 578	185-193		0 432 281 087	
KBL 95 S 149/4	DLL 150 S 211	145-153		0 432 281 082	
KBL 95 S 149/4	DLL 150 S 450	190-198		0 432 281 083	
KBL 95 S 149/4	DLL 150 S 578	185-193		0 432 281 079	
KBL 97 S 133/4	DLLA 27 S 512	175-183		0 432 281 790	
KBL 97 S 173/13	DLL 140 S 248	185-193		0 432 281 097	
KBL 97 S 173/13	DLL 140 S 446	185-193		0 432 281 098	
KBL 97 S 173/13	DLL 140 S 446	216-224		0 432 281 099	
KBL 97 S 173/13	DLL 140 S 586	216-224		0 432 281 101	
KBL 97 S 173/13	DLL 140 S 632	216-224		0 432 281 100	
KBL 97 S 197/4	DLLA 27 S 512	185-193		0 432 281 713	
KBL 97 S 88/4	DLLA 10 S 134	190-198		0 432 281 803	
KBL 97 S 88/4	DLLA 10 S 286	180-188		0 432 281 864	
KBL 99 S 94/4	DLLA 10 S 134	200-208		0 432 281 855	
KBL 99 S 94/4	DLLA 32 S 330	185-193		0 432 281 857	
KBL 99 S 94/4	DLLA 38 S 133	200-208		0 432 281 856	
KBLB 67 S 2/13	DLLB 160 S 544	190-198		0 432 281 776	
KBLY 100 S 2/12	DLA 0 S 2			0 432 281 999	
KBZ 116 T 854	DLZ 154 T 1235			0 432 380 018	
KC 45 S 25/4	DL 0 S 64	200-208		0 432 200 001	
KC 45 SD 21/4	DN 0 SD 130	135-143		0 432 207 015	
KC 45 SD 21/4	DN 0 SD 211	145-153		0 432 207 012	
KC 57 S 42/13	DN 0 S 235	200-208		0 432 206 010	
KC 57 SD 22/4	DN 0 SD 131	170-178		0 432 209 005	
KC 57 SD 23/4	DN 0 S 243	170-178		0 432 206 011	
KC 57 SD 23/4	DN 0 SD 130	145-153		0 432 207 002	
KC 57 SD 23/4	DN 0 SD 130	170-178		0 432 207 008	

 Typ	 Typ	 1st/bar	 2nd/bar	 Ref.		
KC 57 SD 23/4	DN 0 SD 211	145–153		0 432 207 003		
KC 57 SD 23/4	DN 4 S 2	140–148		0 432 206 002		
KC 57 SD 26/13	DN 0 SD 21	125–133		0 432 207 001		
KC 57 SD 39/4	DN 0 SD 131	175–183		0 432 209 003		
KC 57 SD 39/4	DN 0 SD 131	170–178		0 432 209 007		
KC 57 SD 40/13	DN 0 S 235	170–178		0 432 206 012		
KC 57 SD 40/13	DN 0 S 235	200–208		0 432 206 013		
KC 57 SD 40/13	DN 0 SD 130	170–178		0 432 207 006		
KC 70 S 25/13	DN 4 S 2	125–133		0 432 206 003		
KC 70 S 25/13	DN 4 S 2	140–148		0 432 206 005		
KC 70 S 25/13	DN 8 S 138	140–148		0 432 206 004		
KCA 15 S 45	DN 0 SD 253	126–134		0 432 217 092		
KCA 15 S 45	DN 0 SD 304	126–134		0 432 217 229		
KCA 15 S 45	DN 0 SD 304	142–150		0 432 217 251		
KCA 15 S 45	DN 0 SD 311	150–158		0 432 217 255		
KCA 15 S 66	DN 0 SD 252+	130–138		0 432 217 191	0 986 430 198	
KCA 15 S 66	DN 0 SD 302	130–138		0 432 217 259		
KCA 15 S 66	DN 0 SD 302/	130–135		0 432 217 252		
KCA 15 S 66	DN 0 SD 306	150–158		0 432 217 237	0 986 430 270	
KCA 15 S 88	DN 0 SD 304	126–134		0 432 217 275		
KCA 15 S 88	DN 0 SD 304	142–150		0 432 217 276		
KCA 17 S 100	DN 0 SD 301	150–158		0 432 217 303		
KCA 17 S 100	DN 0 SD 301	165–173		0 432 217 311		
KCA 17 S 101	DN 0 SD 301	150–158		0 432 217 304		
KCA 17 S 102	DN 0 SD 252+ /	131–139		0 432 217 306		
KCA 17 S 103	DN 0 SD 313	151–159		0 432 217 307		
KCA 17 S 33/4	DN 0 SD 1510	130–135		0 432 217 060		
KCA 17 S 33/4	DN 0 SD 1510	120–128		0 432 217 070		
KCA 17 S 38/4	DN 0 SD 1510	130–135		0 432 217 069		
KCA 17 S 38/4	DN 0 SD 1510	120–125		0 432 217 071		
KCA 17 S 38/4	DN 0 SD 15100	120–128		0 432 217 073		
KCA 17 S 38/4	DN 0 SD 15100	130–135		0 432 217 075		
KCA 17 S 38/4	DN 0 SD 251	120–128		0 432 217 087		
KCA 17 S 38/4	DN 0 SD 251	130–135		0 432 217 088		
KCA 17 S 38/4	DN 0 SD 251	150–155		0 432 217 103		
KCA 17 S 38/4	DN 0 SD 252	130–135		0 432 217 090		
KCA 17 S 38/4	DN 0 SD 252	120–125		0 432 217 108		
KCA 17 S 38/4	DN 0 SD 252	150–158		0 432 217 137		
KCA 17 S 38/4	DN 0 SD 252+	120–125		0 432 217 152		
KCA 17 S 38/4	DN 0 SD 252+	130–135		0 432 217 193		
KCA 17 S 38/4	DN 0 SD 276/	150–155		0 432 217 189		
KCA 17 S 42	DN 0 SD 1930	140–148		0 432 217 082		
KCA 17 S 42	DN 0 SD 230	115–120		0 432 217 132		
KCA 17 S 42	DN 0 SD 252	130–135		0 432 217 114		
KCA 17 S 42	DN 0 SD 252+	130–135		0 432 217 192		

A254

<p>de</p> <p>Typformel Düsenhalter → Typformel Düse → DHK (Fortsetzung)</p>	<p>en</p> <p>Type designation nozzle holder → Type designation nozzle → Nozzle-and-holder assemblies (continued)</p>	<p>fr</p> <p>Formule de type principaux porte-injecteurs → Formule de type injecteur → Ensembles porte-injecteurs (suite)</p>	<p>it</p> <p>Sigla polverizzatori → Sigla portapolverizzatori → Sigla combinazione portapolverizzatori (seguito)</p>	<p>es</p> <p>Designación de tipo portainyectores → Designación de tipo inyectores → Conjuntos portainyectores (continuación)</p>
---	--	---	--	--



					
KCA 17 S 42	DN 0 SD 252+ /	130-138		0 432 217 227	0 986 430 202
KCA 17 S 42	DN 0 SD 252+ /	135-139		0 432 217 305	
KCA 17 S 42	DN 0 SD 256	130-135		0 432 217 111	
KCA 17 S 42	DN 0 SD 256/	130-135		0 432 217 153	
KCA 17 S 42	DN 0 SD 259	135-143		0 432 217 160	
KCA 17 S 42	DN 0 SD 262/	135-143		0 432 217 133	
KCA 17 S 42	DN 0 SD 272	140-148		0 432 217 156	
KCA 17 S 42	DN 0 SD 272	135-143		0 432 217 196	
KCA 17 S 42	DN 0 SD 282	135-143		0 432 217 171	
KCA 17 S 42	DN 0 SD 287	130-135		0 432 217 181	
KCA 17 S 42	DN 0 SD 287+	130-135		0 432 217 201	0 986 430 201
KCA 17 S 42	DN 0 SD 289	130-135		0 432 217 200	
KCA 17 S 42	DN 0 SD 289	150-155		0 432 217 221	
KCA 17 S 42	DN 0 SD 289	140-145		0 432 217 234	
KCA 17 S 42	DN 0 SD 289/	150-155		0 432 217 235	
KCA 17 S 42	DN 0 SD 299	175-180		0 432 217 218	0 986 430 240
KCA 17 S 42	DN 0 SD 299	150-155		0 432 217 228	
KCA 17 S 42	DN 0 SD 299	130-135		0 432 217 245	
KCA 17 S 42	DN 0 SD 299 A	130-135		0 432 217 248	0 986 430 244
KCA 17 S 42	DN 0 SD 299 A	140-145		0 432 217 300	
KCA 17 S 42	DN 0 SD 299 B	130-135		0 432 217 254	
KCA 17 S 42	DN 0 SD 299 C	175-180		0 432 217 289	0 986 430 375
KCA 17 S 42	DN 0 SD 302	130-138		0 432 217 226	
KCA 17 S 42	DN 0 SD 302/	131-139		0 432 217 250	
KCA 17 S 42	DN 0 SD 302 A	130-138		0 432 217 258	
KCA 17 S 42	DN 0 SD 302 B	130-138		0 432 217 292	
KCA 17 S 42	DN 0 SD 313	130-138		0 432 217 263	0 986 430 267
KCA 17 S 42	DN 0 SD 313	150-158		0 432 217 285	
KCA 17 S 42	DN 12 SD 12	120-128		0 432 217 107	
KCA 17 S 53	DN 0 SD 1930	135-143		0 432 217 122	
KCA 17 S 54	DN 0 SD 252	150-155		0 432 217 136	
KCA 17 S 54	DN 0 SD 268	130-135		0 432 217 140	
KCA 17 S 54	DN 0 SD 276/	150-155		0 432 217 190	
KCA 17 S 69	DN 0 SD 272	135-143		0 432 217 212	
KCA 17 S 70	DN 0 SD 301	150-158		0 432 217 222	0 986 430 249
KCA 17 S 74	DN 0 SD 305	135-143		0 432 217 230	
KCA 17 S 89	DN 0 SD 301	165-173		0 432 217 281	
KCA 17 S 90	DN 0 SD 301	165-173		0 432 217 282	
KCA 17 S 92	DN 0 SD 299	175-180		0 432 217 286	
KCA 17 S 92	DN 0 SD 299 A	140-145		0 432 217 301	
KCA 17 S 96	DN 0 SD 301	150-158		0 432 217 294	
KCA 17 SD 3/13	DN 0 SD 126	150-158		0 432 217 033	
KCA 17 SD 3/13	DN 0 SD 21	100-108		0 432 217 001	
KCA 17 SD 3/13	DN 30 S 2	145-153		0 432 216 006	
KCA 17 SD 3/13	DN 4 SD 24	120-128		0 432 217 024	



KCA 17 SD 3/13	DN 4 SD 24	125–133		0 432 217 029	
KCA 17 SD 3/13	TR-DN 8 S 229	110–118		0 432 216 012	
KCA 17 SD 3/13	DN 8 S 3	110–118		0 432 216 004	
KCA 17 SD 3/13	DN 8 S 3	125–133		0 432 216 009	
KCA 17 SD 3/21	DN 0 SD 195	130–138		0 432 217 038	
KCA 17 SD 30/4	DN 0 SD 193	130–135		0 432 217 064	
KCA 17 SD 30/4	DN 0 SD 1930	125–133		0 432 217 052	
KCA 17 SD 30/4	DN 0 SD 1930	140–148		0 432 217 126	
KCA 17 SD 31/4	DN 0 SD 195	130–135		0 432 217 053	
KCA 18 S 40	DN 0 SD 248	126–134		0 432 217 081	
KCA 18 S 48	DN 0 SD 248	126–134		0 432 217 104	
KCA 20 S 106	DN 0 SD 299 A	120–128		0 432 217 310	
KCA 21 S 71	DN 0 SD 300	154–162		0 432 217 223	0 986 430 241
KCA 21 S 71	DN 0 SD 318	154–162		0 432 217 278	0 986 430 302
KCA 21 S 72	DN 0 SD 300	154–162		0 432 217 224	
KCA 21 S 76	DN 0 SD 300	154–162		0 432 217 236	
KCA 21 S 91	DN 0 SD 318	154–162		0 432 217 279	
KCA 27 S 104	DN 0 SD 324	151–159		0 432 217 308	
KCA 27 S 55	DN 0 SD 261	115–123		0 432 217 161	0 986 430 172
KCA 27 S 55	DN 0 SD 265	115–123		0 432 217 157	0 986 430 197
KCA 27 S 55	DN 0 SD 265	135–143		0 432 217 169	0 986 430 173
KCA 27 S 55	DN 0 SD 310	115–123		0 432 217 262	0 986 430 246
KCA 27 S 55	DN 0 SD 310	135–143		0 432 217 290	0 986 430 505
KCA 27 S 55	DN 0 SD 314	135–143		0 432 217 266	0 986 430 247
KCA 27 S 65	DN 0 SD 272	140–148		0 432 217 183	
KCA 27 S 65	DN 0 SD 292	135–143		0 432 217 197	
KCA 27 S 80	DN 0 SD 309	135–143		0 432 217 246	0 986 430 243
KCA 27 S 80	DN 0 SD 322	135–143		0 432 217 299	0 986 430 449
KCA 27 S 98	DN 0 SD 321	150–158		0 432 217 295	
KCA 27 S 99	DN 0 SD 321	150–158		0 432 217 296	
KCA 30 S 22/4	DN 0 SD 211	125–133		0 432 217 004	
KCA 30 S 35/4	DN 0 SD 240-	115–120		0 432 217 080	
KCA 30 S 35/4	DN 0 SD 240			0 432 217 065	
KCA 30 S 35/4	DN 0 SD 240	135–143		0 432 217 066	0 986 430 171
KCA 30 S 35/4	DN 0 SD 240/	115–120		0 432 217 072	
KCA 30 S 35/4	DN 0 SD 240/	115–123		0 432 217 093	
KCA 30 S 35/4	DN 0 SD 240/	135–143		0 432 217 101	
KCA 30 S 36/4	DN 0 SD 1930	155–163		0 432 217 109	
KCA 30 S 36/4	DN 0 SD 273	155–163		0 432 217 158	
KCA 30 S 36/4	DN 0 SD 274	155–163		0 432 217 165	
KCA 30 S 36/4	DN 0 SD 293	130–138		0 432 217 076	
KCA 30 S 36/4	DN 0 SD 293	155–163		0 432 217 078	0 986 430 080
KCA 30 S 36/4	DN 0 SD 297	155–163		0 432 217 215	0 986 430 235
KCA 30 S 36/4	DN 0 SD 1930	156–163		0 432 217 112	
KCA 30 S 36/4	DN 0 SD 273	155–163		0 432 217 163	

A256

de

Typformel Düsenhalter → Typformel Düse → DHK
(Fortsetzung)

en

Type designation nozzle holder → Type designation nozzle → Nozzle-and-holder assemblies
(continued)

fr

Formule de type principaux porte-injecteurs → Formule de type injecteur → Ensembles porte-injecteurs
(suite)

it

Sigla polverizzatori → Sigla portapolverizzatori → Sigla combinazione portapolverizzatori
(seguito)

es

Designación de tipo portainyectoros → Designación de tipo inyectoros → Conjuntos portainyectoros
(continuación)



KCA 30 S 36/4	DN 0 SD 274	155-163		0 432 217 264	
KCA 30 S 36/4	DN 0 SD 293	130-138		0 432 217 077	
KCA 30 S 36/4	DN 0 SD 293	155-163		0 432 217 079	0 986 430 080
KCA 30 S 36/4	DN 0 SD 297	155-163		0 432 217 214	0 986 430 235
KCA 30 S 36/4	DN 0 SD 193	151-159		0 432 217 067	
KCA 30 S 36/4	DN 0 SD 193	130-135		0 432 217 068	
KCA 30 S 36/4	DN 0 SD 193			0 432 217 117	
KCA 30 S 36/4	DN 0 SD 193			0 432 217 119	
KCA 30 S 36/4	DN 0 SD 293	161-169		0 432 217 095	
KCA 30 S 36/4	DN 0 SD 193	140-148		0 432 217 100	
KCA 30 S 36/4	DN 0 SD 21			9 430 233 004	
KCA 30 S 41	DN 0 SD 259	135-143		0 432 217 148	
KCA 30 S 41	DN 0 SD 301	150-158		0 432 217 273	
KCA 30 S 41	DN 0 SD 321	150-158		0 432 217 297	
KCA 30 S 41	DN 12 SD 1750	125-133		0 432 217 129	
KCA 30 S 41	DN 12 SD 1750	150-158		0 432 217 139	
KCA 30 S 41	DN 12 SD 283	150-158		0 432 217 172	
KCA 30 S 41	DN 12 SD 283	125-133		0 432 217 182	
KCA 30 S 41	DN 12 SD 290	125-133		0 432 217 195	
KCA 30 S 41	DN 12 SD 290	150-158		0 432 217 211	
KCA 30 S 41	DN 12 SD 296	125-133		0 432 217 202	
KCA 30 S 44	DN 0 SD 1930	156-164		0 432 217 110	0 986 430 089
KCA 30 S 44	DN 0 SD 273	130-138		0 432 217 159	0 986 430 086
KCA 30 S 44	DN 0 SD 293	130-138		0 432 217 083	0 986 430 081
KCA 30 S 44	DN 0 SD 294	130-138		0 432 217 198	0 986 430 189
KCA 30 S 44	DN 0 SD 297	130-138		0 432 217 206	
KCA 30 S 44	DN 0 SD 297	155-163		0 432 217 231	
KCA 30 S 44	DN 0 SD 1930	130-138		0 432 217 113	0 986 430 089
KCA 30 S 44	DN 0 SD 273	130-138		0 432 217 164	0 986 430 086
KCA 30 S 44	DN 0 SD 293	130-138		0 432 217 084	0 986 430 081
KCA 30 S 44	DN 0 SD 294	130-138		0 432 217 207	0 986 430 189
KCA 30 S 44	DN 0 SD 297	130-138		0 432 217 210	
KCA 30 S 44	DN 0 SD 297	155-163		0 432 217 232	
KCA 30 S 44	DN 0 SD 193	130-138		0 432 217 118	0 986 430 089
KCA 30 S 44	DN 0 SD 193			0 432 217 120	
KCA 30 S 44	DN 0 SD 274	130-135		0 432 217 178	
KCA 30 S 44	DN 0 SD 1510	115-123		0 432 217 143	
KCA 30 S 44	DN 0 SD 189/	131-137		0 432 217 099	0 986 430 012
KCA 30 S 44	DN 0 SD 1930	140-148		0 432 217 123	
KCA 30 S 44	DN 0 SD 21	130-138		0 432 217 091	
KCA 30 S 44	DN 0 SD 21	170-178		0 432 217 130	
KCA 30 S 44	DN 0 SD 211	130-138		0 432 217 138	
KCA 30 S 44	DN 0 SD 211	170-178		0 432 217 187	
KCA 30 S 44	DN 0 SD 220	115-123		0 432 217 142	0 986 430 020
KCA 30 S 44	DN 0 SD 252+ /	130-138		0 432 217 313	









KCA 30 S 44	DN 0 SD 261	115–123		0 432 217 131	0 986 430 022
KCA 30 S 44	DN 0 SD 265	115–123		0 432 217 141	0 986 430 025
KCA 30 S 44	DN 0 SD 265	135–143		0 432 217 147	0 986 430 184
KCA 30 S 44	DN 0 SD 269	140–148		0 432 217 146	0 986 430 026
KCA 30 S 44	DN 0 SD 288	130–138		0 432 217 188	0 986 430 208
KCA 30 S 44	DN 0 SD 315	130–138		0 432 217 267	0 986 430 304
KCA 30 S 46	DN 0 SD 293	130–138		0 432 217 097	
KCA 30 S 46	DN 0 SD 293	130–138		0 432 217 098	
KCA 30 S 46	DN 0 SD 193	130–138		0 432 217 312	
KCA 30 S 46	DN 0 SD 240/	115–123		0 432 217 125	0 986 430 151
KCA 30 S 46	DN 0 SD 240/	135–143		0 432 217 134	0 986 430 171
KCA 30 S 47	DN 0 SD 193	150–158		0 432 217 102	
KCA 30 S 50	DN 0 SD 193	150–158		0 432 217 106	
KCA 30 S 50	DN 0 SD 259	150–158		0 432 217 115	
KCA 30 S 50	DN 0 SD 286	130–138		0 432 217 180	
KCA 30 S 50	DN 0 SD 286	150–158		0 432 217 184	
KCA 30 S 50	DN 4 SD 24	150–158		0 432 217 194	
KCA 30 S 56	DN 0 SD 259	150–158		0 432 217 167	
KCA 30 S 56	DN 0 SD 286	150–158		0 432 217 185	
KCA 30 S 56	DN 0 SD 300	150–158		0 432 217 220	
KCA 30 S 57	DN 0 SD 259	150–158		0 432 217 168	
KCA 30 S 57	DN 0 SD 286	150–158		0 432 217 186	0 986 430 176
KCA 30 S 57	DN 0 SD 300	150–158		0 432 217 219	
KCA 30 S 78	DN 0 SD 21	170–178		0 432 217 238	
KCA 30 S 79	DN 0 SD 297	130–138		0 432 217 239	0 986 430 187
KCA 30 S 79	DN 0 SD 297	155–163		0 432 217 241	0 986 430 188
KCA 30 S 79	DN 0 SD 297	130–138		0 432 217 271	0 986 430 187
KCA 30 S 79	DN 0 SD 297	130–138		0 432 217 240	0 986 430 187
KCA 30 S 79	DN 0 SD 297	155–163		0 432 217 242	0 986 430 188
KCA 30 S 79	DN 0 SD 297	130–138		0 432 217 272	0 986 430 187
KCA 30 S 81	DN 0 SD 307	145–153		0 432 217 247	
KCA 30 S 82	DN 0 SD 301	150–158		0 432 217 249	
KCA 30 S 83	DN 0 SD 259	150–158		0 432 217 121	
KCA 30 S 84	DN 0 SD 307	145–153		0 432 217 260	
KCA 30 S 85	DN 0 SD 307	145–153		0 432 217 261	
KCA 30 S 87	DN 0 SD 301	150–158		0 432 217 274	
KCA 30 S 94	DN 0 SD 315	130–138		0 432 217 291	
KCA 30 S 94	DN 0 SD 320	130–138		0 432 217 293	0 986 430 520
KCA 30 SD 2/4	DN 0 SD 126	125–133		0 432 217 005	
KCA 30 SD 2/4	DN 0 SD 151	115–120		0 432 217 006	
KCA 30 SD 2/4	DN 0 SD 151			0 432 217 007	
KCA 30 SD 2/4	DN 0 SD 1510	115–123		0 432 217 034	
KCA 30 SD 2/4	DN 0 SD 189	135–143		0 432 217 042	
KCA 30 SD 2/4	DN 0 SD 21	130–138		0 432 217 135	
KCA 30 SD 2/4	DN 0 SD 210	115–120		0 432 217 047	

A258

de	en	fr	it	es
Typformel Düsenhalter → Typformel Düse → DHK (Fortsetzung)	Type designation nozzle holder → Type designation nozzle → Nozzle-and-holder assemblies (continued)	Formule de type principaux porte-injecteurs → Formule de type injecteur → Ensembles porte-injecteurs (suite)	Sigla polverizzatori → Sigla portapolverizzatori → Sigla combinazione portapolverizzatori (seguito)	Designación de tipo portainyectoros → Designación de tipo inyectoros → Conjuntos portainyectoros (continuación)



KCA 30 SD 2/4	DN 0 SD 211	115-120		0 432 217 008	
KCA 30 SD 2/4	DN 0 SD 211	115-120		0 432 217 009	
KCA 30 SD 2/4	DN 0 SD 211	135-143		0 432 217 010	
KCA 30 SD 2/4	DN 0 SD 211	135-143		0 432 217 027	
KCA 30 SD 2/4	DN 0 SD 211	125-133		0 432 217 050	
KCA 30 SD 2/4	DN 0 SD 2110	135-143		0 432 217 039	
KCA 30 SD 2/4	DN 0 SD 2110	115-120		0 432 217 040	
KCA 30 SD 2/4	DN 0 SD 212	125-133		0 432 217 022	
KCA 30 SD 2/4	DN 0 SD 212	140-148		0 432 217 026	
KCA 30 SD 2/4	DN 0 SD 220	115-120		0 432 217 043	
KCA 30 SD 2/4	DN 12 SD 12	135-143		0 432 217 028	
KCA 30 SD 2/4	DN 4 SD 128	110-118		0 432 217 021	
KCA 30 SD 27/4	DN 0 SD 1930	132-137		0 432 217 085	
KCA 30 SD 27/4	DN 0 SD 1930	132-137		0 432 217 086	
KCA 30 SD 27/4	DN 0 SD 193	130-138		0 432 217 058	
KCA 30 SD 27/4	DN 0 SD 193	130-138		0 432 217 059	
KCA 30 SD 27/4	DN 0 SD 1510	115-120		0 432 217 045	
KCA 30 SD 27/4	DN 0 SD 1510	135-143		0 432 217 089	
KCA 30 SD 27/4	DN 0 SD 210	115-120		0 432 217 049	
KCA 30 SD 27/4	DN 0 SD 2110	135-143		0 432 217 057	
KCA 30 SD 27/4	DN 0 SD 220	115-123		0 432 217 054	0 986 430 020
KCA 30 SD 27/4	DN 0 SD 220	135-143		0 432 217 061	
KCA 30 SD 27/4	DN 0 SD 240	115-120		0 432 217 062	
KCA 30 SD 27/4	DN 0 SD 2400	135-143		0 432 217 063	
KCA 30 SD 27/4	DN 12 SD 175	125-133		0 432 217 074	
KCA 30 SD 27/4	DN 4 SD 24	150-158		0 432 217 056	
KCA 36 SD 24/13	DN 0 SD 21	135-143		0 432 217 030	
KCA 36 SD 24/13	DN 0 SD 21	150-158		0 432 217 031	
KCA 51 SD 13/4	DN 0 SD 126	150-158		0 432 217 017	
KCAL 28 S 4	DNL 0 SD 5	130-135		0 432 217 996	
KCAL 28 S 4	DNL 0 SD 5	130-135		0 432 217 997	
KCE 24 S 1	DN 0 SD 273	130-138		0 432 217 145	
KCE 24 S 1	DN 0 SD 294	130-138		0 432 217 199	
KCE 24 S 1	DN 0 SD 297	130-138		0 432 217 205	
KCE 24 S 1	DN 0 SD 273	131-138		0 432 217 213	
KCE 24 S 1	DN 0 SD 294	130-138		0 432 217 208	
KCE 24 S 1	DN 0 SD 297	131-138		0 432 217 209	
KCE 27 S 3	DN 0 SD 310	115-123		0 432 217 253	0 986 430 245
KCE 27 S 3	DN 0 SD 310	135-143		0 432 217 280	0 986 430 388
KCE 27 S 3	DN 0 SD 319	115-123		0 432 217 287	0 986 430 307
KCE 30 S 4	DN 0 SD 312	170-178		0 432 217 256	
KCE 30 S 5	DN 0 SD 312	170-178		0 432 217 257	
KCE 30 S 5	DN 0 SD 312	140-145		0 432 217 268	0 986 430 381
KCE 30 S 6	DN 0 SD 316	170-178		0 432 217 269	
KCE 30 S 7	DN 0 SD 316	170-178		0 432 217 270	





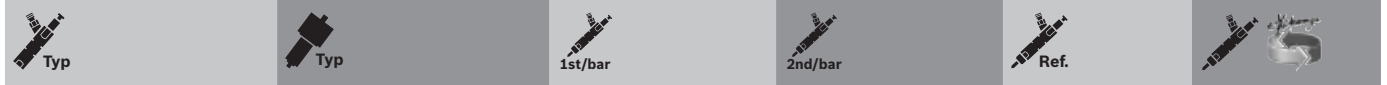

 Typ	 Typ	 1st/bar	 2nd/bar	 Ref.	
KCE 30 S 8	DN 0 SD 299 A	120–125		0 432 217 288	
KD 109 S 70/4	DL 15 S 1017	200–208		0 432 220 001	
KD 43 SA 53/13	DN 0 SD 211	125–133		0 432 227 002	
KD 43 SA 53/13	DN 0 SD 211	135–143		0 432 227 003	
KD 45 S 91/4	DN 0 S 225	145–153		0 432 226 004	
KD 45 SD 80/13	DN 0 SD 211	135–143		0 432 227 023	
KD 55 SA 56/13	DN 0 SD 155	105–110		0 432 229 001	
KD 57 S 92	DN 0 SD 331	120–128		0 432 227 035	
KD 57 SD 77/13	DN 0 SD 165	115–120		0 432 227 018	
KD 57 SD 77/13	DN 0 SD 165	120–128		0 432 227 021	
KD 57 SD 79/13	DN 0 SD 165	125–133		0 432 227 025	
KD 57 SD 79/13	DN 0 SD 211	135–143		0 432 227 027	
KD 57 SD 81/13	DN 0 SD 331	120–128		0 432 227 022	
KD 57 SDA 65/4	DN 12 SD 12	125–133		0 432 227 012	
KD 57 SDA 65/4	DN 4 SD 169	120–128		0 432 227 011	
KD 72 SD 90/4	DN 0 SD 174	180–188		0 432 227 033	
KD 72 SD 90/4	DN 0 SD 211	170–178		0 432 227 034	
KD 72 SDA 68/4	DN 0 SD 149	160–168		0 432 229 002	
KD 72 SDA 68/4	DN 0 SD 155	150–158		0 432 229 003	
KDA 27 SD 3/13	DN 0 SD 211			0 432 237 001	
KDA 27 SD 3/13	DN 0 SD 211			0 432 237 002	
KDA 27 SD 5/13	DN 0 SD 211	125–133		0 432 237 003	
KDA 77 S 7/13	DN 0 SD 174	180–188		0 432 237 006	
KDA 77 S 7/13	DN 0 SD 239	180–188		0 432 237 005	
KDAL 100 S 8/19	DLLA 150 S 292	200–208		0 432 231 884	
KDAL 126 S 13/4	DLL 150 S 545	220–228		0 432 231 013	
KDAL 126 S 17/4	DLL 145 S 951	230–238		0 432 231 045	
KDAL 126 S 17/4	DLL 145 S 988	220–228		0 432 231 043	
KDAL 126 S 17/4	DLL 145 S 989	220–228		0 432 231 041	
KDAL 126 S 17/4	DLL 150 S 1195	220–228		0 432 231 053	
KDAL 126 S 17/4	DLL 150 S 545	225–233		0 432 231 021	
KDAL 126 S 17/4	DLL 150 S 631	225–233		0 432 231 024	
KDAL 126 S 17/4	DLL 150 S 949	220–228		0 432 231 039	
KDAL 126 S 17/4	DLL 150 S 950	220–228		0 432 231 040	
KDAL 127 S 28	DLLA 145 S 1018	250–258		0 432 231 781	
KDAL 127 S 28	DLLA 145 S 1019	250–258		0 432 231 780	
KDAL 127 S 28	DLLA 145 S 1330	250–258		0 432 231 654	
KDAL 127 S 34	DLLA 145 S 1019	250–258		0 432 231 771	
KDAL 127 S 34	DLLA 145 S 1090	250–258		0 432 231 739	
KDAL 127 S 34	DLLA 145 S 944/	250–258		0 432 231 772	
KDAL 130 S 29	DLL 150 S 1093	240–248		0 432 231 048	
KDAL 130 S 29	DLL 150 S 979	240–248		0 432 231 042	
KDAL 37 P 35	DSLA 150 P 933	221–233	381–397	0 432 133 801	
KDAL 37 P 35	DSLA 150 P 934	221–233	381–397	0 432 133 800	
KDAL 37 P 40	DSLA 150 P 1102	221–233	381–397	0 432 133 790	

A260

de	en	fr	it	es
Typformel Düsenhalter → Typformel Düse → DHK (Fortsetzung)	Type designation nozzle holder → Type designation nozzle → Nozzle-and-holder assemblies (continued)	Formule de type principaux porte-injecteurs → Formule de type injecteur → Ensembles porte-injecteurs (suite)	Sigla polverizzatori → Sigla portapolverizzatori → Sigla combinazione portapolverizzatori (seguito)	Designación de tipo portainyectoros → Designación de tipo inyectoros → Conjuntos portainyectoros (continuación)



KDAL 37 P 40	DSLA 150 P 1103	221-233	416-432	0 432 133 791	
KDAL 37 P 40	DSLA 150 P 1495	221-233	416-432	0 432 133 769	
KDAL 37 P 40	DSLA 150 P 1559	221-233	381-397	0 432 133 768	
KDAL 50 S 4/4	DLL 120 S 736	195-203		0 432 231 029	
KDAL 50 S 4/4	DLL 50 S 226	190-198		0 432 231 001	
KDAL 50 S 4/4	DLL 50 S 226	190-198		0 432 231 006	
KDAL 50 S 4/4	DLL 50 S 278	190-198		0 432 231 003	
KDAL 50 S 4/4	DLL 50 S 278	190-198		0 432 231 007	
KDAL 50 S 4/4	DLL 50 S 278	210-218		0 432 231 033	
KDAL 50 S 4/4	DLL 76 S 1114	240-248		0 432 231 049	
KDAL 53 P 29	DSLA 142 P 1025	231-243	351-367	0 432 133 795	
KDAL 53 P 29	DSLA 142 P 770/	231-243	381-397	0 432 133 825	
KDAL 53 P 29	DSLA 142 P 843	231-243	381-397	0 432 133 818	
KDAL 53 P 29	DSLA 142 P 925	231-243	351-367	0 432 133 805	
KDAL 53 P 29	DSLA 142 P 1025	231-243	351-367	0 432 133 794	
KDAL 53 P 29	DSLA 142 P 770/	231-243	381-397	0 432 133 824	
KDAL 53 P 29	DSLA 142 P 843	231-243	381-397	0 432 133 817	
KDAL 53 P 29	DSLA 142 P 925	231-243	351-367	0 432 133 804	
KDAL 53 P 30	DSLA 142 P 770/	231-243	381-397	0 432 133 823	
KDAL 53 P 30	DSLA 142 P 843	231-243	381-397	0 432 133 816	
KDAL 53 P 30	DSLA 142 P 925	231-243	351-367	0 432 133 803	
KDAL 53 P 30	DSLA 142 P 770/	231-243	381-397	0 432 133 822	
KDAL 53 P 30	DSLA 142 P 843	231-243	381-397	0 432 133 815	
KDAL 53 P 30	DSLA 142 P 925	231-243	351-367	0 432 133 802	
KDAL 53 P 39	DSLA 142 P 1025	231-243	351-367	0 432 133 793	
KDAL 53 P 39	DSLA 142 P 1025	231-243	351-367	0 432 133 792	
KDAL 53 P 50	DSLA 142 P 1191	231-243	351-367	0 432 133 786	
KDAL 53 P 50	DSLA 142 P 1191	231-243	351-367	0 432 133 785	
KDAL 53 P 51	DSLA 142 P 1191	231-243	351-367	0 432 133 784	
KDAL 53 P 51	DSLA 142 P 1191	231-243	351-367	0 432 133 783	
KDAL 57 P 23	DSLA 142 P 683	221-233	381-397	0 432 133 836	
KDAL 57 P 23	DSLA 142 P 683	221-233	381-397	0 432 133 835	
KDAL 57 P 24	DSLA 142 P 683	221-233	381-397	0 432 133 834	
KDAL 57 P 24	DSLA 142 P 683	221-233	381-397	0 432 133 833	
KDAL 59 P 11	DLLA 142 P 815	295-303		F 000 439 008	
KDAL 59 P 11	DLLA 145 P 310	240-248		9 430 082 750	
KDAL 59 P 11	DLLA 145 P 618			9 430 082 766	
KDAL 59 P 11	DLLA 148 P 375	240-248		9 430 082 749	
KDAL 59 P 11	DLLA 150 P 588	295-303		9 430 082 764	
KDAL 59 P 12	DSLA 145 P 395	260-274		0 432 133 866	
KDAL 59 P 12	DSLA 145 P 396	260-268		0 432 133 865	
KDAL 59 P 12	DSLA 145 P 414	260-268		0 432 133 863	
KDAL 59 P 14	DLLA 155 P 1258	260-274		0 432 131 630	
KDAL 59 P 14	DLLA 155 P 570	260-274		0 432 131 753	
KDAL 59 P 14	DLLA 155 P 665	260-274		0 432 131 715	







 Typ	 Typ	 1st/bar	 2nd/bar	 Ref.		
KDAL 59 P 14	DLLA 155 P 767	260–274			0 432 131 693	
KDAL 59 P 16	DLLA 145 P 561	240–254			0 432 131 656	
KDAL 59 P 16	DLLA 145 P 561	240–254			0 432 131 722	
KDAL 59 P 16	DLLA 145 P 574	240–254			0 432 131 749	
KDAL 59 P 16	DLLA 145 P 605	180–194			0 432 131 679	
KDAL 59 P 16	DLLA 145 P 605	200–214			0 432 131 697	
KDAL 59 P 16	DLLA 145 P 605	220–234			0 432 131 710	
KDAL 59 P 16	DLLA 145 P 605	220–234			0 432 131 741	
KDAL 59 P 16	DLLA 145 P 606	220–234			0 432 131 717	
KDAL 59 P 16	DLLA 145 P 606	220–234			0 432 131 740	
KDAL 59 P 16	DLLA 145 P 607	220–234			0 432 131 739	
KDAL 59 P 16	DLLA 145 P 758	240–254			0 432 131 676	
KDAL 59 P 16	DLLA 145 P 758	240–254			0 432 131 698	
KDAL 59 P 16	DLLA 145 P 787	220–234			0 432 131 690	
KDAL 59 P 16	DLLA 145 P 788	220–234			0 432 131 688	
KDAL 59 P 16	DLLA 145 P 788	220–234			0 432 131 689	
KDAL 59 P 16	DLLA 145 P 842	240–254			0 432 131 681	
KDAL 59 P 2	DLLA 154 P 332				9 430 082 747	
KDAL 59 P 2	DLLA 155 P 114	245–259			0 432 131 876	
KDAL 59 P 2	DLLA 155 P 157	180–188			0 432 131 870	
KDAL 59 P 2	DLLA 155 P 223	245–259			0 432 131 849	
KDAL 59 P 2	DLLA 155 P 66	245–259			0 432 131 877	
KDAL 59 P 2	DLLA 155 P 67	180–188			0 432 131 868	
KDAL 59 P 2	DLLA 155 P 67	220–234			0 432 131 881	
KDAL 59 P 2	DLLA 155 P 70	245–259			0 432 131 882	
KDAL 59 P 2	DLLA 155 P 74	220–234			0 432 131 875	
KDAL 59 P 2	DLLA 155 P 74	245–259			0 432 131 880	
KDAL 59 P 2	DSLA 155 P 104	260–274			0 432 133 884	
KDAL 59 P 2	DSLA 155 P 104	245–259			0 432 133 888	
KDAL 59 P 2	DSLA 155 P 84	245–259			0 432 133 889	
KDAL 59 P 22	DSLA 145 P 1679	260–272			0 432 133 764	
KDAL 59 P 22	DLLA 145 P 1338	260–272			0 432 131 626	
KDAL 59 P 22	DLLA 145 P 1391	260–272			0 432 131 623	
KDAL 59 P 22	DSLA 145 P 1174	260–272			0 432 133 775	
KDAL 59 P 22	DSLA 145 P 1255	260–272			0 432 133 780	
KDAL 59 P 22	DSLA 145 P 1304	260–274			0 432 133 774	
KDAL 59 P 22	DSLA 145 P 1441	260–272			0 432 133 771	
KDAL 59 P 22	DSLA 145 P 265	260–274			0 432 133 838	
KDAL 59 P 22	DSLA 145 P 768	250–264			0 432 133 826	
KDAL 59 P 3	DLLA 155 P 67	220–228			0 432 131 872	
KDAL 59 P 4	DLLA 155 P 157	180–190			0 432 131 851	
KDAL 59 P 4	DLLA 155 P 343	245–255			0 432 131 821	
KDAL 59 P 4	DLLA 155 P 66	245–253			0 432 131 855	
KDAL 59 P 4	DLLA 155 P 67	220–230			0 432 131 869	
KDAL 59 P 4	DLLA 155 P 74	220–234			0 432 131 854	

A262

<p>de</p> <p>Typformel Düsenhalter → Typformel Düse → DHK (Fortsetzung)</p>	<p>en</p> <p>Type designation nozzle holder → Type designation nozzle → Nozzle-and-holder assemblies (continued)</p>	<p>fr</p> <p>Formule de type principaux porte-injecteurs → Formule de type injecteur → Ensembles porte-injecteurs (suite)</p>	<p>it</p> <p>Sigla polverizzatori → Sigla portapolverizzatori → Sigla combinazione portapolverizzatori (seguito)</p>	<p>es</p> <p>Designación de tipo portainyectoros → Designación de tipo inyectoros → Conjuntos portainyectoros (continuación)</p>
---	--	---	--	--



KDAL 59 P 4	DLLA 155 P 74	245–255		0 432 131 856	
KDAL 59 P 4	DSLA 155 P 104	260–268		0 432 133 882	
KDAL 59 P 4	DSLA 155 P 104	245–253		0 432 133 883	
KDAL 59 P 5	DLLA 155 P 215	235–249		0 432 131 852	
KDAL 59 P 5	DLLA 155 P 273	245–259		0 432 131 836	
KDAL 59 P 5	DLLA 155 P 274	245–259		0 432 131 835	
KDAL 59 P 5	DLLA 155 P 275	180–188		0 432 131 832	
KDAL 59 P 5	DLLA 155 P 277	245–259		0 432 131 837	
KDAL 59 P 5	DSLA 155 P 170	245–259		0 432 133 887	
KDAL 59 P 5	DSLA 155 P 278	245–259		0 432 133 875	
KDAL 59 P 6	DLLA 145 P 420	270–284		0 432 131 799	
KDAL 59 P 6	DLLA 145 P 574	240–254		0 432 131 694	
KDAL 59 P 6	DLLA 145 P 574	240–254		0 432 131 743	
KDAL 59 P 6	DSLA 141 P 1096	265–279		F 000 439 017	
KDAL 59 P 6	DSLA 145 P 1167	260–274		F 000 439 019	
KDAL 59 P 6	DSLA 145 P 1174	260–272		0 432 133 772	
KDAL 59 P 6	DSLA 145 P 1174	260–274		0 432 133 781	
KDAL 59 P 6	DSLA 145 P 1174	260–274		0 432 133 787	
KDAL 59 P 6	DSLA 145 P 1288	260–274		0 432 133 778	
KDAL 59 P 6	DSLA 145 P 263	300–314		0 432 133 868	
KDAL 59 P 6	DSLA 145 P 263	300–314		0 432 133 879	
KDAL 59 P 6	DSLA 145 P 264	300–314		0 432 133 878	
KDAL 59 P 6	DSLA 145 P 462	260–274		0 432 133 859	
KDAL 59 P 6	DSLA 145 P 463	260–274		0 432 133 861	
KDAL 59 P 6	DSLA 145 P 464	260–274		0 432 133 860	
KDAL 59 P 6	DSLA 145 P 477	260–274		0 432 133 844	
KDAL 59 P 6	DSLA 145 P 477	260–274		0 432 133 858	
KDAL 59 P 6	DSLA 145 P 603	260–274		0 432 133 773	
KDAL 59 P 6	DSLA 145 P 681	260–274		0 432 133 837	
KDAL 59 P 6	DSLA 155 P 276	262–276		0 432 133 864	
KDAL 59 P 6	DSLA 155 P 498	260–274		0 432 133 854	
KDAL 59 P 7	DLLA 155 P 273	245–259		0 432 131 841	
KDAL 59 P 7	DLLA 155 P 274	220–234		0 432 131 839	
KDAL 59 P 7	DLLA 155 P 274	245–259		0 432 131 840	
KDAL 59 P 7	DLLA 155 P 275	180–194		0 432 131 838	
KDAL 59 P 7	DLLA 155 P 283	220–234		0 432 131 834	
KDAL 59 P 7	DSLA 155 P 276	260–274		0 432 133 876	
KDAL 59 P 8	DLLA 145 P 309	218–226		9 430 082 736	
KDAL 59 P 8	DLLA 145 P 310	220–228		9 430 082 737	
KDAL 59 P 9	DSLA 145 P 1160	245–253		F 000 439 018	
KDAL 59 P 9	DSLA 145 P 265	245–259		0 432 133 851	
KDAL 59 P 9	DSLA 145 P 265	245–259		0 432 133 877	
KDAL 59 P 9	DSLA 145 P 311	245–259		0 432 133 849	
KDAL 59 P 9	DSLA 145 P 311	245–259		0 432 133 853	
KDAL 59 P 9	DSLA 145 P 311	245–259		0 432 133 873	







 Typ	 Typ	 1st/bar	 2nd/bar	 Ref.		
KDAL 59 P 9	DSLA 145 P 598	245–259			0 432 133 846	
KDAL 59 P 9	DSLA 145 P 599	245–259			0 432 133 845	
KDAL 59 P 9	DSLA 145 P 603	245–259			0 432 133 843	
KDAL 59 P 9 M	DSLA 145 P 311 M	245–259			0 432 133 832	
KDAL 59 P5	DSLA 155 P 276	245–259			0 432 133 874	
KDAL 60 S 10/14	DLLA 23 S 383	175–183			0 432 231 877	
KDAL 62 S 19/19	DLL 152 S 756	250–258			0 432 231 030	
KDAL 62 S 19/19	DLL 152 S 780	250–258			0 432 231 031	
KDAL 62 S 23	DLL 152 S 756	250–258			0 432 231 046	
KDAL 62 S 23	DLL 152 S 780	250–258			0 432 231 034	
KDAL 62 S 24	DLL 152 S 756	250–258			0 432 231 051	
KDAL 62 S 24	DLL 152 S 756	270–278			0 432 231 054	
KDAL 62 S 24	DLL 152 S 780	240–248			0 432 231 050	
KDAL 62 S 24	DLL 152 S 780	270–278			0 432 231 052	
KDAL 62 S 32	DLLZ 147 S 1050	250–258			0 432 231 756	
KDAL 62 S 32	DLLZ 147 S 958	240–248			0 432 231 773	
KDAL 62 S 32	DLLZ 155 S 1133	270–278			0 432 231 711	
KDAL 62 S 32	DLLZ 155 S 1133	300–308			0 432 231 734	
KDAL 62 S 38	DLLZ 147 S 1083	280–288			0 432 231 762	
KDAL 62 S 38	DLLZ 147 S 958	270–278			0 432 231 745	
KDAL 62 S 38	DLLZ 152 S 1229	280–288			0 432 231 696	
KDAL 62 S 38	DLLZ 152 S 1247	280–288			0 432 231 692	
KDAL 62 S 38	DLLZ 155 S 1133	310–318			0 432 231 694	
KDAL 62 S 38	DLLZ 155 S 1133	270–278			0 432 231 698	
KDAL 74 P 10	DLLA 140 P 323	240–248			9 430 082 745	
KDAL 74 P 10	DLLA 144 P 443	250–258			9 430 082 752	
KDAL 74 P 10	DLLA 144 P 553	250–258			9 430 082 756	
KDAL 74 P 10	DLLA 150 P 314	240–248			9 430 082 746	
KDAL 74 P 15	DLLA 137 P 553	250–258			9 430 082 759	
KDAL 74 P 15	DLLA 138 P 820	250–260			F 000 439 006	
KDAL 74 P 17	DLLA 148 P 597				9 430 082 767	
KDAL 74 P 17	DSLA 137 P 793	290–300			F 000 439 005	
KDAL 74 P 19	DLLA 137 P 608	285–293			9 430 082 769	
KDAL 74 P 36	DSLA 137 P 981	290–300			F 000 439 013	
KDAL 74 S 21/19	DLLA 134 S 1201	240–248			0 432 231 653	
KDAL 74 S 21/19	DLLA 137 S 1157	200–208			0 432 231 690	
KDAL 74 S 21/19	DLLA 142 S 1173	200–208			0 432 231 652	
KDAL 74 S 21/19	DLLA 142 S 1257	200–208			0 432 231 651	
KDAL 74 S 21/19	DLLA 142 S 791	200–210			0 432 231 824	
KDAL 74 S 21/19	DLLA 142 S 792	200–210			0 432 231 823	0 986 430 045
KDAL 74 S 21/19	DLLA 142 S 926	200–210			0 432 231 770	
KDAL 74 S 21/19	DLLA 150 S 186	175–185			0 432 231 886	
KDAL 74 S 21/19	DLLA 150 S 187	200–208			0 432 231 826	
KDAL 74 S 21/19	DLLA 150 S 187	200–210			0 432 231 887	0 986 430 056
KDAL 74 S 21/19	DLLA 150 S 2120	200–208			0 432 231 825	

A264

de Typformel Düsenhalter → Typformel Düse → DHK (Fortsetzung)	en Type designation nozzle holder → Type designation nozzle → Nozzle-and-holder assemblies (continued)	fr Formule de type principaux porte-injecteurs → Formule de type injecteur → Ensembles porte-injecteurs (suite)	it Sigla polverizzatori → Sigla portapolverizzatori → Sigla combinazione portapolverizzatori (seguito)	es Designación de tipo portainyectoros → Designación de tipo inyectoros → Conjuntos portainyectoros (continuación)
---	--	---	--	--









KDAL 74 S 21/19	DLLA 150 S 2120	200-210		0 432 231 870	
KDAL 74 S 21/19	DLLA 150 S 514	175-183		0 432 231 872	
KDAL 74 S 21/19	DLLA 150 S 781	200-210		0 432 231 827	
KDAL 74 S 21/19	DLLA 150 S 935	175-185		0 432 231 775	
KDAL 74 S 21/19	DLLA 79 S 390	200-210		0 432 231 880	
KDAL 74 S 21/19	DLLA 79 S 800	200-210		0 432 231 822	
KDAL 74 S 3/19	DLLA 148 S 470	200-208		0 432 231 875	
KDAL 74 S 3/19	DLLA 150 S 186	200-208		0 432 231 865	
KDAL 74 S 3/19	DLLA 63 S 447	200-208		0 432 231 876	
KDAL 74 S 44	DLLA 133 S 1103	200-208		0 432 231 732	
KDAL 74 S 44	DLLA 134 S 1119	200-210		0 432 231 737	
KDAL 74 S 44	DLLA 134 S 1197	200-208		0 432 231 715	
KDAL 74 S 44	DLLA 134 S 1201	240-250		0 432 231 713	0 986 430 210
KDAL 74 S 44	DLLA 137 S 1157	200-210		0 432 231 724	0 986 430 221
KDAL 74 S 44	DLLA 142 S 1096	200-210		0 432 231 736	0 986 430 178
KDAL 74 S 44	DLLA 142 S 1173	200-210		0 432 231 722	0 986 430 214
KDAL 74 S 44	DLLA 142 S 1257	200-210		0 432 231 688	0 986 430 221
KDAL 77 P 25	DSLA 138 P 698	225-239		0 432 133 831	
KDAL 77 P 25	DSLA 138 P 757	250-264		0 432 133 828	
KDAL 80 S 14/14	DLLA 136 S 1043	200-208		0 432 231 750	
KDAL 80 S 14/14	DLLA 150 S 588	175-183		0 432 231 869	
KDAL 80 S 14/14	DLLA 150 S 628	175-183		0 432 231 863	
KDAL 80 S 14/14	DLLA 150 S 653	210-218		0 432 231 861	
KDAL 80 S 14/14	DLLA 25 S 601	175-183		0 432 231 867	
KDAL 80 S 14/14	DLLA 25 S 627	185-193		0 432 231 864	
KDAL 80 S 14/14	DLLA 32 S 759	175-183		0 432 231 836	
KDAL 80 S 14/14	DLLA 34 S 749	175-183		0 432 231 842	
KDAL 80 S 14/14	DLLA 34 S 837	175-183		0 432 231 817	
KDAL 80 S 14/14	DLLA 34 S 876	200-208		0 432 231 793	
KDAL 80 S 20/19	DLLA 144 S 485	175-183		0 432 231 792	
KDAL 80 S 20/19	DLLA 25 S 722	185-193		0 432 231 845	
KDAL 80 S 20/19	DLLA 28 S 589	175-183		0 432 231 844	
KDAL 80 S 20/19	DLLA 28 S 892	175-183		0 432 231 802	
KDAL 80 S 20/19	DLLA 30 S 877			0 432 231 807	
KDAL 80 S 20/19	DLLA 32 S 759	185-193		0 432 231 835	
KDAL 80 S 20/19	DLLA 34 S 749	175-183		0 432 231 833	
KDAL 80 S 20/19	DLLA 34 S 837	175-183		0 432 231 810	
KDAL 80 S 20/19	DLLA 34 S 876	200-208		0 432 231 796	
KDAL 80 S 20/19	DLLA 34 S 876	185-193		0 432 231 808	
KDAL 80 S 25	DLLA 31 S 915	220-228		0 432 231 791	
KDAL 80 S 25	DLLA 32 S 900	240-248		0 432 231 798	
KDAL 80 S 26	DLLA 32 S 900	240-248		0 432 231 794	
KDAL 80 S 27	DLLA 31 S 915	220-228		0 432 231 779	
KDAL 80 S 30	DLLA 30 S 931	185-193		0 432 231 776	
KDAL 80 S 37	DLLA 128 S 1028	200-208		0 432 231 761	







 Typ	 Typ	 1st/bar	 2nd/bar	 Ref.		
KDAL 80 S 37	DLLA 146 S 1245	210–218		0 432 231 693		
KDAL 80 S 42	DLLA 136 S 1034	200–208		0 432 231 742		
KDAL 80 S 42	DLLA 136 S 1034	200–208		0 432 231 760	0 986 430 168	
KDAL 80 S 42	DLLA 136 S 1094	200–208		0 432 231 743		
KDAL 80 S 42	DLLA 136 S 1182	200–208		0 432 231 720		
KDAL 80 S 42	DLLA 140 S 1003	200–208		0 432 231 764	0 986 430 038	
KDAL 80 S 42	DLLA 144 S 829	200–208		0 432 231 814	0 986 430 042	
KDAL 80 S 46	DLLA 131 S 1035	200–208		0 432 231 759		
KDAL 80 S 46	DLLA 131 S 1131			0 432 231 725		
KDAL 80 S 46	DLLA 134 S 1143	200–208		0 432 231 731		
KDAL 80 S 46	DLLA 134 S 1199	200–208		0 432 231 714	0 986 430 211	
KDAL 80 S 46	DLLA 134 S 999	200–208		0 432 231 738		
KDAL 80 S 46	DLLA 134 S 999	200–208		0 432 231 766	0 986 430 133	
KDAL 80 S 46	DLLA 138 S 1191	200–208		0 432 231 717	0 986 430 205	
KDAL 80 S 46	DLLA 142 S 1224	200–208		0 432 231 701		
KDAL 80 S 47	DLLA 131 S 1035	200–208		0 432 231 683		
KDAL 80 S 47	DLLA 131 S 1131	200–210		0 432 231 679		
KDAL 80 S 47	DLLA 134 S 1199	200–208		0 432 231 677	0 986 430 211	
KDAL 80 S 47	DLLA 134 S 999	200–208		0 432 231 704	0 986 430 133	
KDAL 80 S 47	DLLA 136 S 1034	200–208		0 432 231 703	0 986 430 168	
KDAL 80 S 47	DLLA 136 S 1043	200–210		0 432 231 682		
KDAL 80 S 47	DLLA 136 S 1094	200–210		0 432 231 681		
KDAL 80 S 47	DLLA 138 S 1191	200–210		0 432 231 678	0 986 430 205	
KDAL 80 S 47	DLLA 140 S 1003	200–208		0 432 231 680	0 986 430 038	
KDAL 80 S 47	DLLA 142 S 1224	200–210		0 432 231 676	0 986 430 360	
KDAL 80 S 47	DLLA 144 S 485	175–183		0 432 231 687	0 986 430 053	
KDAL 80 S 47	DLLA 144 S 488	175–185		0 432 231 686		
KDAL 80 S 47	DLLA 144 S 747	175–185		0 432 231 685		
KDAL 80 S 47	DLLA 144 S 829	200–208		0 432 231 684	0 986 430 042	
KDAL 80 S 48	DLLA 131 S 1131	200–208		0 432 231 735		
KDAL 80 S 48	DLLA 140 S 1003	175–183		0 432 231 728		
KDAL 80 S 48	DLLA 144 S 829	175–183		0 432 231 729		
KDAL 80 S 50	DLLA 136 S 1002	235–243		0 432 231 763		
KDAL 80 S 50	DLLA 136 S 943	235–243		0 432 231 767		
KDAL 80 S 50	DLLA 136 S 943	200–208		0 432 231 782		
KDAL 80 S 50	DLLA 25 S 722	185–193		0 432 231 850		
KDAL 80 S 50	DLLA 28 S 589	175–183		0 432 231 868		
KDAL 80 S 50	DLLA 30 S 678	175–183		0 432 231 858		
KDAL 80 S 50	DLLA 34 S 837	200–208		0 432 231 795		
KDAL 80 S 51	DLLA 30 S 931	185–193		0 432 231 769		
KDAL 80 S 52	DLLA 138 S 983	265–273		0 432 231 751		
KDAL 80 S 53	DLLA 131 S 1035	200–208		0 432 231 657		
KDAL 80 S 53	DLLA 136 S 1002	280–288		0 432 231 744		
KDAL 80 S 53	DLLA 136 S 1289	210–218		0 432 231 669		
KDAL 80 S 55	DLLA 138 S 983	265–273		0 432 231 768		

A266

de	en	fr	it	es
Typformel Düsenhalter → Typformel Düse → DHK (Fortsetzung)	Type designation nozzle holder → Type designation nozzle → Nozzle-and-holder assemblies (continued)	Formule de type principaux porte-injecteurs → Formule de type injecteur → Ensembles porte-injecteurs (suite)	Sigla polverizzatori → Sigla portapolverizzatori → Sigla combinazione portapolverizzatori (seguito)	Designación de tipo portainyectores → Designación de tipo inyectores → Conjuntos portainyectores (continuación)



 Typ	 Typ	 1st/bar	 2nd/bar	 Ref.	
KDAL 80 S 56	DLL 25 S 834	175-183		0 432 231 805	
KDAL 80 S 56	DLLA 136 S 1002	220-228		0 432 231 656	
KDAL 80 S 56	DLLA 136 S 1002	235-243		0 432 231 765	
KDAL 80 S 56	DLLA 136 S 1034	200-208		0 432 231 666	
KDAL 80 S 56	DLLA 136 S 1102	220-228		0 432 231 740	
KDAL 80 S 56	DLLA 136 S 943	235-243		0 432 231 778	0 986 430 159
KDAL 80 S 56	DLLA 142 S 947	200-208		0 432 231 777	
KDAL 80 S 56	DLLA 27 S 613	175-183		0 432 231 846	
KDAL 80 S 56	DLLA 30 S 678	185-193		0 432 231 839	
KDAL 80 S 56	DLLA 30 S 757	175-183		0 432 231 832	
KDAL 80 S 56	DLLA 31 S 1138	200-208		0 432 231 733	
KDAL 80 S 56	DLLA 34 S 837	200-208		0 432 231 790	
KDAL 80 S 57	DLLA 136 S 1034	220-228		0 432 231 709	
KDAL 80 S 58	DLLA 136 S 1034	220-230		0 432 231 675	
KDAL 80 S 59	DLLA 131 S 1131	200-210		0 432 231 674	0 986 430 508
KDAL 80 S 59	DLLA 140 S 1003	175-185		0 432 231 673	0 986 430 507
KDAL 80 S 59	DLLA 144 S 829	175-185		0 432 231 672	
KDAL 80 S 63	DLLA 131 S 1035+/-	200-210		0 432 231 599	
KDAL 80 S 63	DLLA 134 S 1199+/-	200-208		0 432 231 664	
KDAL 80 S 63	DLLA 134 S 1284+/-	200-208		0 432 231 662	
KDAL 80 S 63	DLLA 134 S 999+/-	200-208		0 432 231 663	
KDAL 80 S 63	DLLA 136 S 1034+/-	200-210		0 432 231 661	
KDAL 80 S 63	DLLA 138 S 1191+/-	200-208		0 432 231 665	
KDAL 80 S 63	DLLA 140 S 1003+/-	200-210		0 432 231 659	
KDAL 80 S 63	DLLA 144 S 485+/-	175-185		0 432 231 658	
KDAL 80 S 63	DLLA 144 S 829+/-	200-210		0 432 231 660	
KDAL 82 S 15/4	DLL 16 S 592	175-183		0 432 231 020	
KDAL 82 S 15/4	DLL 23 S 553	175-183		0 432 231 014	
KDAL 84 P 27	DSLA 145 P 725	250-264		0 432 133 829	
KDAL 84 P 27	DSLA 145 P 778	250-264		0 432 133 821	
KDAL 84 P 27	DSLA 150 P 779	250-264		0 432 133 820	
KDAL 85 P 26	DSLA 140 P 707	250-264		0 432 133 830	
KDAL 95 P 1	DLLA 150 P 46	275-285		0 432 131 886	
KDAL 95 P 1	DLLA 150 P 47	275-285		0 432 131 885	
KDAL 95 P 1	DLLA 150 P 48	275-285		0 432 131 884	
KDAL 95 P 1	DLLA 150 P 49	275-285		0 432 131 883	
KDAL 96 S 16/4	DLL 30 S 1004	175-183		0 432 231 044	
KDAL 96 S 16/4	DLL 35 S 559	175-183		0 432 231 015	
KDAL 96 S 16/4	DLL 35 S 561	175-183		0 432 231 017	
KDAL 96 S 16/4	DLL 35 S 562	175-183		0 432 231 018	
KDAL 96 S 16/4	DLL 38 S 560	175-183		0 432 231 016	
KDEL 109 P 47	DLLA 147 P 538	275-283		0 432 131 758	0 986 430 382
KDEL 109 P 47	DLLA 147 P 569	295-303		0 432 131 754	
KDEL 109 P 62	DLLA 147 P 936	295-303		F 000 439 012	
KDEL 109 P 62	DLLA 142 P 985	275-283		0 432 131 664	

 Typ	 Typ	 1st/bar	 2nd/bar	 Ref.	
KDEL 109 P 62	DLLA 147 P 538	275–283		0 432 131 703	0 986 430 390
KDEL 109 P 62	DLLA 147 P 569	295–303		0 432 131 704	
KDEL 109 P 62	DLLA 147 P 799	275–283		0 432 131 686	
KDEL 109 P 62	DLLA 147 P 861	275–283		0 432 131 674	
KDEL 109 P 62	DLLA 155 P 796	305–313		0 432 131 687	
KDEL 109 P 62	DLLA 155 P 859	305–313		0 432 131 675	
KDEL 59 P 14	DSLA 145 P 477	260–274		0 432 133 857	
KDEL 59 P 22	DSLA 145 P 1253	260–272		0 432 133 779	
KDEL 59 P 22	DSLA 145 P 603	260–272		0 432 133 782	
KDEL 59 P 6	DSLA 145 P 1479	300–314		0 432 133 770	
KDEL 65 P 21	DLLA 148 P 329	290–304		0 432 131 822	
KDEL 65 P 21	DLLA 148 P 408	290–304		0 432 131 806	
KDEL 65 P 21	DLLA 148 P 611	290–304		0 432 131 723	
KDEL 65 P 26	DSLA 150 P 362	201–209	351–363	0 432 133 869	
KDEL 65 P 6	DLLA 148 P 408	290–298		0 432 131 774	
KDEL 65 P 6	DLLA 158 P 161	290–304		0 432 131 867	
KDEL 65 P 6	DLLA 158 P 168	290–298		0 432 131 865	
KDEL 65 P 8	DLLA 160 P 171	252–260		0 432 131 864	
KDEL 65 S 1/13	DLLA 155 S 1205	290–298		0 432 231 710	
KDEL 65 S 1/13	DLLA 155 S 658	270–278		0 432 231 860	
KDEL 65 S 1/13	DLLA 155 S 681	290–298		0 432 231 857	
KDEL 65 S 1/13	DLLA 155 S 695	290–298		0 432 231 855	
KDEL 65 S 1/13	DLLA 155 S 710	255–263		0 432 231 852	
KDEL 65 S 1/13	DLLA 155 S 713	270–278		0 432 231 851	
KDEL 65 S 1/13	DLLA 155 S 729	225–233		0 432 231 848	
KDEL 65 S 1/13	DLLA 155 S 895	290–298		9 430 233 003	
KDEL 65 S 1/13	DLLA 158 S 766	255–263		0 432 231 831	
KDEL 65 S 1/13	DLLA 158 S 920	220–228		9 430 233 012	
KDEL 69 P 43	DLLA 148 P 1200	290–304		0 432 131 641	
KDEL 69 P 43	DLLA 148 P 329	290–304		0 432 131 752	
KDEL 69 P 43	DLLA 148 P 408	290–304		0 432 131 765	
KDEL 69 P 43	DLLA 148 P 522	290–304		0 432 131 766	
KDEL 69 P 43	DLLA 148 P 610	290–304		0 432 131 735	
KDEL 69 P 43	DLLA 148 P 611	290–304		0 432 131 736	
KDEL 69 P 43	DLLA 148 P 612	290–304		0 432 131 737	
KDEL 69 P 43	DLLA 148 P 663	290–304		0 432 131 716	
KDEL 70 P 19	DSLA 78 P 322	190–198		0 432 133 872	
KDEL 75 P 16	DLLA 148 P 325	320–328		0 432 131 685	
KDEL 75 P 16	DLLA 149 P 514	320–328		0 432 131 767	0 986 430 347
KDEL 75 P 16	DSLA 148 P 243	255–263		0 432 133 881	
KDEL 75 P 16	DSLA 148 P 262	255–263		0 432 133 880	
KDEL 75 P 20	DLLA 148 P 325	255–263		0 432 131 823	0 986 430 450
KDEL 75 P 20	DLLA 148 P 461	290–298		0 432 131 785	
KDEL 75 P 22	DSLA 148 P 348	255–263		0 432 133 870	
KDEL 75 P 22	DSLA 149 P 342	255–263		0 432 133 871	

de

Typformel Düsenhalter → Typformel Düse → DHK
(Fortsetzung)

en

Type designation nozzle holder → Type designation nozzle → Nozzle-and-holder assemblies
(continued)

fr

Formule de type principaux porte-injecteurs → Formule de type injecteur → Ensembles porte-injecteurs
(suite)

it







Sigla polverizzatori → Sigla portapolverizzatori → Sigla combinazione portapolverizzatori
(seguito)

es

Designación de tipo portainyectoros → Designación de tipo inyectoros → Conjuntos portainyectoros
(continuación)









KDEL 75 P 36	DLLA 149 P 460	310–318		0 432 131 786	
KDEL 75 P 36	DSLA 149 P 427	320–328		0 432 133 862	
KDEL 75 P 40	DLLA 148 P 500	320–328		0 432 131 771	
KDEL 75 P 40	DLLA 148 P 578	320–328		0 432 131 668	
KDEL 75 P 40	DLLA 149 P 602	320–332		0 432 131 742	
KDEL 75 P 46	DLLA 148 P 578	320–328		0 432 131 748	
KDEL 75 P 46	DLLA 149 P 460	335–343		0 432 131 761	
KDEL 75 P 46	DLLA 149 P 622	320–328		0 432 131 732	
KDEL 75 P 46	DLLA 149 P 697	310–318		0 432 131 705	
KDEL 75 P 46	DLLA 154 P 525	310–318		0 432 131 763	
KDEL 75 P 46	DSLA 149 P 427	320–328		0 432 133 850	
KDEL 75 P 65	DLLA 149 P 831	216–228	396–412	0 432 131 683	
KDEL 75 S 20	DLLA 148 S 1089	255–263		0 432 231 700	
KDEL 75 S 20	DLLA 148 S 1203	255–263		0 432 231 712	
KDEL 75 S 20	DLLA 148 S 1214	255–263		0 432 231 708	
KDEL 75 S 20	DLLA 148 S 1226	255–263		0 432 231 699	
KDEL 75 S 20	DLLA 148 S 1228	255–263		0 432 231 697	
KDEL 77 P 59	DLLA 144 P 666	320–328		0 432 131 714	0 986 430 511
KDEL 77 S 15	DLLA 148 S 1089	255–263		0 432 231 747	0 986 430 334
KDEL 77 S 15	DLLA 148 S 1098	255–263		0 432 231 741	
KDEL 80 P 1/13	DLLA 142 P 14	240–248		0 432 131 889	
KDEL 80 P 32	DLLA 142 P 417	265–275		0 432 131 731	
KDEL 80 P 32	DLLA 142 P 417	235–245		0 432 131 805	
KDEL 80 P 32	DLLA 142 P 418	265–275		0 432 131 730	
KDEL 80 P 32	DLLA 142 P 418	235–245		0 432 131 804	
KDEL 80 P 32	DLLA 142 P 419	265–275		0 432 131 729	
KDEL 80 P 32	DLLA 142 P 419	235–245		0 432 131 803	
KDEL 80 P 32	DLLA 142 P 479	235–245		0 432 131 780	
KDEL 80 P 32	DLLA 142 P 696	220–230		0 432 131 706	
KDEL 80 P 33	DLLA 134 P 846	265–275		0 432 131 680	
KDEL 80 P 33	DLLA 138 P 563	295–305		0 432 131 782	
KDEL 80 P 33	DLLA 142 P 1119	265–275		0 432 131 646	
KDEL 80 P 33	DLLA 142 P 1233	265–275		0 432 131 632	
KDEL 80 P 33	DLLA 142 P 417	265–275		0 432 131 727	0 986 430 325
KDEL 80 P 33	DLLA 142 P 417	235–245		0 432 131 802	0 986 430 378
KDEL 80 P 33	DLLA 142 P 418	265–275		0 432 131 726	0 986 430 326
KDEL 80 P 33	DLLA 142 P 418	235–245		0 432 131 801	0 986 430 265
KDEL 80 P 33	DLLA 142 P 419	265–275		0 432 131 728	0 986 430 327
KDEL 80 P 33	DLLA 142 P 419	235–245		0 432 131 800	0 986 430 264
KDEL 80 P 33	DLLA 142 P 479	235–245		0 432 131 781	0 986 430 361
KDEL 80 P 33	DLLA 142 P 696	220–230		0 432 131 707	
KDEL 80 P 42	DLLA 138 P 505	330–338		0 432 131 770	
KDEL 80 P 66	DLLA 146 P 1218	250–264		0 432 131 636	
KDEL 80 P 66	DLLA 146 P 834	250–264		0 432 131 682	
KDEL 80 P 68	DLLA 142 P 418	265–275		0 432 131 677	







 Typ	 Typ	 1st/bar	 2nd/bar	 Ref.	 Ref.
KDEL 80 P 71	DLLA 142 P 417	265–275		0 432 131 662	
KDEL 80 P 71	DLLA 142 P 418	265–275		0 432 131 661	
KDEL 80 P 71	DLLA 142 P 419	265–275		0 432 131 660	
KDEL 80 P 71	DLLA 142 P 479	235–245		0 432 131 663	
KDEL 82 P 11	DLLA 134 P 180	265–273		0 432 131 858	
KDEL 82 P 11	DLLA 134 P 204	265–273		0 432 131 842	
KDEL 82 P 12	DLLA 146 P 1311/	295–303		0 432 131 857	0 986 430 321
KDEL 82 P 12	DLLA 146 P 203	280–294		0 432 131 669	
KDEL 82 P 12	DLLA 146 P 489	295–303		0 432 131 776	
KDEL 82 P 12	DLLA 146 P 581	320–328		0 432 131 701	
KDEL 82 P 12	DLLA 146 P 708	290–298		0 432 131 700	
KDEL 82 P 12	DLLA 148 P 984	335–343		0 432 131 665	
KDEL 82 P 12	DLLA 150 P 1171	335–343		0 432 131 643	
KDEL 82 P 12	DLLA 152 P 452	320–328		0 432 131 788	0 986 430 312
KDEL 82 P 12	DLLA 152 P 531	320–328		0 432 131 760	0 986 430 451
KDEL 82 P 12	DLLA 152 P 566	320–328		0 432 131 755	
KDEL 82 P 12	DSLA 150 P 805	300–308		0 432 133 819	
KDEL 82 P 12	DSLA 152 P 630	295–303		0 432 133 839	
KDEL 82 P 17	DLLA 134 P 180	265–273		0 432 131 833	
KDEL 82 P 18	DLLA 134 P 296	280–290		0 432 131 829	
KDEL 82 P 18	DLLA 134 P 301	280–290		0 432 131 828	
KDEL 82 P 18	DLLA 134 P 371	250–260		0 432 131 816	
KDEL 82 P 18	DLLA 134 P 372	250–260		0 432 131 817	
KDEL 82 P 18	DLLA 134 P 422	260–270		0 432 131 798	0 986 430 261
KDEL 82 P 18	DLLA 134 P 430	260–270		0 432 131 794	0 986 430 252
KDEL 82 P 18	DLLA 134 P 431	260–270		0 432 131 793	0 986 430 362
KDEL 82 P 18	DLLA 134 P 512	260–270		0 432 131 768	
KDEL 82 P 23	DLLA 134 P 180	265–273		0 432 131 820	0 986 430 257
KDEL 82 P 23	DLLA 134 P 204	265–273		0 432 131 720	
KDEL 82 P 24	DLLA 134 P 180	250–258		0 432 131 819	
KDEL 82 P 25	DLLA 134 P 180	265–273		0 432 131 818	
KDEL 82 P 29	DLLA 152 P 452	320–328		0 432 131 809	
KDEL 82 P 29	DLLA 152 P 531	320–328		0 432 131 759	
KDEL 82 P 30	DLLA 152 P 486/	340–350		0 432 131 779	
KDEL 82 P 38	DSLA 154 P 492/	270–278		0 432 133 855	0 986 430 313
KDEL 82 P 38	DSLA 154 P 625	320–328		0 432 133 840	
KDEL 82 P 48	DLLA 134 P 423	300–310		0 432 131 797	
KDEL 82 P 48	DLLA 134 P 424	300–308		0 432 131 796	
KDEL 82 P 48	DLLA 134 P 435	300–308		0 432 131 791	
KDEL 82 P 48	DLLA 134 P 459	300–308		0 432 131 787	
KDEL 82 P 54	DLLA 152 P 452	320–328		0 432 131 734	
KDEL 82 P 54	DLLA 152 P 531	320–328		0 432 131 733	
KDEL 82 P 55	DSLA 154 P 492/	270–278		0 432 133 842	0 986 430 444
KDEL 82 P 57	DLLA 134 P 422	260–268		9 430 082 771	
KDEL 82 P 69	DLLA 150 P 1207	300–308		0 432 131 640	

A270

de	en	fr	it	es
Typformel Düsenhalter → Typformel Düse → DHK (Fortsetzung)	Type designation nozzle holder → Type designation nozzle → Nozzle-and-holder assemblies (continued)	Formule de type principaux porte-injecteurs → Formule de type injecteur → Ensembles porte-injecteurs (suite)	Sigla polverizzatori → Sigla portapolverizzatori → Sigla combinazione portapolverizzatori (seguito)	Designación de tipo portainyectoros → Designación de tipo inyectoros → Conjuntos portainyectoros (continuación)









 Typ	 Typ	 1st/bar	 2nd/bar	 Ref.	
KDEL 82 P 69	DSLA 152 P 1634	300–308		0 432 133 765	
KDEL 82 P 7	DLLA 144 P 184/	280–294		0 432 131 667	0 986 430 196
KDEL 82 P 7	DLLA 144 P 184/	295–303		0 432 131 853	0 986 430 196
KDEL 82 P 7	DLLA 146 P 166	295–303		0 432 131 866	0 986 430 228
KDEL 82 P 7	DLLA 146 P 166/	295–303		0 432 131 831	0 986 430 228
KDEL 82 P 7	DLLA 146 P 499	295–303		0 432 131 772	
KDEL 82 P 7	DLLA 146 P 581	295–303		0 432 131 747	
KDEL 82 P 7	DLLA 148 P 363	295–303		0 432 131 815	
KDEL 82 P 7	DLLA 148 P 465	295–303		0 432 131 784	
KDEL 82 P 70	DLLA 150 P 1207	300–308		0 432 131 639	
KDEL 82 P 77	DLLA 148 P 984	335–343		0 432 131 628	
KDEL 82 P 77	DLLA 150 P 1171	335–343		0 432 131 629	
KDEL 82 P 77	DLLA 152 P 1231	300–308		0 432 131 633	
KDEL 82 P 78	DLLA 152 P 1231	300–308		0 432 131 631	
KDEL 82 P 9	DLLA 134 P 180	265–273		0 432 131 861	
KDEL 82 P 9	DLLA 140 P 175	265–273		0 432 131 830	
KDEL 82 P 9	DLLA 140 P 175	315–323		0 432 131 863	
KDEL 82 P 91	DLLA 146 P 1453	295–303		0 432 131 622	
KDEL 82 S 10	DLLA 31 S 921	200–208		0 432 231 788	
KDEL 82 S 10	DLLA 31 S 955	200–208		0 432 231 774	
KDEL 82 S 12	DLLA 35 S 918	185–193		0 432 231 783	
KDEL 82 S 16	DLLA 31 S 1079	220–228		0 432 231 748	
KDEL 82 S 18	DLLA 35 S 1190	175–183		0 432 231 718	
KDEL 82 S 7/13	DLLA 35 S 812	185–193		0 432 231 820	
KDEL 82 S 7/13	DLLA 35 S 918	185–193		0 432 231 789	
KDEL 87 P 37	DLLA 150 P 487	340–348		0 432 131 778	
KDEL 87 P 37	DLLA 150 P 488	340–348		0 432 131 777	
KDEL 87 S 19	DLLA 150 S 1192	240–248		0 432 231 716	
KDEL 87 S 8	DLLA 146 S 1175	240–248		0 432 231 721	
KDEL 87 S 8	DLLA 150 S 1065	240–248		0 432 231 757	
KDEL 87 S 8	DLLA 150 S 1151	240–248		0 432 231 726	
KDEL 87 S 8	DLLA 150 S 1216	240–248		0 432 231 706	
KDEL 87 S 8	DLLA 150 S 826	210–218		0 432 231 818	
KDEL 87 S 8	DLLA 150 S 839	210–218		0 432 231 815	
KDEL 89 S 6/13	DLLA 150 S 767	270–278		0 432 231 830	
KDEL 89 S 6/13	DLLA 155 S 879	270–278		0 432 231 806	
KDEL 90 P 35	DLLA 168 P 426	290–298		0 432 131 795	
KDEL 90 P 51	DLLA 150 P 545/	292–300		0 432 131 757	
KDEL 90 P 51	DLLA 155 P 885	280–288		0 432 131 670	
KDEL 90 P 64	DLLA 166 P 1005	290–298		0 432 131 659	
KDEL 90 P 64	DLLA 166 P 1036	290–298		0 432 131 657	
KDEL 90 P 64	DLLA 168 P 1006	290–298		0 432 131 658	
KDEL 90 P 64	DLLA 168 P 426	290–298		0 432 131 696	
KDEL 90 P 64	DLLA 168 P 751	290–298		0 432 131 695	
KDEL 90 P 73	DLLA 158 P 1116	290–298		0 432 131 649	

 Typ	 Typ	 1st/bar	 2nd/bar	 Ref.		
KDEL 90 P 73	DLLA 158 P 1117	290-298		0 432 131 648		
KDEL 90 P 73	DLLA 158 P 1118	290-298		0 432 131 647		
KDEL 90 P 74	DLLA 150 P 545/	310-320		0 432 131 642		
KDEL 90 P 75	DLLA 158 P 1216	200-210		0 432 131 638		
KDEL 90 P 75	DLLA 158 P 1226	200-210		0 432 131 635		
KDEL 90 P 75	DLLA 158 P 1227	200-210		0 432 131 634		
KDEL 90 P 76	DLLA 166 P 1217	200-210		0 432 131 637		
KDEL 90 P 79	DLLA 158 P 1216	200-210		0 432 131 627		
KDEL 90 P 82	DLLA 158 P 1216	200-210		0 432 131 620		
KDEL 90 P 82	DLLA 158 P 1226	200-210		0 432 131 619		
KDEL 90 P 82	DLLA 158 P 1227	200-210		0 432 131 621		
KDEL 90 P 83	DLLA 166 P 1217	200-210		0 432 131 618		
KDEL 90 P 84	DLLA 168 P 426	290-298		0 432 131 617		
KDEL 90 P 85	DLLA 144 P 1646	280-288		0 432 131 613		
KDEL 90 P 85	DLLA 147 P 1548	280-288		0 432 131 614		
KDEL 95 P 44	DLLA 150 P 524	320-328		0 432 131 762		
KDEL 95 S 17	DLLA 155 S 1163	255-263		0 432 231 723		
KDEL 95 S 17	DLLA 155 S 1221	255-263		0 432 231 702	0 986 430 341	
KDEL 95 S 21	DLLA 155 S 1215	255-263		0 432 231 707		
KDEL 95 S 21	DLLA 160 S 1305	255-263		0 432 231 667	0 986 430 330	
KDEL 96 S 22	DLLA 150 S 1220	255-263		0 432 231 705		
KDEL 96 S 22	DLLA 150 S 1295	255-263		0 432 231 668	0 986 430 329	
KDEL 97 P 10	DLLA 142 P 221	305-313		0 432 131 850	0 986 430 031	
KDEL 97 P 10	DLLA 142 P 544	305-313		0 432 131 756		
KDEL 97 P 10	DLLA 146 P 154-	305-313		0 432 131 871	0 986 430 120	
KDEL 97 P 10	DLLA 146 P 190	255-263		0 432 131 859		
KDEL 97 P 10	DLLA 146 P 224	255-263		0 432 131 848		
KDEL 97 P 13	DLLA 150 P 434	305-313		0 432 131 792		
KDEL 97 P 13	DLLA 155 P 230	305-313		0 432 131 846	0 986 430 274	
KDEL 97 P 13	DLLA 155 P 231	305-313		0 432 131 845		
KDEL 97 P 13	DLLA 155 P 302	235-243		0 432 131 789		
KDEL 97 P 13	DLLA 155 P 302	255-263		0 432 131 827		
KDEL 97 P 13	DLLA 155 P 306	265-273		0 432 131 825	0 986 430 213	
KDEL 97 P 13	DLLA 155 P 387	305-313		0 432 131 812		
KDEL 97 P 13	DLLA 155 P 444	265-273		0 432 131 790		
KDEL 97 P 13	DLLA 155 P 686	305-313		0 432 131 711		
KDEL 97 P 13	DSLA 145 P 491	265-273		0 432 133 856		
KDEL 97 P 3	DLLA 142 P 87	305-313		0 432 131 878	0 986 430 031	
KDEL 97 P 31	DLLA 142 P 406	301-311	411-425	0 432 131 807		
KDEL 97 P 31	DLLA 145 P 593	291-299		0 432 131 745		
KDEL 97 P 31	DLLA 145 P 609	291-301		0 432 131 738		
KDEL 97 P 53	DLLA 149 P 601	291-301	421-435	0 432 131 744		
KDEL 97 P 56	DLLA 145 P 593	291-301	421-435	0 432 131 692		
KDEL 97 P 56	DLLA 145 P 609	291-301	421-435	0 432 131 691		
KDEL 97 P 56	DLLA 145 P 627	291-301	421-435	0 432 131 724		

A272

de	en	fr	it	es
Typformel Düsenhalter → Typformel Düse → DHK (Fortsetzung)	Type designation nozzle holder → Type designation nozzle → Nozzle-and-holder assemblies (continued)	Formule de type principaux porte-injecteurs → Formule de type injecteur → Ensembles porte-injecteurs (suite)	Sigla polverizzatori → Sigla portapolverizzatori → Sigla combinazione portapolverizzatori (seguito)	Designación de tipo portainyectoros → Designación de tipo inyectoros → Conjuntos portainyectoros (continuación)



 Typ	 Typ	 1st/bar	 2nd/bar	 Ref.	
KDEL 97 P 56	DLLA 147 P 1374	291-301	421-435	0 432 131 624	
KDEL 97 P 56	DLLA 147 P 1521	291-301	421-435	0 432 131 616	
KDEL 97 P 56	DLLA 147 P 827	291-301	421-435	0 432 131 684	
KDEL 97 P 61	DLLA 146 P 693	305-313		0 432 131 709	
KDEL 97 P 72	DLLA 145 P 1068	181-193	281-297	0 432 131 652	
KDEL 97 P 72	DLLA 150 P 1151	181-193	281-297	0 432 131 644	
KDEL 97 P 80	DLLA 145 P 1348	250-264		0 432 131 625	
KDEL 97 P 80	DLLA 145 P 1547	250-264		0 432 131 615	
KDEL 97 S 11	DLLA 150 S 838/	255-263		0 432 231 799	0 986 430 039
KDEL 97 S 11	DLLA 152 S 899	245-253		0 432 231 800	
KDEL 97 S 14	DLLA 150 S 1064	210-218		0 432 231 752	
KDEL 97 S 23	DLLA 150 S 1248	245-253		0 432 231 691	
KDEL 97 S 4/13	DLLA 150 S 753	210-218		0 432 231 838	
KDEL 97 S 4/13	DLLA 150 S 838/	235-243		0 432 231 816	
KDEL 97 S 9	DLLA 150 S 753	215-223		0 432 231 813	
KDEL 97 S 9	DLLA 150 S 838/	235-243		0 432 231 812	
KDEL 99 P 14	DLLA 144 P 234	305-313		0 432 131 844	
KDEL 99 P 15	DLLA 144 P 467	305-313		0 432 131 783	
KDEL 99 P 15	DLLA 155 P 248	305-313		0 432 131 843	
KDEL 99 P 15	DLLA 155 P 307	260-268		0 432 131 824	0 986 430 212
KDEL 99 P 15	DLLA 155 P 383	305-313		0 432 131 814	
KDEL 99 P 15	DLLA 155 P 386	305-313		0 432 131 813	
KDEL 99 P 39	DLLA 150 P 573	285-293		0 432 131 751	0 986 430 387
KDEL 99 P 39	DLLA 152 P 496	315-323		0 432 131 773	0 986 430 385
KDEL 99 P 5	DLLA 144 P 144	305-313		0 432 131 873	0 986 430 030
KDEL 99 P 60	DLLA 150 P 573	285-293		0 432 131 712	
KDEL 99 P 60	DLLA 152 P 496	315-323		0 432 131 713	
KDELZ 90 S 24	DLLZ 150 S 1287	280-288		0 432 231 670	
KDL 100 S 24/4	DLLA 28 S 297	175-183		0 432 221 868	
KDL 35 S 161	DLLA 35 S 161	175-183		0 432 221 886	
KDL 65 S 27/4	DLLA 155 S 568	230-238		0 432 221 857	
KDL 65 S 27/4	DLLA 155 S 574	230-238		0 432 221 856	
KDL 65 S 27/4	DLLA 155 S 593	230-238		0 432 221 855	
KDL 65 S 27/4	DLLA 155 S 723	230-238		0 432 221 853	
KDL 80 S 17/4	DLLA 23 S 191	175-183		0 432 221 881	
KDL 87 S 6/4	DLLA 27 S 50			0 432 221 882	
KDL 87 S 6/4	DLLA 27 S 50			0 432 221 883	
KDL 87 S 6/4	DLLA 27 S 74	175-183		0 432 221 876	
KDL 87 S 6/4	DLLA 27 S 88			0 432 221 884	
KDL 87 S 9/4	DLLA 27 S 88	175-183		0 432 221 885	
KDL 94 S 16/4	DLLA 35 S 2180	175-183		0 432 221 869	
KDL 94 S 16/4	DLLA 35 S 377	175-183		0 432 221 864	
KDL 94 S 16/4	DLLA 38 S 208	190-198		0 432 221 851	
KDL 94 S 16/4	DLLA 38 S 208	175-183		0 432 221 887	
KDL 94 S 18/13	DLLA 35 S 2180	190-198		0 432 221 849	

A274

de

Ersatzteile für
Düsenhalter-
kombinationen

en

Spare parts for
nozzle-and-holder
assemblies

fr

Pièces de rechange
pour ensembles
porte-injecteurs

it

Ricambi per
combinazione
portapolverizzatori

es

Piezas de repuesto
para conjuntos
portainyectores

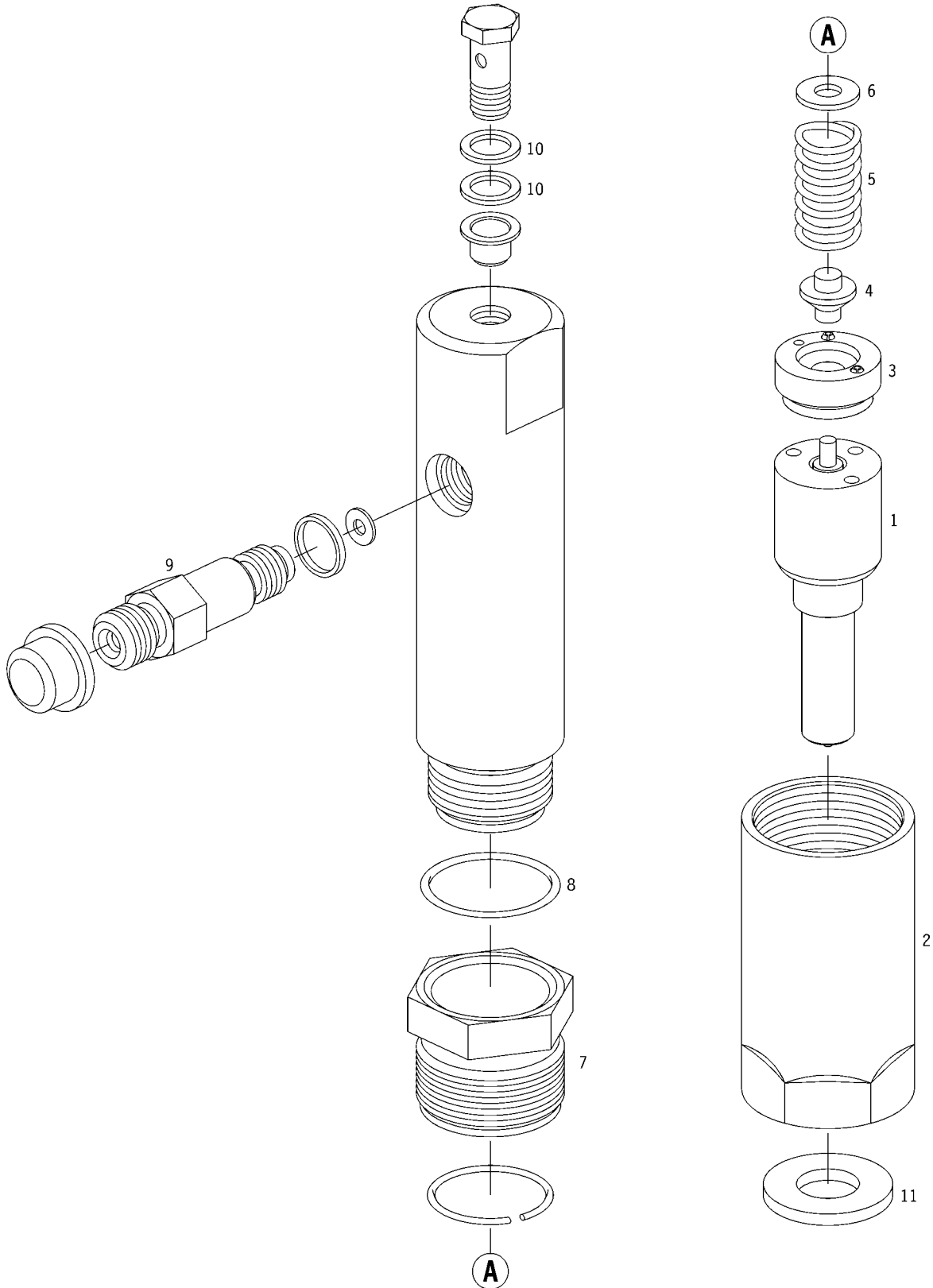

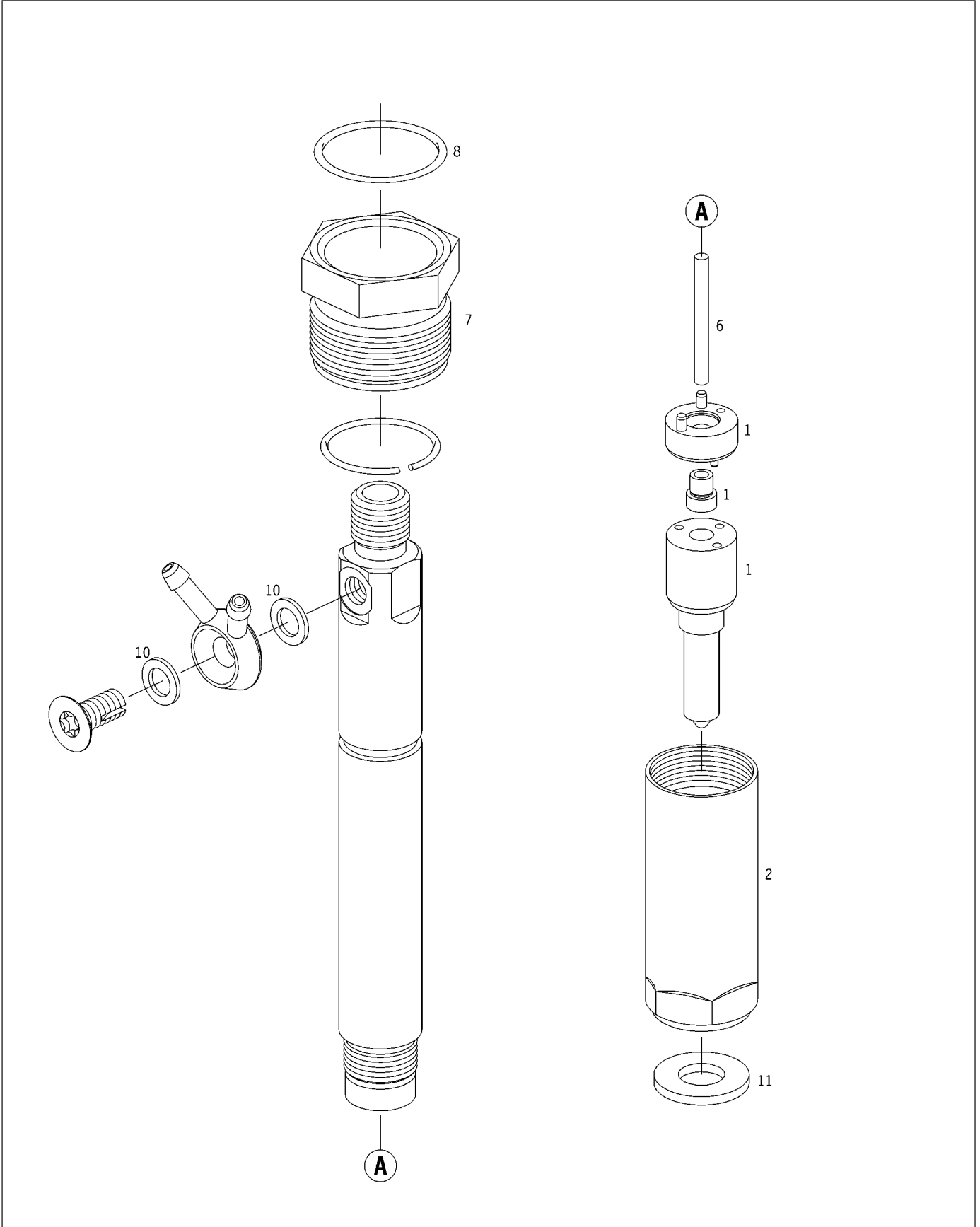

A276

de
Ersatzteile für
Düsenhalter-
kombinationen

en
Spare parts for
nozzle-and-holder
assemblies

fr
Pièces de rechange
pour ensembles
porte-injecteurs

it
Ricambi per
combinazione
portapolverizzatori

es
Piezas de repuesto
para conjuntos
portainyectoros



0 432 131 613	1	0 430 133 921	KDEL 90 P 85	0 433 172 009	DLLA 144 P 1646	2 433 349 115	2 430 136 212
0 432 131 614	1	0 430 133 921	KDEL 90 P 85	0 433 171 956	DLLA 147 P 1548	2 433 349 115	2 430 136 212
0 432 131 615	1	0 430 133 926	KDEL 97 P 80	0 433 171 955	DLLA 145 P 1547	2 433 314 042	2 430 136 212
0 432 131 616	2	0 430 133 952	KDEL 97 P 56	2 437 010 151	DLLA 147 P 1521	2 433 314 042	
0 432 131 617	1	0 430 133 922	KDEL 90 P 84	0 433 171 306	DLLA 168 P 426	2 433 314 042	2 430 136 212
0 432 131 618	1	0 430 133 923	KDEL 90 P 83	0 433 171 767	DLLA 166 P 1217	2 433 314 042	2 430 136 212
0 432 131 619	1	0 430 133 924	KDEL 90 P 82	0 433 171 776	DLLA 158 P 1226	2 433 349 115	2 430 136 212
0 432 131 620	1	0 430 133 924	KDEL 90 P 82	0 433 171 766	DLLA 158 P 1216	2 433 349 115	2 430 136 212
0 432 131 621	1	0 430 133 924	KDEL 90 P 82	0 433 171 777	DLLA 158 P 1227	2 433 349 115	2 430 136 212
0 432 131 622	1	0 430 133 990	KDEL 82 P 91	0 433 171 900	DLLA 146 P 1453	2 433 349 458	2 430 136 166
0 432 131 623	1	0 430 132 012	KDAL 59 P 22	0 433 171 863	DLLA 145 P 1391	2 433 314 182	2 430 134 023
0 432 131 624	2	0 430 133 952	KDEL 97 P 56	2 437 010 144	DLLA 147 P 1374	2 433 314 042	
0 432 131 625	1	0 430 133 926	KDEL 97 P 80	0 433 171 839	DLLA 145 P 1348	2 433 314 042	2 430 136 212
0 432 131 626	1	0 430 132 012	KDAL 59 P 22	0 433 171 830	DLLA 145 P 1338	2 433 314 182	2 430 134 023
0 432 131 627	1	0 430 133 927	KDEL 90 P 79	0 433 171 766	DLLA 158 P 1216	2 433 349 115	2 430 136 212
0 432 131 628	1	0 430 133 929	KDEL 82 P 77	0 433 171 644	DLLA 148 P 984	2 433 349 458	2 430 136 212
0 432 131 629	1	0 430 133 929	KDEL 82 P 77	0 433 171 745	DLLA 150 P 1171	2 433 349 458	2 430 136 212
0 432 131 630	1	0 430 132 009	KDAL 59 P 14	0 433 171 793	DLLA 155 P 1258	2 433 314 182	2 430 134 023
0 432 131 631	1	0 430 133 928	KDEL 82 P 78	0 433 171 781	DLLA 152 P 1231	2 433 349 458	2 430 136 212
0 432 131 632	1	0 430 133 972	KDEL 80 P 33	0 433 171 782	DLLA 142 P 1233	2 433 349 504	2 430 136 212
0 432 131 633	1	0 430 133 929	KDEL 82 P 77	0 433 171 781	DLLA 152 P 1231	2 433 349 458	2 430 136 212
0 432 131 634	1	0 430 133 931	KDEL 90 P 75	0 433 171 777	DLLA 158 P 1227	2 433 349 115	2 430 136 212
0 432 131 635	1	0 430 133 931	KDEL 90 P 75	0 433 171 776	DLLA 158 P 1226	2 433 349 115	2 430 136 212
0 432 131 636	1	0 430 133 944	KDEL 80 P 66	0 433 171 768	DLLA 146 P 1218	2 433 349 434	2 430 136 212
0 432 131 637	1	0 430 133 930	KDEL 90 P 76	0 433 171 767	DLLA 166 P 1217	2 433 314 042	2 430 136 212
0 432 131 638	1	0 430 133 931	KDEL 90 P 75	0 433 171 766	DLLA 158 P 1216	2 433 349 115	2 430 136 212
0 432 131 639	1	0 430 133 940	KDEL 82 P 70	0 433 171 762	DLLA 150 P 1207	2 433 314 053	2 430 136 212
0 432 131 640	1	0 430 133 941	KDEL 82 P 69	0 433 171 762	DLLA 150 P 1207	2 433 314 053	2 430 136 212
0 432 131 641	1	0 430 132 994	KDEL 69 P 43	0 433 171 757	DLLA 148 P 1200	2 433 349 453	2 430 136 166
0 432 131 642	1	0 430 133 932	KDEL 90 P 74	0 433 171 403	DLLA 150 P 545/	2 433 349 438	F 00Z Z20 003
0 432 131 643	1	0 430 133 990	KDEL 82 P 91	0 433 171 745	DLLA 150 P 1171	2 433 349 458	2 430 136 166
0 432 131 644	2	0 430 133 934	KDEL 97 P 72	2 437 010 137	DLLA 150 P 1151	2 433 314 042	
0 432 131 646	1	0 430 133 972	KDEL 80 P 33	0 433 171 723	DLLA 142 P 1119	2 433 349 504	2 430 136 212
0 432 131 647	1	0 430 133 933	KDEL 90 P 73	0 433 171 722	DLLA 158 P 1118	2 433 349 115	2 430 136 212
0 432 131 648	1	0 430 133 933	KDEL 90 P 73	0 433 171 721	DLLA 158 P 1117	2 433 349 115	2 430 136 212
0 432 131 649	1	0 430 133 933	KDEL 90 P 73	0 433 171 720	DLLA 158 P 1116	2 433 349 115	2 430 136 212
0 432 131 652	2	0 430 133 934	KDEL 97 P 72	2 437 010 132	DLLA 145 P 1068	2 433 314 042	
0 432 131 656	1	0 430 132 010	KDAL 59 P 16	9 430 084 751	DLLA 145 P 561	2 433 314 182	2 430 134 023
0 432 131 657	1	0 430 133 946	KDEL 90 P 64	0 433 171 677	DLLA 166 P 1036	2 433 314 042	2 430 136 212
0 432 131 658	1	0 430 133 946	KDEL 90 P 64	0 433 171 650	DLLA 168 P 1006	2 433 314 042	2 430 136 212
0 432 131 659	1	0 430 133 946	KDEL 90 P 64	0 433 171 649	DLLA 166 P 1005	2 433 314 042	2 430 136 212
0 432 131 664	1	0 430 133 948	KDEL 109 P 62	0 433 171 645	DLLA 142 P 985	2 433 314 042	2 430 136 212
0 432 131 665	1	0 430 133 990	KDEL 82 P 91	0 433 171 644	DLLA 148 P 984	2 433 349 458	2 430 136 166
0 432 131 666	1	0 430 133 957	KBEL 90 P 51	0 433 171 403	DLLA 150 P 545/	2 433 314 042	2 430 136 212
0 432 131 667	1	0 430 133 994	KDEL 82 P 7	0 433 171 174	DLLA 144 P 184/	2 433 349 458	2 430 136 166



2 433 124 376	2 434 614 040	3					
2 433 124 376	2 434 614 040	3					
2 433 124 376	2 434 614 040	3		2 433 462 131	2 430 210 027		
			B	2 433 462 131	2 430 210 027		
2 433 124 376	2 434 614 040	3					
2 433 124 376	2 434 614 040	3					
2 433 124 376	2 434 614 040	3					
2 433 124 376	2 434 614 040	3					
2 433 124 388	2 434 614 022	5					
2 433 124 446	2 434 614 028	6		2 433 462 014		2 916 710 602	2 430 105 048
			B	2 433 462 131	2 430 210 027		
2 433 124 376	2 434 614 040	3		2 433 462 131	2 430 210 027		
2 433 124 446	2 434 614 028	6		2 433 462 014		2 916 710 602	F 00V C17 503
2 433 124 376	2 434 614 040	3		F 018 D08 800	2 430 210 027		
2 433 124 376	2 434 614 040	3					
2 433 124 376	2 434 614 040	3					
2 433 124 446	2 434 614 020	1		2 433 462 014			F 00V C17 503
2 433 124 364	2 434 614 040	3					
2 433 124 376	2 434 614 040	3			2 430 210 005		
2 433 124 376	2 434 614 040	3					
2 433 124 376	2 434 614 040	3					
2 433 124 376	2 434 614 040	3			2 430 210 005		
2 433 124 376	2 434 614 040	3					
2 433 124 376	2 434 614 040	3					
2 433 124 364	2 434 614 048	3					
2 433 124 376	2 434 614 048	3					
2 433 124 388	2 434 614 022	5					
F 00Z B20 001	2 434 614 041	3					
2 433 124 388	2 434 614 022	5					
			B	2 433 462 131	2 430 210 027		
2 433 124 376	2 434 614 040	3			2 430 210 005		
2 433 124 376	2 434 614 040	3					
2 433 124 376	2 434 614 040	3					
2 433 124 376	2 434 614 040	3					
			B	2 433 462 131	2 430 210 027		
2 433 124 446	2 434 614 020	1		2 433 462 014			2 430 105 048
2 433 124 376	2 434 614 040	3					
2 433 124 376	2 434 614 040	3					
2 433 124 376	2 434 614 040	3					
2 433 124 376	2 434 614 040	3					
2 433 124 388	2 434 614 022	5					
2 433 124 370	2 434 614 041	3					
2 433 124 388	2 434 614 022	5					

*) siehe Seite 388/see page 388/voir page 388/ver pagina 388/vease página 388

***) siehe Seite 392/see page 392/voir page 392/ver pagina 392/vease página 392

A278

de

Ersatzteile für
Düsenhalter-
kombinationen
(Fortsetzung)

en

Spare parts for
nozzle-and-holder
assemblies
(continued)

fr

Pièces de rechange
pour ensembles
porte-injecteurs
(suite)

it

Ricambi per
combinazione
portapolverizzatori
(seguito)

es









Piezas de repuesto
para conjuntos
portainyectoros
(continuación)



Fig.



0 432 131 668	1	0 430 133 965	KDEL 75 P 40	0 433 171 437	DLLA 148 P 578	2 433 314 042	2 430 136 212
0 432 131 669	1	0 430 133 990	KDEL 82 P 91	0 433 171 169	DLLA 146 P 203	2 433 349 458	2 430 136 166
0 432 131 670	1	0 430 133 957	KBEL 90 P 51	0 433 171 592	DLLA 155 P 885	2 433 314 042	2 430 136 212
0 432 131 674	1	0 430 133 948	KDEL 109 P 62	0 433 171 582	DLLA 147 P 861	2 433 314 042	2 430 136 212
0 432 131 675	1	0 430 133 948	KDEL 109 P 62	0 433 171 581	DLLA 155 P 859	2 433 314 042	2 430 136 212
0 432 131 676	1	0 430 132 010	KDAL 59 P 16	0 433 171 542	DLLA 145 P 758	2 433 314 182	2 430 134 023
0 432 131 677	1	0 430 133 942	KDEL 80 P 68	0 433 171 298	DLLA 142 P 418	2 433 349 504	2 430 136 212
0 432 131 679	1	0 430 132 010	KDAL 59 P 16	0 433 171 453	DLLA 145 P 605	2 433 314 182	2 430 134 023
0 432 131 680	1	0 430 133 972	KDEL 80 P 33	0 433 171 574	DLLA 134 P 846	2 433 349 504	2 430 136 212
0 432 131 681	1	0 430 132 010	KDAL 59 P 16	0 433 171 573	DLLA 145 P 842	2 433 314 182	2 430 134 023
0 432 131 682	1	0 430 133 944	KDEL 80 P 66	0 433 171 569	DLLA 146 P 834	2 433 349 434	2 430 136 212
0 432 131 683	2	0 430 133 945	KDEL 75 P 65	2 437 010 103	DLLA 149 P 831	2 433 314 042	
0 432 131 684	2	0 430 133 952	KDEL 97 P 56	2 437 010 099	DLLA 147 P 827	2 433 314 042	
0 432 131 685	1	0 430 133 986	KDEL 75 P 16	0 433 171 230	DLLA 148 P 325	2 433 314 042	2 430 136 166
0 432 131 686	1	0 430 133 948	KDEL 109 P 62	0 433 171 555	DLLA 147 P 799	2 433 314 042	2 430 136 212
0 432 131 687	1	0 430 133 948	KDEL 109 P 62	0 433 171 554	DLLA 155 P 796	2 433 314 042	2 430 136 212
0 432 131 688	1	0 430 132 010	KDAL 59 P 16	0 433 171 552	DLLA 145 P 788	2 433 314 182	2 430 134 023
0 432 131 689	1	0 430 132 010	KDAL 59 P 16	0 433 171 552	DLLA 145 P 788	2 433 314 182	2 430 134 023
0 432 131 690	1	0 430 132 010	KDAL 59 P 16	0 433 171 551	DLLA 145 P 787	2 433 314 182	2 430 134 023
0 432 131 691	2	0 430 133 952	KDEL 97 P 56	2 437 010 151	DLLA 147 P 1521	2 433 314 042	
0 432 131 692	2	0 430 133 952	KDEL 97 P 56	2 437 010 051	DLLA 145 P 593	2 433 314 042	
0 432 131 693	1	0 430 132 009	KDAL 59 P 14	0 433 171 546	DLLA 155 P 767	2 433 314 182	2 430 134 023
0 432 131 694	1	0 430 132 005	KDAL 59 P 6	0 433 171 435	DLLA 145 P 574	2 433 314 182	2 430 134 023
0 432 131 695	1	0 430 133 946	KDEL 90 P 64	0 433 171 538	DLLA 168 P 751	2 433 314 042	2 430 136 212
0 432 131 696	1	0 430 133 946	KDEL 90 P 64	0 433 171 306	DLLA 168 P 426	2 433 314 042	2 430 136 212
0 432 131 697	1	0 430 132 010	KDAL 59 P 16	0 433 171 453	DLLA 145 P 605	2 433 314 182	2 430 134 023
0 432 131 698	1	0 430 132 010	KDAL 59 P 16	0 433 171 542	DLLA 145 P 758	2 433 314 182	2 430 134 023
0 432 131 699	1	0 430 133 970	KBEL 90 P 35	0 433 171 538	DLLA 168 P 751	2 433 314 042	2 430 136 212
0 432 131 700	1	0 430 133 990	KDEL 82 P 91	0 433 171 519	DLLA 146 P 708	2 433 349 458	2 430 136 166
0 432 131 701	1	0 430 133 990	KDEL 82 P 91	0 433 171 440	DLLA 146 P 581	2 433 349 458	2 430 136 166
0 432 131 702	1	0 430 133 981	KBEL 82 P 23	0 433 171 517	DLLA 134 P 703	2 433 349 111	2 430 136 166
0 432 131 703	1	0 430 133 948	KDEL 109 P 62	0 433 171 398	DLLA 147 P 538	2 433 314 042	2 430 136 212
0 432 131 704	1	0 430 133 948	KDEL 109 P 62	0 433 171 430	DLLA 147 P 569	2 433 314 042	2 430 136 212
0 432 131 705	1	0 430 133 960	KDEL 75 P 46	0 433 171 512	DLLA 149 P 697	2 433 349 438	F 00Z Z20 003
0 432 131 706	1	0 430 133 973	KDEL 80 P 32	0 433 171 511	DLLA 142 P 696	2 433 349 504	2 430 136 212
0 432 131 707	1	0 430 133 972	KDEL 80 P 33	0 433 171 511	DLLA 142 P 696	2 433 349 504	2 430 136 212
0 432 131 708	1	0 430 132 006	KBAL 59 P 7	0 433 171 510	DLLA 145 P 695	2 433 314 182	2 430 134 023
0 432 131 709	1	0 430 133 949	KDEL 97 P 61	0 433 171 508	DLLA 146 P 693	2 433 314 042	2 430 136 212
0 432 131 710	1	0 430 132 010	KDAL 59 P 16	0 433 171 453	DLLA 145 P 605	2 433 314 182	2 430 134 023
0 432 131 711	1	0 430 133 989	KDEL 97 P 13	0 433 171 502	DLLA 155 P 686	2 433 314 042	2 430 136 166
0 432 131 712	1	0 430 133 950	KDEL 99 P 60	0 433 171 434	DLLA 150 P 573	2 433 349 115	2 430 136 236
0 432 131 713	1	0 430 133 950	KDEL 99 P 60	0 433 171 358	DLLA 152 P 496	2 433 349 115	2 430 136 236
0 432 131 714	1	0 430 133 951	KDEL 77 P 59	0 433 171 485	DLLA 144 P 666	2 433 349 265	F 00Z Z20 003
0 432 131 715	1	0 430 132 009	KDAL 59 P 14	0 433 171 484	DLLA 155 P 665	2 433 314 182	2 430 134 023
0 432 131 716	1	0 430 132 994	KDEL 69 P 43	0 433 171 482	DLLA 148 P 663	2 433 349 453	2 430 136 166

								
④	⑤	⑥	⑦	⑧	⑨	⑩	⑪	
2 433 124 376	2 434 614 040	3	2 433 462 143	2 430 210 027				
2 433 124 388	2 434 614 022	5						
2 433 124 370	2 434 614 041	3						
2 433 124 376	2 434 614 040	3	2 433 462 131					
2 433 124 376	2 434 614 040	3	2 433 462 131					
2 433 124 446	2 434 614 020	1	2 433 462 014				2 430 105 042	
2 433 124 364	2 434 614 040	3		2 430 210 005				
2 433 124 446	2 434 614 020	1	2 433 462 014				F 00V C17 503	
2 433 124 376	2 434 614 040	3		2 430 210 005				
2 433 124 446	2 434 614 020	1	2 433 462 014				F 00V C17 503	
2 433 124 376	2 434 614 040	3		2 430 210 005				
2 433 124 376	2 434 614 040	3		2 430 210 005				
		B	2 433 462 143	2 430 210 027				
		B	2 433 462 131	2 430 210 027				
2 433 124 388	2 434 614 022	5	2 433 462 143	2 430 210 027				
2 433 124 376	2 434 614 040	3	2 433 462 131					
2 433 124 376	2 434 614 040	3	2 433 462 131					
2 433 124 446	2 434 614 020	1	2 433 462 014				2 430 105 042	
2 433 124 446	2 434 614 020	1	2 433 462 014				F 00V C17 503	
2 433 124 446	2 434 614 020	1	2 433 462 014				F 00V C17 503	
		B	2 433 462 131	2 430 210 027				
		B	2 433 462 131	2 430 210 027				
2 433 124 446	2 434 614 020	1	2 433 462 014				F 00V C17 503	
2 433 124 446	2 434 614 020	1	2 433 462 014				2 430 105 042	
2 433 124 376	2 434 614 040	3						
2 433 124 376	2 434 614 040	3						
2 433 124 446	2 434 614 020	1	2 433 462 014				F 00V C17 503	
2 433 124 446	2 434 614 020	1	2 433 462 014				F 00V C17 503	
2 433 124 376	2 434 614 040	3						
2 433 124 388	2 434 614 022	5						
2 433 124 388	2 434 614 022	5						
2 433 124 388	2 434 614 022	5						
2 433 124 376	2 434 614 040	3	2 433 462 131					
2 433 124 376	2 434 614 040	3	2 433 462 131					
F 00Z B20 002	2 434 614 040	3	2 433 462 143	2 430 210 027				
2 433 124 364	2 434 614 040	3		2 430 210 005				
2 433 124 376	2 434 614 040	3		2 430 210 005				
2 433 124 446	2 434 614 020	1	2 433 462 014				F 00V C17 503	
2 433 124 376	2 434 614 040	3	2 433 462 131	2 430 210 027				
2 433 124 446	2 434 614 020	1	2 433 462 014				F 00V C17 503	
2 433 124 388	2 434 614 027	5	2 433 462 131	2 430 210 027				
	2 434 614 040	3						
	2 434 614 040	3						
F 00Z B20 002	2 434 614 040	3	2 433 462 143	2 430 210 027				
2 433 124 446	2 434 614 020	1	2 433 462 014				F 00V C17 503	
2 433 124 388	2 434 614 022	5						

*) siehe Seite 388/see page 388/voir page 388/ver pagina 388/vease página 388

**) siehe Seite 392/see page 392/voir page 392/ver pagina 392/vease página 392

de

Ersatzteile für
Düsenhalter-
kombinationen
(Fortsetzung)

en

Spare parts for
nozzle-and-holder
assemblies
(continued)

fr

Pièces de rechange
pour ensembles
porte-injecteurs
(suite)

it

Ricambi per
combinazione
portapolverizzatori
(seguito)

es

Piezas de repuesto
para conjuntos
portainyectoros
(continuación)



Fig.



Ref.



Typ



①



②











③



③

0 432 131 717	1	0 430 132 010	KDAL 59 P 16	0 433 171 454	DLLA 145 P 606	2 433 314 182	2 430 134 023
0 432 131 720	1	0 430 133 981	KBEL 82 P 23	0 433 171 201	DLLA 134 P 204	2 433 349 111	2 430 136 166
0 432 131 722	1	0 430 132 010	KDAL 59 P 16	9 430 084 751	DLLA 145 P 561	2 433 314 182	2 430 134 023
0 432 131 723	1	0 430 132 996	KDEL 65 P 21	0 433 171 458	DLLA 148 P 611	2 433 314 042	2 430 136 166
0 432 131 724	2	0 430 133 952	KDEL 97 P 56	2 437 010 052	DLLA 145 P 627	2 433 314 042	
0 432 131 726	1	0 430 133 972	KDEL 80 P 33	0 433 171 298	DLLA 142 P 418	2 433 349 504	2 430 136 212
0 432 131 727	1	0 430 133 972	KDEL 80 P 33	0 433 171 297	DLLA 142 P 417	2 433 349 504	2 430 136 212
0 432 131 728	1	0 430 133 972	KDEL 80 P 33	0 433 171 299	DLLA 142 P 419	2 433 349 504	2 430 136 212
0 432 131 729	1	0 430 133 973	KDEL 80 P 32	0 433 171 299	DLLA 142 P 419	2 433 349 504	2 430 136 212
0 432 131 730	1	0 430 133 973	KDEL 80 P 32	0 433 171 298	DLLA 142 P 418	2 433 349 504	2 430 136 212
0 432 131 731	1	0 430 133 973	KDEL 80 P 32	0 433 171 297	DLLA 142 P 417	2 433 349 504	2 430 136 212
0 432 131 732	1	0 430 133 960	KDEL 75 P 46	0 433 171 463	DLLA 149 P 622	2 433 349 438	F 00Z Z20 003
0 432 131 733	1	0 430 133 954	KDEL 82 P 54	0 433 171 394	DLLA 152 P 531	2 433 349 458	2 430 136 166
0 432 131 734	1	0 430 133 954	KDEL 82 P 54	0 433 171 326	DLLA 152 P 452	2 433 349 458	2 430 136 166
0 432 131 735	1	0 430 132 994	KDEL 69 P 43	0 433 171 457	DLLA 148 P 610	2 433 349 453	2 430 136 166
0 432 131 736	1	0 430 132 994	KDEL 69 P 43	0 433 171 458	DLLA 148 P 611	2 433 349 453	2 430 136 166
0 432 131 737	1	0 430 132 994	KDEL 69 P 43	0 433 171 459	DLLA 148 P 612	2 433 349 453	2 430 136 166
0 432 131 739	1	0 430 132 010	KDAL 59 P 16	0 433 171 455	DLLA 145 P 607	2 433 314 182	2 430 134 023
0 432 131 740	1	0 430 132 010	KDAL 59 P 16	0 433 171 454	DLLA 145 P 606	2 433 314 182	2 430 134 023
0 432 131 741	1	0 430 132 010	KDAL 59 P 16	0 433 171 453	DLLA 145 P 605	2 433 314 182	2 430 134 023
0 432 131 742	1	0 430 133 965	KDEL 75 P 40	0 433 171 452	DLLA 149 P 602	2 433 314 042	2 430 136 212
0 432 131 743	1	0 430 132 005	KDAL 59 P 6	0 433 171 435	DLLA 145 P 574	2 433 314 182	2 430 134 023
0 432 131 744	2	0 430 133 955	KDEL 97 P 53	2 437 010 053	DLLA 149 P 601	2 433 314 042	
0 432 131 746	1			0 433 171 441	DLLA 151 P 582	2 433 349 111	2 430 136 212
0 432 131 747	1	0 430 133 994	KDEL 82 P 7	0 433 171 440	DLLA 146 P 581	2 433 349 458	2 430 136 166
0 432 131 748	1	0 430 133 960	KDEL 75 P 46	0 433 171 437	DLLA 148 P 578	2 433 349 438	F 00Z Z20 003
0 432 131 749	1	0 430 132 010	KDAL 59 P 16	0 433 171 435	DLLA 145 P 574	2 433 314 182	2 430 134 023
0 432 131 751	1	0 430 133 966	KDEL 99 P 39	0 433 171 434	DLLA 150 P 573	2 433 349 115	2 430 136 212
0 432 131 752	1	0 430 132 994	KDEL 69 P 43	0 433 171 233	DLLA 148 P 329	2 433 349 453	2 430 136 166
0 432 131 753	1	0 430 132 009	KDAL 59 P 14	0 433 171 431	DLLA 155 P 570	2 433 314 182	2 430 134 023
0 432 131 754	1	0 430 133 959	KDEL 109 P 47	0 433 171 430	DLLA 147 P 569	2 433 314 042	2 430 136 212
0 432 131 755	1	0 430 133 990	KDEL 82 P 91	0 433 171 414	DLLA 152 P 566	2 433 349 458	2 430 136 166
0 432 131 756	1	0 430 133 992	KDEL 97 P 10	0 433 171 402	DLLA 142 P 544	2 433 314 042	2 430 136 166
0 432 131 757	1	0 430 133 957	KBEL 90 P 51	0 433 171 403	DLLA 150 P 545/	2 433 314 042	2 430 136 212
0 432 131 758	1	0 430 133 959	KDEL 109 P 47	0 433 171 398	DLLA 147 P 538	2 433 314 042	2 430 136 212
0 432 131 759	1	0 430 133 976	KDEL 82 P 29	0 433 171 394	DLLA 152 P 531	2 433 349 458	2 430 136 166
0 432 131 760	1	0 430 133 990	KDEL 82 P 91	0 433 171 394	DLLA 152 P 531	2 433 349 458	2 430 136 166
0 432 131 761	1	0 430 133 960	KDEL 75 P 46	0 433 171 333	DLLA 149 P 460	2 433 349 438	F 00Z Z20 003
0 432 131 762	1	0 430 133 962	KDEL 95 P 44	0 433 171 387	DLLA 150 P 524	2 433 314 042	2 430 136 212
0 432 131 763	1	0 430 133 960	KDEL 75 P 46	0 433 171 388	DLLA 154 P 525	2 433 349 438	F 00Z Z20 003
0 432 131 765	1	0 430 132 994	KDEL 69 P 43	0 433 171 291	DLLA 148 P 408	2 433 349 453	2 430 136 166
0 432 131 766	1	0 430 132 994	KDEL 69 P 43	0 433 171 386	DLLA 148 P 522	2 433 349 453	2 430 136 166
0 432 131 767	1	0 430 133 986	KDEL 75 P 16	0 433 171 370	DLLA 149 P 514	2 433 314 042	2 430 136 166
0 432 131 768	1	0 430 133 984	KDEL 82 P 18	0 433 171 368	DLLA 134 P 512	2 433 349 122	2 430 136 166
0 432 131 770	1	0 430 133 963	KDEL 80 P 42	0 433 171 364	DLLA 138 P 505	2 433 349 484	2 430 136 166

 ④	 ⑤	 ⑥	 ⑦	 ⑧	 ⑨	 ⑩	 ⑪
2 433 124 446	2 434 614 020	1	2 433 462 014				F 00V C17 503
2 433 124 388	2 434 614 022	5					
2 433 124 446	2 434 614 020	1	2 433 462 014				2 430 105 042
2 433 124 388	2 434 614 022	5					
		B	2 433 462 131	2 430 210 027			
2 433 124 376	2 434 614 040	3		2 430 210 005			
2 433 124 376	2 434 614 040	3		2 430 210 005			
2 433 124 376	2 434 614 040	3		2 430 210 005			
2 433 124 364	2 434 614 040	3		2 430 210 005			
2 433 124 364	2 434 614 040	3		2 430 210 005			
2 433 124 364	2 434 614 040	3		2 430 210 005			
F 00Z B20 002	2 434 614 040	3	2 433 462 143	2 430 210 027			
2 433 124 361	2 434 614 022	5					
2 433 124 361	2 434 614 022	5					
2 433 124 388	2 434 614 022	5					
2 433 124 388	2 434 614 022	5					
2 433 124 446	2 434 614 020	1	2 433 462 014				F 00V C17 503
2 433 124 446	2 434 614 020	1	2 433 462 014				2 430 105 042
2 433 124 446	2 434 614 020	1	2 433 462 014				2 430 105 042
2 433 124 376	2 434 614 040	3	2 433 462 143	2 430 210 027			
2 433 124 446	2 434 614 020	1	2 433 462 014				F 00V C17 503
		B	2 433 462 131	2 430 210 027			
2 433 124 376	2 434 614 040	3					
2 433 124 388	2 434 614 022	5					
F 00Z B20 002	2 434 614 040	3	2 433 462 143	2 430 210 027			
2 433 124 446	2 434 614 020	1	2 433 462 014				F 00V C17 503
2 433 124 376	2 434 614 040	3	2 433 462 131	2 430 210 027			
2 433 124 388	2 434 614 022	5					
2 433 124 446	2 434 614 020	1	2 433 462 014				F 00V C17 503
2 433 124 376	2 434 614 040	3	2 433 462 131				
2 433 124 388	2 434 614 022	5					
2 433 124 388	2 434 614 027	5	2 433 462 131	2 430 210 027			
2 433 124 370	2 434 614 041	3					
2 433 124 376	2 434 614 040	3	2 433 462 131				
2 433 124 361	2 434 614 022	5					
2 433 124 388	2 434 614 022	5					
F 00Z B20 002	2 434 614 040	3	2 433 462 143	2 430 210 027			
2 433 124 376	2 434 614 040	3	2 433 462 143	2 430 210 027			
F 00Z B20 002	2 434 614 040	3	2 433 462 143	2 430 210 027			
2 433 124 388	2 434 614 022	5					
2 433 124 388	2 434 614 022	5					
2 433 124 388	2 434 614 022	5	2 433 462 143	2 430 210 027			
2 433 124 388	2 434 614 022	5					
2 433 124 388	2 434 614 022	5					

*) siehe Seite 388/see page 388/voir page 388/ver pagina 388/vease página 388

**) siehe Seite 392/see page 392/voir page 392/ver pagina 392/vease página 392

A282

de

Ersatzteile für
Düsenhalter-
kombinationen
(Fortsetzung)

en

Spare parts for
nozzle-and-holder
assemblies
(continued)

fr

Pièces de rechange
pour ensembles
porte-injecteurs
(suite)

it

Ricambi per
combinazione
portapolverizzatori
(seguito)

es

Piezas de repuesto
para conjuntos
portainyectores
(continuación)



Fig.



①



②



③

0 432 131 771	1	0 430 133 965	KDEL 75 P 40	0 433 171 361	DLLA 148 P 500	2 433 314 042	2 430 136 212
0 432 131 772	1	0 430 133 994	KDEL 82 P 7	0 433 171 360	DLLA 146 P 499	2 433 349 458	2 430 136 166
0 432 131 773	1	0 430 133 966	KDEL 99 P 39	0 433 171 358	DLLA 152 P 496	2 433 349 115	2 430 136 212
0 432 131 774	1	0 430 132 999	KDEL 65 P 6	0 433 171 291	DLLA 148 P 408	2 433 314 042	2 430 136 166
0 432 131 776	1	0 430 133 990	KDEL 82 P 91	0 433 171 353	DLLA 146 P 489	2 433 349 458	2 430 136 166
0 432 131 777	1	0 430 133 968	KDEL 87 P 37	0 433 171 352	DLLA 150 P 488	2 433 314 042	2 430 136 166
0 432 131 778	1	0 430 133 968	KDEL 87 P 37	0 433 171 351	DLLA 150 P 487	2 433 314 042	2 430 136 166
0 432 131 779	1	0 430 133 975	KDEL 82 P 30	0 433 171 350	DLLA 152 P 486/	2 433 349 458	2 430 136 212
0 432 131 780	1	0 430 133 973	KDEL 80 P 32	0 433 171 345	DLLA 142 P 479	2 433 349 504	2 430 136 212
0 432 131 781	1	0 430 133 972	KDEL 80 P 33	0 433 171 345	DLLA 142 P 479	2 433 349 504	2 430 136 212
0 432 131 782	1	0 430 133 972	KDEL 80 P 33	0 433 171 412	DLLA 138 P 563	2 433 349 504	2 430 136 212
0 432 131 783	1	0 430 133 987	KDEL 99 P 15	0 433 171 337	DLLA 144 P 467	2 433 349 115	2 430 136 166
0 432 131 784	1	0 430 133 994	KDEL 82 P 7	0 433 171 336	DLLA 148 P 465	2 433 349 458	2 430 136 166
0 432 131 785	1	0 430 133 983	KDEL 75 P 20	0 433 171 334	DLLA 148 P 461	2 433 314 042	2 430 136 166
0 432 131 786	1	0 430 133 969	KDEL 75 P 36	0 433 171 333	DLLA 149 P 460	2 433 314 042	2 430 136 212
0 432 131 787	1	0 430 133 958	KDEL 82 P 48	0 433 171 332	DLLA 134 P 459	2 433 349 442	F 00Z Z20 003
0 432 131 788	1	0 430 133 990	KDEL 82 P 91	0 433 171 326	DLLA 152 P 452	2 433 349 458	2 430 136 166
0 432 131 789	1	0 430 133 989	KDEL 97 P 13	0 433 171 218	DLLA 155 P 302	2 433 314 042	2 430 136 166
0 432 131 790	1	0 430 133 989	KDEL 97 P 13	0 433 171 320	DLLA 155 P 444	2 433 314 042	2 430 136 166
0 432 131 791	1	0 430 133 958	KDEL 82 P 48	0 433 171 313	DLLA 134 P 435	2 433 349 442	F 00Z Z20 003
0 432 131 792	1	0 430 133 989	KDEL 97 P 13	0 433 171 312	DLLA 150 P 434	2 433 314 042	2 430 136 166
0 432 131 793	1	0 430 133 984	KDEL 82 P 18	0 433 171 310	DLLA 134 P 431	2 433 349 122	2 430 136 166
0 432 131 794	1	0 430 133 984	KDEL 82 P 18	0 433 171 309	DLLA 134 P 430	2 433 349 122	2 430 136 166
0 432 131 795	1	0 430 133 970	KBEL 90 P 35	0 433 171 306	DLLA 168 P 426	2 433 314 042	2 430 136 212
0 432 131 796	1	0 430 133 958	KDEL 82 P 48	0 433 171 305	DLLA 134 P 424	2 433 349 442	F 00Z Z20 003
0 432 131 797	1	0 430 133 958	KDEL 82 P 48	0 433 171 304	DLLA 134 P 423	2 433 349 442	F 00Z Z20 003
0 432 131 798	1	0 430 133 984	KDEL 82 P 18	0 433 171 303	DLLA 134 P 422	2 433 349 122	2 430 136 166
0 432 131 799	1	0 430 132 005	KDAL 59 P 6	0 433 171 302	DLLA 145 P 420	2 433 314 182	2 430 134 023
0 432 131 800	1	0 430 133 972	KDEL 80 P 33	0 433 171 299	DLLA 142 P 419	2 433 349 504	2 430 136 212
0 432 131 801	1	0 430 133 972	KDEL 80 P 33	0 433 171 298	DLLA 142 P 418	2 433 349 504	2 430 136 212
0 432 131 802	1	0 430 133 972	KDEL 80 P 33	0 433 171 297	DLLA 142 P 417	2 433 349 504	2 430 136 212
0 432 131 803	1	0 430 133 973	KDEL 80 P 32	0 433 171 299	DLLA 142 P 419	2 433 349 504	2 430 136 212
0 432 131 804	1	0 430 133 973	KDEL 80 P 32	0 433 171 298	DLLA 142 P 418	2 433 349 504	2 430 136 212
0 432 131 805	1	0 430 133 973	KDEL 80 P 32	0 433 171 297	DLLA 142 P 417	2 433 349 504	2 430 136 212
0 432 131 806	1	0 430 132 996	KDEL 65 P 21	0 433 171 291	DLLA 148 P 408	2 433 314 042	2 430 136 166
0 432 131 807	2	0 430 133 974	KDEL 97 P 31	2 437 010 054	DLLA 142 P 406	2 433 314 042	
0 432 131 809	1	0 430 133 976	KDEL 82 P 29	0 433 171 326	DLLA 152 P 452	2 433 349 458	2 430 136 166
0 432 131 812	1	0 430 133 989	KDEL 97 P 13	0 433 171 274	DLLA 155 P 387	2 433 314 042	2 430 136 166
0 432 131 813	1	0 430 133 987	KDEL 99 P 15	0 433 171 273	DLLA 155 P 386	2 433 349 115	2 430 136 166
0 432 131 814	1	0 430 133 987	KDEL 99 P 15	0 433 171 270	DLLA 155 P 383	2 433 349 115	2 430 136 166
0 432 131 815	1	0 430 133 994	KDEL 82 P 7	0 433 171 259	DLLA 148 P 363	2 433 349 458	2 430 136 166
0 432 131 816	1	0 430 133 984	KDEL 82 P 18	0 433 171 264	DLLA 134 P 371	2 433 349 122	2 430 136 166
0 432 131 817	1	0 430 133 984	KDEL 82 P 18	0 433 171 265	DLLA 134 P 372	2 433 349 122	2 430 136 166
0 432 131 818	1	0 430 133 979	KDEL 82 P 25	0 433 171 159	DLLA 134 P 180	2 433 349 111	2 430 136 166
0 432 131 819	1	0 430 133 980	KDEL 82 P 24	0 433 171 159	DLLA 134 P 180	2 433 349 111	2 430 136 166



2 433 124 376	2 434 614 040	3	2 433 462 143	2 430 210 027			
2 433 124 388	2 434 614 022	5					
2 433 124 376	2 434 614 040	3	2 433 462 131	2 430 210 027			
2 433 124 388	2 434 614 022	5					
2 433 124 388	2 434 614 022	5					
2 433 124 388	2 434 614 030	5	2 433 462 036	2 430 210 027	2 433 370 440	2 916 710 603	2 430 105 020
2 433 124 388	2 434 614 030	5	2 433 462 036	2 430 210 027	2 433 370 440	2 916 710 603	2 430 105 020
2 433 124 376	2 434 614 040	3					
2 433 124 364	2 434 614 040	3		2 430 210 005			
2 433 124 376	2 434 614 040	3		2 430 210 005			
2 433 124 376	2 434 614 040	3		2 430 210 005			
2 433 124 388	2 434 614 027	5	2 433 462 131	2 430 210 027			
2 433 124 388	2 434 614 022	5					
2 433 124 388	2 434 614 022	5	2 433 462 143	2 430 210 027			
2 433 124 376	2 434 614 040	3	2 433 462 143	2 430 210 027			
F 00Z B20 002	2 434 614 040	3					
2 433 124 388	2 434 614 022	5					
2 433 124 388	2 434 614 027	5	2 433 462 131	2 430 210 027			
2 433 124 388	2 434 614 027	5	2 433 462 131	2 430 210 027			
F 00Z B20 002	2 434 614 040	3					
2 433 124 388	2 434 614 027	5	2 433 462 131	2 430 210 027			
2 433 124 388	2 434 614 022	5					
2 433 124 388	2 434 614 022	5					
2 433 124 376	2 434 614 040	3					
F 00Z B20 002	2 434 614 040	3					
F 00Z B20 002	2 434 614 040	3					
2 433 124 388	2 434 614 022	5					
2 433 124 446	2 434 614 020	1	2 433 462 014				2 430 105 042
2 433 124 376	2 434 614 040	3		2 430 210 005			
2 433 124 376	2 434 614 040	3		2 430 210 005			
2 433 124 376	2 434 614 040	3		2 430 210 005			
2 433 124 364	2 434 614 040	3		2 430 210 005			
2 433 124 364	2 434 614 040	3		2 430 210 005			
2 433 124 364	2 434 614 040	3		2 430 210 005			
2 433 124 364	2 434 614 040	3		2 430 210 005			
2 433 124 388	2 434 614 022	5					
		B	2 433 462 131	2 430 210 027			
2 433 124 361	2 434 614 022	5					
2 433 124 388	2 434 614 027	5	2 433 462 131	2 430 210 027			
2 433 124 388	2 434 614 027	5	2 433 462 131	2 430 210 027			
2 433 124 388	2 434 614 027	5	2 433 462 131	2 430 210 027			
2 433 124 388	2 434 614 022	5					
2 433 124 388	2 434 614 022	5					
2 433 124 388	2 434 614 022	5					
2 433 124 388	2 434 614 022	5					
2 433 124 388	2 434 614 022	5					

*) siehe Seite 388/see page 388/voir page 388/ver pagina 388/vease página 388

**) siehe Seite 392/see page 392/voir page 392/ver pagina 392/vease página 392

de

Ersatzteile für
Düsenhalter-
kombinationen
(Fortsetzung)

en

Spare parts for
nozzle-and-holder
assemblies
(continued)

fr

Pièces de rechange
pour ensembles
porte-injecteurs
(suite)

it

Ricambi per
combinazione
portapolverizzatori
(seguito)

es

Piezas de repuesto
para conjuntos
portainyectoros
(continuación)



Fig.



Ref.



Typ



①



Typ



②



③

0 432 131 820	1	0 430 133 981	KBEL 82 P 23	0 433 171 159	DLLA 134 P 180	2 433 349 111	2 430 136 166
0 432 131 821	1	0 430 132 003	KDAL 59 P 4	0 433 171 244	DLLA 155 P 343	2 433 314 182	2 430 134 023
0 432 131 822	1	0 430 132 996	KDEL 65 P 21	0 433 171 233	DLLA 148 P 329	2 433 314 042	2 430 136 166
0 432 131 823	1	0 430 133 983	KDEL 75 P 20	0 433 171 230	DLLA 148 P 325	2 433 314 042	2 430 136 166
0 432 131 824	1	0 430 133 987	KDEL 99 P 15	0 433 171 222	DLLA 155 P 307	2 433 349 115	2 430 136 166
0 432 131 825	1	0 430 133 989	KDEL 97 P 13	0 433 171 221	DLLA 155 P 306	2 433 314 042	2 430 136 166
0 432 131 827	1	0 430 133 989	KDEL 97 P 13	0 433 171 218	DLLA 155 P 302	2 433 314 042	2 430 136 166
0 432 131 828	1	0 430 133 984	KDEL 82 P 18	0 433 171 217	DLLA 134 P 301	2 433 349 122	2 430 136 166
0 432 131 829	1	0 430 133 984	KDEL 82 P 18	0 433 171 215	DLLA 134 P 296	2 433 349 122	2 430 136 166
0 432 131 830	1	0 430 133 993	KDEL 82 P 9	0 433 171 154	DLLA 140 P 175	2 433 314 053	2 430 136 166
0 432 131 831	1	0 430 133 994	KDEL 82 P 7	0 433 171 214	DLLA 146 P 166/	2 433 349 458	2 430 136 166
0 432 131 832	1	0 430 132 004	KDAL 59 P 5	0 433 171 207	DLLA 155 P 275	2 433 314 182	2 430 134 023
0 432 131 833	1	0 430 133 985	KDEL 82 P 17	0 433 171 159	DLLA 134 P 180	2 433 349 111	2 430 136 166
0 432 131 834	1	0 430 132 006	KBAL 59 P 7	0 433 171 209	DLLA 155 P 283	2 433 314 182	2 430 134 023
0 432 131 835	1	0 430 132 004	KDAL 59 P 5	0 433 171 206	DLLA 155 P 274	2 433 314 182	2 430 134 023
0 432 131 836	1	0 430 132 004	KDAL 59 P 5	0 433 171 205	DLLA 155 P 273	2 433 314 182	2 430 134 023
0 432 131 837	1	0 430 132 004	KDAL 59 P 5	0 433 171 208	DLLA 155 P 277	2 433 314 182	2 430 134 023
0 432 131 838	1	0 430 132 006	KBAL 59 P 7	0 433 171 207	DLLA 155 P 275	2 433 314 182	2 430 134 023
0 432 131 839	1	0 430 132 006	KBAL 59 P 7	0 433 171 206	DLLA 155 P 274	2 433 314 182	2 430 134 023
0 432 131 840	1	0 430 132 006	KBAL 59 P 7	0 433 171 206	DLLA 155 P 274	2 433 314 182	2 430 134 023
0 432 131 841	1	0 430 132 006	KBAL 59 P 7	0 433 171 205	DLLA 155 P 273	2 433 314 182	2 430 134 023
0 432 131 842	1	0 430 133 991	KDEL 82 P 11	0 433 171 201	DLLA 134 P 204	2 433 349 111	2 430 136 166
0 432 131 843	1	0 430 133 987	KDEL 99 P 15	0 433 171 199	DLLA 155 P 248	2 433 349 115	2 430 136 166
0 432 131 844	1	0 430 133 988	KDEL 99 P 14	0 433 171 192	DLLA 144 P 234	2 433 349 115	2 430 136 166
0 432 131 845	1	0 430 133 989	KDEL 97 P 13	0 433 171 189	DLLA 155 P 231	2 433 314 042	2 430 136 166
0 432 131 846	1	0 430 133 989	KDEL 97 P 13	0 433 171 188	DLLA 155 P 230	2 433 314 042	2 430 136 166
0 432 131 848	1	0 430 133 992	KDEL 97 P 10	0 433 171 182	DLLA 146 P 224	2 433 314 042	2 430 136 166
0 432 131 849	1	0 430 132 001	KDAL 59 P 2	0 433 171 170	DLLA 155 P 223	2 433 314 182	2 430 134 023
0 432 131 850	1	0 430 133 992	KDEL 97 P 10	0 433 171 180	DLLA 142 P 221	2 433 314 042	2 430 136 166
0 432 131 851	1	0 430 132 003	KDAL 59 P 4	0 433 171 140	DLLA 155 P 157	2 433 314 182	2 430 134 023
0 432 131 852	1	0 430 132 004	KDAL 59 P 5	0 433 171 177	DLLA 155 P 215	2 433 314 182	2 430 134 023
0 432 131 853	1	0 430 133 994	KDEL 82 P 7	0 433 171 174	DLLA 144 P 184/	2 433 349 458	2 430 136 166
0 432 131 854	1	0 430 132 003	KDAL 59 P 4	0 433 171 074	DLLA 155 P 74	2 433 314 182	2 430 134 023
0 432 131 855	1	0 430 132 003	KDAL 59 P 4	0 433 171 066	DLLA 155 P 66	2 433 314 182	2 430 134 023
0 432 131 856	1	0 430 132 003	KDAL 59 P 4	0 433 171 074	DLLA 155 P 74	2 433 314 182	2 430 134 023
0 432 131 857	1	0 430 133 990	KDEL 82 P 91	0 433 171 818	DLLA 146 P 1311/	2 433 349 458	2 430 136 166
0 432 131 858	1	0 430 133 991	KDEL 82 P 11	0 433 171 159	DLLA 134 P 180	2 433 349 111	2 430 136 166
0 432 131 859	1	0 430 133 992	KDEL 97 P 10	0 433 171 163	DLLA 146 P 190	2 433 314 042	2 430 136 166
0 432 131 861	1	0 430 133 993	KDEL 82 P 9	0 433 171 159	DLLA 134 P 180	2 433 314 053	2 430 136 166
0 432 131 863	1	0 430 133 993	KDEL 82 P 9	0 433 171 154	DLLA 140 P 175	2 433 314 053	2 430 136 166
0 432 131 864	1	0 430 132 998	KDEL 65 P 8	0 433 171 153	DLLA 160 P 171	2 433 314 053	2 430 136 166
0 432 131 865	1	0 430 132 999	KDEL 65 P 6	0 433 171 151	DLLA 158 P 168	2 433 314 042	2 430 136 166
0 432 131 866	1	0 430 133 994	KDEL 82 P 7	0 433 171 149	DLLA 146 P 166	2 433 349 458	2 430 136 166
0 432 131 867	1	0 430 132 999	KDEL 65 P 6	0 433 171 144	DLLA 158 P 161	2 433 314 042	2 430 136 166
0 432 131 868	1	0 430 132 001	KDAL 59 P 2	0 433 171 067	DLLA 155 P 67	2 433 314 182	2 430 134 023



2 433 124 388	2 434 614 022	5					
2 433 120 128	2 434 614 020	1	2 433 462 014				F 00V C17 503
2 433 124 388	2 434 614 022	5					
2 433 124 388	2 434 614 022	5	2 433 462 143	2 430 210 027			
2 433 124 388	2 434 614 027	5	2 433 462 131	2 430 210 027			
2 433 124 388	2 434 614 027	5	2 433 462 131	2 430 210 027			
2 433 124 388	2 434 614 027	5					
2 433 124 388	2 434 614 022	5					
2 433 124 388	2 434 614 022	5					
2 433 124 388	2 434 614 022	5					
2 433 124 388	2 434 614 022	5					
2 433 124 446	2 434 614 020	1	2 433 462 014				F 00V C17 503
2 433 124 388	2 434 614 022	5					
2 433 124 446	2 434 614 020	1	2 433 462 014				F 00V C17 503
2 433 124 446	2 434 614 020	1	2 433 462 014				F 00V C17 503
2 433 124 446	2 434 614 020	1	2 433 462 014				F 00V C17 503
2 433 124 446	2 434 614 020	1	2 433 462 014				F 00V C17 503
2 433 124 446	2 434 614 020	1	2 433 462 014				F 00V C17 503
2 433 124 446	2 434 614 020	1	2 433 462 014				F 00V C17 503
2 433 124 446	2 434 614 020	1	2 433 462 014				F 00V C17 503
2 433 124 388	2 434 614 022	5					
2 433 124 388	2 434 614 027	5	2 433 462 131	2 430 210 027			
2 433 124 388	2 434 614 027	5	2 433 462 131	2 430 210 027			
2 433 124 388	2 434 614 027	5	2 433 462 131	2 430 210 027			
2 433 124 388	2 434 614 027	5	2 433 462 131	2 430 210 027			
2 433 120 128	2 434 614 020	6	2 433 462 014				F 00V C17 503
2 433 124 388	2 434 614 027	5	2 433 462 131	2 430 210 027			F 00V C17 503
2 433 120 128	2 434 614 020	1	2 433 462 014				2 430 105 026
2 433 124 446	2 434 614 020	1	2 433 462 014				F 00V C17 503
2 433 124 388	2 434 614 022	5					
2 433 120 128	2 434 614 020	1	2 433 462 014				2 430 105 026
2 433 120 128	2 434 614 020	1	2 433 462 014				2 430 105 026
2 433 120 128	2 434 614 020	1	2 433 462 014				2 430 105 026
2 433 124 388	2 434 614 022	5					
2 433 124 388	2 434 614 022	5					
2 433 124 388	2 434 614 027	5	2 433 462 131	2 430 210 027			
2 433 124 388	2 434 614 022	5					
2 433 124 388	2 434 614 022	5					
2 433 124 445	2 434 619 040	5					
2 433 124 388	2 434 614 022	5					
2 433 124 388	2 434 614 022	5					
2 433 124 388	2 434 614 022	5					
2 433 120 128	2 434 614 020	6	2 433 462 014				2 430 105 026

*) siehe Seite 388/see page 388/voir page 388/ver pagina 388/vease página 388

***) siehe Seite 392/see page 392/voir page 392/ver pagina 392/vease página 392

de

Ersatzteile für
Düsenhalter-
kombinationen
(Fortsetzung)

en

Spare parts for
nozzle-and-holder
assemblies
(continued)

fr

Pièces de rechange
pour ensembles
porte-injecteurs
(suite)

it

Ricambi per
combinazione
portapolverizzatori
(seguito)

es

Piezas de repuesto
para conjuntos
portainyectoros
(continuación)



Fig.



Ref.



Typ



①



Typ



②



③

0 432 131 869	1	0 430 132 003	KDAL 59 P 4	0 433 171 067	DLLA 155 P 67	2 433 314 182	2 430 134 023
0 432 131 870	1	0 430 132 001	KDAL 59 P 2	0 433 171 140	DLLA 155 P 157	2 433 314 182	2 430 134 023
0 432 131 871	1	0 430 133 992	KDEL 97 P 10	0 433 171 165	DLLA 146 P 154-	2 433 314 042	2 430 136 166
0 432 131 872	1	0 430 132 002	KDAL 59 P 3	0 433 171 067	DLLA 155 P 67	2 433 314 182	2 430 134 023
0 432 131 873	1	0 430 133 995	KDEL 99 P 5	0 433 171 130	DLLA 144 P 144	2 433 349 115	2 430 136 166
0 432 131 875	1	0 430 132 001	KDAL 59 P 2	0 433 171 074	DLLA 155 P 74	2 433 314 182	2 430 134 023
0 432 131 876	1	0 430 132 001	KDAL 59 P 2	0 433 171 103	DLLA 155 P 114	2 433 314 182	2 430 134 023
0 432 131 877	1	0 430 132 001	KDAL 59 P 2	0 433 171 066	DLLA 155 P 66	2 433 314 182	2 430 134 023
0 432 131 878	1	0 430 133 997	KDEL 97 P 3	0 433 171 084	DLLA 142 P 87	2 433 314 042	2 430 136 166
0 432 131 880	1	0 430 132 001	KDAL 59 P 2	0 433 171 074	DLLA 155 P 74	2 433 314 182	2 430 134 023
0 432 131 881	1	0 430 132 001	KDAL 59 P 2	0 433 171 067	DLLA 155 P 67	2 433 314 182	2 430 134 023
0 432 131 882	1	0 430 132 001	KDAL 59 P 2	0 433 171 070	DLLA 155 P 70	2 433 314 182	2 430 134 023
0 432 131 883	1	0 430 133 001	KDAL 95 P 1	0 433 171 049	DLLA 150 P 49	2 433 314 182	2 430 134 023
0 432 131 884	1	0 430 133 001	KDAL 95 P 1	0 433 171 048	DLLA 150 P 48	2 433 314 182	2 430 134 023
0 432 131 885	1	0 430 133 001	KDAL 95 P 1	0 433 171 047	DLLA 150 P 47	2 433 314 182	2 430 134 023
0 432 131 886	1	0 430 133 001	KDAL 95 P 1	0 433 171 046	DLLA 150 P 46	2 433 314 182	2 430 134 023
0 432 131 889	1	0 430 133 999	KDEL 80 P 1/13	0 433 171 015	DLLA 142 P 14	2 433 314 053	2 430 136 166
0 432 133 764	1	0 430 132 012	KDAL 59 P 22	0 433 175 473	DSLA 153 P 1692	2 433 314 182	2 430 134 023
0 432 133 765	1	0 430 133 941	KDEL 82 P 69	0 433 175 469	DSLA 152 P 1634	2 433 314 053	2 430 136 212
0 432 133 768	2	0 430 131 001	KDAL 37 P 40	2 437 010 152	DSLA 150 P 1559	2 433 349 267	
0 432 133 769	2	0 430 131 001	KDAL 37 P 40	2 437 010 150	DSLA 150 P 1495	2 433 349 267	
0 432 133 770	1	0 430 132 005	KDAL 59 P 6	0 433 175 438	DSLA 145 P 1479	2 433 314 182	2 430 134 023
0 432 133 771	1	0 430 132 012	KDAL 59 P 22	0 433 175 426	DSLA 145 P 1441	2 433 314 182	2 430 134 023
0 432 133 772	1	0 430 132 005	KDAL 59 P 6	0 433 175 348	DSLA 145 P 1174	2 433 314 182	2 430 134 023
0 432 133 773	1	0 430 132 005	KDAL 59 P 6	0 433 175 113	DSLA 145 P 603	2 433 314 182	2 430 134 023
0 432 133 774	1	0 430 132 012	KDAL 59 P 22	0 433 175 389	DSLA 145 P 1304	2 433 314 182	2 430 134 023
0 432 133 775	1	0 430 132 012	KDAL 59 P 22	0 433 175 348	DSLA 145 P 1174	2 433 314 182	2 430 134 023
0 432 133 778	1	0 430 132 005	KDAL 59 P 6	0 433 175 380	DSLA 145 P 1288	2 433 314 182	2 430 134 023
0 432 133 779	1	0 430 132 012	KDAL 59 P 22	0 433 175 370	DSLA 145 P 1253	2 433 314 182	2 430 134 023
0 432 133 780	1	0 430 132 012	KDAL 59 P 22	0 433 175 371	DSLA 145 P 1255	2 433 314 182	2 430 134 023
0 432 133 781	1	0 430 132 005	KDAL 59 P 6	0 433 175 348	DSLA 145 P 1174	2 433 314 182	2 430 134 023
0 432 133 782	1	0 430 132 012	KDAL 59 P 22	0 433 175 113	DSLA 145 P 603	2 433 314 182	2 430 134 023
0 432 133 783	2	0 430 132 023	KDAL 53 P 51	2 437 010 139	DSLA 142 P 1191	2 433 349 249	
0 432 133 784	2	0 430 132 023	KDAL 53 P 51	2 437 010 139	DSLA 142 P 1191	2 433 349 249	
0 432 133 785	2	0 430 132 022	KDAL 53 P 50	2 437 010 139	DSLA 142 P 1191	2 433 349 249	
0 432 133 786	2	0 430 132 022	KDAL 53 P 50	2 437 010 139	DSLA 142 P 1191	2 433 349 249	
0 432 133 787	1	0 430 132 005	KDAL 59 P 6	0 433 175 348	DSLA 145 P 1174	2 433 314 182	2 430 134 023
0 432 133 790	2	0 430 131 001	KDAL 37 P 40	2 437 010 133	DSLA 150 P 1102	2 433 349 267	
0 432 133 791	2	0 430 131 001	KDAL 37 P 40	2 437 010 134	DSLA 150 P 1103	2 433 349 267	
0 432 133 792	2	0 430 132 021	KDAL 53 P 39	2 437 010 130	DSLA 142 P 1025	2 433 349 249	
0 432 133 793	2	0 430 132 021	KDAL 53 P 39	2 437 010 130	DSLA 142 P 1025	2 433 349 249	
0 432 133 794	2	0 430 132 016	KDAL 53 P 29	2 437 010 130	DSLA 142 P 1025	2 433 349 249	
0 432 133 795	2	0 430 132 016	KDAL 53 P 29	2 437 010 130	DSLA 142 P 1025	2 433 349 249	
0 432 133 800	2	0 430 132 020	KDAL 37 P 35	2 437 010 128	DSLA 150 P 934	2 433 349 267	
0 432 133 801	2	0 430 132 020	KDAL 37 P 35	2 437 010 129	DSLA 150 P 933	2 433 349 267	



2 433 120 128	2 434 614 020	1	2 433 462 014		2 430 105 026
2 433 120 128	2 434 614 020	6	2 433 462 014		2 430 105 026
2 433 124 388	2 434 614 027	5	2 433 462 131	2 430 210 027	
2 433 120 128	2 434 614 020	1	2 433 462 014		2 430 105 026
2 433 120 127	2 434 614 027	5	2 433 462 131	2 430 210 027	2 430 105 026
2 433 120 128	2 434 614 020	6	2 433 462 014		2 430 105 026
2 433 120 128	2 434 614 020	6	2 433 462 014		2 430 105 026
2 433 120 128	2 434 614 020	6	2 433 462 014		2 430 105 026
2 433 120 127	2 434 614 027	5	2 433 462 131	2 430 210 027	
2 433 120 128	2 434 614 020	6	2 433 462 014		2 430 105 026
2 433 120 128	2 434 614 020	6	2 433 462 014		2 430 105 026
2 433 120 128	2 434 614 020	6	2 433 462 014		2 430 105 026
2 433 120 128	2 434 614 020	1	2 433 462 008		2 430 105 026
2 433 120 128	2 434 614 020	1	2 433 462 008		2 430 105 026
2 433 120 128	2 434 614 020	1	2 433 462 008		2 430 105 026
2 433 120 128	2 434 614 020	1	2 433 462 008		2 430 105 026
2 433 120 127	2 434 614 022	5			
2 433 124 446	2 434 614 028	6	2 433 462 014		2 430 105 048
2 433 124 376	2 434 614 048	3			
		B	2 433 462 144		2 430 105 055
		C	2 433 462 144		2 430 105 055
2 433 124 446	2 434 614 020	1	2 433 462 014		2 430 105 035
2 433 124 446	2 434 614 028	6	2 433 462 014		2 430 105 042
2 433 124 446	2 434 614 020	1	2 433 462 014		2 430 105 048
2 433 124 446	2 434 614 020	1	2 433 462 014		2 430 105 048
2 433 124 446	2 434 614 028	6	2 433 462 014		2 430 105 048
2 433 124 446	2 434 614 028	6	2 433 462 014		2 430 105 048
2 433 124 446	2 434 614 020	1	2 433 462 014		2 430 105 035
2 433 124 446	2 434 614 028	6	2 433 462 014		F 00V C17 503
2 433 124 446	2 434 614 028	6	2 433 462 014		F 00V C17 503
2 433 124 446	2 434 614 020	1	2 433 462 014		F 00V C17 503
2 433 124 446	2 434 614 028	6	2 433 462 014		F 00V C17 503
		C			
		C			
		C			
		C			
2 433 124 446	2 434 614 020	1	2 433 462 014		2 430 105 035
		C	2 433 462 144		2 430 105 055
		C	2 433 462 144		2 430 105 055
		C			
		C			
		C			
		C	2 433 462 144		2 430 105 057
		C	2 433 462 144		2 430 105 055

*) siehe Seite 388/see page 388/voir page 388/ver pagina 388/vease página 388

**) siehe Seite 392/see page 392/voir page 392/ver pagina 392/vease página 392

de

Ersatzteile für
Düsenhalter-
kombinationen
(Fortsetzung)

en

Spare parts for
nozzle-and-holder
assemblies
(continued)

fr

Pièces de rechange
pour ensembles
porte-injecteurs
(suite)

it

Ricambi per
combinazione
portapolverizzatori
(seguito)

es

Piezas de repuesto
para conjuntos
portainyectoros
(continuación)



Fig.



Ref.



Typ



①



Typ



②



③

0 432 133 802	2	0 430 132 017	KDAL 53 P 30	2 437 010 117	DSL A 142 P 925	2 433 349 249	
0 432 133 803	2	0 430 132 017	KDAL 53 P 30	2 437 010 117	DSL A 142 P 925	2 433 349 249	
0 432 133 804	2	0 430 132 016	KDAL 53 P 29	2 437 010 117	DSL A 142 P 925	2 433 349 249	
0 432 133 805	2	0 430 132 016	KDAL 53 P 29	2 437 010 117	DSL A 142 P 925	2 433 349 249	
0 432 133 815	2	0 430 132 017	KDAL 53 P 30	2 437 010 112	DSL A 142 P 843	2 433 349 249	
0 432 133 816	2	0 430 132 017	KDAL 53 P 30	2 437 010 112	DSL A 142 P 843	2 433 349 249	
0 432 133 817	2	0 430 132 016	KDAL 53 P 29	2 437 010 112	DSL A 142 P 843	2 433 349 249	
0 432 133 818	2	0 430 132 016	KDAL 53 P 29	2 437 010 112	DSL A 142 P 843	2 433 349 249	
0 432 133 819	1	0 430 133 990	KDEL 82 P 91	0 433 175 204	DSL A 150 P 805	2 433 349 458	2 430 136 166
0 432 133 820	1	0 430 133 006	KDAL 84 P 27	0 433 175 186	DSL A 150 P 779	2 433 314 182	2 430 134 023
0 432 133 821	1	0 430 133 006	KDAL 84 P 27	0 433 175 185	DSL A 145 P 778	2 433 314 182	2 430 134 023
0 432 133 822	2	0 430 132 017	KDAL 53 P 30	2 437 010 092	DSL A 142 P 770	2 433 349 249	
0 432 133 823	2	0 430 132 017	KDAL 53 P 30	2 437 010 092	DSL A 142 P 770	2 433 349 249	
0 432 133 824	2	0 430 132 016	KDAL 53 P 29	2 437 010 092	DSL A 142 P 770	2 433 349 249	
0 432 133 825	2	0 430 132 016	KDAL 53 P 29	2 437 010 092	DSL A 142 P 770	2 433 349 249	
0 432 133 826	1	0 430 132 012	KDAL 59 P 22	0 433 175 177	DSL A 145 P 768	2 433 314 182	2 430 134 023
0 432 133 828	1	0 430 133 004	KDAL 77 P 25	0 433 175 172	DSL A 138 P 757	2 433 314 182	2 430 134 023
0 432 133 829	1	0 430 133 006	KDAL 84 P 27	0 433 175 159	DSL A 145 P 725	2 433 314 182	2 430 134 023
0 432 133 830	1	0 430 133 005	KDAL 85 P 26	0 433 175 151	DSL A 140 P 707	F 00Z D10 000	2 430 134 023
0 432 133 831	1	0 430 133 004	KDAL 77 P 25	0 433 175 148	DSL A 138 P 698	2 433 314 182	2 430 134 023
0 432 133 832	1	0 430 132 015	KDAL 59 P 9 M	0 433 175 147	DSL A 145 P 311 M	2 433 314 182	2 430 134 023
0 432 133 833	2	0 430 132 014	KDAL 57 P 24	2 437 010 055	DSL A 142 P 683	2 433 349 249	
0 432 133 834	2	0 430 132 014	KDAL 57 P 24	2 437 010 055	DSL A 142 P 683	2 433 349 249	
0 432 133 835	2	0 430 132 013	KDAL 57 P 23	2 437 010 055	DSL A 142 P 683	2 433 349 249	
0 432 133 836	2	0 430 132 013	KDAL 57 P 23	2 437 010 055	DSL A 142 P 683	2 433 349 249	
0 432 133 837	1	0 430 132 005	KDAL 59 P 6	0 433 175 140	DSL A 145 P 681	2 433 314 182	2 430 134 023
0 432 133 838	1	0 430 132 012	KDAL 59 P 22	0 433 175 033	DSL A 145 P 265	2 433 314 182	2 430 134 023
0 432 133 839	1	0 430 133 990	KDEL 82 P 91	0 433 175 120	DSL A 152 P 630	2 433 349 458	2 430 136 166
0 432 133 840	1	0 430 133 967	KDEL 82 P 38	0 433 175 119	DSL A 154 P 625	2 433 314 053	2 430 136 212
0 432 133 842	1	0 430 133 953	KDEL 82 P 55	0 433 175 085	DSL A 154 P 492/	2 433 314 053	2 430 136 212
0 432 133 843	1	0 430 132 007	KDAL 59 P 9	0 433 175 113	DSL A 145 P 603	2 433 314 182	2 430 134 023
0 432 133 844	1	0 430 132 005	KDAL 59 P 6	0 433 175 081	DSL A 145 P 477	2 433 314 182	2 430 134 023
0 432 133 845	1	0 430 132 007	KDAL 59 P 9	0 433 175 112	DSL A 145 P 599	2 433 314 182	2 430 134 023
0 432 133 846	1	0 430 132 007	KDAL 59 P 9	0 433 175 111	DSL A 145 P 598	2 433 314 182	2 430 134 023
0 432 133 849	1	0 430 132 007	KDAL 59 P 9	0 433 175 049	DSL A 145 P 311	2 433 314 182	2 430 134 023
0 432 133 850	1	0 430 133 960	KDEL 75 P 46	0 433 171 387	DLL A 150 P 524	2 433 349 438	F 00Z Z20 003
0 432 133 851	1	0 430 132 007	KDAL 59 P 9	0 433 175 033	DSL A 145 P 265	2 433 314 182	2 430 134 023
0 432 133 853	1	0 430 132 007	KDAL 59 P 9	0 433 175 049	DSL A 145 P 311	2 433 314 182	2 430 134 023
0 432 133 854	1	0 430 132 005	KDAL 59 P 6	0 433 175 086	DSL A 155 P 498	2 433 314 182	2 430 134 023
0 432 133 855	1	0 430 133 967	KDEL 82 P 38	0 433 175 085	DSL A 154 P 492/	2 433 314 053	2 430 136 212
0 432 133 856	1	0 430 133 989	KDEL 97 P 13	0 433 175 084	DSL A 145 P 491	2 433 314 042	2 430 136 166
0 432 133 857	1	0 430 132 009	KDAL 59 P 14	0 433 175 081	DSL A 145 P 477	2 433 314 182	2 430 134 023
0 432 133 858	1	0 430 132 005	KDAL 59 P 6	0 433 175 081	DSL A 145 P 477	2 433 314 182	2 430 134 023
0 432 133 859	1	0 430 132 005	KDAL 59 P 6	0 433 175 076	DSL A 145 P 462	2 433 314 182	2 430 134 023
0 432 133 860	1	0 430 132 005	KDAL 59 P 6	0 433 175 078	DSL A 145 P 464	2 433 314 182	2 430 134 023

A 290

de
Ersatzteile für
Düsenhalter-
kombinationen
(Fortsetzung)

en
Spare parts for
nozzle-and-holder
assemblies
(continued)

fr
Pièces de rechange
pour ensembles
porte-injecteurs
(suite)

it
Ricambi per
combinazione
portapolverizzatori
(seguito)

es
Piezas de repuesto
para conjuntos
portainyectoros
(continuación)



0 432 133 861	1	0 430 132 005	KDAL 59 P 6	0 433 175 077	DSLA 145 P 463	2 433 314 182	2 430 134 023
0 432 133 862	1	0 430 133 969	KDEL 75 P 36	0 433 175 071	DSLA 149 P 427	2 433 314 042	2 430 136 212
0 432 133 863	1	0 430 132 008	KDAL 59 P 12	0 433 175 069	DSLA 145 P 414	2 433 314 182	2 430 134 023
0 432 133 864	1	0 430 132 005	KDAL 59 P 6	0 433 175 039	DSLA 155 P 276	2 433 314 182	2 430 134 023
0 432 133 865	1	0 430 132 008	KDAL 59 P 12	0 433 175 066	DSLA 145 P 396	2 433 314 182	2 430 134 023
0 432 133 866	1	0 430 132 008	KDAL 59 P 12	0 433 175 065	DSLA 145 P 395	2 433 314 182	2 430 134 023
0 432 133 868	1	0 430 132 005	KDAL 59 P 6	0 433 175 031	DSLA 145 P 263	2 433 314 182	2 430 134 023
0 432 133 869	2	0 430 132 995	KDEL 65 P 26	2 437 010 056	DSLA 150 P 362	2 433 314 053	
0 432 133 870	1	0 430 133 982	KDEL 75 P 22	0 433 175 057	DSLA 148 P 348	2 433 314 042	2 430 136 166
0 432 133 871	1	0 430 133 982	KDEL 75 P 22	0 433 175 055	DSLA 149 P 342	2 433 314 042	2 430 136 166
0 432 133 872	1	0 430 132 997	KDEL 70 P 19	0 433 175 053	DSLA 78 P 322	2 433 349 127	2 430 136 166
0 432 133 873	1	0 430 132 007	KDAL 59 P 9	0 433 175 049	DSLA 145 P 311	2 433 314 182	2 430 134 023
0 432 133 874	1	0 430 132 004	KDAL 59 P 5	0 433 175 039	DSLA 155 P 276	2 433 314 182	2 430 134 023
0 432 133 875	1	0 430 132 004	KDAL 59 P 5	0 433 175 040	DSLA 155 P 278	2 433 314 182	2 430 134 023
0 432 133 876	1	0 430 132 006	KBAL 59 P 7	0 433 175 039	DSLA 155 P 276	2 433 314 182	2 430 134 023
0 432 133 877	1	0 430 132 007	KDAL 59 P 9	0 433 175 033	DSLA 145 P 265	2 433 314 182	2 430 134 023
0 432 133 878	1	0 430 132 005	KDAL 59 P 6	0 433 175 032	DSLA 145 P 264	2 433 314 182	2 430 134 023
0 432 133 879	1	0 430 132 005	KDAL 59 P 6	0 433 175 031	DSLA 145 P 263	2 433 314 182	2 430 134 023
0 432 133 880	1	0 430 133 986	KDEL 75 P 16	0 433 175 030	DSLA 148 P 262	2 433 314 042	2 430 136 166
0 432 133 881	1	0 430 133 986	KDEL 75 P 16	0 433 175 022	DSLA 148 P 243	2 433 314 042	2 430 136 166
0 432 133 882	1	0 430 132 003	KDAL 59 P 4	0 433 175 005	DSLA 155 P 104	2 433 314 182	2 430 134 023
0 432 133 883	1	0 430 132 003	KDAL 59 P 4	0 433 175 005	DSLA 155 P 104	2 433 314 182	2 430 134 023
0 432 133 884	1	0 430 132 001	KDAL 59 P 2	0 433 175 005	DSLA 155 P 104	2 433 314 182	2 430 134 023
0 432 133 887	1	0 430 132 004	KDAL 59 P 5	0 433 175 007	DSLA 155 P 170	2 433 314 182	2 430 134 023
0 432 133 888	1	0 430 132 001	KDAL 59 P 2	0 433 175 005	DSLA 155 P 104	2 433 314 182	2 430 134 023
0 432 133 889	1	0 430 132 001	KDAL 59 P 2	0 433 175 004	DSLA 155 P 84	2 433 314 182	2 430 134 023
0 432 191 233	1	0 431 114 935	KBEL 100 P 266	0 433 172 008	DLLA 145 P 1645	F 00Z D20 008	F 00Z Z20 003
0 432 191 236	1	0 431 114 945	KBEL 100 P 253	0 433 171 995	DLLA 156 P 1627	2 433 349 189	F 00Z Z20 003
0 432 191 237	1	0 431 114 946	KBEL 100 P 252	0 433 171 994	DLLA 156 P 1626	2 433 349 189	F 00Z Z20 003
0 432 191 238	1	0 431 114 934	KBEL 100 P 271	0 433 171 986	DLLA 150 P 1614	2 433 349 189	F 00Z Z20 003
0 432 191 239	1	0 431 114 933	KBEL 100 P 272	0 433 171 808	DLLA 150 P 1285	F 00Z D20 012	F 00Z Z20 003
0 432 191 240	1	0 431 114 934	KBEL 100 P 271	0 433 171 978	DLLA 122 P 1602	2 433 349 189	F 00Z Z20 003
0 432 191 241	1	0 431 113 902	KBEL 99 P 269	0 433 171 969	DLLA 146 P 1583	F 00Z D20 010	F 00Z Z20 003
0 432 191 242	1	0 431 114 944	KBEL 100 P 254	0 433 171 948	DLLA 154 P 1538	2 433 349 189	F 00Z Z20 003
0 432 191 244	1	0 431 114 019	KBAL 116 P 146	0 433 171 934	DLLA 152 P 1513	F 00Z D40 000	2 430 136 212
0 432 191 245	1	0 431 114 906	KBEL 99 P 248	0 433 171 928	DLLA 148 P 1506	2 433 349 446	F 00Z Z20 003
0 432 191 247	1	0 431 114 935	KBEL 100 P 266	0 433 171 926	DLLA 145 P 1503	F 00Z D20 008	F 00Z Z20 003
0 432 191 248	1	0 431 114 944	KBEL 100 P 254	0 433 171 916	DLLA 142 P 1481	2 433 349 189	F 00Z Z20 003
0 432 191 249	1	0 431 113 920	KBEL 94 P 219	0 433 171 909	DLLA 152 P 1466	2 433 349 198	F 00Z Z20 003
0 432 191 250	1	0 431 113 921	KBEL 94 P 218	0 433 171 909	DLLA 152 P 1466	2 433 349 197	F 00Z Z20 003
0 432 191 251	1	0 431 114 938	KBEL 100 P 263	0 433 171 908	DLLA 150 P 1464	2 433 349 189	F 00Z Z20 003
0 432 191 252	1	0 431 113 048	KBAL 96 P 119	0 433 171 622	DLLA 151 P 939	2 433 314 182	2 430 134 023
0 432 191 253	1	0 431 114 939	KBEL 106 P 261	0 433 171 901	DLLA 152 P 1454	F 00Z D20 003	F 00Z Z20 000
0 432 191 254	1	0 431 114 939	KBEL 106 P 261	0 433 171 902	DLLA 153 P 1455	F 00Z D20 003	F 00Z Z20 000
0 432 191 256	1	0 431 114 941	KBEL 100 P 259	0 433 171 676	DLLA 160 P 1032+	2 433 349 189	F 00Z Z20 003



2 433 124 446	2 434 614 020	1	2 433 462 014			F 00V C17 503
2 433 124 376	2 434 614 040	3	2 433 462 143	2 430 210 027		
2 433 124 446	2 434 614 020	1	2 433 462 014			
2 433 124 446	2 434 614 020	1	2 433 462 014			F 00V C17 503
2 433 124 446	2 434 614 020	1	2 433 462 014			2 430 105 042
2 433 124 446	2 434 614 020	1	2 433 462 014			F 00V C17 503
2 433 124 446	2 434 614 020	1	2 433 462 014			2 430 105 043
			B			
2 433 124 388	2 434 614 022	5	2 433 462 143	2 430 210 027		
2 433 124 388	2 434 614 022	5	2 433 462 143	2 430 210 027		
2 433 124 388	2 434 614 022	5				
2 433 124 446	2 434 614 028	1	2 433 462 014			2 430 105 042
2 433 124 446	2 434 614 020	1	2 433 462 014			F 00V C17 503
2 433 124 446	2 434 614 020	1	2 433 462 014			F 00V C17 503
2 433 124 446	2 434 614 020	1	2 433 462 014			F 00V C17 503
2 433 124 446	2 434 614 028	1	2 433 462 014			2 430 105 042
2 433 124 446	2 434 614 020	1	2 433 462 014			2 430 105 042
2 433 124 446	2 434 614 020	1	2 433 462 014			2 430 105 042
2 433 124 388	2 434 614 022	5	2 433 462 143	2 430 210 027		
2 433 124 388	2 434 614 022	5	2 433 462 143	2 430 210 027		
2 433 120 128	2 434 614 020	1	2 433 462 014			2 430 105 026
2 433 120 128	2 434 614 020	1	2 433 462 014			2 430 105 026
2 433 120 128	2 434 614 020	6	2 433 462 014			2 430 105 026
2 433 124 446	2 434 614 020	1	2 433 462 014			2 430 105 026
2 433 120 128	2 434 614 020	6	2 433 462 014			2 430 105 026
2 433 120 128	2 434 614 020	6	2 433 462 014			2 430 105 026
F 00Z B20 001	2 434 614 041	3			F 00Z R20 027	2 430 105 049
F 00Z B20 002	2 434 614 040	3			2 433 370 467	
F 00Z B20 002	2 434 614 040	3			F 00Z R20 017	
F 00Z B20 002	2 434 614 040	3			2 433 370 467	
F 00Z B20 002	2 434 614 040	3			F 00Z R20 021	F 00Z M20 001
F 00Z B20 002	2 434 614 040	3			2 433 370 467	
F 00Z B20 002	2 434 614 040	3		2 430 210 081	F 00Z R20 018	F 00V C17 503
F 00Z B20 002	2 434 614 040	3			2 433 370 467	
2 433 124 370	2 434 614 041	3				
F 00Z B20 001	2 434 614 041	3		2 430 210 081		2 430 105 049
F 00Z B20 001	2 434 614 041	3			F 00Z R20 027	2 430 105 049
F 00Z B20 002	2 434 614 040	3			2 433 370 467	
	2 434 614 040	3			F 00R J01 247	
F 00Z B20 002	2 434 614 040	3			F 00R J01 247	
F 00Z B20 001	2 434 614 041	3			2 433 370 472	2 430 105 049
2 433 124 446	2 434 614 020	6				
F 00Z B20 002	2 434 614 040	3		2 430 210 081		F 00Z M20 001
F 00Z B20 002	2 434 614 040	3		2 430 210 081		F 00Z M20 001
F 00Z B20 001	2 434 614 041	3			2 433 370 467	2 430 105 049

*) siehe Seite 388/see page 388/voir page 388/ver pagina 388/vease página 388

**) siehe Seite 392/see page 392/voir page 392/ver pagina 392/vease página 392

de

Ersatzteile für
Düsenhalter-
kombinationen
(Fortsetzung)

en

Spare parts for
nozzle-and-holder
assemblies
(continued)

fr

Pièces de rechange
pour ensembles
porte-injecteurs
(suite)

it

Ricambi per
combinazione
portapolverizzatori
(seguito)

es

Piezas de repuesto
para conjuntos
portainyectoros
(continuación)



Fig.



Ref.



Typ



①



Typ



②



③

0 432 191 257	1	0 431 114 941	KBEL 100 P 259	0 433 171 610	DLLA 150 P 916	2 433 349 189	F 00Z Z20 003
0 432 191 258	1	0 431 114 941	KBEL 100 P 259	0 433 171 741	DLLA 150 P 1164	2 433 349 189	F 00Z Z20 003
0 432 191 259	1	0 431 114 940	KBEL 100 P 258	0 433 171 806	DLLA 142 P 1283	2 433 349 189	F 00Z Z20 003
0 432 191 260	1	0 431 114 943	KBEL 100 P 257	0 433 171 676	DLLA 160 P 1032+	2 433 349 189	F 00Z Z20 003
0 432 191 261	1	0 431 114 942	KBEL 100 P 943	0 433 171 628	DLLA 150 P 943	2 433 349 189	F 00Z Z20 003
0 432 191 262	1	0 431 114 942	KBEL 100 P 943	0 433 171 607	DLLA 150 P 913	2 433 349 189	F 00Z Z20 003
0 432 191 263	1	0 431 114 943	KBEL 100 P 257	0 433 171 610	DLLA 150 P 916	2 433 349 189	F 00Z Z20 003
0 432 191 265	1	0 431 114 942	KBEL 100 P 943	0 433 171 724	DLLA 150 P 1120	2 433 349 189	F 00Z Z20 003
0 432 191 266	1	0 431 114 942	KBEL 100 P 943	0 433 171 450	DLLA 154 P 596	2 433 349 189	F 00Z Z20 003
0 432 191 267	1	0 431 114 942	KBEL 100 P 943	0 433 171 634	DLLA 150 P 957	2 433 349 189	F 00Z Z20 003
0 432 191 268	1	0 431 114 943	KBEL 100 P 257	0 433 171 740	DLLA 150 P 1163	2 433 349 189	F 00Z Z20 003
0 432 191 269	1	0 431 114 943	KBEL 100 P 257	0 433 171 741	DLLA 150 P 1164	2 433 349 189	F 00Z Z20 003
0 432 191 270	1	0 431 114 942	KBEL 100 P 943	0 433 171 806	DLLA 142 P 1283	2 433 349 189	F 00Z Z20 003
0 432 191 271	1	0 431 114 944	KBEL 100 P 254	0 433 171 895	DLLA 146 P 1447	2 433 349 189	F 00Z Z20 003
0 432 191 272	1	0 431 115 988	KBEL 137 P 230	0 433 171 894	DLLA 140 P 1446	F 00Z D20 004	F 00Z Z20 003
0 432 191 273	1	0 421 115 988	KBEL 137 P 230	0 433 171 893	DLLA 140 P 1445	F 00Z D20 004	F 00Z Z20 003
0 432 191 274	1	0 421 115 988	KBEL 137 P 230	0 433 171 892	DLLA 140 P 1444	F 00Z D20 004	F 00Z Z20 003
0 432 191 275	1	0 431 114 944	KBEL 100 P 254	0 433 171 916	DLLA 142 P 1481	2 433 349 189	F 00Z Z20 003
0 432 191 276	1	0 431 114 945	KBEL 100 P 253	0 433 171 566	DLLA 156 P 828+	2 433 349 189	F 00Z Z20 003
0 432 191 277	1	0 431 114 945	KBEL 100 P 253	0 433 171 597	DLLA 156 P 897+	2 433 349 189	F 00Z Z20 003
0 432 191 278	1	0 431 114 945	KBEL 100 P 253	0 433 171 688	DLLA 156 P 1059	2 433 349 189	F 00Z Z20 003
0 432 191 279	1	0 431 114 945	KBEL 100 P 253	0 433 171 680	DLLA 147 P 1049	2 433 349 189	F 00Z Z20 003
0 432 191 280	1	0 431 114 945	KBEL 100 P 253	0 433 171 679	DLLA 147 P 1048	2 433 349 189	F 00Z Z20 003
0 432 191 281	1	0 431 114 945	KBEL 100 P 253	0 433 171 746	DLLA 144 P 1175	2 433 349 189	F 00Z Z20 003
0 432 191 282	1	0 431 114 945	KBEL 100 P 253	0 433 171 797	DLLA 144 P 1264	2 433 349 189	F 00Z Z20 003
0 432 191 283	1	0 431 115 988	KBEL 137 P 230	0 433 171 881	DLLA 140 P 1420	F 00Z D20 004	F 00Z Z20 003
0 432 191 284	1	0 431 115 988	KBEL 137 P 230	0 433 171 882	DLLA 140 P 1421	F 00Z D20 004	F 00Z Z20 003
0 432 191 285	1	0 431 114 944	KBEL 100 P 254	0 433 171 875	DLLA 144 P 1413	2 433 349 189	F 00Z Z20 003
0 432 191 286	1	0 431 114 967	KBEL 100 P 141	0 433 171 874	DLLA 162 P 1408	2 433 349 189	F 00Z Z20 003
0 432 191 287	1	0 431 113 058	KBAL 96 P 137	0 433 171 704	DLLA 148 P 1083	2 433 314 182	2 430 134 023
0 432 191 288	1	0 431 113 905	KBEL 92 P 250	0 433 171 869	DLLA 149 P 1402	2 433 349 446	F 00Z Z20 003
0 432 191 289	1	0 431 115 988	KBEL 137 P 230	0 433 171 866	DLLA 135 P 1399	F 00Z D20 004	F 00Z Z20 003
0 432 191 290	1	0 431 115 988	KBEL 137 P 230	0 433 171 867	DLLA 135 P 1400	F 00Z D20 004	F 00Z Z20 003
0 432 191 291	1	0 431 115 988	KBEL 137 P 230	0 433 171 868	DLLA 135 P 1401	F 00Z D20 004	F 00Z Z20 003
0 432 191 292	1	0 431 113 046	KBAL 96 P 117	0 433 171 849	DLLA 144 P 1369	2 433 349 249	F 00Z Z10 000
0 432 191 294	1	0 431 114 017	KBAL 104 P 134	0 433 171 842	DLLA 150 P 1352	2 433 314 182	2 430 134 023
0 432 191 295	1	0 431 114 017	KBAL 104 P 134	0 433 171 841	DLLA 150 P 1351	2 433 314 182	2 430 134 023
0 432 191 296	1	0 431 113 921	KBEL 94 P 218	0 433 171 840	DLLA 152 P 1349	2 433 349 197	F 00Z Z20 003
0 432 191 297	1	0 431 114 005	KBAL 105 P 29	0 433 171 835	DLLA 140 P 1343	2 433 314 182	2 430 134 023
0 432 191 298	1	0 431 114 005	KBAL 105 P 29	0 433 171 834	DLLA 140 P 1342	2 433 314 182	2 430 134 023
0 432 191 299	1	0 431 114 005	KBAL 105 P 29	0 433 171 833	DLLA 140 P 1341	2 433 314 182	2 430 134 023
0 432 191 300	1	0 431 114 005	KBAL 105 P 29	0 433 171 832	DLLA 140 P 1340	2 433 314 182	2 430 134 023
0 432 191 301	1	0 431 114 962	KBEL 100 P 169	0 433 171 680	DLLA 147 P 1049	2 433 349 189	F 00Z Z20 003
0 432 191 302	1	0 431 114 962	KBEL 100 P 169	0 433 171 679	DLLA 147 P 1048	2 433 349 189	F 00Z Z20 003
0 432 191 303	1	0 431 114 962	KBEL 100 P 169	0 433 171 797	DLLA 144 P 1264	2 433 349 189	F 00Z Z20 003

de

Ersatzteile für
Düsenhalter-
kombinationen
(Fortsetzung)

en

Spare parts for
nozzle-and-holder
assemblies
(continued)

fr

Pièces de rechange
pour ensembles
porte-injecteurs
(suite)

it

Ricambi per
combinazione
portapolverizzatori
(seguito)

es

Piezas de repuesto
para conjuntos
portainyectoros
(continuación)



Fig.



Ref.



Typ



①



Typ











②



③

0 432 191 304	1	0 431 114 962	KBEL 100 P 169	0 433 171 688	DLLA 156 P 1059	2 433 349 189	F 00Z Z20 003
0 432 191 305	1	0 431 114 962	KBEL 100 P 169	0 433 171 566	DLLA 156 P 828+	2 433 349 189	F 00Z Z20 003
0 432 191 306	1	0 431 114 962	KBEL 100 P 169	0 433 171 597	DLLA 156 P 897+	2 433 349 189	F 00Z Z20 003
0 432 191 309	1	0 431 113 920	KBEL 94 P 219	0 433 171 821	DLLA 154 P 1319	2 433 349 198	F 00Z Z20 003
0 432 191 310	1	0 431 113 921	KBEL 94 P 218	0 433 171 821	DLLA 154 P 1319	2 433 349 197	F 00Z Z20 003
0 432 191 312	1	0 431 113 055	KBAL 82 P 131	0 433 171 812	DLLA 146 P 1297	2 433 314 182	2 430 134 023
0 432 191 313	1	0 431 113 058	KBAL 96 P 137	0 433 171 743	DLLA 151 P 1169	2 433 314 182	2 430 134 023
0 432 191 314	1	0 431 114 005	KBAL 105 P 29	0 433 171 810	DLLA 140 P 1294	2 433 314 182	2 430 134 023
0 432 191 315	1	0 431 114 954	KBEL 106 P 228	0 433 171 809	DLLA 152 P 1286	F 00Z D20 003	F 00Z Z20 003
0 432 191 316	1	0 431 114 967	KBEL 100 P 141	0 433 171 807	DLLA 142 P 1284	2 433 349 189	F 00Z Z20 003
0 432 191 317	1	0 431 114 967	KBEL 100 P 141	0 433 171 806	DLLA 142 P 1283	2 433 349 189	F 00Z Z20 003
0 432 191 318	1	0 431 113 909	KBEL 99 P 243	0 433 171 808	DLLA 150 P 1285	2 433 349 446	F 00Z Z20 003
0 432 191 319	1	0 431 115 991	KBEL 137 P 174	0 433 171 802	DLLA 140 P 1278	F 00Z D20 004	F 00Z Z20 003
0 432 191 321	1	0 431 114 962	KBEL 100 P 169	0 433 171 797	DLLA 144 P 1264	2 433 349 189	F 00Z Z20 003
0 432 191 322	1	0 431 114 017	KBAL 104 P 134	0 433 171 787	DLLA 145 P 1240	2 433 314 182	2 430 134 023
0 432 191 323	1	0 431 113 931	KBEL 99 P 188	0 433 171 784	DLLA 148 P 1237	2 433 349 446	F 00Z Z20 003
0 432 191 324	1	0 431 113 046	KBAL 96 P 117	0 433 171 704	DLLA 148 P 1083	2 433 314 182	2 430 134 023
0 432 191 325	1	0 431 113 048	KBAL 96 P 119	0 433 171 623	DLLA 151 P 940	2 433 314 182	2 430 134 023
0 432 191 326	1	0 431 113 052	KBAL 96 P 125	0 433 171 780	DLLA 147 P 1230	2 433 349 249	F 00Z Z10 000
0 432 191 327	1	0 431 113 056	KBAL 96 P 132	0 433 171 779	DLLA 147 P 1229	2 433 314 182	2 430 134 023
0 432 191 328	1	0 431 113 056	KBAL 96 P 132	0 433 171 770	DLLA 144 P 1220	2 433 314 182	2 430 134 023
0 432 191 330	1	0 431 113 055	KBAL 82 P 131	0 433 171 763	DLLA 146 P 1210	2 433 314 182	2 430 134 023
0 432 191 335	1	0 431 114 005	KBAL 105 P 29	0 433 171 756	DLLA 140 P 1199	2 433 314 182	2 430 134 023
0 432 191 336	1	0 431 113 054	KBAL 95 P 130	0 433 171 754	DLLA 145 P 1195	2 433 314 182	2 430 134 023
0 432 191 337	1	0 431 113 052	KBAL 96 P 125	0 433 171 753	DLLA 144 P 1194	2 433 349 249	F 00Z Z10 000
0 432 191 338	1	0 431 114 005	KBAL 105 P 29	0 433 171 748	DLLA 140 P 1181	2 433 314 182	2 430 134 023
0 432 191 339	1	0 431 113 911	KBEL 98 P 238	0 433 171 751	DLLA 145 P 1189	2 433 314 042	2 430 136 212
0 432 191 341	1	0 431 114 005	KBAL 105 P 29	0 433 171 734	DLLA 140 P 1144	2 433 314 182	2 430 134 023
0 432 191 342	1	0 431 114 005	KBAL 105 P 29	0 433 171 748	DLLA 140 P 1181	2 433 314 182	2 430 134 023
0 432 191 343	1	0 431 114 005	KBAL 105 P 29	0 433 171 747	DLLA 140 P 1179	2 433 314 182	2 430 134 023
0 432 191 344	1	0 431 114 962	KBEL 100 P 169	0 433 171 746	DLLA 144 P 1175	2 433 349 189	F 00Z Z20 003
0 432 191 345	1	0 431 113 052	KBAL 96 P 125	0 433 171 744	DLLA 144 P 1170	2 433 349 249	F 00Z Z10 000
0 432 191 346	1	0 431 113 046	KBAL 96 P 117	0 433 171 743	DLLA 151 P 1169	2 433 314 182	2 430 134 023
0 432 191 347	1	0 431 114 951	KBEL 100 P 236	0 433 171 741	DLLA 150 P 1164	2 433 349 189	F 00Z Z20 003
0 432 191 348	1	0 431 114 951	KBEL 100 P 236	0 433 171 740	DLLA 150 P 1163	2 433 349 189	F 00Z Z20 003
0 432 191 349	1	0 431 113 939	KBEL 84 P 162	0 433 171 742	DLLA 153 P 1165	2 433 349 446	F 00Z Z20 003
0 432 191 350	1	0 431 213 912	KBEL 82 P 235	0 433 171 739	DLLA 155 P 1159	F 018 B07 804	F 018 B06 801
0 432 191 351	1	0 431 113 961	KBEL 84 P 93	0 433 175 408	DSLA 143 P 1364	2 433 314 053	2 430 136 166
0 432 191 352	1	0 431 114 007	KBAL 105 P 51	0 433 171 737	DLLA 155 P 1152	2 433 314 182	2 430 134 023
0 432 191 353	1	0 431 113 051	KBAL 96 P 123	0 433 171 623	DLLA 151 P 940	2 433 314 182	2 430 134 023
0 432 191 354	1	0 431 114 005	KBAL 105 P 29	0 433 171 734	DLLA 140 P 1144	2 433 314 182	2 430 134 023
0 432 191 355	1	0 431 113 939	KBEL 84 P 162	0 433 171 735	DLLA 153 P 1146	2 433 349 446	F 00Z Z20 003
0 432 191 356	1	0 431 114 007	KBAL 105 P 51	0 433 171 731	DLLA 155 P 1138	2 433 314 182	2 430 134 023
0 432 191 357	1	0 431 113 923	KBEL 93 P 216	0 433 171 728	DLLA 144 P 1132	2 433 349 446	F 00Z Z20 003
0 432 191 358	1	0 431 113 913	KBEL 84 P 234	0 433 171 486	DLLA 145 P 669	2 433 314 053	2 430 136 212

								
④	⑤	⑥	⑦	⑧	⑨	⑩	⑪	
F 00Z B20 002	2 434 614 040	3			2 433 370 467			
F 00Z B20 002	2 434 614 040	3			2 433 370 467			
F 00Z B20 002	2 434 614 040	3			2 433 370 467			
	2 434 614 040	3			F 00R J01 247			
F 00Z B20 002	2 434 614 040	3			F 00R J01 247			
2 433 124 446	2 434 614 020	1						
2 433 124 446	2 434 614 020	6		F 000 43G 000				
2 433 124 446	2 434 614 020	1					2 430 105 048	
F 00Z B20 002	2 434 614 040	3		2 430 210 081			F 00Z M20 001	
F 00Z B20 001	2 434 614 041	3			2 433 370 467			
F 00Z B20 001	2 434 614 041	3			2 433 370 467			
F 00Z B20 002	2 434 614 040	3			F 00Z R20 012		2 430 105 049	
F 00Z B20 002	2 434 614 040	3						
F 00Z B20 002	2 434 614 040	3			2 433 370 467			
2 433 124 446	2 434 614 020	1						
F 00Z B20 001	2 434 614 041	3		2 430 210 081	F 00Z R20 010		2 430 105 049	
2 433 124 446	2 434 614 020	6						
2 433 124 446	2 434 614 020	1						
F 00Z B10 000	2 434 614 020	6						
2 433 124 446	2 434 614 020	1						
2 433 124 446	2 434 614 020	1						
2 433 124 446	2 434 614 020	1					2 430 105 042	
2 433 124 446	2 434 614 020	6						
F 00Z B10 001	2 434 614 020	6						
2 433 124 446	2 434 614 020	1					2 430 105 042	
2 433 124 376	2 434 614 040	3						
2 433 124 446	2 434 614 020	1					F 00V C17 503	
2 433 124 446	2 434 614 020	1					F 00V C17 503	
2 433 124 446	2 434 614 020	1					F 00V C17 503	
F 00Z B20 002	2 434 614 040	3			2 433 370 467			
F 00Z B10 000	2 434 614 020	6						
2 433 124 446	2 434 614 020	6						
F 00Z B20 001	2 434 614 041	3			2 433 370 467			
F 00Z B20 001	2 434 614 041	3			2 433 370 467			
F 00Z B20 002	2 434 614 040	3		2 430 210 083			F 00V C17 503	
2 433 124 376	F 018 B04 800	3						
2 433 124 388	2 434 614 022	5						
2 433 124 446	2 434 614 020	1					F 00V C17 503	
2 433 124 446	2 434 614 020	6						
2 433 124 446	2 434 614 020	1					2 430 105 042	
F 00Z B20 002	2 434 614 040	3		2 430 210 083			F 00V C17 503	
2 433 124 446	2 434 614 020	1					F 00V C17 503	
F 00Z B20 002	2 434 614 048	3		2 430 210 083			F 00V C17 503	
2 433 124 364	2 434 614 040	3						

*) siehe Seite 388/see page 388/voir page 388/ver pagina 388/vease página 388

**) siehe Seite 392/see page 392/voir page 392/ver pagina 392/vease página 392

de

Ersatzteile für
Düsenhalter-
kombinationen
(Fortsetzung)

en

Spare parts for
nozzle-and-holder
assemblies
(continued)

fr

Pièces de rechange
pour ensembles
porte-injecteurs
(suite)

it

Ricambi per
combinazione
portapolverizzatori
(seguito)

es

Piezas de repuesto
para conjuntos
portainyectores
(continuación)



Fig.



Ref.



Typ



①



Typ











②



③

0 432 191 359	1	0 431 114 967	KBEL 100 P 141	0 433 171 634	DLLA 150 P 957	2 433 349 189	F 00Z Z20 003
0 432 191 360	1	0 431 114 967	KBEL 100 P 141	0 433 171 450	DLLA 154 P 596	2 433 349 189	F 00Z Z20 003
0 432 191 361	1	0 431 113 956	KBEL 98 P 102	0 433 171 726	DLLA 146 P 1122	2 433 314 042	2 430 136 212
0 432 191 362	1	0 431 114 967	KBEL 100 P 141	0 433 171 725	DLLA 147 P 1121	2 433 349 189	F 00Z Z20 003
0 432 191 363	1	0 431 114 967	KBEL 100 P 141	0 433 171 724	DLLA 150 P 1120	2 433 349 189	F 00Z Z20 003
0 432 191 364	1	0 431 113 961	KBEL 84 P 93	0 433 171 711	DLLA 150 P 1110	2 433 314 053	2 430 136 166
0 432 191 365	1	0 431 114 007	KBAL 105 P 51	0 433 171 713	DLLA 155 P 1108	2 433 314 182	2 430 134 023
0 432 191 366	1	0 431 114 967	KBEL 100 P 141	0 433 171 710	DLLA 144 P 1105	2 433 349 189	F 00Z Z20 003
0 432 191 367	1	0 431 113 049	KBAL 96 P 120	0 433 171 709	DLLA 152 P 1104	2 433 349 249	F 00Z Z10 000
0 432 191 368	1	0 431 113 048	KBAL 96 P 119	0 433 171 625	DLLA 151 P 942	2 433 314 182	2 430 134 023
0 432 191 369	1	0 431 113 047	KBAL 96 P 118	0 433 171 533	DLLA 147 P 734	2 433 314 182	2 430 134 023
0 432 191 370	1	0 431 114 967	KBEL 100 P 141	0 433 171 607	DLLA 150 P 913	2 433 349 189	F 00Z Z20 003
0 432 191 371	1	0 431 114 952	KBEL 110 P 233	0 433 171 707	DLLA 152 P 1094	2 433 349 436	2 430 136 212
0 432 191 372	1	0 431 114 967	KBEL 100 P 141	0 433 171 610	DLLA 150 P 916	2 433 349 189	F 00Z Z20 003
0 432 191 373	1	0 431 113 047	KBAL 96 P 118	0 433 171 258	DLLA 147 P 361	2 433 314 182	2 430 134 023
0 432 191 374	1	0 431 113 047	KBAL 96 P 118	0 433 171 257	DLLA 147 P 360	2 433 314 182	2 430 134 023
0 432 191 375	1	0 431 113 047	KBAL 96 P 118	0 433 171 263	DLLA 147 P 370	2 433 314 182	2 430 134 023
0 432 191 376	1	0 431 113 048	KBAL 96 P 119	0 433 171 624	DLLA 151 P 941	2 433 314 182	2 430 134 023
0 432 191 377	1	0 431 113 047	KBAL 96 P 118	0 433 171 329	DLLA 158 P 456/	2 433 314 182	2 430 134 023
0 432 191 378	1	0 431 113 047	KBAL 96 P 118	0 433 171 529	DLLA 158 P 729	2 433 314 182	2 430 134 023
0 432 191 379	1	0 431 113 047	KBAL 96 P 118	0 433 171 530	DLLA 158 P 730	2 433 314 182	2 430 134 023
0 432 191 380	1	0 431 113 046	KBAL 96 P 117	0 433 171 704	DLLA 148 P 1083	2 433 314 182	2 430 134 023
0 432 191 381	1	0 431 114 954	KBEL 106 P 228	0 433 171 703	DLLA 152 P 1081	F 00Z D20 003	F 00Z Z20 003
0 432 191 382	1	0 431 114 954	KBEL 106 P 228	0 433 171 702	DLLA 153 P 1080	F 00Z D20 003	F 00Z Z20 003
0 432 191 383	1	0 431 114 007	KBAL 105 P 51	0 433 171 701	DLLA 155 P 1078	2 433 314 182	2 430 134 023
0 432 191 384	1	0 431 114 967	KBEL 100 P 141	0 433 171 628	DLLA 150 P 943	2 433 349 189	F 00Z Z20 003
0 432 191 385	1	0 431 114 967	KBEL 100 P 141	0 433 171 696	DLLA 142 P 1070	2 433 349 189	F 00Z Z20 003
0 432 191 386	1	0 431 114 955	KBEL 117 P 227	0 433 171 432	DLLA 152 P 571	2 433 314 042	2 430 136 236
0 432 191 387	1	0 431 114 967	KBEL 100 P 141	0 433 171 691	DLLA 150 P 1064	2 433 349 189	F 00Z Z20 003
0 432 191 388	1	0 431 113 940	KBEL 98 P 160	0 433 171 689	DLLA 145 P 1062	2 433 314 042	2 430 136 212
0 432 191 389	1	0 431 113 923	KBEL 93 P 216	0 433 171 687	DLLA 150 P 1057	2 433 349 446	F 00Z Z20 003
0 432 191 390	1	0 431 113 923	KBEL 93 P 216	0 433 171 686	DLLA 144 P 1056	2 433 349 446	F 00Z Z20 003
0 432 191 391	1	0 431 113 923	KBEL 93 P 216	0 433 171 685	DLLA 150 P 1054	2 433 349 446	F 00Z Z20 003
0 432 191 392	1	0 431 113 923	KBEL 93 P 216	0 433 171 684	DLLA 150 P 1053	2 433 349 446	F 00Z Z20 003
0 432 191 393	1	0 431 114 962	KBEL 100 P 169	0 433 171 680	DLLA 147 P 1049	2 433 349 189	F 00Z Z20 003
0 432 191 394	1	0 431 114 962	KBEL 100 P 169	0 433 171 680	DLLA 147 P 1049	2 433 349 189	F 00Z Z20 003
0 432 191 395	1	0 431 114 962	KBEL 100 P 169	0 433 171 679	DLLA 147 P 1048	2 433 349 189	F 00Z Z20 003
0 432 191 396	1	0 431 114 962	KBEL 100 P 169	0 433 171 679	DLLA 147 P 1048	2 433 349 189	F 00Z Z20 003
0 432 191 397	1	0 431 113 914	KBEL 84 P 225	0 433 171 397	DLLA 145 P 536	2 433 314 053	2 430 136 166
0 432 191 398	2	0 431 115 005	KBAL 140 P 74	2 437 010 131	DLLA 145 P 1031	2 433 349 249	
0 432 191 400	1	0 431 114 967	KBEL 100 P 141	0 433 171 676	DLLA 160 P 1032+	2 433 349 189	F 00Z Z20 003
0 432 191 401	2	0 431 115 006	KBAL 140 P 75	2 437 010 131	DLLA 145 P 1031	2 433 349 249	
0 432 191 402	1	0 431 113 918	KBEL 98 P 221	0 433 171 673	DLLA 148 P 1022	2 433 314 042	
0 432 191 403	1	0 431 113 916	KBEL 84 P 223	0 433 171 486	DLLA 145 P 669	2 433 314 053	2 430 136 212
0 432 191 404	1	0 431 113 917	KBEL 98 P 222	0 433 171 673	DLLA 148 P 1022	2 433 314 042	2 430 136 236

								
④	⑤	⑥	⑦	⑧	⑨	⑩	⑪	
F 00Z B20 001	2 434 614 041	3			2 433 370 467			
F 00Z B20 001	2 434 614 041	3			2 433 370 467			
2 433 124 376	2 434 614 040	3						
F 00Z B20 001	2 434 614 041	3			F 00Z R20 007		2 430 105 049	
F 00Z B20 001	2 434 614 041	3			2 433 370 467			
2 433 124 388	2 434 614 022	5						
2 433 124 446	2 434 614 020	1					F 00V C17 503	
F 00Z B20 001	2 434 614 041	3					2 430 105 049	
F 00Z B10 000	2 434 614 020	6						
2 433 124 446	2 434 614 020	1						
2 433 124 446	2 434 614 020	6						
F 00Z B20 001	2 434 614 041	3			2 433 370 467			
2 433 124 376	2 434 614 040	3						
F 00Z B20 001	2 434 614 041	3			2 433 370 467			
2 433 124 446	2 434 614 020	1						
2 433 124 446	2 434 614 020	1						
2 433 124 446	2 434 614 020	1						
2 433 124 446	2 434 614 020	1						
2 433 124 446	2 434 614 020	1						
2 433 124 446	2 434 614 020	1						
2 433 124 446	2 434 614 020	6						
F 00Z B20 002	2 434 614 040	3		2 430 210 081			F 00Z M20 001	
F 00Z B20 002	2 434 614 040	3		2 430 210 081			F 00Z M20 001	
2 433 124 446	2 434 614 020	1					F 00V C17 503	
F 00Z B20 001	2 434 614 041	3			2 433 370 467			
F 00Z B20 001	2 434 614 041	3			2 433 370 467			
	2 434 614 040	3						
F 00Z B20 001	2 434 614 041	3			2 433 370 467		2 430 105 049	
2 433 124 376	2 434 614 040	3						
F 00Z B20 002	2 434 614 048	3		2 430 210 083			F 00V C17 503	
F 00Z B20 002	2 434 614 048	3		2 430 210 083			F 00V C17 503	
F 00Z B20 002	2 434 614 048	3		2 430 210 083			F 00V C17 503	
F 00Z B20 002	2 434 614 048	3		2 430 210 083			F 00V C17 503	
F 00Z B20 002	2 434 614 040	3			2 433 370 467			
F 00Z B20 002	2 434 614 040	3			2 433 370 467		2 430 105 049	
F 00Z B20 002	2 434 614 040	3			2 433 370 467			
F 00Z B20 002	2 434 614 040	3			2 433 370 467		2 430 105 049	
2 433 124 361	2 434 614 022	5				2 916 710 602	F 00V C17 503	
			A					
F 00Z B20 001	2 434 614 041	3			2 433 370 467		2 430 105 049	
			A				F 00V C17 503	
		3						
2 433 124 376	2 434 614 040	6						
	2 434 614 040	3						

*) siehe Seite 388/see page 388/voir page 388/ver pagina 388/vease página 388

**) siehe Seite 392/see page 392/voir page 392/ver pagina 392/vease página 392

de

Ersatzteile für
Düsenhalter-
kombinationen
(Fortsetzung)

en

Spare parts for
nozzle-and-holder
assemblies
(continued)

fr

Pièces de rechange
pour ensembles
porte-injecteurs
(suite)

it

Ricambi per
combinazione
portapolverizzatori
(seguito)

es

Piezas de repuesto
para conjuntos
portainyectoros
(continuación)



Fig.



Ref.



Typ



①



Typ



②



③

0 432 191 405	1	0 431 113 918	KBEL 98 P 221	0 433 171 605	DLLA 148 P 911	2 433 314 042	2 430 136 212
0 432 191 406	1	0 431 113 043	KBAL 96 P 112	0 433 171 258	DLLA 147 P 361	2 433 314 182	2 430 134 023
0 432 191 407	1	0 431 114 967	KBEL 100 P 141	0 433 171 436	DLLA 160 P 577	2 433 349 189	F 00Z Z20 003
0 432 191 408	1	0 431 113 043	KBAL 96 P 112	0 433 171 533	DLLA 147 P 734	2 433 314 182	2 430 134 023
0 432 191 409	1	0 431 115 989	KBEL 162 P 210	0 433 171 658	DLLA 145 P 1015	2 433 349 322	2 430 136 212
0 432 191 410	1	0 431 115 990	KBEL 162 P 209	0 433 171 658	DLLA 145 P 1015	2 433 349 322	2 430 136 212
0 432 191 411	1	0 431 113 043	KBAL 96 P 112	0 433 171 257	DLLA 147 P 360	2 433 314 182	2 430 134 023
0 432 191 412	1	0 431 113 043	KBAL 96 P 112	0 433 171 263	DLLA 147 P 370	2 433 314 182	2 430 134 023
0 432 191 413	1	0 431 113 042	KBAL 95 P 111	0 433 171 657	DLLA 145 P 1014	2 433 314 182	2 430 134 023
0 432 191 414	1	0 431 113 919	KBEL 94 P 220	0 433 171 583	DLLA 154 P 866	2 433 349 198	F 00Z Z20 003
0 432 191 415	1	0 431 113 920	KBEL 94 P 219	0 433 171 583	DLLA 154 P 866	2 433 349 198	F 00Z Z20 003
0 432 191 416	1	0 431 113 921	KBEL 94 P 218	0 433 171 583	DLLA 154 P 866	2 433 349 197	F 00Z Z20 003
0 432 191 417	1	0 431 113 919	KBEL 94 P 220	0 433 171 640	DLLA 152 P 967	2 433 349 198	F 00Z Z20 003
0 432 191 418	1	0 431 113 920	KBEL 94 P 219	0 433 171 640	DLLA 152 P 967	2 433 349 198	F 00Z Z20 003
0 432 191 419	1	0 431 113 921	KBEL 94 P 218	0 433 171 640	DLLA 152 P 967	2 433 349 197	F 00Z Z20 003
0 432 191 420	1	0 431 113 920	KBEL 94 P 219	0 433 171 639	DLLA 154 P 965	2 433 349 198	F 00Z Z20 003
0 432 191 421	1	0 431 113 921	KBEL 94 P 218	0 433 171 639	DLLA 154 P 965	2 433 349 197	F 00Z Z20 003
0 432 191 422	1	0 431 113 923	KBEL 93 P 216	0 433 171 656	DLLA 148 P 1013	2 433 349 446	F 00Z Z20 003
0 432 191 423	1	0 431 114 967	KBEL 100 P 141	0 433 171 655	DLLA 150 P 1012	2 433 349 189	F 00Z Z20 003
0 432 191 424	1	0 431 113 931	KBEL 99 P 188	0 433 171 653	DLLA 148 P 1010	2 433 349 446	F 00Z Z20 003
0 432 191 425	1	0 431 113 940	KBEL 98 P 160	0 433 171 652	DLLA 141 P 1009	2 433 314 042	2 430 136 212
0 432 191 426	1	0 431 113 923	KBEL 93 P 216	0 433 171 651	DLLA 150 P 1008	2 433 349 446	F 00Z Z20 003
0 432 191 427	1	0 431 114 967	KBEL 100 P 141	0 433 171 643	DLLA 150 P 983	2 433 349 189	F 00Z Z20 003
0 432 191 435	1	0 431 113 969	KBEL 98 P 74	0 433 171 636	DLLA 145 P 961	2 433 314 042	2 430 136 166
0 432 191 437	1	0 431 114 967	KBEL 100 P 141	0 433 171 634	DLLA 150 P 957	2 433 349 189	F 00Z Z20 003
0 432 191 438	1	0 431 113 950	KBEL 90 P 124	0 433 171 633	DLLA 142 P 956	2 433 314 042	2 430 136 212
0 432 191 439	1	0 431 113 927	KBEL 98 P 205	0 433 171 605	DLLA 148 P 911	2 433 314 042	2 430 136 212
0 432 191 440	1	0 431 113 961	KBEL 84 P 93	0 433 171 632	DLLA 150 P 952	2 433 314 053	2 430 136 166
0 432 191 446	1	0 431 114 967	KBEL 100 P 141	0 433 171 628	DLLA 150 P 943	2 433 349 189	F 00Z Z20 003
0 432 191 447	1	0 431 115 989	KBEL 162 P 210	0 433 171 534	DLLA 155 P 742	2 433 349 322	2 430 136 212
0 432 191 448	1	0 431 115 990	KBEL 162 P 209	0 433 171 534	DLLA 155 P 742	2 433 349 322	2 430 136 212
0 432 191 449	1	0 431 113 040	KBAL 96 P 101	0 433 171 625	DLLA 151 P 942	2 433 314 182	2 430 134 023
0 432 191 450	1	0 431 113 040	KBAL 96 P 101	0 433 171 624	DLLA 151 P 941	2 433 314 182	2 430 134 023
0 432 191 451	1	0 431 113 026	KBAL 96 P 80	0 433 171 623	DLLA 151 P 940	2 433 314 182	2 430 134 023
0 432 191 452	1	0 431 113 026	KBAL 96 P 80	0 433 171 622	DLLA 151 P 939	2 433 314 182	2 430 134 023
0 432 191 453	1	0 431 114 967	KBEL 100 P 141	0 433 171 620	DLLA 150 P 930	2 433 349 189	F 00Z Z20 003
0 432 191 454	1	0 431 113 935	KBEL 93 P 177	0 433 171 615	DLLA 148 P 924	2 433 349 446	F 00Z Z20 003
0 432 191 456	1	0 431 114 967	KBEL 100 P 141	0 433 171 610	DLLA 150 P 916	2 433 349 189	F 00Z Z20 003
0 432 191 457	1	0 431 114 967	KBEL 100 P 141	0 433 171 634	DLLA 150 P 957	2 433 349 189	F 00Z Z20 003
0 432 191 458	1	0 431 113 926	KBEL 97 P 206	0 433 171 442	DLLA 140 P 583	2 433 349 112	2 430 136 212
0 432 191 459	1	0 431 114 967	KBEL 100 P 141	0 433 171 607	DLLA 150 P 913	2 433 349 189	F 00Z Z20 003
0 432 191 460	1	0 431 113 956	KBEL 98 P 102	0 433 171 606	DLLA 148 P 912	2 433 314 042	2 430 136 212
0 432 191 461	1	0 431 113 956	KBEL 98 P 102	0 433 171 605	DLLA 148 P 911	2 433 314 042	2 430 136 212
0 432 191 463	1	0 431 114 962	KBEL 100 P 169	0 433 171 566	DLLA 156 P 828+	2 433 349 189	F 00Z Z20 003
0 432 191 464	2	0 431 114 957	KBEL 101 P 186	2 437 010 116	DLLA 144 P 908	2 433 314 053	



2 433 124 376	2 434 614 040	3					
2 433 124 446	2 434 614 020	1					
F 00Z B20 001	2 434 614 041	3					2 430 105 049
2 433 124 446	2 434 614 020	1					
2 433 124 995	2 434 614 040	3			2 433 370 507		
2 433 124 376	2 434 614 040	3			2 433 370 507		
2 433 124 446	2 434 614 020	1					
2 433 124 446	2 434 614 020	1					
2 433 124 446	2 434 614 020	6					
	2 434 614 040	3			F 00R J01 247		
	2 434 614 040	3			F 00R J01 247		
F 00Z B20 002	2 434 614 040	3			F 00R J01 247		
	2 434 614 040	3			F 00R J01 247		
	2 434 614 040	3			F 00R J01 247		
F 00Z B20 002	2 434 614 040	3			F 00R J01 247		
	2 434 614 040	3			F 00R J01 247		
F 00Z B20 002	2 434 614 040	3			F 00R J01 247		
	2 434 614 048	3		2 430 210 083			F 00V C17 503
F 00Z B20 001	2 434 614 041	3			2 433 370 475		2 430 105 049
F 00Z B20 001	2 434 614 041	3		2 430 210 081			2 430 105 049
2 433 124 376	2 434 614 040	3					
F 00Z B20 002	2 434 614 048	3		2 430 210 083			F 00V C17 503
F 00Z B20 001	2 434 614 041	3			2 433 370 472		2 430 105 049
2 433 124 388	2 434 614 022	5					
F 00Z B20 001	2 434 614 041	3			2 433 370 467		2 430 105 049
2 433 124 376	2 434 614 040	3				2 916 710 602	
	2 434 614 040	3					
2 433 124 388	2 434 614 022	5					
F 00Z B20 001	2 434 614 041	3			2 433 370 467		2 430 105 049
2 433 124 995	2 434 614 040	3			2 433 370 507		
2 433 124 376	2 434 614 040	3			2 433 370 507		
2 433 124 446	2 434 614 020	1					
2 433 124 446	2 434 614 020	1					
2 433 124 446	2 434 614 020	6					
2 433 124 446	2 434 614 020	6					
F 00Z B20 001	2 434 614 041	3					2 430 105 049
F 00Z B20 002	2 434 614 040	3		2 430 210 083			F 00V C17 503
F 00Z B20 001	2 434 614 041	3					2 430 105 049
F 00Z B20 001	2 434 614 041	3					2 430 105 049
2 433 124 376	2 434 614 040	6					
F 00Z B20 001	2 434 614 041	3			2 433 370 467		2 430 105 049
2 433 124 376	2 434 614 040	3					
2 433 124 376	2 434 614 040	3					
F 00Z B20 002	2 434 614 040	3			2 433 370 467		2 430 105 049

B

*) siehe Seite 388/see page 388/voir page 388/ver pagina 388/vease página 388

**) siehe Seite 392/see page 392/voir page 392/ver pagina 392/vease página 392

A300

de
Ersatzteile für
Düsenhalter-
kombinationen
(Fortsetzung)

en
Spare parts for
nozzle-and-holder
assemblies
(continued)

fr
Pièces de rechange
pour ensembles
porte-injecteurs
(suite)

it
Ricambi per
combinazione
portapolverizzatori
(seguito)

es
Piezas de repuesto
para conjuntos
portainyectoros
(continuación)



0 432 191 465	2	0 431 114 958	KBEL 101 P 185	2 437 010 116	DLLA 144 P 908	2 433 314 053	
0 432 191 466	1	0 431 113 927	KBEL 98 P 205	0 433 171 556	DLLA 145 P 809	2 433 314 042	2 430 136 236
0 432 191 467	1	0 431 114 967	KBEL 100 P 141	0 433 171 599	DLLA 150 P 901	2 433 349 189	F 00Z Z20 003
0 432 191 468	1	0 431 114 959	KBEL 100 P 184	0 433 171 597	DLLA 156 P 897+	2 433 349 189	F 00Z Z20 003
0 432 191 469	1	0 431 114 967	KBEL 100 P 141	0 433 171 595	DLLA 150 P 892	2 433 349 189	F 00Z Z20 003
0 432 191 470	1	0 431 114 969	KBEL 106 P 135	0 433 171 593	DLLA 157 P 888	2 433 349 446	F 00Z Z20 003
0 432 191 471	1	0 431 114 010	KBAL 101 P 67	0 433 171 591	DLLA 147 P 884	2 433 314 182	2 430 134 023
0 432 191 472	1	0 431 113 041	KBAL 96 P 102	0 433 171 329	DLLA 158 P 456/	2 433 314 182	2 430 134 023
0 432 191 473	1	0 431 113 010	KBAL 96 P 41	0 433 171 590	DLLA 147 P 880	2 433 314 182	2 430 134 023
0 432 191 474	1	0 431 113 040	KBAL 96 P 101	0 433 171 446	DLLA 158 P 587	2 433 314 182	2 430 134 023
0 432 191 475	1	0 431 113 040	KBAL 96 P 101	0 433 171 506	DLLA 158 P 691	2 433 314 182	2 430 134 023
0 432 191 479	1	0 431 114 010	KBAL 101 P 67	0 433 171 585	DLLA 147 P 875	2 433 314 182	2 430 134 023
0 432 191 480	1	0 431 113 026	KBAL 96 P 80	0 433 171 586	DLLA 152 P 876	2 433 314 182	2 430 134 023
0 432 191 481	1	0 431 113 026	KBAL 96 P 80	0 433 171 587	DLLA 152 P 877	2 433 314 182	2 430 134 023
0 432 191 482	1	0 431 113 933	KBEL 94 P 180	0 433 171 583	DLLA 154 P 866	2 433 349 198	F 00Z Z20 003
0 432 191 484	1	0 431 113 939	KBEL 84 P 162	0 433 171 514	DLLA 153 P 700	2 433 349 446	F 00Z Z20 003
0 432 191 487	1	0 431 114 010	KBAL 101 P 67	0 433 171 579	DLLA 147 P 854	2 433 314 182	2 430 134 023
0 432 191 488	1	0 431 114 962	KBEL 100 P 169	0 433 171 566	DLLA 156 P 828+	2 433 349 189	F 00Z Z20 003
0 432 191 489	1	0 431 114 962	KBEL 100 P 169	0 433 171 688	DLLA 156 P 1059	2 433 349 189	F 00Z Z20 003
0 432 191 490	1	0 431 113 034	KBAL 95 P 97	0 433 171 577	DLLA 145 P 849	2 433 314 182	2 430 134 023
0 432 191 491	1	0 431 113 931	KBEL 99 P 188	0 433 171 570	DLLA 148 P 836	2 433 349 446	F 00Z Z20 003
0 432 191 492	1	0 431 113 969	KBEL 98 P 74	0 433 171 568	DLLA 145 P 832	2 433 314 042	2 430 136 166
0 432 191 494	2	0 431 114 957	KBEL 101 P 186	2 437 010 098	DLLA 144 P 825	2 433 314 053	
0 432 191 495	2	0 431 114 958	KBEL 101 P 185	2 437 010 098	DLLA 144 P 825	2 433 314 053	
0 432 191 498	1	0 431 113 935	KBEL 93 P 177	0 433 171 525	DLLA 150 P 722	2 433 349 446	F 00Z Z20 003
0 432 191 502	1	0 431 113 947	KBEL 84 P 148	0 433 171 397	DLLA 145 P 536	2 433 314 053	2 430 136 166
0 432 191 503	1	0 431 114 967	KBEL 100 P 141	0 433 171 559	DLLA 150 P 812	2 433 349 189	F 00Z Z20 003
0 432 191 504	1	0 431 114 969	KBEL 106 P 135	0 433 171 557	DLLA 153 P 810	2 433 349 446	F 00Z Z20 003
0 432 191 505	1	0 431 113 937	KBEL 98 P 173	0 433 171 556	DLLA 145 P 809	2 433 314 042	2 430 136 212
0 432 191 506	1	0 431 113 956	KBEL 98 P 102	0 433 171 556	DLLA 145 P 809	2 433 314 042	2 430 136 212
0 432 191 509	1	0 431 113 969	KBEL 98 P 74	0 433 171 550	DLLA 145 P 785	2 433 314 042	2 430 136 166
0 432 191 510	1	0 431 113 026	KBAL 96 P 80	0 433 171 443	DLLA 158 P 584	2 433 314 182	2 430 134 023
0 432 191 511	1	0 431 113 966	KBEL 83 P 78	0 433 171 549	DLLA 135 P 782	2 433 349 126	2 430 136 166
0 432 191 512	1	0 431 113 935	KBEL 93 P 177	0 433 171 526	DLLA 150 P 723	2 433 349 446	F 00Z Z20 003
0 432 191 513	1	0 431 113 936	KBEL 95 P 175	0 433 171 547	DLLA 135 P 769+	2 433 314 042	2 430 136 212
0 432 191 515	1	0 431 113 028	KBAL 72 P 83	0 433 171 281	DLLA 145 P 394	2 433 314 182	2 430 134 023
0 432 191 517	1	0 431 113 950	KBEL 90 P 124	0 433 171 543	DLLA 134 P 760	2 433 314 042	2 430 136 212
0 432 191 518	1	0 431 114 961	KBEL 110 P 172	0 433 171 354	DLLA 144 P 490	2 433 349 436	2 430 136 212
0 432 191 519	1	0 431 114 961	KBEL 110 P 172	0 433 171 501	DLLA 152 P 685	2 433 349 436	2 430 136 212
0 432 191 520	1	0 431 114 961	KBEL 110 P 172	0 433 171 480	DLLA 152 P 660	2 433 349 436	2 430 136 212
0 432 191 521	1	0 431 114 961	KBEL 110 P 172	0 433 171 323	DLLA 144 P 449	2 433 349 436	2 430 136 212
0 432 191 522	1	0 431 114 961	KBEL 110 P 172	0 433 171 324	DLLA 144 P 450	2 433 349 436	2 430 136 212
0 432 191 523	1	0 431 113 006	KBAL 96 P 35	0 433 171 541	DLLA 147 P 754	2 433 314 182	2 430 134 023
0 432 191 524	1	0 431 113 006	KBAL 96 P 35	0 433 171 540	DLLA 147 P 753	2 433 314 182	2 430 134 023
0 432 191 525	1	0 431 113 006	KBAL 96 P 35	0 433 171 539	DLLA 147 P 752	2 433 314 182	2 430 134 023



			B					
	2 434 614 040	3						
F 00Z B20 001	2 434 614 041	3			2 433 370 472		2 430 105 049	
F 00Z B20 002	2 434 614 040	3			2 433 370 467		F 00Z W00 003	
F 00Z B20 001	2 434 614 041	3			2 433 370 472		2 430 105 049	
F 00Z B20 002	2 434 614 040	3			2 433 370 447			
2 433 124 446	2 434 614 010	1						
2 433 124 446	2 434 614 020	1						
2 433 124 446	2 434 614 020	1						
2 433 124 446	2 434 614 020	1						
2 433 124 446	2 434 614 020	1						
2 433 124 446	2 434 614 010	1						
2 433 124 446	2 434 614 020	6						
2 433 124 446	2 434 614 020	1						
	2 434 614 040	3			2 433 370 471			
F 00Z B20 002	2 434 614 040	3		2 430 210 083			F 00V C17 503	
2 433 124 446	2 434 614 010	1						
F 00Z B20 002	2 434 614 040	3			2 433 370 467			
F 00Z B20 002	2 434 614 040	3			2 433 370 467			
2 433 124 446	2 434 614 020	6						
F 00Z B20 001	2 434 614 041	3		2 430 210 081			2 430 105 049	
2 433 124 388	2 434 614 022	5						
F 00Z B20 002	2 434 614 040	3		2 430 210 083			F 00V C17 503	
2 433 124 388	2 434 614 022	5						
F 00Z B20 001	2 434 614 041	3			2 433 370 472		2 430 105 049	
F 00Z B20 002	2 434 614 040	3			2 433 370 447			
2 433 124 364	2 434 614 040	3						
2 433 124 376	2 434 614 040	3						
2 433 124 388	2 434 614 022	5						
2 433 124 446	2 434 614 020	6						
2 433 124 388	2 434 614 030	5				2 916 710 602		
F 00Z B20 002	2 434 614 040	3					F 00V C17 503	
2 433 124 376	2 434 614 040	3			2 433 370 434	2 916 710 603		
2 433 124 446	2 434 614 020	1						
2 433 124 376	2 434 614 040	3				2 916 710 602		
2 433 124 376	2 434 614 040	3						
2 433 124 376	2 434 614 040	3						
2 433 124 376	2 434 614 040	3						
2 433 124 376	2 434 614 040	3						
2 433 124 446	2 434 614 020	1						
2 433 124 446	2 434 614 020	1						
2 433 124 446	2 434 614 020	1						

*) siehe Seite 388/see page 388/voir page 388/ver pagina 388/vease página 388

**) siehe Seite 392/see page 392/voir page 392/ver pagina 392/vease página 392

A302

de
Ersatzteile für
Düsenhalter-
kombinationen
(Fortsetzung)

en
Spare parts for
nozzle-and-holder
assemblies
(continued)









fr
Pièces de rechange
pour ensembles
porte-injecteurs
(suite)

it
Ricambi per
combinazione
portapolverizzatori
(seguito)

es
Piezas de repuesto
para conjuntos
portainyectoros
(continuación)



0 432 191 526	1	0 431 114 962	KBEL 100 P 169	0 433 171 688	DLLA 156 P 1059	2 433 349 189	F 00Z Z20 003
0 432 191 527	2	0 431 115 006	KBAL 140 P 75	2 437 010 057	DLLA 145 P 748	2 433 349 249	
0 432 191 528	2	0 431 115 005	KBAL 140 P 74	2 437 010 057	DLLA 145 P 748	2 433 349 249	
0 432 191 529	1	0 431 113 956	KBEL 98 P 102	0 433 171 211	DLLA 145 P 286	2 433 314 042	2 430 136 212
0 432 191 530	1	0 431 113 026	KBAL 96 P 80	0 433 171 446	DLLA 158 P 587	2 433 314 182	2 430 134 023
0 432 191 531	1	0 431 114 005	KBAL 105 P 29	0 433 171 204	DLLA 155 P 270	2 433 314 182	2 430 134 023
0 432 191 534	1	0 431 115 993	KBEL 162 P 164	0 433 171 534	DLLA 155 P 742	2 433 349 322	2 430 136 212
0 432 191 535	1	0 431 113 006	KBAL 96 P 35	0 433 171 533	DLLA 147 P 734	2 433 314 182	2 430 134 023
0 432 191 537	1	0 431 114 984	KBEL 109 P 81	0 433 171 531	DLLA 142 P 732	2 433 349 131	2 430 136 166
0 432 191 538	1	0 431 113 006	KBAL 96 P 35	0 433 171 530	DLLA 158 P 730	2 433 314 182	2 430 134 023
0 432 191 539	1	0 431 113 006	KBAL 96 P 35	0 433 171 529	DLLA 158 P 729	2 433 314 182	2 430 134 023
0 432 191 540	1	0 431 113 026	KBAL 96 P 80	0 433 171 528	DLLA 158 P 728	2 433 314 182	2 430 134 023
0 432 191 541	1	0 431 113 947	KBEL 84 P 148	0 433 171 317	DLLA 145 P 439	2 433 314 053	2 430 136 166
0 432 191 542	1	0 431 113 947	KBEL 84 P 148	0 433 171 397	DLLA 145 P 536	2 433 314 053	2 430 136 166
0 432 191 543	1	0 431 114 967	KBEL 100 P 141	F 00Z 2TS 002	DLLA 150 P 1205+	2 433 349 189	F 00Z Z20 003
0 432 191 544	1	0 431 113 938	KBEL 93 P 167	0 433 171 526	DLLA 150 P 723	2 433 349 446	F 00Z Z20 003
0 432 191 546	1	0 431 113 939	KBEL 84 P 162	0 433 171 525	DLLA 150 P 722	2 433 349 446	F 00Z Z20 003
0 432 191 551	1	0 431 114 967	KBEL 100 P 141	0 433 171 436	DLLA 160 P 577	2 433 349 189	F 00Z Z20 003
0 432 191 552	1	0 431 114 985	KBEL 117 P 73	0 433 171 521	DLLA 150 P 711	2 433 314 042	2 430 136 166
0 432 191 553	1	0 431 114 967	KBEL 100 P 141	F 00Z 2TS 003	DLLA 154 P 1206+	2 433 349 189	F 00Z Z20 003
0 432 191 556	1	0 431 113 939	KBEL 84 P 162	0 433 171 514	DLLA 153 P 700	2 433 349 446	F 00Z Z20 003
0 432 191 560	1	0 431 115 002	KBAL 137 P 26	0 433 171 507	DLLA 160 P 692	2 433 349 468	2 430 134 023
0 432 191 561	1	0 431 113 010	KBAL 96 P 41	0 433 171 506	DLLA 158 P 691	2 433 314 182	2 430 134 023
0 432 191 565	1	0 431 114 977	KBEL 100 P 118	0 433 171 501	DLLA 152 P 685	2 433 349 436	2 430 136 212
0 432 191 566	1	0 431 113 010	KBAL 96 P 41	0 433 171 496	DLLA 158 P 684	2 433 314 182	2 430 134 023
0 432 191 567	1	0 431 114 965	KBEL 117 P 163	0 433 171 404	DLLA 150 P 550	2 433 349 112	2 430 136 166
0 432 191 568	1	0 431 114 010	KBAL 101 P 67	0 433 171 495	DLLA 147 P 680	2 433 314 182	2 430 134 023
0 432 191 569	1	0 431 114 007	KBAL 105 P 51	0 433 171 494	DLLA 150 P 679	2 433 314 182	2 430 134 023
0 432 191 570	1	0 431 114 969	KBEL 106 P 135	0 433 171 493	DLLA 158 P 678	2 433 349 446	F 00Z Z20 003
0 432 191 571	1	0 431 113 939	KBEL 84 P 162	0 433 171 442	DLLA 140 P 583	2 433 349 446	F 00Z Z20 003
0 432 191 576	1	0 431 114 005	KBAL 105 P 29	0 433 171 487	DLLA 155 P 670	2 433 314 182	2 430 134 023
0 432 191 577	1	0 431 113 947	KBEL 84 P 148	0 433 171 486	DLLA 145 P 669	2 433 314 053	2 430 136 166
0 432 191 578	1	0 431 112 984	KBEL 63 P 66	0 433 171 483	DLLA 160 P 664	2 433 349 449	2 430 136 166
0 432 191 580	1	0 431 114 977	KBEL 100 P 118	0 433 171 480	DLLA 152 P 660	2 433 349 436	2 430 136 212
0 432 191 581	1	0 431 113 940	KBEL 98 P 160	0 433 171 479	DLLA 145 P 659	2 433 314 042	2 430 136 212
0 432 191 582	1	0 431 114 010	KBAL 101 P 67	0 433 171 478	DLLA 147 P 658	2 433 314 182	2 430 134 023
0 432 191 583	1	0 431 114 969	KBEL 106 P 135	0 433 171 465	DLLA 155 P 657	2 433 349 446	F 00Z Z20 003
0 432 191 584	1	0 431 114 972	KBEL 100 P 127	0 433 171 476	DLLA 150 P 652	2 433 349 189	F 00Z Z20 003
0 432 191 585	1	0 431 113 942	KBEL 94 P 156	0 433 171 475	DLLA 158 P 651	2 433 314 053	2 430 136 212
0 432 191 586	1	0 431 114 973	KBEL 100 P 126	0 433 171 474	DLLA 148 P 650	2 433 314 042	2 430 136 212
0 432 191 588	1	0 431 114 005	KBAL 105 P 29	0 433 171 472	DLLA 140 P 637	2 433 314 182	2 430 134 023
0 432 191 589	1	0 431 114 967	KBEL 100 P 141	0 433 171 450	DLLA 154 P 596	2 433 349 189	F 00Z Z20 003
0 432 191 590	1	0 431 114 967	KBEL 100 P 141	0 433 171 471	DLLA 159 P 636	2 433 349 189	F 00Z Z20 003
0 432 191 591	1	0 431 113 947	KBEL 84 P 148	0 433 171 468	DLLA 145 P 632	2 433 314 053	2 430 136 166
0 432 191 592	1	0 431 114 007	KBAL 105 P 51	0 433 171 467	DLLA 140 P 629	2 433 314 182	2 430 134 023

							
④	⑤	⑥	⑦	⑧	⑨	⑩	⑪
F 00Z B20 002	2 434 614 040	3			2 433 370 467		2 430 105 049
		A				2 916 710 602	F 00V C17 503
		A				2 916 710 602	F 00V C17 503
2 433 124 376	2 434 614 040	3					
2 433 124 446	2 434 614 020	6					
2 433 124 446	2 434 614 020	1					F 00V C17 503
2 433 124 376	2 434 614 040	3			2 433 370 507		
2 433 124 446	2 434 614 020	1					
2 433 124 388	2 434 614 027	5				2 916 710 602	
2 433 124 446	2 434 614 020	1					
2 433 124 446	2 434 614 020	1					
2 433 124 446	2 434 614 020	6					
2 433 124 388	2 434 614 022	5					
2 433 124 388	2 434 614 022	5					
F 00Z B20 001	2 434 614 041	3			2 433 370 475		2 430 105 049
F 00Z B20 002	2 434 614 040	3					F 00V C17 503
F 00Z B20 002	2 434 614 040	3					F 00V C17 503
F 00Z B20 001	2 434 614 041	3					2 430 105 049
2 433 124 388	2 434 614 022	5					
F 00Z B20 001	2 434 614 041	3			2 433 370 467		2 430 105 049
F 00Z B20 002	2 434 614 040	3					F 00V C17 503
2 433 124 446	2 434 614 020	6					
2 433 124 446	2 434 614 020	1					
2 433 124 376	2 434 614 040	3					
2 433 124 446	2 434 614 020	1					
2 433 124 388	2 434 614 022	5					
2 433 124 446	2 434 614 010	1					
2 433 124 446	2 434 614 020	1					F 00V C17 503
F 00Z B20 002	2 434 614 040	3			2 433 370 447		F 00V C17 503
F 00Z B20 002	2 434 614 040	3					F 00V C17 503
2 433 124 446	2 434 614 020	1					F 00V C17 503
2 433 124 388	2 434 614 022	5					
2 433 124 388	2 434 614 022	5				2 916 710 602	
2 433 124 376	2 434 614 040	3					
2 433 124 376	2 434 614 040	3					
2 433 124 446	2 434 614 010	1					
F 00Z B20 002	2 434 614 040	3			2 433 370 447		
F 00Z B20 001	2 434 614 041	3			2 433 370 458		
2 433 124 376	2 434 614 040	3					
2 433 124 376	2 434 614 040	3				2 916 710 603	
2 433 124 446	2 434 614 020	1					F 00V C17 503
F 00Z B20 001	2 434 614 041	3			2 433 370 467		2 430 105 049
F 00Z B20 001	2 434 614 041	3					
2 433 124 388	2 434 614 022	5					
2 433 124 446	2 434 614 020	1					F 00V C17 503

*) siehe Seite 388/see page 388/voir page 388/ver pagina 388/vease página 388

**) siehe Seite 392/see page 392/voir page 392/ver pagina 392/vease página 392

A304

de

Ersatzteile für
Düsenhalter-
kombinationen
(Fortsetzung)

en

Spare parts for
nozzle-and-holder
assemblies
(continued)

fr

Pièces de rechange
pour ensembles
porte-injecteurs
(suite)

it

Ricambi per
combinazione
portapolverizzatori
(seguito)

es

Piezas de repuesto
para conjuntos
portainyectoros
(continuación)



Fig.



Ref.



Typ



①



Typ













②



③

0 432 191 593	1	0 431 113 952	KBEL 88 P 115	0 433 171 462	DLLA 150 P 615+	2 433 314 053	2 430 136 166
0 432 191 594	1	0 431 114 005	KBAL 105 P 29	0 433 171 461	DLLA 155 P 614	2 433 314 182	2 430 134 023
0 432 191 595	1	0 431 114 005	KBAL 105 P 29	0 433 171 444	DLLA 150 P 585	2 433 314 182	2 430 134 023
0 432 191 596	1	0 431 114 972	KBEL 100 P 127	0 433 171 450	DLLA 154 P 596	2 433 349 189	F 00Z Z20 003
0 432 191 599	1	0 431 113 010	KBAL 96 P 41	0 433 171 446	DLLA 158 P 587	2 433 314 182	2 430 134 023
0 432 191 600	1	0 431 113 969	KBEL 98 P 74	0 433 171 445	DLLA 148 P 586	2 433 314 042	2 430 136 166
0 432 191 601	1	0 431 114 009	KBAL 105 P 62	0 433 171 444	DLLA 150 P 585	2 433 314 182	2 430 134 023
0 432 191 602	1	0 431 113 010	KBAL 96 P 41	0 433 171 443	DLLA 158 P 584	2 433 314 182	2 430 134 023
0 432 191 603	1	0 431 113 948	KBEL 97 P 136	0 433 171 442	DLLA 140 P 583	2 433 349 112	2 430 136 212
0 432 191 604	1	0 431 114 969	KBEL 106 P 135	0 433 171 438	DLLA 155 P 579+	2 433 349 446	F 00Z Z20 003
0 432 191 605	1	0 431 113 015	KBAL 95 P 53	0 433 171 415	DLLA 144 P 568	2 433 314 182	2 430 134 023
0 432 191 606	1	0 431 114 981	KBEL 108 P 85	0 433 171 413	DLLA 155 P 564	2 433 314 053	2 430 136 166
0 432 191 609	1	0 431 114 970	KBEL 110 P 132	0 433 171 409	DLLA 154 P 557	2 433 314 042	2 430 136 212
0 432 191 610	1	0 431 115 995	KBEL 132 P 110	0 433 171 408	DLLA 155 P 556	2 433 349 172	2 430 136 212
0 432 191 611	1	0 431 114 975	KBEL 117 P 122	0 433 171 407	DLLA 150 P 555	2 433 314 042	2 430 136 212
0 432 191 612	1	0 431 114 975	KBEL 117 P 122	0 433 171 432	DLLA 152 P 571	2 433 314 042	2 430 136 212
0 432 191 613	1	0 431 113 018	KBAL 80 P 58	0 433 171 405	DLLA 150 P 552	2 433 314 182	2 430 134 023
0 432 191 614	1	0 431 114 985	KBEL 117 P 73	0 433 171 404	DLLA 150 P 550	2 433 314 042	2 430 136 166
0 432 191 616	1	0 431 114 955	KBEL 117 P 227	0 433 171 400	DLLA 149 P 541	2 433 314 042	2 430 136 212
0 432 191 617	1	0 431 113 961	KBEL 84 P 93	0 433 171 399	DLLA 135 P 539	2 433 314 053	2 430 136 166
0 432 191 618	1	0 431 113 954	KBEL 83 P 105	0 433 171 397	DLLA 145 P 536	2 433 314 053	2 430 136 166
0 432 191 619	1	0 431 114 005	KBAL 105 P 29	0 433 171 396	DLLA 155 P 534	2 433 314 182	2 430 134 023
0 432 191 620	1	0 431 114 972	KBEL 100 P 127	0 433 171 436	DLLA 160 P 577	2 433 349 189	F 00Z Z20 003
0 432 191 621	1	0 431 113 961	KBEL 84 P 93	0 433 171 393	DLLA 135 P 530	2 433 314 053	2 430 136 166
0 432 191 622	1	0 431 114 973	KBEL 100 P 126	0 433 171 391	DLLA 149 P 528	2 433 314 042	2 430 136 212
0 432 191 623	1	0 431 113 015	KBAL 95 P 53	0 433 171 390	DLLA 144 P 527	2 433 314 182	2 430 134 023
0 432 191 624	1	0 431 113 015	KBAL 95 P 53	0 433 171 390	DLLA 144 P 527	2 433 314 182	2 430 134 023
0 432 191 625	1	0 431 113 015	KBAL 95 P 53	0 433 171 385	DLLA 144 P 521	2 433 314 182	2 430 134 023
0 432 191 626	1	0 431 114 981	KBEL 108 P 85	0 433 171 389	DLLA 153 P 526	2 433 314 053	2 430 136 166
0 432 191 627	1	0 431 113 015	KBAL 95 P 53	0 433 171 385	DLLA 144 P 521	2 433 314 182	2 430 134 023
0 432 191 628	1	0 431 114 005	KBAL 105 P 29	0 433 171 372	DLLA 140 P 518	2 433 314 182	2 430 134 023
0 432 191 629	1	0 431 114 005	KBAL 105 P 29	0 433 171 371	DLLA 140 P 517	2 433 314 182	2 430 134 023
0 432 191 630	1	0 431 113 972	KBEL 100 P 64	0 433 171 369	DLLA 148 P 513	2 433 314 042	2 430 136 166
0 432 191 631	1	0 431 113 950	KBEL 90 P 124	0 433 171 357	DLLA 143 P 495	2 433 314 042	2 430 136 212
0 432 191 632	1	0 431 114 005	KBAL 105 P 29	0 433 171 204	DLLA 155 P 270	2 433 314 182	2 430 134 023
0 432 191 633	1	0 431 114 974	KBEL 100 P 123	0 433 171 366	DLLA 144 P 510	2 433 314 042	2 430 136 212
0 432 191 634	1	0 431 113 956	KBEL 98 P 102	0 433 171 363	DLLA 145 P 504	2 433 314 042	2 430 136 212
0 432 191 635	1	0 431 114 975	KBEL 117 P 122	0 433 171 362	DLLA 151 P 503	2 433 314 042	2 430 136 212
0 432 191 636	1	0 431 114 005	KBAL 105 P 29	0 433 171 359	DLLA 150 P 497	2 433 314 182	2 430 134 023
0 432 191 637	1	0 431 114 007	KBAL 105 P 51	0 433 171 347	DLLA 140 P 483	2 433 314 182	2 430 134 023
0 432 191 638	1	0 431 114 976	KBEL 110 P 121	0 433 171 356	DLLA 157 P 494	2 433 314 042	2 430 136 212
0 432 191 639	1	0 431 114 977	KBEL 100 P 118	0 433 171 354	DLLA 144 P 490	2 433 349 436	2 430 136 212
0 432 191 640	1	0 431 112 968	KBEL 53 P 117	0 433 171 251	DLLA 144 P 354	2 433 314 053	2 430 136 166
0 432 191 641	1	0 431 113 961	KBEL 84 P 93	0 433 171 349	DLLA 143 P 485	2 433 314 053	2 430 136 166
0 432 191 642	1	0 431 114 005	KBAL 105 P 29	0 433 171 347	DLLA 140 P 483	2 433 314 182	2 430 134 023

									
④	⑤	⑥	⑦	⑧	⑨	⑩	⑪		
2 433 124 388	2 434 614 022	5							
2 433 124 446	2 434 614 020	1						2 430 105 042	
2 433 124 446	2 434 614 020	1						2 430 105 042	
F 00Z B20 001	2 434 614 041	3				2 433 370 467			
2 433 124 446	2 434 614 020	1							
2 433 124 388	2 434 614 022	5							
2 433 124 446	2 434 614 020	1						2 430 105 042	
2 433 124 446	2 434 614 020	1							
2 433 124 376	2 434 614 040	3							
F 00Z B20 002	2 434 614 040	3				2 433 370 447			
2 433 124 446	2 434 614 028	1							
2 433 124 388	2 434 614 022	5							
2 433 124 376	2 434 614 040	3					2 916 710 602		
2 433 124 376	2 434 614 040	3					2 916 710 602		
2 433 124 376	2 434 614 040	3							
2 433 124 376	2 434 614 040	3							
2 433 124 446	2 434 614 020	1							
2 433 124 388	2 434 614 022	5							
2 433 124 376	2 434 614 040	3					2 916 710 603		
2 433 124 388	2 434 614 022	5							
2 433 124 388	2 434 614 022	5							
2 433 124 446	2 434 614 020	1						F 00V C17 503	
F 00Z B20 001	2 434 614 041	3				2 433 370 467		2 430 105 049	
2 433 124 388	2 434 614 022	5							
2 433 124 376	2 434 614 040	3					2 916 710 603		
2 433 124 446	2 434 614 028	1							
2 433 124 446	2 434 614 028	1							
2 433 124 446	2 434 614 028	1							
2 433 124 388	2 434 614 022	5							
2 433 124 446	2 434 614 028	1							
2 433 124 446	2 434 614 020	1						F 00V C17 503	
2 433 124 446	2 434 614 020	1						F 00V C17 503	
2 433 124 388	2 434 614 022	5							
2 433 124 376	2 434 614 040	3					2 916 710 602		
2 433 124 446	2 434 614 020	1						2 430 105 042	
2 433 124 376	2 434 614 040	3					2 916 710 603		
2 433 124 376	2 434 614 040	3							
2 433 124 376	2 434 614 040	3							
2 433 124 446	2 434 614 020	1						F 00V C17 503	
2 433 124 446	2 434 614 020	1						F 00V C17 503	
2 433 124 376	2 434 614 040	3					2 916 710 602		
2 433 124 376	2 434 614 040	3							
2 433 124 388	2 434 614 022	5				2 433 370 036			
2 433 124 388	2 434 614 022	5							
2 433 124 446	2 434 614 020	1						F 00V C17 503	

*) siehe Seite 388/see page 388/voir page 388/ver pagina 388/vease página 388

**) siehe Seite 392/see page 392/voir page 392/ver pagina 392/vease página 392

A306

de
Ersatzteile für
Düsenhalter-
kombinationen
(Fortsetzung)

en
Spare parts for
nozzle-and-holder
assemblies
(continued)

fr
Pièces de rechange
pour ensembles
porte-injecteurs
(suite)

it
Ricambi per
combinazione
portapolverizzatori
(seguito)

es
Piezas de repuesto
para conjuntos
portainyectores
(continuación)



0 432 191 643	1	0 431 114 007	KBAL 105 P 51	0 433 171 271	DLLA 140 P 384	2 433 314 182	2 430 134 023
0 432 191 644	1	0 431 113 952	KBEL 88 P 115	0 433 171 346	DLLA 150 P 481+	2 433 314 053	2 430 136 166
0 432 191 645	1	0 431 113 969	KBEL 98 P 74	0 433 171 344	DLLA 145 P 478	2 433 314 042	2 430 136 166
0 432 191 646	1	0 431 113 951	KBEL 96 P 116	0 433 171 287	DLLA 138 P 403	2 433 349 181	2 430 136 166
0 432 191 647	1	0 431 113 952	KBEL 88 P 115	0 433 171 343	DLLA 150 P 476+	2 433 314 053	2 430 136 166
0 432 191 648	1	0 431 113 953	KBEL 78 P 114	0 433 171 342	DLLA 154 P 474	2 433 349 449	2 430 136 166
0 432 191 649	1	0 431 115 002	KBAL 137 P 26	0 433 171 341	DLLA 160 P 473	2 433 349 468	2 430 134 023
0 432 191 650	1	0 431 113 961	KBEL 84 P 93	0 433 171 340	DLLA 143 P 471	2 433 314 053	2 430 136 166
0 432 191 652	1	0 431 112 984	KBEL 63 P 66	0 433 171 338	DLLA 160 P 469	2 433 349 449	2 430 136 166
0 432 191 654	1	0 431 113 006	KBAL 96 P 35	0 433 171 330	DLLA 158 P 457	2 433 314 182	2 430 134 023
0 432 191 655	1	0 431 113 006	KBAL 96 P 35	0 433 171 329	DLLA 158 P 456/	2 433 314 182	2 430 134 023
0 432 191 656	1	0 431 113 006	KBAL 96 P 35	0 433 171 328	DLLA 158 P 455	2 433 314 182	2 430 134 023
0 432 191 657	1	0 431 113 006	KBAL 96 P 35	0 433 171 327	DLLA 158 P 454	2 433 314 182	2 430 134 023
0 432 191 658	1	0 431 113 957	KBEL 98 P 101	0 433 171 335	DLLA 145 P 466	2 433 314 042	2 430 136 166
0 432 191 659	1	0 431 115 995	KBEL 132 P 110	0 433 171 325	DLLA 155 P 451	2 433 349 172	2 430 136 212
0 432 191 660	1	0 431 114 979	KBEL 111 P 109	0 433 171 324	DLLA 144 P 450	2 433 349 436	2 430 136 166
0 432 191 661	1	0 431 114 979	KBEL 111 P 109	0 433 171 323	DLLA 144 P 449	2 433 349 436	2 430 136 166
0 432 191 662	1	0 431 115 996	KBEL 132 P 108	0 433 171 322	DLLA 155 P 447	2 433 349 172	2 430 136 166
0 432 191 664	1	0 431 113 970	KBEL 88 P 70	0 433 171 318	DLLA 155 P 440	2 433 314 053	2 430 136 166
0 432 191 665	1	0 431 113 954	KBEL 83 P 105	0 433 171 317	DLLA 145 P 439	2 433 314 053	2 430 136 166
0 432 191 666	1	0 431 113 956	KBEL 98 P 102	0 433 171 316	DLLA 145 P 438	2 433 314 042	2 430 136 212
0 432 191 667	1	0 431 113 955	KBEL 85 P 104	0 433 171 315	DLLA 135 P 437	2 433 349 176	2 430 136 166
0 432 191 668	1	0 431 112 973	KBEL 53 P 103	0 433 171 314	DLLA 150 P 436	2 433 314 053	2 430 136 166
0 432 191 669	1	0 431 113 956	KBEL 98 P 102	0 433 171 311	DLLA 145 P 433	2 433 314 042	2 430 136 212
0 432 191 670	1	0 431 114 985	KBEL 117 P 73	0 433 171 308	DLLA 150 P 429	2 433 314 042	2 430 136 166
0 432 191 671	1	0 431 113 957	KBEL 98 P 101	0 433 171 307	DLLA 143 P 428	2 433 314 042	2 430 136 166
0 432 191 672	1	0 431 113 958	KBEL 78 P 98	0 433 171 300	DLLA 150 P 421	2 433 314 053	2 430 136 166
0 432 191 673	1	0 431 114 981	KBEL 108 P 85	0 433 171 296	DLLA 153 P 413	2 433 314 053	2 430 136 166
0 432 191 674	1	0 431 113 011	KBAL 95 P 43	0 433 171 295	DLLA 145 P 412	2 433 349 432	2 430 134 023
0 432 191 675	1	0 431 113 011	KBAL 95 P 43	0 433 171 294	DLLA 140 P 411	2 433 349 432	2 430 134 023
0 432 191 676	1	0 431 112 012	KBAL 52 P 21	0 433 171 293	DLLA 144 P 410	2 433 314 182	2 430 134 023
0 432 191 677	1	0 431 114 985	KBEL 117 P 73	0 433 171 290	DLLA 150 P 407	2 433 314 042	2 430 136 166
0 432 191 678	1	0 431 113 977	KBEL 88 P 55	0 433 171 288	DLLA 147 P 404	2 433 314 042	2 430 136 166
0 432 191 679	1	0 431 113 959	KBEL 97 P 96	0 433 171 287	DLLA 138 P 403	2 433 349 428	2 430 136 166
0 432 191 680	1	0 431 113 960	KBEL 97 P 97	0 433 171 286	DLLA 138 P 402	2 433 349 426	2 430 136 166
0 432 191 681	1	0 431 113 960	KBEL 97 P 97	0 433 171 285	DLLA 138 P 401	2 433 349 426	2 430 136 166
0 432 191 682	1	0 431 114 005	KBAL 105 P 29	0 433 171 284	DLLA 140 P 399	2 433 314 182	2 430 134 023
0 432 191 683	1	0 431 113 972	KBEL 100 P 64	0 433 171 282	DLLA 154 P 397	2 433 314 042	2 430 136 166
0 432 191 684	1	0 431 112 014	KBAL 72 P 23	0 433 171 281	DLLA 145 P 394	2 433 314 182	2 430 134 023
0 432 191 685	1	0 431 113 969	KBEL 98 P 74	0 433 171 280	DLLA 145 P 392	2 433 314 042	2 430 136 166
0 432 191 686	1	0 431 113 969	KBEL 98 P 74	0 433 171 279	DLLA 145 P 393	2 433 314 042	2 430 136 166
0 432 191 687	1	0 431 113 961	KBEL 84 P 93	0 433 171 277	DLLA 140 P 390	2 433 314 053	2 430 136 166
0 432 191 688	1	0 431 113 961	KBEL 84 P 93	0 433 171 276	DLLA 140 P 389	2 433 314 053	2 430 136 166
0 432 191 689	1	0 431 113 010	KBAL 96 P 41	0 433 171 272	DLLA 147 P 385	2 433 314 182	2 430 134 023
0 432 191 690	1	0 431 114 006	KBAL 105 P 40	0 433 171 271	DLLA 140 P 384	2 433 314 182	2 430 134 023

A308

de
Ersatzteile für
Düsenhalter-
kombinationen
(Fortsetzung)

en
Spare parts for
nozzle-and-holder
assemblies
(continued)

fr
Pièces de rechange
pour ensembles
porte-injecteurs
(suite)

it
Ricambi per
combinazione
portapolverizzatori
(seguito)

es
Piezas de repuesto
para conjuntos
portainyectores
(continuación)



0 432 191 691	1	0 431 113 962	KBEL 97 P 91	0 433 171 267	DLLA 135 P 374	2 433 349 112	2 430 136 166
0 432 191 692	1	0 431 113 966	KBEL 83 P 78	0 433 171 266	DLLA 135 P 373	2 433 349 126	2 430 136 166
0 432 191 693	1	0 431 113 006	KBAL 96 P 35	0 433 171 263	DLLA 147 P 370	2 433 314 182	2 430 134 023
0 432 191 694	1	0 431 113 972	KBEL 100 P 64	0 433 171 262	DLLA 149 P 369	2 433 314 042	2 430 136 166
0 432 191 695	1	0 431 113 963	KBEL 82 P 90	0 433 171 261	DLLA 135 P 367	2 433 349 416	2 430 136 166
0 432 191 696	1	0 431 112 012	KBAL 52 P 21	0 433 171 252	DLLA 144 P 353	2 433 314 182	2 430 134 023
0 432 191 697	1	0 431 112 012	KBAL 52 P 21	0 433 171 251	DLLA 144 P 354	2 433 314 182	2 430 134 023
0 432 191 698	1	0 431 115 997	KBEL 132 P 89	0 433 171 260	DLLA 150 P 364	2 433 349 109	2 430 136 166
0 432 191 699	1	0 431 113 006	KBAL 96 P 35	0 433 171 258	DLLA 147 P 361	2 433 314 182	2 430 134 023
0 432 191 700	1	0 431 113 006	KBAL 96 P 35	0 433 171 257	DLLA 147 P 360	2 433 314 182	2 430 134 023
0 432 191 702	1	0 431 113 970	KBEL 88 P 70	0 433 171 268	DLLA 152 P 378	2 433 314 053	2 430 136 166
0 432 191 703	1	0 431 114 981	KBEL 108 P 85	0 433 171 254	DLLA 153 P 356	2 433 314 053	2 430 136 166
0 432 191 704	1	0 431 114 981	KBEL 108 P 85	0 433 171 253	DLLA 153 P 355	2 433 314 053	2 430 136 166
0 432 191 705	1	0 431 112 012	KBAL 52 P 21	0 433 171 252	DLLA 144 P 353	2 433 314 182	2 430 134 023
0 432 191 706	1	0 431 112 012	KBAL 52 P 21	0 433 171 251	DLLA 144 P 354	2 433 314 182	2 430 134 023
0 432 191 707	1	0 431 114 005	KBAL 105 P 29	0 433 171 250	DLLA 140 P 351	2 433 314 182	2 430 134 023
0 432 191 708	1	0 431 114 985	KBEL 117 P 73	0 433 171 249	DLLA 148 P 350	2 433 314 042	2 430 136 166
0 432 191 709	1	0 431 114 981	KBEL 108 P 85	0 433 171 248	DLLA 153 P 352	2 433 314 053	2 430 136 166
0 432 191 710	1	0 431 114 985	KBEL 117 P 73	0 433 171 247	DLLA 152 P 347	2 433 314 042	2 430 136 166
0 432 191 711	1	0 431 113 977	KBEL 88 P 55	0 433 171 246	DLLA 150 P 345	2 433 314 042	2 430 136 166
0 432 191 712	1	0 431 113 977	KBEL 88 P 55	0 433 171 245	DLLA 147 P 344	2 433 314 042	2 430 136 166
0 432 191 713	1	0 431 114 981	KBEL 108 P 85	0 433 171 243	DLLA 148 P 341	2 433 314 053	2 430 136 166
0 432 191 714	1	0 431 114 985	KBEL 117 P 73	0 433 171 242	DLLA 152 P 340	2 433 314 042	2 430 136 166
0 432 191 715	1	0 431 114 985	KBEL 117 P 73	0 433 171 241	DLLA 152 P 339	2 433 314 042	2 430 136 166
0 432 191 716	1	0 431 112 979	KBEL 63 P 84	0 433 171 240	DLLA 170 P 338	2 433 314 053	2 430 136 166
0 432 191 717	1	0 431 113 969	KBEL 98 P 74	0 433 171 239	DLLA 145 P 337	2 433 314 042	2 430 136 166
0 432 191 718	1	0 431 114 005	KBAL 105 P 29	0 433 171 196	DLLA 150 P 242	2 433 314 182	2 430 134 023
0 432 191 719	1	0 431 114 985	KBEL 117 P 73	0 433 171 238	DLLA 152 P 336	2 433 314 042	2 430 136 166
0 432 191 720	1	0 431 114 005	KBAL 105 P 29	0 433 171 292	DLLA 150 P 409	2 433 314 182	2 430 134 023
0 432 191 721	1	0 431 114 985	KBEL 117 P 73	0 433 171 237	DLLA 152 P 335	2 433 314 042	2 430 136 166
0 432 191 722	1	0 431 114 985	KBEL 117 P 73	0 433 171 236	DLLA 143 P 334	2 433 314 042	2 430 136 166
0 432 191 723	1	0 431 114 985	KBEL 117 P 73	0 433 171 235	DLLA 143 P 333	2 433 314 042	2 430 136 166
0 432 191 724	1	0 431 113 969	KBEL 98 P 74	0 433 171 232	DLLA 145 P 328	2 433 314 042	2 430 136 166
0 432 191 725	1	0 431 114 987	KBEL 108 P 51	0 433 171 231	DLLA 150 P 326	2 433 349 131	2 430 136 166
0 432 191 726	1	0 431 114 987	KBEL 108 P 51	0 433 171 229	DLLA 150 P 324	2 433 349 131	2 430 136 166
0 432 191 727	1	0 431 113 969	KBEL 98 P 74	0 433 171 234	DLLA 145 P 331	2 433 314 042	2 430 136 166
0 432 191 728	1	0 431 114 987	KBEL 108 P 51	0 433 171 226	DLLA 154 P 316	2 433 349 131	2 430 136 166
0 432 191 729	1	0 431 114 987	KBEL 108 P 51	0 433 171 225	DLLA 150 P 315	2 433 349 131	2 430 136 166
0 432 191 730	1	0 431 114 985	KBEL 117 P 73	0 433 171 224	DLLA 152 P 313	2 433 314 042	2 430 136 166
0 432 191 731	1	0 431 113 967	KBEL 96 P 77	0 433 171 223	DLLA 142 P 312	2 433 349 123	2 430 136 166
0 432 191 732	1	0 431 113 968	KBEL 82 P 76	0 433 171 220	DLLA 140 P 305	2 433 349 119	2 430 136 166
0 432 191 733	1	0 431 114 987	KBEL 108 P 51	0 433 171 216	DLLA 150 P 299	2 433 349 131	2 430 136 166
0 432 191 734	1	0 431 113 977	KBEL 88 P 55	0 433 171 213	DLLA 150 P 291	2 433 314 042	2 430 136 166
0 432 191 735	1	0 431 114 005	KBAL 105 P 29	0 433 171 212	DLLA 140 P 290	2 433 314 182	2 430 134 023
0 432 191 736	1	0 431 113 969	KBEL 98 P 74	0 433 171 211	DLLA 145 P 286	2 433 314 042	2 430 136 166



2 433 124 388	2 434 614 022	5					
2 433 124 388	2 434 614 030	5				2 916 710 602	
2 433 124 446	2 434 614 020	1					
2 433 124 388	2 434 614 022	5					
2 433 124 388	2 434 614 030	5				2 916 710 602	
2 433 124 446	2 434 614 028	1			F 018 J10 800		
2 433 124 446	2 434 614 028	1			F 018 J10 800		
2 433 124 388	2 434 614 022	5					2 430 422 011
2 433 124 446	2 434 614 020	1					
2 433 124 446	2 434 614 020	1					
2 433 124 388	2 434 614 022	5					2 430 105 035
2 433 124 388	2 434 614 022	5					
2 433 124 388	2 434 614 022	5					
2 433 124 446	2 434 614 028	1			F 018 J10 800		
2 433 124 446	2 434 614 028	1			F 018 J10 800		
2 433 124 446	2 434 614 020	1					F 00V C17 503
2 433 124 388	2 434 614 022	5					
2 433 124 388	2 434 614 022	5					
2 433 124 388	2 434 614 022	5					
2 433 124 284	2 434 619 073	5					
2 433 124 284	2 434 619 073	5					
2 433 124 388	2 434 614 022	5					
2 433 124 388	2 434 614 022	5					
2 433 124 388	2 434 614 022	5					
2 433 124 284	2 434 619 073	5				2 916 710 602	
2 433 124 388	2 434 614 022	5					
2 433 124 446	2 434 614 020	1					F 00V C17 503
2 433 124 388	2 434 614 022	5					
2 433 124 446	2 434 614 020	1					F 00V C17 503
2 433 124 388	2 434 614 022	5					
2 433 124 388	2 434 614 022	5					
2 433 124 388	2 434 614 022	5					
2 433 124 388	2 434 614 027	5				2 916 710 602	
2 433 124 388	2 434 614 027	5				2 916 710 602	
2 433 124 388	2 434 614 022	5					
2 433 124 388	2 434 614 027	5				2 916 710 602	
2 433 124 388	2 434 614 027	5				2 916 710 602	
2 433 124 388	2 434 614 022	5					
2 433 124 388	2 434 614 030	5			2 433 370 434	2 916 710 603	
2 433 124 388	2 434 614 027	5				2 916 710 602	
2 433 124 388	2 434 614 027	5				2 916 710 602	
2 433 124 284	2 434 619 073	5					
2 433 124 446	2 434 614 020	1					F 00V C17 503
2 433 124 388	2 434 614 022	5					

*) siehe Seite 388/see page 388/voir page 388/ver pagina 388/vease página 388

**) siehe Seite 392/see page 392/voir page 392/ver pagina 392/vease página 392

A310

de
Ersatzteile für
Düsenhalter-
kombinationen
(Fortsetzung)

en
Spare parts for
nozzle-and-holder
assemblies
(continued)









fr
Pièces de rechange
pour ensembles
porte-injecteurs
(suite)

it
Ricambi per
combinazione
portapolverizzatori
(seguito)

es
Piezas de repuesto
para conjuntos
portainyectores
(continuación)



0 432 191 737	1	0 431 114 985	KBEL 117 P 73	0 433 171 210	DLLA 152 P 285	2 433 314 042	2 430 136 166
0 432 191 738	1	0 431 114 005	KBAL 105 P 29	0 433 171 204	DLLA 155 P 270	2 433 314 182	2 430 134 023
0 432 191 739	1	0 431 112 984	KBEL 63 P 66	0 433 171 203	DLLA 170 P 260	2 433 349 449	2 430 136 166
0 432 191 740	1	0 431 114 005	KBAL 105 P 29	0 433 171 202	DLLA 140 P 257	2 433 314 182	2 430 134 023
0 432 191 741	1	0 431 113 973	KBEL 82 P 63	0 433 171 200	DLLA 135 P 250	2 433 349 119	2 430 136 166
0 432 191 743	1	0 431 113 985	KBEL 97 P 35	0 433 171 197	DLLA 146 P 244	2 433 349 112	2 430 136 166
0 432 191 744	1	0 431 114 004	KBAL 105 P 27	0 433 171 196	DLLA 150 P 242	2 433 314 182	2 430 134 023
0 432 191 745	1	0 431 114 986	KBEL 108 P 60	0 433 171 195	DLLA 148 P 241	2 433 314 053	2 430 136 166
0 432 191 746	1	0 431 114 986	KBEL 108 P 60	0 433 171 194	DLLA 148 P 240	2 433 314 053	2 430 136 166
0 432 191 747	1	0 431 114 987	KBEL 108 P 51	0 433 171 193	DLLA 150 P 235	2 433 349 131	2 430 136 166
0 432 191 749	1	0 431 113 977	KBEL 88 P 55	0 433 171 190	DLLA 150 P 232	2 433 314 042	2 430 136 166
0 432 191 750	1	0 431 115 001	KBAL 137 P 14	0 433 171 187	DLLA 148 P 229	2 433 349 468	2 430 134 023
0 432 191 751	1	0 431 113 976	KBEL 99 P 57	0 433 171 185	DLLA 124 P 227	2 433 349 118	2 430 136 166
0 432 191 752	1	0 431 113 977	KBEL 88 P 55	0 433 171 186	DLLA 150 P 228	2 433 314 042	2 430 136 166
0 432 191 753	1	0 431 113 978	KBEL 98 P 54	0 433 171 179	DLLA 150 P 217	2 433 314 042	2 430 136 166
0 432 191 754	1	0 431 114 003	KBAL 105 P 18	0 433 171 178	DLLA 150 P 216	2 433 314 182	2 430 134 023
0 432 191 755	1	0 431 112 990	KBEL 68 P 40	0 433 171 176	DLLA 150 P 214	2 433 314 053	2 430 136 166
0 432 191 756	1	0 431 114 003	KBAL 105 P 18	0 433 171 175	DLLA 150 P 213	2 433 314 182	2 430 134 023
0 432 191 757	1	0 431 115 002	KBAL 137 P 26	0 433 171 173	DLLA 160 P 209	2 433 349 468	2 430 134 023
0 432 191 758	1	0 431 114 997	KBEL 117 P 7/4	0 433 171 060	DLLA 150 P 60	2 433 314 042	2 430 136 166
0 432 191 759	1	0 431 114 987	KBEL 108 P 51	0 433 171 172	DLLA 154 P 206	2 433 349 131	2 430 136 166
0 432 191 760	1	0 431 114 987	KBEL 108 P 51	0 433 171 171	DLLA 150 P 205	2 433 349 131	2 430 136 166
0 432 191 761	1	0 431 112 986	KBEL 63 P 56/TR	0 433 171 183	DLLA 150 P 225/TR	2 433 349 122	2 430 136 166
0 432 191 762	1	0 431 115 001	KBAL 137 P 14	0 433 171 158	DLLA 155 P 179	2 433 349 468	2 430 134 023
0 432 191 763	1	0 431 113 982	KBEL 95 P 42	0 433 171 168	DLLA 150 P 199	2 433 349 108	2 430 136 166
0 432 191 764	1	0 431 113 985	KBEL 97 P 35	0 433 171 167	DLLA 146 P 197	2 433 349 112	2 430 136 166
0 432 191 765	1	0 431 112 014	KBAL 72 P 23	0 433 171 166	DLLA 140 P 196	2 433 314 182	2 430 134 023
0 432 191 766	1	0 431 113 982	KBEL 95 P 42	0 433 171 162	DLLA 134 P 186	2 433 349 108	2 430 136 166
0 432 191 767	1	0 431 115 001	KBAL 137 P 14	0 433 175 010	DSLA 155 P 185	2 433 349 468	2 430 134 023
0 432 191 768	1	0 431 113 002	KBAL 90 P 11	0 433 171 160	DLLA 140 P 182	2 433 314 182	
0 432 191 769	1	0 431 115 001	KBAL 137 P 14	0 433 171 158	DLLA 155 P 179	2 433 349 468	2 430 134 023
0 432 191 770	1	0 431 114 997	KBEL 117 P 7/4	0 433 171 157	DLLA 150 P 178	2 433 314 042	2 430 136 166
0 432 191 771	1	0 431 114 997	KBEL 117 P 7/4	0 433 171 156	DLLA 150 P 177	2 433 314 042	2 430 136 166
0 432 191 772	1	0 431 115 001	KBAL 137 P 14	0 433 171 152	DLLA 155 P 172	2 433 349 468	2 430 134 023
0 432 191 773	1	0 431 115 999	KBEL 132 P 31	0 433 171 150	DLLA 150 P 167	2 433 349 109	2 430 136 166
0 432 191 775	1	0 431 113 970	KBEL 88 P 70	0 433 171 147	DLLA 148 P 164	2 433 314 053	2 430 136 166
0 432 191 776	1	0 431 113 970	KBEL 88 P 70	0 433 171 146	DLLA 148 P 163	2 433 314 053	2 430 136 166
0 432 191 778	1	0 431 113 990	KBEL 98 P 27	0 433 171 143	DLLA 143 P 160	2 433 314 042	2 430 136 166
0 432 191 779	1	0 431 112 990	KBEL 68 P 40	0 433 171 142	DLLA 150 P 159	2 433 314 053	2 430 136 166
0 432 191 782	1	0 431 113 990	KBEL 98 P 27	0 433 171 139	DLLA 143 P 151	2 433 314 042	2 430 136 166
0 432 191 783	1	0 431 113 002	KBAL 90 P 11	0 433 171 133	DLLA 150 P 147	2 433 314 182	
0 432 191 785	1	0 431 113 987	KBEL 88 P 34	0 433 171 119	DLLA 150 P 131	2 433 314 042	2 430 136 166
0 432 191 786	1	0 431 115 001	KBAL 137 P 14	0 433 171 138	DLLA 155 P 156	2 433 349 468	2 430 134 023
0 432 191 787	1	0 431 113 987	KBEL 88 P 34	0 433 171 131	DLLA 150 P 145	2 433 314 042	2 430 136 166
0 432 191 788	1	0 431 114 997	KBEL 117 P 7/4	0 433 171 134	DLLA 148 P 149	2 433 314 042	2 430 136 166

							
④	⑤	⑥	⑦	⑧	⑨	⑩	⑪
2 433 124 388	2 434 614 022	5					
2 433 124 446	2 434 614 020	1					F 00V C17 503
2 433 124 388	2 434 614 022	5				2 916 710 602	
2 433 124 446	2 434 614 020	1					F 00V C17 503
2 433 124 445	2 434 614 032	5				2 916 710 602	
2 433 124 388	2 434 614 022	5					
2 433 124 446	2 434 614 020	1					F 00V C17 503
2 433 124 388	2 434 614 022	5					
2 433 124 388	2 434 614 022	5					
2 433 124 388	2 434 614 027	5				2 916 710 602	
2 433 124 284	2 434 619 073	5					
2 433 120 128	2 434 614 020	6					
2 433 124 388	2 434 614 030	5			2 433 370 434	2 916 710 603	
2 433 124 284	2 434 619 073	5					
2 433 124 388	2 434 614 022	5				2 916 710 603	
2 433 120 128	2 434 614 028	1					F 00V C17 503
2 433 124 388	2 434 614 022	5					
2 433 120 128	2 434 614 028	1					F 00V C17 503
2 433 124 446	2 434 614 020	6					
2 433 120 127	2 434 614 022	5					
2 433 124 388	2 434 614 027	5				2 916 710 602	
2 433 124 388	2 434 614 027	5				2 916 710 602	
2 433 120 127	2 434 614 030	5			2 433 370 428		
2 433 120 128	2 434 614 020	6					
2 433 124 388	2 434 614 030	5			2 433 370 434	2 916 710 603	
2 433 124 388	2 434 614 022	5					
2 433 124 446	2 434 614 020	1					
2 433 124 388	2 434 614 030	5			2 433 370 434	2 916 710 603	
2 433 120 128	2 434 614 020	6					
2 433 120 128	2 434 614 020	1					2 430 105 026
2 433 120 128	2 434 614 020	6					
2 433 120 127	2 434 614 022	5					
2 433 120 127	2 434 614 022	5					
2 433 120 128	2 434 614 020	6					
2 433 120 127	2 434 614 022	5					2 430 422 011
2 433 124 388	2 434 614 022	5					2 430 105 035
2 433 124 388	2 434 614 022	5					2 430 105 035
2 433 120 127	2 434 614 022	5					
2 433 124 388	2 434 614 022	5					
2 433 120 127	2 434 614 022	5					
2 433 120 128	2 434 614 020	1					2 430 105 026
2 433 120 127	2 434 614 022	5					
2 433 120 128	2 434 614 020	6					
2 433 120 127	2 434 614 022	5					
2 433 120 127	2 434 614 022	5					

*) siehe Seite 388/see page 388/voir page 388/ver pagina 388/vease página 388

**) siehe Seite 392/see page 392/voir page 392/ver pagina 392/vease página 392

A312

de

**Ersatzteile für
Düsenhalter-
kombinationen**
(Fortsetzung)

en

**Spare parts for
nozzle-and-holder
assemblies**
(continued)

fr

**Pièces de rechange
pour ensembles
porte-injecteurs**
(suite)

it

**Ricambi per
combinazione
portapolverizzatori**
(seguito)

es

**Piezas de repuesto
para conjuntos
portainyectoros**
(continuación)



Fig.



Ref.



Typ



①



Typ



②



③

0 432 191 789	1	0 431 113 985	KBEL 97 P 35	0 433 171 127	DLLA 146 P 139	2 433 349 112	2 430 136 166
0 432 191 790	1	0 431 113 985	KBEL 97 P 35	0 433 171 128	DLLA 146 P 140	2 433 349 112	2 430 136 166
0 432 191 792	1	0 431 113 990	KBEL 98 P 27	0 433 171 043	DLLA 150 P 43	2 433 314 042	2 430 136 166
0 432 191 793	1	0 431 112 011	KBAL 72 P 19	0 433 171 126	DLLA 144 P 138	2 433 314 182	2 430 134 023
0 432 191 794	1	0 431 114 003	KBAL 105 P 18	0 433 171 123	DLLA 155 P 135	2 433 314 182	2 430 134 023
0 432 191 795	1	0 431 112 011	KBAL 72 P 19	0 433 171 125	DLLA 150 P 137	2 433 314 182	2 430 134 023
0 432 191 796	1	0 431 114 003	KBAL 105 P 18	0 433 171 121	DLLA 150 P 133	2 433 314 182	2 430 134 023
0 432 191 797	1	0 431 113 005	KBAL 90 P 20	0 433 171 120	DLLA 151 P 132	2 433 314 182	
0 432 191 798	1	0 431 113 987	KBEL 88 P 34	0 433 171 119	DLLA 150 P 131	2 433 314 042	2 430 136 166
0 432 191 799	1	0 431 114 003	KBAL 105 P 18	0 433 171 118	DLLA 150 P 130	2 433 314 182	2 430 134 023
0 432 191 800	1	0 431 114 997	KBEL 117 P 7/4	0 433 171 102	DLLA 150 P 113	2 433 314 042	2 430 136 166
0 432 191 801	1	0 431 113 990	KBEL 98 P 27	0 433 171 116	DLLA 143 P 128	2 433 314 042	2 430 136 166
0 432 191 802	1	0 431 113 990	KBEL 98 P 27	0 433 171 115	DLLA 143 P 127	2 433 314 042	2 430 136 166
0 432 191 803	1	0 431 113 990	KBEL 98 P 27	0 433 171 114	DLLA 143 P 126	2 433 314 042	2 430 136 166
0 432 191 804	1	0 431 114 003	KBAL 105 P 18	0 433 171 113	DLLA 155 P 125	2 433 314 182	2 430 134 023
0 432 191 805	1	0 431 113 990	KBEL 98 P 27	0 433 171 112	DLLA 143 P 123	2 433 314 042	2 430 136 166
0 432 191 806	1	0 431 113 990	KBEL 98 P 27	0 433 171 111	DLLA 143 P 122	2 433 314 042	2 430 136 166
0 432 191 807	1	0 431 113 990	KBEL 98 P 27	0 433 171 110	DLLA 143 P 121	2 433 314 042	2 430 136 166
0 432 191 808	1	0 431 114 997	KBEL 117 P 7/4	0 433 171 108	DLLA 150 P 119	2 433 314 042	2 430 136 166
0 432 191 809	1	0 431 112 011	KBAL 72 P 19	0 433 171 107	DLLA 144 P 118	2 433 314 182	2 430 134 023
0 432 191 810	1	0 431 112 009	KBAL 65 P 9/4	0 433 171 106	DLLA 150 P 117	2 433 314 182	2 430 134 023
0 432 191 812	1	0 431 114 003	KBAL 105 P 18	0 433 171 104	DLLA 150 P 115	2 433 314 182	2 430 134 023
0 432 191 813	1	0 431 114 991	KBEL 115 P 28	0 433 171 102	DLLA 150 P 113	2 433 349 107	2 430 136 166
0 432 191 814	1	0 431 115 001	KBAL 137 P 14	0 433 171 152	DLLA 155 P 172	2 433 349 468	2 430 134 023
0 432 191 815	1	0 431 114 997	KBEL 117 P 7/4	0 433 171 100	DLLA 150 P 110	2 433 314 042	2 430 136 166
0 432 191 817	1	0 431 115 999	KBEL 132 P 31	0 433 171 098	DLLA 150 P 105	2 433 349 109	2 430 136 166
0 432 191 818	1	0 431 113 988	KBEL 95 P 30	0 433 171 095	DLLA 150 P 99	2 433 349 108	2 430 136 166
0 432 191 819	1	0 431 113 989	KBEL 88 P 29	0 433 171 094	DLLA 148 P 98	2 433 314 053	2 430 136 166
0 432 191 820	1	0 431 113 989	KBEL 88 P 29	0 433 171 093	DLLA 148 P 97	2 433 314 053	2 430 136 166
0 432 191 821	1	0 431 114 991	KBEL 115 P 28	0 433 171 060	DLLA 150 P 60	2 433 349 107	2 430 136 166
0 432 191 822	1	0 431 113 990	KBEL 98 P 27	0 433 171 092	DLLA 143 P 96	2 433 314 042	2 430 136 166
0 432 191 824	1	0 431 113 990	KBEL 98 P 27	0 433 171 090	DLLA 143 P 94	2 433 314 042	2 430 136 166
0 432 191 825	1	0 431 113 990	KBEL 98 P 27	0 433 171 089	DLLA 143 P 93	2 433 314 042	2 430 136 166
0 432 191 827	1	0 431 113 996	KBEL 95 P 9/4	0 433 171 088	DLLA 143 P 88	2 433 314 042	2 430 136 166
0 432 191 829	1	0 431 114 992	KBEL 108 P 25	0 433 171 082	DLLA 160 P 85	2 433 349 463	2 430 136 166
0 432 191 830	1	0 431 115 001	KBAL 137 P 14	0 433 171 080	DLLA 155 P 82	2 433 349 468	2 430 134 023
0 432 191 834	1	0 431 114 997	KBEL 117 P 7/4	0 433 171 076	DLLA 150 P 76	2 433 314 042	2 430 136 166
0 432 191 835	1	0 431 114 997	KBEL 117 P 7/4	0 433 171 072	DLLA 150 P 72	2 433 314 042	2 430 136 166
0 432 191 836	1	0 431 113 992	KBEL 78 P 23	0 433 171 071	DLLA 150 P 71	2 433 314 053	2 430 136 166
0 432 191 837	1	0 431 113 993	KBEL 81 P 22	0 433 171 069	DLLA 136 P 69	2 433 349 101	2 430 136 166
0 432 191 838	1	0 431 113 002	KBAL 90 P 11	0 433 171 073	DLLA 152 P 73	2 433 314 182	
0 432 191 839	1	0 431 112 009	KBAL 65 P 9/4	0 433 171 065	DLLA 150 P 65	2 433 314 182	2 430 134 023
0 432 191 840	1	0 431 114 994	KBEL 103 P 21	0 433 171 064	DLLA 150 P 64	2 433 349 101	2 430 136 166
0 432 191 841	1	0 431 114 997	KBEL 117 P 7/4	0 433 171 061	DLLA 150 P 61	2 433 314 042	2 430 136 166
0 432 191 842	1	0 431 114 997	KBEL 117 P 7/4	0 433 171 060	DLLA 150 P 60	2 433 314 042	2 430 136 166



2 433 124 388	2 434 614 022	5					
2 433 124 388	2 434 614 022	5					
2 433 120 127	2 434 614 022	5					
2 433 120 128	2 434 614 020	1					
2 433 120 128	2 434 614 028	1					F 00V C17 503
2 433 120 128	2 434 614 020	1					
2 433 120 128	2 434 614 028	1					F 00V C17 503
2 433 120 128	2 434 614 020	1					F 00V C17 503
2 433 120 127	2 434 614 022	5					
2 433 120 128	2 434 614 028	1					F 00V C17 503
2 433 120 127	2 434 614 022	5					
2 433 120 127	2 434 614 022	5					
2 433 120 127	2 434 614 022	5					
2 433 120 127	2 434 614 022	5					
2 433 120 128	2 434 614 028	1					F 00V C17 503
2 433 120 127	2 434 614 022	5					
2 433 120 127	2 434 614 022	5					
2 433 120 127	2 434 614 022	5					
2 433 120 127	2 434 614 022	5				2 916 710 602	
2 433 120 128	2 434 614 020	1					
2 433 120 128	2 434 614 020	1				2 916 710 602	
2 433 120 128	2 434 614 028	1					F 00V C17 503
2 433 120 127	2 434 614 022	5					
2 433 120 128	2 434 614 020	6					
2 433 120 127	2 434 614 022	5					
2 433 120 127	2 434 614 022	5					2 430 422 011
2 433 120 127	2 434 614 030	5			2 433 370 434	2 916 710 603	
2 433 120 127	2 434 614 022	5					
2 433 120 127	2 434 614 022	5					
2 433 120 127	2 434 614 022	5					
2 433 120 127	2 434 614 022	5					
2 433 120 127	2 434 614 022	5			2 433 370 434	2 916 710 603	
2 433 120 127	2 434 614 027	5				2 916 710 602	
2 433 120 128	2 434 614 020	6					
2 433 120 127	2 434 614 022	5					
2 433 120 127	2 434 614 022	5					
2 433 120 127	2 434 614 022	5					
2 433 120 127	2 434 614 022	5				2 916 710 602	
2 433 120 128	2 434 614 020	1					2 430 105 026
2 433 120 128	2 434 614 020	1				2 916 710 602	
2 433 120 127	2 434 614 022	5				2 916 710 603	
2 433 120 127	2 434 614 022	5					
2 433 120 127	2 434 614 022	5					

*) siehe Seite 388/see page 388/voir page 388/ver pagina 388/vease página 388

**) siehe Seite 392/see page 392/voir page 392/ver pagina 392/vease página 392

A314

de

Ersatzteile für
Düsenhalter-
kombinationen
(Fortsetzung)

en

Spare parts for
nozzle-and-holder
assemblies
(continued)

fr

Pièces de rechange
pour ensembles
porte-injecteurs
(suite)

it

Ricambi per
combinazione
portapolverizzatori
(seguito)

es

Piezas de repuesto
para conjuntos
portainyectoros
(continuación)



Fig.



Ref.



Typ



①



Typ











②



③

0 432 191 843	1	0 431 112 992	KBEL 62 P 20	0 433 171 062	DLLA 130 P 62	2 433 314 042	2 430 136 166
0 432 191 844	1	0 431 114 995	KBEL 104 P 12/13	0 433 171 059	DLLA 150 P 59	2 433 349 101	2 430 136 166
0 432 191 847	1	0 431 112 010	KBAL 62 P 10	0 433 171 053	DLLA 150 P 53	2 433 314 182	
0 432 191 848	1	0 431 114 997	KBEL 117 P 7/4	0 433 171 052	DLLA 150 P 52	2 433 314 042	2 430 136 166
0 432 191 850	1	0 431 113 996	KBEL 95 P 9/4	0 433 171 045	DLLA 143 P 45	2 433 314 042	2 430 136 166
0 432 191 851	1	0 431 112 994	KBEL 64 P 16	0 433 171 044	DLLA 140 P 44	2 433 349 115	2 430 136 166
0 432 191 852	1	0 431 114 997	KBEL 117 P 7/4	0 433 171 043	DLLA 150 P 43	2 433 314 042	2 430 136 166
0 432 191 853	1	0 431 113 994	KBEL 98 P 15	0 433 171 042	DLLA 150 P 42	2 433 314 042	2 430 136 166
0 432 191 854	1	0 431 113 996	KBEL 95 P 9/4	0 433 171 041	DLLA 143 P 40	2 433 314 042	2 430 136 166
0 432 191 855	1	0 431 113 996	KBEL 95 P 9/4	0 433 171 039	DLLA 148 P 38	2 433 314 042	2 430 136 166
0 432 191 856	1	0 431 113 996	KBEL 95 P 9/4	0 433 171 038	DLLA 150 P 37	2 433 314 042	2 430 136 166
0 432 191 857	1	0 431 111 999	KBEL 48 P 13/13	0 433 171 012	DLLA 150 P 11	2 433 314 053	2 430 136 166
0 432 191 860	1	0 431 113 997	KBEL 78 P 10/13	0 433 171 035	DLLA 150 P 34	2 433 314 053	2 430 136 166
0 432 191 861	1	0 431 112 009	KBAL 65 P 9/4	0 433 171 034	DLLA 150 P 33	2 433 314 182	2 430 134 023
0 432 191 862	1	0 431 113 996	KBEL 95 P 9/4	0 433 171 033	DLLA 150 P 32	2 433 314 042	2 430 136 166
0 432 191 863	1	0 431 114 997	KBEL 117 P 7/4	0 433 171 032	DLLA 150 P 31	2 433 314 042	2 430 136 166
0 432 191 864	1	0 431 113 996	KBEL 95 P 9/4	0 433 171 031	DLLA 150 P 30	2 433 314 042	2 430 136 166
0 432 191 865	1	0 431 113 996	KBEL 95 P 9/4	0 433 171 029	DLLA 150 P 28	2 433 314 042	2 430 136 166
0 432 191 868	1	0 431 113 996	KBEL 95 P 9/4	0 433 171 025	DLLA 150 P 24	2 433 314 042	2 430 136 166
0 432 191 870	1	0 431 113 996	KBEL 95 P 9/4	0 433 171 023	DLLA 150 P 22	2 433 314 042	2 430 136 166
0 432 191 872	1	0 431 113 996	KBEL 95 P 9/4	0 433 171 021	DLLA 150 P 20	2 433 314 042	2 430 136 166
0 432 191 878	1	0 431 112 995	KBEL 53 P 2/13	0 433 171 012	DLLA 150 P 11	2 433 314 053	2 430 136 166
0 432 191 879	1	0 431 112 997	KBEL 90 P 5/13	0 433 171 006	DLLA 155 P 5	2 433 314 042	2 430 136 166
0 432 191 880	1	0 431 112 996	KBEL 88 P 1/4	0 433 171 011	DLLA 150 P 10	2 433 314 042	2 430 136 166
0 432 191 881	1	0 431 112 997	KBEL 90 P 5/13	0 433 171 010	DLLA 160 P 9	2 433 314 042	2 430 136 166
0 432 191 882	1	0 431 112 009	KBAL 65 P 9/4	0 433 171 034	DLLA 150 P 33	2 433 314 182	2 430 134 023
0 432 191 885	1	0 431 112 998	KBELZ 90 P 4/13	0 433 171 004	DLLZ 155 P 4	2 433 314 042	
0 432 191 887	1	0 431 112 003	KBAL 65 P 3/13	0 433 171 003	DLLA 150 P 3	2 433 314 182	
0 432 191 889	1	0 431 112 009	KBAL 65 P 9/4	0 433 171 001	DLLA 150 P 1	2 433 314 182	2 430 134 023
0 432 192 876	1	0 431 114 988	KBEL 109 P 44	0 433 171 164	DLLA 150 P 91/+	2 433 314 042	2 430 136 166
0 432 192 881	1	0 431 114 996	KBEL 109 P 11/13	0 433 171 117	DLLA 150 P 91/	2 433 314 042	
0 432 192 883	1	0 431 113 994	KBEL 98 P 15	0 433 171 042	DLLA 150 P 42	2 433 314 042	2 430 136 166
0 432 192 884	1	0 431 113 994	KBEL 98 P 15	0 433 171 040	DLLA 150 P 39	2 433 314 042	2 430 136 166
0 432 192 885	1	0 431 114 996	KBEL 109 P 11/13	0 433 171 030	DLLA 150 P 29	2 433 314 042	
0 432 192 889	1	0 431 114 996	KBEL 109 P 11/13	0 433 171 030	DLLA 150 P 29	2 433 314 042	
0 432 193 455	1	0 431 114 945	KBEL 100 P 253	0 433 175 467	DSLA 144 P 1629	2 433 349 189	F 00Z Z20 003
0 432 193 456	1	0 431 114 945	KBEL 100 P 253	0 433 175 466	DLLA 147 P 1628	2 433 349 189	F 00Z Z20 003
0 432 193 462	1	0 431 113 063	KBAL 85 P 148	0 433 175 451	DSLA 142 P 1501	2 433 314 182	2 430 134 023
0 432 193 463	1	0 431 112 991	KBEL 63 P 37	0 433 175 446	DSLA 150 P 1498	2 433 314 053	2 430 136 166
0 432 193 468	2	0 431 113 059	KBAL 80 P 142	2 437 010 148	DSLA 146 P 1436	2 433 349 249	
0 432 193 469	2	0 431 113 059	KBAL 80 P 142	2 437 010 149	DSLA 148 P 1435	2 433 349 249	
0 432 193 470	2	0 431 113 059	KBAL 80 P 142	2 437 010 145	DSLA 150 P 1434	2 433 349 249	
0 432 193 471	2	0 431 113 059	KBAL 80 P 142	2 437 010 146	DSLA 146 P 1433	2 433 349 249	
0 432 193 472	2	0 431 113 059	KBAL 80 P 142	2 437 010 147	DSLA 148 P 1432	2 433 349 249	
0 432 193 477	1	0 431 114 947	KBEL 100 P 251	0 433 175 416	DSLA 156 P 1411	2 433 349 189	F 00Z Z20 003

								
④	⑤	⑥	⑦	⑧	⑨	⑩	⑪	
2 433 120 127	2 434 614 022	5						
2 433 120 127	2 434 614 022	5				2 916 710 602		
2 433 120 128	2 434 614 020	1					F 00V C17 503	
2 433 120 127	2 434 614 022	5					F 00V C17 503	
2 433 120 127	2 434 614 022	5			2 433 370 434	2 916 710 603		
2 433 120 127	2 434 614 022	5						
2 433 120 127	2 434 614 022	5				2 916 710 602		
2 433 120 127	2 434 614 022	5			2 433 370 434	2 916 710 603		
2 433 120 127	2 434 614 022	5			2 433 370 434	2 916 710 603		
2 433 120 127	2 434 614 022	5			2 433 370 434	2 916 710 603		
2 433 120 128	2 434 614 020	5			2 433 370 036			
2 433 120 127	2 434 614 022	5				2 916 710 602		
2 433 120 128	2 434 614 020	1				2 916 710 602		
2 433 120 127	2 434 614 022	5			2 433 370 434	2 916 710 603		
2 433 120 127	2 434 614 022	5			2 433 370 434	2 916 710 603		
2 433 120 127	2 434 614 022	5			2 433 370 434	2 916 710 603		
2 433 120 127	2 434 614 022	5			2 433 370 434	2 916 710 603		
2 433 120 127	2 434 614 022	5			2 433 370 434	2 916 710 603		
2 433 120 127	2 434 614 022	5			2 433 370 434	2 916 710 603		
2 433 120 127	2 434 614 022	5			2 433 370 434	2 916 710 603		
2 433 120 127	2 434 614 022	5			2 433 370 036			
2 433 120 127	2 434 614 022	5				2 916 710 605	2 430 100 048	
2 433 120 127	2 434 614 022	5				2 916 710 602		
2 433 120 127	2 434 614 022	5				2 916 710 605	2 430 100 048	
2 433 120 128	2 434 614 020	1				2 916 710 602		
2 433 120 127	2 434 614 022	5				2 916 710 605		
2 433 120 128		1				2 916 710 602		
2 433 120 128	2 434 614 020	1				2 916 710 602		
2 433 124 388	2 434 614 027	5			2 433 370 035	2 916 710 603		
2 433 120 127	2 434 614 027	5			2 433 370 035	2 916 710 603	2 430 105 026	
2 433 120 127	2 434 614 022	5				2 916 710 602		
2 433 120 127	2 434 614 022	5				2 916 710 602		
2 433 120 127	2 434 614 027	5			2 433 370 035	2 916 710 603		
2 433 120 127	2 434 614 027	5			2 433 370 035	2 916 710 603		
F 00Z B20 002	2 434 614 040	3			2 433 370 467			
F 00Z B20 002	2 434 614 040	3			2 433 370 467			
2 433 124 422	2 434 614 020	6		F 018 H27 802			2 430 105 042	
2 433 120 127	2 434 614 022	5				2 916 710 602		
			C			2 916 710 602		
			C			2 916 710 602		
			C			2 916 710 602		
			C			2 916 710 602		
F 00Z B20 002	2 434 614 040	3			2 433 370 467			

*) siehe Seite 388/see page 388/voir page 388/ver pagina 388/vease página 388

**) siehe Seite 392/see page 392/voir page 392/ver pagina 392/vease página 392

A316

de
Ersatzteile für
Düsenhalter-
kombinationen
(Fortsetzung)

en
Spare parts for
nozzle-and-holder
assemblies
(continued)

fr
Pièces de rechange
pour ensembles
porte-injecteurs
(suite)

it
Ricambi per
combinazione
portapolverizzatori
(seguito)

es
Piezas de repuesto
para conjuntos
portainyectoros
(continuación)



0 432 193 478	1	0 431 114 945	KBEL 100 P 253	0 433 175 417	DSLA 156 P 1412	2 433 349 189	F 00Z Z20 003
0 432 193 479	1	0 431 114 962	KBEL 100 P 169	0 433 175 417	DSLA 156 P 1412	2 433 349 189	F 00Z Z20 003
0 432 193 480	1	0 431 114 959	KBEL 100 P 184	0 433 175 416	DSLA 156 P 1411	2 433 349 189	F 00Z Z20 003
0 432 193 481	1	0 431 114 959	KBEL 100 P 184	0 433 175 416	DSLA 156 P 1411	2 433 349 189	F 00Z Z20 003
0 432 193 485	1	0 431 114 007	KBAL 105 P 51	0 433 175 406	DSLA 140 P 1361	2 433 314 182	2 430 134 023
0 432 193 508	2	0 431 112 929	KBEL 58 P 242	2 437 010 143	DSLA 150 P 1250	2 433 349 479	
0 432 193 509	2	0 431 112 929	KBEL 58 P 242	2 437 010 143	DSLA 150 P 1250	2 433 349 479	
0 432 193 510	2	0 431 112 930	KBEL 58 P 241	2 437 010 143	DSLA 150 P 1250	2 433 349 479	
0 432 193 511	2	0 431 112 930	KBEL 58 P 241	2 437 010 143	DSLA 150 P 1250	2 433 349 479	
0 432 193 512	2	0 431 111 005	KBAL 40 P 104	2 437 010 141	DSLA 147 P 1243	2 433 349 249	
0 432 193 513	2	0 431 114 013	KBAL 115 P 95	2 437 010 142	DSLA 157 P 1241	2 433 349 249	
0 432 193 514	2	0 431 114 014	KBAL 115 P 96	2 437 010 142	DSLA 157 P 1241	2 433 349 249	
0 432 193 524	1	0 431 113 961	KBEL 84 P 93	0 433 175 341	DSLA 143 P 1154	2 433 314 053	2 430 136 166
0 432 193 525	2	0 431 111 005	KBAL 40 P 104	2 437 010 138	DSLA 147 P 1147	2 433 349 249	
0 432 193 526	2	0 431 113 033	KBAL 75 P 92	2 437 010 136	DSLA 140 P 1145	2 433 349 249	
0 432 193 527	2	0 431 113 025	KBAL 75 P 77	2 437 010 136	DSLA 140 P 1145	2 433 349 249	
0 432 193 532	2	0 431 113 008	KBAL 90 P 37	2 437 010 135	DSLA 140 P 1112	2 433 349 249	
0 432 193 535	1	0 431 113 969	KBEL 98 P 74	0 433 175 320	DSLA 143 P 1099	2 433 314 042	2 430 136 166
0 432 193 541	2	0 431 113 029	KBAL 93 P 85	2 437 010 093	DSLA 150 P 784	2 433 349 249	
0 432 193 542	2	0 431 112 935	KBEL 58 P 202	2 437 010 111	DSLA 150 P 873	2 433 314 053	
0 432 193 543	2	0 431 112 935	KBEL 58 P 202	2 437 010 111	DSLA 150 P 873	2 433 314 053	
0 432 193 544	2	0 431 112 931	KBEL 59 P 226	2 437 010 062	DSLA 150 P 745	2 433 349 302	
0 432 193 545	2	0 431 112 931	KBEL 59 P 226	2 437 010 062	DSLA 150 P 745	2 433 349 302	
0 432 193 549	2	0 431 115 010	KBAL 139 P 113	2 437 010 127	DSLA 145 P 1024	2 433 349 249	
0 432 193 550	2	0 431 112 946	KBEL 58 P 189	2 437 010 126	DSLA 150 P 1019	2 433 314 053	
0 432 193 551	2	0 431 112 946	KBEL 58 P 189	2 437 010 126	DSLA 150 P 1019	2 433 314 053	
0 432 193 552	2	0 431 112 967	KBEL 58 P 119	2 437 010 126	DSLA 150 P 1019	2 433 314 053	
0 432 193 553	2	0 431 112 967	KBEL 58 P 119	2 437 010 126	DSLA 150 P 1019	2 433 314 053	
0 432 193 554	1	0 431 112 942	KBEL 63 P 193	0 433 175 289	DSLA 155 P 1003	2 433 349 449	2 430 136 166
0 432 193 557	1	0 431 113 013	KBAL 78 P 49	0 433 175 083	DSLA 148 P 482	2 433 314 182	2 430 134 023
0 432 193 558	1	0 431 113 014	KBAL 78 P 50	0 433 175 083	DSLA 148 P 482	2 433 314 182	2 430 134 023
0 432 193 563	2	0 431 112 933	KBEL 58 P 213	2 437 010 123	DSLA 145 P 987	2 433 314 053	
0 432 193 564	2	0 431 112 932	KBEL 58 P 214	2 437 010 123	DSLA 145 P 987	2 433 314 053	
0 432 193 565	2	0 431 113 022	KBAL 85 P 63	2 437 010 121	DSLA 139 P 976	2 433 349 249	
0 432 193 566	2	0 431 113 022	KBAL 85 P 63	2 437 010 120	DSLA 145 P 975	2 433 349 249	
0 432 193 567	1	0 431 115 994	KBEL 137 P 161	0 433 175 165	DSLA 140 P 739	2 433 349 306	F 00Z Z20 003
0 432 193 568	1	0 431 115 994	KBEL 137 P 161	0 433 175 167	DSLA 140 P 741	2 433 349 306	F 00Z Z20 003
0 432 193 569	2	0 431 111 005	KBAL 40 P 104	2 437 010 118	DSLA 147 P 919	2 433 349 249	
0 432 193 570	2	0 431 111 005	KBAL 40 P 104	2 437 010 119	DSLA 147 P 918	2 433 349 249	
0 432 193 571	2	0 431 112 021	KBAL 70 P 70	2 437 010 109	DSLA 145 P 870	2 433 349 249	
0 432 193 573	2	0 431 112 934	KBEL 59 P 204	2 437 010 071	DSLA 150 P 672	2 433 349 479	
0 432 193 574	2	0 431 112 934	KBEL 59 P 204	2 437 010 071	DSLA 150 P 672	2 433 349 479	
0 432 193 575	2	0 431 112 935	KBEL 58 P 202	2 437 010 076	DSLA 150 P 442	2 433 314 053	
0 432 193 576	2	0 431 112 935	KBEL 58 P 202	2 437 010 076	DSLA 150 P 442	2 433 314 053	
0 432 193 577	2	0 431 112 935	KBEL 58 P 202	2 437 010 077	DSLA 150 P 520	2 433 314 053	



F 00Z B20 002	2 434 614 040	3			2 433 370 467		
F 00Z B20 002	2 434 614 040	3			2 433 370 467		F 00Z W00 003
F 00Z B20 002	2 434 614 040	3			2 433 370 467		2 430 105 049
F 00Z B20 002	2 434 614 040	3			2 433 370 467		F 00Z W00 003
2 433 124 446	2 434 614 020	1					2 430 105 042
			B				
			B				
			B			2 916 710 602	
			B			2 916 710 602	
			B				F 00V C17 503
			C				
			C				
2 433 124 388	2 434 614 022	5					
			B				F 00V C17 503
			C				
			C				
2 433 124 388	2 434 614 022	5					
			C				
			B				
			B				
			B				
			C				
			B				
			B			2 916 710 602	
			B			2 916 710 602	
2 433 124 445	2 434 614 032	5				2 916 710 602	
2 433 124 446		6					
2 433 124 422		6					
			B				
			B				
			C				
			C				
F 00Z B20 002	2 434 614 040	3					
F 00Z B20 002	2 434 614 040	3					
			B				F 00V C17 503
			B				F 00V C17 503
			C				
			B				
			B				
			B				
			B				
			B				

*) siehe Seite 388/see page 388/voir page 388/ver pagina 388/vease página 388

**) siehe Seite 392/see page 392/voir page 392/ver pagina 392/vease página 392

A318

de

**Ersatzteile für
Düsenhalter-
kombinationen**
(Fortsetzung)

en

**Spare parts for
nozzle-and-holder
assemblies**
(continued)

fr

**Pièces de rechange
pour ensembles
porte-injecteurs**
(suite)

it

**Ricambi per
combinazione
portapolverizzatori**
(seguito)

es

**Piezas de repuesto
para conjuntos
portainyectoros**
(continuación)



Fig.



Ref.



Typ



①



Typ



②



③

0 432 193 578	2	0 431 112 935	KBEL 58 P 202	2 437 010 077	DSL A 150 P 520	2 433 314 053	
0 432 193 579	2	0 431 112 935	KBEL 58 P 202	2 437 010 059	DSL A 150 P 706	2 433 314 053	
0 432 193 580	2	0 431 112 935	KBEL 58 P 202	2 437 010 059	DSL A 150 P 706	2 433 314 053	
0 432 193 581	1	0 431 113 939	KBEL 84 P 162	0 433 175 249	DSL A 152 P 887	2 433 349 446	F 00Z Z20 003
0 432 193 582	2	0 431 113 008	KBAL 90 P 37	2 437 010 114	DSL A 145 P 883	2 433 349 249	
0 432 193 583	2	0 431 113 008	KBAL 90 P 37	2 437 010 113	DSL A 145 P 882	2 433 349 249	
0 432 193 584	2	0 431 112 935	KBEL 58 P 202	2 437 010 071	DSL A 150 P 672	2 433 314 053	
0 432 193 585	2	0 431 112 935	KBEL 58 P 202	2 437 010 071	DSL A 150 P 672	2 433 314 053	
0 432 193 592	2	0 431 112 971	KBEL 58 P 142	2 437 010 111	DSL A 150 P 873	2 433 314 053	
0 432 193 593	2	0 431 112 971	KBEL 58 P 142	2 437 010 111	DSL A 150 P 873	2 433 314 053	
0 432 193 594	2	0 431 112 957	KBEL 58 P 144	2 437 010 111	DSL A 150 P 873	2 433 314 053	
0 432 193 595	2	0 431 112 957	KBEL 58 P 144	2 437 010 111	DSL A 150 P 873	2 433 314 053	
0 432 193 596	1	0 431 113 015	KBAL 95 P 53	0 433 175 229	DSL A 144 P 860	2 433 314 182	2 430 134 023
0 432 193 597	2	0 431 112 938	KBEL 59 P 198	2 437 010 071	DSL A 150 P 672	2 433 349 479	
0 432 193 598	2	0 431 112 938	KBEL 59 P 198	2 437 010 071	DSL A 150 P 672	2 433 349 479	
0 432 193 599	2	0 431 112 939	KBEL 59 P 197	2 437 010 071	DSL A 150 P 672	2 433 349 479	
0 432 193 600	2	0 431 112 939	KBEL 59 P 197	2 437 010 071	DSL A 150 P 672	2 433 349 479	
0 432 193 601	2	0 431 112 024	KBAL 70 P 99	2 437 010 109	DSL A 145 P 870	2 433 349 249	
0 432 193 602	2	0 431 112 936	KBEL 59 P 201	2 437 010 110	DSL A 142 P 851	2 433 349 302	
0 432 193 603	2	0 431 112 936	KBEL 59 P 201	2 437 010 110	DSL A 142 P 851	2 433 349 302	
0 432 193 604	2	0 431 112 937	KBEL 59 P 200	2 437 010 110	DSL A 142 P 851	2 433 349 302	
0 432 193 605	2	0 431 112 937	KBEL 59 P 200	2 437 010 110	DSL A 142 P 851	2 433 349 302	
0 432 193 608	2	0 431 112 946	KBEL 58 P 189	2 437 010 060	DSL A 150 P 764	2 433 314 053	
0 432 193 609	2	0 431 112 946	KBEL 58 P 189	2 437 010 060	DSL A 150 P 764	2 433 314 053	
0 432 193 610	2	0 431 112 940	KBEL 58 P 195	2 437 010 108	DSL A 145 P 619	2 433 314 053	
0 432 193 611	2	0 431 112 941	KBEL 58 P 194	2 437 010 078	DSL A 145 P 619	2 433 314 053	
0 432 193 613	2	0 431 112 943	KBEL 59 P 192	2 437 010 106	DSL A 93 P 838	2 433 349 302	
0 432 193 614	2	0 431 112 943	KBEL 59 P 192	2 437 010 106	DSL A 93 P 838	2 433 349 302	
0 432 193 615	2	0 431 112 944	KBEL 59 P 191	2 437 010 106	DSL A 93 P 838	2 433 349 302	
0 432 193 616	2	0 431 112 944	KBEL 59 P 191	2 437 010 106	DSL A 93 P 838	2 433 349 302	
0 432 193 617	2	0 431 112 945	KBEL 58 P 190	2 437 010 073	DSL A 150 P 646	2 433 349 302	
0 432 193 618	2	0 431 112 945	KBEL 58 P 190	2 437 010 073	DSL A 150 P 646	2 433 349 302	
0 432 193 619	2	0 431 112 946	KBEL 58 P 189	2 437 010 059	DSL A 150 P 706	2 433 314 053	
0 432 193 620	2	0 431 112 946	KBEL 58 P 189	2 437 010 059	DSL A 150 P 706	2 433 314 053	
0 432 193 621	2	0 431 112 946	KBEL 58 P 189	2 437 010 076	DSL A 150 P 442	2 433 314 053	
0 432 193 622	2	0 431 112 946	KBEL 58 P 189	2 437 010 076	DSL A 150 P 442	2 433 314 053	
0 432 193 623	2	0 431 113 032	KBAL 78 P 88	2 437 010 107	DSL A 148 P 837	2 433 349 249	
0 432 193 624	2	0 431 113 032	KBAL 78 P 88	2 437 010 107	DSL A 148 P 837	2 433 349 249	
0 432 193 625	2	0 431 113 031	KBAL 78 P 87	2 437 010 107	DSL A 148 P 837	2 433 349 249	
0 432 193 626	2	0 431 113 031	KBAL 78 P 87	2 437 010 107	DSL A 148 P 837	2 433 349 249	
0 432 193 627	2	0 431 114 014	KBAL 115 P 96	2 437 010 104	DSL A 145 P 835	2 433 349 249	
0 432 193 628	2	0 431 114 013	KBAL 115 P 95	2 437 010 104	DSL A 145 P 835	2 433 349 249	
0 432 193 629	1	0 431 113 939	KBEL 84 P 162	0 433 175 215	DSL A 152 P 830	2 433 349 446	F 00Z Z20 003
0 432 193 630	1	0 431 113 939	KBEL 84 P 162	0 433 175 212	DSL A 152 P 829	2 433 349 446	F 00Z Z20 003
0 432 193 631	2	0 431 113 008	KBAL 90 P 37	2 437 010 087	DSL A 145 P 366	2 433 349 249	

A320

de
Ersatzteile für
Düsenhalter-
kombinationen
(Fortsetzung)







en
Spare parts for
nozzle-and-holder
assemblies
(continued)

fr
Pièces de rechange
pour ensembles
porte-injecteurs
(suite)

it
Ricambi per
combinazione
portapolverizzatori
(seguito)

es
Piezas de repuesto
para conjuntos
portainyectores
(continuación)



								
					①		②	③
0 432 193 632	2		0 431 113 033	KBAL 75 P 92	2 437 010 066	DSLA 140 P 713	2 433 349 249	
0 432 193 633	2		0 431 111 003	KBAL 40 P 91	2 437 010 101	DSLA 149 P 824	2 433 349 249	
0 432 193 634	2		0 431 111 003	KBAL 40 P 91	2 437 010 102	DSLA 147 P 823	2 433 349 249	
0 432 193 635	1		0 431 113 939	KBEL 84 P 162	0 433 175 210	DSLA 153 P 820	2 433 349 446	F 00Z Z20 003
0 432 193 636	2		0 431 112 023	KBAL 70 P 93	2 437 010 097	DSLA 158 P 817	2 433 349 249	
0 432 193 637	2		0 431 113 032	KBAL 78 P 88	2 437 010 080	DSLA 148 P 591	2 433 349 249	
0 432 193 638	2		0 431 113 032	KBAL 78 P 88	2 437 010 080	DSLA 148 P 591	2 433 349 249	
0 432 193 639	2		0 431 113 031	KBAL 78 P 87	2 437 010 080	DSLA 148 P 591	2 433 349 249	
0 432 193 640	2		0 431 113 031	KBAL 78 P 87	2 437 010 080	DSLA 148 P 591	2 433 349 249	
0 432 193 641	1		0 431 114 971	KBEL 109 P 128	0 433 175 208	DSLA 134 P 816	2 433 349 451	2 430 136 212
0 432 193 642	1		0 431 114 010	KBAL 101 P 67	0 433 175 207	DSLA 147 P 814	2 433 314 182	2 430 134 023
0 432 193 643	2		0 431 112 948	KBEL 58 P 182	2 437 010 095	DSLA 145 P 808	2 433 314 053	
0 432 193 644	2		0 431 112 947	KBEL 58 P 183	2 437 010 095	DSLA 145 P 808	2 433 314 053	
0 432 193 645	1		0 431 113 934	KBEL 84 P 178	0 433 175 202	DSLA 153 P 803	2 433 349 446	F 00Z Z20 003
0 432 193 646	1		0 431 113 934	KBEL 84 P 178	0 433 175 201	DSLA 153 P 802	2 433 349 446	F 00Z Z20 003
0 432 193 647	1		0 431 113 934	KBEL 84 P 178	0 433 175 200	DSLA 153 P 801	2 433 349 446	F 00Z Z20 003
0 432 193 648	1		0 431 113 934	KBEL 84 P 178	0 433 175 198	DSLA 153 P 798	2 433 349 446	F 00Z Z20 003
0 432 193 649	1		0 431 113 934	KBEL 84 P 178	0 433 175 197	DSLA 153 P 797	2 433 349 446	F 00Z Z20 003
0 432 193 650	2		0 431 111 002	KBAL 40 P 79	2 437 010 094	DSLA 147 P 794	2 433 349 249	
0 432 193 652	1		0 431 113 934	KBEL 84 P 178	0 433 175 180	DSLA 150 P 773	2 433 349 446	F 00Z Z20 003
0 432 193 653	1		0 431 113 934	KBEL 84 P 178	0 433 175 170	DSLA 150 P 755	2 433 349 446	F 00Z Z20 003
0 432 193 654	1		0 431 114 010	KBAL 101 P 67	0 433 175 191	DSLA 147 P 786	2 433 314 182	2 430 134 023
0 432 193 655	2		0 431 113 029	KBAL 93 P 85	2 437 010 093	DSLA 150 P 784	2 433 349 249	
0 432 193 656	1		0 431 114 971	KBEL 109 P 128	0 433 175 188	DSLA 134 P 781	2 433 349 451	2 430 136 212
0 432 193 659	1		0 431 113 939	KBEL 84 P 162	0 433 175 182	DSLA 150 P 775	2 433 349 446	F 00Z Z20 003
0 432 193 662	2		0 431 112 967	KBEL 58 P 119	2 437 010 059	DSLA 150 P 706	2 433 314 053	
0 432 193 663	2		0 431 112 967	KBEL 58 P 119	2 437 010 059	DSLA 150 P 706	2 433 314 053	
0 432 193 664	1		0 431 113 939	KBEL 84 P 162	0 433 175 180	DSLA 150 P 773	2 433 349 446	F 00Z Z20 003
0 432 193 665	1		0 431 113 939	KBEL 84 P 162	0 433 175 170	DSLA 150 P 755	2 433 349 446	F 00Z Z20 003
0 432 193 666	2		0 431 114 960	KBEL 110 P 176	2 437 010 091	DSLA 134 P 772	2 433 349 257	
0 432 193 669	2		0 431 112 967	KBEL 58 P 119	2 437 010 060	DSLA 150 P 764	2 433 314 053	
0 432 193 670	2		0 431 112 967	KBEL 58 P 119	2 437 010 060	DSLA 150 P 764	2 433 314 053	
0 432 193 676	1		0 431 113 956	KBEL 98 P 102	0 433 175 173	DSLA 147 P 759	2 433 314 042	2 430 136 212
0 432 193 678	1		0 431 113 939	KBEL 84 P 162	0 433 175 170	DSLA 150 P 755	2 433 349 446	F 00Z Z20 003
0 432 193 680	2		0 431 112 949	KBEL 58 P 171	2 437 010 062	DSLA 150 P 745	2 433 349 302	
0 432 193 681	2		0 431 112 949	KBEL 58 P 171	2 437 010 062	DSLA 150 P 745	2 433 349 302	
0 432 193 682	2		0 431 112 950	KBEL 58 P 170	2 437 010 062	DSLA 150 P 745	2 433 349 302	
0 432 193 683	2		0 431 112 950	KBEL 58 P 170	2 437 010 062	DSLA 150 P 745	2 433 349 302	
0 432 193 686	2		0 431 111 002	KBAL 40 P 79	2 437 010 063	DSLA 147 P 535	2 433 349 249	
0 432 193 687	2		0 431 111 002	KBAL 40 P 79	2 437 010 064	DSLA 147 P 716	2 433 349 249	
0 432 193 688	2		0 431 111 002	KBAL 40 P 79	2 437 010 065	DSLA 147 P 715	2 433 349 249	
0 432 193 689	2		0 431 113 025	KBAL 75 P 77	2 437 010 066	DSLA 140 P 713	2 433 349 249	
0 432 193 690	2		0 431 112 022	KBAL 72 P 76	2 437 010 067	DSLA 145 P 712	2 433 349 249	
0 432 193 691	2		0 431 113 022	KBAL 85 P 63	2 437 010 068	DSLA 139 P 710	2 433 349 249	
0 432 193 693	2		0 431 112 959	KBEL 58 P 142	2 437 010 059	DSLA 150 P 706	2 433 314 053	



			C				
			B				F 00V C17 503
			B				F 00V C17 503
F 00Z B20 002	2 434 614 040	3					F 00V C17 503
			C				
			C				
			C				
			C				
2 433 124 376	2 434 614 040	3				2 916 710 602	
2 433 124 446	2 434 614 010	1					
			B				
			B				
F 00Z B20 002	2 434 614 040	3					F 00V C17 503
F 00Z B20 002	2 434 614 040	3					F 00V C17 503
F 00Z B20 002	2 434 614 040	3					F 00V C17 503
F 00Z B20 002	2 434 614 040	3					F 00V C17 503
F 00Z B20 002	2 434 614 040	3	A				F 00V C17 503
F 00Z B20 002	2 434 614 040	3					F 00V C17 503
F 00Z B20 002	2 434 614 040	3					F 00V C17 503
2 433 124 446	2 434 614 010	1					
			C				
2 433 124 376	2 434 614 040	3				2 916 710 602	
F 00Z B20 002	2 434 614 040	3					F 00V C17 503
			B			2 916 710 602	
			B			2 916 710 602	
F 00Z B20 002	2 434 614 040	3					F 00V C17 503
F 00Z B20 002	2 434 614 040	3					F 00V C17 503
			B			2 916 710 602	
			B			2 916 710 602	
2 433 124 376	2 434 614 040	3					
F 00Z B20 002	2 434 614 040	3					F 00V C17 503
			B				
			B				
			B				
			A				F 00V C17 503
			A				F 00V C17 503
			A				F 00V C17 503
			C				
			C				
			C				
			B				

*) siehe Seite 388/see page 388/voir page 388/ver pagina 388/vease página 388
 **) siehe Seite 392/see page 392/voir page 392/ver pagina 392/vease página 392

A322

de
Ersatzteile für
Düsenhalter-
kombinationen
(Fortsetzung)

en
Spare parts for
nozzle-and-holder
assemblies
(continued)

fr
Pièces de rechange
pour ensembles
porte-injecteurs
(suite)

it
Ricambi per
combinazione
portapolverizzatori
(seguito)

es
Piezas de repuesto
para conjuntos
portainyectoros
(continuación)



0 432 193 694	2	0 431 112 959	KBEL 58 P 142	2 437 010 059	DSLA 150 P 706	2 433 314 053	
0 432 193 695	2	0 431 112 957	KBEL 58 P 144	2 437 010 059	DSLA 150 P 706	2 433 314 053	
0 432 193 696	2	0 431 112 957	KBEL 58 P 144	2 437 010 059	DSLA 150 P 706	2 433 314 053	
0 432 193 699	1	0 431 114 011	KBAL 115 P 71	0 433 175 146	DSLA 157 P 687	2 433 314 182	2 430 134 023
0 432 193 700	2	0 431 112 021	KBAL 70 P 70	2 437 010 070	DSLA 145 P 682	2 433 349 249	
0 432 193 701	2	0 431 112 020	KBAL 70 P 69	2 437 010 070	DSLA 145 P 682	2 433 349 249	
0 432 193 702	2	0 431 112 957	KBEL 58 P 144	2 437 010 140	DSLA 150 P 672-	2 433 314 053	
0 432 193 703	2	0 431 112 957	KBEL 58 P 144	2 437 010 140	DSLA 150 P 672-	2 433 314 053	
0 432 193 704	2	0 431 112 959	KBEL 58 P 142	2 437 010 140	DSLA 150 P 672-	2 433 314 053	
0 432 193 705	2	0 431 112 959	KBEL 58 P 142	2 437 010 140	DSLA 150 P 672-	2 433 314 053	
0 432 193 707	2	0 431 112 976	KBEL 58 P 94	2 437 010 072	DSLA 150 P 661	2 433 314 053	
0 432 193 708	2	0 431 112 976	KBEL 58 P 94	2 437 010 072	DSLA 150 P 661	2 433 314 053	
0 432 193 709	2	0 431 112 978	KBEL 58 P 87	2 437 010 072	DSLA 150 P 661	2 433 314 053	
0 432 193 710	2	0 431 112 978	KBEL 58 P 87	2 437 010 072	DSLA 150 P 661	2 433 314 053	
0 432 193 716	2	0 431 112 952	KBEL 58 P 157	2 437 010 073	DSLA 150 P 646	2 433 349 302	
0 432 193 717	2	0 431 112 952	KBEL 58 P 157	2 437 010 073	DSLA 150 P 646	2 433 349 302	
0 432 193 722	1	0 431 113 943	KBEL 90 P 154	0 433 175 130	DSLA 150 P 645	2 433 314 053	2 430 136 166
0 432 193 727	1	0 431 113 012	KBAL 85 P 48	0 433 175 125	DSLA 145 P 626	2 433 349 432	2 430 134 023
0 432 193 728	2	0 431 112 953	KBEL 68 P 152	2 437 010 074	DSLA 140 P 640	2 433 314 053	
0 432 193 730	1	0 431 113 946	KBEL 82 P 149	0 433 175 122	DSLA 135 P 633	2 433 349 416	2 430 136 212
0 432 193 731	2	0 431 113 022	KBAL 85 P 63	2 437 010 075	DSLA 145 P 631	2 433 349 249	
0 432 193 732	2	0 431 112 957	KBEL 58 P 144	2 437 010 076	DSLA 150 P 442	2 433 314 053	
0 432 193 733	2	0 431 112 957	KBEL 58 P 144	2 437 010 076	DSLA 150 P 442	2 433 314 053	
0 432 193 734	2	0 431 112 959	KBEL 58 P 142	2 437 010 076	DSLA 150 P 442	2 433 314 053	
0 432 193 735	2	0 431 112 959	KBEL 58 P 142	2 437 010 076	DSLA 150 P 442	2 433 314 053	
0 432 193 738	2	0 431 112 956	KBEL 58 P 145	2 437 010 077	DSLA 150 P 520		
0 432 193 739	2	0 431 112 956	KBEL 58 P 145	2 437 010 077	DSLA 150 P 520		
0 432 193 742	2	0 431 112 956	KBEL 58 P 145	2 437 010 076	DSLA 150 P 442		
0 432 193 743	2	0 431 112 956	KBEL 58 P 145	2 437 010 076	DSLA 150 P 442		
0 432 193 744	2	0 431 112 959	KBEL 58 P 142	2 437 010 077	DSLA 150 P 520	2 433 314 053	
0 432 193 745	2	0 431 112 959	KBEL 58 P 142	2 437 010 077	DSLA 150 P 520	2 433 314 053	
0 432 193 746	2	0 431 112 957	KBEL 58 P 144	2 437 010 077	DSLA 150 P 520	2 433 314 053	
0 432 193 747	2	0 431 112 957	KBEL 58 P 144	2 437 010 077	DSLA 150 P 520	2 433 314 053	
0 432 193 752	1	0 431 113 953	KBEL 78 P 114	0 433 175 118	DSLA 154 P 620	2 433 349 449	2 430 136 166
0 432 193 753	2	0 431 112 954	KBEL 58 P 147	2 437 010 078	DSLA 145 P 619	2 433 314 053	
0 432 193 754	2	0 431 112 955	KBEL 58 P 146	2 437 010 078	DSLA 145 P 619	2 433 314 053	
0 432 193 755	2	0 431 112 983	KBEL 68 P 67	2 437 010 079	DSLA 155 P 617	2 433 314 053	
0 432 193 756	1	0 431 113 024	KBAL 75 P 65	0 433 175 115	DSLA 140 P 616	2 433 314 182	2 430 134 023
0 432 193 757	1	0 431 114 968	KBEL 110 P 140	0 433 175 114	DSLA 134 P 604	2 433 349 257	2 430 136 166
0 432 193 758	2	0 431 113 023	KBAL 78 P 64	2 437 010 080	DSLA 148 P 591	2 433 349 249	
0 432 193 759	1	0 431 112 960	KBEL 70 P 139	0 433 175 070	DSLA 140 P 425	2 433 349 159	2 430 136 166
0 432 193 762	1	0 431 112 962	KBEL 66 P 137	0 433 175 080	DSLA 140 P 472	2 433 349 159	2 430 136 166
0 432 193 765	1	0 431 113 020	KBAL 95 P 60	0 433 175 108	DSLA 140 P 576	2 433 349 432	2 430 134 023
0 432 193 766	2	0 431 113 008	KBAL 90 P 37	2 437 010 081	DSLA 148 P 575	2 433 349 249	
0 432 193 768	2	0 431 113 019	KBAL 78 P 59	2 437 010 080	DSLA 148 P 591	2 433 349 249	

A324

de
Ersatzteile für
Düsenhalter-
kombinationen
(Fortsetzung)

en
Spare parts for
nozzle-and-holder
assemblies
(continued)

fr
Pièces de rechange
pour ensembles
porte-injecteurs
(suite)

it
Ricambi per
combinazione
portapolverizzatori
(seguito)

es
Piezas de repuesto
para conjuntos
portainyectoros
(continuación)



0 432 193 769	2	0 431 113 019	KBAL 78 P 59	2 437 010 080	DSLA 148 P 591	2 433 349 249	
0 432 193 770	1	0 431 115 002	KBAL 137 P 26	0 433 175 102	DSLA 140 P 562	2 433 349 468	2 430 134 023
0 432 193 771	2	0 431 112 965	KBEL 58 P 131	2 437 010 082	DSLA 150 P 502	2 433 314 053	
0 432 193 773	2	0 431 112 956	KBEL 58 P 145	2 437 010 077	DSLA 150 P 520		
0 432 193 775	2	0 431 112 956	KBEL 58 P 145	2 437 010 076	DSLA 150 P 442		
0 432 193 779	2	0 431 112 956	KBEL 58 P 145	2 437 010 077	DSLA 150 P 520		
0 432 193 781	2	0 431 112 956	KBEL 58 P 145	2 437 010 076	DSLA 150 P 442		
0 432 193 784	2	0 431 112 965	KBEL 58 P 131	2 437 010 082	DSLA 150 P 502	2 433 314 053	
0 432 193 785	2	0 431 112 967	KBEL 58 P 119	2 437 010 084	DSLA 150 P 280-	2 433 314 053	
0 432 193 786	2	0 431 112 967	KBEL 58 P 119	2 437 010 082	DSLA 150 P 502	2 433 314 053	
0 432 193 788	2	0 431 112 966	KBEL 58 P 120	2 437 010 082	DSLA 150 P 502	2 433 314 053	
0 432 193 790	2	0 431 113 023	KBAL 78 P 64	2 437 010 080	DSLA 148 P 591	2 433 349 249	
0 432 193 791	1	0 431 113 015	KBAL 95 P 53	0 433 175 100	DSLA 144 P 547	2 433 314 182	2 430 134 023
0 432 193 793	1	0 431 114 974	KBEL 100 P 123	0 433 175 097	DSLA 149 P 540	2 433 314 042	2 430 136 212
0 432 193 794	2	0 431 112 978	KBEL 58 P 87	2 437 010 076	DSLA 150 P 442	2 433 314 053	
0 432 193 795	2	0 431 112 976	KBEL 58 P 94	2 437 010 076	DSLA 150 P 442	2 433 314 053	
0 432 193 796	1	0 431 115 002	KBAL 137 P 26	0 433 175 096	DSLA 145 P 537	2 433 349 468	2 430 134 023
0 432 193 797	2	0 431 111 001	KBAL 40 P 54	2 437 010 063	DSLA 147 P 535	2 433 349 249	
0 432 193 798	1	0 431 113 949	KBEL 82 P 125	0 433 175 094	DSLA 128 P 523	2 433 349 126	2 430 136 166
0 432 193 803	1	0 431 115 002	KBAL 137 P 26	0 433 175 090	DSLA 137 P 508	2 433 349 468	2 430 134 023
0 432 193 804	1	0 431 115 002	KBAL 137 P 26	0 433 175 089	DSLA 137 P 507	2 433 349 468	2 430 134 023
0 432 193 805	1	0 431 115 002	KBAL 137 P 26	0 433 175 088	DSLA 137 P 506	2 433 349 468	2 430 134 023
0 432 193 806	2	0 431 112 966	KBEL 58 P 120	2 437 010 082	DSLA 150 P 502	2 433 314 053	
0 432 193 807	2	0 431 112 967	KBEL 58 P 119	2 437 010 082	DSLA 150 P 502	2 433 314 053	
0 432 193 808	2	0 431 112 966	KBEL 58 P 120	2 437 010 084	DSLA 150 P 280-	2 433 314 053	
0 432 193 809	2	0 431 112 967	KBEL 58 P 119	2 437 010 084	DSLA 150 P 280-	2 433 314 053	
0 432 193 810	2	0 431 112 976	KBEL 58 P 94	2 437 010 076	DSLA 150 P 442	2 433 314 053	
0 432 193 811	2	0 431 112 978	KBEL 58 P 87	2 437 010 076	DSLA 150 P 442	2 433 314 053	
0 432 193 812	1	0 431 113 014	KBAL 78 P 50	0 433 175 083	DSLA 148 P 482	2 433 314 182	2 430 134 023
0 432 193 813	1	0 431 113 013	KBAL 78 P 49	0 433 175 083	DSLA 148 P 482	2 433 314 182	2 430 134 023
0 432 193 814	1	0 431 113 012	KBAL 85 P 48	0 433 175 082	DSLA 88 P 480	2 433 349 432	2 430 134 023
0 432 193 815	1	0 431 112 969	KBEL 65 P 113	0 433 175 080	DSLA 140 P 472	2 433 349 162	2 430 136 166
0 432 193 816	1	0 431 112 975	KBEL 68 P 100	0 433 175 079	DSLA 135 P 468	2 433 349 162	2 430 136 166
0 432 193 817	1	0 431 112 970	KBEL 66 P 111	0 433 175 075	DSLA 140 P 453	2 433 349 179	2 430 136 166
0 432 193 818	1	0 431 114 984	KBEL 109 P 81	0 433 175 074	DSLA 150 P 448	2 433 349 131	2 430 136 166
0 432 193 819	2	0 431 112 019	KBAL 70 P 46	2 437 010 085	DSLA 145 P 446	2 433 349 249	
0 432 193 820	2	0 431 112 018	KBAL 70 P 45	2 437 010 085	DSLA 145 P 446	2 433 349 249	
0 432 193 823	2	0 431 112 967	KBEL 58 P 119	2 437 010 076	DSLA 150 P 442	2 433 314 053	
0 432 193 824	2	0 431 112 967	KBEL 58 P 119	2 437 010 076	DSLA 150 P 442	2 433 314 053	
0 432 193 825	1	0 431 112 974	KBEL 69 P 99	0 433 175 044	DSLA 140 P 292	2 433 349 159	2 430 136 166
0 432 193 826	1	0 431 112 975	KBEL 68 P 100	0 433 175 070	DSLA 140 P 425	2 433 349 162	2 430 136 166
0 432 193 827	1	0 431 114 984	KBEL 109 P 81	0 433 175 068	DSLA 141 P 405	2 433 349 131	2 430 136 166
0 432 193 828	1	0 431 112 982	KBEL 66 P 69	0 433 175 067	DSLA 140 P 400	2 433 349 121	2 430 136 166
0 432 193 829	2	0 431 112 976	KBEL 58 P 94	2 437 010 083	DSLA 150 P 357	2 433 314 053	
0 432 193 830	2	0 431 112 976	KBEL 58 P 94	2 437 010 083	DSLA 150 P 357	2 433 314 053	



			C					
2 433 124 446	2 434 614 020	6						
			B					
			B					
			B					
			B					
			B					
			B					
			B				2 916 710 602	
			B				2 916 710 602	
			B					
			C					
2 433 124 446	2 434 614 028	1						
2 433 124 376	2 434 614 040	3					2 916 710 603	
			B					
			B					
2 433 124 446	2 434 614 020	6						
			A					F 00V C17 503
2 433 124 388	2 434 614 042	5					2 916 710 602	
2 433 124 446	2 434 614 020	6						
2 433 124 446	2 434 614 020	6						
			B				2 916 710 602	
			B				2 916 710 602	
			B				2 916 710 602	
			B				2 916 710 602	
			B					
2 433 124 422		6						
2 433 124 446		6						
2 433 124 446	2 434 614 020	1						
2 433 124 388	2 434 614 022	5						
2 433 124 388	2 434 614 022	5						
2 433 124 388	2 434 614 022	5						
2 433 124 388	2 434 614 027	5					2 916 710 602	
			C					
			C					
			B				2 916 710 602	
			B				2 916 710 602	
2 433 124 388	2 434 614 022	5						
2 433 124 388	2 434 614 022	5						
2 433 124 388	2 434 614 027	5					2 916 710 602	
			B					
			B					

*) siehe Seite 388/see page 388/voir page 388/ver pagina 388/vease página 388

**) siehe Seite 392/see page 392/voir page 392/ver pagina 392/vease página 392

A326

de
Ersatzteile für
Düsenhalter-
kombinationen
(Fortsetzung)

en
Spare parts for
nozzle-and-holder
assemblies
(continued)

fr
Pièces de rechange
pour ensembles
porte-injecteurs
(suite)

it
Ricambi per
combinazione
portapolverizzatori
(seguito)

es
Piezas de repuesto
para conjuntos
portainyectoros
(continuación)



0 432 193 831	1	0 431 115 003	KBAL 137 P 28	0 433 175 064	DSLA 140 P 381	2 433 349 468	2 430 134 023
0 432 193 832	1	0 431 115 003	KBAL 137 P 28	0 433 175 063	DSLA 145 P 380	2 433 349 468	2 430 134 023
0 432 193 833	1	0 431 115 003	KBAL 137 P 28	0 433 175 062	DSLA 145 P 379	2 433 349 468	2 430 134 023
0 432 193 835	2	0 431 113 008	KBAL 90 P 37	2 437 010 087	DSLA 145 P 366	2 433 349 249	
0 432 193 836	2	0 431 113 007	KBAL 90 P 36	2 437 010 086	DSLA 145 P 365	2 433 349 249	
0 432 193 837	2	0 431 112 977	KBEL 58 P 88	2 437 010 083	DSLA 150 P 357	2 433 314 053	
0 432 193 838	2	0 431 112 978	KBEL 58 P 87	2 437 010 083	DSLA 150 P 357	2 433 314 053	
0 432 193 839	2	0 431 112 977	KBEL 58 P 88	2 437 010 083	DSLA 150 P 357	2 433 314 053	
0 432 193 840	2	0 431 112 978	KBEL 58 P 87	2 437 010 083	DSLA 150 P 357	2 433 314 053	
0 432 193 843	1	0 431 114 983	KBEL 108 P 82	0 433 175 054	DSLA 145 P 330	2 433 349 463	2 430 136 166
0 432 193 844	1	0 431 112 985	KBEL 63 P 62	0 433 175 015	DSLA 150 P 194	2 433 314 053	2 430 136 166
0 432 193 845	1	0 431 114 984	KBEL 109 P 81	0 433 175 048	DSLA 145 P 300	2 433 349 131	2 430 136 166
0 432 193 846	1	0 431 113 965	KBEL 83 P 79	0 433 175 052	DSLA 130 P 321	2 433 349 125	2 430 136 166
0 432 193 847	1	0 431 113 966	KBEL 83 P 78	0 433 175 051	DSLA 130 P 320	2 433 349 126	2 430 136 166
0 432 193 848	1	0 431 114 987	KBEL 108 P 51	0 433 175 050	DSLA 150 P 318	2 433 349 131	2 430 136 166
0 432 193 849	1	0 431 112 015	KBAL 67 P 31	0 433 175 047	DSLA 140 P 297	2 433 349 124	2 430 134 023
0 432 193 850	1	0 431 111 998	KBEL 48 P 38	0 433 175 046	DSLA 150 P 294	2 433 314 053	2 430 136 166
0 432 193 851	1	0 431 111 998	KBEL 48 P 38	0 433 175 046	DSLA 150 P 294	2 433 314 053	2 430 136 166
0 432 193 854	1	0 431 114 987	KBEL 108 P 51	0 433 175 048	DSLA 145 P 300	2 433 349 131	2 430 136 166
0 432 193 855	1	0 431 112 013	KBAL 65 P 22	0 433 175 043	DSLA 155 P 298	2 433 314 182	2 430 134 023
0 432 193 856	2	0 431 112 980	KBEL 53 P 72	2 437 010 084	DSLA 150 P 280-	2 433 314 053	
0 432 193 857	2	0 431 112 980	KBEL 53 P 72	2 437 010 084	DSLA 150 P 280-	2 433 314 053	
0 432 193 858	2	0 431 112 981	KBEL 53 P 71	2 437 010 084	DSLA 150 P 280-	2 433 314 053	
0 432 193 859	2	0 431 112 981	KBEL 53 P 71	2 437 010 084	DSLA 150 P 280-	2 433 314 053	
0 432 193 860	1	0 431 112 982	KBEL 66 P 69	0 433 175 044	DSLA 140 P 292	2 433 349 121	2 430 136 166
0 432 193 861	1	0 431 112 014	KBAL 72 P 23	0 433 175 038	DSLA 142 P 272	2 433 314 182	2 430 134 023
0 432 193 862	1	0 431 115 002	KBAL 137 P 26	0 433 175 037	DSLA 145 P 269	2 433 349 468	2 430 134 023
0 432 193 863	1	0 431 115 002	KBAL 137 P 26	0 433 175 036	DSLA 145 P 268	2 433 349 468	2 430 134 023
0 432 193 864	1	0 431 115 002	KBAL 137 P 26	0 433 175 035	DSLA 145 P 267	2 433 349 468	2 430 134 023
0 432 193 866	2	0 431 112 983	KBEL 68 P 67	2 437 010 088	DSLA 150 P 261	2 433 314 053	
0 432 193 867	1	0 431 113 972	KBEL 100 P 64	0 433 175 027	DSLA 149 P 252	2 433 314 042	2 430 136 166
0 432 193 870	1	0 431 112 985	KBEL 63 P 62	0 433 175 024	DSLA 150 P 246	2 433 314 053	2 430 136 166
0 432 193 873	1	0 431 115 002	KBAL 137 P 26	0 433 175 020	DSLA 148 P 219	2 433 349 468	2 430 134 023
0 432 193 877	2	0 431 112 989	KBEL 53 P 43	2 437 010 089	DSLA 150 P 191	2 433 314 053	
0 432 193 878	2	0 431 112 989	KBEL 53 P 43	2 437 010 089	DSLA 150 P 191	2 433 314 053	
0 432 193 879	2	0 431 113 979	KBEL 98 P 52	2 437 010 090	DSLA 145 P 208	2 433 314 053	
0 432 193 882	1	0 431 113 981	KBEL 84 P 46	0 433 175 016	DSLA 124 P 198	2 433 349 117	2 430 136 166
0 432 193 883	1	0 431 112 985	KBEL 63 P 62	0 433 175 015	DSLA 150 P 194	2 433 314 053	2 430 136 166
0 432 193 884	1	9 430 231 002	KBEL 90 P 18	0 433 175 014	DSLA 160 P 192	2 433 314 042	2 430 136 166
0 432 193 887	1	0 431 112 991	KBEL 63 P 37	0 433 175 006	DSLA 150 P 143	2 433 314 053	2 430 136 166
0 432 200 001	1	0 430 201 002	KC 45 S 25/4	0 433 200 002	DL 0 S 64	2 433 349 506	
0 432 206 002	1	0 430 202 006	KC 57 SD 23/4	0 434 200 002	DN 4 S 2	2 430 360 028	
0 432 206 003	1	0 430 202 037	KC 70 S 25/13	0 434 200 002	DN 4 S 2	2 433 349 506	
0 432 206 004	1	0 430 202 037	KC 70 S 25/13	0 434 200 015	DN 8 S 138	2 433 349 506	
0 432 206 005	1	0 430 202 037	KC 70 S 25/13	0 434 200 002	DN 4 S 2	2 433 349 506	



2 433 124 446	2 434 614 020	6					
2 433 124 446	2 434 614 020	6					
2 433 124 446	2 434 614 020	6					
		C					
		C					
		B					
		B					
		B					
		B					
2 433 124 388	2 434 614 027	5				2 916 710 602	
2 433 124 388	2 434 614 022	5				2 916 710 602	
2 433 124 388	2 434 614 027	5				2 916 710 602	
2 433 124 388	2 434 614 027	5				2 916 710 602	
2 433 124 388	2 434 614 030	5				2 916 710 602	
2 433 124 388	2 434 614 027	5				2 916 710 602	
2 433 124 446	2 434 614 020	1				2 916 710 602	
2 433 124 388	2 434 614 027	5					
2 433 124 388	2 434 614 027	5					
2 433 124 388	2 434 614 027	5				2 916 710 602	
2 433 124 446	2 434 614 020	1				2 916 710 602	
		B					2 430 105 020
		B					2 430 105 020
		B					2 430 105 020
		B					
2 433 124 388	2 434 614 022	5					
2 433 124 446	2 434 614 020	1					
2 433 124 446	2 434 614 020	6					
2 433 124 446	2 434 614 020	6					
2 433 124 446	2 434 614 020	6					
		B					
2 433 124 388	2 434 614 022	5					
2 433 124 388	2 434 614 022	5				2 916 710 602	
2 433 124 446	2 434 614 020	6					
		B					2 430 105 020
		B					2 430 105 020
		B					2 430 105 020
2 433 124 388	2 434 614 022	5				2 916 710 602	
2 433 124 388	2 434 614 022	5				2 916 710 602	
2 433 120 127	2 434 614 022	5					2 430 100 048
2 433 120 127	2 434 614 022	5				2 916 710 602	
	2 434 619 006	7				2 916 710 603	2 430 105 011
2 433 124 300	2 434 619 035	7				2 916 710 603	
	2 434 619 006	7				2 916 710 603	2 430 105 011
	2 434 619 006	7				2 916 710 603	2 430 105 011
	2 434 619 006	7				2 916 710 603	2 430 105 011

*) siehe Seite 388/see page 388/voir page 388/ver pagina 388/vease página 388

***) siehe Seite 392/see page 392/voir page 392/ver pagina 392/vease página 392

A328

de
Ersatzteile für
Düsenhalter-
kombinationen
(Fortsetzung)

en
Spare parts for
nozzle-and-holder
assemblies
(continued)

fr
Pièces de rechange
pour ensembles
porte-injecteurs
(suite)

it
Ricambi per
combinazione
portapolverizzatori
(seguito)

es
Piezas de repuesto
para conjuntos
portainyectoros
(continuación)



0 432 206 010	1	0 430 202 041	KC 57 S 42/13	0 434 200 049	DN 0 S 235	2 430 360 028	
0 432 206 011	1	0 430 202 006	KC 57 SD 23/4	0 434 200 054	DN 0 S 243	2 430 360 028	
0 432 206 012	1	0 430 202 039	KC 57 SD 40/13	0 434 200 049	DN 0 S 235	2 430 360 028	
0 432 206 013	1	0 430 202 039	KC 57 SD 40/13	0 434 200 049	DN 0 S 235	2 430 360 028	
0 432 207 001	1	0 430 202 038	KC 57 SD 26/13	0 434 250 001	DN 0 SD 21	2 430 360 028	
0 432 207 002	1	0 430 202 006	KC 57 SD 23/4	0 434 250 004	DN 0 SD 130	2 430 360 028	
0 432 207 003	1	0 430 202 006	KC 57 SD 23/4	0 434 250 009	DN 0 SD 211	2 430 360 028	
0 432 207 006	1	0 430 202 039	KC 57 SD 40/13	0 434 250 004	DN 0 SD 130	2 430 360 028	
0 432 207 008	1	0 430 202 006	KC 57 SD 23/4	0 434 250 004	DN 0 SD 130	2 430 360 028	
0 432 207 012	1	0 430 201 005	KC 45 SD 21/4	0 434 250 009	DN 0 SD 211	2 433 349 506	
0 432 207 015	1	0 430 201 005	KC 45 SD 21/4	0 434 250 004	DN 0 SD 130	2 433 349 506	
0 432 216 004	1	0 430 211 005	KCA 17 SD 3/13	0 434 200 013	DN 8 S 3		2 430 136 031
0 432 216 006	1	0 430 211 005	KCA 17 SD 3/13	0 434 200 023	DN 30 S 2		2 430 136 031
0 432 216 009	1	0 430 211 005	KCA 17 SD 3/13	0 434 200 013	DN 8 S 3		2 430 136 031
0 432 216 012	1	0 430 211 005	KCA 17 SD 3/13	0 434 200 044	TR-DN 8 S 229		2 430 136 031
0 432 217 001	1	0 430 211 005	KCA 17 SD 3/13	0 434 250 001	DN 0 SD 21		2 430 136 031
0 432 217 005	1	0 430 211 009	KCA 30 SD 2/4	0 434 250 002	DN 0 SD 126		2 430 136 031
0 432 217 006	1	0 430 211 009	KCA 30 SD 2/4	0 434 250 007	DN 0 SD 151		2 430 136 031
0 432 217 007	1	0 430 211 009	KCA 30 SD 2/4	0 434 250 084	DN 0 SD 151		2 430 136 031
0 432 217 008	1	0 430 211 009	KCA 30 SD 2/4	0 434 250 009	DN 0 SD 211		2 430 136 031
0 432 217 009	1	0 430 211 009	KCA 30 SD 2/4	0 434 250 009	DN 0 SD 211		2 430 136 031
0 432 217 010	1	0 430 211 009	KCA 30 SD 2/4	0 434 250 009	DN 0 SD 211		2 430 136 031
0 432 217 021	1	0 430 211 009	KCA 30 SD 2/4	0 434 250 018	DN 4 SD 128		2 430 136 031
0 432 217 022	1	0 430 211 009	KCA 30 SD 2/4	0 434 250 010	DN 0 SD 212		2 430 136 031
0 432 217 024	1	0 430 211 005	KCA 17 SD 3/13	0 434 250 014	DN 4 SD 24		2 430 136 031
0 432 217 026	1	0 430 211 009	KCA 30 SD 2/4	0 434 250 010	DN 0 SD 212		2 430 136 031
0 432 217 027	1	0 430 211 009	KCA 30 SD 2/4	0 434 250 009	DN 0 SD 211		2 430 136 031
0 432 217 028	1	0 430 211 009	KCA 30 SD 2/4	0 434 250 027	DN 12 SD 12		2 430 136 031
0 432 217 029	1	0 430 211 005	KCA 17 SD 3/13	0 434 250 014	DN 4 SD 24		2 430 136 031
0 432 217 030	1	0 430 211 036	KCA 36 SD 24/13	0 434 250 001	DN 0 SD 21		2 430 136 031
0 432 217 031	1	0 430 211 036	KCA 36 SD 24/13	0 434 250 001	DN 0 SD 21		2 430 136 031
0 432 217 033	1	0 430 211 005	KCA 17 SD 3/13	0 434 250 002	DN 0 SD 126		2 430 136 031
0 432 217 034	1	0 430 211 009	KCA 30 SD 2/4	0 434 250 011	DN 0 SD 1510		2 430 136 031
0 432 217 038	1	0 430 211 037	KCA 17 SD 3/21	0 434 250 065	DN 0 SD 195		2 430 136 031
0 432 217 039	1	0 430 211 009	KCA 30 SD 2/4	0 434 250 012	DN 0 SD 2110		2 430 136 031
0 432 217 040	1	0 430 211 009	KCA 30 SD 2/4	0 434 250 012	DN 0 SD 2110		2 430 136 031
0 432 217 042	1	0 430 211 009	KCA 30 SD 2/4	0 434 250 060	DN 0 SD 189		2 430 136 031
0 432 217 043	1	0 430 211 009	KCA 30 SD 2/4	0 434 250 072	DN 0 SD 220		2 430 136 031
0 432 217 045	1	0 430 211 041	KCA 30 SD 27/4	0 434 250 011	DN 0 SD 1510	2 433 458 148	2 430 136 031
0 432 217 047	1	0 430 211 009	KCA 30 SD 2/4	0 434 250 048	DN 0 SD 210		2 430 136 031
0 432 217 049	1	0 430 211 041	KCA 30 SD 27/4	0 434 250 048	DN 0 SD 210	2 433 458 148	2 430 136 031
0 432 217 050	1	0 430 211 009	KCA 30 SD 2/4	0 434 250 009	DN 0 SD 211		2 430 136 031
0 432 217 052	1	0 430 211 043	KCA 17 SD 30/4	0 434 250 092	DN 0 SD 1930		2 430 136 031
0 432 217 053	1	0 430 211 044	KCA 17 SD 31/4	0 434 250 065	DN 0 SD 195		2 430 136 031
0 432 217 054	1	0 430 211 041	KCA 30 SD 27/4	0 434 250 072	DN 0 SD 220	2 433 458 148	2 430 136 031

A330

de
Ersatzteile für
Düsenhalter-
kombinationen
(Fortsetzung)







en
Spare parts for
nozzle-and-holder
assemblies
(continued)

fr
Pièces de rechange
pour ensembles
porte-injecteurs
(suite)

it
Ricambi per
combinazione
portapolverizzatori
(seguito)

es
Piezas de repuesto
para conjuntos
portainyectores
(continuación)



								
					①		②	③
0 432 217 056	1		0 430 211 041	KCA 30 SD 27/4	0 434 250 014	DN 4 SD 24	2 433 458 148	2 430 136 031
0 432 217 057	1		0 430 211 041	KCA 30 SD 27/4	0 434 250 012	DN 0 SD 2110	2 433 458 148	2 430 136 031
0 432 217 058	1		0 430 211 041	KCA 30 SD 27/4	0 434 250 063	DN 0 SD 193	2 433 458 148	2 430 136 031
0 432 217 059	1		0 430 211 041	KCA 30 SD 27/4	0 434 250 063	DN 0 SD 193	2 433 458 148	2 430 136 031
0 432 217 060	1		0 430 211 046	KCA 17 S 33/4	0 434 250 011	DN 0 SD 1510		2 430 136 031
0 432 217 061	1		0 430 211 041	KCA 30 SD 27/4	0 434 250 072	DN 0 SD 220	2 433 458 148	2 430 136 031
0 432 217 062	1		0 430 211 041	KCA 30 SD 27/4	0 434 250 095	DN 0 SD 240	2 433 458 148	2 430 136 031
0 432 217 063	1		0 430 211 041	KCA 30 SD 27/4	0 434 250 096	DN 0 SD 2400	2 433 458 148	2 430 136 031
0 432 217 064	1		0 430 211 043	KCA 17 SD 30/4	0 434 250 063	DN 0 SD 193		2 430 136 031
0 432 217 065	1		0 430 211 047	KCA 30 S 35/4	0 434 250 095	DN 0 SD 240	2 433 458 148	2 430 136 031
0 432 217 066	1		0 430 211 047	KCA 30 S 35/4	0 434 250 095	DN 0 SD 240	2 433 458 148	2 430 136 031
0 432 217 067	1		0 430 211 048	KCA 30 S 36/4	0 434 250 063	DN 0 SD 193	2 433 458 148	2 430 136 145
0 432 217 068	1		0 430 211 048	KCA 30 S 36/4	0 434 250 063	DN 0 SD 193	2 433 458 148	2 430 136 145
0 432 217 069	1		0 430 211 049	KCA 17 S 38/4	0 434 250 011	DN 0 SD 1510	2 433 458 124	2 430 136 145
0 432 217 070	1		0 430 211 046	KCA 17 S 33/4	0 434 250 011	DN 0 SD 1510		2 430 136 031
0 432 217 071	1		0 430 211 049	KCA 17 S 38/4	0 434 250 011	DN 0 SD 1510	2 433 458 124	2 430 136 145
0 432 217 072	1		0 430 211 047	KCA 30 S 35/4	0 434 250 110	DN 0 SD 240/	2 433 458 148	2 430 136 031
0 432 217 073	1		0 430 211 049	KCA 17 S 38/4	0 434 250 100	DN 0 SD 15100	2 433 458 124	2 430 136 145
0 432 217 074	1		0 430 211 041	KCA 30 SD 27/4	0 434 250 045	DN 12 SD 175	2 433 458 148	2 430 136 031
0 432 217 075	1		0 430 211 049	KCA 17 S 38/4	0 434 250 100	DN 0 SD 15100	2 433 458 124	2 430 136 145
0 432 217 076	1		0 430 211 048	KCA 30 S 36/4	0 434 250 103	DN 0 SD 293	2 433 458 148	2 430 136 145
0 432 217 077	1		0 430 211 048	KCA 30 S 36/4	0 434 250 103	DN 0 SD 293	2 433 458 148	2 430 136 145
0 432 217 078	1		0 430 211 048	KCA 30 S 36/4	0 434 250 103	DN 0 SD 293	2 433 458 148	2 430 136 145
0 432 217 079	1		0 430 211 048	KCA 30 S 36/4	0 434 250 103	DN 0 SD 293	2 433 458 148	2 430 136 145
0 432 217 080	1		0 430 211 047	KCA 30 S 35/4	0 434 250 102	DN 0 SD 240-	2 433 458 148	2 430 136 031
0 432 217 081	1		0 430 211 051	KCA 18 S 40	0 434 250 105	DN 0 SD 248		2 430 136 145
0 432 217 082	1		0 430 211 052	KCA 17 S 42	0 434 250 092	DN 0 SD 1930	2 433 458 124	2 430 136 145
0 432 217 083	1		0 430 211 053	KCA 30 S 44	0 434 250 103	DN 0 SD 293	2 433 458 148	2 430 136 145
0 432 217 084	1		0 430 211 053	KCA 30 S 44	0 434 250 103	DN 0 SD 293	2 433 458 148	2 430 136 145
0 432 217 085	1		0 430 211 041	KCA 30 SD 27/4	0 434 250 092	DN 0 SD 1930	2 433 458 148	2 430 136 031
0 432 217 086	1		0 430 211 041	KCA 30 SD 27/4	0 434 250 092	DN 0 SD 1930	2 433 458 148	2 430 136 031
0 432 217 087	1		0 430 211 049	KCA 17 S 38/4	0 434 250 108	DN 0 SD 251	2 433 458 124	2 430 136 145
0 432 217 088	1		0 430 211 049	KCA 17 S 38/4	0 434 250 108	DN 0 SD 251	2 433 458 124	2 430 136 145
0 432 217 089	1		0 430 211 041	KCA 30 SD 27/4	0 434 250 011	DN 0 SD 1510	2 433 458 148	2 430 136 031
0 432 217 090	1		0 430 211 049	KCA 17 S 38/4	0 434 250 109	DN 0 SD 252	2 433 458 124	2 430 136 145
0 432 217 091	1		0 430 211 053	KCA 30 S 44	0 434 250 001	DN 0 SD 21	2 433 458 148	2 430 136 145
0 432 217 092	1		0 430 211 054	KCA 15 S 45	0 434 250 111	DN 0 SD 253	2 433 458 154	2 430 136 161
0 432 217 093	1		0 430 211 047	KCA 30 S 35/4	0 434 250 110	DN 0 SD 240/	2 433 458 148	2 430 136 031
0 432 217 095	1		0 430 211 048	KCA 30 S 36/4	0 434 250 103	DN 0 SD 293	2 433 458 148	2 430 136 145
0 432 217 097	1		0 430 211 056	KCA 30 S 46	0 434 250 103	DN 0 SD 293	2 433 458 148	2 430 136 145
0 432 217 098	1		0 430 211 056	KCA 30 S 46	0 434 250 103	DN 0 SD 293	2 433 458 148	2 430 136 145
0 432 217 099	1		0 430 211 053	KCA 30 S 44	0 434 250 122	DN 0 SD 189/	2 433 458 148	2 430 136 145
0 432 217 100	1		0 430 211 048	KCA 30 S 36/4	0 434 250 063	DN 0 SD 193	2 433 458 148	2 430 136 145
0 432 217 101	1		0 430 211 047	KCA 30 S 35/4	0 434 250 110	DN 0 SD 240/	2 433 458 148	2 430 136 031
0 432 217 102	1		0 430 211 057	KCA 30 S 47	0 434 250 063	DN 0 SD 193	2 433 458 334	



2 433 124 137	2 434 614 010	4						
2 433 124 137	2 434 614 010	4						
2 433 124 137	2 434 614 010	4						
2 433 124 137	2 434 614 010	4						
2 433 124 137	2 434 614 019	4						
2 433 124 137	2 434 614 010	4						
2 433 124 137	2 434 614 010	4						
2 433 124 137	2 434 614 010	4						
2 433 124 137	2 434 614 010	4						
2 433 124 137	2 434 614 010	4						
2 433 124 137	2 434 614 010	4						
2 433 124 373	2 434 619 048	4						
2 433 124 373	2 434 619 048	4						
2 433 124 373	2 434 619 048	4						
2 433 124 373	2 434 619 048	4						
2 433 124 137	2 434 614 019	4						
2 433 124 373	2 434 619 048	4						
2 433 124 137	2 434 614 010	4						
2 433 124 373	2 434 619 048	4						
2 433 124 137	2 434 614 010	4						
2 433 124 373	2 434 619 048	4						
2 433 124 373	2 434 619 048	4						
2 433 124 373	2 434 619 048	4						
2 433 124 373	2 434 619 048	4						
2 433 124 137	2 434 614 010	4						
2 433 124 163	2 434 619 055	4						2 430 190 002
2 433 124 372	2 434 619 047	4						
2 433 124 372	2 434 619 047	4						
2 433 124 372	2 434 619 047	4						
2 433 124 137	2 434 614 010	4						
2 433 124 137	2 434 614 010	4						
2 433 124 373	2 434 619 048	4						
2 433 124 373	2 434 619 048	4						
2 433 124 137	2 434 614 010	4						
2 433 124 373	2 434 619 048	4						
2 433 124 372	2 434 619 047	4						
2 433 124 381	2 434 619 056	4						2 430 190 002
2 433 124 137	2 434 614 010	4						
2 433 124 373	2 434 619 048	4						
2 433 124 372	2 434 619 047	4						
2 433 124 372	2 434 619 047	4						
2 433 124 372	2 434 619 047	4						
2 433 124 372	2 434 619 047	4						
2 433 124 373	2 434 619 048	4						
2 433 124 137	2 434 614 010	4						
2 433 124 160	2 434 619 055	4						2 430 190 002

*) siehe Seite 388/see page 388/voir page 388/ver pagina 388/vease página 388

***) siehe Seite 392/see page 392/voir page 392/ver pagina 392/vease página 392

A332

de
Ersatzteile für
Düsenhalter-
kombinationen
(Fortsetzung)

en
Spare parts for
nozzle-and-holder
assemblies
(continued)

fr
Pièces de rechange
pour ensembles
porte-injecteurs
(suite)

it
Ricambi per
combinazione
portapolverizzatori
(seguito)

es
Piezas de repuesto
para conjuntos
portainyectoros
(continuación)



0 432 217 103	1	0 430 211 049	KCA 17 S 38/4	0 434 250 108	DN 0 SD 251	2 433 458 124	2 430 136 145
0 432 217 104	1	0 430 211 058	KCA 18 S 48	0 434 250 105	DN 0 SD 248	2 433 458 153	2 430 136 145
0 432 217 106	1	0 430 211 060	KCA 30 S 50	0 434 250 063	DN 0 SD 193	2 433 458 334	2 430 136 145
0 432 217 107	1	0 430 211 052	KCA 17 S 42	0 434 250 027	DN 12 SD 12	2 433 458 124	2 430 136 145
0 432 217 108	1	0 430 211 049	KCA 17 S 38/4	0 434 250 109	DN 0 SD 252	2 433 458 124	2 430 136 145
0 432 217 109	1	0 430 211 048	KCA 30 S 36/4	0 434 250 092	DN 0 SD 1930	2 433 458 148	2 430 136 145
0 432 217 110	1	0 430 211 053	KCA 30 S 44	0 434 250 092	DN 0 SD 1930	2 433 458 148	2 430 136 145
0 432 217 111	1	0 430 211 052	KCA 17 S 42	0 434 250 114	DN 0 SD 256	2 433 458 124	2 430 136 145
0 432 217 112	1	0 430 211 048	KCA 30 S 36/4	0 434 250 092	DN 0 SD 1930	2 433 458 148	2 430 136 145
0 432 217 113	1	0 430 211 053	KCA 30 S 44	0 434 250 092	DN 0 SD 1930	2 433 458 148	2 430 136 145
0 432 217 114	1	0 430 211 052	KCA 17 S 42	0 434 250 109	DN 0 SD 252	2 433 458 124	2 430 136 145
0 432 217 115	1	0 430 211 060	KCA 30 S 50	0 434 250 117	DN 0 SD 259	2 433 458 334	2 430 136 145
0 432 217 117	1	0 430 211 048	KCA 30 S 36/4	0 434 250 063	DN 0 SD 193	2 433 458 148	2 430 136 145
0 432 217 118	1	0 430 211 053	KCA 30 S 44	0 434 250 063	DN 0 SD 193	2 433 458 148	2 430 136 145
0 432 217 119	1	0 430 211 048	KCA 30 S 36/4	0 434 250 063	DN 0 SD 193	2 433 458 148	2 430 136 145
0 432 217 120	1	0 430 211 053	KCA 30 S 44	0 434 250 063	DN 0 SD 193	2 433 458 148	2 430 136 145
0 432 217 121	1	0 430 211 092	KCA 30 S 83	0 434 250 117	DN 0 SD 259	2 433 458 334	2 430 136 145
0 432 217 122	1	0 430 211 063	KCA 17 S 53	0 434 250 092	DN 0 SD 1930	2 433 458 124	2 430 136 145
0 432 217 123	1	0 430 211 053	KCA 30 S 44	0 434 250 092	DN 0 SD 1930	2 433 458 148	2 430 136 145
0 432 217 125	1	0 430 211 056	KCA 30 S 46	0 434 250 110	DN 0 SD 240/	2 433 458 148	2 430 136 145
0 432 217 126	1	0 430 211 043	KCA 17 SD 30/4	0 434 250 092	DN 0 SD 1930		2 430 136 031
0 432 217 129	1	0 430 211 065	KCA 30 S 41	0 434 250 119	DN 12 SD 1750	2 433 458 148	2 430 136 145
0 432 217 130	1	0 430 211 053	KCA 30 S 44	0 434 250 001	DN 0 SD 21	2 433 458 148	2 430 136 145
0 432 217 131	1	0 430 211 053	KCA 30 S 44	0 434 250 120	DN 0 SD 261	2 433 458 148	2 430 136 145
0 432 217 132	1	0 430 211 052	KCA 17 S 42	0 434 250 077	DN 0 SD 230	2 433 458 124	2 430 136 145
0 432 217 133	1	0 430 211 052	KCA 17 S 42	0 434 250 121	DN 0 SD 262/	2 433 458 124	2 430 136 145
0 432 217 134	1	0 430 211 056	KCA 30 S 46	0 434 250 110	DN 0 SD 240/	2 433 458 148	2 430 136 145
0 432 217 135	1	0 430 211 009	KCA 30 SD 2/4	0 434 250 001	DN 0 SD 21		2 430 136 031
0 432 217 136	1	0 430 211 064	KCA 17 S 54	0 434 250 109	DN 0 SD 252	2 433 458 124	2 430 136 145
0 432 217 137	1	0 430 211 049	KCA 17 S 38/4	0 434 250 109	DN 0 SD 252	2 433 458 124	2 430 136 145
0 432 217 138	1	0 430 211 053	KCA 30 S 44	0 434 250 009	DN 0 SD 211	2 433 458 148	2 430 136 145
0 432 217 139	1	0 430 211 065	KCA 30 S 41	0 434 250 119	DN 12 SD 1750	2 433 458 148	2 430 136 145
0 432 217 140	1	0 430 211 064	KCA 17 S 54	0 434 250 131	DN 0 SD 268	2 433 458 124	2 430 136 145
0 432 217 141	1	0 430 211 053	KCA 30 S 44	0 434 250 128	DN 0 SD 265	2 433 458 148	2 430 136 145
0 432 217 142	1	0 430 211 053	KCA 30 S 44	0 434 250 072	DN 0 SD 220	2 433 458 148	2 430 136 145
0 432 217 143	1	0 430 211 053	KCA 30 S 44	0 434 250 011	DN 0 SD 1510	2 433 458 148	2 430 136 145
0 432 217 146	1	0 430 211 053	KCA 30 S 44	0 434 250 132	DN 0 SD 269	2 433 458 148	2 430 136 145
0 432 217 147	1	0 430 211 053	KCA 30 S 44	0 434 250 128	DN 0 SD 265	2 433 458 148	2 430 136 145
0 432 217 148	1	0 430 211 065	KCA 30 S 41	0 434 250 117	DN 0 SD 259	2 433 458 148	2 430 136 145
0 432 217 152	1	0 430 211 049	KCA 17 S 38/4	0 434 250 134	DN 0 SD 252+	2 433 458 124	2 430 136 145
0 432 217 153	1	0 430 211 052	KCA 17 S 42	0 434 250 135	DN 0 SD 256/	2 433 458 124	2 430 136 145
0 432 217 156	1	0 430 211 052	KCA 17 S 42	0 434 250 137	DN 0 SD 272	2 433 458 124	2 430 136 145
0 432 217 157	1	0 430 211 066	KCA 27 S 55	0 434 250 128	DN 0 SD 265	2 433 458 156	2 430 136 145
0 432 217 158	1	0 430 211 048	KCA 30 S 36/4	0 434 250 138	DN 0 SD 273	2 433 458 148	2 430 136 145
0 432 217 159	1	0 430 211 053	KCA 30 S 44	0 434 250 138	DN 0 SD 273	2 433 458 148	2 430 136 145

A334

de
Ersatzteile für
Düsenhalter-
kombinationen
(Fortsetzung)

en
Spare parts for
nozzle-and-holder
assemblies
(continued)

fr
Pièces de rechange
pour ensembles
porte-injecteurs
(suite)

it
Ricambi per
combinazione
portapolverizzatori
(seguito)

es
Piezas de repuesto
para conjuntos
portainyectoros
(continuación)



0 432 217 160	1	0 430 211 052	KCA 17 S 42	0 434 250 117	DN 0 SD 259	2 433 458 124	2 430 136 145
0 432 217 161	1	0 430 211 066	KCA 27 S 55	0 434 250 120	DN 0 SD 261	2 433 458 156	2 430 136 145
0 432 217 163	1	0 430 211 048	KCA 30 S 36/4	0 434 250 138	DN 0 SD 273	2 433 458 148	2 430 136 145
0 432 217 164	1	0 430 211 053	KCA 30 S 44	0 434 250 138	DN 0 SD 273	2 433 458 148	2 430 136 145
0 432 217 165	1	0 430 211 048	KCA 30 S 36/4	0 434 250 139	DN 0 SD 274	2 433 458 148	2 430 136 145
0 432 217 167	1	0 430 211 067	KCA 30 S 56	0 434 250 117	DN 0 SD 259	2 433 458 334	2 430 136 145
0 432 217 168	1	0 430 211 068	KCA 30 S 57	0 434 250 117	DN 0 SD 259	2 433 458 334	2 430 136 145
0 432 217 169	1	0 430 211 066	KCA 27 S 55	0 434 250 128	DN 0 SD 265	2 433 458 156	2 430 136 145
0 432 217 171	1	0 430 211 052	KCA 17 S 42	0 434 250 144	DN 0 SD 282	2 433 458 124	2 430 136 145
0 432 217 172	1	0 430 211 065	KCA 30 S 41	0 434 250 145	DN 12 SD 283	2 433 458 148	2 430 136 145
0 432 217 178	1	0 430 211 053	KCA 30 S 44	0 434 250 139	DN 0 SD 274	2 433 458 148	2 430 136 145
0 432 217 180	1	0 430 211 060	KCA 30 S 50	0 434 250 148	DN 0 SD 286	2 433 458 334	2 430 136 145
0 432 217 181	1	0 430 211 052	KCA 17 S 42	0 434 250 149	DN 0 SD 287	2 433 458 124	2 430 136 145
0 432 217 182	1	0 430 211 065	KCA 30 S 41	0 434 250 145	DN 12 SD 283	2 433 458 148	2 430 136 145
0 432 217 183	1	0 430 211 075	KCA 27 S 65	0 434 250 137	DN 0 SD 272	2 433 458 335	2 430 136 171
0 432 217 184	1	0 430 211 060	KCA 30 S 50	0 434 250 148	DN 0 SD 286	2 433 458 334	2 430 136 145
0 432 217 185	1	0 430 211 067	KCA 30 S 56	0 434 250 148	DN 0 SD 286	2 433 458 334	2 430 136 145
0 432 217 186	1	0 430 211 068	KCA 30 S 57	0 434 250 148	DN 0 SD 286	2 433 458 334	2 430 136 145
0 432 217 187	1	0 430 211 053	KCA 30 S 44	0 434 250 009	DN 0 SD 211	2 433 458 148	2 430 136 145
0 432 217 188	1	0 430 211 053	KCA 30 S 44	0 434 250 150	DN 0 SD 288	2 433 458 148	2 430 136 145
0 432 217 189	1	0 430 211 049	KCA 17 S 38/4	0 434 250 151	DN 0 SD 276/	2 433 458 124	2 430 136 145
0 432 217 190	1	0 430 211 064	KCA 17 S 54	0 434 250 151	DN 0 SD 276/	2 433 458 124	2 430 136 145
0 432 217 191	1	0 430 211 076	KCA 15 S 66	0 434 250 134	DN 0 SD 252+		2 430 136 145
0 432 217 192	1	0 430 211 052	KCA 17 S 42	0 434 250 134	DN 0 SD 252+	2 433 458 124	2 430 136 145
0 432 217 193	1	0 430 211 049	KCA 17 S 38/4	0 434 250 134	DN 0 SD 252+	2 433 458 124	2 430 136 145
0 432 217 194	1	0 430 211 060	KCA 30 S 50	0 434 250 014	DN 4 SD 24	2 433 458 334	2 430 136 145
0 432 217 195	1	0 430 211 065	KCA 30 S 41	0 434 250 153	DN 12 SD 290	2 433 458 148	2 430 136 145
0 432 217 196	1	0 430 211 052	KCA 17 S 42	0 434 250 137	DN 0 SD 272	2 433 458 124	2 430 136 145
0 432 217 197	1	0 430 211 075	KCA 27 S 65	0 434 250 154	DN 0 SD 292	2 433 458 335	2 430 136 171
0 432 217 198	1	0 430 211 053	KCA 30 S 44	0 434 250 155	DN 0 SD 294	2 433 458 148	2 430 136 145
0 432 217 200	1	0 430 211 052	KCA 17 S 42	0 434 250 156	DN 0 SD 289	2 433 458 124	2 430 136 145
0 432 217 201	1	0 430 211 052	KCA 17 S 42	0 434 250 157	DN 0 SD 287+	2 433 458 124	2 430 136 145
0 432 217 202	1	0 430 211 065	KCA 30 S 41	0 434 250 158	DN 12 SD 296	2 433 458 148	2 430 136 145
0 432 217 206	1	0 430 211 053	KCA 30 S 44	0 434 250 159	DN 0 SD 297	2 433 458 148	2 430 136 145
0 432 217 207	1	0 430 211 053	KCA 30 S 44	0 434 250 155	DN 0 SD 294	2 433 458 148	2 430 136 145
0 432 217 210	1	0 430 211 053	KCA 30 S 44	0 434 250 159	DN 0 SD 297	2 433 458 148	2 430 136 145
0 432 217 211	1	0 430 211 065	KCA 30 S 41	0 434 250 153	DN 12 SD 290	2 433 458 148	2 430 136 145
0 432 217 212	1	0 430 211 078	KCA 17 S 69	0 434 250 137	DN 0 SD 272	2 433 314 256	2 430 136 145
0 432 217 214	1	0 430 211 048	KCA 30 S 36/4	0 434 250 159	DN 0 SD 297	2 433 458 148	2 430 136 145
0 432 217 215	1	0 430 211 048	KCA 30 S 36/4	0 434 250 159	DN 0 SD 297	2 433 458 148	2 430 136 145
0 432 217 218	1	0 430 211 052	KCA 17 S 42	0 434 250 160	DN 0 SD 299	2 433 458 124	2 430 136 145
0 432 217 219	1	0 430 211 068	KCA 30 S 57	0 434 250 161	DN 0 SD 300	2 433 458 334	2 430 136 145
0 432 217 220	1	0 430 211 067	KCA 30 S 56	0 434 250 161	DN 0 SD 300	2 433 458 334	2 430 136 145
0 432 217 221	1	0 430 211 052	KCA 17 S 42	0 434 250 156	DN 0 SD 289	2 433 458 124	2 430 136 145
0 432 217 222	1	0 430 211 079	KCA 17 S 70	0 434 250 162	DN 0 SD 301	2 433 458 336	2 430 136 145



2 433 124 372	2 434 619 047	4					
2 433 124 372	2 434 619 047	4					2 430 501 011
2 433 124 373	2 434 619 048	4					
2 433 124 372	2 434 619 047	4					
2 433 124 373	2 434 619 048	4					
2 433 124 357	2 434 619 064	2					2 430 190 010
2 433 124 382	2 434 619 064	4					2 430 190 010
2 433 124 372	2 434 619 047	4					
2 433 124 372	2 434 619 047	4					
2 433 124 372	2 434 619 060	4					
2 433 124 372	2 434 619 047	4					
2 433 124 372	2 434 619 047	4					2 430 190 010
2 433 124 372	2 434 619 047	4					
2 433 124 372	2 434 619 047	4					
2 433 124 372	2 434 619 060	4					
2 433 124 372	2 434 619 047	4					2 430 190 002
2 433 124 372	2 434 619 047	4					
2 433 124 357	2 434 619 064	2					2 430 190 010
2 433 124 382	2 434 619 064	4					2 430 190 010
2 433 124 372	2 434 619 047	4					
2 433 124 372	2 434 619 047	4					2 430 501 006
2 433 124 373	2 434 619 048	4					
2 433 124 357	2 434 619 048	2					
2 433 124 372	2 434 619 047	4					
2 433 124 372	2 434 619 047	4					
2 433 124 373	2 434 619 048	4					
2 433 124 372	2 434 619 047	4					2 430 190 010
2 433 124 372	2 434 619 060	4					
2 433 124 372	2 434 619 047	4					
2 433 124 372	2 434 619 047	4					2 430 190 002
2 433 124 372	2 434 619 047	4					
2 433 124 372	2 434 619 047	4					
2 433 124 372	2 434 619 060	4					
2 433 124 372	2 434 619 047	4					
2 433 124 372	2 434 619 047	4					
2 433 124 372	2 434 619 047	4					
2 433 124 372	2 434 619 060	4					
2 433 124 372	2 434 619 047	4					
2 433 124 373	2 434 619 048	4					
2 433 124 373	2 434 619 048	4					
2 433 124 372	2 434 619 047	4					
2 433 124 382	2 434 619 064	4					2 430 190 010
2 433 124 357	2 434 619 064	2					2 430 190 010
2 433 124 372	2 434 619 047	4					
2 433 124 373		4					2 430 190 002

*) siehe Seite 388/see page 388/voir page 388/ver pagina 388/vease página 388

**) siehe Seite 392/see page 392/voir page 392/ver pagina 392/vease página 392

de

Ersatzteile für
Düsenhalter-
kombinationen
(Fortsetzung)

en

Spare parts for
nozzle-and-holder
assemblies
(continued)

fr

Pièces de rechange
pour ensembles
porte-injecteurs
(suite)

it

Ricambi per
combinazione
portapolverizzatori
(seguito)

es

Piezas de repuesto
para conjuntos
portainyectoros
(continuación)



Fig.



Ref.



Typ



①



Typ











②



③

0 432 217 223	1	0 430 211 080	KCA 21 S 71	0 434 250 161	DN 0 SD 300	2 433 458 333	2 430 136 145
0 432 217 224	1	0 430 211 081	KCA 21 S 72	0 434 250 161	DN 0 SD 300	2 433 458 333	2 430 136 145
0 432 217 226	1	0 430 211 052	KCA 17 S 42	0 434 250 163	DN 0 SD 302	2 433 458 124	2 430 136 145
0 432 217 227	1	0 430 211 052	KCA 17 S 42	0 434 250 164	DN 0 SD 252+ /	2 433 458 124	2 430 136 145
0 432 217 228	1	0 430 211 052	KCA 17 S 42	0 434 250 160	DN 0 SD 299	2 433 458 124	2 430 136 145
0 432 217 229	1	0 430 211 054	KCA 15 S 45	0 434 250 898	DN 0 SD 304	2 433 458 154	2 430 136 161
0 432 217 230	1	0 430 211 083	KCA 17 S 74	0 434 250 165	DN 0 SD 305		2 430 136 145
0 432 217 231	1	0 430 211 053	KCA 30 S 44	0 434 250 159	DN 0 SD 297	2 433 458 148	2 430 136 145
0 432 217 232	1	0 430 211 053	KCA 30 S 44	0 434 250 159	DN 0 SD 297	2 433 458 148	2 430 136 145
0 432 217 234	1	0 430 211 052	KCA 17 S 42	0 434 250 156	DN 0 SD 289	2 433 458 124	2 430 136 145
0 432 217 235	1	0 430 211 052	KCA 17 S 42	0 434 250 166	DN 0 SD 289 /	2 433 458 124	2 430 136 145
0 432 217 236	1	0 430 211 085	KCA 21 S 76	0 434 250 161	DN 0 SD 300	2 433 458 333	2 430 136 145
0 432 217 237	1	0 430 211 076	KCA 15 S 66	0 434 250 167	DN 0 SD 306		2 430 136 145
0 432 217 238	1	0 430 211 087	KCA 30 S 78	0 434 250 001	DN 0 SD 21	2 433 458 148	2 430 136 145
0 432 217 239	1	0 430 211 088	KCA 30 S 79	0 434 250 159	DN 0 SD 297	2 433 314 148	2 430 136 145
0 432 217 240	1	0 430 211 088	KCA 30 S 79	0 434 250 159	DN 0 SD 297	2 433 314 148	2 430 136 145
0 432 217 241	1	0 430 211 088	KCA 30 S 79	0 434 250 159	DN 0 SD 297	2 433 314 148	2 430 136 145
0 432 217 242	1	0 430 211 088	KCA 30 S 79	0 434 250 159	DN 0 SD 297	2 433 314 148	2 430 136 145
0 432 217 245	1	0 430 211 052	KCA 17 S 42	0 434 250 160	DN 0 SD 299	2 433 458 124	2 430 136 145
0 432 217 246	1	0 430 211 089	KCA 27 S 80	0 434 250 170	DN 0 SD 309	2 433 458 335	2 430 136 171
0 432 217 247	1	0 430 211 090	KCA 30 S 81	0 434 250 168	DN 0 SD 307	2 433 458 334	2 430 136 145
0 432 217 248	1	0 430 211 052	KCA 17 S 42	0 434 250 171	DN 0 SD 299 A	2 433 458 124	2 430 136 145
0 432 217 249	1	0 430 211 091	KCA 30 S 82	0 434 250 162	DN 0 SD 301	2 433 458 336	2 430 136 145
0 432 217 250	1	0 430 211 052	KCA 17 S 42	0 434 250 172	DN 0 SD 302 /	2 433 458 124	2 430 136 145
0 432 217 251	1	0 430 211 054	KCA 15 S 45	0 434 250 898	DN 0 SD 304	2 433 458 154	2 430 136 161
0 432 217 252	1	0 430 211 076	KCA 15 S 66	0 434 250 172	DN 0 SD 302 /		2 430 136 145
0 432 217 253	1	0 430 211 997	KCE 27 S 3	0 434 250 897	DN 0 SD 310	2 433 458 177	2 430 136 185
0 432 217 254	1	0 430 211 052	KCA 17 S 42	0 434 250 173	DN 0 SD 299 B	2 433 458 124	2 430 136 145
0 432 217 255	1	0 430 211 054	KCA 15 S 45	0 434 250 896	DN 0 SD 311	2 433 458 154	2 430 136 161
0 432 217 256	1	0 430 211 996	KCE 30 S 4	0 434 250 895	DN 0 SD 312	2 433 458 169	2 430 136 185
0 432 217 257	1	0 430 211 995	KCE 30 S 5	0 434 250 895	DN 0 SD 312	2 433 458 169	2 430 136 185
0 432 217 258	1	0 430 211 052	KCA 17 S 42	0 434 250 175	DN 0 SD 302 A	2 433 458 124	2 430 136 145
0 432 217 259	1	0 430 211 076	KCA 15 S 66	0 434 250 163	DN 0 SD 302		2 430 136 145
0 432 217 260	1	0 430 211 093	KCA 30 S 84	0 434 250 168	DN 0 SD 307	2 433 458 334	2 430 136 145
0 432 217 261	1	0 430 211 094	KCA 30 S 85	0 434 250 168	DN 0 SD 307	2 433 458 334	2 430 136 145
0 432 217 262	1	0 430 211 066	KCA 27 S 55	0 434 250 897	DN 0 SD 310	2 433 458 156	2 430 136 145
0 432 217 263	1	0 430 211 052	KCA 17 S 42	0 434 250 174	DN 0 SD 313	2 433 458 124	2 430 136 145
0 432 217 264	1	0 430 211 048	KCA 30 S 36/4	0 434 250 139	DN 0 SD 274	2 433 458 148	2 430 136 145
0 432 217 266	1	0 430 211 066	KCA 27 S 55	0 434 250 176	DN 0 SD 314	2 433 458 156	2 430 136 145
0 432 217 267	1	0 430 211 053	KCA 30 S 44	0 434 250 177	DN 0 SD 315	2 433 458 148	2 430 136 145
0 432 217 268	1	0 430 211 995	KCE 30 S 5	0 434 250 895	DN 0 SD 312	2 433 458 169	2 430 136 185
0 432 217 269	1	0 430 211 994	KCE 30 S 6	0 434 250 894	DN 0 SD 316	2 433 458 169	2 430 136 185
0 432 217 270	1	0 430 211 993	KCE 30 S 7	0 434 250 894	DN 0 SD 316	2 433 458 169	2 430 136 185
0 432 217 271	1	0 430 211 088	KCA 30 S 79	0 434 250 159	DN 0 SD 297	2 433 314 148	2 430 136 145
0 432 217 272	1	0 430 211 088	KCA 30 S 79	0 434 250 159	DN 0 SD 297	2 433 314 148	2 430 136 145

								
④	⑤	⑥	⑦	⑧	⑨	⑩	⑪	
2 433 124 372	2 434 619 060	4						
2 433 124 358	2 434 619 060	2						
2 433 124 381	2 434 619 074	4					2 430 190 002	
2 433 124 381	2 434 619 074	4					2 430 190 002	
2 433 124 382	2 434 619 064	4					2 430 190 010	
2 433 124 357	2 434 619 064	2					2 430 190 010	
2 433 124 380	2 434 619 073	5					2 430 501 011	
2 433 124 372	2 434 619 047	4					2 430 190 002	
2 433 124 358	2 434 619 047	2					2 430 190 002	
2 433 124 372	2 434 619 047	4						
2 433 124 358	2 434 619 047	2						
2 433 124 380	2 434 619 073	5					2 430 501 011	
2 433 124 380	2 434 619 073	5					2 430 190 010	
2 433 124 372	2 434 619 047	4						
2 433 124 372	2 434 619 047	4					2 430 501 011	
2 433 124 372	2 434 619 047	4						
2 433 124 372	2 434 619 047	4					2 430 501 006	
2 433 124 357		2					2 430 190 002	
		4						
2 433 124 358	2 434 619 060	2						
2 433 124 372	2 434 619 060	4						
2 433 124 372	2 434 619 070	4					2 430 105 045	
2 433 124 372	2 434 619 047	4						
2 433 124 358	2 434 619 047	2						
2 433 124 357		2					2 430 190 002	
2 433 124 357		2					2 430 190 002	
2 433 124 372	2 434 619 047	4					2 430 190 010	
2 433 124 358	2 434 619 047	2						
2 433 124 358	2 434 619 047	2						
2 433 124 372	2 434 619 047	4						
2 433 124 372	2 434 619 070	4					2 430 190 010	
2 433 124 357		2					2 430 190 002	
2 433 124 372	2 434 619 047	4						
2 433 124 372	2 434 619 047	4						
2 433 124 372	2 434 619 070	4						
2 433 124 372	2 434 619 070	4						
2 433 124 025	2 434 614 011	7	2 433 458 209					
2 433 104 031	2 434 619 009		2 433 462 061		2 433 370 201	2 916 710 603		
2 433 104 031	2 434 619 009		2 433 462 061		2 433 370 201	2 916 710 603		
2 433 104 031	2 434 619 009		2 433 462 061		2 433 370 201	2 916 710 603		
2 433 104 031	2 434 619 009		2 433 462 061		2 433 370 201	2 916 710 603		
2 433 104 190	2 434 619 003	9	2 433 462 047			2 916 710 603	2 430 105 023	
2 433 104 190	2 434 619 003	9	2 433 462 047			2 916 710 603	2 430 105 023	

*) siehe Seite 388/see page 388/voir page 388/ver pagina 388/vease página 388

**) siehe Seite 392/see page 392/voir page 392/ver pagina 392/vease página 392

A340

de
Ersatzteile für
Düsenhalter-
kombinationen
(Fortsetzung)

en
Spare parts for
nozzle-and-holder
assemblies
(continued)

fr
Pièces de rechange
pour ensembles
porte-injecteurs
(suite)

it
Ricambi per
combinazione
portapolverizzatori
(seguito)

es
Piezas de repuesto
para conjuntos
portainyectoros
(continuación)



0 432 221 856	1	0 430 222 045	KDL 65 S 27/4	0 433 271 274	DLLA 155 S 574	2 433 314 183	
0 432 221 857	1	0 430 222 045	KDL 65 S 27/4	0 433 271 270	DLLA 155 S 568	2 433 314 183	
0 432 221 860	1	0 430 223 022	KDL 94 S 18/13	0 433 271 252	DLLA 38 S 541	2 433 314 049	
0 432 221 864	1	0 430 223 029	KDL 94 S 16/4	0 433 271 151	DLLA 35 S 377	2 433 314 049	
0 432 221 865	1	0 430 223 022	KDL 94 S 18/13	0 433 271 150	DLLA 35 S 376	2 433 314 049	
0 432 221 868	1	0 430 224 016	KDL 100 S 24/4	0 433 271 106	DLLA 28 S 297		
0 432 221 869	1	0 430 223 029	KDL 94 S 16/4	0 433 271 078	DLLA 35 S 2180	2 433 314 049	
0 432 221 875	1	0 430 223 022	KDL 94 S 18/13	0 433 271 078	DLLA 35 S 2180	2 433 314 049	
0 432 221 881	1	0 430 223 014	KDL 80 S 17/4	0 433 271 049	DLLA 23 S 191	2 433 314 049	
0 432 221 885	1	0 430 223 026	KDL 87 S 9/4	0 433 271 016	DLLA 27 S 88	2 433 314 049	
0 432 221 886	1	0 430 223 029	KDL 94 S 16/4	0 433 271 021	DLLA 35 S 161	2 433 314 049	
0 432 221 887	1	0 430 223 029	KDL 94 S 16/4	0 433 271 060	DLLA 38 S 208	2 433 314 049	
0 432 226 004	1	0 430 221 053	KD 45 S 91/4	0 434 200 042	DN 0 S 225	2 430 360 012	
0 432 227 002	1	0 430 221 031	KD 43 SA 53/13	0 434 250 009	DN 0 SD 211	2 433 349 506	
0 432 227 003	1	0 430 221 031	KD 43 SA 53/13	0 434 250 009	DN 0 SD 211	2 433 349 506	
0 432 227 011	1	0 430 222 032	KD 57 SDA 65/4	0 434 250 041	DN 4 SD 169	2 430 360 028	
0 432 227 012	1	0 430 222 032	KD 57 SDA 65/4	0 434 250 027	DN 12 SD 12	2 430 360 028	
0 432 227 018	1	0 430 222 034	KD 57 SD 77/13	0 434 250 037	DN 0 SD 165	2 433 314 032	
0 432 227 021	1	0 430 222 034	KD 57 SD 77/13	0 434 250 037	DN 0 SD 165	2 433 314 032	
0 432 227 022	1	0 430 222 037	KD 57 SD 81/13	0 434 250 238	DN 0 SD 331	2 433 314 032	
0 432 227 023	1	0 430 221 049	KD 45 SD 80/13	0 434 250 009	DN 0 SD 211	2 433 314 031	
0 432 227 025	1	0 430 222 039	KD 57 SD 79/13	0 434 250 037	DN 0 SD 165	2 433 314 032	
0 432 227 027	1	0 430 222 039	KD 57 SD 79/13	0 434 250 009	DN 0 SD 211	2 433 314 032	
0 432 227 033	1	0 430 222 046	KD 72 SD 90/4	0 434 250 046	DN 0 SD 174	2 430 360 028	
0 432 227 034	1	0 430 222 046	KD 72 SD 90/4	0 434 250 009	DN 0 SD 211	2 430 360 028	
0 432 227 035	1	0 430 222 047	KD 57 S 92	0 434 250 238	DN 0 SD 331	2 433 314 032	
0 432 229 002	1	0 430 222 031	KD 72 SDA 68/4	0 434 290 005	DN 0 SD 149		
0 432 229 003	1	0 430 222 031	KD 72 SDA 68/4	0 434 290 006	DN 0 SD 155		
0 432 231 001	1	0 430 232 005	KDAL 50 S 4/4	0 433 220 066	DLL 50 S 226	2 433 317 296	2 430 132 001
0 432 231 003	1	0 430 232 005	KDAL 50 S 4/4	0 433 220 078	DLL 50 S 278	2 433 317 296	2 430 132 001
0 432 231 006	1	0 430 232 005	KDAL 50 S 4/4	0 433 220 066	DLL 50 S 226	2 433 317 296	2 430 132 001
0 432 231 007	1	0 430 232 005	KDAL 50 S 4/4	0 433 220 078	DLL 50 S 278	2 433 317 296	2 430 132 001
0 432 231 013	1	0 430 235 001	KDAL 126 S 13/4	0 433 220 128	DLL 150 S 545	2 433 317 297	2 430 136 198
0 432 231 014	1	0 430 233 004	KDAL 82 S 15/4	0 433 220 129	DLL 23 S 553	2 433 317 295	2 430 136 197
0 432 231 015	1	0 430 233 005	KDAL 96 S 16/4	0 433 220 130	DLL 35 S 559	2 433 317 295	2 430 136 197
0 432 231 016	1	0 430 233 005	KDAL 96 S 16/4	0 433 220 131	DLL 38 S 560	2 433 317 295	2 430 136 197
0 432 231 017	1	0 430 233 005	KDAL 96 S 16/4	0 433 220 132	DLL 35 S 561	2 433 317 295	2 430 136 197
0 432 231 018	1	0 430 233 005	KDAL 96 S 16/4	0 433 220 133	DLL 35 S 562	2 433 317 295	2 430 136 197
0 432 231 020	1	0 430 233 004	KDAL 82 S 15/4	0 433 220 141	DLL 16S 5 92	2 433 317 295	2 430 136 197
0 432 231 021	1	0 430 235 002	KDAL 126 S 17/4	0 433 220 128	DLL 150 S 545	2 433 317 297	2 430 136 198
0 432 231 024	1	0 430 235 002	KDAL 126 S 17/4	0 433 220 147	DLL 150 S 631	2 433 317 297	2 430 136 198
0 432 231 029	1	0 430 232 005	KDAL 50 S 4/4	0 433 220 157	DLL 120 S 736	2 433 317 296	2 430 132 001
0 432 231 030	1	0 430 232 012	KDAL 62 S 19/19	0 433 220 160	DLL 152 S 756	2 433 317 297	2 430 136 095
0 432 231 031	1	0 430 232 012	KDAL 62 S 19/19	0 433 220 163	DLL 152 S 780	2 433 317 297	2 430 136 095
0 432 231 033	1	0 430 232 005	KDAL 50 S 4/4	0 433 220 078	DLL 50 S 278	2 433 317 296	2 430 132 001



2 433 104 190	2 434 619 003	9	2 433 462 047		2 916 710 603	2 430 105 023
2 433 104 190	2 434 619 003	9	2 433 462 047		2 916 710 603	2 430 105 023
2 433 104 031	2 434 619 009		2 433 462 061	2 433 370 201	2 916 710 603	
2 433 104 031	2 434 619 009		2 433 462 061	2 433 370 201	2 916 710 603	
2 433 104 031	2 434 619 009		2 433 462 061	2 433 370 201	2 916 710 603	
2 433 104 044	2 434 619 009	8	2 433 455 045	2 433 370 201	2 916 710 603	
2 433 104 031	2 434 619 009		2 433 462 061	2 433 370 201	2 916 710 603	
2 433 104 031	2 434 619 009		2 433 462 061	2 433 370 201	2 916 710 603	
	2 434 619 009		2 433 462 061	2 433 370 201	2 916 710 603	
2 433 104 431	2 434 619 009			2 433 370 201	2 916 710 603	
2 433 104 031	2 434 619 009		2 433 462 061	2 433 370 201	2 916 710 603	
2 433 104 031	2 434 619 009		2 433 462 061	2 433 370 201	2 916 710 603	
2 433 104 491	2 434 619 006		2 433 462 009		2 916 710 605	
2 433 104 433	2 434 619 009		2 433 455 030	2 433 370 205	2 916 710 603	2 430 105 011
2 433 104 433	2 434 619 009		2 433 455 030	2 433 370 205	2 916 710 603	
2 433 104 433	2 434 619 008		2 433 462 005	2 433 370 205	2 916 710 603	
2 433 104 433	2 434 619 008		2 433 462 005	2 433 370 205	2 916 710 603	
	2 434 614 010		2 433 455 043	2 433 356 066	2 916 710 603	
	2 434 614 010		2 433 455 043	2 433 356 066	2 916 710 603	
2 433 124 064	2 434 614 010		2 433 455 043	2 433 356 066	2 916 710 603	
2 433 124 064	2 434 614 010		2 433 455 043		2 916 710 603	
2 433 124 064	2 434 614 010		2 433 455 043		2 916 710 603	
2 433 124 064	2 434 614 010		2 433 455 043		2 916 710 603	
2 433 104 427	2 434 619 008	8	2 433 462 005		2 916 710 603	
2 433 104 427	2 434 619 008	8	2 433 462 005		2 916 710 603	
2 433 124 064	2 434 614 010		2 433 455 043	2 433 370 469	2 916 710 603	
2 433 104 427	2 434 619 008	8	2 433 462 005		2 916 710 603	
2 433 104 427	2 434 619 008	8	2 433 462 005		2 916 710 603	
2 433 124 086	2 434 619 020	10			2 916 710 603	
2 433 124 086	2 434 619 020	10			2 916 710 603	
2 433 124 086	2 434 619 020	10			2 916 710 603	2 430 422 002
2 433 124 086	2 434 619 020	10			2 916 710 603	2 430 422 002
2 433 124 137	2 434 619 017	4	2 433 455 048		2 916 710 603	2 430 105 020
2 433 124 137	2 434 619 017	4	2 433 462 135			2 430 105 020
2 433 124 137	2 434 619 017	4				
2 433 124 137	2 434 619 017	4				
2 433 124 137	2 434 619 017	4				
2 433 124 137	2 434 619 017	4	2 433 462 135			
2 433 124 137	2 434 619 017	4	2 433 455 048		2 916 710 603	2 430 105 020
2 433 124 137	2 434 619 017	4	2 433 455 048		2 916 710 603	2 430 105 020
2 433 124 086	2 434 619 020	10			2 916 710 603	2 430 422 002
2 433 124 164	2 434 619 043	4				
2 433 124 164	2 434 619 043	4				
2 433 124 086	2 434 619 020	10			2 916 710 603	2 430 422 002

*) siehe Seite 388/see page 388/voir page 388/ver pagina 388/vease página 388

**) siehe Seite 392/see page 392/voir page 392/ver pagina 392/vease página 392

A342

de
Ersatzteile für
Düsenhalter-
kombinationen
(Fortsetzung)

en
Spare parts for
nozzle-and-holder
assemblies
(continued)

fr
Pièces de rechange
pour ensembles
porte-injecteurs
(suite)

it
Ricambi per
combinazione
portapolverizzatori
(seguito)

es
Piezas de repuesto
para conjuntos
portainyectoros
(continuación)



0 432 231 034	1	0 430 232 015	KDAL 62 S 23	0 433 220 163	DLL 152 S 780	2 433 349 514	2 430 136 119
0 432 231 039	1	0 430 235 002	KDAL 126 S 17/4	0 433 220 175	DLL 150 S 949	2 433 317 297	2 430 136 198
0 432 231 040	1	0 430 235 002	KDAL 126 S 17/4	0 433 220 176	DLL 150 S 950	2 433 317 297	2 430 136 198
0 432 231 041	1	0 430 235 002	KDAL 126 S 17/4	0 433 220 185	DLL 145 S 989	2 433 317 297	2 430 136 198
0 432 231 042	1	0 430 235 004	KDAL 130 S 29	0 433 220 182	DLL 150 S 979	2 433 314 256	2 430 136 203
0 432 231 043	1	0 430 235 002	KDAL 126 S 17/4	0 433 220 184	DLL 145 S 988	2 433 317 297	2 430 136 198
0 432 231 044	1	0 430 233 005	KDAL 96 S 16/4	0 433 220 187	DLL 30 S 1004	2 433 317 295	2 430 136 197
0 432 231 045	1	0 430 235 002	KDAL 126 S 17/4	0 433 220 177	DLL 145 S 951	2 433 317 297	2 430 136 198
0 432 231 046	1	0 430 232 015	KDAL 62 S 23	0 433 220 160	DLL 152 S 756	2 433 349 514	2 430 136 119
0 432 231 048	1	0 430 235 004	KDAL 130 S 29	0 433 220 195	DLL 150 S 1093	2 433 314 256	2 430 136 203
0 432 231 049	1	0 430 232 005	KDAL 50 S 4/4	0 433 220 196	DLL 76 S 1114	2 433 317 296	2 430 132 001
0 432 231 050	1	0 430 232 016	KDAL 62 S 24	0 433 220 163	DLL 152 S 780	2 433 349 514	2 430 136 119
0 432 231 051	1	0 430 232 016	KDAL 62 S 24	0 433 220 160	DLL 152 S 756	2 433 349 514	2 430 136 119
0 432 231 052	1	0 430 232 016	KDAL 62 S 24	0 433 220 163	DLL 152 S 780	2 433 349 514	2 430 136 119
0 432 231 053	1	0 430 235 002	KDAL 126 S 17/4	0 433 220 199	DLL 150 S 1195	2 433 317 297	2 430 136 198
0 432 231 054	1	0 430 232 016	KDAL 62 S 24	0 433 220 160	DLL 152 S 756	2 433 349 514	2 430 136 119
0 432 231 599	1	0 430 233 033	KDAL 80 S 63	0 433 272 012	DLLA 131 S 1035+/ 2	2 433 349 155	2 430 136 202
0 432 231 651	1	0 430 232 013	KDAL 74 S 21/19	0 433 271 534	DLLA 142 S 1257	2 433 349 501	2 430 136 202
0 432 231 652	1	0 430 232 013	KDAL 74 S 21/19	0 433 271 518	DLLA 142 S 1173	2 433 349 501	2 430 136 202
0 432 231 653	1	0 430 232 013	KDAL 74 S 21/19	0 433 271 680	DLLA 134 S 1201	2 433 349 501	2 430 136 202
0 432 231 654	1	0 430 235 003	KDAL 127 S 28	0 433 272 004	DLLA 145 S 1330	2 433 314 256	2 430 136 202
0 432 231 655	1	0 430 235 006	KBAL 127 S 34	0 433 272 004	DLLA 145 S 1330	2 433 314 256	2 430 136 202
0 432 231 656	1	0 430 233 028	KDAL 80 S 56	0 433 271 773	DLLA 136 S 1002	2 433 349 155	2 430 136 202
0 432 231 657	1	0 430 233 025	KDAL 80 S 53	0 433 271 486	DLLA 131 S 1035	2 433 349 155	2 430 136 202
0 432 231 658	1	0 430 233 033	KDAL 80 S 63	0 433 271 594	DLLA 144 S 485+/ 2	2 433 349 155	2 430 136 202
0 432 231 659	1	0 430 233 033	KDAL 80 S 63	0 433 271 593	DLLA 140 S 1003+/ 2	2 433 349 155	2 430 136 202
0 432 231 660	1	0 430 233 033	KDAL 80 S 63	0 433 271 592	DLLA 144 S 829+/ 2	2 433 349 155	2 430 136 202
0 432 231 661	1	0 430 233 033	KDAL 80 S 63	0 433 271 591	DLLA 136 S 1034+/ 2	2 433 349 155	2 430 136 202
0 432 231 662	1	0 430 233 033	KDAL 80 S 63	0 433 271 590	DLLA 134 S 1284+/ 2	2 433 349 155	2 430 136 202
0 432 231 663	1	0 430 233 033	KDAL 80 S 63	0 433 271 589	DLLA 134 S 999+/ 2	2 433 349 155	2 430 136 202
0 432 231 664	1	0 430 233 033	KDAL 80 S 63	0 433 271 588	DLLA 134 S 1199+/ 2	2 433 349 155	2 430 136 202
0 432 231 665	1	0 430 233 033	KDAL 80 S 63	0 433 271 587	DLLA 138 S 1191+/ 2	2 433 349 155	2 430 136 202
0 432 231 666	1	0 430 233 028	KDAL 80 S 56	0 433 271 487	DLLA 136 S 1034	2 433 349 155	2 430 136 202
0 432 231 667	1	0 430 233 981	KDEL 95 S 21	0 433 271 614	DLLA 160 S 1305	2 433 314 023	2 430 136 085
0 432 231 668	1	0 430 233 980	KDEL 96 S 22	0 433 271 625	DLLA 150 S 1295	2 433 349 245	2 430 136 085
0 432 231 669	1	0 430 233 025	KDAL 80 S 53	0 433 271 627	DLLA 136 S 1289	2 433 349 155	2 430 136 202
0 432 231 670	1	0 430 233 978	KDELZ 90 S 24	0 433 271 628	DLLZ 150 S 1287	2 433 314 023	2 430 136 173
0 432 231 672	1	0 430 233 031	KDAL 80 S 59	0 433 271 423	DLLA 144 S 829	2 433 349 155	2 430 136 202
0 432 231 673	1	0 430 233 031	KDAL 80 S 59	0 433 271 478	DLLA 140 S 1003	2 433 349 155	2 430 136 202
0 432 231 674	1	0 430 233 031	KDAL 80 S 59	0 433 271 507	DLLA 131 S 1131	2 433 349 155	2 430 136 202
0 432 231 675	1	0 430 233 030	KDAL 80 S 58	0 433 271 487	DLLA 136 S 1034	2 433 349 155	2 430 136 202
0 432 231 676	1	0 430 233 020	KDAL 80 S 47	0 433 271 527	DLLA 142 S 1224	2 433 349 155	2 430 136 202
0 432 231 677	1	0 430 233 020	KDAL 80 S 47	0 433 271 524	DLLA 134 S 1199	2 433 349 155	2 430 136 202
0 432 231 678	1	0 430 233 020	KDAL 80 S 47	0 433 271 521	DLLA 138 S 1191	2 433 349 155	2 430 136 202
0 432 231 679	1	0 430 233 020	KDAL 80 S 47	0 433 271 507	DLLA 131 S 1131	2 433 349 155	2 430 136 202



2 433 124 165	2 434 619 047	4					
2 433 124 137	2 434 619 017	4	2 433 455 048			2 916 710 603	2 430 105 020
2 433 124 137	2 434 619 017	4	2 433 455 048			2 916 710 603	2 430 105 020
2 433 124 137	2 434 619 017	4	2 433 455 048			2 916 710 603	2 430 105 020
2 433 124 455	2 434 619 038	4					
2 433 124 137	2 434 619 017	4	2 433 455 048			2 916 710 603	2 430 105 020
2 433 124 137	2 434 619 017	4					
2 433 124 137	2 434 619 017	4	2 433 455 048			2 916 710 603	2 430 105 020
2 433 124 165	2 434 619 047	4					
2 433 124 455	2 434 619 038	4					
2 433 124 086	2 434 619 020	10				2 916 710 603	2 430 422 002
2 433 124 165	2 434 619 047	4					
2 433 124 165	2 434 619 047	4					
2 433 124 165	2 434 619 047	4					
2 433 124 137	2 434 619 017	4	2 433 455 048			2 916 710 603	2 430 105 020
2 433 124 165	2 434 619 047	4					
2 433 124 137	2 434 619 017	4					
2 433 124 137	2 434 619 017	4				2 916 710 603	
2 433 124 137	2 434 619 017	4				2 916 710 603	
2 433 124 137	2 434 619 017	4				2 916 710 603	
2 433 124 164	2 434 619 047	4	2 433 462 016			2 916 710 603	2 430 105 020
2 433 124 164	2 434 619 047	4	2 433 462 016			2 916 710 603	2 430 105 020
2 433 124 137	2 434 619 017	4				2 916 710 602	
2 433 124 137	2 434 619 017	4				2 916 710 602	
2 433 124 137	2 434 619 017	4					
2 433 124 137	2 434 619 017	4					
2 433 124 137	2 434 619 017	4					
2 433 124 137	2 434 619 017	4					
2 433 124 137	2 434 619 017	4					
2 433 124 137	2 434 619 017	4					
2 433 124 137	2 434 619 017	4					
2 433 124 137	2 434 619 017	4					
2 433 124 137	2 434 619 017	4					
2 433 124 137	2 434 619 017	4				2 916 710 602	
2 433 124 379	2 434 619 040	5	2 433 462 143				
2 433 124 379	2 434 619 040	5	2 433 462 143				
2 433 124 137	2 434 619 017	4				2 916 710 602	
2 433 124 380	2 434 614 017	5					
2 433 124 137	2 434 619 017	4					
2 433 124 137	2 434 619 017	4					
2 433 124 137	2 434 619 017	4					
2 433 124 327	2 434 619 048	4					
2 433 124 137	2 434 619 017	4					
2 433 124 137	2 434 619 017	4					
2 433 124 137	2 434 619 017	4					
2 433 124 137	2 434 619 017	4					

*) siehe Seite 388/see page 388/voir page 388/ver pagina 388/vease página 388

***) siehe Seite 392/see page 392/voir page 392/ver pagina 392/vease página 392

A344

de
Ersatzteile für
Düsenhalter-
kombinationen
(Fortsetzung)

en
Spare parts for
nozzle-and-holder
assemblies
(continued)

fr
Pièces de rechange
pour ensembles
porte-injecteurs
(suite)

it
Ricambi per
combinazione
portapolverizzatori
(seguito)

es
Piezas de repuesto
para conjuntos
portainyectoros
(continuación)



0 432 231 680	1	0 430 233 020	KDAL 80 S 47	0 433 271 478	DLLA 140 S 1003	2 433 349 155	2 430 136 202
0 432 231 681	1	0 430 233 020	KDAL 80 S 47	0 433 271 499	DLLA 136 S 1094	2 433 349 155	2 430 136 202
0 432 231 682	1	0 430 233 020	KDAL 80 S 47	0 433 271 495	DLLA 136 S 1043	2 433 349 155	2 430 136 202
0 432 231 683	1	0 430 233 020	KDAL 80 S 47	0 433 271 486	DLLA 131 S 1035	2 433 349 155	2 430 136 202
0 432 231 684	1	0 430 233 020	KDAL 80 S 47	0 433 271 423	DLLA 144 S 829	2 433 349 155	2 430 136 202
0 432 231 685	1	0 430 233 020	KDAL 80 S 47	0 433 271 366	DLLA 144 S 747	2 433 349 155	2 430 136 202
0 432 231 686	1	0 430 233 020	KDAL 80 S 47	0 433 271 222	DLLA 144 S 488	2 433 349 155	2 430 136 202
0 432 231 687	1	0 430 233 020	KDAL 80 S 47	0 433 271 221	DLLA 144 S 485	2 433 349 155	2 430 136 202
0 432 231 688	1	0 430 232 019	KDAL 74 S 44	0 433 271 534	DLLA 142 S 1257	2 433 349 501	2 430 136 202
0 432 231 690	1	0 430 232 013	KDAL 74 S 21/19	0 433 271 515	DLLA 137 S 1157	2 433 349 501	2 430 136 202
0 432 231 691	1	0 430 233 979	KDEL 97 S 23	0 433 271 649	DLLA 150 S 1248	2 433 314 023	2 430 136 085
0 432 231 692	1	0 430 232 018	KDAL 62 S 38	0 433 271 650	DLLZ 152 S 1247	2 433 349 514	2 430 136 149
0 432 231 693	1	0 430 233 022	KDAL 80 S 50	0 433 271 652	DLLA 146 S 1245	2 433 349 155	2 430 136 202
0 432 231 694	1	0 430 232 018	KDAL 62 S 38	0 433 271 715	DLLZ 155 S 1133	2 433 349 514	2 430 136 149
0 432 231 696	1	0 430 232 018	KDAL 62 S 38	0 433 271 660	DLLZ 152 S 1229	2 433 349 514	2 430 136 149
0 432 231 697	1	0 430 233 982	KDEL 75 S 20	0 433 271 661	DLLA 148 S 1228	2 433 314 023	2 430 136 085
0 432 231 698	1	0 430 232 018	KDAL 62 S 38	0 433 271 715	DLLZ 155 S 1133	2 433 349 514	2 430 136 149
0 432 231 699	1	0 430 233 982	KDEL 75 S 20	0 433 271 663	DLLA 148 S 1226	2 433 314 023	2 430 136 085
0 432 231 700	1	0 430 233 982	KDEL 75 S 20	0 433 271 732	DLLA 148 S 1089	2 433 314 023	2 430 136 085
0 432 231 701	1	0 430 233 019	KDAL 80 S 46	0 433 271 527	DLLA 142 S 1224	2 433 314 256	2 430 136 202
0 432 231 702	1	0 430 233 985	KDEL 95 S 17	0 433 271 665	DLLA 155 S 1221	2 433 314 023	2 430 136 085
0 432 231 703	1	0 430 233 020	KDAL 80 S 47	0 433 271 487	DLLA 136 S 1034	2 433 349 155	2 430 136 202
0 432 231 704	1	0 430 233 020	KDAL 80 S 47	0 433 271 471	DLLA 134 S 999	2 433 349 155	2 430 136 202
0 432 231 705	1	0 430 233 980	KDEL 96 S 22	0 433 271 666	DLLA 150 S 1220	2 433 349 245	2 430 136 085
0 432 231 706	1	0 430 233 993	KDEL 87 S 8	0 433 271 669	DLLA 150 S 1216	2 433 314 023	2 430 136 085
0 432 231 707	1	0 430 233 981	KDEL 95 S 21	0 433 271 670	DLLA 155 S 1215	2 433 314 023	2 430 136 085
0 432 231 708	1	0 430 233 982	KDEL 75 S 20	0 433 271 671	DLLA 148 S 1214	2 433 314 023	2 430 136 085
0 432 231 709	1	0 430 233 029	KDAL 80 S 57	0 433 271 487	DLLA 136 S 1034	2 433 349 155	2 430 136 202
0 432 231 710	1	0 430 232 999	KDEL 65 S 1/13	0 433 271 677	DLLA 155 S 1205	2 433 314 023	2 430 136 085
0 432 231 711	1	0 430 232 017	KDAL 62 S 32	0 433 271 715	DLLZ 155 S 1133	2 433 349 514	2 430 136 149
0 432 231 712	1	0 430 233 982	KDEL 75 S 20	0 433 271 679	DLLA 148 S 1203	2 433 314 023	2 430 136 085
0 432 231 713	1	0 430 232 019	KDAL 74 S 44	0 433 271 680	DLLA 134 S 1201	2 433 349 501	2 430 136 202
0 432 231 714	1	0 430 233 019	KDAL 80 S 46	0 433 271 524	DLLA 134 S 1199	2 433 314 256	2 430 136 202
0 432 231 715	1	0 430 232 019	KDAL 74 S 44	0 433 271 523	DLLA 134 S 1197	2 433 349 501	2 430 136 202
0 432 231 716	1	0 430 233 983	KDEL 87 S 19	0 433 271 683	DLLA 150 S 1192	2 433 314 023	2 430 136 085
0 432 231 717	1	0 430 233 019	KDAL 80 S 46	0 433 271 521	DLLA 138 S 1191	2 433 314 256	2 430 136 202
0 432 231 718	1	0 430 233 984	KDEL 82 S 18	0 433 271 520	DLLA 35 S 1190	2 433 349 238	2 430 136 085
0 432 231 720	1	0 430 233 018	KDAL 80 S 42	0 433 271 519	DLLA 136 S 1182	2 433 314 256	2 430 136 202
0 432 231 721	1	0 430 233 993	KDEL 87 S 8	0 433 271 694	DLLA 146 S 1175	2 433 314 023	2 430 136 085
0 432 231 722	1	0 430 232 019	KDAL 74 S 44	0 433 271 518	DLLA 142 S 1173	2 433 349 501	2 430 136 202
0 432 231 723	1	0 430 233 985	KDEL 95 S 17	0 433 271 701	DLLA 155 S 1163	2 433 314 023	2 430 136 085
0 432 231 724	1	0 430 232 019	KDAL 74 S 44	0 433 271 515	DLLA 137 S 1157	2 433 349 501	2 430 136 202
0 432 231 725	1	0 430 233 019	KDAL 80 S 46	0 433 271 507	DLLA 131 S 1131	2 433 314 256	2 430 136 202
0 432 231 726	1	0 430 233 993	KDEL 87 S 8	0 433 271 709	DLLA 150 S 1151	2 433 314 023	2 430 136 085
0 432 231 728	1	0 430 233 021	KDAL 80 S 48	0 433 271 478	DLLA 140 S 1003	2 433 314 256	2 430 136 202



2 433 124 137	2 434 619 017	4					
2 433 124 137	2 434 619 017	4					
2 433 124 137	2 434 619 017	4					
2 433 124 137	2 434 619 017	4					
2 433 124 137	2 434 619 017	4					
2 433 124 137	2 434 619 017	4					
2 433 124 137	2 434 619 017	4					
2 433 124 137	2 434 619 017	4					
2 433 124 137	2 434 619 017	4				2 916 710 603	
2 433 124 137	2 434 619 017	4				2 916 710 603	
2 433 124 340	2 434 614 038	5	2 433 462 131	2 430 210 027			
2 433 124 165	2 434 619 047	4					
2 433 124 137	2 434 619 017	4					
2 433 124 165	2 434 619 047	4					
2 433 124 165	2 434 619 047	4					
2 433 124 379	2 434 619 040	5	2 433 462 143				
2 433 124 165	2 434 619 047	4					
2 433 124 379	2 434 619 040	5	2 433 462 143				
2 433 124 379	2 434 619 040	5	2 433 462 143				
2 433 124 137	2 434 619 017	4					
2 433 124 379	2 434 619 040	5	2 433 462 143				
2 433 124 137	2 434 619 017	4					
2 433 124 137	2 434 619 017	4					
2 433 124 379	2 434 619 040	5	2 433 462 143				
2 433 124 379	2 434 619 040	5	2 433 462 036	2 430 210 027	2 433 370 035	2 916 710 603	2 430 105 020
2 433 124 379	2 434 619 040	5	2 433 462 143				
2 433 124 379	2 434 619 040	5	2 433 462 143				
2 433 124 327	2 434 619 048	4					
2 433 124 380	2 434 619 040	5				2 916 710 602	
2 433 124 165	2 434 619 047	4					
2 433 124 379	2 434 619 040	5	2 433 462 143				
2 433 124 137	2 434 619 017	4				2 916 710 603	
2 433 124 137	2 434 619 017	4				2 916 710 603	
2 433 124 137	2 434 619 017	4				2 916 710 603	
2 433 124 380	2 434 614 017	5	2 433 462 036	2 430 210 027	2 433 370 035	2 916 710 603	2 430 105 020
2 433 124 137	2 434 619 017	4					
2 433 124 379	2 434 619 040	5				2 916 710 602	
2 433 124 137	2 434 619 017	4					
2 433 124 379	2 434 619 040	5	2 433 462 036	2 430 210 027	2 433 370 035	2 916 710 603	2 430 105 020
2 433 124 137	2 434 619 017	4				2 916 710 603	
2 433 124 379	2 434 619 040	5	2 433 462 143				
2 433 124 137	2 434 619 017	4				2 916 710 603	
2 433 124 137	2 434 619 017	4					
2 433 124 379	2 434 619 040	5	2 433 462 036	2 430 210 027	2 433 370 035	2 916 710 603	2 430 105 020
2 433 124 137	2 434 619 017	4				2 916 710 602	

*) siehe Seite 388/see page 388/voir page 388/ver pagina 388/vease página 388

**) siehe Seite 392/see page 392/voir page 392/ver pagina 392/vease página 392

de

Ersatzteile für
Düsenhalter-
kombinationen
(Fortsetzung)

en

Spare parts for
nozzle-and-holder
assemblies
(continued)

fr

Pièces de rechange
pour ensembles
porte-injecteurs
(suite)

it

Ricambi per
combinazione
portapolverizzatori
(seguito)

es

Piezas de repuesto
para conjuntos
portainyectores
(continuación)



Fig.



Ref.



Typ



①



②



③



③

0 432 231 729	1	0 430 233 021	KDAL 80 S 48	0 433 271 423	DLLA 144 S 829	2 433 314 256	2 430 136 202
0 432 231 731	1	0 430 233 019	KDAL 80 S 46	0 433 271 510	DLLA 134 S 1143	2 433 314 256	2 430 136 202
0 432 231 732	1	0 430 232 019	KDAL 74 S 44	9 430 084 233	DLLA 133 S 1103	2 433 349 501	2 430 136 202
0 432 231 733	1	0 430 233 028	KDAL 80 S 56	0 433 271 509	DLLA 31 S 1138	2 433 349 155	2 430 136 202
0 432 231 734	1	0 430 232 017	KDAL 62 S 32	0 433 271 715	DLLZ 155 S 1133	2 433 349 514	2 430 136 149
0 432 231 735	1	0 430 233 021	KDAL 80 S 48	0 433 271 507	DLLA 131 S 1131	2 433 314 256	2 430 136 202
0 432 231 736	1	0 430 232 019	KDAL 74 S 44	0 433 271 502	DLLA 142 S 1096	2 433 349 501	2 430 136 202
0 432 231 737	1	0 430 232 019	KDAL 74 S 44	0 433 271 503	DLLA 134 S 1119	2 433 349 501	2 430 136 202
0 432 231 738	1	0 430 233 019	KDAL 80 S 46	0 433 271 471	DLLA 134 S 999	2 433 314 256	2 430 136 202
0 432 231 739	1	0 430 235 006	KBAL 127 S 34	0 433 271 498	DLLA 145 S 1090	2 433 314 256	2 430 136 202
0 432 231 740	1	0 430 233 028	KDAL 80 S 56	0 433 271 725	DLLA 136 S 1102	2 433 349 155	2 430 136 202
0 432 231 741	1	0 430 233 987	KDEL 77 S 15	0 433 271 728	DLLA 148 S 1098	2 433 314 023	2 430 136 085
0 432 231 742	1	0 430 233 018	KDAL 80 S 42	0 433 271 487	DLLA 136 S 1034	2 433 314 256	2 430 136 202
0 432 231 743	1	0 430 233 018	KDAL 80 S 42	0 433 271 499	DLLA 136 S 1094	2 433 314 256	2 430 136 202
0 432 231 744	1	0 430 233 025	KDAL 80 S 53	0 433 271 773	DLLA 136 S 1002	2 433 349 155	2 430 136 202
0 432 231 745	1	0 430 232 018	KDAL 62 S 38	0 433 271 798	DLLZ 147 S 958	2 433 349 514	2 430 136 149
0 432 231 747	1	0 430 233 987	KDEL 77 S 15	0 433 271 732	DLLA 148 S 1089	2 433 314 023	2 430 136 085
0 432 231 748	1	0 430 233 986	KDEL 82 S 16	0 433 271 497	DLLA 31 S 1079	2 433 349 221	2 430 136 085
0 432 231 750	1	0 430 233 022	KDAL 80 S 50	0 433 271 495	DLLA 136 S 1043	2 433 349 155	2 430 136 202
0 432 231 751	1	0 430 233 024	KDAL 80 S 52	0 433 271 783	DLLA 138 S 983	2 433 349 155	2 430 136 202
0 432 231 752	1	0 430 233 988	KDEL 97 S 14	0 433 271 748	DLLA 150 S 1064	2 433 314 023	2 430 136 085
0 432 231 756	1	0 430 232 017	KDAL 62 S 32	0 433 271 757	DLLZ 147 S 1050	2 433 349 514	2 430 136 149
0 432 231 757	1	0 430 233 993	KDEL 87 S 8	0 433 271 747	DLLA 150 S 1065	2 433 314 023	2 430 136 085
0 432 231 759	1	0 430 233 019	KDAL 80 S 46	0 433 271 486	DLLA 131 S 1035	2 433 314 256	2 430 136 202
0 432 231 760	1	0 430 233 018	KDAL 80 S 42	0 433 271 487	DLLA 136 S 1034	2 433 314 256	2 430 136 202
0 432 231 761	1	0 430 233 022	KDAL 80 S 50	0 433 271 485	DLLA 128 S 1028	2 433 349 155	2 430 136 202
0 432 231 762	1	0 430 232 018	KDAL 62 S 38	0 433 271 737	DLLZ 147 S 1083	2 433 349 514	2 430 136 149
0 432 231 763	1	0 430 233 022	KDAL 80 S 50	0 433 271 773	DLLA 136 S 1002	2 433 349 155	2 430 136 202
0 432 231 764	1	0 430 233 018	KDAL 80 S 42	0 433 271 478	DLLA 140 S 1003	2 433 314 256	2 430 136 202
0 432 231 765	1	0 430 233 028	KDAL 80 S 56	0 433 271 773	DLLA 136 S 1002	2 433 349 155	2 430 136 202
0 432 231 766	1	0 430 233 019	KDAL 80 S 46	0 433 271 471	DLLA 134 S 999	2 433 314 256	2 430 136 202
0 432 231 767	1	0 430 233 022	KDAL 80 S 50	0 433 271 740	DLLA 136 S 943	2 433 349 155	2 430 136 202
0 432 231 768	1	0 430 233 027	KDAL 80 S 55	0 433 271 783	DLLA 138 S 983	2 433 349 239	2 430 136 202
0 432 231 769	1	0 430 233 023	KDAL 80 S 51	0 433 271 461	DLLA 30 S 931	2 433 349 240	2 430 136 202
0 432 231 770	1	0 430 232 013	KDAL 74 S 21/19	0 433 271 466	DLLA 142 S 926	2 433 349 501	2 430 136 202
0 432 231 771	1	0 430 235 006	KBAL 127 S 34	0 433 271 482	DLLA 145 S 1019	2 433 314 256	2 430 136 202
0 432 231 772	1	0 430 235 006	KBAL 127 S 34	0 433 271 458	DLLA 145 S 944/	2 433 314 256	2 430 136 202
0 432 231 773	1	0 430 232 017	KDAL 62 S 32	0 433 271 798	DLLZ 147 S 958	2 433 349 514	2 430 136 149
0 432 231 774	1	0 430 233 991	KDEL 82 S 10	0 433 271 463	DLLA 31 S 955	2 433 349 221	2 430 136 085
0 432 231 775	1	0 430 232 013	KDAL 74 S 21/19	0 433 271 462	DLLA 150 S 935	2 433 349 501	2 430 136 202
0 432 231 776	1	0 430 233 012	KDAL 80 S 30	0 433 271 461	DLLA 30 S 931	2 433 349 134	2 430 136 202
0 432 231 777	1	0 430 233 028	KDAL 80 S 56	0 433 271 800	DLLA 142 S 947	2 433 349 155	2 430 136 202
0 432 231 778	1	0 430 233 028	KDAL 80 S 56	0 433 271 740	DLLA 136 S 943	2 433 349 155	2 430 136 202
0 432 231 779	1	0 430 233 022	KDAL 80 S 50	0 433 271 452	DLLA 31 S 915	2 433 349 155	2 430 136 202
0 432 231 780	1	0 430 235 003	KDAL 127 S 28	0 433 271 482	DLLA 145 S 1019	2 433 314 256	2 430 136 202



2 433 124 137	2 434 619 017	4					2 916 710 602	
2 433 124 137	2 434 619 017	4						
2 433 124 137	2 434 619 017	4					2 916 710 603	
2 433 124 137	2 434 619 017	4					2 916 710 602	
2 433 124 165	2 434 619 047	4						
2 433 124 137	2 434 619 017	4					2 916 710 602	
2 433 124 137	2 434 619 017	4					2 916 710 603	
2 433 124 137	2 434 619 017	4					2 916 710 603	
2 433 124 164	2 434 619 047	4		2 433 462 016			2 916 710 603	2 430 105 020
2 433 124 137	2 434 619 017	4					2 916 710 602	
2 433 124 379	2 434 619 040	5		2 433 462 143				
2 433 124 137	2 434 619 017	4						
2 433 124 137	2 434 619 017	4						
2 433 124 137	2 434 619 017	4					2 916 710 602	
2 433 124 165	2 434 619 047	4						
2 433 124 379	2 434 619 040	5		2 433 462 143				
2 433 124 380	2 434 619 073	5		2 433 462 131				
2 433 124 137	2 434 619 017	4						
2 433 124 137	2 434 619 040	4						
2 433 124 379	2 434 619 040	5		2 433 462 131				
2 433 124 165	2 434 619 047	4						
2 433 124 379	2 434 619 040	5		2 433 462 036	2 430 210 027	2 433 370 035	2 916 710 603	2 430 105 020
2 433 124 137	2 434 619 017	4						
2 433 124 137	2 434 619 017	4						
2 433 124 137	2 434 619 017	4						
2 433 124 165	2 434 619 047	4						
2 433 124 137	2 434 619 017	4						
2 433 124 137	2 434 619 017	4					2 916 710 602	
2 433 124 137	2 434 619 017	4						
2 433 124 137	2 434 619 017	4						
2 433 124 137	2 434 619 017	4						
2 433 124 137	2 434 619 017	4					2 916 710 603	
2 433 124 164	2 434 619 047	4		2 433 462 016			2 916 710 603	2 430 105 020
2 433 124 164	2 434 619 047	4		2 433 462 016			2 916 710 603	
2 433 124 165	2 434 619 047	4						
2 433 124 379	2 434 619 040	5		2 433 462 131				
2 433 124 137	2 434 619 017	4					2 916 710 603	
2 433 124 137	2 434 619 017	4						
2 433 124 137	2 434 619 017	4					2 916 710 602	
2 433 124 137	2 434 619 017	4					2 916 710 602	2 430 105 020
2 433 124 137	2 434 619 017	4					2 916 710 602	2 430 105 020
2 433 124 164	2 434 619 047	4		2 433 462 016			2 916 710 603	2 430 105 020

*) siehe Seite 388/see page 388/voir page 388/ver pagina 388/vease página 388

**) siehe Seite 392/see page 392/voir page 392/ver pagina 392/vease página 392

de

Ersatzteile für
Düsenhalter-
kombinationen
(Fortsetzung)

en

Spare parts for
nozzle-and-holder
assemblies
(continued)

fr

Pièces de rechange
pour ensembles
porte-injecteurs
(suite)

it

Ricambi per
combinazione
portapolverizzatori
(seguito)

es

Piezas de repuesto
para conjuntos
portainyectoros
(continuación)



Fig.



Ref.



Typ



①



Typ



②



③

0 432 231 781	1	0 430 235 003	KDAL 127 S 28	0 433 271 481	DLLA 145 S 1018	2 433 314 256	2 430 136 202
0 432 231 782	1	0 430 233 022	KDAL 80 S 50	0 433 271 740	DLLA 136 S 943	2 433 349 155	2 430 136 202
0 432 231 783	1	0 430 233 989	KDEL 82 S 12	0 433 271 453	DLLA 35 S 918	2 433 349 316	2 430 136 085
0 432 231 788	1	0 430 233 991	KDEL 82 S 10	0 433 271 454	DLLA 31 S 921	2 433 349 221	2 430 136 085
0 432 231 789	1	0 430 233 994	KDEL 82 S 7/13	0 433 271 453	DLLA 35 S 918	2 433 314 023	2 430 136 085
0 432 231 790	1	0 430 233 028	KDAL 80 S 56	0 433 271 421	DLLA 34 S 837	2 433 349 155	2 430 136 202
0 432 231 791	1	0 430 233 009	KDAL 80 S 25	0 433 271 452	DLLA 31 S 915	2 433 314 256	2 430 136 202
0 432 231 792	1	0 430 233 028	KDAL 80 S 56	0 433 271 221	DLLA 144 S 485	2 433 349 155	2 430 136 202
0 432 231 793	1	0 430 233 022	KDAL 80 S 50	0 433 271 435	DLLA 34 S 876	2 433 349 155	2 430 136 202
0 432 231 794	1	0 430 233 010	KDAL 80 S 26	0 433 271 445	DLLA 32 S 900	2 433 349 134	2 430 136 202
0 432 231 795	1	0 430 233 022	KDAL 80 S 50	0 433 271 421	DLLA 34 S 837	2 433 349 155	2 430 136 202
0 432 231 796	1	0 430 233 028	KDAL 80 S 56	0 433 271 435	DLLA 34 S 876	2 433 349 155	2 430 136 202
0 432 231 798	1	0 430 233 009	KDAL 80 S 25	0 433 271 445	DLLA 32 S 900	2 433 314 256	2 430 136 202
0 432 231 799	1	0 430 233 990	KDEL 97 S 11	0 433 271 837	DLLA 150 S 838/	2 433 314 023	2 430 136 085
0 432 231 800	1	0 430 233 990	KDEL 97 S 11	0 433 271 812	DLLA 152 S 899	2 433 314 023	2 430 136 085
0 432 231 802	1	0 430 233 028	KDAL 80 S 56	0 433 271 442	DLLA 28 S 892	2 433 349 155	2 430 136 202
0 432 231 805	1	0 430 233 028	KDAL 80 S 56	0 433 270 176	DLL 25 S 834	2 433 349 155	2 430 136 202
0 432 231 806	1	0 430 233 995	KDEL 89 S 6/13	0 433 271 822	DLLA 155 S 879	2 433 349 318	2 430 136 085
0 432 231 807	1	0 430 233 028	KDAL 80 S 56	0 433 271 436	DLLA 30 S 877	2 433 349 155	2 430 136 202
0 432 231 808	1	0 430 233 028	KDAL 80 S 56	0 433 271 435	DLLA 34 S 876	2 433 349 155	2 430 136 202
0 432 231 810	1	0 430 233 028	KDAL 80 S 56	0 433 271 421	DLLA 34 S 837	2 433 349 155	2 430 136 202
0 432 231 812	1	0 430 233 992	KDEL 97 S 9	0 433 271 837	DLLA 150 S 838/	2 433 314 023	2 430 136 085
0 432 231 813	1	0 430 233 992	KDEL 97 S 9	0 433 271 868	DLLA 150 S 753	2 433 314 023	2 430 136 085
0 432 231 814	1	0 430 233 018	KDAL 80 S 42	0 433 271 423	DLLA 144 S 829	2 433 314 256	2 430 136 202
0 432 231 815	1	0 430 233 993	KDEL 87 S 8	0 433 271 836	DLLA 150 S 839	2 433 314 023	2 430 136 085
0 432 231 816	1	0 430 233 997	KDEL 97 S 4/13	0 433 271 837	DLLA 150 S 838/	2 433 314 023	2 430 136 085
0 432 231 817	1	0 430 233 022	KDAL 80 S 50	0 433 171 265	DLLA 134 P 372	2 433 349 155	2 430 136 202
0 432 231 818	1	0 430 233 993	KDEL 87 S 8	0 433 271 844	DLLA 150 S 826	2 433 314 023	2 430 136 085
0 432 231 820	1	0 430 233 994	KDEL 82 S 7/13	0 433 271 413	DLLA 35 S 812	2 433 314 023	2 430 136 085
0 432 231 822	1	0 430 232 013	KDAL 74 S 21/19	0 433 271 408	DLLA 79 S 800	2 433 349 501	2 430 136 202
0 432 231 823	1	0 430 232 013	KDAL 74 S 21/19	0 433 271 404	DLLA 142 S 792	2 433 349 501	2 430 136 202
0 432 231 824	1	0 430 232 013	KDAL 74 S 21/19	0 433 271 403	DLLA 142 S 791	2 433 349 501	2 430 136 202
0 432 231 825	1	0 430 232 013	KDAL 74 S 21/19	0 433 271 268	DLLA 150 S 2120	2 433 349 501	2 430 136 202
0 432 231 826	1	0 430 232 013	KDAL 74 S 21/19	0 433 271 046	DLLA 150 S 187	2 433 349 501	2 430 136 202
0 432 231 827	1	0 430 232 013	KDAL 74 S 21/19	0 433 271 394	DLLA 150 S 781	2 433 349 501	2 430 136 202
0 432 231 830	1	0 430 233 995	KDEL 89 S 6/13	0 433 271 863	DLLA 150 S 767	2 433 349 318	2 430 136 085
0 432 231 831	1	0 430 232 999	KDEL 65 S 1/13	0 433 271 864	DLLA 158 S 766	2 433 314 023	2 430 136 085
0 432 231 832	1	0 430 233 028	KDAL 80 S 56	0 433 271 368	DLLA 30 S 757	2 433 349 155	2 430 136 202
0 432 231 833	1	0 430 233 028	KDAL 80 S 56	0 433 271 365	DLLA 34 S 749	2 433 349 155	2 430 136 202
0 432 231 835	1	0 430 233 028	KDAL 80 S 56	0 433 271 370	DLLA 32 S 759	2 433 349 155	2 430 136 202
0 432 231 836	1	0 430 233 022	KDAL 80 S 50	0 433 271 370	DLLA 32 S 759	2 433 349 155	2 430 136 202
0 432 231 838	1	0 430 233 997	KDEL 97 S 4/13	0 433 271 868	DLLA 150 S 753	2 433 314 023	2 430 136 085
0 432 231 839	1	0 430 233 028	KDAL 80 S 56	0 433 271 334	DLLA 30 S 678	2 433 349 155	2 430 136 202
0 432 231 842	1	0 430 233 022	KDAL 80 S 50	0 433 271 365	DLLA 34 S 749	2 433 349 155	2 430 136 202
0 432 231 844	1	0 430 233 028	KDAL 80 S 56	0 433 271 285	DLLA 28 S 589	2 433 349 155	2 430 136 202



2 433 124 164	2 434 619 047	4	2 433 462 016			2 916 710 603	2 430 105 020
2 433 124 137	2 434 619 017	4					
2 433 124 379	2 434 619 040	5	2 433 462 131				
2 433 124 379	2 434 619 040	5	2 433 462 131				
2 433 124 379	2 434 619 040	5	2 433 462 131			2 916 710 602	
2 433 124 137	2 434 619 017	4				2 916 710 602	
2 433 124 455	2 434 619 038	4					
2 433 124 137	2 434 619 017	4				2 916 710 602	
2 433 124 137	2 434 619 017	4					
2 433 124 455	2 434 619 038	4					2 430 105 020
2 433 124 137	2 434 619 017	4					
2 433 124 137	2 434 619 017	4				2 916 710 602	
2 433 124 455	2 434 619 038	4					
2 433 124 379	2 434 619 040	5	2 433 462 131	2 430 210 027			2 430 105 020
2 433 124 379	2 434 619 040	5	2 433 462 131	2 430 210 027			
2 433 124 137	2 434 619 017	4				2 916 710 602	
2 433 124 137	2 434 619 017	4				2 916 710 602	
2 433 124 379	2 434 619 040	5	2 433 462 137	2 430 210 005			
2 433 124 137	2 434 619 017	4				2 916 710 602	
2 433 124 137	2 434 619 017	4				2 916 710 602	
2 433 124 137	2 434 619 017	4				2 916 710 602	
2 433 124 379	2 434 619 040	5	2 433 462 131	2 430 210 027			
2 433 124 379	2 434 619 040	5	2 433 462 131	2 430 210 027			
2 433 124 137	2 434 619 017	4					
2 433 124 379	2 434 619 040	5	2 433 462 036	2 430 210 027	2 433 370 035	2 916 710 603	2 430 105 020
2 433 124 379	2 434 619 040	5	2 433 462 131	2 430 210 027		2 916 710 602	
2 433 124 137	2 434 619 017	5					
2 433 124 379	2 434 619 040	5	2 433 462 036	2 430 210 027	2 433 370 035	2 916 710 603	2 430 105 020
2 433 124 379	2 434 619 040	5	2 433 462 131			2 916 710 602	
2 433 124 137	2 434 619 017	4				2 916 710 603	
2 433 124 137	2 434 619 017	4				2 916 710 603	
2 433 124 137	2 434 619 017	4				2 916 710 603	
2 433 124 137	2 434 619 017	4				2 916 710 603	
2 433 124 137	2 434 619 017	4				2 916 710 603	
2 433 124 379	2 434 619 040	5	2 433 462 137	2 430 210 005			
2 433 124 380	2 434 619 040	5				2 916 710 602	
2 433 124 137	2 434 619 017	4				2 916 710 602	
2 433 124 137	2 434 619 017	4				2 916 710 602	
2 433 124 137	2 434 619 017	4				2 916 710 602	
2 433 124 137	2 434 619 017	4				2 916 710 602	
2 433 124 137	2 434 619 017	4				2 916 710 602	
2 433 124 379	2 434 619 040	5	2 433 462 131	2 430 210 027		2 916 710 602	2 430 105 020
2 433 124 137	2 434 619 017	4				2 916 710 602	2 430 105 020
2 433 124 137	2 434 619 017	4				2 916 710 602	
2 433 124 137	2 434 619 017	4				2 916 710 602	

*) siehe Seite 388/see page 388/voir page 388/ver pagina 388/vease página 388

***) siehe Seite 392/see page 392/voir page 392/ver pagina 392/vease página 392

A350

de
Ersatzteile für
Düsenhalter-
kombinationen
(Fortsetzung)

en
Spare parts for
nozzle-and-holder
assemblies
(continued)

fr
Pièces de rechange
pour ensembles
porte-injecteurs
(suite)

it
Ricambi per
combinazione
portapolverizzatori
(seguito)

es
Piezas de repuesto
para conjuntos
portainyectoros
(continuación)



0 432 231 845	1	0 430 233 028	KDAL 80 S 56	0 433 271 355	DLLA 25 S 722	2 433 349 155	2 430 136 202
0 432 231 846	1	0 430 233 028	KDAL 80 S 56	0 433 271 296	DLLA 27 S 613	2 433 349 155	2 430 136 202
0 432 231 848	1	0 430 232 999	KDEL 65 S 1/13	0 433 271 878	DLLA 155 S 729	2 433 314 023	2 430 136 085
0 432 231 850	1	0 430 233 022	KDAL 80 S 50	0 433 271 355	DLLA 25 S 722	2 433 349 155	2 430 136 202
0 432 231 851	1	0 430 232 999	KDEL 65 S 1/13	0 433 271 883	DLLA 155 S 713	2 433 314 023	2 430 136 085
0 432 231 852	1	0 430 232 999	KDEL 65 S 1/13	0 433 271 884	DLLA 155 S 710	2 433 314 023	2 430 136 085
0 432 231 855	1	0 430 232 999	KDEL 65 S 1/13	0 433 271 890	DLLA 155 S 695	2 433 314 023	2 430 136 085
0 432 231 857	1	0 430 232 999	KDEL 65 S 1/13	0 433 271 895	DLLA 155 S 681	2 433 314 023	2 430 136 085
0 432 231 858	1	0 430 233 022	KDAL 80 S 50	0 433 271 334	DLLA 30 S 678	2 433 349 155	2 430 136 202
0 432 231 860	1	0 430 232 999	KDEL 65 S 1/13	0 433 271 898	DLLA 155 S 658	2 433 314 023	2 430 136 085
0 432 231 861	1	0 430 233 022	KDAL 80 S 50	0 433 271 319	DLLA 150 S 653	2 433 349 155	2 430 136 202
0 432 231 863	1	0 430 233 022	KDAL 80 S 50	0 433 271 307	DLLA 150 S 628	2 433 349 155	2 430 136 202
0 432 231 864	1	0 430 233 022	KDAL 80 S 50	0 433 271 306	DLLA 25 S 627	2 433 349 155	2 430 136 202
0 432 231 865	1	0 430 232 004	KDAL 74 S 3/19	0 433 271 045	DLLA 150 S 186	2 433 317 297	2 430 136 191
0 432 231 867	1	0 430 233 022	KDAL 80 S 50	0 433 271 293	DLLA 25 S 601	2 433 349 155	2 430 136 202
0 432 231 868	1	0 430 233 022	KDAL 80 S 50	0 433 271 285	DLLA 28 S 589	2 433 349 155	2 430 136 202
0 432 231 869	1	0 430 233 022	KDAL 80 S 50	0 433 271 284	DLLA 150 S 588	2 433 349 155	2 430 136 202
0 432 231 870	1	0 430 232 013	KDAL 74 S 21/19	0 433 271 268	DLLA 150 S 2120	2 433 349 501	2 430 136 202
0 432 231 872	1	0 430 232 013	KDAL 74 S 21/19	0 433 271 235	DLLA 150 S 514	2 433 349 501	2 430 136 202
0 432 231 875	1	0 430 232 004	KDAL 74 S 3/19	0 433 271 215	DLLA 148 S 470	2 433 317 297	2 430 136 191
0 432 231 876	1	0 430 232 004	KDAL 74 S 3/19	0 433 271 198	DLLA 63 S 447	2 433 317 297	2 430 136 191
0 432 231 877	1	0 430 232 009	KDAL 60 S 10/14	0 433 271 155	DLLA 23 S 383		2 430 136 191
0 432 231 880	1	0 430 232 013	KDAL 74 S 21/19	0 433 271 160	DLLA 79 S 390	2 433 349 501	2 430 136 202
0 432 231 884	1	0 430 234 003	KDAL 100 S 8/19	0 433 271 103	DLLA 150 S 292		gelöscht
0 432 231 886	1	0 430 232 013	KDAL 74 S 21/19	0 433 271 045	DLLA 150 S 186	2 433 349 501	2 430 136 202
0 432 231 887	1	0 430 232 013	KDAL 74 S 21/19	0 433 271 046	DLLA 150 S 187	2 433 349 501	2 430 136 202
0 432 237 001	1	0 430 231 005	KDA 27 SD 3/13	0 434 250 068	DN 0 SD 211		2 430 136 031
0 432 237 002	1	0 430 231 005	KDA 27 SD 3/13	0 434 250 068	DN 0 SD 211		2 430 136 031
0 432 237 003	1	0 430 231 006	KDA 27 SD 5/13	0 434 250 009	DN 0 SD 211		2 430 136 031
0 432 237 005	1	0 430 233 008	KDA 77 S 7/13	0 434 250 094	DN 0 SD 239	2 433 314 293	2 430 136 115
0 432 237 006	1	0 430 233 008	KDA 77 S 7/13	0 434 250 046	DN 0 SD 174	2 433 314 293	2 430 136 115
0 432 280 006	1	0 431 202 123	KB 50 SA 564/4	0 433 250 056	DL 50 S 1082	2 433 349 031	
0 432 281 005	1	0 431 205 007	KBL 128 S 47/4	0 433 220 058	DLL 150 S 184	2 433 314 065	
0 432 281 006	1	0 431 205 007	KBL 128 S 47/4	0 433 220 060	DLL 150 S 188	2 433 314 065	
0 432 281 025	1	0 431 203 103	KBL 76 S 79/4	0 433 270 102	DLL 18 S 353	2 433 314 065	
0 432 281 029	1	0 431 203 123	KBL 85 S 105/4	0 433 270 113	DLL 150 S 389	2 433 314 066	
0 432 281 035	1	0 431 203 123	KBL 85 S 105/4	0 433 270 116	DLL 150 S 405	2 433 314 066	
0 432 281 037	1	0 431 202 134	KBL 67 S 75	0 433 270 049	DLL 150 S 171	2 433 314 059	
0 432 281 039	1	0 431 203 124	KBL 90 S 104/4	0 433 270 120	DLL 150 S 2641	2 433 314 152	
0 432 281 040	1	0 431 203 103	KBL 76 S 79/4	0 433 270 121	DLL 18 S 418	2 433 314 065	
0 432 281 052	1	0 431 203 124	KBL 90 S 104/4	0 433 270 120	DLL 150 S 2641	2 433 314 152	
0 432 281 058	1	0 431 204 016	KBL 112 S 28/13	0 433 270 136	DLL 150 S 484	2 433 314 066	
0 432 281 059	1	0 431 204 016	KBL 112 S 28/13	0 433 270 138	DLL 150 S 489	2 433 314 066	
0 432 281 062	1	0 431 203 134	KBL 90 S 128/4	0 433 270 120	DLL 150 S 2641	2 433 314 152	
0 432 281 063	1	0 431 203 134	KBL 90 S 128/4	0 433 270 120	DLL 150 S 2641	2 433 314 152	

de

Ersatzteile für
Düsenhalter-
kombinationen
(Fortsetzung)

en

Spare parts for
nozzle-and-holder
assemblies
(continued)

fr

Pièces de rechange
pour ensembles
porte-injecteurs
(suite)

it

Ricambi per
combinazione
portapolverizzatori
(seguito)

es

Piezas de repuesto
para conjuntos
portainyectoros
(continuación)



Fig.



Ref.



Typ



Ref.



Typ



②



③

0 432 281 066	1	0 431 203 103	KBL 76 S 79/4	0 433 270 121	DLL 18 S 418	2 433 314 065
0 432 281 079	1	0 431 203 145	KBL 95 S 149/4	0 433 220 138	DLL 150 S 578	2 433 314 066
0 432 281 082	1	0 431 203 145	KBL 95 S 149/4	0 433 220 063	DLL 150 S 211	2 433 314 066
0 432 281 083	1	0 431 203 145	KBL 95 S 149/4	0 433 220 110	DLL 150 S 450	2 433 314 066
0 432 281 087	1	0 431 203 151	KBL 95 S 149/13	0 433 220 138	DLL 150 S 578	2 433 314 066
0 432 281 088	1	0 431 203 151	KBL 95 S 149/13	0 433 220 063	DLL 150 S 211	2 433 314 066
0 432 281 089	1	0 431 203 151	KBL 95 S 149/13	0 433 220 110	DLL 150 S 450	2 433 314 066
0 432 281 093	1	0 431 203 144	KBL 76 S 148/4	0 433 270 162	DLL 18 S 629	2 433 314 191
0 432 281 094	1	0 431 203 125	KBL 84 S 109/4	0 433 220 079	DLL 120 S 285	2 433 314 016
0 432 281 097	1	0 431 203 156	KBL 97 S 173/13	0 433 220 073	DLL 140 S 248	2 433 314 019
0 432 281 098	1	0 431 203 156	KBL 97 S 173/13	0 433 220 109	DLL 140 S 446	2 433 314 019
0 432 281 099	1	0 431 203 156	KBL 97 S 173/13	0 433 220 109	DLL 140 S 446	2 433 314 019
0 432 281 100	1	0 431 203 156	KBL 97 S 173/13	0 433 220 148	DLL 140 S 632	2 433 314 019
0 432 281 101	1	0 431 203 156	KBL 97 S 173/13	0 433 220 140	DLL 140 S 586	2 433 314 019
0 432 281 102	1	0 431 203 151	KBL 95 S 149/13	0 433 220 063	DLL 150 S 211	2 433 314 066
0 432 281 103	1	0 431 203 125	KBL 84 S 109/4	0 433 220 097	DLL 120 S 352	2 433 314 016
0 432 281 106	1	0 431 203 151	KBL 95 S 149/13	0 433 220 110	DLL 150 S 450	2 433 314 066
0 432 281 107	1	0 431 203 151	KBL 95 S 149/13	0 433 220 063	DLL 150 S 211	2 433 314 066
0 432 281 111	1	0 431 203 151	KBL 95 S 149/13	0 433 220 063	DLL 150 S 211	2 433 314 066
0 432 281 112	1	0 431 202 155	KBL 64 SE 193/4	0 433 270 170	DLL 160 S 705	2 433 314 093
0 432 281 113	1	0 431 202 158	KBL 67 S 201/13	0 433 270 159	DLL 150 S 612	2 433 314 039
0 432 281 115	1	0 431 203 103	KBL 76 S 79/4	0 433 270 121	DLL 18 S 418	2 433 314 065
0 432 281 116	1	0 431 202 158	KBL 67 S 201/13	0 433 270 174	DLL 150 S 790/TR	2 433 314 039
0 432 281 117	1	0 431 202 158	KBL 67 S 201/13	0 433 270 181	DLL 150 S 919/	2 433 314 039
0 432 281 686	1	0 431 204 055	KBL 108 S 178/4	0 433 271 530	DLLA 140 S 1236	2 433 314 034
0 432 281 687	1	0 431 204 055	KBL 108 S 178/4	0 433 271 480	DLLA 140 S 1017	2 433 314 034
0 432 281 688	1	0 431 203 129	KBL 76 S 120/4	0 433 271 736	DLLA 160 S 1084	2 433 314 104
0 432 281 689	1	0 431 203 130	KBL 86 S 121/4	0 433 271 736	DLLA 160 S 1084	2 433 314 103
0 432 281 690	1	0 431 203 164	KBL 76 S 225	0 433 271 263	DLLA 160 S 555	2 433 314 104
0 432 281 691	1	0 431 205 010	KBL 128 S 92/4	0 433 271 440	DLLA 150 S 891/TR	2 433 314 071
0 432 281 692	1	0 431 202 158	KBL 67 S 201/13	0 433 271 494	DLLA 150 S 1052	2 433 314 039
0 432 281 694	1	0 431 202 158	KBL 67 S 201/13	0 433 271 473	DLLA 150 S 1008	2 433 314 039
0 432 281 695	1	0 431 203 161	KBL 76 S 211/4	0 433 271 467	DLLA 144 S 982	2 433 314 065
0 432 281 696	1	0 431 202 158	KBL 67 S 201/13	0 433 271 214	DLLA 150 S 469	2 433 314 039
0 432 281 698	1	0 431 203 153	TR-KBL 80 S 163	0 433 271 451	DLLA 150 S 913	2 433 314 071
0 432 281 699	1	0 431 205 010	KBL 128 S 92/4	0 433 271 446	DLLA 150 S 902	2 433 314 071
0 432 281 700	1	0 431 205 010	KBL 128 S 92/4	0 433 271 440	DLLA 150 S 891/TR	2 433 314 071
0 432 281 702	1	0 431 203 153	TR-KBL 80 S 163	0 433 271 397	DLLA 150 S 788/	2 433 314 071
0 432 281 703	1	0 431 205 010	KBL 128 S 92/4	0 433 271 425	DLLA 150 S 852	2 433 314 071
0 432 281 704	1	0 431 203 160	KBL 88 S 203/4	0 433 271 424	DLLA 145 S 847	2 433 314 034
0 432 281 705	1	0 431 202 133	KBL 74 S 107/4	0 433 271 079	DLLA 160 S 255	2 433 314 059
0 432 281 707	1	0 431 204 023	KBL 112 S 21/13	0 433 271 848	DLLA 150 S 816	2 433 314 066
0 432 281 708	1	0 431 203 161	KBL 76 S 211/4	0 433 271 410	DLLA 144 S 808	2 433 314 065
0 432 281 709	1	0 431 205 010	KBL 128 S 92/4	0 433 271 379	DLLA 150 S 777	2 433 314 071
0 432 281 710	1	0 431 203 160	KBL 88 S 203/4	0 433 271 375	DLLA 145 S 770	2 433 314 034

A354

de
Ersatzteile für
Düsenhalter-
kombinationen
(Fortsetzung)

en
Spare parts for
nozzle-and-holder
assemblies
(continued)









fr
Pièces de rechange
pour ensembles
porte-injecteurs
(suite)

it
Ricambi per
combinazione
portapolverizzatori
(seguito)

es
Piezas de repuesto
para conjuntos
portainyectoros
(continuación)



0 432 281 711	1	0 431 204 023	KBL 112 S 21/13	0 433 271 212	DLLA 150 S 467	2 433 314 066
0 432 281 713	1	0 431 203 159	KBL 97 S 197/4	0 433 271 233	DLLA 27 S 512	2 433 314 189
0 432 281 715	1	0 431 204 032	KBL 112 S 82/13	0 433 271 030	DLLA 150 S 138	2 433 314 066
0 432 281 716	1	0 431 202 150	KBL 70 S 177/4	0 433 271 199	DLLA 145 S 448	2 433 314 018
0 432 281 717	1	0 431 202 156	KBL 64 S 194/4	0 433 271 344	DLLA 160 S 707	2 433 314 093
0 432 281 718	1	0 431 202 150	KBL 70 S 177/4	0 433 271 325	DLLA 141 S 662	2 433 314 018
0 432 281 720	1	0 431 204 023	KBL 112 S 21/13	0 433 271 348	DLLA 150 S 714	2 433 314 066
0 432 281 722	1	0 431 204 016	KBL 112 S 28/13	0 433 271 299	DLLA 150 S 616	2 433 314 066
0 432 281 723	1	0 431 204 053	KBL 112 S 164/13	0 433 271 259	DLLA 150 S 549	2 433 314 057
0 432 281 724	1	0 431 204 055	KBL 108 S 178/4	0 433 271 343	DLLA 160 S 699	2 433 314 034
0 432 281 726	1	0 431 202 148	KBL 67 S 162/13	0 433 271 336	DLA 150 S 682/	2 433 314 039
0 432 281 728	1	0 431 204 023	KBL 112 S 21/13	0 433 271 212	DLLA 150 S 467	2 433 314 066
0 432 281 729	1	0 431 202 136	KBL 73 S 111/4	0 433 271 329	DLLA 150 S 671	2 433 314 156
0 432 281 731	1	0 431 204 055	KBL 108 S 178/4	0 433 271 315	DLLA 160 S 641	2 433 314 034
0 432 281 732	1	0 431 204 055	KBL 108 S 178/4	0 433 271 266	DLLA 140 S 563	2 433 314 034
0 432 281 733	1	0 431 203 103	KBL 76 S 79/4	0 433 271 297	DLLA 25 S 614	2 433 314 065
0 432 281 735	1	0 431 203 142	KBL 90 S 145/13	0 433 271 318	DLLA 155 S 651	2 433 314 082
0 432 281 736	1	0 431 203 158	KBL 90 S 176/4	0 433 271 180	DLLA 150 S 417	2 433 314 152
0 432 281 737	1	0 431 204 054	KBL 106 S 168/4	0 433 271 239	DLLA 155 S 520	2 433 314 059
0 432 281 739	1	0 431 204 054	KBL 106 S 168/4	0 433 271 312	DLLA 155 S 636	2 433 314 059
0 432 281 740	1	0 431 203 155	KBL 82 S 166/4	0 433 271 245	DLLA 150 S 527	2 433 314 193
0 432 281 743	1	0 431 203 155	KBL 82 S 166/4	0 433 271 231	DLLA 145 S 507	2 433 314 193
0 432 281 747	1	0 431 204 053	KBL 112 S 164/13	0 433 271 299	DLLA 150 S 616	2 433 314 057
0 432 281 748	1	0 431 204 053	KBL 112 S 164/13	0 433 271 298	DLLA 150 S 615	2 433 314 057
0 432 281 749	1	0 431 203 098	KBL 87 S 78/4	0 433 271 074	DLLA 150 S 245	2 433 314 059
0 432 281 751	1	0 431 203 129	KBL 76 S 120/4	0 433 271 263	DLLA 160 S 555	2 433 314 104
0 432 281 759	1	0 431 204 039	KBL 114 S 106/4	0 433 271 282	DLLA 24 S 584	2 433 314 057
0 432 281 760	1	0 431 204 048	KBL 117 S 82/13	0 433 271 280	DLLA 150 S 582	2 433 314 066
0 432 281 761	1	0 431 204 036	KBL 117 S 21/13	0 433 271 280	DLLA 150 S 582	2 433 314 066
0 432 281 763	1	0 431 202 136	KBL 73 S 111/4	0 433 271 214	DLLA 150 S 469	2 433 314 156
0 432 281 764	1	0 431 204 016	KBL 112 S 28/13	0 433 271 272	DLLA 150 S 570	2 433 314 066
0 432 281 765	1	0 431 204 016	KBL 112 S 28/13	0 433 271 271	DLLA 150 S 569	2 433 314 066
0 432 281 768	1	0 431 203 130	KBL 86 S 121/4	0 433 271 265	DLLA 160 S 557	2 433 314 103
0 432 281 769	1	0 431 203 130	KBL 86 S 121/4	0 433 271 263	DLLA 160 S 555	2 433 314 103
0 432 281 770	1	0 431 203 098	KBL 87 S 78/4	0 433 271 262	DLLA 150 S 552	2 433 314 059
0 432 281 771	1	0 431 205 010	KBL 128 S 92/4	0 433 271 260	DLLA 150 S 550	2 433 314 071
0 432 281 772	1	0 431 204 016	KBL 112 S 28/13	0 433 271 258	DLLA 150 S 548	2 433 314 066
0 432 281 773	1	0 431 204 016	KBL 112 S 28/13	0 433 271 259	DLLA 150 S 549	2 433 314 066
0 432 281 774	1	0 431 203 152	KBL 91 S 146/13	0 433 271 258	DLLA 150 S 548	2 433 314 059
0 432 281 775	1	0 431 203 152	KBL 91 S 146/13	0 433 271 257	DLLA 150 S 547	2 433 314 059
0 432 281 776	1	0 431 202 143	KBLB 67 S 2/13	0 433 271 255	DLLB 160 S 544	2 433 314 121
0 432 281 777	1	0 431 204 023	KBL 112 S 21/13	0 433 271 240	DLLA 150 S 521	2 433 314 066
0 432 281 779	1	0 431 203 098	KBL 87 S 78/4	0 433 271 036	DLLA 150 S 720	2 433 314 059
0 432 281 783	1	0 431 204 023	KBL 112 S 21/13	0 433 271 240	DLLA 150 S 521	2 433 314 066
0 432 281 785	1	0 431 204 039	KBL 114 S 106/4	0 433 271 238	DLLA 27 S 517	2 433 314 057

								
④	⑤	⑥	⑦	⑧	⑨	⑩	⑪	
2 433 104 011	2 434 619 008				2 433 370 110	2 916 710 603		
	2 434 619 022				2 433 356 007	2 916 710 603	2 430 422 004	
2 433 104 011	2 434 619 008				2 433 370 019	2 916 710 603		
	2 434 614 011					2 916 710 603		
2 433 124 076	2 434 619 028	4			2 433 370 243	2 916 710 603		
	2 434 614 011					2 916 710 603		
2 433 104 011	2 434 619 008				2 433 370 110	2 916 710 603		
2 433 104 011	2 434 619 008				2 433 370 110	2 916 710 603		
2 433 104 011	2 434 619 008				2 433 370 110	2 916 710 603		
2 433 124 093	2 434 614 011					2 916 710 605		
2 433 104 009	2 434 619 009					2 916 710 603		
2 433 104 011	2 434 619 008				2 433 370 110	2 916 710 603		
2 433 124 075	2 434 619 028	4			2 433 370 243	2 916 710 603		
2 433 124 093	2 434 614 011					2 916 710 605		
2 433 124 093	2 434 614 011					2 916 710 605		
2 433 124 029	2 434 614 011	9			2 433 356 069	2 916 710 603		
2 433 104 173	2 434 619 006						2 430 100 048	
2 433 104 171	2 434 619 008				2 433 370 110	2 916 710 616		
	2 434 619 008				2 433 370 110	2 916 710 603		
	2 434 619 008				2 433 370 110	2 916 710 603		
2 433 104 171	2 434 619 008					2 916 710 603		
2 433 104 171	2 434 619 008					2 916 710 603		
2 433 104 011	2 434 619 008				2 433 370 110	2 916 710 603	2 430 105 020	
2 433 104 011	2 434 619 008				2 433 370 110	2 916 710 603		
2 433 104 427	2 434 619 008	8				2 916 710 603		
	2 434 619 028	4						
	2 434 619 003	9			2 433 370 203	2 916 710 603		
2 433 101 013	2 434 619 008				2 433 370 110	2 916 710 603		
2 433 101 013	2 434 619 008				2 433 370 110	2 916 710 603		
2 433 124 075	2 434 619 028	4			2 433 370 243	2 916 710 603		
2 433 104 011	2 434 619 008				2 433 370 110	2 916 710 603		
2 433 104 011	2 434 619 008				2 433 370 110	2 916 710 603		
2 433 124 080	2 434 619 028	4			2 433 370 243			
2 433 124 080	2 434 619 028	4			2 433 370 243			
2 433 104 427	2 434 619 008	8				2 916 710 603		
2 433 104 435	2 434 619 008					2 916 710 603	2 430 422 004	
2 433 104 011	2 434 619 008				2 433 370 110	2 916 710 603		
2 433 104 011	2 434 619 008				2 433 370 110	2 916 710 603		
	2 434 619 008				2 433 370 203	2 916 710 603		
	2 434 619 008				2 433 370 203	2 916 710 603		
	2 434 619 006	8			2 433 356 054	2 916 710 517		
2 433 104 011	2 434 619 008				2 433 370 110	2 916 710 603		
2 433 104 427	2 434 619 008	8				2 916 710 603		
2 433 104 011	2 434 619 008				2 433 370 110	2 916 710 603		
	2 434 619 003	9			2 433 370 203	2 916 710 603		

*) siehe Seite 388/see page 388/voir page 388/ver pagina 388/vease página 388

**) siehe Seite 392/see page 392/voir page 392/ver pagina 392/vease página 392

de

Ersatzteile für
Düsenhalter-
kombinationen
(Fortsetzung)

en

Spare parts for
nozzle-and-holder
assemblies
(continued)

fr

Pièces de rechange
pour ensembles
porte-injecteurs
(suite)

it

Ricambi per
combinazione
portapolverizzatori
(seguito)

es

Piezas de repuesto
para conjuntos
portainyectoros
(continuación)



Fig.



Ref.



Typ



①



Typ











②



③

0 432 281 789	1	0 431 204 036	KBL 117 S 21/13	0 433 271 043	DLLA 150 S 178	2 433 314 066
0 432 281 790	1	0 431 203 137	KBL 97 S 133/4	0 433 271 233	DLLA 27 S 512	2 433 314 189
0 432 281 791	1	0 431 203 136	KBL 89 S 132/4	0 433 271 232	DLLA 160 S 509	2 433 314 179
0 432 281 796	1	0 431 203 134	KBL 90 S 128/4	0 433 271 195	DLLA 150 S 442	2 433 314 152
0 432 281 797	1	0 431 203 134	KBL 90 S 128/4	0 433 271 180	DLLA 150 S 417	2 433 314 152
0 432 281 798	1	0 431 203 134	KBL 90 S 128/4	0 433 271 180	DLLA 150 S 417	2 433 314 152
0 432 281 800	1	0 431 204 032	KBL 112 S 82/13	0 433 271 043	DLLA 150 S 178	2 433 314 066
0 432 281 802	1	0 431 204 023	KBL 112 S 21/13	0 433 271 043	DLLA 150 S 178	2 433 314 066
0 432 281 803	1	0 431 203 109	KBL 97 S 88/4	0 433 271 001	DLLA 10 S 134	2 433 314 066
0 432 281 807	1	0 431 204 023	KBL 112 S 21/13	0 433 271 212	DLLA 150 S 467	2 433 314 066
0 432 281 812	1	0 431 205 010	KBL 128 S 92/4	0 433 271 205	DLLA 150 S 456	2 433 314 071
0 432 281 814	1	0 431 203 129	KBL 76 S 120/4	0 433 271 152	DLLA 160 S 378	2 433 314 104
0 432 281 816	1	0 431 203 124	KBL 90 S 104/4	0 433 271 195	DLLA 150 S 442	2 433 314 152
0 432 281 817	1	0 431 203 129	KBL 76 S 120/4	0 433 271 152	DLLA 160 S 378	2 433 314 104
0 432 281 818	1	0 431 203 130	KBL 86 S 121/4	0 433 271 152	DLLA 160 S 378	2 433 314 103
0 432 281 820	1	0 431 203 098	KBL 87 S 78/4	0 433 271 191	DLLA 150 S 436	2 433 314 059
0 432 281 822	1	0 431 203 124	KBL 90 S 104/4	0 433 271 190	DLLA 150 S 430	2 433 314 152
0 432 281 824	1	0 431 203 124	KBL 90 S 104/4	0 433 271 189	DLLA 150 S 429	2 433 314 152
0 432 281 827	1	0 431 204 042	KBL 122 S 117/4	0 433 271 058	DLLA 150 S 204	2 433 314 066
0 432 281 828	1	0 431 203 124	KBL 90 S 104/4	0 433 271 180	DLLA 150 S 417	2 433 314 152
0 432 281 830	1	0 431 202 136	KBL 73 S 111/4	0 433 271 071	DLLA 150 S 236	2 433 314 156
0 432 281 831	1	0 431 203 098	KBL 87 S 78/4	0 433 271 184	DLLA 150 S 422	2 433 314 059
0 432 281 832	1	0 431 205 010	KBL 128 S 92/4	0 433 271 183	DLLA 150 S 421	2 433 314 071
0 432 281 833	1	0 431 203 124	KBL 90 S 104/4	0 433 271 180	DLLA 150 S 417	2 433 314 152
0 432 281 837	1	0 431 203 123	KBL 85 S 105/4	0 433 271 169	DLLA 150 S 402	2 433 314 066
0 432 281 838	1	0 431 202 133	KBL 74 S 107/4	0 433 271 079	DLLA 160 S 255	2 433 314 059
0 432 281 843	1	0 431 205 010	KBL 128 S 92/4	0 433 271 164	DLLA 150 S 396	2 433 314 071
0 432 281 844	1	0 431 203 103	KBL 76 S 79/4	0 433 271 156	DLLA 18 S 384	2 433 314 065
0 432 281 853	1	0 431 204 036	KBL 117 S 21/13	0 433 271 043	DLLA 150 S 178	2 433 314 066
0 432 281 854	1	0 431 203 098	KBL 87 S 78/4	0 433 271 128	DLLA 110 S 335	2 433 314 059
0 432 281 855	1	0 431 203 119	KBL 99 S 94/4	0 433 271 001	DLLA 10 S 134	2 433 314 051
0 432 281 856	1	0 431 203 119	KBL 99 S 94/4	0 433 271 022	DLLA 38 S 133	2 433 314 051
0 432 281 857	1	0 431 203 119	KBL 99 S 94/4	0 433 271 126	DLLA 32 S 330	2 433 314 051
0 432 281 864	1	0 431 203 109	KBL 97 S 88/4	0 433 271 099	DLLA 10 S 286	2 433 314 066
0 432 281 870	1	0 431 204 032	KBL 112 S 82/13	0 433 271 036	DLLA 150 S 720	2 433 314 066
0 432 281 871	1	0 431 204 032	KBL 112 S 82/13	0 433 271 043	DLLA 150 S 178	2 433 314 066
0 432 281 872	1	0 431 204 032	KBL 112 S 82/13	0 433 271 032	DLLA 150 S 140	2 433 314 066
0 432 281 873	1	0 431 204 023	KBL 112 S 21/13	0 433 271 043	DLLA 150 S 178	2 433 314 066
0 432 281 874	1	0 431 204 023	KBL 112 S 21/13	0 433 271 032	DLLA 150 S 140	2 433 314 066
0 432 281 881	1	0 431 203 098	KBL 87 S 78/4	0 433 271 074	DLLA 150 S 245	2 433 314 059
0 432 281 884	1	0 431 204 014	KBL 103 S 21/13	0 433 271 028	DLLA 150 S 112	2 433 314 066
0 432 281 885	1	0 431 204 014	KBL 103 S 21/13	0 433 271 032	DLLA 150 S 140	2 433 314 066
0 432 281 886	1	0 431 204 014	KBL 103 S 21/13	0 433 271 043	DLLA 150 S 178	2 433 314 066
0 432 281 887	1	0 431 204 014	KBL 103 S 21/13	0 433 271 036	DLLA 150 S 720	2 433 314 066
0 432 281 888	1	0 431 204 016	KBL 112 S 28/13	0 433 271 030	DLLA 150 S 138	2 433 314 066

								
④	⑤	⑥	⑦	⑧	⑨	⑩	⑪	
2 433 101 013	2 434 619 008				2 433 370 110	2 916 710 603		
	2 434 619 022				2 433 370 288	2 916 710 603		
2 433 104 491	2 434 619 009				2 433 370 243			
2 433 104 171	2 434 619 008					2 916 710 603	2 430 422 005	
2 433 104 171	2 434 619 008					2 916 710 603		
2 433 104 171	2 434 619 008					2 916 710 603	2 430 422 005	
2 433 104 011	2 434 619 008				2 433 370 019	2 916 710 603		
2 433 104 011	2 434 619 008				2 433 370 110	2 916 710 603		
	2 434 619 017					2 916 710 603		
2 433 104 011	2 434 619 008				2 433 370 110	2 916 710 603		
2 433 104 435	2 434 619 008					2 916 710 603	2 430 422 004	
	2 434 619 028	4						
2 433 104 171	2 434 619 008				2 433 370 110	2 916 710 603	2 430 422 005	
	2 434 619 028	4						
2 433 124 080	2 434 619 028	4			2 433 370 243			
2 433 104 427	2 434 619 008	8				2 916 710 603		
2 433 104 171	2 434 619 008				2 433 370 110	2 916 710 603	2 430 422 005	
2 433 104 171	2 434 619 008				2 433 370 110	2 916 710 603	2 430 422 005	
	2 434 619 003	7				2 916 710 603		
2 433 104 171	2 434 619 008				2 433 370 110	2 916 710 603	2 430 422 005	
2 433 124 075	2 434 619 028	4			2 433 370 243	2 916 710 603		
2 433 104 427	2 434 619 008	8				2 916 710 603		
2 433 104 435	2 434 619 008					2 916 710 603	2 430 422 004	
2 433 104 171	2 434 619 008				2 433 370 110	2 916 710 603		
2 433 124 071	2 434 614 010					2 916 710 603		
2 433 124 302	2 434 619 003					2 916 710 603		
2 433 104 435	2 434 619 008					2 916 710 603	2 430 422 004	
2 433 124 029	2 434 614 011	9			2 433 356 069	2 916 710 603		
2 433 101 013	2 434 619 008				2 433 370 110	2 916 710 603		
2 433 104 427	2 434 619 008	8				2 916 710 603		
	2 434 619 017					2 916 710 603		
	2 434 619 017					2 916 710 603		
	2 434 619 017					2 916 710 603		
	2 434 619 017					2 916 710 603	2 430 105 011	
2 433 104 011	2 434 619 008				2 433 370 019	2 916 710 603		
2 433 104 011	2 434 619 008				2 433 370 019	2 916 710 603		
2 433 104 011	2 434 619 008				2 433 370 110	2 916 710 603		
2 433 104 011	2 434 619 008				2 433 370 110	2 916 710 603		
2 433 104 427	2 434 619 008	8				2 916 710 603		
	2 434 619 008				2 433 370 110	2 916 710 603		
	2 434 619 008				2 433 370 110	2 916 710 603		
	2 434 619 008				2 433 370 110	2 916 710 603		
	2 434 619 008				2 433 370 110	2 916 710 603		
2 433 104 011	2 434 619 008				2 433 370 110	2 916 710 603		

*) siehe Seite 388/see page 388/voir page 388/ver pagina 388/vease página 388

**) siehe Seite 392/see page 392/voir page 392/ver pagina 392/vease página 392

de

Ersatzteile für
Düsenhalter-
kombinationen
(Fortsetzung)

en

Spare parts for
nozzle-and-holder
assemblies
(continued)

fr

Pièces de rechange
pour ensembles
porte-injecteurs
(suite)

it

Ricambi per
combinazione
portapolverizzatori
(seguito)

es

Piezas de repuesto
para conjuntos
portainyectoros
(continuación)



Fig.



Ref.



Typ



①



Typ



②



③

0 432 281 889	1	0 431 204 016	KBL 112 S 28/13	0 433 271 058	DLLA 150 S 204	2 433 314 066	
0 432 281 999	1	0 431 204 031	KBLY 100 S 2/12	0 433 251 002	DLA 0 S 2	2 433 314 069	
0 432 286 005	1	0 431 201 100	KB 47 SA 539/4	0 434 200 028	DN 4 S 162	2 430 360 012	
0 432 286 008	1	0 431 201 090	KB 35 SA 524/4	0 434 200 013	DN 8 S 3	2 433 349 031	
0 432 286 014	1	0 431 201 115	KB 35 SA 253/13	0 434 200 021	DN 15 S 156	2 433 349 031	
0 432 286 018	1	0 431 201 138	KB 35 SA 600/4	0 434 200 044	TR-DN 8 S 229	2 433 349 031	
0 432 287 004	1	0 431 201 102	KB 35 SA 542/4	0 434 250 013	DN 4 SD 20	2 433 314 055	
0 432 287 005	1	0 431 201 099	KB 35 SD 535/4	0 434 250 048	DN 0 SD 210	2 433 349 031	
0 432 287 007	1	0 431 201 080	KB 40 SD 533/4	0 434 250 002	DN 0 SD 126	2 433 314 173	
0 432 287 008	1	0 431 201 080	KB 40 SD 533/4	0 434 250 041	DN 4 SD 169	2 433 314 173	
0 432 287 011	1	0 431 203 016	KB 80 SA 390/4	0 434 250 005	DN 0 SD 137	2 433 314 055	
0 432 287 016	1	0 431 203 041	KB 95 SA 485/13	0 434 250 014	DN 4 SD 24	2 433 314 055	
0 432 287 020	1	0 431 201 080	KB 40 SD 533/4	0 434 250 041	DN 4 SD 169	2 433 314 173	
0 432 287 021	1	0 431 203 041	KB 95 SA 485/13	0 434 250 012	DN 0 SD 2110	2 433 314 055	
0 432 287 022	1	0 431 203 041	KB 95 SA 485/13	0 434 250 012	DN 0 SD 2110	2 433 314 055	
0 432 287 023	1	0 431 202 068	KB 65 SA 442	0 434 250 014	DN 4 SD 24	2 433 314 055	
0 432 287 024	1	0 431 201 119	KB 35 S 565/4	0 434 250 060	DN 0 SD 189	2 433 349 031	
0 432 287 026	1	0 431 202 045	KB 65 SDA 456/13	0 434 250 001	DN 0 SD 21	2 433 314 055	
0 432 287 027	1	0 431 203 041	KB 95 SA 485/13	0 434 250 012	DN 0 SD 2110	2 433 314 055	
0 432 287 028	1	0 431 201 129	KB 35 SD 571/4	0 434 250 060	DN 0 SD 189	2 433 349 031	
0 432 287 031	1	0 431 201 119	KB 35 S 565/4	0 434 250 063	DN 0 SD 193	2 433 349 031	
0 432 287 034	1	0 431 201 129	KB 35 SD 571/4	0 434 250 009	DN 0 SD 211	2 433 349 031	
0 432 287 038	1	0 431 201 136	KB 37 SA 590/4	0 434 250 001	DN 0 SD 21	2 433 314 187	
0 432 287 039	1	0 431 202 149	KB 50 S 592/13	0 434 250 060	DN 0 SD 189	2 433 314 021	
0 432 287 041	1	0 431 201 137	KB 35 SD 593/4	0 434 250 075	DN 0 SD 228	2 433 349 031	
0 432 287 042	1	0 431 201 137	KB 35 SD 593/4	0 434 250 077	DN 0 SD 230	2 433 349 031	
0 432 287 045	1	0 431 201 136	KB 37 SA 590/4	0 434 250 063	DN 0 SD 193	2 433 314 187	
0 432 287 047	1	0 431 201 119	KB 35 S 565/4	0 434 250 077	DN 0 SD 230	2 433 349 031	
0 432 287 048	1	0 431 202 154	KB 50 S 621/13	0 434 250 060	DN 0 SD 189	2 433 314 021	
0 432 287 049	1	0 431 201 136	KB 37 SA 590/4	0 434 250 092	DN 0 SD 1930	2 433 314 187	
0 432 287 050	1	0 431 201 141	KB 35 S 635	0 434 250 056	DN 4 SD 187	2 433 349 031	
0 432 287 051	1	0 431 201 140	KB 35 S 619/13	0 434 250 047	DNA 0 SD 178	2 433 314 089	
0 432 287 052	1	0 431 201 142	KB 40 S 643	0 434 250 002	DN 0 SD 126	2 433 349 518	
0 432 291 001	1	0 431 213 001	KBAL 97 SC 1/13	0 433 270 071	DLL 145 S 258	2 433 317 071	2 430 136 193
0 432 291 002	1	0 431 213 001	KBAL 97 SC 1/13	0 433 270 072	DLL 145 S 259	2 433 317 071	2 430 136 193
0 432 291 004	1	0 431 213 001	KBAL 97 SC 1/13	0 433 270 074	DLL 145 S 261	2 433 317 071	2 430 136 193
0 432 291 006	1	0 431 214 004	KBAL 118 S 12/4	0 433 220 103	DLL 159 S 411	2 433 317 285	2 430 136 197
0 432 291 007	1	0 431 213 001	KBAL 97 SC 1/13	0 433 270 119	DLL 145 S 416	2 433 317 071	2 430 136 193
0 432 291 010	1	0 431 214 007	KBAL 100 SC 2/13	0 433 270 126	DLL 25 S 444	2 433 314 259	2 430 136 206
0 432 291 011	1	0 431 213 001	KBAL 97 SC 1/13	0 433 270 129	DLL 150 S 454	2 433 317 071	2 430 136 193
0 432 291 024	1	0 431 214 004	KBAL 118 S 12/4	0 433 220 123	DLL 153 S 529	2 433 317 285	2 430 136 197
0 432 291 029	1	0 431 213 019	KBALB 87 S 2/4	0 433 270 114	DLL 150 S 393	2 433 314 295	2 430 136 206
0 432 291 030	1	0 431 212 029	KBAL 65 S 13/13	0 433 270 151	DLL 140 S 591	2 433 314 256	2 430 136 202
0 432 291 032	1	0 431 213 019	KBALB 87 S 2/4	0 433 270 082	DLL 150 S 296	2 433 314 295	2 430 136 206
0 432 291 033	1	0 431 214 014	KBAL 100 S 33/4	0 433 220 143	DLL 150 S 606	2 433 314 165	2 430 136 115



2 433 104 011	2 434 619 008				2 433 370 110	2 916 710 603	
2 433 104 431	2 434 619 006	8					
2 433 104 425	2 434 619 009	8				2 916 710 603	
2 433 104 423	2 434 619 006					2 916 710 616	2 430 105 011
2 433 104 425	2 434 619 006				2 433 357 010	2 916 710 603	
2 433 104 425	2 434 619 009					2 916 710 603	2 430 105 027
2 433 104 423	2 434 619 009	8				2 916 710 603	2 430 105 012
2 433 124 027	2 434 614 011	9			2 433 365 056	2 916 710 517	
2 433 124 026	2 434 614 011	9				2 916 710 603	
2 433 124 026	2 434 614 011	9				2 916 710 603	
	2 434 619 006					2 916 710 616	2 430 105 012
2 433 104 025	2 434 619 006					2 916 710 505	2 430 105 012
2 433 124 026	2 434 614 011	9				2 916 710 603	
2 433 104 025	2 434 619 006					2 916 710 505	2 430 105 012
2 433 104 025	2 434 619 006					2 916 710 505	
2 433 104 036	2 434 619 006					2 916 710 616	2 430 105 012
2 433 124 017	2 434 619 003	9			2 433 356 077	2 916 710 603	
2 433 104 003	2 434 619 008					2 916 710 616	2 430 105 012
2 433 104 025	2 434 619 006					2 916 710 505	2 430 105 012
2 433 124 027	2 434 619 003	9			2 433 365 056	2 916 710 603	
2 433 124 017	2 434 619 003	9			2 433 356 077	2 916 710 603	
2 433 124 027	2 434 619 003	9			2 433 365 056	2 916 710 603	
	2 434 619 009					2 916 710 603	
	2 434 619 003	9			2 433 356 077	2 916 710 603	
2 433 124 017	2 434 619 035	9			2 433 356 077	2 916 710 603	
2 433 124 017	2 434 619 035	9			2 433 356 077	2 916 710 603	
	2 434 619 009					2 916 710 603	
2 433 124 017	2 434 619 003	9			2 433 356 077	2 916 710 603	
	2 434 619 003					2 916 710 603	
	2 434 619 009					2 916 710 603	
2 433 104 423	2 434 619 009						
	2 434 619 008					2 916 710 603	
2 433 124 026	2 434 614 011	9				2 916 710 603	
2 433 124 137	2 434 619 017	4					
2 433 124 137	2 434 619 017	4					
2 433 124 137	2 434 619 017	4					
2 433 124 137	2 434 619 017	4					
2 433 124 137	2 434 619 017	4			1 900 210 022		2 430 100 048
2 433 124 137	2 434 619 017	4					
2 433 124 137	2 434 619 017	4					
2 433 124 137	2 434 614 010	4			2 433 370 297	2 916 710 603	2 430 105 020
2 433 124 137	2 434 619 017	4				2 916 710 603	
2 433 124 137	2 434 614 010	4			2 433 370 297	2 916 710 603	
	2 434 619 017	4				2 916 710 603	

*) siehe Seite 388/see page 388/voir page 388/ver pagina 388/vease página 388

**) siehe Seite 392/see page 392/voir page 392/ver pagina 392/vease página 392

A360

de
Ersatzteile für
Düsenhalter-
kombinationen
(Fortsetzung)

en
Spare parts for
nozzle-and-holder
assemblies
(continued)

fr
Pièces de rechange
pour ensembles
porte-injecteurs
(suite)

it
Ricambi per
combinazione
portapolverizzatori
(seguito)

es
Piezas de repuesto
para conjuntos
portainyectores
(continuación)



0 432 291 035	1	0 431 214 018	KBALC 100 S 7/13	0 433 270 168	DLL 25 S 680	2 433 314 259	2 430 136 206
0 432 291 036	1	0 431 215 004	KBAL 135 S 26/4	0 433 220 155	DLL 160 S 721	2 433 314 256	2 430 136 115
0 432 291 039	1	0 431 214 026	KBAL 112 S 50/13	0 433 220 167	DLL 150 S 805	2 433 314 259	2 430 136 203
0 432 291 040	1	0 431 215 010	KBAL 135 S 58	0 433 220 173	DLL 155 S 942	2 433 314 256	2 430 136 115
0 432 291 041	1	0 431 215 010	KBAL 135 S 58	0 433 220 186	DLL 150 S 997	2 433 314 256	2 430 136 115
0 432 291 042	1	0 431 216 004	KBALZ 150 S 67	0 433 220 190	DLL 155 S 1057	2 433 349 231	2 430 136 203
0 432 291 044	1	0 431 214 029	KBAL 112 S 69	0 433 220 167	DLL 150 S 805	2 433 314 259	2 430 136 204
0 432 291 046	1	0 431 215 018	KBALZ 128 S 80	0 433 220 097	DLL 120 S 352	2 433 349 247	2 430 136 203
0 432 291 047	1	0 431 215 019	KBALZ 127 S 84	0 433 270 191	DLL 155 S 1271	2 433 349 511	2 430 136 203
0 432 291 048	1	0 431 216 004	KBALZ 150 S 67	0 433 220 201	DLL 155 S 1276	2 433 349 231	2 430 136 203
0 432 291 049	1	0 431 216 004	KBALZ 150 S 67	0 433 220 202	DLL 155 S 1300	2 433 349 231	2 430 136 203
0 432 291 493	1	0 431 215 019	KBALZ 127 S 84	0 433 272 038	DLL 155 S 1383	2 433 349 511	2 430 136 203
0 432 291 496	1	0 431 214 036	KBAL 116 S 095	0 433 272 964	DLLA 146 S 1378	2 433 349 232	2 430 136 202
0 432 291 497	1	0 431 212 033	KBAL 65 S 79	0 433 272 966	DLLA 145 S 1368	2 433 314 256	2 430 136 133
0 432 291 498	1	0 431 212 033	KBAL 65 S 79	0 433 272 967	DLLA 145 S 1367	2 433 314 256	2 430 136 133
0 432 291 499	1	0 431 213 982	KBEL 83 S 35	0 433 272 968	DLLA 124 S 1365	2 433 349 225	2 430 136 085
0 432 291 500	1	0 431 214 983	KBELZ 124 S 66	0 433 272 969	DLLZ 140 S 1361	2 433 314 045	2 430 136 173
0 432 291 504	1	0 431 213 982	KBEL 83 S 35	0 433 272 987	DLLA 132 S 1335	2 433 349 225	2 430 136 085
0 432 291 505	1	0 431 213 965	KBEL 81 S 94	0 433 272 997	DLLA 132 S 1320	2 433 349 321	2 430 136 085
0 432 291 506	1	0 431 214 991	KBEL 100 S 31	0 433 272 994	DLLA 155 S 1323	2 433 314 045	2 430 136 085
0 432 291 507	1	0 431 214 991	KBEL 100 S 31	0 433 272 995	DLLA 150 S 1322	2 433 314 045	2 430 136 085
0 432 291 508	1	0 431 214 979	KBEL 123 S 80	0 433 272 996	DLLA 150 S 1321	2 433 314 045	2 430 136 085
0 432 291 509	1	0 431 213 982	KBEL 83 S 35	0 433 272 997	DLLA 132 S 1320	2 433 349 225	2 430 136 085
0 432 291 510	1	0 431 213 029	KBALZ 83 S 85	0 433 271 631	DLLZ 155 S 1281	2 433 349 514	2 430 136 149
0 432 291 511	1	0 431 213 969	KBEL 84 S 82	0 433 272 998	DLLA 150 S 1314	2 433 349 225	2 430 136 085
0 432 291 512	1	0 431 214 987	KBEL 110 S 42	0 433 272 999	DLLA 150 S 1313	2 433 349 209	2 430 136 085
0 432 291 513	1	0 431 214 032	KBAL 116 S 75	0 433 271 601	DLLA 146 S 1310	2 433 349 232	2 430 136 202
0 432 291 514	1	0 431 213 970	KBEL 90 S 76	0 433 271 602	DLLA 135 S 1309	2 433 314 045	2 430 136 085
0 432 291 516	1	0 431 214 980	KBEL 111 S 75	0 433 271 616	DLLA 143 S 1302	2 433 349 225	2 430 136 085
0 432 291 517	1	0 431 214 032	KBAL 116 S 75	0 433 271 624	DLLA 148 S 1298	2 433 349 232	2 430 136 202
0 432 291 518	1	0 431 212 979	KBEL 66 S 91	0 433 271 696	DLLA 145 S 1172	2 433 314 094	2 430 136 085
0 432 291 519	1	0 431 214 980	KBEL 111 S 75	0 433 271 626	DLLA 143 S 1292	2 433 349 225	2 430 136 085
0 432 291 520	1	0 431 213 980	KBEL 90 S 44	0 433 271 685	DLLA 142 S 1188	2 433 314 023	2 430 136 085
0 432 291 521	1	0 431 214 978	KBEL 110 S 83	0 433 271 656	DLLA 150 S 1237	2 433 314 023	2 430 136 085
0 432 291 523	1	0 431 213 027	KBAL 97 S 62	0 433 271 630	DLLA 140 S 1282	2 433 349 226	2 430 136 133
0 432 291 524	1	0 431 213 029	KBALZ 83 S 85	0 433 271 631	DLLZ 155 S 1281	2 433 349 514	2 430 136 149
0 432 291 525	1	0 431 214 978	KBEL 110 S 83	0 433 271 632	DLLA 152 S 1280	2 433 314 023	2 430 136 085
0 432 291 528	1	0 431 214 978	KBEL 110 S 83	0 433 271 635	DLLA 152 S 1277	2 433 314 023	2 430 136 085
0 432 291 529	1	0 431 214 990	KBEL 111 S 36	0 433 271 636	DLLA 144 S 1275	2 433 349 318	2 430 136 085
0 432 291 530	1	0 431 214 031	KBALZ 123 S 73	0 433 271 637	DLLZ 150 S 1274	2 433 349 237	2 430 136 162
0 432 291 531	1	0 431 214 032	KBAL 116 S 75	0 433 271 644	DLLA 148 S 1263	2 433 349 232	2 430 136 202
0 432 291 532	1	0 431 214 990	KBEL 111 S 36	0 433 271 645	DLLA 144 S 1262	2 433 349 318	2 430 136 085
0 432 291 533	1	0 431 214 980	KBEL 111 S 75	0 433 271 646	DLLA 140 S 1252	2 433 349 225	2 430 136 085
0 432 291 534	1	0 431 214 032	KBAL 116 S 75	0 433 271 638	DLLA 148 S 1272	2 433 349 232	2 430 136 202
0 432 291 535	1	0 431 214 980	KBEL 111 S 75	0 433 271 648	DLLA 143 S 1249	2 433 349 225	2 430 136 085



2 433 124 137		4		1 900 210 022			2 430 100 048
2 433 124 137	2 434 619 017	4				2 916 710 603	
2 433 124 455	2 434 619 038	4				2 916 710 605	
2 433 124 147	2 434 619 048	4				2 916 710 603	
2 433 124 147	2 434 619 048	4				2 916 710 603	
2 433 124 455	2 434 619 038	4				2 916 710 603	
2 433 124 455	2 434 619 038	4				2 916 710 605	
2 433 124 335	2 434 619 047	4					
2 433 124 335	2 434 619 047	4					
2 433 124 455	2 434 619 038	4				2 916 710 603	
2 433 124 455	2 434 619 038	4				2 916 710 603	
2 433 124 335	2 434 619 047	4					
2 433 124 137	2 434 619 017	4					
2 433 124 137	2 434 619 017	4					
2 433 124 137	2 434 619 017	4					
2 433 124 379	2 434 619 040	5				2 916 710 602	
2 433 124 379	2 434 619 040	5				2 916 710 602	
2 433 124 379	2 434 619 040	5				2 916 710 602	
2 433 124 379	2 434 619 040	5				2 916 710 602	
2 433 124 379	2 434 619 040	5					
2 433 124 379	2 434 619 040	5				2 916 710 602	
2 433 124 380	2 434 614 017	5				2 916 710 602	
2 433 124 379	2 434 619 040	5				2 916 710 602	
2 433 124 366	2 434 619 048	4					
2 433 124 379	2 434 619 040	5				2 916 710 602	
2 433 124 379	2 434 619 040	5					2 430 422 005
2 433 124 137	2 434 619 017	4					
2 433 124 380	2 434 614 037	5				2 916 710 602	
2 433 124 380	2 434 614 017	5				2 916 710 602	
2 433 124 137	2 434 619 017	4					
2 433 124 379	2 434 619 040	5					
2 433 124 380	2 434 614 017	5				2 916 710 602	
2 433 124 379	2 434 619 040	5				2 916 710 602	
2 433 124 380	2 434 619 073	5					
2 433 124 137	2 434 619 017	4			2 433 370 047	2 916 710 603	
2 433 124 366	2 434 619 048	4					
2 433 124 380	2 434 619 073	5					
2 433 124 380	2 434 619 073	5					
2 433 124 380	2 434 614 017	5					
2 433 124 455	2 434 619 038	4				2 916 710 603	
2 433 124 137	2 434 619 017	4					
2 433 124 380	2 434 614 017	5					
2 433 124 380	2 434 614 017	5				2 916 710 602	
2 433 124 137	2 434 619 017	4					
2 433 124 380	2 434 614 017	5				2 916 710 602	

*) siehe Seite 388/see page 388/voir page 388/ver pagina 388/vease página 388

**) siehe Seite 392/see page 392/voir page 392/ver pagina 392/vease página 392

de

Ersatzteile für
Düsenhalter-
kombinationen
(Fortsetzung)

en

Spare parts for
nozzle-and-holder
assemblies
(continued)

fr

Pièces de rechange
pour ensembles
porte-injecteurs
(suite)

it

Ricambi per
combinazione
portapolverizzatori
(seguito)

es

Piezas de repuesto
para conjuntos
portainyectoros
(continuación)



Fig.



Ref.



Typ



①



Typ



②



③

0 432 291 537	1	0 431 212 031	KBAL 65 S 55	0 433 271 653	DLLA 145 S 1244	2 433 314 256	2 430 136 133
0 432 291 538	1	0 431 213 027	KBAL 97 S 62	0 433 271 654	DLLA 140 S 1242	2 433 349 226	2 430 136 133
0 432 291 539	1	0 431 214 035	KBAL 125 S 83	0 433 271 532	DLLA 160 S 1241	2 433 314 256	2 430 136 202
0 432 291 540	1	0 431 213 980	KBEL 90 S 44	0 433 271 684	DLLA 142 S 1189	2 433 314 023	2 430 136 085
0 432 291 541	1	0 431 213 968	KBEL 75 S 84	0 433 271 705	DLLA 134 S 1155	2 433 314 023	2 430 136 085
0 432 291 542	1	0 431 214 978	KBEL 110 S 83	0 433 271 655	DLLA 150 S 1238	2 433 314 023	2 430 136 085
0 432 291 543	1	0 431 214 978	KBEL 110 S 83	0 433 271 656	DLLA 150 S 1237	2 433 314 023	2 430 136 085
0 432 291 544	1	0 431 212 992	KBEL 56 S 27	0 433 271 657	DLLA 150 S 1234	2 433 349 215	2 430 136 085
0 432 291 545	1	0 431 213 027	KBAL 97 S 62	0 433 271 658	DLLA 140 S 1232	2 433 349 226	2 430 136 133
0 432 291 546	1	0 431 213 969	KBEL 84 S 82	0 433 271 659	DLLA 150 S 1231	2 433 349 225	2 430 136 085
0 432 291 548	1	0 431 214 027	KBAL 100 S 52	0 433 271 664	DLLA 149 S 1225	2 433 314 256	2 430 136 133
0 432 291 549	1	0 431 214 979	KBEL 123 S 80	0 433 271 714	DLLA 150 S 1137	2 433 314 045	2 430 136 085
0 432 291 550	1	0 431 215 015	KBAL 125 S 72	0 433 271 526	DLLA 155 S 1223	2 433 314 256	2 430 136 202
0 432 291 551	1	0 431 214 034	KBAL 100 S 77	0 433 271 673	DLLA 149 S 1209	2 433 314 256	2 430 136 133
0 432 291 552	1	0 431 213 992	KBEL 90 S 3/13	0 433 271 688	DLLA 152 S 1184	2 433 314 023	2 430 136 085
0 432 291 553	1	0 431 212 033	KBAL 65 S 79	0 433 271 667	DLLA 145 S 1218	2 433 314 256	2 430 136 133
0 432 291 554	1	0 431 213 970	KBEL 90 S 76	0 433 271 668	DLLA 140 S 1217	2 433 314 045	2 430 136 085
0 432 291 555	1	0 431 214 980	KBEL 111 S 75	0 433 271 698	DLLA 145 S 1169	2 433 349 225	2 430 136 085
0 432 291 557	1	0 431 214 034	KBAL 100 S 77	0 433 271 675	DLLA 149 S 1207	2 433 314 256	2 430 136 133
0 432 291 558	1	0 431 214 027	KBAL 100 S 52	0 433 271 673	DLLA 149 S 1209	2 433 314 256	2 430 136 133
0 432 291 559	1	0 431 213 974	KBEL 83 S 68	0 433 271 674	DLLA 137 S 1208	2 433 349 225	2 430 136 085
0 432 291 560	1	0 431 214 033	KBEL 101 S 76	0 433 271 675	DLLA 149 S 1207	2 433 349 515	2 430 136 133
0 432 291 561	1	0 431 214 981	KBEL 110 S 73	0 433 271 676	DLLA 145 S 1206	2 433 314 023	2 430 136 085
0 432 291 562	1	0 431 214 032	KBAL 116 S 75	0 433 271 678	DLLA 148 S 1204	2 433 349 232	2 430 136 202
0 432 291 563	1	0 431 215 015	KBAL 125 S 72	0 433 271 525	DLLA 155 S 1202	2 433 314 256	2 430 136 202
0 432 291 564	1	0 431 213 027	KBAL 97 S 62	0 433 271 681	DLLA 140 S 1198	2 433 349 226	2 430 136 133
0 432 291 565	1	0 431 215 016	KBAL 140 S 74	0 433 271 729	DLLA 145 S 1097	2 433 314 165	2 430 136 133
0 432 291 567	1	0 431 213 027	KBAL 97 S 62	0 433 271 682	DLLA 140 S 1193	2 433 349 226	2 430 136 133
0 432 291 568	1	0 431 213 992	KBEL 90 S 3/13	0 433 271 684	DLLA 142 S 1189	2 433 314 023	2 430 136 085
0 432 291 569	1	0 431 213 992	KBEL 90 S 3/13	0 433 271 685	DLLA 142 S 1188	2 433 314 023	2 430 136 085
0 432 291 570	1	0 431 212 982	KBEL 70 S 55	0 433 271 686	DLLA 140 S 1187	2 433 349 235	2 430 136 085
0 432 291 571	1	0 431 213 972	KBEL 95 S 70	0 433 271 687	DLLA 140 S 1186	2 433 314 023	2 430 136 085
0 432 291 572	1	0 431 213 977	KBEL 80 S 61	0 433 271 690	DLLA 160 S 1181	2 433 314 023	2 430 136 085
0 432 291 573	1	0 431 213 992	KBEL 90 S 3/13	0 433 271 691	DLLA 152 S 1180	2 433 314 023	2 430 136 085
0 432 291 574	1	0 431 215 016	KBAL 140 S 74	0 433 271 692	DLLA 145 S 1179	2 433 314 165	2 430 136 133
0 432 291 575	1	0 431 213 973	KBEL 90 S 69	0 433 271 693	DLLA 145 S 1176	2 433 314 045	2 430 136 085
0 432 291 576	1	0 431 213 974	KBEL 83 S 68	0 433 271 695	DLLA 137 S 1174	2 433 349 225	2 430 136 085
0 432 291 577	1	0 431 212 985	KBEL 66 S 47	0 433 271 696	DLLA 145 S 1172	2 433 349 228	2 430 136 085
0 432 291 578	1	0 431 213 982	KBEL 83 S 35	0 433 271 697	DLLA 137 S 1171	2 433 349 225	2 430 136 085
0 432 291 579	1	0 431 214 031	KBALZ 123 S 73	0 433 271 517	DLLZ 150 S 1170	2 433 349 237	2 430 136 162
0 432 291 580	1	0 431 214 982	KBEL 120 S 67	0 433 271 698	DLLA 145 S 1169	2 433 349 225	2 430 136 085
0 432 291 581	1	0 431 214 983	KBELZ 124 S 66	0 433 271 699	DLLZ 140 S 1168	2 433 314 045	2 430 136 173
0 432 291 582	1	0 431 215 016	KBAL 140 S 74	0 433 271 700	DLLA 144 S 1167	2 433 314 165	2 430 136 133
0 432 291 584	1	0 431 214 991	KBEL 100 S 31	0 433 271 704	DLLA 150 S 1158	2 433 314 045	2 430 136 085
0 432 291 585	1	0 431 213 976	KBEL 75 S 62	0 433 271 705	DLLA 134 S 1155	2 433 314 023	2 430 136 085



2 433 124 137	2 434 619 017	4					
2 433 124 137	2 434 619 017	4			2 433 370 047	2 916 710 603	
2 433 124 164	2 434 619 047	4				2 916 710 603	
2 433 124 379	2 434 619 040	5				2 916 710 602	
2 433 124 379	2 434 619 040	5					
2 433 124 380	2 434 619 073	5					
2 433 124 380	2 434 619 073	5					
2 433 124 379	2 434 619 040	5					
2 433 124 137	2 434 619 017	4			2 433 370 047	2 916 710 603	
2 433 124 379	2 434 619 040	5				2 916 710 602	
	2 434 619 017	4					
2 433 124 380	2 434 614 017	5				2 916 710 602	
2 433 124 164	2 434 619 047	4				2 916 710 603	
2 433 124 137	2 434 619 017	4				2 916 710 603	
2 433 124 379	2 434 619 040	5				2 916 710 602	
2 433 124 137	2 434 619 017	4					
2 433 124 380	2 434 614 037	5				2 916 710 602	
2 433 124 380	2 434 614 017	5				2 916 710 602	
2 433 124 137	2 434 619 017	4				2 916 710 603	
	2 434 619 017	4					
2 433 124 380	2 434 614 033	5				2 916 710 602	
2 433 124 137	2 434 619 017	4				2 916 710 603	
2 433 124 380	2 434 619 073	5					
2 433 124 137	2 434 619 017	4					
2 433 124 164	2 434 619 047	4				2 916 710 603	
2 433 124 137	2 434 619 017	4			2 433 370 047	2 916 710 603	
2 433 124 137	2 434 619 017	4			2 433 370 431	2 916 710 603	
2 433 124 137	2 434 619 017	4			2 433 370 047	2 916 710 603	
2 433 124 379	2 434 619 040	5				2 916 710 602	
2 433 124 379	2 434 619 040	5				2 916 710 602	
2 433 124 379	2 434 619 040	5					
2 433 124 380	2 434 619 073	5					
2 433 124 379	2 434 619 040	5				2 916 710 602	
2 433 124 379	2 434 619 040	5				2 916 710 602	
2 433 124 137	2 434 619 017	4			2 433 370 431	2 916 710 603	
2 433 124 379	2 434 619 040	5				2 916 710 602	
2 433 124 380	2 434 614 033	5				2 916 710 602	
2 433 124 379	2 434 619 040	5					
2 433 124 379	2 434 619 040	5				2 916 710 602	
2 433 124 455	2 434 619 038	4				2 916 710 603	
2 433 124 380	2 434 614 017	5				2 916 710 602	
2 433 124 379	2 434 619 040	5				2 916 710 602	
2 433 124 137	2 434 619 017	4			2 433 370 431	2 916 710 603	
2 433 124 379	2 434 619 040	5					
2 433 124 379	2 434 619 040	5					

*) siehe Seite 388/see page 388/voir page 388/ver pagina 388/vease página 388

***) siehe Seite 392/see page 392/voir page 392/ver pagina 392/vease página 392

A364

de
Ersatzteile für
Düsenhalter-
kombinationen
(Fortsetzung)

en
Spare parts for
nozzle-and-holder
assemblies
(continued)

fr
Pièces de rechange
pour ensembles
porte-injecteurs
(suite)

it
Ricambi per
combinazione
portapolverizzatori
(seguito)

es
Piezas de repuesto
para conjuntos
portainyectores
(continuación)



0 432 291 586	1	0 431 213 976	KBEL 75 S 62	0 433 271 706	DLLA 137 S 1154	2 433 314 023	2 430 136 085
0 432 291 587	1	0 431 214 986	KBEL 110 S 43	0 433 271 702	DLLA 145 S 1161	2 433 314 023	2 430 136 085
0 432 291 588	1	0 431 214 986	KBEL 110 S 43	0 433 271 703	DLLA 145 S 1160	2 433 314 023	2 430 136 085
0 432 291 589	1	0 431 212 989	KBEL 65 S 34/TR	0 433 271 512	DLLA 150 S 1148/TR	2 433 349 310	2 430 136 085
0 432 291 590	1	0 431 213 977	KBEL 80 S 61	0 433 271 710	DLLA 158 S 1146	2 433 314 023	2 430 136 085
0 432 291 591	1	0 431 212 031	KBAL 65 S 55	0 433 271 711	DLLA 148 S 1145	2 433 314 256	2 430 136 133
0 432 291 592	1	0 431 212 989	KBEL 65 S 34/TR	0 433 271 789	DLLA 150 S 974/TR	2 433 349 310	2 430 136 085
0 432 291 593	1	0 431 212 981	KBEL 65 S 60	0 433 271 712	DLLA 159 S 1141	2 433 314 023	2 430 136 085
0 432 291 594	1	0 431 214 028	KBAL 116 S 66	0 433 271 713	DLLA 140 S 1140	2 433 349 232	2 430 136 202
0 432 291 595	1	0 431 214 984	KBEL 123 S 59	0 433 271 714	DLLA 150 S 1137	2 433 314 045	2 430 136 085
0 432 291 596	1	0 431 216 003	KBALZ 153 S 53	0 433 271 508	DLLZ 156 S 1134	2 433 349 491	2 430 136 103
0 432 291 598	1	0 431 213 997	KBEL 84 S 4/13	0 433 271 834	DLLA 150 S 843	2 433 314 044	2 430 136 085
0 432 291 599	1	0 431 215 015	KBAL 125 S 72	0 433 271 504	DLLA 156 S 1123	2 433 314 256	2 430 136 202
0 432 291 600	1	0 431 212 982	KBEL 70 S 55	0 433 271 716	DLLA 140 S 1121	2 433 349 235	2 430 136 085
0 432 291 601	1	0 431 215 011	KBAL 125 S 60	0 433 271 347	DLLA 165 S 712	2 433 314 256	2 430 136 202
0 432 291 602	1	0 431 214 986	KBEL 110 S 43	0 433 271 717	DLLA 140 S 1117	2 433 314 023	2 430 136 085
0 432 291 603	1	0 431 214 986	KBEL 110 S 43	0 433 271 718	DLLA 140 S 1116	2 433 314 023	2 430 136 085
0 432 291 604	1	0 431 213 982	KBEL 83 S 35	0 433 271 719	DLLA 134 S 1113	2 433 349 225	2 430 136 085
0 432 291 605	1	0 431 213 982	KBEL 83 S 35	0 433 271 720	DLLA 138 S 1112	2 433 349 225	2 430 136 085
0 432 291 606	1	0 431 213 992	KBEL 90 S 3/13	0 433 271 785	DLLA 142 S 980	2 433 314 023	2 430 136 085
0 432 291 607	1	0 431 215 016	KBAL 140 S 74	0 433 271 723	DLLA 150 S 1105	2 433 314 165	2 430 136 133
0 432 291 608	1	0 431 215 016	KBAL 140 S 74	0 433 271 724	DLLA 150 S 1104	2 433 314 165	2 430 136 133
0 432 291 611	1	0 431 213 978	KBEL 95 S 52	0 433 271 765	DLLA 145 S 1023	2 433 314 094	2 430 136 085
0 432 291 614	1	0 431 215 016	KBAL 140 S 74	0 433 271 727	DLLA 140 S 1099	2 433 314 165	2 430 136 133
0 432 291 615	1	0 431 215 016	KBAL 140 S 74	0 433 271 729	DLLA 145 S 1097	2 433 314 165	2 430 136 133
0 432 291 616	1	0 431 214 985	KBELZ 114 S 50	0 433 271 500	DLLZ 160 S 1095		2 430 136 173
0 432 291 617	1	0 431 214 987	KBEL 110 S 42	0 433 271 731	DLLA 150 S 1091	2 433 349 209	2 430 136 085
0 432 291 618	1	0 431 214 027	KBAL 100 S 52	0 433 271 733	DLLA 154 S 1088	2 433 314 256	2 430 136 133
0 432 291 619	1	0 431 213 979	KBEL 90 S 48/TR	0 433 271 745	DLLA 150 S 1067	2 433 349 209	2 430 136 085
0 432 291 620	1	0 431 212 985	KBEL 66 S 47	0 433 271 734	DLLA 150 S 1087	2 433 349 228	2 430 136 085
0 432 291 621	1	0 431 214 027	KBAL 100 S 52	0 433 271 735	DLLA 154 S 1086	2 433 314 256	2 430 136 133
0 432 291 622	1	0 431 213 979	KBEL 90 S 48/TR	0 433 271 857	DLLA 150 S 798	2 433 349 209	2 430 136 085
0 432 291 623	1	0 431 213 979	KBEL 90 S 48/TR	0 433 271 746	DLLA 150 S 1066	2 433 349 209	2 430 136 085
0 432 291 624	1	9 430 031 259	KBAL 73 S 41/13	0 433 271 736	DLLA 160 S 1084	2 433 314 262	2 430 136 202
0 432 291 625	1	0 431 215 016	KBAL 140 S 74	0 433 271 820	DLLA 150 S 883	2 433 314 165	2 430 136 133
0 432 291 626	1	0 431 212 984	KBEL 65 S 49	0 433 271 738	DLLA 159 S 1082	2 433 314 023	2 430 136 085
0 432 291 627	1	0 431 214 986	KBEL 110 S 43	0 433 271 741	DLLA 140 S 1075	2 433 314 023	2 430 136 085
0 432 291 629	1	0 431 212 987	KBEL 66 S 45	0 433 271 743	DLLA 140 S 1069	2 433 349 213	2 430 136 085
0 432 291 630	1	0 431 213 027	KBAL 97 S 62	0 433 271 744	DLLA 140 S 1068	2 433 349 226	2 430 136 133
0 432 291 631	1	0 431 213 992	KBEL 90 S 3/13	0 433 271 752	DLLA 150 S 1060	2 433 314 023	2 430 136 085
0 432 291 632	1	0 431 215 016	KBAL 140 S 74	0 433 271 753	DLLA 145 S 1059	2 433 314 165	2 430 136 133
0 432 291 633	1	0 431 212 031	KBAL 65 S 55	0 433 271 754	DLLA 148 S 1058	2 433 314 256	2 430 136 133
0 432 291 634	1	0 431 212 985	KBEL 66 S 47	0 433 271 755	DLLA 150 S 1055	2 433 349 228	2 430 136 085
0 432 291 635	1	0 431 214 028	KBAL 116 S 66	0 433 271 756	DLLA 140 S 1054	2 433 349 232	2 430 136 202
0 432 291 636	1	0 431 215 011	KBAL 125 S 60	0 433 271 493	DLLA 165 S 1051	2 433 314 256	2 430 136 202



2 433 124 379	2 434 619 040	5					
2 433 124 380	2 434 619 073	5					
2 433 124 380	2 434 619 073	5					
2 433 124 379	2 434 619 040	5				2 916 710 603	
2 433 124 379	2 434 619 040	5				2 916 710 602	
2 433 124 137	2 434 619 017	4					
2 433 124 379	2 434 619 040	5				2 916 710 603	
2 433 124 380	2 434 619 073	5					
	2 434 619 017	4					
2 433 124 380	2 434 614 017	5				2 916 710 602	
2 433 124 455	2 434 619 047	4					
2 433 124 380	2 434 619 073	5				2 916 710 602	
2 433 124 164	2 434 619 047	4				2 916 710 603	
2 433 124 379	2 434 619 040	5					
2 433 124 164	2 434 619 047	4				2 916 710 603	
2 433 124 380	2 434 619 073	5					
2 433 124 380	2 434 619 073	5					
2 433 124 379	2 434 619 040	5				2 916 710 602	
2 433 124 379	2 434 619 040	5				2 916 710 602	
2 433 124 379	2 434 619 040	5				2 916 710 602	
2 433 124 137	2 434 619 017	4			2 433 370 431	2 916 710 603	
2 433 124 137	2 434 619 017	4			2 433 370 431	2 916 710 603	
2 433 124 379	2 434 619 040	5					
2 433 124 137	2 434 619 017	4			2 433 370 431	2 916 710 603	
2 433 124 137	2 434 619 017	4			2 433 370 431	2 916 710 603	
2 433 124 379	2 434 619 040	5					
2 433 124 379	2 434 619 040	5					2 430 422 005
	2 434 619 017	4					
2 433 124 379	2 434 619 040	5			2 433 370 035	2 916 710 603	2 430 422 005
2 433 124 379	2 434 619 040	5					
	2 434 619 017	4					
2 433 124 379	2 434 619 040	5			2 433 370 035	2 916 710 603	2 430 422 004
2 433 124 379	2 434 619 040	5			2 433 370 035	2 916 710 603	2 430 422 004
2 433 124 137	2 434 619 017	4					
2 433 124 137	2 434 619 017	4			2 433 370 431	2 916 710 603	
2 433 124 379	2 434 619 040	5					
2 433 124 380	2 434 619 073	5					
2 433 124 379	2 434 619 040	5					
2 433 124 137	2 434 619 017	4			2 433 370 047	2 916 710 603	
2 433 124 379	2 434 619 040	5				2 916 710 602	
2 433 124 137	2 434 619 017	4			2 433 370 431	2 916 710 603	
2 433 124 137	2 434 619 017	4					
2 433 124 379	2 434 619 040	5					
	2 434 619 017	4					
2 433 124 164	2 434 619 047	4				2 916 710 603	

*) siehe Seite 388/see page 388/voir page 388/ver pagina 388/vease página 388

**) siehe Seite 392/see page 392/voir page 392/ver pagina 392/vease página 392

de

Ersatzteile für
Düsenhalter-
kombinationen
(Fortsetzung)

en

Spare parts for
nozzle-and-holder
assemblies
(continued)

fr

Pièces de rechange
pour ensembles
porte-injecteurs
(suite)

it

Ricambi per
combinazione
portapolverizzatori
(seguito)

es

Piezas de repuesto
para conjuntos
portainyectores
(continuación)



Fig.



Ref.



Typ



①



②



②



③

0 432 291 637	1	0 431 216 003	KBALZ 153 S 53	0 433 271 492	DLLZ 156 S 1048	2 433 349 491	2 430 136 103
0 432 291 638	1	0 431 212 987	KBEL 66 S 45	0 433 271 759	DLLA 140 S 1039	2 433 349 213	2 430 136 085
0 432 291 640	1	0 431 214 987	KBEL 110 S 42	0 433 271 761	DLLA 155 S 1032	2 433 349 209	2 430 136 085
0 432 291 641	1	0 431 213 982	KBEL 83 S 35	0 433 271 762	DLLA 136 S 1031	2 433 349 225	2 430 136 085
0 432 291 642	1	9 430 031 259	KBAL 73 S 41/13	0 433 271 763	DLLA 160 S 1030	2 433 314 262	2 430 136 202
0 432 291 643	1	0 431 212 028	KBAL 62 S 29/13	0 433 271 763	DLLA 160 S 1030	2 433 314 262	2 430 136 202
0 432 291 644	1	0 431 212 031	KBAL 65 S 55	0 433 271 765	DLLA 145 S 1023	2 433 314 256	2 430 136 133
0 432 291 645	1	0 431 213 980	KBEL 90 S 44	0 433 271 805	DLLA 142 S 924	2 433 314 023	2 430 136 085
0 432 291 646	1	0 431 212 990	KBEL 70 S 33	0 433 271 873	DLLA 150 S 741	2 433 314 094	2 430 136 085
0 432 291 647	1	0 431 214 986	KBEL 110 S 43	0 433 271 767	DLLA 140 S 1021	2 433 314 023	2 430 136 085
0 432 291 648	1	0 431 213 982	KBEL 83 S 35	0 433 271 768	DLLA 136 S 1020	2 433 349 225	2 430 136 085
0 432 291 649	1	0 431 214 987	KBEL 110 S 42	0 433 271 769	DLLA 150 S 1015	2 433 349 209	2 430 136 085
0 432 291 650	1	0 431 213 011	KBAL 77 S 9/13	0 433 271 770	DLLA 160 S 1012	2 433 314 262	2 430 136 202
0 432 291 652	1	0 431 213 026	KBAL 95 S 56	0 433 271 472	DLLA 146 S 1007	2 433 314 256	2 430 136 133
0 432 291 654	1	0 431 213 982	KBEL 83 S 35	0 433 271 774	DLLA 124 S 1001	2 433 349 225	2 430 136 085
0 432 291 655	1	0 431 213 982	KBEL 83 S 35	0 433 271 775	DLLA 136 S 1000	2 433 349 225	2 430 136 085
0 432 291 656	1	0 431 214 989	KBEL 105 S 40	0 433 271 777	DLLA 150 S 998	2 433 314 023	2 430 136 085
0 432 291 657	1	0 431 213 981	KBEL 75 S 39	0 433 271 778	DLLA 160 S 995	2 433 349 227	2 430 136 085
0 432 291 658	1	0 431 212 988	KBEL 67 S 38	0 433 271 778	DLLA 160 S 995	2 433 349 227	2 430 136 085
0 432 291 659	1	0 431 213 985	KBEL 90 S 23	0 433 271 779	DLLA 150 S 994	2 433 314 023	2 430 136 085
0 432 291 660	1	0 431 213 986	KBEL 75 S 22	0 433 271 780	DLLA 150 S 993	2 433 314 023	2 430 136 085
0 432 291 661	1	0 431 214 027	KBAL 100 S 52	0 433 271 781	DLLA 144 S 992	2 433 314 256	2 430 136 133
0 432 291 662	1	0 431 215 012	KBAL 140 S 63	0 433 271 820	DLLA 150 S 883	2 433 314 165	2 430 136 133
0 432 291 663	1	0 431 213 992	KBEL 90 S 3/13	0 433 271 782	DLLA 151 S 985	2 433 314 023	2 430 136 085
0 432 291 664	1	0 431 213 992	KBEL 90 S 3/13	0 433 271 784	DLLA 132 S 981	2 433 314 023	2 430 136 085
0 432 291 665	1	0 431 213 992	KBEL 90 S 3/13	0 433 271 785	DLLA 142 S 980	2 433 314 023	2 430 136 085
0 432 291 666	1	0 431 215 011	KBAL 125 S 60	0 433 271 347	DLLA 165 S 712	2 433 314 256	2 430 136 202
0 432 291 667	1	0 431 213 011	KBAL 77 S 9/13	0 433 271 787	DLLA 150 S 977	2 433 314 262	2 430 136 202
0 432 291 668	1	0 431 213 027	KBAL 97 S 62	0 433 271 788	DLLA 140 S 976	2 433 349 226	2 430 136 133
0 432 291 669	1	0 431 212 032	KBAL 65 S 61	0 433 271 377	DLLA 149 S 775	2 433 314 256	2 430 136 133
0 432 291 670	1	0 431 212 986	KBEL 65 S 46/TR	0 433 271 789	DLLA 150 S 974/TR	2 433 314 094	2 430 136 085
0 432 291 671	1	0 431 213 992	KBEL 90 S 3/13	0 433 271 790	DLLA 151 S 972	2 433 314 023	2 430 136 085
0 432 291 672	1	0 431 214 027	KBAL 100 S 52	0 433 271 791	DLLA 154 S 970	2 433 314 256	2 430 136 133
0 432 291 673	1	0 431 215 011	KBAL 125 S 60	0 433 271 358	DLLA 165 S 727	2 433 314 256	2 430 136 202
0 432 291 674	1	0 431 214 990	KBEL 111 S 36	0 433 271 792	DLLA 147 S 969	2 433 349 318	2 430 136 085
0 432 291 675	1	0 431 214 990	KBEL 111 S 36	0 433 271 793	DLLA 150 S 968	2 433 349 318	2 430 136 085
0 432 291 677	1	0 431 213 982	KBEL 83 S 35	0 433 271 795	DLLA 136 S 964	2 433 349 225	2 430 136 085
0 432 291 678	1	0 431 213 982	KBEL 83 S 35	0 433 271 796	DLLA 124 S 963	2 433 349 225	2 430 136 085
0 432 291 679	1	0 431 216 003	KBALZ 153 S 53	0 433 271 455	DLLZ 154 S 923	2 433 349 491	2 430 136 103
0 432 291 680	1	0 431 212 989	KBEL 65 S 34/TR	0 433 271 797	DLLA 150 S 960/	2 433 349 310	2 430 136 085
0 432 291 681	1	0 431 216 003	KBALZ 153 S 53	0 433 271 464	DLLZ 156 S 957	2 433 349 491	2 430 136 103
0 432 291 682	1	0 431 212 990	KBEL 70 S 33	0 433 271 873	DLLA 150 S 741	2 433 314 094	2 430 136 085
0 432 291 683	1	0 431 216 003	KBALZ 153 S 53	0 433 271 460	DLLZ 156 S 948	2 433 349 491	2 430 136 103
0 432 291 684	1	0 431 213 992	KBEL 90 S 3/13	0 433 271 803	DLLA 151 S 928	2 433 314 023	2 430 136 085
0 432 291 685	1	0 431 214 991	KBEL 100 S 31	0 433 271 804	DLLA 150 S 925	2 433 314 045	2 430 136 085



2 433 124 455	2 434 619 047	4					
2 433 124 379	2 434 619 040	5					
2 433 124 379	2 434 619 040	5					2 430 422 005
2 433 124 379	2 434 619 040	5				2 916 710 602	
2 433 124 137	2 434 619 017	4					
	2 434 619 017	4			2 433 370 243		
2 433 124 137	2 434 619 017	4					
2 433 124 379	2 434 619 040	5				2 916 710 602	
2 433 124 379	2 434 619 040	5					
2 433 124 380	2 434 619 073	5					
2 433 124 379	2 434 619 040	5				2 916 710 602	
2 433 124 379	2 434 619 040	5					2 430 422 005
2 433 124 137	2 434 619 017	4				2 916 710 603	
2 433 124 165	2 434 619 047	4			2 433 370 035		
2 433 124 379	2 434 619 040	5				2 916 710 602	
2 433 124 379	2 434 619 040	5				2 916 710 602	
2 433 124 379	2 434 619 040	5					
2 433 124 379	2 434 619 040	5					
2 433 124 380	2 434 619 073	5			2 433 370 016	2 916 710 603	
2 433 124 380	2 434 619 073	5			2 433 370 016	2 916 710 603	
2 433 124 379	2 434 619 040	5				2 916 710 602	
2 433 124 379	2 434 619 040	5				2 916 710 602	
	2 434 619 017	4					
2 433 124 137	2 434 619 017	4			2 433 370 052	2 916 710 603	2 430 100 048
2 433 124 379	2 434 619 040	5				2 916 710 602	
2 433 124 379	2 434 619 040	5				2 916 710 602	
2 433 124 379	2 434 619 040	5				2 916 710 602	
2 433 124 164	2 434 619 047	4				2 916 710 603	
2 433 124 137	2 434 619 017	4				2 916 710 603	
2 433 124 137	2 434 619 017	4			2 433 370 047	2 916 710 603	
2 433 124 165	2 434 619 047	4					
2 433 124 380	2 434 619 073	5					
2 433 124 379	2 434 619 040	5				2 916 710 602	
	2 434 619 017	4					
2 433 124 164	2 434 619 047	4				2 916 710 603	
2 433 124 380	2 434 614 017	5					
2 433 124 380	2 434 614 017	5					
2 433 124 379	2 434 619 040	5				2 916 710 602	
2 433 124 379	2 434 619 040	5				2 916 710 602	
2 433 124 455	2 434 619 047	4					
2 433 124 379	2 434 619 040	5				2 916 710 603	
2 433 124 455	2 434 619 047	4					
2 433 124 379	2 434 619 040	5				2 916 710 602	
2 433 124 379	2 434 619 040	5					

*) siehe Seite 388/see page 388/voir page 388/ver pagina 388/vease página 388

**) siehe Seite 392/see page 392/voir page 392/ver pagina 392/vease página 392

de

Ersatzteile für
Düsenhalter-
kombinationen
(Fortsetzung)

en

Spare parts for
nozzle-and-holder
assemblies
(continued)

fr

Pièces de rechange
pour ensembles
porte-injecteurs
(suite)

it

Ricambi per
combinazione
portapolverizzatori
(seguito)

es

Piezas de repuesto
para conjuntos
portainyectores
(continuación)



Fig.



Ref.



Typ



①



②



③



③

0 432 291 686	1	0 431 213 992	KBEL 90 S 3/13	0 433 271 805	DLLA 142 S 924	2 433 314 023	2 430 136 085
0 432 291 687	1	0 431 213 025	KBAL 77 S 54	0 433 271 229	DLLA 150 S 501	2 433 314 262	2 430 136 202
0 432 291 688	1	0 431 214 992	KBEL 100 S 29	0 433 271 808	DLLA 150 S 914	2 433 314 023	2 430 136 085
0 432 291 689	1	0 431 212 029	KBAL 65 S 13/13	0 433 271 450	DLLA 156 S 911	2 433 314 256	2 430 136 202
0 432 291 691	1	0 431 213 025	KBAL 77 S 54	0 433 271 448	DLLA 148 S 909	2 433 314 262	2 430 136 202
0 432 291 692	1	0 431 213 992	KBEL 90 S 3/13	0 433 271 809	DLLA 160 S 908	2 433 314 023	2 430 136 085
0 432 291 693	1	0 431 213 992	KBEL 90 S 3/13	0 433 271 810	DLLA 150 S 904	2 433 314 023	2 430 136 085
0 432 291 694	1	0 431 214 992	KBEL 100 S 29	0 433 271 811	DLLA 150 S 903	2 433 314 023	2 430 136 085
0 432 291 695	1	0 431 213 992	KBEL 90 S 3/13	0 433 271 813	DLLA 142 S 897	2 433 314 023	2 430 136 085
0 432 291 696	1	0 431 212 992	KBEL 56 S 27	0 433 271 816	DLLA 146 S 890	2 433 349 215	2 430 136 085
0 432 291 697	1	0 431 212 992	KBEL 56 S 27	0 433 271 817	DLLA 144 S 889	2 433 349 215	2 430 136 085
0 432 291 698	1	0 431 212 031	KBAL 65 S 55	0 433 271 818	DLLA 145 S 886	2 433 314 256	2 430 136 133
0 432 291 699	1	0 431 212 031	KBAL 65 S 55	0 433 271 819	DLLA 148 S 885	2 433 314 256	2 430 136 133
0 432 291 701	1	0 431 213 992	KBEL 90 S 3/13	0 433 271 821	DLLA 150 S 881	2 433 314 023	2 430 136 085
0 432 291 702	1	0 431 214 992	KBEL 100 S 29	0 433 271 823	DLLA 150 S 870	2 433 314 023	2 430 136 085
0 432 291 703	1	0 431 213 997	KBEL 84 S 4/13	0 433 271 824	DLLA 150 S 868	2 433 314 044	2 430 136 085
0 432 291 704	1	0 431 213 025	KBAL 77 S 54	0 433 271 428	DLLA 148 S 862	2 433 314 262	2 430 136 202
0 432 291 707	1	0 431 213 983	KBEL 85 S 28	0 433 271 826	DLLA 160 S 857		2 430 136 085
0 432 291 708	1	0 431 213 983	KBEL 85 S 28	0 433 271 827	DLLA 160 S 856		2 430 136 085
0 432 291 709	1	0 431 213 987	KBEL 88 S 20	0 433 271 827	DLLA 160 S 856		2 430 136 085
0 432 291 710	1	0 431 214 027	KBAL 100 S 52	0 433 271 839	DLLA 155 S 835	2 433 314 256	2 430 136 133
0 432 291 711	1	0 431 213 024	KBALB 87 S 3	0 433 271 828	DLLB 151 S 854	2 433 314 295	2 430 136 206
0 432 291 712	1	0 431 212 992	KBEL 56 S 27	0 433 271 816	DLLA 146 S 890	2 433 349 215	2 430 136 085
0 432 291 713	1	0 431 212 992	KBEL 56 S 27	0 433 271 817	DLLA 144 S 889	2 433 349 215	2 430 136 085
0 432 291 714	1	0 431 213 997	KBEL 84 S 4/13	0 433 271 849	DLLA 150 S 815	2 433 314 044	2 430 136 085
0 432 291 715	1	0 431 213 997	KBEL 84 S 4/13	0 433 271 838	DLLA 150 S 836	2 433 314 044	2 430 136 085
0 432 291 716	1	0 431 213 997	KBEL 84 S 4/13	0 433 271 834	DLLA 150 S 843	2 433 314 044	2 430 136 085
0 432 291 717	1	0 431 213 997	KBEL 84 S 4/13	0 433 271 834	DLLA 150 S 843	2 433 314 044	2 430 136 085
0 432 291 718	1	0 431 214 027	KBAL 100 S 52	0 433 271 835	DLLA 144 S 842	2 433 314 256	2 430 136 133
0 432 291 719	1	0 431 213 997	KBEL 84 S 4/13	0 433 271 838	DLLA 150 S 836	2 433 314 044	2 430 136 085
0 432 291 720	1	0 431 213 997	KBEL 84 S 4/13	0 433 271 838	DLLA 150 S 836	2 433 314 044	2 430 136 085
0 432 291 721	1	0 431 213 985	KBEL 90 S 23	0 433 271 841	DLLA 150 S 830	2 433 314 023	2 430 136 085
0 432 291 723	1	0 431 213 997	KBEL 84 S 4/13	0 433 271 849	DLLA 150 S 815	2 433 314 044	2 430 136 085
0 432 291 724	1	0 431 213 997	KBEL 84 S 4/13	0 433 271 849	DLLA 150 S 815	2 433 314 044	2 430 136 085
0 432 291 725	1	0 431 213 986	KBEL 75 S 22	0 433 271 842	DLLA 150 S 828	2 433 314 023	2 430 136 085
0 432 291 726	1	0 431 212 993	KBEL 64 S 21	0 433 271 843	DLLA 140 S 827	2 433 349 213	2 430 136 085
0 432 291 727	1	0 431 214 015	KBAL 112 S 35/4	0 433 271 871	DLLA 150 S 748	2 433 314 165	2 430 136 133
0 432 291 728	1	0 431 214 011	KBAL 107 S 9/13	0 433 271 845	DLLA 156 S 822	2 433 314 262	2 430 136 202
0 432 291 729	1	0 431 214 025	SIGMA-SH 100	0 433 271 406	SIGMA-IBMD 5826	2 433 314 256	2 430 136 202
0 432 291 730	1	0 431 214 025	SIGMA-SH 100	0 433 271 853	SIGMA-IBMD 5823	2 433 314 256	2 430 136 202
0 432 291 731	1	0 431 213 024	KBALB 87 S 3	0 433 271 846	DLLB 150 S 821	2 433 314 295	2 430 136 206
0 432 291 732	1	0 431 213 987	KBEL 88 S 20	0 433 271 847	DLLA 160 S 817		2 430 136 085
0 432 291 733	1	0 431 213 997	KBEL 84 S 4/13	0 433 271 849	DLLA 150 S 815	2 433 314 044	2 430 136 085
0 432 291 734	1	0 431 213 994	KBEL 75 S 12/4	0 433 271 850	DLLA 151 S 813	2 433 314 023	2 430 136 085
0 432 291 735	1	0 431 213 988	KBEL 95 S 19	0 433 271 851	DLLA 160 S 811	2 433 314 023	2 430 136 085

A370

de
Ersatzteile für
Düsenhalter-
kombinationen
(Fortsetzung)







en
Spare parts for
nozzle-and-holder
assemblies
(continued)

fr
Pièces de rechange
pour ensembles
porte-injecteurs
(suite)

it
Ricambi per
combinazione
portapolverizzatori
(seguito)

es
Piezas de repuesto
para conjuntos
portainyectoros
(continuación)



								
					①		②	③
0 432 291 737	1		0 431 213 990	KBEL 90 S 17/4	0 433 271 855	DLLA 150 S 806	2 433 314 045	2 430 136 085
0 432 291 739	1		0 431 212 019	KBAL 55 S 1/4	0 433 271 090	DLLA 150 S 273	2 433 314 118	2 430 136 202
0 432 291 740	1		0 431 213 991	KBEL 89 S 16/4	0 433 271 856	DLLA 150 S 804	2 433 349 314	2 430 136 085
0 432 291 742	1		0 431 213 019	KBALB 87 S 2/4	0 433 271 400	DLLB 150 S 794	2 433 314 295	2 430 136 206
0 432 291 743	1		0 431 213 993	KBEL 90 S 14/4	0 433 271 859	DLLA 150 S 789	2 433 314 045	2 430 136 085
0 432 291 744	1		0 431 213 005	KBAL 98 S 8/13	0 433 271 377	DLLA 149 S 775	2 433 317 288	2 430 136 191
0 432 291 745	1		0 431 213 005	KBAL 98 S 8/13	0 433 271 376	DLLA 149 S 774	2 433 317 288	2 430 136 191
0 432 291 749	1		0 431 213 994	KBEL 75 S 12/4	0 433 271 894	DLLA 151 S 686	2 433 314 023	2 430 136 085
0 432 291 750	1		0 431 213 004	KBAL 97 S 9/4	0 433 271 357	DLLA 140 S 726	2 433 314 262	2 430 136 202
0 432 291 751	1		0 431 214 012	KBAL 103 S 24/4	0 433 271 032	DLLA 150 S 140	2 433 314 165	2 430 136 133
0 432 291 752	1		0 431 212 029	KBAL 65 S 13/13	0 433 271 377	DLLA 149 S 775	2 433 314 256	2 430 136 202
0 432 291 753	1		0 431 212 029	KBAL 65 S 13/13	0 433 271 376	DLLA 149 S 774	2 433 314 256	2 430 136 202
0 432 291 754	1		0 431 214 996	KBEL 100 S 11/4	0 433 271 862	DLLA 145 S 768	2 433 314 094	2 430 136 085
0 432 291 755	1		0 431 213 997	KBEL 84 S 4/13	0 433 271 879	DLLA 150 S 728	2 433 314 044	2 430 136 085
0 432 291 756	1		0 431 213 019	KBALB 87 S 2/4	0 433 271 374	DLLB 150 S 765	2 433 314 295	2 430 136 206
0 432 291 757	1		0 431 213 995	KBEL 95 S 10/13	0 433 271 184	DLLA 150 S 422	2 433 314 023	2 430 136 085
0 432 291 758	1		0 431 212 029	KBAL 65 S 13/13	0 433 271 373	DLLA 150 S 764	2 433 314 256	2 430 136 202
0 432 291 759	1		0 431 214 024	KBAL 117 S 46/4	0 433 271 865	DLLA 150 S 762	2 433 314 165	
0 432 291 760	1		0 431 214 023	KBAL 112 S 45/4	0 433 271 865	DLLA 150 S 762	2 433 314 165	2 430 136 133
0 432 291 761	1		0 431 213 992	KBEL 90 S 3/13	0 433 271 866	DLLA 160 S 760	2 433 314 023	2 430 136 085
0 432 291 762	1		0 431 212 994	KBEL 62 S 9/13	0 433 271 873	DLLA 150 S 741	2 433 314 094	2 430 136 085
0 432 291 763	1		0 431 214 009	KBAL 100 S 24/4	0 433 271 871	DLLA 150 S 748	2 433 314 165	2 430 136 202
0 432 291 766	1		0 431 214 012	KBAL 103 S 24/4	0 433 271 309	DLLA 150 S 633	2 433 314 165	2 430 136 133
0 432 291 767	1		0 431 213 021	KBAL 95 S 34/4	0 433 271 359	DLLA 155 S 733	2 433 314 265	2 430 136 202
0 432 291 768	1		0 431 214 013	KBAL 112 S 28/4	0 433 271 058	DLLA 150 S 204	2 433 314 165	2 430 136 133
0 432 291 770	1		0 431 215 006	KBAL 125 S 38/4	0 433 271 358	DLLA 165 S 727	2 433 314 256	2 430 136 202
0 432 291 771	1		0 431 213 997	KBEL 84 S 4/13	0 433 271 882	DLLA 150 S 716	2 433 314 044	2 430 136 085
0 432 291 772	1		0 431 213 997	KBEL 84 S 4/13	0 433 271 879	DLLA 150 S 728	2 433 314 044	2 430 136 085
0 432 291 773	1		0 431 213 997	KBEL 84 S 4/13	0 433 271 891	DLLA 150 S 690	2 433 314 044	2 430 136 085
0 432 291 774	1		0 431 213 997	KBEL 84 S 4/13	0 433 271 891	DLLA 150 S 690	2 433 314 044	2 430 136 085
0 432 291 775	1		0 431 213 997	KBEL 84 S 4/13	0 433 271 882	DLLA 150 S 716	2 433 314 044	2 430 136 085
0 432 291 776	1		0 431 213 004	KBAL 97 S 9/4	0 433 271 357	DLLA 140 S 726	2 433 314 262	2 430 136 202
0 432 291 777	1		0 431 214 013	KBAL 112 S 28/4	0 433 271 280	DLLA 150 S 582	2 433 314 165	2 430 136 133
0 432 291 778	1		0 431 213 023	KBAL 84 S 39	0 433 271 356	DLLA 150 S 724		2 430 136 202
0 432 291 781	1		0 431 213 997	KBEL 84 S 4/13	0 433 271 882	DLLA 150 S 716	2 433 314 044	2 430 136 085
0 432 291 782	1		0 431 212 029	KBAL 65 S 13/13	0 433 271 349	DLLA 149 S 715	2 433 314 256	2 430 136 202
0 432 291 783	1		0 431 215 006	KBAL 125 S 38/4	0 433 271 347	DLLA 165 S 712	2 433 314 256	2 430 136 202
0 432 291 784	1		0 431 213 019	KBALB 87 S 2/4	0 433 271 346	DLLB 150 S 711	2 433 314 295	2 430 136 206
0 432 291 785	1		0 431 214 012	KBAL 103 S 24/4	0 433 271 036	DLLA 150 S 720	2 433 314 165	2 430 136 133
0 432 291 786	1		0 431 212 029	KBAL 65 S 13/13	0 433 271 345	DLLA 150 S 708	2 433 314 256	2 430 136 202
0 432 291 788	1		0 431 214 997	KBEL 109 S 6/13	0 433 271 887	DLLA 150 S 700	2 433 314 023	2 430 136 085
0 432 291 789	1		0 431 212 999	KBEL 65 S 1/13	0 433 271 894	DLLA 151 S 686	2 433 314 023	2 430 136 085
0 432 291 790	1		0 431 214 998	KBEL 105 S 5/4	0 433 271 889	DLLA 140 S 696	2 433 314 045	2 430 136 085
0 432 291 791	1		0 431 213 004	KBAL 97 S 9/4	0 433 271 341	DLLA 140 S 694/EE	2 433 314 262	2 430 136 202
0 432 291 792	1		0 431 213 997	KBEL 84 S 4/13	0 433 271 891	DLLA 150 S 690	2 433 314 044	2 430 136 085



2 433 124 379	2 434 619 040	5					2 916 710 602	
2 433 124 137	2 434 614 010	4					2 916 710 603	
2 433 124 379	2 434 619 040	5					2 916 710 602	
2 433 124 137	2 434 614 010	4				2 433 370 297	2 916 710 603	
2 433 124 379	2 434 619 040	5					2 916 710 603	
2 433 124 137	2 434 619 017	4					2 916 710 603	
2 433 124 137	2 434 619 017	4					2 916 710 603	
2 433 124 379	2 434 619 040	5					2 916 710 602	
2 433 124 137	2 434 619 017	4					2 916 710 603	
	2 434 619 017	4				2 433 370 110	2 916 710 603	
2 433 124 137	2 434 619 017	4					2 916 710 603	2 430 105 020
2 433 124 137	2 434 619 017	4					2 916 710 603	2 430 105 020
2 433 124 380	2 434 619 073	5					2 916 710 602	
2 433 124 380	2 434 619 073	5					2 916 710 602	2 430 422 005
2 433 124 137	2 434 614 010	4				2 433 370 297	2 916 710 603	
2 433 124 380	2 434 619 073	5					2 916 710 602	
2 433 124 137	2 434 619 017	4					2 916 710 603	
2 433 124 137	2 434 619 017	4				2 433 370 019	2 916 710 603	
2 433 124 137	2 434 619 017	4				2 433 370 019	2 916 710 603	
2 433 124 379	2 434 619 040	5					2 916 710 602	
2 433 124 379	2 434 619 040	5					2 916 710 602	
2 433 124 137	2 434 619 017	4				2 433 370 110	2 916 710 603	
	2 434 619 017	4				2 433 370 110	2 916 710 603	
2 433 124 455	2 434 619 038	4					2 916 710 603	2 430 105 020
2 433 124 137	2 434 619 017	4					2 916 710 603	
2 433 124 137	2 434 619 017	4					2 916 710 603	
2 433 124 380	2 434 619 073	5					2 916 710 602	
2 433 124 380	2 434 619 073	5					2 916 710 602	2 430 422 005
2 433 124 380	2 434 619 073	5					2 916 710 602	
2 433 124 380	2 434 619 073	5					2 916 710 602	
2 433 124 380	2 434 619 073	5					2 916 710 602	
2 433 124 380	2 434 619 073	5					2 916 710 602	2 430 422 005
2 433 124 137	2 434 619 017	4					2 916 710 603	
2 433 124 137	2 434 619 017	4					2 916 710 603	
2 433 124 137	2 434 619 017	4					2 916 710 603	
2 433 124 455	2 434 619 038	4						
2 433 124 380	2 434 619 073	5					2 916 710 602	
2 433 124 137	2 434 619 017	4					2 916 710 603	
2 433 124 137	2 434 619 017	4					2 916 710 603	
2 433 124 137	2 434 614 010	4				2 433 370 297	2 916 710 603	
	2 434 619 017	4				2 433 370 110	2 916 710 603	
2 433 124 137	2 434 619 017	4					2 916 710 603	
2 433 124 379	2 434 619 040	5				2 433 370 035	2 916 710 603	
2 433 124 379	2 434 619 040	5				2 433 370 016		2 430 105 020
2 433 124 379	2 434 619 040	5					2 916 710 602	
2 433 124 137	2 434 619 017	4					2 916 710 603	
2 433 124 380	2 434 619 073	5					2 916 710 602	2 430 422 005

*) siehe Seite 388/see page 388/voir page 388/ver pagina 388/vease página 388

**) siehe Seite 392/see page 392/voir page 392/ver pagina 392/vease página 392

A372

de

Ersatzteile für
Düsenhalter-
kombinationen
(Fortsetzung)

en

Spare parts for
nozzle-and-holder
assemblies
(continued)

fr

Pièces de rechange
pour ensembles
porte-injecteurs
(suite)

it

Ricambi per
combinazione
portapolverizzatori
(seguito)

es

Piezas de repuesto
para conjuntos
portainyectoros
(continuación)



Fig.



Ref.



Typ



①



Typ



②



③

0 432 291 794	1	0 431 213 019	KBALB 87 S 2/4	0 433 271 340	DLLB 150 S 688	2 433 314 295	2 430 136 206
0 432 291 795	1	0 431 214 012	KBAL 103 S 24/4	0 433 271 281	DLLA 150 S 583	2 433 314 165	2 430 136 133
0 432 291 797	1	0 431 214 012	KBAL 103 S 24/4	0 433 271 058	DLLA 150 S 204	2 433 314 165	2 430 136 133
0 432 291 801	1	0 431 213 004	KBAL 97 S 9/4	0 433 271 333	DLLA 140 S 677	2 433 314 262	2 430 136 202
0 432 291 802	1	0 431 216 001	KBAL 154 SB 1/13	0 433 271 332	DLLB 155 S 675	2 433 349 490	2 430 136 200
0 432 291 804	1	0 431 214 015	KBAL 112 S 35/4	0 433 271 043	DLLA 150 S 178	2 433 314 165	2 430 136 133
0 432 291 806	1	0 431 214 016	KBALC 118 S 6/4	0 433 271 323	DLLC 150 S 660	2 433 317 285	2 430 136 193
0 432 291 807	1	0 431 212 029	KBAL 65 S 13/13	0 433 271 322	DLLA 28 S 656	2 433 314 256	2 430 136 202
0 432 291 808	1	0 431 212 029	KBAL 65 S 13/13	0 433 271 321	DLLA 142 S 655	2 433 314 256	2 430 136 202
0 432 291 813	1	0 431 214 016	KBALC 118 S 6/4	0 433 271 316	DLLC 150 S 646	2 433 317 285	2 430 136 193
0 432 291 814	1	0 431 214 009	KBAL 100 S 24/4	0 433 271 030	DLLA 150 S 138	2 433 314 165	2 430 136 202
0 432 291 816	1	0 431 213 004	KBAL 97 S 9/4	0 433 271 311	DLLA 140 S 635	2 433 314 262	2 430 136 202
0 432 291 818	1	0 431 214 009	KBAL 100 S 24/4	0 433 271 309	DLLA 150 S 633	2 433 314 165	2 430 136 202
0 432 291 819	1	0 431 213 021	KBAL 95 S 34/4	0 433 271 305	DLLA 160 S 626	2 433 314 265	2 430 136 202
0 432 291 820	1	0 431 213 016	KBAL 84 S 30	0 433 271 300	DLLA 150 S 618		2 430 136 202
0 432 291 821	1	0 431 213 016	KBAL 84 S 30	0 433 271 301	DLLA 140 S 619		2 430 136 202
0 432 291 822	1	0 431 213 012	KBAL 97 S 19/4	0 433 271 294	DLLA 150 S 607	2 433 314 165	2 430 136 202
0 432 291 825	1	0 431 214 009	KBAL 100 S 24/4	0 433 271 043	DLLA 150 S 178	2 433 314 165	2 430 136 202
0 432 291 826	1	0 431 214 013	KBAL 112 S 28/4	0 433 271 032	DLLA 150 S 140	2 433 314 165	2 430 136 133
0 432 291 827	1	0 431 216 001	KBAL 154 SB 1/13	0 433 271 291	DLLB 155 S 598	2 433 349 490	2 430 136 200
0 432 291 828	1	0 431 214 013	KBAL 112 S 28/4	0 433 271 030	DLLA 150 S 138	2 433 314 165	2 430 136 133
0 432 291 829	1	0 431 212 029	KBAL 65 S 13/13	0 433 271 276	DLLA 149 S 576	2 433 314 256	2 430 136 202
0 432 291 830	1	0 431 214 009	KBAL 100 S 24/4	0 433 271 032	DLLA 150 S 140	2 433 314 165	2 430 136 202
0 432 291 832	1	0 431 212 029	KBAL 65 S 13/13	0 433 271 177	DLLA 28 S 414	2 433 314 256	2 430 136 202
0 432 291 833	1	0 431 212 029	KBAL 65 S 13/13	0 433 271 186	DLLA 28 S 425	2 433 314 256	2 430 136 202
0 432 291 834	1	0 431 212 029	KBAL 65 S 13/13	0 433 271 178	DLLA 28 S 415	2 433 314 256	2 430 136 202
0 432 291 835	1	0 431 212 029	KBAL 65 S 13/13	0 433 271 223	DLLA 149 S 490	2 433 314 256	2 430 136 202
0 432 291 836	1	0 431 212 029	KBAL 65 S 13/13	0 433 271 162	DLLA 149 S 394	2 433 314 256	2 430 136 202
0 432 291 837	1	0 431 214 012	KBAL 103 S 24/4	0 433 271 281	DLLA 150 S 583	2 433 314 165	2 430 136 133
0 432 291 838	1	0 431 213 011	KBAL 77 S 9/13	0 433 271 269	DLLA 140 S 567	2 433 314 262	2 430 136 202
0 432 291 839	1	0 431 216 001	KBAL 154 SB 1/13	0 433 271 278	DLLB 155 S 580	2 433 349 490	2 430 136 200
0 432 291 842	1	0 431 213 018	KBAL 89 S 8/13	0 433 271 276	DLLA 149 S 576	2 433 317 288	2 430 136 191
0 432 291 843	1	0 431 214 010	KBAL 107 S 23/4	0 433 271 165	DLLA 160 S 397	2 433 314 262	2 430 136 202
0 432 291 844	1	0 431 214 010	KBAL 107 S 23/4	0 433 271 275	DLLA 160 S 575	2 433 314 262	2 430 136 202
0 432 291 847	1	0 431 212 028	KBAL 62 S 29/13	0 433 271 261	DLLA 155 S 551	2 433 314 262	2 430 136 202
0 432 291 849	1	0 431 213 014	KBAL 97 SC 4/13	0 433 271 254	DLLC 150 S 543	2 433 317 071	2 430 136 193
0 432 291 850	1	0 431 213 014	KBAL 97 SC 4/13	0 433 271 254	DLLC 150 S 543	2 433 317 071	2 430 136 193
0 432 291 851	1	0 431 213 014	KBAL 97 SC 4/13	0 433 271 253	DLLC 150 S 542	2 433 317 071	2 430 136 193
0 432 291 853	1	0 431 214 013	KBAL 112 S 28/4	0 433 271 043	DLLA 150 S 178	2 433 314 165	2 430 136 133
0 432 291 854	1	0 431 214 012	KBAL 103 S 24/4	0 433 271 058	DLLA 150 S 204	2 433 314 165	2 430 136 133
0 432 291 855	1	0 431 214 012	KBAL 103 S 24/4	0 433 271 036	DLLA 150 S 720	2 433 314 165	2 430 136 133
0 432 291 856	1	0 431 213 001	KBAL 97 SC 1/13	0 433 271 247	DLLC 150 S 532	2 433 317 071	2 430 136 193
0 432 291 857	1	0 431 212 027	KBAL 61 S 27/4	0 433 271 246	DLLA 152 S 533	2 433 314 256	2 430 136 202
0 432 291 858	1	0 431 214 003	KBAL 107 S 10/4	0 433 271 241	DLLA 150 S 523	2 433 314 262	2 430 136 202
0 432 291 859	1	0 431 214 002	KBAL 107 S 9/4	0 433 271 236	DLLA 150 S 515	2 433 314 262	2 430 136 202

A374

de
Ersatzteile für
Düsenhalter-
kombinationen
(Fortsetzung)

en
Spare parts for
nozzle-and-holder
assemblies
(continued)

fr
Pièces de rechange
pour ensembles
porte-injecteurs
(suite)

it
Ricambi per
combinazione
portapolverizzatori
(seguito)

es
Piezas de repuesto
para conjuntos
portainyectores
(continuación)



0 432 291 861	1	0 431 214 010	KBAL 107 S 23/4	0 433 271 165	DLLA 160 S 397	2 433 314 262	2 430 136 202
0 432 291 862	1	0 431 214 009	KBAL 100 S 24/4	0 433 271 030	DLLA 150 S 138	2 433 314 165	2 430 136 202
0 432 291 864	1	0 431 213 011	KBAL 77 S 9/13	0 433 271 229	DLLA 150 S 501	2 433 314 262	2 430 136 202
0 432 291 865	1	0 431 214 011	KBAL 107 S 9/13	0 433 271 230	DLLA 150 S 506	2 433 314 262	2 430 136 202
0 432 291 866	1	0 431 213 012	KBAL 97 S 19/4	0 433 271 224	DLLA 150 S 494	2 433 314 165	2 430 136 202
0 432 291 867	1	0 431 213 011	KBAL 77 S 9/13	0 433 271 229	DLLA 150 S 501	2 433 314 262	2 430 136 202
0 432 291 868	1	0 431 213 011	KBAL 77 S 9/13	0 433 271 217	DLLA 150 S 475	2 433 314 262	2 430 136 202
0 432 291 869	1	0 431 212 024	KBAL 65 S 13/4	0 433 271 186	DLLA 28 S 425	2 433 314 256	2 430 136 202
0 432 291 874	1	0 431 214 002	KBAL 107 S 9/4	0 433 271 165	DLLA 160 S 397	2 433 314 262	2 430 136 202
0 432 291 875	1	0 431 213 004	KBAL 97 S 9/4	0 433 271 192	DLLA 150 S 437	2 433 314 262	2 430 136 202
0 432 291 877	1	0 431 212 024	KBAL 65 S 13/4	0 433 271 178	DLLA 28 S 415	2 433 314 256	2 430 136 202
0 432 291 878	1	0 431 212 024	KBAL 65 S 13/4	0 433 271 177	DLLA 28 S 414	2 433 314 256	2 430 136 202
0 432 291 879	1	0 431 214 002	KBAL 107 S 9/4	0 433 271 165	DLLA 160 S 397	2 433 314 262	2 430 136 202
0 432 291 881	1	0 431 214 003	KBAL 107 S 10/4	0 433 271 165	DLLA 160 S 397	2 433 314 262	2 430 136 202
0 432 291 882	1	0 431 213 005	KBAL 98 S 8/13	0 433 271 162	DLLA 149 S 394	2 433 317 288	2 430 136 191
0 432 291 883	1	0 431 214 002	KBAL 107 S 9/4	0 433 271 161	DLLA 150 S 392	2 433 314 262	2 430 136 202
0 432 291 886	1	0 431 213 005	KBAL 98 S 8/13	0 433 271 114	DLLA 153 S 308	2 433 317 288	2 430 136 191
0 432 291 887	1	0 431 213 002	KBAL 98 S 8/4	0 433 271 114	DLLA 153 S 308	2 433 317 288	2 430 136 191
0 432 292 001	1	0 431 216 005	KBAL 150 S 87	0 433 220 202	DLL 155 S 1300	2 433 349 231	2 430 136 204
0 432 292 858	1	0 431 215 997	KBEL 162 S 93	0 433 272 958	DLLA 141 S 1404	2 433 349 191	2 430 136 085
0 432 292 859	1	0 431 215 997	KBEL 162 S 93	0 433 272 959	DLLA 144 S 5457	2 433 349 191	2 430 136 085
0 432 292 860	1	0 431 215 997	KBEL 162 S 93	0 433 272 980	DLLA 155 S 1351	2 433 349 191	2 430 136 085
0 432 292 861	1	0 431 215 997	KBEL 162 S 93	0 433 272 985	DLLA 155 S 1348	2 433 349 191	2 430 136 085
0 432 292 862	1	0 431 215 997	KBEL 162 S 93	0 433 272 989	DLLA 150 S 1324	2 433 349 191	2 430 136 085
0 432 292 863	1	0 431 215 997	KBEL 162 S 93	0 433 271 603	DLLA 155 S 1308	2 433 349 191	2 430 136 085
0 432 292 864	1	0 431 215 997	KBEL 162 S 93	0 433 271 604	DLLA 155 S 1307	2 433 349 191	2 430 136 085
0 432 292 865	1	0 431 213 971	KBEL 90 S 71	0 433 271 856	DLLA 150 S 804	2 433 314 023	2 430 136 085
0 432 292 866	1	0 431 213 971	KBEL 90 S 71	0 433 271 764	DLLA 150 S 1029	2 433 314 023	2 430 136 085
0 432 292 867	1	0 431 213 971	KBEL 90 S 71	0 433 271 758	DLLA 150 S 1044	2 433 314 023	2 430 136 085
0 432 292 868	1	0 431 214 030	KBAL 122 S 70	0 433 271 721	DLLA 140 S 1110	2 433 349 508	2 430 136 202
0 432 292 869	1	0 431 214 030	KBAL 122 S 70	0 433 271 722	DLLA 140 S 1109	2 433 349 508	2 430 136 202
0 432 292 870	1	0 431 214 030	KBAL 122 S 70	0 433 271 501	DLLA 140 S 1100	2 433 349 508	2 430 136 202
0 432 292 871	1	0 431 213 979	KBEL 90 S 48/TR	0 433 271 857	DLLA 150 S 798	2 433 349 209	2 430 136 085
0 432 292 872	1	0 431 213 979	KBEL 90 S 48/TR	0 433 271 746	DLLA 150 S 1066	2 433 349 209	2 430 136 085
0 432 292 873	1	0 431 214 994	KBEL 109 S 15/13	0 433 271 745	DLLA 150 S 1067	2 433 349 209	2 430 136 085
0 432 292 874	1	0 431 214 994	KBEL 109 S 15/13	0 433 271 746	DLLA 150 S 1066	2 433 349 209	2 430 136 085
0 432 292 875	1	0 431 213 985	KBEL 90 S 23	0 433 271 758	DLLA 150 S 1044	2 433 314 023	2 430 136 085
0 432 292 876	1	0 431 213 985	KBEL 90 S 23	0 433 271 764	DLLA 150 S 1029	2 433 314 023	2 430 136 085
0 432 292 878	1	0 431 213 985	KBEL 90 S 23	0 433 271 856	DLLA 150 S 804	2 433 314 023	2 430 136 085
0 432 292 879	1	0 431 214 997	KBEL 109 S 6/13	0 433 271 807	DLLA 150 S 916	2 433 314 023	2 430 136 085
0 432 292 880	1	0 431 214 997	KBEL 109 S 6/13	0 433 271 814	DLLA 150 S 896	2 433 314 023	2 430 136 085
0 432 292 881	1	0 431 214 997	KBEL 109 S 6/13	0 433 271 829	DLLA 150 S 853	2 433 314 023	2 430 136 085
0 432 292 882	1	0 431 214 997	KBEL 109 S 6/13	0 433 271 730	DLLA 150 S 851/	2 433 314 023	2 430 136 085
0 432 292 884	1	0 431 214 027	KBAL 100 S 52	0 433 271 839	DLLA 155 S 835	2 433 314 256	2 430 136 133
0 432 292 885	1	0 431 214 994	KBEL 109 S 15/13	0 433 271 857	DLLA 150 S 798	2 433 349 209	2 430 136 085



2 433 124 137	2 434 619 017	4					2 916 710 603	
2 433 124 137	2 434 619 017	4				2 433 370 110	2 916 710 603	
2 433 124 137	2 434 619 017	4					2 916 710 603	
2 433 124 137	2 434 619 017	4					2 916 710 603	
2 433 124 137	2 434 619 017	4				2 433 370 110	2 916 710 603	
2 433 124 137	2 434 619 017	4					2 916 710 603	
2 433 124 137	2 434 619 017	4					2 916 710 603	
2 433 124 137	2 434 619 017	4					2 916 710 603	
2 433 124 137	2 434 619 017	4					2 916 710 603	
	2 434 619 017	4					2 916 710 603	
	2 434 619 017	4					2 916 710 603	
2 433 124 137	2 434 619 017	4					2 916 710 603	
2 433 124 137	2 434 619 021	4					2 916 710 603	
2 433 124 137	2 434 619 017	4					2 916 710 603	2 430 105 020
2 433 124 137	2 434 619 017	4					2 916 710 603	
2 433 124 137	2 434 619 017	4					2 916 710 603	
	2 434 619 017	4					2 916 710 603	
2 433 124 455	2 434 619 038	4					2 916 710 603	
2 433 124 380	2 434 619 073	5						
2 433 124 380	2 434 619 073	5				2 433 370 507		
2 433 124 380	2 434 619 073	5				2 433 370 507		
2 433 124 380	2 434 619 073	5				2 433 370 507		
2 433 124 380	2 434 619 073	5				2 433 370 507		
2 433 124 380	2 434 619 073	5				2 433 370 507		
2 433 124 380	2 434 619 073	5						
2 433 124 379	2 434 619 040	5					2 916 710 602	
2 433 124 379	2 434 619 040	5					2 916 710 602	
2 433 124 379	2 434 619 040	5					2 916 710 602	
2 433 124 137	2 434 619 017	4					2 916 710 603	
2 433 124 137	2 434 619 017	4					2 916 710 603	
2 433 124 379	2 434 619 040	5				2 433 370 035	2 916 710 603	
2 433 124 379	2 434 619 040	5				2 433 370 035	2 916 710 603	
2 433 124 379	2 434 619 040	5				2 433 370 035	2 916 710 603	
2 433 124 379	2 434 619 040	5				2 433 370 035	2 916 710 603	
2 433 124 379	2 434 619 040	5					2 916 710 602	
2 433 124 379	2 434 619 040	5					2 916 710 602	
2 433 124 379	2 434 619 040	5					2 916 710 602	
2 433 124 379	2 434 619 040	5				2 433 370 035	2 916 710 603	2 430 105 020
2 433 124 379	2 434 619 040	5				2 433 370 035	2 916 710 603	
2 433 124 379	2 434 619 040	5				2 433 370 035	2 916 710 603	2 430 105 020
2 433 124 379	2 434 619 040	5				2 433 370 035	2 916 710 603	2 430 105 020
	2 434 619 017	4						
2 433 124 379	2 434 619 040	5				2 433 370 035	2 916 710 603	2 430 422 004

*) siehe Seite 388/see page 388/voir page 388/ver pagina 388/vease página 388

***) siehe Seite 392/see page 392/voir page 392/ver pagina 392/vease página 392

A376

de
Ersatzteile für
Düsenhalter-
kombinationen
(Fortsetzung)

en
Spare parts for
nozzle-and-holder
assemblies
(continued)

fr
Pièces de rechange
pour ensembles
porte-injecteurs
(suite)

it
Ricambi per
combinazione
portapolverizzatori
(seguito)

es
Piezas de repuesto
para conjuntos
portainyectores
(continuación)



0 432 292 886	1	0 431 214 997	KBEL 109 S 6/13	0 433 271 867	DLLA 150 S 754	2 433 314 023	2 430 136 085
0 432 292 887	1	0 431 214 997	KBEL 109 S 6/13	0 433 271 874	DLLA 150 S 739	2 433 314 023	2 430 136 085
0 432 292 889	1	0 431 214 997	KBEL 109 S 6/13	0 433 271 887	DLLA 150 S 700	2 433 314 023	2 430 136 085
0 432 296 001	1	0 431 211 005	KBA 38 S 1/13	0 434 200 021	DN 15 S 156	2 433 314 025	2 430 136 031
0 432 296 002	1	0 431 211 014	KBA 38 SD 22/4	0 434 200 021	DN 15 S 156	2 433 314 025	2 430 136 031
0 432 296 004	1	0 431 211 012	KBA 38 S 16/13	0 434 200 014	DN 8 S 129		2 430 136 031
0 432 296 005	1	0 431 211 014	KBA 38 SD 22/4	0 434 200 021	DN 15 S 156	2 433 314 025	2 430 136 031
0 432 296 007	1	0 431 211 019	KBA 38 SD 25/4	0 434 200 021	DN 15 S 156	2 433 314 025	2 430 136 031
0 432 296 009	1	0 431 211 028	KBA 38 S 36/4	0 434 200 021	DN 15 S 156	2 433 314 025	2 430 136 031
0 432 296 010	1	0 431 211 019	KBA 38 SD 25/4	0 434 200 053	DN 10 S 242	2 433 314 025	2 430 136 031
0 432 296 011	1	0 431 211 028	KBA 38 S 36/4	0 434 200 053	DN 10 S 242	2 433 314 025	2 430 136 031
0 432 297 001	1	0 431 211 005	KBA 38 S 1/13	0 434 250 001	DN 0 SD 21	2 433 314 025	2 430 136 031
0 432 297 002	1	0 431 211 005	KBA 38 S 1/13	0 434 250 001	DN 0 SD 21	2 433 314 025	2 430 136 031
0 432 297 003	1	0 431 211 005	KBA 38 S 1/13	0 434 250 018	DN 4 SD 128	2 433 314 025	2 430 136 031
0 432 297 004	1	0 431 211 005	KBA 38 S 1/13	0 434 250 027	DN 12 SD 12	2 433 314 025	2 430 136 031
0 432 297 007	1	0 431 211 014	KBA 38 SD 22/4	0 434 250 001	DN 0 SD 21	2 433 314 025	2 430 136 031
0 432 297 008	1	0 431 211 013	KBA 43 S 21/4	0 434 250 001	DN 0 SD 21	2 433 314 025	2 430 136 031
0 432 297 011	1	0 431 211 005	KBA 38 S 1/13	0 434 250 001	DN 0 SD 21	2 433 314 025	2 430 136 031
0 432 297 013	1	0 431 211 012	KBA 38 S 16/13	0 434 250 009	DN 0 SD 211		2 430 136 031
0 432 297 016	1	0 431 211 019	KBA 38 SD 25/4	0 434 250 001	DN 0 SD 21	2 433 314 025	2 430 136 031
0 432 297 017	1	0 431 212 021	KBA 50 SD 26/4	0 434 250 001	DN 0 SD 21	2 433 314 026	2 430 136 031
0 432 297 019	1	0 431 212 022	KBA 50 SD 28/4	0 434 250 001	DN 0 SD 21	2 433 314 026	2 430 136 031
0 432 297 022	1	0 431 211 023	KBA 42 SD 30/4	0 434 250 001	DN 0 SD 21	2 433 314 026	2 430 136 031
0 432 297 023	1	0 431 211 019	KBA 38 SD 25/4	0 434 250 001	DN 0 SD 21	2 433 314 025	2 430 136 031
0 432 297 024	1	0 431 211 023	KBA 42 SD 30/4	0 434 250 001	DN 0 SD 21	2 433 314 026	2 430 136 031
0 432 297 025	1	0 431 211 005	KBA 38 S 1/13	0 434 250 009	DN 0 SD 211	2 433 314 025	2 430 136 031
0 432 297 026	1	0 431 211 025	KBA 42 SD 32/4	0 434 250 001	DN 0 SD 21		2 430 136 031
0 432 297 027	1	0 431 212 022	KBA 50 SD 28/4	0 434 250 001	DN 0 SD 21	2 433 314 026	2 430 136 031
0 432 297 028	1	0 431 211 026	KBA 42 SD 33/4	0 434 250 001	DN 0 SD 21	2 433 314 026	2 430 136 031
0 432 297 029	1	0 431 213 020	KBA 86 S 34/13	0 434 250 005	DN 0 SD 137		2 430 136 031
0 432 297 032	1	0 431 211 999	KBE 36 S 2/13	0 434 250 063	DN 0 SD 193	2 433 314 046	2 430 136 167
0 432 297 034	1	0 431 212 995	KBE 58 S 4/4	0 434 250 063	DN 0 SD 193	2 433 314 046	2 430 136 167
0 432 297 035	1	0 431 211 997	KBE 48 S 5/4	0 434 250 060	DN 0 SD 189	2 433 349 204	2 430 136 167
0 432 297 036	1	0 431 212 995	KBE 58 S 4/4	0 434 250 071	DN 0 SD 216	2 433 314 046	2 430 136 167
0 432 297 037	1	0 431 212 995	KBE 58 S 4/4	0 434 250 077	DN 0 SD 230	2 433 314 046	2 430 136 167
0 432 297 038	1	0 431 212 995	KBE 58 S 4/4	0 434 250 063	DN 0 SD 193	2 433 314 046	2 430 136 167
0 432 297 039	1	0 431 211 996	KBE 45 S 6	0 434 250 092	DN 0 SD 1930	2 433 349 204	2 430 136 167
0 432 297 040	1	0 431 212 995	KBE 58 S 4/4	0 434 250 063	DN 0 SD 193	2 433 314 046	2 430 136 167
0 432 297 041	1	0 431 212 995	KBE 58 S 4/4	0 434 250 011	DN 0 SD 1510	2 433 314 046	2 430 136 167
0 432 297 042	1	0 431 212 995	KBE 58 S 4/4	0 434 250 092	DN 0 SD 1930	2 433 314 046	2 430 136 167
0 432 297 043	1	0 431 211 029	KBA 42 S 37	0 434 250 001	DN 0 SD 21	2 433 314 026	2 430 136 031
0 432 297 044	1	0 431 211 995	KBE 48 S 7	0 434 250 063	DN 0 SD 193	2 433 349 204	2 430 136 167
0 432 297 045	1	0 431 211 997	KBE 48 S 5/4	0 434 250 112	DN 0 SD 254	2 433 349 204	2 430 136 167
0 432 297 046	1	0 431 212 991	KBE 58 S 8	0 434 250 063	DN 0 SD 193	2 433 314 046	2 430 136 167
0 432 297 047	1	0 431 212 995	KBE 58 S 4/4	0 434 250 125	DN 0 SD 263	2 433 314 046	2 430 136 167



2 433 124 379	2 434 619 040	5			2 433 370 035	2 916 710 603	
2 433 124 379	2 434 619 040	5			2 433 370 035	2 916 710 603	2 430 105 020
2 433 124 379	2 434 619 040	5			2 433 370 035	2 916 710 603	
2 433 124 137	2 434 614 010	4				2 916 710 603	2 430 105 011
2 433 124 137	2 434 614 010	4			2 433 356 054	2 916 710 603	
2 433 124 137	2 434 614 010	4				2 916 710 603	
2 433 124 137	2 434 614 010	4			2 433 356 054	2 916 710 603	
2 433 124 137	2 434 614 010	4			2 433 356 073	2 916 710 603	
2 433 124 137	2 434 614 010	4			2 433 356 069	2 916 710 603	
2 433 124 137	2 434 614 010	4			2 433 356 073	2 916 710 603	
2 433 124 137	2 434 614 010	4			2 433 356 069	2 916 710 603	
2 433 124 137	2 434 614 010	4				2 916 710 603	2 430 105 011
2 433 124 137	2 434 614 010	4				2 916 710 603	2 430 105 011
2 433 124 137	2 434 614 010	4				2 916 710 603	
2 433 124 137	2 434 614 010	4				2 916 710 603	
2 433 124 137	2 434 614 010	4			2 433 356 054	2 916 710 603	
	2 434 619 002	5				2 916 710 603	
2 433 124 137	2 434 614 010	4				2 916 710 603	2 430 105 011
2 433 124 137	2 434 614 010	4				2 916 710 603	
2 433 124 137	2 434 614 010	4			2 433 356 073	2 916 710 603	
2 433 124 137	2 434 614 010	4			2 433 356 073	2 916 710 603	
2 433 124 137	2 434 614 010	4			2 433 356 080	2 916 710 603	
2 433 124 137	2 434 614 010	4			2 433 356 080	2 916 710 603	
2 433 124 137	2 434 614 010	4				2 916 710 603	2 430 105 011
2 433 124 137	2 434 614 010	4				2 916 710 603	
2 433 124 137	2 434 614 010	4				2 916 710 603	
2 433 124 137	2 434 614 010	4				2 916 710 603	
2 433 124 137	2 434 614 010	4				2 916 710 603	
2 433 124 137	2 434 619 017	4				2 916 710 603	
2 433 124 380	2 434 619 073	5			2 433 370 016	2 916 710 603	
2 433 124 380	2 434 614 017	5				2 916 710 602	2 430 105 012
2 433 124 380	2 434 614 017	5			2 433 370 036	2 916 710 603	2 430 105 012
2 433 124 380	2 434 614 017	5				2 916 710 602	
2 433 124 380	2 434 614 017	5				2 916 710 602	
2 433 124 380	2 434 614 017	5				2 916 710 602	
2 433 124 380	2 434 614 017	5				2 916 710 602	
2 433 124 137	2 434 619 010	4					
2 433 124 379	2 434 619 040	5			2 433 370 036	2 916 710 603	
2 433 124 380	2 434 614 017	5			2 433 370 036	2 916 710 603	
2 433 124 380	2 434 619 073	5				2 916 710 602	
2 433 124 380	2 434 614 017	5				2 916 710 602	

*) siehe Seite 388/see page 388/voir page 388/ver pagina 388/vease página 388

***) siehe Seite 392/see page 392/voir page 392/ver pagina 392/vease página 392

A378

de
Ersatzteile für
Düsenhalter-
kombinationen
(Fortsetzung)

en
Spare parts for
nozzle-and-holder
assemblies
(continued)

fr
Pièces de rechange
pour ensembles
porte-injecteurs
(suite)

it
Ricambi per
combinazione
portapolverizzatori
(seguito)

es
Piezas de repuesto
para conjuntos
portainyectoros
(continuación)



0 432 297 048	1	0 431 212 991	KBE 58 S 8	0 434 250 117	DN 0 SD 259	2 433 314 046	2 430 136 167
0 432 297 049	1	0 431 211 995	KBE 48 S 7	0 434 250 126	DN 0 SD 193/	2 433 349 204	2 430 136 167
0 432 297 050	1	0 431 211 995	KBE 48 S 7	0 434 250 127	DN 0 SD 264	2 433 349 204	2 430 136 167
0 432 297 051	1	0 431 211 997	KBE 48 S 5/4	0 434 250 122	DN 0 SD 189/	2 433 349 204	2 430 136 167
0 432 297 053	1	0 431 212 995	KBE 58 S 4/4	0 434 250 071	DN 0 SD 216	2 433 314 046	2 430 136 167
0 432 297 054	1	0 431 212 991	KBE 58 S 8	0 434 250 117	DN 0 SD 259	2 433 314 046	2 430 136 167
0 432 297 055	1	0 431 212 991	KBE 58 S 8	0 434 250 168	DN 0 SD 307	2 433 314 046	2 430 136 167
0 432 297 056	1	0 431 211 994	KBE 53 S 11	0 434 250 155	DN 0 SD 294	2 433 349 150	2 430 136 167
0 432 297 057	1	0 431 212 991	KBE 58 S 8	0 434 250 162	DN 0 SD 301	2 433 314 046	2 430 136 167
0 432 297 058	1	0 431 212 991	KBE 58 S 8	0 434 250 160	DN 0 SD 299	2 433 314 046	2 430 136 167
0 432 380 004	1	0 431 305 010	KB 125 TA 818/13	0 433 300 186	DL 155 T 271	2 433 349 020	
0 432 380 005	1	0 431 305 010	KB 125 TA 818/13	0 433 300 257	DL 155 T 1112	2 433 349 020	
0 432 380 006	1	0 431 305 014	KB 125 TA 836/13	0 433 300 186	DL 155 T 271	2 433 349 020	
0 432 380 007	1	0 431 307 030	KB 175 TA 838/13	0 433 300 296	DL 145 T 1169	2 433 349 020	
0 432 380 008	1	0 431 307 030	KB 175 TA 838/13	0 433 300 987	DL 145 T 1121+SH	2 433 349 020	
0 432 380 009	1	0 431 305 015	KB 125 TA 839/13	0 433 300 996	DL 155 T 1112+SH	2 433 349 020	
0 432 380 010	1	0 431 305 016	KB 125 TA 840/13	0 433 300 991	DL 155 T 271+SH	2 433 349 020	
0 432 380 011	1	0 431 305 016	KB 125 TA 840/13	0 433 300 990	DL 155 T 1188+SH	2 433 349 020	
0 432 380 012	1	0 431 305 016	KB 125 TA 840/13	0 433 300 989	DL 155 T 1193+SH	2 433 349 020	
0 432 380 013	1	0 431 307 031	KB 175 T 845/13	0 433 300 983	DL 145 T 1205+SH	2 433 349 020	
0 432 380 014	1	0 431 307 031	KB 175 T 845/13	0 433 300 986	DL 145 T 1201+SH	2 433 349 020	
0 432 380 015	1	0 431 305 016	KB 125 TA 840/13	0 433 300 331	DL 165 T 1211	2 433 349 020	
0 432 380 016	1	0 431 307 035	KB 175 T 852	0 433 300 986	DL 145 T 1201+SH	2 433 349 020	2 430 136 111
0 432 380 017	1	0 431 307 035	KB 175 T 852	0 433 300 983	DL 145 T 1205+SH	2 433 349 020	2 430 136 111
0 432 380 018	1	0 431 304 007	KBZ 116 T 854	0 433 350 012	DLZ 154 T 1235	9 432 364 651	
0 432 382 001	1	0 431 327 003	KBF 178 T 5/20	0 433 351 024	DLF 145 T 21	2 433 314 100	
0 432 382 002	1	0 431 327 003	KBF 178 T 5/20	0 433 351 024	DLF 145 T 21	2 433 314 100	
0 432 382 004	1	0 431 328 009	KBF 230 T 16/20	0 433 351 041	DLF 145 T 38	2 433 314 100	
0 432 382 005	1	0 431 327 003	KBF 178 T 5/20	0 433 351 040	DLLF 145 T 8	2 433 314 100	
0 432 382 006	1	0 431 328 009	KBF 230 T 16/20	0 433 351 047	DLF 145 T 44	2 433 314 100	
0 432 382 007	1	0 431 327 008	KBF 175 T 23	0 433 351 058	DLLF 145 T 10	2 433 314 100	2 430 136 101
0 432 382 008	1	0 431 327 008	KBF 175 T 23	0 433 351 060	DLLF 145 T 13	2 433 314 100	2 430 136 101
0 432 382 009	1	0 431 328 011	KBF 230 T 18/20	0 433 351 051	DLLF 145 T 9	2 433 314 100	2 430 136 111
0 432 386 001	1	0 431 302 008	KB 50 TA 448/13	0 434 300 007	DN 6 T 4	2 433 349 020	
0 432 386 002	1	0 431 303 016	KB 80 TA 312/4	0 434 300 008	DN 6 T 49	2 433 349 020	
0 432 390 001	1	0 431 318 001	KBAZ 228 T 1/4	0 433 350 011	DLZ 140 T 1157	2 433 314 085	2 430 136 070
0 432 390 002	1	0 431 315 003	KBA 142 T 7/13	0 433 300 292	DL 150 T 1164	2 433 314 022	9 432 360 131
0 432 390 003	1	0 431 315 003	KBA 142 T 7/13	0 433 300 299	DL 155 T 1171	2 433 314 022	9 432 360 131
0 432 390 004	1	0 431 315 003	KBA 142 T 7/13	0 433 300 302	DL 155 T 1175	2 433 314 022	9 432 360 131
0 432 390 005	1	0 431 316 001	KBAZ 150 T 2/12	0 433 300 310	DL 130 T 1189	2 433 349 402	2 430 136 091
0 432 390 006	1	0 431 316 001	KBAZ 150 T 2/12	0 433 300 310	DL 130 T 1189	2 433 349 402	2 430 136 091
0 432 390 007	1	0 431 315 003	KBA 142 T 7/13	0 433 300 328	DL 150 T 1208	2 433 314 022	9 432 360 131
0 432 390 008	1	0 431 316 001	KBAZ 150 T 2/12	0 433 300 310	DL 130 T 1189	2 433 349 402	2 430 136 091
0 432 390 009	1	0 431 316 001	KBAZ 150 T 2/12	0 433 300 329	DL 120 T 1209	2 433 349 402	2 430 136 091
0 432 390 010	1	0 431 318 002	KBA 208 T 14	0 433 300 330	DL 150 T 1210	2 433 314 085	9 432 360 131



2 433 124 380	2 434 619 073	5				2 916 710 602	2 430 105 012
2 433 124 379	2 434 619 040	5			2 433 370 036	2 916 710 603	2 430 105 012
2 433 124 379	2 434 619 040	5			2 433 370 036	2 916 710 603	
2 433 124 380	2 434 614 017	5			2 433 370 036	2 916 710 603	
2 433 124 380	2 434 614 017	5				2 916 710 602	
2 433 124 380	2 434 619 073	5				2 916 710 602	
2 433 124 380	2 434 619 073	5				2 916 710 602	
2 433 124 380	2 434 619 073	5			2 433 370 016		
2 433 124 380	2 434 619 073	5				2 916 710 602	
2 433 124 380	2 434 619 073	5				2 916 710 602	
2 433 122 001	2 434 619 009				2 433 370 127	2 916 710 505	
2 433 122 001	2 434 619 009				2 433 370 127	2 916 710 505	1 410 105 005
2 433 122 001	2 434 619 008				2 433 370 127	2 916 710 616	1 410 105 005
2 433 122 011	2 434 619 008				2 433 370 041	2 916 710 605	
2 433 122 011	2 434 619 008				2 433 370 041	2 916 710 605	
2 433 122 001	2 434 619 009				2 433 370 028	2 916 710 616	1 410 105 005
2 433 122 001	2 434 619 008				2 433 370 028	2 916 710 616	
2 433 122 001	2 434 619 008				2 433 370 028	2 916 710 616	
2 433 122 001	2 434 619 008				2 433 370 028	2 916 710 616	
2 433 122 011	2 434 619 008					2 916 710 605	1 410 105 005
2 433 122 011	2 434 619 008					2 916 710 605	1 410 105 005
2 433 122 001	2 434 619 008				2 433 370 028	2 916 710 616	1 410 105 005
2 433 122 011	2 434 619 008						1 410 105 005
2 433 122 011	2 434 619 008						1 410 105 005
2 433 122 003	2 434 619 008				9 432 368 150	2 916 710 616	
2 433 122 003	2 434 619 008				2 433 370 103	2 916 710 605	
2 433 122 003	2 434 619 008				2 433 370 103	2 916 710 605	
2 433 122 019	2 434 619 008				2 433 370 270	2 916 710 605	
2 433 122 003	2 434 619 008				2 433 370 103	2 916 710 605	
2 433 122 019	2 434 619 008				2 433 370 270	2 916 710 605	
2 433 123 027	2 434 619 008						1 410 105 005
2 433 123 027	2 434 619 008						1 410 105 005
2 433 122 019	2 434 619 008				2 433 370 270	2 916 710 616	
2 433 122 007	2 434 619 009					2 916 710 616	
2 433 122 005	2 434 619 009				2 433 370 103	2 916 710 605	
9 432 363 850	2 434 619 037	11				2 916 710 605	
9 432 363 850	2 434 619 037	11					
9 432 363 850	2 434 619 037	11					
9 432 363 850	2 434 619 037	11					
9 432 363 846	2 434 619 045	12					
9 432 363 846	2 434 619 045	12					
9 432 363 850	2 434 619 037	11					
9 432 363 846	2 434 619 045	12					
9 432 363 846	2 434 619 045	12					
9 432 363 846	2 434 619 045	12					
	2 434 619 037				2 433 370 009	2 916 710 603	

*) siehe Seite 388/see page 388/voir page 388/ver pagina 388/vease página 388

***) siehe Seite 392/see page 392/voir page 392/ver pagina 392/vease página 392

A380

de
Ersatzteile für
Düsenhalter-
kombinationen
(Fortsetzung)

en
Spare parts for
nozzle-and-holder
assemblies
(continued)

fr
Pièces de rechange
pour ensembles
porte-injecteurs
(suite)

it
Ricambi per
combinazione
portapolverizzatori
(seguito)

es
Piezas de repuesto
para conjuntos
portainyectores
(continuación)



	Fig.	Ref.	Typ	Ref.	TP		
				①		②	③
0 432 390 011	1	0 431 316 001	KBAZ 150 T 2/12	0 433 300 339	DL 130 T 1225	2 433 349 402	2 430 136 091
0 432 390 012	1	0 431 316 001	KBAZ 150 T 2/12	0 433 300 339	DL 130 T 1225	2 433 349 402	2 430 136 091
0 432 390 013	1	0 431 316 001	KBAZ 150 T 2/12	0 433 300 339	DL 130 T 1225	2 433 349 402	2 430 136 091
0 432 390 014	1	0 431 316 001	KBAZ 150 T 2/12	0 433 300 340	DL 120 T 1226	2 433 349 402	2 430 136 091
0 432 390 015	1	0 431 315 003	KBA 142 T 7/13	0 433 300 341	DL 155 T 1228	2 433 314 022	9 432 360 131
0 432 390 016	1	0 431 315 005	KBA 142 T 18	0 433 300 302	DL 155 T 1175	2 433 314 022	9 432 360 131
0 432 390 017	1	0 431 315 003	KBA 142 T 7/13	0 433 300 342	DL 155 T 1229	2 433 314 022	9 432 360 131
0 432 390 018	1	0 431 316 001	KBAZ 150 T 2/12	0 433 300 340	DL 120 T 1226	2 433 349 402	2 430 136 091
0 432 390 019	1	0 431 315 005	KBA 142 T 18	0 433 300 344	DL 155 T 1236	2 433 314 022	9 432 360 131
0 432 390 021	1	0 431 315 003	KBA 142 T 7/13	0 433 300 346	DL 155 T 1243	2 433 314 022	9 432 360 131
0 432 390 023	1	0 431 315 003	KBA 142 T 7/13	0 433 300 347	DL 155 T 1248	2 433 314 022	9 432 360 131
0 432 392 001	1	0 431 326 007	KBAF 157 T 3	0 433 351 059	DLLF 150 T 12	2 433 349 404	9 432 360 101
0 432 392 002	1	0 431 329 003	KBAF 262 T 2	0 433 351 061	DLLF 156 T 14	2 433 349 406	2 430 136 143
0 432 392 003	1	0 431 329 003	KBAF 262 T 2	0 433 351 062	DLLF 156 T 16	2 433 349 406	2 430 136 143
0 432 392 004	1	0 431 329 003	KBAF 262 T 2	0 433 351 063	DLLF 156 T 17	2 433 349 406	2 430 136 143
0 432 392 005	1	0 431 326 006	KBAF 157 T 1	0 433 351 064	DLLF 150 T 18	2 433 349 404	2 430 136 139
0 432 392 006	1	0 431 329 003	KBAF 262 T 2	0 433 351 065	DLLF 156 T 19	2 433 349 406	2 430 136 143
0 432 392 007	1	0 431 329 003	KBAF 262 T 2	0 433 351 069	DLLF 156 T 23	2 433 349 406	2 430 136 143
0 432 480 002	1	0 431 406 007	KB 178 U 906	0 433 421 008	DLLC 144 U 7	9 432 364 652	
0 432 490 002	1	0 431 415 001	KBA 137 U 5	0 433 450 004	DLZ 150 U 1227	2 433 349 408	2 430 136 164
0 432 490 003	1	0 431 415 001	KBA 137 U 5	0 433 450 005	DLZ 150 U 1233	2 433 349 408	2 430 136 164
0 432 582 001	1	0 431 529 001	KBF 280 V 50	0 433 551 002	DLF 155 V 2	9 432 364 667	
9 430 032 141	1	0 431 315 004	KBA 142 T 8/4	9 430 033 302	HB-DL 130 T 1179	2 433 314 085	9 432 360 131
9 430 032 153	1	9 430 031 255	HB-KBL 80 S 192/4	9 430 034 217	HB-DLLA 150 S 719	2 433 314 059	
9 430 032 177	1	0 431 212 028	KBAL 62 S 29/13	9 430 034 219	HB-DLLA 155 S 772	2 433 314 262	2 430 136 202
9 430 032 199	1	0 431 212 028	KBAL 62 S 29/13	9 430 034 701	HB-DLLA 155 S 833	2 433 314 262	2 430 136 202
9 430 032 209	1	9 430 031 255	HB-KBL 80 S 192/4	9 430 034 229	HB-DLLA 142 S 878	2 433 314 059	
9 430 032 235	1	9 430 031 255	HB-KBL 80 S 192/4	9 430 034 273	HB-DLLA 150 S 990	2 433 314 059	
9 430 032 257	1	9 430 031 255	HB-KBL 80 S 192/4	9 430 034 282	HB-DLLA 146 S 1129	2 433 314 059	
9 430 032 264	1	0 430 232 004	KDAL 74 S 3/19	9 430 034 284	HB-DLLA 142 S 1142	2 433 317 297	2 430 136 191
9 430 032 266	1	0 430 211 049	KCA 17 S 38/4	9 430 037 232	HB-DN 0 SD 287	2 433 458 124	2 430 136 145
9 430 032 281	1	9 430 031 255	HB-KBL 80 S 192/4	9 430 034 704	DLLA 146 S 1212	2 433 314 059	
9 430 032 304	1	0 430 232 004	KDAL 74 S 3/19	9 430 034 717	DLLA 142 S 1256	2 433 317 297	2 430 136 191
9 430 082 211	1	0 431 202 126	KB 55 SA 566/4	0 433 250 063	DL 125 S 1091	2 433 349 031	
9 430 082 288	1	9 430 081 238	KBAL 60 S 64	9 430 084 226	DLLA 151 S 991	2 433 314 262	2 430 136 202
9 430 082 289	1	0 431 213 024	KBALB 87 S 3	9 430 084 214	DLLB 151 S 907	2 433 314 295	2 430 136 206
9 430 082 291	1	0 430 232 013	KDAL 74 S 21/19	9 430 084 227	DLLA 142 S 1013	2 433 349 501	2 430 136 202
9 430 082 296	1	0 431 213 024	KBALB 87 S 3	9 430 084 230	DLLB 150 S 1049	2 433 314 295	2 430 136 206
9 430 082 302	1	9 430 081 243	KBAL 75 S 71	9 430 084 237	DLLA 160 S 1122	2 433 314 165	2 430 136 202
9 430 082 305	1	0 430 232 019	KDAL 74 S 44	9 430 084 240	DLLA 138 S 1135	2 433 349 501	2 430 136 202
9 430 082 306	1	0 431 212 994	KBEL 62 S 9/13	9 430 084 241	DLLA 144 S 1162	2 433 314 094	2 430 136 085
9 430 082 309	1	0 431 212 994	KBEL 62 S 9/13	9 430 084 241	DLLA 144 S 1162	2 433 314 094	2 430 136 085
9 430 082 310	1	9 430 081 238	KBAL 60 S 64	9 430 084 243	DLLA 151 S 1200	2 433 314 262	2 430 136 202
9 430 082 313	1	9 430 081 247	KBEL 62 S 78	9 430 084 241	DLLA 144 S 1162	2 433 314 094	2 430 136 085
9 430 082 314	1	9 430 081 247	KBEL 62 S 78	9 430 084 241	DLLA 144 S 1162	2 433 314 094	2 430 136 085



9 432 363 846	2 434 619 045	12					
9 432 363 846	2 434 619 045	12					
9 432 363 846	2 434 619 045	12					
9 432 363 846	2 434 619 045	12					
9 432 363 850	2 434 619 037	11					
9 432 363 850	2 434 619 063	11					
9 432 363 850	2 434 619 037	11					
9 432 363 846	2 434 619 045	12					
9 432 363 850	2 434 619 063	11					
9 432 363 850	2 434 619 037	11					
9 432 363 850	2 434 619 037	11					
9 432 363 850	2 434 619 037	11					
9 432 363 850	2 434 619 037	11				2 916 710 605	
9 432 363 850	2 434 619 037	11				2 916 710 605	
9 432 363 850	2 434 619 037	11				2 916 710 605	
9 432 363 852	2 434 619 037	11					
9 432 363 850	2 434 619 037	11				2 916 710 605	
9 432 363 850	2 434 619 037	11				2 916 710 605	
9 432 363 857	2 434 619 037	13					
9 432 363 854	2 434 619 045	12					
9 432 363 854	2 434 619 045	12					
9 432 363 859	2 434 619 045						
2 433 123 044	2 434 619 037					2 916 710 603	
9 431 033 104	9 431 034 602	8					2 439 999 032
2 433 124 137	2 434 619 017	4					2 430 105 020
	2 434 619 017	4					
9 431 033 104	9 431 034 602	8					2 439 999 032
9 431 033 104	9 431 034 602	8					2 439 999 032
9 431 033 104	9 431 034 602	8					2 439 999 032
2 433 124 137	2 434 619 017	4				2 916 710 603	9 431 030 158
2 433 124 373	2 434 619 048	4					
9 431 033 104	9 431 034 602	8					2 439 999 032
2 433 124 137	2 434 619 017	4				2 916 710 603	9 431 030 158
2 433 104 433	2 434 619 008				2 433 370 110	2 916 710 603	
2 433 124 137	2 434 614 010	4					
2 433 124 137	2 434 614 019	4			2 433 370 297	2 916 710 603	
2 433 124 137	2 434 619 017	4				2 916 710 603	
2 433 124 137	2 434 614 019	4			2 433 370 297	2 916 710 603	
2 433 124 137	2 434 619 017	4			2 433 370 035	2 916 710 603	
2 433 124 137	2 434 619 017	4				2 916 710 603	
2 433 124 379	2 434 619 040	5				2 916 710 602	
2 433 124 379	2 434 619 040	5				2 916 710 602	
2 433 124 137	2 434 614 010	4					
2 433 124 379	2 434 619 040	5					
2 433 124 379	2 434 619 040	5					

*) siehe Seite 388/see page 388/voir page 388/ver pagina 388/vease página 388
 **) siehe Seite 392/see page 392/voir page 392/ver pagina 392/vease página 392

A382

de

Ersatzteile für
Düsenhalter-
kombinationen
(Fortsetzung)

en

Spare parts for
nozzle-and-holder
assemblies
(continued)

fr

Pièces de rechange
pour ensembles
porte-injecteurs
(suite)

it

Ricambi per
combinazione
portapolverizzatori
(seguito)

es

Piezas de repuesto
para conjuntos
portainyectoros
(continuación)



Fig.



Ref.



Typ



①



Typ











②



③

9 430 082 318	1	0 430 233 022	KDAL 80 S 50	9 430 084 244	DLLA 130 S 1253	2 433 349 155	2 430 136 202
9 430 082 326	1	9 430 080 207	KDAL 74 S 64	9 430 084 248	DLLA 137 S 1286	2 433 349 135	2 430 136 202
9 430 082 333	1	0 430 232 013	KDAL 74 S 21/19	9 430 084 245	DLLA 142 S 1264	2 433 349 501	2 430 136 202
9 430 082 334	1	0 430 232 013	KDAL 74 S 21/19	9 430 084 247	DLLA 142 S 1266	2 433 349 501	2 430 136 202
9 430 082 703	1	9 430 081 701	KBEL 84 P 26	9 430 084 703	DLLA 150 P 106	2 433 314 042	2 430 136 166
9 430 082 708	1	9 430 081 701	KBEL 84 P 26	9 430 084 708	DLLA 150 P 112	2 433 314 042	2 430 136 166
9 430 082 711	1	9 430 081 701	KBEL 84 P 26	9 430 084 711	DLLA 150 P 129	2 433 314 042	2 430 136 166
9 430 082 713	1	9 430 081 701	KBEL 84 P 26	9 430 084 712	DLLA 153 P 142	2 433 314 042	2 430 136 166
9 430 082 714	1	9 430 081 701	KBEL 84 P 26	9 430 084 714	DLLA 155 P 153	2 433 314 042	2 430 136 166
9 430 082 715	1	0 431 114 003	KBAL 105 P 18	9 430 084 715	DLLA 150 P 155	2 433 314 182	2 430 134 023
9 430 082 716	1	9 430 081 701	KBEL 84 P 26	9 430 084 716	DLLA 142 P 169	2 433 314 042	2 430 136 166
9 430 082 717	1	9 430 081 704	KBEL 84 P 48	9 430 084 717	DLLA 150 P 174	2 433 314 042	2 430 136 166
9 430 082 718	1	9 430 081 701	KBEL 84 P 26	9 430 084 718	DLLA 150 P 183	2 433 314 042	2 430 136 166
9 430 082 719	1	9 430 081 701	KBEL 84 P 26	9 430 084 719	DLLA 150 P 194	2 433 314 042	2 430 136 166
9 430 082 721	1	9 430 081 703	KBEL 88 P 33	9 430 084 720	DLLA 150 P 207	2 433 314 042	2 430 136 166
9 430 082 722	1	9 430 081 704	KBEL 84 P 48	9 430 084 711	DLLA 150 P 129	2 433 314 042	2 430 136 166
9 430 082 723	1	9 430 081 705	KBEL 64 P 53	0 433 171 044	DLLA 140 P 44	9 431 081 710	2 430 136 166
9 430 082 726	1	9 430 081 704	KBEL 84 P 48	9 430 084 722	DLLA 150 P 226	2 433 314 042	2 430 136 166
9 430 082 727	1	9 430 081 701	KBEL 84 P 26	9 430 084 723	DLLA 150 P 236	2 433 314 042	2 430 136 166
9 430 082 735	1	9 430 081 706	KBEL 85 P 68	9 430 084 731	DLLA 140 P 271		2 430 136 166
9 430 082 736	1	9 430 080 700	KDAL 59 P 8	9 430 084 732	DLLA 145 P 309	2 433 314 182	2 430 134 023
9 430 082 737	1	9 430 080 700	KDAL 59 P 8	9 430 084 733	DLLA 145 P 310	2 433 314 182	2 430 134 023
9 430 082 739	1	9 430 081 701	KBEL 84 P 26	9 430 084 735	DLLA 150 P 281	2 433 314 042	2 430 136 166
9 430 082 740	1	9 430 081 706	KBEL 85 P 68	9 430 084 738	DLLA 139 P 289		2 430 136 166
9 430 082 742	1	9 430 081 706	KBEL 85 P 68	9 430 084 737	DLLA 139 P 288		2 430 136 166
9 430 082 743	1	9 430 081 707	KBAL 105 P 30	9 430 084 734	DLLA 155 P 282	F 000 431 014	2 430 134 023
9 430 082 744	1	9 430 081 706	KBEL 85 P 68	9 430 084 739	DLLA 139 P 303		2 430 136 166
9 430 082 745	1	9 430 080 701	KDAL 74 P 10	9 430 084 740	DLLA 140 P 323	2 433 314 182	2 430 134 023
9 430 082 746	1	9 430 080 701	KDAL 74 P 10	9 430 084 741	DLLA 150 P 314	2 433 314 182	2 430 134 023
9 430 082 747	1	0 430 132 001	KDAL 59 P 2	9 430 084 742	DLLA 154 P 332	2 433 314 182	2 430 134 023
9 430 082 748	1	9 430 081 708	KBAL 105 P 34	9 430 084 743	DLLA 155 P 368	F 000 431 014	2 430 134 023
9 430 082 749	1	9 430 080 702	KDAL 59 P 11	9 430 084 744	DLLA 148 P 375	2 433 314 182	2 430 134 023
9 430 082 750	1	9 430 080 702	KDAL 59 P 11	9 430 084 733	DLLA 145 P 310	2 433 314 182	2 430 134 023
9 430 082 752	1	9 430 080 701	KDAL 74 P 10	9 430 084 746	DLLA 144 P 443	2 433 314 182	2 430 134 023
9 430 082 753	1	9 430 081 709	KBAL 150 P 47	9 430 084 734	DLLA 155 P 282	F 000 431 014	2 430 134 023
9 430 082 754	1	9 430 081 706	KBEL 85 P 68	9 430 084 738	DLLA 139 P 289		2 430 136 166
9 430 082 755	1	9 430 081 706	KBEL 85 P 68	9 430 084 737	DLLA 139 P 288		2 430 136 166
9 430 082 756	1	9 430 080 701	KDAL 74 P 10	9 430 084 747	DLLA 144 P 553	2 433 314 182	2 430 134 023
9 430 082 759	1	9 430 080 703	KDAL 74 P 15	9 430 084 749	DLLA 137 P 553	2 433 314 182	2 430 134 023
9 430 082 762	1	9 430 081 709	KBAL 150 P 47	9 430 084 755	DLLA 140 P 594	F 000 431 014	2 430 134 023
9 430 082 763	1	9 430 081 705	KBEL 64 P 53	9 430 084 003	DLLA 150 X 4	9 431 081 710	2 430 136 166
9 430 082 764	1	9 430 080 702	KDAL 59 P 11	9 430 084 753	DLLA 150 P 588	2 433 314 182	2 430 134 023
9 430 082 766	1	9 430 080 702	KDAL 59 P 11	9 430 084 759	DLLA 145 P 618	2 433 314 182	2 430 134 023
9 430 082 767	1	9 430 080 704	KDAL 74 P 17	9 430 084 756	DLLA 148 P 597	2 433 314 182	2 430 134 023
9 430 082 768	1	9 430 080 707	KBEL 80 P 58	9 430 084 757	DLLA 146 P 600	2 433 349 434	2 430 136 212

								
④	⑤	⑥	⑦	⑧	⑨	⑩	⑪	
2 433 124 137	2 434 619 017	4						
2 433 124 455	2 434 619 047	4					2 916 710 603	
2 433 124 137	2 434 619 017	4					2 916 710 603	
2 433 124 137	2 434 619 017	4					2 916 710 603	
2 433 120 127	2 434 614 022							
2 433 120 127	2 434 614 022							
2 433 120 127	2 434 614 022							
2 433 120 127	2 434 614 022							
2 433 120 128	2 434 614 028	1						F 00V C17 503
2 433 120 127	2 434 614 022							
2 433 120 127	2 434 614 022	5						
2 433 120 127	2 434 614 022							
2 433 120 127	2 434 614 022							
2 433 120 127	2 434 614 022	5						2 916 710 602
2 433 120 127	2 434 614 022	5						
2 433 120 127	2 434 614 022	5						
2 433 120 127	2 434 614 022	5						
2 433 120 127	2 434 614 022							
2 433 124 388	2 434 614 022	5						
2 433 124 446	2 434 614 028	1	2 433 462 014					
2 433 124 446	2 434 614 028	1	2 433 462 014					
2 433 120 127	2 434 614 022							
2 433 124 388	2 434 614 022	5						
2 433 124 388	2 434 614 022	5						
2 433 124 446	2 434 614 028	1						F 00V C17 503
2 433 124 388	2 434 614 022	5						
2 433 124 446	2 434 614 028	1	2 433 462 014				2 916 710 602	
2 433 124 446	2 434 614 028	1	2 433 462 014				2 916 710 602	
2 433 120 128	2 434 614 020	6	2 433 462 014					F 00V C17 503
2 433 120 128	2 434 614 020	1						F 00V C17 503
2 433 124 446	2 434 614 020	1	2 433 462 014					
2 433 124 446	2 434 614 020	1	2 433 462 014					
2 433 124 446	2 434 614 028	1	2 433 462 014				2 916 710 602	
2 433 124 446	2 434 614 020	1						
2 433 124 388	2 434 614 022	5						
2 433 124 388	2 434 614 022	5						
2 433 124 446	2 434 614 028	1	2 433 462 014				2 916 710 602	
2 433 124 446	2 434 614 028	1	2 433 462 014				2 916 710 602	
2 433 124 446	2 434 614 020	1						F 00V C17 503
2 433 120 127	2 434 614 022	5						
2 433 124 446	2 434 614 020	1	2 433 462 014					
2 433 124 446	2 434 614 020	1	2 433 462 014					
2 433 124 446	2 434 614 020	1	2 433 462 014				2 916 710 602	
2 433 124 376	2 434 614 040	3						

*) siehe Seite 388/see page 388/voir page 388/ver pagina 388/vease página 388

**) siehe Seite 392/see page 392/voir page 392/ver pagina 392/vease página 392

A384

de
Ersatzteile für
Düsenhalter-
kombinationen
(Fortsetzung)

en
Spare parts for
nozzle-and-holder
assemblies
(continued)

fr
Pièces de rechange
pour ensembles
porte-injecteurs
(suite)

it
Ricambi per
combinazione
portapolverizzatori
(seguito)

es
Piezas de repuesto
para conjuntos
portainyectoros
(continuación)



9 430 082 769	1	9 430 080 705	KDAL 74 P 19	9 430 084 758	DLLA 137 P 608	2 433 314 182	2 430 134 023
9 430 082 771	1	9 430 080 706	KDEL 82 P 57	0 433 171 303	DLLA 134 P 422	2 433 349 122	2 430 136 166
9 430 233 001	1	0 431 112 997	KBEL 90 P 5/13	0 433 171 010	DLLA 160 P 9	2 433 314 042	2 430 136 166
9 430 233 003	1	0 430 232 999	KDEL 65 S 1/13	0 433 271 815	DLLA 155 S 895	2 433 314 023	2 430 136 085
9 430 233 004	1	0 430 211 048	KCA 30 S 36/4	0 434 250 001	DN 0 SD 21	2 433 458 148	2 430 136 145
9 430 233 005	1	0 431 112 997	KBEL 90 P 5/13	0 433 171 010	DLLA 160 P 9	2 433 314 042	2 430 136 166
9 430 233 006	1	9 430 231 002	KBEL 90 P 18	0 433 171 057	DLLA 160 P 57	2 433 314 042	2 430 136 166
9 430 233 007	1	9 430 231 003	KBEL 90 P 18	0 433 171 058	DLLA 160 P 58		2 430 136 166
9 430 233 008	1	9 430 231 002	KBEL 90 P 18	0 433 171 063	DLLA 160 P 63	2 433 314 042	2 430 136 166
9 430 233 009	1	9 430 231 002	KBEL 90 P 18	0 433 171 057	DLLA 160 P 57	2 433 314 042	2 430 136 166
9 430 233 010	1	9 430 231 002	KBEL 90 P 18	0 433 171 057	DLLA 160 P 57	2 433 314 042	2 430 136 166
9 430 233 011	1	0 431 113 999	KBEL 96 P 6/13	0 433 171 051	DLLA 155 P 51	2 433 314 053	2 430 136 166
9 430 233 012	1	0 430 232 999	KDEL 65 S 1/13	0 433 271 806	DLLA 158 S 920	2 433 314 023	2 430 136 085
9 430 233 014	1	0 431 213 988	KBEL 95 S 19	0 433 271 802	DLLA 160 S 938	2 433 314 023	2 430 136 085
9 430 233 015	1	9 430 231 002	KBEL 90 P 18	0 433 171 086	DLLA 160 P 90	2 433 314 042	2 430 136 166
9 430 233 016	1	9 430 231 002	KBEL 90 P 18	0 433 171 058	DLLA 160 P 58	2 433 314 042	2 430 136 166
9 430 392 204	1	9 430 391 007	KBL 75 S 224/TR	9 430 394 100	DLLA 150 S 1070	9 433 314 307	
F 000 439 000	1	9 430 080 707	KBEL 80 P 58	F 000 430 300	DLLA 142 P 731	2 433 349 434	2 430 136 212
F 000 439 001	1	F 000 430 100	KBAL 85 P 81	F 000 430 301	DLLA 136 P 738	2 433 314 182	2 430 134 023
F 000 439 002	1	F 000 430 100	KBAL 85 P 81	F 000 430 302	DLLA 145 P 749	2 433 314 182	2 430 134 023
F 000 439 005	1	9 430 080 704	KDAL 74 P 17	F 000 430 900	DSLA 137 P 793	2 433 314 182	2 430 134 023
F 000 439 006	1	9 430 080 703	KDAL 74 P 15	F 000 430 304	DLLA 138 P 820	2 433 314 182	2 430 134 023
F 000 439 008	1	9 430 080 702	KDAL 59 P 11	F 000 430 306	DLLA 142 P 815	2 433 314 182	2 430 134 023
F 000 439 010	1	9 430 081 709	KBAL 150 P 47	F 000 430 307	DLLA 150 P 878	F 000 431 014	2 430 134 023
F 000 439 012	1	0 430 133 948	KDEL 109 P 62	F 000 430 308	DLLA 147 P 936	2 433 314 042	2 430 136 212
F 000 439 013	1	F 000 430 200	KDAL 74 P 36	F 000 430 902	DSLA 137 P 981	F 000 431 014	2 430 134 023
F 000 439 014	1	F 000 430 100	KBAL 85 P 81	F 000 430 903	DSLA 139 P 982	2 433 314 182	2 430 134 023
F 000 439 015	1	9 430 081 709	KBAL 150 P 47	F 000 430 904	DSLA 140 P 1002	F 000 431 014	2 430 134 023
F 000 439 017	1	0 430 132 005	KDAL 59 P 6	F 000 430 906	DSLA 141 P 1096	2 433 314 182	2 430 134 023
F 000 439 018	1	0 430 132 007	KDAL 59 P 9	F 000 430 907	DSLA 145 P 1160	2 433 314 182	2 430 134 023
F 000 439 019	1	0 430 132 005	KDAL 59 P 6	F 000 430 908	DSLA 145 P 1167	2 433 314 182	2 430 134 023
F 000 439 025	1			F 000 430 310	DLLA 140 P 1335	2 433 314 182	2 430 134 023
F 000 439 028	1	9 430 081 709	KBAL 150 P 47			F 000 431 014	2 430 134 023
F 002 C7Z 759	1	9 430 031 255	HB-KBL 80 S 192/4	F 002 C30 115	DLLA 146 S 1357	2 433 314 059	
F 002 C7Z 764	1	9 430 031 255	HB-KBL 80 S 192/4	F 002 C30 122	DLLA 148 S 1369	2 433 314 059	
F 002 C8Z 500	1	0 430 232 004	KDAL 74 S 3/19	F 002 C30 100	DLLA 142 S 1317	2 433 317 297	2 430 136 191
F 002 C8Z 501	1	0 430 232 004	KDAL 74 S 3/19	F 002 C30 104	DLLA 150 S 1325	2 433 317 297	2 430 136 191
F 002 C8Z 503	1	0 430 232 004	KDAL 74 S 3/19	F 002 C30 110	DLLA 142 S 1350	2 433 317 297	2 430 136 191
F 00Z 001 000	1			F 00Z 220 000	DLLA 148 P 694	2 433 314 182	2 430 134 023



2 433 124 446	2 434 614 020	1	2 433 462 014		2 916 710 602	
2 433 124 388	2 434 614 022	5				
2 433 120 127	2 434 614 022	5			2 916 710 605	2 430 100 048
2 433 124 380	2 434 619 040	5			2 916 710 602	
2 433 124 373	2 434 619 048	4				
2 433 120 127	2 434 614 022	5			2 916 710 605	2 430 100 048
2 433 120 127	2 434 614 022	5				2 430 100 048
2 433 120 127	2 434 614 022	5				2 430 100 048
2 433 120 127	2 434 614 022	5				2 430 100 048
2 433 120 127	2 434 614 022	5				2 430 100 048
2 433 120 127	2 434 614 022	5				2 430 100 048
2 433 120 127	2 434 614 022	5				2 430 100 048
2 433 120 127	2 434 614 022	5			2 916 710 602	
2 433 124 380	2 434 619 040	5			2 916 710 602	
2 433 124 379	2 434 619 040	5				
2 433 120 127	2 434 614 022	5				2 430 100 048
2 433 120 127	2 434 614 022	5				2 430 100 048
9 431 393 552	2 434 619 008			9 431 393 750		
2 433 124 376	2 434 614 040	3				
2 433 124 446	2 434 614 020	1				
2 433 124 446	2 434 614 020	1				
2 433 124 446	2 434 614 020	1	2 433 462 014		2 916 710 602	
2 433 124 446	2 434 614 028	1	2 433 462 014		2 916 710 602	
2 433 124 446	2 434 614 020	1	2 433 462 014			F 00V C17 503
2 433 124 376	2 434 614 040	3	2 433 462 131			
2 433 124 446	2 434 614 020	1	2 433 462 014		2 916 710 602	
2 433 124 446	2 434 614 020	1				
2 433 124 446	2 434 614 020	1				F 00V C17 503
2 433 124 446	2 434 614 020	1	2 433 462 014			
2 433 124 446	2 434 614 028	1	2 433 462 014			
2 433 124 446	2 434 614 020	1	2 433 462 014			F 00V C17 503
2 433 124 446	2 434 614 020	1	2 433 462 014			
2 433 124 446	2 434 614 020	1				
9 431 033 104	9 431 034 602	8				2 439 999 032
9 431 033 104	9 431 034 602	8				2 439 999 032
2 433 124 137	2 434 619 017	4			2 916 710 603	9 431 030 158
2 433 124 137	2 434 619 017	4			2 916 710 603	9 431 030 158
2 433 124 137	2 434 619 017	4			2 916 710 603	9 431 030 158
2 433 124 446	2 434 614 020	6				

*) siehe Seite 388/see page 388/voir page 388/ver pagina 388/vease página 388

**) siehe Seite 392/see page 392/voir page 392/ver pagina 392/vease página 392

A386

de
Teile für
Düsenhalter
 Zwischenscheiben

en
Parts for
nozzle-holders
 Shims

fr
Pièces pour
porte-injecteurs
 Disques
 intermédiaires

it
Ricambi per
portapolverizzatori
 Rosette intermedie

es
Piezas para
portainyectoros
 Arandelas
 intermedias



Zwischenscheiben/Shims/Disques intermédiaires/Rosette intermedie/Arandelas intermedias

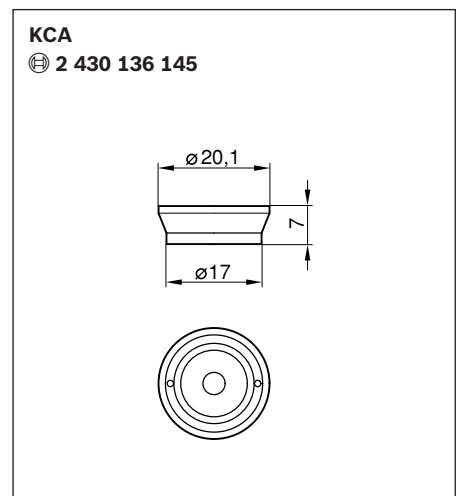
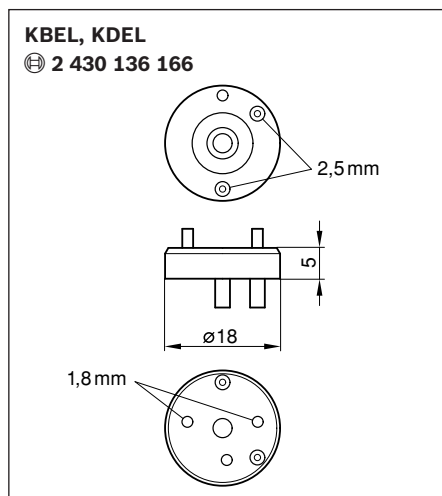
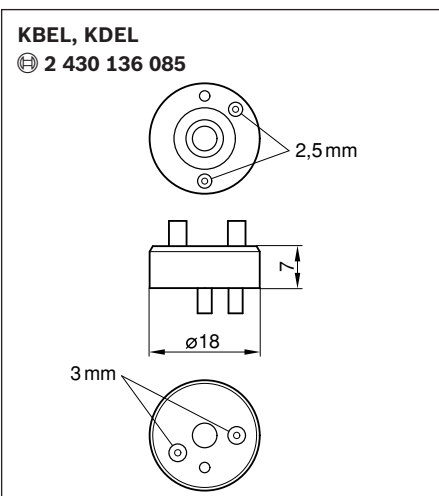
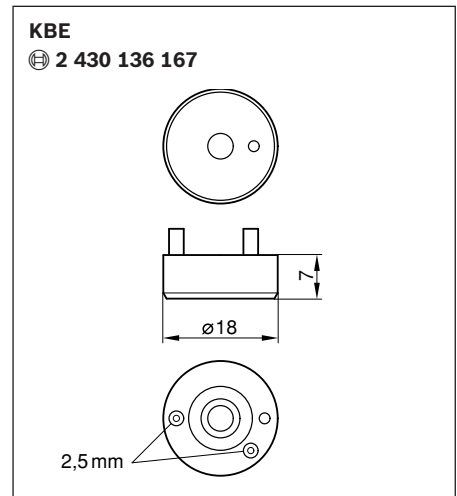
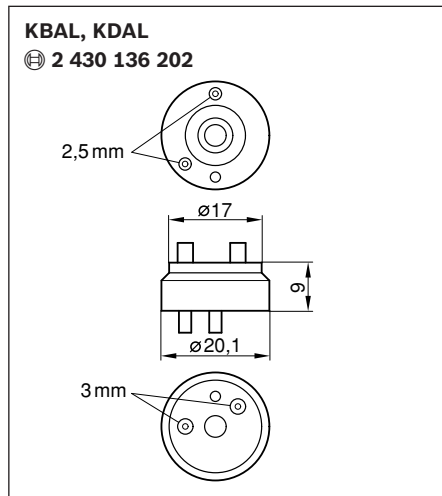
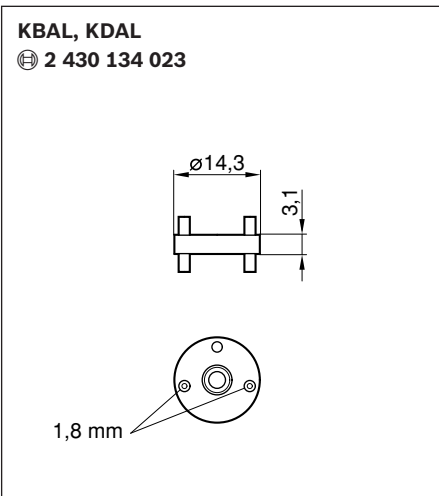
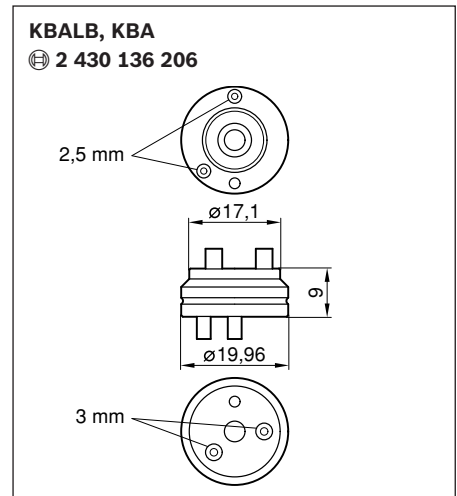
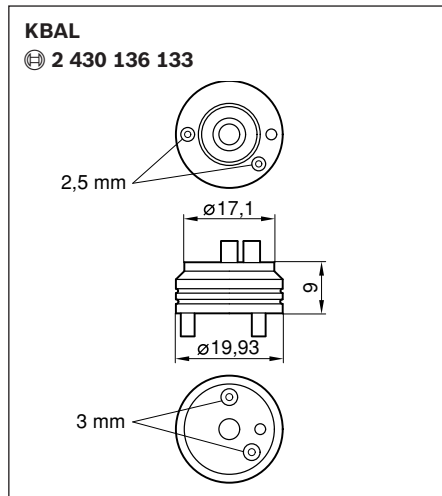
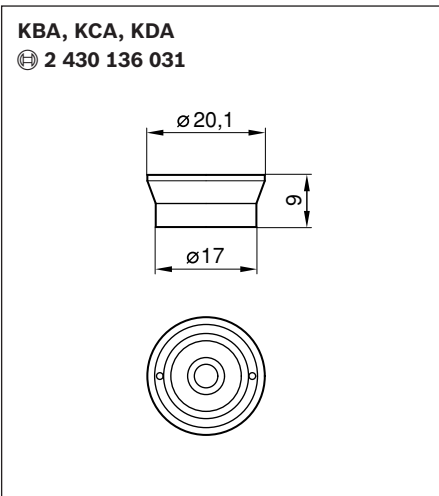

Zwischenscheiben/Shims/Disques intermédiaires/Rosette intermedia/Arandelas intermedias

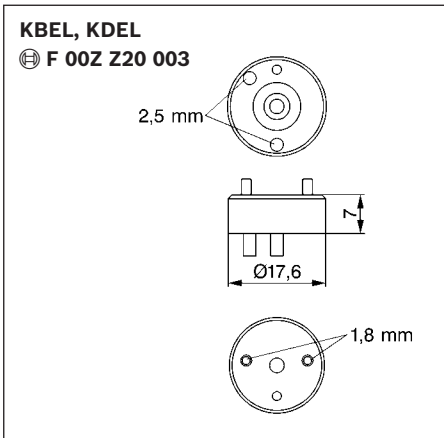
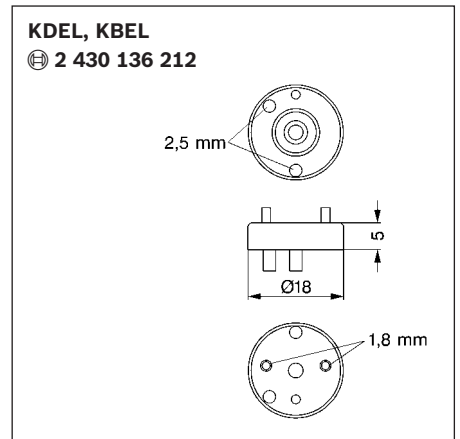
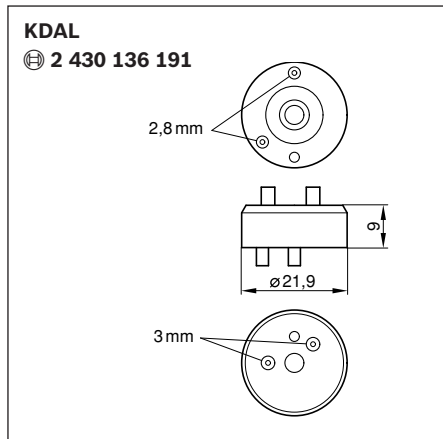
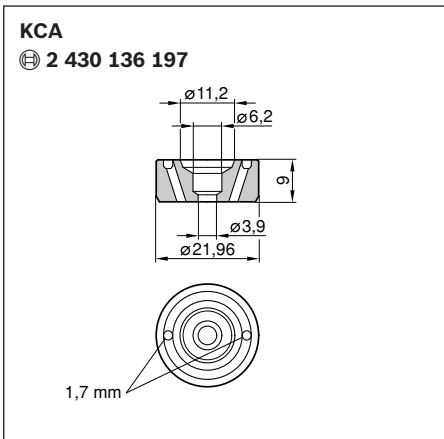

Druckbolzen/Pressure pin/Tiges-poussoirs/Perni di pressione/Pernos de presión

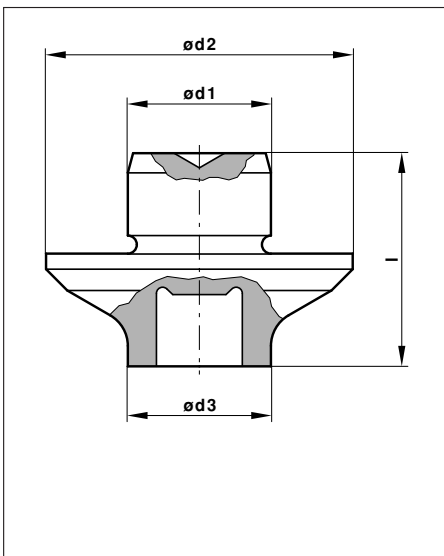

Einbau zwischen Druckfeder und Düsenhalter.
 Installation between spring and nozzle-holder.
 Montage entre le ressort de compression et l'aiguille d'injecteur.
 Montaggio tra molla di compressione e portapolverizzatore.
 Montaje entre resorte de compresión y portainyector.

Applikation	d1 mm	d2 mm	d3 mm	l mm	Ⓜ	ⓧ
KBA...S., KCA...S., KDAL...S.	5,5	11,3	5,0	10,4	2 433 124 137	-
KBAL...P., KDAL...P.	3,1	7,2	3,8	6,0	2 433 124 446	2 433 124 344
KBEL...P., KDEL...P.	3,9	8,0	3,8	6,15	2 433 127 376	-
KBEL...P., KDEL...P.	4,7	9,0	-	4,6	2 433 120 127	2 433 120 112
	4,7	9,0	3,8	6,15	2 433 124 388	2 433 124 352
KBEL...P.	3,9	8,0	3,8	8,15	F 00Z B20 002	-
KBEL...S., KDEL...S.	4,4	9,4	5,0	6,9	2 433 124 379	2 433 124 007
KCA...S.	4,1	9,4	5,0	6,9	2 433 124 380	-
	5,0	11,3	5,0	10,4	2 433 124 354	-
	5,1	11,0	5,0	6,7	2 433 124 161	-
	5,1	11,3	5,0	5,7	2 433 124 372	-

de	en	fr	it	es
Druckausgleichs- scheiben für Düsenhalter- kombinationen	Pressure compen- sation discs for nozzle-and-holder assemblies	Cales de réglage de pression pour ensembles porte- injecteurs	Rosette di com- pensazione della pressione per combinazione porta- polverizzatori	Arandelas de com- pensación de presión para conjuntos portainyectoros



Gruppe/Group/Groupé/Gruppo/Grupo 1

1,00	2 430 102 400	
1,02	2 430 101 036	2 430 102 402
1,04	2 430 101 037	2 430 102 404
1,06	2 430 101 038	2 430 102 406
1,08	2 430 101 039	2 430 102 408
1,01	2 430 101 040	2 430 102 410
1,12	2 430 101 041	2 430 102 412
1,14	2 430 101 042	2 430 102 414
1,16	2 430 101 043	2 430 102 416
1,18	2 430 101 044	2 430 102 418
1,20	2 430 101 045	2 430 102 420
1,22	2 430 101 046	2 430 102 422
1,24	2 430 101 047	2 430 102 424
1,26	2 430 101 048	2 430 102 426
1,28	2 430 101 049	2 430 102 428
1,30	2 430 101 050	2 430 102 430
1,32	2 430 101 051	2 430 102 432
1,34	2 430 101 052	2 430 102 434
1,36	2 430 101 053	2 430 102 436
1,38	2 430 101 054	2 430 102 438
1,40	2 430 101 055	2 430 102 440
1,42	2 430 101 056	2 430 102 442
1,44	2 430 101 057	2 430 102 444
1,46	2 430 101 058	2 430 102 446
1,48	2 430 101 059	2 430 102 448
1,50	2 430 101 060	2 430 102 450
1,52	2 430 101 061	2 430 102 452
1,54	2 430 101 062	2 430 102 454
1,56	2 430 101 063	2 430 102 456
1,58	2 430 101 064	2 430 102 458
1,60	2 430 101 065	2 430 102 460
1,62	2 430 101 066	2 430 102 462
1,64	2 430 101 067	2 430 102 464
1,66	2 430 101 068	2 430 102 466
1,68	2 430 101 069	2 430 102 468
1,70	2 430 101 070	2 430 102 470
1,72	2 430 101 071	2 430 102 472
1,74	2 430 101 072	2 430 102 474
1,76	2 430 101 073	2 430 102 476
1,78	2 430 101 074	2 430 102 478
1,80	2 430 101 075	2 430 102 480
1,82	2 430 101 076	2 430 102 482
1,84	2 430 101 077	2 430 102 484
1,86	2 430 101 078	2 430 102 486

Gruppe/Group/Groupé/Gruppo/Grupo 2

1,88	2 430 101 079	2 430 102 488
1,90	2 430 101 080	2 430 102 490
1,92	2 430 101 081	2 430 102 492
1,94	2 430 101 082	2 430 102 494
1,96	2 430 101 083	2 430 102 496
1,98	2 430 101 084	2 430 102 498
0,80	2 430 101 110	2 430 102 760
0,82	2 430 101 111	2 430 102 762
0,84	2 430 101 112	2 430 102 764
0,86	2 430 101 113	2 430 102 766
0,88	2 430 101 114	2 430 102 768
0,90	2 430 101 115	2 430 102 770
0,92	2 430 101 116	2 430 102 772
0,94	2 430 101 117	2 430 102 774
0,96	2 430 101 118	2 430 102 776
0,98	2 430 101 119	2 430 102 778
1,00	2 430 101 120	2 430 102 780
1,02	2 430 101 121	2 430 102 782
1,04	2 430 101 122	2 430 102 784
1,06	2 430 101 123	2 430 102 786
1,08	2 430 101 124	2 430 102 788
1,01	2 430 101 125	2 430 102 790
1,12	2 430 101 126	2 430 102 792
1,14	2 430 101 127	2 430 102 794
1,16	2 430 101 128	2 430 102 796
1,18	2 430 101 129	2 430 102 798
1,20	2 430 101 130	2 430 102 800
1,22	2 430 101 131	2 430 102 802
1,24	2 430 101 132	2 430 102 804
1,26	2 430 101 133	2 430 102 806
1,28	2 430 101 134	2 430 102 808
1,30	2 430 101 135	2 430 102 810
1,32	2 430 101 136	2 430 102 812
1,34	2 430 101 137	2 430 102 814
1,36	2 430 101 138	2 430 102 816
1,38	2 430 101 139	2 430 102 818
1,40	2 430 101 140	2 430 102 820
1,42	2 430 101 141	2 430 102 822
1,44	2 430 101 142	2 430 102 824
1,46	2 430 101 143	2 430 102 826

Gruppe/Group/Groupé/Gruppo/Grupo 3

1,48	2 430 101 144	2 430 102 828
1,50	2 430 101 145	2 430 102 830
1,52	2 430 101 146	2 430 102 832
1,54	2 430 101 147	2 430 102 834
1,56	2 430 101 148	2 430 102 836
1,58	2 430 101 149	2 430 102 838
1,60	2 430 101 150	2 430 102 840
1,62	2 430 101 151	2 430 102 842
1,64	2 430 101 152	2 430 102 844
1,66	2 430 101 153	2 430 102 846
1,68	2 430 101 154	2 430 102 848
1,70	2 430 101 155	2 430 102 850
1,72	2 430 101 156	2 430 102 852
1,74	2 430 101 157	2 430 102 854
1,76	2 430 101 158	2 430 102 856
1,78	2 430 101 159	2 430 102 858
1,80	2 430 101 160	2 430 102 860
1,82	2 430 101 161	2 430 102 862
1,84	2 430 101 162	2 430 102 864
1,86	2 430 101 163	2 430 102 866
1,88	2 430 101 164	2 430 102 868
1,90	2 430 101 165	2 430 102 870
1,92	2 430 101 166	2 430 102 872
1,94		2 430 102 874
1,96	2 430 101 168	2 430 102 876
1,98	2 430 101 169	2 430 102 878
1,00	2 430 101 800	2 430 102 300
1,02	2 430 101 801	2 430 102 302
1,04	2 430 101 802	2 430 102 304
1,06	2 430 101 803	2 430 102 306
1,08	2 430 101 804	2 430 102 308
1,01	2 430 101 805	2 430 102 310
1,12	2 430 101 806	2 430 102 312
1,14	2 430 101 807	2 430 102 314
1,16	2 430 101 808	2 430 102 316
1,18	2 430 101 809	2 430 102 318
1,20	2 430 101 810	2 430 102 320
1,22	2 430 101 811	2 430 102 322
1,24	2 430 101 812	2 430 102 324
1,26	2 430 101 813	2 430 102 326



1,28	2 430 101 814	2 430 102 328
1,30	2 430 101 815	2 430 102 330
1,32	2 430 101 816	2 430 102 332
1,34	2 430 101 817	2 430 102 334
1,36	2 430 101 818	2 430 102 336

1,38	2 430 101 819	2 430 102 338
1,40	2 430 101 820	2 430 102 340
1,42	2 430 101 821	2 430 102 342
1,44	2 430 101 822	2 430 102 344
1,46	2 430 101 823	2 430 102 346

1,48	2 430 101 824	2 430 102 348
1,50	2 430 101 825	2 430 102 350
1,52	2 430 101 826	2 430 102 352
1,54	2 430 101 827	2 430 102 354
1,56	2 430 101 828	2 430 102 356

1,58	2 430 101 829	2 430 102 358
1,60	2 430 101 830	2 430 102 360
1,62	2 430 101 831	2 430 102 362
1,64	2 430 101 832	2 430 102 364
1,66	2 430 101 833	2 430 102 366

1,68	2 430 101 834	2 430 102 368
1,70	2 430 101 835	2 430 102 370
1,72	2 430 101 836	2 430 102 372
1,74	2 430 101 837	2 430 102 374
1,76	2 430 101 838	2 430 102 376

1,78	2 430 101 839	2 430 102 378
1,80	2 430 101 840	2 430 102 380
1,82	2 430 101 841	2 430 102 382
1,84	2 430 101 842	2 430 102 384
1,86	2 430 101 843	2 430 102 386

1,88	2 430 101 844	2 430 102 388
1,90	2 430 101 845	2 430 102 390
1,92	2 430 101 846	2 430 102 392
1,94	2 430 101 847	2 430 102 394
1,96	2 430 101 848	2 430 102 396

1,98	2 430 101 849	2 430 102 398
------	----------------------	---------------

Gruppe/Group/Groupé/Gruppo/Grupo 4		
0,80	2 430 100 525	2 430 102 880
0,82	2 430 100 526	2 430 102 882
0,84	2 430 100 527	2 430 102 884
0,86	2 430 100 528	2 430 102 886



0,88	2 430 100 529	2 430 102 888
0,90	2 430 100 530	2 430 102 890
0,92	2 430 100 531	2 430 102 892
0,94	2 430 100 532	2 430 102 894
0,96	2 430 100 533	2 430 102 896

0,98	2 430 100 534	2 430 102 898
1,00	2 430 100 535	2 430 102 900
1,02	2 430 100 536	2 430 102 902
1,04	2 430 100 537	2 430 102 904
1,06	2 430 100 538	2 430 102 906

1,08	2 430 100 539	2 430 102 908
1,01	2 430 100 540	2 430 102 910
1,12	2 430 100 541	2 430 102 912
1,14	2 430 100 542	2 430 102 914
1,16	2 430 100 543	2 430 102 916

1,18	2 430 100 544	2 430 102 918
1,20	2 430 100 545	2 430 102 920
1,22	2 430 100 546	2 430 102 922
1,24	2 430 100 547	2 430 102 924
1,26	2 430 100 548	2 430 102 926

1,28	2 430 100 549	2 430 102 928
1,30	2 430 100 550	2 430 102 930
1,32	2 430 100 551	2 430 102 932
1,34	2 430 100 552	2 430 102 934
1,36	2 430 100 553	2 430 102 936

1,38	2 430 100 554	2 430 102 938
1,40	2 430 100 555	2 430 102 940
1,42	2 430 100 556	2 430 102 942
1,44	2 430 100 557	2 430 102 944
1,46	2 430 100 558	2 430 102 946

1,48	2 430 100 559	2 430 102 948
1,50	2 430 100 560	2 430 102 950
1,52	2 430 100 561	2 430 102 952
1,54	2 430 100 562	2 430 102 954
1,56	2 430 100 563	2 430 102 956

1,58	2 430 100 564	2 430 102 958
1,60	2 430 100 565	2 430 102 960
1,62	2 430 100 566	2 430 102 962
1,64	2 430 100 567	2 430 102 964
1,66	2 430 100 568	2 430 102 966

1,68	2 430 100 569	2 430 102 968
1,70	2 430 100 570	2 430 102 970
1,72	2 430 100 571	2 430 102 972
1,74	2 430 100 572	2 430 102 974
1,76	2 430 100 573	2 430 102 976



1,78	2 430 100 574	2 430 102 978
1,80	2 430 100 575	2 430 102 980
1,82	2 430 100 576	2 430 102 982
1,84	2 430 100 577	2 430 102 984
1,86	2 430 100 578	2 430 102 986

1,88	2 430 100 579	2 430 102 988
1,90	2 430 100 580	2 430 102 990
1,92	2 430 100 581	2 430 102 992
1,94	2 430 100 582	2 430 102 994
1,96	2 430 100 583	2 430 102 996

1,98	2 430 100 584	2 430 102 998
------	----------------------	---------------

Gruppe/Group/Groupé/Gruppo/Grupo 5		
0,80	2 430 101 500	2 430 101 680
0,82	2 430 101 501	2 430 101 682
0,84	2 430 101 502	2 430 101 684
0,86	2 430 101 503	2 430 101 686

0,88	2 430 101 504	2 430 101 688
0,90	2 430 101 505	2 430 101 690
0,92	2 430 101 506	2 430 101 692
0,94	2 430 101 507	2 430 101 694
0,96	2 430 101 508	2 430 101 696

0,98	2 430 101 509	2 430 101 698
1,02	2 430 101 511	2 430 101 702
1,06	2 430 101 513	2 430 101 706
1,08	2 430 101 514	2 430 101 708
1,01	2 430 101 515	2 430 101 710









1,14	2 430 101 517	2 430 101 714
1,18	2 430 101 519	2 430 101 718
1,22	2 430 101 521	2 430 101 722
1,26	2 430 101 523	2 430 101 726
1,34	2 430 101 527	2 430 101 734

1,38	2 430 101 529	2 430 101 738
1,42	2 430 101 531	2 430 101 742
1,46	2 430 101 533	2 430 101 746
1,50	2 430 101 535	2 430 101 750
1,54	2 430 101 537	2 430 101 754

1,58	2 430 101 539	2 430 101 758
1,60	2 430 101 540	2 430 101 760
1,62	2 430 101 541	2 430 101 762
1,66	2 430 101 543	2 430 101 766
1,68	2 430 101 544	2 430 101 768



de	en	fr	it	es
Druckausgleichs- scheiben für Düsenhalter- kombinationen (Fortsetzung)	Pressure compen- sation discs for nozzle-and-holder assemblies (continued)	Cales de réglage de pression pour ensembles porte- injecteurs (suite)	Rosette di com- pensazione della pressione per combinazione porta- polverizzatori (seguito)	Arandelas de com- pensación de presión para conjuntos portainyectores (continuación)

   alternativ			   alternativ			   alternativ		
1,70	2 430 101 545	2 430 101 770	1,58	2 430 101 255	2 430 102 158	Gruppe/Group/Groupé/Gruppo/Grupo 9		
1,74	2 430 101 547	2 430 101 774	1,60	2 430 101 256	2 430 102 160	1,00	2 430 100 051	-
1,76	2 430 101 548	2 430 101 776	1,62	2 430 101 257	2 430 102 162	1,02	2 430 100 451	-
1,78	2 430 101 549	2 430 101 778	1,64	2 430 101 258	2 430 102 164	1,05	2 430 100 052	-
1,82	2 430 101 551	2 430 101 782	1,66	2 430 101 259	2 430 102 166	1,07	2 430 100 452	-
1,84	2 430 101 552	2 430 101 784	1,68	2 430 101 260	2 430 102 168	1,10	2 430 100 053	-
1,86	2 430 101 553	2 430 101 786	1,70	2 430 101 261	2 430 102 170	1,12	2 430 100 453	-
1,90	2 430 101 555	2 430 101 790	1,72	2 430 101 262	2 430 102 172	1,15	2 430 100 055	-
1,92	2 430 101 556	2 430 101 792	1,74	2 430 101 263	2 430 102 174	1,17	2 430 100 454	-
1,94	2 430 101 557	2 430 101 794	1,76	2 430 101 264	2 430 102 176	1,20	2 430 100 056	-
1,98	2 430 101 559	2 430 101 798	1,78	2 430 101 265	2 430 102 178	1,22	2 430 100 455	-
			1,80	2 430 101 266	2 430 102 180	1,25	2 430 100 057	-
			1,82	2 430 101 267	2 430 102 182	1,27	2 430 100 456	-
			1,84	2 430 101 268	2 430 102 184	1,30	2 430 100 058	-
			1,86	2 430 101 269	2 430 102 186	1,32	2 430 100 457	-
			1,88	2 430 101 270	2 430 102 188	1,35	2 430 100 060	-
Gruppe/Group/Groupé/Gruppo/Grupo 6			1,90	2 430 101 271	2 430 102 190	1,37	2 430 100 458	-
1,00	2 430 101 226	2 430 102 100	1,92	2 430 101 272	2 430 102 192	1,40	2 430 100 061	-
1,02	2 430 101 227	2 430 102 102	1,94	2 430 101 273	2 430 102 194	1,42	2 430 100 459	-
1,04	2 430 101 228	2 430 102 104	1,96	2 430 101 274	2 430 102 196	1,45	2 430 100 063	-
1,06	2 430 101 229	2 430 102 106	1,98	2 430 101 275	2 430 102 198	1,47	2 430 100 460	-
1,08	2 430 101 230	2 430 102 108				1,50	2 430 100 064	-
1,10	2 430 101 231	2 430 102 110				1,52	2 430 100 461	-
1,12	2 430 101 232	2 430 102 112				1,55	2 430 100 065	-
1,14	2 430 101 233	2 430 102 114				1,57	2 430 100 462	-
1,16	2 430 101 234	2 430 102 116				1,60	2 430 100 066	-
1,18	2 430 101 235	2 430 102 118	Gruppe/Group/Groupé/Gruppo/Grupo 7			1,62	2 430 100 463	-
1,20	2 430 101 236	2 430 102 120	1,00	1 420 100 015	-	1,65	2 430 100 068	-
1,22	2 430 101 237	2 430 102 122	0,10	1 420 100 645	-	1,67	2 430 100 464	-
1,24	2 430 101 238	2 430 102 124	0,20	1 420 100 647	-	1,70	2 430 100 069	-
1,26	2 430 101 239	2 430 102 126	0,50	1 420 100 649	-	1,72	2 430 100 465	-
1,28	2 430 101 240	2 430 102 128	0,15	1 590 100 600	-	1,75	2 430 100 070	-
1,30	2 430 101 241	2 430 102 130	0,25	2 430 100 046	-	1,77	2 430 100 466	-
1,32	2 430 101 242	2 430 102 132	2,00	2 430 100 615	-	1,80	2 430 100 072	-
1,34	2 430 101 243	2 430 102 134				1,82	2 430 100 467	-
1,36	2 430 101 244	2 430 102 136				1,85	2 430 100 073	-
1,38	2 430 101 245	2 430 102 138	Gruppe/Group/Groupé/Gruppo/Grupo 8			1,87	2 430 100 468	-
1,40	2 430 101 246	2 430 102 140	0,35	2 430 100 601	-	1,90	2 430 100 074	-
1,42	2 430 101 247	2 430 102 142	0,40	2 430 100 602	-	1,92	2 430 100 469	-
1,44	2 430 101 248	2 430 102 144	0,45	2 430 100 603	-	1,95	2 430 100 075	-
1,46	2 430 101 249	2 430 102 146	0,50	2 430 100 604	-	1,97	2 430 100 470	-
1,48	2 430 101 250	2 430 102 148	0,55	2 430 100 605	-			
1,50	2 430 101 251	2 430 102 150	0,60	2 430 100 606	-			
1,52	2 430 101 252	2 430 102 152	1,00	2 430 103 005	-			
1,54	2 430 101 253	2 430 102 154	2,00	2 430 103 006	-			
1,58	2 430 101 254	2 430 102 156						

**Gruppe/Group/Groupé/Gruppo/Grupo 10**

1,00	2 430 100 157	-
1,05	2 430 100 158	-
1,15	2 430 100 160	-
1,20	2 430 100 161	-

1,65	2 430 100 170	-
1,80	2 430 100 173	-
1,85	2 430 100 174	-
1,90	2 430 100 175	-

Gruppe/Group/Groupé/Gruppo/Grupo 11

1,00	2 430 100 360	-
1,05	2 430 100 340	-
1,10	2 430 100 341	-
1,15	2 430 100 342	-

1,20	2 430 100 343	-
1,25	2 430 100 344	-
1,30	2 430 100 345	-
1,35	2 430 100 346	-
1,40	2 430 100 347	-

1,45	2 430 100 348	-
1,50	2 430 100 349	-
1,55	2 430 100 350	-
1,60	2 430 100 351	-
1,65	2 430 100 352	-

1,70	2 430 100 353	-
1,75	2 430 100 354	-
1,80	2 430 100 355	-
1,85	2 430 100 356	-
1,90	2 430 100 357	-

1,95	2 430 100 358	-
2,00	2 430 100 359	-

Gruppe/Group/Groupé/Gruppo/Grupo 12

1,00	2 430 100 477	-
1,05	2 430 100 478	-
1,10	2 430 100 479	-
1,15	2 430 100 480	-

1,20	2 430 100 481	-
1,25	2 430 100 482	-
1,30	2 430 100 483	-
1,35	2 430 100 484	-
1,40	2 430 100 485	-



1,45	2 430 100 486	-
1,50	2 430 100 487	-
1,55	2 430 100 488	-
1,60	2 430 100 489	-
1,65	2 430 100 490	-

1,70	2 430 100 491	-
1,75	2 430 100 492	-
1,80	2 430 100 493	-
1,85	2 430 100 494	-
1,90	2 430 100 495	-

1,95	2 430 100 496	-
------	---------------	---

Gruppe/Group/Groupé/Gruppo/Grupo 13

2,00	9 432 360 350	-
1,90	9 432 360 351	-
1,80	9 432 360 352	-
1,70	9 432 360 353	-

1,60	9 432 360 354	-
1,50	9 432 360 355	-
1,40	9 432 360 356	-
1,30	9 432 360 357	-
1,20	9 432 360 358	-

1,10	9 432 360 359	-
1,00	9 432 360 360	-

Gruppe/Group/Groupé/Gruppo/Grupo 14

1,00	2 430 103 100	-
1,02	2 430 103 102	-
1,04	2 430 103 104	-
1,06	2 430 103 106	-

1,08	2 430 103 108	-
1,10	2 430 103 110	-
1,12	2 430 103 112	-
1,14	2 430 103 114	-
1,16	2 430 103 116	-

1,18	2 430 103 118	-
1,20	2 430 103 120	-
1,22	2 430 103 122	-
1,24	2 430 103 124	-
1,26	2 430 103 126	-



1,28	2 430 103 128	-
1,30	2 430 103 130	-
1,32	2 430 103 132	-
1,34	2 430 103 134	-
1,36	2 430 103 136	-

1,38	2 430 103 138	-
1,40	2 430 103 140	-
1,42	2 430 103 142	-
1,44	2 430 103 144	-
1,46	2 430 103 146	-

1,48	2 430 103 148	-
1,50	2 430 103 150	-
1,52	2 430 103 152	-
1,54	2 430 103 154	-
1,56	2 430 103 156	-

1,58	2 430 103 158	-
1,60	2 430 103 160	-
1,62	2 430 103 162	-
1,64	2 430 103 164	-
1,66	2 430 103 166	-

1,68	2 430 103 168	-
1,70	2 430 103 170	-
1,72	2 430 103 172	-
1,74	2 430 103 174	-
1,76	2 430 103 176	-

1,78	2 430 103 178	-
1,80	2 430 103 180	-
1,82	2 430 103 182	-
1,84	2 430 103 184	-
1,86	2 430 103 186	-

1,88	2 430 103 188	-
1,90	2 430 103 190	-
1,92	2 430 103 192	-
1,94	2 430 103 194	-
1,96	2 430 103 196	-

1,98	2 430 103 198	-
------	---------------	---



A392

de
**Druckstifte
für Düsenhalter-
kombinationen**

en
**Pressure pins for
nozzle-and-holder
assemblies**

fr
**Poussoirs pour
ensembles porte-
injecteurs**

it
**Spine di pressione
per combinazione
portapolverizzatori**

es
**Espigas de presión
para conjuntos
portainyectoros**



Gruppe/Group/Groupé/Gruppo/Grupo A	
28,51	2 433 101 302
28,53	2 433 101 304
28,55	2 433 101 306
28,57	2 433 101 308
28,59	2 433 101 310
28,61	2 433 101 312
28,63	2 433 101 314
28,65	2 433 101 316
28,67	2 433 101 318
28,69	2 433 101 320
28,71	2 433 101 322
28,73	2 433 101 324
28,75	2 433 101 326
28,77	2 433 101 328
28,79	2 433 101 330
28,81	2 433 101 332
28,83	2 433 101 334
28,85	2 433 101 336
28,87	2 433 101 338
28,89	2 433 101 340
28,91	2 433 101 342
28,93	2 433 101 344
28,95	2 433 101 346
28,97	2 433 101 348
28,99	2 433 101 350
29,01	2 433 101 352
29,03	2 433 101 354
29,05	2 433 101 356
29,07	2 433 101 358
29,09	2 433 101 360
29,11	2 433 101 362
29,15	2 433 101 366
29,17	2 433 101 368
29,19	2 433 101 370
29,21	2 433 101 372
29,23	2 433 101 374
29,25	2 433 101 376
29,27	2 433 101 378
29,29	2 433 101 380
29,31	2 433 101 382
29,33	2 433 101 384
29,35	2 433 101 386
29,37	2 433 101 388
29,39	2 433 101 390

29,41	2 433 101 392
29,43	2 433 101 394
29,49	2 433 101 400
Gruppe/Group/Groupé/Gruppo/Grupo B	
33,80	2 433 101 200
33,82	2 433 101 202
33,84	2 433 101 204
33,86	2 433 101 206
33,88	2 433 101 208
33,90	2 433 101 210
33,92	2 433 101 212
33,94	2 433 101 214
33,96	2 433 101 216
33,98	2 433 101 218
34,00	2 433 101 220
34,02	2 433 101 222
34,04	2 433 101 224
34,06	2 433 101 226
34,08	2 433 101 228
34,10	2 433 101 230
34,12	2 433 101 232
34,14	2 433 101 234
34,16	2 433 101 236
34,18	2 433 101 238
34,20	2 433 101 240
34,22	2 433 101 242
34,24	2 433 101 244
34,26	2 433 101 246
34,28	2 433 101 248
34,30	2 433 101 250
34,32	2 433 101 252
34,34	2 433 101 254
34,36	2 433 101 256
34,38	2 433 101 258
34,40	2 433 101 260
34,42	2 433 101 262
34,44	2 433 101 264
34,46	2 433 101 266
34,48	2 433 101 268
34,50	2 433 101 270
34,54	2 433 101 274
34,56	2 433 101 276
34,62	2 433 101 282

34,66	2 433 101 286
34,68	2 433 101 288
34,76	2 433 101 296
34,78	2 433 101 298
Gruppe/Group/Groupé/Gruppo/Grupo C	
43,82	2 433 101 102
43,86	2 433 101 106
43,88	2 433 101 108
43,90	2 433 101 110
43,92	2 433 101 112
43,94	2 433 101 114
43,96	2 433 101 116
43,98	2 433 101 118
44,00	2 433 101 120
44,02	2 433 101 122
44,04	2 433 101 124
44,06	2 433 101 126
44,08	2 433 101 128
44,10	2 433 101 130
44,12	2 433 101 132
44,14	2 433 101 134
44,16	2 433 101 136
44,18	2 433 101 138
44,20	2 433 101 140
44,22	2 433 101 142
44,24	2 433 101 144
44,26	2 433 101 146
44,28	2 433 101 148
44,30	2 433 101 150
44,34	2 433 101 154
44,36	2 433 101 156
44,38	2 433 101 158
44,40	2 433 101 160
44,42	2 433 101 162
44,44	2 433 101 164
44,46	2 433 101 166
44,48	2 433 101 168
44,50	2 433 101 170
44,52	2 433 101 172
44,60	2 433 101 180
44,62	2 433 101 182
44,64	2 433 101 184
44,66	2 433 101 186
44,68	2 433 101 188

de

**Teile
für Düsenhalter**
Anschlusssteile,
Dichtungen

en

**Parts
for nozzle-holders**
Connection hardware,
seals

fr

**Pièces
pour porte-injecteurs**
Raccords, joints

it

**Ricambi per
portapolverizzatori**
Pezzi di collegamento,
guarnizioni

es

**Piezas
para portainyectoros**
Piezas de empalme,
juntas



① **Überwurfmuttern**
für Druckleitungen

Gewinde	Bestellnummer
M 12 x 1,5	1 413 313 051
M 14 x 1,5	1 413 313 043

① **Union nuts**
for pressure lines

Thread	Part number
M 12 x 1.5	1 413 313 051
M 14 x 1.5	1 413 313 043

① **Ecrous-raccords**
pour conduites de refoulement

Taraudage	Référence
M 12 x 1,5	1 413 313 051
M 14 x 1,5	1 413 313 043

② **Druckscheiben** (unter Überwurfmutter)
für Druckleitungen

Für Überwurfmutter	Bestellnummer
M 12 x 1,5	1 410 103 025
M 14 x 1,5	1 410 103 023
M 22 x 1,5	1 410 103 033

② **Pressure discs** (underneath
union nut) for pressure lines

For union nut	Part number
M 12 x 1.5	1 410 103 025
M 14 x 1.5	1 410 103 023
M 22 x 1.5	1 410 103 033

② **Rondelles de pression** (sous écrou-
raccord) pour conduites de refoulement

Pour écrou-raccord	Référence
M 12 x 1,5	1 410 103 025
M 14 x 1,5	1 410 103 023
M 22 x 1,5	1 410 103 033

③ **Sechskantmuttern**
(über Ringstutzen)

Verwendung	Gewinde	Bestellnummer
KBL, KDAL	M 14 x 1,5	2 433 300 003
KC	M 14 x 1,5	2 433 300 007
KCA	M 12 x 1,5	2 433 300 000
KD, KDL ..	M 8 x 0,75	2 433 300 010

③ **Hexagon nuts**
(over ring fitting)

Application	Thread	Part number
KBL, KDAL	M 14 x 1.5	2 433 300 003
KC	M 14 x 1.5	2 433 300 007
KCA	M 12 x 1.5	2 433 300 000
KD, KDL ..	M 8 x 0.75	2 433 300 010

③ **Ecrous hexagonaux**
(sur raccords orientables)

Utilisation	Taraudage	Référence
KBL, KDAL	M 14 x 1,5	2 433 300 003
KC	M 14 x 1,5	2 433 300 007
KCA	M 12 x 1,5	2 433 300 000
KD, KDL ..	M 8 x 0,75	2 433 300 010

④ **Ringstutzen**

Verwendung	Anschluss	Bestellnummer
KBL, KDAL	M 8 x 1	2 433 385 026
KC	M 8 x 1	2 433 385 026
	M 10 x 1	2 433 385 025
KCA	M 8 x 1	2 433 385 005

④ **Ring fittings**

Application	Connection	Part number
KBL, KDAL	M 8 x 1	2 433 385 026
KC	M 8 x 1	2 433 385 026
	M 10 x 1	2 433 385 025
KCA	M 8 x 1	2 433 385 005

④ **Raccords orientables**

Utilisation	Orifice	Référence
KBL, KDAL	M 8 x 1	2 433 385 026
KC	M 8 x 1	2 433 385 026
	M 10 x 1	2 433 385 025
KCA	M 8 x 1	2 433 385 005

⑤ **Dichtringe**
(unter Ringstutzen)

Verwendung	Bestellnummer
KBL, KDAL, KC	2 430 290 002
KCA	ohne Dichtring

⑤ **Seal rings**
(under ring fittings)

Application	Part number
KBL, KDAL, KC	2 430 290 002
KCA	without seal ring

⑤ **Joints circulaires**
(sous raccords orientables)

Utilisation	Référence
KBL, KDAL, KC	2 430 290 002
KCA	sans joint

⑥ **Hohlschrauben**

Gewinde	Bestellnummer
M 8 x 1	2 911 202 700
M 10 x 1	2 911 202 701
M 12 x 1,5	2 911 202 702

⑥ **Banjo bolts**

Thread	Part number
M 8 x 1	2 911 202 700
M 10 x 1	2 911 202 701
M 12 x 1.5	2 911 202 702

⑥ **Vis creuses**

Filetage	Référence
M 8 x 1	2 911 202 700
M 10 x 1	2 911 202 701
M 12 x 1,5	2 911 202 702



① **Dadi di raccordo**
per tubazioni di mandata

Filettatura	Numero d'ordinazione
M 12 x 1,5	1 413 313 051
M 14 x 1,5	1 413 313 043

② **Rosette di spinta** (sotto il dado di raccordo) per tubazioni di mandata

Per dado di raccordo	Numero d'ordinazione
M 12 x 1,5	1 410 103 025
M 14 x 1,5	1 410 103 023
M 22 x 1,5	1 410 103 033

③ **Dadi esagonali**
(sopra raccordo anulare)

Impiego	Filettatura	Numero d'ordinazione
KBL, KDAL	M 14 x 1,5	2 433 300 003
KC	M 14 x 1,5	2 433 300 007
KCA	M 12 x 1,5	2 433 300 000
KD, KDL ..	M 8 x 0,75	2 433 300 010

④ **Raccordi anulari**

Impiego	Collegamento	Numero d'ordinazione
KBL, KDAL	M 8 x 1	2 433 385 026
KC	M 8 x 1	2 433 385 026
	M 10 x 1	2 433 385 025
KCA	M 8 x 1	2 433 385 005

⑤ **Anelli di tenuta**
(sotto raccordo anulare)

Impiego	Numero d'ordinazione
KBL, KDAL, KC	2 430 290 002
KCA	senza anello di tenuta

⑥ **Viti cave**

Filettatura	Numero d'ordinazione
M 8 x 1	2 911 202 700
M 10 x 1	2 911 202 701
M 12 x 1,5	2 911 202 702

① **Tuercas de racor**
para tuberías de presión

Rosca	Número de pedido
M 12 x 1,5	1 413 313 051
M 14 x 1,5	1 413 313 043

② **Arandelas de presión** (debajo de la tuerca de racor) para tuberías de presión

Para tuerca de racor	Número de pedido
M 12 x 1,5	1 410 103 025
M 14 x 1,5	1 410 103 023
M 22 x 1,5	1 410 103 033

③ **Tuercas hexagonales**
(sobre tubuladura anular)

Empleo	Rosca	Número de pedido
KBL, KDAL	M 14 x 1,5	2 433 300 003
KC	M 14 x 1,5	2 433 300 007
KCA	M 12 x 1,5	2 433 300 000
KD, KDL ..	M 8 x 0,75	2 433 300 010

④ **Tubuladura anular**

Empleo	Empalme	Número de pedido
KBL, KDAL	M 8 x 1	2 433 385 026
KC	M 8 x 1	2 433 385 026
	M 10 x 1	2 433 385 025
KCA	M 8 x 1	2 433 385 005

⑤ **Juntas anulares**
(debajo de tubuladura anular)

Empleo	Número de pedido
KBL, KDAL, KC	2 430 290 002
KCA	sin junta anular

⑥ **Tornillos huecos**

Rosca	Número de pedido
M 8 x 1	2 911 202 700
M 10 x 1	2 911 202 701
M 12 x 1,5	2 911 202 702



de

Teile für Düsenhalter
Anschlusssteile,
Dichtungen
(Fortsetzung)

en

Parts for nozzle-holders
Connection hardware,
seals
(continued)

fr

Pièces pour porte-injecteurs
Raccords, joints
(suite)

it

Ricambi per portapolverizzatori
Pezzi di collegamento,
guarnizioni
(seguito)

es

Piezas para portainyectoros
Piezas de empalme,
juntas
(continuación)



⑦ Leckölschrauben

Verwendung	Gewinde	Bestellnummer
KC, KD, KDL..	M 8x1	2 433 456 035
KDAL, KDEL ..	M 6	2 433 456 034

⑦ Leak-oil return screws

Application	Thread	Part number
KC, KD, KDL..	M 8x1	2 433 456 035
KDAL, KDEL ..	M 6	2 433 456 034

⑦ Vis pour huile de fuite

Utilisation	Filetage	Référence
KC, KD, KDL..	M 8x1	2 433 456 035
KDAL, KDEL ..	M 6	2 433 456 034

⑧ Kupferflachdichtringe

Abmessungen mm	für Gewinde	Bestellnummer
6x10	M 6x1	2 916 710 602
8x11,5	M 8x1	2 916 710 603
12x15,5	M 12x1,5	2 916 710 607
12x17	M 12x1,5	2 916 710 650
12x18	M 12x1,5	2 916 710 608

⑧ Flat copper seal rings

Dimensions mm	For thread	Part number
6x10	M 6x1	2 916 710 602
8x11,5	M 8x1	2 916 710 603
12x15,5	M 12x1,5	2 916 710 607
12x17	M 12x1,5	2 916 710 650
12x18	M 12x1,5	2 916 710 608

⑧ Joints plats en cuivre

Dimensions mm	pour filetage	Référence
6x10	M 6x1	2 916 710 602
8x11,5	M 8x1	2 916 710 603
12x15,5	M 12x1,5	2 916 710 607
12x17	M 12x1,5	2 916 710 650
12x18	M 12x1,5	2 916 710 608

⑨ Dichtscheiben (zwischen Rohr-anschlussstutzen und Düsenhalter)

Verwendung	Abmessungen mm	Bestellnummer
KBAL .., KDEL ..	10,5x4,5x1	2 430 100 237
KB .., KD, KDA, KDL	12,0x6,5x1	2 430 100 040
KB ..	15,8x7,5x1,5	2 430 100 000

⑨ Sealing disc (between pipe fitting and nozzle-holder)

Application	Dimensions mm	Part number
KBAL .., KDEL ..	10.5x4.5x1	2 430 100 237
KB .., KD, KDA, KDL	12.0x6.5x1	2 430 100 040
KB ..	15.8x7.5x1.5	2 430 100 000

⑨ Rondelles d'étanchéité (entre raccord de tuyauterie et porte-injecteur)

Utilisation	Dimensions mm	Référence
KBAL .., KDEL ..	10,5x4,5x1	2 430 100 237
KB .., KD, KDA, KDL	12,0x6,5x1	2 430 100 040
KB ..	15,8x7,5x1,5	2 430 100 000

⑩ Dichtring (zur Abdichtung der Düsenstanzmutter)

Verwendung	Abmessungen mm	Bestellnummer
KDAL	19,3x1,35x1,7	F 00Z G20 000

⑩ Seal ring (for sealing the nozzle-retaining nut)

Application	Dimensions mm	Part number
KDAL	19.3x1.35x1.7	F 00Z G20 000

⑩ Joint circulaire (étanchéité au niveau de l'écrou de serrage de l'injecteur)

Utilisation	Dimensions mm	Référence
KDAL	19,3x1,35x1,7	F 00Z G20 000

⑪ Dichtring (zur Abdichtung am Düsenhalterschaft)

Verwendung	Abmessungen mm	Bestellnummer
2-Federhalter (Opel)	14,0x1,7x5,5	2 430 223 003

⑪ Seal ring (for sealing the nozzle-holder stem)

Application	Dimensions mm	Part number
2-spring nozzle holder (Opel)	14.0x1.7x5.5	2 430 223 003

⑪ Joint circulaire (étanchéité au niveau du fût du porte-injecteur)

Utilisation	Dimensions mm	Référence
Porte-injecteur à 2 ressorts (Opel)	14,0x1,7x5,5	2 430 223 003

⑫ O-Ring (zur Abdichtung am Düsenhalterschaft)

Verwendung	Abmessungen mm	Bestellnummer
KDEL	18,77x1,78	2 430 210 005
KDEL	20,3x2,4	2 430 210 027
Stufenhalter	18,64x3,5	2 430 210 083
	20,9x3,0	2 430 210 081

⑫ O-ring (for sealing the nozzle-holder stem)

Application	Dimensions mm	Part number
KDEL	18.77x1.78	2 430 210 005
KDEL	20.3x2.4	2 430 210 027
Step-type nozzle-holder	18.64x3.5	2 430 210 083
	20.9x3.0	2 430 210 081

⑫ Joint toriques (étanchéité au niveau du fût du porte-injecteur)

Utilisation	Dimensions mm	Référence
KDEL	18,77x1,78	2 430 210 005
KDEL	20,3x2,4	2 430 210 027
Porte-injecteur étagé	18,64x3,5	2 430 210 083
	20,9x3,0	2 430 210 081

⑦ Viti olio di trafilamento

Impiego	Filettatura	Numero d'ordinazione
KC, KD, KDL..	M 8x1	2 433 456 035
KDAL, KDEL ..	M 6	2 433 456 034

⑦ Tornillos de aceite de fuga

Empleo	Rosca	Número de pedido
KC, KD, KDL..	M 8x1	2 433 456 035
KDAL, KDEL ..	M 6	2 433 456 034

⑧ Anelli di tenuta piatti in rame

Dimensioni mm	per filettatura	Numero d'ordinazione
6x10	M 6x1	2 916 710 602
8x11,5	M 8x1	2 916 710 603
12x15,5	M 12x1,5	2 916 710 607
12x17	M 12x1,5	2 916 710 650
12x18	M 12x1,5	2 916 710 608

⑧ Juntas anulares planas de cobre

Dimensiones mm	para rosca	Número de pedido
6x10	M 6x1	2 916 710 602
8x11,5	M 8x1	2 916 710 603
12x15,5	M 12x1,5	2 916 710 607
12x17	M 12x1,5	2 916 710 650
12x18	M 12x1,5	2 916 710 608

⑨ Rosette di tenuta (tra raccordo collegamento tubo e portapolverizzatore)

Impiego	Dimensioni mm	Numero d'ordinazione
KBAL .., KDEL ..	10,5x4,5x1	2 430 100 237
KB .., KD, KDA, KDL	12,0x6,5x1	2 430 100 040
KB ..	15,8x7,5x1,5	2 430 100 000

⑨ Arandelas estanqueizantes (entre tubuladura de empalme de tubo y portainyector)

Empleo	Dimensiones mm	Número de pedido
KBAL .., KDEL ..	10,5x4,5x1	2 430 100 237
KB .., KD, KDA, KDL	12,0x6,5x1	2 430 100 040
KB ..	15,8x7,5x1,5	2 430 100 000

⑩ Anello di tenuta (per ermetizzazione del dato di serraggio pulverizzatore)

Impiego	Dimensioni mm	Numero d'ordinazione
KDAL	19,3x1,35x1,7	F 00Z G20 000

⑩ Junta anular (para el estanqueizado de la tuerca tensora de inyector)

Empleo	Dimensiones mm	Número de pedido
KDAL	19,3x1,35x1,7	F 00Z G20 000

⑪ Anello di tenuta (per ermetizzazione su corpo portapolverizzatore)

Impiego	Dimensioni mm	Numero d'ordinazione
Portapolverizzatore a 2 molle (Opel)	14,0x1,7x5,5	2 430 223 003

⑪ Junta anular (para el estanqueizado en el vástago del portainyector)

Empleo	Dimensiones mm	Número de pedido
Portainyector de 2 resortes (Opel)	14,0x1,7x5,5	2 430 223 003

⑫ O-Ring (per ermetizzazione su corpo portapolverizzatore)

Impiego	Dimensioni mm	Numero d'ordinazione
KDEL	18,77x1,78	2 430 210 005
KDEL	20,3x2,4	2 430 210 027
Portapolverizzatore a gradino	18,64x3,5	2 430 210 083
	20,9x3,0	2 430 210 081

⑫ Anillo toroidal (para el estanqueizado en el vástago de portainyector)

Empleo	Dimensiones mm	Número de pedido
KDEL	18,77x1,78	2 430 210 005
KDEL	20,3x2,4	2 430 210 027
Portainyector escalonado	18,64x3,5	2 430 210 083
	20,9x3,0	2 430 210 081

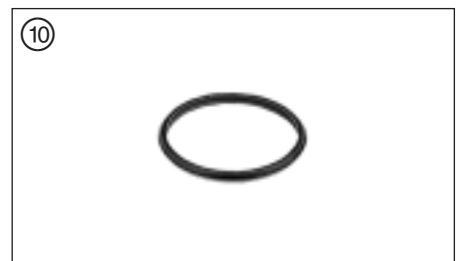

<p>de</p> <p>Teile für Düsenhalter Anschlusssteile, Dichtungen (Fortsetzung)</p>	<p>en</p> <p>Parts for nozzle-holders Connection hardware, seals (continued)</p>	<p>fr</p> <p>Pièces pour porte-injecteurs Raccords, joints (suite)</p>	<p>it</p> <p>Ricambi per portapolverizzatori Pezzi di collegamento, guarnizioni (seguito)</p>	<p>es</p> <p>Piezas para portainyectoros Piezas de empalme, juntas (continuación)</p>
--	--	--	---	---



13 14 Anschlussstutzen (Leckölrücklauf)

Verwendung	Abb.	Bestellnummer
2-Federhalter mit/ohne Nadelbewegungsfühler	13 a	2 430 795 005
	b	2 430 795 003
	14	2 430 795 006

13 14 Fittings (Leakage return)

Application	Fig.	Part number
2-spring nozzle holder with/without needle-motion sensor	13 a	2 430 795 005
	b	2 430 795 003
	14	2 430 795 006

13 14 Raccords (Retour d'huile de fuite)

Utilisation	Fig.	Référence
Porte-injecteur à 2 ressorts avec/sans capteur de déplacement	13 a	2 430 795 005
	b	2 430 795 003
	14	2 430 795 006

15 Gewindegewindeschutzhappen (Verschlusskappen)

Verwendung	Außen-gewinde	Bestellnummer
Innen-gewinde		
M 8 x 1	M 6	1 900 508 002
M 10	-	1 900 508 003
M 10 x 1	M 8 x 1	1 900 508 004
-	M 12 x 1	1 900 508 009
M 12 x 1,5	-	1 900 508 005
	M 12 x 1,5	1 900 508 009
M 14 x 1,5	-	1 900 508 008
-	M 14 x 1,5	1 900 508 011

15 Threaded protective caps (sealing caps)

Application	External Thread	Part number
Internal Thread		
M 8 x 1	M 6	1 900 508 002
M 10	-	1 900 508 003
M 10 x 1	M 8 x 1	1 900 508 004
-	M 12 x 1	1 900 508 009
M 12 x 1,5	-	1 900 508 005
	M 12 x 1,5	1 900 508 009
M 14 x 1,5	-	1 900 508 008
-	M 14 x 1,5	1 900 508 011

15 Capuchons de protection (obturateurs filetés)

Utilisation	Filetage	Référence
Taroudage		
M 8 x 1	M 6	1 900 508 002
M 10	-	1 900 508 003
M 10 x 1	M 8 x 1	1 900 508 004
-	M 12 x 1	1 900 508 009
M 12 x 1,5	-	1 900 508 005
	M 12 x 1,5	1 900 508 009
M 14 x 1,5	-	1 900 508 008
-	M 14 x 1,5	1 900 508 011

16 Senkschraube

Verwendung	Gewinde	Bestellnummer
	M 6	2 433 421 001

16 Countersunk screw

Application	Thread	Part number
	M 6	2 433 421 001

16 Vis à tête fraisée

Utilisation	Filetage	Référence
	M 6	2 433 421 001



13 14 Raccordo di collegamento
(ritorno olio trafileamento)

Impiego	Fig.	Numero d'ordinazione
Portapolverizzatore a 2 molle con/ senza sensore spostamento ago	13 a	2 430 795 005
		2 430 795 003
	14	2 430 795 006

13 14 Tubuladura de empalme
(Retorno del aceite de fugas)

Empleo	Fig.	Número de pedido
Portainyector de 2 resortes con/sin sensor de movimiento de aguja	13 a	2 430 795 005
		2 430 795 003
	14	2 430 795 006

15 Cappucci di protezione filettatura
(cappucci di chiusura)

Impiego Filettatura interna	Filettatura esterna	Numero d'ordinazione
M 8 x 1	M 6	1 900 508 002
M 10	-	1 900 508 003
M 10 x 1	M 8 x 1	1 900 508 004
-	M 12 x 1	1 900 508 009
M 12 x 1,5	-	1 900 508 005
-	M 12 x 1,5	1 900 508 009
M 14 x 1,5	-	1 900 508 008
-	M 14 x 1,5	1 900 508 011

15 Tapas protectoras de rosca
(Tapas de cierre)

Empleo Rosca interior	Rosca exterior	Número de pedido
M 8 x 1	M 6	1 900 508 002
M 10	-	1 900 508 003
M 10 x 1	M 8 x 1	1 900 508 004
-	M 12 x 1	1 900 508 009
M 12 x 1,5	-	1 900 508 005
-	M 12 x 1,5	1 900 508 009
M 14 x 1,5	-	1 900 508 008
-	M 14 x 1,5	1 900 508 011

16 Vite a testa svesata

Impiego	Filettatura	Numero d'ordinazione
	M 6	2 433 421 001

16 Tornillo avellanado

Empleo	Rosca	Número de pedido
	M 6	2 433 421 001

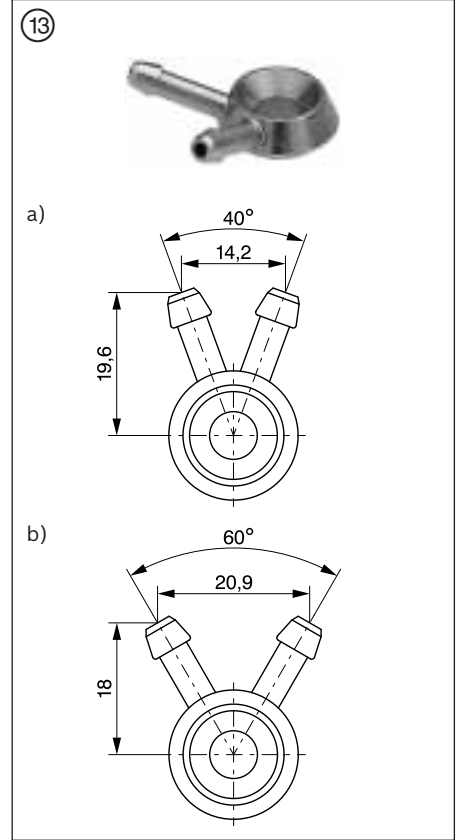

de Wärmeschutz für Düsen
 en Thermal protection for nozzles
 fr Protection thermique pour injecteurs
 it Isolamento termico per polverizzatori
 es Protección antitérmica para inyectores



Wärmeschutzhülsen für Lochdüsen
Thermal-protection sleeves for hole-type nozzles
Douilles calorifuges pour injecteurs à trous
Bussole di isolamento termico per polverizzatori a fori
Manguitos de protección antitérmica para inyectores de orificio

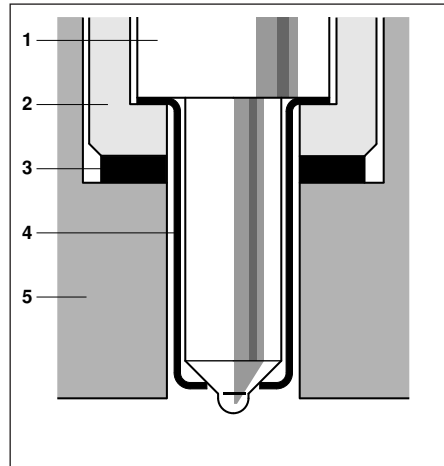
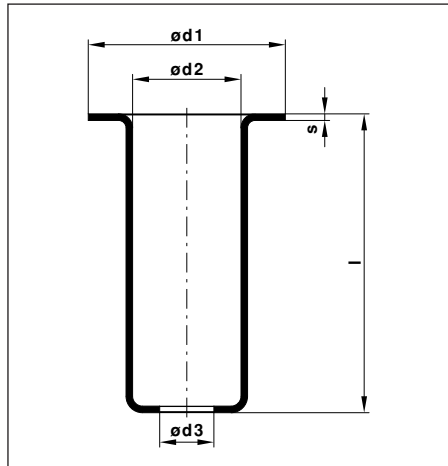

Dichtscheiben für Düsenhalter/CRI mit Loch- und Zapfendüsen
Sealing discs for nozzle-holders/CRI with hole-type and pintle nozzles
Joints pour porte-injecteurs/CRI avec injecteurs à trous ou à téton
Rosette di tenuta per portapolverizzatori/CRI con polverizzatori a fori e polverizzatori a pernetto
Juntas para portainyectores/CRI con inyectores de orificio e inyectores de espiga

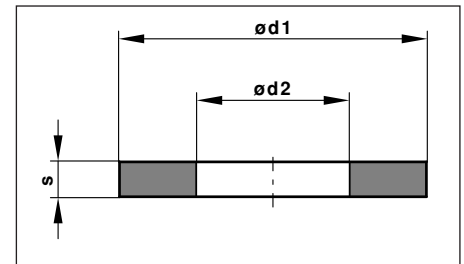

d1 mm	d2 mm	d3 mm	l mm	s mm	⊕
13,6	9,5	6,2	25,0	0,5	2 430 422 011
15,5	9,5	6,2	24,6	0,5	2 430 422 004
16,5	9,5	6,2	25,0	0,5	2 430 422 005
21,0	9,3	9,0	17,3	2,0	2 430 422 002
14,9	7,20	6,9	17,4	1,5	F 00Z W00 003

- 1 Lochdüse
Hole-type nozzle
Injecteur à trous
Polverizzatore a fori
Inyector de orificio
- 2 Düsenspannmutter
Nozzle-retaining nut
Ecrou-raccord d'injecteur
Dado bloccapolverizzatore
Tuerca de sujeción de inyector
- 3 Dichtscheibe
Sealing disc
Joint
Rosetta di tenuta
Junta
- 4 Wärmeschutzhülse
Thermal-protection sleeve
Douille calorifuge
Bussola di isolamento termico
Manguito de protección antitérmica
- 5 Zylinderkopf
Cylinder head
Culasse
Testata
Culata

d1 mm	d2 mm	s mm	⊕
13,0	7,0	2,5	F 00V C17 505
14,0	7,3	1,0	F 002 C71 401
14,0	7,3	2,0	9 431 030 172
14,0	7,3	3,8	9 431 030 171
15,0	7,0	1,5	F 00V C17 503
15,0	7,0	1,5	F 00R J01 453
15,0	7,0	2,0	F 00Z M20 001
15,0	7,0	2,0	F 00V C17 504
15,0	7,0	2,0	F 00R J01 086
15,0	7,3	0,5	2 430 105 048
15,0	7,3	2,0	2 430 105 035
15,0	7,3	2,5	2 430 105 042
15,0	7,3	3,0	2 430 105 043
15,0	9,2	1,5	2 430 105 026
15,1	7,0	1,5	2 430 105 049
15,5	9,3	2,0	2 430 105 023
16,0	7,8	1,3	2 430 105 057
16,0	7,8	1,5	2 430 105 055
16,0	9,7	2,0	2 430 105 021
18,0	11,5	1,5	F 002 C71 402
18,8	9,7	2,0	2 430 105 020
19,3	7,3	2,0	9 432 030 111
19,3	9,7	1,6	2 430 100 048
19,3	9,7	2,0	2 439 999 032
19,3	14,3	2,0	2 430 105 012
19,3	14,3	2,0	9 431 030 161
20,4	15,7	2,0	2 430 105 010
21,0	17,2	1,5	2 430 105 045
21,1	17,4	2,3	2 430 105 044
21,5	15,7	2,0	2 430 105 011
22,6	17,6	3,3	2 430 105 022
24,0	18,2	2,0	1 410 105 005
24,5	16,6	2,0	9 431 030 119
25,9	22,2	1,5	2 430 105 027



Wärmeschutzscheiben für Drosselzapfendüsen
Thermal-protection discs for throttling pintle nozzles
Rondelles calorifuges pour injecteurs à téton et étranglement
Rosette di isolamento termico per polverizzatori a pernetto strozzato
Arandelas de protección antitérmica para inyectoros de espiga con efecto estrangulador

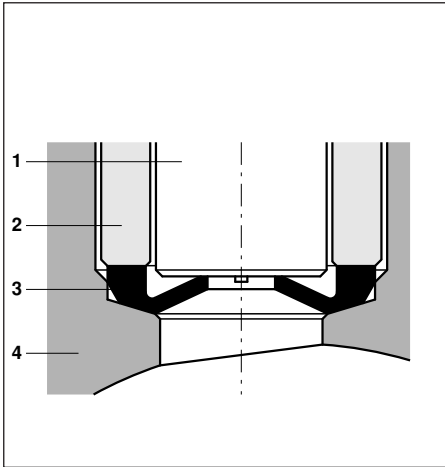

- 1 Drosselzapfendüse
Throttling pintle nozzle
Injecteur à téton et étranglement
Polverizzatore a pernetto strozzato
Inyector de espiga con efecto estrangulador
- 2 Düsenstannmutter
Nozzle-retaining nut
Ecrou-raccord d'injecteur
Dado bloccapolverizzatore
Tuerca de sujeción de inyector
- 3 Wärmeschutzscheibe
Thermal-protection disc
Rondelle calorifuge
Rosetta isolamento termico
Arandela de protección antitérmica
- 4 Zylinderkopf
Cylinder head
Culasse
Testata
Culata

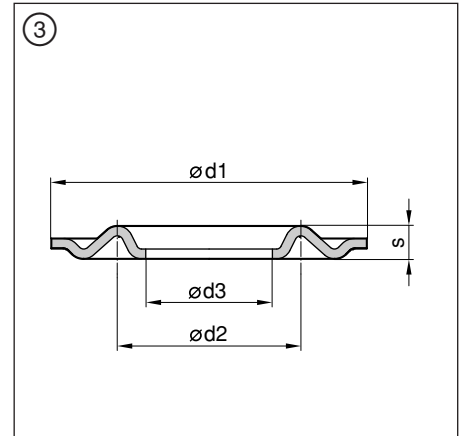
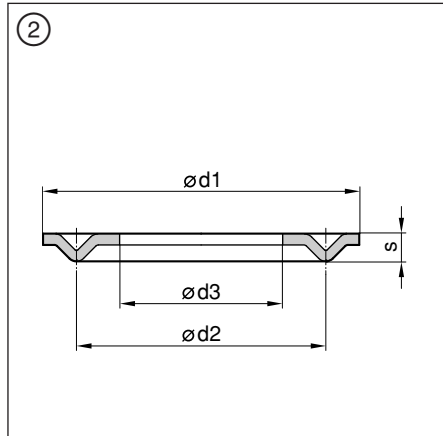
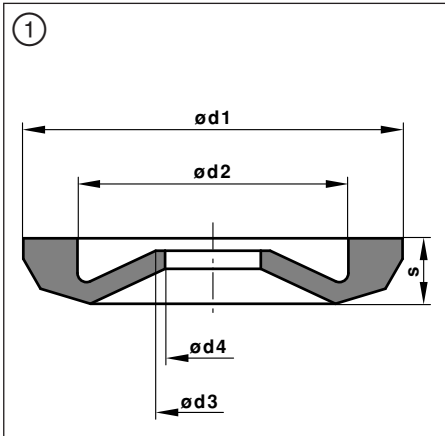

①

d1 mm	d2 mm	d3 mm	l mm	s mm	(H)
13,80	8,00	5,50	-	1,35	2 430 190 010
13,80	10,00	6,50	-	1,35	2 430 190 002
20,10	14,50	11,70	10,00	2,60	2 430 501 009
20,10	14,60	8,80	7,70	2,60	2 430 501 011
20,30	14,40	9,15	7,85	2,75	2 430 501 006
20,30	14,50	-	5,30*	3,50	1 410 501 072

* innen/inside/intérieur/interno/interior

A402

de

Ersatzteile für
Common Rail Injektor

en

Spare parts for
Common Rail
injectors

fr

Pièces de rechange
pour injecteurs
Common Rail

it

Ricambi per iniettori
Common Rail

es

Piezas de repuesto
para inyectores
Common Rail

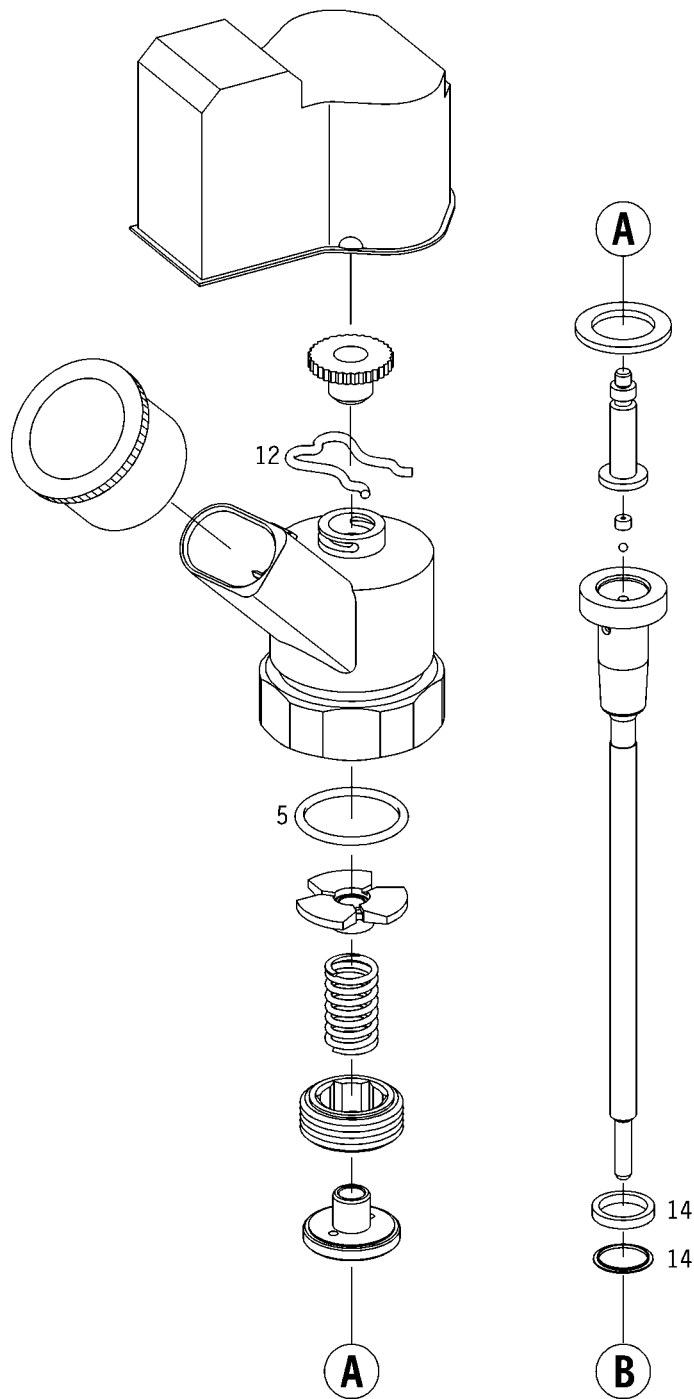

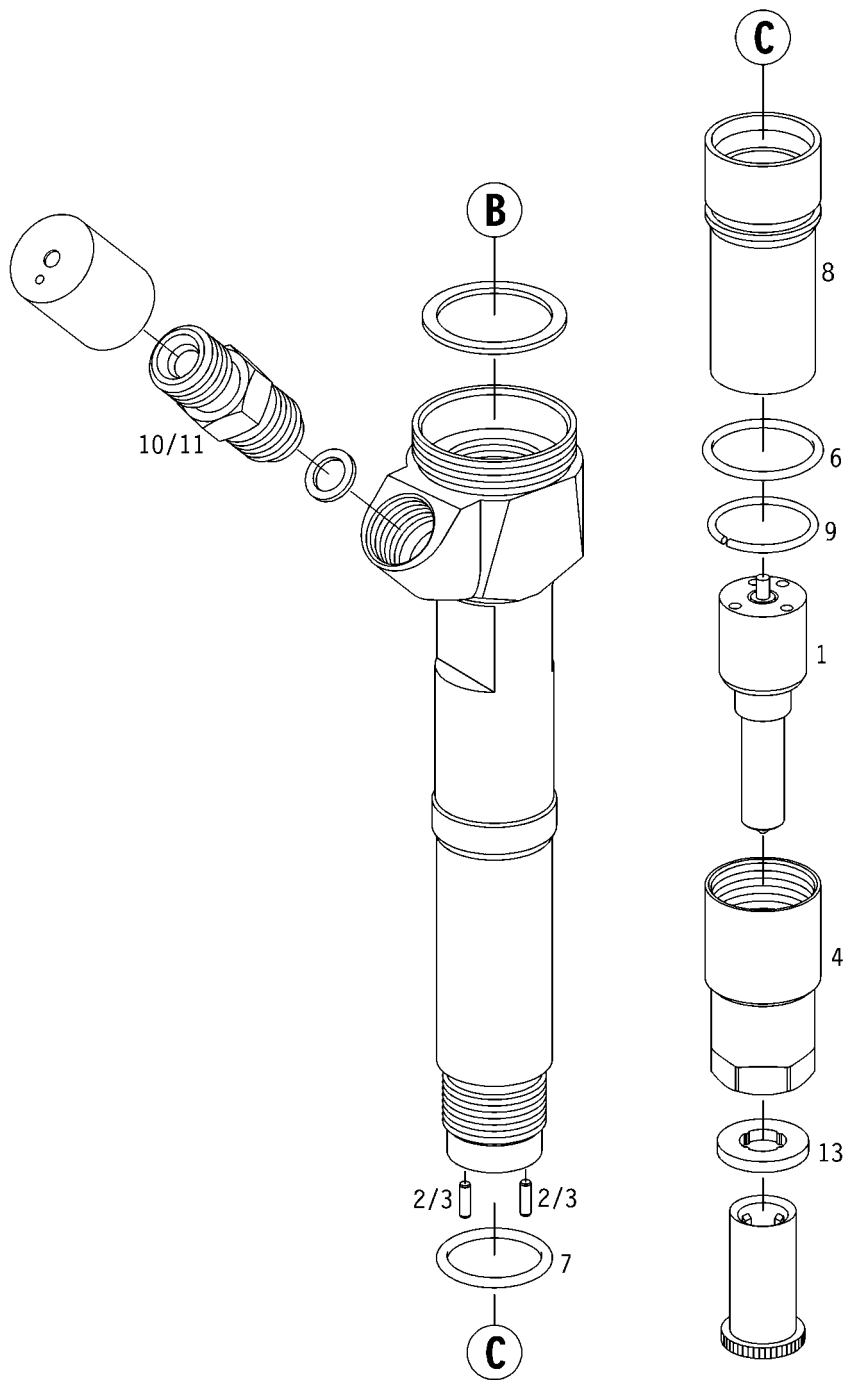

A404

de
Ersatzteile für
Common Rail
Injektoren

en
Spare parts for
Common Rail
Injectors

fr
Pièces de rechange
pour injecteurs
Common Rail

it
Ricambi per iniettori
Common Rail

es
Piezas de repuesto
para inyectoros
Common Rail



①

②

③

④

⑤

0445110001	CR/IPS19/ZEREK10S	0433175175	DSLA 145 P 763	2433201024		F00VC14012	F00VC38002
0445110002	CR/IPS19/ZEREA10S	0433175175	DSLA 145 P 763	2433201024		F00VC14012	F00VC38002
0445110003	CR/IPS19/ZEREA10S	0433175163	DSLA 156 P 736	2433201024		F00VC14012	F00VC38002
0445110004	CR/IPS19/ZEREA10S	0433175163	DSLA 156 P 736	2433201024		F00VC14012	F00VC38002
0445110005	CR/IPS19/ZEREA10S	0433175164	DSLA 156 P 737	2433201024		F00VC14012	F00VC38002
0445110006	CR/IPS19/ZEREA10S	0433175164	DSLA 156 P 737	2433201024		F00VC14012	F00VC38002
0445110008	CR/IPS17/ZEREW10S	0433175196	DSLA 142 P 795	2433201024		F00VC14010	F00VC38002
0445110009	CR/IPS19/ZEREA10S	0433175163	DSLA 156 P 736	2433201024		F00VC14012	F00VC38002
0445110010	CR/IPS19/ZEREA10S	0433175163	DSLA 156 P 736	2433201024		F00VC14012	F00VC38002
0445110011	CR/IPS19/ZEREA10S	0433175163	DSLA 156 P 736	2433201024		F00VC14012	F00VC38002
0445110012	CR/IPS19/ZEREA10S	0433175163	DSLA 156 P 736	2433201024		F00VC14012	F00VC38002
0445110014	CR/IPS19/ZEREA10S	0433175164	DSLA 156 P 737	2433201024		F00VC14012	F00VC38002
0445110015	CR/IPS19/ZEREA10S	0433175164	DSLA 156 P 737	2433201024		F00VC14012	F00VC38002
0445110017	CR/IFS19/ZEREA10S	0433175233	DSLA 160 P 865	2433201024		F00VC14010	F00VC38048
0445110018	CR/IFS19/ZEREA10S	0433175233	DSLA 160 P 865	2433201024		F00VC14010	F00VC38048
0445110019	CR/IPS19/ZEREK10S	0433175363	DSLA 144 P 1213	2433201024		F00VC14012	F00VC38002
0445110020	CR/IPS17/ZEREW10S	0433175196	DSLA 142 P 795	2433201024		F00VC14010	F00VC38002
0445110021	CR/IPS19/ZEREK10S	0433175230	DSLA 140 P 862	2433201024		F00VC14012	F00VC38002
0445110022	CR/IPS19/ZEREA10S	0433175231	DSLA 155 P 863	2433201024		F00VC14012	F00VC38002
0445110023	CR/IPS19/ZEREA10S	0433175231	DSLA 155 P 863	2433201024		F00VC14012	F00VC38002
0445110024	CR/IPS19/ZEREA10S	0433175163	DSLA 156 P 736	2433201024		F00VC14012	F00VC38002
0445110025	CR/IPS19/ZEREA10S	0433175163	DSLA 156 P 736	2433201024		F00VC14012	F00VC38002
0445110028	CR/IFS17/ZEREK10S	0433175234	DSLA 145 P 867	2433201024		F00VC14010	F00VC38042
0445110029	CR/IFS17/ZEREK10S	0433175232	DSLA 145 P 864	2433201024		F00VC14010	F00VC38041
0445110030	CR/IFS17/ZEREK10S	0433175235	DSLA 145 P 868	2433201024		F00VC14010	F00VC38042
0445110031	CR/IFS17/ZEREK10S	0433171930	DLLA 143 P 879	2433201024		F00VC14010	F00VC38042
0445110034	CR/IPS19/ZEREA10S	0433171594	DLLA 156 P 889	2433201024		F00VC14012	F00VC38002
0445110035	CR/IPS19/ZEREA10S	0433171594	DLLA 156 P 889	2433201024		F00VC14012	F00VC38002
0445110036	CR/IFS17/ZEREW10S	0433175250	DSLA 144 P 890	2433201024		F00VC14010	F00VC38002
0445110038	CR/IFS17/ZEREK10S	0433175253	DSLA 145 P 896	2433201024		F00VC14010	F00VC38002
0445110042	CR/IFS19/ZEREA10S	0433175255	DSLA 160 P 904	2433201024		F00VC14010	F00VC38048
0445110043	CR/IFS19/ZEREA10S	0433175255	DSLA 160 P 904	2433201024		F00VC14010	F00VC38048
0445110044	CR/IPS17/ZEREK10S	0433175196	DSLA 142 P 795	2433201024		F00VC14010	F00VC38002
0445110045	CR/IPS19/ZEREA10S	0433171608	DLLA 158 P 914	2433201024		F00VC14012	F00VC38002
0445110046	CR/IPS19/ZEREA10S	0433171608	DLLA 158 P 914	2433201024		F00VC14012	F00VC38002
0445110047	CR/IFS17/ZEREK10S	0433171616	DLLA 145 P 926	2433201024		F00VC14010	F00VC38042
0445110048	CR/IFS17/ZEREK10S	0433171617	DLLA 145 P 927	2433201024		F00VC14010	F00VC38042
0445110049	CR/IFS17/ZEREK10S	0433171618	DLLA 145 P 928	2433201024		F00VC14010	F00VC38042
0445110052	CR/IFS19/ZEREA10S	0433175266	DSLA 160 P 938	2433201024		F00VC14010	F00VC38048
0445110053	CR/IFS19/ZEREA10S	0433175266	DSLA 160 P 938	2433201024		F00VC14010	F00VC38048
0445110054	CR/IPL19/ZEREK20S	0433175314	DSLA 156 P 1079	2433201024		F00VC14012	F00VC38002
0445110055	CR/IPL19/ZEREK20S	0433175314	DSLA 156 P 1079	2433201024		F00VC14012	F00VC38002
0445110056	CR/IPS19/ZEREK10S	0433175268	DSLA 140 P 959	2433201024		F00VC14012	F00VC38002
0445110057	CR/IPS17/ZEREK10S	0433175272	DSLA 144 P 971	2433201024		F00VC14010	F00VC38002
0445110058	CR/IPS17/ZEREK10S	0433171647	DLLA 145 P 998	2433201024		F00VC14010	F00VC38045

de
Ersatzteile für
Common Rail
Injektoren
(Fortsetzung)

en
Spare parts for
Common Rail
Injectors
(continued)

fr
Pièces de rechange
pour injecteurs
Common Rail
(suite)

it
Ricambi per iniettori
Common Rail
(seguito)

es
Piezas de repuesto
para inyectoros
Common Rail
(continuación)



①

②

③

④

⑤

0445110059	CR/IPL19/ZEREK10S	0433171641	DLLA 145 P 978	2433201024		F00VC14010	F00VC38002
0445110060	CR/IFS19/ZEREA10S	0433175273	DSLA 160 P 972	2433201024		F00VC14010	F00VC38048
0445110061	CR/IFS19/ZEREA10S	0433175273	DSLA 160 P 972	2433203043	2433201024	F00VC14010	F00VC38048
0445110062	CR/IPS17/ZEREK10S	0433175431	DSLA 142 P 1474	2433201024		F00VC14010	F00VC38002
0445110063	CR/IPS17/ZEREK10S	0433175278	DSLA 145 P 979	2433201024		F00VC14010	F00VC38002
0445110064	CR/IPL17/ZEREK10S	0433171654	DLLA 150 P 1011	2433201024		F00VC14010	F00VC38002
0445110065	CR/IFS19/ZEREA10S	0433175290	DSLA 160 P 1016	2433201024	2433203043	F00VC14010	F00VC38048
0445110066	CR/IFS19/ZEREA10S	0433175290	DSLA 160 P 1016	2433201024	2433203043	F00VC14010	F00VC38048
0445110068	CR/IPS19/ZEREK10S	0433175288	DSLA 144 P 1021	2433201024		F00VC14012	F00VC38002
0445110069	CR/IPS19/ZEREA10S	0433175298	DSLA 154 P 1034	2433201024		F00VC14012	F00VC38002
0445110070	CR/IPS19/ZEREA10S	0433175298	DSLA 154 P 1034	2433201024		F00VC14012	F00VC38002
0445110071	CR/IPS19/ZEREA10S	0433175163	DSLA 156 P 736	2433201024		F00VC14012	F00VC38002
0445110072	CR/IPS19/ZEREA10S	0433175163	DSLA 156 P 736	2433201024		F00VC14012	F00VC38002
0445110073	CR/IPS19/ZEREA10S	0433171678	DLLA 158 P 1039	2433201024		F00VC14012	F00VC38002
0445110074	CR/IPS19/ZEREA10S	0433171678	DLLA 158 P 1039	2433201024		F00VC14012	F00VC38002
0445110075	CR/IPL20/ZEREA20S	0433175308	DSLA 146 P 1055	2433201024		F00VC14010	F00VC38002
0445110076	CR/IPS17/ZEREK10S	0433175431	DSLA 142 P 1474	2433201024		F00VC14010	F00VC38002
0445110077	CR/IPS19/ZEREA20S	0433175310	DSLA 140 P 1061	2433201024		F00VC14012	F00VC38002
0445110078	CR/IPS19/ZEREA20S	0433175310	DSLA 140 P 1061	2433201024		F00VC14012	F00VC38002
0445110080	CR/IFL17/ZEREA20S	0433171690	DLLA 160 P 1063	2433201024		F00VC14010	F00VC38042
0445110081	CR/IPL19/ZEREA10S	0433171693	DLLA 148 P 1067	2433201024		F00VC14012	F00VC38002
0445110082	CR/IPL17/ZEREK20S	0433171692	DLLA 150 P 1065	2433201024		F00VC14010	F00VC38002
0445110083	CR/IPL17/ZEREK10S	0433171774	DLLA 150 P 1224	2433201024		F00VC14010	F00VC38002
0445110084	CR/IFL19/ZEREK10S	0433171695	DLLA 143 P 1069	2433201024		F00VC14012	F00VC38002
0445110085	CR/IPS17/ZEREK20S	0433175313	DSLA 150 P 1072	2433201024		F00VC14010	F00VC38002
0445110086	CR/IPS19/ZEREK10S	0433175312	DSLA 140 P 1071	2433201024		F00VC14012	F00VC38002
0445110087	CR/IFS19/ZEREK10S	0433175318	DSLA 145 P 1091	2433201024		F00VC14012	F00VC38002
0445110088	CR/IPS19/ZEREK10S	0433175236	DSLA 144 P 869	2433201024		F00VC14012	F00VC38002
0445110089	CR/IPL19/ZEREA10S	0433171706	DLLA 153 P 1090	2433201024		F00VC14012	F00VC38002
0445110090	CR/IPL19/ZEREA10S	0433171706	DLLA 153 P 1090	2433201024		F00VC14012	F00VC38002
0445110091	CR/IPL19/ZEREK10S	0433171719	DLLA 156 P 1114	2433201024		F00VC14010	F00VC38044
0445110092	CR/IPL19/ZEREK10S	0433171719	DLLA 156 P 1114	2433201024		F00VC14010	F00VC38044
0445110093	CR/IPL19/ZEREA10S	0433171717	DLLA 158 P 1106	2433201024		F00VC14012	F00VC38002
0445110094	CR/IPL19/ZEREA10S	0433171717	DLLA 158 P 1106	2433201024		F00VC14012	F00VC38002
0445110095	CR/IPS19/ZEREA10S	0433171712	DLLA 156 P 1107	2433201024		F00VC14012	F00VC38002
0445110096	CR/IPS19/ZEREA10S	0433171712	DLLA 156 P 1107	2433201024		F00VC14012	F00VC38002
0445110097	CR/IPL19/ZEREA10S	0433171718	DLLA 156 P 1111	2433201024		F00VC14012	F00VC38002
0445110098	CR/IPL19/ZEREA10S	0433171718	DLLA 156 P 1111	2433201024		F00VC14012	F00VC38002
0445110099	CR/IPS19/ZEREA10S	0433175326	DSLA 156 P 1113	2433201024		F00VC14012	F00VC38002
0445110100	CR/IPS19/ZEREA10S	0433175326	DSLA 156 P 1113	2433201024		F00VC14012	F00VC38002
0445110101	CR/IPL17/ZEREK10S	0433171654	DLLA 150 P 1011	2433201024		F00VC14010	F00VC38002
0445110102	CR/IFS19/ZEREK10S	0433175327	DSLA 145 P 1115	2433201024		F00VC14012	F00VC38002
0445110103	CR/IPL19/ZEREA10S	0433171718	DLLA 156 P 1111	2433201024		F00VC14012	F00VC38002
0445110104	CR/IPL19/ZEREA10S	0433171718	DLLA 156 P 1111	2433201024		F00VC14012	F00VC38002
0445110105	CR/IPL19/ZEREA10S	0433175395	DSLA 154 P 1320	2433201024		F00VC14012	F00VC38002

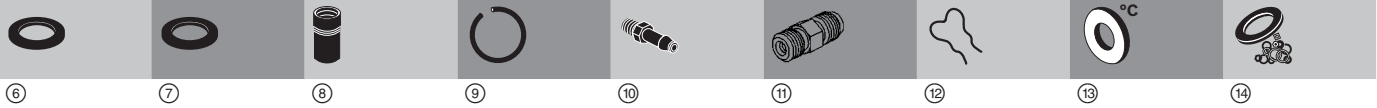

				F00VC16009		F00VC22003	F00VC17503	F00VC99002
		F00VC24503	F00VC23002	F00VC16009		F00VC22003		F00VC99002
		F00VC24503	F00VC23002	F00VC16009		F00VC22003		F00VC99002
				F00VC16009		F00VC22003		F00VC99002
				F00VC16009		F00VC22003		F00VC99002
				F00VC16009		F00VC22003	F00VC17503	F00VC99002
		F00VC24503	F00VC23002	F00VC16009		F00VC22003	F00VC17505	
		F00VC24503	F00VC23002	F00VC16009		F00VC22003	F00VC17505	
				F00VC16009		F00VC22003		
				F00VC16009		F00VC22003		F00VC99002
				F00VC16009		F00VC22003		
				F00VC16009		F00VC22003		F00VC99002
				F00VC16009		F00VC22003		F00VC99002
				F00VC16009		F00VC22003	F00VC17503	F00VC99002
				F00VC16009		F00VC22003		F00VC99002
				F00VC16009		F00VC22003	F00VC17503	F00VC99002
				F00VC16009		F00VC22003	F00VC17503	F00VC99002
		F00VC24005	F00VC23002	F00VC16009		F00VC22003	F00VC17503	
				F00VC16009		F00VC22003		F00VC99002
				F00VC16013		F00VC22003		F00VC99002
				F00VC16009		F00VC22003	F00VC17503	F00VC99002
				F00VC16009		F00VC22003		F00VC99002
				F00VC16009		F00VC22003		F00VC99002
				F00VC16017		F00VC22003		F00VC99002
				F00VC16017		F00VC22003		F00VC99002
				F00VC16009		F00VC22003	F00VC17504	F00VC99002
				F00VC16009		F00VC22003	F00VC17504	F00VC99002
				F00VC16009		F00VC22003		F00VC99002
				F00VC16009		F00VC22003		F00VC99002
				F00VC16017		F00VC22003		F00VC99002
				F00VC16017		F00VC22003		F00VC99002
				F00VC16017		F00VC22003		F00VC99002
				F00VC16017		F00VC22003		F00VC99002
				F00VC16017		F00VC22003		F00VC99002
				F00VC16009		F00VC22003	F00VC17503	F00VC99002
				F00VC16009		F00VC22003		F00VC99002
				F00VC16017		F00VC22003		F00VC99002
				F00VC16017		F00VC22003		F00VC99002
				F00VC16017		F00VC22003		F00VC99002



de
Ersatzteile für
Common Rail
Injektoren
(Fortsetzung)

en
Spare parts for
Common Rail
Injectors
(continued)

fr
Pièces de rechange
pour injecteurs
Common Rail
(suite)

it
Ricambi per iniettori
Common Rail
(seguito)

es
Piezas de repuesto
para inyectoros
Common Rail
(continuación)



①

②

③

④

⑤

0445110106	CR/IPL19/ZEREA10S	0433175395	DSLA 154 P 1320	2433201024		F00VC14012	F00VC38002
0445110107	CR/IPL19/ZEREA10S	0433175395	DSLA 154 P 1320	2433201024		F00VC14012	F00VC38002
0445110108	CR/IPL19/ZEREA10S	0433175395	DSLA 154 P 1320	2433201024		F00VC14012	F00VC38002
0445110109	CR/IFS19/ZEREK10S	0433175334	DSLA 140 P 1131	2433201024		F00VC14013	F00VC38002
0445110110	CR/IPS19/ZEREK10S	0433175337	DSLA 140 P 1142	2433201024		F00VC14013	F00VC38002
0445110111	CR/IPL17/ZEREK10S	0433171771	DLLA 148 P 1221	2433201024		F00VC14010	F00VC38002
0445110112	CR/IPS19/ZEREK10S	0433175377	DSLA 144 P 1271	2433201024		F00VC14012	F00VC38002
0445110113	CR/IFS19/ZEREA10S	0433175338	DSLA 158 P 1143	2433201024	2433203043	F00VC14010	F00VC38048
0445110114	CR/IFS19/ZEREA10S	0433175338	DSLA 158 P 1143	2433203043	2433201024	F00VC14010	F00VC38048
0445110115	CR/IPL19/ZEREA10S	0433175342	DSLA 156 P 1155	2433201024		F00VC14012	F00VC38002
0445110116	CR/IPL19/ZEREA10S	0433175342	DSLA 156 P 1155	2433201024		F00VC14012	F00VC38002
0445110118	CR/IPL17/ZEREK20S	0433171785	DLLA 148 P 1238	2433201024		F00VC14010	F00VC38002
0445110119	CR/IPS19/ZEREK10S	0433175386	DSLA 144 P 1295	2433201024		F00VC14012	F00VC38002
0445110120	CR/IPL19/ZEREA10S	0433171712	DLLA 156 P 1107	2433201024		F00VC14012	F00VC38002
0445110121	CR/IPL19/ZEREA10S	0433171712	DLLA 156 P 1107	2433201024		F00VC14012	F00VC38002
0445110122	CR/IFL17/ZEREA20S	0433171690	DLLA 160 P 1063	2433201024		F00VC14012	F00VC38041
0445110123	CR/IPS19/ZEREA20S	0433175353	DSLA 156 P 1190	2433201024		F00VC14012	F00VC38002
0445110124	CR/IPS19/ZEREA20S	0433175353	DSLA 156 P 1190	2433201024		F00VC14012	F00VC38002
0445110125	CR/IPL19/ZEREA10S	0433171752	DLLA 148 P 1193	2433201024		F00VC14012	F00VC38002
0445110126	CR/IPL17/ZEREK10S	0433171755	DLLA 150 P 1197	2433201024		F00VC14010	F00VC38002
0445110127	CR/IPS19/ZEREK10S	0433175372	DSLA 145 P 1259	2433201024		F00VC14013	F00VC38002
0445110128	CR/IPS19/ZEREA20S	0433171772	DLLA 153 P 1222	2433201024		F00VC14012	F00VC38002
0445110129	CR/IPS19/ZEREA20S	0433171772	DLLA 153 P 1222	2433201024		F00VC14012	F00VC38002
0445110130	CR/IFS17/ZEREK10S	0433171773	DLLA 145 P 1223	2433201024		F00VC14010	F00VC38041
0445110131	CR/IFL17/ZEREA20S	0433171690	DLLA 160 P 1063	2433201024		F00VC14010	F00VC38042
0445110132	CR/IFL19/ZEREA20S	0433171783	DLLA 158 P 1234	2433201024		F00VC14012	F00VC38002
0445110133	CR/IFL19/ZEREA20S	0433171783	DLLA 158 P 1234	2433201024		F00VC14012	F00VC38002
0445110134	CR/IFL19/ZEREK20S	0433171769	DLLA 145 P 1219	2433201024		F00VC14012	F00VC38002
0445110135	CR/IPS19/ZEREK20S	0433175308	DSLA 146 P 1055	2433201024		F00VC14010	F00VC38002
0445110136	CR/IFL17/ZEREK20S	0433171801	DLLA 150 P 1274	2433201024		F00VC14010	F00VC38002
0445110137	CR/IPS19/ZEREA20S	0433171788	DLLA 153 P 1246	2433201024		F00VC14012	F00VC38002
0445110138	CR/IPS19/ZEREA20S	0433171788	DLLA 153 P 1246	2433201024		F00VC14012	F00VC38002
0445110139	CR/IPS19/ZEREA20S	0433175366	DSLA 154 P 1242	2433201024		F00VC14012	F00VC38002
0445110140	CR/IPS19/ZEREA20S	0433175366	DSLA 154 P 1242	2433201024		F00VC14012	F00VC38002
0445110141	CR/IPS19/ZEREK10S	0433171811	DLLA 146 P 1296	2433201024		F00VC14012	F00VC38002
0445110142	CR/IPS17/ZEREK20S	0433175376	DSLA 150 P 1268	2433201024		F00VC14010	F00VC38002
0445110143	CR/IPS17/ZEREK20S	0433175376	DSLA 150 P 1268	2433201024		F00VC14010	F00VC38002
0445110144	CR/IPS19/ZEREK10S	0433175334	DSLA 140 P 1131	2433201024		F00VC14013	F00VC38002
0445110145	CR/IPS19/ZEREK10S	0433175337	DSLA 140 P 1142	2433201024		F00VC14013	F00VC38002
0445110146	CR/IPS19/ZEREK10S	0433175230	DSLA 140 P 862	2433201024		F00VC14013	F00VC38002
0445110149	CR/IFL17/ZEREA20S	0433171796	DLLA 160 P 1262	2433201024		F00VC14010	F00VC38042
0445110150	CR/IPS19/ZEREK20S	0433175373	DSLA 145 P 1263	2433201024		F00VC14013	F00VC38002
0445110151	CR/IPL19/ZEREA10S	0433171798	DLLA 156 P 1265	2433201024		F00VC14012	F00VC38002
0445110152	CR/IPL19/ZEREA10S	0433171798	DLLA 156 P 1265	2433201024		F00VC14012	F00VC38002
0445110153	CR/IPS17/ZEREK20S	0433175313	DSLA 150 P 1072	2433201024		F00VC14010	F00VC38002

A410

de
Ersatzteile für
Common Rail
Injektoren
(Fortsetzung)

en
Spare parts for
Common Rail
Injectors
(continued)

fr
Pièces de rechange
pour injecteurs
Common Rail
(suite)

it
Ricambi per iniettori
Common Rail
(seguito)

es
Piezas de repuesto
para inyectoros
Common Rail
(continuación)



①

②

③

④

⑤

0445110154	CR/IPS17/ZEREK20S	0433175313	DSLA 150 P 1072	2433201024		F00VC14010	F00VC38002
0445110155	CR/IPS19/ZEREAK20S	0433171800	DLLA 153 P 1270	2433201024		F00VC14012	F00VC38002
0445110156	CR/IPS19/ZEREAK20S	0433171800	DLLA 153 P 1270	2433201024		F00VC14012	F00VC38002
0445110157	CR/IFL19/ZEREAK20S	0433171805	DLLA 158 P 1281	2433201024		F00VC14012	F00VC38002
0445110158	CR/IFL19/ZEREAK20S	0433171805	DLLA 158 P 1281	2433201024		F00VC14012	F00VC38002
0445110159	CR/IPL17/ZEREK20S	0433171838	DLLA 148 P 1347	2433201024		F00VC14010	F00VC38002
0445110160	CR/IPS19/ZEREK10S	0433175388	DSLA 145 P 1303	2433201024		F00VC14013	F00VC38002
0445110161	CR/IFL17/ZEREA20S	0433171817	DLLA 160 P 1308	2433201024		F00VC14010	F00VC38041
0445110162	CR/IPS19/ZEREAK20S	0433171788	DLLA 153 P 1246	2433201024		F00VC14012	F00VC38002
0445110163	CR/IPS19/ZEREAK20S	0433171788	DLLA 153 P 1246	2433201024		F00VC14012	F00VC38002
0445110164	CR/IFL17/ZEREAK20S	0433171817	DLLA 160 P 1308	2433201024		F00VC14010	F00VC38042
0445110165	CR/IPL19/ZEREK20S	0433171822	DLLA 142 P 1321	2433201024		F00VC14012	F00VC38002
0445110166	CR/IPS19/ZEREAK20S	0433171856	DLLA 153 P 1378	2433201024		F00VC14012	F00VC38002
0445110167	CR/IPS19/ZEREAK20S	0433171856	DLLA 153 P 1378	2433201024		F00VC14012	F00VC38002
0445110168	CR/IPL17/ZEREK20S	0433171819	DLLA 148 P 1312	2433201024		F00VC14010	F00VC38040
0445110169	CR/IPL17/ZEREK20S	0433171820	DLLA 148 P 1313	2433201024		F00VC14010	F00VC38040
0445110170	CR/IPS19/ZEREAK20S	0433175395	DSLA 154 P 1320	2433201024		F00VC14012	F00VC38002
0445110171	CR/IPS19/ZEREAK20S	0433175395	DSLA 154 P 1320	2433201024		F00VC14012	F00VC38002
0445110172	CR/IPL19/ZEREK20S	0433171823	DLLA 153 P 1322	2433201024		F00VC14012	F00VC38002
0445110173	CR/IPL19/ZEREK10S	0433171829	DLLA 145 P 1337	2433201024		F00VC14010	F00VC38002
0445110174	CR/IPL17/ZEREK20S	0433171785	DLLA 148 P 1238	2433201024		F00VC14010	F00VC38002
0445110175	CR/IPL17/ZEREK20S	0433171828	DLLA 148 P 1334	2433201024		F00VC14010	F00VC38002
0445110176	CR/IPS19/ZEREAK20S	0433171800	DLLA 153 P 1270	2433201024		F00VC14012	F00VC38002
0445110177	CR/IPS19/ZEREAK20S	0433171800	DLLA 153 P 1270	2433201024		F00VC14012	F00VC38002
0445110178	CR/IPS19/ZEREK10S	0433175372	DSLA 145 P 1259	2433201024		F00VC14013	F00VC38002
0445110179	CR/IPS19/ZEREAK20S	0433175366	DSLA 154 P 1242	2433201024		F00VC14012	F00VC38002
0445110180	CR/IPS19/ZEREAK20S	0433175366	DSLA 154 P 1242	2433201024		F00VC14012	F00VC38002
0445110181	CR/IPS19/ZEREAK10S	0433175395	DSLA 154 P 1320	2433201024		F00VC14012	F00VC38002
0445110182	CR/IPS19/ZEREAK10S	0433175395	DSLA 154 P 1320	2433201024		F00VC14012	F00VC38002
0445110183	CR/IPL17/ZEREK20S	0433171889	DLLA 150 P 1437	2433201024		F00VC14010	F00VC38002
0445110184	CR/IFL19/ZEREK10S	0433171695	DLLA 143 P 1069	2433201024		F00VC14012	F00VC38002
0445110185	CR/IPL19/ZEREK10S	0433171847	DLLA 156 P 1367	2433201024		F00VC14010	F00VC38044
0445110186	CR/IPL19/ZEREK10S	0433171848	DLLA 156 P 1368	2433201024		F00VC14010	F00VC38044
0445110187	CR/IPL19/ZEREK10S	0433171846	DLLA 142 P 1363	2433201024		F00VC14012	F00VC38002
0445110188	CR/IFL17/ZEREK20S	0433171853	DLLA 150 P 1373	2433201024		F00VC14010	F00VC38002
0445110189	CR/IPS19/ZEREAK10S	0433175395	DSLA 154 P 1320	2433201024		F00VC14012	F00VC38002
0445110190	CR/IPS19/ZEREAK10S	0433175395	DSLA 154 P 1320	2433201024		F00VC14012	F00VC38002
0445110191	CR/IPS19/ZEREAK20S	0433171788	DLLA 153 P 1246	2433201024		F00VC14012	F00VC38002
0445110192	CR/IPS19/ZEREAK20S	0433171788	DLLA 153 P 1246	2433201024		F00VC14012	F00VC38002
0445110193	CR/IPS19/ZEREAK20S	0433171800	DLLA 153 P 1270	2433201024		F00VC14012	F00VC38002
0445110194	CR/IPS19/ZEREAK20S	0433171800	DLLA 153 P 1270	2433201024		F00VC14012	F00VC38002
0445110195	CR/IPS19/ZEREAK10S	0433175342	DSLA 156 P 1155	2433201024		F00VC14012	F00VC38002
0445110196	CR/IPS19/ZEREAK10S	0433175342	DSLA 156 P 1155	2433201024		F00VC14012	F00VC38002
0445110197	CR/IPS19/ZEREAK10S	0433171706	DLLA 153 P 1090	2433201024		F00VC14012	F00VC38002
0445110198	CR/IPS19/ZEREAK10S	0433171706	DLLA 153 P 1090	2433201024		F00VC14012	F00VC38002



⑥



⑦



⑧



⑨



⑩



⑪



⑫



⑬



⑭



				F00VC16009		F00VC22003		
				F00VC16017		F00VC22003		
				F00VC16017		F00VC22003		
				F00VC16009		F00VC22003	F00VC17505	
				F00VC16009		F00VC22003	F00VC17505	
				F00VC16009		F00VC22003		
				F00VC16009		F00VC22003		F00VC99002
		F00VC24005	F00VC23002	F00VC16009		F00VC22003	F00VC17503	
				F00VC16017		F00VC22003		
				F00VC16017		F00VC22003		
F00VC38041		F00VC24005	F00VC23002	F00VC16009		F00VC22003	F00VC17503	
				F00VC16009		F00VC22003		
				F00VC16017		F00VC22003		
				F00VC16017		F00VC22003		
				F00VC16022		F00VC22003	F00VC17599	
				F00VC16022		F00VC22003	F00VC17599	
				F00VC16017		F00VC22003		
				F00VC16017		F00VC22003		
				F00VC16009		F00VC22003		
				F00VC16009		F00VC22003	F00VC17503	
				F00VC16013		F00VC22003		
				F00VC16013		F00VC22003		
				F00VC16017		F00VC22003		
				F00VC16017		F00VC22003		
				F00VC16009		F00VC22003		F00VC99002
				F00VC16017		F00VC22003		
				F00VC16017		F00VC22003		
				F00VC16017		F00VC22003		
				F00VC16017		F00VC22003		
				F00VC16009		F00VC22003	F00VC17503	
				F00VC16009		F00VC22003		F00VC99002
				F00VC16009		F00VC22003	F00VC17504	
				F00VC16009		F00VC22003	F00VC17504	
				F00VC16009		F00VC22003		
				F00VC16009		F00VC22003	F00VC17504	F00VC99002
				F00VC16017		F00VC22003		
				F00VC16017		F00VC22003		
				F00VC16017		F00VC22003		
				F00VC16017		F00VC22003		
				F00VC16017		F00VC22003		
				F00VC16017		F00VC22003		
				F00VC16017		F00VC22003		
				F00VC16017		F00VC22003		
				F00VC16017		F00VC22003		
				F00VC16017		F00VC22003		

A412

de
Ersatzteile für
Common Rail
Injektoren
(Fortsetzung)

en
Spare parts for
Common Rail
Injectors
(continued)

fr
Pièces de rechange
pour injecteurs
Common Rail
(suite)

it
Ricambi per iniettori
Common Rail
(seguito)

es
Piezas de repuesto
para inyectoros
Common Rail
(continuación)



0445110199	CR/IPS19/ZEREA10S	0433175430	DSLA 156 P 1472	2433201024		F00VC14012	F00VC38002
0445110200	CR/IPS19/ZEREA10S	0433175430	DSLA 156 P 1472	2433201024		F00VC14012	F00VC38002
0445110201	CR/IPS19/ZEREA10S	0433171712	DLLA 156 P 1107	2433201024		F00VC14012	F00VC38002
0445110202	CR/IPS19/ZEREA10S	0433171712	DLLA 156 P 1107	2433201024		F00VC14012	F00VC38002
0445110203	CR/IPS19/ZEREA10S	0433171718	DLLA 156 P 1111	2433201024		F00VC14012	F00VC38002
0445110204	CR/IPS19/ZEREA10S	0433171718	DLLA 156 P 1111	2433201024		F00VC14012	F00VC38002
0445110205	CR/IPS19/ZEREA10S	0433171913	DLLA 156 P 1473	2433201024		F00VC14012	F00VC38002
0445110206	CR/IPS19/ZEREA10S	0433171913	DLLA 156 P 1473	2433201024		F00VC14012	F00VC38002
0445110207	CR/IPS19/ZEREA10S	0433171718	DLLA 156 P 1111	2433201024		F00VC14012	F00VC38002
0445110208	CR/IPS19/ZEREA10S	0433171718	DLLA 156 P 1111	2433201024		F00VC14012	F00VC38002
0445110209	CR/IFL17/ZEREA20S	0433171857	DLLA 160 P 1384	2433201024		F00VC14010	F00VC38041
0445110210	CR/IFL19/ZEREA20S	0433171864	DLLA 158 P 1392	2433201024		F00VC14012	F00VC38002
0445110211	CR/IFL19/ZEREA20S	0433171864	DLLA 158 P 1392	2433201024		F00VC14012	F00VC38002
0445110212	CR/IFL17/ZEREA20S	0433171891	DLLA 162 P 1443	2433201024		F00VC14010	F00VC38042
0445110213	CR/IPL17/ZEREK20S	0433171873	DLLA 148 P 1407	2433201024		F00VC14010	F00VC38002
0445110214	CR/IPS17/ZEREK20S	0433175313	DSLA 150 P 1072	2433201024		F00VC14010	F00VC38002
0445110215	CR/IPS17/ZEREK20S	0433175313	DSLA 150 P 1072	2433201024		F00VC14010	F00VC38002
0445110216	CR/IFL17/ZEREA20S	0433171817	DLLA 160 P 1308	2433201024		F00VC14010	F00VC38041
0445110217	CR/IPS17/ZEREK20S	0433171888	DLLA 145 P 1430	2433201024		F00VC14010	F00VC38002
0445110218	CR/IPS17/ZEREK20S	0433171888	DLLA 145 P 1430	2433201024		F00VC14010	F00VC38002
0445110219	CR/IFL17/ZEREA20S	0433171877	DLLA 160 P 1415	2433201024		F00VC14010	F00VC38042
0445110220	CR/IFL17/ZEREK20S	0433171884	DLLA 150 P 1410	2433201024		F00VC14010	F00VC38002
0445110221	CR/IPL19/ZEREK10S	0433171883	DLLA 135 P 1422	2433201024		F00VC14010	F00VC38002
0445110222	CR/IPL19/ZEREK10S	0433171880	DLLA 156 P 1419	2433201024		F00VC14016	F00VD38010
0445110223	CR/IPL19/ZEREK10S	0433171880	DLLA 156 P 1419	2433201024		F00VC14016	F00VD38010
0445110224	CR/IPL19/ZEREA10S	0433171798	DLLA 156 P 1265	2433201024		F00VC14012	F00VC38002
0445110225	CR/IPL19/ZEREA10S	0433171798	DLLA 156 P 1265	2433201024		F00VC14012	F00VC38002
0445110227	CR/IPS17/ZEREK20S	0433175425	DSLA 150 P 1438	2433201024		F00VC14010	F00VC38002
0445110229	CR/IFL19/ZEREK20S	0433171897	DLLA 145 P 1449	2433201024		F00VC14012	F00VC38002
0445110230	CR/IPL19/ZEREK20S	0433171896	DLLA 143 P 1448	2433201024		F00VC14013	F00VC38002
0445110231	CR/IPL19/ZEREK10S	0433171693	DLLA 148 P 1067	2433201024		F00VC14012	F00VC38002
0445110232	CR/IPL19/ZEREK20S	0433171898	DLLA 153 P 1450	2433201024		F00VC14010	F00VC38044
0445110233	CR/IPL19/ZEREK20S	0433171898	DLLA 153 P 1450	2433201024		F00VC14010	F00VC38044
0445110234	CR/IPL19/ZEREA20S	0433171903	DLLA 152 P 1459	2433201024		F00VC14012	F00VC38002
0445110235	CR/IPL19/ZEREA20S	0433171903	DLLA 152 P 1459	2433201024		F00VC14012	F00VC38002
0445110236	CR/IPL19/ZEREK20S	0433171907	DLLA 153 P 1463	2433201024		F00VC14012	F00VC38002
0445110237	CR/IPL19/ZEREA20S	0433171922	DLLA 153 P 1494	2433201024		F00VC14012	F00VC38002
0445110238	CR/IPL19/ZEREA20S	0433171922	DLLA 153 P 1494	2433201024		F00VC14012	F00VC38002
0445110239	CR/IFL17/ZEREK20S	0433171914	DLLA 150 P 1471	2433201024		F00VC14010	F00VC38002
0445110240	CR/IPS17/ZEREK10S	0433175431	DSLA 142 P 1474	2433201024		F00VC14010	F00VC38002
0445110243	CR/IPL17/ZEREK20S	0433171838	DLLA 148 P 1347	2433201024		F00VC14010	F00VC38002
0445110244	CR/IPL19/ZEREK20S	0433171822	DLLA 142 P 1321	2433201024		F00VC14012	F00VC38002
0445110247	CR/IPL21/ZEREK20S	0433171945	DLLA 138 P 1533	2433201024		F00RJ00422	F00VC38002
0445110248	CR/IPL21/ZEREK20S	0433171945	DLLA 138 P 1533	2433201024		F00RJ00422	F00VC38002
0445110249	CR/IPL19/ZEREK20S	0433171920	DLLA 155 P 1492	2433201024		F00VC14012	F00VC38002

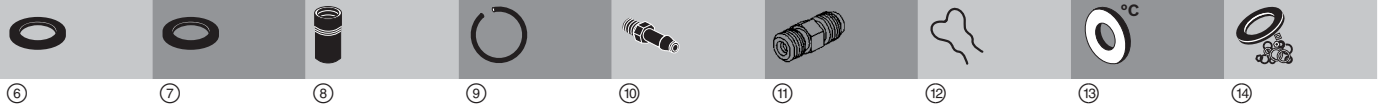

				F00VC16017		F00VC22003		
				F00VC16017		F00VC22003		
				F00VC16017		F00VC22003		
				F00VC16017		F00VC22003		
				F00VC16017		F00VC22003		
				F00VC16017		F00VC22003		
				F00VC16017		F00VC22003		
				F00VC16017		F00VC22003		
				F00VC16017		F00VC22003		
		F00VC24005	F00VC23002	F00VC16009		F00VC22003	F00VC17503	
				F00VC16009		F00VC22003	F00VC17505	
				F00VC16009		F00VC22003	F00VC17505	
F00VC38041		F00VC24005	F00VC23002	F00VC16009		F00VC22003	F00VC17503	
				F00VC16009		F00VC22003		
				F00VC16009		F00VC22003		
F00VC38042		F00VC24005	F00VC23002	F00VC16009		F00VC22003	F00VC17503	
				F00VC16009		F00VC22003	F00VC17503	
				F00VC16009		F00VC22003	F00VC17503	
		F00VC24005	F00VC23002	F00VC16009		F00VC22003	F00VC17503	
				F00VC16009		F00VC22003	F00VC17504	
				F00VC16009		F00VC22003	F00VC17503	F00VC99002
				F00VC16009		F00VC22003	F00VC17503	
				F00VC16009		F00VC22003	F00VC17503	
				F00VC16017		F00VC22003		F00VC99002
				F00VC16017		F00VC22003		F00VC99002
				F00VC16009		F00VC22003		
				F00VC16009		F00VC22003	F00VC17504	
				F00VC16009		F00VC22003	F00VC17504	
				F00VC16017		F00VC22003		
				F00VC16017		F00VC22003		
				F00VC16009		F00VC22003		
				F00VC16017		F00VC22003		
				F00VC16017		F00VC22003		
				F00VC16009		F00VC22003	F00VC17504	F00VC99002
				F00VC16009		F00VC22003		
				F00VC16009		F00VC22003		F00VC99002
				F00VC16009		F00VC22003		
				F00VC16009		F00VC22003		
				F00VC16009		F00VC22005		F00VC99002
				F00VC16020		F00VC22003		

A414

de
Ersatzteile für
Common Rail
Injektoren
(Fortsetzung)

en
Spare parts for
Common Rail
Injectors
(continued)

fr
Pièces de rechange
pour injecteurs
Common Rail
(suite)

it
Ricambi per iniettori
Common Rail
(seguito)

es
Piezas de repuesto
para inyectoros
Common Rail
(continuación)



①

②

③

④

⑤

0445110250	CR/IPL19/ZEREK20S	0433171921	DLLA 155 P 1493	2433201024		F00VC14012	F00VC38002
0445110251	CR/IPL19/ZEREK20S	0433171923	DLLA 139 P 1497	2433201024		F00VC14012	F00VC38002
0445110252	CR/IPL19/ZEREK20S	0433171944	DLLA 143 P 1532	2433201024		F00VC14010	F00VC38002
0445110253	CR/IPL19/ZEREK20S	0433171933	DLLA 150 P 1512	2433201024		F00VC14010	F00VC38002
0445110254	CR/IPL19/ZEREK20S	0433171933	DLLA 150 P 1512	2433201024		F00VC14010	F00VC38002
0445110255	CR/IPL19/ZEREK20S	0433171931	DLLA 156 P 1509	2433201024		F00VC14016	F00VD38010
0445110256	CR/IPL19/ZEREK20V	0433171931	DLLA 156 P 1509	2433201024		F00VC14016	F00VD38010
0445110257	CR/IPL19/ZEREK20S	0433171932	DLLA 150 P 1511	2433201024		F00VC14010	F00VC38002
0445110258	CR/IPL19/ZEREK20S	0433171932	DLLA 150 P 1511	2433201024		F00VC14010	F00VC38002
0445110259	CR/IFL17/ZEREK20S	0433171936	DLLA 149 P 1515	2433201024		F00VC14010	F00VC38002
0445110260	CR/IPL17/ZEREK20S	0433171940	DLLA 152 P 1525	2433201024		F00VC14010	F00VC38002
0445110261	CR/IPL19/ZEREK20S	0433171943	DLLA 145 P 1529	2433201024		F00VC14012	F00VC38002
0445110262	CR/IPS17/ZEREK20S	0433175425	DSLA 150 P 1438	2433201024		F00VC14010	F00VC38002
0445110263	CR/IPS19/ZEREA20S	0433175366	DSLA 154 P 1242	2433201024		F00VC14012	F00VC38002
0445110264	CR/IPS19/ZEREA20S	0433175366	DSLA 154 P 1242	2433201024		F00VC14012	F00VC38002
0445110265	CR/IPL19/ZEREA20S	0433171960	DLLA 150 P 1557	2433201024		F00VC14012	F00VC38002
0445110266	CR/IFS17/ZEREK10S	0433171616	DLLA 145 P 926	2433201024		F00VC14010	F00VC38042
0445110267	CR/IPL19/ZEREA20S	0433171976	DLLA 153 P 1600	2433201024		F00VC14012	F00VC38002
0445110268	CR/IPL19/ZEREA20S	0433171976	DLLA 153 P 1600	2433201024		F00VC14012	F00VC38002
0445110269	CR/IPL19/ZEREK20S	0433171980	DLLA 150 P 1606	2433201024		F00VC14010	F00VC38002
0445110270	CR/IPL19/ZEREK20S	0433171980	DLLA 150 P 1606	2433201024		F00VC14010	F00VC38002
0445110271	CR/IFL17/ZEREK20S	0433171973	DLLA 149 P 1594	2433201024		F00VC14010	F00VC38002
0445110273	CR/IPL19/ZEREK20S	0433171974	DLLA 142 P 1595	2433201024		F00VC14015	F00VC38002
0445110274	CR/IPL19/ZEREK20S	0433171982	DLLA 153 P 1608	2433201024		F00VC14010	F00VC38044
0445110275	CR/IPL19/ZEREK20S	0433171982	DLLA 153 P 1608	2433201024		F00VC14010	F00VC38044
0445110276	CR/IPL17/ZEREK20S	0433171981	DLLA 142 P 1607	2433201024		F00VC14012	F00VC38002
0445110277	CR/IPL19/ZEREK20S	0433171983	DLLA 153 P 1609	2433201024		F00VC14010	F00VC38044
0445110278	CR/IPL19/ZEREK20S	0433171983	DLLA 153 P 1609	2433201024		F00VC14010	F00VC38044
0445110279	CR/IPL19/ZEREK10S	0433171848	DLLA 156 P 1368	2433201024		F00VC14010	F00VC38044
0445110280	CR/IPL19/ZEREK20S	0433171989	DLLA 88 P 1620	2433201024		F00VC14013	F00VC38002
0445110281	CR/IPL19/ZEREK20S	0433171936	DLLA 149 P 1515	2433201024		F00VC14010	F00VC38002
0445110282	CR/IFL17/ZEREK20S	0433171990	DLLA 149 P 1621	2433201024		F00VC14010	F00VC38002
0445110283	CR/IPL19/ZEREK10S	0433171847	DLLA 156 P 1367	2433201024		F00VC14010	F00VC38044
0445110284	CR/IPL17/ZEREK20S	0433171992	DLLA 148 P 1623	2433201024		F00VC14010	F00VC38040
0445110285	CR/IFL17/ZEREK20S	0433171993	DLLA 149 P 1625	2433201024		F00VC14010	F00VC38002
0445110286	CR/IPL17/ZEREK20S	0433172002	DLLA 148 P 1638	2433201024		F00VC14010	F00VC38002
0445110287	CR/IPL17/ZEREK20S	0433172010	DLLA 145 P 1647	2433201024		F00VC14010	F00VC38002
0445110288	CR/IPL19/ZEREK 20S	0433171907	DLLA 153 P 1463	2433201024		F00VC14012	F00VC38038
0445110289	CR/IPL19/ZEREA20S	0433172012	DLLA 160 P 1650	2433201024		F00VC14012	F00VC38002
0445110290	CR/IPL17/ZEREK10S	0433171755	DLLA 150 P 1197	2433201024		F00VC14010	F00VC38002
0445110291	CR/IPL19/ZEREK20S	0433172026	DLLA 155 P 1674	2433201024		F00VC14010	F00VC38002
0445110293	CR/IPL19/ZEREK20S	0433172022	DLLA 150 P 1666	2433201024		F00VC14012	F00VC38002
0445110294	CR/IPS19/ZEREA20S	0433175366	DSLA 154 P 1242	2433201024		F00VC14012	F00VC38002
0445110295	CR/IPS19/ZEREA20S	0433175366	DSLA 154 P 1242	2433201024		F00VC14012	F00VC38002
0445110296	CR/IPL19/ZEREK20S	0433171907	DLLA 153 P 1463	2433201024		F00VC14012	F00VC38038



				F00VC16020		F00VC22003		
				F00VC16009		F00VC22003	F00VC17503	
				F00VC16009		F00VC22003	F00VC17503	F00VC99002
				F00VC16009		F00VC22003	F00VC17503	
				F00VC16009		F00VC22003	F00VC17503	
				F00VC16009		F00VC22003	F00VC17503	
				F00VC16009		F00VC22003	F00VC17503	
				F00VC16009		F00VC22003	F00VC17504	F00VC99002
				F00VC16009		F00VC22003	F00VC17505	
				F00VC16009		F00VC22003		F00VC99002
				F00VC16009		F00VC22003		
				F00VC16017		F00VC22003		
				F00VC16017		F00VC22003		
				F00VC16009		F00VC22003		F00VC99002
F00VC38041				F00VC16009		F00VC22003		F00VC99002
	F00VC24005	F00VC23002		F00VC16009		F00VC22003	F00VC17504	
				F00VC16017		F00VC22003		
				F00VC16017		F00VC22003		
				F00VC16009		F00VC22003	F00VC17503	
				F00VC16009		F00VC22003	F00VC17503	
				F00VC16009		F00VC22003	F00VC17504	F00VC99002
				F00VC16009		F00VC22005		F00VC99002
				F00VC16009		F00VC22003	F00VC17504	
				F00VC16009		F00VC22003	F00VC17504	
				F00VC16009		F00VC22003	F00VC17504	
				F00VC16009		F00VC22003		
				F00VC16009		F00VC22003	F00VC17504	
				F00VC16009		F00VC22003	F00VC17504	
				F00VC16009		F00VC22003	F00VC17504	
				F00VC16009		F00VC22003	F00VC17504	F00VC99002
				F00VC16009		F00VC22003	F00VC17503	
				F00VC16009		F00VC22003	F00VC17503	F00VC99002
				F00VC16009		F00VC22003		
				F00VC16009		F00VC22003	F00VC17503	
				F00VC16009		F00VC22003	F00VC17503	
				F00VC16009		F00VC22003		
				F00VC16009		F00VC22003	F00VC17503	
				F00VC16009		F00VC22003	F00VC17504	
				F00VC16017		F00VC22003		
				F00VC16017		F00VC22003		
				F00VC16009		F00VC22003		

A416

de
Ersatzteile für
Common Rail
Injektoren
(Fortsetzung)

en
Spare parts for
Common Rail
Injectors
(continued)

fr
Pièces de rechange
pour injecteurs
Common Rail
(suite)

it
Ricambi per iniettori
Common Rail
(seguito)

es
Piezas de repuesto
para inyectoros
Common Rail
(continuación)



①

②

③

④

⑤

0445110297	CR/2.2	0433171936	DLLA 149 P 1515	2433201024		F00VC14010	F00VC38002
0445110298	CR/IPL19/ZEREA20S	0433172048	DLLA 139 P 1711	2433201024		F00VC14012	F00VC38002
0445110299	CR/IPL17/ZEREA20S	0433172019	DLLA 148 P 1660	2433201024		F00VC14010	F00VC38002
0445110300	CR/IPL17/ZEREA20S	0433172020	DLLA 152 P 1661	2433201024		F00VC14010	F00VC38002
0445110301	CR/2.2	0433172021	DLLA 146 P 1662	2433201024		F00VC14010	F00VC38002
0445110302	CR/IPL19/ZEREA20S	0433172023	DLLA 150 P 1667	2433201024		F00VC14012	F00VC38002
0445110303	CR/IPL19/ZEREA20S	0433172023	DLLA 150 P 1667	2433201024		F00VC14012	F00VC38002
0445110304	CR/IPL19/ZEREA20S	0433172031	DLLA 150 P 1683	2433201024		F00VC14012	F00VC38002
0445110305	CR/IPL19/ZEREA20S	0433172024	DLLA 82 P 1668	2433201024		F00VC14012	F00VC38002
0445110306	CR/IPL19/ZEREA10S	0433171719	DLLA 156 P 1114	2433201024		F00VC14010	F00VC38044
0445110307	CR/IPL17/ZEREA20S	0433175471	DSLA 146 P 1675	2433201024		F00VC14010	F00VC38002
0445110308	CR/IPL17/ZEREA20	0433172019	DLLA 148 P 1660	2433201024		F00VC14010	F00VC38002
0445110309	CR/2.2	0433172028	DLLA 154 P 1680	2433201024		F00VC14010	F00VC38002
0445110310	CR/IPL17/ZEREA20S	0433172029	DLLA 152 P 1681	2433201024		F00VC14010	F00VC38002
0445110311	CR/IPL17/ZEREA20V	0433171914	DLLA 150 P 1471	2433201024		F00VC14010	F00VC38002
0445110312	CR/IPL20/ZEREA20S	0433172030	DLLA 151P1682	2433201024		F00VC14010	F00VC38002
0445110313	CR/IPL19/ZEREA20S	0433172044	DLLA 147 P 1702	2433201024		F00VC14012	F00VC38002
0445110315	CR/IPL17/ZEREA20S	0433172053	DLLA 148 P 1717	2433201024		F00VC14010	F00VC38040
0445110316	CR/IPL17/ZEREA20S	0433171889	DLLA 150 P 1437	2433201024		F00VC14010	F00VC38002
0445110317	CR/2.0	0433172055	DLLA 145 P 1720	2433201024		F00VC14012	F00VC38002
0445110318	CR/IPL19/ZEREA20S	0433172054	DLLA 156 P 1719	2433201024		F00VC14012	F00VC38002
0445110321	CR/2.0	0433172062	DLLA 145 P 1738	2433201024		F00VC14010	F00VC38002
0445110322	CR/IPL17/ZEREA20S	0433172061	DLLA 150 P 1734	2433201024		F00VC14010	F00VC38002
0445120002	CR/IPS21/ZEREA10S	0433175203	DSLA 136 P 804	2433201024		F00RJ00842	F00VC38002
0445120003	CR/IPL32/ZIRIS10S	0433171562	DLLA 155 P 822	2433201024		F00RJ00215	F00RJ01878
0445120004	CR/IPL32/ZIRIS10S	0433171562	DLLA 155 P 822	2433201024		F00RJ00215	F00RJ00220
0445120005	CR/IPS21/ZERES10S	0433175254	DSLA 158 P 902				
0445120006	CR/IPL21/ZERIS10S	0433171638	DLLZ 157 P 964	2433201024		F00RJ00295	F00RJ00220
0445120007	CR/IFS26/ZIRIS10S	0433175271	DSLA 143 P 970	2433201024		F00RJ00841	F00RJ00220
0445120008	CR/IPS21/ZERES10S	0433175275	DSLA 158 P 974	2433201024		F00RJ01208	F00RJ00220
0445120009	CR/IPL32/ZIRIS10S	0433171648	DLLA 145 P 999	2433201024		F00RJ01208	F00RJ01878
0445120010	CR/IPL32/ZIRIS10S	0433171648	DLLA 145 P 999	2433201024		F00RJ01208	F00RJ01878
0445120011	CR/IPS19/ZEREA10S	0433175297	DSLA 140 P 1033	2433201024		F00RJ00422	F00VC38002
0445120012	CR/IPL21/ZERES10S	0433171681	DLLA 144 P 1050	2433201024		F00RJ00337	F00RJ00220
0445120013	CR/IPL21/ZERES10S	0433171681	DLLA 144 P 1050	2433201024		F00RJ00337	F00RJ00220
0445120014	CR/IPL32/ZIRIS10S	0433171683	DLLA 155 P 1052	2433201024		F00RJ01208	F00RJ00220
0445120015	CR/IPL32/ZIRIS10S	0433171683	DLLA 155 P 1052	2433201024		F00RJ01208	F00RJ01878
0445120016	CR/IPL21/ZERES10S	0433171682	DLLA 140 P 1051	2433201024		F00RJ00337	F00RJ00220
0445120017	CR/IPL21/ZERES10S	0433171682	DLLA 140 P 1051	2433201024		F00RJ00337	F00RJ00220
0445120018	CR/IFS26/ZIRIS10S	0433175309	DSLA 143 P 1058	2433201024		F00RJ00841	2430210081
0445120019	CR/IPL32/ZIRIS10S	0433171699	DLLA 150 P 1076	2433201024		F00RJ01208	F00RJ00220
0445120020	CR/IPL32/ZIRIS10S	0433171699	DLLA 150 P 1076	2433201024		F00RJ01208	F00RJ01878
0445120021	CR/IPS21/ZERES10S	0433175328	DSLA 158 P 1123	2433201024			
0445120022	CR/IPL29/ZIRIS10S	0433171730	DLLA 154 P 1137	2433201024			F00RJ00529
0445120024	CR/IPL29/ZIRIS20S	0433171791	DLLA 144 P 1249	2433201024		F00RJ00713	F00RJ00534

A418

de
Ersatzteile für
Common Rail
Injektoren
(Fortsetzung)

en
Spare parts for
Common Rail
Injectors
(continued)

fr
Pièces de rechange
pour injecteurs
Common Rail
(suite)

it
Ricambi per iniettori
Common Rail
(seguito)

es
Piezas de repuesto
para inyectoros
Common Rail
(continuación)



①

②

③

④

⑤

0445120025	CR/IPL27,5/ZIRIS10S	0433171813	DLLA 150 P 1298	2433201024		F00R J00713	F00R J00835
0445120026	CR/IPL29/ZIRIS20S	0433171837	DLLA 154 P 1346	2433201024		F00R J00713	F00R J00222
0445120027	CR/IPL21/ZEREK20S	0433171860	DLLA 158 P 1385	2433201024		F00R J00713	F00VC38002
0445120028	CR/IFL26/ZIRIS10S	0433171827	DLLA 142 P 1333	2433201024		F00R J00841	2430210081
0445120029	CR/IFL26/ZIRIS10S	0433171843	DLLA 118 P 1357	2433201024		F00R J00713	2430210081
0445120030	CR/IPL26/ZIRIS20S	0433171831	DLLA 146 P 1339	2433201024		F00R J00713	F00R J01028
0445120031	CR/IPL29/ZIRIS10S	0433171814	DLLA 155 P 1301	2433201024		F00R J00713	F00R J00220
0445120032	CR/IFS26/ZIRIS10S	0433175470	DSLA 124 P 1659	2433201024		F00R J00841	2430210081
0445120033	CR/IPL23/ZEREK10S	0433171836	DLLA 150 P 1345	2433201024		F00R J01101	F00VC38002
0445120034	CR/IPL23/ZEREK10S	0433171836	DLLA 150 P 1345	2433201024		F00R J01101	F00VC38002
0445120035	CR/IFL26/ZIRIS10S	0433171844	DLLA 118 P 1358	2433201024		F00R J00713	2430210081
0445120036	CR/IPL19/ZEREK10S	0433171855	DLLA 140 P 1377	2433201024		F00R J00843	F00VC38002
0445120037	CR/IFL26/ZIRIS10S	0433171862	DLLA 144 P 1387	2433201024		F00R J00713	F00R J00220
0445120038	CR/IFL26/ZIRIS10S	0433171861	DLLA 145 P 1386	2433201024		F00R J00713	2430210081
0445120040	CR/IPL26/ZIRIS10S	0433171871	DLLA 146 P 1405	2433201024		F00R J00713	F00R J00529
0445120041	CR/IPL26/ZIRIS10S	0433171872	DLLA 146 P 1406	2433201024		F00R J00713	2430210081
0445120042	CR/IPL21/ZEREK30S	0433171924	DLLA 158 P 1500	2433201024		F00R J00713	F00VC38002
0445120043	CR/IPL21/ZERES10S	0433171870	DLLA 143 P 1404	2433201024		F00R J00713	F00R J00220
0445120044	CR/IPL29/ZIRIS20S	0433171878	DLLA 144 P 1417	2433201024		F00R J00713	F00R J00222
0445120045	CR/IPL29/ZIRIS20S	0433171879	DLLA 154 P 1418	2433201024		F00R J00713	F00R J00222
0445120046	CR/IFL26/ZIRIS10S	0433171876	DLLA 143 P 1414	2433201024		F00R J00841	F00R J01571
0445120047	CR/IFL19/ZEREK20S	0433171885	DLLA 144 P 1423	2433201024		F00VC14012	F00VC38002
0445120048	CR/IFL19/ZEREK20S	0433171886	DLLA 157 P 1424	2433201024		F00VC14012	F00VC38002
0445120049	CR/IFL19/ZEREK20S	0433171887	DLLA 157 P 1425	2433201024		F00VC14012	F00VC38002
0445120050	CR/IFS26/ZIRIS30S	0433171953	DLLA 146 P 1545	2433201024		F00R J00841	F00R J00222
0445120051	CR/IPL23/ZEREK10S	0433171910	DLLA 150 P 1467	2433201024		F00R J01101	F00VC38002
0445120052	CR/IPL23/ZEREK10S	0433171910	DLLA 150 P 1467	2433201024		F00R J01101	F00VC38002
0445120053	CR/IPL29/ZIRIS20S	0433171911	DLLA 154 P 1469	2433201024		F00R J00713	F00R J00534
0445120054	CR/IFL26/ZIRIS20S	0433171947	DLLA 143 P 1536	2433201024		F00R J00841	F00VC38002
0445120055	CR/IPL29/ZIRIS20S	0433171917	DLLA 144 P 1483	2433201024		F00R J00713	F00R J00222
0445120056	CR/IPL29/ZIRIS20S	0433171918	DLLA 146 P 1484	2433201024		F00R J00713	F00R J00222
0445120057	CR/IFS26/ZIRIS20S	0433175456	DSLA 43 P 1535	2433201024		F00R J00841	F00VC38002
0445120059	CR/IFS26/ZIRIS10S	0433175449	DSLA 128 P 1510	2433201024		F00R J00841	F00R J01571
0445120060	CR/IFS26/ZIRIS10S	0433175450	DSLA 143 P 1523	2433201024		F00R J00841	F00R J01571
0445120061	CR/IPL26/ZIRIS20S	0433171939	DLLA 148 P 1524	2433201024		F00R J00713	F00R J00222
0445120062	CR/IPL24/ZERES20S	0433171962	DLLA 152 P 1563	2433201024		F00R J00713	F00R J01605
0445120063	CR/IPL26/ZIRIS20S	0433171961	DLLA 149 P 1562	2433201024		F00R J00713	2430210081
0445120064	CR/IPL28/ZIRIS20S	0433171963	DLLA 150 P 1564	2433201024		F00R J00713	F00R J00222
0445120065	CR/IPL28/ZIRIS20S	0433171967	DLLA 148 P 1580	2433201024		F00R J00713	F00R J00222
0445120066	CR/IPL21/ZERIS20S	0433171964	DLLA 144 P 1565	2433201024		F00R J01101	F00R J01482
0445120067	CR/IPL21/ZERIS20S	0433171968	DLLA 146 P 1581	2433201024		F00R J01101	F00R J00222
0445120068	CR/IPL29/ZIRIS20S	0433171938	DLLA 146 P 1522	2433201024		F00R J00713	F00R J00222
0445120069	CR/IFL26/ZIRIS10S	0433171942	DLLA 143 P 1528	2433201024		F00R J00841	2430210081
0445120070	CR/IFL26/ZIRIS10S	0433171949	DLLA 144 P 1539	2433201024		F00R J00713	2430210081
0445120071	CR/IFL26/ZIRIS10S	0433171951	DLLA 143 P 1541	2433201024		F00R J00841	F00R J01571

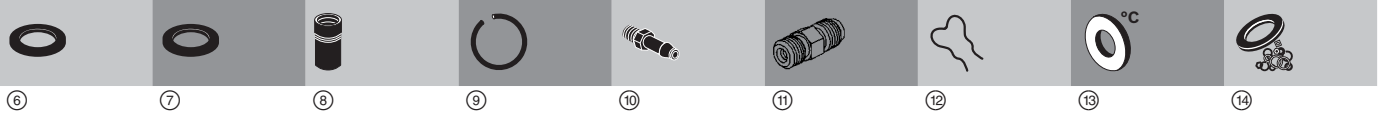

F 00R J00 529	F 00R J00 220				F 00R J00 978		F 00V C17 503	F 00V C99 002
F 00R J00 529	F 00R J00 534				F 00R J00 753		F 00V C17 503	F 00V C99 002
						F 00R J00 322	F 00R J01 086	
2430 210 082	F 00R J00 220		F 00R J00 342		F 00R J00 414		F 00V C17 503	
F 00R J00 220							F 00V C17 503	
F 00R J01 026	F 00R J00 222				F 00R J01 029		F 00V C17 503	
F 00R J00 534					F 00R J01 247		F 00V C17 503	
F 00R J00 220	F 00R J01 571		F 00R J00 342		F 00R J01 572		F 00V C17 503	
					F 00R J00 424	F 00R J00 322		
					F 00R J00 424	F 00R J00 322		
F 00R J00 220							F 00V C17 503	
					F 00R J00 424	F 00R J00 322		
2430 210 081							F 00V C17 503	
F 00R J00 220							F 00V C17 503	
F 00R J00 220	2430 210 081				F 00R J01 191			
F 00R J00 220	F 00R J00 529				F 00R J01 191			
						F 00R J00 322	F 00R J01 086	
				F 00R J00 450	F 00R J00 449			
F 00R J00 534					F 00R J01 247		F 00V C17 503	
F 00R J00 529	F 00R J00 534				F 00R J00 753		F 00V C17 503	
F 00R J00 220	2430 210 081		F 00R J00 342		F 00R J01 572		F 00V C17 503	
			F 00V C23 002			F 00V C22 003		
						F 00V C22 003		
			F 00V C23 002			F 00V C22 003		
							F 00R J01 453	
					F 00R J00 424	F 00R J00 322		
					F 00R J00 424	F 00R J00 322		
F 00R J00 222					F 00R J01 247		F 00V C17 503	
2430 210 082	2430 210 081				F 00R J01 280		F 00V C17 503	
F 00R J00 534					F 00R J01 247		F 00V C17 503	
F 00R J00 534					F 00R J01 247		F 00V C17 503	
2430 210 082	2430 210 081				F 00R J01 280		F 00V C17 503	
F 00R J01 026	F 00R J00 220				F 00R J01 620		F 00R J01 453	
F 00R J01 026	F 00R J00 220				F 00R J01 620		F 00R J01 453	
F 00R J01 026	F 00R J01 028				F 00R J01 029		F 00V C17 503	
F 00R J00 222					F 00R J01 481		F 00R J01 453	
F 00R J00 222	F 00R J00 529				F 00R J01 535			
F 00R J01 456					F 00R J01 457			
F 00R J01 456					F 00R J01 468		F 00R J01 453	
F 00R J00 222					F 00R J01 481		F 00R J01 453	
F 00R J01 482					F 00R J01 481		F 00R J01 453	
F 00R J00 534					F 00R J01 247		F 00V C17 503	
F 00R J00 220	F 00R J01 571		F 00R J00 342		F 00R J01 572		F 00V C17 503	
F 00R J00 220							F 00V C17 503	
F 00R J01 026	F 00R J00 222				F 00R J01 831		F 00R J01 453	

A420

de

**Ersatzteile für
Common Rail
Injektoren**
(Fortsetzung)

en

**Spare parts for
Common Rail
Injectors**
(continued)

fr

**Pièces de rechange
pour injecteurs
Common Rail**
(suite)

it

**Ricambi per iniettori
Common Rail**
(seguito)

es

**Piezas de repuesto
para inyectoros
Common Rail**
(continuación)



0445120074	CR/IPL28/ZIRIS20S	0433171965	DLLA 150 P 1566	2433201024		F00R J00713	F00R J01456
0445120075	CR/IFL26/ZIRIS20S	0433171966	DLLA 137 P 1577	2433201024		F00R J00841	F00VC38002
0445120077	CR/IPL21/ZERES10S	0433171977	DLLA 143 P 1601	2433201024		F00R J00713	F00R J00220
0445120078	CR/IPL26/ZIRIS20S	0433171991	DLLA 150 P 1622	2433201024		F00R J00841	F00R J00222
0445120079	CR/IFS26/ZIRIS10S	0433175464	DSLA 143 P 1604	2433201024		F00R J00841	F00R J00220
0445120080	CR/IPL26/ZIRIS20S	0433171984	DLLA 146 P 1610	2433201024		F00R J00713	F00R J01456
0445120081	CR/IPL24/ZERES20S	0433172017	DLLA 151 P 1656	2433201024		F00R J00713	F00R J01605
0445120082	CR/IPL21/ZEREK30S	0433171985	DLLA 159 P 1611	2433201024		F00R J00713	F00R J00222
0445120083	CR/IPL26/ZIRIS20S	0433172036	DLLA 152 P 1690	2433201024		F00R J00713	F00R J00222
0445120084	CR/IFL32/ZIRIS10S	0433171699	DLLA 150 P 1076	2433201024		F00R J01208	F00R J00220
0445120085	CR/IPL32/ZIRIS10S	0433171648	DLLA 145 P 999	2433201024		F00R J01208	F00R J00220
0445120086	CR/IPL30/ZIRIS20S	0433172016	DLLA 145 P 1655	2433201024		F00R J00713	F00R J01456
0445120087	CR/IPL30/ZIRIS20S	0433172015	DLLA 142 P 1654	2433201024		F00R J00713	F00R J00222
0445120089	CR/IPL21/ZERES10S	0433171988	DLLA 143 P 1619	2433201024		F00R J00713	F00R J00220
0445120092	CR/IPL35/ZERIS30S	0433172011	DLLA 137 P 1648	2433201024		F00R J00842	F00R J00222
0445120094	CR/IFL26/ZIRIS10S	0433172000	DLLA 118 P 1630	2433201024		F00R J00713	2430210081
0445120096	CR/IPL23/ZEREK10S	0433172013	DLLA 146 P 1652	2433201024		F00R J01101	F00VC38002
0445120097	CR/IFL26/ZIRIS10S	0433172001	DLLA 128 P 1635	2433201024		F00R J00713	2430210081
0445120098	CR/IPL26/ZIRIS20S	0433172005	DLLA 154 P 1642	2433201024		F00R J00713	F00R J00222
0445120099	CR/IPL29/ZIRIS20S	0433172003	DLLA 157 P 1640	2433201024		F00R J00713	F00R J00222
0445120100	CR/IPL26/ZIRIS20S	0433172004	DLLA 148 P 1641	2433201024		F00R J00713	F00R J01028
0445120102	CR/IPL29/ZIRIS20S	0433172025	DLLA 148 P 1671	2433201024		F00R J00713	F00R J01456
0445120103	CR/IFS26ZIRIS10S	0433175470	DSLA 124 P 1659	2433201024		F00R J00841	2430210081
0445120105	CR/IPL29/ZIRIS20S	0433172060	DLLA 148 P 1726	2433201024		F00R J00713	F00R J00222
0445120106	CR/IPL32/ZIRIS20S	0433172056	DLLA 153 P 1721	2433201024		F00R J01152	F00R J00222
0445120107	CR/IPL24/ZERES20S	0433172033	DLLA 145 P 1686	2433201024		F00R J00713	F00R J00222
0445120108	CR/IPL23/ZEREK10S	0433172013	DLLA 146 P 1652	2433201024		F00R J01101	F00VC38002
0445120110	CR/IPL26/ZIRIS20S	0433172034	DLLA 148 P 1688	2433201024		F00R J00713	F00R J00222
0445120112	CR/IFL26/ZIRIS10S	0433172027	DLLA 118 P 1677	2433201024		F00R J00713	F00R J00220
0445120113	CR/IFS26/ZIRIS10S	0433175309	DSLA 143 P 1058	2433201024		F00R J00841	F00R J01571
0445120114	CR/IFS26ZIRIS10S	0433175470	DSLA 124 P 1659	2433201024		F00R J00841	F00R J01571
0445120116	CR/IPL27,5/ZIRIS30S	0433172041	DLLA 149 P 1699	2433201024		F00R J00713	F00R J00222
0445120117	CR/IPL28/ZIRIS20S	0433172049	DLLA 150 P 1712	2433201024		F00R J00713	F00R J01456
0445120118	CR/IFS 26/ZI RIS 30S	0433172042	DLLA 145 P 1698	2433201024		F00R J00713	F00R J00222
0445120119	CR/IPL19/ZEREK10S	0433172046	DLLA 136 P 1708	2433201024		F00R J00843	F00VC38002
0445120120	CR/IFL26/ZIRIS10S	0433172037	DLLA 118 P 1691	2433201024		F00R J00713	2430210081
0445120121	CR/IFL26/ZIRIS10S	0433172047	DLLA 142 P 1709	2433201024		F00R J00713	F00R J00220
0445120122	CR/IFL26/ZIRIS10S	0433172045	DLLA 144 P 1707	2433201024		F00R J00713	2430210081
0445120123	CR/IFS26/ZIRIS10S	0433175481	DSLA 140 P 1723	2433201024		F00R J00841	F00R J00220
0445120124	CR/IPL26/ZIRIS20S	0433172038	DLLA 150 P 1695	2433201024		F00R J00841	F00R J00222
0445120125	CR/IFL26/ZIRIS10S	0433172040	DLLA 118 P 1697	2433201024		F00R J00713	2430210081
0445120127	CR/IPL30/ZIRIS20S	0433172039	DLLA 143 P 1696	2433201024		F00R J00713	F00R J00222
0445120128	CR/IPL29/ZIRIS20S	0433171939	DLLA 148 P 1524	2433201024		F00R J00713	F00R J01028
0445120129	CR/IPL24/ZERES20SCRIN2	0433172059	DLLA 146 P 1725	2433201024		F00R J00713	F00R J01605
0445120130	CR/IPL24/ZERES20SCRIN2	0433172058	DLLA 149 P 1724	2433201024		F00R J00713	F00R J00222

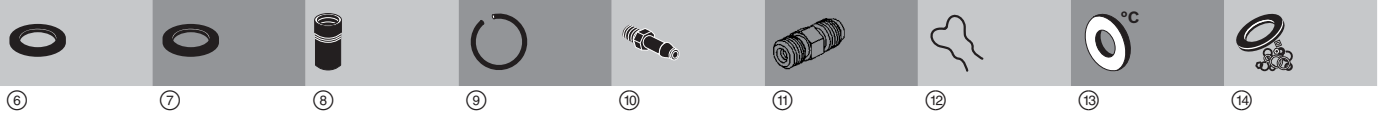

F 00R J00 222					F 00R J01 457			
2430 210 082	2430 210 081				F 00R J01 280		F 00V C17 503	
				F 00R J00 450	F 00R J00 449			
F 00R J01 026	F 00R J01 456				F 00R J01 659		F 00R J01 086	
2430 210 082	2430 210 081		F 00R J00 342		F 00R J00 414		F 00V C17 503	
F 00R J01 026	F 00R J00 222				F 00R J01 685			
F 00R J00 222					F 00R J01 481		F 00R J01 086	
						F 00R J00 322	F 00R J01 086	
F 00R J01 456	F 00V C38 042				F 00R J01 706		F 00R J01 453	
					F 00R J01 919			
					F 00R J01 919			
F 00R J00 222					F 00R J01 730		F 00V C17 503	
					F 00R J01 730		F 00V C17 503	
				F 00R J00 450	F 00R J00 449			
					F 00R J01 821		F 00R J01 299	
F 00R J00 220							F 00V C17 503	
					F 00R J00 424	F 00R J00 322		
F 00R J00 220							F 00V C17 503	
F 00R J00 529	F 00R J00 534				F 00R J00 753		F 00V C17 503	
F 00R J00 529	F 00R J00 534				F 00R J00 753		F 00V C17 503	
F 00R J01 026	F 00R J00 222				F 00R J01 029		F 00V C17 503	
F 00R J00 534	F 00R J00 222				F 00R J01 927		F 00R J01 453	
F 00R J00 220	F 00R J01 571		F 00R J00 342		F 00R J01 572		F 00V C17 503	
F 00R J00 529	F 00R J00 534				F 00R J00 753		F 00V C17 503	
					F 00R J02 057			
F 00R J01 605					F 00R J01 481		F 00R J01 086	
					F 00R J00 424	F 00R J00 322		
F 00R J01 456	F 00V C38 042				F 00R J01 706			
2430 210 081							F 00V C17 503	
F 00R J00 220	2430 210 081		F 00R J00 342		F 00R J01 572		F 00V C17 503	
F 00R J00 220	2430 210 081		F 00R J00 342		F 00R J01 572		F 00V C17 503	
F 00R J00 835	F 00R J01 456				F 00R J02 014		F 00V C17 503	
F 00R J00 222					F 00R J01 659		F 00R J01 086	
F 00R J01 026	F 00R J01 028				F 00R J02 047		F 00V C17 503	
					F 00R J00 424	F 00R J00 322		F 00V C99 002
F 00R J00 220							F 00V C17 503	F 00V C99 002
2430 210 081							F 00V C17 503	F 00V C99 002
F 00R J00 220							F 00V C17 503	F 00V C99 002
F 00R J01 026	F 00R J01 571				F 00R J01 620		F 00R J01 453	F 00V C99 002
F 00R J01 026	F 00R J01 456				F 00R J01 659		F 00R J01 086	F 00V C99 002
F 00R J00 220							F 00V C17 503	F 00V C99 002
F 00R J01 456					F 00R J01 730		F 00V C17 503	F 00V C99 002
F 00R J00 534	F 00R J00 222				F 00R J02 075		F 00V C17 503	F 00V C99 002
F 00R J00 222					F 00R J01 481		F 00R J01 453	F 00V C99 002
F 00R J01 605					F 00R J01 481		F 00R J01 086	F 00V C99 002

A422

de
**Ersatzteile für
 Common Rail
 Injektoren**
 (Fortsetzung)

en
**Spare parts for
 Common Rail
 Injectors**
 (continued)

fr
**Pièces de rechange
 pour injecteurs
 Common Rail**
 (suite)

it
**Ricambi per iniettori
 Common Rail**
 (seguito)

es
**Piezas de repuesto
 para inyectores
 Common Rail**
 (continuación)

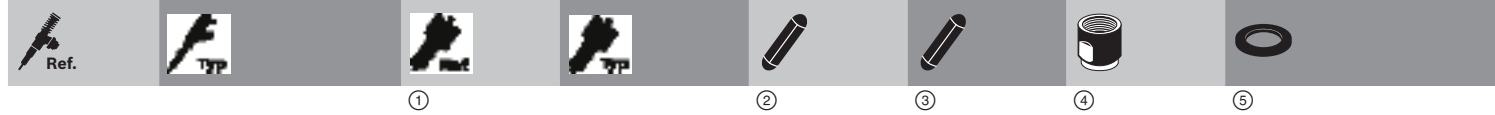

0445120133	CR/IFL26/ZIRIS10S	0433172051	DLLA 145 P 1714	2433201024		F00R J00713	2430210081
0445120135	CR/IPL27.5/ZIRIS30S	0433172057	DLLA 150 P 1722	2433201024		F00R J00713	F00R J00222
0445120136	CR/IPL28/ZIRIS20S	0433171963	DLLA 150 P 1564	2433201024		F00R J00713	F00R J01456
0445120137	CR/IPL28/ZIRIS20S	0433171963	DLLA 150 P 1564	2433201024		F00R J00713	F00R J00222
0445120138	CR/IPL28/ZIRIS20S	0433171965	DLLA 150 P 1566	2433201024		F00R J00713	F00R J00222
0445120139	CR/IPL28/ZIRIS20S	0433171965	DLLA 150 P 1566	2433201024		F00R J00713	F00R J00222
0445120143	CR/IPL26/ZIRIS30S	0433172064	DLLA 147 P 1740	2433201024		F00R J00713	F00R J00222



⑥



⑦



⑧



⑨



⑩



⑪



⑫



⑬



⑭



F 00R J00 220							F 00V C17 503	F 00V C99 002
F 00R J00 835	F 00R J01 456					F 00R J02 014	F 00V C17 503	
F 00R J00 222						F 00R J01 457		F 00V C99 002
F 00R J01 456						F 00R J01 457		F 00V C99 002
F 00R J01 456						F 00R J01 457		F 00V C99 002
F 00R J01 456						F 00R J01 457		F 00V C99 002
F 00R J01 026	F 00R J01 028					F 00R J02 047	F 00V C17 503	
F 00R J01 456						F 00R J01 457		F 00V C99 002

de

Ersatzteile für
Unit Injektoren (Pkw)

en

Repair parts for
Unit Injectors (PV)

fr

Pièces de rechange
pour Unit Injecteurs
(VP)

it

Ricambi per unità
pompa-iniettore
(Autovetture)

es

Piezas de repuesto
para unidad de
bomba-inyector
(Turismos)

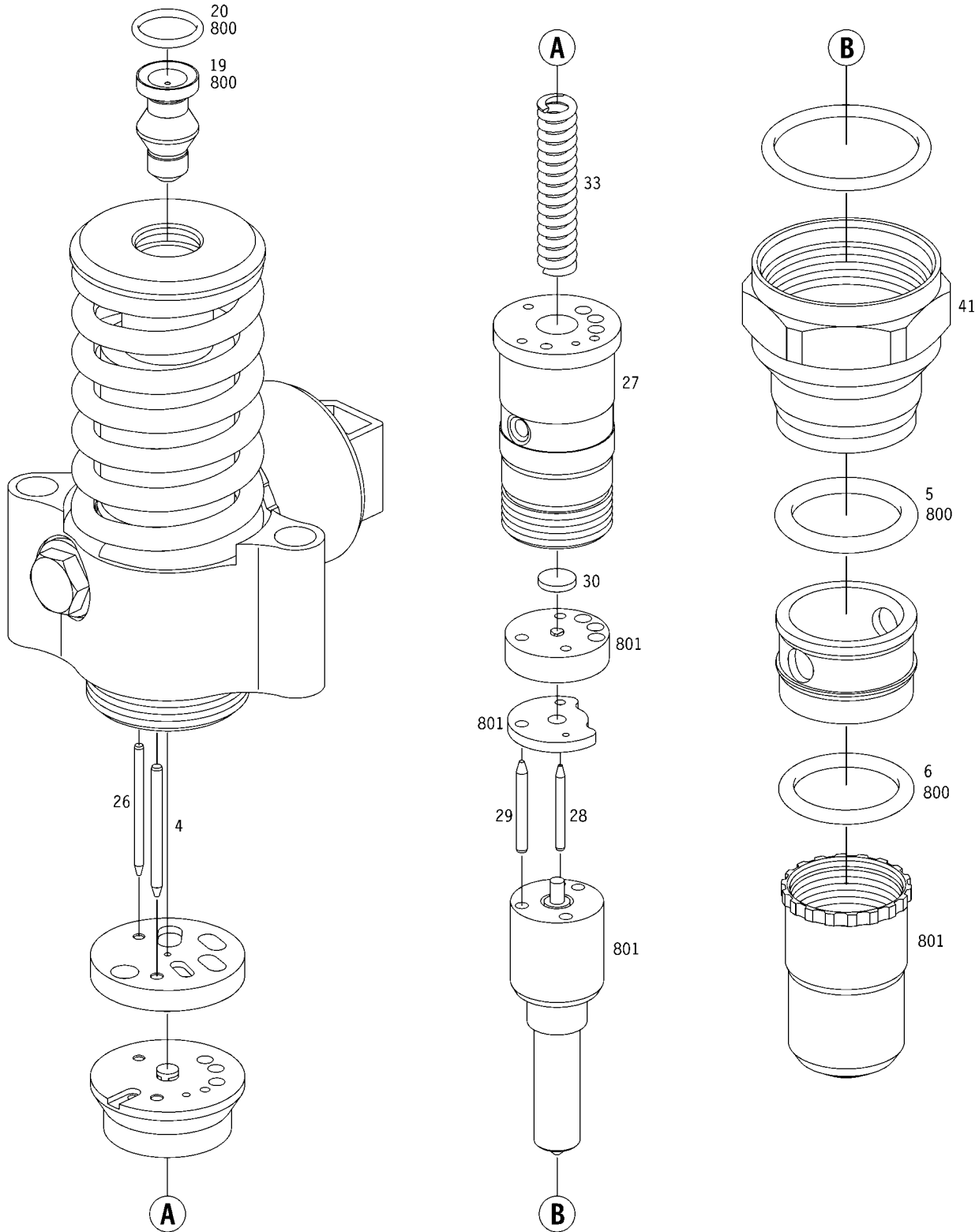

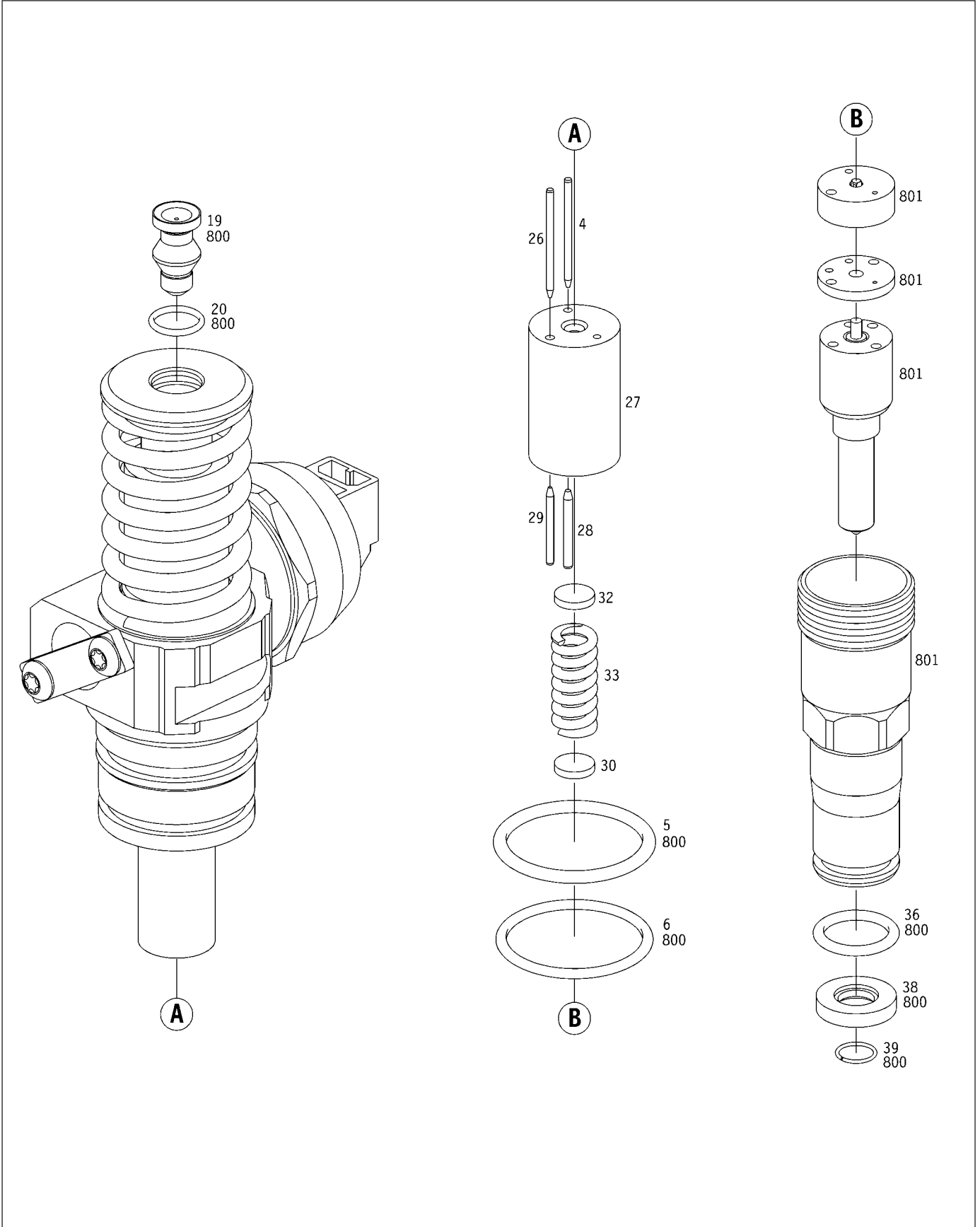

A426

de

Ersatzteile für
Unit Injektoren (Pkw)

en

Repair parts for
Unit Injectors (PV)

fr

Pièces de rechange
pour Unit Injecteurs
(VP)

it

Ricambi per unità
pompa-iniettore
(Autovetture)

es

Piezas de repuesto
para unidad de
bomba-inyector
(Turismos)



Ref.	Fig.	Fig.	Fig.	Fig.		
	801	34	800			
	1 417 010 ...	0 433 175 ...	1 414 010 ...			
0 414 720 033 / ...032 / ...009	288 ±4	1	993	228	DSLA 156 P 856	997
0 414 720 034 / ...031 / ...030 / ...016	288 ±4	1	992	302	DSLA 156 P 1041	997
0 414 720 035 / ...022 / ...007	288 ±4	1	991	189	DSLA 150 P 783	997
0 414 720 036 / ...024 / ...014	288 ±4	1	990	227	DSLA 150 P 855	997
0 414 720 037 / ...025 / ...015	288 ±4	1	989	199	DSLA 150 P 800	997
0 414 720 038 / ...029 / ...023 / ...018	288 ±4	1	988	306	DSLA 150 P 1045	997
0 414 720 039 / ...028 / ...021 / ...013	288 ±4	1	987	304	DSLA 150 P 1043	997
0 414 720 210	292 ±5	1	985	343	DSLA 150 P 1156	997
0 414 720 215 / ...213 / ...208 / ...206 / ...202	292 ±5	1	984	367	DSLA 150 P 1247	997
0 414 720 216 / ...214 / ...209 / ...204 / ...201	292 ±5	1	983	368	DSLA 150 P 1248	997
0 414 720 220	277 ±7	1	982	378	DSLA 150 P 1272	997
0 414 720 221	292 ±5	1	981	402	DSLA 156 P 1336	997
0 414 720 222	292 ±5	1	980	403	DSLA 150 P 1355	997
0 414 720 223	292 ±5	1	979	407	DSLA 150 P 1362	997
0 414 720 225	292 ±5	1	977	418	DSLA 150 P 1426	997
0 414 720 226	292 ±5	1	976	419	DSLA 150 P 1431	997
0 414 720 227	292 ±5	1	975	428	DSLA 150 P 1452	997
0 414 720 228	292 ±5	1	974	429	DSLA148 P1468	997
0 414 720 229	292 ±5	1	973	441	DSLA150 P1489	997
0 414 720 230	292 ±5	1	972	442	DSLA150 P1490	997
0 414 720 232 / ...224	292 ±5	1	978	411	DSLA 156 P 1381	997
0 414 720 309	277,00 bar	1	967	460	DSLA 150 P 1585	997
0 414 720 310	277,00 bar	1	966	461	DSLA 150 P 1586	997
0 414 720 311 / ...305	277,00 bar	1	965	437	DSLA150 P1485	997
0 414 720 312 / ...306	277,00 bar	1	964	447	DSLA 150 P 1499	997
0 414 720 313 / ...307	277,00 bar	1	963	444	DSLA150 P1491	997
0 414 720 314 / ...308	277,00 bar	1	962	448	DSLA 150 P 1508	997
0 414 720 403 / ...402 / ...401	263,00 bar	2	969	379	DSLA 152 P 1287+	996
0 414 720 404	263,00 bar	2	969	379	DSLA 152 P 1287+	996

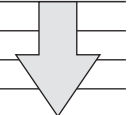

800	5	6	19	20	36	38	39
1 417 010 997	1 410 257 021	1 410 257 029	1 413 127 090	1 410 257 015	1 410 257 027	1 410 157 215	1 410 227 001
1 417 010 996	1 410 257 040	1 410 257 041	1 413 127 090	1 410 257 015			

de

Ersatzteile für
Unit Injektor (Pkw)

en

Repair parts for
Unit Injectors (PV)

fr

Pièces de rechange
pour Unit Injecteurs
(VP)

it

Ricambi per unità
pompa-iniettore
(Autovetture)

es

Piezas de repuesto
para unidades bomba-
inyector (Turismos)

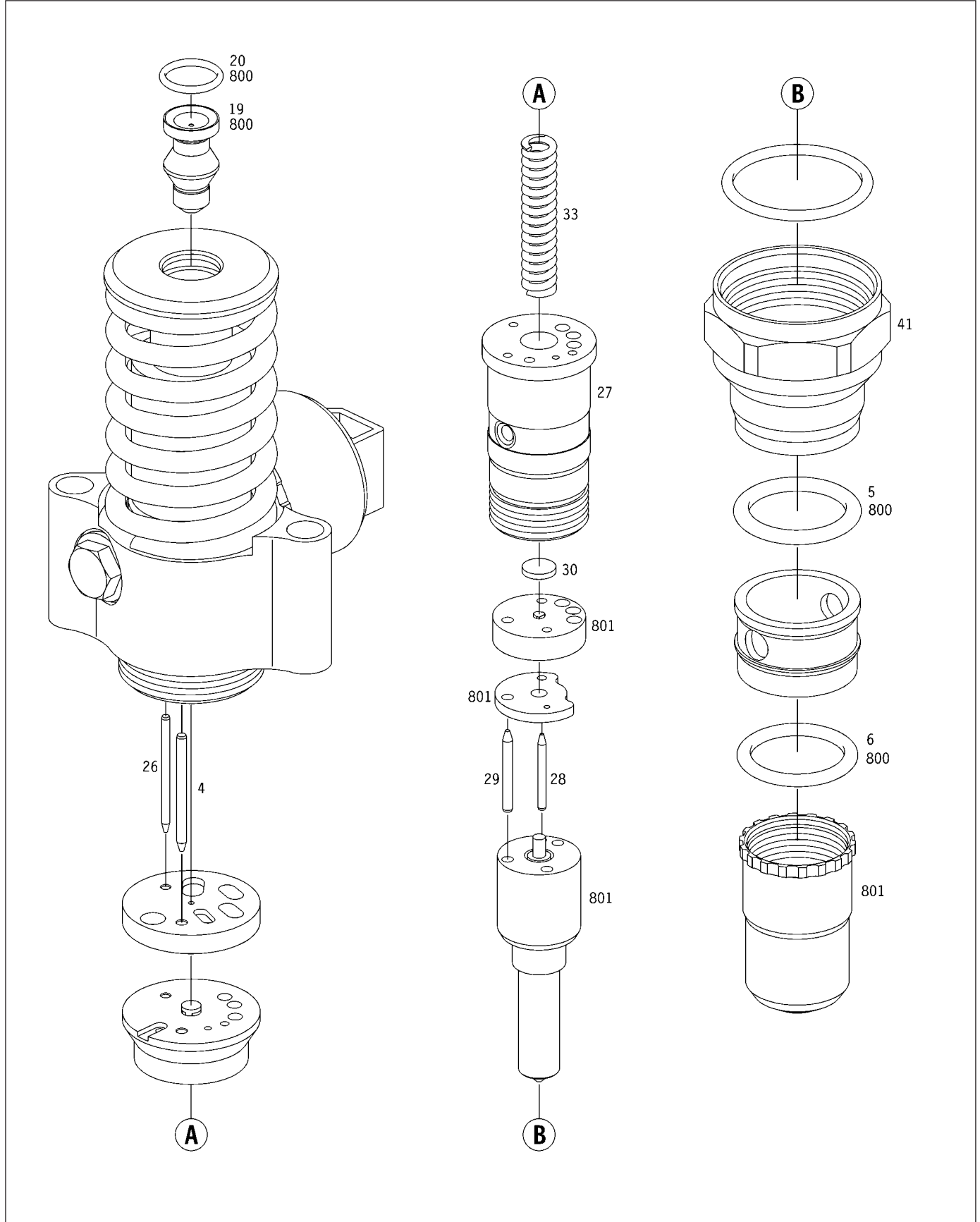

A430

de

Ersatzteile für
Unit Injektoren (Nkw)

en

Repair parts for
Unit Injectors (CV)

fr

Pièces de rechange
pour Unit Injecteurs
(PL)

it

Ricambi per unità
pompa-iniettore
(Autocarri)

es

Piezas de repuesto
para unidad de
bomba-inyector
(Vehículos
industriales)



Fig.



①

②

③

④, ⑤

④

0 414 700 002	4	PDE 90 S 1001	0 433 171 439	DLLA 145 P 580	F 00H N36 515	F 018 B06 804	F 00H N37 926	F 00Z B20 001
0 414 700 003	4	PDE 90 S 1002	0 433 171 596	DLLA 143 P 894	F 00H N37 179	F 018 B06 804	F 00H N37 926	F 00Z B20 001
0 414 700 004	4	PDE 90 S 1003	0 433 171 596	DLLA 143 P 894	F 00H N37 179	F 018 B06 804	F 00H N37 926	F 00Z B20 001
0 414 700 005	4	PDE 90 S 1004	0 433 171 564	DLLA 140 P 826	F 00H N37 179	F 018 B06 804	F 00H N37 926	F 00Z B20 001
0 414 701 004	4	PDE 100 S 2003	0 433 171 433	DLLA 155 P 572	F 00H N35 733	F 018 B06 804	F 00H N37 926	F 00Z B20 001
0 414 701 005	4	PDE 100 S 2004	0 433 171 470	DLLA 150 P 635	F 00H N37 345	F 018 B06 804	F 00H N37 926	F 00Z B20 001
0 414 701 006	4	PDE 100 S 2005	0 433 171 564	DLLA 140 P 826	F 00H N37 258	F 018 B06 804	F 00H N37 926	F 00Z B20 001
0 414 701 007	4	PDE 100 S 2006	0 433 171 575	DLLA 150 P 847	F 00H N37 345	F 018 B06 804	F 00H N37 926	F 00Z B20 001
0 414 701 008	4	PDE 100 S 2007	0 433 171 576	DLLA 150 P 848	F 00H N37 345	F 018 B06 804	F 00H N37 926	F 00Z B20 001
0 414 701 013	4	PDE 100 S 2012	0 433 171 631	DLLA 140 P 947	F 00H N37 591	F 018 B06 804	F 00H N37 926	F 00Z B20 001
0 414 701 016	4	PDE 100 S 2013	0 433 171 598	DLLA 150 P 898	F 00H N37 345	F 018 B06 804	F 00H N37 926	F 00Z B20 001
0 414 701 017	4	PDE 100 S 2014	0 433 171 470	DLLA 150 P 635	F 00H N37 597	F 018 B06 804	F 00H N37 926	F 00Z B20 001
0 414 701 018	4	PDE 100 S 2015	0 433 171 598	DLLA 150 P 898	F 00H N37 597	F 018 B06 804	F 00H N37 926	F 00Z B20 001
0 414 701 019	4	PDE 100 S 2016	0 433 171 576	DLLA 150 P 848	F 00H N37 597	F 018 B06 804	F 00H N37 926	F 00Z B20 001
0 414 701 020	4	PDE 100 S 2017	0 433 171 575	DLLA 150 P 847	F 00H N37 597	F 018 B06 804	F 00H N37 926	F 00Z B20 001
0 414 701 021	4	PDE 100 S 2018	0 433 171 564	DLLA 140 P 826	F 00H N37 258	F 018 B06 804	F 00H N37 926	F 00Z B20 001
0 414 701 022	4	PDE 100 S 2019	0 433 171 631	DLLA 140 P 947	F 00H N37 591	F 018 B06 804	F 00H N37 926	F 00Z B20 001
0 414 701 030	4	PDE 100 S 2021	0 433 171 786	DLLA 150 P 1239	F 00H N37 597	F 018 B06 804	F 00H N37 926	F 00Z B20 001
0 414 701 032	4	PDE 100 S 2022	0 433 171 786	DLLA 150 P 1239	F 00H N37 597	F 018 B06 804	F 00H N37 926	F 00Z B20 001
0 414 701 035	4	PDE 100 S 2024	0 433 171 799	DLLA 150 P 1269	F 00H N37 597	F 018 B06 804	F 00H N37 926	F 00Z B20 001
0 414 702 002	4	PDE 100 S 3001	0 433 171 584	DLLA 155 P 872	F 00H N35 733	F 018 B06 804	F 00H N37 926	F 00Z B20 001
0 414 702 003	4	PDE 100 S 3002	0 433 171 584	DLLA 155 P 872	F 00H N37 110	F 018 B06 804	F 00H N37 926	F 00Z B20 001
0 414 702 005	4	PDE 100 S 3005	0 433 171 584	DLLA 155 P 872	F 00H N37 110	F 018 B06 804	F 00H N37 926	F 00Z B20 001
0 414 702 006	4	PDE 100 S 3006	0 433 171 600	DLLA 152 P 903	F 00H N37 192	F 018 B06 804	F 00H N37 926	F 00Z B20 001
0 414 702 007	4	PDE 100 S 3007	0 433 171 621	DLLA 152 P 932	F 00H N37 192	F 018 B06 804	F 00H N37 926	F 00Z B20 001
0 414 702 009	4	PDE 100 S 3008	0 433 171 646	DLLA 152 P 996	F 00H N37 192	F 018 B06 804	F 00H N37 926	F 00Z B20 001
0 414 702 010	4	PDE 100 S 3009	0 433 171 584	DLLA 155 P 872	F 00H N37 192	F 018 B06 804	F 00H N37 926	F 00Z B20 001
0 414 702 012	4	PDE 100 S 3011	0 433 171 698	DLLA 152 P 1075	F 00H N37 192	F 018 B06 804	F 00H N37 926	F 00Z B20 001
0 414 702 013	4	PDE 100 S 3012	0 433 171 700	DLLA 152 P 1077	F 00H N37 192	F 018 B06 804	F 00H N37 926	F 00Z B20 001
0 414 702 014	4	PDE 100 S 3013	0 433 171 646	DLLA 152 P 996	F 00H N37 192	F 018 B06 804	F 00H N37 926	F 00Z B20 001
0 414 702 015	4	PDE 100 S 3014	0 433 171 789	DLLA 150 P 1244	F 00H N37 192	F 018 B06 804	F 00H N37 926	F 00Z B20 001

