



---

# WATER PUMPS TRUCKS & BUSES

2016

**metelli**group  
AUTOMOTIVE PASSION



---

## **INDICE - INDEX - INDEX - INHALT - INDICE**

Abbreviazioni - Abbreviations - Abréviations - Zeichenerklärung - Abreviaturas	<b>pag. IV</b>
Simbologia - Symbols - Symbologie - Symbole - Simbologia	<b>pag. V</b>
Indice marca e modello - Make and model Index	
Index marque et modèle - Inhalt Marke und Modell - Índice marca y modelo	<b>pag. 1</b>
Applicazioni - Applications - Applications - Anwendungen - Aplicaciones	<b>pag. 1</b>
Lista dei riferimenti - Cross References List	
Table equivalences - Vergleichsliste - Lista de equivalencias	<b>pag. 295</b>
Lista numerica - Numerical list - Liste numérique - Teilnummerliste - Lista numerica	<b>pag. 297</b>
Condizioni di vendita - Conditions of sale	
Conditions de vente - Verkaufsbedingungen - Condiciones de venta	<b>pag. 299</b>



La Metelli nasce il 1° Agosto 1962 quale officina per lavorazioni meccaniche. Nel 1970 prende avvio la produzione delle parti motore e già nel 1975 inizia la fabbricazione delle parti freno e frizione idrauliche. Un ulteriore impulso all'espansione giunge nel 1991 con l'installazione della linea per la produzione dei giunti omocinetiche a cui si aggiungono i semiassi nel 1999. Nel luglio del 2001 la Metelli S.p.A. acquista il 100% della società GRAF S.p.A., produttrice di pompe acqua e dischi freno. Nel 2008 vengono introdotte le pastiglie freno e nel 2010 le ganasce freno a completamento della gamma frenante. Nel 2012 vengono lanciati il Kit distribuzione con pompa acqua e il kit cuffia. A fine 2014 il gruppo Metelli acquisisce le società Fri.Tech. e Trusting, aziende italiane produttrici di pastiglie e ganasce freno.





*Metelli was established on 1st August 1962 as a mechanical engineering workshop. In 1970, the company started producing engine parts and, in 1975, began manufacturing hydraulic brake and clutch parts. A further boost to expansion came in 1991 with the installation of the line for the production of constant velocity joints, later expanded in 1999 to include driveshafts. In July 2001, Metelli Co. acquired 100% of GRAF Co., a leading manufacturer of water pumps and brake discs. In order to complete the brake parts range Metelli introduced brake pads in 2008 and brake shoes in 2010. In 2012 Metelli introduced the timing belt Kit with water pump and boot kit. At the end of 2014, Metelli Group acquires Fri.Tech. and Trusting companies, Italian manufacturers of brake pads and brake shoes*

*La société Metelli a été créée le 1er août 1962 comme atelier d'usinage. En 1970, l'entreprise a démarré la production de composants pour l'industrie des moteurs et a lancé en 1975 la fabrication de pièces de freinage et d'embrayage hydrauliques. En 1991, dans le cadre de sa politique d'expansion, la société a installé une nouvelle ligne pour la production de joints homocinétiques, à laquelle s'est ajoutée en 1999 celle des transmissions. En juillet 2001, Metelli S.p.A. a racheté la totalité de la société GRAF S.p.A., producteur leader de pompes à eau et de disques de frein. En 2008 nous avons introduits dans notre gamme les Plaquettes de Freins et en 2010 les Machoires de Frein à complètement de notre programme de freinage. En 2012 nous avons introduits les kit distribution avec pompe à eau et les kit de soufflet de transmission. Fin 2014 Metelli Group reprend les sociétés Fri.Tech. et Trusting qui sont des sociétés italiennes qui fabriquent plaquettes de frein et mâchoires de frein.*

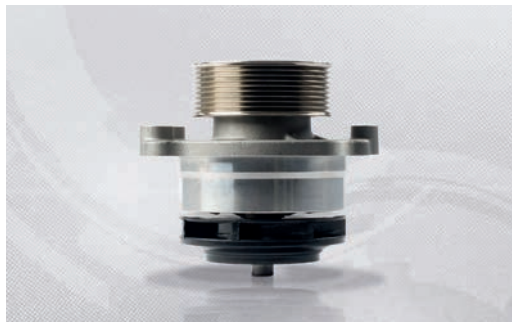
*Die Firma Metelli wurde am 1. August 1962 als mechanische Werkstätte gegründet. 1970 beginnt die Produktion von Motorteilen und bereits 1975 die Fertigung von hydraulischen Bremsenteilen und Kupplungsteilen. Einen weiteren Impuls zur Expansion erhält die Firma im 1991 durch die neue Produktionslinie Radgelenke und im Jahre im 1999 kommen dann Antriebswellen hinzu. Im Juli 2001 aquiriert die Metelli S.p.A. zu 100% die Gesellschaft GRAF S.p.A. auf, eine leitende Herstellerfirma von Wasserpumpen und Bremsscheiben. Im 2008 haben wir Bremsbelaege und im 2010 Bremsbacken in unserem Produktpalette eingefuehrt um unser Bremshydraulikprogramm zu vollstaendingen. Im Jahr 2012 hat Metelli Zusaetzlich Spannrollen Kit mit Wasserpumpe und Faltenbalg-Satz im Programm vorgestellt. Am Ende 2014 hat die Firma Metelli zwei italienische Firmen erworben: Die Firma Fri.Tech. Hersteller von Bremsbelaege und die Firma Trusting Hersteller von Bremsbacken.*

*La firma Metelli nasce el 1 de Agosto de 1962 como taller para mecanizaciones. En 1970 comienza la realización de piezas para motores y ya en 1975 inicia la fabricación de piezas para frenos y embragues hidráulicos. Un mayor impulso a la expansión llega en 1991 con la instalación de una línea para la producción de juntas homocinéticas a las que se añadirán los semiejes en 1999. En el mes de Julio de 2001 Metelli S.p.A. adquiere el 100% de la firma GRAF S.p.A., fabricante líder de bombas de agua y discos de freno. En 2008 se introduce la gama de pastillas de freno y en 2010 la de zapatas de freno para completar la gama de frenos. Los kit distribución con bomba de agua y los fuele se introdujeron en 2012. En el año 2014 el Grupo Metelli adquirió las empresas Fri.Tech. y Trusting, empresas italianas productoras de pastillas y zapatas de freno.*



					
	<b>ABBREVIAZIONI</b>	<b>ABBREVIATIONS</b>	<b>ABRÉVIATIONS</b>	<b>ZEICHENERKLÄRUNG</b>	<b>ABREVIATURAS</b>
<b>16v</b>	16 Valvole	16 Valves	16 Soupapes	16 Ventile	16 Válvulas
<b>AF</b>	Ventilatore automatico	Automatic fan	Ventilateur automat.	Autom. Luefter	Ventilador autom.
<b>Air</b>	Con condizionatore	With air conditioning	Avec climatiseur	Mit Klimaanlage	Con aire acondicionado
<b>A/T</b>	Cambio automatico	Automatic transmission	Automatique	Schaltgetriebe	Cambio automático
<b>BH</b>	Coperchio	Back Housing	Carter	Gegengehäuse	Cárter
<b>-Ch</b>	Fino telaio N.	To chassis No.	Jusqu'au chassis N.	Bis Fahrgestell Nr.	Hasta bastidor
<b>Ch-</b>	Dal telaio N.	From chassis No.	Depuis chassis N.	Ab Fahrgestell Nr.	Desde bastidor N.
<b>CM</b>	Contagiri meccanico	Mecan.revol.counter	Compte tours méc.	Mech.Drehzahlm.	Cuenta revoluc. mee.
<b>Dynamo</b>	Con dinamo	With dynamo	Avec dynamo	Drehstrom-Lichtmasch.	Con dinamo
<b>-Eng.</b>	Fino a motore N.	To engine No.	Jusqu'au moteur N.	Bis Motor Nr.	Hasta motor N.
<b>Eng.-</b>	Dal motore N.	From engine No.	Depuis moteur N.	Ab Motor Nr.	Desde motor N.
<b>-G.Box</b>	Fino a cambio N.	To gear box No.	Jusqu'à boîte vit. N.	Bis Getriebe Nr.	Hasta cambio N.
<b>G.Box-</b>	Dal cambio N.	From gear box No.	Depuis boîte vit. N.	Ab Getriebe Nr.	Desde cambio N.
<b>Impeller</b>	Girante	Impeller	Turbine	Flügelrad	Rodete
<b>Mod.</b>	Modello	Model	Modèle	Model	Modelo
<b>PS</b>	Servosterzo	Power-steering	Direction assistée	Servolenkung	Servo dirección
<b>Pulley</b>	Puleggia	Pulley	Poulie	Riemenscheibe	Polea
<b>RB</b>	Cuscinetto rinforz.	Reinforced bearing	Roulement renforcé	Verstaerkt. Lager	Rodamiento reforzado
<b>Teeth</b>	Denti	Teeth	Dents	Zähne	Dientes
<b>Thermo</b>	Con termocontatto	With thermo contact	Avec thermo contact	Mit thermo Kontakt	Con termo contacto
<b>T.T.</b>	Tutti i tipi	All models	Tous les types	Alle Typen	Todos los tipos
<b>-Vett.</b>	Fino a produz. N.	To production No.	Jusqu'à production N.	Bis Produktion Nr.	Hasta producción N.
<b>Vett.-</b>	Da produz. N.	From production No.	Depuis production N.	Ab Produktion Nr.	Desde producción N.
<b>w/</b>	Con	With	Avec	Mit	Con

					
	<b>SIMBOLOGIA</b>	<b>SYMBOLS</b>	<b>SYMBOLOGIE</b>	<b>SYMBOLE</b>	<b>SIMBOLOGIA</b>
	Marca e modello	Make and model	Marque et modèle	Marke und Modell	Marca y modelo
	Anno	Year	Année	Baujahr	Año
<b>METELLI réf.</b>	<b>METELLI ref.</b>	<b>METELLI part n°</b>	<b>Réf. METELLI</b>	<b>METELLI NR</b>	<b>Ref. METELLI</b>
	Ricambio	Repair kit	Nécessaire	Teilpumpe	Recambio
	Cinghia distribuzione	Timing belt system	Courroie de distribution	Steuerriemen	Correa de distribución
<b>NOTE</b>	Note	Note	Note	Noten	Notas
<b>Ad. OE</b>	Adattabile a OE	Adaptable to OE	Adaptable au OE	Passend zur OE	Adaptable al OE

MAKE - MODEL	PAGE	MAKE - MODEL	PAGE	MAKE - MODEL	PAGE
<b>DAF</b>		P / PA '12/79-'12/93.....	38	Integro (O 550) '1/01-.....	208
65 CF '2/98-'12/00.....	2	Stralis '1/02-.....	40	Intouro '1/05-.....	208
85 '7/92-'2/98.....	2	Trakker '1/04-.....	40	LP-LPK-LPS-LPO '1/67-'3/77.....	208
85 CF '2/98-'12/00.....	4	Turbostar '7/84-'12/93.....	40	O 301 '2/86-'5/87.....	208
95 '9/87-'1/98.....	6	TurboTech '1/90-'1/93.....	40	O 302 '11/64-'11/75.....	210
95 XF '1/97-'9/02.....	10	<b>MAN BUS</b>		O 303 '1/74-'12/92.....	210
CF 65 '1/01-.....	16	Hocl '1/96-.....	40	O 305 '1/69-'12/87.....	212
CF 85 '1/01-.....	16	LION'S COACH '9/95-.....	42	O 307 '1/73-'12/77.....	212
F 2800 '1/74-'9/91.....	20	LION'S STAR '1/93-.....	42	O 309 '1/68-'2/89.....	212
LF 45 '1/01-.....	24	LIONS CITY '8/96-.....	42	O 330 '1/90-.....	212
LF 55 '1/01-.....	24	LIONS COMFORT '9/96-.....	42	O 340 '1/91-'8/95.....	212
XF 105 '10/05-.....	24	Low entry '7/86-'5/94.....	42	O 350 Turismo '8/95-.....	214
XF 95 '9/02-'12/06.....	24	NG '8/92-.....	46	O 355 '1/68-.....	214
<b>IRIS BUS</b>		NL '9/89-.....	48	O 402 '2/86-'12/91.....	214
Arway '1/06-'12/13.....	26	NM '8/87-.....	48	O 403 '9/03-.....	214
Domino '10/03-'12/13.....	26	SD '4/74-'4/94.....	50	O 404 '9/91-'11/92.....	216
Evadys '10/03-'12/13.....	26	SG '1/69-'12/98.....	50	O 405 '1/84-.....	216
Magelys '8/08-'12/13.....	26	SL '1/63-'12/73.....	52	O 407 '1/85-.....	216
<b>IVECO BUS</b>		SL II '1/76-'12/80.....	52	O 408 '1/91-'12/98.....	218
Autobus.....	26	SM '11/87-'2/95.....	52	OH Series '1/70-.....	218
CityClass '1/92-'12/08.....	26	SR '1/76-.....	52	Serie LK-LN2 '1/84-'12/98.....	218
EuroRider '1/92-.....	26	SU '10/76-.....	52	Serie MK '12/87-'9/96.....	218
<b>IVECO TRUCK</b>		UL '9/89-.....	56	Serie NG '8/73-'9/96.....	220
100 '1/73-.....	26	<b>MAN TRUCK</b>		Serie PK '1/77-'12/84.....	224
109 '1/83-'12/91.....	26	E 2000 '5/00-.....	56	Serie SK '1/81-'9/96.....	224
110 '1/73-.....	26	EL '1/93-.....	64	Tourino (O 510) '10/03-.....	226
115.....	28	EM '10/93-.....	64	Touro (O 500) '10/01-.....	228
135.....	28	F 2000 '1/94-.....	64	Travego (O 580) '10/99-.....	228
145 '1/87-.....	28	F 9 '1/83-'12/86.....	84	Unimog '1/73-'12/00.....	228
150 '1/75-.....	28	F 90 '1/87-'6/96.....	84	Zetros '9/08-.....	236
175.....	28	G 90 '9/87-'5/95.....	114	<b>RENAULT TRUCK</b>	
300 '1/74-.....	28	Industrial '1/76-'12/81.....	114	Agora Bus '1/95-.....	236
40/35 '1/66-'12/71.....	28	L 2000 '10/93-.....	114	C '10/80-'6/97.....	236
50 '1/66-'12/86.....	28	M 2000 L '8/95-.....	118	G '10/80-'10/96.....	236
55 '1/70-.....	28	M 2000 M '8/95-.....	120	Kerax '4/96-.....	238
60 '1/79-'12/91.....	28	M 90 '8/88-'6/96.....	124	Magnum '4/87-'12/13.....	240
616 '1/65-'12/71.....	28	NU '9/96-.....	130	Major '10/80-'10/96.....	244
625 '1/71-.....	28	R '5/85-'1/93.....	130	Manager '10/80-'6/97.....	244
645 '1/60-'12/73.....	28	Serie 11000 '1/73-'12/81.....	130	Maxity '5/06-.....	246
65 '1/70-'12/91.....	28	Serie 12000 '1/73-'12/81.....	130	Maxter '5/90-.....	246
653.....	28	Serie 13000 '1/69-'12/81.....	130	Premium I '10/92-'9/05.....	246
655 '1/66-'12/71.....	28	Serie 14000 '1/73-'12/81.....	130	Premium II '10/05-'12/13.....	248
662 '1/60-'12/71.....	28	Serie 15000 '1/69-'12/81.....	132	R '10/80-'10/92.....	250
672 '1/69-.....	30	Serie 16000 '11/69-'12/81.....	132	R312 Bus '1/88-'12/98.....	250
684 '1/70-.....	30	Serie 19000 '1/72-'12/81.....	132	<b>SCANIA TRUCK</b>	
690 '1/62-.....	30	TGA '4/00-'7/16.....	132	112 H '1/81-'12/86.....	250
691 '1/69-.....	30	TGL '5/16-.....	154	112 M '1/81-'12/86.....	250
697 '1/70-.....	30	TGM '5/16-.....	156	113 E '11/91-.....	250
79 '1/83-'12/91.....	30	TGS '7/16-.....	160	113 H '5/88-.....	250
90 '1/70-.....	30	TGX '7/16-.....	164	113 M '11/91-.....	252
95 '1/83-'12/91.....	30	<b>MERCEDES BENZ TRUCK</b>		114 C '5/96-.....	254
Daily - Grinta '1/79-'12/90.....	30	Accelo '5/03-.....	166	114 G '5/96-.....	254
Daily I '1/91-'1/99.....	30	Actros I '4/96-'10/02.....	166	114 L '5/96-.....	254
Daily II '2/99-'4/06.....	32	Actros II/ III '1/03-.....	170	124 C '9/96-.....	254
Daily III '5/06-'12/10.....	34	Atego I '1/98-'10/04.....	176	124 G '5/96-.....	256
Daily IV '1/11-'2/14.....	34	Atego II '10/04-.....	186	124 L '9/96-.....	256
EuroCargo '1/91-'12/11.....	34	Axor I '1/02-'10/04.....	192	143 E '1/91-.....	256
EuroStar '1/93-'12/02.....	36	Axor II '10/04-.....	194	143 H '5/88-.....	256
EuroTech MH '1/98-'12/03.....	36	CapaCity (O 530 GL) '4/07-.....	202	143 M '1/91-.....	256
EuroTech MP '1/92-'12/03.....	36	Citaro (O 530) '1/98-.....	204	164 C '5/00-.....	256
EuroTech MT '1/92-'12/98.....	38	Cito (O 520) '1/98-.....	204	164 G '5/00-.....	258
EuroTrakker '1/93-'12/04.....	38	Conecto (O 345) '11/01-.....	204	164 L '5/00-.....	258
Massif '7/08-'12/11.....	38	Econic '3/98-.....	206	93 H '3/88-.....	258
		Industrial '1/72-.....	206	93 M '3/88-.....	258
				94 C '12/96-.....	258
				94 D '12/96-.....	258
				94 G '8/96-.....	260

MAKE - MODEL	PAGE	MAKE - MODEL	PAGE	MAKE - MODEL	PAGE
94 L '4/97-.....	260				
BR 112DH.....	260				
G II '3/04-.....	260				
K III '11/90-.....	260				
K-Serie '1/06-.....	260				
P II '9/04-.....	262				
R II '3/04-.....	264				
T 113 E '11/91-.....	266				
T 113 H '11/91-.....	266				
T 114 C '3/98-.....	266				
T 114 G '5/96-.....	266				
T 114 L '5/96-.....	268				
T 124 C '9/95-.....	268				
T 124 G '3/97-.....	268				
T 124 L '9/95-.....	268				
T 143 E '1/91-.....	268				
T 143 H '1/91-.....	270				
T 93 H '1/90-.....	270				
T 94 C '9/96-.....	270				
T 94 G '8/96-.....	270				
<b>VOLVO TRUCK</b>					
7700 '6/06-.....	272				
8500 '1/99-.....	272				
8700 '1/99-.....	272				
9700 '10/07-.....	272				
9900 '10/07-.....	272				
A-Serie '1/99-.....	272				
B 12 '1/92-.....	274				
B 54 '1/65-'12/75.....	274				
B 6 '11/91-.....	274				
B 7 '1/99-.....	274				
B 9 '9/05-.....	274				
F 10 '8/77-'12/94.....	274				
F 12 '1/79-'12/94.....	276				
F 16 '1/88-'12/94.....	276				
F 80 '1/65-'12/85.....	276				
FE '5/06-.....	276				
FE II '5/12-.....	278				
FH '5/05-.....	278				
FH 12 '9/01-.....	280				
FH 13 '1/05-.....	282				
FH 16 '8/93-.....	282				
FH 16 II '5/12-.....	284				
FH II '5/12-.....	284				
FL 10 '1/88-'9/98.....	284				
FL 12 '9/95-'9/98.....	284				
FL 7 '9/85-'9/98.....	286				
FL II '5/06-.....	286				
FL III '5/13-.....	288				
FM '9/05-.....	288				
FM 12 '8/98-'9/05.....	290				
FM 7 '9/98-'12/01.....	292				
FM 9 '12/01-'9/05.....	292				
FMX '4/10-.....	292				
FS 7 '9/94-'3/96.....	294				
L.....	294				
N '1/65-.....	294				
N 10 '10/83-'12/89.....	294				
NH 12 '5/99-.....	294				





**24-1060**

**24-1307**

--	--	--	--

--	--	--	--

--	--	--	--

--	--	--	--

		<b>METELLI</b> ref.			<b>NOTE</b>	<b>Adaptable for OES</b>
<b>65 CF '2/98-'12/00</b>						
FA65CF180 (133 kW) Eng.NS133M	98-00	<b>24-1060</b>				1399689
FA65CF210 (156 kW) Eng.NS156M	98-00	<b>24-1060</b>				1399689
FA65CF240 (177 kW) Eng.NS177M	98-00	<b>24-1060</b>				1399689
FAV65CF210 (156 kW) Eng.NS156M	98-00	<b>24-1060</b>				1399689
<b>85 '7/92-'2/98</b>						
FA85.330 (242 kW) Eng.WS242	92-98	<b>24-1307</b>				0681653,0682258,372896,681653,682258/ R 682968/ R
FA85.330 (242 kW) Eng.WS242L	92-98	<b>24-1307</b>				0681653,0682258,372896,681653,682258/ R 682968/ R
FA85.330 (242 kW) Eng.WS242M	92-98	<b>24-1307</b>				0681653,0682258,372896,681653,682258/ R 682968/ R
FA85.360 (268 kW) Eng.WS268	92-98	<b>24-1307</b>				0681653,0682258,372896,681653,682258/ R 682968/ R
FA85.360 (268 kW) Eng.WS268L	92-98	<b>24-1307</b>				0681653,0682258,372896,681653,682258/ R 682968/ R
FA85.360 (268 kW) Eng.WS268M	92-98	<b>24-1307</b>				0681653,0682258,372896,681653,682258/ R 682968/ R
FA85.400 (295 kW) Eng.WS295M	95-98	<b>24-1307</b>				0681653,0682258,372896,681653,682258/ R 682968/ R
FAD85.330 (242 kW) Eng.WS242L	92-98	<b>24-1307</b>				0681653,0682258,372896,681653,682258/ R 682968/ R
FAD85.330 (242 kW) Eng.WS242M	92-98	<b>24-1307</b>				0681653,0682258,372896,681653,682258/ R 682968/ R
FAD85.360 (268 kW) Eng.WS268L	92-98	<b>24-1307</b>				0681653,0682258,372896,681653,682258/ R 682968/ R
FAD85.360 (268 kW) Eng.WS268M	92-98	<b>24-1307</b>				0681653,0682258,372896,681653,682258/ R 682968/ R
FAD85.400 (295 kW) Eng.WS295M	95-98	<b>24-1307</b>				0681653,0682258,372896,681653,682258/ R 682968/ R
FAG/FAR/FAS85.330 (242 kW) Eng.WS242L	92-98	<b>24-1307</b>				0681653,0682258,372896,681653,682258/ R 682968/ R
FAG/FAR/FAS85.330 (242 kW) Eng.WS242M	92-98	<b>24-1307</b>				0681653,0682258,372896,681653,682258/ R 682968/ R
FAG/FAR/FAS85.360 (268 kW) Eng.WS268L	92-98	<b>24-1307</b>				0681653,0682258,372896,681653,682258/ R 682968/ R
FAG/FAR/FAS85.360 (268 kW) Eng.WS268M	92-98	<b>24-1307</b>				0681653,0682258,372896,681653,682258/ R 682968/ R
FAG/FAR/FAS85.400 (295 kW) Eng.WS295M	95-98	<b>24-1307</b>				0681653,0682258,372896,681653,682258/ R 682968/ R
FAT85.330 (242 kW) Eng.WS242L	92-98	<b>24-1307</b>				0681653,0682258,372896,681653,682258/ R 682968/ R
FAT85.330 (242 kW) Eng.WS242M	92-98	<b>24-1307</b>				0681653,0682258,372896,681653,682258/ R 682968/ R
FAT85.360 (268 kW) Eng.WS268L	92-98	<b>24-1307</b>				0681653,0682258,372896,681653,682258/ R 682968/ R
FAT85.360 (268 kW) Eng.WS268M	92-98	<b>24-1307</b>				0681653,0682258,372896,681653,682258/ R 682968/ R
FAT85.400 (295 kW) Eng.WS295M	95-98	<b>24-1307</b>				0681653,0682258,372896,681653,682258/ R 682968/ R
FT85.330 (242 kW) Eng.WS242	92-98	<b>24-1307</b>				0681653,0682258,372896,681653,682258/ R 682968/ R
FT85.330 (242 kW) Eng.WS242L	92-98	<b>24-1307</b>				0681653,0682258,372896,681653,682258/ R 682968/ R
FT85.330 (242 kW) Eng.WS242M	92-98	<b>24-1307</b>				0681653,0682258,372896,681653,682258/ R 682968/ R
FT85.360 (268 kW) Eng.WS268L	92-98	<b>24-1307</b>				0681653,0682258,372896,681653,682258/ R 682968/ R
FT85.360 (268 kW) Eng.WS268M	92-98	<b>24-1307</b>				0681653,0682258,372896,681653,682258/ R 682968/ R
FT85.400 (295 kW) Eng.WS295M	95-98	<b>24-1307</b>				0681653,0682258,372896,681653,682258/ R 682968/ R
FTG85.330 (242 kW) Eng.WS242L	92-98	<b>24-1307</b>				0681653,0682258,372896,681653,682258/ R 682968/ R

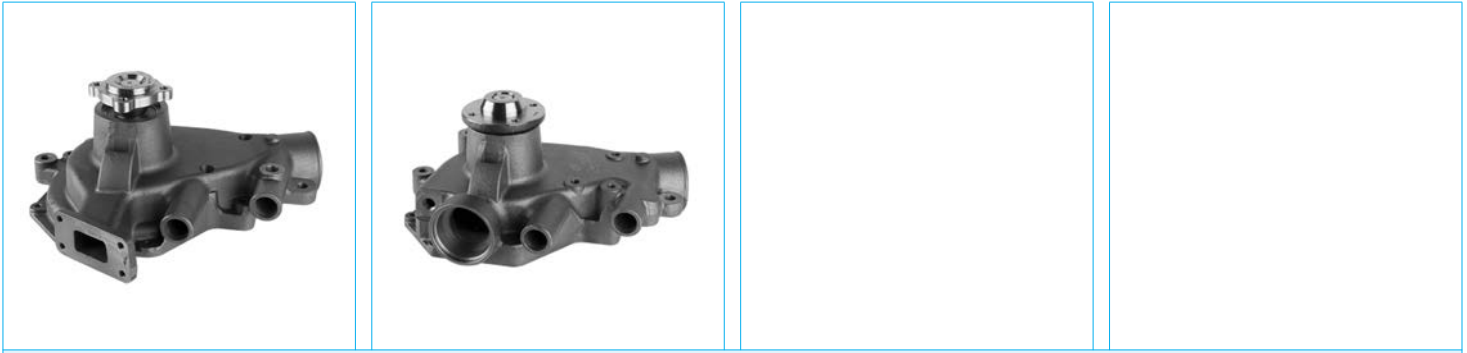

**24-1307**

**24-1317**

--	--	--	--

--	--	--	--

--	--	--	--

--	--	--	--

		<b>METELLI</b> ref.			<b>NOTE</b>	<b>Adaptable for OES</b>
FTG85.330 (242 kW) Eng.WS242M	92-98	<b>24-1307</b>				0681653,0682258,372896,681653,682258/ R 682968/ R
FTG85.360 (268 kW) Eng.WS268L	92-98	<b>24-1307</b>				0681653,0682258,372896,681653,682258/ R 682968/ R
FTG85.360 (268 kW) Eng.WS268M	92-98	<b>24-1307</b>				0681653,0682258,372896,681653,682258/ R 682968/ R
FTG85.400 (295 kW) Eng.WS295M	95-98	<b>24-1307</b>				0681653,0682258,372896,681653,682258/ R 682968/ R
FTT85.330 (242 kW) Eng.WS242L	92-98	<b>24-1307</b>				0681653,0682258,372896,681653,682258/ R 682968/ R
FTT85.330 (242 kW) Eng.WS242M	92-98	<b>24-1307</b>				0681653,0682258,372896,681653,682258/ R 682968/ R
FTT85.360 (268 kW) Eng.WS268L	92-98	<b>24-1307</b>				0681653,0682258,372896,681653,682258/ R 682968/ R
FTT85.360 (268 kW) Eng.WS268M	92-98	<b>24-1307</b>				0681653,0682258,372896,681653,682258/ R 682968/ R
FTT85.400 (295 kW) Eng.WS295M	95-98	<b>24-1307</b>				0681653,0682258,372896,681653,682258/ R 682968/ R
<b>85 CF '2/98-'12/00</b>						
FA85CF340 (250 kW) Eng.XF250M	98-00	<b>24-1317</b>			Impeller Ø 135mm	0063225,0683225/ R,0683386/ R,1262683 1609871,683225R,683386/ 586
FA85CF380 (280 kW) Eng.XF280M	98-00	<b>24-1317</b>			Impeller Ø 135mm	0063225,0683225/ R,0683386/ R,1262683 1609871,683225R,683386/ 586
FA85CF430 (315 kW) Eng.XF315M	98-00	<b>24-1317</b>			Impeller Ø 135mm	0063225,0683225/ R,0683386/ R,1262683 1609871,683225R,683386/ 586
FAC85CF340 (250 kW) Eng.XF250M	98-00	<b>24-1317</b>			Impeller Ø 135mm	0063225,0683225/ R,0683386/ R,1262683 1609871,683225R,683386/ 586
FAC85CF380 (280 kW) Eng.XF280M	98-00	<b>24-1317</b>			Impeller Ø 135mm	0063225,0683225/ R,0683386/ R,1262683 1609871,683225R,683386/ 586
FAC85CF430 (315 kW) Eng.XF315M	98-00	<b>24-1317</b>			Impeller Ø 135mm	0063225,0683225/ R,0683386/ R,1262683 1609871,683225R,683386/ 586
FAD85CF340 (250 kW) Eng.XF250M	98-00	<b>24-1317</b>			Impeller Ø 135mm	0063225,0683225/ R,0683386/ R,1262683 1609871,683225R,683386/ 586
FAD85CF380 (280 kW) Eng.XF280M	98-00	<b>24-1317</b>			Impeller Ø 135mm	0063225,0683225/ R,0683386/ R,1262683 1609871,683225R,683386/ 586
FAD85CF430 (315 kW) Eng.XF315M	98-00	<b>24-1317</b>			Impeller Ø 135mm	0063225,0683225/ R,0683386/ R,1262683 1609871,683225R,683386/ 586
FAG/FAN85CF340 (250 kW) Eng.XF250M	98-00	<b>24-1317</b>			Impeller Ø 135mm	0063225,0683225/ R,0683386/ R,1262683 1609871,683225R,683386/ 586
FAG/FAN85CF380 (280 kW) Eng.XF280M	98-00	<b>24-1317</b>			Impeller Ø 135mm	0063225,0683225/ R,0683386/ R,1262683 1609871,683225R,683386/ 586
FAG/FAN85CF430 (315 kW) Eng.XF315M	98-00	<b>24-1317</b>			Impeller Ø 135mm	0063225,0683225/ R,0683386/ R,1262683 1609871,683225R,683386/ 586
FAR85CF340 (250 kW) Eng.XF250M	98-00	<b>24-1317</b>			Impeller Ø 135mm	0063225,0683225/ R,0683386/ R,1262683 1609871,683225R,683386/ 586
FAR85CF380 (280 kW) Eng.XF280M	98-00	<b>24-1317</b>			Impeller Ø 135mm	0063225,0683225/ R,0683386/ R,1262683 1609871,683225R,683386/ 586
FAR85CF430 (315 kW) Eng.XF315M	98-00	<b>24-1317</b>			Impeller Ø 135mm	0063225,0683225/ R,0683386/ R,1262683 1609871,683225R,683386/ 586
FAS85CF340 (250 kW) Eng.XF250M	98-00	<b>24-1317</b>			Impeller Ø 135mm	0063225,0683225/ R,0683386/ R,1262683 1609871,683225R,683386/ 586
FAS85CF380 (280 kW) Eng.XF280M	98-00	<b>24-1317</b>			Impeller Ø 135mm	0063225,0683225/ R,0683386/ R,1262683 1609871,683225R,683386/ 586
FAS85CF430 (315 kW) Eng.XF315M	98-00	<b>24-1317</b>			Impeller Ø 135mm	0063225,0683225/ R,0683386/ R,1262683 1609871,683225R,683386/ 586
FAT85CF340 (250 kW) Eng.XF250M	98-00	<b>24-1317</b>			Impeller Ø 135mm	0063225,0683225/ R,0683386/ R,1262683 1609871,683225R,683386/ 586
FAT85CF380 (280 kW) Eng.XF280M	98-00	<b>24-1317</b>			Impeller Ø 135mm	0063225,0683225/ R,0683386/ R,1262683 1609871,683225R,683386/ 586
FAT85CF430 (315 kW) Eng.XF315M	98-00	<b>24-1317</b>			Impeller Ø 135mm	0063225,0683225/ R,0683386/ R,1262683 1609871,683225R,683386/ 586
FT85CF340 (250 kW) Eng.XF250M	98-00	<b>24-1317</b>			Impeller Ø 135mm	0063225,0683225/ R,0683386/ R,1262683 1609871,683225R,683386/ 586
FT85CF380 (280 kW) Eng.XF280M	98-00	<b>24-1317</b>			Impeller Ø 135mm	0063225,0683225/ R,0683386/ R,1262683 1609871,683225R,683386/ 586

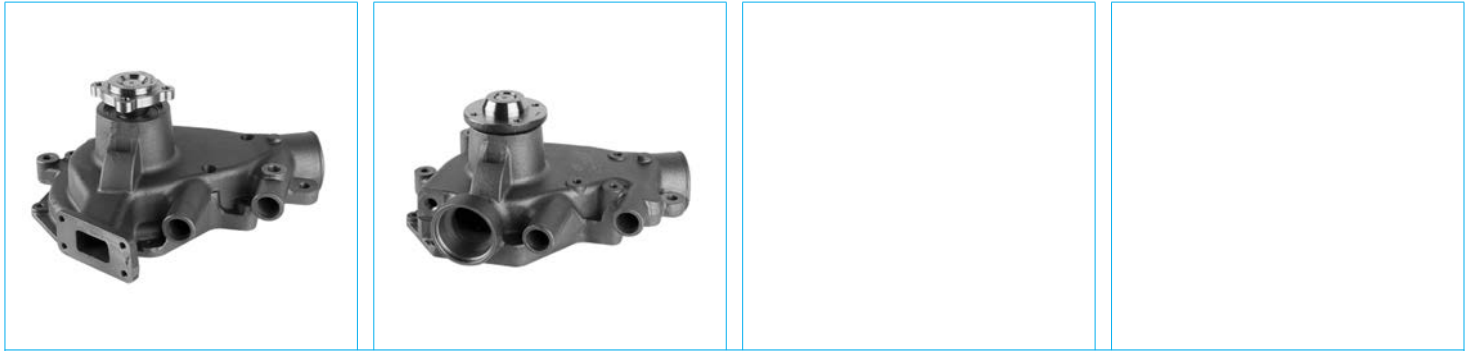

**24-1307**

**24-1317**

--	--	--	--

--	--	--	--

--	--	--	--

--	--	--	--

		<b>METELLI</b> ref.			<b>NOTE</b>	<b>Adaptable for OES</b>
FT85CF430 (315 kW) Eng.XF315M	98-00	<b>24-1317</b>			Impeller Ø 135mm	0063225,0683225/ R,0683386/ R,1262683 1609871,683225R,683386/ 586
FTG85CF340 (250 kW) Eng.XF250M	98-00	<b>24-1317</b>			Impeller Ø 135mm	0063225,0683225/ R,0683386/ R,1262683 1609871,683225R,683386/ 586
FTG85CF380 (280 kW) Eng.XF280M	98-00	<b>24-1317</b>			Impeller Ø 135mm	0063225,0683225/ R,0683386/ R,1262683 1609871,683225R,683386/ 586
FTG85CF430 (315 kW) Eng.XF315M	98-00	<b>24-1317</b>			Impeller Ø 135mm	0063225,0683225/ R,0683386/ R,1262683 1609871,683225R,683386/ 586
FTT85CF340 (250 kW) Eng.XF250M	98-00	<b>24-1317</b>			Impeller Ø 135mm	0063225,0683225/ R,0683386/ R,1262683 1609871,683225R,683386/ 586
FTT85CF430 (315 kW) Eng.XF315M	98-00	<b>24-1317</b>			Impeller Ø 135mm	0063225,0683225/ R,0683386/ R,1262683 1609871,683225R,683386/ 586
<b>95 '9/87-'1/98</b>						
FA95.330 (242 kW) Eng.WS242	90-98	<b>24-1307</b>				0681653,0682258,372896,681653,682258/ R 682968/ R
FA95.360 (268 kW) Eng.WS268	90-98	<b>24-1307</b>				0681653,0682258,372896,681653,682258/ R 682968/ R
FA95.360 (268 kW) Eng.WS268G	90-98	<b>24-1307</b>				0681653,0682258,372896,681653,682258/ R 682968/ R
FA95.360 (268 kW) Eng.WS268L	90-98	<b>24-1307</b>				0681653,0682258,372896,681653,682258/ R 682968/ R
FA95.360 (268 kW) Eng.WS268M	90-98	<b>24-1307</b>				0681653,0682258,372896,681653,682258/ R 682968/ R
FA95.400 (295 kW) Eng.WS295	90-98	<b>24-1307</b>				0681653,0682258,372896,681653,682258/ R 682968/ R
FA95.400 (295 kW) Eng.WS295G	90-98	<b>24-1307</b>				0681653,0682258,372896,681653,682258/ R 682968/ R
FA95.400 (295 kW) Eng.WS295L	90-98	<b>24-1307</b>				0681653,0682258,372896,681653,682258/ R 682968/ R
FA95.400 (295 kW) Eng.WS295M	90-98	<b>24-1307</b>				0681653,0682258,372896,681653,682258/ R 682968/ R
FA95.430 (315 kW) Eng.WS315	92-98	<b>24-1307</b>				0681653,0682258,372896,681653,682258/ R 682968/ R
FA95.430 (315 kW) Eng.WS315G	92-98	<b>24-1307</b>				0681653,0682258,372896,681653,682258/ R 682968/ R
FA95.430 (315 kW) Eng.WS315L	92-98	<b>24-1307</b>				0681653,0682258,372896,681653,682258/ R 682968/ R
FA95.430 (315 kW) Eng.WS315M	92-98	<b>24-1307</b>				0681653,0682258,372896,681653,682258/ R 682968/ R
FAD95.360 (268 kW) Eng.WS268	90-98	<b>24-1307</b>				0681653,0682258,372896,681653,682258/ R 682968/ R
FAD95.360 (268 kW) Eng.WS268G	90-98	<b>24-1307</b>				0681653,0682258,372896,681653,682258/ R 682968/ R
FAD95.360 (268 kW) Eng.WS268L	90-98	<b>24-1307</b>				0681653,0682258,372896,681653,682258/ R 682968/ R
FAD95.360 (268 kW) Eng.WS268M	90-98	<b>24-1307</b>				0681653,0682258,372896,681653,682258/ R 682968/ R
FAD95.400 (295 kW) Eng.WS295	90-98	<b>24-1307</b>				0681653,0682258,372896,681653,682258/ R 682968/ R
FAD95.400 (295 kW) Eng.WS295G	90-98	<b>24-1307</b>				0681653,0682258,372896,681653,682258/ R 682968/ R
FAD95.400 (295 kW) Eng.WS295L	90-98	<b>24-1307</b>				0681653,0682258,372896,681653,682258/ R 682968/ R
FAD95.400 (295 kW) Eng.WS295M	90-98	<b>24-1307</b>				0681653,0682258,372896,681653,682258/ R 682968/ R
FAD95.430 (315 kW) Eng.WS315	92-98	<b>24-1307</b>				0681653,0682258,372896,681653,682258/ R 682968/ R
FAD95.430 (315 kW) Eng.WS315L	92-98	<b>24-1307</b>				0681653,0682258,372896,681653,682258/ R 682968/ R
FAD95.430 (315 kW) Eng.WS315M	92-98	<b>24-1307</b>				0681653,0682258,372896,681653,682258/ R 682968/ R
FAG/FAR/FAS95.360 (268 kW) Eng.WS268	90-98	<b>24-1307</b>				0681653,0682258,372896,681653,682258/ R 682968/ R
FAG/FAR/FAS95.360 (268 kW) Eng.WS268G	90-98	<b>24-1307</b>				0681653,0682258,372896,681653,682258/ R 682968/ R

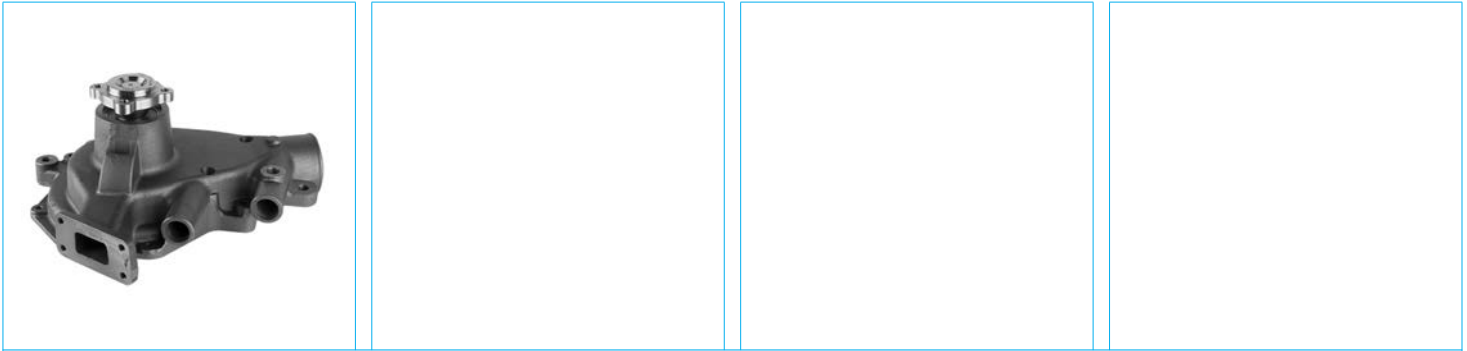

**24-1307**

--	--	--	--

--	--	--	--

--	--	--	--



--	--	--	--

--	--	--	--

--	--	--	--

--	--	--	--

--	--	--	--

		<b>METELLI</b> ref.			<b>NOTE</b>	<b>Adaptable for OES</b>
FAG/FAR/FAS95.360 (268 kW) Eng.WS268L	90-98	<b>24-1307</b>				0681653,0682258,372896,681653,682258/ R 682968/ R
FAG/FAR/FAS95.360 (268 kW) Eng.WS268M	90-98	<b>24-1307</b>				0681653,0682258,372896,681653,682258/ R 682968/ R
FAG/FAR/FAS95.400 (295 kW) Eng.WS295	90-98	<b>24-1307</b>				0681653,0682258,372896,681653,682258/ R 682968/ R
FAG/FAR/FAS95.400 (295 kW) Eng.WS295G	90-98	<b>24-1307</b>				0681653,0682258,372896,681653,682258/ R 682968/ R
FAG/FAR/FAS95.400 (295 kW) Eng.WS295L	90-98	<b>24-1307</b>				0681653,0682258,372896,681653,682258/ R 682968/ R
FAG/FAR/FAS95.400 (295 kW) Eng.WS295M	90-98	<b>24-1307</b>				0681653,0682258,372896,681653,682258/ R 682968/ R
FAG/FAR/FAS95.430 (315 kW) Eng.WS315	92-98	<b>24-1307</b>				0681653,0682258,372896,681653,682258/ R 682968/ R
FAG/FAR/FAS95.430 (315 kW) Eng.WS315L	92-98	<b>24-1307</b>				0681653,0682258,372896,681653,682258/ R 682968/ R
FAG/FAR/FAS95.430 (315 kW) Eng.WS315M	92-98	<b>24-1307</b>				0681653,0682258,372896,681653,682258/ R 682968/ R
FAK95.360 (268 kW) Eng.WS268	90-98	<b>24-1307</b>				0681653,0682258,372896,681653,682258/ R 682968/ R
FAK95.360 (268 kW) Eng.WS268L	90-98	<b>24-1307</b>				0681653,0682258,372896,681653,682258/ R 682968/ R
FAK95.360 (268 kW) Eng.WS268M	90-98	<b>24-1307</b>				0681653,0682258,372896,681653,682258/ R 682968/ R
FAK95.400 (295 kW) Eng.WS295	90-98	<b>24-1307</b>				0681653,0682258,372896,681653,682258/ R 682968/ R
FAK95.400 (295 kW) Eng.WS295L	90-98	<b>24-1307</b>				0681653,0682258,372896,681653,682258/ R 682968/ R
FAK95.400 (295 kW) Eng.WS295M	90-98	<b>24-1307</b>				0681653,0682258,372896,681653,682258/ R 682968/ R
FAK95.430 (315 kW) Eng.WS315	92-98	<b>24-1307</b>				0681653,0682258,372896,681653,682258/ R 682968/ R
FAK95.430 (315 kW) Eng.WS315L	92-98	<b>24-1307</b>				0681653,0682258,372896,681653,682258/ R 682968/ R
FAK95.430 (315 kW) Eng.WS315M	92-98	<b>24-1307</b>				0681653,0682258,372896,681653,682258/ R 682968/ R
FAR/FAS95.330 (242 kW) Eng.WS242	90-98	<b>24-1307</b>				0681653,0682258,372896,681653,682258/ R 682968/ R
FAT95.360 (268 kW) Eng.WS268	90-98	<b>24-1307</b>				0681653,0682258,372896,681653,682258/ R 682968/ R
FAT95.360 (268 kW) Eng.WS268G	90-98	<b>24-1307</b>				0681653,0682258,372896,681653,682258/ R 682968/ R
FAT95.360 (268 kW) Eng.WS268L	90-98	<b>24-1307</b>				0681653,0682258,372896,681653,682258/ R 682968/ R
FAT95.360 (268 kW) Eng.WS268M	90-98	<b>24-1307</b>				0681653,0682258,372896,681653,682258/ R 682968/ R
FAT95.400 (295 kW) Eng.WS295	90-98	<b>24-1307</b>				0681653,0682258,372896,681653,682258/ R 682968/ R
FAT95.400 (295 kW) Eng.WS295G	90-98	<b>24-1307</b>				0681653,0682258,372896,681653,682258/ R 682968/ R
FAT95.400 (295 kW) Eng.WS295L	90-98	<b>24-1307</b>				0681653,0682258,372896,681653,682258/ R 682968/ R
FAT95.400 (295 kW) Eng.WS295M	90-98	<b>24-1307</b>				0681653,0682258,372896,681653,682258/ R 682968/ R
FAT95.430 (315 kW) Eng.WS315	92-98	<b>24-1307</b>				0681653,0682258,372896,681653,682258/ R 682968/ R
FAT95.430 (315 kW) Eng.WS315L	92-98	<b>24-1307</b>				0681653,0682258,372896,681653,682258/ R 682968/ R
FAT95.430 (315 kW) Eng.WS315M	92-98	<b>24-1307</b>				0681653,0682258,372896,681653,682258/ R 682968/ R
FT95.330 (242 kW) Eng.WS242	90-93	<b>24-1307</b>				0681653,0682258,372896,681653,682258/ R 682968/ R
FT95.360 (268 kW) Eng.WS268	90-98	<b>24-1307</b>				0681653,0682258,372896,681653,682258/ R 682968/ R
FT95.360 (268 kW) Eng.WS268G	90-98	<b>24-1307</b>				0681653,0682258,372896,681653,682258/ R 682968/ R









24-1307









24-1317









24-1338

		<b>METELLI</b> ref.			<b>NOTE</b>	<b>Adaptable for OES</b>
FT95.360 (268 kW) Eng.WS268L	90-98	<b>24-1307</b>				0681653,0682258,372896,681653,682258/ R 682968/ R
FT95.360 (268 kW) Eng.WS268M	90-98	<b>24-1307</b>				0681653,0682258,372896,681653,682258/ R 682968/ R
FT95.400 (295 kW) Eng.WS295	90-98	<b>24-1307</b>				0681653,0682258,372896,681653,682258/ R 682968/ R
FT95.400 (295 kW) Eng.WS295G	90-98	<b>24-1307</b>				0681653,0682258,372896,681653,682258/ R 682968/ R
FT95.400 (295 kW) Eng.WS295L	90-98	<b>24-1307</b>				0681653,0682258,372896,681653,682258/ R 682968/ R
FT95.400 (295 kW) Eng.WS295M	90-98	<b>24-1307</b>				0681653,0682258,372896,681653,682258/ R 682968/ R
FT95.430 (315 kW) Eng.WS315	92-98	<b>24-1307</b>				0681653,0682258,372896,681653,682258/ R 682968/ R
FT95.430 (315 kW) Eng.WS315L	92-98	<b>24-1307</b>				0681653,0682258,372896,681653,682258/ R 682968/ R
FT95.430 (315 kW) Eng.WS315M	92-98	<b>24-1307</b>				0681653,0682258,372896,681653,682258/ R 682968/ R
FTG/FTR/FTS95.360 (268 kW) Eng.WS268	90-98	<b>24-1307</b>				0681653,0682258,372896,681653,682258/ R 682968/ R
FTG/FTR/FTS95.360 (268 kW) Eng.WS268L	90-98	<b>24-1307</b>				0681653,0682258,372896,681653,682258/ R 682968/ R
FTG/FTR/FTS95.360 (268 kW) Eng.WS268M	90-98	<b>24-1307</b>				0681653,0682258,372896,681653,682258/ R 682968/ R
FTG/FTR/FTS95.400 (295 kW) Eng.WS295	90-98	<b>24-1307</b>				0681653,0682258,372896,681653,682258/ R 682968/ R
FTG/FTR/FTS95.400 (295 kW) Eng.WS295G	90-98	<b>24-1307</b>				0681653,0682258,372896,681653,682258/ R 682968/ R
FTG/FTR/FTS95.400 (295 kW) Eng.WS295L	90-98	<b>24-1307</b>				0681653,0682258,372896,681653,682258/ R 682968/ R
FTG/FTR/FTS95.400 (295 kW) Eng.WS295M	90-98	<b>24-1307</b>				0681653,0682258,372896,681653,682258/ R 682968/ R
FTG/FTR/FTS95.430 (315 kW) Eng.WS315	92-98	<b>24-1307</b>				0681653,0682258,372896,681653,682258/ R 682968/ R
FTG/FTR/FTS95.430 (315 kW) Eng.WS315L	92-98	<b>24-1307</b>				0681653,0682258,372896,681653,682258/ R 682968/ R
FTG/FTR/FTS95.430 (315 kW) Eng.WS315M	92-98	<b>24-1307</b>				0681653,0682258,372896,681653,682258/ R 682968/ R
FTT95.360 (268 kW) Eng.WS268	90-98	<b>24-1307</b>				0681653,0682258,372896,681653,682258/ R 682968/ R
FTT95.360 (268 kW) Eng.WS268L	90-98	<b>24-1307</b>				0681653,0682258,372896,681653,682258/ R 682968/ R
FTT95.360 (268 kW) Eng.WS268M	90-98	<b>24-1307</b>				0681653,0682258,372896,681653,682258/ R 682968/ R
FTT95.400 (295 kW) Eng.WS295	90-98	<b>24-1307</b>				0681653,0682258,372896,681653,682258/ R 682968/ R
FTT95.400 (295 kW) Eng.WS295G	90-98	<b>24-1307</b>				0681653,0682258,372896,681653,682258/ R 682968/ R
FTT95.400 (295 kW) Eng.WS295L	90-98	<b>24-1307</b>				0681653,0682258,372896,681653,682258/ R 682968/ R
FTT95.400 (295 kW) Eng.WS295M	90-98	<b>24-1307</b>				0681653,0682258,372896,681653,682258/ R 682968/ R
FTT95.430 (315 kW) Eng.WS315	92-98	<b>24-1307</b>				0681653,0682258,372896,681653,682258/ R 682968/ R
FTT95.430 (315 kW) Eng.WS315L	92-98	<b>24-1307</b>				0681653,0682258,372896,681653,682258/ R 682968/ R
FTT95.430 (315 kW) Eng.WS315M	92-98	<b>24-1307</b>				0681653,0682258,372896,681653,682258/ R 682968/ R
<b>95 XF '1/97-'9/02</b>						
FA95XF380 (280 kW) Eng.XF280M	97-02	<b>24-1317</b>			Impeller Ø 135mm	0063225,0683225/ R,0683386/ R,1262683 1609871,683225R,683386/ 586
	97-02	<b>24-1338</b>			Impeller Ø 120mm	1653974,1664762,1738991,1742258/ 59 1747962/ 63,1778280,1828141/ 42/ 62 93103402,931147

			
<p><b>24-1317</b></p>	<p><b>24-1338</b></p>		

		<b>METELLI</b> ref.			<b>NOTE</b>	<b>Adaptable for OES</b>
FA95XF430 (315 kW) Eng.XF315M	97-02	<b>24-1317</b>			Impeller Ø 135mm	0063225,0683225/ R,0683386/ R,1262683 1609871,683225R,683386/ 586
	97-02	<b>24-1338</b>			Impeller Ø 120mm	1653974,1664762,1738991,1742258/ 59 1747962/ 63,1778280,1828141/ 42/ 62 93103402,931147
FA95XF480 (355 kW) Eng.XF355M	97-02	<b>24-1317</b>			Impeller Ø 135mm	0063225,0683225/ R,0683386/ R,1262683 1609871,683225R,683386/ 586
	97-02	<b>24-1338</b>			Impeller Ø 120mm	1653974,1664762,1738991,1742258/ 59 1747962/ 63,1778280,1828141/ 42/ 62 93103402,931147
FA95XF530 (390 kW) Eng.VF390M	97-02	<b>24-1338</b>			Impeller Ø 120mm	1653974,1664762,1738991,1742258/ 59 1747962/ 63,1778280,1828141/ 42/ 62 93103402,931147
FAC95XF380 (280 kW) Eng.XF280M	97-02	<b>24-1317</b>			Impeller Ø 135mm	0063225,0683225/ R,0683386/ R,1262683 1609871,683225R,683386/ 586
	97-02	<b>24-1338</b>			Impeller Ø 120mm	1653974,1664762,1738991,1742258/ 59 1747962/ 63,1778280,1828141/ 42/ 62 93103402,931147
FAC95XF430 (315 kW) Eng.XF315M	97-02	<b>24-1317</b>			Impeller Ø 135mm	0063225,0683225/ R,0683386/ R,1262683 1609871,683225R,683386/ 586
	97-02	<b>24-1338</b>			Impeller Ø 120mm	1653974,1664762,1738991,1742258/ 59 1747962/ 63,1778280,1828141/ 42/ 62 93103402,931147
FAC95XF480 (355 kW) Eng.XF355M	97-02	<b>24-1317</b>			Impeller Ø 135mm	0063225,0683225/ R,0683386/ R,1262683 1609871,683225R,683386/ 586
	97-02	<b>24-1338</b>			Impeller Ø 120mm	1653974,1664762,1738991,1742258/ 59 1747962/ 63,1778280,1828141/ 42/ 62 93103402,931147
FAD95XF380 (280 kW) Eng.XF280M	97-02	<b>24-1317</b>			Impeller Ø 135mm	0063225,0683225/ R,0683386/ R,1262683 1609871,683225R,683386/ 586
	97-02	<b>24-1338</b>			Impeller Ø 120mm	1653974,1664762,1738991,1742258/ 59 1747962/ 63,1778280,1828141/ 42/ 62 93103402,931147
FAD95XF430 (315 kW) Eng.XF315M	97-02	<b>24-1317</b>			Impeller Ø 135mm	0063225,0683225/ R,0683386/ R,1262683 1609871,683225R,683386/ 586
	97-02	<b>24-1338</b>			Impeller Ø 120mm	1653974,1664762,1738991,1742258/ 59 1747962/ 63,1778280,1828141/ 42/ 62 93103402,931147
FAD95XF480 (355 kW) Eng.XF355M	97-02	<b>24-1317</b>			Impeller Ø 135mm	0063225,0683225/ R,0683386/ R,1262683 1609871,683225R,683386/ 586
	97-02	<b>24-1338</b>			Impeller Ø 120mm	1653974,1664762,1738991,1742258/ 59 1747962/ 63,1778280,1828141/ 42/ 62 93103402,931147
FAR95XF380 (280 kW) Eng.XF280M	97-02	<b>24-1317</b>			Impeller Ø 135mm	0063225,0683225/ R,0683386/ R,1262683 1609871,683225R,683386/ 586
	97-02	<b>24-1338</b>			Impeller Ø 120mm	1653974,1664762,1738991,1742258/ 59 1747962/ 63,1778280,1828141/ 42/ 62 93103402,931147
FAR95XF430 (315 kW) Eng.XF315M	97-02	<b>24-1317</b>			Impeller Ø 135mm	0063225,0683225/ R,0683386/ R,1262683 1609871,683225R,683386/ 586
	97-02	<b>24-1338</b>			Impeller Ø 120mm	1653974,1664762,1738991,1742258/ 59 1747962/ 63,1778280,1828141/ 42/ 62 93103402,931147
FAR95XF480 (355 kW) Eng.XF355M	97-02	<b>24-1317</b>			Impeller Ø 135mm	0063225,0683225/ R,0683386/ R,1262683 1609871,683225R,683386/ 586
	97-02	<b>24-1338</b>			Impeller Ø 120mm	1653974,1664762,1738991,1742258/ 59 1747962/ 63,1778280,1828141/ 42/ 62 93103402,931147
FAR95XF530 (390 kW) Eng.VF390M	97-02	<b>24-1338</b>			Impeller Ø 120mm	1653974,1664762,1738991,1742258/ 59 1747962/ 63,1778280,1828141/ 42/ 62 93103402,931147
FAS95XF380 (280 kW) Eng.XF280M	97-02	<b>24-1317</b>			Impeller Ø 135mm	0063225,0683225/ R,0683386/ R,1262683 1609871,683225R,683386/ 586
	97-02	<b>24-1338</b>			Impeller Ø 120mm	1653974,1664762,1738991,1742258/ 59 1747962/ 63,1778280,1828141/ 42/ 62 93103402,931147

			
<p><b>24-1317</b></p>	<p><b>24-1335</b></p>	<p><b>24-1338</b></p>	

		<b>METELLI</b> ref.			<b>NOTE</b>	<b>Adaptable for OES</b>
FAS95XF430 (315 kW) Eng.XF315M	97-02	<b>24-1317</b>			Impeller Ø 135mm	0063225,0683225/ R,0683386/ R,1262683 1609871,683225R,683386/ 586
	97-02	<b>24-1338</b>			Impeller Ø 120mm	1653974,1664762,1738991,1742258/ 59 1747962/ 63,1778280,1828141/ 42/ 62 93103402,931147
FAS95XF480 (355 kW) Eng.XF355M	97-02	<b>24-1317</b>			Impeller Ø 135mm	0063225,0683225/ R,0683386/ R,1262683 1609871,683225R,683386/ 586
	97-02	<b>24-1338</b>			Impeller Ø 120mm	1653974,1664762,1738991,1742258/ 59 1747962/ 63,1778280,1828141/ 42/ 62 93103402,931147
FAS95XF530 (390 kW) Eng.VF390M	97-02	<b>24-1338</b>			Impeller Ø 120mm	1653974,1664762,1738991,1742258/ 59 1747962/ 63,1778280,1828141/ 42/ 62 93103402,931147
FAT95XF380 (280 kW) Eng.XF280M	97-02	<b>24-1317</b>			Impeller Ø 135mm	0063225,0683225/ R,0683386/ R,1262683 1609871,683225R,683386/ 586
	97-02	<b>24-1338</b>			Impeller Ø 120mm	1653974,1664762,1738991,1742258/ 59 1747962/ 63,1778280,1828141/ 42/ 62 93103402,931147
FAT95XF430 (315 kW) Eng.XF315M	97-02	<b>24-1317</b>			Impeller Ø 135mm	0063225,0683225/ R,0683386/ R,1262683 1609871,683225R,683386/ 586
	97-02	<b>24-1338</b>			Impeller Ø 120mm	1653974,1664762,1738991,1742258/ 59 1747962/ 63,1778280,1828141/ 42/ 62 93103402,931147
FAT95XF480 (355 kW) Eng.XF355M	97-02	<b>24-1317</b>			Impeller Ø 135mm	0063225,0683225/ R,0683386/ R,1262683 1609871,683225R,683386/ 586
	97-02	<b>24-1338</b>			Impeller Ø 120mm	1653974,1664762,1738991,1742258/ 59 1747962/ 63,1778280,1828141/ 42/ 62 93103402,931147
FT95XF380 (280 kW) Eng.XF280M	97-02	<b>24-1317</b>			Impeller Ø 135mm	0063225,0683225/ R,0683386/ R,1262683 1609871,683225R,683386/ 586
	97-02	<b>24-1338</b>			Impeller Ø 120mm	1653974,1664762,1738991,1742258/ 59 1747962/ 63,1778280,1828141/ 42/ 62 93103402,931147
FT95XF430 (315 kW) Eng.XF315M	97-02	<b>24-1317</b>			Impeller Ø 135mm	0063225,0683225/ R,0683386/ R,1262683 1609871,683225R,683386/ 586
	97-02	<b>24-1338</b>			Impeller Ø 120mm	1653974,1664762,1738991,1742258/ 59 1747962/ 63,1778280,1828141/ 42/ 62 93103402,931147
FT95XF480 (355 kW) Eng.XF355M	97-02	<b>24-1317</b>			Impeller Ø 135mm	0063225,0683225/ R,0683386/ R,1262683 1609871,683225R,683386/ 586
	97-02	<b>24-1338</b>			Impeller Ø 120mm	1653974,1664762,1738991,1742258/ 59 1747962/ 63,1778280,1828141/ 42/ 62 93103402,931147
FT95XF530 (390 kW) Eng.VF390M	97-02	<b>24-1338</b>			Impeller Ø 120mm	1653974,1664762,1738991,1742258/ 59 1747962/ 63,1778280,1828141/ 42/ 62 93103402,931147
FT95XF530 (390 kW) Eng.XE390C	01-02	<b>24-1335</b>			Impeller Ø 135mm	1282029,1399150/ 336,1609853,683579
	97-02	<b>24-1338</b>			Impeller Ø 120mm	1653974,1664762,1738991,1742258/ 59 1747962/ 63,1778280,1828141/ 42/ 62 93103402,931147
FTG95XF380 (280 kW) Eng.XF280M	97-02	<b>24-1317</b>			Impeller Ø 135mm	0063225,0683225/ R,0683386/ R,1262683 1609871,683225R,683386/ 586
	97-02	<b>24-1338</b>			Impeller Ø 120mm	1653974,1664762,1738991,1742258/ 59 1747962/ 63,1778280,1828141/ 42/ 62 93103402,931147
FTG95XF430 (315 kW) Eng.XF315M	97-02	<b>24-1317</b>			Impeller Ø 135mm	0063225,0683225/ R,0683386/ R,1262683 1609871,683225R,683386/ 586
	97-02	<b>24-1338</b>			Impeller Ø 120mm	1653974,1664762,1738991,1742258/ 59 1747962/ 63,1778280,1828141/ 42/ 62 93103402,931147
FTG95XF480 (355 kW) Eng.XF355M	97-02	<b>24-1317</b>			Impeller Ø 135mm	0063225,0683225/ R,0683386/ R,1262683 1609871,683225R,683386/ 586
	97-02	<b>24-1338</b>			Impeller Ø 120mm	1653974,1664762,1738991,1742258/ 59 1747962/ 63,1778280,1828141/ 42/ 62 93103402,931147

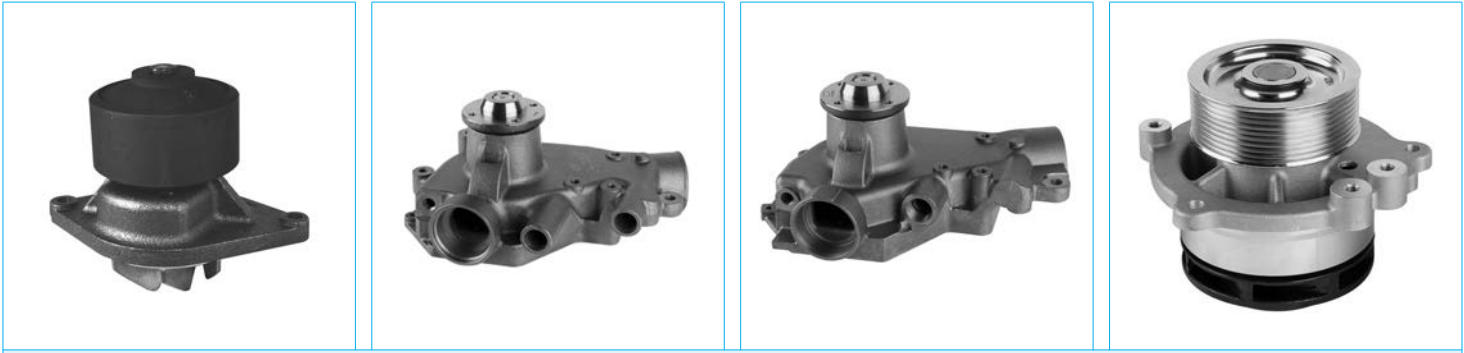

**24-1060**

**24-1317**

**24-1335**

**24-1338**

--	--	--	--

--	--	--	--

--	--	--	--

--	--	--	--

		<b>METELLI</b> ref.			<b>NOTE</b>	<b>Adaptable for OES</b>
FTR95XF380 (280 kW) Eng.XF280M	97-02	<b>24-1317</b>			Impeller Ø 135mm	0063225,0683225/ R,0683386/ R,1262683 1609871,683225R,683386/ 586
	97-02	<b>24-1338</b>			Impeller Ø 120mm	1653974,1664762,1738991,1742258/ 59 1747962/ 63,1778280,1828141/ 42/ 62 93103402,931147
FTR95XF430 (315 kW) Eng.XF315M	97-02	<b>24-1317</b>			Impeller Ø 135mm	0063225,0683225/ R,0683386/ R,1262683 1609871,683225R,683386/ 586
	97-02	<b>24-1338</b>			Impeller Ø 120mm	1653974,1664762,1738991,1742258/ 59 1747962/ 63,1778280,1828141/ 42/ 62 93103402,931147
FTR95XF480 (355 kW) Eng.XF355M	97-02	<b>24-1317</b>			Impeller Ø 135mm	0063225,0683225/ R,0683386/ R,1262683 1609871,683225R,683386/ 586
	97-02	<b>24-1338</b>			Impeller Ø 120mm	1653974,1664762,1738991,1742258/ 59 1747962/ 63,1778280,1828141/ 42/ 62 93103402,931147
FTS95XF380 (280 kW) Eng.XF280M	97-02	<b>24-1317</b>			Impeller Ø 135mm	0063225,0683225/ R,0683386/ R,1262683 1609871,683225R,683386/ 586
	97-02	<b>24-1338</b>			Impeller Ø 120mm	1653974,1664762,1738991,1742258/ 59 1747962/ 63,1778280,1828141/ 42/ 62 93103402,931147
FTS95XF430 (315 kW) Eng.XF315M	97-02	<b>24-1317</b>			Impeller Ø 135mm	0063225,0683225/ R,0683386/ R,1262683 1609871,683225R,683386/ 586
	97-02	<b>24-1338</b>			Impeller Ø 120mm	1653974,1664762,1738991,1742258/ 59 1747962/ 63,1778280,1828141/ 42/ 62 93103402,931147
FTS95XF480 (355 kW) Eng.XF355M	97-02	<b>24-1317</b>			Impeller Ø 135mm	0063225,0683225/ R,0683386/ R,1262683 1609871,683225R,683386/ 586
	97-02	<b>24-1338</b>			Impeller Ø 120mm	1653974,1664762,1738991,1742258/ 59 1747962/ 63,1778280,1828141/ 42/ 62 93103402,931147
FTT95XF430 (315 kW) Eng.XF315M	97-02	<b>24-1317</b>			Impeller Ø 135mm	0063225,0683225/ R,0683386/ R,1262683 1609871,683225R,683386/ 586
	97-02	<b>24-1338</b>			Impeller Ø 120mm	1653974,1664762,1738991,1742258/ 59 1747962/ 63,1778280,1828141/ 42/ 62 93103402,931147
FTT95XF480 (355 kW) Eng.XF355M	97-02	<b>24-1317</b>			Impeller Ø 135mm	0063225,0683225/ R,0683386/ R,1262683 1609871,683225R,683386/ 586
	97-02	<b>24-1338</b>			Impeller Ø 120mm	1653974,1664762,1738991,1742258/ 59 1747962/ 63,1778280,1828141/ 42/ 62 93103402,931147
FTT95XF530 (390 kW) Eng.VF390M	97-02	<b>24-1338</b>			Impeller Ø 120mm	1653974,1664762,1738991,1742258/ 59 1747962/ 63,1778280,1828141/ 42/ 62 93103402,931147
<b>CF 65 '1/01-</b>						
FA 65.300 (220 kW) Eng.GR220	09-	<b>24-1060</b>				1399689
FA65.180 (136 kW) Eng.CE136C	01-	<b>24-1060</b>				1399689
FA65.220 (162 kW) Eng.CE162C	01-	<b>24-1060</b>				1399689
FA65.250 (184 kW) Eng.CE184C	01-	<b>24-1060</b>				1399689
<b>CF 85 '1/01-</b>						
FA/FT85.360 (265 kW) Eng.MX265	06-	<b>24-1338</b>			Impeller Ø 120mm	1653974,1664762,1738991,1742258/ 59 1747962/ 63,1778280,1828141/ 42/ 62 93103402,931147
FA/FT85.380 (280 kW) Eng.XE280C	01-	<b>24-1335</b>			Impeller Ø 135mm	1282029,1399150/ 336,1609853,683579
	01-	<b>24-1338</b>			Impeller Ø 120mm	1653974,1664762,1738991,1742258/ 59 1747962/ 63,1778280,1828141/ 42/ 62 93103402,931147
FA/FT85.410 (300 kW) Eng.MX300	05-	<b>24-1338</b>			Impeller Ø 120mm	1653974,1664762,1738991,1742258/ 59 1747962/ 63,1778280,1828141/ 42/ 62 93103402,931147
FA/FT85.430 (315 kW) Eng.XE315C	01-	<b>24-1335</b>			Impeller Ø 135mm	1282029,1399150/ 336,1609853,683579
	01-	<b>24-1338</b>			Impeller Ø 120mm	1653974,1664762,1738991,1742258/ 59 1747962/ 63,1778280,1828141/ 42/ 62 93103402,931147







**24-1335**



**24-1338**

		<b>METELLI</b> ref.			<b>NOTE</b>	<b>Adaptable for OES</b>
FA/FT85.460 (340 kW) Eng.MX340	05-	<b>24-1338</b>			Impeller Ø 120mm	1653974,1664762,1738991,1742258/ 59 1747962/ 63,1778280,1828141/ 42/ 62 93103402,931147
FA/FT85.480 (355 kW) Eng.XE355C	01-	<b>24-1335</b>			Impeller Ø 135mm	1282029,1399150/ 336,1609853,683579
	01-	<b>24-1338</b>			Impeller Ø 120mm	1653974,1664762,1738991,1742258/ 59 1747962/ 63,1778280,1828141/ 42/ 62 93103402,931147
FA/FT85.510 (375 kW) Eng.MX375	05-	<b>24-1338</b>			Impeller Ø 120mm	1653974,1664762,1738991,1742258/ 59 1747962/ 63,1778280,1828141/ 42/ 62 93103402,931147
FA85.340 (250 kW) Eng.XE250C	01-	<b>24-1335</b>			Impeller Ø 135mm	1282029,1399150/ 336,1609853,683579
	01-	<b>24-1338</b>			Impeller Ø 120mm	1653974,1664762,1738991,1742258/ 59 1747962/ 63,1778280,1828141/ 42/ 62 93103402,931147
FAC/FAD/FAX85.360 (265 kW) Eng.MX265	06-	<b>24-1338</b>			Impeller Ø 120mm	1653974,1664762,1738991,1742258/ 59 1747962/ 63,1778280,1828141/ 42/ 62 93103402,931147
FAC/FAG/FAN/FAX85.460 (340 kW) Eng.MX340	05-	<b>24-1338</b>			Impeller Ø 120mm	1653974,1664762,1738991,1742258/ 59 1747962/ 63,1778280,1828141/ 42/ 62 93103402,931147
FAC/FAX85.410 (300 kW) Eng.MX300	05-	<b>24-1338</b>			Impeller Ø 120mm	1653974,1664762,1738991,1742258/ 59 1747962/ 63,1778280,1828141/ 42/ 62 93103402,931147
FAC/FAX85.510 (375 kW) Eng.MX375	05-	<b>24-1338</b>			Impeller Ø 120mm	1653974,1664762,1738991,1742258/ 59 1747962/ 63,1778280,1828141/ 42/ 62 93103402,931147
FAD/FAG/FAN/FAR/FAS/FAT85.380 (280 kW) Eng.XE280C	01-	<b>24-1335</b>			Impeller Ø 135mm	1282029,1399150/ 336,1609853,683579
	01-	<b>24-1338</b>			Impeller Ø 120mm	1653974,1664762,1738991,1742258/ 59 1747962/ 63,1778280,1828141/ 42/ 62 93103402,931147
FAD/FAG/FAN/FAR/FAS/FAT85.410 (300 kW) Eng.MX300	05-	<b>24-1338</b>			Impeller Ø 120mm	1653974,1664762,1738991,1742258/ 59 1747962/ 63,1778280,1828141/ 42/ 62 93103402,931147
FAD/FAG/FAN/FAR/FAS/FAT85.430 (315 kW) Eng.XE315C	01-	<b>24-1335</b>			Impeller Ø 135mm	1282029,1399150/ 336,1609853,683579
	01-	<b>24-1338</b>			Impeller Ø 120mm	1653974,1664762,1738991,1742258/ 59 1747962/ 63,1778280,1828141/ 42/ 62 93103402,931147
FAD/FAG/FAN/FAR/FAS/FAT85.510 (375 kW) Eng.MX375	05-	<b>24-1338</b>			Impeller Ø 120mm	1653974,1664762,1738991,1742258/ 59 1747962/ 63,1778280,1828141/ 42/ 62 93103402,931147
FAD/FAG/FAN/FAT85.480 (355 kW) Eng.XE355C	01-	<b>24-1335</b>			Impeller Ø 135mm	1282029,1399150/ 336,1609853,683579
	01-	<b>24-1338</b>			Impeller Ø 120mm	1653974,1664762,1738991,1742258/ 59 1747962/ 63,1778280,1828141/ 42/ 62 93103402,931147
FAD/FAR/FAS/FAT85.460 (340 kW) Eng.MX340	05-	<b>24-1338</b>			Impeller Ø 120mm	1653974,1664762,1738991,1742258/ 59 1747962/ 63,1778280,1828141/ 42/ 62 93103402,931147
FAD85.340 (250 kW) Eng.XE250C	01-	<b>24-1335</b>			Impeller Ø 135mm	1282029,1399150/ 336,1609853,683579
	01-	<b>24-1338</b>			Impeller Ø 120mm	1653974,1664762,1738991,1742258/ 59 1747962/ 63,1778280,1828141/ 42/ 62 93103402,931147
FAG/FAN/FAR/FAS/FAT85.340 (250 kW) Eng.XE250C	01-	<b>24-1335</b>			Impeller Ø 135mm	1282029,1399150/ 336,1609853,683579
	01-	<b>24-1338</b>			Impeller Ø 120mm	1653974,1664762,1738991,1742258/ 59 1747962/ 63,1778280,1828141/ 42/ 62 93103402,931147
FAG/FAN85.360 (265 kW) Eng.MX265	06-	<b>24-1338</b>			Impeller Ø 120mm	1653974,1664762,1738991,1742258/ 59 1747962/ 63,1778280,1828141/ 42/ 62 93103402,931147
FAR/FAS/FAT85.360 (265 kW) Eng.MX265	06-	<b>24-1338</b>			Impeller Ø 120mm	1653974,1664762,1738991,1742258/ 59 1747962/ 63,1778280,1828141/ 42/ 62 93103402,931147
FTG/FTP/FTS85.360 (265 kW) Eng.MX265	06-	<b>24-1338</b>			Impeller Ø 120mm	1653974,1664762,1738991,1742258/ 59 1747962/ 63,1778280,1828141/ 42/ 62 93103402,931147



**24-1293**



**24-1305**



**24-1335**



**24-1338**

		<b>METELLI</b> ref.			<b>NOTE</b>	<b>Adaptable for OES</b>
FTG/FTS/FTP/FTT85.510 (375 kW) Eng.MX375	05-	<b>24-1338</b>			Impeller Ø 120mm	1653974,1664762,1738991,1742258/ 59 1747962/ 63,1778280,1828141/ 42/ 62 93103402,931147
FTG/FTS/FTT85.460 (340 kW) Eng.MX340	05-	<b>24-1338</b>			Impeller Ø 120mm	1653974,1664762,1738991,1742258/ 59 1747962/ 63,1778280,1828141/ 42/ 62 93103402,931147
FTG/FTT85.340 (250 kW) Eng.XE250C	01-	<b>24-1335</b>			Impeller Ø 135mm	1282029,1399150/ 336,1609853,683579
	01-	<b>24-1338</b>			Impeller Ø 120mm	1653974,1664762,1738991,1742258/ 59 1747962/ 63,1778280,1828141/ 42/ 62 93103402,931147
FTG/FTT85.380 (280 kW) Eng.XE280C	01-	<b>24-1335</b>			Impeller Ø 135mm	1282029,1399150/ 336,1609853,683579
	01-	<b>24-1338</b>			Impeller Ø 120mm	1653974,1664762,1738991,1742258/ 59 1747962/ 63,1778280,1828141/ 42/ 62 93103402,931147
FTG/FTT85.410 (300 kW) Eng.MX300	05-	<b>24-1338</b>			Impeller Ø 120mm	1653974,1664762,1738991,1742258/ 59 1747962/ 63,1778280,1828141/ 42/ 62 93103402,931147
FTG/FTT85.480 (355 kW) Eng.XE355C	01-	<b>24-1335</b>			Impeller Ø 135mm	1282029,1399150/ 336,1609853,683579
	01-	<b>24-1338</b>			Impeller Ø 120mm	1653974,1664762,1738991,1742258/ 59 1747962/ 63,1778280,1828141/ 42/ 62 93103402,931147
FTS85.410 (300 kW) Eng.MX300	05-	<b>24-1338</b>			Impeller Ø 120mm	1653974,1664762,1738991,1742258/ 59 1747962/ 63,1778280,1828141/ 42/ 62 93103402,931147
FTT85.430 (315 kW) Eng.XE315C	01-	<b>24-1335</b>			Impeller Ø 135mm	1282029,1399150/ 336,1609853,683579
	01-	<b>24-1338</b>			Impeller Ø 120mm	1653974,1664762,1738991,1742258/ 59 1747962/ 63,1778280,1828141/ 42/ 62 93103402,931147
<b>F 2800 '1/74-'9/91</b>						
FA2800DKS (228 kW) Eng.DKS1160	74-86	<b>24-1293</b>			For vehicles without retarder	0506109,0517097,0682260,288619,516724 517097,682260
	74-86	<b>24-1305</b>			With viscous-static fan	0680156R,0682262R,680156,682262
FA2800DKSE (206 kW) Eng.DKS1160E	80-86	<b>24-1293</b>			For vehicles without retarder	0506109,0517097,0682260,288619,516724 517097,682260
	83-91	<b>24-1293</b>			For vehicles without retarder	0506109,0517097,0682260,288619,516724 517097,682260
	83-91	<b>24-1305</b>			With viscous-static fan	0680156R,0682262R,680156,682262
FA2800DKSE (206 kW) Eng.DKV1160	83-91	<b>24-1305</b>			With viscous-static fan	0680156R,0682262R,680156,682262
FA2800DKTD (188 kW) Eng.DKTD1160	74-86	<b>24-1293</b>			For vehicles without retarder	0506109,0517097,0682260,288619,516724 517097,682260
	86-91	<b>24-1293</b>			For vehicles without retarder	0506109,0517097,0682260,288619,516724 517097,682260
	74-86	<b>24-1305</b>			With viscous-static fan	0680156R,0682262R,680156,682262
	86-91	<b>24-1305</b>			With viscous-static fan	0680156R,0682262R,680156,682262
FAB/FAR/FAS2805DKS (228 kW) Eng.DKS1160	74-86	<b>24-1293</b>			For vehicles without retarder	0506109,0517097,0682260,288619,516724 517097,682260
	74-86	<b>24-1305</b>			With viscous-static fan	0680156R,0682262R,680156,682262
FAB2805DKTD,FAS2800DKTD (188 kW) Eng.DKTD1160	74-86	<b>24-1293</b>			For vehicles without retarder	0506109,0517097,0682260,288619,516724 517097,682260
	74-86	<b>24-1305</b>			With viscous-static fan	0680156R,0682262R,680156,682262
FAC2803DKS (228 kW) Eng.DKS1160	74-86	<b>24-1293</b>			For vehicles without retarder	0506109,0517097,0682260,288619,516724 517097,682260
	74-86	<b>24-1305</b>			With viscous-static fan	0680156R,0682262R,680156,682262
FAC2803DKSE (206 kW) Eng.DKS1160E	80-90	<b>24-1293</b>			For vehicles without retarder	0506109,0517097,0682260,288619,516724 517097,682260
	80-90	<b>24-1305</b>			With viscous-static fan	0680156R,0682262R,680156,682262
FAC2803DKTD (188 kW) Eng.DKTD1160	74-91	<b>24-1293</b>			For vehicles without retarder	0506109,0517097,0682260,288619,516724 517097,682260
	74-91	<b>24-1305</b>			With viscous-static fan	0680156R,0682262R,680156,682262
FAD2805DKS (228 kW) Eng.DKS1160	74-86	<b>24-1293</b>			For vehicles without retarder	0506109,0517097,0682260,288619,516724 517097,682260
	74-86	<b>24-1305</b>			With viscous-static fan	0680156R,0682262R,680156,682262
FAD2805DKTD (188 kW) Eng.DKTD1160	74-86	<b>24-1293</b>			For vehicles without retarder	0506109,0517097,0682260,288619,516724 517097,682260
	74-86	<b>24-1305</b>			With viscous-static fan	0680156R,0682262R,680156,682262

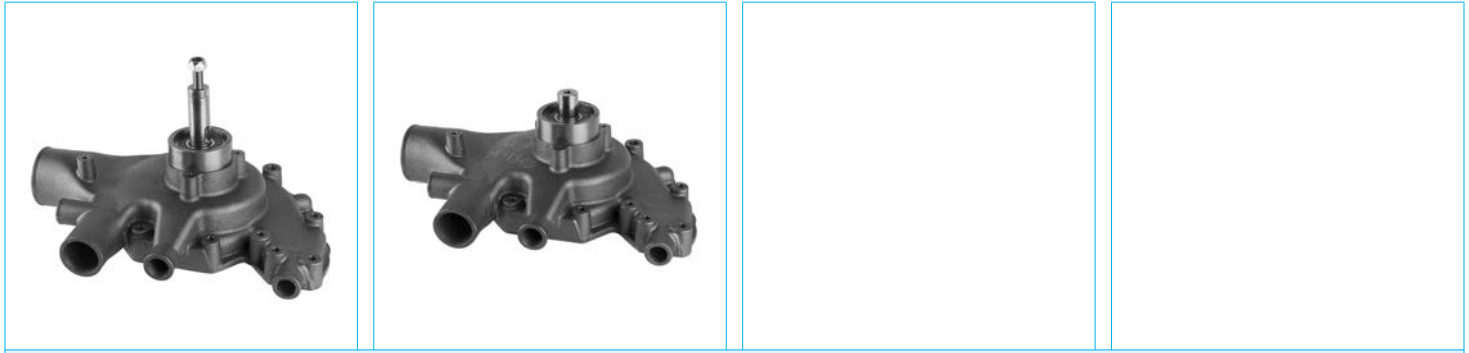

**24-1293**



**24-1305**

--	--	--	--

--	--	--	--

--	--	--	--

--	--	--	--

		<b>METELLI</b> ref.		<b>NOTE</b>	<b>Adaptable for OES</b>
FAD2825DKTD (188 kW) Eng.DKTD1160	74-91	<b>24-1293</b>		For vehicles without retarder	0506109,0517097,0682260,288619,516724 517097,682260
	86-91	<b>24-1293</b>		For vehicles without retarder	0506109,0517097,0682260,288619,516724 517097,682260
	74-91	<b>24-1305</b>		With viscous-static fan	0680156R,0682262R,680156,682262
	86-91	<b>24-1305</b>		With viscous-static fan	0680156R,0682262R,680156,682262
FAG/FAR/FAS2800DKV (212 kW) Eng.DKS1160E	83-91	<b>24-1305</b>		With viscous-static fan	0680156R,0682262R,680156,682262
FAG/FAR/FAS2800DKV (212 kW) Eng.DKV1160	83-91	<b>24-1305</b>		With viscous-static fan	0680156R,0682262R,680156,682262
FAR2804DKSE,FAS2800DKT (206 kW) Eng.DKS1160E	80-86	<b>24-1293</b>		For vehicles without retarder	0506109,0517097,0682260,288619,516724 517097,682260
	80-86	<b>24-1305</b>		With viscous-static fan	0680156R,0682262R,680156,682262
FAS2803DKS (228 kW) Eng.DKS1160	86-91	<b>24-1293</b>		For vehicles without retarder	0506109,0517097,0682260,288619,516724 517097,682260
	86-91	<b>24-1305</b>		With viscous-static fan	0680156R,0682262R,680156,682262
FAS2803DKTD (188 kW) Eng.DKTD1160	86-91	<b>24-1293</b>		For vehicles without retarder	0506109,0517097,0682260,288619,516724 517097,682260
	86-91	<b>24-1305</b>		With viscous-static fan	0680156R,0682262R,680156,682262
FAT2800DKS (228 kW) Eng.DKS1160	74-86	<b>24-1293</b>		For vehicles without retarder	0506109,0517097,0682260,288619,516724 517097,682260
	74-86	<b>24-1305</b>		With viscous-static fan	0680156R,0682262R,680156,682262
FAT2800DKTD (188 kW) Eng.DKTD1160	74-86	<b>24-1293</b>		For vehicles without retarder	0506109,0517097,0682260,288619,516724 517097,682260
	74-86	<b>24-1305</b>		With viscous-static fan	0680156R,0682262R,680156,682262
FAT2805DKS,2825DKS (228 kW) Eng.DKTD1160	86-91	<b>24-1293</b>		For vehicles without retarder	0506109,0517097,0682260,288619,516724 517097,682260
	86-91	<b>24-1305</b>		With viscous-static fan	0680156R,0682262R,680156,682262
FAT2805DKTD,2825DKTD (188 kW) Eng.DKTD1160	86-91	<b>24-1293</b>		For vehicles without retarder	0506109,0517097,0682260,288619,516724 517097,682260
	86-91	<b>24-1305</b>		With viscous-static fan	0680156R,0682262R,680156,682262
FMD2805DKTD,2825DKTD (188 kW) Eng.DKTD1160	74-86	<b>24-1293</b>		For vehicles without retarder	0506109,0517097,0682260,288619,516724 517097,682260
	86-91	<b>24-1293</b>		For vehicles without retarder	0506109,0517097,0682260,288619,516724 517097,682260
	74-86	<b>24-1305</b>		With viscous-static fan	0680156R,0682262R,680156,682262
	86-91	<b>24-1305</b>		With viscous-static fan	0680156R,0682262R,680156,682262
FMD2825DKV (212 kW) Eng.DKV1160	83-91	<b>24-1305</b>		With viscous-static fan	0680156R,0682262R,680156,682262
FT2800DK (206 kW) Eng.DKS1160E	80-91	<b>24-1293</b>		For vehicles without retarder	0506109,0517097,0682260,288619,516724 517097,682260
	80-91	<b>24-1305</b>		With viscous-static fan	0680156R,0682262R,680156,682262
FT2800DKS (228 kW) Eng.DKS1160	74-86	<b>24-1293</b>		For vehicles without retarder	0506109,0517097,0682260,288619,516724 517097,682260
	74-86	<b>24-1305</b>		With viscous-static fan	0680156R,0682262R,680156,682262
FT2800DKTD (188 kW) Eng.DKTD1160	74-86	<b>24-1293</b>		For vehicles without retarder	0506109,0517097,0682260,288619,516724 517097,682260
	74-86	<b>24-1305</b>		With viscous-static fan	0680156R,0682262R,680156,682262
FT2805DKS (228 kW) Eng.DKS1160	86-91	<b>24-1293</b>		For vehicles without retarder	0506109,0517097,0682260,288619,516724 517097,682260
	86-91	<b>24-1305</b>		With viscous-static fan	0680156R,0682262R,680156,682262
FT2805DKTD (188 kW) Eng.DKTD1160	86-91	<b>24-1293</b>		For vehicles without retarder	0506109,0517097,0682260,288619,516724 517097,682260
	86-91	<b>24-1305</b>		With viscous-static fan	0680156R,0682262R,680156,682262
FTS2800DKS (228 kW) Eng.DKS1160	74-86	<b>24-1293</b>		For vehicles without retarder	0506109,0517097,0682260,288619,516724 517097,682260
	74-86	<b>24-1305</b>		With viscous-static fan	0680156R,0682262R,680156,682262
FTS2800DKTD (188 kW) Eng.DKTD1160	74-86	<b>24-1293</b>		For vehicles without retarder	0506109,0517097,0682260,288619,516724 517097,682260
	74-86	<b>24-1305</b>		With viscous-static fan	0680156R,0682262R,680156,682262
FTS2803DKS (228 kW) Eng.DKS1160	86-91	<b>24-1293</b>		For vehicles without retarder	0506109,0517097,0682260,288619,516724 517097,682260
	86-91	<b>24-1305</b>		With viscous-static fan	0680156R,0682262R,680156,682262
FTS2803DKTD (188 kW) Eng.DKTD1160	86-91	<b>24-1293</b>		For vehicles without retarder	0506109,0517097,0682260,288619,516724 517097,682260
	86-91	<b>24-1305</b>		With viscous-static fan	0680156R,0682262R,680156,682262
FTT2800DKS (228 kW) Eng.DKS1160	74-86	<b>24-1293</b>		For vehicles without retarder	0506109,0517097,0682260,288619,516724 517097,682260
	74-86	<b>24-1305</b>		With viscous-static fan	0680156R,0682262R,680156,682262

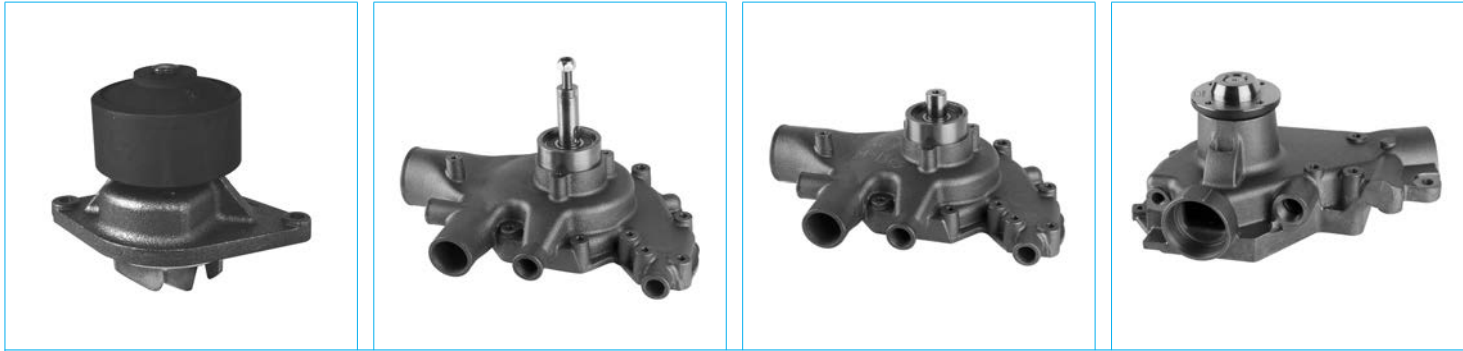

**24-1060**

**24-1293**

**24-1305**

**24-1335**





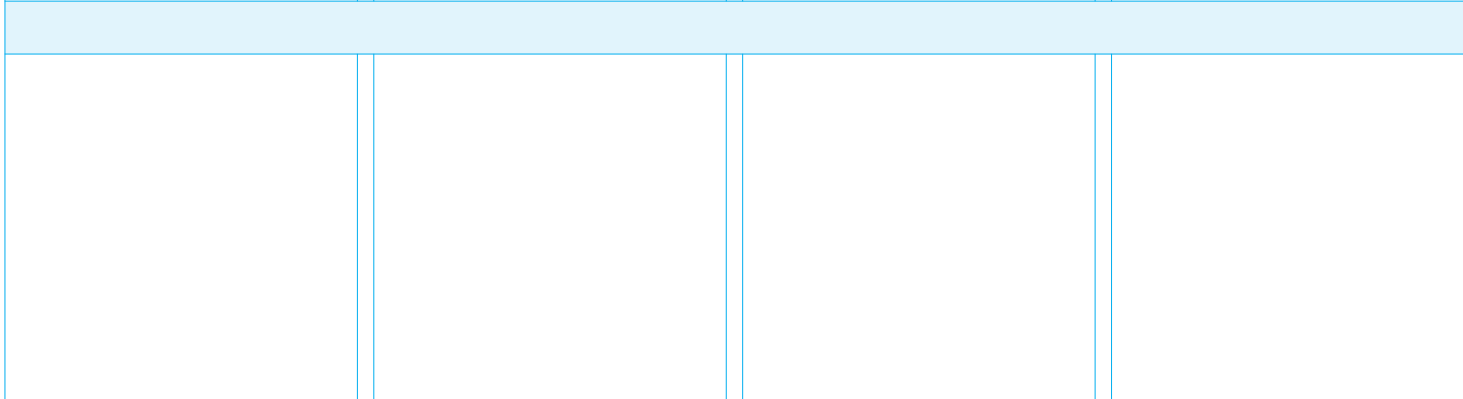
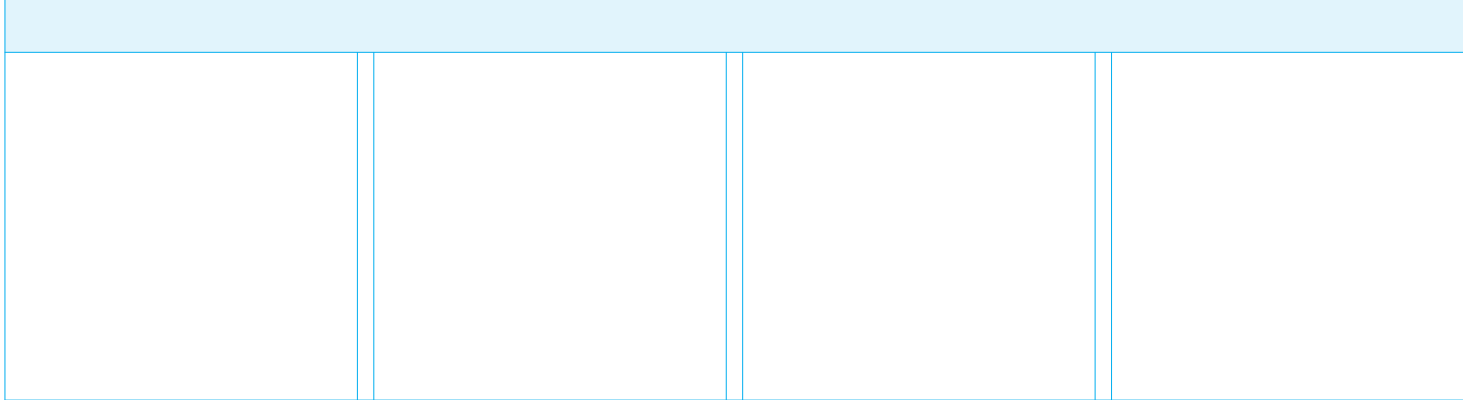
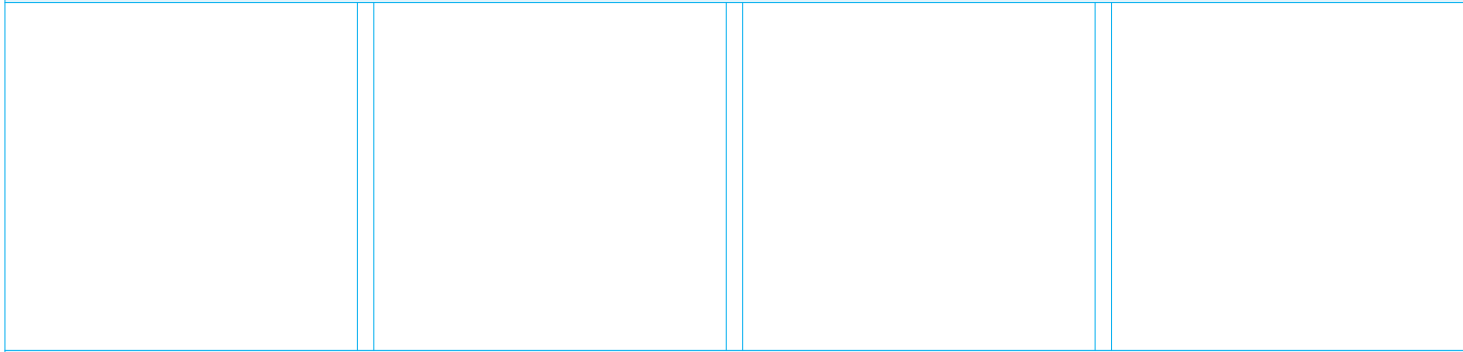







**24-1338**



		<b>METELLI</b> ref.			<b>NOTE</b>	<b>Adaptable for OES</b>
FTT2800DKTD (188 kW) Eng.DKTD1160	74-86	<b>24-1293</b>			For vehicles without retarder	0506109,0517097,0682260,288619,516724 517097,682260
	74-86	<b>24-1305</b>			With viscous-static fan	0680156R,0682262R,680156,682262
FTT2805DKS,2815DKS,2825DKS (225 kW) Eng.DKS1160	86-91	<b>24-1293</b>			For vehicles without retarder	0506109,0517097,0682260,288619,516724 517097,682260
	86-91	<b>24-1305</b>			With viscous-static fan	0680156R,0682262R,680156,682262
FTT2805DKTD (188 kW) Eng.DKTD1160	86-91	<b>24-1293</b>			For vehicles without retarder	0506109,0517097,0682260,288619,516724 517097,682260
	86-91	<b>24-1305</b>			With viscous-static fan	0680156R,0682262R,680156,682262
<b>LF 45 '1/01-</b>						
FA45.150 (110 kW) Eng.BE110C	01-	<b>24-1060</b>				1399689
FA45.170 (123 kW) Eng.BE123C	01-	<b>24-1060</b>				1399689
FA45.180 (136 kW) Eng.CE136C	01-	<b>24-1060</b>				1399689
FA45.180 (136 kW) Eng.FR136S1	06-	<b>24-1060</b>				1399689
FA45.220 (162 kW) Eng.CE162C	01-	<b>24-1060</b>				1399689
FA45.220 (165 kW) Eng.GR165S1	06-	<b>24-1060</b>				1399689
<b>LF 55 '1/01-</b>						
FA 55.210 (152 kW) Eng.FR152	09-	<b>24-1060</b>				1399689
FA 55.300 (220 kW) Eng.GR220	09-	<b>24-1060</b>				1399689
FA55.160 (118 kW) Eng.FR118S1	06-	<b>24-1060</b>				1399689
FA55.170 (123 kW) Eng.BE123C	01-	<b>24-1060</b>				1399689
FA55.180 (136 kW) Eng.CE136C	01-	<b>24-1060</b>				1399689
FA55.180 (136 kW) Eng.FR136S1	06-	<b>24-1060</b>				1399689
FA55.220 (162 kW) Eng.CE162C	01-	<b>24-1060</b>				1399689
FA55.220 (165 kW) Eng.GR165S1	01-	<b>24-1060</b>				1399689
FA55.250 (184 kW) Eng.CE184C	01-	<b>24-1060</b>				1399689
FA55.250 (184 kW) Eng.GR184S1	06-	<b>24-1060</b>				1399689
FA55.290 (210 kW) Eng.GR210S1	06-	<b>24-1060</b>				1399689
FAN55.220 (165 kW) Eng.GR165S1	06-	<b>24-1060</b>				1399689
FAN55.250 (184 kW) Eng.GR184S1	06-	<b>24-1060</b>				1399689
FAN55.290 (210 kW) Eng.GR210S1	06-	<b>24-1060</b>				1399689
FT55.220 (162 kW) Eng.CE162C	01-	<b>24-1060</b>				1399689
FT55.220 (165 kW) Eng.GR165S1	06-	<b>24-1060</b>				1399689
FT55.250 (184 kW) Eng.CE184C	01-	<b>24-1060</b>				1399689
FT55.250 (184 kW) Eng.GR184S1	06-	<b>24-1060</b>				1399689
FT55.290 (210 kW) Eng.GR210S1	06-	<b>24-1060</b>				1399689
<b>XF 105 '10/05-</b>						
FA/FTXF105.410 (300 kW) Eng.MX300	05-	<b>24-1338</b>			Impeller Ø 120mm	1653974,1664762,1738991,1742258/ 59 1747962/ 63,1778280,1828141/ 42/ 62 93103402,931147
FA/FTXF105.460 (340 kW) Eng.MX340	05-	<b>24-1338</b>			Impeller Ø 120mm	1653974,1664762,1738991,1742258/ 59 1747962/ 63,1778280,1828141/ 42/ 62 93103402,931147
FA/FTXF105.510 (375 kW) Eng.MX375	05-	<b>24-1338</b>			Impeller Ø 120mm	1653974,1664762,1738991,1742258/ 59 1747962/ 63,1778280,1828141/ 42/ 62 93103402,931147
FAS/FAR/FANXF105.410 (300 kW) Eng.MX300	05-	<b>24-1338</b>			Impeller Ø 120mm	1653974,1664762,1738991,1742258/ 59 1747962/ 63,1778280,1828141/ 42/ 62 93103402,931147
FAS/FAR/FANXF105.460 (340 kW) Eng.MX340	05-	<b>24-1338</b>			Impeller Ø 120mm	1653974,1664762,1738991,1742258/ 59 1747962/ 63,1778280,1828141/ 42/ 62 93103402,931147
FAS/FAR/FANXF105.510 (375 kW) Eng.MX375	05-	<b>24-1338</b>			Impeller Ø 120mm	1653974,1664762,1738991,1742258/ 59 1747962/ 63,1778280,1828141/ 42/ 62 93103402,931147
<b>XF 95 '9/02-'12/06</b>						
FA/FT95.380 (280 kW) Eng.XE280C	02-	<b>24-1335</b>			Impeller Ø 135mm	1282029,1399150/ 336,1609853,683579
	02-	<b>24-1338</b>			Impeller Ø 120mm	1653974,1664762,1738991,1742258/ 59 1747962/ 63,1778280,1828141/ 42/ 62 93103402,931147
FA/FT95.430 (315 kW) Eng.XE315C	02-	<b>24-1335</b>			Impeller Ø 135mm	1282029,1399150/ 336,1609853,683579



			
<p><b>24-0031</b></p>	<p><b>24-0842</b></p>	<p><b>24-1198</b></p>	<p><b>24-1199</b></p>
			
<p><b>24-1335</b></p>	<p><b>24-1338</b></p>		

		<b>METELLI</b> ref.			<b>NOTE</b>	<b>Adaptable for OES</b>
FA/FT95.430 (315 kW) Eng.XE315C	02-	<b>24-1338</b>			Impeller Ø 120mm	1653974,1664762,1738991,1742258/ 59 1747962/ 63,1778280,1828141/ 42/ 62 93103402,931147
FA/FT95.480 (355 kW) Eng.XE355C	02-	<b>24-1335</b>			Impeller Ø 135mm	1282029,1399150/ 336,1609853,683579
	02-	<b>24-1338</b>			Impeller Ø 120mm	1653974,1664762,1738991,1742258/ 59 1747962/ 63,1778280,1828141/ 42/ 62 93103402,931147
FA/FT95.530 (390 kW) Eng.XE390C	02-	<b>24-1335</b>			Impeller Ø 135mm	1282029,1399150/ 336,1609853,683579
	02-	<b>24-1338</b>			Impeller Ø 120mm	1653974,1664762,1738991,1742258/ 59 1747962/ 63,1778280,1828141/ 42/ 62 93103402,931147
FTG95.380 (250 kW) Eng.XE250C	02-	<b>24-1335</b>			Impeller Ø 135mm	1282029,1399150/ 336,1609853,683579
	02-	<b>24-1338</b>			Impeller Ø 120mm	1653974,1664762,1738991,1742258/ 59 1747962/ 63,1778280,1828141/ 42/ 62 93103402,931147

**IRIS BUS**

<b>Arway '1/06-'12/13</b>						
10.6M, 12M, 12.8M (243 kW) Eng.F2BE3681B	06-	<b>24-1198</b>				504093706
<b>Domino '10/03-'12/13</b>						
HD (280 kW)	06-	<b>24-1198</b>				504093706
HD, HDH (330 kW)	06-	<b>24-1198</b>				504093706
<b>Evadys '10/03-'12/13</b>						
12m (280 kW)	03-	<b>24-1198</b>				504093706
12m (330 kW)	03-	<b>24-1198</b>				504093706
<b>Magelys '8/08-'12/13</b>						
HD (280 kW)	08-13	<b>24-1198</b>				504093706
HD (330 kW)	08-13	<b>24-1198</b>				504093706

**IVECO BUS**

<b>Autobus</b>						
314/3 Eng.8060.12		<b>24-0031</b>				4639182,4655010/ 54,4679242,93191101
315.13 (96-99-101 kW) Eng.8060.04		<b>24-0031</b>				4639182,4655010/ 54,4679242,93191101
315.17 (124 kW) Eng.8060.24		<b>24-0031</b>				4639182,4655010/ 54,4679242,93191101
316.13 (96-99-101 kW) Eng.8060.04		<b>24-0031</b>				4639182,4655010/ 54,4679242,93191101
<b>CityClass '1/92-'12/08</b>						
491.10 (180-200-213 kW) Eng.F2BE0681	92-	<b>24-1199</b>				504029280
491.12/.22/.27 (165-177-200-213 kW) Eng.F2BE0681C	92-	<b>24-1199</b>				504029280
591.10/.22/.27 (180-196-213 kW) Eng.F2BE0681	92-	<b>24-1199</b>				504029280
591.12 (196-213 kW) Eng.F2BE0681	92-	<b>24-1199</b>				504029280
591.18 (259 kW) Eng.F2BE0681A	92-	<b>24-1199</b>				504029280
<b>EuroRider '1/92-</b>						
35	92-	<b>24-1199</b>				504029280
38	92-	<b>24-1198</b>				504093706
43	92-	<b>24-1198</b>				504093706

**IVECO TRUCK**

<b>100 '1/73-</b>						
F13, OM13, EC (90 kW) Eng.8060.02		<b>24-0031</b>				4639182,4655010/ 54,4679242,93191101
NC (90 kW) Eng.8060.02		<b>24-0031</b>				4639182,4655010/ 54,4679242,93191101
<b>109 '1/83-'12/91</b>						
109.14 Zeta (96-99-101 kW) Eng.8060.04/.05		<b>24-0842</b>				98497115
<b>110 '1/73-</b>						
110.14, NC, 130 NC (96-99-101 kW) Eng.8060.04		<b>24-0842</b>				98497115

			
<b>24-0031</b>	<b>24-0077</b>	<b>24-0840</b>	<b>24-0841</b>
			
<b>24-0842</b>			

					NOTE	Adaptable for OES
<b>115</b>						
115.14 - 115.17 (96 kW) Eng.8060.04/.24		<b>24-0842</b>				98497115
<b>135</b>						
135.14 - 135.17 (101 kW) Eng.8060.05		<b>24-0842</b>				98497115
<b>145 '1/87-</b>						
145.17 (105-130 kW) Eng.8060.25		<b>24-0842</b>				98497115
<b>150 '1/75-</b>						
150.20NC, NR, NT Eng.8220.02		<b>24-0842</b>				98497115
F14, OM14, 150.16A, 150.17 (105-130 kW) Eng.8060.25		<b>24-0842</b>				98497115
<b>175</b>						
175.17 (105-130 kW) Eng.8060.25	92-	<b>24-0842</b>				98497115
<b>300 '1/74-</b>						
300 PC, PT, TC (192 kW) Eng.8210.02		<b>24-0077</b>				4606023,4952496
<b>40/35 '1/66-'12/71</b>						
OM 40 - 40/35 NC (60 kW) Eng.8040.02		<b>24-0031</b>				4639182,4655010/ 54,4679242,93191101
<b>50 '1/66-'12/86</b>						
50 - NC/ F8, 0M8 (60 kW) Eng.8040.02		<b>24-0031</b>				4639182,4655010/ 54,4679242,93191101
50.9 Zeta (65 kW) Eng.8040.05	1/87-12/91	<b>24-0840</b>				4813370
	92-	<b>24-0841</b>				98497117
NC, OM (60 kW) Eng.8040.02		<b>24-0031</b>				4639182,4655010/ 54,4679242,93191101
<b>55 '1/70-</b>						
55NC (60 kW) Eng.8040.02		<b>24-0031</b>				4639182,4655010/ 54,4679242,93191101
<b>60 '1/79-'12/91</b>						
60.10 Zeta (73-74 kW) Eng.8340.04	1/87-12/91	<b>24-0840</b>				4813370
60.11 Zeta (75-85 kW) Eng.8040.25B/X		<b>24-0842</b>				98497115
60.8 Zeta (63 kW) Eng.8040.04	1/87-12/91	<b>24-0840</b>				4813370
<b>616 '1/65-'12/71</b>						
616N2 (33 kW) Eng.803A(8030.01)		<b>24-0031</b>				4639182,4655010/ 54,4679242,93191101
616N3 (46 kW) Eng.8030.02		<b>24-0031</b>				4639182,4655010/ 54,4679242,93191101
616N4 (60 kW) Eng.803A(8040.01)		<b>24-0031</b>				4639182,4655010/ 54,4679242,93191101
<b>625 '1/71-</b>						
N2, N2P Eng.804A		<b>24-0031</b>				4639182,4655010/ 54,4679242,93191101
N3 (60 kW) Eng.8040.02		<b>24-0031</b>				4639182,4655010/ 54,4679242,93191101
<b>645 '1/60-'12/73</b>						
N1, N2 (81 kW) Eng.806A		<b>24-0031</b>				4639182,4655010/ 54,4679242,93191101
N3 (90 kW) Eng.8060.02		<b>24-0031</b>				4639182,4655010/ 54,4679242,93191101
<b>65 '1/70-'12/91</b>						
65.10NC (60 kW) Eng.8040.02		<b>24-0031</b>				4639182,4655010/ 54,4679242,93191101
65.9 Zeta (65 kW) Eng.8040.05	1/87-12/91	<b>24-0840</b>				4813370
<b>653</b>						
N - N1 - N2 - N3		<b>24-0031</b>				4639182,4655010/ 54,4679242,93191101
<b>655 '1/66-'12/71</b>						
N (81 kW) Eng.8060.01(806A)		<b>24-0031</b>				4639182,4655010/ 54,4679242,93191101
N, N1 (90 kW) Eng.8060.02		<b>24-0031</b>				4639182,4655010/ 54,4679242,93191101
<b>662 '1/60-'12/71</b>						
N1 (81 kW) Eng.8060.01(806A)		<b>24-0031</b>				4639182,4655010/ 54,4679242,93191101
N2 (81 kW) Eng.8060.01(806A)		<b>24-0031</b>				4639182,4655010/ 54,4679242,93191101
N2, N3 T (90 kW) Eng.8060.02		<b>24-0031</b>				4639182,4655010/ 54,4679242,93191101



**24-0031**



**24-0077**



**24-0161**



**24-0178**



**24-0317**

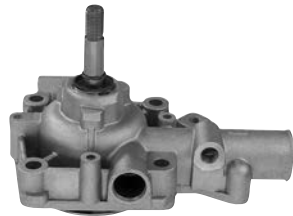

**24-0498**



**24-0499**



**24-0840**



**24-0842**













**24-0914**



**24-1161**

		<b>METELLI</b> ref.			<b>NOTE</b>	<b>Adaptable for OES</b>
<b>672 '1/69-</b>						
N (90 kW) Eng.8060.02		<b>24-0031</b>				4639182,4655010/ 54,4679242,93191101
<b>684 '1/70-</b>						
N, NP (147 kW) Eng.8200.02		<b>24-0077</b>				4606023,4952496
T (147 kW) Eng.8200.03		<b>24-0077</b>				4606023,4952496
<b>690 '1/62-</b>						
N4 (147 kW) Eng.8200.02		<b>24-0077</b>				4606023,4952496
N4, T4 (192 kW) Eng.8210.02		<b>24-0077</b>				4606023,4952496
<b>691 '1/69-</b>						
N, T, TS (192 kW) Eng.8210.02		<b>24-0077</b>				4606023,4952496
<b>697 '1/70-</b>						
N, NP, NT, T, TP (192 kW) Eng.8210.02		<b>24-0077</b>				4606023,4952496
<b>79 '1/83-'12/91</b>						
79.10 Zeta (73-74 kW) Eng.8340.04	1/87-12/91	<b>24-0840</b>				4813370
79.12 T. Zeta (75-85 kW) Eng.8060.25B/X	1/87-12/91	<b>24-0840</b>				4813370
79.14, 79.13 Zeta (96-99-101 kW) Eng.8040.04/.05		<b>24-0842</b>				98497115
<b>90 '1/70-</b>						
NC, OM, F13, OM13 (96-99-101 kW) Eng.8060.04		<b>24-0031</b>				4639182,4655010/ 54,4679242,93191101
OM14 (96-99-101 kW) Eng.8060.04		<b>24-0031</b>				4639182,4655010/ 54,4679242,93191101
<b>95 '1/83-'12/91</b>						
95.14 Zeta (96-99-101 kW) Eng.8060.04		<b>24-0842</b>				98497115
<b>Daily - Grinta '1/79-'12/90</b>						
30.8 (53 kW) Eng.8140.61	79-90	<b>24-0178</b>				4714636,4754850,4764761,7303009
32.8 (53 kW) Eng.8140.61	79-90	<b>24-0178</b>				4714636,4754850,4764761,7303009
35.10 (68 kW) Eng.8140.21	79-90	<b>24-0317</b>				2995627,7303056,99459755
35.10 T. (68 kW) Eng.8140.21	79-90	<b>24-0317</b>				2995627,7303056,99459755
35.12 T. (53 kW) Eng.8140.61	79-90	<b>24-0498</b>			Vett 12675-12679, +AF	2995629,98435994,99459757
35.8 (53 kW) Eng.8140.61	79-90	<b>24-0178</b>				4714636,4754850,4764761,7303009
40.10 (68 kW) Eng.8140.21	79-90	<b>24-0317</b>				2995627,7303056,99459755
40.8 (53 kW) Eng.8140.61	79-90	<b>24-0178</b>				4714636,4754850,4764761,7303009
45.10 (68 kW) Eng.8140.21	79-90	<b>24-0317</b>				2995627,7303056,99459755
49.10 T. (68 kW) Eng.8140.21	79-90	<b>24-0317</b>				2995627,7303056,99459755
<b>Daily I '1/91-'1/99</b>						
30.10 (76 kW) Eng.8140.23	96-99	<b>24-1161</b>				99476298
30.8 (53 kW) Eng.8140.61	91-99	<b>24-0161</b>			+AF	5001833230,7303050
	91-99	<b>24-0178</b>				4714636,4754850,4764761,7303009
	91-95	<b>24-0499</b>			Vett 12497-12674, +AF	98437726,99440728
	96-99	<b>24-0914</b>				5001849884,500300476,500361203 500361919,98438356,98439407,99438900 99448068
30.8 (62 kW) Eng.8140.63	98-99	<b>24-0914</b>				5001849884,500300476,500361203 500361919,98438356,98439407,99438900 99448068
35.10 (68 kW) Eng.8140.21	91-95	<b>24-0161</b>			+AF	5001833230,7303050
	91-95	<b>24-0178</b>				4714636,4754850,4764761,7303009
	96-99	<b>24-0914</b>				5001849884,500300476,500361203 500361919,98438356,98439407,99438900 99448068
35.10 (76 kW) Eng.8140.23	96-99	<b>24-0914</b>				5001849884,500300476,500361203 500361919,98438356,98439407,99438900 99448068
	96-99	<b>24-1161</b>				99476298
35.10 (76 kW) Eng.8140.47R	89-96	<b>24-0914</b>				5001849884,500300476,500361203 500361919,98438356,98439407,99438900 99448068

			
<b>24-0161</b>	<b>24-0178</b>	<b>24-0499</b>	<b>24-0900</b>
			
<b>24-0913</b>	<b>24-0914</b>	<b>24-0915</b>	<b>24-0916</b>
			
<b>24-1156</b>	<b>24-1161</b>		

		<b>METELLI</b> ref.			<b>NOTE</b>	<b>Adaptable for OES</b>
35.12 (85 kW) Eng.8140.47	90-96	<b>24-0914</b>				5001849884,500300476,500361203 500361919,98438356,98439407,99438900 99448068
35.12 V, C (53 kW) Eng.8140.61	91-99	<b>24-0914</b>			Vett 12680-, +AF	5001849884,500300476,500361203 500361919,98438356,98439407,99438900 99448068
35.8 (53 kW) Eng.8140.61	91-95	<b>24-0161</b>			+AF	5001833230,7303050
	91-95	<b>24-0178</b>				4714636,4754850,4764761,7303009
	91-95	<b>24-0499</b>			Vett 12497-12674, +AF	98437726,99440728
	96-99	<b>24-0914</b>				5001849884,500300476,500361203 500361919,98438356,98439407,99438900 99448068
35.8 (62 kW) Eng.8140.63	98-99	<b>24-0914</b>				5001849884,500300476,500361203 500361919,98438356,98439407,99438900 99448068
	96-98	<b>24-0916</b>				2995624,500361455
40.10 (68 kW) Eng.8140.21	91-95	<b>24-0161</b>			+AF	5001833230,7303050
	91-95	<b>24-0178</b>				4714636,4754850,4764761,7303009
40.10 (76 kW) Eng.8140.23	96-99	<b>24-0914</b>				5001849884,500300476,500361203 500361919,98438356,98439407,99438900 99448068
	96-99	<b>24-1161</b>				99476298
40.8 (53 kW) Eng.8140.61	91-95	<b>24-0161</b>			+AF	5001833230,7303050
	91-95	<b>24-0178</b>				4714636,4754850,4764761,7303009
45.10 (76 kW) Eng.8140.23	96-99	<b>24-0914</b>				5001849884,500300476,500361203 500361919,98438356,98439407,99438900 99448068
	96-99	<b>24-1161</b>				99476298
45.10 TD (68 kW) Eng.8140.21	91-95	<b>24-0161</b>			+AF	5001833230,7303050
	91-95	<b>24-0178</b>				4714636,4754850,4764761,7303009
45.12 (85 kW) Eng.8140.47	90-	<b>24-0914</b>				5001849884,500300476,500361203 500361919,98438356,98439407,99438900 99448068
45.12 TD (85 kW) Eng.8140.47	91-99	<b>24-0914</b>				5001849884,500300476,500361203 500361919,98438356,98439407,99438900 99448068
49.10 (76 kW) Eng.8140.23	96-99	<b>24-0914</b>				5001849884,500300476,500361203 500361919,98438356,98439407,99438900 99448068
	96-99	<b>24-1161</b>				99476298
49.10 (76 kW) Eng.8140.47R	89-96	<b>24-0914</b>				5001849884,500300476,500361203 500361919,98438356,98439407,99438900 99448068
49.10 TD (68 kW) Eng.8140.21	91-95	<b>24-0161</b>			+AF	5001833230,7303050
	91-95	<b>24-0178</b>				4714636,4754850,4764761,7303009
	96-99	<b>24-0914</b>				5001849884,500300476,500361203 500361919,98438356,98439407,99438900 99448068
49.12 TD (68 kW) Eng.8140.21	96-99	<b>24-0914</b>				5001849884,500300476,500361203 500361919,98438356,98439407,99438900 99448068
59.12 TD (85 kW) Eng.8140.21/.47	96-99	<b>24-0914</b>				5001849884,500300476,500361203 500361919,98438356,98439407,99438900 99448068

**Daily II '2/99-'4/06**

29L11 2.8 D (62-78 kW) Eng.8140.43C/B	99-	<b>24-0915</b>				500362859
29L12 2.3JTD (70 kW) Eng.F1AE0481C	99-	<b>24-0900</b>		•		504033770
35C11V 2.8 D (78 kW) Eng.8140.43C/B	99-	<b>24-0913</b>				500316451,500362834
35C13V 2.8 D (92-94 kW) Eng.8140.43S	99-	<b>24-0915</b>				500362859
35C14 3.0JTD (96 kW) Eng.F1CE0481A	05-	<b>24-1156</b>				504113544,504360207,504369725
35C15V (107 kW) Eng.8140.43N	99-06	<b>24-0915</b>				500362859
35S11 2.8 D (78 kW) Eng.8140.43C	99-	<b>24-0913</b>				500316451,500362834
35S13 2.8 D (92 kW) Eng.8140.43S	99-	<b>24-0915</b>				500362859
35S15 2.8 D (107 kW) Eng.8140.43N	99-06	<b>24-0915</b>				500362859
40C15 (107 kW) Eng.8140.43N	01-	<b>24-0915</b>				500362859



		<p>N° denti / teeth = 21 Ø 57</p> 	<p>N° denti / teeth = 21 Ø 57</p> 
<p><b>24-0843</b></p>	<p><b>24-0844</b></p>	<p><b>24-0845</b></p>	<p><b>24-0846</b></p>
			
<p><b>24-0900</b></p>	<p><b>24-0915</b></p>	<p><b>24-1026</b></p>	<p><b>24-1060</b></p>
			
<p><b>24-1156</b></p>			

		METELLI ref.			NOTE	Adaptable for OES
50C11 2.8 D (78 kW) Eng.8140.43C/B	99-	<b>24-0915</b>				500362859
50C13 2.8 D (92-94 kW) Eng.8140.43S	99-	<b>24-0915</b>				500362859
50C14 3.0JTD (136 kW) Eng.F1CE0481A	05-	<b>24-1156</b>				504113544,504360207,504369725
50C15 (107 kW) Eng.8140.43N	01-06	<b>24-0915</b>				500362859
65C14 3.0JTD (100 kW) Eng.F1CE0481A	04-	<b>24-1156</b>				504113544,504360207,504369725
65C15 2.8 TD (107-90 kW) Eng.8140.43N	99-06	<b>24-0915</b>				500362859
<b>Daily III '5/06-'12/10</b>						
2.3 HPI (100 kW) Eng.F1AE0481HA	06-	<b>24-0900</b>		•		504033770
2.3 HPI (71-78 kW) Eng.F1AE0481FA	06-	<b>24-0900</b>		•		504033770
2.3 HPI (78-93 kW) Eng.F1AE0481FA	09-	<b>24-0900</b>		•		504033770
3.0 HPI (108-130 kW) Eng.F1CE0481FA	06-	<b>24-1156</b>				504113544,504360207,504369725
3.0 HPT (130 kW) Eng.F1CE0481HC	07-	<b>24-1156</b>				504113544,504360207,504369725
3.0 Nat. Power (100 kW) Eng.F1CE0441A	10-	<b>24-1156</b>				504113544,504360207,504369725
3.0 TT (103 kW) Eng.F1CE3481LC	10-	<b>24-1156</b>				504113544,504360207,504369725
3.0 TT (125 kW) Eng.F1CE0481HA	10-	<b>24-1156</b>				504113544,504360207,504369725
<b>Daily IV '1/11-'2/14</b>						
2.3 HPI (78 kW) Eng.F1AE3481A	11-	<b>24-0900</b>		•		504033770
2.3 HPI (93 kW) Eng.F1AE3481B	11-	<b>24-0900</b>		•		504033770
3.0 HPI (100 kW)	11-	<b>24-1026</b>				504102572,504248581
3.0 HPI (107 kW) Eng.F1CE3481J/F1CE3481L	11-	<b>24-1026</b>				504102572,504248581
3.0 HPT (125 kW) Eng.F1CE3481C/F1CE3481K	11-	<b>24-1026</b>				504102572,504248581
3.0 HPT (130 kW)	11-	<b>24-1026</b>				504102572,504248581
3.0 HPT (150 kW) Eng.F1CE3481D	11-	<b>24-1026</b>				504102572,504248581
<b>EuroCargo '1/91-'12/11</b>						
100 E 15 (105-130 kW) Eng.8060.25R	91-	<b>24-0843</b>				98415831
100 E 15 (105-130 kW) Eng.8060.45R	91-	<b>24-0843</b>				98415831
100 E 17 (125 kW) Eng.F4AE0481A	00-	<b>24-1060</b>				504062854
100 E 18 (130 kW) Eng.8060.25V	91-00	<b>24-0843</b>				98415831
100 E 18 (134 kW) Eng.F4AE0681E	00-	<b>24-1060</b>				504062854
100 E 21 (152-105 kW) Eng.8060.45	91-	<b>24-0843</b>				98415831
100 E 21 (154 kW) Eng.F4AE0681D	00-	<b>24-1060</b>				504062854
120 E 15 (105-130 kW) Eng.8060.25R	91-	<b>24-0843</b>				98415831
120 E 18 (130 kW) Eng.8060.25V	92-	<b>24-0843</b>				98415831
120 E 18 (134 kW) Eng.F4AE0681E	00-	<b>24-1060</b>				504062854
120 E 23 (167 kW) Eng.8060.45S/.6090	91-	<b>24-0844</b>				4838676
120 E 24 (176 kW) Eng.F4AE0681B	00-	<b>24-1060</b>				504062854
120 E 28 (202 kW) Eng.F4AE0681A	00-	<b>24-1060</b>				504062854
120 EL 17 (125 kW) Eng.F4AE0481A	00-	<b>24-1060</b>				504062854
120 EL 21 (154 kW) Eng.F4AE0681D	00-	<b>24-1060</b>				504062854
130 E 15 (105-130 kW) Eng.8060.25R	94-	<b>24-0843</b>				98415831
130 E 18 (130-105 kW) Eng.8060.25V	92-	<b>24-0843</b>				98415831
130 E 18 (134 kW) Eng.F4AE0681E	00-	<b>24-1060</b>				504062854
130 E 23 (167 kW) Eng.8060.45S/.6090	92-	<b>24-0844</b>				4838676
130 E 24 (176 kW) Eng.F4AE0681B	00-	<b>24-1060</b>				504062854
130 E 28 (202 kW) Eng.F4AE0681A	00-	<b>24-1060</b>				504062854
140 E 18 (134 kW) Eng.F4AE0681E	00-	<b>24-1060</b>				504062854
140 E 24 (176 kW) Eng.F4AE0681B	00-	<b>24-1060</b>				504062854
150 E 18 (134 kW) Eng.F4AE0681E	00-	<b>24-1060</b>				504062854
150 E 23 (167 kW) Eng.8060.45S/.6090	92-	<b>24-0844</b>				4838676
150 E 24 (176 kW) Eng.F4AE0681B	00-	<b>24-1060</b>				504062854
150 E 27, 170 E 27, 180 E 27 (196-176 kW) Eng.8360.46/R	92-	<b>24-0845</b>				42532083,98439476
	92-	<b>24-0846</b>	•			42532082,42535615
150 E 28 (202 kW) Eng.F4AE0681A	00-	<b>24-1060</b>				504062854
180 E 21 (154 kW) Eng.F4AE0681D	00-	<b>24-1060</b>				504062854
180 E 24 (176 kW) Eng.F4AE0681B	00-	<b>24-1060</b>				504062854
180 E 28 (202 kW) Eng.F4AE0681A	00-	<b>24-1060</b>				504062854
320 E 27 (196-176 kW) Eng.8360.46/R	92-	<b>24-0845</b>				42532083,98439476
	92-	<b>24-0846</b>	•			42532082,42535615

	<p>N° denti / teeth = 23 Ø 62,5</p> 	<p>N° denti / teeth = 23 Ø 62,5</p> 	<p>N° denti / teeth = 19 Ø 65</p> 
<p><b>24-0843</b></p>	<p><b>24-0849</b></p>	<p><b>24-0850</b></p>	<p><b>24-0852</b></p>
 <p>12 Ribs</p>	 <p>10 Ribs</p>		
<p><b>24-0942</b></p>	<p><b>24-0968</b></p>	<p><b>24-0969</b></p>	<p><b>24-1060</b></p>

		<b>METELLI</b> ref.			<b>NOTE</b>	<b>Adaptable for OES</b>
320 E 28 (202 kW) Eng.F4AE0681A	00-	<b>24-1060</b>				504062854
60 E 12 (75-85 kW) Eng.8040.25B/X	91-96	<b>24-0843</b>				98415831
65 E 12 (75-85 kW) Eng.8040.25B/X	91-	<b>24-0843</b>				98415831
65 E 13 (95 kW) Eng.F4AE0481D	00-	<b>24-1060</b>				504062854
65 E 14 (100 kW) Eng.8040.45	91-	<b>24-0843</b>				98415831
65 E 15 (110 kW) Eng.F4AE0481C	00-	<b>24-1060</b>				504062854
75 E 12 (75-85 kW) Eng.8040.25B/X	91-	<b>24-0843</b>				98415831
75 E 13 (95 kW) Eng.F4AE0481D	00-	<b>24-1060</b>				504062854
75 E 14 (100 kW) Eng.8040.45	91-	<b>24-0843</b>				98415831
75 E 15 (105-130 kW) Eng.8060.25R	91-00	<b>24-0843</b>				98415831
75 E 15 (110 kW) Eng.F4AE0481C	00-	<b>24-1060</b>				504062854
75 E 17 (125 kW) Eng.F4AE0481A	00-	<b>24-1060</b>				504062854
75 E 18 (134 kW) Eng.F4AE0681E	00-	<b>24-1060</b>				504062854
80 E 15 (105-130 kW) Eng.8060.25R	91-	<b>24-0843</b>				98415831
80 E 17 (125 kW) Eng.F4AE0481A	00-	<b>24-1060</b>				504062854
80 E 18 (105-130 kW) Eng.8060.25V	91-	<b>24-0843</b>				98415831
80 E 18 (134 kW) Eng.F4AE0681E	00-	<b>24-1060</b>				504062854
80 E 21 (105-152 kW) Eng.8060.45	91-	<b>24-0843</b>				98415831
80 E 21 (154 kW) Eng.F4AE0681D	00-	<b>24-1060</b>				504062854
80 EL 15 (110 kW) Eng.F4AE0481C	00-	<b>24-1060</b>				504062854
90 E 17 (125 kW) Eng.F4AE0481A	00-	<b>24-1060</b>				504062854
90 E 18 (134 kW) Eng.F4AE0681E	00-	<b>24-1060</b>				504062854
90 E 21 (154 kW) Eng.F4AE0681D	00-	<b>24-1060</b>				504062854
<b>EuroStar '1/93-'12/02</b>						
LD 190 E 42 (243-265-272-277-309 kW) Eng.8210.42/K/L	93-95	<b>24-0852</b>	•			98479675,99445447
	96-	<b>24-0969</b>				500350785,93190285
LD 190 E 47 (345 kW) Eng.8210.42M	93-95	<b>24-0852</b>	•			98479675,99445447
	96-	<b>24-0969</b>				500350785,93190285
LD 240 E 42 (243-265-272-277-309 kW) Eng.8210.42/K/L	93-95	<b>24-0852</b>	•			98479675,99445447
	96-	<b>24-0969</b>				500350785,93190285
LD 240 E 47 (345 kW) Eng.8210.42M	93-95	<b>24-0852</b>	•			98479675,99445447
	96-	<b>24-0969</b>				500350785,93190285
LD 440 E 42 (243-265-272-277-309 kW) Eng.8210.42/K/L	93-95	<b>24-0852</b>	•			98479675,99445447
	96-	<b>24-0969</b>				500350785,93190285
LD 440 E 47 (345 kW) Eng.8210.42M	93-95	<b>24-0852</b>	•			98479675,99445447
	96-	<b>24-0969</b>				500350785,93190285
LD 440 E 48 (353 kW) Eng.F3BE0681E	01-02	<b>24-0942</b>				500356553,5801807827
<b>EuroTech MH '1/98-'12/03</b>						
190 E 24 (180 kW) Eng.F2BE0681D	98-	<b>24-0968</b>				99483937
190 E 27 (200 kW) Eng.F2BE0681C	98-	<b>24-0968</b>				99483937
190 E 27 (200 kW) Eng.F2BE0681F	98-	<b>24-0968</b>				99483937
190 E 31 (228 kW) Eng.F2BE0681B	98-	<b>24-0968</b>				99483937
190 E 35 (259 kW) Eng.F2BE0681A	98-	<b>24-0968</b>				99483937
260 E 24 (180 kW) Eng.F2BE0681D	99-	<b>24-0968</b>				99483937
260 E 27 (200 kW) Eng.F2BE0681C	99-	<b>24-0968</b>				99483937
260 E 27 (200 kW) Eng.F2BE0681F	99-	<b>24-0968</b>				99483937
260 E 31 (228 kW) Eng.F2BE0681B	99-	<b>24-0968</b>				99483937
260 E 35 (259 kW) Eng.F2BE0681A	99-	<b>24-0968</b>				99483937
400/440 E 31 (228 kW) Eng.F2BE0681B	98-	<b>24-0968</b>				99483937
400/440 E 35 (259 kW) Eng.F2BE0681A	98-	<b>24-0968</b>				99483937
<b>EuroTech MP '1/92-'12/03</b>						
180 E 34, 190 E 34, 190 E 38, 240 E 38 (221-234-254-276 kW) Eng.8460.41	92-93	<b>24-0849</b>			+BH	500350797,61318939
	92-93	<b>24-0850</b>	•			500350798,93190284
180 E 42 (243-265-272-277-309 kW) Eng.8210.42/K/L	92-93	<b>24-0852</b>	•			98479675,99445447
190 E 42 (243-265-272-277-309 kW) Eng.8210.42/K/L	93-95	<b>24-0852</b>	•			98479675,99445447
	96-	<b>24-0969</b>				500350785,93190285
240 E 42 (243-265-272-277-309 kW) Eng.8210.42/K/L	92-95	<b>24-0852</b>	•			98479675,99445447

<p>N° denti / teeth = 23 Ø 62,5</p> 	<p>N° denti / teeth = 23 Ø 62,5</p> 	<p>N° denti / teeth = 19 Ø 65</p> 	<p>N° denti / teeth = 24 Ø 63</p> 
<p><b>24-0849</b></p>	<p><b>24-0850</b></p>	<p><b>24-0852</b></p>	<p><b>24-0853</b></p>
<p>12 Ribs</p> 	<p>10 Ribs</p> 		
<p><b>24-0942</b></p>	<p><b>24-0968</b></p>	<p><b>24-0969</b></p>	<p><b>24-1156</b></p>

		<b>METELLI</b> ref.			<b>NOTE</b>	<b>Adaptable for OES</b>
240 E 42 (243-265-272-277-309 kW) Eng.8210.42/K/L	96-	<b>24-0969</b>				500350785,93190285
260 E 42 (243-265-272-277-309 kW) Eng.8210.42/K/L	94-95	<b>24-0852</b>	•			98479675,99445447
	96-	<b>24-0969</b>				500350785,93190285
400 E 38 (221-234-254-276 kW) Eng.8460.41L	92-	<b>24-0849</b>			+BH	500350797,61318939
	92-	<b>24-0850</b>	•			500350798,93190284
400 E 38 (221-234-254-276 kW) Eng.8460.41N	92-	<b>24-0849</b>			+BH	500350797,61318939
	92-	<b>24-0850</b>	•			500350798,93190284
400 E 42 (309 kW) Eng.8210.42L	92-95	<b>24-0852</b>	•			98479675,99445447
	96-	<b>24-0969</b>				500350785,93190285
400/440 E 34 (221-234-254-276 kW) Eng.8460.41	92-	<b>24-0849</b>			+BH	500350797,61318939
	92-	<b>24-0850</b>	•			500350798,93190284
440 E 38 (221-234-254-276 kW) Eng.8460.41	93-	<b>24-0849</b>			+BH	500350797,61318939
	93-	<b>24-0850</b>	•			500350798,93190284
440 E 42 (243-265-272-277-309 kW) Eng.8210.42/K/L	93-95	<b>24-0852</b>	•			98479675,99445447
	96-	<b>24-0969</b>				500350785,93190285
<b>EuroTech MT '1/92-'12/98</b>						
180 E 30 (221-234-254-276 kW) Eng.8460.41	92-	<b>24-0849</b>			+BH	500350797,61318939
	92-	<b>24-0850</b>	•			500350798,93190284
180 E 34 (221-234-254-276 kW) Eng.8460.41	92-93	<b>24-0849</b>			+BH	500350797,61318939
	92-93	<b>24-0850</b>	•			500350798,93190284
190 E 30 (221-234-254-276 kW) Eng.8460.41	97-98	<b>24-0849</b>			+BH	500350797,61318939
	97-98	<b>24-0850</b>	•			500350798,93190284
400 E 34 (221-234-254-276 kW) Eng.8460.41	92-	<b>24-0849</b>			+BH	500350797,61318939
	92-	<b>24-0850</b>	•			500350798,93190284
<b>EuroTrakker '1/93-'12/04</b>						
MP 190 E 31 (228 kW) Eng.F2BE0681B	99-04	<b>24-0968</b>				99483937
MP 190 E 34 (221-234-254-276 kW) Eng.8460.41	93-	<b>24-0849</b>			+BH	500350797,61318939
	93-	<b>24-0850</b>	•			500350798,93190284
MP 190 E 35 (259 kW) Eng.F2BE0681A	99-04	<b>24-0968</b>				99483937
MP 190 E 37 (243-265-272-277-309 kW) Eng.8210.42/K/L	93-95	<b>24-0852</b>	•			98479675,99445447
	96-	<b>24-0969</b>				500350785,93190285
MP 190 E 38 (280 kW) Eng.F3BE0681G	01-04	<b>24-0942</b>				500356553,5801807827
MP 190 E 42 (243-265-272-277-309 kW) Eng.8210.42/K/L	93-	<b>24-0969</b>				500350785,93190285
MP 190 E 44 (324 kW) Eng.F3BE0681C	00-04	<b>24-0942</b>				500356553,5801807827
MP 260 E 31 (228 kW) Eng.F2BE0681B	99-04	<b>24-0968</b>				99483937
MP 260 E 35 (259 kW) Eng.F2BE0681A	99-04	<b>24-0968</b>				99483937
MP 260 E 38 (280 kW) Eng.F3BE0681G	01-04	<b>24-0942</b>				500356553,5801807827
MP 260 E 44 (324 kW) Eng.F3BE0681C	00-04	<b>24-0942</b>				500356553,5801807827
MP 340 E 35 (259 kW) Eng.F2BE0681A	99-04	<b>24-0968</b>				99483937
MP 340 E 38 (280 kW) Eng.F3BE0681G	01-04	<b>24-0942</b>				500356553,5801807827
MP 340 E 44 (324 kW) Eng.F3BE0681C	01-04	<b>24-0942</b>				500356553,5801807827
MP 380 E 34 (221-234-254-276 kW) Eng.8460.41	93-	<b>24-0849</b>			+BH	500350797,61318939
	93-	<b>24-0850</b>	•			500350798,93190284
MP 380 E 37, MP 380 E 42, MP 410 E 37, MP 410 E 42 (243-265-272-277-309 kW) Eng.8210.42/K/L	93-95	<b>24-0852</b>	•			98479675,99445447
	96-	<b>24-0969</b>				500350785,93190285
MP 380 E 38 (280 kW) Eng.F3BE0681G	01-04	<b>24-0942</b>				500356553,5801807827
MP 380 E 44 (324 kW) Eng.F3BE0681C	01-04	<b>24-0942</b>				500356553,5801807827
MP 410 E 38 (280 kW) Eng.F3BE0681G	01-04	<b>24-0942</b>				500356553,5801807827
MP 720 E 37 (243-265-272-277-309 kW) Eng.8210.42/K/L	93-	<b>24-0969</b>				500350785,93190285
MP 720 E 42 (243-265-272-277-309 kW) Eng.8210.42/K/L	93-95	<b>24-0852</b>	•			98479675,99445447
	96-	<b>24-0969</b>				500350785,93190285
<b>Massif '7/08-'12/11</b>						
3.0 HPI (107 kW) Eng.F1CE0481FA	08-	<b>24-1156</b>				504113544,504360207,504369725
3.0 HPT (130 kW) Eng.F1CE0481HA	08-	<b>24-1156</b>				504113544,504360207,504369725
<b>P / PA '12/79-'12/93</b>						
330.36 (243-265-272-277-309 kW) Eng.8210.42/K/L	89-92	<b>24-0853</b>			+BH	98468830,99458098

<p>N° denti / teeth = 19 Ø 65</p> 	<p>N° denti / teeth = 19 Ø 65 ~14</p> 	<p>N° denti / teeth = 24 Ø 63</p> 	<p>N° denti / teeth = 24 Ø 63</p> 
<p><b>24-0847</b></p>	<p><b>24-0848</b></p>	<p><b>24-0853</b></p>	<p><b>24-0854</b></p>
<p>12 Ribs</p> 	<p>10 Ribs</p> 		
<p><b>24-0942</b></p>	<p><b>24-0968</b></p>	<p><b>24-1224</b></p>	<p><b>24-1235</b></p>
			
<p><b>24-1331</b></p>			

		<b>METELLI</b> ref.			<b>NOTE</b>	<b>Adaptable for OES</b>
330.36 (243-265-272-277-309 kW) Eng.8210.42/K/L	89-92	<b>24-0854</b>	•			42530032,93190286
<b>Stralis '1/02-</b>						
AD/AT 190S27 (200 kW) Eng.F2BE0681F	04-	<b>24-0968</b>				99483937
AD/AT 190S30 (218 kW) Eng.F2BE0681E	04-	<b>24-0968</b>				99483937
AD/AT 190S31 (228 kW) Eng.F2BE0681B	03-	<b>24-0968</b>				99483937
AD/AT 190S35 (259 kW) Eng.F2BE0681A	03-	<b>24-0968</b>				99483937
AD/AT 260S27 (200 kW) Eng.F2BE0681F	04-	<b>24-0968</b>				99483937
AD/AT 260S30 (218 kW) Eng.F2BE0681E	04-	<b>24-0968</b>				99483937
AD/AT 260S31 (228 kW) Eng.F2BE0681B	03-	<b>24-0968</b>				99483937
AD/AT 260S35 (259 kW) Eng.F2BE0681A	03-	<b>24-0968</b>				99483937
AD/AT 260S36 (265 kW) Eng.F2BE3681A	07-	<b>24-0968</b>				99483937
AD/AT 440S35 (259 kW) Eng.F2BE0681A	03-	<b>24-0968</b>				99483937
AS 260S48 (353 kW) Eng.F3BE0681E	02-	<b>24-0942</b>				500356553,5801807827
AS 260S54 (397 kW) Eng.F3BE0681A	02-	<b>24-0942</b>				500356553,5801807827
AS 440S48 (353 kW) Eng.F3BE0681E	02-	<b>24-0942</b>				500356553,5801807827
AS 440S54 (397 kW) Eng.F3BE0681A	02-	<b>24-0942</b>				500356553,5801807827
<b>Trakker '1/04-</b>						
AD/AT 180T27 (200 kW) Eng.F2BE0681F	05-	<b>24-0968</b>				99483937
AD/AT 190T27 (200 kW) Eng.F2BE0681F	05-	<b>24-0968</b>				99483937
AD/AT 190T31 (228 kW) Eng.F2BE0681B	04-	<b>24-0968</b>				99483937
AD/AT 190T35 (259 kW) Eng.F2BE0681A	04-	<b>24-0968</b>				99483937
AD/AT 190T38 (280 kW) Eng.F3BE0681G	05-	<b>24-0942</b>				500356553,5801807827
AD/AT 190T44 (324 kW) Eng.F3BE0681C	05-	<b>24-0942</b>			ZF	500356553,5801807827
AD/AT 260T31 (228 kW) Eng.F2BE0681B	04-	<b>24-0968</b>				99483937
AD/AT 260T35 (259 kW) Eng.F2BE0681A	04-	<b>24-0968</b>				99483937
AD/AT 260T38 (280 kW) Eng.F3BE0681G	04-	<b>24-0942</b>				500356553,5801807827
AD/AT 400T35 (259 kW) Eng.F2BE0681A	05-	<b>24-0968</b>				99483937
<b>Turbostar '7/84-'12/93</b>						
190.36 (243-265-272-277-309 kW) Eng.8210.42/K/L	87-93	<b>24-0847</b>			+BH	98468832,99458099
	87-93	<b>24-0848</b>	•			42530033
	87-93	<b>24-0853</b>			+BH	98468830,99458098
	87-93	<b>24-0854</b>	•			42530032,93190286
<b>TurboTech '1/90-'1/93</b>						
190.36 (243-265-272-277-309 kW) Eng.8210.42/K/L	90-92	<b>24-0847</b>			+BH	98468832,99458099
	90-92	<b>24-0848</b>	•			42530033
	90-92	<b>24-0853</b>			+BH	98468830,99458098
	90-92	<b>24-0854</b>	•			42530032,93190286
220.36 (243-265-272-277-309 kW) Eng.8210.42/K/L	90-93	<b>24-0847</b>			+BH	98468832,99458099
	90-93	<b>24-0848</b>	•			42530033
	90-93	<b>24-0853</b>			+BH	98468830,99458098
	90-93	<b>24-0854</b>	•			42530032,93190286
240.36 (243-265-272-277-309 kW) Eng.8210.42/K/L	90-92	<b>24-0847</b>			+BH	98468832,99458099
	90-92	<b>24-0848</b>	•			42530033
	90-92	<b>24-0853</b>			+BH	98468830,99458098
	90-92	<b>24-0854</b>	•			42530032,93190286
<b>MAN BUS</b>						
<b>Hocl '1/96-</b>						
11.220 (162 kW) Eng.DO826LOH15	96-	<b>24-1331</b>			Impeller Ø 125mm	51065006575/ 6606/ 6612 51065006669/ 9575/ 9606/ 9612
14.280 (206 kW) Eng.DO836LOH02	96-	<b>24-1331</b>			Impeller Ø 125mm	51065006575/ 6606/ 6612 51065006669/ 9575/ 9606/ 9612
18.360 (265 kW) Eng.D2066LOH02/06/27	06-14	<b>24-1224</b>			+Retarder	51065006642/ 6675/ 6694/ 9642/ 9675/ 9694
	06-14	<b>24-1235</b>				51065006646/ 6676/ 6695/ 7050 51065009050/ 9646/ 9676/ 9695
18.400 (294 kW) Eng.D2066LOH03,28	06-14	<b>24-1224</b>			+Retarder	51065006642/ 6675/ 6694/ 9642/ 9675/ 9694
	06-14	<b>24-1235</b>				51065006646/ 6676/ 6695/ 7050 51065009050/ 9646/ 9676/ 9695





**24-1224**



**24-1235**



**24-1294**



**24-1298**



**24-1302**



**24-1319**



**24-1321**



**24-1336**

		<b>METELLI</b> ref.			<b>NOTE</b>	<b>Adaptable for OES</b>
18.440 (324 kW) Eng.D2066LOH04,08	06-09	<b>24-1224</b>			+Retarder	51065006642/ 6675/ 6694/ 9642/ 9675/ 9694
	06-09	<b>24-1235</b>				51065006646/ 6676/ 6695/ 7050 51065009050/ 9646/ 9676/ 9695
24.440 (324 kW) Eng.D2066LOH04,08	06-09	<b>24-1224</b>			+Retarder	51065006642/ 6675/ 6694/ 9642/ 9675/ 9694
	06-09	<b>24-1235</b>				51065006646/ 6676/ 6695/ 7050 51065009050/ 9646/ 9676/ 9695
<b>LION'S COACH '9/95-</b>						
FRH 352,RH 353 (257 kW) Eng.D2866LOH26 FRH 402,RH 403 (294 kW) Eng.D2866LOH23	95-	<b>24-1294</b>			For vehicles without retarder; Impeller Ø 125mm	51065006282/ 6387/ 9282/ 9387
	95-	<b>24-1298</b>			For vehicles without retarder, w/o pulley; Impeller Ø 135mm, Incl Eletronic fuel Injection pump	51065006408/ 6492/ 9492
	95-	<b>24-1302</b>			For vehicles with retarder, w/o pulley	51065006426/ 6490/ 9426/ 9490
RH 413 (301 kW) Eng.D2866LOH29	00-	<b>24-1294</b>			For vehicles without retarder; Impeller Ø 125mm	51065006282/ 6387/ 9282/ 9387
	00-	<b>24-1298</b>			For vehicles without retarder, w/o pulley; Impeller Ø 135mm, Incl Eletronic fuel Injection pump	51065006408/ 6492/ 9492
	00-	<b>24-1302</b>			For vehicles with retarder, w/o pulley	51065006426/ 6490/ 9426/ 9490
RH 463, RHC 464 (338 kW) Eng.D2876LOH03/02	00-	<b>24-1298</b>			For vehicles without retarder, w/o pulley; Impeller Ø 135mm, Incl Eletronic fuel Injection pump	51065006408/ 6492/ 9492
	00-	<b>24-1302</b>			For vehicles with retarder, w/o pulley	51065006426/ 6490/ 9426/ 9490
RHC 414 (301 kW) Eng.D2866LOH34	02-	<b>24-1294</b>			For vehicles without retarder; Impeller Ø 125mm	51065006282/ 6387/ 9282/ 9387
	02-	<b>24-1298</b>			For vehicles without retarder, w/o pulley; Impeller Ø 135mm, Incl Eletronic fuel Injection pump	51065006408/ 6492/ 9492
	02-	<b>24-1302</b>			For vehicles with retarder, w/o pulley	51065006426/ 6490/ 9426/ 9490
<b>LION'S STAR '1/93-</b>						
FRH 352,RH 353 (257 kW) Eng.D2866LOH26	95-	<b>24-1294</b>			For vehicles without retarder; Impeller Ø 125mm	51065006282/ 6387/ 9282/ 9387
	95-	<b>24-1298</b>			For vehicles without retarder, w/o pulley; Impeller Ø 135mm, Incl Eletronic fuel Injection pump	51065006408/ 6492/ 9492
	95-	<b>24-1302</b>			For vehicles with retarder, w/o pulley	51065006426/ 6490/ 9426/ 9490
FRH 402,RH 403 (294 kW) Eng.D2866LOH23	95-	<b>24-1294</b>			For vehicles without retarder; Impeller Ø 125mm	51065006282/ 6387/ 9282/ 9387
	95-	<b>24-1298</b>			For vehicles without retarder, w/o pulley; Impeller Ø 135mm, Incl Eletronic fuel Injection pump	51065006408/ 6492/ 9492
	95-	<b>24-1302</b>			For vehicles with retarder, w/o pulley	51065006426/ 6490/ 9426/ 9490
FRH 422 (309 kW) Eng.D2866LOH20	93-96	<b>24-1294</b>			For vehicles without retarder; Impeller Ø 125mm	51065006282/ 6387/ 9282/ 9387
	93-96	<b>24-1298</b>			For vehicles without retarder, w/o pulley; Impeller Ø 135mm, Incl Eletronic fuel Injection pump	51065006408/ 6492/ 9492
	93-96	<b>24-1302</b>			For vehicles with retarder, w/o pulley	51065006426/ 6490/ 9426/ 9490
RH 414, RHS 414 (301 kW) Eng.D2866LOH39/34	00-	<b>24-1294</b>			For vehicles without retarder; Impeller Ø 125mm	51065006282/ 6387/ 9282/ 9387
	00-	<b>24-1298</b>			For vehicles without retarder, w/o pulley; Impeller Ø 135mm, Incl Eletronic fuel Injection pump	51065006408/ 6492/ 9492
	00-	<b>24-1302</b>			For vehicles with retarder, w/o pulley	51065006426/ 6490/ 9426/ 9490
RH 464, RHS 464 (338 kW) Eng.D2876LOH03	00-	<b>24-1298</b>			For vehicles without retarder, w/o pulley; Impeller Ø 135mm, Incl Eletronic fuel Injection pump	51065006408/ 6492/ 9492
	00-	<b>24-1302</b>			For vehicles with retarder, w/o pulley	51065006426/ 6490/ 9426/ 9490
<b>LIONS CITY '8/96-</b>						
A 23 (191 kW) Eng.D2866LUH22	94-	<b>24-1294</b>			For vehicles without retarder; Impeller Ø 125mm	51065006282/ 6387/ 9282/ 9387
	96-	<b>24-1302</b>			For vehicles with retarder, w/o pulley	51065006426/ 6490/ 9426/ 9490
<b>LIONS COMFORT '9/96-</b>						
RN 313 (228 kW) Eng.D2866LUH20	96-	<b>24-1294</b>			For vehicles without retarder; Impeller Ø 125mm	51065006282/ 6387/ 9282/ 9387
	96-	<b>24-1298</b>			For vehicles without retarder, w/o pulley; Impeller Ø 135mm, Incl Eletronic fuel Injection pump	51065006408/ 6492/ 9492
	96-	<b>24-1302</b>			For vehicles with retarder, w/o pulley	51065006426/ 6490/ 9426/ 9490
RN 313 (228 kW) Eng.D2866LUH26	96-	<b>24-1294</b>			For vehicles without retarder; Impeller Ø 125mm	51065006282/ 6387/ 9282/ 9387
	96-	<b>24-1298</b>			For vehicles without retarder, w/o pulley; Impeller Ø 135mm, Incl Eletronic fuel Injection pump	51065006408/ 6492/ 9492
	96-	<b>24-1302</b>			For vehicles with retarder, w/o pulley	51065006426/ 6490/ 9426/ 9490
RN 353 (257 kW) Eng.D2866LUH21	97-	<b>24-1294</b>			For vehicles without retarder; Impeller Ø 125mm	51065006282/ 6387/ 9282/ 9387
	97-	<b>24-1298</b>			For vehicles without retarder, w/o pulley; Impeller Ø 135mm, Incl Eletronic fuel Injection pump	51065006408/ 6492/ 9492
	97-	<b>24-1302</b>			For vehicles with retarder, w/o pulley	51065006426/ 6490/ 9426/ 9490
<b>Low entry '7/86-'5/94</b>						
19.322 (235 kW) Eng.D2865LF03	90-94	<b>24-1298</b>			For vehicles without retarder, w/o pulley; Impeller Ø 135mm, Incl Eletronic fuel Injection pump	51065006408/ 6492/ 9492
	90-94	<b>24-1302</b>			For vehicles with retarder, w/o pulley	51065006426/ 6490/ 9426/ 9490
	90-94	<b>24-1319</b>			For vehicles with retarder, w pulley	51065006546/ 9546
	90-94	<b>24-1321</b>			For vehicles without retarder, w pulley	51065006545/ 6547/ 9545/ 9547
	90-94	<b>24-1336</b>			w/ Pulley	51065006548/ 9548
19.322 (235 kW) Eng.D2865LF06	90-94	<b>24-1298</b>			For vehicles without retarder, w/o pulley; Impeller Ø 135mm, Incl Eletronic fuel Injection pump	51065006408/ 6492/ 9492





			
<b>24-1298</b>	<b>24-1302</b>	<b>24-1319</b>	<b>24-1321</b>
			
<b>24-1336</b>			



			
<b>24-1235</b>	<b>24-1294</b>	<b>24-1298</b>	<b>24-1302</b>
			
<b>24-1308</b>	<b>24-1319</b>	<b>24-1321</b>	<b>24-1323</b>
			
<b>24-1324</b>	<b>24-1336</b>		

		<b>METELLI</b> ref.			<b>NOTE</b>	<b>Adaptable for OES</b>
25.372 (272 kW) Eng.D2866LF05	90-92	<b>24-1336</b>			w/ Pulley	51065006548/ 9548
25.422 (309 kW) Eng.D2866LF06	90-92	<b>24-1298</b>			For vehicles without retarder, w/o pulley; Impeller Ø 135mm, Incl Electronic fuel Injection pump	51065006408/ 6492/ 9492
	90-92	<b>24-1302</b>			For vehicles with retarder, w/o pulley	51065006426/ 6490/ 9426/ 9490
	90-92	<b>24-1319</b>			For vehicles with retarder, w pulley	51065006546/ 9546
	90-92	<b>24-1321</b>			For vehicles without retarder, w pulley	51065006545/ 6547/ 9545/ 9547
	90-92	<b>24-1336</b>			w/ Pulley	51065006548/ 9548
25.422 (309 kW) Eng.D2866LF09	90-92	<b>24-1302</b>			For vehicles with retarder, w/o pulley	51065006426/ 6490/ 9426/ 9490
	90-92	<b>24-1319</b>			For vehicles with retarder, w pulley	51065006546/ 9546
	90-92	<b>24-1321</b>			For vehicles without retarder, w pulley	51065006545/ 6547/ 9545/ 9547
	90-92	<b>24-1336</b>			w/ Pulley	51065006548/ 9548
26.322 (235 kW) Eng.D2865LF03/ LF06	90-94	<b>24-1298</b>			For vehicles without retarder, w/o pulley; Impeller Ø 135mm, Incl Electronic fuel Injection pump	51065006408/ 6492/ 9492
	90-94	<b>24-1302</b>			For vehicles with retarder, w/o pulley	51065006426/ 6490/ 9426/ 9490
	90-94	<b>24-1319</b>			For vehicles with retarder, w pulley	51065006546/ 9546
	90-94	<b>24-1321</b>			For vehicles without retarder, w pulley	51065006545/ 6547/ 9545/ 9547
26.372 (272 kW) Eng.D2866LF03	90-94	<b>24-1298</b>			For vehicles without retarder, w/o pulley; Impeller Ø 135mm, Incl Electronic fuel Injection pump	51065006408/ 6492/ 9492
	90-94	<b>24-1302</b>			For vehicles with retarder, w/o pulley	51065006426/ 6490/ 9426/ 9490
	90-94	<b>24-1319</b>			For vehicles with retarder, w pulley	51065006546/ 9546
	90-94	<b>24-1321</b>			For vehicles without retarder, w pulley	51065006545/ 6547/ 9545/ 9547
26.372 (272 kW) Eng.D2866LF05	90-94	<b>24-1298</b>			For vehicles without retarder, w/o pulley; Impeller Ø 135mm, Incl Electronic fuel Injection pump	51065006408/ 6492/ 9492
	90-94	<b>24-1302</b>			For vehicles with retarder, w/o pulley	51065006426/ 6490/ 9426/ 9490
	90-94	<b>24-1319</b>			For vehicles with retarder, w pulley	51065006546/ 9546
	90-94	<b>24-1321</b>			For vehicles without retarder, w pulley	51065006545/ 6547/ 9545/ 9547
26.422 (309 kW) Eng.D2866LF06	90-94	<b>24-1298</b>			For vehicles without retarder, w/o pulley; Impeller Ø 135mm, Incl Electronic fuel Injection pump	51065006408/ 6492/ 9492
	90-94	<b>24-1302</b>			For vehicles with retarder, w/o pulley	51065006426/ 6490/ 9426/ 9490
	90-94	<b>24-1319</b>			For vehicles with retarder, w pulley	51065006546/ 9546
	90-94	<b>24-1321</b>			For vehicles without retarder, w pulley	51065006545/ 6547/ 9545/ 9547
26.422 (309 kW) Eng.D2866LF09	90-94	<b>24-1298</b>			For vehicles without retarder, w/o pulley; Impeller Ø 135mm, Incl Electronic fuel Injection pump	51065006408/ 6492/ 9492
	90-94	<b>24-1302</b>			For vehicles with retarder, w/o pulley	51065006426/ 6490/ 9426/ 9490
	90-94	<b>24-1319</b>			For vehicles with retarder, w pulley	51065006546/ 9546
	90-94	<b>24-1321</b>			For vehicles without retarder, w pulley	51065006545/ 6547/ 9545/ 9547
<b>NG '8/92-</b>						
NG 262 (191 kW) Eng.D2865LUH09	97-98	<b>24-1298</b>			For vehicles without retarder, w/o pulley; Impeller Ø 135mm, Incl Electronic fuel Injection pump	51065006408/ 6492/ 9492
	97-98	<b>24-1302</b>			For vehicles with retarder, w/o pulley	51065006426/ 6490/ 9426/ 9490
NG 262/272 (191-198 kW) Eng.D0826LUH01	92-98	<b>24-1308</b>			w/ Pulley; Installation height 79,5 mm	51065006480/ 9480,51065063043
	92-98	<b>24-1323</b>			Impeller Ø 125mm	51065006537/ 9537
	92-98	<b>24-1324</b>			w/ Pulley; Installation height 90,0 mm	51065006543/ 6569/ 9543/ 9569
NG 312 (228-235 kW) Eng.D2865LUH07	95-98	<b>24-1298</b>			For vehicles without retarder, w/o pulley; Impeller Ø 135mm, Incl Electronic fuel Injection pump	51065006408/ 6492/ 9492
	95-98	<b>24-1302</b>			For vehicles with retarder, w/o pulley	51065006426/ 6490/ 9426/ 9490
NG 312/313 (228-231 kW) Eng.D2866LUH26	98-	<b>24-1294</b>			For vehicles without retarder; Impeller Ø 125mm	51065006282/ 6387/ 9282/ 9387
	98-	<b>24-1298</b>			For vehicles without retarder, w/o pulley; Impeller Ø 135mm, Incl Electronic fuel Injection pump	51065006408/ 6492/ 9492
	98-	<b>24-1302</b>			For vehicles with retarder, w/o pulley	51065006426/ 6490/ 9426/ 9490
NG 313 (228 kW) Eng.D2066LUH12	06-09	<b>24-1235</b>				51065006646/ 6676/ 6695/ 7050 51065009050/ 9646/ 9676/ 9695
NG 313 (228 kW) Eng.D2066LUH22	06-09	<b>24-1235</b>				51065006646/ 6676/ 6695/ 7050 51065009050/ 9646/ 9676/ 9695
NG 323 (235 kW) Eng.D2066LUH42	07-14	<b>24-1235</b>				51065006646/ 6676/ 6695/ 7050 51065009050/ 9646/ 9676/ 9695
NG 353 (257 kW) Eng.D2066LUH13	07-14	<b>24-1235</b>				51065006646/ 6676/ 6695/ 7050 51065009050/ 9646/ 9676/ 9695
NG 353 (257 kW) Eng.D2066LUH23	07-14	<b>24-1235</b>				51065006646/ 6676/ 6695/ 7050 51065009050/ 9646/ 9676/ 9695
NG 363 (264 kW) Eng.D2066LUH48	07-14	<b>24-1235</b>				51065006646/ 6676/ 6695/ 7050 51065009050/ 9646/ 9676/ 9695

			
<b>24-1227</b>	<b>24-1234</b>	<b>24-1235</b>	<b>24-1294</b>
			
<b>24-1298</b>	<b>24-1302</b>	<b>24-1308</b>	<b>24-1310</b>
			
<b>24-1323</b>	<b>24-1324</b>		



		<b>METELLI</b> ref.	 	<b>NOTE</b>	<b>Adaptable for OES</b>
<b>NL '9/89-</b>					
NL 202 (157 kW) Eng.D0826LUH/213	92-	<b>24-1308</b>		w/ Pulley; Installation height 79,5 mm	51065006480/ 9480,51065063043
	89-94	<b>24-1323</b>		Impeller Ø 125mm	51065006537/ 9537
	89-94	<b>24-1324</b>		w/ Pulley; Installation height 90,0 mm	51065006543/ 6569/ 9543/ 9569
NL 202/222/223 (157-162 kW) Eng.D0826LUH03	92-	<b>24-1308</b>		w/ Pulley; Installation height 79,5 mm	51065006480/ 9480,51065063043
	92-	<b>24-1323</b>		Impeller Ø 125mm	51065006537/ 9537
	89-94	<b>24-1324</b>		w/ Pulley; Installation height 90,0 mm	51065006543/ 6569/ 9543/ 9569
NL 202/222/223 (157-162 kW) Eng.D0826LUH12	91-	<b>24-1308</b>		w/ Pulley; Installation height 79,5 mm	51065006480/ 9480,51065063043
	92-	<b>24-1323</b>		Impeller Ø 125mm	51065006537/ 9537
	89-94	<b>24-1324</b>		w/ Pulley; Installation height 90,0 mm	51065006543/ 6569/ 9543/ 9569
NL 202/262/263 (184 kW) Eng.D0826LUH	90-93	<b>24-1308</b>		w/ Pulley; Installation height 79,5 mm	51065006480/ 9480,51065063043
	91-	<b>24-1323</b>		Impeller Ø 125mm	51065006537/ 9537
	89-94	<b>24-1324</b>		w/ Pulley; Installation height 90,0 mm	51065006543/ 6569/ 9543/ 9569
NL 243 (180 kW) Eng.E2866DUH03/04	07-14	<b>24-1294</b>		For vehicles without retarder; Impeller Ø 125mm	51065006282/ 6387/ 9282/ 9387
	07-14	<b>24-1298</b>		For vehicles without retarder, w/o pulley; Impeller Ø 135mm, Incl Electronic fuel Injection pump	51065006408/ 6492/ 9492
	07-14	<b>24-1302</b>		For vehicles with retarder, w/o pulley	51065006426/ 6490/ 9426/ 9490
NL 262 (191 kW) Eng.D2865LUH09	97-	<b>24-1298</b>		For vehicles without retarder, w/o pulley; Impeller Ø 135mm, Incl Electronic fuel Injection pump	51065006408/ 6492/ 9492
	97-	<b>24-1302</b>		For vehicles with retarder, w/o pulley	51065006426/ 6490/ 9426/ 9490
NL 262/263 (191 kW) Eng.D2866LUH22	98-	<b>24-1294</b>		For vehicles without retarder; Impeller Ø 125mm	51065006282/ 6387/ 9282/ 9387
	98-	<b>24-1298</b>		For vehicles without retarder, w/o pulley; Impeller Ø 135mm, Incl Electronic fuel Injection pump	51065006408/ 6492/ 9492
	98-	<b>24-1302</b>		For vehicles with retarder, w/o pulley	51065006426/ 6490/ 9426/ 9490
NL 273 (199 kW) Eng.D2066LUH11/ LUH21	06-09	<b>24-1235</b>			51065006646/ 6676/ 6695/ 7050 51065009050/ 9646/ 9676/ 9695
NL 283 (206 kW) Eng.D2066LUH41	06-09	<b>24-1235</b>			51065006646/ 6676/ 6695/ 7050 51065009050/ 9646/ 9676/ 9695
NL 312 (228-235 kW) Eng.D2865LUH07	95-98	<b>24-1298</b>		For vehicles without retarder, w/o pulley; Impeller Ø 135mm, Incl Electronic fuel Injection pump	51065006408/ 6492/ 9492
	95-98	<b>24-1302</b>		For vehicles with retarder, w/o pulley	51065006426/ 6490/ 9426/ 9490
NL 313 (228 kW) Eng.D2066LUH12	06-09	<b>24-1235</b>			51065006646/ 6676/ 6695/ 7050 51065009050/ 9646/ 9676/ 9695
NL 313 (228 kW) Eng.D2066LUH22	06-09	<b>24-1235</b>			51065006646/ 6676/ 6695/ 7050 51065009050/ 9646/ 9676/ 9695
NL 313 (228 kW) Eng.D2866LUH26	98-	<b>24-1294</b>		For vehicles without retarder; Impeller Ø 125mm	51065006282/ 6387/ 9282/ 9387
	98-	<b>24-1298</b>		For vehicles without retarder, w/o pulley; Impeller Ø 135mm, Incl Electronic fuel Injection pump	51065006408/ 6492/ 9492
	98-	<b>24-1302</b>		For vehicles with retarder, w/o pulley	51065006426/ 6490/ 9426/ 9490
NL 313 (228 kW) Eng.E2876LUH02	07-14	<b>24-1298</b>		For vehicles without retarder, w/o pulley; Impeller Ø 135mm, Incl Electronic fuel Injection pump	51065006408/ 6492/ 9492
NL 323 (235 kW) Eng.D2066LUH42	06-09	<b>24-1235</b>			51065006646/ 6676/ 6695/ 7050 51065009050/ 9646/ 9676/ 9695
<b>NM '8/87-</b>					
NM 152 (110 kW) Eng.D0826OH02	90-93	<b>24-1310</b>		Impeller Ø 135mm	51065003178/ 6463/ 6495/ 9463/ 9495
	90-93	<b>24-1323</b>		Impeller Ø 125mm	51065006537/ 9537
NM 152 (114 kW) Eng.D0824LOH01	92-97	<b>24-1323</b>		Impeller Ø 125mm	51065006537/ 9537
NM 182/192 (130-140 kW) Eng.D0826LOH01	90-97	<b>24-1310</b>		Impeller Ø 135mm	51065003178/ 6463/ 6495/ 9463/ 9495
	90-97	<b>24-1323</b>		Impeller Ø 125mm	51065006537/ 9537
NM 182/192 (130-140 kW) Eng.D0826TOH	90-97	<b>24-1310</b>		Impeller Ø 135mm	51065003178/ 6463/ 6495/ 9463/ 9495
	90-97	<b>24-1323</b>		Impeller Ø 125mm	51065006537/ 9537
NM 222/223 (162 kW) Eng.D0826LUH12	87-	<b>24-1308</b>		w/ Pulley; Installation height 79,5 mm	51065006480/ 9480,51065063043
	96-	<b>24-1310</b>		Impeller Ø 135mm	51065003178/ 6463/ 6495/ 9463/ 9495
	96-	<b>24-1323</b>		Impeller Ø 125mm	51065006537/ 9537
	96-	<b>24-1324</b>		w/ Pulley; Installation height 90,0 mm	51065006543/ 6569/ 9543/ 9569
NM 223 (162 kW) Eng.D0826LOH15	87-	<b>24-1310</b>		Impeller Ø 135mm	51065003178/ 6463/ 6495/ 9463/ 9495
	87-	<b>24-1323</b>		Impeller Ø 125mm	51065006537/ 9537
NM 243 (176 kW) Eng.D0836LOH52	87-	<b>24-1227</b>		M16x1,5	51065006651/ 6680/ 7079/ 9079 51065009651/ 9680/ 9700
	87-	<b>24-1234</b>		Impeller Ø 135mm, M14x1,5	51065006679/ 6699/ 7064/ 7078 51065009064/ 9078/ 9679/ 9699
NM 243 (176 kW) Eng.D0836LOH56	87-	<b>24-1227</b>		M16x1,5	51065006651/ 6680/ 7079/ 9079 51065009651/ 9680/ 9700
	87-	<b>24-1234</b>		Impeller Ø 135mm, M14x1,5	51065006679/ 6699/ 7064/ 7078 51065009064/ 9078/ 9679/ 9699
NM 253 (184 kW) Eng.D0836LOH61	87-	<b>24-1227</b>		M16x1,5	51065006651/ 6680/ 7079/ 9079 51065009651/ 9680/ 9700







			
<p><b>24-1227</b></p>	<p><b>24-1234</b></p>	<p><b>24-1294</b></p>	<p><b>24-1298</b></p>
			
<p><b>24-1302</b></p>			

		<b>METELLI</b> ref.			<b>NOTE</b>	<b>Adaptable for OES</b>
NM 253 (184 kW) Eng.D0836LOH61	87-	<b>24-1234</b>			Impeller Ø 135mm, M14x1,5	51065006679/ 6699/ 7064/ 7078 51065009064/ 9078/ 9679/ 9699
NM 283 (206 kW) Eng.D0836LOH51/ LOH55	87-	<b>24-1227</b>			M16x1,5	51065006651/ 6680/ 7079/ 9079 51065009651/ 9680/ 9700
	87-	<b>24-1234</b>			Impeller Ø 135mm, M14x1,5	51065006679/ 6699/ 7064/ 7078 51065009064/ 9078/ 9679/ 9699
NM 293 (213 kW) Eng.D0836LOH60	87-	<b>24-1227</b>			M16x1,5	51065006651/ 6680/ 7079/ 9079 51065009651/ 9680/ 9700
	87-	<b>24-1234</b>			Impeller Ø 135mm, M14x1,5	51065006679/ 6699/ 7064/ 7078 51065009064/ 9078/ 9679/ 9699
<b>SD '4/74-'4/94</b>						
SD 200 (125-144-177 kW) Eng.D2566HM/M/ME/MH/MR/MU	76-80	<b>24-1294</b>			For vehicles without retarder, Impeller Ø 125mm	51065006282/ 6387/ 9282/ 9387
	76-80	<b>24-1298</b>			For vehicles without retarder, w/o pulley; Impeller Ø 135mm, Incl Eletronic fuel Injection pump	51065006408/ 6492/ 9492
	76-80	<b>24-1302</b>			For vehicles with retarder, w/o pulley	51065006426/ 6490/ 9426/ 9490
SD 200 (128 kW) Eng.D2566MUH/175	75-80	<b>24-1294</b>			For vehicles without retarder, Impeller Ø 125mm	51065006282/ 6387/ 9282/ 9387
	75-80	<b>24-1298</b>			For vehicles without retarder, w/o pulley; Impeller Ø 135mm, Incl Eletronic fuel Injection pump	51065006408/ 6492/ 9492
	75-80	<b>24-1302</b>			For vehicles with retarder, w/o pulley	51065006426/ 6490/ 9426/ 9490
SD 200 (141-147 kW) Eng.D2566MUH/192/200	75-86	<b>24-1294</b>			For vehicles without retarder, Impeller Ø 125mm	51065006282/ 6387/ 9282/ 9387
	75-86	<b>24-1298</b>			For vehicles without retarder, w/o pulley; Impeller Ø 135mm, Incl Eletronic fuel Injection pump	51065006408/ 6492/ 9492
	75-86	<b>24-1302</b>			For vehicles with retarder, w/o pulley	51065006426/ 6490/ 9426/ 9490
SD 200 (162 kW) Eng.D2566MUH/220	75-86	<b>24-1294</b>			For vehicles without retarder, Impeller Ø 125mm	51065006282/ 6387/ 9282/ 9387
	79-86	<b>24-1298</b>			For vehicles without retarder, w/o pulley; Impeller Ø 135mm, Incl Eletronic fuel Injection pump	51065006408/ 6492/ 9492
	79-86	<b>24-1302</b>			For vehicles with retarder, w/o pulley	51065006426/ 6490/ 9426/ 9490
SD 202 (125-144-177 kW) Eng.D2566HM/M/ME/MH/MR/MU	76-80	<b>24-1294</b>			For vehicles without retarder, Impeller Ø 125mm	51065006282/ 6387/ 9282/ 9387
	76-80	<b>24-1298</b>			For vehicles without retarder, w/o pulley; Impeller Ø 135mm, Incl Eletronic fuel Injection pump	51065006408/ 6492/ 9492
	76-80	<b>24-1302</b>			For vehicles with retarder, w/o pulley	51065006426/ 6490/ 9426/ 9490
SD 202 (155 kW) Eng.D2566UH	79-86	<b>24-1294</b>			For vehicles without retarder, Impeller Ø 125mm	51065006282/ 6387/ 9282/ 9387
	85-94	<b>24-1298</b>			For vehicles without retarder, w/o pulley; Impeller Ø 135mm, Incl Eletronic fuel Injection pump	51065006408/ 6492/ 9492
	85-94	<b>24-1302</b>			For vehicles with retarder, w/o pulley	51065006426/ 6490/ 9426/ 9490
<b>SG '1/69-'12/98</b>						
SG 12.0 (176-265 kW) Eng.D2866	83-98	<b>24-1294</b>			For vehicles without retarder, Impeller Ø 125mm	51065006282/ 6387/ 9282/ 9387
	83-98	<b>24-1298</b>			For vehicles without retarder, w/o pulley; Impeller Ø 135mm, Incl Eletronic fuel Injection pump	51065006408/ 6492/ 9492
	83-98	<b>24-1302</b>			For vehicles with retarder, w/o pulley	51065006426/ 6490/ 9426/ 9490
SG 15-9 T. (223-294 kW) Eng.D2566MK/ML/MT	76-98	<b>24-1294</b>			For vehicles without retarder, Impeller Ø 125mm	51065006282/ 6387/ 9282/ 9387
	76-98	<b>24-1298</b>			For vehicles without retarder, w/o pulley; Impeller Ø 135mm, Incl Eletronic fuel Injection pump	51065006408/ 6492/ 9492
	76-98	<b>24-1302</b>			For vehicles with retarder, w/o pulley	51065006426/ 6490/ 9426/ 9490
SG 220 (147-162 kW) Eng.D2566MUM/200	80-85	<b>24-1294</b>			For vehicles without retarder, Impeller Ø 125mm	51065006282/ 6387/ 9282/ 9387
	80-85	<b>24-1298</b>			For vehicles without retarder, w/o pulley; Impeller Ø 135mm, Incl Eletronic fuel Injection pump	51065006408/ 6492/ 9492
	80-85	<b>24-1302</b>			For vehicles with retarder, w/o pulley	51065006426/ 6490/ 9426/ 9490
SG 220/240/242 (177 kW) Eng.D2566MUH/240	80-86	<b>24-1294</b>			For vehicles without retarder, Impeller Ø 125mm	51065006282/ 6387/ 9282/ 9387
	80-86	<b>24-1298</b>			For vehicles without retarder, w/o pulley; Impeller Ø 135mm, Incl Eletronic fuel Injection pump	51065006408/ 6492/ 9492
	80-86	<b>24-1302</b>			For vehicles with retarder, w/o pulley	51065006426/ 6490/ 9426/ 9490
SG 240 HÜ (206 kW) Eng.D2566MTUH/280	81-86	<b>24-1294</b>			For vehicles without retarder, Impeller Ø 125mm	51065006282/ 6387/ 9282/ 9387
	81-86	<b>24-1298</b>			For vehicles without retarder, w/o pulley; Impeller Ø 135mm, Incl Eletronic fuel Injection pump	51065006408/ 6492/ 9492
	81-86	<b>24-1302</b>			For vehicles with retarder, w/o pulley	51065006426/ 6490/ 9426/ 9490
SG 240/242 (177-180 kW) Eng.D2866UH/240	85-94	<b>24-1294</b>			For vehicles without retarder, Impeller Ø 125mm	51065006282/ 6387/ 9282/ 9387
	85-94	<b>24-1298</b>			For vehicles without retarder, w/o pulley; Impeller Ø 135mm, Incl Eletronic fuel Injection pump	51065006408/ 6492/ 9492
	85-94	<b>24-1302</b>			For vehicles with retarder, w/o pulley	51065006426/ 6490/ 9426/ 9490
SG 240/292 (213 kW) Eng.D2866TUH/290	84-89	<b>24-1294</b>			For vehicles without retarder, Impeller Ø 125mm	51065006282/ 6387/ 9282/ 9387
	84-89	<b>24-1298</b>			For vehicles without retarder, w/o pulley; Impeller Ø 135mm, Incl Eletronic fuel Injection pump	51065006408/ 6492/ 9492
	84-89	<b>24-1302</b>			For vehicles with retarder, w/o pulley	51065006426/ 6490/ 9426/ 9490
SG 242/292 (224-229 kW) Eng.D2866TOH/310	85-94	<b>24-1294</b>			For vehicles without retarder, Impeller Ø 125mm	51065006282/ 6387/ 9282/ 9387
	85-94	<b>24-1298</b>			For vehicles without retarder, w/o pulley; Impeller Ø 135mm, Incl Eletronic fuel Injection pump	51065006408/ 6492/ 9492
	85-94	<b>24-1302</b>			For vehicles with retarder, w/o pulley	51065006426/ 6490/ 9426/ 9490

			
<b>24-1224</b>	<b>24-1227</b>	<b>24-1234</b>	<b>24-1294</b>
			
<b>24-1298</b>	<b>24-1302</b>	<b>24-1310</b>	<b>24-1323</b>

		<b>METELLI</b> ref.		<b>NOTE</b>	<b>Adaptable for OES</b>
SG 242/292 (224-229 kW) Eng.D2866TUH/290	85-94	<b>24-1294</b>		For vehicles without retarder, Impeller Ø 125mm	51065006282/ 6387/ 9282/ 9387
	85-94	<b>24-1298</b>		For vehicles without retarder, w/o pulley; Impeller Ø 135mm, Incl Electronic fuel Injection pump	51065006408/ 6492/ 9492
	85-94	<b>24-1302</b>		For vehicles with retarder, w/o pulley	51065006426/ 6490/ 9426/ 9490
SG 312/322 (228-235 kW) Eng.D2865LUH08	94-97	<b>24-1298</b>		For vehicles without retarder, w/o pulley; Impeller Ø 135mm, Incl Electronic fuel Injection pump	51065006408/ 6492/ 9492
<b>SL '1/63-'12/73</b>					
SL 11.4 (125-144-177 kW) Eng.D2566HM/M/ME/MH/MR/MU	76-80	<b>24-1294</b>		For vehicles without retarder, Impeller Ø 125mm	51065006282/ 6387/ 9282/ 9387
	76-80	<b>24-1298</b>		For vehicles without retarder, w/o pulley; Impeller Ø 135mm, Incl Electronic fuel Injection pump	51065006408/ 6492/ 9492
	76-80	<b>24-1302</b>		For vehicles with retarder, w/o pulley	51065006426/ 6490/ 9426/ 9490
SL 200 (125-144-177 kW) Eng.D2566MUH/240	80-86	<b>24-1294</b>		For vehicles without retarder, Impeller Ø 125mm	51065006282/ 6387/ 9282/ 9387
	80-86	<b>24-1298</b>		For vehicles without retarder, w/o pulley; Impeller Ø 135mm, Incl Electronic fuel Injection pump	51065006408/ 6492/ 9492
	80-86	<b>24-1302</b>		For vehicles with retarder, w/o pulley	51065006426/ 6490/ 9426/ 9490
SL 200 (147-150 kW) Eng.D2566UH/205 SL 200 (177 kW) Eng.D2866UH/240	80-87	<b>24-1294</b>		For vehicles without retarder, Impeller Ø 125mm	51065006282/ 6387/ 9282/ 9387
	80-87	<b>24-1298</b>		For vehicles without retarder, w/o pulley; Impeller Ø 135mm, Incl Electronic fuel Injection pump	51065006408/ 6492/ 9492
	80-87	<b>24-1302</b>		For vehicles with retarder, w/o pulley	51065006426/ 6490/ 9426/ 9490
<b>SL II '1/76-'12/80</b>					
SL 202 (147-155 kW) Eng.D2566UH	84-93	<b>24-1294</b>		For vehicles without retarder, Impeller Ø 125mm	51065006282/ 6387/ 9282/ 9387
	84-93	<b>24-1302</b>		For vehicles with retarder, w/o pulley	51065006426/ 6490/ 9426/ 9490
SL 202 (176-180-265 kW) Eng.D2866UH/240	84-94	<b>24-1294</b>		For vehicles without retarder, Impeller Ø 125mm	51065006282/ 6387/ 9282/ 9387
	84-94	<b>24-1298</b>		For vehicles without retarder, w/o pulley; Impeller Ø 135mm, Incl Electronic fuel Injection pump	51065006408/ 6492/ 9492
	84-94	<b>24-1302</b>		For vehicles with retarder, w/o pulley	51065006426/ 6490/ 9426/ 9490
SL 283 (206 kW) Eng.D0836LOH55	76-80	<b>24-1227</b>		M16x1,5	51065006651/ 6680/ 7079/ 9079 51065009651/ 9680/ 9700
	76-80	<b>24-1234</b>		Impeller Ø 135mm, M14x1,5	51065006679/ 6699/ 7064/ 7078 51065009064/ 9078/ 9679/ 9699
SL 353 (257 kW) Eng.D2066LOH12/13	76-80	<b>24-1224</b>		+Retarder	51065006642/ 6675/ 6694/ 9642/ 9675/ 9694
SL 363 (264 kW) Eng.D2066LOH27	76-80	<b>24-1224</b>		+Retarder	51065006642/ 6675/ 6694/ 9642/ 9675/ 9694
<b>SM '11/87-'2/95</b>					
SM 152 (110-114 kW) Eng.D0826OH02	87-94	<b>24-1310</b>		Impeller Ø 135mm	51065003178/ 6463/ 6495/ 9463/ 9495
	87-94	<b>24-1323</b>		Impeller Ø 125mm	51065006537/ 9537
SM 182/192 (130-140 kW) Eng.D0826LOH01/TOH	87-95	<b>24-1310</b>		Impeller Ø 135mm	51065003178/ 6463/ 6495/ 9463/ 9495
	87-95	<b>24-1323</b>		Impeller Ø 125mm	51065006537/ 9537
<b>SR '1/76-</b>					
SR 11.4 (125-144-177 kW) Eng.D2566HM/M/ME/MH/MR/MU	76-80	<b>24-1294</b>		For vehicles without retarder, Impeller Ø 125mm	51065006282/ 6387/ 9282/ 9387
	76-80	<b>24-1298</b>		For vehicles without retarder, w/o pulley; Impeller Ø 135mm, Incl Electronic fuel Injection pump	51065006408/ 6492/ 9492
	76-80	<b>24-1302</b>		For vehicles with retarder, w/o pulley	51065006426/ 6490/ 9426/ 9490
SR 15.9 T. (223-294 kW) Eng.D2566MK/ML/MT	76-	<b>24-1294</b>		For vehicles without retarder, Impeller Ø 125mm	51065006282/ 6387/ 9282/ 9387
	76-	<b>24-1298</b>		For vehicles without retarder, w/o pulley; Impeller Ø 135mm, Incl Electronic fuel Injection pump	51065006408/ 6492/ 9492
	76-	<b>24-1302</b>		For vehicles with retarder, w/o pulley	51065006426/ 6490/ 9426/ 9490
SR 240 (177 kW) Eng.D2566MUH/240	75-83	<b>24-1294</b>		For vehicles without retarder, Impeller Ø 125mm	51065006282/ 6387/ 9282/ 9387
	75-83	<b>24-1298</b>		For vehicles without retarder, w/o pulley; Impeller Ø 135mm, Incl Electronic fuel Injection pump	51065006408/ 6492/ 9492
	75-83	<b>24-1302</b>		For vehicles with retarder, w/o pulley	51065006426/ 6490/ 9426/ 9490
SR 280 (206 kW) Eng.D2566MTUH/280	77-86	<b>24-1294</b>		For vehicles without retarder, Impeller Ø 125mm	51065006282/ 6387/ 9282/ 9387
	77-86	<b>24-1298</b>		For vehicles without retarder, w/o pulley; Impeller Ø 135mm, Incl Electronic fuel Injection pump	51065006408/ 6492/ 9492
	77-86	<b>24-1302</b>		For vehicles with retarder, w/o pulley	51065006426/ 6490/ 9426/ 9490
SR 321 H (235 kW) Eng.D2566MKUH/320	82-86	<b>24-1294</b>		For vehicles without retarder, Impeller Ø 125mm	51065006282/ 6387/ 9282/ 9387
	82-86	<b>24-1298</b>		For vehicles without retarder, w/o pulley; Impeller Ø 135mm, Incl Electronic fuel Injection pump	51065006408/ 6492/ 9492
	82-86	<b>24-1302</b>		For vehicles with retarder, w/o pulley	51065006426/ 6490/ 9426/ 9490
<b>SU '10/76-</b>					
SU 11.4 (125-144-177 kW) Eng.D2566HM	76-80	<b>24-1294</b>		For vehicles without retarder, Impeller Ø 125mm	51065006282/ 6387/ 9282/ 9387
	76-80	<b>24-1298</b>		For vehicles without retarder, w/o pulley; Impeller Ø 135mm, Incl Electronic fuel Injection pump	51065006408/ 6492/ 9492
	76-80	<b>24-1302</b>		For vehicles with retarder, w/o pulley	51065006426/ 6490/ 9426/ 9490
SU 12.0 (176-265 kW) Eng.D2866	83-	<b>24-1294</b>		For vehicles without retarder, Impeller Ø 125mm	51065006282/ 6387/ 9282/ 9387

			
<p><b>24-1227</b></p>	<p><b>24-1234</b></p>	<p><b>24-1235</b></p>	<p><b>24-1294</b></p>
			
<p><b>24-1298</b></p>	<p><b>24-1302</b></p>	<p><b>24-1331</b></p>	

		<b>METELLI</b> ref.			<b>NOTE</b>	<b>Adaptable for OES</b>
SU 12.0 (176-265 kW) Eng.D2866	83-	<b>24-1298</b>			For vehicles without retarder, w/o pulley; Impeller Ø 135mm, Incl Electronic fuel Injection pump	51065006408/ 6492/ 9492
	83-	<b>24-1302</b>			For vehicles with retarder, w/o pulley	51065006426/ 6490/ 9426/ 9490
SU 15.9 T. (223-294 kW) Eng.D2566MK/ML/MT	76-	<b>24-1294</b>			For vehicles without retarder, Impeller Ø 125mm	51065006282/ 6387/ 9282/ 9387
	76-	<b>24-1298</b>			For vehicles without retarder, w/o pulley; Impeller Ø 135mm, Incl Electronic fuel Injection pump	51065006408/ 6492/ 9492
	76-	<b>24-1302</b>			For vehicles with retarder, w/o pulley	51065006426/ 6490/ 9426/ 9490
SU 240 (147-150 kW) Eng.D2566MUH/200/ UH/205	80-89	<b>24-1294</b>			For vehicles without retarder, Impeller Ø 125mm	51065006282/ 6387/ 9282/ 9387
	80-89	<b>24-1298</b>			For vehicles without retarder, w/o pulley; Impeller Ø 135mm, Incl Electronic fuel Injection pump	51065006408/ 6492/ 9492
	80-89	<b>24-1302</b>			For vehicles with retarder, w/o pulley	51065006426/ 6490/ 9426/ 9490
SU 240 (177 kW) Eng.D2566MUH/240	75-86	<b>24-1294</b>			For vehicles without retarder, Impeller Ø 125mm	51065006282/ 6387/ 9282/ 9387
	75-86	<b>24-1298</b>			For vehicles without retarder, w/o pulley; Impeller Ø 135mm, Incl Electronic fuel Injection pump	51065006408/ 6492/ 9492
	75-86	<b>24-1302</b>			For vehicles with retarder, w/o pulley	51065006426/ 6490/ 9426/ 9490
SU 240 (177 kW) Eng.D2866UH/240	86-89	<b>24-1294</b>			For vehicles without retarder, Impeller Ø 125mm	51065006282/ 6387/ 9282/ 9387
	86-89	<b>24-1298</b>			For vehicles without retarder, w/o pulley; Impeller Ø 135mm, Incl Electronic fuel Injection pump	51065006408/ 6492/ 9492
	86-89	<b>24-1302</b>			For vehicles with retarder, w/o pulley	51065006426/ 6490/ 9426/ 9490
SU 240 (206 kW) Eng.D2566MTUH/280	82-86	<b>24-1294</b>			For vehicles without retarder, Impeller Ø 125mm	51065006282/ 6387/ 9282/ 9387
	82-86	<b>24-1298</b>			For vehicles without retarder, w/o pulley; Impeller Ø 135mm, Incl Electronic fuel Injection pump	51065006408/ 6492/ 9492
	82-86	<b>24-1302</b>			For vehicles with retarder, w/o pulley	51065006426/ 6490/ 9426/ 9490
SU 240 (213 kW) Eng.D2866TOH/290	86-89	<b>24-1294</b>			For vehicles without retarder, Impeller Ø 125mm	51065006282/ 6387/ 9282/ 9387
	86-89	<b>24-1298</b>			For vehicles without retarder, w/o pulley; Impeller Ø 135mm, Incl Electronic fuel Injection pump	51065006408/ 6492/ 9492
	86-89	<b>24-1302</b>			For vehicles with retarder, w/o pulley	51065006426/ 6490/ 9426/ 9490
SU 242 (180 kW) Eng.D2866UH/240	87-93	<b>24-1294</b>			For vehicles without retarder, Impeller Ø 125mm	51065006282/ 6387/ 9282/ 9387
	87-93	<b>24-1298</b>			For vehicles without retarder, w/o pulley; Impeller Ø 135mm, Incl Electronic fuel Injection pump	51065006408/ 6492/ 9492
	87-93	<b>24-1302</b>			For vehicles with retarder, w/o pulley	51065006426/ 6490/ 9426/ 9490
SU 243 (176 kW) Eng.D0836LOH56	05-09	<b>24-1227</b>			M16x1,5	51065006651/ 6680/ 7079/ 9079 51065009651/ 9680/ 9700
	05-09	<b>24-1234</b>			Impeller Ø 135mm, M14x1,5	51065006679/ 6699/ 7064/ 7078 51065009064/ 9078/ 9679/ 9699
SU 263 (191 kW) Eng.D0836LOH62	05-09	<b>24-1227</b>			M16x1,5	51065006651/ 6680/ 7079/ 9079 51065009651/ 9680/ 9700
	05-09	<b>24-1234</b>			Impeller Ø 135mm, M14x1,5	51065006679/ 6699/ 7064/ 7078 51065009064/ 9078/ 9679/ 9699
SU 263 (265 kW) Eng.D2866LUH25	03-	<b>24-1294</b>			For vehicles without retarder, Impeller Ø 125mm	51065006282/ 6387/ 9282/ 9387
	03-	<b>24-1298</b>			For vehicles without retarder, w/o pulley; Impeller Ø 135mm, Incl Electronic fuel Injection pump	51065006408/ 6492/ 9492
	03-	<b>24-1302</b>			For vehicles with retarder, w/o pulley	51065006426/ 6490/ 9426/ 9490
SU 272 (198 kW) Eng.D2865LUH02	93-95	<b>24-1298</b>			For vehicles without retarder, w/o pulley; Impeller Ø 135mm, Incl Electronic fuel Injection pump	51065006408/ 6492/ 9492
SU 273 (198 kW) Eng.D2066LUH11	06-09	<b>24-1235</b>				51065006646/ 6676/ 6695/ 7050 51065009050/ 9646/ 9676/ 9695
SU 273 (198 kW) Eng.D2066LUH21	06-09	<b>24-1235</b>				51065006646/ 6676/ 6695/ 7050 51065009050/ 9646/ 9676/ 9695
SU 283 (206 kW) Eng.D0836LOH02	03-	<b>24-1227</b>			M16x1,5	51065006651/ 6680/ 7079/ 9079 51065009651/ 9680/ 9700
	03-	<b>24-1234</b>			Impeller Ø 135mm, M14x1,5	51065006679/ 6699/ 7064/ 7078 51065009064/ 9078/ 9679/ 9699
	03-	<b>24-1331</b>			Impeller Ø 125mm	51065006575/ 6606/ 6612 51065006669/ 9575/ 9606/ 9612
SU 292 (229 kW) Eng.D2866TOH/310	92-93	<b>24-1294</b>			For vehicles without retarder, Impeller Ø 125mm	51065006282/ 6387/ 9282/ 9387
	92-93	<b>24-1298</b>			For vehicles without retarder, w/o pulley; Impeller Ø 135mm, Incl Electronic fuel Injection pump	51065006408/ 6492/ 9492
	92-93	<b>24-1302</b>			For vehicles with retarder, w/o pulley	51065006426/ 6490/ 9426/ 9490
SU 293 (213 kW) Eng.D0836LOH60	03-	<b>24-1227</b>			M16x1,5	51065006651/ 6680/ 7079/ 9079 51065009651/ 9680/ 9700
	03-	<b>24-1234</b>			Impeller Ø 135mm, M14x1,5	51065006679/ 6699/ 7064/ 7078 51065009064/ 9078/ 9679/ 9699
SU 313 (228 kW) Eng.D2066LUH12	06-09	<b>24-1235</b>				51065006646/ 6676/ 6695/ 7050 51065009050/ 9646/ 9676/ 9695
SU 313 (228 kW) Eng.D2066LUH22	06-09	<b>24-1235</b>				51065006646/ 6676/ 6695/ 7050 51065009050/ 9646/ 9676/ 9695
SU 313 (228 kW) Eng.D2866LUH24	03-	<b>24-1294</b>			For vehicles without retarder, Impeller Ø 125mm	51065006282/ 6387/ 9282/ 9387
	03-	<b>24-1298</b>			For vehicles without retarder, w/o pulley; Impeller Ø 135mm, Incl Electronic fuel Injection pump	51065006408/ 6492/ 9492
	03-	<b>24-1302</b>			For vehicles with retarder, w/o pulley	51065006426/ 6490/ 9426/ 9490
SU 320 (235 kW) Eng.D2066LUH32	03-	<b>24-1235</b>				51065006646/ 6676/ 6695/ 7050 51065009050/ 9646/ 9676/ 9695
SU 322 (198-235 kW) Eng.D2865LUH08	95-97	<b>24-1298</b>			For vehicles without retarder, w/o pulley; Impeller Ø 135mm, Incl Electronic fuel Injection pump	51065006408/ 6492/ 9492





			
<b>24-1235</b>	<b>24-1294</b>	<b>24-1298</b>	<b>24-1302</b>
			
<b>24-1319</b>	<b>24-1321</b>	<b>24-1330</b>	





		<b>METELLI</b> ref.			<b>NOTE</b>	<b>Adaptable for OES</b>
SU 353 (257 kW) Eng.D2066LUH13	06-09	<b>24-1235</b>				51065006646/ 6676/ 6695/ 7050 51065009050/ 9646/ 9676/ 9695
SU 353 (257 kW) Eng.D2066LUH23	06-09	<b>24-1235</b>				51065006646/ 6676/ 6695/ 7050 51065009050/ 9646/ 9676/ 9695
SU 360 (264 kW) Eng.D2066LUH33	07-	<b>24-1235</b>				51065006646/ 6676/ 6695/ 7050 51065009050/ 9646/ 9676/ 9695
SU 9.9 (228-235 kW) Eng.D2865LUH08	95-97	<b>24-1298</b>			For vehicles without retarder, w/o pulley; Impeller Ø 135mm, Incl Eletronic fuel Injection pump	51065006408/ 6492/ 9492
<b>UL '9/89-</b>						
UL 242 (177 kW) Eng.D2866UH/240	89-93	<b>24-1294</b>			For vehicles without retarder, Impeller Ø 125mm	51065006282/ 6387/ 9282/ 9387
	89-93	<b>24-1298</b>			For vehicles without retarder, w/o pulley; Impeller Ø 135mm, Incl Eletronic fuel Injection pump	51065006408/ 6492/ 9492
	89-93	<b>24-1302</b>			For vehicles with retarder, w/o pulley	51065006426/ 6490/ 9426/ 9490
UL 272 (198 kW) Eng.D2865LUH05	93-	<b>24-1298</b>			For vehicles without retarder, w/o pulley; Impeller Ø 135mm, Incl Eletronic fuel Injection pump	51065006408/ 6492/ 9492
	93-	<b>24-1302</b>			For vehicles with retarder, w/o pulley	51065006426/ 6490/ 9426/ 9490
UL 272 (198-235 kW) Eng.D2865LUH02	93-	<b>24-1298</b>			For vehicles without retarder, w/o pulley; Impeller Ø 135mm, Incl Eletronic fuel Injection pump	51065006408/ 6492/ 9492
	93-	<b>24-1302</b>			For vehicles with retarder, w/o pulley	51065006426/ 6490/ 9426/ 9490
UL 292 (213 kW) Eng.D2866TUH01	89-93	<b>24-1294</b>			For vehicles without retarder, Impeller Ø 125mm	51065006282/ 6387/ 9282/ 9387
	89-93	<b>24-1298</b>			For vehicles without retarder, w/o pulley; Impeller Ø 135mm, Incl Eletronic fuel Injection pump	51065006408/ 6492/ 9492
	89-93	<b>24-1302</b>			For vehicles with retarder, w/o pulley	51065006426/ 6490/ 9426/ 9490
UL 312/322 (228-235 kW) Eng.D2865LUH07/LUH08	92-96	<b>24-1298</b>			For vehicles without retarder, w/o pulley; Impeller Ø 135mm, Incl Eletronic fuel Injection pump	51065006408/ 6492/ 9492
	92-96	<b>24-1302</b>			For vehicles with retarder, w/o pulley	51065006426/ 6490/ 9426/ 9490
UL 313 (228 kW) Eng.D2866LUH26	96-	<b>24-1294</b>			For vehicles without retarder, Impeller Ø 125mm	51065006282/ 6387/ 9282/ 9387
	96-	<b>24-1298</b>			For vehicles without retarder, w/o pulley; Impeller Ø 135mm, Incl Eletronic fuel Injection pump	51065006408/ 6492/ 9492
	96-	<b>24-1302</b>			For vehicles with retarder, w/o pulley	51065006426/ 6490/ 9426/ 9490
UL 353 (257 kW) Eng.D2866LUH21	97-	<b>24-1294</b>			For vehicles without retarder, Impeller Ø 125mm	51065006282/ 6387/ 9282/ 9387
	97-	<b>24-1298</b>			For vehicles without retarder, w/o pulley; Impeller Ø 135mm, Incl Eletronic fuel Injection pump	51065006408/ 6492/ 9492
	97-	<b>24-1302</b>			For vehicles with retarder, w/o pulley	51065006426/ 6490/ 9426/ 9490
UL 9.9 (191 kW) Eng.D2865LUH09	96-98	<b>24-1298</b>			For vehicles without retarder, w/o pulley; Impeller Ø 135mm, Incl Eletronic fuel Injection pump	51065006408/ 6492/ 9492
	96-98	<b>24-1302</b>			For vehicles with retarder, w/o pulley	51065006426/ 6490/ 9426/ 9490

**MAN TRUCK**
**E 2000 '5/00-**

19.310 (228 kW) Eng.D2866LF23	00-	<b>24-1298</b>			For vehicles without retarder, w/o pulley; Impeller Ø 135mm, Incl Eletronic fuel Injection pump	51065006408/ 6492/ 9492
	00-	<b>24-1302</b>			For vehicles with retarder, w/o pulley	51065006426/ 6490/ 9426/ 9490
	00-	<b>24-1319</b>			For vehicles with retarder, w pulley	51065006546/ 9546
	00-	<b>24-1321</b>			For vehicles without retarder, w pulley	51065006545/ 6547/ 9545/ 9547
	00-	<b>24-1330</b>		•		51065000298,51065006066/ 7033/ 7036 51065007043/ 7045/ 7047/ 7048/ 7051 51065007052/ 7065/ 7066/ 7088/ 7089 51065009045/ 9047/ 9048/ 9052/ 9066
19.360 (265 kW) Eng.D2866LF24	00-	<b>24-1298</b>			For vehicles without retarder, w/o pulley; Impeller Ø 135mm, Incl Eletronic fuel Injection pump	51065006408/ 6492/ 9492
	00-	<b>24-1302</b>			For vehicles with retarder, w/o pulley	51065006426/ 6490/ 9426/ 9490
	00-	<b>24-1319</b>			For vehicles with retarder, w pulley	51065006546/ 9546
	00-	<b>24-1321</b>			For vehicles without retarder, w pulley	51065006545/ 6547/ 9545/ 9547
	00-	<b>24-1330</b>		•		51065000298,51065006066/ 7033/ 7036 51065007043/ 7045/ 7047/ 7048/ 7051 51065007052/ 7065/ 7066/ 7088/ 7089 51065009045/ 9047/ 9048/ 9052/ 9066
19.410 (301 kW) Eng.D2866LF25	00-	<b>24-1298</b>			For vehicles without retarder, w/o pulley; Impeller Ø 135mm, Incl Eletronic fuel Injection pump	51065006408/ 6492/ 9492
	00-	<b>24-1302</b>			For vehicles with retarder, w/o pulley	51065006426/ 6490/ 9426/ 9490
	00-	<b>24-1319</b>			For vehicles with retarder, w pulley	51065006546/ 9546
	00-	<b>24-1321</b>			For vehicles without retarder, w pulley	51065006545/ 6547/ 9545/ 9547
	00-	<b>24-1330</b>		•		51065000298,51065006066/ 7033/ 7036 51065007043/ 7045/ 7047/ 7048/ 7051 51065007052/ 7065/ 7066/ 7088/ 7089 51065009045/ 9047/ 9048/ 9052/ 9066
19.460 (338 kW) Eng.D2876LF03	00-	<b>24-1298</b>			For vehicles without retarder, w/o pulley; Impeller Ø 135mm, Incl Eletronic fuel Injection pump	51065006408/ 6492/ 9492
	00-	<b>24-1302</b>			For vehicles with retarder, w/o pulley	51065006426/ 6490/ 9426/ 9490
	00-	<b>24-1319</b>			For vehicles with retarder, w pulley	51065006546/ 9546
	00-	<b>24-1321</b>			For vehicles without retarder, w pulley	51065006545/ 6547/ 9545/ 9547



			
<p><b>24-1298</b></p>	<p><b>24-1302</b></p>	<p><b>24-1319</b></p>	<p><b>24-1321</b></p>
			
<p><b>24-1330</b></p>			

		<b>METELLI</b> ref.			<b>NOTE</b>	<b>Adaptable for OES</b>
19.460 (338 kW) Eng.D2876LF03	00-	<b>24-1330</b>		•		51065000298,51065006066/ 7033/ 7036 51065007043/ 7045/ 7047/ 7048/ 7051 51065007052/ 7065/ 7066/ 7088/ 7089 51065009045/ 9047/ 9048/ 9052/ 9066
26.310 (228 kW) Eng.D2866LF23 26.360 (265 kW) Eng.D2866LF24 26.410 (301 kW) Eng.D2866LF25	00-	<b>24-1298</b>			For vehicles without retarder, w/o pulley; Impeller Ø 135mm, Incl Eletronic fuel Injection pump	51065006408/ 6492/ 9492
	00-	<b>24-1302</b>			For vehicles with retarder, w/o pulley	51065006426/ 6490/ 9426/ 9490
	00-	<b>24-1319</b>			For vehicles with retarder, w pulley	51065006546/ 9546
	00-	<b>24-1321</b>			For vehicles without retarder, w pulley	51065006545/ 6547/ 9545/ 9547
	00-	<b>24-1330</b>		•		51065000298,51065006066/ 7033/ 7036 51065007043/ 7045/ 7047/ 7048/ 7051 51065007052/ 7065/ 7066/ 7088/ 7089 51065009045/ 9047/ 9048/ 9052/ 9066
26.460 (338 kW) Eng.D2876LF03	00-	<b>24-1298</b>			For vehicles without retarder, w/o pulley; Impeller Ø 135mm, Incl Eletronic fuel Injection pump	51065006408/ 6492/ 9492
	00-	<b>24-1302</b>			For vehicles with retarder, w/o pulley	51065006426/ 6490/ 9426/ 9490
	00-	<b>24-1319</b>			For vehicles with retarder, w pulley	51065006546/ 9546
	00-	<b>24-1330</b>		•		51065000298,51065006066/ 7033/ 7036 51065007043/ 7045/ 7047/ 7048/ 7051 51065007052/ 7065/ 7066/ 7088/ 7089 51065009045/ 9047/ 9048/ 9052/ 9066
28.230 (170 kW) Eng.E2866DF01	00-	<b>24-1298</b>			For vehicles without retarder, w/o pulley; Impeller Ø 135mm, Incl Eletronic fuel Injection pump	51065006408/ 6492/ 9492
	00-	<b>24-1302</b>			For vehicles with retarder, w/o pulley	51065006426/ 6490/ 9426/ 9490
	00-	<b>24-1319</b>			For vehicles with retarder, w pulley	51065006546/ 9546
28.310 (228 kW) Eng.D2866LF23	00-	<b>24-1298</b>			For vehicles without retarder, w/o pulley; Impeller Ø 135mm, Incl Eletronic fuel Injection pump	51065006408/ 6492/ 9492
	00-	<b>24-1302</b>			For vehicles with retarder, w/o pulley	51065006426/ 6490/ 9426/ 9490
	00-	<b>24-1319</b>			For vehicles with retarder, w pulley	51065006546/ 9546
	00-	<b>24-1321</b>			For vehicles without retarder, w pulley	51065006545/ 6547/ 9545/ 9547
	00-	<b>24-1330</b>		•		51065000298,51065006066/ 7033/ 7036 51065007043/ 7045/ 7047/ 7048/ 7051 51065007052/ 7065/ 7066/ 7088/ 7089 51065009045/ 9047/ 9048/ 9052/ 9066
28.360 (265 kW) Eng.D2866LF24	00-	<b>24-1298</b>			For vehicles without retarder, w/o pulley; Impeller Ø 135mm, Incl Eletronic fuel Injection pump	51065006408/ 6492/ 9492
	00-	<b>24-1302</b>			For vehicles with retarder, w/o pulley	51065006426/ 6490/ 9426/ 9490
	00-	<b>24-1319</b>			For vehicles with retarder, w pulley	51065006546/ 9546
	00-	<b>24-1321</b>			For vehicles without retarder, w pulley	51065006545/ 6547/ 9545/ 9547
	00-	<b>24-1330</b>		•		51065000298,51065006066/ 7033/ 7036 51065007043/ 7045/ 7047/ 7048/ 7051 51065007052/ 7065/ 7066/ 7088/ 7089 51065009045/ 9047/ 9048/ 9052/ 9066
28.410 (301 kW) Eng.D2866LF25	00-	<b>24-1298</b>			For vehicles without retarder, w/o pulley; Impeller Ø 135mm, Incl Eletronic fuel Injection pump	51065006408/ 6492/ 9492
	00-	<b>24-1302</b>			For vehicles with retarder, w/o pulley	51065006426/ 6490/ 9426/ 9490
	00-	<b>24-1319</b>			For vehicles with retarder, w pulley	51065006546/ 9546
	00-	<b>24-1321</b>			For vehicles without retarder, w pulley	51065006545/ 6547/ 9545/ 9547
	00-	<b>24-1330</b>		•		51065000298,51065006066/ 7033/ 7036 51065007043/ 7045/ 7047/ 7048/ 7051 51065007052/ 7065/ 7066/ 7088/ 7089 51065009045/ 9047/ 9048/ 9052/ 9066
28.460 (338 kW) Eng.D2876LF03	00-	<b>24-1298</b>			For vehicles without retarder, w/o pulley; Impeller Ø 135mm, Incl Eletronic fuel Injection pump	51065006408/ 6492/ 9492
	00-	<b>24-1302</b>			For vehicles with retarder, w/o pulley	51065006426/ 6490/ 9426/ 9490
	00-	<b>24-1319</b>			For vehicles with retarder, w pulley	51065006546/ 9546
	00-	<b>24-1321</b>			For vehicles without retarder, w pulley	51065006545/ 6547/ 9545/ 9547



**24-1298**



**24-1302**







**24-1319**



**24-1321**



**24-1330**

		<b>METELLI</b> ref.			<b>NOTE</b>	<b>Adaptable for OES</b>
28.460 (338 kW) Eng.D2876LF03	00-	<b>24-1330</b>		•		51065000298,51065006066/ 7033/ 7036 51065007043/ 7045/ 7047/ 7048/ 7051 51065007052/ 7065/ 7066/ 7088/ 7089 51065009045/ 9047/ 9048/ 9052/ 9066
29.460 (338 kW) Eng.D2876LF03	00-	<b>24-1298</b>			For vehicles without retarder, w/o pulley; Impeller Ø 135mm, Incl Eletronic fuel Injection pump	51065006408/ 6492/ 9492
	00-	<b>24-1302</b>			For vehicles with retarder, w/o pulley	51065006426/ 6490/ 9426/ 9490
	00-	<b>24-1319</b>			For vehicles with retarder, w pulley	51065006546/ 9546
	00-	<b>24-1321</b>			For vehicles without retarder, w pulley	51065006545/ 6547/ 9545/ 9547
30.310 (228 kW) Eng.D2866LF23 30.360 (265 kW) Eng.D2866LF24	00-	<b>24-1298</b>			For vehicles without retarder, w/o pulley; Impeller Ø 135mm, Incl Eletronic fuel Injection pump	51065006408/ 6492/ 9492
	00-	<b>24-1302</b>			For vehicles with retarder, w/o pulley	51065006426/ 6490/ 9426/ 9490
	00-	<b>24-1319</b>			For vehicles with retarder, w pulley	51065006546/ 9546
	00-	<b>24-1321</b>			For vehicles without retarder, w pulley	51065006545/ 6547/ 9545/ 9547
30.410 (301 kW) Eng.D2866LF25	00-	<b>24-1298</b>			For vehicles without retarder, w/o pulley; Impeller Ø 135mm, Incl Eletronic fuel Injection pump	51065006408/ 6492/ 9492
	00-	<b>24-1302</b>			For vehicles with retarder, w/o pulley	51065006426/ 6490/ 9426/ 9490
	00-	<b>24-1319</b>			For vehicles with retarder, w pulley	51065006546/ 9546
	00-	<b>24-1321</b>			For vehicles without retarder, w pulley	51065006545/ 6547/ 9545/ 9547
30.460 (338 kW) Eng.D2876LF03	00-	<b>24-1298</b>			For vehicles without retarder, w/o pulley; Impeller Ø 135mm, Incl Eletronic fuel Injection pump	51065006408/ 6492/ 9492
	00-	<b>24-1302</b>			For vehicles with retarder, w/o pulley	51065006426/ 6490/ 9426/ 9490
	00-	<b>24-1319</b>			For vehicles with retarder, w pulley	51065006546/ 9546
	00-	<b>24-1321</b>			For vehicles without retarder, w pulley	51065006545/ 6547/ 9545/ 9547
32.310 (228 kW) Eng.D2866LF23	00-	<b>24-1298</b>			For vehicles without retarder, w/o pulley; Impeller Ø 135mm, Incl Eletronic fuel Injection pump	51065006408/ 6492/ 9492
	00-	<b>24-1302</b>			For vehicles with retarder, w/o pulley	51065006426/ 6490/ 9426/ 9490
	00-	<b>24-1319</b>			For vehicles with retarder, w pulley	51065006546/ 9546
	00-	<b>24-1330</b>		•		51065000298,51065006066/ 7033/ 7036 51065007043/ 7045/ 7047/ 7048/ 7051 51065007052/ 7065/ 7066/ 7088/ 7089 51065009045/ 9047/ 9048/ 9052/ 9066
32.360 (265 kW) Eng.D2866LF24	00-	<b>24-1298</b>			For vehicles without retarder, w/o pulley; Impeller Ø 135mm, Incl Eletronic fuel Injection pump	51065006408/ 6492/ 9492
	00-	<b>24-1302</b>			For vehicles with retarder, w/o pulley	51065006426/ 6490/ 9426/ 9490
	00-	<b>24-1319</b>			For vehicles with retarder, w pulley	51065006546/ 9546
	00-	<b>24-1321</b>			For vehicles without retarder, w pulley	51065006545/ 6547/ 9545/ 9547
	00-	<b>24-1330</b>		•		51065000298,51065006066/ 7033/ 7036 51065007043/ 7045/ 7047/ 7048/ 7051 51065007052/ 7065/ 7066/ 7088/ 7089 51065009045/ 9047/ 9048/ 9052/ 9066
32.410 (301 kW) Eng.D2866LF25	00-	<b>24-1298</b>			For vehicles without retarder, w/o pulley; Impeller Ø 135mm, Incl Eletronic fuel Injection pump	51065006408/ 6492/ 9492
	00-	<b>24-1302</b>			For vehicles with retarder, w/o pulley	51065006426/ 6490/ 9426/ 9490
	00-	<b>24-1319</b>			For vehicles with retarder, w pulley	51065006546/ 9546
	00-	<b>24-1321</b>			For vehicles without retarder, w pulley	51065006545/ 6547/ 9545/ 9547
	00-	<b>24-1330</b>		•		51065000298,51065006066/ 7033/ 7036 51065007043/ 7045/ 7047/ 7048/ 7051 51065007052/ 7065/ 7066/ 7088/ 7089 51065009045/ 9047/ 9048/ 9052/ 9066
32.460 (338 kW) Eng.D2876LF03	00-	<b>24-1298</b>			For vehicles without retarder, w/o pulley; Impeller Ø 135mm, Incl Eletronic fuel Injection pump	51065006408/ 6492/ 9492
	00-	<b>24-1302</b>			For vehicles with retarder, w/o pulley	51065006426/ 6490/ 9426/ 9490
	00-	<b>24-1319</b>			For vehicles with retarder, w pulley	51065006546/ 9546
	00-	<b>24-1321</b>			For vehicles without retarder, w pulley	51065006545/ 6547/ 9545/ 9547
33.360 (265 kW) Eng.D2876LF03	00-	<b>24-1298</b>			For vehicles without retarder, w/o pulley; Impeller Ø 135mm, Incl Eletronic fuel Injection pump	51065006408/ 6492/ 9492
	00-	<b>24-1302</b>			For vehicles with retarder, w/o pulley	51065006426/ 6490/ 9426/ 9490
	00-	<b>24-1319</b>			For vehicles with retarder, w pulley	51065006546/ 9546

			
<b>24-1298</b>	<b>24-1302</b>	<b>24-1319</b>	<b>24-1321</b>
			
<b>24-1330</b>			



			
24-1294	24-1298	24-1301	24-1302
			
24-1308	24-1310	24-1319	24-1321
			
24-1323	24-1324	24-1330	24-1336





		<b>METELLI</b> ref.			<b>NOTE</b>	<b>Adaptable for OES</b>
50.460 (338 kW) Eng.D2876LF03	00-	<b>24-1302</b>			For vehicles with retarder, w/o pulley	51065006426/ 6490/ 9426/ 9490
	00-	<b>24-1319</b>			For vehicles with retarder, w pulley	51065006546/ 9546
	00-	<b>24-1321</b>			For vehicles without retarder, w pulley	51065006545/ 6547/ 9545/ 9547
50.600 (441 kW) Eng.D2840LF21	00-	<b>24-1298</b>			For vehicles without retarder, w/o pulley; Impeller Ø 135mm, Incl Electronic fuel Injection pump	51065006408/ 6492/ 9492
	00-	<b>24-1302</b>			For vehicles with retarder, w/o pulley	51065006426/ 6490/ 9426/ 9490
<b>EL '1/93-</b>						
EL 202/262 (157-162 kW) Eng.D0826LUH	94-97	<b>24-1323</b>			Impeller Ø 125mm	51065006537/ 9537
	94-97	<b>24-1324</b>			w/ Pulley; Installation height 90,0 mm	51065006543/ 6569/ 9543/ 9569
EL 262 (191 kW) Eng.D2866LUH	98-	<b>24-1294</b>			For vehicles without retarder; Impeller Ø 125mm	51065006282/ 6387/ 9282/ 9387
	98-	<b>24-1298</b>			For vehicles without retarder, w/o pulley; Impeller Ø 135mm, Incl Electronic fuel Injection pump	51065006408/ 6492/ 9492
	98-	<b>24-1302</b>			For vehicles with retarder, w/o pulley	51065006426/ 6490/ 9426/ 9490
<b>EM '10/93-</b>						
EM 192 (140 kW) Eng.D0826LOH06	93-97	<b>24-1310</b>			Impeller Ø 135mm	51065003178/ 6463/ 6495/ 9463/ 9495
	93-97	<b>24-1323</b>			Impeller Ø 125mm	51065006537/ 9537
EM 222/223 (157-162 kW) Eng.D0826LUH	96-	<b>24-1308</b>			w/ Pulley; Installation height 79,5 mm	51065006480/ 9480,51065063043
	96-	<b>24-1323</b>			Impeller Ø 125mm	51065006537/ 9537
	96-	<b>24-1324</b>			w/ Pulley; Installation height 90,0 mm	51065006543/ 6569/ 9543/ 9569
EM 223 (162 kW) Eng.D0826LOH15	97-	<b>24-1310</b>			Impeller Ø 135mm	51065003178/ 6463/ 6495/ 9463/ 9495
	97-	<b>24-1323</b>			Impeller Ø 125mm	51065006537/ 9537
<b>F 2000 '1/94-</b>						
12.8 (338 kW) Eng.D2876LF03	98-	<b>24-1298</b>			For vehicles without retarder, w/o pulley; Impeller Ø 135mm, Incl Electronic fuel Injection pump	51065006408/ 6492/ 9492
	98-	<b>24-1301</b>			For vehicles with retarder; w/o pulley; Injection Pump with electronic control unit	51065006479/ 9479
	98-	<b>24-1302</b>			For vehicles with retarder, w/o pulley	51065006426/ 6490/ 9426/ 9490
	98-	<b>24-1319</b>			For vehicles with retarder, w pulley	51065006546/ 9546
	98-	<b>24-1321</b>			For vehicles without retarder, w pulley	51065006545/ 6547/ 9545/ 9547
	98-	<b>24-1330</b>		•		51065000298,51065006066/ 7033/ 7036 51065007043/ 7045/ 7047/ 7048/ 7051 51065007052/ 7065/ 7066/ 7088/ 7089 51065009045/ 9047/ 9048/ 9052/ 9066
18.273 (198-235 kW) Eng.D2865LOH/LUH/LF	89-	<b>24-1298</b>			For vehicles without retarder, w/o pulley; Impeller Ø 135mm, Incl Electronic fuel Injection pump	51065006408/ 6492/ 9492
	89-	<b>24-1301</b>			For vehicles with retarder; w/o pulley; Injection Pump with electronic control unit	51065006479/ 9479
	89-	<b>24-1302</b>			For vehicles with retarder, w/o pulley	51065006426/ 6490/ 9426/ 9490
19.233 (170 kW) Eng.E2866DF01	96-	<b>24-1298</b>			For vehicles without retarder, w/o pulley; Impeller Ø 135mm, Incl Electronic fuel Injection pump	51065006408/ 6492/ 9492
	96-	<b>24-1301</b>			For vehicles with retarder; w/o pulley; Injection Pump with electronic control unit	51065006479/ 9479
	96-	<b>24-1302</b>			For vehicles with retarder, w/o pulley	51065006426/ 6490/ 9426/ 9490
	96-	<b>24-1319</b>			For vehicles with retarder, w pulley	51065006546/ 9546
19.273 (198 kW) Eng.D2865LF22 9.293 (213 kW) Eng.D2865LF20/LF24	94-95	<b>24-1298</b>			For vehicles without retarder, w/o pulley; Impeller Ø 135mm, Incl Electronic fuel Injection pump	51065006408/ 6492/ 9492
	94-95	<b>24-1301</b>			For vehicles with retarder; w/o pulley; Injection Pump with electronic control unit	51065006479/ 9479
	94-95	<b>24-1302</b>			For vehicles with retarder, w/o pulley	51065006426/ 6490/ 9426/ 9490
	94-95	<b>24-1319</b>			For vehicles with retarder, w pulley	51065006546/ 9546
	94-95	<b>24-1321</b>			For vehicles without retarder, w pulley	51065006545/ 6547/ 9545/ 9547
	94-95	<b>24-1336</b>			w/ Pulley	51065006548/ 9548
19.314 (228 kW) Eng.D2866LF34	98-	<b>24-1298</b>			For vehicles without retarder, w/o pulley; Impeller Ø 135mm, Incl Electronic fuel Injection pump	51065006408/ 6492/ 9492
	98-	<b>24-1301</b>			For vehicles with retarder; w/o pulley; Injection Pump with electronic control unit	51065006479/ 9479
	98-	<b>24-1302</b>			For vehicles with retarder, w/o pulley	51065006426/ 6490/ 9426/ 9490
	98-	<b>24-1319</b>			For vehicles with retarder, w pulley	51065006546/ 9546
	98-	<b>24-1321</b>			For vehicles without retarder, w pulley	51065006545/ 6547/ 9545/ 9547
	98-	<b>24-1330</b>		•		51065000298,51065006066/ 7033/ 7036 51065007043/ 7045/ 7047/ 7048/ 7051 51065007052/ 7065/ 7066/ 7088/ 7089 51065009045/ 9047/ 9048/ 9052/ 9066



			
<b>24-1298</b>	<b>24-1301</b>	<b>24-1302</b>	<b>24-1319</b>
			
<b>24-1321</b>	<b>24-1330</b>	<b>24-1336</b>	

		<b>METELLI</b> ref.			<b>NOTE</b>	<b>Adaptable for OES</b>
19.323 (235 kW) Eng.D2865LF23	94-95	<b>24-1298</b>			For vehicles without retarder, w/o pulley; Impeller Ø 135mm, Incl Electronic fuel Injection pump	51065006408/ 6492/ 9492
	94-95	<b>24-1301</b>			For vehicles with retarder; w/o pulley; Injection Pump with electronic control unit	51065006479/ 9479
	94-95	<b>24-1302</b>			For vehicles with retarder, w/o pulley	51065006426/ 6490/ 9426/ 9490
	94-95	<b>24-1319</b>			For vehicles with retarder, w pulley	51065006546/ 9546
	94-95	<b>24-1321</b>			For vehicles without retarder, w pulley	51065006545/ 6547/ 9545/ 9547
	94-95	<b>24-1336</b>			w/ Pulley	51065006548/ 9548
19.343 (250 kW) Eng.D2865LF21	94-	<b>24-1298</b>			For vehicles without retarder, w/o pulley; Impeller Ø 135mm, Incl Electronic fuel Injection pump	51065006408/ 6492/ 9492
	94-	<b>24-1301</b>			For vehicles with retarder; w/o pulley; Injection Pump with electronic control unit	51065006479/ 9479
	94-	<b>24-1302</b>			For vehicles with retarder, w/o pulley	51065006426/ 6490/ 9426/ 9490
	94-	<b>24-1319</b>			For vehicles with retarder, w pulley	51065006546/ 9546
	94-	<b>24-1321</b>			For vehicles without retarder, w pulley	51065006545/ 6547/ 9545/ 9547
	94-	<b>24-1336</b>			w/ Pulley	51065006548/ 9548
19.364 (265 kW) Eng.D2866LF35	98-	<b>24-1298</b>			For vehicles without retarder, w/o pulley; Impeller Ø 135mm, Incl Electronic fuel Injection pump	51065006408/ 6492/ 9492
	98-	<b>24-1301</b>			For vehicles with retarder; w/o pulley; Injection Pump with electronic control unit	51065006479/ 9479
	98-	<b>24-1302</b>			For vehicles with retarder, w/o pulley	51065006426/ 6490/ 9426/ 9490
	98-	<b>24-1319</b>			For vehicles with retarder, w pulley	51065006546/ 9546
	98-	<b>24-1321</b>			For vehicles without retarder, w pulley	51065006545/ 6547/ 9545/ 9547
	98-	<b>24-1330</b>		•		51065000298,51065006066/ 7033/ 7036 51065007043/ 7045/ 7047/ 7048/ 7051 51065007052/ 7065/ 7066/ 7088/ 7089 51065009045/ 9047/ 9048/ 9052/ 9066
19.373 (272 kW) Eng.D2866LF21 19.403 (294 kW) Eng.D2866LF20	94-95	<b>24-1298</b>			For vehicles without retarder, w/o pulley; Impeller Ø 135mm, Incl Electronic fuel Injection pump	51065006408/ 6492/ 9492
	94-95	<b>24-1301</b>			For vehicles with retarder; w/o pulley; Injection Pump with electronic control unit	51065006479/ 9479
	94-95	<b>24-1302</b>			For vehicles with retarder, w/o pulley	51065006426/ 6490/ 9426/ 9490
	94-95	<b>24-1319</b>			For vehicles with retarder, w pulley	51065006546/ 9546
	94-95	<b>24-1321</b>			For vehicles without retarder, w pulley	51065006545/ 6547/ 9545/ 9547
	94-95	<b>24-1330</b>		•		51065000298,51065006066/ 7033/ 7036 51065007043/ 7045/ 7047/ 7048/ 7051 51065007052/ 7065/ 7066/ 7088/ 7089 51065009045/ 9047/ 9048/ 9052/ 9066
19.414 (228-301 kW) Eng.D2866LF31	98-	<b>24-1298</b>			For vehicles without retarder, w/o pulley; Impeller Ø 135mm, Incl Electronic fuel Injection pump	51065006408/ 6492/ 9492
	98-	<b>24-1301</b>			For vehicles with retarder; w/o pulley; Injection Pump with electronic control unit	51065006479/ 9479
	98-	<b>24-1302</b>			For vehicles with retarder, w/o pulley	51065006426/ 6490/ 9426/ 9490
	98-	<b>24-1319</b>			For vehicles with retarder, w pulley	51065006546/ 9546
	98-	<b>24-1321</b>			For vehicles without retarder, w pulley	51065006545/ 6547/ 9545/ 9547
	98-	<b>24-1330</b>		•		51065000298,51065006066/ 7033/ 7036 51065007043/ 7045/ 7047/ 7048/ 7051 51065007052/ 7065/ 7066/ 7088/ 7089 51065009045/ 9047/ 9048/ 9052/ 9066
19.423 (309 kW) Eng.D2866LF22	94-95	<b>24-1298</b>			For vehicles without retarder, w/o pulley; Impeller Ø 135mm, Incl Electronic fuel Injection pump	51065006408/ 6492/ 9492
	94-95	<b>24-1301</b>			For vehicles with retarder; w/o pulley; Injection Pump with electronic control unit	51065006479/ 9479
	94-95	<b>24-1302</b>			For vehicles with retarder, w/o pulley	51065006426/ 6490/ 9426/ 9490
	94-95	<b>24-1319</b>			For vehicles with retarder, w pulley	51065006546/ 9546
	94-95	<b>24-1321</b>			For vehicles without retarder, w pulley	51065006545/ 6547/ 9545/ 9547
	94-95	<b>24-1330</b>		•		51065000298,51065006066/ 7033/ 7036 51065007043/ 7045/ 7047/ 7048/ 7051 51065007052/ 7065/ 7066/ 7088/ 7089 51065009045/ 9047/ 9048/ 9052/ 9066
19.463 (338 kW) Eng.D2876LF02	94-	<b>24-1298</b>			For vehicles without retarder, w/o pulley; Impeller Ø 135mm, Incl Electronic fuel Injection pump	51065006408/ 6492/ 9492
	94-	<b>24-1301</b>			For vehicles with retarder; w/o pulley; Injection Pump with electronic control unit	51065006479/ 9479
	94-	<b>24-1302</b>			For vehicles with retarder, w/o pulley	51065006426/ 6490/ 9426/ 9490
	94-	<b>24-1319</b>			For vehicles with retarder, w pulley	51065006546/ 9546
	94-	<b>24-1321</b>			For vehicles without retarder, w pulley	51065006545/ 6547/ 9545/ 9547
	94-	<b>24-1330</b>		•		51065000298,51065006066/ 7033/ 7036 51065007043/ 7045/ 7047/ 7048/ 7051 51065007052/ 7065/ 7066/ 7088/ 7089 51065009045/ 9047/ 9048/ 9052/ 9066

			
<b>24-1298</b>	<b>24-1301</b>	<b>24-1302</b>	<b>24-1319</b>
			
<b>24-1321</b>	<b>24-1330</b>	<b>24-1336</b>	

		<b>METELLI ref.</b>			<b>NOTE</b>	<b>Adaptable for OES</b>
19.464 (338 kW) Eng.D2876LF06	98-	<b>24-1298</b>			For vehicles without retarder, w/o pulley; Impeller Ø 135mm, Incl Eletronic fuel Injection pump	51065006408/ 6492/ 9492
	98-	<b>24-1301</b>			For vehicles with retarder; w/o pulley; Injection Pump with electronic control unit	51065006479/ 9479
	98-	<b>24-1302</b>			For vehicles with retarder, w/o pulley	51065006426/ 6490/ 9426/ 9490
	98-	<b>24-1319</b>			For vehicles with retarder, w pulley	51065006546/ 9546
	98-	<b>24-1321</b>			For vehicles without retarder, w pulley	51065006545/ 6547/ 9545/ 9547
	98-	<b>24-1330</b>		•		51065000298,51065006066/ 7033/ 7036 51065007043/ 7045/ 7047/ 7048/ 7051 51065007052/ 7065/ 7066/ 7088/ 7089 51065009045/ 9047/ 9048/ 9052/ 9066
19.603 (441 kW) Eng.D2840LF20	96-	<b>24-1298</b>			For vehicles without retarder, w/o pulley; Impeller Ø 135mm, Incl Eletronic fuel Injection pump	51065006408/ 6492/ 9492
23.293 (213 kW) Eng.D2865LF20	94-	<b>24-1298</b>			For vehicles without retarder, w/o pulley; Impeller Ø 135mm, Incl Eletronic fuel Injection pump	51065006408/ 6492/ 9492
	94-	<b>24-1301</b>			For vehicles with retarder; w/o pulley; Injection Pump with electronic control unit	51065006479/ 9479
	94-	<b>24-1302</b>			For vehicles with retarder, w/o pulley	51065006426/ 6490/ 9426/ 9490
	94-	<b>24-1319</b>			For vehicles with retarder, w pulley	51065006546/ 9546
	94-	<b>24-1336</b>			w/ Pulley	51065006548/ 9548
23.293 (213 kW) Eng.D2865LF24 23.343 (250 kW) Eng.D2865LF21	94-	<b>24-1298</b>			For vehicles without retarder, w/o pulley; Impeller Ø 135mm, Incl Eletronic fuel Injection pump	51065006408/ 6492/ 9492
	94-	<b>24-1301</b>			For vehicles with retarder; w/o pulley; Injection Pump with electronic control unit	51065006479/ 9479
	94-	<b>24-1302</b>			For vehicles with retarder, w/o pulley	51065006426/ 6490/ 9426/ 9490
	94-	<b>24-1319</b>			For vehicles with retarder, w pulley	51065006546/ 9546
	94-	<b>24-1321</b>			For vehicles without retarder, w pulley	51065006545/ 6547/ 9545/ 9547
23.403 (294 kW) Eng.D2866LF20	94-	<b>24-1298</b>			For vehicles without retarder, w/o pulley; Impeller Ø 135mm, Incl Eletronic fuel Injection pump	51065006408/ 6492/ 9492
	94-	<b>24-1301</b>			For vehicles with retarder; w/o pulley; Injection Pump with electronic control unit	51065006479/ 9479
	94-	<b>24-1302</b>			For vehicles with retarder, w/o pulley	51065006426/ 6490/ 9426/ 9490
	94-	<b>24-1319</b>			For vehicles with retarder, w pulley	51065006546/ 9546
	94-	<b>24-1321</b>			For vehicles without retarder, w pulley	51065006545/ 6547/ 9545/ 9547
23.463 (338 kW) Eng.D2876LF02	94-	<b>24-1298</b>			For vehicles without retarder, w/o pulley; Impeller Ø 135mm, Incl Eletronic fuel Injection pump	51065006408/ 6492/ 9492
	94-	<b>24-1301</b>			For vehicles with retarder; w/o pulley; Injection Pump with electronic control unit	51065006479/ 9479
	94-	<b>24-1302</b>			For vehicles with retarder, w/o pulley	51065006426/ 6490/ 9426/ 9490
	94-	<b>24-1319</b>			For vehicles with retarder, w pulley	51065006546/ 9546
	94-	<b>24-1321</b>			For vehicles without retarder, w pulley	51065006545/ 6547/ 9545/ 9547
24.273 (198 kW) Eng.D2865LF22 24.293 (213 kW) Eng.D2865LF24	94-	<b>24-1298</b>			For vehicles without retarder, w/o pulley; Impeller Ø 135mm, Incl Eletronic fuel Injection pump	51065006408/ 6492/ 9492
	94-	<b>24-1301</b>			For vehicles with retarder; w/o pulley; Injection Pump with electronic control unit	51065006479/ 9479
	94-	<b>24-1302</b>			For vehicles with retarder, w/o pulley	51065006426/ 6490/ 9426/ 9490
	94-	<b>24-1319</b>			For vehicles with retarder, w pulley	51065006546/ 9546
	94-	<b>24-1321</b>			For vehicles without retarder, w pulley	51065006545/ 6547/ 9545/ 9547
	94-	<b>24-1336</b>			w/ Pulley	51065006548/ 9548
24.323 (235 kW) Eng.D2865LF23	94-95	<b>24-1298</b>			For vehicles without retarder, w/o pulley; Impeller Ø 135mm, Incl Eletronic fuel Injection pump	51065006408/ 6492/ 9492
	94-95	<b>24-1301</b>			For vehicles with retarder; w/o pulley; Injection Pump with electronic control unit	51065006479/ 9479
	94-95	<b>24-1302</b>			For vehicles with retarder, w/o pulley	51065006426/ 6490/ 9426/ 9490
	94-95	<b>24-1319</b>			For vehicles with retarder, w pulley	51065006546/ 9546
	94-95	<b>24-1321</b>			For vehicles without retarder, w pulley	51065006545/ 6547/ 9545/ 9547
	94-95	<b>24-1336</b>			w/ Pulley	51065006548/ 9548
24.343 (250 kW) Eng.D2865LF21	94-	<b>24-1298</b>			For vehicles without retarder, w/o pulley; Impeller Ø 135mm, Incl Eletronic fuel Injection pump	51065006408/ 6492/ 9492
	94-	<b>24-1301</b>			For vehicles with retarder; w/o pulley; Injection Pump with electronic control unit	51065006479/ 9479
	94-	<b>24-1302</b>			For vehicles with retarder, w/o pulley	51065006426/ 6490/ 9426/ 9490

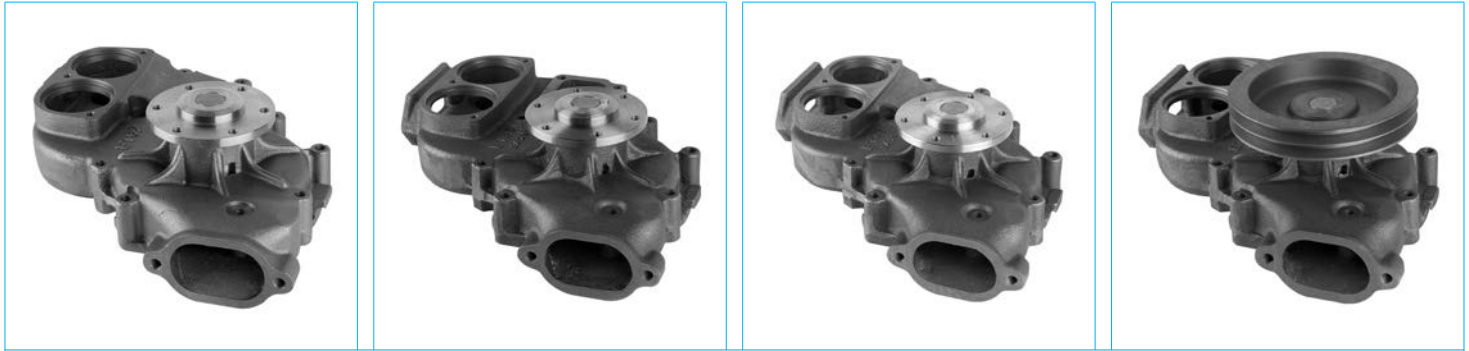

**24-1298**

**24-1301**

**24-1302**

**24-1319**

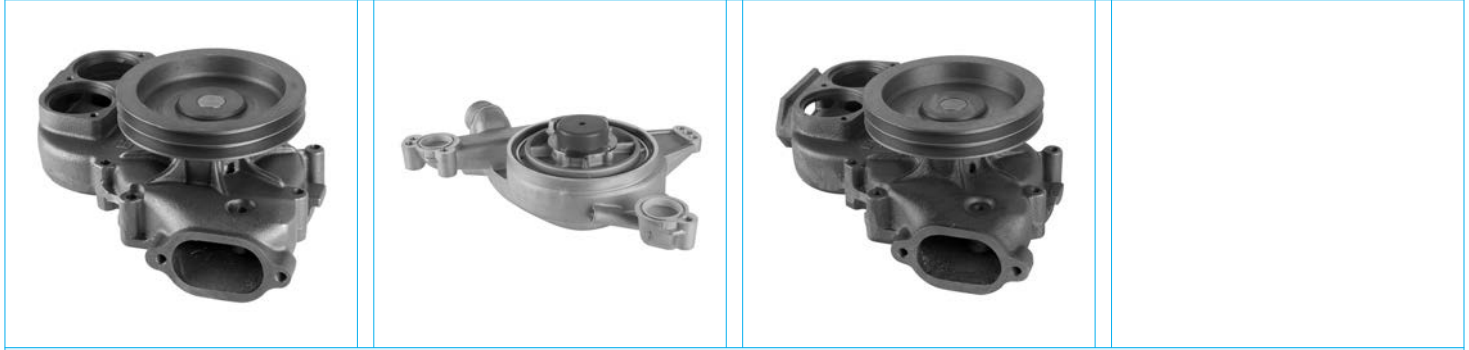



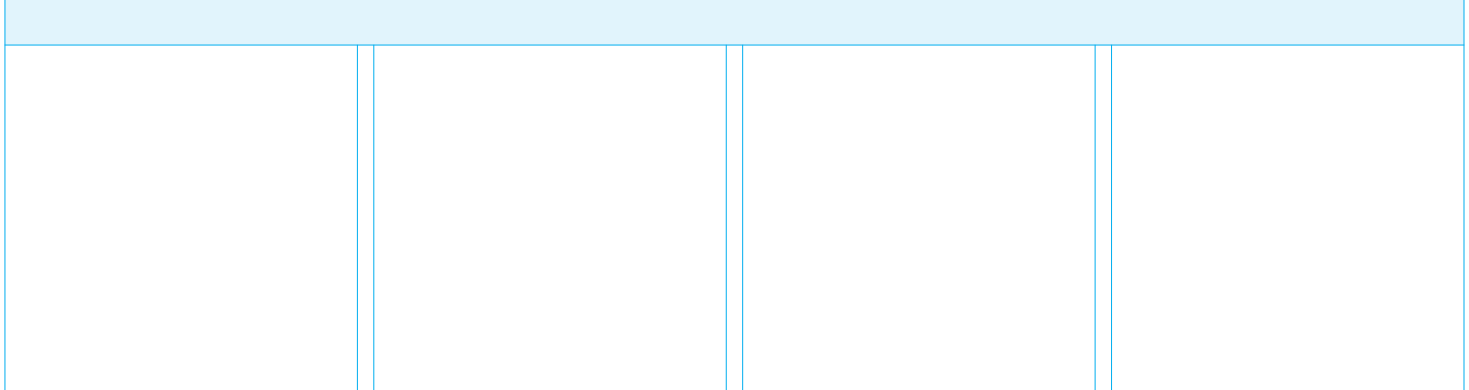
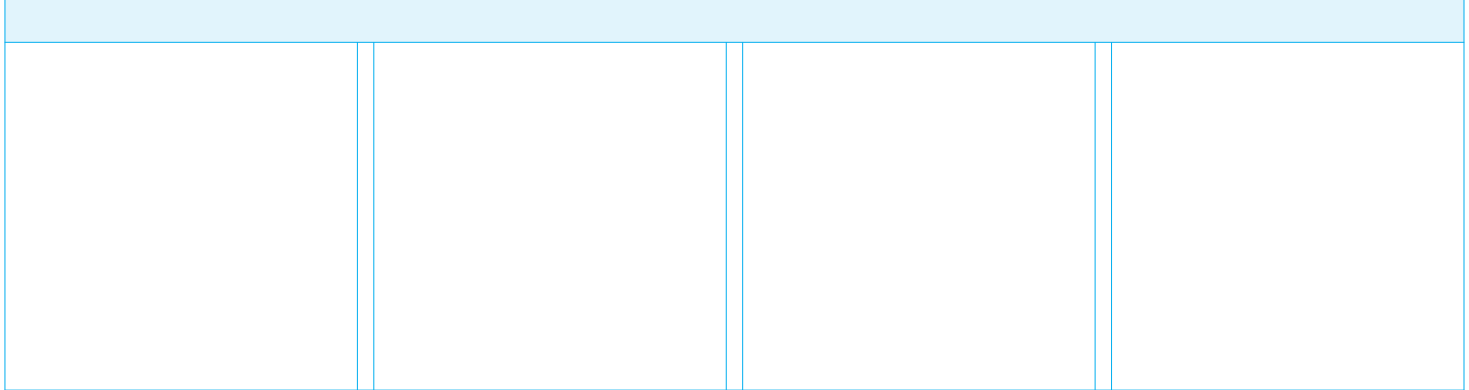
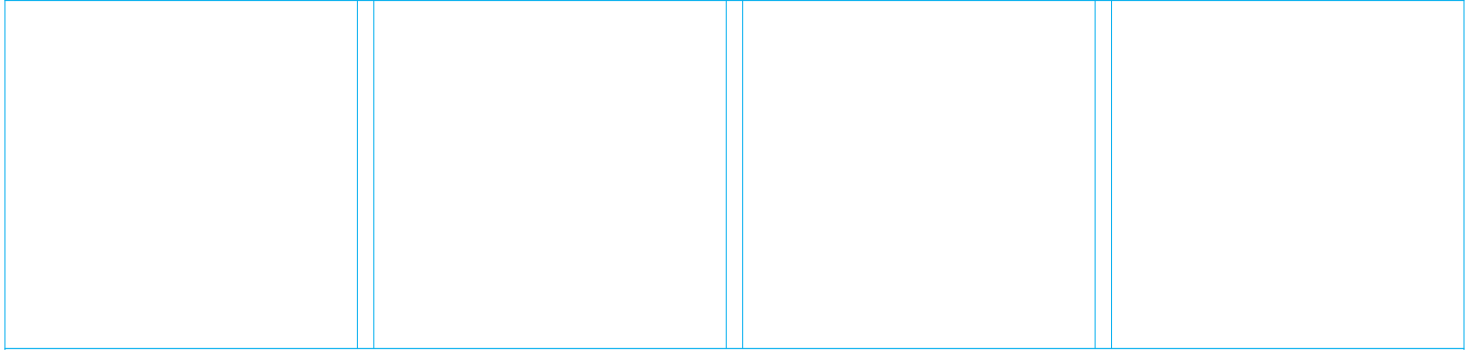

**24-1321**

**24-1330**

**24-1336**



		<b>METELLI</b> ref.			<b>NOTE</b>	<b>Adaptable for OES</b>
24.343 (250 kW) Eng.D2865LF21	94-	<b>24-1319</b>			For vehicles with retarder, w pulley	51065006546/ 9546
	94-	<b>24-1321</b>			For vehicles without retarder, w pulley	51065006545/ 6547/ 9545/ 9547
	94-	<b>24-1336</b>			w/ Pulley	51065006548/ 9548
24.373 (272 kW) Eng.D2866LF21 24.403 (294 kW) Eng.D2866LF20	94-95	<b>24-1298</b>			For vehicles without retarder, w/o pulley; Impeller Ø 135mm, Incl Eletronic fuel Injection pump	51065006408/ 6492/ 9492
	94-95	<b>24-1301</b>			For vehicles with retarder; w/o pulley; Injection Pump with electronic control unit	51065006479/ 9479
	94-95	<b>24-1302</b>			For vehicles with retarder, w/o pulley	51065006426/ 6490/ 9426/ 9490
	94-95	<b>24-1319</b>			For vehicles with retarder, w pulley	51065006546/ 9546
	94-95	<b>24-1321</b>			For vehicles without retarder, w pulley	51065006545/ 6547/ 9545/ 9547
	94-95	<b>24-1330</b>		•		51065000298,51065006066/ 7033/ 7036 51065007043/ 7045/ 7047/ 7048/ 7051 51065007052/ 7065/ 7066/ 7088/ 7089 51065009045/ 9047/ 9048/ 9052/ 9066
	94-95	<b>24-1298</b>			For vehicles without retarder, w/o pulley; Impeller Ø 135mm, Incl Eletronic fuel Injection pump	51065006408/ 6492/ 9492
24.423 (309 kW) Eng.D2866LF22	94-95	<b>24-1301</b>			For vehicles with retarder; w/o pulley; Injection Pump with electronic control unit	51065006479/ 9479
	94-95	<b>24-1302</b>			For vehicles with retarder, w/o pulley	51065006426/ 6490/ 9426/ 9490
	94-95	<b>24-1319</b>			For vehicles with retarder, w pulley	51065006546/ 9546
	94-95	<b>24-1321</b>			For vehicles without retarder, w pulley	51065006545/ 6547/ 9545/ 9547
	94-95	<b>24-1330</b>		•		51065000298,51065006066/ 7033/ 7036 51065007043/ 7045/ 7047/ 7048/ 7051 51065007052/ 7065/ 7066/ 7088/ 7089 51065009045/ 9047/ 9048/ 9052/ 9066
	94-	<b>24-1298</b>			For vehicles without retarder, w/o pulley; Impeller Ø 135mm, Incl Eletronic fuel Injection pump	51065006408/ 6492/ 9492
	94-	<b>24-1301</b>			For vehicles with retarder; w/o pulley; Injection Pump with electronic control unit	51065006479/ 9479
24.463 (338 kW) Eng.D2876LF02	94-	<b>24-1302</b>			For vehicles with retarder, w/o pulley	51065006426/ 6490/ 9426/ 9490
	94-	<b>24-1319</b>			For vehicles with retarder, w pulley	51065006546/ 9546
	94-	<b>24-1321</b>			For vehicles without retarder, w pulley	51065006545/ 6547/ 9545/ 9547
	94-	<b>24-1330</b>		•		51065000298,51065006066/ 7033/ 7036 51065007043/ 7045/ 7047/ 7048/ 7051 51065007052/ 7065/ 7066/ 7088/ 7089 51065009045/ 9047/ 9048/ 9052/ 9066
	96-	<b>24-1298</b>			For vehicles without retarder, w/o pulley; Impeller Ø 135mm, Incl Eletronic fuel Injection pump	51065006408/ 6492/ 9492
	96-	<b>24-1301</b>			For vehicles with retarder; w/o pulley; Injection Pump with electronic control unit	51065006479/ 9479
26.233 (170 kW) Eng.E2866DF01	96-	<b>24-1302</b>			For vehicles with retarder, w/o pulley	51065006426/ 6490/ 9426/ 9490
	96-	<b>24-1319</b>			For vehicles with retarder, w pulley	51065006546/ 9546
	94-95	<b>24-1298</b>			For vehicles without retarder, w/o pulley; Impeller Ø 135mm, Incl Eletronic fuel Injection pump	51065006408/ 6492/ 9492
	94-95	<b>24-1301</b>			For vehicles with retarder; w/o pulley; Injection Pump with electronic control unit	51065006479/ 9479
26.273 (198 kW) Eng.D2865LF22	94-95	<b>24-1302</b>			For vehicles with retarder, w/o pulley	51065006426/ 6490/ 9426/ 9490
	94-95	<b>24-1319</b>			For vehicles with retarder, w pulley	51065006546/ 9546
	94-95	<b>24-1321</b>			For vehicles without retarder, w pulley	51065006545/ 6547/ 9545/ 9547
	94-95	<b>24-1336</b>			w/ Pulley	51065006548/ 9548
	94-	<b>24-1298</b>			For vehicles without retarder, w/o pulley; Impeller Ø 135mm, Incl Eletronic fuel Injection pump	51065006408/ 6492/ 9492
	94-	<b>24-1301</b>			For vehicles with retarder; w/o pulley; Injection Pump with electronic control unit	51065006479/ 9479
	94-	<b>24-1302</b>			For vehicles with retarder, w/o pulley	51065006426/ 6490/ 9426/ 9490
26.293 (213 kW) Eng.D2865LF20	94-	<b>24-1319</b>			For vehicles with retarder, w pulley	51065006546/ 9546
	94-	<b>24-1321</b>			For vehicles without retarder, w pulley	51065006545/ 6547/ 9545/ 9547
	94-	<b>24-1336</b>			w/ Pulley	51065006548/ 9548
	94-	<b>24-1298</b>			For vehicles without retarder, w/o pulley; Impeller Ø 135mm, Incl Eletronic fuel Injection pump	51065006408/ 6492/ 9492
	94-	<b>24-1301</b>			For vehicles with retarder; w/o pulley; Injection Pump with electronic control unit	51065006479/ 9479
	94-	<b>24-1302</b>			For vehicles with retarder, w/o pulley	51065006426/ 6490/ 9426/ 9490
26.293 (213 kW) Eng.D2865LF24	94-	<b>24-1319</b>			For vehicles with retarder, w pulley	51065006546/ 9546
	94-	<b>24-1321</b>			For vehicles without retarder, w pulley	51065006545/ 6547/ 9545/ 9547
	94-	<b>24-1336</b>			w/ Pulley	51065006548/ 9548
	94-	<b>24-1298</b>			For vehicles without retarder, w/o pulley; Impeller Ø 135mm, Incl Eletronic fuel Injection pump	51065006408/ 6492/ 9492
	94-	<b>24-1301</b>			For vehicles with retarder; w/o pulley; Injection Pump with electronic control unit	51065006479/ 9479
	94-	<b>24-1302</b>			For vehicles with retarder, w/o pulley	51065006426/ 6490/ 9426/ 9490
26.314 (228 kW) Eng.D2866LF23	01-	<b>24-1298</b>			For vehicles without retarder, w/o pulley; Impeller Ø 135mm, Incl Eletronic fuel Injection pump	51065006408/ 6492/ 9492
	01-	<b>24-1301</b>			For vehicles with retarder; w/o pulley; Injection Pump with electronic control unit	51065006479/ 9479
	01-	<b>24-1302</b>			For vehicles with retarder, w/o pulley	51065006426/ 6490/ 9426/ 9490
	01-	<b>24-1319</b>			For vehicles with retarder, w pulley	51065006546/ 9546
	01-	<b>24-1321</b>			For vehicles without retarder, w pulley	51065006545/ 6547/ 9545/ 9547



**24-1298**



**24-1301**



**24-1302**



**24-1319**







**24-1321**



**24-1330**







**24-1336**

		<b>METELLI</b> ref.			<b>NOTE</b>	<b>Adaptable for OES</b>
26.314 (228 kW) Eng.D2866LF23	01-	<b>24-1330</b>		•		51065000298,51065006066/ 7033/ 7036 51065007043/ 7045/ 7047/ 7048/ 7051 51065007052/ 7065/ 7066/ 7088/ 7089 51065009045/ 9047/ 9048/ 9052/ 9066
26.323 (235 kW) Eng.D2865LF23 26.343 (250 kW) Eng.D2865LF21	94-95	<b>24-1298</b>			For vehicles without retarder, w/o pulley; Impeller Ø 135mm, Incl Electronic fuel Injection pump	51065006408/ 6492/ 9492
	94-95	<b>24-1301</b>			For vehicles with retarder; w/o pulley; Injection Pump with electronic control unit	51065006479/ 9479
	94-95	<b>24-1302</b>			For vehicles with retarder, w/o pulley	51065006426/ 6490/ 9426/ 9490
	94-95	<b>24-1319</b>			For vehicles with retarder, w pulley	51065006546/ 9546
	94-95	<b>24-1321</b>			For vehicles without retarder, w pulley	51065006545/ 6547/ 9545/ 9547
26.364 (265 kW) Eng.D2866LF24	94-95	<b>24-1336</b>			w/ Pulley	51065006548/ 9548
	01-	<b>24-1298</b>			For vehicles without retarder, w/o pulley; Impeller Ø 135mm, Incl Electronic fuel Injection pump	51065006408/ 6492/ 9492
	01-	<b>24-1301</b>			For vehicles with retarder; w/o pulley; Injection Pump with electronic control unit	51065006479/ 9479
	01-	<b>24-1302</b>			For vehicles with retarder, w/o pulley	51065006426/ 6490/ 9426/ 9490
	01-	<b>24-1319</b>			For vehicles with retarder, w pulley	51065006546/ 9546
26.373 (272 kW) Eng.D2866LF21	01-	<b>24-1321</b>			For vehicles without retarder, w pulley	51065006545/ 6547/ 9545/ 9547
	01-	<b>24-1330</b>		•		51065000298,51065006066/ 7033/ 7036 51065007043/ 7045/ 7047/ 7048/ 7051 51065007052/ 7065/ 7066/ 7088/ 7089 51065009045/ 9047/ 9048/ 9052/ 9066
	94-95	<b>24-1298</b>			For vehicles without retarder, w/o pulley; Impeller Ø 135mm, Incl Electronic fuel Injection pump	51065006408/ 6492/ 9492
	94-95	<b>24-1301</b>			For vehicles with retarder; w/o pulley; Injection Pump with electronic control unit	51065006479/ 9479
	94-95	<b>24-1302</b>			For vehicles with retarder, w/o pulley	51065006426/ 6490/ 9426/ 9490
26.403 (294 kW) Eng.D2866LF20	94-95	<b>24-1319</b>			For vehicles with retarder, w pulley	51065006546/ 9546
	94-95	<b>24-1321</b>			For vehicles without retarder, w pulley	51065006545/ 6547/ 9545/ 9547
	94-95	<b>24-1330</b>		•		51065000298,51065006066/ 7033/ 7036 51065007043/ 7045/ 7047/ 7048/ 7051 51065007052/ 7065/ 7066/ 7088/ 7089 51065009045/ 9047/ 9048/ 9052/ 9066
	94-	<b>24-1298</b>			For vehicles without retarder, w/o pulley; Impeller Ø 135mm, Incl Electronic fuel Injection pump	51065006408/ 6492/ 9492
	94-	<b>24-1301</b>			For vehicles with retarder; w/o pulley; Injection Pump with electronic control unit	51065006479/ 9479
26.414 (301 kW) Eng.D2866LF25	94-	<b>24-1302</b>			For vehicles with retarder, w/o pulley	51065006426/ 6490/ 9426/ 9490
	94-	<b>24-1319</b>			For vehicles with retarder, w pulley	51065006546/ 9546
	94-	<b>24-1321</b>			For vehicles without retarder, w pulley	51065006545/ 6547/ 9545/ 9547
	01-	<b>24-1298</b>			For vehicles without retarder, w/o pulley; Impeller Ø 135mm, Incl Electronic fuel Injection pump	51065006408/ 6492/ 9492
	01-	<b>24-1301</b>			For vehicles with retarder; w/o pulley; Injection Pump with electronic control unit	51065006479/ 9479
26.423 (309 kW) Eng.D2866LF22	01-	<b>24-1302</b>			For vehicles with retarder, w/o pulley	51065006426/ 6490/ 9426/ 9490
	01-	<b>24-1319</b>			For vehicles with retarder, w pulley	51065006546/ 9546
	01-	<b>24-1321</b>			For vehicles without retarder, w pulley	51065006545/ 6547/ 9545/ 9547
	01-	<b>24-1330</b>		•		51065000298,51065006066/ 7033/ 7036 51065007043/ 7045/ 7047/ 7048/ 7051 51065007052/ 7065/ 7066/ 7088/ 7089 51065009045/ 9047/ 9048/ 9052/ 9066
	94-95	<b>24-1298</b>			For vehicles without retarder, w/o pulley; Impeller Ø 135mm, Incl Electronic fuel Injection pump	51065006408/ 6492/ 9492
26.463 (338 kW) Eng.D2876LF02 26.464 (338 kW) Eng.D2876LF03	94-95	<b>24-1301</b>			For vehicles with retarder; w/o pulley; Injection Pump with electronic control unit	51065006479/ 9479
	94-	<b>24-1302</b>			For vehicles with retarder, w/o pulley	51065006426/ 6490/ 9426/ 9490
	94-	<b>24-1319</b>			For vehicles with retarder, w pulley	51065006546/ 9546
	94-	<b>24-1321</b>			For vehicles without retarder, w pulley	51065006545/ 6547/ 9545/ 9547



			
<p><b>24-1298</b></p>	<p><b>24-1301</b></p>	<p><b>24-1302</b></p>	<p><b>24-1319</b></p>
			
<p><b>24-1321</b></p>	<p><b>24-1330</b></p>	<p><b>24-1336</b></p>	

		<b>METELLI</b> ref.			<b>NOTE</b>	<b>Adaptable for OES</b>
26.463 (338 kW) Eng.D2876LF02 26.464 (338 kW) Eng.D2876LF03	94-	<b>24-1330</b>		•		51065000298,51065006066/ 7033/ 7036 51065007043/ 7045/ 7047/ 7048/ 7051 51065007052/ 7065/ 7066/ 7088/ 7089 51065009045/ 9047/ 9048/ 9052/ 9066
26.603 (441 kW) Eng.D2840LF20	96-	<b>24-1298</b>			For vehicles without retarder, w/o pulley; Impeller Ø 135mm, Incl Eletronic fuel Injection pump	51065006408/ 6492/ 9492
27.273 (198 kW) Eng.D2865LF22	94-95	<b>24-1298</b>			For vehicles without retarder, w/o pulley; Impeller Ø 135mm, Incl Eletronic fuel Injection pump	51065006408/ 6492/ 9492
	94-95	<b>24-1301</b>			For vehicles with retarder; w/o pulley; Injection Pump with electronic control unit	51065006479/ 9479
	94-95	<b>24-1302</b>			For vehicles with retarder, w/o pulley	51065006426/ 6490/ 9426/ 9490
	94-95	<b>24-1319</b>			For vehicles with retarder, w pulley	51065006546/ 9546
	94-95	<b>24-1321</b>			For vehicles without retarder, w pulley	51065006545/ 6547/ 9545/ 9547
	94-95	<b>24-1336</b>			w/ Pulley	51065006548/ 9548
27.293 (213 kW) Eng.D2865LF20/LF24	94-	<b>24-1298</b>			For vehicles without retarder, w/o pulley; Impeller Ø 135mm, Incl Eletronic fuel Injection pump	51065006408/ 6492/ 9492
	94-	<b>24-1301</b>			For vehicles with retarder; w/o pulley; Injection Pump with electronic control unit	51065006479/ 9479
	94-	<b>24-1302</b>			For vehicles with retarder, w/o pulley	51065006426/ 6490/ 9426/ 9490
	94-	<b>24-1319</b>			For vehicles with retarder, w pulley	51065006546/ 9546
	94-	<b>24-1321</b>			For vehicles without retarder, w pulley	51065006545/ 6547/ 9545/ 9547
	94-	<b>24-1336</b>			w/ Pulley	51065006548/ 9548
27.314 (228 kW) Eng.D2866LF23	98-	<b>24-1298</b>			For vehicles without retarder, w/o pulley; Impeller Ø 135mm, Incl Eletronic fuel Injection pump	51065006408/ 6492/ 9492
	98-	<b>24-1301</b>			For vehicles with retarder; w/o pulley; Injection Pump with electronic control unit	51065006479/ 9479
	98-	<b>24-1302</b>			For vehicles with retarder, w/o pulley	51065006426/ 6490/ 9426/ 9490
	98-	<b>24-1319</b>			For vehicles with retarder, w pulley	51065006546/ 9546
	98-	<b>24-1321</b>			For vehicles without retarder, w pulley	51065006545/ 6547/ 9545/ 9547
	98-	<b>24-1330</b>		•		51065000298,51065006066/ 7033/ 7036 51065007043/ 7045/ 7047/ 7048/ 7051 51065007052/ 7065/ 7066/ 7088/ 7089 51065009045/ 9047/ 9048/ 9052/ 9066
27.323 (235 kW) Eng.D2865LF23	94-95	<b>24-1298</b>			For vehicles without retarder, w/o pulley; Impeller Ø 135mm, Incl Eletronic fuel Injection pump	51065006408/ 6492/ 9492
	94-95	<b>24-1301</b>			For vehicles with retarder; w/o pulley; Injection Pump with electronic control unit	51065006479/ 9479
	94-95	<b>24-1302</b>			For vehicles with retarder, w/o pulley	51065006426/ 6490/ 9426/ 9490
	94-95	<b>24-1319</b>			For vehicles with retarder, w pulley	51065006546/ 9546
	94-95	<b>24-1321</b>			For vehicles without retarder, w pulley	51065006545/ 6547/ 9545/ 9547
	94-95	<b>24-1336</b>			w/ Pulley	51065006548/ 9548
27.343 (250 kW) Eng.D2865LF21	94-	<b>24-1298</b>			For vehicles without retarder, w/o pulley; Impeller Ø 135mm, Incl Eletronic fuel Injection pump	51065006408/ 6492/ 9492
	94-	<b>24-1301</b>			For vehicles with retarder; w/o pulley; Injection Pump with electronic control unit	51065006479/ 9479
	94-	<b>24-1302</b>			For vehicles with retarder, w/o pulley	51065006426/ 6490/ 9426/ 9490
	94-	<b>24-1319</b>			For vehicles with retarder, w pulley	51065006546/ 9546
	94-	<b>24-1321</b>			For vehicles without retarder, w pulley	51065006545/ 6547/ 9545/ 9547
	94-	<b>24-1336</b>			w/ Pulley	51065006548/ 9548
27.364 (265 kW) Eng.D2866LF24	01-	<b>24-1298</b>			For vehicles without retarder, w/o pulley; Impeller Ø 135mm, Incl Eletronic fuel Injection pump	51065006408/ 6492/ 9492
	01-	<b>24-1301</b>			For vehicles with retarder; w/o pulley; Injection Pump with electronic control unit	51065006479/ 9479
	01-	<b>24-1302</b>			For vehicles with retarder, w/o pulley	51065006426/ 6490/ 9426/ 9490
	01-	<b>24-1319</b>			For vehicles with retarder, w pulley	51065006546/ 9546
	01-	<b>24-1321</b>			For vehicles without retarder, w pulley	51065006545/ 6547/ 9545/ 9547
	01-	<b>24-1330</b>		•		51065000298,51065006066/ 7033/ 7036 51065007043/ 7045/ 7047/ 7048/ 7051 51065007052/ 7065/ 7066/ 7088/ 7089 51065009045/ 9047/ 9048/ 9052/ 9066
27.373 (272 kW) Eng.D2866LF21	94-95	<b>24-1298</b>			For vehicles without retarder, w/o pulley; Impeller Ø 135mm, Incl Eletronic fuel Injection pump	51065006408/ 6492/ 9492
	94-95	<b>24-1301</b>			For vehicles with retarder; w/o pulley; Injection Pump with electronic control unit	51065006479/ 9479
	94-95	<b>24-1302</b>			For vehicles with retarder, w/o pulley	51065006426/ 6490/ 9426/ 9490
	94-95	<b>24-1319</b>			For vehicles with retarder, w pulley	51065006546/ 9546

			
<b>24-1298</b>	<b>24-1301</b>	<b>24-1302</b>	<b>24-1319</b>
			
<b>24-1321</b>	<b>24-1330</b>	<b>24-1336</b>	

		<b>METELLI ref.</b>			<b>NOTE</b>	<b>Adaptable for OES</b>
27.373 (272 kW) Eng.D2866LF21	94-95	<b>24-1321</b>			For vehicles without retarder, w pulley	51065006545/ 6547/ 9545/ 9547
	94-95	<b>24-1330</b>		•		51065000298,51065006066/ 7033/ 7036 51065007043/ 7045/ 7047/ 7048/ 7051 51065007052/ 7065/ 7066/ 7088/ 7089 51065009045/ 9047/ 9048/ 9052/ 9066
27.403 (294 kW) Eng.D2866LF20	94-	<b>24-1298</b>			For vehicles without retarder, w/o pulley; Impeller Ø 135mm, Incl Eletronic fuel Injection pump	51065006408/ 6492/ 9492
	94-	<b>24-1301</b>			For vehicles with retarder; w/o pulley; Injection Pump with electronic control unit	51065006479/ 9479
	94-	<b>24-1302</b>			For vehicles with retarder, w/o pulley	51065006426/ 6490/ 9426/ 9490
	94-	<b>24-1319</b>			For vehicles with retarder, w pulley	51065006546/ 9546
	94-	<b>24-1321</b>			For vehicles without retarder, w pulley	51065006545/ 6547/ 9545/ 9547
	94-	<b>24-1330</b>		•		51065000298,51065006066/ 7033/ 7036 51065007043/ 7045/ 7047/ 7048/ 7051 51065007052/ 7065/ 7066/ 7088/ 7089 51065009045/ 9047/ 9048/ 9052/ 9066
27.414 (301 kW) Eng.D2866LF25	01-	<b>24-1298</b>			For vehicles without retarder, w/o pulley; Impeller Ø 135mm, Incl Eletronic fuel Injection pump	51065006408/ 6492/ 9492
	01-	<b>24-1301</b>			For vehicles with retarder; w/o pulley; Injection Pump with electronic control unit	51065006479/ 9479
	01-	<b>24-1302</b>			For vehicles with retarder, w/o pulley	51065006426/ 6490/ 9426/ 9490
	01-	<b>24-1319</b>			For vehicles with retarder, w pulley	51065006546/ 9546
	01-	<b>24-1321</b>			For vehicles without retarder, w pulley	51065006545/ 6547/ 9545/ 9547
	01-	<b>24-1330</b>		•		51065000298,51065006066/ 7033/ 7036 51065007043/ 7045/ 7047/ 7048/ 7051 51065007052/ 7065/ 7066/ 7088/ 7089 51065009045/ 9047/ 9048/ 9052/ 9066
27.423 (309 kW) Eng.D2866LF22	94-95	<b>24-1298</b>			For vehicles without retarder, w/o pulley; Impeller Ø 135mm, Incl Eletronic fuel Injection pump	51065006408/ 6492/ 9492
	94-95	<b>24-1301</b>			For vehicles with retarder; w/o pulley; Injection Pump with electronic control unit	51065006479/ 9479
	94-95	<b>24-1302</b>			For vehicles with retarder, w/o pulley	51065006426/ 6490/ 9426/ 9490
	94-95	<b>24-1319</b>			For vehicles with retarder, w pulley	51065006546/ 9546
	94-95	<b>24-1321</b>			For vehicles without retarder, w pulley	51065006545/ 6547/ 9545/ 9547
	94-95	<b>24-1330</b>		•		51065000298,51065006066/ 7033/ 7036 51065007043/ 7045/ 7047/ 7048/ 7051 51065007052/ 7065/ 7066/ 7088/ 7089 51065009045/ 9047/ 9048/ 9052/ 9066
27.463 (338 kW) Eng.D2876LF02 27.464 (338 kW) Eng.D2876LF03	94-	<b>24-1298</b>			For vehicles without retarder, w/o pulley; Impeller Ø 135mm, Incl Eletronic fuel Injection pump	51065006408/ 6492/ 9492
	94-	<b>24-1301</b>			For vehicles with retarder; w/o pulley; Injection Pump with electronic control unit	51065006479/ 9479
	94-	<b>24-1302</b>			For vehicles with retarder, w/o pulley	51065006426/ 6490/ 9426/ 9490
	94-	<b>24-1319</b>			For vehicles with retarder, w pulley	51065006546/ 9546
	94-	<b>24-1321</b>			For vehicles without retarder, w pulley	51065006545/ 6547/ 9545/ 9547
	94-	<b>24-1330</b>		•		51065000298,51065006066/ 7033/ 7036 51065007043/ 7045/ 7047/ 7048/ 7051 51065007052/ 7065/ 7066/ 7088/ 7089 51065009045/ 9047/ 9048/ 9052/ 9066
27.603 (441 kW) Eng.D2840LF20	96-	<b>24-1298</b>			For vehicles without retarder, w/o pulley; Impeller Ø 135mm, Incl Eletronic fuel Injection pump	51065006408/ 6492/ 9492
32.293 (213 kW) Eng.D2865LF24	95-	<b>24-1298</b>			For vehicles without retarder, w/o pulley; Impeller Ø 135mm, Incl Eletronic fuel Injection pump	51065006408/ 6492/ 9492
	95-	<b>24-1301</b>			For vehicles with retarder; w/o pulley; Injection Pump with electronic control unit	51065006479/ 9479
	95-	<b>24-1302</b>			For vehicles with retarder, w/o pulley	51065006426/ 6490/ 9426/ 9490
	95-	<b>24-1319</b>			For vehicles with retarder, w pulley	51065006546/ 9546
	95-	<b>24-1321</b>			For vehicles without retarder, w pulley	51065006545/ 6547/ 9545/ 9547
	95-	<b>24-1336</b>			w/ Pulley	51065006548/ 9548
32.314 (228 kW) Eng.D2866LF23	01-	<b>24-1298</b>			For vehicles without retarder, w/o pulley; Impeller Ø 135mm, Incl Eletronic fuel Injection pump	51065006408/ 6492/ 9492
	01-	<b>24-1301</b>			For vehicles with retarder; w/o pulley; Injection Pump with electronic control unit	51065006479/ 9479
	01-	<b>24-1302</b>			For vehicles with retarder, w/o pulley	51065006426/ 6490/ 9426/ 9490
	01-	<b>24-1319</b>			For vehicles with retarder, w pulley	51065006546/ 9546
	01-	<b>24-1321</b>			For vehicles without retarder, w pulley	51065006545/ 6547/ 9545/ 9547
	01-	<b>24-1330</b>		•		51065000298,51065006066/ 7033/ 7036 51065007043/ 7045/ 7047/ 7048/ 7051 51065007052/ 7065/ 7066/ 7088/ 7089 51065009045/ 9047/ 9048/ 9052/ 9066

			
<b>24-1298</b>	<b>24-1301</b>	<b>24-1302</b>	<b>24-1319</b>
			
<b>24-1321</b>	<b>24-1330</b>	<b>24-1336</b>	

		<b>METELLI ref.</b>			<b>NOTE</b>	<b>Adaptable for OES</b>
32.343 (250 kW) Eng.D2865LF21	95-	<b>24-1298</b>			For vehicles without retarder, w/o pulley; Impeller Ø 135mm, Incl Eletronic fuel Injection pump	51065006408/ 6492/ 9492
	95-	<b>24-1301</b>			For vehicles with retarder; w/o pulley; Injection Pump with electronic control unit	51065006479/ 9479
	95-	<b>24-1302</b>			For vehicles with retarder, w/o pulley	51065006426/ 6490/ 9426/ 9490
	95-	<b>24-1319</b>			For vehicles with retarder, w pulley	51065006546/ 9546
	95-	<b>24-1321</b>			For vehicles without retarder, w pulley	51065006545/ 6547/ 9545/ 9547
	95-	<b>24-1336</b>			w/ Pulley	51065006548/ 9548
32.364 (265 kW) Eng.D2866LF24	01-	<b>24-1298</b>			For vehicles without retarder, w/o pulley; Impeller Ø 135mm, Incl Eletronic fuel Injection pump	51065006408/ 6492/ 9492
	01-	<b>24-1301</b>			For vehicles with retarder; w/o pulley; Injection Pump with electronic control unit	51065006479/ 9479
	01-	<b>24-1302</b>			For vehicles with retarder, w/o pulley	51065006426/ 6490/ 9426/ 9490
	01-	<b>24-1319</b>			For vehicles with retarder, w pulley	51065006546/ 9546
	01-	<b>24-1321</b>			For vehicles without retarder, w pulley	51065006545/ 6547/ 9545/ 9547
	01-	<b>24-1330</b>		•		5106500298,51065006066/ 7033/ 7036 51065007043/ 7045/ 7047/ 7048/ 7051 51065007052/ 7065/ 7066/ 7088/ 7089 51065009045/ 9047/ 9048/ 9052/ 9066
32.403 (294 kW) Eng.D2866LF20	95-	<b>24-1298</b>			For vehicles without retarder, w/o pulley; Impeller Ø 135mm, Incl Eletronic fuel Injection pump	51065006408/ 6492/ 9492
	95-	<b>24-1301</b>			For vehicles with retarder; w/o pulley; Injection Pump with electronic control unit	51065006479/ 9479
	95-	<b>24-1302</b>			For vehicles with retarder, w/o pulley	51065006426/ 6490/ 9426/ 9490
	95-	<b>24-1319</b>			For vehicles with retarder, w pulley	51065006546/ 9546
	95-	<b>24-1321</b>			For vehicles without retarder, w pulley	51065006545/ 6547/ 9545/ 9547
	95-	<b>24-1330</b>		•		5106500298,51065006066/ 7033/ 7036 51065007043/ 7045/ 7047/ 7048/ 7051 51065007052/ 7065/ 7066/ 7088/ 7089 51065009045/ 9047/ 9048/ 9052/ 9066
32.414 (301 kW) Eng.D2866LF25	01-	<b>24-1298</b>			For vehicles without retarder, w/o pulley; Impeller Ø 135mm, Incl Eletronic fuel Injection pump	51065006408/ 6492/ 9492
	01-	<b>24-1301</b>			For vehicles with retarder; w/o pulley; Injection Pump with electronic control unit	51065006479/ 9479
	01-	<b>24-1302</b>			For vehicles with retarder, w/o pulley	51065006426/ 6490/ 9426/ 9490
	01-	<b>24-1319</b>			For vehicles with retarder, w pulley	51065006546/ 9546
	01-	<b>24-1330</b>		•		5106500298,51065006066/ 7033/ 7036 51065007043/ 7045/ 7047/ 7048/ 7051 51065007052/ 7065/ 7066/ 7088/ 7089 51065009045/ 9047/ 9048/ 9052/ 9066
32.463 (338 kW) Eng.D2876LF02 32.464 (338 kW) Eng.D2876LF03	95-	<b>24-1298</b>			For vehicles without retarder, w/o pulley; Impeller Ø 135mm, Incl Eletronic fuel Injection pump	51065006408/ 6492/ 9492
	95-	<b>24-1301</b>			For vehicles with retarder; w/o pulley; Injection Pump with electronic control unit	51065006479/ 9479
	95-	<b>24-1302</b>			For vehicles with retarder, w/o pulley	51065006426/ 6490/ 9426/ 9490
	95-	<b>24-1319</b>			For vehicles with retarder, w pulley	51065006546/ 9546
	95-	<b>24-1321</b>			For vehicles without retarder, w pulley	51065006545/ 6547/ 9545/ 9547
	95-	<b>24-1330</b>		•		5106500298,51065006066/ 7033/ 7036 51065007043/ 7045/ 7047/ 7048/ 7051 51065007052/ 7065/ 7066/ 7088/ 7089 51065009045/ 9047/ 9048/ 9052/ 9066
33.323 (235 kW) Eng.D2865LF23	94-95	<b>24-1298</b>			For vehicles without retarder, w/o pulley; Impeller Ø 135mm, Incl Eletronic fuel Injection pump	51065006408/ 6492/ 9492
	94-95	<b>24-1301</b>			For vehicles with retarder; w/o pulley; Injection Pump with electronic control unit	51065006479/ 9479
	94-95	<b>24-1302</b>			For vehicles with retarder, w/o pulley	51065006426/ 6490/ 9426/ 9490
	94-95	<b>24-1319</b>			For vehicles with retarder, w pulley	51065006546/ 9546
	94-95	<b>24-1321</b>			For vehicles without retarder, w pulley	51065006545/ 6547/ 9545/ 9547
	94-95	<b>24-1336</b>			w/ Pulley	51065006548/ 9548
33.343 (250 kW) Eng.D2865LF21	94-	<b>24-1298</b>			For vehicles without retarder, w/o pulley; Impeller Ø 135mm, Incl Eletronic fuel Injection pump	51065006408/ 6492/ 9492
	94-	<b>24-1301</b>			For vehicles with retarder; w/o pulley; Injection Pump with electronic control unit	51065006479/ 9479
	94-	<b>24-1302</b>			For vehicles with retarder, w/o pulley	51065006426/ 6490/ 9426/ 9490
	94-	<b>24-1319</b>			For vehicles with retarder, w pulley	51065006546/ 9546
	94-	<b>24-1321</b>			For vehicles without retarder, w pulley	51065006545/ 6547/ 9545/ 9547
	94-	<b>24-1336</b>			w/ Pulley	51065006548/ 9548
33.373 (272 kW) Eng.D2866LF21	94-95	<b>24-1298</b>			For vehicles without retarder, w/o pulley; Impeller Ø 135mm, Incl Eletronic fuel Injection pump	51065006408/ 6492/ 9492
	94-95	<b>24-1301</b>			For vehicles with retarder; w/o pulley; Injection Pump with electronic control unit	51065006479/ 9479
	94-95	<b>24-1302</b>			For vehicles with retarder, w/o pulley	51065006426/ 6490/ 9426/ 9490
	94-95	<b>24-1319</b>			For vehicles with retarder, w pulley	51065006546/ 9546
	94-95	<b>24-1321</b>			For vehicles without retarder, w pulley	51065006545/ 6547/ 9545/ 9547

			
<p><b>24-1298</b></p>	<p><b>24-1301</b></p>	<p><b>24-1302</b></p>	<p><b>24-1319</b></p>
			
<p><b>24-1321</b></p>	<p><b>24-1330</b></p>	<p><b>24-1336</b></p>	





		<b>METELLI</b> ref.			<b>NOTE</b>	<b>Adaptable for OES</b>
33.373 (272 kW) Eng.D2866LF21	94-95	<b>24-1330</b>		•		51065000298,51065006066/ 7033/ 7036 51065007043/ 7045/ 7047/ 7048/ 7051 51065007052/ 7065/ 7066/ 7088/ 7089 51065009045/ 9047/ 9048/ 9052/ 9066
33.403 (294 kW) Eng.D2866LF20	94-	<b>24-1298</b>			For vehicles without retarder, w/o pulley; Impeller Ø 135mm, Incl Eletronic fuel Injection pump	51065006408/ 6492/ 9492
	94-	<b>24-1301</b>			For vehicles with retarder; w/o pulley; Injection Pump with electronic control unit	51065006479/ 9479
	94-	<b>24-1302</b>			For vehicles with retarder, w/o pulley	51065006426/ 6490/ 9426/ 9490
	94-	<b>24-1319</b>			For vehicles with retarder, w pulley	51065006546/ 9546
	94-	<b>24-1321</b>			For vehicles without retarder, w pulley	51065006545/ 6547/ 9545/ 9547
	94-	<b>24-1330</b>		•		51065000298,51065006066/ 7033/ 7036 51065007043/ 7045/ 7047/ 7048/ 7051 51065007052/ 7065/ 7066/ 7088/ 7089 51065009045/ 9047/ 9048/ 9052/ 9066
33.423 (309 kW) Eng.D2866LF22 33.463 (338 kW) Eng.D2876LF02	94-95	<b>24-1298</b>			For vehicles without retarder, w/o pulley; Impeller Ø 135mm, Incl Eletronic fuel Injection pump	51065006408/ 6492/ 9492
	94-95	<b>24-1301</b>			For vehicles with retarder; w/o pulley; Injection Pump with electronic control unit	51065006479/ 9479
	94-95	<b>24-1302</b>			For vehicles with retarder, w/o pulley	51065006426/ 6490/ 9426/ 9490
	94-95	<b>24-1319</b>			For vehicles with retarder, w pulley	51065006546/ 9546
	94-95	<b>24-1321</b>			For vehicles without retarder, w pulley	51065006545/ 6547/ 9545/ 9547
	94-95	<b>24-1330</b>		•		51065000298,51065006066/ 7033/ 7036 51065007043/ 7045/ 7047/ 7048/ 7051 51065007052/ 7065/ 7066/ 7088/ 7089 51065009045/ 9047/ 9048/ 9052/ 9066
33.603 (441 kW) Eng.D2840LF20	96-	<b>24-1298</b>			For vehicles without retarder, w/o pulley; Impeller Ø 135mm, Incl Eletronic fuel Injection pump	51065006408/ 6492/ 9492
35.343 (250 kW) Eng.D2865LF21	95-	<b>24-1298</b>			For vehicles without retarder, w/o pulley; Impeller Ø 135mm, Incl Eletronic fuel Injection pump	51065006408/ 6492/ 9492
	95-	<b>24-1301</b>			For vehicles with retarder; w/o pulley; Injection Pump with electronic control unit	51065006479/ 9479
	95-	<b>24-1302</b>			For vehicles with retarder, w/o pulley	51065006426/ 6490/ 9426/ 9490
	95-	<b>24-1319</b>			For vehicles with retarder, w pulley	51065006546/ 9546
	95-	<b>24-1321</b>			For vehicles without retarder, w pulley	51065006545/ 6547/ 9545/ 9547
	95-	<b>24-1336</b>			w/ Pulley	51065006548/ 9548
35.364 (265 kW) Eng.D2866LF24	01-	<b>24-1298</b>			For vehicles without retarder, w/o pulley; Impeller Ø 135mm, Incl Eletronic fuel Injection pump	51065006408/ 6492/ 9492
	01-	<b>24-1301</b>			For vehicles with retarder; w/o pulley; Injection Pump with electronic control unit	51065006479/ 9479
	01-	<b>24-1302</b>			For vehicles with retarder, w/o pulley	51065006426/ 6490/ 9426/ 9490
	01-	<b>24-1319</b>			For vehicles with retarder, w pulley	51065006546/ 9546
	01-	<b>24-1321</b>			For vehicles without retarder, w pulley	51065006545/ 6547/ 9545/ 9547
	01-	<b>24-1330</b>		•		51065000298,51065006066/ 7033/ 7036 51065007043/ 7045/ 7047/ 7048/ 7051 51065007052/ 7065/ 7066/ 7088/ 7089 51065009045/ 9047/ 9048/ 9052/ 9066
35.403 (294 kW) Eng.D2866LF20	95-	<b>24-1298</b>			For vehicles without retarder, w/o pulley; Impeller Ø 135mm, Incl Eletronic fuel Injection pump	51065006408/ 6492/ 9492
	95-	<b>24-1301</b>			For vehicles with retarder; w/o pulley; Injection Pump with electronic control unit	51065006479/ 9479
	95-	<b>24-1302</b>			For vehicles with retarder, w/o pulley	51065006426/ 6490/ 9426/ 9490
	95-	<b>24-1319</b>			For vehicles with retarder, w pulley	51065006546/ 9546
	95-	<b>24-1321</b>			For vehicles without retarder, w pulley	51065006545/ 6547/ 9545/ 9547
	95-	<b>24-1330</b>		•		51065000298,51065006066/ 7033/ 7036 51065007043/ 7045/ 7047/ 7048/ 7051 51065007052/ 7065/ 7066/ 7088/ 7089 51065009045/ 9047/ 9048/ 9052/ 9066
35.414 (301 kW) Eng.D2866LF25	01-	<b>24-1298</b>			For vehicles without retarder, w/o pulley; Impeller Ø 135mm, Incl Eletronic fuel Injection pump	51065006408/ 6492/ 9492
	01-	<b>24-1301</b>			For vehicles with retarder; w/o pulley; Injection Pump with electronic control unit	51065006479/ 9479
	01-	<b>24-1302</b>			For vehicles with retarder, w/o pulley	51065006426/ 6490/ 9426/ 9490
	01-	<b>24-1319</b>			For vehicles with retarder, w pulley	51065006546/ 9546
	01-	<b>24-1321</b>			For vehicles without retarder, w pulley	51065006545/ 6547/ 9545/ 9547
	01-	<b>24-1330</b>		•		51065000298,51065006066/ 7033/ 7036 51065007043/ 7045/ 7047/ 7048/ 7051 51065007052/ 7065/ 7066/ 7088/ 7089 51065009045/ 9047/ 9048/ 9052/ 9066
35.463 (338 kW) Eng.D2876LF02 35.464 (338 kW) Eng.D2876LF03	95-	<b>24-1298</b>			For vehicles without retarder, w/o pulley; Impeller Ø 135mm, Incl Eletronic fuel Injection pump	51065006408/ 6492/ 9492



			
<b>24-1298</b>	<b>24-1301</b>	<b>24-1302</b>	<b>24-1319</b>
			
<b>24-1321</b>	<b>24-1330</b>	<b>24-1336</b>	

		<b>METELLI</b> ref.			<b>NOTE</b>	<b>Adaptable for OES</b>
35.463 (338 kW) Eng.D2876LF02 35.464 (338 kW) Eng.D2876LF03	95-	<b>24-1301</b>			For vehicles with retarder; w/o pulley; Injection Pump with electronic control unit	51065006479/ 9479
	95-	<b>24-1302</b>			For vehicles with retarder, w/o pulley	51065006426/ 6490/ 9426/ 9490
	95-	<b>24-1319</b>			For vehicles with retarder, w pulley	51065006546/ 9546
	95-	<b>24-1321</b>			For vehicles without retarder, w pulley	51065006545/ 6547/ 9545/ 9547
	95-	<b>24-1330</b>		•		51065000298,51065006066/ 7033/ 7036 51065007043/ 7045/ 7047/ 7048/ 7051 51065007052/ 7065/ 7066/ 7088/ 7089 51065009045/ 9047/ 9048/ 9052/ 9066
37.414 (301 kW) Eng.D2866LF25	98-	<b>24-1298</b>			For vehicles without retarder, w/o pulley; Impeller Ø 135mm, Incl Eletronic fuel Injection pump	51065006408/ 6492/ 9492
	98-	<b>24-1301</b>			For vehicles with retarder; w/o pulley; Injection Pump with electronic control unit	51065006479/ 9479
	98-	<b>24-1302</b>			For vehicles with retarder, w/o pulley	51065006426/ 6490/ 9426/ 9490
	98-	<b>24-1319</b>			For vehicles with retarder, w pulley	51065006546/ 9546
	98-	<b>24-1321</b>			For vehicles without retarder, w pulley	51065006545/ 6547/ 9545/ 9547
	98-	<b>24-1330</b>		•		51065000298,51065006066/ 7033/ 7036 51065007043/ 7045/ 7047/ 7048/ 7051 51065007052/ 7065/ 7066/ 7088/ 7089 51065009045/ 9047/ 9048/ 9052/ 9066
37.464 (338 kW) Eng.D2876LF03	98-	<b>24-1298</b>			For vehicles without retarder, w/o pulley; Impeller Ø 135mm, Incl Eletronic fuel Injection pump	51065006408/ 6492/ 9492
	98-	<b>24-1301</b>			For vehicles with retarder; w/o pulley; Injection Pump with electronic control unit	51065006479/ 9479
	98-	<b>24-1302</b>			For vehicles with retarder, w/o pulley	51065006426/ 6490/ 9426/ 9490
	98-	<b>24-1319</b>			For vehicles with retarder, w pulley	51065006546/ 9546
	98-	<b>24-1321</b>			For vehicles without retarder, w pulley	51065006545/ 6547/ 9545/ 9547
	98-	<b>24-1330</b>		•		51065000298,51065006066/ 7033/ 7036 51065007043/ 7045/ 7047/ 7048/ 7051 51065007052/ 7065/ 7066/ 7088/ 7089 51065009045/ 9047/ 9048/ 9052/ 9066
40.273 (198 kW) Eng.D2865LF22	94-	<b>24-1298</b>			For vehicles without retarder, w/o pulley; Impeller Ø 135mm, Incl Eletronic fuel Injection pump	51065006408/ 6492/ 9492
	94-	<b>24-1301</b>			For vehicles with retarder; w/o pulley; Injection Pump with electronic control unit	51065006479/ 9479
	94-	<b>24-1302</b>			For vehicles with retarder, w/o pulley	51065006426/ 6490/ 9426/ 9490
	94-	<b>24-1319</b>			For vehicles with retarder, w pulley	51065006546/ 9546
	94-	<b>24-1321</b>			For vehicles without retarder, w pulley	51065006545/ 6547/ 9545/ 9547
	94-	<b>24-1336</b>			w/ Pulley	51065006548/ 9548
40.403 (294 kW) Eng.D2866LF20	94-	<b>24-1298</b>			For vehicles without retarder, w/o pulley; Impeller Ø 135mm, Incl Eletronic fuel Injection pump	51065006408/ 6492/ 9492
	94-	<b>24-1301</b>			For vehicles with retarder; w/o pulley; Injection Pump with electronic control unit	51065006479/ 9479
	94-	<b>24-1302</b>			For vehicles with retarder, w/o pulley	51065006426/ 6490/ 9426/ 9490
	94-	<b>24-1319</b>			For vehicles with retarder, w pulley	51065006546/ 9546
	94-	<b>24-1321</b>			For vehicles without retarder, w pulley	51065006545/ 6547/ 9545/ 9547
	94-	<b>24-1330</b>		•		51065000298,51065006066/ 7033/ 7036 51065007043/ 7045/ 7047/ 7048/ 7051 51065007052/ 7065/ 7066/ 7088/ 7089 51065009045/ 9047/ 9048/ 9052/ 9066
40.463 (338 kW) Eng.D2876LF01	94-	<b>24-1298</b>			For vehicles without retarder, w/o pulley; Impeller Ø 135mm, Incl Eletronic fuel Injection pump	51065006408/ 6492/ 9492
	94-	<b>24-1301</b>			For vehicles with retarder; w/o pulley; Injection Pump with electronic control unit	51065006479/ 9479
	94-	<b>24-1302</b>			For vehicles with retarder, w/o pulley	51065006426/ 6490/ 9426/ 9490
	94-	<b>24-1319</b>			For vehicles with retarder, w pulley	51065006546/ 9546
	94-	<b>24-1321</b>			For vehicles without retarder, w pulley	51065006545/ 6547/ 9545/ 9547
	94-	<b>24-1330</b>		•		51065000298,51065006066/ 7033/ 7036 51065007043/ 7045/ 7047/ 7048/ 7051 51065007052/ 7065/ 7066/ 7088/ 7089 51065009045/ 9047/ 9048/ 9052/ 9066
41.343 (250 kW) Eng.D2865LF21	95-	<b>24-1298</b>			For vehicles without retarder, w/o pulley; Impeller Ø 135mm, Incl Eletronic fuel Injection pump	51065006408/ 6492/ 9492
	95-	<b>24-1301</b>			For vehicles with retarder; w/o pulley; Injection Pump with electronic control unit	51065006479/ 9479
	95-	<b>24-1302</b>			For vehicles with retarder, w/o pulley	51065006426/ 6490/ 9426/ 9490
	95-	<b>24-1319</b>			For vehicles with retarder, w pulley	51065006546/ 9546
	95-	<b>24-1321</b>			For vehicles without retarder, w pulley	51065006545/ 6547/ 9545/ 9547
	95-	<b>24-1336</b>			w/ Pulley	51065006548/ 9548
41.403 (294 kW) Eng.D2866LF20	95-	<b>24-1298</b>			For vehicles without retarder, w/o pulley; Impeller Ø 135mm, Incl Eletronic fuel Injection pump	51065006408/ 6492/ 9492

			
<b>24-1292</b>	<b>24-1294</b>	<b>24-1298</b>	<b>24-1301</b>
			
<b>24-1302</b>	<b>24-1319</b>	<b>24-1321</b>	<b>24-1330</b>
			
<b>24-1336</b>			

		<b>METELLI ref.</b>			<b>NOTE</b>	<b>Adaptable for OES</b>
41.403 (294 kW) Eng.D2866LF20	95-	<b>24-1301</b>			For vehicles with retarder; w/o pulley; Injection Pump with electronic control unit	51065006479/ 9479
	95-	<b>24-1302</b>			For vehicles with retarder, w/o pulley	51065006426/ 6490/ 9426/ 9490
	95-	<b>24-1319</b>			For vehicles with retarder, w pulley	51065006546/ 9546
	95-	<b>24-1321</b>			For vehicles without retarder, w pulley	51065006545/ 6547/ 9545/ 9547
	95-	<b>24-1330</b>		•		51065000298,51065006066/ 7033/ 7036 51065007043/ 7045/ 7047/ 7048/ 7051 51065007052/ 7065/ 7066/ 7088/ 7089 51065009045/ 9047/ 9048/ 9052/ 9066
41.463 (338 kW) Eng.D2876LF02 41.464 (338 kW) Eng.D2876LF06	95-	<b>24-1298</b>			For vehicles without retarder, w/o pulley; Impeller Ø 135mm, Incl Eletronic fuel Injection pump	51065006408/ 6492/ 9492
	95-	<b>24-1301</b>			For vehicles with retarder; w/o pulley; Injection Pump with electronic control unit	51065006479/ 9479
	95-	<b>24-1302</b>			For vehicles with retarder, w/o pulley	51065006426/ 6490/ 9426/ 9490
	95-	<b>24-1319</b>			For vehicles with retarder, w pulley	51065006546/ 9546
	95-	<b>24-1321</b>			For vehicles without retarder, w pulley	51065006545/ 6547/ 9545/ 9547
	95-	<b>24-1330</b>		•		51065000298,51065006066/ 7033/ 7036 51065007043/ 7045/ 7047/ 7048/ 7051 51065007052/ 7065/ 7066/ 7088/ 7089 51065009045/ 9047/ 9048/ 9052/ 9066
<b>F 9 '1/83-'12/86</b>						
15.192 (141 kW) Eng.D2565MF	83-86	<b>24-1292</b>			For vehicles without retarder	51065006204/ 6213/ 6214/ 6215/ 6216/ 6218 51065006219/ 6221/ 6222/ 6223/ 6224/ 6225 51065006228/ 6229/ 9228
<b>F 90 '1/87-'6/96</b>						
18.3 (245-268 kW) Eng.D2840ME/MF/MH	80-96	<b>24-1298</b>			For vehicles without retarder, w/o pulley; Impeller Ø 135mm, Incl Eletronic fuel Injection pump	51065006408/ 6492/ 9492
	80-96	<b>24-1302</b>			For vehicles with retarder, w/o pulley	51065006426/ 6490/ 9426/ 9490
19.242 (177 kW) Eng.D2866F/240	88-89	<b>24-1294</b>			For vehicles without retarder; Impeller Ø 125mm	51065006282/ 6387/ 9282/ 9387
	88-89	<b>24-1298</b>			For vehicles without retarder, w/o pulley; Impeller Ø 135mm, Incl Eletronic fuel Injection pump	51065006408/ 6492/ 9492
	88-89	<b>24-1301</b>			For vehicles with retarder; w/o pulley; Injection Pump with electronic control unit	51065006479/ 9479
	88-89	<b>24-1302</b>			For vehicles with retarder, w/o pulley	51065006426/ 6490/ 9426/ 9490
	88-89	<b>24-1319</b>			For vehicles with retarder, w pulley	51065006546/ 9546
	88-89	<b>24-1321</b>			For vehicles without retarder, w pulley	51065006545/ 6547/ 9545/ 9547
19.262 (191 kW) Eng.D2865LF/260	89-90	<b>24-1298</b>			For vehicles without retarder, w/o pulley; Impeller Ø 135mm, Incl Eletronic fuel Injection pump	51065006408/ 6492/ 9492
	89-90	<b>24-1301</b>			For vehicles with retarder; w/o pulley; Injection Pump with electronic control unit	51065006479/ 9479
	89-90	<b>24-1302</b>			For vehicles with retarder, w/o pulley	51065006426/ 6490/ 9426/ 9490
	89-90	<b>24-1319</b>			For vehicles with retarder, w pulley	51065006546/ 9546
	89-90	<b>24-1321</b>			For vehicles without retarder, w pulley	51065006545/ 6547/ 9545/ 9547
	89-90	<b>24-1336</b>			w/ Pulley	51065006548/ 9548
19.272 (198 kW) Eng.D2865LF02	90-95	<b>24-1298</b>			For vehicles without retarder, w/o pulley; Impeller Ø 135mm, Incl Eletronic fuel Injection pump	51065006408/ 6492/ 9492
	90-95	<b>24-1301</b>			For vehicles with retarder; w/o pulley; Injection Pump with electronic control unit	51065006479/ 9479
	90-95	<b>24-1302</b>			For vehicles with retarder, w/o pulley	51065006426/ 6490/ 9426/ 9490
	90-95	<b>24-1319</b>			For vehicles with retarder, w pulley	51065006546/ 9546
	90-95	<b>24-1321</b>			For vehicles without retarder, w pulley	51065006545/ 6547/ 9545/ 9547
	90-95	<b>24-1336</b>			w/ Pulley	51065006548/ 9548
19.272 (198 kW) Eng.D2865LF05	86-90	<b>24-1298</b>			For vehicles without retarder, w/o pulley; Impeller Ø 135mm, Incl Eletronic fuel Injection pump	51065006408/ 6492/ 9492
	90-95	<b>24-1301</b>			For vehicles with retarder; w/o pulley; Injection Pump with electronic control unit	51065006479/ 9479
	90-95	<b>24-1302</b>			For vehicles with retarder, w/o pulley	51065006426/ 6490/ 9426/ 9490
	90-95	<b>24-1319</b>			For vehicles with retarder, w pulley	51065006546/ 9546
	90-95	<b>24-1321</b>			For vehicles without retarder, w pulley	51065006545/ 6547/ 9545/ 9547
	90-95	<b>24-1336</b>			w/ Pulley	51065006548/ 9548
19.292 (213 kW) Eng.D2866LF/290	86-90	<b>24-1294</b>			For vehicles without retarder; Impeller Ø 125mm	51065006282/ 6387/ 9282/ 9387
	90-96	<b>24-1298</b>			For vehicles without retarder, w/o pulley; Impeller Ø 135mm, Incl Eletronic fuel Injection pump	51065006408/ 6492/ 9492
	86-90	<b>24-1301</b>			For vehicles with retarder; w/o pulley; Injection Pump with electronic control unit	51065006479/ 9479
	86-90	<b>24-1302</b>			For vehicles with retarder, w/o pulley	51065006426/ 6490/ 9426/ 9490
	86-90	<b>24-1319</b>			For vehicles with retarder, w pulley	51065006546/ 9546
	86-90	<b>24-1321</b>			For vehicles without retarder, w pulley	51065006545/ 6547/ 9545/ 9547

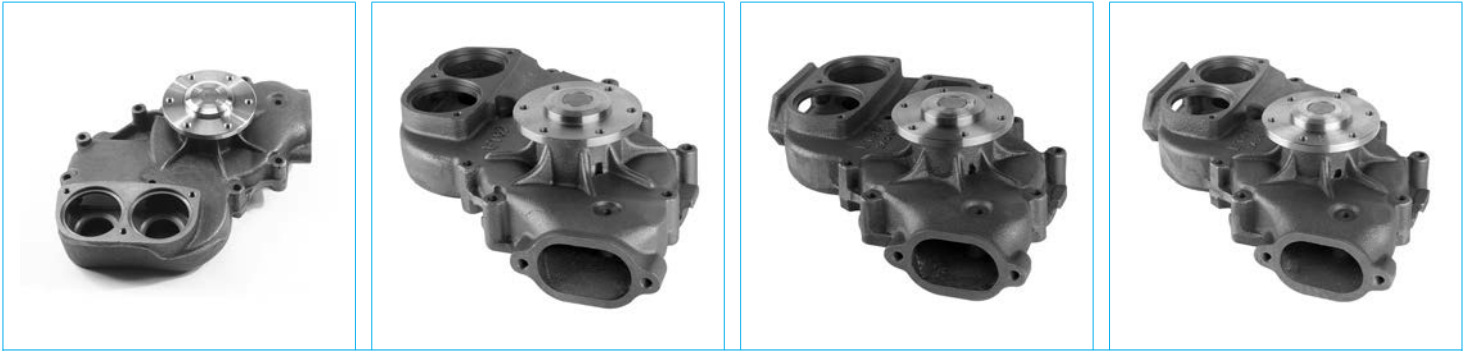

**24-1294**

**24-1298**

**24-1301**

**24-1302**

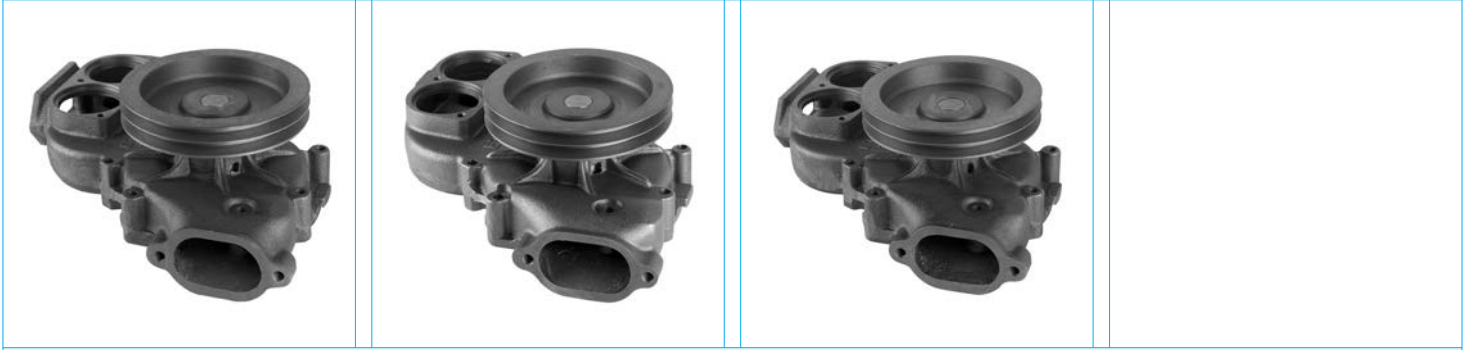

**24-1319**

**24-1321**

**24-1336**

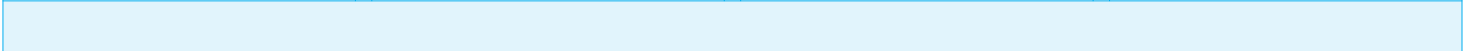
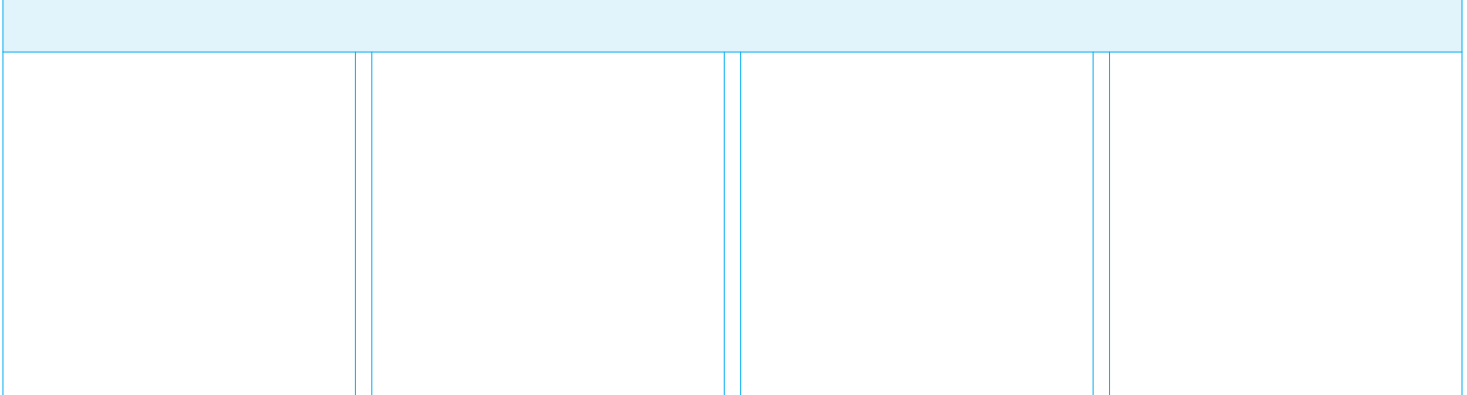
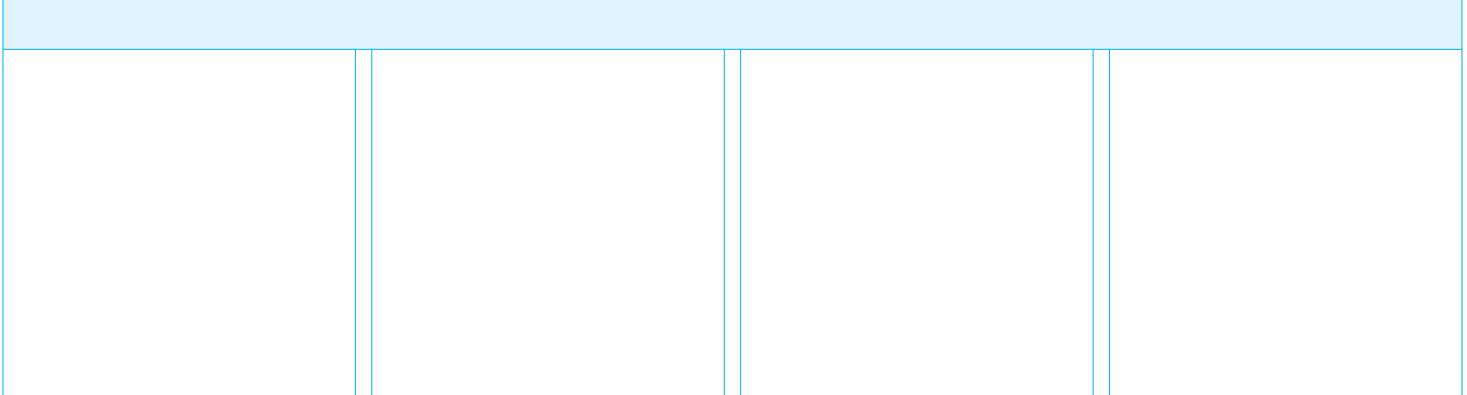
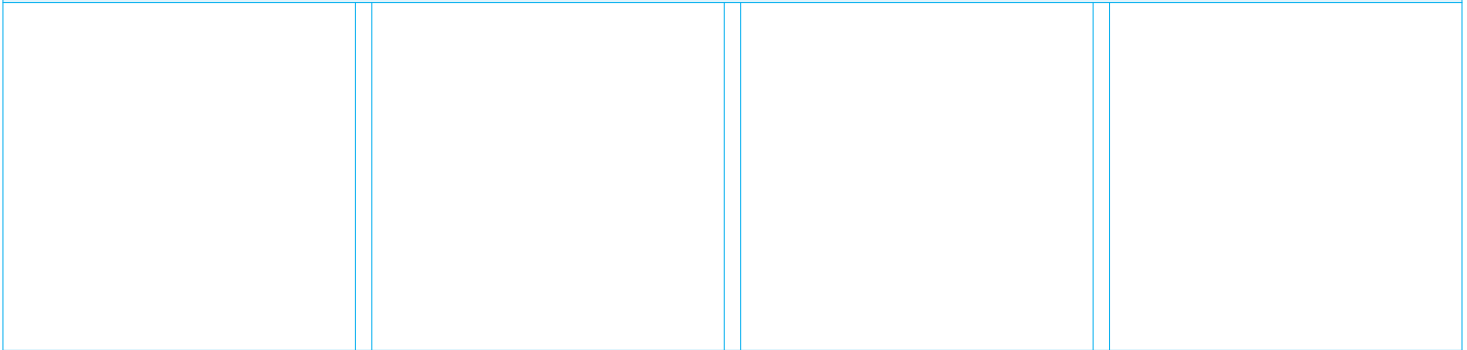

		<b>METELLI</b> ref.			<b>NOTE</b>	<b>Adaptable for OES</b>
19.292 (213 kW) Eng.D2866LF/290	86-90	<b>24-1336</b>			w/ Pulley	51065006548/ 9548
19.322 (235 kW) Eng.D2865LF03/LF06	90-96	<b>24-1298</b>			For vehicles without retarder, w/o pulley; Impeller Ø 135mm, Incl Electronic fuel Injection pump	51065006408/ 6492/ 9492
	90-96	<b>24-1301</b>			For vehicles with retarder; w/o pulley; Injection Pump with electronic control unit	51065006479/ 9479
	90-96	<b>24-1302</b>			For vehicles with retarder, w/o pulley	51065006426/ 6490/ 9426/ 9490
	90-96	<b>24-1319</b>			For vehicles with retarder, w pulley	51065006546/ 9546
	90-96	<b>24-1321</b>			For vehicles without retarder, w pulley	51065006545/ 6547/ 9545/ 9547
	90-96	<b>24-1336</b>			w/ Pulley	51065006548/ 9548
19.332 (243 kW) Eng.D2866LF/330	86-90	<b>24-1294</b>			For vehicles without retarder; Impeller Ø 125mm	51065006282/ 6387/ 9282/ 9387
	86-90	<b>24-1298</b>			For vehicles without retarder, w/o pulley; Impeller Ø 135mm, Incl Electronic fuel Injection pump	51065006408/ 6492/ 9492
	86-90	<b>24-1301</b>			For vehicles with retarder; w/o pulley; Injection Pump with electronic control unit	51065006479/ 9479
	86-90	<b>24-1302</b>			For vehicles with retarder, w/o pulley	51065006426/ 6490/ 9426/ 9490
	86-90	<b>24-1319</b>			For vehicles with retarder, w pulley	51065006546/ 9546
	94-96	<b>24-1321</b>			For vehicles without retarder, w pulley	51065006545/ 6547/ 9545/ 9547
	86-90	<b>24-1336</b>			w/ Pulley	51065006548/ 9548
19.342 (250-213 kW) Eng.D2865LF09	94-96	<b>24-1298</b>			For vehicles without retarder, w/o pulley; Impeller Ø 135mm, Incl Electronic fuel Injection pump	51065006408/ 6492/ 9492
	94-96	<b>24-1301</b>			For vehicles with retarder; w/o pulley; Injection Pump with electronic control unit	51065006479/ 9479
	94-96	<b>24-1302</b>			For vehicles with retarder, w/o pulley	51065006426/ 6490/ 9426/ 9490
	94-96	<b>24-1319</b>			For vehicles with retarder, w pulley	51065006546/ 9546
	86-90	<b>24-1321</b>			For vehicles without retarder, w pulley	51065006545/ 6547/ 9545/ 9547
	94-96	<b>24-1336</b>			w/ Pulley	51065006548/ 9548
19.362 (265 kW) Eng.D2866KF/LXF	86-90	<b>24-1294</b>			For vehicles without retarder; Impeller Ø 125mm	51065006282/ 6387/ 9282/ 9387
	86-90	<b>24-1298</b>			For vehicles without retarder, w/o pulley; Impeller Ø 135mm, Incl Electronic fuel Injection pump	51065006408/ 6492/ 9492
	86-90	<b>24-1301</b>			For vehicles with retarder; w/o pulley; Injection Pump with electronic control unit	51065006479/ 9479
	86-90	<b>24-1302</b>			For vehicles with retarder, w/o pulley	51065006426/ 6490/ 9426/ 9490
	86-90	<b>24-1319</b>			For vehicles with retarder, w pulley	51065006546/ 9546
	94-96	<b>24-1321</b>			For vehicles without retarder, w pulley	51065006545/ 6547/ 9545/ 9547
	86-90	<b>24-1336</b>			w/ Pulley	51065006548/ 9548
19.372 (249-265 kW) Eng.D2866LXF	90-95	<b>24-1294</b>			For vehicles without retarder; Impeller Ø 125mm	51065006282/ 6387/ 9282/ 9387
	90-95	<b>24-1298</b>			For vehicles without retarder, w/o pulley; Impeller Ø 135mm, Incl Electronic fuel Injection pump	51065006408/ 6492/ 9492
	90-95	<b>24-1301</b>			For vehicles with retarder; w/o pulley; Injection Pump with electronic control unit	51065006479/ 9479
	90-95	<b>24-1302</b>			For vehicles with retarder, w/o pulley	51065006426/ 6490/ 9426/ 9490
	90-95	<b>24-1319</b>			For vehicles with retarder, w pulley	51065006546/ 9546
	90-95	<b>24-1321</b>			For vehicles without retarder, w pulley	51065006545/ 6547/ 9545/ 9547
	90-95	<b>24-1336</b>			w/ Pulley	51065006548/ 9548
19.372 (272 kW) Eng.D2866LF03	90-96	<b>24-1294</b>			For vehicles without retarder; Impeller Ø 125mm	51065006282/ 6387/ 9282/ 9387
	90-96	<b>24-1298</b>			For vehicles without retarder, w/o pulley; Impeller Ø 135mm, Incl Electronic fuel Injection pump	51065006408/ 6492/ 9492
	90-96	<b>24-1301</b>			For vehicles with retarder; w/o pulley; Injection Pump with electronic control unit	51065006479/ 9479
	90-96	<b>24-1302</b>			For vehicles with retarder, w/o pulley	51065006426/ 6490/ 9426/ 9490
	90-96	<b>24-1319</b>			For vehicles with retarder, w pulley	51065006546/ 9546
	90-96	<b>24-1321</b>			For vehicles without retarder, w pulley	51065006545/ 6547/ 9545/ 9547
	90-96	<b>24-1336</b>			w/ Pulley	51065006548/ 9548
19.372 (272 kW) Eng.D2866LF05	90-96	<b>24-1294</b>			For vehicles without retarder; Impeller Ø 125mm	51065006282/ 6387/ 9282/ 9387
	90-96	<b>24-1298</b>			For vehicles without retarder, w/o pulley; Impeller Ø 135mm, Incl Electronic fuel Injection pump	51065006408/ 6492/ 9492
	90-96	<b>24-1301</b>			For vehicles with retarder; w/o pulley; Injection Pump with electronic control unit	51065006479/ 9479
	90-96	<b>24-1302</b>			For vehicles with retarder, w/o pulley	51065006426/ 6490/ 9426/ 9490
	90-96	<b>24-1319</b>			For vehicles with retarder, w pulley	51065006546/ 9546
	90-96	<b>24-1321</b>			For vehicles without retarder, w pulley	51065006545/ 6547/ 9545/ 9547
	90-96	<b>24-1336</b>			w/ Pulley	51065006548/ 9548
19.372 (272 kW) Eng.D2866LF15	90-96	<b>24-1294</b>			For vehicles without retarder; Impeller Ø 125mm	51065006282/ 6387/ 9282/ 9387
	94-96	<b>24-1298</b>			For vehicles without retarder, w/o pulley; Impeller Ø 135mm, Incl Electronic fuel Injection pump	51065006408/ 6492/ 9492
	90-96	<b>24-1301</b>			For vehicles with retarder; w/o pulley; Injection Pump with electronic control unit	51065006479/ 9479
	90-96	<b>24-1302</b>			For vehicles with retarder, w/o pulley	51065006426/ 6490/ 9426/ 9490
	90-96	<b>24-1319</b>			For vehicles with retarder, w pulley	51065006546/ 9546

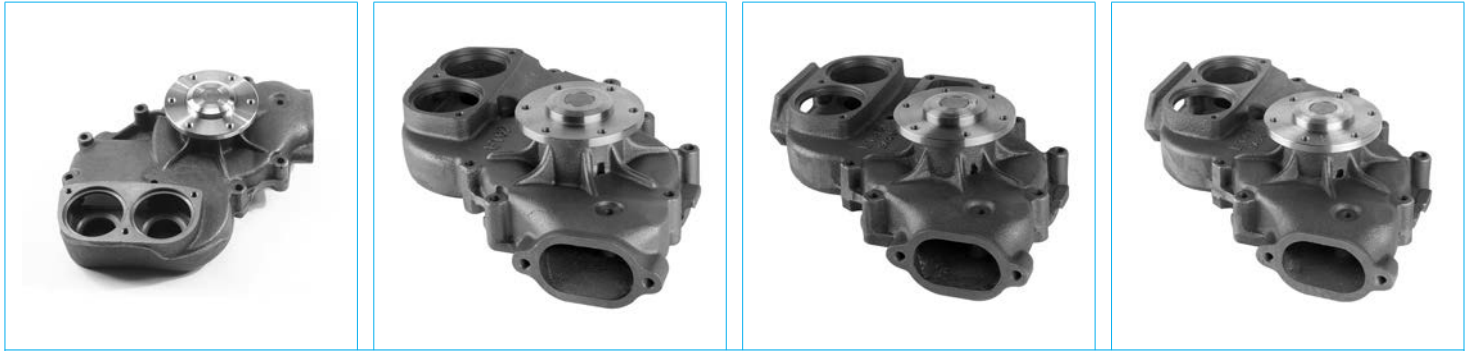

**24-1294**

**24-1298**

**24-1301**

**24-1302**

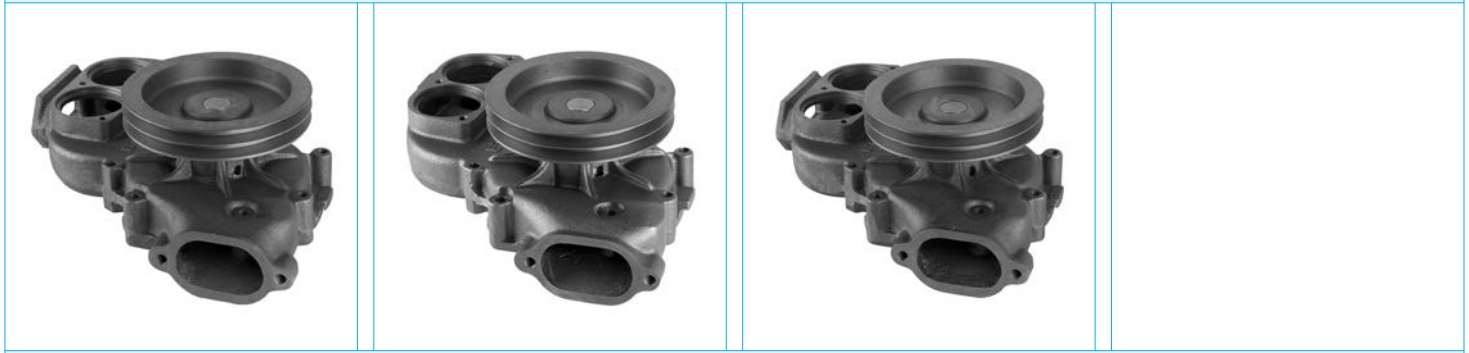



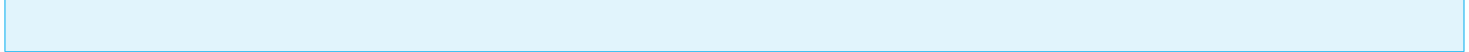
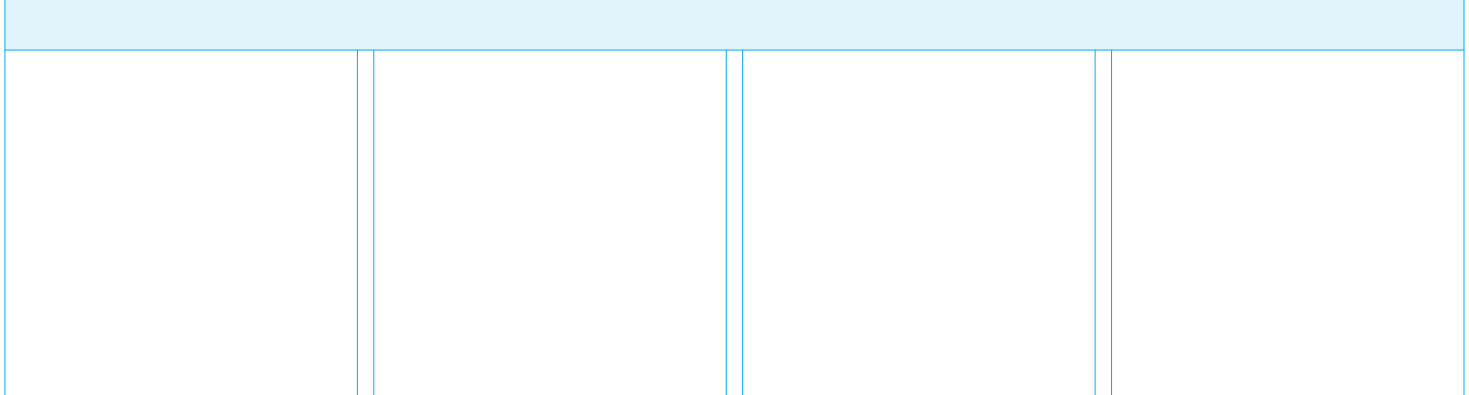
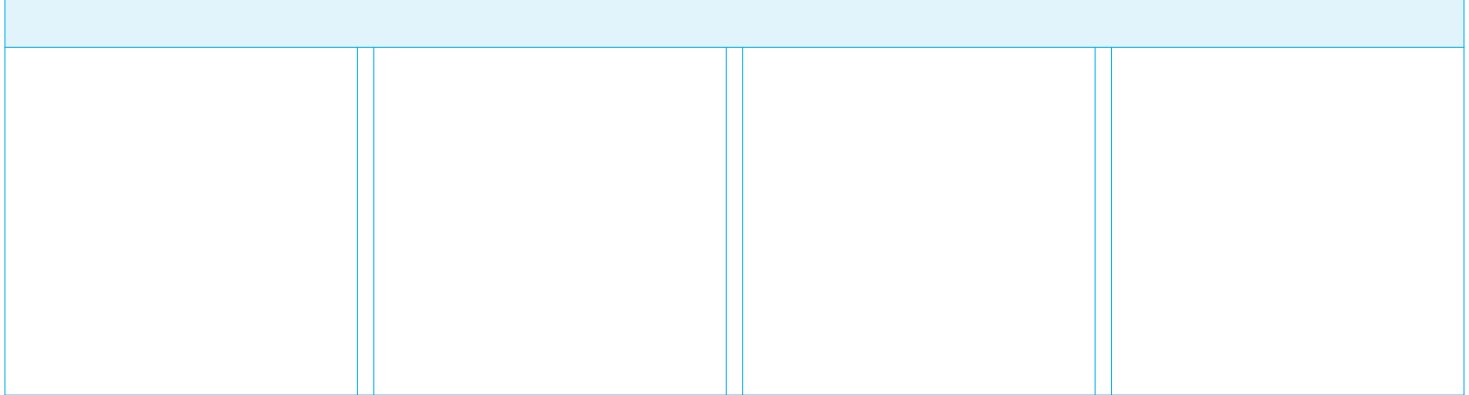
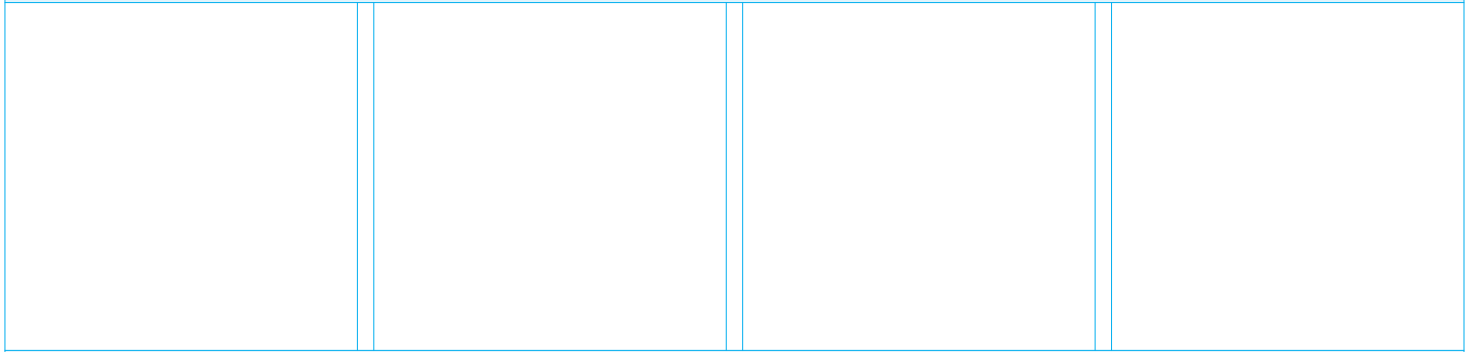

**24-1319**

**24-1321**

**24-1336**



		<b>METELLI</b> ref.			<b>NOTE</b>	<b>Adaptable for OES</b>
19.372 (272 kW) Eng.D2866LF15	90-96	<b>24-1321</b>			For vehicles without retarder, w pulley	51065006545/ 6547/ 9545/ 9547
	90-96	<b>24-1336</b>			w/ Pulley	51065006548/ 9548
19.402 (294 kW) Eng.D2866LF16	90-96	<b>24-1294</b>			For vehicles without retarder; Impeller Ø 125mm	51065006282/ 6387/ 9282/ 9387
	90-96	<b>24-1298</b>			For vehicles without retarder, w/o pulley; Impeller Ø 135mm, Incl Eletronic fuel Injection pump	51065006408/ 6492/ 9492
	94-96	<b>24-1301</b>			For vehicles with retarder; w/o pulley; Injection Pump with electronic control unit	51065006479/ 9479
	94-96	<b>24-1302</b>			For vehicles with retarder, w/o pulley	51065006426/ 6490/ 9426/ 9490
	94-96	<b>24-1319</b>			For vehicles with retarder, w pulley	51065006546/ 9546
	94-96	<b>24-1321</b>			For vehicles without retarder, w pulley	51065006545/ 6547/ 9545/ 9547
	94-96	<b>24-1336</b>			w/ Pulley	51065006548/ 9548
19.422 (309 kW) Eng.D2866LF06/LF09	90-96	<b>24-1294</b>			For vehicles without retarder; Impeller Ø 125mm	51065006282/ 6387/ 9282/ 9387
	90-96	<b>24-1298</b>			For vehicles without retarder, w/o pulley; Impeller Ø 135mm, Incl Eletronic fuel Injection pump	51065006408/ 6492/ 9492
	90-96	<b>24-1301</b>			For vehicles with retarder; w/o pulley; Injection Pump with electronic control unit	51065006479/ 9479
	90-96	<b>24-1302</b>			For vehicles with retarder, w/o pulley	51065006426/ 6490/ 9426/ 9490
	90-96	<b>24-1319</b>			For vehicles with retarder, w pulley	51065006546/ 9546
	90-96	<b>24-1321</b>			For vehicles without retarder, w pulley	51065006545/ 6547/ 9545/ 9547
	90-96	<b>24-1336</b>			w/ Pulley	51065006548/ 9548
19.422 (309 kW) Eng.D2866LF10	90-95	<b>24-1294</b>			For vehicles without retarder; Impeller Ø 125mm	51065006282/ 6387/ 9282/ 9387
	87-90	<b>24-1298</b>			For vehicles without retarder, w/o pulley; Impeller Ø 135mm, Incl Eletronic fuel Injection pump	51065006408/ 6492/ 9492
	90-95	<b>24-1301</b>			For vehicles with retarder; w/o pulley; Injection Pump with electronic control unit	51065006479/ 9479
	90-95	<b>24-1302</b>			For vehicles with retarder, w/o pulley	51065006426/ 6490/ 9426/ 9490
	90-95	<b>24-1319</b>			For vehicles with retarder, w pulley	51065006546/ 9546
	90-95	<b>24-1321</b>			For vehicles without retarder, w pulley	51065006545/ 6547/ 9545/ 9547
	90-95	<b>24-1336</b>			w/ Pulley	51065006548/ 9548
19.462 (338-382 kW) Eng.D2840LF/460	90-96	<b>24-1298</b>			For vehicles without retarder, w/o pulley; Impeller Ø 135mm, Incl Eletronic fuel Injection pump	51065006408/ 6492/ 9492
	87-90	<b>24-1302</b>			For vehicles with retarder, w/o pulley	51065006426/ 6490/ 9426/ 9490
19.502 (368 kW) Eng.D2840LF01	90-96	<b>24-1298</b>			For vehicles without retarder, w/o pulley; Impeller Ø 135mm, Incl Eletronic fuel Injection pump	51065006408/ 6492/ 9492
	90-96	<b>24-1302</b>			For vehicles with retarder, w/o pulley	51065006426/ 6490/ 9426/ 9490
19.502 (368 kW) Eng.D2840LF04/LF06	90-96	<b>24-1298</b>			For vehicles without retarder, w/o pulley; Impeller Ø 135mm, Incl Eletronic fuel Injection pump	51065006408/ 6492/ 9492
	90-96	<b>24-1302</b>			For vehicles with retarder, w/o pulley	51065006426/ 6490/ 9426/ 9490
21.9 T. (530-735 kW) Eng.D2840LF/LFX	90-96	<b>24-1298</b>			For vehicles without retarder, w/o pulley; Impeller Ø 135mm, Incl Eletronic fuel Injection pump	51065006408/ 6492/ 9492
	90-96	<b>24-1302</b>			For vehicles with retarder, w/o pulley	51065006426/ 6490/ 9426/ 9490
24.242 (177 kW) Eng.D2866F/240	88-90	<b>24-1294</b>			For vehicles without retarder; Impeller Ø 125mm	51065006282/ 6387/ 9282/ 9387
	88-90	<b>24-1298</b>			For vehicles without retarder, w/o pulley; Impeller Ø 135mm, Incl Eletronic fuel Injection pump	51065006408/ 6492/ 9492
	88-90	<b>24-1301</b>			For vehicles with retarder; w/o pulley; Injection Pump with electronic control unit	51065006479/ 9479
	88-90	<b>24-1302</b>			For vehicles with retarder, w/o pulley	51065006426/ 6490/ 9426/ 9490
	88-90	<b>24-1319</b>			For vehicles with retarder, w pulley	51065006546/ 9546
	88-90	<b>24-1321</b>			For vehicles without retarder, w pulley	51065006545/ 6547/ 9545/ 9547
24.262 (191 kW) Eng.D2865LF/260	88-90	<b>24-1298</b>			For vehicles without retarder, w/o pulley; Impeller Ø 135mm, Incl Eletronic fuel Injection pump	51065006408/ 6492/ 9492
	88-90	<b>24-1301</b>			For vehicles with retarder; w/o pulley; Injection Pump with electronic control unit	51065006479/ 9479
	88-90	<b>24-1302</b>			For vehicles with retarder, w/o pulley	51065006426/ 6490/ 9426/ 9490
	88-90	<b>24-1319</b>			For vehicles with retarder, w pulley	51065006546/ 9546
	88-90	<b>24-1321</b>			For vehicles without retarder, w pulley	51065006545/ 6547/ 9545/ 9547
	88-90	<b>24-1336</b>			w/ Pulley	51065006548/ 9548
24.272 (198 kW) Eng.D2865LF02/LF05	90-95	<b>24-1298</b>			For vehicles without retarder, w/o pulley; Impeller Ø 135mm, Incl Eletronic fuel Injection pump	51065006408/ 6492/ 9492
	90-95	<b>24-1301</b>			For vehicles with retarder; w/o pulley; Injection Pump with electronic control unit	51065006479/ 9479
	90-95	<b>24-1302</b>			For vehicles with retarder, w/o pulley	51065006426/ 6490/ 9426/ 9490
	90-95	<b>24-1319</b>			For vehicles with retarder, w pulley	51065006546/ 9546
	90-95	<b>24-1321</b>			For vehicles without retarder, w pulley	51065006545/ 6547/ 9545/ 9547
	90-95	<b>24-1336</b>			w/ Pulley	51065006548/ 9548
24.292 (213 kW) Eng.D2866LF/290	86-90	<b>24-1294</b>			For vehicles without retarder; Impeller Ø 125mm	51065006282/ 6387/ 9282/ 9387
	86-90	<b>24-1298</b>			For vehicles without retarder, w/o pulley; Impeller Ø 135mm, Incl Eletronic fuel Injection pump	51065006408/ 6492/ 9492



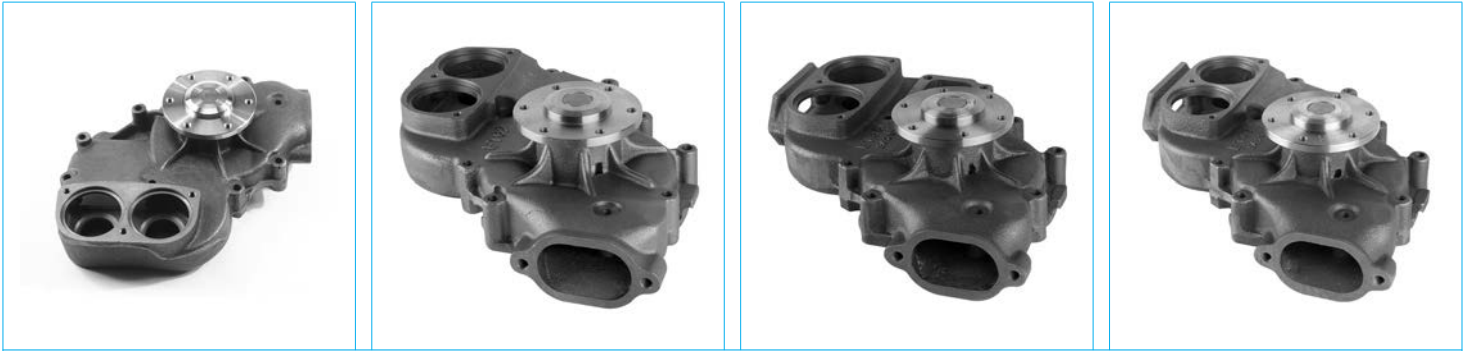

**24-1294**

**24-1298**

**24-1301**

**24-1302**





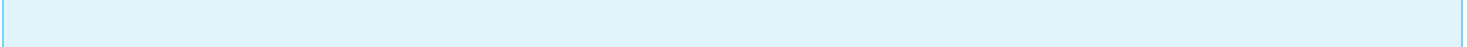
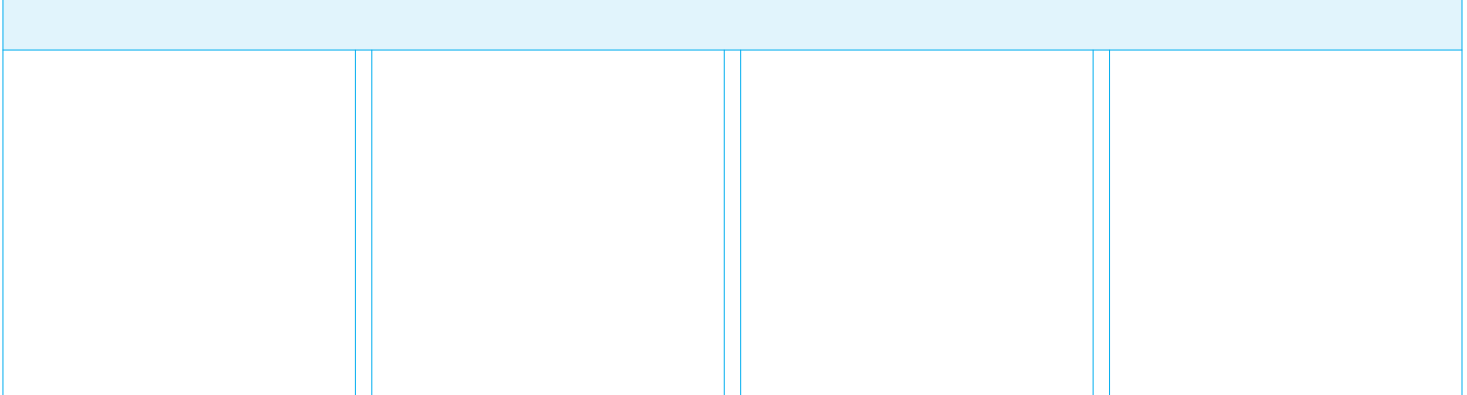
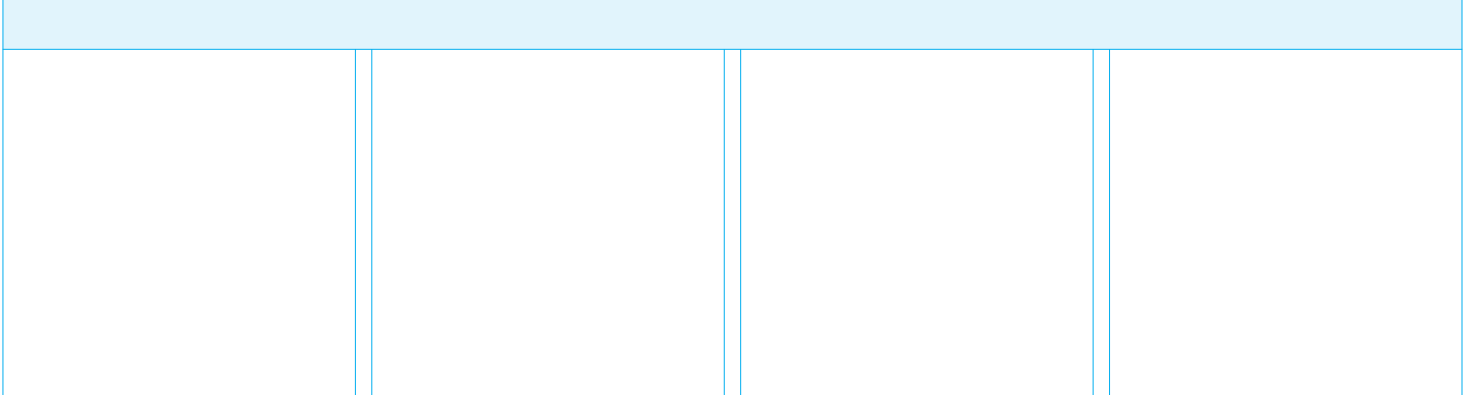
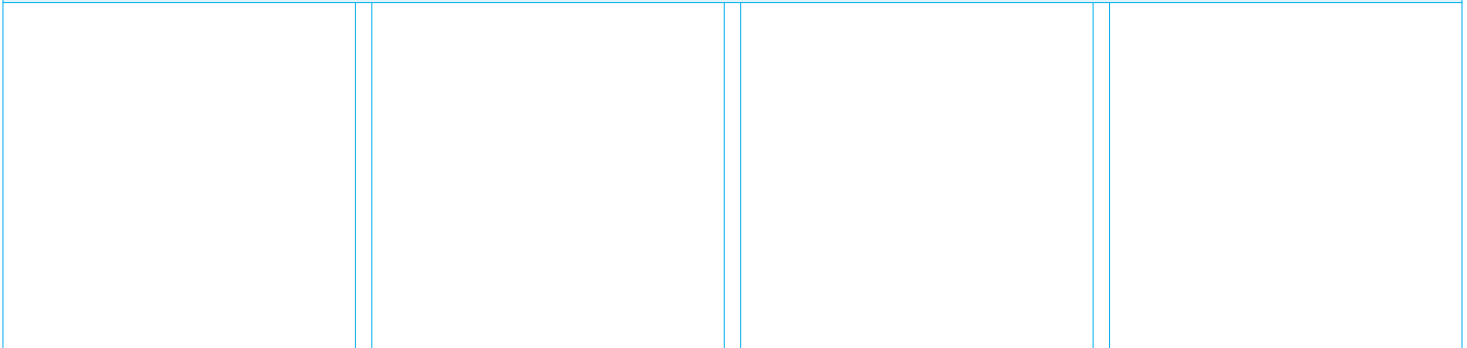

**24-1319**

**24-1321**

**24-1336**



		<b>METELLI</b> ref.			<b>NOTE</b>	<b>Adaptable for OES</b>
24.292 (213 kW) Eng.D2866LF/290	86-90	<b>24-1301</b>			For vehicles with retarder; w/o pulley; Injection Pump with electronic control unit	51065006479/ 9479
	86-90	<b>24-1302</b>			For vehicles with retarder, w/o pulley	51065006426/ 6490/ 9426/ 9490
	86-90	<b>24-1319</b>			For vehicles with retarder, w pulley	51065006546/ 9546
	86-90	<b>24-1321</b>			For vehicles without retarder, w pulley	51065006545/ 6547/ 9545/ 9547
	86-90	<b>24-1336</b>			w/ Pulley	51065006548/ 9548
24.302 (220 kW) Eng.D2866LF04	90-95	<b>24-1294</b>			For vehicles without retarder; Impeller Ø 125mm	51065006282/ 6387/ 9282/ 9387
	90-95	<b>24-1298</b>			For vehicles without retarder, w/o pulley; Impeller Ø 135mm, Incl Eletronic fuel Injection pump	51065006408/ 6492/ 9492
	90-95	<b>24-1301</b>			For vehicles with retarder; w/o pulley; Injection Pump with electronic control unit	51065006479/ 9479
	90-95	<b>24-1302</b>			For vehicles with retarder, w/o pulley	51065006426/ 6490/ 9426/ 9490
	90-95	<b>24-1319</b>			For vehicles with retarder, w pulley	51065006546/ 9546
	90-95	<b>24-1321</b>			For vehicles without retarder, w pulley	51065006545/ 6547/ 9545/ 9547
	90-95	<b>24-1336</b>			w/ Pulley	51065006548/ 9548
24.322 (235 kW) Eng.D2865LF03/LF06	90-95	<b>24-1298</b>			For vehicles without retarder, w/o pulley; Impeller Ø 135mm, Incl Eletronic fuel Injection pump	51065006408/ 6492/ 9492
	90-95	<b>24-1301</b>			For vehicles with retarder; w/o pulley; Injection Pump with electronic control unit	51065006479/ 9479
	90-95	<b>24-1302</b>			For vehicles with retarder, w/o pulley	51065006426/ 6490/ 9426/ 9490
	90-95	<b>24-1319</b>			For vehicles with retarder, w pulley	51065006546/ 9546
	90-95	<b>24-1321</b>			For vehicles without retarder, w pulley	51065006545/ 6547/ 9545/ 9547
	90-95	<b>24-1336</b>			w/ Pulley	51065006548/ 9548
24.332 (243 kW) Eng.D2866LF/330	86-90	<b>24-1294</b>			For vehicles without retarder; Impeller Ø 125mm	51065006282/ 6387/ 9282/ 9387
	86-90	<b>24-1298</b>			For vehicles without retarder, w/o pulley; Impeller Ø 135mm, Incl Eletronic fuel Injection pump	51065006408/ 6492/ 9492
	86-90	<b>24-1301</b>			For vehicles with retarder; w/o pulley; Injection Pump with electronic control unit	51065006479/ 9479
	86-90	<b>24-1302</b>			For vehicles with retarder, w/o pulley	51065006426/ 6490/ 9426/ 9490
	86-90	<b>24-1319</b>			For vehicles with retarder, w pulley	51065006546/ 9546
	86-90	<b>24-1321</b>			For vehicles without retarder, w pulley	51065006545/ 6547/ 9545/ 9547
	86-90	<b>24-1336</b>			w/ Pulley	51065006548/ 9548
	86-90	<b>24-1336</b>			w/ Pulley	51065006548/ 9548
24.342 (250-213 kW) Eng.D2865LF09	94-95	<b>24-1298</b>			For vehicles without retarder, w/o pulley; Impeller Ø 135mm, Incl Eletronic fuel Injection pump	51065006408/ 6492/ 9492
	94-95	<b>24-1301</b>			For vehicles with retarder; w/o pulley; Injection Pump with electronic control unit	51065006479/ 9479
	94-95	<b>24-1302</b>			For vehicles with retarder, w/o pulley	51065006426/ 6490/ 9426/ 9490
	94-95	<b>24-1319</b>			For vehicles with retarder, w pulley	51065006546/ 9546
	94-95	<b>24-1321</b>			For vehicles without retarder, w pulley	51065006545/ 6547/ 9545/ 9547
	94-95	<b>24-1336</b>			w/ Pulley	51065006548/ 9548
24.362 (265 kW) Eng.D2866KF/LXF	86-90	<b>24-1294</b>			For vehicles without retarder; Impeller Ø 125mm	51065006282/ 6387/ 9282/ 9387
	86-90	<b>24-1298</b>			For vehicles without retarder, w/o pulley; Impeller Ø 135mm, Incl Eletronic fuel Injection pump	51065006408/ 6492/ 9492
	86-90	<b>24-1301</b>			For vehicles with retarder; w/o pulley; Injection Pump with electronic control unit	51065006479/ 9479
	86-90	<b>24-1302</b>			For vehicles with retarder, w/o pulley	51065006426/ 6490/ 9426/ 9490
	86-90	<b>24-1319</b>			For vehicles with retarder, w pulley	51065006546/ 9546
	86-90	<b>24-1321</b>			For vehicles without retarder, w pulley	51065006545/ 6547/ 9545/ 9547
	86-90	<b>24-1336</b>			w/ Pulley	51065006548/ 9548
	86-90	<b>24-1336</b>			w/ Pulley	51065006548/ 9548
24.372 (249-265 kW) Eng.D2866LXF	05/90-12/90	<b>24-1294</b>			For vehicles without retarder; Impeller Ø 125mm	51065006282/ 6387/ 9282/ 9387
	05/90-12/90	<b>24-1298</b>			For vehicles without retarder, w/o pulley; Impeller Ø 135mm, Incl Eletronic fuel Injection pump	51065006408/ 6492/ 9492
	86-90	<b>24-1301</b>			For vehicles with retarder; w/o pulley; Injection Pump with electronic control unit	51065006479/ 9479
	05/90-12/90	<b>24-1302</b>			For vehicles with retarder, w/o pulley	51065006426/ 6490/ 9426/ 9490
	05/90-12/90	<b>24-1319</b>			For vehicles with retarder, w pulley	51065006546/ 9546
	05/90-12/90	<b>24-1321</b>			For vehicles without retarder, w pulley	51065006545/ 6547/ 9545/ 9547
	05/90-12/90	<b>24-1336</b>			w/ Pulley	51065006548/ 9548
	05/90-12/90	<b>24-1336</b>			w/ Pulley	51065006548/ 9548
24.372 (272 kW) Eng.D2866LF03	90-95	<b>24-1294</b>			For vehicles without retarder; Impeller Ø 125mm	51065006282/ 6387/ 9282/ 9387
	90-95	<b>24-1298</b>			For vehicles without retarder, w/o pulley; Impeller Ø 135mm, Incl Eletronic fuel Injection pump	51065006408/ 6492/ 9492
	86-90	<b>24-1301</b>			For vehicles with retarder; w/o pulley; Injection Pump with electronic control unit	51065006479/ 9479
	90-95	<b>24-1302</b>			For vehicles with retarder, w/o pulley	51065006426/ 6490/ 9426/ 9490
	90-95	<b>24-1319</b>			For vehicles with retarder, w pulley	51065006546/ 9546
	90-95	<b>24-1321</b>			For vehicles without retarder, w pulley	51065006545/ 6547/ 9545/ 9547
	90-95	<b>24-1336</b>			w/ Pulley	51065006548/ 9548
	90-95	<b>24-1336</b>			w/ Pulley	51065006548/ 9548
24.372 (272 kW) Eng.D2866LF15	90-95	<b>24-1294</b>			For vehicles without retarder; Impeller Ø 125mm	51065006282/ 6387/ 9282/ 9387

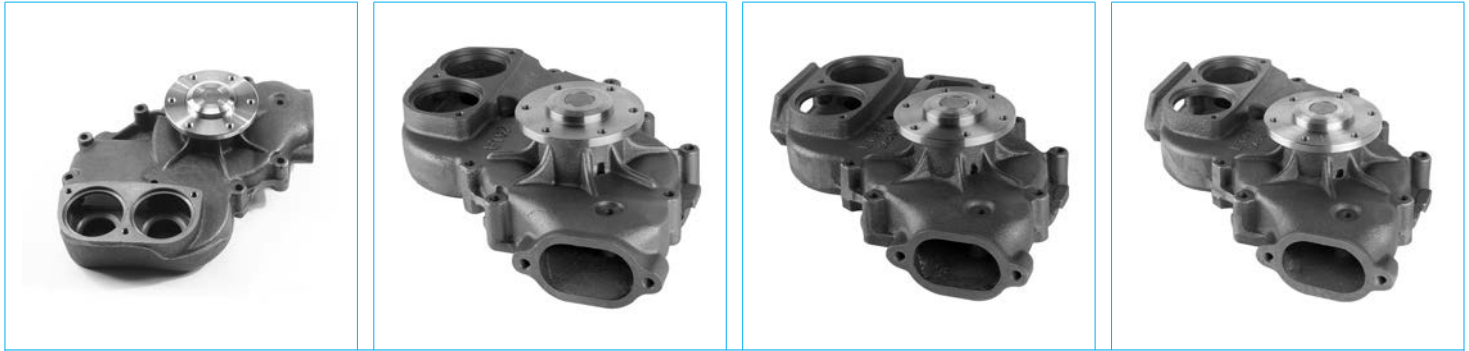

**24-1294**

**24-1298**

**24-1301**

**24-1302**

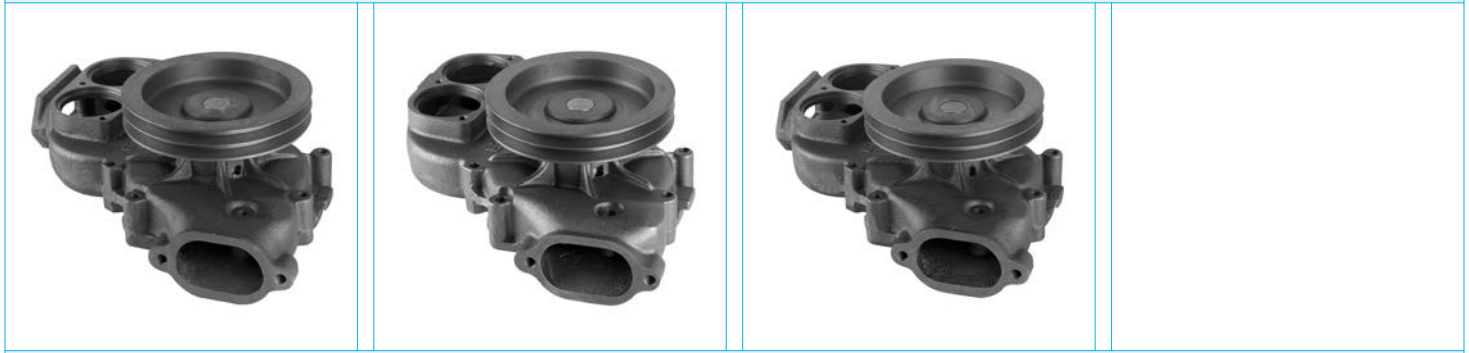

**24-1319**

**24-1321**

**24-1336**

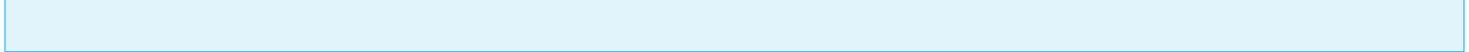
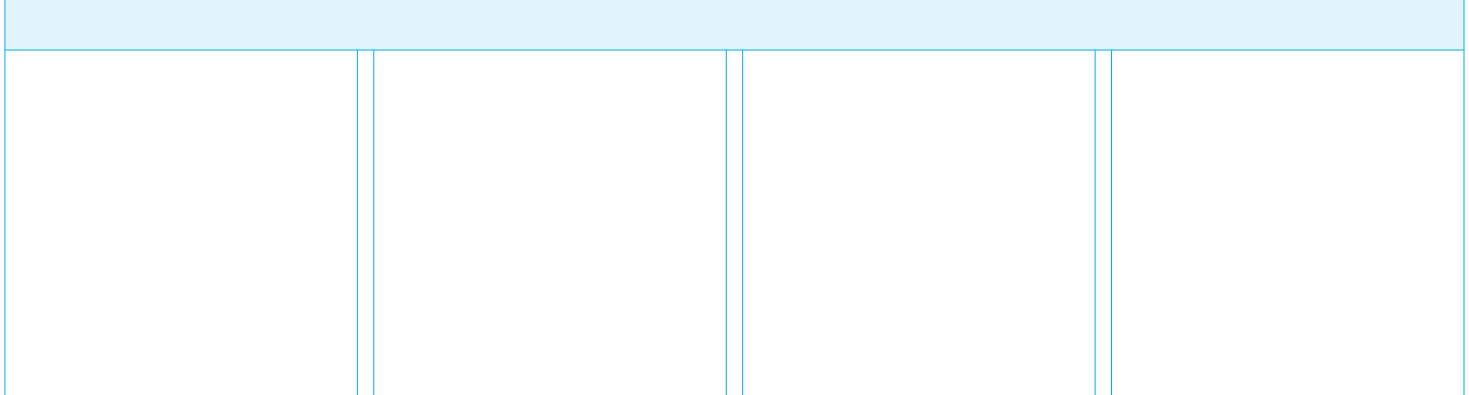
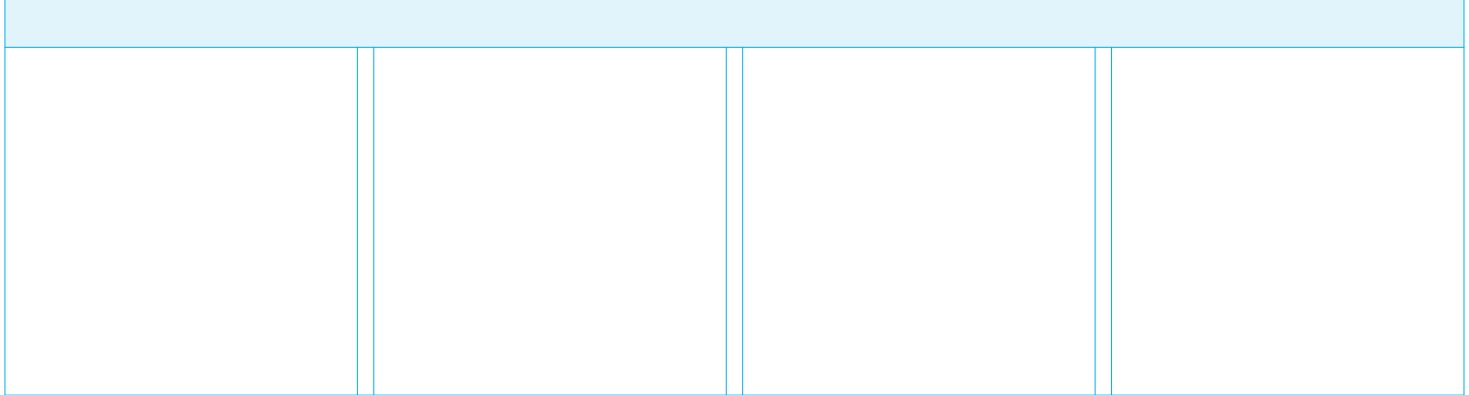
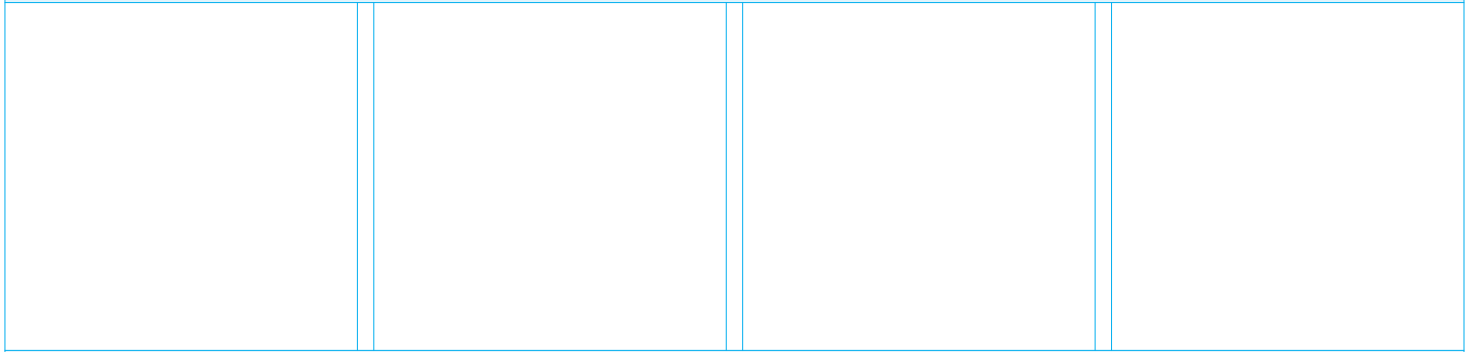

		<b>METELLI</b> ref.			<b>NOTE</b>	<b>Adaptable for OES</b>	
24.372 (272 kW) Eng.D2866LF15	90-95	<b>24-1298</b>			For vehicles without retarder, w/o pulley; Impeller Ø 135mm, Incl Eletronic fuel Injection pump	51065006408/ 6492/ 9492	
	05/90-12/90	<b>24-1301</b>			For vehicles with retarder; w/o pulley; Injection Pump with electronic control unit	51065006479/ 9479	
	90-95	<b>24-1302</b>			For vehicles with retarder, w/o pulley	51065006426/ 6490/ 9426/ 9490	
	90-95	<b>24-1319</b>			For vehicles with retarder, w pulley	51065006546/ 9546	
	90-95	<b>24-1321</b>			For vehicles without retarder, w pulley	51065006545/ 6547/ 9545/ 9547	
	90-95	<b>24-1336</b>			w/ Pulley	51065006548/ 9548	
24.402 (294 kW) Eng.D2866LF16	94-95	<b>24-1294</b>			For vehicles without retarder; Impeller Ø 125mm	51065006282/ 6387/ 9282/ 9387	
	94-95	<b>24-1298</b>			For vehicles without retarder, w/o pulley; Impeller Ø 135mm, Incl Eletronic fuel Injection pump	51065006408/ 6492/ 9492	
	90-95	<b>24-1301</b>			For vehicles with retarder; w/o pulley; Injection Pump with electronic control unit	51065006479/ 9479	
	94-95	<b>24-1302</b>			For vehicles with retarder, w/o pulley	51065006426/ 6490/ 9426/ 9490	
	94-95	<b>24-1319</b>			For vehicles with retarder, w pulley	51065006546/ 9546	
	94-95	<b>24-1321</b>			For vehicles without retarder, w pulley	51065006545/ 6547/ 9545/ 9547	
24.422 (309 kW) Eng.D2866LF06/LF09	90-95	<b>24-1294</b>			For vehicles without retarder; Impeller Ø 125mm	51065006282/ 6387/ 9282/ 9387	
	90-95	<b>24-1298</b>			For vehicles without retarder, w/o pulley; Impeller Ø 135mm, Incl Eletronic fuel Injection pump	51065006408/ 6492/ 9492	
	90-95	<b>24-1301</b>			For vehicles with retarder; w/o pulley; Injection Pump with electronic control unit	51065006479/ 9479	
	90-95	<b>24-1302</b>			For vehicles with retarder, w/o pulley	51065006426/ 6490/ 9426/ 9490	
	90-95	<b>24-1319</b>			For vehicles with retarder, w pulley	51065006546/ 9546	
	90-95	<b>24-1321</b>			For vehicles without retarder, w pulley	51065006545/ 6547/ 9545/ 9547	
24.462 (338-382 kW) Eng.D2840LF/460	89-90	<b>24-1298</b>			For vehicles without retarder, w/o pulley; Impeller Ø 135mm, Incl Eletronic fuel Injection pump	51065006408/ 6492/ 9492	
	89-90	<b>24-1302</b>			For vehicles with retarder, w/o pulley	51065006426/ 6490/ 9426/ 9490	
	24.502 (368 kW) Eng.D2840LF01	02/90-12/90	<b>24-1298</b>			For vehicles without retarder, w/o pulley; Impeller Ø 135mm, Incl Eletronic fuel Injection pump	51065006408/ 6492/ 9492
		02/90-12/90	<b>24-1302</b>			For vehicles with retarder, w/o pulley	51065006426/ 6490/ 9426/ 9490
	25.272 (198 kW) Eng.D2865LF02/LF05	90-93	<b>24-1298</b>			For vehicles without retarder, w/o pulley; Impeller Ø 135mm, Incl Eletronic fuel Injection pump	51065006408/ 6492/ 9492
		90-93	<b>24-1301</b>			For vehicles with retarder; w/o pulley; Injection Pump with electronic control unit	51065006479/ 9479
90-93		<b>24-1302</b>			For vehicles with retarder, w/o pulley	51065006426/ 6490/ 9426/ 9490	
90-93		<b>24-1319</b>			For vehicles with retarder, w pulley	51065006546/ 9546	
90-93		<b>24-1321</b>			For vehicles without retarder, w pulley	51065006545/ 6547/ 9545/ 9547	
90-93		<b>24-1336</b>			w/ Pulley	51065006548/ 9548	
25.302 (220 kW) Eng.D2866LF04	90-91	<b>24-1294</b>			For vehicles without retarder; Impeller Ø 125mm	51065006282/ 6387/ 9282/ 9387	
	90-91	<b>24-1298</b>			For vehicles without retarder, w/o pulley; Impeller Ø 135mm, Incl Eletronic fuel Injection pump	51065006408/ 6492/ 9492	
	90-91	<b>24-1301</b>			For vehicles with retarder; w/o pulley; Injection Pump with electronic control unit	51065006479/ 9479	
	90-91	<b>24-1302</b>			For vehicles with retarder, w/o pulley	51065006426/ 6490/ 9426/ 9490	
	90-91	<b>24-1319</b>			For vehicles with retarder, w pulley	51065006546/ 9546	
	90-91	<b>24-1321</b>			For vehicles without retarder, w pulley	51065006545/ 6547/ 9545/ 9547	
25.322 (235 kW) Eng.D2865LF03	90-92	<b>24-1298</b>			For vehicles without retarder, w/o pulley; Impeller Ø 135mm, Incl Eletronic fuel Injection pump	51065006408/ 6492/ 9492	
	90-92	<b>24-1301</b>			For vehicles with retarder; w/o pulley; Injection Pump with electronic control unit	51065006479/ 9479	
	90-92	<b>24-1302</b>			For vehicles with retarder, w/o pulley	51065006426/ 6490/ 9426/ 9490	
	90-92	<b>24-1319</b>			For vehicles with retarder, w pulley	51065006546/ 9546	
	90-92	<b>24-1321</b>			For vehicles without retarder, w pulley	51065006545/ 6547/ 9545/ 9547	
	90-92	<b>24-1336</b>			w/ Pulley	51065006548/ 9548	
25.322 (235 kW) Eng.D2865LF06	90-92	<b>24-1298</b>			For vehicles without retarder, w/o pulley; Impeller Ø 135mm, Incl Eletronic fuel Injection pump	51065006408/ 6492/ 9492	
	90-92	<b>24-1301</b>			For vehicles with retarder; w/o pulley; Injection Pump with electronic control unit	51065006479/ 9479	
	90-92	<b>24-1302</b>			For vehicles with retarder, w/o pulley	51065006426/ 6490/ 9426/ 9490	
	90-92	<b>24-1319</b>			For vehicles with retarder, w pulley	51065006546/ 9546	
	90-92	<b>24-1321</b>			For vehicles without retarder, w pulley	51065006545/ 6547/ 9545/ 9547	
	90-92	<b>24-1336</b>			w/ Pulley	51065006548/ 9548	
25.372 (249-265 kW) Eng.D2866LXF	90-93	<b>24-1294</b>			For vehicles without retarder; Impeller Ø 125mm	51065006282/ 6387/ 9282/ 9387	
	90-93	<b>24-1298</b>			For vehicles without retarder, w/o pulley; Impeller Ø 135mm, Incl Eletronic fuel Injection pump	51065006408/ 6492/ 9492	
	90-93	<b>24-1301</b>			For vehicles with retarder; w/o pulley; Injection Pump with electronic control unit	51065006479/ 9479	
	90-93	<b>24-1302</b>			For vehicles with retarder, w/o pulley	51065006426/ 6490/ 9426/ 9490	

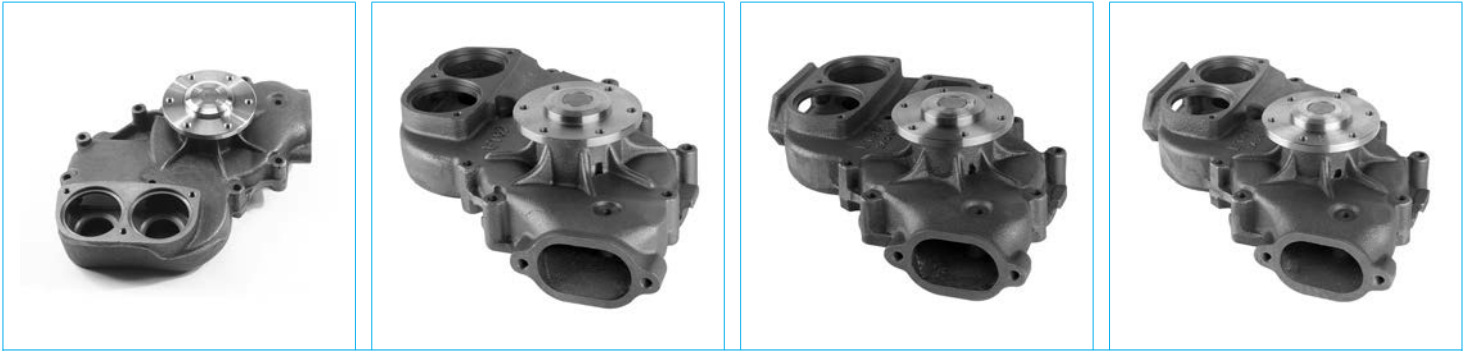

**24-1294**

**24-1298**

**24-1301**

**24-1302**

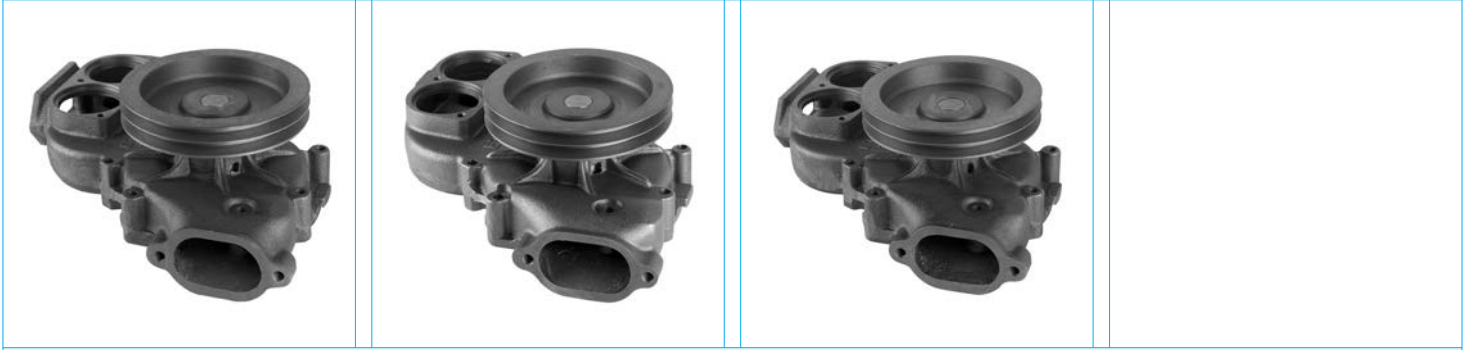



**24-1319**

**24-1321**

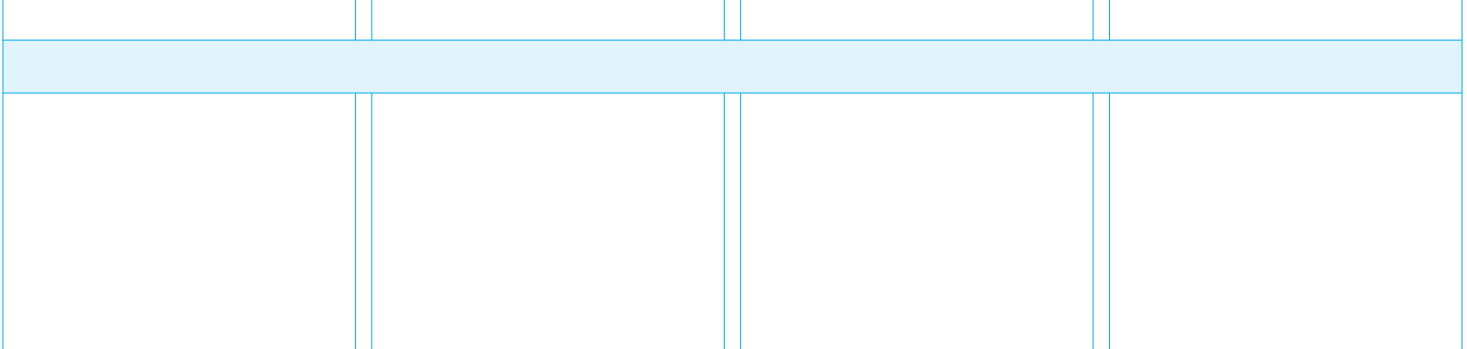
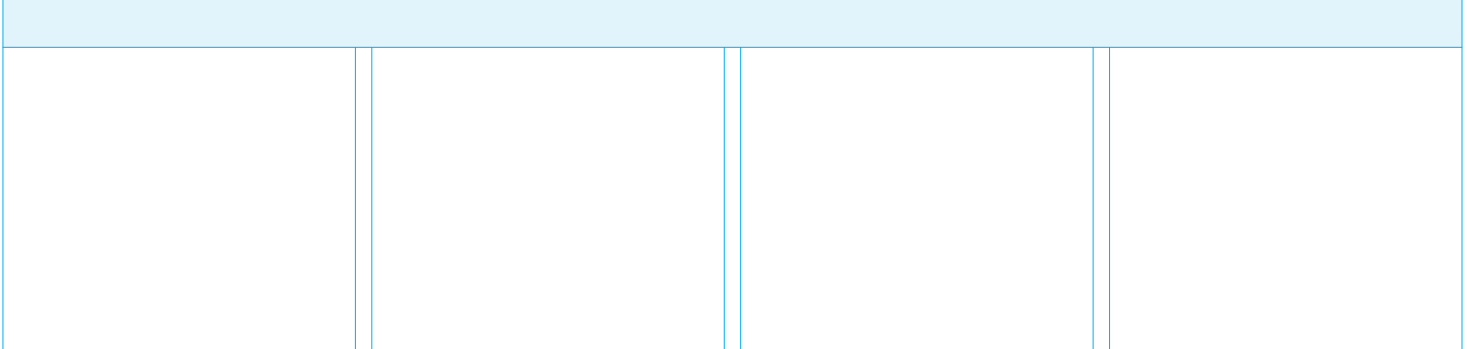
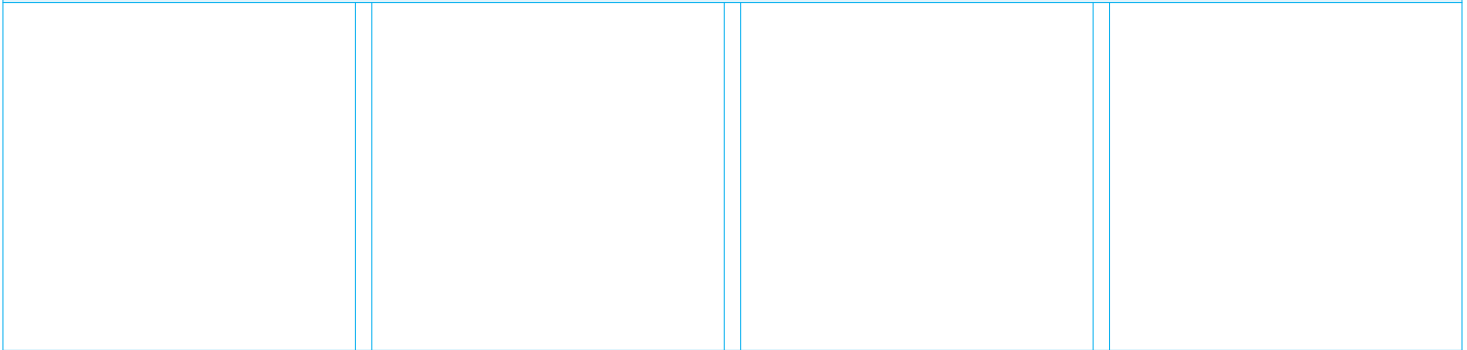
**24-1336**



		<b>METELLI</b> ref.		<b>NOTE</b>	<b>Adaptable for OES</b>
25.372 (249-265 kW) Eng.D2866LXF	90-93	<b>24-1319</b>		For vehicles with retarder, w pulley	51065006546/ 9546
	90-93	<b>24-1321</b>		For vehicles without retarder, w pulley	51065006545/ 6547/ 9545/ 9547
	90-93	<b>24-1336</b>		w/ Pulley	51065006548/ 9548
25.372 (272 kW) Eng.D2866LF03/LF05	90-93	<b>24-1294</b>		For vehicles without retarder; Impeller Ø 125mm	51065006282/ 6387/ 9282/ 9387
	90-93	<b>24-1298</b>		For vehicles without retarder, w/o pulley; Impeller Ø 135mm, Incl Eletronic fuel Injection pump	51065006408/ 6492/ 9492
	90-93	<b>24-1301</b>		For vehicles with retarder; w/o pulley; Injection Pump with electronic control unit	51065006479/ 9479
	90-93	<b>24-1302</b>		For vehicles with retarder, w/o pulley	51065006426/ 6490/ 9426/ 9490
	90-93	<b>24-1319</b>		For vehicles with retarder, w pulley	51065006546/ 9546
	90-93	<b>24-1321</b>		For vehicles without retarder, w pulley	51065006545/ 6547/ 9545/ 9547
	90-93	<b>24-1336</b>		w/ Pulley	51065006548/ 9548
25.422 (309 kW) Eng.D2866LF06/LF09	90-92	<b>24-1294</b>		For vehicles without retarder; Impeller Ø 125mm	51065006282/ 6387/ 9282/ 9387
	90-92	<b>24-1298</b>		For vehicles without retarder, w/o pulley; Impeller Ø 135mm, Incl Eletronic fuel Injection pump	51065006408/ 6492/ 9492
	90-92	<b>24-1301</b>		For vehicles with retarder; w/o pulley; Injection Pump with electronic control unit	51065006479/ 9479
	90-92	<b>24-1302</b>		For vehicles with retarder, w/o pulley	51065006426/ 6490/ 9426/ 9490
	90-92	<b>24-1319</b>		For vehicles with retarder, w pulley	51065006546/ 9546
	90-92	<b>24-1321</b>		For vehicles without retarder, w pulley	51065006545/ 6547/ 9545/ 9547
	90-92	<b>24-1336</b>		w/ Pulley	51065006548/ 9548
25.502 (368 kW) Eng.D2840LF01	90-92	<b>24-1298</b>		For vehicles without retarder, w/o pulley; Impeller Ø 135mm, Incl Eletronic fuel Injection pump	51065006408/ 6492/ 9492
	90-92	<b>24-1302</b>		For vehicles with retarder, w/o pulley	51065006426/ 6490/ 9426/ 9490
25.502 (368 kW) Eng.D2840LF04	90-92	<b>24-1298</b>		For vehicles without retarder, w/o pulley; Impeller Ø 135mm, Incl Eletronic fuel Injection pump	51065006408/ 6492/ 9492
	90-92	<b>24-1302</b>		For vehicles with retarder, w/o pulley	51065006426/ 6490/ 9426/ 9490
26.242 (177 kW) Eng.D2866F/240	88-89	<b>24-1294</b>		For vehicles without retarder; Impeller Ø 125mm	51065006282/ 6387/ 9282/ 9387
	88-89	<b>24-1298</b>		For vehicles without retarder, w/o pulley; Impeller Ø 135mm, Incl Eletronic fuel Injection pump	51065006408/ 6492/ 9492
	88-89	<b>24-1301</b>		For vehicles with retarder; w/o pulley; Injection Pump with electronic control unit	51065006479/ 9479
	88-89	<b>24-1302</b>		For vehicles with retarder, w/o pulley	51065006426/ 6490/ 9426/ 9490
	88-89	<b>24-1319</b>		For vehicles with retarder, w pulley	51065006546/ 9546
	88-89	<b>24-1321</b>		For vehicles without retarder, w pulley	51065006545/ 6547/ 9545/ 9547
26.262 (191 kW) Eng.D2865LF/260	88-90	<b>24-1298</b>		For vehicles without retarder, w/o pulley; Impeller Ø 135mm, Incl Eletronic fuel Injection pump	51065006408/ 6492/ 9492
	88-90	<b>24-1301</b>		For vehicles with retarder; w/o pulley; Injection Pump with electronic control unit	51065006479/ 9479
	88-90	<b>24-1302</b>		For vehicles with retarder, w/o pulley	51065006426/ 6490/ 9426/ 9490
	88-90	<b>24-1319</b>		For vehicles with retarder, w pulley	51065006546/ 9546
	88-90	<b>24-1321</b>		For vehicles without retarder, w pulley	51065006545/ 6547/ 9545/ 9547
	88-90	<b>24-1336</b>		w/ Pulley	51065006548/ 9548
26.272 (198 kW) Eng.D2865LF02	90-96	<b>24-1298</b>		For vehicles without retarder, w/o pulley; Impeller Ø 135mm, Incl Eletronic fuel Injection pump	51065006408/ 6492/ 9492
	90-96	<b>24-1301</b>		For vehicles with retarder; w/o pulley; Injection Pump with electronic control unit	51065006479/ 9479
	90-96	<b>24-1302</b>		For vehicles with retarder, w/o pulley	51065006426/ 6490/ 9426/ 9490
	90-96	<b>24-1319</b>		For vehicles with retarder, w pulley	51065006546/ 9546
	90-96	<b>24-1321</b>		For vehicles without retarder, w pulley	51065006545/ 6547/ 9545/ 9547
	90-96	<b>24-1336</b>		w/ Pulley	51065006548/ 9548
26.272 (198 kW) Eng.D2865LF05	90-96	<b>24-1298</b>		For vehicles without retarder, w/o pulley; Impeller Ø 135mm, Incl Eletronic fuel Injection pump	51065006408/ 6492/ 9492
	90-96	<b>24-1301</b>		For vehicles with retarder; w/o pulley; Injection Pump with electronic control unit	51065006479/ 9479
	90-96	<b>24-1302</b>		For vehicles with retarder, w/o pulley	51065006426/ 6490/ 9426/ 9490
	90-96	<b>24-1319</b>		For vehicles with retarder, w pulley	51065006546/ 9546
	90-96	<b>24-1321</b>		For vehicles without retarder, w pulley	51065006545/ 6547/ 9545/ 9547
	90-96	<b>24-1336</b>		w/ Pulley	51065006548/ 9548
26.292 (213 kW) Eng.D2866LF/290	87-90	<b>24-1294</b>		For vehicles without retarder; Impeller Ø 125mm	51065006282/ 6387/ 9282/ 9387
	87-90	<b>24-1298</b>		For vehicles without retarder, w/o pulley; Impeller Ø 135mm, Incl Eletronic fuel Injection pump	51065006408/ 6492/ 9492
	87-90	<b>24-1301</b>		For vehicles with retarder; w/o pulley; Injection Pump with electronic control unit	51065006479/ 9479
	87-90	<b>24-1302</b>		For vehicles with retarder, w/o pulley	51065006426/ 6490/ 9426/ 9490
	87-90	<b>24-1319</b>		For vehicles with retarder, w pulley	51065006546/ 9546
	87-90	<b>24-1321</b>		For vehicles without retarder, w pulley	51065006545/ 6547/ 9545/ 9547
	87-90	<b>24-1336</b>		w/ Pulley	51065006548/ 9548

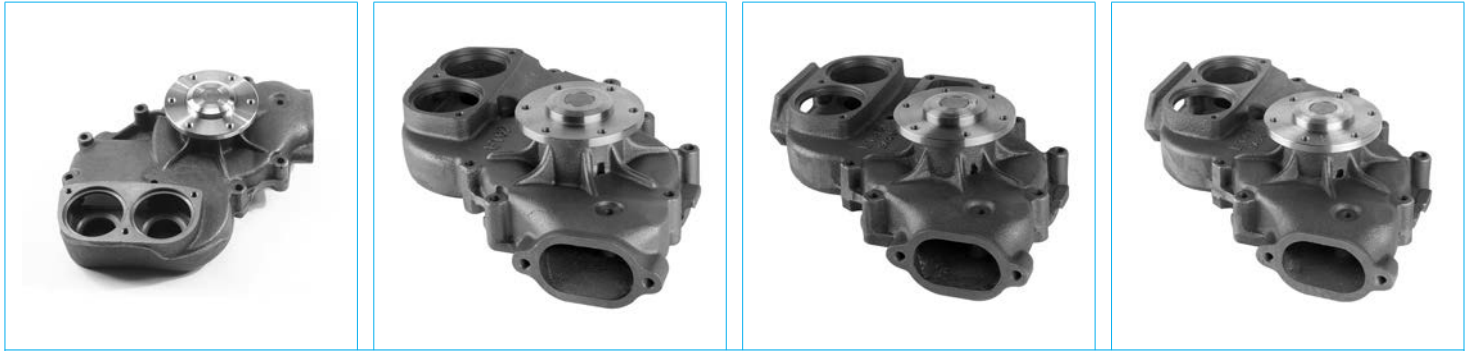

**24-1294**

**24-1298**

**24-1301**

**24-1302**

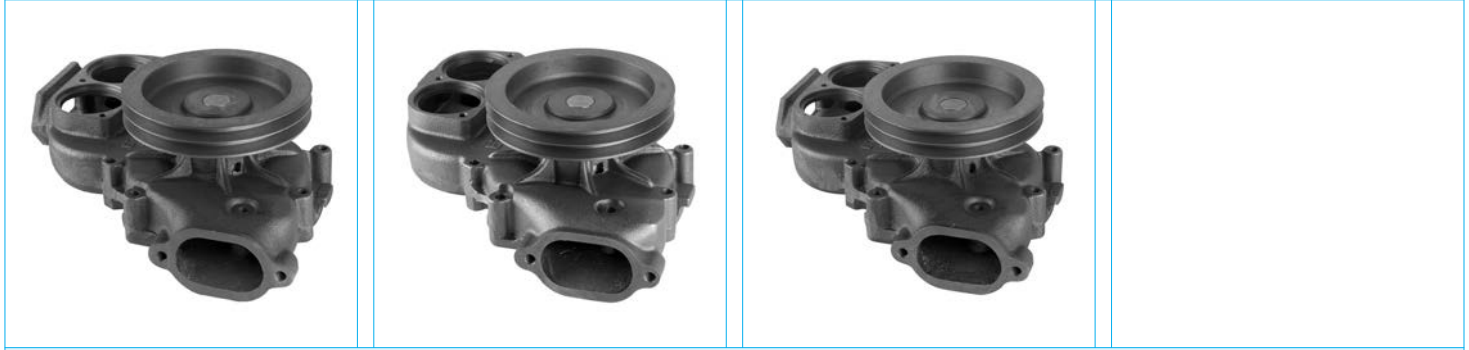



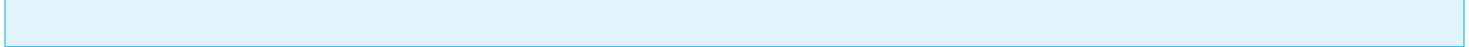
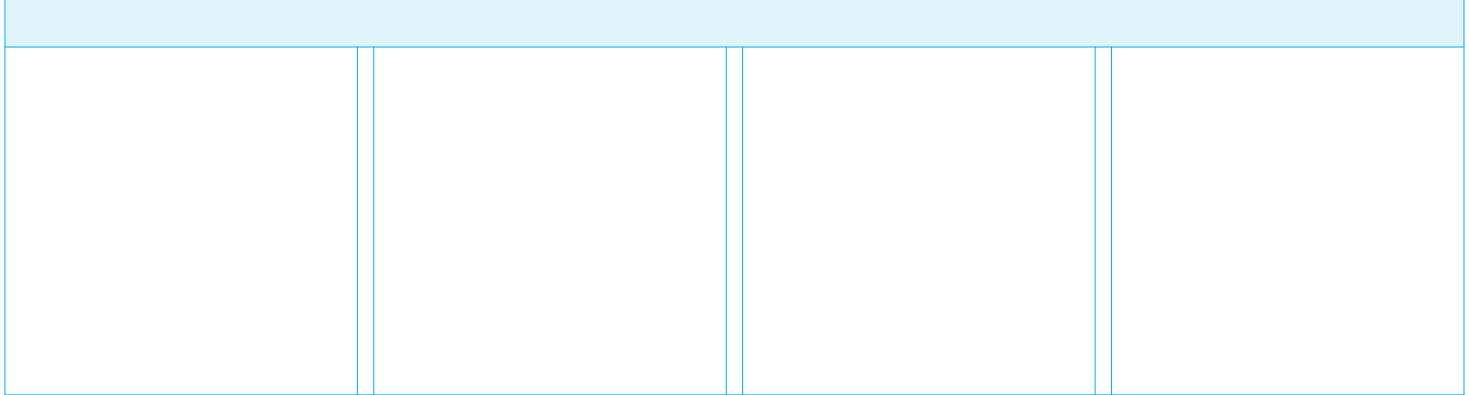
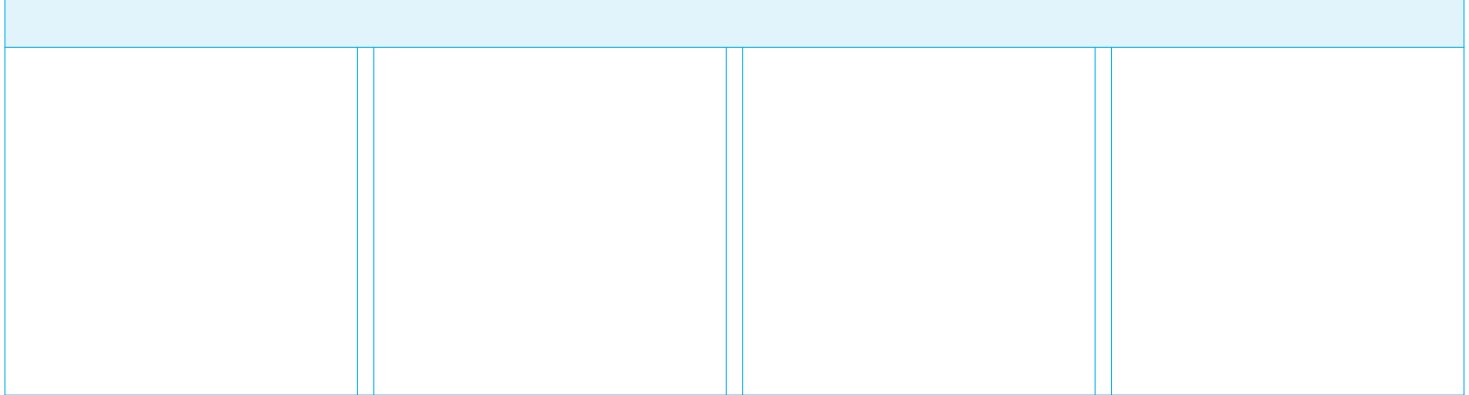
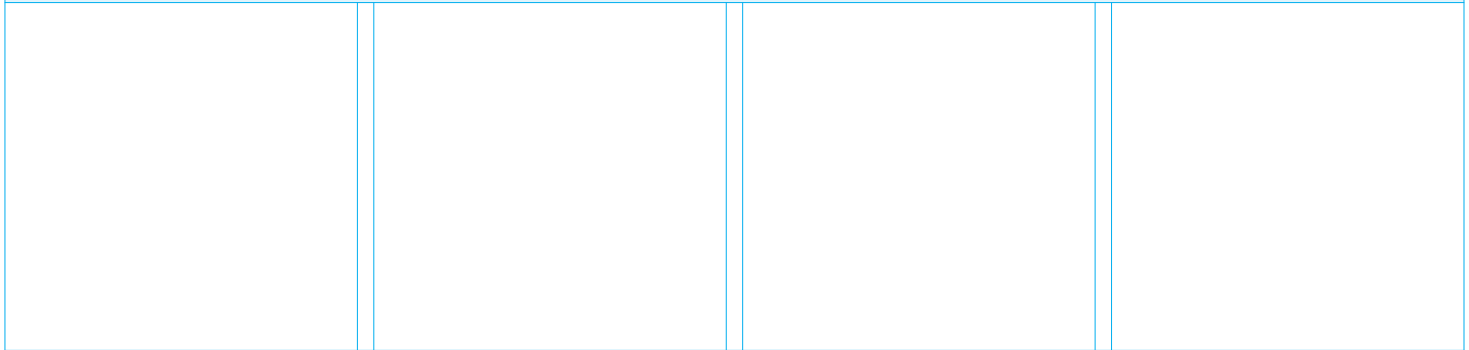

**24-1319**

**24-1321**

**24-1336**



		<b>METELLI</b> ref.	 	<b>NOTE</b>	<b>Adaptable for OES</b>
26.302 (220 kW) Eng.D2866LF04	90-91	<b>24-1294</b>		For vehicles without retarder; Impeller Ø 125mm	51065006282/ 6387/ 9282/ 9387
	90-91	<b>24-1298</b>		For vehicles without retarder, w/o pulley; Impeller Ø 135mm, Incl Electronic fuel Injection pump	51065006408/ 6492/ 9492
	90-91	<b>24-1301</b>		For vehicles with retarder; w/o pulley; Injection Pump with electronic control unit	51065006479/ 9479
	90-91	<b>24-1302</b>		For vehicles with retarder, w/o pulley	51065006426/ 6490/ 9426/ 9490
	90-91	<b>24-1319</b>		For vehicles with retarder, w pulley	51065006546/ 9546
	90-91	<b>24-1321</b>		For vehicles without retarder, w pulley	51065006545/ 6547/ 9545/ 9547
	90-91	<b>24-1336</b>		w/ Pulley	51065006548/ 9548
26.322 (235 kW) Eng.D2865LF03/LF06	90-96	<b>24-1298</b>		For vehicles without retarder, w/o pulley; Impeller Ø 135mm, Incl Electronic fuel Injection pump	51065006408/ 6492/ 9492
	90-96	<b>24-1301</b>		For vehicles with retarder; w/o pulley; Injection Pump with electronic control unit	51065006479/ 9479
	90-96	<b>24-1302</b>		For vehicles with retarder, w/o pulley	51065006426/ 6490/ 9426/ 9490
	90-96	<b>24-1319</b>		For vehicles with retarder, w pulley	51065006546/ 9546
	90-96	<b>24-1321</b>		For vehicles without retarder, w pulley	51065006545/ 6547/ 9545/ 9547
	90-96	<b>24-1336</b>		w/ Pulley	51065006548/ 9548
26.332 (243 kW) Eng.D2865LF/330	87-90	<b>24-1294</b>		For vehicles without retarder; Impeller Ø 125mm	51065006282/ 6387/ 9282/ 9387
	87-90	<b>24-1298</b>		For vehicles without retarder, w/o pulley; Impeller Ø 135mm, Incl Electronic fuel Injection pump	51065006408/ 6492/ 9492
	87-90	<b>24-1301</b>		For vehicles with retarder; w/o pulley; Injection Pump with electronic control unit	51065006479/ 9479
	87-90	<b>24-1302</b>		For vehicles with retarder, w/o pulley	51065006426/ 6490/ 9426/ 9490
	87-90	<b>24-1319</b>		For vehicles with retarder, w pulley	51065006546/ 9546
	87-90	<b>24-1321</b>		For vehicles without retarder, w pulley	51065006545/ 6547/ 9545/ 9547
	87-90	<b>24-1336</b>		w/ Pulley	51065006548/ 9548
26.342 (250-213 kW) Eng.D2865LF09	94-96	<b>24-1298</b>		For vehicles without retarder, w/o pulley; Impeller Ø 135mm, Incl Electronic fuel Injection pump	51065006408/ 6492/ 9492
	94-96	<b>24-1301</b>		For vehicles with retarder; w/o pulley; Injection Pump with electronic control unit	51065006479/ 9479
	94-96	<b>24-1302</b>		For vehicles with retarder, w/o pulley	51065006426/ 6490/ 9426/ 9490
	94-96	<b>24-1319</b>		For vehicles with retarder, w pulley	51065006546/ 9546
	94-96	<b>24-1321</b>		For vehicles without retarder, w pulley	51065006545/ 6547/ 9545/ 9547
	94-96	<b>24-1336</b>		w/ Pulley	51065006548/ 9548
26.362 (265 kW) Eng.D2866KF/LXF	87-90	<b>24-1294</b>		For vehicles without retarder; Impeller Ø 125mm	51065006282/ 6387/ 9282/ 9387
	87-90	<b>24-1298</b>		For vehicles without retarder, w/o pulley; Impeller Ø 135mm, Incl Electronic fuel Injection pump	51065006408/ 6492/ 9492
	87-90	<b>24-1301</b>		For vehicles with retarder; w/o pulley; Injection Pump with electronic control unit	51065006479/ 9479
	87-90	<b>24-1302</b>		For vehicles with retarder, w/o pulley	51065006426/ 6490/ 9426/ 9490
	87-90	<b>24-1319</b>		For vehicles with retarder, w pulley	51065006546/ 9546
	87-90	<b>24-1321</b>		For vehicles without retarder, w pulley	51065006545/ 6547/ 9545/ 9547
	87-90	<b>24-1336</b>		w/ Pulley	51065006548/ 9548
26.372 (272 kW) Eng.D2866LF03	90-96	<b>24-1294</b>		For vehicles without retarder; Impeller Ø 125mm	51065006282/ 6387/ 9282/ 9387
	90-96	<b>24-1298</b>		For vehicles without retarder, w/o pulley; Impeller Ø 135mm, Incl Electronic fuel Injection pump	51065006408/ 6492/ 9492
	90-96	<b>24-1301</b>		For vehicles with retarder; w/o pulley; Injection Pump with electronic control unit	51065006479/ 9479
	90-96	<b>24-1302</b>		For vehicles with retarder, w/o pulley	51065006426/ 6490/ 9426/ 9490
	90-96	<b>24-1319</b>		For vehicles with retarder, w pulley	51065006546/ 9546
	90-96	<b>24-1321</b>		For vehicles without retarder, w pulley	51065006545/ 6547/ 9545/ 9547
	90-96	<b>24-1336</b>		w/ Pulley	51065006548/ 9548
26.372 (272 kW) Eng.D2866LF05	90-96	<b>24-1294</b>		For vehicles without retarder; Impeller Ø 125mm	51065006282/ 6387/ 9282/ 9387
	90-96	<b>24-1298</b>		For vehicles without retarder, w/o pulley; Impeller Ø 135mm, Incl Electronic fuel Injection pump	51065006408/ 6492/ 9492
	90-96	<b>24-1301</b>		For vehicles with retarder; w/o pulley; Injection Pump with electronic control unit	51065006479/ 9479
	90-96	<b>24-1302</b>		For vehicles with retarder, w/o pulley	51065006426/ 6490/ 9426/ 9490
	90-96	<b>24-1319</b>		For vehicles with retarder, w pulley	51065006546/ 9546
	90-96	<b>24-1321</b>		For vehicles without retarder, w pulley	51065006545/ 6547/ 9545/ 9547
	90-96	<b>24-1336</b>		w/ Pulley	51065006548/ 9548
26.372 (272 kW) Eng.D2866LF15	90-96	<b>24-1294</b>		For vehicles without retarder; Impeller Ø 125mm	51065006282/ 6387/ 9282/ 9387
	90-96	<b>24-1298</b>		For vehicles without retarder, w/o pulley; Impeller Ø 135mm, Incl Electronic fuel Injection pump	51065006408/ 6492/ 9492
	90-96	<b>24-1301</b>		For vehicles with retarder; w/o pulley; Injection Pump with electronic control unit	51065006479/ 9479
	90-96	<b>24-1302</b>		For vehicles with retarder, w/o pulley	51065006426/ 6490/ 9426/ 9490
	90-96	<b>24-1319</b>		For vehicles with retarder, w pulley	51065006546/ 9546
	90-96	<b>24-1321</b>		For vehicles without retarder, w pulley	51065006545/ 6547/ 9545/ 9547



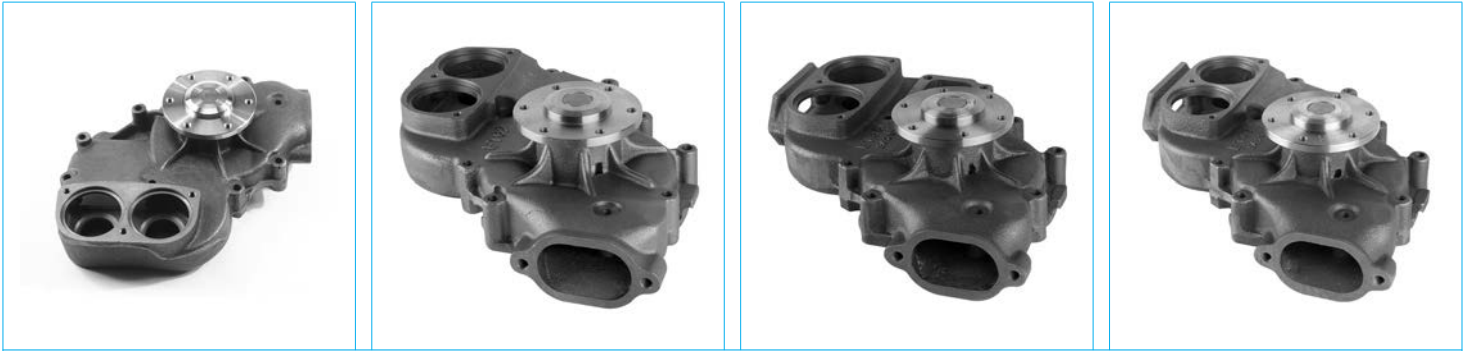

**24-1294**

**24-1298**

**24-1301**

**24-1302**

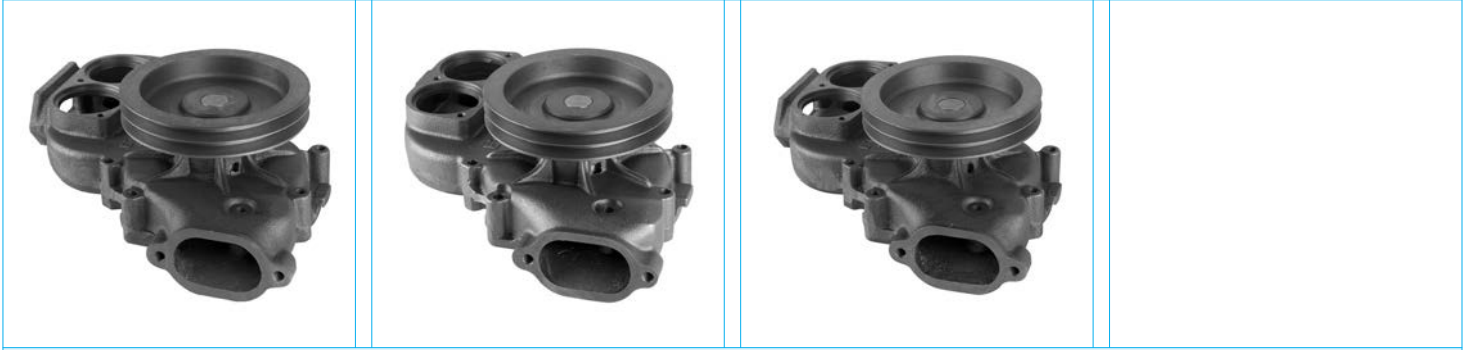

**24-1319**

**24-1321**

**24-1336**

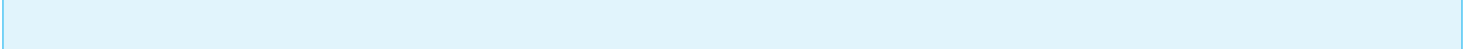
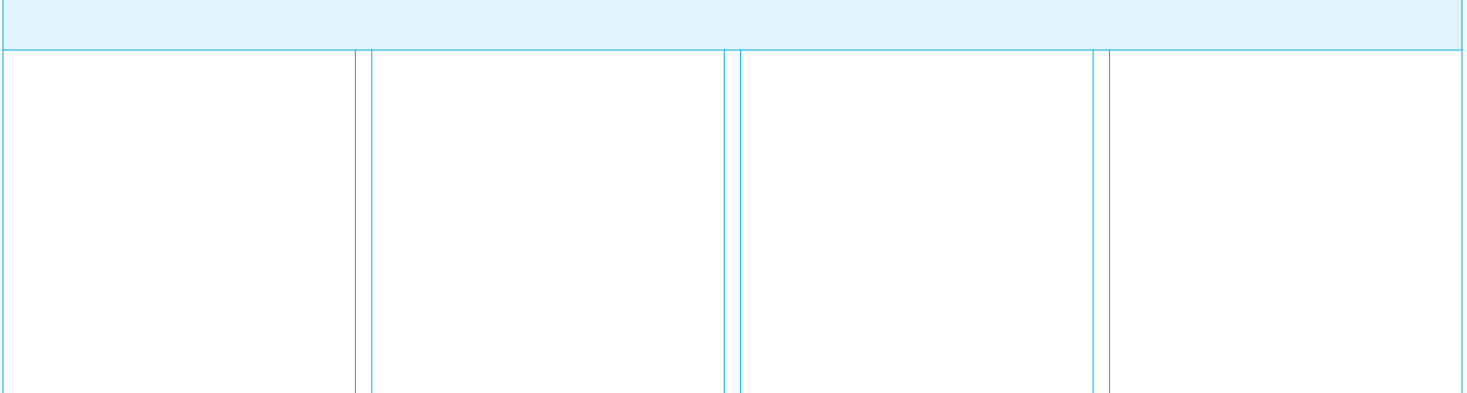
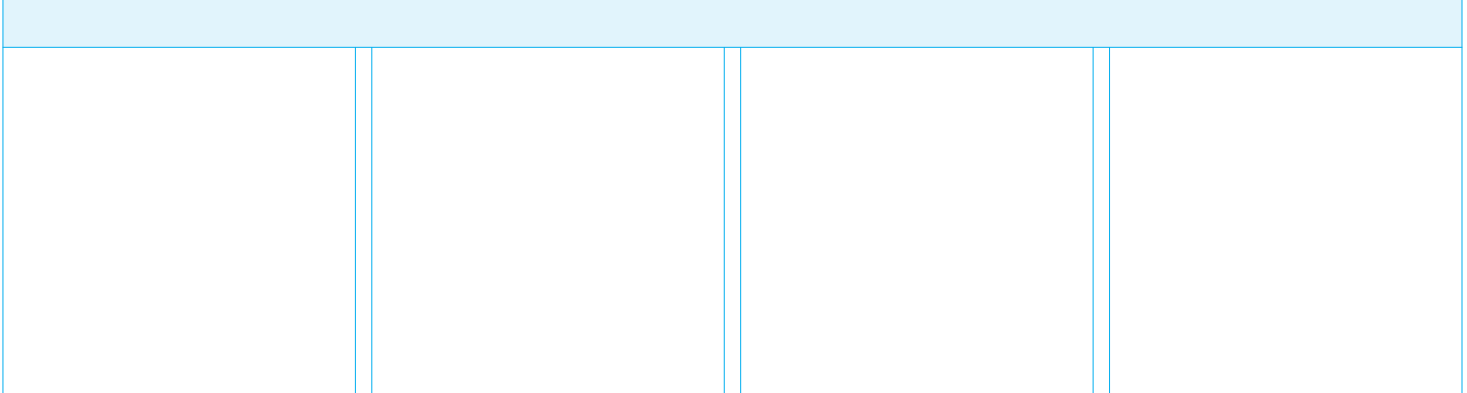
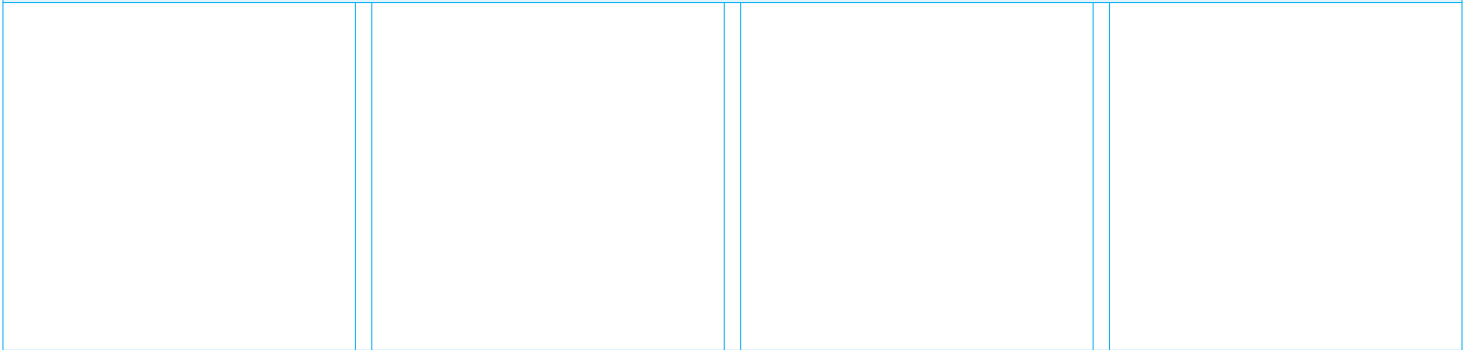

		<b>METELLI</b> ref.			<b>NOTE</b>	<b>Adaptable for OES</b>
26.372 (272 kW) Eng.D2866LF15	90-96	<b>24-1336</b>			w/ Pulley	51065006548/ 9548
26.402 (294 kW) Eng.D2866LF16	94-96	<b>24-1294</b>			For vehicles without retarder; Impeller Ø 125mm	51065006282/ 6387/ 9282/ 9387
	94-96	<b>24-1298</b>			For vehicles without retarder, w/o pulley; Impeller Ø 135mm, Incl Electronic fuel Injection pump	51065006408/ 6492/ 9492
	94-96	<b>24-1301</b>			For vehicles with retarder; w/o pulley; Injection Pump with electronic control unit	51065006479/ 9479
	94-96	<b>24-1302</b>			For vehicles with retarder, w/o pulley	51065006426/ 6490/ 9426/ 9490
	94-96	<b>24-1319</b>			For vehicles with retarder, w pulley	51065006546/ 9546
	94-96	<b>24-1321</b>			For vehicles without retarder, w pulley	51065006545/ 6547/ 9545/ 9547
	94-96	<b>24-1336</b>			w/ Pulley	51065006548/ 9548
26.422 (309 kW) Eng.D2866LF06/LF09	90-96	<b>24-1294</b>			For vehicles without retarder; Impeller Ø 125mm	51065006282/ 6387/ 9282/ 9387
	90-96	<b>24-1298</b>			For vehicles without retarder, w/o pulley; Impeller Ø 135mm, Incl Electronic fuel Injection pump	51065006408/ 6492/ 9492
	90-96	<b>24-1301</b>			For vehicles with retarder; w/o pulley; Injection Pump with electronic control unit	51065006479/ 9479
	90-96	<b>24-1302</b>			For vehicles with retarder, w/o pulley	51065006426/ 6490/ 9426/ 9490
	90-96	<b>24-1319</b>			For vehicles with retarder, w pulley	51065006546/ 9546
	90-96	<b>24-1321</b>			For vehicles without retarder, w pulley	51065006545/ 6547/ 9545/ 9547
	90-96	<b>24-1336</b>			w/ Pulley	51065006548/ 9548
26.462 (338-382 kW) Eng.D2840LF/460	89-90	<b>24-1298</b>			For vehicles without retarder, w/o pulley; Impeller Ø 135mm, Incl Electronic fuel Injection pump	51065006408/ 6492/ 9492
	89-90	<b>24-1302</b>			For vehicles with retarder, w/o pulley	51065006426/ 6490/ 9426/ 9490
26.502 (368 kW) Eng.D2840LF01	90-96	<b>24-1298</b>			For vehicles without retarder, w/o pulley; Impeller Ø 135mm, Incl Electronic fuel Injection pump	51065006408/ 6492/ 9492
	90-96	<b>24-1302</b>			For vehicles with retarder, w/o pulley	51065006426/ 6490/ 9426/ 9490
26.502 (368 kW) Eng.D2840LF04/LF06	90-96	<b>24-1298</b>			For vehicles without retarder, w/o pulley; Impeller Ø 135mm, Incl Electronic fuel Injection pump	51065006408/ 6492/ 9492
	90-96	<b>24-1302</b>			For vehicles with retarder, w/o pulley	51065006426/ 6490/ 9426/ 9490
32.262 (191 kW) Eng.D2865LF/260	89-90	<b>24-1298</b>			For vehicles without retarder, w/o pulley; Impeller Ø 135mm, Incl Electronic fuel Injection pump	51065006408/ 6492/ 9492
	89-90	<b>24-1301</b>			For vehicles with retarder; w/o pulley; Injection Pump with electronic control unit	51065006479/ 9479
	89-90	<b>24-1302</b>			For vehicles with retarder, w/o pulley	51065006426/ 6490/ 9426/ 9490
	89-90	<b>24-1319</b>			For vehicles with retarder, w pulley	51065006546/ 9546
	89-90	<b>24-1321</b>			For vehicles without retarder, w pulley	51065006545/ 6547/ 9545/ 9547
	89-90	<b>24-1336</b>			w/ Pulley	51065006548/ 9548
32.272 (198 kW) Eng.D2865LF02/LF05	90-95	<b>24-1298</b>			For vehicles without retarder, w/o pulley; Impeller Ø 135mm, Incl Electronic fuel Injection pump	51065006408/ 6492/ 9492
	90-95	<b>24-1301</b>			For vehicles with retarder; w/o pulley; Injection Pump with electronic control unit	51065006479/ 9479
	90-95	<b>24-1302</b>			For vehicles with retarder, w/o pulley	51065006426/ 6490/ 9426/ 9490
	90-95	<b>24-1319</b>			For vehicles with retarder, w pulley	51065006546/ 9546
	90-95	<b>24-1321</b>			For vehicles without retarder, w pulley	51065006545/ 6547/ 9545/ 9547
	90-95	<b>24-1336</b>			w/ Pulley	51065006548/ 9548
32.292 (213 kW) Eng.D2866LF/290	88-90	<b>24-1294</b>			For vehicles without retarder; Impeller Ø 125mm	51065006282/ 6387/ 9282/ 9387
	88-90	<b>24-1298</b>			For vehicles without retarder, w/o pulley; Impeller Ø 135mm, Incl Electronic fuel Injection pump	51065006408/ 6492/ 9492
	88-90	<b>24-1301</b>			For vehicles with retarder; w/o pulley; Injection Pump with electronic control unit	51065006479/ 9479
	88-90	<b>24-1302</b>			For vehicles with retarder, w/o pulley	51065006426/ 6490/ 9426/ 9490
	88-90	<b>24-1319</b>			For vehicles with retarder, w pulley	51065006546/ 9546
	88-90	<b>24-1321</b>			For vehicles without retarder, w pulley	51065006545/ 6547/ 9545/ 9547
	88-90	<b>24-1336</b>			w/ Pulley	51065006548/ 9548
32.302 (220 kW) Eng.D2866LF04	90-91	<b>24-1294</b>			For vehicles without retarder; Impeller Ø 125mm	51065006282/ 6387/ 9282/ 9387
	90-91	<b>24-1298</b>			For vehicles without retarder, w/o pulley; Impeller Ø 135mm, Incl Electronic fuel Injection pump	51065006408/ 6492/ 9492
	90-91	<b>24-1301</b>			For vehicles with retarder; w/o pulley; Injection Pump with electronic control unit	51065006479/ 9479
	90-91	<b>24-1302</b>			For vehicles with retarder, w/o pulley	51065006426/ 6490/ 9426/ 9490
	90-91	<b>24-1319</b>			For vehicles with retarder, w pulley	51065006546/ 9546
	90-91	<b>24-1321</b>			For vehicles without retarder, w pulley	51065006545/ 6547/ 9545/ 9547
	90-91	<b>24-1336</b>			w/ Pulley	51065006548/ 9548
32.322 (235 kW) Eng.D2865LF03/LF06	90-96	<b>24-1298</b>			For vehicles without retarder, w/o pulley; Impeller Ø 135mm, Incl Electronic fuel Injection pump	51065006408/ 6492/ 9492
	90-96	<b>24-1301</b>			For vehicles with retarder; w/o pulley; Injection Pump with electronic control unit	51065006479/ 9479
	90-96	<b>24-1302</b>			For vehicles with retarder, w/o pulley	51065006426/ 6490/ 9426/ 9490
	90-96	<b>24-1319</b>			For vehicles with retarder, w pulley	51065006546/ 9546

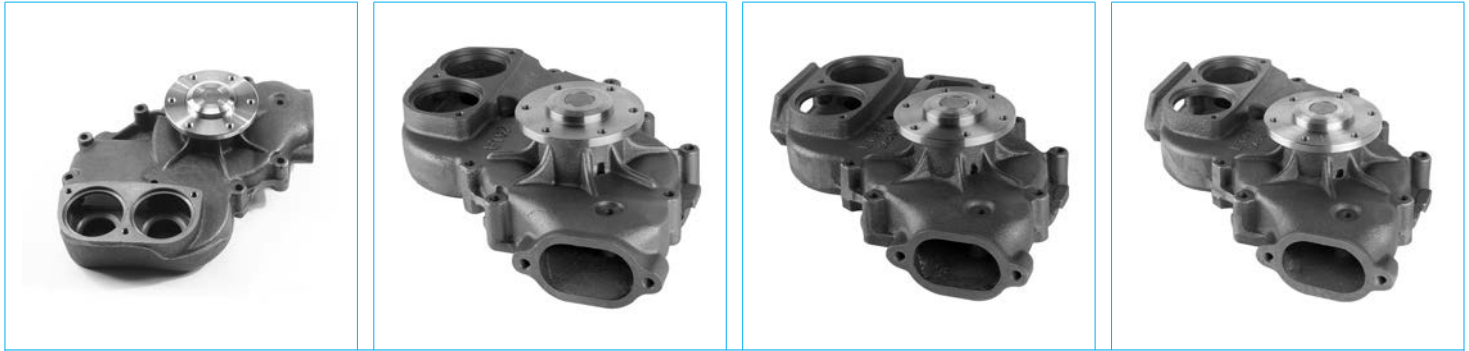

**24-1294**

**24-1298**

**24-1301**

**24-1302**

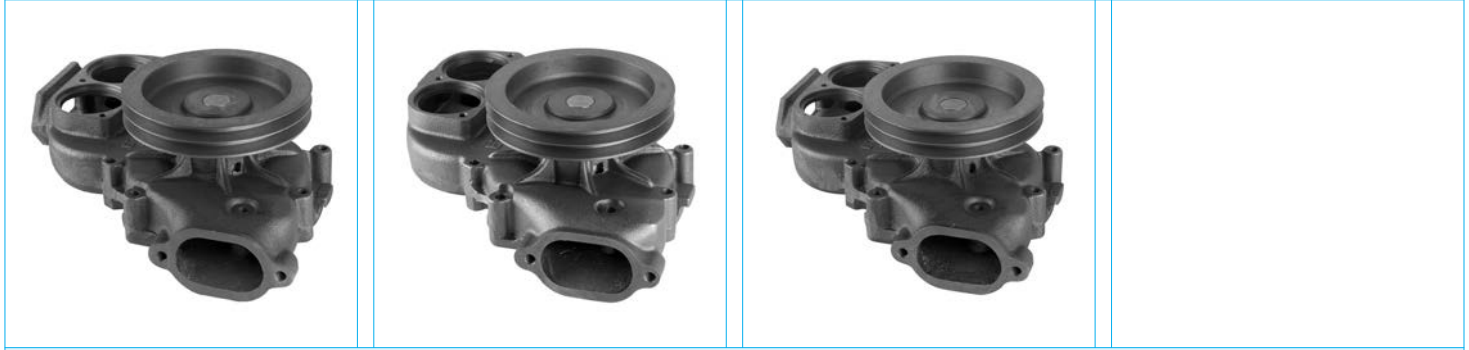

**24-1319**

**24-1321**

**24-1336**

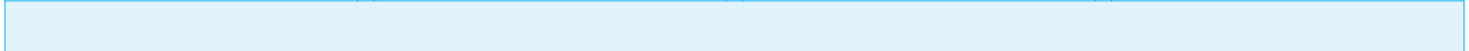
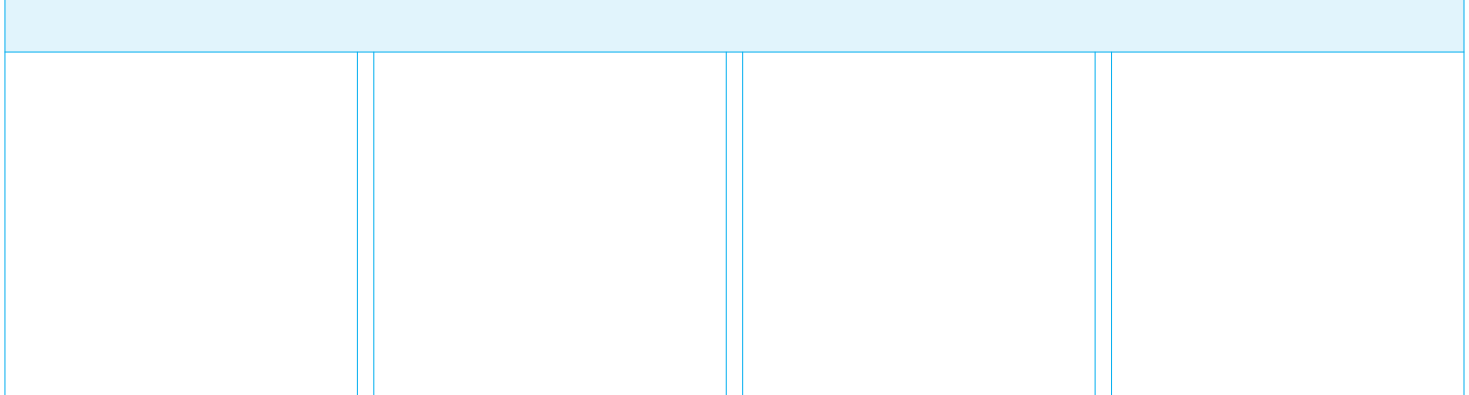
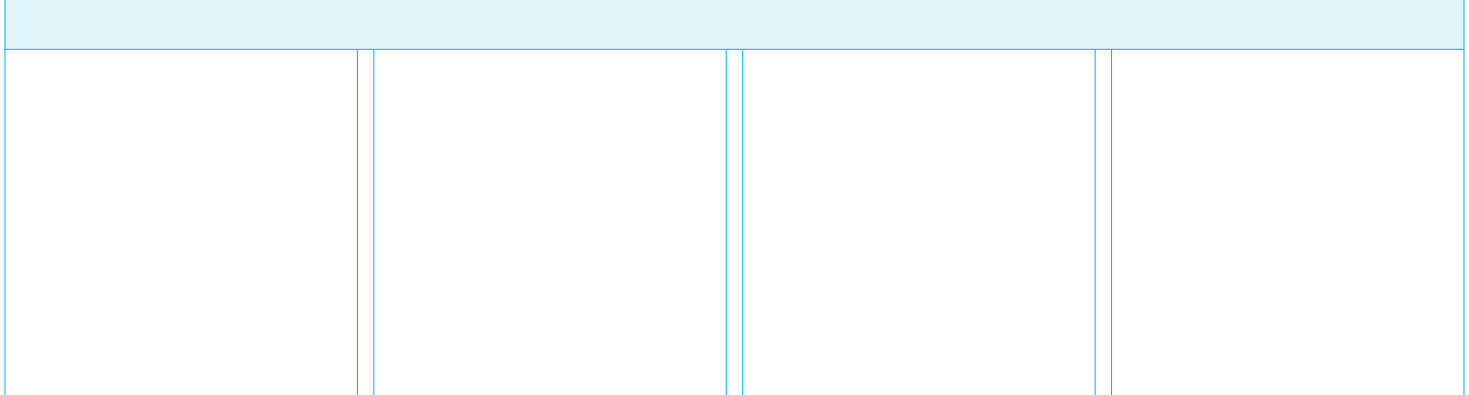
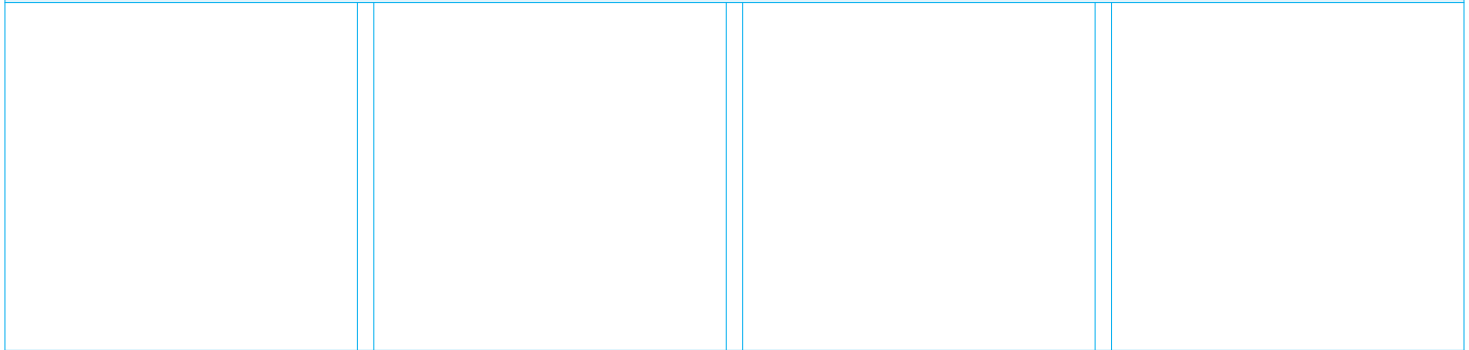

		<b>METELLI</b> ref.			<b>NOTE</b>	<b>Adaptable for OES</b>
32.322 (235 kW) Eng.D2865LF03/LF06	90-96	<b>24-1321</b>			For vehicles without retarder, w pulley	51065006545/ 6547/ 9545/ 9547
	90-96	<b>24-1336</b>			w/ Pulley	51065006548/ 9548
32.332 (243 kW) Eng.D2866LF/330	88-90	<b>24-1294</b>			For vehicles without retarder; Impeller Ø 125mm	51065006282/ 6387/ 9282/ 9387
	88-90	<b>24-1298</b>			For vehicles without retarder, w/o pulley; Impeller Ø 135mm, Incl Eletronic fuel Injection pump	51065006408/ 6492/ 9492
	88-90	<b>24-1301</b>			For vehicles with retarder; w/o pulley; Injection Pump with electronic control unit	51065006479/ 9479
	88-90	<b>24-1302</b>			For vehicles with retarder, w/o pulley	51065006426/ 6490/ 9426/ 9490
	88-90	<b>24-1319</b>			For vehicles with retarder, w pulley	51065006546/ 9546
	88-90	<b>24-1321</b>			For vehicles without retarder, w pulley	51065006545/ 6547/ 9545/ 9547
	88-90	<b>24-1336</b>			w/ Pulley	51065006548/ 9548
32.342 (250-213 kW) Eng.D2865LF09	94-96	<b>24-1298</b>			For vehicles without retarder, w/o pulley; Impeller Ø 135mm, Incl Eletronic fuel Injection pump	51065006408/ 6492/ 9492
	94-96	<b>24-1301</b>			For vehicles with retarder; w/o pulley; Injection Pump with electronic control unit	51065006479/ 9479
	94-96	<b>24-1302</b>			For vehicles with retarder, w/o pulley	51065006426/ 6490/ 9426/ 9490
	94-96	<b>24-1319</b>			For vehicles with retarder, w pulley	51065006546/ 9546
	94-96	<b>24-1321</b>			For vehicles without retarder, w pulley	51065006545/ 6547/ 9545/ 9547
	94-96	<b>24-1336</b>			w/ Pulley	51065006548/ 9548
32.362 (265 kW) Eng.D2866LXF	88-90	<b>24-1294</b>			For vehicles without retarder; Impeller Ø 125mm	51065006282/ 6387/ 9282/ 9387
	88-90	<b>24-1298</b>			For vehicles without retarder, w/o pulley; Impeller Ø 135mm, Incl Eletronic fuel Injection pump	51065006408/ 6492/ 9492
	88-90	<b>24-1301</b>			For vehicles with retarder; w/o pulley; Injection Pump with electronic control unit	51065006479/ 9479
	88-90	<b>24-1302</b>			For vehicles with retarder, w/o pulley	51065006426/ 6490/ 9426/ 9490
	88-90	<b>24-1319</b>			For vehicles with retarder, w pulley	51065006546/ 9546
	88-90	<b>24-1321</b>			For vehicles without retarder, w pulley	51065006545/ 6547/ 9545/ 9547
	88-90	<b>24-1336</b>			w/ Pulley	51065006548/ 9548
32.372 (249-265 kW) Eng.D2866LXF	88-90	<b>24-1294</b>			For vehicles without retarder; Impeller Ø 125mm	51065006282/ 6387/ 9282/ 9387
	90-96	<b>24-1298</b>			For vehicles without retarder, w/o pulley; Impeller Ø 135mm, Incl Eletronic fuel Injection pump	51065006408/ 6492/ 9492
	90-96	<b>24-1301</b>			For vehicles with retarder; w/o pulley; Injection Pump with electronic control unit	51065006479/ 9479
	90-96	<b>24-1302</b>			For vehicles with retarder, w/o pulley	51065006426/ 6490/ 9426/ 9490
	90-96	<b>24-1319</b>			For vehicles with retarder, w pulley	51065006546/ 9546
	90-96	<b>24-1321</b>			For vehicles without retarder, w pulley	51065006545/ 6547/ 9545/ 9547
	90-96	<b>24-1336</b>			w/ Pulley	51065006548/ 9548
32.372 (272 kW) Eng.D2866LF03/LF05	90-96	<b>24-1294</b>			For vehicles without retarder; Impeller Ø 125mm	51065006282/ 6387/ 9282/ 9387
	90-96	<b>24-1298</b>			For vehicles without retarder, w/o pulley; Impeller Ø 135mm, Incl Eletronic fuel Injection pump	51065006408/ 6492/ 9492
	90-96	<b>24-1301</b>			For vehicles with retarder; w/o pulley; Injection Pump with electronic control unit	51065006479/ 9479
	90-96	<b>24-1302</b>			For vehicles with retarder, w/o pulley	51065006426/ 6490/ 9426/ 9490
	90-96	<b>24-1319</b>			For vehicles with retarder, w pulley	51065006546/ 9546
	90-96	<b>24-1321</b>			For vehicles without retarder, w pulley	51065006545/ 6547/ 9545/ 9547
	90-96	<b>24-1336</b>			w/ Pulley	51065006548/ 9548
32.372 (272 kW) Eng.D2866LF15	90-96	<b>24-1294</b>			For vehicles without retarder; Impeller Ø 125mm	51065006282/ 6387/ 9282/ 9387
	90-96	<b>24-1298</b>			For vehicles without retarder, w/o pulley; Impeller Ø 135mm, Incl Eletronic fuel Injection pump	51065006408/ 6492/ 9492
	90-96	<b>24-1301</b>			For vehicles with retarder; w/o pulley; Injection Pump with electronic control unit	51065006479/ 9479
	90-96	<b>24-1302</b>			For vehicles with retarder, w/o pulley	51065006426/ 6490/ 9426/ 9490
	90-96	<b>24-1319</b>			For vehicles with retarder, w pulley	51065006546/ 9546
	90-96	<b>24-1321</b>			For vehicles without retarder, w pulley	51065006545/ 6547/ 9545/ 9547
	90-96	<b>24-1336</b>			w/ Pulley	51065006548/ 9548
32.402 (294 kW) Eng.D2866LF16	94-96	<b>24-1294</b>			For vehicles without retarder; Impeller Ø 125mm	51065006282/ 6387/ 9282/ 9387
	94-96	<b>24-1298</b>			For vehicles without retarder, w/o pulley; Impeller Ø 135mm, Incl Eletronic fuel Injection pump	51065006408/ 6492/ 9492
	94-96	<b>24-1301</b>			For vehicles with retarder; w/o pulley; Injection Pump with electronic control unit	51065006479/ 9479
	94-96	<b>24-1302</b>			For vehicles with retarder, w/o pulley	51065006426/ 6490/ 9426/ 9490
	94-96	<b>24-1319</b>			For vehicles with retarder, w pulley	51065006546/ 9546
	94-96	<b>24-1321</b>			For vehicles without retarder, w pulley	51065006545/ 6547/ 9545/ 9547
	94-96	<b>24-1336</b>			w/ Pulley	51065006548/ 9548
32.422 (309 kW) Eng.D2866LF06/LF09	90-96	<b>24-1294</b>			For vehicles without retarder; Impeller Ø 125mm	51065006282/ 6387/ 9282/ 9387
	90-96	<b>24-1298</b>			For vehicles without retarder, w/o pulley; Impeller Ø 135mm, Incl Eletronic fuel Injection pump	51065006408/ 6492/ 9492
	90-96	<b>24-1301</b>			For vehicles with retarder; w/o pulley; Injection Pump with electronic control unit	51065006479/ 9479

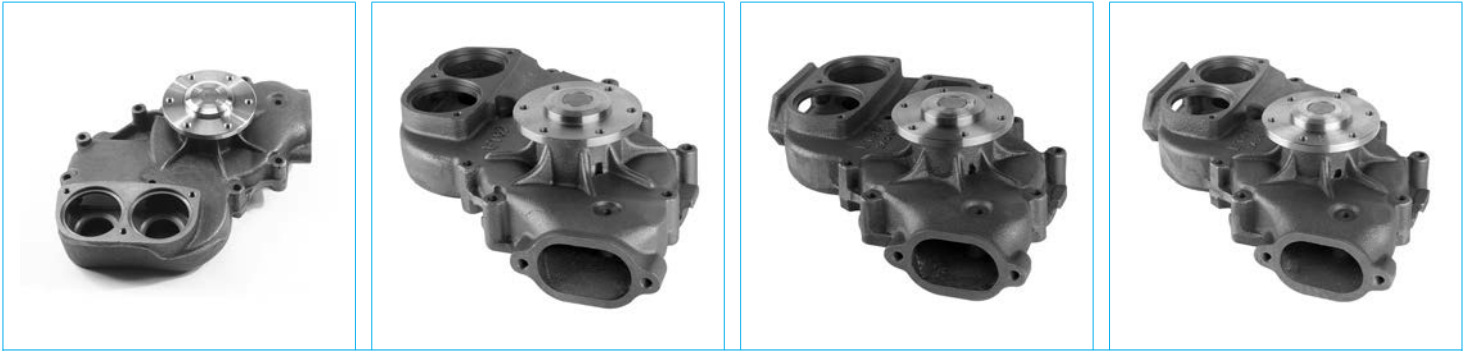

**24-1294**

**24-1298**

**24-1301**

**24-1302**

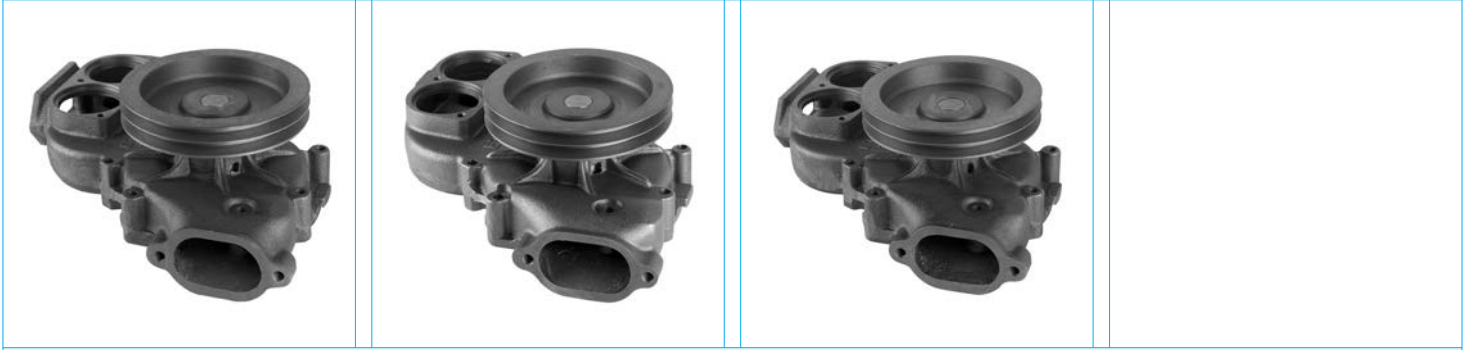

**24-1319**

**24-1321**

**24-1336**

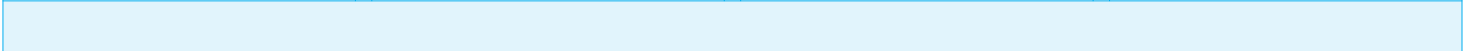
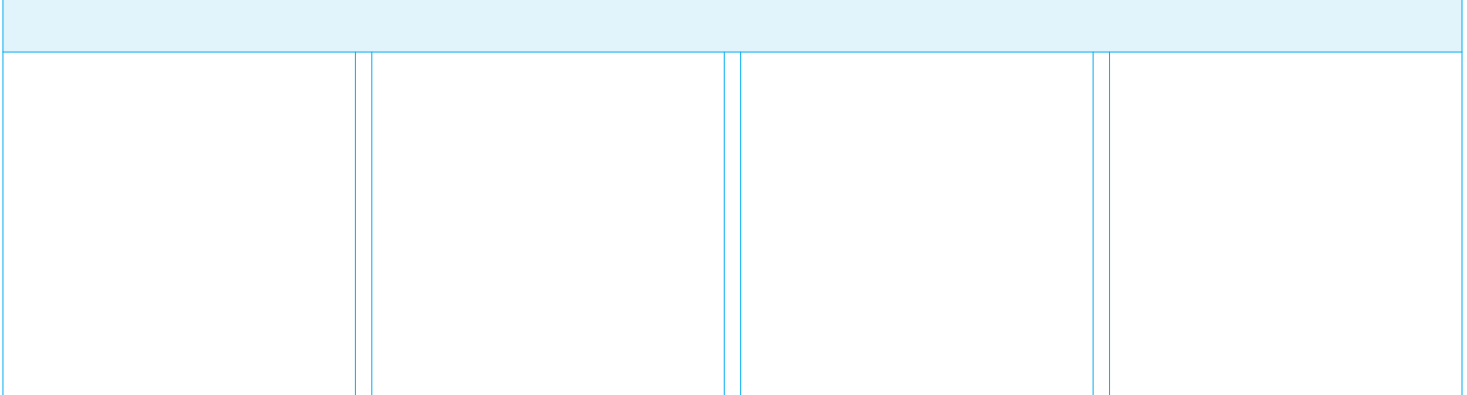
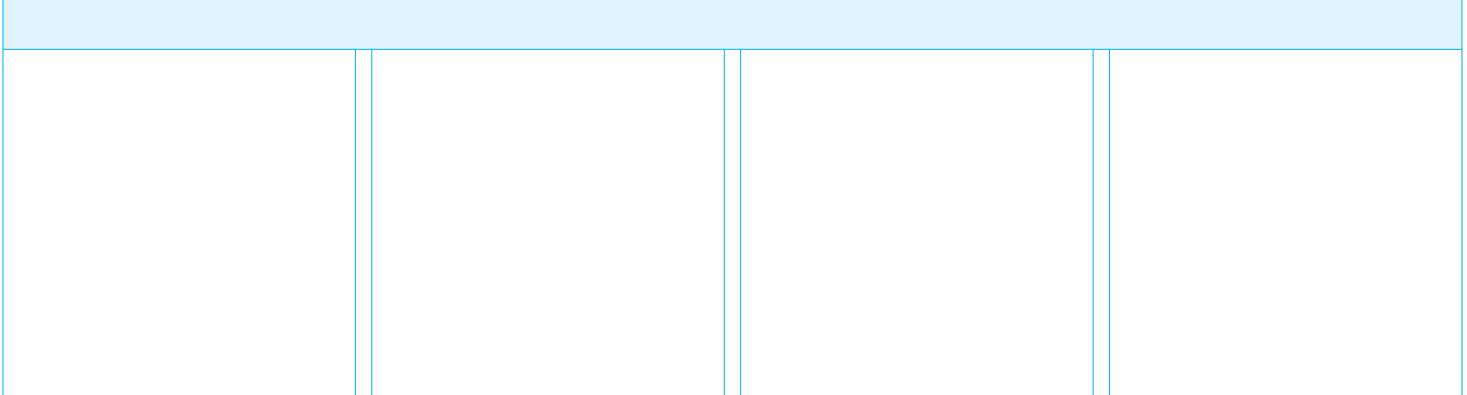
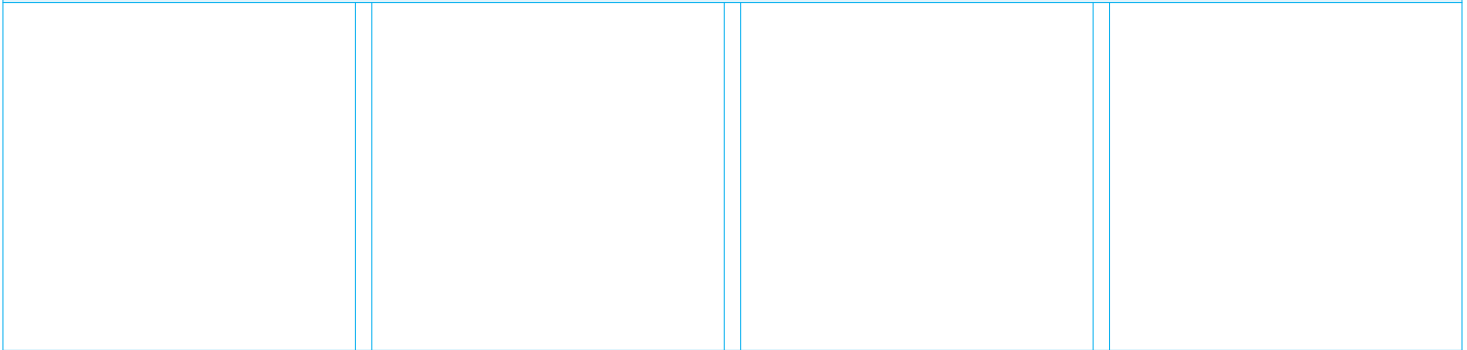

		<b>METELLI</b> ref.			<b>NOTE</b>	<b>Adaptable for OES</b>
32.422 (309 kW) Eng.D2866LF06/LF09	90-96	<b>24-1302</b>			For vehicles with retarder, w/o pulley	51065006426/ 6490/ 9426/ 9490
	90-96	<b>24-1319</b>			For vehicles with retarder, w pulley	51065006546/ 9546
	90-96	<b>24-1321</b>			For vehicles without retarder, w pulley	51065006545/ 6547/ 9545/ 9547
	90-96	<b>24-1336</b>			w/ Pulley	51065006548/ 9548
33.242 (177 kW) Eng.D2866F/240	01/88-08/88	<b>24-1294</b>			For vehicles without retarder; Impeller Ø 125mm	51065006282/ 6387/ 9282/ 9387
	01/88-08/88	<b>24-1298</b>			For vehicles without retarder, w/o pulley; Impeller Ø 135mm, Incl Eletronic fuel Injection pump	51065006408/ 6492/ 9492
	01/88-08/88	<b>24-1301</b>			For vehicles with retarder; w/o pulley; Injection Pump with electronic control unit	51065006479/ 9479
	01/88-08/88	<b>24-1302</b>			For vehicles with retarder, w/o pulley	51065006426/ 6490/ 9426/ 9490
	01/88-08/88	<b>24-1319</b>			For vehicles with retarder, w pulley	51065006546/ 9546
	01/88-08/88	<b>24-1321</b>			For vehicles without retarder, w pulley	51065006545/ 6547/ 9545/ 9547
33.262 (191 kW) Eng.D2865LF/260	89-90	<b>24-1298</b>			For vehicles without retarder, w/o pulley; Impeller Ø 135mm, Incl Eletronic fuel Injection pump	51065006408/ 6492/ 9492
	89-90	<b>24-1301</b>			For vehicles with retarder; w/o pulley; Injection Pump with electronic control unit	51065006479/ 9479
	89-90	<b>24-1302</b>			For vehicles with retarder, w/o pulley	51065006426/ 6490/ 9426/ 9490
	89-90	<b>24-1319</b>			For vehicles with retarder, w pulley	51065006546/ 9546
	89-90	<b>24-1321</b>			For vehicles without retarder, w pulley	51065006545/ 6547/ 9545/ 9547
	89-90	<b>24-1336</b>			w/ Pulley	51065006548/ 9548
33.272 (191-198 kW) Eng.D2865LF05	92-95	<b>24-1298</b>			For vehicles without retarder, w/o pulley; Impeller Ø 135mm, Incl Eletronic fuel Injection pump	51065006408/ 6492/ 9492
	92-95	<b>24-1301</b>			For vehicles with retarder; w/o pulley; Injection Pump with electronic control unit	51065006479/ 9479
	92-95	<b>24-1302</b>			For vehicles with retarder, w/o pulley	51065006426/ 6490/ 9426/ 9490
	92-95	<b>24-1319</b>			For vehicles with retarder, w pulley	51065006546/ 9546
	92-95	<b>24-1321</b>			For vehicles without retarder, w pulley	51065006545/ 6547/ 9545/ 9547
	92-95	<b>24-1336</b>			w/ Pulley	51065006548/ 9548
33.292 (213 kW) Eng.D2866LF/290	88-90	<b>24-1294</b>			For vehicles without retarder; Impeller Ø 125mm	51065006282/ 6387/ 9282/ 9387
	88-90	<b>24-1298</b>			For vehicles without retarder, w/o pulley; Impeller Ø 135mm, Incl Eletronic fuel Injection pump	51065006408/ 6492/ 9492
	88-90	<b>24-1301</b>			For vehicles with retarder; w/o pulley; Injection Pump with electronic control unit	51065006479/ 9479
	88-90	<b>24-1302</b>			For vehicles with retarder, w/o pulley	51065006426/ 6490/ 9426/ 9490
	88-90	<b>24-1319</b>			For vehicles with retarder, w pulley	51065006546/ 9546
	88-90	<b>24-1321</b>			For vehicles without retarder, w pulley	51065006545/ 6547/ 9545/ 9547
	88-90	<b>24-1336</b>			w/ Pulley	51065006548/ 9548
33.322 (235 kW) Eng.D2865LF03/LF06	91-96	<b>24-1298</b>			For vehicles without retarder, w/o pulley; Impeller Ø 135mm, Incl Eletronic fuel Injection pump	51065006408/ 6492/ 9492
	91-96	<b>24-1301</b>			For vehicles with retarder; w/o pulley; Injection Pump with electronic control unit	51065006479/ 9479
	91-96	<b>24-1302</b>			For vehicles with retarder, w/o pulley	51065006426/ 6490/ 9426/ 9490
	91-96	<b>24-1319</b>			For vehicles with retarder, w pulley	51065006546/ 9546
	91-96	<b>24-1321</b>			For vehicles without retarder, w pulley	51065006545/ 6547/ 9545/ 9547
	91-96	<b>24-1336</b>			w/ Pulley	51065006548/ 9548
33.332 (243 kW) Eng.D2866LF/330	87-90	<b>24-1294</b>			For vehicles without retarder; Impeller Ø 125mm	51065006282/ 6387/ 9282/ 9387
	87-90	<b>24-1298</b>			For vehicles without retarder, w/o pulley; Impeller Ø 135mm, Incl Eletronic fuel Injection pump	51065006408/ 6492/ 9492
	87-90	<b>24-1301</b>			For vehicles with retarder; w/o pulley; Injection Pump with electronic control unit	51065006479/ 9479
	87-90	<b>24-1302</b>			For vehicles with retarder, w/o pulley	51065006426/ 6490/ 9426/ 9490
	87-90	<b>24-1319</b>			For vehicles with retarder, w pulley	51065006546/ 9546
	87-90	<b>24-1321</b>			For vehicles without retarder, w pulley	51065006545/ 6547/ 9545/ 9547
	87-90	<b>24-1336</b>			w/ Pulley	51065006548/ 9548
33.342 (250-213 kW) Eng.D2865LF09	94-96	<b>24-1298</b>			For vehicles without retarder, w/o pulley; Impeller Ø 135mm, Incl Eletronic fuel Injection pump	51065006408/ 6492/ 9492
	94-96	<b>24-1301</b>			For vehicles with retarder; w/o pulley; Injection Pump with electronic control unit	51065006479/ 9479
	94-96	<b>24-1302</b>			For vehicles with retarder, w/o pulley	51065006426/ 6490/ 9426/ 9490
	94-96	<b>24-1319</b>			For vehicles with retarder, w pulley	51065006546/ 9546
	94-96	<b>24-1321</b>			For vehicles without retarder, w pulley	51065006545/ 6547/ 9545/ 9547
	94-96	<b>24-1336</b>			w/ Pulley	51065006548/ 9548
33.362 (265 kW) Eng.D2866KF	88-90	<b>24-1294</b>			For vehicles without retarder; Impeller Ø 125mm	51065006282/ 6387/ 9282/ 9387
	87-90	<b>24-1298</b>			For vehicles without retarder, w/o pulley; Impeller Ø 135mm, Incl Eletronic fuel Injection pump	51065006408/ 6492/ 9492
	87-90	<b>24-1301</b>			For vehicles with retarder; w/o pulley; Injection Pump with electronic control unit	51065006479/ 9479
	87-90	<b>24-1302</b>			For vehicles with retarder, w/o pulley	51065006426/ 6490/ 9426/ 9490
	87-90	<b>24-1319</b>			For vehicles with retarder, w pulley	51065006546/ 9546

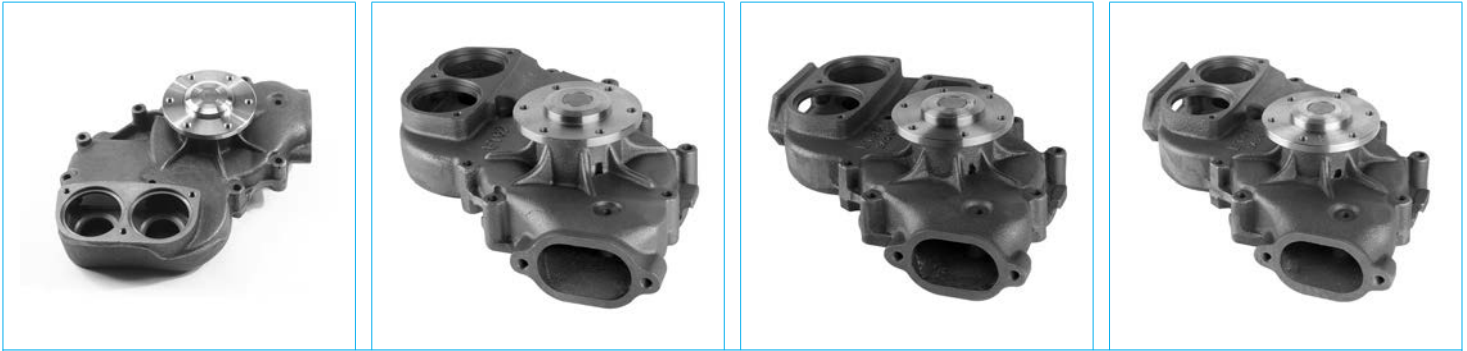

**24-1294**

**24-1298**

**24-1301**

**24-1302**

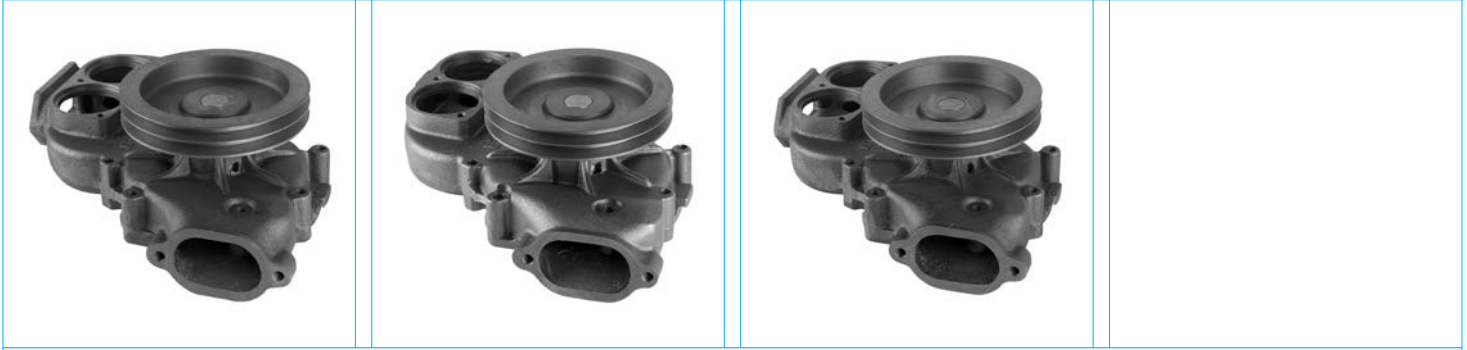



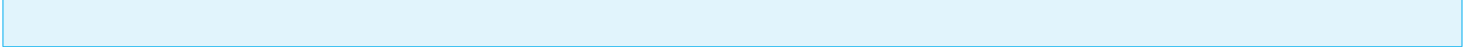
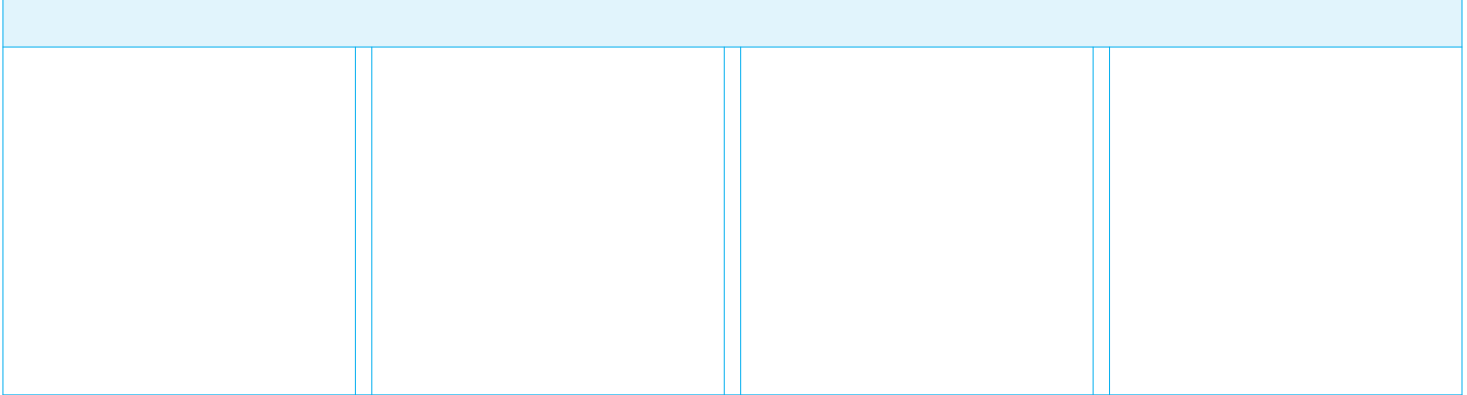
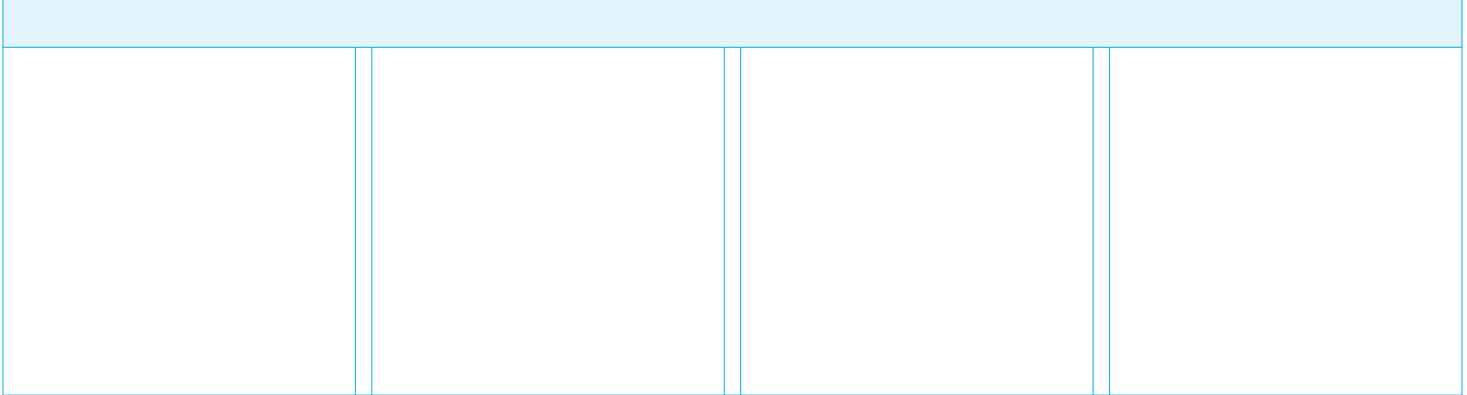
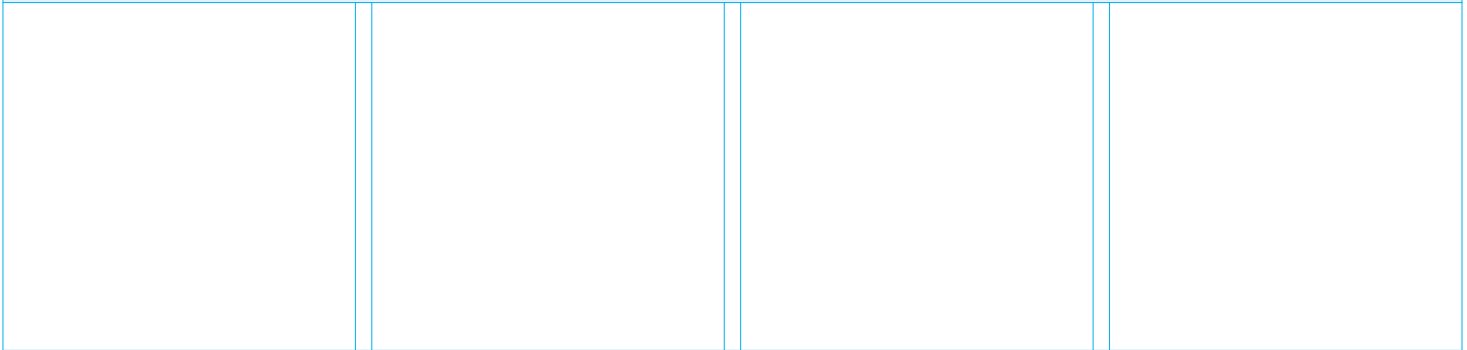

**24-1319**

**24-1321**

**24-1336**



		<b>METELLI</b> ref.			<b>NOTE</b>	<b>Adaptable for OES</b>
33.362 (265 kW) Eng.D2866KF	87-90	<b>24-1321</b>			For vehicles without retarder, w pulley	51065006545/ 6547/ 9545/ 9547
	87-90	<b>24-1336</b>			w/ Pulley	51065006548/ 9548
33.362 (265 kW) Eng.D2866LXF	91-96	<b>24-1294</b>			For vehicles without retarder; Impeller Ø 125mm	51065006282/ 6387/ 9282/ 9387
	88-90	<b>24-1298</b>			For vehicles without retarder, w/o pulley; Impeller Ø 135mm, Incl Eletronic fuel Injection pump	51065006408/ 6492/ 9492
	88-90	<b>24-1301</b>			For vehicles with retarder; w/o pulley; Injection Pump with electronic control unit	51065006479/ 9479
	88-90	<b>24-1302</b>			For vehicles with retarder, w/o pulley	51065006426/ 6490/ 9426/ 9490
	88-90	<b>24-1319</b>			For vehicles with retarder, w pulley	51065006546/ 9546
	88-90	<b>24-1321</b>			For vehicles without retarder, w pulley	51065006545/ 6547/ 9545/ 9547
	88-90	<b>24-1336</b>			w/ Pulley	51065006548/ 9548
33.372 (272 kW) Eng.D2866LF03/LF05	91-96	<b>24-1294</b>			For vehicles without retarder; Impeller Ø 125mm	51065006282/ 6387/ 9282/ 9387
	91-96	<b>24-1298</b>			For vehicles without retarder, w/o pulley; Impeller Ø 135mm, Incl Eletronic fuel Injection pump	51065006408/ 6492/ 9492
	91-96	<b>24-1301</b>			For vehicles with retarder; w/o pulley; Injection Pump with electronic control unit	51065006479/ 9479
	91-96	<b>24-1302</b>			For vehicles with retarder, w/o pulley	51065006426/ 6490/ 9426/ 9490
	91-96	<b>24-1319</b>			For vehicles with retarder, w pulley	51065006546/ 9546
	91-96	<b>24-1321</b>			For vehicles without retarder, w pulley	51065006545/ 6547/ 9545/ 9547
	91-96	<b>24-1336</b>			w/ Pulley	51065006548/ 9548
33.372 (272 kW) Eng.D2866LF15	91-96	<b>24-1294</b>			For vehicles without retarder; Impeller Ø 125mm	51065006282/ 6387/ 9282/ 9387
	91-96	<b>24-1298</b>			For vehicles without retarder, w/o pulley; Impeller Ø 135mm, Incl Eletronic fuel Injection pump	51065006408/ 6492/ 9492
	91-96	<b>24-1301</b>			For vehicles with retarder; w/o pulley; Injection Pump with electronic control unit	51065006479/ 9479
	91-96	<b>24-1302</b>			For vehicles with retarder, w/o pulley	51065006426/ 6490/ 9426/ 9490
	91-96	<b>24-1319</b>			For vehicles with retarder, w pulley	51065006546/ 9546
	91-96	<b>24-1321</b>			For vehicles without retarder, w pulley	51065006545/ 6547/ 9545/ 9547
	91-96	<b>24-1336</b>			w/ Pulley	51065006548/ 9548
33.402 (294 kW) Eng.D2866LF16	94-96	<b>24-1294</b>			For vehicles without retarder; Impeller Ø 125mm	51065006282/ 6387/ 9282/ 9387
	94-96	<b>24-1298</b>			For vehicles without retarder, w/o pulley; Impeller Ø 135mm, Incl Eletronic fuel Injection pump	51065006408/ 6492/ 9492
	94-96	<b>24-1301</b>			For vehicles with retarder; w/o pulley; Injection Pump with electronic control unit	51065006479/ 9479
	94-96	<b>24-1302</b>			For vehicles with retarder, w/o pulley	51065006426/ 6490/ 9426/ 9490
	94-96	<b>24-1319</b>			For vehicles with retarder, w pulley	51065006546/ 9546
	94-96	<b>24-1321</b>			For vehicles without retarder, w pulley	51065006545/ 6547/ 9545/ 9547
	94-96	<b>24-1336</b>			w/ Pulley	51065006548/ 9548
33.422 (309 kW) Eng.D2866LF06/LF09	94-96	<b>24-1294</b>			For vehicles without retarder; Impeller Ø 125mm	51065006282/ 6387/ 9282/ 9387
	94-96	<b>24-1298</b>			For vehicles without retarder, w/o pulley; Impeller Ø 135mm, Incl Eletronic fuel Injection pump	51065006408/ 6492/ 9492
	94-96	<b>24-1301</b>			For vehicles with retarder; w/o pulley; Injection Pump with electronic control unit	51065006479/ 9479
	94-96	<b>24-1302</b>			For vehicles with retarder, w/o pulley	51065006426/ 6490/ 9426/ 9490
	92-96	<b>24-1319</b>			For vehicles with retarder, w pulley	51065006546/ 9546
	94-96	<b>24-1321</b>			For vehicles without retarder, w pulley	51065006545/ 6547/ 9545/ 9547
	94-96	<b>24-1336</b>			w/ Pulley	51065006548/ 9548
33.462 (338-382 kW) Eng.D2840LF/460	89-90	<b>24-1298</b>			For vehicles without retarder, w/o pulley; Impeller Ø 135mm, Incl Eletronic fuel Injection pump	51065006408/ 6492/ 9492
	89-90	<b>24-1302</b>			For vehicles with retarder, w/o pulley	51065006426/ 6490/ 9426/ 9490
33.502 (368 kW) Eng.D2840LF01	91-96	<b>24-1298</b>			For vehicles without retarder, w/o pulley; Impeller Ø 135mm, Incl Eletronic fuel Injection pump	51065006408/ 6492/ 9492
	91-96	<b>24-1302</b>			For vehicles with retarder, w/o pulley	51065006426/ 6490/ 9426/ 9490
33.502 (368 kW) Eng.D2840LF04	91-96	<b>24-1298</b>			For vehicles without retarder, w/o pulley; Impeller Ø 135mm, Incl Eletronic fuel Injection pump	51065006408/ 6492/ 9492
	91-96	<b>24-1302</b>			For vehicles with retarder, w/o pulley	51065006426/ 6490/ 9426/ 9490
33.502 (368 kW) Eng.D2840LF06	91-96	<b>24-1298</b>			For vehicles without retarder, w/o pulley; Impeller Ø 135mm, Incl Eletronic fuel Injection pump	51065006408/ 6492/ 9492
	91-96	<b>24-1302</b>			For vehicles with retarder, w/o pulley	51065006426/ 6490/ 9426/ 9490
35.262 (191 kW) Eng.D2865LF/260	89-90	<b>24-1298</b>			For vehicles without retarder, w/o pulley; Impeller Ø 135mm, Incl Eletronic fuel Injection pump	51065006408/ 6492/ 9492
	89-90	<b>24-1301</b>			For vehicles with retarder; w/o pulley; Injection Pump with electronic control unit	51065006479/ 9479
	89-90	<b>24-1302</b>			For vehicles with retarder, w/o pulley	51065006426/ 6490/ 9426/ 9490
	89-90	<b>24-1319</b>			For vehicles with retarder, w pulley	51065006546/ 9546
	89-90	<b>24-1321</b>			For vehicles without retarder, w pulley	51065006545/ 6547/ 9545/ 9547
35.272 (198 kW) Eng.D2865LF02	89-90	<b>24-1336</b>			w/ Pulley	51065006548/ 9548
	90-92	<b>24-1298</b>			For vehicles without retarder, w/o pulley; Impeller Ø 135mm, Incl Eletronic fuel Injection pump	51065006408/ 6492/ 9492



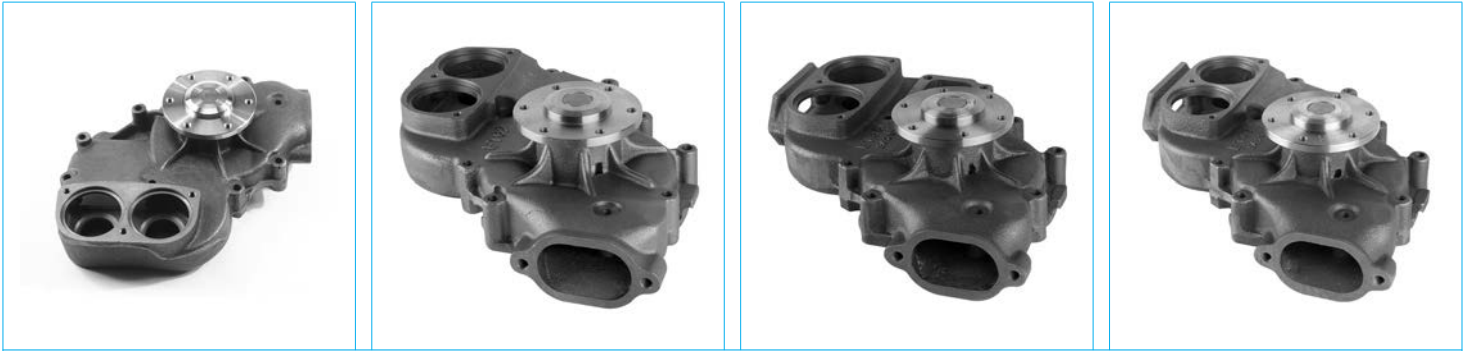

**24-1294**

**24-1298**

**24-1301**

**24-1302**

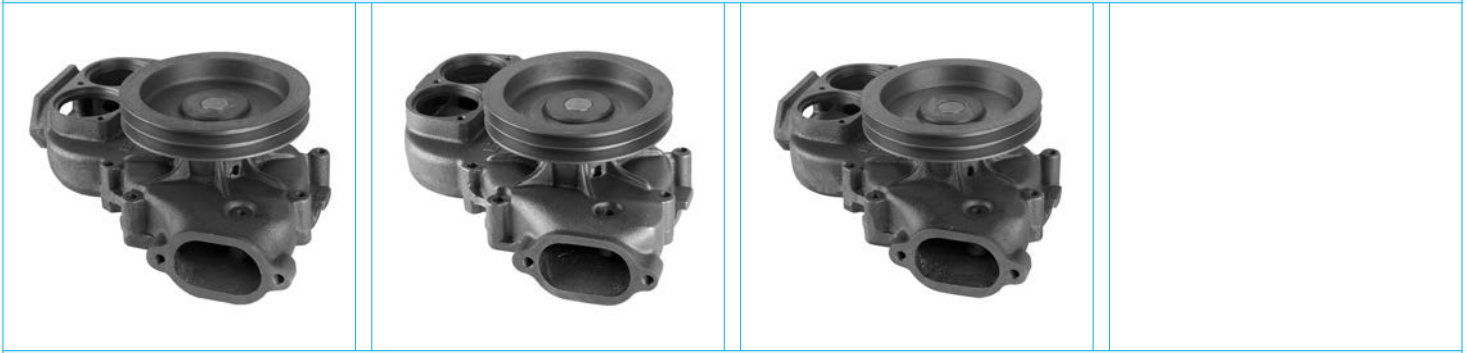

**24-1319**

**24-1321**

**24-1336**

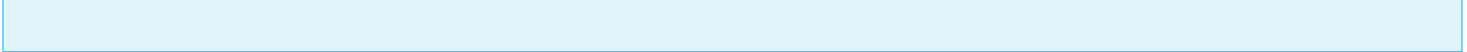
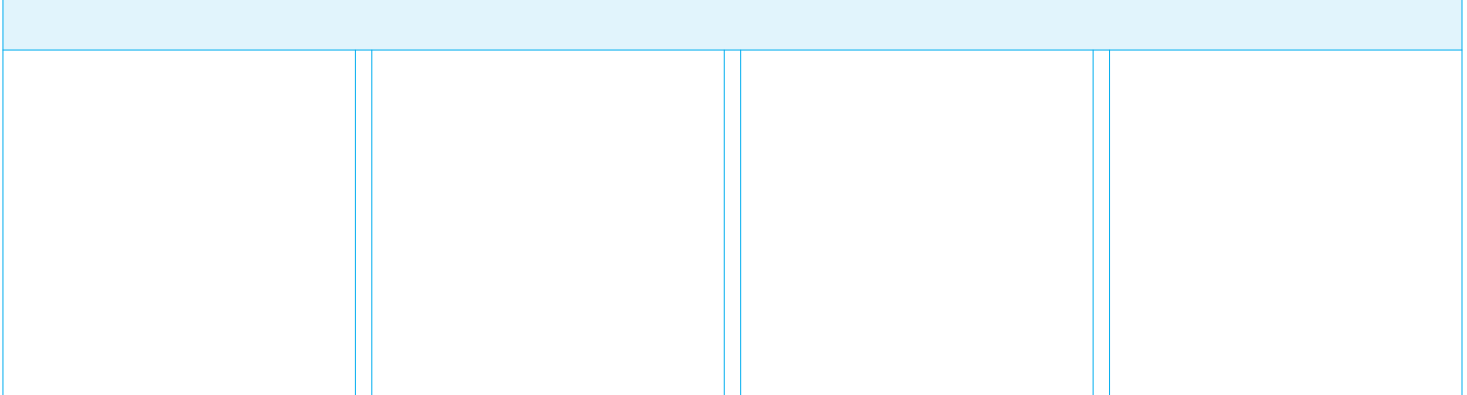
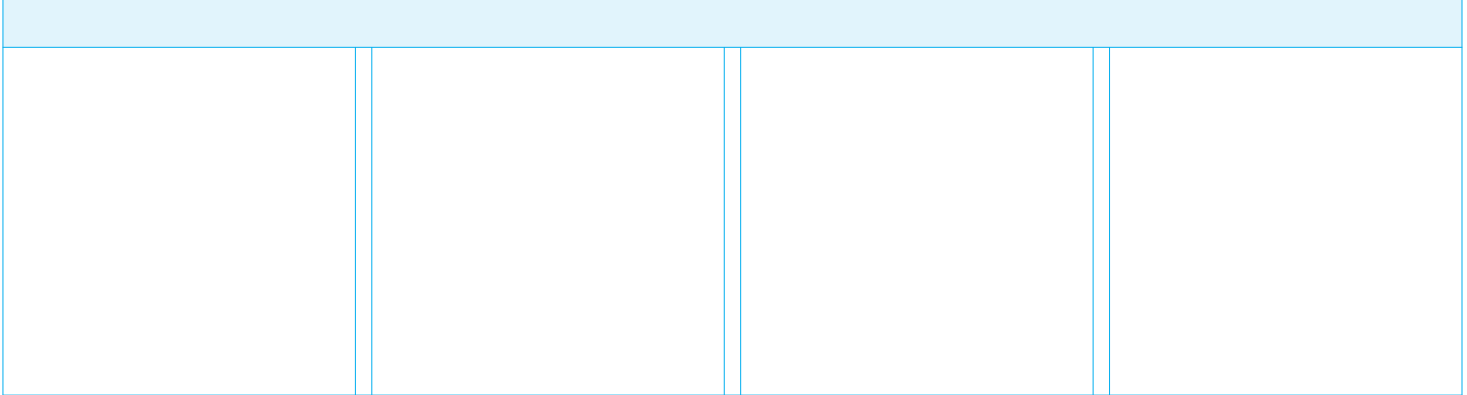
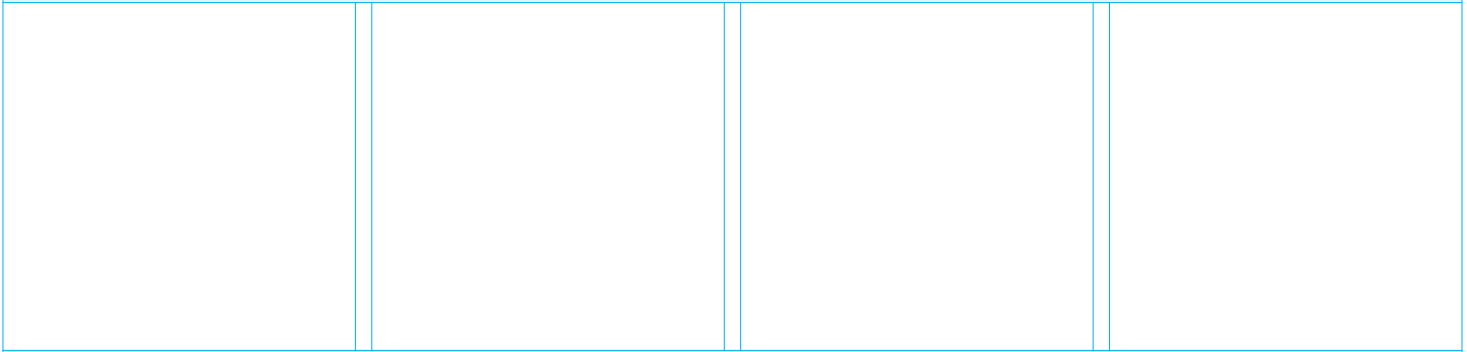

		<b>METELLI</b> ref.			<b>NOTE</b>	<b>Adaptable for OES</b>
35.272 (198 kW) Eng.D2865LF02	90-92	<b>24-1301</b>			For vehicles with retarder; w/o pulley; Injection Pump with electronic control unit	51065006479/ 9479
	90-92	<b>24-1302</b>			For vehicles with retarder, w/o pulley	51065006426/ 6490/ 9426/ 9490
	90-92	<b>24-1319</b>			For vehicles with retarder, w pulley	51065006546/ 9546
	90-92	<b>24-1321</b>			For vehicles without retarder, w pulley	51065006545/ 6547/ 9545/ 9547
	90-92	<b>24-1336</b>			w/ Pulley	51065006548/ 9548
35.292 (213 kW) Eng.D2866LFZ/290 35.302 (220 kW) Eng.D2866LF04	88-95	<b>24-1294</b>			For vehicles without retarder; Impeller Ø 125mm	51065006282/ 6387/ 9282/ 9387
	88-95	<b>24-1298</b>			For vehicles without retarder, w/o pulley; Impeller Ø 135mm, Incl Eletronic fuel Injection pump	51065006408/ 6492/ 9492
	88-95	<b>24-1301</b>			For vehicles with retarder; w/o pulley; Injection Pump with electronic control unit	51065006479/ 9479
	88-95	<b>24-1302</b>			For vehicles with retarder, w/o pulley	51065006426/ 6490/ 9426/ 9490
	88-95	<b>24-1319</b>			For vehicles with retarder, w pulley	51065006546/ 9546
	88-95	<b>24-1321</b>			For vehicles without retarder, w pulley	51065006545/ 6547/ 9545/ 9547
35.322 (235 kW) Eng.D2865LF03/LF06	90-96	<b>24-1298</b>			For vehicles without retarder, w/o pulley; Impeller Ø 135mm, Incl Eletronic fuel Injection pump	51065006408/ 6492/ 9492
	90-96	<b>24-1301</b>			For vehicles with retarder; w/o pulley; Injection Pump with electronic control unit	51065006479/ 9479
	90-96	<b>24-1302</b>			For vehicles with retarder, w/o pulley	51065006426/ 6490/ 9426/ 9490
	90-96	<b>24-1319</b>			For vehicles with retarder, w pulley	51065006546/ 9546
	90-96	<b>24-1321</b>			For vehicles without retarder, w pulley	51065006545/ 6547/ 9545/ 9547
	90-96	<b>24-1336</b>			w/ Pulley	51065006548/ 9548
35.332 (243 kW) Eng.D2866LFZ/330	88-95	<b>24-1294</b>			For vehicles without retarder; Impeller Ø 125mm	51065006282/ 6387/ 9282/ 9387
	88-95	<b>24-1298</b>			For vehicles without retarder, w/o pulley; Impeller Ø 135mm, Incl Eletronic fuel Injection pump	51065006408/ 6492/ 9492
	94-96	<b>24-1301</b>			For vehicles with retarder; w/o pulley; Injection Pump with electronic control unit	51065006479/ 9479
	88-95	<b>24-1302</b>			For vehicles with retarder, w/o pulley	51065006426/ 6490/ 9426/ 9490
	88-95	<b>24-1319</b>			For vehicles with retarder, w pulley	51065006546/ 9546
	88-95	<b>24-1321</b>			For vehicles without retarder, w pulley	51065006545/ 6547/ 9545/ 9547
	88-95	<b>24-1336</b>			w/ Pulley	51065006548/ 9548
35.342 (250-213 kW) Eng.D2865LF09	94-96	<b>24-1298</b>			For vehicles without retarder, w/o pulley; Impeller Ø 135mm, Incl Eletronic fuel Injection pump	51065006408/ 6492/ 9492
	88-90	<b>24-1301</b>			For vehicles with retarder; w/o pulley; Injection Pump with electronic control unit	51065006479/ 9479
	94-96	<b>24-1302</b>			For vehicles with retarder, w/o pulley	51065006426/ 6490/ 9426/ 9490
	94-96	<b>24-1319</b>			For vehicles with retarder, w pulley	51065006546/ 9546
	94-96	<b>24-1321</b>			For vehicles without retarder, w pulley	51065006545/ 6547/ 9545/ 9547
35.362 (265 kW) Eng.D2866LXF	94-96	<b>24-1336</b>			w/ Pulley	51065006548/ 9548
	88-90	<b>24-1294</b>			For vehicles without retarder; Impeller Ø 125mm	51065006282/ 6387/ 9282/ 9387
	88-90	<b>24-1298</b>			For vehicles without retarder, w/o pulley; Impeller Ø 135mm, Incl Eletronic fuel Injection pump	51065006408/ 6492/ 9492
	90-95	<b>24-1301</b>			For vehicles with retarder; w/o pulley; Injection Pump with electronic control unit	51065006479/ 9479
	88-90	<b>24-1302</b>			For vehicles with retarder, w/o pulley	51065006426/ 6490/ 9426/ 9490
	88-90	<b>24-1319</b>			For vehicles with retarder, w pulley	51065006546/ 9546
35.372 (249-265 kW) Eng.D2866LXF	88-90	<b>24-1321</b>			For vehicles without retarder, w pulley	51065006545/ 6547/ 9545/ 9547
	88-90	<b>24-1336</b>			w/ Pulley	51065006548/ 9548
	90-95	<b>24-1294</b>			For vehicles without retarder; Impeller Ø 125mm	51065006282/ 6387/ 9282/ 9387
	90-95	<b>24-1298</b>			For vehicles without retarder, w/o pulley; Impeller Ø 135mm, Incl Eletronic fuel Injection pump	51065006408/ 6492/ 9492
	90-97	<b>24-1301</b>			For vehicles with retarder; w/o pulley; Injection Pump with electronic control unit	51065006479/ 9479
	90-95	<b>24-1302</b>			For vehicles with retarder, w/o pulley	51065006426/ 6490/ 9426/ 9490
	90-95	<b>24-1319</b>			For vehicles with retarder, w pulley	51065006546/ 9546
35.372 (272 kW) Eng.D2866LF03	94-96	<b>24-1321</b>			For vehicles without retarder, w pulley	51065006545/ 6547/ 9545/ 9547
	90-95	<b>24-1336</b>			w/ Pulley	51065006548/ 9548
	90-97	<b>24-1294</b>			For vehicles without retarder; Impeller Ø 125mm	51065006282/ 6387/ 9282/ 9387
	90-97	<b>24-1298</b>			For vehicles without retarder, w/o pulley; Impeller Ø 135mm, Incl Eletronic fuel Injection pump	51065006408/ 6492/ 9492
	90-97	<b>24-1301</b>			For vehicles with retarder; w/o pulley; Injection Pump with electronic control unit	51065006479/ 9479
	90-97	<b>24-1302</b>			For vehicles with retarder, w/o pulley	51065006426/ 6490/ 9426/ 9490
	90-97	<b>24-1319</b>			For vehicles with retarder, w pulley	51065006546/ 9546
35.372 (272 kW) Eng.D2866LF05/LF15	88-90	<b>24-1321</b>			For vehicles without retarder, w pulley	51065006545/ 6547/ 9545/ 9547
	90-97	<b>24-1336</b>			w/ Pulley	51065006548/ 9548
	90-97	<b>24-1294</b>			For vehicles without retarder; Impeller Ø 125mm	51065006282/ 6387/ 9282/ 9387

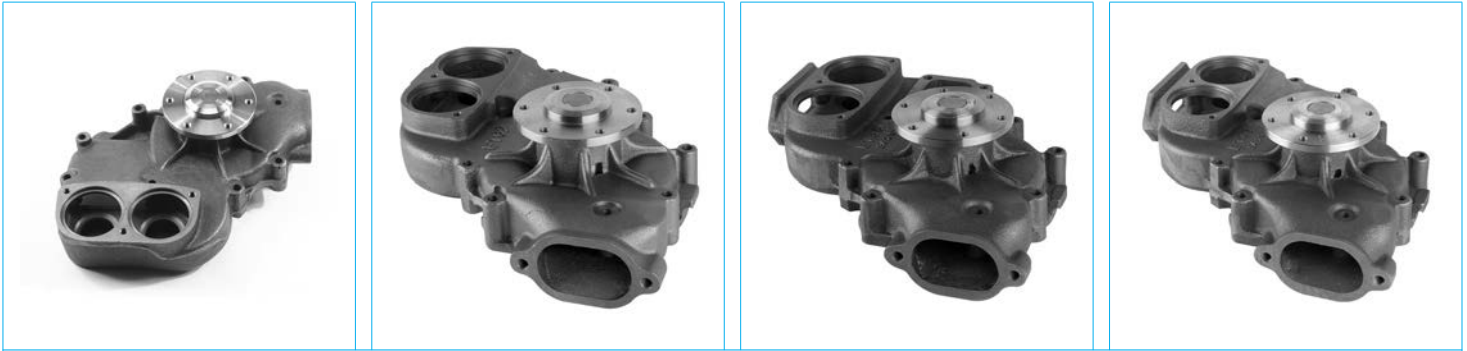

**24-1294**

**24-1298**

**24-1301**

**24-1302**

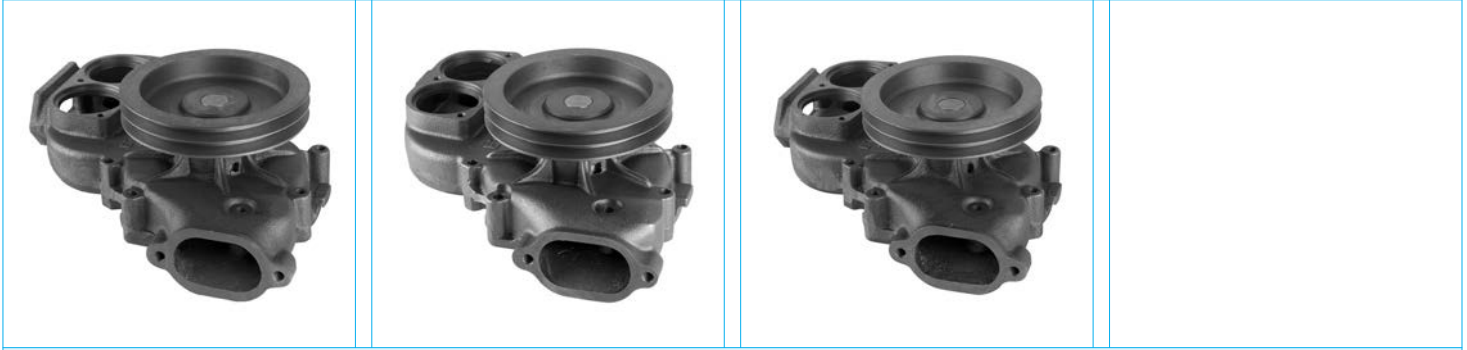

**24-1319**

**24-1321**

**24-1336**

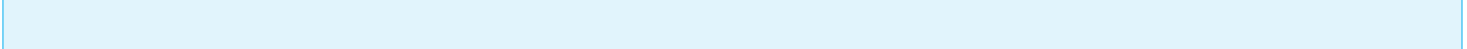
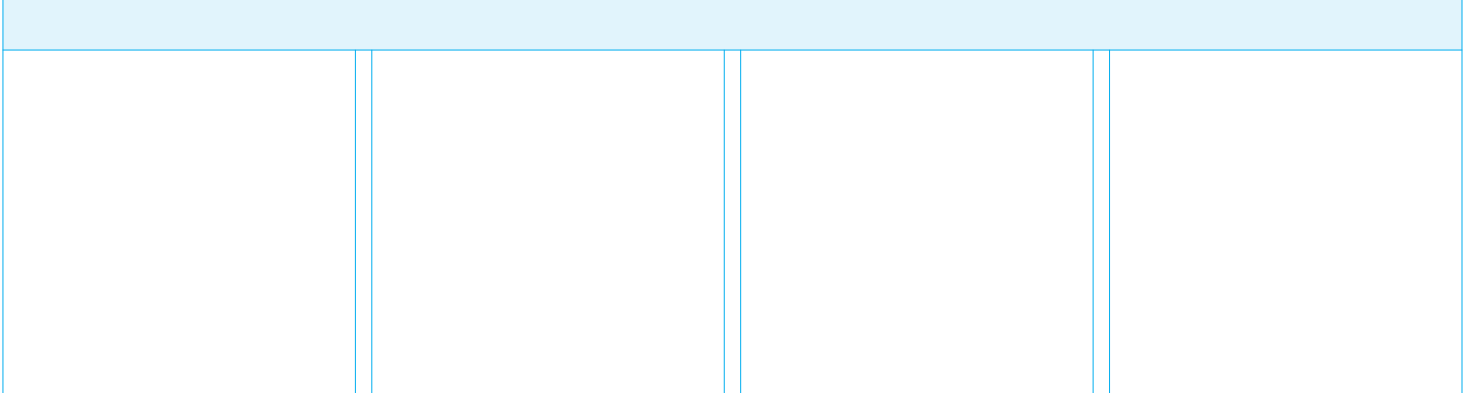
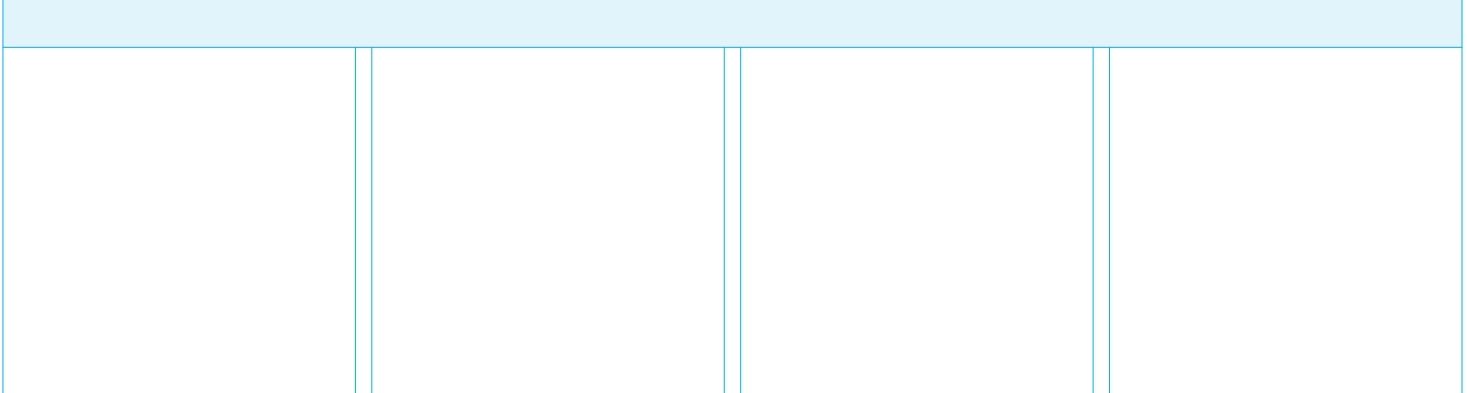
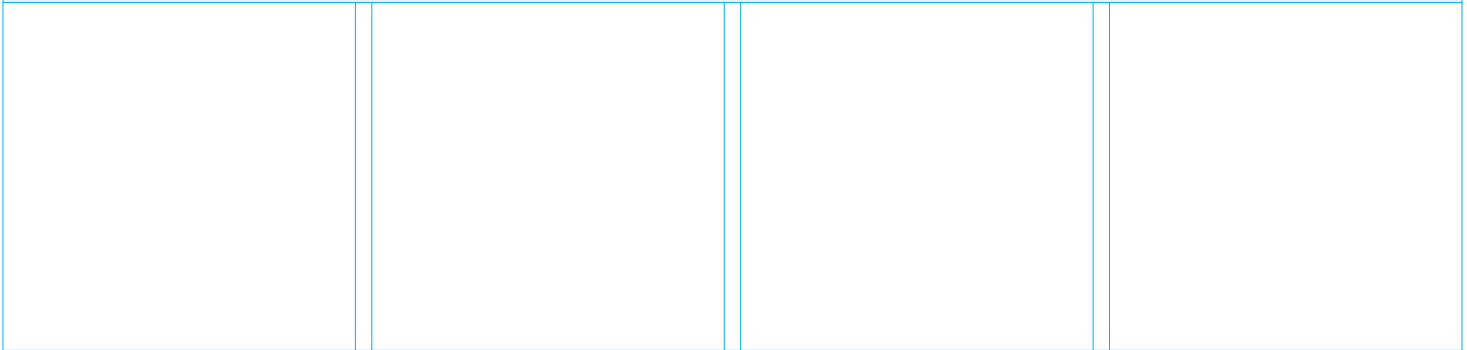

		METELLI ref.			NOTE	Adaptable for OES
35.372 (272 kW) Eng.D2866LF05/LF15	90-97	<b>24-1298</b>			For vehicles without retarder, w/o pulley; Impeller Ø 135mm, Incl Electronic fuel Injection pump	51065006408/ 6492/ 9492
	90-97	<b>24-1301</b>			For vehicles with retarder; w/o pulley; Injection Pump with electronic control unit	51065006479/ 9479
	90-97	<b>24-1302</b>			For vehicles with retarder, w/o pulley	51065006426/ 6490/ 9426/ 9490
	90-97	<b>24-1319</b>			For vehicles with retarder, w pulley	51065006546/ 9546
	90-95	<b>24-1321</b>			For vehicles without retarder, w pulley	51065006545/ 6547/ 9545/ 9547
	90-97	<b>24-1336</b>			w/ Pulley	51065006548/ 9548
35.402 (294 kW) Eng.D2866LF16	94-97	<b>24-1294</b>			For vehicles without retarder; Impeller Ø 125mm	51065006282/ 6387/ 9282/ 9387
	94-97	<b>24-1298</b>			For vehicles without retarder, w/o pulley; Impeller Ø 135mm, Incl Electronic fuel Injection pump	51065006408/ 6492/ 9492
	94-97	<b>24-1301</b>			For vehicles with retarder; w/o pulley; Injection Pump with electronic control unit	51065006479/ 9479
	94-97	<b>24-1302</b>			For vehicles with retarder, w/o pulley	51065006426/ 6490/ 9426/ 9490
	94-97	<b>24-1319</b>			For vehicles with retarder, w pulley	51065006546/ 9546
	90-97	<b>24-1321</b>			For vehicles without retarder, w pulley	51065006545/ 6547/ 9545/ 9547
35.422 (309 kW) Eng.D2866LF06/LF09	90-97	<b>24-1294</b>			For vehicles without retarder; Impeller Ø 125mm	51065006282/ 6387/ 9282/ 9387
	90-97	<b>24-1298</b>			For vehicles without retarder, w/o pulley; Impeller Ø 135mm, Incl Electronic fuel Injection pump	51065006408/ 6492/ 9492
	90-97	<b>24-1301</b>			For vehicles with retarder; w/o pulley; Injection Pump with electronic control unit	51065006479/ 9479
	90-97	<b>24-1302</b>			For vehicles with retarder, w/o pulley	51065006426/ 6490/ 9426/ 9490
	90-97	<b>24-1319</b>			For vehicles with retarder, w pulley	51065006546/ 9546
	90-97	<b>24-1321</b>			For vehicles without retarder, w pulley	51065006545/ 6547/ 9545/ 9547
40.372 (272 kW) Eng.D2866LF03	91-96	<b>24-1294</b>			For vehicles without retarder; Impeller Ø 125mm	51065006282/ 6387/ 9282/ 9387
	91-96	<b>24-1298</b>			For vehicles without retarder, w/o pulley; Impeller Ø 135mm, Incl Electronic fuel Injection pump	51065006408/ 6492/ 9492
	91-96	<b>24-1301</b>			For vehicles with retarder; w/o pulley; Injection Pump with electronic control unit	51065006479/ 9479
	91-96	<b>24-1302</b>			For vehicles with retarder, w/o pulley	51065006426/ 6490/ 9426/ 9490
	91-96	<b>24-1319</b>			For vehicles with retarder, w pulley	51065006546/ 9546
	91-96	<b>24-1321</b>			For vehicles without retarder, w pulley	51065006545/ 6547/ 9545/ 9547
40.372 (272 kW) Eng.D2866LF05	91-96	<b>24-1294</b>			For vehicles without retarder; Impeller Ø 125mm	51065006282/ 6387/ 9282/ 9387
	91-96	<b>24-1298</b>			For vehicles without retarder, w/o pulley; Impeller Ø 135mm, Incl Electronic fuel Injection pump	51065006408/ 6492/ 9492
	91-96	<b>24-1301</b>			For vehicles with retarder; w/o pulley; Injection Pump with electronic control unit	51065006479/ 9479
	91-96	<b>24-1302</b>			For vehicles with retarder, w/o pulley	51065006426/ 6490/ 9426/ 9490
	91-96	<b>24-1319</b>			For vehicles with retarder, w pulley	51065006546/ 9546
	91-96	<b>24-1321</b>			For vehicles without retarder, w pulley	51065006545/ 6547/ 9545/ 9547
40.372 (272 kW) Eng.D2866LF15	91-96	<b>24-1294</b>			For vehicles without retarder; Impeller Ø 125mm	51065006282/ 6387/ 9282/ 9387
	91-96	<b>24-1298</b>			For vehicles without retarder, w/o pulley; Impeller Ø 135mm, Incl Electronic fuel Injection pump	51065006408/ 6492/ 9492
	91-96	<b>24-1301</b>			For vehicles with retarder; w/o pulley; Injection Pump with electronic control unit	51065006479/ 9479
	91-96	<b>24-1302</b>			For vehicles with retarder, w/o pulley	51065006426/ 6490/ 9426/ 9490
	91-96	<b>24-1319</b>			For vehicles with retarder, w pulley	51065006546/ 9546
	91-96	<b>24-1321</b>			For vehicles without retarder, w pulley	51065006545/ 6547/ 9545/ 9547
40.402 (294 kW) Eng.D2866LF16	95-96	<b>24-1294</b>			For vehicles without retarder; Impeller Ø 125mm	51065006282/ 6387/ 9282/ 9387
	95-96	<b>24-1298</b>			For vehicles without retarder, w/o pulley; Impeller Ø 135mm, Incl Electronic fuel Injection pump	51065006408/ 6492/ 9492
	95-96	<b>24-1301</b>			For vehicles with retarder; w/o pulley; Injection Pump with electronic control unit	51065006479/ 9479
	95-96	<b>24-1302</b>			For vehicles with retarder, w/o pulley	51065006426/ 6490/ 9426/ 9490
	95-96	<b>24-1319</b>			For vehicles with retarder, w pulley	51065006546/ 9546
	95-96	<b>24-1321</b>			For vehicles without retarder, w pulley	51065006545/ 6547/ 9545/ 9547
40.422 (309 kW) Eng.D2866LF06	91-96	<b>24-1294</b>			For vehicles without retarder; Impeller Ø 125mm	51065006282/ 6387/ 9282/ 9387
	91-96	<b>24-1298</b>			For vehicles without retarder, w/o pulley; Impeller Ø 135mm, Incl Electronic fuel Injection pump	51065006408/ 6492/ 9492
	91-96	<b>24-1301</b>			For vehicles with retarder; w/o pulley; Injection Pump with electronic control unit	51065006479/ 9479
	91-96	<b>24-1302</b>			For vehicles with retarder, w/o pulley	51065006426/ 6490/ 9426/ 9490

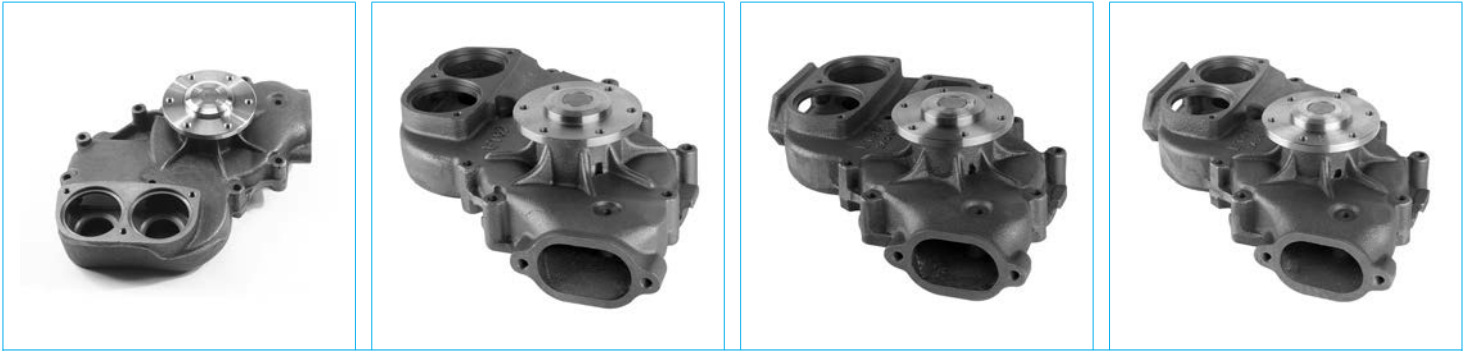

**24-1294**

**24-1298**

**24-1301**

**24-1302**

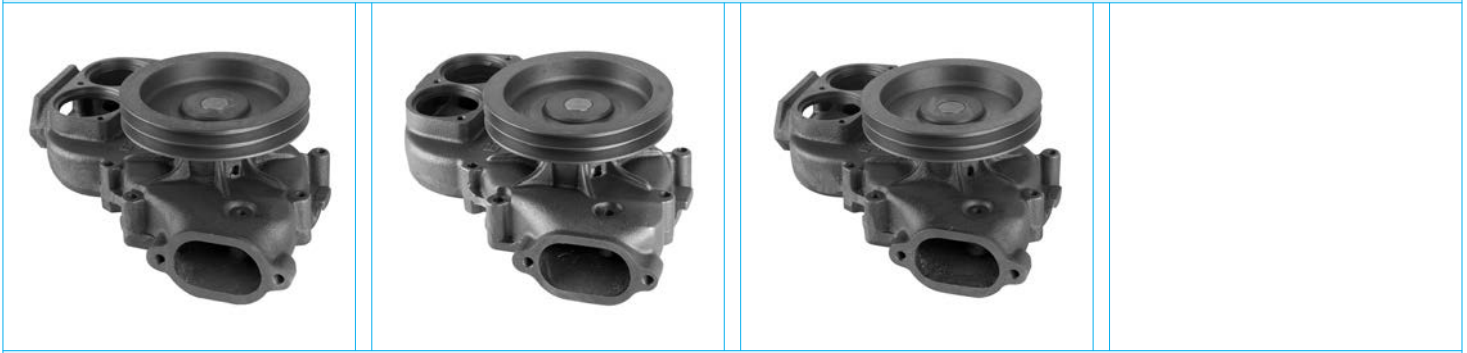

**24-1319**

**24-1321**

**24-1336**

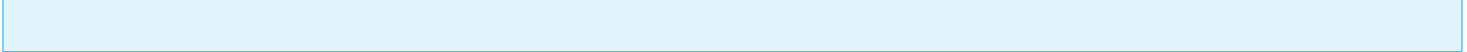
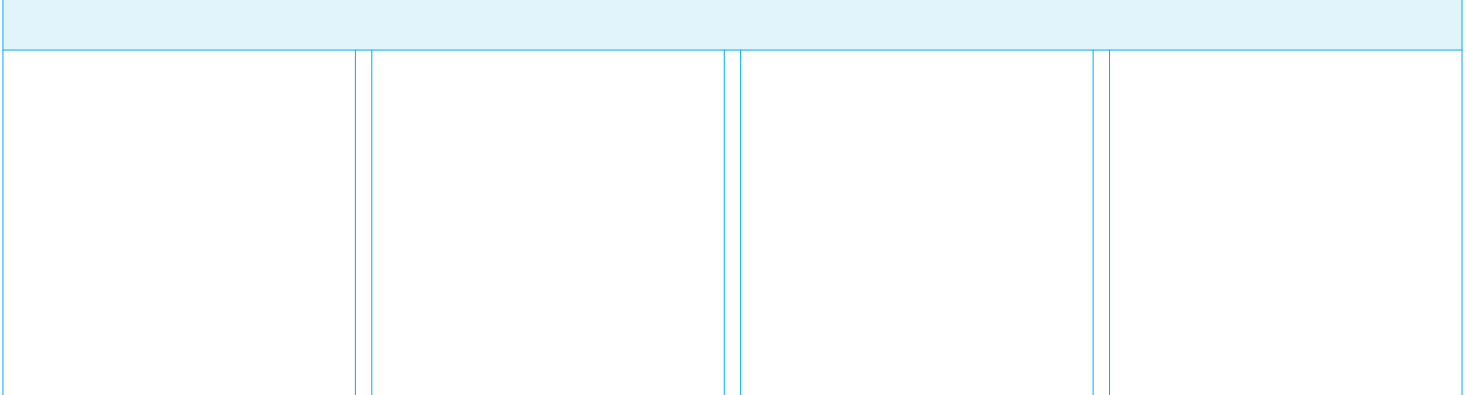
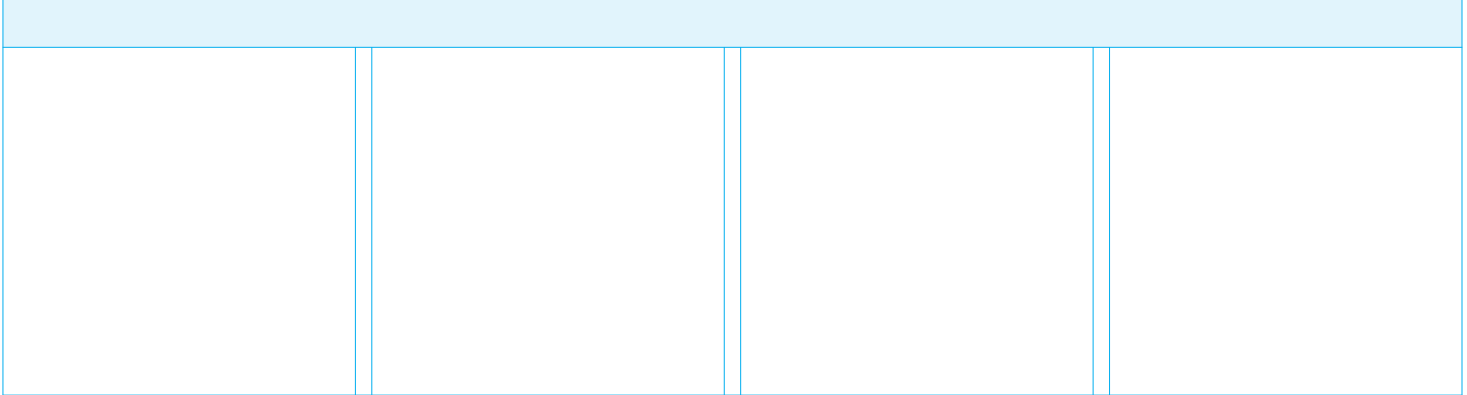
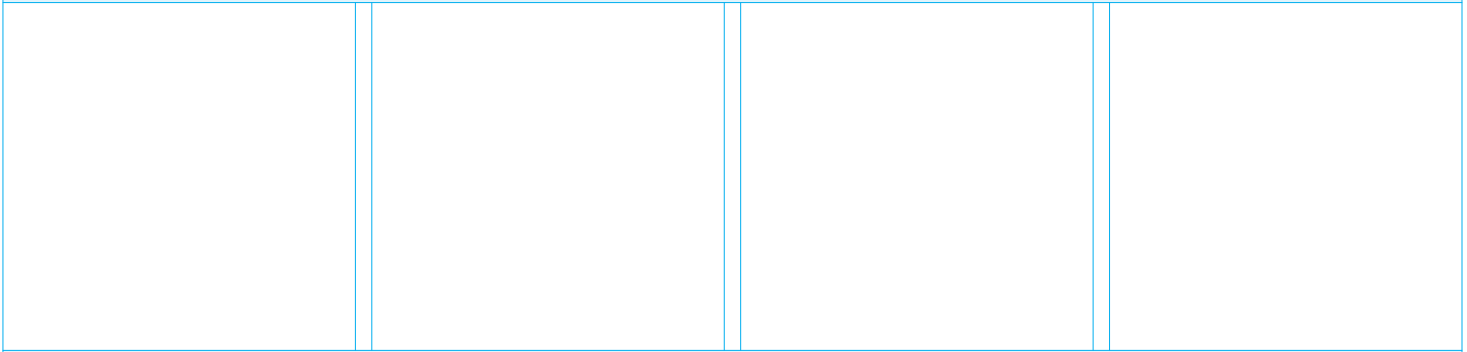

		<b>METELLI</b> ref.			<b>NOTE</b>	<b>Adaptable for OES</b>
40.422 (309 kW) Eng.D2866LF06	91-96	<b>24-1319</b>			For vehicles with retarder, w pulley	51065006546/ 9546
	91-96	<b>24-1321</b>			For vehicles without retarder, w pulley	51065006545/ 6547/ 9545/ 9547
	91-96	<b>24-1336</b>			w/ Pulley	51065006548/ 9548
40.422 (309 kW) Eng.D2866LF09	91-96	<b>24-1294</b>			For vehicles without retarder; Impeller Ø 125mm	51065006282/ 6387/ 9282/ 9387
	91-96	<b>24-1298</b>			For vehicles without retarder, w/o pulley; Impeller Ø 135mm, Incl Eletronic fuel Injection pump	51065006408/ 6492/ 9492
	91-96	<b>24-1301</b>			For vehicles with retarder; w/o pulley; Injection Pump with electronic control unit	51065006479/ 9479
	91-96	<b>24-1302</b>			For vehicles with retarder, w/o pulley	51065006426/ 6490/ 9426/ 9490
	91-96	<b>24-1319</b>			For vehicles with retarder, w pulley	51065006546/ 9546
	91-96	<b>24-1321</b>			For vehicles without retarder, w pulley	51065006545/ 6547/ 9545/ 9547
	91-96	<b>24-1336</b>			w/ Pulley	51065006548/ 9548
40.462 (338-382 kW) Eng.D2840LF/460	89-90	<b>24-1298</b>			For vehicles without retarder, w/o pulley; Impeller Ø 135mm, Incl Eletronic fuel Injection pump	51065006408/ 6492/ 9492
	89-90	<b>24-1302</b>			For vehicles with retarder, w/o pulley	51065006426/ 6490/ 9426/ 9490
40.502 (368 kW) Eng.D2840LF01/LF04/LF06	90-96	<b>24-1298</b>			For vehicles without retarder, w/o pulley; Impeller Ø 135mm, Incl Eletronic fuel Injection pump	51065006408/ 6492/ 9492
	90-96	<b>24-1302</b>			For vehicles with retarder, w/o pulley	51065006426/ 6490/ 9426/ 9490
41.262 (191 kW) Eng.D2865LF/260	89-90	<b>24-1298</b>			For vehicles without retarder, w/o pulley; Impeller Ø 135mm, Incl Eletronic fuel Injection pump	51065006408/ 6492/ 9492
	89-90	<b>24-1301</b>			For vehicles with retarder; w/o pulley; Injection Pump with electronic control unit	51065006479/ 9479
	89-90	<b>24-1302</b>			For vehicles with retarder, w/o pulley	51065006426/ 6490/ 9426/ 9490
	89-90	<b>24-1319</b>			For vehicles with retarder, w pulley	51065006546/ 9546
	89-90	<b>24-1321</b>			For vehicles without retarder, w pulley	51065006545/ 6547/ 9545/ 9547
	89-90	<b>24-1336</b>			w/ Pulley	51065006548/ 9548
41.272 (198 kW) Eng.D2865LF02	90-91	<b>24-1298</b>			For vehicles without retarder, w/o pulley; Impeller Ø 135mm, Incl Eletronic fuel Injection pump	51065006408/ 6492/ 9492
	90-91	<b>24-1301</b>			For vehicles with retarder; w/o pulley; Injection Pump with electronic control unit	51065006479/ 9479
	90-91	<b>24-1302</b>			For vehicles with retarder, w/o pulley	51065006426/ 6490/ 9426/ 9490
	90-91	<b>24-1319</b>			For vehicles with retarder, w pulley	51065006546/ 9546
	90-91	<b>24-1321</b>			For vehicles without retarder, w pulley	51065006545/ 6547/ 9545/ 9547
	90-91	<b>24-1336</b>			w/ Pulley	51065006548/ 9548
41.292 (213 kW) Eng.D2866LF/290 41.332 (243 kW) Eng.D2866LF/330	88-90	<b>24-1294</b>			For vehicles without retarder; Impeller Ø 125mm	51065006282/ 6387/ 9282/ 9387
	88-90	<b>24-1298</b>			For vehicles without retarder, w/o pulley; Impeller Ø 135mm, Incl Eletronic fuel Injection pump	51065006408/ 6492/ 9492
	88-90	<b>24-1301</b>			For vehicles with retarder; w/o pulley; Injection Pump with electronic control unit	51065006479/ 9479
	88-90	<b>24-1302</b>			For vehicles with retarder, w/o pulley	51065006426/ 6490/ 9426/ 9490
	88-90	<b>24-1319</b>			For vehicles with retarder, w pulley	51065006546/ 9546
	88-90	<b>24-1321</b>			For vehicles without retarder, w pulley	51065006545/ 6547/ 9545/ 9547
	88-90	<b>24-1336</b>			w/ Pulley	51065006548/ 9548
41.322 (235 kW) Eng.D2865LF03/LF06	90-96	<b>24-1298</b>			For vehicles without retarder, w/o pulley; Impeller Ø 135mm, Incl Eletronic fuel Injection pump	51065006408/ 6492/ 9492
	90-96	<b>24-1301</b>			For vehicles with retarder; w/o pulley; Injection Pump with electronic control unit	51065006479/ 9479
	90-96	<b>24-1302</b>			For vehicles with retarder, w/o pulley	51065006426/ 6490/ 9426/ 9490
	90-96	<b>24-1319</b>			For vehicles with retarder, w pulley	51065006546/ 9546
	90-96	<b>24-1321</b>			For vehicles without retarder, w pulley	51065006545/ 6547/ 9545/ 9547
	90-96	<b>24-1336</b>			w/ Pulley	51065006548/ 9548
41.342 (250-213 kW) Eng.D2865LF09	94-96	<b>24-1298</b>			For vehicles without retarder, w/o pulley; Impeller Ø 135mm, Incl Eletronic fuel Injection pump	51065006408/ 6492/ 9492
	94-96	<b>24-1301</b>			For vehicles with retarder; w/o pulley; Injection Pump with electronic control unit	51065006479/ 9479
	94-96	<b>24-1302</b>			For vehicles with retarder, w/o pulley	51065006426/ 6490/ 9426/ 9490
	94-96	<b>24-1319</b>			For vehicles with retarder, w pulley	51065006546/ 9546
	90-96	<b>24-1321</b>			For vehicles without retarder, w pulley	51065006545/ 6547/ 9545/ 9547
	94-96	<b>24-1336</b>			w/ Pulley	51065006548/ 9548
41.362 (265 kW) Eng.D2866LXF	88-90	<b>24-1294</b>			For vehicles without retarder; Impeller Ø 125mm	51065006282/ 6387/ 9282/ 9387
	88-90	<b>24-1298</b>			For vehicles without retarder, w/o pulley; Impeller Ø 135mm, Incl Eletronic fuel Injection pump	51065006408/ 6492/ 9492
	88-90	<b>24-1301</b>			For vehicles with retarder; w/o pulley; Injection Pump with electronic control unit	51065006479/ 9479
	88-90	<b>24-1302</b>			For vehicles with retarder, w/o pulley	51065006426/ 6490/ 9426/ 9490

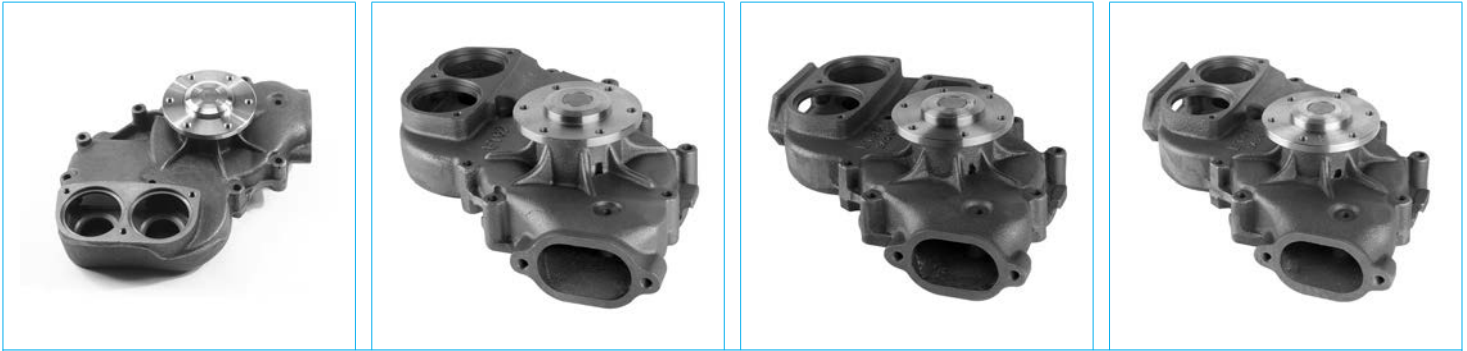

**24-1294**

**24-1298**

**24-1301**

**24-1302**

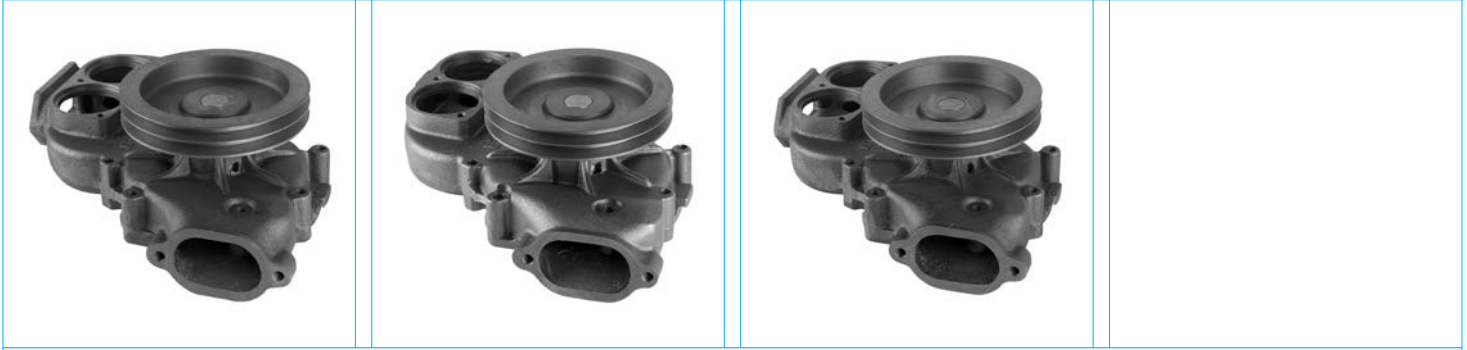

**24-1319**

**24-1321**

**24-1336**

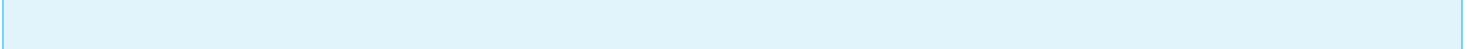
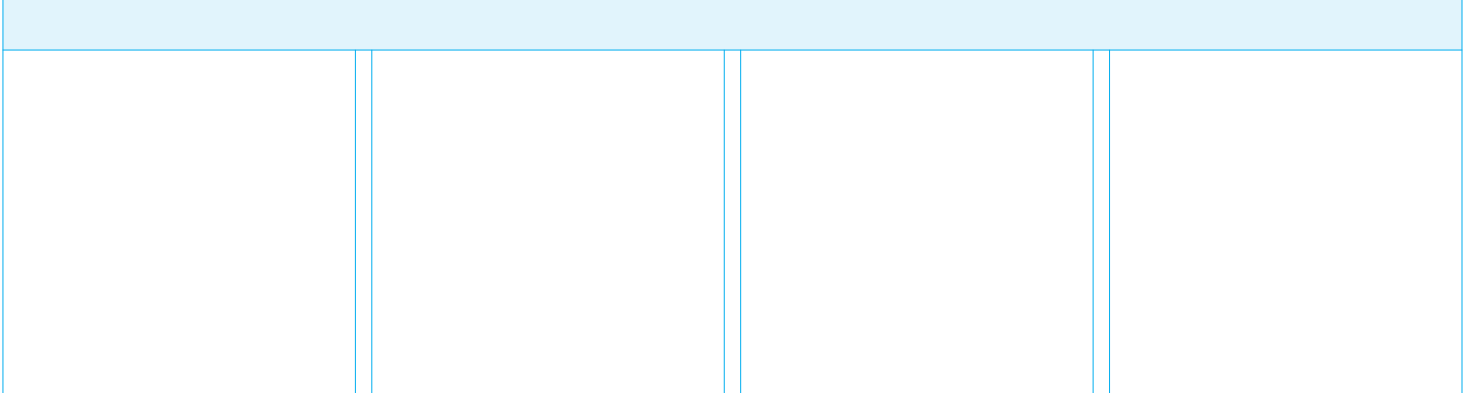
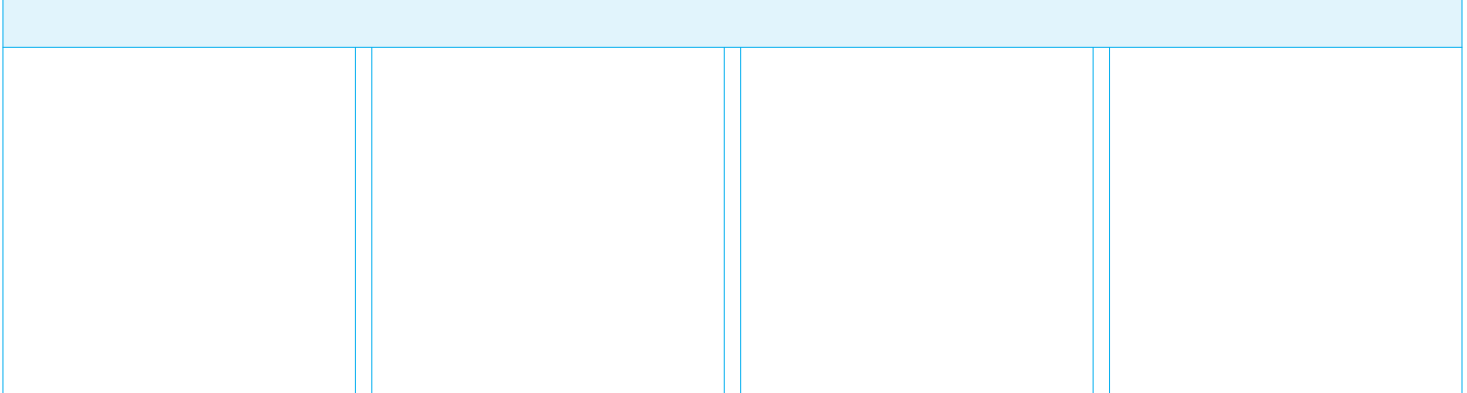
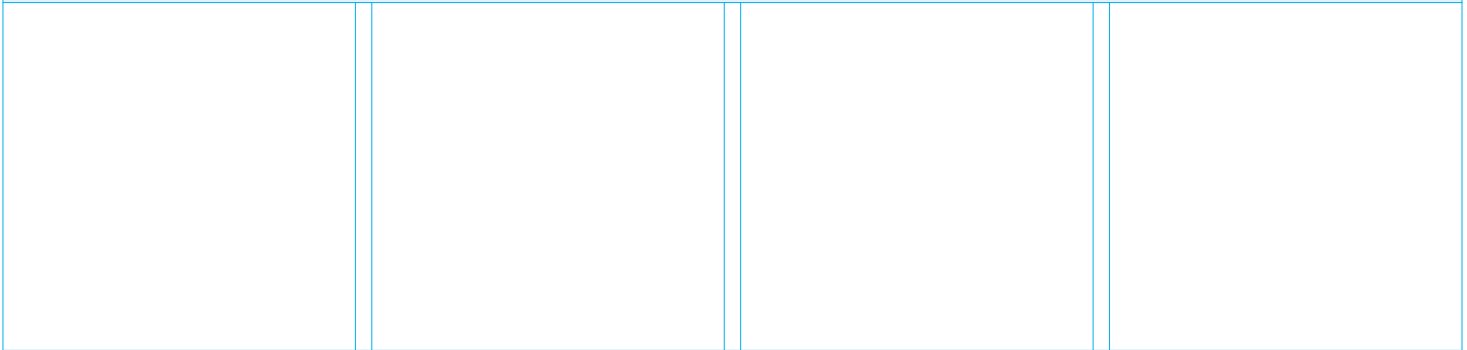



		<b>METELLI</b> ref.			<b>NOTE</b>	<b>Adaptable for OES</b>
41.362 (265 kW) Eng.D2866LXF	88-90	<b>24-1319</b>			For vehicles with retarder, w pulley	51065006546/ 9546
	90-96	<b>24-1321</b>			For vehicles without retarder, w pulley	51065006545/ 6547/ 9545/ 9547
	88-90	<b>24-1336</b>			w/ Pulley	51065006548/ 9548
41.372 (272 kW) Eng.D2866LF03/LF05	90-96	<b>24-1294</b>			For vehicles without retarder; Impeller Ø 125mm	51065006282/ 6387/ 9282/ 9387
	90-96	<b>24-1298</b>			For vehicles without retarder, w/o pulley; Impeller Ø 135mm, Incl Eletronic fuel Injection pump	51065006408/ 6492/ 9492
	90-96	<b>24-1301</b>			For vehicles with retarder; w/o pulley; Injection Pump with electronic control unit	51065006479/ 9479
	90-96	<b>24-1302</b>			For vehicles with retarder, w/o pulley	51065006426/ 6490/ 9426/ 9490
	90-96	<b>24-1319</b>			For vehicles with retarder, w pulley	51065006546/ 9546
	90-96	<b>24-1321</b>			For vehicles without retarder, w pulley	51065006545/ 6547/ 9545/ 9547
	90-96	<b>24-1336</b>			w/ Pulley	51065006548/ 9548
	90-96	<b>24-1294</b>			For vehicles without retarder; Impeller Ø 125mm	51065006282/ 6387/ 9282/ 9387
41.372 (272 kW) Eng.D2866LF15	90-96	<b>24-1298</b>			For vehicles without retarder, w/o pulley; Impeller Ø 135mm, Incl Eletronic fuel Injection pump	51065006408/ 6492/ 9492
	90-96	<b>24-1301</b>			For vehicles with retarder; w/o pulley; Injection Pump with electronic control unit	51065006479/ 9479
	90-96	<b>24-1302</b>			For vehicles with retarder, w/o pulley	51065006426/ 6490/ 9426/ 9490
	90-96	<b>24-1319</b>			For vehicles with retarder, w pulley	51065006546/ 9546
	90-96	<b>24-1321</b>			For vehicles without retarder, w pulley	51065006545/ 6547/ 9545/ 9547
	90-96	<b>24-1336</b>			w/ Pulley	51065006548/ 9548
	90-96	<b>24-1294</b>			For vehicles without retarder; Impeller Ø 125mm	51065006282/ 6387/ 9282/ 9387
	90-96	<b>24-1298</b>			For vehicles without retarder, w/o pulley; Impeller Ø 135mm, Incl Eletronic fuel Injection pump	51065006408/ 6492/ 9492
41.402 (294 kW) Eng.D2866LF16	94-96	<b>24-1301</b>			For vehicles with retarder; w/o pulley; Injection Pump with electronic control unit	51065006479/ 9479
	94-96	<b>24-1302</b>			For vehicles with retarder, w/o pulley	51065006426/ 6490/ 9426/ 9490
	94-96	<b>24-1319</b>			For vehicles with retarder, w pulley	51065006546/ 9546
	94-96	<b>24-1321</b>			For vehicles without retarder, w pulley	51065006545/ 6547/ 9545/ 9547
	94-96	<b>24-1336</b>			w/ Pulley	51065006548/ 9548
	90-96	<b>24-1294</b>			For vehicles without retarder; Impeller Ø 125mm	51065006282/ 6387/ 9282/ 9387
	90-96	<b>24-1298</b>			For vehicles without retarder, w/o pulley; Impeller Ø 135mm, Incl Eletronic fuel Injection pump	51065006408/ 6492/ 9492
	90-96	<b>24-1301</b>			For vehicles with retarder; w/o pulley; Injection Pump with electronic control unit	51065006479/ 9479
41.422 (309 kW) Eng.D2866LF06/LF09	90-96	<b>24-1302</b>			For vehicles with retarder, w/o pulley	51065006426/ 6490/ 9426/ 9490
	90-96	<b>24-1319</b>			For vehicles with retarder, w pulley	51065006546/ 9546
	90-96	<b>24-1321</b>			For vehicles without retarder, w pulley	51065006545/ 6547/ 9545/ 9547
	90-96	<b>24-1336</b>			w/ Pulley	51065006548/ 9548
	90-96	<b>24-1294</b>			For vehicles without retarder; Impeller Ø 125mm	51065006282/ 6387/ 9282/ 9387
	90-96	<b>24-1298</b>			For vehicles without retarder, w/o pulley; Impeller Ø 135mm, Incl Eletronic fuel Injection pump	51065006408/ 6492/ 9492
	90-96	<b>24-1301</b>			For vehicles with retarder; w/o pulley; Injection Pump with electronic control unit	51065006479/ 9479
	90-96	<b>24-1302</b>			For vehicles with retarder, w/o pulley	51065006426/ 6490/ 9426/ 9490
48.292 (213 kW) Eng.D2866LF/290	89-90	<b>24-1319</b>			For vehicles with retarder, w pulley	51065006546/ 9546
	89-90	<b>24-1321</b>			For vehicles without retarder, w pulley	51065006545/ 6547/ 9545/ 9547
	89-90	<b>24-1336</b>			w/ Pulley	51065006548/ 9548
	89-90	<b>24-1294</b>			For vehicles without retarder; Impeller Ø 125mm	51065006282/ 6387/ 9282/ 9387
	89-90	<b>24-1298</b>			For vehicles without retarder, w/o pulley; Impeller Ø 135mm, Incl Eletronic fuel Injection pump	51065006408/ 6492/ 9492
	89-90	<b>24-1301</b>			For vehicles with retarder; w/o pulley; Injection Pump with electronic control unit	51065006479/ 9479
	89-90	<b>24-1302</b>			For vehicles with retarder, w/o pulley	51065006426/ 6490/ 9426/ 9490
	89-90	<b>24-1319</b>			For vehicles with retarder, w pulley	51065006546/ 9546
48.332 (243 kW) Eng.D2866LF/330	89-90	<b>24-1321</b>			For vehicles without retarder, w pulley	51065006545/ 6547/ 9545/ 9547
	89-90	<b>24-1336</b>			w/ Pulley	51065006548/ 9548
	89-90	<b>24-1294</b>			For vehicles without retarder; Impeller Ø 125mm	51065006282/ 6387/ 9282/ 9387
	89-90	<b>24-1298</b>			For vehicles without retarder, w/o pulley; Impeller Ø 135mm, Incl Eletronic fuel Injection pump	51065006408/ 6492/ 9492
	89-90	<b>24-1301</b>			For vehicles with retarder; w/o pulley; Injection Pump with electronic control unit	51065006479/ 9479
	89-90	<b>24-1302</b>			For vehicles with retarder, w/o pulley	51065006426/ 6490/ 9426/ 9490
	89-90	<b>24-1319</b>			For vehicles with retarder, w pulley	51065006546/ 9546
	89-90	<b>24-1321</b>			For vehicles without retarder, w pulley	51065006545/ 6547/ 9545/ 9547
48.362 (265 kW) Eng.D2866LXF	89-90	<b>24-1336</b>			w/ Pulley	51065006548/ 9548
	89-90	<b>24-1321</b>			For vehicles without retarder, w pulley	51065006545/ 6547/ 9545/ 9547
	89-90	<b>24-1319</b>			For vehicles with retarder, w pulley	51065006546/ 9546
	89-90	<b>24-1302</b>			For vehicles with retarder, w/o pulley	51065006426/ 6490/ 9426/ 9490
	89-90	<b>24-1301</b>			For vehicles with retarder; w/o pulley; Injection Pump with electronic control unit	51065006479/ 9479
	89-90	<b>24-1298</b>			For vehicles without retarder, w/o pulley; Impeller Ø 135mm, Incl Eletronic fuel Injection pump	51065006408/ 6492/ 9492
	89-90	<b>24-1294</b>			For vehicles without retarder; Impeller Ø 125mm	51065006282/ 6387/ 9282/ 9387
	89-90	<b>24-1336</b>			w/ Pulley	51065006548/ 9548



			
<b>24-1234</b>	<b>24-1292</b>	<b>24-1294</b>	<b>24-1298</b>
			
<b>24-1302</b>	<b>24-1306</b>	<b>24-1310</b>	<b>24-1322</b>
			
<b>24-1323</b>	<b>24-1331</b>		

		<b>METELLI</b> ref.			<b>NOTE</b>	<b>Adaptable for OES</b>
48.462 (338-382 kW) Eng.D2840LF/460	89-90	<b>24-1298</b>			For vehicles without retarder, w/o pulley; Impeller Ø 135mm, Incl Electronic fuel Injection pump	51065006408/ 6492/ 9492
	89-90	<b>24-1302</b>			For vehicles with retarder, w/o pulley	51065006426/ 6490/ 9426/ 9490
<b>G 90 '9/87-'5/95</b>						
10.150 (110-114 kW) Eng.D0826GF01	87-93	<b>24-1310</b>			Impeller Ø 135mm	51065003178/ 6463/ 6495/ 9463/ 9495
	87-93	<b>24-1323</b>			Impeller Ø 125mm	51065006537/ 9537
10.150 (110-114 kW) Eng.D0826GF03	87-93	<b>24-1310</b>			Impeller Ø 135mm	51065003178/ 6463/ 6495/ 9463/ 9495
	87-93	<b>24-1323</b>			Impeller Ø 125mm	51065006537/ 9537
6.100 (75 kW) Eng.D0824GF01	87-93	<b>24-1323</b>			Impeller Ø 125mm	51065006537/ 9537
6.100 (75 kW) Eng.D0824GF02	87-93	<b>24-1323</b>			Impeller Ø 125mm	51065006537/ 9537
8.100 (75 kW) Eng.D0824GF01	87-93	<b>24-1323</b>			Impeller Ø 125mm	51065006537/ 9537
8.100 (75 kW) Eng.D0824GF02	87-93	<b>24-1323</b>			Impeller Ø 125mm	51065006537/ 9537
8.150 (110-114 kW) Eng.D0826GF	87-95	<b>24-1310</b>			Impeller Ø 135mm	51065003178/ 6463/ 6495/ 9463/ 9495
	87-95	<b>24-1323</b>			Impeller Ø 125mm	51065006537/ 9537
8.150 (110-114 kW) Eng.D0826GF01	88-93	<b>24-1310</b>			Impeller Ø 135mm	51065003178/ 6463/ 6495/ 9463/ 9495
	88-93	<b>24-1323</b>			Impeller Ø 125mm	51065006537/ 9537
8.150 (110-114 kW) Eng.D0826GF03	88-95	<b>24-1310</b>			Impeller Ø 135mm	51065003178/ 6463/ 6495/ 9463/ 9495
	88-95	<b>24-1323</b>			Impeller Ø 125mm	51065006537/ 9537
9.150 (110-114 kW) Eng.D0826GF	87-93	<b>24-1310</b>			Impeller Ø 135mm	51065003178/ 6463/ 6495/ 9463/ 9495
	87-93	<b>24-1323</b>			Impeller Ø 125mm	51065006537/ 9537
9.150 (110-114 kW) Eng.D0826GF01	88-93	<b>24-1310</b>			Impeller Ø 135mm	51065003178/ 6463/ 6495/ 9463/ 9495
	88-93	<b>24-1323</b>			Impeller Ø 125mm	51065006537/ 9537
9.150 (110-114 kW) Eng.D0826GF03	88-93	<b>24-1310</b>			Impeller Ø 135mm	51065003178/ 6463/ 6495/ 9463/ 9495
	88-93	<b>24-1323</b>			Impeller Ø 125mm	51065006537/ 9537
<b>Industrial '1/76-'12/81</b>						
9.5 T. (169 kW) Eng.D2565MT/MK	76-81	<b>24-1292</b>			For vehicles without retarder	51065006204/ 6213/ 6214/ 6215/ 6216/ 6218 51065006219/ 6221/ 6222/ 6223/ 6224/ 6225 51065006228/ 6229/ 9228
	76-81	<b>24-1294</b>			For vehicles without retarder; Impeller Ø 125mm	51065006282/ 6387/ 9282/ 9387
<b>L 2000 '10/93-</b>						
10.150 (114-118 kW) Eng.D0824LFO	95-96	<b>24-1306</b>			For vehicles without retarder, Impeller Ø 125mm	51065006462/ 6476/ 9462/ 9476
	95-96	<b>24-1322</b>			For vehicles without retarder, Impeller Ø 110mm	51065006515/ 6532/ 9515/ 9532
	95-96	<b>24-1323</b>			Impeller Ø 125mm	51065006537/ 9537
10.153 (114 kW) Eng.D0824LFL01/5	93-96	<b>24-1306</b>			For vehicles without retarder, Impeller Ø 125mm	51065006462/ 6476/ 9462/ 9476
	93-96	<b>24-1322</b>			For vehicles without retarder, Impeller Ø 110mm	51065006515/ 6532/ 9515/ 9532
	93-96	<b>24-1323</b>			Impeller Ø 125mm	51065006537/ 9537
10.163 (114-118 kW) Eng.D0824LFL02/6/9	94-	<b>24-1306</b>			For vehicles without retarder, Impeller Ø 125mm	51065006462/ 6476/ 9462/ 9476
	94-	<b>24-1322</b>			For vehicles without retarder, Impeller Ø 110mm	51065006515/ 6532/ 9515/ 9532
	94-	<b>24-1323</b>			Impeller Ø 125mm	51065006537/ 9537
10.185 (132 kW) Eng.D0834LFL03	00-	<b>24-1234</b>			Impeller Ø 135mm, M14x1,5	51065006679/ 6699/ 7064/ 7078 51065009064/ 9078/ 9679/ 9699
	00-	<b>24-1331</b>			Impeller Ø 125mm	51065006575/ 6606/ 6612 51065006669/ 9575/ 9606/ 9612
10.220 (162 kW) Eng.D0826LFL03	95-	<b>24-1306</b>			For vehicles without retarder, Impeller Ø 125mm	51065006462/ 6476/ 9462/ 9476
	95-	<b>24-1310</b>			Impeller Ø 135mm	51065003178/ 6463/ 6495/ 9463/ 9495
	95-	<b>24-1322</b>			For vehicles without retarder, Impeller Ø 110mm	51065006515/ 6532/ 9515/ 9532
	95-	<b>24-1323</b>			Impeller Ø 125mm	51065006537/ 9537
10.223 (162-169 kW) Eng.D0826LFL02/6	93-96	<b>24-1306</b>			For vehicles without retarder, Impeller Ø 125mm	51065006462/ 6476/ 9462/ 9476
	93-96	<b>24-1310</b>			Impeller Ø 135mm	51065003178/ 6463/ 6495/ 9463/ 9495
	93-96	<b>24-1322</b>			For vehicles without retarder, Impeller Ø 110mm	51065006515/ 6532/ 9515/ 9532
	93-96	<b>24-1323</b>			Impeller Ø 125mm	51065006537/ 9537
10.224 (162 kW) Eng.D0826LFL03	94-	<b>24-1306</b>			For vehicles without retarder, Impeller Ø 125mm	51065006462/ 6476/ 9462/ 9476
	94-	<b>24-1310</b>			Impeller Ø 135mm	51065003178/ 6463/ 6495/ 9463/ 9495
	94-	<b>24-1322</b>			For vehicles without retarder, Impeller Ø 110mm	51065006515/ 6532/ 9515/ 9532
	94-	<b>24-1323</b>			Impeller Ø 125mm	51065006537/ 9537
10.225 (162-206 kW) Eng.D0836LFL02	00-	<b>24-1234</b>			Impeller Ø 135mm, M14x1,5	51065006679/ 6699/ 7064/ 7078 51065009064/ 9078/ 9679/ 9699
	00-	<b>24-1322</b>			For vehicles without retarder, Impeller Ø 110mm	51065006515/ 6532/ 9515/ 9532
	00-	<b>24-1331</b>			Impeller Ø 125mm	51065006575/ 6606/ 6612 51065006669/ 9575/ 9606/ 9612
12.185 (132 kW) Eng.D0834LFL03	99-	<b>24-1331</b>			Impeller Ø 125mm	51065006575/ 6606/ 6612 51065006669/ 9575/ 9606/ 9612

			
<b>24-1234</b>	<b>24-1306</b>	<b>24-1310</b>	<b>24-1322</b>
			
<b>24-1323</b>	<b>24-1331</b>		

		<b>METELLI ref.</b>		<b>NOTE</b>	<b>Adaptable for OES</b>
12.225 (162-206 kW) Eng.D0836LFL02	99-	<b>24-1234</b>		Impeller Ø 135mm, M14x1,5	51065006679/ 6699/ 7064/ 7078 51065009064/ 9078/ 9679/ 9699
	99-	<b>24-1322</b>		For vehicles without retarder, Impeller Ø 110mm	51065006515/ 6532/ 9515/ 9532
	99-	<b>24-1331</b>		Impeller Ø 125mm	51065006575/ 6606/ 6612 51065006669/ 9575/ 9606/ 9612
8.103 (75 kW) Eng.D0824FL01	93-96	<b>24-1306</b>		For vehicles without retarder, Impeller Ø 125mm	51065006462/ 6476/ 9462/ 9476
	93-96	<b>24-1322</b>		For vehicles without retarder, Impeller Ø 110mm	51065006515/ 6532/ 9515/ 9532
	93-96	<b>24-1323</b>		Impeller Ø 125mm	51065006537/ 9537
8.113 (81 kW) Eng.D0824LFL04	95-	<b>24-1306</b>		For vehicles without retarder, Impeller Ø 125mm	51065006462/ 6476/ 9462/ 9476
	95-	<b>24-1322</b>		For vehicles without retarder, Impeller Ø 110mm	51065006515/ 6532/ 9515/ 9532
	95-	<b>24-1323</b>		Impeller Ø 125mm	51065006537/ 9537
8.113 (83 kW) Eng.D0824LFL08	00-	<b>24-1306</b>		For vehicles without retarder, Impeller Ø 125mm	51065006462/ 6476/ 9462/ 9476
	00-	<b>24-1322</b>		For vehicles without retarder, Impeller Ø 110mm	51065006515/ 6532/ 9515/ 9532
	00-	<b>24-1323</b>		Impeller Ø 125mm	51065006537/ 9537
8.145 (103 kW) Eng.D0834LFL02	00-	<b>24-1323</b>		Impeller Ø 125mm	51065006537/ 9537
8.150 (114-118 kW) Eng.D0824LFO	95-	<b>24-1306</b>		For vehicles without retarder, Impeller Ø 125mm	51065006462/ 6476/ 9462/ 9476
	95-	<b>24-1322</b>		For vehicles without retarder, Impeller Ø 110mm	51065006515/ 6532/ 9515/ 9532
	95-	<b>24-1323</b>		Impeller Ø 125mm	51065006537/ 9537
8.153 (114 kW) Eng.D0824LFL01/5	93-96	<b>24-1306</b>		For vehicles without retarder, Impeller Ø 125mm	51065006462/ 6476/ 9462/ 9476
	93-96	<b>24-1322</b>		For vehicles without retarder, Impeller Ø 110mm	51065006515/ 6532/ 9515/ 9532
	93-96	<b>24-1323</b>		Impeller Ø 125mm	51065006537/ 9537
8.163 (104 kW) Eng.D0824LFL07	95-	<b>24-1306</b>		For vehicles without retarder, Impeller Ø 125mm	51065006462/ 6476/ 9462/ 9476
	95-	<b>24-1322</b>		For vehicles without retarder, Impeller Ø 110mm	51065006515/ 6532/ 9515/ 9532
	95-	<b>24-1323</b>		Impeller Ø 125mm	51065006537/ 9537
8.163 (114-118 kW) Eng.D0824LFL02/6/9	95-	<b>24-1306</b>		For vehicles without retarder, Impeller Ø 125mm	51065006462/ 6476/ 9462/ 9476
	95-	<b>24-1322</b>		For vehicles without retarder, Impeller Ø 110mm	51065006515/ 6532/ 9515/ 9532
	95-	<b>24-1323</b>		Impeller Ø 125mm	51065006537/ 9537
8.185 (132 kW) Eng.D0834LFL03	00-	<b>24-1234</b>		Impeller Ø 135mm, M14x1,5	51065006679/ 6699/ 7064/ 7078 51065009064/ 9078/ 9679/ 9699
	00-	<b>24-1331</b>		Impeller Ø 125mm	51065006575/ 6606/ 6612 51065006669/ 9575/ 9606/ 9612
8.220 (162 kW) Eng.D0826LFL03	95-	<b>24-1306</b>		For vehicles without retarder, Impeller Ø 125mm	51065006462/ 6476/ 9462/ 9476
	95-	<b>24-1310</b>		Impeller Ø 135mm	51065003178/ 6463/ 6495/ 9463/ 9495
	95-	<b>24-1322</b>		For vehicles without retarder, Impeller Ø 110mm	51065006515/ 6532/ 9515/ 9532
	95-	<b>24-1323</b>		Impeller Ø 125mm	51065006537/ 9537
8.223 (162-169 kW) Eng.D0826LFL02/6	93-96	<b>24-1306</b>		For vehicles without retarder, Impeller Ø 125mm	51065006462/ 6476/ 9462/ 9476
	93-96	<b>24-1310</b>		Impeller Ø 135mm	51065003178/ 6463/ 6495/ 9463/ 9495
	93-96	<b>24-1322</b>		For vehicles without retarder, Impeller Ø 110mm	51065006515/ 6532/ 9515/ 9532
	93-96	<b>24-1323</b>		Impeller Ø 125mm	51065006537/ 9537
8.224 (162 kW) Eng.D0826LFL03	94-	<b>24-1306</b>		For vehicles without retarder, Impeller Ø 125mm	51065006462/ 6476/ 9462/ 9476
8.225 (162 kW) Eng.D0826LFL10	94-	<b>24-1310</b>		Impeller Ø 135mm	51065003178/ 6463/ 6495/ 9463/ 9495
	94-	<b>24-1322</b>		For vehicles without retarder, Impeller Ø 110mm	51065006515/ 6532/ 9515/ 9532
	94-	<b>24-1323</b>		Impeller Ø 125mm	51065006537/ 9537
8.225 (162-206 kW) Eng.D0836LFL02	00-	<b>24-1234</b>		Impeller Ø 135mm, M14x1,5	51065006679/ 6699/ 7064/ 7078 51065009064/ 9078/ 9679/ 9699
	00-	<b>24-1322</b>		For vehicles without retarder, Impeller Ø 110mm	51065006515/ 6532/ 9515/ 9532
	00-	<b>24-1331</b>		Impeller Ø 125mm	51065006575/ 6606/ 6612 51065006669/ 9575/ 9606/ 9612
9.145 (103 kW) Eng.D0834LFL02	00-	<b>24-1323</b>		Impeller Ø 125mm	51065006537/ 9537
9.153 (114 kW) Eng.D0824LFL01/5	93-96	<b>24-1306</b>		For vehicles without retarder, Impeller Ø 125mm	51065006462/ 6476/ 9462/ 9476
	93-96	<b>24-1322</b>		For vehicles without retarder, Impeller Ø 110mm	51065006515/ 6532/ 9515/ 9532
	93-96	<b>24-1323</b>		Impeller Ø 125mm	51065006537/ 9537
9.163 (104 kW) Eng.D0824LFL07	95-97	<b>24-1306</b>		For vehicles without retarder, Impeller Ø 125mm	51065006462/ 6476/ 9462/ 9476
	95-97	<b>24-1322</b>		For vehicles without retarder, Impeller Ø 110mm	51065006515/ 6532/ 9515/ 9532
	95-97	<b>24-1323</b>		Impeller Ø 125mm	51065006537/ 9537
9.163 (114-118 kW) Eng.D0824LFL02/6/9	94-	<b>24-1306</b>		For vehicles without retarder, Impeller Ø 125mm	51065006462/ 6476/ 9462/ 9476
	94-	<b>24-1322</b>		For vehicles without retarder, Impeller Ø 110mm	51065006515/ 6532/ 9515/ 9532
	94-	<b>24-1323</b>		Impeller Ø 125mm	51065006537/ 9537
9.185 (132 kW) Eng.D0834LFL03	00-	<b>24-1234</b>		Impeller Ø 135mm, M14x1,5	51065006679/ 6699/ 7064/ 7078 51065009064/ 9078/ 9679/ 9699
	00-	<b>24-1331</b>		Impeller Ø 125mm	51065006575/ 6606/ 6612 51065006669/ 9575/ 9606/ 9612



**24-1234**



**24-1306**



**24-1310**



**24-1322**



**24-1323**



**24-1331**

		<b>METELLI</b> ref.			<b>NOTE</b>	<b>Adaptable for OES</b>
9.223 (162 kW) Eng.D0826LFL02/6	93-96	<b>24-1306</b>			For vehicles without retarder, Impeller Ø 125mm	51065006462/ 6476/ 9462/ 9476
	93-96	<b>24-1310</b>			Impeller Ø 135mm	51065003178/ 6463/ 6495/ 9463/ 9495
	93-96	<b>24-1322</b>			For vehicles without retarder, Impeller Ø 110mm	51065006515/ 6532/ 9515/ 9532
	93-96	<b>24-1323</b>			Impeller Ø 125mm	51065006537/ 9537
9.224 (162 kW) Eng.D0826LFL03	94-	<b>24-1306</b>			For vehicles without retarder, Impeller Ø 125mm	51065006462/ 6476/ 9462/ 9476
	94-	<b>24-1310</b>			Impeller Ø 135mm	51065003178/ 6463/ 6495/ 9463/ 9495
	94-	<b>24-1322</b>			For vehicles without retarder, Impeller Ø 110mm	51065006515/ 6532/ 9515/ 9532
	94-	<b>24-1323</b>			Impeller Ø 125mm	51065006537/ 9537
9.225 (162-206 kW) Eng.D0836LFL02	00-	<b>24-1234</b>			Impeller Ø 135mm, M14x1,5	51065006679/ 6699/ 7064/ 7078 51065009064/ 9078/ 9679/ 9699
	00-	<b>24-1322</b>			For vehicles without retarder, Impeller Ø 110mm	51065006515/ 6532/ 9515/ 9532
	00-	<b>24-1331</b>			Impeller Ø 125mm	51065006575/ 6606/ 6612 51065006669/ 9575/ 9606/ 9612
<b>M 2000 L '8/95-</b>						
12.163 (114 kW) Eng.D0824LFL06/LF09	95-	<b>24-1306</b>			For vehicles without retarder, Impeller Ø 125mm	51065006462/ 6476/ 9462/ 9476
	95-	<b>24-1322</b>			For vehicles without retarder, Impeller Ø 110mm	51065006515/ 6532/ 9515/ 9532
	95-	<b>24-1323</b>			Impeller Ø 125mm	51065006537/ 9537
12.224 (162 kW) Eng.D0826LFL03	95-	<b>24-1306</b>			For vehicles without retarder, Impeller Ø 125mm	51065006462/ 6476/ 9462/ 9476
	95-	<b>24-1310</b>			Impeller Ø 135mm	51065003178/ 6463/ 6495/ 9463/ 9495
	95-	<b>24-1322</b>			For vehicles without retarder, Impeller Ø 110mm	51065006515/ 6532/ 9515/ 9532
	95-	<b>24-1323</b>			Impeller Ø 125mm	51065006537/ 9537
12.224 (162 kW) Eng.D0826LFL10	95-	<b>24-1306</b>			For vehicles without retarder, Impeller Ø 125mm	51065006462/ 6476/ 9462/ 9476
	95-	<b>24-1310</b>			Impeller Ø 135mm	51065003178/ 6463/ 6495/ 9463/ 9495
	95-	<b>24-1322</b>			For vehicles without retarder, Impeller Ø 110mm	51065006515/ 6532/ 9515/ 9532
	95-	<b>24-1323</b>			Impeller Ø 125mm	51065006537/ 9537
14.163 (114 kW) Eng.D0824LFL06	95-	<b>24-1306</b>			For vehicles without retarder, Impeller Ø 125mm	51065006462/ 6476/ 9462/ 9476
	95-	<b>24-1322</b>			For vehicles without retarder, Impeller Ø 110mm	51065006515/ 6532/ 9515/ 9532
	95-	<b>24-1323</b>			Impeller Ø 125mm	51065006537/ 9537
14.163 (114 kW) Eng.D0824LFL09	95-	<b>24-1306</b>			For vehicles without retarder, Impeller Ø 125mm	51065006462/ 6476/ 9462/ 9476
	95-	<b>24-1322</b>			For vehicles without retarder, Impeller Ø 110mm	51065006515/ 6532/ 9515/ 9532
	95-	<b>24-1323</b>			Impeller Ø 125mm	51065006537/ 9537
14.224 (162 kW) Eng.D0826LFL03	95-	<b>24-1306</b>			For vehicles without retarder, Impeller Ø 125mm	51065006462/ 6476/ 9462/ 9476
	95-	<b>24-1310</b>			Impeller Ø 135mm	51065003178/ 6463/ 6495/ 9463/ 9495
	95-	<b>24-1322</b>			For vehicles without retarder, Impeller Ø 110mm	51065006515/ 6532/ 9515/ 9532
	95-	<b>24-1323</b>			Impeller Ø 125mm	51065006537/ 9537
14.224 (162 kW) Eng.D0826LFL10	95-	<b>24-1306</b>			For vehicles without retarder, Impeller Ø 125mm	51065006462/ 6476/ 9462/ 9476
	95-	<b>24-1310</b>			Impeller Ø 135mm	51065003178/ 6463/ 6495/ 9463/ 9495
	95-	<b>24-1322</b>			For vehicles without retarder, Impeller Ø 110mm	51065006515/ 6532/ 9515/ 9532
	95-	<b>24-1323</b>			Impeller Ø 125mm	51065006537/ 9537
14.225 (162 kW) Eng.D0836LFL02	00-	<b>24-1234</b>			Impeller Ø 135mm, M14x1,5	51065006679/ 6699/ 7064/ 7078 51065009064/ 9078/ 9679/ 9699
	00-	<b>24-1322</b>			For vehicles without retarder, Impeller Ø 110mm	51065006515/ 6532/ 9515/ 9532
	00-	<b>24-1331</b>			Impeller Ø 125mm	51065006575/ 6606/ 6612 51065006669/ 9575/ 9606/ 9612
14.255 (180 kW) Eng.D0836LFL05	00-	<b>24-1234</b>			Impeller Ø 135mm, M14x1,5	51065006679/ 6699/ 7064/ 7078 51065009064/ 9078/ 9679/ 9699
	00-	<b>24-1322</b>			For vehicles without retarder, Impeller Ø 110mm	51065006515/ 6532/ 9515/ 9532
	00-	<b>24-1331</b>			Impeller Ø 125mm	51065006575/ 6606/ 6612 51065006669/ 9575/ 9606/ 9612
14.264 (191 kW) Eng.D0826LFL09	95-	<b>24-1306</b>			For vehicles without retarder, Impeller Ø 125mm	51065006462/ 6476/ 9462/ 9476
	95-	<b>24-1310</b>			Impeller Ø 135mm	51065003178/ 6463/ 6495/ 9463/ 9495
	95-	<b>24-1322</b>			For vehicles without retarder, Impeller Ø 110mm	51065006515/ 6532/ 9515/ 9532
	95-	<b>24-1323</b>			Impeller Ø 125mm	51065006537/ 9537
14.284 (206 kW) Eng.D0836LF01	98-	<b>24-1234</b>			Impeller Ø 135mm, M14x1,5	51065006679/ 6699/ 7064/ 7078 51065009064/ 9078/ 9679/ 9699
	98-	<b>24-1322</b>			For vehicles without retarder, Impeller Ø 110mm	51065006515/ 6532/ 9515/ 9532
	98-	<b>24-1331</b>			Impeller Ø 125mm	51065006575/ 6606/ 6612 51065006669/ 9575/ 9606/ 9612
14.285 (206 kW) Eng.D0836LFL03	00-	<b>24-1322</b>			For vehicles without retarder, Impeller Ø 110mm	51065006515/ 6532/ 9515/ 9532
	00-	<b>24-1331</b>			Impeller Ø 125mm	51065006575/ 6606/ 6612 51065006669/ 9575/ 9606/ 9612
15.163 (114 kW) Eng.D0824LFL06	95-	<b>24-1306</b>			For vehicles without retarder, Impeller Ø 125mm	51065006462/ 6476/ 9462/ 9476



**24-1234**



**24-1306**



**24-1310**







**24-1322**



**24-1323**



**24-1331**





		<b>METELLI</b> ref.			<b>NOTE</b>	<b>Adaptable for OES</b>
15.163 (114 kW) Eng.D0824LFL06	95-	<b>24-1322</b>			For vehicles without retarder, Impeller Ø 110mm	51065006515/ 6532/ 9515/ 9532
	95-	<b>24-1323</b>			Impeller Ø 125mm	51065006537/ 9537
15.163 (114 kW) Eng.D0824LFL09	95-	<b>24-1306</b>			For vehicles without retarder, Impeller Ø 125mm	51065006462/ 6476/ 9462/ 9476
	95-	<b>24-1322</b>			For vehicles without retarder, Impeller Ø 110mm	51065006515/ 6532/ 9515/ 9532
	95-	<b>24-1323</b>			Impeller Ø 125mm	51065006537/ 9537
15.224 (162 kW) Eng.D0826LFL03	95-	<b>24-1306</b>			For vehicles without retarder, Impeller Ø 125mm	51065006462/ 6476/ 9462/ 9476
	95-	<b>24-1310</b>			Impeller Ø 135mm	51065003178/ 6463/ 6495/ 9463/ 9495
	95-	<b>24-1322</b>			For vehicles without retarder, Impeller Ø 110mm	51065006515/ 6532/ 9515/ 9532
	95-	<b>24-1323</b>			Impeller Ø 125mm	51065006537/ 9537
15.224 (162 kW) Eng.D0826LFL10	95-	<b>24-1306</b>			For vehicles without retarder, Impeller Ø 125mm	51065006462/ 6476/ 9462/ 9476
	95-	<b>24-1310</b>			Impeller Ø 135mm	51065003178/ 6463/ 6495/ 9463/ 9495
	95-	<b>24-1322</b>			For vehicles without retarder, Impeller Ø 110mm	51065006515/ 6532/ 9515/ 9532
	95-	<b>24-1323</b>			Impeller Ø 125mm	51065006537/ 9537
15.225 (162 kW) Eng.D0836LFL02	99-	<b>24-1234</b>			Impeller Ø 135mm, M14x1,5	51065006679/ 6699/ 7064/ 7078 51065009064/ 9078/ 9679/ 9699
	99-	<b>24-1322</b>			For vehicles without retarder, Impeller Ø 110mm	51065006515/ 6532/ 9515/ 9532
	99-	<b>24-1331</b>			Impeller Ø 125mm	51065006575/ 6606/ 6612 51065006669/ 9575/ 9606/ 9612
15.255 (180 kW) Eng.D0836LFL05	99-	<b>24-1234</b>			Impeller Ø 135mm, M14x1,5	51065006679/ 6699/ 7064/ 7078 51065009064/ 9078/ 9679/ 9699
	99-	<b>24-1322</b>			For vehicles without retarder, Impeller Ø 110mm	51065006515/ 6532/ 9515/ 9532
	99-	<b>24-1331</b>			Impeller Ø 125mm	51065006575/ 6606/ 6612 51065006669/ 9575/ 9606/ 9612
15.264 (191 kW) Eng.D0826LFL09	95-	<b>24-1306</b>			For vehicles without retarder, Impeller Ø 125mm	51065006462/ 6476/ 9462/ 9476
	95-	<b>24-1310</b>			Impeller Ø 135mm	51065003178/ 6463/ 6495/ 9463/ 9495
	95-	<b>24-1322</b>			For vehicles without retarder, Impeller Ø 110mm	51065006515/ 6532/ 9515/ 9532
	95-	<b>24-1323</b>			Impeller Ø 125mm	51065006537/ 9537
15.284 (206 kW) Eng.D0836LF01	98-	<b>24-1234</b>			Impeller Ø 135mm, M14x1,5	51065006679/ 6699/ 7064/ 7078 51065009064/ 9078/ 9679/ 9699
	98-	<b>24-1322</b>			For vehicles without retarder, Impeller Ø 110mm	51065006515/ 6532/ 9515/ 9532
	98-	<b>24-1331</b>			Impeller Ø 125mm	51065006575/ 6606/ 6612 51065006669/ 9575/ 9606/ 9612
15.285 (206 kW) Eng.D0836LFL03	99-	<b>24-1322</b>			For vehicles without retarder, Impeller Ø 110mm	51065006515/ 6532/ 9515/ 9532
	99-	<b>24-1331</b>			Impeller Ø 125mm	51065006575/ 6606/ 6612 51065006669/ 9575/ 9606/ 9612
18.224 (162 kW) Eng.D0826LFL03	95-	<b>24-1306</b>			For vehicles without retarder, Impeller Ø 125mm	51065006462/ 6476/ 9462/ 9476
	95-	<b>24-1310</b>			Impeller Ø 135mm	51065003178/ 6463/ 6495/ 9463/ 9495
	95-	<b>24-1322</b>			For vehicles without retarder, Impeller Ø 110mm	51065006515/ 6532/ 9515/ 9532
	95-	<b>24-1323</b>			Impeller Ø 125mm	51065006537/ 9537
18.224 (162 kW) Eng.D0826LFL10	95-	<b>24-1306</b>			For vehicles without retarder, Impeller Ø 125mm	51065006462/ 6476/ 9462/ 9476
	95-	<b>24-1310</b>			Impeller Ø 135mm	51065003178/ 6463/ 6495/ 9463/ 9495
	95-	<b>24-1322</b>			For vehicles without retarder, Impeller Ø 110mm	51065006515/ 6532/ 9515/ 9532
	95-	<b>24-1323</b>			Impeller Ø 125mm	51065006537/ 9537
18.255 (180 kW) Eng.D0836LFL05	99-	<b>24-1234</b>			Impeller Ø 135mm, M14x1,5	51065006679/ 6699/ 7064/ 7078 51065009064/ 9078/ 9679/ 9699
	99-	<b>24-1322</b>			For vehicles without retarder, Impeller Ø 110mm	51065006515/ 6532/ 9515/ 9532
	99-	<b>24-1331</b>			Impeller Ø 125mm	51065006575/ 6606/ 6612 51065006669/ 9575/ 9606/ 9612
18.264 (191 kW) Eng.D0826LFL09	95-	<b>24-1306</b>			For vehicles without retarder, Impeller Ø 125mm	51065006462/ 6476/ 9462/ 9476
	95-	<b>24-1310</b>			Impeller Ø 135mm	51065003178/ 6463/ 6495/ 9463/ 9495
	95-	<b>24-1322</b>			For vehicles without retarder, Impeller Ø 110mm	51065006515/ 6532/ 9515/ 9532
	95-	<b>24-1323</b>			Impeller Ø 125mm	51065006537/ 9537
18.284 (206 kW) Eng.D0836LF01	98-	<b>24-1234</b>			Impeller Ø 135mm, M14x1,5	51065006679/ 6699/ 7064/ 7078 51065009064/ 9078/ 9679/ 9699
	98-	<b>24-1322</b>			For vehicles without retarder, Impeller Ø 110mm	51065006515/ 6532/ 9515/ 9532
	98-	<b>24-1331</b>			Impeller Ø 125mm	51065006575/ 6606/ 6612 51065006669/ 9575/ 9606/ 9612
18.285 (206 kW) Eng.D0836LFL03	99-	<b>24-1322</b>			For vehicles without retarder, Impeller Ø 110mm	51065006515/ 6532/ 9515/ 9532
	99-	<b>24-1331</b>			Impeller Ø 125mm	51065006575/ 6606/ 6612 51065006669/ 9575/ 9606/ 9612
7.3 (93-118 kW) Eng.D0836M/HM/HM/U	69-73	<b>24-1322</b>			For vehicles without retarder, Impeller Ø 110mm	51065006515/ 6532/ 9515/ 9532
<b>M 2000 M '8/95-</b>						
12.225 (162 kW) Eng.D0836LF04	03-	<b>24-1322</b>			For vehicles without retarder, Impeller Ø 110mm	51065006515/ 6532/ 9515/ 9532
	03-	<b>24-1331</b>			Impeller Ø 125mm	51065006575/ 6606/ 6612 51065006669/ 9575/ 9606/ 9612





			
<b>24-1306</b>	<b>24-1310</b>	<b>24-1322</b>	<b>24-1323</b>
			
<b>24-1331</b>			







			
<p><b>24-1298</b></p>	<p><b>24-1302</b></p>	<p><b>24-1306</b></p>	<p><b>24-1310</b></p>
			
<p><b>24-1319</b></p>	<p><b>24-1321</b></p>	<p><b>24-1322</b></p>	<p><b>24-1323</b></p>
			
<p><b>24-1331</b></p>			

		<b>METELLI</b> ref.			<b>NOTE</b>	<b>Adaptable for OES</b>
25.225 (162 kW) Eng.D0836LF02	03-	<b>24-1322</b>			For vehicles without retarder, Impeller Ø 110mm	51065006515/ 6532/ 9515/ 9532
	03-	<b>24-1331</b>			Impeller Ø 125mm	51065006575/ 6606/ 6612 51065006669/ 9575/ 9606/ 9612
25.225 (162 kW) Eng.D0836LF04	03-	<b>24-1322</b>			For vehicles without retarder, Impeller Ø 110mm	51065006515/ 6532/ 9515/ 9532
	03-	<b>24-1331</b>			Impeller Ø 125mm	51065006575/ 6606/ 6612 51065006669/ 9575/ 9606/ 9612
25.264 (191 kW) Eng.D0826LF17	95-	<b>24-1306</b>			For vehicles without retarder, Impeller Ø 125mm	51065006462/ 6476/ 9462/ 9476
	95-	<b>24-1310</b>			Impeller Ø 135mm	51065003178/ 6463/ 6495/ 9463/ 9495
	95-	<b>24-1322</b>			For vehicles without retarder, Impeller Ø 110mm	51065006515/ 6532/ 9515/ 9532
25.285 (206 kW) Eng.D0836LF03	03-	<b>24-1322</b>			For vehicles without retarder, Impeller Ø 110mm	51065006515/ 6532/ 9515/ 9532
	03-	<b>24-1331</b>			Impeller Ø 125mm	51065006575/ 6606/ 6612 51065006669/ 9575/ 9606/ 9612
<b>M 90 '8/88-'6/96</b>						
12.152 (110-114 kW) Eng.D0826F01	88-94	<b>24-1306</b>			For vehicles without retarder, Impeller Ø 125mm	51065006462/ 6476/ 9462/ 9476
	88-94	<b>24-1310</b>			Impeller Ø 135mm	51065003178/ 6463/ 6495/ 9463/ 9495
	88-94	<b>24-1323</b>			Impeller Ø 125mm	51065006537/ 9537
12.152 (110-114 kW) Eng.D0826F02	88-94	<b>24-1306</b>			For vehicles without retarder, Impeller Ø 125mm	51065006462/ 6476/ 9462/ 9476
	88-94	<b>24-1310</b>			Impeller Ø 135mm	51065003178/ 6463/ 6495/ 9463/ 9495
	88-94	<b>24-1323</b>			Impeller Ø 125mm	51065006537/ 9537
12.192 (140 kW) Eng.D0826LF01/LF05	90-96	<b>24-1306</b>			For vehicles without retarder, Impeller Ø 125mm	51065006462/ 6476/ 9462/ 9476
	90-96	<b>24-1310</b>			Impeller Ø 135mm	51065003178/ 6463/ 6495/ 9463/ 9495
	90-96	<b>24-1323</b>			Impeller Ø 125mm	51065006537/ 9537
12.192 (140 kW) Eng.D0826LF07	90-96	<b>24-1306</b>			For vehicles without retarder, Impeller Ø 125mm	51065006462/ 6476/ 9462/ 9476
	90-96	<b>24-1310</b>			Impeller Ø 135mm	51065003178/ 6463/ 6495/ 9463/ 9495
	90-96	<b>24-1323</b>			Impeller Ø 125mm	51065006537/ 9537
12.222 (162 kW) Eng.D0826LF11	94-96	<b>24-1306</b>			For vehicles without retarder, Impeller Ø 125mm	51065006462/ 6476/ 9462/ 9476
	94-96	<b>24-1310</b>			Impeller Ø 135mm	51065003178/ 6463/ 6495/ 9463/ 9495
	94-96	<b>24-1323</b>			Impeller Ø 125mm	51065006537/ 9537
12.232 (169 kW) Eng.D0826LF02/LF06/LF08	88-96	<b>24-1306</b>			For vehicles without retarder, Impeller Ø 125mm	51065006462/ 6476/ 9462/ 9476
	88-96	<b>24-1310</b>			Impeller Ø 135mm	51065003178/ 6463/ 6495/ 9463/ 9495
	88-96	<b>24-1323</b>			Impeller Ø 125mm	51065006537/ 9537
12.262 (191 kW) Eng.D0826LF13	95-96	<b>24-1306</b>			For vehicles without retarder, Impeller Ø 125mm	51065006462/ 6476/ 9462/ 9476
	95-96	<b>24-1310</b>			Impeller Ø 135mm	51065003178/ 6463/ 6495/ 9463/ 9495
	95-96	<b>24-1323</b>			Impeller Ø 125mm	51065006537/ 9537
12.272 (198 kW) Eng.D0826LF04	92-96	<b>24-1306</b>			For vehicles without retarder, Impeller Ø 125mm	51065006462/ 6476/ 9462/ 9476
	92-96	<b>24-1310</b>			Impeller Ø 135mm	51065003178/ 6463/ 6495/ 9463/ 9495
	92-96	<b>24-1323</b>			Impeller Ø 125mm	51065006537/ 9537
12.272 (198-235 kW) Eng.D2865LF02	91-92	<b>24-1298</b>			For vehicles without retarder, w/o pulley; Impeller Ø 135mm, Incl Electronic fuel Injection pump	51065006408/ 6492/ 9492
	91-92	<b>24-1302</b>			For vehicles with retarder, w/o pulley	51065006426/ 6490/ 9426/ 9490
	91-92	<b>24-1319</b>			For vehicles with retarder, w pulley	51065006546/ 9546
	91-92	<b>24-1321</b>			For vehicles without retarder, w pulley	51065006545/ 6547/ 9545/ 9547
14.152 (110-114 kW) Eng.D0826F01	88-94	<b>24-1306</b>			For vehicles without retarder, Impeller Ø 125mm	51065006462/ 6476/ 9462/ 9476
	88-94	<b>24-1310</b>			Impeller Ø 135mm	51065003178/ 6463/ 6495/ 9463/ 9495
	88-94	<b>24-1323</b>			Impeller Ø 125mm	51065006537/ 9537
14.152 (110-114 kW) Eng.D0826F02	88-94	<b>24-1306</b>			For vehicles without retarder, Impeller Ø 125mm	51065006462/ 6476/ 9462/ 9476
	88-94	<b>24-1310</b>			Impeller Ø 135mm	51065003178/ 6463/ 6495/ 9463/ 9495
	88-94	<b>24-1323</b>			Impeller Ø 125mm	51065006537/ 9537
14.152 (114 kW) Eng.D0824LF01	94-96	<b>24-1306</b>			For vehicles without retarder, Impeller Ø 125mm	51065006462/ 6476/ 9462/ 9476
	94-96	<b>24-1323</b>			Impeller Ø 125mm	51065006537/ 9537
14.162 (118 kW) Eng.D0824LF02	95-96	<b>24-1306</b>			For vehicles without retarder, Impeller Ø 125mm	51065006462/ 6476/ 9462/ 9476
	95-96	<b>24-1323</b>			Impeller Ø 125mm	51065006537/ 9537
14.192 (137 kW) Eng.D0826TF	88-90	<b>24-1306</b>			For vehicles without retarder, Impeller Ø 125mm; w/o Pulley	51065006462/ 6476/ 9462/ 9476
	88-90	<b>24-1310</b>			Impeller Ø 135mm; w/o Pulley	51065003178/ 6463/ 6495/ 9463/ 9495
	88-90	<b>24-1323</b>			Impeller Ø 125mm; w/o Pulley	51065006537/ 9537
14.192 (140 kW) Eng.D0826LF01	90-96	<b>24-1306</b>			For vehicles without retarder, Impeller Ø 125mm	51065006462/ 6476/ 9462/ 9476
	90-96	<b>24-1310</b>			Impeller Ø 135mm	51065003178/ 6463/ 6495/ 9463/ 9495

			
<b>24-1298</b>	<b>24-1302</b>	<b>24-1306</b>	<b>24-1310</b>
			
<b>24-1319</b>	<b>24-1321</b>	<b>24-1323</b>	<b>24-1336</b>

		<b>METELLI</b> ref.			<b>NOTE</b>	<b>Adaptable for OES</b>
14.192 (140 kW) Eng.D0826LF01	90-96	<b>24-1323</b>			Impeller Ø 125mm	51065006537/ 9537
14.192 (140 kW) Eng.D0826LF05	90-96	<b>24-1306</b>			For vehicles without retarder, Impeller Ø 125mm	51065006462/ 6476/ 9462/ 9476
	90-96	<b>24-1310</b>			Impeller Ø 135mm	51065003178/ 6463/ 6495/ 9463/ 9495
	90-96	<b>24-1323</b>			Impeller Ø 125mm	51065006537/ 9537
14.192 (140 kW) Eng.D0826LF07	90-96	<b>24-1306</b>			For vehicles without retarder, Impeller Ø 125mm	51065006462/ 6476/ 9462/ 9476
	90-96	<b>24-1310</b>			Impeller Ø 135mm	51065003178/ 6463/ 6495/ 9463/ 9495
	90-96	<b>24-1323</b>			Impeller Ø 125mm	51065006537/ 9537
14.222 (162 kW) Eng.D0826LF11	94-96	<b>24-1306</b>			For vehicles without retarder, Impeller Ø 125mm	51065006462/ 6476/ 9462/ 9476
	94-96	<b>24-1310</b>			Impeller Ø 135mm	51065003178/ 6463/ 6495/ 9463/ 9495
	94-96	<b>24-1323</b>			Impeller Ø 125mm	51065006537/ 9537
14.232 (160 kW) Eng.D0826LF/217/Silent	90-95	<b>24-1306</b>			For vehicles without retarder, Impeller Ø 125mm	51065006462/ 6476/ 9462/ 9476
	90-95	<b>24-1310</b>			Impeller Ø 135mm	51065003178/ 6463/ 6495/ 9463/ 9495
	90-95	<b>24-1323</b>			Impeller Ø 125mm	51065006537/ 9537
14.232 (169 kW) Eng.D0826LF02/LF06/LF08	88-96	<b>24-1306</b>			For vehicles without retarder, Impeller Ø 125mm	51065006462/ 6476/ 9462/ 9476
	88-96	<b>24-1310</b>			Impeller Ø 135mm	51065003178/ 6463/ 6495/ 9463/ 9495
	88-96	<b>24-1323</b>			Impeller Ø 125mm	51065006537/ 9537
14.262 (191 kW) Eng.D0826LF13	95-96	<b>24-1306</b>			For vehicles without retarder, Impeller Ø 125mm	51065006462/ 6476/ 9462/ 9476
	95-96	<b>24-1310</b>			Impeller Ø 135mm	51065003178/ 6463/ 6495/ 9463/ 9495
	95-96	<b>24-1323</b>			Impeller Ø 125mm	51065006537/ 9537
14.272 (198 kW) Eng.D0826LF04	92-96	<b>24-1306</b>			For vehicles without retarder, Impeller Ø 125mm	51065006462/ 6476/ 9462/ 9476
	92-96	<b>24-1310</b>			Impeller Ø 135mm	51065003178/ 6463/ 6495/ 9463/ 9495
	92-96	<b>24-1323</b>			Impeller Ø 125mm	51065006537/ 9537
14.272 (198-235 kW) Eng.D2865LF02	91-92	<b>24-1298</b>			For vehicles without retarder, w/o pulley; Impeller Ø 135mm, Incl Electronic fuel Injection pump	51065006408/ 6492/ 9492
	91-92	<b>24-1302</b>			For vehicles with retarder, w/o pulley	51065006426/ 6490/ 9426/ 9490
	91-92	<b>24-1319</b>			For vehicles with retarder, w pulley	51065006546/ 9546
	91-92	<b>24-1321</b>			For vehicles without retarder, w pulley	51065006545/ 6547/ 9545/ 9547
	91-92	<b>24-1336</b>			w/ Pulley	51065006548/ 9548
17.192 (137 kW) Eng.D0826TF	88-90	<b>24-1306</b>			For vehicles without retarder, Impeller Ø 125mm	51065006462/ 6476/ 9462/ 9476
	88-90	<b>24-1310</b>			Impeller Ø 135mm	51065003178/ 6463/ 6495/ 9463/ 9495
	88-90	<b>24-1323</b>			Impeller Ø 125mm	51065006537/ 9537
17.192 (140 kW) Eng.D0826LF01	90-96	<b>24-1306</b>			For vehicles without retarder, Impeller Ø 125mm	51065006462/ 6476/ 9462/ 9476
	90-96	<b>24-1310</b>			Impeller Ø 135mm	51065003178/ 6463/ 6495/ 9463/ 9495
	90-96	<b>24-1323</b>			Impeller Ø 125mm	51065006537/ 9537
17.192 (140 kW) Eng.D0826LF05	90-96	<b>24-1306</b>			For vehicles without retarder, Impeller Ø 125mm	51065006462/ 6476/ 9462/ 9476
	90-96	<b>24-1310</b>			Impeller Ø 135mm	51065003178/ 6463/ 6495/ 9463/ 9495
	90-96	<b>24-1323</b>			Impeller Ø 125mm	51065006537/ 9537
17.192 (140 kW) Eng.D0826LF07	90-96	<b>24-1306</b>			For vehicles without retarder, Impeller Ø 125mm	51065006462/ 6476/ 9462/ 9476
	90-96	<b>24-1310</b>			Impeller Ø 135mm	51065003178/ 6463/ 6495/ 9463/ 9495
	90-96	<b>24-1323</b>			Impeller Ø 125mm	51065006537/ 9537
17.222 (162 kW) Eng.D0826LF11	94-96	<b>24-1306</b>			For vehicles without retarder, Impeller Ø 125mm	51065006462/ 6476/ 9462/ 9476
	94-96	<b>24-1310</b>			Impeller Ø 135mm	51065003178/ 6463/ 6495/ 9463/ 9495
	94-96	<b>24-1323</b>			Impeller Ø 125mm	51065006537/ 9537
17.232 (160 kW) Eng.D0826LF/217/Silent	90-95	<b>24-1306</b>			For vehicles without retarder, Impeller Ø 125mm	51065006462/ 6476/ 9462/ 9476
	90-95	<b>24-1310</b>			Impeller Ø 135mm	51065003178/ 6463/ 6495/ 9463/ 9495
	90-95	<b>24-1323</b>			Impeller Ø 125mm	51065006537/ 9537
17.232 (169 kW) Eng.D0826LF06	88-96	<b>24-1306</b>			For vehicles without retarder, Impeller Ø 125mm	51065006462/ 6476/ 9462/ 9476
	88-96	<b>24-1310</b>			Impeller Ø 135mm	51065003178/ 6463/ 6495/ 9463/ 9495
	88-96	<b>24-1323</b>			Impeller Ø 125mm	51065006537/ 9537
17.232 (169 kW) Eng.D0826LF08	88-96	<b>24-1306</b>			For vehicles without retarder, Impeller Ø 125mm	51065006462/ 6476/ 9462/ 9476
	88-96	<b>24-1310</b>			Impeller Ø 135mm	51065003178/ 6463/ 6495/ 9463/ 9495
	88-96	<b>24-1323</b>			Impeller Ø 125mm	51065006537/ 9537
17.272 (198 kW) Eng.D0826LF04	92-95	<b>24-1306</b>			For vehicles without retarder, Impeller Ø 125mm	51065006462/ 6476/ 9462/ 9476
	92-95	<b>24-1310</b>			Impeller Ø 135mm	51065003178/ 6463/ 6495/ 9463/ 9495
	92-95	<b>24-1323</b>			Impeller Ø 125mm	51065006537/ 9537
17.272 (198-235 kW) Eng.D2865LF02	91-95	<b>24-1298</b>			For vehicles without retarder, w/o pulley; Impeller Ø 135mm, Incl Electronic fuel Injection pump	51065006408/ 6492/ 9492
	91-95	<b>24-1302</b>			For vehicles with retarder, w/o pulley	51065006426/ 6490/ 9426/ 9490
	91-95	<b>24-1319</b>			For vehicles with retarder, w pulley	51065006546/ 9546
	91-95	<b>24-1321</b>			For vehicles without retarder, w pulley	51065006545/ 6547/ 9545/ 9547
	91-95	<b>24-1336</b>			w/ Pulley	51065006548/ 9548
18.192 (140 kW) Eng.D0826LF01	90-96	<b>24-1306</b>			For vehicles without retarder, Impeller Ø 125mm	51065006462/ 6476/ 9462/ 9476

			
<b>24-1298</b>	<b>24-1302</b>	<b>24-1306</b>	<b>24-1310</b>
			
<b>24-1319</b>	<b>24-1321</b>	<b>24-1323</b>	<b>24-1336</b>

		<b>METELLI</b> ref.			<b>NOTE</b>	<b>Adaptable for OES</b>
18.192 (140 kW) Eng.D0826LF01	90-96	<b>24-1310</b>			Impeller Ø 135mm	51065003178/ 6463/ 6495/ 9463/ 9495
	90-96	<b>24-1323</b>			Impeller Ø 125mm	51065006537/ 9537
18.192 (140 kW) Eng.D0826LF05	90-96	<b>24-1306</b>			For vehicles without retarder, Impeller Ø 125mm	51065006462/ 6476/ 9462/ 9476
	90-96	<b>24-1310</b>			Impeller Ø 135mm	51065003178/ 6463/ 6495/ 9463/ 9495
	90-96	<b>24-1323</b>			Impeller Ø 125mm	51065006537/ 9537
18.192 (140 kW) Eng.D0826LF07	90-96	<b>24-1306</b>			For vehicles without retarder, Impeller Ø 125mm	51065006462/ 6476/ 9462/ 9476
	90-96	<b>24-1310</b>			Impeller Ø 135mm	51065003178/ 6463/ 6495/ 9463/ 9495
	90-96	<b>24-1323</b>			Impeller Ø 125mm	51065006537/ 9537
18.222 (162 kW) Eng.D0826LF11	94-96	<b>24-1306</b>			For vehicles without retarder, Impeller Ø 125mm	51065006462/ 6476/ 9462/ 9476
	94-96	<b>24-1310</b>			Impeller Ø 135mm	51065003178/ 6463/ 6495/ 9463/ 9495
	94-96	<b>24-1323</b>			Impeller Ø 125mm	51065006537/ 9537
18.232 (169 kW) Eng.D0826LF02/LF06/LF08	90-96	<b>24-1306</b>			For vehicles without retarder, Impeller Ø 125mm	51065006462/ 6476/ 9462/ 9476
	90-96	<b>24-1310</b>			Impeller Ø 135mm	51065003178/ 6463/ 6495/ 9463/ 9495
	90-96	<b>24-1323</b>			Impeller Ø 125mm	51065006537/ 9537
18.262 (191 kW) Eng.D0826LF13	95-96	<b>24-1306</b>			For vehicles without retarder, Impeller Ø 125mm	51065006462/ 6476/ 9462/ 9476
	95-96	<b>24-1310</b>			Impeller Ø 135mm	51065003178/ 6463/ 6495/ 9463/ 9495
	95-96	<b>24-1323</b>			Impeller Ø 125mm	51065006537/ 9537
18.272 (198 kW) Eng.D0826LF04	92-96	<b>24-1306</b>			For vehicles without retarder, Impeller Ø 125mm	51065006462/ 6476/ 9462/ 9476
	92-96	<b>24-1310</b>			Impeller Ø 135mm	51065003178/ 6463/ 6495/ 9463/ 9495
	92-96	<b>24-1323</b>			Impeller Ø 125mm	51065006537/ 9537
18.272 (198-235 kW) Eng.D2865LF02	91-94	<b>24-1298</b>			For vehicles without retarder, w/o pulley, Impeller Ø 135mm, Incl Electronic fuel Injection pump	51065006408/ 6492/ 9492
	91-94	<b>24-1302</b>			For vehicles with retarder, w/o pulley	51065006426/ 6490/ 9426/ 9490
	91-94	<b>24-1319</b>			For vehicles with retarder, w pulley	51065006546/ 9546
	91-94	<b>24-1321</b>			For vehicles without retarder, w pulley	51065006545/ 6547/ 9545/ 9547
	91-94	<b>24-1336</b>			w/ Pulley	51065006548/ 9548
24.192 (140 kW) Eng.D0826LF01	89-96	<b>24-1306</b>			For vehicles without retarder, Impeller Ø 125mm	51065006462/ 6476/ 9462/ 9476
	89-96	<b>24-1310</b>			Impeller Ø 135mm	51065003178/ 6463/ 6495/ 9463/ 9495
	89-96	<b>24-1323</b>			Impeller Ø 125mm	51065006537/ 9537
24.192 (140 kW) Eng.D0826LF05	89-96	<b>24-1306</b>			For vehicles without retarder, Impeller Ø 125mm	51065006462/ 6476/ 9462/ 9476
	89-96	<b>24-1310</b>			Impeller Ø 135mm	51065003178/ 6463/ 6495/ 9463/ 9495
	89-96	<b>24-1323</b>			Impeller Ø 125mm	51065006537/ 9537
24.192 (140 kW) Eng.D0826LF07	89-96	<b>24-1306</b>			For vehicles without retarder, Impeller Ø 125mm	51065006462/ 6476/ 9462/ 9476
	89-96	<b>24-1310</b>			Impeller Ø 135mm	51065003178/ 6463/ 6495/ 9463/ 9495
	89-96	<b>24-1323</b>			Impeller Ø 125mm	51065006537/ 9537
24.222 (162 kW) Eng.D0826LF11	94-96	<b>24-1306</b>			For vehicles without retarder, Impeller Ø 125mm	51065006462/ 6476/ 9462/ 9476
	94-96	<b>24-1310</b>			Impeller Ø 135mm	51065003178/ 6463/ 6495/ 9463/ 9495
	94-96	<b>24-1323</b>			Impeller Ø 125mm	51065006537/ 9537
24.232 (160 kW) Eng.D0826LF/217/Silent	90-95	<b>24-1306</b>			For vehicles without retarder, Impeller Ø 125mm	51065006462/ 6476/ 9462/ 9476
	90-95	<b>24-1310</b>			Impeller Ø 135mm	51065003178/ 6463/ 6495/ 9463/ 9495
	90-95	<b>24-1323</b>			Impeller Ø 125mm	51065006537/ 9537
24.232 (169 kW) Eng.D0826LF02	89-96	<b>24-1306</b>			For vehicles without retarder, Impeller Ø 125mm	51065006462/ 6476/ 9462/ 9476
	89-96	<b>24-1310</b>			Impeller Ø 135mm	51065003178/ 6463/ 6495/ 9463/ 9495
	89-96	<b>24-1323</b>			Impeller Ø 125mm	51065006537/ 9537
24.232 (169 kW) Eng.D0826LF06	89-96	<b>24-1306</b>			For vehicles without retarder, Impeller Ø 125mm	51065006462/ 6476/ 9462/ 9476
	89-96	<b>24-1310</b>			Impeller Ø 135mm	51065003178/ 6463/ 6495/ 9463/ 9495
	89-96	<b>24-1323</b>			Impeller Ø 125mm	51065006537/ 9537
24.232 (169 kW) Eng.D0826LF08	89-96	<b>24-1306</b>			For vehicles without retarder, Impeller Ø 125mm	51065006462/ 6476/ 9462/ 9476
	89-96	<b>24-1310</b>			Impeller Ø 135mm	51065003178/ 6463/ 6495/ 9463/ 9495
	89-96	<b>24-1323</b>			Impeller Ø 125mm	51065006537/ 9537
24.262 (191 kW) Eng.D0826LF13	95-96	<b>24-1306</b>			For vehicles without retarder, Impeller Ø 125mm	51065006462/ 6476/ 9462/ 9476
	95-96	<b>24-1310</b>			Impeller Ø 135mm	51065003178/ 6463/ 6495/ 9463/ 9495
	95-96	<b>24-1323</b>			Impeller Ø 125mm	51065006537/ 9537
24.272 (198 kW) Eng.D0826LF04	92-96	<b>24-1306</b>			For vehicles without retarder, Impeller Ø 125mm	51065006462/ 6476/ 9462/ 9476
	92-96	<b>24-1310</b>			Impeller Ø 135mm	51065003178/ 6463/ 6495/ 9463/ 9495
	92-96	<b>24-1323</b>			Impeller Ø 125mm	51065006537/ 9537
24.272 (198-235 kW) Eng.D2865LF02	91-94	<b>24-1298</b>			For vehicles without retarder, w/o pulley, Impeller Ø 135mm, Incl Electronic fuel Injection pump	51065006408/ 6492/ 9492
	91-94	<b>24-1302</b>			For vehicles with retarder, w/o pulley	51065006426/ 6490/ 9426/ 9490
	91-94	<b>24-1319</b>			For vehicles with retarder, w pulley	51065006546/ 9546
	91-94	<b>24-1321</b>			For vehicles without retarder, w pulley	51065006545/ 6547/ 9545/ 9547
	91-94	<b>24-1336</b>			w/ Pulley	51065006548/ 9548





			
<b>24-1292</b>	<b>24-1294</b>	<b>24-1298</b>	<b>24-1302</b>
			
<b>24-1308</b>	<b>24-1323</b>	<b>24-1324</b>	

		<b>METELLI</b> ref.			<b>NOTE</b>	<b>Adaptable for OES</b>
<b>NU '9/96-</b>						
NU 263 (191 kW) Eng.D0826LUH13	87-94	<b>24-1308</b>			w/ Pulley; Installation height 79,5 mm	51065006480/ 9480,51065063043
	98-	<b>24-1323</b>			Impeller Ø 125mm	51065006537/ 9537
	98-	<b>24-1324</b>			w/ Pulley; Installation height 90,0 mm	51065006543/ 6569/ 9543/ 9569
NU 263 (191 kW) Eng.D2865LUH09	96-98	<b>24-1298</b>			For vehicles without retarder, w/o pulley; Impeller Ø 135mm, Incl Eletronic fuel Injection pump	51065006408/ 6492/ 9492
	96-98	<b>24-1302</b>			For vehicles with retarder, w/o pulley	51065006426/ 6490/ 9426/ 9490
NU 263 (191 kW) Eng.D2866LUH22	98-	<b>24-1294</b>			For vehicles without retarder; Impeller Ø 125mm	51065006282/ 6387/ 9282/ 9387
	98-	<b>24-1298</b>			For vehicles without retarder, w/o pulley; Impeller Ø 135mm, Incl Eletronic fuel Injection pump	51065006408/ 6492/ 9492
	98-	<b>24-1302</b>			For vehicles with retarder, w/o pulley	51065006426/ 6490/ 9426/ 9490
NU 313 (228 kW) Eng.D2866LUH26	98-	<b>24-1294</b>			For vehicles without retarder; Impeller Ø 125mm	51065006282/ 6387/ 9282/ 9387
	98-	<b>24-1298</b>			For vehicles without retarder, w/o pulley; Impeller Ø 135mm, Incl Eletronic fuel Injection pump	51065006408/ 6492/ 9492
	98-	<b>24-1302</b>			For vehicles with retarder, w/o pulley	51065006426/ 6490/ 9426/ 9490
NU 313 15M (228 kW) Eng.D2866LUH26	98-	<b>24-1294</b>			For vehicles without retarder; Impeller Ø 125mm	51065006282/ 6387/ 9282/ 9387
	98-	<b>24-1298</b>			For vehicles without retarder, w/o pulley; Impeller Ø 135mm, Incl Eletronic fuel Injection pump	51065006408/ 6492/ 9492
	98-	<b>24-1302</b>			For vehicles with retarder, w/o pulley	51065006426/ 6490/ 9426/ 9490
NU 353 15M (257 kW) Eng.D2866LUH21	98-	<b>24-1294</b>			For vehicles without retarder; Impeller Ø 125mm	51065006282/ 6387/ 9282/ 9387
	98-	<b>24-1298</b>			For vehicles without retarder, w/o pulley; Impeller Ø 135mm, Incl Eletronic fuel Injection pump	51065006408/ 6492/ 9492
	98-	<b>24-1302</b>			For vehicles with retarder, w/o pulley	51065006426/ 6490/ 9426/ 9490
<b>R '5/85-'1/93</b>						
FRH 362 (265-274-176 kW) Eng.D2866KUH/360	85-92	<b>24-1294</b>			For vehicles without retarder; Impeller Ø 125mm	51065006282/ 6387/ 9282/ 9387
	85-92	<b>24-1298</b>			For vehicles without retarder, w/o pulley; Impeller Ø 135mm, Incl Eletronic fuel Injection pump	51065006408/ 6492/ 9492
	85-92	<b>24-1302</b>			For vehicles with retarder, w/o pulley	51065006426/ 6490/ 9426/ 9490
R 292,FR 292,FRH 292 (213-229 kW) Eng.D2866TOH/310	85-93	<b>24-1294</b>			For vehicles without retarder; Impeller Ø 125mm	51065006282/ 6387/ 9282/ 9387
	95-93	<b>24-1298</b>			For vehicles without retarder, w/o pulley; Impeller Ø 135mm, Incl Eletronic fuel Injection pump	51065006408/ 6492/ 9492
	85-93	<b>24-1302</b>			For vehicles with retarder, w/o pulley	51065006426/ 6490/ 9426/ 9490
R 292,FR 292,FRH 292 (213-229 kW) Eng.D2866TUH/290	85-93	<b>24-1294</b>			For vehicles without retarder; Impeller Ø 125mm	51065006282/ 6387/ 9282/ 9387
	85-93	<b>24-1298</b>			For vehicles without retarder, w/o pulley; Impeller Ø 135mm, Incl Eletronic fuel Injection pump	51065006408/ 6492/ 9492
	85-93	<b>24-1302</b>			For vehicles with retarder, w/o pulley	51065006426/ 6490/ 9426/ 9490
<b>Serie 11000 '1/73-'12/81</b>						
11168 9.5 (92-141 kW) Eng.D2565HM/M/ME/MF/MH/MR	76-81	<b>24-1292</b>			For vehicles without retarder	51065006204/ 6213/ 6214/ 6215/ 6216/ 6218 51065006219/ 6221/ 6222/ 6223/ 6224/ 6225 51065006228/ 6229/ 9228
	76-81	<b>24-1294</b>			For vehicles without retarder; Impeller Ø 125mm	51065006282/ 6387/ 9282/ 9387
<b>Serie 12000 '1/73-'12/81</b>						
12168 9.5 (92-141 kW) Eng.D2565HM/M/ME/MF/MH/MR	76-81	<b>24-1292</b>			For vehicles without retarder	51065006204/ 6213/ 6214/ 6215/ 6216/ 6218 51065006219/ 6221/ 6222/ 6223/ 6224/ 6225 51065006228/ 6229/ 9228
	76-81	<b>24-1294</b>			For vehicles without retarder; Impeller Ø 125mm	51065006282/ 6387/ 9282/ 9387
<b>Serie 13000 '1/69-'12/81</b>						
13168 9.5 (92-141 kW) Eng.D2565HM/M/ME/MF/MH/MR	76-81	<b>24-1292</b>			For vehicles without retarder	51065006204/ 6213/ 6214/ 6215/ 6216/ 6218 51065006219/ 6221/ 6222/ 6223/ 6224/ 6225 51065006228/ 6229/ 9228
	76-81	<b>24-1294</b>			For vehicles without retarder; Impeller Ø 125mm	51065006282/ 6387/ 9282/ 9387
<b>Serie 14000 '1/73-'12/81</b>						
14168 9.5 (92-141 kW) Eng.D2565HM/M/ME/MF/MH/MR	76-81	<b>24-1292</b>			For vehicles without retarder	51065006204/ 6213/ 6214/ 6215/ 6216/ 6218 51065006219/ 6221/ 6222/ 6223/ 6224/ 6225 51065006228/ 6229/ 9228
	76-81	<b>24-1294</b>			For vehicles without retarder; Impeller Ø 125mm	51065006282/ 6387/ 9282/ 9387
14192 9.5 (92-141 kW) Eng.D2565HM/M/ME/MF/MH/MR	76-81	<b>24-1292</b>			For vehicles without retarder	51065006204/ 6213/ 6214/ 6215/ 6216/ 6218 51065006219/ 6221/ 6222/ 6223/ 6224/ 6225 51065006228/ 6229/ 9228
	76-81	<b>24-1294</b>			For vehicles without retarder; Impeller Ø 125mm	51065006282/ 6387/ 9282/ 9387

			
<b>24-1224</b>	<b>24-1225</b>	<b>24-1292</b>	<b>24-1294</b>
			
<b>24-1298</b>	<b>24-1302</b>	<b>24-1319</b>	<b>24-1321</b>
			
<b>24-1330</b>			

		<b>METELLI</b> ref.			<b>NOTE</b>	<b>Adaptable for OES</b>
<b>Serie 15000 '1/69-'12/81</b>						
15168 9.5 (92-141 kW) Eng.D2565HM/M/ME/MF/MH/MR	76-81	<b>24-1292</b>			For vehicles without retarder	51065006204/ 6213/ 6214/ 6215/ 6216/ 6218 51065006219/ 6221/ 6222/ 6223/ 6224/ 6225 51065006228/ 6229/ 9228
	76-81	<b>24-1294</b>			For vehicles without retarder; Impeller Ø 125mm	51065006282/ 6387/ 9282/ 9387
15192 9.5 (92-141 kW) Eng.D2565HM/M/ME/MF/MH/MR	76-81	<b>24-1292</b>			For vehicles without retarder	51065006204/ 6213/ 6214/ 6215/ 6216/ 6218 51065006219/ 6221/ 6222/ 6223/ 6224/ 6225 51065006228/ 6229/ 9228
	76-81	<b>24-1294</b>			For vehicles without retarder; Impeller Ø 125mm	51065006282/ 6387/ 9282/ 9387
<b>Serie 16000 '11/69-'12/81</b>						
16168 9.5 (92-141 kW) Eng.D2565HM/M/ME/MF/MH/MR	76-81	<b>24-1292</b>			For vehicles without retarder	51065006204/ 6213/ 6214/ 6215/ 6216/ 6218 51065006219/ 6221/ 6222/ 6223/ 6224/ 6225 51065006228/ 6229/ 9228
	76-81	<b>24-1294</b>			For vehicles without retarder; Impeller Ø 125mm	51065006282/ 6387/ 9282/ 9387
<b>Serie 19000 '1/72-'12/81</b>						
19168 9.5 (92-141 kW) Eng.D2565HM/M/ME/MF/MH/MR	76-81	<b>24-1292</b>			For vehicles without retarder	51065006204/ 6213/ 6214/ 6215/ 6216/ 6218 51065006219/ 6221/ 6222/ 6223/ 6224/ 6225 51065006228/ 6229/ 9228
	76-81	<b>24-1294</b>			For vehicles without retarder; Impeller Ø 125mm	51065006282/ 6387/ 9282/ 9387
<b>TGA '4/00-'7/16</b>						
18.310 (228 kW) Eng.D2866LF36/26	00-	<b>24-1298</b>			For vehicles without retarder, w/o pulley; Impeller Ø 135mm, Incl Eletronic fuel Injection pump	51065006408/ 6492/ 9492
	00-	<b>24-1302</b>			For vehicles with retarder, w/o pulley	51065006426/ 6490/ 9426/ 9490
	00-	<b>24-1319</b>			For vehicles with retarder, w pulley	51065006546/ 9546
	00-	<b>24-1321</b>			For vehicles without retarder, w pulley	51065006545/ 6547/ 9545/ 9547
	00-	<b>24-1330</b>		•		51065000298,51065006066/ 7033/ 7036 51065007043/ 7045/ 7047/ 7048/ 7051 51065007052/ 7065/ 7066/ 7088/ 7089 51065009045/ 9047/ 9048/ 9052/ 9066
18.310, 18.320 (228 kW) Eng.D2066LF04	04-	<b>24-1224</b>			+Retarder	51065006642/ 6675/ 6694/ 9642/ 9675/ 9694
	04-	<b>24-1225</b>			-Retarder	51065006637/ 7049/ 9049
18.310, 18.320 (228-235 kW) Eng.D2066LF14	04-	<b>24-1224</b>			+Retarder	51065006642/ 6675/ 6694/ 9642/ 9675/ 9694
	04-	<b>24-1225</b>			-Retarder	51065006637/ 7049/ 9049
18.310, 18.320 (228-235 kW) Eng.D2066LF35	04-	<b>24-1224</b>			+Retarder	51065006642/ 6675/ 6694/ 9642/ 9675/ 9694
	04-	<b>24-1225</b>			-Retarder	51065006637/ 7049/ 9049
18.350, 18.360 (257-265 kW) Eng.D2066LF03	04-	<b>24-1224</b>			+Retarder	51065006642/ 6675/ 6694/ 9642/ 9675/ 9694
	04-	<b>24-1225</b>			-Retarder	51065006637/ 7049/ 9049
18.350, 18.360 (257-265 kW) Eng.D2066LF33	04-	<b>24-1224</b>			+Retarder	51065006642/ 6675/ 6694/ 9642/ 9675/ 9694
	04-	<b>24-1225</b>			-Retarder	51065006637/ 7049/ 9049
18.360 (265-176 kW) Eng.D2866LF37/27	00-	<b>24-1298</b>			For vehicles without retarder, w/o pulley; Impeller Ø 135mm, Incl Eletronic fuel Injection pump	51065006408/ 6492/ 9492
	00-	<b>24-1302</b>			For vehicles with retarder, w/o pulley	51065006426/ 6490/ 9426/ 9490
	00-	<b>24-1319</b>			For vehicles with retarder, w pulley	51065006546/ 9546
	00-	<b>24-1321</b>			For vehicles without retarder, w pulley	51065006545/ 6547/ 9545/ 9547
	00-	<b>24-1330</b>		•		51065000298,51065006066/ 7033/ 7036 51065007043/ 7045/ 7047/ 7048/ 7051 51065007052/ 7065/ 7066/ 7088/ 7089 51065009045/ 9047/ 9048/ 9052/ 9066
18.390 (287 kW) Eng.D2066LF02	04-	<b>24-1224</b>			+Retarder	51065006642/ 6675/ 6694/ 9642/ 9675/ 9694
	04-	<b>24-1225</b>			-Retarder	51065006637/ 7049/ 9049
18.390, 18.400 (287-294 kW) Eng.D2066LF02,LF12,LF32,LF37	04-	<b>24-1224</b>			+Retarder	51065006642/ 6675/ 6694/ 9642/ 9675/ 9694
	04-	<b>24-1225</b>			-Retarder	51065006637/ 7049/ 9049
18.410 (301 kW) Eng.D2866LF28	00-	<b>24-1298</b>			For vehicles without retarder, w/o pulley; Impeller Ø 135mm, Incl Eletronic fuel Injection pump	51065006408/ 6492/ 9492

			
<b>24-1224</b>	<b>24-1225</b>	<b>24-1298</b>	<b>24-1302</b>
			
<b>24-1319</b>	<b>24-1321</b>	<b>24-1330</b>	

		<b>METELLI</b> ref.		<b>NOTE</b>	<b>Adaptable for OES</b>
18.410 (301 kW) Eng.D2866LF28	00-	<b>24-1302</b>		For vehicles with retarder, w/o pulley	51065006426/ 6490/ 9426/ 9490
	00-	<b>24-1319</b>		For vehicles with retarder, w pulley	51065006546/ 9546
	00-	<b>24-1321</b>		For vehicles without retarder, w pulley	51065006545/ 6547/ 9545/ 9547
	00-	<b>24-1330</b>	•		51065000298,51065006066/ 7033/ 7036 51065007043/ 7045/ 7047/ 7048/ 7051 51065007052/ 7065/ 7066/ 7088/ 7089 51065009045/ 9047/ 9048/ 9052/ 9066
18.410 (301 kW) Eng.D2866LF32	00-	<b>24-1298</b>		For vehicles without retarder, w/o pulley; Impeller Ø 135mm, Incl Electronic fuel Injection pump	51065006408/ 6492/ 9492
	00-	<b>24-1302</b>		For vehicles with retarder, w/o pulley	51065006426/ 6490/ 9426/ 9490
	00-	<b>24-1319</b>		For vehicles with retarder, w pulley	51065006546/ 9546
	00-	<b>24-1321</b>		For vehicles without retarder, w pulley	51065006545/ 6547/ 9545/ 9547
	00-	<b>24-1330</b>	•		51065000298,51065006066/ 7033/ 7036 51065007043/ 7045/ 7047/ 7048/ 7051 51065007052/ 7065/ 7066/ 7088/ 7089 51065009045/ 9047/ 9048/ 9052/ 9066
18.430, 18.440 (316-324 kW) Eng.D2066LF01	04-	<b>24-1224</b>		+Retarder	51065006642/ 6675/ 6694/ 9642/ 9675/ 9694
	04-	<b>24-1225</b>		-Retarder	51065006637/ 7049/ 9049
18.430, 18.440 (316-324 kW) Eng.D2066LF11	04-	<b>24-1224</b>		+Retarder	51065006642/ 6675/ 6694/ 9642/ 9675/ 9694
	04-	<b>24-1225</b>		-Retarder	51065006637/ 7049/ 9049
18.430, 18.440 (316-324 kW) Eng.D2066LF31	06-	<b>24-1224</b>		+Retarder	51065006642/ 6675/ 6694/ 9642/ 9675/ 9694
	06-	<b>24-1225</b>		-Retarder	51065006637/ 7049/ 9049
18.460 (338 kW) Eng.D2876LF04	00-	<b>24-1298</b>		For vehicles without retarder, w/o pulley; Impeller Ø 135mm, Incl Electronic fuel Injection pump	51065006408/ 6492/ 9492
	00-	<b>24-1302</b>		For vehicles with retarder, w/o pulley	51065006426/ 6490/ 9426/ 9490
	00-	<b>24-1319</b>		For vehicles with retarder, w pulley	51065006546/ 9546
	00-	<b>24-1321</b>		For vehicles without retarder, w pulley	51065006545/ 6547/ 9545/ 9547
	00-	<b>24-1330</b>	•		51065000298,51065006066/ 7033/ 7036 51065007043/ 7045/ 7047/ 7048/ 7051 51065007052/ 7065/ 7066/ 7088/ 7089 51065009045/ 9047/ 9048/ 9052/ 9066
18.460 (338 kW) Eng.D2876LF07	00-	<b>24-1298</b>		For vehicles without retarder, w/o pulley; Impeller Ø 135mm, Incl Electronic fuel Injection pump	51065006408/ 6492/ 9492
	00-	<b>24-1302</b>		For vehicles with retarder, w/o pulley	51065006426/ 6490/ 9426/ 9490
	00-	<b>24-1319</b>		For vehicles with retarder, w pulley	51065006546/ 9546
	00-	<b>24-1321</b>		For vehicles without retarder, w pulley	51065006545/ 6547/ 9545/ 9547
	00-	<b>24-1330</b>	•		51065000298,51065006066/ 7033/ 7036 51065007043/ 7045/ 7047/ 7048/ 7051 51065007052/ 7065/ 7066/ 7088/ 7089 51065009045/ 9047/ 9048/ 9052/ 9066
18.480 (353 kW) Eng.D2876LF01	06-	<b>24-1298</b>		For vehicles without retarder, w/o pulley; Impeller Ø 135mm, Incl Electronic fuel Injection pump	51065006408/ 6492/ 9492
	06-	<b>24-1302</b>		For vehicles with retarder, w/o pulley	51065006426/ 6490/ 9426/ 9490
	06-	<b>24-1319</b>		For vehicles with retarder, w pulley	51065006546/ 9546
	06-	<b>24-1321</b>		For vehicles without retarder, w pulley	51065006545/ 6547/ 9545/ 9547
	06-	<b>24-1330</b>	•		51065000298,51065006066/ 7033/ 7036 51065007043/ 7045/ 7047/ 7048/ 7051 51065007052/ 7065/ 7066/ 7088/ 7089 51065009045/ 9047/ 9048/ 9052/ 9066
18.480 (353 kW) Eng.D2876LF12	02-	<b>24-1298</b>		For vehicles without retarder, w/o pulley; Impeller Ø 135mm, Incl Electronic fuel Injection pump	51065006408/ 6492/ 9492
	02-	<b>24-1302</b>		For vehicles with retarder, w/o pulley	51065006426/ 6490/ 9426/ 9490
	02-	<b>24-1319</b>		For vehicles with retarder, w pulley	51065006546/ 9546
	02-	<b>24-1321</b>		For vehicles without retarder, w pulley	51065006545/ 6547/ 9545/ 9547
	02-	<b>24-1330</b>	•		51065000298,51065006066/ 7033/ 7036 51065007043/ 7045/ 7047/ 7048/ 7051 51065007052/ 7065/ 7066/ 7088/ 7089 51065009045/ 9047/ 9048/ 9052/ 9066
18.510 (375 kW) Eng.D2876LF05	00-	<b>24-1298</b>		For vehicles without retarder, w/o pulley; Impeller Ø 135mm, Incl Electronic fuel Injection pump	51065006408/ 6492/ 9492
	00-	<b>24-1302</b>		For vehicles with retarder, w/o pulley	51065006426/ 6490/ 9426/ 9490
	00-	<b>24-1319</b>		For vehicles with retarder, w pulley	51065006546/ 9546
	00-	<b>24-1321</b>		For vehicles without retarder, w pulley	51065006545/ 6547/ 9545/ 9547
	00-	<b>24-1330</b>	•		51065000298,51065006066/ 7033/ 7036 51065007043/ 7045/ 7047/ 7048/ 7051 51065007052/ 7065/ 7066/ 7088/ 7089 51065009045/ 9047/ 9048/ 9052/ 9066
18.530 (390 kW) Eng.D2876LF13	02-	<b>24-1298</b>		For vehicles without retarder, w/o pulley; Impeller Ø 135mm, Incl Electronic fuel Injection pump	51065006408/ 6492/ 9492
	02-	<b>24-1302</b>		For vehicles with retarder, w/o pulley	51065006426/ 6490/ 9426/ 9490



**24-1224**



**24-1225**



**24-1298**



**24-1302**





**24-1319**



**24-1321**





**24-1330**



		<b>METELLI</b> ref.		<b>NOTE</b>	<b>Adaptable for OES</b>
18.530 (390 kW) Eng.D2876LF13	02-	<b>24-1319</b>		For vehicles with retarder, w pulley	51065006546/ 9546
	02-	<b>24-1321</b>		For vehicles without retarder, w pulley	51065006545/ 6547/ 9545/ 9547
	02-	<b>24-1330</b>	•		51065000298,51065006066/ 7033/ 7036 51065007043/ 7045/ 7047/ 7048/ 7051 51065007052/ 7065/ 7066/ 7088/ 7089 51065009045/ 9047/ 9048/ 9052/ 9066
19.350 (257 kW) Eng.D2066LF03	04-	<b>24-1224</b>		+Retarder	51065006642/ 6675/ 6694/ 9642/ 9675/ 9694
19.390 (287 kW) Eng.D2066LF02	04-	<b>24-1224</b>		+Retarder	51065006642/ 6675/ 6694/ 9642/ 9675/ 9694
24.350 (257-265 kW) Eng.D2066LF03	04-	<b>24-1224</b>		+Retarder	51065006642/ 6675/ 6694/ 9642/ 9675/ 9694
	04-	<b>24-1225</b>		-Retarder	51065006637/ 7049/ 9049
24.350 (257-265 kW) Eng.D2066LF13	04-	<b>24-1224</b>		+Retarder	51065006642/ 6675/ 6694/ 9642/ 9675/ 9694
	04-	<b>24-1225</b>		-Retarder	51065006637/ 7049/ 9049
24.350 (257-265 kW) Eng.D2066LF33	04-	<b>24-1224</b>		+Retarder	51065006642/ 6675/ 6694/ 9642/ 9675/ 9694
	04-	<b>24-1225</b>		-Retarder	51065006637/ 7049/ 9049
	04-	<b>24-1302</b>		For vehicles with retarder, w/o pulley	51065006426/ 6490/ 9426/ 9490
24.360 (265-176 kW) Eng.D2866LF27	01-	<b>24-1298</b>		For vehicles without retarder, w/o pulley; Impeller Ø 135mm, Incl Eletronic fuel Injection pump	51065006408/ 6492/ 9492
	01-	<b>24-1302</b>		For vehicles with retarder, w/o pulley	51065006426/ 6490/ 9426/ 9490
	01-	<b>24-1319</b>		For vehicles with retarder, w pulley	51065006546/ 9546
	01-	<b>24-1321</b>		For vehicles without retarder, w pulley	51065006545/ 6547/ 9545/ 9547
24.390 (287-294 kW) Eng.D2066LF02	04-	<b>24-1224</b>		+Retarder	51065006642/ 6675/ 6694/ 9642/ 9675/ 9694
	04-	<b>24-1225</b>		-Retarder	51065006637/ 7049/ 9049
24.390 (287-294 kW) Eng.D2066LF12	06-14	<b>24-1224</b>		+Retarder	51065006642/ 6675/ 6694/ 9642/ 9675/ 9694
	04-	<b>24-1225</b>		-Retarder	51065006637/ 7049/ 9049
24.390 (287-294 kW) Eng.D2066LF32	06-14	<b>24-1224</b>		+Retarder	51065006642/ 6675/ 6694/ 9642/ 9675/ 9694
	04-	<b>24-1225</b>		-Retarder	51065006637/ 7049/ 9049
24.410 (301 kW) Eng.D2866LF28	01-	<b>24-1298</b>		For vehicles without retarder, w/o pulley; Impeller Ø 135mm, Incl Eletronic fuel Injection pump	51065006408/ 6492/ 9492
	01-	<b>24-1302</b>		For vehicles with retarder, w/o pulley	51065006426/ 6490/ 9426/ 9490
	01-	<b>24-1319</b>		For vehicles with retarder, w pulley	51065006546/ 9546
	01-	<b>24-1321</b>		For vehicles without retarder, w pulley	51065006545/ 6547/ 9545/ 9547
	01-	<b>24-1330</b>	•		51065000298,51065006066/ 7033/ 7036 51065007043/ 7045/ 7047/ 7048/ 7051 51065007052/ 7065/ 7066/ 7088/ 7089 51065009045/ 9047/ 9048/ 9052/ 9066
24.430 (316-324 kW) Eng.D2066LF01	04-	<b>24-1224</b>		+Retarder	51065006642/ 6675/ 6694/ 9642/ 9675/ 9694
	04-	<b>24-1225</b>		-Retarder	51065006637/ 7049/ 9049
24.430 (316-324 kW) Eng.D2066LF11	04-	<b>24-1224</b>		+Retarder	51065006642/ 6675/ 6694/ 9642/ 9675/ 9694
	04-	<b>24-1225</b>		-Retarder	51065006637/ 7049/ 9049
24.430 (316-324 kW) Eng.D2066LF23	04-	<b>24-1224</b>		+Retarder	51065006642/ 6675/ 6694/ 9642/ 9675/ 9694
	04-	<b>24-1225</b>		-Retarder	51065006637/ 7049/ 9049
24.430 (316-324 kW) Eng.D2066LF31	04-	<b>24-1224</b>		+Retarder	51065006642/ 6675/ 6694/ 9642/ 9675/ 9694
	04-	<b>24-1225</b>		-Retarder	51065006637/ 7049/ 9049
24.460 (338 kW) Eng.D2876LF04	01-	<b>24-1298</b>		For vehicles without retarder, w/o pulley; Impeller Ø 135mm, Incl Eletronic fuel Injection pump	51065006408/ 6492/ 9492
	01-	<b>24-1302</b>		For vehicles with retarder, w/o pulley	51065006426/ 6490/ 9426/ 9490
	01-	<b>24-1319</b>		For vehicles with retarder, w pulley	51065006546/ 9546
	01-	<b>24-1321</b>		For vehicles without retarder, w pulley	51065006545/ 6547/ 9545/ 9547
	01-	<b>24-1330</b>	•		51065000298,51065006066/ 7033/ 7036 51065007043/ 7045/ 7047/ 7048/ 7051 51065007052/ 7065/ 7066/ 7088/ 7089 51065009045/ 9047/ 9048/ 9052/ 9066







			
<b>24-1224</b>	<b>24-1225</b>	<b>24-1234</b>	<b>24-1298</b>
			
<b>24-1302</b>	<b>24-1319</b>	<b>24-1321</b>	<b>24-1330</b>

		<b>METELLI ref.</b>		<b>NOTE</b>	<b>Adaptable for OES</b>
24.480 (353 kW) Eng.D2676LF01	06-	<b>24-1224</b>		+Retarder	51065006642/ 6675/ 6694/ 9642/ 9675/ 9694
24.480 (353 kW) Eng.D2876LF12	02-	<b>24-1298</b>		For vehicles without retarder, w/o pulley; Impeller Ø 135mm, Incl Electronic fuel Injection pump	51065006408/ 6492/ 9492
	02-	<b>24-1302</b>		For vehicles with retarder, w/o pulley	51065006426/ 6490/ 9426/ 9490
	02-	<b>24-1319</b>		For vehicles with retarder, w pulley	51065006546/ 9546
	02-	<b>24-1321</b>		For vehicles without retarder, w pulley	51065006545/ 6547/ 9545/ 9547
	02-	<b>24-1330</b>	•		51065000298,51065006066/ 7033/ 7036 51065007043/ 7045/ 7047/ 7048/ 7051 51065007052/ 7065/ 7066/ 7088/ 7089 51065009045/ 9047/ 9048/ 9052/ 9066
24.510 (375 kW) Eng.D2876LF05	01-	<b>24-1298</b>		For vehicles without retarder, w/o pulley; Impeller Ø 135mm, Incl Electronic fuel Injection pump	51065006408/ 6492/ 9492
	01-	<b>24-1302</b>		For vehicles with retarder, w/o pulley	51065006426/ 6490/ 9426/ 9490
	01-	<b>24-1319</b>		For vehicles with retarder, w pulley	51065006546/ 9546
	01-	<b>24-1321</b>		For vehicles without retarder, w pulley	51065006545/ 6547/ 9545/ 9547
	01-	<b>24-1330</b>	•		51065000298,51065006066/ 7033/ 7036 51065007043/ 7045/ 7047/ 7048/ 7051 51065007052/ 7065/ 7066/ 7088/ 7089 51065009045/ 9047/ 9048/ 9052/ 9066
24.530 (390 kW) Eng.D2876LF13	01-	<b>24-1298</b>		For vehicles without retarder, w/o pulley; Impeller Ø 135mm, Incl Electronic fuel Injection pump	51065006408/ 6492/ 9492
	01-	<b>24-1302</b>		For vehicles with retarder, w/o pulley	51065006426/ 6490/ 9426/ 9490
	01-	<b>24-1319</b>		For vehicles with retarder, w pulley	51065006546/ 9546
	01-	<b>24-1321</b>		For vehicles without retarder, w pulley	51065006545/ 6547/ 9545/ 9547
	01-	<b>24-1330</b>	•		51065000298,51065006066/ 7033/ 7036 51065007043/ 7045/ 7047/ 7048/ 7051 51065007052/ 7065/ 7066/ 7088/ 7089 51065009045/ 9047/ 9048/ 9052/ 9066
26.280 (206 kW) Eng.D0836LF41	02-	<b>24-1234</b>		Impeller Ø 135mm, M14x1,5	51065006679/ 6699/ 7064/ 7078 51065009064/ 9078/ 9679/ 9699
26.310 (228 kW) Eng.D2866LF36/26	00-	<b>24-1298</b>		For vehicles without retarder, w/o pulley; Impeller Ø 135mm, Incl Electronic fuel Injection pump	51065006408/ 6492/ 9492
	00-	<b>24-1302</b>		For vehicles with retarder, w/o pulley	51065006426/ 6490/ 9426/ 9490
	00-	<b>24-1319</b>		For vehicles with retarder, w pulley	51065006546/ 9546
	00-	<b>24-1321</b>		For vehicles without retarder, w pulley	51065006545/ 6547/ 9545/ 9547
	00-	<b>24-1330</b>	•		51065000298,51065006066/ 7033/ 7036 51065007043/ 7045/ 7047/ 7048/ 7051 51065007052/ 7065/ 7066/ 7088/ 7089 51065009045/ 9047/ 9048/ 9052/ 9066
26.310, 26.320 (228-235 kW) Eng.D2066LF04	04-	<b>24-1224</b>		+Retarder	51065006642/ 6675/ 6694/ 9642/ 9675/ 9694
	04-	<b>24-1225</b>		-Retarder	51065006637/ 7049/ 9049
26.310, 26.320 (228-235 kW) Eng.D2066LF35	06-14	<b>24-1224</b>		+Retarder	51065006642/ 6675/ 6694/ 9642/ 9675/ 9694
	04-	<b>24-1225</b>		-Retarder	51065006637/ 7049/ 9049
26.330 (240 kW) Eng.D0836LF44	02-	<b>24-1234</b>		Impeller Ø 135mm, M14x1,5	51065006679/ 6699/ 7064/ 7078 51065009064/ 9078/ 9679/ 9699
26.350, 24.360 (257-265 kW) Eng.D2066LF03	04-	<b>24-1224</b>		+Retarder	51065006642/ 6675/ 6694/ 9642/ 9675/ 9694
	04-	<b>24-1225</b>		-Retarder	51065006637/ 7049/ 9049
26.350, 24.360 (257-265 kW) Eng.D2066LF13	06-14	<b>24-1224</b>		+Retarder	51065006642/ 6675/ 6694/ 9642/ 9675/ 9694
	04-	<b>24-1225</b>		-Retarder	51065006637/ 7049/ 9049
26.350, 24.360 (257-265 kW) Eng.D2066LF33	04-	<b>24-1224</b>		+Retarder	51065006642/ 6675/ 6694/ 9642/ 9675/ 9694
	04-	<b>24-1225</b>		-Retarder	51065006637/ 7049/ 9049
26.360 (265-176 kW) Eng.D2866LF27	01-	<b>24-1298</b>		For vehicles without retarder, w/o pulley; Impeller Ø 135mm, Incl Electronic fuel Injection pump	51065006408/ 6492/ 9492
	01-	<b>24-1302</b>		For vehicles with retarder, w/o pulley	51065006426/ 6490/ 9426/ 9490
	01-	<b>24-1319</b>		For vehicles with retarder, w pulley	51065006546/ 9546
	01-	<b>24-1321</b>		For vehicles without retarder, w pulley	51065006545/ 6547/ 9545/ 9547
	01-	<b>24-1330</b>	•		51065000298,51065006066/ 7033/ 7036 51065007043/ 7045/ 7047/ 7048/ 7051 51065007052/ 7065/ 7066/ 7088/ 7089 51065009045/ 9047/ 9048/ 9052/ 9066
26.360 (265-176 kW) Eng.D2866LF37	00-	<b>24-1298</b>		For vehicles without retarder, w/o pulley; Impeller Ø 135mm, Incl Electronic fuel Injection pump	51065006408/ 6492/ 9492
	00-	<b>24-1302</b>		For vehicles with retarder, w/o pulley	51065006426/ 6490/ 9426/ 9490
	00-	<b>24-1319</b>		For vehicles with retarder, w pulley	51065006546/ 9546
	00-	<b>24-1321</b>		For vehicles without retarder, w pulley	51065006545/ 6547/ 9545/ 9547

			
<b>24-1224</b>	<b>24-1225</b>	<b>24-1298</b>	<b>24-1302</b>
			
<b>24-1319</b>	<b>24-1321</b>	<b>24-1330</b>	

		<b>METELLI</b> ref.		<b>NOTE</b>	<b>Adaptable for OES</b>
26.360 (265-176 kW) Eng.D2866LF37	00-	<b>24-1330</b>		•	51065000298,51065006066/ 7033/ 7036 51065007043/ 7045/ 7047/ 7048/ 7051 51065007052/ 7065/ 7066/ 7088/ 7089 51065009045/ 9047/ 9048/ 9052/ 9066
26.390 (287-294 kW) Eng.D2066LF12	04-	<b>24-1225</b>		-Retarder	51065006637/ 7049/ 9049
26.390 (287-294 kW) Eng.D2066LF24	06-14	<b>24-1224</b>		+Retarder	51065006642/ 6675/ 6694/ 9642/ 9675/ 9694
	04-	<b>24-1225</b>		-Retarder	51065006637/ 7049/ 9049
26.390 (287-294 kW) Eng.D2066LF32	04-	<b>24-1224</b>		+Retarder	51065006642/ 6675/ 6694/ 9642/ 9675/ 9694
	04-	<b>24-1225</b>		-Retarder	51065006637/ 7049/ 9049
26.390, 26.400 (287-294 kW) Eng.D2066LF02	06-14	<b>24-1224</b>		+Retarder	51065006642/ 6675/ 6694/ 9642/ 9675/ 9694
	04-	<b>24-1225</b>		-Retarder	51065006637/ 7049/ 9049
26.410 (301 kW) Eng.D2866LF28	00-	<b>24-1298</b>		For vehicles without retarder, w/o pulley; Impeller Ø 135mm, Incl Electronic fuel Injection pump	51065006408/ 6492/ 9492
	00-	<b>24-1302</b>		For vehicles with retarder, w/o pulley	51065006426/ 6490/ 9426/ 9490
	00-	<b>24-1319</b>		For vehicles with retarder, w pulley	51065006546/ 9546
	00-	<b>24-1321</b>		For vehicles without retarder, w pulley	51065006545/ 6547/ 9545/ 9547
	00-	<b>24-1330</b>		•	51065000298,51065006066/ 7033/ 7036 51065007043/ 7045/ 7047/ 7048/ 7051 51065007052/ 7065/ 7066/ 7088/ 7089 51065009045/ 9047/ 9048/ 9052/ 9066
26.410 (301 kW) Eng.D2866LF32	02-	<b>24-1298</b>		For vehicles without retarder, w/o pulley; Impeller Ø 135mm, Incl Electronic fuel Injection pump	51065006408/ 6492/ 9492
	02-	<b>24-1302</b>		For vehicles with retarder, w/o pulley	51065006426/ 6490/ 9426/ 9490
	02-	<b>24-1319</b>		For vehicles with retarder, w pulley	51065006546/ 9546
	02-	<b>24-1321</b>		For vehicles without retarder, w pulley	51065006545/ 6547/ 9545/ 9547
	02-	<b>24-1330</b>		•	51065000298,51065006066/ 7033/ 7036 51065007043/ 7045/ 7047/ 7048/ 7051 51065007052/ 7065/ 7066/ 7088/ 7089 51065009045/ 9047/ 9048/ 9052/ 9066
26.430 (316-324 kW) Eng.D2066LF23	04-	<b>24-1224</b>		+Retarder	51065006642/ 6675/ 6694/ 9642/ 9675/ 9694
	04-	<b>24-1225</b>		-Retarder	51065006637/ 7049/ 9049
26.430, 26.440 (316-324 kW) Eng.D2066LF01	04-	<b>24-1224</b>		+Retarder	51065006642/ 6675/ 6694/ 9642/ 9675/ 9694
	04-	<b>24-1225</b>		-Retarder	51065006637/ 7049/ 9049
26.430, 26.440 (316-324 kW) Eng.D2066LF11	04-	<b>24-1225</b>		-Retarder	51065006637/ 7049/ 9049
26.430, 26.440 (316-324 kW) Eng.D2066LF31	04-	<b>24-1224</b>		+Retarder	51065006642/ 6675/ 6694/ 9642/ 9675/ 9694
	04-	<b>24-1225</b>		-Retarder	51065006637/ 7049/ 9049
	04-	<b>24-1302</b>		For vehicles with retarder, w/o pulley	51065006426/ 6490/ 9426/ 9490
26.460 (338 kW) Eng.D2876LF04	01-	<b>24-1298</b>		For vehicles without retarder, w/o pulley; Impeller Ø 135mm, Incl Electronic fuel Injection pump	51065006408/ 6492/ 9492
	01-	<b>24-1302</b>		For vehicles with retarder, w/o pulley	51065006426/ 6490/ 9426/ 9490
	01-	<b>24-1319</b>		For vehicles with retarder, w pulley	51065006546/ 9546
	01-	<b>24-1321</b>		For vehicles without retarder, w pulley	51065006545/ 6547/ 9545/ 9547
	01-	<b>24-1330</b>		•	51065000298,51065006066/ 7033/ 7036 51065007043/ 7045/ 7047/ 7048/ 7051 51065007052/ 7065/ 7066/ 7088/ 7089 51065009045/ 9047/ 9048/ 9052/ 9066
26.460 (338 kW) Eng.D2876LF07	01-	<b>24-1298</b>		For vehicles without retarder, w/o pulley; Impeller Ø 135mm, Incl Electronic fuel Injection pump	51065006408/ 6492/ 9492
	01-	<b>24-1302</b>		For vehicles with retarder, w/o pulley	51065006426/ 6490/ 9426/ 9490
	01-	<b>24-1319</b>		For vehicles with retarder, w pulley	51065006546/ 9546
	01-	<b>24-1321</b>		For vehicles without retarder, w pulley	51065006545/ 6547/ 9545/ 9547
	01-	<b>24-1330</b>		•	51065000298,51065006066/ 7033/ 7036 51065007043/ 7045/ 7047/ 7048/ 7051 51065007052/ 7065/ 7066/ 7088/ 7089 51065009045/ 9047/ 9048/ 9052/ 9066
26.480 (353 kW) Eng.D2676LF01	06-	<b>24-1224</b>		+Retarder	51065006642/ 6675/ 6694/ 9642/ 9675/ 9694
26.480 (353 kW) Eng.D2876LF12	02-	<b>24-1298</b>		For vehicles without retarder, w/o pulley; Impeller Ø 135mm, Incl Electronic fuel Injection pump	51065006408/ 6492/ 9492
	02-	<b>24-1302</b>		For vehicles with retarder, w/o pulley	51065006426/ 6490/ 9426/ 9490
	02-	<b>24-1319</b>		For vehicles with retarder, w pulley	51065006546/ 9546
	02-	<b>24-1321</b>		For vehicles without retarder, w pulley	51065006545/ 6547/ 9545/ 9547

			
<b>24-1224</b>	<b>24-1225</b>	<b>24-1298</b>	<b>24-1302</b>
			
<b>24-1319</b>	<b>24-1321</b>	<b>24-1330</b>	

		<b>METELLI</b> ref.			<b>NOTE</b>	<b>Adaptable for OES</b>
26.480 (353 kW) Eng.D2876LF12	02-	<b>24-1330</b>		•		51065000298,51065006066/ 7033/ 7036 51065007043/ 7045/ 7047/ 7048/ 7051 51065007052/ 7065/ 7066/ 7088/ 7089 51065009045/ 9047/ 9048/ 9052/ 9066
26.510 (375 kW) Eng.D2876LF05	00-	<b>24-1298</b>			For vehicles without retarder, w/o pulley; Impeller Ø 135mm, Incl Eletronic fuel Injection pump	51065006408/ 6492/ 9492
	00-	<b>24-1302</b>			For vehicles with retarder, w/o pulley	51065006426/ 6490/ 9426/ 9490
	00-	<b>24-1319</b>			For vehicles with retarder, w pulley	51065006546/ 9546
	00-	<b>24-1321</b>			For vehicles without retarder, w pulley	51065006545/ 6547/ 9545/ 9547
	00-	<b>24-1330</b>		•		51065000298,51065006066/ 7033/ 7036 51065007043/ 7045/ 7047/ 7048/ 7051 51065007052/ 7065/ 7066/ 7088/ 7089 51065009045/ 9047/ 9048/ 9052/ 9066
26.530 (390 kW) Eng.D2876LF13	01-	<b>24-1298</b>			For vehicles without retarder, w/o pulley; Impeller Ø 135mm, Incl Eletronic fuel Injection pump	51065006408/ 6492/ 9492
	01-	<b>24-1302</b>			For vehicles with retarder, w/o pulley	51065006426/ 6490/ 9426/ 9490
	01-	<b>24-1319</b>			For vehicles with retarder, w pulley	51065006546/ 9546
	01-	<b>24-1321</b>			For vehicles without retarder, w pulley	51065006545/ 6547/ 9545/ 9547
	01-	<b>24-1330</b>		•		51065000298,51065006066/ 7033/ 7036 51065007043/ 7045/ 7047/ 7048/ 7051 51065007052/ 7065/ 7066/ 7088/ 7089 51065009045/ 9047/ 9048/ 9052/ 9066
28.310 (228 kW) Eng.D2866LF26	02-	<b>24-1298</b>			For vehicles without retarder, w/o pulley; Impeller Ø 135mm, Incl Eletronic fuel Injection pump	51065006408/ 6492/ 9492
	02-	<b>24-1302</b>			For vehicles with retarder, w/o pulley	51065006426/ 6490/ 9426/ 9490
	02-	<b>24-1319</b>			For vehicles with retarder, w pulley	51065006546/ 9546
	02-	<b>24-1321</b>			For vehicles without retarder, w pulley	51065006545/ 6547/ 9545/ 9547
	02-	<b>24-1330</b>		•		51065000298,51065006066/ 7033/ 7036 51065007043/ 7045/ 7047/ 7048/ 7051 51065007052/ 7065/ 7066/ 7088/ 7089 51065009045/ 9047/ 9048/ 9052/ 9066
28.320 (228-235 kW) Eng.D2066LF04,LF14,LF28,LF39	06-	<b>24-1224</b>			+Retarder	51065006642/ 6675/ 6694/ 9642/ 9675/ 9694
	06-	<b>24-1225</b>			-Retarder	51065006637/ 7049/ 9049
28.350, 28.360 (257-265 kW) Eng.D2066LF03,LF13,LF27,LF38	04-	<b>24-1225</b>			-Retarder	51065006637/ 7049/ 9049
28.360 (265-176 kW) Eng.D2866LF27	02-	<b>24-1298</b>			For vehicles without retarder, w/o pulley; Impeller Ø 135mm, Incl Eletronic fuel Injection pump	51065006408/ 6492/ 9492
	02-	<b>24-1302</b>			For vehicles with retarder, w/o pulley	51065006426/ 6490/ 9426/ 9490
	02-	<b>24-1319</b>			For vehicles with retarder, w pulley	51065006546/ 9546
	02-	<b>24-1321</b>			For vehicles without retarder, w pulley	51065006545/ 6547/ 9545/ 9547
	02-	<b>24-1330</b>		•		51065000298,51065006066/ 7033/ 7036 51065007043/ 7045/ 7047/ 7048/ 7051 51065007052/ 7065/ 7066/ 7088/ 7089 51065009045/ 9047/ 9048/ 9052/ 9066
28.390, 28.400 (287-294 kW) Eng.D2066LF02	07-	<b>24-1224</b>			+Retarder	51065006642/ 6675/ 6694/ 9642/ 9675/ 9694
	07-	<b>24-1225</b>			-Retarder	51065006637/ 7049/ 9049
28.390, 28.400 (287-294 kW) Eng.D2066LF26	05-	<b>24-1224</b>			+Retarder	51065006642/ 6675/ 6694/ 9642/ 9675/ 9694
	05-	<b>24-1225</b>			-Retarder	51065006637/ 7049/ 9049
28.410 (301 kW) Eng.D2866LF28	02-	<b>24-1298</b>			For vehicles without retarder, w/o pulley; Impeller Ø 135mm, Incl Eletronic fuel Injection pump	51065006408/ 6492/ 9492
	02-	<b>24-1302</b>			For vehicles with retarder, w/o pulley	51065006426/ 6490/ 9426/ 9490
	02-	<b>24-1319</b>			For vehicles with retarder, w pulley	51065006546/ 9546
	02-	<b>24-1321</b>			For vehicles without retarder, w pulley	51065006545/ 6547/ 9545/ 9547
	02-	<b>24-1330</b>		•		51065000298,51065006066/ 7033/ 7036 51065007043/ 7045/ 7047/ 7048/ 7051 51065007052/ 7065/ 7066/ 7088/ 7089 51065009045/ 9047/ 9048/ 9052/ 9066
28.430, 28.440 (316-324 kW) Eng.D2066LF11	04-	<b>24-1224</b>			+Retarder	51065006642/ 6675/ 6694/ 9642/ 9675/ 9694
	04-	<b>24-1225</b>			-Retarder	51065006637/ 7049/ 9049
28.460 (338 kW) Eng.D2876LF04	02-	<b>24-1298</b>			For vehicles without retarder, w/o pulley; Impeller Ø 135mm, Incl Eletronic fuel Injection pump	51065006408/ 6492/ 9492
	02-	<b>24-1302</b>			For vehicles with retarder, w/o pulley	51065006426/ 6490/ 9426/ 9490
	02-	<b>24-1319</b>			For vehicles with retarder, w pulley	51065006546/ 9546
	02-	<b>24-1321</b>			For vehicles without retarder, w pulley	51065006545/ 6547/ 9545/ 9547
	02-	<b>24-1330</b>		•		51065000298,51065006066/ 7033/ 7036 51065007043/ 7045/ 7047/ 7048/ 7051 51065007052/ 7065/ 7066/ 7088/ 7089 51065009045/ 9047/ 9048/ 9052/ 9066
28.480 (353 kW) Eng.D2876LF12	02-	<b>24-1298</b>			For vehicles without retarder, w/o pulley; Impeller Ø 135mm, Incl Eletronic fuel Injection pump	51065006408/ 6492/ 9492

			
<b>24-1224</b>	<b>24-1225</b>	<b>24-1298</b>	<b>24-1302</b>
			
<b>24-1319</b>	<b>24-1321</b>	<b>24-1330</b>	



		<b>METELLI</b> ref.			<b>NOTE</b>	<b>Adaptable for OES</b>
28.480 (353 kW) Eng.D2876LF12	02-	<b>24-1302</b>			For vehicles with retarder, w/o pulley	51065006426/ 6490/ 9426/ 9490
	02-	<b>24-1319</b>			For vehicles with retarder, w pulley	51065006546/ 9546
	02-	<b>24-1321</b>			For vehicles without retarder, w pulley	51065006545/ 6547/ 9545/ 9547
	02-	<b>24-1330</b>		•		51065000298,51065006066/ 7033/ 7036 51065007043/ 7045/ 7047/ 7048/ 7051 51065007052/ 7065/ 7066/ 7088/ 7089 51065009045/ 9047/ 9048/ 9052/ 9066
28.510 (375 kW) Eng.D2876LF05	02-	<b>24-1298</b>			For vehicles without retarder, w/o pulley; Impeller Ø 135mm, Incl Electronic fuel Injection pump	51065006408/ 6492/ 9492
	02-	<b>24-1302</b>			For vehicles with retarder, w/o pulley	51065006426/ 6490/ 9426/ 9490
	02-	<b>24-1319</b>			For vehicles with retarder, w pulley	51065006546/ 9546
	02-	<b>24-1321</b>			For vehicles without retarder, w pulley	51065006545/ 6547/ 9545/ 9547
	02-	<b>24-1330</b>		•		51065000298,51065006066/ 7033/ 7036 51065007043/ 7045/ 7047/ 7048/ 7051 51065007052/ 7065/ 7066/ 7088/ 7089 51065009045/ 9047/ 9048/ 9052/ 9066
28.530 (390 kW) Eng.D2876LF13	02-	<b>24-1298</b>			For vehicles without retarder, w/o pulley; Impeller Ø 135mm, Incl Electronic fuel Injection pump	51065006408/ 6492/ 9492
	02-	<b>24-1302</b>			For vehicles with retarder, w/o pulley	51065006426/ 6490/ 9426/ 9490
	02-	<b>24-1319</b>			For vehicles with retarder, w pulley	51065006546/ 9546
	02-	<b>24-1321</b>			For vehicles without retarder, w pulley	51065006545/ 6547/ 9545/ 9547
	02-	<b>24-1330</b>		•		51065000298,51065006066/ 7033/ 7036 51065007043/ 7045/ 7047/ 7048/ 7051 51065007052/ 7065/ 7066/ 7088/ 7089 51065009045/ 9047/ 9048/ 9052/ 9066
32,350, 32,360 (257-265 kW) Eng.D2066LF03,LF13,LF27,LF38	04-	<b>24-1224</b>			+Retarder	51065006642/ 6675/ 6694/ 9642/ 9675/ 9694
	04-	<b>24-1225</b>			-Retarder	51065006637/ 7049/ 9049
32.310 (228 kW) Eng.D2866LF26	02-	<b>24-1298</b>			For vehicles without retarder, w/o pulley; Impeller Ø 135mm, Incl Electronic fuel Injection pump	51065006408/ 6492/ 9492
	02-	<b>24-1302</b>			For vehicles with retarder, w/o pulley	51065006426/ 6490/ 9426/ 9490
	02-	<b>24-1319</b>			For vehicles with retarder, w pulley	51065006546/ 9546
	02-	<b>24-1321</b>			For vehicles without retarder, w pulley	51065006545/ 6547/ 9545/ 9547
	02-	<b>24-1330</b>		•		51065000298,51065006066/ 7033/ 7036 51065007043/ 7045/ 7047/ 7048/ 7051 51065007052/ 7065/ 7066/ 7088/ 7089 51065009045/ 9047/ 9048/ 9052/ 9066
32.360 (265-176 kW) Eng.D2866LF27	02-	<b>24-1298</b>			For vehicles without retarder, w/o pulley; Impeller Ø 135mm, Incl Electronic fuel Injection pump	51065006408/ 6492/ 9492
	02-	<b>24-1302</b>			For vehicles with retarder, w/o pulley	51065006426/ 6490/ 9426/ 9490
	02-	<b>24-1319</b>			For vehicles with retarder, w pulley	51065006546/ 9546
	02-	<b>24-1321</b>			For vehicles without retarder, w pulley	51065006545/ 6547/ 9545/ 9547
	02-	<b>24-1330</b>		•		51065000298,51065006066/ 7033/ 7036 51065007043/ 7045/ 7047/ 7048/ 7051 51065007052/ 7065/ 7066/ 7088/ 7089 51065009045/ 9047/ 9048/ 9052/ 9066
32.410 (301 kW) Eng.D2866LF28	02-	<b>24-1298</b>			For vehicles without retarder, w/o pulley; Impeller Ø 135mm, Incl Electronic fuel Injection pump	51065006408/ 6492/ 9492
	02-	<b>24-1302</b>			For vehicles with retarder, w/o pulley	51065006426/ 6490/ 9426/ 9490
	02-	<b>24-1319</b>			For vehicles with retarder, w pulley	51065006546/ 9546
	02-	<b>24-1321</b>			For vehicles without retarder, w pulley	51065006545/ 6547/ 9545/ 9547
	02-	<b>24-1330</b>		•		51065000298,51065006066/ 7033/ 7036 51065007043/ 7045/ 7047/ 7048/ 7051 51065007052/ 7065/ 7066/ 7088/ 7089 51065009045/ 9047/ 9048/ 9052/ 9066
32.430, 32.440 (316-324 kW) Eng.D2066LF11	05-	<b>24-1224</b>			+Retarder	51065006642/ 6675/ 6694/ 9642/ 9675/ 9694
	05-	<b>24-1225</b>			-Retarder	51065006637/ 7049/ 9049
32.430, 32.440 (316-324 kW) Eng.D2066LF31	04-	<b>24-1224</b>			+Retarder	51065006642/ 6675/ 6694/ 9642/ 9675/ 9694
	04-	<b>24-1225</b>			-Retarder	51065006637/ 7049/ 9049
32.460 (338 kW) Eng.D2876LF04	02-	<b>24-1298</b>			For vehicles without retarder, w/o pulley; Impeller Ø 135mm, Incl Electronic fuel Injection pump	51065006408/ 6492/ 9492
	02-	<b>24-1302</b>			For vehicles with retarder, w/o pulley	51065006426/ 6490/ 9426/ 9490
	02-	<b>24-1319</b>			For vehicles with retarder, w pulley	51065006546/ 9546
	02-	<b>24-1321</b>			For vehicles without retarder, w pulley	51065006545/ 6547/ 9545/ 9547
	02-	<b>24-1330</b>		•		51065000298,51065006066/ 7033/ 7036 51065007043/ 7045/ 7047/ 7048/ 7051 51065007052/ 7065/ 7066/ 7088/ 7089 51065009045/ 9047/ 9048/ 9052/ 9066
32.480 (353 kW) Eng.D2876LF12	02-	<b>24-1298</b>			For vehicles without retarder, w/o pulley; Impeller Ø 135mm, Incl Electronic fuel Injection pump	51065006408/ 6492/ 9492
	02-	<b>24-1302</b>			For vehicles with retarder, w/o pulley	51065006426/ 6490/ 9426/ 9490





			
<b>24-1224</b>	<b>24-1225</b>	<b>24-1298</b>	<b>24-1302</b>
			
<b>24-1319</b>	<b>24-1321</b>	<b>24-1330</b>	

		<b>METELLI ref.</b>			<b>NOTE</b>	<b>Adaptable for OES</b>
32.480 (353 kW) Eng.D2876LF12	02-	<b>24-1319</b>			For vehicles with retarder, w pulley	51065006546/ 9546
	02-	<b>24-1321</b>			For vehicles without retarder, w pulley	51065006545/ 6547/ 9545/ 9547
	02-	<b>24-1330</b>		•		51065000298,51065006066/ 7033/ 7036 51065007043/ 7045/ 7047/ 7048/ 7051 51065007052/ 7065/ 7066/ 7088/ 7089 51065009045/ 9047/ 9048/ 9052/ 9066
33.350, 33.360 (257-265 kW) Eng.D2066LF03	05-	<b>24-1224</b>			+Retarder	51065006642/ 6675/ 6694/ 9642/ 9675/ 9694
	05-	<b>24-1225</b>			-Retarder	51065006637/ 7049/ 9049
33.350, 33.360 (257-265 kW) Eng.D2066LF13	05-	<b>24-1224</b>			+Retarder	51065006642/ 6675/ 6694/ 9642/ 9675/ 9694
	05-	<b>24-1225</b>			-Retarder	51065006637/ 7049/ 9049
33.350, 33.360 (257-265 kW) Eng.D2066LF33	05-	<b>24-1224</b>			+Retarder	51065006642/ 6675/ 6694/ 9642/ 9675/ 9694
	05-	<b>24-1225</b>			-Retarder	51065006637/ 7049/ 9049
33.360 (265-176 kW) Eng.D2866LF27	00-	<b>24-1298</b>			For vehicles without retarder, w/o pulley; Impeller Ø 135mm, Incl Eletronic fuel Injection pump	51065006408/ 6492/ 9492
	00-	<b>24-1302</b>			For vehicles with retarder, w/o pulley	51065006426/ 6490/ 9426/ 9490
	02-	<b>24-1319</b>			For vehicles with retarder, w pulley	51065006546/ 9546
	00-	<b>24-1321</b>			For vehicles without retarder, w pulley	51065006545/ 6547/ 9545/ 9547
	00-	<b>24-1330</b>		•		51065000298,51065006066/ 7033/ 7036 51065007043/ 7045/ 7047/ 7048/ 7051 51065007052/ 7065/ 7066/ 7088/ 7089 51065009045/ 9047/ 9048/ 9052/ 9066
33.390, 33.400 (287-294 kW) Eng.D2066LF02	04-	<b>24-1224</b>			+Retarder	51065006642/ 6675/ 6694/ 9642/ 9675/ 9694
	04-	<b>24-1225</b>			-Retarder	51065006637/ 7049/ 9049
33.390, 33.400 (287-294 kW) Eng.D2066LF12	04-	<b>24-1224</b>			+Retarder	51065006642/ 6675/ 6694/ 9642/ 9675/ 9694
	04-	<b>24-1225</b>			-Retarder	51065006637/ 7049/ 9049
33.390, 33.400 (287-294 kW) Eng.D2066LF32	05-	<b>24-1224</b>			+Retarder	51065006642/ 6675/ 6694/ 9642/ 9675/ 9694
	05-	<b>24-1225</b>			-Retarder	51065006637/ 7049/ 9049
33.410 (301 kW) Eng.D2866LF28	02-	<b>24-1298</b>			For vehicles without retarder, w/o pulley; Impeller Ø 135mm, Incl Eletronic fuel Injection pump	51065006408/ 6492/ 9492
	02-	<b>24-1302</b>			For vehicles with retarder, w/o pulley	51065006426/ 6490/ 9426/ 9490
	02-	<b>24-1319</b>			For vehicles with retarder, w pulley	51065006546/ 9546
	02-	<b>24-1321</b>			For vehicles without retarder, w pulley	51065006545/ 6547/ 9545/ 9547
	02-	<b>24-1330</b>		•		51065000298,51065006066/ 7033/ 7036 51065007043/ 7045/ 7047/ 7048/ 7051 51065007052/ 7065/ 7066/ 7088/ 7089 51065009045/ 9047/ 9048/ 9052/ 9066
33.410 (301 kW) Eng.D2866LF32	00-	<b>24-1298</b>			For vehicles without retarder, w/o pulley; Impeller Ø 135mm, Incl Eletronic fuel Injection pump	51065006408/ 6492/ 9492
	00-	<b>24-1302</b>			For vehicles with retarder, w/o pulley	51065006426/ 6490/ 9426/ 9490
	00-	<b>24-1319</b>			For vehicles with retarder, w pulley	51065006546/ 9546
	00-	<b>24-1321</b>			For vehicles without retarder, w pulley	51065006545/ 6547/ 9545/ 9547
	00-	<b>24-1330</b>		•		51065000298,51065006066/ 7033/ 7036 51065007043/ 7045/ 7047/ 7048/ 7051 51065007052/ 7065/ 7066/ 7088/ 7089 51065009045/ 9047/ 9048/ 9052/ 9066
33.430, 33.440 (316-324 kW) Eng.D2066LF01	05-	<b>24-1224</b>			+Retarder	51065006642/ 6675/ 6694/ 9642/ 9675/ 9694
	05-	<b>24-1225</b>			-Retarder	51065006637/ 7049/ 9049
33.430, 33.440 (316-324 kW) Eng.D2066LF11	06-	<b>24-1224</b>			+Retarder	51065006642/ 6675/ 6694/ 9642/ 9675/ 9694
	06-	<b>24-1225</b>			-Retarder	51065006637/ 7049/ 9049
33.430, 33.440 (316-324 kW) Eng.D2066LF31	05-	<b>24-1225</b>			-Retarder	51065006637/ 7049/ 9049
33.460 (338 kW) Eng.D2876LF04	02-	<b>24-1298</b>			For vehicles without retarder, w/o pulley; Impeller Ø 135mm, Incl Eletronic fuel Injection pump	51065006408/ 6492/ 9492
	02-	<b>24-1302</b>			For vehicles with retarder, w/o pulley	51065006426/ 6490/ 9426/ 9490
	02-	<b>24-1319</b>			For vehicles with retarder, w pulley	51065006546/ 9546
	02-	<b>24-1321</b>			For vehicles without retarder, w pulley	51065006545/ 6547/ 9545/ 9547
	02-	<b>24-1330</b>		•		51065000298,51065006066/ 7033/ 7036 51065007043/ 7045/ 7047/ 7048/ 7051 51065007052/ 7065/ 7066/ 7088/ 7089 51065009045/ 9047/ 9048/ 9052/ 9066
33.460 (338 kW) Eng.D2876LF07	02-	<b>24-1298</b>			For vehicles without retarder, w/o pulley; Impeller Ø 135mm, Incl Eletronic fuel Injection pump	51065006408/ 6492/ 9492
	02-	<b>24-1302</b>			For vehicles with retarder, w/o pulley	51065006426/ 6490/ 9426/ 9490
	02-	<b>24-1319</b>			For vehicles with retarder, w pulley	51065006546/ 9546





			
<b>24-1224</b>	<b>24-1225</b>	<b>24-1298</b>	<b>24-1302</b>
			
<b>24-1319</b>	<b>24-1321</b>	<b>24-1330</b>	

		<b>METELLI ref.</b>		<b>NOTE</b>	<b>Adaptable for OES</b>
33.460 (338 kW) Eng.D2876LF07	02-	<b>24-1321</b>		For vehicles without retarder, w pulley	51065006545/ 6547/ 9545/ 9547
	02-	<b>24-1330</b>	•		51065000298,51065006066/ 7033/ 7036 51065007043/ 7045/ 7047/ 7048/ 7051 51065007052/ 7065/ 7066/ 7088/ 7089 51065009045/ 9047/ 9048/ 9052/ 9066
33.480 (353 kW) Eng.D2676LF05	06-	<b>24-1224</b>		+Retarder	51065006642/ 6675/ 6694/ 9642/ 9675/ 9694
33.480 (353 kW) Eng.D2876LF12	02-	<b>24-1298</b>		For vehicles without retarder, w/o pulley; Impeller Ø 135mm, Incl Eletronic fuel Injection pump	51065006408/ 6492/ 9492
	02-	<b>24-1302</b>		For vehicles with retarder, w/o pulley	51065006426/ 6490/ 9426/ 9490
	02-	<b>24-1319</b>		For vehicles with retarder, w pulley	51065006546/ 9546
	02-	<b>24-1321</b>		For vehicles without retarder, w pulley	51065006545/ 6547/ 9545/ 9547
	02-	<b>24-1330</b>	•		51065000298,51065006066/ 7033/ 7036 51065007043/ 7045/ 7047/ 7048/ 7051 51065007052/ 7065/ 7066/ 7088/ 7089 51065009045/ 9047/ 9048/ 9052/ 9066
33.510 (375 kW) Eng.D2876LF05	02-	<b>24-1298</b>		For vehicles without retarder, w/o pulley; Impeller Ø 135mm, Incl Eletronic fuel Injection pump	51065006408/ 6492/ 9492
	02-	<b>24-1302</b>		For vehicles with retarder, w/o pulley	51065006426/ 6490/ 9426/ 9490
	02-	<b>24-1319</b>		For vehicles with retarder, w pulley	51065006546/ 9546
	02-	<b>24-1321</b>		For vehicles without retarder, w pulley	51065006545/ 6547/ 9545/ 9547
	02-	<b>24-1330</b>	•		51065000298,51065006066/ 7033/ 7036 51065007043/ 7045/ 7047/ 7048/ 7051 51065007052/ 7065/ 7066/ 7088/ 7089 51065009045/ 9047/ 9048/ 9052/ 9066
33.530 (390 kW) Eng.D2876LF13	02-	<b>24-1298</b>		For vehicles without retarder, w/o pulley; Impeller Ø 135mm, Incl Eletronic fuel Injection pump	51065006408/ 6492/ 9492
	02-	<b>24-1302</b>		For vehicles with retarder, w/o pulley	51065006426/ 6490/ 9426/ 9490
	02-	<b>24-1319</b>		For vehicles with retarder, w pulley	51065006546/ 9546
	02-	<b>24-1321</b>		For vehicles without retarder, w pulley	51065006545/ 6547/ 9545/ 9547
	02-	<b>24-1330</b>	•		51065000298,51065006066/ 7033/ 7036 51065007043/ 7045/ 7047/ 7048/ 7051 51065007052/ 7065/ 7066/ 7088/ 7089 51065009045/ 9047/ 9048/ 9052/ 9066
35.310, 35.320 (228-235 kW) Eng.D2066LF04,LF35,LF39	04-	<b>24-1224</b>		+Retarder	51065006642/ 6675/ 6694/ 9642/ 9675/ 9694
	04-	<b>24-1225</b>		-Retarder	51065006637/ 7049/ 9049
35.350, 35.360 (257-265 kW) Eng.D2066LF03,LF13,LF33,LF38	04-	<b>24-1224</b>		+Retarder	51065006642/ 6675/ 6694/ 9642/ 9675/ 9694
	04-	<b>24-1225</b>		-Retarder	51065006637/ 7049/ 9049
35.360 (265 kW) Eng.DF2866LF27	06-	<b>24-1298</b>		For vehicles without retarder, w/o pulley; Impeller Ø 135mm, Incl Eletronic fuel Injection pump	51065006408/ 6492/ 9492
	06-	<b>24-1302</b>		For vehicles with retarder, w/o pulley	51065006426/ 6490/ 9426/ 9490
	06-	<b>24-1319</b>		For vehicles with retarder, w pulley	51065006546/ 9546
	06-	<b>24-1321</b>		For vehicles without retarder, w pulley	51065006545/ 6547/ 9545/ 9547
35.390, 35.400 (287-294 kW) Eng.D2066LF02,LF12,LF32,LF37	04-	<b>24-1224</b>		+Retarder	51065006642/ 6675/ 6694/ 9642/ 9675/ 9694
	04-	<b>24-1225</b>		-Retarder	51065006637/ 7049/ 9049
35.410 (301 kW) Eng.D2866LF28	06-	<b>24-1298</b>		For vehicles without retarder, w/o pulley; Impeller Ø 135mm, Incl Eletronic fuel Injection pump	51065006408/ 6492/ 9492
	06-	<b>24-1302</b>		For vehicles with retarder, w/o pulley	51065006426/ 6490/ 9426/ 9490
	06-	<b>24-1319</b>		For vehicles with retarder, w pulley	51065006546/ 9546
	06-	<b>24-1321</b>		For vehicles without retarder, w pulley	51065006545/ 6547/ 9545/ 9547
	06-	<b>24-1330</b>	•		51065000298,51065006066/ 7033/ 7036 51065007043/ 7045/ 7047/ 7048/ 7051 51065007052/ 7065/ 7066/ 7088/ 7089 51065009045/ 9047/ 9048/ 9052/ 9066
35.430, 35.440 (316-324 kW) Eng.D2066LF01,LF11,LF31,LF36	04-	<b>24-1224</b>		+Retarder	51065006642/ 6675/ 6694/ 9642/ 9675/ 9694
	04-	<b>24-1225</b>		-Retarder	51065006637/ 7049/ 9049
35.460 (338 kW) Eng.D2876LF04	02-	<b>24-1298</b>		For vehicles without retarder, w/o pulley; Impeller Ø 135mm, Incl Eletronic fuel Injection pump	51065006408/ 6492/ 9492
	02-	<b>24-1302</b>		For vehicles with retarder, w/o pulley	51065006426/ 6490/ 9426/ 9490
	02-	<b>24-1319</b>		For vehicles with retarder, w pulley	51065006546/ 9546
	02-	<b>24-1321</b>		For vehicles without retarder, w pulley	51065006545/ 6547/ 9545/ 9547
	02-	<b>24-1330</b>	•		51065000298,51065006066/ 7033/ 7036 51065007043/ 7045/ 7047/ 7048/ 7051 51065007052/ 7065/ 7066/ 7088/ 7089 51065009045/ 9047/ 9048/ 9052/ 9066
35.480 (353 kW) Eng.D2676LF01	04-	<b>24-1224</b>		+Retarder	51065006642/ 6675/ 6694/ 9642/ 9675/ 9694
35.480 (353 kW) Eng.D2876LF12	06-	<b>24-1298</b>		For vehicles without retarder, w/o pulley; Impeller Ø 135mm, Incl Eletronic fuel Injection pump	51065006408/ 6492/ 9492





			
<b>24-1224</b>	<b>24-1225</b>	<b>24-1298</b>	<b>24-1302</b>
			
<b>24-1319</b>	<b>24-1321</b>	<b>24-1330</b>	





		<b>METELLI</b> ref.		<b>NOTE</b>	<b>Adaptable for OES</b>
35.480 (353 kW) Eng.D2876LF12	06-	<b>24-1302</b>		For vehicles with retarder, w/o pulley	51065006426/ 6490/ 9426/ 9490
	06-	<b>24-1319</b>		For vehicles with retarder, w pulley	51065006546/ 9546
	06-	<b>24-1321</b>		For vehicles without retarder, w pulley	51065006545/ 6547/ 9545/ 9547
	06-	<b>24-1330</b>	•		51065000298,51065006066/ 7033/ 7036 51065007043/ 7045/ 7047/ 7048/ 7051 51065007052/ 7065/ 7066/ 7088/ 7089 51065009045/ 9047/ 9048/ 9052/ 9066
37.310, 37.320 (228-235 kW) Eng.D2066LF04	04-	<b>24-1224</b>		+Retarder	51065006642/ 6675/ 6694/ 9642/ 9675/ 9694
	04-	<b>24-1225</b>		-Retarder	51065006637/ 7049/ 9049
37.310, 37.320 (228-235 kW) Eng.D2066LF35	04-	<b>24-1225</b>		-Retarder	51065006637/ 7049/ 9049
37.350, 37.360 (257-265 kW) Eng.D2066LF13	04-	<b>24-1224</b>		+Retarder	51065006642/ 6675/ 6694/ 9642/ 9675/ 9694
	04-	<b>24-1225</b>		-Retarder	51065006637/ 7049/ 9049
40.390, 40.400 (287-294 kW) Eng.D2066LF02	05-	<b>24-1224</b>		+Retarder	51065006642/ 6675/ 6694/ 9642/ 9675/ 9694
	05-	<b>24-1225</b>		-Retarder	51065006637/ 7049/ 9049
40.390, 40.400 (287-294 kW) Eng.D2066LF06	05-	<b>24-1224</b>		+Retarder	51065006642/ 6675/ 6694/ 9642/ 9675/ 9694
	05-	<b>24-1225</b>		-Retarder	51065006637/ 7049/ 9049
40.390, 40.400 (287-294 kW) Eng.D2066LF37	05-	<b>24-1224</b>		+Retarder	51065006642/ 6675/ 6694/ 9642/ 9675/ 9694
	05-	<b>24-1225</b>		-Retarder	51065006637/ 7049/ 9049
40.410 (301 kW) Eng.D2866LF28	04-	<b>24-1298</b>		For vehicles without retarder, w/o pulley; Impeller Ø 135mm, Incl Electronic fuel Injection pump	51065006408/ 6492/ 9492
	04-	<b>24-1302</b>		For vehicles with retarder, w/o pulley	51065006426/ 6490/ 9426/ 9490
	04-	<b>24-1319</b>		For vehicles with retarder, w pulley	51065006546/ 9546
	04-	<b>24-1321</b>		For vehicles without retarder, w pulley	51065006545/ 6547/ 9545/ 9547
40.410 (301 kW) Eng.D2866LF32	04-	<b>24-1330</b>	•		51065000298,51065006066/ 7033/ 7036 51065007043/ 7045/ 7047/ 7048/ 7051 51065007052/ 7065/ 7066/ 7088/ 7089 51065009045/ 9047/ 9048/ 9052/ 9066
	04-	<b>24-1298</b>		For vehicles without retarder, w/o pulley; Impeller Ø 135mm, Incl Electronic fuel Injection pump	51065006408/ 6492/ 9492
	04-	<b>24-1302</b>		For vehicles with retarder, w/o pulley	51065006426/ 6490/ 9426/ 9490
	04-	<b>24-1319</b>		For vehicles with retarder, w pulley	51065006546/ 9546
40.410 (301 kW) Eng.D2866LF32	04-	<b>24-1321</b>		For vehicles without retarder, w pulley	51065006545/ 6547/ 9545/ 9547
	04-	<b>24-1330</b>	•		51065000298,51065006066/ 7033/ 7036 51065007043/ 7045/ 7047/ 7048/ 7051 51065007052/ 7065/ 7066/ 7088/ 7089 51065009045/ 9047/ 9048/ 9052/ 9066
	04-	<b>24-1298</b>		For vehicles without retarder, w/o pulley; Impeller Ø 135mm, Incl Electronic fuel Injection pump	51065006408/ 6492/ 9492
	04-	<b>24-1302</b>		For vehicles with retarder, w/o pulley	51065006426/ 6490/ 9426/ 9490
40.430, 40.440 (316-324 kW) Eng.D2066LF01	05-	<b>24-1224</b>		+Retarder	51065006642/ 6675/ 6694/ 9642/ 9675/ 9694
	05-	<b>24-1225</b>		-Retarder	51065006637/ 7049/ 9049
	04-	<b>24-1298</b>		For vehicles without retarder, w/o pulley; Impeller Ø 135mm, Incl Electronic fuel Injection pump	51065006408/ 6492/ 9492
	04-	<b>24-1302</b>		For vehicles with retarder, w/o pulley	51065006426/ 6490/ 9426/ 9490
40.460 (338 kW) Eng.D2876LF07	04-	<b>24-1319</b>		For vehicles with retarder, w pulley	51065006546/ 9546
	04-	<b>24-1321</b>		For vehicles without retarder, w pulley	51065006545/ 6547/ 9545/ 9547
	04-	<b>24-1330</b>	•		51065000298,51065006066/ 7033/ 7036 51065007043/ 7045/ 7047/ 7048/ 7051 51065007052/ 7065/ 7066/ 7088/ 7089 51065009045/ 9047/ 9048/ 9052/ 9066
	04-	<b>24-1298</b>		For vehicles without retarder, w/o pulley; Impeller Ø 135mm, Incl Electronic fuel Injection pump	51065006408/ 6492/ 9492
40.480 (353 kW) Eng.D2876LF12	04-	<b>24-1302</b>		For vehicles with retarder, w/o pulley	51065006426/ 6490/ 9426/ 9490
	04-	<b>24-1319</b>		For vehicles with retarder, w pulley	51065006546/ 9546
	04-	<b>24-1321</b>		For vehicles without retarder, w pulley	51065006545/ 6547/ 9545/ 9547
	04-	<b>24-1330</b>	•		51065000298,51065006066/ 7033/ 7036 51065007043/ 7045/ 7047/ 7048/ 7051 51065007052/ 7065/ 7066/ 7088/ 7089 51065009045/ 9047/ 9048/ 9052/ 9066
40.480 (353 kW) Eng.D2876LF25	04-	<b>24-1298</b>		For vehicles without retarder, w/o pulley; Impeller Ø 135mm, Incl Electronic fuel Injection pump	51065006408/ 6492/ 9492
	04-	<b>24-1302</b>		For vehicles with retarder, w/o pulley	51065006426/ 6490/ 9426/ 9490
	04-	<b>24-1319</b>		For vehicles with retarder, w pulley	51065006546/ 9546
	04-	<b>24-1321</b>		For vehicles without retarder, w pulley	51065006545/ 6547/ 9545/ 9547
40.480 (353 kW) Eng.D2876LF25	04-	<b>24-1330</b>	•		51065000298,51065006066/ 7033/ 7036 51065007043/ 7045/ 7047/ 7048/ 7051 51065007052/ 7065/ 7066/ 7088/ 7089 51065009045/ 9047/ 9048/ 9052/ 9066

			
<b>24-1224</b>	<b>24-1225</b>	<b>24-1298</b>	<b>24-1302</b>
			
<b>24-1319</b>	<b>24-1321</b>	<b>24-1330</b>	

		<b>METELLI</b> ref.			<b>NOTE</b>	<b>Adaptable for OES</b>
41.350, 41.360 (257-265 kW) Eng.D2066LF03,LF07,LF13,LF33,LF38	04-	<b>24-1224</b>			+Retarder	51065006642/ 6675/ 6694/ 9642/ 9675/ 9694
	04-	<b>24-1225</b>			-Retarder	51065006637/ 7049/ 9049
41.360 (265-176 kW) Eng.D2866LF27/37	03-	<b>24-1298</b>			For vehicles without retarder, w/o pulley; Impeller Ø 135mm, Incl Eletronic fuel Injection pump	51065006408/ 6492/ 9492
	03-	<b>24-1302</b>			For vehicles with retarder, w/o pulley	51065006426/ 6490/ 9426/ 9490
	03-	<b>24-1319</b>			For vehicles with retarder, w pulley	51065006546/ 9546
	03-	<b>24-1321</b>			For vehicles without retarder, w pulley	51065006545/ 6547/ 9545/ 9547
	03-	<b>24-1330</b>		•		51065000298,51065006066/ 7033/ 7036 51065007043/ 7045/ 7047/ 7048/ 7051 51065007052/ 7065/ 7066/ 7088/ 7089 51065009045/ 9047/ 9048/ 9052/ 9066
	04-	<b>24-1224</b>			+Retarder	51065006642/ 6675/ 6694/ 9642/ 9675/ 9694
41.390, 41.400 (287-294 kW) Eng.D2066LF12	04-	<b>24-1224</b>			+Retarder	51065006637/ 7049/ 9049
	04-	<b>24-1225</b>			-Retarder	51065006637/ 7049/ 9049
41.410 (301 kW) Eng.D2866LF28	06-	<b>24-1298</b>			For vehicles without retarder, w/o pulley; Impeller Ø 135mm, Incl Eletronic fuel Injection pump	51065006408/ 6492/ 9492
	06-	<b>24-1302</b>			For vehicles with retarder, w/o pulley	51065006426/ 6490/ 9426/ 9490
	06-	<b>24-1319</b>			For vehicles with retarder, w pulley	51065006546/ 9546
	06-	<b>24-1321</b>			For vehicles without retarder, w pulley	51065006545/ 6547/ 9545/ 9547
	06-	<b>24-1330</b>		•		51065000298,51065006066/ 7033/ 7036 51065007043/ 7045/ 7047/ 7048/ 7051 51065007052/ 7065/ 7066/ 7088/ 7089 51065009045/ 9047/ 9048/ 9052/ 9066
41.430, 41.440 (316-324 kW) Eng.D2066LF01	04-	<b>24-1224</b>			+Retarder	51065006642/ 6675/ 6694/ 9642/ 9675/ 9694
	04-	<b>24-1225</b>			-Retarder	51065006637/ 7049/ 9049
41.430, 41.440 (316-324 kW) Eng.D2066LF31	04-	<b>24-1224</b>			+Retarder	51065006642/ 6675/ 6694/ 9642/ 9675/ 9694
	04-	<b>24-1225</b>			-Retarder	51065006637/ 7049/ 9049
41.460 (338 kW) Eng.D2876LF07	03-	<b>24-1298</b>			For vehicles without retarder, w/o pulley; Impeller Ø 135mm, Incl Eletronic fuel Injection pump	51065006408/ 6492/ 9492
	03-	<b>24-1302</b>			For vehicles with retarder, w/o pulley	51065006426/ 6490/ 9426/ 9490
	03-	<b>24-1319</b>			For vehicles with retarder, w pulley	51065006546/ 9546
	03-	<b>24-1321</b>			For vehicles without retarder, w pulley	51065006545/ 6547/ 9545/ 9547
	03-	<b>24-1330</b>		•		51065000298,51065006066/ 7033/ 7036 51065007043/ 7045/ 7047/ 7048/ 7051 51065007052/ 7065/ 7066/ 7088/ 7089 51065009045/ 9047/ 9048/ 9052/ 9066
41.480 (353 kW) Eng.D2676LF01	06-	<b>24-1224</b>			+Retarder	51065006642/ 6675/ 6694/ 9642/ 9675/ 9694
41.480 (353 kW) Eng.D2876LF12	06-	<b>24-1298</b>			For vehicles without retarder, w/o pulley; Impeller Ø 135mm, Incl Eletronic fuel Injection pump	51065006408/ 6492/ 9492
	06-	<b>24-1302</b>			For vehicles with retarder, w/o pulley	51065006426/ 6490/ 9426/ 9490
	06-	<b>24-1319</b>			For vehicles with retarder, w pulley	51065006546/ 9546
	06-	<b>24-1321</b>			For vehicles without retarder, w pulley	51065006545/ 6547/ 9545/ 9547
	06-	<b>24-1330</b>		•		51065000298,51065006066/ 7033/ 7036 51065007043/ 7045/ 7047/ 7048/ 7051 51065007052/ 7065/ 7066/ 7088/ 7089 51065009045/ 9047/ 9048/ 9052/ 9066
41.530 (353 kW) Eng.D2876LF12	06-	<b>24-1298</b>			For vehicles without retarder, w/o pulley; Impeller Ø 135mm, Incl Eletronic fuel Injection pump	51065006408/ 6492/ 9492
	06-	<b>24-1302</b>			For vehicles with retarder, w/o pulley	51065006426/ 6490/ 9426/ 9490
	06-	<b>24-1319</b>			For vehicles with retarder, w pulley	51065006546/ 9546
	06-	<b>24-1321</b>			For vehicles without retarder, w pulley	51065006545/ 6547/ 9545/ 9547
	06-	<b>24-1330</b>		•		51065000298,51065006066/ 7033/ 7036 51065007043/ 7045/ 7047/ 7048/ 7051 51065007052/ 7065/ 7066/ 7088/ 7089 51065009045/ 9047/ 9048/ 9052/ 9066
41.530 (390 kW) Eng.D2876LF13	02-	<b>24-1298</b>			For vehicles without retarder, w/o pulley; Impeller Ø 135mm, Incl Eletronic fuel Injection pump	51065006408/ 6492/ 9492
	02-	<b>24-1302</b>			For vehicles with retarder, w/o pulley	51065006426/ 6490/ 9426/ 9490
	02-	<b>24-1319</b>			For vehicles with retarder, w pulley	51065006546/ 9546
	02-	<b>24-1321</b>			For vehicles without retarder, w pulley	51065006545/ 6547/ 9545/ 9547
	02-	<b>24-1330</b>		•		51065000298,51065006066/ 7033/ 7036 51065007043/ 7045/ 7047/ 7048/ 7051 51065007052/ 7065/ 7066/ 7088/ 7089 51065009045/ 9047/ 9048/ 9052/ 9066
41.660 (485 kW) Eng.D2840LF25	02-	<b>24-1298</b>			For vehicles without retarder, w/o pulley; Impeller Ø 135mm, Incl Eletronic fuel Injection pump	51065006408/ 6492/ 9492
	02-	<b>24-1302</b>			For vehicles with retarder, w/o pulley	51065006426/ 6490/ 9426/ 9490
TG 12.0 (176-265 kW) Eng.D2866	83-	<b>24-1298</b>			For vehicles without retarder, w/o pulley; Impeller Ø 135mm, Incl Eletronic fuel Injection pump	51065006408/ 6492/ 9492
	83-	<b>24-1302</b>			For vehicles with retarder, w/o pulley	51065006426/ 6490/ 9426/ 9490



			
<b>24-1227</b>	<b>24-1234</b>	<b>24-1319</b>	<b>24-1321</b>
			
<b>24-1330</b>			



		<b>METELLI</b> ref.			<b>NOTE</b>	<b>Adaptable for OES</b>
TG 12.0 (176-265 kW) Eng.D2866	83-	<b>24-1319</b>			For vehicles with retarder, w pulley	51065006546/ 9546
	83-	<b>24-1321</b>			For vehicles without retarder, w pulley	51065006545/ 6547/ 9545/ 9547
	83-	<b>24-1330</b>		•		51065000298,51065006066/ 7033/ 7036 51065007043/ 7045/ 7047/ 7048/ 7051 51065007052/ 7065/ 7066/ 7088/ 7089 51065009045/ 9047/ 9048/ 9052/ 9066
<b>TGL '5/16-</b>						
10.180 (132 kW) Eng.D0834LFL41	05-	<b>24-1227</b>			M16x1,5	51065006651/ 6680/ 7079/ 9079 51065009651/ 9680/ 9700
	05-	<b>24-1234</b>			Impeller Ø 135mm, M14x1,5	51065006679/ 6699/ 7064/ 7078 51065009064/ 9078/ 9679/ 9699
10.210 (151 kW) Eng.D0834LFL42	05-	<b>24-1227</b>			M16x1,5	51065006651/ 6680/ 7079/ 9079 51065009651/ 9680/ 9700
	05-	<b>24-1234</b>			Impeller Ø 135mm, M14x1,5	51065006679/ 6699/ 7064/ 7078 51065009064/ 9078/ 9679/ 9699
10.220 (162 kW) Eng.D0834LFL65/68	05-	<b>24-1227</b>			M16x1,5	51065006651/ 6680/ 7079/ 9079 51065009651/ 9680/ 9700
	05-	<b>24-1234</b>			Impeller Ø 135mm, M14x1,5	51065006679/ 6699/ 7064/ 7078 51065009064/ 9078/ 9679/ 9699
10.240 (176 kW) Eng.D0836LFL40	05-	<b>24-1227</b>			M16x1,5	51065006651/ 6680/ 7079/ 9079 51065009651/ 9680/ 9700
	05-	<b>24-1234</b>			Impeller Ø 135mm, M14x1,5	51065006679/ 6699/ 7064/ 7078 51065009064/ 9078/ 9679/ 9699
10.250 (184 kW) Eng.D0836LFL63/66	05-	<b>24-1227</b>			M16x1,5	51065006651/ 6680/ 7079/ 9079 51065009651/ 9680/ 9700
	05-	<b>24-1234</b>			Impeller Ø 135mm, M14x1,5	51065006679/ 6699/ 7064/ 7078 51065009064/ 9078/ 9679/ 9699
12.180 (132 kW) Eng.D0834LFL41	05-	<b>24-1227</b>			M16x1,5	51065006651/ 6680/ 7079/ 9079 51065009651/ 9680/ 9700
	05-	<b>24-1234</b>			Impeller Ø 135mm, M14x1,5	51065006679/ 6699/ 7064/ 7078 51065009064/ 9078/ 9679/ 9699
12.210 (151 kW) Eng.D0834LFL42	05-	<b>24-1227</b>			M16x1,5	51065006651/ 6680/ 7079/ 9079 51065009651/ 9680/ 9700
	05-	<b>24-1234</b>			Impeller Ø 135mm, M14x1,5	51065006679/ 6699/ 7064/ 7078 51065009064/ 9078/ 9679/ 9699
12.220 (162 kW) Eng.D0834LFL65/68	05-	<b>24-1227</b>			M16x1,5	51065006651/ 6680/ 7079/ 9079 51065009651/ 9680/ 9700
	05-	<b>24-1234</b>			Impeller Ø 135mm, M14x1,5	51065006679/ 6699/ 7064/ 7078 51065009064/ 9078/ 9679/ 9699
12.240 (176 kW) Eng.D0836LFL40	05-	<b>24-1227</b>			M16x1,5	51065006651/ 6680/ 7079/ 9079 51065009651/ 9680/ 9700
	05-	<b>24-1234</b>			Impeller Ø 135mm, M14x1,5	51065006679/ 6699/ 7064/ 7078 51065009064/ 9078/ 9679/ 9699
12.250 (184 kW) Eng.D0836LFL63/66	05-	<b>24-1227</b>			M16x1,5	51065006651/ 6680/ 7079/ 9079 51065009651/ 9680/ 9700
	05-	<b>24-1234</b>			Impeller Ø 135mm, M14x1,5	51065006679/ 6699/ 7064/ 7078 51065009064/ 9078/ 9679/ 9699
7.150 (110 kW) Eng.D0834LFL40	05-	<b>24-1227</b>			M16x1,5	51065006651/ 6680/ 7079/ 9079 51065009651/ 9680/ 9700
	05-	<b>24-1234</b>			Impeller Ø 135mm, M14x1,5	51065006679/ 6699/ 7064/ 7078 51065009064/ 9078/ 9679/ 9699
7.180 (132 kW) Eng.D0834LFL41	05-	<b>24-1227</b>			M16x1,5	51065006651/ 6680/ 7079/ 9079 51065009651/ 9680/ 9700
	05-	<b>24-1234</b>			Impeller Ø 135mm, M14x1,5	51065006679/ 6699/ 7064/ 7078 51065009064/ 9078/ 9679/ 9699
7.220 (162 kW) Eng.D0834LFL65/62	05-	<b>24-1227</b>			M16x1,5	51065006651/ 6680/ 7079/ 9079 51065009651/ 9680/ 9700
	05-	<b>24-1234</b>			Impeller Ø 135mm, M14x1,5	51065006679/ 6699/ 7064/ 7078 51065009064/ 9078/ 9679/ 9699
7.250 (184 kW) Eng.D0836LFL60/63	05-	<b>24-1227</b>			M16x1,5	51065006651/ 6680/ 7079/ 9079 51065009651/ 9680/ 9700
	05-	<b>24-1234</b>			Impeller Ø 135mm, M14x1,5	51065006679/ 6699/ 7064/ 7078 51065009064/ 9078/ 9679/ 9699
8.180 (132 kW) Eng.D0834LFL41	05-	<b>24-1227</b>			M16x1,5	51065006651/ 6680/ 7079/ 9079 51065009651/ 9680/ 9700



**24-1227**



**24-1234**

		<b>METELLI</b> ref.		<b>NOTE</b>	<b>Adaptable for OES</b>
8.180 (132 kW) Eng.D0834LFL41	05-	<b>24-1234</b>		Impeller Ø 135mm, M14x1,5	51065006679/ 6699/ 7064/ 7078 51065009064/ 9078/ 9679/ 9699
8.210 (151 kW) Eng.D0834LFL42	05-	<b>24-1227</b>		M16x1,5	51065006651/ 6680/ 7079/ 9079 51065009651/ 9680/ 9700
	05-	<b>24-1234</b>		Impeller Ø 135mm, M14x1,5	51065006679/ 6699/ 7064/ 7078 51065009064/ 9078/ 9679/ 9699
8.220 (162 kW) Eng.D0834LFL65/68	05-	<b>24-1227</b>		M16x1,5	51065006651/ 6680/ 7079/ 9079 51065009651/ 9680/ 9700
	05-	<b>24-1234</b>		Impeller Ø 135mm, M14x1,5	51065006679/ 6699/ 7064/ 7078 51065009064/ 9078/ 9679/ 9699
8.240 (176 kW) Eng.D0836LFL40	05-	<b>24-1227</b>		M16x1,5	51065006651/ 6680/ 7079/ 9079 51065009651/ 9680/ 9700
	05-	<b>24-1234</b>		Impeller Ø 135mm, M14x1,5	51065006679/ 6699/ 7064/ 7078 51065009064/ 9078/ 9679/ 9699
8.250 (184 kW) Eng.D0836LFL66/63	05-	<b>24-1234</b>		Impeller Ø 135mm, M14x1,5	51065006679/ 6699/ 7064/ 7078 51065009064/ 9078/ 9679/ 9699
<b>TGM '5/16-</b>					
12.240 (176 kW) Eng.D0836LFL50	05-	<b>24-1227</b>		M16x1,5	51065006651/ 6680/ 7079/ 9079 51065009651/ 9680/ 9700
	05-	<b>24-1234</b>		Impeller Ø 135mm, M14x1,5	51065006679/ 6699/ 7064/ 7078 51065009064/ 9078/ 9679/ 9699
12.250 (184 kW) Eng.D0836LFL63/66	05-	<b>24-1227</b>		M16x1,5	51065006651/ 6680/ 7079/ 9079 51065009651/ 9680/ 9700
	05-	<b>24-1234</b>		Impeller Ø 135mm, M14x1,5	51065006679/ 6699/ 7064/ 7078 51065009064/ 9078/ 9679/ 9699
12.280 (206 kW) Eng.D0836LFL51	05-	<b>24-1227</b>		M16x1,5	51065006651/ 6680/ 7079/ 9079 51065009651/ 9680/ 9700
	05-	<b>24-1234</b>		Impeller Ø 135mm, M14x1,5	51065006679/ 6699/ 7064/ 7078 51065009064/ 9078/ 9679/ 9699
12.290 (213 kW) Eng.D0836LFL64/67	05-	<b>24-1227</b>		M16x1,5	51065006651/ 6680/ 7079/ 9079 51065009651/ 9680/ 9700
	05-	<b>24-1234</b>		Impeller Ø 135mm, M14x1,5	51065006679/ 6699/ 7064/ 7078 51065009064/ 9078/ 9679/ 9699
13.240 (176 kW) Eng.D0836LFL40	06-	<b>24-1227</b>		M16x1,5	51065006651/ 6680/ 7079/ 9079 51065009651/ 9680/ 9700
	06-	<b>24-1234</b>		Impeller Ø 135mm, M14x1,5	51065006679/ 6699/ 7064/ 7078 51065009064/ 9078/ 9679/ 9699
13.240 (176 kW) Eng.D0836LFL50	06-	<b>24-1227</b>		M16x1,5	51065006651/ 6680/ 7079/ 9079 51065009651/ 9680/ 9700
	06-	<b>24-1234</b>		Impeller Ø 135mm, M14x1,5	51065006679/ 6699/ 7064/ 7078 51065009064/ 9078/ 9679/ 9699
13.250 (184 kW) Eng.D0836LFL63/66	05-	<b>24-1227</b>		M16x1,5	51065006651/ 6680/ 7079/ 9079 51065009651/ 9680/ 9700
	05-	<b>24-1234</b>		Impeller Ø 135mm, M14x1,5	51065006679/ 6699/ 7064/ 7078 51065009064/ 9078/ 9679/ 9699
13.280 (206 kW) Eng.D0836LFL51	06-	<b>24-1227</b>		M16x1,5	51065006651/ 6680/ 7079/ 9079 51065009651/ 9680/ 9700
	06-	<b>24-1234</b>		Impeller Ø 135mm, M14x1,5	51065006679/ 6699/ 7064/ 7078 51065009064/ 9078/ 9679/ 9699
13.280 (206 kW) Eng.D0836LFL54	05-	<b>24-1227</b>		M16x1,5	51065006651/ 6680/ 7079/ 9079 51065009651/ 9680/ 9700
	05-	<b>24-1234</b>		Impeller Ø 135mm, M14x1,5	51065006679/ 6699/ 7064/ 7078 51065009064/ 9078/ 9679/ 9699
13.290 (213 kW) Eng.D0836LFL64/67	05-	<b>24-1227</b>		M16x1,5	51065006651/ 6680/ 7079/ 9079 51065009651/ 9680/ 9700
	05-	<b>24-1234</b>		Impeller Ø 135mm, M14x1,5	51065006679/ 6699/ 7064/ 7078 51065009064/ 9078/ 9679/ 9699
15.240 (176 kW) Eng.D0836LFL50	05-	<b>24-1227</b>		M16x1,5	51065006651/ 6680/ 7079/ 9079 51065009651/ 9680/ 9700
	05-	<b>24-1234</b>		Impeller Ø 135mm, M14x1,5	51065006679/ 6699/ 7064/ 7078 51065009064/ 9078/ 9679/ 9699
15.250 (184 kW) Eng.D0836LFL63/66	05-	<b>24-1227</b>		M16x1,5	51065006651/ 6680/ 7079/ 9079 51065009651/ 9680/ 9700
	05-	<b>24-1234</b>		Impeller Ø 135mm, M14x1,5	51065006679/ 6699/ 7064/ 7078 51065009064/ 9078/ 9679/ 9699

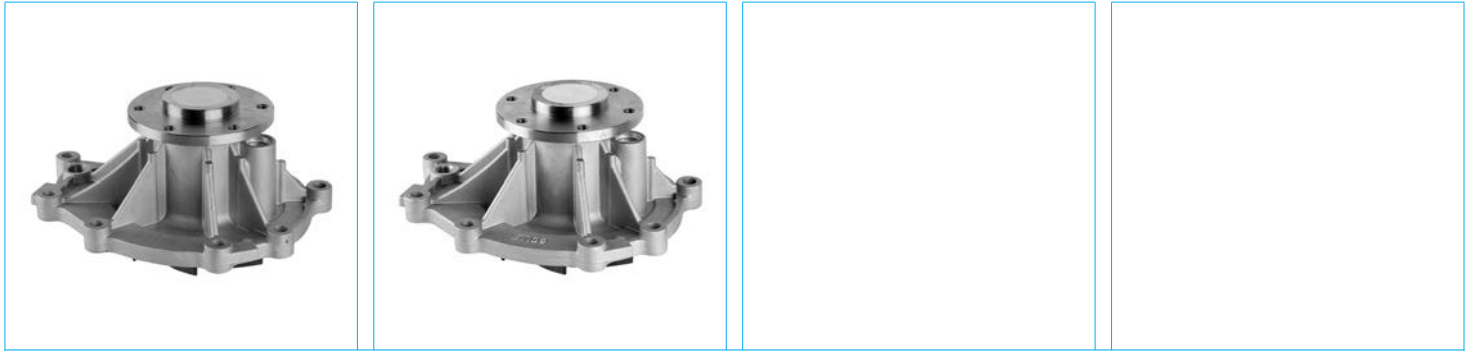

**24-1227**

**24-1234**

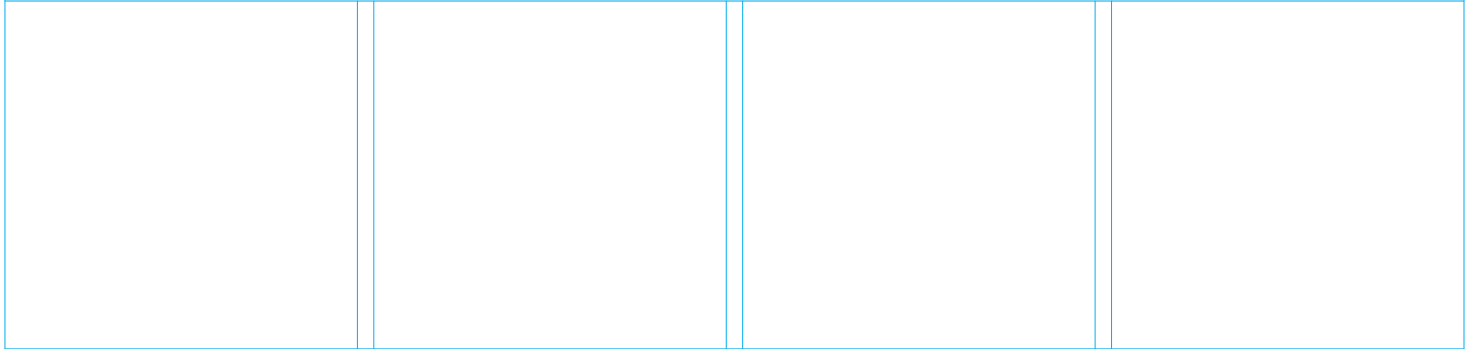
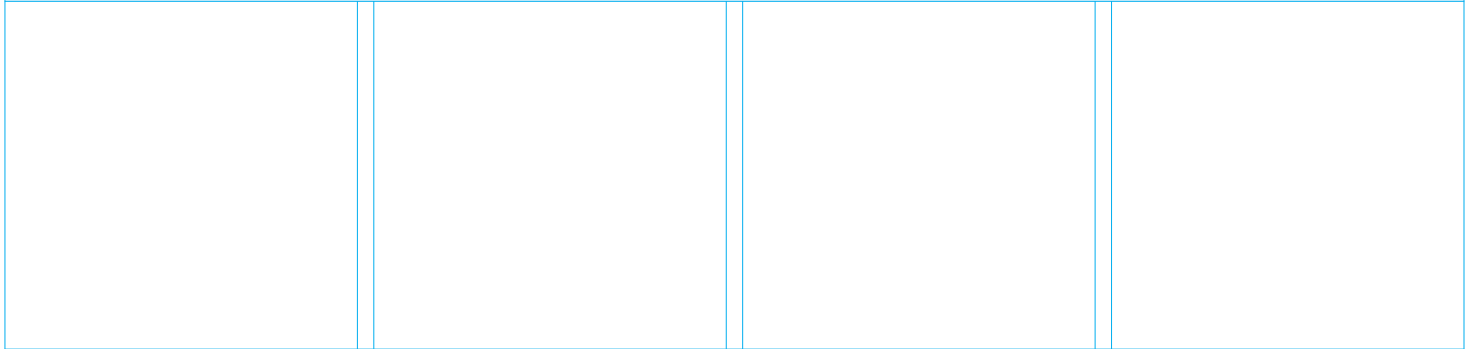
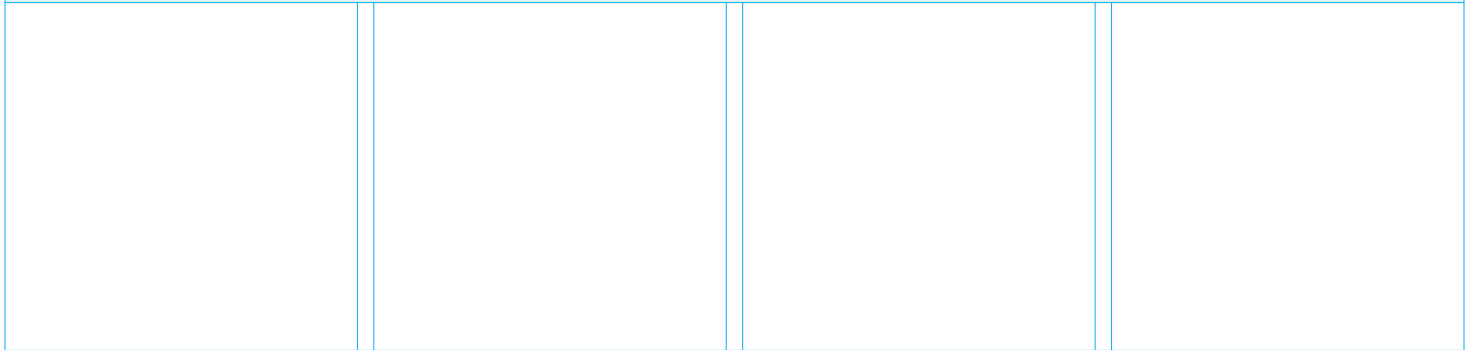
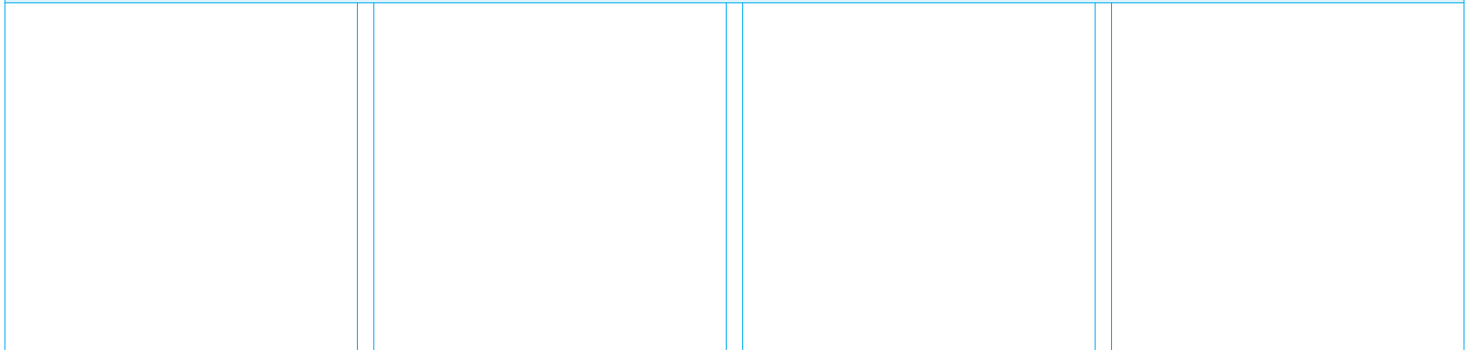



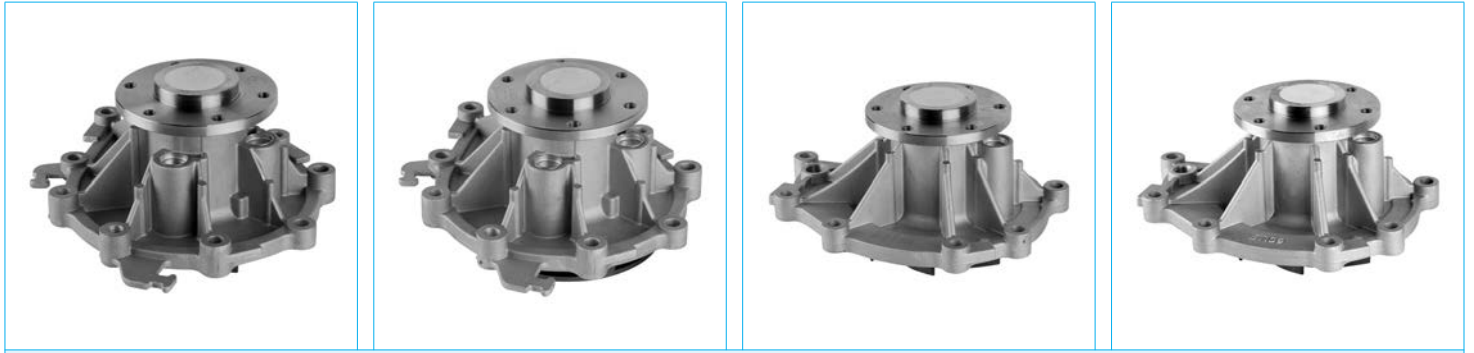

**24-1224**

**24-1225**

**24-1227**

**24-1234**

--	--	--	--

--	--	--	--

--	--	--	--

--	--	--	--

		<b>METELLI</b> ref.			<b>NOTE</b>	<b>Adaptable for OES</b>
22.280 (206 kW) Eng.D0836LFL54	05-	<b>24-1234</b>			Impeller Ø 135mm, M14x1,5	51065006679/ 6699/ 7064/ 7078 51065009064/ 9078/ 9679/ 9699
22.290 (213 kW) Eng.D0836LFL64/67	05-	<b>24-1227</b>			M16x1,5	51065006651/ 6680/ 7079/ 9079 51065009651/ 9680/ 9700
	05-	<b>24-1234</b>			Impeller Ø 135mm, M14x1,5	51065006679/ 6699/ 7064/ 7078 51065009064/ 9078/ 9679/ 9699
26.280 (206 kW) Eng.D0836LFL51	06-	<b>24-1227</b>			M16x1,5	51065006651/ 6680/ 7079/ 9079 51065009651/ 9680/ 9700
	06-	<b>24-1234</b>			Impeller Ø 135mm, M14x1,5	51065006679/ 6699/ 7064/ 7078 51065009064/ 9078/ 9679/ 9699
26.280 (206 kW) Eng.D0836LFL54	05-	<b>24-1227</b>			M16x1,5	51065006651/ 6680/ 7079/ 9079 51065009651/ 9680/ 9700
	05-	<b>24-1234</b>			Impeller Ø 135mm, M14x1,5	51065006679/ 6699/ 7064/ 7078 51065009064/ 9078/ 9679/ 9699
26.290 (213 kW) Eng.D0836LFL64/67	05-	<b>24-1227</b>			M16x1,5	51065006651/ 6680/ 7079/ 9079 51065009651/ 9680/ 9700
	05-	<b>24-1234</b>			Impeller Ø 135mm, M14x1,5	51065006679/ 6699/ 7064/ 7078 51065009064/ 9078/ 9679/ 9699
26.330 (240 kW) Eng.D0836LFL52	06-	<b>24-1227</b>			M16x1,5	51065006651/ 6680/ 7079/ 9079 51065009651/ 9680/ 9700
	06-	<b>24-1234</b>			Impeller Ø 135mm, M14x1,5	51065006679/ 6699/ 7064/ 7078 51065009064/ 9078/ 9679/ 9699
26.330 (240 kW) Eng.D0836LFL55	05-	<b>24-1227</b>			M16x1,5	51065006651/ 6680/ 7079/ 9079 51065009651/ 9680/ 9700
	05-	<b>24-1234</b>			Impeller Ø 135mm, M14x1,5	51065006679/ 6699/ 7064/ 7078 51065009064/ 9078/ 9679/ 9699
26.340 (250 kW) Eng.D0836LFL65/68	05-	<b>24-1227</b>			M16x1,5	51065006651/ 6680/ 7079/ 9079 51065009651/ 9680/ 9700
	05-	<b>24-1234</b>			Impeller Ø 135mm, M14x1,5	51065006679/ 6699/ 7064/ 7078 51065009064/ 9078/ 9679/ 9699
<b>TGS '7/16-</b>						
18.320 (235 kW) Eng.D2066LF28	07-	<b>24-1224</b>			+Retarder	51065006642/ 6675/ 6694/ 9642/ 9675/ 9694
	07-	<b>24-1225</b>			-Retarder	51065006637/ 7049/ 9049
18.320 (235 kW) Eng.D2066LF39	07-	<b>24-1224</b>			+Retarder	51065006642/ 6675/ 6694/ 9642/ 9675/ 9694
	07-	<b>24-1225</b>			-Retarder	51065006637/ 7049/ 9049
18.350 (257 kW) Eng.D2066LF03	07-	<b>24-1225</b>			-Retarder	51065006637/ 7049/ 9049
18.360 (265 kW) Eng.D2066LF27	07-	<b>24-1224</b>			+Retarder	51065006642/ 6675/ 6694/ 9642/ 9675/ 9694
	07-	<b>24-1225</b>			-Retarder	51065006637/ 7049/ 9049
18.360 (265 kW) Eng.D2066LF38	07-	<b>24-1224</b>			+Retarder	51065006642/ 6675/ 6694/ 9642/ 9675/ 9694
	07-	<b>24-1225</b>			-Retarder	51065006637/ 7049/ 9049
18.390 (287 kW) Eng.D2066LF02	08-	<b>24-1225</b>			-Retarder	51065006637/ 7049/ 9049
18.400 (294 kW) Eng.D2066LF26	07-	<b>24-1224</b>			+Retarder	51065006642/ 6675/ 6694/ 9642/ 9675/ 9694
	07-	<b>24-1225</b>			-Retarder	51065006637/ 7049/ 9049
18.430 (316 kW) Eng.D2066LF01	07-	<b>24-1225</b>			-Retarder	51065006637/ 7049/ 9049
18.440 (324 kW) Eng.D2066LF25/26	07-	<b>24-1224</b>			+Retarder	51065006642/ 6675/ 6694/ 9642/ 9675/ 9694
	07-	<b>24-1225</b>			-Retarder	51065006637/ 7049/ 9049
18.480 (353 kW) Eng.D2676LF05	07-	<b>24-1224</b>			+Retarder	51065006642/ 6675/ 6694/ 9642/ 9675/ 9694
18.480 (353 kW) Eng.D2676LF14	07-	<b>24-1224</b>			+Retarder	51065006642/ 6675/ 6694/ 9642/ 9675/ 9694
18.540 (397 kW) Eng.D2676LF13	07-	<b>24-1224</b>			+Retarder	51065006642/ 6675/ 6694/ 9642/ 9675/ 9694
19.350 (257 kW) Eng.D2066LF03	07-	<b>24-1225</b>			-Retarder	51065006637/ 7049/ 9049
19.360 (265 kW) Eng.D2066LF07/48/64	11-	<b>24-1225</b>			-Retarder	51065006637/ 7049/ 9049
19.390 (287 kW) Eng.D2066LF02	08-	<b>24-1225</b>			-Retarder	51065006637/ 7049/ 9049
19.400 (294 kW) Eng.D2066LF06/49/63	11-	<b>24-1225</b>			-Retarder	51065006637/ 7049/ 9049
19.430 (316 kW) Eng.D2066LF01	07-	<b>24-1225</b>			-Retarder	51065006637/ 7049/ 9049
19.440 (324 kW) Eng.D2066LF50/62	11-	<b>24-1225</b>			-Retarder	51065006637/ 7049/ 9049
21.360 (265 kW) Eng.D2066LF07/48/64	07-	<b>24-1225</b>			-Retarder	51065006637/ 7049/ 9049



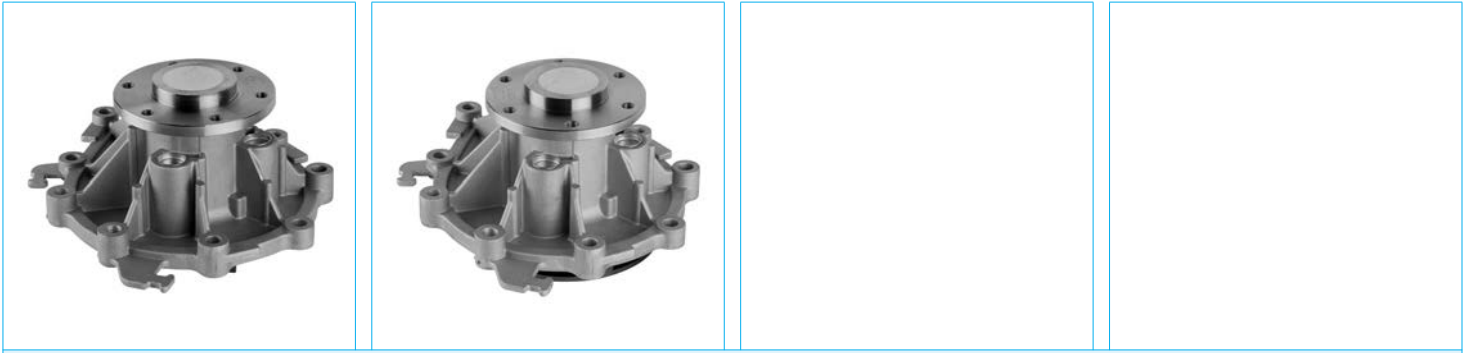

**24-1224**



**24-1225**

--	--	--	--

--	--	--	--

--	--	--	--

--	--	--	--

		<b>METELLI</b> ref.		<b>NOTE</b>	<b>Adaptable for OES</b>
21.400 (294 kW) Eng.D2066LF06/49/63	07-	<b>24-1225</b>		-Retarder	51065006637/ 7049/ 9049
21.440 (324 kW) Eng.D2066LF50/62	07-	<b>24-1225</b>		-Retarder	51065006637/ 7049/ 9049
24.320 (235 kW) Eng.D2066LF28/39/43/53/68	07-	<b>24-1225</b>		-Retarder	51065006637/ 7049/ 9049
24.400 (294 kW) Eng.D2066LF26	07-	<b>24-1224</b>		+Retarder	51065006642/ 6675/ 6694/ 9642/ 9675/ 9694
	07-	<b>24-1225</b>		-Retarder	51065006637/ 7049/ 9049
24.440 (324 kW) Eng.D2066LF25/26	07-	<b>24-1224</b>		+Retarder	51065006642/ 6675/ 6694/ 9642/ 9675/ 9694
	07-	<b>24-1225</b>		-Retarder	51065006637/ 7049/ 9049
24.480 (353 kW) Eng.D2676LF05/LF14	07-	<b>24-1224</b>		+Retarder	51065006642/ 6675/ 6694/ 9642/ 9675/ 9694
24.540 (397 kW) Eng.D2676LF13	07-	<b>24-1224</b>		+Retarder	51065006642/ 6675/ 6694/ 9642/ 9675/ 9694
26.320 (235 kW) Eng.D2066LF28/39/43/53/68	08-	<b>24-1225</b>		-Retarder	51065006637/ 7049/ 9049
26.350 (257 kW) Eng.D2066LF03	07-	<b>24-1225</b>		-Retarder	51065006637/ 7049/ 9049
26.360 (265 kW) Eng.D2066LF67/38/42/27/48/07/64/52	08-	<b>24-1225</b>		-Retarder	51065006637/ 7049/ 9049
26.390 (287 kW) Eng.D2066LF02	08-	<b>24-1225</b>		-Retarder	51065006637/ 7049/ 9049
26.400 (294 kW) Eng.D2066LF06/26/37/41/49/51/61/63	08-	<b>24-1225</b>		-Retarder	51065006637/ 7049/ 9049
26.430 (316 kW) Eng.D2066LF01	07-	<b>24-1225</b>		-Retarder	51065006637/ 7049/ 9049
26.440 (324 kW) Eng.D2066LF25/36/40/50/62	07-	<b>24-1225</b>		-Retarder	51065006637/ 7049/ 9049
28.320 (235 kW) Eng.D2066LF39/43/68	08-	<b>24-1225</b>		-Retarder	51065006637/ 7049/ 9049
28.350 (257 kW) Eng.D2066LF03	08-	<b>24-1225</b>		-Retarder	51065006637/ 7049/ 9049
28.360 (265 kW) Eng.D2066LF38/48/67/42/64	08-	<b>24-1225</b>		-Retarder	51065006637/ 7049/ 9049
28.390 (287 kW) Eng.D2066LF02	08-	<b>24-1225</b>		-Retarder	51065006637/ 7049/ 9049
28.400 (294 kW) Eng.D2066LF37/41/49/61/63	08-	<b>24-1225</b>		-Retarder	51065006637/ 7049/ 9049
28.430 (316 kW) Eng.D2066LF01	08-	<b>24-1225</b>		-Retarder	51065006637/ 7049/ 9049
28.440 (324 kW) Eng.D2066LF36/40/50/62	08-	<b>24-1225</b>		-Retarder	51065006637/ 7049/ 9049
32.320 (235 kW) Eng.D2066LF28/39/43/53/68	09-	<b>24-1225</b>		-Retarder	51065006637/ 7049/ 9049
32.350 (257 kW) Eng.D2066LF03	08-	<b>24-1225</b>		-Retarder	51065006637/ 7049/ 9049
32.360 (265 kW) Eng.D2066LF38/42/67/27	07-	<b>24-1225</b>		-Retarder	51065006637/ 7049/ 9049
32.390 (287 kW) Eng.D2066LF02	08-	<b>24-1225</b>		-Retarder	51065006637/ 7049/ 9049
32.400 (294 kW) Eng.D2066LF26/37/41/61/49/51	07-	<b>24-1225</b>		-Retarder	51065006637/ 7049/ 9049
32.440 (324 kW) Eng.D2066LF25/36/40	07-	<b>24-1225</b>		-Retarder	51065006637/ 7049/ 9049
33.320 (235 kW) Eng.D2066LF39/43/68	08-	<b>24-1225</b>		-Retarder	51065006637/ 7049/ 9049
33.350 (257 kW) Eng.D2066LF03	08-	<b>24-1225</b>		-Retarder	51065006637/ 7049/ 9049
33.360 (265 kW) Eng.D2066LF07/38/42/48/64/67	07-	<b>24-1225</b>		-Retarder	51065006637/ 7049/ 9049
33.390 (287 kW) Eng.D2066LF02	08-	<b>24-1225</b>		-Retarder	51065006637/ 7049/ 9049
33.400 (294 kW) Eng.D2066LF06/26/37/41/49/61/63	08-	<b>24-1225</b>		-Retarder	51065006637/ 7049/ 9049
33.430 (316 kW) Eng.D2066LF01	08-	<b>24-1225</b>		-Retarder	51065006637/ 7049/ 9049
33.440 (324 kW) Eng.D2066LF25/36/40/50/62	07-	<b>24-1225</b>		-Retarder	51065006637/ 7049/ 9049
35.320 (235 kW) Eng.D2066LF28/39/43/53/68	07-	<b>24-1225</b>		-Retarder	51065006637/ 7049/ 9049
35.350 (257 kW) Eng.D2066LF03	08-	<b>24-1225</b>		-Retarder	51065006637/ 7049/ 9049
35.360 (265 kW) Eng.D2066LF27/38/42/48/52/64/67	07-	<b>24-1225</b>		-Retarder	51065006637/ 7049/ 9049
35.390 (287 kW) Eng.D2066LF02	08-	<b>24-1225</b>		-Retarder	51065006637/ 7049/ 9049
35.400 (294 kW) Eng.D2066LF41/61/26/37/49/51/63	07-	<b>24-1225</b>		-Retarder	51065006637/ 7049/ 9049
35.430 (316 kW) Eng.D2066LF01	08-	<b>24-1225</b>		-Retarder	51065006637/ 7049/ 9049
35.440 (324 kW) Eng.D2066LF25/36/40/50/62	07-	<b>24-1225</b>		-Retarder	51065006637/ 7049/ 9049
37.320 (235 kW) Eng.D2066LF28/39/43/53/68	07-	<b>24-1225</b>		-Retarder	51065006637/ 7049/ 9049
37.360 (265 kW) Eng.D2066LF27/38/42/67	07-	<b>24-1225</b>		-Retarder	51065006637/ 7049/ 9049
37.400 (294 kW) Eng.D2066LF26/37/41/61	07-	<b>24-1225</b>		-Retarder	51065006637/ 7049/ 9049
37.440 (324 kW) Eng.D2066LF25/36/40	07-	<b>24-1225</b>		-Retarder	51065006637/ 7049/ 9049
40.360 (265 kW) Eng.D2066LF48/07/64	08-	<b>24-1225</b>		-Retarder	51065006637/ 7049/ 9049
40.390 (287 kW) Eng.D2066LF02	08-	<b>24-1225</b>		-Retarder	51065006637/ 7049/ 9049
40.400 (294 kW) Eng.D2066LF06/49/63	11-	<b>24-1225</b>		-Retarder	51065006637/ 7049/ 9049
40.430 (316 kW) Eng.D2066LF01	08-	<b>24-1225</b>		-Retarder	51065006637/ 7049/ 9049
40.440 (324 kW) Eng.D2066LF50/62	11-	<b>24-1225</b>		-Retarder	51065006637/ 7049/ 9049
41.320 (235 kW) Eng.D2066LF39/43/68	08-	<b>24-1225</b>		-Retarder	51065006637/ 7049/ 9049
41.350 (257 kW) Eng.D2066LF03	08-	<b>24-1225</b>		-Retarder	51065006637/ 7049/ 9049
41.360 (265 kW) Eng.D2066LF07/27/38/42/48/64/67	08-	<b>24-1225</b>		-Retarder	51065006637/ 7049/ 9049
41.390 (287 kW) Eng.D2066LF02	08-	<b>24-1225</b>		-Retarder	51065006637/ 7049/ 9049
41.400 (294 kW) Eng.D2066LF06/26/37/41/49/51/61/63	07-	<b>24-1225</b>		-Retarder	51065006637/ 7049/ 9049
41.430 (316 kW) Eng.D2066LF01	07-	<b>24-1225</b>		-Retarder	51065006637/ 7049/ 9049
41.440 (324 kW) Eng.D2066LF25/36/40/50/62	07-	<b>24-1225</b>		-Retarder	51065006637/ 7049/ 9049



**24-1224**



**24-1225**

		<b>METELLI</b> ref.			<b>NOTE</b>	<b>Adaptable for OES</b>
<b>TGX '7/16-</b>						
18.360 (265 kW) Eng.D2066LF38	07-	<b>24-1224</b>			+Retarder	51065006642/ 6675/ 6694/ 9642/ 9675/ 9694
	07-	<b>24-1225</b>			-Retarder	51065006637/ 7049/ 9049
18.400 (294 kW) Eng.D2066LF26	07-	<b>24-1224</b>			+Retarder	51065006642/ 6675/ 6694/ 9642/ 9675/ 9694
	07-	<b>24-1225</b>			-Retarder	51065006637/ 7049/ 9049
18.440 (324 kW) Eng.D2066LF25	07-	<b>24-1224</b>			+Retarder	51065006642/ 6675/ 6694/ 9642/ 9675/ 9694
	07-	<b>24-1225</b>			-Retarder	51065006637/ 7049/ 9049
18.480 (353 kW) Eng.D2676LF14	07-	<b>24-1224</b>			+Retarder	51065006642/ 6675/ 6694/ 9642/ 9675/ 9694
18.540 (397 kW) Eng.D2676LF13	07-	<b>24-1224</b>			+Retarder	51065006642/ 6675/ 6694/ 9642/ 9675/ 9694
24.360 (265 kW) Eng.D2066LF38	07-	<b>24-1224</b>			+Retarder	51065006642/ 6675/ 6694/ 9642/ 9675/ 9694
	07-	<b>24-1225</b>			-Retarder	51065006637/ 7049/ 9049
24.400 (294 kW) Eng.D2066LF26	07-	<b>24-1224</b>			+Retarder	51065006642/ 6675/ 6694/ 9642/ 9675/ 9694
	07-	<b>24-1225</b>			-Retarder	51065006637/ 7049/ 9049
24.440 (324 kW) Eng.D2066LF25	07-	<b>24-1224</b>			+Retarder	51065006642/ 6675/ 6694/ 9642/ 9675/ 9694
	07-	<b>24-1225</b>			-Retarder	51065006637/ 7049/ 9049
24.480 (353 kW) Eng.D2676LF14	07-	<b>24-1224</b>			+Retarder	51065006642/ 6675/ 6694/ 9642/ 9675/ 9694
26.320 (235 kW) Eng.D2066LF28	07-	<b>24-1224</b>			+Retarder	51065006642/ 6675/ 6694/ 9642/ 9675/ 9694
	07-	<b>24-1225</b>			-Retarder	51065006637/ 7049/ 9049
26.360 (265 kW) Eng.D2066LF38	07-	<b>24-1224</b>			+Retarder	51065006642/ 6675/ 6694/ 9642/ 9675/ 9694
	07-	<b>24-1225</b>			-Retarder	51065006637/ 7049/ 9049
26.360 (265 kW) Eng.D2066LF38/42/67	07-	<b>24-1225</b>			-Retarder	51065006637/ 7049/ 9049
26.400 (294 kW) Eng.D2066LF37/41/61	07-	<b>24-1225</b>			-Retarder	51065006637/ 7049/ 9049
26.440 (324 kW) Eng.D2066LF25	07-	<b>24-1224</b>			+Retarder	51065006642/ 6675/ 6694/ 9642/ 9675/ 9694
	07-	<b>24-1225</b>			-Retarder	51065006637/ 7049/ 9049
26.440 (324 kW) Eng.D2066LF36	07-	<b>24-1224</b>			+Retarder	51065006642/ 6675/ 6694/ 9642/ 9675/ 9694
	07-	<b>24-1225</b>			-Retarder	51065006637/ 7049/ 9049
26.440 (324 kW) Eng.D2066LF36/40	07-	<b>24-1225</b>			-Retarder	51065006637/ 7049/ 9049
26.480 (353 kW) Eng.D2676LF05	07-	<b>24-1224</b>			+Retarder	51065006642/ 6675/ 6694/ 9642/ 9675/ 9694
26.480 (353 kW) Eng.D2676LF14	07-	<b>24-1224</b>			+Retarder	51065006642/ 6675/ 6694/ 9642/ 9675/ 9694
26.540 (397 kW) Eng.D2676LF13	07-	<b>24-1224</b>			+Retarder	51065006642/ 6675/ 6694/ 9642/ 9675/ 9694
28.360 (265 kW) Eng.D2066LF38	07-	<b>24-1224</b>			+Retarder	51065006642/ 6675/ 6694/ 9642/ 9675/ 9694
	07-	<b>24-1225</b>			-Retarder	51065006637/ 7049/ 9049
28.400 (294 kW) Eng.D2066LF26	07-	<b>24-1224</b>			+Retarder	51065006642/ 6675/ 6694/ 9642/ 9675/ 9694
	07-	<b>24-1225</b>			-Retarder	51065006637/ 7049/ 9049
28.400 (294 kW) Eng.D2066LF37	07-	<b>24-1224</b>			+Retarder	51065006642/ 6675/ 6694/ 9642/ 9675/ 9694
	07-	<b>24-1225</b>			-Retarder	51065006637/ 7049/ 9049
28.440 (324 kW) Eng.D2066LF36	07-	<b>24-1224</b>			+Retarder	51065006642/ 6675/ 6694/ 9642/ 9675/ 9694
	07-	<b>24-1225</b>			-Retarder	51065006637/ 7049/ 9049
28.480 (353 kW) Eng.D2676LF05	07-	<b>24-1224</b>			+Retarder	51065006642/ 6675/ 6694/ 9642/ 9675/ 9694
32.360 (265 kW) Eng.D2066LF38	07-	<b>24-1224</b>			+Retarder	51065006642/ 6675/ 6694/ 9642/ 9675/ 9694
	07-	<b>24-1225</b>			-Retarder	51065006637/ 7049/ 9049
32.440 (265 kW) Eng.D2066LF38/42/67	07-	<b>24-1225</b>			-Retarder	51065006637/ 7049/ 9049

			
<b>24-1224</b>	<b>24-1225</b>	<b>24-1312</b>	<b>24-1320</b>
			
<b>24-1341</b>	<b>24-1342</b>		

		<b>METELLI</b> ref.			<b>NOTE</b>	<b>Adaptable for OES</b>
33.400 (294 kW) Eng.D2066LF26	07-	<b>24-1224</b>			+Retarder	51065006642/ 6675/ 6694/ 9642/ 9675/ 9694
	07-	<b>24-1225</b>			-Retarder	51065006637/ 7049/ 9049
33.440 (324 kW) Eng.D2066LF36	07-	<b>24-1224</b>			+Retarder	51065006642/ 6675/ 6694/ 9642/ 9675/ 9694
	07-	<b>24-1225</b>			-Retarder	51065006637/ 7049/ 9049
33.540 (397 kW) Eng.D2676LF13	07-	<b>24-1224</b>			+Retarder	51065006642/ 6675/ 6694/ 9642/ 9675/ 9694

**MERCEDES BENZ TRUCK**

<b>Accelo '5/03-</b>						
915 (110 kW) Eng.OM904.965/.966	03-	<b>24-1320</b>			For vehicles without retarder	904 200 02 01/ 04 01/ 06 01/ 07 01/ 08 01 904 200 19 01/ 20 01/ 22 01/ 25 01/ 26 01 904 200 27 01/ 28 01/ 29 01/ 32 01/ 38 01 904 200 43 01/ 49 01/ 50 01

**Actros I '4/96-'10/02**

1831 (230 kW) Eng.OM541.920/.926/.941	96-02	<b>24-1312</b>			For vehicles with retarder; Without fastening eyes for axial fan	541 200 10 01 542 200 06 01/ 16 01/ 20 01
1835 (260 kW) Eng.OM541.922/.927	96-02	<b>24-1312</b>			For vehicles with retarder; Without fastening eyes for axial fan	541 200 10 01 542 200 06 01/ 16 01/ 20 01
1840 (290 kW) Eng.OM541.923/.924	96-02	<b>24-1312</b>			For vehicles with retarder; Without fastening eyes for axial fan	541 200 10 01 542 200 06 01/ 16 01/ 20 01
1843 (315 kW) Eng.OM541.925/.921/.947	96-02	<b>24-1312</b>			For vehicles with retarder; Without fastening eyes for axial fan	541 200 10 01 542 200 06 01/ 16 01/ 20 01
1848 (350 kW) Eng.OM542.921/.925	96-02	<b>24-1312</b>			For vehicles with retarder; Without fastening eyes for axial fan	541 200 10 01 542 200 06 01/ 16 01/ 20 01
	96-02	<b>24-1341</b>			For vehicles without retarder; With fastening eyes for axial fan	542 200 25 01
	96-02	<b>24-1342</b>			For vehicles with retarder; With fastening eyes for axial fan	542 200 26 01
1853 (390 kW) Eng.OM542.920	96-02	<b>24-1312</b>			For vehicles with retarder; Without fastening eyes for axial fan	541 200 10 01 542 200 06 01/ 16 01/ 20 01
	96-02	<b>24-1341</b>			For vehicles without retarder; With fastening eyes for axial fan	542 200 25 01
	96-02	<b>24-1342</b>			For vehicles with retarder; With fastening eyes for axial fan	542 200 26 01
1857 (420 kW) Eng.OM542.922	97-02	<b>24-1312</b>			For vehicles with retarder; Without fastening eyes for axial fan	541 200 10 01 542 200 06 01/ 16 01/ 20 01
	97-02	<b>24-1341</b>			For vehicles without retarder; With fastening eyes for axial fan	542 200 25 01
	97-02	<b>24-1342</b>			For vehicles with retarder; With fastening eyes for axial fan	542 200 26 01
2031 (230 kW) Eng.OM541.920/.926	97-02	<b>24-1312</b>			For vehicles with retarder; Without fastening eyes for axial fan	541 200 10 01 542 200 06 01/ 16 01/ 20 01
2035 (260 kW) Eng.OM541.922/.927/.943	96-02	<b>24-1312</b>			For vehicles with retarder; Without fastening eyes for axial fan	541 200 10 01 542 200 06 01/ 16 01/ 20 01
2040 (290 kW) Eng.OM541.923/.924	96-02	<b>24-1312</b>			For vehicles with retarder; Without fastening eyes for axial fan	541 200 10 01 542 200 06 01/ 16 01/ 20 01
2043 (315 kW) Eng.OM541.925	96-02	<b>24-1312</b>			For vehicles with retarder; Without fastening eyes for axial fan	541 200 10 01 542 200 06 01/ 16 01/ 20 01
2048 (350 kW) Eng.OM542.925	96-02	<b>24-1312</b>			For vehicles with retarder; Without fastening eyes for axial fan	541 200 10 01 542 200 06 01/ 16 01/ 20 01
	96-02	<b>24-1341</b>			For vehicles without retarder; With fastening eyes for axial fan	542 200 25 01
	96-02	<b>24-1342</b>			For vehicles with retarder; With fastening eyes for axial fan	542 200 26 01
2053 (390 kW) Eng.OM542.920	96-02	<b>24-1312</b>			For vehicles with retarder; Without fastening eyes for axial fan	541 200 10 01 542 200 06 01/ 16 01/ 20 01
	96-02	<b>24-1341</b>			For vehicles without retarder; With fastening eyes for axial fan	542 200 25 01
	96-02	<b>24-1342</b>			For vehicles with retarder; With fastening eyes for axial fan	542 200 26 01
2531 (230 kW) Eng.OM541.920/.940	96-02	<b>24-1312</b>			For vehicles with retarder; Without fastening eyes for axial fan	541 200 10 01 542 200 06 01/ 16 01/ 20 01
2535 (260 kW) Eng.OM541.922/.942	96-02	<b>24-1312</b>			For vehicles with retarder; Without fastening eyes for axial fan	541 200 10 01 542 200 06 01/ 16 01/ 20 01
2540 (290 kW) Eng.OM541.923/.944	96-02	<b>24-1312</b>			For vehicles with retarder; Without fastening eyes for axial fan	541 200 10 01 542 200 06 01/ 16 01/ 20 01
2543 (315 kW) Eng.OM541.925/.946	96-02	<b>24-1312</b>			For vehicles with retarder; Without fastening eyes for axial fan	541 200 10 01 542 200 06 01/ 16 01/ 20 01
2548 (350 kW) Eng.OM542.921	96-02	<b>24-1312</b>			For vehicles with retarder; Without fastening eyes for axial fan	541 200 10 01 542 200 06 01/ 16 01/ 20 01
	96-02	<b>24-1341</b>			For vehicles without retarder; With fastening eyes for axial fan	542 200 25 01

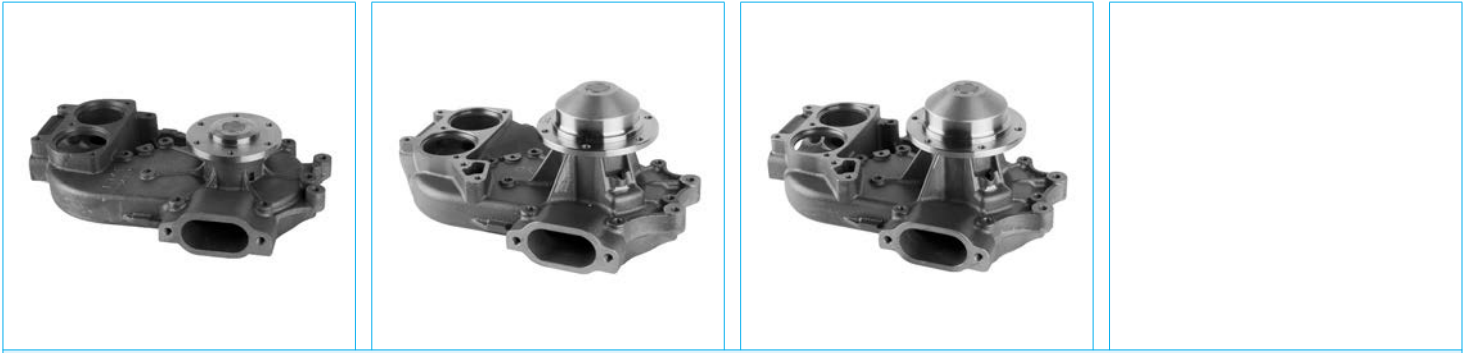

**24-1312**

**24-1341**

**24-1342**

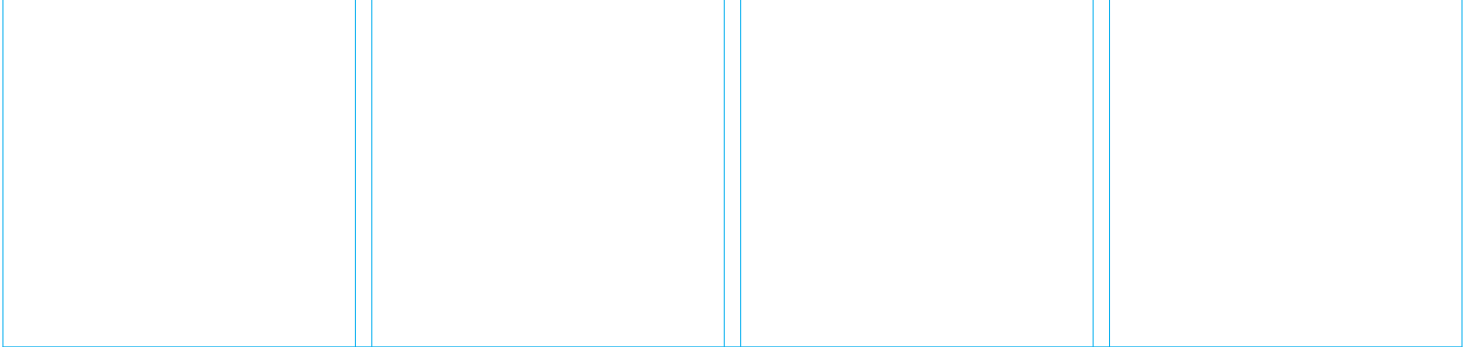
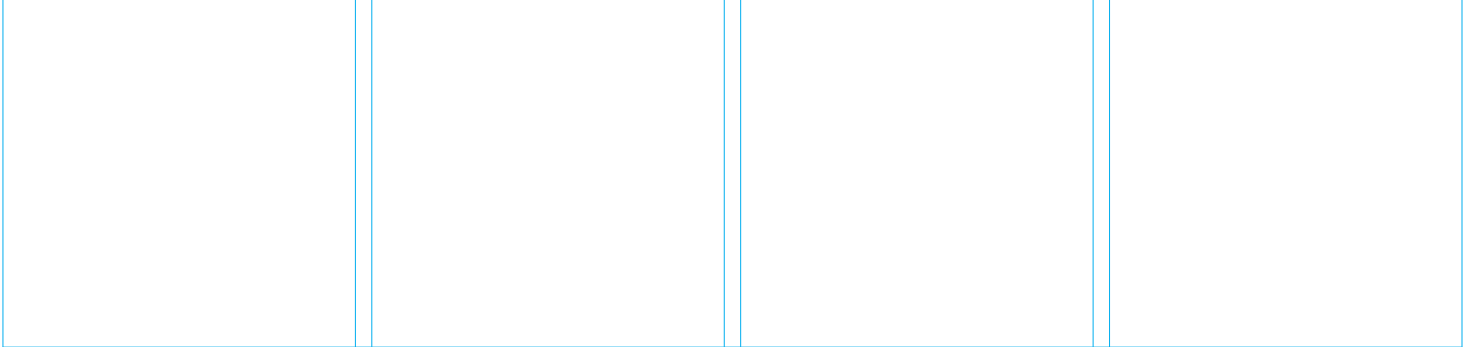
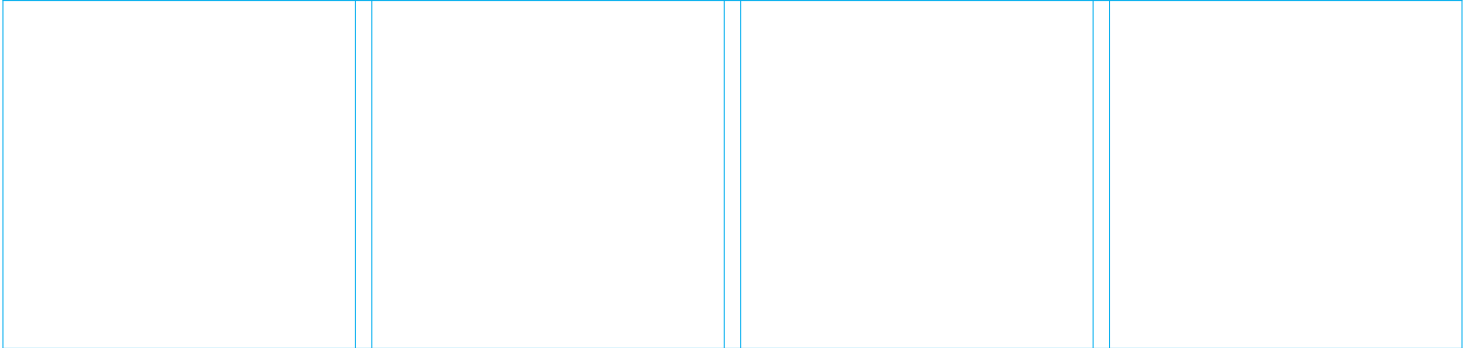
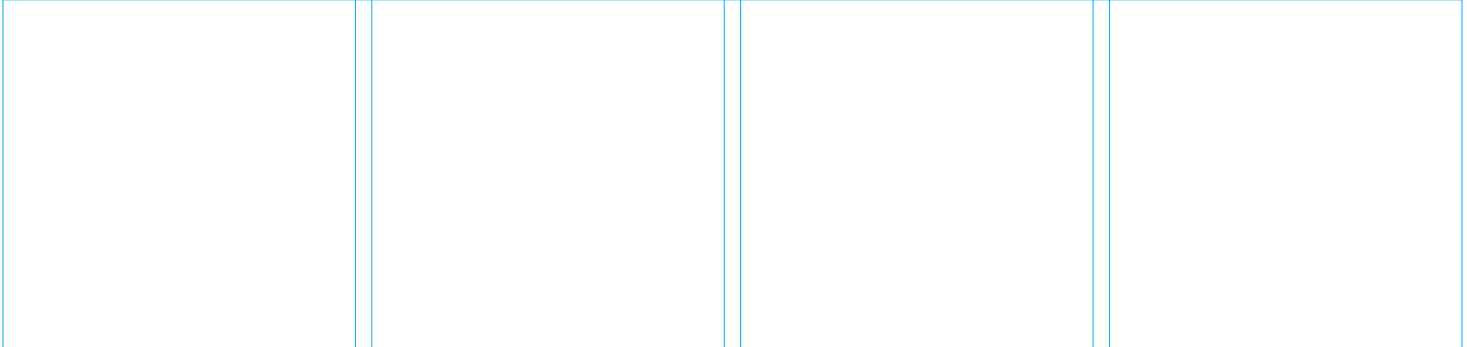





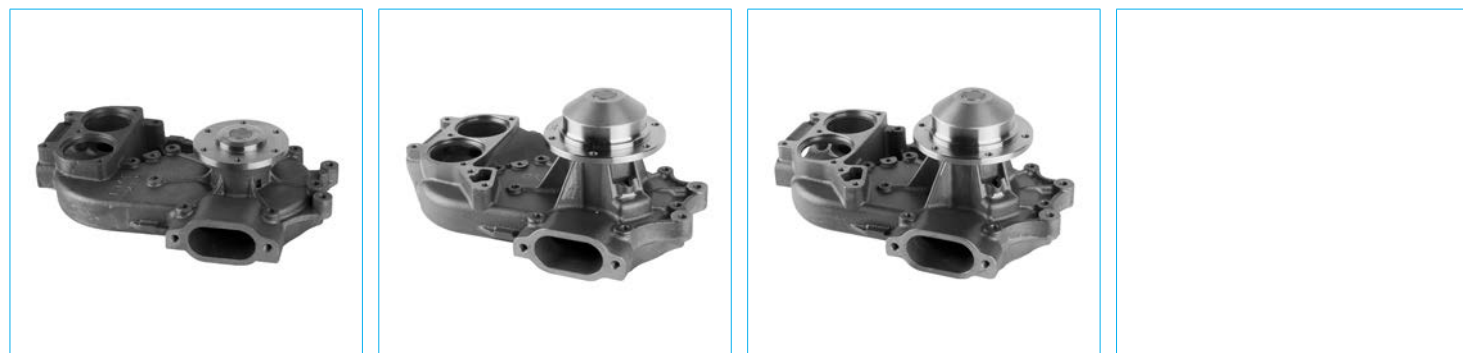



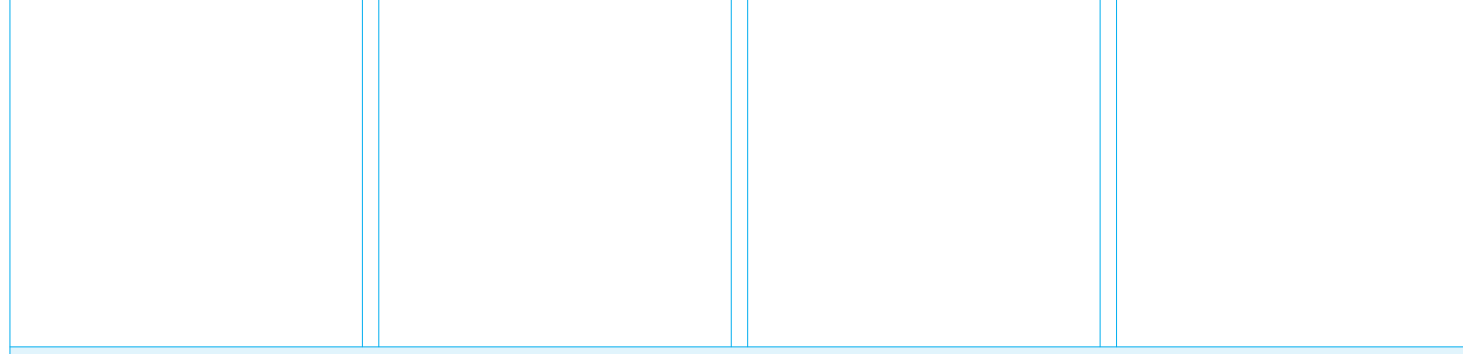
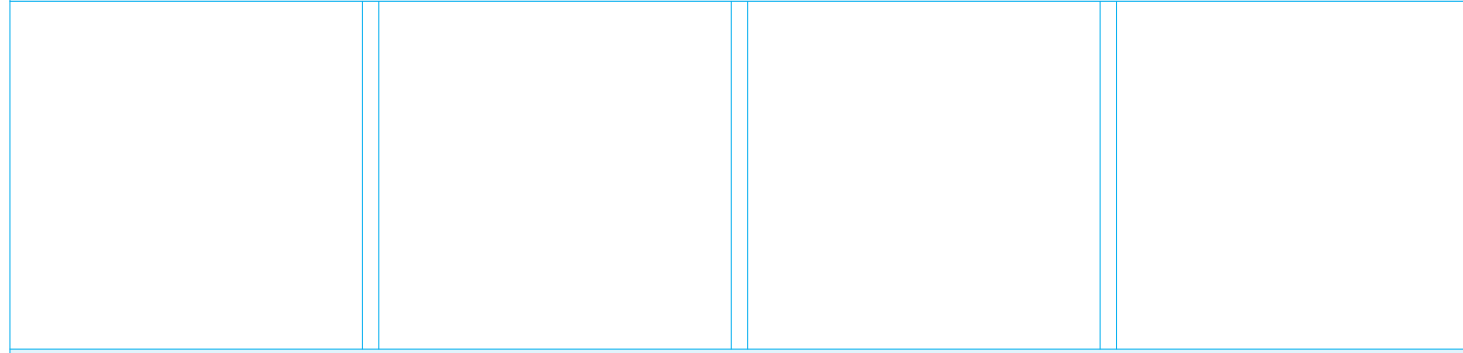
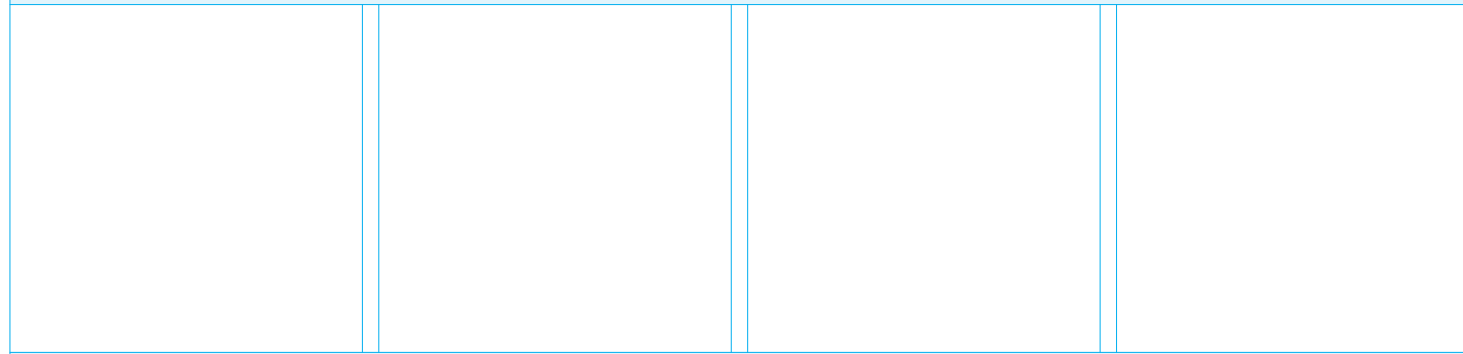
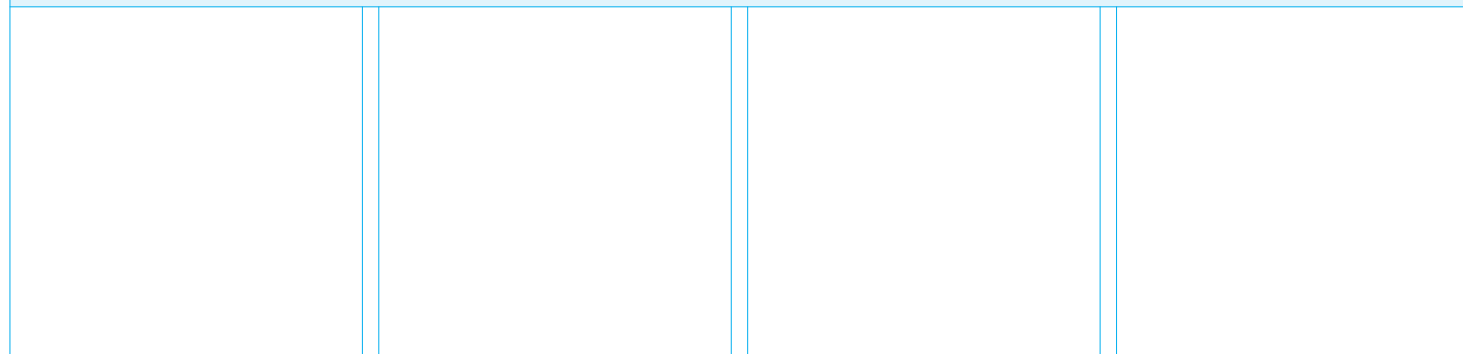

**24-1312**

**24-1341**

**24-1342**



		<b>METELLI ref.</b>			<b>NOTE</b>	<b>Adaptable for OES</b>
3357 (420 kW) Eng.OM542.922	97-02	<b>24-1312</b>			For vehicles with retarder; Without fastening eyes for axial fan	541 200 10 01 542 200 06 01/ 16 01/ 20 01
	97-02	<b>24-1341</b>			For vehicles without retarder; With fastening eyes for axial fan	542 200 25 01
	97-02	<b>24-1342</b>			For vehicles with retarder; With fastening eyes for axial fan	542 200 26 01
4140 (290 kW) Eng.OM541.923	97-02	<b>24-1312</b>			For vehicles with retarder; Without fastening eyes for axial fan	541 200 10 01 542 200 06 01/ 16 01/ 20 01
4140 (290 kW) Eng.OM541.924	97-02	<b>24-1312</b>			For vehicles with retarder; Without fastening eyes for axial fan	541 200 10 01 542 200 06 01/ 16 01/ 20 01
4143 (315 kW) Eng.OM541.921	97-02	<b>24-1312</b>			For vehicles with retarder; Without fastening eyes for axial fan	541 200 10 01 542 200 06 01/ 16 01/ 20 01
4143 (315 kW) Eng.OM541.925	97-02	<b>24-1312</b>			For vehicles with retarder; Without fastening eyes for axial fan	541 200 10 01 542 200 06 01/ 16 01/ 20 01
4148 (350 kW) Eng.OM542.921	97-02	<b>24-1312</b>			For vehicles with retarder; Without fastening eyes for axial fan	541 200 10 01 542 200 06 01/ 16 01/ 20 01
	97-02	<b>24-1341</b>			For vehicles without retarder; With fastening eyes for axial fan	542 200 25 01
	97-02	<b>24-1342</b>			For vehicles with retarder; With fastening eyes for axial fan	542 200 26 01
4148 (350 kW) Eng.OM542.925	97-02	<b>24-1312</b>			For vehicles with retarder; Without fastening eyes for axial fan	541 200 10 01 542 200 06 01/ 16 01/ 20 01
	97-02	<b>24-1341</b>			For vehicles without retarder; With fastening eyes for axial fan	542 200 25 01
	97-02	<b>24-1342</b>			For vehicles with retarder; With fastening eyes for axial fan	542 200 26 01
<b>Actros II/ III '1/03-</b>						
1831 AK (230 kW) Eng.OM541.926/.941	03-	<b>24-1312</b>			For vehicles with retarder; Without fastening eyes for axial fan	541 200 10 01 542 200 06 01/ 16 01/ 20 01
1831 K (230 kW) Eng.OM541.920/.940	03-	<b>24-1312</b>			For vehicles with retarder; Without fastening eyes for axial fan	541 200 10 01 542 200 06 01/ 16 01/ 20 01
1832 (235 kW) Eng.OM541.940/.970	03-	<b>24-1312</b>			For vehicles with retarder; Without fastening eyes for axial fan	541 200 10 01 542 200 06 01/ 16 01/ 20 01
1832 (235 kW) Eng.OM541.971	03-	<b>24-1312</b>			For vehicles with retarder; Without fastening eyes for axial fan	541 200 10 01 542 200 06 01/ 16 01/ 20 01
1835 AK (260 kW) Eng.OM541.927/.943	03-	<b>24-1312</b>			For vehicles with retarder; Without fastening eyes for axial fan	541 200 10 01 542 200 06 01/ 16 01/ 20 01
1835 K (260 kW) Eng.OM541.922/.942	03-	<b>24-1312</b>			For vehicles with retarder; Without fastening eyes for axial fan	541 200 10 01 542 200 06 01/ 16 01/ 20 01
1836 (265 kW) Eng.OM541.942	03-	<b>24-1312</b>			For vehicles with retarder; Without fastening eyes for axial fan	541 200 10 01 542 200 06 01/ 16 01/ 20 01
1840 AK (290 kW) Eng.OM541.924/.945	03-	<b>24-1312</b>			For vehicles with retarder; Without fastening eyes for axial fan	541 200 10 01 542 200 06 01/ 16 01/ 20 01
1840 K (290 kW) Eng.OM541.923/.944	03-	<b>24-1312</b>			For vehicles with retarder; Without fastening eyes for axial fan	541 200 10 01 542 200 06 01/ 16 01/ 20 01
1841 (300 kW) Eng.OM541.944/.974	03-	<b>24-1312</b>			For vehicles with retarder; Without fastening eyes for axial fan	541 200 10 01 542 200 06 01/ 16 01/ 20 01
1844 (315-320 kW) Eng.OM541.921/.946	03-	<b>24-1312</b>			For vehicles with retarder; Without fastening eyes for axial fan	541 200 10 01 542 200 06 01/ 16 01/ 20 01
1844 (320 kW) Eng.OM541.946/.976	03-	<b>24-1312</b>			For vehicles with retarder; Without fastening eyes for axial fan	541 200 10 01 542 200 06 01/ 16 01/ 20 01
1846 (335 kW) Eng.OM541.948/.980	03-	<b>24-1312</b>			For vehicles with retarder; Without fastening eyes for axial fan	541 200 10 01 542 200 06 01/ 16 01/ 20 01
1846 (335 kW) Eng.OM541.981	03-	<b>24-1312</b>			For vehicles with retarder; Without fastening eyes for axial fan	541 200 10 01 542 200 06 01/ 16 01/ 20 01
1848 (350 kW) Eng.OM541.948/.978	03-	<b>24-1312</b>			For vehicles with retarder; Without fastening eyes for axial fan	541 200 10 01 542 200 06 01/ 16 01/ 20 01
	03-	<b>24-1312</b>			For vehicles with retarder; Without fastening eyes for axial fan	541 200 10 01 542 200 06 01/ 16 01/ 20 01
	03-	<b>24-1341</b>			For vehicles without retarder; With fastening eyes for axial fan	542 200 25 01
1850/1851 (370-375 kW) Eng.OM542.940/.960	03-	<b>24-1312</b>			For vehicles with retarder; Without fastening eyes for axial fan	541 200 10 01 542 200 06 01/ 16 01/ 20 01
	03-	<b>24-1341</b>			For vehicles without retarder; With fastening eyes for axial fan	542 200 25 01
	03-	<b>24-1342</b>			For vehicles with retarder; With fastening eyes for axial fan	542 200 26 01
1854 (395 kW) Eng.OM542.942	03-	<b>24-1312</b>			For vehicles with retarder; Without fastening eyes for axial fan	541 200 10 01 542 200 06 01/ 16 01/ 20 01
	03-	<b>24-1341</b>			For vehicles without retarder; With fastening eyes for axial fan	542 200 25 01
	03-	<b>24-1342</b>			For vehicles with retarder; With fastening eyes for axial fan	542 200 26 01
1854 (395-405 kW) Eng.OM542.942/.962	03-	<b>24-1312</b>			For vehicles with retarder; Without fastening eyes for axial fan	541 200 10 01 542 200 06 01/ 16 01/ 20 01

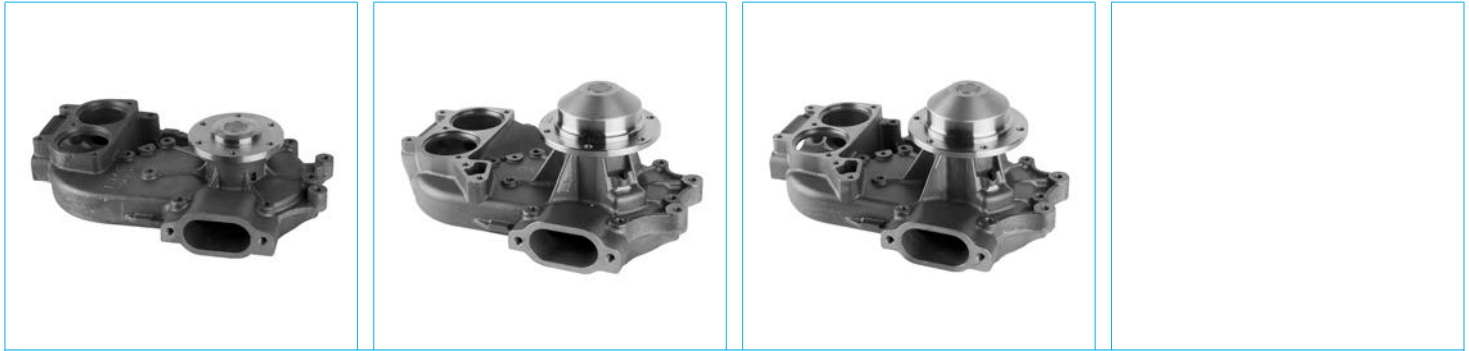

**24-1312**

**24-1341**

**24-1342**

--	--	--	--

--	--	--	--

--	--	--	--

--	--	--	--





**24-1312**



**24-1341**



**24-1342**



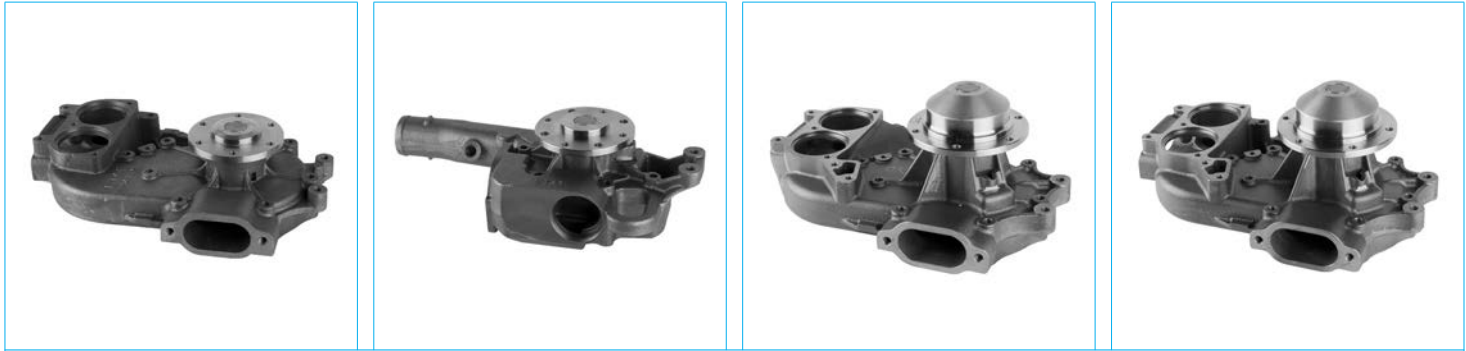





**24-1312**

**24-1320**

**24-1341**

**24-1342**

		<b>METELLI ref.</b>			<b>NOTE</b>	<b>Adaptable for OES</b>
3344 (315-320 kW) Eng.OM541.921	03-	<b>24-1312</b>			For vehicles with retarder; Without fastening eyes for axial fan	541 200 10 01 542 200 06 01/ 16 01/ 20 01
3344 (315-320 kW) Eng.OM541.946/.947	03-	<b>24-1312</b>			For vehicles with retarder; Without fastening eyes for axial fan	541 200 10 01 542 200 06 01/ 16 01/ 20 01
3344 (320 kW) Eng.OM541.946/.976	03-	<b>24-1312</b>			For vehicles with retarder; Without fastening eyes for axial fan	541 200 10 01 542 200 06 01/ 16 01/ 20 01
3344 (320 kW) Eng.OM541.947	03-	<b>24-1312</b>			For vehicles with retarder; Without fastening eyes for axial fan	541 200 10 01 542 200 06 01/ 16 01/ 20 01
3346 (335 kW) Eng.OM541.948	03-	<b>24-1312</b>			For vehicles with retarder; Without fastening eyes for axial fan	541 200 10 01 542 200 06 01/ 16 01/ 20 01
3346 (335 kW) Eng.OM541.949	03-	<b>24-1312</b>			For vehicles with retarder; Without fastening eyes for axial fan	541 200 10 01 542 200 06 01/ 16 01/ 20 01
3348 (350 kW) Eng.OM541.948	03-	<b>24-1312</b>			For vehicles with retarder; Without fastening eyes for axial fan	541 200 10 01 542 200 06 01/ 16 01/ 20 01
3348 (350 kW) Eng.OM542.921	03-	<b>24-1312</b>			For vehicles with retarder; Without fastening eyes for axial fan	541 200 10 01 542 200 06 01/ 16 01/ 20 01
	03-	<b>24-1341</b>			For vehicles without retarder; With fastening eyes for axial fan	542 200 25 01
	03-	<b>24-1342</b>			For vehicles with retarder; With fastening eyes for axial fan	542 200 26 01
3350/3351 (370-375 kW) Eng.OM542.940	03-	<b>24-1312</b>			For vehicles with retarder; Without fastening eyes for axial fan	541 200 10 01 542 200 06 01/ 16 01/ 20 01
	03-	<b>24-1341</b>			For vehicles without retarder; With fastening eyes for axial fan	542 200 25 01
	03-	<b>24-1342</b>			For vehicles with retarder; With fastening eyes for axial fan	542 200 26 01
3351 (370-375 kW) Eng.OM542.941	03-	<b>24-1312</b>			For vehicles with retarder; Without fastening eyes for axial fan	541 200 10 01 542 200 06 01/ 16 01/ 20 01
	03-	<b>24-1341</b>			For vehicles without retarder; With fastening eyes for axial fan	542 200 25 01
	03-	<b>24-1342</b>			For vehicles with retarder; With fastening eyes for axial fan	542 200 26 01
3351 (375 kW) Eng.OM542.940	03-	<b>24-1312</b>			For vehicles with retarder; Without fastening eyes for axial fan	541 200 10 01 542 200 06 01/ 16 01/ 20 01
	03-	<b>24-1341</b>			For vehicles without retarder; With fastening eyes for axial fan	542 200 25 01
	03-	<b>24-1342</b>			For vehicles with retarder; With fastening eyes for axial fan	542 200 26 01
3354/3355 (395-405 kW) Eng.OM542.942/.962	03-	<b>24-1312</b>			For vehicles with retarder; Without fastening eyes for axial fan	541 200 10 01 542 200 06 01/ 16 01/ 20 01
	03-	<b>24-1341</b>			For vehicles without retarder; With fastening eyes for axial fan	542 200 25 01
	03-	<b>24-1342</b>			For vehicles with retarder; With fastening eyes for axial fan	542 200 26 01
3355 (405 kW) Eng.OM542.962	03-	<b>24-1312</b>			For vehicles with retarder; Without fastening eyes for axial fan	541 200 10 01 542 200 06 01/ 16 01/ 20 01
	03-	<b>24-1341</b>			For vehicles without retarder; With fastening eyes for axial fan	542 200 25 01
	03-	<b>24-1342</b>			For vehicles with retarder; With fastening eyes for axial fan	542 200 26 01
4140 (290-300 kW) Eng.OM541.923/.944	03-	<b>24-1312</b>			For vehicles with retarder; Without fastening eyes for axial fan	541 200 10 01 542 200 06 01/ 16 01/ 20 01
4141 (300 kW) Eng.OM541.974	03-	<b>24-1312</b>			For vehicles with retarder; Without fastening eyes for axial fan	541 200 10 01 542 200 06 01/ 16 01/ 20 01
4144 (315-320 kW) Eng.OM541.925/.946/.976	03-	<b>24-1312</b>			For vehicles with retarder; Without fastening eyes for axial fan	541 200 10 01 542 200 06 01/ 16 01/ 20 01
4144 (320 kW) Eng.OM541.976	03-	<b>24-1312</b>			For vehicles with retarder; Without fastening eyes for axial fan	541 200 10 01 542 200 06 01/ 16 01/ 20 01
4146 (335 kW) Eng.OM541.948	03-	<b>24-1312</b>			For vehicles with retarder; Without fastening eyes for axial fan	541 200 10 01 542 200 06 01/ 16 01/ 20 01
4148 (350 kW) Eng.OM541.948	03-	<b>24-1312</b>			For vehicles with retarder; Without fastening eyes for axial fan	541 200 10 01 542 200 06 01/ 16 01/ 20 01
4151 (375 kW) Eng.OM542.960	03-	<b>24-1312</b>			For vehicles with retarder; Without fastening eyes for axial fan	541 200 10 01 542 200 06 01/ 16 01/ 20 01
	05-	<b>24-1341</b>			For vehicles without retarder; With fastening eyes for axial fan	542 200 25 01
	05-	<b>24-1342</b>			For vehicles with retarder; With fastening eyes for axial fan	542 200 26 01
<b>Atego I '1/98-'10/04</b>						
1017 (125 kW) Eng.OM904.911	98-04	<b>24-1320</b>			For vehicles without retarder	904 200 02 01/ 04 01/ 06 01/ 07 01/ 08 01 904 200 19 01/ 20 01/ 22 01/ 25 01/ 26 01 904 200 27 01/ 28 01/ 29 01/ 32 01/ 38 01 904 200 43 01/ 49 01/ 50 01
1017/1018 (125-130 kW) Eng.OM904.911/.913/.917	98-04	<b>24-1320</b>			For vehicles without retarder	904 200 02 01/ 04 01/ 06 01/ 07 01/ 08 01 904 200 19 01/ 20 01/ 22 01/ 25 01/ 26 01 904 200 27 01/ 28 01/ 29 01/ 32 01/ 38 01 904 200 43 01/ 49 01/ 50 01





**24-1320**



**24-1333**

		<b>METELLI</b> ref.			<b>NOTE</b>	<b>Adaptable for OES</b>
1023 (170 kW) Eng.OM906.910	98-04	<b>24-1320</b>			For vehicles without retarder	904 200 02 01/ 04 01/ 06 01/ 07 01/ 08 01 904 200 19 01/ 20 01/ 22 01/ 25 01/ 26 01 904 200 27 01/ 28 01/ 29 01/ 32 01/ 38 01 904 200 43 01/ 49 01/ 50 01
	98-04	<b>24-1333</b>				906 200 09 01/ 12 01/ 13 01/ 14 01/ 18 01 906 200 20 01/ 22 01/ 24 01/ 29 01/ 32 01 906 200 38 01/ 42 01/ 45 01/ 48 01/ 54 01 906 200 57 01/ 65 01
1214 (100 kW) Eng.OM904.910/.916	98-04	<b>24-1320</b>			For vehicles without retarder	904 200 02 01/ 04 01/ 06 01/ 07 01/ 08 01 904 200 19 01/ 20 01/ 22 01/ 25 01/ 26 01 904 200 27 01/ 28 01/ 29 01/ 32 01/ 38 01 904 200 43 01/ 49 01/ 50 01
1215 (112 kW) Eng.OM904.922	98-04	<b>24-1320</b>			For vehicles without retarder	904 200 02 01/ 04 01/ 06 01/ 07 01/ 08 01 904 200 19 01/ 20 01/ 22 01/ 25 01/ 26 01 904 200 27 01/ 28 01/ 29 01/ 32 01/ 38 01 904 200 43 01/ 49 01/ 50 01
1217 (125 kW) Eng.OM904.911	98-04	<b>24-1320</b>			For vehicles without retarder	904 200 02 01/ 04 01/ 06 01/ 07 01/ 08 01 904 200 19 01/ 20 01/ 22 01/ 25 01/ 26 01 904 200 27 01/ 28 01/ 29 01/ 32 01/ 38 01 904 200 43 01/ 49 01/ 50 01
1223 (170 kW) Eng.OM906.910	98-04	<b>24-1320</b>			For vehicles without retarder	904 200 02 01/ 04 01/ 06 01/ 07 01/ 08 01 904 200 19 01/ 20 01/ 22 01/ 25 01/ 26 01 904 200 27 01/ 28 01/ 29 01/ 32 01/ 38 01 904 200 43 01/ 49 01/ 50 01
	98-04	<b>24-1333</b>				906 200 09 01/ 12 01/ 13 01/ 14 01/ 18 01 906 200 20 01/ 22 01/ 24 01/ 29 01/ 32 01 906 200 38 01/ 42 01/ 45 01/ 48 01/ 54 01 906 200 57 01/ 65 01
1225 (180 kW) Eng.OM906.919	98-04	<b>24-1320</b>			For vehicles without retarder	904 200 02 01/ 04 01/ 06 01/ 07 01/ 08 01 904 200 19 01/ 20 01/ 22 01/ 25 01/ 26 01 904 200 27 01/ 28 01/ 29 01/ 32 01/ 38 01 904 200 43 01/ 49 01/ 50 01
	98-04	<b>24-1333</b>				906 200 09 01/ 12 01/ 13 01/ 14 01/ 18 01 906 200 20 01/ 22 01/ 24 01/ 29 01/ 32 01 906 200 38 01/ 42 01/ 45 01/ 48 01/ 54 01 906 200 57 01/ 65 01
1228 (205 kW) Eng.OM906.911	98-04	<b>24-1320</b>			For vehicles without retarder	904 200 02 01/ 04 01/ 06 01/ 07 01/ 08 01 904 200 19 01/ 20 01/ 22 01/ 25 01/ 26 01 904 200 27 01/ 28 01/ 29 01/ 32 01/ 38 01 904 200 43 01/ 49 01/ 50 01
	98-04	<b>24-1333</b>				906 200 09 01/ 12 01/ 13 01/ 14 01/ 18 01 906 200 20 01/ 22 01/ 24 01/ 29 01/ 32 01 906 200 38 01/ 42 01/ 45 01/ 48 01/ 54 01 906 200 57 01/ 65 01
1317 (125 kW) Eng.OM904.911	98-04	<b>24-1320</b>			For vehicles without retarder	904 200 02 01/ 04 01/ 06 01/ 07 01/ 08 01 904 200 19 01/ 20 01/ 22 01/ 25 01/ 26 01 904 200 27 01/ 28 01/ 29 01/ 32 01/ 38 01 904 200 43 01/ 49 01/ 50 01
1317/1318 (125-130 kW) Eng.OM904.911/.913	98-04	<b>24-1320</b>			For vehicles without retarder	904 200 02 01/ 04 01/ 06 01/ 07 01/ 08 01 904 200 19 01/ 20 01/ 22 01/ 25 01/ 26 01 904 200 27 01/ 28 01/ 29 01/ 32 01/ 38 01 904 200 43 01/ 49 01/ 50 01



**24-1320**



**24-1333**

		<b>METELLI</b> ref.		<b>NOTE</b>	<b>Adaptable for OES</b>
1323 (170 kW) Eng.OM906.910	98-04	<b>24-1320</b>		For vehicles without retarder	904 200 02 01/ 04 01/ 06 01/ 07 01/ 08 01 904 200 19 01/ 20 01/ 22 01/ 25 01/ 26 01 904 200 27 01/ 28 01/ 29 01/ 32 01/ 38 01 904 200 43 01/ 49 01/ 50 01
	98-04	<b>24-1333</b>			906 200 09 01/ 12 01/ 13 01/ 14 01/ 18 01 906 200 20 01/ 22 01/ 24 01/ 29 01/ 32 01 906 200 38 01/ 42 01/ 45 01/ 48 01/ 54 01 906 200 57 01/ 65 01
1325 (180 kW) Eng.OM906.919	98-04	<b>24-1320</b>		For vehicles without retarder	904 200 02 01/ 04 01/ 06 01/ 07 01/ 08 01 904 200 19 01/ 20 01/ 22 01/ 25 01/ 26 01 904 200 27 01/ 28 01/ 29 01/ 32 01/ 38 01 904 200 43 01/ 49 01/ 50 01
	98-04	<b>24-1333</b>			906 200 09 01/ 12 01/ 13 01/ 14 01/ 18 01 906 200 20 01/ 22 01/ 24 01/ 29 01/ 32 01 906 200 38 01/ 42 01/ 45 01/ 48 01/ 54 01 906 200 57 01/ 65 01
1328 (205 kW) Eng.OM906.911	98-04	<b>24-1320</b>		For vehicles without retarder	904 200 02 01/ 04 01/ 06 01/ 07 01/ 08 01 904 200 19 01/ 20 01/ 22 01/ 25 01/ 26 01 904 200 27 01/ 28 01/ 29 01/ 32 01/ 38 01 904 200 43 01/ 49 01/ 50 01
	98-04	<b>24-1333</b>			906 200 09 01/ 12 01/ 13 01/ 14 01/ 18 01 906 200 20 01/ 22 01/ 24 01/ 29 01/ 32 01 906 200 38 01/ 42 01/ 45 01/ 48 01/ 54 01 906 200 57 01/ 65 01
1517 (125 kW) Eng.OM904.911	98-04	<b>24-1320</b>		For vehicles without retarder	904 200 02 01/ 04 01/ 06 01/ 07 01/ 08 01 904 200 19 01/ 20 01/ 22 01/ 25 01/ 26 01 904 200 27 01/ 28 01/ 29 01/ 32 01/ 38 01 904 200 43 01/ 49 01/ 50 01
1523 (170 kW) Eng.OM906.910	98-04	<b>24-1320</b>		For vehicles without retarder	904 200 02 01/ 04 01/ 06 01/ 07 01/ 08 01 904 200 19 01/ 20 01/ 22 01/ 25 01/ 26 01 904 200 27 01/ 28 01/ 29 01/ 32 01/ 38 01 904 200 43 01/ 49 01/ 50 01
	98-04	<b>24-1333</b>			906 200 09 01/ 12 01/ 13 01/ 14 01/ 18 01 906 200 20 01/ 22 01/ 24 01/ 29 01/ 32 01 906 200 38 01/ 42 01/ 45 01/ 48 01/ 54 01 906 200 57 01/ 65 01
1525 (180 kW) Eng.OM906.919	98-04	<b>24-1320</b>		For vehicles without retarder	904 200 02 01/ 04 01/ 06 01/ 07 01/ 08 01 904 200 19 01/ 20 01/ 22 01/ 25 01/ 26 01 904 200 27 01/ 28 01/ 29 01/ 32 01/ 38 01 904 200 43 01/ 49 01/ 50 01
	98-04	<b>24-1333</b>			906 200 09 01/ 12 01/ 13 01/ 14 01/ 18 01 906 200 20 01/ 22 01/ 24 01/ 29 01/ 32 01 906 200 38 01/ 42 01/ 45 01/ 48 01/ 54 01 906 200 57 01/ 65 01
1528 (205 kW) Eng.OM906.911	98-04	<b>24-1320</b>		For vehicles without retarder	904 200 02 01/ 04 01/ 06 01/ 07 01/ 08 01 904 200 19 01/ 20 01/ 22 01/ 25 01/ 26 01 904 200 27 01/ 28 01/ 29 01/ 32 01/ 38 01 904 200 43 01/ 49 01/ 50 01
	98-04	<b>24-1333</b>			906 200 09 01/ 12 01/ 13 01/ 14 01/ 18 01 906 200 20 01/ 22 01/ 24 01/ 29 01/ 32 01 906 200 38 01/ 42 01/ 45 01/ 48 01/ 54 01 906 200 57 01/ 65 01



**24-1320**



**24-1333**

		<b>METELLI</b> ref.			<b>NOTE</b>	<b>Adaptable for OES</b>
1823 (170 kW) Eng.OM906.920	98-04	<b>24-1320</b>			For vehicles without retarder	904 200 02 01/ 04 01/ 06 01/ 07 01/ 08 01 904 200 19 01/ 20 01/ 22 01/ 25 01/ 26 01 904 200 27 01/ 28 01/ 29 01/ 32 01/ 38 01 904 200 43 01/ 49 01/ 50 01
	98-04	<b>24-1333</b>				906 200 09 01/ 12 01/ 13 01/ 14 01/ 18 01 906 200 20 01/ 22 01/ 24 01/ 29 01/ 32 01 906 200 38 01/ 42 01/ 45 01/ 48 01/ 54 01 906 200 57 01/ 65 01
1823 (170 kW) Eng.OM906.920/.925	98-04	<b>24-1320</b>			For vehicles without retarder	904 200 02 01/ 04 01/ 06 01/ 07 01/ 08 01 904 200 19 01/ 20 01/ 22 01/ 25 01/ 26 01 904 200 27 01/ 28 01/ 29 01/ 32 01/ 38 01 904 200 43 01/ 49 01/ 50 01
	98-04	<b>24-1333</b>				906 200 09 01/ 12 01/ 13 01/ 14 01/ 18 01 906 200 20 01/ 22 01/ 24 01/ 29 01/ 32 01 906 200 38 01/ 42 01/ 45 01/ 48 01/ 54 01 906 200 57 01/ 65 01
1823 (170 kW) Eng.OM906.922	98-04	<b>24-1320</b>			For vehicles without retarder	904 200 02 01/ 04 01/ 06 01/ 07 01/ 08 01 904 200 19 01/ 20 01/ 22 01/ 25 01/ 26 01 904 200 27 01/ 28 01/ 29 01/ 32 01/ 38 01 904 200 43 01/ 49 01/ 50 01
	98-04	<b>24-1333</b>				906 200 09 01/ 12 01/ 13 01/ 14 01/ 18 01 906 200 20 01/ 22 01/ 24 01/ 29 01/ 32 01 906 200 38 01/ 42 01/ 45 01/ 48 01/ 54 01 906 200 57 01/ 65 01
1828 (205 kW) Eng.OM906.921/.926	98-04	<b>24-1320</b>			For vehicles without retarder	904 200 02 01/ 04 01/ 06 01/ 07 01/ 08 01 904 200 19 01/ 20 01/ 22 01/ 25 01/ 26 01 904 200 27 01/ 28 01/ 29 01/ 32 01/ 38 01 904 200 43 01/ 49 01/ 50 01
	98-04	<b>24-1333</b>				906 200 09 01/ 12 01/ 13 01/ 14 01/ 18 01 906 200 20 01/ 22 01/ 24 01/ 29 01/ 32 01 906 200 38 01/ 42 01/ 45 01/ 48 01/ 54 01 906 200 57 01/ 65 01
1828 (205 kW) Eng.OM906.923	98-04	<b>24-1320</b>			For vehicles without retarder	904 200 02 01/ 04 01/ 06 01/ 07 01/ 08 01 904 200 19 01/ 20 01/ 22 01/ 25 01/ 26 01 904 200 27 01/ 28 01/ 29 01/ 32 01/ 38 01 904 200 43 01/ 49 01/ 50 01
	98-04	<b>24-1333</b>				906 200 09 01/ 12 01/ 13 01/ 14 01/ 18 01 906 200 20 01/ 22 01/ 24 01/ 29 01/ 32 01 906 200 38 01/ 42 01/ 45 01/ 48 01/ 54 01 906 200 57 01/ 65 01
2523 (205 kW) Eng.OM906.920	98-04	<b>24-1320</b>			For vehicles without retarder	904 200 02 01/ 04 01/ 06 01/ 07 01/ 08 01 904 200 19 01/ 20 01/ 22 01/ 25 01/ 26 01 904 200 27 01/ 28 01/ 29 01/ 32 01/ 38 01 904 200 43 01/ 49 01/ 50 01
	98-04	<b>24-1333</b>				906 200 09 01/ 12 01/ 13 01/ 14 01/ 18 01 906 200 20 01/ 22 01/ 24 01/ 29 01/ 32 01 906 200 38 01/ 42 01/ 45 01/ 48 01/ 54 01 906 200 57 01/ 65 01
2528 (205 kW) Eng.OM906.921/.926	98-04	<b>24-1320</b>			For vehicles without retarder	904 200 02 01/ 04 01/ 06 01/ 07 01/ 08 01 904 200 19 01/ 20 01/ 22 01/ 25 01/ 26 01 904 200 27 01/ 28 01/ 29 01/ 32 01/ 38 01 904 200 43 01/ 49 01/ 50 01



**24-1320**



**24-1333**

		<b>METELLI</b> ref.			<b>NOTE</b>	<b>Adaptable for OES</b>
2528 (205 kW) Eng.OM906.921/.926	98-04	<b>24-1333</b>				906 200 09 01/ 12 01/ 13 01/ 14 01/ 18 01 906 200 20 01/ 22 01/ 24 01/ 29 01/ 32 01 906 200 38 01/ 42 01/ 45 01/ 48 01/ 54 01 906 200 57 01/ 65 01
2628 (205 kW) Eng.OM906.921	98-04	<b>24-1320</b>			For vehicles without retarder	904 200 02 01/ 04 01/ 06 01/ 07 01/ 08 01 904 200 19 01/ 20 01/ 22 01/ 25 01/ 26 01 904 200 27 01/ 28 01/ 29 01/ 32 01/ 38 01 904 200 43 01/ 49 01/ 50 01
	98-04	<b>24-1333</b>				906 200 09 01/ 12 01/ 13 01/ 14 01/ 18 01 906 200 20 01/ 22 01/ 24 01/ 29 01/ 32 01 906 200 38 01/ 42 01/ 45 01/ 48 01/ 54 01 906 200 57 01/ 65 01
712 (90 kW) Eng.OM904.909	98-04	<b>24-1320</b>			For vehicles without retarder	904 200 02 01/ 04 01/ 06 01/ 07 01/ 08 01 904 200 19 01/ 20 01/ 22 01/ 25 01/ 26 01 904 200 27 01/ 28 01/ 29 01/ 32 01/ 38 01 904 200 43 01/ 49 01/ 50 01
714 (100 kW) Eng.OM904.910/.916	98-04	<b>24-1320</b>			For vehicles without retarder	904 200 02 01/ 04 01/ 06 01/ 07 01/ 08 01 904 200 19 01/ 20 01/ 22 01/ 25 01/ 26 01 904 200 27 01/ 28 01/ 29 01/ 32 01/ 38 01 904 200 43 01/ 49 01/ 50 01
715 (112 kW) Eng.OM904.922	98-04	<b>24-1320</b>			For vehicles without retarder	904 200 02 01/ 04 01/ 06 01/ 07 01/ 08 01 904 200 19 01/ 20 01/ 22 01/ 25 01/ 26 01 904 200 27 01/ 28 01/ 29 01/ 32 01/ 38 01 904 200 43 01/ 49 01/ 50 01
717 (125 kW) Eng.OM904.911/.917	98-04	<b>24-1320</b>			For vehicles without retarder	904 200 02 01/ 04 01/ 06 01/ 07 01/ 08 01 904 200 19 01/ 20 01/ 22 01/ 25 01/ 26 01 904 200 27 01/ 28 01/ 29 01/ 32 01/ 38 01 904 200 43 01/ 49 01/ 50 01
812 (90 kW) Eng.OM904.909	98-04	<b>24-1320</b>			For vehicles without retarder	904 200 02 01/ 04 01/ 06 01/ 07 01/ 08 01 904 200 19 01/ 20 01/ 22 01/ 25 01/ 26 01 904 200 27 01/ 28 01/ 29 01/ 32 01/ 38 01 904 200 43 01/ 49 01/ 50 01
814 (100 kW) Eng.OM904.910/.916	98-04	<b>24-1320</b>			For vehicles without retarder	904 200 02 01/ 04 01/ 06 01/ 07 01/ 08 01 904 200 19 01/ 20 01/ 22 01/ 25 01/ 26 01 904 200 27 01/ 28 01/ 29 01/ 32 01/ 38 01 904 200 43 01/ 49 01/ 50 01
815 (112 kW) Eng.OM904.922	98-04	<b>24-1320</b>			For vehicles without retarder	904 200 02 01/ 04 01/ 06 01/ 07 01/ 08 01 904 200 19 01/ 20 01/ 22 01/ 25 01/ 26 01 904 200 27 01/ 28 01/ 29 01/ 32 01/ 38 01 904 200 43 01/ 49 01/ 50 01
815 (112 kW) Eng.OM906.922	98-04	<b>24-1320</b>			For vehicles without retarder	904 200 02 01/ 04 01/ 06 01/ 07 01/ 08 01 904 200 19 01/ 20 01/ 22 01/ 25 01/ 26 01 904 200 27 01/ 28 01/ 29 01/ 32 01/ 38 01 904 200 43 01/ 49 01/ 50 01
	98-04	<b>24-1333</b>				906 200 09 01/ 12 01/ 13 01/ 14 01/ 18 01 906 200 20 01/ 22 01/ 24 01/ 29 01/ 32 01 906 200 38 01/ 42 01/ 45 01/ 48 01/ 54 01 906 200 57 01/ 65 01
817 (125 kW) Eng.OM904.911	98-04	<b>24-1320</b>			For vehicles without retarder	904 200 02 01/ 04 01/ 06 01/ 07 01/ 08 01 904 200 19 01/ 20 01/ 22 01/ 25 01/ 26 01 904 200 27 01/ 28 01/ 29 01/ 32 01/ 38 01 904 200 43 01/ 49 01/ 50 01





**24-1320**



**24-1333**

		<b>METELLI</b> ref.			<b>NOTE</b>	<b>Adaptable for OES</b>
823 (170 kW) Eng.OM906.910	98-04	<b>24-1320</b>			For vehicles without retarder	904 200 02 01/ 04 01/ 06 01/ 07 01/ 08 01 904 200 19 01/ 20 01/ 22 01/ 25 01/ 26 01 904 200 27 01/ 28 01/ 29 01/ 32 01/ 38 01 904 200 43 01/ 49 01/ 50 01
	98-04	<b>24-1333</b>				906 200 09 01/ 12 01/ 13 01/ 14 01/ 18 01 906 200 20 01/ 22 01/ 24 01/ 29 01/ 32 01 906 200 38 01/ 42 01/ 45 01/ 48 01/ 54 01 906 200 57 01/ 65 01
917 (125 kW) Eng.OM904.911	98-04	<b>24-1320</b>			For vehicles without retarder	904 200 02 01/ 04 01/ 06 01/ 07 01/ 08 01 904 200 19 01/ 20 01/ 22 01/ 25 01/ 26 01 904 200 27 01/ 28 01/ 29 01/ 32 01/ 38 01 904 200 43 01/ 49 01/ 50 01
917 (125 kW) Eng.OM904.917	98-04	<b>24-1320</b>			For vehicles without retarder	904 200 02 01/ 04 01/ 06 01/ 07 01/ 08 01 904 200 19 01/ 20 01/ 22 01/ 25 01/ 26 01 904 200 27 01/ 28 01/ 29 01/ 32 01/ 38 01 904 200 43 01/ 49 01/ 50 01
923 (170 kW) Eng.OM906.910	98-04	<b>24-1320</b>			For vehicles without retarder	904 200 02 01/ 04 01/ 06 01/ 07 01/ 08 01 904 200 19 01/ 20 01/ 22 01/ 25 01/ 26 01 904 200 27 01/ 28 01/ 29 01/ 32 01/ 38 01 904 200 43 01/ 49 01/ 50 01
	98-04	<b>24-1333</b>				906 200 09 01/ 12 01/ 13 01/ 14 01/ 18 01 906 200 20 01/ 22 01/ 24 01/ 29 01/ 32 01 906 200 38 01/ 42 01/ 45 01/ 48 01/ 54 01 906 200 57 01/ 65 01
925 (205 kW) Eng.OM906.919	98-04	<b>24-1320</b>			For vehicles without retarder	904 200 02 01/ 04 01/ 06 01/ 07 01/ 08 01 904 200 19 01/ 20 01/ 22 01/ 25 01/ 26 01 904 200 27 01/ 28 01/ 29 01/ 32 01/ 38 01 904 200 43 01/ 49 01/ 50 01
	98-04	<b>24-1333</b>				906 200 09 01/ 12 01/ 13 01/ 14 01/ 18 01 906 200 20 01/ 22 01/ 24 01/ 29 01/ 32 01 906 200 38 01/ 42 01/ 45 01/ 48 01/ 54 01 906 200 57 01/ 65 01
<b>Atego II '10/04-</b>						
1022 (160 kW) Eng.OM924.920	04-	<b>24-1320</b>			For vehicles without retarder	904 200 02 01/ 04 01/ 06 01/ 07 01/ 08 01 904 200 19 01/ 20 01/ 22 01/ 25 01/ 26 01 904 200 27 01/ 28 01/ 29 01/ 32 01/ 38 01 904 200 43 01/ 49 01/ 50 01
1023/1024 (170-175 kW) Eng.OM902.916	04-	<b>24-1320</b>			For vehicles without retarder	904 200 02 01/ 04 01/ 06 01/ 07 01/ 08 01 904 200 19 01/ 20 01/ 22 01/ 25 01/ 26 01 904 200 27 01/ 28 01/ 29 01/ 32 01/ 38 01 904 200 43 01/ 49 01/ 50 01
1023/1024 (170-175 kW) Eng.OM906.910/.915	04-	<b>24-1320</b>			For vehicles without retarder	904 200 02 01/ 04 01/ 06 01/ 07 01/ 08 01 904 200 19 01/ 20 01/ 22 01/ 25 01/ 26 01 904 200 27 01/ 28 01/ 29 01/ 32 01/ 38 01 904 200 43 01/ 49 01/ 50 01
	04-	<b>24-1333</b>				906 200 09 01/ 12 01/ 13 01/ 14 01/ 18 01 906 200 20 01/ 22 01/ 24 01/ 29 01/ 32 01 906 200 38 01/ 42 01/ 45 01/ 48 01/ 54 01 906 200 57 01/ 65 01



**24-1320**



**24-1333**

		<b>METELLI</b> ref.			<b>NOTE</b>	<b>Adaptable for OES</b>
1222 (160 kW) Eng.OM924.920	04-	<b>24-1320</b>			For vehicles without retarder	904 200 02 01/ 04 01/ 06 01/ 07 01/ 08 01 904 200 19 01/ 20 01/ 22 01/ 25 01/ 26 01 904 200 27 01/ 28 01/ 29 01/ 32 01/ 38 01 904 200 43 01/ 49 01/ 50 01
1223/1224 (170-175 kW) Eng.OM902.916	04-	<b>24-1320</b>			For vehicles without retarder	904 200 02 01/ 04 01/ 06 01/ 07 01/ 08 01 904 200 19 01/ 20 01/ 22 01/ 25 01/ 26 01 904 200 27 01/ 28 01/ 29 01/ 32 01/ 38 01 904 200 43 01/ 49 01/ 50 01
1223/1224 (170-175 kW) Eng.OM906.910/.915	04-	<b>24-1320</b>			For vehicles without retarder	904 200 02 01/ 04 01/ 06 01/ 07 01/ 08 01 904 200 19 01/ 20 01/ 22 01/ 25 01/ 26 01 904 200 27 01/ 28 01/ 29 01/ 32 01/ 38 01 904 200 43 01/ 49 01/ 50 01
	04-	<b>24-1333</b>				906 200 09 01/ 12 01/ 13 01/ 14 01/ 18 01 906 200 20 01/ 22 01/ 24 01/ 29 01/ 32 01 906 200 38 01/ 42 01/ 45 01/ 48 01/ 54 01 906 200 57 01/ 65 01
1228/1229 (205-210 kW) Eng.OM906.911/.916	04-	<b>24-1320</b>			For vehicles without retarder	904 200 02 01/ 04 01/ 06 01/ 07 01/ 08 01 904 200 19 01/ 20 01/ 22 01/ 25 01/ 26 01 904 200 27 01/ 28 01/ 29 01/ 32 01/ 38 01 904 200 43 01/ 49 01/ 50 01
	04-	<b>24-1333</b>				906 200 09 01/ 12 01/ 13 01/ 14 01/ 18 01 906 200 20 01/ 22 01/ 24 01/ 29 01/ 32 01 906 200 38 01/ 42 01/ 45 01/ 48 01/ 54 01 906 200 57 01/ 65 01
1322 (160 kW) Eng.OM924.920	04-	<b>24-1320</b>			For vehicles without retarder	904 200 02 01/ 04 01/ 06 01/ 07 01/ 08 01 904 200 19 01/ 20 01/ 22 01/ 25 01/ 26 01 904 200 27 01/ 28 01/ 29 01/ 32 01/ 38 01 904 200 43 01/ 49 01/ 50 01
1323/1324 (170-175 kW) Eng.OM906.910/.915	04-	<b>24-1320</b>			For vehicles without retarder	904 200 02 01/ 04 01/ 06 01/ 07 01/ 08 01 904 200 19 01/ 20 01/ 22 01/ 25 01/ 26 01 904 200 27 01/ 28 01/ 29 01/ 32 01/ 38 01 904 200 43 01/ 49 01/ 50 01
	04-	<b>24-1333</b>				906 200 09 01/ 12 01/ 13 01/ 14 01/ 18 01 906 200 20 01/ 22 01/ 24 01/ 29 01/ 32 01 906 200 38 01/ 42 01/ 45 01/ 48 01/ 54 01 906 200 57 01/ 65 01
1328/1329 (205-210 kW) Eng.OM906.911/.916	04-	<b>24-1320</b>			For vehicles without retarder	904 200 02 01/ 04 01/ 06 01/ 07 01/ 08 01 904 200 19 01/ 20 01/ 22 01/ 25 01/ 26 01 904 200 27 01/ 28 01/ 29 01/ 32 01/ 38 01 904 200 43 01/ 49 01/ 50 01
	04-	<b>24-1333</b>				906 200 09 01/ 12 01/ 13 01/ 14 01/ 18 01 906 200 20 01/ 22 01/ 24 01/ 29 01/ 32 01 906 200 38 01/ 42 01/ 45 01/ 48 01/ 54 01 906 200 57 01/ 65 01
1418/1718 (130 kW) Eng.OM904.962/967/968	11-	<b>24-1320</b>			For vehicles without retarder	904 200 02 01/ 04 01/ 06 01/ 07 01/ 08 01 904 200 19 01/ 20 01/ 22 01/ 25 01/ 26 01 904 200 27 01/ 28 01/ 29 01/ 32 01/ 38 01 904 200 43 01/ 49 01/ 50 01
1418/1718 (130 kW) Eng.OM904.972/973/976	11-	<b>24-1320</b>			For vehicles without retarder	904 200 02 01/ 04 01/ 06 01/ 07 01/ 08 01 904 200 19 01/ 20 01/ 22 01/ 25 01/ 26 01 904 200 27 01/ 28 01/ 29 01/ 32 01/ 38 01 904 200 43 01/ 49 01/ 50 01



**24-1320**



**24-1333**

		<b>METELLI</b> ref.		<b>NOTE</b>	<b>Adaptable for OES</b>
1522 (160 kW) Eng.OM924.920	04-	<b>24-1320</b>		For vehicles without retarder	904 200 02 01/ 04 01/ 06 01/ 07 01/ 08 01 904 200 19 01/ 20 01/ 22 01/ 25 01/ 26 01 904 200 27 01/ 28 01/ 29 01/ 32 01/ 38 01 904 200 43 01/ 49 01/ 50 01
1523/1524 (170-175 kW) Eng.OM906.910/.915	04-	<b>24-1320</b>		For vehicles without retarder	904 200 02 01/ 04 01/ 06 01/ 07 01/ 08 01 904 200 19 01/ 20 01/ 22 01/ 25 01/ 26 01 904 200 27 01/ 28 01/ 29 01/ 32 01/ 38 01 904 200 43 01/ 49 01/ 50 01
	04-	<b>24-1333</b>			906 200 09 01/ 12 01/ 13 01/ 14 01/ 18 01 906 200 20 01/ 22 01/ 24 01/ 29 01/ 32 01 906 200 38 01/ 42 01/ 45 01/ 48 01/ 54 01 906 200 57 01/ 65 01
1528/1529 (205-210 kW) Eng.OM906.911/.916	04-	<b>24-1320</b>		For vehicles without retarder	904 200 02 01/ 04 01/ 06 01/ 07 01/ 08 01 904 200 19 01/ 20 01/ 22 01/ 25 01/ 26 01 904 200 27 01/ 28 01/ 29 01/ 32 01/ 38 01 904 200 43 01/ 49 01/ 50 01
	04-	<b>24-1333</b>			906 200 09 01/ 12 01/ 13 01/ 14 01/ 18 01 906 200 20 01/ 22 01/ 24 01/ 29 01/ 32 01 906 200 38 01/ 42 01/ 45 01/ 48 01/ 54 01 906 200 57 01/ 65 01
1725 K (180 kW) Eng.OM906.983/985/988	11-	<b>24-1320</b>		For vehicles without retarder	904 200 02 01/ 04 01/ 06 01/ 07 01/ 08 01 904 200 19 01/ 20 01/ 22 01/ 25 01/ 26 01 904 200 27 01/ 28 01/ 29 01/ 32 01/ 38 01 904 200 43 01/ 49 01/ 50 01
	11-	<b>24-1333</b>			906 200 09 01/ 12 01/ 13 01/ 14 01/ 18 01 906 200 20 01/ 22 01/ 24 01/ 29 01/ 32 01 906 200 38 01/ 42 01/ 45 01/ 48 01/ 54 01 906 200 57 01/ 65 01
1725 K (180 kW) Eng.OM906.990	11-	<b>24-1320</b>		For vehicles without retarder	904 200 02 01/ 04 01/ 06 01/ 07 01/ 08 01 904 200 19 01/ 20 01/ 22 01/ 25 01/ 26 01 904 200 27 01/ 28 01/ 29 01/ 32 01/ 38 01 904 200 43 01/ 49 01/ 50 01
	11-	<b>24-1333</b>			906 200 09 01/ 12 01/ 13 01/ 14 01/ 18 01 906 200 20 01/ 22 01/ 24 01/ 29 01/ 32 01 906 200 38 01/ 42 01/ 45 01/ 48 01/ 54 01 906 200 57 01/ 65 01
712/713 (90-95 kW) Eng.OM904.909/.911/.915/.917	04-	<b>24-1320</b>		For vehicles without retarder	904 200 02 01/ 04 01/ 06 01/ 07 01/ 08 01 904 200 19 01/ 20 01/ 22 01/ 25 01/ 26 01 904 200 27 01/ 28 01/ 29 01/ 32 01/ 38 01 904 200 43 01/ 49 01/ 50 01
812/813 (90-95 kW) Eng.OM904.909/.911/.917	04-	<b>24-1320</b>		For vehicles without retarder	904 200 02 01/ 04 01/ 06 01/ 07 01/ 08 01 904 200 19 01/ 20 01/ 22 01/ 25 01/ 26 01 904 200 27 01/ 28 01/ 29 01/ 32 01/ 38 01 904 200 43 01/ 49 01/ 50 01
822 (160 kW) Eng.OM924.920	04-	<b>24-1320</b>		For vehicles without retarder	904 200 02 01/ 04 01/ 06 01/ 07 01/ 08 01 904 200 19 01/ 20 01/ 22 01/ 25 01/ 26 01 904 200 27 01/ 28 01/ 29 01/ 32 01/ 38 01 904 200 43 01/ 49 01/ 50 01
823/824 (170-175 kW) Eng.OM906.910/.915	04-	<b>24-1320</b>		For vehicles without retarder	904 200 02 01/ 04 01/ 06 01/ 07 01/ 08 01 904 200 19 01/ 20 01/ 22 01/ 25 01/ 26 01 904 200 27 01/ 28 01/ 29 01/ 32 01/ 38 01 904 200 43 01/ 49 01/ 50 01



**24-1320**



**24-1326**



**24-1327**



**24-1329**



**24-1333**

		<b>METELLI</b> ref.			<b>NOTE</b>	<b>Adaptable for OES</b>
823/824 (170-175 kW) Eng.OM906.910/.915	04-	<b>24-1333</b>				906 200 09 01/ 12 01/ 13 01/ 14 01/ 18 01 906 200 20 01/ 22 01/ 24 01/ 29 01/ 32 01 906 200 38 01/ 42 01/ 45 01/ 48 01/ 54 01 906 200 57 01/ 65 01
922 (160 kW) Eng.OM924.920	04-	<b>24-1320</b>			For vehicles without retarder	904 200 02 01/ 04 01/ 06 01/ 07 01/ 08 01 904 200 19 01/ 20 01/ 22 01/ 25 01/ 26 01 904 200 27 01/ 28 01/ 29 01/ 32 01/ 38 01 904 200 43 01/ 49 01/ 50 01
923/924 (170-175 kW) Eng.OM906.910/.915	04-	<b>24-1320</b>			For vehicles without retarder	904 200 02 01/ 04 01/ 06 01/ 07 01/ 08 01 904 200 19 01/ 20 01/ 22 01/ 25 01/ 26 01 904 200 27 01/ 28 01/ 29 01/ 32 01/ 38 01 904 200 43 01/ 49 01/ 50 01
	04-	<b>24-1333</b>				906 200 09 01/ 12 01/ 13 01/ 14 01/ 18 01 906 200 20 01/ 22 01/ 24 01/ 29 01/ 32 01 906 200 38 01/ 42 01/ 45 01/ 48 01/ 54 01 906 200 57 01/ 65 01
<b>Axor I '1/02-'10/04</b>						
1823 (170 kW) Eng.OM906.920	02-04	<b>24-1320</b>			For vehicles without retarder	904 200 02 01/ 04 01/ 06 01/ 07 01/ 08 01 904 200 19 01/ 20 01/ 22 01/ 25 01/ 26 01 904 200 27 01/ 28 01/ 29 01/ 32 01/ 38 01 904 200 43 01/ 49 01/ 50 01
1835 (260 kW) Eng.OM457.937	02-04	<b>24-1326</b>			For vehicles with retarder; Open hole	457 200 02 01/ 05 01/ 11 01/ 25 01/ 27 01
	02-04	<b>24-1327</b>			For vehicles with retarder; Close hole	442 200 04 01/ 06 01/ 07 01/ 09 01 457 200 10 01/ 24 01/ 28 01
	02-04	<b>24-1329</b>			For vehicles without retarder	457 200 08 01/ 19 01/ 23 01/ 29 01
1840 (295 kW) Eng.OM457.937	02-04	<b>24-1326</b>			For vehicles with retarder; Open hole	457 200 02 01/ 05 01/ 11 01/ 25 01/ 27 01
	02-04	<b>24-1327</b>			For vehicles with retarder; Close hole	442 200 04 01/ 06 01/ 07 01/ 09 01 457 200 10 01/ 24 01/ 28 01
	02-04	<b>24-1329</b>			For vehicles without retarder	457 200 08 01/ 19 01/ 23 01/ 29 01
1843 (315 kW) Eng.OM457.937	02-04	<b>24-1326</b>			For vehicles with retarder; Open hole	457 200 02 01/ 05 01/ 11 01/ 25 01/ 27 01
	02-04	<b>24-1327</b>			For vehicles with retarder; Close hole	442 200 04 01/ 06 01/ 07 01/ 09 01 457 200 10 01/ 24 01/ 28 01
	02-04	<b>24-1329</b>			For vehicles without retarder	457 200 08 01/ 19 01/ 23 01/ 29 01
2523 (170 kW) Eng.OM906.920	02-04	<b>24-1320</b>			For vehicles without retarder	904 200 02 01/ 04 01/ 06 01/ 07 01/ 08 01 904 200 19 01/ 20 01/ 22 01/ 25 01/ 26 01 904 200 27 01/ 28 01/ 29 01/ 32 01/ 38 01 904 200 43 01/ 49 01/ 50 01
2528 (205 kW) Eng.OM906.921	02-04	<b>24-1320</b>			For vehicles without retarder	904 200 02 01/ 04 01/ 06 01/ 07 01/ 08 01 904 200 19 01/ 20 01/ 22 01/ 25 01/ 26 01 904 200 27 01/ 28 01/ 29 01/ 32 01/ 38 01 904 200 43 01/ 49 01/ 50 01
2535 (260 kW) Eng.OM457.937	02-04	<b>24-1326</b>			For vehicles with retarder; Open hole	457 200 02 01/ 05 01/ 11 01/ 25 01/ 27 01
	02-04	<b>24-1327</b>			For vehicles with retarder; Close hole	442 200 04 01/ 06 01/ 07 01/ 09 01 457 200 10 01/ 24 01/ 28 01
	02-04	<b>24-1329</b>			For vehicles without retarder	457 200 08 01/ 19 01/ 23 01/ 29 01
2540 (295 kW) Eng.OM457.937	02-04	<b>24-1326</b>			For vehicles with retarder; Open hole	457 200 02 01/ 05 01/ 11 01/ 25 01/ 27 01
	02-04	<b>24-1327</b>			For vehicles with retarder; Close hole	442 200 04 01/ 06 01/ 07 01/ 09 01 457 200 10 01/ 24 01/ 28 01
	02-04	<b>24-1329</b>			For vehicles without retarder	457 200 08 01/ 19 01/ 23 01/ 29 01
2543 (315 kW) Eng.OM457.937	02-04	<b>24-1326</b>			For vehicles with retarder; Open hole	457 200 02 01/ 05 01/ 11 01/ 25 01/ 27 01
	02-04	<b>24-1327</b>			For vehicles with retarder; Close hole	442 200 04 01/ 06 01/ 07 01/ 09 01 457 200 10 01/ 24 01/ 28 01







**24-1320**



**24-1329**



**24-1333**

		<b>METELLI ref.</b>		<b>NOTE</b>	<b>Adaptable for OES</b>
2543 (315 kW) Eng.OM457.937	02-04	<b>24-1329</b>		For vehicles without retarder	457 200 08 01/ 19 01/ 23 01/ 29 01
2623 (170 kW) Eng.OM906.920	02-04	<b>24-1320</b>		For vehicles without retarder	904 200 02 01/ 04 01/ 06 01/ 07 01/ 08 01 904 200 19 01/ 20 01/ 22 01/ 25 01/ 26 01 904 200 27 01/ 28 01/ 29 01/ 32 01/ 38 01 904 200 43 01/ 49 01/ 50 01
2628 (205 kW) Eng.OM906.921	02-04	<b>24-1320</b>		For vehicles without retarder	904 200 02 01/ 04 01/ 06 01/ 07 01/ 08 01 904 200 19 01/ 20 01/ 22 01/ 25 01/ 26 01 904 200 27 01/ 28 01/ 29 01/ 32 01/ 38 01 904 200 43 01/ 49 01/ 50 01
3228 (205 kW) Eng.OM906.921	02-04	<b>24-1320</b>		For vehicles without retarder	904 200 02 01/ 04 01/ 06 01/ 07 01/ 08 01 904 200 19 01/ 20 01/ 22 01/ 25 01/ 26 01 904 200 27 01/ 28 01/ 29 01/ 32 01/ 38 01 904 200 43 01/ 49 01/ 50 01
<b>Axor II '10/04-</b>					
1824 (175 kW) Eng.OM906.920	04-	<b>24-1320</b>		For vehicles without retarder	904 200 02 01/ 04 01/ 06 01/ 07 01/ 08 01 904 200 19 01/ 20 01/ 22 01/ 25 01/ 26 01 904 200 27 01/ 28 01/ 29 01/ 32 01/ 38 01 904 200 43 01/ 49 01/ 50 01
	04-	<b>24-1333</b>			906 200 09 01/ 12 01/ 13 01/ 14 01/ 18 01 906 200 20 01/ 22 01/ 24 01/ 29 01/ 32 01 906 200 38 01/ 42 01/ 45 01/ 48 01/ 54 01 906 200 57 01/ 65 01
1824 (175 kW) Eng.OM906.922	04-	<b>24-1320</b>		For vehicles without retarder	904 200 02 01/ 04 01/ 06 01/ 07 01/ 08 01 904 200 19 01/ 20 01/ 22 01/ 25 01/ 26 01 904 200 27 01/ 28 01/ 29 01/ 32 01/ 38 01 904 200 43 01/ 49 01/ 50 01
	04-	<b>24-1333</b>			906 200 09 01/ 12 01/ 13 01/ 14 01/ 18 01 906 200 20 01/ 22 01/ 24 01/ 29 01/ 32 01 906 200 38 01/ 42 01/ 45 01/ 48 01/ 54 01 906 200 57 01/ 65 01
1828/1829 (205-210 kW) Eng.OM906.921/.926	04-	<b>24-1320</b>		For vehicles without retarder	904 200 02 01/ 04 01/ 06 01/ 07 01/ 08 01 904 200 19 01/ 20 01/ 22 01/ 25 01/ 26 01 904 200 27 01/ 28 01/ 29 01/ 32 01/ 38 01 904 200 43 01/ 49 01/ 50 01
	04-	<b>24-1333</b>			906 200 09 01/ 12 01/ 13 01/ 14 01/ 18 01 906 200 20 01/ 22 01/ 24 01/ 29 01/ 32 01 906 200 38 01/ 42 01/ 45 01/ 48 01/ 54 01 906 200 57 01/ 65 01
1828/1829 (205-210 kW) Eng.OM906.923/.928	04-	<b>24-1320</b>		For vehicles without retarder	904 200 02 01/ 04 01/ 06 01/ 07 01/ 08 01 904 200 19 01/ 20 01/ 22 01/ 25 01/ 26 01 904 200 27 01/ 28 01/ 29 01/ 32 01/ 38 01 904 200 43 01/ 49 01/ 50 01
	04-	<b>24-1333</b>			906 200 09 01/ 12 01/ 13 01/ 14 01/ 18 01 906 200 20 01/ 22 01/ 24 01/ 29 01/ 32 01 906 200 38 01/ 42 01/ 45 01/ 48 01/ 54 01 906 200 57 01/ 65 01
1833 (240 kW) Eng.OM926.913	04-	<b>24-1320</b>		For vehicles without retarder	904 200 02 01/ 04 01/ 06 01/ 07 01/ 08 01 904 200 19 01/ 20 01/ 22 01/ 25 01/ 26 01 904 200 27 01/ 28 01/ 29 01/ 32 01/ 38 01 904 200 43 01/ 49 01/ 50 01

			
<p><b>24-1320</b></p>	<p><b>24-1326</b></p>	<p><b>24-1327</b></p>	<p><b>24-1329</b></p>
			
<p><b>24-1333</b></p>			

		<b>METELLI</b> ref.			<b>NOTE</b>	<b>Adaptable for OES</b>
1833 (240 kW) Eng.OM926.913	04-	<b>24-1333</b>				906 200 09 01/ 12 01/ 13 01/ 14 01/ 18 01 906 200 20 01/ 22 01/ 24 01/ 29 01/ 32 01 906 200 38 01/ 42 01/ 45 01/ 48 01/ 54 01 906 200 57 01/ 65 01
1835/3535 (260 kW) Eng.OM457.937	09-	<b>24-1326</b>			For vehicles with retarder; Open hole	457 200 02 01/ 05 01/ 11 01/ 25 01/ 27 01
	09-	<b>24-1327</b>			For vehicles with retarder; Close hole	442 200 04 01/ 06 01/ 07 01/ 09 01 457 200 10 01/ 24 01/ 28 01
	09-	<b>24-1329</b>			For vehicles without retarder	457 200 08 01/ 19 01/ 23 01/ 29 01
1836 (265 kW) Eng.OM457.937/.948	04-	<b>24-1326</b>			For vehicles with retarder; Open hole	457 200 02 01/ 05 01/ 11 01/ 25 01/ 27 01
	04-	<b>24-1327</b>			For vehicles with retarder; Close hole	442 200 04 01/ 06 01/ 07 01/ 09 01 457 200 10 01/ 24 01/ 28 01
	04-	<b>24-1329</b>			For vehicles without retarder	457 200 08 01/ 19 01/ 23 01/ 29 01
1840 (295 kW) Eng.OM457.937/.948	04-	<b>24-1326</b>			For vehicles with retarder; Open hole	457 200 02 01/ 05 01/ 11 01/ 25 01/ 27 01
	04-	<b>24-1327</b>			For vehicles with retarder; Close hole	442 200 04 01/ 06 01/ 07 01/ 09 01 457 200 10 01/ 24 01/ 28 01
	04-	<b>24-1329</b>			For vehicles without retarder	457 200 08 01/ 19 01/ 23 01/ 29 01
1843 (315 kW) Eng.OM457.948	04-	<b>24-1326</b>			For vehicles with retarder; Open hole	457 200 02 01/ 05 01/ 11 01/ 25 01/ 27 01
	04-	<b>24-1327</b>			For vehicles with retarder; Close hole	442 200 04 01/ 06 01/ 07 01/ 09 01 457 200 10 01/ 24 01/ 28 01
	04-	<b>24-1329</b>			For vehicles without retarder	457 200 08 01/ 19 01/ 23 01/ 29 01
1933 S (240 kW) Eng.OM926.921	11-	<b>24-1320</b>			For vehicles without retarder	904 200 02 01/ 04 01/ 06 01/ 07 01/ 08 01 904 200 19 01/ 20 01/ 22 01/ 25 01/ 26 01 904 200 27 01/ 28 01/ 29 01/ 32 01/ 38 01 904 200 43 01/ 49 01/ 50 01
	11-	<b>24-1333</b>				906 200 09 01/ 12 01/ 13 01/ 14 01/ 18 01 906 200 20 01/ 22 01/ 24 01/ 29 01/ 32 01 906 200 38 01/ 42 01/ 45 01/ 48 01/ 54 01 906 200 57 01/ 65 01
1933 S (240 kW) Eng.OM926.990	11-	<b>24-1320</b>			For vehicles without retarder	904 200 02 01/ 04 01/ 06 01/ 07 01/ 08 01 904 200 19 01/ 20 01/ 22 01/ 25 01/ 26 01 904 200 27 01/ 28 01/ 29 01/ 32 01/ 38 01 904 200 43 01/ 49 01/ 50 01
	11-	<b>24-1333</b>				906 200 09 01/ 12 01/ 13 01/ 14 01/ 18 01 906 200 20 01/ 22 01/ 24 01/ 29 01/ 32 01 906 200 38 01/ 42 01/ 45 01/ 48 01/ 54 01 906 200 57 01/ 65 01
2035 (260 kW) Eng.OM457.910/.917/.918	11-	<b>24-1326</b>			For vehicles with retarder; Open hole	457 200 02 01/ 05 01/ 11 01/ 25 01/ 27 01
	11-	<b>24-1327</b>			For vehicles with retarder; Close hole	442 200 04 01/ 06 01/ 07 01/ 09 01 457 200 10 01/ 24 01/ 28 01
	11-	<b>24-1329</b>			For vehicles without retarder	457 200 08 01/ 19 01/ 23 01/ 29 01
2035/2036 (260 kW) Eng.OM457.910/917/918	11-	<b>24-1326</b>			For vehicles with retarder; Open hole	457 200 02 01/ 05 01/ 11 01/ 25 01/ 27 01
	11-	<b>24-1327</b>			For vehicles with retarder; Close hole	442 200 04 01/ 06 01/ 07 01/ 09 01 457 200 10 01/ 24 01/ 28 01
	11-	<b>24-1329</b>			For vehicles without retarder	457 200 08 01/ 19 01/ 23 01/ 29 01
2040 (295 kW) Eng.OM457.910/.917/.918	11-	<b>24-1326</b>			For vehicles with retarder; Open hole	457 200 02 01/ 05 01/ 11 01/ 25 01/ 27 01
	11-	<b>24-1327</b>			For vehicles with retarder; Close hole	442 200 04 01/ 06 01/ 07 01/ 09 01 457 200 10 01/ 24 01/ 28 01
	11-	<b>24-1329</b>			For vehicles without retarder	457 200 08 01/ 19 01/ 23 01/ 29 01
2040/2041 (295 kW) Eng.OM457.910/917/918	11-	<b>24-1326</b>			For vehicles with retarder; Open hole	457 200 02 01/ 05 01/ 11 01/ 25 01/ 27 01
	11-	<b>24-1327</b>			For vehicles with retarder; Close hole	442 200 04 01/ 06 01/ 07 01/ 09 01 457 200 10 01/ 24 01/ 28 01
	11-	<b>24-1329</b>			For vehicles without retarder	457 200 08 01/ 19 01/ 23 01/ 29 01



**24-1320**



**24-1326**



**24-1327**



**24-1329**



**24-1333**

		<b>METELLI</b> ref.			<b>NOTE</b>	<b>Adaptable for OES</b>
2044 (315 kW) Eng.OM457.910/.917/.918	11-	<b>24-1326</b>			For vehicles with retarder; Open hole	457 200 02 01/ 05 01/ 11 01/ 25 01/ 27 01
	11-	<b>24-1327</b>			For vehicles with retarder; Close hole	442 200 04 01/ 06 01/ 07 01/ 09 01 457 200 10 01/ 24 01/ 28 01
	11-	<b>24-1329</b>			For vehicles without retarder	457 200 08 01/ 19 01/ 23 01/ 29 01
2044/3343/3344/4144 (315 kW) Eng.OM457.910/917/918	11-	<b>24-1326</b>			For vehicles with retarder; Open hole	457 200 02 01/ 05 01/ 11 01/ 25 01/ 27 01
	11-	<b>24-1327</b>			For vehicles with retarder; Close hole	442 200 04 01/ 06 01/ 07 01/ 09 01 457 200 10 01/ 24 01/ 28 01
	11-	<b>24-1329</b>			For vehicles without retarder	457 200 08 01/ 19 01/ 23 01/ 29 01
2523 (170 kW) Eng.OM906.920	11-	<b>24-1333</b>				906 200 09 01/ 12 01/ 13 01/ 14 01/ 18 01 906 200 20 01/ 22 01/ 24 01/ 29 01/ 32 01 906 200 38 01/ 42 01/ 45 01/ 48 01/ 54 01 906 200 57 01/ 65 01
2528/2529 (205-210 kW) Eng.OM906.921/.926	04-	<b>24-1320</b>			For vehicles without retarder	904 200 02 01/ 04 01/ 06 01/ 07 01/ 08 01 904 200 19 01/ 20 01/ 22 01/ 25 01/ 26 01 904 200 27 01/ 28 01/ 29 01/ 32 01/ 38 01 904 200 43 01/ 49 01/ 50 01
	04-	<b>24-1333</b>				906 200 09 01/ 12 01/ 13 01/ 14 01/ 18 01 906 200 20 01/ 22 01/ 24 01/ 29 01/ 32 01 906 200 38 01/ 42 01/ 45 01/ 48 01/ 54 01 906 200 57 01/ 65 01
2528/3028/3228 (205 kW) Eng.OM906.921	11-	<b>24-1320</b>			For vehicles without retarder	904 200 02 01/ 04 01/ 06 01/ 07 01/ 08 01 904 200 19 01/ 20 01/ 22 01/ 25 01/ 26 01 904 200 27 01/ 28 01/ 29 01/ 32 01/ 38 01 904 200 43 01/ 49 01/ 50 01
	11-	<b>24-1333</b>				906 200 09 01/ 12 01/ 13 01/ 14 01/ 18 01 906 200 20 01/ 22 01/ 24 01/ 29 01/ 32 01 906 200 38 01/ 42 01/ 45 01/ 48 01/ 54 01 906 200 57 01/ 65 01
2533 (240 kW) Eng.OM926.913	04-	<b>24-1320</b>			For vehicles without retarder	904 200 02 01/ 04 01/ 06 01/ 07 01/ 08 01 904 200 19 01/ 20 01/ 22 01/ 25 01/ 26 01 904 200 27 01/ 28 01/ 29 01/ 32 01/ 38 01 904 200 43 01/ 49 01/ 50 01
	04-	<b>24-1333</b>				906 200 09 01/ 12 01/ 13 01/ 14 01/ 18 01 906 200 20 01/ 22 01/ 24 01/ 29 01/ 32 01 906 200 38 01/ 42 01/ 45 01/ 48 01/ 54 01 906 200 57 01/ 65 01
2536 (265 kW) Eng.OM457.937/.948	04-	<b>24-1326</b>			For vehicles with retarder; Open hole	457 200 02 01/ 05 01/ 11 01/ 25 01/ 27 01
	04-	<b>24-1327</b>			For vehicles with retarder; Close hole	442 200 04 01/ 06 01/ 07 01/ 09 01 457 200 10 01/ 24 01/ 28 01
	04-	<b>24-1329</b>			For vehicles without retarder	457 200 08 01/ 19 01/ 23 01/ 29 01
2540 (295 kW) Eng.OM457.937/.948	04-	<b>24-1326</b>			For vehicles with retarder; Open hole	457 200 02 01/ 05 01/ 11 01/ 25 01/ 27 01
	04-	<b>24-1327</b>			For vehicles with retarder; Close hole	442 200 04 01/ 06 01/ 07 01/ 09 01 457 200 10 01/ 24 01/ 28 01
	04-	<b>24-1329</b>			For vehicles without retarder	457 200 08 01/ 19 01/ 23 01/ 29 01
2543 (315 kW) Eng.OM457.937/.948	04-	<b>24-1326</b>			For vehicles with retarder; Open hole	457 200 02 01/ 05 01/ 11 01/ 25 01/ 27 01
	04-	<b>24-1327</b>			For vehicles with retarder; Close hole	442 200 04 01/ 06 01/ 07 01/ 09 01 457 200 10 01/ 24 01/ 28 01
	04-	<b>24-1329</b>			For vehicles without retarder	457 200 08 01/ 19 01/ 23 01/ 29 01
2628 (205-210 kW) Eng.OM906.921/.926	04-	<b>24-1320</b>			For vehicles without retarder	904 200 02 01/ 04 01/ 06 01/ 07 01/ 08 01 904 200 19 01/ 20 01/ 22 01/ 25 01/ 26 01 904 200 27 01/ 28 01/ 29 01/ 32 01/ 38 01 904 200 43 01/ 49 01/ 50 01



**24-1320**



**24-1326**



**24-1327**





**24-1329**



**24-1333**

		<b>METELLI</b> ref.			<b>NOTE</b>	<b>Adaptable for OES</b>
2628 (205-210 kW) Eng.OM906.921/.926	04-	<b>24-1333</b>				906 200 09 01/ 12 01/ 13 01/ 14 01/ 18 01 906 200 20 01/ 22 01/ 24 01/ 29 01/ 32 01 906 200 38 01/ 42 01/ 45 01/ 48 01/ 54 01 906 200 57 01/ 65 01
2633 (240 kW) Eng.OM926.913	04-	<b>24-1320</b>			For vehicles without retarder	904 200 02 01/ 04 01/ 06 01/ 07 01/ 08 01 904 200 19 01/ 20 01/ 22 01/ 25 01/ 26 01 904 200 27 01/ 28 01/ 29 01/ 32 01/ 38 01 904 200 43 01/ 49 01/ 50 01
	04-	<b>24-1333</b>				906 200 09 01/ 12 01/ 13 01/ 14 01/ 18 01 906 200 20 01/ 22 01/ 24 01/ 29 01/ 32 01 906 200 38 01/ 42 01/ 45 01/ 48 01/ 54 01 906 200 57 01/ 65 01
2636 (265 kW) Eng.OM457.937/.948	04-	<b>24-1326</b>			For vehicles with retarder; Open hole	457 200 02 01/ 05 01/ 11 01/ 25 01/ 27 01
	04-	<b>24-1327</b>			For vehicles with retarder; Close hole	442 200 04 01/ 06 01/ 07 01/ 09 01 457 200 10 01/ 24 01/ 28 01
	04-	<b>24-1329</b>			For vehicles without retarder	457 200 08 01/ 19 01/ 23 01/ 29 01
2640 (295 kW) Eng.OM457.956/.957	04-	<b>24-1326</b>			For vehicles with retarder; Open hole	457 200 02 01/ 05 01/ 11 01/ 25 01/ 27 01
	04-	<b>24-1327</b>			For vehicles with retarder; Close hole	442 200 04 01/ 06 01/ 07 01/ 09 01 457 200 10 01/ 24 01/ 28 01
	04-	<b>24-1329</b>			For vehicles without retarder	457 200 08 01/ 19 01/ 23 01/ 29 01
2643 (315 kW) Eng.OM457.956/.957	04-	<b>24-1326</b>			For vehicles with retarder; Open hole	457 200 02 01/ 05 01/ 11 01/ 25 01/ 27 01
	04-	<b>24-1327</b>			For vehicles with retarder; Close hole	442 200 04 01/ 06 01/ 07 01/ 09 01 457 200 10 01/ 24 01/ 28 01
	04-	<b>24-1329</b>			For vehicles without retarder	457 200 08 01/ 19 01/ 23 01/ 29 01
2644 (315 kW) Eng.OM457.918	11-	<b>24-1326</b>			For vehicles with retarder; Open hole	457 200 02 01/ 05 01/ 11 01/ 25 01/ 27 01
	11-	<b>24-1327</b>			For vehicles with retarder; Close hole	442 200 04 01/ 06 01/ 07 01/ 09 01 457 200 10 01/ 24 01/ 28 01
	11-	<b>24-1329</b>			For vehicles without retarder	457 200 08 01/ 19 01/ 23 01/ 29 01
2644 (315 kW) Eng.OM457.937	11-	<b>24-1326</b>			For vehicles with retarder; Open hole	457 200 02 01/ 05 01/ 11 01/ 25 01/ 27 01
	11-	<b>24-1327</b>			For vehicles with retarder; Close hole	442 200 04 01/ 06 01/ 07 01/ 09 01 457 200 10 01/ 24 01/ 28 01
	11-	<b>24-1329</b>			For vehicles without retarder	457 200 08 01/ 19 01/ 23 01/ 29 01
2644 (315 kW) Eng.OM457.948	11-	<b>24-1326</b>			For vehicles with retarder; Open hole	457 200 02 01/ 05 01/ 11 01/ 25 01/ 27 01
	11-	<b>24-1327</b>			For vehicles with retarder; Close hole	442 200 04 01/ 06 01/ 07 01/ 09 01 457 200 10 01/ 24 01/ 28 01
	11-	<b>24-1329</b>			For vehicles without retarder	457 200 08 01/ 19 01/ 23 01/ 29 01
2831 (225 kW) Eng.OM926.926/930/932	11-	<b>24-1320</b>			For vehicles without retarder	904 200 02 01/ 04 01/ 06 01/ 07 01/ 08 01 904 200 19 01/ 20 01/ 22 01/ 25 01/ 26 01 904 200 27 01/ 28 01/ 29 01/ 32 01/ 38 01 904 200 43 01/ 49 01/ 50 01
	11-	<b>24-1333</b>				906 200 09 01/ 12 01/ 13 01/ 14 01/ 18 01 906 200 20 01/ 22 01/ 24 01/ 29 01/ 32 01 906 200 38 01/ 42 01/ 45 01/ 48 01/ 54 01 906 200 57 01/ 65 01
3236 (265 kW) Eng.OM457.956/.957	04-	<b>24-1326</b>			For vehicles with retarder; Open hole	457 200 02 01/ 05 01/ 11 01/ 25 01/ 27 01
	04-	<b>24-1327</b>			For vehicles with retarder; Close hole	442 200 04 01/ 06 01/ 07 01/ 09 01 457 200 10 01/ 24 01/ 28 01
	04-	<b>24-1329</b>			For vehicles without retarder	457 200 08 01/ 19 01/ 23 01/ 29 01
3240 (295 kW) Eng.OM457.937/.948	04-	<b>24-1326</b>			For vehicles with retarder; Open hole	457 200 02 01/ 05 01/ 11 01/ 25 01/ 27 01
	05-	<b>24-1327</b>			For vehicles with retarder; Close hole	442 200 04 01/ 06 01/ 07 01/ 09 01 457 200 10 01/ 24 01/ 28 01
	05-	<b>24-1329</b>			For vehicles without retarder	457 200 08 01/ 19 01/ 23 01/ 29 01



			
<b>24-1326</b>	<b>24-1327</b>	<b>24-1329</b>	

		<b>METELLI</b> ref.			<b>NOTE</b>	<b>Adaptable for OES</b>
3240 (295 kW) Eng.OM457.956/957	04-	<b>24-1326</b>			For vehicles with retarder; Open hole	457 200 02 01/ 05 01/ 11 01/ 25 01/ 27 01
	04-	<b>24-1327</b>			For vehicles with retarder; Close hole	442 200 04 01/ 06 01/ 07 01/ 09 01 457 200 10 01/ 24 01/ 28 01
	04-	<b>24-1329</b>			For vehicles without retarder	457 200 08 01/ 19 01/ 23 01/ 29 01
3243 (315 kW) Eng.OM457.956/957	04-	<b>24-1326</b>			For vehicles with retarder; Open hole	457 200 02 01/ 05 01/ 11 01/ 25 01/ 27 01
	04-	<b>24-1327</b>			For vehicles with retarder; Close hole	442 200 04 01/ 06 01/ 07 01/ 09 01 457 200 10 01/ 24 01/ 28 01
	04-	<b>24-1329</b>			For vehicles without retarder	457 200 08 01/ 19 01/ 23 01/ 29 01
3335 (260 kW) Eng.OM457.937	04-	<b>24-1326</b>			For vehicles with retarder; Open hole	457 200 02 01/ 05 01/ 11 01/ 25 01/ 27 01
	04-	<b>24-1327</b>			For vehicles with retarder; Close hole	442 200 04 01/ 06 01/ 07 01/ 09 01 457 200 10 01/ 24 01/ 28 01
	04-	<b>24-1329</b>			For vehicles without retarder	457 200 08 01/ 19 01/ 23 01/ 29 01
3335 (260 kW) Eng.OM457.962	08-	<b>24-1326</b>			For vehicles with retarder; Open hole	457 200 02 01/ 05 01/ 11 01/ 25 01/ 27 01
	08-	<b>24-1327</b>			For vehicles with retarder; Close hole	442 200 04 01/ 06 01/ 07 01/ 09 01 457 200 10 01/ 24 01/ 28 01
	08-	<b>24-1329</b>			For vehicles without retarder	457 200 08 01/ 19 01/ 23 01/ 29 01
3335/4135 (260 kW) Eng.OM457.956/957	09-	<b>24-1326</b>			For vehicles with retarder; Open hole	457 200 02 01/ 05 01/ 11 01/ 25 01/ 27 01
	09-	<b>24-1327</b>			For vehicles with retarder; Close hole	442 200 04 01/ 06 01/ 07 01/ 09 01 457 200 10 01/ 24 01/ 28 01
	09-	<b>24-1329</b>			For vehicles without retarder	457 200 08 01/ 19 01/ 23 01/ 29 01
3340 (295 kW) Eng.OM457.937	04-	<b>24-1326</b>			For vehicles with retarder; Open hole	457 200 02 01/ 05 01/ 11 01/ 25 01/ 27 01
	04-	<b>24-1327</b>			For vehicles with retarder; Close hole	442 200 04 01/ 06 01/ 07 01/ 09 01 457 200 10 01/ 24 01/ 28 01
	04-	<b>24-1329</b>			For vehicles without retarder	457 200 08 01/ 19 01/ 23 01/ 29 01
3340/3341 (295 kW) Eng.OM457.962	09-	<b>24-1326</b>			For vehicles with retarder; Open hole	457 200 02 01/ 05 01/ 11 01/ 25 01/ 27 01
	09-	<b>24-1327</b>			For vehicles with retarder; Close hole	442 200 04 01/ 06 01/ 07 01/ 09 01 457 200 10 01/ 24 01/ 28 01
	09-	<b>24-1329</b>			For vehicles without retarder	457 200 08 01/ 19 01/ 23 01/ 29 01
3340/3341/4140 (295 kW) Eng.OM457.910/917/918	09-	<b>24-1326</b>			For vehicles with retarder; Open hole	457 200 02 01/ 05 01/ 11 01/ 25 01/ 27 01
	09-	<b>24-1327</b>			For vehicles with retarder; Close hole	442 200 04 01/ 06 01/ 07 01/ 09 01 457 200 10 01/ 24 01/ 28 01
	09-	<b>24-1329</b>			For vehicles without retarder	457 200 08 01/ 19 01/ 23 01/ 29 01
3343 (315 kW) Eng.OM457.937	04-	<b>24-1326</b>			For vehicles with retarder; Open hole	457 200 02 01/ 05 01/ 11 01/ 25 01/ 27 01
	04-	<b>24-1327</b>			For vehicles with retarder; Close hole	442 200 04 01/ 06 01/ 07 01/ 09 01 457 200 10 01/ 24 01/ 28 01
	04-	<b>24-1329</b>			For vehicles without retarder	457 200 08 01/ 19 01/ 23 01/ 29 01
3344/4143 (315 kW) Eng.OM457.956/957	09-	<b>24-1326</b>			For vehicles with retarder; Open hole	457 200 02 01/ 05 01/ 11 01/ 25 01/ 27 01
	09-	<b>24-1327</b>			For vehicles with retarder; Close hole	442 200 04 01/ 06 01/ 07 01/ 09 01 457 200 10 01/ 24 01/ 28 01
	09-	<b>24-1329</b>			For vehicles without retarder	457 200 08 01/ 19 01/ 23 01/ 29 01
4140 (295 kW) Eng.OM457.956/957	09-	<b>24-1326</b>			For vehicles with retarder; Open hole	457 200 02 01/ 05 01/ 11 01/ 25 01/ 27 01
	09-	<b>24-1327</b>			For vehicles with retarder; Close hole	442 200 04 01/ 06 01/ 07 01/ 09 01 457 200 10 01/ 24 01/ 28 01
	09-	<b>24-1329</b>			For vehicles without retarder	457 200 08 01/ 19 01/ 23 01/ 29 01
<b>CapaCity (O 530 GL) '4/07-</b>						
CapaCity (354 kW) Eng.OM457.950/973	07-	<b>24-1326</b>			For vehicles with retarder; Open hole	457 200 02 01/ 05 01/ 11 01/ 25 01/ 27 01
	07-	<b>24-1327</b>			For vehicles with retarder; Close hole	442 200 04 01/ 06 01/ 07 01/ 09 01 457 200 10 01/ 24 01/ 28 01
	07-	<b>24-1329</b>			For vehicles without retarder	457 200 08 01/ 19 01/ 23 01/ 29 01



**24-1320**



**24-1326**



**24-1327**



**24-1329**



**24-1333**

		<b>METELLI</b> ref.			<b>NOTE</b>	<b>Adaptable for OES</b>
<b>Citaro (O 530) '1/98-</b>						
Citaro G (205 kW) Eng.OM906.960/.930/.961	99-	<b>24-1333</b>				906 200 09 01/ 12 01/ 13 01/ 14 01/ 18 01 906 200 20 01/ 22 01/ 24 01/ 29 01/ 32 01 906 200 38 01/ 42 01/ 45 01/ 48 01/ 54 01 906 200 57 01/ 65 01
Citaro L (205 kW) Eng.OM906.930/.960	99-	<b>24-1333</b>				906 200 09 01/ 12 01/ 13 01/ 14 01/ 18 01 906 200 20 01/ 22 01/ 24 01/ 29 01/ 32 01 906 200 38 01/ 42 01/ 45 01/ 48 01/ 54 01 906 200 57 01/ 65 01
Citaro N (180 kW) Eng.OM906.962/.963	99-	<b>24-1333</b>				906 200 09 01/ 12 01/ 13 01/ 14 01/ 18 01 906 200 20 01/ 22 01/ 24 01/ 29 01/ 32 01 906 200 38 01/ 42 01/ 45 01/ 48 01/ 54 01 906 200 57 01/ 65 01
Citaro N (185 kW) Eng.OM457.942	04-	<b>24-1326</b>			For vehicles with retarder; Open hole	457 200 02 01/ 05 01/ 11 01/ 25 01/ 27 01
	98-	<b>24-1327</b>			For vehicles with retarder; Close hole	442 200 04 01/ 06 01/ 07 01/ 09 01 457 200 10 01/ 24 01/ 28 01
	98-	<b>24-1329</b>			For vehicles without retarder	457 200 08 01/ 19 01/ 23 01/ 29 01
Citaro N (205 kW) Eng.OM906.930	98-	<b>24-1333</b>				906 200 09 01/ 12 01/ 13 01/ 14 01/ 18 01 906 200 20 01/ 22 01/ 24 01/ 29 01/ 32 01 906 200 38 01/ 42 01/ 45 01/ 48 01/ 54 01 906 200 57 01/ 65 01
Citaro N (205 kW) Eng.OM906.960/.961	98-	<b>24-1333</b>				906 200 09 01/ 12 01/ 13 01/ 14 01/ 18 01 906 200 20 01/ 22 01/ 24 01/ 29 01/ 32 01 906 200 38 01/ 42 01/ 45 01/ 48 01/ 54 01 906 200 57 01/ 65 01
Citaro N (220 kW) Eng.OM457.934/.942	98-	<b>24-1326</b>			For vehicles with retarder; Open hole	457 200 02 01/ 05 01/ 11 01/ 25 01/ 27 01
	98-	<b>24-1327</b>			For vehicles with retarder; Close hole	442 200 04 01/ 06 01/ 07 01/ 09 01 457 200 10 01/ 24 01/ 28 01
	98-	<b>24-1329</b>			For vehicles without retarder	457 200 08 01/ 19 01/ 23 01/ 29 01
Citaro N (260 kW) Eng.OM457.942	98-	<b>24-1326</b>			For vehicles with retarder; Open hole	457 200 02 01/ 05 01/ 11 01/ 25 01/ 27 01
	98-	<b>24-1327</b>			For vehicles with retarder; Close hole	442 200 04 01/ 06 01/ 07 01/ 09 01 457 200 10 01/ 24 01/ 28 01
	98-	<b>24-1329</b>			For vehicles without retarder	457 200 08 01/ 19 01/ 23 01/ 29 01
<b>Cito (O 520) '1/98-</b>						
4.2 (130 kW) Eng.OM904.942	98-	<b>24-1320</b>			For vehicles without retarder	904 200 02 01/ 04 01/ 06 01/ 07 01/ 08 01 904 200 19 01/ 20 01/ 22 01/ 25 01/ 26 01 904 200 27 01/ 28 01/ 29 01/ 32 01/ 38 01 904 200 43 01/ 49 01/ 50 01
<b>Conecto (O 345) '11/01-</b>						
C, H, M, UE (185-220-260 kW) Eng.OM457.942	01-	<b>24-1327</b>			For vehicles with retarder; Close hole	442 200 04 01/ 06 01/ 07 01/ 09 01 457 200 10 01/ 24 01/ 28 01
	01-	<b>24-1329</b>			For vehicles without retarder	457 200 08 01/ 19 01/ 23 01/ 29 01
C, H, UE (205 kW) Eng.OM906.960	01-	<b>24-1320</b>			For vehicles without retarder	904 200 02 01/ 04 01/ 06 01/ 07 01/ 08 01 904 200 19 01/ 20 01/ 22 01/ 25 01/ 26 01 904 200 27 01/ 28 01/ 29 01/ 32 01/ 38 01 904 200 43 01/ 49 01/ 50 01
	01-	<b>24-1333</b>				906 200 09 01/ 12 01/ 13 01/ 14 01/ 18 01 906 200 20 01/ 22 01/ 24 01/ 29 01/ 32 01 906 200 38 01/ 42 01/ 45 01/ 48 01/ 54 01 906 200 57 01/ 65 01

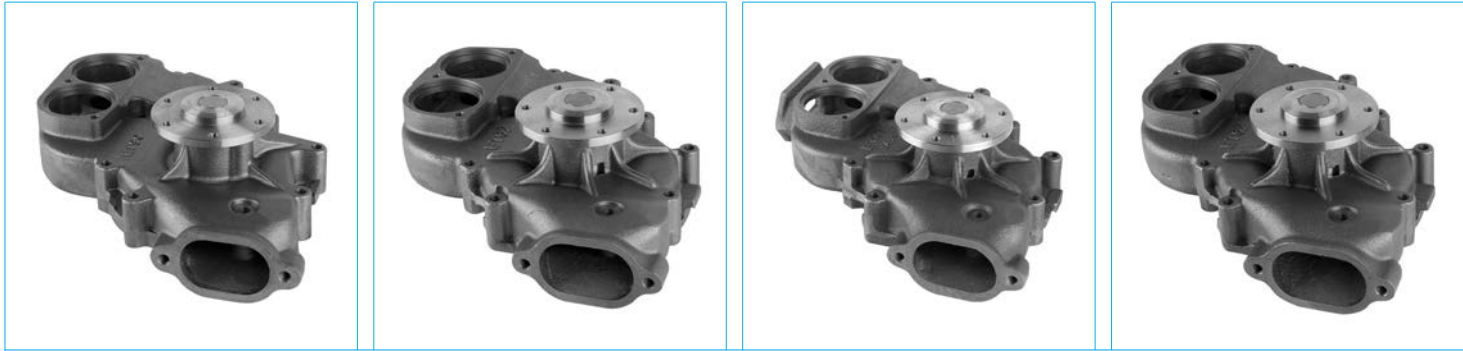

**24-1292**

**24-1298**

**24-1302**

**24-1309**

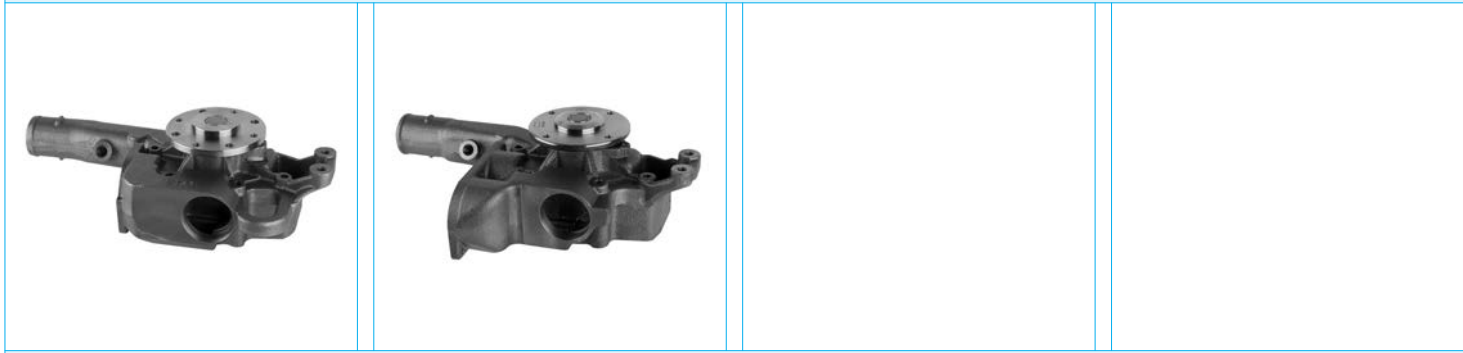





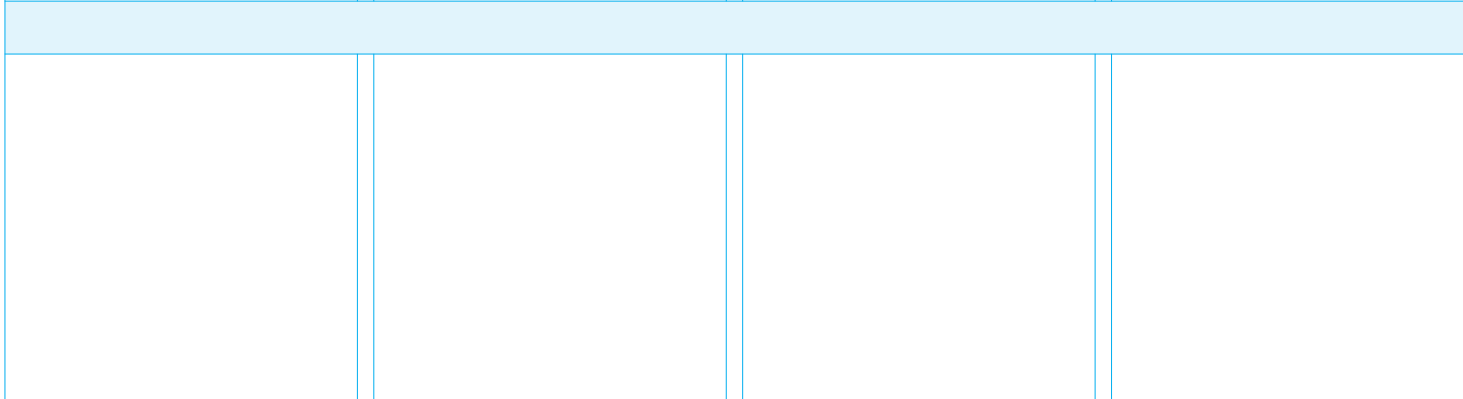
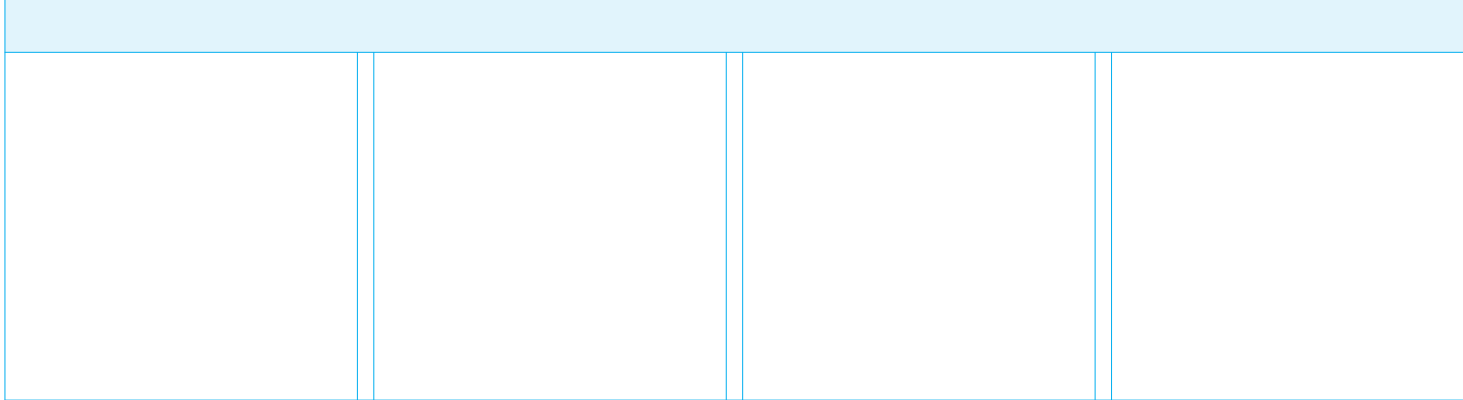
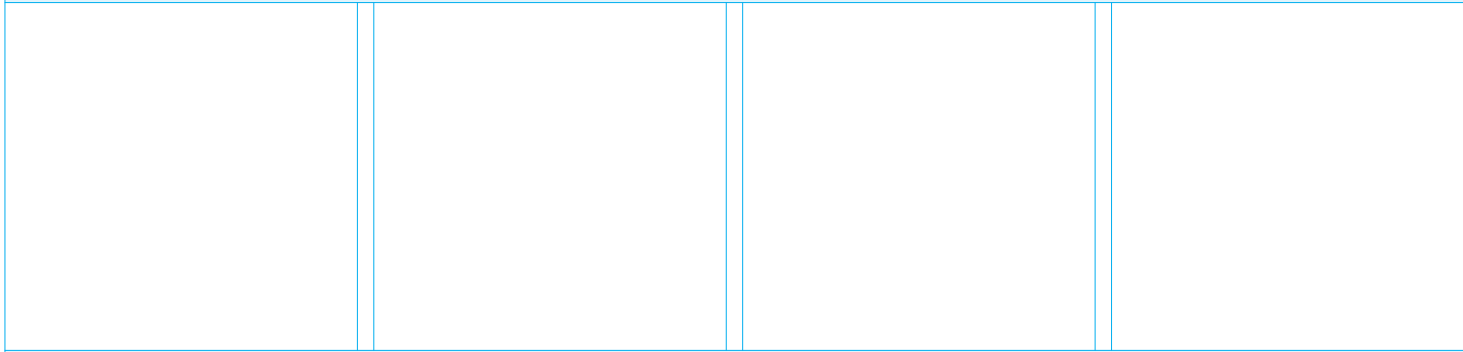









**24-1320**

**24-1333**



		<b>METELLI</b> ref.			<b>NOTE</b>	<b>Adaptable for OES</b>
<b>Econic '3/98-</b>						
1823 (170 kW) Eng.OM906.940	98-	<b>24-1320</b>			For vehicles without retarder	904 200 02 01/ 04 01/ 06 01/ 07 01/ 08 01 904 200 19 01/ 20 01/ 22 01/ 25 01/ 26 01 904 200 27 01/ 28 01/ 29 01/ 32 01/ 38 01 904 200 43 01/ 49 01/ 50 01
	98-	<b>24-1333</b>				906 200 09 01/ 12 01/ 13 01/ 14 01/ 18 01 906 200 20 01/ 22 01/ 24 01/ 29 01/ 32 01 906 200 38 01/ 42 01/ 45 01/ 48 01/ 54 01 906 200 57 01/ 65 01
1828/2628 (205 kW) Eng.OM906.900	00-	<b>24-1333</b>				906 200 09 01/ 12 01/ 13 01/ 14 01/ 18 01 906 200 20 01/ 22 01/ 24 01/ 29 01/ 32 01 906 200 38 01/ 42 01/ 45 01/ 48 01/ 54 01 906 200 57 01/ 65 01
1833/2633 (240 kW) Eng.OM926.924	06-	<b>24-1320</b>			For vehicles without retarder	904 200 02 01/ 04 01/ 06 01/ 07 01/ 08 01 904 200 19 01/ 20 01/ 22 01/ 25 01/ 26 01 904 200 27 01/ 28 01/ 29 01/ 32 01/ 38 01 904 200 43 01/ 49 01/ 50 01
	06-	<b>24-1333</b>				906 200 09 01/ 12 01/ 13 01/ 14 01/ 18 01 906 200 20 01/ 22 01/ 24 01/ 29 01/ 32 01 906 200 38 01/ 42 01/ 45 01/ 48 01/ 54 01 906 200 57 01/ 65 01
1833/2633/3233 (240 kW) Eng.OM926.934	01-	<b>24-1320</b>			For vehicles without retarder	904 200 02 01/ 04 01/ 06 01/ 07 01/ 08 01 904 200 19 01/ 20 01/ 22 01/ 25 01/ 26 01 904 200 27 01/ 28 01/ 29 01/ 32 01/ 38 01 904 200 43 01/ 49 01/ 50 01
	01-	<b>24-1333</b>				906 200 09 01/ 12 01/ 13 01/ 14 01/ 18 01 906 200 20 01/ 22 01/ 24 01/ 29 01/ 32 01 906 200 38 01/ 42 01/ 45 01/ 48 01/ 54 01 906 200 57 01/ 65 01
2628 (205 kW) Eng.OM906.941/.952	98-	<b>24-1320</b>			For vehicles without retarder	904 200 02 01/ 04 01/ 06 01/ 07 01/ 08 01 904 200 19 01/ 20 01/ 22 01/ 25 01/ 26 01 904 200 27 01/ 28 01/ 29 01/ 32 01/ 38 01 904 200 43 01/ 49 01/ 50 01
	98-	<b>24-1333</b>				906 200 09 01/ 12 01/ 13 01/ 14 01/ 18 01 906 200 20 01/ 22 01/ 24 01/ 29 01/ 32 01 906 200 38 01/ 42 01/ 45 01/ 48 01/ 54 01 906 200 57 01/ 65 01
2633 (240 kW) Eng.OM926.921	01-	<b>24-1320</b>			For vehicles without retarder	904 200 02 01/ 04 01/ 06 01/ 07 01/ 08 01 904 200 19 01/ 20 01/ 22 01/ 25 01/ 26 01 904 200 27 01/ 28 01/ 29 01/ 32 01/ 38 01 904 200 43 01/ 49 01/ 50 01
	01-	<b>24-1333</b>				906 200 09 01/ 12 01/ 13 01/ 14 01/ 18 01 906 200 20 01/ 22 01/ 24 01/ 29 01/ 32 01 906 200 38 01/ 42 01/ 45 01/ 48 01/ 54 01 906 200 57 01/ 65 01
<b>Industrial '1/72-</b>						
11.9 TD (206 kW) Eng.OM447A/LA	86-	<b>24-1302</b>			For vehicles with retarder, w/o pulley	422 200 06 01
	86-	<b>24-1309</b>			For vehicles without retarder; Eng. -744215	403 200 76 01/ 77 01 422 200 13 01/ 14 01,441 200 03 01
20.6 D (184-236 kW) Eng.OM404	72-	<b>24-1292</b>			For vehicles without retarder; Eng. 744216-	403 200 27 01/ 32 01/ 34 01 403 200 35 01/ 49 01/ 70 01
	72-	<b>24-1298</b>			For vehicles without retarder, w/o pulley; Impeller Ø 135mm, Incl Electronic fuel Injection pump	403 200 57 01,422 200 05 01/ 10 01
	72-	<b>24-1302</b>			For vehicles with retarder, w/o pulley	422 200 06 01

			
<b>24-0870</b>	<b>24-0871</b>	<b>24-1295</b>	<b>24-1296</b>
			
<b>24-1298</b>	<b>24-1299</b>	<b>24-1300</b>	<b>24-1302</b>
			
<b>24-1309</b>	<b>24-1320</b>	<b>24-1325</b>	<b>24-1326</b>
			
<b>24-1327</b>	<b>24-1329</b>	<b>24-1333</b>	

		<b>METELLI</b> ref.			<b>NOTE</b>	<b>Adaptable for OES</b>
21.9 D (309-390-404-452 kW) Eng.OM424A/LA	81-	<b>24-1309</b>			For vehicles without retarder; Eng. -744215	403 200 76 01/ 77 01 422 200 13 01/ 14 01,441 200 03 01
21.9 D (392-478-610 kW) Eng.OM444A/LA	86-	<b>24-1298</b>			For vehicles without retarder, w/o pulley; Impeller Ø 135mm, Incl Electronic fuel Injection pump	403 200 57 01,422 200 05 01/ 10 01
	86-	<b>24-1302</b>			For vehicles with retarder, w/o pulley	422 200 06 01
	86-	<b>24-1309</b>			For vehicles without retarder; Eng. -744215	403 200 76 01/ 77 01 422 200 13 01/ 14 01,441 200 03 01
<b>Integro (O 550) '1/01-</b>						
O 550 (210 kW) Eng.OM926.939	06-	<b>24-1320</b>			For vehicles without retarder	904 200 02 01/ 04 01/ 06 01/ 07 01/ 08 01 904 200 19 01/ 20 01/ 22 01/ 25 01/ 26 01 904 200 27 01/ 28 01/ 29 01/ 32 01/ 38 01 904 200 43 01/ 49 01/ 50 01
	06-	<b>24-1333</b>				906 200 09 01/ 12 01/ 13 01/ 14 01/ 18 01 906 200 20 01/ 22 01/ 24 01/ 29 01/ 32 01 906 200 38 01/ 42 01/ 45 01/ 48 01/ 54 01 906 200 57 01/ 65 01
O 550 (220-260-300 kW) Eng.OM457.952/.964/.965	01-	<b>24-1326</b>			For vehicles with retarder; Open hole	457 200 02 01/ 05 01/ 11 01/ 25 01/ 27 01
	01-	<b>24-1327</b>			For vehicles with retarder; Close hole	442 200 04 01/ 06 01/ 07 01/ 09 01 457 200 10 01/ 24 01/ 28 01
	01-	<b>24-1329</b>			For vehicles without retarder	457 200 08 01/ 19 01/ 23 01/ 29 01
<b>Intouro '1/05-</b>						
Intouro, E, M, EM (210 kW) Eng.OM926.939	05-	<b>24-1320</b>			For vehicles without retarder	904 200 02 01/ 04 01/ 06 01/ 07 01/ 08 01 904 200 19 01/ 20 01/ 22 01/ 25 01/ 26 01 904 200 27 01/ 28 01/ 29 01/ 32 01/ 38 01 904 200 43 01/ 49 01/ 50 01
	05-	<b>24-1333</b>				906 200 09 01/ 12 01/ 13 01/ 14 01/ 18 01 906 200 20 01/ 22 01/ 24 01/ 29 01/ 32 01 906 200 38 01/ 42 01/ 45 01/ 48 01/ 54 01 906 200 57 01/ 65 01
Intouro, E, M, EM (220 kW) Eng.OM457.965	05-	<b>24-1326</b>			For vehicles with retarder; Open hole	457 200 02 01/ 05 01/ 11 01/ 25 01/ 27 01
	05-	<b>24-1327</b>			For vehicles with retarder; Close hole	442 200 04 01/ 06 01/ 07 01/ 09 01 457 200 10 01/ 24 01/ 28 01
	05-	<b>24-1329</b>			For vehicles without retarder	457 200 08 01/ 19 01/ 23 01/ 29 01
Intouro, E, M, EM (260 kW) Eng.OM457.965	05-	<b>24-1326</b>			For vehicles with retarder; Open hole	457 200 02 01/ 05 01/ 11 01/ 25 01/ 27 01
	05-	<b>24-1327</b>			For vehicles with retarder; Close hole	442 200 04 01/ 06 01/ 07 01/ 09 01 457 200 10 01/ 24 01/ 28 01
	05-	<b>24-1329</b>			For vehicles without retarder	457 200 08 01/ 19 01/ 23 01/ 29 01
Intouro, E, M, EM (300 kW) Eng.OM457.965	05-	<b>24-1326</b>			For vehicles with retarder; Open hole	457 200 02 01/ 05 01/ 11 01/ 25 01/ 27 01
	05-	<b>24-1327</b>			For vehicles with retarder; Close hole	442 200 04 01/ 06 01/ 07 01/ 09 01 457 200 10 01/ 24 01/ 28 01
	05-	<b>24-1329</b>			For vehicles without retarder	457 200 08 01/ 19 01/ 23 01/ 29 01
<b>LP-LPK-LPS-LPO '1/67-'3/77</b>						
608,709,808,809 (63 kW) Eng.OM314.910/944	69-84	<b>24-1296</b>			Eng -456936	
	69-84	<b>24-1300</b>			Eng 456937-	314 200 35 01/ 41 01/ 47 01
811 (81 kW) Eng.OM352	69-73	<b>24-1295</b>			Impeller Ø 88mm	352 200 38 01/ 74 01/ 84 01/ 94 01/ 353 200 03 01/ 04 01/ 36 01/ 29 01/ 42 01
	69-73	<b>24-1299</b>			Impeller Ø 94,5mm	353 200 21 01/ 37 01
911 (81 kW) Eng.OM352.907/986/911/353.909	67-77	<b>24-0870</b>				353 200 56 01
	67-77	<b>24-1295</b>			Impeller Ø 88mm	352 200 38 01/ 74 01/ 84 01/ 94 01/ 353 200 03 01/ 04 01/ 36 01/ 29 01/ 42 01
	67-77	<b>24-1299</b>			Impeller Ø 94,5mm	353 200 21 01/ 37 01
<b>O 301 '2/86-'5/87</b>						
O 301 (100 kW) Eng.OM366.917	86-91	<b>24-0871</b>				366 200 59 01
	86-87	<b>24-1325</b>				366 200 54 01/ 67 01/ 68 01 390 200 00 01



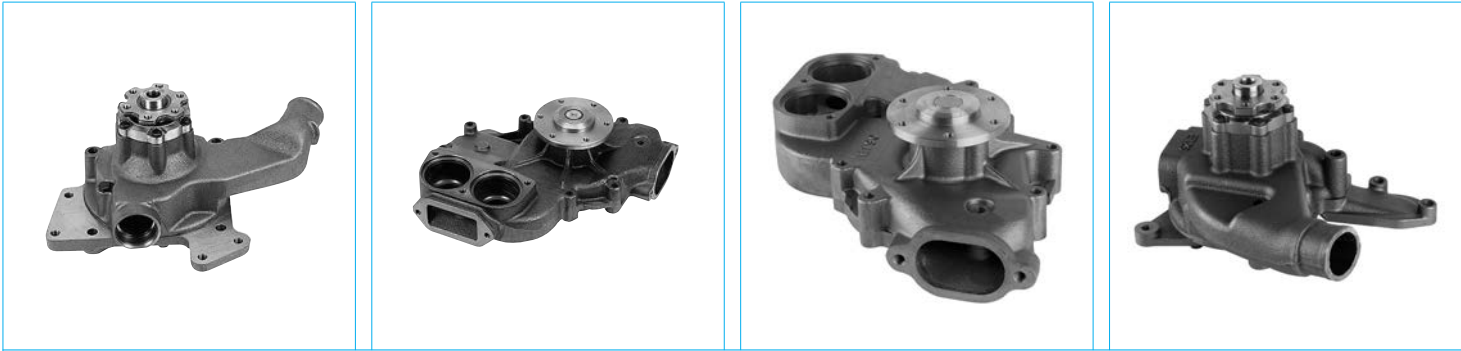

**24-0871**

**24-0872**

**24-1292**

**24-1295**



**24-1299**



**24-1301**



**24-1302**



**24-1309**



**24-1325**



**24-1328**

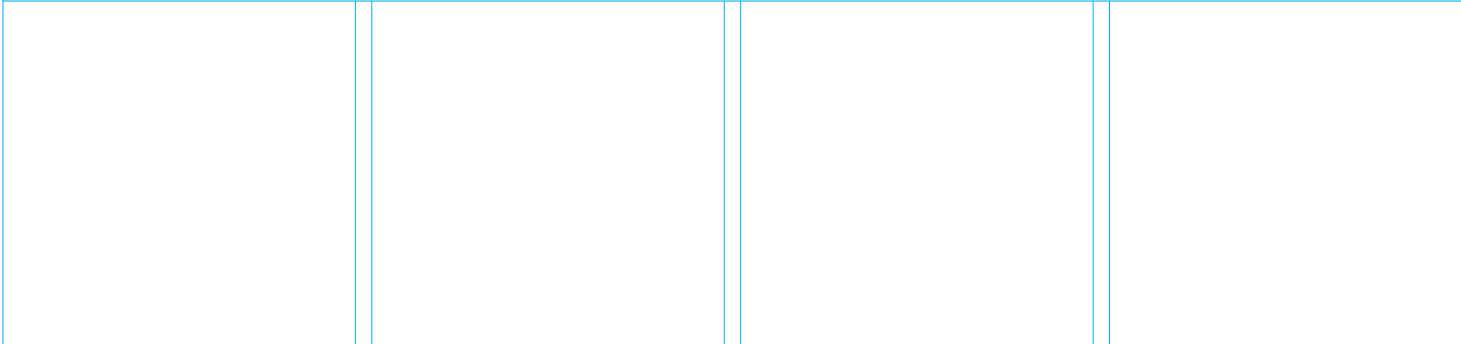
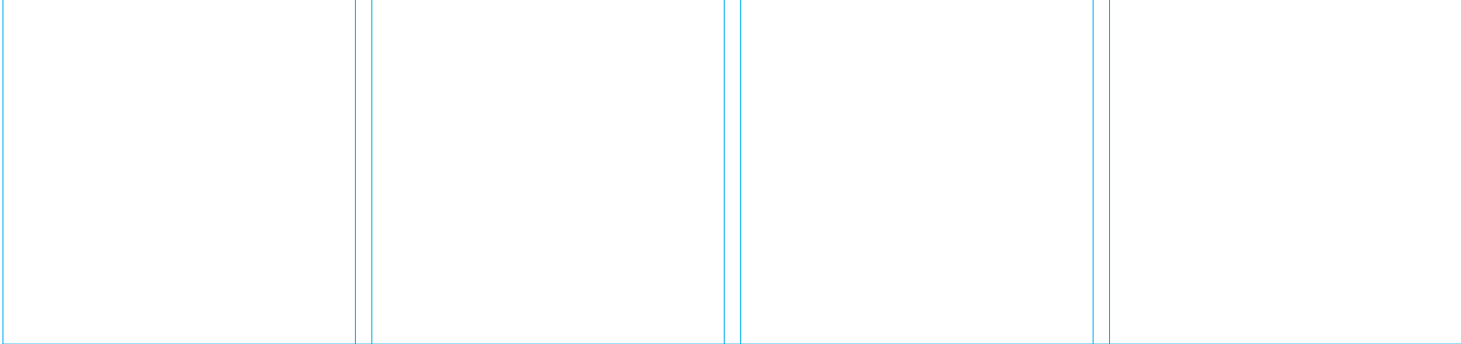

		<b>METELLI</b> ref.			<b>NOTE</b>	<b>Adaptable for OES</b>
O 301 (125 kW) Eng.OM366.965	86-91	<b>24-0871</b>				366 200 59 01
	86-87	<b>24-1325</b>				366 200 54 01/ 67 01/ 68 01 390 200 00 01
<b>O 302 '11/64-'11/75</b>						
O 302 (130 kW) Eng.OM353.906	67-77	<b>24-1295</b>			Impeller Ø 88mm	352 200 38 01/ 74 01/ 84 01/ 94 01/ 353 200 03 01/ 04 01/ 36 01/ 29 01/ 42 01
	68-	<b>24-1299</b>			Impeller Ø 94,5mm	353 200 21 01/ 37 01
O 302 (159 kW) Eng.OM421.908/.904	87-96	<b>24-1328</b>			Eng. 744216-	422 200 11 01/ 16 01
O 302 (96 kW) Eng.OM352.980/.993	64-74	<b>24-1295</b>			Impeller Ø 88mm	352 200 38 01/ 74 01/ 84 01/ 94 01/ 353 200 03 01/ 04 01/ 36 01/ 29 01/ 42 01
	64-74	<b>24-1299</b>			Impeller Ø 94,5mm	353 200 21 01/ 37 01
<b>O 303 '1/74-'12/92</b>						
11.0 D (159 kW) Eng.OM421.908/OM441.908/.909/.911	85-99	<b>24-0872</b>				403 200 73 01
	80-92	<b>24-1302</b>			For vehicles with retarder, w/o pulley	422 200 06 01
	80-92	<b>24-1309</b>			For vehicles without retarder; Eng. -744215	403 200 76 01/ 77 01 422 200 13 01/ 14 01,441 200 03 01
	80-92	<b>24-1328</b>			Eng. 744216-	422 200 11 01/ 16 01
	80-89	<b>24-1302</b>			For vehicles with retarder, w/o pulley	422 200 06 01
	80-89	<b>24-1328</b>			Eng. 744216-	422 200 11 01/ 16 01
11.0 D (184 kW) Eng.OM421.951/.950	85-99	<b>24-0872</b>				403 200 73 01
	85-89	<b>24-1302</b>			For vehicles with retarder, w/o pulley	422 200 06 01
	85-89	<b>24-1309</b>			For vehicles without retarder; Eng. -744215	403 200 76 01/ 77 01 422 200 13 01/ 14 01,441 200 03 01
	85-89	<b>24-1328</b>			Eng. 744216-	422 200 11 01/ 16 01
11.0 D (200 kW) Eng.OM441.950/.953	87-92	<b>24-1328</b>			Eng. 744216-	422 200 11 01/ 16 01
11.3 D (165 kW) Eng.OM441.918	87-	<b>24-1328</b>			Eng. 744216-	422 200 11 01/ 16 01
12.7 D (188 kW) Eng.OM402.907	75-99	<b>24-0872</b>				403 200 73 01
	75-83	<b>24-1292</b>			For vehicles without retarder; Eng. 744216-	403 200 27 01/ 32 01/ 34 01 403 200 35 01/ 49 01/ 70 01
	75-83	<b>24-1302</b>			For vehicles with retarder, w/o pulley	422 200 06 01
	75-83	<b>24-1309</b>			For vehicles without retarder; Eng. -744215	403 200 76 01/ 77 01 422 200 13 01/ 14 01,441 200 03 01
	75-83	<b>24-1328</b>			Eng. 744216-	422 200 11 01/ 16 01
14.6 D (206 kW) Eng.OM422.908/.917	87-99	<b>24-0872</b>				403 200 73 01
	80-87	<b>24-1301</b>			For vehicles with retarder	403 200 64 01/ 75 01 422 200 07 01/ 12 01,442 200 12 01
	80-87	<b>24-1302</b>			For vehicles with retarder, w/o pulley	422 200 06 01
	80-87	<b>24-1309</b>			For vehicles without retarder; Eng. -744215	403 200 76 01/ 77 01 422 200 13 01/ 14 01,441 200 03 01
	80-87	<b>24-1328</b>			Eng. 744216-	422 200 11 01/ 16 01
14.6 D (243 kW) Eng.OM422.951/.963	87-99	<b>24-0872</b>				403 200 73 01
	80-87	<b>24-1301</b>			For vehicles with retarder	403 200 64 01/ 75 01 422 200 07 01/ 12 01,442 200 12 01
	80-87	<b>24-1302</b>			For vehicles with retarder, w/o pulley	422 200 06 01
	80-87	<b>24-1309</b>			For vehicles without retarder; Eng. -744215	403 200 76 01/ 77 01 422 200 13 01/ 14 01,441 200 03 01
	80-87	<b>24-1328</b>			Eng. 744216-	422 200 11 01/ 16 01
14.6 D (260 kW) Eng.OM442.954/955/960/961	87-92	<b>24-0872</b>				403 200 73 01
	87-92	<b>24-1302</b>			For vehicles with retarder, w/o pulley	422 200 06 01
	87-92	<b>24-1309</b>			For vehicles without retarder; Eng. -744215	403 200 76 01/ 77 01 422 200 13 01/ 14 01,441 200 03 01
	87-92	<b>24-1328</b>			Eng. 744216-	422 200 11 01/ 16 01
16.0 D (235 kW) Eng.OM403.918	75-83	<b>24-1292</b>			For vehicles without retarder; Eng. 744216-	403 200 27 01/ 32 01/ 34 01 403 200 35 01/ 49 01/ 70 01
	75-83	<b>24-1302</b>			For vehicles with retarder, w/o pulley	422 200 06 01
	75-83	<b>24-1309</b>			For vehicles without retarder; Eng. -744215	403 200 76 01/ 77 01 422 200 13 01/ 14 01,441 200 03 01
	75-83	<b>24-1328</b>			Eng. 744216-	422 200 11 01/ 16 01
9.6 D (141 kW) Eng.OM401.907/.908/.912	74-99	<b>24-0872</b>				403 200 73 01
	74-83	<b>24-1292</b>			For vehicles without retarder; Eng. 744216-	403 200 27 01/ 32 01/ 34 01 403 200 35 01/ 49 01/ 70 01
	74-83	<b>24-1302</b>			For vehicles with retarder, w/o pulley	422 200 06 01
	74-83	<b>24-1309</b>			For vehicles without retarder; Eng. -744215	403 200 76 01/ 77 01 422 200 13 01/ 14 01,441 200 03 01

			
<p><b>24-0872</b></p>	<p><b>24-1292</b></p>	<p><b>24-1295</b></p>	<p><b>24-1296</b></p>
			
<p><b>24-1299</b></p>	<p><b>24-1300</b></p>	<p><b>24-1302</b></p>	<p><b>24-1309</b></p>
			
<p><b>24-1328</b></p>			

		<b>METELLI</b> ref.			<b>NOTE</b>	<b>Adaptable for OES</b>
9.6 D (141 kW) Eng.OM401.907/.908/.912	74-83	<b>24-1328</b>			Eng. 744216-	422 200 11 01/ 16 01
<b>O 305 '1/69-'12/87</b>						
11.0 D (132 kW) Eng.OM407.905/908	73-77	<b>24-0872</b>				403 200 73 01
	73-77	<b>24-1292</b>			For vehicles without retarder; Eng. 744216-	403 200 27 01/ 32 01/ 34 01 403 200 35 01/ 49 01/ 70 01
	73-77	<b>24-1302</b>			For vehicles with retarder, w/o pulley	422 200 06 01
	73-77	<b>24-1309</b>			For vehicles without retarder; Eng. -744215	403 200 76 01/ 77 01 422 200 13 01/ 14 01,441 200 03 01
	73-77	<b>24-1328</b>			Eng. 744216-	422 200 11 01/ 16 01
11.0 D (155 kW) Eng.OM407.909/.910/.911	73-77	<b>24-1292</b>			For vehicles without retarder; Eng. 744216-	403 200 27 01/ 32 01/ 34 01 403 200 35 01/ 49 01/ 70 01
	73-77	<b>24-1328</b>			Eng. 744216-	422 200 11 01/ 16 01
11.0 D (206 kW) Eng.OM407.951/955	73-77	<b>24-0872</b>				403 200 73 01
	79-87	<b>24-1292</b>			For vehicles without retarder; Eng. 744216-	403 200 27 01/ 32 01/ 34 01 403 200 35 01/ 49 01/ 70 01
	79-87	<b>24-1302</b>			For vehicles with retarder, w/o pulley	422 200 06 01
	79-87	<b>24-1309</b>			For vehicles without retarder; Eng. -744215	403 200 76 01/ 77 01 422 200 13 01/ 14 01,441 200 03 01
	79-87	<b>24-1328</b>			Eng. 744216-	422 200 11 01/ 16 01
11.4 D (147 kW) Eng.OM407.913/.914	76-87	<b>24-1292</b>			For vehicles without retarder; Eng. 744216-	403 200 27 01/ 32 01/ 34 01 403 200 35 01/ 49 01/ 70 01
	76-87	<b>24-1328</b>			Eng. 744216-	422 200 11 01/ 16 01
11.4 D (177 kW) Eng.OM407.917	76-87	<b>24-1292</b>			For vehicles without retarder; Eng. 744216-	403 200 27 01/ 32 01/ 34 01 403 200 35 01/ 49 01/ 70 01
	76-87	<b>24-1328</b>			Eng. 744216-	422 200 11 01/ 16 01
11.4 D (177 kW) Eng.OM407.919	78-87	<b>24-1292</b>			For vehicles without retarder; Eng. 744216-	403 200 27 01/ 32 01/ 34 01 403 200 35 01/ 49 01/ 70 01
	78-87	<b>24-1328</b>			Eng. 744216-	422 200 11 01/ 16 01
8.7 D (125-141 kW) Eng.OM360.911	73-77	<b>24-0872</b>				403 200 73 01
	69-73	<b>24-1328</b>			Eng. 744216-	422 200 11 01/ 16 01
<b>O 307 '1/73-'12/77</b>						
11.0 D (132 kW) Eng.OM407.905	73-77	<b>24-0872</b>				403 200 73 01
	73-77	<b>24-1292</b>			For vehicles without retarder; Eng. 744216-	403 200 27 01/ 32 01/ 34 01 403 200 35 01/ 49 01/ 70 01
	73-77	<b>24-1302</b>			For vehicles with retarder, w/o pulley	422 200 06 01
	73-77	<b>24-1309</b>			For vehicles without retarder; Eng. -744215	403 200 76 01/ 77 01 422 200 13 01/ 14 01,441 200 03 01
	73-77	<b>24-1328</b>			Eng. 744216-	422 200 11 01/ 16 01
11.0 D (155 kW) Eng.OM407.907/.911	73-77	<b>24-1292</b>			For vehicles without retarder; Eng. 744216-	403 200 27 01/ 32 01/ 34 01 403 200 35 01/ 49 01/ 70 01
	73-77	<b>24-1328</b>			Eng. 744216-	422 200 11 01/ 16 01
11.4 D (147 kW) Eng.OM407.915	76-87	<b>24-1292</b>			For vehicles without retarder; Eng. 744216-	403 200 27 01/ 32 01/ 34 01 403 200 35 01/ 49 01/ 70 01
	76-87	<b>24-1328</b>			Eng. 744216-	422 200 11 01/ 16 01
11.4 D (177 kW) Eng.OM407.916/.918	73-77	<b>24-1292</b>			For vehicles without retarder; Eng. 744216-	403 200 27 01/ 32 01/ 34 01 403 200 35 01/ 49 01/ 70 01
	73-77	<b>24-1328</b>			Eng. 744216-	422 200 11 01/ 16 01
11.4 D (206 kW) Eng.OM407.955	76-87	<b>24-1292</b>			For vehicles without retarder; Eng. 744216-	403 200 27 01/ 32 01/ 34 01 403 200 35 01/ 49 01/ 70 01
<b>O 309 '1/68-'2/89</b>						
O 309 (63 kW) Eng.OM314.948/.946/.959/.962/963	70-89	<b>24-1296</b>			Eng -456936	
	70-89	<b>24-1300</b>			Eng 456937-	314 200 35 01/ 41 01/ 47 01
O 309 (96 kW) Eng.OM353.963/.966/.968/.969	77-89	<b>24-1295</b>			Impeller Ø 88mm	352 200 38 01/ 74 01/ 84 01/ 94 01/ 353 200 03 01/ 04 01/ 36 01/ 29 01/ 42 01
	77-89	<b>24-1299</b>			Impeller Ø 94,5mm	353 200 21 01/ 37 01
<b>O 330 '1/90-</b>						
330 (260 kW) Eng.OM442.955/.961	90-	<b>24-1328</b>			Eng. 744216-	422 200 11 01/ 16 01
<b>O 340 '1/91-'8/95</b>						
Tourismo (250 kW) Eng.OM441.994/.995	85-	<b>24-1309</b>			For vehicles without retarder; Eng. -744215	403 200 76 01/ 77 01 422 200 13 01/ 14 01,441 200 03 01
Tourismo (280 kW) Eng.OM402.984/.995	75-99	<b>24-0872</b>				403 200 73 01

			
<b>24-0872</b>	<b>24-1292</b>	<b>24-1297</b>	<b>24-1302</b>
			
<b>24-1309</b>	<b>24-1325</b>	<b>24-1326</b>	<b>24-1327</b>
			
<b>24-1328</b>	<b>24-1329</b>	<b>24-1341</b>	<b>24-1342</b>

		<b>METELLI</b> ref.			<b>NOTE</b>	<b>Adaptable for OES</b>
Tourismo (280 kW) Eng.OM402.984/.995	92-95	<b>24-1292</b>			For vehicles without retarder; Eng. 744216-	403 200 27 01/ 32 01/ 34 01 403 200 35 01/ 49 01/ 70 01
	85-	<b>24-1309</b>			For vehicles without retarder; Eng. -744215	403 200 76 01/ 77 01 422 200 13 01/ 14 01,441 200 03 01
	92-95	<b>24-1328</b>			Eng. 744216-	422 200 11 01/ 16 01
<b>O 350 Tourismo '8/95-</b>						
Tourismo (185-220-300 kW) Eng.OM457.941/.952/.965	03-	<b>24-1326</b>			For vehicles with retarder; Open hole	457 200 02 01/ 05 01/ 11 01/ 25 01/ 27 01
	03-	<b>24-1329</b>			For vehicles without retarder	457 200 08 01/ 19 01/ 23 01/ 29 01
Tourismo (220-260-310 kW) Eng.OM457.944/.952/.961/.965	03-	<b>24-1326</b>			For vehicles with retarder; Open hole	457 200 02 01/ 05 01/ 11 01/ 25 01/ 27 01
	03-	<b>24-1329</b>			For vehicles without retarder	457 200 08 01/ 19 01/ 23 01/ 29 01
Tourismo (250 kW) Eng.OM441.980	95-	<b>24-1302</b>			For vehicles with retarder, w/o pulley	422 200 06 01
	84-	<b>24-1309</b>			For vehicles without retarder; Eng. -744215	403 200 76 01/ 77 01 422 200 13 01/ 14 01,441 200 03 01
	95-	<b>24-1328</b>			Eng. 744216-	422 200 11 01/ 16 01
Tourismo (250 kW) Eng.OM445.934	95-	<b>24-1328</b>			Eng. 744216-	422 200 11 01/ 16 01
Tourismo (260 kW) Eng.OM457.941/.953/.961/.965	03-	<b>24-1326</b>			For vehicles with retarder; Open hole	457 200 02 01/ 05 01/ 11 01/ 25 01/ 27 01
	03-	<b>24-1329</b>			For vehicles without retarder	457 200 08 01/ 19 01/ 23 01/ 29 01
Tourismo (260 kW) Eng.OM457.944/.953/.961	03-	<b>24-1326</b>			For vehicles with retarder; Open hole	457 200 02 01/ 05 01/ 11 01/ 25 01/ 27 01
	03-	<b>24-1329</b>			For vehicles without retarder	457 200 08 01/ 19 01/ 23 01/ 29 01
Tourismo (260-310 kW) Eng.OM457.944	03-	<b>24-1326</b>			For vehicles with retarder; Open hole	457 200 02 01/ 05 01/ 11 01/ 25 01/ 27 01
	03-	<b>24-1327</b>			For vehicles with retarder; Close hole	442 200 04 01/ 06 01/ 07 01/ 09 01 457 200 10 01/ 24 01/ 28 01
	03-	<b>24-1329</b>			For vehicles without retarder	457 200 08 01/ 19 01/ 23 01/ 29 01
Tourismo (280 kW) Eng.OM402.970	75-99	<b>24-0872</b>				403 200 73 01
	95-	<b>24-1292</b>			For vehicles without retarder; Eng. 744216-	403 200 27 01/ 32 01/ 34 01 403 200 35 01/ 49 01/ 70 01
	85-	<b>24-1309</b>			For vehicles without retarder; Eng. -744215	403 200 76 01/ 77 01 422 200 13 01/ 14 01,441 200 03 01
	95-	<b>24-1328</b>			Eng. 744216-	422 200 11 01/ 16 01
Tourismo (280 kW) Eng.OM446.938	95-	<b>24-1328</b>			Eng. 744216-	422 200 11 01/ 16 01
Tourismo (310 kW) Eng.OM457.944	03-	<b>24-1326</b>			For vehicles with retarder; Open hole	457 200 02 01/ 05 01/ 11 01/ 25 01/ 27 01
	03-	<b>24-1329</b>			For vehicles without retarder	457 200 08 01/ 19 01/ 23 01/ 29 01
Tourismo (315-335 kW) Eng.OM457.953/.961	03-	<b>24-1326</b>			For vehicles with retarder; Open hole	457 200 02 01/ 05 01/ 11 01/ 25 01/ 27 01
	03-	<b>24-1329</b>			For vehicles without retarder	457 200 08 01/ 19 01/ 23 01/ 29 01
Tourismo (320 kW) Eng.OM542.948	03-	<b>24-1341</b>			For vehicles without retarder; With fastening eyes for axial fan	542 200 25 01
	03-	<b>24-1342</b>			For vehicles with retarder; With fastening eyes for axial fan	542 200 26 01
Tourismo (350-370 kW) Eng.OM542.948/.966	03-	<b>24-1341</b>			For vehicles without retarder; With fastening eyes for axial fan	542 200 25 01
	03-	<b>24-1342</b>			For vehicles with retarder; With fastening eyes for axial fan	542 200 26 01
Tourismo (350-370 kW) Eng.OM542.966	03-	<b>24-1341</b>			For vehicles without retarder; With fastening eyes for axial fan	542 200 25 01
	03-	<b>24-1342</b>			For vehicles with retarder; With fastening eyes for axial fan	542 200 26 01
<b>O 355 '1/68-</b>						
11.6 TD (136-155-177-191-205 kW) Eng.OM355/H/A	68-	<b>24-1297</b>				
<b>O 402 '2/86-'12/91</b>						
O 402 (100 kW) Eng.OM366.917	86-91	<b>24-1325</b>				366 200 54 01/ 67 01/ 68 01 390 200 00 01
O 402 (125 kW) Eng.OM366.965	86-91	<b>24-1325</b>				366 200 54 01/ 67 01/ 68 01 390 200 00 01
<b>O 403 '9/03-</b>						
O 403 (250 kW) Eng.OM441.980/.934	03-	<b>24-1328</b>			Eng. 744216-	422 200 11 01/ 16 01
O 403 (260 kW) Eng.OM457.944	03-	<b>24-1326</b>			For vehicles with retarder; Open hole	457 200 02 01/ 05 01/ 11 01/ 25 01/ 27 01
	03-	<b>24-1327</b>			For vehicles with retarder; Close hole	442 200 04 01/ 06 01/ 07 01/ 09 01 457 200 10 01/ 24 01/ 28 01
	03-	<b>24-1329</b>			For vehicles without retarder	457 200 08 01/ 19 01/ 23 01/ 29 01

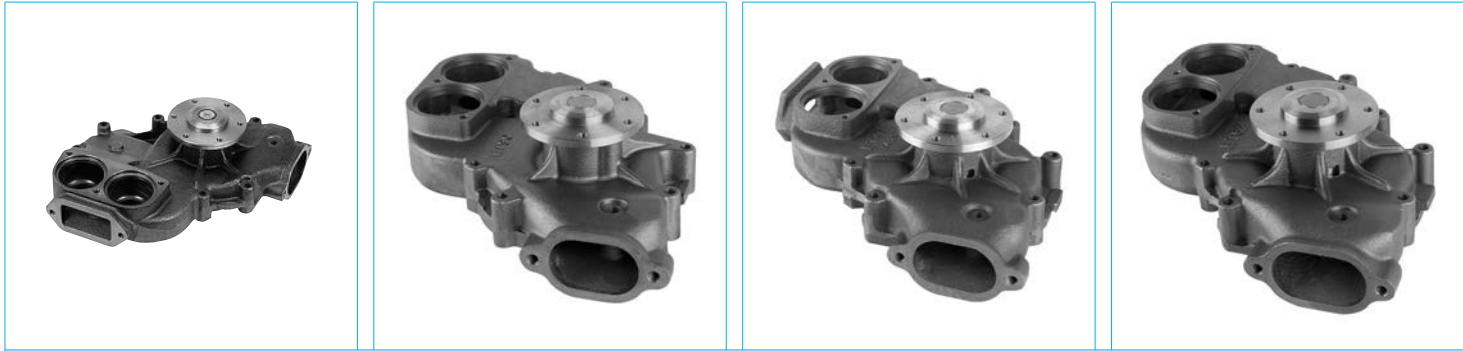

**24-0872**

**24-1292**

**24-1302**

**24-1309**

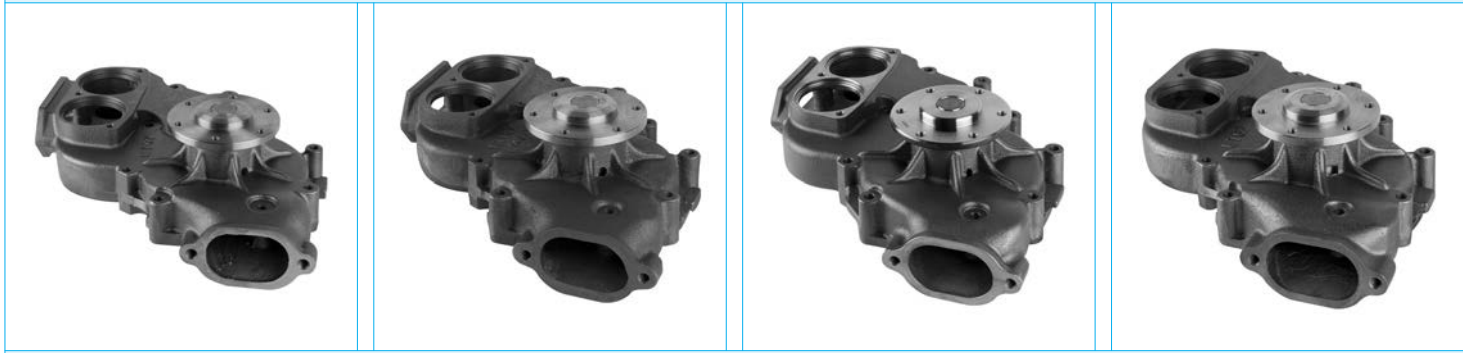

**24-1326**

**24-1327**

**24-1328**

**24-1329**

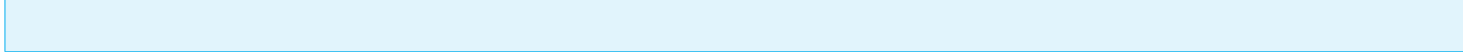
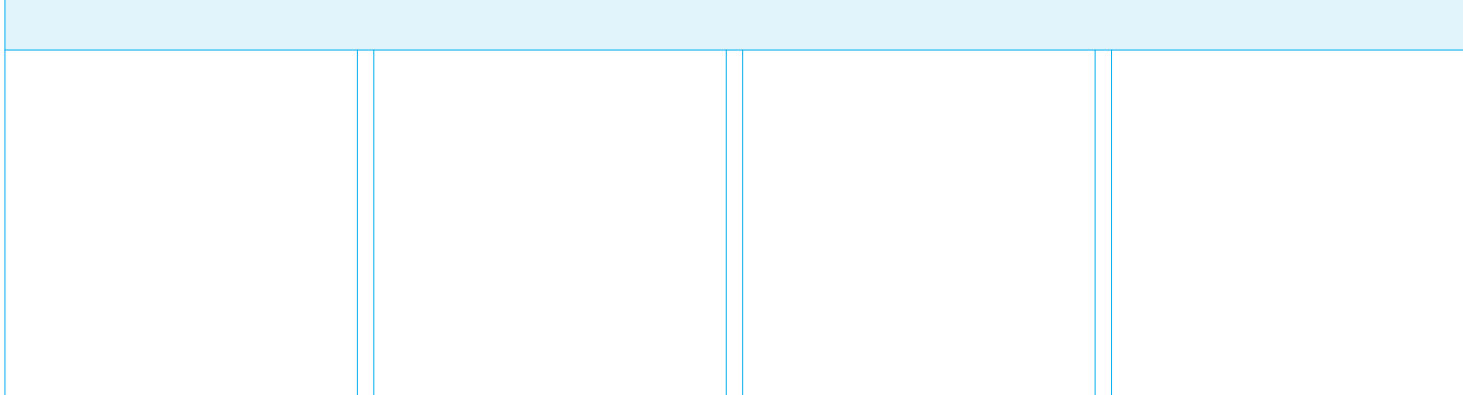
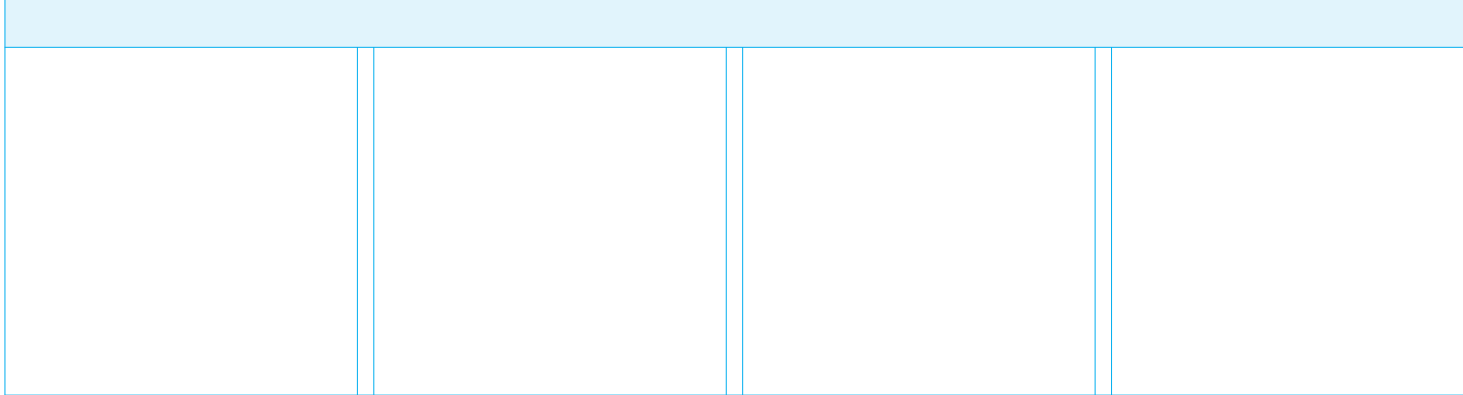
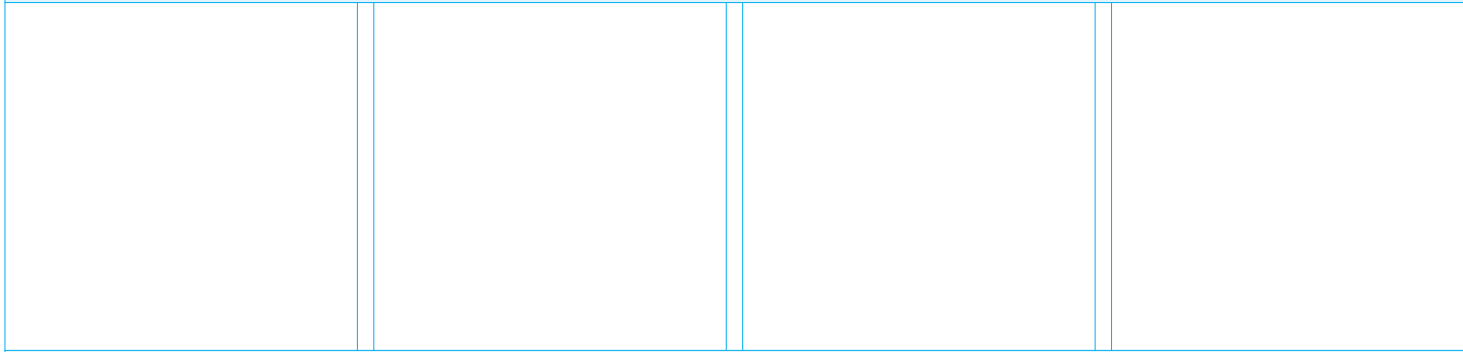

		<b>METELLI</b> ref.			<b>NOTE</b>	<b>Adaptable for OES</b>
O 403 (280 kW) Eng.OM402.970	03-	<b>24-1292</b>			For vehicles without retarder; Eng. 744216-	403 200 27 01/ 32 01/ 34 01 403 200 35 01/ 49 01/ 70 01
	03-	<b>24-1328</b>			Eng. 744216-	422 200 11 01/ 16 01
O 403 (280 kW)	03-	<b>24-1328</b>			Eng. 744216-	422 200 11 01/ 16 01
O 403 (310 kW) Eng.OM457.944	03-	<b>24-1326</b>			For vehicles with retarder; Open hole	457 200 02 01/ 05 01/ 11 01/ 25 01/ 27 01
	03-	<b>24-1327</b>			For vehicles with retarder; Close hole	442 200 04 01/ 06 01/ 07 01/ 09 01 457 200 10 01/ 24 01/ 28 01
	03-	<b>24-1329</b>			For vehicles without retarder	457 200 08 01/ 19 01/ 23 01/ 29 01
<b>O 404 '9/91-'11/92</b>						
10.9 D (213 kW) Eng.OM445.935	94-99	<b>24-1328</b>			Eng. 744216-	422 200 11 01/ 16 01
10.9 D (250 kW) Eng.OM441.980/OM445.934	91-99	<b>24-1328</b>			Eng. 744216-	422 200 11 01/ 16 01
11.3 D (151 kW) Eng.OM441.922	73-77	<b>24-0872</b>				403 200 73 01
	91-92	<b>24-1302</b>			For vehicles with retarder, w/o pulley	422 200 06 01
	91-92	<b>24-1309</b>			For vehicles without retarder; Eng. -744215	403 200 76 01/ 77 01 422 200 13 01/ 14 01,441 200 03 01
	91-92	<b>24-1328</b>			Eng. 744216-	422 200 11 01/ 16 01
11.3 D (165 kW) Eng.OM441.921	91-92	<b>24-1328</b>			Eng. 744216-	422 200 11 01/ 16 01
12.7 D (280 kW) Eng.OM402.970/.974	91-99	<b>24-1292</b>			For vehicles without retarder; Eng. 744216-	403 200 27 01/ 32 01/ 34 01 403 200 35 01/ 49 01/ 70 01
	91-99	<b>24-1328</b>			Eng. 744216-	422 200 11 01/ 16 01
14.6 D (280 kW) Eng.OM446.938	94-99	<b>24-1328</b>			Eng. 744216-	422 200 11 01/ 16 01
15.1 D (213 kW) Eng.OM442.930	91-92	<b>24-1328</b>			Eng. 744216-	422 200 11 01/ 16 01
9.5 D (200 kW) Eng.OM401.974	91-	<b>24-1292</b>			For vehicles without retarder; Eng. 744216-	403 200 27 01/ 32 01/ 34 01 403 200 35 01/ 49 01/ 70 01
	91-	<b>24-1328</b>			Eng. 744216-	422 200 11 01/ 16 01
9.5 D (213 kW) Eng.OM401.970	91-99	<b>24-1292</b>			For vehicles without retarder; Eng. 744216-	403 200 27 01/ 32 01/ 34 01 403 200 35 01/ 49 01/ 70 01
	91-99	<b>24-1328</b>			Eng. 744216-	422 200 11 01/ 16 01
9.8 D (200 kW) Eng.OM401.974	91-99	<b>24-1292</b>			For vehicles without retarder; Eng. 744216-	403 200 27 01/ 32 01/ 34 01 403 200 35 01/ 49 01/ 70 01
	91-99	<b>24-1328</b>			Eng. 744216-	422 200 11 01/ 16 01
<b>O 405 '1/84-</b>						
12.0 D (150 kW) Eng.OM447.905/911/913/914/970/973	84-01	<b>24-0872</b>				403 200 73 01
	84-	<b>24-1302</b>			For vehicles with retarder, w/o pulley	422 200 06 01
	84-	<b>24-1309</b>			For vehicles without retarder; Eng. -744215	403 200 76 01/ 77 01 422 200 13 01/ 14 01,441 200 03 01
12.0 D (150-170 kW) Eng.OM427H	84-01	<b>24-0872</b>				403 200 73 01
	85-	<b>24-1302</b>			For vehicles with retarder, w/o pulley	422 200 06 01
	85-	<b>24-1309</b>			For vehicles without retarder; Eng. -744215	403 200 76 01/ 77 01 422 200 13 01/ 14 01,441 200 03 01
12.0 D (177 kW) Eng.OM447.907/908/910/956/957/971/974	84-01	<b>24-0872</b>				403 200 73 01
	85-	<b>24-1302</b>			For vehicles with retarder, w/o pulley	422 200 06 01
	85-	<b>24-1309</b>			For vehicles without retarder; Eng. -744215	403 200 76 01/ 77 01 422 200 13 01/ 14 01,441 200 03 01
	85-	<b>24-1328</b>			Eng. 744216-	422 200 11 01/ 16 01
12.0 D (177 kW) Eng.OM447.955/959/976/978	84-01	<b>24-0872</b>				403 200 73 01
	85-	<b>24-1302</b>			For vehicles with retarder, w/o pulley	422 200 06 01
	85-	<b>24-1309</b>			For vehicles without retarder; Eng. -744215	403 200 76 01/ 77 01 422 200 13 01/ 14 01,441 200 03 01
	85-	<b>24-1328</b>			Eng. 744216-	422 200 11 01/ 16 01
12.0 D (206 kW) Eng.OM447.950	84-01	<b>24-0872</b>				403 200 73 01
	85-	<b>24-1309</b>			For vehicles without retarder; Eng. -744215	403 200 76 01/ 77 01 422 200 13 01/ 14 01,441 200 03 01
<b>O 407 '1/85-</b>						
12.0 D (177 kW) Eng.OM447.906/954/990	84-01	<b>24-0872</b>				403 200 73 01
	87-	<b>24-1302</b>			For vehicles with retarder, w/o pulley	422 200 06 01
	87-	<b>24-1309</b>			For vehicles without retarder; Eng. -744215	403 200 76 01/ 77 01 422 200 13 01/ 14 01,441 200 03 01
	87-	<b>24-1328</b>			Eng. 744216-	422 200 11 01/ 16 01
12.0 D (220 kW) Eng.OM447.985/.991	91-01	<b>24-1328</b>			Eng. 744216-	422 200 11 01/ 16 01





**24-0871**



**24-0872**



**24-0873**



**24-1292**



**24-1301**



**24-1302**



**24-1303**



**24-1309**



**24-1320**



**24-1325**



**24-1328**

		<b>METELLI</b> ref.			<b>NOTE</b>	<b>Adaptable for OES</b>
<b>O 408 '1/91-'12/98</b>						
O 408 (177 kW) Eng.OM447.908/.912/.958/.992	84-01	<b>24-0872</b>				403 200 73 01
	91-98	<b>24-1302</b>			For vehicles with retarder, w/o pulley	422 200 06 01
	86-	<b>24-1309</b>			For vehicles without retarder; Eng. -744215	403 200 76 01/ 77 01 422 200 13 01/ 14 01,441 200 03 01
	91-98	<b>24-1328</b>			Eng. 744216-	422 200 11 01/ 16 01
O 408 (220 kW) Eng.OM447.987/.993	84-01	<b>24-0872</b>				403 200 73 01
	92-98	<b>24-1302</b>			For vehicles with retarder, w/o pulley	422 200 06 01
	86-	<b>24-1309</b>			For vehicles without retarder; Eng. -744215	403 200 76 01/ 77 01 422 200 13 01/ 14 01,441 200 03 01
	92-98	<b>24-1328</b>			Eng. 744216-	422 200 11 01/ 16 01
<b>OH Series '1/70-</b>						
1417 (125 kW) Eng.OM366.957	70-	<b>24-1325</b>				366 200 54 01/ 67 01/ 68 01 390 200 00 01
1625, 1625L (184 kW) Eng.OM422.915	70-	<b>24-1301</b>			For vehicles with retarder	403 200 64 01/ 75 01 422 200 07 01/ 12 01,442 200 12 01
1628, 1628L (206 kW) Eng.OM422.918	70-	<b>24-1301</b>			For vehicles with retarder	403 200 64 01/ 75 01 422 200 07 01/ 12 01,442 200 12 01
1634L (250 kW) Eng.OM445.934	70-	<b>24-1328</b>			Eng. 744216-	422 200 11 01/ 16 01
1829L (213 kW) Eng.OM445.935	70-	<b>24-1328</b>			Eng. 744216-	422 200 11 01/ 16 01
<b>Serie LK-LN2 '1/84-'12/98</b>						
1114,1117 Eng.OM356/357	84-98	<b>24-0871</b>				366 200 59 01
1114,L,K,S,1117,1120,1314,1317,1320,814, (100-116-125-148 kW) Eng.OM366.905/914/962/988	84-98	<b>24-1325</b>				366 200 54 01/ 67 01/ 68 01 390 200 00 01
1120,1124 Eng.OM356/357	84-98	<b>24-0871</b>				366 200 59 01
1217 Eng.OM356/357	84-98	<b>24-0871</b>				366 200 59 01
1314,1317,1320,1324 Eng.OM356/357	84-98	<b>24-0871</b>				366 200 59 01
1514,1517,1520,1524 Eng.OM356/357	84-98	<b>24-0871</b>				366 200 59 01
609/709/809 D (63-66 kW) Eng.OM364.906/907/911/912/918/919/920/921	84-98	<b>24-1303</b>				364 200 01 01/ 09 01/ 14 01/ 20 01
611/711/811 D (85 kW) Eng.OM364.950/952/954	86-94	<b>24-1303</b>				364 200 01 01/ 09 01/ 14 01/ 20 01
711,811,814,1117,1317,1517,817,917 (77-90-100-125 kW) Eng.OM904.905/906/907	96-98	<b>24-1320</b>			For vehicles without retarder	904 200 02 01/ 04 01/ 06 01/ 07 01/ 08 01 904 200 19 01/ 20 01/ 22 01/ 25 01/ 26 01 904 200 27 01/ 28 01/ 29 01/ 32 01/ 38 01 904 200 43 01/ 49 01/ 50 01
814,817,914,917 Eng.OM356/357	84-98	<b>24-0871</b>				366 200 59 01
<b>Serie MK '12/87-'9/96</b>						
1222 A (151-160 kW) Eng.OM441.905/913/914/923/926	88-94	<b>24-1309</b>			For vehicles without retarder; Eng. -744215	403 200 76 01/ 77 01 422 200 13 01/ 14 01,441 200 03 01
	88-94	<b>24-1328</b>			Eng. 744216-	422 200 11 01/ 16 01
1222,1226,1234 Eng.OM445/441	89-96	<b>24-0873</b>				403 200 71 01
	89-96	<b>24-1328</b>			Eng. 744216-	422 200 11 01/ 16 01
1224 AF,1226,1227,1422,1424,1722,1726,1824 (180-200-230 kW) Eng.OM401	87-96	<b>24-0873</b>				403 200 71 01
	87-96	<b>24-1292</b>			For vehicles without retarder; Eng. 744216-	403 200 27 01/ 32 01/ 34 01 403 200 35 01/ 49 01/ 70 01
	87-96	<b>24-1302</b>			For vehicles with retarder, w/o pulley	422 200 06 01
	86-	<b>24-1309</b>			For vehicles without retarder; Eng. -744215	403 200 76 01/ 77 01 422 200 13 01/ 14 01,441 200 03 01
	87-96	<b>24-1328</b>			Eng. 744216-	422 200 11 01/ 16 01
1224,1417,1420 Eng.OM356/357	87-96	<b>24-0871</b>				366 200 59 01
	87-96	<b>24-1328</b>			Eng. 744216-	422 200 11 01/ 16 01
1226,1426,1722,1726,2426,2527 Eng.OM442/440	87-96	<b>24-0873</b>				403 200 71 01
	87-96	<b>24-1302</b>			For vehicles with retarder, w/o pulley	422 200 06 01
	87-96	<b>24-1309</b>			For vehicles without retarder; Eng. -744215	403 200 76 01/ 77 01 422 200 13 01/ 14 01,441 200 03 01
	87-96	<b>24-1328</b>			Eng. 744216-	422 200 11 01/ 16 01
1422 F,1722,1726,1733,2422,2426,2433 (151-160-243-250 kW) Eng.OM441	88-94	<b>24-1309</b>			For vehicles without retarder; Eng. -744215	403 200 76 01/ 77 01 422 200 13 01/ 14 01,441 200 03 01
	88-94	<b>24-1328</b>			Eng. 744216-	422 200 11 01/ 16 01
1422,1722,1726,1824,1827,1831 Eng.OM401	87-96	<b>24-0873</b>				403 200 71 01
	87-96	<b>24-1292</b>			For vehicles without retarder; Eng. 744216-	403 200 27 01/ 32 01/ 34 01 403 200 35 01/ 49 01/ 70 01



**24-0870**



**24-0871**



**24-0873**



**24-1292**



**24-1294**



**24-1295**



**24-1299**



**24-1302**



**24-1309**



**24-1325**













**24-1328**

		<b>METELLI</b> ref.			<b>NOTE</b>	<b>Adaptable for OES</b>
1422,1722,1726,1824,1827,1831 Eng.OM401	87-96	<b>24-1302</b>			For vehicles with retarder, w/o pulley	422 200 06 01
	86-	<b>24-1309</b>			For vehicles without retarder; Eng. -744215	403 200 76 01/ 77 01 422 200 13 01/ 14 01,441 200 03 01
	87-96	<b>24-1328</b>			Eng. 744216-	422 200 11 01/ 16 01
1422,1722,2422 Eng.OM441	87-96	<b>24-0873</b>				403 200 71 01
	87-96	<b>24-1309</b>			For vehicles without retarder; Eng. -744215	403 200 76 01/ 77 01 422 200 13 01/ 14 01,441 200 03 01
	87-96	<b>24-1328</b>			Eng. 744216-	422 200 11 01/ 16 01
1717,1720,1722,1820,2420 Eng.OM356/357	87-96	<b>24-0871</b>				366 200 59 01
	87-96	<b>24-1328</b>			Eng. 744216-	422 200 11 01/ 16 01
1733,1824,1827,1831,1834 Eng.OM445/441	87-96	<b>24-0873</b>				403 200 71 01
1824 AK,2024 (180 kW) Eng.OM401.984	93-96	<b>24-1292</b>			For vehicles without retarder; Eng. 744216-	403 200 27 01/ 32 01/ 34 01 403 200 35 01/ 49 01/ 70 01
	93-96	<b>24-1302</b>			For vehicles with retarder, w/o pulley	422 200 06 01
	93-96	<b>24-1309</b>			For vehicles without retarder; Eng. -744215	403 200 76 01/ 77 01 422 200 13 01/ 14 01,441 200 03 01
	93-96	<b>24-1328</b>			Eng. 744216-	422 200 11 01/ 16 01
2426,2524,2527,2531 Eng.OM401	87-96	<b>24-0873</b>				403 200 71 01
	87-96	<b>24-1292</b>			For vehicles without retarder; Eng. 744216-	403 200 27 01/ 32 01/ 34 01 403 200 35 01/ 49 01/ 70 01
	87-96	<b>24-1302</b>			For vehicles with retarder, w/o pulley	422 200 06 01
	86-	<b>24-1309</b>			For vehicles without retarder; Eng. -744215	403 200 76 01/ 77 01 422 200 13 01/ 14 01,441 200 03 01
	87-96	<b>24-1328</b>			Eng. 744216-	422 200 11 01/ 16 01
2524,2527,2531,2534,2426,2433 Eng.OM445/441	87-96	<b>24-0873</b>				403 200 71 01
	87-96	<b>24-1328</b>			Eng. 744216-	422 200 11 01/ 16 01
2631,S,B (180-200-230 kW) Eng.OM401.979	92-96	<b>24-1292</b>			For vehicles without retarder; Eng. 744216-	403 200 27 01/ 32 01/ 34 01 403 200 35 01/ 49 01/ 70 01
	92-96	<b>24-1309</b>			For vehicles without retarder; Eng. -744215	403 200 76 01/ 77 01 422 200 13 01/ 14 01,441 200 03 01
<b>Serie NG '8/73-'9/96</b>						
1017,1217,1617 (124 kW) Eng.OM353.950/951/952/953/954/970/971/975	75-91	<b>24-1294</b>			For vehicles without retarder; Impeller Ø 125mm	403 200 06 01/ 36 01/ 44 01/ 51 01 403 200 71 01/ 01 01/ 02 01/
	75-91	<b>24-1295</b>			Impeller Ø 88mm	352 200 38 01/ 74 01/ 84 01/ 94 01/ 353 200 03 01/ 04 01/ 36 01/ 29 01/ 42 01
	75-91	<b>24-1299</b>			Impeller Ø 94,5mm	353 200 21 01/ 37 01
1219 A,K,1419,1619,1719,1919,2219 (141 kW) Eng.OM401.906/905/915/918/919/914	89-96	<b>24-0873</b>				403 200 71 01
	75-96	<b>24-1292</b>			For vehicles without retarder; Eng. 744216-	403 200 27 01/ 32 01/ 34 01 403 200 35 01/ 49 01/ 70 01
	75-96	<b>24-1294</b>			For vehicles without retarder; Impeller Ø 125mm	403 200 06 01/ 36 01/ 44 01/ 51 01 403 200 71 01/ 01 01/ 02 01/
	75-96	<b>24-1309</b>			For vehicles without retarder; Eng. -744215	403 200 76 01/ 77 01 422 200 13 01/ 14 01,441 200 03 01
	75-96	<b>24-1328</b>			Eng. 744216-	422 200 11 01/ 16 01
1219 A,K,1419,1619,1719,1919,2219 (141 kW) Eng.OM401.909/916/923/925/926	89-96	<b>24-0873</b>				403 200 71 01
	75-96	<b>24-1292</b>			For vehicles without retarder; Eng. 744216-	403 200 27 01/ 32 01/ 34 01 403 200 35 01/ 49 01/ 70 01
	75-96	<b>24-1294</b>			For vehicles without retarder; Impeller Ø 125mm	403 200 06 01/ 36 01/ 44 01/ 51 01 403 200 71 01/ 01 01/ 02 01/
	75-96	<b>24-1309</b>			For vehicles without retarder; Eng. -744215	403 200 76 01/ 77 01 422 200 13 01/ 14 01,441 200 03 01
	75-96	<b>24-1328</b>			Eng. 744216-	422 200 11 01/ 16 01
1222,2222,1422,1622,1922 (141-159 kW) Eng.OM421.905/906	82-90	<b>24-1294</b>			For vehicles without retarder; Impeller Ø 125mm	403 200 06 01/ 36 01/ 44 01/ 51 01 403 200 71 01/ 01 01/ 02 01/
	82-90	<b>24-1309</b>			For vehicles without retarder; Eng. -744215	403 200 76 01/ 77 01 422 200 13 01/ 14 01,441 200 03 01
	82-90	<b>24-1328</b>			Eng. 744216-	422 200 11 01/ 16 01
1414,1420,1614,1620,2220 Eng.OM366	84-91	<b>24-0871</b>				366 200 59 01
	73-96	<b>24-1294</b>			For vehicles without retarder; Impeller Ø 125mm	403 200 06 01/ 36 01/ 44 01/ 51 01 403 200 71 01/ 01 01/ 02 01/
	73-96	<b>24-1325</b>				366 200 54 01/ 67 01/ 68 01 390 200 00 01
	73-96	<b>24-1328</b>			Eng. 744216-	422 200 11 01/ 16 01
1417 Eng.OM353	75-84	<b>24-0870</b>				353 200 56 01

			
<b>24-0871</b>	<b>24-0873</b>	<b>24-1292</b>	<b>24-1294</b>
			
<b>24-1295</b>	<b>24-1298</b>	<b>24-1299</b>	<b>24-1301</b>
			
<b>24-1309</b>	<b>24-1325</b>	<b>24-1328</b>	

		<b>METELLI ref.</b>			<b>NOTE</b>	<b>Adaptable for OES</b>
1417 Eng.OM353	73-96	<b>24-1294</b>			For vehicles without retarder; Impeller Ø 125mm	403 200 06 01/ 36 01/ 44 01/ 51 01 403 200 71 01/ 01 01/ 02 01/
	73-96	<b>24-1295</b>			Impeller Ø 88mm	352 200 38 01/ 74 01/ 84 01/ 94 01/ 353 200 03 01/ 04 01/ 36 01/ 29 01/ 42 01
	73-96	<b>24-1299</b>			Impeller Ø 94,5mm	353 200 21 01/ 37 01
1417 C,CA,CK,CAK,1617 (125 kW) Eng.OM366.951	84-91	<b>24-0871</b>				366 200 59 01
	84-91	<b>24-1294</b>			For vehicles without retarder; Impeller Ø 125mm	403 200 06 01/ 36 01/ 44 01/ 51 01 403 200 71 01/ 01 01/ 02 01/
	84-91	<b>24-1325</b>				366 200 54 01/ 67 01/ 68 01 390 200 00 01
1419 C,CL,1619,2219 (141 kW) Eng.OM362.906/909	83-85	<b>24-1294</b>			For vehicles without retarder; Impeller Ø 125mm	403 200 06 01/ 36 01/ 44 01/ 51 01 403 200 71 01/ 01 01/ 02 01/
	83-85	<b>24-1328</b>			Eng. 744216-	422 200 11 01/ 16 01
1424 F,1624,2224 (176 kW) Eng.OM402.911/910/914/919/923/927/928	75-87	<b>24-0873</b>				403 200 71 01
	75-87	<b>24-1292</b>			For vehicles without retarder; Eng. 744216-	403 200 27 01/ 32 01/ 34 01 403 200 35 01/ 49 01/ 70 01
	75-87	<b>24-1294</b>			For vehicles without retarder; Impeller Ø 125mm	403 200 06 01/ 36 01/ 44 01/ 51 01 403 200 71 01/ 01 01/ 02 01/
	75-96	<b>24-1309</b>			For vehicles without retarder; Eng. -744215	403 200 76 01/ 77 01 422 200 13 01/ 14 01,441 200 03 01
	75-87	<b>24-1328</b>			Eng. 744216-	422 200 11 01/ 16 01
1622,L,2222 (150 kW) Eng.OM441.906/907	82-91	<b>24-1294</b>			For vehicles without retarder; Impeller Ø 125mm	403 200 06 01/ 36 01/ 44 01/ 51 01 403 200 71 01/ 01 01/ 02 01/
	82-91	<b>24-1309</b>			For vehicles without retarder; Eng. -744215	403 200 76 01/ 77 01 422 200 13 01/ 14 01,441 200 03 01
	82-91	<b>24-1328</b>			Eng. 744216-	422 200 11 01/ 16 01
1626,1926,2026,2226,2626 (188 kW) Eng.OM402.906/910/911/912/916	74-87	<b>24-0873</b>				403 200 71 01
	74-87	<b>24-1292</b>			For vehicles without retarder; Eng. 744216-	403 200 27 01/ 32 01/ 34 01 403 200 35 01/ 49 01/ 70 01
	74-87	<b>24-1294</b>			For vehicles without retarder; Impeller Ø 125mm	403 200 06 01/ 36 01/ 44 01/ 51 01 403 200 71 01/ 01 01/ 02 01/
	74-87	<b>24-1309</b>			For vehicles without retarder; Eng. -744215	403 200 76 01/ 77 01 422 200 13 01/ 14 01,441 200 03 01
	74-87	<b>24-1328</b>			Eng. 744216-	422 200 11 01/ 16 01
1632,1932,2032,2232,2632 (235 kW) Eng.OM403.916/932/931/935	74-83	<b>24-0873</b>				403 200 71 01
	74-83	<b>24-1292</b>			For vehicles without retarder; Eng. 744216-	403 200 27 01/ 32 01/ 34 01 403 200 35 01/ 49 01/ 70 01
	74-83	<b>24-1294</b>			For vehicles without retarder; Impeller Ø 125mm	403 200 06 01/ 36 01/ 44 01/ 51 01 403 200 71 01/ 01 01/ 02 01/
	86-	<b>24-1309</b>			For vehicles without retarder; Eng. -744215	403 200 76 01/ 77 01 422 200 13 01/ 14 01,441 200 03 01
	74-83	<b>24-1328</b>			Eng. 744216-	422 200 11 01/ 16 01
1644,S,LS,1944,2244,2644 (320 kW) Eng.OM442.951/953/980	86-89	<b>24-1294</b>			For vehicles without retarder; Impeller Ø 125mm	403 200 06 01/ 36 01/ 44 01/ 51 01 403 200 71 01/ 01 01/ 02 01/
	86-	<b>24-1309</b>			For vehicles without retarder; Eng. -744215	403 200 76 01/ 77 01 422 200 13 01/ 14 01,441 200 03 01
	86-89	<b>24-1328</b>			Eng. 744216-	422 200 11 01/ 16 01
1928,1933,1425,1938,2025,2028,2033 (206-243-184-276 kW) Eng.OM422	80-91	<b>24-0873</b>				403 200 71 01
	80-91	<b>24-1294</b>			For vehicles without retarder; Impeller Ø 125mm	403 200 06 01/ 36 01/ 44 01/ 51 01 403 200 71 01/ 01 01/ 02 01/
	80-91	<b>24-1301</b>			For vehicles with retarder	403 200 64 01/ 75 01 422 200 07 01/ 12 01,442 200 12 01
	80-91	<b>24-1309</b>			For vehicles without retarder; Eng. -744215	403 200 76 01/ 77 01 422 200 13 01/ 14 01,441 200 03 01
	80-91	<b>24-1328</b>			Eng. 744216-	422 200 11 01/ 16 01
1935 AK,2035,2036,1635,2235,2635,3535 (260-269 kW) Eng.OM442.950/952/958/962	86-91	<b>24-1294</b>			For vehicles without retarder; Impeller Ø 125mm	403 200 06 01/ 36 01/ 44 01/ 51 01 403 200 71 01/ 01 01/ 02 01/
	86-91	<b>24-1309</b>			For vehicles without retarder; Eng. -744215	403 200 76 01/ 77 01 422 200 13 01/ 14 01,441 200 03 01
	86-91	<b>24-1328</b>			Eng. 744216-	422 200 11 01/ 16 01
1936 AS,AK,2036,1636,2236,2636,3250,3 (261-368 kW) Eng.OM423.905/906/907/908	81-96	<b>24-0873</b>				403 200 71 01
	81-96	<b>24-1298</b>			For vehicles without retarder, w/o pulley; Impeller Ø 135mm, Incl Electronic fuel Injection pump	403 200 57 01,422 200 05 01/ 10 01
	81-96	<b>24-1328</b>			Eng. 744216-	422 200 11 01/ 16 01
2226,L,S,LS,2626 (188 kW) Eng.OM402.924/926	74-80	<b>24-0873</b>				403 200 71 01
	74-80	<b>24-1292</b>			For vehicles without retarder; Eng. 744216-	403 200 27 01/ 32 01/ 34 01 403 200 35 01/ 49 01/ 70 01

			
<b>24-0870</b>	<b>24-0873</b>	<b>24-0874</b>	<b>24-1294</b>
			
<b>24-1295</b>	<b>24-1296</b>	<b>24-1298</b>	<b>24-1299</b>
			
<b>24-1300</b>	<b>24-1301</b>	<b>24-1309</b>	<b>24-1328</b>

		<b>METELLI</b> ref.			<b>NOTE</b>	<b>Adaptable for OES</b>
2226,L,S,LS,2626 (188 kW) Eng.OM402.924/926	74-80	<b>24-1294</b>			For vehicles without retarder; Impeller Ø 125mm	403 200 06 01/ 36 01/ 44 01/ 51 01 403 200 71 01/ 01 01/ 02 01/
	74-80	<b>24-1309</b>			For vehicles without retarder; Eng. -744215	403 200 76 01/ 77 01 422 200 13 01/ 14 01,441 200 03 01
	74-80	<b>24-1328</b>			Eng. 744216-	422 200 11 01/ 16 01
2228,2233,2238,2628,2633,2638 (206-243-184-276 kW) Eng.OM422	80-91	<b>24-0873</b>				403 200 71 01
	80-91	<b>24-1294</b>			For vehicles without retarder; Impeller Ø 125mm	403 200 06 01/ 36 01/ 44 01/ 51 01 403 200 71 01/ 01 01/ 02 01/
	80-91	<b>24-1301</b>			For vehicles with retarder	403 200 64 01/ 75 01 422 200 07 01/ 12 01,442 200 12 01
	80-91	<b>24-1309</b>			For vehicles without retarder; Eng. -744215	403 200 76 01/ 77 01 422 200 13 01/ 14 01,441 200 03 01
	80-91	<b>24-1328</b>			Eng. 744216-	422 200 11 01/ 16 01
3025 B (184 kW) Eng.OM422.920	85-91	<b>24-0873</b>				403 200 71 01
	85-91	<b>24-1294</b>			For vehicles without retarder; Impeller Ø 125mm	403 200 06 01/ 36 01/ 44 01/ 51 01 403 200 71 01/ 01 01/ 02 01/
	85-91	<b>24-1301</b>			For vehicles with retarder	403 200 64 01/ 75 01 422 200 07 01/ 12 01,442 200 12 01
	85-91	<b>24-1309</b>			For vehicles without retarder; Eng. -744215	403 200 76 01/ 77 01 422 200 13 01/ 14 01,441 200 03 01
	85-91	<b>24-1328</b>			Eng. 744216-	422 200 11 01/ 16 01
3025 B,3028,3228,3328,3528 (184-206 kW) Eng.OM422.919/921	85-91	<b>24-0873</b>				403 200 71 01
	85-91	<b>24-1294</b>			For vehicles without retarder; Impeller Ø 125mm	403 200 06 01/ 36 01/ 44 01/ 51 01 403 200 71 01/ 01 01/ 02 01/
	85-91	<b>24-1301</b>			For vehicles with retarder	403 200 64 01/ 75 01 422 200 07 01/ 12 01,442 200 12 01
	85-91	<b>24-1309</b>			For vehicles without retarder; Eng. -744215	403 200 76 01/ 77 01 422 200 13 01/ 14 01,441 200 03 01
	85-91	<b>24-1328</b>			Eng. 744216-	422 200 11 01/ 16 01
3250 A,AF,3850 (368 kW) Eng.OM423.950/951	85-94	<b>24-0874</b>				422 200 10 01
	85-94	<b>24-1298</b>			For vehicles without retarder, w/o pulley; Impeller Ø 135mm, Incl Electronic fuel Injection pump	403 200 57 01,422 200 05 01/ 10 01
3328 K,B (206 kW) Eng.OM422.914	82-87	<b>24-0873</b>				403 200 71 01
	82-87	<b>24-1294</b>			For vehicles without retarder; Impeller Ø 125mm	403 200 06 01/ 36 01/ 44 01/ 51 01 403 200 71 01/ 01 01/ 02 01/
	82-87	<b>24-1301</b>			For vehicles with retarder	403 200 64 01/ 75 01 422 200 07 01/ 12 01,442 200 12 01
	82-87	<b>24-1309</b>			For vehicles without retarder; Eng. -744215	403 200 76 01/ 77 01 422 200 13 01/ 14 01,441 200 03 01
	82-87	<b>24-1328</b>			Eng. 744216-	422 200 11 01/ 16 01
3333,B,K (243 kW) Eng.OM422.954	80-91	<b>24-0873</b>				403 200 71 01
	80-91	<b>24-1294</b>			For vehicles without retarder; Impeller Ø 125mm	403 200 06 01/ 36 01/ 44 01/ 51 01 403 200 71 01/ 01 01/ 02 01/
	80-91	<b>24-1301</b>			For vehicles with retarder	403 200 64 01/ 75 01 422 200 07 01/ 12 01,442 200 12 01
	80-91	<b>24-1309</b>			For vehicles without retarder; Eng. -744215	403 200 76 01/ 77 01 422 200 13 01/ 14 01,441 200 03 01
	80-91	<b>24-1328</b>			Eng. 744216-	422 200 11 01/ 16 01
3535 K (260-269 kW) Eng.OM442.959	87-94	<b>24-1294</b>			For vehicles without retarder; Impeller Ø 125mm	403 200 06 01/ 36 01/ 44 01/ 51 01 403 200 71 01/ 01 01/ 02 01/
	87-94	<b>24-1309</b>			For vehicles without retarder; Eng. -744215	403 200 76 01/ 77 01 422 200 13 01/ 14 01,441 200 03 01
	87-94	<b>24-1328</b>			Eng. 744216-	422 200 11 01/ 16 01
813,911,913 Eng.OM352/353	73-96	<b>24-0870</b>				353 200 56 01
	73-96	<b>24-1294</b>			For vehicles without retarder; Impeller Ø 125mm	403 200 06 01/ 36 01/ 44 01/ 51 01 403 200 71 01/ 01 01/ 02 01/
	73-96	<b>24-1295</b>			Impeller Ø 88mm	352 200 38 01/ 74 01/ 84 01/ 94 01/ 353 200 03 01/ 04 01/ 36 01/ 29 01/ 42 01
	73-96	<b>24-1299</b>			Impeller Ø 94,5mm	353 200 21 01/ 37 01
<b>Serie PK '1/77-'12/84</b>						
3.8 D (63 kW) Eng.OM314.910	77-84	<b>24-1296</b>			Eng -456936	
	77-84	<b>24-1300</b>			Eng 456937-	314 200 35 01/ 41 01/ 47 01
<b>Serie SK '1/81-'9/96</b>						
1224,1226,2024 (180-200-230 kW) Eng.OM401.975/979/984	93-	<b>24-0873</b>				403 200 71 01



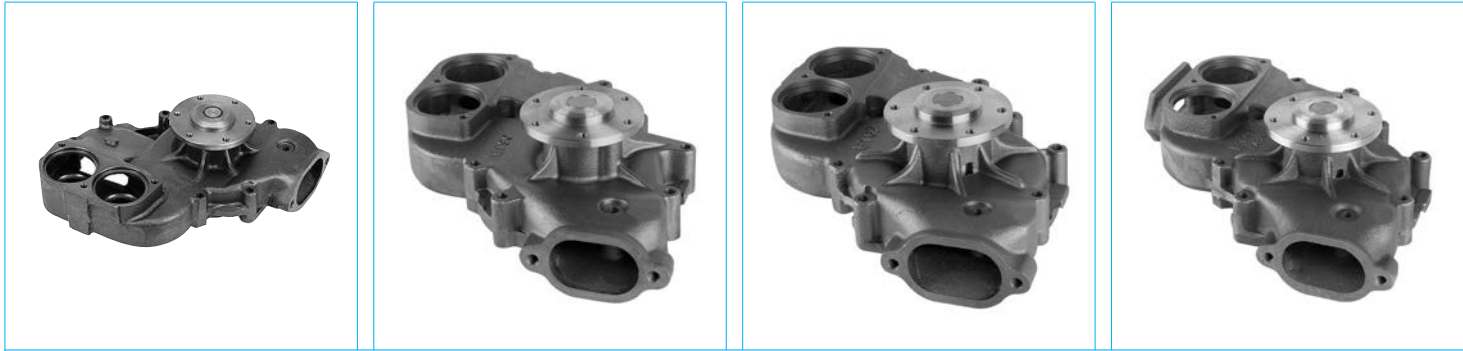

**24-0873**

**24-1292**

**24-1298**

**24-1302**

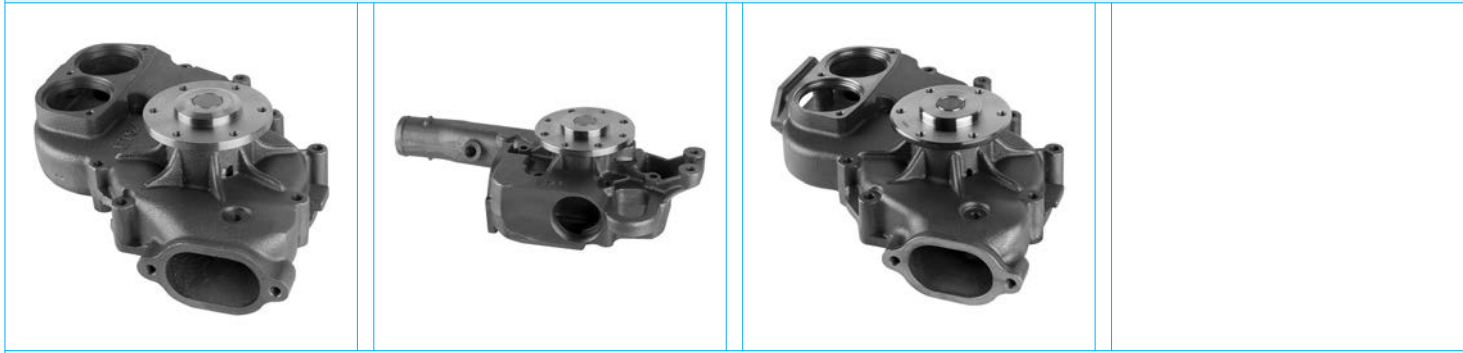

**24-1309**

**24-1320**

**24-1328**

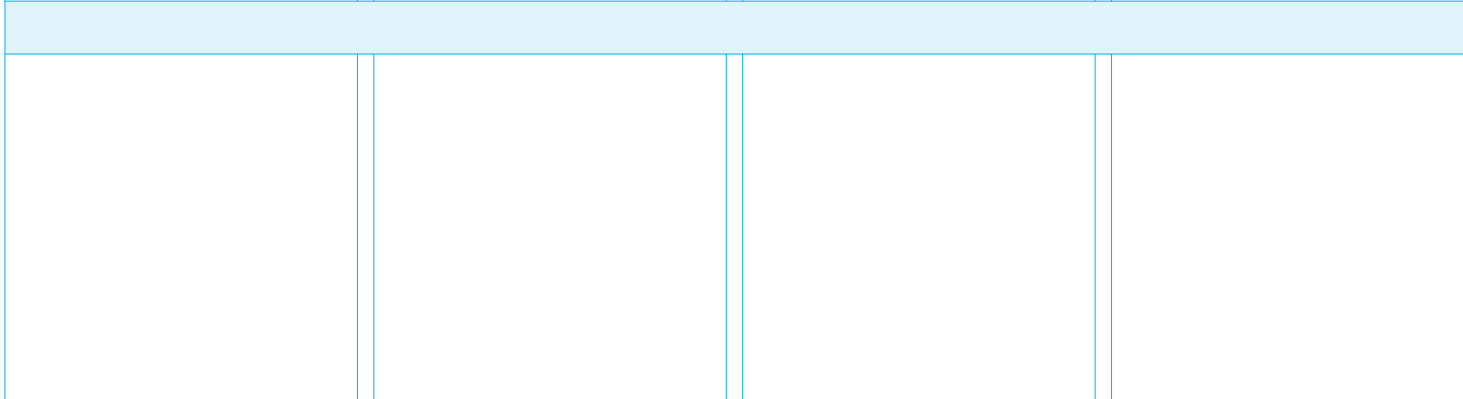
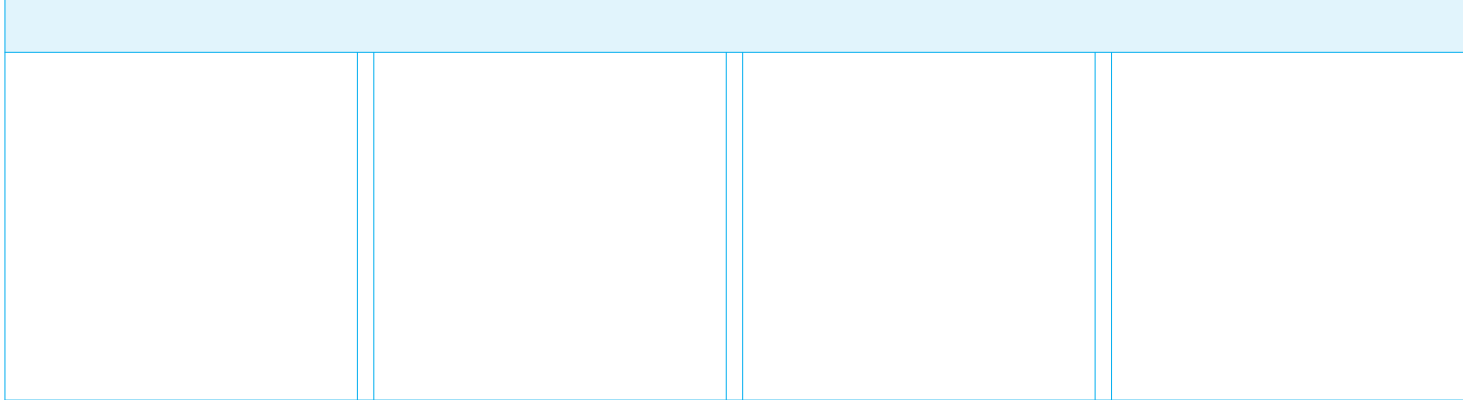
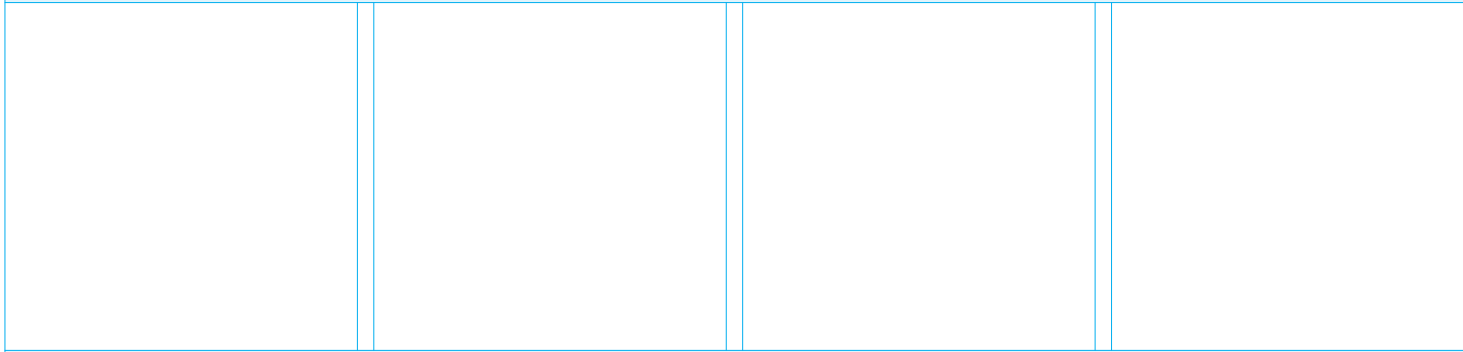

		<b>METELLI</b> ref.			<b>NOTE</b>	<b>Adaptable for OES</b>
1224,1226,2024 (180-200-230 kW) Eng.OM401.975/979/984	93-96	<b>24-1292</b>			For vehicles without retarder; Eng. 744216-	403 200 27 01/ 32 01/ 34 01 403 200 35 01/ 49 01/ 70 01
	86-	<b>24-1309</b>			For vehicles without retarder; Eng. -744215	403 200 76 01/ 77 01 422 200 13 01/ 14 01,441 200 03 01
1735,1748,1838,1844,1935,1948 Eng.OM440/446	87-96	<b>24-1328</b>			Eng. 744216-	422 200 11 01/ 16 01
1735,1935,2435,2635,3235,3535 (250-260-269 kW) Eng.OM442	88-94	<b>24-0873</b>				403 200 71 01
	86-	<b>24-1309</b>			For vehicles without retarder; Eng. -744215	403 200 76 01/ 77 01 422 200 13 01/ 14 01,441 200 03 01
	88-94	<b>24-1328</b>			Eng. 744216-	422 200 11 01/ 16 01
1831,1834 Eng.OM445/441	89-96	<b>24-0873</b>				403 200 71 01
	87-96	<b>24-1328</b>			Eng. 744216-	422 200 11 01/ 16 01
1831,2024,2031,2629,2631 Eng.OM401	87-96	<b>24-0873</b>				403 200 71 01
	87-96	<b>24-1292</b>			For vehicles without retarder; Eng. 744216-	403 200 27 01/ 32 01/ 34 01 403 200 35 01/ 49 01/ 70 01
	87-96	<b>24-1309</b>			For vehicles without retarder; Eng. -744215	403 200 76 01/ 77 01 422 200 13 01/ 14 01,441 200 03 01
	87-96	<b>24-1328</b>			Eng. 744216-	422 200 11 01/ 16 01
1838,1840 Eng.OM402/440	91-96	<b>24-0873</b>				403 200 71 01
	87-96	<b>24-1292</b>			For vehicles without retarder; Eng. 744216-	403 200 27 01/ 32 01/ 34 01 403 200 35 01/ 49 01/ 70 01
	86-	<b>24-1309</b>			For vehicles without retarder; Eng. -744215	403 200 76 01/ 77 01 422 200 13 01/ 14 01,441 200 03 01
	87-96	<b>24-1328</b>			Eng. 744216-	422 200 11 01/ 16 01
1922 (151-160 kW) Eng.OM441.905/914/923/926	89-94	<b>24-0873</b>				403 200 71 01
	89-94	<b>24-1302</b>			For vehicles with retarder, w/o pulley	422 200 06 01
	86-	<b>24-1309</b>			For vehicles without retarder; Eng. -744215	403 200 76 01/ 77 01 422 200 13 01/ 14 01,441 200 03 01
	89-94	<b>24-1328</b>			Eng. 744216-	422 200 11 01/ 16 01
1935 S,K,AS,AK (250-260-269 kW) Eng.OM442.942,944,963,964,976	89-94	<b>24-0873</b>				403 200 71 01
	89-94	<b>24-1302</b>			For vehicles with retarder, w/o pulley	422 200 06 01
	86-	<b>24-1309</b>			For vehicles without retarder; Eng. -744215	403 200 76 01/ 77 01 422 200 13 01/ 14 01,441 200 03 01
	89-94	<b>24-1328</b>			Eng. 744216-	422 200 11 01/ 16 01
2024,2031,2631 Eng.OM445/441	89-96	<b>24-0873</b>				403 200 71 01
	87-96	<b>24-1302</b>			For vehicles with retarder, w/o pulley	422 200 06 01
	87-96	<b>24-1328</b>			Eng. 744216-	422 200 11 01/ 16 01
2031,2038,2044,2050 Eng.OM440/446	87-96	<b>24-1328</b>			Eng. 744216-	422 200 11 01/ 16 01
2031,2038,2538,2629,2635,2638 Eng.OM402/440	91-96	<b>24-0873</b>				403 200 71 01
	87-96	<b>24-1292</b>			For vehicles without retarder; Eng. 744216-	403 200 27 01/ 32 01/ 34 01 403 200 35 01/ 49 01/ 70 01
	86-	<b>24-1309</b>			For vehicles without retarder; Eng. -744215	403 200 76 01/ 77 01 422 200 13 01/ 14 01,441 200 03 01
	87-96	<b>24-1328</b>			Eng. 744216-	422 200 11 01/ 16 01
2435,2448,2538,2544,2550,2553 Eng.OM440/446	87-96	<b>24-1328</b>			Eng. 744216-	422 200 11 01/ 16 01
2629,2635,2638,2644,2650 Eng.OM440/446	87-96	<b>24-1328</b>			Eng. 744216-	422 200 11 01/ 16 01
3233,3234,3534 Eng.OM445/441	89-96	<b>24-0873</b>				403 200 71 01
	87-96	<b>24-1302</b>			For vehicles with retarder, w/o pulley	422 200 06 01
	87-96	<b>24-1328</b>			Eng. 744216-	422 200 11 01/ 16 01
3235,3238,3253,3535,3538,3550 Eng.OM440/446	87-96	<b>24-1328</b>			Eng. 744216-	422 200 11 01/ 16 01
3238,3535 Eng.OM402/440	91-96	<b>24-0873</b>				403 200 71 01
	87-96	<b>24-1292</b>			For vehicles without retarder; Eng. 744216-	403 200 27 01/ 32 01/ 34 01 403 200 35 01/ 49 01/ 70 01
	86-	<b>24-1309</b>			For vehicles without retarder; Eng. -744215	403 200 76 01/ 77 01 422 200 13 01/ 14 01,441 200 03 01
	87-96	<b>24-1328</b>			Eng. 744216-	422 200 11 01/ 16 01
3336 (261 kW) Eng.OM423.905	81-91	<b>24-1298</b>			For vehicles without retarder, w/o pulley; Impeller Ø 135mm, Incl Electronic fuel Injection pump	403 200 57 01,422 200 05 01/ 10 01

**Tourino (O 510) '10/03-**

TOURINO (180 kW) Eng.OM906.962	03-	<b>24-1320</b>			For vehicles without retarder	904 200 02 01/ 04 01/ 06 01/ 07 01/ 08 01 904 200 19 01/ 20 01/ 22 01/ 25 01/ 26 01 904 200 27 01/ 28 01/ 29 01/ 32 01/ 38 01 904 200 43 01/ 49 01/ 50 01



**24-1295**



**24-1299**



**24-1303**



**24-1320**



**24-1326**



**24-1327**



**24-1329**



**24-1333**



**24-1341**



**24-1342**

		<b>METELLI</b> ref.			<b>NOTE</b>	<b>Adaptable for OES</b>
TOURINO (180 kW) Eng.OM906.962	03-	<b>24-1333</b>				906 200 09 01/ 12 01/ 13 01/ 14 01/ 18 01 906 200 20 01/ 22 01/ 24 01/ 29 01/ 32 01 906 200 38 01/ 42 01/ 45 01/ 48 01/ 54 01 906 200 57 01/ 65 01
TOURINO (205 kW) Eng.OM906.961	03-	<b>24-1320</b>			For vehicles without retarder	904 200 02 01/ 04 01/ 06 01/ 07 01/ 08 01 904 200 19 01/ 20 01/ 22 01/ 25 01/ 26 01 904 200 27 01/ 28 01/ 29 01/ 32 01/ 38 01 904 200 43 01/ 49 01/ 50 01
	03-	<b>24-1333</b>				906 200 09 01/ 12 01/ 13 01/ 14 01/ 18 01 906 200 20 01/ 22 01/ 24 01/ 29 01/ 32 01 906 200 38 01/ 42 01/ 45 01/ 48 01/ 54 01 906 200 57 01/ 65 01
<b>Touro (O 500) '10/01-</b>						
Touro (260 kW) Eng.OM457.944	01-	<b>24-1326</b>			For vehicles with retarder; Open hole	457 200 02 01/ 05 01/ 11 01/ 25 01/ 27 01
	01-	<b>24-1327</b>			For vehicles with retarder; Close hole	442 200 04 01/ 06 01/ 07 01/ 09 01 457 200 10 01/ 24 01/ 28 01
	01-	<b>24-1329</b>			For vehicles without retarder	457 200 08 01/ 19 01/ 23 01/ 29 01
Touro (310 kW) Eng.OM457.944	01-	<b>24-1326</b>			For vehicles with retarder; Open hole	457 200 02 01/ 05 01/ 11 01/ 25 01/ 27 01
	01-	<b>24-1327</b>			For vehicles with retarder; Close hole	442 200 04 01/ 06 01/ 07 01/ 09 01 457 200 10 01/ 24 01/ 28 01
	01-	<b>24-1329</b>			For vehicles without retarder	457 200 08 01/ 19 01/ 23 01/ 29 01
<b>Travego (O 580) '10/99-</b>						
O 580-15 (260 kW) Eng.OM457.940	99-	<b>24-1326</b>			For vehicles with retarder; Open hole	457 200 02 01/ 05 01/ 11 01/ 25 01/ 27 01
	99-	<b>24-1327</b>			For vehicles with retarder; Close hole	442 200 04 01/ 06 01/ 07 01/ 09 01 457 200 10 01/ 24 01/ 28 01
	99-	<b>24-1329</b>			For vehicles without retarder	457 200 08 01/ 19 01/ 23 01/ 29 01
O 580-15 (300 kW) Eng.OM457.936/.938	99-	<b>24-1326</b>			For vehicles with retarder; Open hole	457 200 02 01/ 05 01/ 11 01/ 25 01/ 27 01
	99-	<b>24-1327</b>			For vehicles with retarder; Close hole	442 200 04 01/ 06 01/ 07 01/ 09 01 457 200 10 01/ 24 01/ 28 01
	99-	<b>24-1329</b>			For vehicles without retarder	457 200 08 01/ 19 01/ 23 01/ 29 01
O 580-17 (310 kW) Eng.OM457.944	99-	<b>24-1326</b>			For vehicles with retarder; Open hole	457 200 02 01/ 05 01/ 11 01/ 25 01/ 27 01
	99-	<b>24-1327</b>			For vehicles with retarder; Close hole	442 200 04 01/ 06 01/ 07 01/ 09 01 457 200 10 01/ 24 01/ 28 01
	99-	<b>24-1329</b>			For vehicles without retarder	457 200 08 01/ 19 01/ 23 01/ 29 01
O 580-17 (320 kW) Eng.OM542.948	99-	<b>24-1341</b>			For vehicles without retarder; With fastening eyes for axial fan	542 200 25 01
	99-	<b>24-1342</b>			For vehicles with retarder; With fastening eyes for axial fan	542 200 26 01
O 580-17 (350 kW) Eng.OM542.948	99-	<b>24-1341</b>			For vehicles without retarder; With fastening eyes for axial fan	542 200 25 01
	99-	<b>24-1342</b>			For vehicles with retarder; With fastening eyes for axial fan	542 200 26 01
<b>Unimog '1/73-'12/00</b>						
100,110,1100L (74-81 kW) Eng.OM353.901/.940/.980	77-88	<b>24-1295</b>			Impeller Ø 88mm	352 200 38 01/ 74 01/ 84 01/ 94 01/ 353 200 03 01/ 04 01/ 36 01/ 29 01/ 42 01
	77-88	<b>24-1299</b>			Impeller Ø 94,5mm	353 200 21 01/ 37 01
100,110T,1100T (74-81 kW) Eng.OM353.901/.940/.980	77-88	<b>24-1295</b>			Impeller Ø 88mm	352 200 38 01/ 74 01/ 84 01/ 94 01/ 353 200 03 01/ 04 01/ 36 01/ 29 01/ 42 01
	77-88	<b>24-1299</b>			Impeller Ø 94,5mm	353 200 21 01/ 37 01
1000 (70 kW) Eng.OM353.962	77-88	<b>24-1295</b>			Impeller Ø 88mm	352 200 38 01/ 74 01/ 84 01/ 94 01/ 353 200 03 01/ 04 01/ 36 01/ 29 01/ 42 01
	77-88	<b>24-1299</b>			Impeller Ø 94,5mm	353 200 21 01/ 37 01
1000T (81 kW) Eng.OM353.940/.980	77-82	<b>24-1295</b>			Impeller Ø 88mm	352 200 38 01/ 74 01/ 84 01/ 94 01/ 353 200 03 01/ 04 01/ 36 01/ 29 01/ 42 01
	77-82	<b>24-1299</b>			Impeller Ø 94,5mm	353 200 21 01/ 37 01
110,110L (75-77 kW) Eng.OM364.955/.958	92-00	<b>24-1303</b>				364 200 01 01/ 09 01/ 14 01/ 20 01
1150,1150L (81 kW) Eng.OM353.940	88-00	<b>24-1295</b>			Impeller Ø 88mm	352 200 38 01/ 74 01/ 84 01/ 94 01/ 353 200 03 01/ 04 01/ 36 01/ 29 01/ 42 01
	88-00	<b>24-1299</b>			Impeller Ø 94,5mm	353 200 21 01/ 37 01



**24-0870**



**24-1295**



**24-1299**



**24-1303**



**24-1325**

		<b>METELLI</b> ref.			<b>NOTE</b>	<b>Adaptable for OES</b>
1150L (92 kW) Eng.OM353.907	77-88	<b>24-0870</b>				353 200 56 01
	88-00	<b>24-1295</b>			Impeller Ø 88mm	352 200 38 01/ 74 01/ 84 01/ 94 01/ 353 200 03 01/ 04 01/ 36 01/ 29 01/ 42 01
	88-00	<b>24-1299</b>			Impeller Ø 94,5mm	353 200 21 01/ 37 01
1200 (92 kW) Eng.OM353.973/.995	77-88	<b>24-0870</b>				353 200 56 01
	82-84	<b>24-1295</b>			Impeller Ø 88mm	352 200 38 01/ 74 01/ 84 01/ 94 01/ 353 200 03 01/ 04 01/ 36 01/ 29 01/ 42 01
	82-84	<b>24-1299</b>			Impeller Ø 94,5mm	353 200 21 01/ 37 01
1200 (92 kW) Eng.OM356.950/.954	92-00	<b>24-1325</b>				366 200 54 01/ 67 01/ 68 01 390 200 00 01
1200 (92 kW) Eng.OM366.949	88-00	<b>24-1325</b>				366 200 54 01/ 67 01/ 68 01 390 200 00 01
1200T (92 kW) Eng.OM353.973/.995	77-88	<b>24-0870</b>				353 200 56 01
	83-84	<b>24-1295</b>			Impeller Ø 88mm	352 200 38 01/ 74 01/ 84 01/ 94 01/ 353 200 03 01/ 04 01/ 36 01/ 29 01/ 42 01
	83-84	<b>24-1299</b>			Impeller Ø 94,5mm	353 200 21 01/ 37 01
1200T (92 kW) Eng.OM356.954	91-00	<b>24-1325</b>				366 200 54 01/ 67 01/ 68 01 390 200 00 01
1200T (92 kW) Eng.OM366.949	88-00	<b>24-1325</b>				366 200 54 01/ 67 01/ 68 01 390 200 00 01
125,1100L (92 kW) Eng.OM353.907	77-88	<b>24-0870</b>				353 200 56 01
	77-88	<b>24-1295</b>			Impeller Ø 88mm	352 200 38 01/ 74 01/ 84 01/ 94 01/ 353 200 03 01/ 04 01/ 36 01/ 29 01/ 42 01
	77-88	<b>24-1299</b>			Impeller Ø 94,5mm	353 200 21 01/ 37 01
1250 (92 kW) Eng.OM353.973/.995	77-88	<b>24-0870</b>				353 200 56 01
	84-	<b>24-1295</b>			Impeller Ø 88mm	352 200 38 01/ 74 01/ 84 01/ 94 01/ 353 200 03 01/ 04 01/ 36 01/ 29 01/ 42 01
	84-	<b>24-1299</b>			Impeller Ø 94,5mm	353 200 21 01/ 37 01
1250,1250L (92 kW) Eng.OM356.950/.954	92-00	<b>24-1325</b>				366 200 54 01/ 67 01/ 68 01 390 200 00 01
1250,1250L (92 kW) Eng.OM366.949	88-00	<b>24-1325</b>				366 200 54 01/ 67 01/ 68 01 390 200 00 01
1250L (100 kW) Eng.OM366.955	88-00	<b>24-1325</b>				366 200 54 01/ 67 01/ 68 01 390 200 00 01
130,140 (98-103 kW) Eng.OM364.982/.985	92-00	<b>24-1303</b>				364 200 01 01/ 09 01/ 14 01/ 20 01
1300 (92 kW) Eng.OM353.973/.995	77-88	<b>24-0870</b>				353 200 56 01
	77-84	<b>24-1295</b>			Impeller Ø 88mm	352 200 38 01/ 74 01/ 84 01/ 94 01/ 353 200 03 01/ 04 01/ 36 01/ 29 01/ 42 01
	77-84	<b>24-1299</b>			Impeller Ø 94,5mm	353 200 21 01/ 37 01
1300,1300L (92-96 kW) Eng.OM353.961/.973	77-88	<b>24-0870</b>				353 200 56 01
	77-88	<b>24-1295</b>			Impeller Ø 88mm	352 200 38 01/ 74 01/ 84 01/ 94 01/ 353 200 03 01/ 04 01/ 36 01/ 29 01/ 42 01
	77-88	<b>24-1299</b>			Impeller Ø 94,5mm	353 200 21 01/ 37 01
1350L (100 kW) Eng.OM366.955	88-00	<b>24-1325</b>				366 200 54 01/ 67 01/ 68 01 390 200 00 01
1400 (100 kW) Eng.OM366.947/.948	88-00	<b>24-1325</b>				366 200 54 01/ 67 01/ 68 01 390 200 00 01
1400 (100 kW) Eng.OM366.955/.956	88-00	<b>24-1325</b>				366 200 54 01/ 67 01/ 68 01 390 200 00 01
140L (100-103 kW) Eng.OM364.985	93-00	<b>24-1303</b>				364 200 01 01/ 09 01/ 14 01/ 20 01
140T (98 kW) Eng.OM364.982	92-00	<b>24-1303</b>				364 200 01 01/ 09 01/ 14 01/ 20 01
1450,1450L (100 kW) Eng.OM366.947/.948	88-00	<b>24-1325</b>				366 200 54 01/ 67 01/ 68 01 390 200 00 01
1450,1450L (100 kW) Eng.OM366.955/.956	88-00	<b>24-1325</b>				366 200 54 01/ 67 01/ 68 01 390 200 00 01
1500 (110 kW) Eng.OM353.958	77-88	<b>24-1295</b>			Impeller Ø 88mm	352 200 38 01/ 74 01/ 84 01/ 94 01/ 353 200 03 01/ 04 01/ 36 01/ 29 01/ 42 01
	77-88	<b>24-1299</b>			Impeller Ø 94,5mm	353 200 21 01/ 37 01
1500T (110 kW) Eng.OM353.958	77-88	<b>24-1295</b>			Impeller Ø 88mm	352 200 38 01/ 74 01/ 84 01/ 94 01/ 353 200 03 01/ 04 01/ 36 01/ 29 01/ 42 01
	77-88	<b>24-1299</b>			Impeller Ø 94,5mm	353 200 21 01/ 37 01
1550 (110 kW) Eng.OM353.958	86-88	<b>24-1295</b>			Impeller Ø 88mm	352 200 38 01/ 74 01/ 84 01/ 94 01/ 353 200 03 01/ 04 01/ 36 01/ 29 01/ 42 01
	86-88	<b>24-1299</b>			Impeller Ø 94,5mm	353 200 21 01/ 37 01
1550L (100 kW) Eng.OM366.955/.956	88-00	<b>24-1325</b>				366 200 54 01/ 67 01/ 68 01 390 200 00 01

			
<b>24-0870</b>	<b>24-1295</b>	<b>24-1299</b>	<b>24-1320</b>
			
<b>24-1325</b>	<b>24-1333</b>		

		<b>METELLI</b> ref.			<b>NOTE</b>	<b>Adaptable for OES</b>
1550L (125 kW) Eng.OM366.963	92-00	<b>24-1325</b>				366 200 54 01/ 67 01/ 68 01 390 200 00 01
1550L (150-157 kW) Eng.OM366.984	88-00	<b>24-1325</b>				366 200 54 01/ 67 01/ 68 01 390 200 00 01
1550L (92-96 kW) Eng.OM353.961/.995	77-88	<b>24-0870</b>				353 200 56 01
	86-88	<b>24-1295</b>			Impeller Ø 88mm	352 200 38 01/ 74 01/ 84 01/ 94 01/ 353 200 03 01/ 04 01/ 36 01/ 29 01/ 42 01
	86-88	<b>24-1299</b>			Impeller Ø 94,5mm	353 200 21 01/ 37 01
1600 (115 kW) Eng.OM366.949	88-00	<b>24-1325</b>				366 200 54 01/ 67 01/ 68 01 390 200 00 01
1600 (150-157 kW) Eng.OM366.984	89-00	<b>24-1325</b>				366 200 54 01/ 67 01/ 68 01 390 200 00 01
1650,1650L (115 kW) Eng.OM366.948/.949	88-00	<b>24-1325</b>				366 200 54 01/ 67 01/ 68 01 390 200 00 01
1650,1650L (150-157 kW) Eng.OM366.984	89-00	<b>24-1325</b>				366 200 54 01/ 67 01/ 68 01 390 200 00 01
1700,1700L (122-125 kW) Eng.OM366.963	88-00	<b>24-1325</b>				366 200 54 01/ 67 01/ 68 01 390 200 00 01
1700,1700L (124 kW) Eng.OM353.959	78-88	<b>24-1295</b>			Impeller Ø 88mm	352 200 38 01/ 74 01/ 84 01/ 94 01/ 353 200 03 01/ 04 01/ 36 01/ 29 01/ 42 01
	78-88	<b>24-1299</b>			Impeller Ø 94,5mm	353 200 21 01/ 37 01
1700L (124 kW) Eng.OM353.959	78-88	<b>24-1295</b>			Impeller Ø 88mm	352 200 38 01/ 74 01/ 84 01/ 94 01/ 353 200 03 01/ 04 01/ 36 01/ 29 01/ 42 01
	78-88	<b>24-1299</b>			Impeller Ø 94,5mm	353 200 21 01/ 37 01
1700T (122-125 kW) Eng.OM366.963	88-00	<b>24-1325</b>				366 200 54 01/ 67 01/ 68 01 390 200 00 01
2100 (155-157 kW) Eng.OM366.984	89-00	<b>24-1325</b>				366 200 54 01/ 67 01/ 68 01 390 200 00 01
2100T (155-157 kW) Eng.OM366.984	89-00	<b>24-1325</b>				366 200 54 01/ 67 01/ 68 01 390 200 00 01
2150 (155-157 kW) Eng.OM366.984	89-00	<b>24-1325</b>				366 200 54 01/ 67 01/ 68 01 390 200 00 01
2150,2150L (155-157 kW) Eng.OM366.984	89-00	<b>24-1325</b>				366 200 54 01/ 67 01/ 68 01 390 200 00 01
300 (110 kW) Eng.OM904.927	03/00-12/00	<b>24-1320</b>			For vehicles without retarder	904 200 02 01/ 04 01/ 06 01/ 07 01/ 08 01 904 200 19 01/ 20 01/ 22 01/ 25 01/ 26 01 904 200 27 01/ 28 01/ 29 01/ 32 01/ 38 01 904 200 43 01/ 49 01/ 50 01
300 (130 kW) Eng.OM904.928	03/00-12/00	<b>24-1320</b>			For vehicles without retarder	904 200 02 01/ 04 01/ 06 01/ 07 01/ 08 01 904 200 19 01/ 20 01/ 22 01/ 25 01/ 26 01 904 200 27 01/ 28 01/ 29 01/ 32 01/ 38 01 904 200 43 01/ 49 01/ 50 01
3000 (110 kW) Eng.OM904.953	03/00-12/00	<b>24-1320</b>			For vehicles without retarder	904 200 02 01/ 04 01/ 06 01/ 07 01/ 08 01 904 200 19 01/ 20 01/ 22 01/ 25 01/ 26 01 904 200 27 01/ 28 01/ 29 01/ 32 01/ 38 01 904 200 43 01/ 49 01/ 50 01
3000 (130 kW) Eng.OM904.952	03/00-12/00	<b>24-1320</b>			For vehicles without retarder	904 200 02 01/ 04 01/ 06 01/ 07 01/ 08 01 904 200 19 01/ 20 01/ 22 01/ 25 01/ 26 01 904 200 27 01/ 28 01/ 29 01/ 32 01/ 38 01 904 200 43 01/ 49 01/ 50 01
400 (130 kW) Eng.OM904.928	03/00-12/00	<b>24-1320</b>			For vehicles without retarder	904 200 02 01/ 04 01/ 06 01/ 07 01/ 08 01 904 200 19 01/ 20 01/ 22 01/ 25 01/ 26 01 904 200 27 01/ 28 01/ 29 01/ 32 01/ 38 01 904 200 43 01/ 49 01/ 50 01
400 (170 kW) Eng.OM906.935	03/00-12/00	<b>24-1333</b>				906 200 09 01/ 12 01/ 13 01/ 14 01/ 18 01 906 200 20 01/ 22 01/ 24 01/ 29 01/ 32 01 906 200 38 01/ 42 01/ 45 01/ 48 01/ 54 01 906 200 57 01/ 65 01



			
<b>24-1295</b>	<b>24-1296</b>	<b>24-1299</b>	<b>24-1300</b>
			
<b>24-1320</b>	<b>24-1333</b>		

		<b>METELLI</b> ref.			<b>NOTE</b>	<b>Adaptable for OES</b>
4000 (110 kW) Eng.OM904.953	03/00-12/00	<b>24-1320</b>			For vehicles without retarder	904 200 02 01/ 04 01/ 06 01/ 07 01/ 08 01 904 200 19 01/ 20 01/ 22 01/ 25 01/ 26 01 904 200 27 01/ 28 01/ 29 01/ 32 01/ 38 01 904 200 43 01/ 49 01/ 50 01
4000 (130 kW) Eng.OM904.952	03/00-12/00	<b>24-1320</b>			For vehicles without retarder	904 200 02 01/ 04 01/ 06 01/ 07 01/ 08 01 904 200 19 01/ 20 01/ 22 01/ 25 01/ 26 01 904 200 27 01/ 28 01/ 29 01/ 32 01/ 38 01 904 200 43 01/ 49 01/ 50 01
500,GNNA (170-172 kW) Eng.OM906.935	03/00-12/00	<b>24-1320</b>			For vehicles without retarder	904 200 02 01/ 04 01/ 06 01/ 07 01/ 08 01 904 200 19 01/ 20 01/ 22 01/ 25 01/ 26 01 904 200 27 01/ 28 01/ 29 01/ 32 01/ 38 01 904 200 43 01/ 49 01/ 50 01
	10/00-12/00	<b>24-1333</b>				906 200 09 01/ 12 01/ 13 01/ 14 01/ 18 01 906 200 20 01/ 22 01/ 24 01/ 29 01/ 32 01 906 200 38 01/ 42 01/ 45 01/ 48 01/ 54 01 906 200 57 01/ 65 01
500,GNNA (205-209 kW) Eng.OM906.955/.967	03/00-12/00	<b>24-1320</b>			For vehicles without retarder	904 200 02 01/ 04 01/ 06 01/ 07 01/ 08 01 904 200 19 01/ 20 01/ 22 01/ 25 01/ 26 01 904 200 27 01/ 28 01/ 29 01/ 32 01/ 38 01 904 200 43 01/ 49 01/ 50 01
	10/00-12/00	<b>24-1333</b>				906 200 09 01/ 12 01/ 13 01/ 14 01/ 18 01 906 200 20 01/ 22 01/ 24 01/ 29 01/ 32 01 906 200 38 01/ 42 01/ 45 01/ 48 01/ 54 01 906 200 57 01/ 65 01
54 (40 kW) Eng.OM314.916	66-72	<b>24-1296</b>			Eng -456936	
	66-72	<b>24-1300</b>			Eng 456937-	314 200 35 01/ 41 01/ 47 01
65,70 (48 kW) Eng.OM352.919	65-66	<b>24-1295</b>			Impeller Ø 88mm	352 200 38 01/ 74 01/ 84 01/ 94 01/ 353 200 03 01/ 04 01/ 36 01/ 29 01/ 42 01
	65-66	<b>24-1299</b>			Impeller Ø 94,5mm	353 200 21 01/ 37 01
65T,70T (48 kW) Eng.OM352.919	65-66	<b>24-1295</b>			Impeller Ø 88mm	352 200 38 01/ 74 01/ 84 01/ 94 01/ 353 200 03 01/ 04 01/ 36 01/ 29 01/ 42 01
	69-88	<b>24-1299</b>			Impeller Ø 94,5mm	353 200 21 01/ 37 01
66,72 (55 kW) Eng.OM314.917	69-88	<b>24-1296</b>			Eng -456936	
	69-88	<b>24-1300</b>			Eng 456937-	314 200 35 01/ 41 01/ 47 01
72,80 (48-55 kW) Eng.OM314.917	69-77	<b>24-1296</b>			Eng -456936	
	69-77	<b>24-1300</b>			Eng 456937-	314 200 35 01/ 41 01/ 47 01
80,84,90 (62-66 kW) Eng.OM352.903	69-76	<b>24-1295</b>			Impeller Ø 88mm	352 200 38 01/ 74 01/ 84 01/ 94 01/ 353 200 03 01/ 04 01/ 36 01/ 29 01/ 42 01
	69-00	<b>24-1299</b>			Impeller Ø 94,5mm	353 200 21 01/ 37 01
80,84,90 (62-66 kW) Eng.OM353.902	69-88	<b>24-1295</b>			Impeller Ø 88mm	352 200 38 01/ 74 01/ 84 01/ 94 01/ 353 200 03 01/ 04 01/ 36 01/ 29 01/ 42 01
	69-76	<b>24-1299</b>			Impeller Ø 94,5mm	353 200 21 01/ 37 01
800 (53-55 kW) Eng.OM314.917	05/88-12/88	<b>24-1296</b>			Eng -456936	
	77-88	<b>24-1296</b>			Eng -456936	
	05/88-12/88	<b>24-1300</b>			Eng 456937-	314 200 35 01/ 41 01/ 47 01
	77-88	<b>24-1300</b>			Eng 456937-	314 200 35 01/ 41 01/ 47 01
800L (53-55 kW) Eng.OM314.917	77-88	<b>24-1296</b>			Eng -456936	
	77-88	<b>24-1300</b>			Eng 456937-	314 200 35 01/ 41 01/ 47 01
80T,90T (59-66 kW) Eng.OM352.903/.984	69-00	<b>24-1295</b>			Impeller Ø 88mm	352 200 38 01/ 74 01/ 84 01/ 94 01/ 353 200 03 01/ 04 01/ 36 01/ 29 01/ 42 01
	77-00	<b>24-1299</b>			Impeller Ø 94,5mm	353 200 21 01/ 37 01
900 (62 kW) Eng.OM353.902	77-00	<b>24-1295</b>			Impeller Ø 88mm	352 200 38 01/ 74 01/ 84 01/ 94 01/ 353 200 03 01/ 04 01/ 36 01/ 29 01/ 42 01
	77-88	<b>24-1299</b>			Impeller Ø 94,5mm	353 200 21 01/ 37 01
900 (81 kW) Eng.OM353.940	77-88	<b>24-1295</b>			Impeller Ø 88mm	352 200 38 01/ 74 01/ 84 01/ 94 01/ 353 200 03 01/ 04 01/ 36 01/ 29 01/ 42 01
	67-77	<b>24-1299</b>			Impeller Ø 94,5mm	353 200 21 01/ 37 01



**24-1320**



**24-1333**



**24-1343**



		<b>METELLI</b> ref.			NOTE	Adaptable for OES
<b>Zetros '9/08-</b>						
1833A (240 kW) Eng.OM926.935/.936/.947	08-	<b>24-1320</b>			For vehicles without retarder	904 200 02 01/ 04 01/ 06 01/ 07 01/ 08 01 904 200 19 01/ 20 01/ 22 01/ 25 01/ 26 01 904 200 27 01/ 28 01/ 29 01/ 32 01/ 38 01 904 200 43 01/ 49 01/ 50 01
	08-	<b>24-1333</b>				906 200 09 01/ 12 01/ 13 01/ 14 01/ 18 01 906 200 20 01/ 22 01/ 24 01/ 29 01/ 32 01 906 200 38 01/ 42 01/ 45 01/ 48 01/ 54 01 906 200 57 01/ 65 01
2733A (240 kW) Eng.OM926.935/.936/.947	08-	<b>24-1320</b>			For vehicles without retarder	904 200 02 01/ 04 01/ 06 01/ 07 01/ 08 01 904 200 19 01/ 20 01/ 22 01/ 25 01/ 26 01 904 200 27 01/ 28 01/ 29 01/ 32 01/ 38 01 904 200 43 01/ 49 01/ 50 01
	08-	<b>24-1333</b>				906 200 09 01/ 12 01/ 13 01/ 14 01/ 18 01 906 200 20 01/ 22 01/ 24 01/ 29 01/ 32 01 906 200 38 01/ 42 01/ 45 01/ 48 01/ 54 01 906 200 57 01/ 65 01





**RENAULT TRUCK**

<b>Agora Bus '1/95-</b>						
Agora (186-188 kW) Eng.MIDR0620.45	95-	<b>24-1343</b>		•		50 01 837 309,50 10 330 029
<b>C '10/80-'6/97</b>						
C 260.19 (192 kW) Eng.MIDS0620.45	80-89	<b>24-1343</b>		•		50 01 837 309,50 10 330 029
C 260.26 (192 kW) Eng.MIDS0620.45	85-89	<b>24-1343</b>		•		50 01 837 309,50 10 330 029
C 280.19 (202 kW) Eng.MIDS0620.45	92-96	<b>24-1343</b>		•		50 01 837 309,50 10 330 029
C 290.19,C 300.19 (214-222 kW) Eng.MIDR0620.45	90-91	<b>24-1343</b>		•		50 01 837 309,50 10 330 029
	92-	<b>24-1343</b>		•		50 01 837 309,50 10 330 029
C 290.19/T (214 kW) Eng.MIDR0620.45	90-91	<b>24-1343</b>		•		50 01 837 309,50 10 330 029
C 290.26,C 300.26 (214-222 kW) Eng.MIDR0620.45	90-91	<b>24-1343</b>		•		50 01 837 309,50 10 330 029
	92-	<b>24-1343</b>		•		50 01 837 309,50 10 330 029
	92-97	<b>24-1343</b>		•		50 01 837 309,50 10 330 029
C 300.19 (222 kW) Eng.MIDR0620.45	90-91	<b>24-1343</b>		•		50 01 837 309,50 10 330 029
C 300.24 (222 kW) Eng.MIDR0620.45	90-91	<b>24-1343</b>		•		50 01 837 309,50 10 330 029
C 300.26 (222 kW) Eng.MIDR0620.45	90-91	<b>24-1343</b>		•		50 01 837 309,50 10 330 029
C 340.19/T (249 kW) Eng.MIDR0620.45	91-96	<b>24-1343</b>		•		50 01 837 309,50 10 330 029
C 340ti.17/T (249 kW) Eng.MIDR0620.45	91-96	<b>24-1343</b>		•		50 01 837 309,50 10 330 029
C 340ti.19/T (249 kW) Eng.MIDR0620.45	91-96	<b>24-1343</b>		•		50 01 837 309,50 10 330 029
CCH 300.26 (222 kW) Eng.MIDR0620.45	91-92	<b>24-1343</b>		•		50 01 837 309,50 10 330 029
CCH 300.30 (222 kW) Eng.MIDR0620.45	91-92	<b>24-1343</b>		•		50 01 837 309,50 10 330 029

**G '10/80-'10/96**

G 220.17 (161 kW) Eng.MIDS0620.45	91-92	<b>24-1343</b>		•		50 01 837 309,50 10 330 029
G 220.19 (161 kW) Eng.MIDS0620.45	91-92	<b>24-1343</b>		•		50 01 837 309,50 10 330 029
G 260.15 (192-202 kW) Eng.MIDS0620.45	80-89	<b>24-1343</b>		•		50 01 837 309,50 10 330 029
G 260.16 (192-202 kW) Eng.MIDS0620.45	85-89	<b>24-1343</b>		•		50 01 837 309,50 10 330 029
G 260.17 (192-202 kW) Eng.MIDS0620.45	80-89	<b>24-1343</b>		•		50 01 837 309,50 10 330 029
G 260.17 (202 kW) Eng.MIDS0620.45	90-91	<b>24-1343</b>		•		50 01 837 309,50 10 330 029
G 260.19 (192-202 kW) Eng.MIDS0620.45	80-89	<b>24-1343</b>		•		50 01 837 309,50 10 330 029
G 260.22 (192-202 kW) Eng.MIDS0620.45	87-89	<b>24-1343</b>		•		50 01 837 309,50 10 330 029
G 260.24 (192-202 kW) Eng.MIDS0620.45	87-89	<b>24-1343</b>		•		50 01 837 309,50 10 330 029
G 280.13 (202 kW) Eng.MIDS0620.45	90-91	<b>24-1343</b>		•		50 01 837 309,50 10 330 029
G 280.15 (202 kW) Eng.MIDS0620.45	90-91	<b>24-1343</b>		•		50 01 837 309,50 10 330 029
G 280.16 (202 kW) Eng.MIDS0620.45	90-91	<b>24-1343</b>		•		50 01 837 309,50 10 330 029
G 280.18 (202 kW) Eng.MIDS0620.45	90-91	<b>24-1343</b>		•		50 01 837 309,50 10 330 029
G 280.19 (202 kW) Eng.MIDS0620.45	90-91	<b>24-1343</b>		•		50 01 837 309,50 10 330 029
G 280.24 (202 kW) Eng.MIDS0620.45	90-91	<b>24-1343</b>		•		50 01 837 309,50 10 330 029
G 280.26 (202 kW) Eng.MIDS0620.45	90-91	<b>24-1343</b>		•		50 01 837 309,50 10 330 029
G 290.17 (214-222 kW) Eng.MIDR0620.45	85-90	<b>24-1343</b>		•		50 01 837 309,50 10 330 029
G 290.19 (214-222 kW) Eng.MIDR0620.45	85-90	<b>24-1343</b>		•		50 01 837 309,50 10 330 029

			
<p><b>24-1204</b></p>	<p><b>24-1340</b></p>	<p><b>24-1343</b></p>	

		<b>METELLI</b> ref.			<b>NOTE</b>	<b>Adaptable for OES</b>
G 290.22 (214-222 kW) Eng.MIDR0620.45	85-90	<b>24-1343</b>		•		50 01 837 309,50 10 330 029
G 290.24 (214-222 kW) Eng.MIDR0620.45	85-90	<b>24-1343</b>		•		50 01 837 309,50 10 330 029
G 290.26 (214-222 kW) Eng.MIDR0620.45	85-90	<b>24-1343</b>		•		50 01 837 309,50 10 330 029
G 300.13 (222 kW) Eng.MIDR0620.45	90-91	<b>24-1343</b>		•		50 01 837 309,50 10 330 029
G 300.15 (222 kW) Eng.MIDR0620.45	90-91	<b>24-1343</b>		•		50 01 837 309,50 10 330 029
G 300.16 (222 kW) Eng.MIDR0620.45	90-91	<b>24-1343</b>		•		50 01 837 309,50 10 330 029
G 300.17 (222 kW) Eng.MIDR0620.45	3/91-10/91	<b>24-1343</b>		•		50 01 837 309,50 10 330 029
G 300.19 (222 kW) Eng.MIDR0620.45	86-91	<b>24-1343</b>		•		50 01 837 309,50 10 330 029
G 300.24 (222 kW) Eng.MIDR0620.45	88-91	<b>24-1343</b>		•		50 01 837 309,50 10 330 029
G 300.25 (222 kW) Eng.MIDR0620.45	88-91	<b>24-1343</b>		•		50 01 837 309,50 10 330 029
G 300.26 (222 kW) Eng.MIDR0620.45	88-91	<b>24-1343</b>		•		50 01 837 309,50 10 330 029
G 320.19 (240 kW) Eng.MIDR0620.45	91-92	<b>24-1343</b>		•		50 01 837 309,50 10 330 029
G 320.24 (240 kW) Eng.MIDR0620.45	91-92	<b>24-1343</b>		•		50 01 837 309,50 10 330 029
G 330.13 (240 kW) Eng.MIDR0620.45	90-92	<b>24-1343</b>		•		50 01 837 309,50 10 330 029
G 330.15 (240 kW) Eng.MIDR0620.45	91-92	<b>24-1343</b>		•		50 01 837 309,50 10 330 029
G 330.16 (240 kW) Eng.MIDR0620.45	91-92	<b>24-1343</b>		•		50 01 837 309,50 10 330 029
G 330.17 (240 kW) Eng.MIDR0620.45	91-92	<b>24-1343</b>		•		50 01 837 309,50 10 330 029
G 330.24 (240 kW) Eng.MIDR0620.45	91-92	<b>24-1343</b>		•		50 01 837 309,50 10 330 029
G 330.26 (240 kW) Eng.MIDR0620.45	91-92	<b>24-1343</b>		•		50 01 837 309,50 10 330 029
G 340ti.19/T,G 330.19/T (240-249 kW) Eng.MIDR0620.45	92-96	<b>24-1343</b>		•		50 01 837 309,50 10 330 029
<b>Kerax '4/96-</b>						
260.18 (188 kW) Eng.MIDR0620.45	96-	<b>24-1343</b>		•		50 01 837 309,50 10 330 029
260.18/B (188 kW) Eng.MIDR0620.45	96-	<b>24-1343</b>		•		50 01 837 309,50 10 330 029
270.18 (195 kW) Eng.dCi11-270	96-	<b>24-1340</b>		•		50 01 857 427,50 01 858 484 50 10 477 005/ 162/ 321/ 734 50 10 550 549/ 550/ 551/ 552 74 22 189 466
300.18/B (219 kW) Eng.MIDR0620.45	96-	<b>24-1343</b>		•		50 01 837 309,50 10 330 029
300.26/A (219 kW) Eng.MIDR0620.45	96-	<b>24-1343</b>		•		50 01 837 309,50 10 330 029
300.26/B (219 kW) Eng.MIDR0620.45	96-	<b>24-1343</b>		•		50 01 837 309,50 10 330 029
320.18 (230 kW) Eng.dCi11G	96-	<b>24-1340</b>		•		50 01 857 427,50 01 858 484 50 10 477 005/ 162/ 321/ 734 50 10 550 549/ 550/ 551/ 552 74 22 189 466
320.26 (230 kW) Eng.dCi11G	96-	<b>24-1340</b>		•		50 01 857 427,50 01 858 484 50 10 477 005/ 162/ 321/ 734 50 10 550 549/ 550/ 551/ 552 74 22 189 466
340.18 (249 kW) Eng.MIDR0620.45	96-	<b>24-1343</b>		•		50 01 837 309,50 10 330 029
340.18/B (249 kW) Eng.MIDR0620.45	96-	<b>24-1343</b>		•		50 01 837 309,50 10 330 029
340.26 (249 kW) Eng.MIDR0620.45	96-	<b>24-1343</b>		•		50 01 837 309,50 10 330 029
340.26/A (249 kW) Eng.MIDR0620.45	96-	<b>24-1343</b>		•		50 01 837 309,50 10 330 029
340.26/B (249 kW) Eng.MIDR0620.45	96-	<b>24-1343</b>		•		50 01 837 309,50 10 330 029
340.32/A (249 kW) Eng.MIDR0620.45	96-	<b>24-1343</b>		•		50 01 837 309,50 10 330 029
370.18 (266 kW) Eng.dCi11E	96-	<b>24-1340</b>		•		50 01 857 427,50 01 858 484 50 10 477 005/ 162/ 321/ 734 50 10 550 549/ 550/ 551/ 552 74 22 189 466
370.18 (272 kW) Eng.DXi11	96-	<b>24-1204</b>			w/o pulley	74 20 744 939/ 940,74 85 000 763 74 85 013 068
370.26 (266 kW) Eng.dCi11E	96-	<b>24-1340</b>		•		50 01 857 427,50 01 858 484 50 10 477 005/ 162/ 321/ 734 50 10 550 549/ 550/ 551/ 552 74 22 189 466
370.26 (272 kW) Eng.DXi11	96-	<b>24-1204</b>			w/o pulley	74 20 744 939/ 940,74 85 000 763 74 85 013 068
370.32 (266 kW) Eng.dCi11E	96-	<b>24-1340</b>		•		50 01 857 427,50 01 858 484 50 10 477 005/ 162/ 321/ 734 50 10 550 549/ 550/ 551/ 552 74 22 189 466
370.32 (272 kW) Eng.DXi11	96-	<b>24-1204</b>			w/o pulley	74 20 744 939/ 940,74 85 000 763 74 85 013 068
410.18 (302 kW) Eng.DXi11	96-	<b>24-1204</b>			w/o pulley	74 20 744 939/ 940,74 85 000 763 74 85 013 068

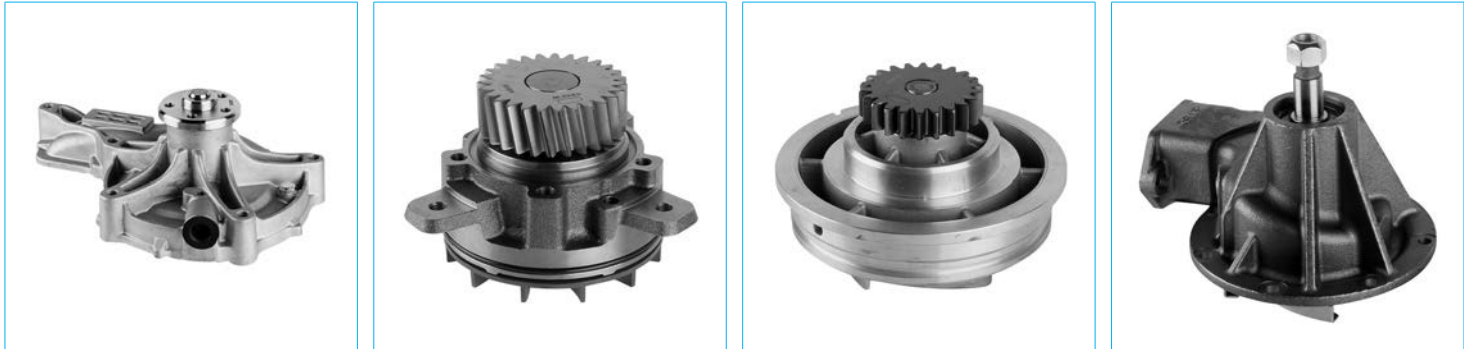

**24-1204**

**24-1332**

**24-1340**

**24-1344**

--	--	--	--

--	--	--	--

--	--	--	--

--	--	--	--

		<b>METELLI</b> ref.			<b>NOTE</b>	<b>Adaptable for OES</b>
410.26 (302 kW) Eng.DXi11	96-	<b>24-1204</b>			w/o pulley	74 20 744 939/ 940,74 85 000 763 74 85 013 068
410.32 (302 kW) Eng.DXi11	96-	<b>24-1204</b>			w/o pulley	74 20 744 939/ 940,74 85 000 763 74 85 013 068
420.18 (303 kW) Eng.dCi11C	96-	<b>24-1340</b>		•		50 01 857 427,50 01 858 484 50 10 477 005/ 162/ 321/ 734 50 10 550 549/ 550/ 551/ 552 74 22 189 466
420.26 (303 kW) Eng.dCi11C	96-	<b>24-1340</b>		•		50 01 857 427,50 01 858 484 50 10 477 005/ 162/ 321/ 734 50 10 550 549/ 550/ 551/ 552 74 22 189 466
420.32 (303 kW) Eng.dCi11C	96-	<b>24-1340</b>		•		50 01 857 427,50 01 858 484 50 10 477 005/ 162/ 321/ 734 50 10 550 549/ 550/ 551/ 552 74 22 189 466
420.34 (303 kW) Eng.dCi11C	96-	<b>24-1340</b>		•		50 01 857 427,50 01 858 484 50 10 477 005/ 162/ 321/ 734 50 10 550 549/ 550/ 551/ 552 74 22 189 466
450.18 (331 kW) Eng.DXi11	96-	<b>24-1204</b>			w/o pulley	74 20 744 939/ 940,74 85 000 763 74 85 013 068
450.26 (331 kW) Eng.DXi11	96-	<b>24-1204</b>			w/o pulley	74 20 744 939/ 940,74 85 000 763 74 85 013 068
450.32 (331 kW) Eng.DXi11	96-	<b>24-1204</b>			w/o pulley	74 20 744 939/ 940,74 85 000 763 74 85 013 068
460.32 (339 kW) Eng.DXi13	05-	<b>24-1204</b>			w/o pulley	74 20 744 939/ 940,74 85 000 763 74 85 013 068
	05-	<b>24-1332</b>		•		50 01 866 278,74 20 734 268
500.32 (368 kW) Eng.DXi13	05-	<b>24-1332</b>		•		50 01 866 278,74 20 734 268

**Magnum '4/87-'12/13**

AE 390.18 (287 kW) Eng.MIDR0624.65	92-	<b>24-1344</b>				50 01 863 728/ 754,50 01 875 237 52 00 537 899,52 00 551 856
AE 390.18T (287 kW) Eng.MIDR0624.65	92-	<b>24-1344</b>				50 01 863 728/ 754,50 01 875 237 52 00 537 899,52 00 551 856
AE 390.19 (287 kW) Eng.MIDR0624.65	92-	<b>24-1344</b>				50 01 863 728/ 754,50 01 875 237 52 00 537 899,52 00 551 856
AE 390.19T (287 kW) Eng.MIDR0624.65	92-	<b>24-1344</b>				50 01 863 728/ 754,50 01 875 237 52 00 537 899,52 00 551 856
AE 390.26 (287 kW) Eng.MIDR0624.65	92-	<b>24-1344</b>				50 01 863 728/ 754,50 01 875 237 52 00 537 899,52 00 551 856
AE 420ti.18 (305 kW) Eng.MIDR0635.40	92-	<b>24-1344</b>				50 01 863 728/ 754,50 01 875 237 52 00 537 899,52 00 551 856
AE 420ti.18T (305 kW) Eng.MIDR0635.40	92-	<b>24-1344</b>				50 01 863 728/ 754,50 01 875 237 52 00 537 899,52 00 551 856
AE 420ti.19 (305 kW) Eng.MIDR0635.40	92-	<b>24-1344</b>				50 01 863 728/ 754,50 01 875 237 52 00 537 899,52 00 551 856
AE 420ti.19T (305 kW) Eng.MIDR0635.40	92-	<b>24-1344</b>				50 01 863 728/ 754,50 01 875 237 52 00 537 899,52 00 551 856
AE 420ti.22T (305 kW) Eng.MIDR0635.40	92-	<b>24-1344</b>				50 01 863 728/ 754,50 01 875 237 52 00 537 899,52 00 551 856
AE 420ti.24 (305 kW) Eng.MIDR0635.40	92-	<b>24-1344</b>				50 01 863 728/ 754,50 01 875 237 52 00 537 899,52 00 551 856
AE 420ti.24T (305 kW) Eng.MIDR0635.40	92-	<b>24-1344</b>				50 01 863 728/ 754,50 01 875 237 52 00 537 899,52 00 551 856
AE 420ti.26 (305 kW) Eng.MIDR0635.40	92-	<b>24-1344</b>				50 01 863 728/ 754,50 01 875 237 52 00 537 899,52 00 551 856
AE 420ti.26T (305 kW) Eng.MIDR0635.40	92-	<b>24-1344</b>				50 01 863 728/ 754,50 01 875 237 52 00 537 899,52 00 551 856
AE 430.18 (316 kW) Eng.MIDR0624.65	92-	<b>24-1344</b>				50 01 863 728/ 754,50 01 875 237 52 00 537 899,52 00 551 856
AE 430.18T (316 kW) Eng.MIDR0624.65	92-	<b>24-1344</b>				50 01 863 728/ 754,50 01 875 237 52 00 537 899,52 00 551 856
AE 430.19 (316 kW) Eng.MIDR0624.65	92-	<b>24-1344</b>				50 01 863 728/ 754,50 01 875 237 52 00 537 899,52 00 551 856



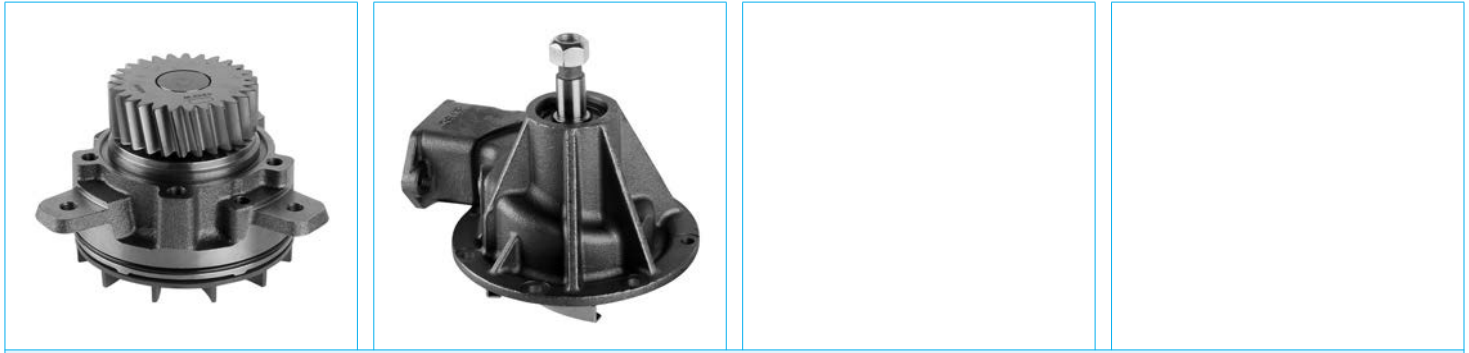





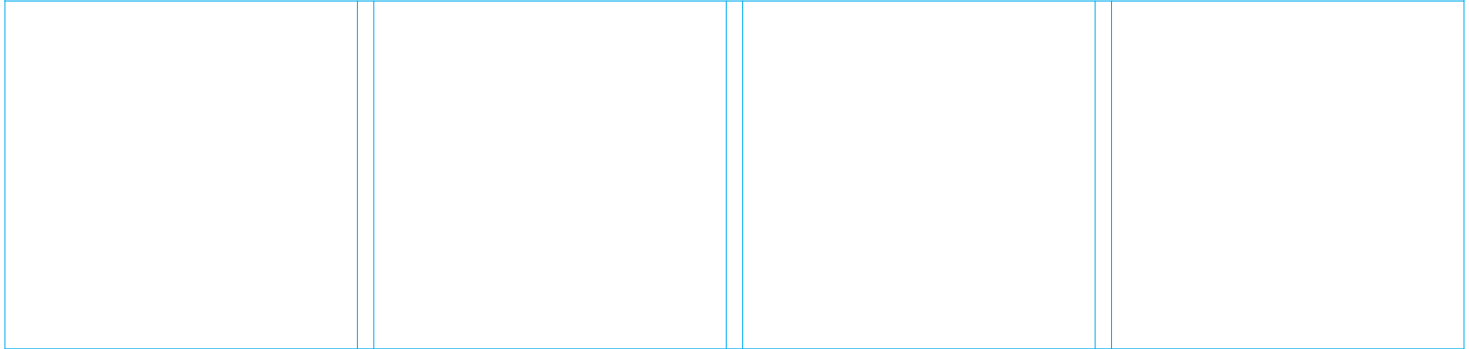
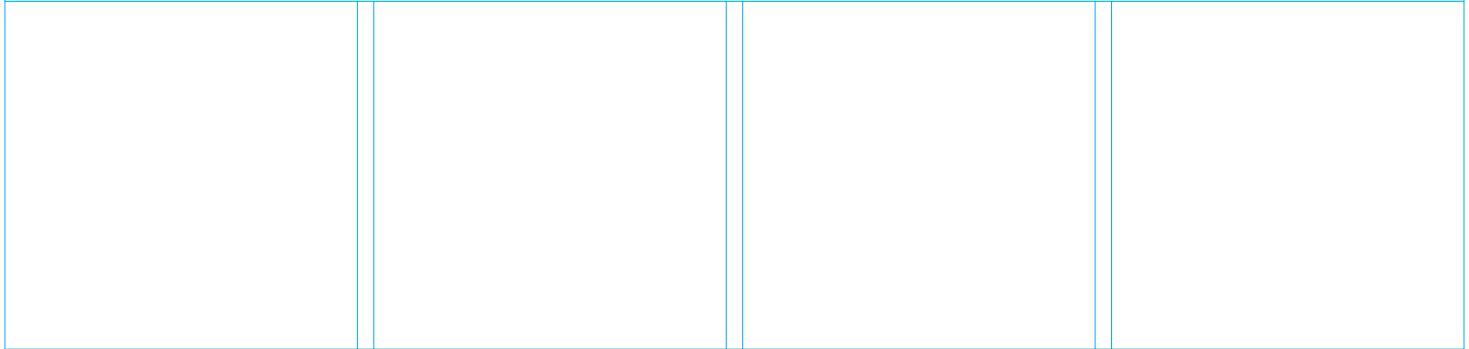
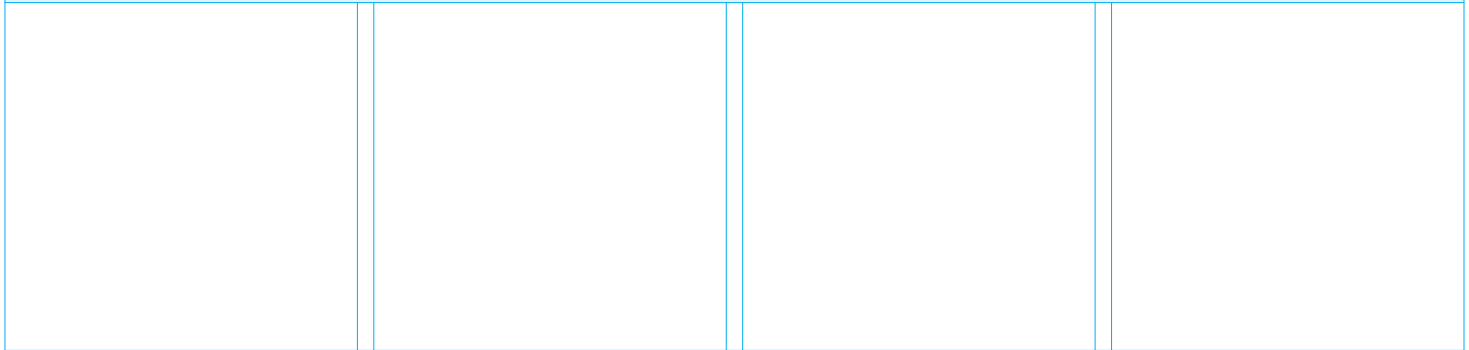
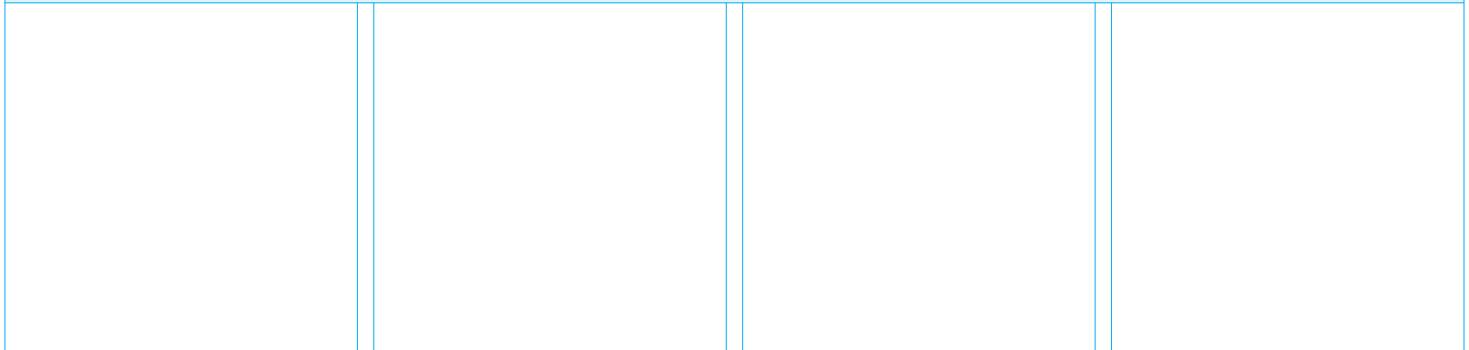

**24-1332**

**24-1344**



		<b>METELLI</b> ref.			<b>NOTE</b>	<b>Adaptable for OES</b>
AE 430.19T (316 kW) Eng.MIDR0624.65	92-	<b>24-1344</b>				50 01 863 728/ 754,50 01 875 237 52 00 537 899,52 00 551 856
AE 430.26 (316 kW) Eng.MIDR0624.65	94-	<b>24-1344</b>				50 01 863 728/ 754,50 01 875 237 52 00 537 899,52 00 551 856
AE 430.26T (316 kW) Eng.MIDR0624.65	96-	<b>24-1344</b>				50 01 863 728/ 754,50 01 875 237 52 00 537 899,52 00 551 856
AE 470.18 (346 kW) Eng.MIDR0624.65	92-	<b>24-1344</b>				50 01 863 728/ 754,50 01 875 237 52 00 537 899,52 00 551 856
AE 470.18T (346 kW) Eng.MIDR0624.65	92-	<b>24-1344</b>				50 01 863 728/ 754,50 01 875 237 52 00 537 899,52 00 551 856
AE 470.19 (346 kW) Eng.MIDR0624.65	92-	<b>24-1344</b>				50 01 863 728/ 754,50 01 875 237 52 00 537 899,52 00 551 856
AE 470.19T (346 kW) Eng.MIDR0624.65	92-	<b>24-1344</b>				50 01 863 728/ 754,50 01 875 237 52 00 537 899,52 00 551 856
AE 470.26 (346 kW) Eng.MIDR0624.65	92-	<b>24-1344</b>				50 01 863 728/ 754,50 01 875 237 52 00 537 899,52 00 551 856
AE 470.26T (346 kW) Eng.MIDR0624.65	92-	<b>24-1344</b>				50 01 863 728/ 754,50 01 875 237 52 00 537 899,52 00 551 856
AE 520.18 (390 kW) Eng.Mack-EE9-530	91-	<b>24-1344</b>				50 01 863 728/ 754,50 01 875 237 52 00 537 899,52 00 551 856
AE 520.18T (390 kW) Eng.Mack-EE9-530	92-	<b>24-1344</b>				50 01 863 728/ 754,50 01 875 237 52 00 537 899,52 00 551 856
AE 520.19 (390 kW) Eng.Mack-EE9-530	91-	<b>24-1344</b>				50 01 863 728/ 754,50 01 875 237 52 00 537 899,52 00 551 856
AE 520.19T (390 kW) Eng.Mack-EE9-530	92-	<b>24-1344</b>				50 01 863 728/ 754,50 01 875 237 52 00 537 899,52 00 551 856
AE 520.22T (390 kW) Eng.Mack-EE9-530	92-	<b>24-1344</b>				50 01 863 728/ 754,50 01 875 237 52 00 537 899,52 00 551 856
AE 520.24 (390 kW) Eng.Mack-EE9-530	92-	<b>24-1344</b>				50 01 863 728/ 754,50 01 875 237 52 00 537 899,52 00 551 856
AE 520.24T (390 kW) Eng.Mack-EE9-530	92-	<b>24-1344</b>				50 01 863 728/ 754,50 01 875 237 52 00 537 899,52 00 551 856
AE 520.26 (390 kW) Eng.Mack-EE9-530	92-	<b>24-1344</b>				50 01 863 728/ 754,50 01 875 237 52 00 537 899,52 00 551 856
AE 520.26T (390 kW) Eng.Mack-EE9-530	87-	<b>24-1344</b>				50 01 863 728/ 754,50 01 875 237 52 00 537 899,52 00 551 856
AE 560.18 (412 kW) Eng.Mack-EE9-560	92-	<b>24-1344</b>				50 01 863 728/ 754,50 01 875 237 52 00 537 899,52 00 551 856
AE 560.18T (412 kW) Eng.Mack-EE9-560	92-	<b>24-1344</b>				50 01 863 728/ 754,50 01 875 237 52 00 537 899,52 00 551 856
AE 560.19 (412 kW) Eng.Mack-EE9-560	92-	<b>24-1344</b>				50 01 863 728/ 754,50 01 875 237 52 00 537 899,52 00 551 856
AE 560.19T (412 kW) Eng.Mack-EE9-560	92-	<b>24-1344</b>				50 01 863 728/ 754,50 01 875 237 52 00 537 899,52 00 551 856
AE 560.26 (412 kW) Eng.Mack-EE9-560	92-	<b>24-1344</b>				50 01 863 728/ 754,50 01 875 237 52 00 537 899,52 00 551 856
AE 560.26T (412 kW) Eng.Mack-EE9-560	96-	<b>24-1344</b>				50 01 863 728/ 754,50 01 875 237 52 00 537 899,52 00 551 856
DXi 12 440.18 (324 kW) Eng.DXi12	01-	<b>24-1332</b>		•		50 01 866 278,74 20 734 268
DXi 12 440.18 T (324 kW) Eng.DXi12	01-	<b>24-1332</b>		•		50 01 866 278,74 20 734 268
DXi 12 440.24 (324 kW) Eng.DXi12	01-	<b>24-1332</b>		•		50 01 866 278,74 20 734 268
DXi 12 440.26 (324 kW) Eng.DXi12	01-	<b>24-1332</b>		•		50 01 866 278,74 20 734 268
DXi 12 440.26 T (324 kW) Eng.DXi12	01-	<b>24-1332</b>		•		50 01 866 278,74 20 734 268
DXi 12 480.18 (353 kW) Eng.DXi12	01-	<b>24-1332</b>		•		50 01 866 278,74 20 734 268
DXi 12 480.18 T (353 kW) Eng.DXi12	01-	<b>24-1332</b>		•		50 01 866 278,74 20 734 268
DXi 12 480.24 (353 kW) Eng.DXi12	01-	<b>24-1332</b>		•		50 01 866 278,74 20 734 268
DXi 12 480.26 (353 kW) Eng.DXi12	01-	<b>24-1332</b>		•		50 01 866 278,74 20 734 268
DXi 12 480.26 T (353 kW) Eng.DXi12	01-	<b>24-1332</b>		•		50 01 866 278,74 20 734 268
DXi 13 460.18 T (339 kW) Eng.DXi13	05-	<b>24-1332</b>		•		50 01 866 278,74 20 734 268
DXi 13 460.24 (339 kW) Eng.DXi13	05-	<b>24-1332</b>		•		50 01 866 278,74 20 734 268
DXi 13 460.25 (339 kW) Eng.DXi13	05-	<b>24-1332</b>		•		50 01 866 278,74 20 734 268
DXi 13 460.26 (339 kW) Eng.DXi13	05-	<b>24-1332</b>		•		50 01 866 278,74 20 734 268
DXi 13 460.26 T (339 kW) Eng.DXi13	05-	<b>24-1332</b>		•		50 01 866 278,74 20 734 268
DXi 13 500.18 T (368 kW) Eng.DXi13	05-	<b>24-1332</b>		•		50 01 866 278,74 20 734 268
DXi 13 500.24 (368 kW) Eng.DXi13	05-	<b>24-1332</b>		•		50 01 866 278,74 20 734 268
DXi 13 500.25 (368 kW) Eng.DXi13	05-	<b>24-1332</b>		•		50 01 866 278,74 20 734 268

			
<p><b>24-1332</b></p>	<p><b>24-1343</b></p>	<p><b>24-1344</b></p>	

		METELLI ref.			NOTE	Adaptable for OES
DXi 13 500.26 (368 kW) Eng.DXi13	05-	<b>24-1332</b>		•		50 01 866 278,74 20 734 268
DXi 13 500.26 T (368 kW) Eng.DXi13	05-	<b>24-1332</b>		•		50 01 866 278,74 20 734 268
DXi 13 520.19 (382 kW) Eng.DXi13	09-	<b>24-1332</b>		•		50 01 866 278,74 20 734 268
DXi 13 520.24 (382 kW) Eng.DXi13	09-	<b>24-1332</b>		•		50 01 866 278,74 20 734 268
DXi 13 520.25 (382 kW) Eng.DXi13	09-	<b>24-1332</b>		•		50 01 866 278,74 20 734 268
DXi 13 520.26 (382 kW) Eng.DXi13	09-	<b>24-1332</b>		•		50 01 866 278,74 20 734 268
E.TECH 400.18 (295 kW) Eng.MACKE.TECHA/46	00-	<b>24-1344</b>				50 01 863 728/ 754,50 01 875 237 52 00 537 899,52 00 551 856
E.TECH 400.18T (295 kW) Eng.MACKE.TECHA/46	00-	<b>24-1344</b>				50 01 863 728/ 754,50 01 875 237 52 00 537 899,52 00 551 856
E.TECH 400.24 (295 kW) Eng.MACKE.TECHA/46	00-	<b>24-1344</b>				50 01 863 728/ 754,50 01 875 237 52 00 537 899,52 00 551 856
E.TECH 400.26 (295 kW) Eng.MACKE.TECHA/46	00-	<b>24-1344</b>				50 01 863 728/ 754,50 01 875 237 52 00 537 899,52 00 551 856
E.TECH 440.18 (324 kW) Eng.MACKE.TECHB/46	00-	<b>24-1344</b>				50 01 863 728/ 754,50 01 875 237 52 00 537 899,52 00 551 856
E.TECH 440.18T (324 kW) Eng.MACKE.TECHB/46	00-	<b>24-1344</b>				50 01 863 728/ 754,50 01 875 237 52 00 537 899,52 00 551 856
E.TECH 440.24 (324 kW) Eng.MACKE.TECHB/46	00-	<b>24-1344</b>				50 01 863 728/ 754,50 01 875 237 52 00 537 899,52 00 551 856
E.TECH 440.26 (324 kW) Eng.MACKE.TECHB/46	00-	<b>24-1344</b>				50 01 863 728/ 754,50 01 875 237 52 00 537 899,52 00 551 856
E.TECH 440.26T (324 kW) Eng.MACKE.TECHB/46	00-	<b>24-1344</b>				50 01 863 728/ 754,50 01 875 237 52 00 537 899,52 00 551 856
E.TECH 480.18 (347-353 kW) Eng.MACKE.TEHC/46	00-	<b>24-1344</b>				50 01 863 728/ 754,50 01 875 237 52 00 537 899,52 00 551 856
E.TECH 480.18T (347-353 kW) Eng.MACKE.TEHC/46	00-	<b>24-1344</b>				50 01 863 728/ 754,50 01 875 237 52 00 537 899,52 00 551 856
E.TECH 480.24 (347-353 kW) Eng.MACKE.TEHC/46	00-	<b>24-1344</b>				50 01 863 728/ 754,50 01 875 237 52 00 537 899,52 00 551 856
E.TECH 480.26 (347-353 kW) Eng.MACKE.TEHC/46	00-	<b>24-1344</b>				50 01 863 728/ 754,50 01 875 237 52 00 537 899,52 00 551 856
E.TECH 480.26T (347-353 kW) Eng.MACKE.TEHC/46	00-	<b>24-1344</b>				50 01 863 728/ 754,50 01 875 237 52 00 537 899,52 00 551 856
<b>Major '10/80-'10/96</b>						
R 340ti.16/T (249 kW) Eng.MIDR0620.45	92-96	<b>24-1343</b>		•		50 01 837 309,50 10 330 029
R 340ti.17 (249 kW) Eng.MIDR0620.45	91-96	<b>24-1343</b>		•		50 01 837 309,50 10 330 029
R 340ti.18 (249 kW) Eng.MIDR0620.45	91-96	<b>24-1343</b>		•		50 01 837 309,50 10 330 029
R 340ti.18/T (249 kW) Eng.MIDR0620.45	92-96	<b>24-1343</b>		•		50 01 837 309,50 10 330 029
R 340ti.19 (249 kW) Eng.MIDR0620.45	91-96	<b>24-1343</b>		•		50 01 837 309,50 10 330 029
R 340ti.19/T (249 kW) Eng.MIDR0620.45	91-96	<b>24-1343</b>		•		50 01 837 309,50 10 330 029
R 340ti.24 (249 kW) Eng.MIDR0620.45	91-96	<b>24-1343</b>		•		50 01 837 309,50 10 330 029
R 340ti.26 (249 kW) Eng.MIDR0620.45	91-96	<b>24-1343</b>		•		50 01 837 309,50 10 330 029
<b>Manager '10/80-'6/97</b>						
G 220.17 BOM (161-168 kW) Eng.MIDS0620.45	92-96	<b>24-1343</b>		•		50 01 837 309,50 10 330 029
G 220.19 BOM (161-168 kW) Eng.MIDS0620.45	92-96	<b>24-1343</b>		•		50 01 837 309,50 10 330 029
G 270.13 SP (195 kW) Eng.MIDR0620.45	80-97	<b>24-1343</b>		•		50 01 837 309,50 10 330 029
G 270.14 SP (195 kW) Eng.MIDR0620.45	80-97	<b>24-1343</b>		•		50 01 837 309,50 10 330 029
G 280.13,G 270.13 (195-202 kW) Eng.MIDR0620.45	80-97	<b>24-1343</b>		•		50 01 837 309,50 10 330 029
G 280.15,G 270.15 (195-202 kW) Eng.MIDR0620.45	80-97	<b>24-1343</b>		•		50 01 837 309,50 10 330 029
G 280.16 (202 kW) Eng.MIDS0620.45	87-93	<b>24-1343</b>		•		50 01 837 309,50 10 330 029
G 280.16,G 270.16 (195-202 kW) Eng.MIDR0620.45	80-97	<b>24-1343</b>		•		50 01 837 309,50 10 330 029
G 280.17,G 270.18 (195-202 kW) Eng.MIDR0620.45	80-97	<b>24-1343</b>		•		50 01 837 309,50 10 330 029
G 280.19 (202 kW) Eng.MIDS0620.45	92-93	<b>24-1343</b>		•		50 01 837 309,50 10 330 029
G 280.19,G 270.19 (195-202 kW) Eng.MIDR0620.45	80-97	<b>24-1343</b>		•		50 01 837 309,50 10 330 029
G 280.24 (202 kW) Eng.MIDS0620.45	91-93	<b>24-1343</b>		•		50 01 837 309,50 10 330 029
G 280.26,G 270.26 (195-202 kW) Eng.MIDR0620.45	80-97	<b>24-1343</b>		•		50 01 837 309,50 10 330 029
G 300.13 (222 kW) Eng.MIDR0620.45	80-96	<b>24-1343</b>		•		50 01 837 309,50 10 330 029
G 300.15 (222 kW) Eng.MIDR0620.45	80-96	<b>24-1343</b>		•		50 01 837 309,50 10 330 029
G 300.16 (222 kW) Eng.MIDR0620.45	91-93	<b>24-1343</b>		•		50 01 837 309,50 10 330 029
G 300.17 (222 kW) Eng.MIDR0620.45	87-96	<b>24-1343</b>		•		50 01 837 309,50 10 330 029
G 300.18 (222 kW) Eng.MIDR0620.45	90-96	<b>24-1343</b>		•		50 01 837 309,50 10 330 029
G 300.19 (222 kW) Eng.MIDR0620.45	87-96	<b>24-1343</b>		•		50 01 837 309,50 10 330 029
G 300.24 (222 kW) Eng.MIDR0620.45	80-96	<b>24-1343</b>		•		50 01 837 309,50 10 330 029



**24-1066**



**24-1340**



**24-1343**

		<b>METELLI</b> ref.			<b>NOTE</b>	<b>Adaptable for OES</b>
G 300.25 (222 kW) Eng.MIDR0620.45	91-96	<b>24-1343</b>		•		50 01 837 309,50 10 330 029
G 300.26 (222 kW) Eng.MIDR0620.45	87-96	<b>24-1343</b>		•		50 01 837 309,50 10 330 029
G 330.13 (240 kW) Eng.MIDR0620.45	92-93	<b>24-1343</b>		•		50 01 837 309,50 10 330 029
G 330.15 (240 kW) Eng.MIDR0620.45	92-93	<b>24-1343</b>		•		50 01 837 309,50 10 330 029
G 330.17 (240 kW) Eng.MIDR0620.45	92-93	<b>24-1343</b>		•		50 01 837 309,50 10 330 029
G 330.18 (240 kW) Eng.MIDR0620.45	92-96	<b>24-1343</b>		•		50 01 837 309,50 10 330 029
G 330.19 (240 kW) Eng.MIDR0620.45	91-93	<b>24-1343</b>		•		50 01 837 309,50 10 330 029
G 330.24 (240 kW) Eng.MIDR0620.45	92-96	<b>24-1343</b>		•		50 01 837 309,50 10 330 029
G 330.26 (240 kW) Eng.MIDR0620.45	91-93	<b>24-1343</b>		•		50 01 837 309,50 10 330 029
G 340ti.16,G 330.16 (240-249 kW) Eng.MIDR0620.45	91-96	<b>24-1343</b>		•		50 01 837 309,50 10 330 029
G 340ti.17,G 330.19 (240-249 kW) Eng.MIDR0620.45	91-96	<b>24-1343</b>		•		50 01 837 309,50 10 330 029
G 340ti.18,G 330.18 (240-249 kW) Eng.MIDR0620.45	91-96	<b>24-1343</b>		•		50 01 837 309,50 10 330 029
G 340ti.18/T (249 kW) Eng.MIDR0620.45	92-96	<b>24-1343</b>		•		50 01 837 309,50 10 330 029
G 340ti.19,G 330.19 (240-249 kW) Eng.MIDR0620.45	92-96	<b>24-1343</b>		•		50 01 837 309,50 10 330 029
G 340ti.26,G 330.26 (240-249 kW) Eng.MIDR0620.45	91-96	<b>24-1343</b>		•		50 01 837 309,50 10 330 029
<b>Maxity '5/06-</b>						
110.28 (81 kW) Eng.DXi2,5	06-	<b>24-1066</b>				-
110.32 (81 kW) Eng.DXi2,5	06-	<b>24-1066</b>				-
110.35 (81 kW) Eng.DXi2,5	06-	<b>24-1066</b>				-
130.35 (96 kW) Eng.DXi2,5	06-	<b>24-1066</b>				-
130.45 (96 kW) Eng.DXi2,5	06-	<b>24-1066</b>				-
<b>Maxter '5/90-</b>						
G 270.19 (195 kW) Eng.MIDR0620.45	90-	<b>24-1343</b>		•		50 01 837 309,50 10 330 029
G 280.18 (202 kW) Eng.MIDS0620.45	92-96	<b>24-1343</b>		•		50 01 837 309,50 10 330 029
G 300.18 (222 kW) Eng.MIDR0620.45	92-96	<b>24-1343</b>		•		50 01 837 309,50 10 330 029
G 300.19 (219 kW) Eng.MIDR0620.45	92-	<b>24-1343</b>		•		50 01 837 309,50 10 330 029
G 300.19 (222 kW) Eng.MIDR0620.45	92-96	<b>24-1343</b>		•		50 01 837 309,50 10 330 029
G 300.26 (219 kW) Eng.MIDR0620.45	92-	<b>24-1343</b>		•		50 01 837 309,50 10 330 029
G 300.26 (222 kW) Eng.MIDR0620.45	92-96	<b>24-1343</b>		•		50 01 837 309,50 10 330 029
G 340ti.18/T (249 kW) Eng.MIDR0620.45	92-	<b>24-1343</b>		•		50 01 837 309,50 10 330 029
G 340ti.19 (249 kW) Eng.MIDR0620.45	92-96	<b>24-1343</b>		•		50 01 837 309,50 10 330 029
G 340ti.25/A,B (249 kW) Eng.MIDR0620.45	91-96	<b>24-1343</b>		•		50 01 837 309,50 10 330 029
G 340ti.26/B,C (249 kW) Eng.MIDR0620.45	91-96	<b>24-1343</b>		•		50 01 837 309,50 10 330 029
G 340ti.32/A,B,C (249 kW) Eng.MIDR0620.45	91-96	<b>24-1343</b>		•		50 01 837 309,50 10 330 029
G 340ti.34 (249 kW) Eng.MIDR0620.45	92-	<b>24-1343</b>		•		50 01 837 309,50 10 330 029
G 340ti.40 (249 kW) Eng.MIDR0620.45	92-	<b>24-1343</b>		•		50 01 837 309,50 10 330 029
<b>Premium I '10/92-'9/05</b>						
Distribution 260.16 (188 kW) Eng.MIDR0620.45	92-	<b>24-1343</b>		•		50 01 837 309,50 10 330 029
Distribution 260.18 (188 kW) Eng.MIDR0620.45	92-	<b>24-1343</b>		•		50 01 837 309,50 10 330 029
Distribution 260.19 (188 kW) Eng.MIDR0620.45	92-	<b>24-1343</b>		•		50 01 837 309,50 10 330 029
Distribution 300.16 (219 kW) Eng.MIDR0620.45	92-	<b>24-1343</b>		•		50 01 837 309,50 10 330 029
Distribution 300.18 (219 kW) Eng.MIDR0620.45	92-	<b>24-1343</b>		•		50 01 837 309,50 10 330 029
Distribution 300.19 (219 kW) Eng.MIDR0620.45	92-	<b>24-1343</b>		•		50 01 837 309,50 10 330 029
Distribution 300.26 (219 kW) Eng.MIDR0620.45	92-	<b>24-1343</b>		•		50 01 837 309,50 10 330 029
Distribution 320.18, 320.24, 320.26 (230 kW) Eng.dCi11G	92-	<b>24-1340</b>		•		50 01 857 427,50 01 858 484 50 10 477 005/ 162/ 321/ 734 50 10 550 549/ 550/ 551/ 552 74 22 189 466
Distribution 340.18 (249 kW) Eng.MIDR0620.45	92-	<b>24-1343</b>		•		50 01 837 309,50 10 330 029
Distribution 340.19 (249 kW) Eng.MIDR0620.45	92-	<b>24-1343</b>		•		50 01 837 309,50 10 330 029
Distribution 340.26 (249 kW) Eng.MIDR0620.45	92-	<b>24-1343</b>		•		50 01 837 309,50 10 330 029
Distribution 370.18 (266 kW) Eng.dCi11E	92-	<b>24-1340</b>		•		50 01 857 427,50 01 858 484 50 10 477 005/ 162/ 321/ 734 50 10 550 549/ 550/ 551/ 552 74 22 189 466

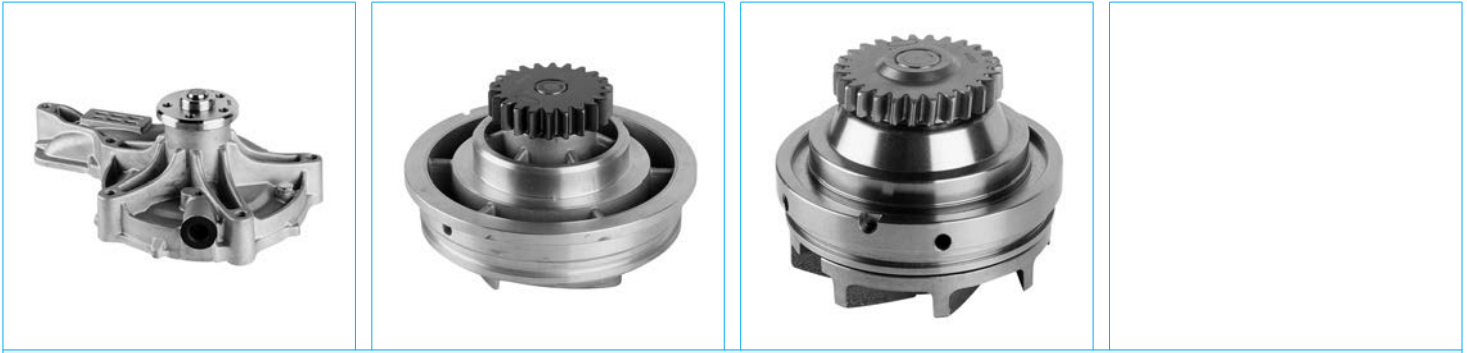

**24-1204**

**24-1340**





**24-1343**

--	--	--	--

--	--	--	--

--	--	--	--

--	--	--	--

		<b>METELLI</b> ref.			<b>NOTE</b>	<b>Adaptable for OES</b>
Distribution 370.24 (266 kW) Eng.dCi11E	92-	<b>24-1340</b>		•		50 01 857 427,50 01 858 484 50 10 477 005/ 162/ 321/ 734 50 10 550 549/ 550/ 551/ 552 74 22 189 466
Distribution 370.26 (266 kW) Eng.dCi11E	92-	<b>24-1340</b>		•		50 01 857 427,50 01 858 484 50 10 477 005/ 162/ 321/ 734 50 10 550 549/ 550/ 551/ 552 74 22 189 466
Distribution 420.18 (303 kW) Eng.dCi11C	92-	<b>24-1340</b>		•		50 01 857 427,50 01 858 484 50 10 477 005/ 162/ 321/ 734 50 10 550 549/ 550/ 551/ 552 74 22 189 466
Route 300.16 (219 kW) Eng.MIDR0620.45	96-	<b>24-1343</b>		•		50 01 837 309,50 10 330 029
Route 300.18 (219 kW) Eng.MIDR0620.45	96-	<b>24-1343</b>		•		50 01 837 309,50 10 330 029
Route 300.19 (219 kW) Eng.MIDR0620.45	96-	<b>24-1343</b>		•		50 01 837 309,50 10 330 029
Route 320.18 (230 kW) Eng.dCi11G	92-	<b>24-1340</b>		•		50 01 857 427,50 01 858 484 50 10 477 005/ 162/ 321/ 734 50 10 550 549/ 550/ 551/ 552 74 22 189 466
Route 340.18 (249 kW) Eng.MIDR0620.45	92-	<b>24-1343</b>		•		50 01 837 309,50 10 330 029
Route 340.19 (249 kW) Eng.MIDR0620.45	92-	<b>24-1343</b>		•		50 01 837 309,50 10 330 029
Route 340.24 (249 kW) Eng.MIDR0620.45	92-	<b>24-1343</b>		•		50 01 837 309,50 10 330 029
Route 340.26 (249 kW) Eng.MIDR0620.45	92-	<b>24-1343</b>		•		50 01 837 309,50 10 330 029
Route 370.18 (266 kW) Eng.dCi11E	92-	<b>24-1340</b>		•		50 01 857 427,50 01 858 484 50 10 477 005/ 162/ 321/ 734 50 10 550 549/ 550/ 551/ 552 74 22 189 466
Route 370.24 (266 kW) Eng.dCi11E	92-	<b>24-1340</b>		•		50 01 857 427,50 01 858 484 50 10 477 005/ 162/ 321/ 734 50 10 550 549/ 550/ 551/ 552 74 22 189 466
Route 370.26 (266 kW) Eng.dCi11E	92-	<b>24-1340</b>		•		50 01 857 427,50 01 858 484 50 10 477 005/ 162/ 321/ 734 50 10 550 549/ 550/ 551/ 552 74 22 189 466
Route 420.18 (303 kW) Eng.dCi11C	92-	<b>24-1340</b>		•		50 01 857 427,50 01 858 484 50 10 477 005/ 162/ 321/ 734 50 10 550 549/ 550/ 551/ 552 74 22 189 466
Route 420.24 (303 kW) Eng.dCi11C	92-	<b>24-1340</b>		•		50 01 857 427,50 01 858 484 50 10 477 005/ 162/ 321/ 734 50 10 550 549/ 550/ 551/ 552 74 22 189 466
Route 420.25 (303 kW) Eng.dCi11C	92-	<b>24-1340</b>		•		50 01 857 427,50 01 858 484 50 10 477 005/ 162/ 321/ 734 50 10 550 549/ 550/ 551/ 552 74 22 189 466
Route 420.26 (303 kW) Eng.dCi11C	92-	<b>24-1340</b>		•		50 01 857 427,50 01 858 484 50 10 477 005/ 162/ 321/ 734 50 10 550 549/ 550/ 551/ 552 74 22 189 466
<b>Premium II '10/05-'12/13</b>						
370.18/.26 (272 kW) Eng.DXi11	05-	<b>24-1204</b>			w/o pulley	74 20 744 939/ 940,74 85 000 763 74 85 013 068
380.18/.19/.26/.32 (280 kW) Eng.DXi11	06-	<b>24-1204</b>			w/o pulley	74 20 744 939/ 940,74 85 000 763 74 85 013 068
410.18/.24/.25/.26 (302 kW) Eng.DXi11	06-	<b>24-1204</b>			w/o pulley	74 20 744 939/ 940,74 85 000 763 74 85 013 068
430.18/.19/.26/.32 (316 kW) Eng.DXi11	06-	<b>24-1204</b>			w/o pulley	74 20 744 939/ 940,74 85 000 763 74 85 013 068
440.18/.19/.26/.32 (324 kW) Eng.DXi11	05-	<b>24-1204</b>			w/o pulley	74 20 744 939/ 940,74 85 000 763 74 85 013 068
450.18/.24/.25/.26 (331 kW) Eng.DXi11	06-	<b>24-1204</b>			w/o pulley	74 20 744 939/ 940,74 85 000 763 74 85 013 068





**24-0869**



**24-1201**



**24-1204**



**24-1343**

		<b>METELLI</b> ref.			<b>NOTE</b>	<b>Adaptable for OES</b>
460.18/.19/.26/.32 (339 kW) Eng.DXi11	06-	<b>24-1204</b>			w/o pulley	74 20 744 939/ 940,74 85 000 763 74 85 013 068
<b>R '10/80-'10/92</b>						
R 330.17 (240-249 kW) Eng.MIDR0620.45	90-91	<b>24-1343</b>		•		50 01 837 309,50 10 330 029
R 330.19 (240-249 kW) Eng.MIDR0620.45	90-91	<b>24-1343</b>		•		50 01 837 309,50 10 330 029
R 330.24 (240-249 kW) Eng.MIDR0620.45	90-91	<b>24-1343</b>		•		50 01 837 309,50 10 330 029
R 340ti.16 (249 kW) Eng.MIDR0620.45	88-91	<b>24-1343</b>		•		50 01 837 309,50 10 330 029
R 340ti.17 (249 kW) Eng.MIDR0620.45	88-91	<b>24-1343</b>		•		50 01 837 309,50 10 330 029
R 340ti.18 (249 kW) Eng.MIDR0620.45	88-91	<b>24-1343</b>		•		50 01 837 309,50 10 330 029
R 340ti.19 (249 kW) Eng.MIDR0620.45	88-91	<b>24-1343</b>		•		50 01 837 309,50 10 330 029
R 340ti.24 (249 kW) Eng.MIDR0620.45	88-91	<b>24-1343</b>		•		50 01 837 309,50 10 330 029
R 340ti.26 (249 kW) Eng.MIDR0620.45	88-91	<b>24-1343</b>		•		50 01 837 309,50 10 330 029
<b>R312 Bus '1/88-'12/98</b>						
R312 (145 kW) Eng.MIDR0620.45	88-98	<b>24-1343</b>		•		50 01 837 309,50 10 330 029
<b>SCANIA TRUCK</b>						
<b>112 H '1/81-'12/86</b>						
280 (206 kW) Eng.DS11.14	81-86	<b>24-0869</b>				1314406
305 (224 kW) Eng.DS11.15	81-86	<b>24-0869</b>				1314406
<b>112 M '1/81-'12/86</b>						
305 (224-232 kW) Eng.DS11.15	81-86	<b>24-0869</b>				1314406
<b>113 E '11/91-</b>						
320 (235-239 kW) Eng.DSC11.16	91-	<b>24-0869</b>				1314406
	91-	<b>24-1201</b>			Impeller Ø 105mm	0570951/ 5,10570951/ 5,1353072,1372365 1508533/ 6,1570951/ 5,1896752,508533 570951/ 55/ 62
320 (235-239 kW) Eng.DSC11.17	91-	<b>24-0869</b>				1314406
	91-	<b>24-1201</b>			Impeller Ø 105mm	0570951/ 5,10570951/ 5,1353072,1372365 1508533/ 6,1570951/ 5,1896752,508533 570951/ 55/ 62
320 (235-239 kW) Eng.DSC11.21	91-	<b>24-0869</b>				1314406
	91-	<b>24-1201</b>			Impeller Ø 105mm	0570951/ 5,10570951/ 5,1353072,1372365 1508533/ 6,1570951/ 5,1896752,508533 570951/ 55/ 62
360 (265-267 kW) Eng.DSC11.13	91-	<b>24-0869</b>				1314406
	91-	<b>24-1201</b>			Impeller Ø 105mm	0570951/ 5,10570951/ 5,1353072,1372365 1508533/ 6,1570951/ 5,1896752,508533 570951/ 55/ 62
360 (265-267 kW) Eng.DSC11.18	91-	<b>24-0869</b>				1314406
	91-	<b>24-1201</b>			Impeller Ø 105mm	0570951/ 5,10570951/ 5,1353072,1372365 1508533/ 6,1570951/ 5,1896752,508533 570951/ 55/ 62
360 (265-267 kW) Eng.DSC11.23	91-	<b>24-0869</b>				1314406
	91-	<b>24-1201</b>			Impeller Ø 105mm	0570951/ 5,10570951/ 5,1353072,1372365 1508533/ 6,1570951/ 5,1896752,508533 570951/ 55/ 62
360 (265-267 kW) Eng.DSC11.30	91-	<b>24-0869</b>				1314406
	91-	<b>24-1201</b>			Impeller Ø 105mm	0570951/ 5,10570951/ 5,1353072,1372365 1508533/ 6,1570951/ 5,1896752,508533 570951/ 55/ 62
380 (280 kW) Eng.DSC11.22	94-	<b>24-0869</b>				1314406
	94-	<b>24-1201</b>			Impeller Ø 105mm	0570951/ 5,10570951/ 5,1353072,1372365 1508533/ 6,1570951/ 5,1896752,508533 570951/ 55/ 62
380 (280 kW) Eng.DSC11.70	91-	<b>24-0869</b>				1314406
	91-	<b>24-1201</b>			Impeller Ø 105mm	0570951/ 5,10570951/ 5,1353072,1372365 1508533/ 6,1570951/ 5,1896752,508533 570951/ 55/ 62
<b>113 H '5/88-</b>						
310 (228-229 kW) Eng.DSC11.06	88-	<b>24-0869</b>				1314406



**24-0869**



**24-1201**

		<b>METELLI</b> ref.			<b>NOTE</b>	<b>Adaptable for OES</b>
310 (228-229 kW) Eng.DSC11.06	88-	<b>24-1201</b>			Impeller Ø 105mm	0570951/ 5,10570951/ 5,1353072,1372365 1508533/ 6,1570951/ 5,1896752,508533 570951/ 55/ 62
310 (228-229 kW) Eng.DSC11.08	90-	<b>24-0869</b>				1314406
	90-	<b>24-1201</b>			Impeller Ø 105mm	0570951/ 5,10570951/ 5,1353072,1372365 1508533/ 6,1570951/ 5,1896752,508533 570951/ 55/ 62
320 (235-239 kW) Eng.DSC11.16	91-	<b>24-0869</b>				1314406
	91-	<b>24-1201</b>			Impeller Ø 105mm	0570951/ 5,10570951/ 5,1353072,1372365 1508533/ 6,1570951/ 5,1896752,508533 570951/ 55/ 62
320 (235-239 kW) Eng.DSC11.17	91-	<b>24-0869</b>				1314406
	91-	<b>24-1201</b>			Impeller Ø 105mm	0570951/ 5,10570951/ 5,1353072,1372365 1508533/ 6,1570951/ 5,1896752,508533 570951/ 55/ 62
320 (235-239 kW) Eng.DSC11.21	91-	<b>24-0869</b>				1314406
	91-	<b>24-1201</b>			Impeller Ø 105mm	0570951/ 5,10570951/ 5,1353072,1372365 1508533/ 6,1570951/ 5,1896752,508533 570951/ 55/ 62
360 (265-267 kW) Eng.DSC11.13	91-	<b>24-0869</b>				1314406
	91-	<b>24-1201</b>			Impeller Ø 105mm	0570951/ 5,10570951/ 5,1353072,1372365 1508533/ 6,1570951/ 5,1896752,508533 570951/ 55/ 62
360 (265-267 kW) Eng.DSC11.18	91-	<b>24-0869</b>				1314406
	91-	<b>24-1201</b>			Impeller Ø 105mm	0570951/ 5,10570951/ 5,1353072,1372365 1508533/ 6,1570951/ 5,1896752,508533 570951/ 55/ 62
360 (265-267 kW) Eng.DSC11.23	91-	<b>24-0869</b>				1314406
	91-	<b>24-1201</b>			Impeller Ø 105mm	0570951/ 5,10570951/ 5,1353072,1372365 1508533/ 6,1570951/ 5,1896752,508533 570951/ 55/ 62
360 (265-267 kW) Eng.DSC11.30	91-	<b>24-0869</b>				1314406
	91-	<b>24-1201</b>			Impeller Ø 105mm	0570951/ 5,10570951/ 5,1353072,1372365 1508533/ 6,1570951/ 5,1896752,508533 570951/ 55/ 62
380 (280 kW) Eng.DSC11.22	94-	<b>24-0869</b>				1314406
	94-	<b>24-1201</b>			Impeller Ø 105mm	0570951/ 5,10570951/ 5,1353072,1372365 1508533/ 6,1570951/ 5,1896752,508533 570951/ 55/ 62
380 (280 kW) Eng.DSC11.70	91-	<b>24-0869</b>				1314406
	91-	<b>24-1201</b>			Impeller Ø 105mm	0570951/ 5,10570951/ 5,1353072,1372365 1508533/ 6,1570951/ 5,1896752,508533 570951/ 55/ 62
<b>113 M '11/91-</b>						
320 (235-239 kW) Eng.DSC11.16	91-	<b>24-0869</b>				1314406
	91-	<b>24-1201</b>			Impeller Ø 105mm	0570951/ 5,10570951/ 5,1353072,1372365 1508533/ 6,1570951/ 5,1896752,508533 570951/ 55/ 62
320 (235-239 kW) Eng.DSC11.17	91-	<b>24-0869</b>				1314406
	91-	<b>24-1201</b>			Impeller Ø 105mm	0570951/ 5,10570951/ 5,1353072,1372365 1508533/ 6,1570951/ 5,1896752,508533 570951/ 55/ 62
320 (235-239 kW) Eng.DSC11.21	91-	<b>24-0869</b>				1314406
	91-	<b>24-1201</b>			Impeller Ø 105mm	0570951/ 5,10570951/ 5,1353072,1372365 1508533/ 6,1570951/ 5,1896752,508533 570951/ 55/ 62
360 (265-267 kW) Eng.DSC11.13	91-	<b>24-0869</b>				1314406
	91-	<b>24-1201</b>			Impeller Ø 105mm	0570951/ 5,10570951/ 5,1353072,1372365 1508533/ 6,1570951/ 5,1896752,508533 570951/ 55/ 62
360 (265-267 kW) Eng.DSC11.18	91-	<b>24-0869</b>				1314406
	91-	<b>24-1201</b>			Impeller Ø 105mm	0570951/ 5,10570951/ 5,1353072,1372365 1508533/ 6,1570951/ 5,1896752,508533 570951/ 55/ 62
360 (265-267 kW) Eng.DSC11.23	91-	<b>24-0869</b>				1314406



**24-0869**



**24-1201**

		<b>METELLI</b> ref.			<b>NOTE</b>	<b>Adaptable for OES</b>
360 (265-267 kW) Eng.DSC11.23	91-	<b>24-1201</b>			Impeller Ø 105mm	0570951/ 5,10570951/ 5,1353072,1372365 1508533/ 6,1570951/ 5,1896752,508533 570951/ 55/ 62
360 (265-267 kW) Eng.DSC11.30	91-	<b>24-0869</b>				1314406
	91-	<b>24-1201</b>			Impeller Ø 105mm	0570951/ 5,10570951/ 5,1353072,1372365 1508533/ 6,1570951/ 5,1896752,508533 570951/ 55/ 62
380 (280 kW) Eng.DSC11.22	94-	<b>24-0869</b>				1314406
	94-	<b>24-1201</b>			Impeller Ø 105mm	0570951/ 5,10570951/ 5,1353072,1372365 1508533/ 6,1570951/ 5,1896752,508533 570951/ 55/ 62
380 (280 kW) Eng.DSC11.70	91-	<b>24-0869</b>				1314406
	91-	<b>24-1201</b>			Impeller Ø 105mm	0570951/ 5,10570951/ 5,1353072,1372365 1508533/ 6,1570951/ 5,1896752,508533 570951/ 55/ 62
<b>114 C '5/96-</b>						
340 (250 kW) Eng.DC11.01	98-	<b>24-1201</b>			Impeller Ø 105mm	0570951/ 5,10570951/ 5,1353072,1372365 1508533/ 6,1570951/ 5,1896752,508533 570951/ 55/ 62
340 (250 kW) Eng.DC11.03	99-	<b>24-1201</b>			Impeller Ø 105mm	0570951/ 5,10570951/ 5,1353072,1372365 1508533/ 6,1570951/ 5,1896752,508533 570951/ 55/ 62
340 (250 kW) Eng.DSC11.79	96-	<b>24-1201</b>			Impeller Ø 105mm	0570951/ 5,10570951/ 5,1353072,1372365 1508533/ 6,1570951/ 5,1896752,508533 570951/ 55/ 62
380 (280 kW) Eng.DC11.02	98-	<b>24-1201</b>			Impeller Ø 105mm	0570951/ 5,10570951/ 5,1353072,1372365 1508533/ 6,1570951/ 5,1896752,508533 570951/ 55/ 62
<b>114 G '5/96-</b>						
340 (250 kW) Eng.DC11.01	98-	<b>24-1201</b>			Impeller Ø 105mm	0570951/ 5,10570951/ 5,1353072,1372365 1508533/ 6,1570951/ 5,1896752,508533 570951/ 55/ 62
340 (250 kW) Eng.DC11.03	99-	<b>24-1201</b>			Impeller Ø 105mm	0570951/ 5,10570951/ 5,1353072,1372365 1508533/ 6,1570951/ 5,1896752,508533 570951/ 55/ 62
340 (250 kW) Eng.DSC11.79	96-	<b>24-1201</b>			Impeller Ø 105mm	0570951/ 5,10570951/ 5,1353072,1372365 1508533/ 6,1570951/ 5,1896752,508533 570951/ 55/ 62
380 (280 kW) Eng.DC11.02	98-	<b>24-1201</b>			Impeller Ø 105mm	0570951/ 5,10570951/ 5,1353072,1372365 1508533/ 6,1570951/ 5,1896752,508533 570951/ 55/ 62
<b>114 L '5/96-</b>						
340 (250 kW) Eng.DC11.01	98-	<b>24-1201</b>			Impeller Ø 105mm	0570951/ 5,10570951/ 5,1353072,1372365 1508533/ 6,1570951/ 5,1896752,508533 570951/ 55/ 62
340 (250 kW) Eng.DC11.03	99-	<b>24-1201</b>			Impeller Ø 105mm	0570951/ 5,10570951/ 5,1353072,1372365 1508533/ 6,1570951/ 5,1896752,508533 570951/ 55/ 62
340 (250 kW) Eng.DSC11.79	96-	<b>24-1201</b>			Impeller Ø 105mm	0570951/ 5,10570951/ 5,1353072,1372365 1508533/ 6,1570951/ 5,1896752,508533 570951/ 55/ 62
380 (280 kW) Eng.DC11.02	98-	<b>24-1201</b>			Impeller Ø 105mm	0570951/ 5,10570951/ 5,1353072,1372365 1508533/ 6,1570951/ 5,1896752,508533 570951/ 55/ 62
380 (280 kW) Eng.DC11.04	99-	<b>24-1201</b>			Impeller Ø 105mm	0570951/ 5,10570951/ 5,1353072,1372365 1508533/ 6,1570951/ 5,1896752,508533 570951/ 55/ 62
<b>124 C '9/96-</b>						
360 (265 kW) Eng.DSC12.02	96-	<b>24-1201</b>			Impeller Ø 105mm	0570951/ 5,10570951/ 5,1353072,1372365 1508533/ 6,1570951/ 5,1896752,508533 570951/ 55/ 62

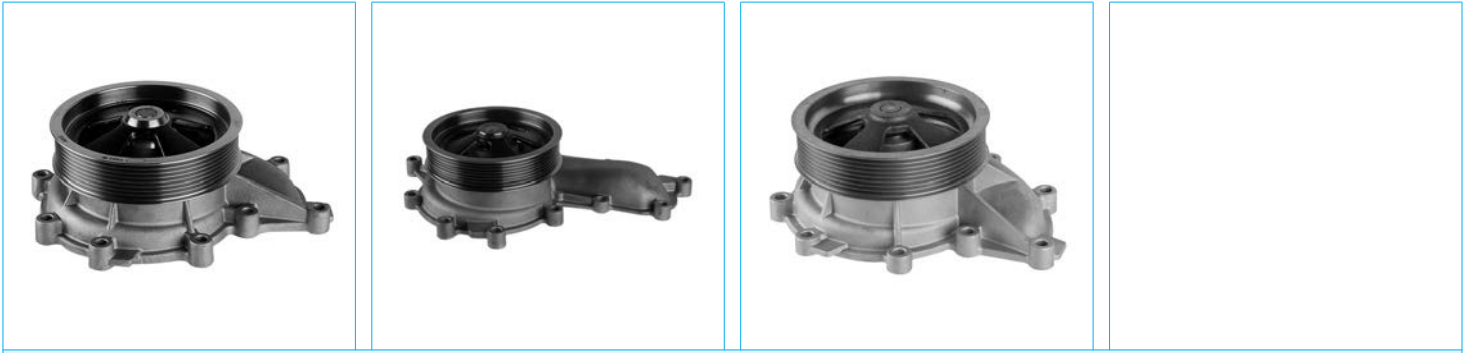





**24-1201**

**24-1207**

**24-1212**

		<b>METELLI</b> ref.			<b>NOTE</b>	<b>Adaptable for OES</b>
400 (294 kW) Eng.DSC12.01	96-	<b>24-1201</b>			Impeller Ø 105mm	0570951/ 5,10570951/ 5,1353072,1372365 1508533/ 6,1570951/ 5,1896752,508533 570951/ 55/ 62
<b>124 G '5/96-</b>						
360 (265 kW) Eng.DSC12.02	96-	<b>24-1201</b>			Impeller Ø 105mm	0570951/ 5,10570951/ 5,1353072,1372365 1508533/ 6,1570951/ 5,1896752,508533 570951/ 55/ 62
400 (294 kW) Eng.DSC12.01	96-	<b>24-1201</b>			Impeller Ø 105mm	0570951/ 5,10570951/ 5,1353072,1372365 1508533/ 6,1570951/ 5,1896752,508533 570951/ 55/ 62
<b>124 L '9/96-</b>						
360 (265 kW) Eng.DSC12.02	96-	<b>24-1201</b>			Impeller Ø 105mm	0570951/ 5,10570951/ 5,1353072,1372365 1508533/ 6,1570951/ 5,1896752,508533 570951/ 55/ 62
400 (294 kW) Eng.DSC12.01	96-	<b>24-1201</b>			Impeller Ø 105mm	0570951/ 5,10570951/ 5,1353072,1372365 1508533/ 6,1570951/ 5,1896752,508533 570951/ 55/ 62
420 (309 kW) Eng.DSC12.05	97-	<b>24-1201</b>			Impeller Ø 105mm	0570951/ 5,10570951/ 5,1353072,1372365 1508533/ 6,1570951/ 5,1896752,508533 570951/ 55/ 62
<b>143 E '1/91-</b>						
420 (309 kW) Eng.DSC14.08	91-	<b>24-1212</b>				0570952,10570952/ 6,1365481/ 841 1508534,1570956,570952/ 6
450 (331-333 kW) Eng.DSC14.03	91-	<b>24-1212</b>				0570952,10570952/ 6,1365481/ 841 1508534,1570956,570952/ 6
450 (331-333 kW) Eng.DSC14.10	91-	<b>24-1212</b>				0570952,10570952/ 6,1365481/ 841 1508534,1570956,570952/ 6
500 (368 kW) Eng.DSC14.09	91-	<b>24-1212</b>				0570952,10570952/ 6,1365481/ 841 1508534,1570956,570952/ 6
500 (368 kW) Eng.DSC14.16	91-	<b>24-1212</b>				0570952,10570952/ 6,1365481/ 841 1508534,1570956,570952/ 6
<b>143 H '5/88-</b>						
400 (297 kW) Eng.DSC14.06	91-	<b>24-1212</b>				0570952,10570952/ 6,1365481/ 841 1508534,1570956,570952/ 6
420 (309 kW) Eng.DSC14.08	91-	<b>24-1212</b>				0570952,10570952/ 6,1365481/ 841 1508534,1570956,570952/ 6
450 (331-333 kW) Eng.DSC14.03	91-	<b>24-1212</b>				0570952,10570952/ 6,1365481/ 841 1508534,1570956,570952/ 6
450 (331-333 kW) Eng.DSC14.10	91-	<b>24-1212</b>				0570952,10570952/ 6,1365481/ 841 1508534,1570956,570952/ 6
500 (368 kW) Eng.DSC14.09	91-	<b>24-1212</b>				0570952,10570952/ 6,1365481/ 841 1508534,1570956,570952/ 6
500 (368 kW) Eng.DSC14.16	91-	<b>24-1212</b>				0570952,10570952/ 6,1365481/ 841 1508534,1570956,570952/ 6
<b>143 M '1/91-</b>						
420 (309 kW) Eng.DSC14.08	91-	<b>24-1212</b>				0570952,10570952/ 6,1365481/ 841 1508534,1570956,570952/ 6
450 (331-333 kW) Eng.DSC14.03	91-	<b>24-1212</b>				0570952,10570952/ 6,1365481/ 841 1508534,1570956,570952/ 6
450 (331-333 kW) Eng.DSC14.10	91-	<b>24-1212</b>				0570952,10570952/ 6,1365481/ 841 1508534,1570956,570952/ 6
500 (368 kW) Eng.DSC14.09	91-	<b>24-1212</b>				0570952,10570952/ 6,1365481/ 841 1508534,1570956,570952/ 6
500 (368 kW) Eng.DSC14.16	91-	<b>24-1212</b>				0570952,10570952/ 6,1365481/ 841 1508534,1570956,570952/ 6
<b>164 C '5/00-</b>						
480 (353 kW) Eng.DC16.02	00-	<b>24-1207</b>				10570954/ 958,1433792,1510404 1549481/ 2,1570954,1793989,570954/ 8
580 (426 kW) Eng.DC16.01	00-	<b>24-1207</b>				10570954/ 958,1433792,1510404 1549481/ 2,1570954,1793989,570954/ 8



			
<p><b>24-1201</b></p>	<p><b>24-1207</b></p>	<p><b>24-1334</b></p>	<p><b>24-1339</b></p>

		<b>METELLI</b> ref.			<b>NOTE</b>	<b>Adaptable for OES</b>
<b>164 G '5/00-</b>						
480 (353 kW) Eng.DC16.02	00-	<b>24-1207</b>				10570954/ 958,1433792,1510404 1549481/ 2,1570954,1793989,570954/ 8
580 (426 kW) Eng.DC16.01	00-	<b>24-1207</b>				10570954/ 958,1433792,1510404 1549481/ 2,1570954,1793989,570954/ 8
<b>164 L '5/00-</b>						
480 (353 kW) Eng.DC16.02	00-	<b>24-1207</b>				10570954/ 958,1433792,1510404 1549481/ 2,1570954,1793989,570954/ 8
580 (426 kW) Eng.DC16.01	00-	<b>24-1207</b>				10570954/ 958,1433792,1510404 1549481/ 2,1570954,1793989,570954/ 8
<b>93 H '3/88-</b>						
220 (162 kW) Eng.DSC9.10	91-	<b>24-1334</b>			Impeller Ø 88mm	0570953/ 957,1380897,1486098,1510490 570953/ 57/ 61,571157
250 (185 kW) Eng.DSC9.07	91-	<b>24-1334</b>			Impeller Ø 88mm	0570953/ 957,1380897,1486098,1510490 570953/ 57/ 61,571157
280 (207-208 kW) Eng.DSC9.02	91-95	<b>24-1334</b>			Impeller Ø 88mm	0570953/ 957,1380897,1486098,1510490 570953/ 57/ 61,571157
280 (207-208 kW) Eng.DSC9.08	91-	<b>24-1334</b>			Impeller Ø 88mm	0570953/ 957,1380897,1486098,1510490 570953/ 57/ 61,571157
<b>93 M '3/88-</b>						
220 (162 kW) Eng.DSC9.10	91-	<b>24-1334</b>			Impeller Ø 88mm	0570953/ 957,1380897,1486098,1510490 570953/ 57/ 61,571157
250 (185 kW) Eng.DSC9.07	91-	<b>24-1334</b>			Impeller Ø 88mm	0570953/ 957,1380897,1486098,1510490 570953/ 57/ 61,571157
280 (207 kW) Eng.DSC9.02	88-95	<b>24-1334</b>			Impeller Ø 88mm	0570953/ 957,1380897,1486098,1510490 570953/ 57/ 61,571157
280 (207-208 kW) Eng.DSC9.08	91-	<b>24-1334</b>			Impeller Ø 88mm	0570953/ 957,1380897,1486098,1510490 570953/ 57/ 61,571157
<b>94 C '12/96-</b>						
260 (191 kW) Eng.DSC9.12	96-	<b>24-1334</b>			Impeller Ø 88mm	0570953/ 957,1380897,1486098,1510490 570953/ 57/ 61,571157
310 (228 kW) Eng.DSC9.13	97-	<b>24-1334</b>			Impeller Ø 88mm	0570953/ 957,1380897,1486098,1510490 570953/ 57/ 61,571157
310 (228 kW) Eng.DSC9.15	97-	<b>24-1334</b>			Impeller Ø 88mm	0570953/ 957,1380897,1486098,1510490 570953/ 57/ 61,571157
<b>94 D '12/96-</b>						
220 (162 kW) Eng.DSC9.11	96-	<b>24-1334</b>			Impeller Ø 88mm	0570953/ 957,1380897,1486098,1510490 570953/ 57/ 61,571157
230 (169 kW) Eng.DC9.01	99-	<b>24-1201</b>			Impeller Ø 105mm	0570951/ 5,10570951/ 5,1353072,1372365 1508533/ 6,1570951/ 5,1896752,508533 570951/ 55/ 62
	99-	<b>24-1334</b>			Impeller Ø 88mm	0570953/ 957,1380897,1486098,1510490 570953/ 57/ 61,571157
	99-	<b>24-1339</b>			Impeller Ø 112mm	0570959/ 964/ 965,10570959/ 64,1546188 1570959,1787120/ 23,1789522,546188 570959/ 64/ 65
230 (169 kW) Eng.DC9.04	00-	<b>24-1201</b>			Impeller Ø 105mm	0570951/ 5,10570951/ 5,1353072,1372365 1508533/ 6,1570951/ 5,1896752,508533 570951/ 55/ 62
	00-	<b>24-1334</b>			Impeller Ø 88mm	0570953/ 957,1380897,1486098,1510490 570953/ 57/ 61,571157
	00-	<b>24-1339</b>			Impeller Ø 112mm	0570959/ 964/ 965,10570959/ 64,1546188 1570959,1787120/ 23,1789522,546188 570959/ 64/ 65
260 (191 kW) Eng.DSC9.12	96-	<b>24-1334</b>			Impeller Ø 88mm	0570953/ 957,1380897,1486098,1510490 570953/ 57/ 61,571157
310 (228 kW) Eng.DSC9.13	97-	<b>24-1334</b>			Impeller Ø 88mm	0570953/ 957,1380897,1486098,1510490 570953/ 57/ 61,571157
310 (228 kW) Eng.DSC9.15	97-	<b>24-1334</b>			Impeller Ø 88mm	0570953/ 957,1380897,1486098,1510490 570953/ 57/ 61,571157



**24-1201**

**24-1334**

**24-1339**

		<b>METELLI</b> ref.			NOTE	Adaptable for OES
<b>94 G '8/96-</b>						
220 (162 kW) Eng.DSC9.11	96-	<b>24-1334</b>			Impeller Ø 88mm	0570953/ 957,1380897,1486098,1510490 570953/ 57/ 61,571157
260 (191 kW) Eng.DSC9.12	96-	<b>24-1334</b>			Impeller Ø 88mm	0570953/ 957,1380897,1486098,1510490 570953/ 57/ 61,571157
310 (228 kW) Eng.DSC9.13	97-	<b>24-1334</b>			Impeller Ø 88mm	0570953/ 957,1380897,1486098,1510490 570953/ 57/ 61,571157
310 (228 kW) Eng.DSC9.15	97-	<b>24-1334</b>			Impeller Ø 88mm	0570953/ 957,1380897,1486098,1510490 570953/ 57/ 61,571157
<b>94 L '4/97-</b>						
310 (228 kW) Eng.DSC9.13	97-	<b>24-1334</b>			Impeller Ø 88mm	0570953/ 957,1380897,1486098,1510490 570953/ 57/ 61,571157
310 (228 kW) Eng.DSC9.15	97-	<b>24-1334</b>			Impeller Ø 88mm	0570953/ 957,1380897,1486098,1510490 570953/ 57/ 61,571157
<b>BR 112DH</b>						
11.0 Eng.D11	99-	<b>24-1339</b>			Impeller Ø 112mm	0570959/ 964/ 965,10570959/ 64,1546188 1570959,1787120/ 23,1789522,546188 570959/ 64/ 65
<b>G II '3/04-</b>						
230 (169 kW) Eng.DC9.13/DC9.16	04-	<b>24-1201</b>			Impeller Ø 105mm	0570951/ 5,10570951/ 5,1353072,1372365 1508533/ 6,1570951/ 5,1896752,508533 570951/ 55/ 62
	04-	<b>24-1339</b>			Impeller Ø 112mm	0570959/ 964/ 965,10570959/ 64,1546188 1570959,1787120/ 23,1789522,546188 570959/ 64/ 65
230 (169 kW) Eng.DC9.30/DC9.35	07-	<b>24-1201</b>			Impeller Ø 105mm	0570951/ 5,10570951/ 5,1353072,1372365 1508533/ 6,1570951/ 5,1896752,508533 570951/ 55/ 62
	07-	<b>24-1339</b>			Impeller Ø 112mm	0570959/ 964/ 965,10570959/ 64,1546188 1570959,1787120/ 23,1789522,546188 570959/ 64/ 65
270 (198 kW) Eng.DC9.12/DC9.17	04-	<b>24-1201</b>			Impeller Ø 105mm	0570951/ 5,10570951/ 5,1353072,1372365 1508533/ 6,1570951/ 5,1896752,508533 570951/ 55/ 62
	04-	<b>24-1339</b>			Impeller Ø 112mm	0570959/ 964/ 965,10570959/ 64,1546188 1570959,1787120/ 23,1789522,546188 570959/ 64/ 65
310 (228 kW) Eng.DC9.11/DC9.18	04-	<b>24-1201</b>			Impeller Ø 105mm	0570951/ 5,10570951/ 5,1353072,1372365 1508533/ 6,1570951/ 5,1896752,508533 570951/ 55/ 62
	04-	<b>24-1339</b>			Impeller Ø 112mm	0570959/ 964/ 965,10570959/ 64,1546188 1570959,1787120/ 23,1789522,546188 570959/ 64/ 65
<b>K III '11/90-</b>						
113 (228 kW) Eng.DSC11.08	90-	<b>24-1201</b>			Impeller Ø 105mm	0570951/ 5,10570951/ 5,1353072,1372365 1508533/ 6,1570951/ 5,1896752,508533 570951/ 55/ 62
113 CLB (280 kW) Eng.DSC11.22	92-	<b>24-1201</b>			Impeller Ø 105mm	0570951/ 5,10570951/ 5,1353072,1372365 1508533/ 6,1570951/ 5,1896752,508533 570951/ 55/ 62
93 CL (208 kW) Eng.DSC9.08	91-	<b>24-1334</b>			Impeller Ø 88mm	0570953/ 957,1380897,1486098,1510490 570953/ 57/ 61,571157
<b>K-Serie '1/06-</b>						
230 (169 kW) Eng.DC9.16	09-	<b>24-1201</b>			Impeller Ø 105mm	0570951/ 5,10570951/ 5,1353072,1372365 1508533/ 6,1570951/ 5,1896752,508533 570951/ 55/ 62
	09-	<b>24-1339</b>			Impeller Ø 112mm	0570959/ 964/ 965,10570959/ 64,1546188 1570959,1787120/ 23,1789522,546188 570959/ 64/ 65

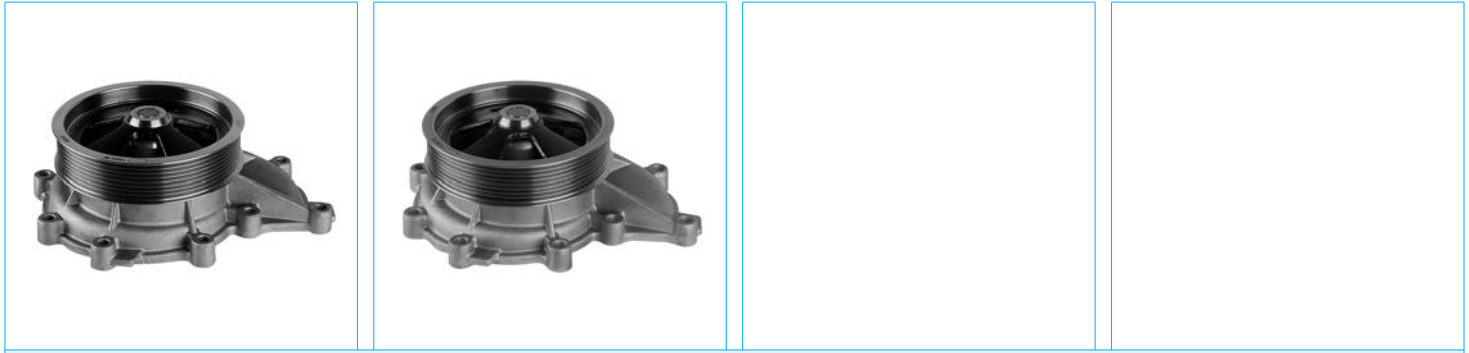

**24-1201**

**24-1339**



--	--	--	--

--	--	--	--

--	--	--	--

--	--	--	--

		<b>METELLI</b> ref.			<b>NOTE</b>	<b>Adaptable for OES</b>
250 (184 kW) Eng.DC9.109/114	06-	<b>24-1201</b>			Impeller Ø 105mm	0570951/ 5,10570951/ 5,1353072,1372365 1508533/ 6,1570951/ 5,1896752,508533 570951/ 55/ 62
	06-	<b>24-1339</b>			Impeller Ø 112mm	0570959/ 964/ 965,10570959/ 64,1546188 1570959,1787120/ 23,1789522,546188 570959/ 64/ 65
270 (198 kW) Eng.DC9E.02	06-	<b>24-1339</b>			Impeller Ø 112mm	0570959/ 964/ 965,10570959/ 64,1546188 1570959,1787120/ 23,1789522,546188 570959/ 64/ 65
280 (206 kW) Eng.DC9.29	09-	<b>24-1201</b>			Impeller Ø 105mm	0570951/ 5,10570951/ 5,1353072,1372365 1508533/ 6,1570951/ 5,1896752,508533 570951/ 55/ 62
	09-	<b>24-1339</b>			Impeller Ø 112mm	0570959/ 964/ 965,10570959/ 64,1546188 1570959,1787120/ 23,1789522,546188 570959/ 64/ 65
310 (228 kW) Eng.DC9.110	06-	<b>24-1201</b>			Impeller Ø 105mm	0570951/ 5,10570951/ 5,1353072,1372365 1508533/ 6,1570951/ 5,1896752,508533 570951/ 55/ 62
	06-	<b>24-1339</b>			Impeller Ø 112mm	0570959/ 964/ 965,10570959/ 64,1546188 1570959,1787120/ 23,1789522,546188 570959/ 64/ 65
320 (235 kW) Eng.DC9.32	11-	<b>24-1201</b>			Impeller Ø 105mm	0570951/ 5,10570951/ 5,1353072,1372365 1508533/ 6,1570951/ 5,1896752,508533 570951/ 55/ 62
	11-	<b>24-1339</b>			Impeller Ø 112mm	0570959/ 964/ 965,10570959/ 64,1546188 1570959,1787120/ 23,1789522,546188 570959/ 64/ 65
<b>P II '9/04-</b>						
230 (169 kW) Eng.DC9.01/DC9.04	04-	<b>24-1201</b>			Impeller Ø 105mm	0570951/ 5,10570951/ 5,1353072,1372365 1508533/ 6,1570951/ 5,1896752,508533 570951/ 55/ 62
	04-	<b>24-1339</b>			Impeller Ø 112mm	0570959/ 964/ 965,10570959/ 64,1546188 1570959,1787120/ 23,1789522,546188 570959/ 64/ 65
230 (169 kW) Eng.DC9.13	04-	<b>24-1201</b>			Impeller Ø 105mm	0570951/ 5,10570951/ 5,1353072,1372365 1508533/ 6,1570951/ 5,1896752,508533 570951/ 55/ 62
	04-	<b>24-1339</b>			Impeller Ø 112mm	0570959/ 964/ 965,10570959/ 64,1546188 1570959,1787120/ 23,1789522,546188 570959/ 64/ 65
230 (169 kW) Eng.DC9.16	04-	<b>24-1201</b>			Impeller Ø 105mm	0570951/ 5,10570951/ 5,1353072,1372365 1508533/ 6,1570951/ 5,1896752,508533 570951/ 55/ 62
	04-	<b>24-1339</b>			Impeller Ø 112mm	0570959/ 964/ 965,10570959/ 64,1546188 1570959,1787120/ 23,1789522,546188 570959/ 64/ 65
230 (169 kW) Eng.DC9.30/DC9.35	07-	<b>24-1201</b>			Impeller Ø 105mm	0570951/ 5,10570951/ 5,1353072,1372365 1508533/ 6,1570951/ 5,1896752,508533 570951/ 55/ 62
	07-	<b>24-1339</b>			Impeller Ø 112mm	0570959/ 964/ 965,10570959/ 64,1546188 1570959,1787120/ 23,1789522,546188 570959/ 64/ 65
250 (184 kW) Eng.DC09.109/DC09.111	13-	<b>24-1201</b>			Impeller Ø 105mm	0570951/ 5,10570951/ 5,1353072,1372365 1508533/ 6,1570951/ 5,1896752,508533 570951/ 55/ 62
260 (191 kW) Eng.DC9.02/DC9.05	04-	<b>24-1201</b>			Impeller Ø 105mm	0570951/ 5,10570951/ 5,1353072,1372365 1508533/ 6,1570951/ 5,1896752,508533 570951/ 55/ 62
	04-	<b>24-1339</b>			Impeller Ø 112mm	0570959/ 964/ 965,10570959/ 64,1546188 1570959,1787120/ 23,1789522,546188 570959/ 64/ 65
270 (198 kW) Eng.DC9.12	04-	<b>24-1201</b>			Impeller Ø 105mm	0570951/ 5,10570951/ 5,1353072,1372365 1508533/ 6,1570951/ 5,1896752,508533 570951/ 55/ 62

			
<p><b>24-1201</b></p>	<p><b>24-1207</b></p>	<p><b>24-1339</b></p>	

		<b>METELLI</b> ref.			<b>NOTE</b>	<b>Adaptable for OES</b>
270 (198 kW) Eng.DC9.12	04-	<b>24-1339</b>			Impeller Ø 112mm	0570959/ 964/ 965,10570959/ 64,1546188 1570959,1787120/ 23,1789522,546188 570959/ 64/ 65
280 (206 kW) Eng.DC9.29	04-	<b>24-1201</b>			Impeller Ø 105mm	0570951/ 5,10570951/ 5,1353072,1372365 1508533/ 6,1570951/ 5,1896752,508533 570951/ 55/ 62
	04-	<b>24-1339</b>			Impeller Ø 112mm	0570959/ 964/ 965,10570959/ 64,1546188 1570959,1787120/ 23,1789522,546188 570959/ 64/ 65
300 (220 kW) Eng.DC9.03/DC9.06	04-	<b>24-1201</b>			Impeller Ø 105mm	0570951/ 5,10570951/ 5,1353072,1372365 1508533/ 6,1570951/ 5,1896752,508533 570951/ 55/ 62
	04-	<b>24-1339</b>			Impeller Ø 112mm	0570959/ 964/ 965,10570959/ 64,1546188 1570959,1787120/ 23,1789522,546188 570959/ 64/ 65
310 (228 kW) Eng.DC9.11	04-	<b>24-1201</b>			Impeller Ø 105mm	0570951/ 5,10570951/ 5,1353072,1372365 1508533/ 6,1570951/ 5,1896752,508533 570951/ 55/ 62
	04-	<b>24-1339</b>			Impeller Ø 112mm	0570959/ 964/ 965,10570959/ 64,1546188 1570959,1787120/ 23,1789522,546188 570959/ 64/ 65
310 (228 kW) Eng.DC9.18	04-	<b>24-1201</b>			Impeller Ø 105mm	0570951/ 5,10570951/ 5,1353072,1372365 1508533/ 6,1570951/ 5,1896752,508533 570951/ 55/ 62
	04-	<b>24-1339</b>			Impeller Ø 112mm	0570959/ 964/ 965,10570959/ 64,1546188 1570959,1787120/ 23,1789522,546188 570959/ 64/ 65
320 (235 kW) Eng.DC09.108/DC09.22/.32/.37	13-	<b>24-1201</b>			Impeller Ø 105mm	0570951/ 5,10570951/ 5,1353072,1372365 1508533/ 6,1570951/ 5,1896752,508533 570951/ 55/ 62
500 (368 kW) Eng.DC16.04/DC16.06/DC16.09	00-	<b>24-1207</b>				10570954/ 958,1433792,1510404 1549481/ 2,1570954,1793989,570954/ 8
560 (412 kW) Eng.DC16.05/DC16.18	00-	<b>24-1207</b>				10570954/ 958,1433792,1510404 1549481/ 2,1570954,1793989,570954/ 8
580 (426 kW) Eng.DC16.03	00-	<b>24-1207</b>				10570954/ 958,1433792,1510404 1549481/ 2,1570954,1793989,570954/ 8
620 (456 kW) Eng.DC16.08/DC16.17	00-	<b>24-1207</b>				10570954/ 958,1433792,1510404 1549481/ 2,1570954,1793989,570954/ 8
<b>R II '3/04-</b>						
230 (169 kW) Eng.DC9.13/DC9.16	04-	<b>24-1201</b>			Impeller Ø 105mm	0570951/ 5,10570951/ 5,1353072,1372365 1508533/ 6,1570951/ 5,1896752,508533 570951/ 55/ 62
	04-	<b>24-1339</b>			Impeller Ø 112mm	0570959/ 964/ 965,10570959/ 64,1546188 1570959,1787120/ 23,1789522,546188 570959/ 64/ 65
270 (198 kW) Eng.DC9.12/DC9.17	04-	<b>24-1201</b>			Impeller Ø 105mm	0570951/ 5,10570951/ 5,1353072,1372365 1508533/ 6,1570951/ 5,1896752,508533 570951/ 55/ 62
	04-	<b>24-1339</b>			Impeller Ø 112mm	0570959/ 964/ 965,10570959/ 64,1546188 1570959,1787120/ 23,1789522,546188 570959/ 64/ 65
310 (228 kW) Eng.DC9.11/DC9.18	04-	<b>24-1201</b>			Impeller Ø 105mm	0570951/ 5,10570951/ 5,1353072,1372365 1508533/ 6,1570951/ 5,1896752,508533 570951/ 55/ 62
	04-	<b>24-1339</b>			Impeller Ø 112mm	0570959/ 964/ 965,10570959/ 64,1546188 1570959,1787120/ 23,1789522,546188 570959/ 64/ 65
500 (368 kW) Eng.DC16.04/.06/.09/.19/.22	00-	<b>24-1207</b>				10570954/ 958,1433792,1510404 1549481/ 2,1570954,1793989,570954/ 8
520 (382 kW) Eng.DC16.101	00-	<b>24-1207</b>				10570954/ 958,1433792,1510404 1549481/ 2,1570954,1793989,570954/ 8
560 (412 kW) Eng.DC16.05/DC16.18	00-	<b>24-1207</b>				10570954/ 958,1433792,1510404 1549481/ 2,1570954,1793989,570954/ 8
580 (426 kW) Eng.DC16.03	00-	<b>24-1207</b>				10570954/ 958,1433792,1510404 1549481/ 2,1570954,1793989,570954/ 8





**24-1201**

**24-1207**

--	--	--	--

--	--	--	--

--	--	--	--

--	--	--	--

		<b>METELLI</b> ref.			<b>NOTE</b>	<b>Adaptable for OES</b>
580 (426 kW) Eng.DC16.102	00-	<b>24-1207</b>				10570954/ 958,1433792,1510404 1549481/ 2,1570954,1793989,570954/ 8
620 (456 kW) Eng.DC16.08/17	00-	<b>24-1207</b>				10570954/ 958,1433792,1510404 1549481/ 2,1570954,1793989,570954/ 8
730 (537 kW) Eng.DC16.21	00-	<b>24-1207</b>				10570954/ 958,1433792,1510404 1549481/ 2,1570954,1793989,570954/ 8
<b>T 113 E '11/91-</b>						
320 (235-239 kW) Eng.DSC11.16	91-	<b>24-1201</b>			Impeller Ø 105mm	0570951/ 5,10570951/ 5,1353072,1372365 1508533/ 6,1570951/ 5,1896752,508533 570951/ 55/ 62
320 (235-239 kW) Eng.DSC11.17	91-	<b>24-1201</b>			Impeller Ø 105mm	0570951/ 5,10570951/ 5,1353072,1372365 1508533/ 6,1570951/ 5,1896752,508533 570951/ 55/ 62
320 (235-239 kW) Eng.DSC11.21	91-	<b>24-1201</b>			Impeller Ø 105mm	0570951/ 5,10570951/ 5,1353072,1372365 1508533/ 6,1570951/ 5,1896752,508533 570951/ 55/ 62
360 (266-267 kW) Eng.DSC11.13	91-	<b>24-1201</b>			Impeller Ø 105mm	0570951/ 5,10570951/ 5,1353072,1372365 1508533/ 6,1570951/ 5,1896752,508533 570951/ 55/ 62
360 (266-267 kW) Eng.DSC11.18	91-	<b>24-1201</b>			Impeller Ø 105mm	0570951/ 5,10570951/ 5,1353072,1372365 1508533/ 6,1570951/ 5,1896752,508533 570951/ 55/ 62
360 (266-267 kW) Eng.DSC11.23	91-	<b>24-1201</b>			Impeller Ø 105mm	0570951/ 5,10570951/ 5,1353072,1372365 1508533/ 6,1570951/ 5,1896752,508533 570951/ 55/ 62
<b>T 113 H '11/91-</b>						
320 (235-239 kW) Eng.DSC11.16	91-	<b>24-1201</b>			Impeller Ø 105mm	0570951/ 5,10570951/ 5,1353072,1372365 1508533/ 6,1570951/ 5,1896752,508533 570951/ 55/ 62
320 (235-239 kW) Eng.DSC11.17	91-	<b>24-1201</b>			Impeller Ø 105mm	0570951/ 5,10570951/ 5,1353072,1372365 1508533/ 6,1570951/ 5,1896752,508533 570951/ 55/ 62
320 (235-239 kW) Eng.DSC11.21	91-	<b>24-1201</b>			Impeller Ø 105mm	0570951/ 5,10570951/ 5,1353072,1372365 1508533/ 6,1570951/ 5,1896752,508533 570951/ 55/ 62
360 (266-267 kW) Eng.DSC11.13	91-	<b>24-1201</b>			Impeller Ø 105mm	0570951/ 5,10570951/ 5,1353072,1372365 1508533/ 6,1570951/ 5,1896752,508533 570951/ 55/ 62
360 (266-267 kW) Eng.DSC11.18	91-	<b>24-1201</b>			Impeller Ø 105mm	0570951/ 5,10570951/ 5,1353072,1372365 1508533/ 6,1570951/ 5,1896752,508533 570951/ 55/ 62
360 (266-267 kW) Eng.DSC11.23	91-	<b>24-1201</b>			Impeller Ø 105mm	0570951/ 5,10570951/ 5,1353072,1372365 1508533/ 6,1570951/ 5,1896752,508533 570951/ 55/ 62
<b>T 114 C '3/98-</b>						
340 (250 kW) Eng.DC11.01	98-	<b>24-1201</b>			Impeller Ø 105mm	0570951/ 5,10570951/ 5,1353072,1372365 1508533/ 6,1570951/ 5,1896752,508533 570951/ 55/ 62
340 (250 kW) Eng.DC11.03	99-	<b>24-1201</b>			Impeller Ø 105mm	0570951/ 5,10570951/ 5,1353072,1372365 1508533/ 6,1570951/ 5,1896752,508533 570951/ 55/ 62
380 (280 kW) Eng.DC11.02	98-	<b>24-1201</b>			Impeller Ø 105mm	0570951/ 5,10570951/ 5,1353072,1372365 1508533/ 6,1570951/ 5,1896752,508533 570951/ 55/ 62
<b>T 114 G '5/96-</b>						
340 (250 kW) Eng.DC11.01	98-	<b>24-1201</b>			Impeller Ø 105mm	0570951/ 5,10570951/ 5,1353072,1372365 1508533/ 6,1570951/ 5,1896752,508533 570951/ 55/ 62
340 (250 kW) Eng.DC11.03	99-	<b>24-1201</b>			Impeller Ø 105mm	0570951/ 5,10570951/ 5,1353072,1372365 1508533/ 6,1570951/ 5,1896752,508533 570951/ 55/ 62











**24-1201**







**24-1212**

		<b>METELLI</b> ref.			<b>NOTE</b>	<b>Adaptable for OES</b>
340 (250 kW) Eng.DSC11.79	96-	<b>24-1201</b>			Impeller Ø 105mm	0570951/ 5,10570951/ 5,1353072,1372365 1508533/ 6,1570951/ 5,1896752,508533 570951/ 55/ 62
380 (280 kW) Eng.DC11.02	98-	<b>24-1201</b>			Impeller Ø 105mm	0570951/ 5,10570951/ 5,1353072,1372365 1508533/ 6,1570951/ 5,1896752,508533 570951/ 55/ 62
<b>T 114 L '5/96-</b>						
340 (250 kW) Eng.DC11.01	98-	<b>24-1201</b>			Impeller Ø 105mm	0570951/ 5,10570951/ 5,1353072,1372365 1508533/ 6,1570951/ 5,1896752,508533 570951/ 55/ 62
340 (250 kW) Eng.DC11.03	99-	<b>24-1201</b>			Impeller Ø 105mm	0570951/ 5,10570951/ 5,1353072,1372365 1508533/ 6,1570951/ 5,1896752,508533 570951/ 55/ 62
340 (250 kW) Eng.DSC11.79	96-	<b>24-1201</b>			Impeller Ø 105mm	0570951/ 5,10570951/ 5,1353072,1372365 1508533/ 6,1570951/ 5,1896752,508533 570951/ 55/ 62
380 (280 kW) Eng.DC11.02	98-	<b>24-1201</b>			Impeller Ø 105mm	0570951/ 5,10570951/ 5,1353072,1372365 1508533/ 6,1570951/ 5,1896752,508533 570951/ 55/ 62
<b>T 124 C '9/95-</b>						
360 (265 kW) Eng.DSC12.02	95-	<b>24-1201</b>			Impeller Ø 105mm	0570951/ 5,10570951/ 5,1353072,1372365 1508533/ 6,1570951/ 5,1896752,508533 570951/ 55/ 62
400 (294 kW) Eng.DSC12.01	96-	<b>24-1201</b>			Impeller Ø 105mm	0570951/ 5,10570951/ 5,1353072,1372365 1508533/ 6,1570951/ 5,1896752,508533 570951/ 55/ 62
420 (309 kW) Eng.DC12.01	98-	<b>24-1201</b>			Impeller Ø 105mm	0570951/ 5,10570951/ 5,1353072,1372365 1508533/ 6,1570951/ 5,1896752,508533 570951/ 55/ 62
420 (309 kW) Eng.DSC12.05	97-	<b>24-1201</b>			Impeller Ø 105mm	0570951/ 5,10570951/ 5,1353072,1372365 1508533/ 6,1570951/ 5,1896752,508533 570951/ 55/ 62
<b>T 124 G '3/97-</b>						
360 (265 kW) Eng.DSC12.02	97-	<b>24-1201</b>			Impeller Ø 105mm	0570951/ 5,10570951/ 5,1353072,1372365 1508533/ 6,1570951/ 5,1896752,508533 570951/ 55/ 62
400 (294 kW) Eng.DSC12.01	97-	<b>24-1201</b>			Impeller Ø 105mm	0570951/ 5,10570951/ 5,1353072,1372365 1508533/ 6,1570951/ 5,1896752,508533 570951/ 55/ 62
420 (309 kW) Eng.DC12.01	98-	<b>24-1201</b>			Impeller Ø 105mm	0570951/ 5,10570951/ 5,1353072,1372365 1508533/ 6,1570951/ 5,1896752,508533 570951/ 55/ 62
420 (309 kW) Eng.DSC12.05	97-	<b>24-1201</b>			Impeller Ø 105mm	0570951/ 5,10570951/ 5,1353072,1372365 1508533/ 6,1570951/ 5,1896752,508533 570951/ 55/ 62
<b>T 124 L '9/95-</b>						
360 (265 kW) Eng.DSC12.02	95-	<b>24-1201</b>			Impeller Ø 105mm	0570951/ 5,10570951/ 5,1353072,1372365 1508533/ 6,1570951/ 5,1896752,508533 570951/ 55/ 62
400 (294 kW) Eng.DSC12.01	96-	<b>24-1201</b>			Impeller Ø 105mm	0570951/ 5,10570951/ 5,1353072,1372365 1508533/ 6,1570951/ 5,1896752,508533 570951/ 55/ 62
420 (309 kW) Eng.DSC12.05	97-	<b>24-1201</b>			Impeller Ø 105mm	0570951/ 5,10570951/ 5,1353072,1372365 1508533/ 6,1570951/ 5,1896752,508533 570951/ 55/ 62
<b>T 143 E '1/91-</b>						
420 (309 kW) Eng.DSC14.08	91-	<b>24-1212</b>				0570952,10570952/ 6,1365481/ 841 1508534,1570956,570952/ 6
450 (331-333 kW) Eng.DSC14.03	91-	<b>24-1212</b>				0570952,10570952/ 6,1365481/ 841 1508534,1570956,570952/ 6







			
<p><b>24-1201</b></p>	<p><b>24-1212</b></p>	<p><b>24-1334</b></p>	<p><b>24-1339</b></p>

		<b>METELLI</b> ref.			<b>NOTE</b>	<b>Adaptable for OES</b>
450 (331-333 kW) Eng.DSC14.10	91-	<b>24-1212</b>				0570952,10570952/ 6,1365481/ 841 1508534,1570956,570952/ 6
500 (368 kW) Eng.DSC14.09	91-	<b>24-1212</b>				0570952,10570952/ 6,1365481/ 841 1508534,1570956,570952/ 6
500 (368 kW) Eng.DSC14.16	91-	<b>24-1212</b>				0570952,10570952/ 6,1365481/ 841 1508534,1570956,570952/ 6
<b>T 143 H '1/91-</b>						
420 (309 kW) Eng.DSC14.08	91-	<b>24-1212</b>				0570952,10570952/ 6,1365481/ 841 1508534,1570956,570952/ 6
450 (331-333 kW) Eng.DSC14.03	91-	<b>24-1212</b>				0570952,10570952/ 6,1365481/ 841 1508534,1570956,570952/ 6
450 (331-333 kW) Eng.DSC14.10	91-	<b>24-1212</b>				0570952,10570952/ 6,1365481/ 841 1508534,1570956,570952/ 6
500 (368 kW) Eng.DSC14.09	91-	<b>24-1212</b>				0570952,10570952/ 6,1365481/ 841 1508534,1570956,570952/ 6
500 (368 kW) Eng.DSC14.16	91-	<b>24-1212</b>				0570952,10570952/ 6,1365481/ 841 1508534,1570956,570952/ 6
<b>T 93 H '1/90-</b>						
250 (185 kW) Eng.DSC9.07	91-	<b>24-1334</b>			Impeller Ø 88mm	0570953/ 957,1380897,1486098,1510490 570953/ 57/ 61,571157
280 (207-208 kW) Eng.DSC9.02	91-95	<b>24-1334</b>			Impeller Ø 88mm	0570953/ 957,1380897,1486098,1510490 570953/ 57/ 61,571157
280 (207-208 kW) Eng.DSC9.08	91-	<b>24-1334</b>			Impeller Ø 88mm	0570953/ 957,1380897,1486098,1510490 570953/ 57/ 61,571157
<b>T 94 C '9/96-</b>						
260 (191 kW) Eng.DSC9.12	96-	<b>24-1334</b>			Impeller Ø 88mm	0570953/ 957,1380897,1486098,1510490 570953/ 57/ 61,571157
310 (228 kW) Eng.DSC9.13	96-	<b>24-1334</b>			Impeller Ø 88mm	0570953/ 957,1380897,1486098,1510490 570953/ 57/ 61,571157
<b>T 94 G '8/96-</b>						
220 (162 kW) Eng.DSC9.11	96-	<b>24-1334</b>			Impeller Ø 88mm	0570953/ 957,1380897,1486098,1510490 570953/ 57/ 61,571157
230 (169 kW) Eng.DC9.01	99-	<b>24-1201</b>			Impeller Ø 105mm	0570951/ 5,10570951/ 5,1353072,1372365 1508533/ 6,1570951/ 5,1896752,508533 570951/ 55/ 62
	99-	<b>24-1339</b>			Impeller Ø 112mm	0570959/ 964/ 965,10570959/ 64,1546188 1570959,1787120/ 23,1789522,546188 570959/ 64/ 65
260 (191 kW) Eng.DSC9.12	96-	<b>24-1334</b>			Impeller Ø 88mm	0570953/ 957,1380897,1486098,1510490 570953/ 57/ 61,571157
310 (221-228 kW) Eng.DC9.03	99-	<b>24-1201</b>			Impeller Ø 105mm	0570951/ 5,10570951/ 5,1353072,1372365 1508533/ 6,1570951/ 5,1896752,508533 570951/ 55/ 62
	99-	<b>24-1339</b>			Impeller Ø 112mm	0570959/ 964/ 965,10570959/ 64,1546188 1570959,1787120/ 23,1789522,546188 570959/ 64/ 65
310 (221-228 kW) Eng.DSC9.13	96-	<b>24-1334</b>			Impeller Ø 88mm	0570953/ 957,1380897,1486098,1510490 570953/ 57/ 61,571157
310 (221-228 kW) Eng.DSC9.15	97-	<b>24-1334</b>			Impeller Ø 88mm	0570953/ 957,1380897,1486098,1510490 570953/ 57/ 61,571157
<b>T 94 L '9/96-</b>						
310 (228 kW) Eng.DSC9.13	96-	<b>24-1334</b>			Impeller Ø 88mm	0570953/ 957,1380897,1486098,1510490 570953/ 57/ 61,571157
310 (228 kW) Eng.DSC9.15	97-	<b>24-1334</b>			Impeller Ø 88mm	0570953/ 957,1380897,1486098,1510490 570953/ 57/ 61,571157

			
<b>24-1204</b>	<b>24-1211</b>	<b>24-1316</b>	<b>24-1318</b>
			
<b>24-1332</b>	<b>24-1337</b>		

		<b>METELLI</b> ref.			NOTE	Adaptable for OES
<b>7700 '6/06-</b>						
7700 (191 kW) Eng.D9B260	06-	<b>24-1204</b>			w/o pulley	20538845,20744939/ 940,20761306 21228793,21468471,3161436,85000486 85020085
	06-	<b>24-1211</b>			w/ pulley	20411880,20857085,85000214
7700 (228 kW) Eng.D9B310	06-	<b>24-1204</b>			w/o pulley	20538845,20744939/ 940,20761306 21228793,21468471,3161436,85000486 85020085
	06-	<b>24-1211</b>			w/ pulley	20411880,20857085,85000214
7700 (265 kW) Eng.D9B360	06-	<b>24-1204</b>			w/o pulley	20538845,20744939/ 940,20761306 21228793,21468471,3161436,85000486 85020085
	06-	<b>24-1211</b>			w/ pulley	20411880,20857085,85000214
<b>8500 '1/99-</b>						
8500 (265 kW) Eng.D9B360	99-	<b>24-1204</b>			w/o pulley	20538845,20744939/ 940,20761306 21228793,21468471,3161436,85000486 85020085
	06-	<b>24-1211</b>			w/ pulley	20411880,20857085,85000214
<b>8700 '1/99-</b>						
8700 (213 kW) Eng.D7E290	99-	<b>24-1318</b>		•		1675750,20575653,3183908/ 9,420759 465884,471500,477397/ 770,8112184/ 5 8113522/ 3,8192050,85000387
8700 (250 kW) Eng.D7F340	99-	<b>24-1318</b>		•		1675750,20575653,3183908/ 9,420759 465884,471500,477397/ 770,8112184/ 5 8113522/ 3,8192050,85000387
<b>9700 '10/07-</b>						
9700 (309 kW) Eng.D13C420	09-	<b>24-1204</b>			w/o pulley	20538845,20744939/ 940,20761306 21228793,21468471,3161436,85000486 85020085
	06-	<b>24-1211</b>			w/ pulley	20411880,20857085,85000214
9700 (338 kW) Eng.D13C460	09-	<b>24-1204</b>			w/o pulley	20538845,20744939/ 940,20761306 21228793,21468471,3161436,85000486 85020085
	06-	<b>24-1211</b>			w/ pulley	20411880,20857085,85000214
<b>9900 '10/07-</b>						
9900 (309 kW) Eng.D13C420	09-	<b>24-1204</b>			w/o pulley	20538845,20744939/ 940,20761306 21228793,21468471,3161436,85000486 85020085
	06-	<b>24-1211</b>			w/ pulley	20411880,20857085,85000214
9900 (338 kW) Eng.D13C460	09-	<b>24-1204</b>			w/o pulley	20538845,20744939/ 940,20761306 21228793,21468471,3161436,85000486 85020085
	06-	<b>24-1211</b>			w/ pulley	20411880,20857085,85000214
<b>A-Serie '1/99-</b>						
A25D (224 kW) Eng.D9A300	05-	<b>24-1204</b>			w/o pulley	20538845,20744939/ 940,20761306 21228793,21468471,3161436,85000486 85020085
	06-	<b>24-1211</b>			w/ pulley	20411880,20857085,85000214
A30D (251 kW) Eng.D9A340	05-	<b>24-1204</b>			w/o pulley	20538845,20744939/ 940,20761306 21228793,21468471,3161436,85000486 85020085
	06-	<b>24-1211</b>			w/ pulley	20411880,20857085,85000214
A35D (289 kW) Eng.D12C390/D390	03-	<b>24-1332</b>		•		20431135/ 51,20713787,20734268,3803909 81070305,8113274/ 75,8170305/ 833 85000076/ 452
A40D (309 kW) Eng.D12A420/C420/D420	03-	<b>24-1316</b>		•	M/T	1001698,1547155,8112275,8113117,8148460 8149941
	03-	<b>24-1337</b>		•	For vehicles with retarder	1676713,8112889/ 3155,8149882



			
<p><b>24-1204</b></p>	<p><b>24-1211</b></p>	<p><b>24-1304</b></p>	<p><b>24-1316</b></p>
			
<p><b>24-1318</b></p>	<p><b>24-1332</b></p>	<p><b>24-1337</b></p>	

		<b>METELLI</b> ref.			NOTE	Adaptable for OES
<b>B 12 '1/92-</b>						
B 12 (262 kW) Eng.TD122FH	92-94	<b>24-1304</b>			• +BH	1545261,1675945,1698616/ 20,1699786/ 90 20431484,3184802,422791,468250/ 937 470232,478405,478845,479164,479931 8112520/ 683,8113157/ 431,8121802 8149937
B 12 (291-298 kW) Eng.TD122FL	92-94	<b>24-1304</b>			• +BH	1545261,1675945,1698616/ 20,1699786/ 90 20431484,3184802,422791,468250/ 937 470232,478405,478845,479164,479931 8112520/ 683,8113157/ 431,8121802 8149937
B 12 (291-298 kW) Eng.TD123ES	92-94	<b>24-1304</b>			• +BH	1545261,1675945,1698616/ 20,1699786/ 90 20431484,3184802,422791,468250/ 937 470232,478405,478845,479164,479931 8112520/ 683,8113157/ 431,8121802 8149937
B 12 (309 kW) Eng.D12A420	92-	<b>24-1316</b>			• M/T	1001698,1547155,8112275,8113117,8148460 8149941
	92-	<b>24-1337</b>			• For vehicles with retarder	1676713,8112889/ 3155,8149882
B 12 (309 kW) Eng.D12C420/D420	09-	<b>24-1332</b>			•	20431135/ 51,20713787,20734268,3803909 81070305,8113274/ 75,8170305/ 833 85000076/ 452
<b>B 54 '1/65-'12/75</b>						
6.7 TD (110-152 kW) Eng.TD70A/B/C	99-	<b>24-1318</b>			•	1675750,20575653,3183908/ 9,420759 465884,471500,477397/ 770,8112184/ 5 8113522/ 3,8192050,85000387
<b>B 6 '11/91-</b>						
B6R, LE (132 kW) Eng.TD63E	99-	<b>24-1318</b>			•	1675750,20575653,3183908/ 9,420759 465884,471500,477397/ 770,8112184/ 5 8113522/ 3,8192050,85000387
B6R, LE (154 kW) Eng.TD63ES	99-	<b>24-1318</b>			•	1675750,20575653,3183908/ 9,420759 465884,471500,477397/ 770,8112184/ 5 8113522/ 3,8192050,85000387
<b>B 7 '1/99-</b>						
7.1D (213 kW) Eng.D7	99-	<b>24-1318</b>			•	1675750,20575653,3183908/ 9,420759 465884,471500,477397/ 770,8112184/ 5 8113522/ 3,8192050,85000387
<b>B 9 '9/05-</b>						
9.4 D (191-228-265 kW) Eng.D9B	05-	<b>24-1204</b>			w/o pulley	20538845,20744939/ 940,20761306 21228793,21468471,3161436,85000486 85020085
	06-	<b>24-1211</b>			w/ pulley	20411880,20857085,85000214
<b>F 10 '8/77-'12/94</b>						
300 (215-220 kW) Eng.TD101F/FA	85-87	<b>24-1304</b>			• +BH	1545261,1675945,1698616/ 20,1699786/ 90 20431484,3184802,422791,468250/ 937 470232,478405,478845,479164,479931 8112520/ 683,8113157/ 431,8121802 8149937
320 (228-235 kW) Eng.TD102FM	91-94	<b>24-1304</b>			• +BH	1545261,1675945,1698616/ 20,1699786/ 90 20431484,3184802,422791,468250/ 937 470232,478405,478845,479164,479931 8112520/ 683,8113157/ 431,8121802 8149937
320 (228-235 kW) Eng.TD103E/ES	91-94	<b>24-1304</b>			• +BH	1545261,1675945,1698616/ 20,1699786/ 90 20431484,3184802,422791,468250/ 937 470232,478405,478845,479164,479931 8112520/ 683,8113157/ 431,8121802 8149937

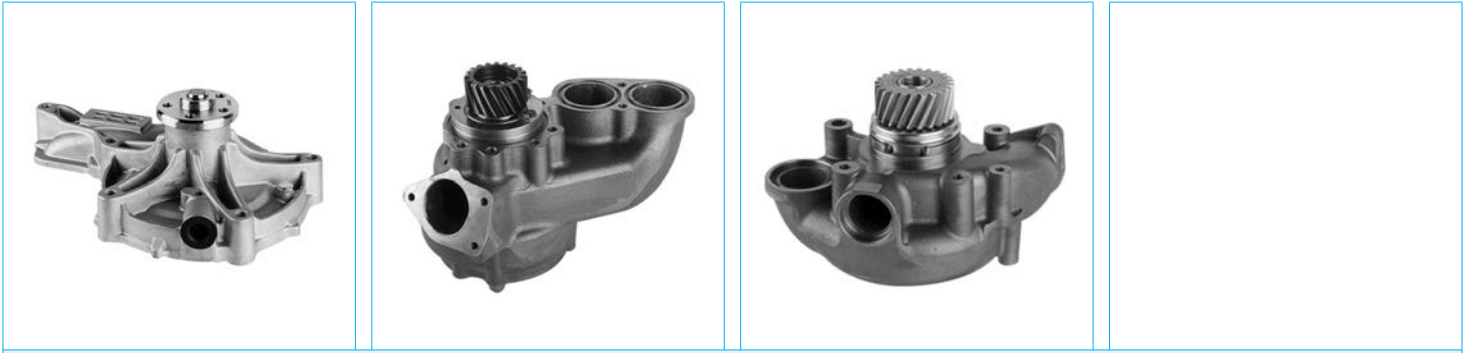

**24-1204**

**24-1304**

**24-1318**



--	--	--	--





--	--	--	--

--	--	--	--

--	--	--	--

		<b>METELLI</b> ref.			<b>NOTE</b>	<b>Adaptable for OES</b>
<b>F 12 '1/79-'12/94</b>						
320, 330 (235-243 kW) Eng.TD121G	79-87	<b>24-1304</b>			• +BH	1545261,1675945,1698616/ 20,1699786/ 90 20431484,3184802,422791,468250/ 937 470232,478405,478845,479164,479931 8112520/ 683,8113157/ 431,8121802 8149937
360 (262 kW) Eng.TD122F	88-94	<b>24-1304</b>			• +BH	1545261,1675945,1698616/ 20,1699786/ 90 20431484,3184802,422791,468250/ 937 470232,478405,478845,479164,479931 8112520/ 683,8113157/ 431,8121802 8149937
370 (272 kW) Eng.TD121F	83-86	<b>24-1304</b>			• +BH	1545261,1675945,1698616/ 20,1699786/ 90 20431484,3184802,422791,468250/ 937 470232,478405,478845,479164,479931 8112520/ 683,8113157/ 431,8121802 8149937
400 (291 kW) Eng.TD122FL/FS	89-94	<b>24-1304</b>			• +BH	1545261,1675945,1698616/ 20,1699786/ 90 20431484,3184802,422791,468250/ 937 470232,478405,478845,479164,479931 8112520/ 683,8113157/ 431,8121802 8149937
400 (291-298 kW) Eng.TD123ES	92-94	<b>24-1304</b>			• +BH	1545261,1675945,1698616/ 20,1699786/ 90 20431484,3184802,422791,468250/ 937 470232,478405,478845,479164,479931 8112520/ 683,8113157/ 431,8121802 8149937
410 (291-298 kW) Eng.TD122FL/FS	89-94	<b>24-1304</b>			• +BH	1545261,1675945,1698616/ 20,1699786/ 90 20431484,3184802,422791,468250/ 937 470232,478405,478845,479164,479931 8112520/ 683,8113157/ 431,8121802 8149937
410 (291-298 kW) Eng.TD123ES	92-94	<b>24-1304</b>			• +BH	1545261,1675945,1698616/ 20,1699786/ 90 20431484,3184802,422791,468250/ 937 470232,478405,478845,479164,479931 8112520/ 683,8113157/ 431,8121802 8149937
<b>F 16 '1/88-'12/94</b>						
470 (342 kW) Eng.TD162F	88-89	<b>24-1204</b>			w/o pulley	20538845,20744939/ 940,20761306 21228793,21468471,3161436,85000486 85020085
485 (357 kW) Eng.TD162F	90-92	<b>24-1204</b>			w/o pulley	20538845,20744939/ 940,20761306 21228793,21468471,3161436,85000486 85020085
500 (368 kW) Eng.TD163ES	92-94	<b>24-1204</b>			w/o pulley	20538845,20744939/ 940,20761306 21228793,21468471,3161436,85000486 85020085
<b>F 80 '1/65-'12/85</b>						
86 (106-110 kW) Eng.D70	99-	<b>24-1318</b>			•	1675750,20575653,3183908/ 9,420759 465884,471500,477397/ 770,8112184/ 5 8113522/ 3,8192050,85000387
86 (110-152 kW) Eng.TD70A/B/C	99-	<b>24-1318</b>			•	1675750,20575653,3183908/ 9,420759 465884,471500,477397/ 770,8112184/ 5 8113522/ 3,8192050,85000387
86 (162 kW) Eng.TD70E/F/G/H	99-	<b>24-1318</b>			•	1675750,20575653,3183908/ 9,420759 465884,471500,477397/ 770,8112184/ 5 8113522/ 3,8192050,85000387
<b>FE '5/06-</b>						
240-18 (177 kW) Eng.D7E240	99-	<b>24-1318</b>			•	1675750,20575653,3183908/ 9,420759 465884,471500,477397/ 770,8112184/ 5 8113522/ 3,8192050,85000387

			
<p><b>24-1204</b></p>	<p><b>24-1211</b></p>	<p><b>24-1318</b></p>	

		<b>METELLI ref.</b>			<b>NOTE</b>	<b>Adaptable for OES</b>
240-22 (177 kW) Eng.D7E240	99-	<b>24-1318</b>		•		1675750,20575653,3183908/ 9,420759 465884,471500,477397/ 770,8112184/ 5 8113522/ 3,8192050,85000387
240-26 (177 kW) Eng.D7E240	99-	<b>24-1318</b>		•		1675750,20575653,3183908/ 9,420759 465884,471500,477397/ 770,8112184/ 5 8113522/ 3,8192050,85000387
240-26 (177 kW) Eng.D7E240/F240	99-	<b>24-1318</b>		•		1675750,20575653,3183908/ 9,420759 465884,471500,477397/ 770,8112184/ 5 8113522/ 3,8192050,85000387
260-18/-26 (191 kW) Eng.D7F260	99-	<b>24-1318</b>		•		1675750,20575653,3183908/ 9,420759 465884,471500,477397/ 770,8112184/ 5 8113522/ 3,8192050,85000387
280-18 (206 kW) Eng.D7E280	99-	<b>24-1318</b>		•		1675750,20575653,3183908/ 9,420759 465884,471500,477397/ 770,8112184/ 5 8113522/ 3,8192050,85000387
280-22 (206 kW) Eng.D7E280	99-	<b>24-1318</b>		•		1675750,20575653,3183908/ 9,420759 465884,471500,477397/ 770,8112184/ 5 8113522/ 3,8192050,85000387
280-26 (206 kW) Eng.D7E280	99-	<b>24-1318</b>		•		1675750,20575653,3183908/ 9,420759 465884,471500,477397/ 770,8112184/ 5 8113522/ 3,8192050,85000387
300-18/-26 (221 kW) Eng.D7F300	99-	<b>24-1318</b>		•		1675750,20575653,3183908/ 9,420759 465884,471500,477397/ 770,8112184/ 5 8113522/ 3,8192050,85000387
320-18 (235 kW) Eng.D7E320	99-	<b>24-1318</b>		•		1675750,20575653,3183908/ 9,420759 465884,471500,477397/ 770,8112184/ 5 8113522/ 3,8192050,85000387
320-22 (235 kW) Eng.D7E320	99-	<b>24-1318</b>		•		1675750,20575653,3183908/ 9,420759 465884,471500,477397/ 770,8112184/ 5 8113522/ 3,8192050,85000387
320-26 (235 kW) Eng.D7E320	99-	<b>24-1318</b>		•		1675750,20575653,3183908/ 9,420759 465884,471500,477397/ 770,8112184/ 5 8113522/ 3,8192050,85000387
340-18/-26 (250 kW) Eng.D7F340	99-	<b>24-1318</b>		•		1675750,20575653,3183908/ 9,420759 465884,471500,477397/ 770,8112184/ 5 8113522/ 3,8192050,85000387
<b>FE II '5/12-</b>						
240 (177 kW) Eng.D7E240	99-	<b>24-1318</b>		•		1675750,20575653,3183908/ 9,420759 465884,471500,477397/ 770,8112184/ 5 8113522/ 3,8192050,85000387
240 (177 kW) Eng.D7F240	99-	<b>24-1318</b>		•		1675750,20575653,3183908/ 9,420759 465884,471500,477397/ 770,8112184/ 5 8113522/ 3,8192050,85000387
260 (191 kW) Eng.D7F260	99-	<b>24-1318</b>		•		1675750,20575653,3183908/ 9,420759 465884,471500,477397/ 770,8112184/ 5 8113522/ 3,8192050,85000387
280 (206 kW) Eng.D7E280	99-	<b>24-1318</b>		•		1675750,20575653,3183908/ 9,420759 465884,471500,477397/ 770,8112184/ 5 8113522/ 3,8192050,85000387
300 (221 kW) Eng.D7F300	99-	<b>24-1318</b>		•		1675750,20575653,3183908/ 9,420759 465884,471500,477397/ 770,8112184/ 5 8113522/ 3,8192050,85000387
320 (235 kW) Eng.D7E320	99-	<b>24-1318</b>		•		1675750,20575653,3183908/ 9,420759 465884,471500,477397/ 770,8112184/ 5 8113522/ 3,8192050,85000387
340 (250 kW) Eng.D7F340	99-	<b>24-1318</b>		•		1675750,20575653,3183908/ 9,420759 465884,471500,477397/ 770,8112184/ 5 8113522/ 3,8192050,85000387
<b>FH '5/05-</b>						
400 (294 kW) Eng.D13A400	05-	<b>24-1204</b>			w/o pulley	20538845,20744939/ 940,20761306 21228793,21468471,3161436,85000486 85020085
	06-	<b>24-1211</b>			w/ pulley	20411880,20857085,85000214

			
<p><b>24-1204</b></p>	<p><b>24-1211</b></p>	<p><b>24-1316</b></p>	<p><b>24-1332</b></p>
			
<p><b>24-1337</b></p>			

		<b>METELLI</b> ref.			<b>NOTE</b>	<b>Adaptable for OES</b>
400 (294 kW) Eng.D13B400/A400	05-	<b>24-1204</b>			w/o pulley	20538845,20744939/ 940,20761306 21228793,21468471,3161436,85000486 85020085
	06-	<b>24-1211</b>			w/ pulley	20411880,20857085,85000214
420 (309 kW) Eng.D13C420	09-	<b>24-1204</b>			w/o pulley	20538845,20744939/ 940,20761306 21228793,21468471,3161436,85000486 85020085
	06-	<b>24-1211</b>			w/ pulley	20411880,20857085,85000214
440 (324 kW) Eng.D13A440	05-	<b>24-1204</b>			w/o pulley	20538845,20744939/ 940,20761306 21228793,21468471,3161436,85000486 85020085
	06-	<b>24-1211</b>			w/ pulley	20411880,20857085,85000214
440 (324 kW) Eng.D13B440/A440	05-	<b>24-1204</b>			w/o pulley	20538845,20744939/ 940,20761306 21228793,21468471,3161436,85000486 85020085
	06-	<b>24-1211</b>			w/ pulley	20411880,20857085,85000214
460 (338 kW) Eng.D13C460	09-	<b>24-1204</b>			w/o pulley	20538845,20744939/ 940,20761306 21228793,21468471,3161436,85000486 85020085
	06-	<b>24-1211</b>			w/ pulley	20411880,20857085,85000214
480 (353 kW) Eng.D13A480	05-	<b>24-1204</b>			w/o pulley	20538845,20744939/ 940,20761306 21228793,21468471,3161436,85000486 85020085
	06-	<b>24-1211</b>			w/ pulley	20411880,20857085,85000214
500 (368 kW) Eng.D13B500	07-	<b>24-1204</b>			w/o pulley	20538845,20744939/ 940,20761306 21228793,21468471,3161436,85000486 85020085
	06-	<b>24-1211</b>			w/ pulley	20411880,20857085,85000214
500 (368 kW) Eng.D13B500/C500/K500	07-	<b>24-1204</b>			w/o pulley	20538845,20744939/ 940,20761306 21228793,21468471,3161436,85000486 85020085
	06-	<b>24-1211</b>			w/ pulley	20411880,20857085,85000214
520 (382 kW) Eng.D13A520	05-	<b>24-1204</b>			w/o pulley	20538845,20744939/ 940,20761306 21228793,21468471,3161436,85000486 85020085
	06-	<b>24-1211</b>			w/ pulley	20411880,20857085,85000214
540 (397 kW) Eng.D13C540	09-	<b>24-1204</b>			w/o pulley	20538845,20744939/ 940,20761306 21228793,21468471,3161436,85000486 85020085
	06-	<b>24-1211</b>			w/ pulley	20411880,20857085,85000214
550 (404 kW) Eng.D16C550	05-	<b>24-1204</b>			w/o pulley	20538845,20744939/ 940,20761306 21228793,21468471,3161436,85000486 85020085
	06-	<b>24-1211</b>			w/ pulley	20411880,20857085,85000214
610 (449 kW) Eng.D16C610	05-	<b>24-1204</b>			w/o pulley	20538845,20744939/ 940,20761306 21228793,21468471,3161436,85000486 85020085
	06-	<b>24-1211</b>			w/ pulley	20411880,20857085,85000214
<b>FH 12 '9/01-</b>						
340 (250 kW) Eng.D12A340	93-	<b>24-1316</b>			• M/T	1001698,1547155,8112275,8113117,8148460 8149941
	93-	<b>24-1337</b>			• For vehicles with retarder	1676713,8112889/ 3155,8149882
340 (250 kW) Eng.D12C340	98-	<b>24-1332</b>			•	20431135/ 51,20713787,20734268,3803909 81070305,8113274/ 75,8170305/ 833 85000076/ 452
340 (250 kW) Eng.D12D340	01-	<b>24-1332</b>			•	20431135/ 51,20713787,20734268,3803909 81070305,8113274/ 75,8170305/ 833 85000076/ 452
380 (279 kW) Eng.D12A380	93-	<b>24-1316</b>			• M/T	1001698,1547155,8112275,8113117,8148460 8149941
	93-	<b>24-1337</b>			• For vehicles with retarder	1676713,8112889/ 3155,8149882
380 (279 kW) Eng.D12C380	98-	<b>24-1332</b>			•	20431135/ 51,20713787,20734268,3803909 81070305,8113274/ 75,8170305/ 833 85000076/ 452



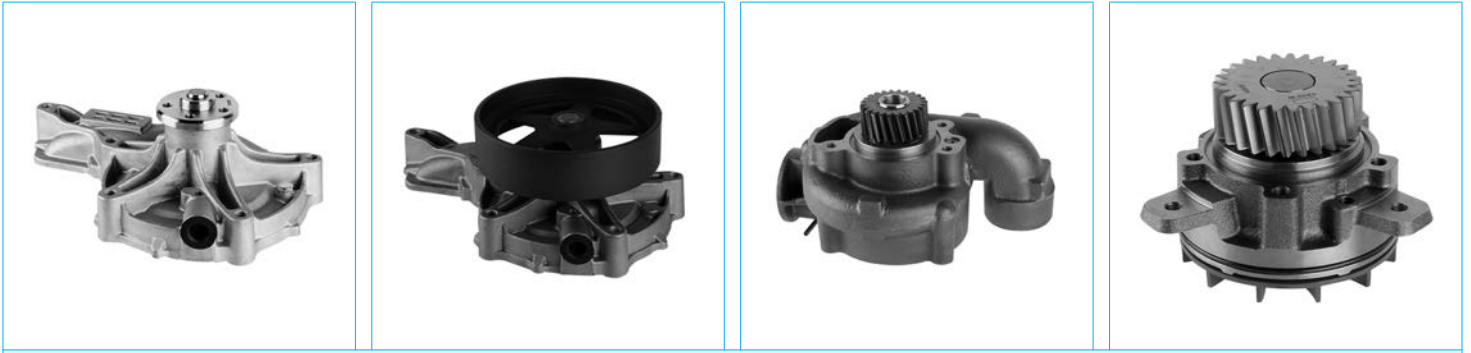

**24-1204**

**24-1211**





**24-1316**

**24-1332**

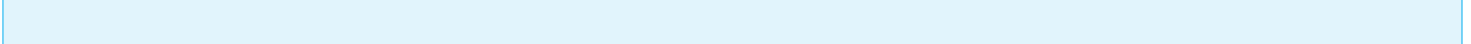
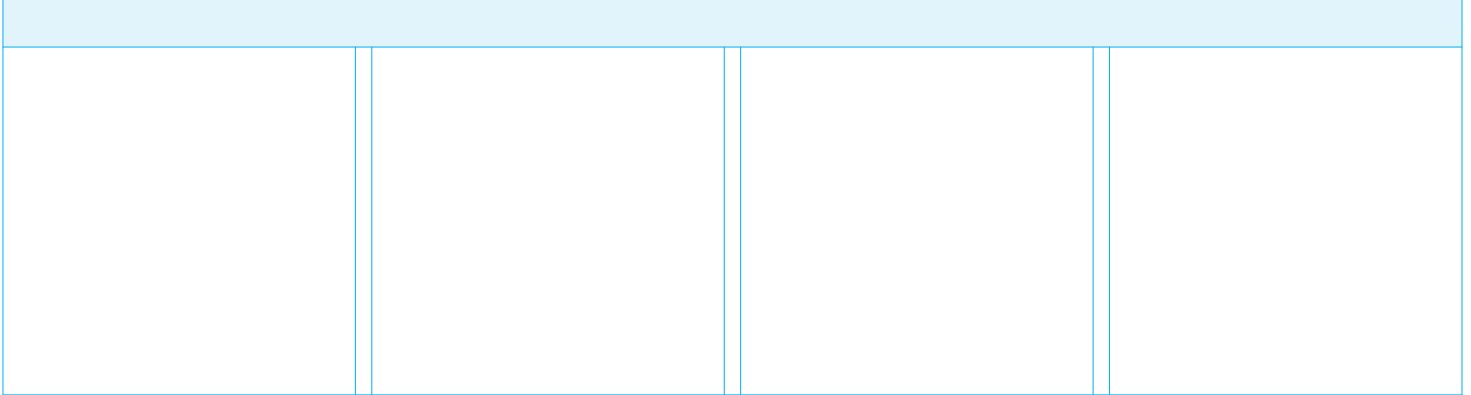
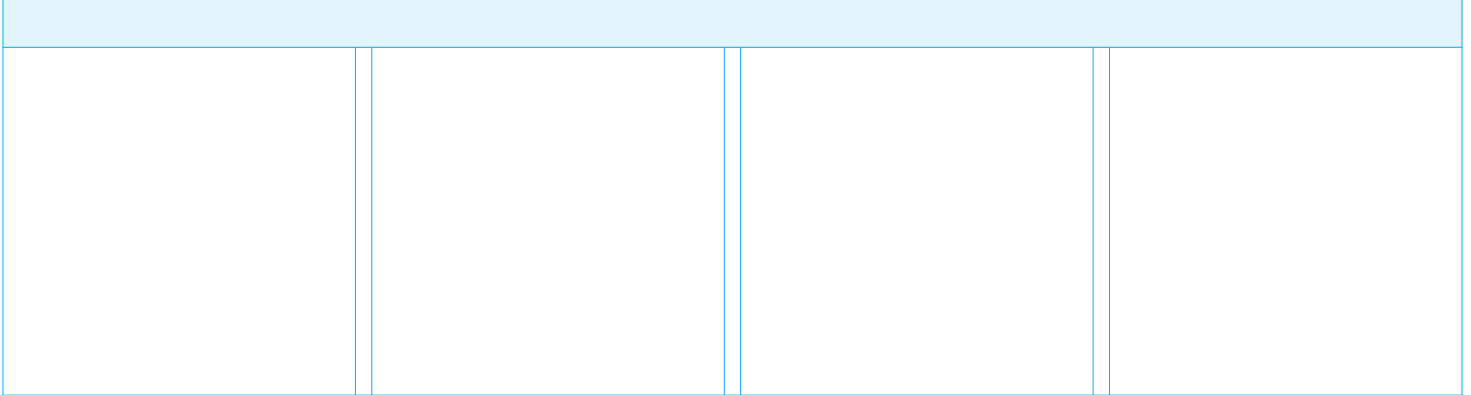
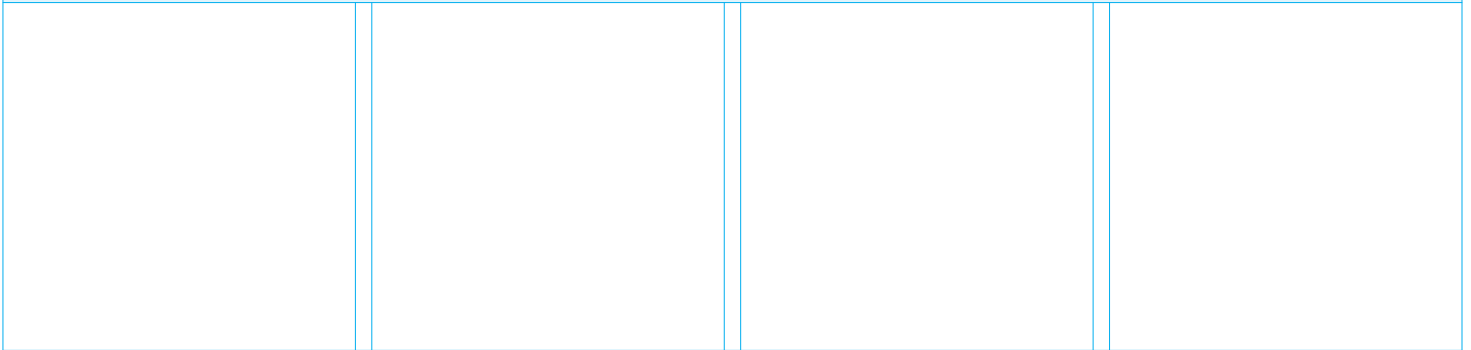





**24-1337**





		<b>METELLI</b> ref.			<b>NOTE</b>	<b>Adaptable for OES</b>
380 (279 kW) Eng.D12D380	01-	<b>24-1332</b>			•	20431135/ 51,20713787,20734268,3803909 81070305,8113274/ 75,8170305/ 833 85000076/ 452
420 (309 kW) Eng.D12A420	95-	<b>24-1316</b>			•	M/T 1001698,1547155,8112275,8113117,8148460 8149941
	95-	<b>24-1337</b>			•	For vehicles with retarder 1676713,8112889/ 3155,8149882
420 (309 kW) Eng.D12C420	98-	<b>24-1332</b>			•	20431135/ 51,20713787,20734268,3803909 81070305,8113274/ 75,8170305/ 833 85000076/ 452
420 (309 kW) Eng.D12D420	01-	<b>24-1332</b>			•	20431135/ 51,20713787,20734268,3803909 81070305,8113274/ 75,8170305/ 833 85000076/ 452
460 (338 kW) Eng.D12C460	98-	<b>24-1332</b>			•	20431135/ 51,20713787,20734268,3803909 81070305,8113274/ 75,8170305/ 833 85000076/ 452
460 (338 kW) Eng.D12D460	01-	<b>24-1332</b>			•	20431135/ 51,20713787,20734268,3803909 81070305,8113274/ 75,8170305/ 833 85000076/ 452
<b>FH 13 '1/05-</b>						
400 (294 kW) Eng.D13A400	05-	<b>24-1204</b>				w/o pulley 20538845,20744939/ 940,20761306 21228793,21468471,3161436,85000486 85020085
	06-	<b>24-1211</b>				w/ pulley 20411880,20857085,85000214
440 (324 kW) Eng.D13A440	05-	<b>24-1204</b>				w/o pulley 20538845,20744939/ 940,20761306 21228793,21468471,3161436,85000486 85020085
	06-	<b>24-1211</b>				w/ pulley 20411880,20857085,85000214
480 (353 kW) Eng.D13A480	05-	<b>24-1204</b>				w/o pulley 20538845,20744939/ 940,20761306 21228793,21468471,3161436,85000486 85020085
	06-	<b>24-1211</b>				w/ pulley 20411880,20857085,85000214
520 (382 kW) Eng.D13A520	05-	<b>24-1204</b>				w/o pulley 20538845,20744939/ 940,20761306 21228793,21468471,3161436,85000486 85020085
	06-	<b>24-1211</b>				w/ pulley 20411880,20857085,85000214
<b>FH 16 '8/93-</b>						
470 (346 kW) Eng.D16A470	93-99	<b>24-1204</b>				w/o pulley 20538845,20744939/ 940,20761306 21228793,21468471,3161436,85000486 85020085
	06-	<b>24-1211</b>				w/ pulley 20411880,20857085,85000214
520 (382 kW) Eng.D16A520	93-02	<b>24-1204</b>				w/o pulley 20538845,20744939/ 940,20761306 21228793,21468471,3161436,85000486 85020085
	06-	<b>24-1211</b>				w/ pulley 20411880,20857085,85000214
520 (382 kW) Eng.D16B520	98-	<b>24-1204</b>				w/o pulley 20538845,20744939/ 940,20761306 21228793,21468471,3161436,85000486 85020085
	06-	<b>24-1211</b>				w/ pulley 20411880,20857085,85000214
540 (396-404 kW) Eng.D16E540	03-	<b>24-1204</b>				w/o pulley 20538845,20744939/ 940,20761306 21228793,21468471,3161436,85000486 85020085
	06-	<b>24-1211</b>				w/ pulley 20411880,20857085,85000214
540/ 550 Eng.D16C550	07-	<b>24-1204</b>				w/o pulley 20538845,20744939/ 940,20761306 21228793,21468471,3161436,85000486 85020085
	06-	<b>24-1211</b>				w/ pulley 20411880,20857085,85000214
540/ 550 Eng.D16G540/E540	07-	<b>24-1204</b>				w/o pulley 20538845,20744939/ 940,20761306 21228793,21468471,3161436,85000486 85020085
	06-	<b>24-1211</b>				w/ pulley 20411880,20857085,85000214
550 (396-404 kW) Eng.D16C550	03-	<b>24-1204</b>				w/o pulley 20538845,20744939/ 940,20761306 21228793,21468471,3161436,85000486 85020085
	06-	<b>24-1211</b>				w/ pulley 20411880,20857085,85000214





			
<b>24-1204</b>	<b>24-1211</b>	<b>24-1304</b>	<b>24-1316</b>
			
<b>24-1337</b>			

		<b>METELLI</b> ref.			<b>NOTE</b>	<b>Adaptable for OES</b>
580 (426 kW) Eng.D16E580	03-	<b>24-1204</b>			w/o pulley	20538845,20744939/ 940,20761306 21228793,21468471,3161436,85000486 85020085
	09-	<b>24-1204</b>			w/o pulley	20538845,20744939/ 940,20761306 21228793,21468471,3161436,85000486 85020085
	06-	<b>24-1211</b>			w/ pulley	20411880,20857085,85000214
600 (441 kW) Eng.D16G600	06-	<b>24-1204</b>			w/o pulley	20538845,20744939/ 940,20761306 21228793,21468471,3161436,85000486 85020085
	06-	<b>24-1211</b>			w/ pulley	20411880,20857085,85000214
610 (449 kW) Eng.D16C610	03-	<b>24-1204</b>			w/o pulley	20538845,20744939/ 940,20761306 21228793,21468471,3161436,85000486 85020085
	07-	<b>24-1204</b>			w/o pulley	20538845,20744939/ 940,20761306 21228793,21468471,3161436,85000486 85020085
	06-	<b>24-1211</b>			w/ pulley	20411880,20857085,85000214
660 (485 kW) Eng.D16E660	06-	<b>24-1204</b>			w/o pulley	20538845,20744939/ 940,20761306 21228793,21468471,3161436,85000486 85020085
	07-	<b>24-1204</b>			w/o pulley	20538845,20744939/ 940,20761306 21228793,21468471,3161436,85000486 85020085
	06-	<b>24-1211</b>			w/ pulley	20411880,20857085,85000214
700 (515 kW) Eng.D16G700	09-	<b>24-1204</b>			w/o pulley	20538845,20744939/ 940,20761306 21228793,21468471,3161436,85000486 85020085
	06-	<b>24-1211</b>			w/ pulley	20411880,20857085,85000214
<b>FH 16 II '5/12-</b>						
540 (396 kW) Eng.D16G540	06-	<b>24-1211</b>			w/ pulley	20411880,20857085,85000214
600 (441 kW) Eng.D16G600	06-	<b>24-1211</b>			w/ pulley	20411880,20857085,85000214
700 (515 kW) Eng.D16G700	06-	<b>24-1211</b>			w/ pulley	20411880,20857085,85000214
750 (551 kW) Eng.D16G750	06-	<b>24-1211</b>			w/ pulley	20411880,20857085,85000214
<b>FH II '5/12-</b>						
420 (309 kW) Eng.D13C420/K420	12-	<b>24-1204</b>			w/o pulley	20538845,20744939/ 940,20761306 21228793,21468471,3161436,85000486 85020085
	06-	<b>24-1211</b>			w/ pulley	20411880,20857085,85000214
460 (338 kW) Eng.D13C460/K460	12-	<b>24-1204</b>			w/o pulley	20538845,20744939/ 940,20761306 21228793,21468471,3161436,85000486 85020085
	06-	<b>24-1211</b>			w/ pulley	20411880,20857085,85000214
500 (368 kW) Eng.D13C500/K500	12-	<b>24-1204</b>			w/o pulley	20538845,20744939/ 940,20761306 21228793,21468471,3161436,85000486 85020085
	06-	<b>24-1211</b>			w/ pulley	20411880,20857085,85000214
540 (397 kW) Eng.D13C540/K540	12-	<b>24-1204</b>			w/o pulley	20538845,20744939/ 940,20761306 21228793,21468471,3161436,85000486 85020085
	06-	<b>24-1211</b>			w/ pulley	20411880,20857085,85000214
<b>FL 10 '1/88-'9/98</b>						
280 (202-209 kW) Eng.TD101G	01/88-05/88	<b>24-1304</b>			• +BH	1545261,1675945,1698616/ 20,1699786/ 90 20431484,3184802,422791,468250/ 937 470232,478405,478845,479164,479931 8112520/ 683,8113157/ 431,8121802 8149937
<b>FL 12 '9/95-'9/98</b>						
380 (279 kW) Eng.D12A380	95-98	<b>24-1316</b>			• M/T	1001698,1547155,8112275,8113117,8148460 8149941
	95-98	<b>24-1337</b>			• For vehicles with retarder	1676713,8112889/ 3155,8149882





		<b>METELLI</b> ref.			<b>NOTE</b>	<b>Adaptable for OES</b>
420 (279 kW) Eng.D12A420	95-98	<b>24-1316</b>			M/T	1001698,1547155,8112275,8113117,8148460 8149941
	95-98	<b>24-1337</b>			• For vehicles with retarder	1676713,8112889/ 3155,8149882
420 (309 kW) Eng.D12A420	95-98	<b>24-1316</b>			M/T	1001698,1547155,8112275,8113117,8148460 8149941
	95-98	<b>24-1337</b>			• For vehicles with retarder	1676713,8112889/ 3155,8149882
<b>FL 7 '9/85-'9/98</b>						
230 (169-173 kW) Eng.D7B230	99-	<b>24-1318</b>			•	1675750,20575653,3183908/ 9,420759 465884,471500,477397/ 770,8112184/ 5 8113522/ 3,8192050,85000387
230 (169-173 kW) Eng.TD71F	99-	<b>24-1318</b>			•	1675750,20575653,3183908/ 9,420759 465884,471500,477397/ 770,8112184/ 5 8113522/ 3,8192050,85000387
230 (169-173 kW) Eng.TD73E	99-	<b>24-1318</b>			•	1675750,20575653,3183908/ 9,420759 465884,471500,477397/ 770,8112184/ 5 8113522/ 3,8192050,85000387
260 (191 kW) Eng.D7B260	99-	<b>24-1318</b>			•	1675750,20575653,3183908/ 9,420759 465884,471500,477397/ 770,8112184/ 5 8113522/ 3,8192050,85000387
260 (191 kW) Eng.TD73ES	99-	<b>24-1318</b>			•	1675750,20575653,3183908/ 9,420759 465884,471500,477397/ 770,8112184/ 5 8113522/ 3,8192050,85000387
290 (210 kW) Eng.D7A285	99-	<b>24-1318</b>			•	1675750,20575653,3183908/ 9,420759 465884,471500,477397/ 770,8112184/ 5 8113522/ 3,8192050,85000387
<b>FL II '5/06-</b>						
240-12 (177 kW) Eng.D7E240	99-	<b>24-1318</b>			•	1675750,20575653,3183908/ 9,420759 465884,471500,477397/ 770,8112184/ 5 8113522/ 3,8192050,85000387
240-14 (177 kW) Eng.D7F240/E240	99-	<b>24-1318</b>			•	1675750,20575653,3183908/ 9,420759 465884,471500,477397/ 770,8112184/ 5 8113522/ 3,8192050,85000387
240-15 (177 kW) Eng.D7E240	99-	<b>24-1318</b>			•	1675750,20575653,3183908/ 9,420759 465884,471500,477397/ 770,8112184/ 5 8113522/ 3,8192050,85000387
240-16 (177 kW) Eng.D7E240	99-	<b>24-1318</b>			•	1675750,20575653,3183908/ 9,420759 465884,471500,477397/ 770,8112184/ 5 8113522/ 3,8192050,85000387
240-16 (177 kW) Eng.D7F240/E240	99-	<b>24-1318</b>			•	1675750,20575653,3183908/ 9,420759 465884,471500,477397/ 770,8112184/ 5 8113522/ 3,8192050,85000387
240-18 (177 kW) Eng.D7E240	99-	<b>24-1318</b>			•	1675750,20575653,3183908/ 9,420759 465884,471500,477397/ 770,8112184/ 5 8113522/ 3,8192050,85000387
260-12 (191 kW) Eng.D7F260	99-	<b>24-1318</b>			•	1675750,20575653,3183908/ 9,420759 465884,471500,477397/ 770,8112184/ 5 8113522/ 3,8192050,85000387
260-12/-14/-15/-16/-18 (191 kW) Eng.D7F260	99-	<b>24-1318</b>			•	1675750,20575653,3183908/ 9,420759 465884,471500,477397/ 770,8112184/ 5 8113522/ 3,8192050,85000387
260-14 (191 kW) Eng.D7D260	99-	<b>24-1318</b>			•	1675750,20575653,3183908/ 9,420759 465884,471500,477397/ 770,8112184/ 5 8113522/ 3,8192050,85000387
260-15 (191 kW) Eng.D7F260	99-	<b>24-1318</b>			•	1675750,20575653,3183908/ 9,420759 465884,471500,477397/ 770,8112184/ 5 8113522/ 3,8192050,85000387
260-16 (191 kW) Eng.D7F260	99-	<b>24-1318</b>			•	1675750,20575653,3183908/ 9,420759 465884,471500,477397/ 770,8112184/ 5 8113522/ 3,8192050,85000387
260-18 (191 kW) Eng.D7F260	99-	<b>24-1318</b>			•	1675750,20575653,3183908/ 9,420759 465884,471500,477397/ 770,8112184/ 5 8113522/ 3,8192050,85000387





			
<p><b>24-1204</b></p>	<p><b>24-1211</b></p>	<p><b>24-1318</b></p>	

		<b>METELLI</b> ref.			<b>NOTE</b>	<b>Adaptable for OES</b>
280-12 (206 kW) Eng.D7E280	99-	<b>24-1318</b>		•		1675750,20575653,3183908/ 9,420759 465884,471500,477397/ 770,8112184/ 5 8113522/ 3,8192050,85000387
280-14 (206 kW) Eng.D7E280	99-	<b>24-1318</b>		•		1675750,20575653,3183908/ 9,420759 465884,471500,477397/ 770,8112184/ 5 8113522/ 3,8192050,85000387
280-15 (206 kW) Eng.D7E280	99-	<b>24-1318</b>		•		1675750,20575653,3183908/ 9,420759 465884,471500,477397/ 770,8112184/ 5 8113522/ 3,8192050,85000387
280-16 (206 kW) Eng.D7E280	99-	<b>24-1318</b>		•		1675750,20575653,3183908/ 9,420759 465884,471500,477397/ 770,8112184/ 5 8113522/ 3,8192050,85000387
280-18 (206 kW) Eng.D7E280	99-	<b>24-1318</b>		•		1675750,20575653,3183908/ 9,420759 465884,471500,477397/ 770,8112184/ 5 8113522/ 3,8192050,85000387
290-12 (213 kW) Eng.D7F290	99-	<b>24-1318</b>		•		1675750,20575653,3183908/ 9,420759 465884,471500,477397/ 770,8112184/ 5 8113522/ 3,8192050,85000387
290-12/-14/-16/-18 (213 kW) Eng.D7F290	99-	<b>24-1318</b>		•		1675750,20575653,3183908/ 9,420759 465884,471500,477397/ 770,8112184/ 5 8113522/ 3,8192050,85000387
290-14 (213 kW) Eng.D7F290	99-	<b>24-1318</b>		•		1675750,20575653,3183908/ 9,420759 465884,471500,477397/ 770,8112184/ 5 8113522/ 3,8192050,85000387
290-16 (213 kW) Eng.D7F290	99-	<b>24-1318</b>		•		1675750,20575653,3183908/ 9,420759 465884,471500,477397/ 770,8112184/ 5 8113522/ 3,8192050,85000387
290-18 (213 kW) Eng.D7F290	99-	<b>24-1318</b>		•		1675750,20575653,3183908/ 9,420759 465884,471500,477397/ 770,8112184/ 5 8113522/ 3,8192050,85000387
<b>FL III '5/13-</b>						
240 (177 kW) Eng.D7F240/D7E240	99-	<b>24-1318</b>		•		1675750,20575653,3183908/ 9,420759 465884,471500,477397/ 770,8112184/ 5 8113522/ 3,8192050,85000387
260 (191 kW) Eng.D7F260	99-	<b>24-1318</b>		•		1675750,20575653,3183908/ 9,420759 465884,471500,477397/ 770,8112184/ 5 8113522/ 3,8192050,85000387
280 (206 kW) Eng.D7E280	99-	<b>24-1318</b>		•		1675750,20575653,3183908/ 9,420759 465884,471500,477397/ 770,8112184/ 5 8113522/ 3,8192050,85000387
290 (213 kW) Eng.D7F290	99-	<b>24-1318</b>		•		1675750,20575653,3183908/ 9,420759 465884,471500,477397/ 770,8112184/ 5 8113522/ 3,8192050,85000387
<b>FM '9/05-</b>						
300 (221 kW) Eng.D9B300	05-	<b>24-1204</b>			w/o pulley	20538845,20744939/ 940,20761306 21228793,21468471,3161436,85000486 85020085
	06-	<b>24-1211</b>			w/ pulley	20411880,20857085,85000214
330 (243 kW) Eng.D11C330/K330	06-	<b>24-1211</b>			w/ pulley	20411880,20857085,85000214
340 (250 kW) Eng.D9B340	05-	<b>24-1204</b>			w/o pulley	20538845,20744939/ 940,20761306 21228793,21468471,3161436,85000486 85020085
	06-	<b>24-1211</b>			w/ pulley	20411880,20857085,85000214
360 (264 kW) Eng.D13A360	05-	<b>24-1204</b>			w/o pulley	20538845,20744939/ 940,20761306 21228793,21468471,3161436,85000486 85020085
	06-	<b>24-1211</b>			w/ pulley	20411880,20857085,85000214
360 (264 kW) Eng.D13B360	07-	<b>24-1204</b>			w/o pulley	20538845,20744939/ 940,20761306 21228793,21468471,3161436,85000486 85020085
	06-	<b>24-1211</b>			w/ pulley	20411880,20857085,85000214
370 (272 kW) Eng.D11C370/K370	06-	<b>24-1211</b>			w/ pulley	20411880,20857085,85000214







			
<p><b>24-1204</b></p>	<p><b>24-1211</b></p>	<p><b>24-1332</b></p>	

		<b>METELLI</b> ref.			<b>NOTE</b>	<b>Adaptable for OES</b>
380 (280 kW) Eng.D13C380	12-	<b>24-1204</b>			w/o pulley	20538845,20744939/ 940,20761306 21228793,21468471,3161436,85000486 85020085
	06-	<b>24-1211</b>			w/ pulley	20411880,20857085,85000214
380 (280 kW) Eng.D9B380	05-	<b>24-1204</b>			w/o pulley	20538845,20744939/ 940,20761306 21228793,21468471,3161436,85000486 85020085
	06-	<b>24-1211</b>			w/ pulley	20411880,20857085,85000214
390 (287 kW) Eng.D11B390	06-	<b>24-1211</b>			w/ pulley	20411880,20857085,85000214
400 (294 kW) Eng.D13A400	05-	<b>24-1204</b>			w/o pulley	20538845,20744939/ 940,20761306 21228793,21468471,3161436,85000486 85020085
	06-	<b>24-1211</b>			w/ pulley	20411880,20857085,85000214
400 (294 kW) Eng.D13B400	07-	<b>24-1204</b>			w/o pulley	20538845,20744939/ 940,20761306 21228793,21468471,3161436,85000486 85020085
	06-	<b>24-1211</b>			w/ pulley	20411880,20857085,85000214
410 (302 kW) Eng.D11C410/K410	06-	<b>24-1211</b>			w/ pulley	20411880,20857085,85000214
420 (309 kW) Eng.D13C420/K420	12-	<b>24-1204</b>			w/o pulley	20538845,20744939/ 940,20761306 21228793,21468471,3161436,85000486 85020085
	06-	<b>24-1211</b>			w/ pulley	20411880,20857085,85000214
430 (243 kW) Eng.D11A430	06-	<b>24-1211</b>			w/ pulley	20411880,20857085,85000214
440 (324 kW) Eng.D13A440	05-	<b>24-1204</b>			w/o pulley	20538845,20744939/ 940,20761306 21228793,21468471,3161436,85000486 85020085
	06-	<b>24-1211</b>			w/ pulley	20411880,20857085,85000214
440 (324 kW) Eng.D13B440	07-	<b>24-1204</b>			w/o pulley	20538845,20744939/ 940,20761306 21228793,21468471,3161436,85000486 85020085
	06-	<b>24-1211</b>			w/ pulley	20411880,20857085,85000214
450 (332 kW) Eng.D11C450/K450	06-	<b>24-1211</b>			w/ pulley	20411880,20857085,85000214
460 (338 kW) Eng.D13C460/K460	12-	<b>24-1204</b>			w/o pulley	20538845,20744939/ 940,20761306 21228793,21468471,3161436,85000486 85020085
	06-	<b>24-1211</b>			w/ pulley	20411880,20857085,85000214
480 (353 kW) Eng.D13A480	05-	<b>24-1204</b>			w/o pulley	20538845,20744939/ 940,20761306 21228793,21468471,3161436,85000486 85020085
	06-	<b>24-1211</b>			w/ pulley	20411880,20857085,85000214
500 (368 kW) Eng.D13B500	07-	<b>24-1204</b>			w/o pulley	20538845,20744939/ 940,20761306 21228793,21468471,3161436,85000486 85020085
	06-	<b>24-1211</b>			w/ pulley	20411880,20857085,85000214
500 (368 kW) Eng.D13C500/K500	12-	<b>24-1204</b>			w/o pulley	20538845,20744939/ 940,20761306 21228793,21468471,3161436,85000486 85020085
	06-	<b>24-1211</b>			w/ pulley	20411880,20857085,85000214
<b>FM 12 '8/98-'9/05</b>						
340 (250 kW) Eng.D12C340	98-05	<b>24-1332</b>		•		20431135/ 51,20713787,20734268,3803909 81070305,8113274/ 75,8170305/ 833 85000076/ 452
340 (250 kW) Eng.D12D340	01-05	<b>24-1332</b>		•		20431135/ 51,20713787,20734268,3803909 81070305,8113274/ 75,8170305/ 833 85000076/ 452
380 (279 kW) Eng.D12C380	98-05	<b>24-1332</b>		•		20431135/ 51,20713787,20734268,3803909 81070305,8113274/ 75,8170305/ 833 85000076/ 452
380 (279 kW) Eng.D12D380	01-05	<b>24-1332</b>		•		20431135/ 51,20713787,20734268,3803909 81070305,8113274/ 75,8170305/ 833 85000076/ 452
420 (309 kW) Eng.D12C420	98-05	<b>24-1332</b>		•		20431135/ 51,20713787,20734268,3803909 81070305,8113274/ 75,8170305/ 833 85000076/ 452

			
<p><b>24-1204</b></p>	<p><b>24-1211</b></p>	<p><b>24-1318</b></p>	<p><b>24-1332</b></p>

		<b>METELLI</b> ref.			<b>NOTE</b>	<b>Adaptable for OES</b>
420 (309 kW) Eng.D12D420	01-05	<b>24-1332</b>		•		20431135/ 51,20713787,20734268,3803909 81070305,8113274/ 75,8170305/ 833 85000076/ 452
460 (338 kW) Eng.D12C460	98-05	<b>24-1332</b>		•		20431135/ 51,20713787,20734268,3803909 81070305,8113274/ 75,8170305/ 833 85000076/ 452
<b>FM 7 '9/98-'12/01</b>						
250 (184 kW) Eng.D7C250	99-	<b>24-1318</b>		•		1675750,20575653,3183908/ 9,420759 465884,471500,477397/ 770,8112184/ 5 8113522/ 3,8192050,85000387
290 (213 kW) Eng.D7C290	99-	<b>24-1318</b>		•		1675750,20575653,3183908/ 9,420759 465884,471500,477397/ 770,8112184/ 5 8113522/ 3,8192050,85000387
<b>FM 9 '12/01-'9/05</b>						
260 (191 kW) Eng.D9A260	01-05	<b>24-1204</b>			w/o pulley	20538845,20744939/ 940,20761306 21228793,21468471,3161436,85000486 85020085
	06-	<b>24-1211</b>			w/ pulley	20411880,20857085,85000214
300 (221 kW) Eng.D9A300	01-05	<b>24-1204</b>			w/o pulley	20538845,20744939/ 940,20761306 21228793,21468471,3161436,85000486 85020085
	06-	<b>24-1211</b>			w/ pulley	20411880,20857085,85000214
340 (250 kW) Eng.D9A340	01-05	<b>24-1204</b>			w/o pulley	20538845,20744939/ 940,20761306 21228793,21468471,3161436,85000486 85020085
	06-	<b>24-1211</b>			w/ pulley	20411880,20857085,85000214
380 (279 kW) Eng.D9A380	01-05	<b>24-1204</b>			w/o pulley	20538845,20744939/ 940,20761306 21228793,21468471,3161436,85000486 85020085
	06-	<b>24-1211</b>			w/ pulley	20411880,20857085,85000214
<b>FMX '4/10-</b>						
330 (243 kW) Eng.D11C330	06-	<b>24-1211</b>			w/ pulley	20411880,20857085,85000214
330 (243 kW) Eng.D11C330/K330	06-	<b>24-1211</b>			w/ pulley	20411880,20857085,85000214
370 (272 kW) Eng.D11C370/K370	06-	<b>24-1211</b>			w/ pulley	20411880,20857085,85000214
380 (280 kW) Eng.D13C380	13-	<b>24-1204</b>			w/o pulley	20538845,20744939/ 940,20761306 21228793,21468471,3161436,85000486 85020085
	06-	<b>24-1211</b>			w/ pulley	20411880,20857085,85000214
380 (285 kW) Eng.D13C380	10-	<b>24-1204</b>			w/o pulley	20538845,20744939/ 940,20761306 21228793,21468471,3161436,85000486 85020085
	06-	<b>24-1211</b>			w/ pulley	20411880,20857085,85000214
380 Eng.D13C380	13-	<b>24-1204</b>			w/o pulley	20538845,20744939/ 940,20761306 21228793,21468471,3161436,85000486 85020085
	06-	<b>24-1211</b>			w/ pulley	20411880,20857085,85000214
400 (294 kW) Eng.D13B400	12-	<b>24-1204</b>			w/o pulley	20538845,20744939/ 940,20761306 21228793,21468471,3161436,85000486 85020085
	06-	<b>24-1211</b>			w/ pulley	20411880,20857085,85000214
410 (302 kW) Eng.D11C410/K410	06-	<b>24-1211</b>			w/ pulley	20411880,20857085,85000214
420 (309 kW) Eng.D13C420/K420	13-	<b>24-1204</b>			w/o pulley	20538845,20744939/ 940,20761306 21228793,21468471,3161436,85000486 85020085
	06-	<b>24-1211</b>			w/ pulley	20411880,20857085,85000214
430 (316 kW) Eng.D11A430	06-	<b>24-1211</b>			w/ pulley	20411880,20857085,85000214
440 (324 kW) Eng.D13A440	12-	<b>24-1204</b>			w/o pulley	20538845,20744939/ 940,20761306 21228793,21468471,3161436,85000486 85020085
	06-	<b>24-1211</b>			w/ pulley	20411880,20857085,85000214
450 (332 kW) Eng.D11C450/K450	06-	<b>24-1211</b>			w/ pulley	20411880,20857085,85000214

			
<b>24-1204</b>	<b>24-1211</b>	<b>24-1304</b>	<b>24-1318</b>
			
<b>24-1332</b>			

		<b>METELLI</b> ref.			<b>NOTE</b>	<b>Adaptable for OES</b>
460 (338 kW) Eng.D13C460/K460	13-	<b>24-1204</b>			w/o pulley	20538845,20744939/ 940,20761306 21228793,21468471,3161436,85000486 85020085
	06-	<b>24-1211</b>			w/ pulley	20411880,20857085,85000214
480 (353 kW) Eng.D13A480	12-	<b>24-1204</b>			w/o pulley	20538845,20744939/ 940,20761306 21228793,21468471,3161436,85000486 85020085
	06-	<b>24-1211</b>			w/ pulley	20411880,20857085,85000214
500 (368 kW) Eng.D13C500/K500	13-	<b>24-1204</b>			w/o pulley	20538845,20744939/ 940,20761306 21228793,21468471,3161436,85000486 85020085
	06-	<b>24-1211</b>			w/ pulley	20411880,20857085,85000214
<b>FS 7 '9/94-'3/96</b>						
230 (169 kW) Eng.D7B230	99-	<b>24-1318</b>		•		1675750,20575653,3183908/ 9,420759 465884,471500,477397/ 770,8112184/ 5 8113522/ 3,8192050,85000387
260 (191 kW) Eng.D7B260	99-	<b>24-1318</b>		•		1675750,20575653,3183908/ 9,420759 465884,471500,477397/ 770,8112184/ 5 8113522/ 3,8192050,85000387
<b>L</b>						
495 Eng.D96B/TD96B	05-	<b>24-1204</b>			w/o pulley	20538845,20744939/ 940,20761306 21228793,21468471,3161436,85000486 85020085
<b>N '1/65-</b>						
86 (106-110 kW) Eng.D70	99-	<b>24-1318</b>		•		1675750,20575653,3183908/ 9,420759 465884,471500,477397/ 770,8112184/ 5 8113522/ 3,8192050,85000387
<b>N 10 '10/83-'12/89</b>						
270 (202 kW) Eng.TD101G	83-88	<b>24-1304</b>		•	+BH	1545261,1675945,1698616/ 20,1699786/ 90 20431484,3184802,422791,468250/ 937 470232,478405,478845,479164,479931 8112520/ 683,8113157/ 431,8121802 8149937
300 (220 kW) Eng.TD101F	85-89	<b>24-1304</b>		•	+BH	1545261,1675945,1698616/ 20,1699786/ 90 20431484,3184802,422791,468250/ 937 470232,478405,478845,479164,479931 8112520/ 683,8113157/ 431,8121802 8149937
<b>NH 12 '5/99-</b>						
380 (279 kW) Eng.D12C380	99-	<b>24-1332</b>		•		20431135/ 51,20713787,20734268,3803909 81070305,8113274/ 75,8170305/ 833 85000076/ 452
420 (309 kW) Eng.D12C420	00-	<b>24-1332</b>		•		20431135/ 51,20713787,20734268,3803909 81070305,8113274/ 75,8170305/ 833 85000076/ 452







METELLI ref.	MARCA MAKE	PAGINA PAGE	METELLI ref.	MARCA MAKE	PAGINA PAGE	METELLI ref.	MARCA MAKE	PAGINA PAGE
24-0031	Iveco Bus / Iveco Truck	26, 28, 30	24-1212	Scania Truck	256, 268, 270	24-1302	Man Bus / Man Truck / Mercedes Benz Truck	42, 44, 46, 48, 50, 52, 54, 56, 58, 60, 62, 64, 66, 68, 70, 72, 74, 76, 78, 80, 82, 84, 86, 88, 90, 92, 94, 96, 98, 100, 102, 104, 106, 108, 110, 112, 114, 124, 126, 128, 130, 132, 134, 136, 138, 140, 142, 144, 146, 148, 150, 152, 206, 208, 210, 212, 214, 216, 218, 220, 226
24-0077	Iveco Truck	28, 30	24-1224	Man Bus / Man Truck	40, 42, 52, 132, 134, 136, 138, 140, 142, 144, 146, 148, 150, 152, 160, 162, 164, 166			
24-0161	Iveco Truck	30, 32						
24-0178	Iveco Truck	30, 32						
24-0317	Iveco Truck	30						
24-0498	Iveco Truck	30						
24-0499	Iveco Truck	30, 32	24-1225	Man Bus / Man Truck	132, 134, 136, 138, 140, 142, 144, 146, 148, 150, 152, 160, 162, 164, 166			
24-0840	Iveco Truck	28, 30						
24-0841	Iveco Truck	28						
24-0842	Iveco Truck	26, 28, 30						
24-0843	Iveco Truck	34, 36						
24-0844	Iveco Truck	34	24-1227	Man Bus / Man Truck	48, 50, 52, 54, 154, 156, 158, 160			
24-0845	Iveco Truck	34						
24-0846	Iveco Truck	34						
24-0847	Iveco Truck	40						
24-0848	Iveco Truck	40						
24-0849	Iveco Truck	36, 38	24-1234	Man Bus / Man Truck	48, 50, 52, 54, 114, 116, 118, 120, 138, 154, 156, 158, 160			
24-0850	Iveco Truck	36, 38						
24-0852	Iveco Truck	36, 38						
24-0853	Iveco Truck	38, 40						
24-0854	Iveco Truck	40						
24-0869	Scania Truck	250, 252, 254	24-1235	Man Bus / Man Truck	40, 42, 46, 48, 54, 56			
24-0870	Mercedes Benz Truck	208, 220, 224, 230, 232						
24-0871	Mercedes Benz Truck	208, 210, 218, 220, 222						
24-0872	Mercedes Benz Truck	210, 212, 214, 216, 218						
24-0873	Mercedes Benz Truck	218, 220, 222, 224, 226						
24-0874	Mercedes Benz Truck	224	24-1292	Man Truck / Mercedes Benz Truck	84, 114, 130, 132, 206, 210, 212, 214, 216, 218, 220, 222, 226			
24-0900	Iveco Truck	32, 34						
24-0913	Iveco Truck	32						
24-0914	Iveco Truck	30, 32						
24-0915	Iveco Truck	32, 34						
24-0916	Iveco Truck	32	24-1293	Daf Truck	20, 22, 24			
24-0942	Iveco Truck	36, 38, 40						
24-0968	Iveco Truck	36, 38, 40						
24-0969	Iveco Truck	36, 38						
24-1026	Iveco Truck	34						
24-1060	Daf Truck / Iveco Truck	2, 16, 24, 34, 36	24-1294	Man Bus / Man Truck / Mercedes Benz Truck	42, 46, 48, 50, 52, 54, 56, 64, 84, 86, 88, 90, 92, 94, 96, 98, 100, 102, 104, 106, 108, 110, 112, 114, 130, 132, 220, 222, 224			
24-1066	Renault Truck	246						
24-1156	Iveco Truck	32, 34, 38						
24-1161	Iveco Truck	30, 32						
24-1198	Iris Bus / Iveco Bus / Iveco Truck	26						
24-1199	Iveco Bus / Iveco Truck	26	24-1295	Mercedes Benz Truck	208, 210, 212, 220, 222, 224, 228, 230, 232, 234			
24-1201	Scania Truck	250, 252, 254, 256, 258, 260, 262, 264, 266, 268, 270						
24-1204	Renault Truck / Volvo Truck	238, 240, 248, 250, 272, 274, 276, 278, 280, 282, 284, 288, 290, 292, 294						
24-1207	Scania Truck	256, 258, 264, 266						
24-1211	Volvo Truck	272, 274, 278, 280, 282, 284, 288, 290, 292, 294						
			24-1296	Mercedes Benz Truck	208, 212, 224, 234	24-1303	Mercedes Benz Truck	218, 228, 230
			24-1297	Mercedes Benz Truck	214	24-1304	Volvo Truck	274, 276, 284, 294
			24-1298	Man Bus / Man Truck / Mercedes Benz Truck	42, 44, 46, 48, 50, 52, 54, 56, 58, 60, 62, 64, 66, 68, 70, 72, 74, 76, 78, 80, 82, 84, 86, 88, 90, 92, 94, 96, 98, 100, 102, 104, 106, 108, 110, 112, 114, 130, 132, 134, 136, 138, 140, 142, 144, 146, 148, 150, 152, 206, 208, 222, 224, 226	24-1305	Daf Truck	20, 22, 24
						24-1306	Man Bus / Man Truck	114, 116, 118, 120, 122, 124, 126, 128
						24-1307	Daf Truck	2, 4, 6, 8, 10
						24-1308	Man Bus / Man Truck	46, 48, 64, 130
						24-1309	Mercedes Benz Truck	206, 208, 210, 212, 214, 216, 218, 220, 222, 224, 226
						24-1310	Man Bus / Man Truck	48, 52, 64, 114, 116, 118, 120, 122, 124, 126, 128
						24-1312	Mercedes Benz Truck	166, 168, 170, 172, 174, 176
						24-1316	Volvo Truck	272, 274, 280, 282, 284, 286
						24-1317	Daf Truck	4, 6, 10, 12, 14, 16
						24-1318	Volvo Truck	272, 274, 276, 278, 286, 288, 292, 294
						24-1319	Man Bus / Man Truck	42, 44, 46, 56, 58, 60, 62, 64, 66, 68, 70, 72, 74, 76, 78, 80, 82, 84, 86, 88, 90, 92, 94, 96, 98, 100, 102, 104, 106, 108, 110, 112, 124, 126, 128, 132, 134, 136, 138, 140, 142, 144, 146, 148, 150, 152, 154
						24-1320	Mercedes Benz Truck	166, 176, 178, 180, 182, 184, 186, 188, 190, 192, 194, 196, 198, 200, 204, 206, 208, 218, 226, 228, 232, 234, 236

METELLI ref.	MARCA MAKE	PAGINA PAGE	METELLI ref.	MARCA MAKE	PAGINA PAGE	METELLI ref.	MARCA MAKE	PAGINA PAGE
24-1321	Man Bus / Man Truck	42, 44, 46, 56, 58,	24-1339	Scania Truck	258, 260, 262, 264,			
		60, 62, 64, 66, 68,		270				
		70, 72, 74, 76, 78,	24-1340	Renault Truck	238, 240, 246, 248			
		80, 82, 84, 86, 88,	24-1341	Mercedes Benz Truck	166, 168, 170, 172,			
		90, 92, 94, 96, 98,		174, 176, 214, 228				
		100, 102, 104, 106,	24-1342	Mercedes Benz Truck	166, 168, 170, 172,			
108, 110, 112, 124,		174, 176, 214, 228						
		126, 128, 132, 134,	24-1343	Renault Truck	236, 238, 244, 246,			
		136, 138, 140, 142,			248, 250			
		144, 146, 148, 150,	24-1344	Renault Truck	240, 242, 244			
		152, 154						
24-1322	Man Truck	114, 116, 118, 120, 122, 124						
24-1323	Man Bus / Man Truck	46, 48, 52, 64, 114, 116, 118, 120, 122, 124, 126, 128, 130						
24-1324	Man Bus / Man Truck	46, 48, 64, 130						
24-1325	Mercedes Benz Truck	208, 210, 214, 218, 220, 222, 230, 232						
24-1326	Mercedes Benz Truck	192, 196, 198, 200, 202, 204, 208, 214, 216, 228						
24-1327	Mercedes Benz Truck	192, 196, 198, 200, 202, 204, 208, 214, 216, 228						
24-1328	Mercedes Benz Truck	210, 212, 214, 216, 218, 220, 222, 224, 226						
24-1329	Mercedes Benz Truck	192, 194, 196, 198, 200, 202, 204, 208, 214, 216, 228						
24-1330	Man Bus / Man Truck	56, 58, 60, 62, 64, 66, 68, 70, 72, 74, 76, 78, 80, 82, 84, 132, 134, 136, 138, 140, 142, 144, 146, 148, 150, 152, 154						
24-1331	Man Bus / Man Truck	40, 54, 114, 116, 118, 120, 122, 124						
24-1332	Renault Truck / Volvo Truck	240, 242, 244, 272, 274, 280, 282, 290, 292, 294						
24-1333	Mercedes Benz Truck	178, 180, 182, 184, 186, 188, 190, 192, 194, 196, 198, 200, 204, 206, 208, 228, 232, 234, 236						
24-1334	Scania Truck	258, 260, 270						
24-1335	Daf Truck	14, 16, 18, 20, 24, 26						
24-1336	Man Bus / Man Truck	42, 44, 46, 64, 66, 68, 70, 72, 74, 76, 78, 80, 82, 84, 86, 88, 90, 92, 94, 96, 98, 100, 102, 104, 106, 108, 110, 112, 126, 128						
24-1337	Volvo Truck	272, 274, 280, 282, 284, 286						
24-1338	Daf Truck	10, 12, 14, 16, 18, 20, 24, 26						